

BUILD NEWS



Charleston, S. C.: An 18th century farce struck the keynote of the ceremonies.

ARCHITECTURAL

Record



Church Street Front

CHARLESTON OPENS HISTORIC PLAYHOUSE WITH HISTORIC PLAY

SIMONS & LAPHAM
Architects

DOUGLAS D. ELLINGTON
Architectural Research Consultant

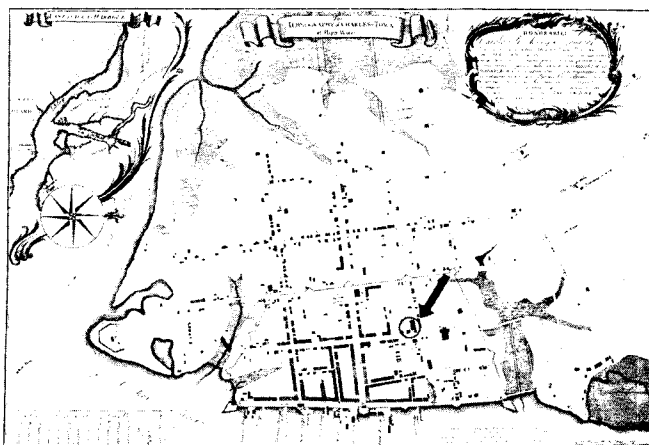

A 1739 map of "Charles Towne" establishes the site of Dock Street Theater as being at Church and Queen Streets (arrow). While Charleston disputes with Williamsburg and New Orleans credit for America's oldest theater, she shares with no one the claim that Charleston's was the first building specifically designed for that purpose.

ON FEBRUARY 12, 1736 the Charleston gentry saw a new playhouse opened with a performance of a broad Restoration comedy, "The Recruiting Officer." Two centuries later (November 26) the Charleston gentry saw the same play (censored) in the same spot in something like the same setting. Largely because of WPA, whose Harry L. Hopkins dedicated the building, Charleston was able to restore its old Planters Hotel, built in 1806, and to reproduce the theater which previously had partially occupied the site. Result of three years of community effort, in which everybody from the mayor to Federal Theater and Art groups and WPA labor participated, the project was in charge of the firm of Simons & Lapham, Charleston's ace restorationists, and Douglas D. Ellington, WPA's own architectural consultant. Besides the theater, the building as reconstructed contains a restaurant, to be leased to some caterer who can reproduce the old cuisine; eight modern apartments; a green room which can be used for lectures, recitals, and small dramatic productions; and a foyer which may be hired for entertainments.

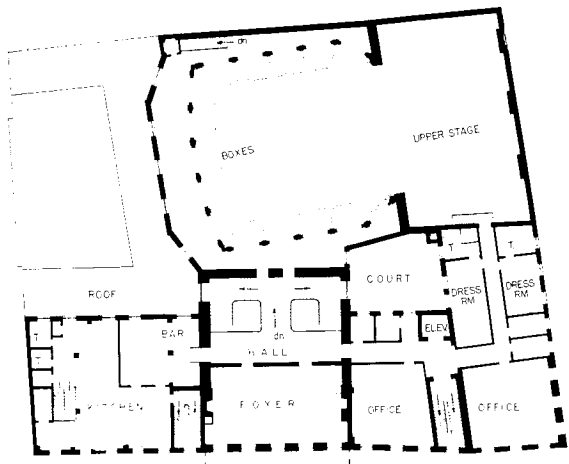

Second Floor Plan

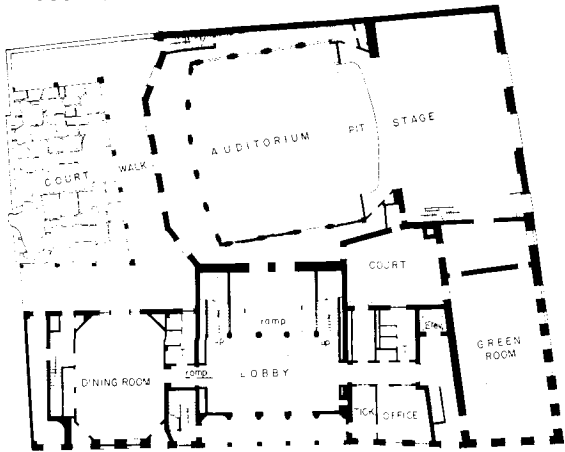

First Floor Plan

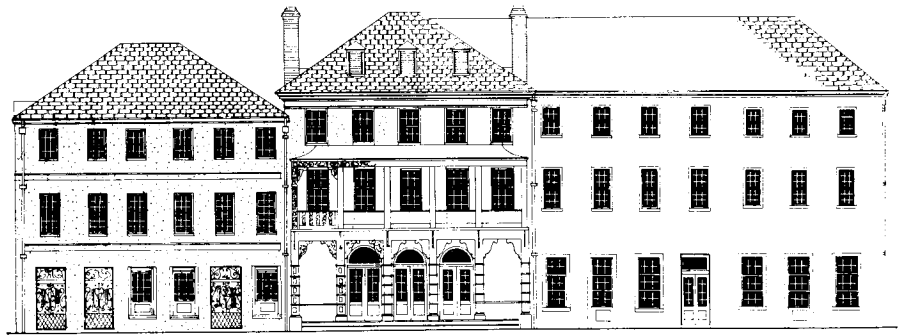

Church Street Elevation

THE technique of restoration in Charleston differs substantially from that in vogue elsewhere in that it is "freer" and tends to preserve, externally at least, the cumulative effects of age and use. In this instance, little was done to the exterior beyond repairing the brickwork and balcony, installing new sash and frames, and giving the repaired wall areas a thin color wash to duplicate the soft rose of the old stucco. Internally, however, the structure was entirely rebuilt. Occupying the exterior corner of the plot, the old L-shaped hotel actually consisted of four buildings of varying ages, all in advanced decay. The short leg of the L was gutted and reinforced—becoming the stage (left) for the new theater—while the remainder was replanned for new uses, only the lobby retaining its original dimensions. All exterior walls and foundations were reinforced, while floors, partitions, and roof were entirely rebuilt, largely of steel and concrete.

Not shown here is the third floor, which has been converted into a series of eight apartments with independent entrances at right and left of main lobby. Lobby, Green Room, Theater, Dining Room, and Foyer appear on subsequent pages.



Photo by Frances Benjamin Johnston

So convincing is the handiwork of Messrs. Simons, Lap- ham, and Ellington, that only the concrete slab of the balcony betrays the fact that the old facade is little more than a stage drop for a modern fire-resistant structure. In the center is St. Philip's, whose steeple long served as a lighthouse, and (right) the Gothic Revival of the Huguenot Church.

Frances Benjamin Johnston



Main Stairway, rebuilt

CENTRAL feature of the Lobby is the stairway, a painstaking ferroconcrete replica of the original; since the railing was missing, the architects copied a cast-iron and mahogany contemporary. The magnificent Adam doorways on the landing, leading into the second-floor boxes, are originals from the Mitchell King mansion, built in 1805.

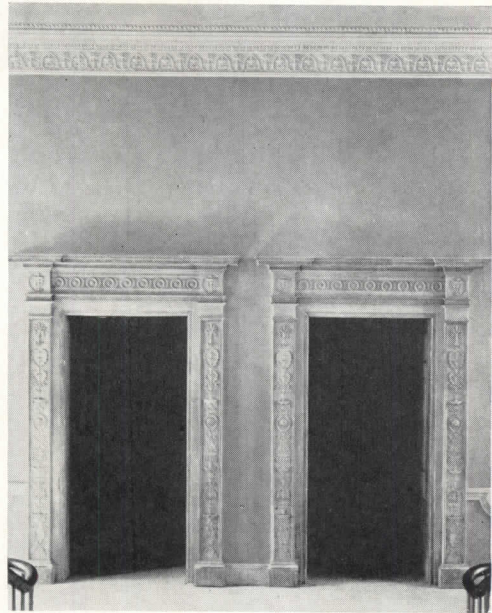

Frances Benjamin Johnston

Entrance to Boxes



H. R. Jacobs

Stairway before restoration



Frances Benjamin Johnston

THE entrance, with its cast-iron balcony and recessed porch (left), dates from 1835 when the hotel was remodeled. Though the balcony is typical of the period, the columns are anomalous; of rusticated brownstone—a rare enough material in Charleston—their carved mahogany brackets only add to their generally exotic character. All this the architects wisely left untouched except for necessary repairs. The lobby itself, dating from the same period, was restored to its original Greek Revival. However, by using Adam woodwork and plaster detail on the balcony and second-floor levels, the architects carried the sequence one stage farther back: from that to the late Renaissance of the Theater proper is only a step, stylistically speaking—1780 to 1730.

RESTORATION

SINCE painstaking research revealed no data on the original theater itself, the reconstruction took place along

lines indicated by contemporary structures elsewhere—particularly in London. The seating of the Charles II theater differed from that of today; the tiers of boxes—proximate equivalent of modern balconies—

were considered most desirable, while the “pit”—the modern “orchestra”—was only fitted with rough benches. This seating principle was followed in the Charleston project.

Although all modern theatrical equipment is present, it is concealed by an interior as archaeologically precise as research could make it; even the lighting fixtures were based on carved and gilded originals. The woodwork is a specially-selected natural cypress, the curtains all a deep red velvet, the plaster sand-finished in a warm tint. All scenery, curtains, and costumes were done by the S. C. Federal Art Project.

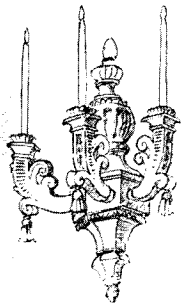

Frances Benjamin Johnston

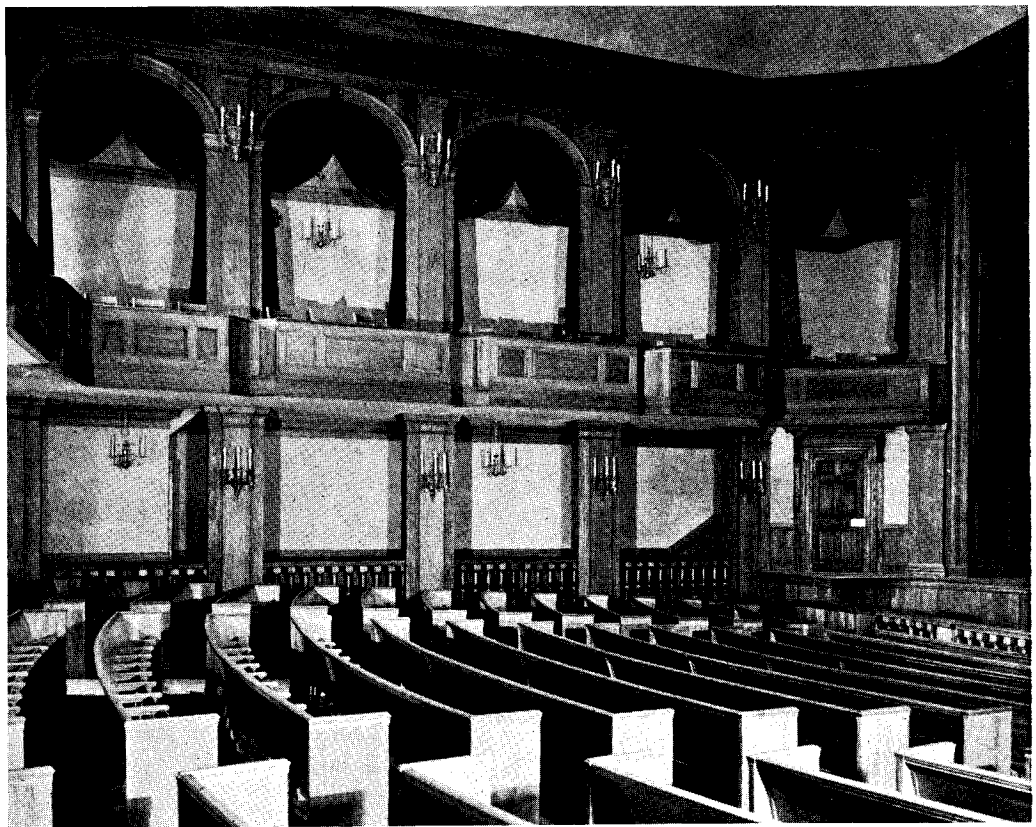

Frances Benjamin Johnston

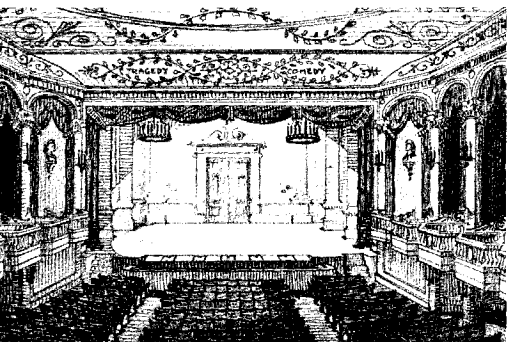

Peck

Research study for Restoration theater



Peck

Dress rehearsal for Restoration drama

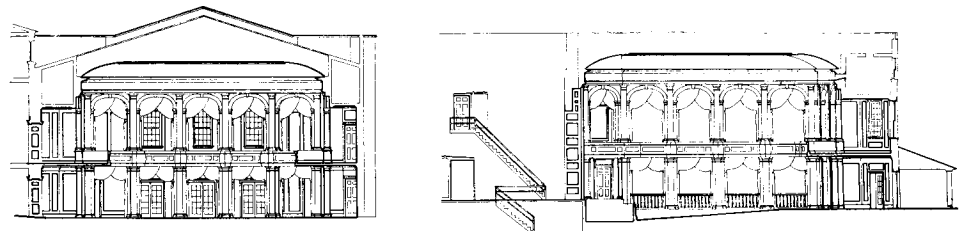

Transverse section (left) and longitudinal section (right). The eighteenth century architect was prevented by structural limitations from using the balcony; hence the boxes. The coved ceiling—a copy of that of contemporary St. Michael's—permitted indirect lighting, a fireproof projection booth in the cornice (right).

Photos by Frances Benjamin Johnston

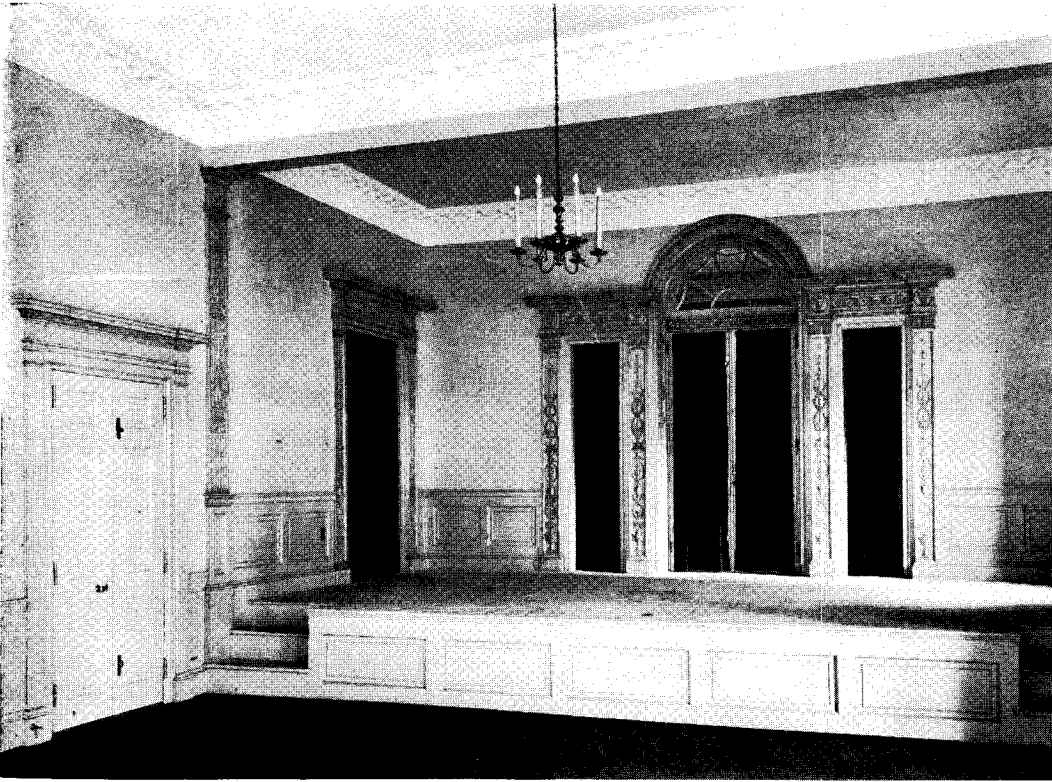

Small Stage, Green Room

WHETHER the original Dock Street Theater had a Green Room is a moot question; but in its present incarnation it has one, fitted with a superb Palladian window (which leads directly onto the main stage), doorways, mantel, and wainscot from the Charleston Museum's collection of historic woodwork. Here the architects have used a soft gray-green for wall color and an off-white plaster cornice and ceiling. The doorways have been only cleaned and waxed, giving a "pickled pine" effect; the wainscot and mantel (right) have been painted wall color but in a deeper tone.



Mantel, Green Room

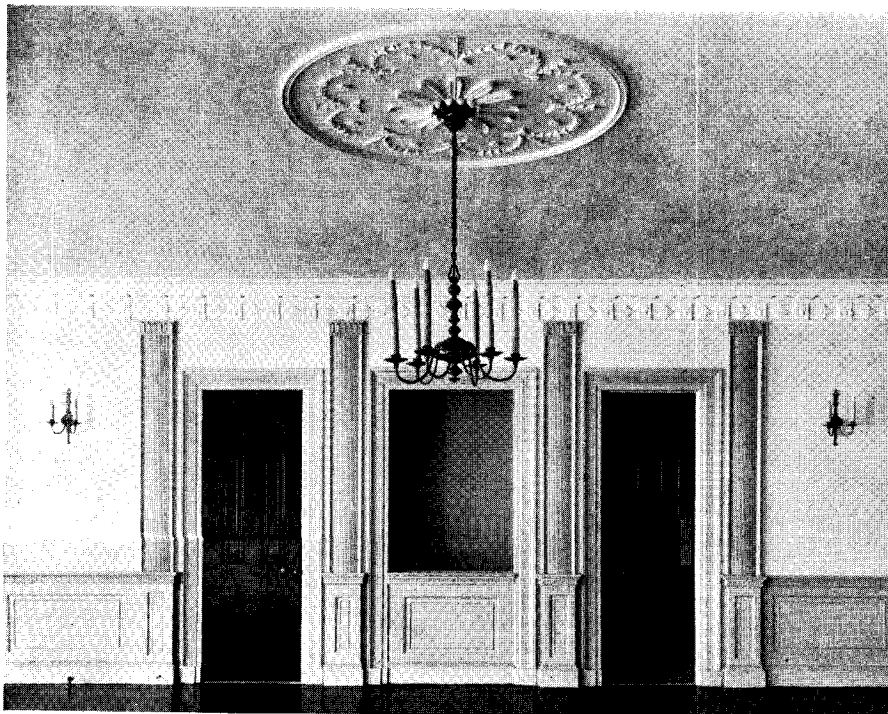

THE first-floor Dining Room, with its courtyard (right), gives Charleston a much needed dining place with "local color" for her tourist trade. Connected to the second-floor Bar and Kitchen by means of dumb-waiter and separate stair, it forms a separate unit, to be leased to a caterer who can "reproduce the old Charleston cuisine." The Dining Room's unusual woodwork, all original, is painted a grayed blue-green; plaster walls and ceiling are a soft yellow; doors are mahogany.

RESTORATION

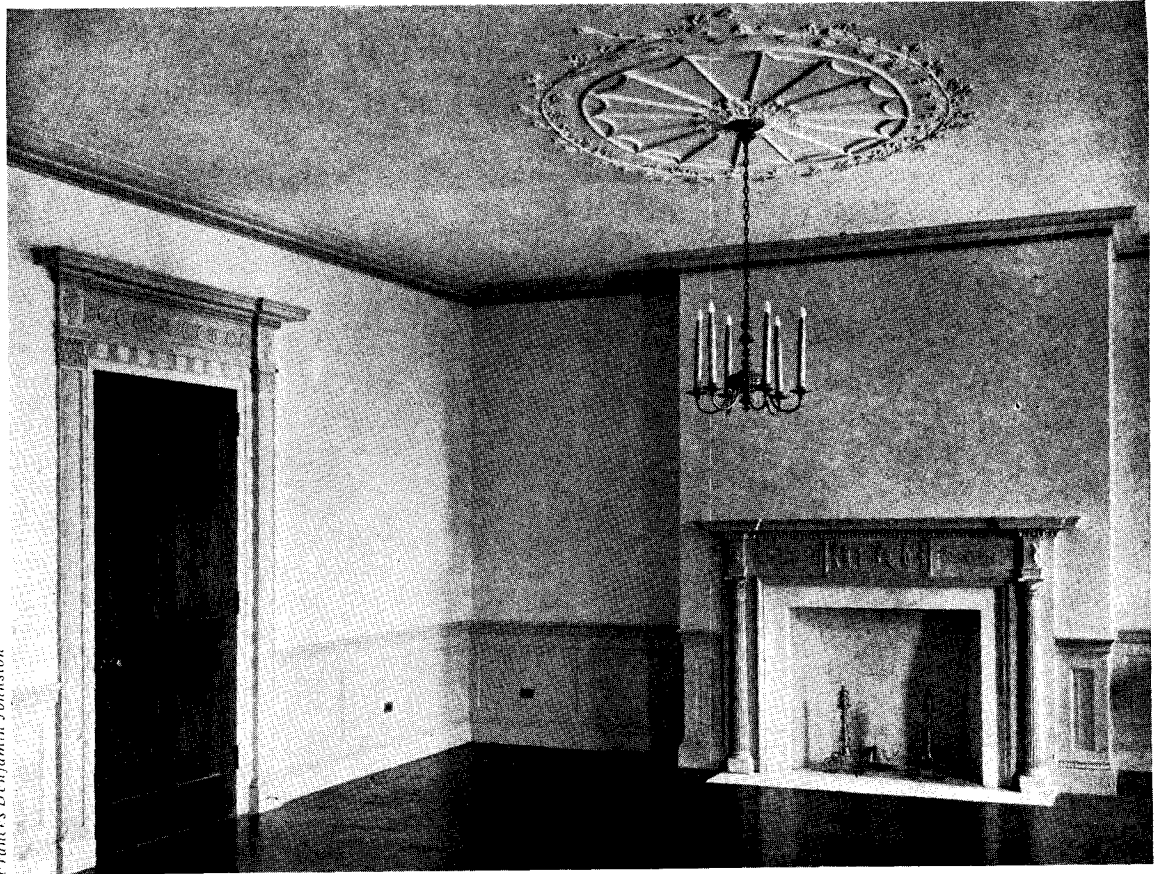

Frances Benjamin Johnston

Detail, second-floor Foyer



H. R. Jacobs

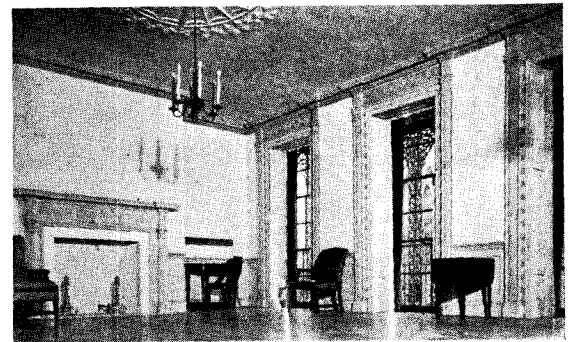

Before and after views of the second-floor Foyer



Frances Benjamin Johnston

IN the restoration of the Planters Hotel and reconstruction of the Dock Street Theater, the architects were constantly faced with gaps in the architectural history of the buildings. Thus their work ran the gamut from restoration of the Lobby—where only the stair rail was missing—to complete reconstruction of the Theater—whose general character could only be conjectured. In the Foyer (above) they met still another design problem; existing detail was clearly Victorian yet records showed the room to date from 1835; but, since no original Greek Revival detail was available, they moved the date still farther back and installed the Adam detail from the King Mansion.

Aside from working and mechanical drawings, Messrs. Simons & Lapham turned out over 100 detail sheets covering all aspects of the work. Built with WPA labor, the project represents an investment of over \$350,000.

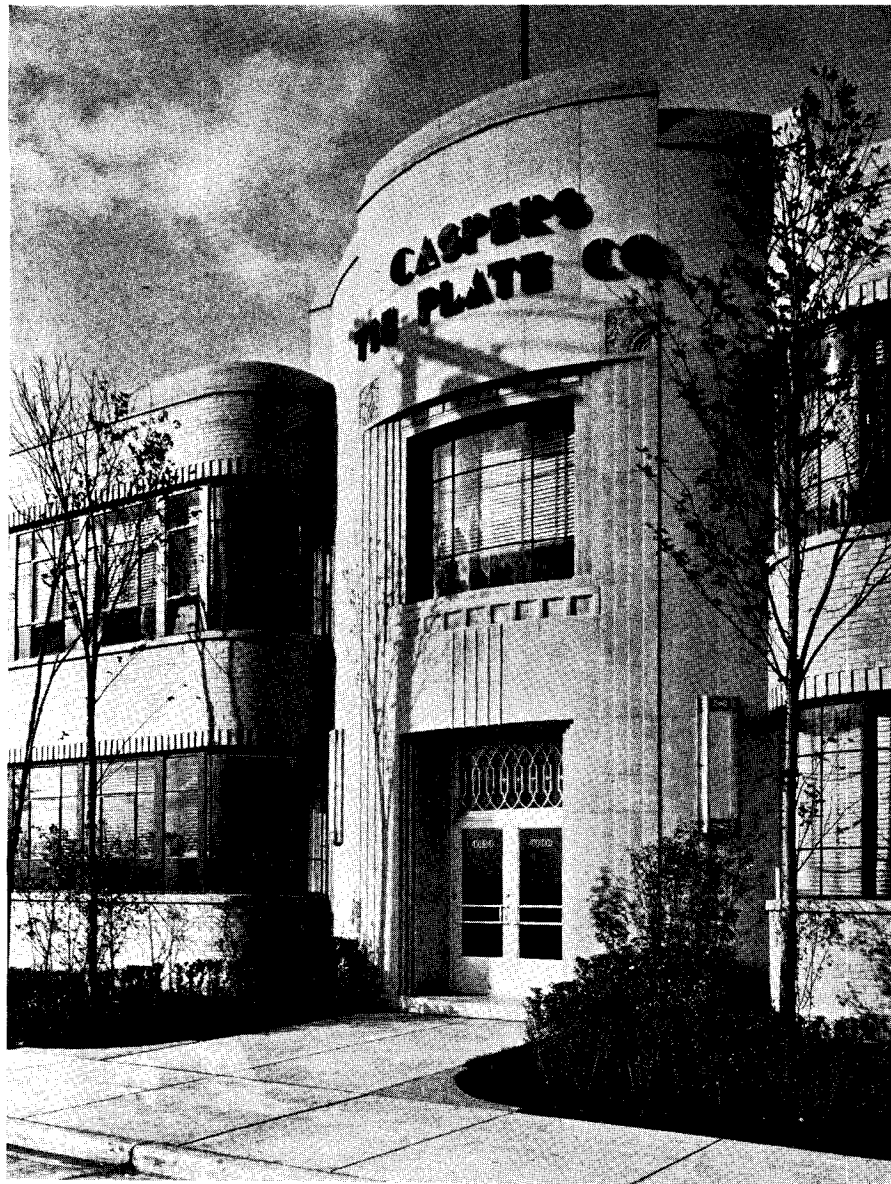

Main entrance to the new Caspers plant (above) with block plan (right, above) and general view of office and manufacturing sections (right, below).

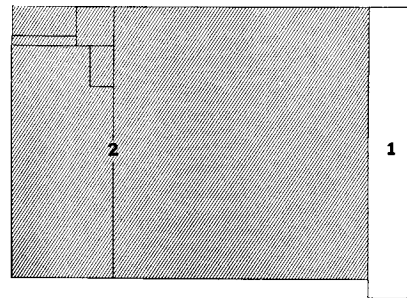

(1) Office (2) Manufacturing

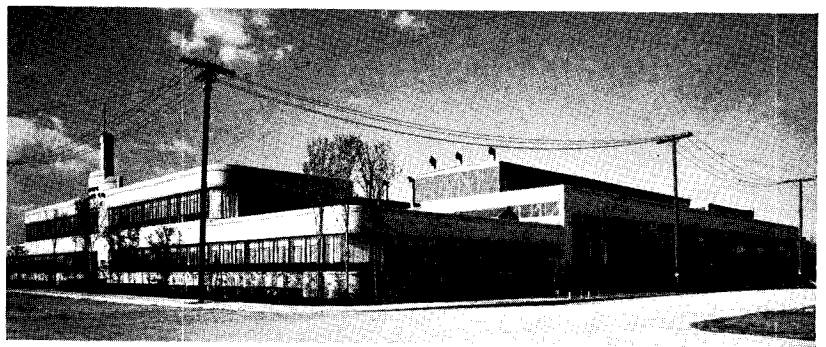

CHICAGO: NEW PLANT STREAMLINED FOR EFFICIENCY

A RECENT ADDITION to Chicago's famed "city within a city" Central Manufacturing District, is the new plant for Caspers Tin Plate Company designed by A. Epstein. A medium-sized structure for light manufacturing (lithographed metalware), the Caspers plant reflects the increasingly important trend in industrial architecture toward "restyling" the factory to meet standards already accepted in other building types. In planning, construc-

tion, and equipment, the Caspers plant reflects the drive toward these new standards. Organized in two principal units—manufacturing and clerical—the plan is further subdivided for a rational flow pattern: the first floor provides for shipping, receiving, and storage at the rear, manufacturing in the center, and secondary manufacturing operations as well as personnel accommodations along the front under the offices. The construction is

A. EPSTEIN
Structural Engineer

"Art marble" and carpeted floors, linoleum covered and painted walls and a wide use of patterned fabrics give the public areas and executive offices a degree of sophistication not usual in suburban "plant offices."

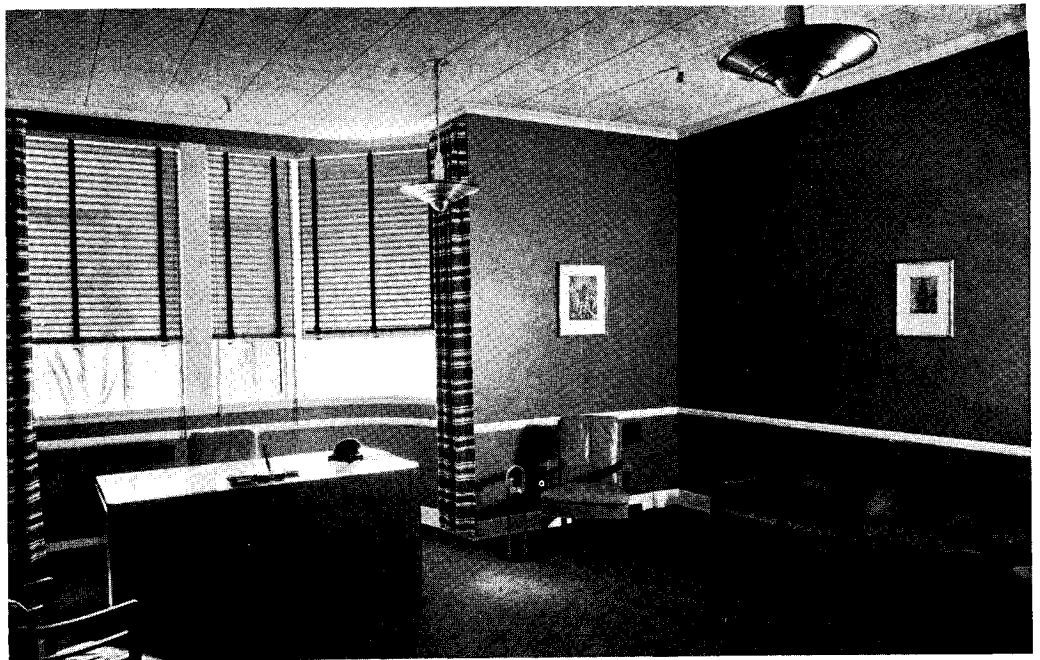

Executive Office

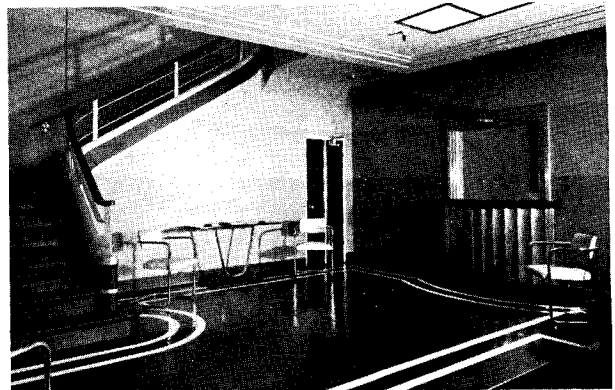

Lobby



General Office

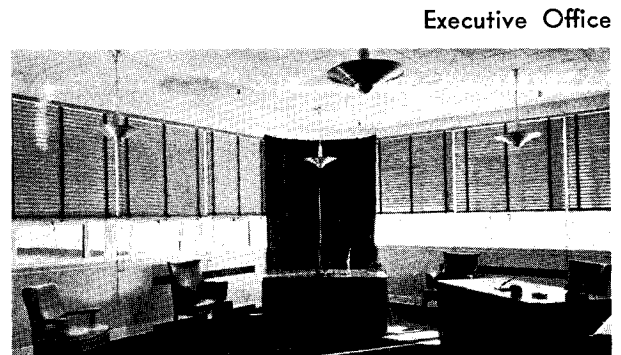

Executive Office

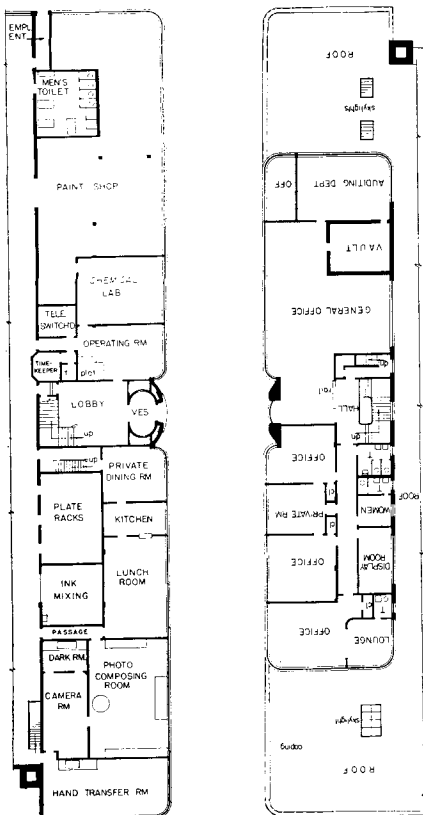

First and Second Floor Plans

simple and as modern as building codes would allow: steel frame with brick curtain walls, Robertson Keystone floor and roof system in the office portion, sound and temperature insulation in the offices. Efficient daylighting is achieved by continuous strip windows in the office portion and by wall- and monitor-type windows in the shop; daylighting is everywhere supplemented with controlled lighting. Complete air conditioning is provided for (though not yet installed) in the office while unit heaters are used elsewhere. Unusual attention has been given by the designer to details generally ignored in industrial work—to brick, terra cotta and metal detail, to interior finishes, equipment, and landscaping; even so, total cost was held to \$276,000 or 14.5c per cu. ft.

Photos by J. M. Houlette

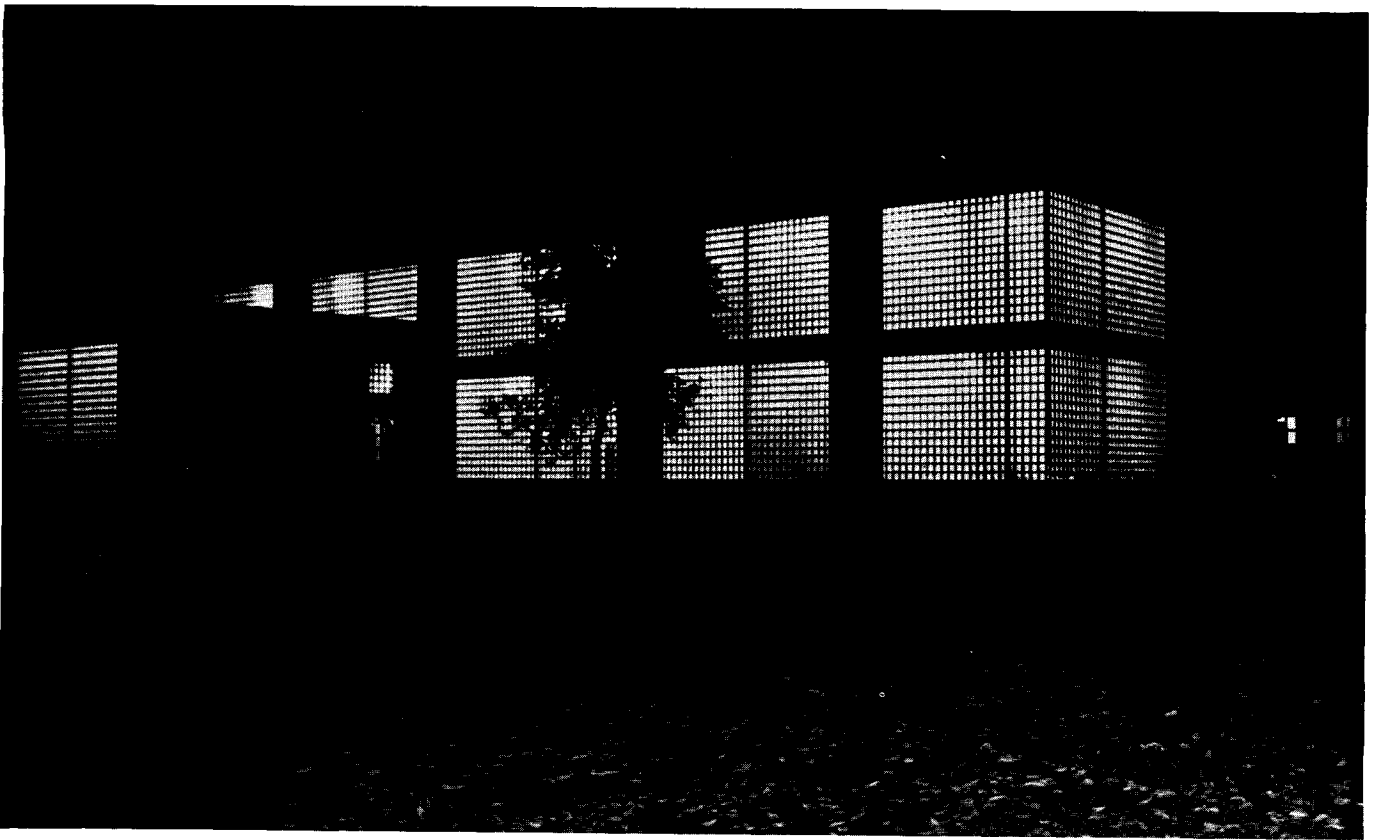

IOWA SCHOOL ADDITION MAKES NEW USE OF CANTILEVER

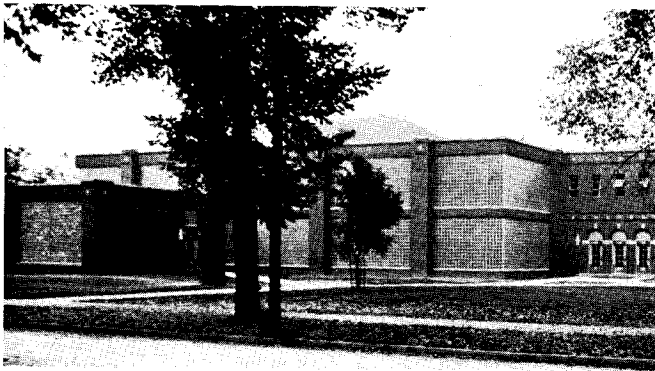

OREN THOMAS

Architect

PUBLIC BUILDINGS are seldom as uncompromisingly functional as this recent addition by Oren Thomas to the consolidated school at Elkader, Iowa; except for a few bits of stone "trim" on the facade, there is literally no architectural detail in the building. Faced with a limited budget and an open-minded School Board, Architect Thomas obviously made his choice: he gave up plastered partitions for glass-block exterior walls, furred ceilings for air conditioning, "finish" for fire resistance. In many ways, the result suggests new standards of performance.

Although the plan was largely determined by conditions at the site, it has several important features which spring from the structural innovations employed. In the first place, structural bearings are independent of partitions. Columns are placed at the edge of the normal side aisle of the school room, which permits of a cantilever condition at the exterior wall, and three equal spans between these points, rather than the usual short center span for school buildings at corridor. This, in turn, permitted a continuous locker and borrowed light condition at the corridor partition and also a continuation of the exterior glass without consideration of bearing. This system of construction proved economical on account of uniform two-way slab construction with the cantilever at outside producing a negative bending moment over the outside support to offset the positive moment of the continuous span.

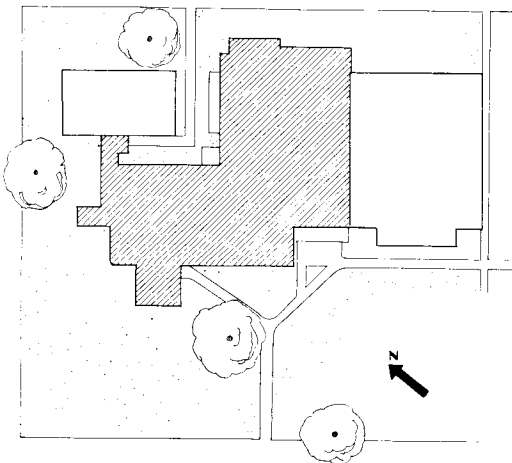

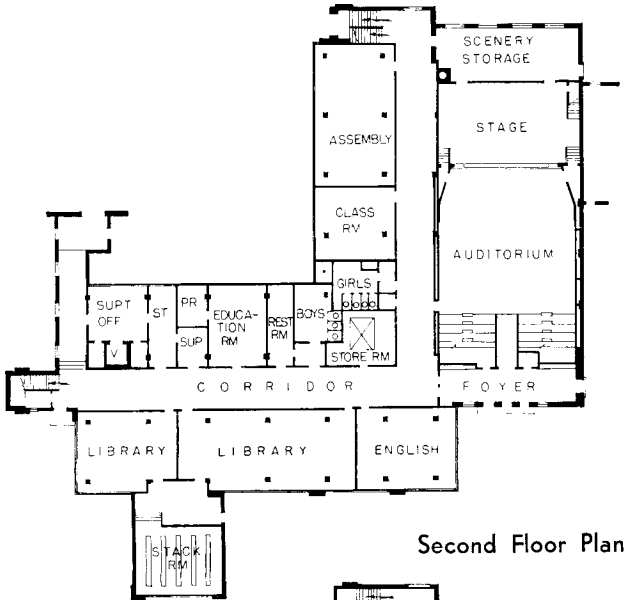

Second Floor Plan

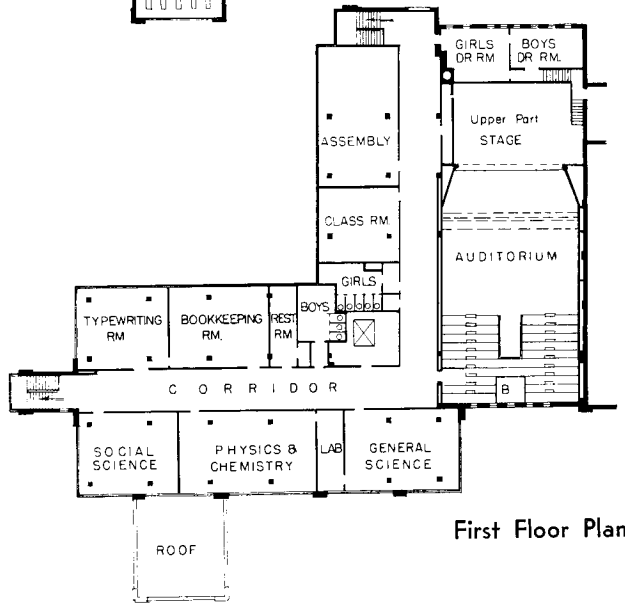

First Floor Plan



Superintendent's Office



Library Charging Room

Typical Classroom

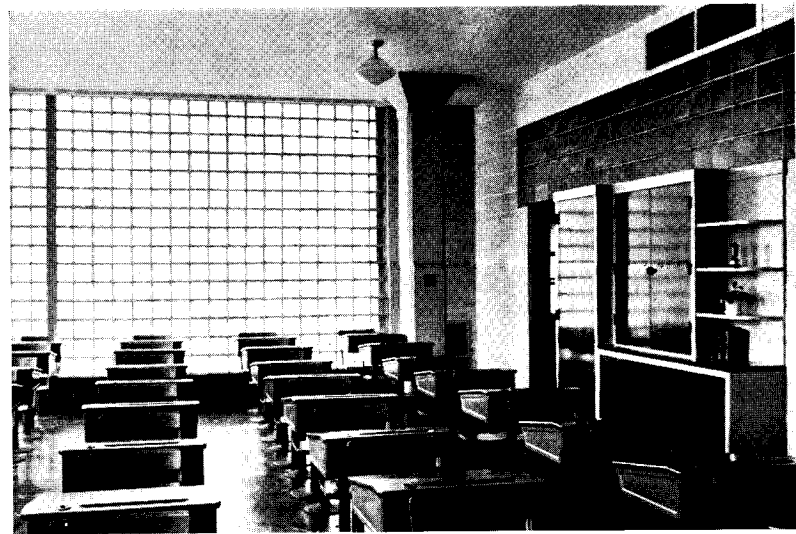

In terms of equipment, the Elkader structure is advanced; it is completely air conditioned, although cooling was omitted since the structure is not in use during hot weather. It has the first of the new public address systems designed by RCA for school buildings, in addition to which the auditorium (see next page) is wired for sound. The daylighting is excellent, glass block masonry eliminating the old bugaboo of orientation: this is supplemented by use of an absorbent color on front walls, reflecting color on side and rear walls. All floors are rubber tiled; only the ceilings are plastered.

IOWA SCHOOL

Photos by J. M. Howlette

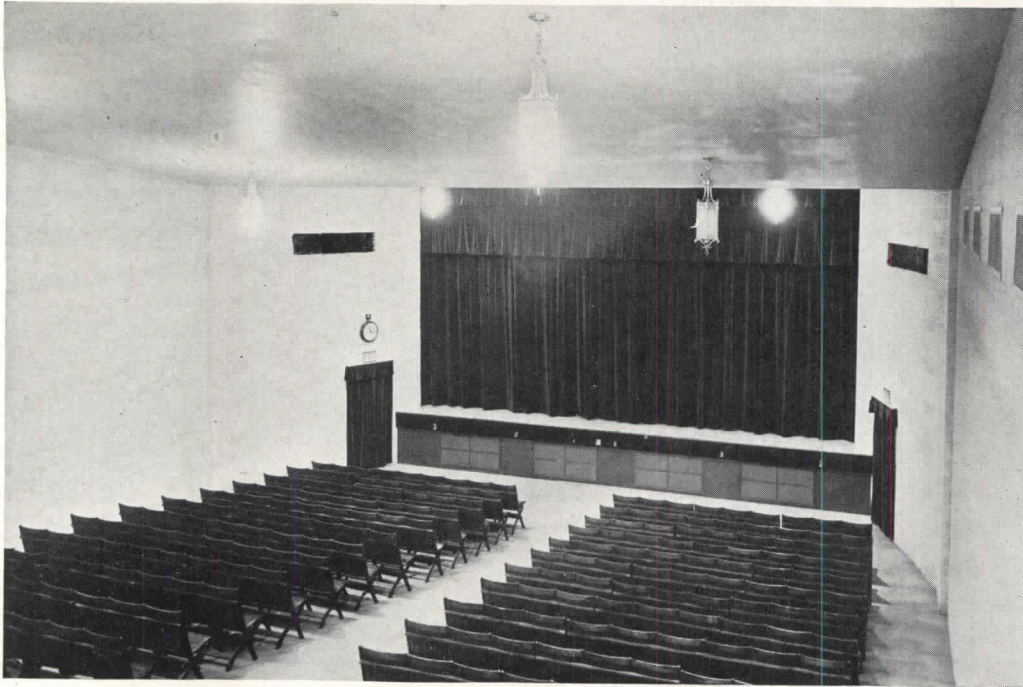

General View, Auditorium

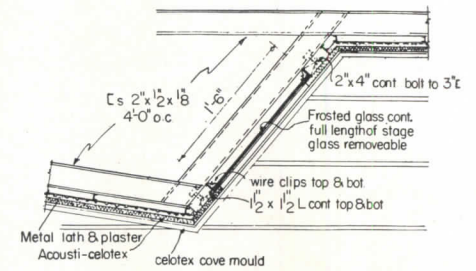

Detail, opening to Lighting Gallery

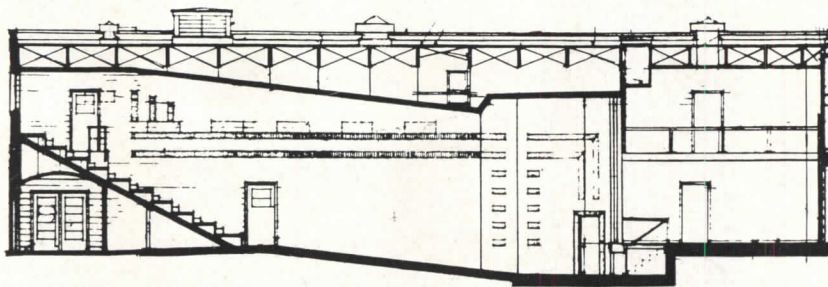

Longitudinal Section, Auditorium

Except for the lighting fixtures, the auditorium shows the same stern functionalism displayed elsewhere. An unusual section provides excellent sight lines, while a fully equipped stage provides for theatricals or talking pictures; spotlights for the former are arranged in an ingenious gallery (above) while a projection booth is located at the rear. (See plan, page 29).

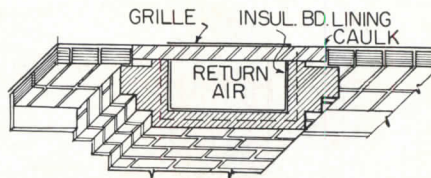
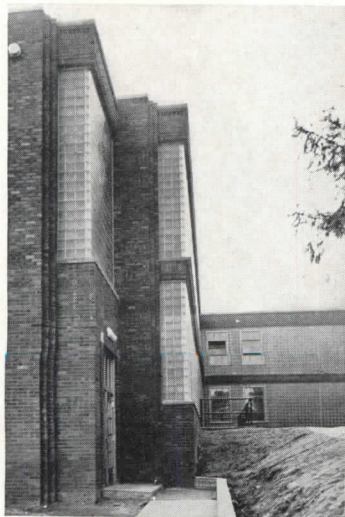

Detail, Typical Pier

Although at first glance merely a repetition of the ornamental piers of the old building, the piers actually serve a novel purpose—that of housing return air ducts and serving as plumbing stacks for the laboratories. While not load-bearing, they are an integral part of the glass and masonry curtain walls.

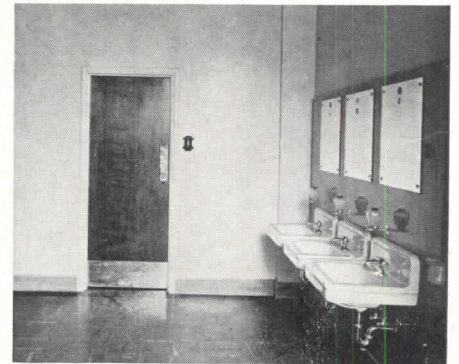

Toilet (above) and Corridor (below)



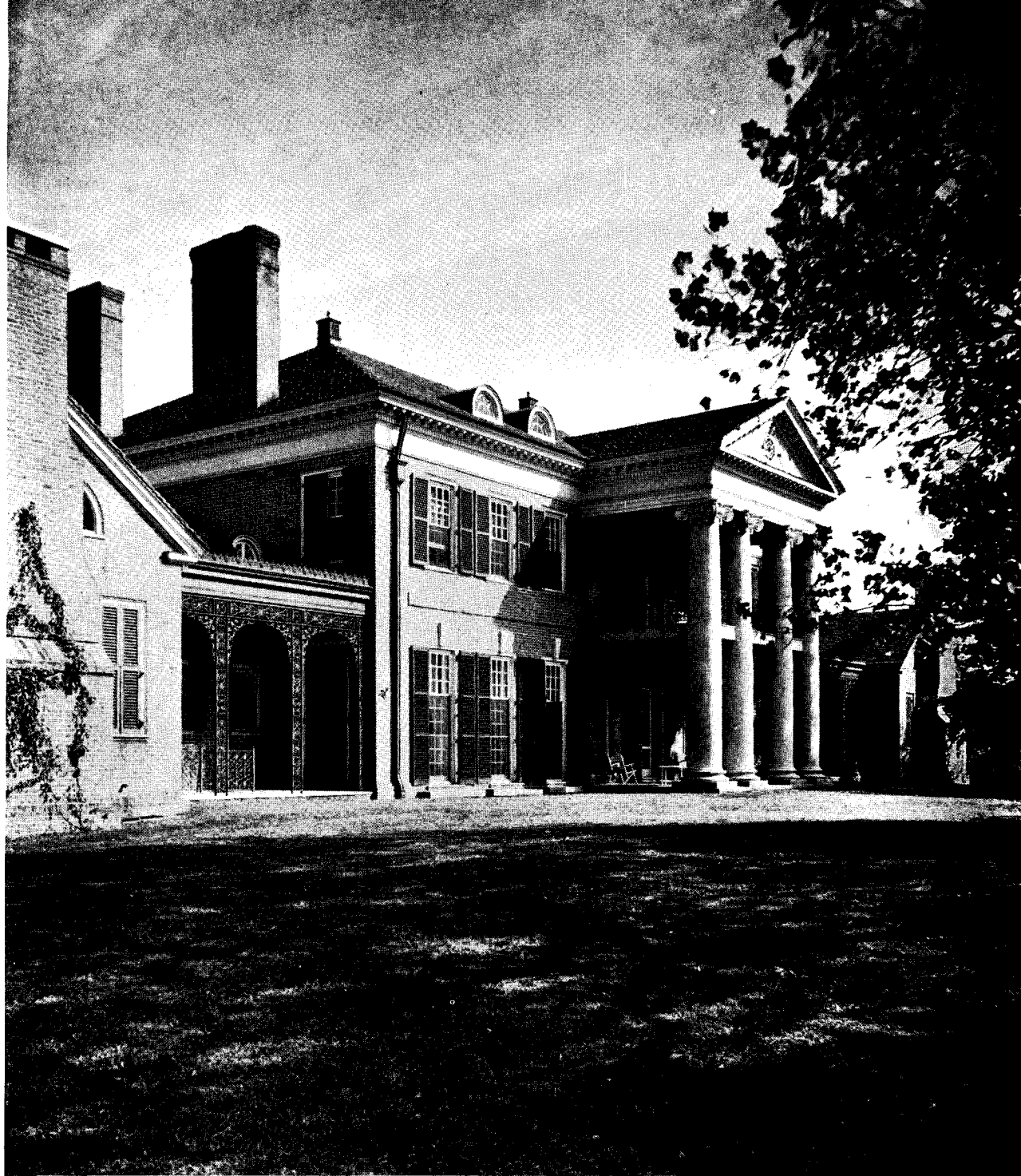

Wiles

"OAK HILL": MODERN ECLECTICISM IN THE BLUEGRASS



IN THE HEART of the Tennessee bluegrass, on a 100-acre farm once devoted to race horses, stands "Oak Hill", home of Mr. and Mrs. John Hancock Cheek. Designed by the Nashville firm of Warfield and Keeble, "Oak Hill" does—despite its elaborate eclecticism—achieve what the owners most desired: simplicity and spaciousness in the traditional Southern pattern. Credit for this the architects share with the landscape architect, Robert S. Sturtevant, whose planting is simple and authentic. (Aside from a garden, more or less formal, ante-bellum landscaping was casual; except for door side boxwoods, "foundation planting" was unheard of.) Design of the house itself pivots around a central mass of Natchez inspiration, flanked by two one-story wings showing Williamsburg influence; the cast-iron trellage on the galleries is from the New Orleans Garden District.

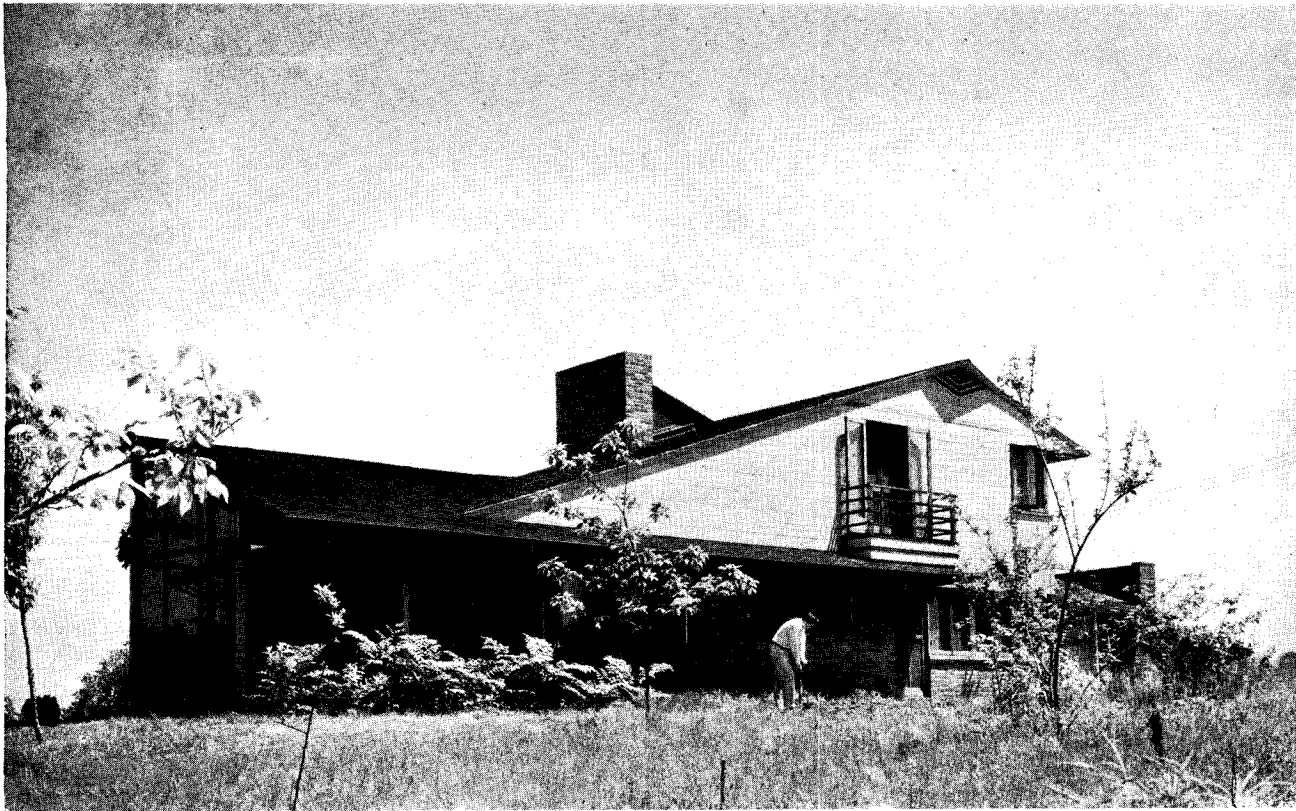

Rear Elevation

THIS NEW ST. LOUIS RESIDENCE LOST DESIGNER 3 JOBS

LESS COMPLICATED actually in roof plan than it looks, the residence for Mr. and Mrs. Reginald Jackson in St. Louis shows the influence of the Midwest's Frank Lloyd Wright without being in any sense a slavish imitation. And like Wright's work, this house has caused a diversity of comment. Said Architect Armstrong, in this regard: "I consider it one of my most satisfactory buildings to date, but a great many people in St. Louis can't stand it. It has definitely lost me three jobs so far." For a climate such as that of St. Louis, wide eaves are particularly effective as a protection against strong sunlight. The interesting lean-to effect of the porch roof produces a maximum of air and light on one side, and cuts off glare on the west. Diamond-shaped louvers at the ridge of the gabled roof over the second floor provide ventilation for bedrooms, while triangular windows, ingeniously placed beside the chimney, act as exhausts for hot air which flows up the stair well. A simple plan establishes a nice relationship between working and living areas, and allows easy circulation. Location of principal first-floor rooms was determined by the view from the plot, while prevailing night breezes influenced the disposition of second-floor rooms. For economy of wood framing, the house was designed on a 16" module, and this proved successful as well in the matter of scale. The exterior finish is of wood and brick; the roof is wood shingle. The cost for the house was \$12,000 and the landscaping amounted to \$500.

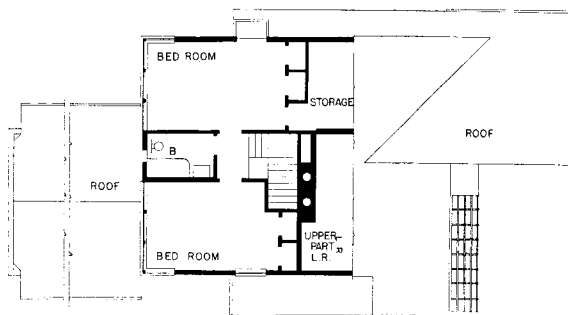

Second Floor Plan

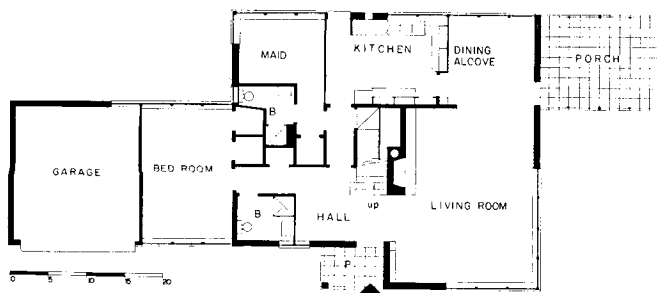

First Floor Plan

HARRIS ARMSTRONG

Architect

A night view of the living room taken from the terrace shows an effective use of simple materials. The rectangular window is nicely scaled to the size and shape of the room.



By day the same window reflects the terrace and lawn. Here the wide eaves are not covered by shingles, but form a trellis for vines.

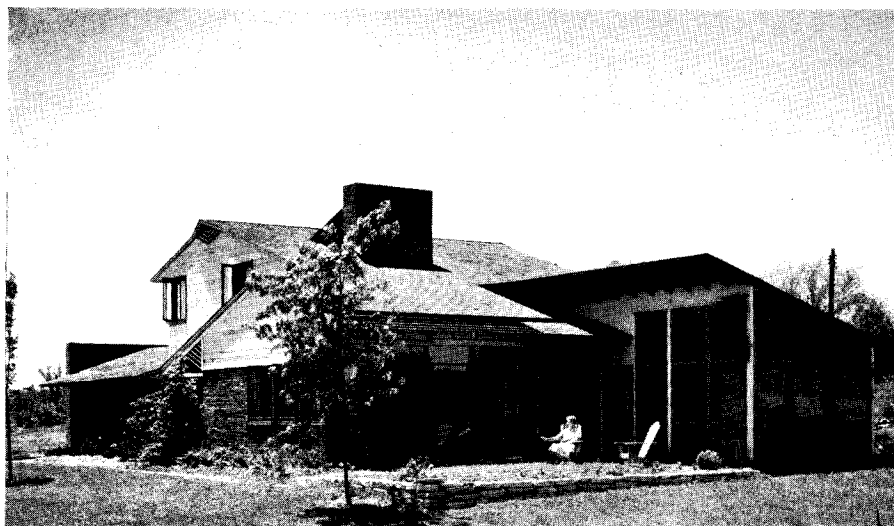
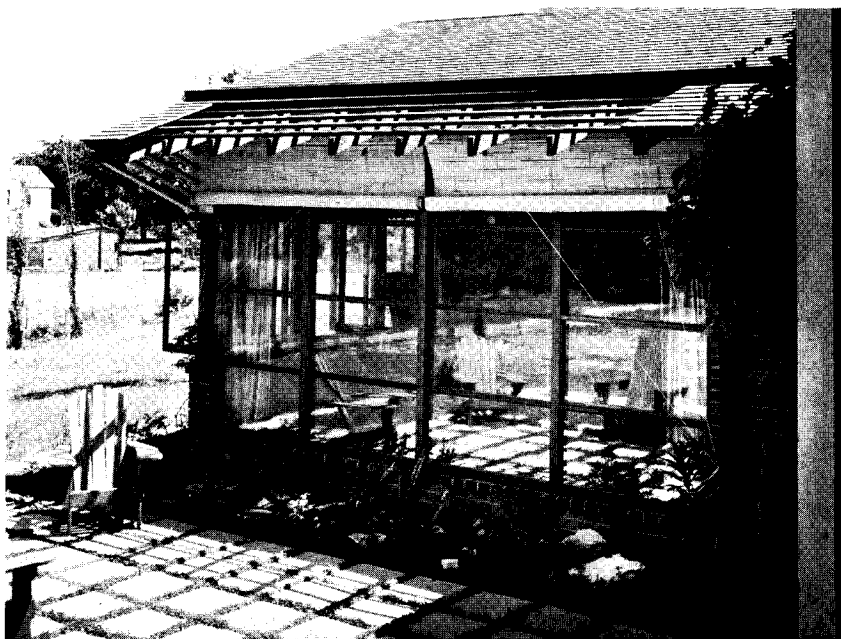

The eave detail on the porch provides a wide overhang of dark wood which cuts down the reflected glare.

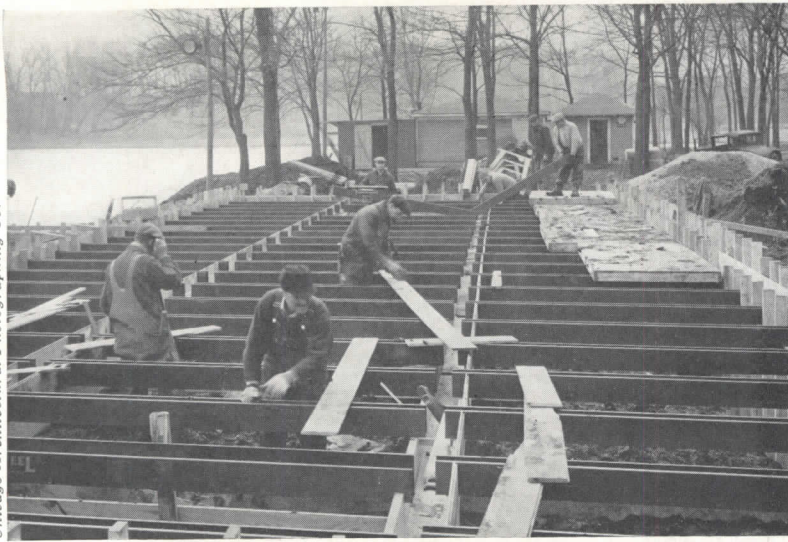

THE STEEL SECTIONS SHOWN ABOVE ACT AS FORMS for poured-in-place concrete beams on which rest light-weight concrete precast slabs. The slabs are laid in a



stagger arrangement (see diagram) on the steel forms; concrete beams are then poured (above, left) to form a monolithic structure of slabs and supporting beams.

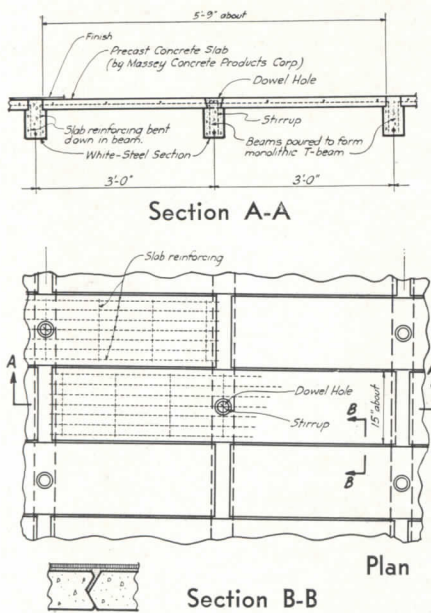

Precast Concrete Slabs are Used for Floors and Roof

THE STRUCTURAL action of a patented system of precast, lightweight concrete slabs supported by poured-in-place concrete beams, is now being tested at the Research Foundation of Armour Institute of Technology. Devised by Eugene A. White of Chicago, the system involves the use of slabs, 5'-9" long and 13" wide, each of which is designed to act as a unit with the poured-in-place concrete beams. Design of the system hinges on the assumption that slab and supporting beams act as a monolithic structure, and that they may be designed in accordance with usual T-beam procedure. From Armour Institute's tests on floor panels and a 10' x 10' test panel there is indication that the assumption is valid.

Specially designed pressed-steel sections, of sufficient rigidity to support

the slabs during construction, provide forms for the beams. Mesh reinforcing from the ends of each slab is extended into the beams to join beams and slabs securely. The reinforcing also acts as stirrups in the beam. Dowel holes in the center of slabs, into which stirrups are inserted, provide additional union between slabs and beams. Slabs are prefabricated of lightweight aggregate to exact specifications in steel forms. A tight-fitting longitudinal joint between slabs results from accurate control of slab dimensions.

When used for roof construction the longitudinal joints are filled with plastic cement. The steel beam section acts as a purlin to which the precast slab is attached. Weight of a standard 2-in. floor slab is 17 lbs. per sq. ft.; a roof slab weighs 13 lbs. per sq. ft.

Experiments Yield New Facts on Structural Action of Steel Members

FUNDAMENTAL to good structural design is the recently ascertained fact that stresses travel along paths determined by the form of the structure and arrangement of its loads. By learning the habits of stresses, design by form as much as by calculation and theory is possible. Of less immediate use to builders, but destined for future results is the conclusion that the measurement of strains by the "rosette" method will provide a powerful and adaptable tool for the study of structural action. These two conclusions were deduced as byproduct findings in experiments on knee-shaped steel frames carried out by the Bureau of Standards for the AISC. The principal result of the test—that knee frames as commonly

designed are adequate for the intended purpose—actually is of less permanent usefulness than the accidental findings.

[In the so-called "rosette" method of strain measurement, diameters are drawn on a hypothetical circle taken at any point on the knee brace. Hence the name "rosette." Strain gauges placed on these diameters indicate the amount of strain under loads. By loading the knee brace at points on the diameter equidistant from the center of the circle, the direction of maximum stress is found.]

Study of Iron Atoms Results in Lightweight Steel

INCREASED knowledge of the atomic behavior of heat-treated iron is re-

sponsible for the production of a lightweight steel without attendant decrease in strength, Dr. John Johnston, Research Director for U. S. Steel, recently reported to members of Philadelphia's Franklin Institute. This progress in the understanding of molecular activity in making steel is of particular interest to the building field because of the extensive possibilities for lightweight steel in structural design. High-tensile steels, such as stainless steel, already important in the construction of trains, buses, etc., are now available in sheets only 2/100-in. thick. At present, the main object of the steel industry—according to Dr. Johnston, is to improve the fitness of steel at no greater overall cost to the public.

NEW MATERIALS AID THE BUILDING DESIGNER

Combines Properties of Rubber and Cement

RECENTLY announced is Ucrete, a product which combines the properties of both cement and rubber, developed by F. Hulse and Company, Ltd., Woodlesford, Leeds, England. Ucrete is available in both powder and solution form, and can be made into mixtures which vary in property according to the outstanding ingredients. A greater percentage of solution produces a flexible, resilient material with properties of insulation and resistance to abrasion, whereas more powder in the mixture gives a greater factor of hardness. Advantages claimed by the manufacturer for this new material are not only that it is waterproof like rubber and sets like cement, but that it is not dependent on evaporation, is dustless, does not form brittle objects when molded, and has good wearing and adhesive properties. It can be used for bricks, roofing, tiles, door handles, wainscoting, caulking for woodwork, layers for tennis courts, roads and paths, etc., according to the manufacturer.

Asbestos-Cement Tile Needs no Protective Coating

AN ASBESTOS-CEMENT siding, Trafford Tile, has been introduced in this country by Keasbey & Mattison Company, Ambler, Pa. Trafford Tile is a composition of asbestos fiber and Portland Cement, requiring no protective coating over its natural gray finish; it is fire- and weather-resistant. Available in lengths of from 3 to 8 ft., in areas of from 11 to 29 sq. ft., the tile should be of interest to building designers faced with the demand for large industrial units of skeleton construction.

Inexpensive Adhesive Bonds Metal Sheets

A NEW BONDING material holds in place the copper sheets used as wall decoration in the Board of Directors' Room at the New York World's Fair Administration Building. This product was developed for the American Brass Company by a self-styled "unemployed" dabbler in adhesives, Benjamin Albrecht, in the cellar of his home in Rowayton, Connecticut. The product is inexpensive: 25 gal. cost approximately \$7.50, and will cover 1,000 sq. ft. of wall surface. Although there is a wide potential demand for effective metal-holding adhesives, the inventor maintains that manufacture by the formula—the secret and as yet unpatented property of Mr. Albrecht—will continue in his cellar.

Plastic Material Resists Corrosives

SYNTHETIC PLASTICS, of recent invention and increasing importance, are continually demonstrating the variety of their use. Just announced for distribution is a sprayable, corrosion-resistant plastic which acts as a protective coat for concrete, steel, and wooden structures. Developed by the American Concrete and Steel Pipe Company of Los Angeles, "Amercoat" is said not only to be inert (within a temperature range of 50° F. to 150° F.) to corrosive agencies, but also to bond to the base material. Although not designed to resist abrasion, as a synthetic plastic it has strength and resiliency enough to give it considerable resistance to the abrasive actions of solids or liquids. It is claimed to have a tensile strength of 200 lbs. per sq. in. In addition to its resistance to corrosion, Amercoat is said to be inert to the destructive action of sea water, and is repellent to barnacle types of growths when applied to ships' hulls. Three solutions comprise the protective covering—a prime coat, an enamel, and a seal coat—but since the coatings are quick-drying, the spraying application can be considered a continuous process. It is nominally applied to a thickness of 1/64" but coatings of any desired thickness from 1/100" to 1/16" may be sprayed on. Its efficiency does not depend on thickness of coating, according to Amercoat's manufacturers.

Beaded Channel Drain Protects Against Seepage

DEVELOPED by Republic Steel Corporation, Cleveland, Ohio, Triple Drain is a new roofing product. It is said to be proof against leakage from driving rain or capillary attraction (syphonage or seepage). Triple Drain's beaded channel makes a tight fit at the overlapping edge and creates a vacuum action. Any rain passing this pouch is carried by gravity into the center drain. Available in three types of metal—steel, copper-bearing steel, and Toncan Iron—Triple Drain comes in gauges of 26, 28, and 29, and lengths of 5 to 12 ft., with a covering width of 24 in.

Cane Fiberboard Has Abestos Cement Surface

NOW IN production at the Celotex Corporation's Metuchen, N. J., plant is a new insulating board. The product consists of a core of cane fiber surfaced on one or both sides with a fire-resistant layer of asbestos cement.

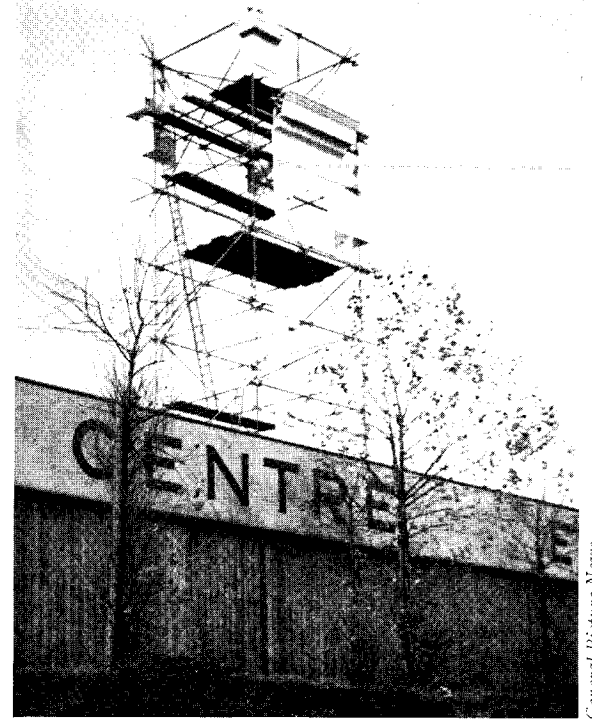

General Picture News

ELABORATE SCAFFOLDING OF ultramodern design supports plaster casts of the Classic friezes which will adorn the New Civic Hall at Birmingham, England. Thus, it is hoped, the British architects will be spared the "disappointment sometimes permanently suffered when they see their completed building" with detail out of scale. (Recently Nazi architects put up a full-scale plaster model of entire facade of a building to get Hitler's o.k. on design.)

Architects Urged to Design Bomb-resistant Buildings

ONE STEP CLOSER to American building designers came the boom of war when last month Willard K. Smith, editor of *News and Opinion*, bluntly advised architects to take heed of what is now happening in Shanghai and Madrid. Because in the event of war New York would not be invulnerable to aerial attacks, architects should consider the possibility of bombardment in designing new buildings for that city. Evidently alarmed to the point of comment by the recent explosion of a bomb that penetrated two floors below the roof of a Shanghai department store, Mr. Smith in his article advocates roof reinforcement for repulsion of explosives and as a mounting for anti-aircraft guns. How serious the matter would be in case of an aerial attack on the metropolis is borne out by the statement that very few roofs of New York's present high buildings could support such a gun, because its weight at recoil is 30,000 lbs.



New Screen Mounting Eliminates Rigid "Frame"

THE INVENTION of a means of enlarging the visual field of the motion picture screen without actually increasing its size was recently announced by Ben Schlanger, New York theater architect. For two years Mr. Schlanger and Jacob Gilston, electrical engineer, worked on the problem of eliminating the artificial black border which frames the present motion picture screen (above, left). Finally, by an arrangement of diffusing and reflecting surfaces behind the screen (diagram, right) they were able to create a shadowy border around the picture which simulates for the spectator the peripheral vision of reality (above, right). Because the only light used to produce this effect is that of the projection beam, the picture edge blends into the surrounding field. The intensity of light and color on this field constantly changes with the light and color of the projected picture. Light from the projector falls on the marginal area of the screen and, penetrating it, is diffused and reflected by the concave surfaces behind and beyond the screen edge. No attempt is made to create on the extended field any definition or duplication of forms occurring on the

marginal areas of the screen. In addition to automatic synchronization of light on these areas with that on the contiguous field, the invention makes possible the control of light on side walls of the auditorium. For successful results, says Mr. Schlanger, side walls should be so designed as to reject or receive, to a proper degree, light from the screen. This is accomplished by splaying the wall surfaces at angles which direct the light into the unused space between screen and audience.

Not only does the "Screen Synchrofield" (for which patent claims have already been allowed by the U. S. Government) enlarge the visual field for the spectator, but, according to Mr. Schlanger, it increases the effective area of the screen for image placement in filming the picture. Panoramic views will be enhanced by the apparent extension of sky and horizon. Especially effective will be the use of "Screen Synchrofield" in connection with the showing of colored films. The artificial hardness of brilliant colors will be softened when surrounded by the subdued tones of the colors on the peripheral screen.

The essential of this invention is the

BY MEANS OF A CONCAVE mounting for the screen (below), Mr. Schlanger eliminates the hard and arbitrary frame within which all action formerly took place, achieves instead an image which merges with its periphery (above).

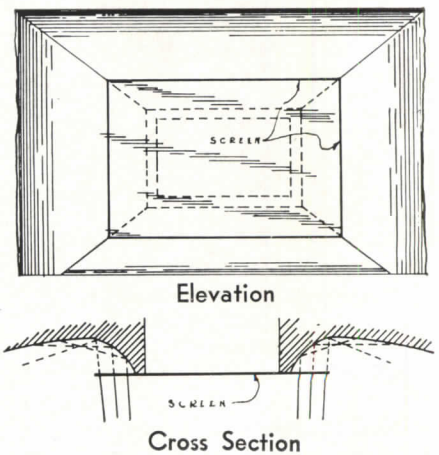

diffusing and reflecting surface. It can easily be installed in existing theaters or incorporated in the design of new theaters. Cost of installation is estimated by Mr. Schlanger at from \$150 to \$500, depending upon size of proscenium and medium employed—that is, plaster or composition board.

Movies Soon to Have 3 Dimensions in Both Sight and Sound

DEVELOPED from the three-dimensional sound system of Bell Telephone Laboratories, "stereophonic" movies made their unofficial debut at a recent meeting of the Society of Motion Picture Engineers in New York. On this new type of film two sound tracks are squeezed into the space on the film usually occupied by one track. These two independent sound systems feed two loud speakers which are so arranged that the sound from the screen is given direction and depth. Stereophonic movies, however, will not be commercially distributed for some time.

"Stereoscopic" movies, also in the process of development, make use of

polarized light to produce a visual three-dimensional effect. In making these movies two cameras with similar lenses are used. Scenes are "shot" with the cameras spaced at distances similar to the spacing of human eyes. The two films are flashed on the screen simultaneously from a projector whose optical system is like that of the cameras. Because the audience wears glasses with lenses of Polaroid, a synthetic substance which cuts out all light except that which vibrates in one direction, only one picture is apparent. (For detailed report of Polaroid, see RECORD, March, 1936, page 243.) One lens of the Polaroid glasses is blind to all the light

the other one can see, so that each eye sees one picture. This is the same principle as that used in the old stereoscope whose views of Niagara awed past generations.

New Camera Catches 80,000 per Second

USING a continually operating film system with revolving lenses which give 1,000 exposures per second, German General Electric Company has developed a new high-speed camera, which, by additional subdivision of the exposure, both vertical and horizontal, achieves the almost incredible total of 80,000 exposures per second.

LIGHTING: NEW STANDARDS INDICATED, NEW EQUIPMENT FOLLOWS

McCandless Urges Study of Building Illumination

CAMPAIGNS for better lighting conditions, carried on for the past few years by electrical companies, have focused the attention of building designer and public on the importance of light to life. That all too often this necessity is neglected by architects in design of structures—residential as well as commercial and industrial—was the thesis of a recent talk by Yale's noted lighting authority, Stanley McCandless, before members of the New York Architectural League. Reason for this neglect, baldly stated Mr. McCandless, is ignorance.

Because light is a tool by means of which can be obtained visibility, comfort, composition, and atmosphere, it should be a major consideration from the inception of a building design. This is of particular importance, says Mr. McCandless, in relation to exterior design of structures; floodlighting has produced some grotesque results. When given a direction, like sunlight, light gives shadows which show the modeling of the form. The aspect of a floodlit building at night should be that of an architectural entity, according to Mr. McCandless, not that of a floating tower or detached block of masonry.

Columbia Initiates Building Illumination Course

AS A DIRECT answer to the need for education in lighting, clearly stated by Mr. McCandless, comes Columbia University's announcement of a basic course in Illumination of Buildings. Planned primarily for architects and designers, the course includes discussion of such topics as coordination of light and architecture; lighting for seeing; incandescent and gaseous light sources; light standards and control; color in lighting; commercial, industrial and residential lighting; stage lighting, decorative and exterior lighting; and modern trends and future possibilities. Realizing that the best source of information on so complex and fluctuating a subject is the lighting industry itself, the university asked a number of specialists to conduct the classes.

Surveys Show Importance of Light and Color

IN A RECENTLY concluded survey by members of the Illuminating Engineers Society, lighting conditions of nine typical New York City public school classrooms were studied. The IES report condemned the use of cream-colored walls, long a standard in the school room, and recommended in their place various combinations of colors whose

effect on students is salutary. Several color schemes were suggested by the IES: blue-green upper wall, slightly darker lower wall; buff upper wall, gray lower wall. (For similar use of color in classrooms, see RECORD, November 1937; page 39.)

Reports from lighting bureaus in various sections of this country show that the average illumination in school classrooms is only 20% of what it should be. Although the recommended minimum for artificial illumination in schools is 20 foot-candles of light, the existing lighting in classrooms covered by the survey averaged only 4 foot-candles. As a direct result of these surveys, experiments in lighting were conducted at Tuscumbia, Alabama, to determine the effect of improved lighting conditions on scholarship performance. From these experiments it was found that the percentage of failures was considerably lower among pupils who worked under modern lighting conditions than among those subjected to the effect of existing lighting.

[Two groups of 34 students each, all in the same grade and with equally high grades were selected for the Tuscumbia test. The two teachers were switched back and forth so as to provide equal instruction. Group A had its classes in a room where existing lighting was retained. Group B sat in a room relighted according to modern standards. At the end of three years the score on failures was: Group A, 11; Group B, 2. In a similar experiment at Lebanon, Pa., children in a well-lighted room showed 28% more improvement than those in a poorly lighted room.]

Proposed Mercury Lamp Will Rival Sun

MEANWHILE, in the field of electrical research, developments have been going on apace. Recent experiments have led to the discovery of a law which relates candlepower per unit volume to watts per unit volume of arc stream. In addition, scientists have found that there exists a constant ratio between watts per cm and lumens per cm. Knowledge of these two important relationships brings nearer to realization the general commercial use of very high power mercury vapor arcs. By measuring the arc stream of lamps already in practical laboratory application, the wattage required to operate a mercury arc lamp of any desired per-unit brightness, can be determined. It is possible at the same time to simplify the study of materials, the object of which is to produce a lamp capable of withstanding the extreme temperature of 14,000°—hotter than the sun's surface—and the abnormal pressure of 1,100 lb. per sq. in.

Still in the laboratory stage, however, is a lamp with an arc stream whose brightness approximates that of the sun.

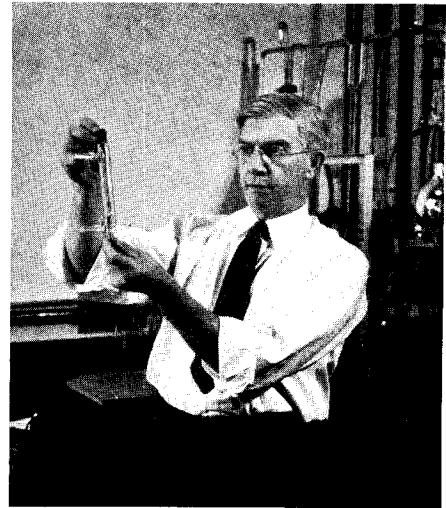

[A new water-cooled quartz mercury arc lamp by Westinghouse (above) has distinct possibilities of application not only to problems of floodlighting and headlighting in general, but also (and significantly) in anti-aircraft protection. Such mercury arc lamps, at present comparatively easy to produce and operate, are capable of intensities in the arc stream which are eight or ten times as great as those of the tungsten filament lamp.]

Lensless Fixture For Auditorium Use

SINCE SPECIFIC types of buildings require special lighting, manufacturers of electrical equipment have occupied themselves in solving the problem of obtaining the best kind of light for a particular purpose. Two developments along this line concern auditorium and store illumination. Based on the principle of collecting light from a lamp with a reflector which redirects most of the light to a focal point, the Rambusch Downlighting fixture is intended especially for use in auditoriums and theaters. The reflector is set into the ceiling of the hall in such a way that the narrowest part of the light beam coincides with a small opening in the ceiling. No lenses are used, as the reflector distributes the light at angles of from 30° to 60°, depending on the installation. Made of metal spinings of the size and shape required for the particular installation, the Rambusch reflector may have an inside finish of aluminum for white light, or of pure gold plate for a warmer light. By setting reflectors flush or nearly flush with the ceiling, interference of stage view from hanging fixtures is eliminated.

(Continued on next page)

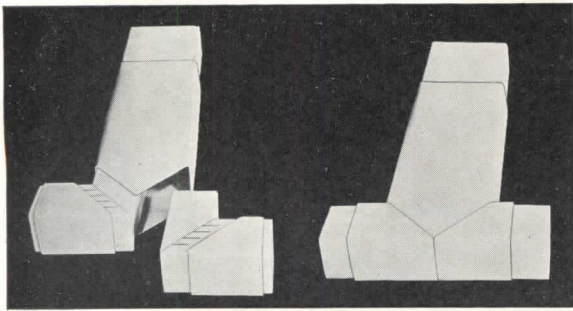

PREFABRICATED AND NON-METAL-lic, this new line of duct parts was recently introduced by Cincinnati's Philip Carey Co. Coming in wide variety of shapes and sizes, "Careyduct" has a strength and friction factor comparable to metal, while having the insulating value of asbestos. Absence of metal materially reduces transmission of noise from the mechanical equipment.

New "Storlite" Combines Direct-Indirect Feature

DESIGNED especially for store lighting, Westinghouse's Storlite, a direct-indirect light unit, not only gives a general ceiling illumination, but provides a maximum of light on merchandise. White thermoplastic louvers, of a high translucency, are mounted in four concentric circles on a hinged frame. These louvers, and the outer reflector of aluminum, give a wide range of light, and are not visible at the normal angles of sight. The upper portion of the outer reflector is left open so as to direct light to the ceiling. Storlite, in two models, Standard and DeLuxe, is said to have a lighting intensity on merchandise two or three times that of ordinary units.

Standardized Voltage Promises Longer Lamp Life

THE TREND toward a standardized voltage of 120 for electrical equipment, a long-felt need, shows signs of a growing popularity. Not only has this standardization value as a means of insuring uniformity of light and life of lamp, but it would also put new life into other appliances and devices. Although in the early years of the industry several voltages were necessary—the nature of the lamp filament prevented the manufacture of a product with standard voltage rating—there is no longer any such need. With the advent of the three-phase, four-wire network, the trend toward a standardized voltage of 115 was upset, and the use of 120 volts increased. In four years the relative number of 120-volt users has jumped from 33 to 46 percent. This rate of change is considerably more rapid than usual, as the practice is to raise the voltage piecemeal over a period of time.

California's Fair has Extensive Landscape Program

THE SALT of the earth—a distinct liability to landscape architects—must be leached from 100 acres of black sand, dredged from San Francisco Bay to make Treasure Island, before planting operations can begin for the Golden Gate Exposition. How best to accomplish this is yet to be determined; but characteristically Californian is the project of enriching these 20,000,000 cu. yds. of sand with 100,000 yds. of rich topsoil from the Sacramento river delta. A thousand varieties of growing things, including 4,000 trees and 40,000 shrubs—all indigenous to Pacific climates and nations but present within California's state boundaries—will be transplanted to the island. The project calls for propagation of plants from seedlings as well; for this purpose an "electric hotbed" in Balboa Park, San Diego, is being used. A thermostatic control keeps the soil at a constant temperature of 60° and thus doubles the rate of growth. From the stock in these beds, which are electrically heated by highly-resistant cables laid among the roots, cuttings are taken every 17 days, moved to other beds, then to outdoor locations. To keep the plants pest-free, they are chemically fed, without mulching of any kind. Strategems used to guarantee maximum performance in 1939 are various: some specimens are kept trimmed of their blossoms so that strength will go into structural growth; others too large or not sufficiently well-furnished to accord with plans, are "topped" and induced to put new roots high on their stems. Trees are held boxed at Balboa Park and in the Bay region until time for their transplanting. During its "rest" period, the tree is sprayed periodically and fed with a solution of one ounce of ammonium sulphate for each square foot of box.

N. Y. Savings Banks Impose Strict Building Requirements

AS A FURTHER STEP in the campaign for improved building construction, more stringent minimum requirements for six-story apartment houses were recently adopted by the Group V Mortgage Information Bureau, comprising savings banks in the boroughs of Brooklyn and Queens, New York. Of particular interest to designers—in view of the 1936 Bronx apartment collapse in which 17 men were killed—are the stipulations that architectural supervision shall be furnished and that each building shall have a building superintendent on the job during the entire time of construction. Also included in the revised speci-

fications are stricter requirements as to size of floor beams, and the prohibition of use of second-hand steel, and second-hand brick, because of its misuse by builders and its improper cleaning and laying.

Association Plans Drive For Increased Gas Use

INITIATING a program which is intended "to benefit the public, the building industry and the architectural profession," the American Gas Association will soon announce details of a demonstration of gas-equipped homes. In cooperation with local architects and builders, the gas industry plans to erect model homes and modernize existing homes with up-to-date gas equipment. Inquiries which come as a result of this program will be referred to local architects and builders, as the Association will furnish no house plans to prospects. Through its newly established Home Appliance Planning Bureau, the Association will advise the building profession on all matters pertaining to gas appliance installation. Although the gas industry has until lately occupied a back seat by reason of the prominence of the nation's electric companies, figures show it to be no mean competitor. The 1,500 gas companies in the U. S. serve 80,500,000 persons through 16,500,000 meters, and annual revenues aggregate \$770,000,000 annually.

Traveling Exhibit Shows USSR's 5- and 10-Year Plans

AN EXHIBITION of Housing and City Planning in the USSR, recently shown at Avery Hall, Columbia University, is now on a tour of the country. Designed by Alan Mather, New York architect, and edited by Talbot Faulkner Hamlin, librarian of Columbia's School of Architecture, the exhibit purposes to illustrate "the dynamic and rational qualities of Soviet architecture and city construction." It includes photographs and plans depicting the results of both First and Second Five Year Plans in housing and town planning, as well as photographs of Pre-Revolutionary Russian architecture. Also illustrated is the historical development of Soviet architecture, 1918-1937, in which selected works of the "Constructivist, Formalist, and Functionalist" schools represent the design tendencies which caused the redirection of official architecture along its present lines. Sponsors for the exhibition are William Lescaze, Carlton S. Proctor, Isadore Rosenfield and Simon Breines. The American Russian Institute, 56 W. 45 St., New York City, is responsible for reservations and rental of the exhibit.

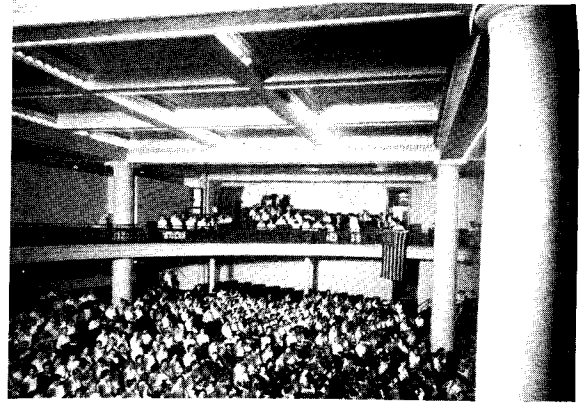
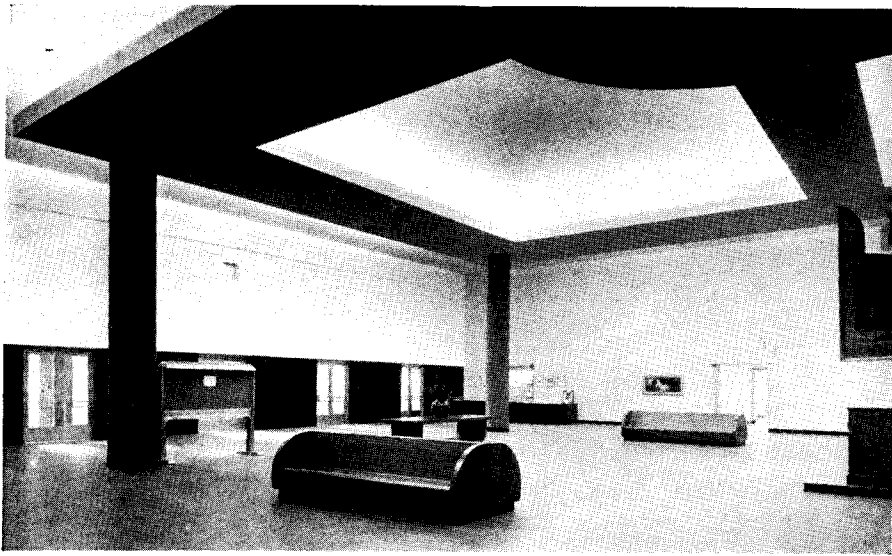

THE MUSEUM'S OLD AUDITORIUM (above), converted into a soft-lighted entrance hall (left), has gray walls and cobalt blue columns. The renovated Classic Court (below).

Brooklyn Museum's Complex Program Housed in Renovated Quarters

FOR BROOKLYN MUSEUM'S new program in community activity, a new building might have seemed imperative; but such a project would have required considerable funds—and funds the Museum had not. Nothing daunted, Director Philip Youtz obtained a WPA allotment and went to work on the old familiar structure. His new program called for more than structural changes: it involved the very function of the museum in community life. Room after room filled with Greek vases, Egyptian vases, Etruscan vases, Chinese vases, drew dust, not visitors, Dr. Youtz found.

Various cultures are now rearranged in chronological rather than topical order, so as to lend verisimilitude to the pageant of history. Arts are not sepa-

rated from crafts; examples from the same period are logically arranged so as to give a complete picture of a particular civilization. In remodeling the old building, the Museum has added many features symbolic of its new function in the community. There is a hall for symphony concerts, organ recitals, and dance programs; a cooperative dance studio; a restaurant; a public reading and print study room; a special Egyptian reading room; and special facilities for the study of textiles.

So successful has been the Museum's program in connection with children that an addition to the present structure is shortly to be erected to house a special Children's Museum. Plans for this have already been drawn by William Lescaze.

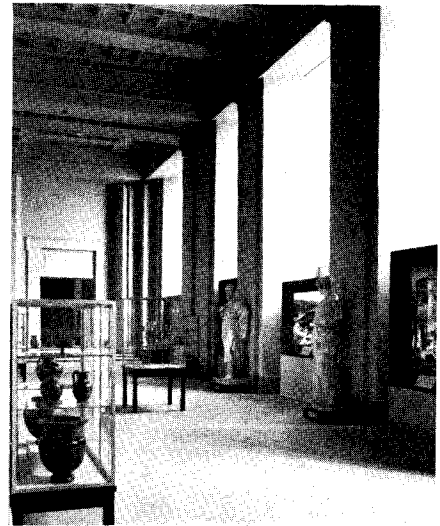

Modernization of Architectural Competitions Proposed;

THE BELIEF that architectural competitions are the best method of selecting designs and architects for the erection of buildings which involve expenditure of public funds has led to the formation of a National Competitions Committee for Architecture and the Allied Arts. To accomplish its purpose—Federal legislation favoring competitions as the method of selecting architects for public edifices—the Committee intends to collect information from this and other countries on the conduct of competitions. This is no startling innovation, for already in such countries as England, France, Italy, USSR, and Switzerland, the competition system is accepted procedure. That there is need for such procedure is clear from the controversies which arose over selection of designs for the Oregon State Capitol (RECORD, August, 1936; pages 76-80) and the Jefferson Memorial (RECORD, June, 1937; pages 24-26).

By formulating recommendations for the satisfactory conduct of competitions for a variety of problems, the committee

expects to work out sound methods of overcoming objections to competitions. To this end it wishes to secure, for ultimate use in Washington, the official support of organized groups. Assurance has been made that, if there is demand enough, a bill making competitions the accepted form of procedure for selection of architects for public buildings, will be introduced into congress under the aegis of Congressman Otha D. Wearin.

AISC opens competition

To stimulate interest in a safety program for prevention of traffic accidents, the American Institute of Steel Construction is sponsoring a competition for the design of an elevated highway. Notification of intention to enter the competition should be made immediately to the Institute, 200 Madison Avenue, New York City. Information and details of the competition may be obtained from V. G. Eden, Executive Secretary, at the above address. All drawings are due on March 31, 1938.

3 Competitions Under Way Fellowship offers year of travel

Competition for the annual J. H. Steedman Memorial Traveling Fellowship in Architecture, \$1,500 in value, is announced. It is open to architects between the ages of 21 and 31 who have worked at least a year in the office of a St. Louis architect. Registration blanks are obtainable on written request from the Secretary, School of Architecture, Washington University, St. Louis, Missouri, and must be returned no later than January 29.

AIA announces LeBrun Scholarship

A nationwide competition for the 1938 LeBrun Travelling Scholarship has been announced by the New York Chapter of the American Institute of Architects. The scholarship, valued at \$1,400, is open to men between the ages of 23 and 30 who have practiced architecture for at least three years and have never received any other travelling scholarship. Nominations must be made by Institute members before January 15, and sent to Oliver Reagan, 101 Park Avenue, New York City.

Leonard Frank



1. Vancouver, Canada

Cheroyon



2. Cachan, France

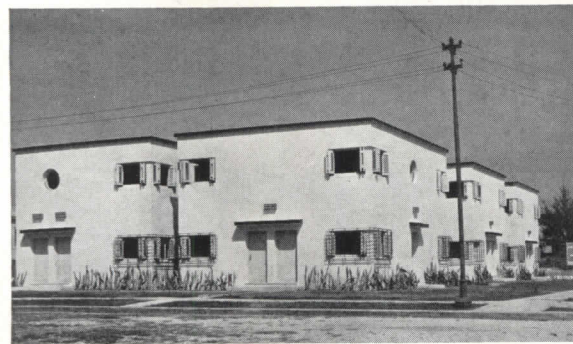

3. Havana, Cuba

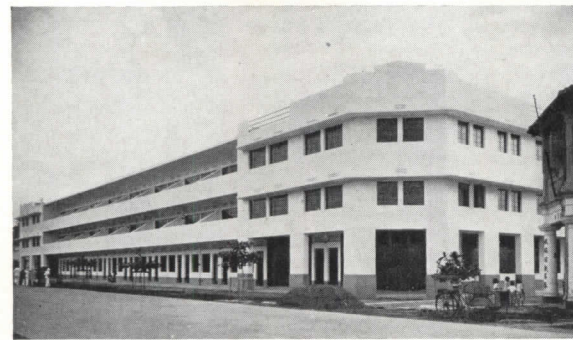

4. Singapore, India

NEW BUILDINGS IN DIFFERENT parts of the world show a surprising similarity in design. Architects for these various projects are: (1) City Hall: Townley and Matheson of Vancouver; (2) "La Belle Image", Ecole Maternelle: Chollet and Mathou, government architects; (3) Medium-rental housing development: Capablanca and Santana of Havana; (4) Low-cost housing scheme: L. Langdon Williams of Singapore.

NEW PUBLICATIONS

General

Glass in Architecture and Decoration. By Raymond McGrath and A. C. Frost. Architectural Press, 9 Queen Anne's Gate, Westminster SW1, England.

Heating, Ventilating and Air Conditioning Fundamentals. By William H. Severns. John Wiley & Sons, 440 Fourth Ave., New York City. Price \$4.

Housing and Town Planning Lectures at Columbia University, 1936-37. By Sir Raymond Unwin. Sub-committee on Research and Statistics, Central Housing Committee, Washington, D. C.

Municipal and County Parks in the United States, 1935. U. S. Government Printing Office, Washington, D. C.

Period Influences in Interior Decoration. By Walter Rendell Storey. Harper & Bros., 49 E. 33 St., New York City. Price, \$3.

The Modern Flat. By F. R. S. Yorke, and Frederick Gibberd. Architectural Press, Westminster SW1, England.

The Modern House. By F. R. S. Yorke, Architectural Press, Westminster SW1, England.

Structural Materials & Parts

Bethlehem Open Web Steel Joists. Bethlehem Steel Co., Bethlehem, Pa.

Hard Facing With Haynes Stellite Products. Fourth Edition, Revised. Haynes Stellite Co., Kokomo, Ind.

Modern Interiors with Carstenite. Algoma Plywood and Veneer Co., 1234 N. Halsted St., Chicago, Ill.

Penmetal Adjustable Furring System for Damp Proofing Brick Walls. Penn Metal Co., Inc., 40 Central St., Boston, Mass.

Philippine Mahogany. Philippine Mahogany Manufacturers' Import Association, 111 W. Seventh St., Los Angeles, Cal.

Electrical Equipment

Bryant Superior Wiring Devices, Catalog No. 37. The Bryant Electric Co., Bridgeport, Conn.

Commercial and Industrial Lighting Equipment. Bright Light Reflector Co., Brooklyn, N. Y.

Remote Control Switches. Automatic Switch Co., 154 Grand St., New York City.

Air Conditioning & Insulation

Adco-Corning Filler Insulation, Bulletin No. 35-67. American District Steam Co., North Tonaawanda, N. Y.

Trane Air Conditioning Manual. By William Goodman. The Trane Co., LaCrosse, Wis. Price, \$5.

CHANGE OF ADDRESS

The RECORD publishes changes of address only on request, making no attempt to keep a day-to-day account. Only organization in the country with facilities for this is Sweet's Catalog Service, whose painstakingly maintained list undergoes an average of 23 changes per day for every working day in the year.

William A. Mitchell, architect, is now located at 309 South Avenue, Summit, N. J.

Samuel M. Kurtz, architect, has opened an office for the practice of architecture at 1170 Gun Hill Road, Bronx, N. Y.

Jones, Roessle, Olschner & Wiener, architects of Shreveport, Louisiana, have opened a branch office in the James Building, Ruston, La.

John Porter Clark, architect, announces that he is no longer affiliated with the firm of Van Pelt & Lind, and that he will continue the practice of architecture at his same location on North Palm Canyon Drive, Palm Springs.

Andrew R. Morison, AIA, and Cornelius L. T. Gabler, AIA, have formed a partnership under the firm name of Morison & Gabler, architects, 616 Murphy Building, Detroit, Mich.

Dudley E. Jones and Lucian Minor Dent, architects, announce the formation of a partnership for the practice of architecture at 1011 Sterick Building, Memphis, Tenn.

George G. Miller, architect, formerly of Miller & Goldhammer, announces the removal of his office to 67 West 44 Street, New York City.

CALENDAR OF EVENTS

- **January 12-15**—Annual Conference, American Institute of Decorators, Chicago, Ill.
- **January 17-19**—Annual Meeting, Society of Landscape Architects, Williamsburg, Va.
- **January 24-28**—Annual Meeting, American Society of Heating and Ventilating Engineers, Hotel Biltmore, New York City.
- **January 24-28**—Fifth International Heating and Ventilating Exposition, Grand Central Palace, New York City.
- **January 24-28**—Winter Convention, American Institute of Electrical Engineers, New York City.
- **January 24-28**—Annual Meeting, American Society of Refrigerating Engineers, Hotel Roosevelt, New York City.
- **January 25-26**—Midwinter Meeting, National Warm Air Heating and Air Conditioning Association, Hotel Roosevelt, New York City.



Adjustable Texsteel Sheave
Adjusted for Minimum Diameter
Low Speed

Adjustable Texsteel Sheave
Adjusted for Maximum Diameter
High Speed

Announcing

... the new **TWO GROOVE ADJUSTABLE** Texsteel sheave

The Allis-Chalmers Mfg. Co., originators of variable speed sheaves, for Texrope V-Belt Drives, and pioneers of their application to fans and blowers, now offers, at low cost, a new two groove Adjustable Texsteel Sheave . . . in addition to the already introduced single groove Adjustable Texsteel Sheave and, for greater capacities, the Vari-Pitch Texrope Sheave.

It takes but a moment to adjust these sheaves to larger or smaller diameters, thus effecting a variation in speed of 25% to 33%. This means, that by a simple adjustment, a greater or lesser

fan speed is obtained, and consequently the volume of air is precisely controlled to meet seasonal changes, or variable existing conditions. Improved design has greatly increased the strength of these sheaves and so insures silent operation permanently.

The Texrope Division of the Allis-Chalmers Mfg. Co. can now supply a complete range of sizes in variable speed sheaves for every kind of heating and ventilating application.

For additional information and prices write for leaflet No. 2278.

Belts by Goodrich

841

TEXROPE DIVISION
ALLIS-CHALMERS

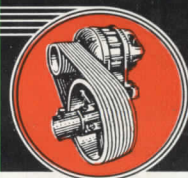

M I L W A U K E E W I S C O N S I N

Inexpensive, yet effective..... DOUBLE-COURSING

Introduces the new vogue in side wall construction!

Wide shingle exposures—far wider than were usual in the past—with charming deep shadow lines that accentuate and emphasize, actually **COST LESS** when this fully proven method is used. But there is no sacrifice of **QUALITY**.

The exposed shingles are of the highest grade, edge-grain red cedar. Only half as many are needed. Underneath are shingles of a lower grade more economical in price, protected from the weather . . . on the outer course 100% edge-grain No. 1 Certigrades. The result is a more substantial, effective wall *plus* the high heat insulating value of this low-density but extremely durable wood.

Economy in construction, with greater latitude in handling from the architectural point of view, and definite assurance of long-time performance, are matters of interest to architect and client alike.

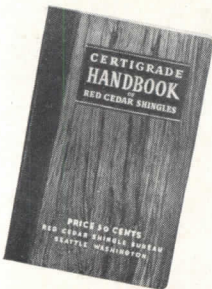
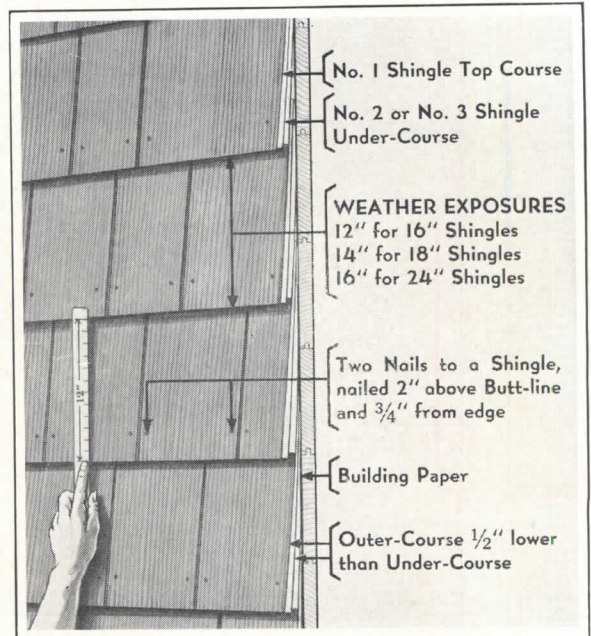

This handbook prepared by a wood technologist mailed free on request. 100 pages detailing uses, application and technical data. Write—

RED CEDAR SHINGLE BUREAU
Seattle, Wash., U. S. A.
or Vancouver, B. C., Canada.

The Certigrade label on every bundle is your assurance of correct grades guaranteed by official inspection. F. H. A. makes it easy to pay—advise your client.

CERTIGRADE *Red Cedar Shingles*
FOR SALE BY ESTABLISHED LUMBER DEALERS

Here's a New
PITTCO METAL SASH

which broadens the possibilities
 for effective Store Front Design

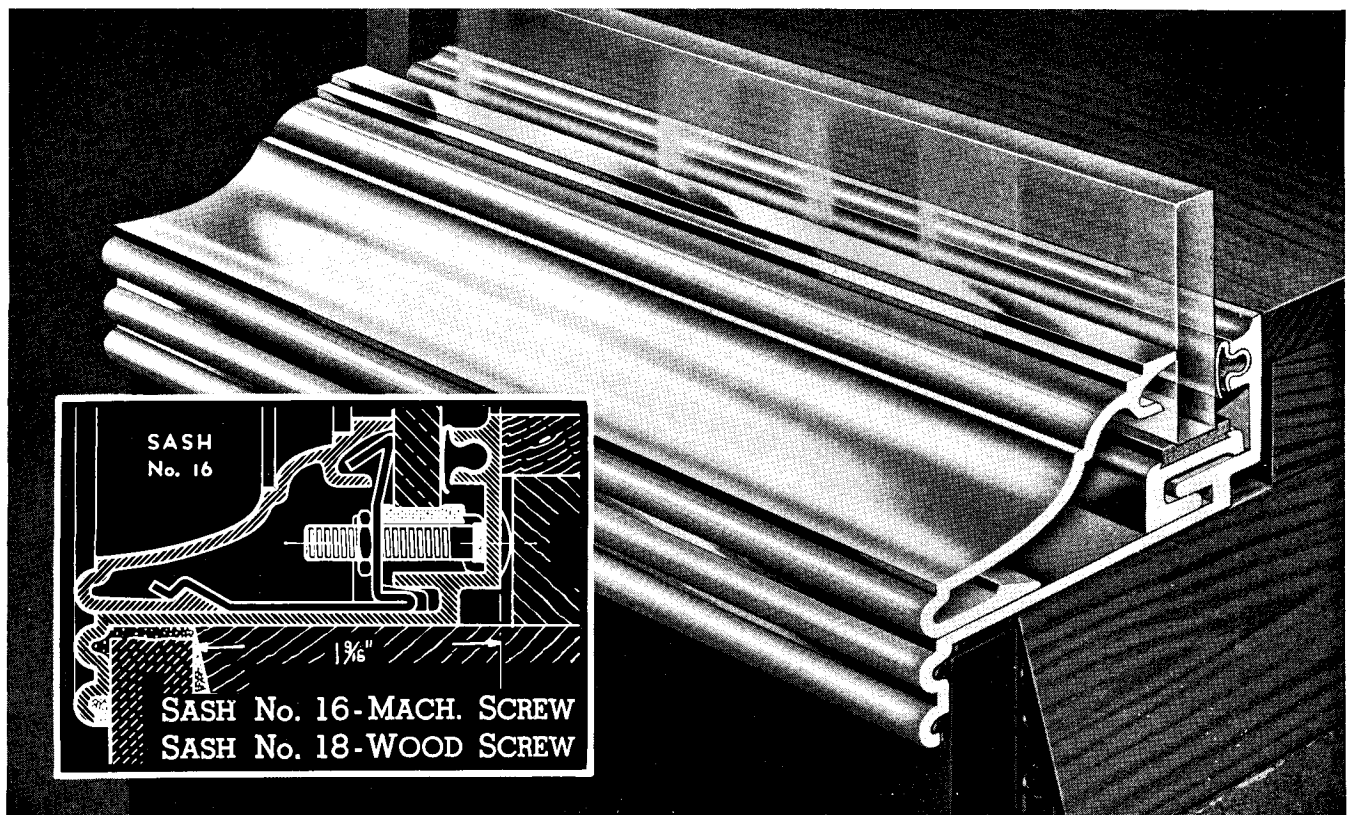

THIS new member of the Pittco Metal family presents a variation of the well-known No. 10 Pittco Sash which the architect will find extremely useful in designing store fronts of beauty and effectiveness.

As illustrated, the new Pittco Sash includes a beaded face member which overlaps the facing material used on the front. This results in two desirable advantages. First, it increases the attractiveness and display

value of the show window . . . because the double bead of the new face member combines with the bead on the sash unit itself to form a wide, effective frame for the show window, setting off the merchandise displayed in a pleasing manner. And second, it adds to the durability and continued good looks of the front by protecting, with its overlap, the edges of the facing material.

You will find this new Pittco Sash

a worthy addition to the present line of Pittco Metal units, which has won the enthusiastic approval of architects throughout the country. We invite you to send the coupon for complete information and detail drawings of various applications of Pittco Store Front Metal.

PITTCO
 STORE FRONT METAL

Paint * **PITTSBURGH** * *Glass*
PLATE GLASS COMPANY

Makers of WALLHIDE PAINT • WATERSPAR ENAMEL AND VARNISH • SUN-PROOF PAINT • FLORIHIDE • POLISHED PLATE GLASS • MIRRORS • PENNVERNON WINDOW GLASS • DUPLATE SAFETY GLASS • PITTCO STORE FRONT METAL •
 Distributors of PC GLASS BLOCKS and CARRARA STRUCTURAL GLASS

Pittsburgh Plate Glass Company,
 2100A Grant Bldg., Pittsburgh, Pa.
 Please send me, without obligation, your
 folder containing full information on Pittco
 Store Front Metal and detail drawings.

Name.....
 Street.....
 City..... State.....

A new, harder
MILL POLISHED
sheet

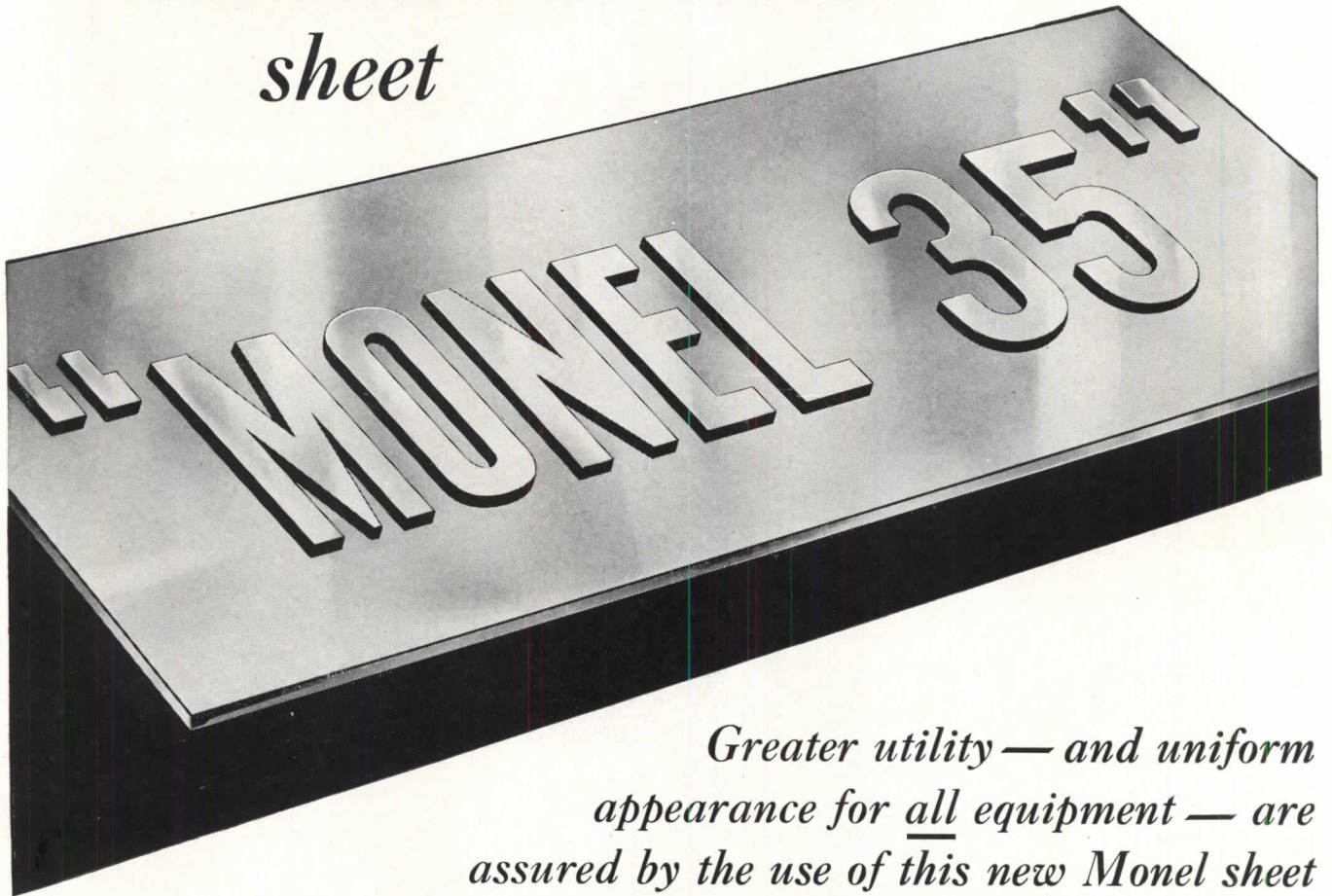

Greater utility — and uniform appearance for all equipment — are assured by the use of this new Monel sheet

HARDER, stiffer, more resistant to denting: That is one characteristic of the new Monel 35 sheet — the property that makes this form of Monel* more *useful* than ever. And the second important characteristic of Monel 35 is its uniform mill finish: For it provides absolute assurance that *all* equipment, regardless of when or where fabricated, will have the *same identical silvery satin appearance* — standard finish produced at the mill.

Yet none of Monel's well-known advantages are sacrificed. Specify Monel 35 and you build into your clients' equipment the same sound qualities for which Monel has always been famed—strength, toughness, complete freedom from rust, and stout resistance to

corrosion. That is why, more than ever before, Monel is the ideal sheet metal for kick plates, push plates, cove bases, and for food service, clinical, hospital and laundry equipment.

Where lasting beauty and uniform appearance are of paramount importance, remember—"Monel 35". And for lastingly leak-proof roofs, safe, sturdy ceilings—Monel sheet and Monel tie-wire respectively. Write for further information on Monel for architectural requirements. Address:

THE INTERNATIONAL NICKEL COMPANY, INC.
67 Wall Street
New York, N. Y.



*Monel is a registered trade-mark applied to an alloy containing approximately two-thirds Nickel and one-third copper. This alloy is mined, smelted, refined, rolled and marketed solely by International Nickel.



VALUABLE

free book

FOR ARCHITECTS AND BUILDERS

Here is an interesting book you will find very helpful in planning heating for residential projects. It suggests the adaptability of Anthracite heat to budgets of any size. It shows how homes can be made most attractive to clients. It suggests new possibilities in basement planning, in new or old homes.

This book is the first of its kind. It stresses no manufacturer's product. Herein you find a complete review of all that is newest, most efficient, and most economical in modern Anthracite equipment. It tells how an inexpensive thermostat, and an Anthracite furnace or boiler, provide real automatic heat—and fueling periods as much as 12 hours apart. The book describes magazine-feed boilers that need no fueling attention from 24 to 48 hours—even days at a time. It describes modern automatic Anthracite burners that need no fueling attention all season long, and automatically remove ash to sealed containers.

Send for this time-saving book. Send for actual performance records of approved Anthracite equipment. Use the personal service of our trained field men, on Anthracite problems. Simply write to ANTHRACITE INDUSTRIES, INC., Chrysler Building, New York.

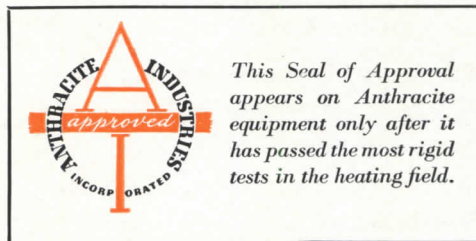

This Seal of Approval appears on Anthracite equipment only after it has passed the most rigid tests in the heating field.



THE SOLID FUEL FOR SOLID COMFORT

A NEW SIGN OF ENDURANCE

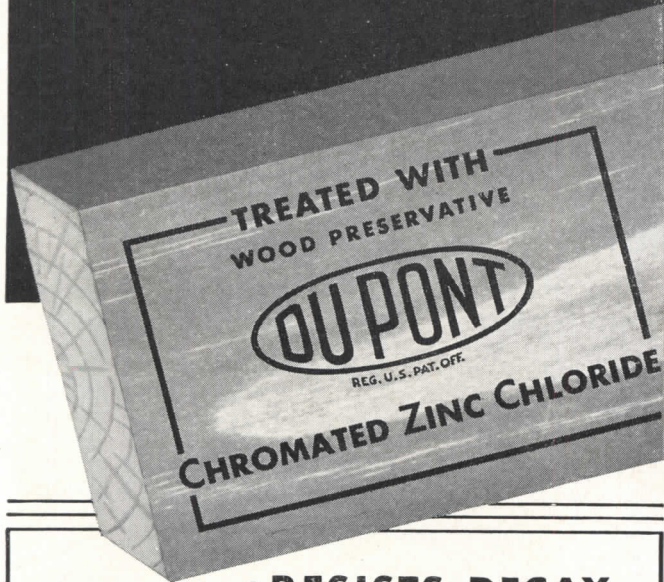

- RESISTS DECAY
- REPELS TERMITES
- RETARDS FIRE

This mark will be used by wood treating plants applying Du Pont Chromated Zinc Chloride by approved methods. It means that the lumber thus treated is capable of outlasting 3 to 10 installations of ordinary wood.

Du Pont Chromated Zinc Chloride is known as a "salt." It is clean, odorless, paintable, safe to handle and can be readily worked.

Wherever wood construction is planned for industrial or domestic buildings such as houses, mill roofs, schools or warehouse floors, the recommended use of Chromated Zinc Chloride will prove an economical investment.

Send for a copy of Standard Treating Specifications

E. I. DU PONT DE NEMOURS & CO., INC.
GRASELLI CHEMICALS DEPARTMENT
 WILMINGTON  DELAWARE

SPECIFY LUMBER TREATED WITH CHROMATED ZINC CHLORIDE

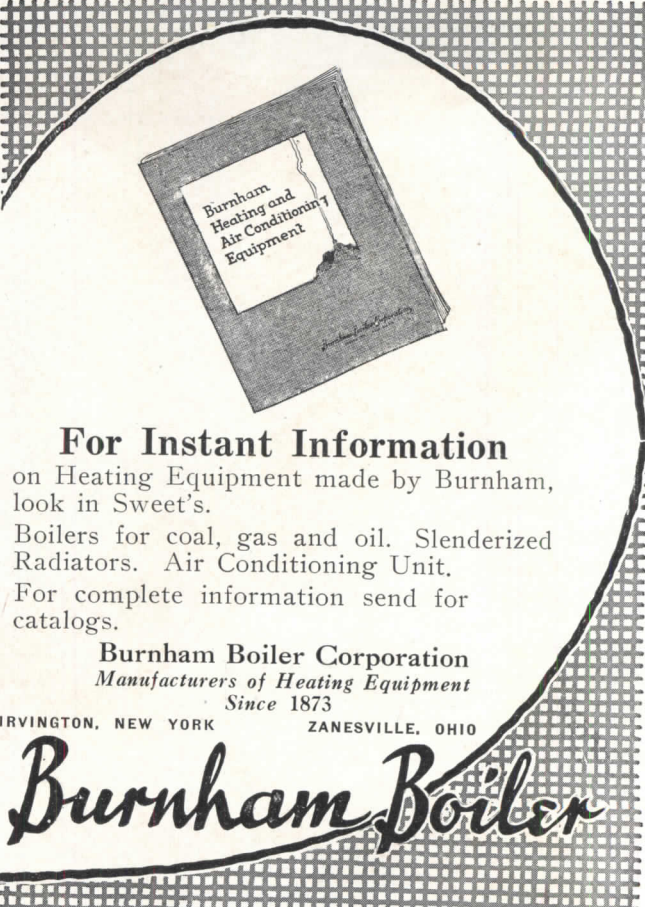

For Instant Information
 on Heating Equipment made by Burnham, look in Sweet's.
 Boilers for coal, gas and oil. Slenderized Radiators. Air Conditioning Unit.
 For complete information send for catalogs.

Burnham Boiler Corporation
Manufacturers of Heating Equipment
 Since 1873

IRVINGTON, NEW YORK ZANESVILLE, OHIO

Burnham Boiler

The MOSAIC Steps Out

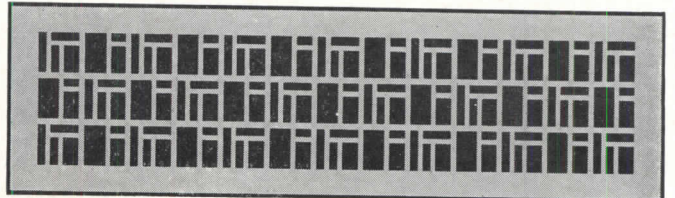

A New Hendrick Grille

Destined to be one of the most popular Hendrick patterns, the new Mosaic is winning extensive popularity.

Its simple good taste assures an atmosphere of dignity for interiors with which it is used.

Its 63% open area promises ideal conditions of heating and ventilating.

The Mosaic, like all Hendrick Grilles, is furnished in any desired commercially-rolled metal.

Write for illustrated literature.

Hendrick Manufacturing Co.

19 Dundaff Street, Carbondale, Pa.

Offices and Representatives in principal cities. See phone book. Mfrs. of Mitco Open Steel Flooring, Mitco Shur-Site Treads and Mitco Armorgrids, Hendrick Perforated Metals and Screens.

Your 1938 Catalog



Return ◦ *this* ◦ *Coupon*

for this book of *today's* complete line of H & H developments in Wiring Devices . . . hundreds of *new* listings in quickly get-at-able form. Combined price lists and index in separate color section for handy reference. Bright, soil-proof cover identified at a glance. Every wanted wiring device made most *conveniently available* to you . . . Use the Coupon!

To HART & HEGEMAN DIVISION, Hartford, Conn.
Send your new Wiring Device Catalog "W" to

(Name) _____

(Company) _____

(Address) _____

(City & State) _____

10

HART & HEGEMAN DIVISION
THE ARROW-HART & HEGEMAN ELECTRIC CO. HARTFORD, CONN.



*Please the woman
and the plan is sold*

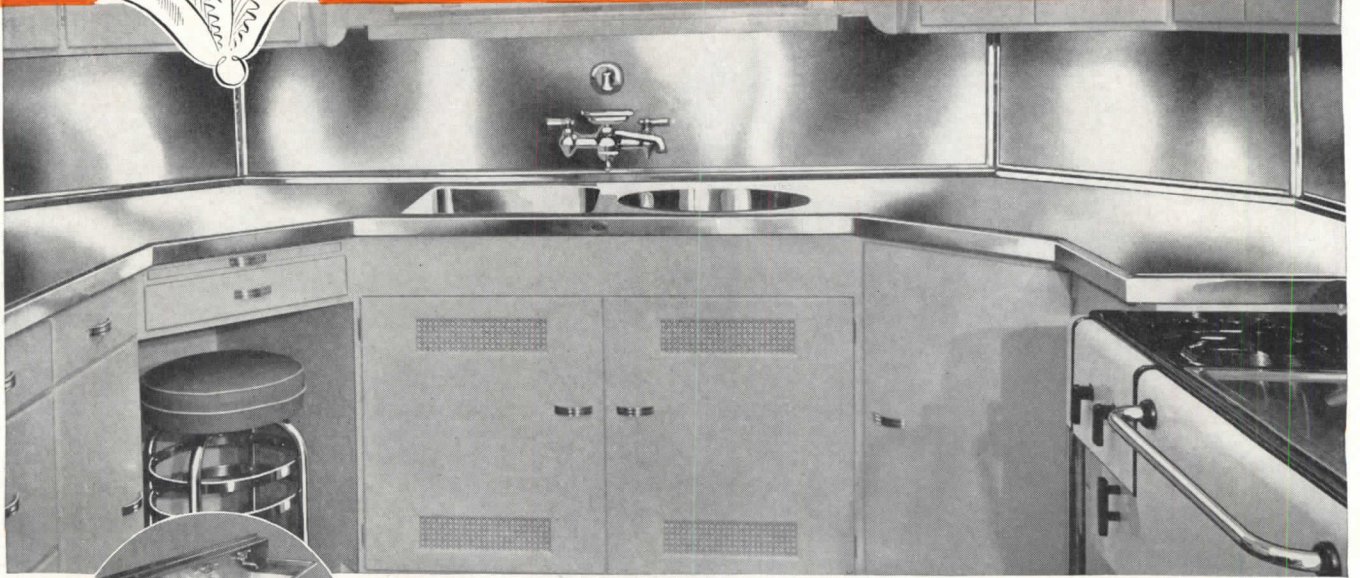

Laundry tubs of gleaming ENDURO Stainless Steel brighten the laundry — are the pride and joy of housewives.

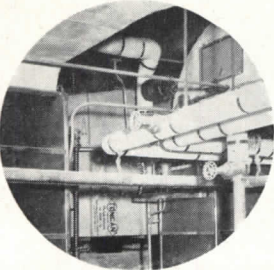

**Toncan Copper Molybdenum Iron resists rust — insures long life and low cost for ducts and piping.*

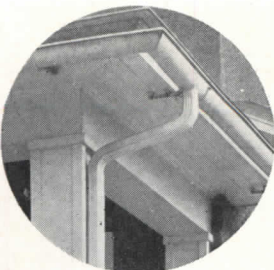

Roofing, flashing, eaves troughs, conductor pipes, etc., will last years longer when made of Toncan Iron. See Sweet's.

● "Cherchez la femme"—and win her approval of your plans through the generous use of Republic *ENDURO Stainless Steel.

Suggest a bright, cheerful kitchen with a lustrous sink and drain, work and back boards of clean, sanitary, stainless ENDURO. It will not cost as much as you or she might think—and, even though it does mean a few dollars more than the cost of less durable, less attractive materials, it will be more than worth it to the home owner and to you in the increased satisfaction produced.

ENDURO—the same perfected stainless steel that is being widely used throughout industry wherever sanitation, cleanliness, beauty and long life are desired—is available in a variety of products and shapes for building purposes. See Sweet's for detailed information and write us for names of fabricators and manufacturers.

*Reg. U. S. Pat. Off.



Republic Steel
Corporation

GENERAL OFFICES . . . CLEVELAND, OHIO
ALLOY STEEL DIVISION . MASSILLON, OHIO

DESIGN TRENDS

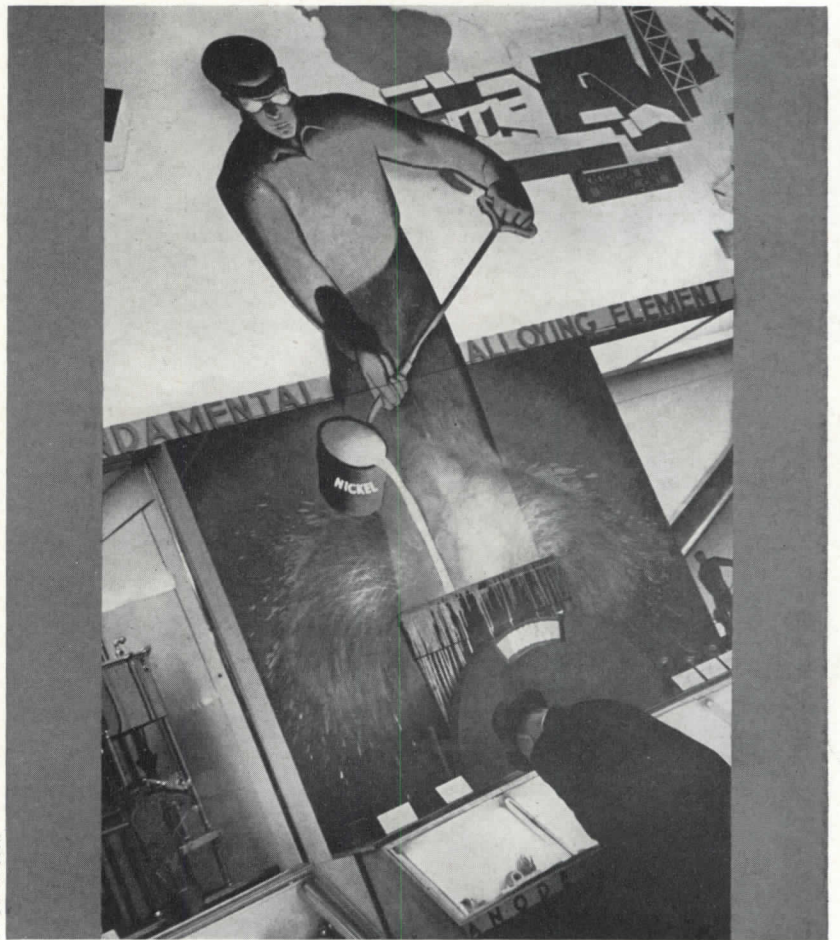

F. S. Lincoln

Display is intended to express an idea—to make it “visual” so that it may be understood at a glance. See pages 52-59.

ARCHITECTURAL

Record

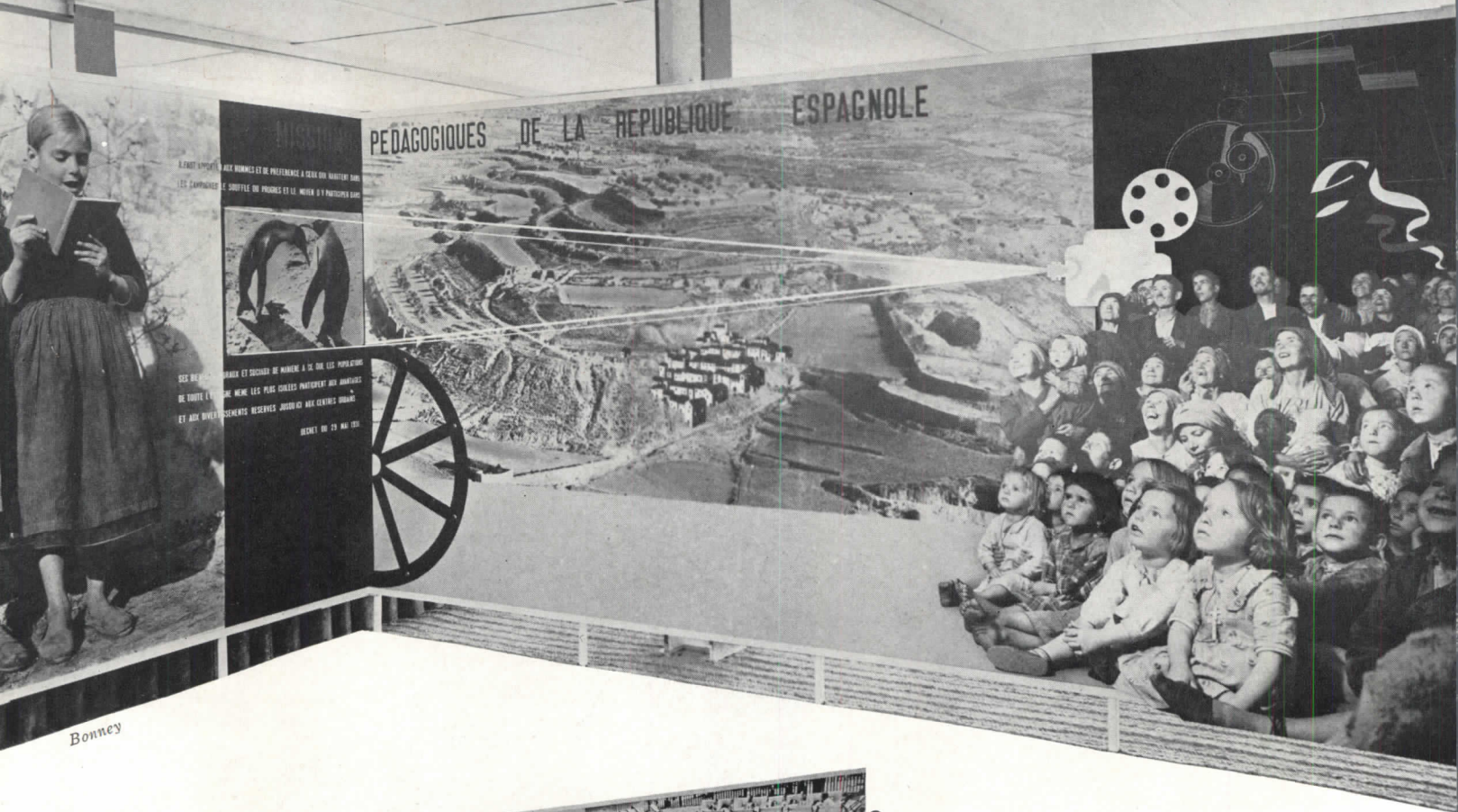

Bonney



Bonney

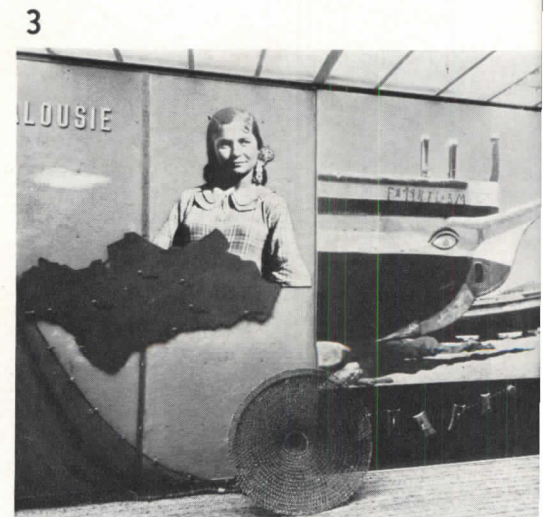

Bonney

1. Photomontage in Spanish Pavilion at the Paris Exposition showing use of motion pictures in education of children. Enlarged photographs of children are at right looking toward screen. The projection camera is in silhouette, 2 inches from wall, and is connected with screen by white tape. 2. "Schools continue in spite of Revolution": demonstrated by montage in Spanish Pavilion at Paris Exposition. Figure at left is shown safeguarding historic buildings. 3. Display of Provincial Spain consisting of photo enlargements, cut-out map and baskets.

Display Presentations for Architects and Other Designers

By HERBERT MATTER

DISPLAY, temporary or permanent (a museum is its ultimate form), has primarily an educational aim. This aim is achieved by arresting attention and by expressing an idea, visualized so as to be understood at a glance, or by introducing a conception or product shown as a single view or in a sequence of views.

Display design demands of the architect and designer the adoption of several methods of design expression. The faculty of seeing and the capacity of the average public to grasp shapes, images, colors, and ideas will determine the character and method of display. The mental reaction of spectators is still another factor considered by the display specialist.

We can summarize the better known visual methods of display technique as follows:

1. *Isotype method*, developed by Dr. Otto Neurath, Director of the International Foundation for Visual Education, which makes use of pictograph symbols for indicating an idea. Neurath would assemble, in expositions and museums, education pictographs, models, photographs, and other exhibits with motion pictures as elements of an informative whole. For examples, see page 58.

2. *Photography* serves to visualize salient ideas or commodities. In the hands of the designer these can be presented with single emphasis or the display may have sequence developed step by step to the theme. Photography offers a realistic picture and is most readily understood. It offers possibilities for expanding existing limits of illustration. See pages 55, 57.

3. *Delineated poster design* is a form of artificial illustration. It consists of linear pattern on flat surfaces. It is a method that permits a control of thought created by the designer. Drawing and photography are sometimes combined.

(Continued on page 54)

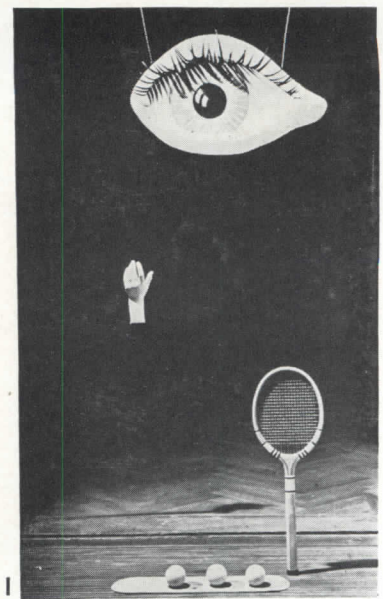

1



2

ISOTYPE

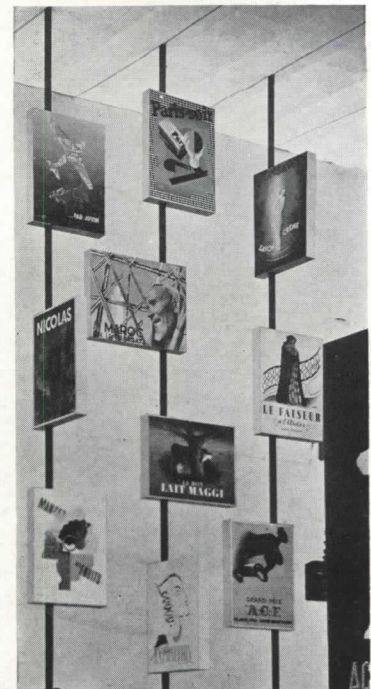

1. Advertising display for tennis by Hans Fischer. 2. Isotype illustration developed by Dr. Otto Neurath shows pictograph symbols for coniferous and deciduous trees. 3. Display and spectator seating, Spanish Pavilion, Paris Exposition, 1937. 4. Window display for scarves by Hans Fischer.

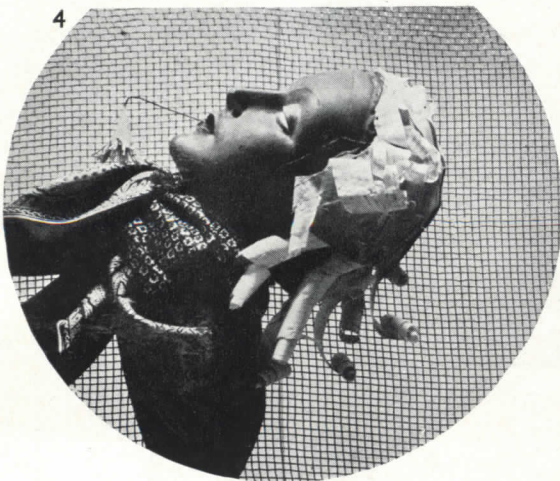

4



3

Bonney

Photography Creates a New Display Technique

DISPLAY must serve, above all, as a medium for conveying thought from author or sponsor of an idea to the public. The salient thought is given emphasis by clearly understood interpretation, by special lighting, and by organization of display material.

Principles which apply to display technique may be summarized as follows:

- Present an idea with a single view where possible or with a sequence of ideas related to a theme.
- Combine multiplicity and clearness; avoid overcrowding.
- Satisfy many interests; avoid monotony.
- Do not word what can be visualized.
- Introduce movement in order to arrest attention.
- Develop the display with a sequence of optical and representational images, unified or leading to the salient subject.

Photography has special advantages as a medium for display. It permits the suggestion of reality and is easily understood by the average spectator. It is a natural language since the subjects presented are from life and because "photographic method" implies truth. In addition, photography offers possibilities for expanding its existing limits.

The photomural presenting a single view of an object or a scene is given far greater scope if several associated views are combined to compose the mural; this is known as photomontage. It makes possible the unification of a many-sided subject with a result that may be more forceful than the single view.

New materials have opened the way to a recent and contemporary display technique. Products of metal, glass, plastics, and wood veneers have been used in the construction of display and as a part of the exhibit. Photography, as an instance, can be shown on transparent Lumarith (a cellulose acetate) or on glass with diffused illumination from the back. Such displays are far more brilliant and create more attention than when shown on opaque surfaces. Photography on similar transparent surfaces can be used so as to be viewed from two sides.

(Continued on page 56)



D i s p l a y
P r e s e n t a t i o n s

GIGANTIC FRAME FOR OUTDOOR DISPLAY. The display space is flexible and can be used for large and small pictures, conforming to the subdivision of squares. In the frame illustrated the theme (physical activity or health) is shown in the large view of an athletic figure. A sequence of smaller views appears at the bottom, representing a meditative boy who ponders, craves, and finally demands—milk. These smaller views are the incidentals and may be changed from time to time. The photographic display is on a transparent membrane so that it may be viewed from either side. Emphasis can be produced by spotlighting parts of the exhibit. *Designs by Matter.*

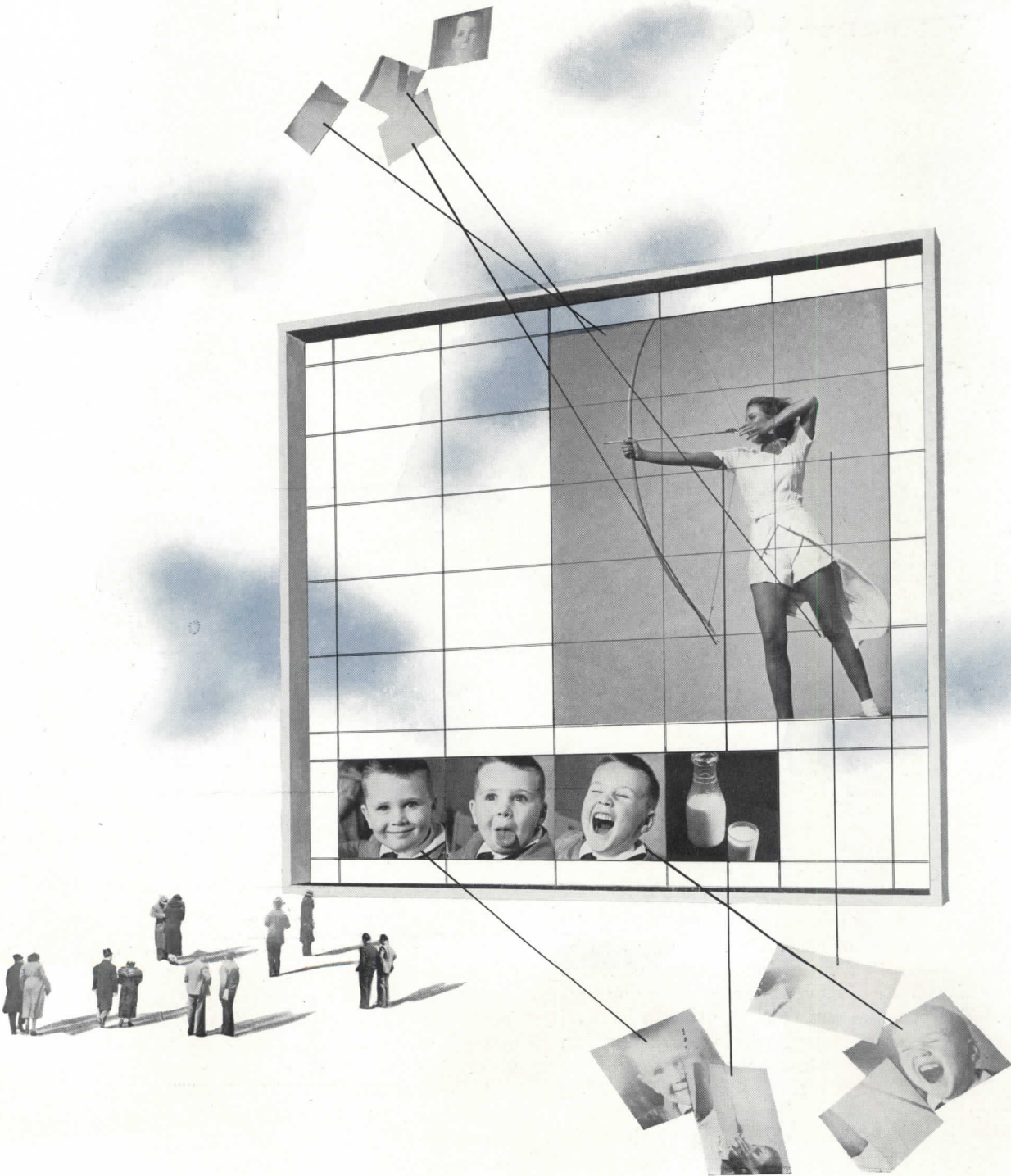



DISPLAY WITH BACK AND FORTH MOTION. Dual contrasting photographs are shown one at a time. One view after the other is blanked out by the shuttle movement. The introduction of motion is intended to arrest the attention of spectators. The idea presented is stressed by continuous repetition. *Designs by Matter.*

(Continued from page 54)

Movement in display is intended primarily to raise the attention-arresting value of an exhibit. It may also be used to create contrasting images or a variety of views. Illustrations of such use of movement are shown on pages 56 and 57. The proposal was recently made to have all exhibits, moving and changing, within a room of an exposition. The exhibit case that can be operated by the spectator is an older and nevertheless successful version of this trend.

It is now the task of designers to employ the third dimension and to make displays an integral part of the

area where spectators gather. For outdoor display we already have the skywriters who fill an increasingly important role in advertising. Projection can be made on clouds of smoke or gaseous vapor, utilizing color and form to create impression. Messrs. Beaudoin and Lods devised such a grandiose spectacle in Paris last year—visible from all points of the exposition. Sound effects and illumination were combined to produce a display composition. Smoke was released and sent to a considerable height for screens on which light in color was projected.

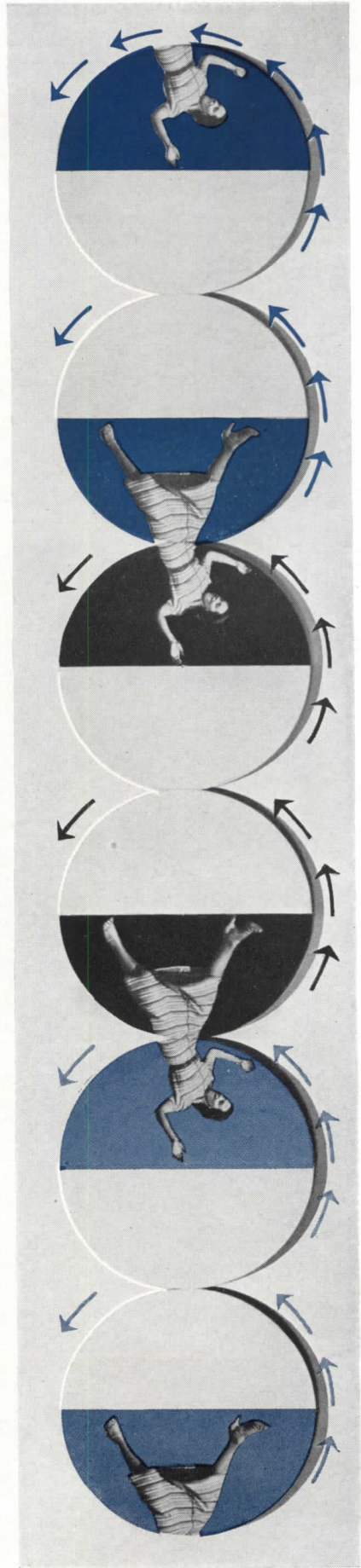
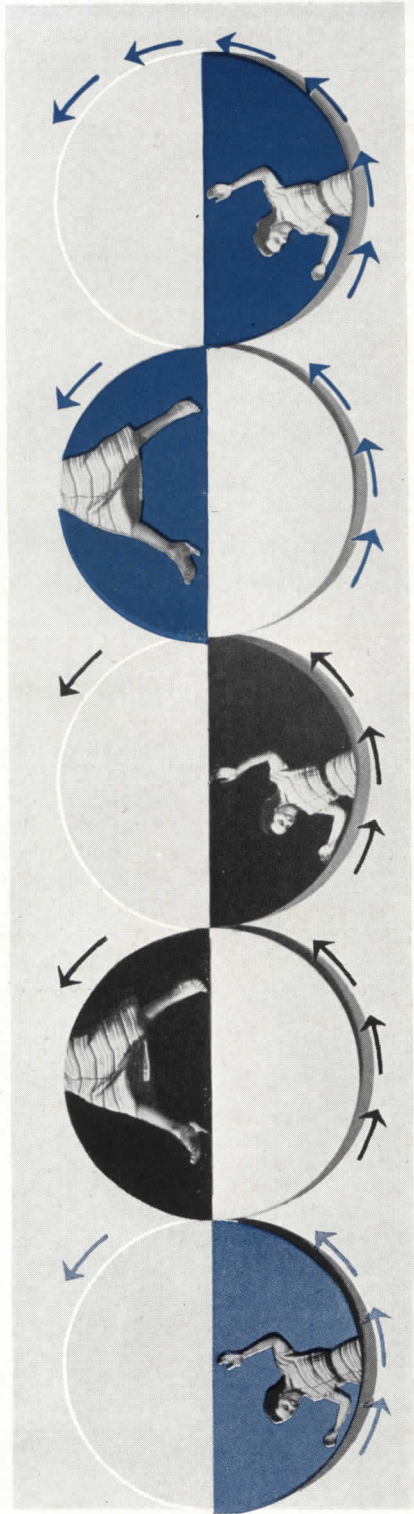

DISPLAY WITH REVOLVING IMAGES, proposed as a method applicable to a variety of designs. The figure is shown at left-hand column at the moment when it is in a correct position. The figure is animated by revolving through the series of positions shown in the adjoining columns. Color is used to distinguish the elements and relationship and to attract attention.

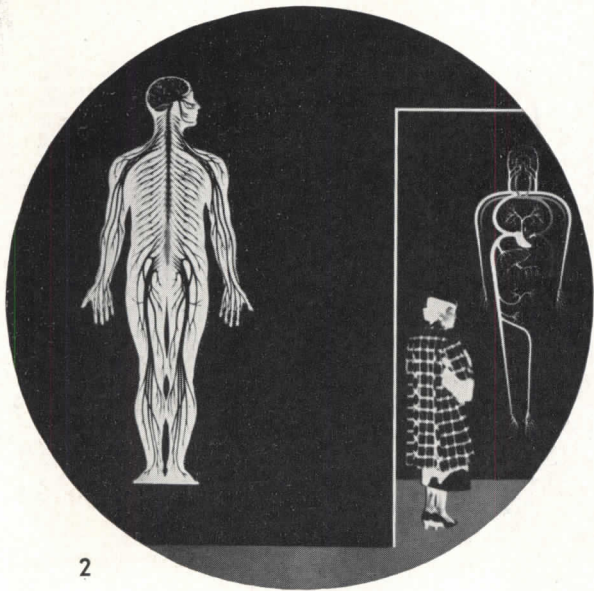
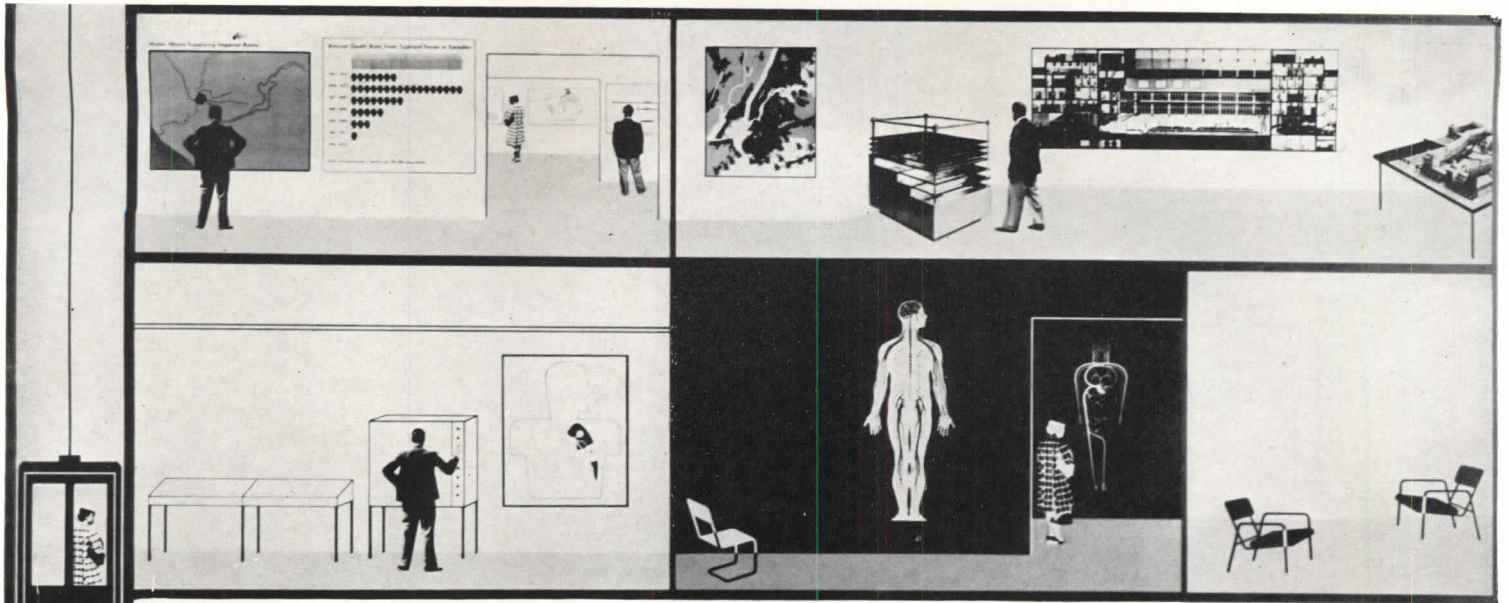

Isotype Exhibition Technique

ISOTYPE exhibition principles, first developed by Dr. Otto Neurath, are the same to whatever purpose the method may be applied. It is a method of representation which is understood by the poorly educated and by individuals educated only in certain fields; this means in the end all people, since no single person is informed in all fields of knowledge.

A suitable basis for such a common education and information is *visualization* of all important problems. For this purpose visual aids are used which are self-explanatory.

The ideal exposition and museum is one which houses educational pictographs, models, photos, and other exhibits with motion pictures, transparent views, and drawings as elements of an informative whole. Correlation between different exhibits and different parts of the exposition is built up by visual coordination.

1. Interior of display museum with different ceiling heights and different methods of visual presentation including charts, cases, devices operated by spectator, transparent

charts illuminated from behind. 2. Detail of transparent chart. 3. Display case, spectator-operated. 4. Plan and section of museum with movable walls and partitions.

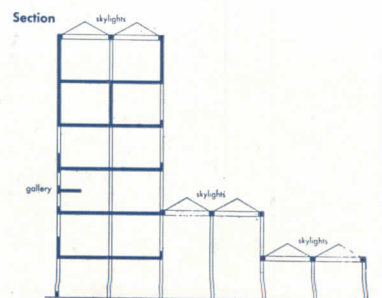
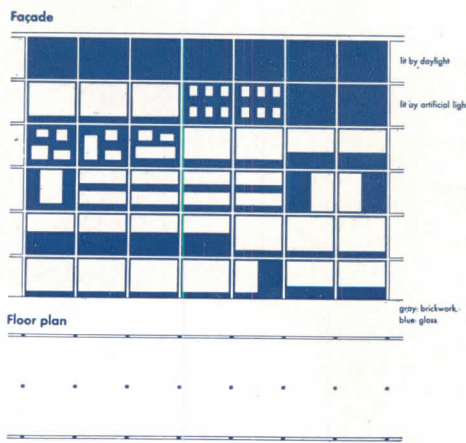
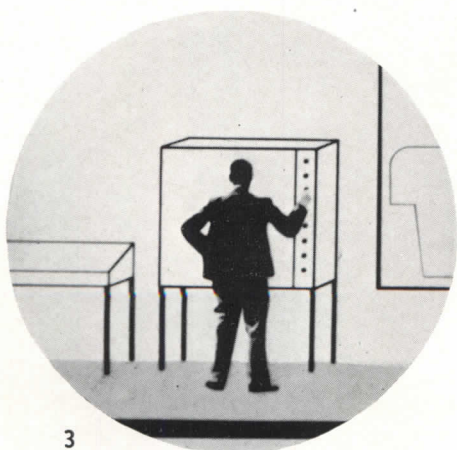

Movable walls, movable ceilings, movable windows
According to Dr. Josef Frank's scheme

Static Display
Presentations
With Sequence

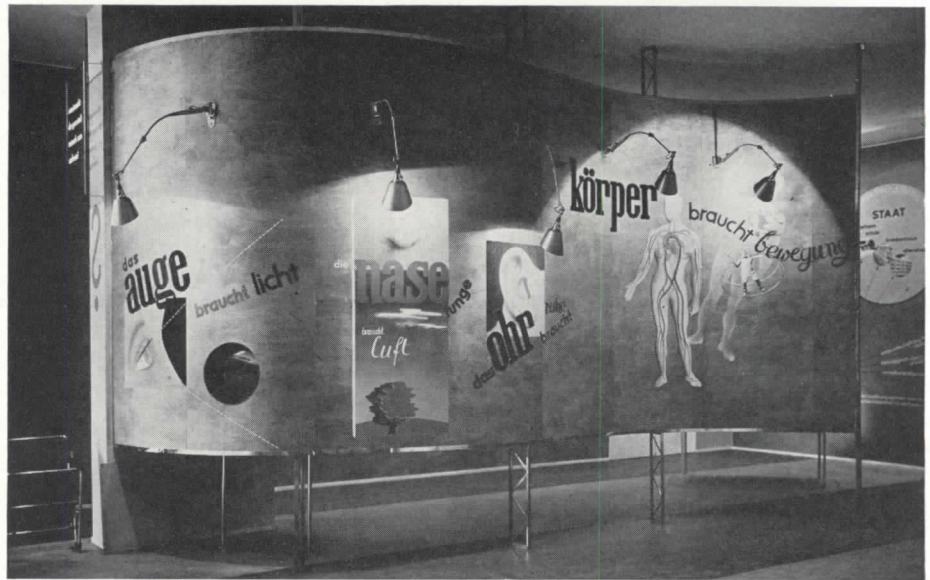
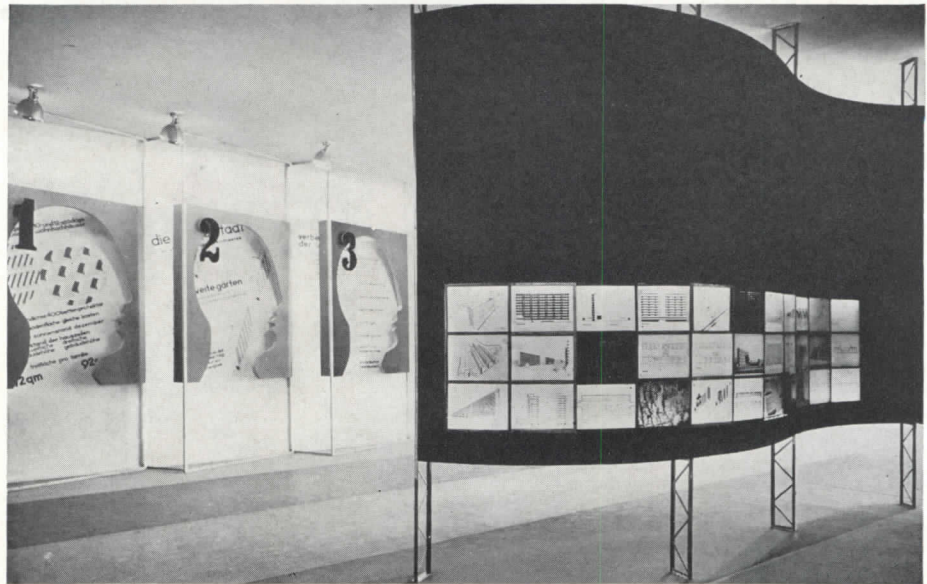

Photos by Berliner-Bild-Bericht

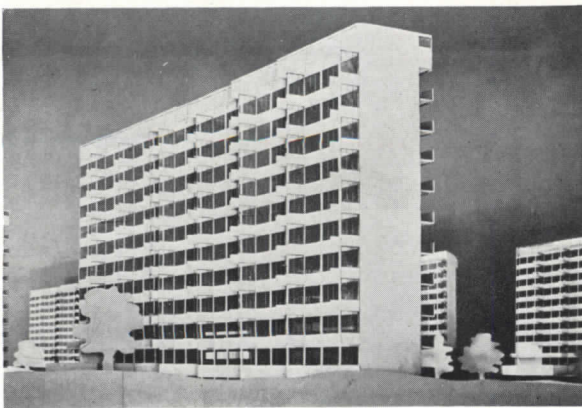

NEED FOR HOUSING demonstrated by a sequence of posters. The theme of the exhibit is: mankind requires housing with open plumbing, abundance of light, recreation facilities, schools and common laundries. The theme of the second illustration shown on reverse side is: the eye needs light; fresh air is necessary for breathing; the ear requires quiet; the body demands healthful activity. At lower left appears the answer in the form of a proposed multi-story apartment with an abundance of windows, fire safety, and wide open spaces. The exhibit was designed by Professor Xanti Schawinsky of Black Mountain College, North Carolina. Professor Walter Gropius, now of Harvard, was the architect for the proposed housing project.

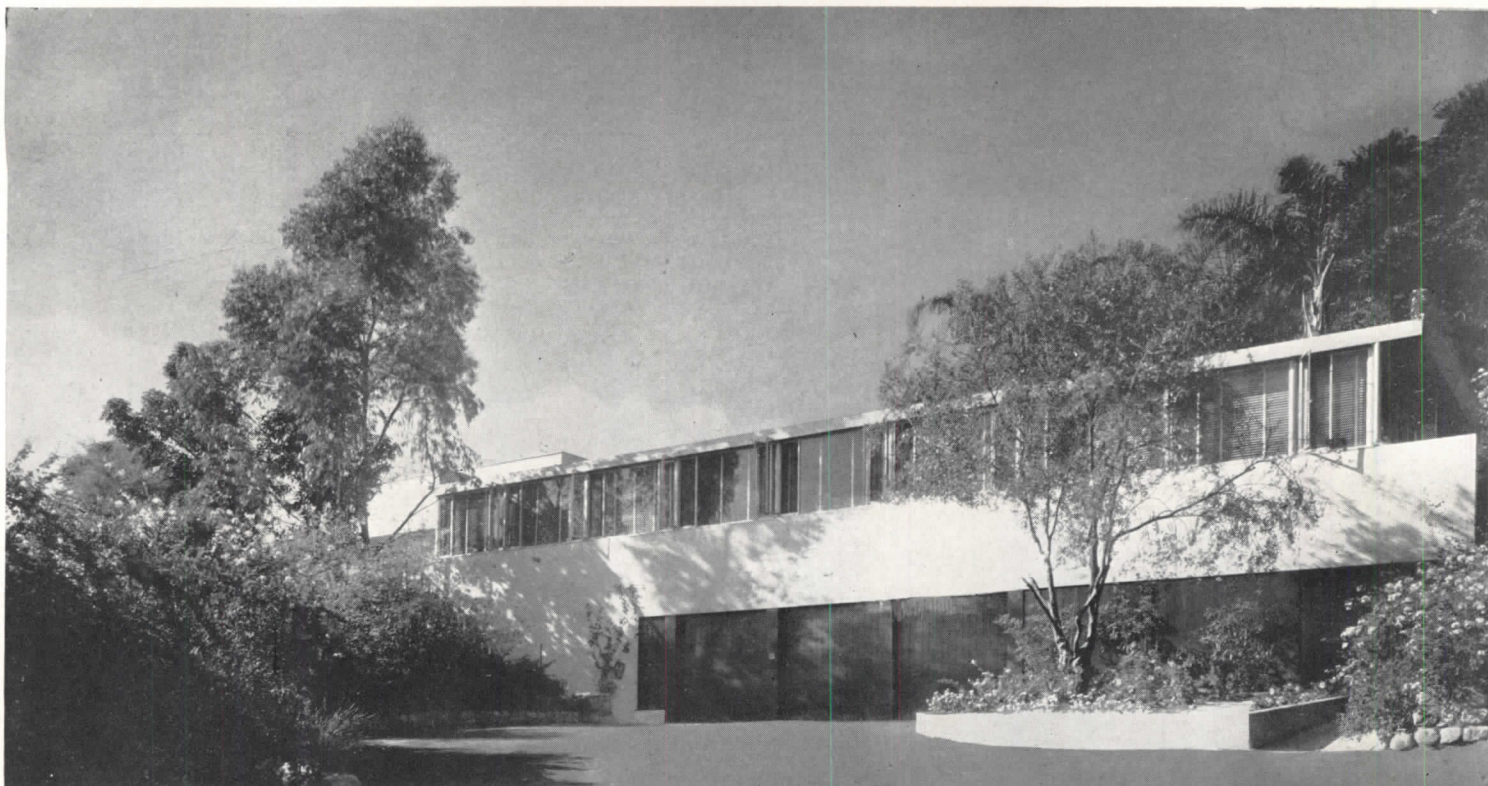

STEEL FRAME permits adoption of continuous steel sash. Richard J. Neutra, Architect.

How America Builds 1937-38^{*}

Influences on the Trend of Building Design

By RICHARD J. NEUTRA

TECHNICAL INNOVATIONS have more significantly influenced the generic development in design of buildings than artistic skill of the architect. Richard J. Neutra was one of the first to discover and adopt novel structural systems and materials as part of the designing equipment of the architect.

TECHNOLOGICAL ADVANCES—new materials and processes—well advertised by active distributors, have markedly influenced the trend of formal design in America. The design so furthered may not fully measure up to the true possibilities of these discoveries.

In previous writings the author has endeavored to show that these technical innovations, commercially campaigned for, have more significantly influenced the generic development of design than has the initiative of outstanding designers. Although America can justly boast of ingenious designers and creatively independent think-

*HOW AMERICA BUILDS, 1927, Stuttgart, Germany. It is now a decade since this book was published. The following years have shown decisive progress in the development and acceptance of new construction methods and new materials.—(Ed.)

ers among its architects, there nevertheless remains the anonymous and powerful drift stimulated by technical progress.

Frank Lloyd Wright, John Root, Louis H. Sullivan, and Irving Gill should have a profoundly deserved credit for clarifying the problems of contemporary building design in the turmoil of academic eclecticism and its "good taste." It is for the younger generations to participate in the intricate renovation of architectural education and in the conscientious organization of an architectural practice of widening scope.

The approved training schools of architecture, while abandoning archeological instruction based on Vitruvius, Palladio, and Vignola, are to some extent still clinging

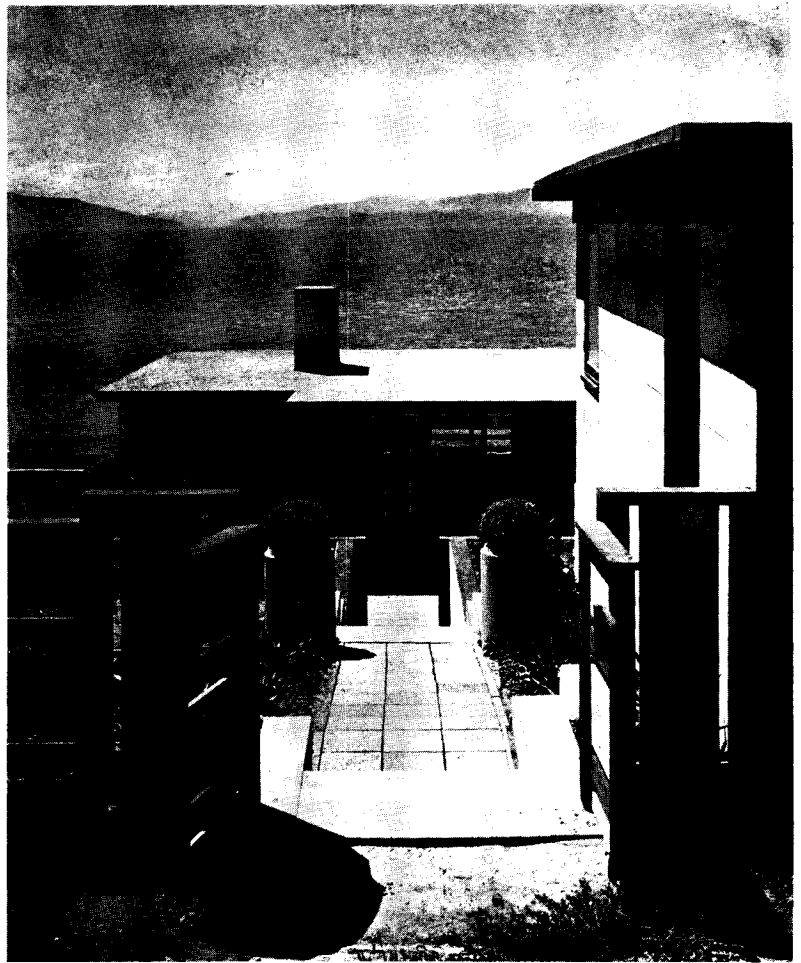
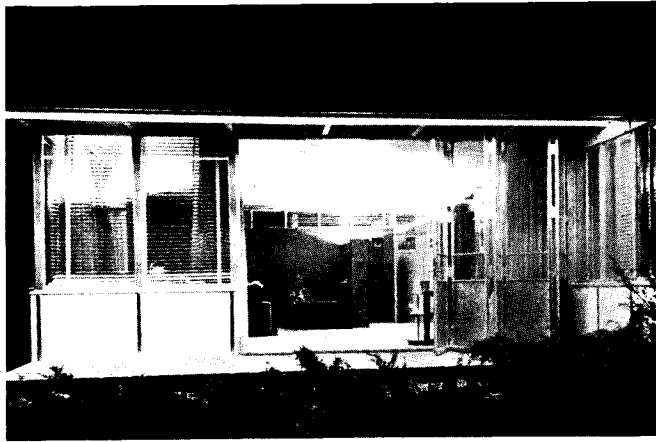

Upper left: House built of waterproofed plywood with collapsible glass partitions. Richard J. Neutra, Architect. Lower left: Glass walls with light-steel frame made possible by cantilever and wide spacing of supports. House in Los Angeles. R. M. Schindler, Architect. Above: Precast concrete wall units for walls of house and for paving. House in Richmond Shore, California. William Wilson Wurster, Architect.

to an educational procedure that breeds individual aspirations and a belief in a type of superarchitectural genius. The great improvising individualist, however appropriate he may have been to certain past generations, is an anachronism in the modern world. The Italian Renaissance gave birth to this type, exemplified by Giorgio Vasari, father of "fictionized history." Today's development obviously requires a new expression.

The socio-economic setting of the post-middle ages and the proto-industrial era had indeed produced a professional man in architecture with an activity and a slant on life entirely different from ours. This may seem self-evident. However, the pseudo-educational method of inducing sixty young college students, sitting in competition side by side, to develop in a few hours sixty original independent sketches of an intricate project, such as a municipal library, produces in these unprepared men the feeling that such an approach to architectural solu-

tions is still possible or even appropriate. It is neither.

In reality the present possibilities in the field of design, which urgently require an enthusiastic and new-spirited generation of professionals, are principally twofold:

- 1) *Cooperative, painstaking, basic research.*
- 2) *Efficient evolution of most recent, technically refined precedent.*

I am inclined to mention the first of these as of major importance. The second, however, offers a vastly larger employment market to the graduate of a training school, and, if properly understood, need by no means be contemptible routine or devoid of creative elements.

The extensive American mass market of building materials, supplies, finishes, installations, has hardly a counterpart on the European continent, which is severely cut up and divided by a multitude of customs-boundary lines. Here the market permits an easier-spreading migration of "design particles", so to speak, and that

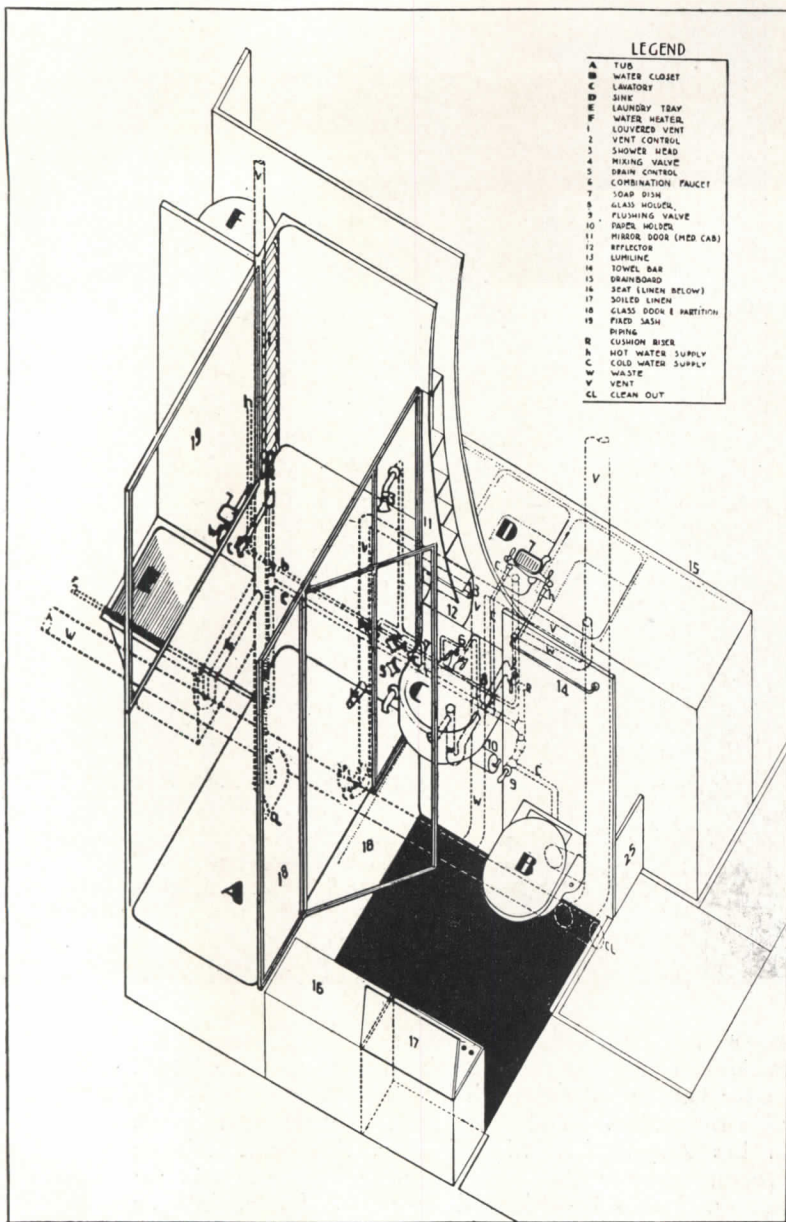
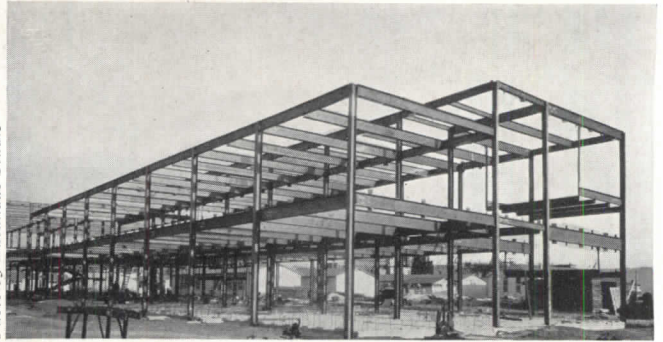

Photo by Luckhaus Studio



At left: Prefabricated bathroom, showing combined plumbing for bathroom, kitchen, and porch. Steel Craft House by Richard J. Neutra, Architect. Above, upper: Steel skeleton of standard parts, designed to resist lateral forces of earth shock and wind pressure. Richard J. Neutra, Architect. Above, lower: Expanded metal studs cut to length by torch, joined together by welding to produce strong and light building frame.

broad exploitation of structural schemes which effectively support industrialization of building operations. However, as this privately managed industrialization is quite departmental in character, a true integration of the manifold living forces involved in building design is indeed rare. How to bring about such a workable coordination is a problem, perhaps more puzzling in the United States than in other countries with fewer technical offerings.

Although engineering inventiveness may be applied successfully to the design and economical production of elements, the standards developed rarely interlock. Standard unit dimensions of wall-forming or covering slabs and panels, stock sizes of steel sash, stock widths of insulation boards, sheet glass, glass bricks, flooring materials, etc. are strangely lacking in interrelation. Attempts, like those of Bemis Industries, Incorporated, to develop a common denominator of dimension, still remain largely theoretical. Prefabrication of houses has long been

predicted and attempted; now actually gaining weight as a popular issue, it will act as a catalyzer even outside of its own realm. It demonstrates for the entire field of building the new and exacting interdependence of half-finished industrial products which have superseded the "raw material" of ancient building design.

But in most instances manufacturers still seem to fit their brand new products not to each other, but to an obsolete species of wood frame or masonry shell. The very same lack of inter-adjustment hampers integral accommodation for heating, plumbing, mechanical, and electrical installations. This, to be sure, is easily explained by commercial considerations. Even such a progressive development as the one- or two-piece copper bathroom designed by Buckminster Fuller for the Phelps Dodge Corporation and incorporated in one of our projects, must also cater, to a degree, to the "alteration market." It must generally attempt to take into account applica-

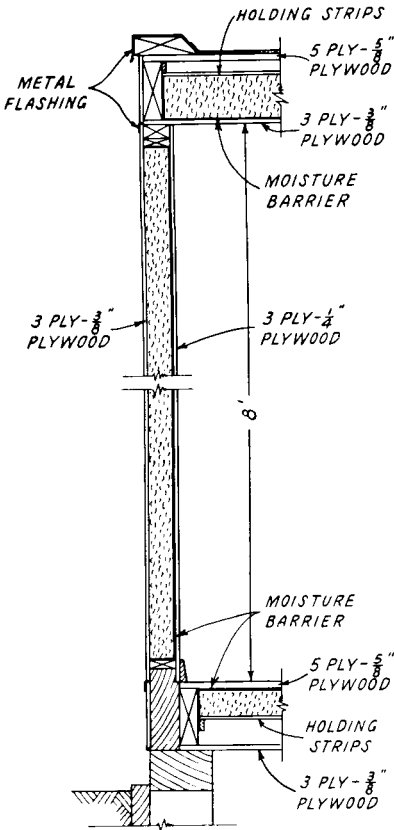

Section Through Wall

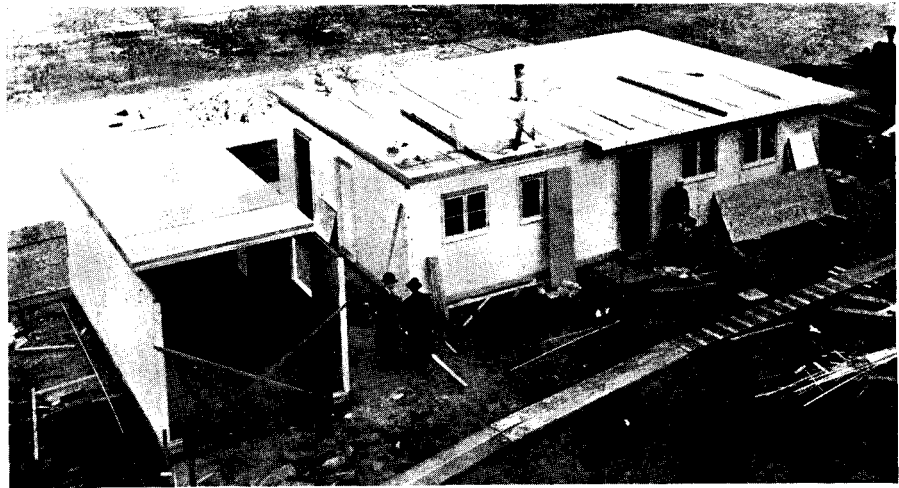

PREFABRICATED PLYWOOD HOUSE by Forest Products Laboratory at Madison, Wisconsin. Walls and roof are of built-up units of waterproof plywood.

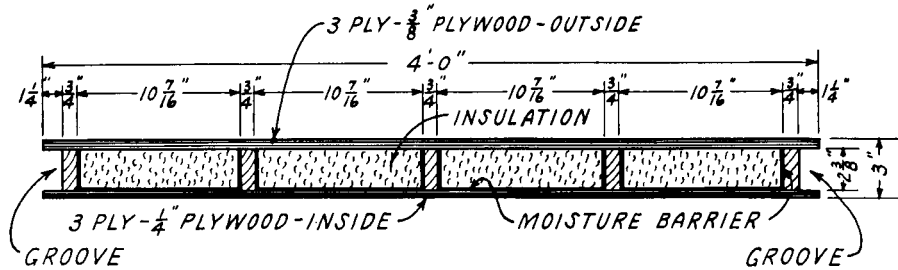

Typical Wall Section

THIS NEW HOUSE by the Forest Products Laboratory incorporates the latest findings in the use of plywood made up with synthetic-resin adhesive. There is provision for moisture barriers within wall, floor, and roof panels. Mineral insulation within walls provides heat and sound insulation. Plywood floors have $\frac{1}{8}$ " hardwood veneer as wearing surface.

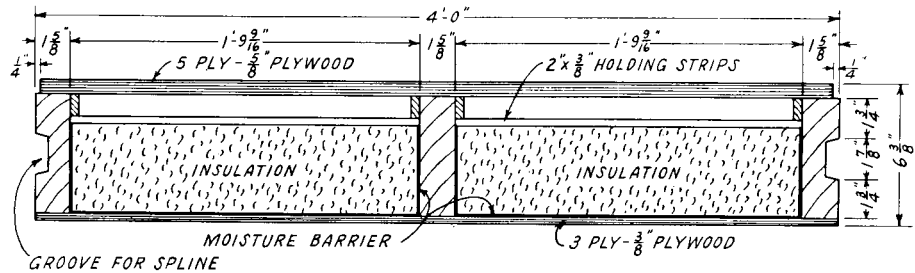

Roof Panel

bility to obsolescent structural frames still customary in the locality of the presumed sales transactions.

Similar *commercial relationships of the progressively new to the disappearing old*, I have found, are effective in all industrial regions, from Japan to Czechoslovakia. This phenomenon, indigenous to each of these regions, constitutes a severe impediment to rational design, which may as quickly result in a so-called "International Style."

Spirit and spread is probably less international in this style than in the Baroque or in the Classic, which operated from Petersburg to Buenos Aires and from Copenhagen to Colonial Hongkong. The merely formal stylistic practice and ambition of those periods was essentially less dependent on the technical substratum and on avail-

ability of materials than our present approach, which programatically subjects itself to an economical and technically logical application of industrially produced elements pertaining to construction, installation, and finishing. The world distribution of this "New Raw Material" is at the moment more than ever retarded, because it is controlled by patent rights, monopolies, inimical tariff politics, particularistic building routine, and legislation.

For the time being, at least, stylistic superficialities have a more marked cosmopolitan range than the harmoniously coordinated manufacture which typically underlies the new building design and which could furnish it with truly convincing power.

Reviews of New Books

THE MODERN HOUSE IN ENGLAND. By F. R. S. Yorke. Published by The Architectural Press, London. Handled in U. S. A. by Architectural Record. Price, \$5.

THIS book by the author of *The Modern House* is of equal interest to the architect and to the layman. It is the only book devoted exclusively to modern houses built in England that has so far been published. In the houses with which it is concerned planning is more free than in the houses of the past, and construction is enlivened by new materials in the hands of a new generation of architects. Its pages illustrate vividly the contribution the modern architect is making in the sphere of modern living, in evolving a new and rational domestic architecture, free from the ties imposed by academic styles. Almost all the houses included in the book were built within the past two years.

Back in 1920 W. R. Lethaby wrote concerning domestic architecture: "The chief obstruction to our having better houses has been the superstition that they should be built in a style. There is a great difference between being built in an imitative style—Elizabethan, Jacobean, or Georgian—and being built with style. A motor car is built with thought for 'style', that is finish and elegance, but it is not built to look like a sedan chair or a stage-coach. To be concerned with style imitations and what the Americans call period design is not only irrational in itself, but it blocks the way to any possibility of true development."

The houses illustrated include examples in brick, frame, and concrete. The architects represented are not all of them English in origin since inclusion is made of work by Walter Gropius, Mendelsohn and Chermayeff, Howe and Lescaze, Lubetkin, and Marcel Breuer, a working partner of F. R. S. Yorke.

PARKWAYS AND LAND VALUES. By John Nolen and Henry V. Hubbard. Harvard University Press, Cambridge, Mass. Price, \$1.50.

THIS is Volume Eleven of the Harvard City Planning Studies. The automobile is largely responsible for the growth of parkways. With autos and other transportation, great possibilities for decentralized habitation and recreation were made available.

How far can it be proved that the parkway justifies itself economically? That is the question discussed in this volume. It resolves itself into two questions: (1) What is a parkway, what does it cost, what benefits does it produce, who reaps these benefits and in what proportion?; (2) How can these benefits, through equitable assessments, be made a source of income to the community at large to offset the costs of the parkways?

REPORT ON PROGRESS OF THE WORKS PROGRAM. March, 1937. Works Progress Administration. Harry L. Hopkins, Administrator. Washington, D. C.

THIS is one of three recent public documents which, together, give a comprehensive view of the economic and

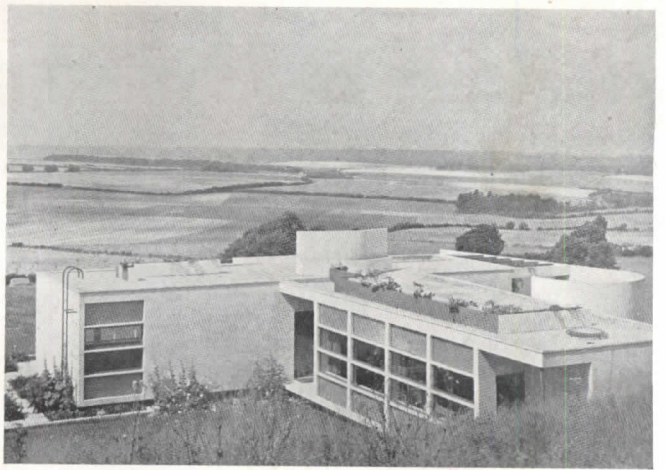

From "The Modern House in England" by F. R. S. Yorke

social problems of the United States created by industrialization and urbanization. The others are "Technological Trends and National Policy" and "Our Cities, Their Role in the National Economy", both published by the National Resources Committee. Among the functions with which the Works Progress Administration is invested is that of coordinating the execution of the work relief program as a whole. In the present report, therefore, Mr. Hopkins covers the activities of all Federal agencies participating in the works program, of which there are 14, ranging from the Department of Agriculture to the War Department.

The report is primarily of interest to students of relief. However, it has a certain suggestive value for architects engaged in city planning. This is particularly true of the brief but first-hand discussion of causes of unemployment. One of the objectives of city planning has come to be stability of employment by such a balance and grouping of industries as will insure continuous production with the least disturbance of labor at any stage of the business cycle.

Unemployment is to a considerable extent local in origin and to that extent it must be cured locally. But it is local by metropolitan units not by the parochial units of local government. A system of local government which comprises 182,000 taxing jurisdictions is too antiquated to deal with unemployment or with any other major urban problem. If city planning is coextensive with the welfare of the city or of the metropolitan district, it must first of all concern itself with modernization of local government before much can be done to bring about a sound industrial structure within the city or district.

Although unemployment is of local origin to the extent that it is due to local unbalance of industry, its fundamental causes are national. It is a link in a chain of phenomena, including business cycles and urbanism itself, connected with technology. Hence, the Federal Government is evolving a program for dealing with unemployment which promises to include not only relief for the (employable) unemployed and unemployment insurance but also control of the purely technological causes of unemployment.

Meanwhile, the mitigation of unemployment, currently estimated to have a range of from 4 million in prosperity to 15 million in depression, is a local city planning responsibility as well as a Federal obligation.

Building Volume and Cost Trends

By **CLYDE SHUTE**, *Manager, Statistical & Research Division, F. W. Dodge Corporation*

TOTAL BUILDING — 37 EASTERN STATES PLANNED BY ARCHITECTS OR ENGINEERS AND BY OTHERS FIRST TEN MONTHS 1937

| CLASSIFICATION | ARCHITECT-ENGINEER PLANNED | | PLANNED BY OTHERS | | TOTAL Thous. Dollars (000 Omitted) |
|------------------------------|----------------------------|-----------|-------------------|-----------|--|
| | Thous. Dollars | % | Thous. Dollars | % | |
| Commercial Buildings | 162,816 | 62 | 98,860 | 38 | 261,676 |
| Industrial Buildings | 160,643 | 58 | 118,601 | 42 | 279,244 |
| Educational Buildings | 161,249 | 93 | 12,495 | 7 | 173,744 |
| Hospitals & Institutions | 57,575 | 88 | 8,127 | 12 | 65,702 |
| Public Buildings | 74,434 | 86 | 12,364 | 14 | 86,798 |
| Religious & Memorial | 26,803 | 82 | 5,819 | 18 | 32,622 |
| Social & Recreational | 52,678 | 75 | 17,443 | 25 | 70,121 |
| Total Non-Residential | 696,198 | 72 | 273,709 | 28 | 969,907 |
| Apartment & Hotels | 173,601 | 89 | 22,366 | 11 | 195,967 |
| 1 & 2 Family Houses | 273,913 | 45 | 331,995 | 55 | 605,908 |
| Total Residential | 447,514 | 56 | 354,361 | 44 | 801,875 |
| TOTAL BUILDING | 1,143,712 | 65 | 628,070 | 35 | 1,771,782 |

Construction Cost Index: A Guide for Determining Construction Costs by Use of Charts, pp. 66, 67.

THE BASE DATA for the charts displayed on the next two pages have been secured from E. H. Boeckh & Associates, Incorporated.

The United States average for each type of construction for 1926-1929 is used as the base period, or 100, because prices of both labor and materials showed greatest stability during these years.

Six general construction types will be presented, at the rate of two per month, because the quantities of the different building materials and the amounts of the different classes of labor vary in each type of building. The six types* to be shown will appear in the following order: (1) Brick, (2) Steel, (3) Frame, (4) Brick and Wood, (5) Brick and Concrete, and (6) Brick and Steel.

Sixteen representative but widely scattered cities will be shown monthly for each type displayed because material prices and labor rates are different in the various localities and do not change at the same time in all cities, nor to the same degree.

The index numbers indicate the relationship of the current or reproduction cost of a building at any given time, in any given place, to the 1926-1929 United States average cost for an identical building.

The plotting of the data provides readers with a quick and efficient method of construction cost comparisons.

* The first two types were presented in December, 1937; pp. 75-77.

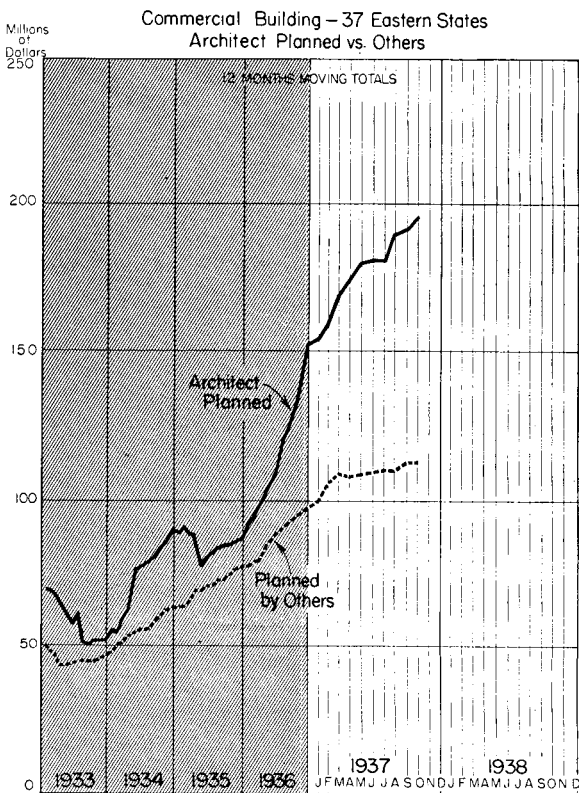
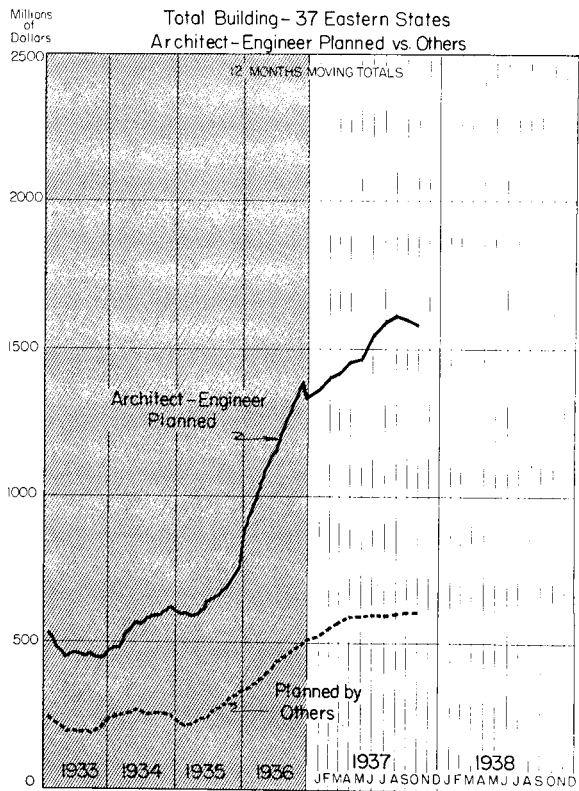

Diagrams showing construction volume.

Data and charts for this page are provided by the Statistical & Research Division of F. W. Dodge Corporation and are based upon Dodge Reports for 37 Eastern States.

CONSTRUCTION COST INDEX*

Frame Buildings

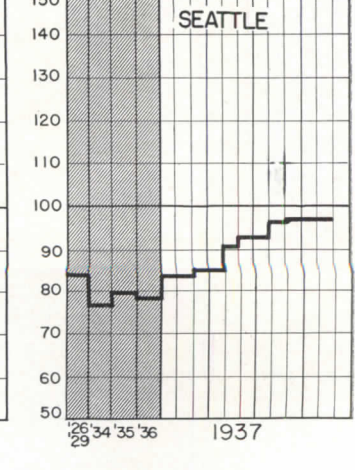
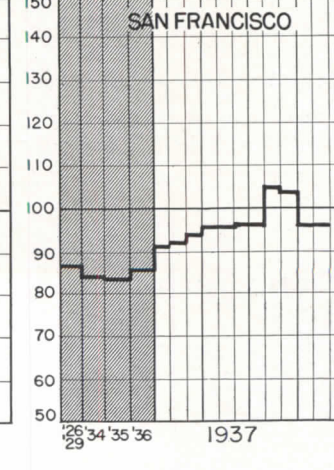
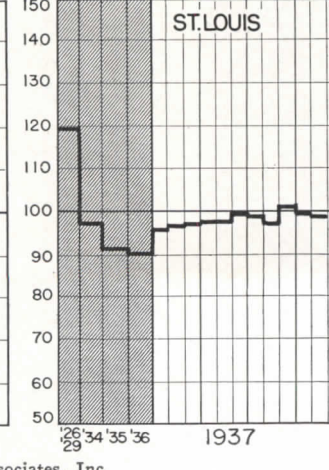
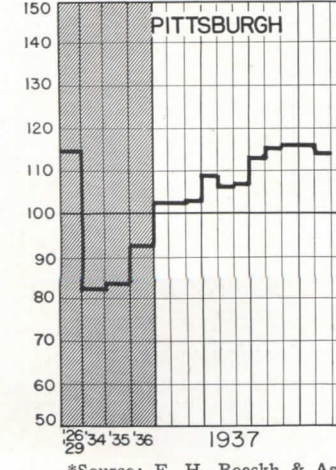
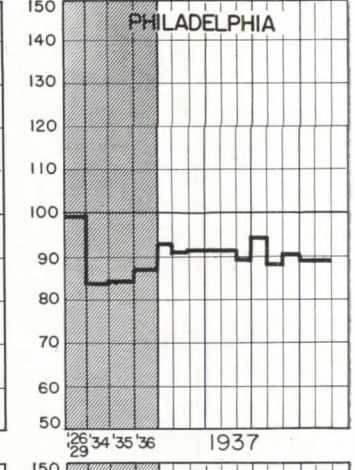
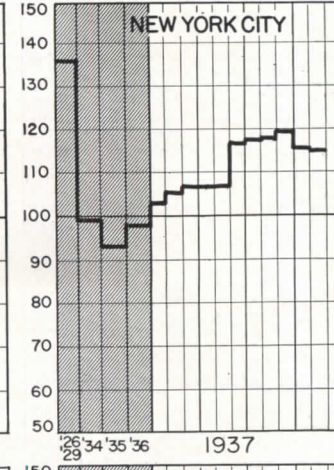
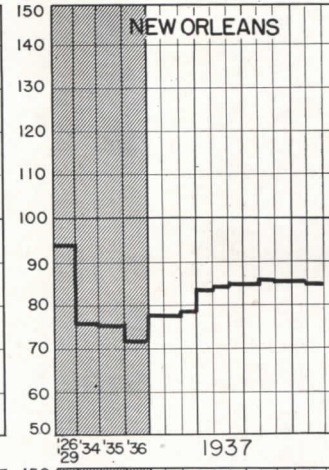
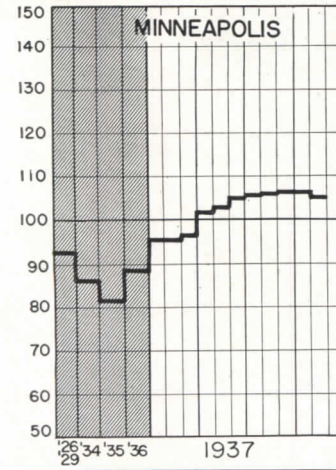
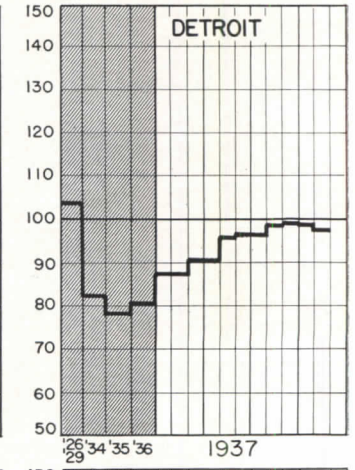
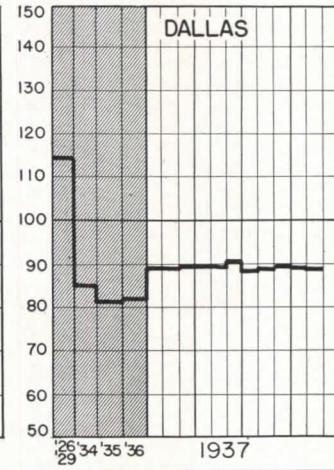
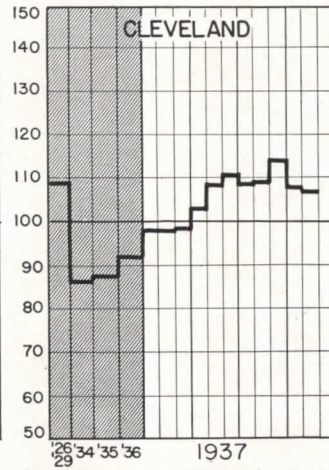
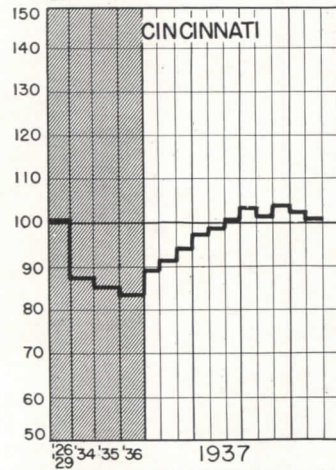
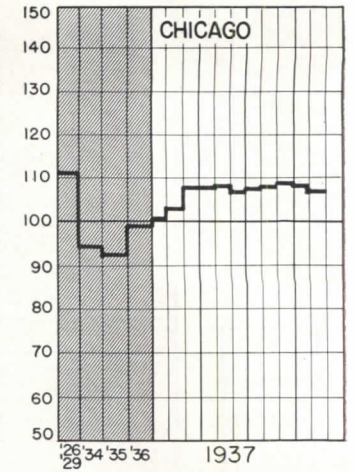
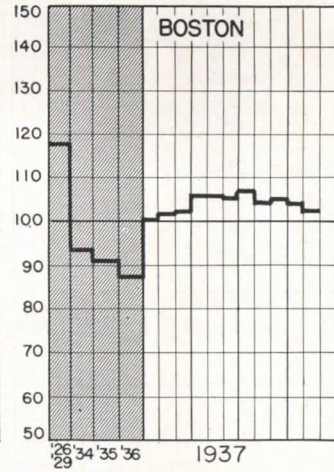
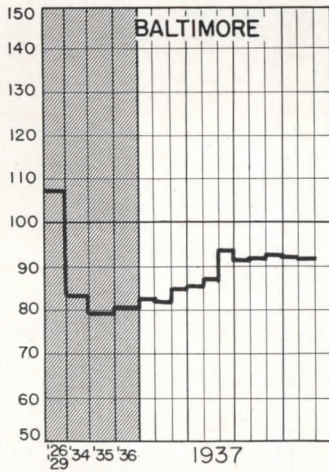
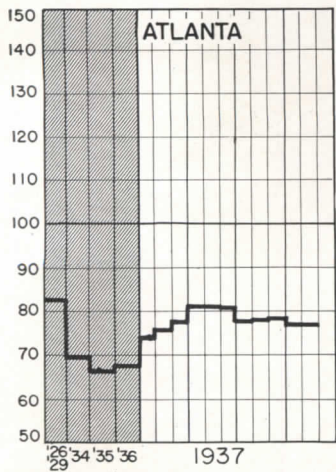

*Source: E. H. Boeckh & Associates, Inc.

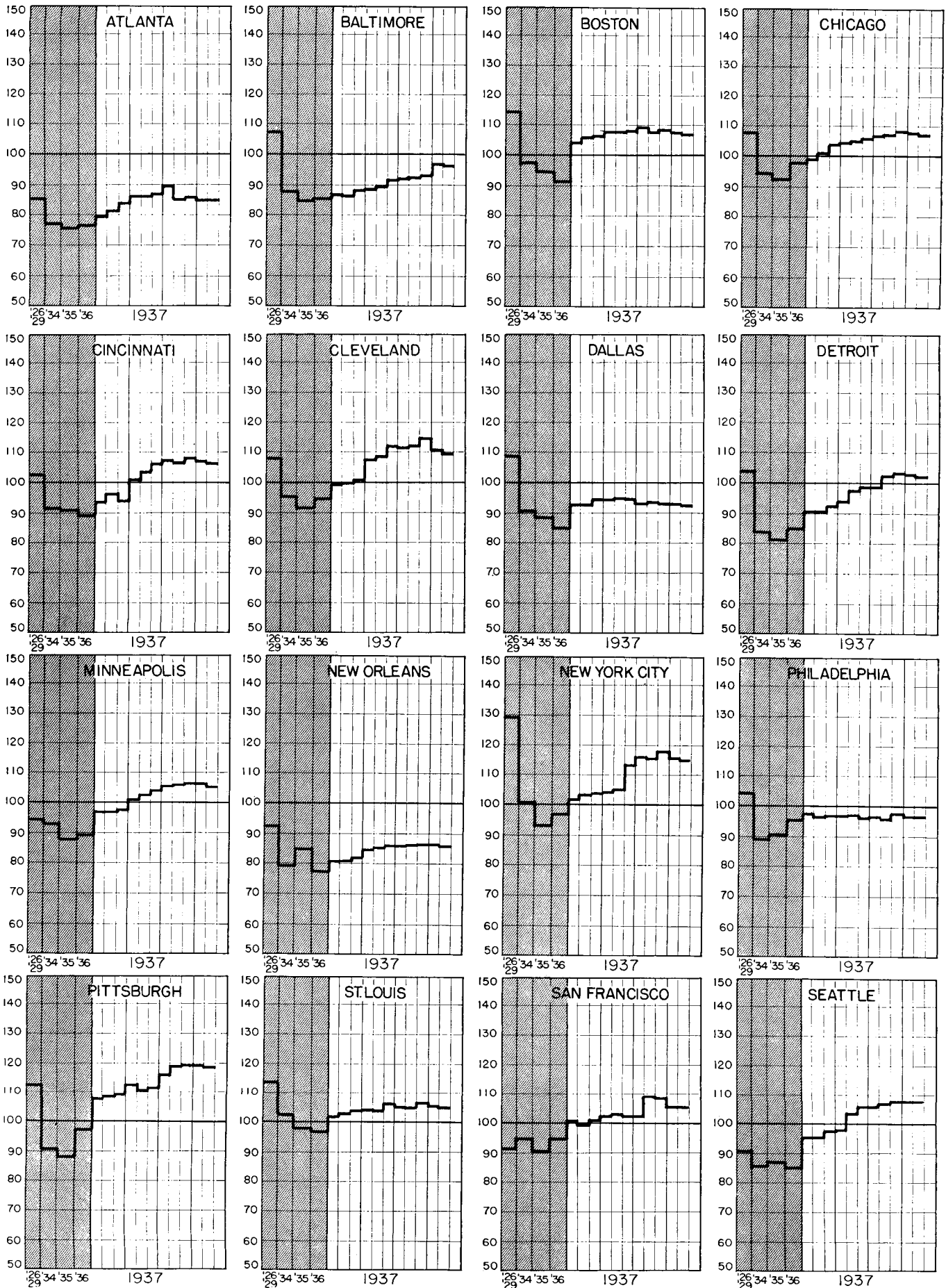

*Source: E. H. Boeckh & Associates, Inc.

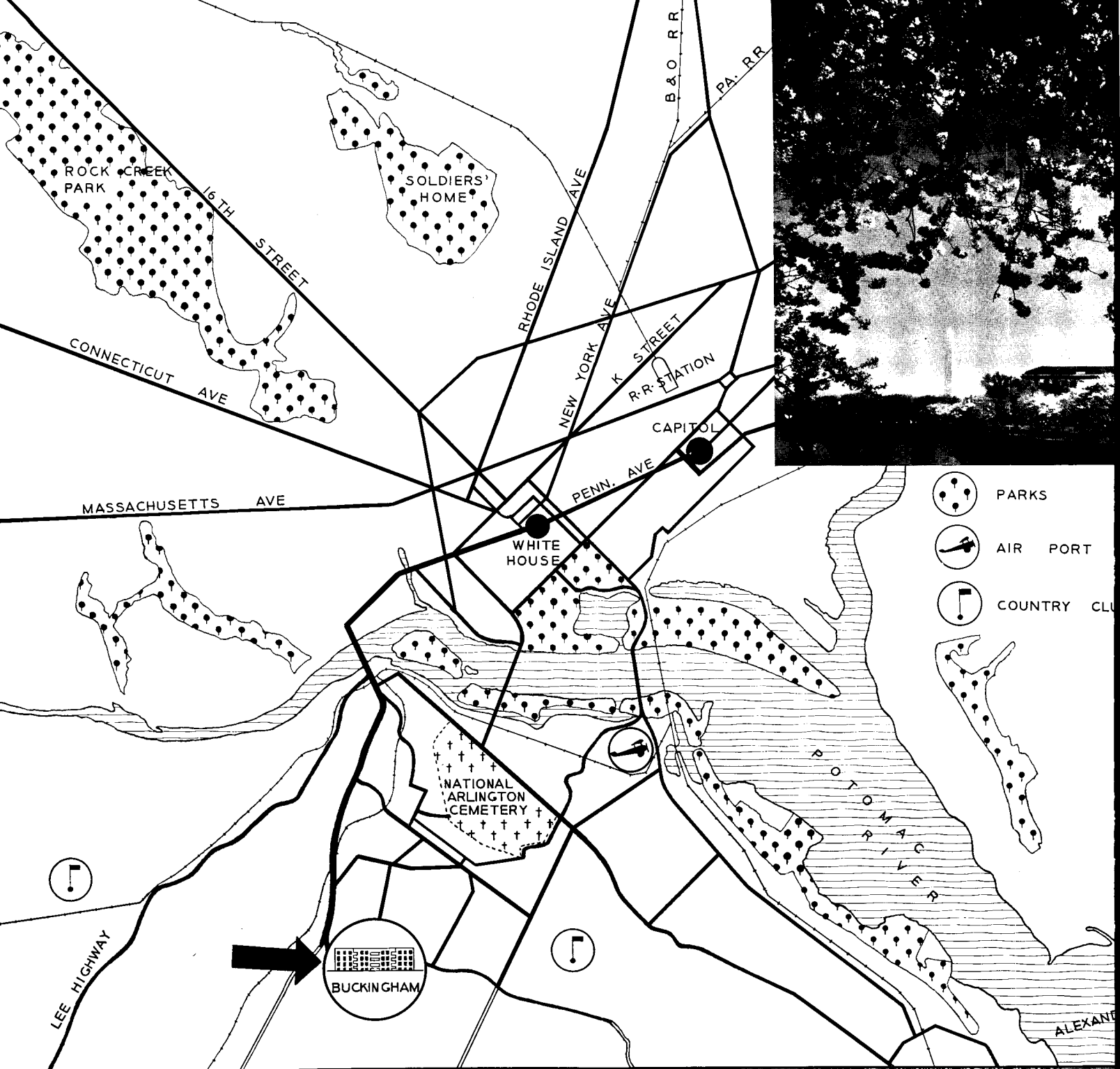

Buckingham: Housing Laboratory

By OSCAR FISHER

ONE OF Henry Wright's last designs, executed with automobile manufacturer's assembly technique, produces without subsidy a planned community described authoritatively as "one of the most significant of all that have been constructed in America to date."

OUT OF A WELTER of housing experimentation and housing discussion, there has gradually come a realization that only a small fraction of our population can be properly housed on a subsidy basis. Better housing for the great majority of American families who are neither very poor nor very rich can only be achieved in what may be termed the "American way"—production by private enterprise of a constantly improving product with a constant lowering of costs. The aim of the builders of Buckingham is to provide homes which will fit the purchasing power of the unbuilt-for 90 percent of Americans.

The Committee for Economic and Social Progress, Inc., which sponsored the Buckingham project, believes that "twenty-nine million families could not have been put on wheels in the United States had the automobile industry waited for companies, individuals, or government to supply them because they were sorry that people had to walk. It was only because a vast demand existed for production at prices that could be afforded by the mass buying population. Good roads, built by government, have aided private capital to develop the automobile industry. Government encouragement to private housing should be of this type."

To unlock the door holding back private capital from the construction field the sponsoring committee formulated the following program:

1. That a group of home building companies be formed with an average capital of \$1,000,000 each, at least two to function in each metropolitan area.

2. That a free flow of long-term mortgage money be provided at lower interest rates and based upon larger percentage loans.

3. That planned communities should be built as demonstrations of the practicability of the Committee's program.

Builders of Buckingham

Buckingham, the first project to enter the field under the Committee's sponsorship, is being built by Paramount Communities, Inc. The Committee's function is advisory and its assistance is available to any home building project. It does not, however, participate financially.

The site planning and architectural design of Buckingham was done by the late Henry Wright, assisted by Allan F. Kamstra and Albert Lueders.

Allan F. Kamstra, AIA, Technical Director and Vice President, worked with Henry Wright and Clarence

Stein on Chatham Village, Hillside, Radburn, and Resettlement Administration's Bound Brook and Greenbelt projects. Kamstra says that he learned on Buckingham to buy shrewdly as well as to hold the reins on design and construction.

Albert Lueders, AIA, Director of Architecture, worked with Stein and Wright for 17 years. He learned from them what *not* to do and is applying that knowledge in Buckingham.

Mr. Allie S. Freed, chairman of the Committee for Economic and Social Progress, Inc.,* is also president of Paramount Communities, Inc.

Bringing his experience from the efficient automobile manufacturing industry (Paramount Motors Corporation), Mr. Freed discovered that home building was not actually an industry, but an agglomeration of guilds each operating independently: finance unrelated to planning and construction; architects and builders unconnected with material manufacturers; and real estate and management in close contact with housing consumers, but not with the designers and builders of shelter.

Mr. Freed's first task was to preach reform of this archaic system. To give his preaching validity he entered the field and he is now in a position to say, "Do as I do," rather than "Do as I preach." He insists that although Buckingham is lower in cost than recent government housing, it is not "low-cost" housing. Its importance lies in its economies and improved quality made possible by large-scale operation.

Buckingham is intended as a physical pattern for rental housing in the large middle income group,—that is, families earning from \$1,500 to \$3,000 a year. The community is planned for 2,000 families and is to cost \$8,000,000. There is no subsidy of any kind involved. The Government's participation is limited to insurance of the mortgage by the Federal Housing Administration. The profit motive operates as in every business undertaking.

*Other members of the Committee are:—T. W. Appleby, President, Ohio National Life Insurance Co.; Emmett M. Baum, Vice President, Hickey-Freeman Co.; William J. Baxter, President, International Economic Research Bureau; John D. Biggers, President, Libbey-Owens-Ford Glass Co.; Morton Bodfish, Executive Vice President, United States Building & Loan League; Saul Cohn, President, City Stores Co.; Wallace B. Donham, Dean, Harvard School of Business Administration; Thomas S. Holden, Vice President, F. W. Dodge Corp.; Arthur C. Holden, Holden, McLaughlin and Associates; Charles R. Hook, President, American Rolling Mill Co.; Charles F. Lewis, Director, The Buhl Foundation; F. W. Lovejoy, President, Eastman Kodak Co.; Lee Pressman, General Counsel, C.I.O.; Paul J. Torchiana, Vice President, Collins & Aikman Corp.; H. S. Wherrett, President, Pittsburgh Plate Glass Co.

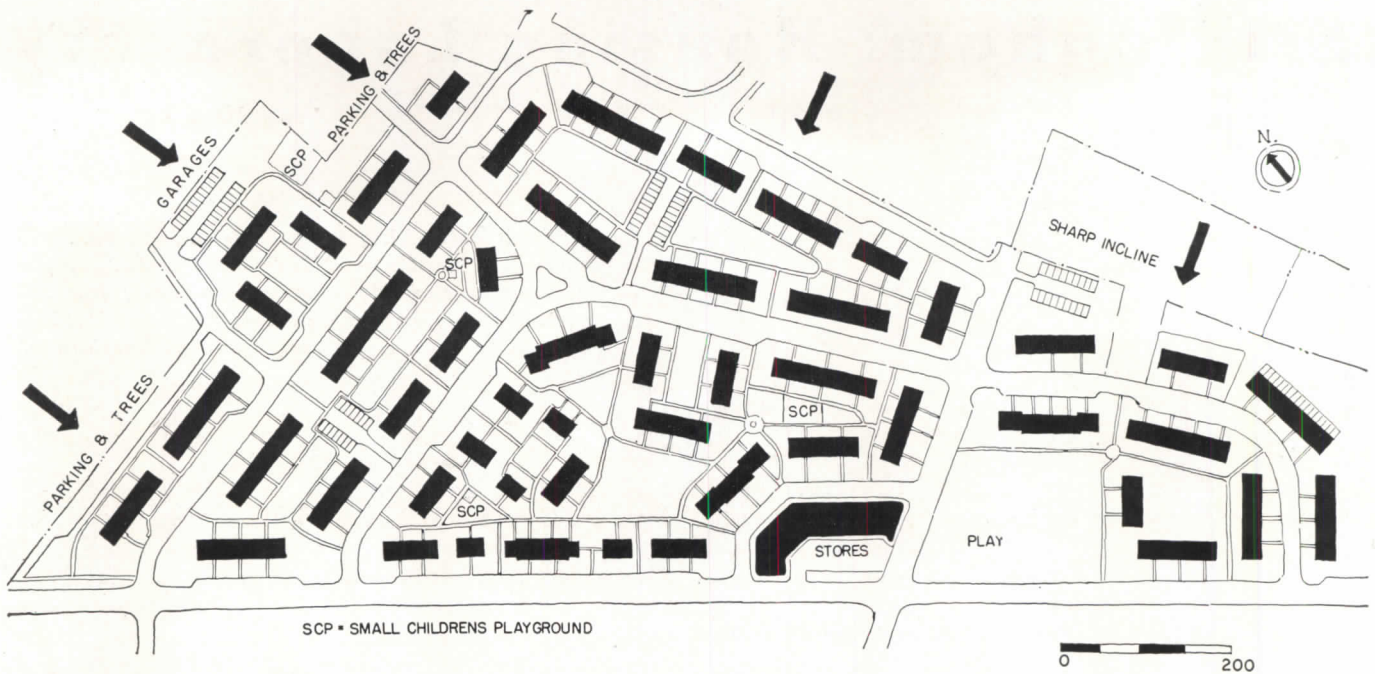

As a laboratory for testing theories and bringing remedies into sharp focus in the attempt to provide economically sound housing for the forgotten 90 percent, Buckingham can serve as an excellent example. If we are not to be satisfied with building a few scattered Utopias which it is impracticable to reproduce in great numbers, it is to projects like Buckingham that we must turn: here are the physical and financial patterns of the future; here is the beginning of a new kind of business—the building of homes as a manufacturing enterprise.

Community Plan

The project will cover about 100 acres when completed. The area now built covers approximately 30 acres with a building coverage of about 20 percent of the site. The remainder is devoted to landscaped parks, play areas, and streets. The play spaces for younger children are scattered throughout the project. A large play area, a community building, and a school are to be situated near the center of the complete community, where they may be reached with ease and safety from any part of the development. Stores are conveniently located at the point where a business zone has been established.

The street system in the area now completed for 622 families is planned for convenient and safe circulation. Heavy traffic is shunted around the community. Local traffic is slowed down by means of narrow angular streets. This is accomplished without recourse to costly curved roads or the now popular cul-de-sac streets.

Parking bays in the streets provide an innovation which preserves the full street width for traffic and an orderliness not otherwise possible. The parking bays grew out of the need to provide for the Washingtonians' habit of parking outdoors rather than in garages; they have advantages, however, for daytime use in any locality. The borders of the community have been provided with buffers, to prevent the intrusion of undesirable influences. The walks were laid out to take care of surface drainage, as well as for circulation.

The completed part of Buckingham, a pioneering pattern for rental housing of the future. Traffic within the community is slowed down for safety by angular street plan, an improvement on the curvilinear plan often used unnecessarily. Arrows point out buffers.

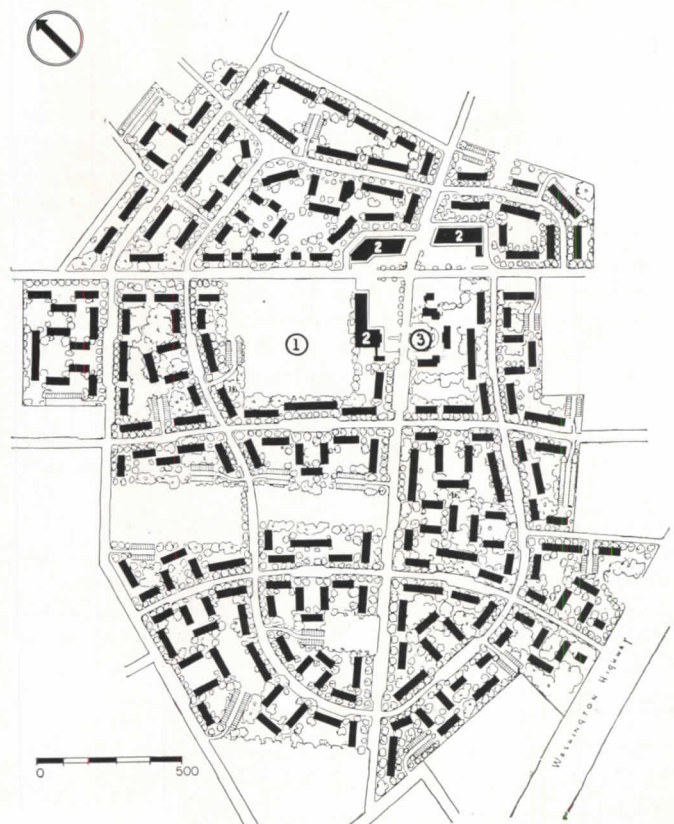

Plan of Buckingham when entire project is completed; a neighborhood unit of 2,000 families almost completely self-contained. "Through-traffic" is shunted around the community. Local services and recreational requirements are provided at points of greatest convenience and safety. 1. Proposed School Site and Playground; 2. Shops; 3. Community Center.



Photo by F. S. Lincoln

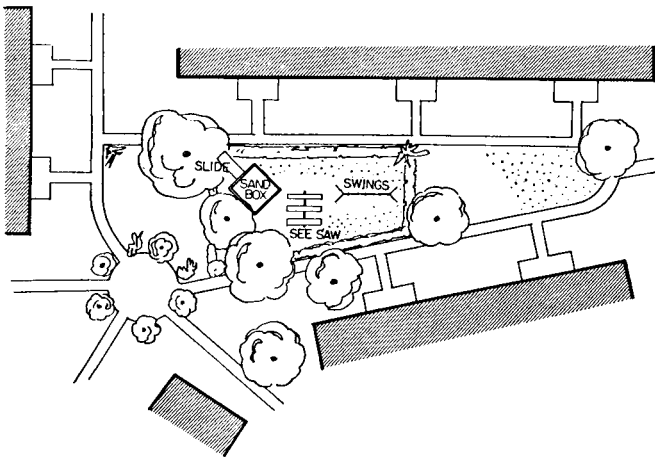

Plan and view of one of the convenient play-spaces for younger children. Tenant-owner consultations revealed their proper design and location after the project was occupied. The combination of builder-owner-management in Buckingham made such adaptability of plan possible.

When compared with the ordinary allotment plan, Buckingham's spaciousness serves to demonstrate the advantage of this type of development. There is 10 percent less area in streets than in the typical gridiron plan. Instead of giving each house a yard of limited utility, the building area is concentrated and the open spaces are merged into large areas. Under most existing zoning ordinances this kind of comprehensive planning could not be achieved in residential districts. The desirability

of revising present zoning laws to permit such development in residential neighborhoods should be considered.

According to many observers the project when completed will be the nearest realization of a planned neighborhood unit in the United States. Because it is rental housing, neighborhood control can be continuous, a difficult problem in groups built for sale. Mr. Charles F. Lewis, builder of Chatham Village, said when speaking of Buckingham: "This skillfully planned project promises to be one of the most significant of all that have been constructed in America to date."

Experiment, geared to production with a watchful eye on the market, was the key to the designing and building of the units. Most of them are two stories in height and their design follows a simplified Georgian. Flexibility of organization is demonstrated by the shift during construction to a higher ratio of smaller apartments. When applications for apartments started pouring in, it was found that there was a greater demand for the three-room units than had been anticipated. Whereupon Mr. Freed, accustomed to sudden shifts in assembly-line production, made the change without permitting the increasing cost of the project to deter him. Similarly, it was found that the dining space in the living rooms proved more popular than in the kitchens, hence later units were so built. One three-story unit with cantilevered balconies, a flat-roof deck, and panels of glass brick was built as a feeler of public reaction to non-traditional design. Its roof deck and balconies proved to be popular and will help to guide the design in the remainder of the community. A group of buildings around one of the commons was painted white. Variations in

TABLE A. Area in square feet

| Sections | Block Area | | | | Building Area | Land Area Per Room | | Coverage | | Number of Rooms | Number of Families |
|----------------------------|------------------|----------------|------------------|--------------|----------------|--------------------|------------|---------------|-----------------|-----------------|--------------------|
| | Gross Area | Streets | Net Area | % Streets | | Gross | Net | With Streets | Without Streets | | |
| | | | | | | | | | | | |
| Section One | 1,125,729 | 174,880 | 950,849 | 15.53 | 192,466 | 672 | 553 | 18.22% | 21.55% | 1,720 | 524 |
| Section Two | 179,732 | 11,119 | 168,613 | 6.19 | 34,725 | 580 | 544 | 19.32% | 20.59% | 310 | 98 |
| Totals and Averages | 1,305,461 | 185,999 | 1,119,462 | 12.72 | 227,191 | 643 | 556 | 17.40% | 20.11% | 2,030 | 622 |



entrance details lend restrained individuality and serve to identify other groups. Striking out in all directions without too bold experimentation, this project encompasses within a small space and a short time the experiences and pioneering steps of an emerging home-building industry.

Construction

Construction started in March, 1937. By December, 622 families were living in Buckingham. With the experience gained in the building of this first unit, construction can now proceed even more rapidly. The quality of construction is superior to housing far above its price class.

In the field of materials, precedent has been made which, if expanded, may be a more vital step forward than prefabrication of houses. Prefabrication in fact, rather than as a wishful fancy, can develop through large-scale building like Buckingham. The first steps to be taken were direct buying and packaging of materials in complete units. This permitted economies in handling, breakage, and installation. Repetition of operations and continuous use of construction equipment and forms accomplished further economies.

Exterior: Walls are 8", made of brick and hollow tile, and are dampproofed on the inside. Cinder blocks are used where nailing is required. The construction is as

1. Mechanical ditchdigger breaking ground in March 1937. 2. Laying hollow tile wall between apartments. 3. Floor slab ready for concrete. 4. One building after another was raised from floor level to floor level in regular progression. Concrete for floor slabs was poured from control towers. 5. Roughing for two adjoining bathrooms, showing an economy of connections. A single vent serves two W. C.'s. 6. Braising a joint in the water supply lines. The piping is made a one-piece job, which should last as long as the building itself.

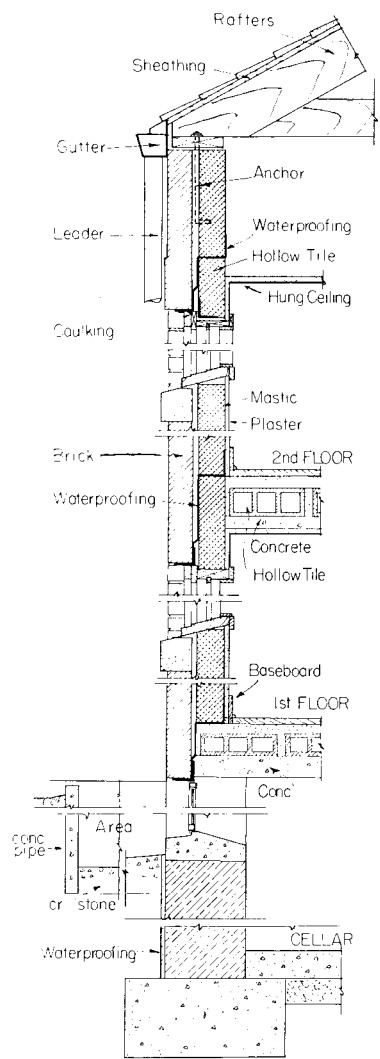

Section through typical exterior wall

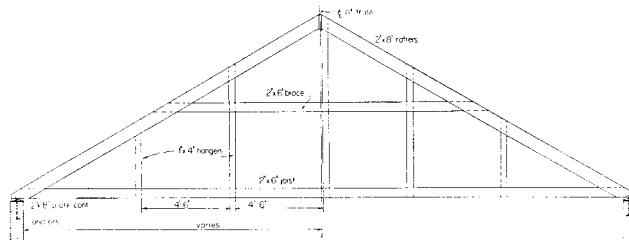

Roof framing, showing bracing and ties. The second floor ceiling is hung from the ties.

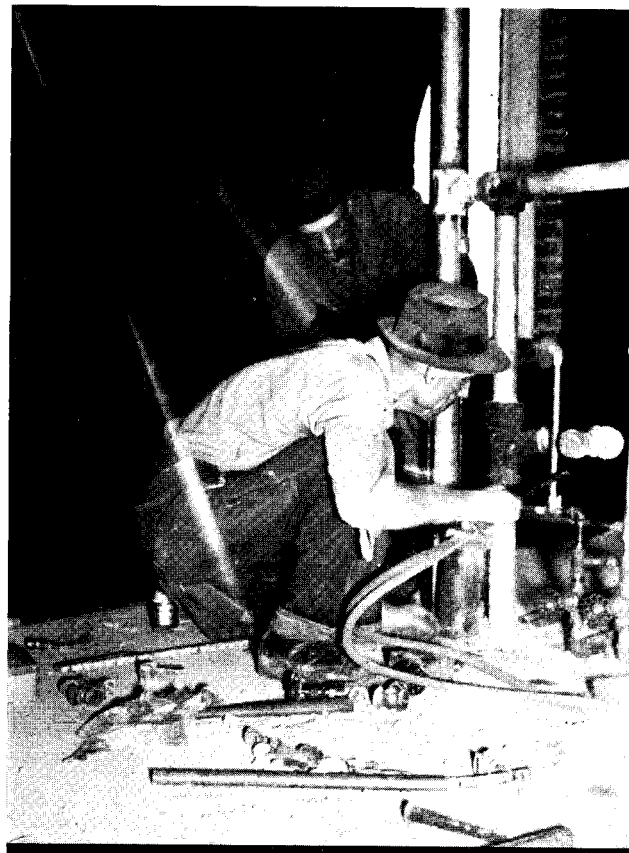

6

5

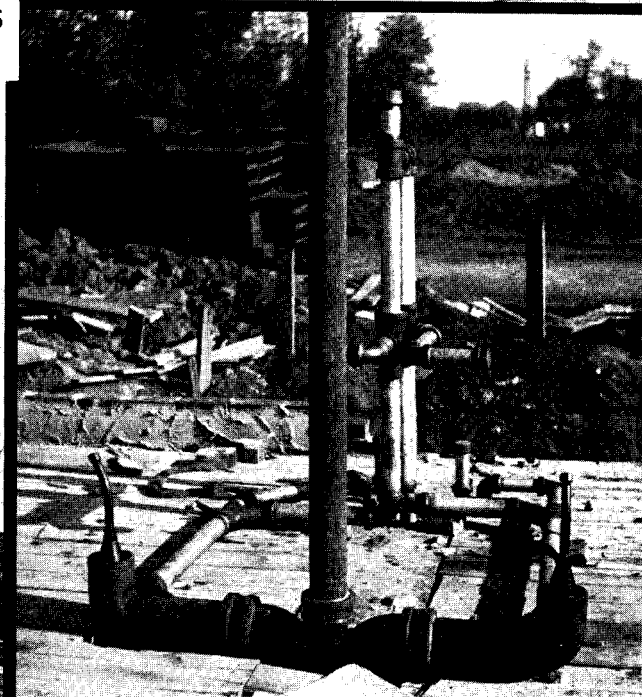

4

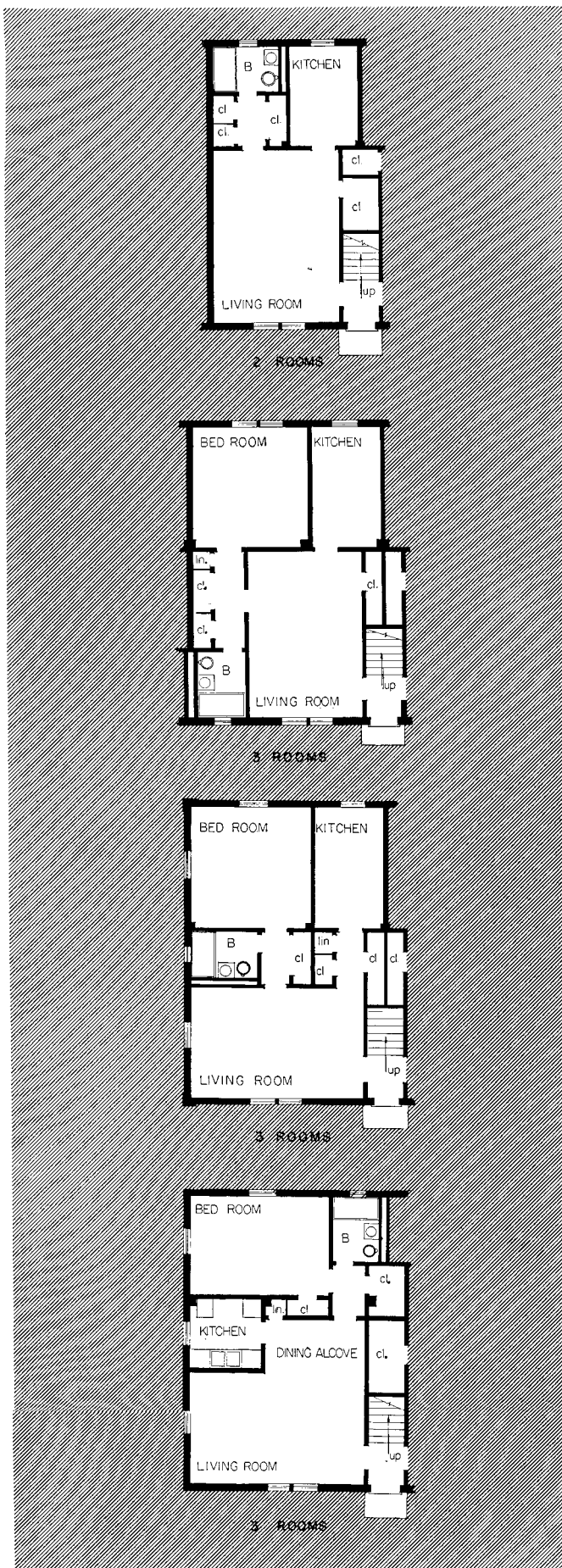

Plans of typical apartments. Left and opposite.

| | | |
|-------------------|------------------|------------|
| 2-room apartments | 7.72% | of project |
| 3-room apartments | 67.35% | of project |
| 4-room apartments | 20.11% | of project |
| 5-room apartments | 3.87% | of project |
| 6-room apartments |63% | of project |
| 7-room apartments |32% | of project |

The "Ford unit" is what Mr. Freed calls the suite shown at bottom left; it is the most popular unit and can be easily reproduced in large numbers in any type of planned-community development.

nearly fireproof as practicable. Exposed wood on the exterior was kept to a minimum for fire protection and low maintenance. The roof is constructed of wood rafters with the second floor ceiling hung. The roofing is slate. Copper gutters and leaders drain to dry wells. Wood double-hung windows are rot-proofed, primed with aluminum paint, metal weatherstripped, and operated with sash balancers. Full screens are supplied. Cast stone is used at the entrances for trim and in some units for sills and lintels. Entrance porches where they occur are of painted malleable cast-iron.

Interior: The floor system is concrete T-beams, reinforced concrete and hollow tile slabs. Forms for concreting were reused continuously. The finished floor is oak block laid on hot mastic. There are no bearing partitions. Partitions are 3" gypsum; 4" hollow tile is used between apartments. The second-floor ceiling is hung and is insulated with rock wool. The tile for bathrooms was bought directly from factory, and packaged for each bathroom. This practically eliminated the usual 10 percent breakage cost. Inside doors throughout are flush-faced and have metal bucks. The three-coat plaster job is finished with casein paint. Trim is enamelled. Kitchen cabinets are metal.

Plumbing: Bathroom fixtures are pressed steel. Copper tubing with a braised joint fitting was used for the water supply, a quality job not ordinarily utilized in small

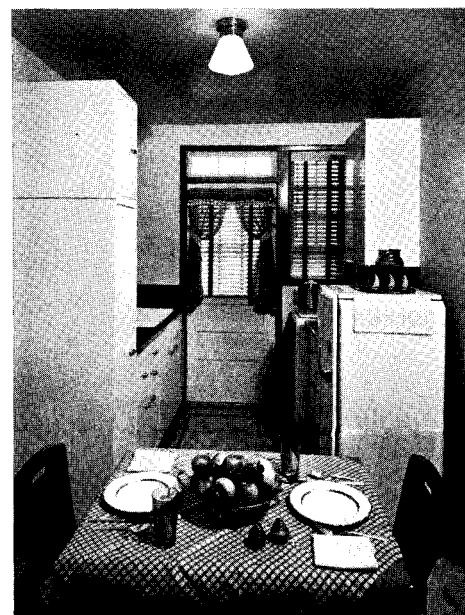

Kitchen with dining space. In later-built units the dining space were included in living rooms. Smaller families preferred multiple-use spaciousness to small enclosed spaces. (Right) Bathroom with pressed

house construction. The large scale of the project and cooperation with the manufacturer permitted its use at a low cost. Pipe spaces are formed between bathrooms with 3" hollow tile partitions. Sixty percent of the units are equipped for both gas and electric ranges; forty percent are equipped with gas ranges.

Electricity: All exterior wires were put underground at the owner's expense. The extra cost (three times the cost of overhead) was justified by the improved appearance. Transformers are above ground. Circuit breakers were used instead of fuses in each apartment. Sheradized conduit was used throughout.

Heating: The heating system, originally planned for one-pipe steam, was changed to hot water for economy of operation. Part of the project has circulating pumps. Area "A" operates on gravity. Each unit has its own boiler and oil burner. The system is designed to maintain a constant temperature of 68°. It is operated automatically by thermostatic control from the outside temperature, which regulates the flow of hot water from the boiler. Hot water is supplied from coils in the boiler.

Landscaping: Landscape plan is by H. E. Van Gelder. The open areas are grass with trees placed for shade and as enclosure of the housing plot.

Money

Rental projects have many advantages over those built for sale because of their long-term investment character. More favorable financing can be secured. With a general understanding of their economic soundness, they will receive even better terms in the future. The excellent record of the few examples extant in the United States proves their desirability from the investment standpoint.

Organized to earn an income return by renting decent dwelling accommodations to families of moderate means the City and Suburban Homes Company of New York has paid dividends continuously for the last 37 years at an average annual rate of 4.65 percent. The Washing-

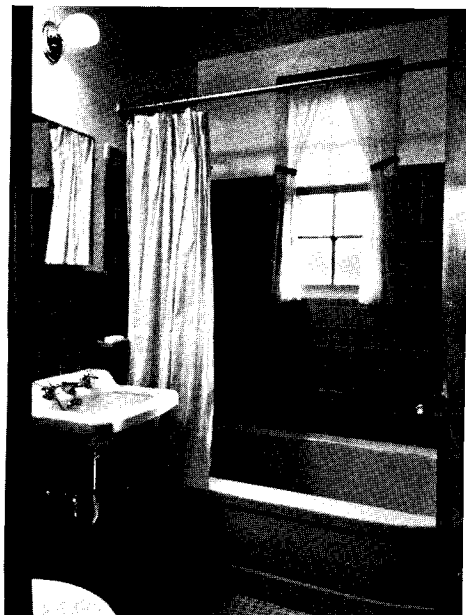

Steel fixtures, tile floor, and wainscot in color. Special packaging of bathroom tiles, with delivery in room-unit lots, constituted one of many purchasing economies at Buckingham.

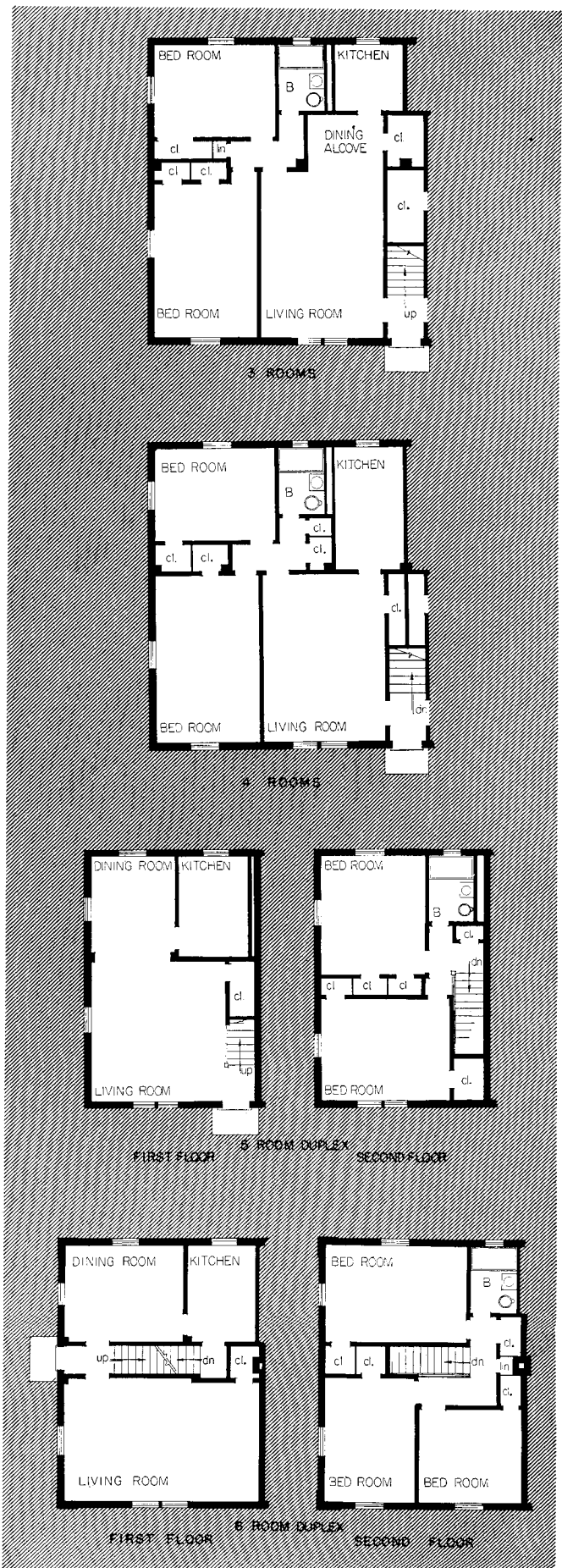

ton Sanitary Improvement Company paid annual dividends of 5 percent continuously from 1897 to 1923, and from 1923 to the present time, including every depression year, 6 percent per annum. The Washington Sanitary Housing Company has paid 5 percent per annum continuously through the past ten years. Six non-co-operative apartment projects built in New York City under the New York State Housing Board have all been consistent dividend-payers in good times and bad. Chatham Village in Pittsburgh opened its doors in January, 1932. It had 98 percent occupancy in six weeks, and has never had less than that. It has earned and paid a substantial dividend during each depression year.

Long-term planning, quality construction, low maintenance design, market analysis and neighborhood control are the factors in which rental projects have definite superiority. Large-scale development, with its economies and other advantages, is more feasible in rental housing. These advantages, however, are not yet reflected in the financing of such projects. The present system of undercapitalized home building companies depending upon an insecure flow of mortgage credit cannot possibly make for an efficient industry. The total cost of financing on stabilized investment housing should not be more than 4 percent per annum. The level payment at Buckingham is 7 percent per annum, comprised of 4½ percent mortgage interest, ½ percent FHA insurance and 2 percent amortization. The effective interest rate is 5¼ percent. Contrast this with the situation in Great Britain where, with no government aid, 4½ percent is the maximum effective interest rate. One percent reduction in interest or amortization makes possible a 10 percent reduction in rents or carrying charges.

Mortgage insurance is costing the first 524 families in Buckingham on the average nearly \$1.50 a month, only slightly less than the cost of the electricity they consume. Yet FHA-insured mortgages are not absolutely essential to the financing of large-scale rental projects; there are various other ways in which they are likely to be financed in the future, when investors and lending institutions

come to a full realization of the sound investment character of this type of planned-community project.

Buckingham's construction and controlled environment can last for 75 years, yet it must be completely written off in 22 or 23 years, thus requiring this generation to pay unduly increased rents for the housing of future generations.

Tenants and Rents

The tenants of Buckingham are a cross section of the large middle income group. Housing democracy is actually being established. There is no segregation of economic levels, of Park Avenue pattern or of our institutionalized poverty housing. In fact, a deliberate effort has been made to scatter higher and lower income families throughout the community. The median annual income per family is \$2,482—about 77 percent earn \$3,172 per year or less.

The fact that families of somewhat higher income moved to Buckingham proves its desirability. That a greater number of families of lower income have not been able to take advantage of the reasonable rentals is evidence that there are not enough Buckinghams.

The average family in Buckingham pays under 25 percent of its income for rent.

Costs

Though it is too early to give final cost figures, the estimates that have been released by the management and shown in Table E (page 77) indicate roughly a construction cost of \$1,181 per room. The maintenance is estimated to cost \$47.54 per room per year.

Management

Buckingham has been promoted, planned, built, owned, and managed by one organization, resulting in a high degree of flexibility and integration. The influence of one operation on another is immediately reflected in planning and execution. This interdependence is an important part of the story of Buckingham.

Table B. Annual Income, First 400 Tenants

| Mean Family Income | Tenants | | | |
|--------------------|------------|---------------|------------|--------|
| | Families | Percent | | |
| | | % | Cumulative | |
| \$1,375 | 4 | 1.00 | 1.00 | 100.00 |
| \$1,745 | 43 | 10.75 | 11.75 | 99.00 |
| \$2,156 | 114 | 28.50 | 40.25 | 88.25 |
| \$2,657 | 65 | 16.25 | 56.50 | 59.75 |
| \$3,172 | 85 | 21.25 | 77.75 | 43.50 |
| \$3,673 | 44 | 11.00 | 88.75 | 22.25 |
| \$4,101 | 24 | 6.00 | 94.75 | 11.25 |
| \$4,607 | 11 | 2.75 | 97.50 | 5.25 |
| \$5,750 | 10 | 2.50 | 100.00 | 2.50 |
| \$2,482 | 400 | 100.00 | | |

Table C.

| Apartments Type | Number | % | Range of Rents | Rental Income | | Average No Rooms per Family |
|------------------------|------------|---------------|------------------------|-----------------|------------------|-----------------------------|
| | | | | Monthly | Annually | |
| Simplex | | | | | | |
| 2 Room | 48 | 7.72 | \$35.00-\$36.50 | \$1,746 | \$20,952 | |
| 3 Room | 412 | 67.35 | \$41.00-\$46.50 | 17,842 | 214,104 | |
| 4 Room | 126 | 20.11 | \$51.00-\$56.50 | 6,943 | 83,316 | |
| 5 Room | 4 | .65 | \$65.00 | 260 | 3,120 | |
| Duplex | | | | | | |
| 5 Room | 20 | 3.22 | \$65.00-\$82.50 | 1,455 | 17,460 | |
| 6 Room | 10 | .63 | \$77.00-\$87.50 | 810 | 9,720 | |
| 7 Room | 2 | .32 | \$80.00 | 160 | 1,920 | |
| Total—all types | 622 | 100.00 | \$35.00-\$87.50 | \$29,216 | \$350,592 | 3.26 |
| Average Rent Per Apt. | | | | \$46.97 | \$563.65 | |
| Average Rent Per Room | | | | \$14.37 | \$172.71 | |



Photo by F. S. Lincoln

A street in Buckingham. Urban conveniences combined with spacious parking areas create a new and improved pattern for rental housing.

TABLE D.

| Percent Income Paid for Rent | Families | Total % |
|------------------------------|------------|---------------|
| Less than 10% | 4 | 1.00 |
| 10%–15% | 44 | 11.00 |
| 15%–20% | 134 | 33.50 |
| 20%–25% | 106 | 26.50 |
| 25%–30% | 83 | 20.75 |
| 30% and over | 29 | 7.25 |
| Total All Classes | 400 | 100.00 |

*Based on Analysis of 1st 400 Tenants.

TABLE E—Estimated Capital Requirements, Sections One and Two

| | |
|---|--------------------|
| Land Improvement | \$155,000 |
| Structures | 2,398,585 |
| Physical Improvements | \$2,553,585 |
| Total Carrying Charges and Expenses during Construction | 62,025 |
| Total Cost of Project Excluding Land | \$2,615,610 |
| Cash Reserved for opening expenses, working capital and other necessary outlays | 23,075 |
| Total Capital Requirements Excluding Land | \$2,638,685 |
| Capitalized Value of Land 1,325,078 sq. ft. @ .248 per sq. ft. | 328,000 |
| TOTAL CAPITALIZATION | \$2,966,685 |

TABLE F—Estimated Income and Expenses, Sections One and Two Number of Rooms, 2030

| | |
|---|------------------|
| Earnings: | |
| Room Rentals | \$349,932 |
| Stores | 15,000 |
| Garages | 6,960 |
| Total Potential Income | \$371,892 |
| Less Vacancies Assumed | 28,890 |
| Gross Income Expectancy | \$343,002 |
| Operating Costs | |
| Per annum | \$96,510 |
| Taxes | 22,000 |
| Social Security and other Taxes | 2,500 |
| Total | 121,010 |
| Cash Available for Debt Service | \$221,992 |
| Annual Fixed charges | 150,500 |
| Cash available for Income Taxes, Dividends and Surplus | \$71,492 |



Photos by Lincoln

Local street showing recessed parking-bay in use. Adequate street width is preserved for local traffic, while orderliness with economy is promoted.

With owner-builder-management control the plan can be continuously adapted to suit the changing needs of the community. An example may be cited of the provisions for children's play spaces. Their design, location, and extent are being determined as the project becomes occupied and where the need for them becomes apparent.

In a housing democracy, such as Buckingham aims to be, a mutually satisfactory relationship must be maintained between the management and the tenants. Hence a lease has been devised with a provision for cancellation by either party on 30 days' notice.

The majority of tenants come from America's biggest industry—Government. A sincere effort is being made to determine tenant needs and preferences and to promote economy in this manner. This is done, not by questionnaires, but by the sensitive barometer of the tenants' pocket; for instance, Venetian blinds and extra clothes driers are provided reasonably at the tenants' expense. All the tenants voted for them. Provision has been made for replacement of all fixtures within a normal period. For example, the cost of replacing kitchen ranges every seven years is included in the monthly rent.

Qualities that will simplify management are embodied in the plan of Buckingham. Environment that is controlled, with community services and facilities for recrea-

tion, will be an influence for a pleasant community atmosphere.

Labor

The building of Buckingham has convinced the management that labor relations in the home building field need radical revision. Mr. Freed maintains: "The itinerant, non-union labor, that eats only when it doesn't rain, that enjoys proper family relations only when building is done in its own areas, the labor that knows no continuity of employment, and certainly no economic security, cannot be the answer. On the other hand, union labor, working but a few hours at a time at high hourly rates of pay (though their annual income is pathetic), squabbling over jurisdiction, preventing all forms of progress, resisting even the simplest forms of efficiency producing machinery, cannot be the answer. The \$2-an-hour man working but a few months each year can neither produce a home economically for the 75c-an-hour-man in other industries, nor for himself with his own low annual income. An illustration was supplied by the recent rejected application of a \$1.75-an-hour bricklayer from a Resettlement Administration village because his income was too low and too irregular. The solution will probably come when large building companies operating continuously are able to make long-term contracts with their labor. Labor would exchange a high hourly rate and low annual income for a higher annual income and greater economic security."

(For a full report of management of Buckingham see Real Estate Record National Edition for January 1, 1938.)

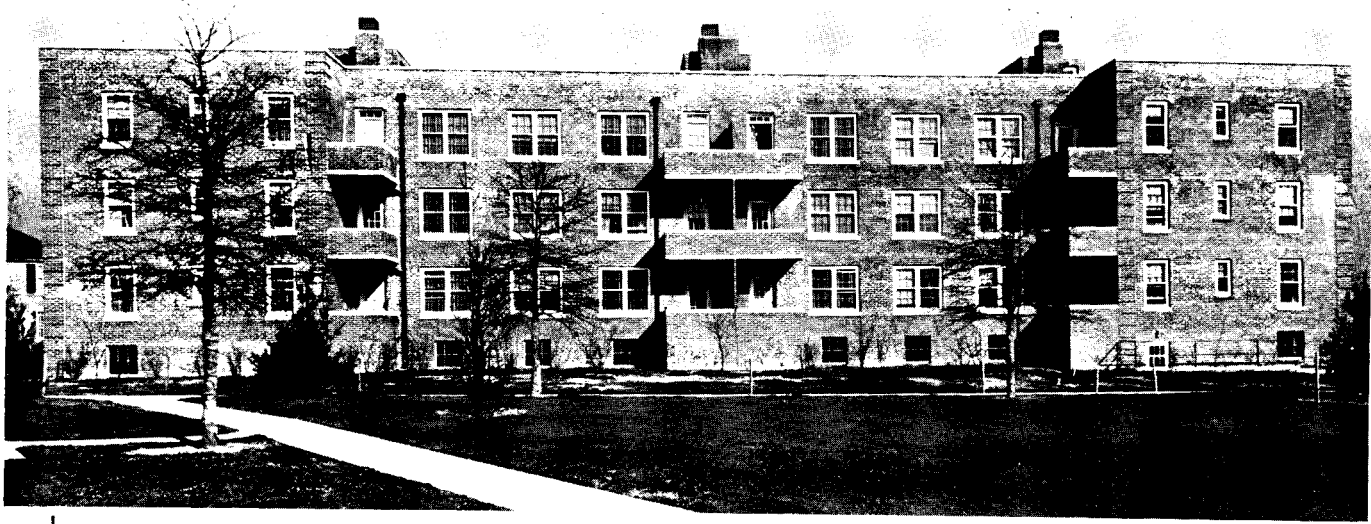

1

2

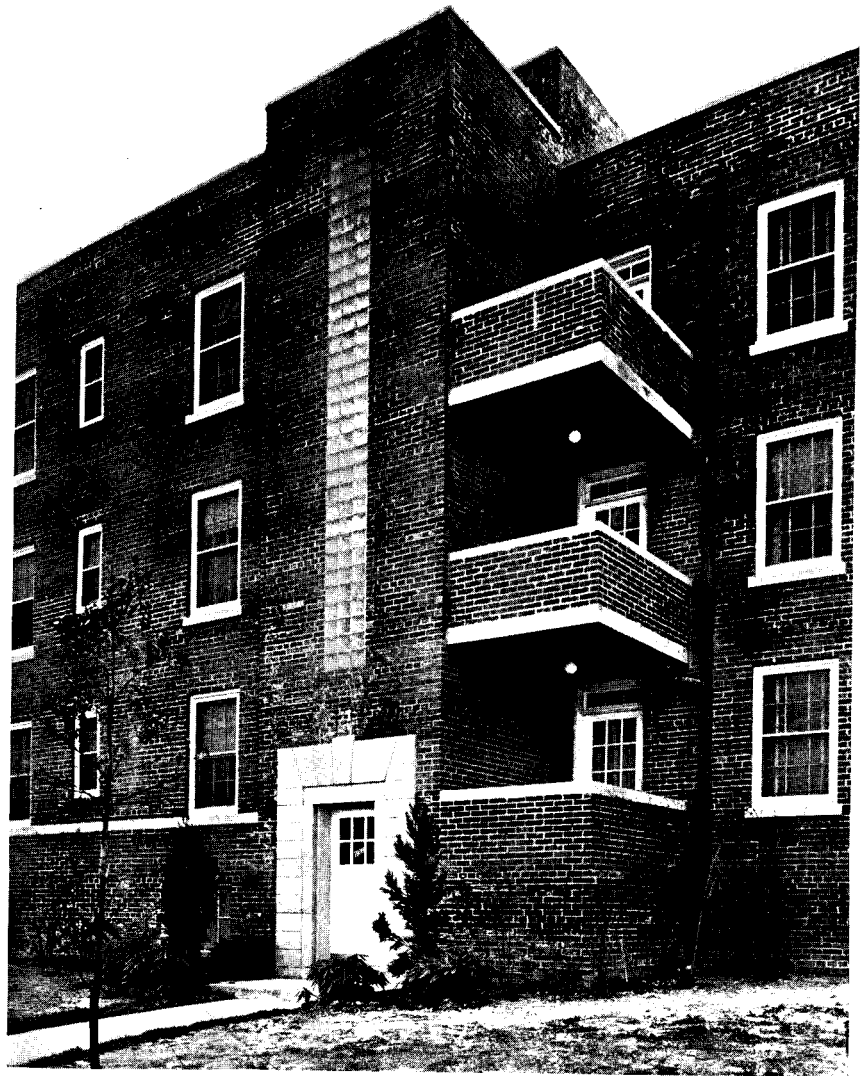

1. The balconies and roof deck of this modern unit proved popular. Miss Fola La Follette, sister of the Senator, occupies one of these suites. Non-traditional design did not deter tenants who were anxious to obtain the accommodation features offered in these apartments. 2. Exterior of stair hall. Glass brick is correctly used where light is desired and operation of sash would be an inconvenience. The stair hall is ventilated by grilles in the bulkhead.



Photos by F. S. Lincoln

1, 2. Two views of a "U" court with brick painted white. A unit group of five buildings surrounding a court, capable of being reproduced as a single investment project, or multiplied indefinitely in larger developments of either gridiron or irregular plan. Groups are here given individuality and an intimate character not usually achieved in large projects. 3. View of a street on the periphery of the project where buffers have been provided to exclude outside influences. 4. Detail of a simple cast-stone entrance.



3



2

Raymond Kenny of the Resettlement Administration, Allie S. Freed, Mrs. Franklin D. Roosevelt and Miles Colean on a recent inspection tour of Buckingham. Mrs. Roosevelt said: "It is a delightful development—well planned—gives one a feeling that there is a possibility of doing many things on a community basis that would make life easier for the individual family."

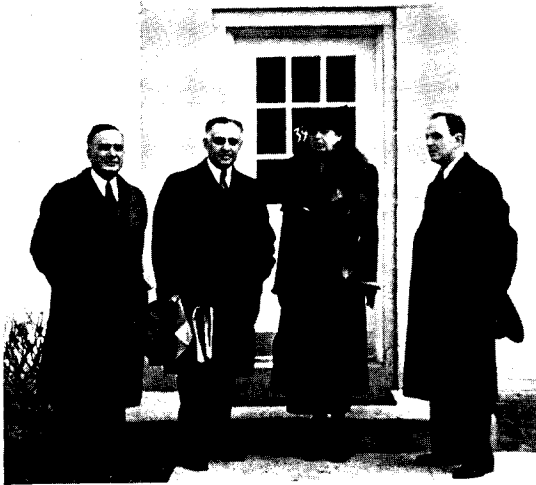

4





1
Photos by F. S. Lincoln



2



3

1, 2. Views of typical area developed as a park in Buckingham. The spaciousness attained is far above that of the usual single-family house development. It is pleasanter than the ordinary series of yards of pocket-handkerchief size. 3. Living room interior.

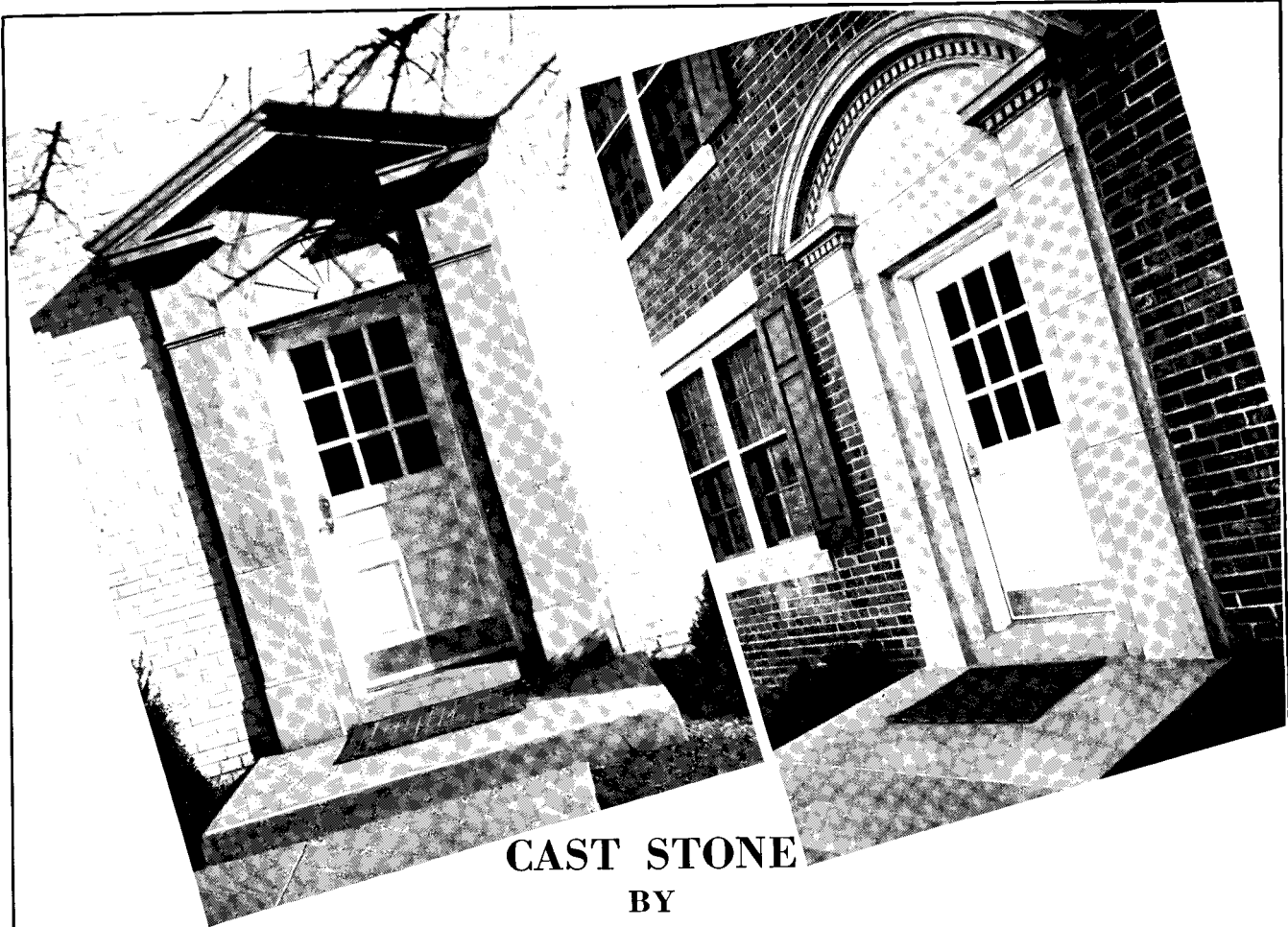

CAST STONE
BY

EDMONDS ART STONE CO., INC.

"Members of the Cast Stone Institute"

2135 Queens Chapel Road, N. E.
WASHINGTON, D. C.

125 SEPARATE ENTRANCES

of

11 DIFFERENT TYPES

SILLS
LINTELS
BELTS
CORNICES
COPINGS

used to date in

"BUCKINGHAM"





Buckingham

CHOSE "UNITED COLONIAL" BRICK

PART of the charm of Buckingham is the soft tone and texture of the "United Colonial" brick which was selected. Brick bespeaks of substantiality and this "United Colonial" brick not only looks well now but time will not erase its attractiveness.

Just as Lee's mansion, in its hillside setting as one crosses into Arlington County is a landmark in brick seen from the Washington side of the Potomac, so "United Colonial" brick at Buckingham will be

another landmark of beauty for Arlington. After much research and investigation, Buckingham and United Clay arrived at a load bearing wall using "United Colonial" face brick as a veneer backed with a combination of "Speedtile" and "United" back-up tile. This decision was reached because it merged attractiveness with all the sturdy fireproof qualities of hollow tile. The section of the wall below illustrates in detail the method of construction used.

One of the most important considerations given to the Buckingham development was the question of wall construction.

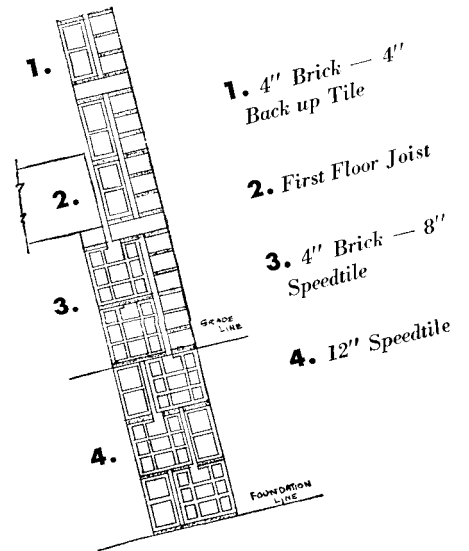
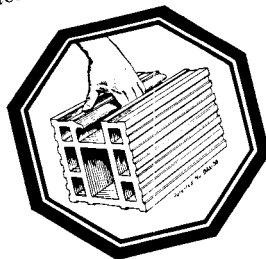

Buckingham Community, Inc.
ARLINGTON, VIRGINIA

OFFICE OF PRESIDENT

Mr. E. T. Chewing, President
United Clay Products Company
951 Investment Building
Washington, D. C.

Dear Mr. Chewing:

I wanted you to know how pleased I am with the appearance and attractiveness of the "United Colonial" brick which you have supplied us for the entire Buckingham project.

We made quite an exhaustive study of various types of wall constructions. Frankly, we wanted a fireproof wall, which would be weather-tight and which would be durable. We selected your Speedtile and Backup Tile with your brick as veneer because we would get these features we wanted to obtain and a sturdy load-bearing wall at the same time.

Not only have your products been more than satisfactory, but your service has been excellent. We are proud of the relationship of mutual confidence between the supplier of the largest volume of materials used at Buckingham and those who have been responsible for the planning and building of the project itself.

Cordially yours,
BUCKINGHAM COMMUNITY, INC.

By: *A. S. Freed*
A. S. Freed, President.

December
8th,
1937.

With twenty-three
buildings completed
and many of them
occupied by tenants,
this testimonial from
the owner speaks for
itself.

WATER-TIGHT WALLS OF FIREPROOF DURABLE *Speedtile*

Not only was the question of beauty and durability, of fireproof and water-tight walls studied in detail before a single foundation was dug, but also economy was a part and parcel of the whole problem. Undue economy of materials was removed from consideration because a less enduring wall meant plaster cracks or a less fireproof wall meant higher insurance rates, and so on. But economy in construction method, in labor through wise use of Speedtile, meant *real* economy on the job as a whole.

United Clay is proud of its part in building Buckingham both as a supplier of its own manufactured products, such as hollow tile and brick, but as a distributor for such leading products as Johns-Manville Rock Wool, Milcor metal lath, Mathieson Alkali plaster, Hy-Test Mortar, Medusa Portland Cement, Owens-Illinois Insulux Glass Block, and others.

THE UNITED CLAY PRODUCTS CO.
INVESTMENT BUILDING, WASHINGTON, D. C.
504 1/2 ST. PAUL ST., BALTIMORE, MD:



BUCKINGHAM

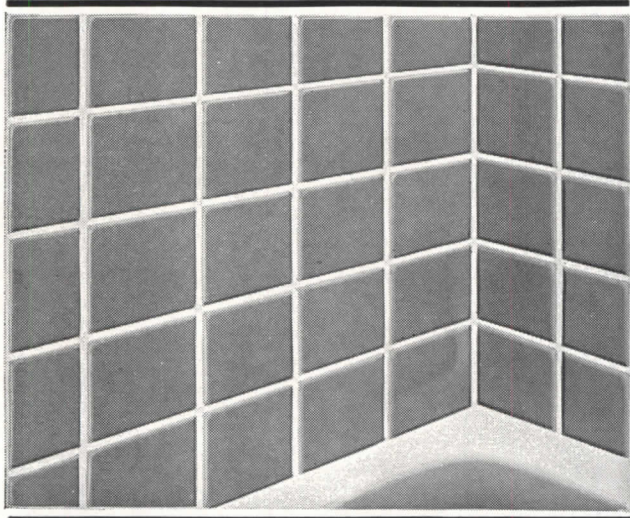

Superior Tiles

SUPERIOR Bright and Matt
Glazed Wall Tiles
installed in BUCKINGHAM
bathrooms and kitchens
are the product of

SUPERIOR CERAMIC CORPORATION
ANDERSON, INDIANA, U. S. A.

SMYSER-ROYER CAST IRON VERANDAS GO TO BUCKINGHAM TOWN



Smyser-Royer cast iron verandas used on operation-built dwellings add a note of charm to simple design. Buckingham Community, Arlington, Va.

Smyser-Royer cast iron verandas meet a variety of needs for all types of construction. The cost is moderate. Each design adaptable to your specified dimensions.

Write for complete catalogue and prices.

**MAIN OFFICE AND WORKS: YORK, PA.
PHILADELPHIA OFFICE: ARCHITECTS' BUILDING
17TH AND SANSON STREETS**

SMYSER-ROYER COMPANY



MASONRY CEMENT MAKES

Buckingham

AN ENDURING DEVELOPMENT

"After careful study we selected Hy-Test Masonry cement for the mortar for our brickwork and we made no mistake."

—Allie S. Freed.

HY-TEST

CEMENT CO.,
Philadelphia, Penna.

BUCKINGHAM SELECTS PETRO

on its "*Best by Test*" record

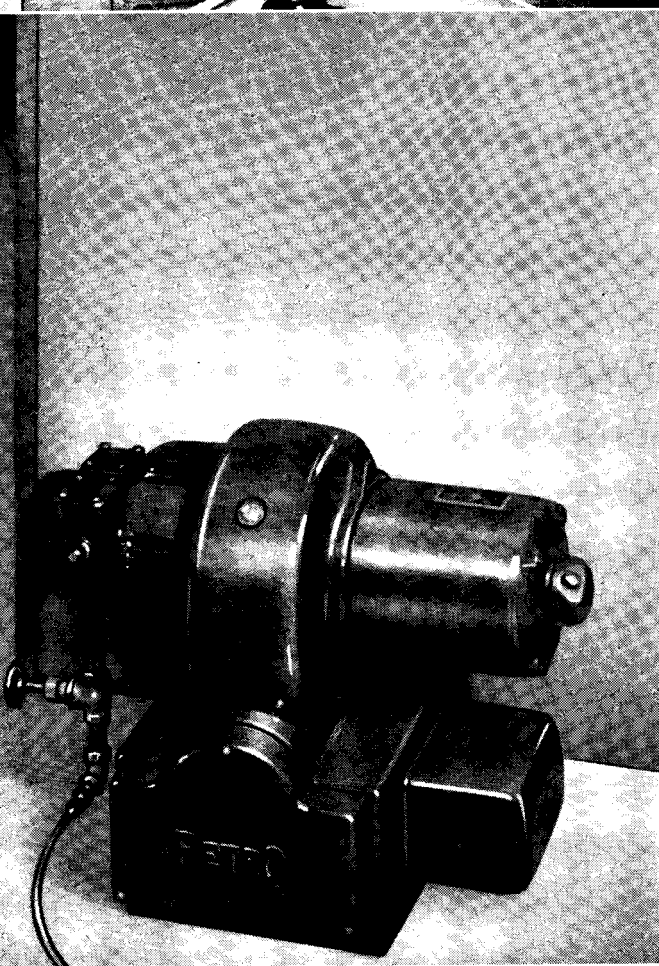

Petro Oil Burners. Models P20 (as shown), P21 and P22 have been specified for all the dwellings in the Buckingham Community, Arlington, Va.

HOW do oil burners perform in actual service? What are their comparative combustion efficiencies—how much heat do they generate—on how much fuel?

These are the kinds of "brass tacks" questions the sponsors asked *themselves* before specifying the equipment for Buckingham Community, Arlington, Va.—questions *they* then proceeded to answer by actual performance tests on all makes of competitive oil burners under consideration. They went out after facts—and got them.

For all the buildings in this famous community project, the oil burners selected were Petro.

PETROLEUM HEAT & POWER COMPANY, STAMFORD, CONNECTICUT

Each Petro Oil Burner is a "miser" that has the knack of squeezing every drop of fuel oil heat-dry!



PETRO-NOKOL

DOMESTIC . . . COMMERCIAL  INDUSTRIAL OIL BURNERS

OLDEST AND LARGEST ORGANIZATION EXCLUSIVELY DEVOTED TO OIL HEATING

BUCKINGHAM and READING HARDWARE
WORKED AS



IN OBTAINING DURABLE HARDWARE

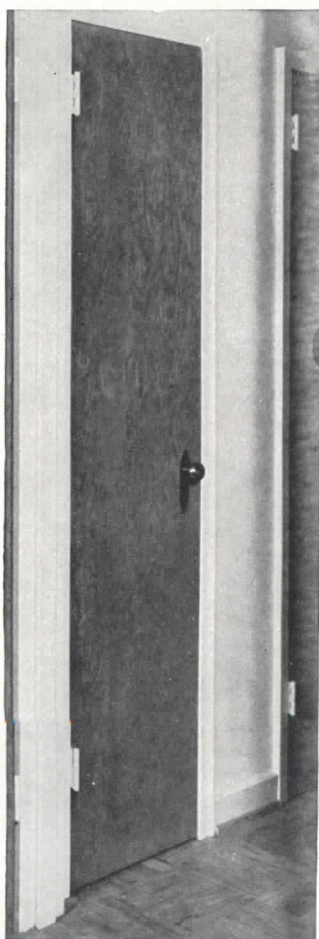

Established
1852

● It was a thrilling experience to work with the owners of Buckingham toward a goal of beauty—with durability above all.

Locks constructed to endure more than ordinary use over a long period of time. Entrance Door locks with protecting faces to guard against the manipulations of thieves and with sturdy working parts of bronze and cadmium plated steel to assure long life. All other locks of equally high quality each with functions and finishes appropriate to the room door on which it is used.

Door plates and knobs of genuine bronze attractively finished in chromium and soft silver-like colorings in harmony with the beautiful gray-stained tones of the doors.

Since 1852, Reading has been manufacturing fine hardware and lawn mowers, and in Buckingham we feel we have achieved the utmost in helpful cooperation with an owner who insisted on hardware of character and durability.

READING HARDWARE CORP.

General Offices, Reading, Pa.

New York Philadelphia Chicago San Francisco

Manufacturers of Builders' Hardware and Lawn Mowers

READING



WHAT'S INSIDE?

In a watch, it's not the beauty of the outer case, but the precisely-machined springs and balances that assure split-second accuracy in time-keeping.

In plumbing fixtures, "what's inside" is equally important. In Speakman valves, it's not the external beauty that insures continuous trouble-free operation, but the precision alignment of renewable working parts.

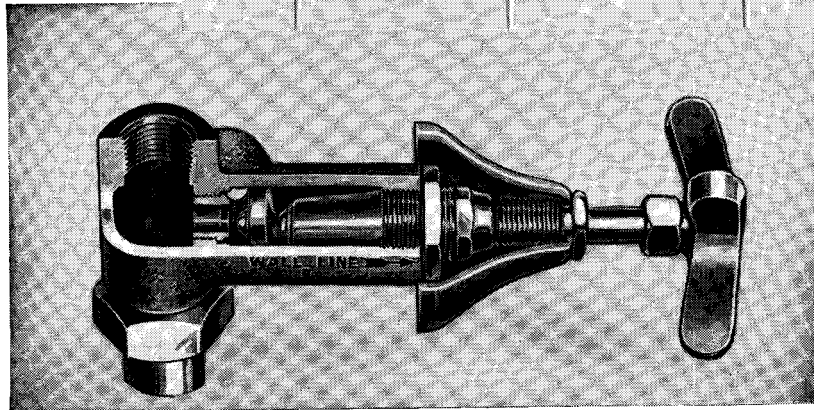
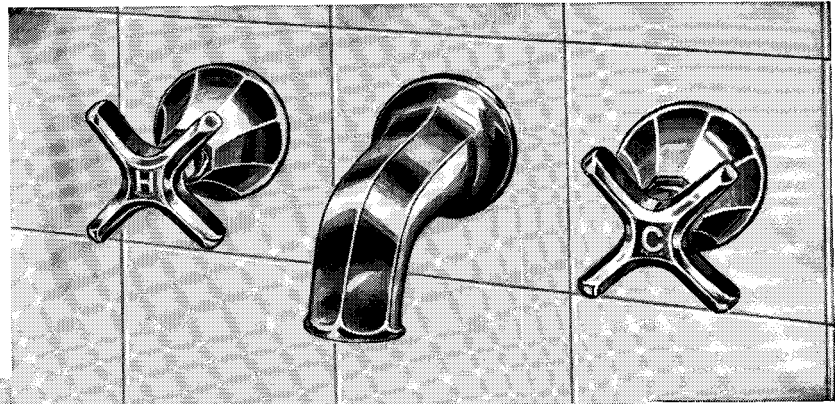

Speakman fixtures selected for

BUCKINGHAM COMMUNITY

OUTSTANDING features of SPEAKMAN SHOWERS and FIXTURES

- 1—Attractive designs
- 2—Renewable valve seats
- 3—Swivel discs
- 4—Long life washers
- 5—Monel Metal washer screws
- 6—All wearing parts renewable
- 7—Extra large waterway areas
- 8—Pressure-tested heavy brass castings
- 9—Precision workmanship
- 10—Durable, high lustre chromium plate finish

In the \$10,000,000 Buckingham Community project at Arlington, Va., you will see Speakman showers, shower and bath combinations, lavatory and sink fixtures.

All are designed and constructed to give years of satisfactory service. They have many features of internal construction and design—renewable valve seats, swivel discs, encased washers, monel metal washer screws, large waterway areas and accurate machining—features the home owner will probably never see. Yet these are the very features that assure trouble-free service for years to come.

In the complete Speakman line, you will find fixtures for every purpose—every purse. Each and every item is backed by Speakman's 68-year-old reputation for quality.

We invite you to investigate the outstanding features of the Anystream Self-Cleaning Shower Head, the Mixometer Valve, the Si-Flo Flush Valve, the Grace-line Sink Fixture and other Speakman Showers and Fixtures. Write today for complete descriptive literature. SPEAKMAN COMPANY, WILMINGTON, DELAWARE. *Quality fixtures since 1869.*

SPEAKMAN

SHOWERS • SHOWER HEADS • BATH FIXTURES • SI-FLO (SILENT) FLUSH VALVES
LAVATORY FIXTURES • SINK FIXTURES • INSTITUTIONAL AND INDUSTRIAL FIXTURES

SHOWERS AND FIXTURES

**FURTHER CONCRETE
EVIDENCE OF**



**"MALTA" QUALIFYING
FOR MODERN CONSTRUCTION**

BUCKINGHAM COMMUNITY, INC.

ARLINGTON, VIRGINIA

The Malta Manufacturing Co.,
Malta, Ohio
Gentlemen:

I wish to take this opportunity to express our appreciation of the fine spirit of cooperation your company has shown in the provision of window frames for our project.

As you no doubt know, the decision to place our contracts for your product was made after a great deal of deliberation. In all modesty, we wish to express ourselves as being thoroughly satisfied with our decision in choosing your product.

There may be other manufacturers of window frames who can, and do produce a product that equals yours, but we are thoroughly confident that we could not have secured from any manufacturer a higher standard of quality, combined with the service that you have given us. In a large project such as Buckingham, service is of equal importance with quality. You have successfully achieved both of these, in our estimation.

Very truly yours,

A. S. Freed, President
Buckingham Community, Inc.

December eighth 1937

Modern Building Is Better When MALTA SUPREME FRAMES Are Installed

FOR FREE
SAMPLE WRITE

MALTA MANUFACTURING COMPANY

MALTA, OHIO

*Buckingham Community
Arlington, Virginia*

USED

HORN PAINT

A PRODUCT FOR EVERY SURFACE A PRODUCT FOR EVERY PURPOSE

"Paint Can Be Made No Better"

A. C. HORN COMPANY
ESTABLISHED 1897
LONG ISLAND CITY, N. Y.

BUCKINGHAM COMMUNITY Chooses G-E RANGES and G-E REFRIGERATORS

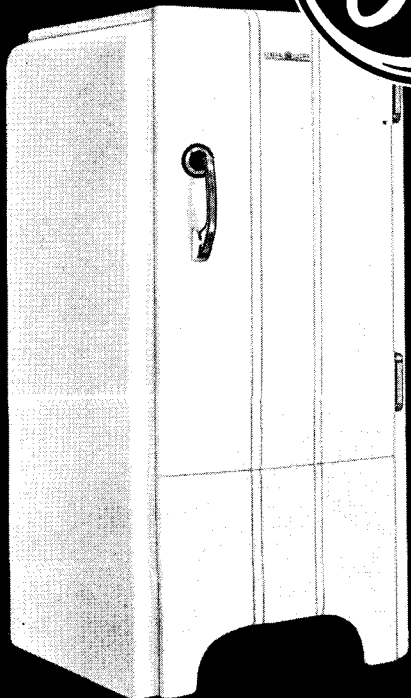
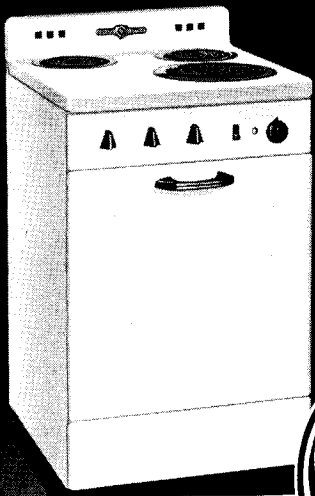

G-E KITCHEN APPLIANCES MAKE APARTMENTS EASIER TO RENT... HOMES EASIER TO SELL

After exhaustive tests and careful comparisons by the engineering staff of the project, General Electric *Triple-Thrift* Refrigerators and General Electric Automatic Ranges have been selected for installation in the tremendous Buckingham Community development.

In selecting the General Electric Refrigerator as their first choice, this staff of engineers reflected the first choice of millions—and General Electric Refrigerators are now popularly priced. All General Electric Ranges now are equipped with the famous Hi-Speed Calrod Cooking Units which are faster, last longer and are economical.

Let us send you complete details about General Electric kitchen appliances and the General Electric Unit Kitchens which make apartments easier to rent and homes easier to sell. Address General Electric Company, Appliance Division, Section CR-1, Nela Park, Cleveland, Ohio.

GENERAL  ELECTRIC

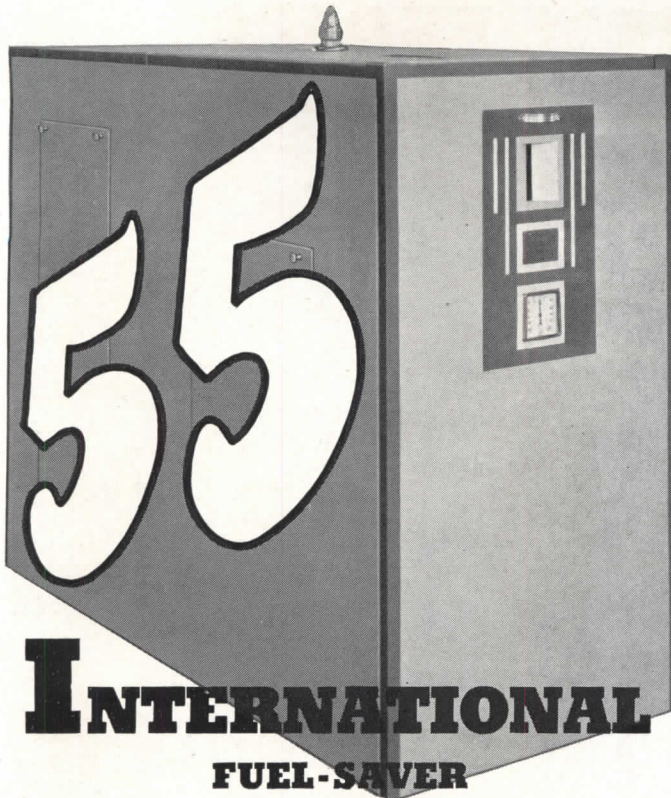

**INTERNATIONAL
FUEL-SAVER
WATER TUBE
STEEL HEATING
BOILERS**

Give Buckingham Economical Heat.

Fifty-five International "Fuel-Saver" Water Tube Steel Heating Boilers have been installed in Buckingham, the new model housing community near Washington. Selection was made after a thorough study of the relative merits of various types, on such points as fuel economy, heating efficiency and low upkeep costs. Developers everywhere are following the trend to the water tube principle in a welded steel boiler, as expressed in the International "Fuel-Saver."

**INTERNATIONAL
BOILER WORKS, INC.**
East Stroudsburg, Penn.

General Sales Office
101 Park Avenue
New York, N. Y.

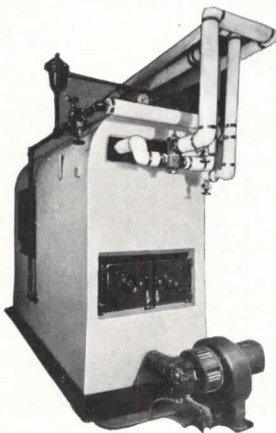

FOR 1938

SEE SWEET'S CATALOG
Page 26/112



"Baxter Cabinets"

Insure Tenant Satisfaction in Buckingham —

● The forethought and careful planning of Buckingham Community is reflected in the details that assure the maximum comfort and convenience of its tenants.

The Baxter Steel Equipment Company takes pride in the fact that Buckingham kitchens are equipped with Baxter Steel Cabinets. In such a development as Buckingham, low maintenance costs are as important as original cost. Because of their rugged construction and trouble free operation Baxter Cabinets were selected as standard equipment.

Price and quality placed 10,000 Baxter Cabinets in the three major Government Resettlement Projects at Berwyn, Cincinnati and Milwaukee.

Baxter Steel Equipment Company
Indianapolis, Indiana

AT THE BUCKINGHAM PROJECT....

Over 70,000 Walseal brazed joints insure permanency and trouble-free hot and cold water piping. A Walseal joint is stronger and will resist corrosion better than either the pipe or fitting.

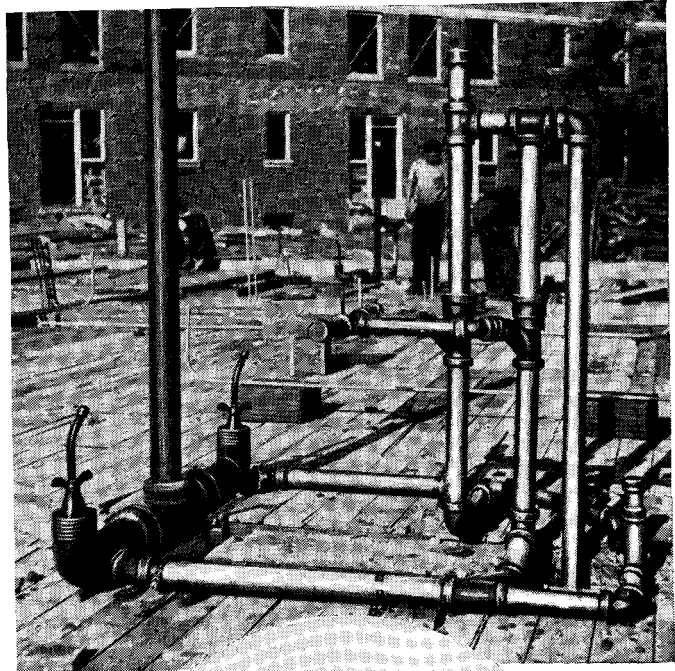
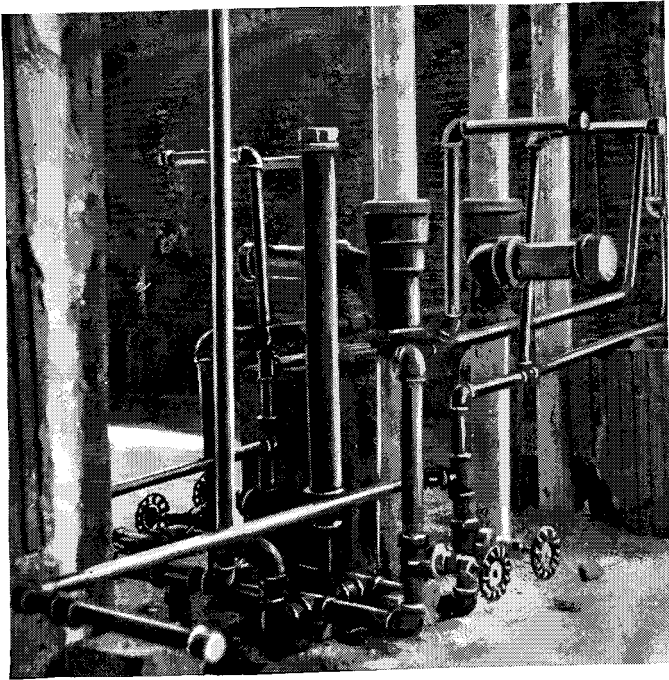

Walseal

Walseal Fittings and Walseal Valves are threadless bronze fittings and valves with the brazing alloy—Sil-Fos—incorporated as a ring in each opening. These modern fittings and valves were designed to improve copper and brass piping. The use of Walseal in the Buckingham Project proves that the braze-welded job on plumbing piping is obtainable at no increase in cost.

Wherever a large number of similar types of bath and kitchen units are to be installed, the use of Walseal Fittings and Walseal Valves is the surest way of making tight, non-ferrous joints at low cost.

Write for Catalogue 46 and booklet giving detailed information on "How To Make A Walseal Joint."

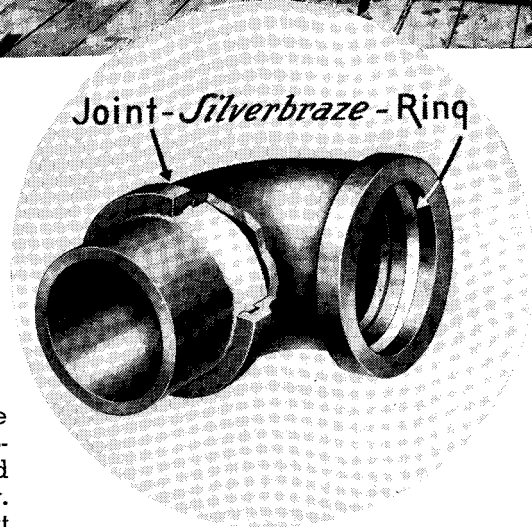

WALWORTH Drainage Fittings...
Cast Iron Screw Fittings... Malleable Fittings... Cast Iron Soil Pipe... Soil Pipe Fittings... are other Walworth Quality Products used on the Buckingham Project in the waste and vent piping.

WALWORTH

WALWORTH COMPANY
60 EAST 42nd STREET, NEW YORK

VALVES
FITTINGS
and TOOLS

Backed by
96 Years' Service

DISTRIBUTORS IN PRINCIPAL
CITIES THROUGHOUT THE WORLD

Excerpt from a letter addressed to Air Reduction
by Mr. A. S. Freed, Chairman of the Committee for
Economic and Social Progress and President of
Buckingham Community, Inc.

...ing about. How-
ever, we are sure you will find this an important relationship. For when we de-
cided to build Buckingham, as the finest example of large scale private housing,
we made very careful study of the materials market. Yours was one of the com-
panies selected to furnish materials for the project.

AIRCO appreciates this recognition by the builders of Buckingham

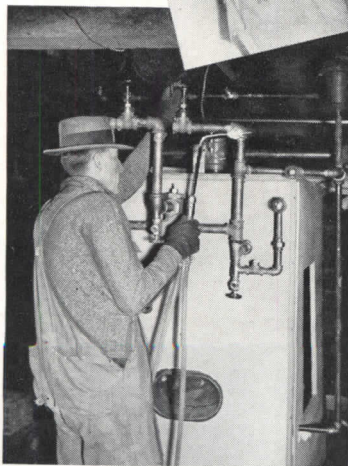
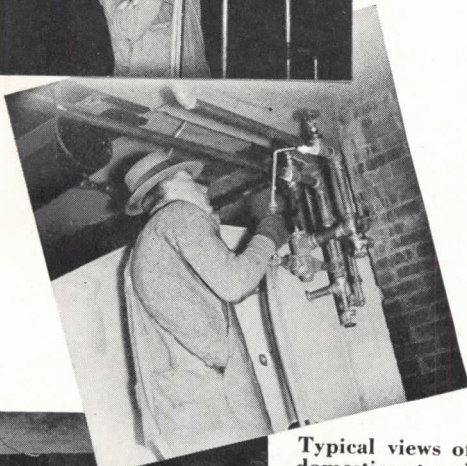
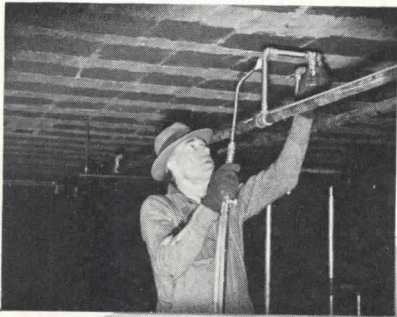

Typical views of the domestic water piping being installed in the 62 buildings of the Buckingham housing project. WAL-SEAL Threadless Bronze Valves and Fittings are being used practically throughout, assuring permanently leak-proof water systems. The brazing of these fittings, totaling approximately 80,000 joints, is being done entirely with AIRCO Oxygen and Acetylene and AIRCO-DB Apparatus.

AIRCO considers it a real privilege to participate, through the use of its products, in this valuable and far-reaching contribution to the progress of housing in America—the Buckingham project.

And AIRCO also values this additional confirmation of the established merit of its products, because selection was made after "very careful study of the materials market."

AIRCO Gases, and AIRCO Welding and Cutting Apparatus and Supplies, thrive on comparisons, for their exceptional quality, and their many time-labor-money saving features, make them stand out in any company.

In addition, there is the service that goes with AIRCO products—the cooperation of a trained and experienced engineering staff, available to all customers, for instruction in how to get the maximum benefit from the use of AIRCO products, and for solving special welding and cutting problems—a service worthy of the name.

AIR REDUCTION SALES COMPANY

General Offices: 60 East 42nd Street
New York, N. Y.

THE NATION-WIDE WELDING AND CUTTING SUPPLY SERVICE
OFFICES and DISTRIBUTING STATIONS in PRINCIPAL CITIES

Anything and Everything for GAS and ELECTRIC ARC WELDING and GAS CUTTING



Boilers for solid fuel - stoker or hand fired. A size and type for every heating need.

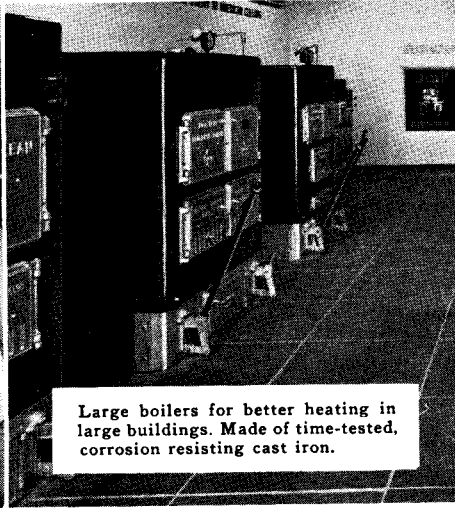

Large boilers for better heating in large buildings. Made of time-tested, corrosion resisting cast iron.



Oil Burning Boilers provide abundant domestic hot water as well as abundant, automatic heat.

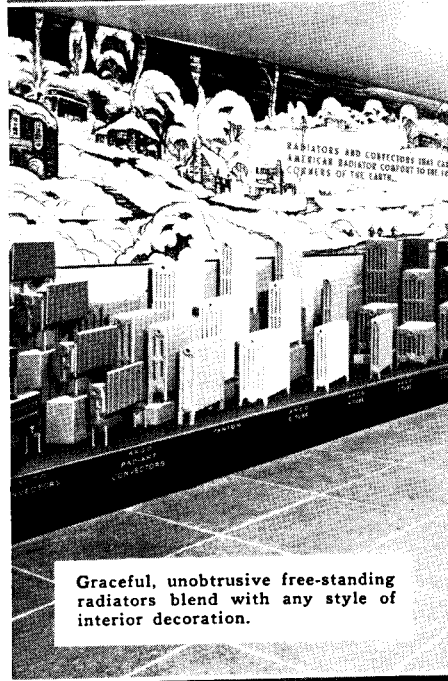

Graceful, unobtrusive free-standing radiators blend with any style of interior decoration.

World's Largest Manufacturer Offers
UNRESTRICTED CHOICE
of Heating & Air Conditioning Products

Born out of research in great thermal laboratories... backed by half a century's experience... American Radiator offers to the architect and builder the world's most complete line of heating and air conditioning products.

Some of them are illustrated here, as displayed in the amazing Comfort-Exhibit in the new showroom at 40 West 40th Street.

American Radiator occupies a dominant position in the housing industry. A staff of heating experts is always ready to assist you with plans, and recommend correct equipment for any heating or air conditioning installation.



New Radiant Convectors, concealed beneath windows, supply Radiant as well as Convected Heat.

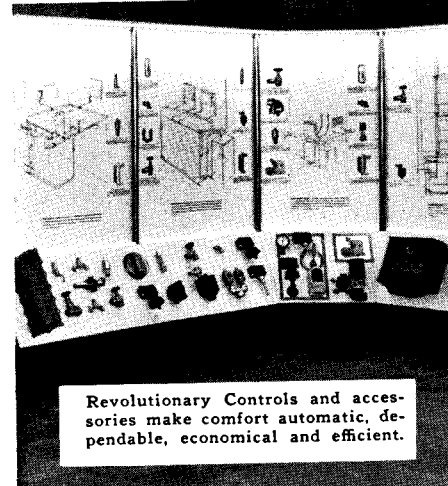

Revolutionary Controls and accessories make comfort automatic, dependable, economical and efficient.



Residential Air Conditioning that bears the *best known name in heating* - American Radiator.



Complete American Radiator Conditioning Systems provide every requirement for residential winter comfort.

AMERICAN RADIATOR COMPANY

DIVISION OF **AMERICAN RADIATOR & STANDARD SANITARY CORPORATION**

40 West 40th Street, New York, N. Y.

... and for *Buckingham Community* kitchens,
modern, money-saving Sealex Linoleum

HIGH in tenant appeal—low in cost and maintenance! Sealex Veltone Linoleum was a logical choice for kitchen floors in Buckingham Community homes.

The universal appeal of its rich marbled design ... its perfectly smooth sanitary surface which is so easy to clean ... its quietness and resilience underfoot ... no wonder Sealex Veltone Linoleum helps get leases signed quickly! And owners certainly appreciate the economy of Sealex Linoleum. Moderate in first cost, it never needs refinishing!

Installed by authorized contractors, Sealex Floors are backed by a guaranty bond fully covering your investment. Write for details.
CONGOLEUM-NAIRN INC., KEARNY, NEW JERSEY



SEALEX LINOLEUM
TRADEMARK REGISTERED

Floors and Walls

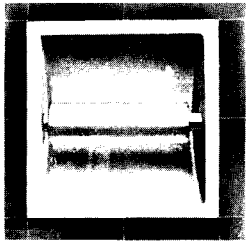
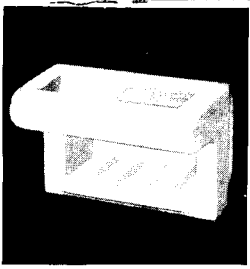
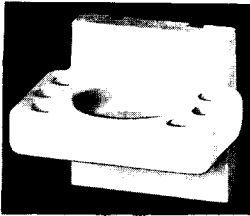

HIGH FIRED

*Bathroom
Accessories*
for BUCKINGHAM

On Buckingham, as on all jobs, BAY RIDGE bathroom accessories are guaranteed against crazing. BAY RIDGE specializes in making high fired colors to match various shades of tile.

BAY RIDGE SPECIALTY CO., INC.
Potteries - - - Trenton, N. J.

New York Office
67 West 44th Street

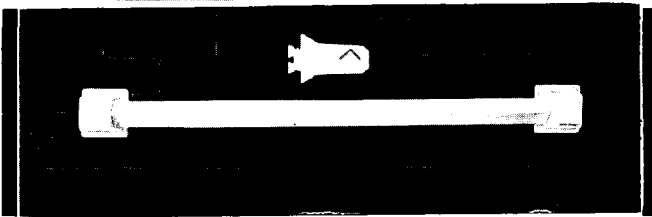

FIR REZO DOORS

as used in

BUCKINGHAM COMMUNITY PROJECT

For information
as to where these
can be obtained in
your vicinity,

write

**M & M Wood
Working Co.**
KENTON STATION,
PORTLAND, OREGON.

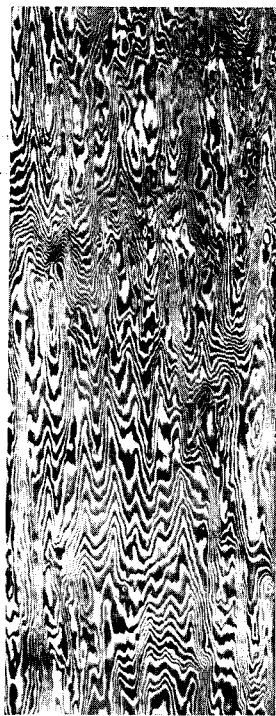

We are pleased to announce that

WHITE TOP PLASTER

*is being used exclusively
in the construction of*

BUCKINGHAM COMMUNITY BUILDINGS

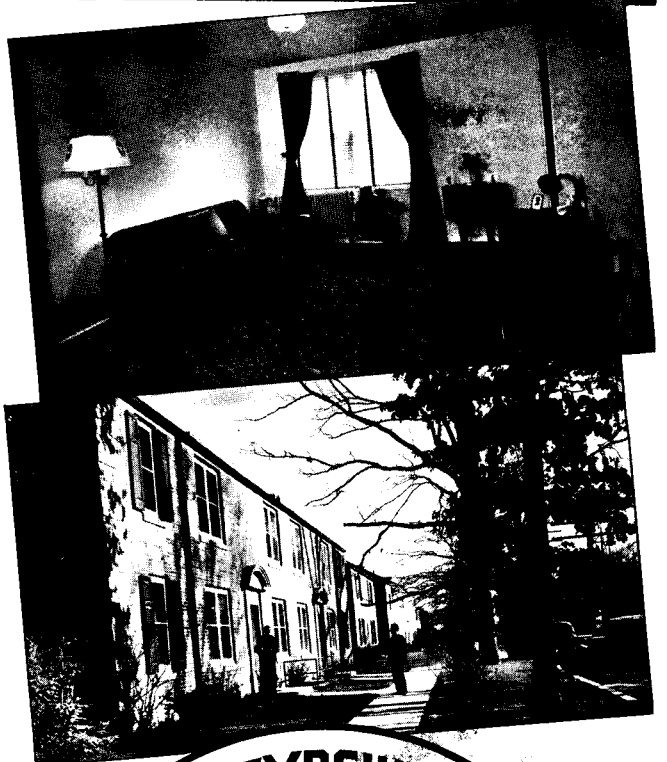

The MATHIESON ALKALI WORKS (Inc.)
GYPSUM DIVISION

Sales Headquarters
1625 ECKINGTON PLACE, N. E. - WASHINGTON, D. C.
A complete line of gypsum and related building products

**GYPSUM PLASTER—GYPSUM BLOCK
GYPSUM WALLBOARD—GYPSUM LATH**

BUCKINGHAM COMMUNITY—an excellent example of modern low-rental housing developments. Located just outside of Washington, D.C., at Arlington, Va. Every building is insulated with Johns-Manville Rock Wool Home Insulation.



Johns-Manville Rock Wool adds
YEAR-ROUND COMFORT and FUEL SAVINGS
to this *outstanding* housing project

MODERN building materials play a leading role throughout Buckingham's 62 multiple-family dwellings that are completed or under construction in Arlington, Va. Johns-Manville

Rock Wool Home Insulation is one of them, and its benefits are important to both the owner and the tenants.

Laid in full thickness over all top-floor ceilings, Johns-Manville Rock Wool makes rooms warmer and easier to heat even in bitter winter weather. On hot summer days rooms are up to 15° cooler. You'll find that better builders all over the country are using Johns-Manville Rock Wool Home Insulation in their houses for these reasons.

We have just completed a thorough investigation of 90 homes, in different parts of the country, that have been insulated with J-M Rock Wool from one to ten years. You will be interested in a report of this test, which shows convincingly that J-M Rock Wool gives exceptional service under all conditions and lasts as long as the house itself.

A copy of this performance report is yours for the asking. Write Johns-Manville, 22 East 40th Street, New York City.



APPLYING Johns-Manville Ful-Thick Rock Wool Home Insulation in an open attic.



JOHNS-MANVILLE
Rock Wool Home Insulation



SALUTE

TO BUCKINGHAM COMMUNITY

GENERAL ELECTRIC extends its heartiest congratulations to the many men whose vision, skill and untiring efforts have today resulted in one of the country's outstanding low cost housing developments—Buckingham Community, Arlington, Va.

It was an honor and a privilege for General Electric to assist in equipping this project, and to make available the facilities of its Home Bureau.

The consulting services of the Home Bureau are available to architects,

builders, realtors and home owners without charge. Home Bureau engineers and experts have access to General Electric's many years of experience and research, and they welcome all kitchen, wiring, lighting, heating and air conditioning questions. If you are faced with a problem in any of these fields, let the Home Bureau and its staff assist you in solving it. Address all inquiries: General Electric Home Bureau, 570 Lexington Avenue, New York City.

GENERAL  **ELECTRIC**

"Buckingham gave us a problem"



HERE IS HOW WE SOLVED IT

A new up-to-date method of hanging more than thirty thousand windows on the Buckingham Community, with Unique Sash Balances instead of the usual weights necessitated a revolutionary change in the type of weather stripping.

In addition, several thousand doors were thoroughly weather-proofed.

The confidence of Engineers in selecting the ACCURATE METAL WEATHER STRIP CO. for this exceptional operation, places us at the lead in the industry.

We announce several new and exceptionally effective weatherproof brass saddles."

F. W. Kammeret

ACCURATE METAL WEATHER STRIP CO.
216 East 26th Street, New York, N. Y.

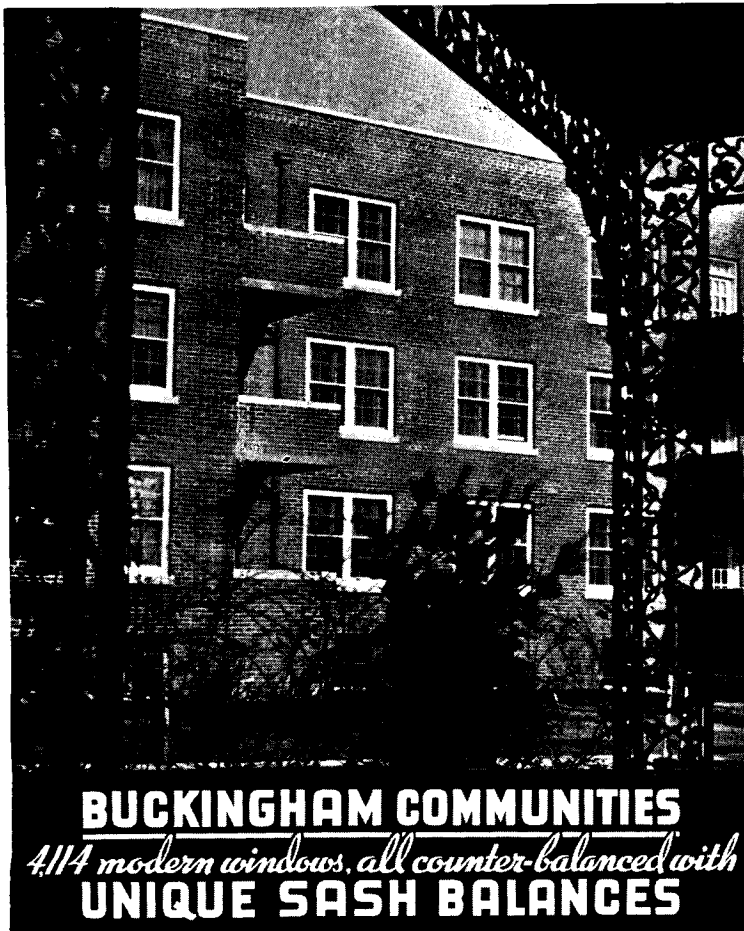

BUCKINGHAM COMMUNITIES
4,114 modern windows, all counter-balanced with
UNIQUE SASH BALANCES

The Same Story

A GAIN and again as in thousands of buildings—UNIQUE Sash Balances in modern window construction. A few lines tell the reasons:

Weathertight and better window construction

Narrow mullions and narrow trim

Maximum light and more wall space

Perfectly balanced sash and trouble-free windows for the life of the building

The Unique Sash Balance makes all this possible at no added cost and a saving in many cases.

LITERATURE SUPPLIED ON REQUEST

UNIQUE WINDOW BALANCE CORP'N
295 East 133rd Street New York, N. Y.

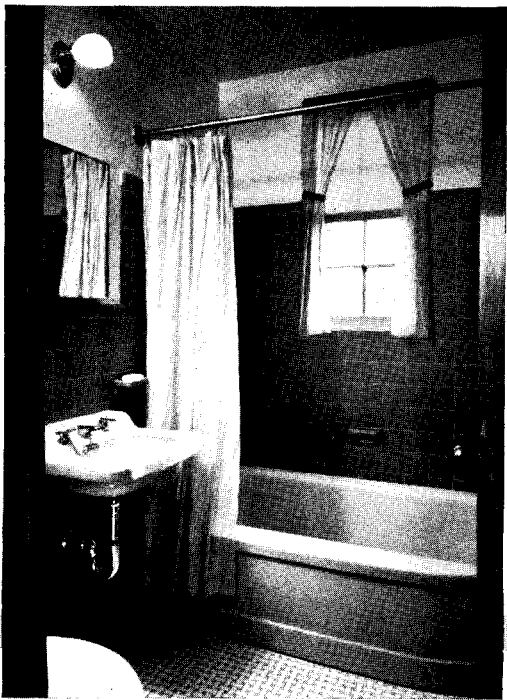

ALL BUCKINGHAM BATHROOMS EQUIPPED

with

BRIGGS

Beautyware
PLUMBING FIXTURES

● Color in the Buckingham bathrooms contributes charm and individuality. A safety bottom tub with rim seat and a 2¼ gallon capacity lavatory illustrate how Briggs Beautyware provides comfort and economy of space.



CREATING A NEW SENSE OF PERSONAL LUXURY FOR THE FAMILY



● The pleasing effect of the colorful Briggs Beautyware bathrooms complements the attractive exterior of this and all other Buckingham mansionettes at Arlington, Va.

WITH sparkling beauty that immediately attracts the eye, Briggs Beautyware bathroom, kitchen and service room fixtures add a note of distinction and utility to every home. A high-luster porcelain enamel, acid-resisting finish in single or two-tone color combinations on a pure ingot iron base, guarantees long life and enduring beauty. Complete, practical specification and model data covering a wide range of fixtures is a further incentive to always specify Briggs Beautyware.

BRIGGS MANUFACTURING COMPANY
PLUMBING WARE DIVISION • DETROIT, MICHIGAN



● Striking a new note in multiple home unit construction, Buckingham establishes a practical pattern for better living through the use of Briggs' smart, modern plumbing fixtures.

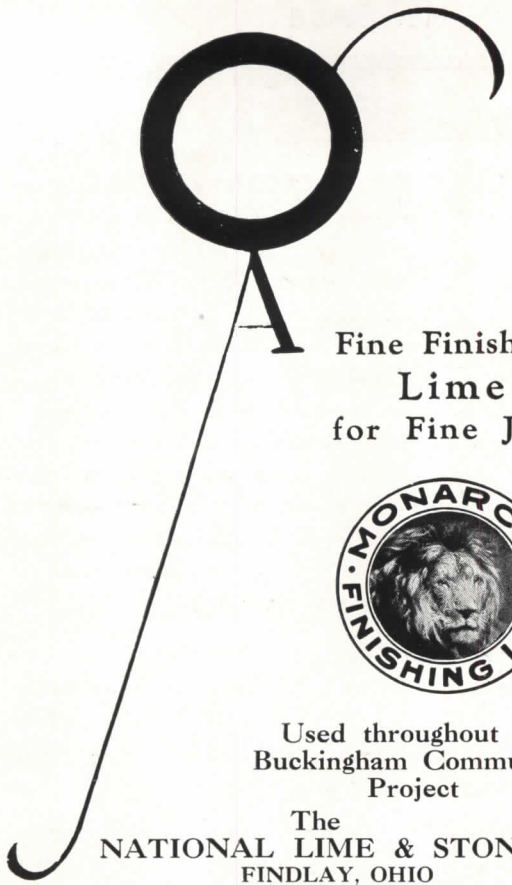

**Fine Finishing
Lime
for Fine Jobs**



Used throughout on
 Buckingham Community
 Project

The
NATIONAL LIME & STONE CO.
 FINDLAY, OHIO

Reprints
 of the story on
BUCKINGHAM

**Available for distribu-
 tion to those interested.
 While they last, copies
 will be mailed without
 charge in the order of
 receipt of applications.**

Address Librarian

ARCHITECTURAL RECORD
119 WEST 40TH ST., NEW YORK, N. Y.

ANTONIN RAYMOND

HIS ARCHITECTURAL WORK

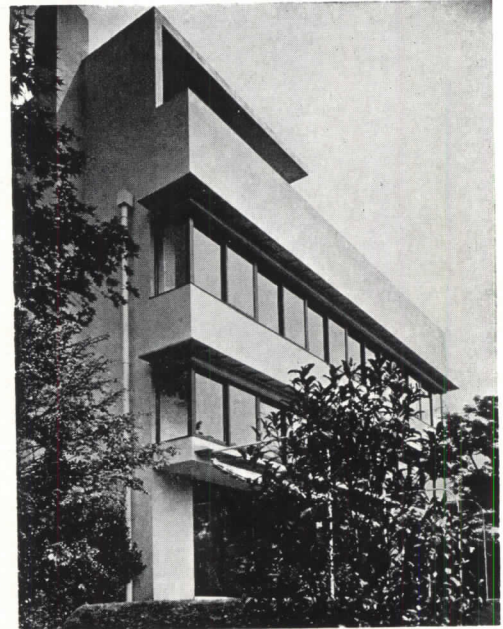

172 pages, 11 by 12 inches. Cloth. 294 illustrations, including exterior and interior views, details, plans, models. \$6, postpaid, in United States.

This book is the pictorial presentation of the work of an American architect—born in Europe—who has practiced chiefly in Japan and who has more than 400 buildings to his credit there. It contains many residences, including a number of summer cottages, as well as schools, factories, office buildings, public buildings, etc. Among the buildings shown are the Tokyo Golf Club, the Architect's own residence, the French Embassy at Tokyo, the Russian Embassy and Consular Buildings, and the factory of the Toyo Otis Elevator Company.

Raymond is notable for the freedom of his approach to all the problems involved—engineering, design and construction. He says, "I use new, modern materials, without disguise, because they are more economical and efficient than old materials. The finding of the very simplest form for everything is the only true solution."

THE ARCHITECTURAL RECORD,
 119 West 40th Street, New York, N. Y.

Enclosed is \$6.00 for which send me a copy of Antonin Raymond—
 His Work in Japan, 1920-1935.

NAME

ADDRESS

CITY and STATE.....

AR 1-38

JOURNALISM catching up with ARCHITECTURE

Ponder for a moment the extensive subject of architecture. Reflect on the events occurring daily which ultimately will affect your future and the future of the buildings you design. Reflect also on the trends under way which will do the same thing. And then, in terms of design, try and translate these events and trends into desirable standards for different types of buildings.

No wonder authorities state that architecture is going through a period of transition; no wonder schools are changing curriculums; no wonder editors are researching for approaches which will enable them—and you—to keep abreast of these kaleidoscopic developments.

It was in pursuit of the latter that *Record* editors hit on what we believe was a significant truth; *jour-*



nalism was lagging behind architecture! Accelerating developments were taxing the capacity of journalistic techniques evolved in calmer, less eventful days. They were appearing on the horizon so fast that editors and readers alike were deprived of that all-important requisite to comprehension—*perspective*. An isolated event, for example, would be given, in text and in picture, the emphasis of a bona fide trend, and often as not what was only a trend would be presented as an accepted standard.

To bring order out of this chaos, to enable journalism to catch up with architecture, the *Record* adopted a few months ago what in magazine circles is being called "the chronological approach." How this operates, what it means to you, is briefly reviewed below.

"THREE MAGAZINES WITHIN A MAGAZINE"



This section concerns itself with events relating to architecture. New buildings, new products and news of a professional, social or economic nature are reported as events only. They may foreshadow trends but only the passing of time will provide the perspective necessary for them to be recorded as such.



This section also embraces the entire field of architecture, but is restricted to trends. Recurring events of a similar character presage a trend. When investigation reveals that one is under way, and that it is important, someone is promptly given the job of analyzing it for *Record* readers.

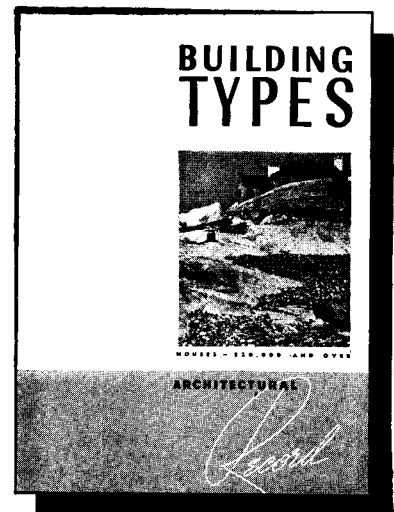

With the passing of time, trends may spend themselves or may emerge as standards for certain types of buildings. Editors of this section first determine those building types most important to the majority of *Record* readers, and then interpret current desirable standards for those types.

PUBLISHED BY F. W. DODGE CORPORATION

Inseparable!

MINNEAPOLIS-HONEYWELL
AUTOMATIC CONTROLS

AUTOMATIC HEATING AND
TRUE AIR CONDITIONING



**MINNEAPOLIS-HONEYWELL
REGULATOR COMPANY**

2804 FOURTH AVENUE SOUTH, MINNEAPOLIS, MINN.

LARGEST AND OLDEST MANUFACTURERS OF AUTOMATIC CONTROLS AND
CONTROL SYSTEMS. BRANCH AND DISTRIBUTING OFFICES IN ALL PRINCIPAL CITIES.

BROWN INDUSTRIAL INSTRUMENTS • NATIONAL PNEUMATIC CONTROLS

BUILDING TYPES



HOTELS - A Reference Study

ARCHITECTURAL

Record

Economic Aspects of Hotel Design

By R. STANLEY SWEELEY

LOOKING BACKWARD on the awesome total of \$159,439,200, which represents hotel construction contracts awarded in 1929, the total of \$16,841,300 for the first 11 months of 1937 seems paltry indeed. Between these figures, however, which are based on work in the 37 Eastern states, further examination reveals a slight but steady improvement since the low point of 1933 when the total was a little more than \$5,000,000 worth of contracts.

Analysis

A recent survey suggests that the larger part of this work was divided as follows:

1. *Resort hotels.* With winter sports becoming increasingly popular, there appears to be a wide trend toward winter vacationing. Reflecting this comparatively new tendency are a number of hotels projected solely or partially for the purpose of accommodating winter sports enthusiasts. Hotels of this type are often remote from urban centers, their location determined by the terrain. Planning must be comprehensive: elements like shoe repair shops, diverse amusement and entertainment areas, photo development rooms, and the like, many of them unnecessary in a centrally located hotel, must be included. Comparative isolation also makes necessary more complete pro-

visions for the storage of large quantities of supplies, both perishable and imperishable.

A large portion of the total work in 1937 was located in the South-eastern states.

2. *Modernization.* Alterations and additions have also accounted for a considerable portion of the hotel construction of the past year. Public areas have been primary objects of modernization, but the work has been extended to guest rooms and mechanical installations. This field will probably continue to absorb an important part of the total volume.

About 37 percent of the total hotel business is done in three states—New York, Illinois, and California—and preponderantly in the large cities of these states. It is also interesting that while the hotels of 300 rooms or more represent less than 2 percent of the total number of hotels in operation, nevertheless they account for almost 40 percent of all receipts. It is not surprising, therefore, that a large percentage of modernization work has been confined to the commercial hotels of the large cities, where, in addition, competition is particularly keen and where innovations are constantly sought.

Revenue and Expense

A recent survey of the United States Department of Commerce

states that slightly more than 80 percent of all hotel revenue is derived from room rentals and the sale of meals. Curiously, service is reported to be of primary importance from the guests' standpoint, while the quality of the food served is apparently a matter of secondary concern. From this, it should follow that the largest possible proportion of hotel space must be rentable. Further, the quality of service is certainly largely dependent on the plan and on the mechanical installations.

Among the minor departments of a typical hotel which are operated for profit, statistics reveal a uniform inclusion of the following: guests' laundry, cigar stand, valet, barber shop, garage, commissary, delicatessen or food shop, baths, beauty shop, newsstand, candy or soda shop, in the order named. These normally show a profit ranging in size from 51 percent for the valet department to 18 percent for the cigar stand. On the other hand, the telephone department, included in practically all hotels, generally shows a loss.

In regard to the supplying of heat, light, and power,* hotels now in operation are divided as follows:

- (1) 76 percent manufacture steam and buy electricity;
- (2) 18 percent buy both steam and electricity;
- (3) 5 percent manufacture both steam and electricity.

The hotels in Group (1) have a normal net cost for heat, light, and power of \$.23 a room a day against a net cost of \$.33 for Group (2) and \$.262 for Group (3). This does not mean necessarily that it is cheapest to manufacture steam and buy electricity. For the hotels of Group (1) are smaller than those of Group (2) or (3) and have a lower average room rate. Careful consideration must be given to the local rate and fuel situation before making a decision as to the type of equipment to be installed.

Since a complete and detailed treatment of hotels is impossible within the space of this study, a bibliography is included for further reference.

*A comparison of operating costs, and revenues, based on these classifications, is presented in "Normal Hotel Operation" by John Courtney, Department of Hotel Administration, Cornell University.

TREND IN HOTEL CONSTRUCTION SINCE 1929

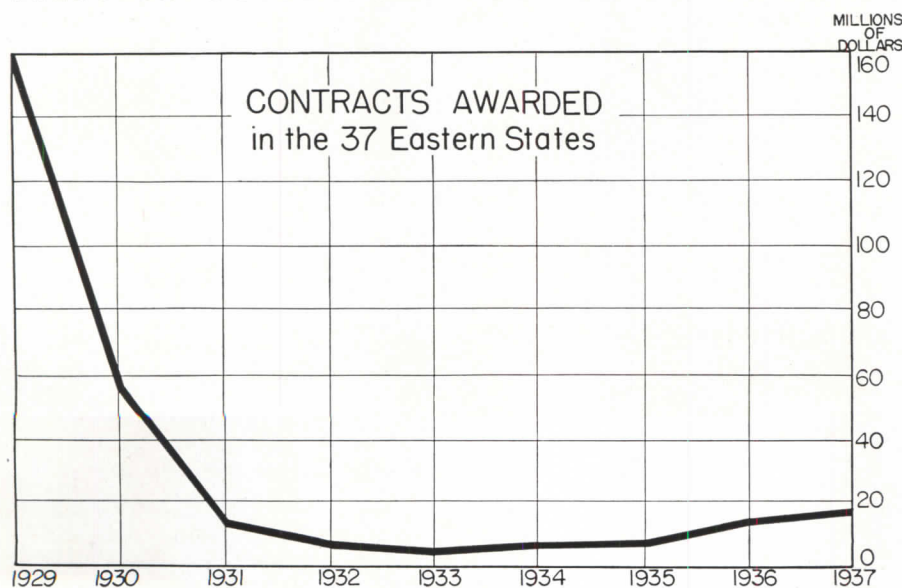

Standards in Planning Today's Hotel

By F. H. RANDOLPH and C. I. SAYLES

F. H. RANDOLPH,
Professor of Hotel Engineering, Department of Hotel Administration, Cornell University; and experienced Hotel Engineering Consultant.

C. I. SAYLES,
Assistant Professor of Hotel Engineering, Department of Hotel Administration, Cornell University; and Manager of Star Lake Inn, Star Lake, N. Y.

THE HOTEL is a business whose organization must be planned as carefully as an automotive assembly plant. Its chief functions are the sale of rooms and food. However, service is of paramount importance and is receiving distinct emphasis.

Architects may take pride in the fact that the best designed hotels attract the greater percentage of the desirable public. From the guest's standpoint, service is the deciding element in the selection of a hotel. Victor F. Ludewig determined this from 357 anonymous guests selected at random from numerous hotels. His findings, reported in Bulletin 6 of the Department of Hotel Administration at Cornell University, are shown abridged in Table I.

Of particular note is the emphasis laid on personal service, and the neglect of "modernity." However, those who support contemporary concepts of design need not be dismayed, for their case is strengthened by the conclusions reached. In the first place, although an attempt was made to secure representative replies, the average rate paid by this group of guests

TABLE I — PERCENTAGE OF TIMES EACH FACTOR WAS MENTIONED AS IMPORTANT IN HOTEL SELECTION

| | |
|-------------------------------|-----|
| Food Quality | 0 |
| Personal Service | |
| Courteous service | 19 |
| Cleanliness | 9 |
| Quiet | 6 |
| Privacy | 3 |
| Subtotal | 37 |
| Equipment | |
| Comfortable equipment | 14 |
| Surroundings | 4 |
| Radio in room | 3 |
| Modernity | 0 |
| Subtotal | 21 |
| Social | |
| Reputation, prestige | 11 |
| Type of patronage | 7 |
| Subtotal | 18 |
| Economic | |
| Rates | 14 |
| Food prices | 3 |
| Subtotal | 17 |
| Site | |
| Parking space | 5 |
| Convention headquarters | 1 |
| Location | 1 |
| Subtotal | 7 |
| TOTAL | 100 |

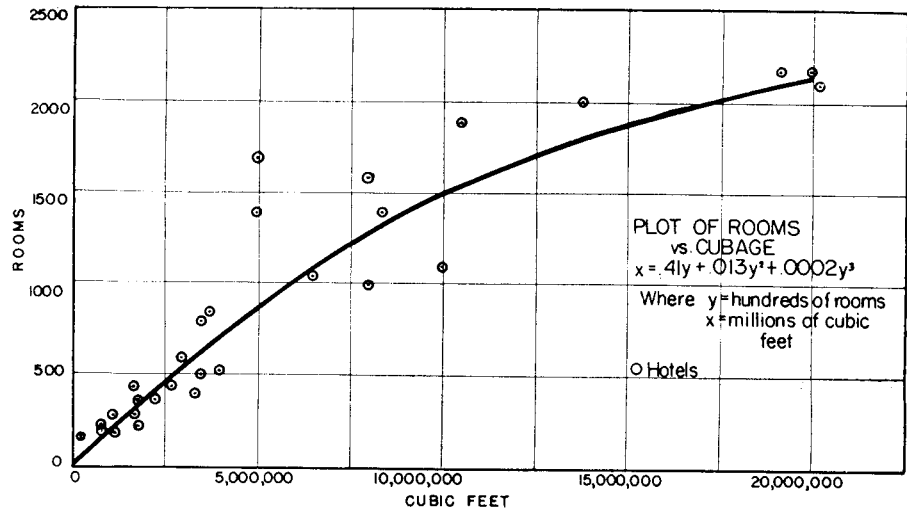

Figure 1

was \$3.31 per day, the implication clearly being that the hotels patronized were relatively up-to-date.

In the second place, the very factor so strongly emphasized, that of service, is a direct result of modern planning, for without the telephone, internal communication systems, the properly arranged front office, high speed elevators advantageously located, wisely selected storage and service facilities, and a host of other items, good hotel service could neither be provided nor maintained. And so, the intangible value of service becomes the concern of the architect, the engineer, and the operator, all working closely together within the boundaries imposed by cost.

Classifications

Hotels may be classified as:

- Transient commercial.
- Residential or apartment.
- Combined transient and residential.
- Resort: either all year round or seasonal.

Aside from trends in specific community needs, the public's preference in certain large metropolitan areas, is definitely for residential hotels. This is necessarily so where wealth is concentrated and residences are

being forced farther and farther from business centers. This does not imply, *per se*, that all communities need residential hotels.

An apparently opposite trend is found in the seasonal mountain resort. Not so long ago, one large frame building supplied all of the needs of a vacation-seeking clientele. The present trend indicates that a central recreation and dining building surrounded by a group of cottages is now the preferred arrangement. This is as close as the resort can come, financially, to fulfilling the guest's desire for quiet, privacy, and freedom from fire hazards, which are inherent in the more modern city structure.

The size of a first-class hotel, centrally located, is largely determined automatically. The minimum size of an available hotel will be fixed by the ground rent of the space it occupies, the maximum size by numbers of potential guests available. Between these two extremes, in the long run, is not so wide a margin as might be supposed.

Space

The cubage of the hotel as related to rooms, is illustrated in Figure 1. Notice, by way of contrast, that the cubic footage per room for the smaller



Photo by Hedrich Blessing

Lobby, Hotel Shoreland, Chicago

hotel is less than for the larger hotel. The hotel of 500 rooms (and under) has about 5,000 cu. ft. per room, while the large hotel of 2,300 rooms has about 10,000 cu. ft. per room. This is because the larger hotel has more public space per room, more adequate service areas, and in addition may have engine rooms where its own power is made.

Rooms

Today, guests are requiring fewer suites than formerly: roughly, half as many. In order to obtain the most flexible arrangement, the architect and hotel man are building suites which, fundamentally, are separate guest rooms and which may be sold as such if their use in suites is not warranted. Figure 2 shows a desirable arrangement, but it should be

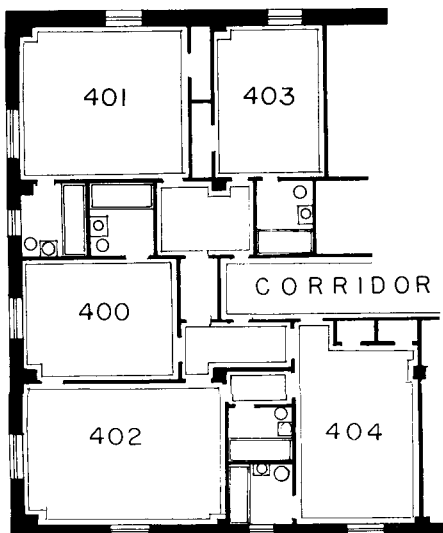

Figure 2

borne in mind that the keys to Rooms 400, 401, and 402 should also unlock the common vestibule door opening into the hall, and that the common door should bear the room numbers of the doors concealed by it. The entire matter of master keys, sub-master keys, and grand master keys had best be taken up with one of the large concerns manufacturing locks.

Two rooms with a connecting bath are no longer easily sold, not even in resort hotels. Connecting rooms are still wanted, but each should have its separate bath. In the future, it may not be surprising to see a few rooms each equipped with two complete bathrooms.

Guests are not too particular about the size of the room, provided it has adequate closet facilities. In this respect, men are rapidly becoming as critical as women. Where stays are of long duration and rates are high, the size of the room becomes a matter of more concern. In resorts, a room 12' x 18', unbroken by projections, is considered very desirable. In general, the partitions of the room should be built around its desired complement of furniture. Twin beds are generally preferred. The following areas are suggested:

| | |
|--------------------|-----------------|
| Single rooms | 142-156 sq. ft. |
| Double rooms | 170-236 sq. ft. |
| Parlors | 180-225 sq. ft. |
| Sample rooms | 244-267 sq. ft. |

These are not, of course, standardized sizes. Space for clothes-closets and bathrooms is additional.

Dining Areas

Today's social habits are to some extent bringing into demand the more formal types of public rooms. The grand ballroom of many a hotel, so long the despair of the operator, is finding a gradual return to favor. The hotel is certainly being used more widely for outside social affairs than before, although much of the activity is centered around the bar. Here emphasis is no longer laid on ceiling height; the emphasis has shifted to providing adequate ventilation. In general, ceiling heights have been gradually dropping in the public rooms of hotels and in guest rooms, as well, the minimum being about 9 ft. for bars and cafes, 10 ft. for lobbies, and 8 ft. for guest rooms.

Except for special occasions, however, a formal atmosphere is not wanted by the average guest of today. The formal dining room is frequently deserted in favor of the coffee shop, grill, or cafe, where lower prices

prevail. The place of the formal dining room is being taken by banquet rooms for private parties, or by roof gardens where dinner dances and floor shows may be held. Just what type of food service facilities should be provided is a reflection of the community and its preferences.

The space devoted to these various dining rooms, together with the capacity in persons served per seat per hour, may be determined arbitrarily as follows:

| | Sq. ft. per seat | Meals served per hour |
|--|---------------------|-----------------------------|
| Waiter service dining rooms | 14 | 1-1½ |
| Banquet rooms | 10 | |
| Lunch rooms and coffee shops with counter service | 18 | 3½ |
| Same, with table service in addition | 16 | 2½ |
| Cafeterias | 15 | 2½ |
| Fountain tea rooms..... | 15 | |

Kitchens

The sizes of the kitchens to supply these dining rooms are determined as follows:

Kitchens for food service only—45% of total dining room space.
Food and drinking facilities—45% of total dining room space.

Hotel lunchroom kitchens:

- (1) Complete preparation and cooking facilities—40% of dining and counter space.
- (2) Complete preparation, cooking, and drinking—43% of dining and counter space.
- (3) Bulk cooking received from main kitchen—25% of dining and counter space.
- (4) Drinking, additional to (3)—30% of dining and counter space.

Cafeteria counter and kitchen space for complete preparation—42% of dining space.

Cafeteria kitchen proper—30% of combined dining and serving space.

Banquet kitchens of service type with cooking from main kitchen—25% of banquet dining space.

Complete preparation for banquet service—42% of banquet dining space.

Storage

Storeroom and storage refrigerator space cannot be so specifically determined, though, in general, 25% of the area of the kitchen may be taken. This does not apply to installations where large quantities of food must be held in storage. Bake shops average in size about 25% of the main kitchen area.*

Area Check List

There is no relation, and there should not be, between the size of the city hotel and the size of the dining room facilities. The sizes of lobby

* (Above values taken from C. W. Schroeder, Pick-Barth, and others.)

bies, lounges, combined lobbies and lounges, and laundry space are indicated by the graphs of Figure 3.

The multitude of space requirements for the working part of a hotel are best explained by specific example. The following represents the spaces and their sizes for a well-planned hotel of 350 rooms which will generate its own steam and electricity. Considerable variation may well be expected in different hotels of this size.

| | Sq. Ft. |
|----------------------------------|---------|
| 1. Public Space | |
| Lobby (incl.) | 4,300 |
| Front Office | |
| Auto Club | |
| Porter's Desk | |
| Well Hole | 2,000 |
| Lounge | 1,500 |
| Writing Room | 500 |
| Ladies' Toilet | 300 |
| Ladies' Parlor | 300 |
| Mens' Toilet | 400 |
| 2. Concession Space | |
| Barber's Shop (7 ch.) | 700 |
| Beauty Parlor (4 ch.) | 700 |
| Cigar and News Stand | 150 |
| Valet | 500 |
| 3. Sub-rentals (7 stores) | |
| Florist | 500 |
| Men's Shop | 800 |
| Dress Shop | 800 |
| Telegraph | 800 |
| Additional Store No. 1 | 800 |
| No. 2 | 800 |
| 6 Storage Spaces at 150 | 900 |
| Drug Store | 1,500 |
| Storage Space | 300 |
| Broker's Office | 1,000 |
| 4. Food Service Space | |
| Main Dining Room | 2,950 |
| Check Room | 85 |
| Pr. Dining Rooms (2) | 1,370 |
| Ball Room | 3,620 |
| Service Pantry | 700 |
| Check Room | 150 |
| Main Kitchen | 3,500 |
| Steward's Storerooms | 3,500 |
| Help's Dining Room | 660 |
| Coffee Shop | 3,415 |
| 5. Guest Room Space | |
| Rooms (each) | |
| Single | 142 |
| Double | 170 |
| Parlors | 180 |
| Sample | 244 |
| Linen Room (each floor) | 200 |
| Linen Chute (each floor) | 9 |
| Slop Sink (each floor) | 25 |
| Rubbish Chute | 9 |
| Corridors (each floor) | 1,610 |



Photo by Emile Denisson

Lobby, Hampshire House, residential hotel, New York City. Dorothy Draper, Inc., Decorators. A. Rollin Caughey, Architect

| | | | |
|---|--|--|-------|
| Elevator Shafts, Guest; Elevator Foyer; Elevator Shafts, Service; Service Corridor; Stairways (width 5'+) | | Paper Hanger and Painter | 200 |
| | | Refrigeration | 1,200 |
| | | Compressors; Condensers; Brine Storage; Ice Freezing Tank; Ice Storage Room; Ice Crushing; Brine Pumps | |
| | | Heating and Ventilating Fans (as required) | |
| | | Air Washers 8' x 20' | |
| | | Ducts | |
| | | Vacuum Pumps (2) | 30 |
| | | Linen Facilities | |
| | | Receiving Room | 200 |
| | | Laundry | 1,500 |
| | | Clean Sorting Room | 225 |
| | | Housekeeper's Office | 180 |
| | | Mending Room | 210 |
| | | Main Linen Storage | 300 |
| | | Cot and Mattress Storage | 260 |
| | | Blanket Storage | 240 |
| | | Help's Facilities | |
| | | Locker Rooms (2) | 300 |
| | | Wash Rooms (2) | 210 |
| | | Toilets (2) | 150 |
| | | Miscellaneous | |
| | | Paper Chute | 12 |
| | | Baling | 500 |
| | | Garbage Storage | 200 |
| | | Package Room | 100 |
| | | Trunk Room | 300 |
| | | Furniture Storage | 510 |
| | | Offices | |
| | | Executive | 400 |
| | | Accounting | 475 |
| | | Receiving Clerk | 140 |

6. General Service Space

| | |
|----------------------------|-------|
| Steam Production | |
| Boiler Room | 1,500 |
| Fuel Storage | 250 |
| Ash Handling | 110 |
| Ash Hoist | 25 |
| Boiler Stack | 80 |
| Feed Pumps | 65 |
| Draft Fans | 120 |
| Wash Room | 80 |
| Electrical Supply | |
| Engine Room | 1,200 |
| Switch Board | 100 |
| Transformers | 100 |
| Auxiliary Equipment | |
| Roof Tanks | 175 |
| Water Softeners | 120 |
| Salt Storage | 120 |
| Water Heaters | 150 |
| Water Pumps | 100 |
| Fire Pump | 30 |
| Sewage Disposal Pumps | 50 |
| Central Vacuum Cleaner | 35 |
| Engineer's Office | 200 |
| Engineer's Storeroom | 310 |
| Machine and Pipe Shop | 250 |
| Electrician and Locksmith | 300 |
| Carpenter and Upholsterer | 210 |

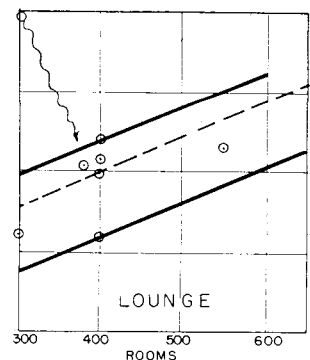
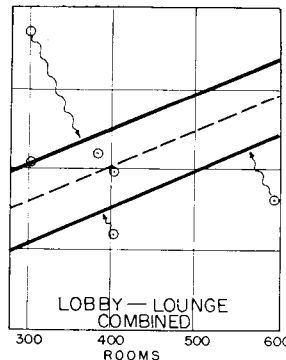
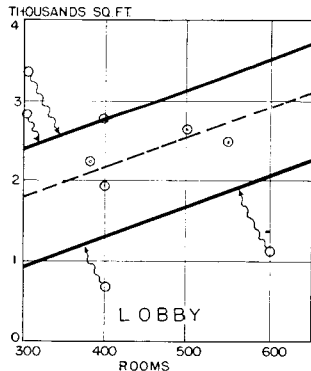
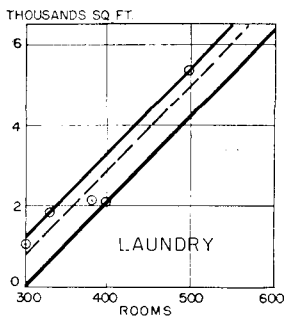

Figure 3

Area Integration

The correlation of the various areas indicated is a matter of some concern. The chart presented here, Figure 4, of Adjacency Relations of Fundamental Functional Areas, attempts to show the more important. These relations exist in all hotels, though in the larger hotels the dotted line connections are more remote, both in distance and in direct personal contact, direct supervision being delegated to subordinates. Double lines indicate necessity for close proximity.

In addition, two main arteries of travel must be before the architect: guests with their various aims must flow without congestion or cross traffic throughout the house, and employees must have ready access to their specific job areas, without interfering with and, in many cases, without being seen by guests. Although presumably obvious, the importance of this point must not be overlooked.

In general, the person who is not a resident guest, but who is using the hotel's facilities for dining and dancing, likes to reach his destination rather unobtrusively without having to parade across a lobby. He prefers a lounge nearby with checkroom and retiring room facilities in the immediate neighborhood. To a large extent, this meets the wishes of the manager as well, who in turn likes such gatherings to have no disturbing effect on the normal course of business and, if possible, to make minimum demands on elevator service. This indicates the desirability of banquet rooms and evening restaurants on or below the mezzanine.

Writing rooms should be made somewhat inaccessible to the general public in order to save stationery. The front office should be conveniently located to entrances, and the number of entrances should be as few as is feasible, to cut down the number of doormen and bellmen.

Office Areas

Executive offices should find a place in the plan in accordance with the chart showing relations of functional areas, their sizes conforming with general business office space. As the hotel increases in size, the functions of the manager's office will be delegated to other departments such as Maitre d'Hôtel, Executive Assistant Manager, Publicity Manager, Promotion Manager, and so on. Each of these needs his own office, which

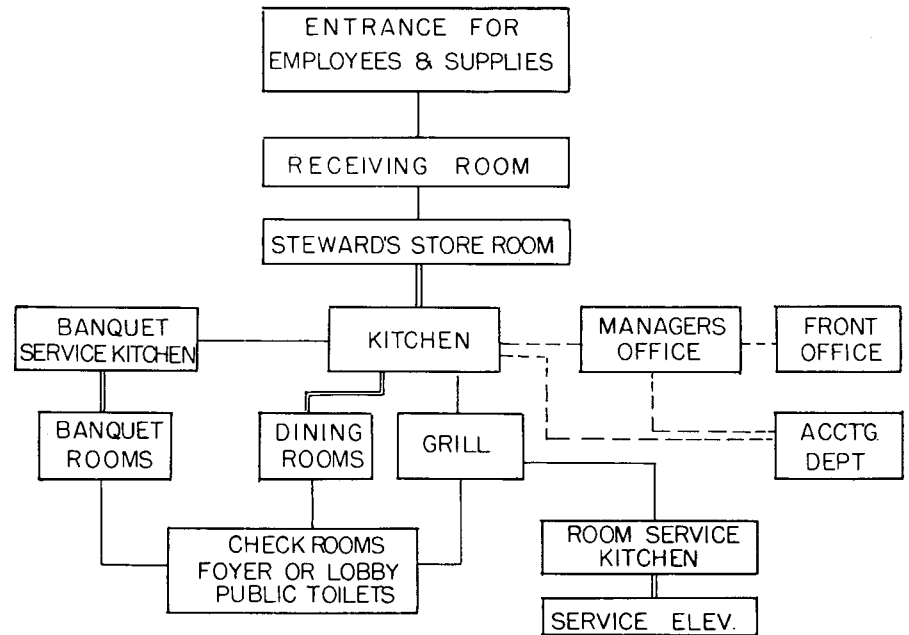

Figure 4. Adjacency relations of fundamental functional areas

should be about the size of the average guest room. Such departmentalization will not occur in hotels under 250 rooms, and may not go as far as indicated even in larger hotels.

Front-office planning, in general, must provide for registration clerks, information and mail clerks, and cashiers. In hotels of 100 rooms, all these functions will be handled by one clerk; from 100 to 200 rooms by two clerks; above 200 by three or more. The room clerks' area must adjoin the cashiers' area, with provision made for transmitting documentary information, but with personal access barred. It is desirable, too, to have the information clerk adjacent to the room clerk. Provision must be made for location of information racks and room racks, so placed that they are completely concealed from the guest, and the clerks can reach them with their right hand. In large installations, additional space may have to be provided for mail sorting rooms, tube rooms, and telephone information operators.

Storage Areas

A more complete analysis of storage spaces than that given in the functional analysis would run somewhat as follows:

1. Bulk storage of foods: groceries, canned goods, perishables (meats, vegetables, dairy products).
2. Beverage storage, some refrigerated.
3. Kitchen refrigerators for the day's use.
4. China, glass and silver storage.
5. Table linens.

6. Cleaning supplies, also brooms and mops in daily use.
7. Garbage, empty containers, glass bottles.
8. Banquet tables and chairs.
9. Kitchen fuel storage, if required.
10. Room service storage of service tables, bed tables, card tables, and folding chairs.
11. Maids' cleaning closets.
12. Storage for outdoor furniture and recreation supplies.
13. Housekeepers' supplies; linens, blankets, portable lamps, rugs, soap, toilet paper, glassware. Bed, mattress and pillow storage, uniforms.
14. Record storage, house bank storage—both in form of vaults.
15. Screens, awnings, storm windows and doors.
16. Storage spaces for subrentals.
17. Storage of printed stationery and accessories.
18. Wastebasket rubbish from guest rooms.
19. Engineer's storeroom: lamp bulbs, plumbing supplies, duplicate keys.
20. Guest property storage: vault space for money and valuables; trunk storage, hand baggage checkroom in charge of porter or bell captain near lobby, package room for mail and delivery packages, dogs.

Extra spaces needed for resorts.

The importance of these various areas depends upon the size of the hotel.

Hospital Facilities

Hospital facilities will probably take up the space allotted to two or three guest rooms. They should be on the mezzanine or lower floors, and should be adequately supplied with plumbing, lighting and ventilation facilities, and electrical outlets. They

should be equally accessible to guests and staff and should be very near a service elevator, which in turn runs the height of the building and is reasonably accessible to the street.

Mechanical Equipment

In general, guests in emphasizing service, demand indirectly the latest in mechanical equipment. Among these are modern elevators; refrigerating units placed where needed throughout the hotel rather than centralized; ice cubes from individual pockets rather than broken from large pieces of ice; central vacuum cleaning systems; accounting machines; and many such devices.

Air conditioning is receiving much attention from hotel men just now. It is practically a necessity in restaurants and bars, and in some cases in public meeting rooms. Its use in cooling guest rooms is at present largely confined to hotels south of a line drawn from St. Louis to Washington, although some hotels are now experimenting with unit room coolers as far north as Chicago. Relief from hay fever is one of the values credited to an installation of this type. There is, at present, a compensating return from air conditioned rooms, which represents business drawn from establishments which are not air conditioned. When all competing places have once installed air conditioning, this preferential factor will disappear. Installation costs are running from \$200 to \$500 per ton of refrigeration required, the average being somewhere between \$200 and \$300. Extensive duct systems laid throughout a hotel impose an additional responsibility on the architect and engineer in eliminating smoke and fire hazards augmented by the presence of these flues.

Services

The guest has become accustomed, in large hotels, to having his laundry and valet work done while he sleeps. Hence, a valet department must be included, and in many instances a guest laundry as well. He likes the "In-a-door" type of service where he will not be annoyed by giving or receiving his garments.

To facilitate the delivery of messages, the Hotel Astor in New York employs an electrical device which lights a bulb in the guest room when a message is placed in the mail box.

As the hotel increases in ground area covered, the problem of vertical traffic becomes important. Two choices are open: complete centrali-

zation of elevators with closer supervision of intervals and speeds; or decentralization with less walking on the part of the guest from a remote wing to the central elevator.

Obsolescence

Style changes and a rapid technical advance determine obsolescence in hotels to a marked degree. Rates applied to an obsolescence factor may be as varied as the hotels, though with modern construction and developments, recently built hotels should not suffer greatly. Over the last twenty years this factor has been of decided importance in determining the practical abandonment or loss of prestige of many hotels. To attempt to evaluate it is extremely difficult, though in general hotels suffer more quickly than most other building types. Air conditioning is very apt to produce the most rapid obsolescence. In the past, the plant as a whole has become obsolete long before its physical life has come to an end; but the rate at which this has progressed has, in the past five years, slowed up considerably.

Maintenance

Proper design can do much to cut operating costs. Proper selection of wearing surfaces is the most common example. A combination of appearance, safety, wear, sanitation, and comfort is indeed hard to secure. Slippery and hard floors account for a large share of physical injury and dish breakage in the dining room and kitchen. Easily cleaned floors near entrances protect expensive rugs in public rooms; comfortable floors in elevators, front offices, and kitchens cut down employee fatigue, which is particularly expensive in terms of efficiency and morale.

Ceilings and lighting fixtures should be readily cleaned, from the

standpoint of appearance and primary and secondary light output. From a labor standpoint, walls should be easily renovated, bathroom corners should be rounded and wall-hung fixtures employed. Electric outlets in guest rooms should be so selected as not to receive the usual type of attachment. This prevents use of heating elements, with attendant line overload, expense, and damage to furniture tops. In this connection, in residential and resort hotels of the better class, ironing boards and outlets can well be built into the room.

To facilitate plumbing repair, pipe lines and conduits should be readily accessible; pipe shafts serving guest bathrooms should be large enough to enter and work in.

In existing structures, no particular fault seems to predominate, though isolated examples of poor planning serve to illustrate several points. The correlation between building and engine rooms has been unfortunate in some instances, requiring the removal of the dining room floor to re-flue a boiler, or the cutting away of foundation walls to dismount an engine part. Kitchens employing steam for cooking have been installed without steam boilers of high enough pressure to supply them. Facilities for supplying fuel have been so located as to interfere with normal street traffic. Improper traffic routes for employees have necessitated linen handling through lobbies or supply handling through dining rooms.

Costs

For a quick estimate of the cost of hotel construction, the per-room basis may be used. Professor John Courtney of the Department of Hotel Administration at Cornell University presents Figure 5, showing the relation between rate, volume per room, and cost per room. To differentiate for size of the hotel, Table 2 is used. The volume per room may be secured by computation from Figure 1.

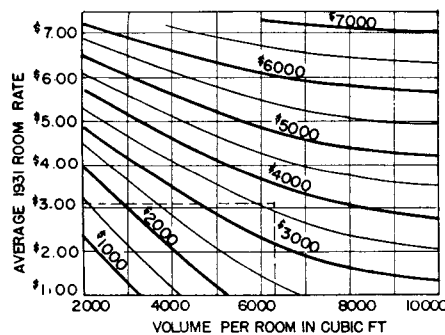

Figure 5. Normal building cost to the room for transient hotels according to the average room rate and volume.

| Size of hotel (rooms) | Multiply value obtained from Figure 1 by this figure |
|-----------------------|--|
| not more than 100 | 0.94 |
| 101 - 150 | 0.95 |
| 151 - 200 | 0.97 |
| 201 - 250 | 1.00 |
| 251 - 300 | 1.04 |
| 301 - 350 | 1.07 |
| 351 - 400 | 1.10 |
| 401 - 450 | 1.13 |
| 450 and over | 1.15 |

Table 2. Correction factors by which any value obtained from Figure 1 may be multiplied in order to correct for size of the hotel.



Sun Valley Lodge

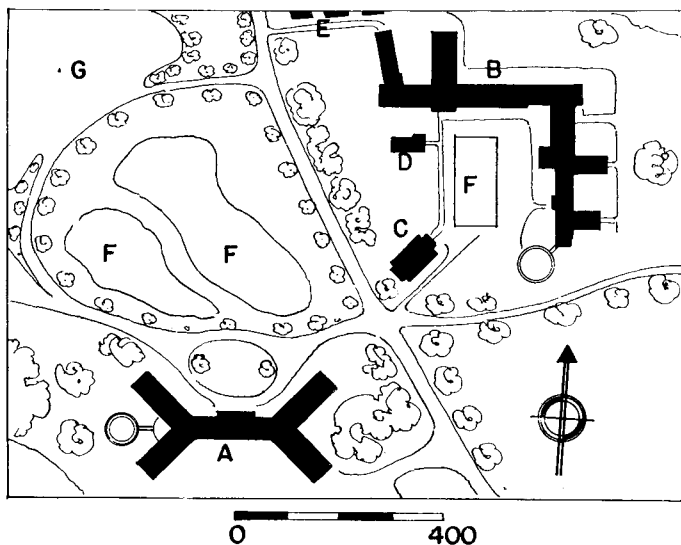

Plot Plan

- | | |
|-----------------------|---------------------|
| A. Sun Valley Lodge | D. Guesthouse |
| B. New Challenger Inn | E. Service Cottages |
| C. Theater | F. Skating Rink |
| G. Parking Area | |

SUN VALLEY KETCHUM, IDAHO

GILBERT STANLEY UNDERWOOD AND CO.
Architects - Engineers

THIS DEVELOPMENT is situated in a little sheltered valley and was oriented for maximum winter sunlight. The mountains which surround it, and which afford an extraordinary terrain and climate for skiing and other winter sports, determined the location. Because of Sun Valley's comparative isolation, it was necessary to include unusually large areas for storage and for employees' lodgings. Although intended primarily for operation during the three winter months, the resort is open for three months in the summer.

The facilities which sport demands—instruction, sale and storage of equipment, rest and recovery—are all provided for in the planning. The strenuous and somewhat hazardous character of some sports makes inclusion of a complete medical and surgical element a necessity in a hotel group so isolated.



New Challenger Inn — Rear of Theater at right

SUN VALLEY LODGE

First Floor Plan

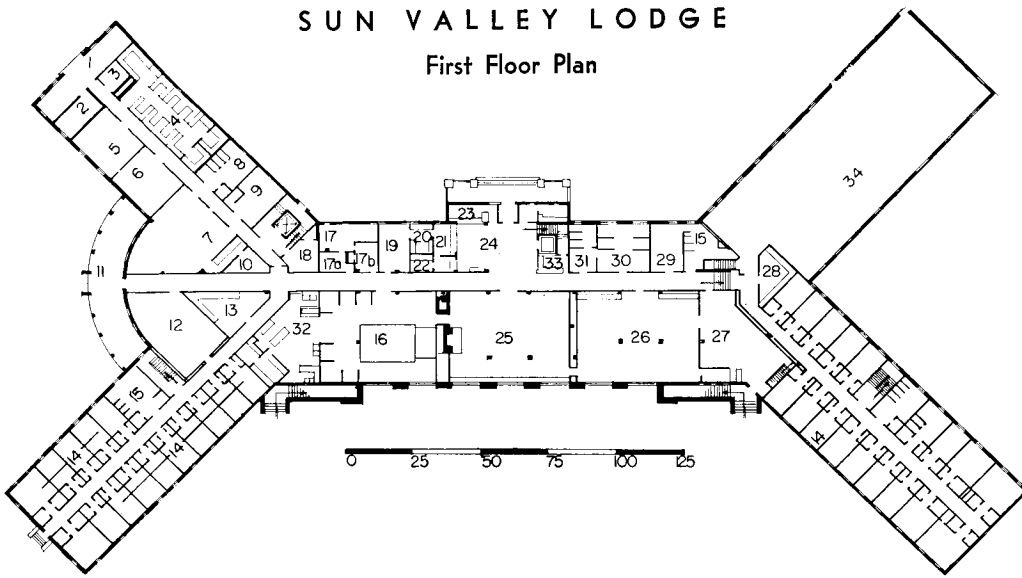

First Floor

1. Concrete Loading Platforms
2. Fireproof Storage
3. Steward's Office
4. Store Room
5. Ice Manufacture
6. Administrative Employees' Dining Room
7. Employees' Dining Room
8. Male Employees' Toilet
9. Valet
10. Scullery
11. Porch
12. Game Room
13. Locker Room
14. Bachelor Bed Room
15. Men's Toilet
16. Club Room with Dance Floor
17. Doctor's Office
- 17a. Nurse's Room
- 17b. X-ray Room
18. Soiled Linen Room
19. Manager's Office
20. Bookkeeper
21. Clerk
22. Vault (Cashier's Office Ad-joins)
23. Ass't Manager and Ski Master
24. Lobby
25. Lounge
26. Shop
27. Ski Room
28. Clean Linen
29. Barber Shop
30. Beauty Shop
31. Powder Room
32. Short Order Kitchen
33. Sales Stand
34. Male and Female Employees' Bedrooms

Second Floor Plan

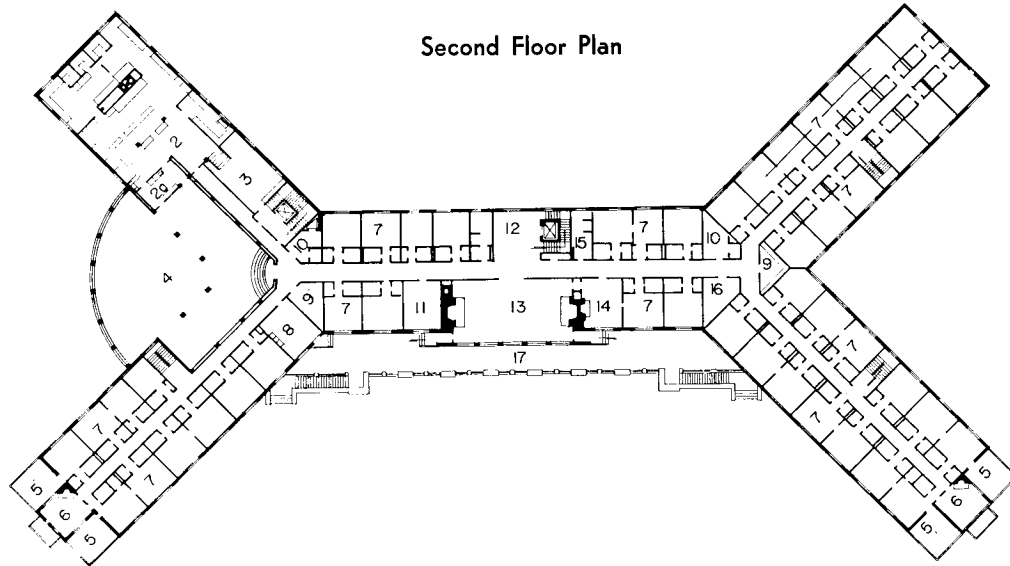

Second Floor

1. Bake Shop, Butcher Shop, Refrigerators
2. Main Kitchen
- 2a. Waiters' Pantry
3. Room Service Pantry
4. Main Dining Room
5. Sun Deck
6. Sun Room
7. Guest Rooms
8. Service Pantry
9. Fresh Linen
10. Soiled Linen
11. Card Room
12. Foyer
13. Sun Room Lounge
14. Sitting Room
15. Women's Toilet
16. Storage Room
17. Terrace

Third Floor Plan

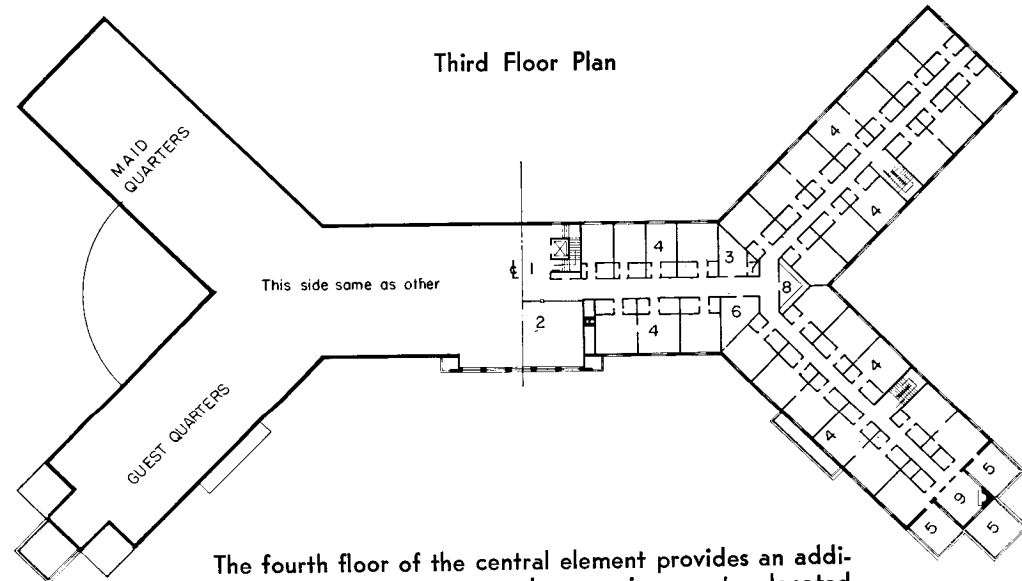

Third Floor

1. Foyer
2. Upper Part of Sun Room Lounge
3. Soiled Linen
4. Guest Room
5. Sun Deck
6. Storage
7. Janitor
8. Fresh Linen
9. Sun Room

The fourth floor of the central element provides an additional 14 guest rooms and a serving pantry located adjacent to the elevator lobby. On the south, three rooms give onto a private balcony. The entire lodge accommodates 250 guests.

PLAN OF NEW CHALLENGER INN

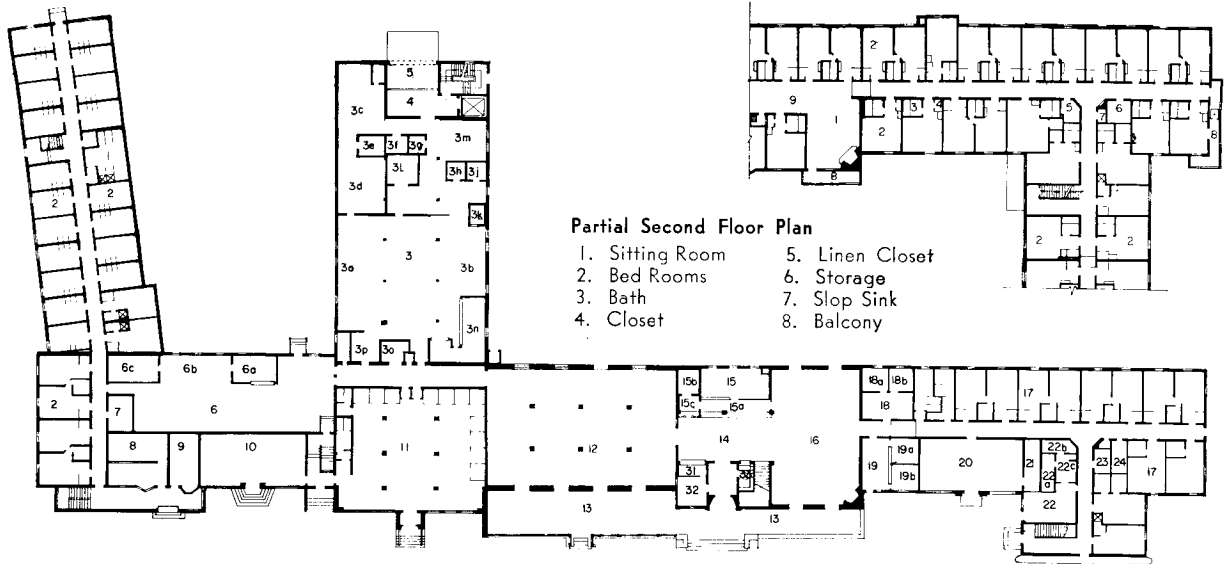

Partial Second Floor Plan

- 1. Sitting Room
- 2. Bed Rooms
- 3. Bath
- 4. Closet
- 5. Linen Closet
- 6. Storage
- 7. Slop Sink
- 8. Balcony

First Floor Plan

- 1. Male Employees' Baths
- 2. Male Employees' Bed Rooms
- 3. Main Kitchen
- 3a. Pantry
- 3b. Cold Meats
- 3c. Bake Shop
- 3d. Pastry
- 3e. Pastry Refrigerator
- 3f. Bakery Refrigerator
- 3g. Garbage Refrigerator
- 3h. Cooked Vegetable Refrigerator
- 3i. Fruit Refrigerator
- 3k. Cold Meat Refrigerator
- 3l. Scullery
- 3m. Room Service Pantry
- 3n. Dish Pantry
- 3o. Waiters' Pantry
- 3p. Checker (Linen Room Adjoins)
- 4. Loading Platform
- 5. Truck Area
- 6. Employees' Cafeteria
- 6a. Dish Pantry
- 6b. Service Area
- 6c. Kitchen
- 7. Linen Storage
- 8. U. S. Post Office
- 9. Shoe Repair Shop
- 10. Guest Recreation Room
- 11. Weinstube
- 12. Dining Room
- 13. Terrace
- 14. Lobby
- 15. Bookkeeper
- 15a. Clerk
- 15b. Vault
- 15c. Cashier
- 16. Lounge
- 17. Guest Bed Rooms
- 18. Secretary's Office
- 18a. General Manager's Office
- 18b. Assistant Manager's Office
- 19. Public Space
- 19a. Telegraph
- 19b. Ticket Office
- 20. Drug Store
- 21. Storage
- 22. Photo Shop
- 22a. Printing Room
- 22b. Desk Room
- 22c. Work Room
- 23. Linen Storage
- 24. Storage
- 25. Porch
- 26. General Store
- 27. Ski Shop
- 28. Batchelors' Dormitory
- 29. Women's Toilet
- 30. Men's Toilet (Dressing Room Adjoins)
- 31. Cigars and Newstand
- 32. Telephone Exchange
- 33. Checkroom
- 34. Men's Toilet
- 35. Women's Toilet

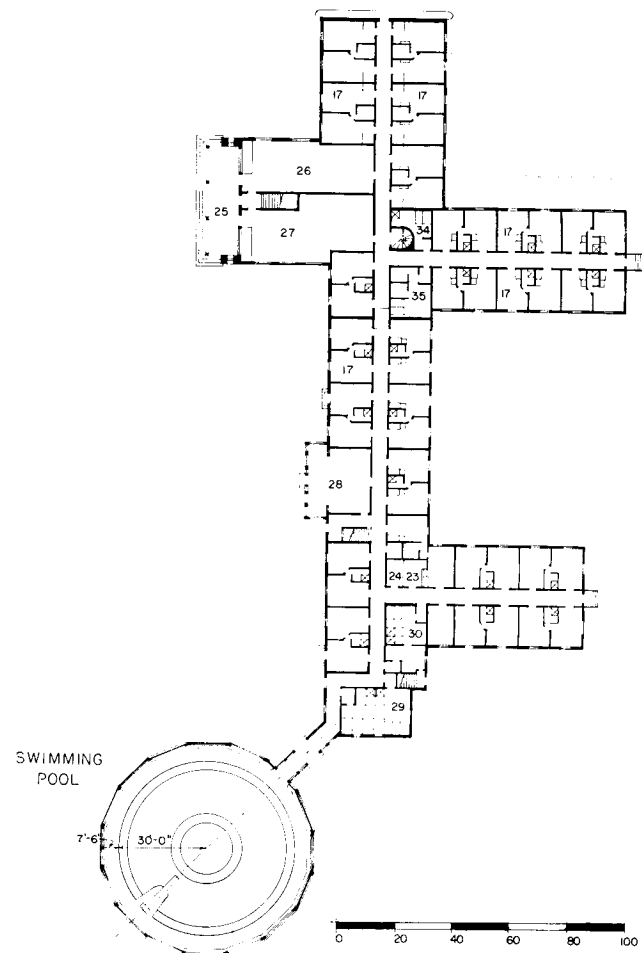

THE New Challenger Inn of Sun Valley, Idaho, is an independent plant furnishing shelter, food, and entertainment to 400 guests. Its major distinction, of course, is its unusual skiing ground, the towlines and other facilities of which the guests share with those of the Lodge, located some 200 yards to the southwest.

The Inn quadrangle includes a skating rink, 85' x 180', a small, detached guesthouse of 20 rooms, and a motion-picture theater seating about 500 persons. The open-air, glass-enclosed swimming pool is similar to one adjoining

the Lodge, and both are furnished with steamheated water for winter use. Tennis courts are also available for summer guests.

The structure devotes a considerable portion of its first floor to a shopping center, two dining rooms, recreation rooms, etc., and also includes a small night club. It is distinguished from its neighbor, Sun Valley Lodge, in that its furnishings and appointments are far less costly. This is logical enough, since rates are scaled for guests of more modest means.



SUN VALLEY LODGE

Swimming Pool

SCHEDULE OF EQUIPMENT AND MATERIALS

| | |
|--------------------|---|
| FOUNDATIONS | Concrete |
| STRUCTURE | Reinforced concrete |
| EXTERIOR | |
| Wall | Concrete poured against oiled forms with rough grain molded in concrete; regular horizontal "boards" spaced by horizontal battens; chemically stained to simulate rough plank |
| Roof | Wood-shingled roof on mopped two-ply felt, Colonial "Fit Tight" |
| Sash | Double-hung wood sash; bronze mesh screens |
| INTERIOR | |
| Floors | Reinforced concrete slabs, joist and pan system Finishes: cement and carpet; rubber tile in corridors and play room; tile in bath and toilet rooms |

| | |
|-------------------------|--|
| INSULATION | Rock wool and gypsum block |
| WATERPROOFING | Integral and asphaltic |
| HEATING | Steam, American Radiator & Standard Sanitary Corp.; Erie City boilers |
| AIR CONDITIONING | Air circulation and humidification |
| LIGHTING | Designed especially for Sun Valley: direct and indirect; flush-type in some cases—Schweitzer Bros., Inc. |
| HARDWARE | Brass, Sargent & Co. |
| PAINTING | Sherwin-Williams Co. |
| PLUMBING | Kohler Co. colored fixtures |
| GLASS | Standard and plate glass, Pittsburgh Plate Glass Co. |

Cost of Sun Valley Lodge: 45c per cu. ft.; total, \$800,000. Furnishings and landscaping, an additional \$370,000.



Sun Room Lounge



South Terrace



Sun Room Lounge



Dance Floor

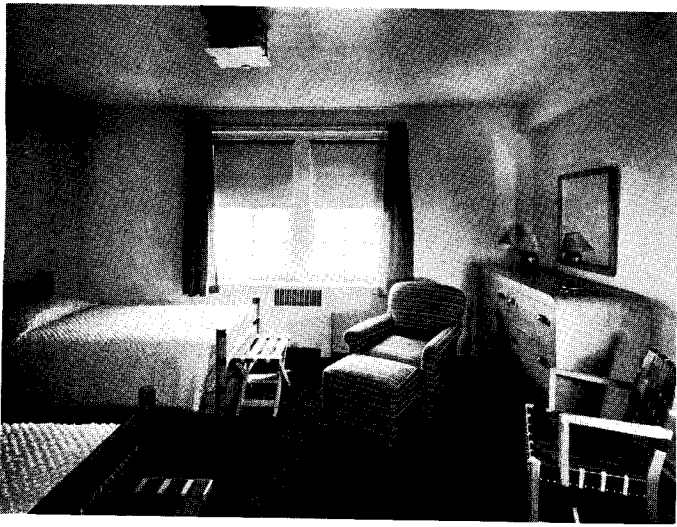

Guest Double Room

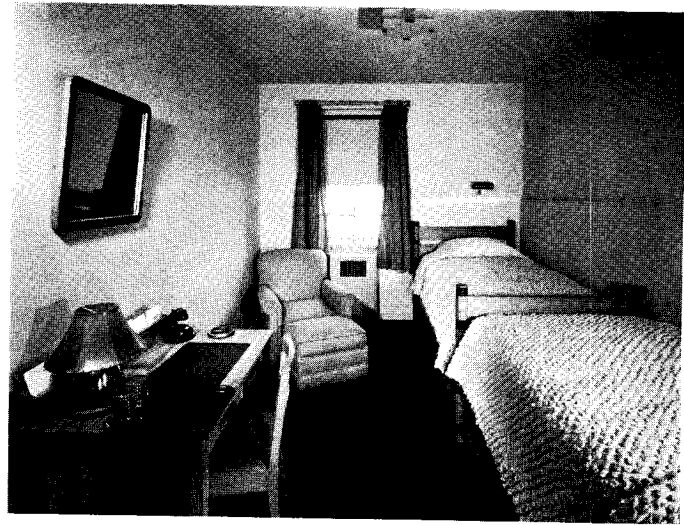

Bachelor Double Room



Main Dining Room

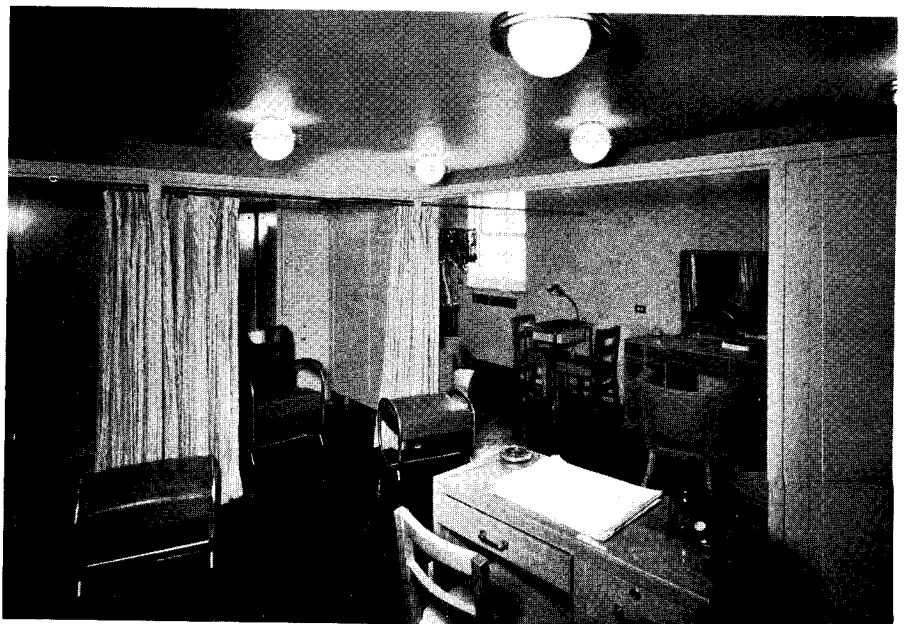

Beauty Shop

SUN VALLEY LODGE

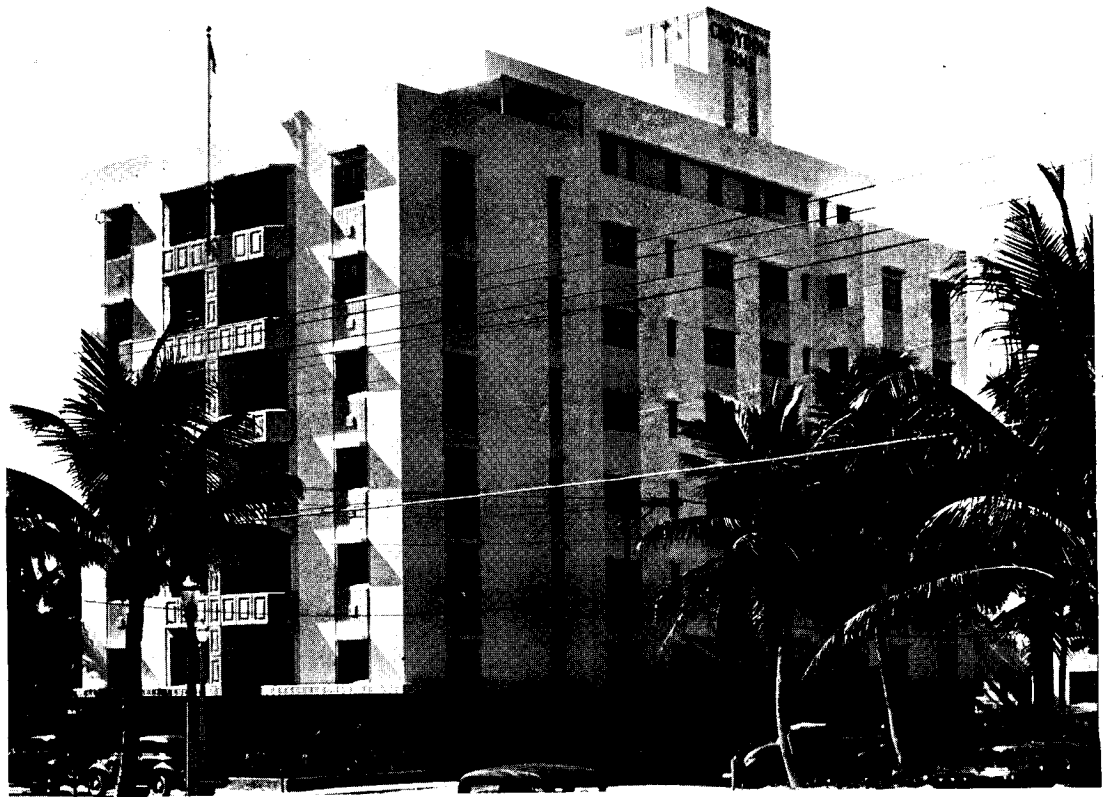

E. DEAN PARMELEE
Architect

**CROYDON ARMS HOTEL
MIAMI BEACH, FLORIDA**

IN PLANNING the Croydon Arms Hotel, it was necessary to provide for a varied clientele—some preferring hotel rooms and others apartments suitable for light housekeeping: it was essential that rooms, bathrooms, and closets should be large. The proportionate number of apartments to hotel rooms was important: the plan, as finally worked out, provides 18 three-room apartments and 67 hotel rooms—the apartments being readily convertible into hotel rooms if this should later be found profitable.

The L-shaped plan was dictated by the direction of the prevailing breezes—from the south and east—and the view; the ocean is about 300 feet to the east, across Collins Avenue.

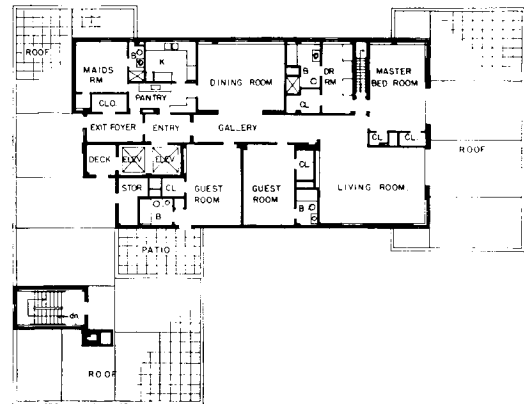

Penthouse Floor Plan

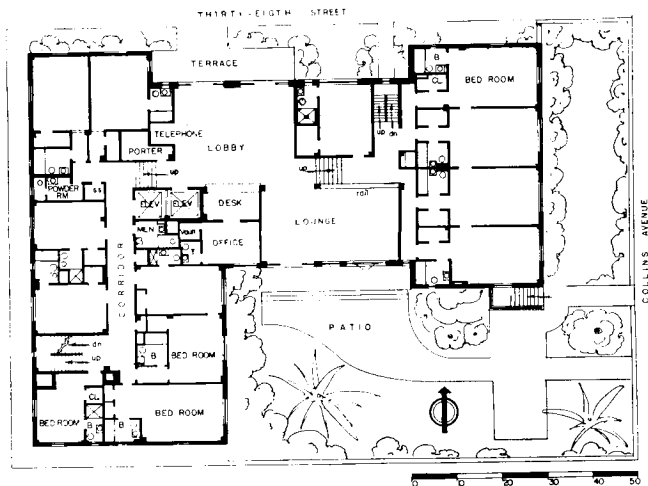

First Floor Plan

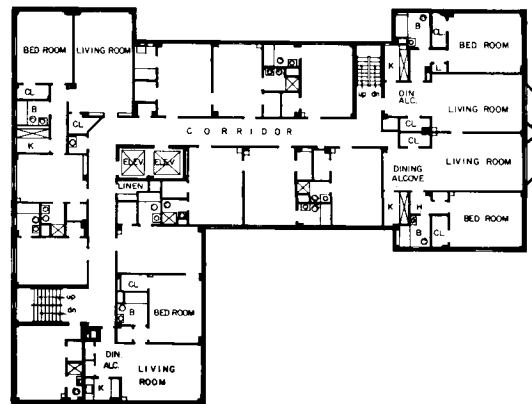

Typical Floor Plan



View of Patio and Lounge Entrance

THE LOBBY is entered on 38th Street and the lounge opens onto a landscaped patio. In the basement, which is two-thirds above ground, are a coffee shop, beauty parlor, and barber shop. There is no basement under the lobby and lounge. The basement under the rear part of the building contains servants' rooms, storage rooms, and a boiler room equipped with an oil-burning steam-heating plant and an oil-burning hot-water heater.

Every room in the building is steam-heated for the few cold days of a Miami winter.

The exterior of the building is done entirely in painted stucco, except for the front balconies and continuous flower boxes at the first floor level, which are pre-cast concrete, also painted. The color scheme is white for the body, coral pink on the windows and spandrels. Projecting hoods shield the windows from sun and rain.

SCHEDULE OF EQUIPMENT AND MATERIALS

| | |
|-------------|---|
| FOUNDATIONS | Concrete piles |
| STRUCTURE | Reinforced concrete |
| EXTERIOR | |
| Walls | Concrete blocks: finished with cement stucco; impregnated stucco |
| Roof | Cement surface for decks; gravel over pent-house—Johns-Manville, 20-year bonded |
| INTERIOR | |
| Partitions | Gypsum blocks, U. S. Gypsum Co. |
| Ceilings | Plastered directly on ceilings; no furring |
| Floors | Reinforced concrete slabs Finishes: cement and carpet; terrazzo in lobby and coffee shop |

| | |
|--------------------|--|
| INSULATION | Celotex on roofs |
| WATERPROOFING | Integral, around boiler room only |
| HEATING | Steam, National boilers and radiators; Williams Oil-O-Matic oil burner |
| ELEVATORS | Otis Elevator Co. |
| HARDWARE | Russwin |
| PLUMBING | U. S. fixtures |
| SASH | Steel (galvanized) casement, Metzger |
| SCREENS | Copper-bronze |
| GLASS | Plate glass, Pittsburgh Plate Glass Co. |
| GENERAL CONTRACTOR | Carl Green |



Lobby



Lounge

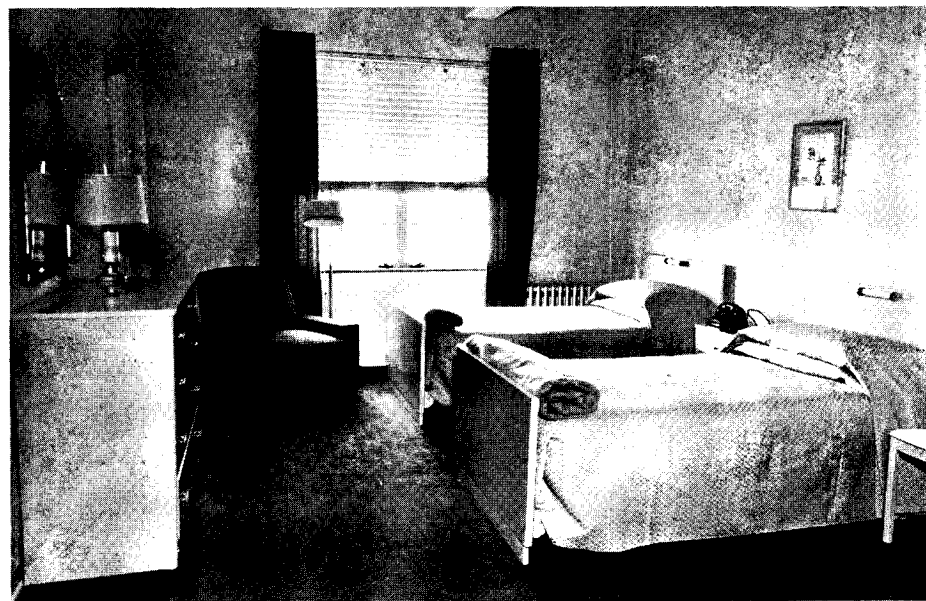

Typical Bedroom



Photos by Berry-Hilton Co., Inc.

**DEMPSEY'S VANDERBILT HOTEL
MIAMI BEACH, FLORIDA**

HENRY HOHAUSER
Architect

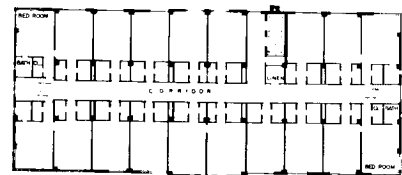

Typical Floor Plan

OVERLOOKING the Atlantic Ocean, this 120-room resort hotel affords to guests the maximum of sunlight, with corner windows, sun decks, and terraces. Room sizes average 12' x 16' and closets are 3'-6" x 6'-6".

Also provided is a bar, described as the longest in the South; it was designed by Thomas W. Lamb, Architect.

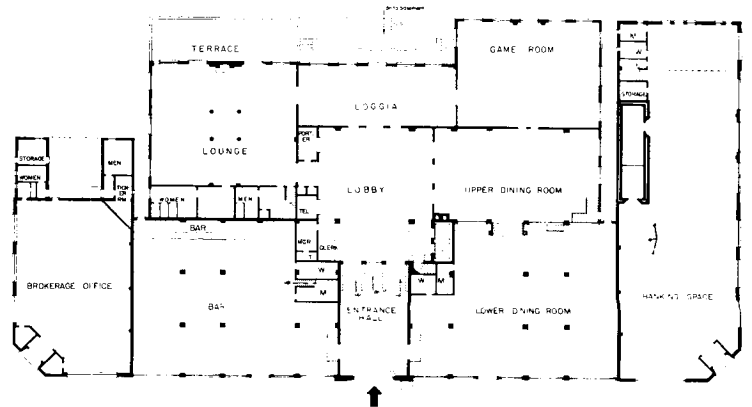

First Floor Plan

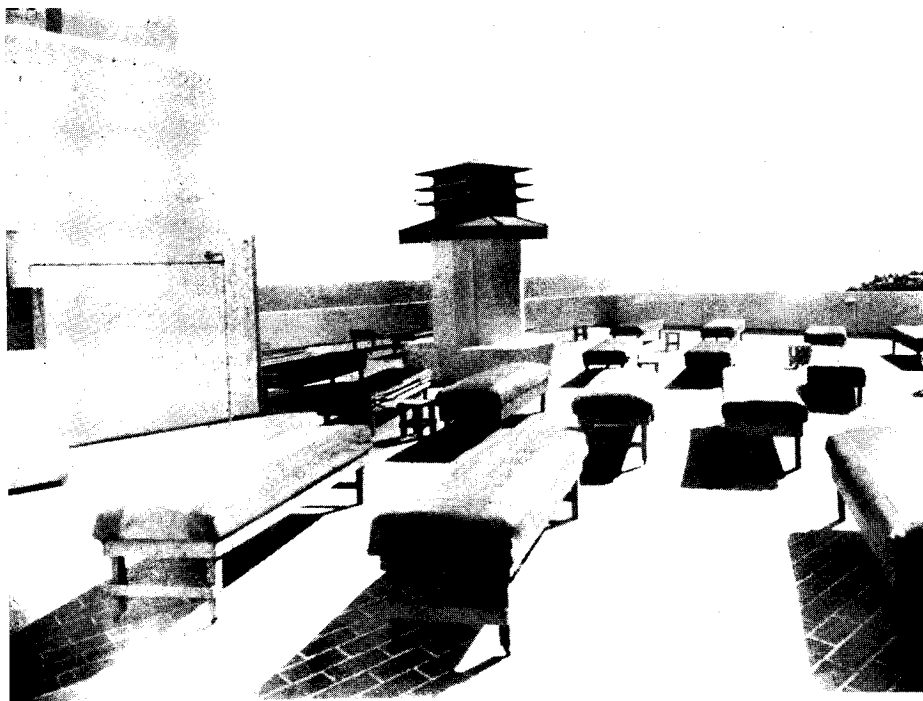

Roof Sun Deck

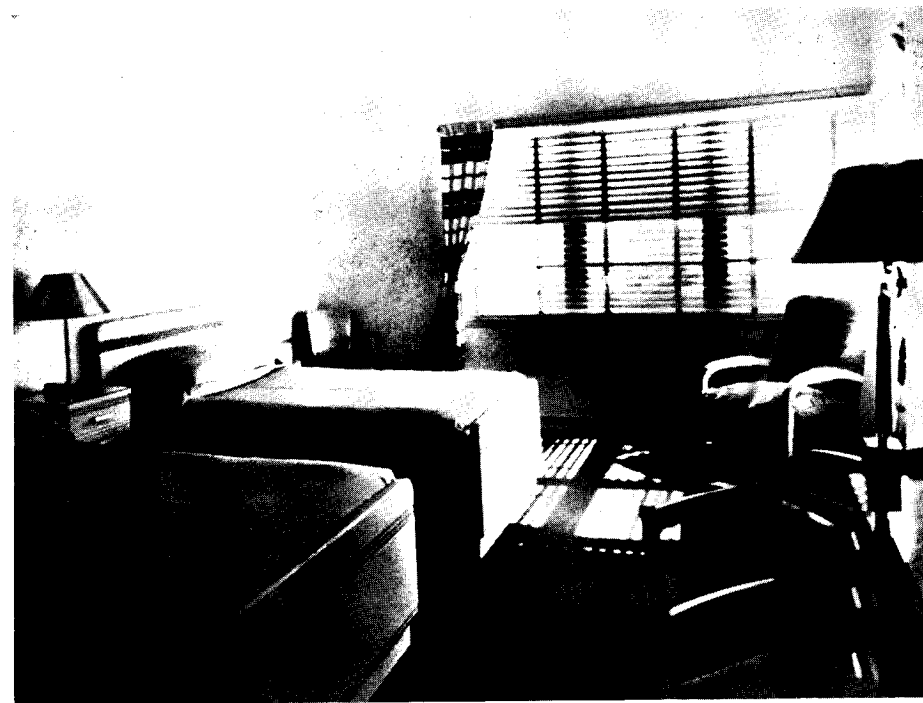

Typical Corner Room

SCHEDULE OF EQUIPMENT AND MATERIALS

| | |
|-------------------|--|
| FOUNDATION | Spread reinforced concrete footings, and reinforced concrete foundation walls |
| STRUCTURE | Reinforced concrete construction; concrete pan floors; concrete block exterior curtain walls |
| EXTERIOR | |
| Roof | Certain-teed twenty-year tar and gravel roof for penthouse; Certain-teed foundation and Quarry Tile at solarium roof |
| Metal Work | Copper |
| Sash | Cypress double-hung windows; copper screens |
| INTERIOR | |
| Floors | Terrazzo; quarry tile; cement finish; and carpeting |
| Walls | Sheet rock and galvanized wire lath; scratch plaster; U. S. Gypsum Red Top finish plaster, factory-made color |

Doors

Exterior: Cypress with bronze thresholds, weather-stripping. Interior: Magnolia Louver doors and Miracle doors

Partitions

Gypsum blocks and clay tile

PAINTING

Du Pont de Nemours Co. Interior plaster walls not painted. Exterior has a lime wash stucco paint, with Crystex integral waterproofing; floors shellacked and waxed

GLASS

"A" quality double-strength, Libbey-Owens-Ford

PLUMBING

Standard Sanitary Manufacturing Co. fixtures

HEATING

York Oil Burning Heating Plant

GENERAL CONTRACTORS

O'Neill & Orr.

Total cost, including furnishings, \$445,000.



MAYFAIR HOTEL, MIAMI BEACH, FLORIDA
HENRY HOHAUSER, Architect

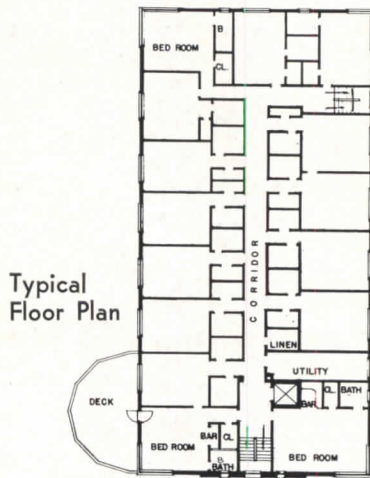
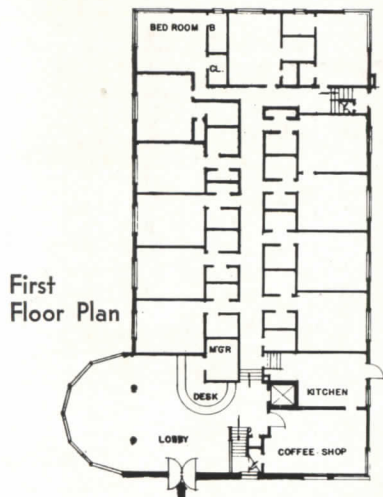

SCHEDULE OF EQUIPMENT AND MATERIALS

| | |
|-----------------------------|--|
| FOUNDATION STRUCTURE | Reinforced concrete Wall bearing; wood joist construction; reinforced concrete columns and tie beams around entire building at each floor for stiffening only |
| EXTERIOR | |
| Walls | Hollow concrete blocks, 8" x 8" x 16", furred |
| Roof | Wood rafters and sheathing; 10-year bonded, 3 ply, built-up asphaltic roofing, gravel surface, Carey Co. |
| Sash | Truscon Steel Company steel casement sash and screens |
| INTERIOR | |
| Floors | Sealex standard grade linoleum in kitchens; semi-vitrified tile floors in bathrooms; oak elsewhere |
| Walls | Sheet rock lath reinforced in corners with Clinton cloth; finish plaster U. S. Gypsum Red Top with integral color pigment, slightly textured finish |
| DOORS | Cypress with Barland weatherproofing thresholds and weatherstripping |
| PAINTING | Du Pont Company. Interior plaster walls not painted. Exterior has a lime wash stucco paint, with Crystex integral waterproofing; floors shellacked and waxed |
| PLUMBING | Standard Sanitary Manufacturing Co. fixtures |
| HEATING | Gar Wood oil burning heating plant |
| GLASS | "B" quality of double-strength, Libbey-Owens-Ford. |

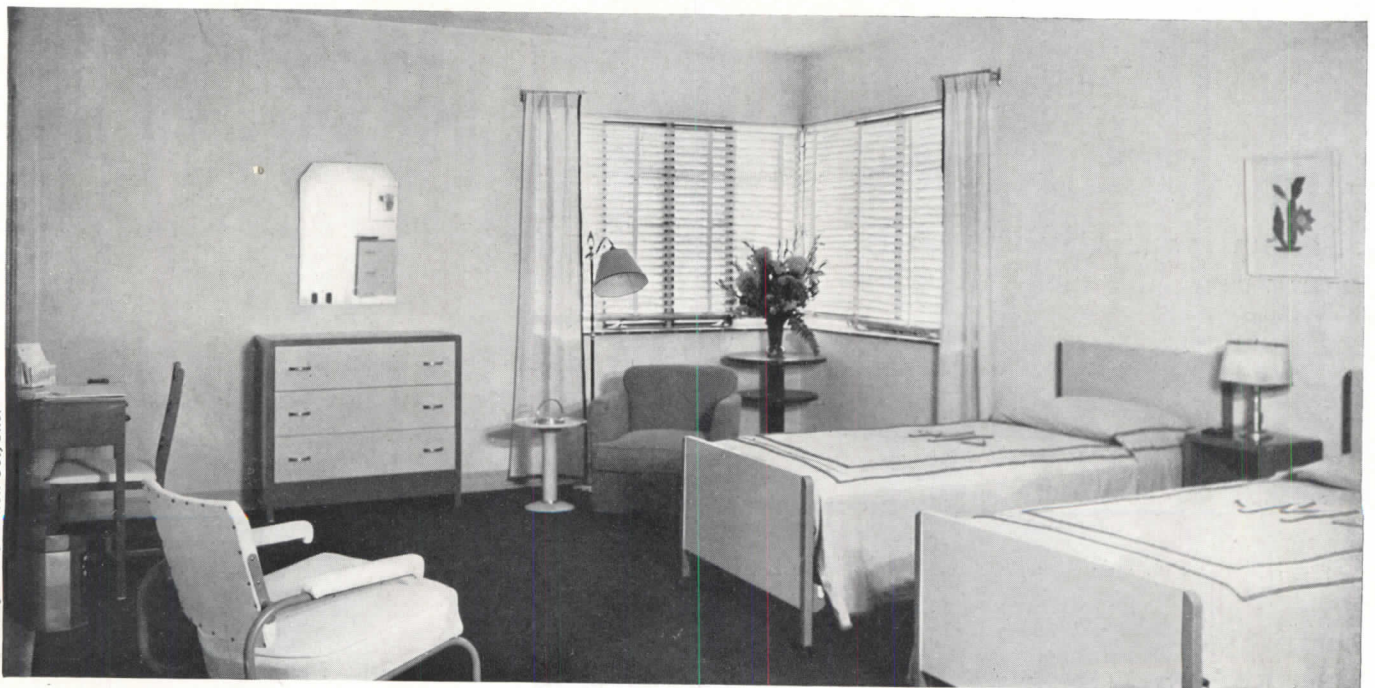

Photo by Berry-Hilton Co., Inc.



HOTEL POHJANHOIVI ROVANIEMI, FINLAND

P. E. BLOMSTEDT, Architect

THIS commercial hotel of about 40 rooms is located on the western shore of the Kemijoki River. It faces the town on the south and an open park on the north.

Considerable area is devoted to display space for the use of traveling salesmen who frequent the hotel.

In addition to the river view, the spectacle of Ounasvaara Mountain, the arctic aurora borealis, and, during the summer, the midnight sun, may be seen from the lounge. The public rooms are oriented to the north, facing these phenomena. The fourth floor includes, besides a lounge, similar to that on the third floor, 17 guest rooms and a large terrace to the south.

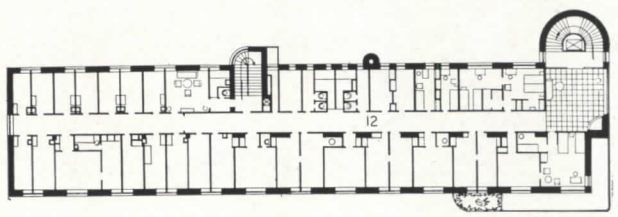

Third Floor Plan

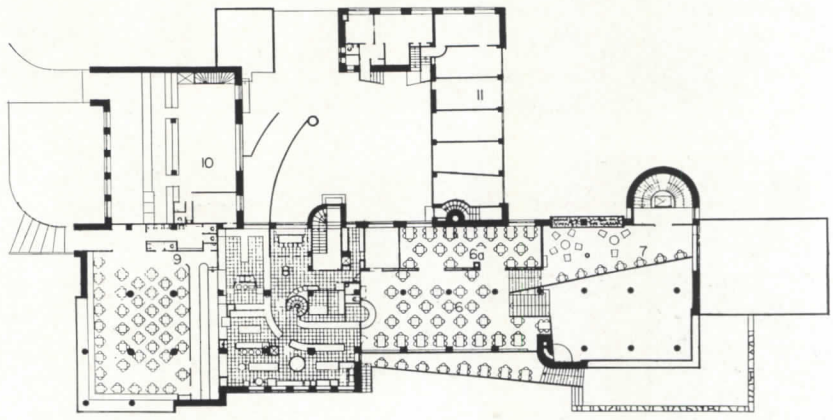

Second Floor Plan

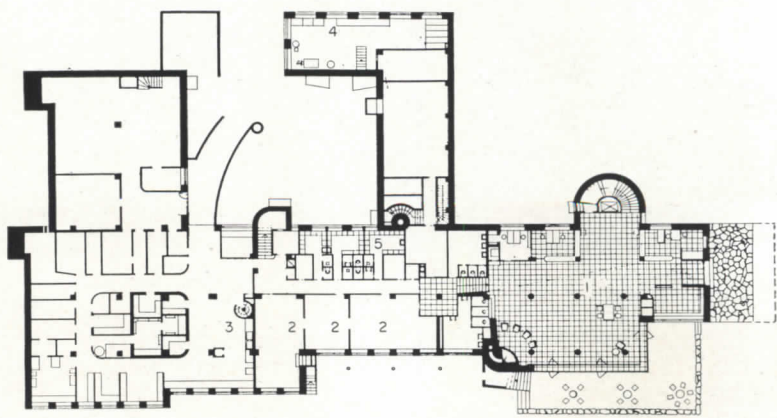

First Floor Plan

- 1. Entrance Hall
- 2. Display Room
- 3. Storage Room
- 4. Laundry
- 5. Employees' Dressing Room
- 6. Dining Room
- 6a. Private Dining Room
- 7. Entrance Hall Balcony
- 8. Kitchen Department
- 9. Cafeteria
- 10. Retail Liquor Store
- 11. Garage
- 12. Corridor

Photos by H. Iffland, courtesy Finnish Travel Information Bureau



First Floor Entrance Lobby



Balcony of Entrance Lobby

THE large window of the lobby consists of two glass walls about 27" apart, with the intermediate space being utilized for planting. Humidity condensation on the glass is prevented by the blowing of heated air from radiators sunk in the floor. The air returns to the lobby through evenly

spaced openings along the upper edge of the inner glass wall. The floor of the entrance lobby is of alternate squares of gray and black rubber tile. Balcony floor is of china blue linoleum. The ceiling is painted white, columns beige. Lobby furniture is upholstered in blue leather.



Dining Room

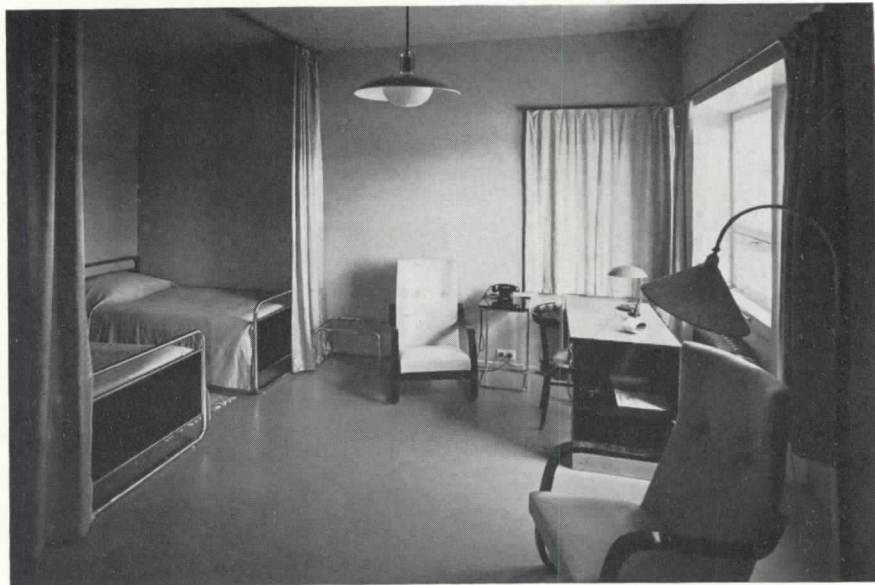

Double Guest Room

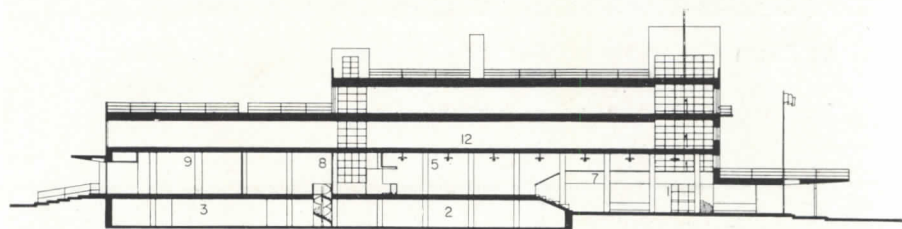

Section

- | | |
|-----------------------------|--------------------------|
| 1. Entrance Hall | 7. Entrance Hall Balcony |
| 2. Display Room | 8. Kitchen Department |
| 3. Storage Room | 9. Cafeteria |
| 5. Employee's Dressing Room | 12. Corridor |

UTMOST flexibility was provided by designing the structure, as well as the mechanical installations, to permit the future addition of two stories. The length of the bed was used as the module for room layout, room depths being

made two bed lengths. Thus, all single rooms can be used as double rooms, accommodating four beds when necessary. The structure is of reinforced concrete construction with partitions of masonry and insulating materials.



Lounge Bar

**HOTEL STATLER
CLEVELAND, OHIO**

WALKER AND WEEKS
Architects

RORIMER-BROOKS STUDIOS
Decorators



Photos by Parade Studios, Inc.

Terrace Room

THE STATLER HOTELS in Cleveland and Detroit have recently opened new Lounge Bars and Terrace Rooms. The new rooms occupy areas that were formerly used for stores and offices, and in both hotels new entrances have been provided. The new rooms have their own kitchen facilities and other services separate from the other existing accommodations.

The capacity of the Cleveland Lounge Bar is estimated to be about 125, while that of the Terrace Room is 280. The Detroit Lounge Bar (opposite) has a capacity of about 250.

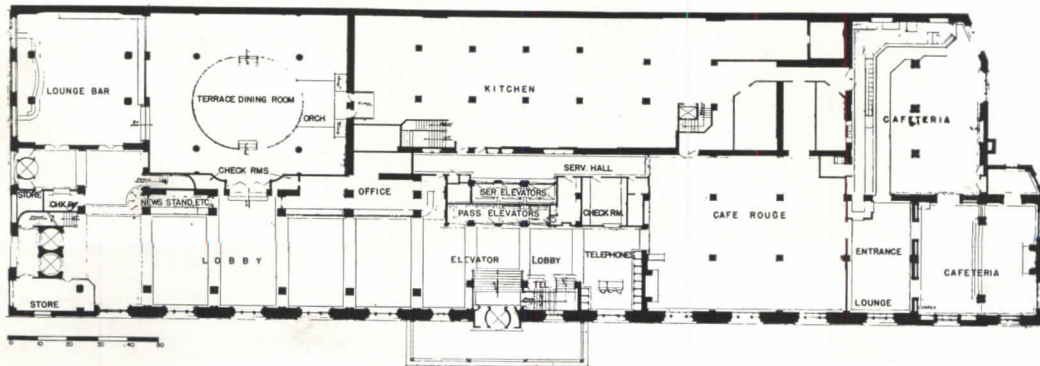

Plan

**HOTEL STATLER
DETROIT, MICHIGAN**

SMITH, HINCHMAN AND GRYLL
Architects

RORIMER-BROOKS STUDIOS
Decorators



Barton Studios

Lounge Bar

IN THE Cleveland Lounge Bar (opposite), Japanese ash has been used throughout, the walls being fully paneled with it. The colors of the Terrace Room are peacock blue, oyster white, light lacquer red, and ebony black, with all the metalwork done in gold.

Gray and platinum dominate in the Promenade of the Detroit Statler. The bar of the Lounge has a color scheme of walnut, gold, and ebony black. The pillars of the Lounge are all peacock blue with gold vertical ornament.



Industrial Pictures, Inc.

Promenade

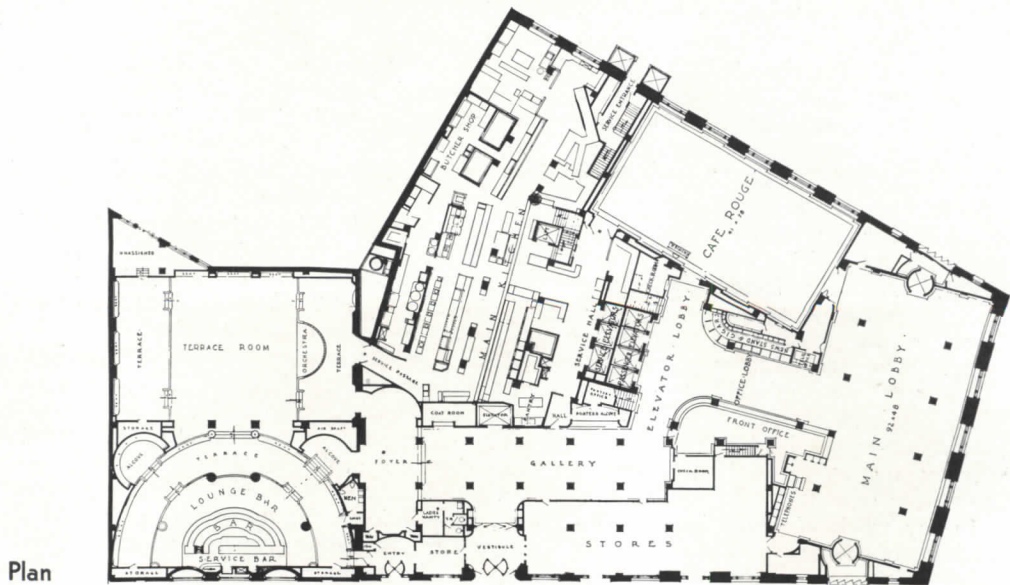

Plan

It Pays to Rehabilitate Hotels

By LOUIS TOTH, C.P.A.

Member of Horwath & Horwath, Specialists in Hotel Accounting; Co-author, "Hotel Accounting"

DURING the worst years of the depression, most hotel properties were woefully neglected; this was not because hotel owners and managers were shortsighted, but because, with income dwindling and only about half the available rooms needed, a desperate attempt was made to save equities by postponing all repair and maintenance work. But experience proves that a hotel merely kept in operation cannot long maintain its competitive position; business will go to the hotels that are more modern and up-to-the-minute.

Although it is generally known that a major rehabilitation or improvement program, if judiciously carried out, pays handsome dividends, its exact effect on profits is difficult to measure. Comparison of the profits before a program has been started with those after its completion does not prove much; it is merely a starting point. Weight must be given to the trend of business of the hotel in question and of competing hotels; for if the general trend is upward, it is obvious that all the increase in this particular hotel cannot be ascribed to the physical improvements made. Then again, the actual result of operations may be affected by the trends of wage rates and of market prices of the supplies the hotel uses, and by such uncontrollable expenses as taxes. Furthermore, the operating profit may be better merely because the expenditure for repairs and maintenance is less after the hotel has been completely renovated, than before. Briefly, one must determine as accurately as possible, on the basis of trends and all other available facts, what the result of operations would have been had the improvements not been made, and compare the estimate of operating profit so arrived at with the actual result. Another factor that complicates comparison of "before and after" results is change in management. If an aggressive new manager takes over the rehabilitated hotel, there is no estimating how much of the improvement is due to his more efficient methods and how much to the better condition of the property.

In my work of reviewing the operating statements of many hotels I

have seen many striking examples of the effect of physical improvements on profits. I shall cite a few of them here, with facts and figures.

Examples

A transient hotel of about a thousand rooms had been doing a business of about \$200,000 a year in food and beverages—a rather small volume for its size. It had an old-fashioned dining room, with the high ceiling and walnut-paneled walls associated with hotels of some years back—a slow, sleepy place, in spite of the dance music it offered. The volume of sales being small for the size of the kitchen and dining room, the hotel could barely eke out a profit of \$10,000 a year on its food and beverage business. Then an aggressive and courageous manager took over the property. His first act was to tear out the old dining room and replace it with an ultramodern one. This necessitated further alterations in the building and the removal of a part of the kitchen. The total cost was about \$215,000. In the first twelve months after the opening of the new dining room sales jumped to \$600,000, and the profit to \$150,000, in spite of a considerable increase in wage rates. The room will probably repay its cost, with interest, in less than two years.

Then there is another hotel of about the same size, the business of which, because of its neglected physical condition, had been drifting slowly downward, though the trend in business in other hotels of the city had been decidedly upward. When the owners finally realized that without some investment in rehabilitation, the inevitable end would be the loss of their equity, they could raise only \$350,000, less than half the amount needed to do a thorough job. However, they made the best of the available funds and, while the hotel is still far from being prosperous, limited rehabilitation and improvement made it possible to reverse the trend and to cut annual losses by \$202,000.

The manager of a residential hotel showed how a program of rehabilitation can be carried out without raising any new funds for the purpose, if the owners are willing to be patient.

This hotel was acquired by a financial institution through foreclosure. The income was just about sufficient to pay taxes, occupancy hovering between 50 and 60 percent. It was decided to engage a new manager and when the man considered for the post inspected the hotel, he immediately realized that at least \$40,000 would be required to put the property in such physical condition as would make success possible. He agreed to undertake the management on condition that for 18 months he would be allowed to use all earnings above taxes for rehabilitation and improvements. The work progressed step by step and the contractors were paid, in accordance with a previous understanding, 90 and 120 days after completion of the contracts. In 18 months the manager plowed back \$60,000 into the property, and then he had an occupancy of 90 percent and earnings just slightly less than 5 percent of the financial institution's original investment in the mortgage.

The receiver of a transient hotel of about 500 rooms took over the management of the property when, in spite of improving business in other hotels, its sales were at a standstill and operating profits on the down grade. Building, equipment, and furniture had been sadly neglected for years because of a lack of funds. The receiver asked the court to approve a program of rehabilitation to be financed out of earnings that would otherwise be available to pay current taxes, and after some persuasion approval was given. In the first two years \$277,000 was spent on rehabilitation. Not only was the downward trend of operating profits stopped, but the second year showed an increase of \$46,000. Encouraged, the receiver modernized the restaurant facilities and made some other improvements at a cost of \$68,000, with the result that, despite rising wage rates, the operating profit in the third year showed a further rise of \$53,000. Thus, with a total investment of \$345,000, the hotel was brought back to life and it is now earning \$99,000 a year more than before and still improving.

But perhaps the most interesting case is that of a transient hotel that

was already in excellent condition when the air conditioning of about 250 rooms was undertaken. The hotel was doing fairly good business, except in the summer months. The management realized that, because of the climate, the benefit from the investment in air conditioning would probably be limited to three months of the year. The work was done at a cost of approximately \$75,000.

Business at this hotel had been on the upgrade before this improvement was made and the trend in this and in competing hotels indicated that the gross income from rooms in July, August, and September would average about \$3,500 a month more than in the preceding year. The actual increase was \$15,500 a month, or \$12,000 more than the trend indicated. A liberal estimate of the cost of operating the air conditioning equipment is \$1,500 a month. The cost of servicing the additional occupied rooms was more than covered by the proportionate increase in income from the restaurant and from other hotel facilities. Thus, there was an increase in operating profit of \$10,500 a month as a direct result of air conditioning. This increase for the three summer months was sufficient to return interest and more than one-third of the investment.

The records of this hotel show that during the summer 72 percent of its transient guests wanted air conditioned rooms. And the additional guests included persons, in some cases whole families, who moved from their homes into the air conditioned rooms for the hottest days of the summer. Before the air conditioning, its room business in July and August went down to about 63 percent of the average for other months of the year. After air conditioning the drop was only to 78 percent. This means that during the summer months the staff did not have to be reduced to the same extent as in former years; there were fewer changes in personnel as a result of more stable employment, and consequently better morale.

The effect on the employees is not the least important result of the physical rehabilitation of a hotel property. Where the property is permitted to deteriorate and an air of general stagnation pervades the house, employees become careless and inattentive; service suffers and, as a consequence, the decline in business is accelerated. It is not possible to maintain an alert and efficient staff of employees in a shabby hotel, and it is hard to do it in one out of date.



Hotel Belmont Plaza, New York City. Main dining room before modernization.

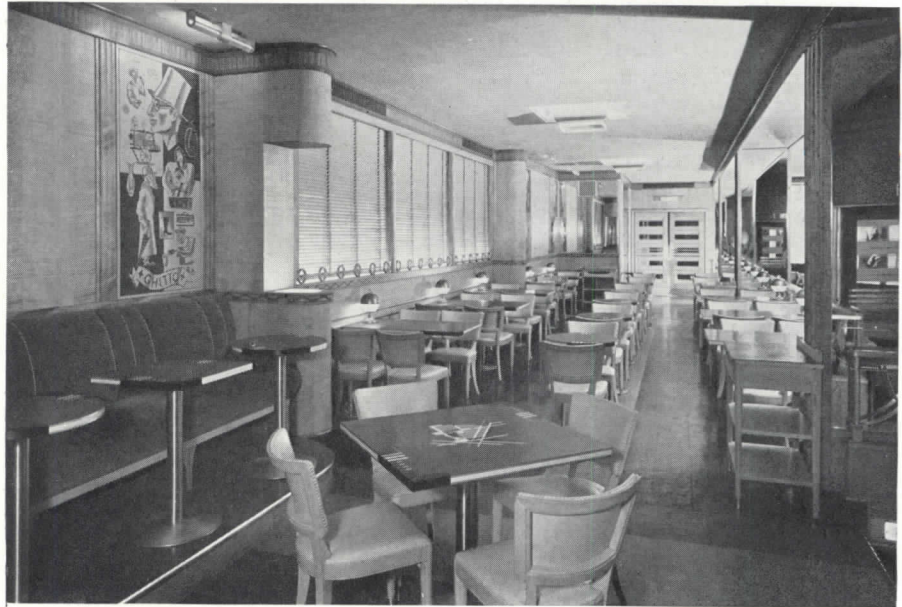

Glass Hat Restaurant, Hotel Belmont Plaza, after modernization.



Dance floor area of Glass Hat Restaurant. J. C. Lessman, Designer.

Communication Systems in Modern Hotels

By F. H. RANDOLPH

ABOUT seven hundred linear feet of wires, tubes, and pipes per room are required for communication systems of large commercial hotels. This may serve to indicate the extensive ramifications demanded by present-day standards of service. For telephone service alone, the Waldorf Astoria uses 315 ft. of wire per room.

Yet as recently as fifty years ago, direct speech and the handwritten message were still relied upon as the chief means of communication. The human element was entrusted with nine-tenths of work while only one-tenth of it was performed by mechanical or electrical means. Today, one might venture to state that the ratio is reversed, or what amounts to the same thing, that modern devices deliver the message in one-tenth the time required of a bell boy or other servant. The mechanical links of the chain carry a surprisingly large portion of the load. Without them, service would be crippled severely.

The successful operation of a large hotel is appreciably dependent upon positive yet flexible systems of intercommunication between the many and widely separated operating departments. A tremendous organization is required to operate the modern house of several hundred rooms. The organization must be perfected to the point of efficient performance of its functions, accomplishing accurately and quickly the desired results in service to guests and in economy of operation.

Forms of Communication

Telegraph: At the present day, multiplex telegraphy enables eight messages to be transmitted simultaneously over a single long distance line. The simplex machine, developed since 1922, is used on the shorter lines.

In the hotel, the telegraph is generally operated as a concession and handled on a percentage basis. In some hotels, the apparatus in the telegraph office consists of the "key and sounder" to permit the operator to send the message over the telegraph lines. However, in the larger cities, the operator now generally teletypes the message to the central telegraph

office where it is received and sent over another line to its destination. Some city hotels not having a telegraph office frequently have a magneto signaling device so that by turning a crank the front-office clerk can signal the telegraph office to send a messenger to pick up the telegram.

Telephone: The telephone traffic in a typical 400-room transient hotel located in a large city requires a two-position switchboard. A two-position switchboard accommodates two attendants simultaneously. In such a hotel, the switchboard equipment should be located in the front office, adjacent to the front desk. This arrangement permits the night clerk to handle the switchboard between the hours of 11 p.m. and 8 a.m. when relatively few calls are made. The hotel is thus saved the expense of a night telephone attendant. Only if the hotel is of such a size as to require the full time of one or more attendants at the switchboard after midnight, should the telephone room be located elsewhere. The tendency in the larger metropolitan hotels is to place the switchboard in some more or less remote quarter where quiet will be insured and where floor space is not especially valuable. Probably the telephone exchange had best be located in the larger hotels on the

"service floor" or on the top floor of the building; or it may be adjacent to the accounting offices. In any event, it is advisable to remove the switchboard from noise and confusion that might impair the service during the busiest hours of the day.

Provision for teletype or telautograph machines in the telephone switchboard is not generally considered necessary in hotels which have the telephone exchange in the front office. Such equipment, however, is required in the larger hotels where the switchboard is remotely located.

Dictograph: In a certain 1,000-room hotel, a privately owned telephone system, the dictograph, is used to connect the room clerk and cashier, private offices and bookkeeping department. The use of a direct wire eliminates waiting for a connection to be made by the exchange operator and thus expedites service.

Quite recently the dictograph has been finding a place in large hotel kitchens. It uses loud speakers at several stations about the kitchen and permits the chef or the steward to carry on a conversation with a cook. The chef or steward does not have to leave his desk and the cook is not interrupted in his duties by having to "answer the telephone." The combined loud speaker and sensitive transmitter at the cook's station permit him to receive the message and make his reply in as convenient a manner as if the party were at his elbow.

Speaking tubes: Restaurants still use speaking tubes for relaying orders to the kitchens, but, for the most part, other systems of communication have been substituted.

Wires are run with greater ease than tubes. Furthermore, a separate tube line must connect each pair of stations as switching devices are not practical. The use of a tin whistle in disc form at the mouth-piece is objectionable but is quite necessary if auxiliary signal devices are to be avoided. Dust collects in time and the occasional use of compressed air for cleaning is a nuisance. However, there is little or nothing of a mechanical nature in speaking tubes to get out of order, practically no main-



Telephone switchboard at the Waldorf Astoria Hotel, New York.

tenance attention is needed, and no special skill is required in their use. For relatively short distances, speaking tubes will probably continue to be used.

General Departmental Systems

The special message-carrying systems used between departments are the telautograph, teletype, and pneumatic tubes. They are used chiefly for the transmission of routine messages and are superior to the telephone in promoting accuracy and in fixing responsibility. Accuracy is improved because misunderstandings of words, especially room numbers, are practically eliminated. Responsibility becomes definite for there is a record of the message, generally in duplicate. Unlike the telephone, it is unnecessary for a person to be at the receiving end as the message is not verbal but on paper.

Although the arrangement of such systems differs necessarily with the type and size of hotel, in a medium-size house it would be fundamentally as follows:

Sending Station

Room Clerk
Housekeeper
Housekeeper
Telephone Operator

Receiving Station

Housekeeper
Room Clerk
Engineer
Kitchen

Usual Type of Message

Room "change" and "departure"
Room "O.K." reports
"Repair" orders
"Room service" orders

Telautograph: Telautographs are electrically operated instruments that transmit the handwriting of the sender to one or more receiving stations simultaneously with the writing of the original message.

The equipment consists of transmitting or sending stations, receiving stations, selecting switch keys, a source of electrical energy, and the wiring. Every transmitting station is combined with a receiver so that all messages, both outgoing and incoming, appear on the roll of paper. Receiving station instruments simply record messages sent them from the various transmitting stations. Selecting switch keys are installed only at the sending stations for the routing of messages to their desired destinations. The source of electrical energy is a generator supplying direct current at 120 volts. The generator is coupled to a motor which is operated

from the available power supply. The electric wiring carries relatively little current, as only one ampere is required to operate a machine, so no special precautions are necessary when installing the wiring.

Probably the minimum telautograph equipment that would be installed would consist of the following:

Room Clerk—Transmitting and Receiving Instrument
Linen Room—Transmitting and Receiving Instrument
Engineer—Receiving Instrument only

This would be considered adequate for hotels up to 150 rooms in size. Larger houses would need a more extensive system.

Teletype: One of the most recent devices to increase in popularity is the teletype or, as it is frequently called, the teletypewriter. In comparatively recent years business has felt the actual need of a long-distance typewriter.

Pneumatic tubes: Air is the force which propels the carriers through pneumatic tubes, and the systems may be divided into three classes according to the manner of using the air: namely, one using air pressure only, one using vacuum only, and one combining both pressure and vacuum. The individual requirements and limitations determine the type which is best used.

The essential characteristics of each of these three systems are as follows:

(1) The Vacuum Tube System is used in two forms, the Twin Line Vacuum System and the Combination Line Vacuum System.

The Twin Line Vacuum System is used between two stations to give simultaneous and rapid communication in both directions. Two tubes are obviously required to connect the two stations. This system is used to meet two common conditions: first, where service is required between only two points; and second, where continuous and heavy duty service is required between various substations and the central station. It is adapted to installations where it is necessary to move substations occasionally. The Twin Line Vacuum System represents the highest development in pneumatic tube service for it will handle message carriers in rapid succession. For these reasons it is recommended for large hotels having many tube stations and a large volume of message traffic. The open end arrangement is used and all lines have air moving through them continu-

ously. The Twin Line Vacuum System is sometimes used to supplement one of the other forms of tube systems to handle especially heavy traffic between two particular stations.

The Combination Line Vacuum System is arranged so that three or four substations send messages to the central station through a common tube. Separate tubes convey messages from the central station to each sub-station. This method permits economy in installation and in power for operation in hotels where traffic is not sufficient to warrant twin lines for each substation. Floor stations, one above the other, are frequently served by this Combination Line Vacuum System.

(2) The Vacuum-Pressure Tube System is used when several substations can be connected in series on a single return line to the central station. Independent lines deliver carriers from the central station to each substation. This system is cheaper to install and operate than the independent twin vacuum line type. It is quite similar to the Combination Line Vacuum System as far as the path of the carriers is concerned, but differs in respect to the air connections. This system is used in medium- and small-size installations requiring up to 6 or 8 stations. The necessity of connecting the substations in series on the return line imposes some limitations on the locations of the stations. If it becomes necessary to move a substation, difficulties are likely to be encountered.

(3) The Single Tube Automatic Pressure System is used between two stations for sending in both directions through a single tube. Such a system is recommended for light-duty, intermittent service where not more than three carriers an hour is the usual load. Heavy-duty traffic should be handled by one of the other systems. The Single Tube Automatic Pressure system finds application in automobile service stations where compressed air is available and where 24-hour service is required. In hotels it is used satisfactorily to reduce installation costs of light-duty lines.

In the various tube systems, the carriers are moved by relatively low air pressure which is generally from 1 to 5 lbs. per sq. in., depending upon the length of the lines. Carriers move with a speed of about 30 feet a second or approximately 20 miles an hour.

The central tube station in a hotel is best located in or adjacent to the front office where it can be properly supervised. Tube lines connect with

TABULATED COMPARATIVE SUMMARY OF GENERAL DEPARTMENTAL COMMUNICATION SYSTEMS

| | TELETYPE | TELAUTOGRAPH | PNEUMATIC TUBE |
|---------------------|---|---|---|
| ADVANTAGES | A clearly typed message on a page or on a plain or gummed tape as is desired. | No special skill required to operate. | May be used for distribution of mail (or other original documents) to guest floors and departments. |
| | Can send to several stations simultaneously. | Can send to several stations simultaneously. | Carbon copies may be made for sending to several stations. |
| DISADVANTAGES | Connects with subscribers all over the country if desired. | Handwriting may serve to identify the sender. | May carry small articles: room keys, cash. |
| | Higher wage paid to operators: about \$5 per week extra. | Careless sending results in an unintelligible message. | Causes noise which may be objectionable at certain stations. |
| | Volume of messages must be large to justify the cost. | May require considerable attention from service man. | Delay may occur if message goes through a central station. |
| SERVICE ARRANGEMENT | Subscription rates from Telephone Company which owns and services the entire equipment. | Message roll is rather bulky and cumbersome for filing or for reference purposes. | Sender may run short of carriers. |
| | | Rental and maintenance service by Telautograph Corporation. | Installation may be difficult in an existing building. |
| | | Hotel owns the wiring. | Purchased outright from manufacturers. |
| | | | Maintenance by hotel force. |

guest floor stations, telephone room, restaurant, kitchen, laundry, engineer, housekeeper, bell captain, porter, package room, valet, etc. It is advisable to have the billing clerk and cashier's cage adjacent to the central tube station to expedite the handling of charge slips. If the hotel is a large one and has several restaurants as well as room service pantries, the food service messages are best handled through a separate central tube station in the main kitchen, convenient to the kitchen cashier or food checker.

For general interdepartmental service, a convenient-size pneumatic tube is 2¼ inches in diameter. If the hotel uses the individual floor service system with a clerk on each floor, the volume of guests' mail makes it advisable to have tubes to these stations 3 or 4 inches in diameter. The inside diameter of these carriers is about an inch less than that of the tube, so smaller sizes are not practical. A few hotels have "newspaper size" pneumatic tubes, 3 inches by 6 inches, for delivery of mail to floor stations. If all mail for guests is kept at the front desk, and it is desired to install a tube system in an existing hotel, 1¼-inch tubes are often found satisfactory in providing a compromise between adequate size and low installation cost. When planning a pneumatic tube installation it is well to consider having all tubes of the same size so that all carriers in use throughout the house will be interchangeable. This will mean that the largest car-

riers required will determine the size for all lines and increase both the cost and space requirements of the installation.

Obviously pneumatic tubes are not only communication systems but transportation systems as well. Room keys, cash, checks, and other small articles are readily carried. Tubes have the distinct advantage of making it possible to carry the original document whether it be guests' mail, telegrams, signed checks, or reports.

Radio

In large cities, guests expect to be able to hear radio programs in their rooms if the hotel is thoroughly modern. Loud speakers are preferred for this service instead of ear phones, but the volume should be such as not to disturb guests in adjoining rooms. Many hotels have radio equipment permanently installed, but others have a number of instruments available and rent them to guests.

A large banquet hall requires a "public address system" which enables guests in all parts of the room to hear the speaker without difficulty.

Annunciator Call Systems

The annunciator, operated by push buttons in guest rooms, has generally been superseded by the modern tendency to place a telephone in every room. Annunciators, however, play an important part for certain special call systems in modern houses. These are the elevator signal system, porter call, bell boy call, burglar alarm, and

fire alarm. In a few instances, a mail indicator has been placed in guest rooms. Carriage call systems may be considered as modified annunciator systems, for they operate in a similar manner.

Selection of Communication Systems

In planning the communication systems for a proposed hotel or in checking up on a given installation with improvements in mind, an analysis of message traffic is advisable. It is suggested that a large chart be prepared to indicate the several types of messages and the various stations concerned. Each type of message can be indicated by lines of a different color. For instance the diagram would show the routing of a departure notice in a large organization. The message originates at the cashier's station and is sent to various points.

Such an analysis, when carefully made, will show the extent of the services to be performed. Then further study will indicate the type of system best used. As a result, the house should be able to plan its communication systems to be neither inadequate nor excessive, but thoroughly satisfactory.

An ideal communication system fulfills the following requirements: accuracy, durability, speed, silence, compactness, simplicity, ease and rapidity of operation, flexibility of location, economy in power requirements, economy in supplies used, low maintenance costs, reasonable initial installation cost.

Bibliography of Hotel Design

Prepared by ROBERT ROGERS

Acoustics

Acoustics and Architecture. P. E. Sabine. McGraw-Hill Book Co. 1932. **Bibliography of the Acoustics of Building.** Acoustical Society of America: Vol. 3, pp. 14-43, 1931.

Air Conditioning

Air-Conditioning for Restaurants. M. G. Harbula. Heating and Ventilating: Vol. 28, pp. 41-4, August; pp. 84-8, September 1931.

Ballroom Air Conditioning System; Adolphus Hotel, Dallas. F. W. Robe. Heating and Ventilating: Vol. 33, p. 347, February, 1936.

Bibliography of Information on Air Conditioning. U. S. Department of Commerce. 29 pp., 1933.

Commercial Air Conditioning. (Bibliography) Refrigerating Engineering: Vol. 26, pp. 301-3, 322, 1933.

Estimating Annual Power and Water Costs for Air-Conditioning. E. P. Wells. Heating and Ventilating: Vol. 30, pp. 39-40, February, 1933.

New Brunswick Hotel Has Modern Cold Water System. E. Deuss. Ice and Refrigeration: Vol. 83, pp. 61-2, 1932.

Restaurant Air Conditioning. P. V. Simpson. Refrigerating World: Vol. 68, pp. 43-4, January, 1933.

Space Cooling With Ice. C. V. Robinson. Refrigerating World: Vol. 65, pp. 10-16, 1930. Heating and Ventilating: Vol. 26, No. 11, pp. 58-63, November, 1929.

Summarize Cooling Data Now. A. Merle. Air Conditioning Installation in the Barnum Hotel, Bridgeport, Connecticut. Domestic Engineering: Vol. 142, p. 172, 1933.

Waldorf-Astoria. Proper Operation of Hotel Heating and Air Conditioning Equipment Assured by Signal System. Heating, Piping and Air Conditioning: Vol. 3, p. 897, 1931.

Wet Air Cooler. Ice and Cold Storage. (Bibliography) J. H. Dannies. Vol. 34, No. 401, 402, pp. 200-3, August pp. 224-8, September, 1931.

Air Conditioning Equipment

Cleaning the Air. Heating and Ventilating: Vol. 30, pp. 13-19, June, 1933.

Data on Hotel Air Conditioning. H. H. Pease. Refrigerating Engineering: Vol. 26, p. 155, 1933.

Reference List of Air Filters. Heating and Ventilating: Vol. 30, pp. 17-21, October, 1933.

Selecting the Cooling Equipment. G. B. Helmrich. Heating and Ventilating: Vol. 30, pp. 19-26, July, 1933.

Air Conditioning Installation

Air-Conditioning Equipment for the Chateau Laurier. P. H. Bryce. Heating and Ventilating: Vol. 27, No. 10, pp. 93-4, 1930.

Complete Data on a Large Hotel Air Conditioning Job. Harrington Hotel,

Washington, D. C. With Cost Data. J. B. Hewett. Heating-Piping: Vol. 9, pp. 160-4, March, 1937.

Guest Room Air Conditioning Expected to Create Hotel Business. Heating-Piping: Vol. 9, p. 308, May, 1937.

It Pays to Furnish Conditioned Air. W. Parks. Domestic Engineering: Vol. 133, No. 1, pp. 46-8, 1930.

Modern Air Conditioning Systems Increase Patronage of Older Hotels. H. L. Branigan. Heating, Piping and Air Conditioning: Vol. 2, pp. 748-9, 1930.

Baking Ovens

Bakery Ovens. H. Carlton. Food Industries: Vol. 5, pp. 510-2, 1933. Manually operated, low first cost and wide application: Vol. 6, pp. 12-14, January, 1934. Small mechanical bake ovens for adaptability and low cost production: Vol. 6, pp. 110-12, March, 1934. Large capacity ovens for low unit-cost production.

Handling Machinery Reduces Baking Costs and Speeds Production. C. N. Tannel. Materials Handling and Distribution: Vol. 8, pp. 11-14, 1932.

Large Cooking Equipment. Electrical Review: Vol. 105, pp. 676-8, 1929.

Natural Gas in Modern Bakery. C. R. Washburn. Natural Gas: Vol. 13, No. 9, pp. 35-6, 1932.

Boilers

Combustion Control Systems. J. L. Hodgson and L. L. Robinson. Engineering: Vol. 137, pp. 134-6, 162-4, 1934.

Selbsttaetige Feuerungsregler in Dampfkraftwerken. A. Heinig. Archiv Für Wärmewirtschaft: Vol. 13, pp. 77-8, 1932.

Solving the Problem of Wet Steam. Power Plant Engineering: Vol. 38, pp. 14-5, January, 1934.

Conveyors

Mechanical Handling in Cake Bakery. G. F. Zimmer. Mechanical Handling: Vol. 19, pp. 183-9, 1932.

Soup to Nuts on Conveyors. E. J. Tournier. Factory and Industrial Management: Vol. 83, pp. 250-1, 1932.

The Place of Conveyors in Modern Biscuit Manufacture. G. F. Zimmer. Mechanical Handling: Vol. 19, pp. 111-16, 1932.

Use and Application of Portable Conveyors. J. B. Bray. American Society of Mechanical Engineers: 6 pp. April 13-17, 1931. See also Canadian Machinery and Manufacturing News: Vol. 42, pp. 164, 166, 1931.

Cooking

Application of Gas to Large Kitchens. G. Prud'hon. Journal des Usines à Gaz: Vol. 53, pp. 550-58, 573-83, 1929. See also Genie Civil: Vol. 96, pp. 253-6, 286, 9, 1930.

Bibliography on Commercial Cooking and Baking Articles, 1925-33 inclusive.

Edison Electric Institute Bulletin: Vol. 2, pp. 59-61, February, 1934.

Commercial Cooking and Baking. (Bibliography) W. Easton. Electrical Review (London): Vol. 113, pp. 75-7, July 21, 1933.

Commercial Cooking By Electricity. T. Settle. Institution of Electrical Engineers Journal: Vol. 71, pp. 171-80 (pp. 180-91), 1932.

Die Gasgrossküche in Hotel Reichshof in Hamburg. W. Jantzen. Gas und Wasserfach: Vol. 75, No. 38, September 17, 1932. English Abstract in Gas Journal: Vol. 200, No. 3620, p. 97, 1932.

Elektrisches Kochen. F. Moertzach. Berlin Julius Springer: 178 pp. 1932.

Energy Demand of Large Cooking Installation. F. Mörtzsch. Association Suisse des Electriciens Bulletin: Vol. 21, p. 136, 1930.

Large Cooking Equipment. Electrical Review (London): Vol. 72, pp. 39-40, July 8, 1933.

Large Gas Cooking Stove of Surface Combustion Company Type. Journal des Usines à Gaz: Vol. 53, No. 13, pp. 333-335, 1929.

Large Gas-Heated Kitchen. G. Prud'hon. Journal des Usines à Gaz: Vol. 53, pp. 158-62, 1929.

Design

California Hotel Offers Novel Housing. American Builder: Vol. 59, pp. 53-5, November, 1937.

Efficient Planning for Economical Operation. J. O. Post. Architectural Forum: Vol. 51, pp. 607-701, 1929.

Hotel Bedrooms and Baths. Jule Robert von Sternberg. American Architect: Vol. 151, pp. 85-95.

The New Hotel. P. M. Hooper. Architectural Forum: Vol. 51, pp. 583-667, 1929.

Electric Power

Analysis and Synthesis of Load Curves as an Aid in Economic Investigation. R. Schneider. Elektro-technische Zeit: Vol. 50, pp. 337-41, 383-90, 1929.

Analysis of Power and Heat Supply for Hotels. L. E. Habben. Power: Vol. 75, p. 35, June 14 and 21; pp. 885-8, 811-14, 1932.

Electric Service for Hotels and Office Buildings. National Electric Light Association Proceedings: Vol. 88, meeting June 8-12, pp. 417-44, 1931. See also National Electric Light Association Report: No. 112, January, 1931, 28 pp.

Generated or Purchased Power for The New Yorker. L. H. Morrison. Power: Vol. 70, pp. 830-2, 1929.

Heat, Light, and Power Costs in New York City Hotels. E. C. Romine. Power: Vol. 73, No. 7, pp. 304-6, February 17, 1931.

How to Determine and Distribute Hotel Power Costs. F. W. Randolph. Hotel Management: Vol. 21, p. 292, Section 1, 1932.

Power and Heat Supply to Hotels. L. E. Habben. *Power*: Vol. 75, pp. 885-911, 1932.

Electrical Equipment

Cumberland Hotel, London. *Electrical Equipment*. *Electrician*: Vol. 111, pp. 749-51, December 15, 1933.

Electricity at the New Waldorf. *Electrical World*: Vol. 98, No. 16, p. 700, October 17, 1931.

Electricity in Restaurants and Cafes. A. E. G. *Progress*: Vol. 5, No. 6/7, pp. 180-5, 1929.

Electrical Installation for a Small Commercial Hotel. F. Latzer. *Electrical Specifications*: No. 3, pp. 20-6, 1930.

Elevators

Automatic Dispatching Improves Elevator Service. F. A. Annett. *Power*: Vol. 71, pp. 986-7, 1930.

Chart Shows How Many Years of Elevator Life. *Power*: Vol. 77, pp. 130-1, March, 1933.

Elevator Signal Systems Using Flashlight Annunciators. F. A. Annett. *Power*: Vol. 71, pp. 589-91, 1930.

Forty-Three Stories of Vertical Traffic. E. W. Yearsley. *Power*: Vol. 70, pp. 850-53, 1929.

Pliotron Tubes Level Elevators in McGraw-Hill Building. *Power*: Vol. 74, No. 18, pp. 632-5, November 3, 1931.

Selecting Apartment Elevators. W. T. White. *Architectural Forum*: Vol. 53, pp. 385-7, 1930.

Fire Protection

Automatic Fire Alarm Systems. W. H. Rodda. *Weekly Underwriter*: Vol. 128, pp. 251-3, 445-7, February 4, March 4, 1933.

Hotel Fire Hazards. G. W. Booth. *Weekly Underwriter*: Vol. 137, pp. 494-6, September 4, 1937.

Test of Theatre Proscenium Curtains. N. D. Mitchell. U. S. Bureau of Standards. Research Paper 603. Bureau of Standards Journal of Research: Vol. 11, p. 491, 1933.

Floors

Developing New Wood Product Through Research. T. D. Perry. American Society Mechanical Engineering. Advanced Paper. Meeting, October 15-16, 1931. 7 pp. See also *Wood Industries*: Vol. 53, No. 5, pp. 21-30, January-April, 1931. *Woodworking Industries*: Vol. 9, No. 5, pp. 17-19, 32, May, 1931.

Developing New Wood Product through Research. T. D. Perry. American Society Mechanical Engineering: Vol. 54, pp. 49-56, 1932.

Linoleum and Cork Composition Flooring Materials. C. S. Taylor. *Architectural Forum*: Vol. 49, pp. 577-582, 1928.

Longer Life for Concrete Floors. *Chemical Age*, London: Vol. 27, p. 435, November 5, 1932.

Modern Floor Finishing. F. N. Vanderwalker. 85 pp. S. C. Johnson & Son: Racine, Wisconsin, 1933.

National Lumber Manufacturers Association. N. S. Perkins. Construction Information Series: Vol. 4, No. 15, 1930. 31 pp.

Proposed Recommended Practice for Heavy Duty Floor Finish. *Concrete*: Vol. 37, No. 2, pp. 37-8, 1930.

Resilient Flooring Materials. American Architecture: Vol. 143, pp. 89-95, March, 1933.

Rubber Floor Coverings Compared to other Floor Coverings. F. J. Schöps. *Gummi-Zeitung*: Vol. 44, pp. 1044-6, 1930.

Steel Bar Joist Construction in a Garage and Hotel. *Engineering News-Record*: Vol. 103, pp. 289-90, 1929.

Wear Resistance of Natural Stone Flooring. D. W. Kessler. United States Bureau Standards. Research Paper, No. 612. Bureau Standards Journal of Research: Vol. 11, p. 635, 1933.

What Is a Proper Floor? A Big Question. A. E. Hansen. *Food Industries*: Vol. 4, pp. 391-3, 1932.

Fuels

Commercial Standards for Fuel Oil. *Power Plant Engineering*: Vol. 35, pp. 404-5, 1931.

Comparative Data on Solid, Liquid and Gaseous Fuels. Committee of Ten of the Coal and Heating Industries, Chicago. *Educational Bulletin*, No. 6. 25 pp.

Deshler Hotel Changes to Coal Burning. *Power Plant Engineering*: Vol. 34, pp. 262-266, 1930.

Oil as a Boiler Fuel. F. W. Ellis. *Southern Power Journal*: Vol. 50, No. 8, pp. 10-13, 1932.

Preheating of Fuel Oil. K. Steiner, P. R. Unger. *Heating, Piping and Air Conditioning*: Vol. 3, pp. 297-303, 1931.

Pulverized Coal Enters the Hotel Field. B. H. Pisow. *Power*: Vol. 70, pp. 836-39, 1929.

Pulverizer Sizes and Installation Details from Operation Viewpoint. C. F. Hawley. *Power*: Vol. 75, pp. 96-7, 1932.

Relative Economy of Pulverized Coal, Oil, and Gas as Boiler-Plant Fuels. M. Frisch. *Fuel and Steam Power*: Vol. 52, pp. 67-77, 1930. See also *Paper Trade Journal*: Vol. 90, pp. 57-66, 1930.

Relative Fuel Economy of Electricity, Gas, Oil, and Solid Fuel as Heating Agents. D. H. Barker. *Institution of Electrical Engineering Journal*: Vol. 72, pp. 269-95, April 1933. Discussion: Vol. 72, pp. 296-312, 431-4, April-May. Vol. 73, pp. 452-3.

Furniture

Furniture—Its Selection and Use. National Committee Wood Utilization Department of Commerce. Report 1931. 113 pp.

Garages

Requirement of Hotel Garage Design. R. B. Whitman. *Architectural Forum*: Vol. 51, pp. 751-4, 1929.

Gas Appliances

Automatic Gas Burners. C. B. Segeler. *Heating, Piping and Air-Conditioning*: Vol. 4, pp. 516-20, 1932.

Gas for Hotels and Restaurants. *Gas Journal (London)*: Vol. 215, pp. 379-81, August 12, 1936.

Hotel and Restaurant Symposium Held at Pittsburgh. *Gas Age*: Vol. 73, pp. 275-6, March 24, 1934.

New Type of Gas Burners for Broilers Developed. A. Forward. *Gas Age-Record*: Vol. 63, pp. 901-02, 1929. See also *Gas World*: Vol. 91, No. 23-47, pp. 81-2, 1929.

Heating and Ventilation

Automatic Coal Heat with Mechanical Stokers. (Bibliography) Committee of Ten. *Coal and Heating Industries*. Chicago. *Educational Bulletin* No. 5, 43 pp. 25 cents.

Code of Minimum Requirements for the Heating and Ventilation of Buildings. American Society of Heating and Ventilating Engineers: 1929, 152 pp.

Degree days in 1000 Cities. *Heating and Ventilating*: Vol. 26, No. 10, pp. 79-81, 1929.

Developments in Heating and Ventilation. (Bibliography) *Power*: Vol. 75, p. 31, 1932.

Economic Use of Steam in Modern Buildings. F. A. Gunther. *Heating, Piping and Air Conditioning*: Vol. 2, pp. 527-9, 1930.

Emissivity of Paints for Decreasing or Increasing Heat Radiation from Surfaces. United States Bureau of Standards. *Technologic Papers*, 254. Bureau Standards *Technologic Papers*: Vol. 18, p. 171, 1924-5.

Factors Affecting the Heating of Rooms with Steam Radiators. University of Illinois Engineering Experimental Station. *Bulletin* No. 223, March 31, 1931, 104 pp.

Heating and Ventilating of Hotels. H. J. Cullen. *Architectural Forum*: Vol. 51, pp. 755-60, 1929.

Heating and Ventilating Specifications. H. L. Alt. *Heating and Ventilating*: Vol. 25, pp. 3-5, 7-11, March-May, July-November, 1929, pp. 86, 74-5, 80-4, 72-5, 71-3, 66-9, 69-73.

Heat Output of Concealed Radiators. E. A. Allicutt. *Heating, Piping and Air Conditioning*: Vol. 5, pp. 267-74, May, 1933.

If You Are Heating a Hotel: Study of 40 Hotels. C. I. Sayles. *Power*: Vol. 81, pp. 681-3, November, 1937.

Modernizing Steam Heating Systems with Pumps. J. A. Masek. *Heating and Ventilating*: Vol. 30, pp. 35-8, February, 1933.

Plumbing, Heating and Ventilating the Modern Hotel. T. N. Thomson. *Plumbers Trade Journal*: Vol. 48, pp. 696, 698-9, 772, 1928.

Reference Lists of Oil Burning Equipment. (Bibliography) *Heating and Ventilating*: Vol. 30, pp. 15-26, April, 1933.

Six Years of Degree Day Records. *Heating and Ventilating*: Vol. 30, pp. 7-9, September, 1933.

Heating Economy

Conserving Heat Waste for Building Warming. C. L. Hubbard. *Power*: Vol. 71, pp. 631-3, 1930.

Heating with Exhaust Steam. P. West. *Power*: Vol. 73, pp. 1004-1005, 1931.

Reclamation and Salvage of Flue Heat. R. Trautschold. *Paper Trade Journal*: Vol. 92, No. 6, pp. 58-60, 1931.

Utilization of Waste Heat. P. West. *Heating, Piping and Air Conditioning*: Vol. 2, pp. 947-56, 1930.

Heating Efficiency

Hotel Heating and Ventilating and Interesting Problems. A. Maclaren. *Power House*: Vol. 23, No. 10, pp. 37-9, 1929.

New Hotel Waldorf Astoria. C. R. Place. *Heating, Piping and Air Conditioning*: Vol. 3, No. 4, pp. 275-82, April, 1931.

Kitchen Equipment

Kitchen Equipment. F. C. Laut. Domestic Engineering, London: Vol. 50, pp. 167-71, 1930.

Planung und Betrieb Elektrischen Grossküchen. F. Mörtzsch. Elektrizitätswirtschaft: Vol. 30, No. 22, pp. 614-8, November, 1931.

Selecting and Operating Laundry, Kitchen and Hospital Equipment. H. C. Russell. Heating and Ventilating: Vol. 26, pp. 93-97, No. 3, 1929.

3000 Meals an Hour. W. J. Pampel and H. E. Wilson. Factory and Industrial Management: Vol. 81, pp. 977-9, 1931.

Zur Wirtschaftlichkeit der Elektrischen Grossküche. (Efficiency of Large Electric Kitchens.) A. Weizert, L. Roesner. Elektrizitätswirtschaft: Vol. 30, No. 22, pp. 625-30, November, 1931.

Laundries

Hotel Laundries. C. W. Spencer. Architectural Forum: Vol. 51, pp. 771-3, 1929.

Improving the Laundry Heat Balance. E. F. Sibley. Power Plant Engineering: Vol. 34, pp. 1030-2, 1930.

Lighting

Bibliography on Lighting Published in Monthly Numbers of the Illuminating Engineer.

Color Lighting. St. George Hotel. F. J. Cadevas. American Illuminating Engineering Society. Transactions: Vol. 25, p. 282, 1930.

Electric Lighting of Buildings. A. B. Read and J. W. T. Walsh. American Institute El. Engineers: Vol. 72, p. 93, 1933.

Electric Light on Metal in Architecture. E. Clute. Electrical Specifications: Vol. 3, No. 5, pp. 14-22, 1931.

Glazes and Facings Used in Architecture in Relation to Lighting. Leblanc and co-authors. Société Française Electric Bulletin: Vol. 1, pp. 36-60, 257, 1931.

Hotel Lighting: Installation at The Grand, Birmingham. Electrician: Vol. 110, p. 10, 1933.

Illumination as an Art. Illuminating Engineering, London: Vol. 24, pp. 84, 111, 35, 1931.

Illumination Characteristics of Organic Plastics. A. Paulus and C. S. Worlaide. American Illuminating Engineering Society. Transactions: Vol. 27, p. 749, 1933.

Light and Architecture. A. L. Powell. American Institute Electrical Engineers Journal: Vol. 48, p. 561, 1929. See also Illuminating Engineering, London: Vol. 22, pp. 89, 109, 1929. W. Maitford. Electrician: Vol. 102, p. 375, 1929.

Lighting of the New Waldorf-Astoria Hotel. L. H. Graves. American Illuminating Engineering Society. Transactions: Vol. 26, p. 939, 1931.

Lighting the Modern Inn. R. L. Zahour. Electrical Journal: Vol. 29, pp. 118-119, 1932.

Light Reflecting Properties of Paint. Foundry: Vol. 61, p. 38, April, 1933.

Material Vision—Light and Optics as They Relate To Interior Design. C. B. Ryder. Architecture: Vol. 67, pp. 93-8, February, 1933.

Modern Hotel Lighting; Reconstruction of the Grand Hotel, Sheffield. Light and Lighting: Vol. 30, p. 206, July, 1937.

Methods Used to Select Commercial Lighting Fixtures. K. Staley. Electrical World: Vol. 102, pp. 494-6, October 14, 1933.

Modern Art Lighting in Europe. H. Maisonneuve. American Illuminating Engineering Society. Transactions: Vol. 24, p. 456, 1929.

Reflecting Characteristics of Wall Paints. D. L. Gamble. American Illuminating Engineering Society. Transactions: Vol. 28, p. 345, 1933.

Remarkable Lighting at The Piccadilly Hotel. Electrical Times: Vol. 7, pp. 833, 834, 1930.

Modernization

Hotel Remodeling Project. Domestic Engineering, Chicago: Vol. 134, No. 6, pp. 37-39, March 21, 1931.

How to Make Remodeling Estimates. Domestic Engineering, Chicago: Vol. 143, pp. 47-8, March, 1934.

Modernization of Facilities in a Cleveland Hotel. Engineering News-Record: Vol. 110, pp. 552-4, 1933.

Modernizing Methods for Hotels and Apartments. Architectural Forum: Vol. 57, pp. 29-32, 1933.

Remodeled Hotel Shows 33% Increase: Carter Hotel, Cleveland. M. A. Boyd.

Hotel Saranac reduced its coal bill

\$2371⁰⁰
per year
(35.7%)



Hotel Saranac, Saranac Lake, N. Y.

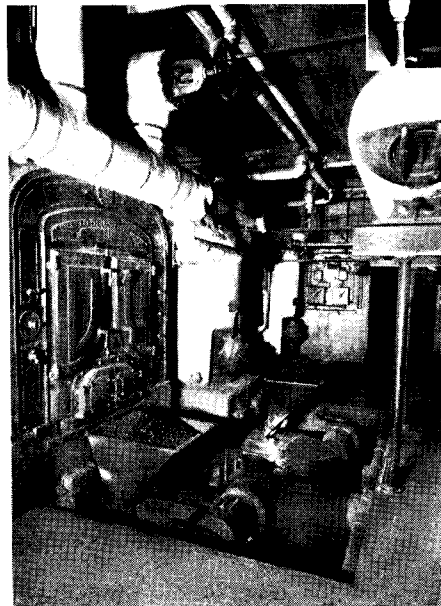

Two Detroit LoStokers installed at Hotel Saranac

by installing DETROIT STOKERS

Mr. Wm. H. Scopes, President of the Hotel Saranac Corporation, Saranac Lake, N. Y., reports an average annual coal cost of \$6,647.00 for the four years preceding the installation of two Detroit Stokers. During the two years since the Detroit Stokers were placed in service, the average fuel cost was only \$4,276.00 per year. This saving of \$2,371.00 per year amounts to 35.7%.

Quoting from Mr. Scopes' report: "In addition to the saving in fuel cost, we have been able to save about \$90.00 per month in other costs."

There is a Detroit Stoker for every kind of service in plants both large and small. Write for Bulletin 364.

DETROIT STOKER CO.

Sales and Engineering Offices:
Fifth Floor, General Motors Bldg.,
Detroit, Mich.

Works at Monroe, Mich.

District Offices in Principal Cities

BUILT IN CANADA AT LONDON, ONTARIO

MODERNIZE AND ECONOMIZE WITH

DETROIT SINCE 1898 **STOKERS**

Domestic Engineering, Chicago: Vol. 142, pp. 38-41, September, 1933.
Remodeling Hotel La Salle, Chicago. Architectural Forum: Vol. 67, pp. 213-5, September, 1937.

Noise Elimination

Elastic Properties of Various Materials and Their Effect on Transmission of Vibrations. B. E. Eisenhour. F. G. Tyzzer. Franklin Institute Journal: Vol. 214, pp. 691-707, 1932.

Fan Noise. R. G. Berthold. Siemens Zeitschrift: Vol. 11, pp. 90, 138, 1931. Science Abstracts B, Vol. 34, No. 1814, 1931.

How to Smother Vibration. A. H. Adams. Power: Vol. 75, pp. 200-3, 1932.

Noise in Heating and Air-Conditioning. S. R. Lewis. Heating, Piping and Air-Conditioning: Vol. 5, pp. 198-9, April, 1933.

Preventing Noise Transmission in Buildings. (Bibliography) R. C. Allen. Power: Vol. 73, pp. 692-5, 1931.

Silencing Ventilators. J. Lindner. Zeits für Technische Physik: Vol. 136, pp. 289-91, 1932.

Some Practical Methods of Eliminating Noise. E. S. Buck. Heating and Ventilating: Vol. 29, No. 8, p. 28, 1932.

Some Studies on Absorption of Noise in Ventilating Ducts. G. L. Larson, R. F. Norris. Heating, Piping and Air-Conditioning: Vol. 3, pp. 59-64, 1931.

Paint

Physical and Chemical Examination of Paints, Varnishes, Lacquers and Colors. H. A. Gardner. 5th Edition. Washington, D. C., Institute of Paint and Varnish Research, 1930, 952 pp.

Plumbing

Plumbing Don'ts. R. M. Starbuck, Jr. Domestic Engineering, Chicago: Vol. 130, No. 6, pp. 55-58, 148-50, March 22, 1930. Vol. 131, No. 1, pp. 80, 82, 169-71, 173, April 4, 1930.

Proper Water Supply and Drainage Piping for Hotel. (Bibliography) F. H. Waring. American Water Works Association Journal: Vol. 28, pp. 242-50, February, 1936.

Report of A.W.W.A. Committee on Hotel Sanitation. American Water Works Association Journal: Vol. 28, pp. 251-6, February, 1936.

Survey of Potential Health Hazards Due to Faulty Plumbing in Swimming Pools, Hotel, Milk Plants and Hospitals. W. S. Johnson. American Water Works Association Journal: Vol. 28, pp. 214-33, February, 1936.

World's Largest Hotel Has Multiple Drainage: Waldorf-Astoria. Plumbers Trade Journal: Vol. 91, No. 6, pp. 7-8, 31, September 15, 1931.

Power Plants

Diesel Power—With Steam Combination. Power: Vol. 72, pp. 842-5, 1930.

Joint Use of Diesel and Steam Engines to Balance Heat and Power. E. J. Kates. Oil and Gas. Power: Vol. 52, pp. 19-27, 1930. See also Power Plant Engineering: Vol. 34, pp. 748-50, 1930.

Steam and Diesel. Diesel Engines for Peak Load. F. H. Schweitzer. Electrical World: Vol. 94, pp. 1269-72, 1929. See also Mechanical Engineering: Vol. 52, pp. 622, 1930.

Radio Equipment

Apartment House Antenna Distribution System. Projection Engineering: Vol. 3, No. 5, pp. 17-22, 1931.

Centralized Radio and Public Address System in a Large Hotel. Radio Engineering: Vol. 11, No. 5, p. 31, 1931.

Radio Equipment. Hotel Radio to Pay its Way. E. Y. Pone. Radio Engineering: Vol. 11, No. 8, pp. 33-4, August, 1931.

Loudspeakers Added to Existing Public Address or Radio Installation. D. B. Looney. Projection Engineering: Vol. 3, No. 5, p. 10, 1931.

Radio Program Distribution Over Light-Circuits. T. D. MacCoun. Electronics: Vol. 2, pp. 682-693, 706, 1931.

Refrigerants

Data on Properties of Refrigerants—Charts and Tables. Refrigerating World: Vol. 69, pp. 14-17, January, 1934.

Ideal and Practical Refrigerant Requirements. J. E. Starr. J. B. Churchill. Power House Management: Vol. 26, No. 4, pp. 28-9, 41, 1932.

Refrigerants. A. H. Nuckolls. 118 pp. Issued by National Board of Fire Underwriters.

Sound Insulation

Control of Sound in Buildings. F. R. Watson. Heating, Piping and Air-Conditioning: Vol. 2, pp. 992-6, 1930.

Sound Insulating Values of Wall Constructions. Contract Record: Vol. 46, pp. 479-81, 1932.

Valuation of Paints for Acoustic Treatments. Oil, Paint and Drug Reporter: Extra Edition, Vol. 124, pp. 54-71, November 16, 1933.

Steam Power Plants

Coal and Ash Handling Plant in a Large Hotel. Cossiers Mechanical Handling: Vol. 17, pp. 80-81, 1930.

How to Select the Right Oil Burners. H. S. Klotz. Power: Vol. 77, p. 212, April, 1933.

Temperature Control

Temperature and Pressure Control Equipment. Product Engineering: Vol. 3, pp. 334-6, 1932.

Textiles

Comparison of Value in Soft Floor Coverings. A. G. Ashcroft. Melliand Textile Monthly: Vol. 4, pp. 447-9, 511-13, 573-5, 632-4, 678-80, 721-4, October, 1932-March, 1933.

Vacuum Cleaners

Central Cleaning by Electricity. H. P. Vowles. World Power: Vol. 18, pp. 107-10, 1932.

Industrial Proper Practices to Observe for Vacuum Cleaner Piping Systems. L. C. Smith. Heating, Piping and Air-Conditioning: Vol. 3, No. 10, pp. 852-7, 1931.

CALK all Joints WITH PECORA COMPOUND

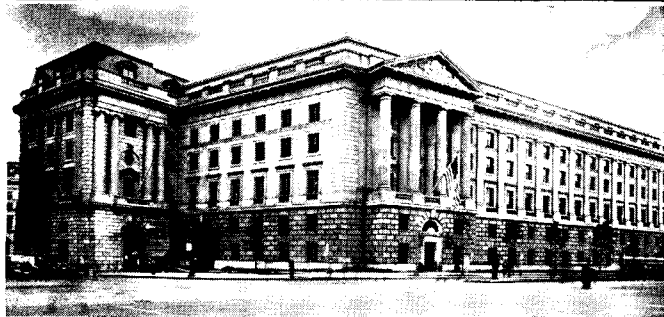

U. S. POST OFFICE DEPARTMENT
WASHINGTON, D. C.
And More Than 300 Other Federal Buildings
Sealed Weather-tight With Pecora Calking Compound

Air Conditioning demands Calked Joints

TEMPERATURE control is a vital factor in air conditioning. Such control is materially aided when calking is provided around all window and door frames, and when all air duct joints are sealed. In addition, a weather-tight structure assures heat conservation (fuel saving). The preferred calking material is Pecora.

It is impervious to heat, cold and moisture. Properly applied, it will not dry out, crack or chip. Equally applicable to glass, wood, stone, and metal; or any combination of materials.

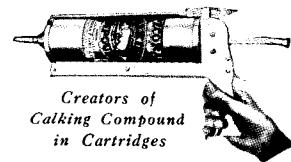

Write for new Folder

Pecora Paint Company, Inc.

SECOND STREET & ERIE AVENUE, PHILADELPHIA, PA.

Member of Producers' Council, Inc.
Established 1862 by Smith Bowen

ALSO MORTAR STAINS ● SASH PUTTIES ● SUCTION MASTICS