

BUILDING NEWS



Official U. S. Navy photo

Experimental Ship-Model Basin . . . See pp. 34 to 37.

ARCHITECTURAL
RECORD

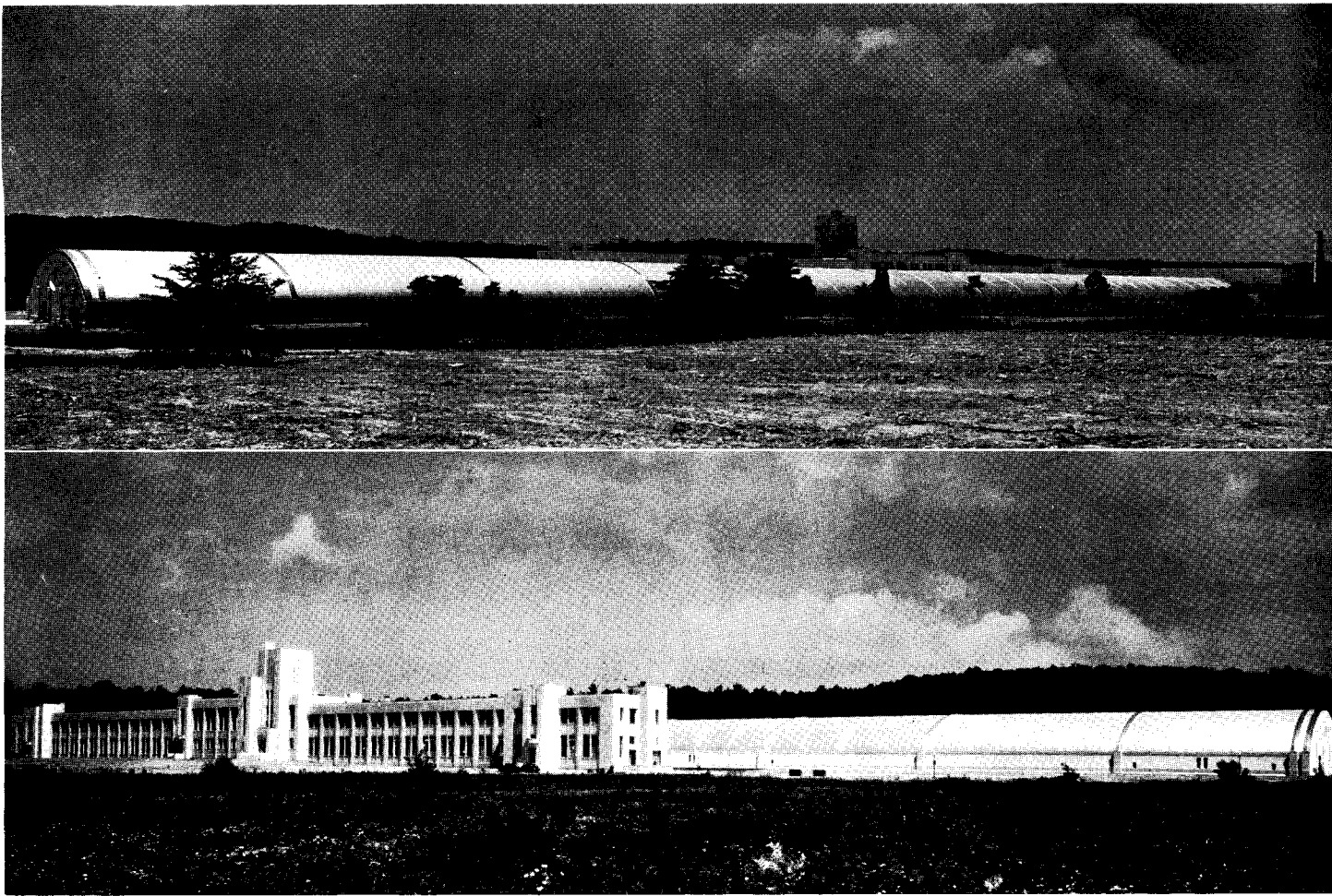

INNOVATIONS MARK CONSTRUCTION OF EXPERIMENTAL-MODEL BASIN

REAR-ADMIRAL BEN MOREELL, U.S.N., Designer

THE DAVID W. TAYLOR Model Basin at Carderock, Md., provides unequalled facilities for the testing of ship models. The project, costing \$3,500,000, includes a Basin building 1,300 ft. long, as well as shop, office, and laboratory buildings which form a continuous group 871 ft. in length.

All buildings are of reinforced concrete. The shop, office, and laboratory structures are among the first buildings of such size to be designed as continuous, rigid frames. Thus, the structure is considered as a single unit instead of as a combination of isolated members: account is taken of the effect of a load anywhere on the structure upon stresses in all other parts; smaller sections and greater economy of material are thereby made possible. These buildings are faced with precast aggregate concrete panels (Dextone Mo-Sai), which are used as exterior forms for the poured structural concrete; an excellent bond is obtained and half the panel thickness is assumed as effective structurally. Panels are a mixture of opaque and translucent quartz with

Atlas white Portland cement for the facing. They are heavily reinforced and the concrete itself is reported to be of unusual density and strength, averaging 7,500 pounds per square inch in compression after 28 days. These panels can be cast in much larger sections than is practicable for natural stone.

The shop, office, and laboratory buildings run parallel to the Basin building. The shop provides facilities for making models to be towed and self-propelled in the basins. The laboratory contains equipment for testing propellers and the strength and vibration characteristics of various ship constructions. It also includes a small model basin in the basement. The office building provides drafting and computing rooms, a photographic laboratory, and a museum, in addition to administrative facilities. A heating plant, electrical substation, water-purification plant, and sewage-disposal plant are also provided. Lieutenant-Commander Hugo C. Fischer of the Navy Civil Engineers Corps was in charge of construction at the site.

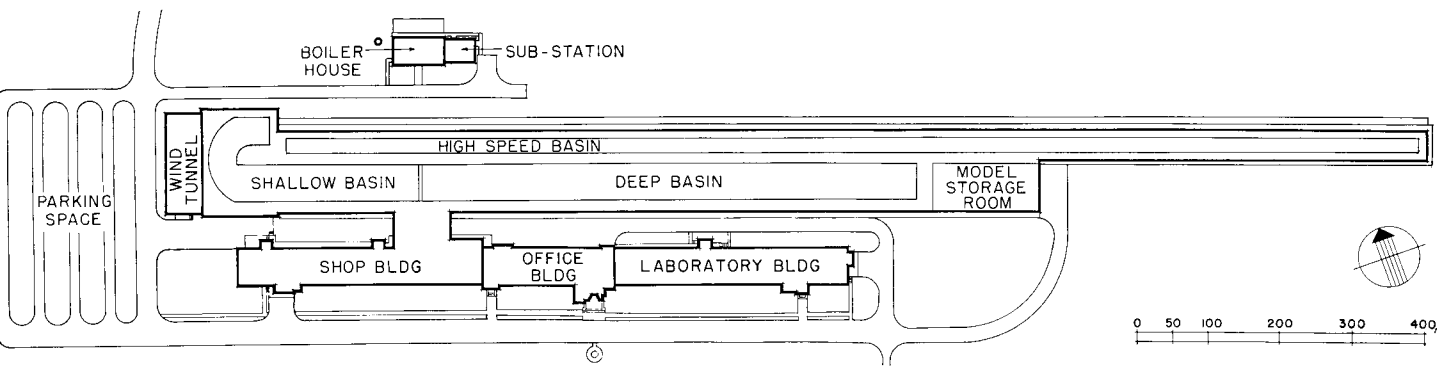

Plot plan

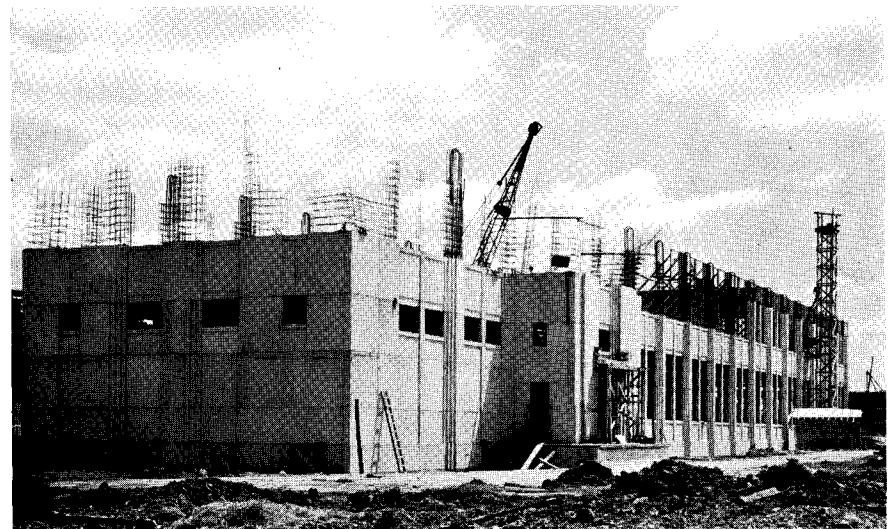
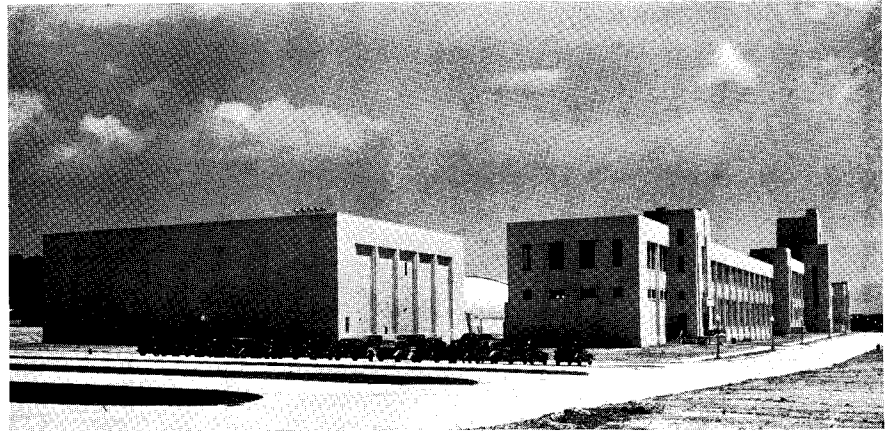

Shop, office, and laboratory buildings are faced with precast concrete panels which serve as exterior forms for the poured structural concrete.

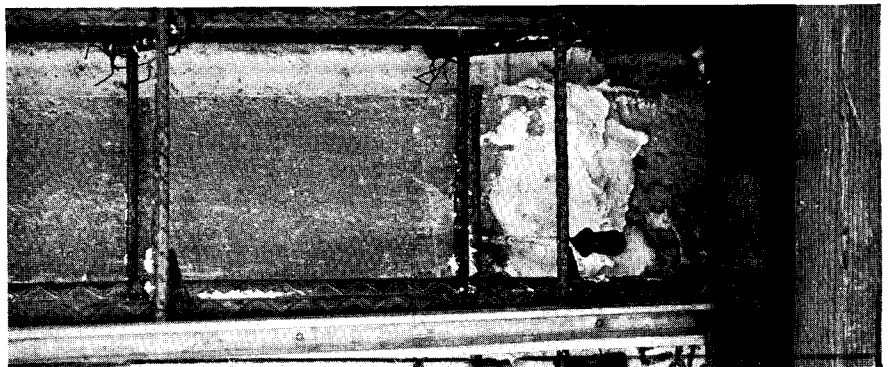

View showing method of securing precast-concrete face panels to backforms



U. S. Navy Photos

THE BASIN building is founded on solid rock; the lower 14 ft. of the deep basin are in fact dug out of the rock itself. This is important because the slightest sinking would throw out of alignment the sensitive machinery used in testing. Further, rails atop the basin walls, on which the towing carriages travel, are set parallel to the earth's curvature to a tolerance of 5/1,000ths of an inch; for the surface of the water in the basins, when it is perfectly quiescent, follows that level.

The main section of the building is a vaulted structure, a three-hinged barrel arch of reinforced concrete, without ribs or projections of any kind; it is said to be the first arch of its kind ever built. The arch is 1,188 ft. long, with a clear span of 110 ft.; it is 8 in. thick at the crown and 12 in. thick at the abutments; expansion joints are spaced 120 ft. on centers. The three hinges of the arch serve, first, to make the stress analysis statically determinate, removing uncertainties in the design procedure; and, second, to minimize the effects of so-called "parasitical stresses" (shrinkage, rib-shortening, plastic flow, temperature and humidity variations, abutment yielding), with resulting reductions in sizes of sections, and therefore in the cost of superstructure and

foundations. The hinges, invented by an eminent engineer, Augustin Mesnager, are of reinforced concrete, like the arch itself. The crown hinge is reinforced by eight 1/2-in. round, corrosion-resistant steel bars per foot. The abutment hinges are made of eight 5/8-in. round, intermediate-grade, carbon-steel bars per foot. The mortar covers over the hinges were placed 14 days after decentering; this to permit adjustment for dead-load rib-shortening, initial shrinkage, and initial abutment deflections while the hinges were in their most flexible condition. Tests, including the loading to destruction of a quarter-size model, were conducted before building began; and design procedures were based on those tests.

The arch-roofed main section encloses a high-speed basin with a 10-ft. water depth, a deep basin 22 ft. deep, and a shallow basin with a 10-ft. depth. The shallow basin is a continuation of the deep basin at one end, separated from the latter by a removable caisson; at the other end it continues into a turning basin with a radius of 70 ft.

The underside of the vault is lined with a 2-in. thickness of Thermax insulation. There are no openings for natural light in any part of the Basin building, all light and ventilation being artificially provided.

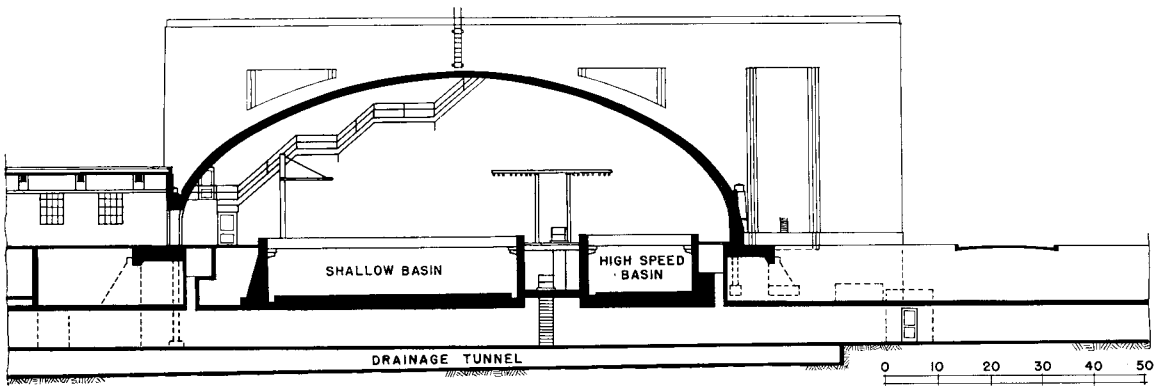

Section

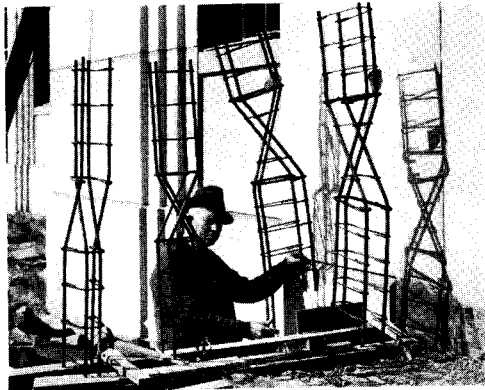

Hinge assemblies as received: abutment hinges at right, crown hinges at left.

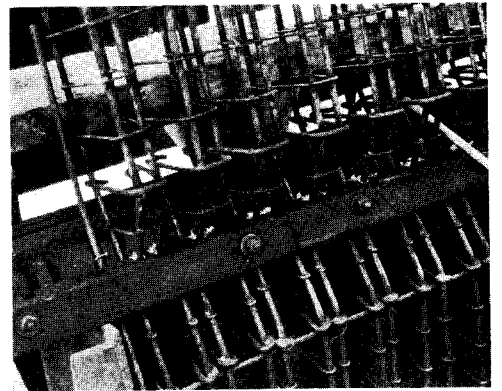

Abutment hinges in place; the concrete cover will be a shield against corrosion.

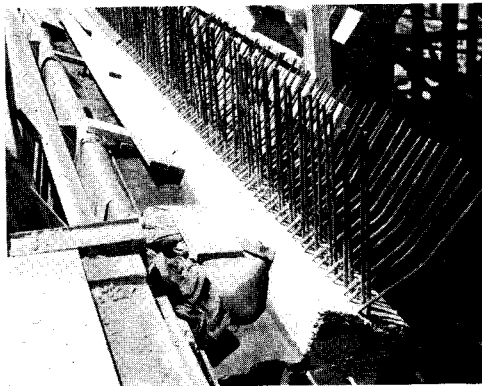

Abutment hinge bars after casting; concrete cover adds to strength of hinge.



Section of arch reinforcing is picked up by crane for placing on arch centering.



View showing placement of insulation serving as the bottom form of the arch.

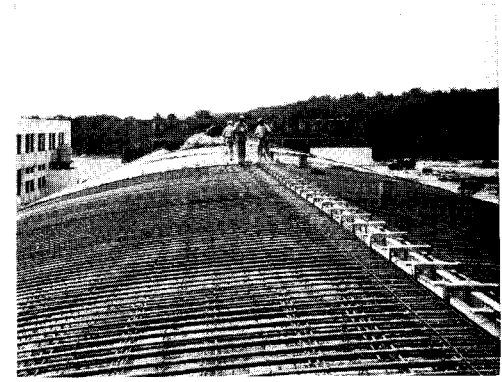

Top of arch, showing reinforcing steel; thickness of arch at crown is 8 inches.



For greater privacy, working areas are elevated above street level. The awnings may be raised or lowered from within.

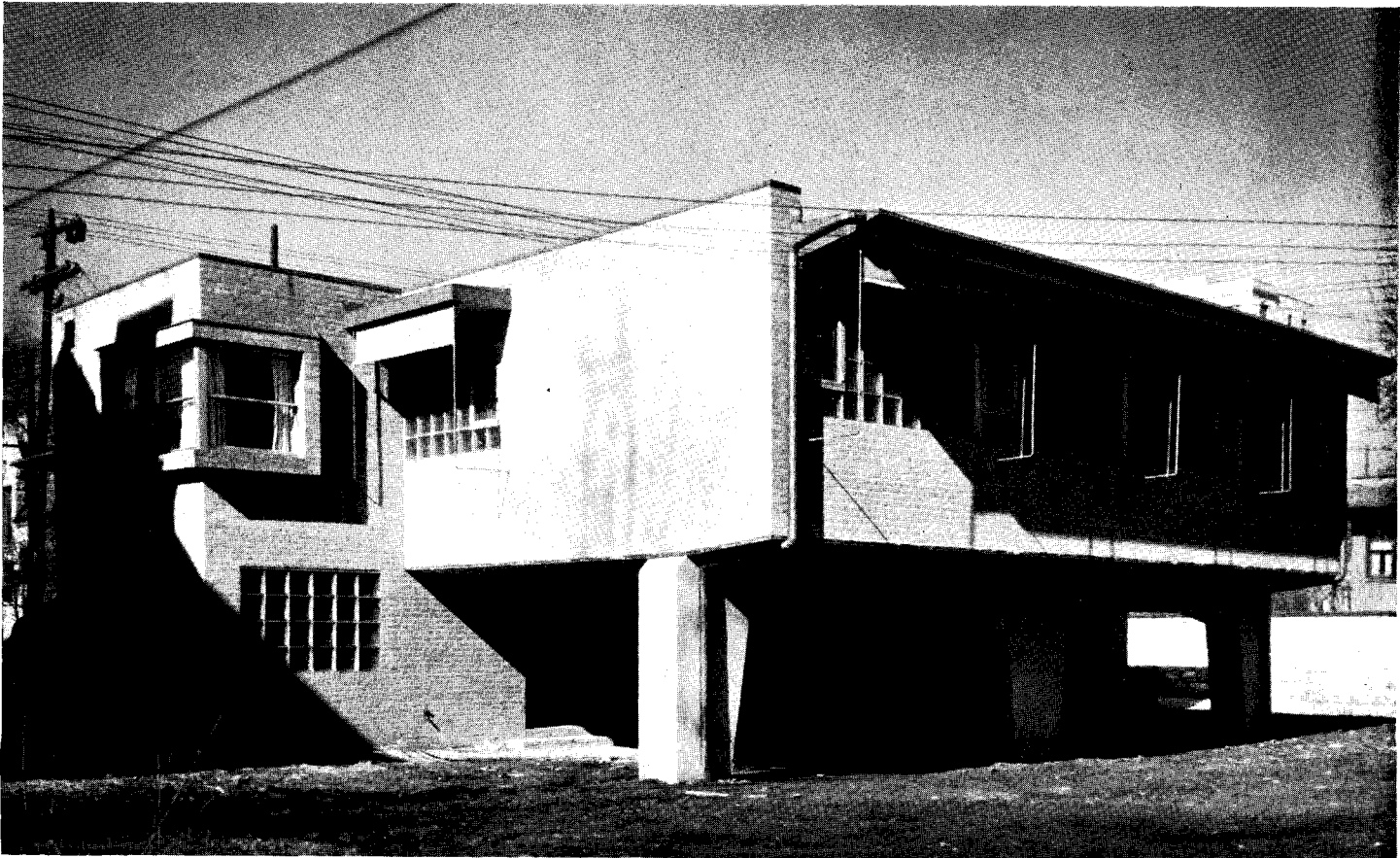

There is parking space here for six automobiles. An examining room for special cases is provided on the lower level.

PHYSICIAN'S OFFICE DESIGNED FOR CONTROL FROM CENTRAL POINT

HARRIS ARMSTRONG, Architect

THE PROBLEM involved in the design of this physician's office in St. Louis, Mo., was the provision of a single-floor working area for a specialist with a large practice; at the same time, this area was to be removed from the scrutiny of passersby. This was done by elevating the office above street level, an arrangement which also permitted the use of space in the rear for automobile parking.

The work area has been so laid out that the receptionist at the observation window between waiting room and secretarial center is the coordinator of the work of the office: she operates the switchboard, makes appointments, takes patients to their examination rooms, works signal lights that tell the doctor which rooms are occupied and which patient is to be seen next, puts the patient's "history file" beside the door where the doctor may see it before entering the room, etc.

The building is completely air-conditioned, with all air exhausted through fans in the laboratory, the room which is the source of most of the medicinal odors.

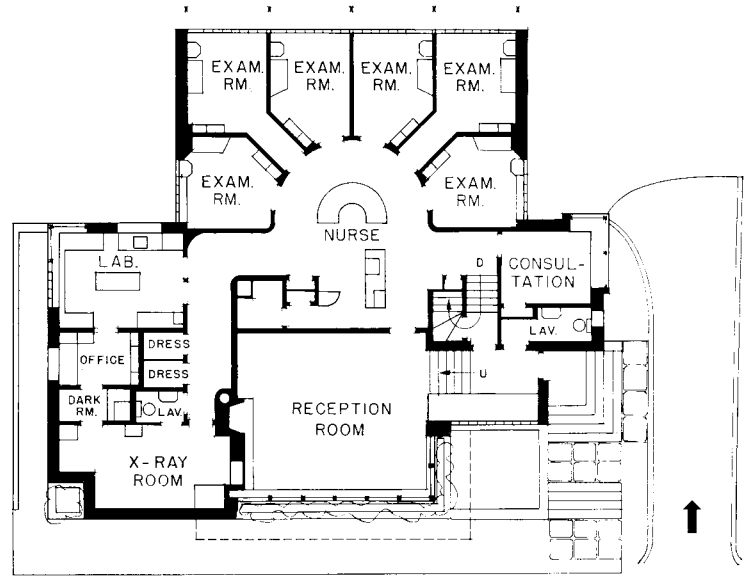

First floor

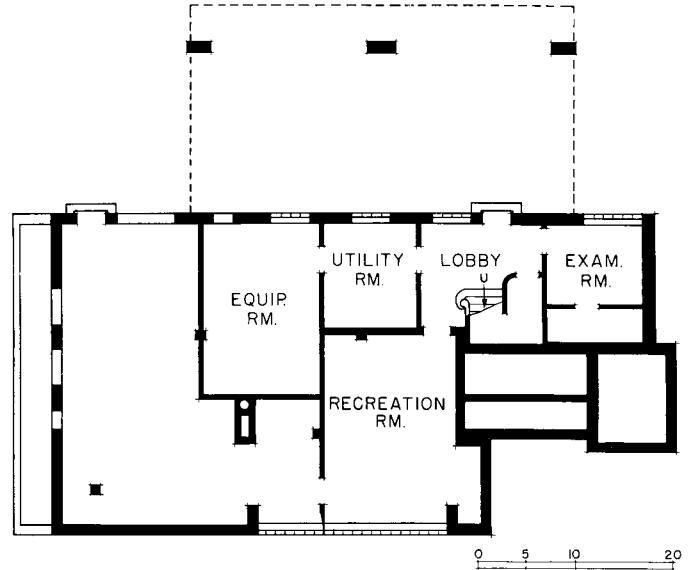

Basement

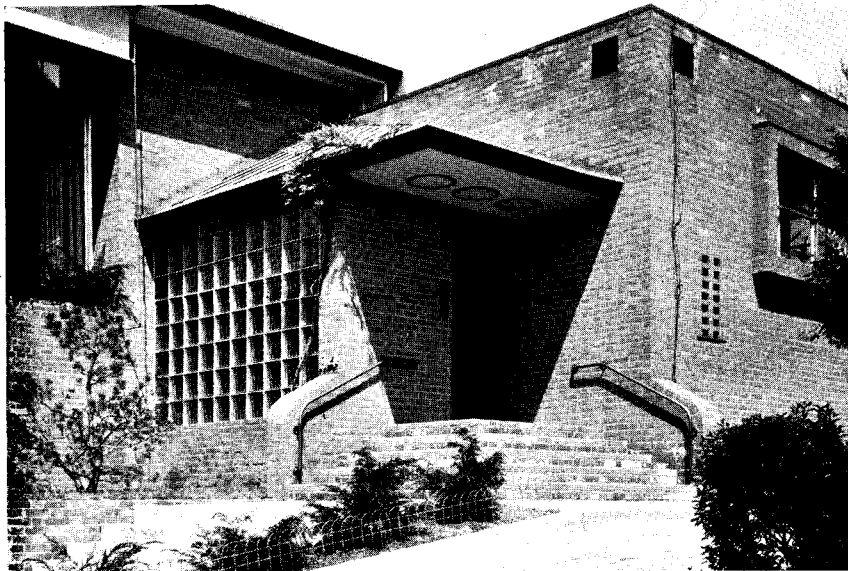



The main desk commands a view of all examination rooms.



One of the examination rooms



View of the laboratory

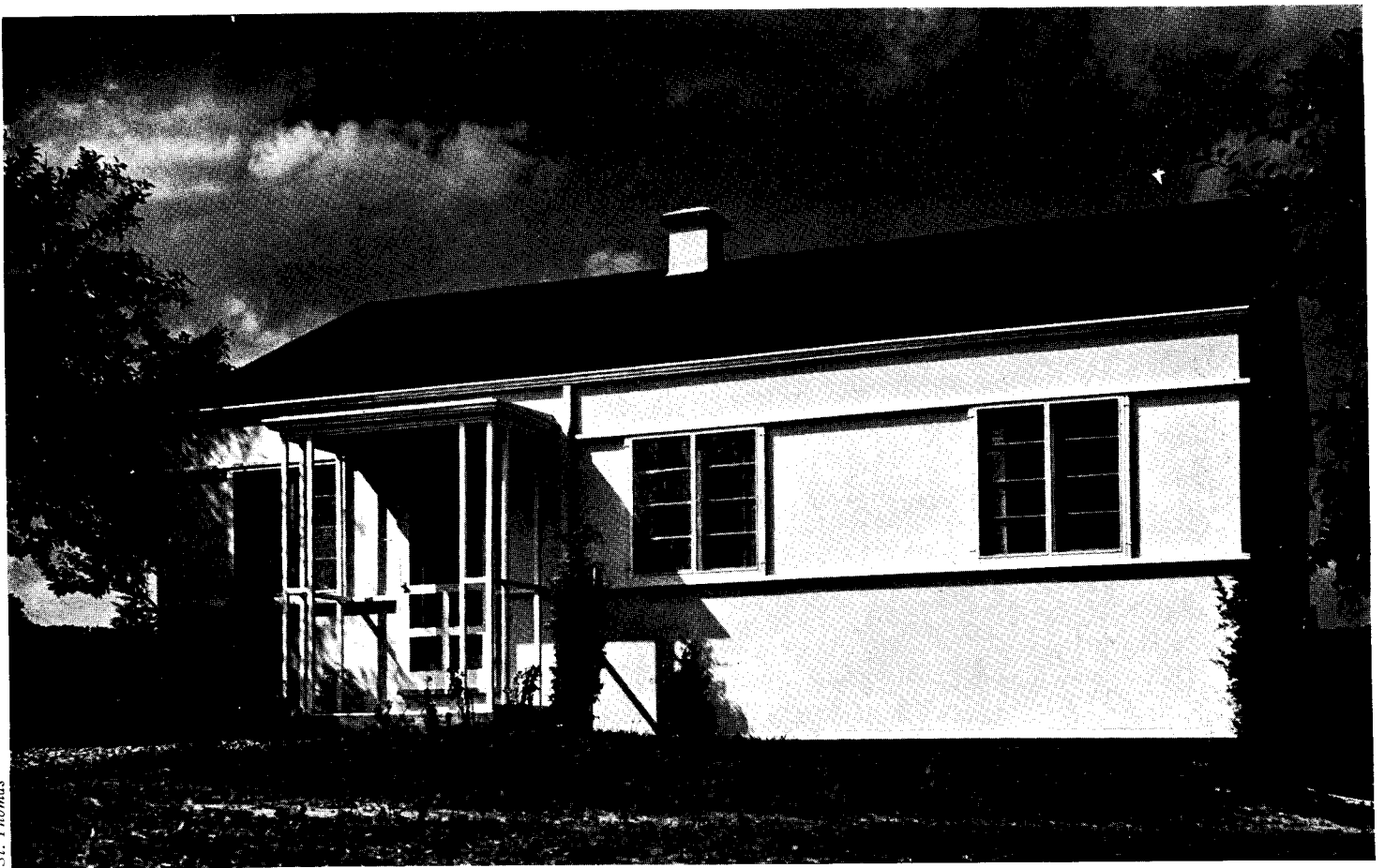

RESEARCH IN LOW-COST HOUSING YIELDS A SOLUTION IN PLYWOOD

JOHN B. PIERCE FOUNDATION, Designers

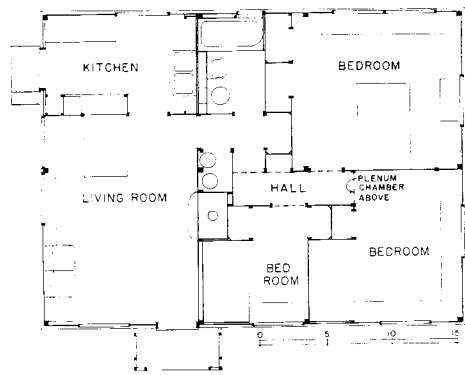

Plan

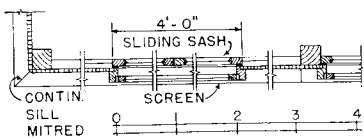
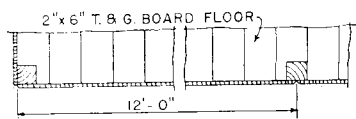

Details of wall construction

THE JOHN B. PIERCE Foundation, which for years has researched the problem of low-cost housing, has now built a house at Lebanon, N. J. to test its conclusions. The design of this house was developed after an investigation of the possibilities of various materials and structural systems for low-cost housing; this in addition to time-studies of household functions, and inquiries into the living habits of low-income families and their possible bias against design innovations. A peaked roof was decided upon partly to avoid sales resistance to the flat roof; little space is wasted, however, it is claimed, because some space would be needed for insulation, no matter which roof-type was used. Most furniture, except chairs, is built-in; this reduces initial expenses and makes for maximum efficiency in the performance of domestic tasks. Exterior walls consist of a series of wall girders in which plywood panels act as webs and horizontal cross-members as flanges. In tests at Columbia the ultimate strength of these girders proved to be almost five times their design load in this one-story house. The windows, stock casement sash, can be slid back, leaving the entire window space open; with the plywood panels tested under maximum load, they could still be operated.

The shell of the house was erected practically complete between 8 a.m. and 4:15 p.m. of one day. Although about two weeks passed before completion of construction and installation of equipment, it is estimated that, with more experience and better organization, the work could be done in about four days. The assembling was done by four men who had never previously erected such a house. Cost of a single house is estimated at approximately \$1,700.

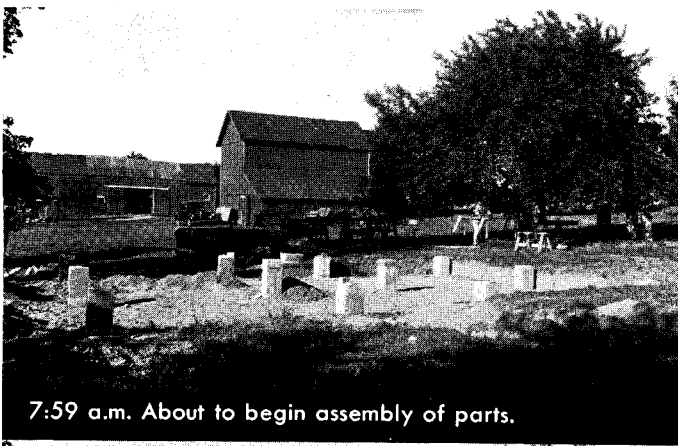

7:59 a.m. About to begin assembly of parts.

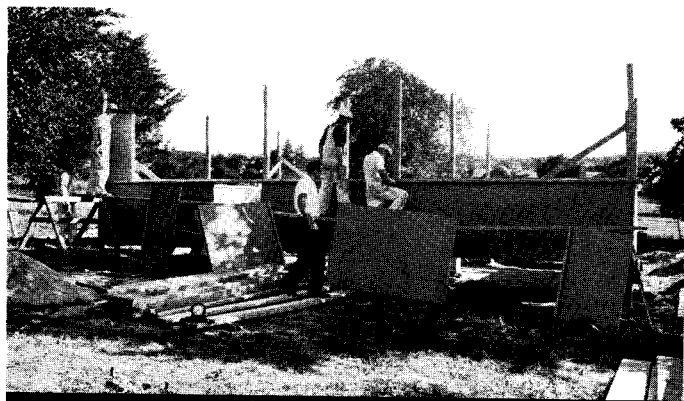

8:36 a.m. Placing the first deep-girder wall beams.

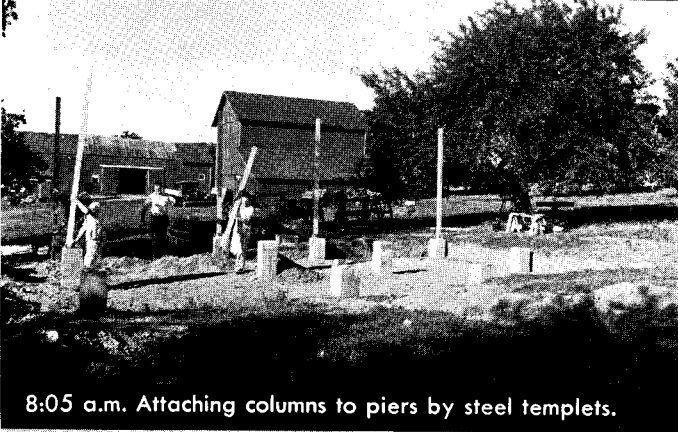

8:05 a.m. Attaching columns to piers by steel templates.

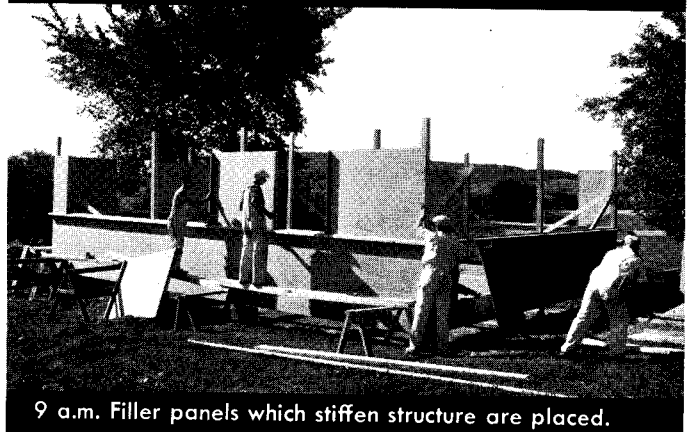

9 a.m. Filler panels which stiffen structure are placed.

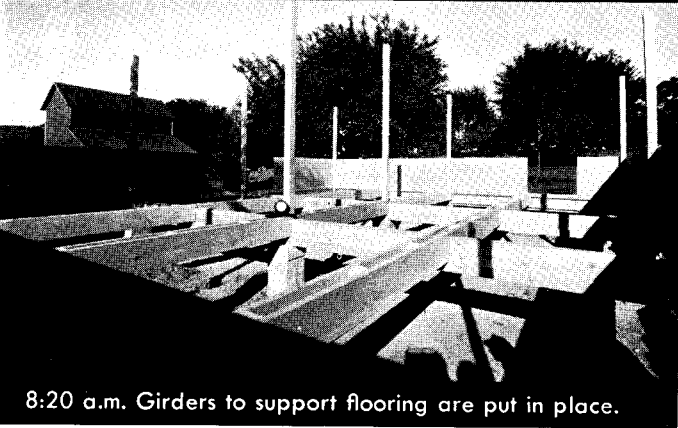

8:20 a.m. Girders to support flooring are put in place.

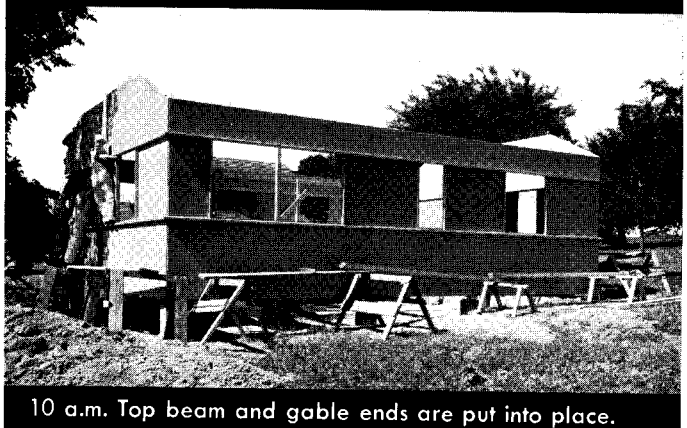

10 a.m. Top beam and gable ends are put into place.

Photos by Eric J. Baker

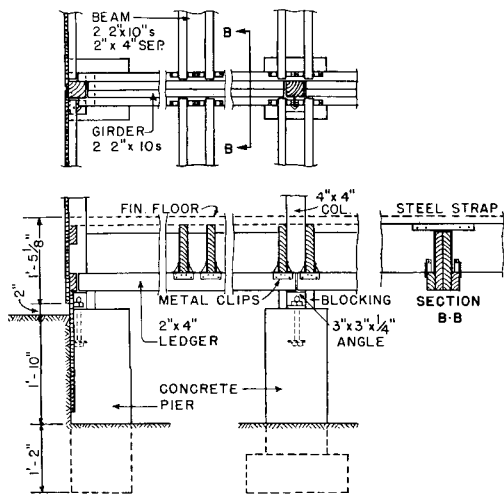

Plan and section of floor construction

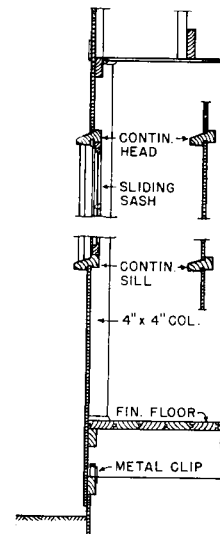

Section through exterior wall 0 1 2 3 4

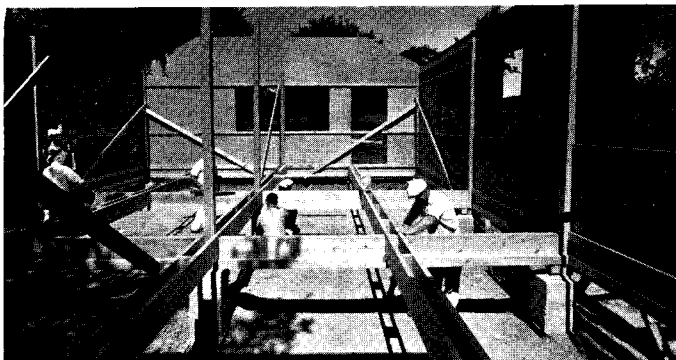

10:30 a.m. Cross-bridged girders are spaced 8 ft. apart.

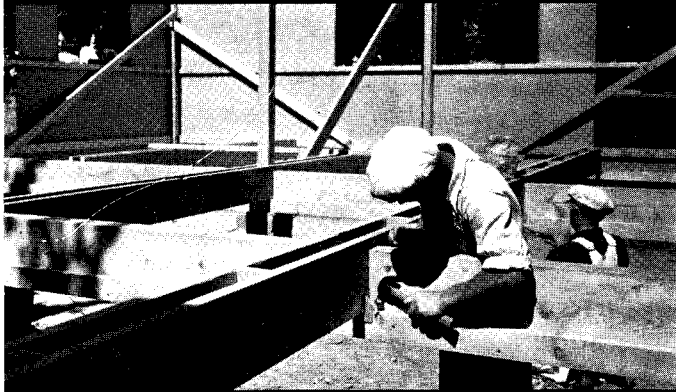

10:35 a.m. Framing members are attached with stirrups.



11 a.m. The ceiling girders are now put into place.

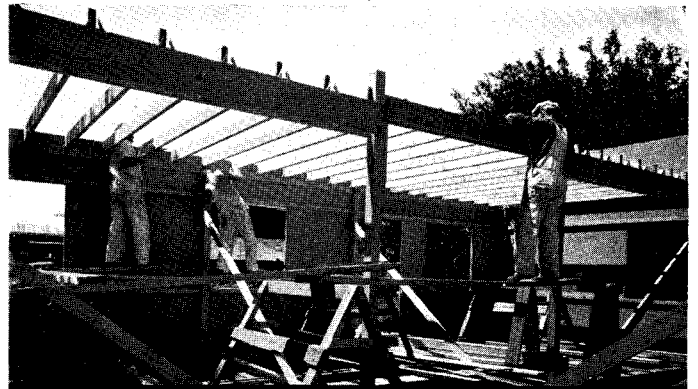

12 m. The ceiling joists are here being installed.



2 p.m. Nailing rafters; sheathing and shingles over.

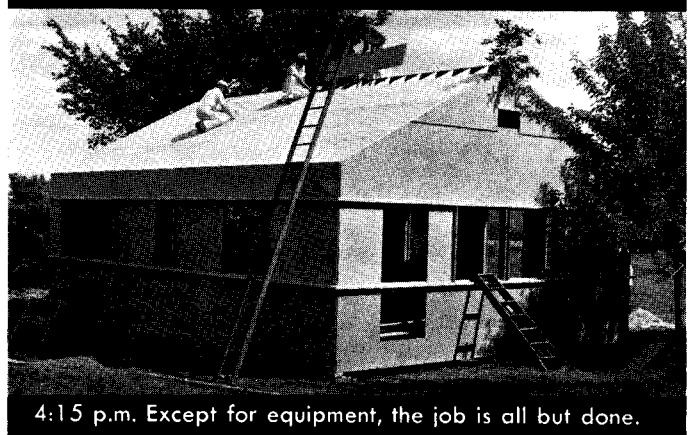

4:15 p.m. Except for equipment, the job is all but done.

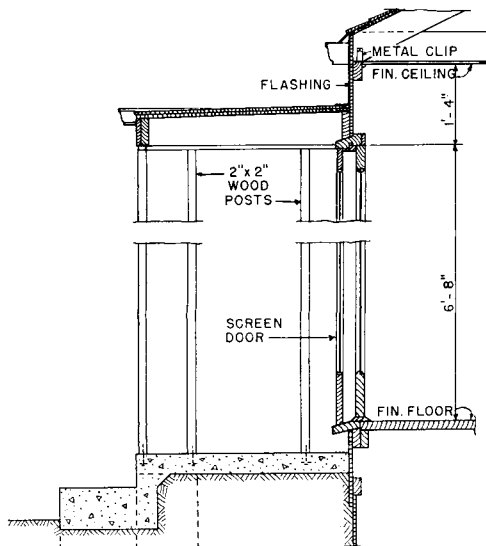

Section at main entrance

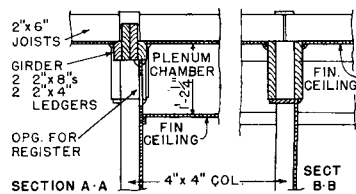
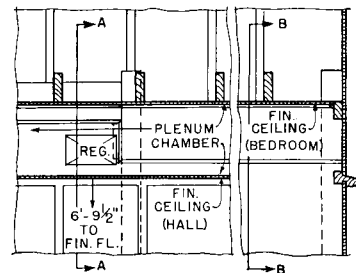

Section through ceiling



View of living room with kitchen beyond. Note the continuous wiring at the baseboards and table.



Living room from kitchen. At left is the hot-air furnace, with grate and double doors, used here as a fireplace.

PLYWOOD HOUSE



St. Thomas

When not in use, the living-room table can be folded back in sections.

WALL PANELS are a single thickness of $\frac{7}{8}$ -in. resin-bonded plywood, glued and nailed to the posts and cross-members. Resin films within the plywood act as vapor barriers. The floor is insulated with Sisalkraft paper "Bostiched" to the tops of the girders and drawn tight. Insulating value of the construction has not yet been tested empirically. The Pierce Foundation intends to put a family in the house, maintaining comfortable living conditions within it through next winter; temperatures, condensation, etc., will be regularly recorded.

The heating system, a coal-fired hot-air furnace, is a "tailor-made" model not yet in production. The unit is located between a pair of closets off the living-room wall; it has a grate and double doors and may be used as a living-room fireplace. Space over the ceiling of the hallway is used as a plenum chamber and for ducts through which heat is transmitted to other rooms of the house. The chimney is of asbestos-cement; it acts, too, as a vent for the attic and for the hot-water system.

The waste and vent piping has been so laid out that it can be pre-assembled, with only two field connections necessary; in fact, the most complex of the units (that which joins all the soil lines and vents) could easily be precast in one piece, and lifted into place by one man.

The wiring system is a combination of conventional methods and a recent development of the Pierce Foundation not yet available generally. Outlet strips are continuous around baseboards, wainscots, etc., providing outlets in some areas every six inches and in other areas at somewhat larger intervals.

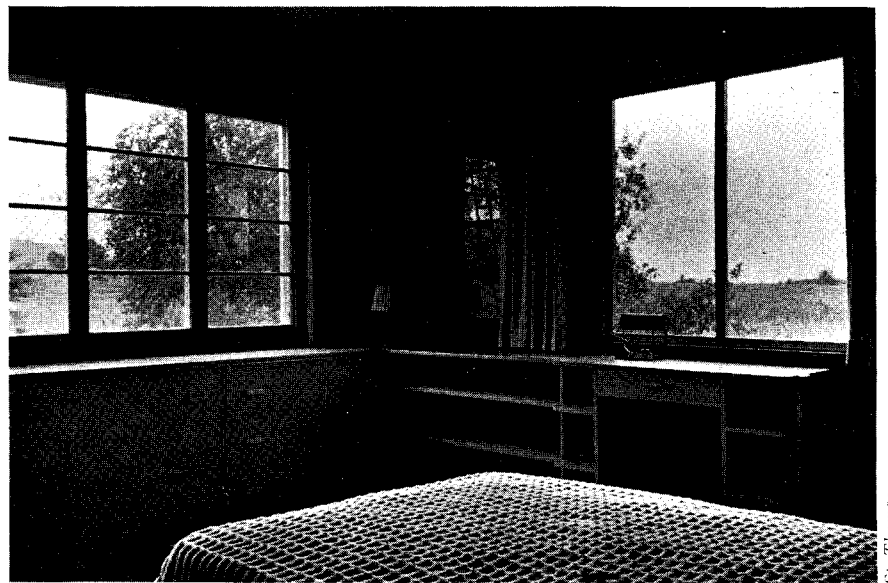

St. Thomas

Sash can be slid back, permitting full use of window space for ventilation.



Eric J. Baker

Bedroom with double-decker bunks. Most furniture, except chairs, is built-in.

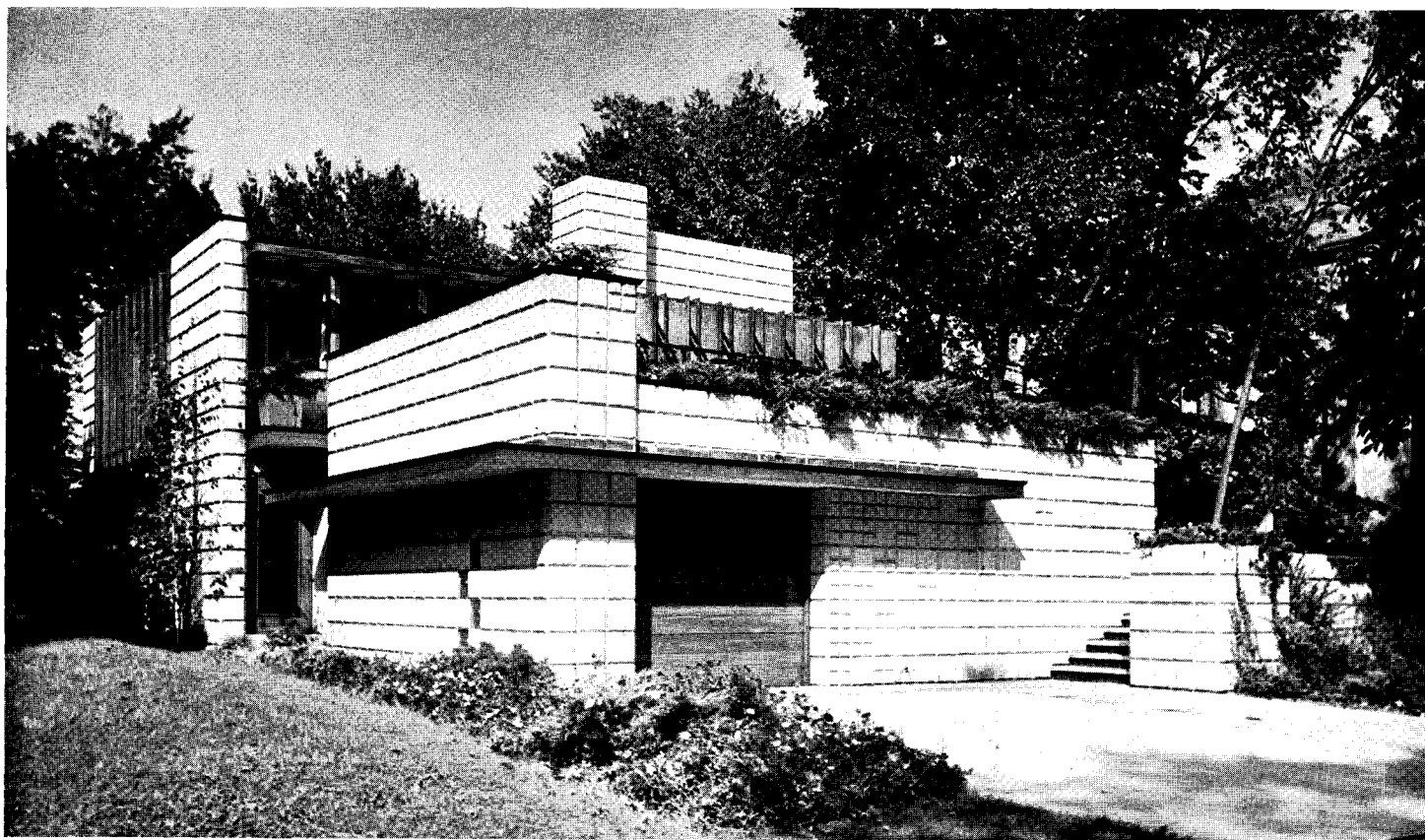

The garage faces the street and is an integral part of the house; steps at right lead up to terrace and thence to the entrance.



Right: cinder block, glass block, and copper are used on one wall; left: the living room's casement windows overlook the terrace.

MICHIGAN RESIDENCE HAS CINDER-BLOCK EXTERIOR AND INTERIOR FINISH

ALDEN B. DOW, Architect

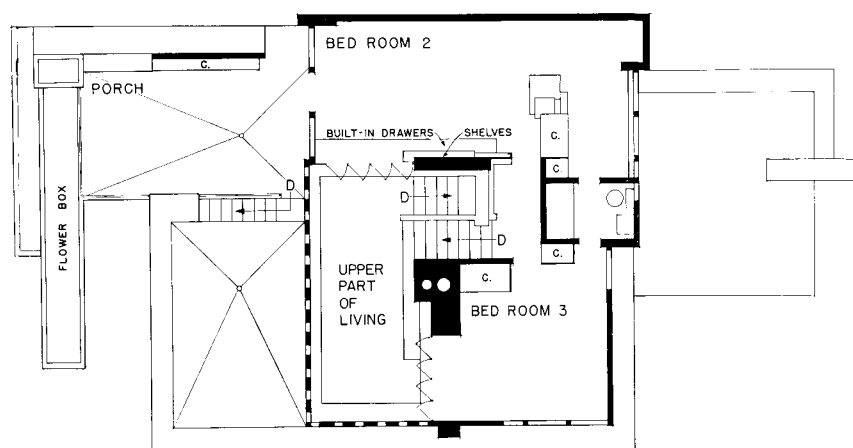

Second floor

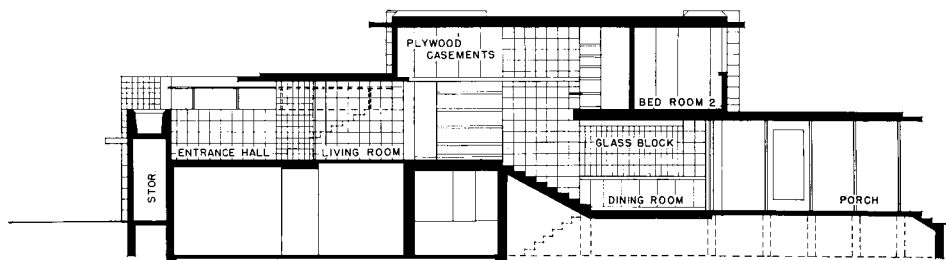

Section

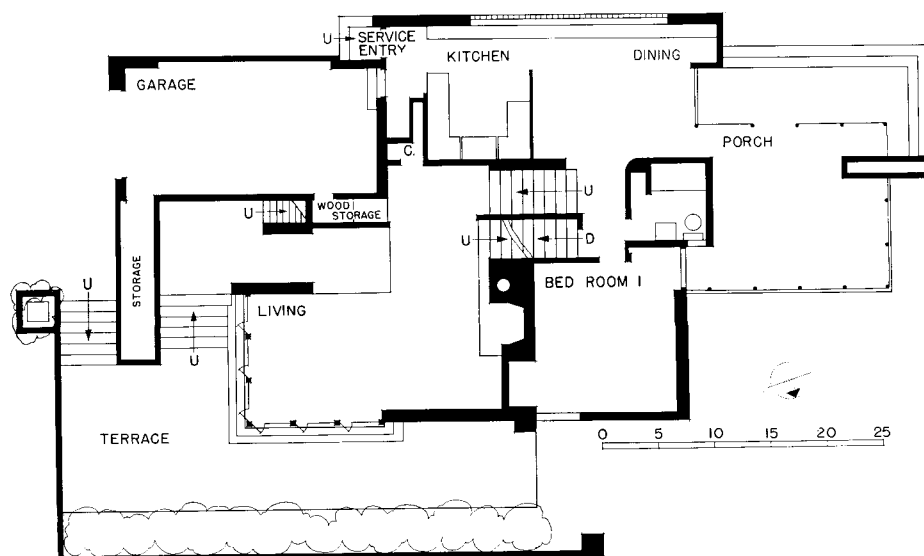

First floor

THE RESIDENCE of Miss Mary Dow at Saginaw, Mich., features an interesting combination of materials and an unusual arrangement of floor levels. The structure, resting on a cement-block foundation, is of unit cinder blocks. Use of these unit blocks gives an overall decorative pattern to the exterior; green copper panels above the living room and on one wall and cypress trim are the only variations. Entrance to the house is not direct; since the building covers most of its plot, this permits considerable privacy from the nearby street. On the same level with the entrance is the living room. The rear portion of the house is planned on the split-level principle: from the living room, stairs lead down to dining room, kitchen, bedroom, and porch; stairs lead up from living room to the other two bedrooms. Ceilings (and bedroom walls) are of sand-float finish plaster, with red cypress trim. Living-room and dining-room walls are of the same unit block as the exterior. Floors in living and sleeping areas are carpeted in deep blue; linoleum is used in the kitchen; terraces, garage, and basement are cement floored. All roofs are insulated with 4-in. rockwool.

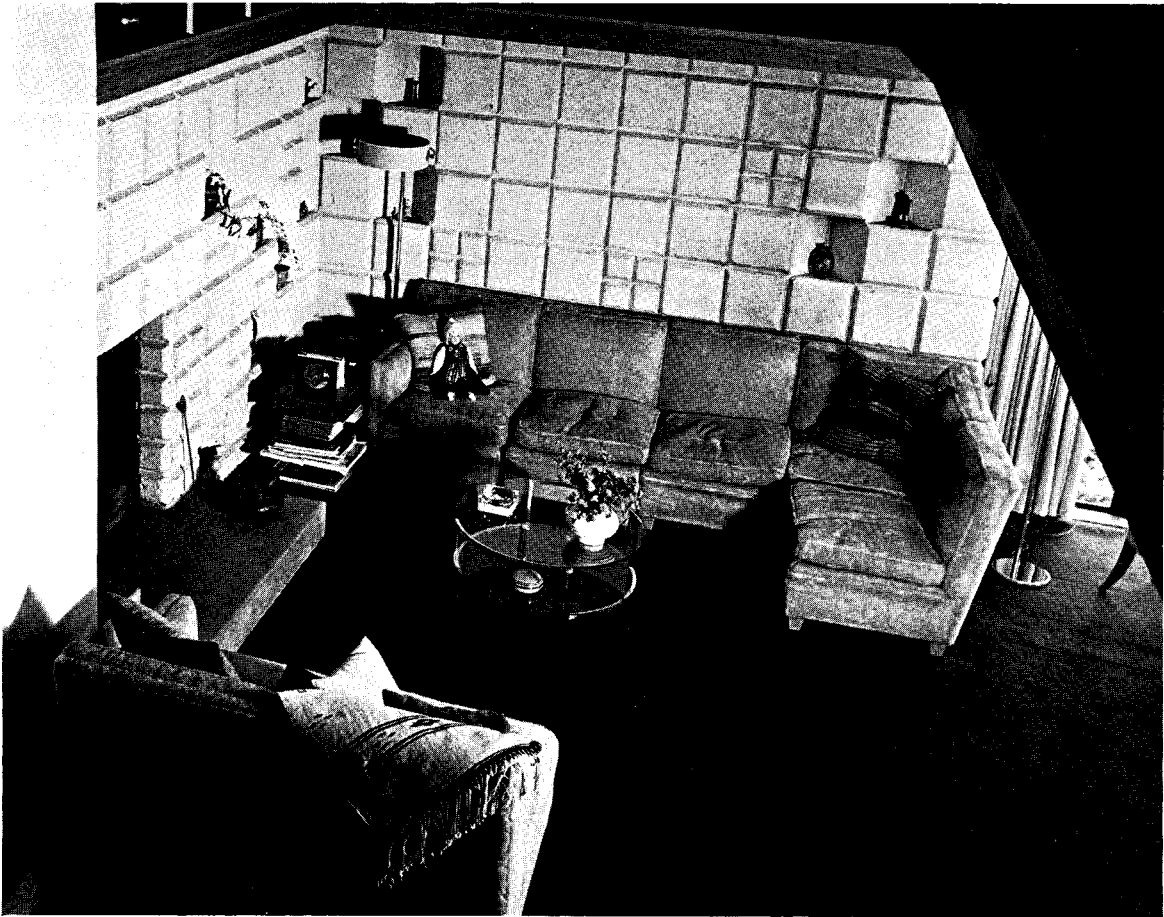

Fireplace group in living room seen through wood casements which open on Bedroom 2.



Left, looking toward wood casements; right, looking down from landing toward dining level.



Figure 1

Unit cooking equipment permits flexible design

THE THERMADOR Electrical Mfg. Company of Los Angeles has added to its line of Built-in Ranges, a series of flexible cooking units for kitchens of all sizes. Enclosed-tube type cooking tops, baking and warming ovens are supplied as independent units to be built into standard kitchen cabinets in the most convenient locations for use (Fig. 1). Where it is desirable for the range to supply space heating (in southern and western states), Thermador provides an electric room heater and circulating fan built into a compartment below the range.

Treadle-controlled group shower

THE BRADLEY Washfountain Company of Milwaukee announces a water-saving group shower operated by a treadle (Fig. 2). Pretempered water is used to assure safety and to reduce water consumption. Both circular and semi-circular, five- and three-person models are available, with or without partitions. The unit is 7 ft. in diameter, has baked enamel finish on sheet and tubular steel, and a single central drain connection.

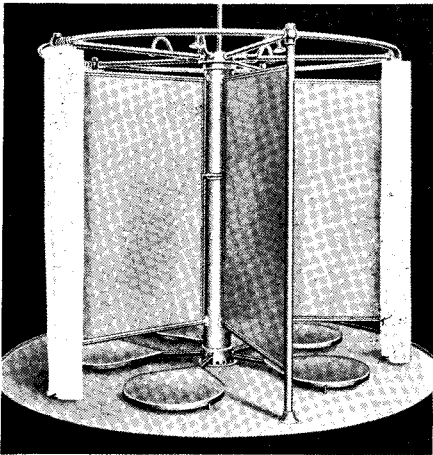

Figure 2

Delayed-action light switch

A UNIQUE SAFETY device for home owners in the form of an adjustable toggle switch which permits the light to stay on from 20 to 60 seconds after the switch is snapped off is now being marketed by the S & W Mfg. Company of Downey, Calif. This switch, called the Delay-O-Lite, has been approved by the Underwriters' Laboratories, Inc. It is recommended for hallways, bedrooms, children's rooms, porches, garages, and basements. Quickly installed with a screwdriver, it will fit a standard switch box and replace the ordinary wall type of toggle switch which it resembles. This device is limited to loads from 40 to 250 watts.

Revolving file facilitates reference work

BECAUSE THE latest telephone books and commercial directories of over 1000

cities in 118 countries of the world had to be easily available for quick reference, J. E. Sitterly & Sons, Inc., of New York City, publishers of Importers' Guide, installed a motorized, rotating file (Fig. 3). Around its 50-ft. circumference are filed hundreds of these books, each clearly indexed. The drum turns one revolution per minute permitting the circulation clerks seated at specially designed desks to select any reference needed to check changes in address and firm style of overseas houses.

The entire construction is lined with Armstrong's corkboard to silence mechanical noises.

Precision control from automatic hydraulic door closer

YALE AND TOWNE Mfg. Company of Stamford, Conn., has extended the function of the familiar door closer by providing photoelectric or switch control for a small electric pump which supplies hydraulic pressure to the piston of the closing device on the hinged door. Other types of automatic door on the market work by compressed air; this system, known as "The Phantom Door-man," employs hydraulics to give smooth, efficient operation. The liquid used acts as a lubricant and cannot freeze, making the device suitable for exposed installation. The regular closer spring closes the door when the pressure is relieved. Closers may be visible or concealed. Pressure may be regulated and is automatically graduated at beginning and end of swing.

This automatic control has applications in industrial plants, hotels, restaurants, office buildings, stores, terminals, and hospitals, for traffic, air-conditioning, and advertising purposes.

Pneumatic-rubber door silencer

AN INEXPENSIVE device for reducing the noise of closing wood or metal doors has been brought out by Glynn-Johnson Corporation of Chicago. Three small and tamper-proof buttons of live moulded rubber with cushioning air pockets are provided for mounting on the stop of the door frame. They are inconspicuous and cannot be pulled off.



Figure 3

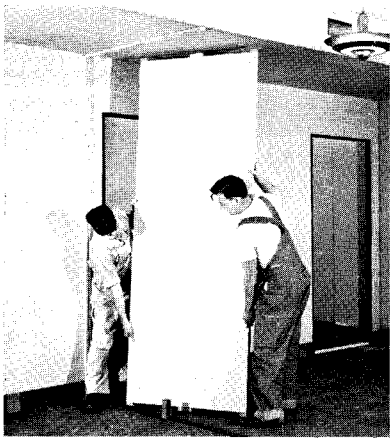

Figure 4

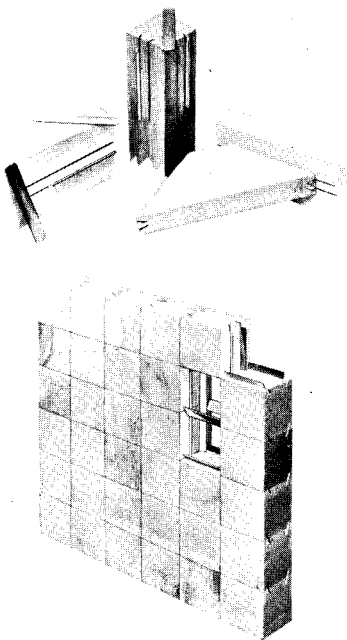

Figure 5

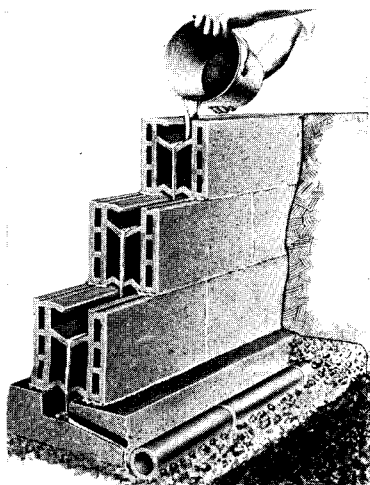

Figure 6

New low-cost movable partition

A NEW low-cost movable partition, Transite Walls-Universal Type, for subdividing offices and partitioning off departments in plants and factories, has recently been announced by Johns-Manville. Through new developments in design and construction, the manufacturer reports, this new type of partition wall is easy and economical to erect and equally as simple to dismantle and re-locate (Fig. 4).

The panels which form the finished wall are $1\frac{3}{4}$ in. thick, consisting of a sealed light-weight core faced on both sides with $\frac{1}{8}$ -in. Transite, a fireproof, permanent, asbestos-cement material. While the finished wall panel is only $1\frac{3}{4}$ in. thick, comparative tests by the manufacturer reveal sound isolation values equal to a 3-in. wall of conventional partition construction.

Transite Walls-Universal Type are furnished in large, light-weight panels which are firmly anchored to steel floor channels concealed in the partition. The walls are made in both free-standing and ceiling-height types, with or without borrowed lights, and with a complete line of all necessary accessories, including hardware, light metal frames, door bucks, and doors. Doors are of the same construction as the wall panels and are available in two finishes—wood veneer over Transite and natural Transite to match the finish of the wall panels. In appearance, Transite Walls-Universal Type show flush surfaces with a soft gray finish which may be waxed or painted on the job.

Double spline fastening promises many uses

A RECENTLY PATENTED method of joining materials, the Homer Spline Lock, is announced by the Doughty Marketing Corporation of New York City, sole licensing agent. Two inclined keys or splines form a laterally locked construction which can slide either initially for permanent placement of parts, or loosely to permit accurate operation of sliding equipment such as drawers or windows (Fig. 5).

Metal, wood, plastic, and tile applications have been made, and joinery de-

tails such as tongues and grooves, dowels, and dovetails have been replaced cheaply and with greater strength by this process. Precision equipment is available for shop production of this joint in any material, and hand tools for grooving on the job.

Many applications are claimed for the system in the building field: in millwork, in finishes such as block flooring and tile, and a large field in the more economical production of furniture and cabinetwork. A completely pre-fit window can be sent knocked-down to the job and assembled quickly. Jamb, head, sash, and casing are all matched-grooved with precision shop equipment and furnished with splines for job assembly without work with tools. The splines form a weatherstrip and double track for each sash, the width of splines and depth of grooves being gauged to provide expansion joints where needed. Substantial savings are effected in milling, omission of parting strips, and job labor. The increased strength permits smaller members and greater glass areas.

The Homer Spline Lock is also applicable to flush door construction for bonding core strips and stiles.

One of the great advantages of this detail is the elimination of the slow traditional method of clamping glued joints. Glue is still used but the spline lock itself operates as an internal clamp allowing continuous fabrication without the interference of bulky accessory clamps.

Wall tile with internal drainage

NATCO DRI-SPEEDWALL terra-cotta tiles (Fig. 6) have a central trough to drain seepage to top of footing and out of wall. Recently put into production by the National Fireproofing Corporation of Pittsburgh, Pa., this trough also eliminates through-wall mortar joints and helps form the standard Speedwall handle to facilitate laying. Face size is $7\frac{3}{4}$ by 16 in. and thicknesses are $3\frac{3}{4}$, 8, 10, and 12 in. There are special closure and other non-draining units. The tiles are available in glazed and unglazed finishes, afford some insulation value, and resist fire, decay, and termites.

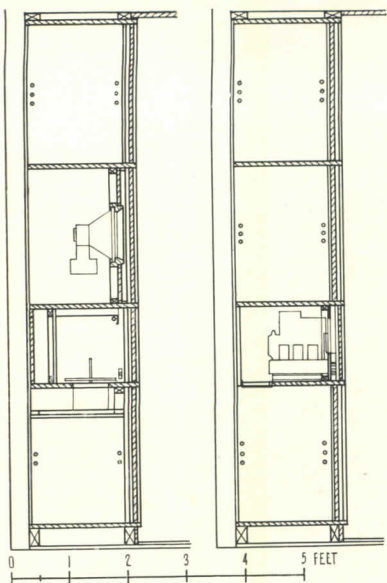

Section through radio and phonograph

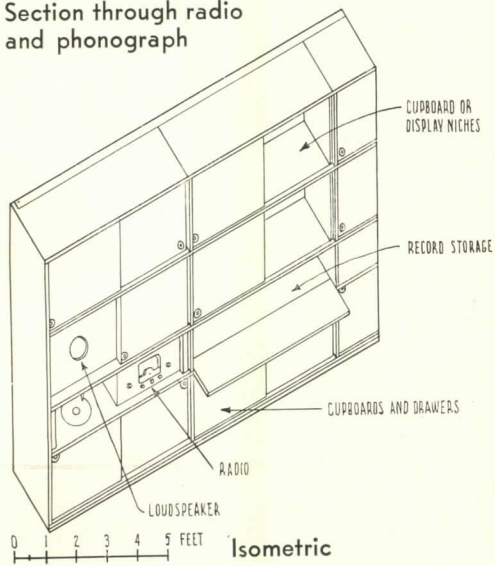

Isometric

1. SERGE CHERMAYEFF
Architect

ARRANGED ALONG ONE wall of this living room are compartments and cupboards for display and storage. The unit permits considerable variation of pattern, since all the display compartments have sliding fronts and adjustable shelves; they are specially designed for showing works of art. Below these are cabinets with tambour shutters for radio and phonograph, and with drop fronts for record storage and liquor. The bottom row of cupboards and drawers is for storage. The entire unit is finished in walnut; interiors of cabinets are white; drop flaps are of white linoleum.

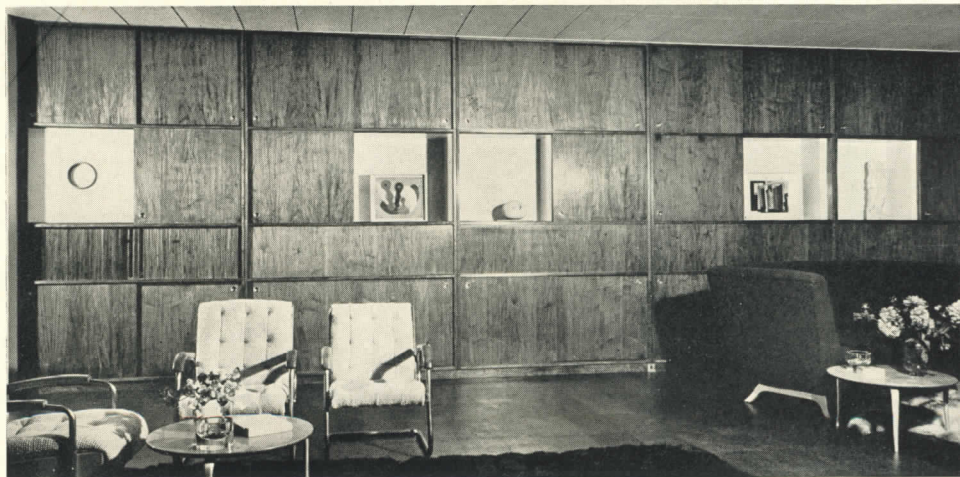

NEW DWELLING UNITS

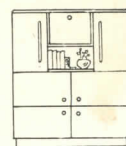

STORAGE

NEW DWELLING UNITS: STORAGE

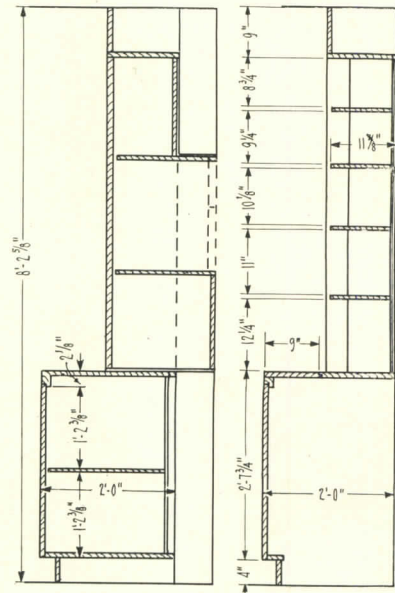

Sections through

2. J. R. DAVIDSON

Designer

THIS STORAGE UNIT features space for books, radio, phonograph, and records, in addition to cupboards for miscellaneous objects. Bookshelves are open; the other compartments have doors. The unit is of Japanese oak, bleached and waxed; supports for the bookshelves are of heavy glass. The top of the record-player compartment is hinged and opens upward, facilitating use of the instrument. Radio control dials are contained in a separate compartment from the loudspeaker. In the center of the compartment at left is an opening through which motion pictures are projected from a passage back of the bookcase wall.

Materials and equipment

Bookcase: Japanese oak, executed by Soulé Manufacturing Co. Radio and record player, Capehart. Hardware: invisible hinges, Soss Manufacturing Co., Inc.

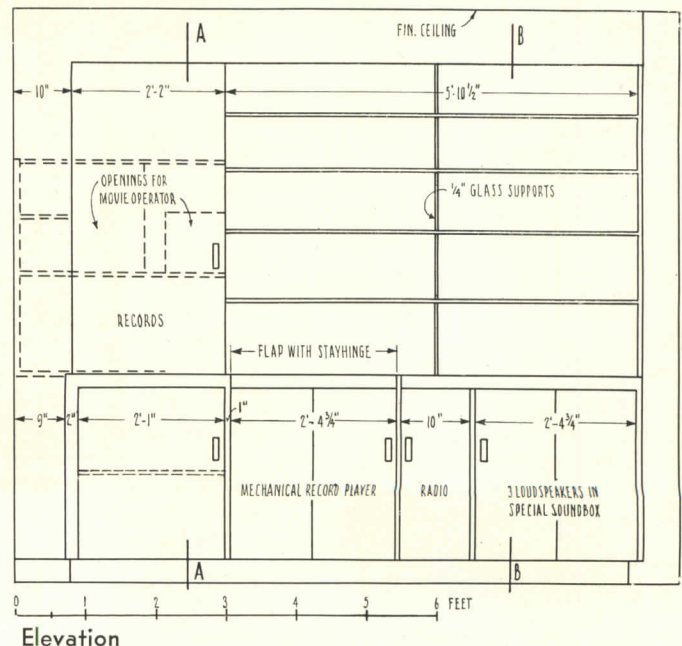

Elevation



3. EUGENE & LEE SCHOEN Decorators

RECEDING DOORS on the upper portion of this unit permit changes in the wall pattern and at the same time keep books dust-free. The unit contains, in addition to shelves, a lock-up compartment in the lower section for larger books and papers. The upper portion is of wood painted in a light color; the receding doors are covered with natural rawhide. The lower portion is finished in brown sucupira wood. Chairs and tables have frames of the same material; chairs are upholstered in plum and purple velvet. Lighting is indirect, and comes from a cove which runs around the room above the book shelves.

Materials and equipment

Book storage unit: Pusey & Jones Corp. Chairs and table: specially designed, executed by Schmieg & Kotzian. Lighting: reflectors, Frink Corp. Rug: brown chenille, Mohawk Carpet Co.

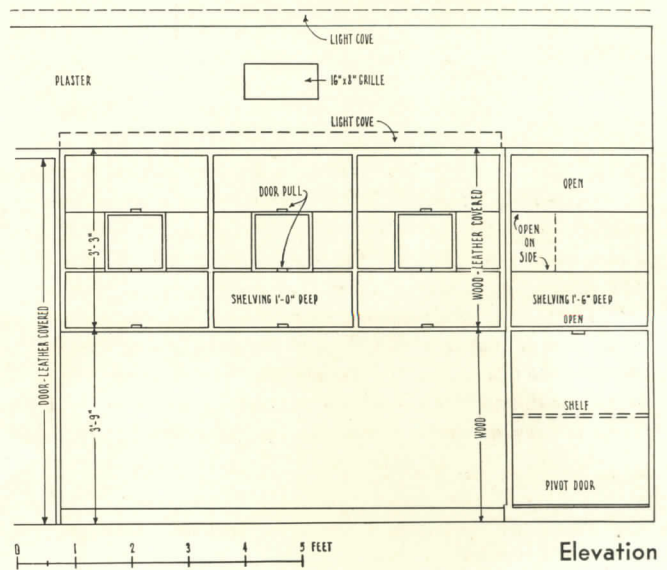

Rollin W. Bailey



4. SAMUEL GLASER
Architect

SPACE UNDER THE gable of a dormer alcove is here used to advantage for book and personal storage. Bookshelves on the left are of plywood, painted, and are left open. To give variety of pattern and provide for books of different sizes and for magazines, the four upper shelves are higher than the two lower ones. The unit on the right, also of plywood, consists of a cupboard with two shelves for storage of hats, bed linen, or miscellaneous objects; and of six drawers for storing dress accessories, underwear, etc.

Materials and equipment

Windows; Steel casement, Detroit Steel Products Co.; glass, Libbey-Owens-Ford.

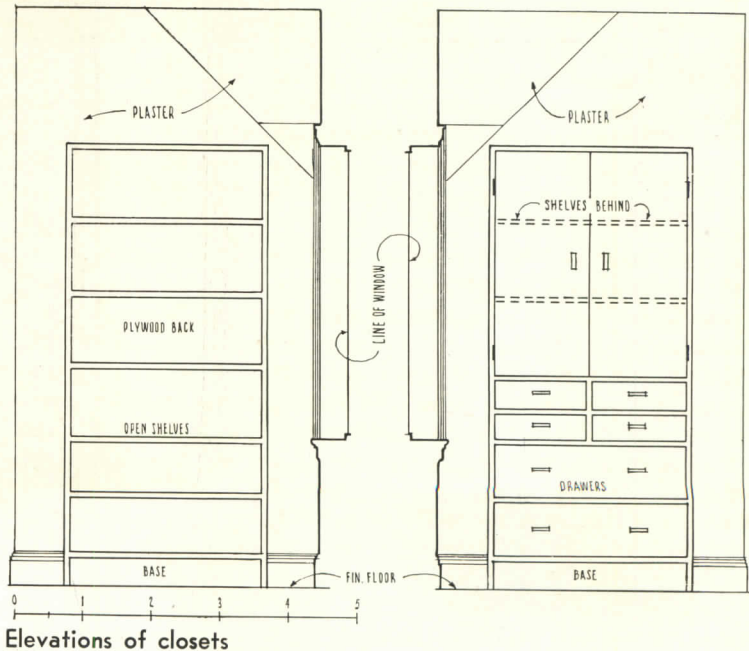

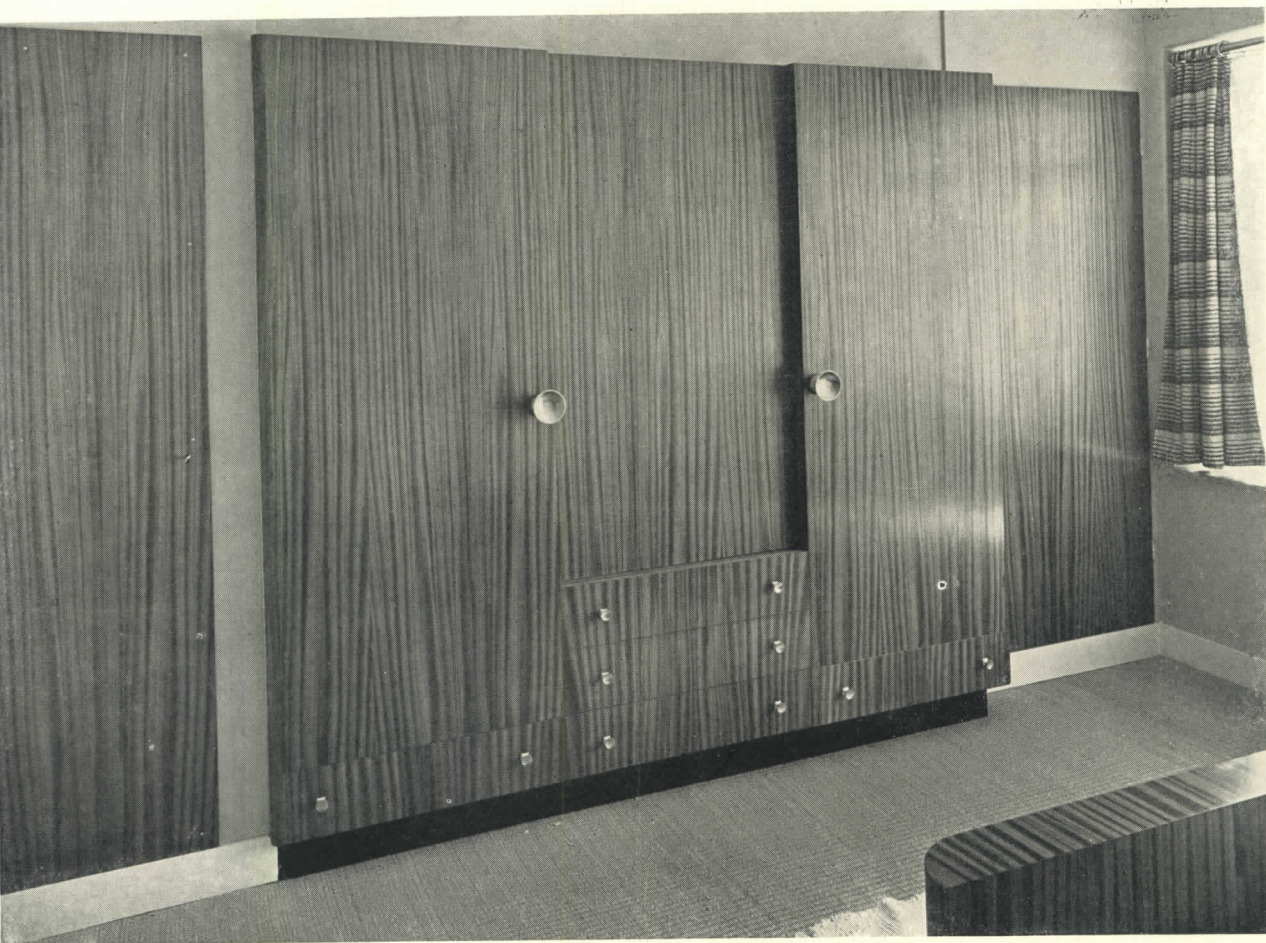

5. RITS VAN WITSEN Interior Designer

THIS WARDROBE, built into an existing recess, really consists of three parts, since there were already two side closets of different depths. The entire front of the wardrobe was surfaced with sapoli mahogany so as to unify the several parts. The center cabinet (C) is for bed linen; below it are drawers for miscellaneous storage. Although most closets are designed for women, this unit recognizes the specific storage needs of a man's apparel: Closets A and B are planned to accommodate hats, overcoats, sport jackets, suits, boots, shirts, etc. Closets D and E are for women's clothes, with compartments for long and short dresses, hats, shoes, etc. Of particular interest is the use to which the doors are put. Doors on closets A and E have full-length mirrors with lumiline lights; there are tie racks on the man's side, and hooks for belts on the woman's side. The other doors have shallow drawers for underwear, and hangers for umbrellas and canes. All clothes racks can be pulled entirely out of the wardrobe. The compartment for women's hats is accessible from below.

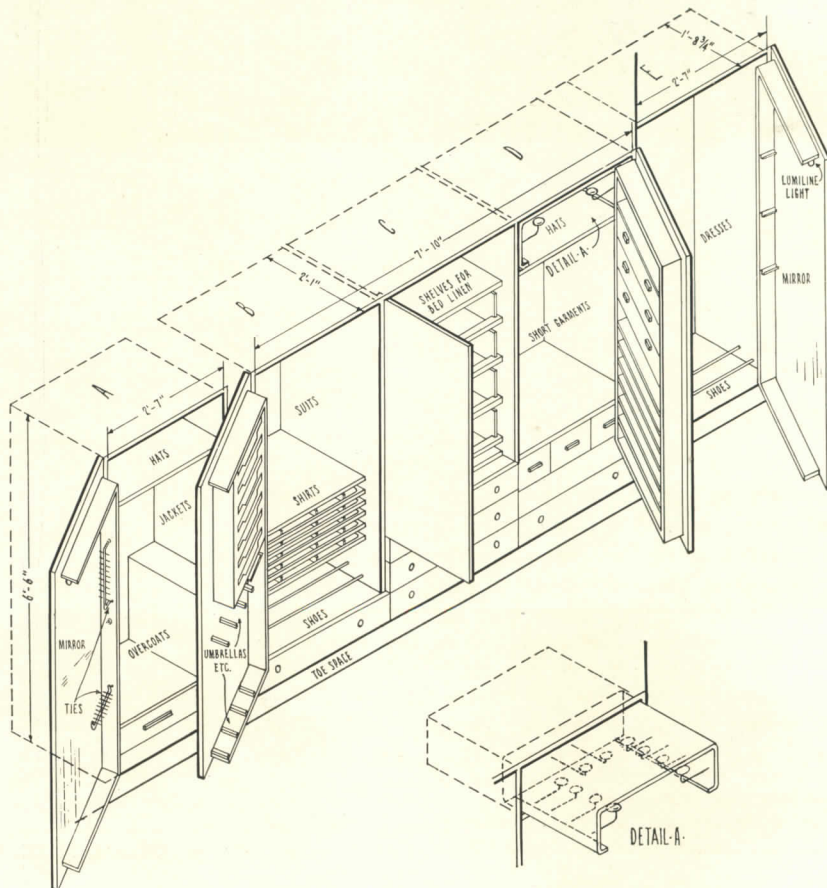

NEW DWELLING UNITS: STORAGE

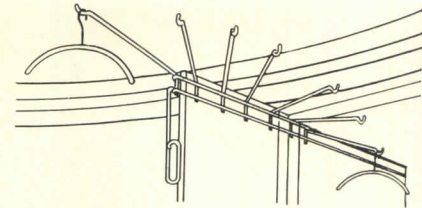
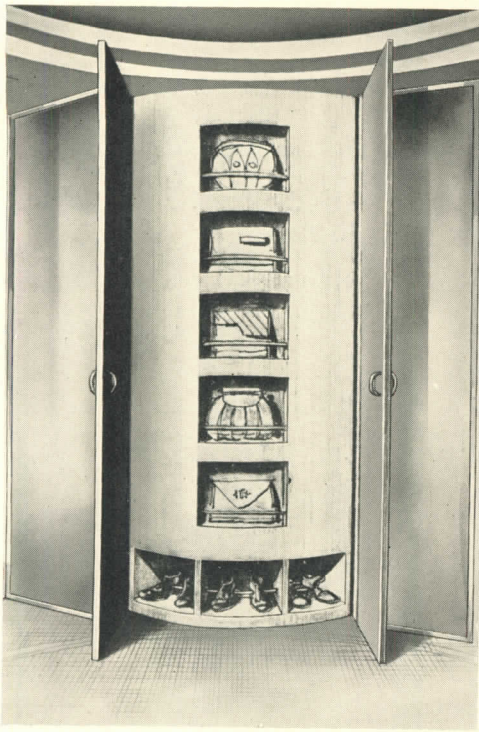

Detail of sliding hangers

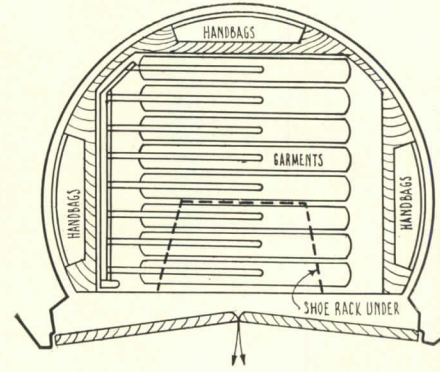

Plan of Closet A

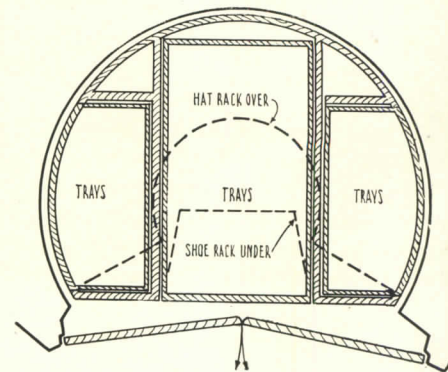
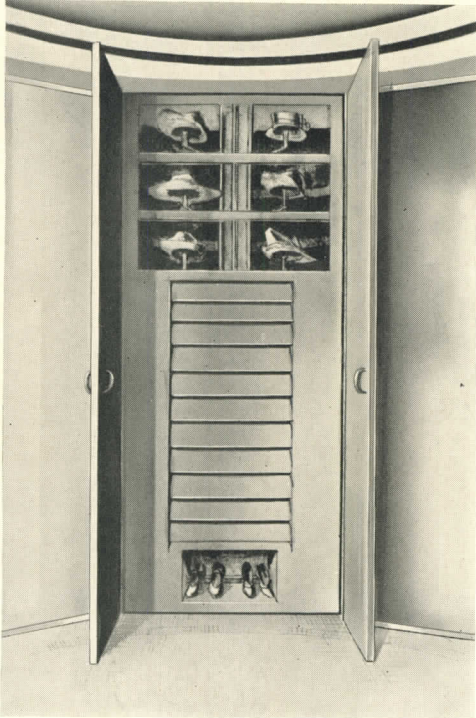
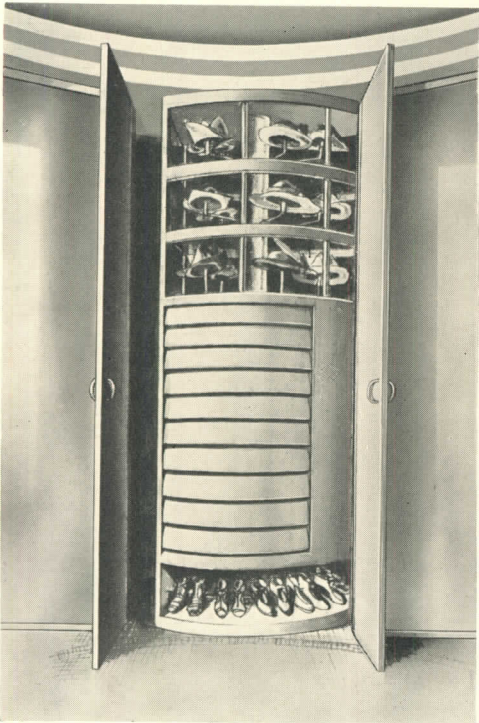

Plan of closet B

6. A. KIMBEL & SON, Decorators

In these two closets a woman's entire wardrobe can be stored, including such accessories as handbags and gloves. Inside each closet is a circular unit of wood which revolves about a central pivot. Closet A houses garments, handbags, and shoes; closet B has an open hat rack, trays, and shoe racks. The outsides of the doors and the walls are mirrored. The floor is tiled.

Materials and equipment

Mirrors: Gotham Glass Co. Metal shapes: Charles Arcularius. Tile: Mueller Mosaic Co.

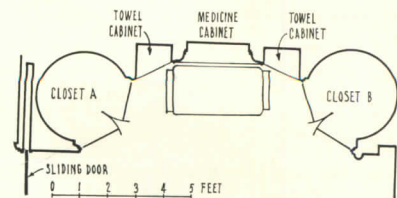

Plan showing relation of closets A and B



7. MICHAEL GOODMAN
Architect

THIS REVOLVING CORNER cabinet for kitchen equipment makes ingenious use of what would ordinarily be waste space. Not only is considerable storage space gained in this way, but the objects stored in the cabinet are made more accessible, since it revolves in both directions. Construction is simple and consists of two plywood shelves with metal rims hung on a special bronze hinge.

Materials and equipment

Cabinet: executed by Paramount Built-in Fixtures. Linoleum: brown and yellow, Armstrong Cork Co. Tile: white with brown trim, Gladding McBean. Glass: Libbey-Owens-Ford.

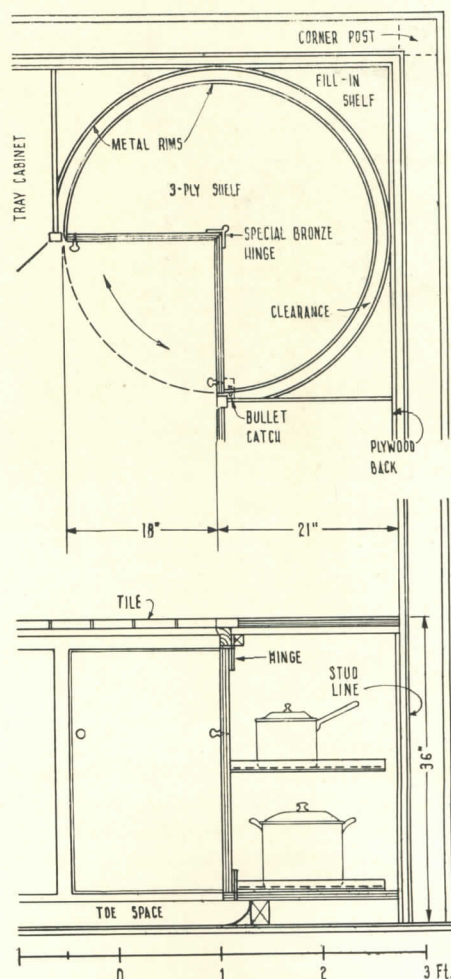

Top, plan. At bottom, section

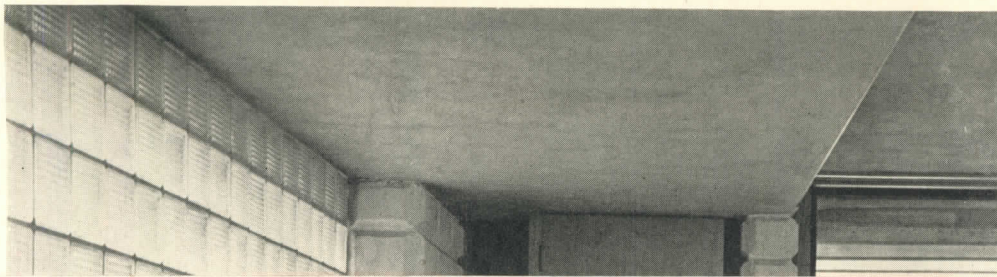

ON CORRE

A DEFINITION AND THE

by **FREDERICK J. KIESLER**

Director, Laboratory of Design-Correlation
Columbia School of Architecture

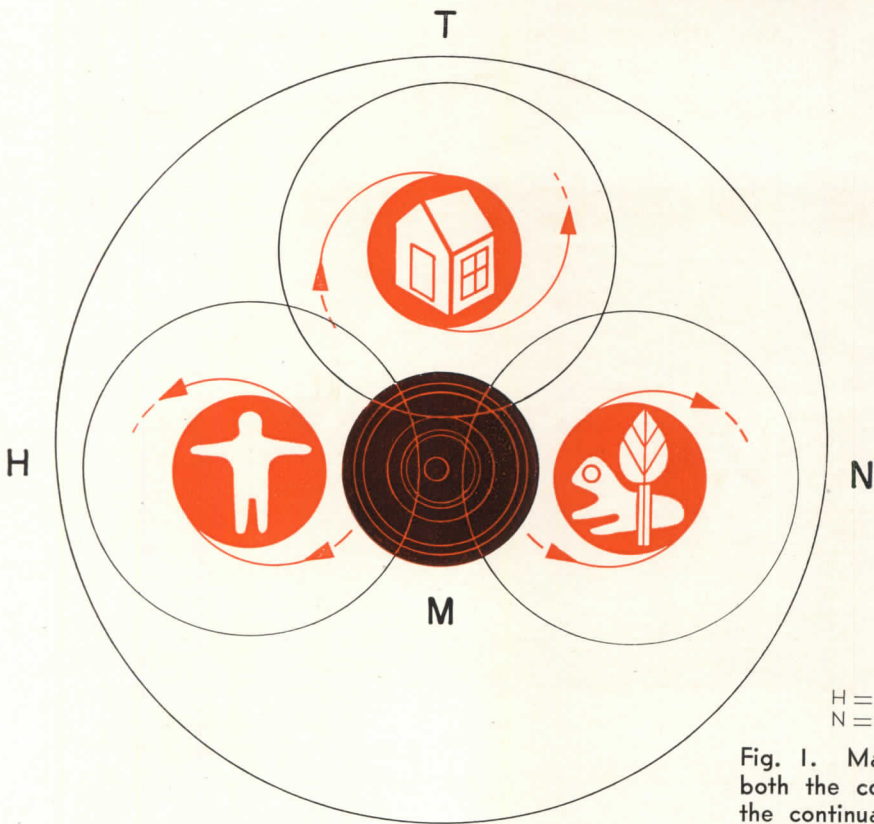

H = Human environment
N = Natural environment

T = Technological environment
M = Man

Fig. 1. Man = heredity + environment. This diagram expresses both the continual action of the total environment on man and the continual interaction of its constituent parts on one another.

In this paper* I propose to show that the perennial crisis in architectural history is due to the perennial lack of a science dealing with the fundamental laws which seem to govern *man as a nucleus of forces*; that until we develop and apply such a science to the field of building design, it will continue to exist as a series of disparate, overspecialized, and unevenly distributed products; and that only such a new science can eliminate the arbitrary divisions of architecture into: Art, Technology, and Economy, and make architecture a socially constructive factor in man's daily activities.

Today we face the task of formulating the *general* laws of the foundations that underly the many specialized sciences, not in terms of metaphysics (such as religion or philosophy) but in terms of work-energies; and the *specific* task of formulating those that govern building design. But the two are intimately related and we in the building field cannot solve our special problems without comprehension of the foundations of such part-sciences, e.g. physics, chemistry, biology, etc. Thus, it would seem imperative that we summarize some of the concepts of modern science and investigate their validity for our specific problem.

Concepts from science for the building designer

Man is born in evolution of hereditary trends. He is the nucleus of forces which act upon him, and upon which he acts. Forces are energies. We assume, with contemporary science, that they are of an electromagnetic nature. The interrelation of organic and inorganic matter is a mutual bombardment of energies which have two characteristics: those of integration and those of disintegration.

By means of gravitation, electricity generates energy into solids of visible matter. This is integration. By magnetism

and radiation, electricity degenerates energy into tenuous, invisible matter. This is disintegration.

If this general principle of anabolic and catabolic energies were the sole principle of existence, we would have a static, unchanging world. But these two forces (positive and negative) interchange through physico-chemical reactions, one force striving always for a preponderance over the other. In this way *variations* are constantly created; and in this process of creation, new nuclear concepts and new environments are in continual formation.

Reality and form

The mutual biological interdependence of organisms is, in the final analysis, the result of the primary demands of all creatures: proper food, habitat, reproduction, defense against inimical forces. Life is an expression of the cooperation, jostling, and strife of individual with individual, and of species with species, for these primary needs.

*In an earlier manuscript of Mr. Kiesler's ("From Architecture to Life," for Brewer, Warren and Putnam, 1930) the groundwork of this paper was laid; it was first read in approximately its present form at a Symposium on Science and Design held by the Alumnae Association of the Massachusetts Institute of Technology, June 6, 1938; this is its first appearance in print.—Ed.

SM AND BIOTECHNIQUE

A NEW APPROACH TO BUILDING DESIGN

The visible result of these activating forces is called *matter* and constitutes what is commonly understood as reality. The reason for this superficial interpretation of reality lies in the limitation of man's senses in relation to the forces of the universe. For matter is only one of the expressions of Reality, and not reality itself. If matter alone were reality, life would be static.

What we call "forms," whether they are natural or artificial, are only the visible trading posts of integrating and disintegrating forces mutating at low rates of speed. Reality consists of these two categories of forces which interact constantly in visible and invisible configurations (Fig. 2). *This exchange of inter-acting forces I call CO-REALITY, and the science of its relationships, CORREALISM. The term "correalism" expresses the dynamics of continual interaction between man and his natural and technological environments.*

Natural, social, and technological heredity

Biology has divided these forces into two main categories: Heredity and Environment. Man had to evolve a method for dealing with the effects of these overwhelming forces upon himself. For this purpose he created technological environment to help him in his physical survival even within the short span of the age-potential of his own species. This is made more difficult because man is biologically unfit to transmit his experiences to his offspring: each child has to begin anew its adaptations to nature. In short: contrary to prevailing belief, acquired traits and habits of parents can not be transmuted into the make-up of body cells and, by way of

procreation, given to their children.*

By providing unchangeable genes within the germ-cells *Nature* has safeguarded herself from man interfering fundamentally with her aims, whatever they may be. This "sealed order" of the germ cell contains nature's will which man can influence *during his own life-time, but not beyond that.* This places a deep responsibility upon those who "design" technological environment, because the restriction of its application to only *one* life-span makes it so much more needed as part of man's defense-mechanism. It appears, then, that the only human experiences that can be inherited by children are those of customs and habits by way of: training and education, thus "social heredity" is the only tool man can rely upon. Just as all living organisms are generated through their own species from a long chain of generations, so do ideologies or man-made objects generate from a long line of older ideologies or objects of similar functions. Thus a contemporary chair, for instance, is the product of many generations of other tools for man to rest his body in fatigue. This is heredity in technology.

What is technological environment?

When the biologist speaks of environment, he invariably means the geographical and animal environment. This definition is perhaps accurate for all creatures except man. For man alone has developed a third environment: a *technological* one which has been his steady companion from his very inception. This technological environment, from "shirts to shelter," has become one of the constituent parts of his total environment. Thus, the classification of environment becomes three- instead of two-fold, as in Fig. 1:

1. natural environment
2. human environment
3. technological environment

*The part of Darwin's theory which stated that "acquired characteristics are inheritable" has been disproven. (August Weissmann, 1880.) Thomas H. Morgan: "... the belief in the inheritance of acquired characteristics is not based on scientific evidence but on the very human desire to pass on one's acquisitions to one's children."

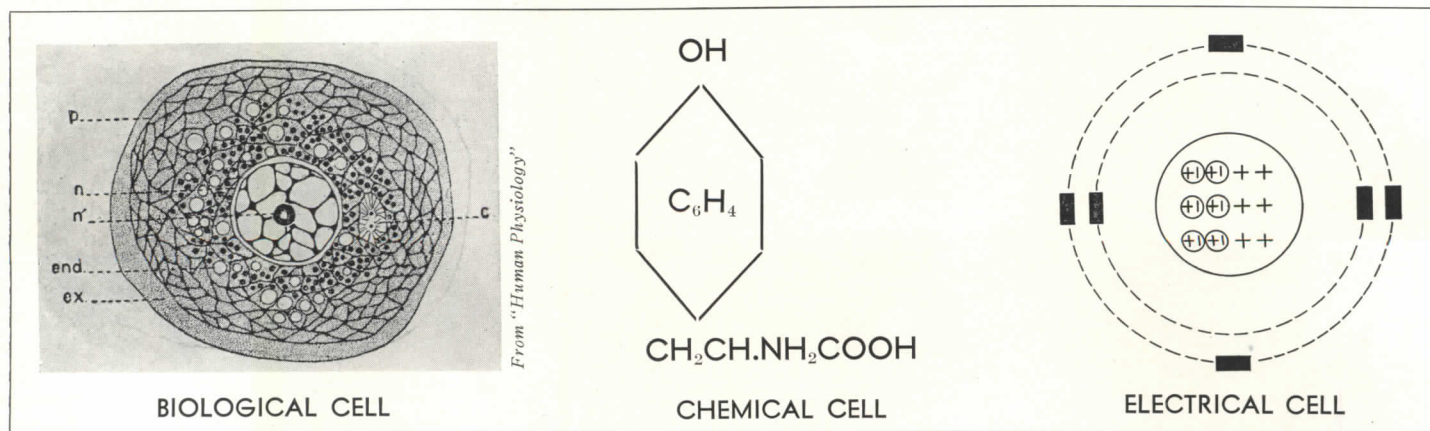

Fig. 2—The nuclear concept of production as expressed in three of the sciences. Note that though the forces involved are expressed in different terms, their basic organization is similar.

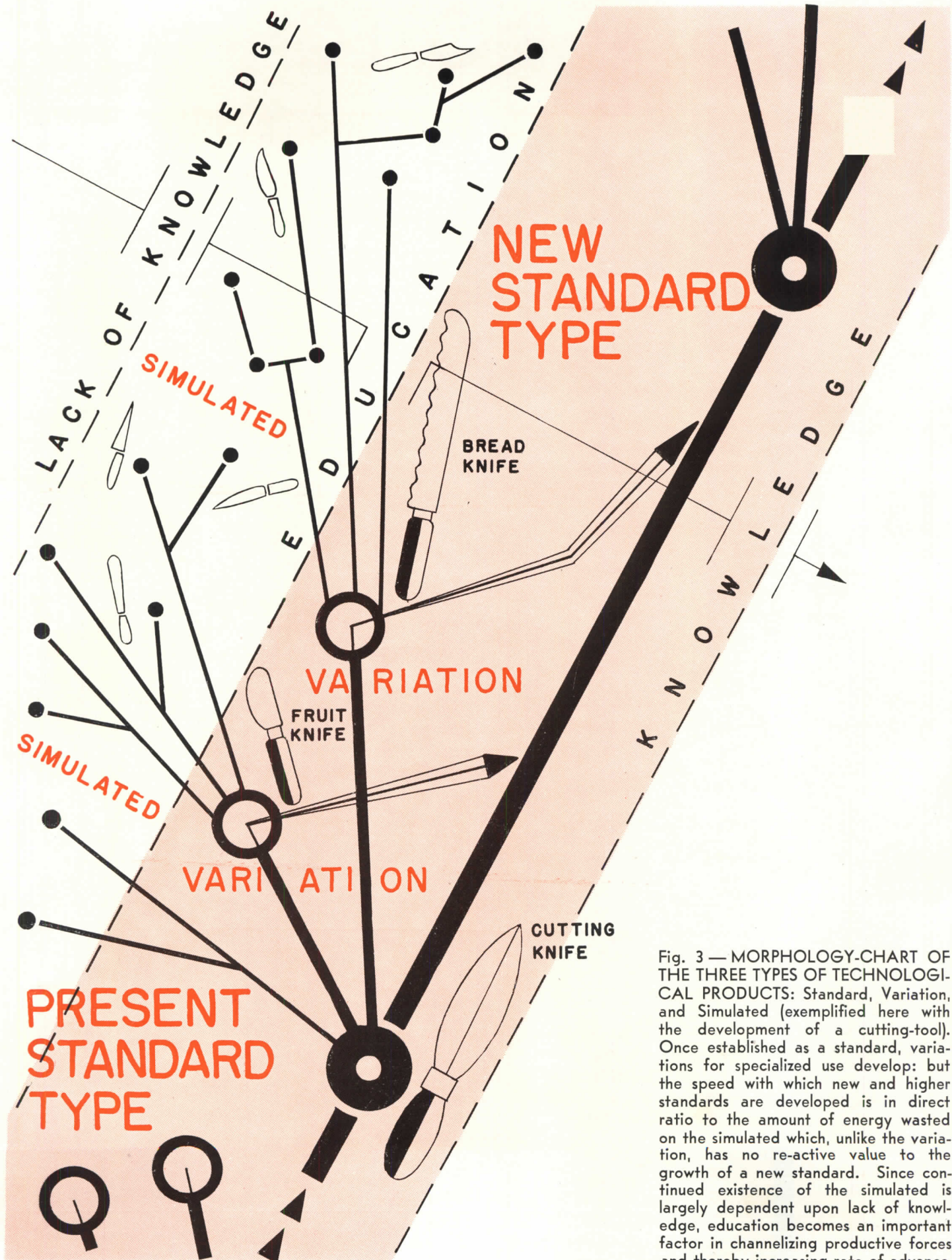

Fig. 3 — MORPHOLOGY-CHART OF THE THREE TYPES OF TECHNOLOGICAL PRODUCTS: Standard, Variation, and Simulated (exemplified here with the development of a cutting-tool). Once established as a standard, variations for specialized use develop: but the speed with which new and higher standards are developed is in direct ratio to the amount of energy wasted on the simulated which, unlike the variation, has no re-active value to the growth of a new standard. Since continued existence of the simulated is largely dependent upon lack of knowledge, education becomes an important factor in channelizing productive forces and thereby increasing rate of advance.

But it is this last factor of technological environment which concerns us here, since it is in this field that the architect works. Man-made, technological tool-objects have been in existence since the Ice Age. *But no branch of science so far has undertaken to investigate, analyze, chart, and measure the direct and indirect, voluntary and involuntary effects of technological environment upon man; nor has any branch of science charted and formulated the laws which govern the development of technology. We have had numerous accounts of the history of technology but no study of the need-morphology of its growth.*

In studying the history of the science of biology one can find with amazement the lack of observation and systematization of natural phenomena: for twenty centuries after the Greeks, no new theory of natural science came until the appearance of Lamarck and Darwin. The scientific theory of evolution is essentially the product of the last hundred years.

An analogous situation exists in technology, and we need not be surprised that no new theory on the phenomena of design has been forthcoming. Just as the scientists of the Middle Ages thought that horses produced wasps; asses, hornets; and cheese, mice, so modern men think that it is industry which produces the technological environment. In reality, the technological environment is produced by *human needs*: absolute needs and simulated needs.

Of what does this technological environment consist? In its simplest terms, it is made up of a whole system of tools, which man has developed for better control of nature. I use the term "tool" advisedly. It is generally agreed that the difference between a machine and a tool is the power by which it is driven, whether manually or by the forces of man's environment—e.g., natural (water) or synthetic (electricity). But this distinction of isolated technological fields must be replaced by an understanding of technological invention as a whole. For the purposes of this analysis, I therefore define "tool" as: *any implement created by man for increased control of nature.* The term "tool" is preferable to the term "machine" because it brings us back to the origin of the machine, and to its ultimate purpose: *enabling man to reach levels of higher productivity.* In this sense, *everything which man uses in his struggle for existence is a tool* and, as such, part of a man-made technological environment, from shirts to shelter, from cannons to poetry, from telephones to painting. No tool exists in isolation. Every technological device is *co-real*: its existence is conditioned by the flux of man's struggle, hence by its relation to his *total environment*.

The persistence of technological environment is marked by constant, if only indirect, infiltration of converted forces embodied in the manufacture of our homes, workshops, transportation shelters, etc. The ratio of fabricated environment to natural environment varies according to the ways in which men make their living. Today, men in urban areas spend about 88% of their time indoors; in suburban areas about 70%; and in rural areas about 43%.

A qualitative classification of tools

But we must keep in mind that the *technological environment affects man's development, and that technology itself follows laws of heredity in its own development.* We then

observe that the principle of heredity also operates in technology. Thus the progressive development of any tool—a knife, a factory, a home—does not follow a straight line any more than does a species of plant or animal. On the contrary, production of any tool in our industrial era seems to develop along three characteristic lines. (Fig. 3.)

The *Standard Type*, developed by absolute need.

The *Variation*, evolved from the Standard Type for auxiliary purposes.

The *Simulated* springs directly or indirectly from one of the two foregoing types. This third group of products—and it is by far the largest—distinguishes itself from the *Standard* and the *Variation* chiefly by a lack of material efficiency and insignificant changes in design and materials.

Each of these three types has its special fertilization grounds in which it develops. The *Standard* grows out of scientific knowledge. The *Variations* are a natural adaptation of the Standard to specific conditions, and are therefore valid. The *Simulated* product and its temporary survival is only made possible by a lack of knowledge within its social environment.

The Simulated are the widest in distribution, the shortest lived, and the most rapidly replaced. The result is a dispersion of energy and a conflict of creative forces whose destructive effect is to slow down the rise of the original standard to higher levels of efficiency.

Adjustments to the basic needs of man require the elimination of the Simulated and control of the Variations. In the readjustment of industry, the forces (man- and machine-power) which are producing the Simulated will be absorbed into the areas of the Standard and its Variations, thus reinforcing their productivity.

Evolution of Need: from deficiency to efficiency

Since nature demonstrates her will toward *mutative continuity*, man's aim seems also to be: *to sustain and prolong life.* By experience he learned that he was unable to do so with the physical equipment which he inherited. He was therefore compelled to extend the powers of his natural equipment to meet the forces of environment. He had to add to his natural equipment, artificial equipment of defense and offense. Tool-making began. *Man's inherent desire for higher productivity* began to find its material expression.

Man, then, builds tools; and from them arises that man-made complex of relationships which we have called the technological environment. But in order to correct the many obvious maladjustments of this environment, it is necessary to ask: What is the nature of its origin? What is a need? How do needs arise? Are they natural or artificial? Are they static or in evolution? A definition of needs has today become of prime importance to the designer of technological environment. *Investigation on this crucial point cannot be based upon the study of architecture but must be based upon the study of man.* Our duty would therefore be to re-define needs, and upon this basis to re-organize the technological

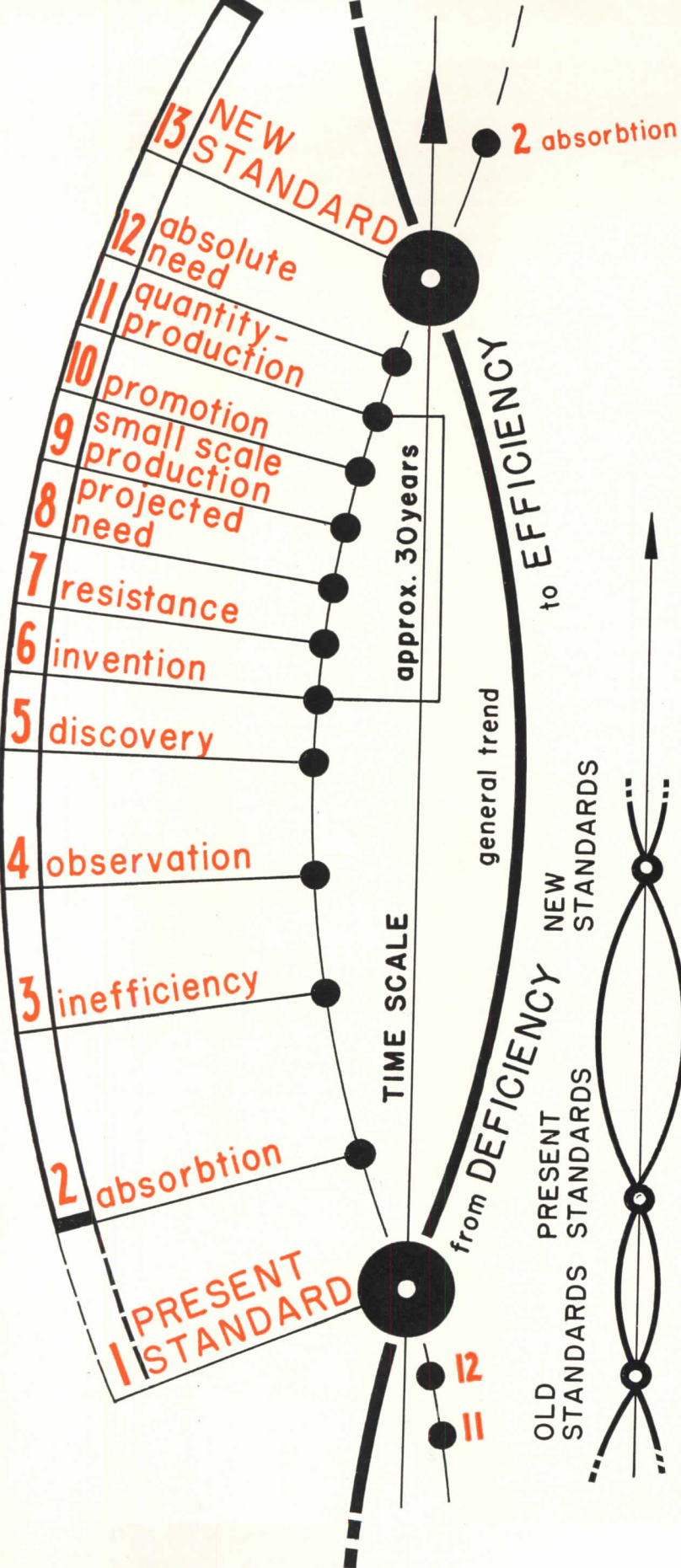

Fig. 4—Every need follows a characteristic pattern of development. A minimum of twelve progressive stages can be detected in progression from one standard to the next.

environment. The accompanying chart (Fig. 4) of the evolution of needs may help to clarify the problem.

We must keep in mind that science in all its branches is based upon man's deficiencies. The direction of man's creation tends constantly from deficiency to efficiency. The main stages in this recurring development are marked by a rise from one standard of living to another. Sociologists speak of "higher" and "lower" standards, but we can only speak of correalist standards, since concepts of higher and lower are entirely relative.* *Needs are not static: they evolve.* The intermediary stages of the evolution of needs, as Fig. indicates, seem to develop in the following progression:

1. Present standard
2. Standard is absorbed
3. Absorption demonstrates inefficiency
4. Inefficiency leads to observation
5. Observation leads to discovery
6. Discovery leads to invention
7. Invention meets resistance
8. Resistance leads to "projected need"
9. Projected need leads to small-scale production
10. Small-scale production generates promotion
11. Promotion leads to quantity production
12. Quantity production creates absolute need
13. Absolute need becomes new standard

Fig. 4 shows that actual needs are not the direct incentive to technological and socio-economic changes, as is commonly assumed. Needs evolve, and that evolution is based on the nuclear character of the human structure and its environment.**

Health is man's ultimate need

The failure of an artificial tool to protect man, leads to impaired physical resistance. His health is unbalanced. If by the power of his tools the re-generation of his de-generated physique fails, man's health declines in a progression from fatigue to death. *The fundamental denominator, therefore, to account for the validity of any technological environment, is man's health.* Measured by this crucial, all-embracing criterion of health, technology is one of the most powerful factors for preserving man's energy.

Health appears to be that bodily condition in which the various materials and processes that maintain life-activity are in functional equilibrium.

The resistance-capacity of an individual is the degree in which this equilibrium is able to withstand or absorb the

*PROGRESS OF TOOLS RELATIVE TO TIME STRATUM: There is no abstract technological progress. Each stratum of the social development in man's history has produced its own tools to deal with various old and new forces. Each new environment creates new varieties or new standard types of tools which lose their validity if applied backward or forward in history.

**Examples of nuclear production in industry: corn, subjected to mechanical and chemical treatment, also yields starch, dextrin, glucose, oils, feeds, and other valuable by-products. The hulls of oats yield furfural, a valuable starting point for chemical synthesis. Waste sugar cane, from which the sugar has been extracted, forms the raw material for making wall-board and insulation. Saw mill wastes are converted into building materials. Similarly, carbon is the nuclear factor for many products: we encounter it in our heating arrangements in the form of coke, charcoal, and coal; we use it in our pencils as graphite, etc.

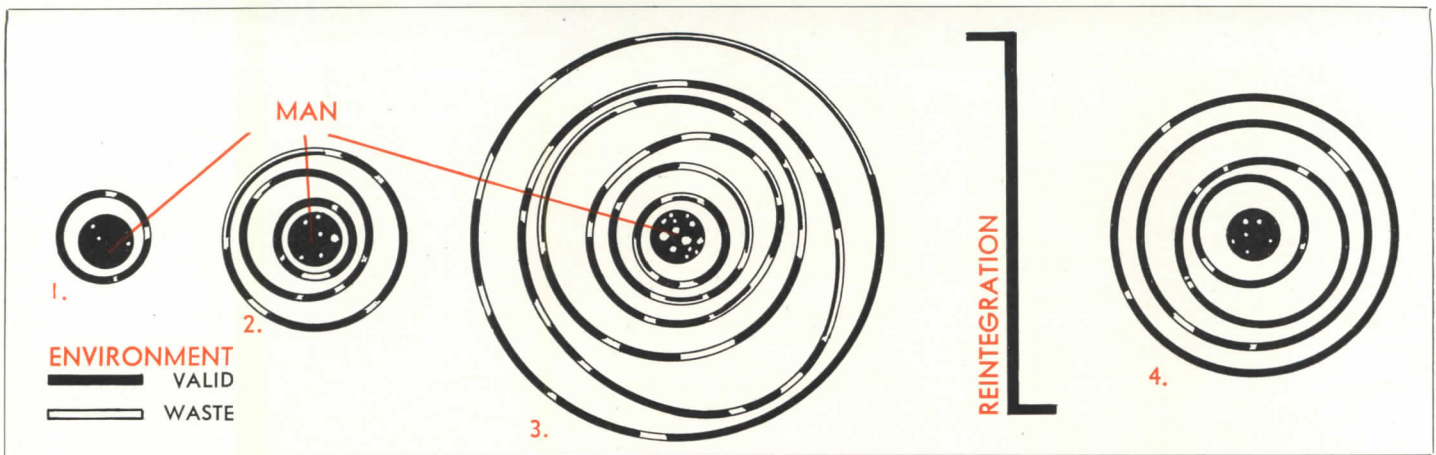

Fig. 5—Throughout his historical development man has steadily added to his technological environment. In his primitive stages this relationship was relatively well balanced (1); but through ancient and medieval times (2), this relationship became increasingly complex and unwieldy, until today (3) man's health is literally threatened by the very tools he created to protect it. Needed, therefore, is a planned re-integration of the technological environment, based upon elimination of waste (simulated) products and increased emphasis on new and higher standard types (4).

impacts of the environment. There are two sets of these factors: external and internal. The external factors belong to the exigencies of the natural environment. The internal factors are psycho-physiological and are intrinsic to the individual.

Health was originally maintained by organic adaptation to environment. Some of these adaptations are essentially functional (digestion, temperature, blood pressure, etc.), or essentially structural (pigmentation, posture, etc.). There are also adaptations to the human environment, as represented by socio-economic relations (state institutions, industry, trade, marriage, etc.).

The concept of health recognizes fatigue as a part of a continuous natural process. Fatigue is normally produced by the expenditure of energy incident to psycho-physiological action (voluntary and involuntary). This expended energy, under normal conditions, is replaced by means of physico-chemical processes in the body. *When the processes of expending and replacement are in proper balance, we may speak of an optimum efficiency. When this is not the case, we have inefficiency, or waste of energy: de-generation.**

Environmental control and the maintenance of health

What are the factors which impair the efficiency of the body? Obviously, maladjustments between the body and some parts of its environment, external or internal. Technological environment can be of vital importance in relieving such maladjustments by *protection against fatigue* (preventive) and by *relief of fatigue* (curative).

Unfortunately, history proves that this technological en-

*FATIGUE—Fatigue may arise in: (1) the central nervous system, (2) the muscular system, (3) in both combined.

"Fatigue may be subjective as experienced by the worker or objective as noted in his actions and output. From a thorough consideration of the literature it is quite evident that a vast amount of emphasis has been laid upon the mechanical or extrinsic factors influencing the working capacity while the multiplicity of original physical and mental states that may limit the working capacity have become almost wholly neglected." From WASTE IN INDUSTRY, published by Federated American Engineering Societies, Washington, D. C.

vironment has not always been *per se* beneficial to man's health: on the contrary. Thus, we come to the second factor: In which direction, then, shall technological environment be developed? Development of industry for industry's sake is worse than art for art's sake. Imperative, therefore, is the control of direction of technological production. What is environmental control? Since the means of control are part of the environment, the term would appear to mean simply control of environment by environment. The term becomes clearer, however, when we remember that environment is threefold: natural, human, and technological. Environment control, then, is control of the human and natural environment through *technological environment*.

But control in relation to what? From the correalist viewpoint there can be only one answer: *in relation to man's health*. Control of environment becomes, then, control of health: not control of the environment's health, but control of the health of man and society by environment. The proper term will then read: *technological control of environment or environmental control by technology*.

The maintenance or adequate "management" of technological environment can have only one purpose: *to maintain the equilibrium of its health*. In turn, the maintenance of the technological environment in proper health can have only one purpose: *the maintenance of the equilibrium of man's health*.

Health, the criterion of building design

Hitherto architecture has been judged from four viewpoints: (1) beauty, (2) durability, (3) practicability, and (4) low cost. But these four factors have never altogether coincided in a single work. If a piece of architecture is not beautiful, it is excused on the ground of being cheap; if not cheap, it is excused as being durable; if not practical, it is perhaps beautiful. It would appear, then, that the only way to resolve these age-old contradictions is to find one criterion which will do for all. *This criterion, in my opinion, can only be health*. The rest may be left to personal idiosyncrasies on the part of the consumers and producers, so long as these do not impair the essential criterion.

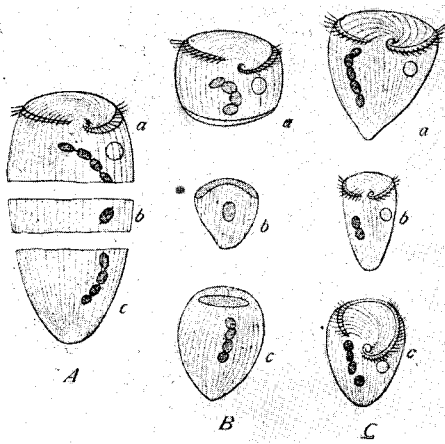
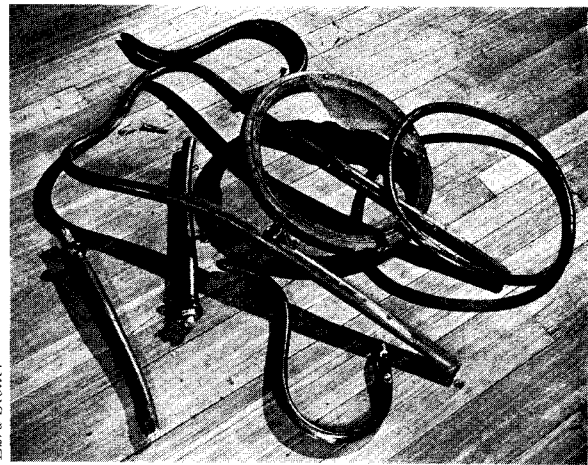

Fig. 6. NATURE'S method of building: cell division (left). Unicellular animal Stentor cut into 3 pieces, each of which grows into perfect animal in 24 hrs.

MAN'S method of building: joining of parts (right). Birth and death of a chair.



Ezra Stoller

Thus, architecture, in the future, will not be judged chiefly by its beauty of rhythm, juxtaposition of materials, contemporary style, etc., etc.; it can only be judged by its power to maintain and enhance man's well-being—physical and mental. *Architecture thus becomes a tool for the control of man's health, its de-generation and re-generation.*

"Form follows function" an obsolete design formula

In the early Twenties, there was again much loose talk about functional design. But when we examine the buildings which were then built, and the drawings which were then presented, we find that no new functions had been invented. All that happened was that, by debunking old *décor* and adding new gadgets, new forms had been wrapped around conventional ways of living. No one could define what function was. Worse still: no new building principles adequate to a new idea of environmental order had been conceived (Fig. 7).

The problem was posed in the manner of the Scholastics: should function follow form, or form follow function? Architecture was thus saddled with a new version of an old conundrum: which came first, the hen or the egg? What was overlooked was the very essence of the problem: the inter-relation of form and function with *structure* and the fact that, genetically, all three are contained within the protoplasm of thought.

If we abandon the Scholastic approach, the contemporary

designer can learn a valuable lesson from the hen and the egg. In 1912, at the Rockefeller Institute for Medical Research, a hen's egg in process of hatching was opened. The developing chick was removed, and the tiny fleck of its heart was cut out. This bit of living tissue was transferred to a solution in a test tube. There, protected from germs, poisons, heat, and cold and provided with a never-failing supply of oxygen, sugar, and other nutrients, it lived and flourished far better than the heart cells in any living chick ever did.

This experiment confirms the view that, while life comes only from life, it is also dependent on its technological environment. By changing the physical environment, life may be quickened and increased, retarded or destroyed.*

What was done for the bit of living tissue at the Rockefeller Institute, experimenters have not yet been able to accomplish for the animal as a whole. But the experiment indicates that a planned chemical environment can be as beneficial for man as for other animals; equally important for man is a properly planned technological environment.

The question investigated in connection with the chick's heart is: at what point and by what means does inanimate matter pass over and become alive? "To find that

*Jickeli (1902) and Carrel (1912) put forward the hypothesis and finally experimental proof that aging (and death) result from imperfect metabolism within the cell and the subsequent clogging of the cytoplasm with injurious waste. Carrel has shown clearly (tissue-work) a relative potential immortality of the cell, and at the same time its subordination to the fate of the whole organism.

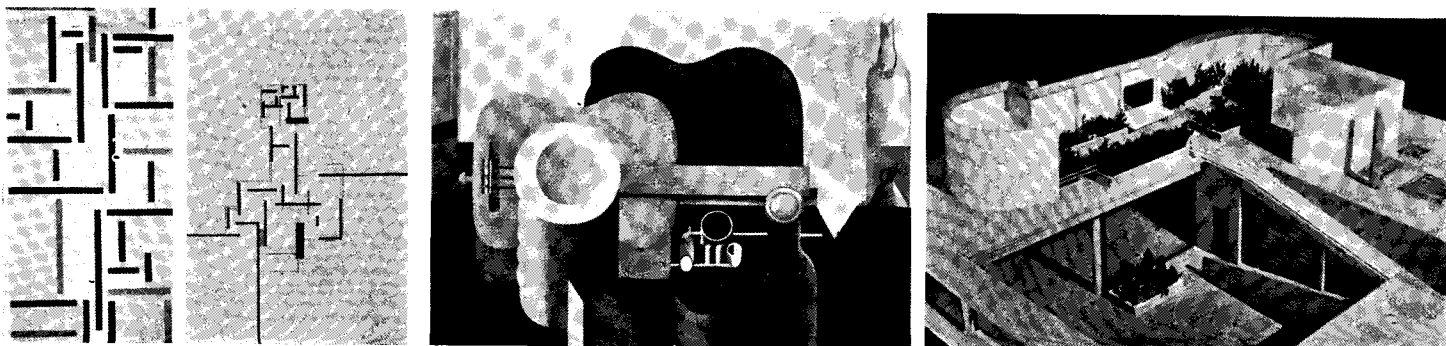

Fig. 7—From *Cubism and Abstract Art* (Museum of Modern Art, N. Y. C.) come the following pertinent comments on functionalism: "This is not to say that Le Corbusier's architecture is an outgrowth of his painting; they were, rather, interdependent developments united by the same esthetic and the same immaculate taste (left, above) . . . Mies van der Rohe's plan for a country house done in 1922, a year after Doesburg's arrival in Berlin, may be compared with Doesburg's painting, *Russian dance*, of 1918. The resemblance is obvious and by no means superficial (right, above)."

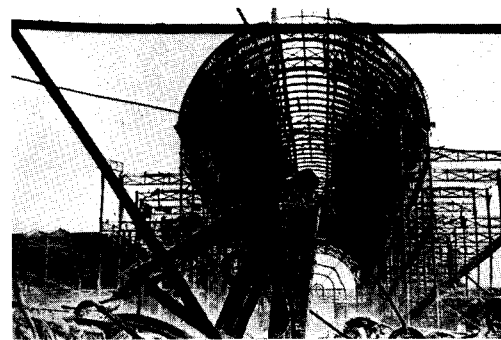
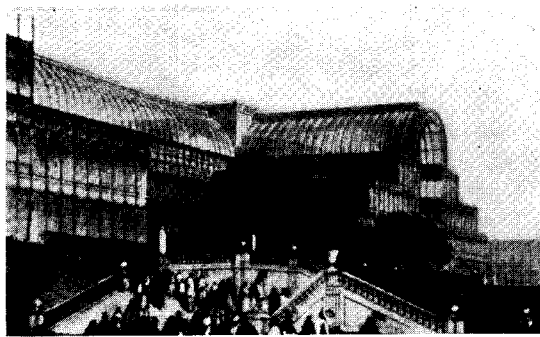
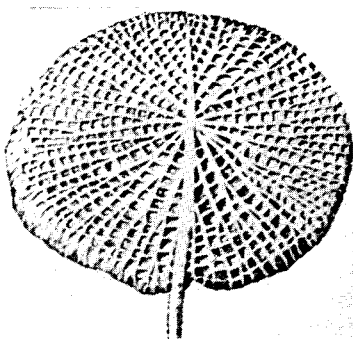

Fig. 8—Impressed by the extraordinary construction of the leaves of an African lily which had been recently brought to England, Paxton designed his famous but ill-starred Crystal Palace. Nevertheless—viewed with its scientific and cultural context of Victorian England—Paxton's investigations rank among the few really great ones of architecture.

bridge between nature and man has become the grand quest of science." Similarly, finding the bridge between man and artificial, man-built, technological environment must become the grand quest of future building design.

New definition of function

We must examine what function has meant, and what function will come to mean in the future, as it concerns the designer. We cannot conceive of function as something static, else growth would cease. The inter-action of environment and man, and the evolution of that inter-action to new possibilities, is not a direct result of environment. It is rather the development by environment of something which was *already inherent* physiologically in the organism.

Function depends not only on natural environment, but also on artificial environment. If functional design depended on the *status quo* of man, it could never develop. It would take care only of man's traditional aspects. But man's evolution has proven that changing environment increases or decreases man's potentialities. Technological environment, being a part of the complex of environmental forces, must consciously contribute to the extraction and development of man's inherent possibilities into a higher order. What these possibilities are depends on the designer's ability to envision and realize them.*

Any form is incomplete in itself: it is identified by what it emanates, visibly or invisibly, voluntarily or involuntarily.

*In attitudes toward the technological environment, we observe three tendencies as to morphological principle: (a) the functional or synthetic, (b) the formal or transcendental, (c) the mechanical-materialist or disintegrative. The mechanical-materialist attitude is not distinctively biological, but is common to nearly all fields of thought. (It dates back to the Greek atomists. The self-deceiving triumph of mechanistic science in the nineteenth century led many to accept mechanical materialism as the only possible scientific method.) Even in biology, but especially in design, it is more akin to the formal than the functional attitude.

The new designer will therefore define function as: *a specific nucleus to actions*. (Fig. 2) It is erroneous to suppose that form follows function. This concept must be replaced by the proper progression of: (1) structure, (2) function, (3) form. All functions and all forms are contained in the structure.

Defining design and Biotechnique

As in the case of electricity, a polarization creates a nucleus of relationships. These relationships are latent potentialities for further development. In this respect, *all possible needs of man are ever-present, but it is only by the demands of the special environmental stimuli that the specific need is brought to the fore*.

Thus it appears that not only is the formula "form follows function" inadequate; the "functional design" based on that formula is likewise inadequate. The term "design" must be re-defined. Since the building designer deals with *forces, not objects*, design is therefore, in my definition, *not the circumscription of a solid but a deliberate polarization of natural forces towards a specific human purpose*.

Such a science of design I have called BIOTECHNIQUE* because it is the *special skill of man which he has developed to influence life in a desired direction*. Biotechnics, a term which Sir Patric Geddes has employed, can be used only in speaking of *nature's* method of building, not of *man's*. There can be no inter-change of these two methods, because nature and man build on two different principles: *nature builds by cell division with the aim of continuity*; man can only build by *joining parts together into a unique structure without continuity*. Nevertheless, man-made joinings are ultimately controlled not by man but by nature. The process of disruption through natural forces becomes imminent from the very moment of joining parts. Building design must, therefore, aim at the reduction of joints, making for higher resistance, higher rigidity, easier maintenance, lower costs. Such considerations led me to develop *Continuous Construction***

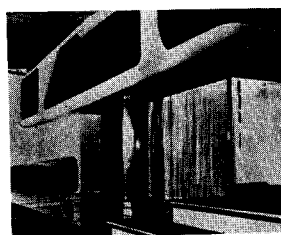
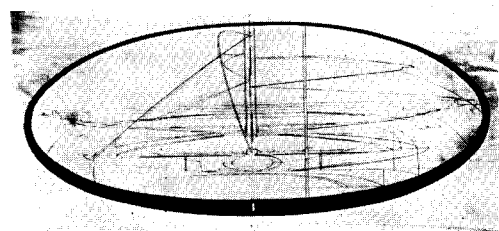

*The term "biotechnique" appeared first in my treatise on "Town Planning," as "Vitalbau" in "De Stijl" No. 10/11, Paris, 1925, and in America first in "Hound and Horn," May 1934.

**Not actually formulated until my plans of *The Endless* were exhibited in Paris, 1925, and New York, 1933 (left). View of my Space-House (New York, 1933) showing first continuous construction in shelter design and also continuous window framing (right).

Courtesy Columbia U. Library Photo. Div.

The more man recognizes his limitations in building "for a lifetime," the more valid is his structure. As a biologist has said: "We doubt that an engine might be conceived to which we might bear witness that, after we might have broken it into a hundred pieces, it would reform immediately into a hundred single complete engines. But take that graceful animal, the fresh-water polyp, that is found attached to water lilies in the pond, and cut it into pieces: tomorrow you will find that each piece has become a complete polyp."

The new designer will learn to understand the methods by which nature builds to meet her purposes (biotechnics): but he will not imitate her methods. He will draw the necessary conclusion from the disaster which befell London's Crystal Palace.* (Fig. 8)

The Biotechnical approach tries to develop the possibilities of specific actions contained in any nucleus of human physiology. (Note congruity of this fact with concept of Fig. 2). These potentialities remain at first undiscovered. Only with time are they individually or collectively developed until finally they are consciously demanded. The result will be entirely *new functions* within the old framework of what was considered "human nature," sustained by inventions.

The objective: minimum biotechnical standards

The two approaches—biotechnical and functional—develop from unlike sources and lead to unlike results. On the one

*That structure was built in 1851 by Paxton in imitation of the structural principles of the African water lily's foliage, with its longitudinal and transverse girders. This was an essentially romantic attempt to fashion a man-built structure by *literal application* of nature's design principles. The collapse of the Crystal Palace (1936) was inevitable (Fig. 8). (The fireproofing of buildings—then as now—is far more important than the pursuit of "new forms.")

hand, functional design derives from the traditional behavior of any tool; on the other hand, biotechnical design derives from the evolutionary potentialities of man. Functional design develops an object. Biotechnical design develops the human being. Functional design is oscillating. Biotechnical design is inventive. A functional object is inert. A biotechnical object is re-active. (See Figs. 10, 12).

The biotechnician emerges as an important factor in the evolution of society toward a higher standard of living through the control of elements of fatigue and forces of re-generation. This leads to the discovery that no part of the human body is mono-functional; rather, each minute detail is again of nuclear make-up with corollary functions.*

Such development can be furthered by the biotechnician who formulates and helps to realize a *biotechnical minimum standard*. Such a biotechnical minimum standard must be based on Correalism and not on mere architectural derivations, which tend to house lower-income groups in dwarf reproductions of giant villas. The *biotechnical minimum standard is that technological environment of home, workplace, and their corollaries which meets the optimum needs of man's health*.

Every object that meets a need is living: it is only dead when it ceases to meet a need or when the need itself disappears. Anything of nature's creation which fulfills a need

*J. R. de la H. Marett: RACE, SEX, AND ENVIRONMENT. Hutchinson's Scientific and Technical Publications, London, 1936:

Page 127: Not only the evolution of the erect attitude, but also the expansion of the brain and skull, and the loss of body hair, are all viewed as the results of atavistic, and probably rapid, reactions to mineral-deficiency. A single relatively short period of severe iodine-shortage is thought to have precipitated the large anatomical change from ape to man.

Fig. 9—METABOLISM-CHART OF MOBILE-HOME-LIBRARY. The effects of the new product upon environment and the inter-relationships of new and existing forces are indicated in group- and part-constituents. The validity of the Mobile-Home-Library and its ultimate obsolescence is anticipated by placing the Mobile-Home-Library relative to the continuous development of tools for thought-communication.

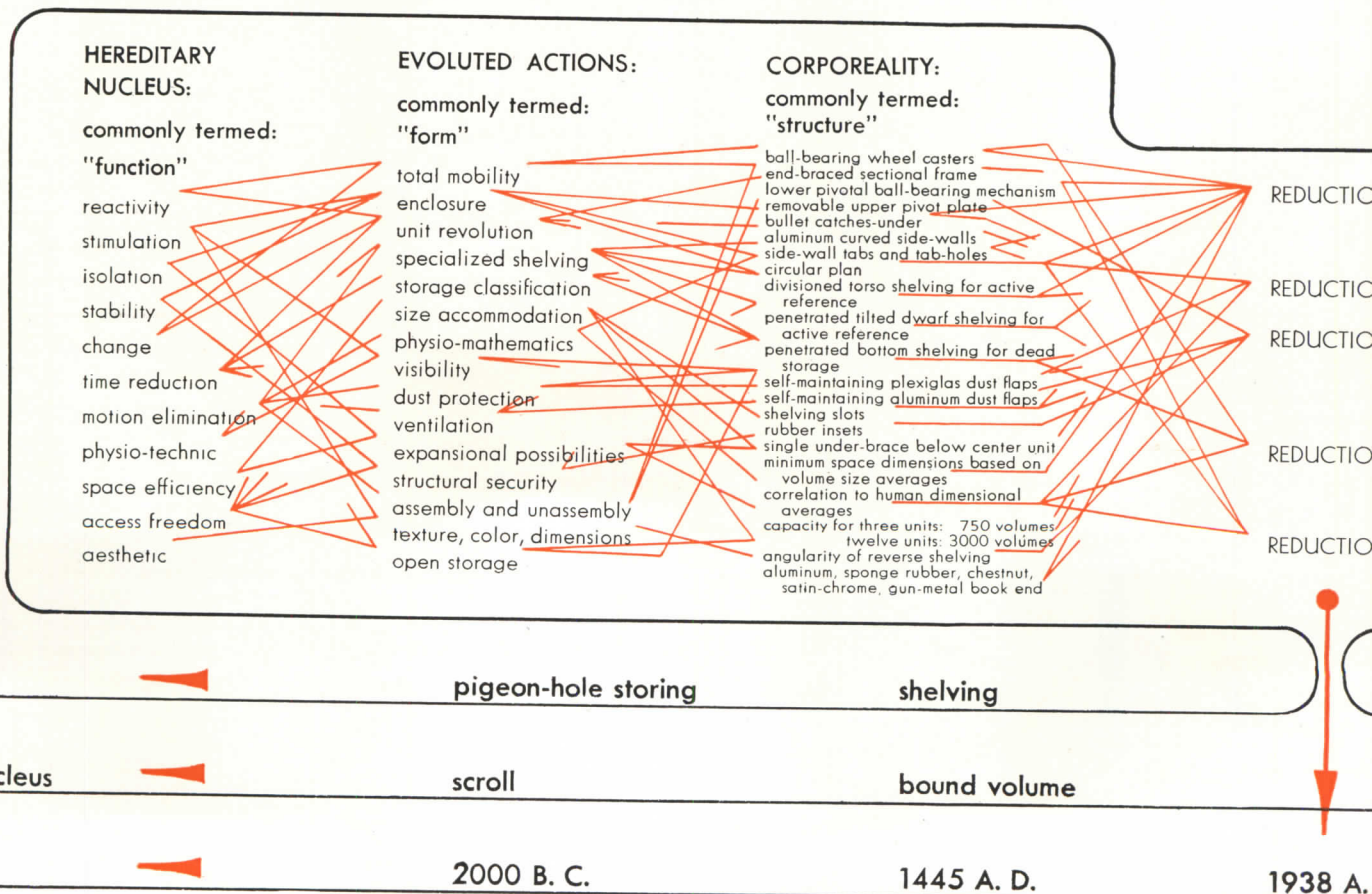

is a living organism. Similarly, every creation of man's technology is a living organism, whether it be a pillbox, a house, or a motor. Since the criterion of life is activation, we assume that a man no longer active is dead. By analogy we assume that because an object does not express itself in visible activity, it also is dead.

Here our judgment is determined by the limitations of our senses; for, as a matter of fact, when an object moves (a moving locomotive, a flashing electric bulb) we automatically say: it is alive. Conversely, when an object does not move, we automatically assume: it is dead. Our assumption of what is alive or dead is chiefly the result of optical observation. But this nerve center is "short-sighted." With a microscope we can see that a dead piece of cheese is very much alive. The revision of our judgments as to what is "alive" or "dead" must, for the time being, depend solely upon a more profound observation of facts.

Architecture: generator and de-generator of human energy

The floor on which one walks, the chair on which one sits, the bed on which one rests, the wall that protects, the roof that shelters, and all other units of the man-built environment are significant for what they are: but they also possess *nuclear multiple-force*. It is commonly assumed that these are dead objects; actually they represent an interplay of action with one another and with nature. They are a constant exchange of anabolic and catabolic forces within themselves, and in their coordination with human beings, and through human beings with themselves again, they constitute high potential energy centers.

The modern physicist speaks of constant bombardment of the earth by invisible cosmic rays, of radiation and radioactive elements which cannot be seen or felt, but which, in time, can exert a deadly or beneficent effect upon all life. *This is equally true of the "inter-stellar" organization of a house, a town, or a city.* But here the forces at work are

composed not only of animate and inanimate matter, but also of artificial technological bodies.

Biotechnique as a force of re-generation

The orbit, region, and scope of the activity of technological bodies (be they houses, machinery, or any other tool) are the objectives of the future biotechnician. He will find that any structure he builds is *worth only as much as the ratio of its force of re-generation.*

Despite the imperative need for health-yielding technological tools, obsolete manufacture clutters the market.* As far as the building designer is concerned, his contribution to halting such anti-social types of production will be the constant use of the biotechnical approach. (See Fig. 6.)

The biotechnical approach has led me to the *evolutionary method of design which, instead of taking its departure from prevailing commodities, employs the study of general physiotechnics.* This enables the biotechnician to avoid giving a mere narrative survey of phenomena, and—on the basis of a genetic account of an unfolding process—to create the necessary need-service. The Mobile-Home-Library shown on the following pages, represents a test of the validity of biotechnical design. The storing of books in the home was chosen as an objective for the first laboratory test because: (1) it is a need in every family's home, and (2) it has become so standardized in the form of a "bookcase" that its re-design seemed at the beginning a wasteful undertaking. The Mobile-Home-Library thus constitutes a documentation for this general statement: *Functionalism shifts the strain from the technological tool to the human being; but, here, biotechnique shifts the strain from the human being to the tool.*

*WASTE IN INDUSTRY. By the Committee on Elimination of Waste in Industry of the Federated American Engineering Societies, Washington, D. C., 1921.

CORREALISM

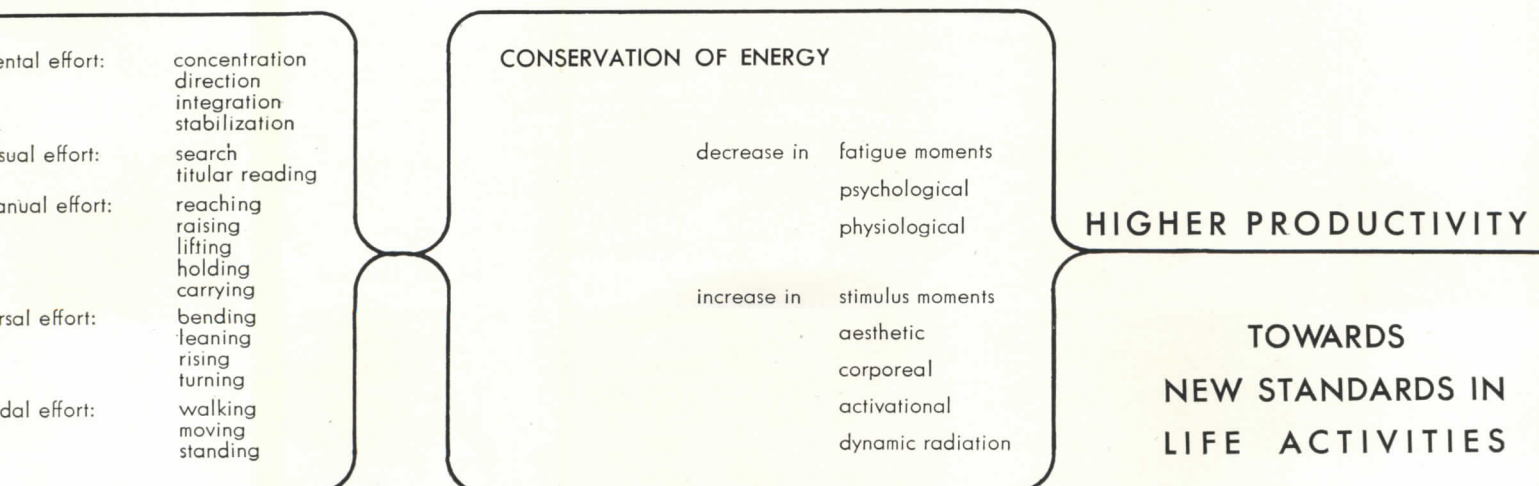

filing

photo-cell-unit

microfilm

opto-phonetics

1937-1950 A. D.

2000 A. D.

THE MOBILE-HOME-LIBRARY

designed and built by the Laboratory of Design-Correlation under the direction of Frederick J. Kiesler
 associated students: Alden Thompson, David Tukey, Ronald Kaufmann, Joseph Tanaka

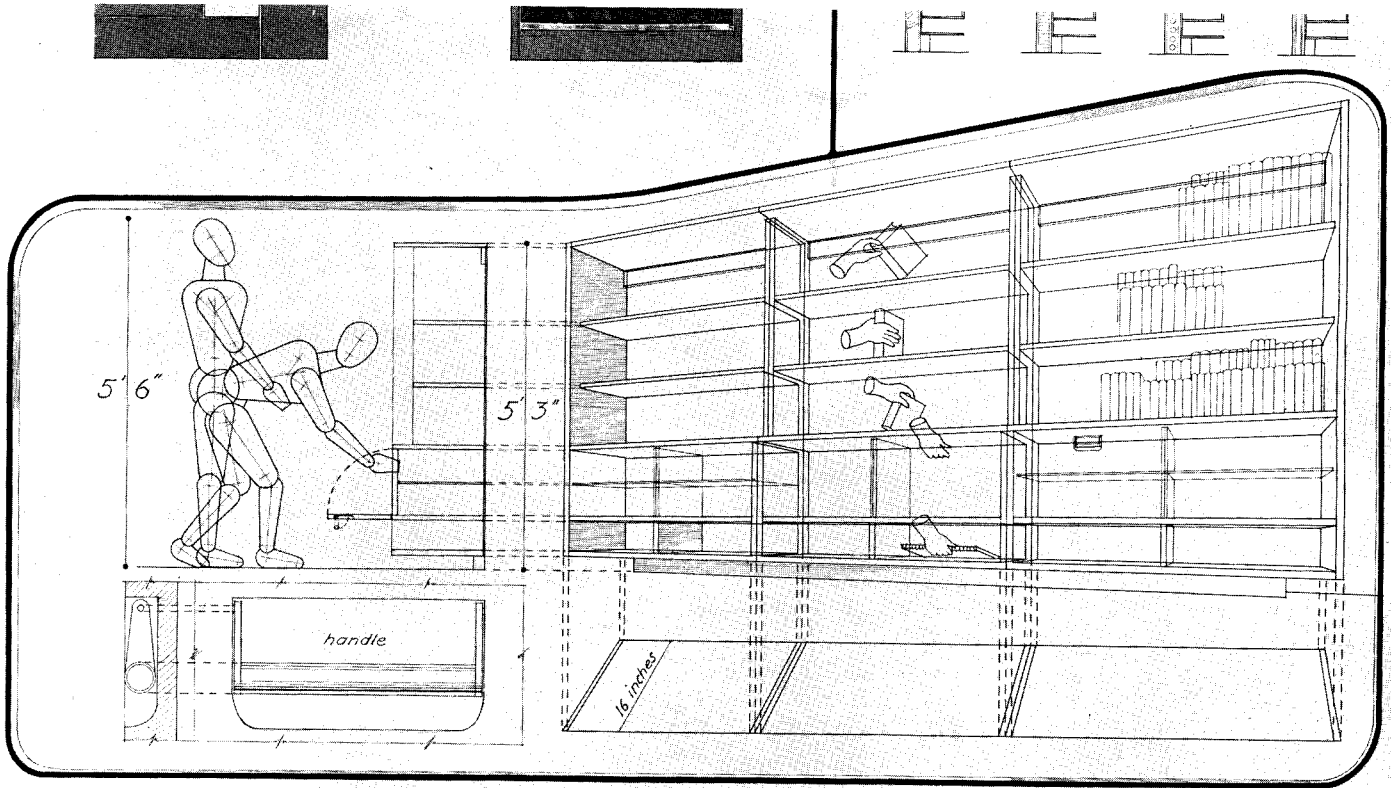

Fig. 10. Part of a large chart summarizing the results of the first stage of the project. Its graphic organization of the factors to be considered proved to be of great value in the final design. The diagram shown above already includes many of the principles which were incorporated into the final design; contrast, however, the human user (left) with that in Fig. 12.

THE LABORATORY of Design-Correlation was established in the Autumn of 1937 as part of the School of Architecture at Columbia University in New York City under Dean Leopold Arnaud. Its main purpose was to develop new methods of approach to building design and to test by actual construction the validity of biotechnique. The study was facilitated by permitting not only "professional designers" to join the Laboratory but also those outside the School who wished to coordinate their specific knowledge in other fields of science. We realized that the first test of "re-housing biotechnically" had to be (a) a familiar part of everyday life (b) one obviously accepted as satisfactory. We selected

book-storing as the process to be investigated.

Unfortunately, it is impossible in this short space to account for all the findings of a year and a half of study and laboratory work—an account which the Laboratory hopes to publish in the near future. Suffice it to say that, employing the inductive method of reasoning, it soon became evident that entirely new "methods of approach" had to be evolved before any synthesis was possible. For a summary of all the design principles currently employed in bookcases led to one conclusion: *they place the preponderance of strain upon the user, not the tool.*

In reviewing the history of book-storing in Western civi-

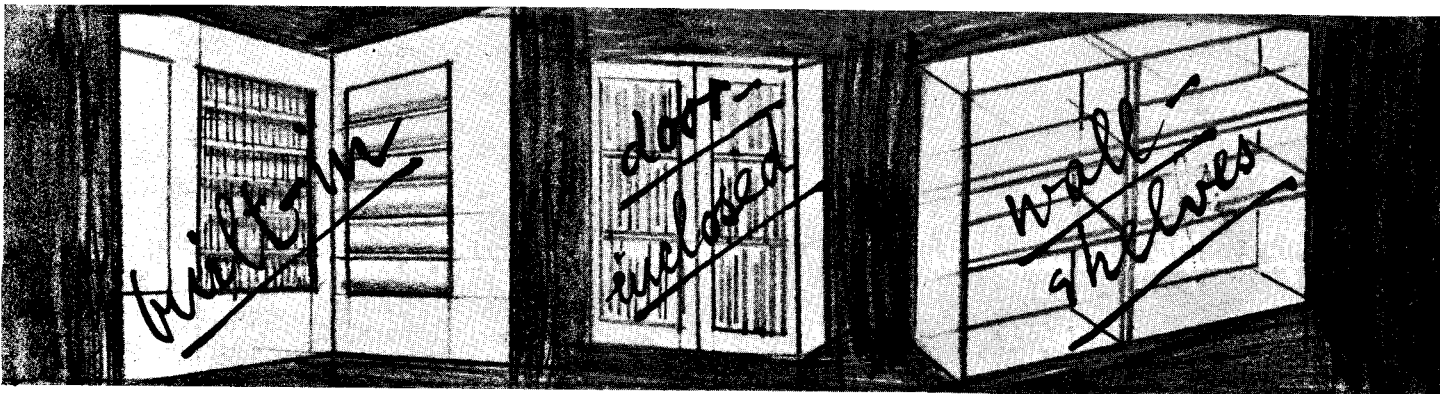

Fig. 11. Some of the many simulated types of book storing units; all are biotechnically sub-standard.

lization, we found no trace of a standardized terminology to identify the various relationships which exist between man (either reading or storing books) and his special tool for this purpose (in this instance, the so-called "bookcase"). Indeed the only generally accepted term which we found in our research was that of *dwarf shelves*—i.e., bookcases in medieval libraries either reaching up to the window sill or free-standing to an approximate height of 4'6". We therefore charted the physiological relationships between man and bookcase and tabulated the results as shown in Fig. 12.

By inductive methods we discovered that book-storing can be broken down into four major classifications:

- (1) temporary storing
- (2) active reference storing
- (3) inactive reference storing
- (4) dead storing

This constituted a discovery, and one which had great bearing on the final evolution of a new biotechnical tool for book-storing in the home, since these four stages are obviously closely related to physical, teleological, and economic obsolescence. It also had great bearing on the provisions for various types of printed matter—newspapers, magazines, reference magazines, fiction, non-fiction, and reference books. Such factors were in turn influenced by the variations in the ages of the members of the family. Last—though not least—was the economic aspect, both as to actual price and service-validity; this would obviously be influenced by the income level of the family and the layout of the housing facilities they could afford.

Biotechnically, the problem thus resolved itself into six major aspects:

1. Space technics: Shelf capacity was doubled by an increase from the normal depth of 10 to 12 in. to only 15 in.
2. Flexibility: Each individual unit, as well as the entire assembly, rotates 360° (see Fig. 13). The total assembly can be easily moved from one location to another. Capacity can be easily increased or reduced by addition or subtraction of individual units (see Fig. 14).
3. Construction system: Available manufacturing facilities and existing price levels were recognized in the design.
4. Dust control: Contrary to popular belief, books enjoy an optimum life span at atmospheric conditions closely approximating those needed by man. Continuous ventilation is guaranteed by elimination of doors. Dust is controlled by transparent flaps (see Fig. 17 and 18).
5. Content grouping: The design of our library unit permits grouping according to content, irrespective of variations in individual book sizes.
6. Fatigue reduction: By designing each unit of the library—as well as the total assembly—according to the physical limitations of man, strain on user is reduced to a minimum (see Fig. 12).

We developed several basic designs of which this is one. It constitutes what we have called a *new standard type* and from it we have developed many *variations* adapted to the special needs of social economy (see Fig. 16). The Mobile-Home-Library thus recognizes the principles set forth in Fig. 3. It is thus subject both to *variation* (to meet specific needs) and *improvement* (to become ultimately obsoleted by a new standard). Even more important, it recognizes that books are themselves subject to similar laws of development and may ultimately be replaced by newer "tools of communication"—microfilm, television, reading by optophonetics, etc. This factor is precisely indicated in Fig. 9, where the position of the Mobile-Home Library is appropriately located in time as well as technological advance.

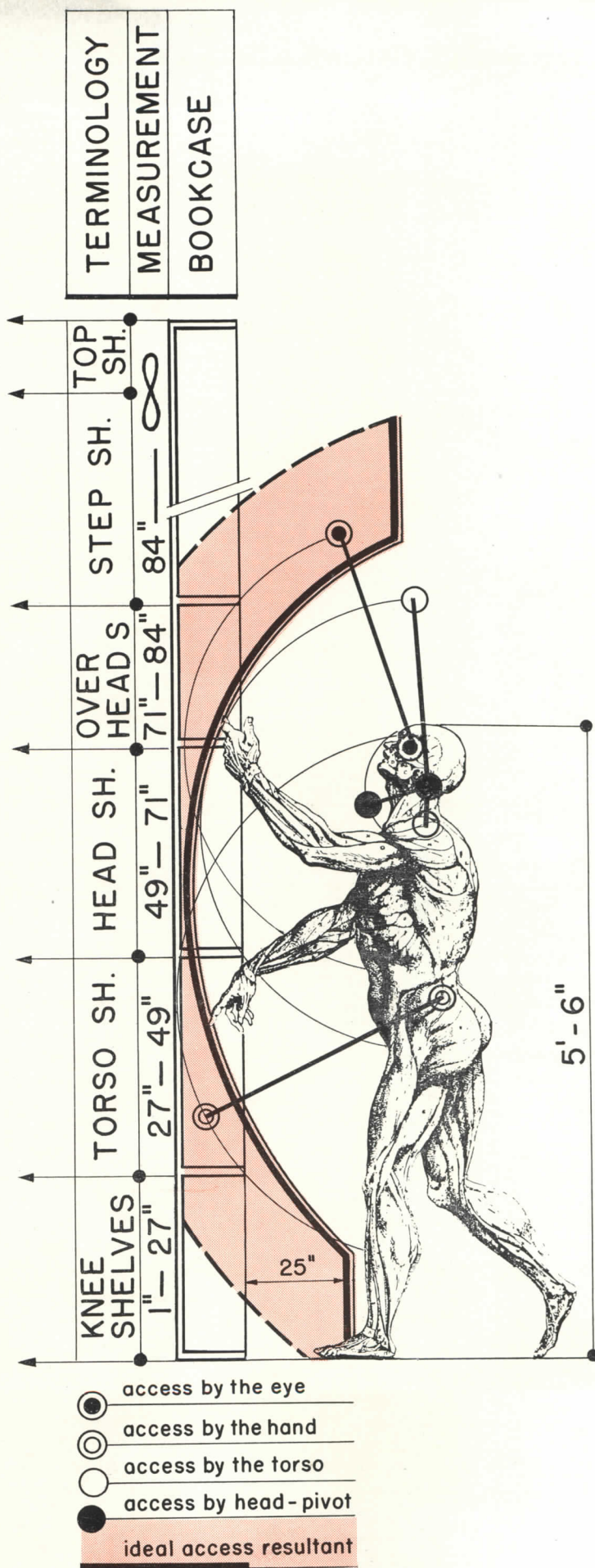

Fig. 12. Correlation-chart of book-storing



13. Model, first Mobile-Home-Library; designed and built at the Laboratory of Design-Correlation, School of Architecture, Colu



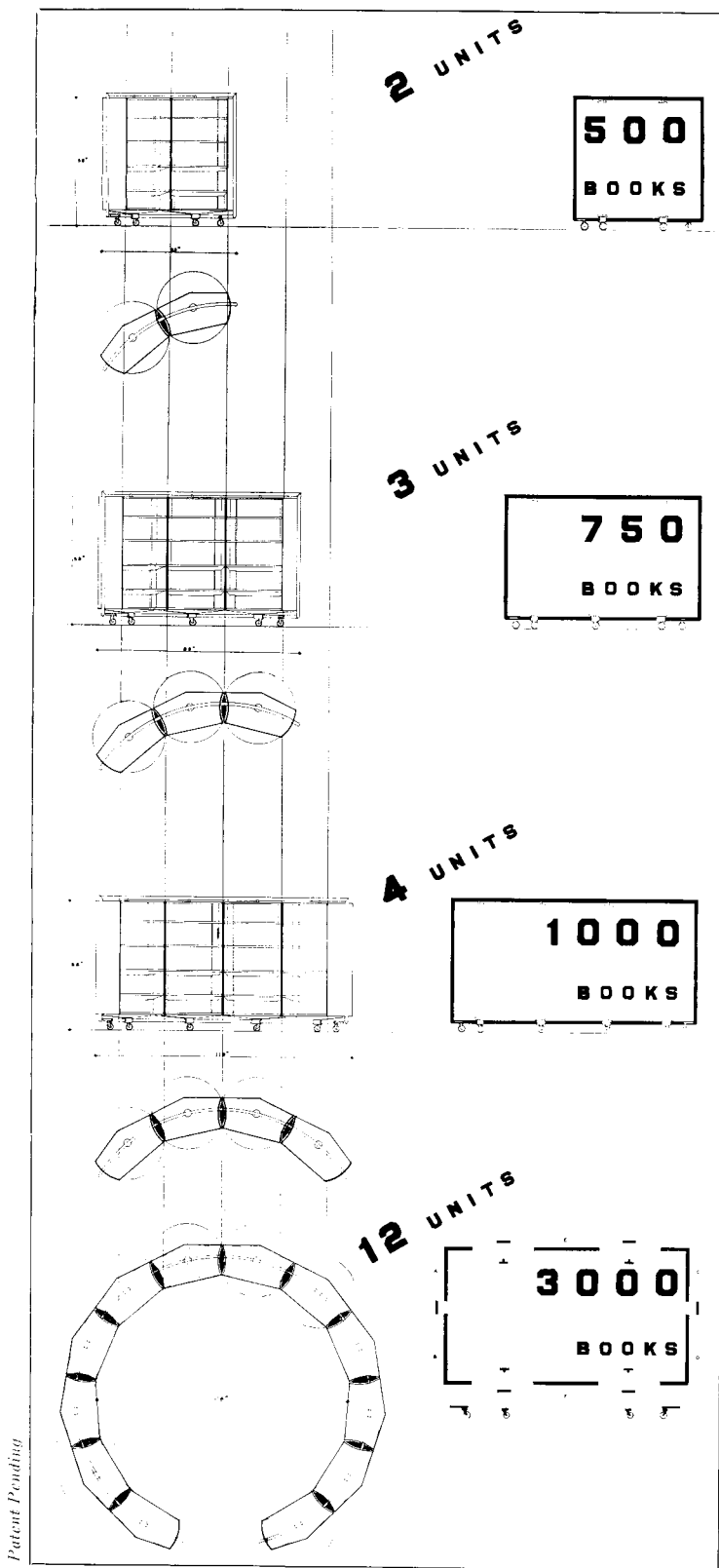

Fig. 14. Unit plan of STANDARD-TYPE Mobile-Home-Library

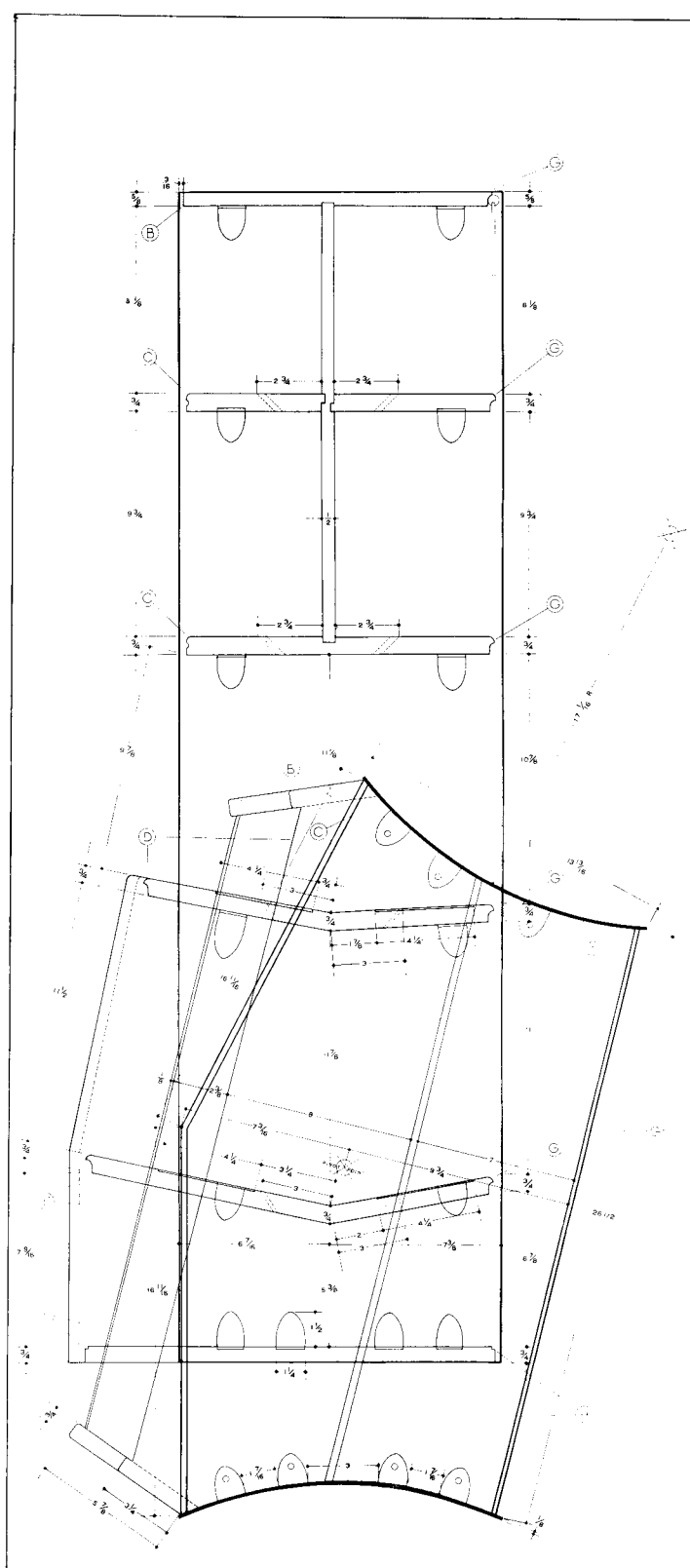
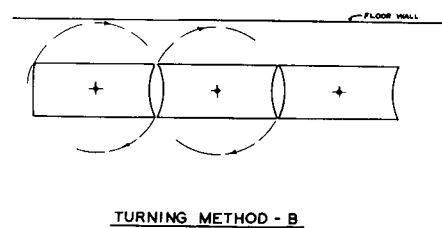
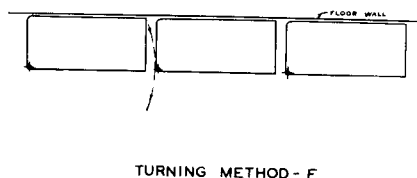

Fig. 15. Shop drawings of STANDARD-TYPE Mobile-Home-Library



TURNING METHOD - B



TURNING METHOD - F

Fig. 16. Two of many possible VARIATION TYPES of the Mobile-Home-Library: these were designed to meet a variety of limitations of present day house planning.

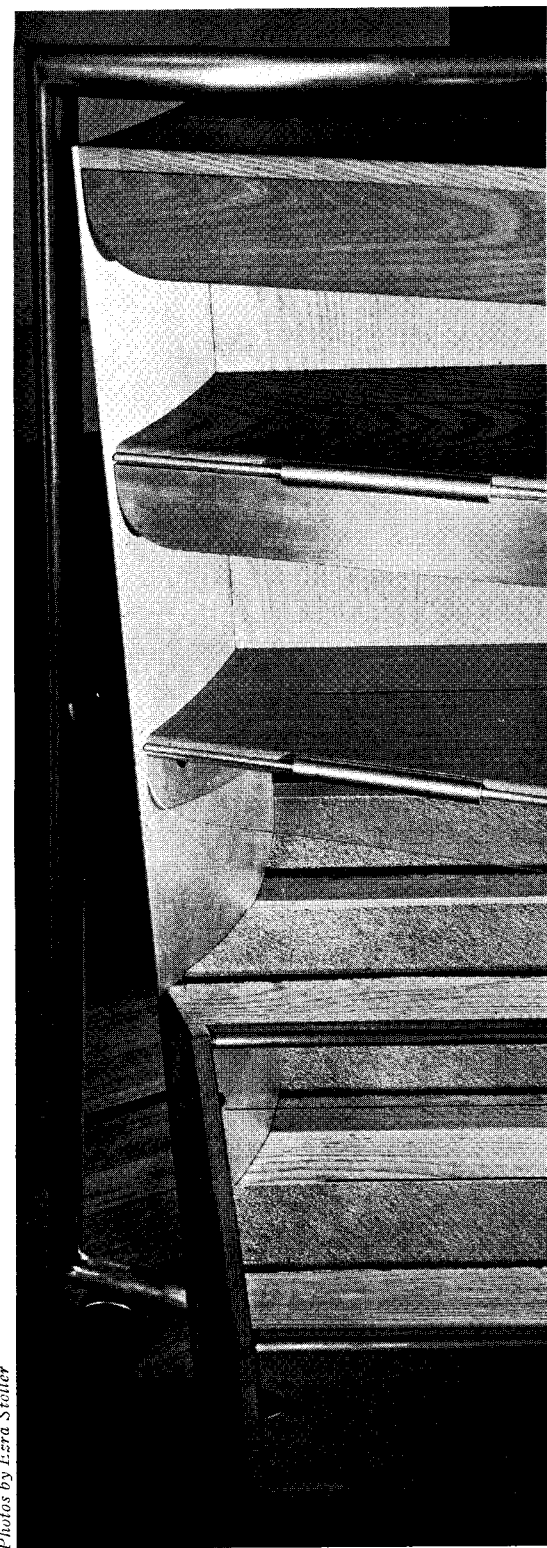

Photos by Ezra Steiner

Fig. 17—Schedule of materials used in Mobile-Home-Library: chestnut wood for its strength, light weight, and warm color; steel frame for its strength and economy; aluminum end-pieces for light weight and easy stamping; inlay of sponge rubber for gripping reclining books; transparent plastic dust flaps for visibility of titles (price-saving by substituting wood or metal flaps); vertical plywood panel through upper two torso shelves for privacy in use.

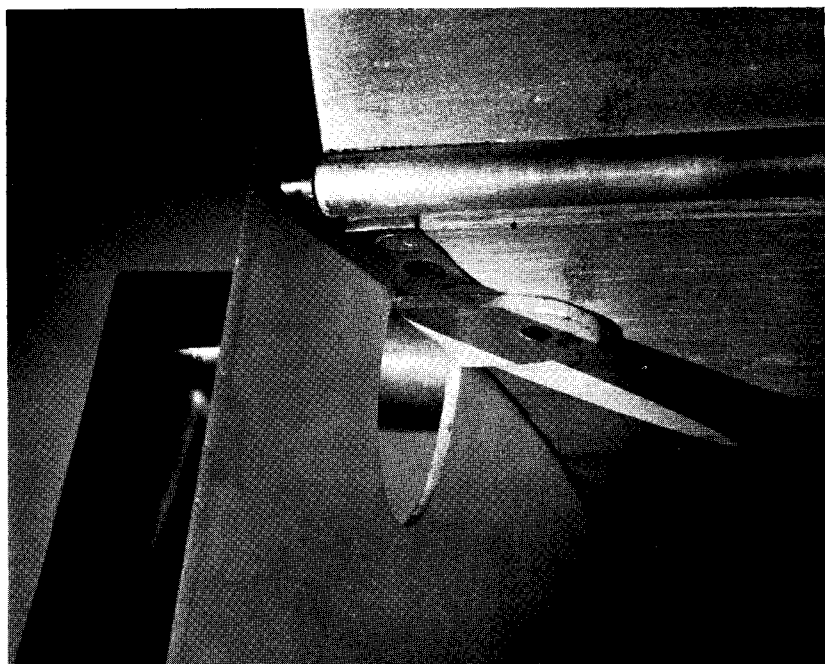

Fig. 18—Detail of special hinged construction of dust flap

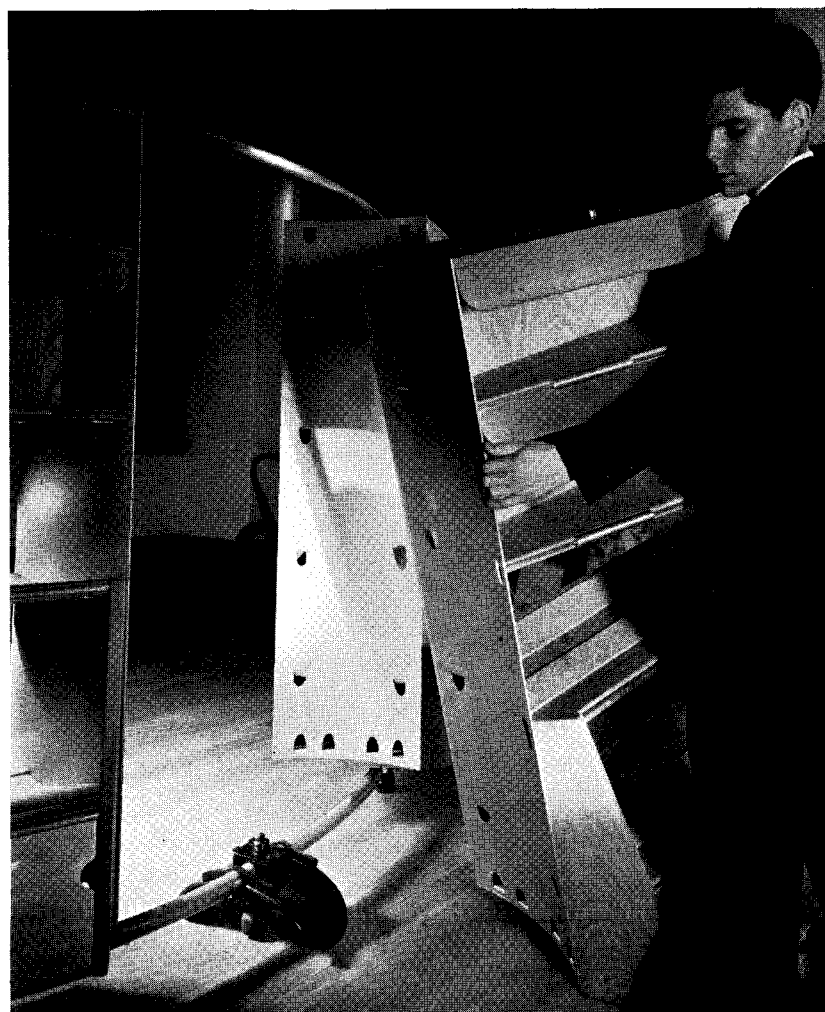

Fig. 19—Detail showing ease of adding or removing individual units to or from steel frame. The frame itself is subject to telescopic expansion or contraction. An emergency support (visible at bottom) $\frac{1}{2}$ in. from the floor prevents tipping where only two units are used and knee shelves are loaded; it is not required in assemblies of more than two units.



Westinghouse

Efficiency of the tungsten-filament lamp is now approaching its practical limits. The coiled-coil filament, shown here greatly magnified, has made possible an increase in efficiency of about 10%; recoiling the coil on itself reduces the amount of wattage drained away by the gas in the bulb and increases the wattage available for light.

THE CONTROL OF LIGHT

LIGHT is one phase of environment which, inside the limits of a building, it is the function of a building designer to control. Natural light is constantly fluctuating in intensity, direction, and chromaticity, and is not subject to the degree of control which it is possible to achieve with artificial light. Further, there are seeing tasks, for the most efficient performance of which, luminous environments different from the natural one are desirable. Control of light within buildings is therefore increasingly accomplished by artificial sources, which become ever more efficient and more specialized.

In the past, building designers have made relatively limited use of color; before the advent of the fluorescent lamp, the production of light of a particular spectral distribution required the use of filters absorbing one-third to over 90% of the light. More recently, the availability of fluorescent lamps producing colored light at efficiencies equivalent to or better than those of incandescent lamps without filters have contributed to a wider use of color by the designer. Gas- and vapor-discharge lamps, too, offer possibilities in the use of color. But the luminous efficiencies of all gases except neon are relatively low. And the vapor-discharge lamps are all deficient in the spectrum; the sodium-vapor lamp, for example, lacks red and blue completely, and red or blue objects illuminated by a sodium lamp appear black.

The non-visible spectrum, too, now receives more attention. Ultraviolet radiation, produced almost exclusively by electric-discharge lamps, is used for the sterilization of water, air, irradiation of food materials, photo-reproduction, etc. Sources, producing wavelengths in the middle- and near-ultraviolet range ("black light"), are used for activating fluorescent materials in theater shows, advertisements, and exhibitions. (Their use in ARP lighting has been discussed in Britain: key points, exit signs, dials, regulators, etc., could be marked with fluorescent paints so that, in emergencies, they could be operated under "black light".) Wavelengths in the near-ultraviolet range have therapeutic properties. Lighting which combines ultraviolet with visible light may perform several functions; thus, the germicidal properties of a 50-watt mercury lamp are held sufficient to purify 10,000 cu. ft. of air per minute. The combination of gas or vapor discharges with each other and the combination of discharge with incandescent sources also offer many possibilities.

The designer is concerned with intensities as well as the spectral distribution of light: concealment of the light source to prevent glare may involve problems of structural integration; selection of surfaces will be affected by their reflection characteristics; sound-absorptive materials tend to be light-absorptive as well, and this consideration, too, may influence the choice of surfaces. Control of intensities involves problems of temperature control; in this connection, the effect of various colors on a person's sense of temperature may be a factor in their selection. Maintenance of air purity is also an important factor; it has been estimated that loss of lighting efficiency because of dust deposits on equipment and reflecting surfaces may be as much as one-third.

It is in the integration of lighting with the other operational systems in buildings that the designer masters the technic of light control.

Special acknowledgment for aid in the preparation of this study is made to H. L. Logan, Managing Engineer, Controlens Division, Holophane Co., Inc. Acknowledgment is also made to J. L. Stair, Consulting Engineer, Curtis Lighting, Inc.; John T. Bailey, Westinghouse Lamp Division. Various publications of the General Electric Company and of Westinghouse Electric and Manufacturing Company were also useful. But none of these persons or sources are responsible for specific statements made here, unless it is so stated.

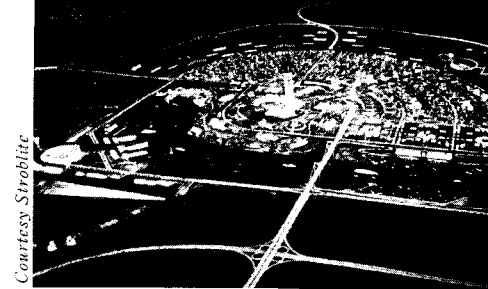

Courtesy Strobite

"Black light". "Democracy": fluorescent paints glow under near-ultraviolet light.

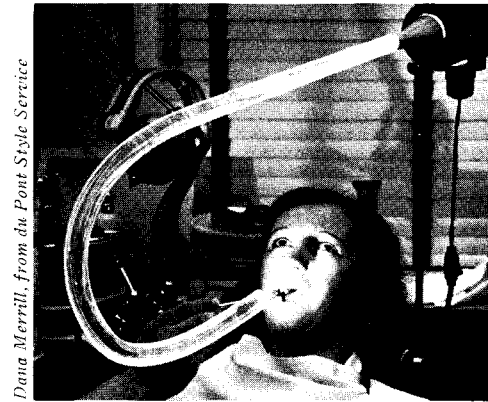

Dana Merrill, from du Pont Style Service

"Bent light". Some plastics have the property of internal reflection of light.

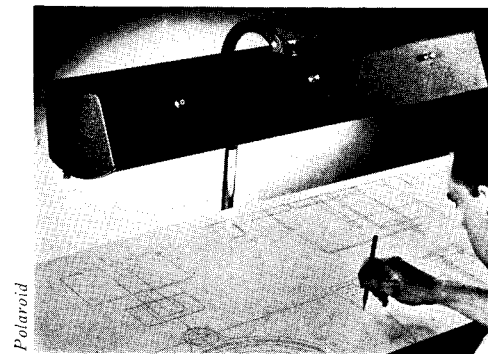

Polaroid

"Polarized light". Polarizing glass transmits only vertical vibrations, eliminating glare.

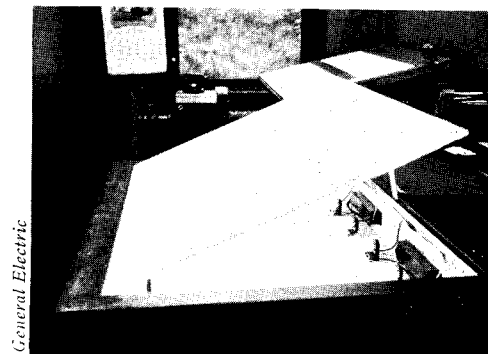

General Electric

"Cool light". Fluorescent tubes radiate less heat per lumen of incandescent lamps.

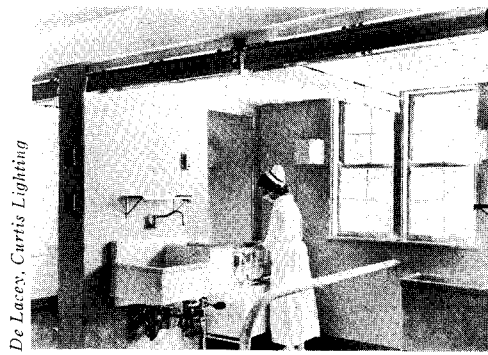

De Lacey, Curtis Lighting

"Germicidal light". Ultraviolet radiation has the property of killing bacteria.

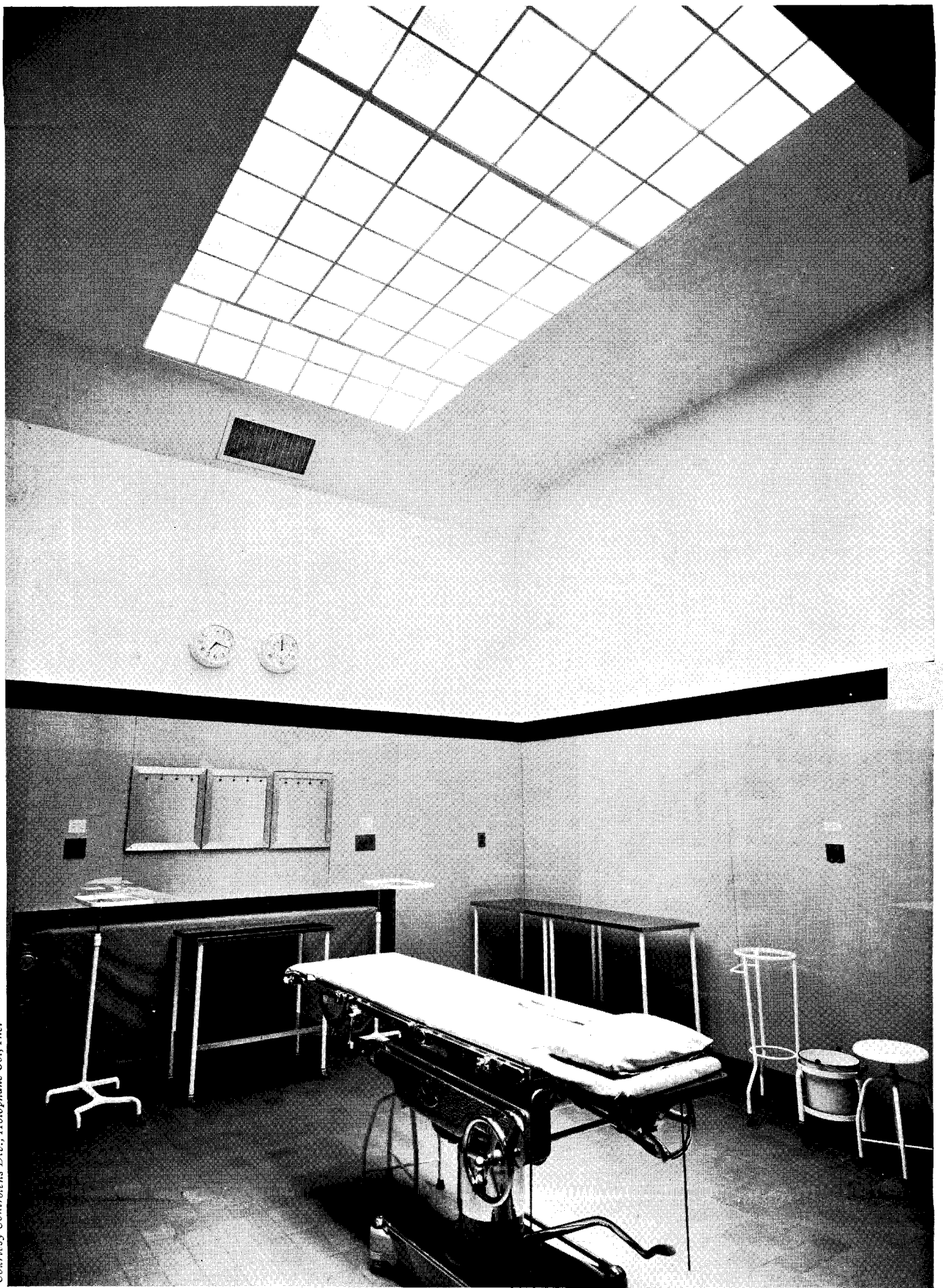

Courtesy Controlens Div., Holophane Co., Inc.

Direct lighting, multiple-lens controlled: the source is built-in, permitting easy integration with air conditioning.

The Luminous Environment*

RESEARCH in lighting is focusing more sharply: it is aiming at the development of the complete specification and control of all the numerous and complicated factors that enter into the lighting of a field of view. The conception of the "ideal luminous environment" is emerging. This conception embraces all the features of the use of luminous radiation in the external environment and correctly relates them to the physiological and psychological characteristics of the observer that are involved in all types of seeing activities.

Nature provides a luminous environment by which our eyes are conditioned and to which they are adapted. The average characteristics of this environment are the features of the ideal luminous environment for activities normal to outdoor conditions. However, some of the conditions surrounding visual tasks in artificially lighted interiors differ from outdoor conditions, and the tasks separately vary in their optical needs, requiring the synthesis of different "ideal" luminous environments, each one best suited to a particular type of visual activity and "surround."

Outdoor seeing, for instance, is mainly "parallel" seeing, that is, the objects seen are sufficiently distant and the details large enough to permit the eyes to remain parallel. Indoor conditions, with the nearness of everything to the eyes, causes them to converge and so many indoor seeing tasks require practically continuously converging vision. Surgical operating is an example. Intense concentration of vision is aided by similarly intense concentration of light accompanied by generous relaxation zones in the area outside of the operating field.

Reflected glare is a minor and intermittent condition in outdoor seeing. Polished or semi-polished surfaces that cause reflected glare are widely found in artificial environments. One instance, the environment necessary for the scribing of bright metal, calls for light sources of low brightness and area larger than the surface worked on, so the "highlight" will be entirely spread over it. (Incidentally, lighting such work with conventional equipment results in dazzle patterns of alternate bright and dark areas that confuse vision and sap the worker's energy). These large-area, low-brightness sources must also be arranged in relation to the reflecting surfaces of the lower part of the field of view, in such a way as to provide zones of rest for the eyes.

Industry offers a greater variety of critical visual tasks than any other type of human activity, and the complex requirements of ideal luminous environments, not only for industry but for all varieties of visual needs, are being gradually worked out.

Glare control

It is becoming increasingly possible to control glare from light sources. Originally, as bare lamps became offensive they were covered with shades which hid the lamps from the eyes, or were shielded by reflectors that redirected the light away from the eyes. Later these accessories developed principally into two kinds of enclosing "globes": diffusing ("white" glass) and redirecting (prismatic). As lighting intensities

mounted, direct glare from the lighting units tended to get out of hand again and reflected glare became a serious annoyance. This led, on the one hand, to the practice of turning the lighting units, and the lighting, upside down, so-to-speak, by aiming the light at the ceiling (indirect lighting), and, on the other hand, to the development of narrower distributions from lighting equipment with less light sent in the directions of the eyes. The indirect method temporarily brought both direct and reflected glare within tolerable limits, while the refinements in the direct method relieved direct glare.

As lighting levels rose still higher, the indirect method made the entire upper part of the interior too bright, both directly and as reflected from polished working surfaces. This has stimulated studies in brightness which reveal that the eye is best adapted to a brightness above the horizontal axis of sight about 50% greater than that below. Therefore, ceilings and upper walls can be one-half brighter than the lower parts of interiors. However, when the light is sent to the ceiling first, the upper "half" of the interior may appear from seven to fifteen times brighter than the lower "half."

While this was going on, direct lighting was moved to the ceiling, became an integral part of the structure, built-in, and took the form of lenses or louvers. This was supported by studies that showed that such lighting could be designed to permit a satisfactory distribution of brightness throughout the entire field of view. It also uncovered the need for the designer to include control of the colors, textures, and arrangements of surfaces that comprise the field of view.

This is because when light is sent to the lower "half" of the field of view first, the upper "half" in interiors sometimes seems a little dark. This "darkness" is due to the finishes used being darker than the equivalent surfaces in nature. If brighter finishes are used for floors, lower walls, furnishings, etc., and their arrangements as secondary sources of light carefully studied, the added reflection can raise the brightness of the upper portions of interiors appreciably, without the aid of supplementary light thrown directly from the light sources onto the ceiling.

This evolution of the direct lighting method has made possible the control of direct glare up to the levels of daylight; and where lenses or louvers are combined into areas of respectable size, plus control of the reflecting characteristics of the environment, reflected glare is also materially reduced and even eliminated.

Another illustration of this general principle of controlled direct lighting is also under way, in which the hanging fixture is retained but equipped with lenses or louvers in the bottom to provide controlled direct light, and its parts arranged to send some light also to the ceiling.

At present, one definite trend is toward controlled direct lighting: the needs of other systems within buildings work in its favor; for direct lighting requires furred ceilings, thus providing space for pipes, ducts, etc., and so creating job conditions favorable to air conditioning, which also requires such space. Further, other things being equal, it puts a smaller refrigeration load on the air-conditioning system. It does

*H. L. Logan, Managing Engineer, Controlens Division, Holophane Co.

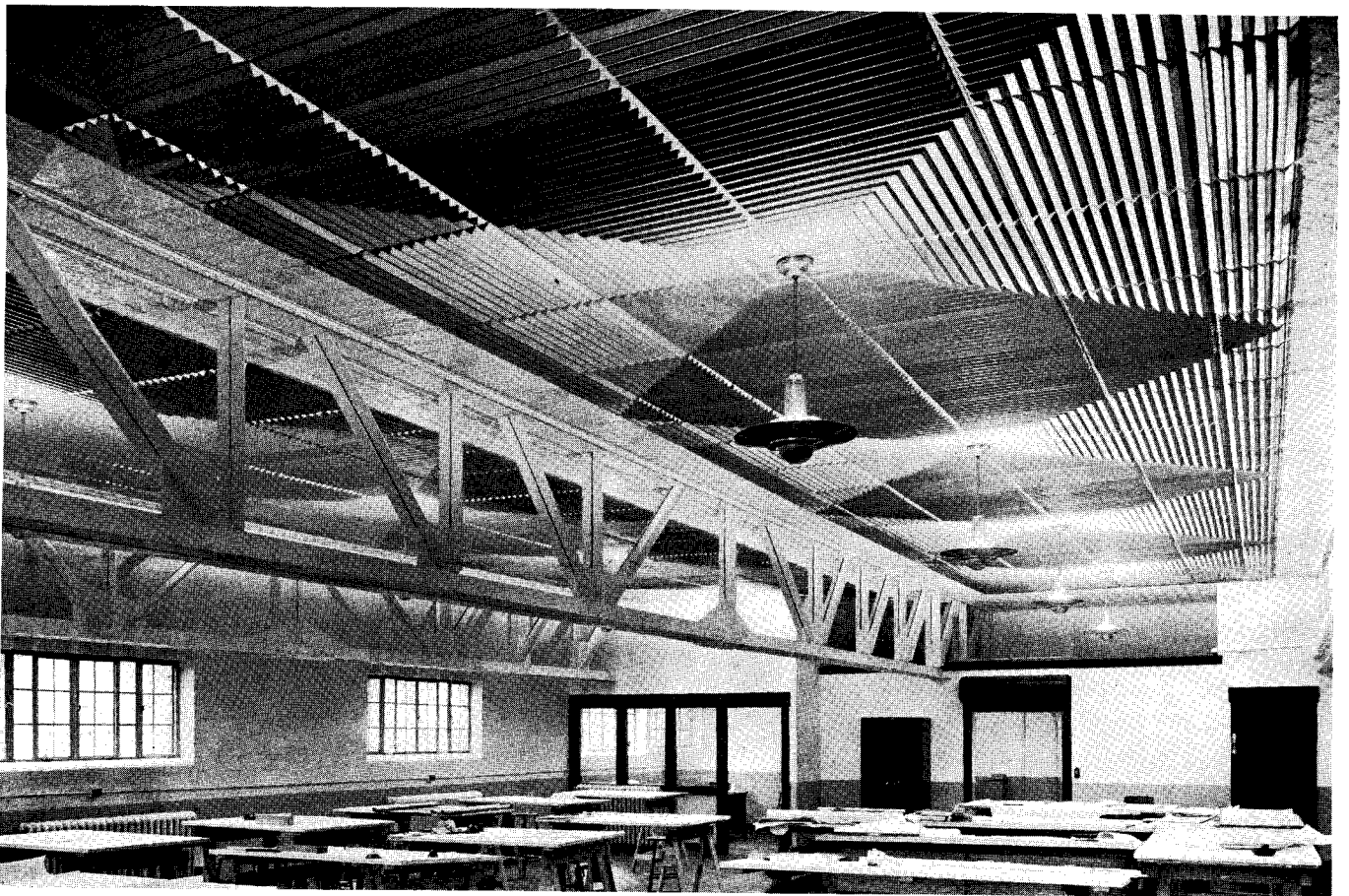

Waltz

Reflecting ridges return light almost straight down; thus, more light reaches work surfaces than from diffusing ceilings.

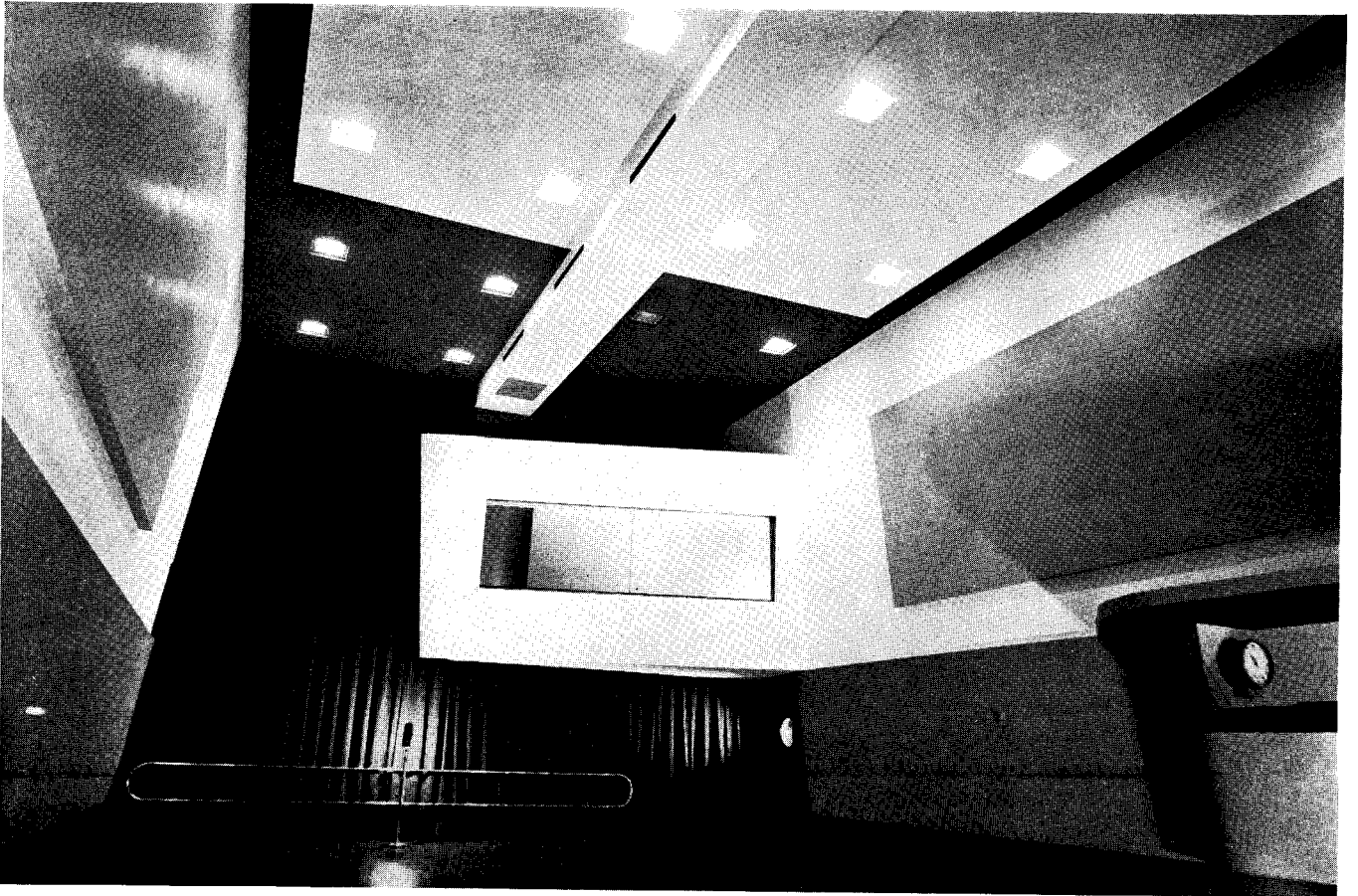

Courtesy Controls Div., Holophane Co., Inc.

Problems of sound control, air conditioning, structure, etc., influence the design of lighting. Walls are tilted here to prevent "flutter". Two-way vision without reflection is obtained with tilted glass panes at lower right.

not depend upon light reflection from the upper areas of the interior and so helps sound control by permitting the use of efficient sound-absorbing media (which tend to be light-absorbing).

The indirect method, up to now, has depended upon diffuse reflection from the surroundings. This results in as much light coming directly to the eye from the walls and ceiling as reaches the work. The light that strikes the work is partly absorbed, so that when it reaches the eye from the work the latter appears darker than the walls and ceiling, causing reversed contrast. An effort to overcome this is now proceeding by the use of redirecting metal ceilings, instead of the more usual diffusing materials. These ceilings consist of large, pressed-metal panels, with reflecting ridges that return most of the light almost straight down instead of scattering it all over the interior. Therefore, at ordinary angles of sight these ceilings do not appear overbright, and do not send enough light to the walls to make them too bright. At the same time they do cause more light to reach the work than from diffusing ceilings.

Another improved indirect lighting technic consists of building the ceiling of large coffers, with vertical side walls deep enough to hide the bright pans from long sights; or making the ceiling a continuous succession of half cylinders so that only a small portion of the ceiling, and hence of the light, is directed toward the eyes from any given point of view. In these methods, the reflecting panels, recessed coffers, or multiple-barrelled vaults are lighted by indirect sources suspended underneath.

All of these technics satisfactorily control direct glare, but none of them eliminate reflected glare. The bane of reflected glare can be ended by three methods:

1. Fixing the location of the light and the reflecting surface so that the reflection goes away from, instead of toward, the observer (unidirectional lighting).
2. Polarizing the light, either at the light source or by special polarizing spectacles used by the observer.
3. Avoiding the use of surfaces that cause annoying and interfering reflections.

Unidirectional lighting has a limited application, although where it can be used it is a good solution. A possible use is the lighting of standard school classrooms where the desks are fixed in place. Another is the lighting of accounting, tabulating, addressing, and other fixed business machines.

Polarization has a still more limited application, and has the handicap of cutting the lighting level in half. It is, at present, relatively costly when applied to the lighting source. However, there are some cases where it is the best solution. It will undoubtedly be more widely used as the technic of its application becomes better known.

The most generally applicable method, the use of surfaces which do not cause reflected glare, is coming into use. Calendered paper and polished desk tops are disappearing from schools. Glass and other shiny desk surfaces are being omitted from offices. Bright machine surfaces are vanishing. Surgical instruments are now provided in dull finishes, and so on.

Color control

Daylight is "white", varying from an unsaturated bluish

white (north sky), to an unsaturated orange or even purplish white at sunset. It also contains all the spectrum colors, i. e., it has a continuous spectrum. The tungsten-filament lamp generates an unsaturated yellowish white light, within the range of daylight variation. It also contains all the colors of the spectrum. Tests show no measurable improvement in vision by equal levels of daylight over light from the tungsten-filament lamp. Apparently, any light that is dominantly white and has a continuous spectrum is satisfactory for most visual purposes. The advent of the "daylight" fluorescent lamp has made available a source of light in which the proportions of the various colors are closer to what might be termed "average" daylight than is the case with light from the tungsten-filament lamp.

There is a trend in industry towards non-white light of the blue-green line-spectrum (discontinuous-spectrum) type, characteristic of the mercury arc. This trend is mainly confined to metallic fields of view. The most accurate and searching laboratory tests have discovered no visual benefit from this peculiar light, but its users insist that it is more revealing in the case of metal surfaces than is any variation of white light.

Continuously accurate color-matching by visual inspection is practically impossible. In daylight, there are continual fluctuations, both in intensity and in color composition. A "match" at 9 a.m. is not likely to be one at 11 a.m. If the matching is done under artificial daylight, someone must first decide just what kind of daylight will be duplicated and then a filter must be made that will reduce the excess colors in the artificial source to the desired proportion. The filter and lamp will both age and consequently introduce error. Further, the original formula will be prejudicial to the blue or the red groups depending upon whether the attempt was made to match north daylight or some other kind. The development of the spectroradiometric photometer, which automatically draws an analysis of the color studied on a graph, now makes color-matching mathematically certain by removing the need for a fallible human observer. The future will therefore probably see the visual task of color matching entirely replaced by the machine.

Other Controls

Another form of automatic control is spreading—the use of photoelectric-cell equipment to replace manual control of lights by automatic. The cell is adjusted so that when the daylight in an interior falls below a predetermined point, the lights are turned on by the device and turned off again, if and when the daylight again rises to the desired level. This also removes the uncertain results due to the fallible judgment of the human observer—for example, a teacher in a classroom.

For specifying and testing lighting, several new instruments are now available to the designer: a light meter which measures, with greater precision than does the human eye, the amount of light available for any seeing task; a visibility meter by which it becomes possible to evaluate the relative ease of seeing objects which vary in size, shape, etc.; a meter by which measurements of brightness can be made. All these instruments are portable and self-contained.

General Electric

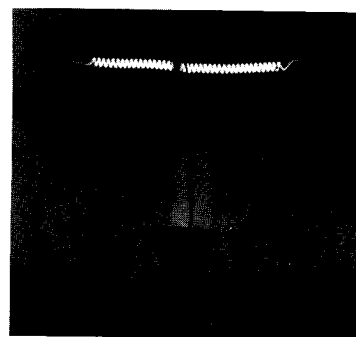
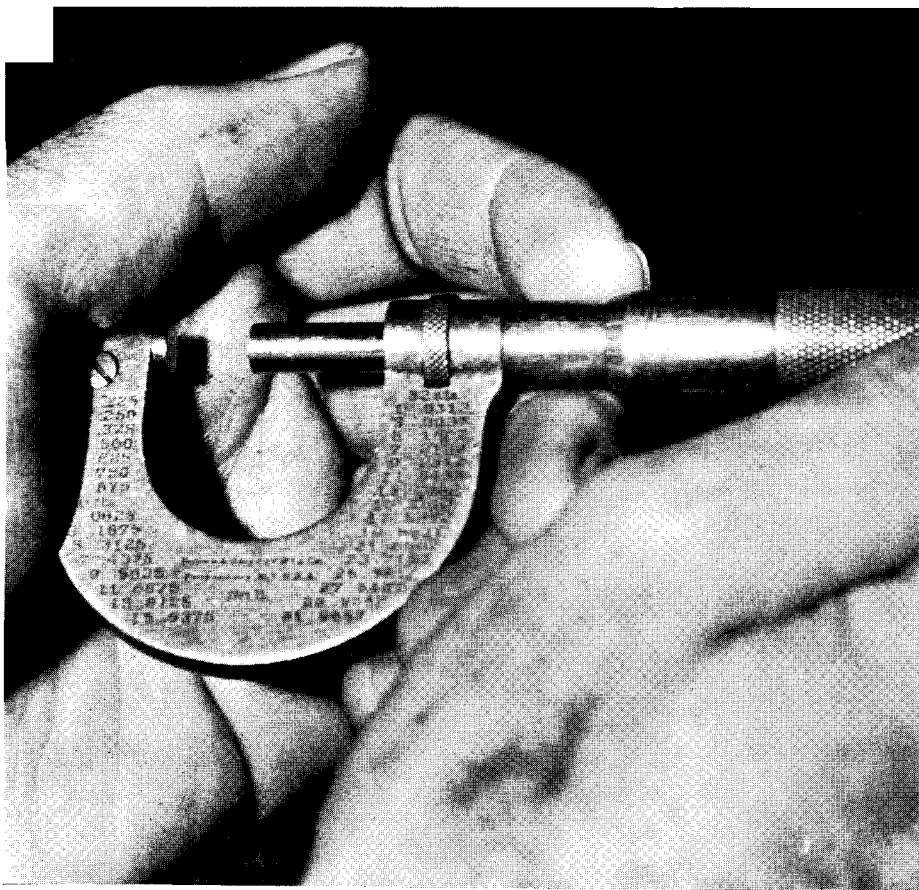

Coiled-coil incandescent lamp.



A lighted 4-ft. fluorescent tube.

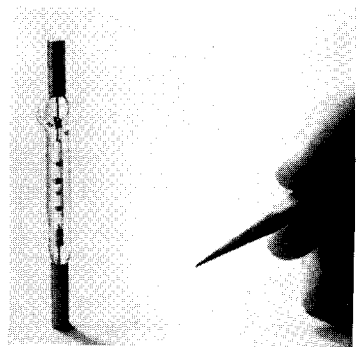

High-intensity capillary lamp.

General Electric

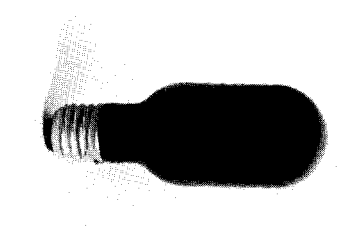
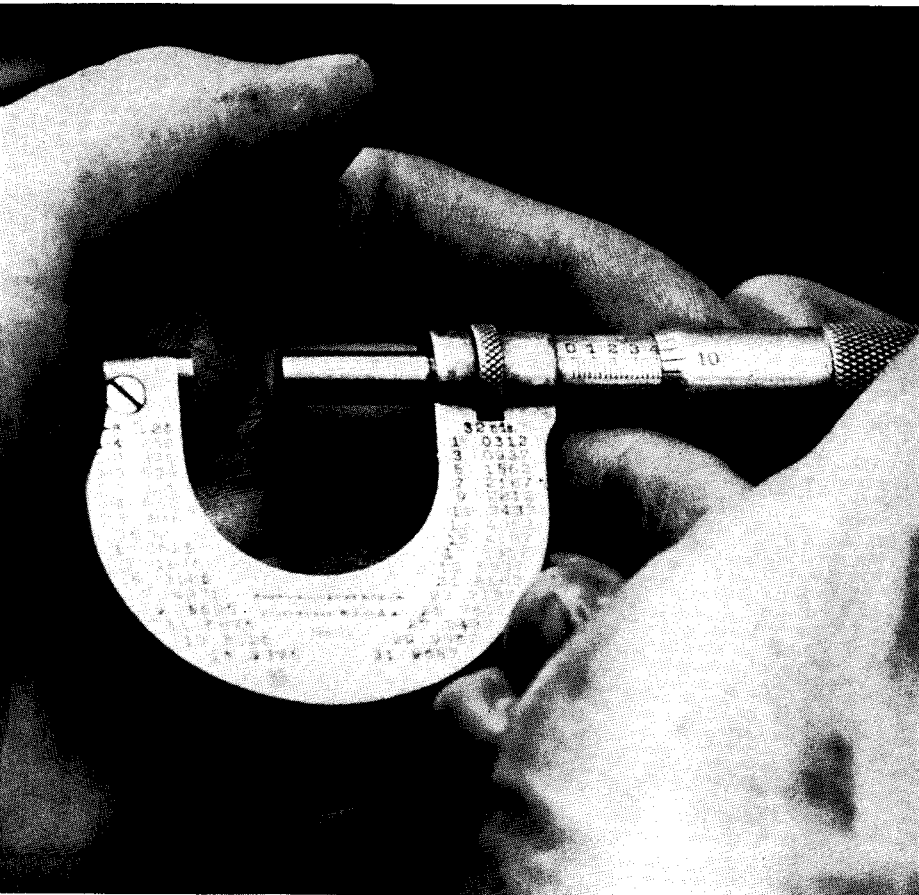

Bulb is opaque to visible light.

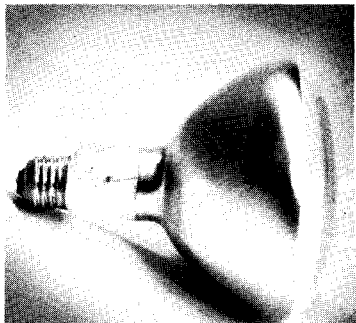

Reflector and bulb are one.

Photos courtesy of Westinghouse

Light used to overcome reduced visibility is often wasted because of glare. Above are two photos of a micrometer: in the top photo, reflected glare from a concentrating-type source makes reading of the barrel markings difficult; the lower photo shows the same micrometer, lighted by a large-area source.

Trends in Light Sources

ABOUT four-fifths of a billion incandescent lamps were sold in the United States last year. A recent improvement, the coiled-coil filament, has increased their efficiency, which is, however, approaching its practical limits. New light sources are becoming available.

Fluorescent lamps

The fluorescent lamp, an electric discharge source, is a tubular bulb with an electrode sealed in each end. The bulb contains a small globule of mercury to produce a vapor at low pressure, and argon gas at low pressure to facilitate starting. Mercury is used as the conducting vapor because of its relatively high efficiency in the production of the ultraviolet radiation which activates the "phosphor" coating the inside surface of the tube. These phosphors absorb the ultraviolet energy and reradiate it at the longer wavelengths which are visible to the eye. Each phosphor has its characteristic color of fluorescence and, by mixing them, it is possible to produce radiation in almost any part of the spectrum.

The efficiencies at which these lamps produce colored light are far higher than those produced by incandescent sources with colored filters. Green is produced at efficiencies of the order of 50 to 60 lumens per watt (including auxiliary losses: see below) and blue light at about 15 to 18 lumens per watt. These efficiencies may be compared with the one or two lumens per watt produced by green incandescent lamps and the fraction of a lumen per watt delivered by blue incandescent lamps. The difference between the efficiencies of "daylight" fluorescent lamps and filament lamps is, of course, much less.

The heat produced by a lighting system is a major factor in the design of cooling systems. Fluorescent lamps radiate less heat per lumen than do filament lamps. For example, a standard 40-watt inside-frosted filament lamp gives about 475 lumens, and radiates about 78 per cent of its input, or about 31 watts; the 15-watt fluorescent lamp gives about 450 lumens, but radiates only 47 per cent of its input, or about 8 watts when it is used bare. (Most of the waste energy is *conducted* from fluorescent lamps and *radiated* from filament lamps. Conducted heat tends to remain at the ceiling and may be removed with relatively little effect on air temperature. But radiated heat accompanies the light, with obvious effects on the comfort of persons in the room.) Thus, for equal lumens from the two light sources, approximately one-fourth as much heat is radiated from fluorescent as from incandescent lamps.

Like other electric discharge sources, fluorescent lamps do not run directly from the line but require an auxiliary which also consumes power—from 10% to 25% of the lamp wattage. Unlike filament lamps, which have a power factor of almost 100%, a fluorescent lamp with its auxiliary, as used on an AC circuit, has a power factor of about 60%; that is, only about 60% of the current going through the wiring system does useful work, the rest returning to the central station. Thus, a wiring system for fluorescent lighting equipment must have a capacity sufficient to care for about two-thirds again as much current as does useful work. However, equipment is now becoming available which corrects the

power factor to 85% or higher.

Another characteristic of fluorescent lighting has been cyclic flicker, a variation in light output caused by cyclic changes in current on AC circuits. In incandescent lamps, flicker is ordinarily not obvious because the metal filament stores energy, producing a persistence of glow; this afterglow is less pronounced in arc lamps and the flicker is more noticeable. Flicker can be reduced by using two-lamp auxiliaries which cause the high point in light output from one lamp to correspond with the low point from the other lamp.

Fluorescent lamps are thus far not available in the higher wattages and many units are therefore required to light a room. Their future development appears to be partly limited by inherent characteristics. Thus, the tubes are limited to a minimum diameter of about $\frac{3}{4}$ in.; narrower tubes would pile up energy on the powder that could not be converted efficiently. And they are limited to a maximum diameter of about $1\frac{1}{2}$ in.: the mercury in the tube reabsorbs energy if there is too long a travel path through the mercury vapor; a total path of $\frac{3}{4}$ in. (total diameter of tube, $1\frac{1}{2}$ in.) has been found to be about a maximum to permit present efficiencies—wider tubes have a lower efficiency.

Fluorescent lamps do not operate at full efficiency if air temperature around them exceeds 90°F. or drops to 30°F.

High-intensity mercury-vapor lamps

The fluorescent lamp is a light source of low brightness and extended area. A different source, of high intensity and small area is the high-intensity mercury-vapor lamp, introduced at the Chicago Exposition in 1933; there are now available at least 6 different wattages and 16 different types—floodlights, searchlights, "black light," sunlamps, etc. One of the most recent of these is a quartz capillary tube, highest in wattage and smallest in size of all mercury lamps. This is a 1,000-watt, water-cooled lamp, with an efficiency of 65 lumens per watt. Surpassing in brilliancy most known illuminants, the arc attains a brightness of the order of 30,000 candles per square centimeter. The capillary tube is about three inches long, the arc stream itself less than an inch in length. The quartz tube is cooled by a moving stream of water through a glass water jacket in which the lamp is operated; the arc would otherwise melt the quartz. The light emitted has the characteristic yellow-green and blue-violet radiation of the mercury spectrum, plus more red radiation than other mercury sources. It also radiates near-ultraviolet,

Projector and reflector lamps

Other lamps, in which the bulb and reflector are combined in a single unit, are becoming increasingly available. In one projector, a lens plate and a reflector of highly accurate contour are made as integral parts of the lamp. The two parts, of heat-resisting glass, are molded separately and later fused together. Since the reflector is sealed inside the lamp, the reflecting surface is protected from all causes of depreciation except a slight blackening from filament evaporation. In another unit, the reflector is one piece with the bulb, of the same type of glass as that used in the ordinary bulbs.

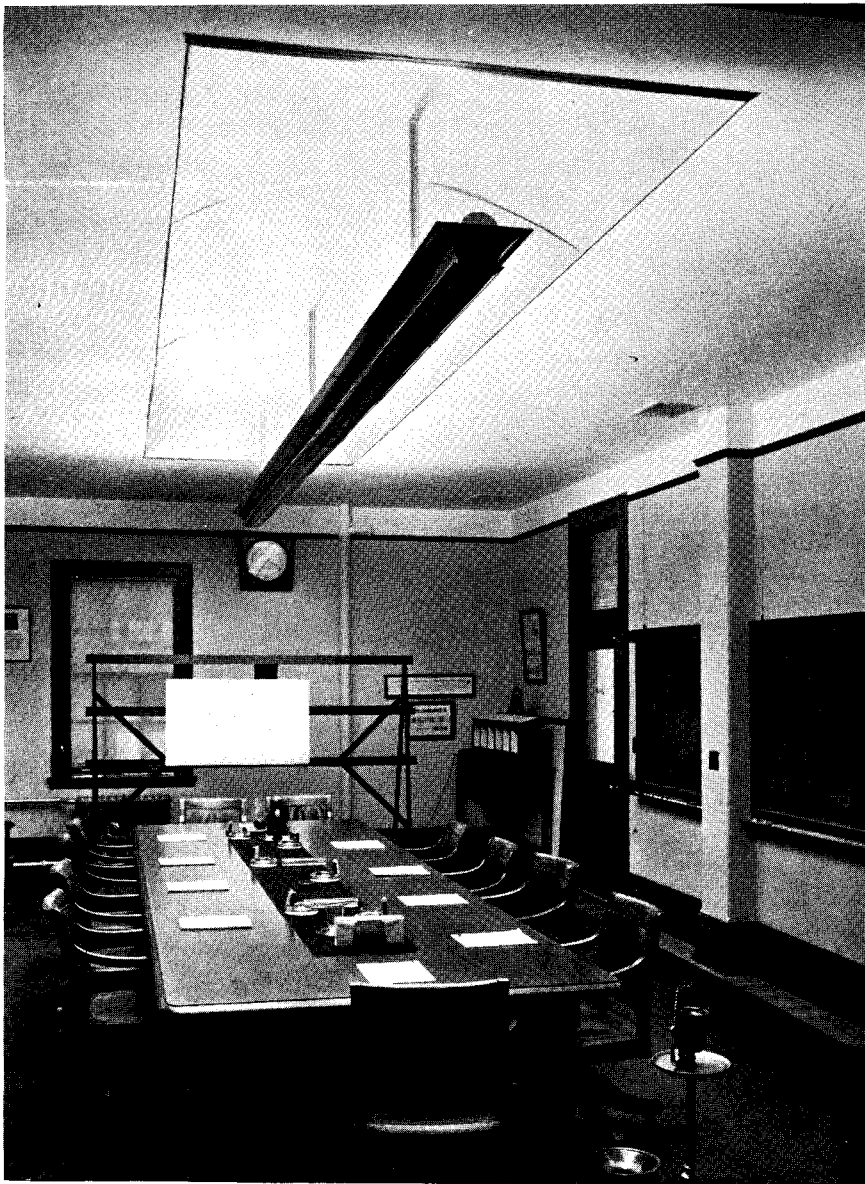

General Electric

A parabolic section of etched aluminum has been recessed into the ceiling. A Fresnel lens of heat-resisting glass has been placed above each lamp to concentrate light into a plane at all points perpendicular to the parabolic ceiling.

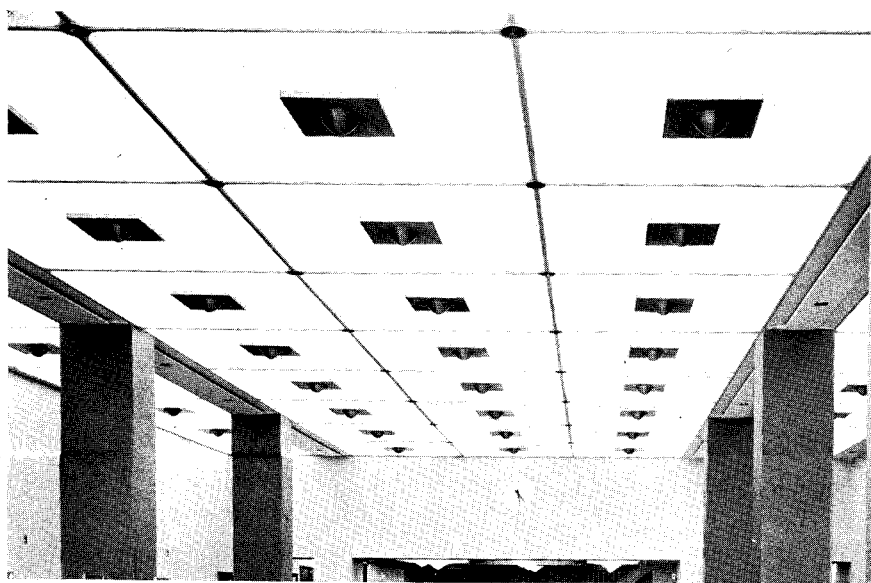

General Electric

Lamps are concealed in holders in coffers, with sprinkler-heads at corners.

Other Equipments

IN USING the higher intensities of light without simply increasing wattages, the designer has employed increasingly specialized equipment for controlling the light from those sources with maximum efficiency. There is a trend on the one hand toward "built-in" lighting, and on the other toward a combination of the light source with the "fixture." (In new silvered-bowl, projector, and reflector lamps, for example, the reflector is an integral part of the lamp.)

Among other recent developments in lighting "fixtures" are:

1. "Self-illuminated" fixtures in which some of the light from the lamp bulb within the fixture is redirected over the exterior surface of the bowl, thus eliminating the heavy and "dead" appearance of opaque luminaires.

2. "Light-Hood" units, which include a "ceiling" illuminated from below by shaded lamps; the light is thus localized and diffused.

3. Employment of large luminous areas, a method which simulates indirect illumination in which the ceiling becomes the source of light.

4. Lighting through small ceiling apertures: the rays of light cross at the ceiling opening and spread over wide areas; overlapping of the circles of light results in a relatively uniform distribution of light.

5. Increased use of plastics. Plastics are lighter in weight than glass or metal, permitting savings in structural details, and greater safety in the use of overhead fixtures. They are less breakable than glass and less likely to crack from sudden temperature changes. Thickness, color, and shape can be controlled with precision, and optical characteristics can be varied to suit requirements as to transmission, reflection, and diffusion; but they are not practical for control by refraction. Some plastics can transfer light by internal reflection, like diffused quartz. The use of plastics with the larger filament lamps and with electric discharge sources is still limited because of inability to withstand the temperatures developed. They will probably be used more widely with the cooler fluorescent lamps.

6. Other new materials, such as: Alzak, a new reflecting surface of aluminum, which is more highly reflective and more resistant to corrosion; non-reflecting glass which increases light transmission to more than 99%.

NO ES ON NEW BOOKS

A DESIGN STUDENT'S GUIDE TO THE NEW YORK WORLD'S FAIR. Compiled for *PM Magazine* by the Laboratory School of Industrial Design. 32 pp. 5³/₈ by 7³/₄ in. Regular price, 50¢. Special to design students, 35¢.

JOHN McANDREW, Curator of Architecture at the Museum of Modern Art, describes the Guide in his foreword as "a specialized and selective Baedeker of sights not to be missed, chosen and briefly analyzed by people seriously concerned with the aesthetic qualities of design and well informed in the many technical and practical considerations involved."

The editors themselves, in their introduction, assert three basic criteria governing selection of material: buildings, exhibits, and miscellaneous features were included on the bases of their functional suitability, exploitation of technological facilities, and use of appropriate materials in design and construction. Under four headings—national, international, commercial, and miscellaneous (e.g. Aquacade, Parachute Jump), the editors catalog and briefly annotate those features of the Fair which they consider outstanding from the standpoint of the layman as well as the designer. The resulting coverage, while by no means exhaustive, is sufficiently representative, particularly with regard to the criteria involved.

Text and illustrations are supplemented with a glossary of terms, including nomenclature coined especially for the Fair.

TERRACRETE: BUILDING WITH RAMMED EARTH-CEMENT, by Francis Macdonald, Chemical Engineer. 46 pp. 6 by 9 in. Price, \$1.00.

FROM literature on *pisé de terre* (rammed earth), on soils and roads, from examination of rammed-earth houses and discussion with their builders, from experimental work with forms and earth-cement mixtures, Francis Macdonald assembled the information which led to the selection of the soil-cement material, Terracrete, as the subject of his booklet. He analyzes the composition and costs of Terracrete walls; discusses the preparations for building; tests and selection of soils and the forms

and rammers required in the manufacture of the material; and describes the processes of constructing foundations, joists, sills, lintels, gables, etc., after the preliminary work has been done. He concludes that "Terracrete offers much for little. Enduring walls require only a good soil, thorough mixing of the cement, and ramming at the proper moisture."

ETCHINGS: NEW YORK WORLD'S FAIR. "BUILDING THE WORLD OF TOMORROW". Etchings and text by Gordon W. Gilkey, M.F.A. Foreword by Grover A. Whalen, President, New York World's Fair. Introduction by George McAneny, Chairman of the Board of Directors, New York World's Fair. Published by Charles Scribner's Sons, New York. 54 plates and facing page text. 8¹/₂ by 11¹/₄ in. Price, \$5.00.

WITH an introductory incisement of the Empire State Building, where the World's Fair was germinated in idea and plan, the artist commences his steel-point case history of "Building the World of Tomorrow." Serial impressions unroll as a pageant of the Fair's growth—from the initial problems of construction to the successive completion of the buildings and exhibits, the wide avenues and the extraordinary vistas.

Grover Whalen, in his foreword, declares that the hand of the artist has caught "something of the sweep and meaning, something of the rhythm and purpose of this great undertaking which is designed to implement the thoughts and aspirations of men ever seeking a new and better world."

IN SEARCH OF A LIVING ARCHITECTURE, by Albert Frey. Published by Architectural Book Publishing Co., Inc., New York. 95 pp. 10¹/₂ by 7³/₄ in. Price, \$3.75.

PRELIMINARY to examining the function of modern materials and technics in the satisfaction of contemporary structural needs and in the creation of a living architecture, the author advances certain general laws which have governed the evolution of architectural form. The truly great and abiding forms of the past, like "trees, streams, flowers, and mountains, all justify them-

selves in terms of purpose as well as of beauty."

However, Mr. Frey observes, "imitation of the form, lacking the control of practicability, sinks into mere ornament, a hindrance rather than a stimulation to the development of idea and thought. . . . The creative technique of our time goes into the production of objects derived from present conditions, not into the copies of traditional form."

In the lights of shape, space, composition, and comparability with form in nature and traditional architecture, the author goes on in his book to investigate, through a series of variegated case expositions, the application of modern methods and materials in shaping structurally for human needs, and in creating a great and abiding architectural form that is essentially our own and truly expressive of our times and culture.

ARCHITECTURE AS A CAREER. Published by The Institute of Research, Chicago. 16 pp. 8¹/₂ by 11 in. Price, \$1.00.

AS RESEARCH No. 12 in the series dedicated by the Institute to the answering of Youth's inevitable question "What shall I be," this monograph is addressed both to young persons possessed of certain evident qualities supporting their inclinations along an architectural bent, and to elders who would encourage and direct these nascent talents to a satisfactory vocational conclusion.

By presenting brief vignettes into the architecture of tradition as well as that of the present day, the editors demonstrate "how closely architecture is connected to the practical as well as the ideal life of man and how it has developed from sheer necessity to an art which embodies the principles for which a people stand."

Preliminary qualifications for the architectural aspirant are defined, steps in training—possible schools and probable courses—are discussed, and advantages, disadvantages, and opportunities in professional practice are realistically weighed. Moreover, such considerations as required capital, investment return, and salaries of architectural personnel are sifted with the practical sobriety warranted by these issues.

(Continued on page 132)

ACCURATE

Performance

HELMET SEAL

Protection

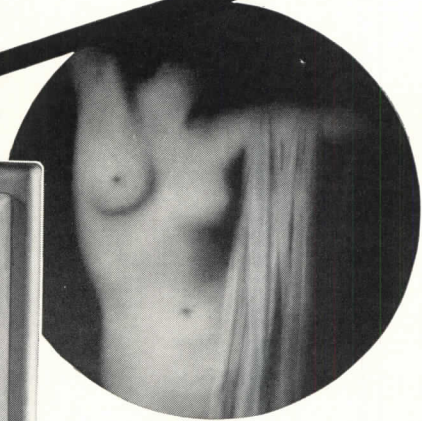

Helmet Seal Construction
Adjustable Throttling Range
Greater Sensitivity
Increased Capacity
Smaller Compressor Required

SCULPTURED BEAUTY
Styled by Henry Dreyfus, the Gradustat is as modern in its performance as is its design. It inaugurates a new degree of accuracy and responsiveness in pneumatic control.

THE NEW Minneapolis-Honeywell Gradustat is the only pneumatic thermostat with the famous and exclusive Helmet Seal Construction. Helmet Seal effectively protects all working parts against jampering, foreign matter or corrosion and insures long, trouble-free service. The Gradustat brings a new degree of accuracy and responsiveness, and permits much closer control of large space heating. It uses air only when changing

position of valves or dampers, reducing the size of the compressor required by approximately 80%, and increases capacity so that each Gradustat can control a far greater number of units than the ordinary pneumatic thermostat. The Gradustat is but one of the many Minneapolis-Honeywell contributions to the pneumatic control field. Minneapolis-Honeywell Regulator Company, 2804 Fourth Avenue South, Minneapolis, Minn.

MINNEAPOLIS-HONEYWELL

Gradutrol System
... OF PNEUMATIC CONTROL

BUILDING TYPES



Courtesy F.H.A.

LOW-RENT SUBURBAN APARTMENT BUILDINGS

FORTHCOMING ISSUES: 1939 — October, Theaters; November, Houses; December, Hospitals. **PRECEDING ISSUES:** 1939 — August, High Schools; July, Houses; June, Factories; May, Houses; April, Retail Stores; March, Housing Developments; February, Elementary Schools; January, Restaurants.

ARCHITECTURAL
RECORD

LOW-RENT

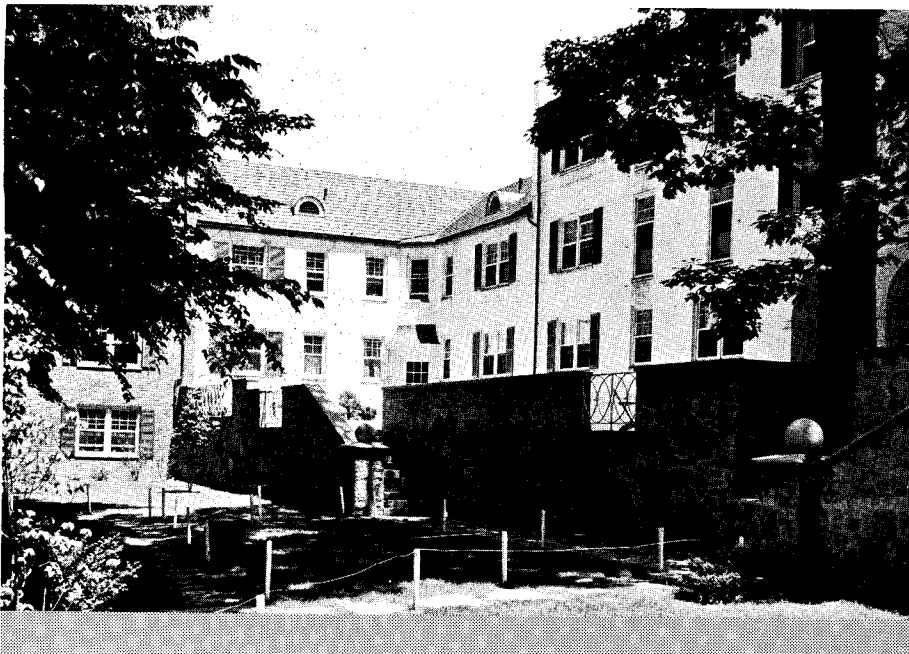

This reference study deals with the type of rental housing that private enterprise is making available to "white-collar" families in the middle-income group. Much of this housing is currently being developed as suburban garden apartments—large-scale projects providing flats and duplex dwellings variously combined to produce the amenities of a restricted residential neighborhood in a landscaped setting. A number of such projects have been approved for mortgage insurance by the Federal Housing Administration. This issue presents case studies of two such projects. In addition, it contains design data based on the FHA Rental Housing Division's experience with tenant and management problems, site development, and dwelling-unit design.

INDEX

Design Elements Which Affect Rentability and Operation	89-92
Project-planning Elements	93-100
Site Development	93, 94
Orientation	95, 96
Dwelling Units	97-100
Case Studies	101-114
Wyvernwood Housing, Los Angeles, Calif.	101-107
Site	101
Dwelling Units	102-104
Equipment	105
Construction, Job Organization	106, 107
Interlaken Garden Apts., Westchester Co., N. Y.	108-114
Site	108, 109
Dwelling Units	110-112
Construction	113
Equipment	114

Except where noted, photographs in this section are published through the courtesy of FHA. At left: top, Olentangy Village, Columbus, O., Raymond Snow, Architect; center, Meadowbrook, Plainfield, N. J., Louis Justement, Architect; bottom, Buckingham Community, Arlington, Va., Allan Kamstra, Architect

SUBURBAN APARTMENT BUILDINGS

DESIGN ELEMENTS WHICH AFFECT RENTABILITY AND OPERATION: A discussion of factors considered important by tenants and managers, reflecting experience of the FHA, Rental Housing Division, Sections of Appraisal and Management, with apartments all over the country. Suggestions contained form flexible design bases, adaptable to varying local conditions.

SITE DEVELOPMENT

Amount of expenditure for landscaping depends upon rent level, and consequently on capitalization which can be supported. In low-rent projects, land immediately adjacent to buildings, central "parks," and circulation areas require initial treatment and maintenance. The more open the site, the greater is the necessity for complete landscaping. In general, tenants appreciate landscaping and are quickly impressed by deficiencies or lack of maintenance.

"Superblock" development of plots, including provision of gardened courts, ample trafficways with pedestrian underpasses, parking areas, centralized garbage stations, elimination of service alleys, etc., is most feasible in projects containing several hundred rental units. To the extent to which tenants comprehend the safety and quiet produced, superblock planning may be demanded; factors such as gardened courts, wide roadways, and methods of garbage disposal which create little nuisance, are more likely to be requested because tenants come intimately in contact with them.

Outlook is important, particularly as regards the value of pleasant views or vistas as aids to renting. Sufficient clearance between buildings to permit free air circulation and adequate light, and to insure privacy, is considered more important.

Community facilities such as stores are essential to the success of housing projects and have to be provided if not available in the neighborhood; but auditoria, recreation rooms, dance pavilions, have been found necessary only in larger projects where management is prepared to supply the initiative which results in their full use.

Health facilities have not been operated to date in privately financed projects; in fact, in large developments, physicians, dentists, etc., have competed for space. While in some cases nursery schools may be needed, FHA has had no experience with their operation.

Garages, traffic ways: Tenants object to walking any great distance from roads or garage compounds. The probable maximum distance from road, parking space, or garage court to any dwelling is 300 ft.; even this is considered excessive. Small garage groups or parking spaces, distributed throughout the development, are desirable.

Sitting terraces are desirable particularly when individual porches are not provided; *clothes-drying* yards are a necessity unless ample indoor space is available; but *gardens* for tenant-maintenance need only be supplied for free-standing house developments, occasionally for row houses or duplex apartments. Ordinarily, tenants of multi-family dwellings cannot be relied upon to maintain private areas to any uniformly satisfactory degree. As rents drop below



Project - maintained grounds which retain residential character: Meadowbrook, Plainfield, N. J.; Louis Justement, Architect.

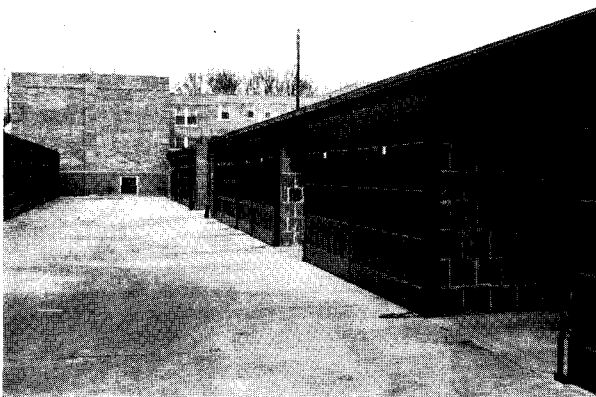

Garage compound, Colonial Village, Arlington, Va.; Harvey Warwick, Architect.

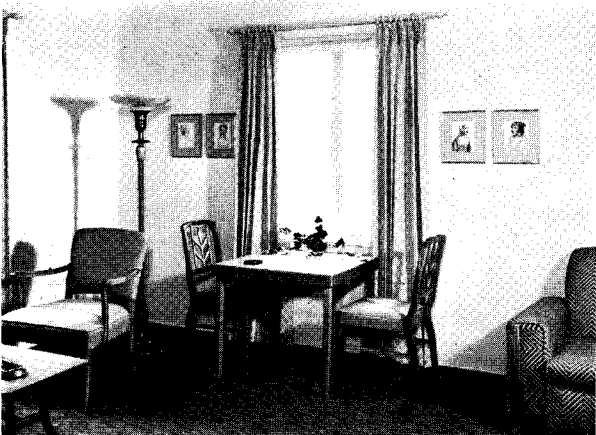

George D. Haight

Typical living - room interior, Wyvernwood, Los Angeles, Calif.; Witmer and Watson, Architects.



Whittington

Typical kitchen equipment, also in Wyvernwood.

\$10.00 per room per month, difficulty of providing terraces, yards, and gardens increases.

Recreation areas: Necessity for all types of recreational areas depends, to an extent, upon location of the site with respect to natural facilities, municipal playgrounds, etc. Play lots for small children (2 to 6 yrs.) may be provided in a ratio up to one lot per hundred dwelling units; but, while some use will be made of such facilities if unsupervised, an attendant is necessary to render them most useful. Surfaced play areas for older children (6 to 12 yrs.) may be provided in the same ratio and with similar reservations.

Game lots for youths and adults, with facilities for such sports as do not require expensive equipment or elaborate area development (softball, badminton, horseshoe pitching, etc.), are ordinarily highly desirable. Adult tenants in large developments use this type of area, and others such as tennis courts, extensively.

Installation and upkeep of swimming and wading pools is ordinarily too expensive, unless patronage from outside the project can be relied upon, and the resultant noise and confusion tolerated.

TYPES and ARRANGEMENT of BUILDINGS

Types of buildings vary in popularity, depending to some extent on local custom. Other considerations include: code requirements, levels of taxation, land values, type of neighborhood, local building costs, and income-level of expected tenants.

Heights are limited by rentability, necessity for elevators, code requirements as to fireproofness, etc. Four-story walk-up apartments are economically unsatisfactory; in three-story walk-ups, third floors are hard to rent. Elevators are necessary for houses more than three stories high, but are not often financially justified in houses less than six stories high. Where rental levels are above the average, elevator-equipped houses are usually most popular; but such preferences may be outweighed by the decided advantages of modern plot plan and building layout inherent in properly designed two-story walk-up buildings. The two-story type is most

generally popular in suburban developments, and in some urban centers.

Costs of management and operation are generally greater in elevator-equipped buildings than in walk-ups. Hence, low rent levels tend to require use of walk-up houses. Since as buildings increase in height, construction costs far outweigh land costs, there is a trend toward developments consisting of one-story houses. Given proper local conditions, initial land, construction, and maintenance costs for one-story developments may be favorably balanced against costs for other types; and rentability, residential character, natural ventilation, etc., are enhanced by use of one-story units.

Building arrangement: *U*-shaped buildings with courts occur most frequently in projects where coverage is high; *T*-shaped and strip units are most frequent in open developments. Economic and topographical factors, management costs, etc., govern selection. Arrangement of units for maximum ventilation, efficient stair location, and elimination of "buried" or partly buried rooms, tends to simplify management problems in renting and maintaining spaces.

Land coverage: Tenants desire low land coverage, but are not always able to pay the rents necessary for maintaining large open areas. From 20 to 30 families per acre has been found economical for outlying garden-type developments. As coverage decreases, ground maintenance costs increase disproportionately along with land cost per unit. Clearances of not less than 20 feet between buildings are desirable.

Orientation for sun and air is desired by most tenants. Southern exposures and adequate ventilation are preferred (see also "Dwelling Layout"). Tenants will accept unusual court arrangements or staggered plans, unless the building's appearance is adversely affected. Such building arrangements do not ordinarily affect management costs greatly except as public, project-maintained space is increased.

Garages are desired in all portions of the country, and are commonly supplied in northern states. Where rental levels ex-

ceed minima, garages are frequently heated. In warmer climates, off-street parking is often substituted. Tenants will pay additional rent for garages, but do not show particular preference for detached garages. Compounds, with sufficient space between garage rows for maneuvering cars easily, satisfy most requirements. Parking under buildings, or in similarly congested spaces, may require services of an attendant; however, such services are generally paid for by car owners directly.

DWELLING LAYOUT

Management and public areas: In projects consisting of numerous two- or three-story walk-up buildings, janitor or management space in each building is uneconomical. A single central office for even large projects, with immediate control over help's locker rooms, tool rooms, work shops, and paint shops, is desirable in order to produce low operating costs.

In large elevator-equipped buildings, a first-floor corridor connecting all elevator banks and management offices tends to reduce operating cost; but this desideratum must be balanced against the necessity for many entrances when but few apartments are grouped about each elevator shaft. Contrary to requirements for most elevator buildings, first-floor lobbies are not needed in average two- or three-story buildings.

Common storage, recreation, and utility space: Dead-storage space of 30 sq. ft. per unit, usually in basements, is the average; in a few cases, this may be reduced to the minimum necessary for trunks and hand baggage. Basement storage space, easily accessible, for baby carriages, outdoor furniture, garden tools, bicycles, etc., is considered essential by both tenants and management. Amount depends upon type of development and on equipment which tenants may be reasonably expected to possess. Individual spaces are not usually needed. Ramps to baby carriage rooms are desirable.

Laundry space is required, no matter what the rental level; but it may be included in kitchens, as noted under "Equipment." Laundries are preferably accessible to all apartments without need

for leaving the building, and require good ventilation and toilet facilities. Access to boiler rooms is undesirable. Water-resistant finishes, and floor drains to permit hosing-down, are desirable to aid in preserving sanitary conditions.

Recreational spaces, such as hobby rooms, common recreation rooms, ping-pong rooms, etc., are not usually demanded, but have sometimes been included in larger projects.

Apartment size: While lower unit costs may be obtained by including apartments of five or more rooms, costs to tenants of large units approach carrying charges plus upkeep of small houses. Consequently, in non-subsidized developments, one- and two-bedroom units are most easily rented. Percentage of variously sized units varies locally. Where rents do not exceed \$10 to \$11 per room, more five-room apartments may be introduced than where rents range upward from \$15 per room. Also, in general, the closer the project lies to a metropolitan center, the fewer becomes the number of rooms per unit.

Room types and sizes: Kitchens of the "strip" type, or having any dimension less than 7 ft., or as small in area as 60 sq. ft., are considered unsatisfactory by most tenants. Dining rooms are not required, particularly in one- or two-bedroom units, except as local custom demands. Dining alcoves off kitchens (rather than appendages of living rooms) are considered satisfactory; in smaller units, family dining space within the kitchen has been found desirable.

Bedrooms preferably have no dimension less than 10 ft.; for a \$15 per room rent, a master bedroom 12½ or 13 by 15 ft. is adequate. Living rooms less than 12 by 17 ft., where rents range from \$13 to \$16 per room, are hard to rent.

In general, room sizes vary according to rent and local custom. In the South, larger floor areas, higher ceilings, and more dining space are required than in the North. Foyers are universally desirable except at lowest rental levels. Halls may be needed, particularly in larger units, for privacy of access to all rooms. Additional lavatories may be desirable in larger units at higher rentals.

Closets: A closet adjacent to the entrance, clothing closet in each bedroom, small linen closet, provision for cleaning materials, and kitchen cabinets are all desirable. Fitted wardrobe closets are not demanded; and, if luggage space is provided elsewhere, large storage spaces are unnecessary.

Orientation and ventilation: In almost every case, certain living-room exposures, depending on local conditions, are demanded; but ventilation is often of more importance than orientation for sunlight. Living rooms with southern exposures are most generally preferred, but latitude and direction of prevailing breezes may dictate otherwise. Southern exposure in the South is less important; and west or southwest exposures may render bedrooms undesirable due to heat from afternoon sunlight.

Through-ventilation of apartments as units is considered more important than cross-ventilation of rooms only. Movement of air through an entire apartment aids in reducing heat, odors, and stuffiness. These factors often control building layout.

Porches and decks: While not universally demanded by tenants, provision of private outdoor spaces may increase rentability of apartments and reduce management problems. Hoods over entrance doors aid in keeping public halls clean. Flat roof decks can be advantageously designed for tenant use, but can usually be included only in fireproof construction for higher rental levels.

CONSTRUCTION and FINISH

Type of construction, such as fireproof or fire-resistant, is seldom of interest to tenants in two-story buildings. As to provision of exits, and type of construction for taller buildings, building codes usually govern. Windows which operate easily, walls and floors plumb and true to level, unwarped and easily operated doors, constitute the kind of structural features noticed by tenants.

Insulation of walls and ceilings, and attic ventilation, are considered important by tenants. Where economically possible, soundproofing between apartments is

desirable, although as tenants become used to noises, complaints decrease.

Exterior finish: All types of exterior finishing materials have proved acceptable to tenants, provided the general appearance is pleasing. In a very few cases, antipathy to wood exterior finish has been noted.

Interior finish: For living rooms, wood strip, wood block, or possibly parquet floors of natural finished oak are preferred; for bedrooms, strip or block floors; for kitchens, linoleum; for bathrooms, such impervious materials as ceramic tile, although there is some tendency to use linoleum or rubber tile.

For walls and ceilings, there appears to be a trend away from paper, in living and bedrooms, although costs of papering and painting are comparable and redecorating is commonly done seasonally. In some cases, washing painted surfaces may replace complete redecoration. Sheet finishing materials such as plywood or plasterboard are not generally desired by tenants at present. In bathrooms, impervious wall materials, such as ceramic tile, are usually preferred.

EQUIPMENT

Heating: Tenants usually express no particular preference as to type of heating system except to demand adequacy and some degree of local regulation. Individual heaters (space or room types) are sometimes provided in southern localities, but where heating seasons extend five months or longer, heat is preferably supplied by the management. Depending on project size, heating plants may serve from 4 to 10 families or more; but ordinarily a single central plant, with combustion under strict control, is most efficient. Local conditions, however, govern.

Hot-water or two-pipe steam systems, with recessed, console, or concealed radiators of cast iron, are most popular. In most instances, fireplaces in living rooms, with or without heat ducts to other spaces, are not ordinarily provided, but may be considered where heating seasons are short. Kitchen ventilating fans are necessary where rent

levels permit; and in warmer states, attic ventilation has become common.

Laundry equipment may include tubs and substantial ironing boards; and washing machines, small mangles, and automatic gas dryers, the latter three items preferably provided with coin metering devices. Of these, washing machines are not essential requirements; and in the smaller dwelling units, sink-and-tray combinations may be provided in kitchens. Laundry chutes are not considered advisable.

Kitchen equipment consisting of sink, gas stove, automatic refrigerator, and ample cabinet space is usually demanded. Four-burner cabinet ranges and double-drainboard sinks are desirable for all but the smallest low-rental apartments. Complete "unit" or "electrified" kitchens of types publicized by several manufacturers are demanded only for comparatively high rental levels.

Plumbing: Shower heads over bathtubs are usually required; separate stall showers are seldom demanded. Modern equipment is necessary, but preferences are not usually expressed for any particular types. Tenants are not interested in piping materials; but management finds the use of corrosion-resisting pipe economical, particularly in localities where corrosion or tuberculation of water supply lines necessitate periodic replacements.

Electrical: In kitchens and bedrooms, permanent ceiling fixtures are considered essential; in living rooms, their use may be a matter of local preference. Bathrooms require fixtures to supply light for shaving, etc.; otherwise wall brackets are generally unpopular. Numerous duplex convenience outlets are necessary.

While special radio outlets and pre-installed antennae are highly desirable in order to prevent indiscriminate placing of unsightly wires, tenants do not specifically demand this convenience. Special telephone outlets in each apartment, and intercommunicating telephones, are seldom demanded except in high-rent developments. In large multi-family units, intercommunicating telephone connections to entrance doors are desirable.

PROJECT PLANNING ELEMENTS: Suggestions for good practice in design, based on FHA experience



Falkland, Slicer - Spring, Md.; Louis Jusemeh, architect

MATERIAL contained in the following pages was developed from drawings and notes prepared by the staff and director of the Architectural Section, Rental Housing Division, Federal Housing Administration. Data represent experience accumulated over a period of several years.

Emphasis is placed throughout on low-rent apartment problems, with comparisons and contrasts between various types of planning when space permits. In such a brief survey, only the high points of planning can be touched upon; therefore information of kinds not previously published is shown. Stock strip, tee, cross, ell, and zee plans, which can be copied without regard to local factors whose existence might render the stock solution unusable, are considered less important than the basic qualities which make the finished product livable, economical, and, hence, profitable to the owner.

Problems of site selection and development, building organization, and dwelling-unit layout are aggravated by the necessity for low rents. In the usual case, added cost of development or maintenance rarely, and then only remotely, increases rental value. It is not to be expected that any one site will be most satisfactory from all points of view, or that a predetermined solution will satisfy all local requirements. The same is true of dwelling units.

Basic factors which govern low-cost housing design are therefore presented as flexibly as possible, in the hope that they will be considered guides to adjusting the multiplicity of local variables, not as rigid formulae. Final selections are usually compromises, based on the designer's judgment. The list of items is by no means exhaustive, but will serve to illustrate types of alternatives which may present themselves.

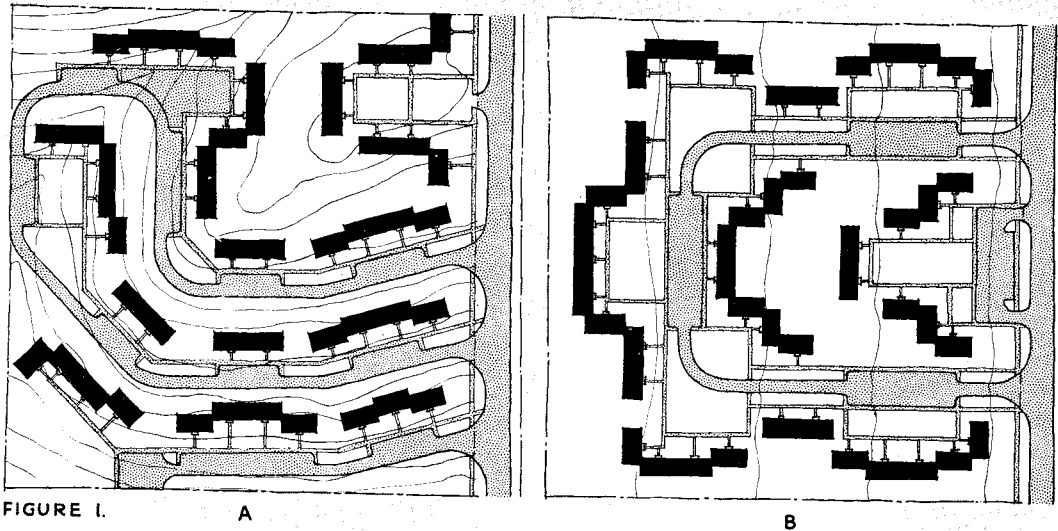

FIGURE 1. A

B

Choice of site may not always be a part of the architect's job. However, all other factors being equal, level or gently sloping sites present few serious topographic difficulties as compared with hilly sites.

Fig. 1 shows, on similar plots, one hilly and one almost level, comparison of access roads, of cut and fill, and of surface drainage systems necessary.

Fig. 2, A through D, compares construction problems and costs for level and steep sites. Sketch E illustrates objections to sites containing soft, compacted fill.

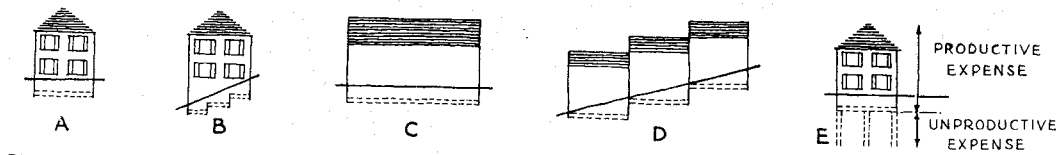

FIGURE 2.

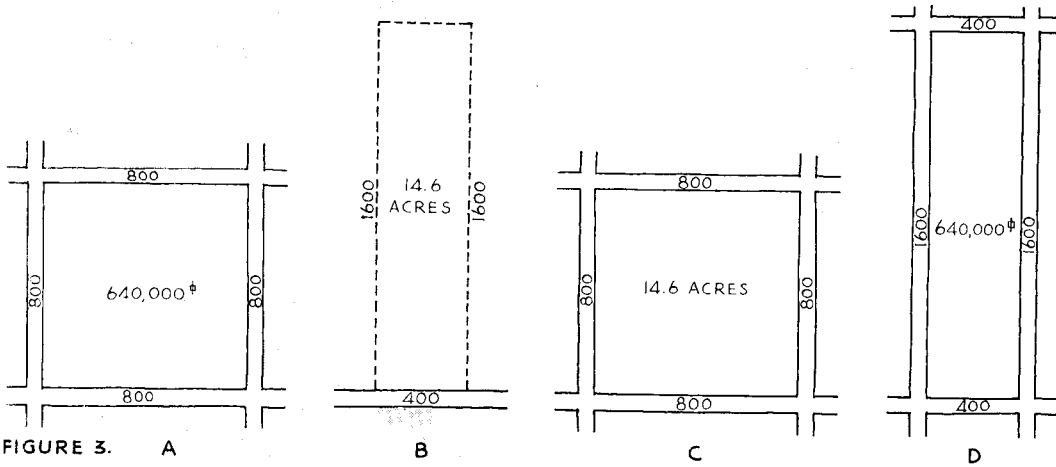

FIGURE 3. A

B

C

D

Fig. 3 contains comparisons of square and long, narrow sites of identical areas. In sketch A, buildings may be serviced from existing peripheral streets; in B, interior roads will be needed. Similarly, where new peripheral roads, utilities, etc., must be provided at the project's expense, sites approaching square shapes have been found preferable.

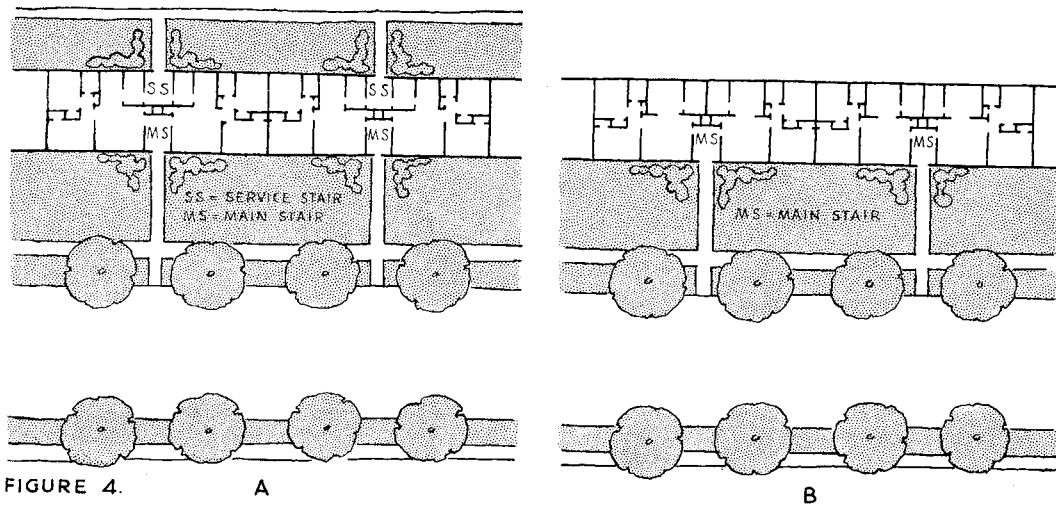

FIGURE 4. A

B

Fig. 4: Rental levels ought to be considered in developing site and building plans. Compare developments for (A) high-rent, (B) low-rent, both walk-up projects. In B, tenants sacrifice some amenities. Service stairs and walks are omitted. Deliveries, and garbage and trash removal, are through front door and main stair.

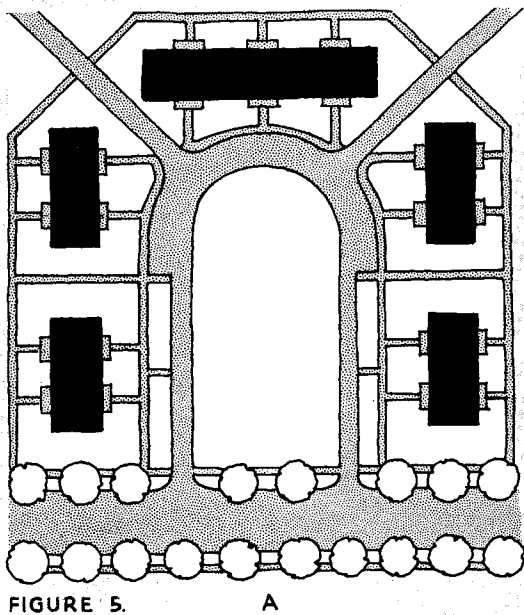
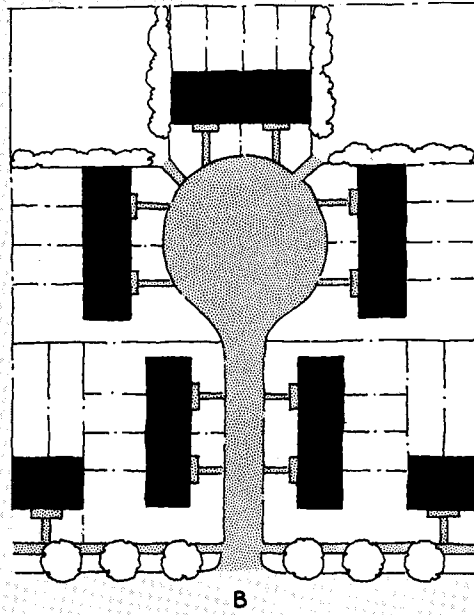

FIGURE 5. A



B

Fig. 5 extends principles stated in Fig. 4 to complete developments. Sketches A (high-rent) and B (low-rent) both show court arrangements. In addition to omission of segregated service entrances previously noted, sketch B requires less highway frontage, living areas of apartments may face quiet rear yards, much of the ground may be tenant-maintained.

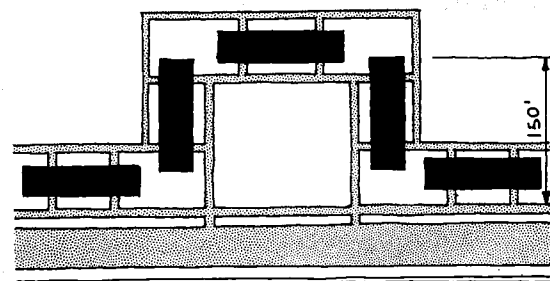
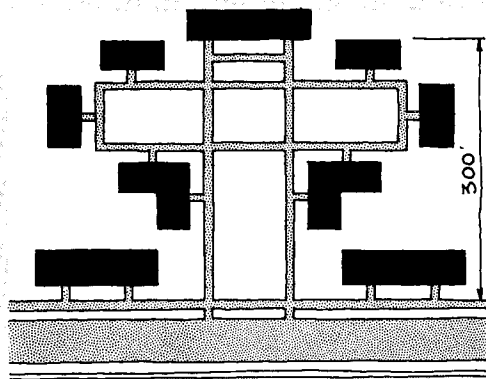

FIGURE 6. A



B

Fig. 6: Greater permissible walking distance from low-rent buildings to streets (sketch B) permits deeper development without accessory roads, and less frontage per family than in high-rent projects (sketch A).

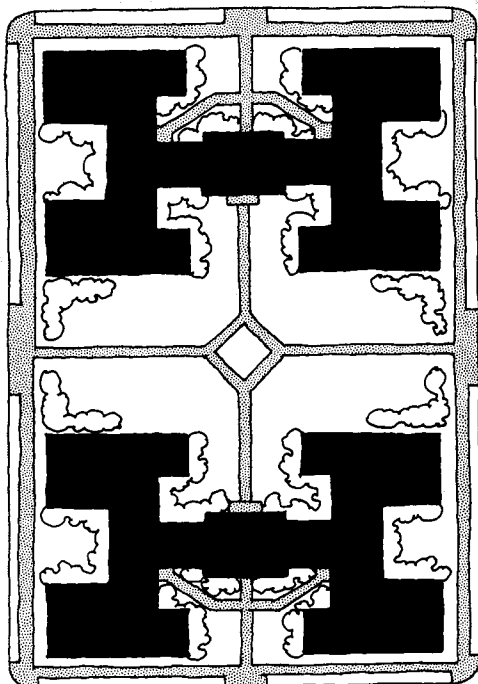
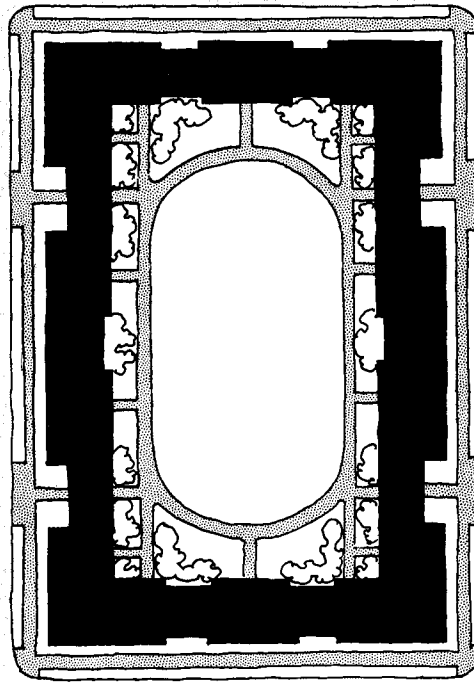

FIGURE 7. A



B

Fig. 7 illustrates effect of building type on site planting cost and maintenance. Complex shapes (A) create many small spaces to be landscaped. Simple shapes (B) produce simple, easily-treated areas in which each planting group enters the view from every direction.

SUNLIGHT

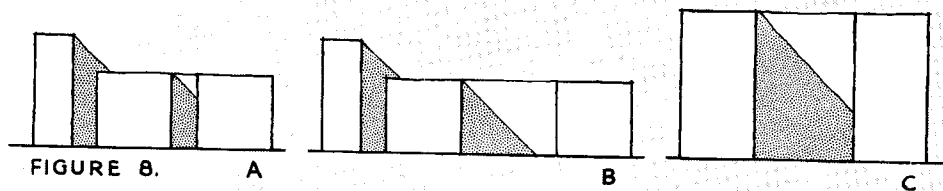

Fig. 8: Effects of court widths: A, three-story buildings with narrow courts; B, three-story buildings with wider courts; C, six-story buildings with same court width as in "B."

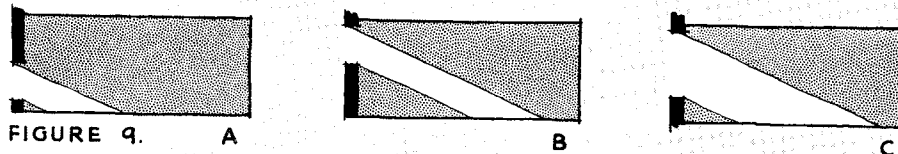

Fig. 9: Influence of vertical window position and height on amount of sun admitted, assuming a common sun angle.

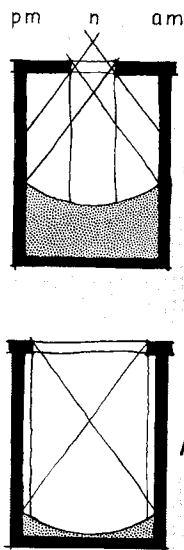

FIGURE 10.

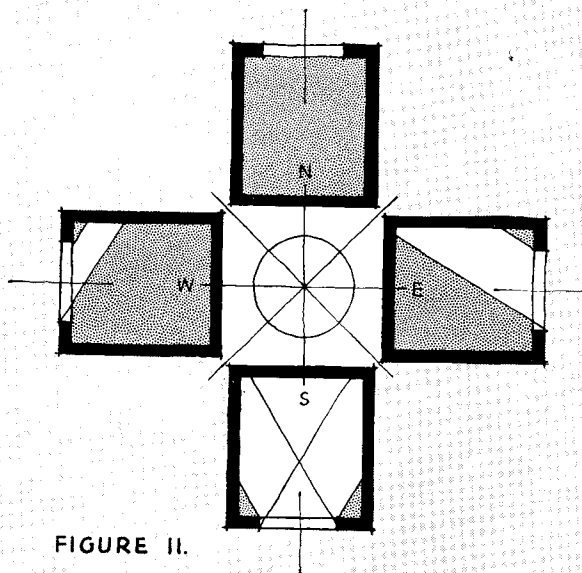

FIGURE 11.

Fig. 10: Effect of window width on amount of sun admitted.

Fig. 11: Plans showing amounts of sun which enter rooms faced north, south, east, or west, on December 21. This method of plan study may be adapted to any sun angle.

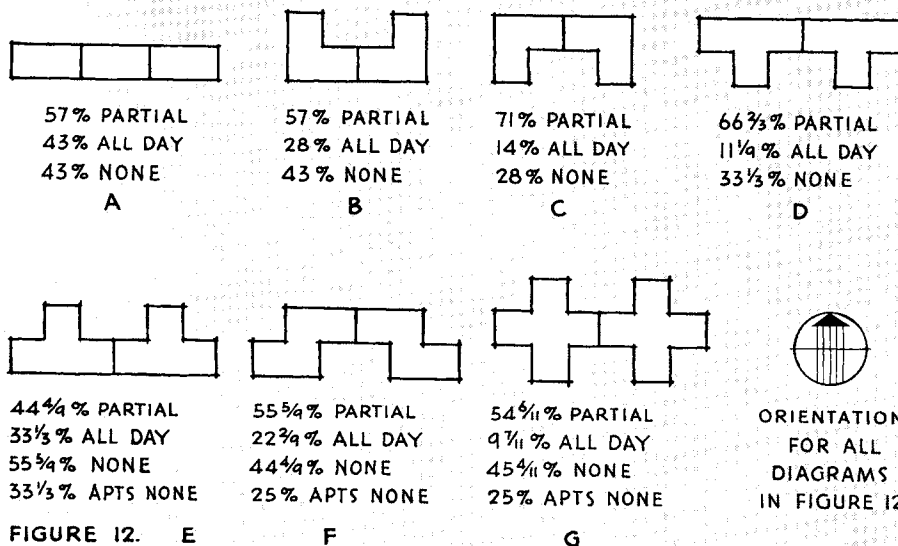

FIGURE 12. E

Fig. 12: Analytical studies showing proportions of building perimeters which receive sun on December 21. Of these, the simpler forms (A through D) have been found most easy to arrange so that all parts have some sun; A, B, so that all living rooms and principal bedrooms have ample sunlight. When four apartments are grouped around a common stair (F, G) 50% are well favored, 50% not.

VENTILATION

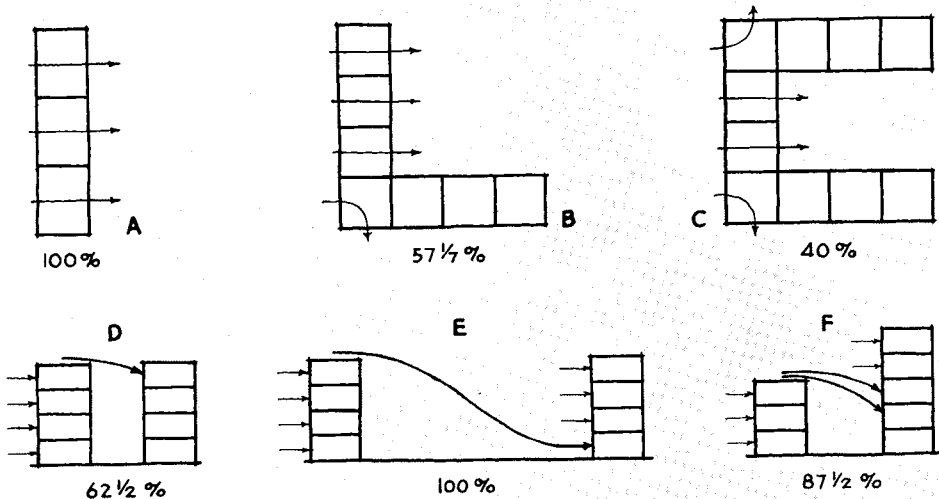
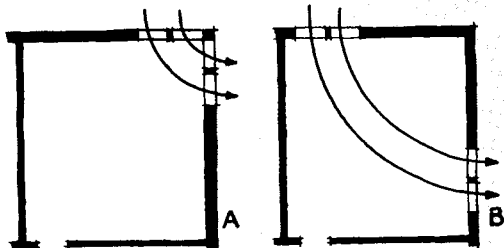
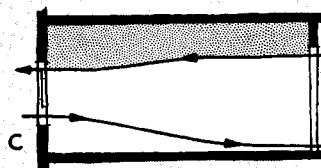

FIGURE 13.



DIFFERENCE IN DIRECT AIR CIRCULATION BETWEEN CORNER WINDOWS AND EQUIVALENT WINDOW AREA AT REMOTE CORNERS



CHECK DIRECTION OF AIR TRAVEL. GRAY AREA INDICATES POCKET AT CEILING WITH LOW WINDOW HEAD

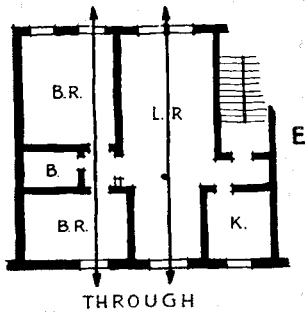
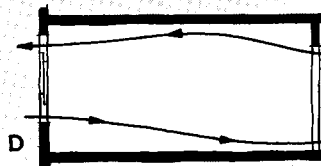

THROUGH

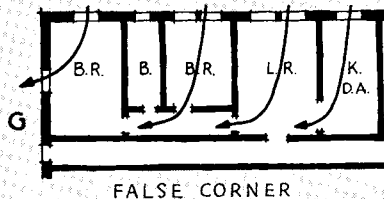

FALSE CORNER

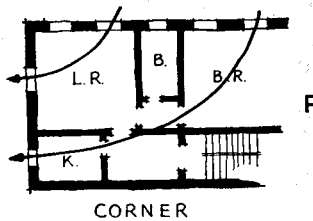

CORNER

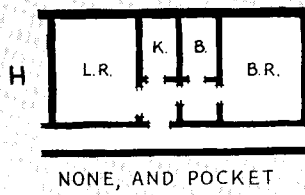

NONE, AND POCKET

FIGURE 14.

Building location with respect to prevailing breezes often outweighs orientation for sun as a planning factor.

Fig. 13: A, B, and C indicate in plan the value of various building arrangements in regard to ventilation, assuming direction of prevailing wind. Percentages show proportions of through-ventilated apartments. Sketches D, E, and F have a similar significance in relation to cross-section.

Fig. 14 illustrates dwelling-unit layout as affecting ventilation. Sketches A and B show typical corner rooms in plan. C and D are sections.

Effective through-apartment ventilation is obtained by plans in sketches E and F; a limited amount is obtainable with type G; type H provides no degree of ventilation unless corridor door is opened.

DWELLING UNIT LAYOUT

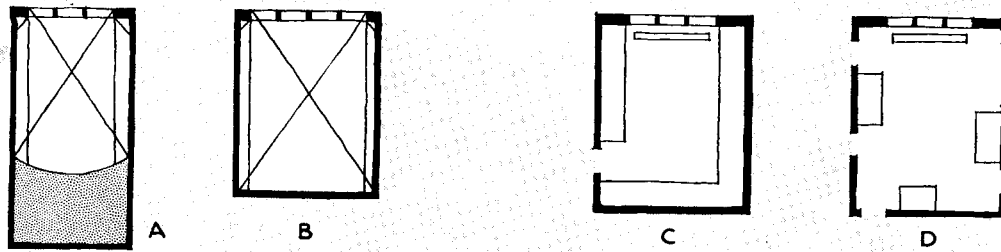

QUALITY OF SPACE FIGURE 15

Fig. 15, A and B, contrasts natural lighting of rooms of equivalent areas but different proportions. Wall space available for furniture in similar rooms with (C) one door, and (D) five doors, is indicated.

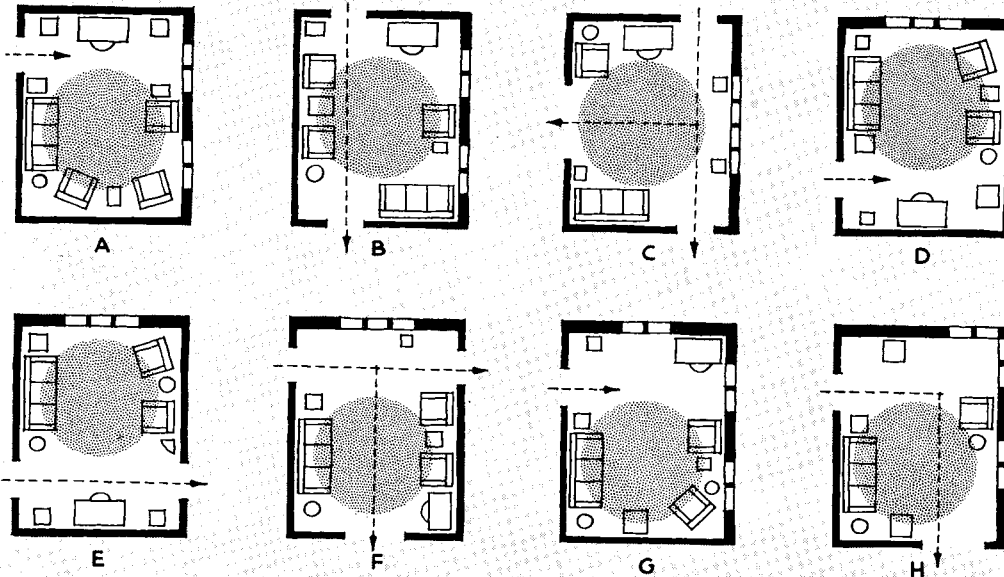

LIVING SPACE FIGURE 16

Fig. 16 shows living rooms considered from the point of view of possible furniture groupings and interference by necessary circulation. Circles indicate conversational groups; dotted lines show circulation.

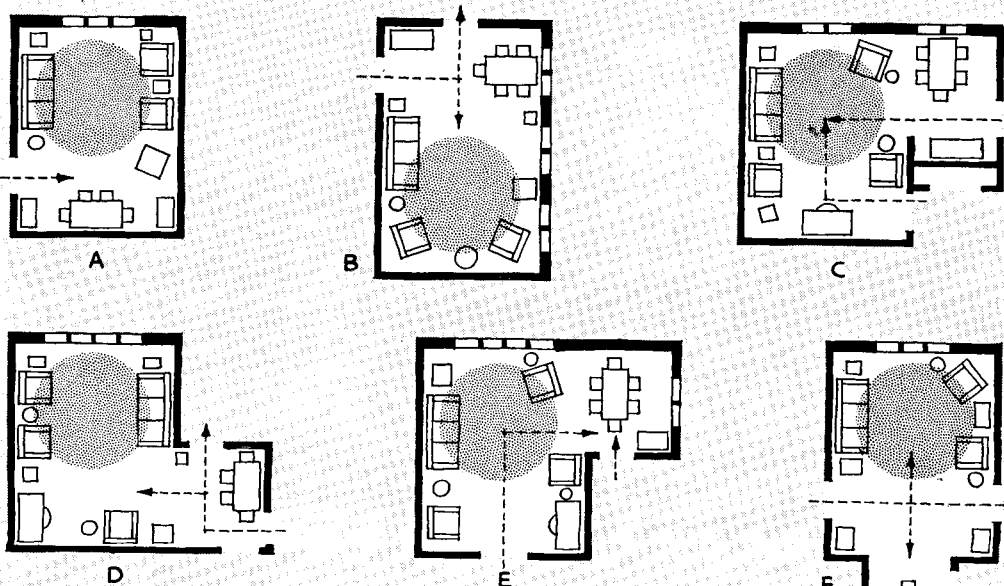

LIVING-DINING SPACE FIGURE 17

Fig. 17 indicates similar relationships, complicated by adding constantly-used dining space.

DWELLING UNIT LAYOUT

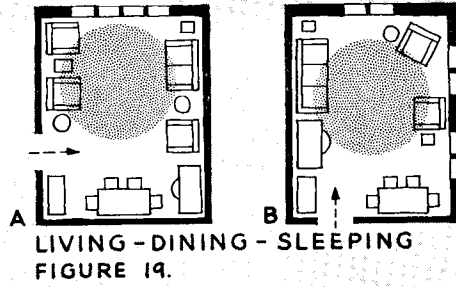
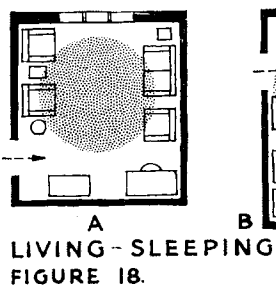

Fig. 18: Sleeping accommodations: use of sofa-beds, or love-seat combinations, simplifies the problem.

Fig. 19 shows that furniture for living, dining, and sleeping may be accommodated in a single room little, if any, larger than the average apartment living room.

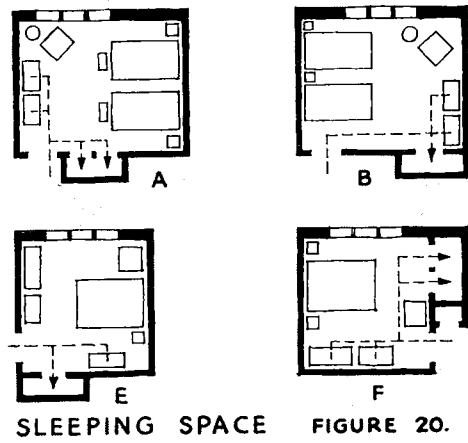

Fig. 20: Types of bedrooms with convenient circulation, showing relationship of doors, beds, closets, and dressers to achieve maximum usable space.

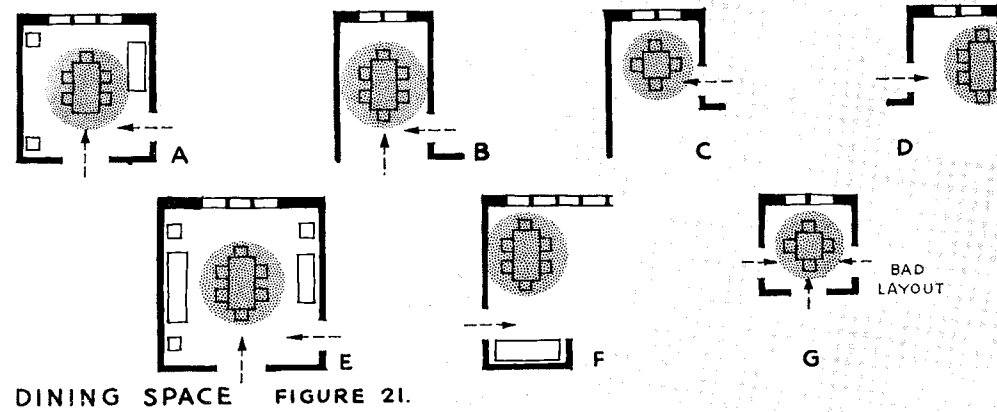

Fig. 21: Planning of dining space is often a matter of what can be done with available room. Providing separate kitchen, living-room, and bedroom entrances makes space difficult to use.

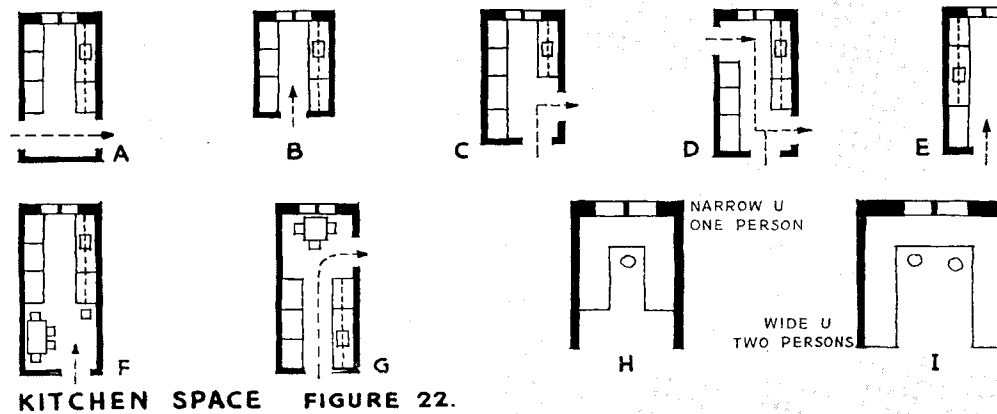

Fig. 22, kitchens, emphasizes importance of door locations and sufficient work space.

DWELLING UNIT LAYOUT

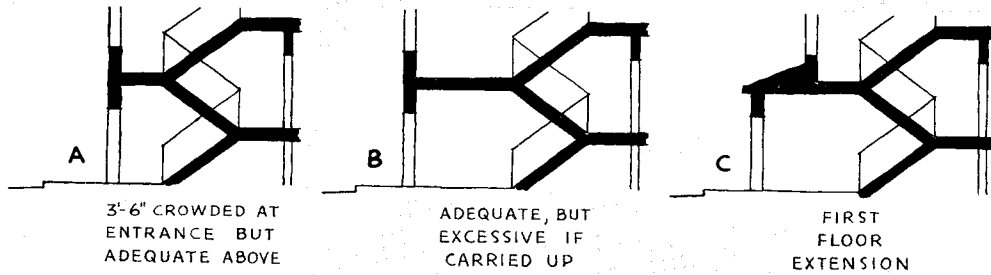

Fig. 23: Various stair arrangements: Type A has too narrow a first-floor vestibule for most cases; type B wastes space on upper floors; type C, often called the "dog-house", is a satisfactory compromise.

ENTRANCES

FIGURE 23.

PRIVATE HALLS

FIGURE 24.

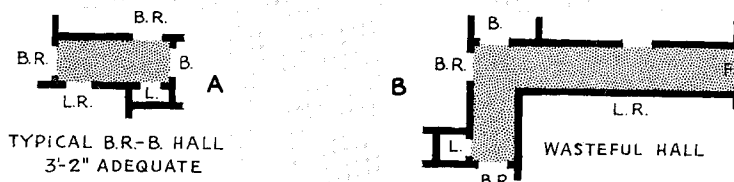

Fig. 24: Contrast between reasonable (A) and excessive (B) private hall space; 3-ft. 2-in. dimension refers to width.

PRIVATE FOYERS

FIGURE 25.

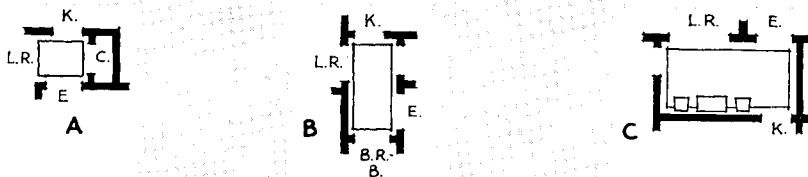

Fig. 25: Foyers of different sizes are required for different rental levels.

DOORS AND OPENINGS

FIGURE 26.

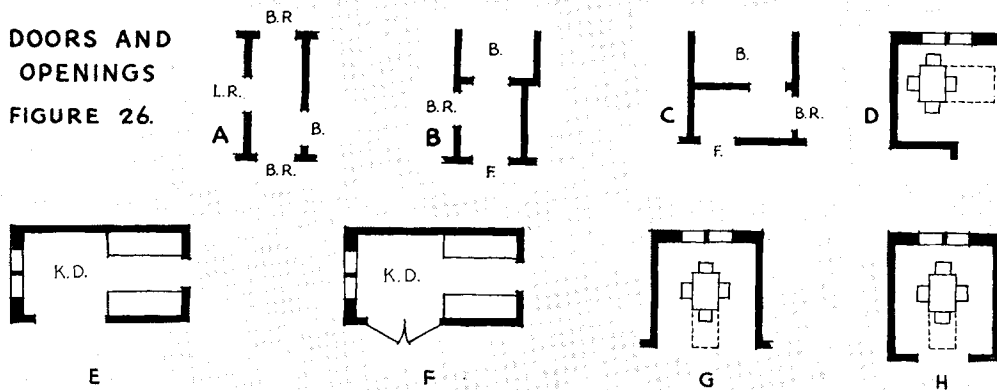

Fig. 26: Visibility of bathroom door, and resultant lack of privacy, is greater in sketch B than in A or C. Sketches D, E, and G show three types of dining alcoves; use of doors or restricted openings as in F and H prevents table from being temporarily extended.

CLOSETS

FIGURE 27.

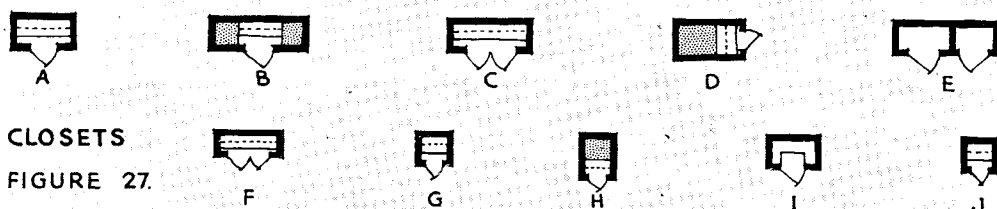
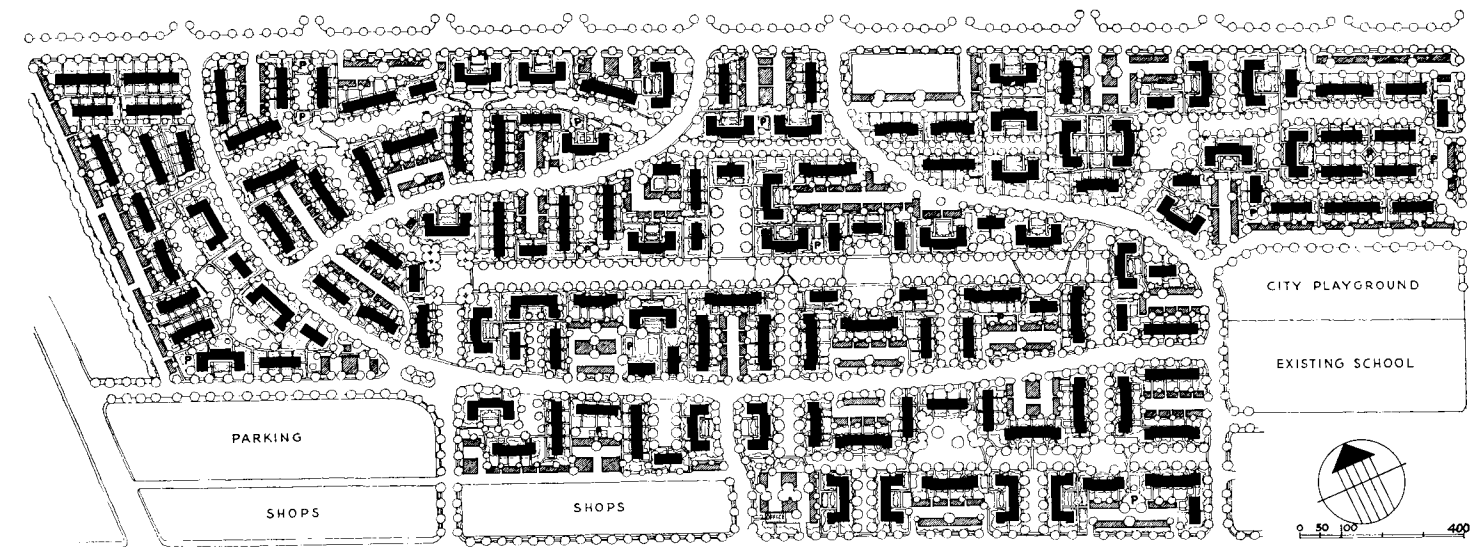

Fig. 27: Types of closet space: Type C is more usable than B, but doors may occupy needed wall space. Clothes closets are preferably at least 2 ft. deep; linen closets, 1 ft. 4 in.; broom closets, 1 ft. 6 in. to 2 ft.

CASE STUDIES: 1102-APARTMENT DEVELOPMENT



WYVERNWOOD VILLAGE HOUSING PROJECT

Los Angeles, California

DAVID J. WITMER,
LOYALL F. WATSON, Architects

HAMMOND SADLER, Landscape
Architect

THE SITE consists of 72 acres of rolling ground on which a previous subdivision had been established. The few lots sold were re-bought; and the few acres which had been acquired by the local school board, and by the playground commission, had been put to compatible uses in advantageous locations.

Existing "gridiron" subdivision was discarded. Existing streets, services, and utilities were scrapped. The entire area was rezoned.

The tract is surrounded by completely or partially obsolete housing, commercial buildings, and light-manufactur-

ing areas. Wyvernwood, $\frac{1}{4}$ mile wide by $\frac{3}{4}$ mile long, is detached by topography from surrounding property, and will house more than 1,000 families. Hence, it was decided that the community would not be subject to damaging outside influences.

Location is open to prevailing breezes and a distant view. Site was developed to include community shops; to discourage through traffic; to provide a garage close to each dwelling unit; and to safeguard children at play. Private gardens and landscaped parks are provided. Coverage is less than 25 per cent.



TWO-STORY FLAT BUILDINGS

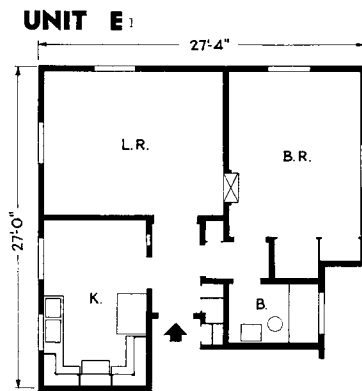
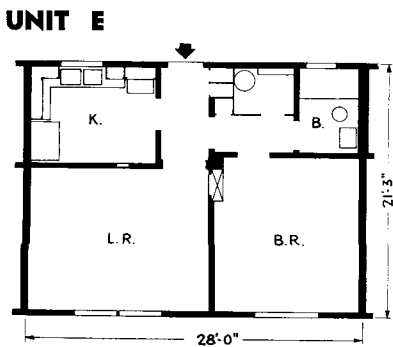
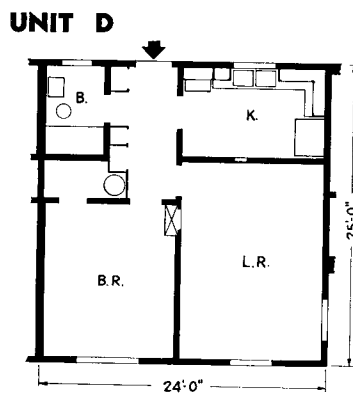
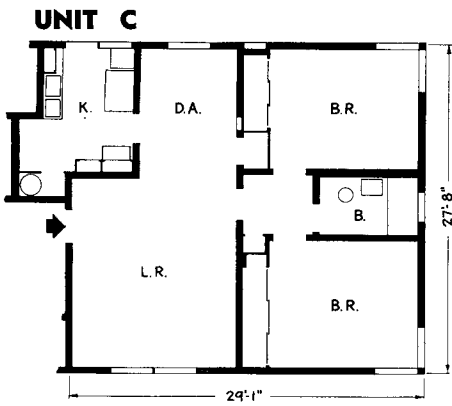

Schemes showing how C and D units are combined into buildings. Shaded areas indicate public spaces.

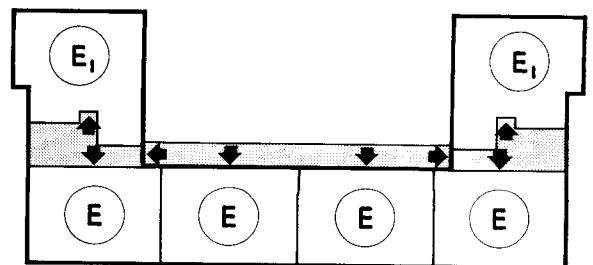
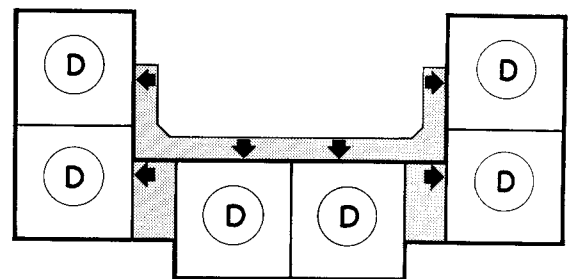
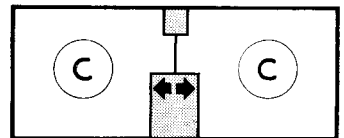

Above, units E and E₁ combined in a typical building. Outdoor access, from porches and balconies, is used in many cases.

RENTAL RATES

3-room apts.	\$29.25 to \$33.25 per mo.
5-room apts.	35.00 to 40.00 " "
6-room apts.	43.75 to 55.00 " "

Rentals vary according to location, sightliness, and convenience; and include an electric range, refrigerator, water, and garden maintenance. Most 6-room units are \$50.00 per mo.; few are \$55.00.

COST PER ROOM: Approximately \$792, including land improvements and fees, but not including land costs.

NUMBER OF APARTMENTS

Rooms per apt.	Number of apts.
3-room	420
4 1/2, 5-room	608
6-room	74
Total no. apartments	1102

Incomes of expected tenants range from \$125 to \$200 per month; rental rates were set to come within 20 to 25 per cent of family incomes.

It was decided that desirable tenants would not climb more than one flight of stairs; hence buildings are limited to two stories in height. Privacy for each dwelling unit, low maintenance costs, and provision for economical operation were all controlling factors. In addition, high degrees of livability, convenience, accessibility, unobstructed light and air, sufficient and modern sanitation, and pleasant views were considered essential.

After plotting a minimum of 60-ft. streets, all parallel to contours, units were combined into buildings placed according to the following criteria: dwellings do not face each other across

distances less than 60 ft.; individual yards, 25 to 30 ft. deep, occur at the rear of each larger dwelling unit; garage compounds were placed, where practicable, to form rear walls of gardens; sanitary garbage depots were placed in each garage compound; each building contains sufficient dwelling units to offer maximum construction economies without sacrificing residential character.

A topographical site model was needed to coordinate these requirements with site conditions; and to provide a flow of open space throughout the site, with courts, parks, children's play yards and badminton courts, and interior walks. Dwelling units face toward landscaped areas, not toward streets. Most buildings are so oriented that some sun enters each room.

TWO-STORY DUPLEXES

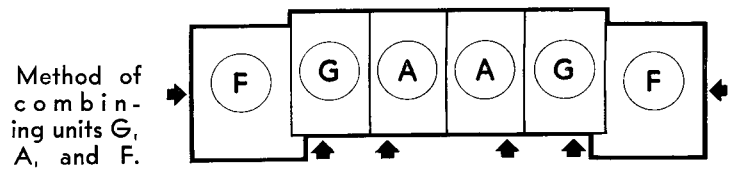
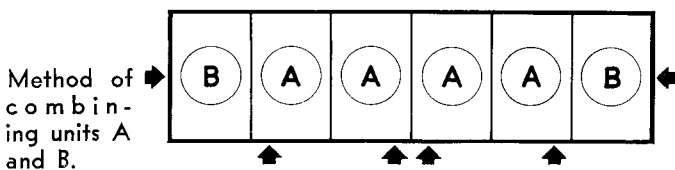
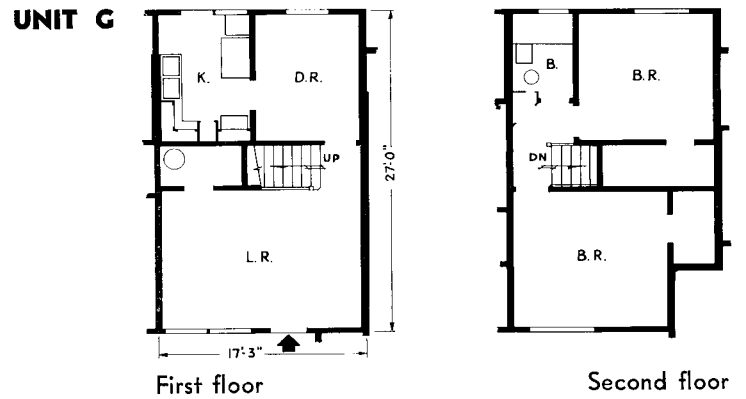
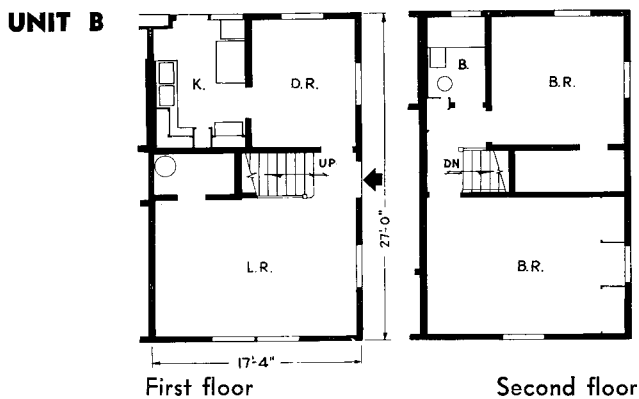
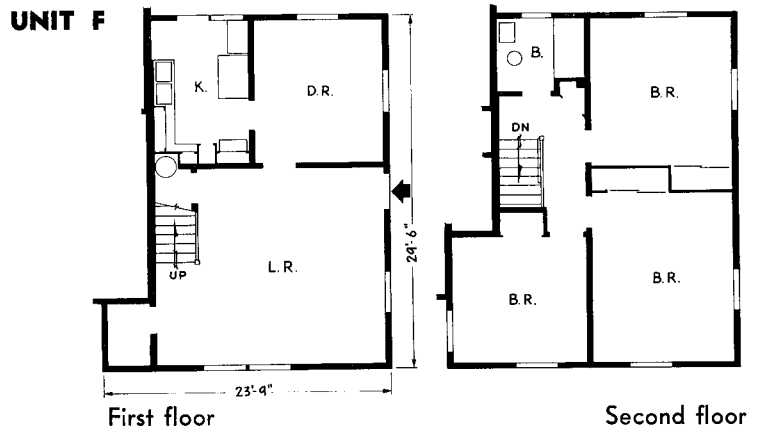
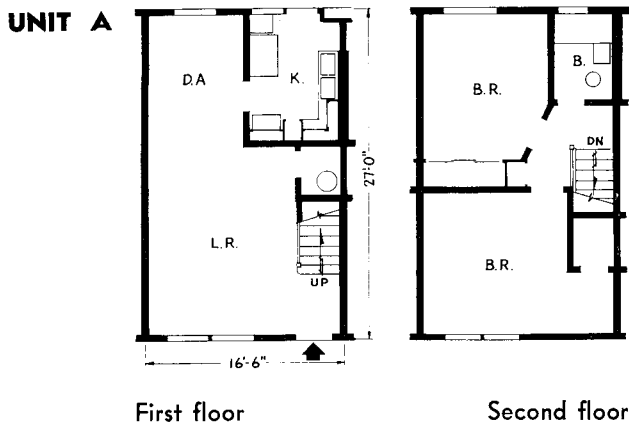

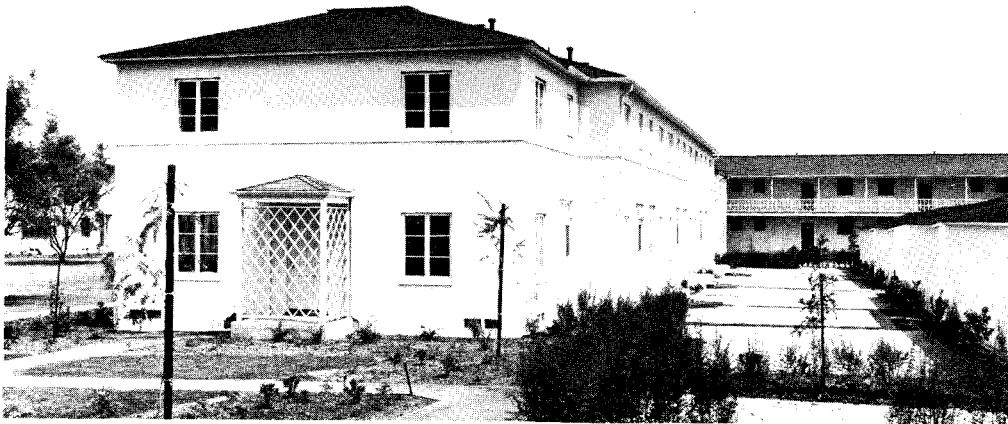

Typical exterior, showing accessibility of garage compounds whose walls form rear boundaries of private yards. Note also balcony for second-floor access.



Two typical living-room interiors, showing interior finish. Semi-indirect lighting fixtures were specially designed.



Photos by Haight



Typical bathroom

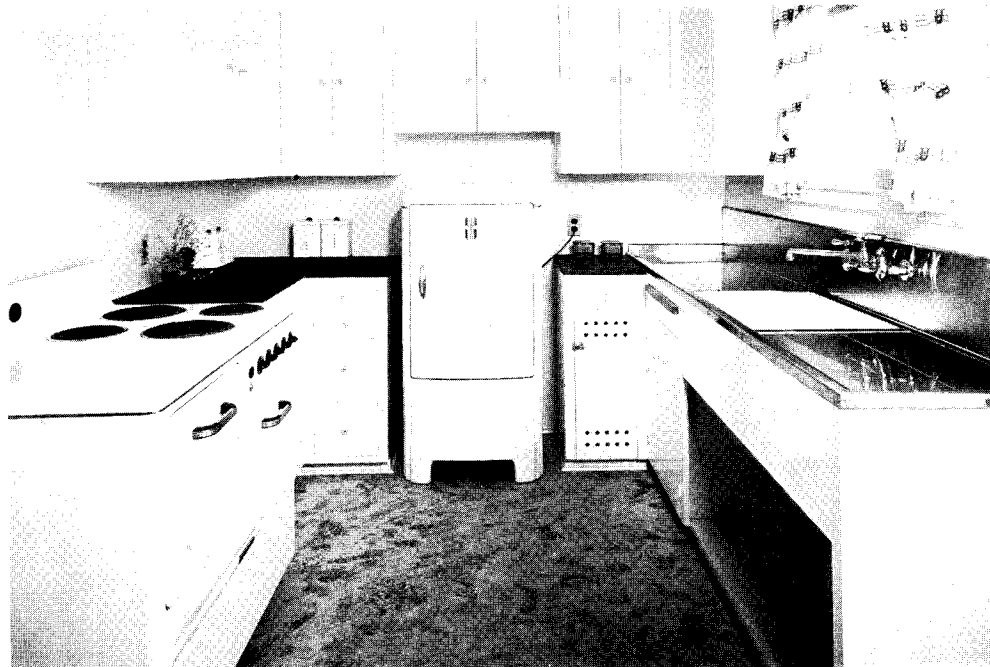

Typical kitchen with electric range and refrigerator, metal-topped cabinet-sink

Dick Whitington



Insulated, double-stud wall between bath and kitchen of adjacent apartments.

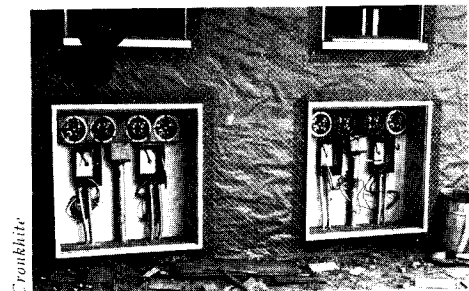

Electric-meter housings serve two apartments apiece.

Heating. Each dwelling unit is equipped with an independent, gas-fired, pilot-lighted floor furnace, which is vented through a fireproofed metal duct built into the wall. Operating cost is borne entirely by tenants. Neither the problem nor the cost of heating is serious. Domestic hot water is supplied from automatic electric storage heaters, one to each building. Hot-water heaters are designed to heat water during periods of low electrical consumption, and store it during other hours.

Electric service. Each dwelling unit is separately metered. Radio outlets and aeriels are included. Westinghouse electric ranges and outlets for irons are independently circuited. Each room has one ceiling fixture, each bathroom a wall bracket. Kitchens sometimes have two ceiling fixtures. Bathrooms and dining rooms have at least one duplex convenience outlet, kitchens and bedrooms at least two, living rooms generally three.

Kitchens have tray-and-sink combinations, with specially designed stainless steel covers and double drainboards. Built-in Worley metal ironing boards and clothes racks are provided. Cabinets are of special design, with most ac-

cessible shelves available for the greatest quantity of the most-used china, glassware, etc. In some units, dining space is included in kitchens. Refrigerators are Frigidaires.

Bathrooms have Standard Sanitary fixtures, Sloan valves, and recessed tubs and showers. Wainscots are "Plystone" board. Piping is Mueller brass. Medicine cabinets are steel, with 16 by 24-in. mirrors. Clothes hampers are not provided.

Storage. For dwelling units, bedroom closets and wardrobes are provided. In "F" units, coat and storage closets under stairs are large enough for luggage, a bicycle, and a card table, as well as coats. In all garages, large storage shelves are placed. Coat-closet provisions other than those in "F" units are small, since no great amount of over-clothing is ordinarily needed in the locality. Linen and broom closets are included in all dwelling units.

For project maintenance, janitors' utility closets are provided in all buildings containing 12 dwelling units. Six grounds-maintenance equipment rooms are distributed throughout the development. Shops for carpenters, etc., are near the Administration Building.



Cronkhite

Formwork for concrete foundations was sectional; as fast as sections were stripped from one building they were set up for another.

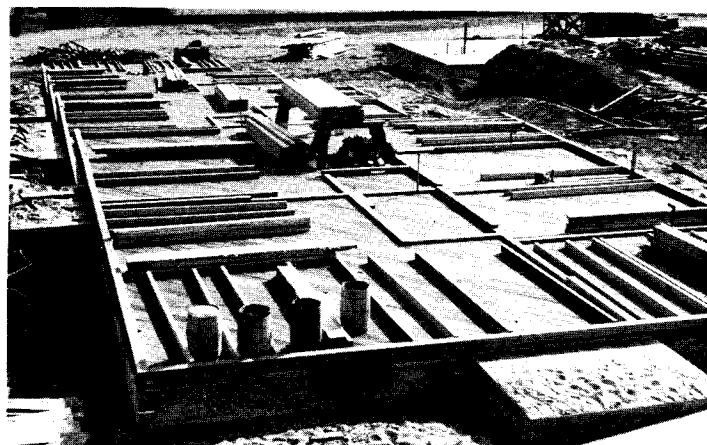

After the rough floor was laid, pre-cut studs, and bundles each containing framing for one opening, were spotted for erection.

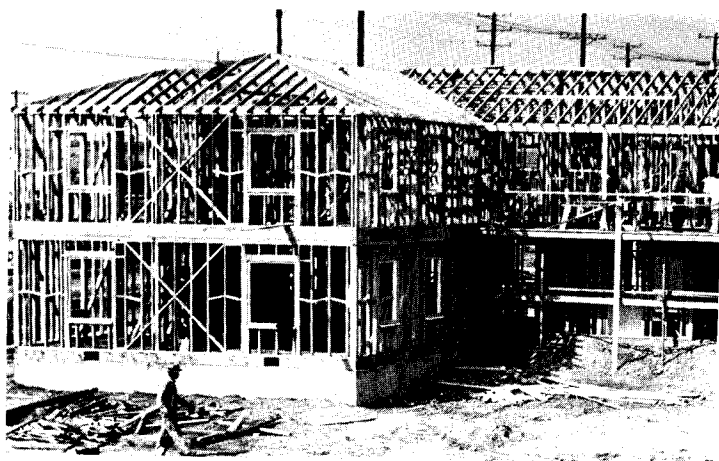

Cronkhite

Framing nearing completion on an "E" type building. Notice continuous cut-in diagonal bracing, and prefabricated roof trusses.



Courtesy Lindgren & Swinerton, Inc.

Siskraft paper and lath for exterior stucco were applied directly over the stiffened framing, omitting sheathing.

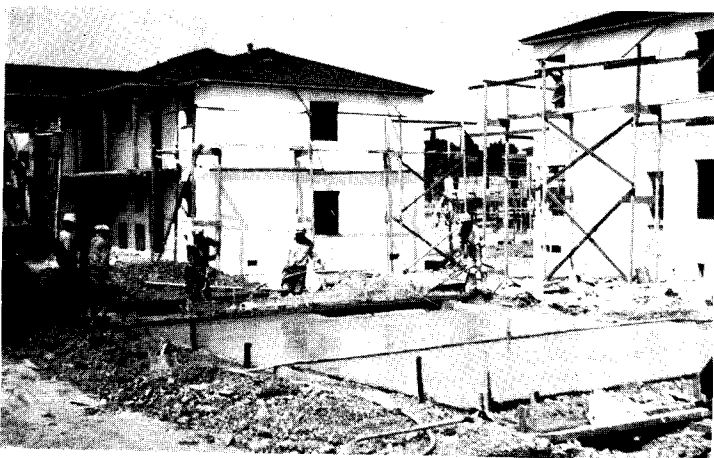

Photos by Lindgren & Swinerton, Inc.

Garage floors were poured as units, and screeded with steel beams having plow-handles at either end—a two-man operation.



On the monolithic floor, wood-framed garages were built, following construction methods similar to those for dwelling units.

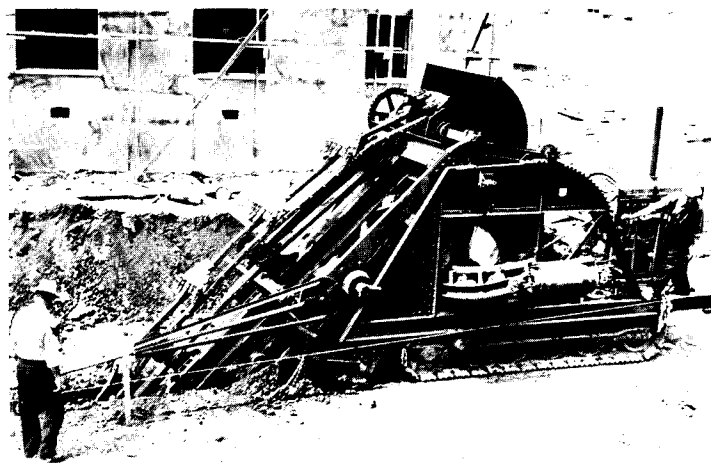
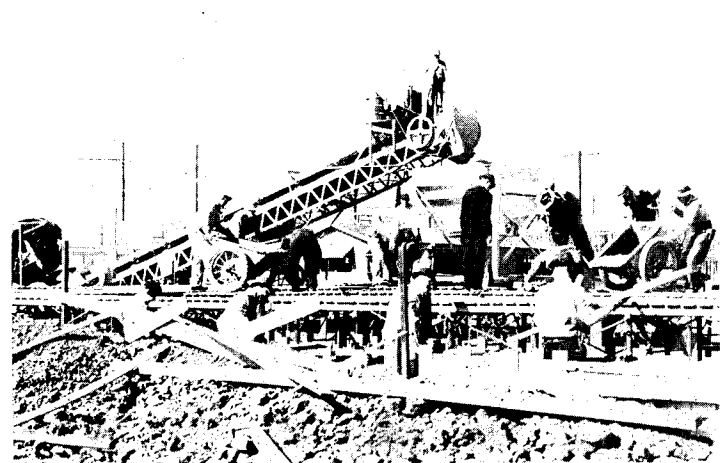

Concrete was transit-mixed, deposited on conveyor-belts, dumped into hoppers, poured into rubber-tired buggies. Buggy-tracks were re-usable, on adjustable pipe-frames.

Ditches for sewers, piping, sewage lines, electrical lines, etc., were dug by one-man machines along lines laid out in advance by the engineering crew.

Construction. Buildings are all two stories high, without basement. Foundations are poured concrete. Continuous walls are used over solid soil; reinforced beams resting on concrete piers, which are carried to solid bearing, are used where fill occurs. Earth under first floors is excavated to a minimum depth of 1 ft. 6 in.

Framing is entirely wood. First floor joists are zinc-chromated, 2 by 8 in., continuous, and carried on intermediate treated wood girders. Second-floor joists are continuous 2-by-10's. Roofs are framed with prefabricated trusses built up of 2 by 4-in. stock nailed together. Exterior walls are stud, with continuous, diagonal, cut-in braces to stiffen the frame. Sisalkraft paper is fastened directly to studs over wires 6 in. on centers. Roofs are covered with edge-grain Red Cedar shingles.

Interiors are lathed with U. S. Gypsum plaster-base. Finish is U. S. G. hard plaster. Walls and ceilings are painted. Floors are oak in most spaces; linoleum in kitchens and baths; asphalt tile in public spaces.

Insulation against heat or cold was considered uneconomical. Roof spaces have screened vents at eaves and ridge. Sound insulation is provided between apartments. Where kitchens and bathrooms adjoin, partitions are staggered-stud, packed with "Palco" (shredded, vermin-and-fire-resistant Redwood bark). At other common walls, plaster-base was attached with U. S. Gypsum spring clips to reduce sound transmission.

Finish floors rest on sleepers which float on fiberboard supported by rough floors.

Job organization was completely integrated, including designing, purchasing, fabricating, and constructing. Sectional site plans were overlaid with 200-ft. coordinates which were transferred to the site. Cut and fill were balanced. Limited variation of room shapes and sizes, and of buildings, permitted use of mass-production methods in the field. From the starting operation, grading on the south side, work flowed continuously from building to building. Grading crews completed operations in blocks and moved on to adjacent blocks. Engineering crews staked out buildings. Each operation was performed by a crew organized for the purpose. The desired schedule of one building per day has at certain times been exceeded.

Delivery of lumber was started three months before construction; prefabrication took place in a mill 24 miles from the project. Joists, plates, studs, bundled opening framing, etc., were assembled by building number, with lumber needed first on top of each load. Roof trusses were assembled on the ground and crane-hoisted into place.

In some instances, ordinarily expensive materials were so combined and installed that costs-in-place compared favorably with less initially-expensive material installed by ordinary methods. For instance, special techniques permitted use of stainless steel drainboards in kitchens.

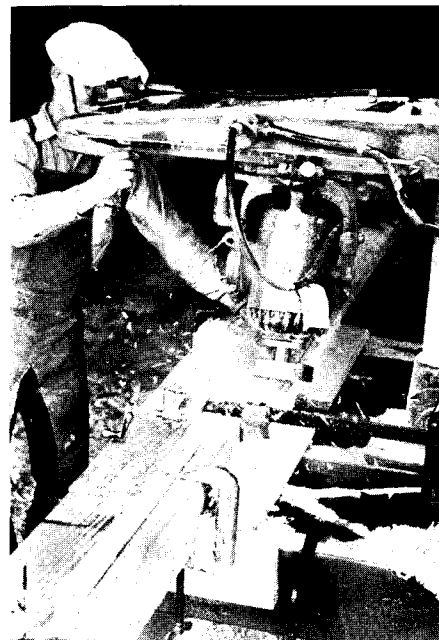
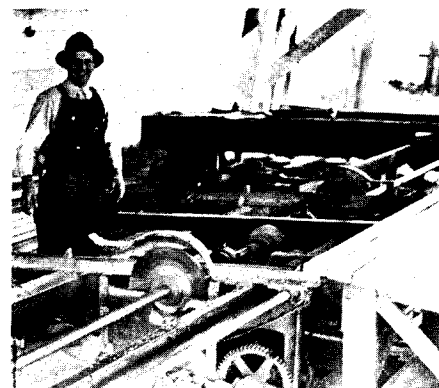

Photos by Cronkite

Mill work and framing were prefabricated. Above, cutting studs and stair carriages precisely by machine.

441-ACRE DEVELOPMENT NEAR NEW YORK

Fairchild Aerial Surveys, Inc.

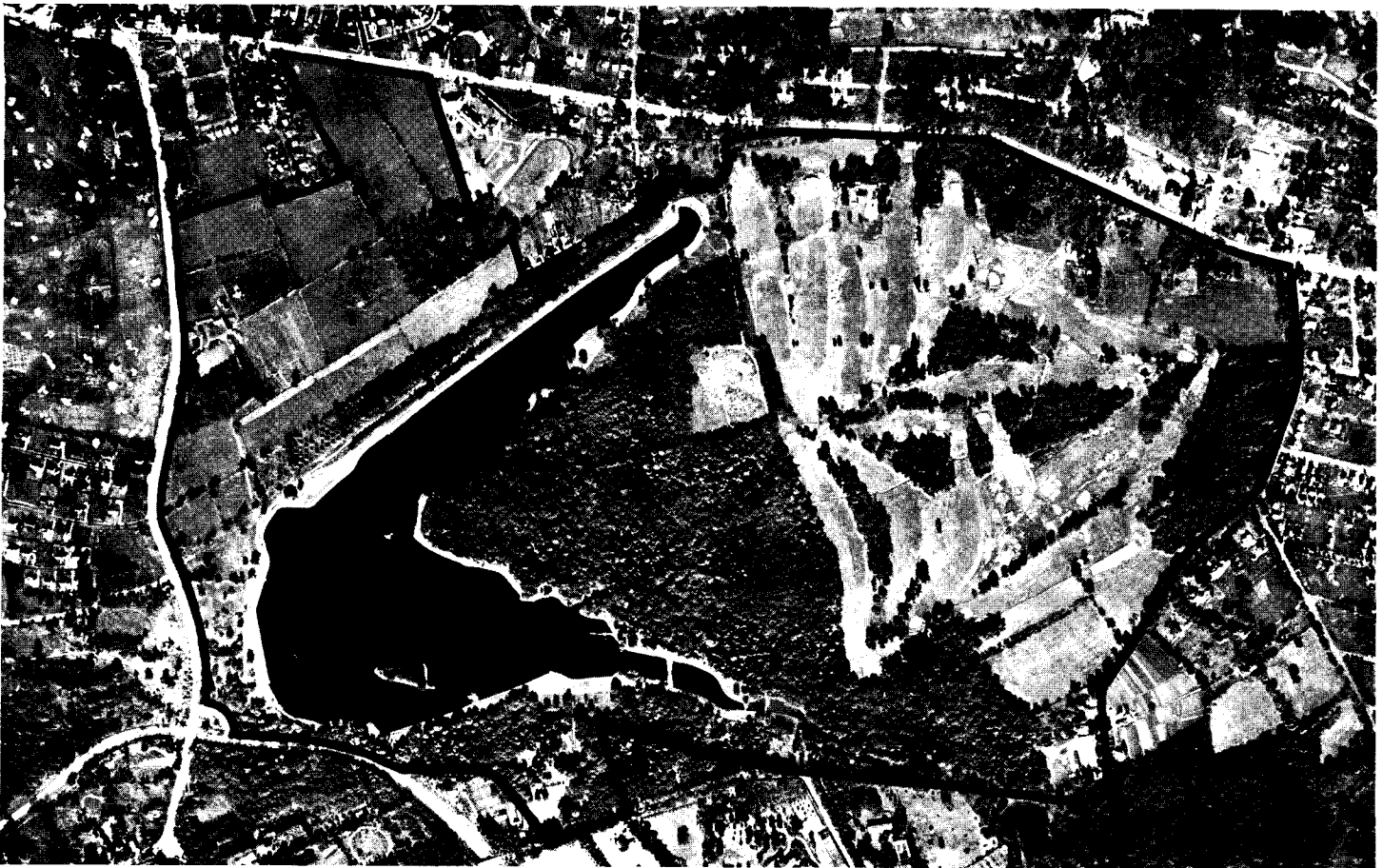

Air view of entire property, showing lake

INTERLAKEN GARDEN APARTMENTS Westchester County, New York

de YOUNG and MOSCOWITZ, Architects

GILMORE D. CLARKE and

MICHAEL RAPUANO, Landscape Architects

Plot plan: portion now being developed is shown in black and white; the area shown in gray will be constructed next. Both are at upper left of photo above.

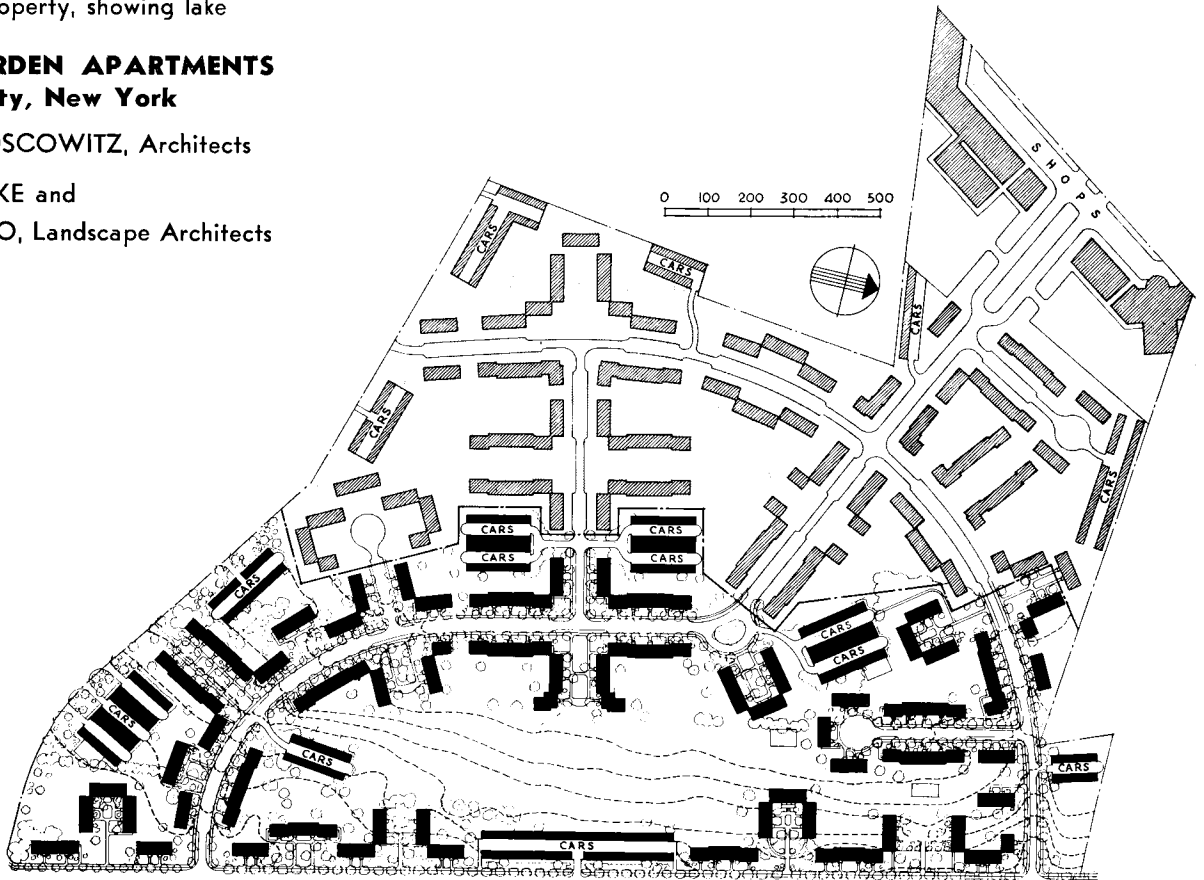

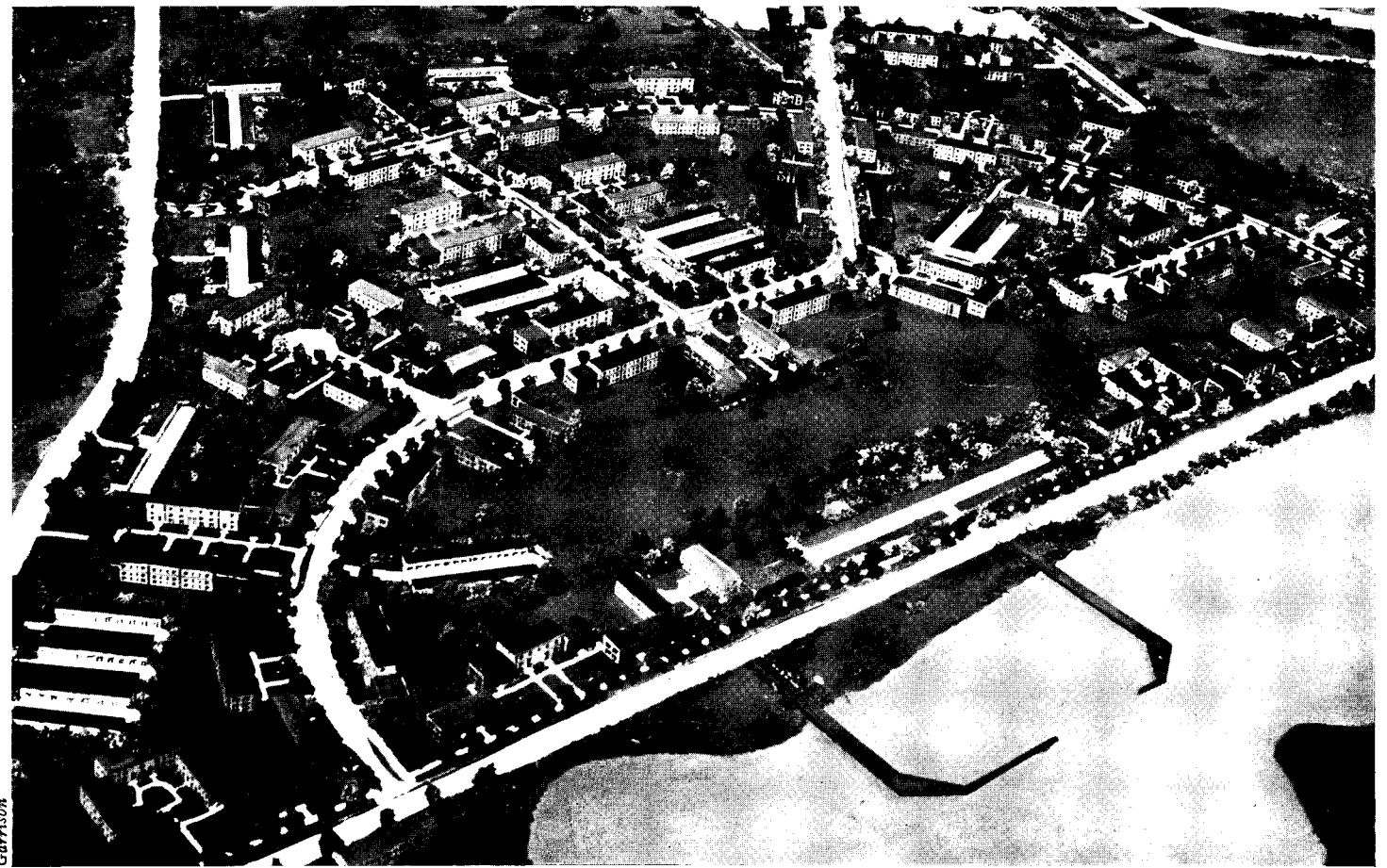

Model of first two stages of development

THIS DEVELOPMENT will ultimately become one of the largest privately-owned and operated housing projects in the country. It was conceived by Winfred Watson, vice-president of the real estate firm of William A. White and Sons. The tract had been assembled by the late Adrian Iselin and held by his heirs for some seventy-five years. It had served as a watershed for the lake, which was formerly a reservoir for a local water-supply system, but had since been abandoned for that purpose.

According to Mr. Watson, the project was evolved from ideas which were generated by the 1929 report of New York's Regional Plan Association. For the first stage of construction, an FHA insured mortgage of \$2,200,000 was obtained; the remainder of the financing is private.

The site includes a 67-acre lake, on whose western shore lies the first area

developed, 40 acres in extent. The accompanying plot plan also shows the second stage of development (shaded portion) which will include a shopping center and a theater, near two intersecting main highways, at the main entrance to the entire property. Construction will be started on the second unit early in 1940, according to present plans. The remainder of the site, which includes a country club embracing 120 acres, may eventually be developed either with apartments or retained in nearly its present state for tenants' recreational use.

The entire project, when completed, will house 3,500 families at an approximate total cost of \$20,000,000. In the first stage are included 525 apartments grouped in two- and three-story buildings, with land coverage at approximately 14 per cent. The remainder of the area will be occupied by parks, play-

grounds, lawns, drives, and the lake.

The site, sixteen miles from New York City, is served by a railroad station less than a mile away, and by buses running along marginal highways. Nearly 20 miles of paved interior roads will be needed.

The terrain is rolling and heavily wooded. Most of the trees will be preserved. The lake will be retained for use by the new community's residents. There will be a boat basin, visible in the model photograph above.

Buildings in the first developments are so located that views are restricted as little as possible, and are widely separated to maintain tenants' privacy. Garages are grouped in compounds. Children's playgrounds are laid out so that no child has to cross a roadway to reach a play area. Playgrounds will be enclosed and equipped with slides, sandpiles, and similar facilities.

CASE STUDIES **INTERLAKEN GARDEN APARTMENTS** (continued)



Garrison

Detail of model showing buildings 28 through 35

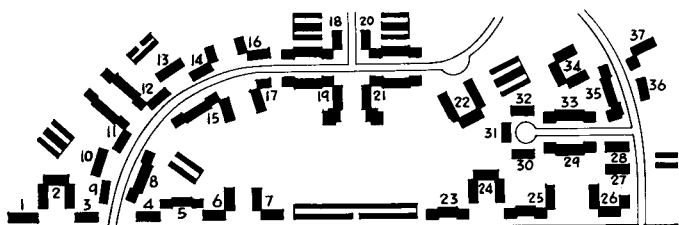

Key plan, first stage of development

LEGEND

Building Number	Type of Unit	Building Number	Type of Unit	Building Number	Type of Unit
1	H	14	DD	26	D _r DE _r
2	DDD	15	EC _r E _r D	27	D
3	D	16	D _r D _r	28	D
4	D	17	D _r E	29	EC _r E _r
5	E _r BE	18	E _r C _r ED _r	30	D
6	DD	19	ECE _r DA	31	B
7	D _r D _r	20	DECE _r	32	D _r
8	EC _r E _r	21	EC _r E _r D _r A _r	33	E _r CE
9	D	22	H _r DH	34	DDD _r
10	C	23	E _r BE	35	EC _r A
11	E _r CED	24	DDD _r	36	D
12	EC _r E _r D _r	25	E _r BED	37	DE _r
13	C				

Note: r subscript indicates unit reversed.

TWO-STORY FLATS: UNIT H, 3½ and 4-room apartments; total number of H units, three

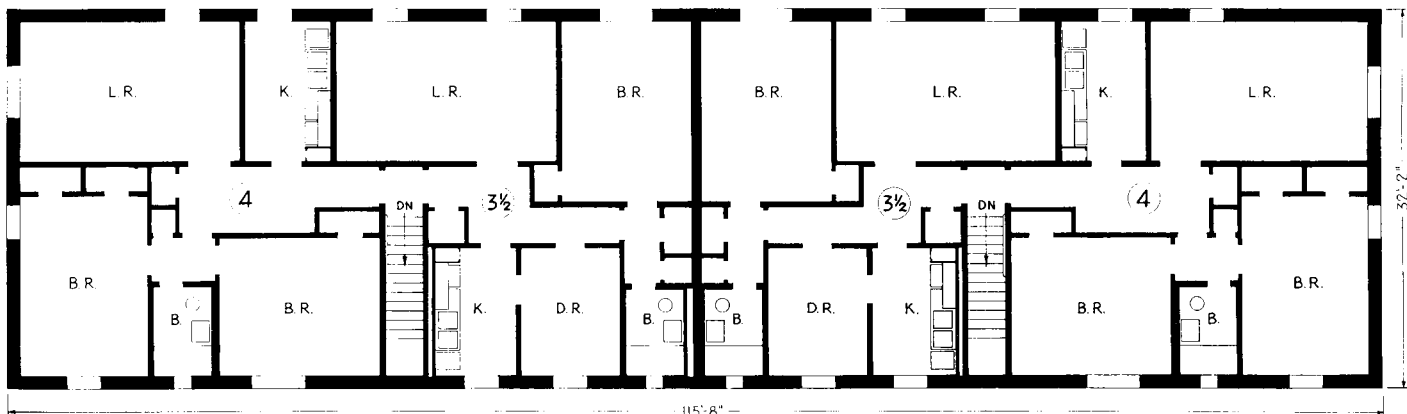

Second floor

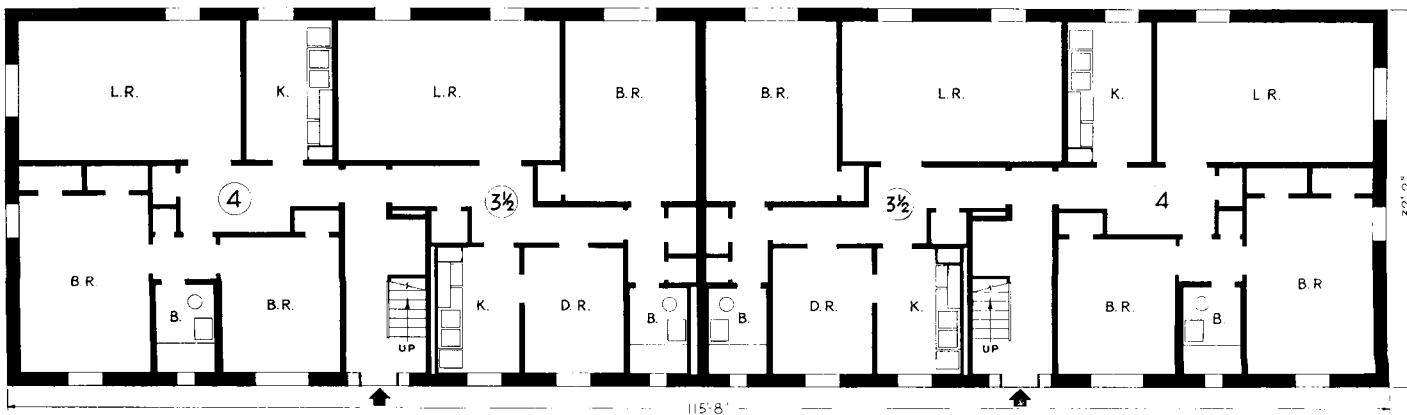

First floor

DWELLING UNITS

THREE-STORY DUPLEXES: UNIT B

5-room apartments on first floor, 5-room duplexes on second and third floors; total number of B units, four.

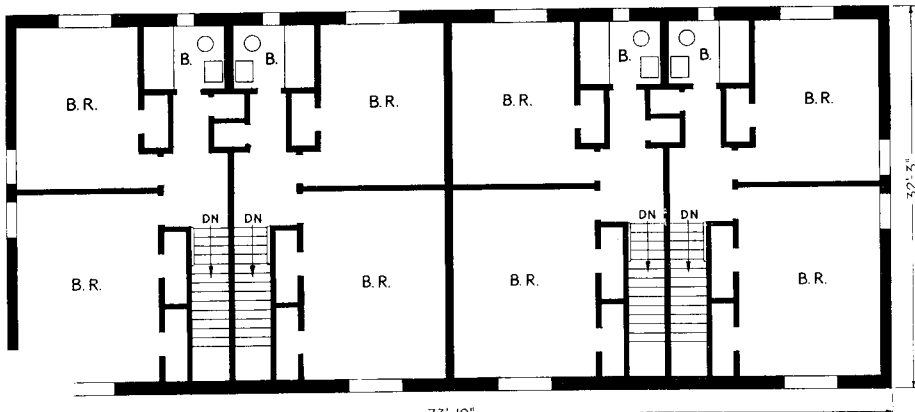

Third floor

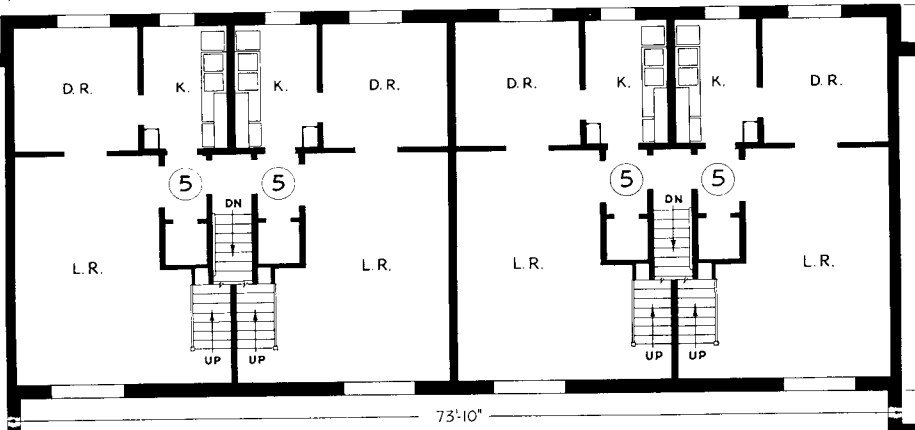

Second floor

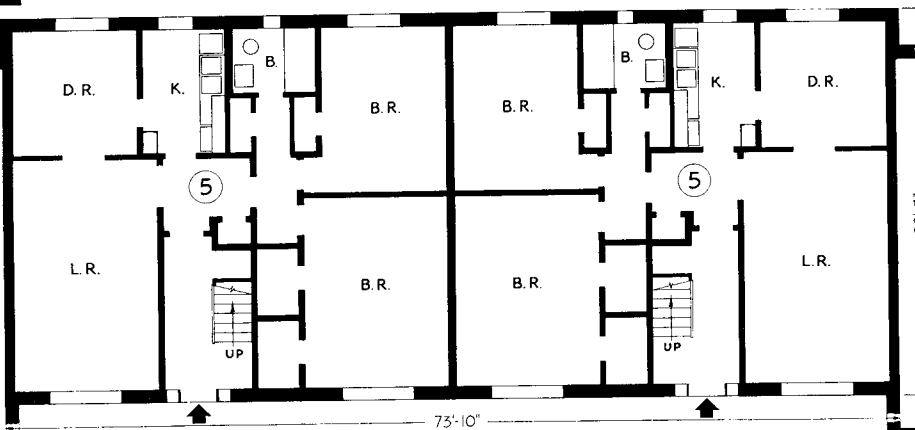

First floor

UNIT C (not shown) is similar to Unit B at left, but contains three 5-room apartments on the first floor with six 5-room duplexes above. Total number of C units is 13.

Cost per room averaged \$1240, not including land costs. The average 3-room apartment will rent for approximately \$60 per month.

NUMBER OF APTS. IN FIRST STAGE

Rooms per Apt.	Number of Apts.	Rental Range
2 1/2	33	\$45.50 to \$52.50
3	93	56.00 to 60.00
3 1/2	88	67.00 to 71.50
4	164	74.00 to 80.50
5	141	84.00 to 98.00
6	6	111.50 to 115.00

Total 525

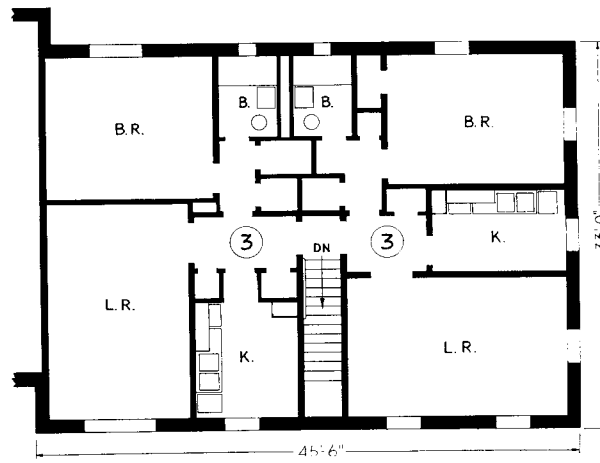
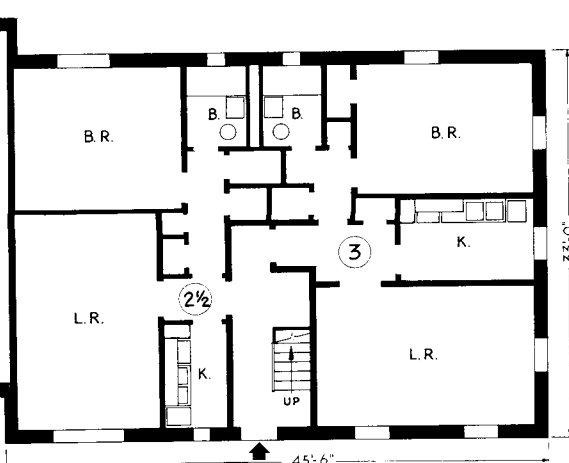

TWO - STORY FLATS: UNIT E

2 1/2 and 3-room apartments; total number of E units, 30.

Left, first floor.
Right, second floor

TWO-STORY FLATS: UNIT E, 2½, 3, and 6-room apartments; total number of E units, thirty

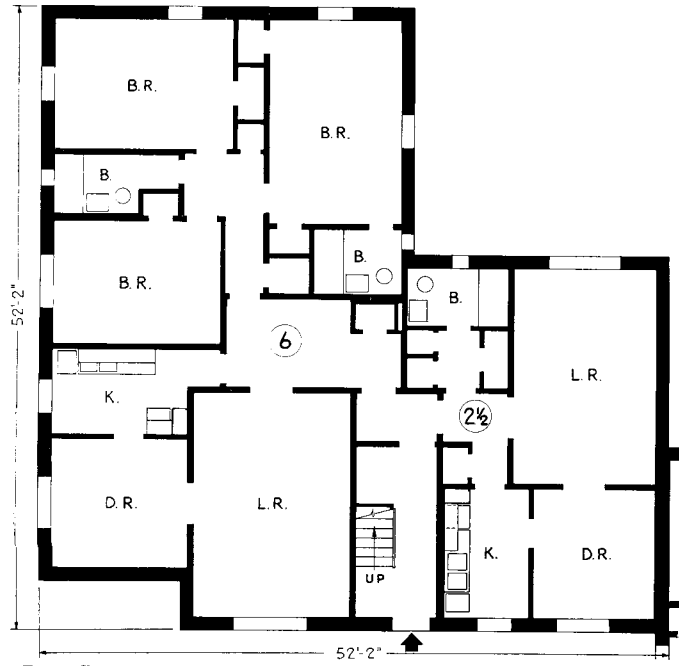

First floor

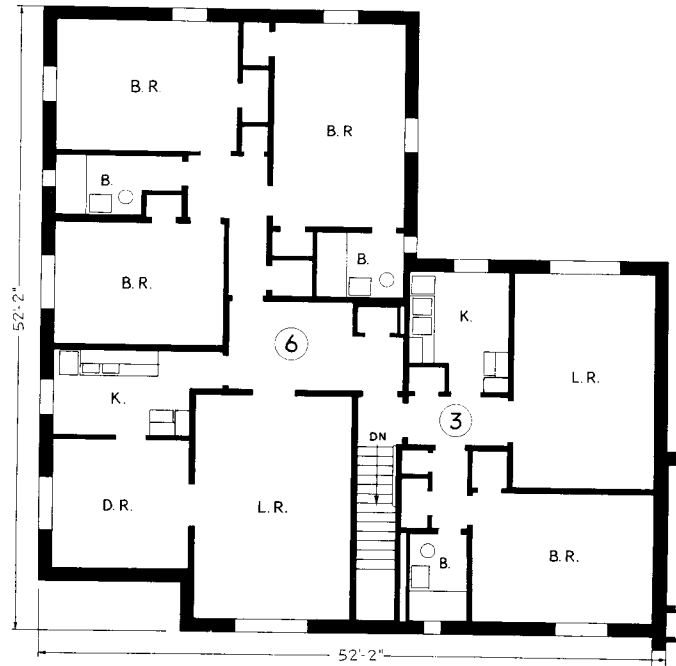

Second floor

TWO-STORY FLATS: UNIT B, 3½ and 4-room apartments; total number of B units, four

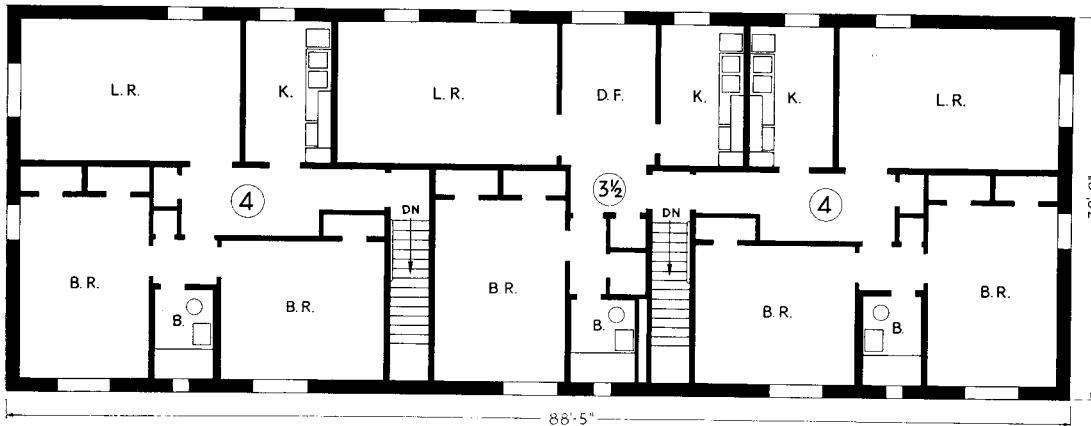

Second floor

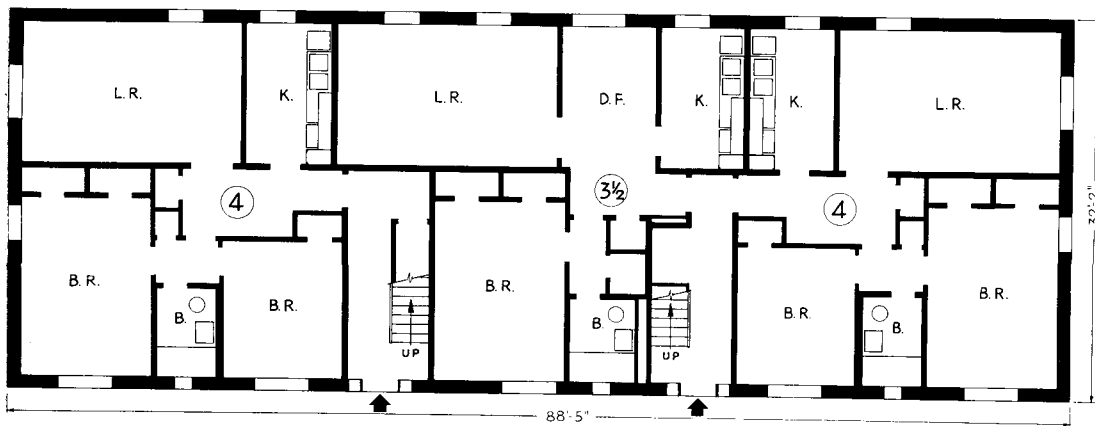

First floor

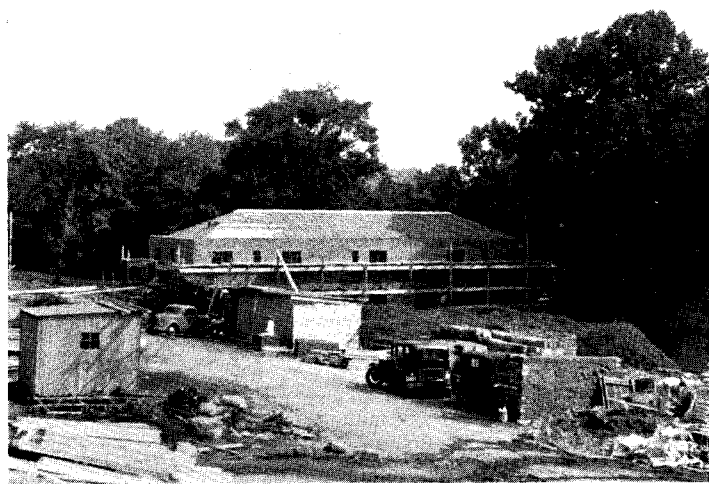

General construction views

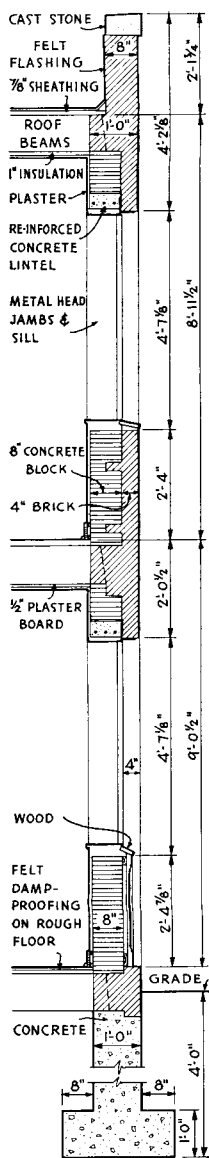

Typical wall section; interior plaster is applied directly to cinder-block backing.

Construction methods. Because the six typical dwelling units (and reversed plans of each, making a total of 12) were variously combined in the 37 buildings, each building is to some extent different from any other in the development. Consequently, "production-line" methods of job organization could not be fully utilized. Construction is proceeding by groups of buildings from south to north along the lakefront, and in a circle back to the starting point. Some buildings will be completed and occupied before ground is broken for others. By October 1st, 153 apartments and 84 garages are expected to be completed.

The job's size results in large savings on some materials and equipment. Steel sash were all ordered at one time, from schedules furnished the manufacturer. Such factors, and the simultaneous ordering of similar bathroom and kitchen equipment for 525 dwelling units, permitted mass-production manufacturing methods.

Buildings have concrete foundations which extend below frost lines. Basements are omitted except where needed for boiler rooms, meter rooms, and tenants' storage bins.

Exterior walls are faced with brick, on cinder-block backing. Cinder block is parged with mastic on interior faces. Windows are Fenestra steel sash, manufactured by the Detroit Steel Products Co. Sills are slate; copings, marble.

Floors and roof are wood-framed. Hipped roofs are slated; flat roofs have 20-year built-up surfacing. To prevent

the penetration of dampness through first floors over unexcavated basements, a layer of vapor-proof paper was applied between rough and finish floors. Interior partitions are framed of wood.

Interior finish. Walls and ceilings are plastered on Rockwall lath applied directly to the waterproofed cinder-block backing of interior walls; gypsum lath is used on partitions. Metal corner heads are installed at all horizontal intersections of plane surfaces; and vertical intersections where structural materials change. Metal lath is used in stair halls and boiler-room ceilings.

Plaster is prepared for painting according to tenants' choice of five standard color schemes. Flat paint is used in living and bedrooms; enamel in kitchens and baths. Bathrooms have tiled wainscots. Floors are oak in living and bedrooms, tile in baths, linoleum in kitchens, and asphalt tile in halls.

Ventilation and insulation. Attic spaces are ventilated through louvers. Basements not fully excavated are also louvered. Top-floor ceilings are insulated with Celotex lath and J-M mineral wool.

Sound insulation. Bearing partitions are 8 or 12-in. cinder block. Stud partitions between dwelling units are constructed of staggered studs, with a blanket-type insulation between the resulting independent walls. Floors are increased in respect to sound-resistance by use of sound-deadening felt applied between rough and finish floors.

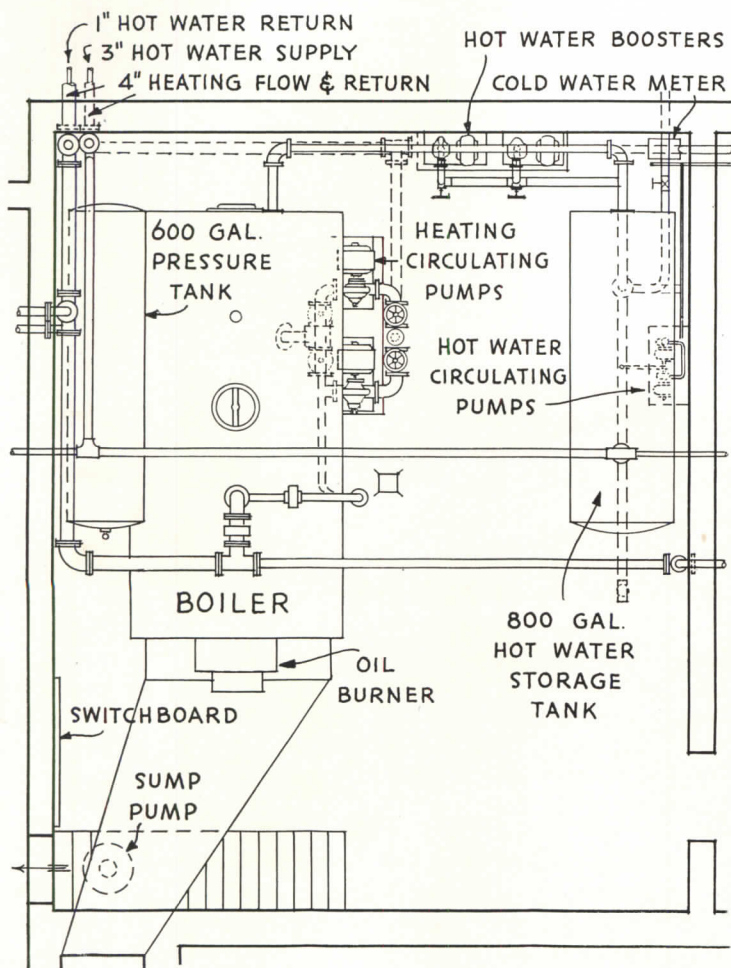

Typical boiler room

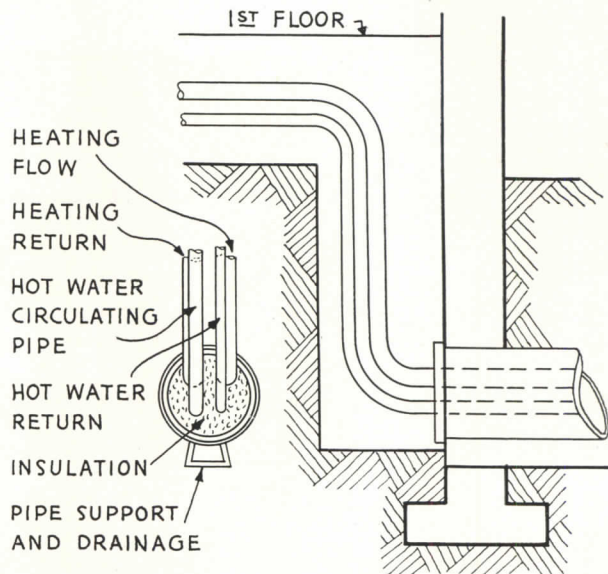

Typical heating supply, main details

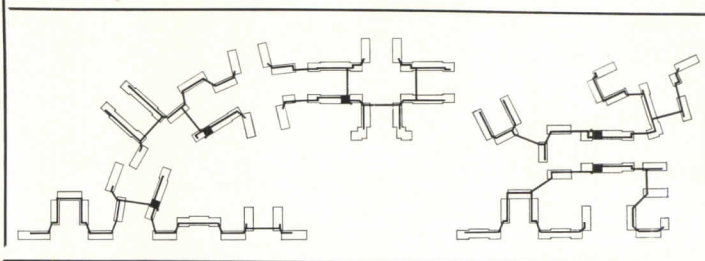

Heating plot plan, first stage only; black squares indicate boiler rooms.

Heating and hot water are supplied to buildings in the first stage of construction from five central plants, each hooked up to a group of buildings as indicated above. Systems are circulating hot-water, powered by boilers equipped with York oil burners. Use of several central rather than independent systems was decided upon to facilitate maintenance, replacement of parts, etc. Worthington circulating pumps are provided in duplicate as a safeguard against failure of the system.

Minneapolis-Honeywell controls are operated from boiler rooms as an economy measure. Radiators are narrow-column type, manufactured by the American Radiator Co. Pipe is by Bethlehem Steel Co., with Grinnell fittings and Fairbanks gate valves.

Electricity and gas are included in the tenants' rent, and are mastermeters in boiler rooms.

Ceiling lighting fixtures are supplied in foyers, kitchens, and baths only. No wall brackets are provided; the remainder of the rooms have duplex convenience outlets located in accordance with National Electrical Code recommendations.

Other electrical services installed include provision for an outside telephone in each apartment; electrical front-door openers; independent, fused radio circuits and power connections; separate circuits for refrigeration; and a duplex, 1200-watt utility outlet in each apartment. Outside lighting, including porch and entrance lights, is time-controlled for economy. Panel boards are

installed in each building.

Garbage collections will occur twice daily, and are provided by the community. Incinerators are not provided.

Kitchen equipment includes combination sinks and trays, by the Briggs Manufacturing Co.; gas ranges; and laundry driers. Refrigerators are Kelvinators.

Bathrooms likewise have Briggs fixtures, with Savoy fittings. Showers are included over tubs, but no separate shower stalls are provided. Bathroom windows are mechanically operated. Each bath has a built-in hamper.

Storage. Main bedrooms usually have two closets, other bedrooms, one. Coat, cleaning, and linen closets are also provided. Thirty sq. ft. of bulk storage space per apartment is provided in basements near boiler rooms.