

BUILDING NEWS

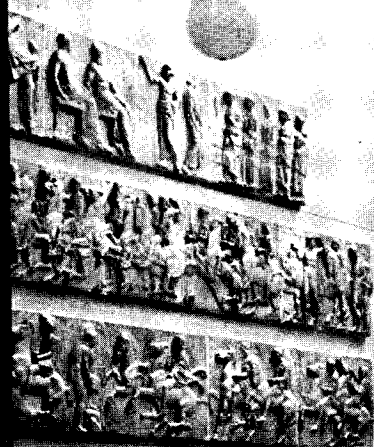

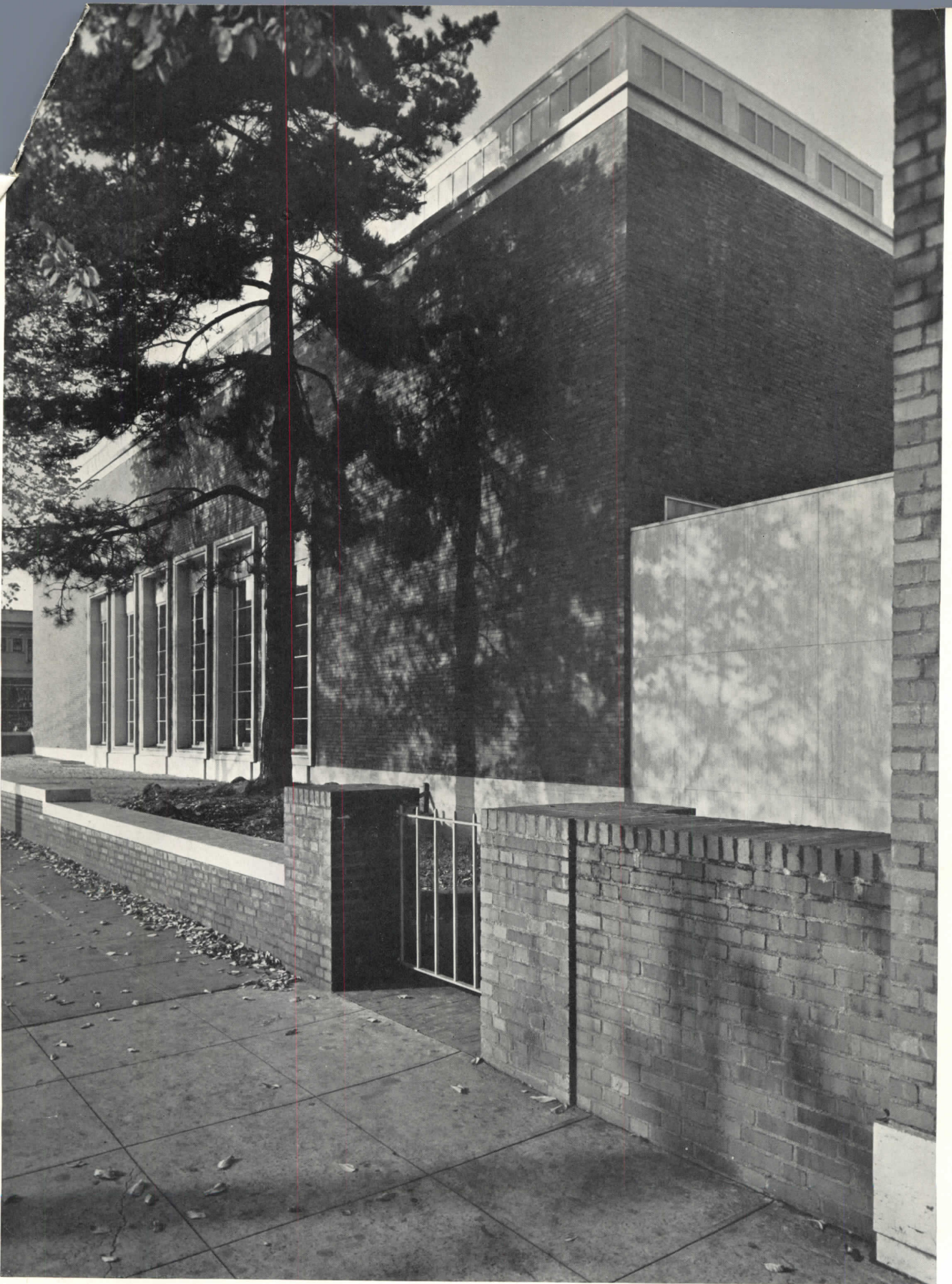

Roger Sturtevant photos

MUSEUM WING FEATURES CONTROL OF LIGHT AND ATMOSPHERE

A. E. DOYLE & ASSOCIATE, Architects

SECOND STAGE in the reconstruction of the Portland, Oreg., Museum of Art, the new wing in memory of Josephine and Solomon Hirsch, constitutes a further development of the design principles evolved by the same architects in the first unit built in 1932. The terms of the Hirsch bequest were such that the new addition had to be used exclusively for exhibition purposes. Since the Museum also sponsors an active art school, this meant that the architects had not only to organize all the units into a workable whole, but think also "in terms of future and final development—which may eventually occupy the full city block of 200 by 200 ft."

Aside from problems of plan, the main concern, according to the architects, "was to provide an economical, dignified, safe, and well-lighted structure." How well they succeeded is apparent. The new Hirsch wing follows and develops the precedent set in their first unit (right, below) with a confident and formal clarity which marks a notable advance in museum design. The need for economy has actually been exploited—as in the adroit use of Roman Travertine trim for common brick walls (facing page). Major emphasis has been laid always on performance—the best possible environment for canvases, tapestries, sculpture, and works of art. In this connection, both the lighting (p. 34) and system for atmospheric control (p. 33) merit attention.

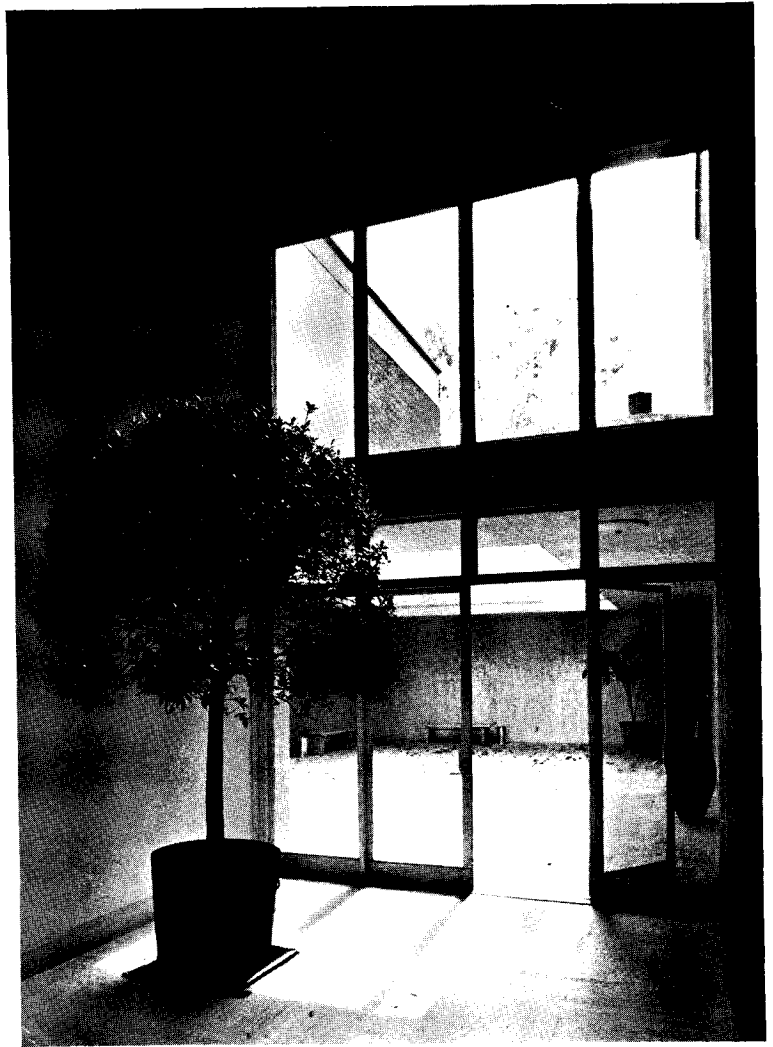

Sculpture courtyard between original building and the new wing.

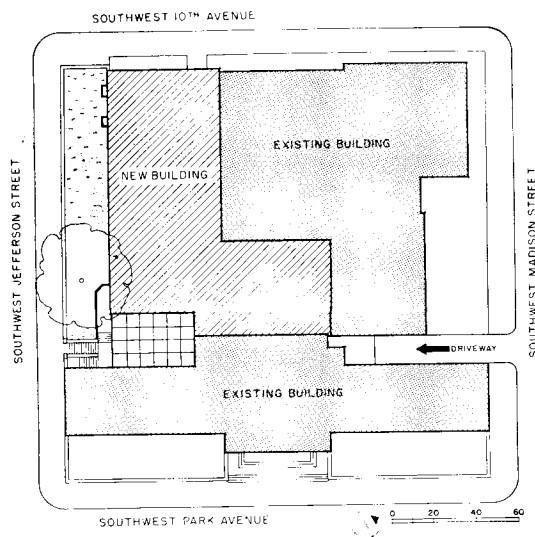

Plot plan

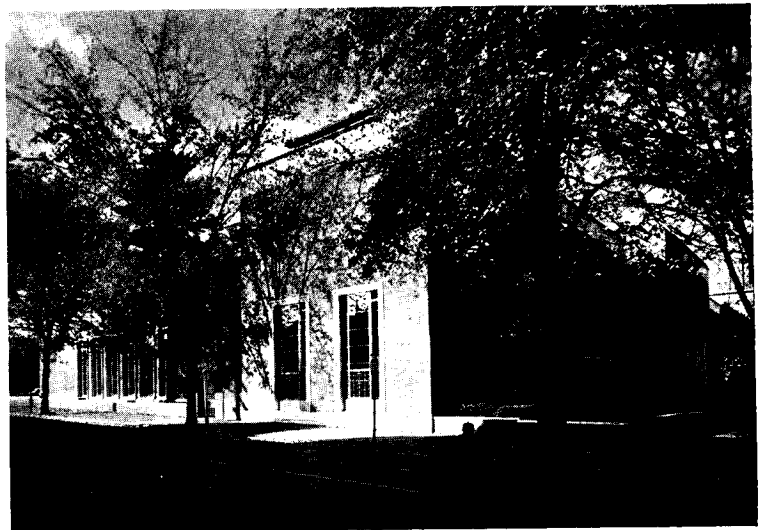

General view of the Portland Museum: the new wing is at the left.

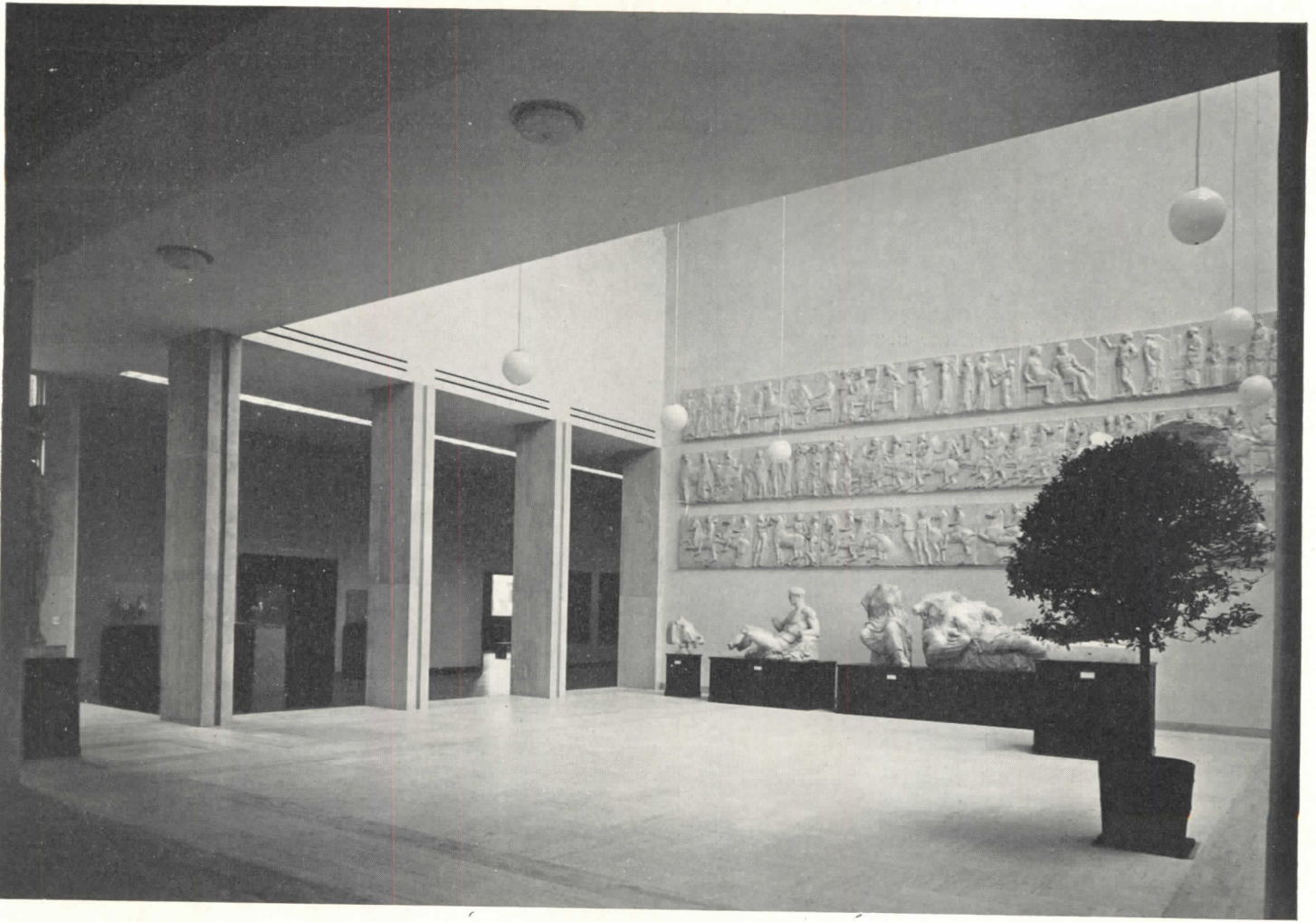

Room No. 1, looking from beneath the balcony through 16-ft. marble columns into the corridor. The floor is also marble.

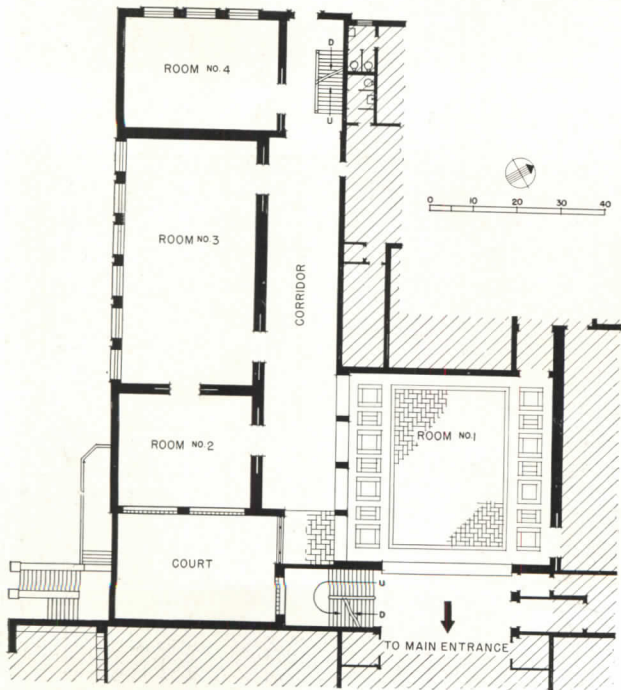

First floor

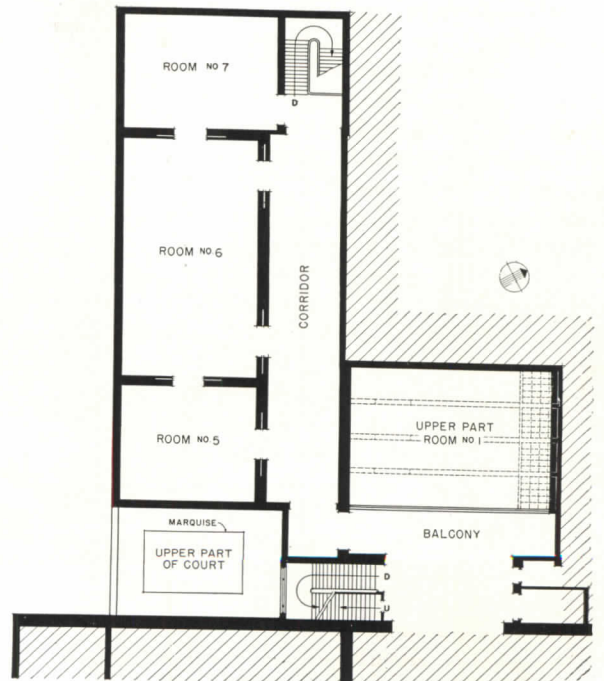

Second floor

NEW MUSEUM WING

THE INTERIOR of the building is kept as simple as possible to form an unobtrusive, well-lighted background for the various exhibit items. The walls of the galleries are surfaced with burlap, stretched over asbestos paper, which in turn is cemented to 1½-in. sheeting nailed directly to the concrete grounds. The floors of the entry hall and cast room are of marble. All other gallery floors are oak Bruce blocks cemented onto concrete.

The air-conditioning system is of considerable interest inasmuch as protection and preservation of art objects demanded a completely dust-free atmosphere, held at a constant level of humidity.

The heating medium is district steam in copper coils; cooling and dehumidification are accomplished through water in coils. An air washer takes care of humidification and an automatic air filter keeps the air clean.

Outside and recirculated air is mixed in constant proportion. Air is preheated or precooled, depending on its condition, by coil face and by-pass dampers to a wet-bulb datum; humidified to 50% relative humidity by face and by-pass dampers at the washer; taken through an air filter and fan and supplied to 3 plenum chambers. One of these has heating coils; one, re-cooling coils; and the third, tempered air only. From these chambers, air is mixed either from the tempered and warm or from the tempered and cool chambers as required for each room by separate heating and cooling thermostats. The humidity is reset automatically when outside temperature drops below the level at which 50% relative humidity within rooms condenses moisture on the windows. An exhaust fan discharges a constant amount of air equal to that taken from outside.

Air-supply grilles are located high in each room and consist of special fabricated steel or architectural concrete slots. These vary in size and shape to harmonize with architectural details. Note, for instance, the horizontal slots above the openings in Room No. 1 opposite. Return grilles are located at outside walls in the baseboard.

All supply ducts are insulated with "Dux-sulation". Fans, Sturtevant; heating and cooling coils, McQuay; motors, G-E; condensation pump, Nash Engineering; controls, Minneapolis-Honeywell; automatic air filter, American Air Filter Co.; air washer, Portland Heating & Ventilating Supply Co.

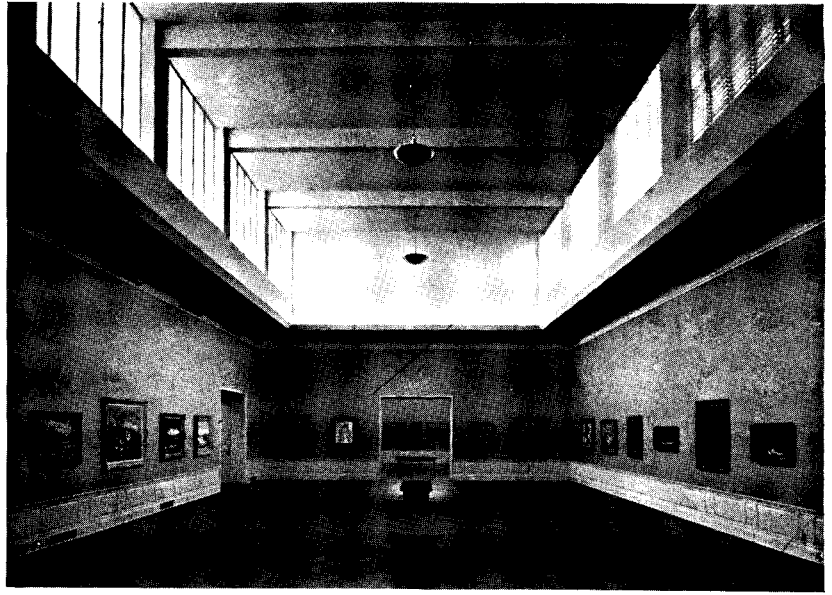

Room No. 6.

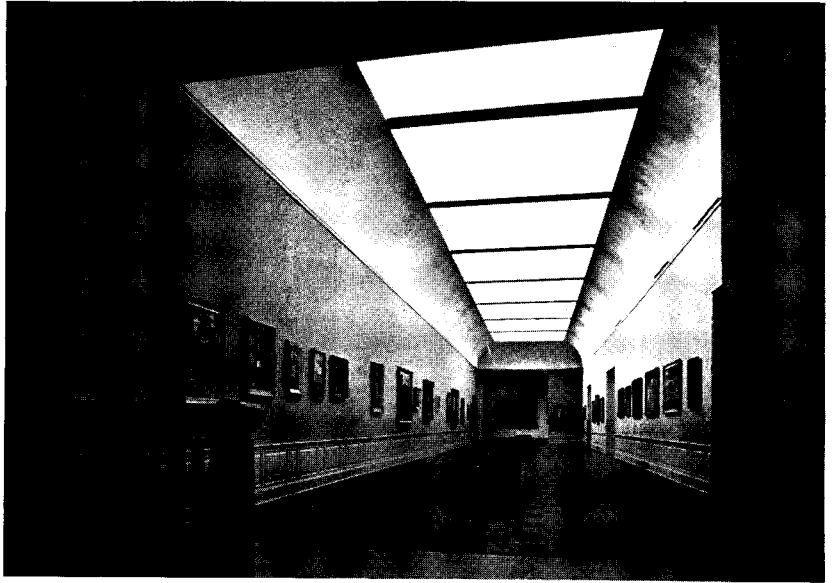

Second-floor corridor.

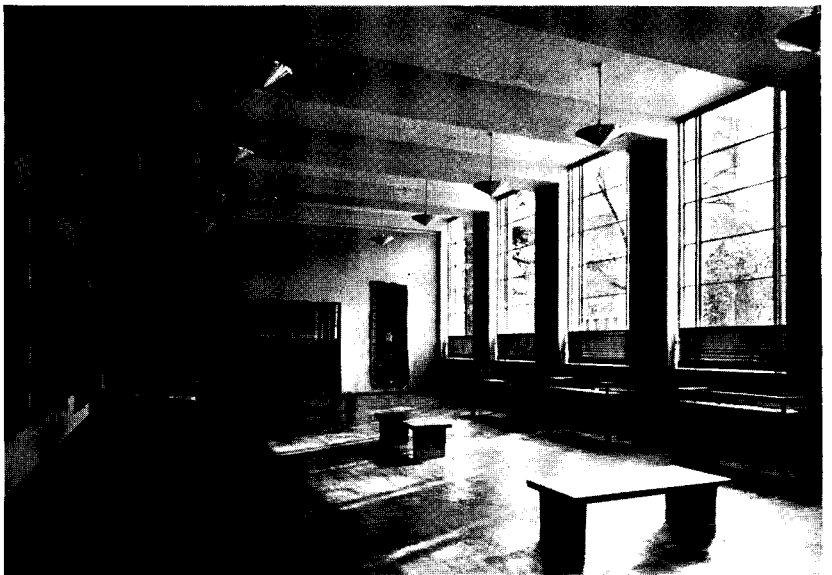

Room No. 3.

NEW MUSEUM WING

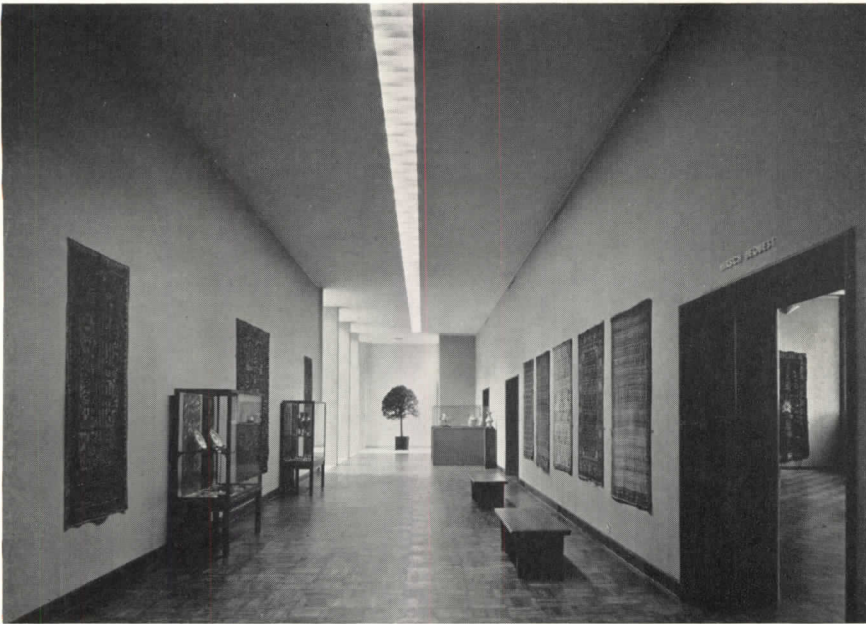

A ribbon of recessed light lines the center of the ceiling in the corridor on the first floor.

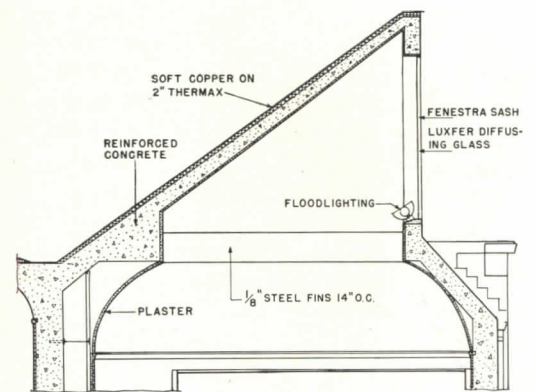
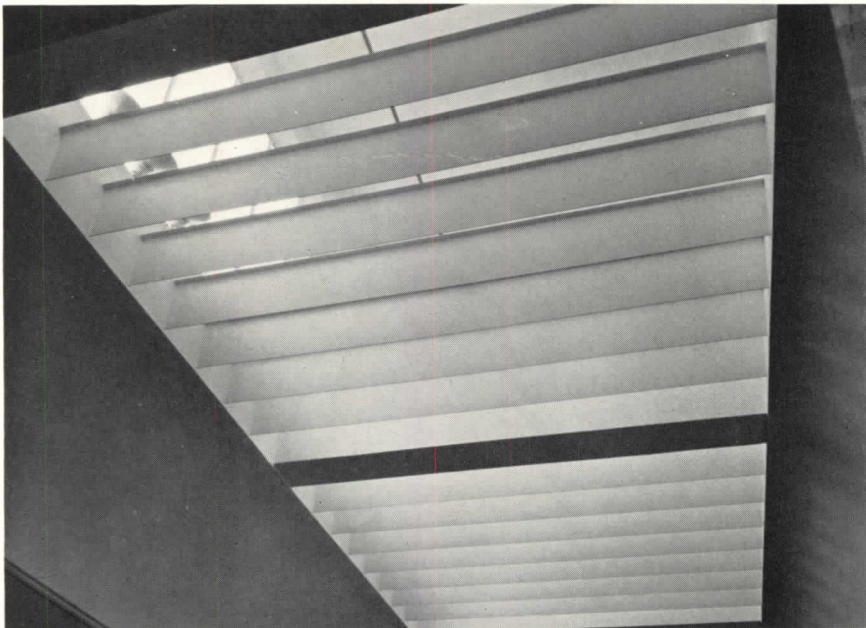

Second-floor corridor. Metal fins 14 in. o.c. diffuse and equalize light from a sawtooth skylight.

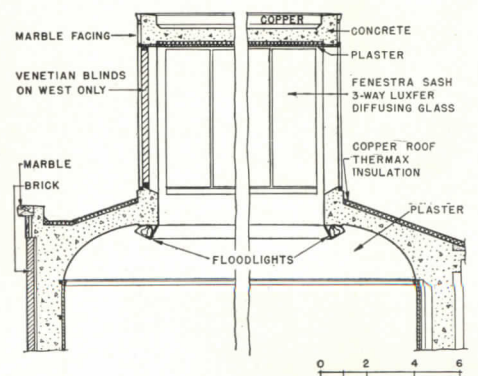
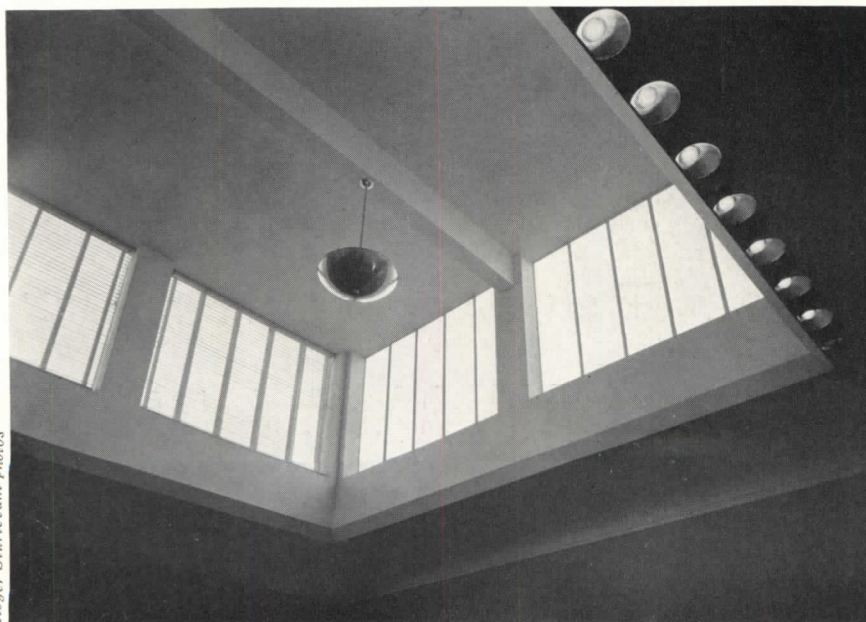

A clerestory of fixed steel sash with special glass daylight the second-floor galleries.

Roger Sturtevant photos

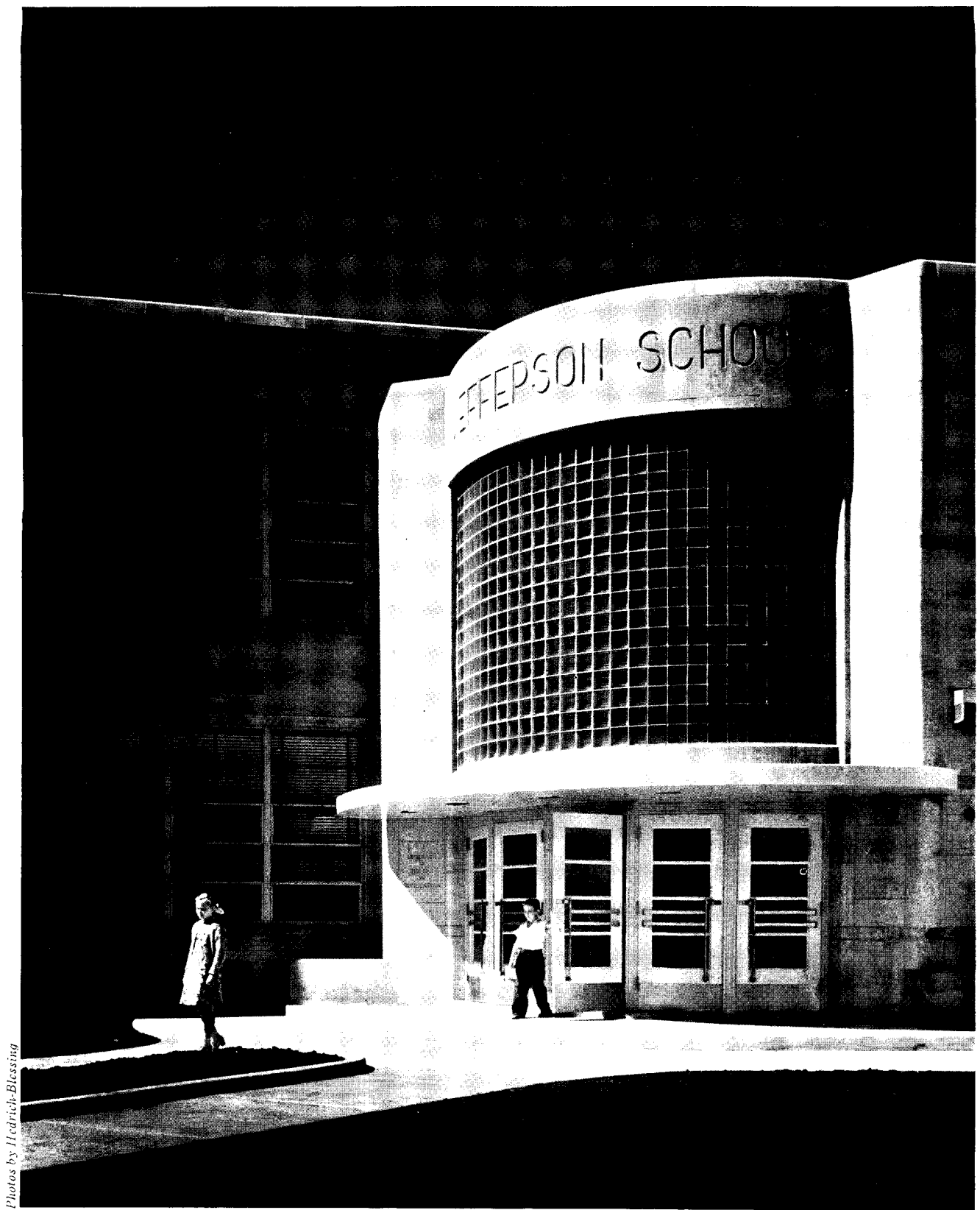

Photos by Hedrich-Blessing

LOW UNIT COST ACHIEVED IN MODERN SCHOOL STRUCTURE

LOUIS H. GERDING, Architect

THE NEW JEFFERSON SCHOOL at Ottawa, Ill., is a building which was economically constructed without sacrifice of either structural soundness or first-rate equipment. In fact, for a school plant in a small city with limited funds at its disposal, the design and equipment are unusually advanced. Approximate total cost was \$300,000.

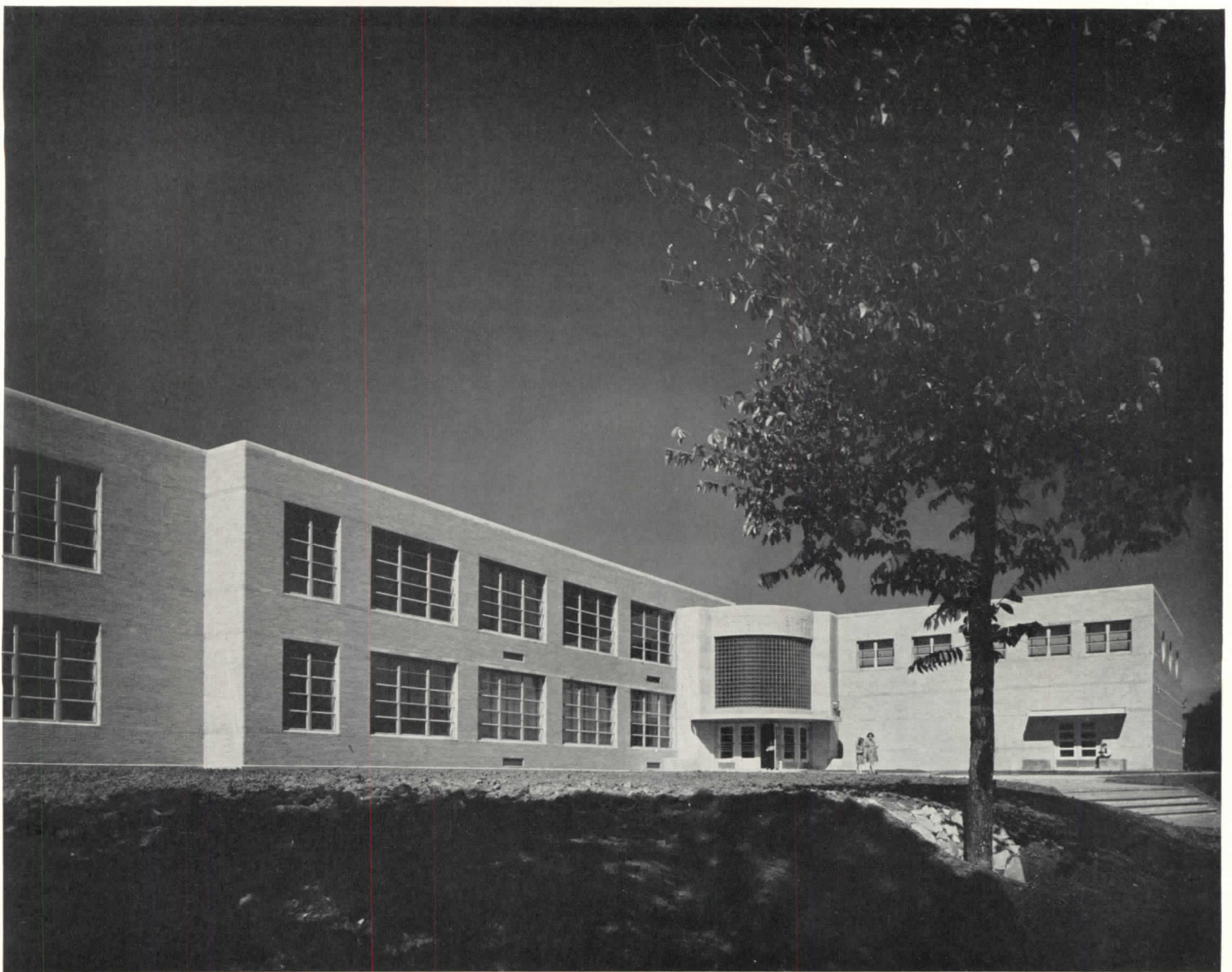

The curved entrance unit at the corner dominates the design. The panel of P-C glass block lights the main stairway landing.

CONSTRUCTION is as efficient as it is simple. The first and second floors and the roof are of steel pan joists, continuous between spandrel beams in the outside walls and over two interior walls. These joists are 6 by 10½ in. on 36-in. centers. The three clear spans are 21 ft. 2 in., 12 ft. 2 in., and 21 ft. 2 in. Over the 12 ft. 4-in. window openings, the lintel beams are 20 in. deep and rest on 3 ft. 6-in. brick piers.

At the corners, the parapets are confined longitudinally by reinforced concrete bolsters 8 in. square and 10 in. high. Every 25 ft. the parapets have compressive joints formed by using compressible waterproof pads in place of mortar between the bricks.

The lighting system consists of fully recessed down-lighting units, equipped with Holophane lens for distribution without glare or shadow. In all classrooms, the outer lights are controlled by photoelectric cells, with separate control for each exposure of the building.

Each classroom has a complete winter air-conditioning system, governing temperature, humidity, and air movement. This consists of pneumatic temperature-controlled concealed convectors and automatically controlled unit ventilators.



A wainscot of National Fireproofing 8 by 16-in. tile rims the auditorium.

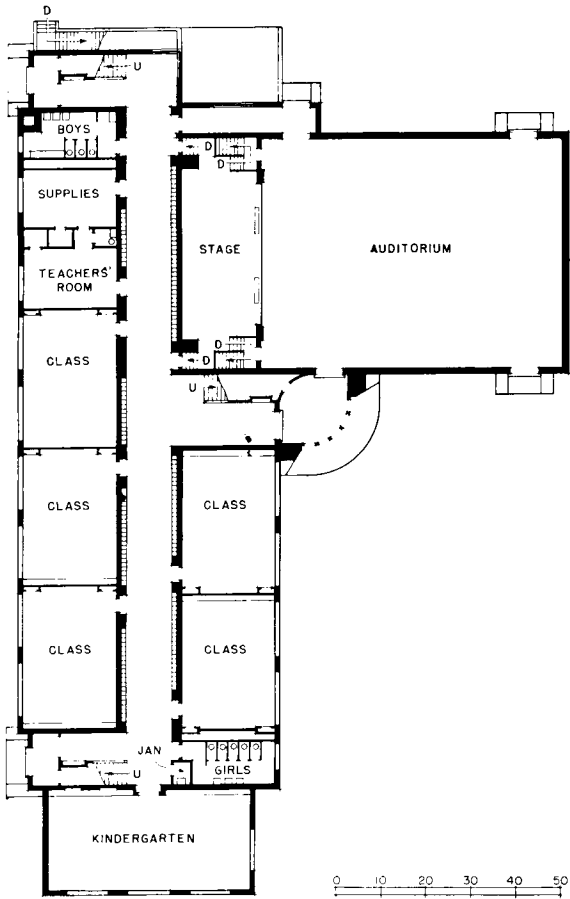

First floor

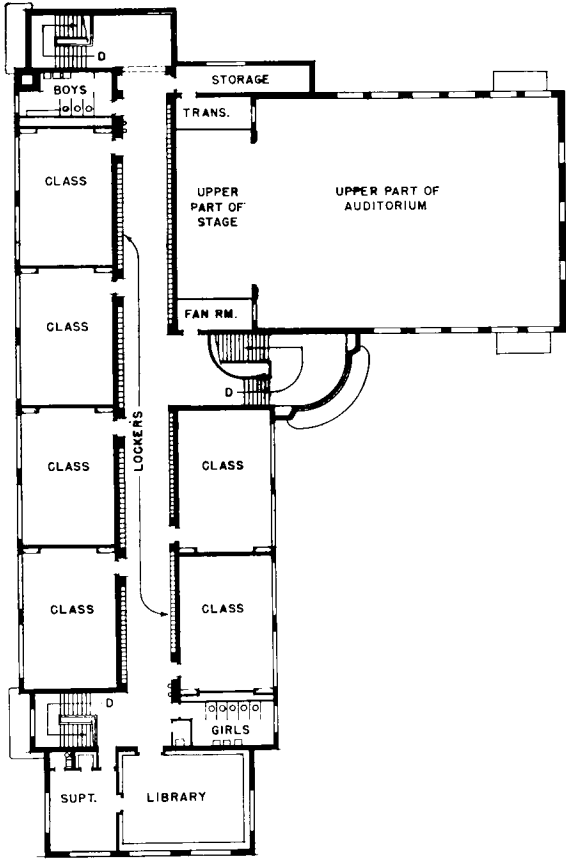

Second floor



corridors have built-in Medart lockers and Sealex linoleum floors. The kindergarten is flexibly equipped to handle its diversified uses.

ELEMENTARY SCHOOL

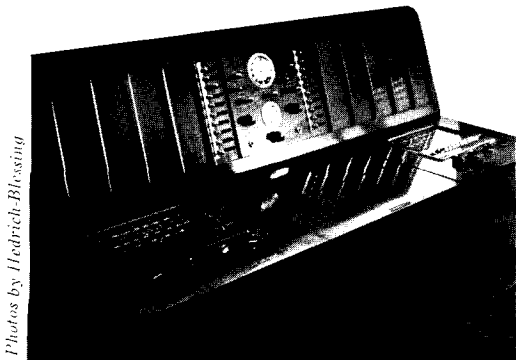
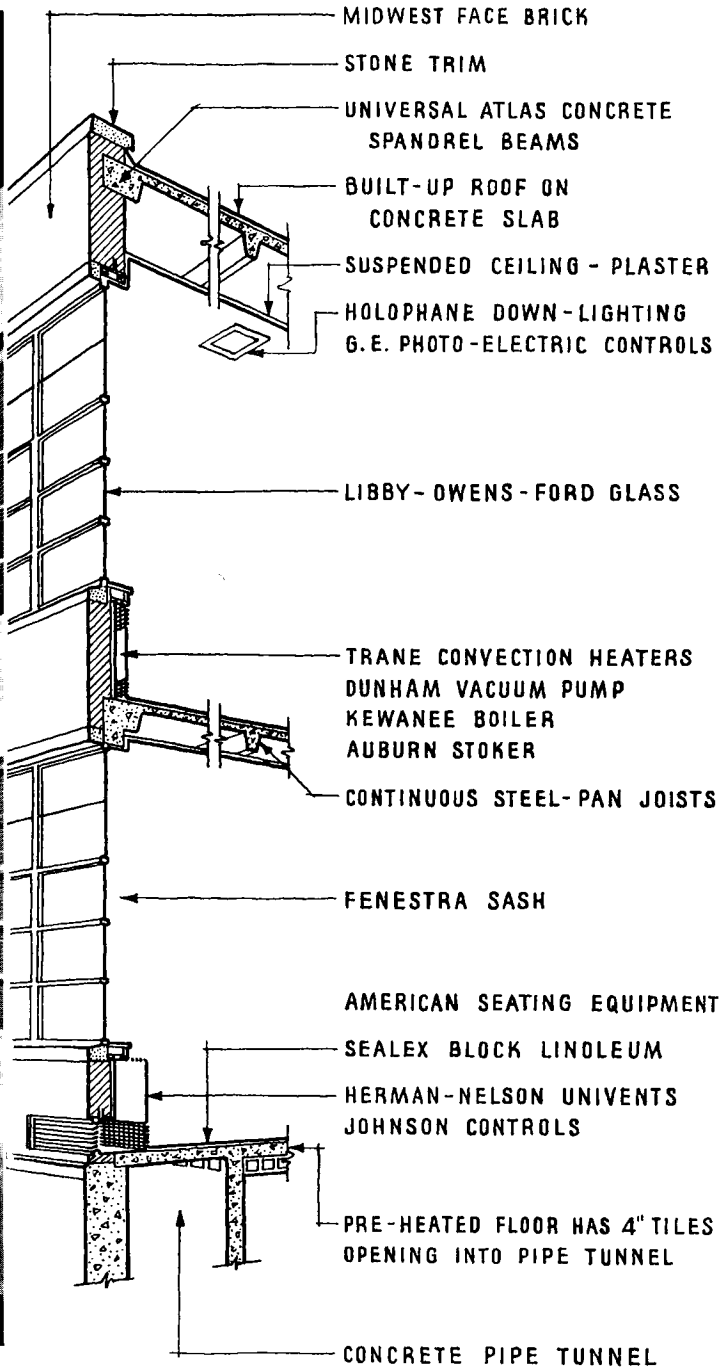

Photos by Hedrich-Blessing

An RCA public-address system runs throughout the building. The photograph at left shows the main control board, located in the principal's office. Each of the main rooms has a microphone and speaker. The principal can talk to any room or group of rooms. Any teacher can communicate directly with the principal or with other rooms. A radio or recorded program may be funneled wherever desired, and it is also possible for a teacher to keep track of what is going on in her room although she may be in a room at the other end of the building.



AUDITORIUM AT AN ANGLE MAKES EFFICIENT USE OF RECTANGULAR SITE

HAROLD SPITZNAGEL, Architect



IN THE DESIGN of the Hollywood Theater at Sioux Falls, S. D., the architect had an interesting combination of owner desires and site limitations. The site faces west on a main business street. To the right is a two-story building. At the rear is a parking lot, and on the left is an alley. Within this framework, the owner hoped to have not only a theater, but three or four stores with main-street frontages. Mr. Spitznagel solved the problem by placing the theater auditorium at a 45° angle (see plans, next page), which reduced foyer and lobby length to a minimum and left the rest of the frontage to divide among four store units, one opening into the theater vestibule.

Working with Mr. Spitznagel on color treatment was Palmer Eide of Sioux Falls. The side walls of the auditorium are of Kalite acoustical plaster, in four shades of tan, with a blue-gray wainscot. Rear wall: maroon Celotex. Ceiling: wine-colored plaster. Floor: blue cement. American Seating: natural birch, gray backs, terra-cotta Fabricoid seat cushions.

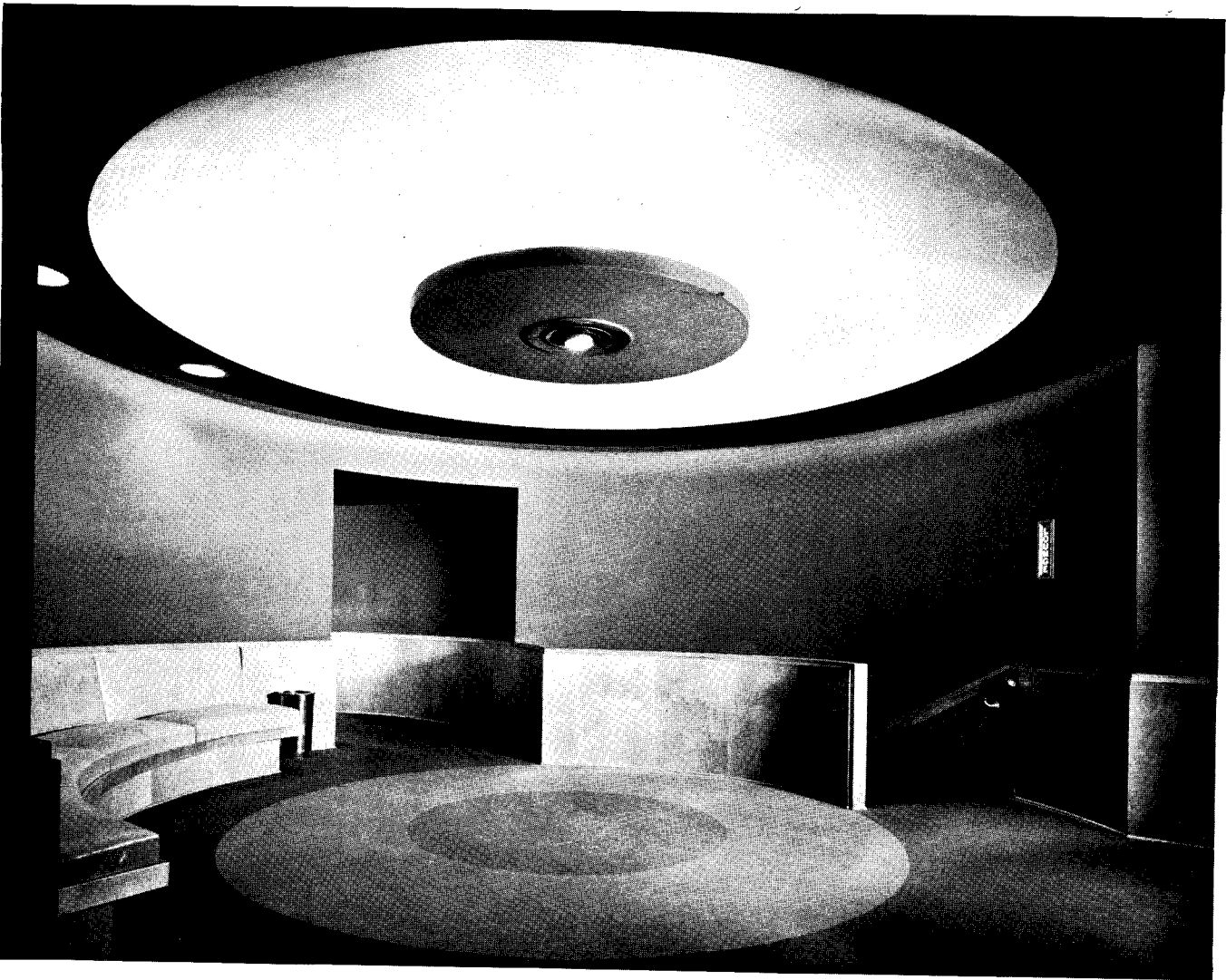

Natural white-birch wainscot. Ceiling, walls: maroon and gray. Pink, gray, and blue carpet. Lemon-yellow leather seat.

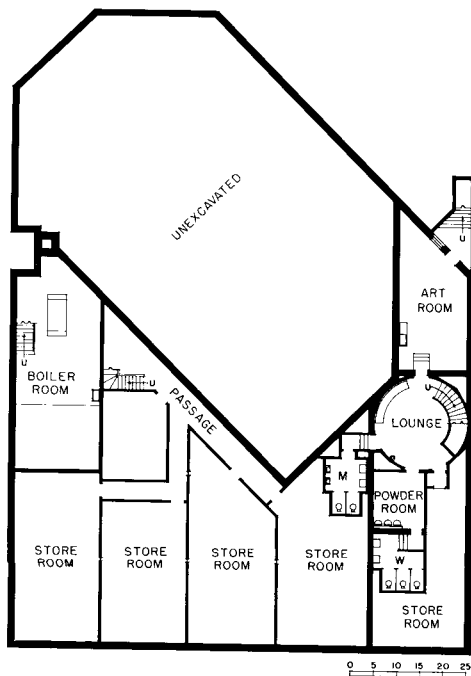

Basement

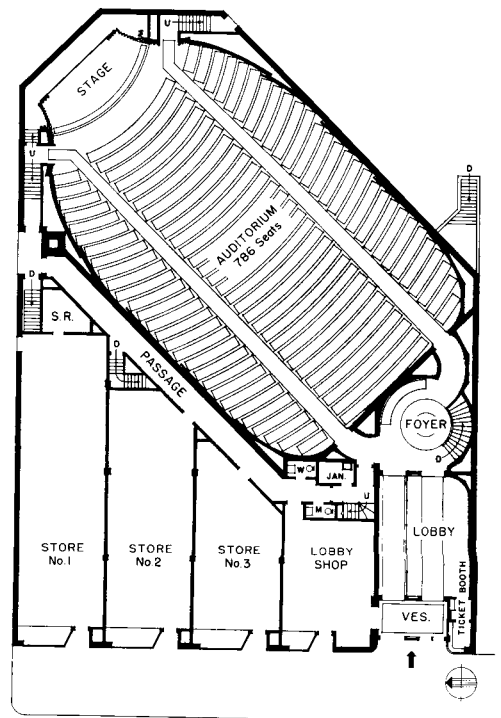

First floor

SIoux FALLS THEATER

"UNLIKE MOST theater owners," says the architect, "my client was willing to accept a design which did not include such familiar trappings as lavish applied ornament, complicated floor patterns, and gilded and tasseled furnishings." Throughout the building he has organized his mechanical services and structural elements in such a way that they serve aesthetic as well as utilitarian purposes. Thus, in the circular foyer, the Anemostat has served as the basis for a vigorous design: again in the auditorium, the vertical light covers become a principal decorative feature.

The theater proper is air-conditioned by Chrysler, using natural gas fuel. All concealed lighting employs fluorescent tubing. The projector is a Simplex, by International Projection, and the sound system is by Western Electric.

The structure is steel framed. Exterior surfacing is buff brick, with Virginia serpentine base and slate coping. Beneath the canopy, the theater front is of blue-gray porcelain.

Insulite is used for insulation, and hardware throughout the building is satin-finished chrome, supplied by Yale and Towne. In the vestibule and lobby, both floors and walls are surfaced in Goodyear rubber.

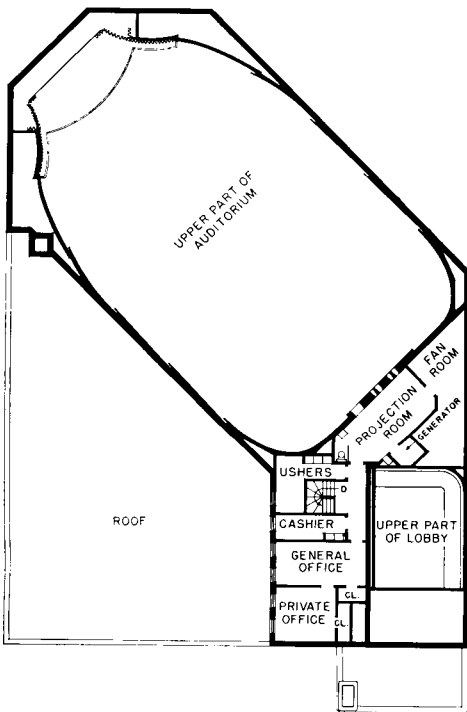

Second floor

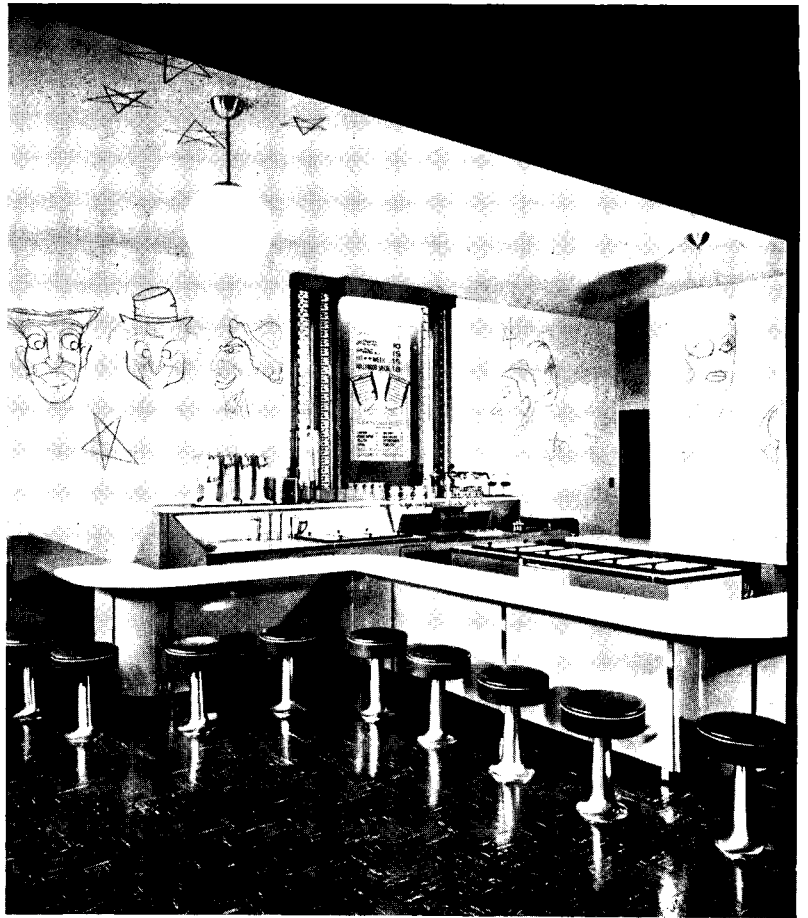

Wall decorations in lobby shop by Marion Utley. Rubber-tile flooring.

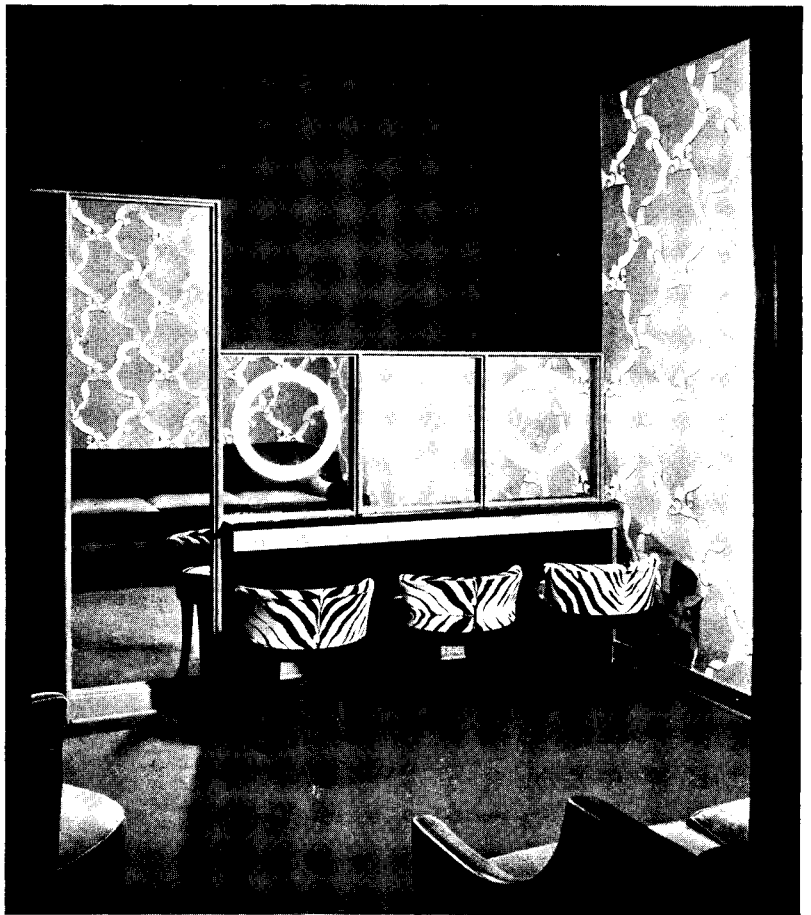

Feature of the powder room is integration of lighting units with mirrors.

ATLANTA, GA.: THREE SHOPS IN ONE STORE FOR MIXED CLIENTELE

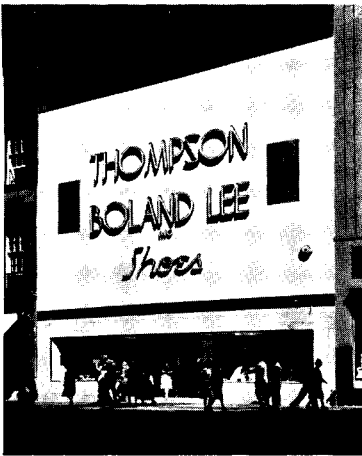

IVEY and CROOK, Architects

JAMES F. EPPENSTEIN, Designer and Consultant

ONE OF THE problems involved in the design of this modern shoe store was to provide a convenient and complete men's department in a store with a clientele consisting principally of women and children. Following a trend that is becoming increasingly familiar in shops where this problem exists (see AR 12/39, p. 35), the architects decided to locate this department in the most favored position—as close to the main entrance as possible. The plan of the entrance unit is a significant part of the scheme, both as a logical device for splitting traffic to the different departments and as a stimulant to sales. The three show windows by Kawneer serve the three departments, and the baffle arrangement serves to "pull" the customer into the store; triple doors of Herculite in effect make the entire ground floor part of the inner window-display system. Stairs leading to the children's department and basement are at right.



Hedrich-Blessing Photos

Woodwork is bleached mahogany with brass trim. Heating and air conditioning by G-E; lighting fixtures, special design by Solar L



Wide-carpeted stairs of gradual rise lead from the main entrance up to the children's store.



Women's section

ATLANTA SHOE STORE

THE THREE PARTS of this southern shop are clearly differentiated and defined without destroying the unity of the design as a whole. To accomplish this, the architects employed subtle changes in color and texture against a unifying background. On the ground floor, for example, the light amber tone of the bleached-mahogany wainscoting and neutral rose tones of the wall above are carried around the entire area and follow the stairs, both up and down. But in the women's section, a more feminine touch is added in the color treatment of upholstery and furnishings. A beige carpet serves as a base for chairs upholstered in rose and beige and sofas in French blue. The draperies match the chairs. In the men's section, the character is changed by leather upholstery for the chairs in a rich forest green that matches the carpet in this area. Again unifying both of the areas, the wood frames of the chairs are the bleached mahogany of the walls.

Upstairs—and separated from visual association with the ground floor—the architects have considered children's tastes. The walls above the bleached-walnut cases are painted a clear orange. The structural columns are brown, and chairs are upholstered in both brown and tangerine. Centering this sales area is a colorful revolving display case.

The structural limitations of a remodeled building are here used to good advantage. Down the center of all floors is a row of structural columns: on the first floor, these serve to divide the men's and women's sections. In the children's room above, the columns are used as central points around which chairs and displays are grouped.

In organization of stock, the shop follows the current trend of high-lighted display of a comparatively few items, with most of the stock stored out of sight. All stock is conveniently located at the various points of sale. Exception to this is the use of long open-display cases between entrance area and the women's section. These serve as an extension of the window-display system for leading women shoppers back to their particular department without interruption of interest.

Supplementing the staircase is an Otis elevator. Other items of materials or equipment: Armor Insulating Co. glass wool; Benjamin Moore paints; Crane water heater; "Standard" plumbing fixtures; Sprinkler system by Georgia Sprinkler Co.; Corbin hardware; Armstrong linoleum and asphalt tile; Art Metal Construction Co. hollow-metal doors; Bigelow-Sanford carpets. The display sign on the front of the building, Claude Neon Southern Corp.

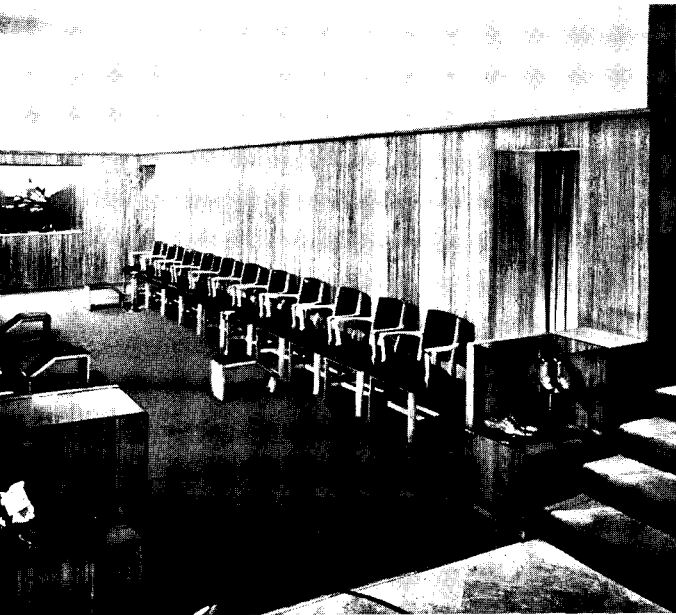

Men's section



Children's section



An unbroken window 247 ft. long results from novel integration of elements.

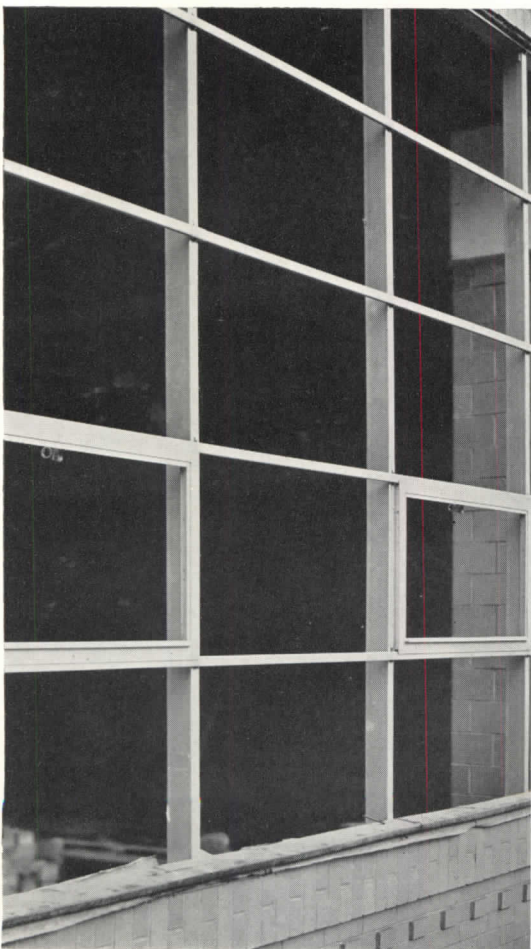

Aluminum and Steel Members in New Window System

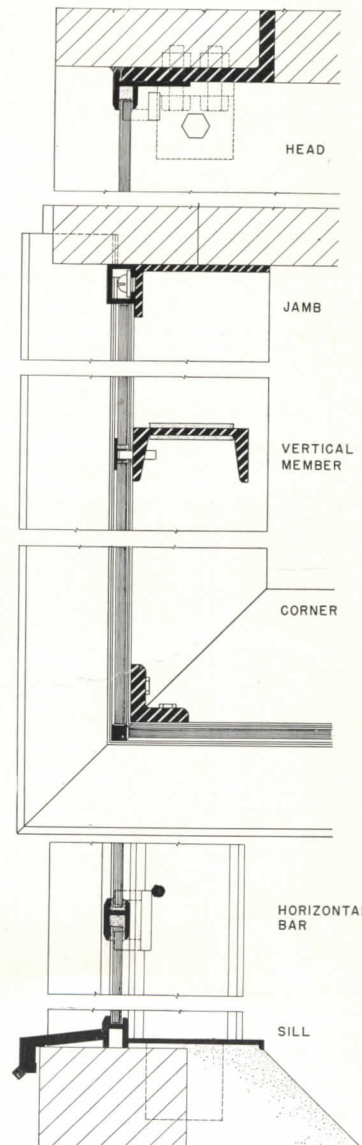
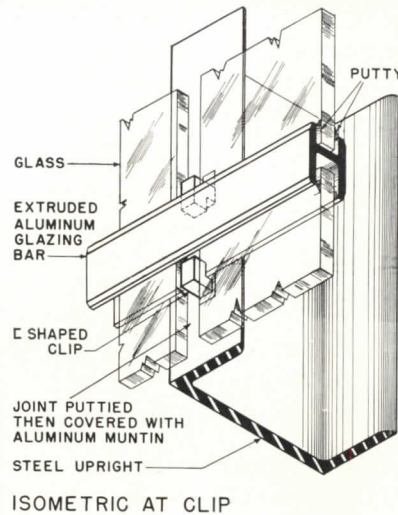

THE NEW FENESTRATION system shown is at the South Vocational High School, Pittsburgh. From the exterior, the finished system looks like an unbroken aluminum-sash window. Actually it is a novel integration of upright steel members, horizontal aluminum glazing bars, putty, glass, and vertical aluminum muntins, assembled in the field in that order. The purpose of the unit is to provide, maintenance-free, substantially complete aluminum windows of any desired length at comparatively low cost.

Upright steel members are spaced 39 in. apart and anchored to both the structural steel at top and the brickwork at bottom. Horizontal H-shaped aluminum-channel glazing bars, 16 to 20 ft. in length, are then attached to the steel work by means of C-shaped clips, as seen in the cutaway isometric drawing. Expansion and contraction are taken care of by $\frac{3}{8}$ -in. gaps between the lengths, covered by inconspicuous aluminum caps.

Both channels of the horizontal bars are bedded with putty and the glass is installed, with joints occurring at the vertical steel members. These glass joints, also bedded in putty, are closed by vertical muntins.

After the glass is set, excess putty is struck off on a line with the legs of the H, resulting in a neat joint, usually accomplished by application of glazing moulds. No screws or bolt heads are visible from the exterior of the building.

Ventilator panels, glazed with clear glass, are inserted at regular intervals in place of the fixed glass. The rest of the system is fitted with frosted glass, both to diffuse the light and prevent direct sunlight from falling on desks.

Among the economies claimed for the system are simple field assembly of pre-cut metal shapes and ease of maintenance (aluminum does not need painting). Furthermore, window washing is also comparatively simple, as the aluminum bars project but $\frac{1}{8}$ in.

Patents on this type of window construction have been applied for by E. K. Geysler, Pittsburgh window contractor, who not only designed the extruded shape, but also developed the simplified method of field assembly. The special parts were manufactured by Aluminum Company of America.

Photos by Johnston & Johnston, Inc.

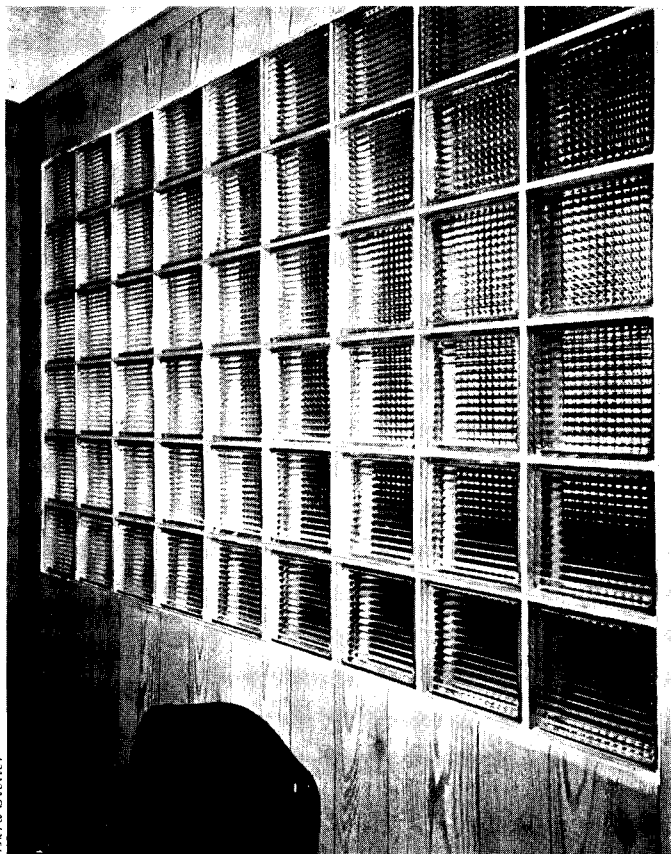

Ezana Stoller

Partitions using Revere's recently developed metal members with Insulux blocks (above) and P-C (below).

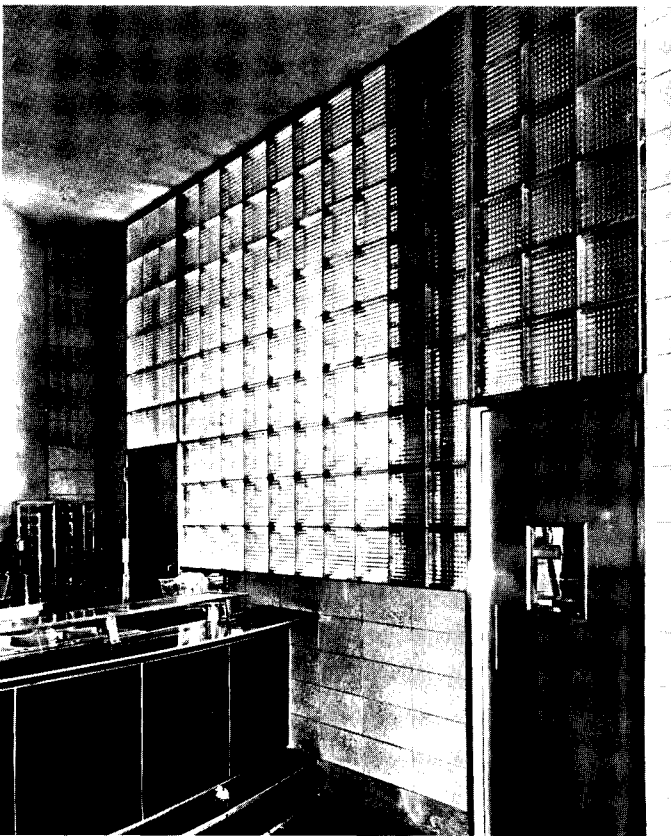

Underwood & Underwood

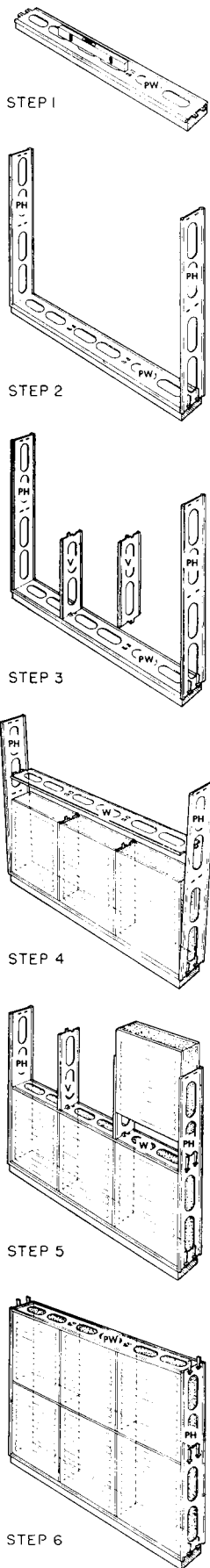

Prefabricated metal shapes for new glass-block partition

WHAT IS ESSENTIALLY a new interior partitioning system is made possible by the series of prefabricated metal members just announced by Revere Copper and Brass, Inc. Designed in collaboration with Owens-Illinois and Pittsburgh-Corning for use with either company's block, the metal members make possible rapid, accurate, and "dry" erection of glass-block partitions; design of the metal shapes is such as to meet all typical conditions — i.e., wiring, windows, doors, rounded corners, etc.; and — most important from a maintenance point-of-view — 100% salvageability of both metal and glass units makes possible easy dismantling and re-erection.

Two basic shapes are used: the *Standard*, used in setting the individual blocks to form the wall or panel, and the *Perimeter*, which encloses the entire assembly. Each of these shapes is fabricated in three different ways to provide various means of interlocking.

Erection is at once simple and accurate (see diagrams at left). Every course of blocks is held in uniform alignment. Supplementary members are provided for doors, windows, and cased openings. Metal members do not form a load-bearing panel, but give structural strength to the assembly. Loads on continuous horizontal members are uniformly distributed through vertical members. Construction is sufficiently flexible to allow for expansion and contraction.

Members are fabricated for two standard sizes of glass blocks: 12 by 12 in. and 8 by 8 in. (Unless demand is great enough, no shapes for 6-in. blocks will be developed.) All stock shapes are prefabricated for panel widths and heights up to 12 ft. Metal shapes for wider panels will be fabricated on order, but widths beyond 20 ft. and heights above 12 ft. are not recommended.

Shapes are available in architectural bronze and aluminum alloy; these can be used singly or in combination.

Because of the difference in glass-block profiles, Revere makes two series of metal shapes. One is adapted for erecting Owens-Illinois Insulux Glass Blocks and the other for Pittsburgh Corning's P-C Glass Blocks. These two companies will act as sole distributors of the extruded metal shapes.

NEW EQUIPMENTS



"Heat trap" in the roof of M.I.T.'s new experiment in conversion of solar energy. Note (upper left) the pyrheliometer, an instrument for recording sunlight intensities.

M.I.T. Investigates Domestic Use of Solar Heat

IN THIS small, houselike experimental laboratory, Massachusetts Institute of Technology engineers have begun investigations into the possibilities of using solar radiation as a heat source for winter house heating, summer air conditioning, and power generation. The research is being conducted by a committee under the chairmanship of Associate Professor Hoyt C. Hottel of the Department of Chemical Engineering.

The house is designed to trap the sun's heat falling on the roof and store it in the basement for future use. In this first phase of the Institute's studies, the type of heat trap used consists of a shallow boxlike heat-collecting device, inset into the roof proper. The bottom of the box is a thin sheet of metal, painted black to absorb the utmost amount of solar energy. Firmly fixed to the underside of the sheet is a series of small, thin-walled metal tubes which are heated by contact with the sheet and which in turn heat water circulated through them.

The top of the box—the roof surface—consists of several covers of glass, interspaced with dead air regions, through which nearly all the sunlight can pass, but back through which little heat can escape. The sunlight is con-

verted to heat when it strikes the metal sheet. As an additional heat conserver, a layer of mineral wool occurs beneath the "box."

After water is heated in the collector, it passes through completely insulated pipes to a large storage tank in the basement. This tank is so insulated that it loses very little heat over long periods of time. It may even be possible to save this heat for as long as half a year, depending on the size of the tank. To utilize this stored heat for heating purposes, a system of forced air circulation is employed in which the air passes through ducts, one wall of which is the hot side of the tank.

Different types of paint, different thicknesses of glass, and different roof angles will all be studied. Possibilities of using solar heat for power generation or in a refrigeration system operating on an absorption principle, utilizing sunlight as the heat source, will be investigated as well. In addition, experiments will be carried on in regard to using a sunlight collector large enough to heat the house directly, with only a small storage tank for emergency use during cloudy weather, or its reverse—a small collector with a tank large enough to store an entire winter's supply of heat.

New compressor cools self with own refrigerant

A 16-CYLINDER V-type unit requiring only 1/3 the space and weighing only 2/3 as much as conventional compressors of same capacity has been developed by Westinghouse Electric & Mfg. Co. Among new features are: (1) refrigerant cooling for the motor, (2) sealed-in lubrication, (3) a reversible oil pump.

Impressive reduction of size and weight is largely due to ingenious use of refrigerant itself to cool motor—Freon gas at 50° F. is sucked at low pressure across motor windings for cooling. Hermetic sealing of all moving parts and pressure lubrication reduce friction and obviate the shaft-seal necessary with external motors. Direct connection of motor and compressor eliminates belt and permits single foundation with units always aligned.

Projection unit heater combined with Anemostat

RECENTLY ANNOUNCED by the Trane Company is the combination of their projection unit heater with the Anemostat Air Distributor (see AR 6/37, p. 40). Marking the first time that the Anemostat has been used with any but a duct system, the new product (see below) is designed for accurate control of air temperature and distribution for specific areas. It is available in 7 sizes with heater diameters of from 2 to 4 ft., in combination with anemostats of diameters from 15 to 38 in. Units are made for either steam or hot water, combined with 3- or 4-cone anemostats for mounting heights respectively above or below 12 ft.

The projection unit heater consists of a 2-row extended surface coil permitting unhampered expansion and contraction by virtue of its circular form.

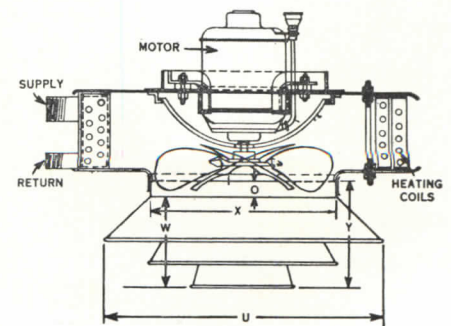

NEW HOUSES AND NEW HOUSE UNITS



HOUSES OREGON, FLORIDA, WASHINGTON, MASSACHUSETTS



Photos by Roger Sturtevant

HOUSE ON A STEEP HILLSIDE IN OREGON

Architect ROI L. MORIN had a challenging site problem—a slope toward the east of from 30 to 45 degrees with a widespread view of the environs of Portland. The Dr. William A. Shea family consisted of three. Room for one servant was needed. The owners desired a "somewhat modern" house. Mr. Morin's split-level plan solves the site problem ingeniously, and the spirited character of the house derives from a blend of elements both modern and old.

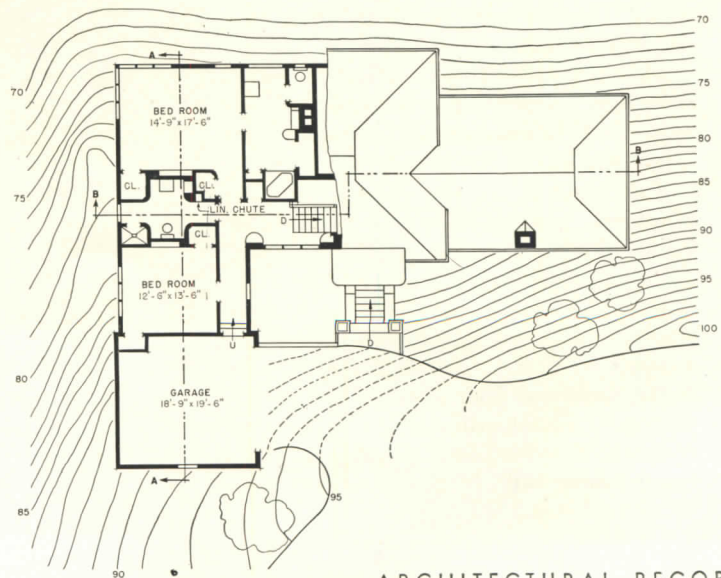
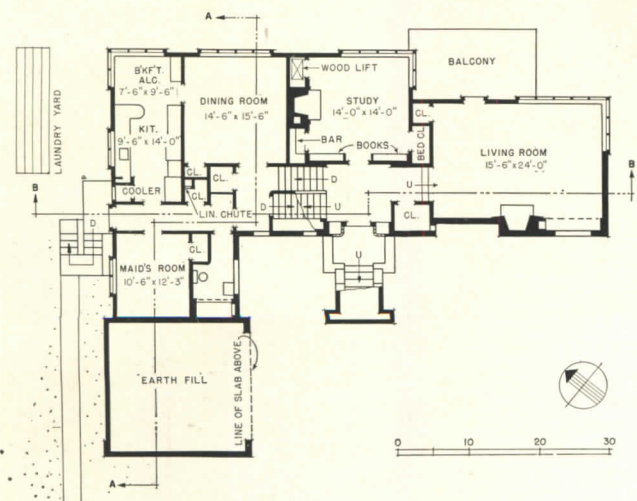

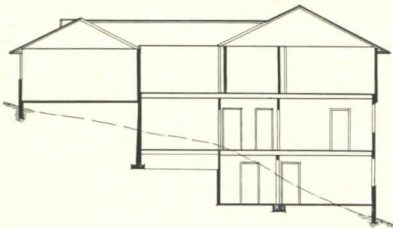

Section A-A

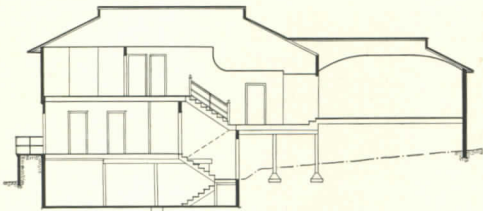

Section B-B

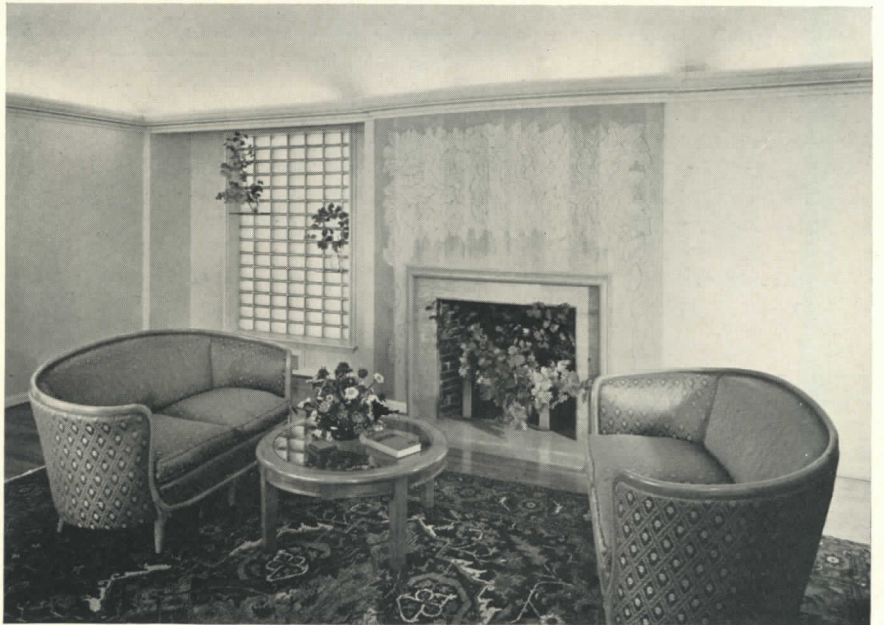

THE HOUSE is replete with convenient built-in features. In the study, one closet contains a wood lift rising from the basement. Another closet contains a small bar. A third is a bed closet, making the room a possible guest room. Particularly noteworthy is the cruciform bathroom on the top level, with the re-entrant angles serving useful purposes in four different areas.

Of special interest in the living room (top) is the cove lighting unit, in which G-E fluorescent tubes in "daylight" and "white" colors are used. At the left of the fireplace is an Insulux glass-block window panel. The mantel breast is of carved pine, in natural finish.

In the gray and red kitchen-dining alcove unit (center), a noteworthy relation exists both in plan and in the unified window treatment of the two parts.

The window in the master bedroom (bottom) opens up the whole corner of the room to the far-flung view. Colors: dusty pink walls and white trim.

Exterior: stucco, drop siding, Roman-type brick veneer, red cedar shingles. Insulation: U. S. G. Red Top Glass Wool in walls; Redwood fiber bark in second-floor ceiling. Chamberlin Weatherstripping. Heating: Fox Sunbeam furnace with Hart low-pressure oil burner. Minneapolis-Honeywell controls.

HOUSE ON A 60-FT. LOT IN FLORIDA

WAHL SNYDER and WILLARD LOWRY, Architects, planned this one-story Miami Beach house for sale purposes. In the architects' own words: "Our aim was to build a quality house, convenient, appealing to the eye, with the livability and equipment of an expensive home, yet at a nominal cost." How successful the venture was is shown in the accompanying photographs, in the fact that the cost of construction was \$7,200, and that the house was sold to Mr. and Mrs. Jacob Slaff shortly after it was furnished.



Photos by Ernest Graham

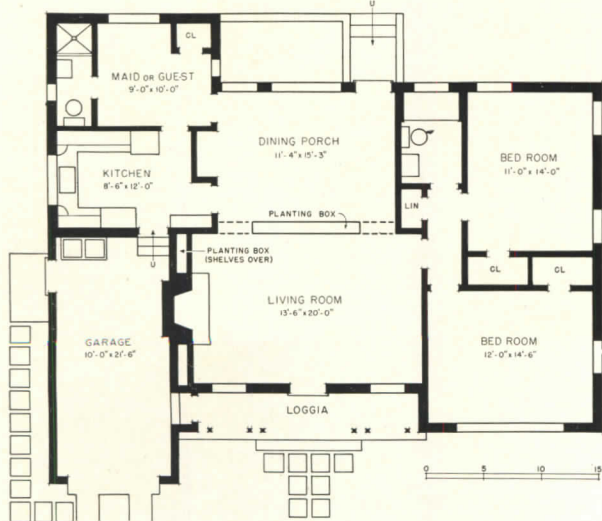

A VARIATION on a typical Florida theme, this small house has a number of fresh and noteworthy details. The living room and dining porch are essentially a single unit; yet a novel low dividing wall, topped by a planting box, defines each of the areas. Planting boxes are also incorporated either side of the fireplace, below built-in shelves. Behind extensions of the mantel breast, lumiline strips are concealed, which produce a dramatic, non-glare light source. Roof: white, Brady interlocking cement shingle tile. Walls: light coral stucco on concrete block, Old Cuban brick, white trim; aquamarine door trim. Sash: Fenestra steel casements. Floors: oak (kitchen: Armstrong linoleum. Dining porch: terrazzo). Doors: Wheeler Osgood Laminex Streamliner. Hardware: Schlage. Glass and Mirrors: Pittsburgh Plate Glass Company.

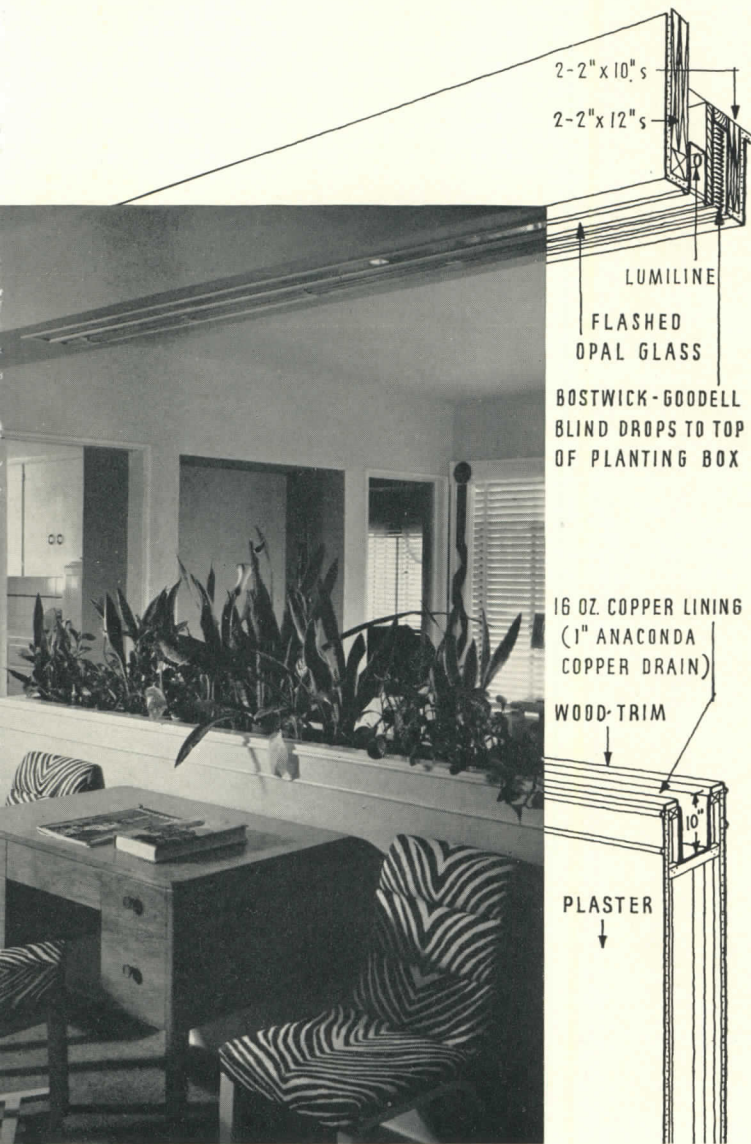

Between living room and dining porch is this flexible dividing wall. With blind dropped, the areas are effectively separated.

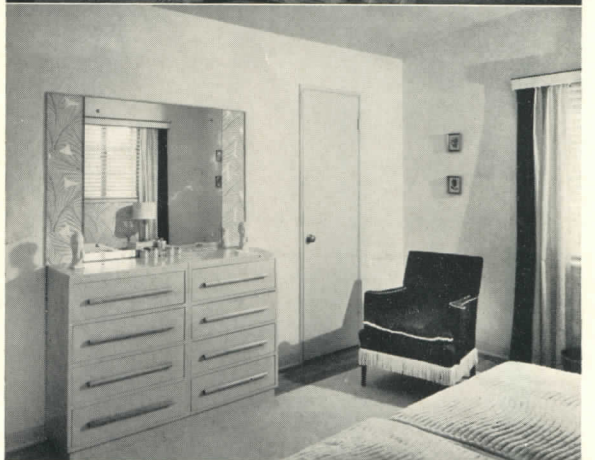

Top: living-room fireplace. Note built-in shelves and plant boxes.

Center: two sides of front bedroom. Bone-white walls, salmon ceiling.

Bottom: rear bedroom. Light aqua-marine walls, lemon-yellow ceiling.



HOUSE ON A HIGH LAWN IN WASHINGTON

This Northwestern version of Colonial, designed by EDWIN J. IVEY, Architect, ELIZABETH AYER, Associate, is the Seattle home of Mr. and Mrs. W. W. Chambers and their five-year-old son. The exterior coloring emphasizes the fresh handling of a traditional form. Walls: deep Colonial yellow. Pilasters and trim: white. Roof and shutters: very deep moss green. The house, garage, and retaining wall (but not the fence) came within a \$10,000 budget.

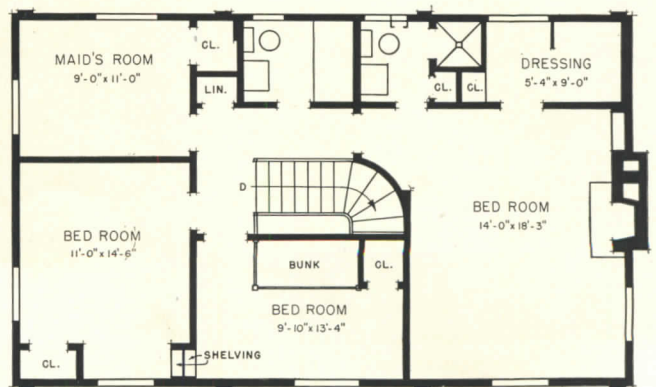
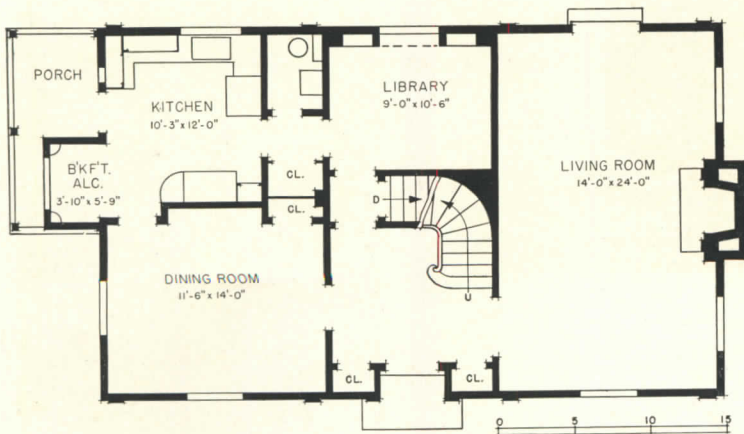

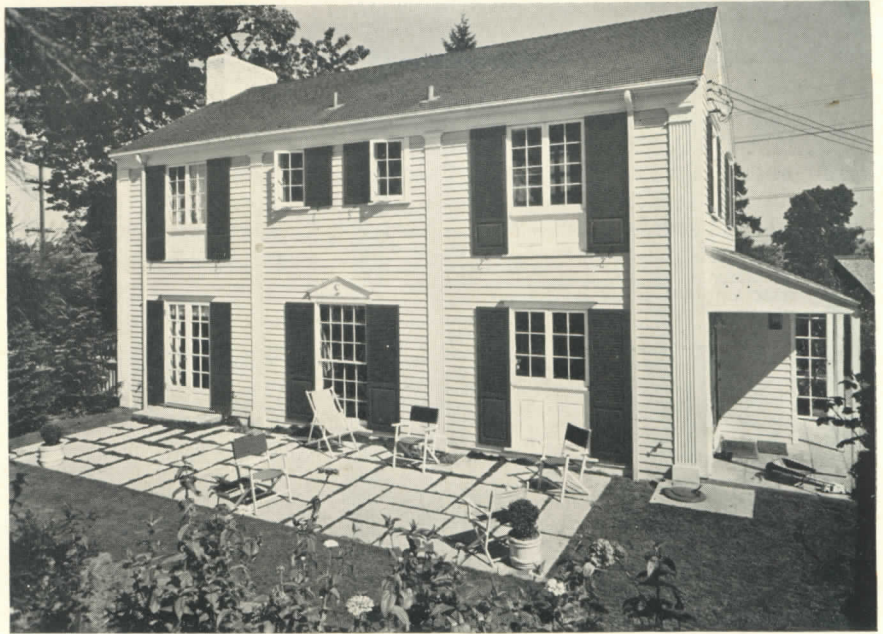

Both roof shingles and cedar siding are laid $4\frac{1}{2}$ in. to the weather. Chamberlin weatherstripping, Benj. Moore paints, Sargent hardware.



Double doors lead out to the garden terrace. The plaster walls are coral; the trim, eggshell coral. The rug is cedar-toned. Marble is used for the facing of the fireplace.



In the owners' bedroom, wallpaper and paneling are pleasingly combined. Both the face and hearth of the fireplace are tile. The home has conditioned-air heat, serviced by a Harrison Sales furnace.

HOUSE

ON AN OCEAN BLUFF IN MASSACHUSETTS

ROYAL BARRY WILLS, Architect, and Collaborating Architects HUGH STUBBINS and MARC PETER designed this dramatic modern house at Marblehead Neck for Mr. and Mrs. Howard A. Colby and their two young children. The modern form was largely determined by the site's advantages and limitations described on the facing page. The nautical flavor of the detail derives from the owners' love of the sea.

Photos by Haskell

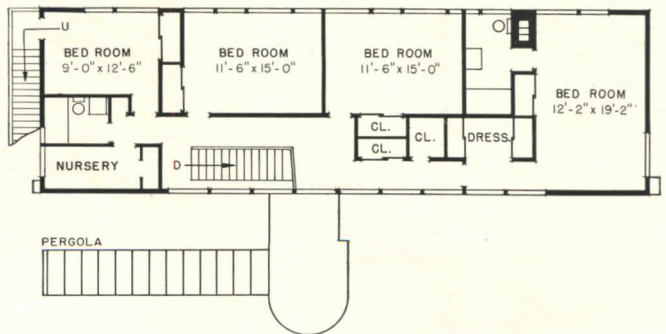
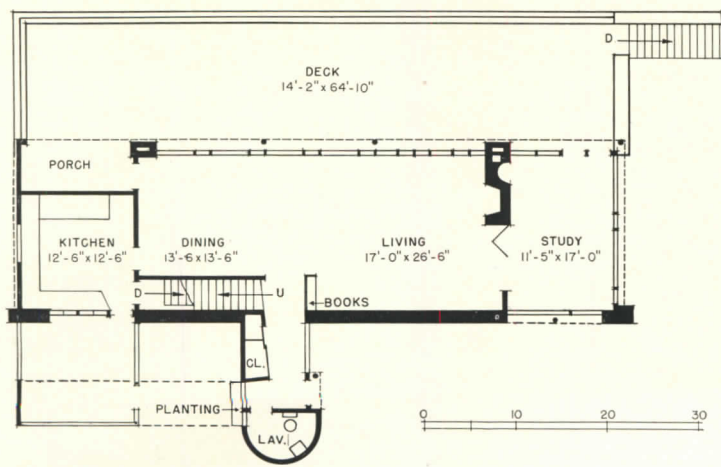

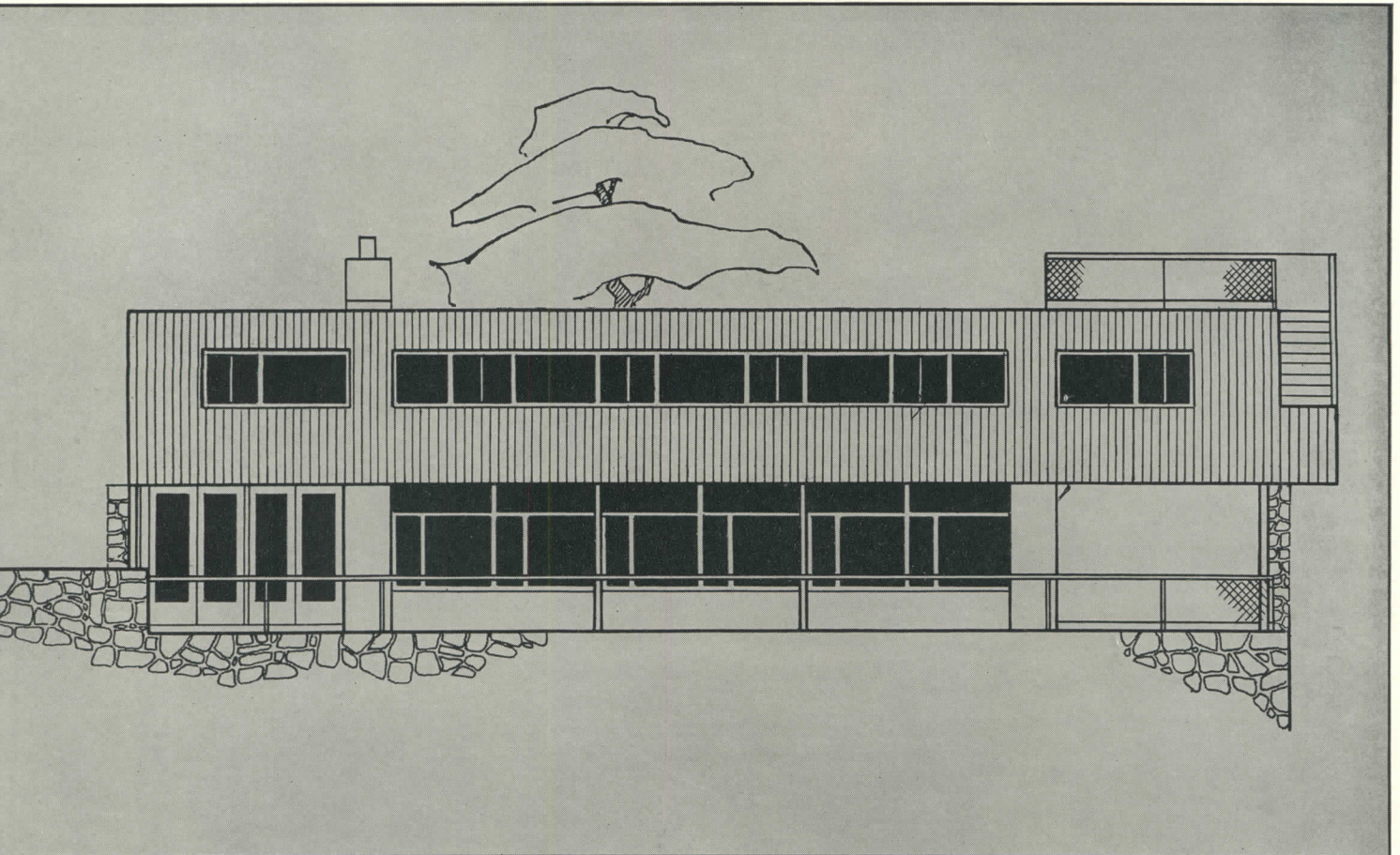
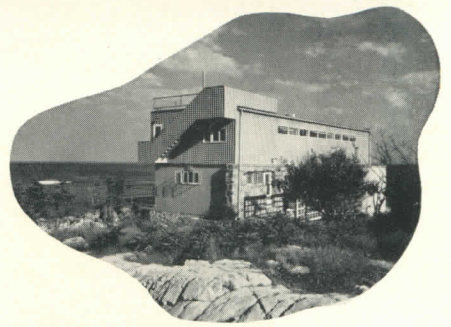

THE SITE is a rocky point of land with an unrestricted view over the Atlantic and Marblehead's famous yacht-racing waters. The road at the rear, however, is comparatively close and heavily traveled—particularly on summer weekends. Moreover, an angle in the road occurs at about this point, and the noise of traffic rounding the turn is quite objectionable. Hence the architects' basic scheme—a shield against both view and noise on the highway side; as much openness as possible on the ocean side. The architectural result: practically a solid wall facing the highway; in effect, a wall of glass toward the ocean.

The use of a flat roof was determined by the owner's desire for a vantage point from which he could view the yacht races. From this elevated deck, water is visible on every side. The deck is reached by an outside stairway leading from one of the bedrooms. To bring this area into closer contact with the rest of the house, Mr. Colby has had installed an intercommunicating telephone system which goes from the deck to the front door and to several points within the house.

In plan, the house has many unusual features. By design-

ing the entrance unit with its lavatory as a projection from the main body of the house, family and service entrances and approaches are effectively separated. The angle of the wall of the entrance-hall closet and bottom step of the stairs is a device for preparing a person visually for entering the very large living-dining area. A minimum of interior partitions permits the greatest informality of living. Upstairs, the series of bedrooms is a straightforward solution to site conditions.

The house is built on a ledge, with stone foundations and a frame of wood. Exposed columns are of steel, and the ship-like railings are fashioned from 1½-in. pipe and Anchor wire mesh. Exterior walls are of native stone and vertical boarding—flush on the first floor, boards and battens on the second. The roof is built up of tar and gravel, and the white-painted sash are Hope steel casements. The wood exterior walls are painted gray.

On the interior, the house is finished throughout with pine. Ceilings are covered with Johns-Manville insulating panels. For lighting fixtures, the owner had the architects use various types of ships' lights.

HOUSE ON AN OCEAN BLUFF

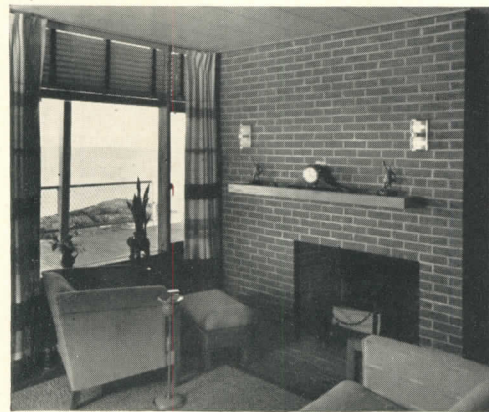
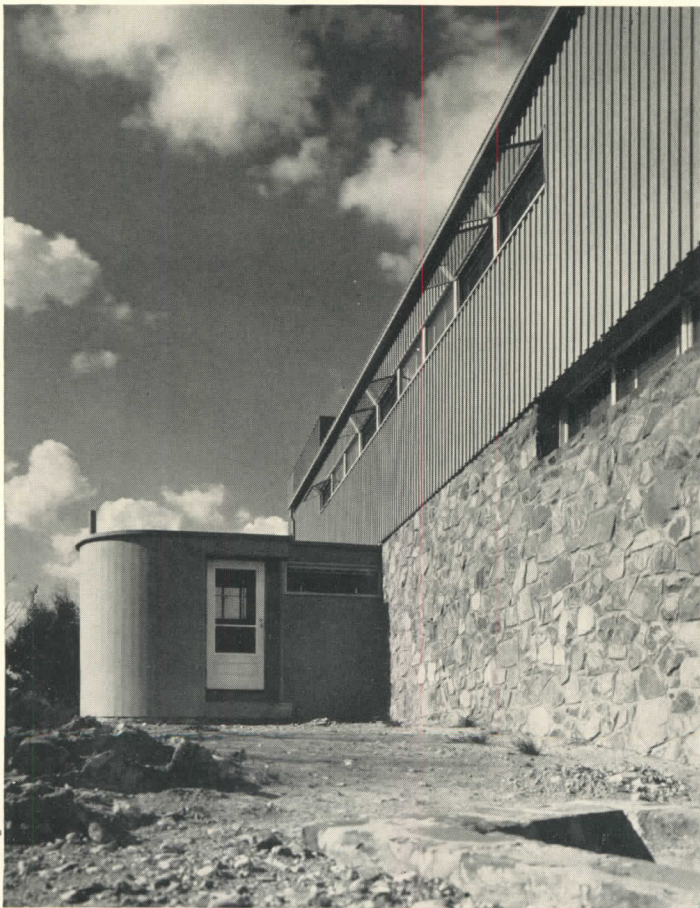

Above: window beside living-room fireplace.

At left, above: the cantilevered stair leading from the bedroom up to the roof deck.

Below: the flush-boarded entrance unit. Insulation: U. S. G. Red Top Wool. Plumbing fixtures, furnace, and oil burner: American Radiator and Standard Sanitary Corp.

Photos by Haskell

NEW HOUSES AND NEW HOUSE UNITS

Kraetsch and Kraetsch, Architects

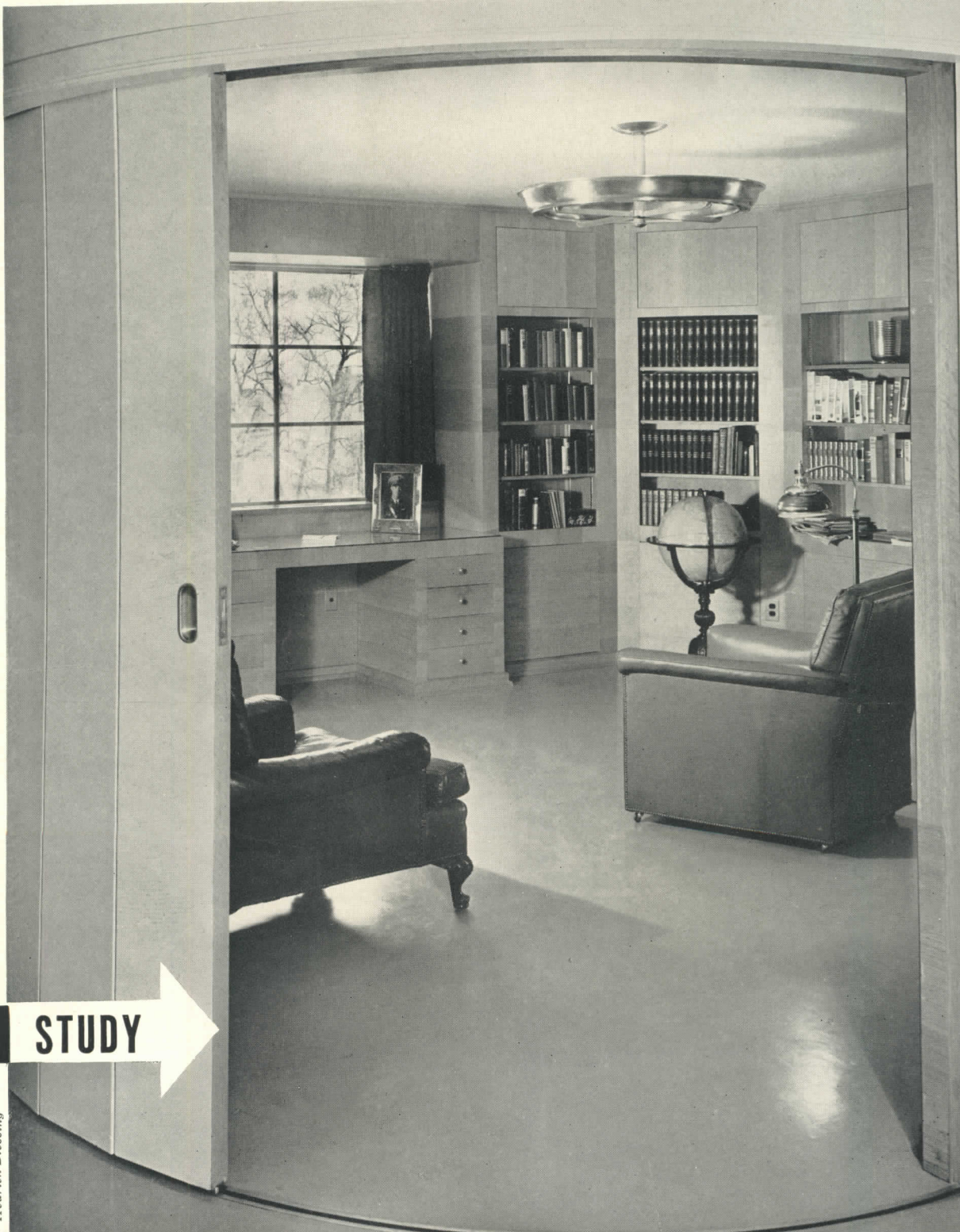

UNITS **STUDY** 

Hedrich-Blessing

UNITS STUDY

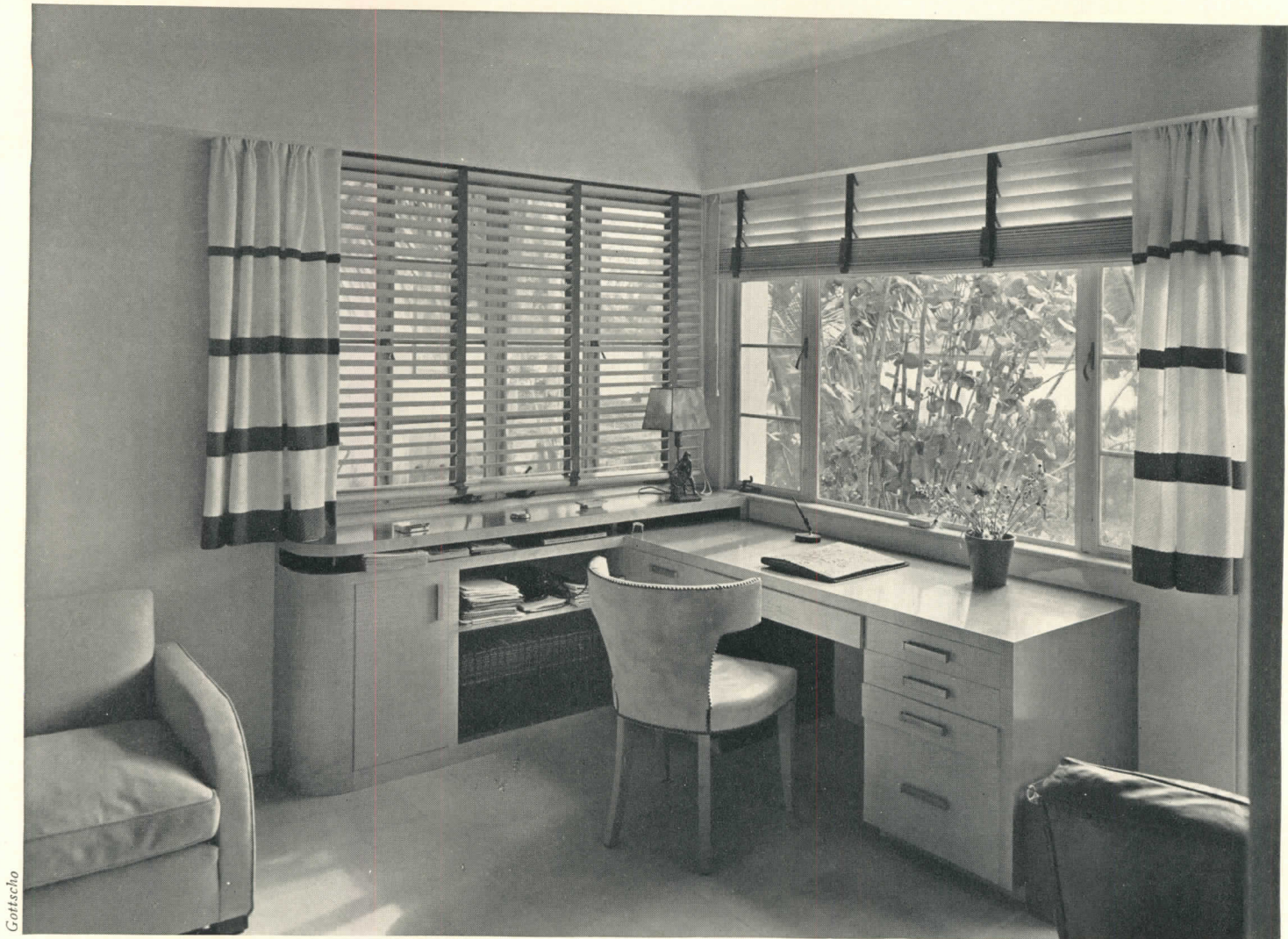

Gottschalo

2. WEED and REEDER Architects

DESIGNED to fit under a corner window, this study unit consists of a desk, shelves, and a storage cabinet with adjustable shelf. Materials necessary to study are easily accessible; the desk top provides ample work space; and the cabinet top allows for overflow. All exposed woodwork is natural-color harewood; the cabinet top, knee-hole, and side of desk are lacquered in dull blue. Dull-chrome tubing supports the cabinet top. Walls of the room are gray-beige; ceiling is yellow. The draperies are white worsted with bands of dull blue edged with red cord.

Materials and equipment

Fabric: Stroheim and Romann. Desk: specially designed; executed by Zermann-Acme Woodworking Corp.

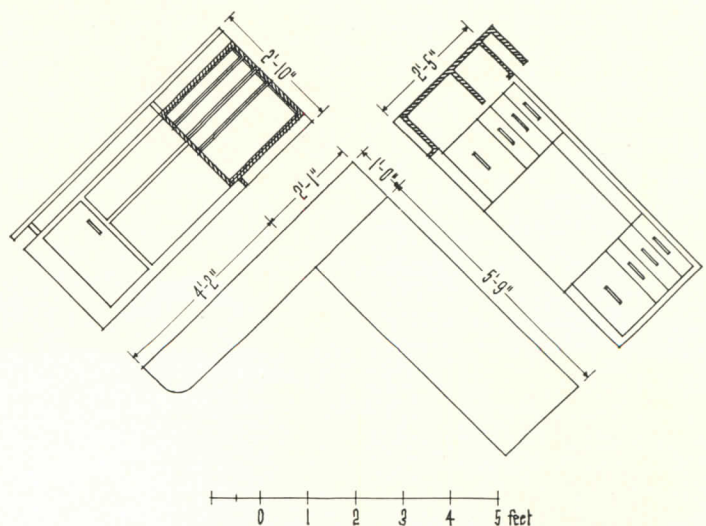



Roger Sturtevant

3. PAUL THIRY and ALBAN A. SHAY Architects

ALTHOUGH THIS STUDY unit is an integral part of the bedroom, its particular function is recognized and subtly differentiated from the rest of the room. The work space consists of a table with shelves of various heights and widths within easy reach; adjacent are cupboards and more shelves. The ceiling is of white plaster; walls are beige plaster except over shelves where natural-color wallboard is used. The trim boards are of vertical-grained fir, stained moss green and rubbed; the interiors are painted wine. Floors are of dark green with a deep-wine carpet.

Materials and equipment
Walls: plaster, U. S. Gypsum Co.; wall board, Litecol, Masonite Corp. Floors: Pabco Mastipave, The Paraffine Companies, Inc. Sash: steel, Fentron Steel Works. Glass brick: Owens-Illinois Glass Co.

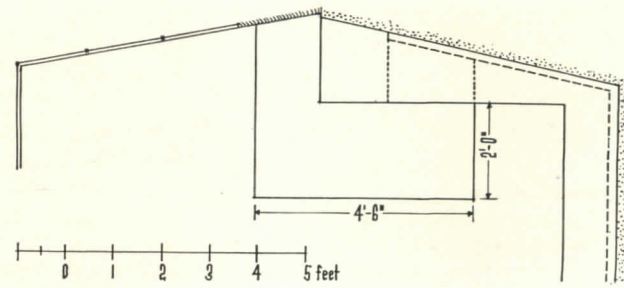
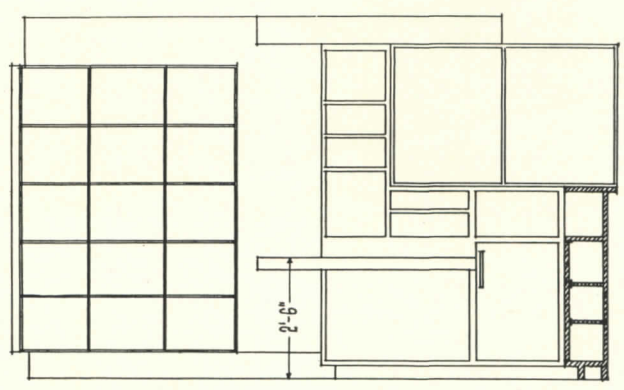

UNITS STUDY



Ernest Ludwigh

4. J. R. DAVIDSON

Designer

DESIGNED FOR A PANTRY, this study unit uses a minimum of space. Its attached seat swings out for use, or fits under the desk when not required. Provision is made for storage of cookbooks, account books, writing materials, etc., on shelves and in cabinets. The desk is of wood, painted white. A concealed light over the shelf illuminates the work space. A special signal system connects the pantry with other parts of the house.

Materials and equipment

Lighting: Hollywood Lighting Fixture Co. Paint: Fuller and Co.

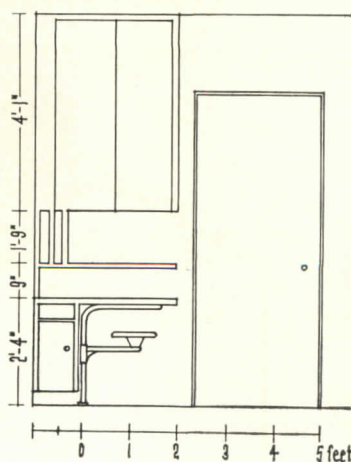

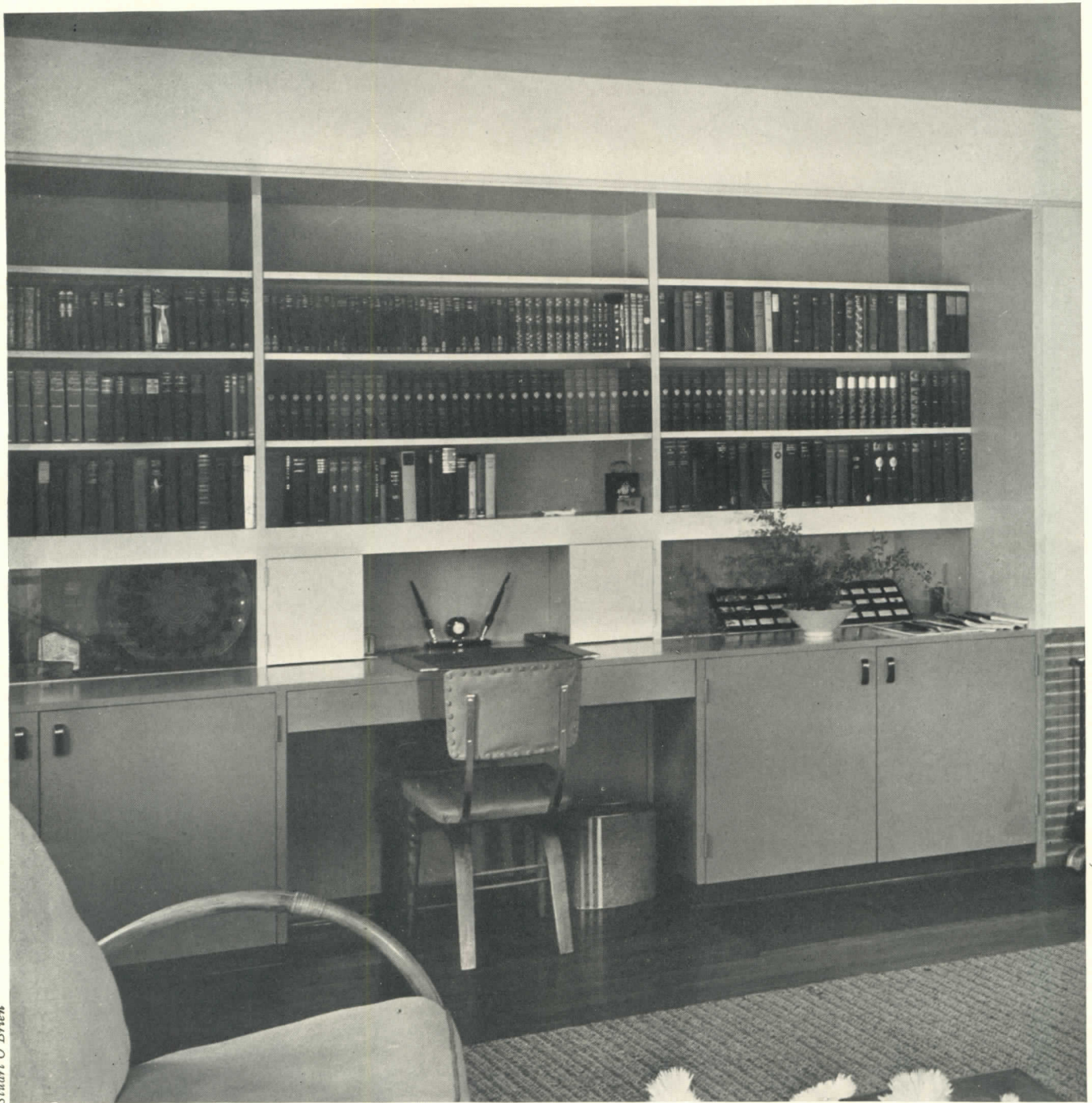

Stuart O'Brien

5. ERLE WEBSTER and ADRIAN WILSON

Architects

PART OF A living room, this study unit is decorative as well as useful. At either side of the desk are large cabinets; above these and behind the open counter are display cases with sliding plate-glass doors. The entire unit is of Douglas fir, enameled parchment color above the desk, and terra cotta below; backs of book cases are light blue-green.

Materials and equipment

Walls and ceiling: plaster, La Habra Interior Stucco Co. Paint: Columbia Varnish Co. Chair: upholstery, tan Fabrikoid, Masland Corp. Lighting: desk, Lumiline, Luminaire Co.

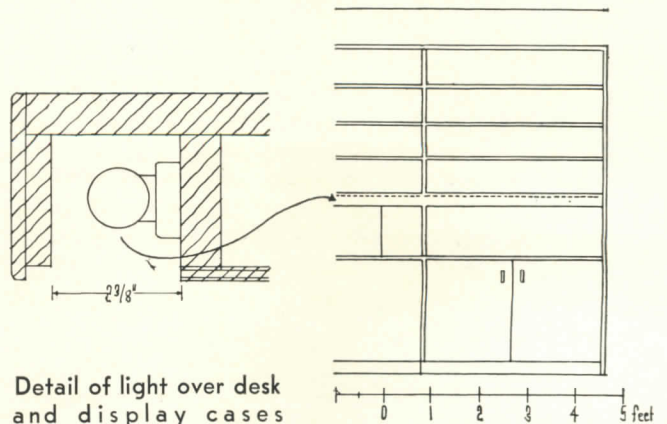

UNITS STUDY



6. F. MARSTON JAMES

Designer

THIS STUDY UNIT is designed with two levels to provide proper height for writing and for typing. In addition to open work space, the unit has a central drawer and a cabinet for file storage; behind the cabinet door is a regulation-size file drawer. Desk top is of maple-veneer plywood, varnished. Legs are of iron pipe, lacquered blue-green.

Materials and equipment

Desk: Weldbord, U. S. Plywood Corp. Paint: Pratt and Lambert, Inc. Chair: Alvar Aalto. Lamp: designed by Paul Henningsen, manufactured by Louis Poulsen.

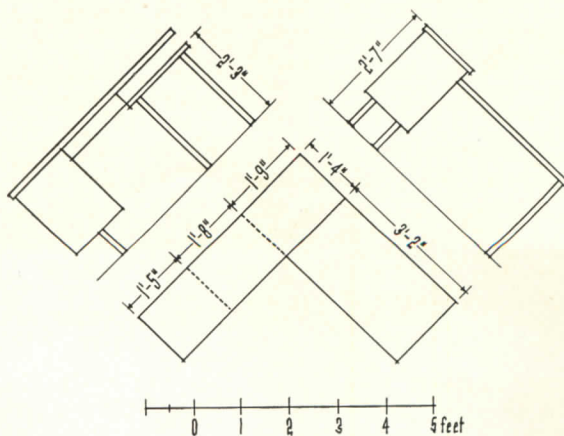

DESIGN TRENDS

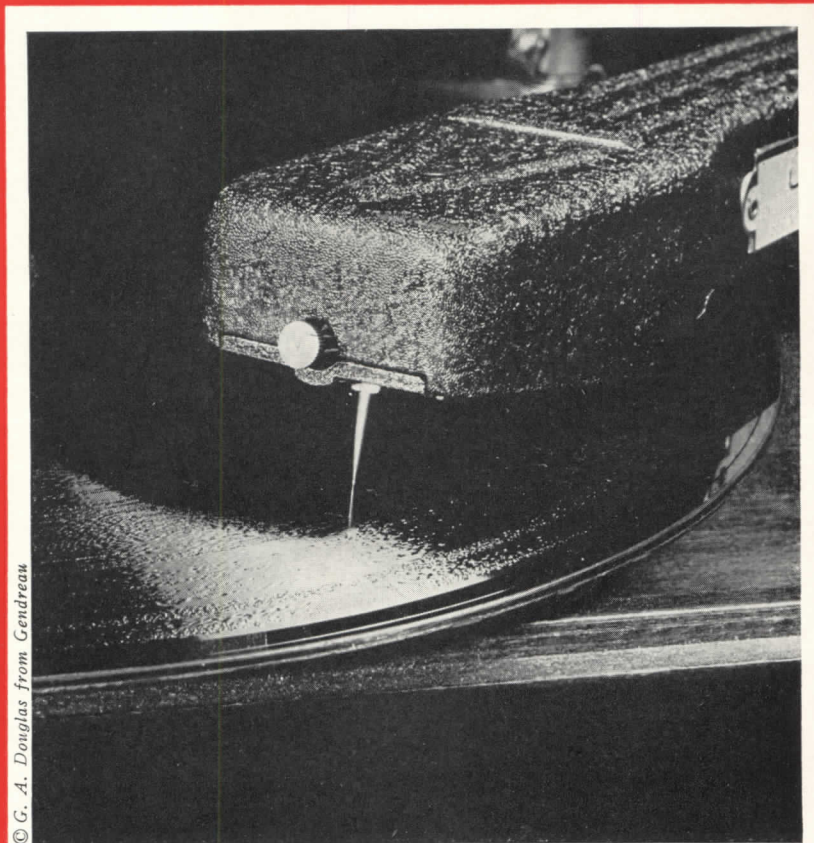

© G. A. Douglas from Gendreau

New problems of sound control are raised by the increased precision demanded by broadcasting and sound recording. . . . See pp. 66-73.

ARCHITECTURAL
RECORD



RCA. phonograph-recording studio: the reverberation period is controlled by operable louvers with sound-absorbent materials behind them; by opening or closing the louvers it becomes possible to vary reverberation to suit any type of recording.

Courtesy "Architectural Review"

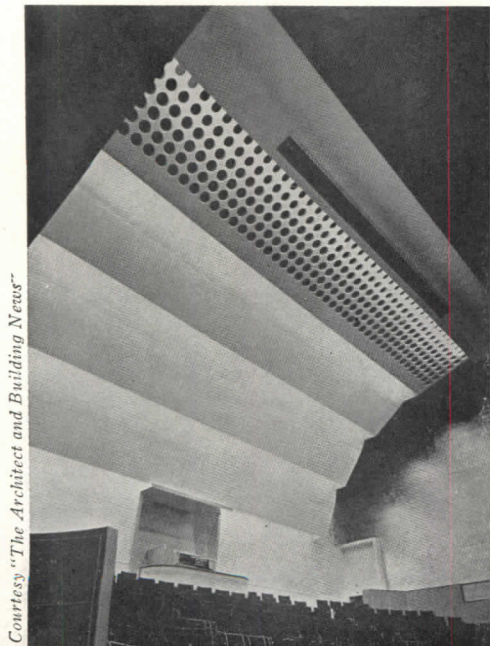

Directional control of sound reflection by use of an acoustical hood composed of inclined planes of different materials.

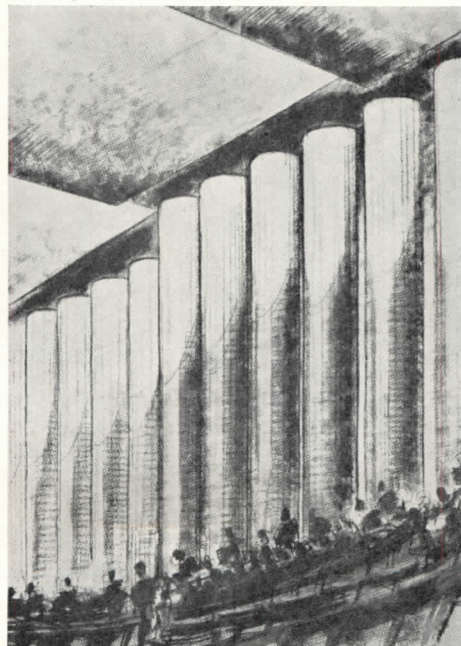

Control of absorptivity: scheme in which wall cylinders are rotated to expose parts that give a desired reverberation.



Control of spectrum: absorption varies with frequency; researchers seek materials of relatively uniform absorption curves.

CONTROL OF SOUND IN BUILDINGS

Increased precision of sound control is characteristic of an advanced technology: this is true of sounds which are an essential material of productive activity (broadcasting, sound recording, teaching, etc.) and those which are a by-product of it (noise). In buildings this involves increasingly an integration of sound with other systems of control—lighting, sanitation, structure, etc.; to achieve this integration is the function of the building designer.

UP TO 12 OR 15 YEARS AGO, "architectural acoustics" was based largely on empirical data; stop watch and ear were the instruments of measurement. But the development of broadcasting and sound recording involved a tremendous development of electro-acoustic equipment—amplifiers, loudspeakers, microphones, etc.—instruments which made possible increased precision in sound measurement. (There are oscillators, for example, which run at frequencies that keep time to an accuracy of one part in ten billion.)

The use of a public address system makes it possible to reach much larger audiences and to adapt almost any type of auditorium to programs of sound; intensities may be increased hundreds of times; microphones and loudspeakers may be so located that listeners cannot tell whether they hear direct or reproduced sound. The use of such equipment permits an increase in the ratio of direct to reflected sound; for with the greater intensities made possible by electrical amplification, there is less need for the added acoustic power supplied by reflection.

Broadcasting and sound-recording rooms are used for various types of programs, for each of which different reverberation values may be wanted: organ music, for example, will need a longer reverberation time than speech. Further, the frequency range of programs varies widely. Most sound-absorbent materials, which depend for effectiveness on their porosity, are relatively inefficient at the low frequencies; and to reduce the frequency discrimination which often results, absorption characteristics must be varied accordingly.

This need for greater precision and flexibility in sound control has brought a reexamination of reverberation theory and methods of determining sound-absorption coefficients. The assumption now seems doubtful that measurements of "absorptivity" and "reflectivity," made on samples of limited size, will, when multiplied by the area of

Acknowledgment for assistance in the preparation of this study is made to Dr. Paul E. Sabine, Riverbank Laboratories; Dr. Keron C. Morrical, R.C.A. Manufacturing Co., Inc.; Mr. O. B. Hanson, National Broadcasting Co.; Celotex Corporation; Johns-Manville Corporation; United States Gypsum Company; Armstrong Cork Company; Acoustical Materials Association; American Standards Association. But none of these persons or sources are responsible for specific statements made in this study except where it is so indicated. Other useful references are listed.

that material in a room, give the contribution of the material to the total equivalent absorption of the room. There have been relatively wide discrepancies among the measurements obtained on presumably identical materials by different observers in different laboratories. Considerable disagreement is also reported in experimental results by use of different methods of determining absorption coefficients. It is not yet possible, by use of any existing reverberation theory, to ascertain *precisely* a unique absorption coefficient of a material from measurements made in different reverberation chambers under different experimental conditions.

These advances in the technic of sound control are not confined to specialized building types like broadcasting and sound-recording studios. A consideration of the reverberation period of a room in which a listener's radio is located may have an effect on the "design for reverberation" of the studio in which a program originates. Microphones pick up sounds that are disregarded in direct listening; therefore, the sound level of broadcasting and sound-recording studios can be no more than a few decibels above the audible threshold. Problems of lowering noises of the air-conditioning system, noises transmitted by structure, by pipes, conduits and other equipment; problems of integrating sound control with lighting, air distribution, structure, etc.—these are critical in the design of such rooms, and solutions employed in their design are increasingly applicable to other building types.

References

1. Architectural Acoustics. By Paul E. Sabine. Journal of Acoustical Society of America. July, 1939.
2. Measurement of Sound Absorption Coefficients from the Viewpoint of the Testing Laboratory. By Paul E. Sabine. Journal of Acoustical Society of America. July, 1939.
3. Insulation Characteristics for Ideal Partitions. By Keron C. Morrical. Journal of Acoustical Society of America. October, 1939.
4. Comparison of Sound Absorption Coefficients Obtained by Different Methods. By F. T. Willig. Journal of Acoustical Society of America. April, 1939.
5. A Fugue in Cycles and Bels. By John Mills. D. Van Nostrand Company, New York. 1935.
6. Applied Acoustics. 2nd Edition. By Harry F. Olson and Frank Massa. P. Blakiston's Son & Co., Inc., Philadelphia, Pa. 1939.

Courtesy National Broadcasting Co.



N.B.C. studio with sliding panels, rock wool with perforated metal over; V'd plaster between panels breaks up sound waves, preventing "flutter."

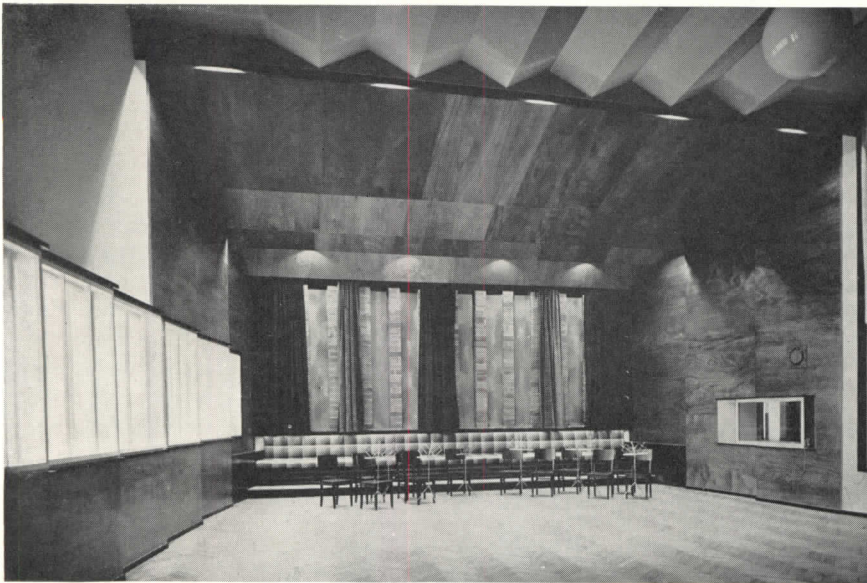

Globe

Broadcasting studio, Germany: mobile drapes and panels control reverberation.

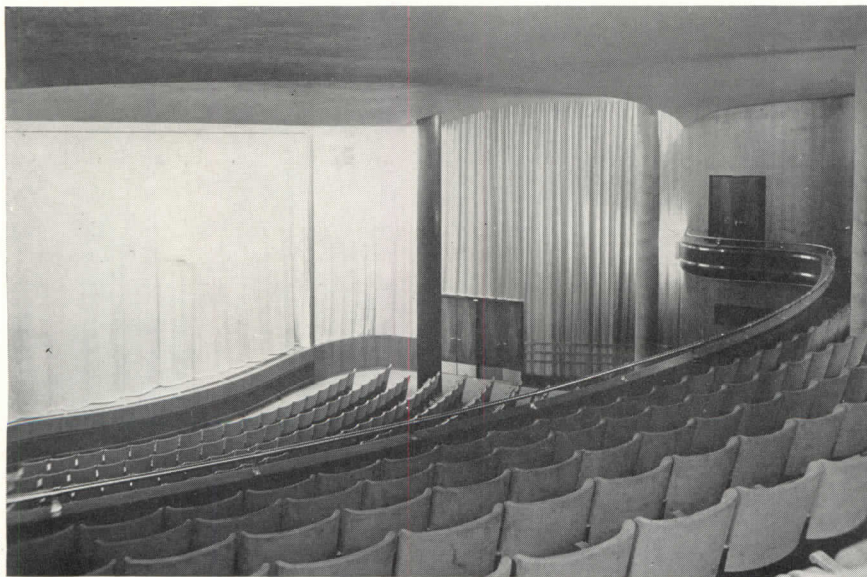

Globe

Theater in Sweden: curtains are extended for greater absorption near stage.

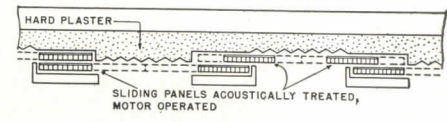
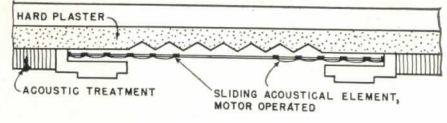
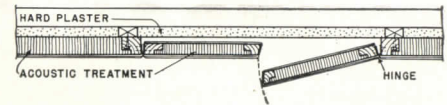

Acoustical panels invented by O. B. Hanson of N.B.C. The change in reverberation period in one studio equipped with sliding panels is from .65 seconds, with panels closed and hard plaster covered, to 1.15 seconds with panels open and hard plaster exposed.

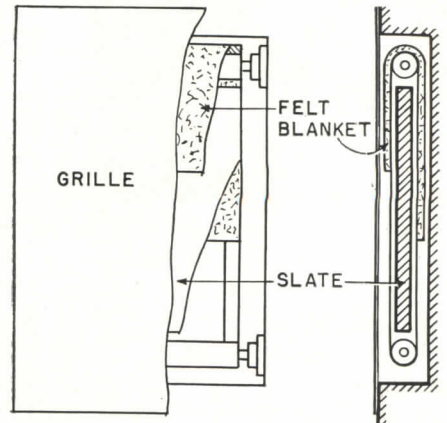

Scheme for reverberation control by Harry F. Olson and Frank Massa of R.C.A. (Applied Acoustics, P. Blakiston's Son & Co., Inc., Philadelphia, Pa.)

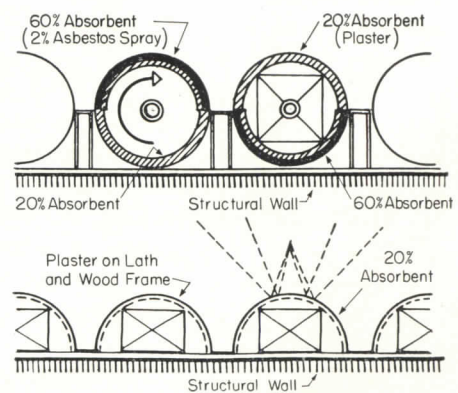

Scheme for reverberation control by G. S. Inglefield and S. Mohilever.

In rooms or buildings used for various types of programs, each requiring different optimum values of reverberation, precision and flexibility of reverberation control is desirable. This may be obtained by varying the units of absorptive or reflective material in a room—by use of sliding curtains, operable louvers, hinged or motor-operated sliding panels; the use of mobile cylindrical rollers and wall sections has also been proposed.

The Sonic Environment*

THE RANGE OF physical intensities to which the ear responds is enormous, even though the intensities of the loudest sounds are small when expressed in ordinary mechanical units of energy. A sound so intense as to be painful is of the order of ten trillion times the minimum audible intensity. The intensity of speech is of the order of one to ten million times the minimum audible intensity, so that, on a logarithmic scale of intensity, conversational speech level falls about the middle of the range which the human ear will accommodate.

The loudness of sound depends both on the frequency and intensity. For a given pitch the loudness does not vary as the intensity, but more nearly as the logarithm of the intensity, if we measure loudness in units corresponding to the minimum perceptible difference of intensities. For this and other reasons, it has been found convenient to use a logarithmic scale, on which sound-intensity levels are expressed in decibels above an arbitrarily defined zero, just as temperatures are measured above a fixed temperature. The range on such a scale from threshold of hearing to a painfully loud sound is about 130 decibels.

Quieting of noise originating within a room is effected by applying sound-absorbent material to the walls and (or) ceilings. Usually, because of the lack of wall surface, the major part of the absorbent material in offices has to be applied to ceilings. The absorbing efficiency of a material is given by its "coefficient of absorption", which is that fraction of the sound energy which is not reflected after striking the material. The absorption coefficient of a given material varies with frequency and will depend also upon the thickness, and to a lesser degree upon the method of mounting. The sound-absorptive properties of materials are due to their compressibility, flexibility, or porosity, or in some cases to a combination of all three. Most absorbents of the porous type absorb more strongly at frequencies above 500 vibrations per second than at frequencies below this. In practice, the average of measured values of the absorption coefficients measured at octave intervals from 250 to 2000 cycles is taken as the "noise coefficient" of the material. While it is true that under a fixed set of conditions, the degree of quieting that can be effected by absorbent treatment is greater, the greater the noise coefficient of the material used, it does not follow that the quieting effect is directly proportional to the coefficient. Moreover, absorbent treatment on walls or ceiling does not diminish the direct sound from the source. What it does do is to diminish the enhancement of noise within a room that results from the repeated reflection of sound from the otherwise highly reflective surfaces of walls and ceilings. This reflected sound results in the prolongation of the successive elements of the noise and this cumulative action builds up a noise level many times greater than would result from the same source in unenclosed space. This prolongation is technically known as *reverberation*, and it has been shown both experimentally and on theoretical grounds that the contribution of this reverberant portion of the acoustical energy to the total physical intensity of sound within a room is inversely proportional to the total absorption of the bounding surfaces. This total absorption is the sum of the products

obtained by multiplying each area by its coefficient of absorption. Increasing the absorption decreases the physical intensity of the reverberant sound in inverse ratio, thus lowering the noise level in decibels by an amount which is ten times the logarithm of the ratio of the total absorption after treatment to the total absorption of the untreated room. Thus, if treating an office ceiling increases the total absorption of the entire room by a factor of 4, the noise level will be reduced by ten times the logarithm of 4, which is 6.0 decibels. The effect of treatment must then be computed in any particular case on the basis of the factor by which the total absorption is increased. Obviously this factor is not uniquely determined by the coefficient of absorption of the absorbent material used.

The situation is further complicated by the fact that the ear does not judge relative loudness of sound in direct proportion either to the physical intensity or to the noise level in decibels. Data have been obtained, however, from which the relative loudness as quantitatively judged by a normal hearing person can be obtained from the difference in intensity level stated in decibels. The following figures, taken from the Bulletin of the Acoustical Materials Association, show the reduction in loudness of noise in an office 50 by 20 by 10 ft., brought about by treating the ceiling with absorbent materials having the absorption coefficients shown:

Coef. of Material	Decibel Reduction	Loudness Reduction	
		60-db Original Noise Level	70-db Original Noise Level
.40	6.0	34%	30%
.60	7.5	41%	36%
.80	8.6	45%	40%

It is important to note from the foregoing that the percentage of loudness reduction does not increase directly as the absorption coefficient of the material. It follows, therefore, that in the choice of materials used for quieting, consideration can and should be given to properties other than their absorptivities. Thus, for example, in the treatment of hospital corridors, kitchens, and service rooms, where quiet is of prime importance, advantages from the standpoint of sanitation and surface renewal may well outweigh slight differences in absorption coefficients. Where indirect lighting is used, high light reflection and ability to withstand repeated painting with small loss of absorbing efficiency are properties that should enter into the choice of acoustical materials.

At one time, hair felt or other felt-like blankets were the materials chiefly used for acoustical correction and quieting. Absorbents of this character were either cemented or wired in place between furring strips, and surfaced with cloth fabrics stretched over the furring. The accumulation of dust and dirt on the fabric, with the necessity for frequent painting or renewal, was objectionable, and repeated painting materially lowered the acoustical efficiency. It was early discovered that an impervious membrane, such as oilcloth with artificial perforations, could be used in place of the fabric covering, even though the perforated area was a small percentage of the total area of the absorbent surface. Shortly after, it was found that a perforated metal membrane could be used as a surfacing member, without loss of absorbing efficiency. The perforated metal has the added advantage of sufficient structural strength to allow its use as a supporting means for the absorbing pads, and at the same time will withstand repeated cleanings and

*Dr. Paul E. Sabine, Riverbank Laboratories.

Gottsecho

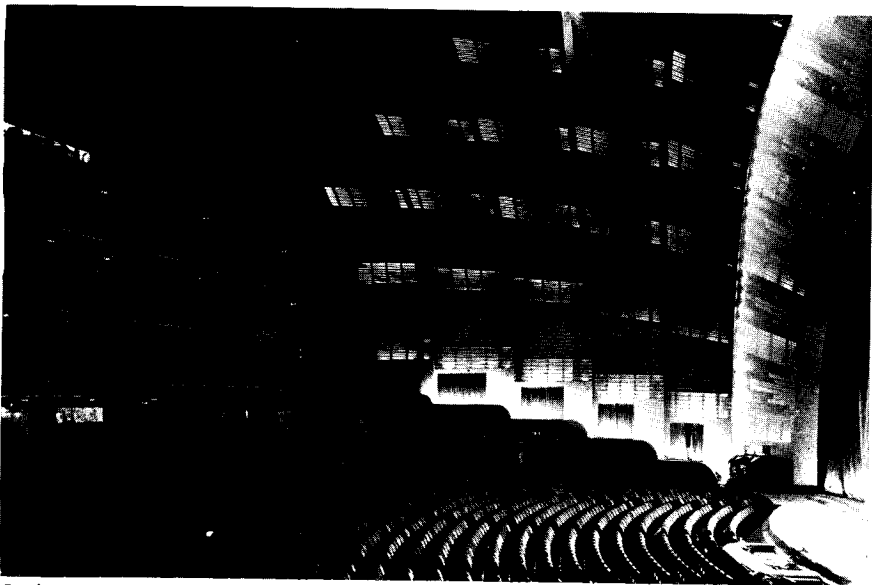

Ceiling arches designed for sound reflection also house concealed lighting.

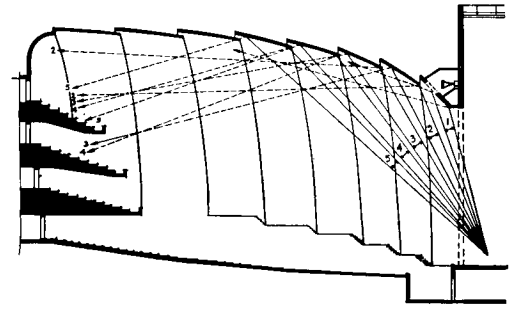

Longitudinal section of Music Hall, Radio City, showing lines of sound reflection from ceiling arches and the spaces for spotlights.

Universal Photo Service, courtesy John-Manville



Fels Planetarium: the dome had to be spherical and highly light-reflective, but should reflect sound scarcely at all because of "focusing".

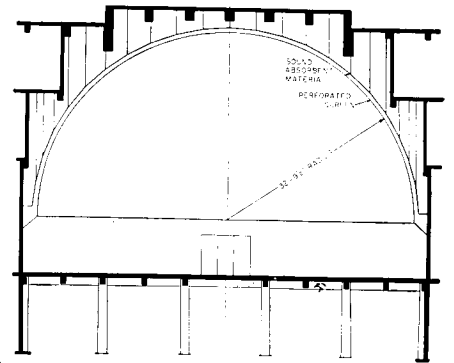

Solution: a perforated-metal screen with absorbent material applied to the main walls back of and above the dome of planetarium.

Courtesy U. S. Gypsum



Integration of sound control and air conditioning: space between structural and suspended ceilings is a plenum; air passes through perforated-metal pans.

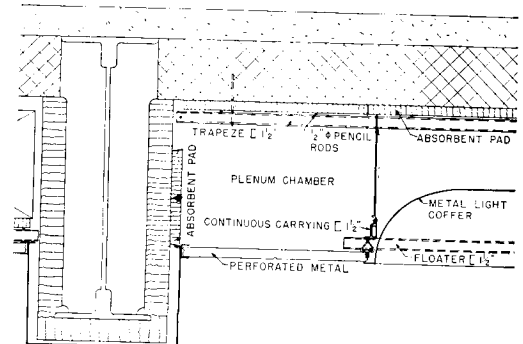

Integration of sound control with lighting and air conditioning: space between structural and perforated-metal ceilings is a plenum chamber; heat generated by lighting is carried off in air-conditioning outflow.

redecorations. The light reflection for a white-painted surface of this character with 4608 holes per square foot, each hole being .068 in. in diameter, may show a light-reflection coefficient as high as 73%. The noise-reduction coefficient, using a 1¼-in. pad of mineral wool, is 85%.

One recent development has been the integration of acoustical construction with both lighting and air conditioning. In one system, the perforated metal is formed as shallow pans, 12 by 24 in., which carry the absorbent pad and which are clipped into special T-runners. A clearance of 6 in. or more between the structural ceiling and the suspended acoustical ceiling may serve as a supply plenum from which the air is fed by means of air-flow channels formed in the metal pans through the perforated metal. Thus the entire acoustical ceiling acts as an inlet grille for the air-conditioning system. Return grilles are distributed about the room at base-board level. The air flow is usually low, only 2 or 3 ft. per minute. The passage of the air even at these low velocities may result in the accumulation of dust around the edges of the perforations, but if the pans are of enamelled metal, the removal of dust accumulation by washing is relatively simple.

Coffer and trough lighting can also be readily worked into this type of acoustical installation. A combination of acoustical treatment, air conditioning, and coffer lighting is illustrated in a new office building in Des Moines. Here the ceiling is divided into bays by beams extending 18 in. below the ceiling slab. The absorbent pads are cemented directly to the sides of the beams and the undersurface of the slab, while the perforated metal is carried on the T-runners suspended at a lower level, but slightly above the level of the beam soffits. Carried on the same suspension are the lighting coffers, with concealed indirect lighting. The air distribution is effected by ducts that run in the space between the perforated metal and the flat arch construction of the ceiling proper.

The perforated metal suspended at some distance from the main ceiling construction also lends itself readily to trough lighting with fluorescent tubes. Light coffers 12 in. wide and of any desired length may be carried on the T-runners, replacing a section of the perforated metal pans. This system has the advantage that the lighting trough can be removed if desired, and the old location filled with the perforated pans.

It should be pointed out in this connection that the suspension of unbacked porous absorbents with any considerable air space back of them is apt to lead to the collection of dust on the surface due to "breathing". This is apt to occur particularly where there is even a slight difference in pressure on the two sides of the porous material as a result of the operation of the air-conditioning system.

The following approximate values of the light-reflection coefficients of a few of the more common materials are compiled from results published in Transactions of I.E.S., April 1938. Noise reduction coefficients are taken from Bulletin No. 6, March 1938, of the Acoustical Materials Association.

	Noise Coef.	Light Reflection
1¼-in. cane tile, 441 3/16-in. holes per sq. ft., smooth surface, white	.80	.77
1¼-in. compressed wood fiber, rough surface, white	.75	.73
1-in. compressed mineral fiber, pitted surface, white	.75	.74
1½-in. compressed cork particles, rough surface, white	.65	.73
½-in. acoustical plaster, granular surface, unpainted	.50	.53

(Note: The apparent correlation between sound absorption and light reflection is quite fortuitous. These values are illustrative only. The absorption coefficient of any given material depends upon its thickness.)

In addition to quieting, sound control has the further object of providing satisfactory hearing conditions in audience rooms. The acoustical properties of an auditorium are good if the sound is sufficiently loud in all parts of the room, if the components of complex sounds maintain their original intensities, and if the successive elements of speech and music are clear and distinct from each other and are free from extraneous disturbing noises. Good acoustic properties result more from avoiding acoustical defects than from applying devices for improving hearing conditions. The chief sources of acoustical difficulties are: (a) excessive reverberation, (b) focused reflections resulting either in strong discrete echoes, or in inequalities of intensity because of interference, and (c) quality distortion because of selective absorption of surface materials. A further defect is sometimes encountered in rooms of recent design in which sound-absorptive treatment has been overdone, and the reverberation has been reduced beyond a desirable lower limit.

Reverberation can be controlled (a) by a proper adjustment of the total volume of the room to the seating capacity, and (b) by the use of absorbent treatment to bring the reverberation within the desired limits. As a general rule, the ceiling height of an auditorium should be such that the cubic footage is between 150 and 175 times the seating capacity. With this volume, the natural absorption of sound by the audience will be sufficient to bring the reverberation to a desired value. If probable conditions of use indicate that the room will frequently be used by audiences of considerably less than capacity, the deficiency of absorption can be taken care of either by specifying heavily upholstered seats, or by specifying the application of the necessary area of a suitable absorbent. If other design requirements call for a volume to seating-capacity ratio greater than the foregoing, additional absorption will be needed. In any situation, the requirement in units of additional absorption can be worked out in advance by well-established formulae.

Extended spherical or cylindrical concave surfaces, with centers of curvature that fall within the seating space or in the stage area, are unfailing sources of focused echoes, or localized difficulties caused by interference. In theaters for the spoken drama, without electrical amplification, hearing at distances greater than 100 ft. is difficult. A lower stage, and a much sharper rise from front to rear in the main-floor seating than is ordinarily used would markedly improve hearing conditions in the highest-priced seats.

The talking motion-picture theater offers a number of acoustical problems. Perhaps the most common is "slap-back", a pronounced doubling of speech sounds caused by reflection from the rear wall; it is particularly noticeable in the front main-floor seats. This is due to reflection of sound from the rear wall and is accentuated by any curvature which the latter may have. It is most pronounced in theaters that are otherwise heavily damped with absorbents. In more reverberant rooms it is lost in the general reverberation. Application of absorbents to the rear wall may alleviate but frequently will not cure the trouble. Adjustment of the sound source, so that a minimum of directly radiated energy falls upon rear wall, may help. Such theaters will usually stand considerably more absorbent treatment than concert halls or auditoriums for general use, because of the greater range of intensities possible with electrical amplification.

Armstrong Cork

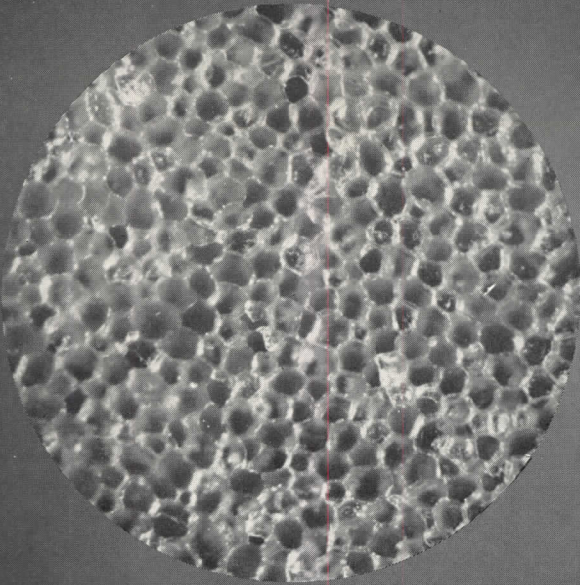

Celotex

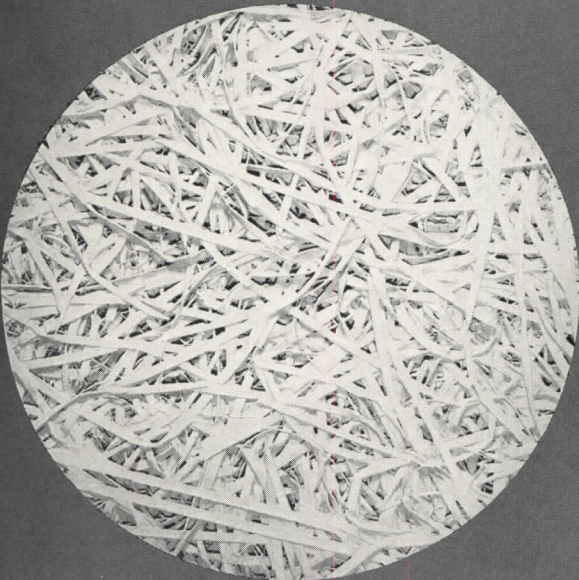

Celotex

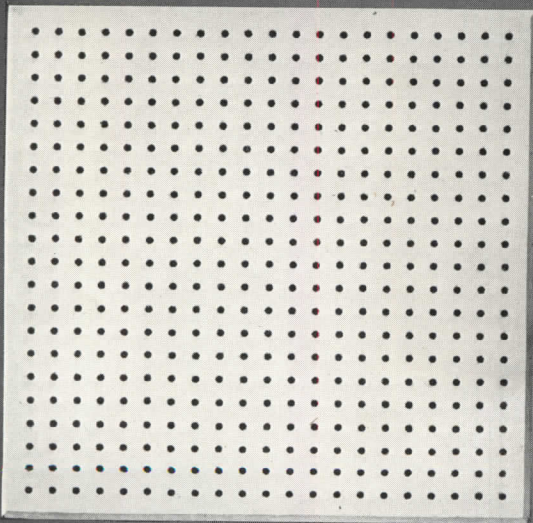

Sound absorption depends on porosity, compressibility, or flexibility, or all three: cork (top, 250 x), cement-timber, perforated tile. Sound insulation depends on weight, stiffness, internal friction, solidity, etc.

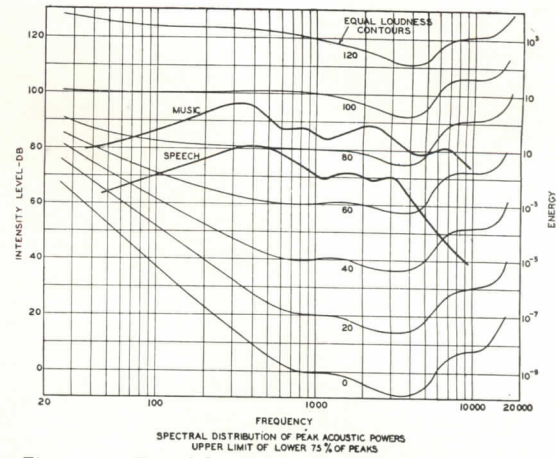

Figure 1: Equal loudness contours

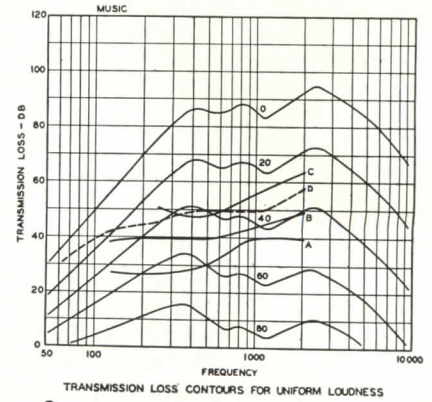

Figure 2

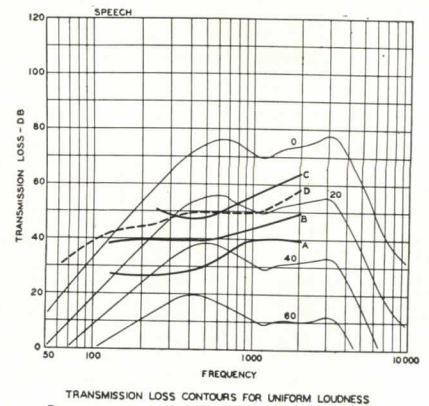

Figure 3

PERFORMANCE OF VARIOUS SOUND INSULATING MATERIALS

	MUSIC	SPEECH
PARTITION A 4" hollow clay tile with 1" plaster each side	67 db at 350 c.p.s.	50 db at 430 c.p.s.
PARTITION B 2" x 4" wood studs, wood lath, gypsum scratch and brown coats and smooth white finish plaster each side	52 db at 350 c.p.s.	38 db at 500 c.p.s.
PARTITION C 8" brick plastered each side, scratch, brown, and smooth finish	45 db at 450 c.p.s.	29 db at 500 c.p.s.
PARTITION D special light face resiliently mounted to 6" tile wall, each outside face plastered as above	42 db at 370 c.p.s.	27 db at 600 c.p.s.

Sound Insulation*

THE SPECIFICATION of sound insulation resolves itself, in its simplest form, to the determination of the loudness of the sound against which insulation is desired and the loudness of the noise level below which it must be reduced. For example, it is planned to erect a theater in a location where the noise level is 75 decibels, and the noise level in the theater due to ventilating and projection equipment, audience, etc., is 35 db. The walls, roof, windows, etc., must each furnish an insulation of 40 db, or that sufficient to reduce the outside noise to less than the 35 db noise level inside.

Actually, it is not quite so simple as this, for consideration must be taken of the frequency distribution of the sounds and of the mechanism of hearing. Figure 1 shows the frequency distribution of representative symphony music and of average declamatory speech, and it will be noticed that both types of sounds have the greatest energy or power around 350 to 400 cycles per second (F to G above middle C). Another region of relatively greater loudness occurs in the region 2000 to 3000 cycles per second (third C to G above middle C). In general, random noise has a fairly uniform distribution, having slightly more energy in the middle frequency than in the higher or lower frequencies; office noise tends to contain more high frequencies because of the presence of typewriters, adding machines, etc.

Figure 1 also shows a family of what are called "Equal Loudness Contours" for the human ear. They show the manner in which the sensation of hearing varies with the frequency of the sound and with the intensity of the sound. Among other things, they show that the ear is less sensitive at the lower frequencies, that it takes more sound power to produce the same loudness. They tell also that the ear is most sensitive at about 3500 cycles per second. As an example, a sound having an intensity level of 60 db will produce a sensation of loudness of 60 db at 1000 cycles per second (this fact is not coincidence but definition), of only 37 db at 100 cycles per second, and of 48 db at 10,000 cycles per second. Suppose now that the sound energy were uniformly reduced 20 db by a volume control. The resulting loudness at 100 cycles per second would be about 3 db, a loudness reduction of 34 db, inaudible under most circumstances; the loudness at 1000 cycles per second would be 40 db, or a reduction of 20 db; and the loudness at 10,000 cycles per second about 41 db, or a reduction of 19 db. Now this has a very important bearing on the problem, for a partition or other building unit is going to give a similar reduction in sound, except that the reduction will not be uniform as in the example of the volume control; it is going to attenuate sound whose energy is not uniformly distributed throughout the audible range but distributed in a manner exemplified by the two curves in Figure 1; and, lastly, the resulting sound will be judged in terms of the loudness received by the ear.

On the basis of these considerations, two sets of curves, Figure 2 and Figure 3, have been prepared, one for the music and one for the speech distribution of energy as shown in Figure 1, showing the attenuation that a particular building unit must have in each case to reduce that type of sound to the equal loudness level indicated. Examination of Figure

2 shows that for music an "ideal" partition, or one which has just sufficient insulation at each frequency and no "unused" insulation anywhere, must provide a maximum of attenuation at about 2500 cycles per second. On each family of curves have been drawn the attenuation characteristics of four types of partitions commonly used in the building industry: (A) 4-in. hollow clay tile with 1-in. plaster each side; (B) 2 by 4-in. wood studs, wood lath, gypsum scratch and brown coats, and smooth white-finish plaster each side; (C) 8-in. brick plastered each side, scratch, brown, and smooth finish; and (D) special light-face resiliently mounted to 6-in. tile wall, each outside face plastered as above. As an example of the use of these curves, take partition A, a 4-in. hollow clay tile commonly used in the construction of apartment houses. It will reduce symphony music played on one side to a loudness level of 43 db at 125 cycles per second, to 67 db at 350 cycles per second, to 47 db at 1000 cycles per second, and to 48 db at 2000 cycles per second. Obviously, the point of failure is at 350 c.p.s. where the received sound rises to a loudness of 67 db. *This condition can be used as a statement of merit of the partition, a statement of the minimum performance to be expected of it. If the noise level on the receiving side is 67 db or higher, the partition gives satisfactory performance, but if the noise level is below 67 db, sound in the region of 350 c.p.s. will be heard coming through the partition.*

The use of a single number instead of a table of figures, or a graph, to describe the effectiveness of a structure is a very desirable feature. In the past, an average value has been taken, but in light of what has been said above, it can be seen that use of an average figure is likely to be misleading and productive of wrong results. For instance, a partition may have a satisfactory average value of attenuation, but have it by virtue of possessing too much attenuation for some frequencies and insufficient for others, and the result is that it fails to deliver the job expected of it. This condition is often noticeable in apartment houses and office buildings when a few particular notes of a neighbor's music or conversation are transmitted by the partition. Use of a minimum performance figure rather than an average figure will prevent such occurrences as this.

The results of observing the performance of the four representative partitions in the light of the characteristics of the incident sound and the characteristics of the ear are given in the table. The attenuation curve of any other partition can be sketched on these same backgrounds and the performance figure correspondingly determined.

In locations in which sounds of unusual character are encountered, and if the importance of the building justifies the expense, a noise survey and analysis should be made to determine the sound level existing there and its distribution throughout the frequency spectrum. From these data, a family of curves can be made up similar to those shown for speech and music and the performance of the sound insulating structure judged in the same manner.

The property of sound insulation is obtained by a combination of the weight, stiffness, internal friction, solidity, etc., which factors are internal to the structure and do not in general appear in the finished surfaces.

*Dr. K. C. Morrical, R. C. A. Manufacturing Co., Inc.

NOTES ON NEW BOOKS

INFECTION OF AIR. By W. F. Wells, M. W. Wells, and Stuart Mudd. *American Journal of Public Health*, 29, (8), 863, 1939. Published by the American Public Health Association, 50 W. 50th St., New York City.

BUILDING DESIGNERS are interested in the effect of ventilation design and air conditioning on the spread of infection. During the past few years a considerable body of data has been accumulated which shows that the air within rooms of public assemblage may be infectious, and recent studies have shown that something can be done about it.

There are certain important factors which should be kept in mind when considering the problem of air-borne infection. The length of exposure to the infected atmosphere, and the amount of infection present are two factors which are of prime importance in determining the hazard of a given air. The rate of addition of disease germs to the atmosphere is another factor which should be taken into account.

Very little can be done by designers to alter lengths of exposure. However, the relative periods of time spent in hospitals, assembly halls, churches, and railway cars are obvious, and they should be considered in weighing the various factors which must be considered before spending money on air-sterilizing equipment.

Wells has developed a simple direct technic for measuring sanitary ventilation, and application of this technic to the air of typical public places has resulted in the assembly of much pertinent information. For instance, the effect of dilution on the numbers of microorganisms in the atmosphere has been studied, and it is possible to demonstrate the chances of survival of germs under varying conditions of air change. The fact that air changes within buildings are often 10 times as rapid in the summer as in the winter may explain in part the lower rate of spread of upper respiratory infections during the summer. The much larger dilution of infected atmosphere by pure air during the open-window months probably reduces the chance of spread by droplet nuclei.

Wells and his associates point out the danger of adding contaminants to the atmosphere of confined spaces. Evidence gathered in two or three instances

shows the need for providing safe air supplies when mechanical ventilating systems are used. Recirculated air should be treated so as to be made safe.

Of the many devices for controlling air-borne infections that have been suggested, only two practical procedures have so far been developed: (1) mechanically induced high rates of air change; and (2) sterilization of atmospheres with ultraviolet light.

Sanitary ventilation tests in experimental cubicles at the Henry Phipps Institute in Philadelphia indicate that curtains of ultraviolet light remove upwards of 98.6% of test organisms passing between cubicles. Trial installations of light barriers at several hospitals are demonstrating the effectiveness of this method of controlling air-borne infections.

In summary, the building designer should realize that epidemic characteristics vary considerably, that the possibility of spreading infection by air no longer can be ignored, and that equipment is being developed for use in preventing the spread of disease by infected air. The control of enteric infections was accomplished when it became generally recognized that certain sanitary precautions could be taken to prevent or allay the contamination of water or food. Recognition of a vehicle of contagion (infected air) may likewise suggest the means of preventing epidemic respiratory infection.

—M. A. POND
Instructor in Public Health, Yale Univ.

GOTHIC CATHEDRALS: *Paris, Chartres, Amiens, Reims.* Photographs by Martin Hürlimann, text by Paul Clemen. B. H. Blackwell, Ltd., Oxford, England. 164 plates, 220 pages. 9 by 12 in. Price: \$7.00.

IN THIS photographic survey of the great French Cathedrals, Mr. Hürlimann points out that his pictures are intended to record "above all, the visitor's spontaneous impression (of the cathedrals): for the photographs owe their origin not to the analysis of a scholar but to the overwhelming impression these sculptures made on a man of our generation." This attitude is perhaps responsible for the book's chief merit: for the camera is concentrated not only on detailed aspects of these much-photographed and much-

visited monuments, but also on details rarely seen either by tourist or camera.

Mr. Hürlimann's photographs are uniformly good; most of his details are excellent. Mr. Clemen's text, while "atmospheric," constitutes a compact history of the four famous structures.

WROUGHT IRON: *Its Manufacture, Characteristics, and Applications,* by James Aston and Edward B. Story. Second Edition. Published by A. M. Byers Co., Pittsburgh. 97 pp. 6 by 9 in. Price: \$1.00.*

This second edition, revised on the basis of suggestions and criticisms offered to the first and amplified to embrace the latest developments in wrought-iron production and application, is offered as a "source of up-to-date information on wrought iron for all who are interested in problems of material selection, as well as for those students in colleges and universities who may some day become responsible for engineering specifications." Valuable chapters are included on quality standards, specifications and durability testing, characteristics, and the vigorously multiplying list of applications of wrought-iron in industry and construction. Numerous photographs have been employed to illustrate the text.

*Publishers inform us book will be supplied free to Record readers sending requests on their own business stationery.

Architect Will Share Profits

A NEW YORK architect with many years successful practice seeks an arrangement with another New York (Manhattan) architect or firm with sufficient organization to handle additional work. He writes:

"I propose to share the profits of my work (with a moderate minimum guarantee) in exchange for office, drafting space, and clerical service, and will not expect to share profits of the other party's work. If desirable, my present well-located quarters, adequate for the proposed arrangement, are available at low rental. I am a Columbia graduate; a member of A.I.A. and other leading architectural societies."

Inquiries welcome. Address Box A-1, ARCHITECTURAL RECORD.

BUILDING TYPES



Photo by Mott Stuaos, Burton Senatt, architect.

RESTAURANTS AND BARS

PRECEDING ISSUES: 1939 — December, Hospitals; November, Houses; October, Theaters; September, Apartment Houses; August, High Schools; July, Houses; June, Factories; May, Houses. **FORTHCOMING ISSUES, 1940—** February, Factories; March, Houses; April, Vocational Schools; May, Houses.



Mott Studios

Air-conditioned dining booths, Los Angeles Union Passenger Terminal Restaurant. Donald Parkinson, consulting architect.

RESTAURANT AND BAR DESIGN

This study is in a sense complementary to a previous one devoted to restaurant design which appeared in the January 1939 issue. At that time, space requirements for various types of seating and service areas were tabulated. In the present study, emphasis is placed upon the mechanical services—heating, ventilating, air conditioning, lighting.

In addition, there are included analyses of space allowances in actual practice; and seven case studies, whose range covers most of the design problems likely to be encountered.

Technical and planning data have been contributed by the staff of "Restaurant Management," by the office of Scott and Teegen, architects, and by A. N. Brent and T. Elliott Tolson, Jr., engineers of the Penn-Harris Hotel, Harrisburg, Pa., and the Hotel Bristol, New York City, respectively.

THE SUCCESS of a restaurant's or bar's design may in some sense be measured by the financial success of the establishment. This, in turn, is dependent upon customer satisfaction—upon development of a congenial environment, upon adequate provision for the customers' comfort, and, of course, upon quality of food and food service.

All of these ideals can be attained to a degree commensurate with the type of establishment under consideration. Not all of them are the designer's concern, except as he provides facilities. And because local conditions vary widely, and because most restaurants or bars are peculiarly susceptible to local, personal influences, standard data is difficult to obtain and develop. Even the broad pattern of general performance standards is often seemingly violated—and successfully.

In certain fields, manufacturers or suppliers of equipment maintain consulting staffs which can apply to specific situations knowledge gained from many similar experiences. Kitchen equipment, dining equipment, heating and air-conditioning plants, acoustic treatment, lighting provisions, are among those fields in which technical assistance is readily accessible.

In view of the lack of standardized solutions, it is most interesting to note the almost universal demand for air-conditioning systems in restaurants and bars, as reported by surveys made independently by the editors of "Restaurant Management" and by air-condition-

ing manufacturers. Surveys were made of restaurant owners and employees. Questions asked were intensely practical: "Do you find patronage increased as a result of air conditioning?" "Do individual checks amount to more in air-conditioned establishments?" "Do your customers like air conditioning?" "Do you work more efficiently in air-conditioned rooms?" The answers were almost universally affirmative—"Yes" being the answer in from 75 to 100% of the cases.

While similar practical data on the value of acoustic control is not available, the practice of acoustically surfacing the ceilings, at least of dining rooms and cocktail lounges, has been rapidly gaining favor. The degree to which other sound-control methods are practiced varies. In almost all restaurant types, some acoustic treatment in kitchens is highly desirable for comfort. Not in every case, however, can the necessary expense be borne. In more luxurious establishments, where patrons' checks are larger, carpet on floors deadens much noise; but carpet maintenance is expensive. Partitions between kitchens or pantries and dining areas should preferably have a sound reduction factor of 40 to 60 decibels.

The desirable noise level in dining areas ranges from 60 to 75 decibels, depending on such factors as location, type of service, etc. In bars and cocktail lounges, where the surroundings are intended to be more intimate in character, lower levels are desirable.

INDEX	Page No.
Restaurant and Bar Design	77
Analyses of Restaurant Plan Types	78, 79
Time-Saver Standards Data	80-83
Heating, Ventilating,	
Air Conditioning	80-82
Lighting	83
Case Studies	84-102
Schaefer Center	84-87
Chapin's Open Kitchen	88, 89
Seagram's Private Bar	90, 91
The Brook Club	92-94
Candlelight House	95-97
Blue Fountain Room,	
Hotel LaSalle	98, 99
Scott's Restaurant	100-102

ANALYSES OF RESTAURANT PLAN TYPES

On these pages are presented plans of four different types of restaurants, and analyses of their seating capacities in terms of floor space. Plans have been selected from the work of Scott and Teegen, Architects; all examples are in New York City. The fact that they have a common origin and locale eliminates two variables which might affect a comparison. The remaining factors include purpose, or type of establishment, and those local conditions—such as shapes and sizes of areas available—which affect any design problem.

These analyses do not represent conscious standards evolved in the office of Scott and Teegen, but they illustrate a method by which standards are formulated, and, modified to suit local practice, may serve as guides for similar projects.

All plans at 1/16-in. scale.

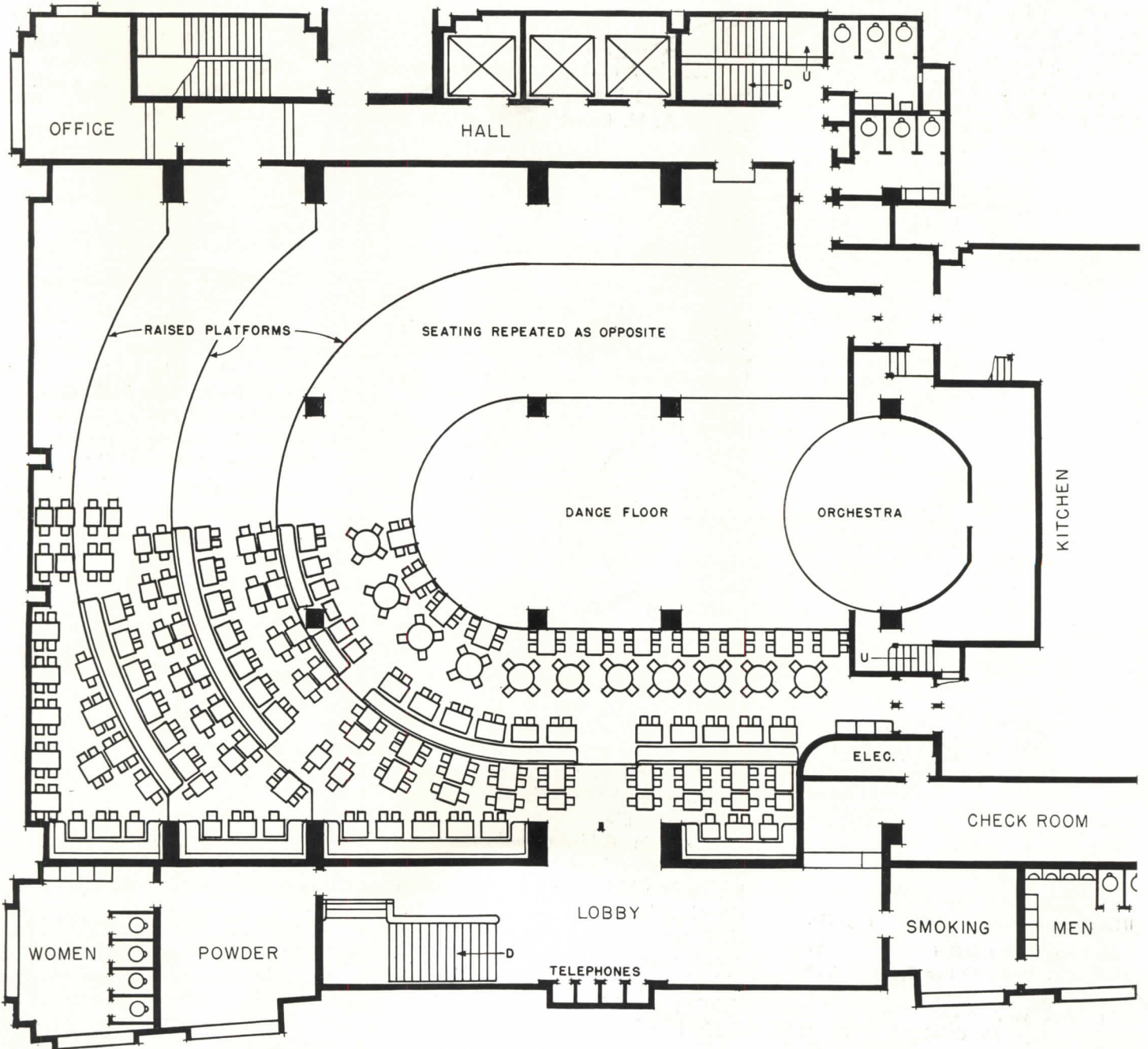

1. PARADISE RESTAURANT: Built in the heyday of Broadway night clubs, with the purpose of providing a maximum number of patrons with spectacular, yet moderately priced entertainment, the Paradise has minimum space allowances per seat.

AREAS AND CAPACITY

Space	Sq. ft.
Dining tables	5,357
Dance floor	925
Orchestra and stage	342
Total dining room	6,624
Supplementary spaces	8,491
Grand total	15,115

Capacity	
Normal seats	700
Extras on dance floor	72
Sq. ft. per seat (dining room only)—	
Normal seating	= 9.5
Maximum seating	= 8.6
Sq. ft. per seat (incl. supplementary spaces)—	
Normal seating	= 21.6
Maximum seating	= 19.6

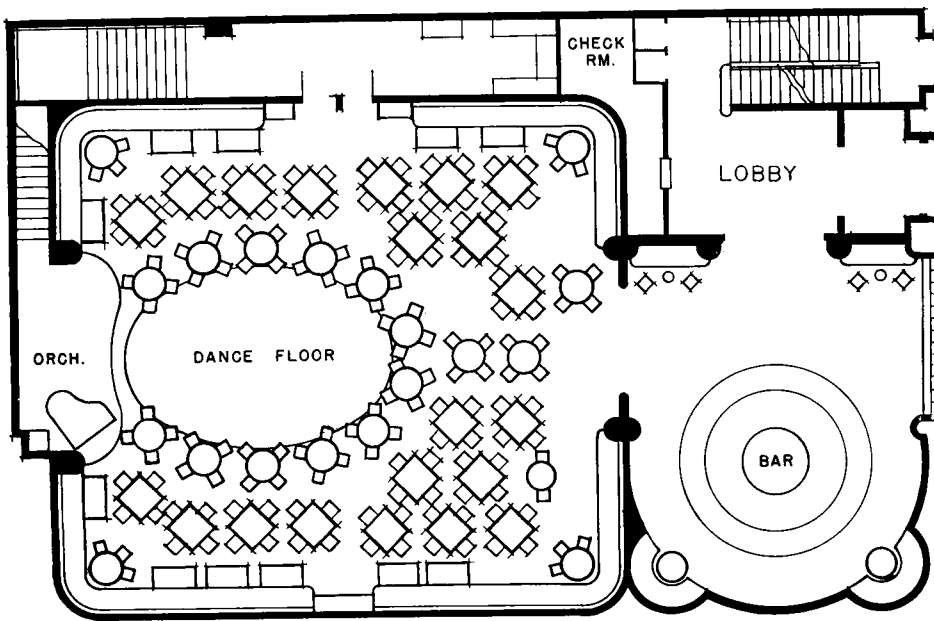

2: THE HOUSE OF MORGAN: This night club, completed a few years ago, is more intimate and luxurious than the Paradise. However, a prime consideration in planning was to provide for a maximum number of paying customers, including bar standees. Kitchen is on floor below.

AREAS AND CAPACITY

Space	Sq. ft.
Dining floor	1,626
Dance floor	259
Orchestra	136
<hr/>	
Total dining room	2,021
Bar	974
<hr/>	
Total public areas	2,995
Capacity	Seats
Dining room	192
Bar seats*	48
<hr/>	
Total	240
Sq. ft. per dining room seat	10.5
Sq. ft. per bar seat*	20.3

*Not including standees; bar also provides circulation.

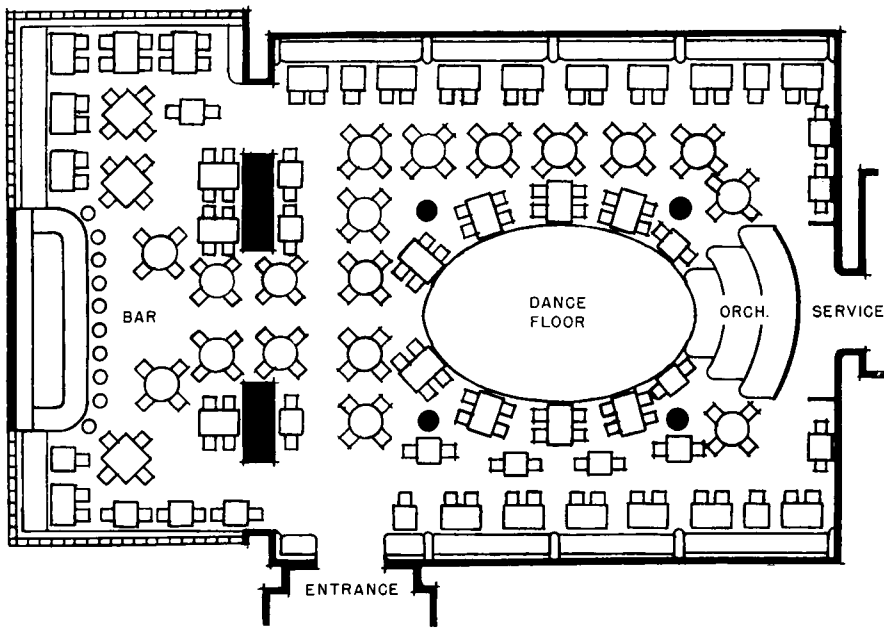

3: RESTAURANT LA RUE: One of the more luxurious and expensive of New York's restaurants provides a greater area per seat.

AREAS AND CAPACITY

Space	Sq. ft.
Dining floor	1,831
Dance floor	271
Orchestra	98
<hr/>	
Total dining room	2,200
Bar	810
<hr/>	
Total public areas	3,010
Capacity	Seats
Dining room	176
Bar	84
<hr/>	
Total	260
Sq. ft. per dining room seat	12.5
Sq. ft. per bar seat	9.6

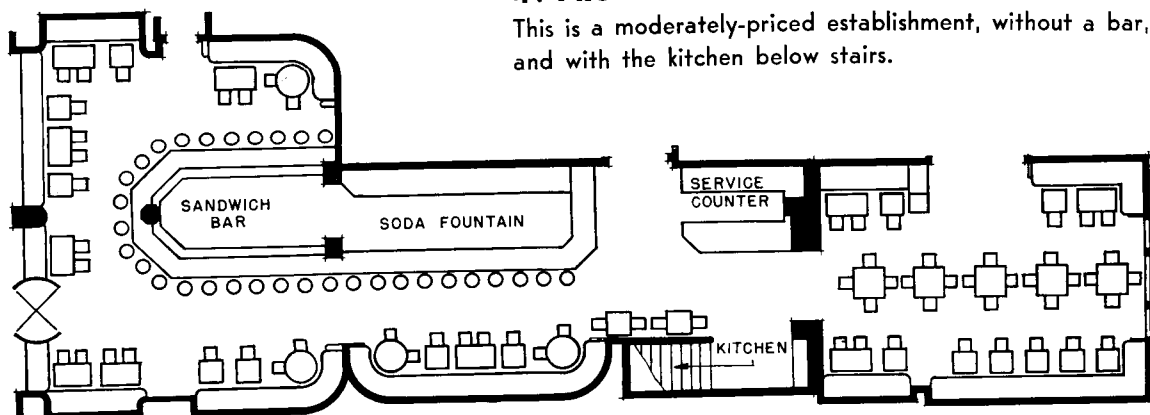

4: PROPOSED RESTAURANT & LUNCH ROOM: This is a moderately-priced establishment, without a bar, and with the kitchen below stairs.

AREAS AND CAPACITY

Space	Sq. ft.
Table service*	1,314
Counter stools*	281
<hr/>	
Total dining room	1,595
First-floor work areas	465
<hr/>	
Total first floor	2,060
Capacity	Seats
Tables	114
Sandwich and soda bars	30
<hr/>	
Total	144
Sq. ft. per table seat*	11.5
Sq. ft. per counter stool*	9.4

*Not incl. work space.



MECHANICAL SYSTEMS FOR COMFORT AND ECONOMY

1: AIR CONDITIONING, HEATING, VENTILATING

HEATING, ventilating, and air-conditioning systems for restaurants and bars are subject to certain conditions peculiar to this type of installation.

Restaurant occupancy may vary from zero to maximum one or more times daily, depending on the number of meals served, the number of times entertainment is offered, etc. Each person who enters changes the load imposed on the heating system by the amount of his bodily heat loss. In the aggregate, this may account for a considerable fluctuation in heating demands. Some form of modulating control is therefore desirable.

Also, there should exist within dining areas no "cold pockets", no concentrations of heat, and no drafts. Any one of these might make some seating locations undesirable and cause loss of revenue. Heating and air-conditioning systems are preferably designed so that all areas, including semiprivate accommodations such as booths or alcoves, table locations along windows, air pockets behind interior columns, etc., as well as general open areas, are equally comfortable.

A common source of drafts due to air infiltration is the street entrance. Vesti-

bules provide a measure of protection; but in practice both vestibule doors are often open simultaneously. To offset this disadvantage, revolving doors may be used; or local means may be provided for heating or cooling the inflowing air.

Heat and odors generated within the kitchen are customarily dissipated by means of ventilation, natural or mechanical.

Employee comfort is difficult to maintain at a uniform maximum, partly because of the difference in temperature between kitchen and dining room, partly because employees are constantly in motion while patrons are not. And since customer satisfaction is essential to a restaurant's or bar's success, customer comfort is the prime consideration. However, maintenance of satisfactory temperature and atmospheric conditions for customers goes far toward alleviating employee discomfort.

Another condition is the periodic remodeling which many restaurants undergo. While it is obviously impossible to anticipate all changes, it is desirable to select, design, and install heating, conditioning, or ventilating systems to permit a reasonable degree of flexibility.

HEATING METHODS

On the basis of surveys* of both management and employees, and expressions of engineering opinion, air conditioning appears generally desirable as the basic means for heating restaurants and bars. There are, of course, conditions under which air conditioning may be inadvisable, or which require supplementary heating by other means.

Air-conditioning systems should preferably provide control of temperature, of humidity, of air distribution and velocity, and cleaning. Several types of systems are available, most of them equally satisfactory. Selection depends on local factors, such as: comparison of installation and operating costs; size and disposition of spaces to be conditioned; space available for such portions of the system as cooling towers, ducts, etc. Most desirable is a system whose operating costs vary as the load on the system varies. If small "portable" units are used, these may be manually or automatically turned on or off as needed. Of the numerous central-plant systems, many have automatic controls which adjust themselves to the load im-

*York Ice Machinery Corp.: "Atmosphere and Efficiency."

posed instead of running at 100% capacity to accommodate minute demands.

In general, for establishments whose size warrants, and particularly when a competent engineer can supervise operation (as in the case of a restaurant in a hotel or apartment building), a central air-conditioning plant is preferred.

Cooling: A system which provides for re-using the refrigerant, such as one equipped with a water-cooling tower, is desirable. Ice cooling may prove desirable, particularly in certain types of jobs, such as remodeling.

It is possible to connect air-conditioning compressors "in series" with kitchen refrigeration compressors; so that on extremely hot and humid days, when an overload might otherwise be thrown on the air-cooling apparatus, one or more kitchen compressors may be temporarily diverted for air conditioning. Engineers, however, state that the air-conditioning and kitchen loads cannot be satisfactorily handled as a combined single load on the compressor system. Such equipment as steam decalorators may be advisable when conditions permit.

Temperature and humidity control are in practice inseparable, but are here discussed, to an extent, independently. Maintenance of a varying differential between indoor and outdoor dry-bulb temperatures has been found healthful and comfortable for patrons, although to employees working temperatures may seem too high. The Hotel Bristol in New York City, for example, maintains in dining rooms a base temperature of 71° F, which is raised 1° for every 3° rise in outdoor temperature. Indoor temperature may be held as high as 81° F when the outdoor temperature is 101° F, etc.* For these purposes, automatic modulating controls may be used. In addition, some type of manual control is commonly included.

Relative humidity control influences appreciably the temperature to be maintained. Two general operating techniques are based on contrasting approaches to the problem: to reduce refrigeration requirements, comparatively low temperatures may be maintained in conjunction with high humidities; or to reduce temperature contrasts upon entering and leaving cooled spaces, higher dry-bulb temperatures may be main-

tained in conjunction with humidities well below 50%. This latter scheme requires more refrigeration, with present conventional apparatus, but results in greater customer comfort. Different methods of operation thus cause the required refrigeration capacity to vary.

Air composition and cleaning standards have been published in the American Society of Heating and Ventilating Engineers' Handbook (1939), and are in most cases prescribed by Boards of Health or other local governing bodies.

A certain proportion of fresh air is always required. Location of fresh-air intakes requires study to insure against drawing odoriferous or polluted air into the system. The use of ionizers or ozonators may be advisable.

Ductwork and outlets: Large ducts, without abrupt bends, reducers, or other fittings which may cause whistling or roaring, are desirable. In some cases, for instance in remodeling jobs, these conditions are unavoidable and sound-deadening is required. The necessary materials are best applied after the system is installed, when noise effects can be studied with apparatus running.

Supply outlets are almost always best located high on walls or columns, or on ceilings, with return inlets low. Outlet locations need study to insure even, draftless distribution. Both horizontal and vertical directional controls are desirable at all outlets. Both adjustable vanes and outlets with fixed baffles are in common use.

Desirable air velocities are subject to great variation, and depend upon such factors as: size of ducts and outlets; length of throw; dimensions and shapes of spaces conditioned; desired noise level; and others.

Special considerations: Local heating at entrances may consist of an independent hot-blast heater with its air flow directed across the opening vertically or horizontally; or may be supplied from a special outlet in the air-conditioning system, perhaps with an individual additional heat source in the air stream. (See also "Steam or Water Systems.")

Incandescent electric lighting adds to the air-conditioning load approximately 3.4 Btu of sensible heat per watt hour. Depending on local conditions, increased demands due to lighting may thus become an important factor. The use of types of lighting which produce relatively little heat, such as fluorescent

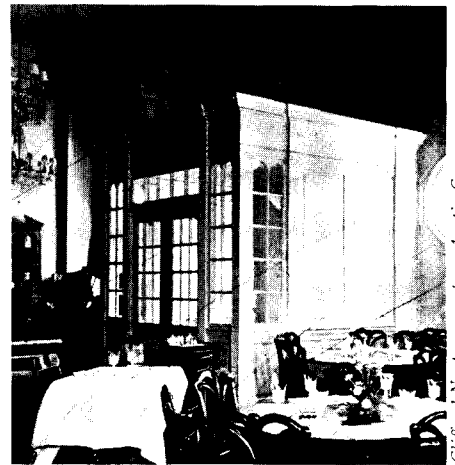

Clifford Norton, courtesy Austin Co.

Vestibule helps reduce infiltration.



Courtesy Celotex

Open radiators at seats reduce comfort.



Matt Studios

Kitchens, the greatest heat source, need special ventilation facilities.

*A.S.H.V.E. "Guide", 1939, states: "Effective temperatures as high as 75°F at times have been found satisfactory in very warm weather."

1: AIR CONDITIONING, HEATING, VENTILATING (continued)



Directional supply grilles, restaurant in Ottumwa Hotel, Ottumwa, Iowa.

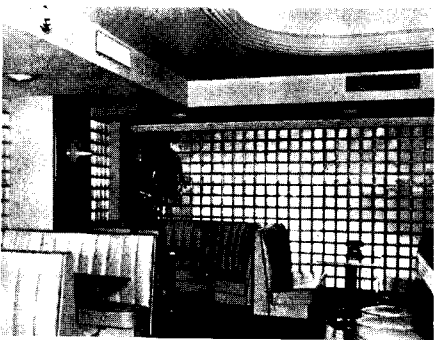

N. N. Woodworth

Air-conditioned grillroom, West Hotel, Sioux City, Ia.; Finke Display, designers.



Tyner & Murphy

Combined air and lighting sources, Union Station, Kansas City; R. J. Raney-Holabird & Root, architects.



Mott Studios

Exhaust over coffee urns, Carl's Viewpark Restaurant, Los Angeles; W. L. Schmolle, architect.

lamps, may be advantageous.

Cooking heat may also add to the cooling load, particularly when cooking equipment, rotisseries, etc., are in dining spaces. A 1-gal. coffee urn adds approximately 3400 Btu per hour; a heavy-duty electric range (usually located in the kitchen) may approach 40,000 Btu.

Steam or water systems may sometimes be required to furnish supplementary heating when an air-conditioning system's distribution cannot be designed fully to cover the space, or for such special purposes as elimination of condensation on windows, or heating entrances. When a restaurant is not open in summer and consequently cooling is not needed, or when an air-conditioning system is otherwise rendered undesirable, a steam or water system may prove most economical.

The system should be designed to maintain an indoor winter temperature of 71-72° F. Modulating valves and thermostatic controls aid in accomplishing this end. If the restaurant has considerable exposed wall and window area, it may be advisable to size the boiler and system to provide 25-50% more radiation for emergencies than the average methods of computing radiation indicate to be the normal design load. Otherwise, on the few days each season which are colder than the average minimum outdoor temperatures used for calculations, an establishment may suffer loss of patronage which may continue into warmer periods.

Radiators or convectors are preferably located so no seated patron is overheated by them. There arise cases in which such a layout is impossible to achieve; movable chairs and tables complicate the problem.

For these reasons, it is desirable to enclose all dining room and bar radiators in insulated cabinets with top outlet grilles and baseboard inlets. With radiators located under windows, this practice has the added advantage of so directing the heat stream that it most effectively combats both condensation on window glazing and air infiltration.

Since use of enclosures may lower the radiator's efficiency, and since heat from top outlets is diverted away from direct contact with its ultimate objective—the patron's body—oversizing of individual radiators is considered preferable to exact design for each unit. Radiators used at entrances are often not enclosed; ample capacity is most important here.

New heating methods, such as radiant panel heating, are ordinarily too expensive, at least in their present stages of development, for installation in the average restaurant or bar. However, engineers see no drawbacks to their use when first costs are reduced, provided operating costs and appearance value prove satisfactory.

VENTILATING SYSTEMS

Ventilation is relied upon as the chief means of removing kitchen heat, odors, and smoke. Preventing these objectionable elements from entering the dining area may become a serious problem. Probably the most common method, considering the great number of small, inexpensive restaurants, is the ordinary exhaust fan. Another method, applicable to air-conditioned establishments, employs a simple kitchen vent, and requires the building up of a slight positive air pressure within dining areas. Under these conditions air flow is always from the dining room to the kitchen in a practically continuous current which carries smoke and odors along with it. In designing a system of this kind it is necessary to provide slightly less exhaust capacity than supply of recirculated and fresh air.

In special cases, as in isolated areas within large restaurants, or when cooking odors accompany "sizzling platters" into the dining area, etc., it may be necessary to install special vents in dining rooms. Usually, however, odors are rendered unobjectionable by the ordinary processes of air conditioning.

It is of course imperative that no air exhausted from kitchens, locker rooms, toilets, etc., be recirculated.



Combined direct and indirect lighting, milk bar, Chapin's Open Kitchen, Cleveland; Wilbur Henry Adams, designer.

Luckhaus Studios



Diffused direct ceiling-panel lighting, Gotham Cafe, Hollywood, used as design motif; Richard Neutra, architect.

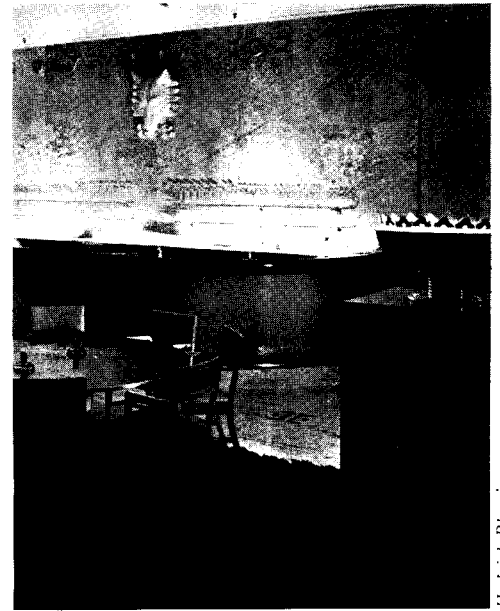

Decorative and work light from panels in back-bar top; bar in Merchandise Mart, Chicago. Shaw, Naess, and Murphy, architects.

ALL OF THE numerous types of lighting are used for various purposes in restaurants and bars. In general, neon and similar gaseous tubular lighting are considered desirable for "flashy" outside lighting; incandescent, fluorescent, and similar types for interior use. Beyond these generalities, local conditions, such as the character of the establishment, govern selection of type. Fluorescent lamps require more installation expense than incandescent lamps, but are reportedly less expensive to operate and generate less heat—an important factor in regard to air conditioning.

Intensities given in the accompanying table can be used as general guides in design, but are not intended to be exact recommendations. Special considerations govern practice.

There is ordinarily a great discrepancy between natural daytime lighting in the street and artificial illumination in a vestibule or foyer, particularly if street walls are opaque. Any hazards to passage, such as steps, require intensified lighting.

In dining areas, lighting is recognized to be important to attractive food service. Indirect lighting methods, such as cove lighting, have been widely used, often in conjunction with some form of

direct downlighting. In newer restaurants, fixtures with exposed lamps, or highly concentrated displays in the dining area proper, are not common. Private dining rooms which may be used for meetings, at which motion pictures, etc., may be shown, may require a means of dimming light.

The night club's dining-dancing space needs somewhat different treatment. Here the orchestra and entertainers may need special lighting facilities of a theatrical nature. Spotlights, preferably inconspicuously housed in ceilings or column caps, are required; they may be operated from a concealed control booth. General lighting for the entire room is often dimmer-equipped. Displays centering around the orchestra or stage may become comparatively brilliant and colorful.

In cocktail lounges, an even, subdued lighting level seems to be desirable, with displays concentrated at the bar. Diffused general lighting, with low-intensity, intimate local lighting, is common practice. For special effects, many modern translucent materials—plastics, special glass, marble, etc.—are available. Sparkle and brilliance are often obtained at bars with various types of mirrors and metals. The bartender's

work counter needs the highest intensity of light, sometimes supplied by directional downlighting, sometimes by light sources beneath the bar top.

Color of light is extremely important where women are expected to patronize the establishment. It has been observed that women prefer lighting whose color range contains predominantly pink tones, and that restaurants and cocktail lounges so lighted have increased feminine patronage.

RECOMMENDED AVERAGE LIGHTING INTENSITIES

Location	Purpose	Foot-candles*
Foyers	general	5-10
	coat-check	5
Public dining	general	5
	cashier's desk	10-20
Private dining	general	5
	meetings	10
Bars	general	5
	work board	10-20
Service counters	general	5
Kitchens	general	5-20
	special	30-40
Storage	general food	5
	dead	2
Rest rooms	general	10

*Ranges of intensities shown indicate divergence in opinions of authorities consulted, which include General Electric's Manual, "Hotel Lighting," and engineers experienced in the field. The footcandle values represent order of magnitude rather than exact levels of illumination. See text also.

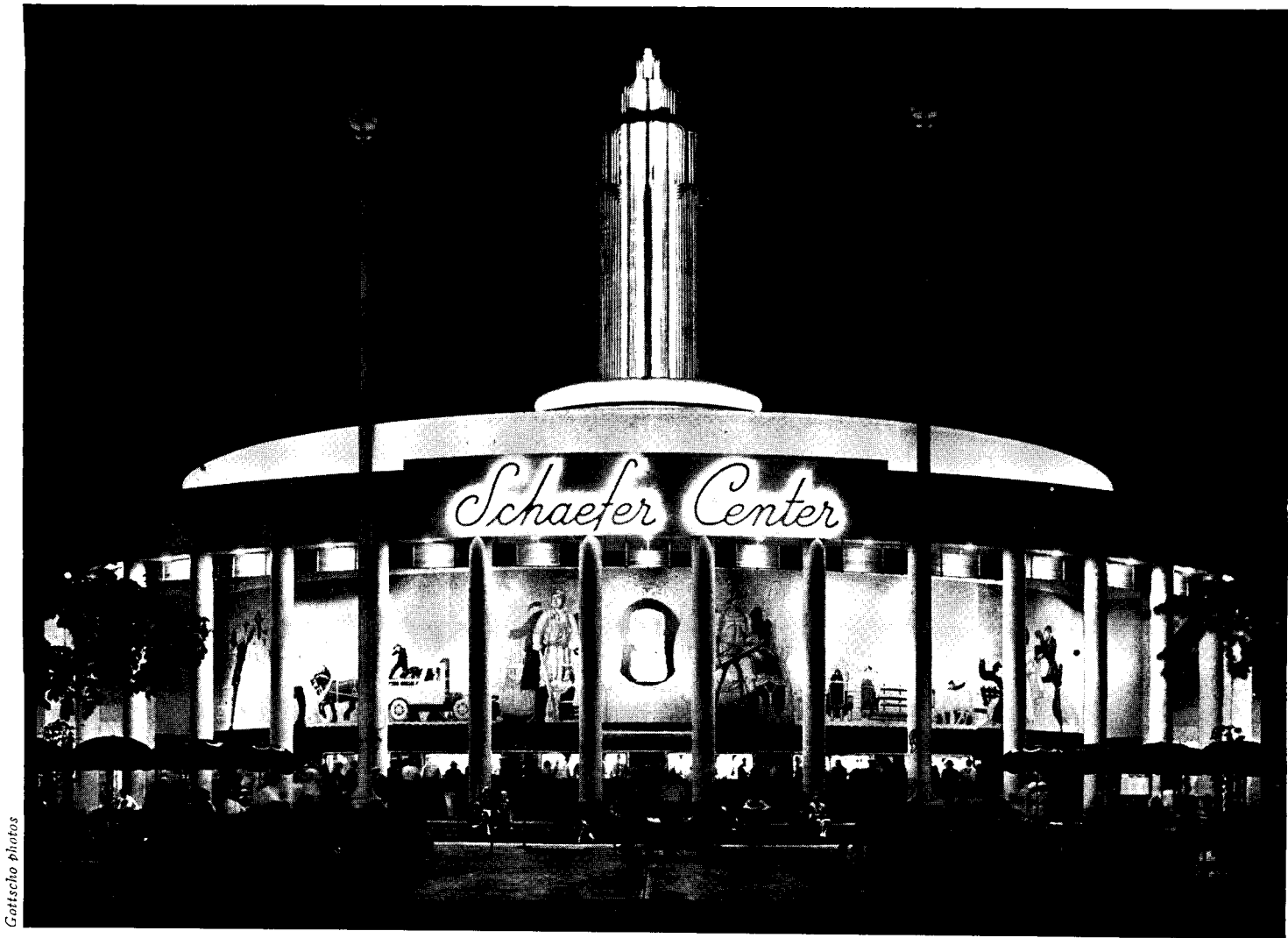

Gottschalk photos

SCHAEFER CENTER, NEW YORK WORLD'S FAIR 1939

EGGERS and HIGGINS, Architects

THE DESIGN OF this restaurant presented some unusual and interesting problems in planning. Being on a plaza, with important avenues converging from all corners, it was important to have the restaurant accessible from all sides. This necessitated placing the kitchen and service portions in the central part of the plan, surrounded by a circular restaurant space, an arrangement which permitted easy access to and from the kitchen at every part of the restaurant, with a minimum distance to be travelled

by the waiters, and free circulation.

Large areas of glass in the main dining room gave an unusual open air appearance which was enhanced when the windows were raised. For additional dining space outdoors there was provided a terrace surrounding the building. The terrace was partially covered by an overhanging marquise.

The dining room accommodated approximately 1100 persons without crowding; there was space for about 570 on the dining terraces.



One of the restaurant entrances.

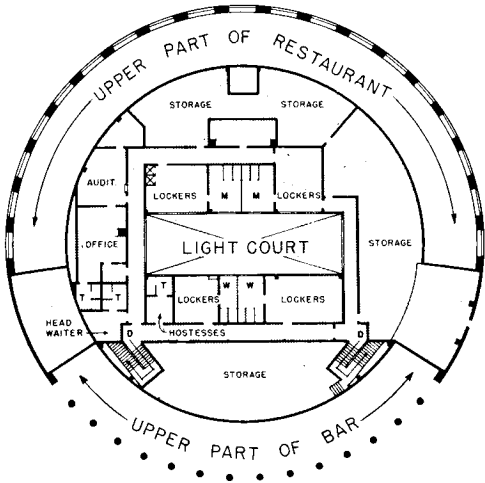
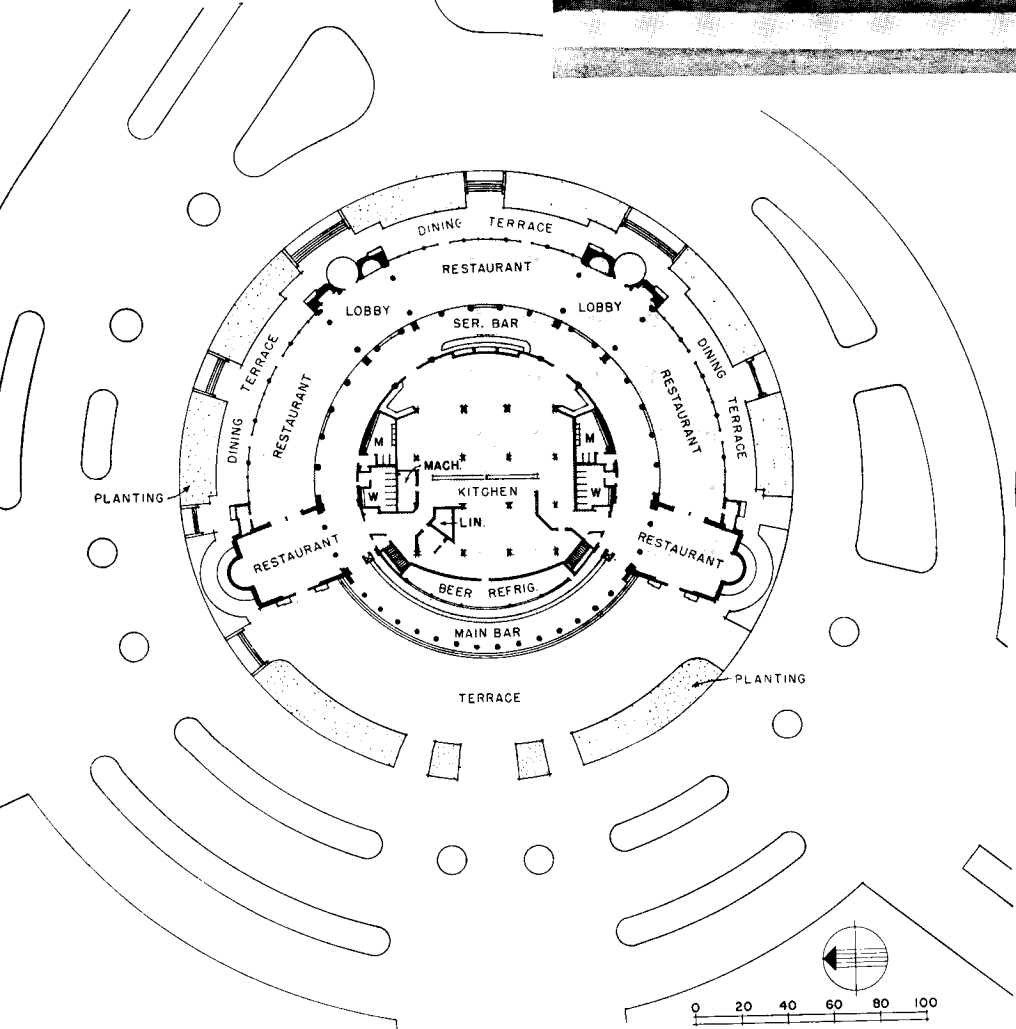

At left, first floor and plot plan, showing the plaza which determined the restaurant's circular shape. On the peak day, 33,400 glasses of beer were served at the main bar. Above, plan of mezzanine shows all rooms facing inward toward light court.



Left, a 120-ft. outdoor bar faces the main avenue of approach. Back of the bar, at eye level, a long plate-glass window provides a view of the interior of the beer refrigerator. Note Venetian blinds between columns. Below, part of the continuous dining space which encircles the kitchen. Murals on wall depict countries historically associated with beer brewing.



Gottschio photos

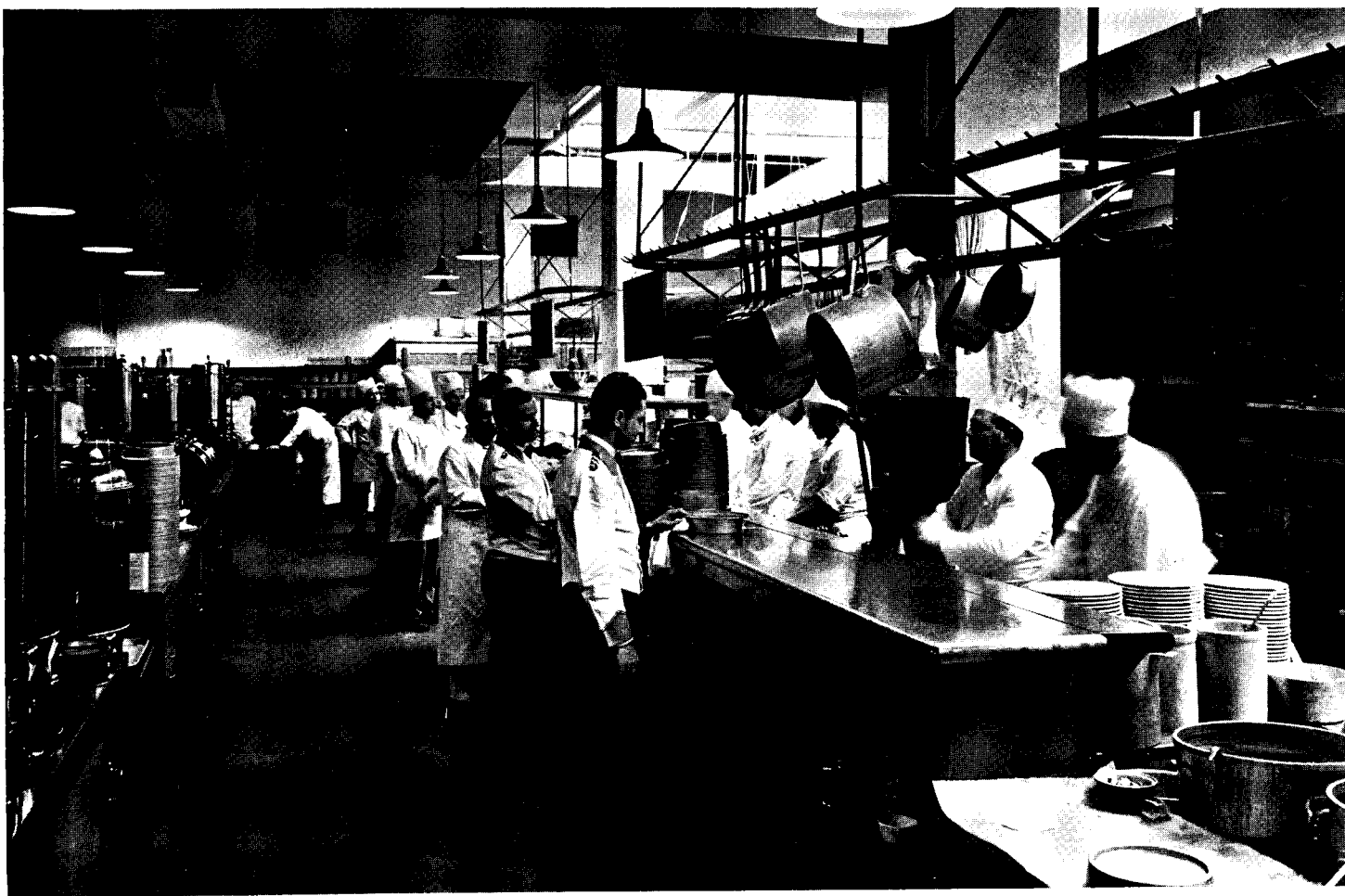

From the skylighted central kitchen, 12,665 meals were served on October 14, 1939, the day of maximum attendance.

MOST OF THE structural problems encountered in the Schaefer Center are similar to those previously reported in ARCHITECTURAL RECORD.* Public areas were made as accessible as possible; the bar was entirely open, with Venetian blinds between exterior columns for protection from sun.

In practice, the building was considered to have worked out well. The central kitchen, skylighted and ventilated, proved satisfactory in reducing travel to the various dining spaces; and the location of offices, employee facilities, and storage areas in the mezzanine provided the building with enough height to cause it to dominate its surroundings. Mezzanine spaces originally left unfinished were required for additional storage space; their conversion was easily done.

*AR 11/38 and 8/39.

MATERIALS AND EQUIPMENT

Structure: Steel skeleton on wood piling; wood joists and studding. **Exterior:** Gypsum board, painted; wood decorative columns; composition roof; steel frame tower, sheathed in wood, chrome copper covering, American Nickeloid Corp.; galvanized iron copings and flashing; cement terraces; aluminum Venetian blinds between portico columns, J. G. Wilson Corp.; bar and fittings, Liquid Carbonic Corp.; mural over bar by Arthur Crisp; wood sash, frames, and doors; rock-wool insulation. **Interior:** Gypsum-board walls and ceilings, painted; wood decorative columns; wood doors; floors, restaurant—asphalt tile, bar—Armstrong Cork-pave, kitchen—magnesite, mezzanine—wood; murals by Andre Duranceau—depicting story of "Beer through the Ages". **Heating:** Gas-fired unit heaters in restaurant. **Ventilating:** Mechanical exhaust in restaurant kitchen. **Plumbing:** Bryant water heater; fixtures, Crane Co.; kitchen equipment, Nathan Strauss-Duparquet. **Electric:** Flush reflectors and spotlights for murals, in bar and restaurant; tower illuminated by built-in trough receptacles; animated fountain effect produced by flasher.

REMODELED STORES HOUSE U-SHAPED RESTAURANT



Glen L. Palmer photos

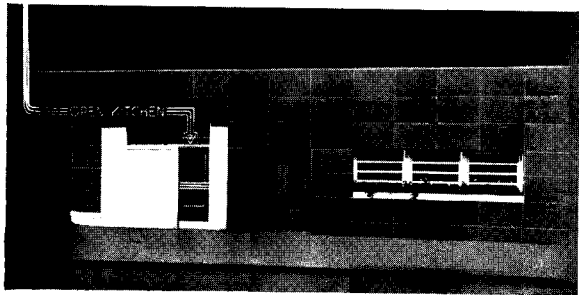

Above, new exterior; below, before remodeling.



CHAPIN'S OPEN KITCHEN, CLEVELAND, OHIO

WILBUR HENRY ADAMS, Designer

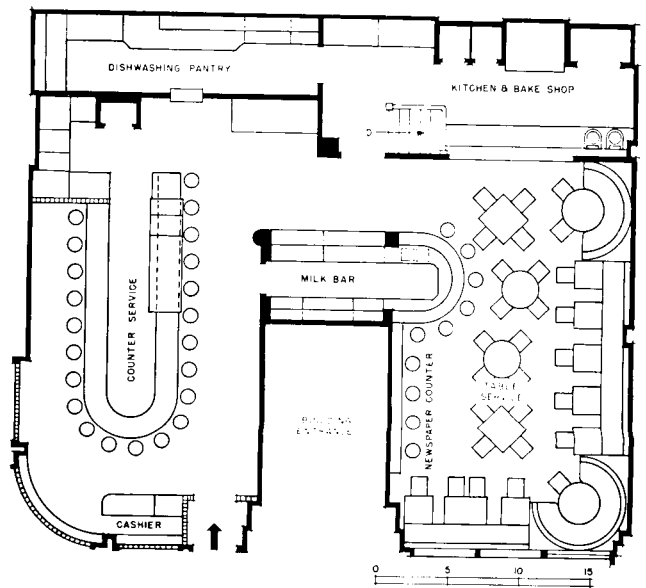

First floor

CHAPIN'S RESTAURANT replaces two stores on the first floor of a large brick apartment and commercial building. The U-shaped plan results from retaining the apartment vestibule and stairs in their original location, between the stores. Kitchen and bakeshop in the rear of the restaurant are separated from dining areas by counters and furred ceilings.

Restaurant ceilings are acoustically treated. The establishment is heated by surplus heat from the kitchen, plus a single radiator which is part of the building's heating system. An air-exhaust system is provided. A unique feature is the Newspaper Bar for the convenience of eat-and-read patrons.

MATERIALS AND EQUIPMENT

Exterior

Walls: Brick painted white; glass block, Pittsburgh Corning; porcelain enamel panels on wood furring strips. **Sash:** Wood. **Signs:** Red and white neon.

Interior

Floors: Restaurant, tan Armstrong battleship linoleum on cement; kitchen, cement with hardening paint; basement, painted concrete. **Base:** Brown rubber. **Walls:** Plaster and paint in cream color; canvas murals along one wall and milk bar, depicting animal characters; basement walls enameled in white. **Ceilings:** Johns-Manville Transite, with Hinde & Dauche acoustic treatment. **Counter and table tops:** Tan Armstrong battleship linoleum.

Equipment

Lounges: DuPont "Fabricoid," Sponge Air Seat Company. **Lighting:** Restaurant and kitchen, fluorescent lamps, General Electric Co. **Plumbing:** Hot-water lines, copper, Chase Brass & Copper Co., Inc.; cold-water lines, wrought iron; fixtures and equipment in wash rooms downstairs, Standard Sanitary & Mfg. Co. **Ventilating:** Fan and duct system, ILG Electric Ventilating Co. **Hardware:** Chromium. **Kitchen and serving equipment:** "Enduro" stainless steel, Republic Steel Corp.; refrigerators, United Cork Companies; compressors, 3 General Electric, 2 Frigidaire, located in basement; French fryer, Edison Electric; one griddle, Edison Electric; oven, charcoal burner, heavy-duty range, short-order range, American Stove Co.; Electric range, Hot Point.



Top, table-service portion of restaurant, at right of which is now installed the Newspaper Bar shown in the lower photograph.

PRIVATE BAR IN DISTILLER'S OFFICE SUITE

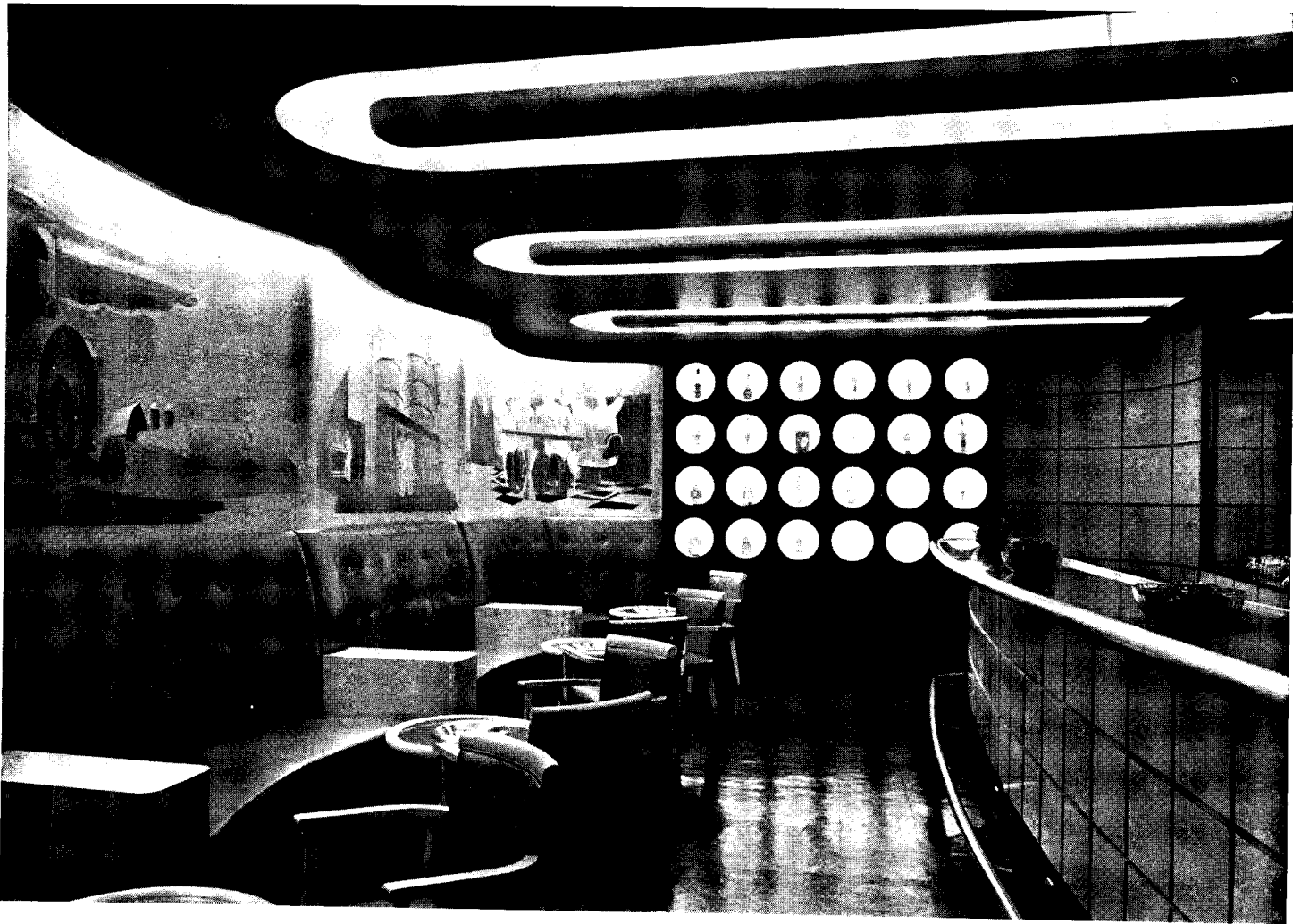

Photos by Gottscho

EXECUTIVES' BAR, SEAGRAM DISTILLERS CORPORATION, CHRYSLER BUILDING, NEW YORK, N. Y.

MORRIS LAPIDUS, Architect
 Assoc. of Ross-Frankel, Inc.

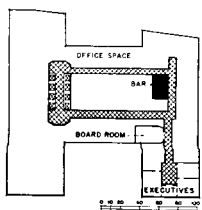

Key plan of Seagram offices, showing relation of bar to board room and executives' offices.

USED BY OFFICERS for entertaining buyers and for their own refreshment, this bar is an integral part of the company's offices. Murals are by Stuyvesant Van Veen.

All lighting, even of the striking bottle display rack which faces the entrance, is fluorescent. Especially noteworthy are the indirect ceiling troughs. Fluorescent lamps are ordinarily exposed; their low surface brightness usually reduces glare to an unobjectionable minimum. Here, however, the lamps are concealed.

MATERIALS AND EQUIPMENT

Walls: Paneled in bleached rift-sawn Oak and East Indian Rosewood, U. S. Plywood Corp. **Floor:** Dark brown rubber tile, Armstrong Cork Products Co. **Ceiling:** Plastered. **Back-bar:** Mirror, Pittsburgh Plate Glass Co. **Bar:** Stainless steel, manufactured by S. Blickman, Inc. **Bar top:** Formica, Formica Insulation Co. **Ceiling lighting:** Fluorescent lamps, General Electric; special fixtures, Lighting Distributors, Inc. **Display lighting:** General Electric fluorescent lamps. **Hardware:** Rixon. **Refrigerator:** Kelvinator. **Settees:** Upholstered with foam sponge rubber, by U. S. Rubber Co.; covered with leather, Lackawanna Leather Co.



The simple mirror behind the bar effectively increases the small room's spaciousness.

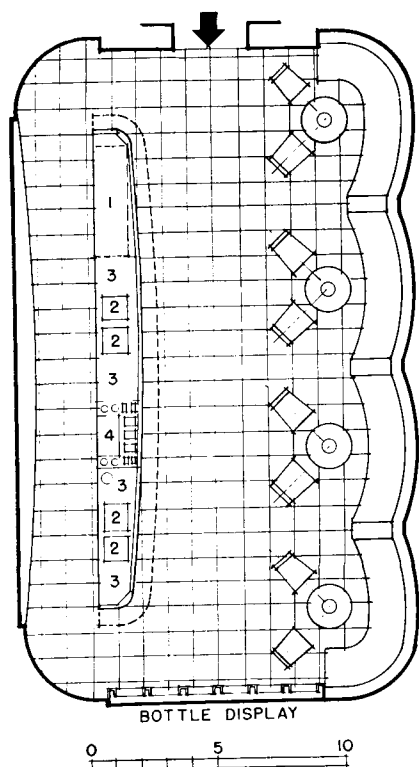

Plan of bar: 1. Refrigerator. 2. Sinks. 3. Drainboards. 4. Cocktail rack.



Totally indirect fluorescent lighting supplies all illumination.

NIGHT CLUB RESTAURANT IN SOUTH

Coffey Photos

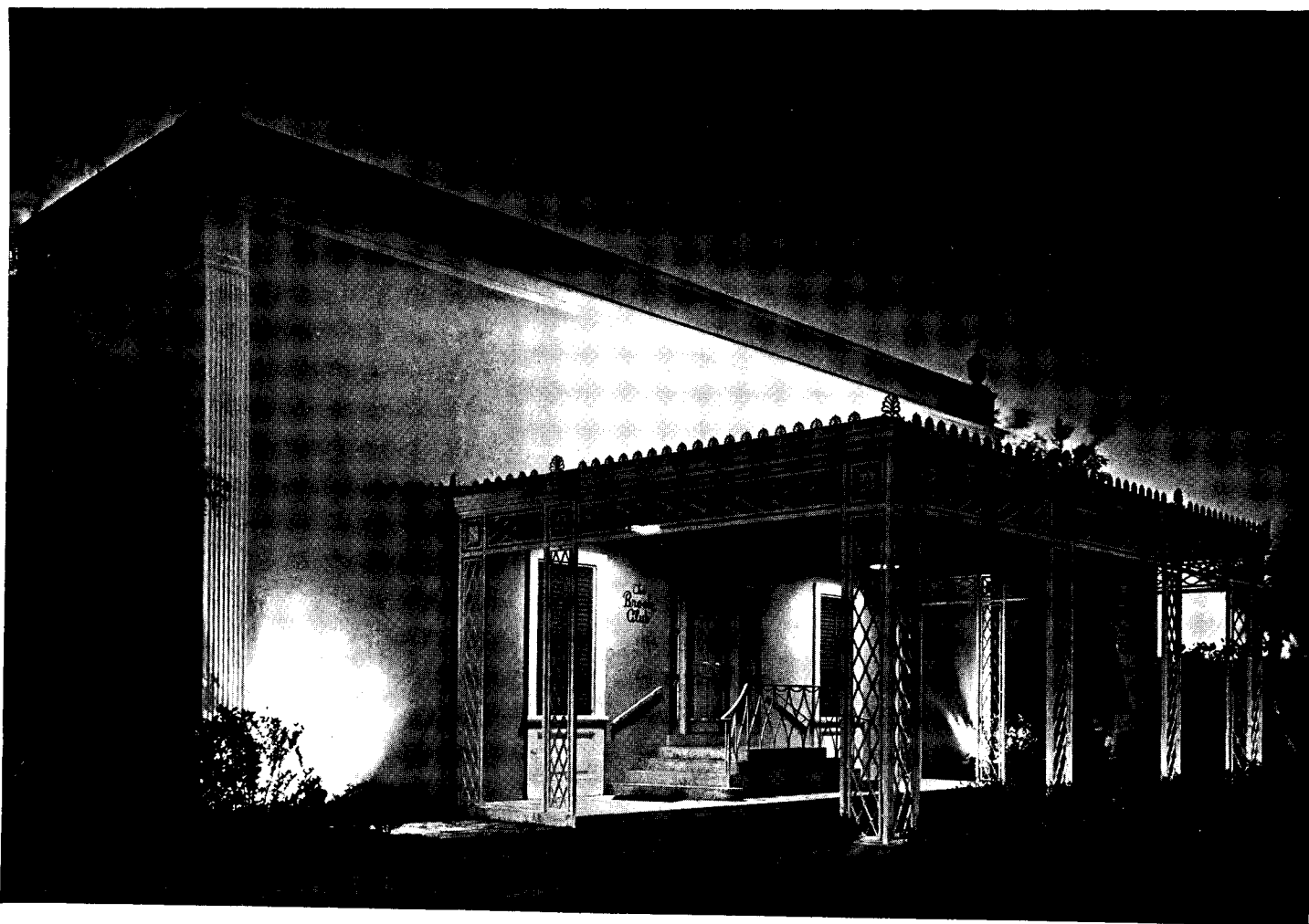

THE BROOK CLUB, MIAMI BEACH, FLA.

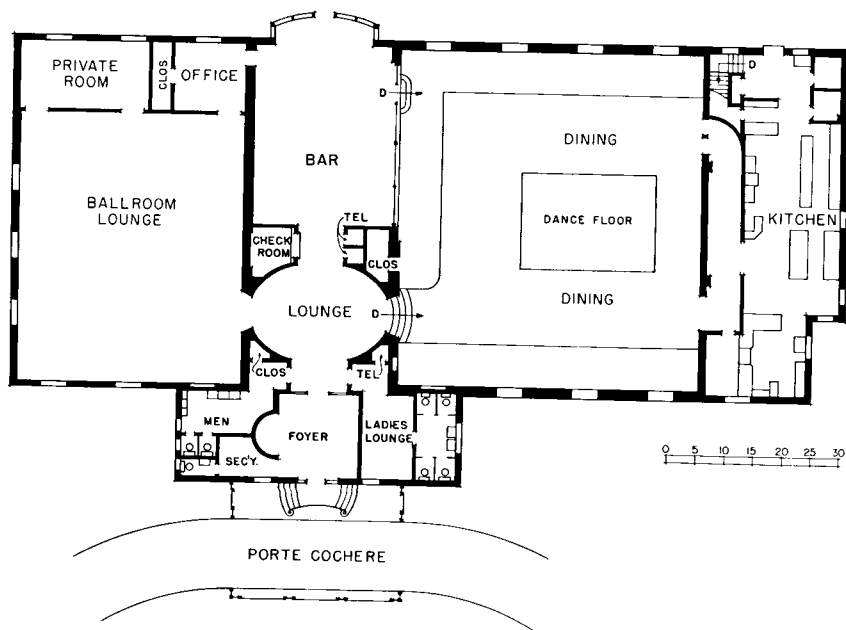

First floor

ROBERT LAW WEED and
EDWIN T. REEDER, Architects

THROUGHOUT the Brook Club, the ostrich plume is used as a decorative motif. The color scheme includes powder-blue walls, pale pink ceilings, purple carpets, and purple, gray, or pink furnishings. In the main dining room, indirect lighting is rose-colored.



Main dining room has dimmer-operated indirect lighting and recesses for ceiling spotlights used for entertainments. Air is exhausted through grille in ceiling by an attic fan. No heating system is needed.

MATERIALS AND EQUIPMENT

Structure: Reinforced concrete frame on spread footings, no cellar, 8-in. concrete block walls with 3/4-in. Sec-waterproofed stucco on exterior. Roof, steel trusses, wood purlins and sheathing, 15-year Johns-Manville built-up roof. Double-hung wood sash. Unique balances, Pittsburgh glass, copper screens.

Interior finish: Floors, wood on wood joists, with Bigelow-Sanford carpet; cement in kitchen; Mosaic tile in toilets and powder rooms; wood and linoleum on second floor. Ceilings, plaster throughout. Walls, surfaced with 24-in. squares of 1-in. Celotex which also serves as insulation. Trim and cabinets, Magnolia wood; mahogany bar. Walls and ceilings painted, Texolite, U. S. Gypsum Co.; sash, DuPont DuLux enamel.

Equipment: Electrical system, galvanized steel tube, 30% rubber-covered wire; Keep-A-Light emergency system; special fixtures, dimmers, etc., by Century Lighting Co. and Westinghouse Elec. & Supply Co. Standard Sanitary plumbing fixtures, Byer's wrought-iron piping cast-iron soil lines.

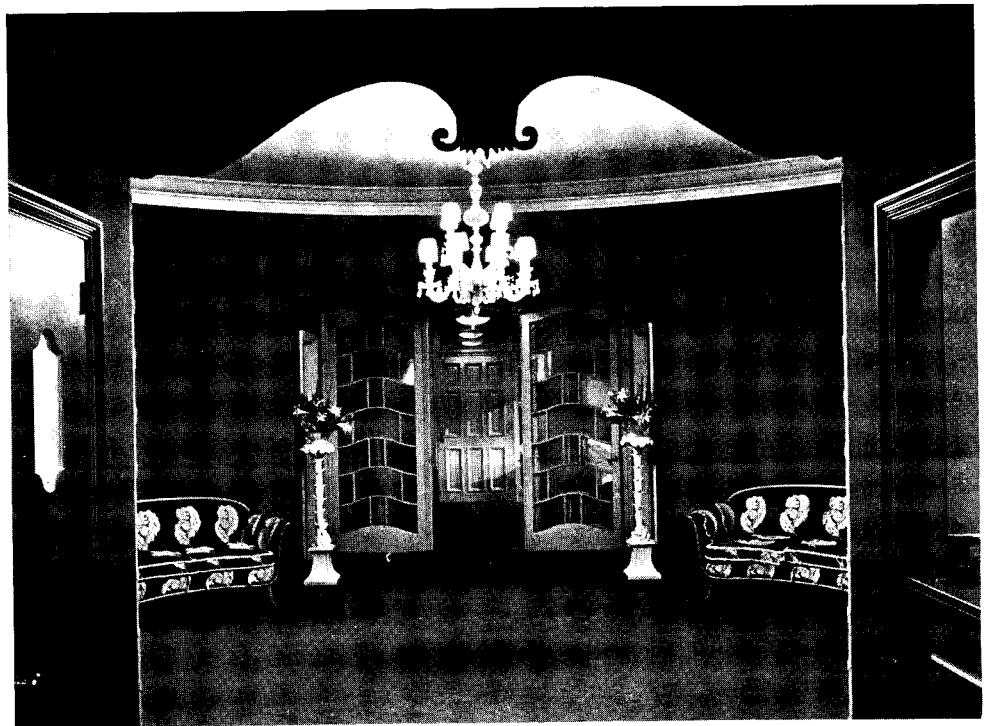

Oval lounge permits free circulation.

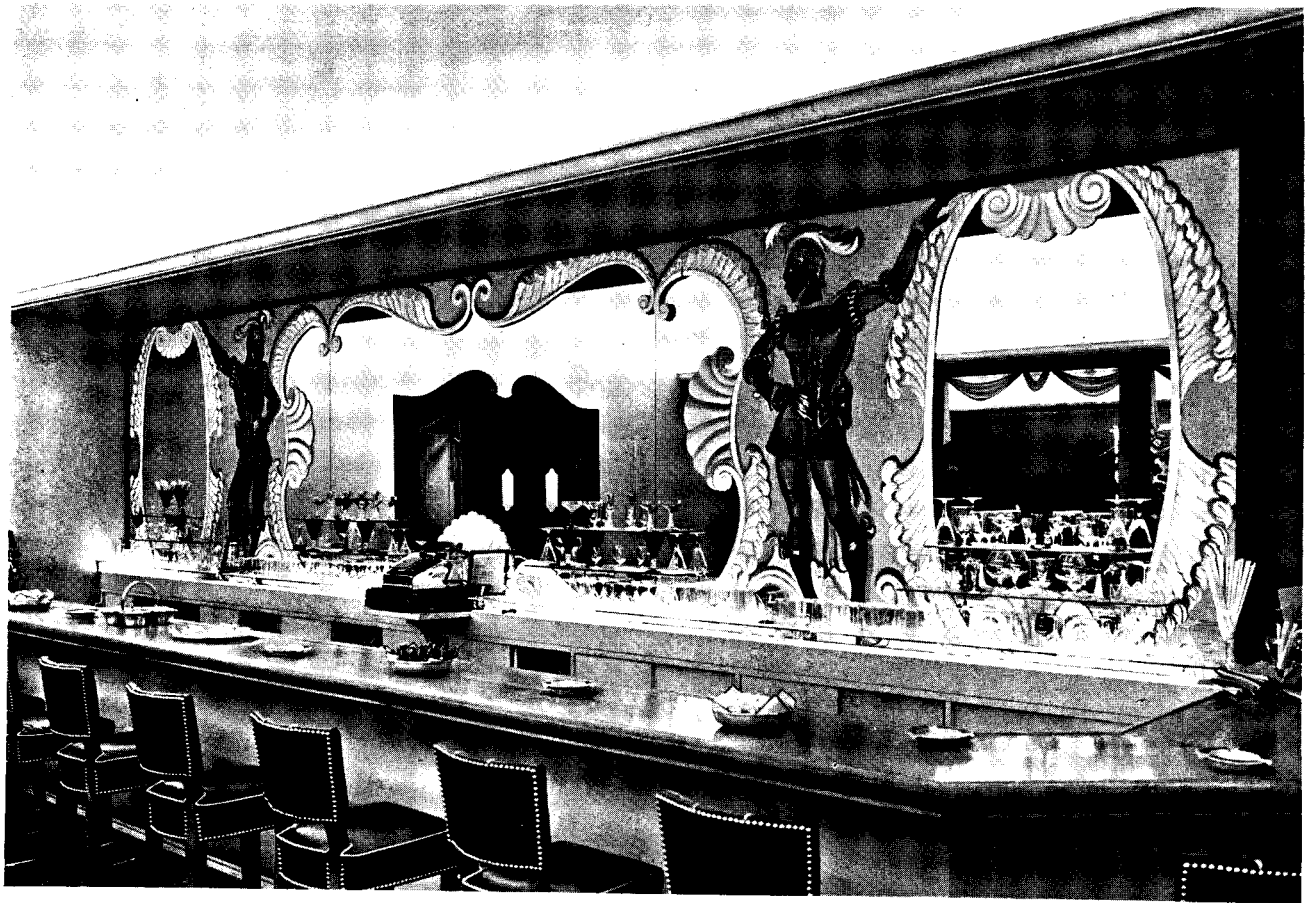

Gottschow photos

Back-bar mural is also by Christopher Clark. Face of the mahogany-topped bar is lacquered and has a carpet-covered step instead of a rail. The same color scheme is carried out here as in other rooms: gray, powder-blue, and pink, with purple carpet and blue Formica tabletops.

Check room and telephone booths are on opposite sides of the passage between lounge and bar.

FAMILY RESTAURANT NEAR RESIDENTIAL SUBURBS

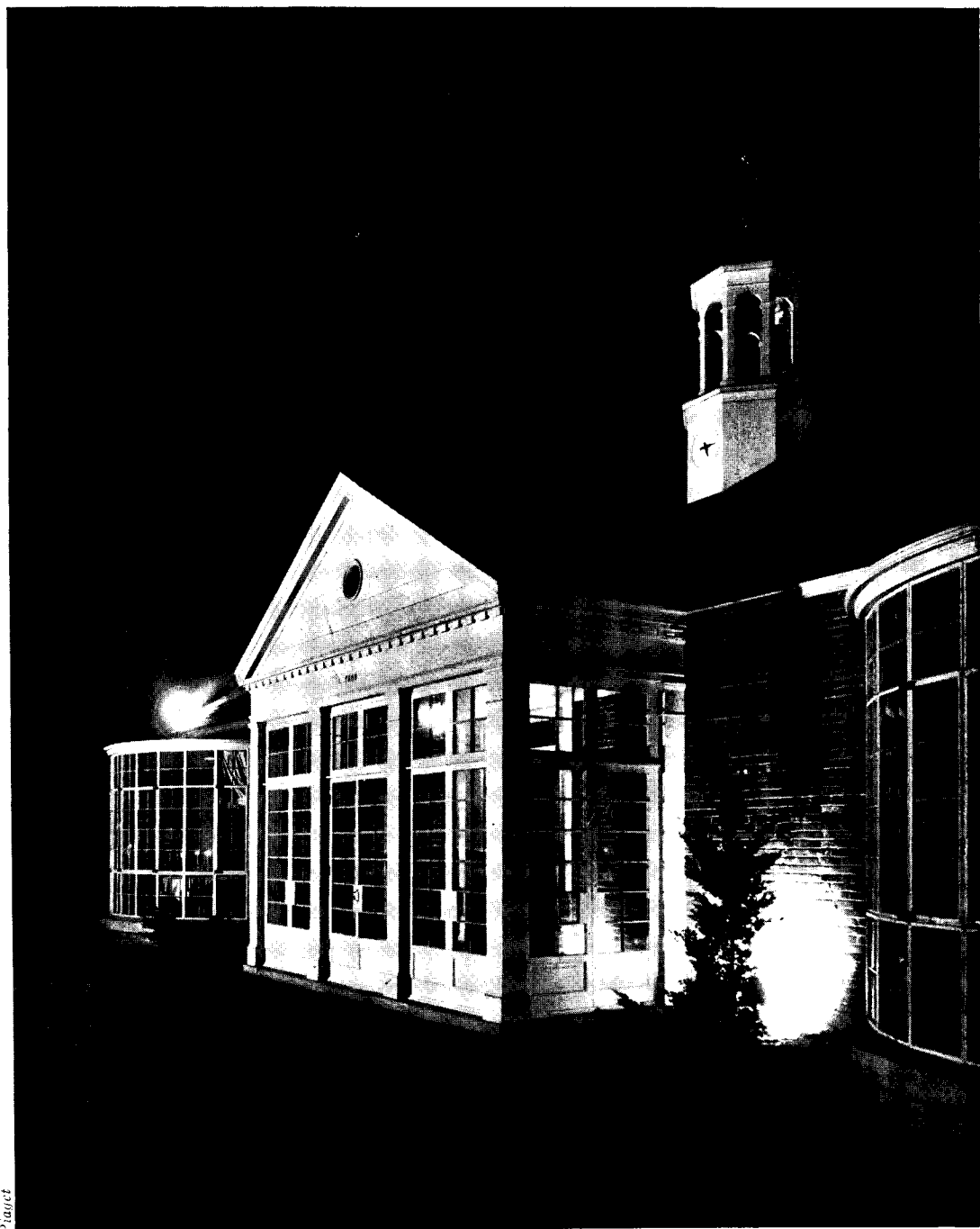

Piaget

CANDLELIGHT HOUSE, ST. LOUIS, MO.

MARITZ, YOUNG, and DUSARD, Architects

CANDLELIGHT HOUSE is built on an unrestricted plot adjacent to Lake Forest, a wooded residential suburb of St. Louis. Its atmosphere is consciously domestic; it is the kind of place to which families repair for Sunday dinner. Although the building is uppretentious and apparently not over-large, places for 422 patrons can be provided, in-

cluding stools at the Tap Room bar and seats for 200 in the basement meeting room. Ample parking space is provided on the property, and there is a large dining terrace fronting on one of the neighborhood's main boulevards. A combination of radiation and air conditioning is used for heating and cooling. Lighting is from incandescent fixtures.

Picquet photos



Main dining room was designed for patrons from the surrounding residential district and maintains a domestic character.

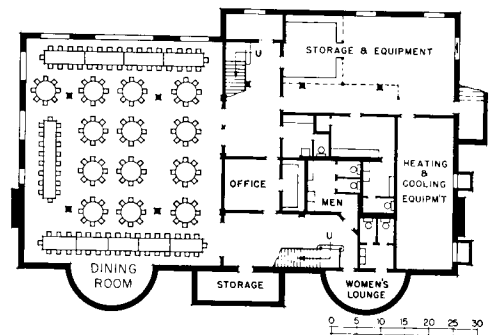
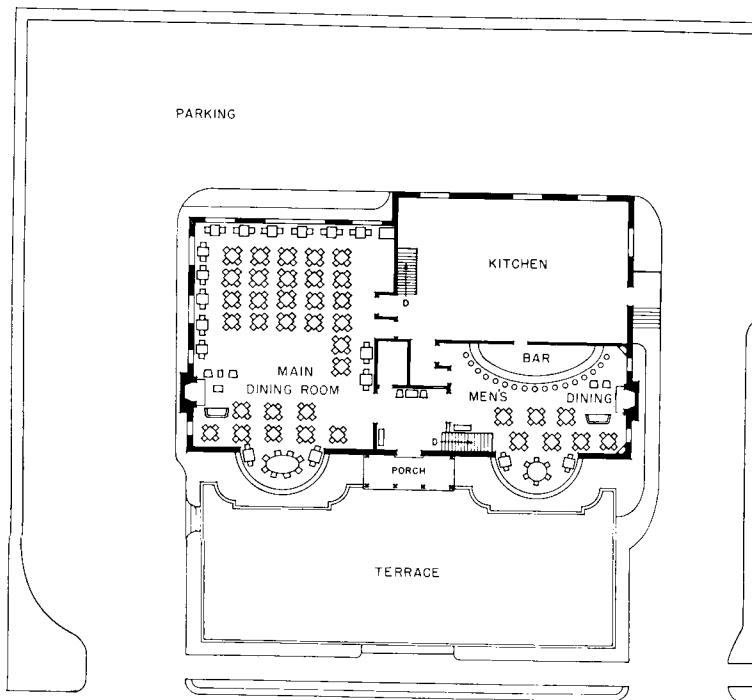

At left, first-floor plan; above, basement. Dining terrace is much used in summer. Main dining room accommodates 158; basement dining room, for meetings, can seat up to 200.



The elliptical bar in the Tap Room has stools for 16, with table seating for 38 more. Kitchen is behind bar.



Entrance foyer, showing special heating provisions, also treatment of check room.

DINNER-DANCE ROOM IN METROPOLITAN HOTEL

Hedrich-Blessing photos

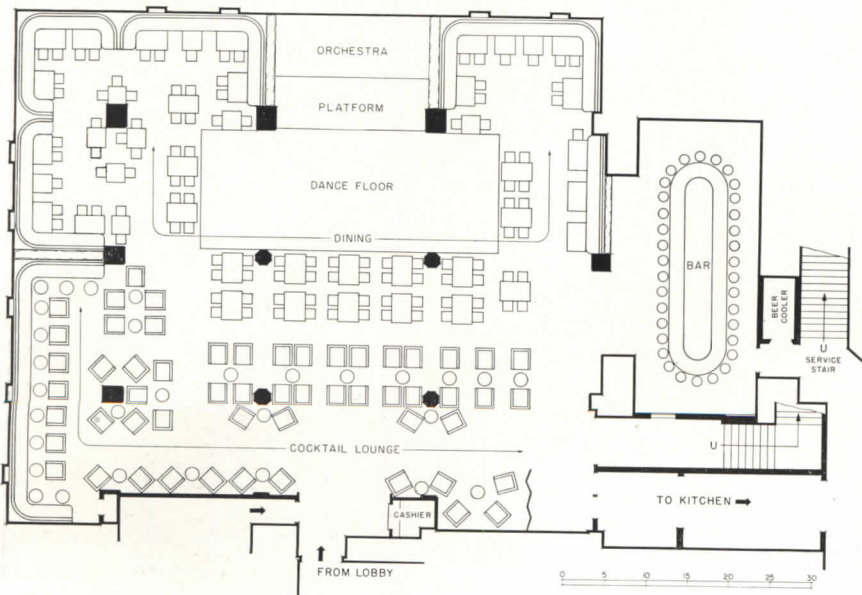

BLUE FOUNTAIN ROOM LA SALLE HOTEL CHICAGO, ILL.

HOLABIRD and ROOT, Architects

THIS restaurant's ceiling is of precast sections of plaster suspended by metal hangers. Joints are covered with white cords. At intersections are white suspended downlighting fixtures which simulate tassels. To supplement this lighting there is illumination from coves and niches along the walls.



There is no partition between cocktail lounge and dining space.



Special grilles exhaust tobacco and liquor odors; murals by Edgar Miller.

MATERIALS AND EQUIPMENT

Floor: Covered with burgundy carpet, Bigelow-Sanford. **Walls:** Painted blue and white, lead and oil paint. Figures in niches, white plaster, modeled by Edgar Miller. **Ceiling:** Precast suspended plaster panels painted blue, with white cords and pendants. **Columns:** Sheathed with pink mirrors. **Lighting:** Special wall brackets, metal painted white. Ceiling, direct fixtures concealed in pendants. **Furniture:** Existing hotel furniture remodeled in hotel carpenter shops. **China:** Special design by Holabird and Root, manufactured by Buffalo Pottery Company, supplied by Albert Pick & Company.

REMODELED RESTAURANT AND BAR IN CHICAGO

Hedrich-Blessing photos

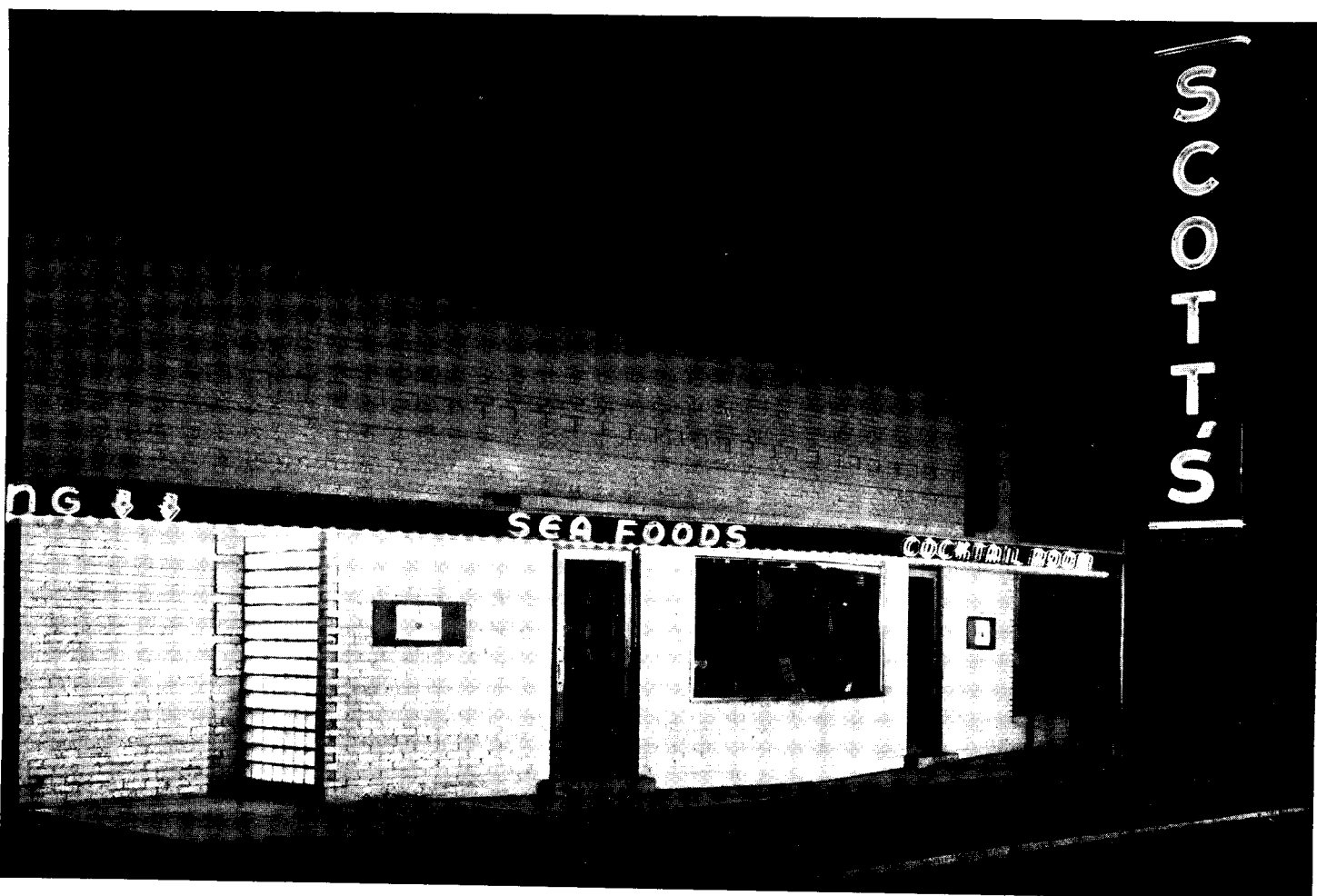

Photograph below, exterior before remodeling.

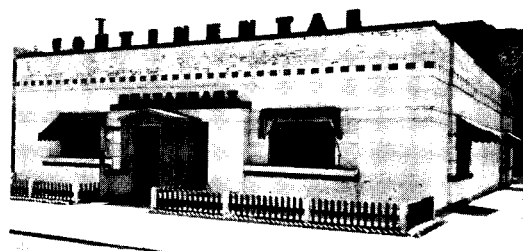

SCOTT'S RESTAURANT, CHICAGO, ILL.; J. F. EPPENSTEIN, Architect

THOUGH small, this restaurant contains three separate public rooms—restaurant, bar, and “Hunt Room” or cocktail lounge—plus rest rooms and vestibules. These spaces and the facade were remodeled; the kitchen remained as it was. The restaurant seats 62 persons; lounge, 15; and bar, 35 plus standees. Parking space for patrons’ cars is provided beside the building.

The bar is designed to resemble a midway, with games for the amusement of patrons. Restaurant is on two levels.

MATERIALS AND EQUIPMENT

Exterior: Existing brick painted white, maroon trim. **Display windows:** Flutex glass, Libbey-Owens-Ford. **Interior walls:** Vestibules, painted tangerine; restaurant, Lastic veneer, natural mahogany with white bas-relief ornament; bar, Fabricona by H. B. Wiggins Sons, with carved wood figures; cocktail lounge, knotty pine and wallpaper. **Floors:** Cocktail lounge, multicolored carpet; bar, natural-colored linoleum. **Bar and bar equipment:** Albert Pick Co.; front and wainscot, walnut; dubonnet leatherette upholstery; metal awning, painted; glass, Flutex, Libbey-Owens-Ford. **Special lighting:** Solar Light Company. **Loud speakers:** Radio Corp. America. **Hardware:** Midwest Hardware Co. **Millwork, paneling:** Nollan and Wolf.



Above, mahogany-veneered restaurant walls have applied carved-wood bas-reliefs by Bernard Rosenthal; note semi-enclosed service table in foreground. At right, dining booth at window between vestibules.

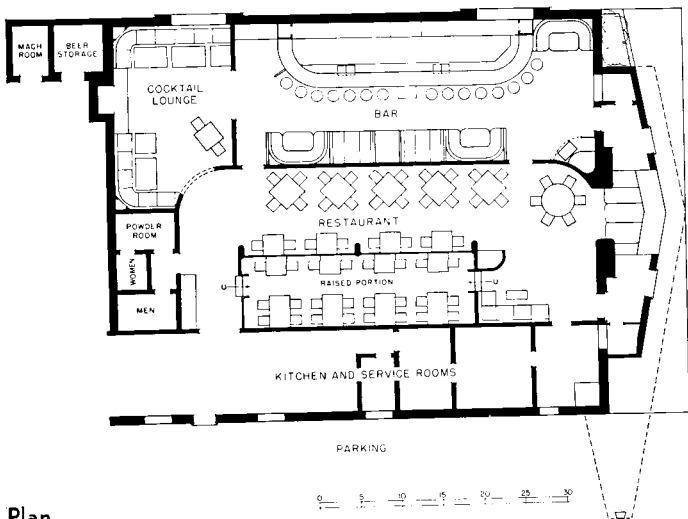
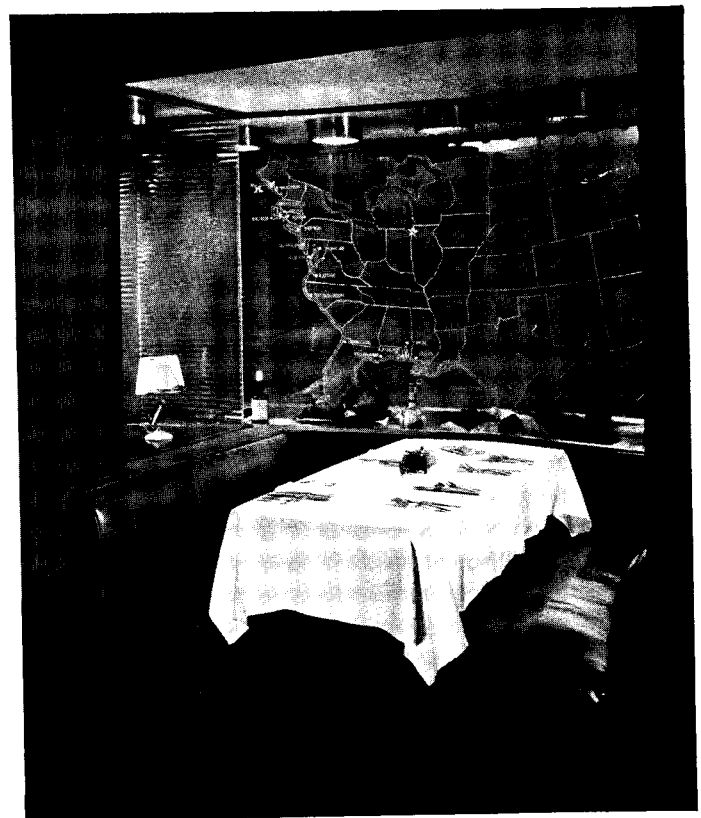

Plan

Heirich-Blessing photos



The gayly striped awning over the Midway Bar is of metal, and serves to mask the high-key lighting required both for display and for illuminating the bartender's work space.

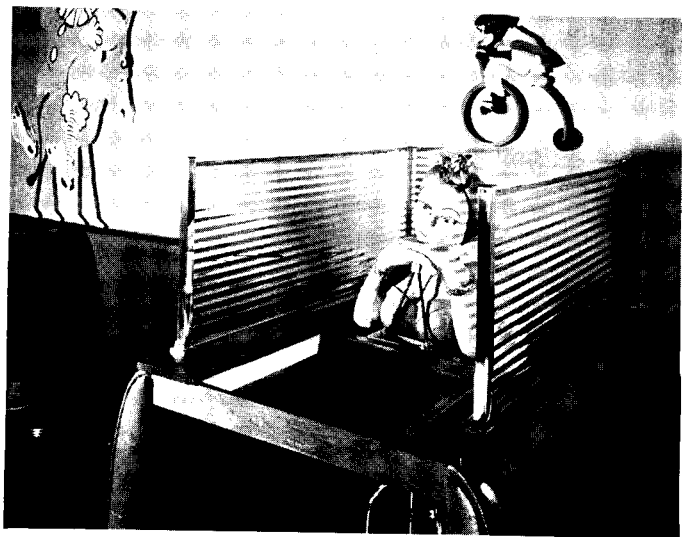

Flutex glass encloses the booth in which is played one of the many popular games.

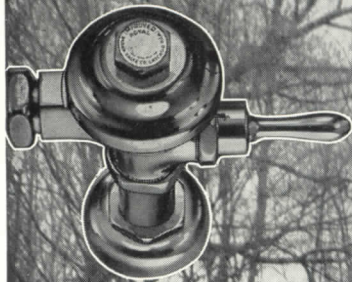

QUIET WATER

FOR all new installations specify Sloan *Quiet-Flush*, the world's most universally used flush valves which now afford the added advantage of utter quiet.

For all modernizing or replacement work—remember that any installation of Sloan Royal, Star, Crown or Naval Flush Valves, regardless of when installed, may now be made *completely quiet* by installing two silencing elements. Merely replace the present stop valve; then insert a new guide and seat in the flush valve itself. This easily accomplished change not only reduces flush valve noises to a whisper, but gives the user practically a new installation. Sloan *Quiet-Flush* is of particular interest to hotels, hospitals, apartments, offices—every place where noise elimination is desired.

Sloan *Quiet-Flush* is unlike any other silencing device. It combines the best features of generally known methods with important contributions from Sloan research. Write today for descriptive folder.

See our comprehensive Catalog in Sweets

SLOAN VALVE COMPANY
4300 WEST LAKE STREET • CHICAGO

SLOAN *Quiet Flush* VALVES

Dining Comfort Assured by

JOHNSON CONTROL

THE "BRAIN" OF THE AIR CONDITIONING SYSTEM

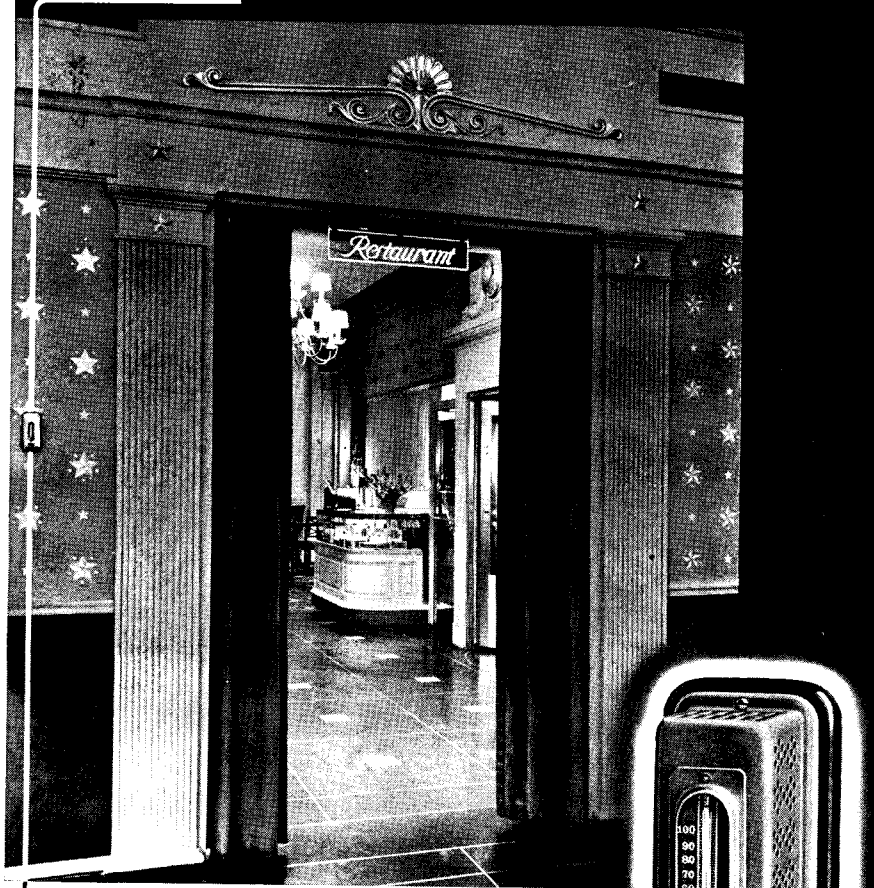

Stouffer's Restaurant, East 42nd Street, New York City. Dwight James Baum, architect. Jaros, Baum & Balles, consulting engineers. Frigidaire, Inc., air conditioning contractors.

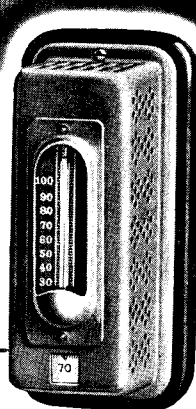

Year-round dining comfort in Stouffer's new restaurant in New York's 42nd Street is provided by four air conditioning systems. Johnson automatic temperature control supplies the operating brainwork. Important in this control system are Johnson's modulating attachments for thermostatic expansion valves. This exclusive Johnson feature assures uniform temperatures of the air delivered by the cooling coils . . . Stouffer's on Fifth Avenue also has "control by Johnson."

How often have restaurant patrons been heard to say: "It's too cold and clammy in here"? That can't happen when air conditioning, designed by competent engineers and installed by experienced contractors, is controlled automatically by a Johnson System, adapted by Johnson's trained staff of technical experts.

Ask for Bulletins describing Johnson Modulating Attachments for Cooling Coils

JOHNSON

Automatic TEMPERATURE AND AIR CONDITIONING *Control*

JOHNSON SERVICE COMPANY: MILWAUKEE, WIS. AND DIRECT BRANCHES IN PRINCIPAL CITIES

WITH RECORD READERS

(Continued from page 10)

architect in the United States or Canada may propose any other architect or any architectural draftsman as a candidate; for Group II the faculty or head of any qualified architectural school in the United States or Canada may propose candidates. Further information and forms for proposal may be obtained from the American Institute of Architects, 1741 New York Avenue, Washington, D. C.

New Addresses

THE RECORD publishes changed and new addresses only on request, making no attempt to keep a day-by-day account. The only organization in the country with facilities for doing this is Sweet's Catalog Service, whose painstakingly maintained list undergoes an average revision of 23 changes for every working day in the year. Below are the new addresses recently brought to our attention:

L. Phillips Clark, Architect, and *C. A. Smith, II*, Associate Architect, are practicing under that firm name with offices in the Harvey Building, West Palm Beach, Fla. . . . *Leslie A. Libby*, Chief Engineering Draftsman (architectural) at the U. S. Submarine Base, New London, may be addressed at 126 Mohegan Ave., New London, Conn. . . . The new address of *D. H. McCain* is c/o the Rev. E. F. Church, 345 West 12th Ave., Vancouver, B. C. . . . *Edward R. McMahon*, Industrial Designer, has changed his address to 128 Washington Place, New York, N. Y. . . . *Antonin Raymond* announces the removal of his offices to 132 E. 58th St., New York, N. Y. Mr. Raymond also writes that he is "contemplating the acceptance of a small number of apprentices to his architectural studio—at his New Hope, Pa., farm." Further information may be obtained directly from Mr. Raymond. . . . The office of *Milton Sherman*, Architect, is now at 277 Broadway, New York, N. Y.

Manufacturers' Publications

Carrier Architectural Catalog. Information on Carrier Equipment for Air Conditioning, Commercial Refrigeration, and Space Heating. Carrier Corp., Syracuse, N. Y.

The Phantom Doorman Catalog and Data Sheets. Information on the automatic electric-eye door opener and closer for entrance, lounge, and service doors. Yale and Towne Mfg. Co., Stamford, Conn.