

A line as black as night!

Typhonite Eldorado Pencils make such lines! Opaque lines! Lines firm and solid, lines as black as a black feline. This is the kind of line wanted in today's drawings—because today's blueprints must be clean as the path of a bullet.

Why is the *Typhonite* Eldorado line so opaquely black? Simply because the Eldorado's lead is *Typhonite*. No other drawing pencil has *Typhonite* leads. *Typhonite* is created out of natural graphite by an exclusive Dixon process. Try *Typhonite* Eldorado Pencils in any of the 17 degrees of your choice.

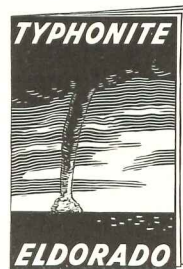

This interesting, informative booklet, a little history of pencil making, is yours for the asking. Please write on your business or professional stationery.

Pencil Sales Department 225-J1
JOSEPH DIXON CRUCIBLE CO. • JERSEY CITY, N. J.

A
Statement
ON
**ASARCO
TUBE-LOY**
BY
**AMERICAN
SMELTING
AND
REFINING
COMPANY**

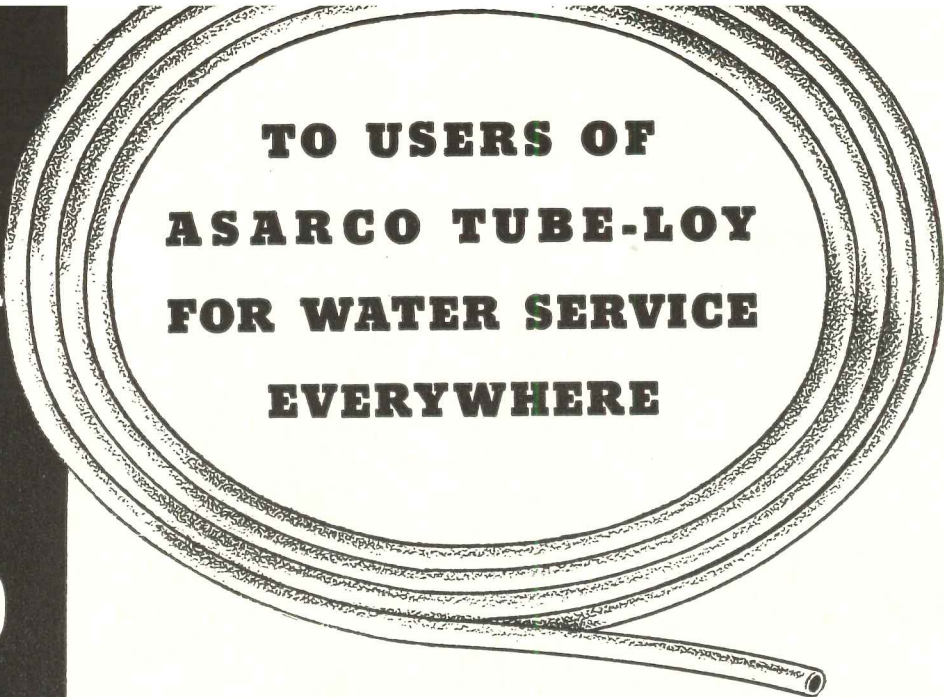

**TO USERS OF
ASARCO TUBE-LOY
FOR WATER SERVICE
EVERYWHERE**

The demand for ASARCO TUBE-LOY has been steadily growing. Our manufacturing, research and shipping departments are working constantly to embody every possible improvement in the product. The following statements will be of interest to TUBE-LOY users.

QUALITY: All extrusion facilities have been equipped with automatic quality control. The research department is now responsible for UNIFORMITY of all TUBE-LOY prior to shipment.

PACKING: Our shipping department reports packaging improvements. TUBE-LOY for LOCAL DELIVERIES will be wrapped in straw pads plus additional outside paper wrapping mechanically applied. All LONG DISTANCE SHIPMENTS will be packed identically as above and inserted in specially designed cartons. Test shipments satisfactory.

INTERIOR USE: It is obvious that usage of TUBE-LOY for interior installation presents problems at variance with those encountered in water service. Approval for this purpose, therefore, must be withheld until research investigations are complete. WE RECOMMEND ASARCO TUBE-LOY FOR WATER SERVICE FROM MAIN TO METER. WE CANNOT YET RECOMMEND ASARCO TUBE-LOY FOR INTERIOR PURPOSES.

We appreciate the constructive criticisms and helpful suggestions that have resulted in the widespread acceptance of ASARCO TUBE-LOY. Such continued cooperation will aid us in being of maximum service to those who rely on TUBE-LOY as a preferred water service medium.

AMERICAN SMELTING AND REFINING COMPANY
LEAD PRODUCTS DEPARTMENT • 120 BROADWAY, NEW YORK

A *New* Technique for Sash Replacement — INSULUX Panels That Require *No Metal*

HOW TO REPLACE
WOOD WINDOWS IN 12" BRICK WALLS

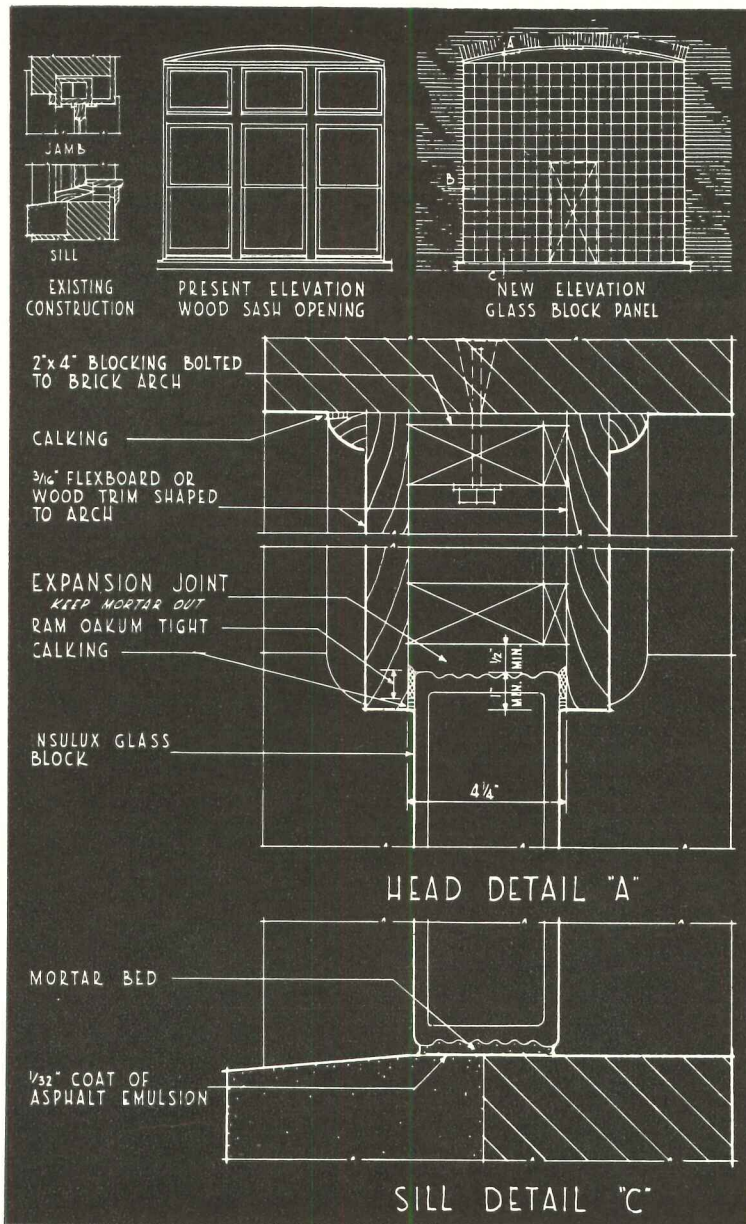

Arched head wood windows may be replaced with glass block by removing the sash and altering the opening:

1. Coat sill with asphalt emulsion;
2. Bolt wood stops on interior to form a chase with existing exterior brick;
3. Bolt wood blocking to arched masonry head to take exterior and interior wood trim or flexboard.

Free This new 16-page book of special details shows how to install glass block panels without metal. It covers sash replacement and new construction. Write for your copy today.

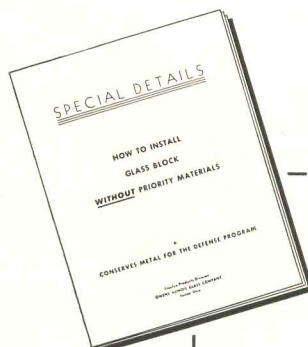

Send for **FREE** detail book

This new technique—planned by Owens-Illinois engineers and proved by severe tests—permits you to frame glass block panels with alternate materials, thus saving critical defense materials.

It works for almost any size opening—demands no steel or priority materials of any kind although it provides for conversion in the future to standard construction if desired—can be combined with sash where you wish vision or ventilation.

When you specify INSULUX Glass Block for sash replacement, priority rulings need not delay improvements or repairs to light-transmitting areas.

And you are assured of quick construction for INSULUX is available for prompt delivery.

For sash replacement, INSULUX Glass Block insures generous light transmission, quick construction and low maintenance cost—and releases needed priority metals for national defense.

The new INSULUX book—with a wide variety of details—covers almost every type of installation. It will prove a valuable addition to your reference library. Write for your copy today.

**PROMPT DELIVERY ON INSULUX GLASS BLOCK
—SAVE PRIORITY METALS BY USING INSULUX**

OWENS-ILLINOIS
INSULUX
Glass Block

OWENS-ILLINOIS GLASS COMPANY, INSULUX Products Division Dept. 17, Ohio Building, Toledo, Ohio.
Gentlemen: Please send me, without obligation, your free book on "How to Install Glass Block *Without* Priority Materials."

Name.....
Address.....
City..... State.....

PROVEN PROTECTION
FOR UNDERGROUND HEATING LINES

BYERS WROUGHT IRON

"Out of sight, out of mind" doesn't apply to underground lines—unless specifications are based on experience, and drawn with care. Not only must internal corrosive action be combated, but external attack as well: From the soil when the pipe is buried . . . from moisture when it is enclosed in a conduit or tunnel.

For the underground steam and return lines serving the alterations and additions at the Riverside Hospital, the architect and engineer specified wrought iron. Its unusual durability in this application is a matter of general knowledge. Just recently a large steam heating company installed a 700' run of 15" wrought iron main. A middle western college used 14" wrought iron line in a concrete box tunnel. At a Cincinnati suburb, 3½ miles of wrought iron main, used to distribute steam from a central plant, was found "still in perfect condition" after 14 years.

Wrought iron was also specified for a number of other corrosive services at Riverside; hot and cold water risers and branch lines 2" and over; concealed rain leaders; vent lines 1½" and under; and all drainage in direct connection with fixtures.

If you have a specification problem involving underground heating lines . . . or any other building service where ordinary materials do not give satisfaction, let our Engineering Service Department provide you with actual case histories of wrought iron's performance. For some interesting general information, see our bulletin, "Wrought Iron for Piping Systems."

A. M. Byers Company, Pittsburgh, Pa. Established 1864. Boston, New York, Philadelphia, Washington, Chicago, St. Louis, Houston, Seattle, San Francisco.

**BYERS
GENUINE
WROUGHT IRON**

Tubular and Hot Rolled Products
Steel Tubular Products

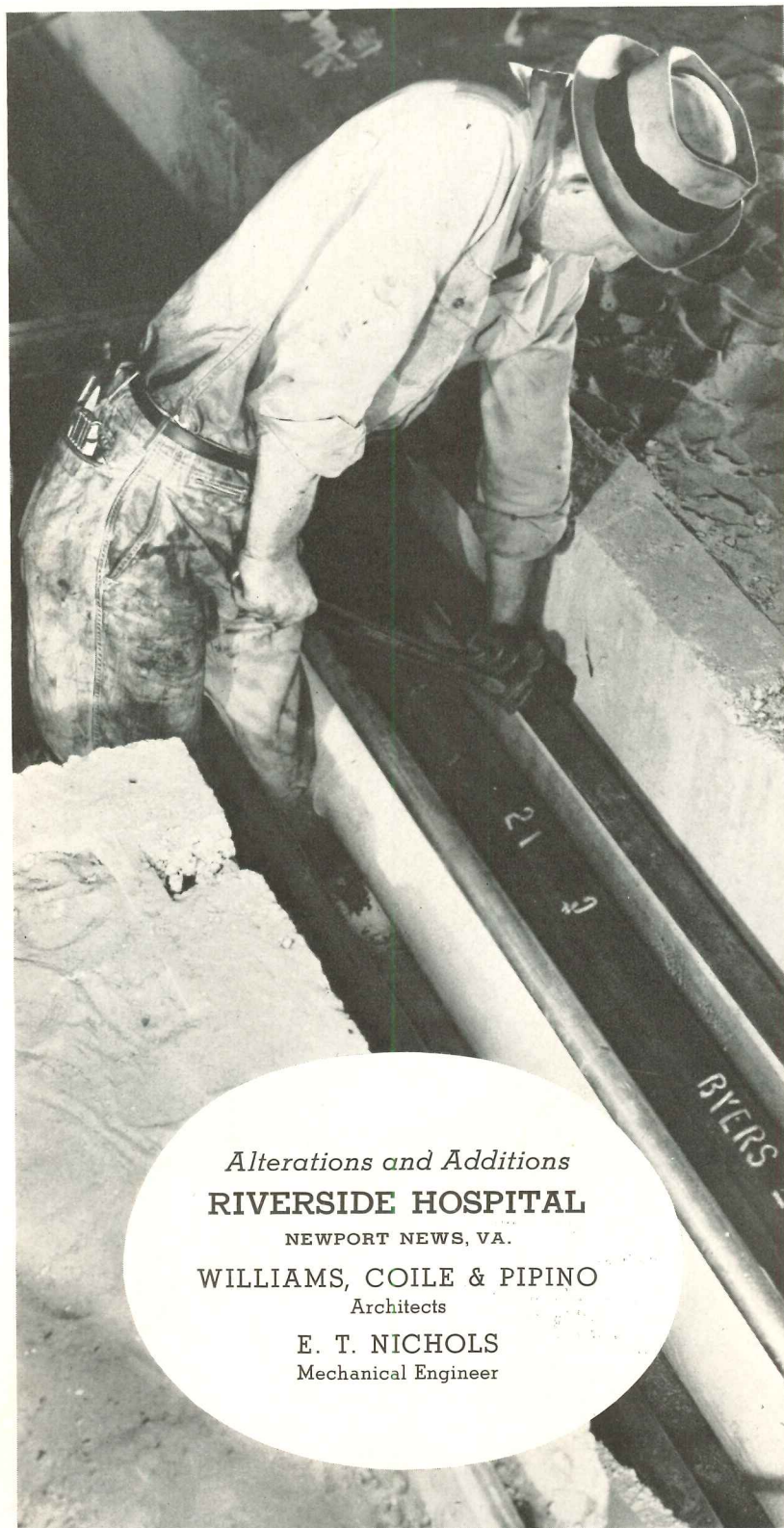

Alterations and Additions
RIVERSIDE HOSPITAL

NEWPORT NEWS, VA.

WILLIAMS, COILE & PIPINO
Architects

E. T. NICHOLS
Mechanical Engineer

CORROSION COSTS YOU MORE THAN WROUGHT IRON

Photos used in the montage on the cover are courtesy Gottscho, Roger Sturtevant, St. Thomas. Thomas Korn, M. L. Pruitt and Dupre Morgan & Co.

JANUARY 1942

record

ARCHITECTURAL

COMBINED WITH
AMERICAN ARCHITECT AND ARCHITECTURE

BEHIND THE RECORD

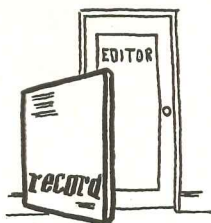

CONSTRUCTION ESTIMATES SOAR

Pearl Harbor and war declarations last month caused the defense program to expand into a war program. And almost overnight the volume of construction requirements sky-rocketed.

In mid-November, F. W. Dodge Corporation issued 1942 construction estimates which, closely conforming to those of OPM, anticipated a 20 per cent increase in dollar volume of *defense construction* over 1941 and a decline of about two-thirds in dollar volume for *non-defense construction*. Thus a 32 per cent decrease for 1942 was anticipated in the volume of total construction for the 37 Eastern states covered by Dodge figures.

Most recent OPM estimates indicate that defense construction in 1942 will be greater by 75 per cent or more than that of 1941.

It is therefore reasonable to think that the total war construction program—including essential building for civilian needs—may equal or even exceed the total 1941 volume.

Thomas S. Holden, President of F. W. Dodge Corporation and Editorial Director of ARCHITECTURAL RECORD, points to the increased requirements of a vastly enlarged Army, Navy and air force for explanation of the soaring 1942 con-

(continued on page 7)

NEWS AND NEW BUILDINGS

A RECORD SURVEY OF BUILDINGS NEEDED.....	37
TOTAL WAR MEANS ALL-OUT CONSERVATION.....	41
HOUSES OF WOOD.....	49
Lake Oswego, Ore.....	50
Seattle, Wash.....	52
San Francisco, Calif.....	53
Seattle, Wash.....	54
Moraga, Calif.....	56
Menlo Park, Calif.....	56
Inverness, Calif.....	58
Seattle, Wash.....	60
SPECIFICATION STANDARDS FOR GOVERNMENT WORK.....	61

INDUSTRIAL BUILDINGS... A BUILDING TYPES STUDY

WAR REQUIREMENTS TO ACCELERATE PROGRESS IN DESIGN..	65
Type of Buildings.....	66
Plan Organization.....	67
Conditions Due to War.....	68
STRUCTURE AND CONSTRUCTION.....	69
TIME-SAVER STANDARDS.....	75
BEHIND THE RECORD.....	5
WITH RECORD READERS.....	10
NEWS FROM WASHINGTON.....	16
TRENDS IN BRIEF.....	24
REVIEWS OF CURRENT LITERATURE.....	26
CURRENT TRENDS OF BUILDING COSTS.....	33
NEWS OF MATERIALS AND EQUIPMENT.....	82
ARCHITECTURE MEETS ADVERTISING.....	84
INDEX TO ADVERTISEMENTS.....	106
INDEX TO VOLUME 90.....	109

Copyright, 1942, by F. W. Dodge Corp. All rights reserved.

Editorial Director: Thomas S. Holden. Managing Editor: Roger Wade Sherman, AIA. Associate Editors: Frank G. Lopez Jr., George A. Sanderson, Emerson Goble. Art Director: Gene Hawley. Desk Editor: Catherine Woolley.

ARCHITECTURAL RECORD (combined with American Architect and Architecture) is published monthly by F. W. DODGE CORPORATION, 119 West 40th Street, New York. Thomas S. Holden, Pres.; Howard J. Barringer, Vice Pres. and Treas.; Irving W. Hadsell, Vice Pres.; H. Judd Payne, Vice Pres.; Chauncey L. Williams, Vice Pres.; Sanford D. Stockton Jr., Secy.; Walter F. De Saix, Asst. Treas.; Edwin H. Freed, Asst. Treas. Member Audit Bureau of Circulations and Associated Business Papers, Inc. ARCHITECTURAL RECORD is indexed in Reader's Guide, Art Index, and Industrial Arts Index. Subscription rates: United States and Possessions, Canada, Cuba, Mexico, Central and South America, \$3 the year, \$5 for two years, \$6 for three years; elsewhere, \$5 the year; single copy, \$1. Circulation Manager: Robert C. MacDougall.

Manuscripts, photographs, and drawings which conform to RECORD'S editorial aims are welcomed. Every effort will be made to return material (if accompanied by stamped, addressed envelopes); but the editors will not be responsible for losses.

Other Dodge Services: REAL ESTATE RECORD AND BUILDERS' GUIDE, SWEET'S CATALOG FILES, HOME OWNER'S CATALOGS, DODGE REPORTS, and DODGE STATISTICAL RESEARCH SERVICE.

“We shall need and demand . . . doubled and quadrupled production — ever increasing” . . .

From the President's Address to the Nation — Dec. 9, 1941

In his historic December 9th address, The President indicated two broad policies to bring the armaments of the nation to the highest achievable levels. First, by the establishment of a seven-day work week. Second, by building new plants, enlarging and converting old plants for war needs.

ARCHITECTS AND ENGINEERS share, with management, the responsibility of getting this monumental job done with the greatest speed. In specifying new construction or factory expansion it is important to remember how much *PLANNED LIGHTING* can do to speed production, increase efficiency, save costly errors and avoid accident.

Fundamentally, the principles of war time lighting do not differ from those of peace time lighting. It is only that, under conditions of national emergency, the planning and execution are far more difficult. So much has to be accomplished in so short a time. Moreover, there is no margin for compromise, no time for trial and error.

Today, there is another requirement for plant lighting equipment. As part of the *intermediate machinery* of production it must conserve the three basic elements required by the *immediate machines* of war. The lighting job must be engineered so that:

- 1—It will conserve **Critical Materials**—the units should be designed and constructed so that they require a minimum of metals.
- 2—It will conserve **Man Power**—providing the best seeing and working conditions through proper control and distribution.
- 3—It will conserve **Electrical Power**—providing efficient illumination with the smallest expenditure of current.

For speedy, sound solution of your lighting problems under present conditions — consult the Holophane Engineering Department. This organization, regarded as authority in all matters of illumination since 1898 — offers advice and engineering help without obligation.

Write for data today.



HOLOPHANE COMPANY, INC. . . . 342 Madison Avenue, New York City

HOLOPHANE COMPANY, LTD., 385 Yonge Street, Toronto, Canada

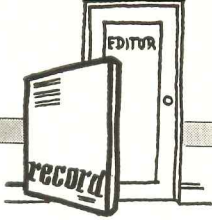

(continued from page 5)

struction estimates. In a recent statement, Mr. Holden said in part:

Every type of construction project for Army, Navy, and air corps will be required in increasing numbers—troop housing, flying fields, naval bases, fortifications, shipyards, ammunition and supply depots, recreation centers and every other type of military structure. Defense plant construction is slated for substantial increase over previous estimates. In addition to factories there will be required large numbers of warehouse buildings of various types. Essential commercial and community facilities to serve defense housing will also be required in increasing amounts.

While non-defense construction will be on a minimum basis, critical materials will be made available for necessary maintenance and repairs, and structures requiring very little metal, such as farm buildings, will not be restricted, according to present rulings.

Numerous urban centers now in the non-defense class will be designated as defense areas. An appreciable amount of war construction will be undertaken in strategic points outside the United States, which will employ American architects, engineers, contracting organizations, and building labor and require shipment of construction materials.

The war construction program promises to employ through the year 1942 practically the entire construction industry.

Naturally, certain members of the industry, including some designers and building craftsmen with specialized techniques not essential for war projects—and some producers of building specialties made of critical materials and rated as non-essential—will have to adapt themselves to new activities, either in war construction or in other war production. Some will have to take work away from home; some private architects, some contractors and some sub-contractors ordinarily engaged in work now classed as non-essential may become employees of large designing or contracting organizations or of government agencies. However, the war program will of necessity utilize practically every private construction organization or facility that is geared to handle war construction projects and will encourage the formation of new ones.

REMODELING NEXT MONTH

Remodeling offers one practical means of effecting conservation of scarce materials and at the same time meeting many current building requirements. OPM has recognized this double-barreled potential; and thus remodeling in several categories of construction rates the blessing of priorities. . . . In February we're presenting a noteworthy list of remodeled jobs that includes houses, stores, apartments and even a church; short

articles by architects who have specialized in remodeling work; and a series of Time-Saver Standards on structural remodeling details for foundations, floors and walls—practical data of ace value to any designer with a remodeling project on his boards. . . . Harold R. Sleeper's compilation of Federal and ASTM Specifications will continue; there will be a report of what's new in Reinforced Concrete; and the B.T. Study will be on Restaurants.

QUERY—AND TOTAL ANSWER

A letter from Keith Sellers Heine, Hartford, Conn. architect, arrived too late for publication last month. Since war was declared, his question seems academic to us. But because it has undoubtedly been in the minds of many architects and engineers, we're running it anyway. And on pages 41 and 48 of this issue appears the answer to Mr. Heine's query. If "total war means all-out conservation" we're convinced that percentage figures would offer very little immediate help in finding ways and means of saving critical material—not only in small houses but in every type of building construction.

Mr. Heine wrote:

Why wouldn't some reliable figures showing what percentage of the total amount of critical metals are used in the building industry tell us whether the SPAB is using good judgment in forbidding their use in non-defense building? In other words, if we know—and also if the SPAB knows—whether the building industry used 1 per cent, 5 per cent or 10 per cent of all the steel, copper, lead or zinc produced in this country in 1940, they would have some definite basis on which to work, and we would have some definite basis on which to talk—or quit talking.

It would also be interesting to know what percentage of these critical metals was used in residential building, and what percentage in non-residential building. . . .

Then there is also the line that the SPAB has drawn showing where defense housing stops. I have just completed a large house for a top-rank executive of a large aircraft company. Personally I would consider him a much more important defense worker than six of his machinists. Certainly there are a large number of defense workers who are not in the habit of living in the type of house that \$6,000 limits us to in Connecticut.

Another interesting comparison would be to see what percentage of critical metals is still being used in lipstick containers, compacts, tobacco cans and cocktail shakers, and other non-essential products.

There must have been a much larger percentage of houses built in 1940 costing under \$7,500 than there were costing more. Those costing more of course should have steel girders, copper or brass pipe and copper flashings. Therefore the percentage of critical metals used in the houses costing \$7,500 or more during any given year should also prove very interesting.

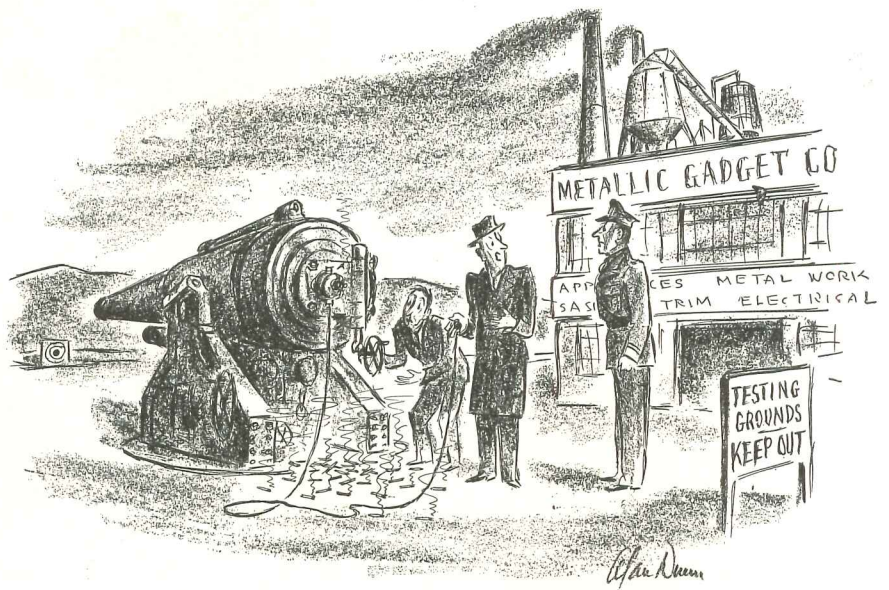

"I'm afraid the boys are a little new at making these things, Colonel—you press the button and it delivers a lighted cigarette."
—Drawn for the RECORD by Alan Dunn

Sloan Flush Valves?
take



Rockefeller Center



for example

ROCKEFELLER CENTER, probably the largest real estate development in recent history, stands as both a monument to the genius of the late John D. Rockefeller and a symbol of American enterprise. Its fourteen

buildings house more than 25,000 tenants and accommodate over 100,000 visitors daily. Its 5,000,000 square feet of floor space afford services ranging from the famous Music Hall with a seating capacity of 6,200 to twenty-four restaurants, eleven foreign consulates, the press and radio center of the world, and schools which teach everything from shorthand to dancing.

This hundred million dollar project is completely Sloan equipped. Why should this property, in common with literally thousands of other large companies and institutions, give such recognition to Sloan Flush Valves? Simply because Sloan Flush Valves give the greatest dollar value.

Why SLOAN Flush VALVES?

THEY SAVE WATER. Because of the accuracy and permanence of adjustment Sloan Valves save their owners water *all* of the time. And Saved water is saved money—not only in reduced consumption of water but in reduced pumping and man-power costs.

THEY REDUCE MAINTENANCE EXPENSE. Sloan Flush Valves cost but $\frac{1}{2}\text{¢}$ to $1\frac{1}{2}\text{¢}$ per valve per year to maintain. Entire installations in service for years without being touched are constantly reported.

THEY SAVE REPLACEMENT. Sloan Valve durability may be verified in your locality. Installations 15, 20 and 25 years old are common to every section of the country and every type of building.

that's why in office buildings, schools, hospitals, hotels, institutions, factories, apartments or public buildings, the vast majority of flush valves are Sloan. Indeed, there are more Sloan Flush Valves sold than all other makes combined.

SLOAN VALVE COMPANY, 4300 W. LAKE STREET • CHICAGO

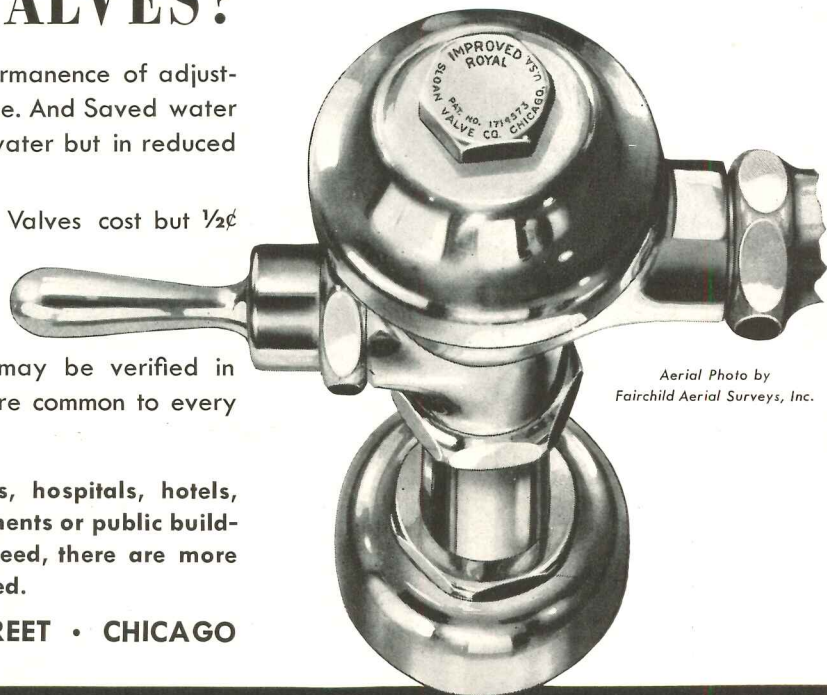

Aerial Photo by
Fairchild Aerial Surveys, Inc.

SLOAN Flush VALVES

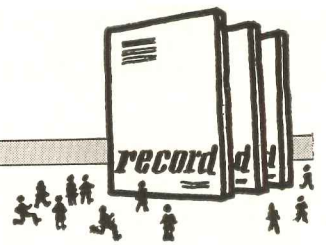

AIA Fights Curtailment of Building; Demands Government Use Architects' Skill in Planning for Protection

ARCHITECTS continued this month to wage a stubborn fight against priority rulings drastically curtailing new construction, as well as against Government failure to make full use of the architects' abilities in preparations for war. Calling on the Government to utilize the vast reservoir of unused technical skill in the architectural and allied planning professions, *Frederick J. Woodbridge* of New York, chairman of the Committee on Architectural Services of AIA, declared that the disaster at Pearl Harbor revealed tragic results of a lack of protective planning.

"Hickam Field was as obvious a target, or more so, than any commercial airport. The hangars were lined up to make it as easy as possible to do the maximum damage with the least effort," Mr. Woodbridge pointed out. "In fact," he said, "many planes must have been destroyed not by bombs but by collapsing roofs of

hangars adjacent to a hit. The great barracks shown in the newspapers seem designed to afford the greatest destructive power to a single hit.

"Architects have struggled in vain with authorities," he continued, "to consider natural concealment or scattered and staggered plans to avoid such catastrophies. Various excuses have been given; some, in the light of recent events, are ludicrous—such as 'a certain air post is not in a danger zone; it is 250 miles from a border.'

"Usually any extra cost is frowned upon. But surely it would be cheaper to spend half as much again on an installation that would escape destruction than to have to replace an entire establishment, not to mention irreparable loss of life.

"There exists in the country a large body of highly trained technicians who are able and willing to make their important contribution to the war effort. These men are experts fundamentally equipped to deal with camouflage and planning for protection. It makes little difference in what capacity architects are used. The all-

important fact is that the nation truly cannot afford not to use them."

* * *

AN URGENT APPEAL to the architectural profession for cooperation in civilian protection was issued to 71 chapters of AIA by *Horace W. Peaslee* of Washington, chairman of the Institute's National Committee on Civilian Protection (AR 9/41, p. 20, 10/41, p. 10).

"The first job of the chapter committees," Mr. Peaslee explained, "is to prime the chapter membership on the fundamentals of protective construction. The second is to make each chapter a force in local defense measures."

The national committee, Mr. Peaslee revealed, will include nine regional members corresponding to the general subdivision of the United States by the Office of Civilian Defense. Chapter presidents and regional directors of the Institute are asked to nominate an architect residing in their area to serve as a regional member.

The national committee seeks from

(continued on page 12)

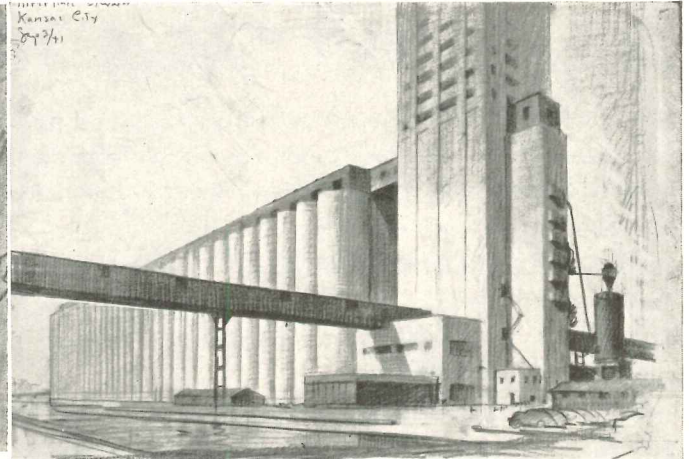
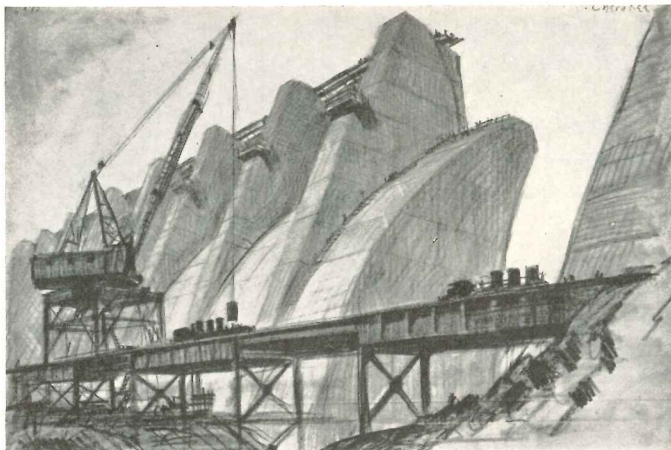

TVA dam in Tennessee, grain elevator in Kansas City, and Ford factory in Detroit are three of more than 100 sketched studies of dynamic American architecture produced by Hugh Ferriss. Mr. Ferriss received a 1941 Brunner award from the New York Architectural League to carry out this project. His sketches are being finished in anticipation of a show at the League. Plans include the probable publication of a book.



American Air Filters protect men, materials and machines in National Defense Plants

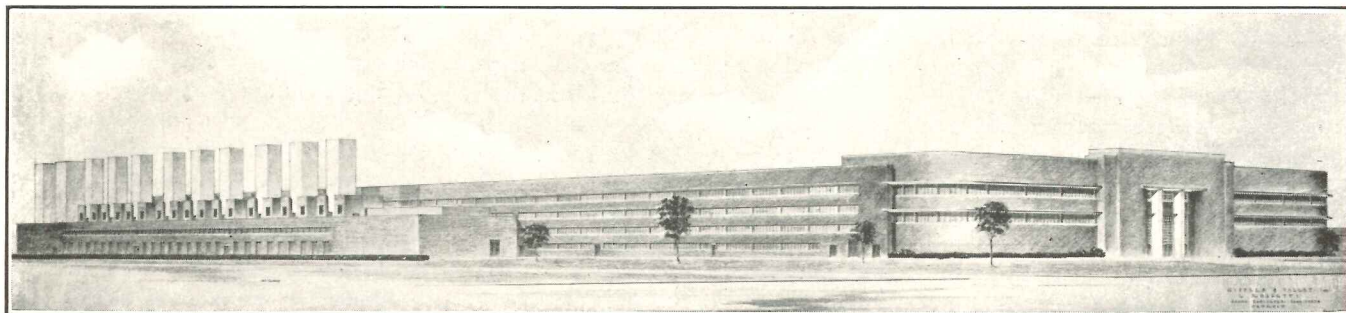

AIRCRAFT BUILDING — FORD MOTOR CO. — TYPICAL OF NEW DEFENSE PLANTS SERVED BY AAF FILTERS

...wherever production must not be slowed down by destructive DUST, SMOKE, SOOT OR FUMES...

Wherever the countless defense materiel are being made, clean air is playing a vital role in keeping production lines moving at unprecedented speed. Men and women who operate machines must breathe freely of clean wholesome air . . . and those machines must be protected from the ravages of dust. AAF filtration and dust control equipment delivered to plants engaged directly in making war materials comprises approximately 92% of our output. Bulletins describing in detail the entire line of American Air Filter products are available on request.

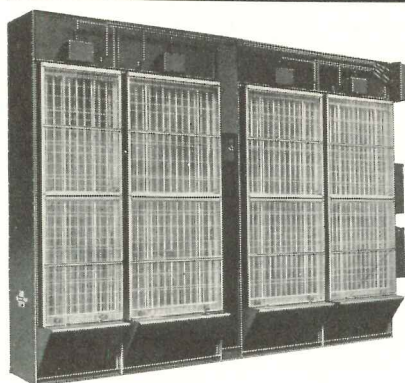

AMERICAN ELECTRO-MATIC FILTER

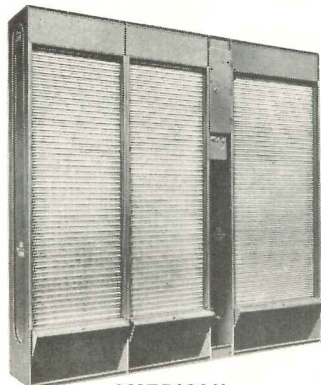

AMERICAN AUTOMATIC FILTER

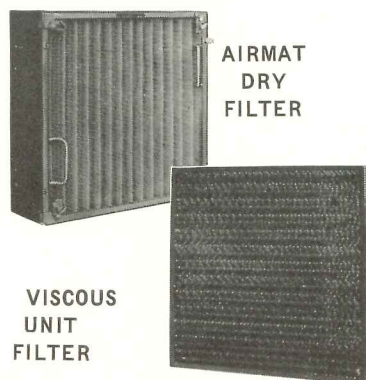

AIRMAT DRY FILTER

VISCOUS UNIT FILTER

THE ELECTRO-MATIC FILTER combines electrical precipitation with automatic air filtration to obtain the highest efficiency in the removal of atmospheric dust and smoke. Widely used in aircraft motor manufacturing plants. Ask for Bulletin No. 250C.

THE AMERICAN AUTOMATIC FILTER is completely automatic in its operation, eliminating need of attention and assuring satisfactory performance at all times. Widely used in airplane assembly plants, tank arsenals, etc. Ask for Bulletin No. 241.

AAF AIRMAT DRY FILTER uses standard Airmat medium in continuous sheet form furnished in 225 foot rolls. Approved by National Board of Fire Underwriters. Extensively used in ordnance and powder plants. Ask for Bulletin No. 230C.

PERMANENT WASHABLE VISCOUS UNIT FILTER for industrial air cleaning where sturdy construction, high efficiency and large dust holding capacity are essential. Widely used for cleaning air supplied to barracks and theatres in army camps and cantonments. Ask for Bulletin No. 201D.

When writing for Bulletins, please address 386 Central Avenue, Louisville, Kentucky.

TYPICAL COMPANIES NOW USING AMERICAN AIR FILTER EQUIPMENT

- BOEING AIRPLANE COMPANY
- ALLISON DIVISION OF G. M.
- CURTISS WRIGHT CORPORATION
- FORD MOTOR COMPANY
- GENERAL MOTORS
- NORTH AMERICAN AVIATION
- STUDEBAKER CORPORATION
- EDW. G. BUDD CO.
- DUPONT COMPANY
- SPRINGFIELD ARSENAL
- U. S. NAVAL YARDS
- CATERPILLAR TRACTOR CO
- CHRYSLER MOTORS CO.
- HUDSON MOTORS CO.
- HARLEY-DAVIDSON COMPANY
- VULTEE AIRCRAFT CO.
- DOUGLAS AIRCRAFT CO.

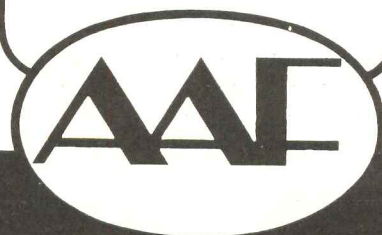

AMERICAN AIR FILTER COMPANY, INC., LOUISVILLE, KY.

(continued from page 10)



each chapter information as to local developments relating to protective construction, planning for evacuation, camps, camouflage and the activities of architectural, engineering or landscape professions in these fields. A roster of individual technicians in the New York area who have had air raid experience abroad will be compiled for national reference.

"We must recognize the possibility," Mr. Peaslee stated, "that almost any part of the country can, and may be, subjected to enough long-range 'token' bombings to disturb the civilian population generally and to precipitate demands which we as architects will be called upon to meet."

* * *

PETER BRUST of Milwaukee, director of the Illinois-Wisconsin District of AIA, declared Midwest architects demand modification of the SPAB priority ruling. He pointed out that while non-defense construction is expected to come to a complete stop, the automotive industry is permitted 60 per cent of normal production. "The products of the construction industry," Mr. Brust said, "require about 20 per cent of critical materials to 80 per cent of non-critical materials, while the product of the automobile industry requires 98 per cent of critical materials, yet the construction industry is expected to fold up completely while the automotive industry is curbed but 40 per cent of normal."

* * *

CENTRAL ILLINOIS Chapter of AIA stated in its quarterly News Bulletin that a recent survey disclosed the following: If private building proceeded at the rate of \$3,600,000 per year, it would use only 1.37 per cent of the steel production, 4.32 per cent of the copper production; 2.56 per cent of the zinc production; 5 to 10 per cent of the lead supply. No aluminum would be necessary.

* * *

THREE architectural groups recorded in resolutions their protest against the SPAB ruling on priorities. The Western Mountain District of AIA, em-

bracing Washington, Oregon, Utah, Colorado and Montana, pointed out in its resolution that the percentage of critical materials required in civilian construction was "infinitesimal" in comparison with the loss in production resulting from strikes. The ruling, it was stated, has forced a virtually complete stoppage of private building in the five states. "There is also incontrovertible evidence of the wasteful use of critical materials in defense construction projects designed by and issued from the Federal bureaus," the resolution continued. "The correction of the above conditions is imperative if the building industry with its millions of persons involved is to continue to function."

The resolution of the Westchester County (N. Y.) Society of Architects protested the drastic curtailment as "unnecessary, unwarranted and unfair." The resolution demanded that if restrictions must be applied, similar restrictions be placed on all non-defense industries, and that a national committee be formed comprising all branches of the construction industry to work out fair restrictions and regulations.

New Jersey Chapter of AIA and the New Jersey Society of Architects jointly recommended that the regulation be changed to eliminate the price restriction of the dwelling unit, and that where restrictions are necessary they be applied only to the quantity of critical materials to be used in the dwelling unit as set forth in the present regulations.

* * *

MEANWHILE Richmond H. Shreve, president of AIA, after conferring with priority leaders declared that OPM officials would give the "green light" to all private building which does not require the use of critical materials and labor. "There is no prohibition," he stated, "against the use of building materials, such as wood, cement and masonry, and processed goods, such as hardware and plumbing fixtures, if they are already in private stock. The Government does not desire to take nails, roofing, or other finished goods al-

ready in the hands of the retail business men.

"On the contrary, it is desirable that the building industry continue buying building materials from the local business men and employing local labor. If existing stocks are used up, there is the possibility that the Government will allow the shelves of the small business men to be restocked, providing more materials are available for the manufacture of finished goods after the first rush of Government buying lessens to a steady, calculable demand."

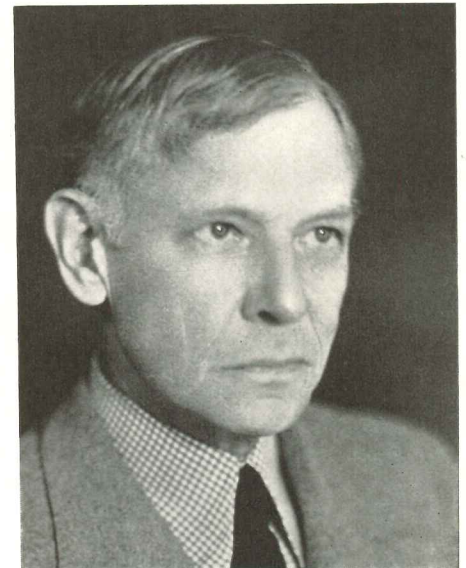

Louis Simon Retires

LOUIS A. SIMON, Supervising Architect since 1934 of the Public Buildings Administration, Federal Works Agency, has retired from Government service after 45 years in the design and supervision of Federal architecture. President Roosevelt had issued five executive orders extending the length of his term beyond the normal retirement age.

Mr. Simon during his long career had supervised designs for more than a billion dollars worth of Federal construction. The list includes many buildings in Washington, as well as post offices, court houses, custom houses, Federal houses, Federal hos-

(continued on page 14)

**TECHNICAL
LIBRARY
OF
KOPPERS**

THE INDUSTRY THAT SERVES ALL INDUSTRY



How To Specify for a "No-Headache" Roof



How Water-Cooled Roofs Control Heat and Humidity



How To Prevent Water Damage to Building Foundations



How Dampproofing Differs From Waterproofing And Where To Use It



How Pressure-treated Timber Can Solve Many Priorities Problems

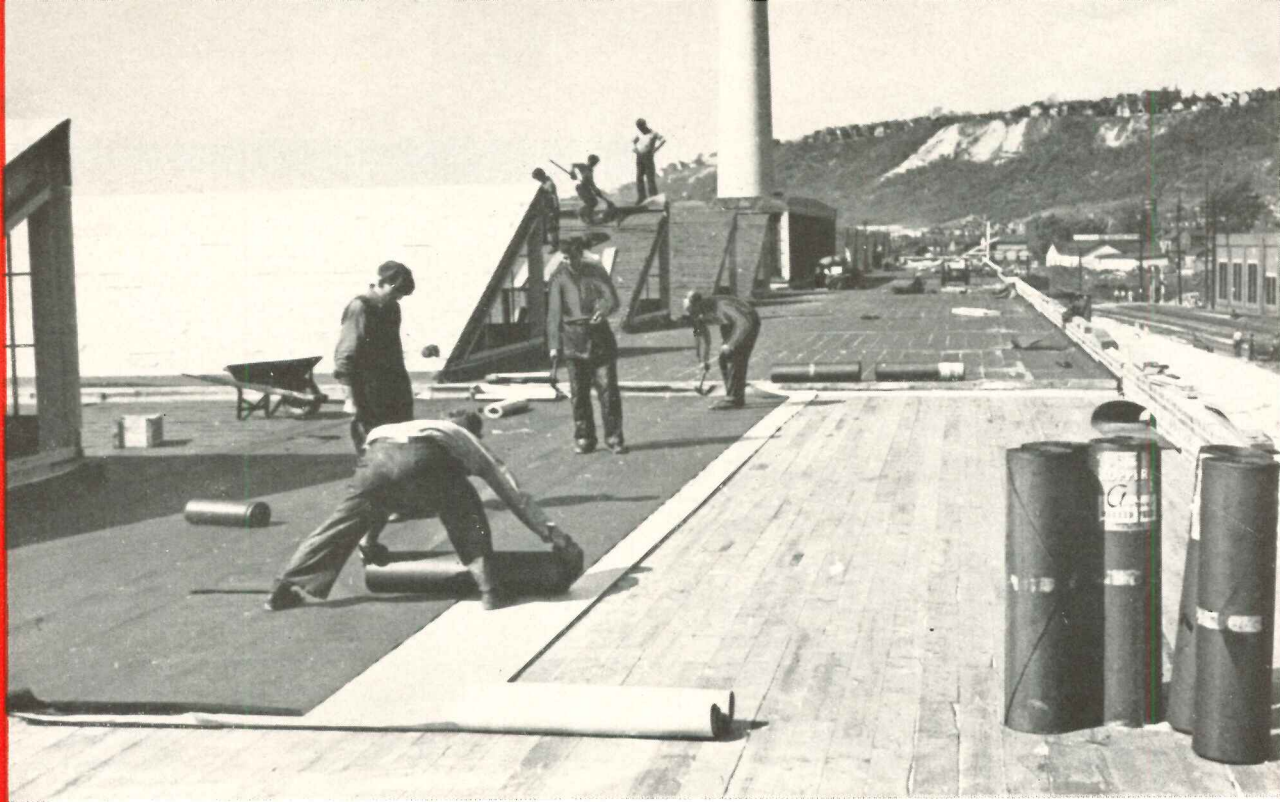

This is a "No-headache" roof

- ... No headache for your client
- ... No headache for you

You may have had some experience with a "headache" roof. For every headache it gives your client, your client is apt to give you a string of headaches.

If you have had that sad experience, you will find assurance in the many old records of 20 years, 30 years or even 40 years of trouble-free service that have been given by roofs of coal tar pitch.

Coal tar pitch lasts because it can

resist water. It lasts because it has the power to heal small breaks and present an unbroken surface to the elements. Coal tar pitch roofs last because their slag or gravel surface protects them from sun, hail and wind.

For your client's sake . . . and for your own sake . . . stick to coal tar pitch.

**KOPPERS COMPANY
PITTSBURGH, PA.**

KOPPERS COAL TAR PITCH ROOFING AND WATERPROOFING

use **K O P P E R S** *products*

KOPPERS COMPANY
1277 Koppers Bldg., (19) Pittsburgh, Pa.
Please send me copies of these folders:

NAME.....
TITLE.....
FIRM.....
ADDRESS.....

- | | |
|---|---|
| <input type="checkbox"/> "Roofing Specifications" | <input type="checkbox"/> "Where to Use Pressure-treated Timber" |
| <input type="checkbox"/> "Water-Cooled Roofs" | <input type="checkbox"/> "How to Measure Depth of Penetration in Pressure-treated Timber" |
| <input type="checkbox"/> "Steep Roofs of Coal Tar Pitch" | <input type="checkbox"/> "Pressure-treated Poles" |
| <input type="checkbox"/> "Membrane Waterproofing Specifications" | <input type="checkbox"/> "Painting of Creosoted Wood" |
| <input type="checkbox"/> "Dampproofing" | <input type="checkbox"/> "Creosote" |
| <input type="checkbox"/> "Waterproofing and Dampproofing Waterworks" | <input type="checkbox"/> "Disinfectants" |
| <input type="checkbox"/> "Waterproofing and Gasproofing Sewage Disposal Plants" | <input type="checkbox"/> "Paving with Tarmac" |



STEAM Heats America

© 1940

Producing heat is only part of the heating job. Putting heat where you want it, when you want it is the big job—the job modern Steam Heating does best. See fact story below. For details write Warren Webster & Company, Camden, New Jersey.

LAKWOOD HOSPITAL PROVES ECONOMY OF MODERN STEAM HEAT

Webster Moderator Systems Used in Existing Building and New Addition with Fine Results

DESIRED HEAT IN EVERY ROOM

Doubtful Whether Boiler Could Carry Increased Heating Load without Webster Control

Cleveland, O.—At Lakewood Hospital, in suburban Cleveland, a new 4-story addition completed in 1939 more than doubled the heating load. But coal consumption increased only 30 per cent.

Hospital authorities point out that the effectiveness of the installation is due to the balanced heat distribution provided by two Webster Moderator Systems of Steam Heating.



Lakewood Hospital, Cleveland, O.

Both the existing building and the new addition were Moderator-equipped as part of the building program. It is doubtful whether the boiler could carry the increased heating load without Webster Control.

Desired temperatures are now maintained in every section.

The heating units in the new addition are modern concealed Webster System Radiators, which harmonize with the decorative scheme and increase available floor space.

The nationally known consulting engineers, John Paul Jones, Cary & Millar, Inc., of Cleveland, designed the heating installation. The Maurer Bros. Co., of Cleveland, were the heating contractors. The Hospital has a total of 7,464 sq. ft. of installed direct radiation, of which 4,433 sq. ft. is in the new addition.

Copper & Conrad, Cleveland architectural firm, designed the new addition. Schirmer-Schneider Co., of Cleveland, was general contractor.

WITH RECORD READERS

(continued from page 12)

pitals and defense housing projects throughout the country. He is also credited with the design of the Roosevelt Library at Hyde Park, N. Y.

His years in architectural service saw a great change in the character of Federal buildings. From the more florid styles which characterized the last decade of the 19th century and the early years of the 20th century, Federal buildings have been gradually simplified toward modern classic. One of Mr. Simon's contributions was the suggested use of American Colonial in Government buildings outside Washington.

Awards

TWO AWARDS are announced by Dean Leopold Arnaud of the Columbia School of Architecture. The 1941 Sherman Prize goes to *Don P. Reimann* of New York City for his design of a recreation building in a Long Island army cantonment. The problem was submitted by *Ely Jacques Kahn* and *Robert Allan Jacobs*, official architects for the United Service Organizations. Mr. Reimann planned an L-shaped structure with social hall in one wing, lounge in the other.

To *Paul Pippin* of Severna Park, Md. was awarded the Hamlin Prize, bestowed yearly for a decorative design. Mr. Pippin's winning design was for a fountain in a housing development. His structure of brick and reinforced concrete combines as a unit a bus stop with waiting rooms, public toilets and fountain.

Miss Coit Reports on Low-Cost Housing

THE October and November issues of *The Octagon*, AIA journal, contained a report on an exhaustive study of lower and low-cost housing design recently completed by *Elisabeth Coit*, AIA. Working on an Edward Langley Scholarship, Miss Coit visited 120 low-cost developments in this country, as well as many in Europe, and she has reported on the type and size of families who want housing, what the low-income

client thinks he needs or would like to have, and what architects and other experts in the more architectural aspects of home-making think he ought to have. The report is subdivided to consider in detail such factors in home planning and building as cost of housing, room uses and sizes, kitchens, bathrooms, basements, surface finishes, windows and outdoor living space.

Personal

RICHMOND H. SHREVE, president of the American Institute of Architects, has been elected an honorary corresponding member of the Royal Institute of British Architects.

* * *

APPOINTMENT of *Edmund Randolph Purves* of Philadelphia as Washington representative of AIA is announced. Mr. Purves will work with the 71 chapters of the Institute in the formulation of an emergency program for architects.

* * *

FREDERICK P. KEPPEL, former president of Carnegie Corporation, has received the Medal of Honor of the American Group of the Société des Architectes Diplomes par le Gouvernement. The medal is awarded to a layman "for distinguished service in the advancement of art and architecture." *Julian Clarence Levi*, president of the American Group, praised Mr. Keppel for his extraordinary contributions to the cause of architectural education and to the furtherance of public appreciation of art and architecture.

* * *

THE ASSOCIATION has been announced of *Raymond Hill Wilcox* and *Edward H. Laird*, landscape architects and town planners, with offices to be located in the Union Guardian Building, Detroit.

* * *

GEORGE FREDERICK ASHLEY of San Francisco has resigned from FHA after five and a half years. He is succeeded as Chief Architect for the Northern California District by his former assistant, *Albert H. Winter*.

STEEL DECK

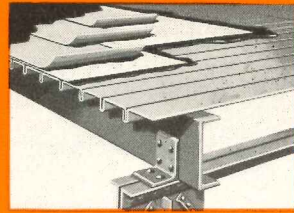

Section of Mahon Steel Roof Deck, as assembled in installation, showing application of insulation and roofing material.

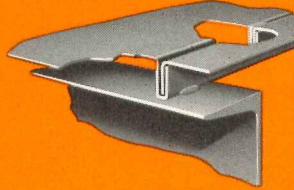

Section showing interlocking ribs and method of welding Mahon Steel Deck Plates to supporting purlins and wedge-weld locking of plates together between purlins.

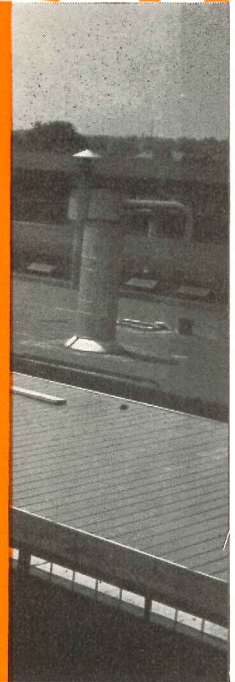

The Practical **ROOF** Construction for Industrial Building Production

FIRE SAFETY . . . STRENGTH . . . PERMANENCE . . . SPEEDY INSTALLATION

In the tremendous industrial building program that lies ahead in '42, every architect and builder is charged with the responsibility of providing materials that will insure the greatest possible security. Too much stress cannot be laid upon the importance of firesafe, permanent construction, particularly in the ROOF of the building — a *vulnerable part of any plant*. Mahon Steel Roof Deck, manufactured entirely of steel, provides practical and economical overhead protection. Both plant and equipment are protected by a roof welded into a solid unit of rigid, ribbed steel that

provides exceptional strength and security. In addition to these advantages of firesafety and permanence, Mahon Steel Roof Deck offers definite economies in construction. Due to its light weight and rigidity, considerable savings may be effected throughout the entire supporting structure. Investigate these advantages and economies and the speed and ease with which this superior roof can be installed. Send for the NEW Mahon Steel Roof Deck catalogue. Consult with our engineers. Get the complete information today — before your next project is planned and built.

THE R. C. MAHON COMPANY • DETROIT • CHICAGO

Representatives in Principal Cities

*Manufacturers of Steel Roof Deck, Rolling Steel Doors, Shutters and Grilles;
Kalamein Doors, Tin Clad Doors, Cast Iron Roof Sumps and Sump Recesses.*

MAHON

By KENDALL K. HOYT



GOVERNMENT MOVES TO STRENGTHEN DEFENSE CONSTRUCTION

New executive powers . . . Priorities and quotas . . . Maintenance supplies . . . Government housing reorganization

WITH THE OUTBREAK OF WAR, immediate orders issued and laws passed are general in their bearing upon all industry and all phases of civilian life. As this report is written, only two weeks after the bombing of Pearl Harbor, specific details affecting the construction industry of course remain to be worked out after the most urgent measures are in motion. But the whole trend is certain to be toward the prompt strengthening of construction needed for defense and the restriction of almost all non-defense phases.

Broad authority granted by Congress under the First War Powers Act of 1941 will allow the President to remove restrictions on contract letting to bring more business into war production. It is thought that a small business loan agency will be set up so that potential Government contractors can get funds at once rather than go through the complex procedure of applying to RFC and other lending agencies. This offers architects an early prospect of work on plant expansions in their localities.

Potentially, the measure should make it possible to bring more private capital into defense housing work. Spreading of production into new areas should serve as a basis for increased participation by building and loan associations and banks.

The contract powers of the bill permit the President to eliminate competitive bidding, let contracts without performance bonds, amend contracts with consent of the contractor, and make progress payments up to any amount on contracts.

Federal housing reorganization

The War Powers Act allows the President not only to reorganize and shift the functions of any Federal

agency but to transfer appropriations. Thus it is possible to make complete realignments of activities with great speed. So the long pending reorganization of the duplicating and conflicting agencies which deal with housing and construction now can be effected by a stroke of the pen.

For the moment, the situation is about as reported last month. No action has yet been announced on the report embodying Judge Rosenman's recommendations. But, in the face of emergency needs, it is not to be expected that anything as important as defense housing will long be left at loose ends. Rumor was that the Rosenman report was sidetracked because it needed legislation which now becomes unnecessary.

While formal statements of policy have not been handed down, opinion is that agencies such as FHA which are generally credited with having done a good job will get a good break while PBA, which did not take hold of its defense work as well as might have been hoped, is likely to be in the bottom of the reshuffle. Quite possibly the Defense Housing Coordinator's office will ride through in fair shape.

Rationing

Materials, of course, will become increasingly tight with heavy pressure even on defense housing to utilize substitutes for critical materials to the fullest extent possible. Judging from procedures applied to manufacturing industries, it is to be expected that construction people will be called in and asked to estimate the materials needed for a specific volume of essential work ahead. The practice with other industries has been to check the estimates carefully and then allow 20 per cent or 30 per cent less than the

apparent need as a leeway to force economies and the use of substitutes.

A rigid minimum quota, if not an absolute ban, is to be expected for non-defense construction other than that needed for public health and safety. In the certified defense area, likely procedure is to require contractors to file a bill of materials similar to Form PD 25-A, the form used for the Production Requirements Plan. Such itemizations can be scaled down to encourage substitutions.

Priorities

It is to be emphasized that the allocation plan does not eliminate the individual preference rating certificate.

The order affecting maintenance and operating supplies for manufacturers and producing plants has been somewhat liberalized. Heretofore, acceptances of such supplies for inventory could not exceed 100 per cent of the maximum dollar value purchased in the corresponding calendar quarter of 1940. The limit has been upped to 110 per cent.

A new "P-100" order has been devised, replacing the former P-22. It is not permitted to purchase materials under the order for expansion or betterment. The user in such a case must file a PD-1. Utilities are forbidden to undertake any substantial expansion without express permission from OPM.

An emergency fund of \$300,000,000 has been appropriated for dormitories, trailers, and portable houses for urgent use in providing temporary shelter for defense workers.

Another \$300,000,000 is being added to the Lanham Act authorization under which \$300,000,000 previously has been appropriated and allocated. This additional Lanham Act fund has been pending in Congress for months and as we go to press is

(continued on page 18)

CURRENT TRENDS OF BUILDING COSTS

Compiled by Clyde Shute, Manager, Statistical and Research Division, F. W. Dodge Corporation, from data collected by E. H. Boeckh & Associates, Inc.

CURVES INDICATE trend of the combined material and labor costs in the field of residential frame construction. The base line, 100, represents the U. S. average for 1926-1929 for residential frame construction.

Tabular information gives cost index numbers for the nine common classes of construction. The base, 100, in each of the nine classes represents the U. S. average for 1926-1929 for each particular group. The tables show the index numbers for the

month for both this year and last.

Cost comparisons, as percentage differences for any particular class of construction, are possible between localities or periods within the same city by a simple process of dividing the difference between the two index numbers by one of them. For example: if index for city A is 110 and index for city B is 95 (both indexes for A and B must be for the same class of construction), then costs in A are approximately 16% higher

than in B $\left(\frac{110-95}{95} = 0.158 \right)$. Conversely it may be said that costs in B are approximately 14% lower than in A $\left(\frac{100-95}{110} = 0.136 \right)$.

Similar cost comparisons, however, cannot be made between different classes of construction since the index numbers for each class of construction relate to a different U. S. average for 1926-1929.

CONSTRUCTION COST INDEX United States average including materials and labor, for 1926-1929 equals 100

ATLANTA

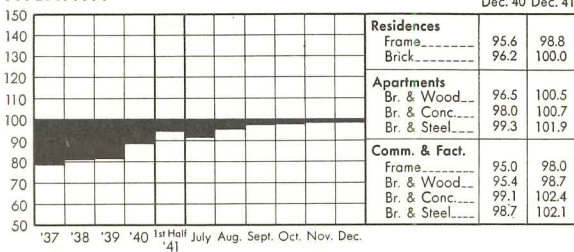

CHICAGO

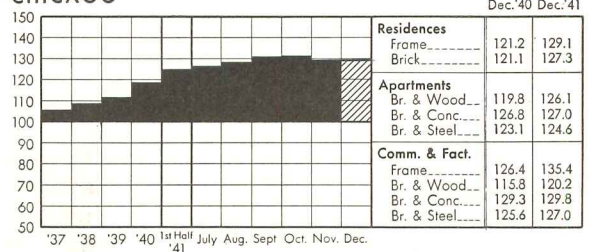

BALTIMORE

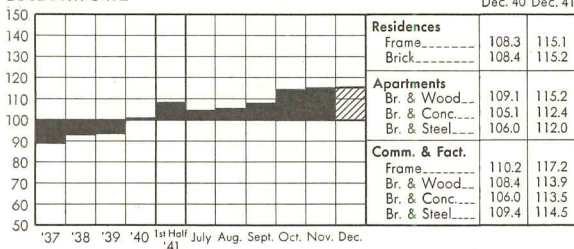

CINCINNATI

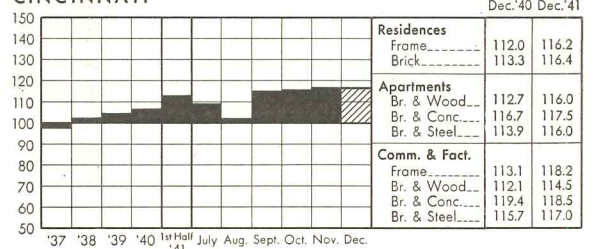

BIRMINGHAM

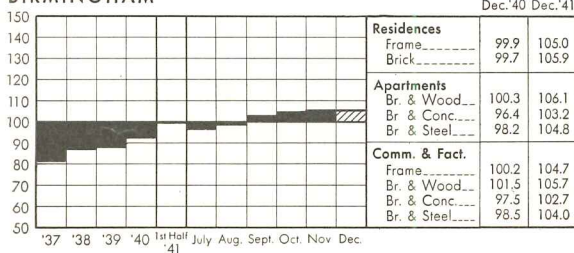

CLEVELAND

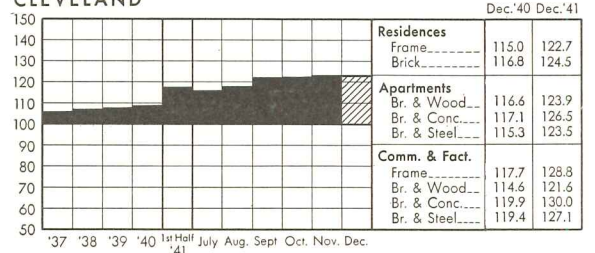

BOSTON

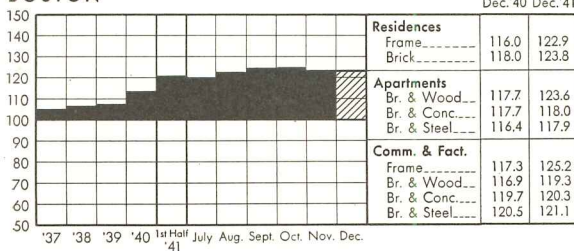

DALLAS

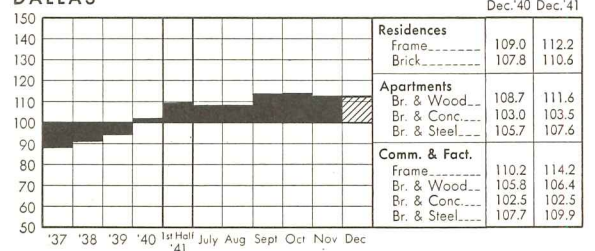

CURRENT TRENDS OF BUILDING COSTS

DENVER

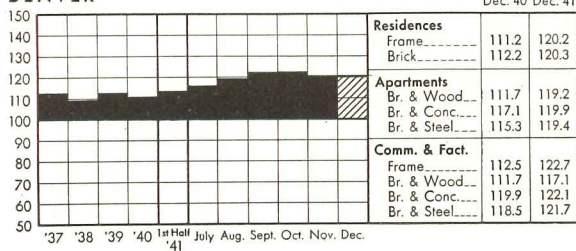

NEW YORK

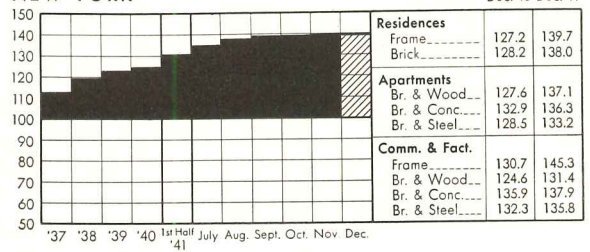

DETROIT

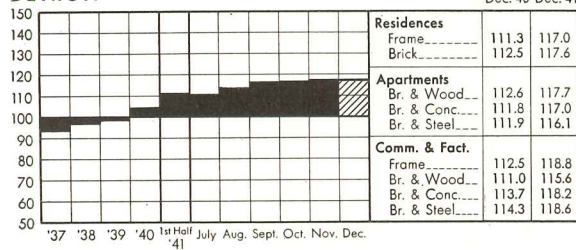

PHILADELPHIA

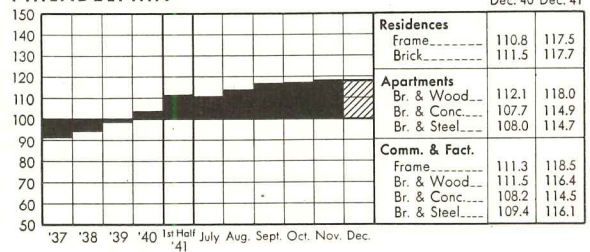

KANSAS CITY

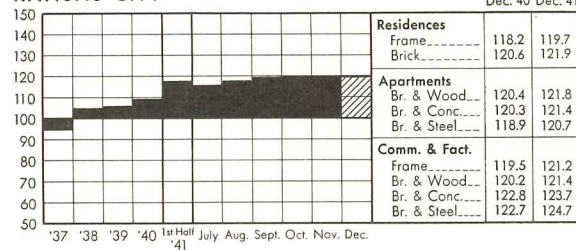

PITTSBURGH

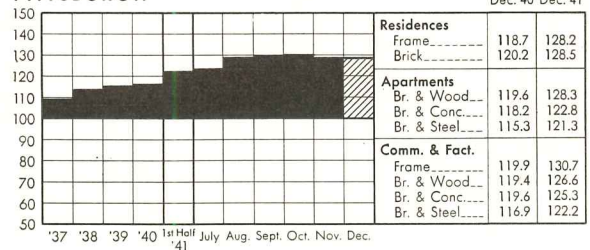

LOS ANGELES

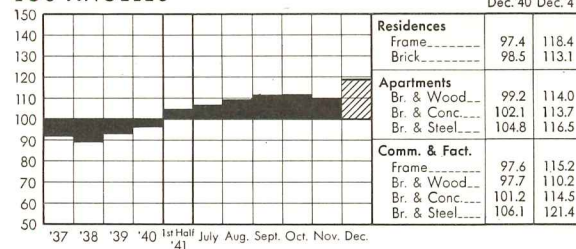

ST. LOUIS

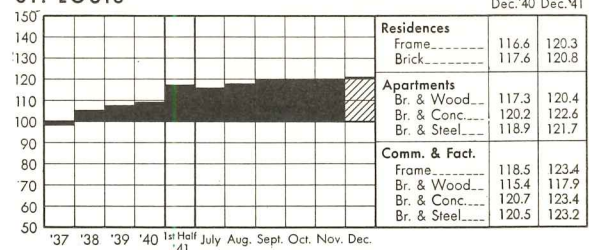

MINNEAPOLIS

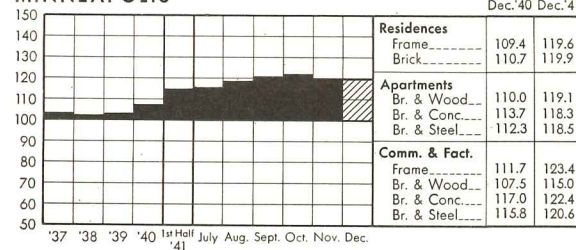

SAN FRANCISCO

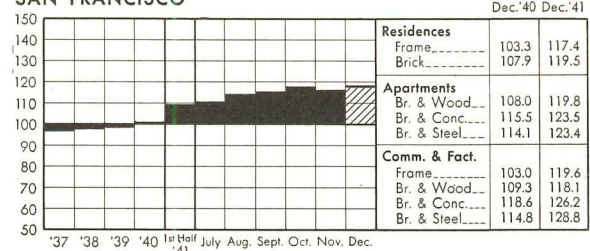

NEW ORLEANS

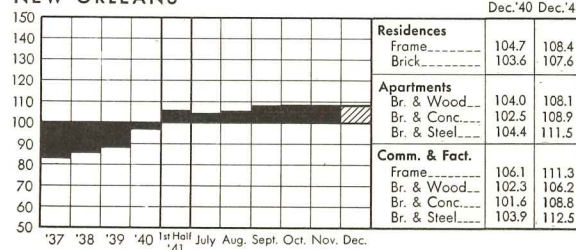

SEATTLE

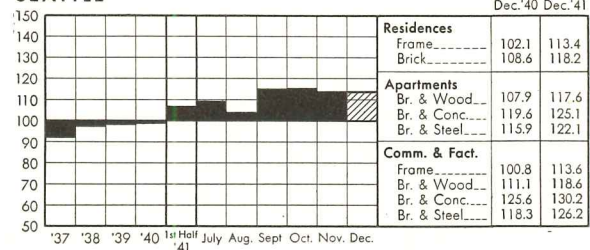

TIMBERGRAIN IS NEW, REVOLUTIONARY!

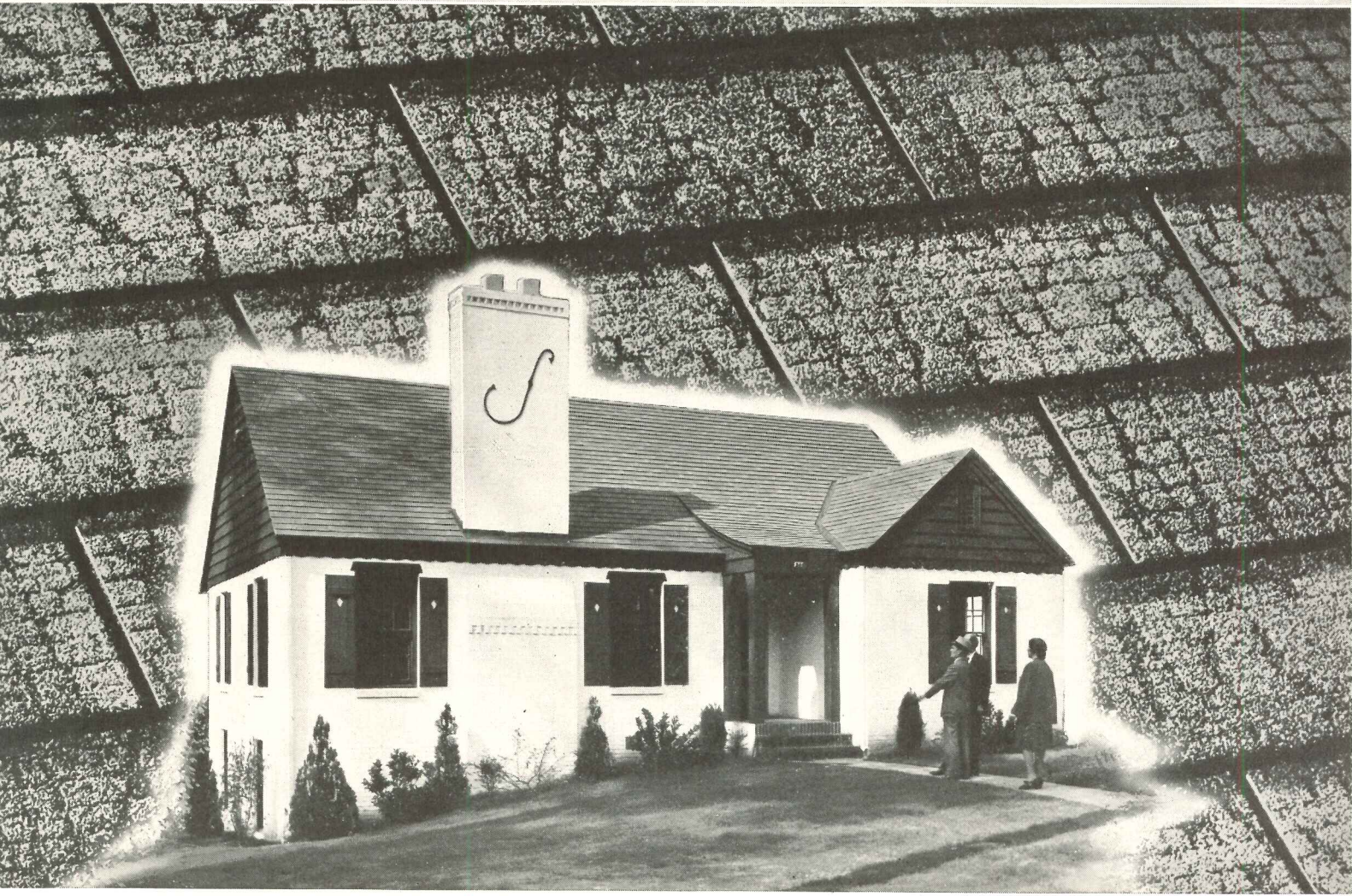

You've never before seen such *beauty* in an asphalt shingle!

"It's the most beautiful asphalt shingle I've ever seen!"

Everywhere, they're saying that—Architects, Builders and Contractors! What they're all talking about is Ruberoid's extraordinary new asphalt shingle—TIMBERGRAIN.

Seldom has a new shingle received such widespread and enthusiastic endorsement. This mass approval from members of the building profession is justified because of Timbergrain's new and revolutionary features.

First of all, Timbergrain has a *textured* surface that is rough, rugged, *built-up*. Combined with two-toned coloring, this built-up surface provides unusual transverse shadow effects, that lend distinctiveness to the roof.

Secondly, Timbergrain has extra thick butts, accentuated by deep,

black, *built-in* shadow lines—providing a roof of character, massiveness and beauty. Timbergrain has an average approximate weight of 250 lbs. per square.

Thirdly, Timbergrain's extra thickness gives greater strength, more weather protection and more safety.

For new homes — or homes being remodeled — Timbergrain is the year's sensation! Let your clients have the advantage of outward beauty, and inward long life and durability. Timbergrain is time-honored Ruberoid quality through and through.

Be sure to see this style leader, Timbergrain. Available in Greentone, Redwood, Bluetone and Slatetone blends. Write for colorful folder and complete information. Address Dept. AR-1. The Ruberoid Co., 500 Fifth Avenue, New York, N. Y.



RU-BER-OID

ROOFING AND BUILDING PRODUCTS



Thanks

FOR YOUR HELP
IN MAKING 1941
THE *biggest year*
IN OUR HISTORY

MINNEAPOLIS-HONEYWELL
REGULATOR COMPANY

P.S. For the fourth successive year Minneapolis-Honeywell sales of both pneumatic and electric controls for heating, ventilating and air conditioning reached a new high. In addition, the facilities of M-H were actively engaged in supplying vital products and materiel for defense.

A RECORD Survey of

BUILDINGS NEEDED

for Civilian Health and Welfare in War-Time Production Centers

WHAT TYPES OF NEW CONSTRUCTION ARE ESSENTIAL TODAY? The RECORD here furthers its investigation of a problem important alike to building interests and to the all-out prosecution of the war effort. Last month the detailed analysis of building needs in one defense community, Portsmouth, N. H., highlighted the planning problems of defense communities and their need for many types of building projects.

For a more comprehensive analysis of the national situation the RECORD queried the mayors of the 340 municipalities included in 275 official defense areas. Following pages give a composite picture of requirements for hospitals; schools; municipal facilities; transportation terminals; recreational facilities; and commercial buildings. Charted figures are in per cent of total cities reporting to the RECORD.

WHAT BUILDING PROJECTS that are essential to civilian welfare will be permitted to go forward in war time? This is one of many important questions that are today being addressed to Washington. But it is clear that this one cannot be answered categorically by any Federal department.

While, of course SPAB (Supply Priorities and Allocations Board) is virtually the sole arbiter of building, it obviously must depend on local information for a judgment as to what types of buildings are essential, and how essential they are. SPAB has indicated its willingness to give priorities assistance to projects necessary to civilian health and safety, but it cannot properly administer its own ruling without factual data on specific community problems.

If an influx of defense workers has doubled the population of a community and has overloaded its water supply system, there is a pressing need; the expansion or extension of the system is vital to health. In another community civilian safety and health might be endangered by inadequate hospital facilities. Morale might be the problem in another area, where, as in the last war, workers in defense industries have been unsettled by poor housing conditions, lack of schools or recreational facilities. Clearly such inadequacies of municipal plants are not to be arbitrarily judged in Washington. But, also obviously, they are important to civilian welfare and vital to the war effort.

Moreover, such construction needs are immediate. They are not to be regarded as a backlog of post-emergency work; they are a direct essential of a war that depends on factory production.

What are those construction requirements? How important are they in our war preparedness?

Reports from the mayors of 123 defense area cities, responding to the RECORD's questionnaire inquiry, indicate clearly that the dislocations of the defense program with respect to community facilities are considerable, and that there is still a major building job to be done on the home front. The reports of municipal officials also bring to light a serious deficiency in community planning.

The mayors' reports are illuminating both for their

statistics and for their lack of statistics. A few cities patently had given serious and detailed study to their problems of sudden growth, and were able to report just which municipal facilities were overloaded and what new construction projects would have to be undertaken in order to maintain the services and standards of the community. But those were a conspicuous minority. Most officials obviously were not able to document their construction needs, no matter how positively they expressed them. Reading a little between the lines of the reports it becomes evident that many of the communities caught flat-footed by the sudden rush of incoming workers are still flat-footed. Many have made surveys of population changes, but have used the results only to measure a direct need for housing, leaving other municipal building needs yet to be discovered.

The survey left little doubt, however, that the defense effort has overtaxed the municipal plant and existing commercial buildings in many categories. Taking together all reports that definitely listed construction requirements, the survey showed, for example, that 52 per cent of defense communities need new hospitals; that 60 per cent ought to have new schools; 55 per cent, parking facilities; 44 per cent, apartment buildings. Complete returns on the following pages.

One large city, with several defense industries, totalled its building requirements at \$33,224,000. At the other end of the scale, one unincorporated spot on the defense map reported its population jumping from 700 to 1,700 to 2,500 for 1942, and remarked, "We need just about all it takes to make a town."

With such conditions existing it is apparent that the building requirements of the defense program cannot be thought of solely in terms of industrial buildings and defense housing and army cantonments. There are still many unfulfilled needs for the "17 men behind each gunner."

PHOTOS USED IN MONTAGES on pages 38, 39 and 40 are courtesy St. Thomas, Orville K. Blake, Eric J. Baker, Vories Fisher, Roy C. Hyskell, Gottscho, Roger Sturtevant, W. A. McConnell Co., Joseph W. Molitor, George H. Van Anda, Sigurd Fischey, Paul Peters, M. L. Pruitt, Arthur Haskell, William Rittase, FHA, USHA, PWA, ESA and PBA.



1. HEALTH

AS DEFENSE WORKERS and their families crowd into industrial communities, it would seem inevitable that present health facilities in many areas will become inadequate. Thus one would expect that hospitals and health clinics would loom large as an important and immediate construction requirement. This was borne out by results of the RECORD's survey; and the outline chart above indicates that in 56 per cent of all the communities reporting new hospital facilities of some sort were required. 28 per cent said they also required health clinics.

The mayor of one Eastern city of around 160,000 suggested a plan for filling needs by remarking: "The City Plan Commission has undertaken, through the cooperation of various departments of this city, a six-year program for future guidance. . . . In consultation with representatives of several Federal departments, a comprehensive outline was given concerning work which might be undertaken in this defense area. Among the proposals advocated was one for construction of a new isolation hospital for which the city had appropriated \$150,000. . . . It was felt that the appropriation would not be sufficient to construct and equip a building which would meet the requirement. . . . Favorable action has been taken on a request for a Federal grant, and an allotment amounting to \$153,994 has been approved in Washington. Consequently, \$303,994 is now available for this hospital program."

2. EDUCATION

INCREASED POPULATION of defense area towns is not, by itself, a sign that growth will continue. And because all the new population cannot be regarded as of permanent character, the problem of providing adequate educational facilities is apparently one of the most difficult which city officials have to face. A general need is obvious. New housing for defense workers generates new residential communities which in turn call for new schools. But the job of adjusting temporary requirements to a long-range civic program is a difficult one.

This complication of the school problem was put tersely by the mayor of one city who reported a need for new schools "just outside the city boundaries." Even if the city's schools might be adequate in the aggregate to care for the newcomers, that is small comfort if new residential neighborhoods are far removed from existing school buildings. It has been suggested that overtaxed school systems might go on a double-shift operation. But that solution also depends on proper location.

The survey did not clarify generally what types or sizes of school structures were now necessary. From towns of a few hundred population to cities with a population of over 800,000 questionnaires indicated that presumably types of required school buildings would embrace a similarly wide range, from the most up-to-date plant for vocational education to the modern prototype of the one-classroom country schoolhouse.

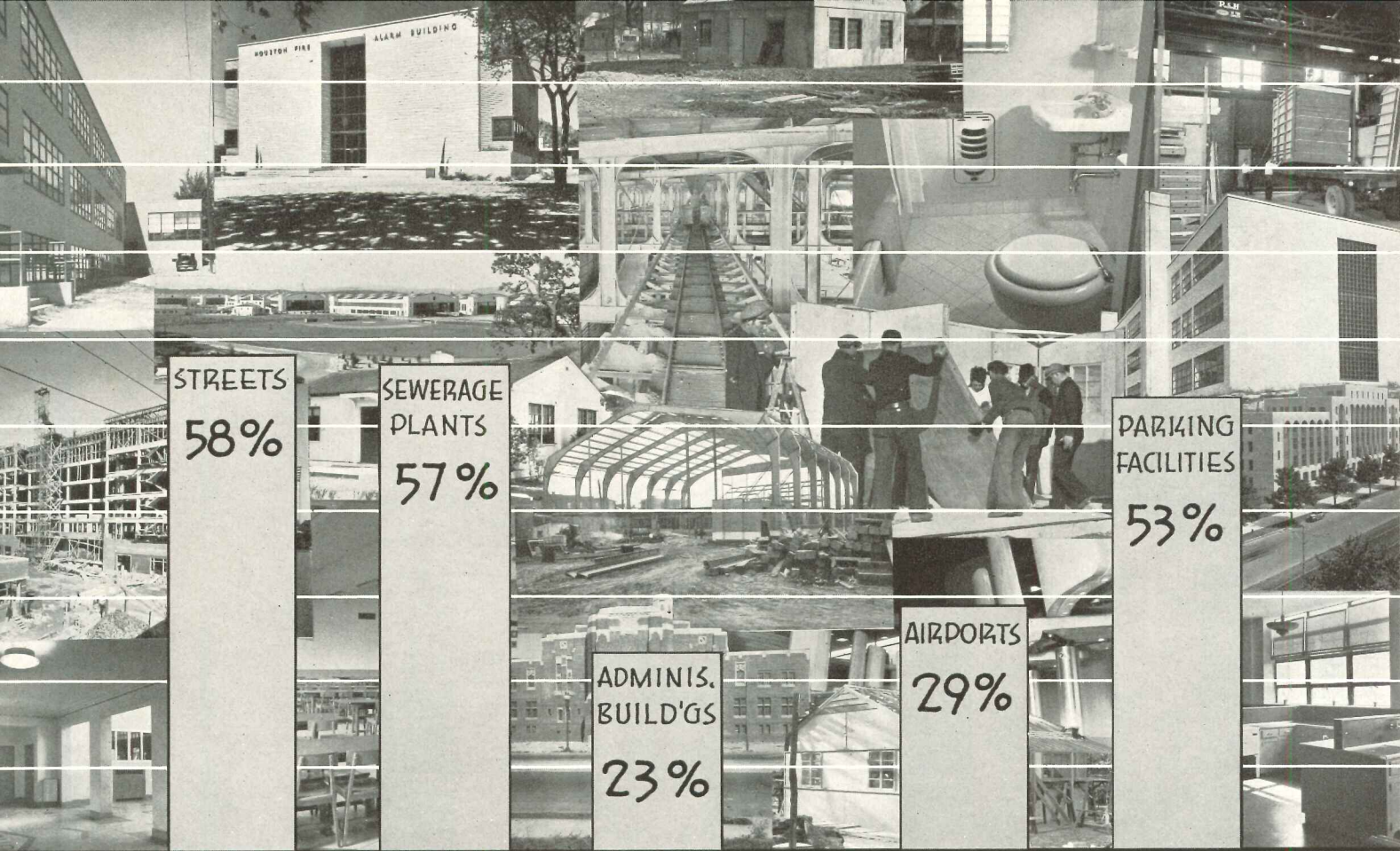

3. MUNICIPAL

ONE RESULT of our current industrial expansion is the overnight growth of small rural communities into thriving centers. In a great number of instances this sudden increase in population has come upon communities the municipal facilities of which are completely inadequate to cope with problems of traffic, public utilities, municipal administration and fire and police protection which unheralded expansion has brought into existence.

Thus, as one would expect, the RECORD's survey showed a very high percentage of requirements for various kinds of municipal buildings and for public works. Many of the questionnaires were returned with each item under this heading checked to indicate a need for construction.

The construction requirements listed were diverse, ranging from resurfacing of streets to \$3,000,000 worth of fire stations. One city totaled its need for street work alone at \$10,000,000. At the other end of the scale one little town said it needed a combination city hall, fire and police station.

As the chart shows, new streets were deemed necessary in 58 per cent of the communities reporting and new sewerage systems and plants in 57 per cent of the communities. The other new construction requirements (in percentages of cities reporting) were as follows: street widenings, 45 per cent; grade crossings, 43 per cent; water lines, 35 per cent; fire stations, 41 per cent; police stations, 21 per cent; administrative buildings, 23.

4. TRANSPORTATION

AS MIGHT BE EXPECTED in view of requirements for new streets and street-widening, the RECORD's survey showed that provisions for modern transportation facilities are almost as much needed as are the buildings necessary to house and care for a community's population.

It is significant that the automobile still represents a major problem for the small village as well as the large city. The sudden and growing congestion of a preparedness boom for which few, if any, towns were at all prepared has not helped an already bad situation—a situation indicated by the fact that parking facilities were listed as a most pressing requirement in 53 per cent of the communities reporting.

Bus stations and terminals were listed on 13 per cent of the questionnaires and warehouses on 11 per cent.

Airports were checked as required in 24 per cent of communities, indicating that twice as many defense areas need—or think they need—airports as need bus stations. It may or may not be significant that quite a few of the defense areas expressing a desire for a new airport were small towns. For example, five towns listing them have populations respectively of 13,000, 24,000, 16,600, 34,000 and 43,000; and the town of 16,600 wants an airport costing a cool \$1,000,000.

It would be fair to conclude that the future commercial importance of our expanding aircraft production facilities is becoming widely recognized.

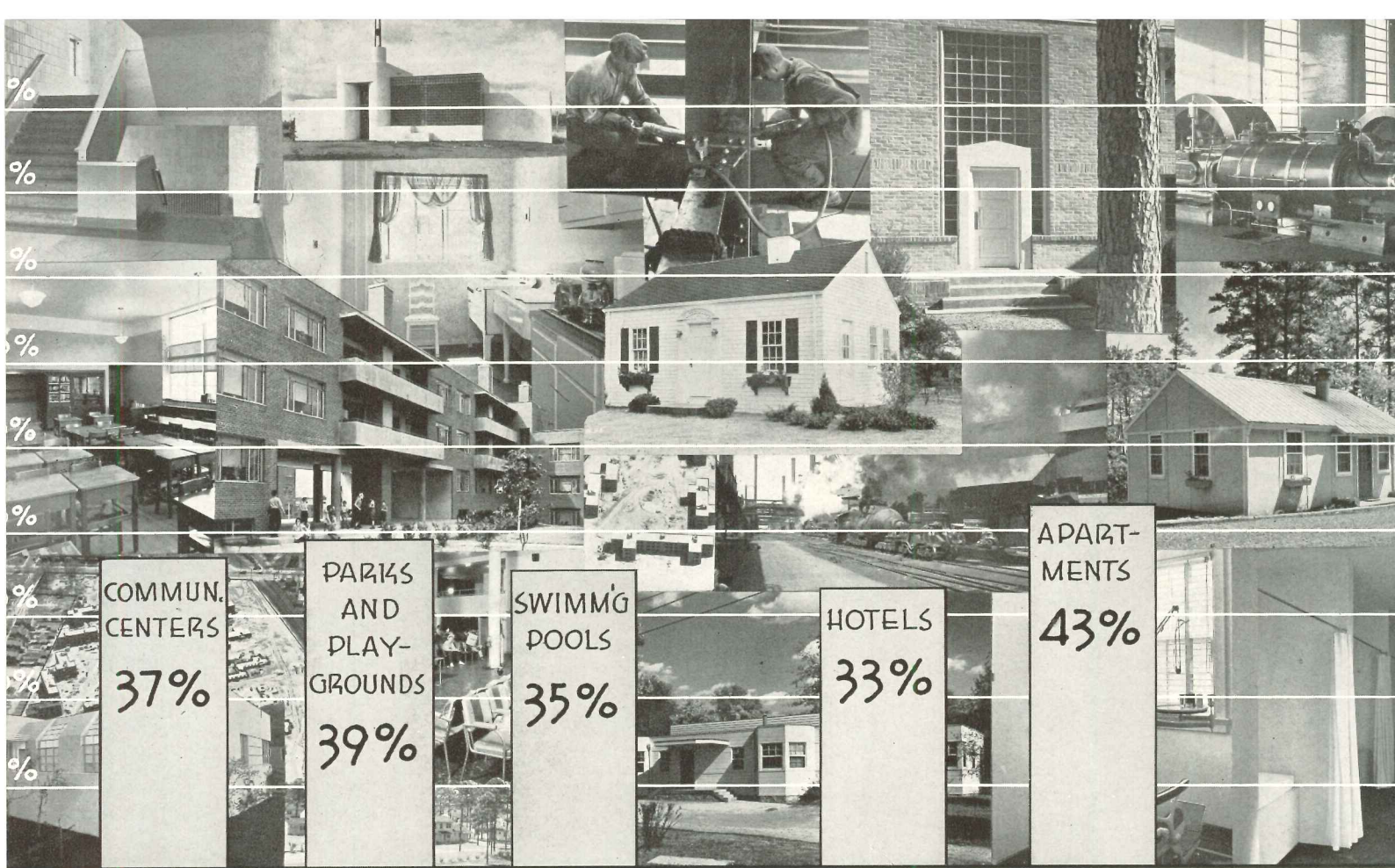

5. RECREATION

ONE COULD PROBABLY start a nice argument as to how necessary to all-out war are community centers, parks and playgrounds, and swimming pools. Opinion would probably range from that of the disciplinarian who would snort that such things, even for defense workers, were pure nonsense in a time of war effort, to that of the psychologist who would insist that they played an essential part in the maintenance of a morale sufficient to win a war of production. Be that as it may, it is clear in the survey returns that the modern community understands its obligations to citizens as extending beyond essential utilities and protective services, extending specifically to the provision of swimming pools, playgrounds and community buildings. The returns also indicate that municipal officials feel their responsibility for such types of recreational projects more clearly than they do for other types of buildings in the general classification of recreational.

Thus theaters were listed in only 11 per cent of the returns and churches in only 2 per cent. Such discrepancies in the returns would seem to indicate that city officials feel no immediate obligation to provide such facilities, other than to measure the actual needs of an expanding population. At any rate, the returns leave little doubt that boomtime conditions in defense areas have overloaded community facilities all along the line and that a great need is recognized.

6. COMMERCIAL

ANALYSIS OF THE RETURNS for the whole questionnaire shows that municipal officials were either not disposed or not prepared to discuss requirements for commercial structures, except possibly housing. Thus, it is not surprising to see such buildings as stores and offices with very low percentages. And it is understandable that apartments would be listed as a requirement in 43 per cent of the communities replying.

It is rather surprising, however, that hotels were listed as an immediate need in such a large proportion of communities reporting.

The full vote for commercial structures was: hotels 33 per cent, apartments 43, stores 9, office buildings 9, dance halls 6, taverns 1.

From these figures one might deduce a general situation in which restaurants, offices, stores and the like could be rearranged to fill the needs of a majority of communities for the duration of the wartime emergency. But it is doubtful that the tabulation of this commercial portion of the questionnaire—aside from the first two classifications—means very much as indicating requirements for such buildings in defense areas. Very likely the survey emphasizes a need for more detailed study of each individual community and a more efficient programming of construction requirements to fill not only wartime demands but also those which will develop during the inevitable post-war period.

TOTAL WAR MEANS ALL-OUT CONSERVATION

LONG BEFORE PEARL HARBOR the construction industry had been caught up, for the second time within a generation, in the straight-jacket turmoil of war.

It makes little difference that before December 8, 1941, the war was undeclared. In its November, 1941, issue—shortly after SPAB's famous building curtailment order and weeks before the first Japanese bomber droned out of the dawn over Diamond Head—ARCHITECTURAL RECORD called it WAR!

And in doing so the RECORD forecast some of the difficulties that lay ahead. It said, "Building as usual has gone by the board"; and it called on architects, engineers, builders and manufacturers to accept the challenge to their technical ingenuity suddenly created by growing scarcities of materials.

In recognizing that challenge the RECORD implied a promise to report progress on this newest of emergency fronts—to report on the new ways and new means being developed for doing the most with the least in building.

The following pages constitute the first such report. Others will follow in the months to come. And they will appear in whatever scope and detail are justified by results of research efforts, inventive skills and experienced energies of building technicians working under the increasing pressure of time and spurred by the increasing realization of wartime necessities.

Speaking bluntly, this first report is far less complete than the RECORD would like it to be. Some portions of it are unavoidably vague. In some others RECORD editors regard the material as sophomore-elementary.

But it does constitute a fair cross section of current technical efforts to conserve critical materials. As such it is important to the building industry. For the very absence of several significant suggestions that might have been contributed points to the existence of a yawning complacency in a number of places—a state of mind which ARCHITECTURAL RECORD believes must quickly and sharply be revised if we are to make the most of the grim and pinching years of war that lie ahead.

The plain fact is that, so far, little has been accomplished in the way of providing technical solutions to new, wartime construction problems. Already these problems are many and varied. They are increasing in scope and complexity daily.

Furthermore, in several quarters there apparently exists either inability or unwillingness to grasp the true significance of the present situation. This apathy is impeding many technical developments necessary to anticipate construction difficulties caused by shortages of materials. These shortages are becoming increasingly serious as our military production program grows. Within a few short months they will doubtless vitally affect all types and phases of building.

The RECORD believes that the time for lip-service is past. Materials critical to military and naval success MUST be conserved in building.

If this involves new design techniques, let architects and engineers get busy at once. If it means that vested interests must be disturbed, let manufacturers bestir themselves to produce alternate materials for new markets. And let labor pigeon-hole its rules of jurisdiction and liberalize its policies so that such materials can be installed without costly delays. And if Government agencies for building are being unduly wasteful under the blanket of priorities, let them immediately revise procedures and align themselves with all other elements of building in facing the realities of an all-out war existence.

ARCHITECTURAL RECORD'S future reports on War Economy Construction have not yet been scheduled. They will be published as material becomes available; and will appear as often as circumstances may require. For present thoughts and facts concerning methods of saving critical materials, the RECORD sought out and interviewed technical leaders in Government, in research, in trade associations. In addition, a number of individual architects, engineers and manufacturers of building products have contributed to the information presented here.

IT'S NOT "WHY" CONSERVATION? NOT "HOW MUCH?" IT'S WAR NECESSITY

HOW REALLY CRITICAL are materials used in building construction? And how plentiful are building products made from those materials?

In the minds of all with a stake in the building field these two questions are probably uppermost today. Answers to them would sweep away the cobwebs of confusion that have gathered as a result of many conflicting reports and opinions, and serve immediately to clarify the need for rigorous control (vested now in the system of priorities and allocations which will undoubtedly bear more heavily as the months go on). Finally they would offer a guide to future technical practices as one means of avoiding the blind alleys of unbuildable designs and impossible specifications.

Unfortunately no one can answer both completely. And based on information available to date the RECORD can only report on the first. An answer to the second would involve data on dealers' stocks, manufacturers' inventories and production schedules—all of which come under the heading of trade secrets to which even Mr. Leon Henderson and his able staff are but minor parties.

Culled from OPM pronouncements to date, critical materials in building are, in the main, metals, rubber, jute, wool, cork and some plastics. All are vitally important to our current war effort.

But to building the metals bulk most significantly. Of those in cur-

rent use (aluminum, nickel, tin, zinc, chromium, lead, copper, iron and steel), not all are equally important nor equally scarce—at least in the relative sense that construction cannot well proceed without them. But they *are* scarce as the following table, released by the Research Institute of America, indicates. Figures show the ratio that the 1942 estimated civilian supply will bear to civilian demand after military requirements have been met. For example the demand for aluminum will be six times the available supply. Obviously all scarcities will tend to increase as military production mushrooms.

Commodity	Ratio of Supply to Civilian Demand	
	1941	1942
Aluminum	1:52	1:6
Brass	1:3	1:4
Cadmium	1:1.1	1:1.3
Chromite	1:0.9	1:1
Cobalt	1:3	1:1.3
Copper	1:1.2	1:2
Lead	1:1	1:1.1
Magnesium	1:0	None for civilians
Nickel	1:0	None for civilians
Pig Iron	1:1.1	1:1
Tin	1:0.8	...
Tungsten	1:1	1:1.7
Zinc	1:1.5	...

These figures alone illustrate clearly that with demand exceeding the available supply in almost every instance the conservation of metals in building is not a matter of "Why?" or even of "How much?" but simply "Where and how can it be done?"

It's fairly obvious that *if* metals are generally conserved, more bombers or battleships can ultimately be

built. And it may be of passing academic interest to learn that a small house contains four to five thousand pounds of metal. What is much more to the point is the compound fact that: 1, some of these metals are virtually unnecessary to efficient building; 2, some may be replaced by alternate materials which, at least temporarily, will prove satisfactory; and 3, some for which no adequate substitute has yet been found are absolutely required in nearly all types of construction.

So the answer to the "Where and How" question starts with *Elimination*—a fairly simple matter of common sense analysis, goes through *Simplification*—use of relatively few units of standard types and sizes, and *Substitution to Conservation Through Redesign*.

Following this pattern aluminum, chromium, nickel, cadmium and all but an insignificant amount of tin (in solder and even then probably replaceable with silver) can be ruled out of most currently needed building projects.

That leaves iron, steel, lead, zinc, copper and brass subject to whatever simplification and substitution may be possible. Each of course is essential to some extent if buildings are to contain any modern mechanical equipment. And since *all* are scarce, their use in any type of building—factories, cantonments, hospitals and schools as well as small houses—ought to be kept to an absolute minimum.

EARLY CONSERVATION IDEAS IN CONSTRUCTION

THERE IS LITTLE QUESTION that structural redesign combined with the use of alternate materials can effect a substantial conservation in the construction of almost every type of building.

The degree to which metals can be saved in specialized structures such as industrial plants depends, of course, upon the circumstances surrounding each individual problem. And the complete answer to conservation in other types of building construction has not yet been fully written.

Indeed, the majority of suggestions and recommendations which have so far been offered—and on which the RECORD is able to report now—refer primarily to houses. By and large, these recommendations are concerned with details; and each point may seem to the casual reader somewhat insignificant. But in combination, they will effect, according to Howard P. Vermilya, Director of FHA's Technical Division, a total saving of 82 per cent of the critical materials used in the

metallic items which customarily have been employed in the structural part of a house alone.

FHA's technical staff has estimated that we can safely leave out of the average type of "defense house" about 99 per cent of the copper, 55 per cent of the zinc and 23 per cent of the iron and steel which heretofore have been used. This saving can be made without substantially reducing the size of the house. But Mr. Vermilya has estimated that the average house con-

structed during the war emergency period under the present \$6,000 price ceiling will contain approximately 300 square feet less of floor area than before. This would tend, of course, to increase the total poundage of critical materials saved.

Conservation suggestions which follow were compiled from a number of sources, including The American Iron and Steel Institute, The Douglas Fir Plywood Association, The National Lumber Manufacturers' Association, The Portland Cement Association, The Structural Clay Products Institute, The National Bureau of Standards, and a number of Government agencies which include OEM's Division of Defense Housing Coordination, OPM, SPAB, FHA, USHA, and HOLC. It is fair to state that these suggestions represent only preliminary findings so far as the majority of these trade associations and agencies are concerned. In other words, a great deal of investigation in structural re-design and much experimentation with new products and alternate materials is now in progress toward the end of recommending still other and possibly more effective methods for conservation.

In surveying work done to date and in efforts to apply the conservation ideas which have resulted, one point must clearly be borne in mind: If anything is to be built, *some* critical materials must be employed.

Therefore, the goal of conservation must necessarily become not the elimination of every metallic item (although that increasingly will be regarded as an ideal) but the elimination of metal which is most critically scarce and the substitution for it of some other material which is comparatively less scarce. For example: where copper has been used for through-wall flashing, a substitute for it is now being manufactured in the form of a ferrous metal sheet completely covered by a baked-on, coal-tar-pitch enamel. Another example is the recommendation of the Bureau of Standards for using paint or pitch to protect steel from corrosion as a substitute for zinc coating.

Much initial effort is also being made to achieve conservation through simplification of trade practices. The National Bureau of Standards Chief of the Division of Simplified Practice, Dr. Edwin W. Ely, has been working since mid-November with the OPM Conservation Bureau. Dr. Ely's prime objective is the early reduction of manufactured items to make available only a

comparatively small number of standardized units in place of a formerly wide range of types. The construction industry can probably look for a vastly curtailed choice in a great number of equipment units which employ to a substantial degree such critical materials as copper, zinc, chromium and tin. Even so far, the application of simplified practice in the case of range boilers and expansion tanks has reduced the number of types from 130 to 13. Sizes and types of large tube cast iron radiators have been similarly reduced from 33 to 17 varieties.

To illustrate ways in which conservation may be achieved, the following suggestions have been confined specifically to the typical frame house; they will suggest to the ingenious architect and engineer various other ways in other types of structures where the objective may be achieved.

In a typical frame house points of potential conservation occur from foundation to ridgepole. They involve two possible approaches in the saving of metals: One is elimination and the other is the use of alternate materials or substitution.

It is too early in the effort toward conservation to report on any significant number of new products or materials which can be satisfactorily used as substitutes for those which must be eliminated, but in a large number of cases existing products can be adapted to new uses.

In the basement, a number of conservation opportunities exist. Where concrete foundations are used that require reinforcement, plain concrete of greater section, natural stone or masonry foundations may be substituted.

In place of pipe column supports, it is possible to use masonry piers or wood posts supported on a concrete base extending at least 3 in. above finish basement floor (see sketch).

In place of a steel girder, a wood beam or built-up girder, or loadbearing masonry wall can be used.

Steel basement sash can be replaced with wood sash.

In the case of a house built on a reinforced slab laid on the ground, a thicker slab may be employed without reinforcement.

Instead of metallic waterproofing or dampproofing, a non-metallic coating can be used.

In place of metal stirrups or strap-hangers to support long-span joists,



Pre-cast concrete lintels, requiring steel only in the pencil rod reinforcing, may be used in place of steel lintels, with considerable metal saving

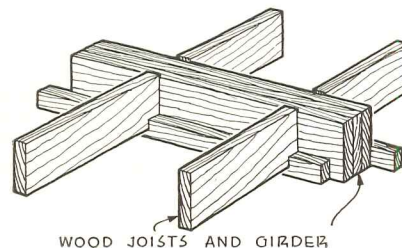

With joist hangers and steel girders banned, wood construction again comes to the fore. Designed to equalize shrinkage (braced or Western framing)

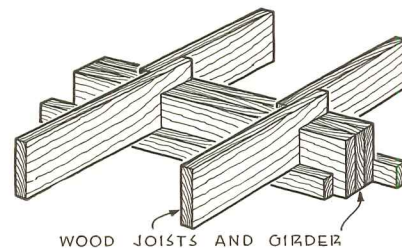

For balloon framing this girder construction also equalizes shrinkage. The joists should bear on the ledger strips, not directly on the girder itself

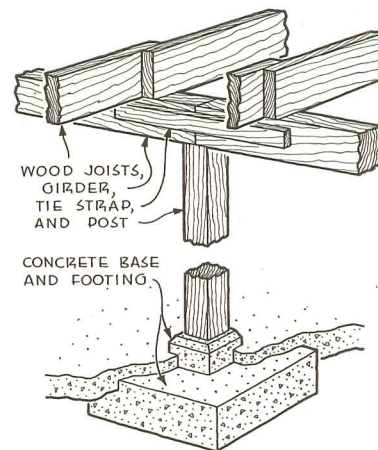

Considerable quantities of steel can be saved by eliminating pipe columns, joist hangers, girders, tie straps. Elevated base protects post from moisture

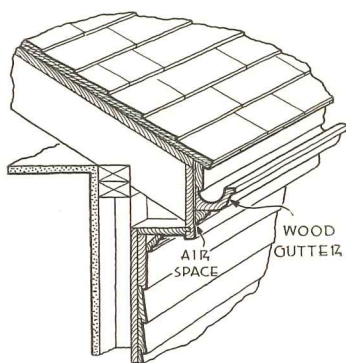

The wooden gutter might almost be called a symbol of conservation, so much heralded has it been of late. Perhaps it is because it suggests a return to pioneering building practices

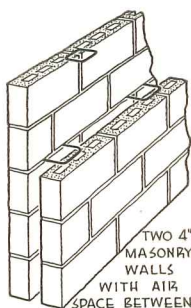

Typical of one type of conservation is the modern cavity wall construction, for with a small quantity of reinforcing wire it brings substantial savings of such items as nails, metal lath, lintels

support the joists either on a wood girder or on ledger strips (see sketches).

In walls, where possible, use building paper or composition in place of copper or other metal.

Omit breaks in the building wall line to eliminate step flashing.

In place of metal lath, use one of the board laths or use wood lath.

In fireplaces, use brick arch in place of steel lintel.

In place of lintel angles of steel, brick jack arches or wood or precast reinforced concrete units may be employed.

For hardware, use plastics (where available), glass, or at least cast or black iron in place of brass.

Use wood cabinets instead of metal in kitchens, baths, etc.

For roofs, eliminate breaks in roof line and save step flashing.

With flat roofs eliminate parapets by extending the roof out over the wall line.

Use board, blanket or fiber-vat insulating materials instead of metal sheets or foil. And use added insulation, thus cutting down on the size of the heating system needed (see Heating section).

Wood gutters can be used instead of metal (see drawing).

In place of metal use tile downspouts.

For porch roof, use painted canvas

or even heavy roofing paper instead of metal for the time being. Or increase the slope and use wood, asphalt or asbestos shingles.

In other types of construction, savings of metal can also become significant. In a house built of concrete units, for example, nails (used to the extent of about 400 to 500 pounds in frame construction) are largely eliminated. Plaster can be applied directly to masonry-unit partitions, eliminating all lath. If concrete is used in larger sections than customary, the amount of reinforcing steel needed is materially reduced. If wood floors are framed into the masonry walls, reinforcing needed in slab-type floors is avoided. Exterior concrete walls can be finished with a cement base and water paint instead of with lead or zinc-base paints required for other types of surfaces.

Walls of brick or stone, of course, require no exterior paint finish. Where the modern cavity-wall construction is properly built (see drawing), moisture and condensation can be eliminated. Hence, also, furring, metal lath, etc.

Finally, any and all systems which employ abundant native materials or those which are locally made of non-vital materials will offer considerable economies, including the fact that the transportation problem is simplified. And—if worse comes to worst—very suitable houses are still being built of logs, stabilized rammed earth, and waterproofed adobe bricks.

RE-DESIGN BRINGS CONSERVATION IN PLUMBING

IF EXISTING STANDARDS of sanitation are to be maintained during these war-time years the plumbing system in every type of building is as much of a "must" as ever. But proof that certain traditional practices in plumbing design and installation have been needlessly wasteful is contained in new recommendations which have recently been issued by OPM.

These new plumbing standards were developed for housing as a result of conferences held with OPM officials by the National Association of Master Plumbers and the United Association of Journeymen Plumbers and Steamfitters of the United States. They are being adopted at once for all Government housing projects and will be extended to all civil construction in offi-

cially designated defense areas.

Substantially similar to comparable provisions in the National Bureau of Standards' "Plumbing Manual" BMS 66 (AR 11/41, T-SS., pp. 91-96), the OPM code will save, according to estimates, some 30,000 tons of cast iron, 7,500 tons of steel, 3,750 tons of lead and several thousand tons of miscellaneous materials which ordinarily enter in the construction of plumbing systems. These figures are based on the construction of 500,000 one-family units for defense housing—a figure, it will be recalled, which C. F. Palmer, Defense Housing Coordinator, set some time ago as needed to fulfill emergency requirements.

In summary, the new plumbing code restricts:

1. Use of material other than cast iron, galvanized steel, and lead for soil-and-waste piping within the building and to a point not more than 5 ft. outside the building. This rules out copper and brass pipes from this part of the system. And extra heavy cast iron pipe cannot be used except where it is to be installed underground. Depending upon the particular types of installations involved, less iron and steel pipe will probably be used than formerly.

The foregoing applies only to the drainage part of the plumbing system. Copper and brass pipe for water supply lines is recognized by OPM as desirable in areas where soil and water conditions bring about rapid disintegration or excessive corrosion of iron and steel pipes.

2. Size of pipes for stacks and house drains. To and including an installation embodying three complete bathrooms and kitchen sinks, soil stacks and house drains will be 3-in. pipes instead of the 4-in. size formerly used in the majority of cases. This will prove to be a construction economy also, for a 3-in. soil can be installed in a standard stud partition without need for furring.

3. Method of Venting. Stack vents, back vents, relief vents, dual vents, wet vents or a combination of these vent forms are allowed. This permits a greater flexibility and vastly more economy in design than was usual in the traditional system wherein little or no use was made of wet vents, which in many plumbing codes have been prohibited.

4. Distance from vent to trap. This has

been set so that the total fall in the fixture drain from trap weir to vent fitting is not more than one pipe diameter. Also, the developed length of drain from trap weir to vent fitting may not be less than two pipe diameters nor more than 50 ft.

Commenting on the over-all conservation of materials that will be effected by widespread use of these new plumbing standards, V. T. Manas of USHA's technical division says: "In addition to the conservation of materials by the streamlining of the plumbing piping system, recommendations for substitution of strategic materials are being made, based on extensive studies and tests constantly being conducted by manufacturers and the Federal agencies. Among some of the substitutes under consideration are cast zinc, lead, steel 'sheet and tube,' glass, and 'molded and tube' plastics.

"Die-cast zinc alloy is acceptable as an alternate for brass in trimmings, fittings and accessories for parts which do not carry water under pressure. An organic lacquer or enamel finish may be furnished on all exposed surfaces in lieu of chromium or nickel plating. Plastic veneer, cork, wood, porcelain-ware, stone-ware are all applicable to fixtures and fixture trimmings such as handles, escutcheons, traps, waste tubes (not under pressures), shower heads, towel and safety bars, curtain rods, closet seats, and so on.

"Obviously, the above do not include all the possibilities, and continuous study is being carried on. In addition to substitution it is natural to expect the plumbing industry to confine itself to standardization—manufacture of a minimum number of units to be supplied rather than a complete line from which to select."

PLENTY OF POSSIBILITIES IN WIRING

IF THE INEXORABLE NECESSITY for wiring materials for any kind of building seems an effective block to conservation efforts, investigation reveals that the situation is not nearly as hopeless as first thoughts might indicate.

It is true, of course, that you cannot build much of a structure without electric wiring. And it is true that wiring requires two materials that are definitely critical—copper and rubber. But it is also true that ingenuity finds a fertile field in the use of these materials to permit a maximum quantity of building with minimum material requirements. It has been shown that substantial savings of copper and rubber are possible, and that in many types of buildings steel and zinc can be entirely eliminated. The savings are found all along the line, from manufacturing through design of the electrical system to installation.

Here are, for example, 11 suggestions from a report published in the Edison Electric Institute Bulletin,* as "a partial list of some points for simplifying wiring systems, which if applied to the nation as a whole will release appreciable amounts of steel, copper, and rubber for sorely needed facilities:

- "1. Use no conduit or steel tubing except in those types of construction where its use is necessary.
- "2. Use no steel outlet boxes where porcelain or composition boxes could be used.
- "3. Use non-metallic sheathed cable of the covered neutral type of assembly.
- "4. Where armored cable is required for some special reason, use the bare neutral type.
- "5. Where construction requires raceways, use a bare neutral conductor and thin-wall insulation on insulated conductors.
- "6. Where raceways are required, use electric metallic tubing (thin-wall conduit) in preference to rigid steel conduit wherever practical. Fiber duct and transit conduit may also be used in many cases, particularly on the larger sizes.
- "7. Use the neutral conductor as a grounding conductor throughout the wiring system.
- "8. Use multiwire branch circuits, with a common neutral wherever possible.
- "9. In revamping old installations now using 'double fusing,' convert to grounded system and obtain double the number of circuits, with the same fuses (or breakers).
- "10. Where additional wiring capacity is needed for existing two-wire branch circuits, 60 per cent to 100 per cent additional can be obtained with same wire in many cases by converting to three- and four-wire multiwire branch circuits.
- "11. Make use of thin-wall insulating mediums for cable assemblies."

wiring systems and materials. Most notable of these, in Item 3, is the "covered neutral type of assembly."

E. S. McConnell, of the Edison Electric Institute, explains that there are four methods of electric wiring in general use. "All four methods require the use of copper and rubber. Two of these methods also require the use of steel and zinc (for galvanizing) as indicated in the following tabulation. A fifth method, called covered neutral cable (CNX) has been used in a small way for many years. Trial installation status has been in effect since 1935, and something over 7,500 installations

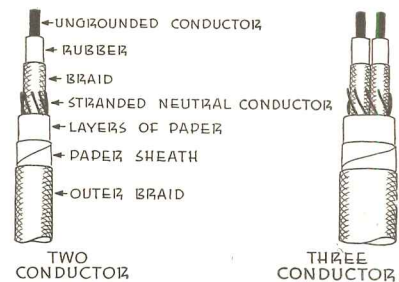

Suggested for saving rubber, steel and zinc is the "covered neutral" type of wiring cable, a non-metallic sheathed cable with a stranded, uninsulated neutral wire wound spirally around the central "hot" wire

* "Conservation of Materials for Defense Wiring," H. R. Stevenson and O. K. Coleman, Edison Electric Institute Bulletin, November, 1941.

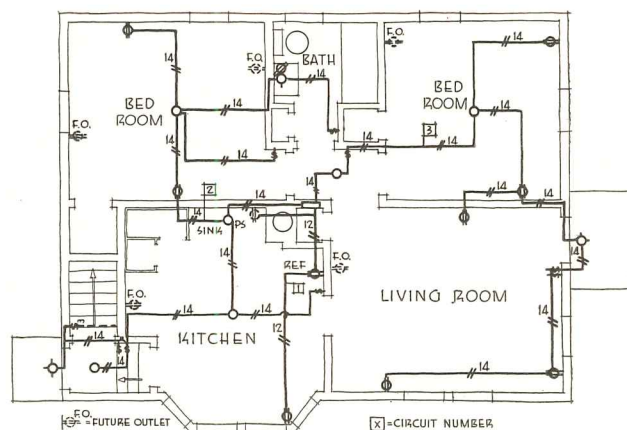
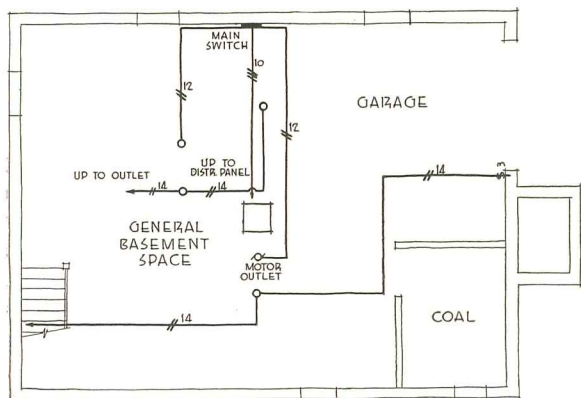

A wiring layout for a defense housing unit, designed for a very minimum of wiring runs to the restricted number of outlets now permitted, yet so arranged that more outlets can be added in the future without rearranging the system. Diagram prepared by the Adequate Wiring Bureau, St. Louis Electrical Board of Trade

in all parts of the United States have demonstrated its entire safety and reliability."

Wiring Method of Material	Proportionate Use of			
	Copper	Rubber	Steel	Zinc
Wire in Conduit.....	100%	100%	100%	100%
Armored Cable (BX).....	100	100	20	20
Non-Metallic Sheathed Cable	100	100	None	None
Knob and Tube Wiring.....	100	100	None	None
Covered Neutral Cable.....	100	50	None	None

Every 1,000 feet of No. 14 two-conductor armored cable (BX), continues Mr. McConnell, requires 170 pounds of galvanized steel, "which contributes nothing to the usefulness, safety, reliability, or length of life of the wiring system in several situations." The use of covered neutral cable in place of armored cable (BX) would save all of the steel and zinc and half of the rubber.

On the basis of total amounts of armored and non-metallic sheathed cable in 1941 (523,000,000 ft. of armored, 569,000,000 ft. of non-metallic sheathed) Mr. McConnell has estimated possible savings as follows: rubber 1,380 tons; tin 22 tons; paper 138 tons; cotton 191 tons; zinc 1,374 tons; steel 43,130 tons.

These are conservative quantities based on the minimum conductor size and two-conductor cable. Since substantial portions of the total footage of cable are of larger sizes, or more than two conductors (perhaps 20 per cent of the total) the actual savings of vital materials would be somewhat larger than indicated. Also, these quantities do not include substantial amounts of knob-and-tube wiring and wiring in conduit, which if included would increase the savings in rubber, tin, zinc, and steel.

The covered neutral cable, as the accompanying sketches indicate, is a non-metallic sheathed cable having one

of its conductors, the neutral, wound around the other. The neutral conductor, which is not insulated, consists of a number of strands wound around the insulated "hot" wire (or wires) in the center.

While the covered neutral system has not been in widespread use, and the cable is not universally stocked, there should not be great difficulty in this respect. The cable is approved for "trial installations" by the National Electrical Code, and thousands of buildings have been wired with it with entirely satisfactory results. It is said that the cable can be made on machines now available; indeed, it is easier to make than more common types. Thus the principal thing required to realize the savings is simply the acceptance of the covered neutral type of cable, and perhaps the necessity of the war emergency will see the overcoming of objections to a material-saving development.

Actually the covered neutral cable is credited with two definite safety advantages. For one thing, the absence of insulation on the neutral conductor, which is grounded, affords positive protection against any possibility of the "hot" sheath, since the grounded neutral is itself the sheath for the live conductor. Also the polarization of this type of cable is very definite, avoiding any possibility of an inadvertent error in connections.

Suggestion No. 4 above mentions another type of cable assembly—the "bare neutral armored cable." This is simply the conventional armored cable except that there is no insulation on the neutral wire. Though non-metallic types are generally preferable for non-fireproof construction, where the

armored cable is required the bare neutral cable does offer possibilities. It is smaller in diameter than conventional types and uses less rubber, braid and steel.

Also the bare neutral is called superior from the standpoint of safety. The bare neutral gives positive protection against the "hot" sheath, thus overcoming one objection to the conventional armored cable.

There is also the considerable saving in steel through the use of non-metallic outlet boxes. Based on the average use of one outlet box for each 15 ft. of cable, at .6 pound each, it is estimated that the use of non-metallic boxes would result in an annual saving of 22,000 tons of steel.

Besides these advances in wiring systems and cables there is also the possibility of saving through restriction of the number of electrical outlets, and through economical design of runs and connections.

OPM has taken a position for the restriction in the number of outlets; in its interpretation of the defense housing critical list it limits outlets to roughly two-thirds of what is generally considered to be "adequate wiring." Technicians have pointed out the number of outlets is by no means the sole criterion of savings, that indeed the search for savings would better be directed toward finding the shortest distances in the "geometry" of the building.

It is pointed out also that the design of the system should be directed toward a future adequate installation, and the plan developed toward the easy extension of the wiring at a later date. Studies along this line have been seriously pursued by the Adequate

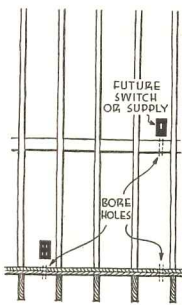

Simple preparations for future installation of additional outlets. Non-metallic boxes may be installed now, and holes drilled through sill plates and sub-floors, with strings hung in them to facilitate cable pulling

Wiring Bureau of the St. Louis Electrical Board of Trade. P. E. McCaughey reports them thus:

"We have been constantly urging electrical contractors to use *less* wire to give a *better* wiring installation. We

urge this because the longer a wire, the more energy is wasted. There is really nothing complicated about our so-called simplified wiring system; we simply make an intensive study of the geometry of the installation, to connect outlets by the shortest possible route. This, however, seems to be proving revolutionary to the industry . . . because the industry has always had a plentiful supply of copper, and the waste of wire in unnecessarily long runs, caused by lack of planning, has been accepted as standard practice. . . .

"Our bureau was called upon to lay out wiring systems that would provide a minimum amount of copper, full electrical efficiency, and finally provisions for the installation of future outlets.

"At this time we will be unable to install all of the outlets which are necessary for a wiring system that will be safe and convenient. Therefore we carefully select the positions of the outlets that we can install now, and prepare the structure where necessary

to install the additional outlets when they become available. This preparation involves only the boring of holes, and does not require any critical materials. When it is necessary to bore through fire-stops or stud-bracings, we require a string to be hung from this hole, so that when a future switch is installed, it may be fished up from the basement. In some cases where two-story structures are involved, the future outlets may be selected so that they are on opposite walls from an outlet already installed. In others, the addition of only 12 in. of cable will answer the purpose for the installation of a future outlet. . . . The wiring of houses is as important to the electrical industry as the construction of modern highways is to the automobile industry. If we can contribute in some way to make these electrical highways modern, by avoiding unnecessary long narrow lanes, and sharp curves, then the appliances can travel over them at full speed and provide real satisfaction."

IT'S STANDARDS VS. CONSERVATION IN HEATING

SO MANY AND SO DIVERSE are the possibilities for saving metal in heating systems, that conservation here is primarily the responsibility of designers, and of course, their clients. In other words, a conservation program logically begins with the question, how much saving must be made? Or, how important is metal saving relative to other considerations in the particular project?

Conceivably, certain types of structures can be built without central heating, or at least with some makeshift installation that would use a relatively small amount of critical materials. On the other hand, the utility and economic soundness of nearly every building project involve the necessity for a workable heating plant. To an extent, then, it is necessary to face the fact that reasonable standards demand sizable quantities of metals, some of which are definitely critical in the war emergency, and that priorities assistance may be necessary to complete a sound project.

The considerations involved cover a fairly wide range between the two extremes, including everything from the obvious point of location of the project on the weather map to things like: the

use and expected life of the buildings, ownership or rental status, type and term of mortgage financing, construction and layout of buildings. On such factors rests the decision as to different types of heating systems, from space heaters and floor furnaces to forced warm air or radiator distribution systems. Such matters can only be settled in terms of specific projects, but they are important, for they are likely to be more of a factor in total material savings than any possible economies in the design or installation of particular types of equipment.

And with Washington making the rules within which such decisions will be permitted, there is still much confusion in the whole matter of conservation in heating systems. And Washington officials, from OPM through all of the housing and construction agencies, must add other imponderables, including the question of how far it is necessary to disrupt the vast commercial system for manufacture, distribution, design and installation of heating equipment to meet American standards. There was considerable evidence, speaking as of pre-Pearl Harbor days at least, that Washington was under pressure to preserve vested interests in

heavy-materials industries. And there was much to be said in support of the claims made, as, for example, the fact that ore used for making cast iron is not suitable (at least not without expensive processing) for the making of armor plate. Be that as it may, Washington has to date been disposed to leave maximum leeway in the choice of equipment and distribution materials in relation to desirable standards.

Perhaps of more direct interest here are the possibilities for conservation available to designers within each type of heating system. Here are some of them as they are currently being discussed:

1. **The increased use of insulation and storm sash** to reduce the over-all heating load and thus to cut required sizes of heaters and distribution equipment throughout the building.
2. **The development of smaller heaters**, of advanced design and good efficiency. An especial opportunity for savings in this respect lies in defense housing units, many of which are smaller in total cubage than the average unit for which heaters have heretofore been designed. Engineers of USHA report, for

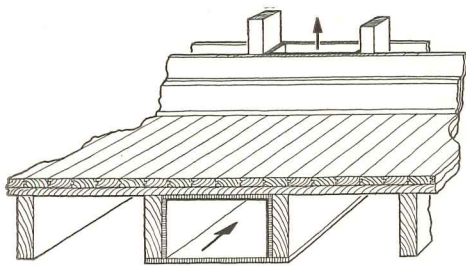

Currently receiving new attention is a simple idea for saving metal duct work in warm air heating—the "panning" of spaces between joists with fire-resistant board, or even plywood if metal is used near the heater

example, extended cooperation with manufacturers in the development of small furnaces of closely integrated design, to have an over-all capacity of around 60,000 B.t.u. It has been said that some heaters might well go down to 40,000. Typical of the newer heaters, made by several manufacturers, is the "columnar" unit illustrated in the drawings herewith. It has over-all dimensions of 26 by 26 in., has a blower built in, and in tests has shown efficiencies of from 65 to 70 per cent.

3. Careful design of distribution systems to use a minimum of materials. This is a wide field of opportunity now being given close scrutiny by many different technical groups.

Beginning with simpler ideas such as the "panning" of spaces between joists to serve as warm air ducts, the possibilities range upward to fairly complicated developments. It is perfectly possible, say engineers, to use panned joist spaces for both supply and return ducts. On the warm side, they say, metal ducts should be used within 6 ft. of the furnace, but from there on strictly fireproof materials are not necessary, the main requirement

being that the space be reasonably smooth and tight. It is even possible to close the opening at the bottom of the joists with plywood and use a layer of asbestos or building paper at the top of the space to prevent excessive leakage. There are also developments in fiber ducts or prefabricated ducts made of asbestos.

The simplification of duct installations offers wide possibilities. The drawings show how far it is possible to go in cutting down duct work and still achieve a full forced air distribution in a small defense housing unit.

Along this general line, the defense housing program has generated a newly intensified study of floor furnaces and other ductless heaters and various plenum chamber ideas. The current status of these studies is that they seem to indicate wide possibilities, but that there are several "provided" to be considered. At any rate, the final solutions have not appeared. A factor of considerable importance is the layout of the rooms and halls in the housing unit—the house almost has to be designed around the heater for full success. Also, tests of ductless heaters in the laboratory disclose some surprising vagaries in the installations. At the same time, very good results have been achieved, and the metal-saving possibilities are obvious.

In radiator heating systems similar scrutiny is being given to distribution systems. For one extreme, tests are under way of centrally located boilers with radiators installed on the inside walls instead of under windows. Obviously, such an installation involves a minimum of distribution lines, but the plan is still considered as being in the idea stage.

An interesting distribution idea is

reported from the Chicago area. In a group of 550 houses recently completed by the Fred J. Walsh Company, ranging in price from \$4,500 to \$5,700, hot water heating has been used in 470. Two economical pipe layouts were used, with considerable savings in net weight of pipes in comparison with more conventional systems. In one, a one-pipe system, a header runs from the boiler in a utility room to the foundation, where it connects with black steel pipe running underneath the four outside walls of the house. This pipe, equipped with shunt fittings, carries the hot water to the radiators; as well as the colder return water to the boiler. The pipe leads back to the boiler and the circulator is installed in the return end.

In the other system an octopus or cluster piping system was used. The hot water supply line from the top of the boiler is extended down to the floor of the utility room and continues underneath the floor to a point approximately in the center of the building. This portion of the piping is of 1 in. black steel pipe. At the end of the supply line, a manifold fitting is placed. From this fitting tubing runs to each radiator. The return line is duplicated into a return manifold fitting, which is also connected to the return at the boiler by 1 in. black steel pipe. An obvious difficulty is that the tubing is presumably copper.

These two hot water systems offer a saving in material and labor over the conventional two-pipe system. It is claimed that the saving on this job was about 40 per cent in net weight of pipe.

From a few examples of this kind it is clear that possibilities are many and varied. Also that to date only the merest beginnings have been made.

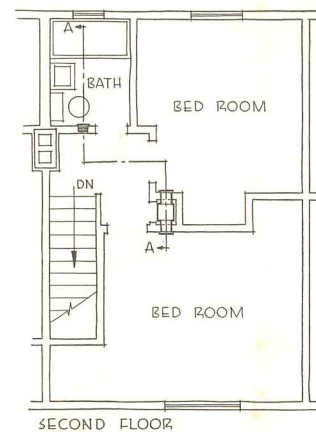
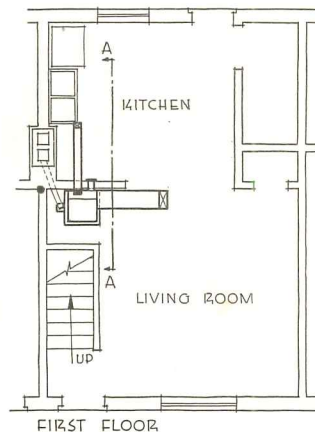
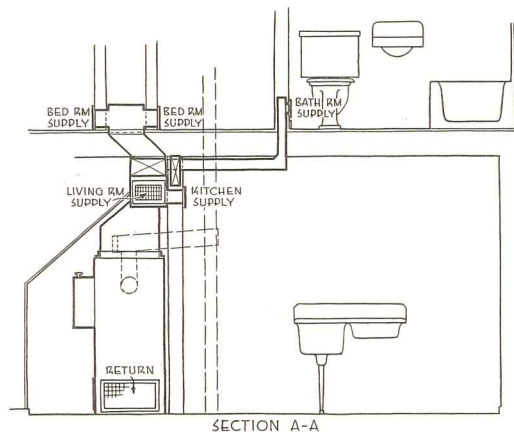

Conservation in the heating system here combines a new "columnar" type of forced air furnace with just about an absolute minimum of duct work. The furnace measures just 26 by 26 in., and has a built-in blower. It is installed in an open closet off the living room, and has a return opening in the bottom, so that no return ducts are necessary. Installed in a defense housing project of the USHA, in Baltimore. Architect, Lucius R. White, Jr.

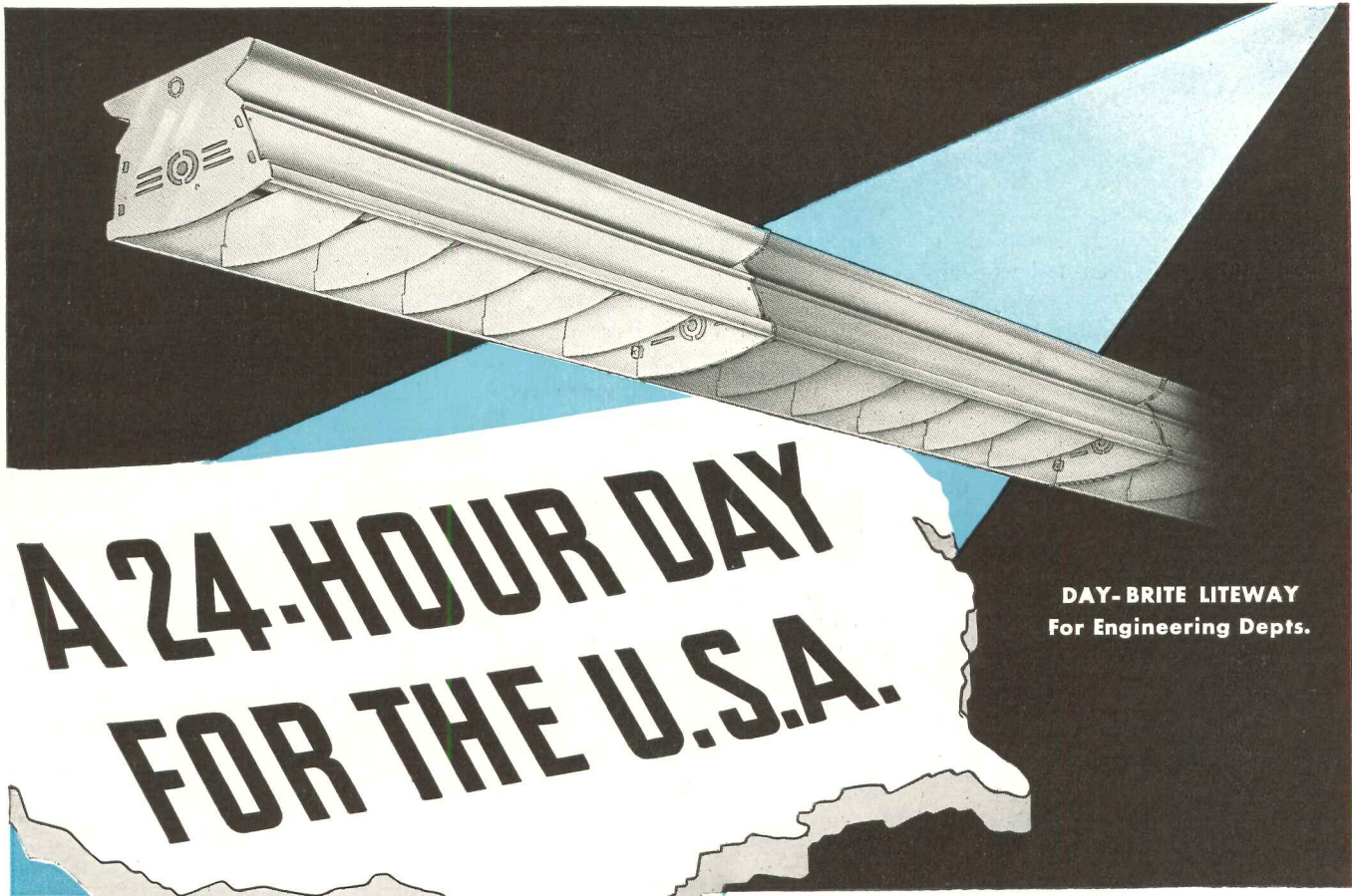

A 24-HOUR DAY FOR THE U.S.A.

DAY-BRITE LITEWAY
For Engineering Depts.

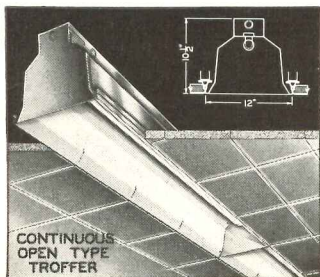

CONTINUOUS
OPEN TYPE
TROFFER

Cross section and installation view of Day-Brite Continuous Single-row Open-type Troffer.

ON the front line of Victory, light makes right — 24 hours a day! Seeing better means doing better! And, that's where Day-Brite Fixtures help — they utilize the higher efficiency of fluorescent lighting . . . Backed by 18 years' specialized lighting experience, they are designed and engineered to lessen eye fatigue and assure the clearer vision necessary for greater accuracy, closer tolerances, quantity output and fewer rejects . . . DAY-BRITE IS THE LIGHT LINE OF VICTORY! . . . Consult Day-Brite Engineering Representatives, located in principal cities . . . Nationally distributed through all Leading Electrical Supply Houses.

DAY-BRITE LIGHTING, INC., 5423 Bulwer Ave., St. Louis, Mo.

Whatever you need in Fluorescent Fixtures is available in the Complete Day-Brite Line! A large, modern plant geared to high-speed, accurate, quantity production every step of the way. Send for catalogs.



THE COMPLETE LINE
OF FLUORESCENT
LIGHTING FIXTURES



32

(Continued from page 16)



about to be blasted loose. It is expected that expenditure will be restricted to family units rather than quarters for single men and women.

Truman report

Detailed recommendations, with sharp criticisms of the defense housing program, were offered in Senator Truman's report from the Committee on Education and Labor on the House-approved Lanham Act extension.

Previous appropriations and authorizations for defense housing, the report stated, have amounted to \$792,330,987, not including the \$600,000,000 for temporary shelter and Lanham Act work noted in the foregoing section. Lanham Act construction so far is tabulated thus:

	Units	Projects
Public Building Administration	32,527	147
U. S. Housing Authority Division of Defense Housing, FWA	16,413	55
Mutual Ownership Defense Housing Div., FWA	4,600	10
Navy Department	2,762	9
Farm Security Administration	1,485	6
Alley Dwelling Authority (D.C.)	550	2
War Department	495	1
Tennessee Valley Authority	250	1

In addition, numerous local housing authorities have entered the picture.

The Truman report pointed out that the four agencies first named in the above list all are under the Federal Works Administration but all have their own staffs with duplication and far too little coordination.

The report praises the U. S. Housing Authority for carrying out its work more speedily than the other agencies although it uses the competitive bidding system while many of the other projects have been on a cost-plus basis.

More economical construction is credited to USHA, with the aid of local housing authorities whose aid the report recommends should be used to the fullest extent possible.

"These housing authorities are

most cognizant of local problems and local needs. They have, in most instances, available personnel and are readily adaptable to supervise the construction of defense housing."

The present act limits average cost of projects to \$3,500 with a top ceiling of \$3,950. The Truman report disfavors upping these figures to \$3,750 and \$4,500.

FEDERAL AGENCIES AFFECTING ARCHITECTURAL PRACTICE

The dominance of defense work in architectural practice for the duration and the many changes in Federal procedure over the past year have led us to prepare this brief directory of the principal Federal agencies involved with housing work.

Coordinator of Defense Housing. Certifies areas for defense housing projects and makes studies aimed toward joint action among Federal agencies.

Federal Works Agency. This is the mother "holding company" of most of the agencies engaged in housing, both defense and non-defense. Naturally, emphasis now is on defense housing. Under it come the PBA, the USHA, the Division of Defense Housing, the Mutual Ownership Defense Housing.

Public Buildings Administration. Thus far, PBA has built, is building, or has been authorized to build more than 34,000 family dwelling units. Most of these have been defense homes. PBA uses staff architects. To apply for employment as a PBA architect a letter should be written to the Supervising Architect, Public Buildings Administration, Seventh and D Streets, S. W., Washington, D. C. The letter should include information as to age, education, previous experience—what type of houses or buildings the applicant has had experience in designing, where the applicant has practiced—and indication as to salary requirement. Most of the staff architects are under a Civil Service status, but some few are appointed independently. The director has indicated that with an expanded program under the additional \$300,000,000 of Lanham Act funds, outside architects will be retained.

United States Housing Authority. The United States Housing Authority makes loans to public housing authorities to fi-

nance up to 90 per cent of the cost of low-rent housing. Under special wartime authorization, the Authority may also engage directly in construction of projects. The USHA uses architects from the locality of the housing project to be constructed almost without exception.

Architects desiring to be considered for employment on USHA projects should do two things. (1.) Contact their local housing authority or the housing authority nearest to them; should submit to such local authority a complete history outlining in detail their education and experience in the low-cost dwelling unit field. Anything that could bolster their case as being a good, experienced architect in that field should be submitted with the application. (2.) Submit the same information to the Personnel Officer, United States Housing Authority, North Interior Building, Washington, D. C.

Architects already in the field of low-cost house construction may receive expert technical assistance on problems in their particular work by writing to the Director, Technical Division, United States Housing Authority. This assistance will generally be rendered where the architect is working on public housing. On private housing financed by private institutions, the FHA should be contacted. (See FHA discussion elsewhere in this directory.)

More than 28,000 family dwelling units have been assigned to the USHA for construction. More are coming, and with each assignment job opportunities increase.

Division of Defense Housing. Has been assigned over 21,000 family dwelling units for construction. It employs architects from the locality where projects are to be erected. The procedure to follow in order to gain employment as an architect for one of its projects is similar to that outlined above under USHA. It appears that this agency will have more and more to do under the defense housing boom. Local papers should be closely watched to see if projects are being planned.

Mutual Ownership Defense Housing. This is principally an agency dealing with financing of defense homes for purchase under a new cooperative system insured by Government funds. It has been assigned more than 7,000 units for construction. Private architects are used in some instances. Details of operation of the agency can be obtained from Director.

War Department. Is, of course very active in construction. In the housing of enlisted personnel, the Public Buildings Administration has been

(continued on page 20)

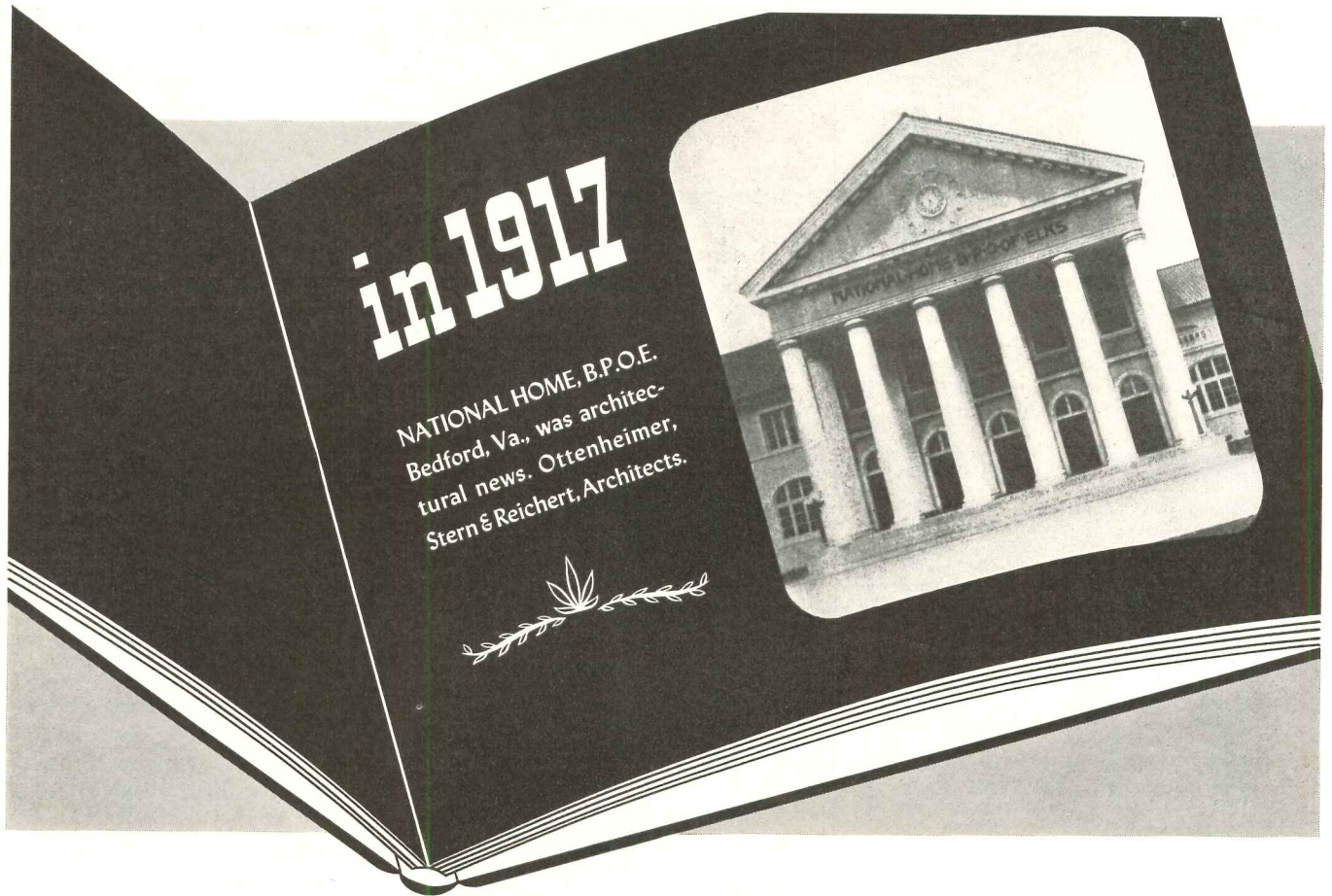

MANY PAYNE FURNACES OF THAT DAY ARE STILL IN OPERATION

Gas heating, like architecture, has progressively changed in the past quarter-century. Yet, even PAYNE's early models were so soundly engineered that they serve their owners efficiently today. ☆ PAYNEHEAT reliability, performance and fuel economy are established by years of research, laboratory testing and, even more important, successful operation under every conceivable condition. ☆ For information on PAYNE's 69 modern styles and sizes, check with your PAYNEHEAT Contractor or Gas Company. Also, see Sweet's, Western States AEC, or our convenient AIA file. (Send for one!)

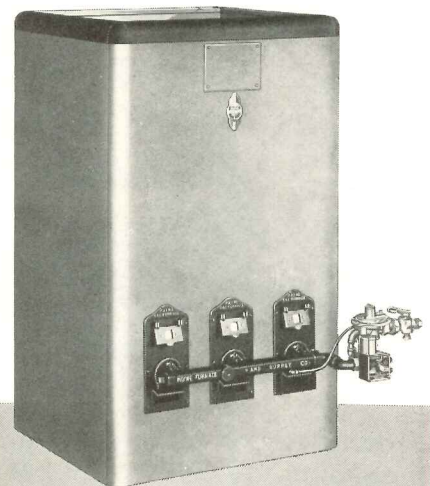

Illustrated: PAYNE Gravity Unit. Also: Modern Console, Zoneair, Floor Furnace, Duplex Furnace, Spacesaver Unit, Sentry Forced Air Unit, Industrial Units.

FOR FURTHER INFORMATION
SEE OUR CATALOG IN SWEET'S

PAYNEHEAT

MORE THAN A QUARTER-CENTURY OF  SPECIALIZATION

Payne Furnace & Supply Co., Inc., Beverly Hills, California

(Continued from page 18)

PLAN SAFE STAIR TREADS AND WALKWAYS!

Architects and engineers engaged on industrial plant construction and modernization, military buildings, and government housing projects are specifying ORCO SAFETY TREADS AND FLOORING after investigation of the merits of these unique *non-slip* products.

NOTE THESE ADVANTAGES!

1. *Permanently Non-Slip*: the Alundum abrasive aggregate uniformly distributed in the walking surface never wears smooth or slippery and provides a *sure-grip even when wet*.
2. Treads are non-slip throughout surface INCLUDING NOSINGS.
3. Nothing to catch heels as there are no ridges, grooves, or sharp corners.
4. *Sound absorbing* quality deadens noise of foot traffic.
5. *Exceptional durability*. Uniformly distributed Alundum aggregate protects base of molded rubber which cannot wear faster than the aggregate.
6. *Attractive appearance*. Standard colors provide selectivity to harmonize with surroundings and provide various design patterns and color schemes.
7. Easy to install with ORCO Bonding Cement over all types of sub-surfaces such as steel, concrete, stone, wood, etc.

PROMPT DELIVERIES

Efficient manufacturing and distributing facilities make possible prompt deliveries anywhere. *Write for samples.*

ORCO
SAFETY TREADS
AND FLOORING

CONTAINS
NORTON
ALUNDUM
ABRASIVE
AGGREGATE

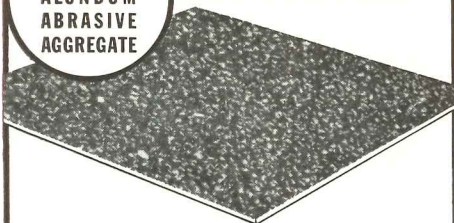

**For further information,
see our catalog in Sweet's**

Refer to "Sweet's-12/8" for complete details, standard colors, specifications, lists of representative users and installation photographs of ORCO SAFETY TREADS AND FLOORING. Or, write for reprint copy of our catalog in "Sweet's."

THE OHIO RUBBER COMPANY
NO. 500 BEN HUR AVE. • WILLOUGHBY, OHIO

handling construction operations. In the cantonment construction, a shift is contemplated from the office of the Construction Quartermaster General to the Corps of Engineers. This has not yet been consummated. Staff architects of the War Department prepare all initial plans and specifications, in collaboration with army engineers, for cantonment construction. Best chances for selling architectural services lie in contacting successful bidders on cantonment construction jobs or other War Department construction and selling them on using services of outside architects in an advisory and supervisory capacity. Specialized knowledge in the field of drainage, office building construction and dormitory work would be helpful.

Navy Department. The Bureau of Yards and Docks, Housing Section, Navy Department, handles all housing construction for the Navy. Outside architects are used and generally selected from the vicinity where the construction is to take place. So far, the Navy has built only about 2,500 units, but this should be increased.

Federal Housing Administration. An insuring agency and does not construct homes or lend money. However, to facilitate the development of low-cost housing it does render valuable technical assistance to the architect who desires to avail himself of this information. Any architect who is planning houses or projects required to meet FHA standards may receive information and suggestions from the nearest FHA insuring office. Since the establishment of the Technical Division of FHA, continuous studies regarding new building materials and methods have been made. Results of the studies are available to architects. Such circulars as "Property Standards," with "Minimum Construction Requirements for New Dwellings" for the region in which the property is located, or "Subdivision Standards," are free on request. A list of other circulars of a technical nature helpful

to architects may be obtained from the Information Division of FHA.

Defense Homes Corporation. This is an RFC affiliate set up by Executive Order and operating on monies allocated from the President's special emergency funds. It employs local architects whenever projects are being planned and is interested in small house design ranging from \$2,500 to \$6,000 depending on the locality of the project. No figure is available as to how many homes or what funds have been expended by Defense Homes Corporation in its efforts. Employment as an architect on Defense Homes projects may be obtained by writing to the Defense Homes Corporation, Washington, D. C. Qualifications and experience should be outlined with particular reference to small house architectural planning. The letter of application will be kept in a reference file by the DHC and when a project comes up in the locality from which the applicant applied, it will be reviewed, along with others, and selections will be made.

Farm Security Administration. Makes loans to farmers to enable them to become farm owners. It also completed and operates about 151 projects inherited from the former Resettlement Administration. Some prefabricated houses are financed by FSA and plans for farm homes or buildings along these lines may get consideration from FSA if submitted. Also step-gap housing including trailers and demountables.

Home Owners Loan Corporation. Inactive since 1936 insofar as new operations are concerned, HOLC has now set up a special \$100,000 fund for architectural advice on the need for repair and for repair to homes in defense areas so as to make them more habitable and suitable for defense workers. Local architects are used on this modernization and repair work. Architects desiring to enter this field should contact the nearest Federal Savings and Loan Insurance Corporation office.



SPECIFY "PENNVERNON"

... NOT JUST "WINDOW GLASS"

• What makes good window glass? Primarily, two qualities: good vision and surface beauty. Pennvernon Window Glass provides these two advantages in high degree. For a sheet glass, it is remarkably free from the defects which frequently tend to distort vision. And it has a brilliant, reflective surface finish on both sides of the sheet. Look *through* Pennvernon Window Glass . . . or look *at* it . . . and in either case, you know immediately that it is a glass thoroughly worthy of quality windows.

PENNVERNON WINDOW GLASS
PITTSBURGH PLATE GLASS COMPANY

"PITTSBURGH" stands for Quality Glass and Paint



A **Q**-PANEL
EVERY 9 MINUTES

ENCLOSES
NEW FLOOR SPACE

Quick!

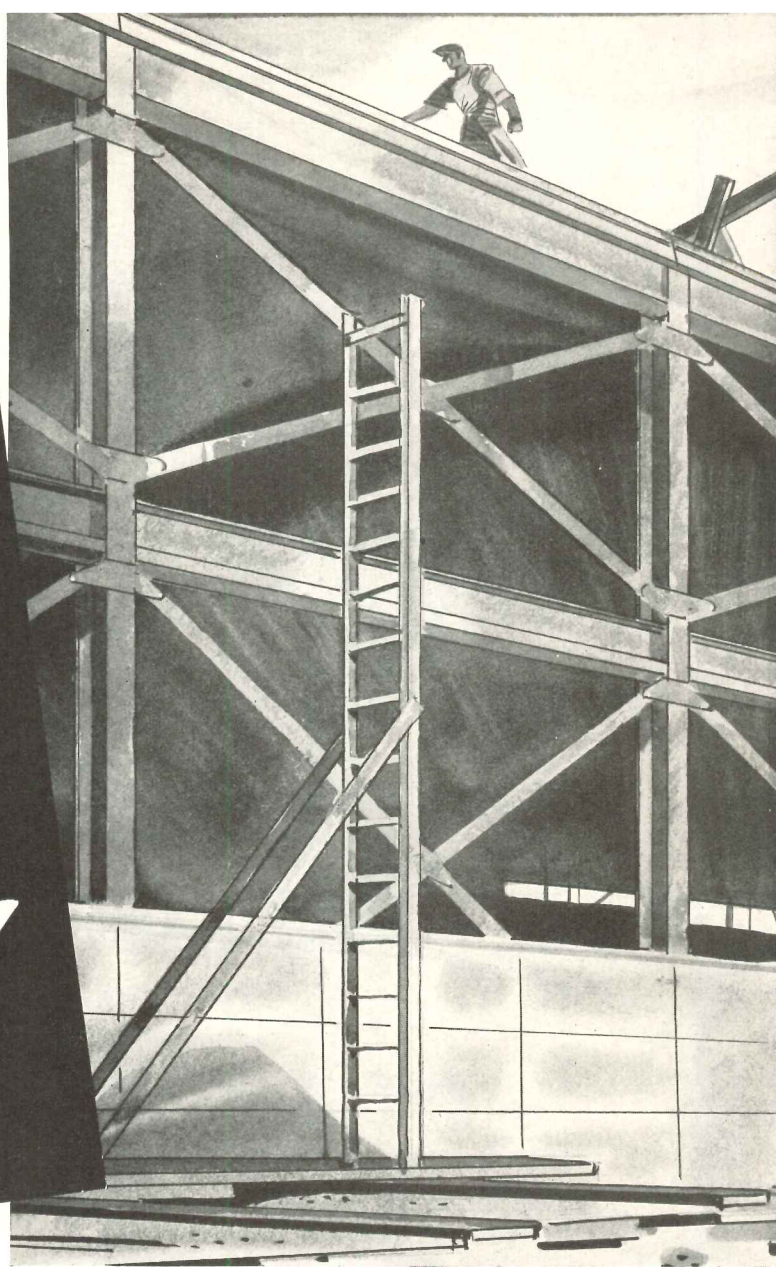

Now you can "Specify Speed" and get "50 square feet of factory wall every 9 minutes." With the suddenly imposed demand for new plants and additions . . . "black-out" or "daylighted" . . . the speed of Q-Panel erection and the enduring qualities of Q-Panel construction will be factors in the all-out effort.

Each Q-Panel Section is a complete insulated structural unit, cut to the proper length and furnished in widths that facilitate easy handling and rapid placement. Interlocking lips on the edges of each section automatically lock them to-

THE IDEAL MATERIAL

gether when fastened to the structural framework of the building. Q-Units for floors, roofs and partitions are placed with equal speed. For each of these uses they provide a permanent and most durable form of construction.



This 23-Acre Aviation Plant at Dallas was built in 105 days for North American Aviation, Inc., J. Gordon Turnbull, Consulting Engineer; James Stewart & Co., Inc., General Contractors. Q-Panels were also used in the 32-Acre Plant for this company at Kansas City.

ROBERTSON Q

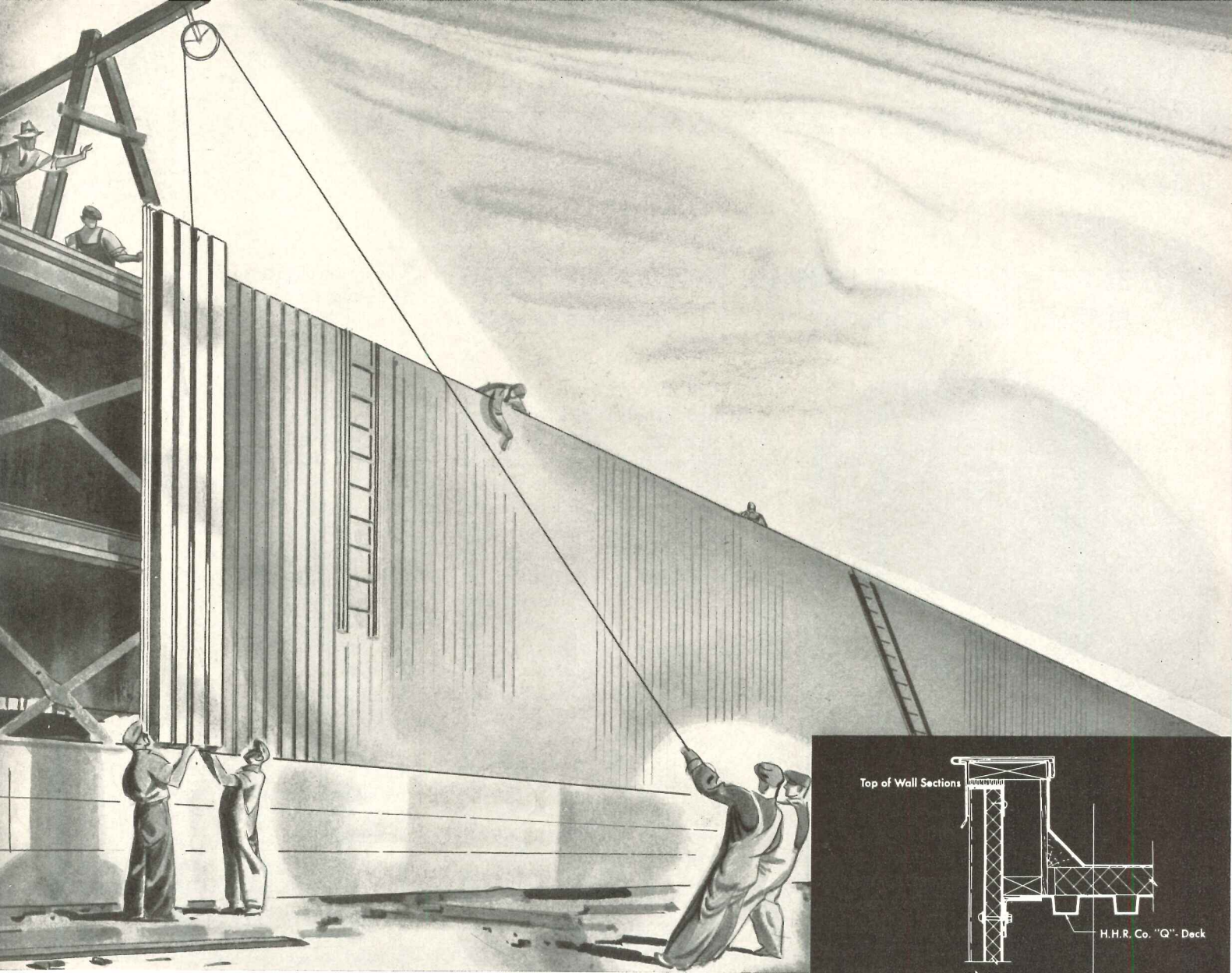

FOR "BLACKOUT" BUILDINGS

Q-Panel construction is well suited to use in a wide range of structures . . . aircraft buildings, munitions plants, powerhouses and other types of manufacturing buildings. *It facilitates winter building because it is "dry" construction.* No waiting for wet materials to set, no fire hazard from combustible forms. It is a permanent form of construction, for Q-Panels have a 100% salvage value.

Further details in addition to the cross section shown opposite will be gladly furnished together with cost estimates.

H. H. ROBERTSON COMPANY
FARMERS BANK BUILDING . . . PITTSBURGH, PA.

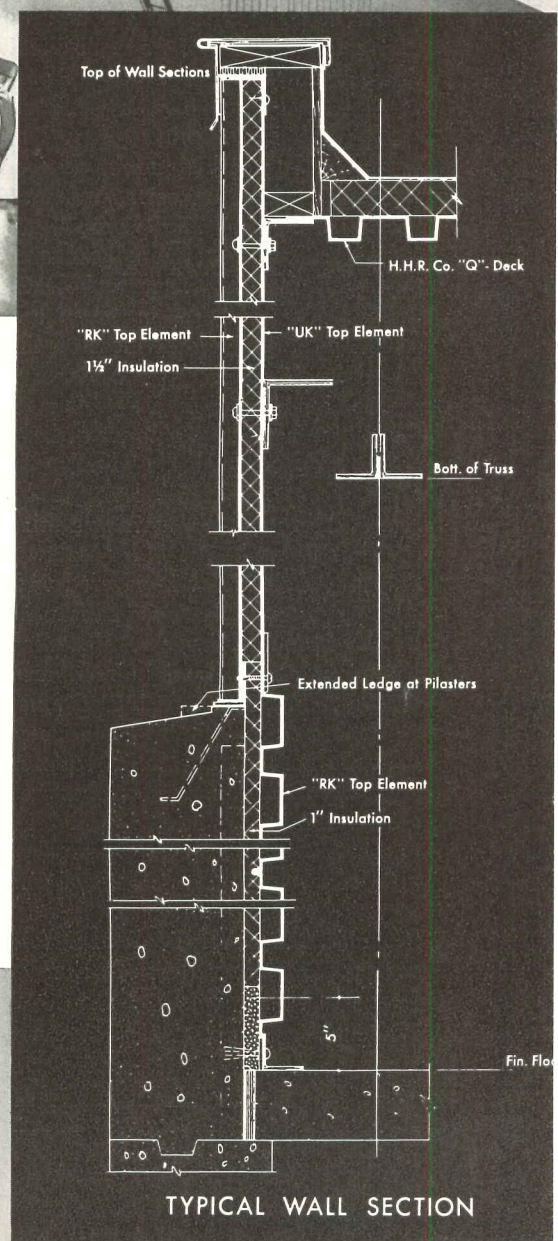

- PANELS

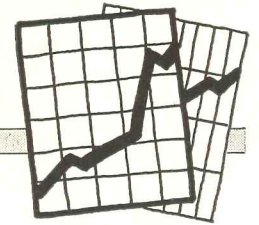

BRITISH ARCHITECTS SAID GOODBYE TO THEIR ART BUT EARN WARTIME BREAD AND BUTTER

By EUGENE REID, ARIBA

Courtesy "The Architect's Journal"



THIS DESK used to be covered with papers, letters from clients, letters to contractors, half-written specifications, smudgy bits of tracing paper, and all the odds and ends you generally find on a desk that is the heart of a moderate architectural practice. Now it is empty, a deserted waste of green hide. And all because Herr Schinkelgrüber in Germany wants us to live his way of life, and we here, in Britain, and you there, in the Americas, have quite different ideas on the subject.

One immediate manifestation of that difference is the amount of light that comes through the window in front of me to light this desk and the rest of the room. It is exactly a third of what it used to be because two-thirds of the window is covered with a very substantial bituminous felt, the result of a rather large bomb falling one night about two hundred yards up the road and destroying an office block and some slummy house property. I, here at this desk, suffered only the inconvenience of shattered glass lying everywhere, a cold blast of air coming through the paneless openings, and a patch of fallen ceiling. The people who lived in that office block lost their livelihood. And the people who lived in the slummy houses lost their lives.

* * *

Another manifestation of that difference is the closeness with which our two nations have drawn together. Not only is this new intimacy seen in the stupendous stream of arms that is coming across the Atlantic (and as one humble British citizen may I say simply: "Thank you, citizens of U. S. A., for those arms," a sentiment which is echoed in the minds of forty million other persons like me in this island), but over here we are becoming America-conscious in all sorts of ways.

We get home in the evening, for instance, and turn up the radio for the 6 o'clock news, one of the high-spot listening hours of the day; we listen for the latest news from the eastern front; have the bombers been over our own country today? But what is the first item? We are told to stand by for a direct broadcast from America, and presently we hear President Roosevelt, in clear, incisive language addressing Congress. Well, when that sort of thing happens, when from out of the blue we hear the voice of the American people taking first place on the B.B.C's 6 o'clock news, it makes those four thousand miles of ocean between us seem very short miles indeed.

But this kind of thing occurs nearly every day. You walk down the Strand, here in London, and presently you pass the uniform of the United States Navy Department. You walk into a club, and you are introduced to an official of the U. S. A. Board of Education who has flown over to see how our army is being trained in the technical schools. He will tell you quite casually that only two or three days ago he was discussing with his senior in Washington the very point you are raising. Only two or three days ago! The Clipper and Herr Schinkelgrüber have together done a

good job of work in drawing our two countries together.

And then we hear regularly your star broadcasters, Raymond Gram Swing, Elmer Davis and Dorothy Thompson. We hear about your culture, of that great poet of democracy, Walt Whitman. And when last September London was badly hurt by the bombs, the press and everyone else here began thinking about replanning. It was our great Liberal daily, the News-Chronicle, that went outside this island for an opinion as to how it should be done. It went to America, to that silver-haired visionary from Wisconsin, Frank Lloyd Wright.

* * *

So, in one way and another, we seem to be learning quite a few things about each other, and the time seems to have arrived when, like the nations of which we are a part, we architects here should get on speaking terms with you fellows over there. Let me begin, then, by telling you how the profession over here earns its proverbial bread and butter in wartime, for, despite Herr Schinkelgrüber, we do still eat butter, when we have any coupons left.

Architecture, being an art that flourishes most when the stock market is brisk, wilts when things are not going well financially and positively fades when it meets the fierce glare of war. And that is precisely what happened to architecture over here in September, 1939. The day war was declared we said good-bye to our art.

In the offices of the private architects and in the public offices preliminary schemes were shelved, and buildings that were being erected were stopped if they were not essential to the war effort, or if they had not reached a stage where stoppage would be harmful to the work already done. And so it is that you go about London today and see steel frames that have risen silently to the skies for two years, foundation works that

(continued on page 92)

Why so many of
Today's Schools
are being built
of Douglas Fir
Plywood

1 The best of today's schools are flexible in plan—capable of being easily adapted to changing needs. Because Douglas Fir Plywood permits the architect greater leeway in design—and gives the taxpayer more for his money at the same time—this "modern miracle in wood" is being specified extensively for both interior and exterior finish. Douglas Fir Plywood is as ideal for demountable units as for permanent construction.

2 Douglas Fir Plywood has many structural advantages: It builds kick-proof and crack-free walls and wainscoting. Used as sheathing or exterior finish, it makes walls 5.9 times as rigid as horizontal board sheathing, 40% more rigid than diagonal board sheathing . . . *vitally important advantages in earthquake or high wind areas.* Douglas Fir Plywood affords excellent insulation . . . is receptive to any finish. It forms smooth, flawless concrete surfaces at lower cost. The big panels minimize labor, speed construction.

3 There is a type or grade, size and thickness of Douglas Fir Plywood for every building purpose. Each panel is made in strict accordance with U. S. Commercial Standard CS45-40 and "grade trade-marked" for easy specification and positive identification. For more details, read the Douglas Fir Plywood Association section in Sweet's Catalog or write Douglas Fir Plywood Association, Tacoma, Washington, for literature.

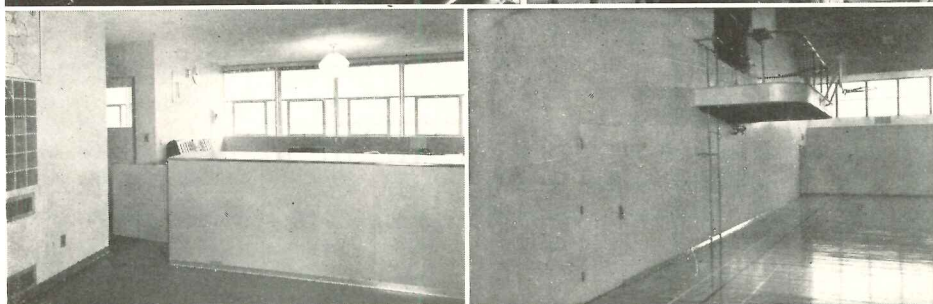
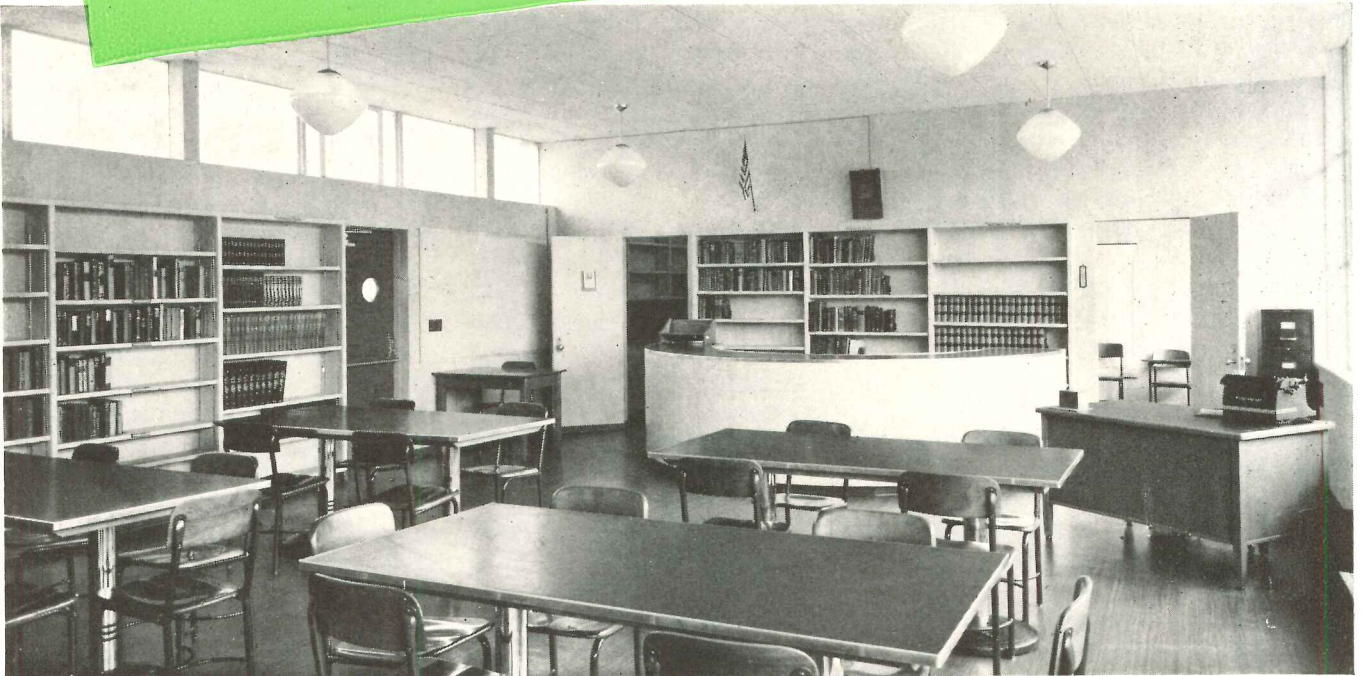

BEAUTY AND DURABILITY are combined in the Douglas Fir Plywood walls of the Acalanes Union High School, Lafayette, Calif. This photograph shows the library, but all the walls were given a natural finish to produce the human, intimate effect desired throughout. Franklin & Kump, architects, designed this flexible, multi-use school.

BOTH COUNTERS AND CUPBOARDS at Acalanes Union High are constructed of Douglas Fir Plywood, Plypanel grade. All plywood wall panels were butted together without battens.

THE GYMNASIUM was lined with 3/4-inch Douglas Fir Plywood. Regardless of the rough treatment given them, these durable yet attractive plywood walls will never crack nor puncture.

DOUGLAS FIR PLYWOOD
Real Lumber
**MADE LARGER, LIGHTER
SPLIT-PROOF
STRONGER**



SPECIFY DOUGLAS FIR PLYWOOD BY THESE "GRADE TRADE-MARKS"

PLYPANEL D.F.P.A.
TRADE MARK REG. U. S. PAT. OFF.

EXT. - D.F.P.A.
TRADE MARK REG. U. S. PAT. OFF.



By ELISABETH COIT, AIA

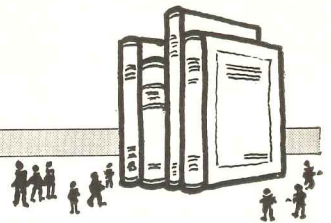

THE ARCHITECTURAL HERITAGE OF THE MERRIMACK: Early Houses and Gardens. By John Mead Howells. New York, Architectural Book Publishing Co., 1941. xxiii, 229 pp., 9 1/4 by 12 1/4 in., \$10.00

THIS collection of 302 reproductions of photographs and drawings, forming a parallel volume to Mr. Howell's "Architectural Heritage of the Piscataqua," presents not only the houses and gardens as far north as Concord, N. H., but also churches and other public buildings, headstones, weathercocks, wallpapers, an occasional significant biographical note, and a good general introduction, the whole forming a fine architectural history of the region as well as a history of its architecture, during two centuries.

Many of the houses, particularly the three-story "square mansions" on Newburyport's High Street, the Spencer-Pierce-Little house in Newbury, Whittier's birthplace at East Haverhill, Pearson Hall of Phillips Andover Academy, will delight none the less for being already familiar. Others less well known, and especially the many fine interiors, enrich one's architectural experience, all the more so because many of the houses shown are no longer standing.

This work is one architects will want not only to own but to see made available to a wide public even if it involves urging their local libraries to buy it. For here in a beautiful book, conceived, assembled, designed, even to the format and jacket, by an architect—or rather, by two architects, for the introduction, as packed with thought and feeling as a sonnet in the best tradition, is by William Graves Perry—are shown and explained the essentials of those comely, picturesque and well-preserved buildings of universal appeal. Design, material, workmanship are exhibited from all points of view, demonstrated in terms of "Usefulness and Accommodation, Lastingness and Hand-someness." A thousand details complete the picture: gardens or summer houses, including one in "Chippendale Gothic," garden and block

layouts from the Historic American Buildings Survey collection at the Library of Congress, figures from Lord Timothy Dexter's establishment, a buttery, a roof-space, covered bridges, some account of outstanding figures—all presented with such clearness and proportion that the Merrimack country's past as expressed in its buildings lives again.

BALI. By Philip Hanson Hiss. New York, Duell, Sloan and Pearce, 1941. 112 pp., 9 by 12 in., \$4.50

EIGHTY varied and beautiful photographs illustrate this vivid, interpretive discussion of the people, customs, history and art of Bali, which the much travelled photographer-author considers the most beautiful and absorbing of the many countries he has seen.

The section on art and architecture perhaps best portrays the extraordinary vigor and intensity of the beauty-loving "cultured peasant" who has never worked for a wage, who houses his various domestic functions on a series of simple roofed platforms within a mud-walled court while he adorns the temples of his gods with a profusion of offerings surely far richer than any other people has recorded its gods capable of enjoying.

These temples, built of a soft sandstone, disintegrate quickly and new ones are constantly being built by cooperative community labor. Plans are seldom drawn. The work is assigned by the village council and each generation adorns its building, composed of great dryset blocks, with those things it thinks will please the gods: free-standing statues and figurines, high and low relief scrollwork, masks, plant forms and current events. A cyclist in well-tailored, close-fitting cap and jacket and snug figured shorts rides a machine with sunflower wheels. A touring car of about thirty years ago, realism superbly stylized, is held up—but just held up—by a man with a gun. All these and dragons too.

BUILDING INSULATION. By Paul D. Close. Chicago, American Technical Society, 1941. 328 pp., 6 1/2 by 8 1/4 in., illus. \$3.00

AN ENTIRELY PRACTICAL text book, by the technical secretary of the Insulation Board Institute, on sound and heat insulation for comfort, for economy, and for good acoustics. To clear, readable explanations reinforced with 41 tables and 158 illustrations are added descriptions of over two hundred insulating materials now on the market, and several of these are included in the tables showing conductivities and conductances of building and insulating materials.

THE MISSIONS OF CALIFORNIA. By Will Connell. New York, Hastings House, 1941. 105 pp., 6 by 8 in., illus. \$2.00

OVER 150 photographs with just enough text to pull together for us in highly satisfying fashion the twenty-one missions erected along a six hundred mile line. There is a short account of the structure—materials, style, history, rôle, present condition—of each establishment, all but three of which were erected within thirty years, of native material, chiefly by unskilled Indians under the direction of the Franciscan Fathers, themselves possessing little knowledge beyond recollection of old world buildings.

PERIODICAL LITERATURE

PENCIL POINTS DATA SHEETS. Prepared by Don Graf. Pencil Points, New York, 1932-1941

BECAUSE he was embarrassed by the fact that with two degrees in architecture he still had to ask his chief for the dimensions of a 2-by-4, Donald Mitchell Graf, AIA, took to noting down such information for future reference, and his notes were used by all his colleagues. That is the origin of the Data Sheets series which has just completed its first decade with almost a thousand items. For in addition to the 480 published—four each month—by our friendly contemporary, 500 have been prepared

(continued on page 28)

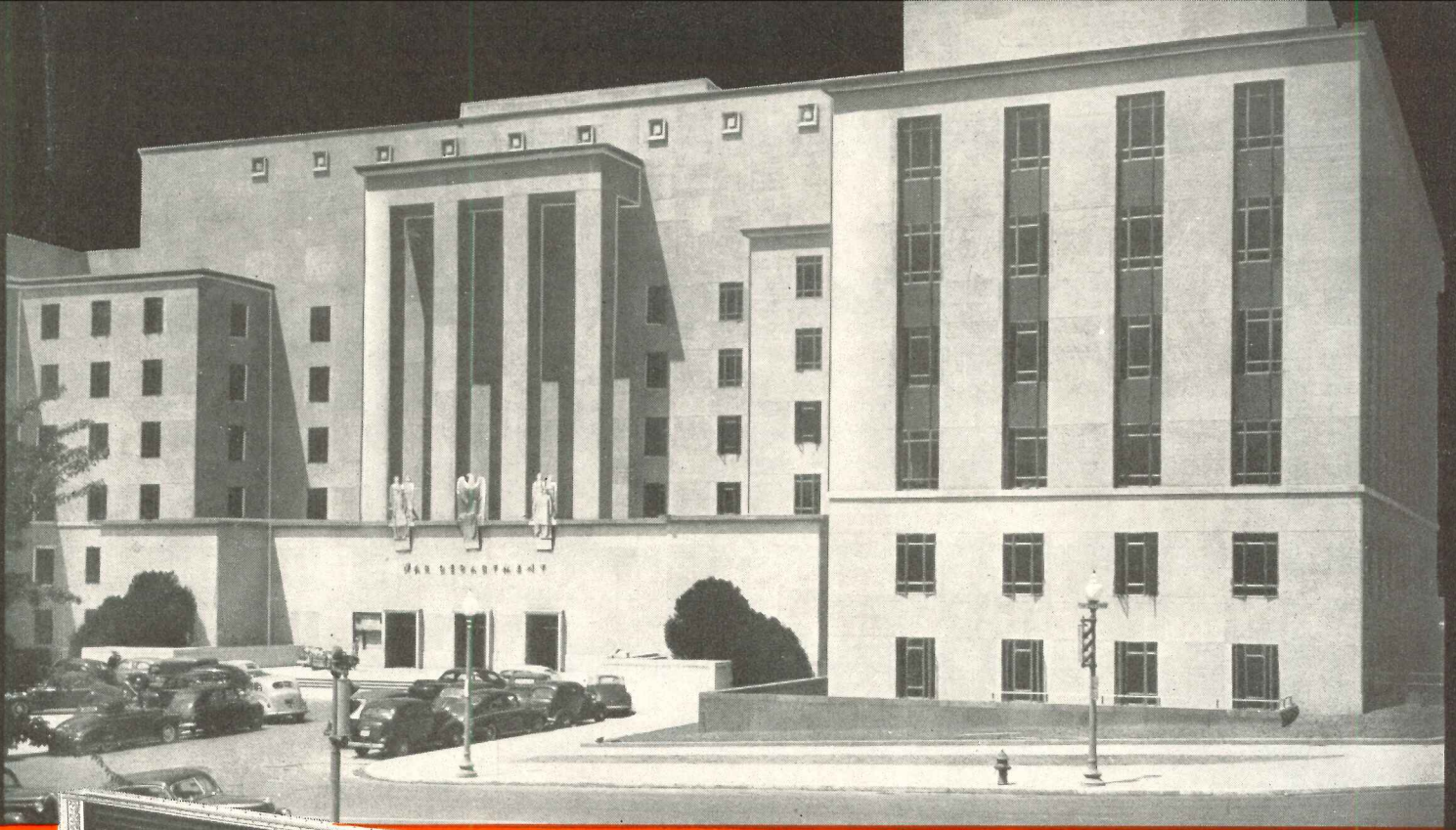

General Contractor: John McShain, Inc., Philadelphia and Washington.
Air Conditioning and Heating Contractor: Carlson Bros. of Michigan, Inc., Detroit.

Actively Engaged!

McQUAY COILS HEAT AND COOL THE NEW WAR DEPARTMENT BUILDING IN WASHINGTON

DAY and NIGHT—McQuay is actively engaged in supplying *Proven McQuay Products* for National defense projects, such as the heating and cooling coils in the newly completed War Department Building in Washington, D. C.

McQuay Standard, Down Flow and Blower type Unit Heaters, as well as Convectors, are also on the job, providing essential industrial temperature control in many U. S. Air and Naval Bases, Cantonments, Munition Plants, Armament Factories, as well as in Aircraft and Naval vessels.

When specifying dependable McQuay heating and cooling equipment, you are enlisting the services of an organization dedicated to the building of Quality products and delivering them on time.

McQUAY, INC., 1605 Broadway Northeast, Minneapolis, Minnesota. Representatives in principal cities.

SEE US AT THE PHILADELPHIA SHOW • BOOTHS 310-312-314



Blast Heating Coil



Water Cooling Coil



Standard Unit Heater



Down Flow Unit Heater

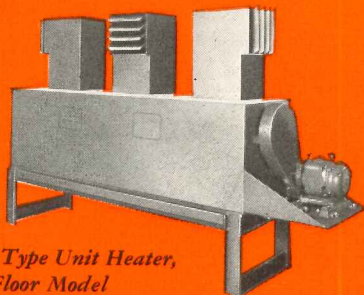

Blower Type Unit Heater,
Floor Model

McQuay
INC.

One of a series of advertisements depicting the part of McQuay, Inc., in the defense program.

AIR TEMPERING EQUIPMENT
ESPECIALLY DESIGNED
FOR INDUSTRY

(continued from page 26)

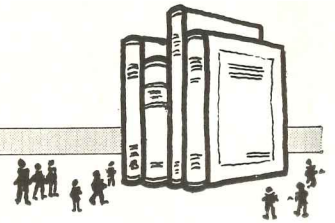

for various manufacturers who, either individually or in groups, have distributed almost five million copies to architects and others the world over, so that we may learn conveniently the dimensions of things from a 2-by-4 to a stock pane of glass and the latest Cadillac.

ASHER BENJAMIN. . . . By Florence Thompson Howe. Antiques, New York, Dec., 1941; pp. 364-6, illus.

RECALLING personally the time when "New England did not contain a single professional architect," and convinced that "the contents of two-thirds of the foreign publications on

architecture are unsuited to America," the modest, probably self-taught "Country Builders' Assistant," in addition to building many houses and churches in Massachusetts and Vermont found time to teach in Boston and write seven books on architectural design and practice. These appeared at intervals over nearly fifty years. They are written expressly for the house carpenter who after completion of his apprenticeship went forth and for good or ill made his country's architecture. One is for carpenters and joiners, two treat of the "Rudiments" and the "Elements" respectively—alias the classic styles—and one the "practice" of architecture; and the enduring charm of much Colonial building is "largely due to these books."

THREE DIMENSIONAL TOWN PLANNING. By Aileen and William Tatton Brown. Architectural Review, Cheam, England, Sept., 1941, pp. 82-85, illus.

A PRACTICAL DISCUSSION of town planning as a science, the purpose of which is not primarily to create effects but to establish a correct relationship between open spaces, buildings and efficient services, particularly with regard to a commercial and industrial area.

Services include motor roads as well as gas, water, electric and sewage mains. No pedestrian should be allowed under any circumstances whatever to set foot in the carriage way. Pedestrians shopping would use a ramp from the roofs of business buildings, cars would park always in basement garages except for the short pull-in stops off the traffic routes. Embayed bus stops should be constructed in connection with facilities for crossing the road. Large buildings should be sited on main roads only with sufficient access space to avoid traffic congestion. Only building units large enough to give adequate surrounding open space and useful roof space should be tolerated. Monumental buildings and vistas have value only when not approached by quick-moving traffic routes.

(continued on page 30)

NEW AIRCRAFT ENGINES PLANT selects Bradleys also

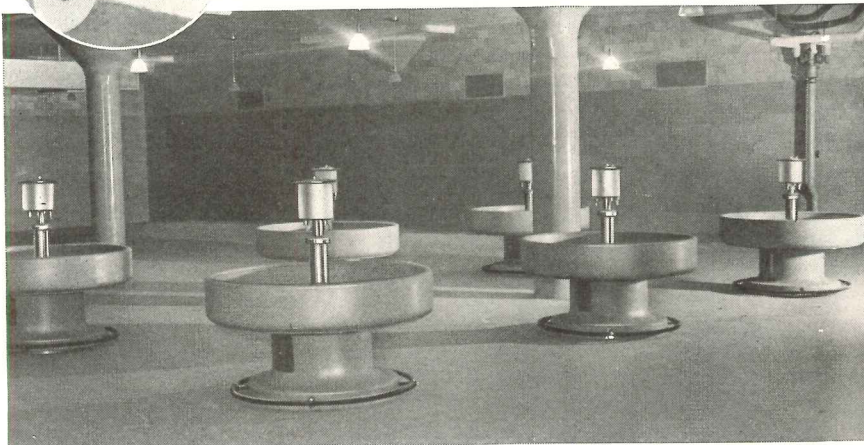
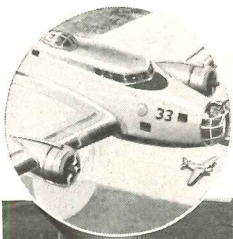

A section of the employees' washroom and locker room showing modern facilities supplied for workers at the Buick-Chicago plant where mass production of aircraft engines is scheduled.

BECAUSE industry recognizes the need for ample and sanitary wash fixtures in reducing man-day losses due to skin affections (Dermatitis), building architects, engineers and plant managements include Bradley Washfountains in their plans.

Bradleys provide the maximum in sanitation, 8 to 10 persons wash simultaneously, each in clean running water with no danger of contamination.

Bradleys save space, water and installation time. One Washfountain requires only one set of piping connections:—hot water, cold water and drain, while for conventional "single person" wash basins to serve the same

number, 8 to 10 times as many piping connections are required.

Successfully employed for over 20 years in plants of all sizes, you can rest assured that to specify Bradley Washfountains in your plans will meet with immediate approval. Our experienced washroom consultants are ready to make recommendations that will save your time. Catalog 4010 mailed on request. BRADLEY WASH-FOUNTAIN CO., 2227 West Michigan St., Milwaukee, Wis.

BRADLEY
Washfountains

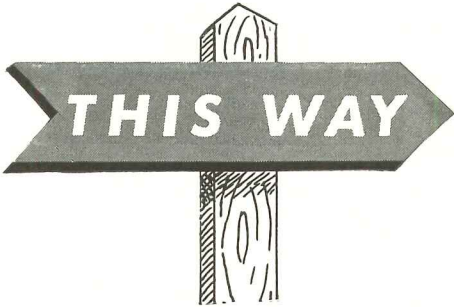

TO SATISFIED CLIENTS AND SELF PROTECTION

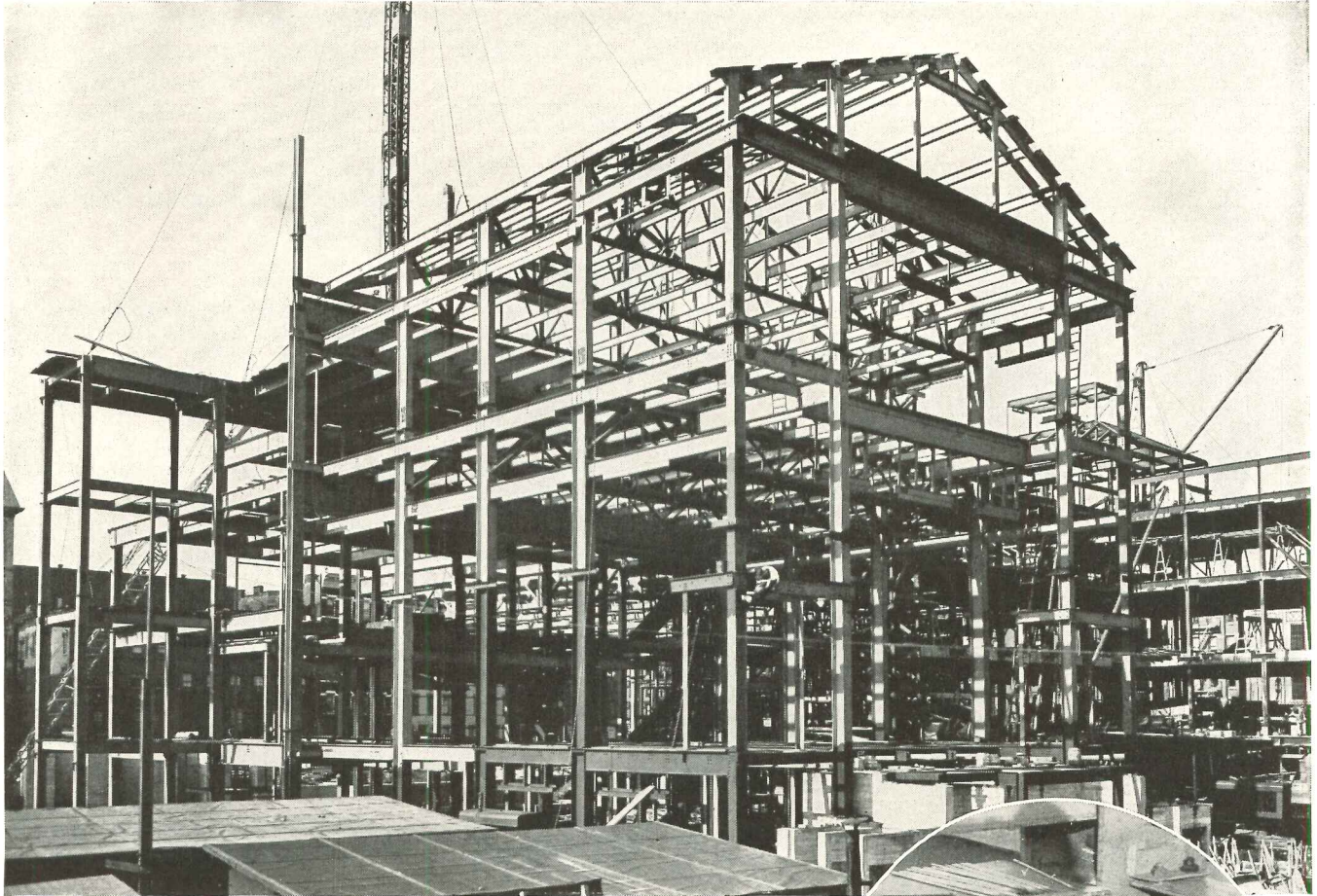

Welded construction — that's the direct route to stronger, lighter structures. This modern method of erecting buildings is more economical . . . it saves material . . . eliminates punching and drilling costs . . . speeds up erection time . . . reduces handling of heavy pieces in the shop. Welded surfaces are smooth, therefore easy to clean and paint. They leave less area exposed to corrosion.

Architects and designers should feel free to consult Air Reduction on all problems involving welded construction. Write for full details.

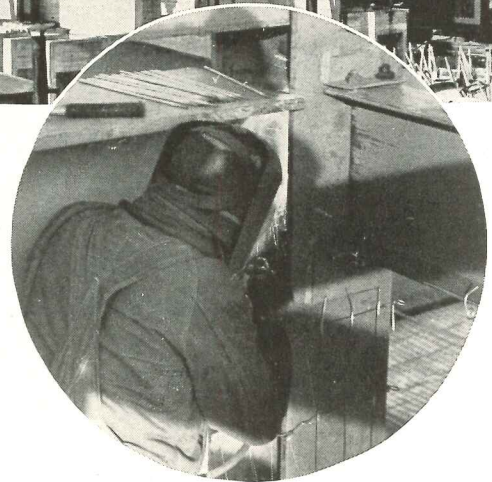

Air Reduction

General Offices: 60 EAST 42nd ST., NEW YORK, N. Y.

IN TEXAS

MAGNOLIA-AIRCO GAS PRODUCTS CO.

AIRCO DISTRICT OFFICES IN PRINCIPAL CITIES



Anything and Everything for **GAS WELDING or CUTTING and ARC WELDING**

REVIEWS OF CURRENT LITERATURE

(continued from page 28)

VALUE OF ORNAMENTAL PLANTING.

... By Harris A. Reynolds. Landscape Architecture, Boston, Oct., 1941, p. 9

THE WORTH of trees and shrubs to the average home owner is estimated cooperatively by the Boston Society of Landscape Architects, the Boston Real Estate Exchange and the New

England Nurserymen's Association thus: In a residential section where land costs 15 cents a sq. ft. and house and unplanted land \$8,000, of two adjoining properties the one that was artistically planted would be worth 9 per cent more than the one without such planting (one of the co-

operating members thought 26.5 per cent). If selling points total 100, the share contributed by good planting would be 12½. As to whether planting has more weight in raising the selling price or bringing about a quicker sale, three-fourths of the members thought quicker sales. Moreover, most of the materials of a house and its furnishings will suffer loss of value as years go by, while a reasonable sum invested in planting will appreciate to about seven-fold after five years.

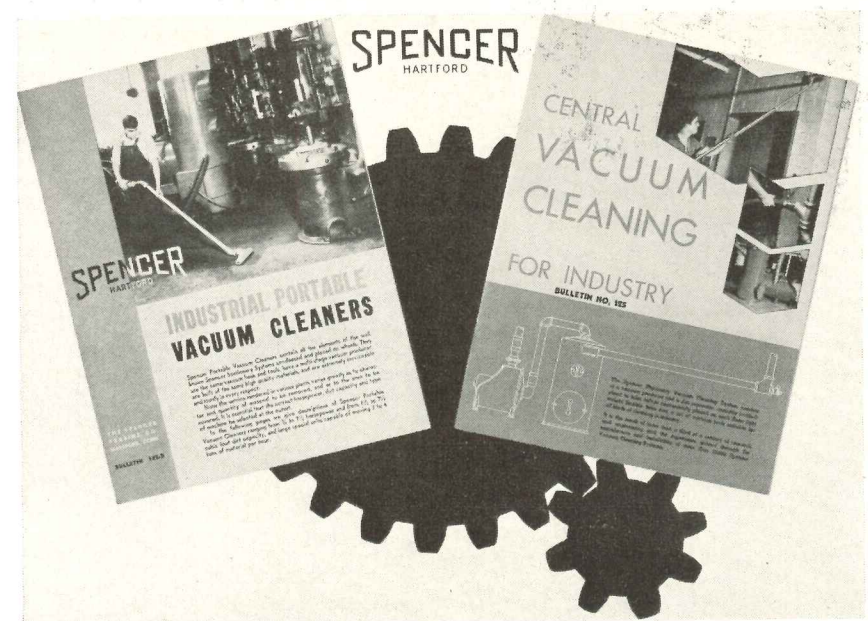

WHEREVER WHEELS TURN There's need for SPENCER VACUUM

The wheels of industry are producing mountains of waste and acres of dust these days, with less idle time for cleaning and fewer men to do the work.

HERE'S HOW SPENCER VACUUM CLEANING SAVES MEN... SAVES TIME... SAVES MATERIALS

Removes debris during working hours with smaller cleaning force.

Removes dust—underfoot or from walls, pipes and overhead.

Cleans machinery—inside and out, without scattering dust.

Reclaims valuable metals, powders, chemicals.

Improves working conditions—health, safety, fire, explosions.

Cleans finished goods, cartons, trucks and freight cars.

Ask for Bulletin 102R on Portables or 125R on Spencer Stationary Vacuum Cleaning Systems.

THE SPENCER TURBINE COMPANY, HARTFORD, CONN.

PORTABLE CLEANERS ¾ TO 7½ H.P.; STATIONARY SYSTEMS UP TO 100 H.P.

SPENCER VACUUM

5-228A

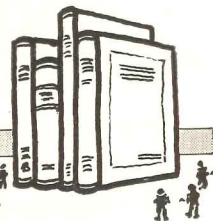

LIGHT WEIGHT INTERLOCKING CLAY TILE SHINGLE CUTS USUAL ROOF- LOAD IN HALF. Brick and Clay Record, Chicago, Nov., 1941, p. 23

DESCRIBES tile used in Los Angeles low-cost housing and in marine barracks in San Diego and officers' quarters in Honolulu. Available in a wide variety of colors and textures including a new russet mixture similar in appearance to redwood shakes, this tile weighs only 675 lbs. a sq. ft. as compared with 1,300-1,500 for the usual shingle or mission tile. The tiles are 8 by 12 in., made with a bevelled edge which gives the appearance of a heavier butt line when in position. Each has two nail holes and one larger hole for wiring. They are laid with a 3-in. head lap so that 200 suffice for a square.

Each tile has three longitudinal ribs ⅝ in. thick. The intermediate space is ⅜ in. thick. There is relatively little warping. The interlocking system has a lock wide enough to permit vertical joints to vary slightly, and the butt line may also be varied to modify the shadow and thus enhance the appearance.

LIGHTING DATA SHEETS: SERIES IX. Illuminating Engineers Society, New York, 1942. \$1.00 per series to members, \$2.00 to non-members

THE current series of 24 sheets, to be published during 1942, will present descriptive data on actual lighting installations illustrative of good engineering practice. Sets of any of the eight series previously published are also available.

When you plan for HEALTH

New concentrations of population in defense areas create new health problems . . . emphasize the need for well-equipped hospitals. And here, Crane renders special aid to the architect . . . offering him plumbing equipment for every hospital department . . . each fixture designed with a thorough understanding of hospital needs, and embodying latest technical developments. The Crane hospital catalog gives you, in brief form, the results of Crane research . . . provides a dependable guide for the selection of hospital plumbing equipment.



Crane surgeon's washbasins are available in a variety of styles—each designed in collaboration with surgeons.



Many Crane hospital fixtures are made of Duraclay—an all-ceramic material which does not crack, craze or stain, and which is immune to thermal shocks.



For utility room, examination room, wash room—in fact any department of the hospital—the complete Crane line includes equipment specifically designed for every need.

CRANE

CRANE CO., GENERAL OFFICES: 836 S. MICHIGAN AVE., CHICAGO
PLUMBING • HEATING • PIPE • PUMPS • FITTINGS • VALVES

NATION-WIDE SERVICE THROUGH BRANCHES, WHOLESALERS, PLUMBING AND HEATING CONTRACTORS

ALUMINUM, THE FUTURE, AND YOU

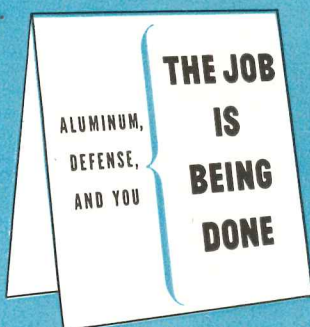

RIGHT NOW OUR FACTORIES have only one interest: to make more Defense Aluminum than the world has ever seen before. Every resource we can muster is concentrated on that job.

WHEN AMERICA HAS WON THROUGH to make the world safe for our children to live in . . . the saying is: What a lot of aluminum is going to be available for everybody.

THE REAL POINT TO PONDER is how to get set to make that deluge of light metal work for you. In the kind of world we're going to have, sure as fate, the man who fails to call, *now*, on every resource at his command is going to be left at the post.

WE'VE COINED A WORD:

IMAGINEERING. It's the fine art of deciding where you go from here. It's the act of thinking out what you are going to face, and doing something about it now. *Imagination* plus *engineering* is a formula for the future you're going to hear more about.

A MAN CAN be producing for Defense at top speed and be imagineering at one and the same time. In fact, the more he is devoted to Defense now, the more he needs imagineering for **THE DAY WHEN.**

OBVIOUSLY, you can imagineer with steel, copper, glass, zinc, plastics, or what have you. We hope you will, because the world is going to need better use of all materials than it ever saw before.

THE CLOSER YOU GET TO FUNDAMENTALS the more quickly you must decide that the great need is going to be for the very things Alcoa Aluminum does best: Lightness with strength, resistance to corrosion, reflectivity, workability and all the rest of its powers all wrapped up in a low-cost package full of unlimited possibilities for you, personally, in your business.

TWO HEADS ARE BETTER THAN ONE. Already, many an industry, many a company, has called us into an imagineering session. We've seen things projected that will make news when the curtain can be lifted. Usually we've been able to help with some imagineering of our own.

DOES THIS SUGGEST ACTION? WE HOPE SO.

Aluminum Company of America, Pittsburgh, Penn.

ALCOA ALUMINUM





Erven Jourdan

HOUSES OF WOOD

WITH WAR NEEDS requiring practically unlimited amounts of strategic building materials, those that are not vitally affected by priority rulings become tremendously important. One such, of course, is wood. The following group of low- and medium-cost frame houses gives fresh emphasis to this old, reliable material. We have restricted our selection to recently completed work in Washington, Oregon and Northern California—both because this area is such a rich source of wood and because the architects of the region have contributed so much to its use, in both its traditional and newer forms.

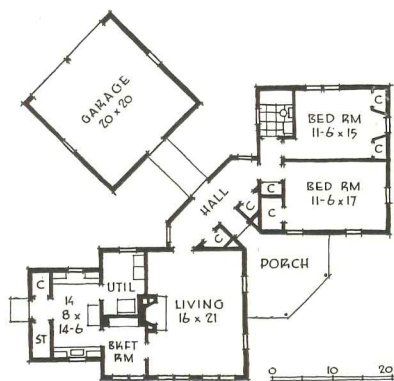
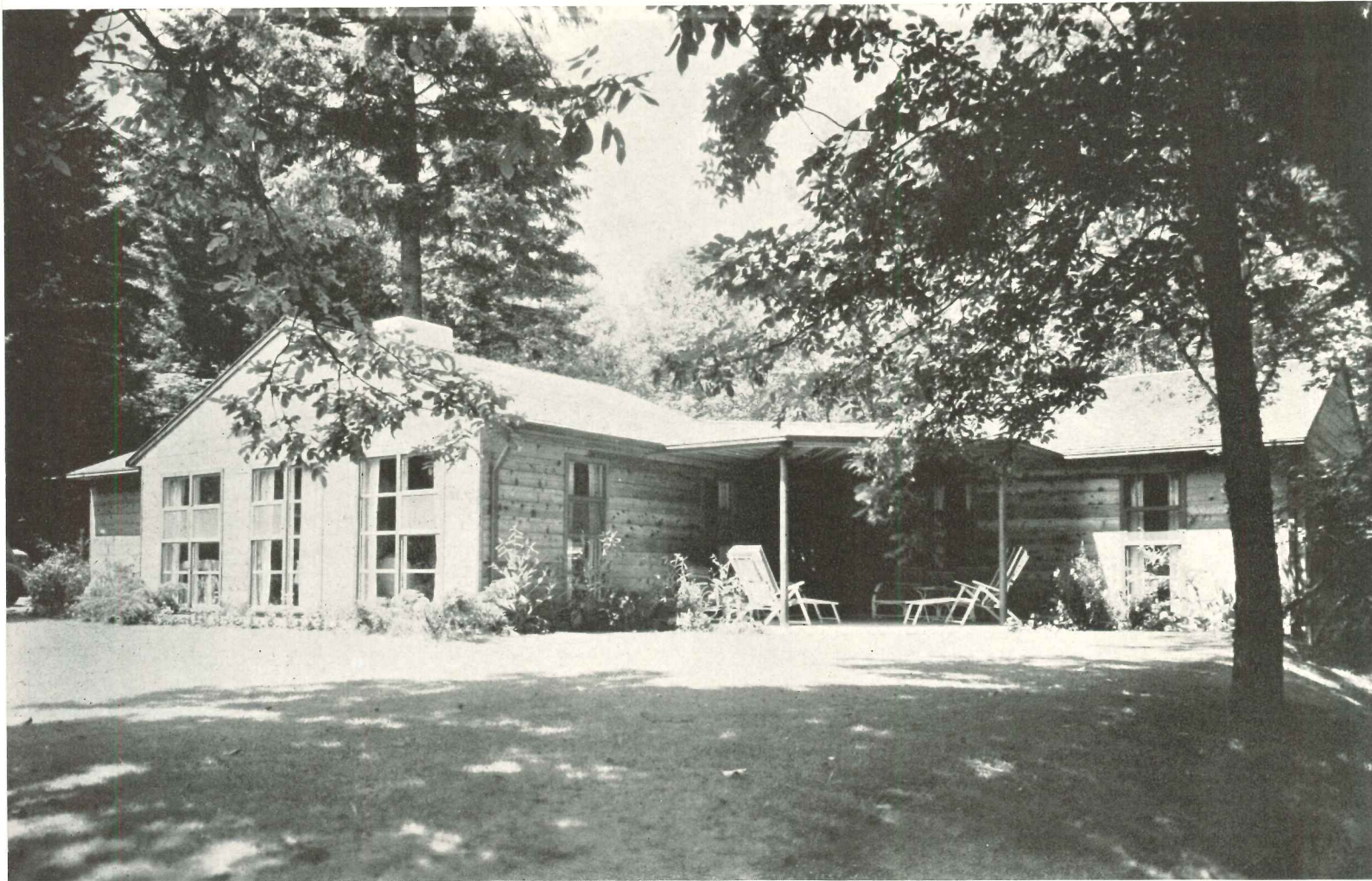

WADE PIPES, Architect

SITE CONDITIONS DETERMINED THE PLAN of this \$4,000 house overlooking Lake Oswego, Ore. The portion of ground on which the house itself is built is solid ground; the lawn area facing the lake is filled land. As laid out, the house extends on both sides to the edge of the solid ground. The fact that nearly everyone approaches the house by car explains the unusual location of the garage in front of the front door, to which it is connected by a covered passage. This arrangement also serves to form an effective shield from the traveled road for the main living rooms and porch on the lake side. As there is no basement, the house is built on a membrane-waterproofed concrete slab. Finish floors throughout the house are of asphalt tile. The natural color exterior walls of the frame house are of cedar shiplap in an inexpensive grade, finished with a transparent waterproof coat. The windows were made to detail with a movable section. Doors are of a hollow slab type; interior walls are plastered. Door and window trim and base were applied and oiled before plastering, with a small half-round finish moulding put on later. W. C. Bauman was the builder.

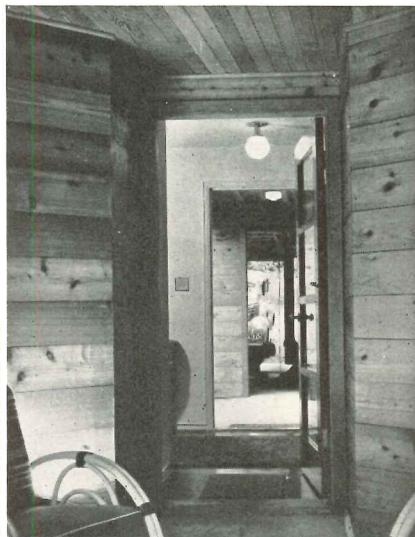

FROM PORCH to front hall to garage



GARAGE at left

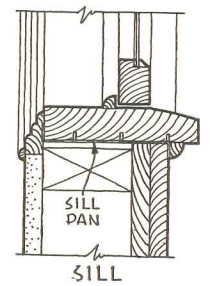
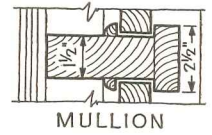
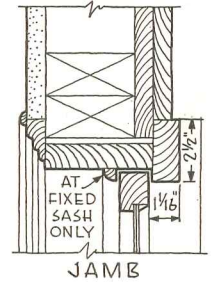
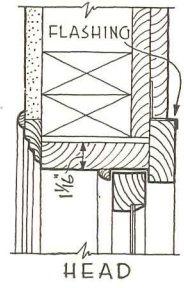

GARAGE AND FRONT DOOR are joined by a covered passage



PORCH

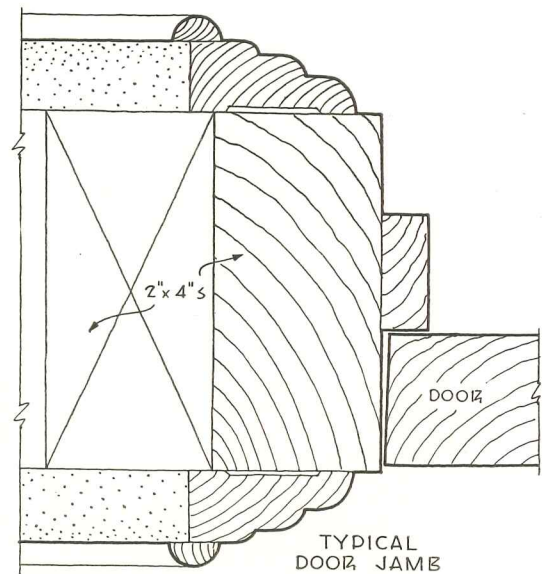

DONALD DWIGHT WILLIAMS, Architect

THE ARCHITECT COMMENTS: "It represents about as much house for the money as this office has produced." Including the architect's fee, this Seattle house cost \$5,400. To make it appear as large as possible, an S-shape plan was adopted, using the maximum allowable width on the lot. Particularly economical is the handling of the utility and heating plant spaces. Even the space above them is utilized as storage space. Heating plant and fireplace share a single chimney. At the right of the entrance is an "extra" room that may serve as a den, guest room, play room or other use. The house is wood frame, surfaced in cedar with cedar shingles on the roof. There was no general contractor. The architect and the owner let the sub-contracts.

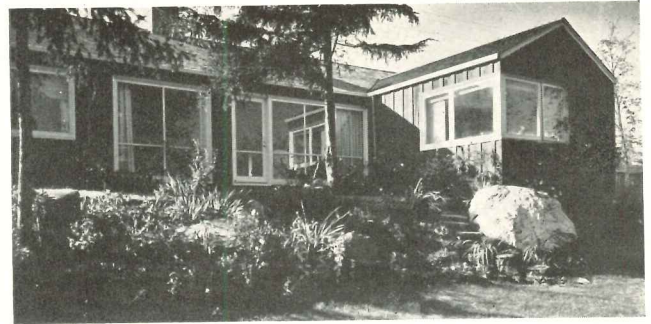
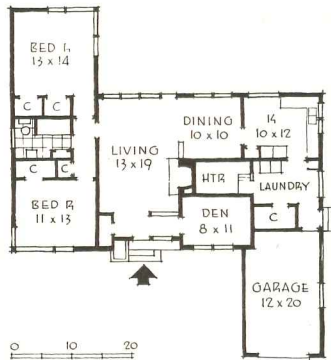

REAR VIEW



FRONT DOOR

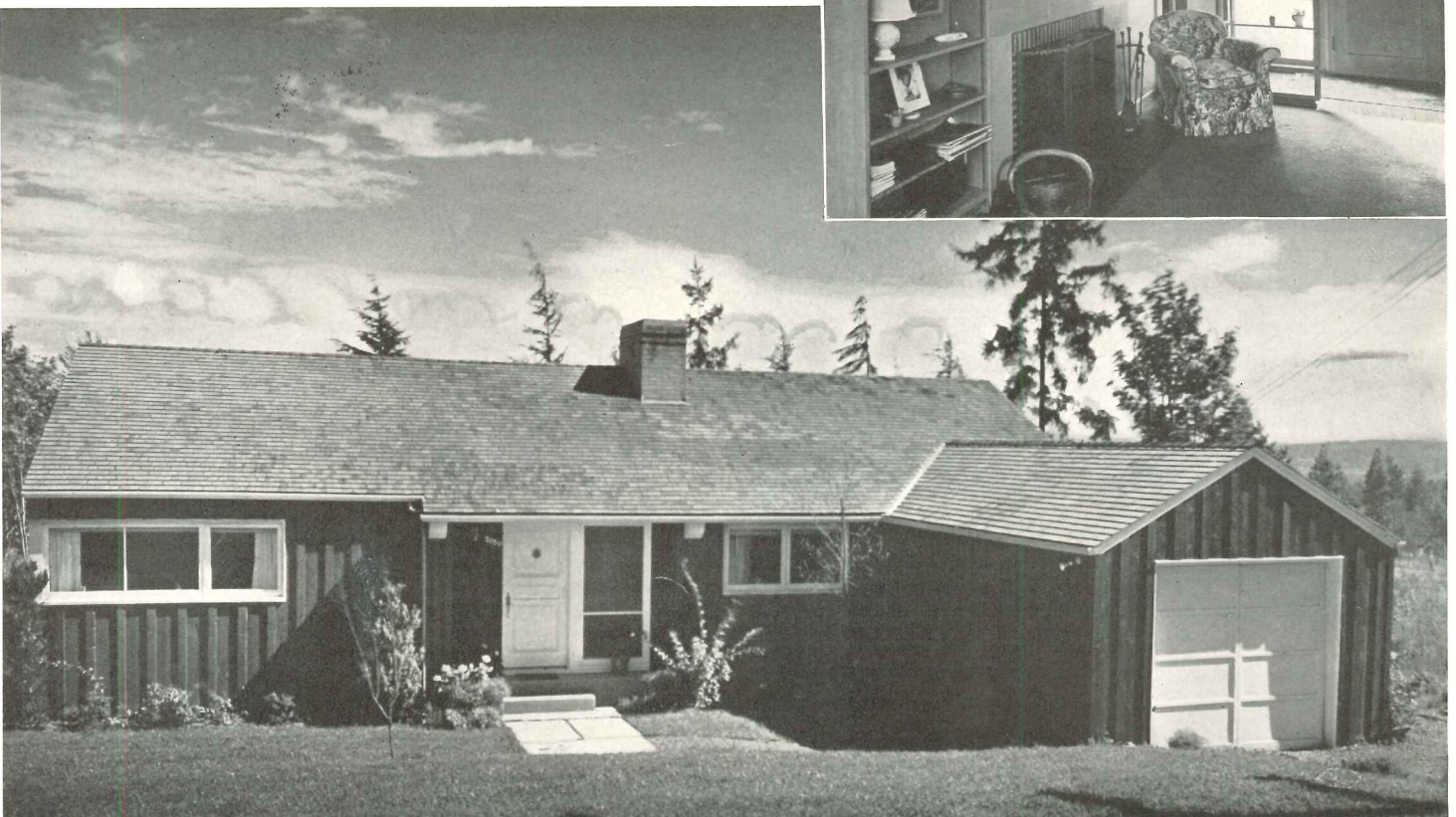



STREET FRONT

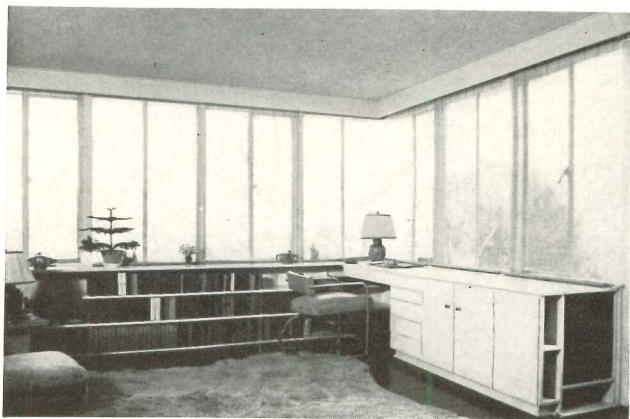

Photos by Judith Shtutman

LIVING ROOM

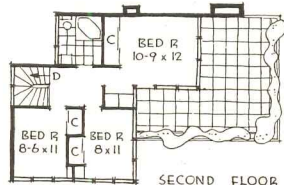
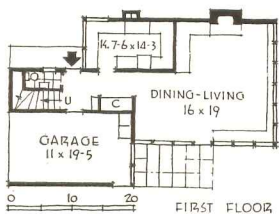

RICHARD J. NEUTRA, Architect
OTTO WINKLER, Associate

COMPACT PLANNING AND FLEXIBILITY distinguish this hillside house in San Francisco. An especially notable plan element is the nice relationship between the entrance hall and the garage, kitchen and living room. Hardly less noteworthy are the closet provisions on the second floor. With service areas all on the street front, living quarters attain the ultimate in privacy. The irregular-shaped general living area suggests a variety of uses and furniture placements. Above this room is a generous living deck which makes a safe outdoor play place for children and capitalizes a dramatic view of a canyon. Framing consists of a chassis of 4-by-4 rabbetted posts; exterior surfaces are of siding and waterproofed plywood panels. Cost of the house was \$7,000. Adolph Strate was the contractor.

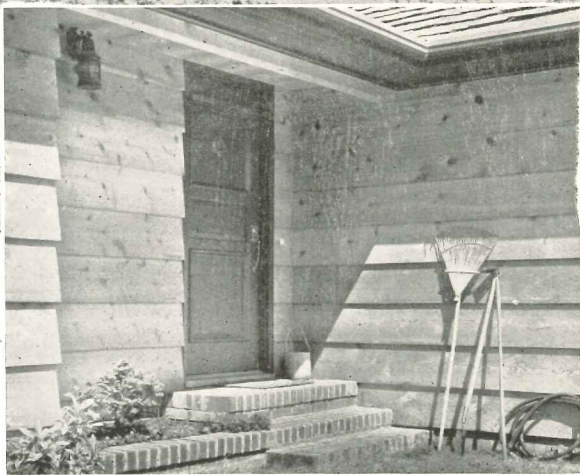

FRONT DOOR

DONALD DWIGHT WILLIAMS, Architect

STRICTLY A FRAME HOUSE, this home is located on a large piece of wooded property about eight miles outside Seattle, Wash. Since space was not a limiting factor, the plan is widely spread out, the basement is eliminated, and separate rooms for the heating plant and laundry are provided on the ground floor. In actual use, the utility room serves as the owner's den, with a bar opening into the main living room. The house is entirely conventional in construction, except that the exterior siding is of unbeveled, 1-by-12 cedar boarding. The roof is surfaced with thick cedar shakes. The covered loggia provides sheltered access to the house from the garage in inclement weather. Including the architect's fee, the house cost \$5,700. The architect's office handled all construction, subletting the contracts in cooperation with the owner.

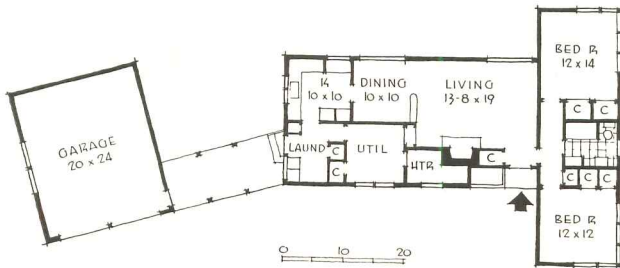

Photographs by Walter Steinhard

WOOD THROUGHOUT.
Roof is of cedar shakes



REAR WINDOWS. Siding is plain cedar boarding



MARSHALL DEAN & JOHN HUDSPETH, Architects

PLAN ORGANIZATION of this Moraga, Calif., house involves a number of unconventional solutions. There is no dining room; instead, one end of the glazed gallery overlooking the garden is used. This gallery not only serves as dining space, but, with the sliding windows rolled back, it becomes a protected garden loggia. Advantage was taken of the slope of the site to the rear by introducing a tri-level scheme, with the main bedrooms a half flight up from the gallery and a basement under them. The main living areas occupy the entire length of the walls facing the most favored orientation and outlook; the garage and house entrance are relegated to the other side. Construction is all of wood—fir framing, redwood siding, cedar shingles. Sash are white pine casements. Contractor on the job was Hugh G. Patrick.

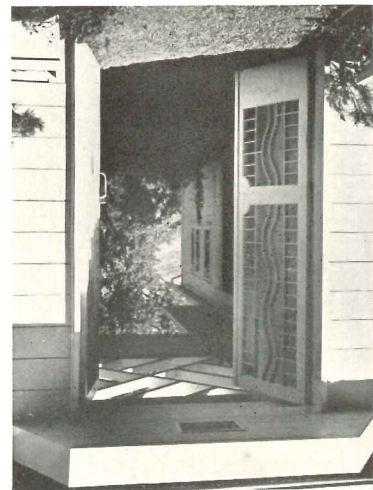

ENTRANCE. Garage at right

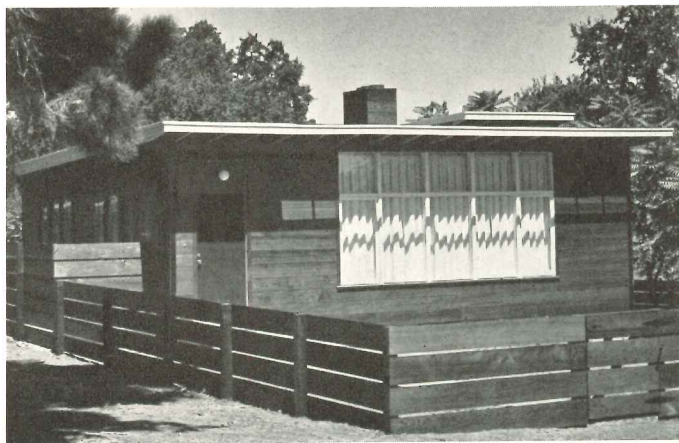

MARIO CORBETT, Architect

LOW COST and a straightforward use of wood are perhaps the two most newsworthy features of this Menlo Park, Calif., house. Total cost, including architect's and landscaping fees came to \$4,300. The bedroom unit above the garage serves as either a den or as a rental unit. A few of the features which helped to produce so much house for so little: an uncomplicated rectangular plan; simple materials (flush exterior redwood siding, fir plywood panels, insulation board, hard pine floors); out-opening casements that operate off the studs.

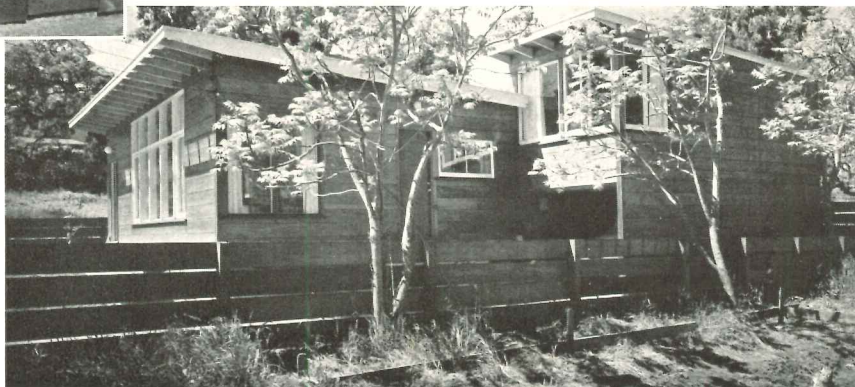
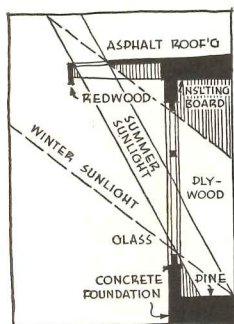

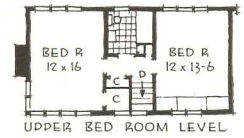
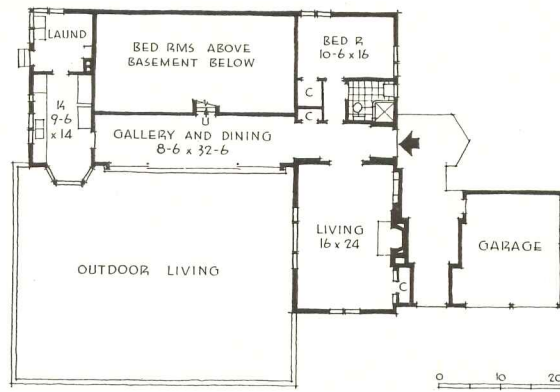
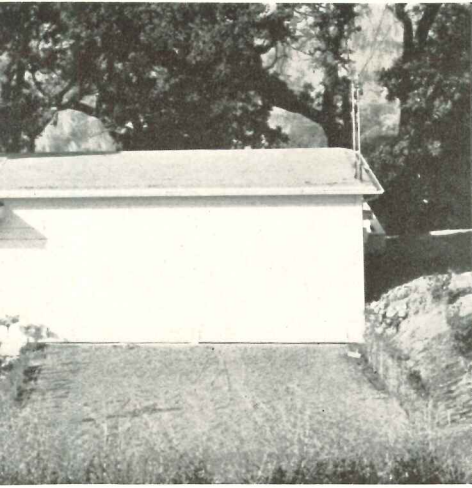

GLAZED GALLERY. Enclosed garden at left

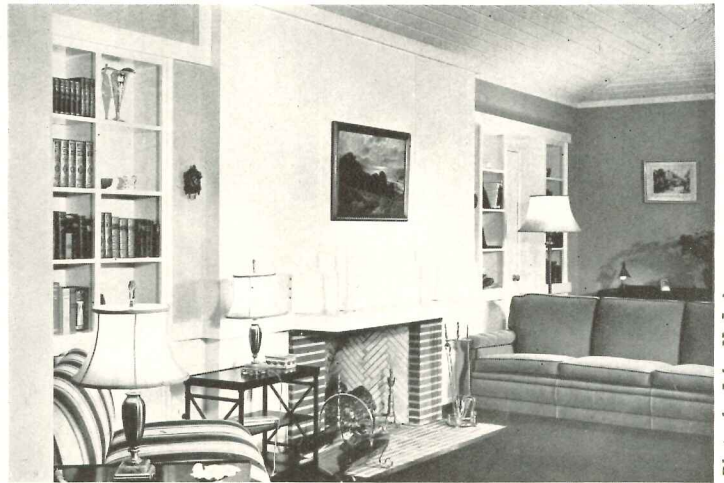

LIVING ROOM.

Photos by John H. Lohman

THE ARCHITECT comments: "As it stands, the plan meets the specific requirements of the client, but should added circulation be desired, it would be possible to open the kitchen onto the bedroom hall."



STUDY 11 x 17
RM. OVER GARAGE

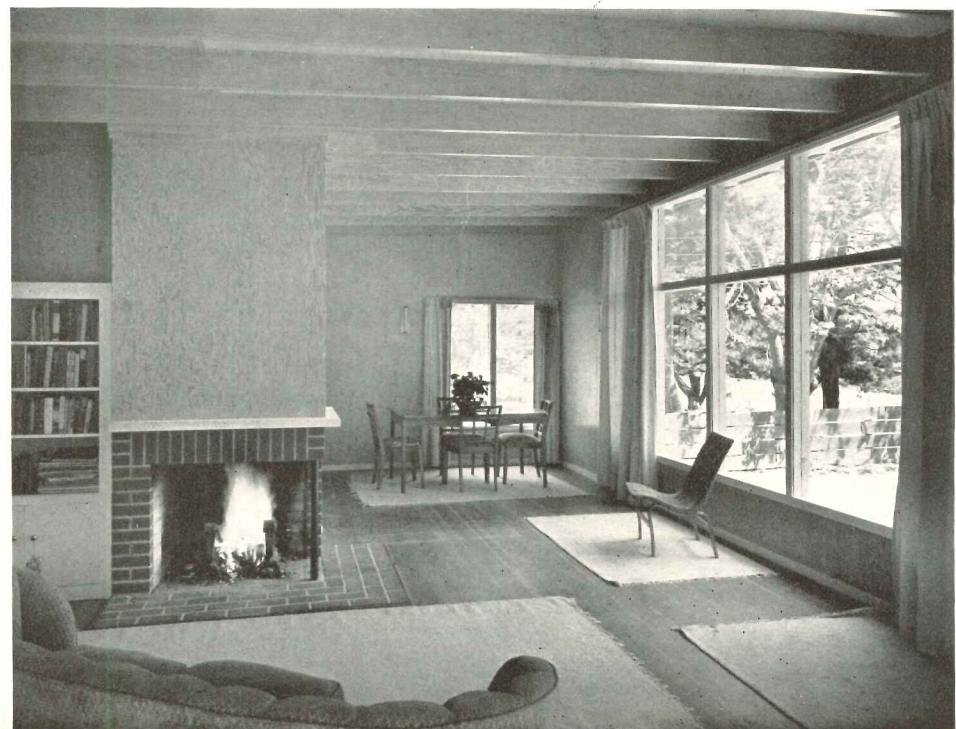

LIVING-DINING ROOM. Floors are hard pine; walls, fir plywood; exposed rafters, Douglas fir

Photos by Philip Fern, Sonya Noskowiak



VINCENT G. RANEY,
Architect

THIS ALL-WOOD HOUSE commands a magnificent outlook over steep forest slopes and a bay of the Pacific at Inverness, Calif. In addition to comfortable quarters for the owner and his wife—all on the ground floor to avoid excessive up-and-downstairs travel—two other bedrooms were needed for the use of married children or other visitors. Except for the garage, kitchen and bath, the ground floor is made up of two large living areas—one a combined living-dining room, the other a combined living-bedroom. Each of these areas has its own fireplace, and each is many-windowed toward the garden and view. Structure throughout is of wood frame with rough sawn redwood boards and battens on the exterior. An interesting color contrast is provided by using light stained fir sheathing above exposed rafter members of redwood; this contrast of tones appears both in the living room ceiling and in the soffit under the eaves outside. The roof is of cedar shingles; sash and gutters are redwood; flooring is of oak plank. Including architect's fee, the cost of the house was \$7,500. The contractor was Asa Douthit.



Photos by Roger Shurtevant

GENERAL VIEW from garden side

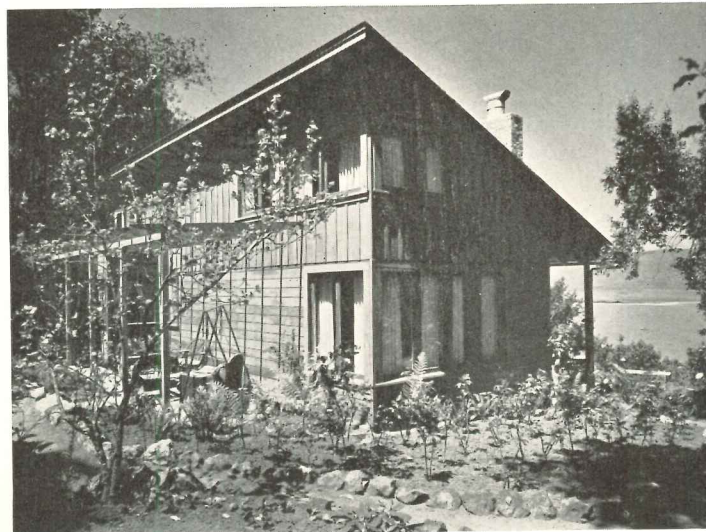

BEDROOM WING

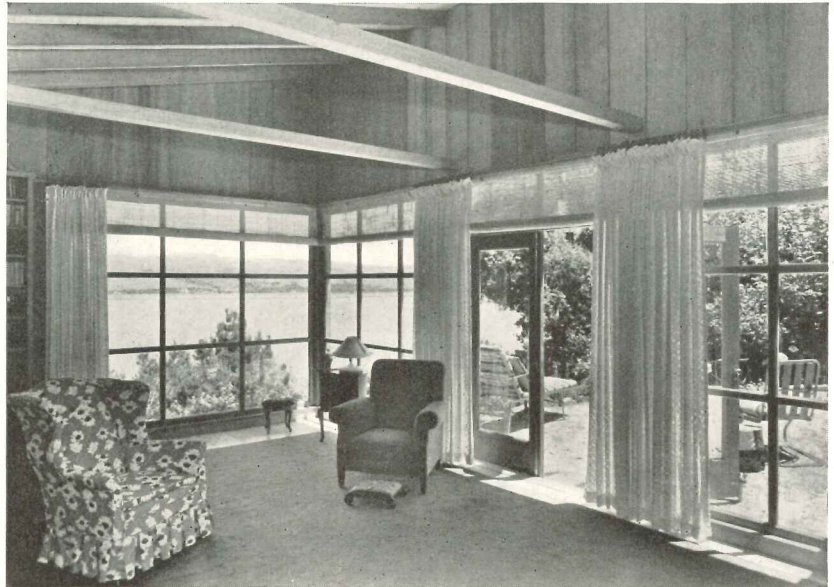
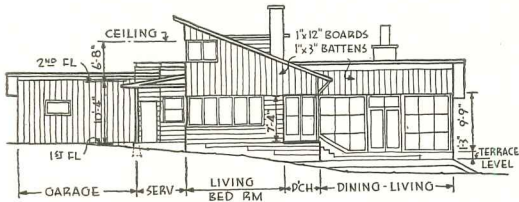

LIVING ROOM corner window

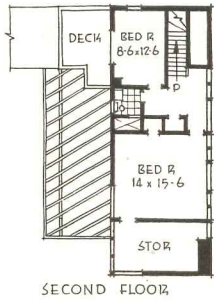

SECOND FLOOR

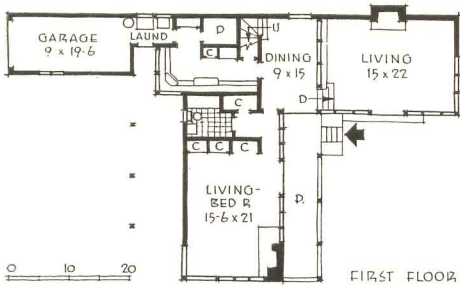

FIRST FLOOR



LIVING ROOM. Dining area on upper level at rear

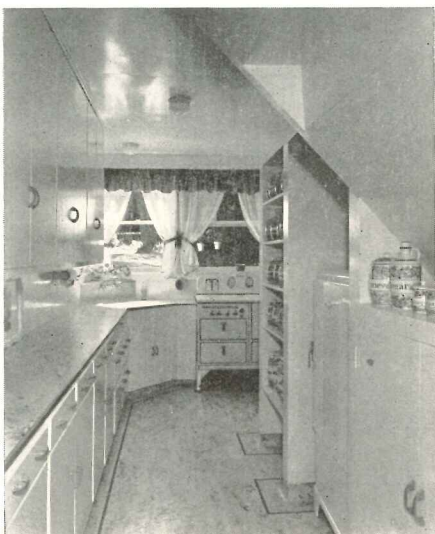

KITCHEN

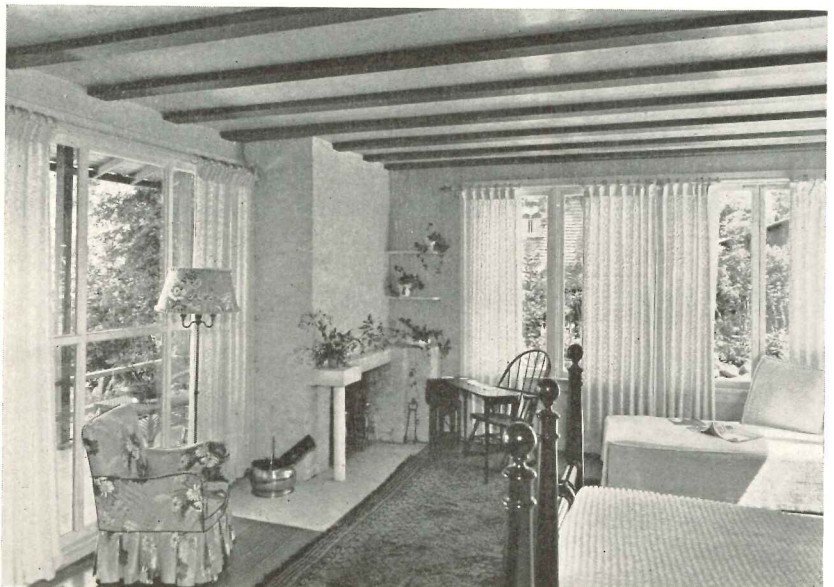

LIVING BEDROOM. Note plywood between redwood ceiling beams

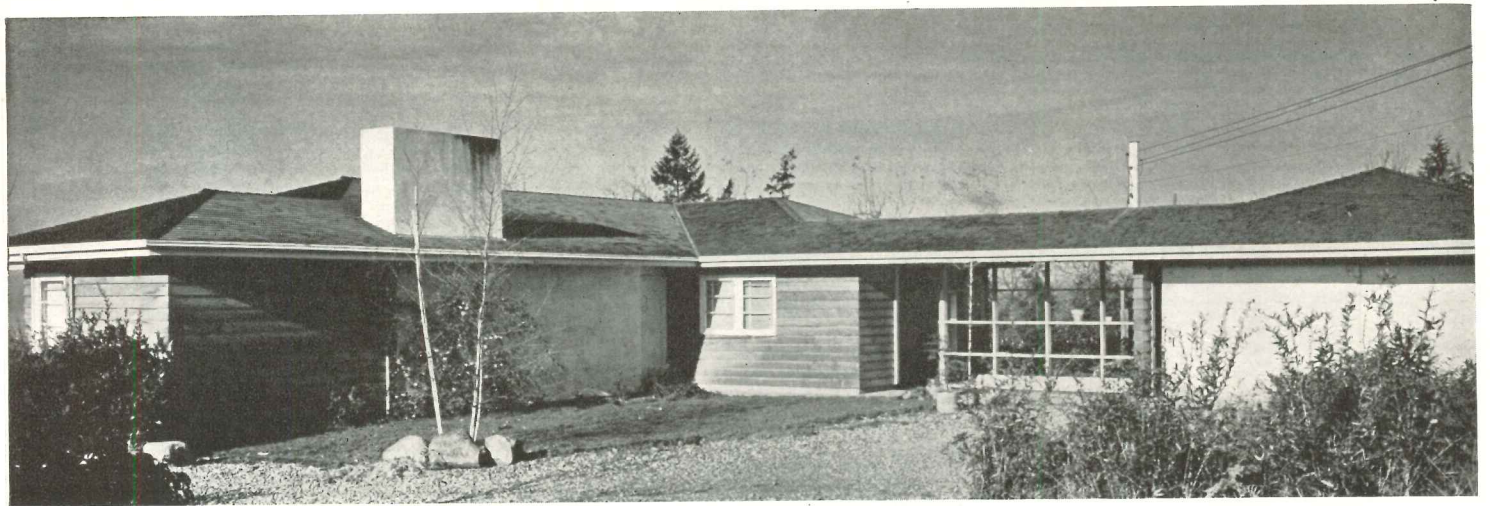

JOHN R. SPROULE, Architect

BUILT ON A SLIGHTLY BLUFF with outlook to the rear, this Seattle, Wash., house has a notable organization of a simple L-shaped floor plan. Location of the entrance with respect to other areas reduces circulation space practically to a minimum. In the wing at the right of the front door the three bedrooms are economically grouped. The general living room is divided for its separate functions merely by low, built-in storage cabinets that project into the room. Bevel siding of cedar finishes exterior walls; the chimney and wall at left of the entrance are surfaced in stucco. Gutters are of wood; the roof is of vertical grain cedar shingles. The contractor was J. E. Lone.

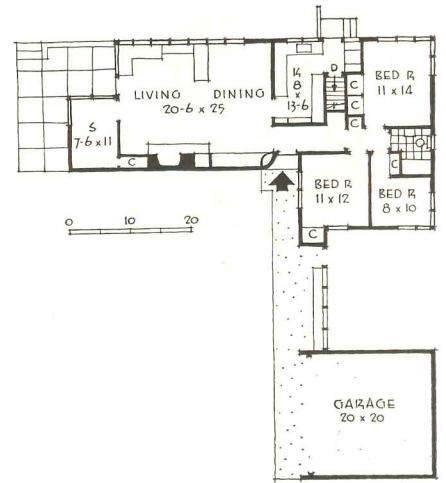

Photos by Ernest Kassowitz

SMITH, CARROLL & JOHANSON, Architects

UNUSUALLY SUCCESSFUL is the handling of circulation in this compact, three-bedroom Seattle house. Disposition of areas is such that the central hallway provides access to any part of the house without the necessity of passing through another area. The corner entrance to the living room provides a high degree of privacy for this room. The utility room, placed between the main house and the garage, serves several purposes: a laundry, a flower room, an enclosed passage from house to garage or a playroom. The builder was H. E. Forsman.

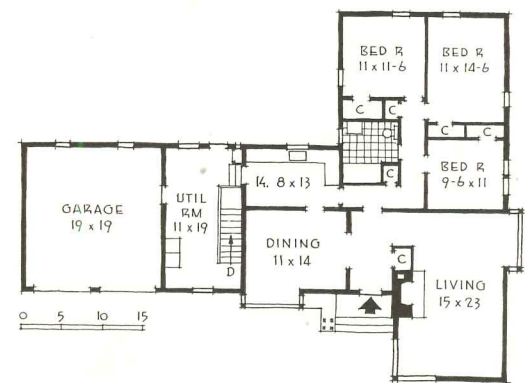

SPECIFICATION STANDARDS FOR GOVERNMENT WORK

By HAROLD R. SLEEPER, AIA

NOW AND IN THE NEAR FUTURE many private architects will be engaged in work for the Federal Government. Such work will be done under pressure and little time is available for research.

To aid in the preparation of specifications the following lists may prove helpful, especially to those architects who are not familiar with the ramifications of the Federal Specifications. Even the Index to these Specifications is a whole volume; in the search for building materials such items as "head-cheese," "goggles" and "dotted swiss" have to be waded through.

Yet the use of Federal Specification references, even if not actually required by the Government agency, is of value. When properly used they provide for more equitable bidding and

save time and space in the specifications.

Those architects who are accustomed to employing the American Society of Testing Materials Standard Specification may well continue its use and, where possible, to use both Federal and A.S.T.M. Specifications.

The purpose of this article is to make available such standards (those most frequently required) segregated by trades, and listed in parallel form. Other standard references which may be found useful are placed at the ends of the Trade Divisions.

Brief notes indicate specification qualifications which must accompany the inclusion of a reference. By means of the reference numbers the original

specification may be read to secure the required data; in many cases enough data is included herein to make such reading unnecessary. The writer has found that standard reference numbers are being casually used, without the proper qualifications. Where the cheapest material is expected, such use may be satisfactory, but otherwise, grades, types and other details should be included.

For instance, it is not sufficient to state that all brick shall comply with Federal Specification SS-B-656. This Specification contains three grades of bricks of different absorption and strength; therefore the grade should be stated for the specific uses. In addition, the size, color and texture should be stated.

FEDERAL SPECIFICATIONS

The Specification symbol used to designate a Federal Specification has three component parts. Example: QQ-S-721.

(1) Group for Procurement to which the Specification relates. (The first capital letter or letters, as QQ-S-721, QQ is the Metal Group. Groups which contain building materials are as follows:

Group "J"—Cables and Wire (Insulated).
Group "O"—Chemicals (Fire Extinguishers, Linoleum Paste).
Group "P"—Cleaning and Polishing Materials. (Wax).
Group "R"—Coal-Tar and Products. (Pitch and Tar).
Group "W"—Electric Apparatus.
Group "AA"—Furniture (Steel Cabinets, Safes, Steel Shelving).
Group "DD"—Glass and Glassware.
Group "FF"—Hardware.

Group "HH"—Insulating Materials.
Group "JJ"—Knit Goods, Netting, Webbing (Fire Hose).
Group "MM"—Lumber and Timber.
Group "QQ"—Metals.
Group "RR"—Metal Products (Screen Cloth, Fencing, Sieves, Enameled Iron Wall Tile, Safety Treads).
Group "SS"—Minerals and Products (non-metallic) (Aggregates, Cement, Brick, Granite, Asphalt, Gypsum, Lime, Plaster, Roofing Materials, Slate, Cast Stone, Acoustic Tile, Sewer Pipe, Asphalt Tile, Clay Tile, Gypsum Tile, Gypsum Wall and Plaster Board, etc.
Group "TT"—Paint, Pigments, Varnishes and Products.
Group "UU"—Paper and Products.
Group "WW"—Pipe, Pipe-Fittings, Plumbing Fixtures, Tubes and Tubing.
Group "ZZ"—Rubber and Rubber-

Goods (Rubber Floor Covering).
Group "CCC"—Textiles (Shade Cloth).

Group "DDD"—Textile-Products (Window Shades, Rollers, etc.)

Group "LLL"—Wood-Products (Venetian Blinds, Insulating Fibre Board, Linoleum, Cork Tile, Turpentine).

(2) The initial letter of the title of the material, QQ-S-721a, "S" refers to Steel.

(3) A serial number determined by the alphabetical location of the title, QQ-S-721a.

(4) A small letter after the last number indicates that the Specification has been revised—QQ-S-721a. Amendments and minor changes are printed on a separate green sheet. A statement to the effect that "All amendments to date are to be included" should be used for each reference.

AMERICAN SOCIETY FOR TESTING MATERIALS SPECIFICATIONS

The A.S.T.M. serial designation prefix is explained as follows:

(1) Initial letter indicates the general classification. A 7-39, "A" indicates Ferrous Metals.

The general classifications are as follows, and do not correspond with the groups of the Federal Specifications:

"A"—Ferrous Metals.
"B"—Non-Ferrous Metals.
"E"—Ferrous Metals and Non-Ferrous Metal, Metallography, General Methods of Testing.
(The above are in Part I, "Metals")
"C"—Cementitious Materials; Masonry Building Units, Stone, and Slate; Refractories, Fire Brick; Glass and Glass Products; Pipe and Drain Tile; Concrete and Concrete Aggregates.
"D"—Waterproofing and Roofing Materials; Timber and Timber Preservatives; Paint, Varnish, and

Related Products.

"E"—General Testing Methods.
(The above are in Part II, "Non-Metallic Materials")

(2) The first number indicates the numerical sequence and is a fixed designation.

(3) The number following the dash indicates the year of the original adoption as Standard or, in the case of revision, the last year of revision.

(4) Tentative standards are identified by the letter "T" at the end of the designation.

In the interest of conservation of certain strategic materials, Federal Specifications have been issued as "Emergency Alternate Specifications." These Specifications are designated by placing an "E" before the designation which is superseded or amended. Many of these Specifications are concerned with the substitution of zinc-

coating-galvanizing (by electroplating or sherardizing) for zinc-coating (galvanizing) by the hot-dipped process.

They should be used with the Standard Specifications as amendments or in some cases as substitutions, where the alternate is acceptable for the use intended.

These alternates have been noted after the Federal Specifications to which they apply.

The American Society for Testing Materials is also issuing emergency alternate provisions with the designation "EA" preceding the usual designation.

Many of the A.S.T.M. Standards, the Simplified Practice Recommendations, and Commercial Standards, have been adopted by the American Standards Association as "American Standards" and these have been given two designations or symbols.

DIVISION 1. MASONRY MATERIALS

Including Concrete, Brick, Block and Tile

FED. SPEC.

- Cement; Portland** Fed. Spec. SS-C-191b
- Cement; Portland, high-early strength** Fed. Spec. SS-C-201
- Cement; Portland, pozzolana** Fed. Spec. SS-C-208
- Cement; Portland, sulphate-resisting** Fed. Spec. SS-C-211a
- Cement; Portland, moderate heat of hardening** Fed. Spec. SS-C-206a
- Cements; hydraulic; General Specification** Fed. Spec. SS-C-158a
(Methods of sampling, inspection and testing.)
This specification is referred to in the other specifications for Portland Cement and need not be referred to in Architect's specifications.
- Cement; Masonry** (Masonry cement for use in masonry mortars) Fed. Spec. SS-C-181b
Specify Type I where not exposed to frost action, Type II for general use; specify whether water repellent or nonstaining (to limestone).
- Quicklime; (for) structural purposes** Fed. Spec. SS-Q-351
Specify Type C—Calcium or Type M—Magnesium if one type only is desired.
- Lime; hydrated (for) structural purposes** Fed. Spec. SS-L-351
Specify Type "M"—"Masons'" for all work except for finish coat plaster; use Type "F"—"Finishing." (Finishing may be used for above.)
- Lime; hydraulic, hydrated** Fed. Spec. SS-L-361
Specify: Type C—calcium
Type M—magnesium
State whether water repellent is to be added.
- Aggregate (for) Portland Cement Concrete** Fed. Spec. SS-A-281
(State if all types of aggregates are not desired.)
Specify Class: 1—Fine aggregate (sand) (Natural sand, prepared stone sand, prepared blast furnace sand, slag sand or other inert materials.)
2—Coarse aggregate (crushed stone, gravel, blast furnace slag, or other inert materials.)
Specify Grade: A—Used in general.
B—Used in concrete not exposed to weather.
- Brick; Building (common) clay** Fed. Spec. SS-B-656
Specify: Grade, size, color and texture; if absorption requirements are waived, so state. "H" grade. Absorption 10% or less. Mod. rupture 600 lbs./sq. in. or less. "M" grade. Absorption 16% or less. Mod. rupture 450-600 lbs./sq. in. or less. "S" grade. Absorption no limit. Mod. rupture 300-450 lbs./sq. in. or less.
- Brick; Concrete** Fed. Spec. SS-B-663
Specify Grade: H—hard, M—medium, S—soft. (Use H and M for exterior walls.) Specify size, color and texture if required. State if absorption requirements are waived.
- Brick; Sand-Lime** Fed. Spec. SS-B-681
Specify Grade: H—hard, M—medium, S—soft. H and M for exposure to weather or soil. Specify size, color and texture if required. State if absorption required may be waived.
- Brick, Fire Clay: See Heating and Ventilating**

A. S. T. M. SPEC.

- Sampling and Physical Testing of Portland Cement, Standard Methods of** A.S.T.M. C 77-40
(Need not be referred to in Architects' specifications.)
- Portland Cement** A.S.T.M. C 150-41
Specify Type: When no type is specified Type I shall be used. Types are as follows:
Type I for general construction use.
Type II where exposed to moderate sulphate action or where moderate heat of hydration is required.
Type III High early strength.
Type IV Low heat of hydration.
Type V High sulphate resistance.
- Natural Cement** A.S.T.M. C 10-37
- Masonry Cement** (Cement for use in conjunction with sand in making mortar for laying units of masonry) A.S.T.M. C 91-40
State if nonstaining to limestone is required.
- Quicklime (for) structural purposes** A.S.T.M. C 5-26
- Hydrated Lime (for) structural purposes** A.S.T.M. C 6-31
Specify Masons' hydrate or finishing lime for all work except for finish coat of plaster where finishing hydrate shall be used.
- Hydraulic Hydrated Lime for structural purposes** A.S.T.M. C 141-38 T
(For mortar, in concrete either as sole cementitious material or as a blend or admixture. Specify either high calcium or magnesium type.)
- Concrete Aggregates** A.S.T.M. C 33-40
Specify if all types of aggregate are not desired—i.e. natural sand, sand prepared from stone, blast furnace slag, gravel or other inert material.
- Lightweight Aggregates for Concrete** A.S.T.M. C 130-39
Specify alternate limits of specification where required.
- Glazed Building Units** A.S.T.M. C 126-39 T
(Brick and Tile with vitreous glaze-excluding salt glaze.) Specify sizes and shapes, textures and colors.
- Building Brick (made from clay or shale)** A.S.T.M. C 62-41 T
- | Specify Grade: | Aver. Min. Compressive strength (brick flat-wise) psi. gross area | Aver. Max. Water absorption Boiling | Aver. Max. Saturation Coef. |
|--|---|-------------------------------------|-----------------------------|
| Grade SW
High degree of frost resistance (foundation courses, retaining walls) | 3000 | 17% | 0.78 |
| Grade MW
Moderate degree of frost resistance (face brick above ground) | 2500 | 22% | |
| Grade NW
Back-up or interior use or where no frost occurs (or with frost in dry localities) | 1500 | No limit | No limit |
- Specify: Size, color, texture and finish (and uniformity).
- Concrete Building Brick** A.S.T.M. C 55-37
Specify Grade: Grade A—frost-resistant.
Grade B—Back-up or interior use.
Specify Color, texture, finish (and uniformity). (Size 2 1/4" x 3 3/8" x 8".)
- Sand—Lime, Building Brick** A.S.T.M. C 73-39
Specify Grade:
Grade SW—Highly frost-resistant (for foundation courses and parapets in N. E. of U. S.)
Grade MW—Moderately frost-resistant. (Face brick for other than foundations and parapets, or for all exterior uses in less severe climates.)
Grade NW—For back-up or interior masonry or use where no frost action or frost action where dry climate.
Specify color, texture, finish (and conformity if desired).

FED. SPEC.

Concrete Units; Masonry, Hollow (Concrete Blocks)
FED. SPEC. SS-C-621
 Specify Type: load-bearing or non-load-bearing. Each type may be secured in weight of concrete more or less than 100 lbs. per cubic foot. (Use less if light weight aggregate is required.) Specify whether load-bearing blocks are to have shell thickness of 3/4" to 1 1/4" or 1 1/2" and over.
 Specify size of blocks, and special closures and fillers. (A wide range of aggregates is allowed by this specification.)

Tile, Partition, Gypsum FED. SPEC. SS-T-316

Tile; Structural Clay, Floor FED. SPEC. SS-T-321
 Specify Grade: M—medium or S—soft; size and shape.

Tile; Structural Clay, Load-Bearing, Wall FED. SPEC. SS-T-341
 Specify Grade: H—hard (suitable for exterior walls); M—medium (suitable for exterior wall), S—soft. Specify size and shape, scored or scratched for stucco and plaster; state whether freezing and thawing requirements are to be met.

Tile; Structural, Clay, Non-Load-Bearing FED. SPEC. SS-T-351
 (Partition, fireproofing and furring.) Specify Grade: M—medium (power absorption and stronger than S—soft). Specify: Shape, size, scored or scratched for plaster or stucco; state if absorption requirements are waived.

Filler; Expansion Joint, Prefomed, Non-Extruding, Resilient Types (for Concrete) FED. SPEC. HH-F-341

Bars; Reinforcement, Concrete FED. SPEC. QQ-B-71a
 (Government requests that design minimize to maximum extent amount used.) Specify Type: A—plain, B—deformed, C—hot twisted; D—cold twisted.
 Specify Grade: 1 structural, billet steel;
 2 intermediate, billet steel;
 3 intermediate, car-axle-steel;
 4 hard, billet-steel,
 5 hard, rail-steel.

A. S. T. M. SPEC.

Hollow Load-Bearing Concrete Masonry Units (Concrete Blocks) A.S.T.M. C 90-39
 Specify if minimum face shell thickness is to be 1 1/4" and over or 3/4" to 1 1/4". Specify texture, finish and uniformity of color if desired. (A wide range of aggregates is allowed by this specification.)

Solid Load-Bearing Concrete Masonry Units A.S.T.M. C 145-40
 These concrete blocks have 75% or more net area, solid, and they are stronger than C 90-39 Hollow Units. Specify Grade A (stronger) or B. Specify texture, finish and uniformity of color, if desired.

Hollow Non-Load-Bearing Concrete Masonry Units A.S.T.M. C 129-39
 Specify surface texture, finish or uniformity of color where same are required.

Gypsum Partition Tile or Block A.S.T.M. C 52-41 T
 Specify if solid tile are required.

Structural Clay Floor Tile A.S.T.M. C 57-39
 Specify: Grade FT1 (stronger) or FT2 and any special color, texture or finish desired.

Structural Clay Load-Bearing Wall Tile A.S.T.M. C 34-41
 Specify: Grade LBX. General use, adapted for exposed weathering and suitable for application of stucco. Grade LB. Use where not exposed to frost action and for back-up. Specify if special color, texture or finish is desired.

Structural Clay Non-Load-Bearing Tile A.S.T.M. C 56-41
 (Partitions, fireproofing and furring.) Grade NB only. Specify if particular color, texture or finish is required. (Standard sizes are specified.)

Prefomed Expansion Joint Fillers for Concrete A.S.T.M. D 544-41
 Specify Type: Type I cork; Type II self-expanding cork; Type III sponge rubber; Type IV cork rubber. Specify sizes.

Billet-Steel Bars for Concrete Reinforcement A.S.T.M. A 15-39
 Specify class—Plain, deformed, and cold-twisted. Specify grade of plain or deformed bars—structural, intermediate, or hard. (Also American Standard Assoc. A50.1-1939)

Rail Steel Bars for Concrete Reinforcement A.S.T.M. A 16-35
 Specify class—Plain, deformed or hot-twisted. (Also American Standard Assoc. A50.2-1936)

Cold-Drawn Steel Wire for Concrete Reinforcement A.S.T.M. A 82-34
 Specify gauge and mesh. (Also American Standard Assoc. A50.3-1936)

Axle-Steel Bars for Concrete Reinforcement A.S.T.M. A 160-39
 Specify class—Plain or deformed.
 Specify grade—Structural, intermediate or hard.

Fabricated Steel Bar or Rod Mats for Concrete Reinforcement A.S.T.M. A 184-37
 Specify: Type of bar material used for fabricating mats.
 Grade of steel.
 Plain or deformed bars.
 Clipped or welded mats.

Welded Steel Wire Fabric for Concrete Reinforcement A.S.T.M. A 185-37
 Specify: Gauges, spacings, arrangement of wires; furnished in flat sheets or rolls.

Curing Portland-Cement Concrete A.S.T.M. C 80-34
 Specify method:
 (a) Bituminous coverings
 (b) Calcium chloride admixture
 (c) Calcium chloride application
 (d) Wet covering

Mortar for Reinforced Brick Masonry A.S.T.M. C 161-41 T
 Specify either Property Specification (acceptability based on properties of materials, and of the mortar mixture) or, Proportion Specification (acceptability based on properties of materials and fixed proportions of mortar materials).

Ready Mixed Concrete A.S.T.M. C 94-41 T
 Specify type, quality and strength, etc. of concrete by one or more of the various methods.

OTHER REFERENCES

The following Simplified Practice Recommendations:—

- Rough and smooth Face Brick R 7
- Sand-Lime Brick (sizes) R 38
- Concrete Building Units (sizes) R 32
- Hollow Building Tile R 12

Simplified Practice Recommendation A.S.T.M. 1940

- Sidewalk floor and roof lights R 49
- Steel reinforcing spirals R 53
- Clay tiles for floors and walls R 61
- Coarse aggregates (crushed stone, gravel and slag) R 163

Gypsum Partition Tile and Fireproofing
 Gypsum Association, Chicago, Ill. 1940.

Handbook, Standardized Glazed Brick and Tile
 Glazed Brick and Tile Institute
 1427 Eye Street, N.W.,
 Washington, D. C.

Steel Reinforcing Bars
 American Standards Association A47-1932
 (Also Simplified Practice Recommendation R 26-30).

Recommended Practice and Standard Specifications for Concrete and Reinforced Concrete
 Report of Joint Committee on Standard Specifications for Concrete and Reinforced Concrete.

OTHER REFERENCES

Design and Construction Data

Brick Cavity Walls—

Brick Manufacturers' Association of New York, Inc.,
2721 Grand Central Terminal. 1940.

Forms for Concrete Joist Construction Floor

American Standards Association A 48-1932
(Also Simplified Practice Recommendation R 87-32).

"Reinforced Concrete," "A manual of Standard Practice"
Concrete Reinforcing Steel Institute. 1940.

DIVISION 2. STONE, SLATE & CAST STONE

FED. SPEC.

Stone; Architectural, Cast

FED. SPEC. SS-S-721

Specify Type:

Type I Homogeneous throughout.

Type II Cast stone with not less than 1" facing.

A.S.T.M. TESTS

Standard Methods of Tests for Natural Building Stone

as follows:

Absorption and apparent specific gravity	A.S.T.M. C 97-36
Flexure	A.S.T.M. C 99-36
Modulus of Elasticity	A.S.T.M. C 100-36
Shearing	A.S.T.M. C 102-36
Tentative for Compressive Strength	A.S.T.M. C 170-41 T

OTHER REFERENCES

Colors and Finishes for Cast Stone

Commercial Standard CS 53-35

Calking Lead—

Commercial Standards CS 94-41

"Indiana Limestone"—

Indiana Limestone Institute
Promotional Division 1941.

"Granite in Architecture"—

National Building Granite Quarries Association.

Standard Methods of Testing Slate as follows:

Water absorption	A.S.T.M. C 121-31
Flexure	A.S.T.M. C 120-31

DIVISION 3. WATERPROOFING & DAMPPROOFING

FED. SPEC.

Asphalt-Primer; (for) roofing and waterproofing

FED. SPEC. SS-A-701

Roof-coating, asphalt, brushing consistency

FED. SPEC. SS-R-451

For dampproofing on masonry, cement and steel.
Use over primer.

Cement, bituminous, plastic

FED. SPEC. SS-C-153

For use with plastic flashing used with bituminous roofing. Specify: Type I for use with flashing felt; Type I or II (coal tar base) may be used on coal tar pitch for repair of metal roofing or as expansion joint material for concrete or masonry.

Pitch; coal-tar (for) mineral-surfaced built-up roofing, waterproofing and dampproofing

FED. SPEC. R-P-381

Specify Type: (Both types to be used with coal-tar saturated felt.)

Type I for use with felt for roofing and waterproofing with slope not over 1" per foot.

Type II for use with felt for roofing and waterproofing as ply cement in membrane waterproofing or alone as dampproofing. Use in locations where temperature will not exceed 100° F.

Cotton-Fabric; woven, coal-tar-saturated

FED. SPEC. HH-C-591

For use in membrane waterproofing, with coal-tar-pitch.

Cotton Fabric; woven, asphaltic-saturated

FED. SPEC. HH-C-581a

For use in membrane waterproofing, with asphalt.

Asphalt; (for) built-up roofing, waterproofing and dampproofing

FED. SPEC. SS-A-666

Specify Type III. Asphalt for waterproofing and dampproofing shall be free from inorganic matter.

Felt; coal-tar-saturated (for) roofing and waterproofing

FED. SPEC. HH-F-201

For use in built-up roofs and membrane waterproofing.

Felt; asphalt-saturated (for) flashing, roofing and waterproofing. Specify: Type I

FED. SPEC. HH-F-191

For waterproofing with asphalt.

OTHER REFERENCES

Asphalt

Simplified Practice Recommendation. R 4

A.S.T.M. SPEC.

Primer for use with Asphalt in Dampproofing and Waterproofing

A.S.T.M. D 41-41

Asphalt Mastic for use in waterproofing, asphalt cement, mineral filler, mineral aggregate

A.S.T.M. D 491-41

Bituminous Grout for use in waterproofing below ground level

A.S.T.M. D 171-41

Bituminous Grout for use in waterproofing above ground level

A.S.T.M. D 170-41

Coal-Tar Pitch for Roofing, Dampproofing and Waterproofing

A.S.T.M. D 450-41

For use as a mopping coat in built-up roofs with slag or gravel, as a mopping coat in dampproofing or as a plying or mopping cement in membrane waterproofing. Specify Type: Type A mopping coat for built-up roofs, mopping coat in dampproofing or as a plying cement in membrane waterproofing above ground when not exposed to temperatures over 125° F; Type B mopping coat in dampproofing, or as a plying cement in membrane waterproofing below grade (moderate temperature.)

Woven Cotton Fabrics Saturated with Bituminous Substances for use in Waterproofing

A.S.T.M. D 173-40 T

Specify: Whether cloth is to be waterproofed with coal-tar-pitch or asphalt. For use in membrane waterproofing.

Asphalt for Dampproofing and Waterproofing

A.S.T.M. D 449-37 T

For mopping coat in dampproofing, or as a plying or mopping cement in membrane waterproofing.

Coal-tar Saturated Roofing Felt for use in Waterproofing and in constructing Built-up Roofs

A.S.T.M. D 227-41

Asphalt-Saturated Roofing Felt for use in Waterproofing and in constructing Built-up Roofs

A.S.T.M. D 226-41 T

Felt saturated but not coated for use in membrane waterproofing specify felts of 15 lbs. or 30 lbs., widths 32" or 36".

NOTE: Specification Standards will be continued in the February issue of ARCHITECTURAL RECORD.

INDUSTRIAL BUILDINGS

A BUILDING TYPES STUDY

"IT IS QUESTIONABLE whether the enormity of the building program for national defense is generally appreciated. . . . Never in history has so staggering a program been undertaken . . . nor . . . as much accomplished. . . . For manufacturing buildings there has been developed a certain type . . . generally accepted as the best . . . the one-story structure of incombustible materials, with enormous uninterrupted floor spaces under one roof, with a minimum of columns."

—From a speech by ALBERT KAHN

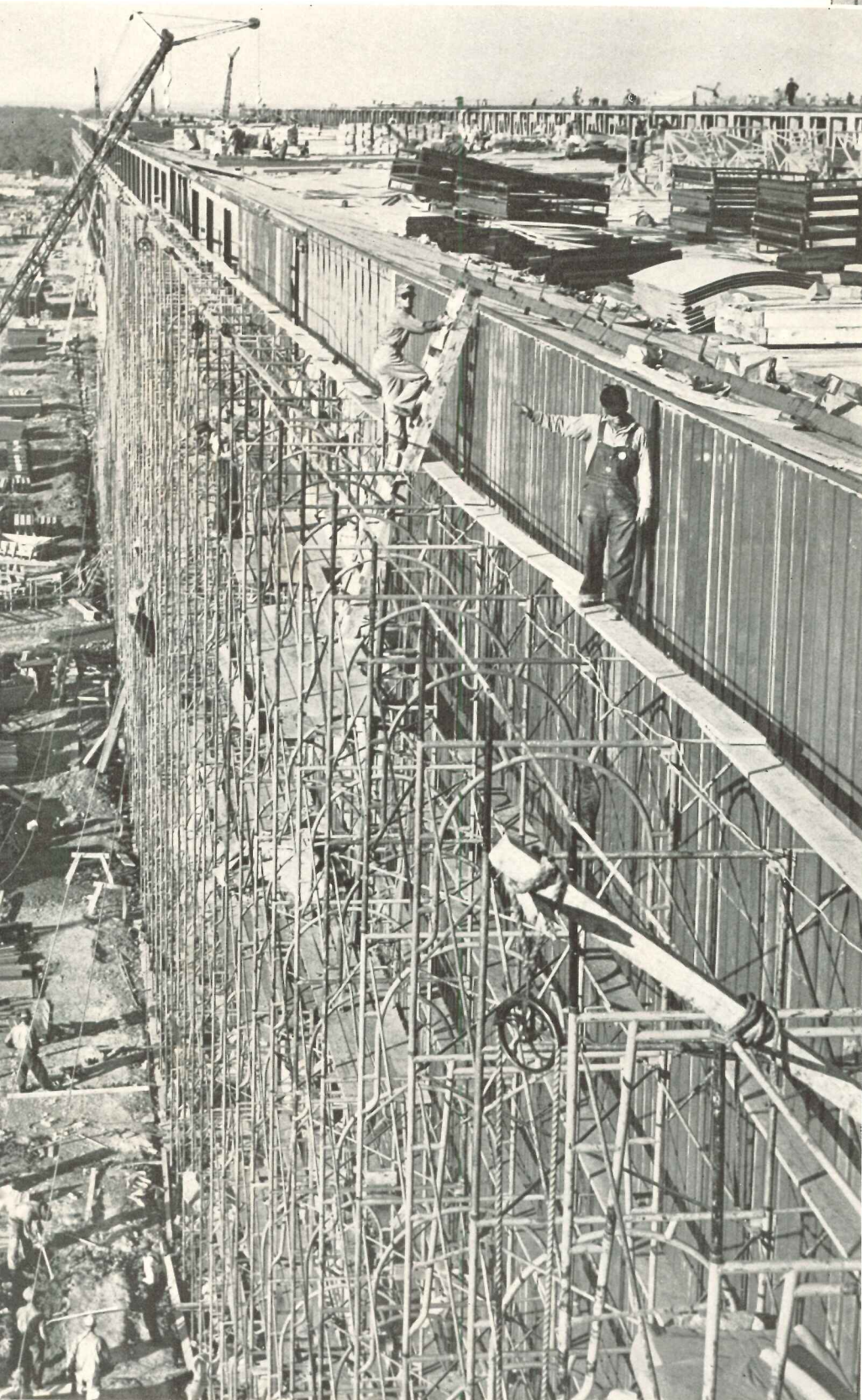
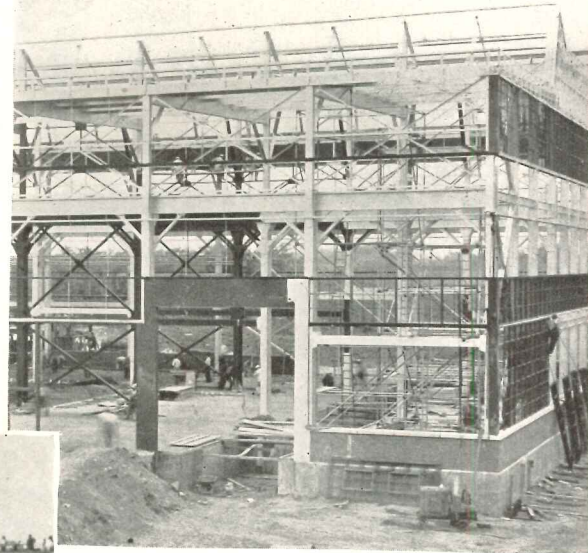

THE EXCERPTS from Albert Kahn's address, made shortly before the declaration of war, are at once heartening and challenging. What we have already accomplished is miraculous; but we must now pile miracle on top of miracle. The necessity for more plants will continue to stimulate designers and builders of factories.

Great encouragement can be based upon the demonstration, in factory job after factory job, of the American ability to find a way out of any dilemma. We are short of materials. We cannot always get available materials to the job in time. We must supply plants organized around entirely new manufacturing techniques with buildings which satisfy their peculiar needs. We must produce with speed—speed—speed!

In meeting these demands to date, we have produced not makeshifts, but rather new wonders of design, engineering and construction which are incredible advances on previous practice. Thus our war effort has caused us to cram into a few short months the progress we would not normally achieve in years.

This study is produced under difficulties. It has, of necessity, to be short; which means that not every advance can be covered. We are at war; which means that the RECORD's editors must cooperate with the Government to prevent leakage of information which might be of value to an enemy. Identification of plants by name or location is omitted from this issue. The editors are certain that, under the circumstances, subscribers will approve such a policy.

WAR REQUIREMENTS ACCELERATE

1. TYPE OF BUILDINGS

THE TYPE OF MANUFACTURING to be done has determined, basically, the type of plant. But other considerations must modify decisions made today. Primarily, what materials of those available can be gotten to the site in sufficient quantity, and in time? And to what extent are buildings and manufacturing equipment likely to be subjected directly to war's ravages—to bombing, to sabotage?

The manufacturing processes may demand a windowless plant, in which air, light, and sound are maintained at optimum conditions for continuous manufacturing. Three- or even two-shift operations of a precise nature may require this. But maintenance equipment for such a plant is costly and extensive; and though, in time of war, after-the-war operating methods and costs are not primary considerations, they should be recognized as problems we will some day face. The daylighted factory has many advantages.

Too, though most of the examples in this study are from huge plants, we will probably reach a point at which smaller units for sub-contracting operators will be necessary. Therefore we must develop general principles and details applicable to all types of plants, large or small.

Experience has shown that one-story manufacturing areas are satisfactory for most types of armament production. Urban land values of course require multi-story buildings for reasons of economy; but few armament plants are being built in congested areas. Some types of manufacturing—notably, making explosives—demand construction of many small units rather than one large one.

The most serious bottleneck lies in obtaining and fabricating steel framing. Structural shapes most readily available must be employed; to speed deliveries, substitutions of one shape or product for another are to be expected. Standardization to the greatest possible degree, and above all, simplicity of design and construction, are essential.

Realization of a plant's exposure to attack or sabotage may compel use of windowless plants for blackout purposes, or of means of blacking out sash and protecting the plant's structure, utilities, machines and men.



WINDOWED

Expansion of this typical daylighted plant upped plane production at least 300 per cent. Albert Kahn Associated Architects and Engineers, Inc.

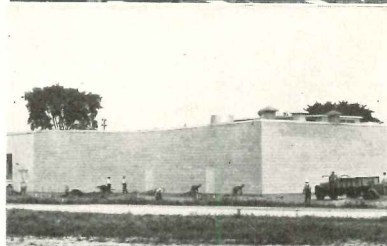

WINDOWLESS

In this "controlled conditions" plant night shifts can produce aviation devices as precisely as day shifts. The Austin Co., designers and builders

PROGRESS IN DESIGN

2. PLAN ORGANIZATION

ECONOMICAL PLANNING today is more important than ever, and embraces more than economy of space and materials. Units have to be laid out and constructed so plant expansion can proceed without interrupting manufacturing processes. Expansion may be horizontal for one-story areas, vertical for multi-storied administration, engineering, or heating buildings, etc. So rapid is today's pace that, often, before a new unit is placed in service additions start.

Within the structure, employee services such as toilet and locker facilities, lunch rooms, etc., are commonly provided in several types of locations: in mezzanines which thus utilize otherwise waste space contained in the depth of roof trusses; in lean-tos, balconies, raised platforms, etc.; on the main floor, usually in low-headroom areas undesirable for other purposes; or, a new development, in a full or partial basement under the manufacturing area. This latter scheme permits use of basement walkways as plant entrances, distributing workers directly to their stations.

PLANT UNDER ONE ROOF

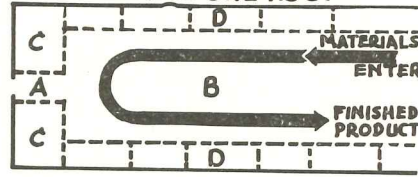

- A = ENTRANCE
- B = MANUFACTURING AREA
- C = OFFICES, DESIGN DEPT, ETC.
- D = EMPLOYEES, MAINTENANCE, HEATING, ETC.

BUILDINGS DISPERSED

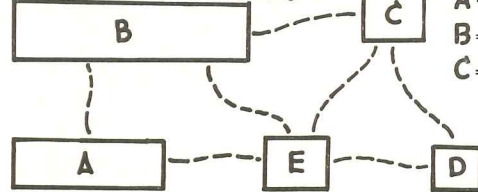

- A = ADMINISTRAT'N
- B = ASSEMBLY
- C = POWER STATION
- D = BOILER HOUSE
- E = PARTS MFR. SUB-ASSEMBLY

ASSEMBLY B'LD'G

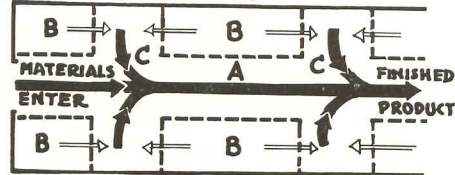

- A = MAIN PRODUCTION LINE
- B = MEZZANINES FOR STOCK, PARTS, ETC.
- C = CROSS-OVER AISLES

Column spacings are today never less than 40 ft.; often 200 ft. or more in at least one direction. Above are typical plan schemes



Dimit Bros.

HANGING MEZZANINE

Space is saved by housing some processes in mezzanines carried in roof trusses—a device sometimes improved on by utilizing double-decked mezzanines



Geo. A. Ostertag

BASEMENT UTILIZATION

Above, a cafeteria; right, wash room—both in basements of their respective aviation plants—typify use of basements for employee facilities



Employee areas may be located so each worker's locker, etc., is close to his work station. All three photos are of plants designed by the Kahn organization

3. CONDITIONS DUE TO WAR WE CANNOT DESIGN FOR WAR merely by taking protective measures. We are expanding our manufacturing economy at a rate which, in normal times, would be financially unsound. Therefore we are putting into assembly-line production planes, tanks, armaments of all kinds—and even the basic machine tools! This type of development means tremendous spans and clearances for at least assembly areas in plants producing such things as bombers and turret-lathes. It entails design for stresses unheard of a few months ago. It necessitates, in view of difficulties in obtaining materials, design to utilize the most abundantly available materials; design so simple that substitution of one dimension or material for another will not require redesign of the entire structure.

There remains much to be done in the way of protective design. Utilities must be considered: heating, lighting, power supply, water supply, ventilation, the utilities necessary to manufacturing such as process steam lines, etc. European practice has often been to provide at least two, often three, widely dispersed sources for each of these. Now we hear of American plants in which the sources are duplicated, or where emergency units such as battery-operated lighting systems are provided. New Army bomber plants have boiler houses, etc., located somewhat away from the main assembly building, so that a direct bomb-hit, though it may destroy part, cannot put the entire plant out of operation for long.

Structurally, the ideal building is said to be: “. . . of framed, fire-resistant construction, with walls of sufficient thickness to resist (bomb) fragments and roofs at least heavy enough to stop light incendiary bombs” (from “Protective Construction, Structure Series, Bulletin No. 1,” Office for Emergency Management).

Below and on page 79 are shown examples of methods of protecting plants against flying debris, of providing for blackouts, etc. Equally important is provision of shelter for employees during raids. In this connection, it may be necessary to provide, at strategic locations in the plant, individual shelters for key men who supervise machines or processes whose continued operation, even during a raid, is vital to the plant.

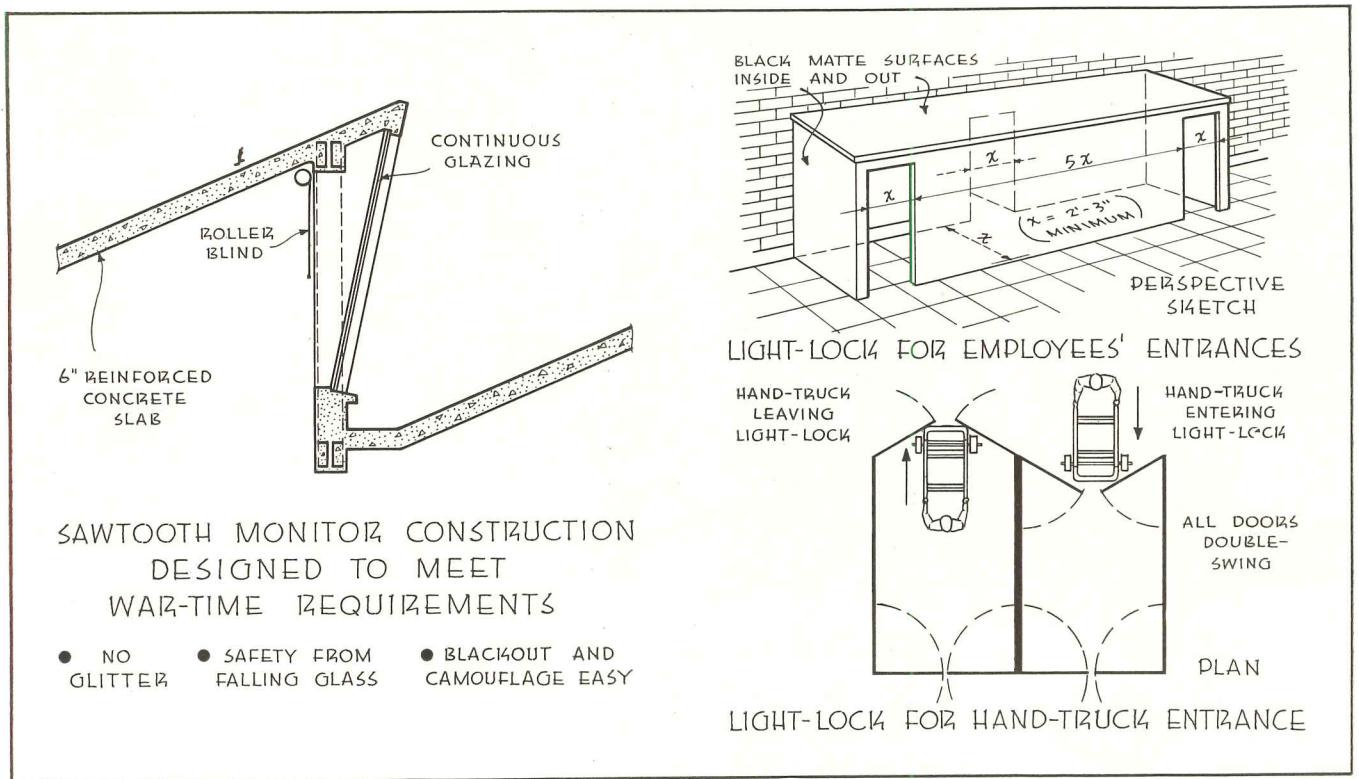

STRUCTURE AND CONSTRUCTION

1. **MUST** be practicable in view of today's labor and materials markets;
2. **MUST** permit ultra-rapid construction if the plant is to serve its purpose;
3. **MUST** provide for safety of plant and process if attacked;
4. **MUST** provide for the safety of workers under air attack particularly;
5. **MUST**, as a factory building, meet the requirements of the industry it serves.

BOMBING has had little effect on English plants in comparison with effort expended. (A British metal roofing salesman reports in a current periodical that though his company provided steel roofing for 30,000 buildings in 18 years before the war, only 2 $\frac{1}{4}$ per cent has had to be replaced; at the same time, five times as much of the same material has been installed on new roofs.) Yet to omit precautions is senseless. Bomb damage may be actual destruction of parts of a plant due to direct hits, and successive collapse of resulting overloaded portions; may result from penetration of the building's shell by bomb fragments from near misses, or from flying glass or other brittle material; may be due to earth shock from explosions in soil outside the plant or the traveling, pulse-like "knock-on" effect which a direct hit on one part of a structure transmits to another.

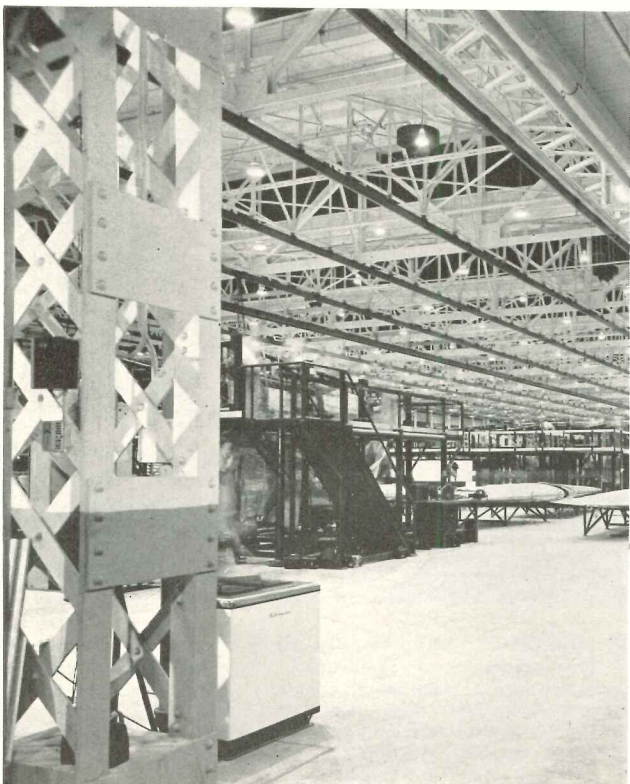

In the bomber assembly plant, at left, designed and built by The Austin Co., white cement floors reduce the amount of current required for lighting, speed up production. Note also lattice columns, which save steel

FOUNDATIONS, FLOORS

Most noteworthy developments in this portion of the factory building are several ingenious means of increasing its efficiency. Typical is the use of white Portland cement or white terrazzo as a topping course for floors. The particular advantage is substantial reduction of the lighting load. The practice is said to be helpful in assembly operations, in that it speeds up operations which have to be lighted from below. In numerous cases, areas of an assembly building, where "clean" operations are performed, are white-floored; other areas have a standard cement topping.

In other plants, use has been made of a $\frac{3}{4}$ -in. asphalt traffic surface, laid over a cement slab.

There has also been developed, for one job in particular, a footing detail in which column dowels do not pierce the continuous waterproofing membrane.

WHAT TYPE OF STRUCTURE?

BRITISH AND AMERICAN authorities agree* that, for protection against the effects of high explosive bombing, "the ideal wall . . . consists of panel walls . . . built independently of the steel framework" so that a near miss may demolish walls without doing extensive damage to framing. Rigid framing is considered least subject to destruction from direct hits, near misses, or the earthquake-like force called "earth shock," a phenomenon which usually destroys load-bearing masonry walls, particularly if unreinforced.

There are numerous means of conserving steel. Most obvious is increasing allowable stresses (or reducing assumed loads)—not justifiable except in extreme cases. Second is to follow standard practice, but to choose a framing system for steel economy. This implies careful study of alternative designs, possibly evolution of new details. In one case, arched bottom chords for trusses were substituted for straight chords, with substantial savings. In another, welding all but a few joints produced savings. In still others, box latticed columns proved economical. The British have experimented with box columns made up of two angles welded together, or two channels, latticed, etc. Again, heavy column sections may be available when the more commonly used light ones are not.

Third, we may substitute other materials for portions or all of the steel frame. Examples of this are: hollow concrete box girders and columns, used in one case as rigid frames spanning 140 ft.; timber trusses supported on concrete columns; use of wood entirely for framing (see pp. 73, 74 et seq.)

* Dept. of Scientific and Industrial Research, London; Office for Emergency Management, Washington.

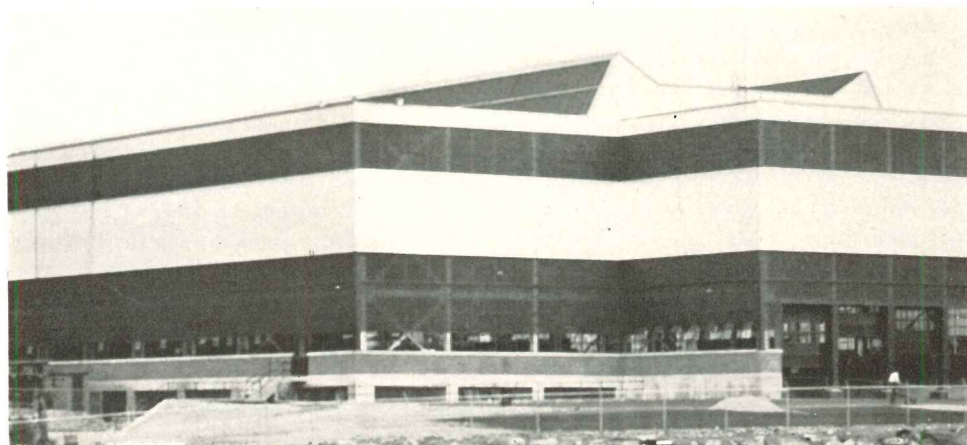

Bellingers

STEEL-FRAMED, daylighted plants: top, an Eastern machine-tool assembly building where three cranes travel side-by-side. Alexander Crosett, engineer, designed a simple structure of single-section girders rigidly framed to columns which carry tremendous, variable crane loads. Structural design was laid out to permit use of trusses if these proved more practicable. Turner Construction Co., builders. Left, tractor sales and service building, Francis George Davidson, architect; built by Neighborgall and Leach, Inc.

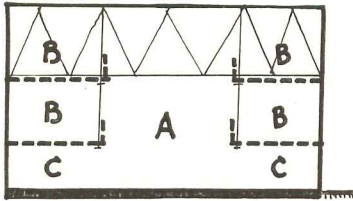

USE OF MEZZANINES

- A = MAIN PRODUCTION LINE
- B = HUNG MEZZANINES FOR PARTS, SUB-ASSEMBLIES, ETC.
- C = EMPLOYEE FACILITIES, ETC.

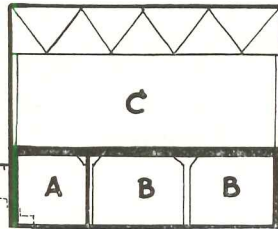

EMPLOYEE FACILITIES IN A BASEMENT

- A = EMPLOYEE'S ENTRANCE CORRIDOR
- B = TOILETS, CAFETERIA, ETC.
- C = MANUFACTURING FLOOR

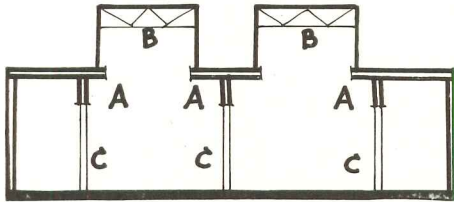

CANTILEVERED ROOF FRAMING

- A = CANTILEVERS SUPPORTED ON JACK-TRUSSES
- B = MONITORS
- C = COLUMNS

Above and to left, several section-diagrams indicating how efficient plan organization may affect selection of a structural system. All are taken from actual examples of recently constructed factories

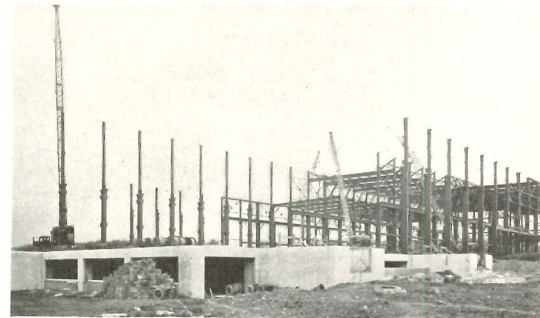
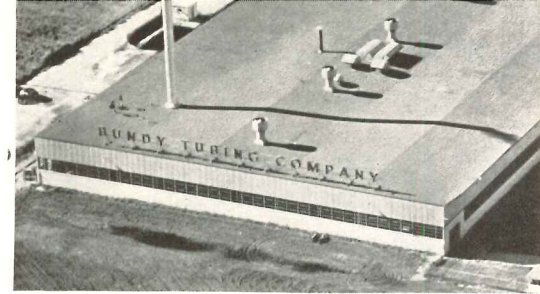

Manning Bros.

WINDOWED or WINDOWLESS, the enclosing envelope—walls and roof—should be only loosely tied to the structural frame. This holds true for small as well as large plants. Top, omission of monitors saved steel in this plant by Smith, Hinchman and Grylls. Center, framing simplicity exemplified in the three-aisled plant for mass-produced machine tools described on the opposite page. Lower, monitors supported on cantilevered framing carried on trusses also reduce steel required; Giffels and Vallet—L. Rossetti, architects and engineers. Below, one of two identical windowless aircraft assembly plants designed by the Austin Co. and built by Austin and Manhattan-Long

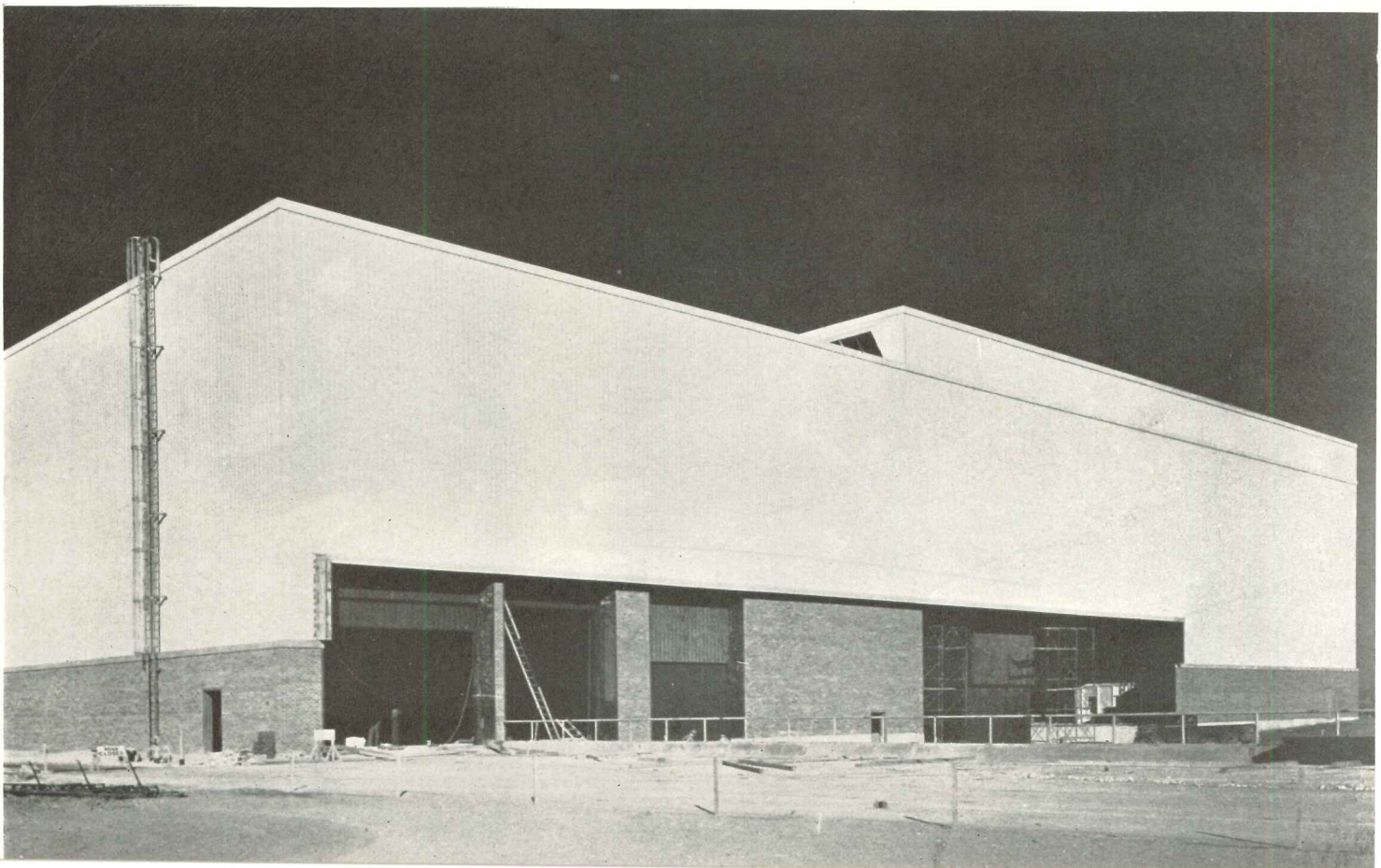

WALLS AND ROOF

SINCE COMPLETE PROTECTION against high explosive bombs is impractical because money, time and materials required are disproportionate to the degree of safety achievable, walls and roofs must be designed to limit damage as far as possible. The same design will effectively limit sabotage aimed at the structure. While not supported by definitive tests, the following requirements are based on a commonsense interpretation of experience.

First, the envelope should be highly resistant to piercing by bomb fragments. "Fragment-proof" construction, like "bombproof," is almost impossible since large fragments may travel faster than rifle bullets. Second, it should be nearly proof against incendiary bombs. Since the average incendiary weighs only a little over two pounds, this is practicable. Third, it should be non-shattering; that is, the materials of which it is composed should not be capable of being transformed into missiles which could damage machines or cause casualties. This automatically eliminates many brittle materials; if glazing is used, provisions have to be made for attaching blackout and splinter-proof screens. Many new plants have windows fitted with clips to which screens can be quickly attached. Fourth, it should be easily repaired; that is, replaceable in sections.

Requirements for normal operations have been stepped up by the existence of a state of war. The problem of controlling air, light and sound becomes highly important in any plant that operates more than one shift; for precise work it becomes imperative. All types of enclosures, "windowed" as well as "windowless," have been adapted to meet this need. Solutions range from complete atmospheric control in windowless plants (the most advanced example is detailed below) to provision of a slight, dust-excluding atmospheric pressure, maintained by the ventilating system. In other cases, test rooms or precision-manufacturing spaces may be specially enclosed, conditioned, lighted, etc.—all within a typical "windowed" plant.

Added together, these basic requirements tend to eliminate unit masonry—brick, cinder block, etc.—for walls of plants exposed to bombing, except for base courses extending not more than 12 ft. above grade.

Sheet metal, particularly if protected from weather, combined with non-fireproof materials such as insulating board, can be bolted to the framing. Reinforced concrete slabs and barrel vaults have been successfully used for roofs. Wood construction, which has many merits, is discussed on the following pages.

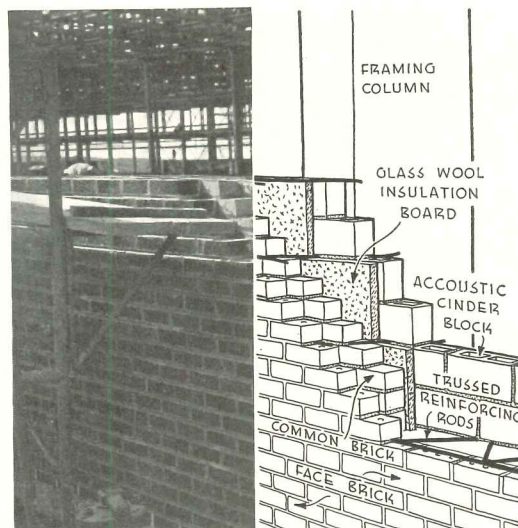
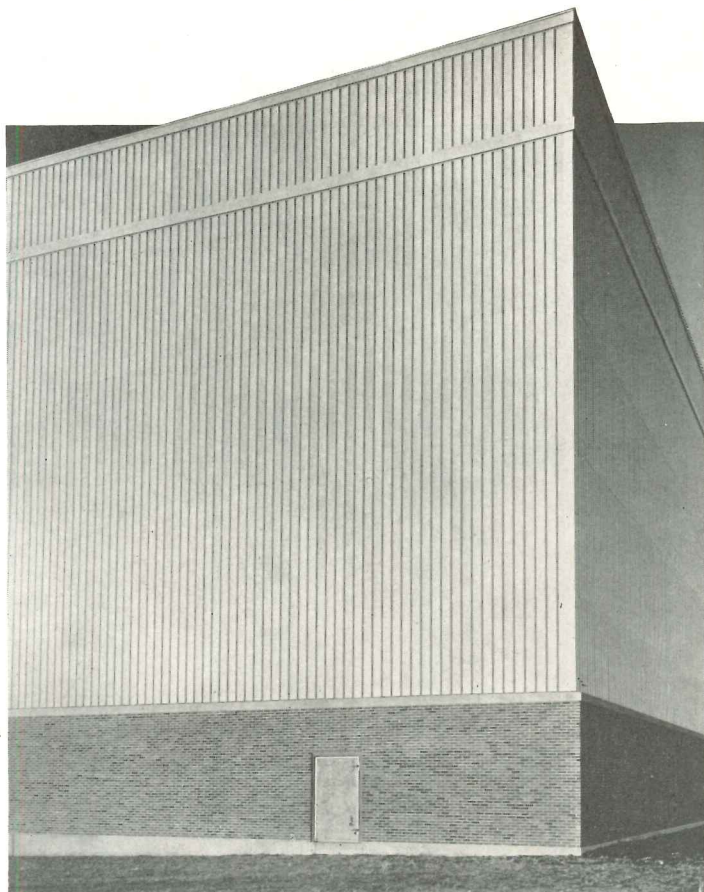

Left, exterior appearance when completed, and above, method of constructing the 12-ft.-high reinforced masonry portion of the wall, of the revolutionary type of construction described on page 73

GLASS WOOL INSULATION BOARD

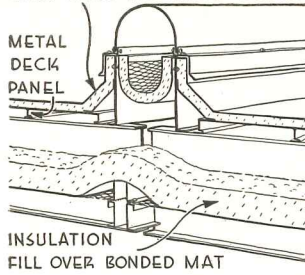

ABOVE, expansion joint; BELOW, wall construction

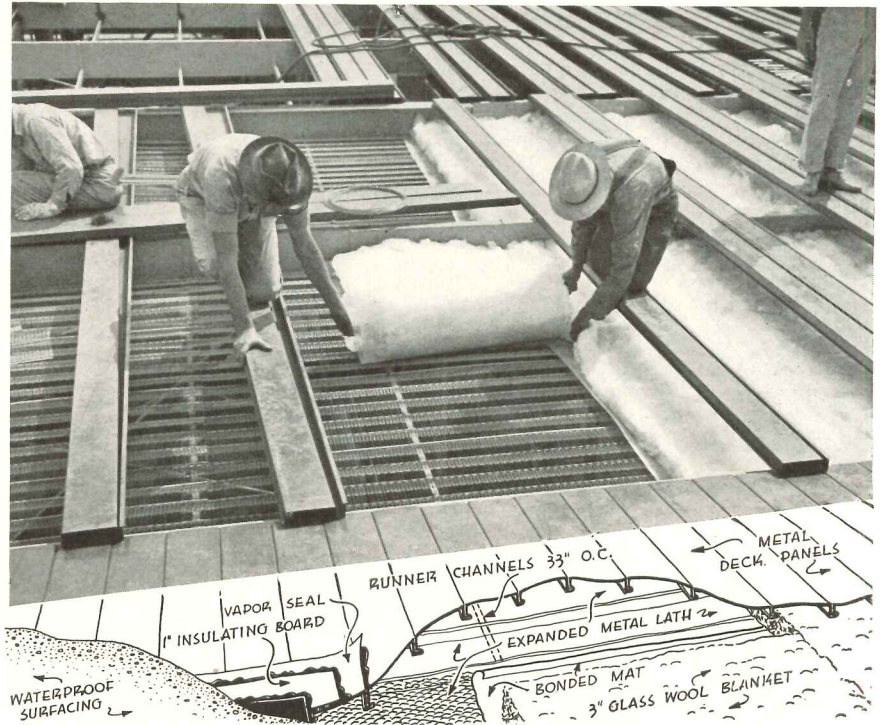
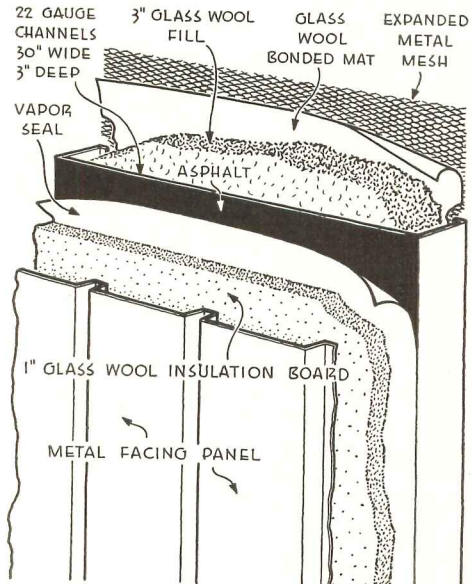

Detail of roof construction

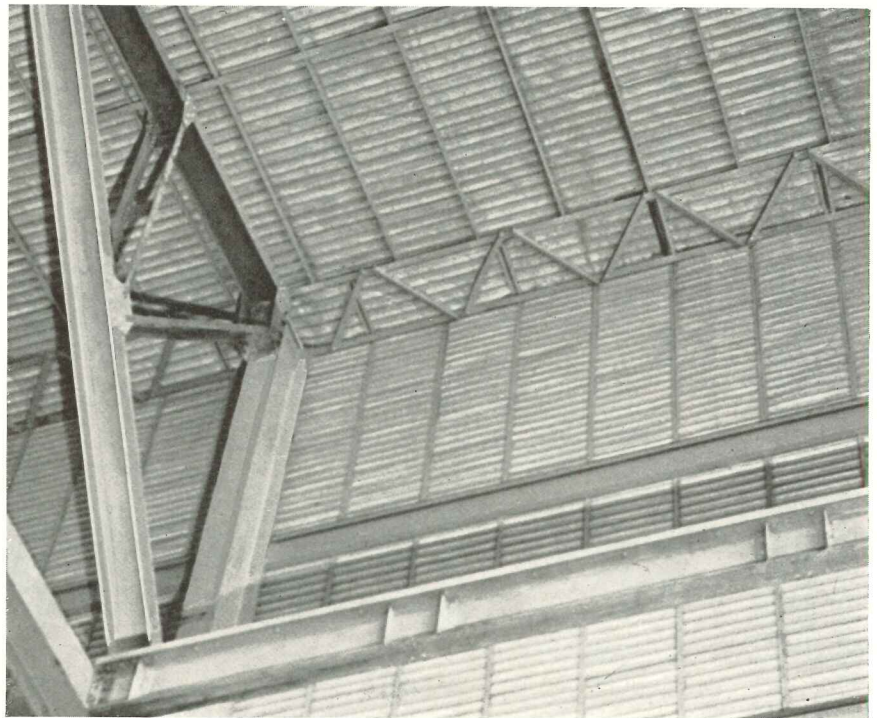

Appearance of interior wall and roof surfaces

NEW BLACKOUT CONSTRUCTION. To the designers and builders—The Austin Co.—and to the manufacturers and distributors of special yet readily obtainable materials involved, all of whom collaborated in developing this highly efficient type of construction, great credit is due.

For certain new bomber assembly plants the Army set up a series of requirements which seemed almost impossible of attainment. The plants were to be windowless, with controlled conditions; to be built with utmost speed, of available materials. Physical wall and roof requirements and performances achieved were as follows:

WALLS

	Required	Actual Performance
Thickness	8"	6"
Lb./sq. ft.	20	10
Coef. Trans.14 Btu	.07 Btu
Heat Capacity	Low	Very Low
Sound, Noise Absorption	60%	75%+
Light Reflection	Greatest	
(Natural finish) ...	Possible	Good
Condensation, Vapor Control	100%	Excellent
Fire Resistance	100%	Excellent
Bomb and Incendiary Protection	Shatterproof	Shatterproof
Maintenance	Least possible	Low

ROOFS

	Required	Actual Performance
Thickness	—	5" approx.
Lb. sq. ft.	11	11
Coef. Trans.125 Btu	.06 Btu
Heat Capacity	—	Very low
Sound, Noise Absorption	60%	75%+
(Remainder same as for walls.)		

Most unusual is the use of glass wool to form a continuous blanket over the entire walls, roof and doors. This is used in three forms: a felted membrane, exposed on interior surfaces; a backing of glass wool fill; semi-rigid glass wool board. The latter ex-

tends even between vertical masonry courses in the lower walls.

Roof assembly was built up on the job as indicated in top photograph. Walls are built of panel units, each 30 in. wide, 3 in. thick, clipped to the framing, vapor-sealed, and covered with glass wool board and ribbed metal facing, which is painted. Fiber washers at bolts prevent breaks in the vapor-seal. Flues in this outer metal surfacing serve to carry off any condensed moisture.

On inside surfaces, ordinary expanded metal lath, exposed, holds the glass wool mat in place. Thus the entire inner surface

is nearly white; together with white cement floors, this factor helps substantially in reducing consumption of current for lighting purposes. This, in turn, reduces the heating load which must be taken care of by air conditioning equipment.

Other items of interest in these particular plants include: use of 200-w. fluorescent lighting units; complete air conditioning; size of transverse roof trusses (so large they could not be transported—had to be job-assembled); use of floodlights clustered on poles to permit day and night construction of the buildings.

Leonard Frank, courtesy "Engineering News-Record"

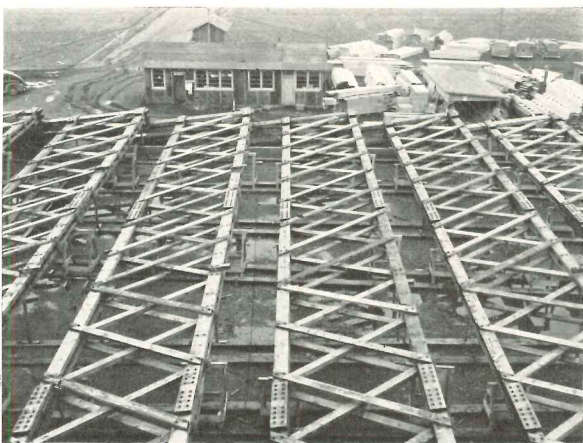

128-ft. timber trusses for a Canadian aircraft plant

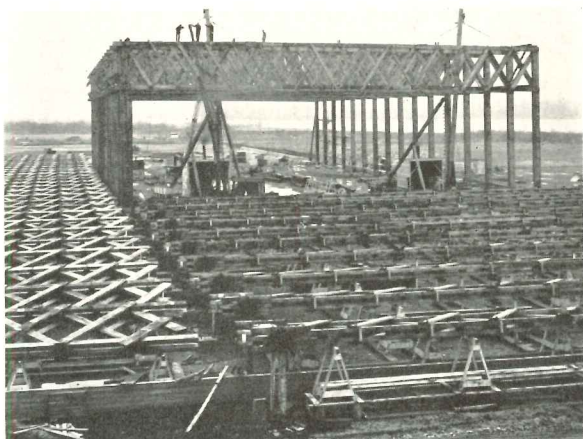

Trusses hoisted into place from trestles on which they were assembled; below, exterior views show assembly portion

ENTIRELY OF WOOD

WITH AVAILABILITY of metals in some sense limited, report of the all-wood aircraft plant built in Canada by Carter-Halls-Aldinger Co., Ltd., D. Colville, architect, is most timely.

Briefly, the framing consists of treated timber trusses, connector-joined, fabricated on the site. Floors are of concrete on a base of rolled cinders and gravel made necessary by the low site. Column footings are concrete capped wood piles. Exterior walls are surfaced with weatherproof plywood; even the sash are of wood. In addition, a seaplane ramp is paved with timbers, some of them 16 by 16 in., 60 ft. long.

In only one relatively small portion—240 ft. from one end, used for final assembly—was it necessary to use steel. Here, use of steel made it possible to eliminate all but one column. Even so, only the main trusses in this area are steel; fill-in members are wood trusses.

Once they had been broken in, a crew of 15 carpenters and 20 laborers assembled five trusses per 8-hr. shift. A total of 59 wood trusses were required.

Exterior panels, of 5-ply, hot-pressed plywood, were rabbeted on all edges to provide 3/4-in. shiplap joints. First and second coats of paint were of fire-retarding composition, brushed on; third coat was sprayed.

A fire which occurred during construction, before installation of fire-protective systems, burned out some plywood sheathing before a hose could be gotten from the nearby city. Only a few diagonal truss members, however, were sufficiently damaged to require replacing. This unexpected test considerably increased confidence in the ability of the structure to withstand fire.

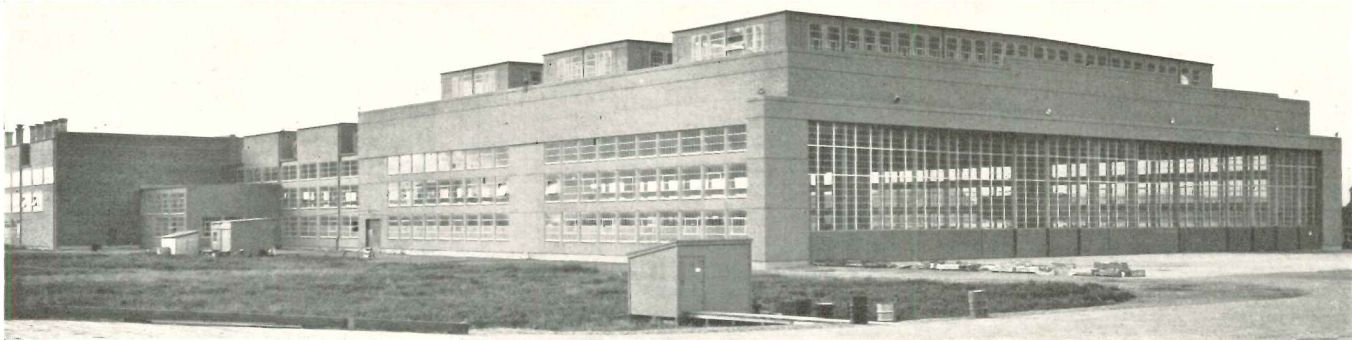

Wood Factory Construction: 1—TYPES AVAILABLE

WOOD CONSTRUCTION of types suitable for factory buildings has been developed in principle by such agencies as the U. S. Forest Products Laboratories, the National Lumber Manufacturers' Association and numerous private and semi-private laboratories, companies, etc. On this sheet are general design principles only. Others in this and later issues will contain data on specific phases of design. The designer should bear in mind that information in these Time-Saver Standards sheets is intended to serve as a guide, not as a solution to a specific problem.

TYPES OF WOOD CONSTRUCTION

Wood has been used both for exterior surfacing and as framing. Chief surfacing material is weatherproof plywood such as the resin-bonded type. Much has been published concerning its flexibility, availability in large sheets and varying thicknesses, etc.; consequently further discussion of plywood will be omitted from this sheet.

Framing systems. At least three distinct types of wood framing systems are available and suitable for spanning the large, open areas required for modern manufacturing methods. Some of these are proprietary. The designer is reminded that use of a proprietary name is not intended to exclude from the discussion similar systems not mentioned by name.

Laminated wood arches are a compar-

tively new and versatile development. The arches are made up, either whole or in section, by gluing seasoned boards together around forms to produce arches of sizes and shapes not obtainable in solid wood. These arches are strong enough to permit their use without trussing or bracing. Hence they may prove advantageous when high, wide, unobstructed interiors are desired for all or part of an industrial building. On the basis of research at the Forest Products Laboratory, their design may be varied widely to conform to differing requirements of span, clearance, roof design, etc. Arches of the 3-hinged type, having spans up to 120 ft., are already in service. Laminated wood framing, being composed of chemically inert materials, is particularly suitable where chemical fumes, etc., might cause corrosion if other framing materials were used.

Cellular arches, such as the familiar "Lamella" truss, take advantage of the high compressive strength (parallel to grain) of short lengths of lumber to distribute roof loads evenly over the entire structure. Generally of a continuous, barrel-vault form, these are sometimes provided with tie-rods to take the thrust at haunches. They are suitable for many types of conditions.

Standard trusses, like in principle to trusses of steel, are often fabricated of wood. Types most commonly used in factory construction are shown on this page; others are also used for special

cases. Their development and use have been considerably increased and made more practicable by the development of special timber connectors. Standardized details for connector-joined trusses are available for spans up to 200 ft.

Mill construction, familiar to most designers, makes use of the flooring material itself—heavy planking—to add strength and stiffness to the structural frame. Its principles and methods of design are covered in standard handbooks. Chief drawback is the requirement of heavy posts at frequent intervals, which renders it unsuitable for many manufacturing areas. However, for areas which do not require large clear spans, mill construction is suitable.

Timber connectors provide added strength at bolted joints, and thus permit the use of framing members (columns, beams, truss members, etc.) made up of multiple timbers separated by spacer blocks, as well as strengthening simple structural joints. The advantage of multiple "spaced" members is that they combine great strength with minimum weight. Use of connectors for simple joints makes it possible to apply engineering design data accumulated in recent years (development of means for measuring strength, holding power, etc., of nailed joints has not been universally recognized in the U. S.).

Connectors serve to increase the bearing area of wood-to-wood or wood-to-

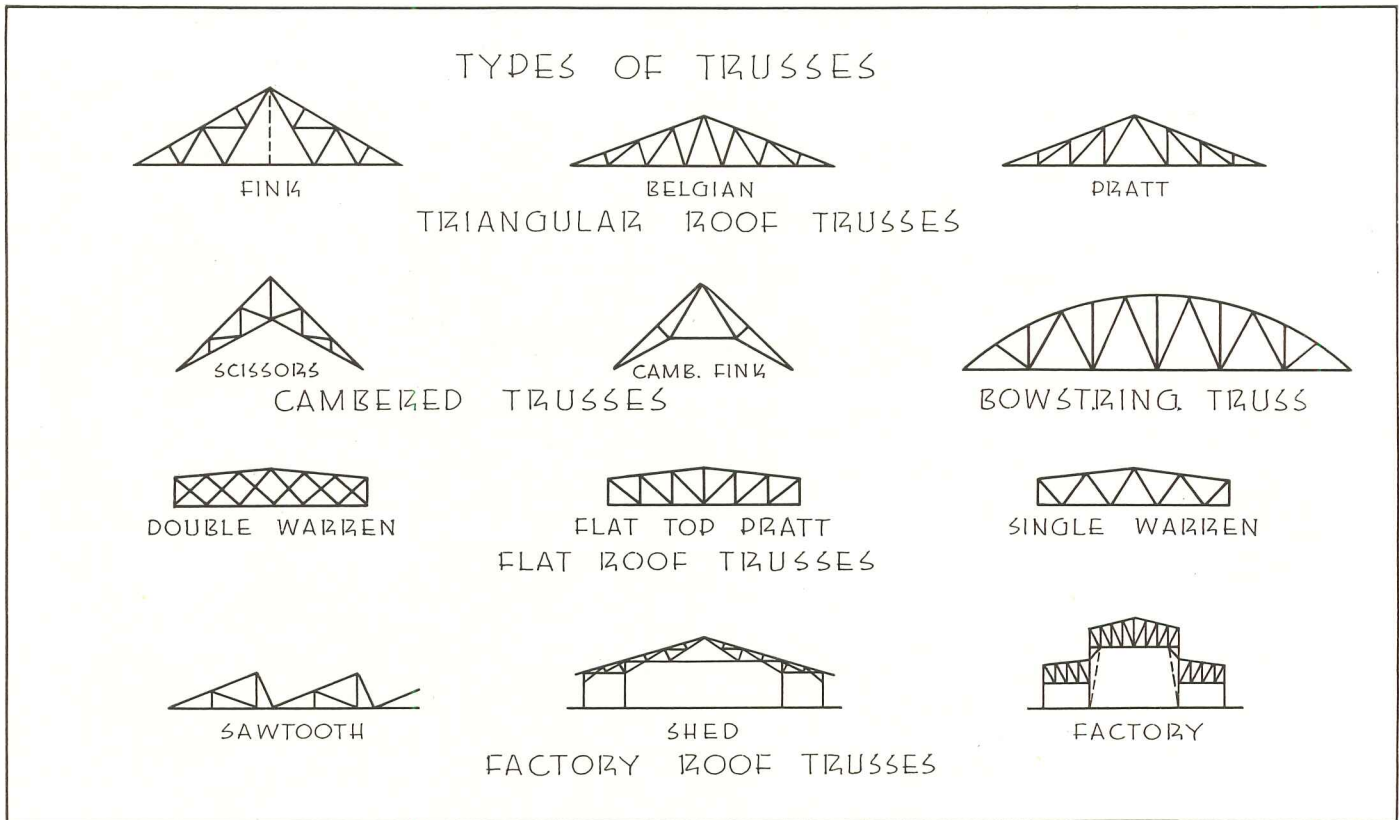

Wood Factory Construction: 1—TYPES AVAILABLE

metal joints. They can serve in any form of timber construction where load is transmitted from one timber to another or from a timber to metal. Types of connectors fall into three main classes: *toothed connectors*, provided with teeth, spikes or corrugations, often forced into position by pressure; *rings*, toothed or plain; and *disks* or short, wide dowels—the latter two usually placed in position in precut grooves or holes.

Connectors are held in place by bolting the members together. Design of connector-joints is an engineering process for which simple design methods have been standardized (see bibliography). Connectors are available in cadmium or galvanized steel, and in non-ferrous materials.

Fire Safety. Properly constructed and protected timber structures are little, if any, more subject to fire damage than other types of structures. The usual practice of equipping a timber-framed plant with sprinklers, and if the plant is large or isolated, of providing sufficient fire-fighting equipment, is not a requirement substantially in excess of needs for other types of construction. Usually the product manufactured is more combustible than the building, and requires these protective measures whatever the structural system may be.

Framing timbers will withstand fire, so far as collapse of structural members is concerned, for relatively long exposures. The surface of the timber chars, but its heart continues to carry substantial loads. Surfacing materials, such as plywood, are more subject to destruction by fire, and are preferably protected by fire-retarding paints—usually containing borax—or other treatment. Local codes should be consulted in this respect.

BIBLIOGRAPHY

This bibliography contains only items published by the National Lumber Manufacturers' Association and its affiliates. In addition, factual reports and design data are obtainable from the Forest Products Laboratory, U. S. Dept. of Agriculture, Madison, Wis., and from the National Bureau of Standards, U. S. Dept. of Commerce, Washington, D. C. Orders for publications of the latter bureau should be sent directly to the Superintendent of Documents, U. S. Government Printing Office, Washington, D. C. Orders for items below may be sent to the National Lumber Manufacturers' Association, 1337 Connecticut Ave., Washington, D. C. Items are free unless price is noted.

Modern Timber Roof Trusses. 12 pp. illus. Timber-connector trusses.

Wood Trusses. 48 pp. Technical data on mechanics of timber construction for 9 common types of trusses. (Supp. No. 5 to "Wood Structural Design Data," see below.) Price, 15s.

Engineering in Timber. 24 pp. Picture catalog with discussions.

Manual of Timber Connector Construction. 16 pp. Safe-load tables, etc., for all types of connectors (supplement No. 6 to "Wood Struct. Design Data.")

Typical Lumber Designs. 8 pp. Standardized truss designs, etc., with quantities and materials lists.

Designing Timber Connector Structures. 24 pp. Principles of connector designing.

Factory Sash Plans. Folder on factory sash of cypress.

Douglas Fir Use Book. 212 pp. Technical reference and design data book for architects, engineers, designers. Price, \$1.

Bolted Joints of Douglas Fir. Includes safe load tables (supp. No. 1 to "Douglas Fir Use Book.")

Working Strength of Nails, Spikes, Drift Bolts and Wood Screws in West Coast Woods. (Supp. No. 2 to "Douglas Fir Use Book.")

Strength of Lag Screws in Douglas Fir. With safe load tables (supp. No. 3 to "Douglas Fir Use Book.")

Bearing Strength of Wood at Angles to the Grain, Hankinson formula. (Supp. No. 4 to "Douglas Fir Use Book.")

Southern Pine Manual of Standard Wood Construction. 200 pp. Pocket size technical manual. Price, \$1.

Wood Structural Design Data. 300 pp. Basic technical information on all types of structural design in all types of wood. Price, \$1.25.

Working Stresses for Structural Lumber. 4 pp. Allowable working stresses and formulae for all types of woods (supp. No. 1 to "Wood Struct. Design Data.")

Bolted Wood Joints. 4 pp. Safe loads on common bolts and bolted timber joints (supp. No. 2 to "Wood Struct. Design Data.")

Maximum Spans for Joists and Rafters. 16 pp. Max. allowable spans, etc. (supp. No. 3 to "Wood Struct. Design Data.") Price, 10c.

Wood Columns—Safe Loads. 24 pp. Tables and graphs, for both solid and spaced (connector-joined) columns (supp. No. 4 to "Wood Struct. Design Data.") Price, 10c.

Stud Walls—Safe Axial Loads. 8 pp. Data on strength of stud walls for from 7 to 10 ft. studs, sizes 2-x-4 to 2-x-8 (supp. No. 7 to "Wood Struct. Design Data.") Price 5c.

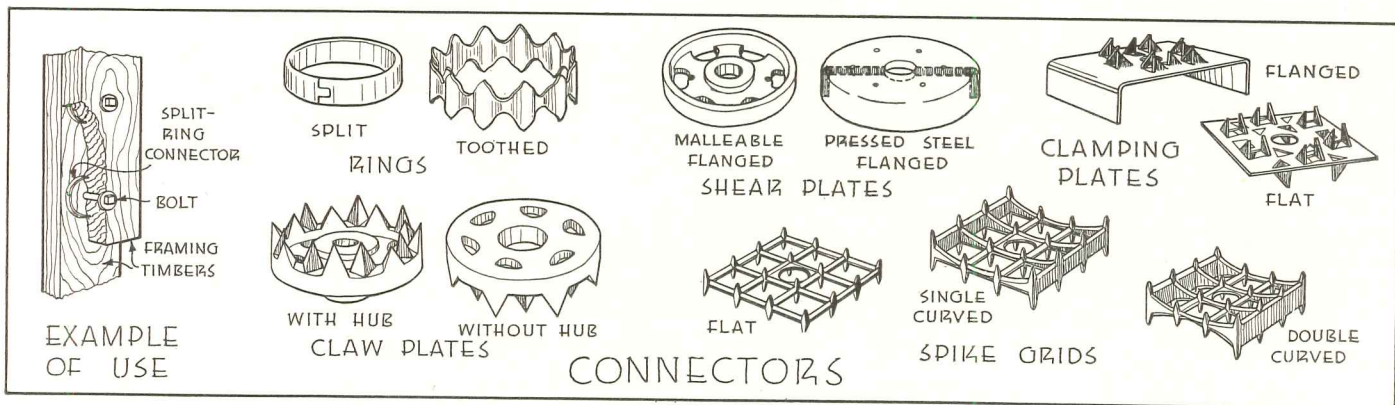

Wood Factory Construction: 2—FORMULAE, STRESSES

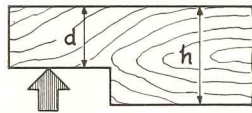

$$V = \frac{2bd^2H}{3h} \text{ in which.}$$

- V = Maximum end reaction
- H = Maximum permitted horizontal shear stress
- b = Breadth of joist
- d = Height of joist above notch
- h = Total depth of joist

ABOVE, formula for beams notched at bearing points. RIGHT, formula for compression on surfaces inclined to grain.

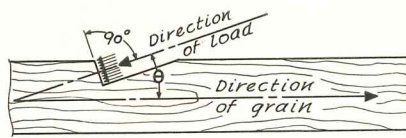

$$n = \frac{cq}{c \sin^2 \theta + q \cos^2 \theta} \text{ in which:}$$

- n = Allowable unit stress on inclined surface
- c = unit stress (compression) parallel to grain
- q = unit stress (compression) perpendicular to grain
- θ = angle in degrees between direction of load and direction of grain

if checking exceeds limits.

Bearing surfaces, less than 6 in. long (including washers, where length of bearing equals washer diameter) may be computed for compression stresses perpendicular to grain increased as follows:

Bearing length	1/2 in.	1 in.	1 1/2 in.	2 in.	3 in.	4 in.
Factor	1.85	1.60	1.45	1.30	1.15	1.10

For other exceptions, consult the Association.

COLUMNS

More complete data on column design will be given in subsequent Time-Saver Standards, or may be obtained from the Association.

Short columns are those whose length does not exceed 11 times their least diameter. Intermediate columns are those between 11 and "K" times as long as their least dimension (see formulae). Long columns are those more than "K" times their least dimension. Spaced col-

umns have two or more members separated at ends and middle points, and joined by metal connectors.

SOLID COLUMN

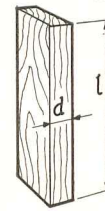

- $\frac{l}{d}$ should not exceed 50
- l = total unsupported length (inches)
- d = dimension of least side (inches)

SPACED COLUMN Condition "a"

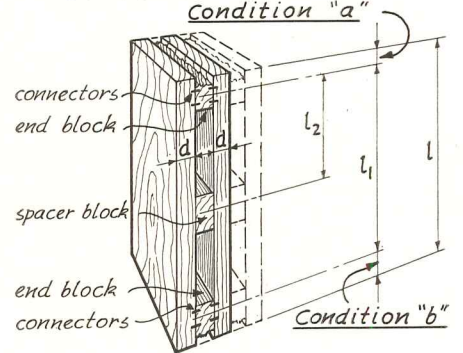

For each individual member: $\frac{l}{d}$ should not exceed 80 nor should $\frac{l_2}{d} \times 1.25$ exceed 50

Condition "a" = connector within $\frac{l_2}{20}$ from column end
 Condition "b" = connector from $\frac{l_2}{20}$ to $\frac{l_1}{10}$ from column end

COLUMN FORMULAE

SHORT COLUMNS:

$$\frac{P}{A} = c, \text{ in which:}$$

- P = total load (lbs)
- A = actual cross sectional area in square inches
- c = allowable unit stress (lbs./in²) in compression parallel to grain

INTERMEDIATE COLUMNS:

$$\frac{P}{A} = c \left[1 - \frac{1}{2} \left(\frac{l}{Kd} \right)^4 \right], \text{ in which:}$$

- $K = \frac{\pi}{2} \sqrt{\frac{E}{6c}} = 0.64 \sqrt{\frac{E}{c}}$, at which:
- $\frac{P}{A} = \frac{2c}{3}$ and.
- E = modulus of elasticity
- K = minimum value of $\frac{l}{d}$ at which column will behave as a long column.

LONG COLUMNS:

$$\frac{P}{A} = \frac{\pi^2 E}{36 \left(\frac{l}{d} \right)^2} = \frac{0.274 E}{\left(\frac{l}{d} \right)^2}$$

WORKING STRESSES — STRUCTURAL LUMBER — COLUMNS, COMPRESSION MEMBERS*

For long-continued or permanent loads: See text for additional data.

Stress-grades, Species	Commercial Name	Allowable unit stresses in compression parallel to grain (columns) (c) in pounds per square inch of net cross-sectional area for ratios of length-to-least dimension (l/d) equaling									
		Short Columns 1 1/2 ft or less	l/d 14	l/d 17	l/d 20	l/d 23	l/d 26	l/d 30	l/d 35	l/d 40	l/d 50
1200#c WHITE ASH 1000#c WHITE ASH 900#c WHITE ASH	1200#c White Ash 1000#c White Ash 900#c White Ash	1200 1000 900	1142 966 876	1074 926 847	959 859 798	777 753 722	608	457	336	257	164
800#c WESTERN RED CEDAR	Structural	800	762	716	638	619	405	304	223	170	109
1200#c TIDEWATER RED CYPRESS 1000#c TIDEWATER RED CYPRESS	1200#c Tidewater Red Cypress 1000#c Tidewater Red Cypress	1200 1000	1110 947	1003 885	822 780	622	486	365	268	206	132
1200#c SOUTHERN CYPRESS 1000#c SOUTHERN CYPRESS	1200#c Southern Cypress 1000#c Southern Cypress	1200 1000	1110 947	1003 885	822 780	622	486	365	268	206	132
1300#c DENSE DOUGLAS FIR (COAST REGION) 1200#c CLOSE-GRAINED DOUGLAS FIR (COAST REGION) 1100#c DOUGLAS FIR (COAST REGION) 880#c DOUGLAS FIR (COAST REGION)	Dense Select Structural Select Structural No. 1 Timbers No. 1 Dimension	1300 1200 1100 880	1235 1148 1060 860	1158 1088 1015 837	1030 986 937 796	899 827 811 705	649	487	358	274	175
1466#c DENSE DOUGLAS FIR (INLAND EMPIRE) 1175#c CLOSE-GRAINED DOUGLAS FIR (INLAND EMPIRE) 1050#c DOUGLAS FIR (INLAND EMPIRE)	Select Structural Structural Common Structural	1466 1175 1050	1373 1120 1011	1263 1057 955	1080 947 886	829 776 765	649	487	358	274	175
700#c EASTERN HEMLOCK 720#c WEST COAST HEMLOCK	Select Structural No. 1 Dimension	700 720	678 706	653 698	611 660	554	446	335	246	188	121
1100#c OAK, RED AND WHITE 1000#c OAK, RED AND WHITE 900#c OAK, RED AND WHITE	1100#c Oak, Red and White 1000#c Oak, Red and White 900#c Oak, Red and White	1100 1000 900	1055 966 876	1003 922 847	914 859 798	774 753 722	608	457	336	257	164
1450#c DENSE LONGLEAF SOUTHERN PINE 1300#c DENSE LONGLEAF SOUTHERN PINE 1200#c DENSE LONGLEAF SOUTHERN PINE 1000#c DENSE LONGLEAF SOUTHERN PINE	Select Structural Prime Structural Merchantable Structural Structural Sa, Edge & Sound No. 1 Structural	1450 1300 1200 1000	1360 1235 1148 970	1255 1158 1098 935	1076 1030 986 876	822 829 827 783	649	487	358	274	175
1450#c DENSE SHORTLEAF SOUTHERN PINE 1300#c DENSE SHORTLEAF SOUTHERN PINE 1200#c DENSE SHORTLEAF SOUTHERN PINE 1000#c DENSE SHORTLEAF SOUTHERN PINE	Dense Select Structural Dense Structural Dense Str. Sa, Edge & Sound Dense No. 1 Structural	1450 1300 1200 1000	1360 1235 1148 970	1255 1158 1098 935	1076 1030 986 876	822 829 827 783	649	487	358	274	175
1200#c CLOSE-GRAINED REDWOOD 1100#c CLOSE-GRAINED REDWOOD 1000#c CLOSE-GRAINED REDWOOD	1200#c Close-Grained Redwood 1100#c Close-Grained Redwood 1000#c Close-Grained Redwood	1200 1100 1000	1110 1031 947	1003 948 885	822 812 780	622	486	365	268	206	132

*For stresses other than compression parallel to grain, see reverse.

Wood Factory Construction: 2—FORMULAE, STRESSES

WORKING STRESSES — STRUCTURAL LUMBER — BEAMS, STRINGERS, JOISTS, PLANKS

For long-continued or permanent loads. See text for additional data.

Stress-grades, Species	Commercial Name	Allowable Unit Stresses in Pounds Per Square Inch (a)							
		Tension (b) & Extreme Fibre in Bending	Max. Horizontal Shear	Compression Perpendicular to Grain	Modulus of Elasticity				
1800#f WHITE ASH 1600#f WHITE ASH 1400#f WHITE ASH 1200#f WHITE ASH	1800#f White Ash 1600#f White Ash 1400#f White Ash 1200#f White Ash	1800 1600 1400 1200	120 120 120 100	} 500	1500000				
1000#f WESTERN RED CEDAR	Structural	1000	100			200	1000000		
1400#f TIDEWATER RED CYPRESS 1100#f TIDEWATER RED CYPRESS	1400#f Tidewater Red Cypress 1100#f Tidewater Red Cypress	1400 1100	120 100			} 300	1200000		
1400#f SOUTHERN CYPRESS 1100#f SOUTHERN CYPRESS	1400#f Southern Cypress 1100#f Southern Cypress	1400 1100	120 100					300	1200000
1800#f DENSE DOUGLAS FIR (COAST REGION) 1600#f CLOSE-GRAINED DOUGLAS FIR (COAST REGION) 1200#f DOUGLAS FIR (COAST REGION) 900#f DOUGLAS FIR (COAST REGION)	Dense Select Structural Select Structural 1200#f Framing and Joist 900#f Framing and Joist	1800 1600 1200 900	120 100 100 100	} 380 345 325 325	} 1600000				
1800#f DENSE DOUGLAS FIR (INLAND EMPIRE) 1600#f CLOSE-GRAINED DOUGLAS FIR (INLAND EMPIRE) 1200#f DOUGLAS FIR (INLAND EMPIRE)	Select Structural Structural Common Structural	1800 1600 1200	120 85 80			380 335 315	1600000 } 1500000		
1100#f EASTERN HEMLOCK 1000#f EASTERN HEMLOCK 900#f EASTERN HEMLOCK 800#f EASTERN HEMLOCK	Select Structural 1000 SG Eastern Hemlock 900 SG Eastern Hemlock 800 SG Eastern Hemlock	1100 1000 900 800	70 52 52 52			} 300	1100000		
1040#f WEST COAST HEMLOCK	No. 1 Dimension	1040(c)	100					300	1400000
1800#f OAK, RED AND WHITE 1600#f OAK, RED AND WHITE 1400#f OAK, RED AND WHITE 1200#f OAK, RED AND WHITE	1800#f Oak, Red and White 1600#f Oak, Red and White 1400#f Oak, Red and White 1200#f Oak, Red and White	1800 1600 1400 1200	120 120 120 100	} 500	1500000				
1000#f NORWAY PINE 900#f NORWAY PINE 800#f NORWAY PINE	1000 SG Norway Pine 900 SG Norway Pine 800 SG Norway Pine	1000 900 800	64 64 64					300	1200000
2000#f DENSE LONGLEAF SOUTHERN PINE 1800#f DENSE LONGLEAF SOUTHERN PINE 1600#f DENSE LONGLEAF SOUTHERN PINE 1600#f DENSE LONGLEAF SOUTHERN PINE 1400#f DENSE LONGLEAF SOUTHERN PINE 1400#f DENSE LONGLEAF SOUTHERN PINE 1400#f DENSE LONGLEAF SOUTHERN PINE 1050#f DENSE LONGLEAF SOUTHERN PINE	Select Structural Prime Structural Merchantable Structural Structural Sq. Edge & Sound No. 1 Structural No. 1 L. L. Dimension No. 2 L. L.—1050f Dimension	2000 1800 1600 1600 1400 1400 1400 1050	100 100 100 100 100 100 100 100			} 380	1600000		
2000#f DENSE SHORTLEAF SOUTHERN PINE 1800#f DENSE SHORTLEAF SOUTHERN PINE 1600#f DENSE SHORTLEAF SOUTHERN PINE 1400#f DENSE SHORTLEAF SOUTHERN PINE 1400#f DENSE SHORTLEAF SOUTHERN PINE 1200#f SHORTLEAF SOUTHERN PINE 1050#f DENSE SHORTLEAF SOUTHERN PINE 900#f SHORTLEAF SOUTHERN PINE	Dense Select Structural Dense Structural Dense Str. Sq. Edge & Sound Dense No. 1 Structural No. 1 Dense Dimension No. 1 Dimension No. 2 Dense—1050f Dimension No. 2 Medium Grain—900f Dim.	2000 1800 1600 1400 1400 1400 1200 1050 900	100 100 100 100 100 100 100 100					380	1600000
1600#f CLOSE-GRAINED REDWOOD 1400#f CLOSE-GRAINED REDWOOD 1200#f CLOSE-GRAINED REDWOOD	1600#f Close-Grained Redwood Dense Select All-Ht. Redwood Select All-Heart Redwood	1600 1400 1200	80 80 70	} 267	1200000				
1200#f EASTERN SPRUCE 1100#f EASTERN SPRUCE 1000#f EASTERN SPRUCE	1200#f Eastern Spruce 1100#f Eastern Spruce 1000#f Eastern Spruce	1200 1100 1000	90 80 80					} 250	1200000

(a) For stresses in compression parallel to grain, see reverse.
 (b) Tension parallel to grain only.
 (c) With slope of grain not more than 1 to 10.

FACTORY CONSTRUCTION: A. R. P. DESIGN

Data contained herein are from various American and British publications, the principal sources being "Blackouts," and "Protective Construction, Structures Series, Bulletin No. 1," both published by the Division of State and Local Cooperation, Office for Emergency Management.

PROTECTION FROM BOMBS

Suggestions are based on the assumption that complete protection of the building against direct hits is impractical; protection against bomb fragments, splintered glass, debris, etc., can be achieved.

New plants should be framed construction; wall-bearing structures will not withstand bombing. Curtain walls and roof should be at least sufficiently strong to prevent penetration by light incendiary bombs. Protection comparable to that afforded by a 5-in.-thick reinforced concrete roof slab is sufficient for this purpose. If the entire plant is not so constructed, protection is desirable at least at key points: power stations, boiler houses, stations for workers who must remain on duty to operate essential machinery.

Masonry walls of brick, cinder block, etc., provide satisfactory protection only if confined to heights of not more than 12 ft. above grade, and if at least 13 in. thick. Reinforcement is highly desirable.

Brittle materials which would disintegrate into missile-like fragments should be eliminated as far as possible.

Glass requires provisions to prevent fragments from injuring men, machines or products. Methods are described under "Blackouts," below. Likewise, materials such as *plaster* should be eliminated or protected, so that, when it dis-

integrates under bombing, particles cannot get into machinery and disrupt operation.

Entrances and exits may require erection of baffle walls. These should be of thicknesses shown in the accompanying table, "Protection Against Bomb Fragments." They are preferably located at a distance from the building wall equal to the total exit width, and are from 2 to 3 times as long as the exit width. If intended to act also as light-baffles, they must be 5 times as long as exit width.

Framing and enclosure: In design of buildings to resist bombing effects, vulnerability of wall-bearing structures narrows choice of structures to one where the frame is constructed of steel or reinforced concrete. If connections of girders and columns are made strong, and if framing is continuous, extensive collapse is very unlikely.

Industrial structures with light roof covering should be designed, if possible, so that destruction of one main member, such as a roof girder or column, will not overload adjacent members to the extent that spreading collapse results. Connections of roof members to columns should be designed strongly enough to permit considerable distortion of columns, or lateral displacement of bases, without failure.

Wall panels of one- or two-story industrial steel- or concrete-framed buildings should not be bonded to columns or other structural elements.

Existing plants. Such provisions listed under "New Plants" as are applicable are highly desirable. In addition, walls which are not reasonably proof against bomb fragments may be protected by sandbag barriers, or supplementary walls (see table). Sandbag barriers 4 ft. thick at the base, 2 ft. thick at top, and

8 ft. high, will protect lower portions of walls against splinters. If possible, approx. 2 in. should be left between the sandbag wall and the building wall. Outer face of the sandbag wall should have a slope of 1:4.

Communications must be maintained for emergency service. Duplication of lines and location of telephones in shelter and first-aid stations are necessary for adequate control.

Utilities buildings require special precautions to insure uninterrupted plant oper-

PROTECTION AGAINST DELAYED-ACTION BOMBS

Size of bomb	3,400-lb. reinf. concrete Total depth of crater (ft.)	Proof Thick- ness (ft.)
100 lb.	1.2	2.4
300 lb.	2.0	4.0
500 lb.	2.6	5.2
1,100 lb.	4.3	8.6
2,000 lb.	5.8	11.6

Note: Proof thickness and crater depth based on continuously supported slabs. Data are not final; tests now in progress should give more exact data for subsequent publication.

PROTECTION AGAINST BOMB FRAGMENTS

For 500-lb. bomb at distance of 50 ft.	
Type of material	Thickness required
Mild steel plate	1 1/2 in.
Brick wall 1	13 1/2 in.
Plain concrete	15 in.
Reinforced concrete 2	12 in.
Spec. reinf. concrete 3	10 in.
Sand, earth revetment	30 in.
Gravel, stone, between wood or corrugated iron sheathing	24 in.

1. May be somewhat reduced. 2. Normal reinforcement. 3. Reinf. for high local diagonal tension.

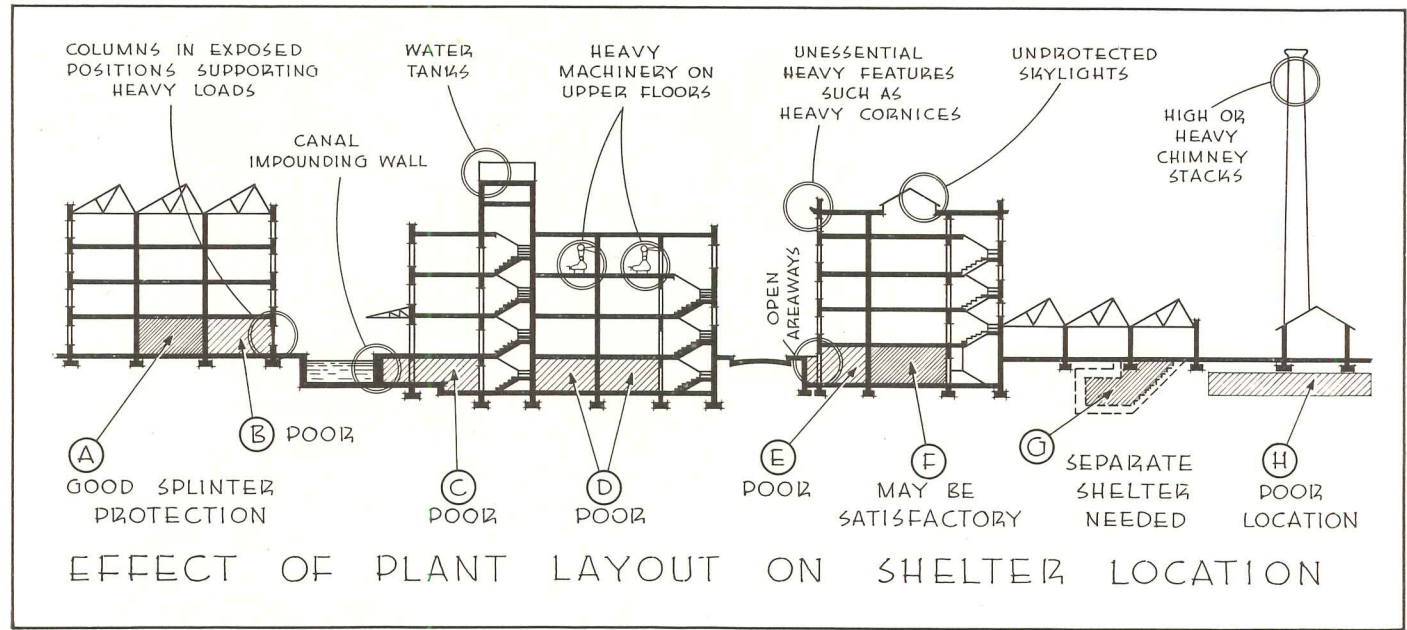

Selection of shelter location: bear in mind hazards from existing conditions. Structural items circled are potential hazards which make indicated locations unsafe. Location "F" might be made safe if skylight were adequately protected. At "H," use of Venturi stack would lessen danger

FACTORY CONSTRUCTION: A. R. P. DESIGN

ation. One of the best methods is to have all sources of power interconnected. All vital control apparatus and conductors should be duplicated and should be so arranged that if one unit is destroyed, its duplicate could be put immediately into service.

Statements made previously relative to new and existing plants are applicable to power-plant structures. Walls should be thick enough to give protection against bomb fragments. Large windows may be partly closed with sandbags, or preferably with concrete or brick walls. Individual power units may be given protection by sandbag or brick protective walls around each unit. Provision should be made for adequate fire-fighting equipment, and for concrete fire walls or barriers to prevent such spread of fire as might occur with oil-filled transformers and switches.

Outdoor stations should be arranged so that damaged sections may be "sectionalized" or cut off quickly and service restored over undamaged sections. Wide separation of vulnerable units, such as transformers, will decrease liability to, and extent of, damage. Outdoor substations preferably should be of latticed angle iron construction, and transformers and oil switches may be protected by walls of concrete, brick, or sandbags as previously described.

Outside flow line equipment, including penstocks, oil piping, gas pipes, and other vital appurtenances of hydroelectric plants should be placed underground or in strongly constructed con-

crete ducts or tunnels, wherever this is feasible and financially practical.

Steam plants are probably more liable to injury than hydroelectric plants. Protection may be obtained, in general, by putting concrete or sandbag walls about boiler rooms and isolating as much as possible the various plant elements.

FIRE FIGHTING

Incendiary bombs may be expected to pierce light roofs and burn on the top floor. It is most important to take all possible steps to reduce fire risk by having adequate portable fire-fighting equipment in addition to permanent installations which may be damaged. Reserve supplies of water in static tanks or other reservoirs should be provided. Stocks of inflammable material should be reduced as far as possible.

BLACKOUTS, SPLINTER PROTECTION

If secured directly to the glass, blackout materials should extend over the sash frame in order to prevent light leaks at edges. If hung loosely, the obscuring material should overlap all edges of the opening from 1 to 2 ft. Any device used should be extremely simple, easily handled and installed, so any person, even if unaccustomed to such work, can install the device without difficulty.

Suitable materials for application directly to glass include: paint, opaque pa-

pers, cardboard, opaque textiles, patented films, etc. In this connection, if glass is expected to be destroyed again and again, such methods as painting have little value; but curtains, removable panels, etc., may remain in useful condition though glass is destroyed.

Materials applied directly to glass have value in reducing danger from flying glass, provided they are secured continuously to the glass with a cement not soluble in water, and have sufficient tensile strength. Heavy papers and fabrics, tapes, etc., may be applied in patterns which leave clear rectangles not over 6 in. in their greatest dimension, if they are intended as splinter protection only.

Glass-protecting screens may be of light metal or wood frames covered with any of the building boards, plywood, thin metal, roofing felt; or with combinations of wire netting and fabric, etc. Skylight and window frames may be fitted with clips to support them. Such screens should be hung flexibly, on the inside of the opening, so that they may "give" with the blast and help dissipate its force.

Screens to protect openings from bomb fragments are, however, hung outside openings. Devices such as "blast mattresses" of steel wool, matted chicken wire or similar material, encased in strong, heavy cloth, may be hung outside openings. These have to overlap on all sides from 2 to 2½ ft. or more. Steel shutters, plank battens, etc., are also satisfactory.

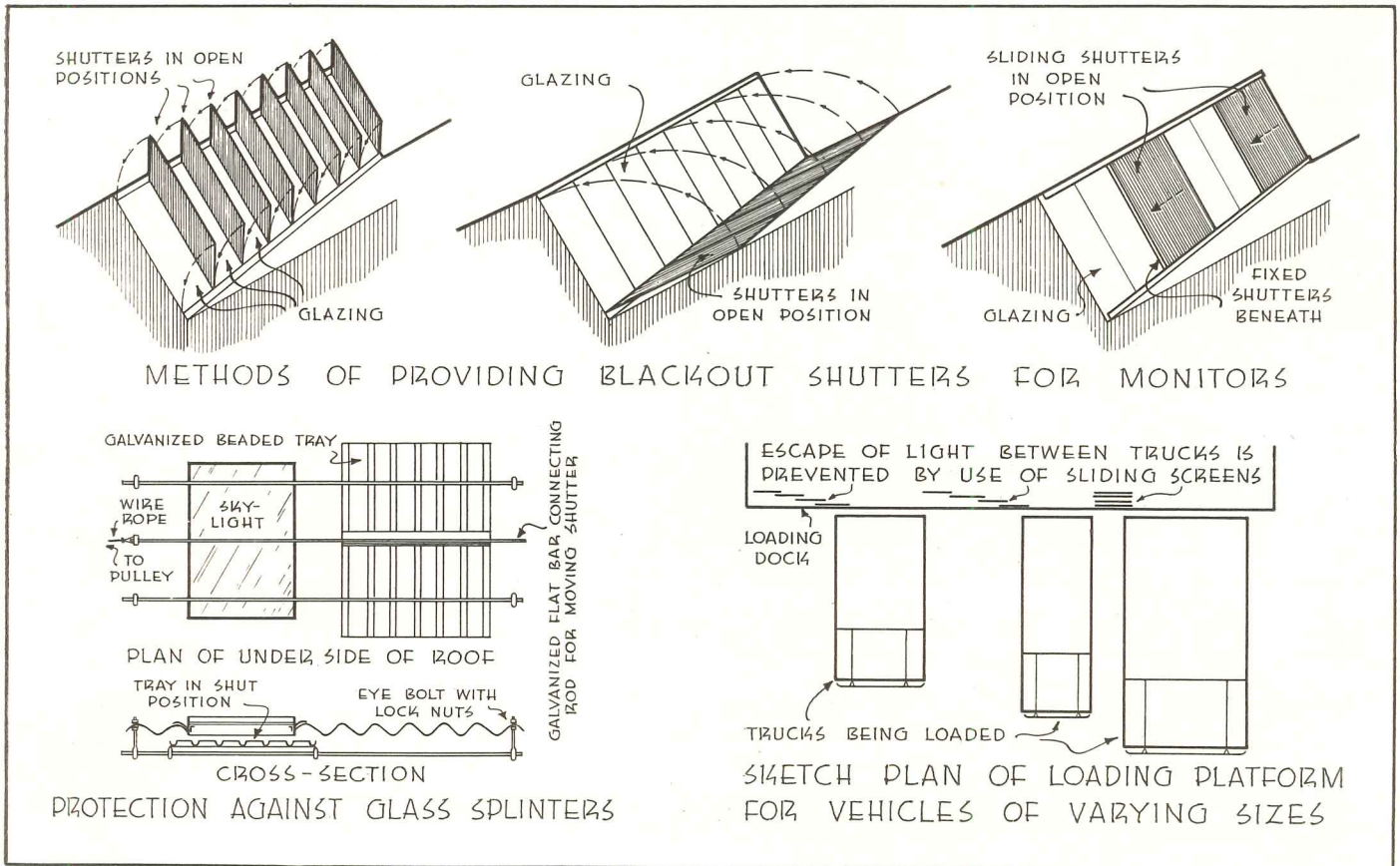

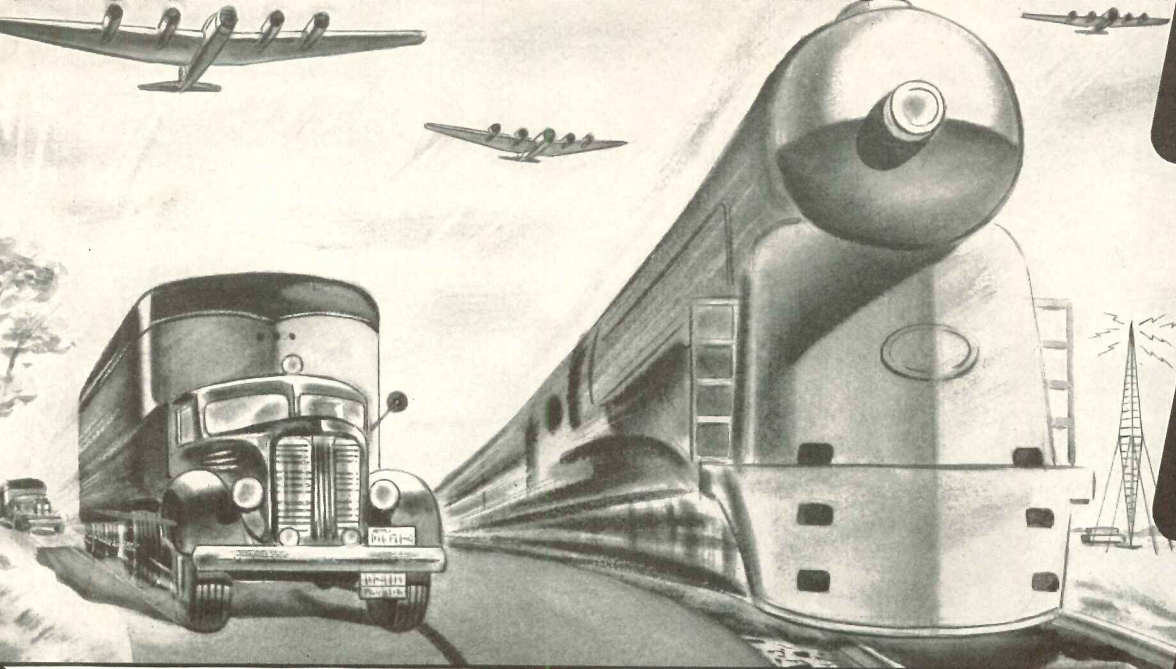

**IMPORTANT
JOSAM PRODUCTS
FOR DEFENSE
CONSTRUCTION**

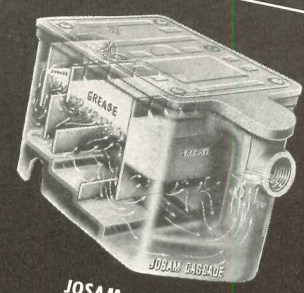

**JOSAM GREASE
INTERCEPTOR**

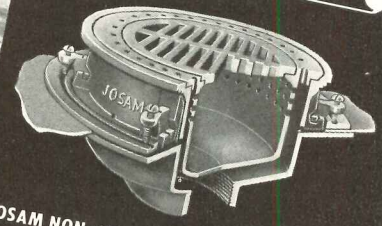

JOSAM NON-CLOG TRIPLE DRAINAGE DRAINS



JOSAM GAS-OIL INTERCEPTOR

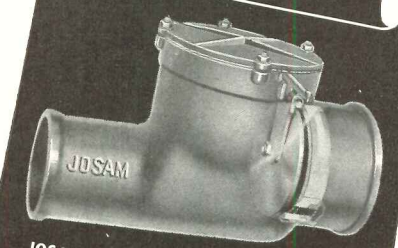

JOSAM OPEN SEAT BACKWATER VALVE

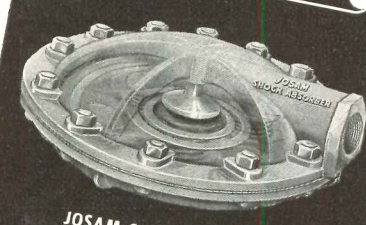

**JOSAM SHOCK ABSORBER
TO ELIMINATE WATER HAMMER**



JOSAM ROOF DRAINS



IS PREPARED FOR ALL-OUT WARTIME SERVICE



With America at war, *speed* in deliveries is vital . . . imperative. Realizing this, JOSAM has geared up its organization, increased its facilities, speeded up its production, to do its part to supply America promptly and adequately with the plumbing products essential to our country's gigantic wartime program.

To this end, JOSAM pledges all of its resources, facilities and determination to cooperate to the fullest extent in meeting the Government's wartime requirements.

We have the plant—a complete factory and foundry, modern and fully equipped for high speed production on a large scale. The main plant at Michigan City, Indiana, plus subsidiary plants in the South and on the West Coast, supplemented by emergency warehouse stocks at strategic points throughout the country, provides for unusually prompt service wherever and whenever needed.

We have the personnel—business heads and executives capable of meeting the present urgent demands . . . skilled men on the production line who know their jobs and are doing their utmost to meet greatly speeded up schedules.

We have the products—a complete line of exclusive plumbing specialties covering the drainage requirements of every type of building that may be needed for war or defense projects. Every effort is being made to maintain substantial stocks for immediate shipment. Due to the part that JOSAM is playing in the present emergency, we are assured of ample supplies of necessary raw materials to handle all priority requirements without delay.

But *speed* isn't the whole story. With quick delivery we also guarantee quality products, intelligent service and every possible help within our power.

If you haven't ordered the Pocket Manual of Specifications for Plumbing Drainage Systems and Roughing-in Measurements, do it today. It's FREE!

JOSAM MANUFACTURING CO.

Main Sales and Engineering Offices, EMPIRE BUILDING, CLEVELAND, OHIO
 Factory and Foundry, Michigan City, Indiana Representatives in all Principal Cities
 WEST COAST MANUFACTURERS AND DISTRIBUTORS
JOSAM-PACIFIC COMPANY, 765 Folsom St., San Francisco, Cal.

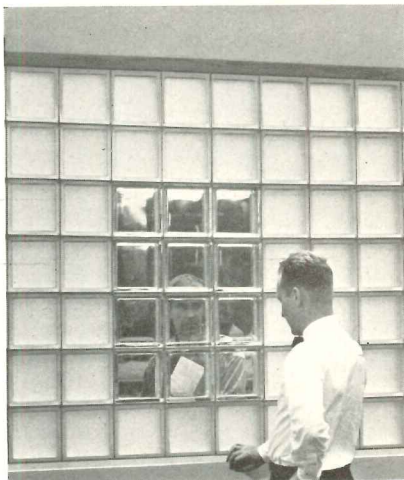

Figure 1

Transparent Glass Building Block

DEVELOPMENT of a transparent glass building block that is said to afford almost window-like vision has been announced. The new block is designed for specific needs where some outside vision is desired through panels of non-transparent glass blocks, and permits general vision of large objects or movements. With this visual quality, the manufacturer claims, is combined the insulation property of the usual glass block, which is approximately that of a solid masonry wall 8 in. thick. Several courses of transparent block, or a few blocks, may be combined with a conventional glass block pattern. Pittsburgh Corning Corp., Pittsburgh, Pa. (See figure 1.)

Furnace for Defense Housing

ANNOUNCED as suitable for defense housing is a new coal burning warm air furnace with a rated capacity of 80,000 BTU's per hour and 6,000 CMF at $\frac{1}{4}$ in. static pressure. The unit has an insulated baked enamel gray cabinet and requires 26 by 26 in. Designed in accordance with the specifications of the Procurement Division of the U. S. Treasury Department, and is said to meet requirements of FWA, USHA, PBA and FHA. Fitzgibbons Boiler Company, Inc., 101 Park Ave., New York City.

Lime Meets Federal Specifications

A NEW TYPE of hydrated lime is said to be the first lime to meet the federal specifications written to eliminate troubles with finish coats that have been reported in post offices, schools, office buildings, etc. during recent years. An epidemic of falling plaster, on jobs 5 to 10 years old, led to investigation, and the conclusion was that unhydrated magnesia in the finishing lime caused the trouble. Outstanding property of the new lime, so far as builders and plasterers are concerned, is the fact that it eliminates the necessity of soaking but can be given 15 to 20 minutes to absorb water, then mixed and used. United States Gypsum Company, Chicago, Ill.

Modulating Steam Control System

IMPROVEMENT is announced in a patented modulating steam control system for installation on one- or two-pipe steam heating systems in schools, office and apartment buildings, industrial plants, etc. The model operates in conjunction with a three-point control thermostat, which, the manufacturer claims, consistently maintains inside temperatures within a narrow range of plus or minus one degree F. The manufacturer claims fuel savings of 15 to 30 per cent over manual operation, as well as over ordinary thermostatic operation. Maintenance cost is said to be practically nil. Major Controls Sales Division, 12 Norfolk St., Cambridge, Mass.

Studless Partition for Plaster Walls

IN THE INTEREST of conserving steel and of low cost, a studless two-in. solid plaster and metal lath partition has been designed, with metal or wood base. The manufacturer says steel channel studs are eliminated, reducing the amount of steel required for partition work by 40 per cent and the cost of the partition, ready for plastering, by approximately 20 per cent. Penn Metal Company Inc., 40 Central St., Boston, Mass.

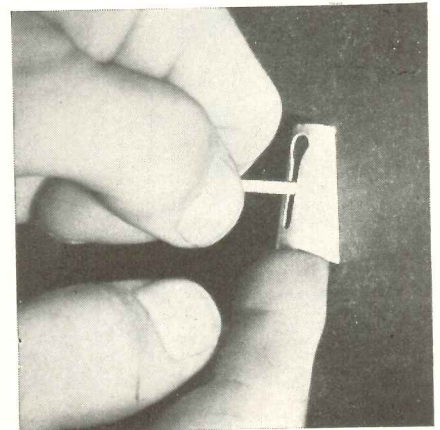

Figure 2

Fasteners Secure Siding to Sheathing

FASTENERS for securing asbestos siding to sheathing, recently developed, are said to give these advantages: More windproof wall, better looking job, low cost of wall construction, elimination of furring strips, cut in nailing time, reduction of shingle breakage. The fasteners are slipped over the tips of the siding nails which protrude through the inner face of the sheathing. The nail is pulled home by forcing the wedge-shaped fastener in place with pliers, and an outward pull on the nail head causes the fastener to tighten its hold. United States Gypsum Company, Chicago, Ill. (See figure 2.)

Precision Control of Concrete

PRECISION control of concrete manufacture is a new type of engineering service now being offered. The service includes equipping the concrete plant with the control method, supplying a concrete technician to supervise control and make necessary tests, and furnishing with every batch of concrete a certificate which guarantees the water-cement ratio and weights of all ingredients and certifies the 28-day strength to be expected. Scientific Concrete Service Corp., McLachlen Building, Washington, D. C.

(continued on page 88)



Gold Bond BUILDS PRIVACY WITHOUT PARTITIONS

IN many progressive business offices workers are enjoying a new quiet and seclusion—without being cramped into stuffy little cubicles. The new Chicago office of the Charles Bruning Company is an example. This well-known manufacturer of reproduction papers and equipment wanted his office employees to have the privacy that makes work more pleasant and more efficient, yet hesitated to cut spacious rooms into a maze of small cubby-holes. Gold Bond Sound Control experts helped solve this “quiet-without-partitions” problem with Acoustimetal ceilings.

All over America, Gold Bond acoustical research and service is solving new sound control problems in every field from army arsenals to hospital corridors. The Gold Bond Acoustical Distributor in your community has all this experience at his disposal to help you find the right answer

on your next job . . . to help select the best materials . . . to supervise the installation . . . and to guarantee results.

Extra Protection

You build better with Gold Bond, because National Gypsum's laboratories have developed more than 150 finer wall and ceiling products—including plaster, lime, wallboard, lath, wall paint, insulation and sound control materials. 300 representatives—every one a trained building specialist—and 10,000 Gold Bond dealers are ready to supply you with materials from 21 strategically-located plants. And when you specify Gold Bond exclusively, you get the added protection of having *one* dependable manufacturer responsible for *all* wall and ceiling materials. Refer to Sweet's, and write for specifications on all Gold Bond sound control products. National Gypsum Company, Buffalo, New York.



Architect, Victor L. Charn, Installation by Fisher-Busse Co., Chicago

GOLD BOND ACOUSTIMETAL in the ceilings of the general offices of the Charles Bruning Company, Chicago, Illinois. Acoustimetal has an AMA coefficient of .99 at 512 cycles, meets engineers specifications for indirect lighting, is fireproof, durable, verminproof, replaceable, easily cleaned—the finest sound control material on the market today.



Producing Units at:

NEW YORK, N. Y. . . . CLARENCE CENTER, N. Y. . . . AKRON, N. Y. . . . PORTSMOUTH, N. H. . . . NATIONAL CITY, MICH. . . . FORT DODGE, IA.
 MEDICINE LODGE, KAN. . . . ROTAN, TEX. . . . SAVANNAH, GA. . . . LUCKEY, O. . . . BELLEFONTE, PA. . . . YORK, PA. . . . ORANDA, VA.
 SALTVILLE, VA. . . . NILES, O. . . . MOBILE, ALA. . . . NEWBURGH, N. Y. . . . ALEXANDRIA, IND. . . . DUBUQUE, IA. . . . DOVER, N. J.

ARCHITECTURE

INFORMATIVE ADVERTISING IS

All those things architects have been asking of advertisers (via these pages) during the last year are not just whimsies of professional pomp—they are honest reactions born of an actual need. Summed up, they indicate that what architects really want is a type of advertising that helps them do a better job.

An informative advertisement gives the reader data upon which he can evaluate the product in terms of his own requirements. Whether it is addressed to housewife, aviator, industrialist or engineer, it is fundamentally the same—differing only in the point of view it assumes, the language it speaks. Good advertising follows the same basic principles for every field.

The sort of advertising that architects seek is not unreasonable—or new. It is currently sponsored by successful advertisers in many fields, as a cursory inspection of almost any periodical will reveal. To manufacturers of building products, they offer valuable ideas which might well be applied to their own merchandising problems.

—RONALD ALLWORK

No sooner said than done is the caption for these two illustrations which prove, incidentally, that what architects wish for in the way of advertising isn't at all a pipe dream. Frederick H. Kock suggested on these pages last month that he would like to see manufacturers advertise a simplified chart of product application. Several pages away, in the same issue, Inco was answering the request.

8 STRONG, RUSTLESS Metals
...each with a DIFFERENT PLUS!

Extra hardness, heat-resistance, non-magnetism, fire-resistance and other qualities available in Inco Nickel Alloys.

Alloy	Approximate Composition	Average Mechanical Properties			
		Tensile Strength (psi)	Yield Strength (psi)	Elongation (%)	Reduction of Area (%)
MONEL	68% Ni, 32% Cu	100,000	50,000	40	50
"B" MONEL	68% Ni, 32% Cu, 2% Fe	100,000	50,000	40	50
"K" MONEL	68% Ni, 32% Cu, 2% Fe, 2% Al	100,000	50,000	40	50
"RE" MONEL	68% Ni, 32% Cu, 2% Fe, 2% Al, 2% Mn	100,000	50,000	40	50
"S" MONEL	68% Ni, 32% Cu, 2% Fe, 2% Al, 2% Mn, 2% Si	100,000	50,000	40	50
NICKEL	99.9% Ni	100,000	50,000	40	50
"Z" NICKEL	99.9% Ni, 0.1% C	100,000	50,000	40	50
INCONEL	70% Ni, 30% Cr	100,000	50,000	40	50

INCO NICKEL ALLOYS
MONEL - "B" MONEL - "K" MONEL - "RE" MONEL - "S" MONEL - NICKEL - "Z" NICKEL
Inco - Dept. 100 - Dept. 100 - Dept. 100 - Dept. 100 - Dept. 100

MEETS ADVERTISING

WHAT ARCHITECTS WANT MORE OF

TECHNICAL INFORMATION that "talks the language" of the reader is an attribute of almost every good advertisement. If it gives sufficient data it performs a useful service, because it provides the reader with a sound basis for buying. The advertisement at the right recognizes the technical aspects of the housewife's job. It provides her with technical information in the form of recipes, enabling her to achieve the result promised.

Advertising like this closely parallels the type architects have asked for.

NEW MATERIALS, and new uses of old materials, are of tremendous interest to progressive designers in every field. The ad of this manufacturer also talks the language of the reader (in this case an aircraft designer) by illustrating graphically where the product might be used to accomplish a better job—and to relieve, incidentally, a critical shortage in other materials. To designers, who "think" with their pencil, one drawing is still "worth a thousand words."

ANYONE INTERESTED in purchasing a product needs information and data which will enable him to appraise its features in terms of his own particular requirements. Though these will vary with the field, such things as appearance, performance, application, and cost are important. An advertisement which answers questions like this for the buyer of industrial equipment is illustrated at the right. Doesn't it suggest an advertising pattern which many of the messages addressed to architects might follow?

NEWS IS THE MEDIUM by which everyone is kept informed of the events and developments in their particular sphere of interests. Some manufacturers, like the one whose ad is reproduced here, successfully employ the editorial type of advertisement. To be useful, however, it must have a readership value comparable to that of the editorial pages it resembles.

Architects look to their professional journals to keep them informed on current practices. News, whether it appears in an editorial or advertisement, is of vital interest.

Lady, you'll win on looks alone

All your old favorite dishes will be "beauties" — WHEN YOU JUST ADD WALNUTS

DIAMOND WALNUTS *Free*

LOW IN COST — HIGH IN FOOD VALUE

Micarta
helps build U.S. Air Supremacy

When without special design...
This heavy-duty plastic is used...
To add to the many...
To replace parts...
Micarta weighs approximately...

Westinghouse
AVIATION

WALKER-TURNER RADIAL DRILL

FOR DRILLING, ROUTING, REAMING, PROFILING

\$355

PROMPT DELIVERY to plants engaged in defense production

WALKER-TURNER MACHINE TOOLS FOR METAL, WOOD AND PLASTICS

U.S. INDUSTRIAL CHEMICALS, INC.
60 EAST 42nd ST., N. Y. BRANCHES IN ALL PRINCIPAL CITIES

U.S. CHEMICAL NEWS

Impregnated Cloth Replaces Glass in Shattered Windows

Fusel Oil Gains in Importance In Extending Butanol Supplies

Find Mixed Solvent Best For Glycerine Extraction

Impregnated Fabrics Used To Repel Windburn Ulcers

Wider Use of Fuel Oil

Properties	REFINED FUEL OIL	BUTANOL
Specific Gravity	0.81	0.81
Boiling Point	300°C	118°C
Freezing Point	-18°C	-115°C
Flash Point	100°C	35°C
Autoignition Temp.	450°C	250°C
Heat of Combustion	10,000 cal/g	10,000 cal/g
Heat of Vaporization	10,000 cal/g	10,000 cal/g
Heat of Solution	10,000 cal/g	10,000 cal/g
Heat of Dilution	10,000 cal/g	10,000 cal/g
Heat of Mixing	10,000 cal/g	10,000 cal/g
Heat of Reaction	10,000 cal/g	10,000 cal/g
Heat of Formation	10,000 cal/g	10,000 cal/g
Heat of Polymerization	10,000 cal/g	10,000 cal/g
Heat of Oxidation	10,000 cal/g	10,000 cal/g
Heat of Reduction	10,000 cal/g	10,000 cal/g
Heat of Neutralization	10,000 cal/g	10,000 cal/g
Heat of Hydrolysis	10,000 cal/g	10,000 cal/g
Heat of Saponification	10,000 cal/g	10,000 cal/g
Heat of Esterification	10,000 cal/g	10,000 cal/g
Heat of Amidation	10,000 cal/g	10,000 cal/g
Heat of Acylation	10,000 cal/g	10,000 cal/g
Heat of Nitration	10,000 cal/g	10,000 cal/g
Heat of Sulfonation	10,000 cal/g	10,000 cal/g
Heat of Phenylation	10,000 cal/g	10,000 cal/g
Heat of Halogenation	10,000 cal/g	10,000 cal/g
Heat of Chlorination	10,000 cal/g	10,000 cal/g
Heat of Bromination	10,000 cal/g	10,000 cal/g
Heat of Iodination	10,000 cal/g	10,000 cal/g
Heat of Fluorination	10,000 cal/g	10,000 cal/g
Heat of Azidation	10,000 cal/g	10,000 cal/g
Heat of Nitrosation	10,000 cal/g	10,000 cal/g
Heat of Sulfonation	10,000 cal/g	10,000 cal/g
Heat of Phenylation	10,000 cal/g	10,000 cal/g
Heat of Halogenation	10,000 cal/g	10,000 cal/g
Heat of Chlorination	10,000 cal/g	10,000 cal/g
Heat of Bromination	10,000 cal/g	10,000 cal/g
Heat of Iodination	10,000 cal/g	10,000 cal/g
Heat of Fluorination	10,000 cal/g	10,000 cal/g
Heat of Azidation	10,000 cal/g	10,000 cal/g
Heat of Nitrosation	10,000 cal/g	10,000 cal/g

Books on

WAR TIME BUILDING AND AIR DEFENSE

The books listed below are especially recommended for architects and engineers who wish to specialize in solving the many technical problems pertaining to war-time construction and the protection of the civilian population.

1. **PLANNED A. R. P.**, by Tecton, Architects. 138 pages — extensively illustrated with photographs, diagrams and maps — Price \$2.50.
2. **CIVIL AIR DEFENSE**, by Lt. Col. Augustin M. Prentiss, U.S.A. A 334-page illustrated treatise on the protection of the civil population against air attack — Price \$2.75.
3. **BOMBS AND BOMBING**, by Willy Ley. 124 pages — A brisk, popular survey explaining how the several kinds of bombs are made and their probable effect on buildings of different types and on air raid shelters — Price \$1.25.
4. **WARTIME BUILDING CONSTRUCTION** — 1st American Edition 1942 — This book reviews the general principles of wartime building. There is a special section devoted to the construction of single-story buildings to provide living quarters for armed forces, also for temporary office accommodation and hospitals; a section devoted to the methods used for the application of reinforced concrete construction — Price \$4.00.
5. **CIVIL DEFENSE**, by C. W. Glover. Over 900 pages — fully illustrated, revised and enlarged. The most complete and authoritative book on the subject. This volume discusses in detail the precautions necessary for the protection of the civilian population — Price \$16.50.
6. **AIR RAID PRECAUTIONS—1941**. An authoritative book compiled by various British experts based on actual experiences during air raids. It contains the best available scientific data pertaining to shelters, emergency watch towers, respiratory equipment, etc.—Price \$3.00.
7. **AIR RAID DEFENSE**, by Dr. Curt Wachtel, 1941. The purpose of this book is to convey the many and varied aspects of Air Raid Defense. All measures and methods discussed or recommended in this book are practiced somewhere in Europe — Price \$3.50.

Check on the order form the numbers of the books you want, and mail to Architectural Record with your remittance — no extra charge for postage.

ARCHITECTURAL RECORD, 119 West 40th Street, New York, N. Y.

Please send 1. 2. 3. 4. 5. 6. 7.

Check or money order for..... is enclosed.

Name

Address

City and State.....

AR 1-42

TIME-TESTED 51 YEARS; LABORATORY TESTED EVERY DAY

H & H SWITCHES

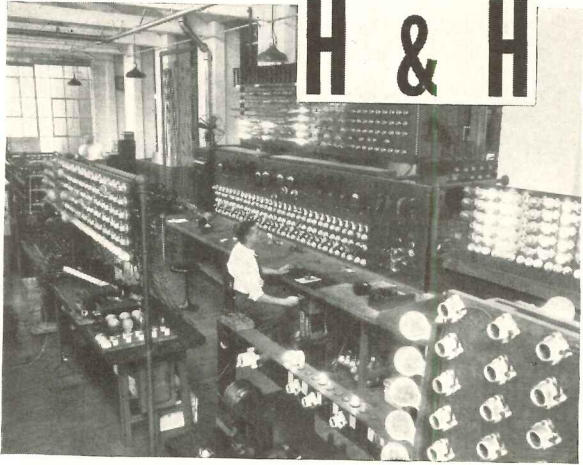

Engineer making insulation or dielectric tests. 250 V. Snap Switches tested at 900 V., A.C.; 600 V. Switches tested at 1500 V., A.C.

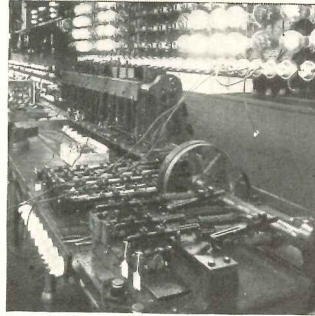

Life-testing machines for Tumbler Switches.

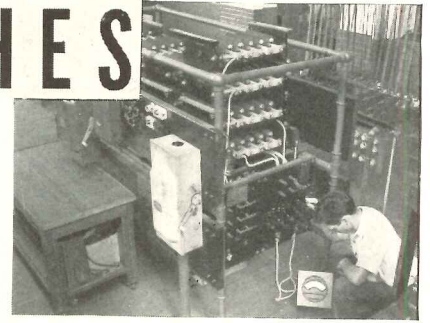

Non-inductive resistance load equipment. For testing higher-rated switches up to 600 Amps., 250 V.

FOR PRE-DETERMINED PERFORMANCE

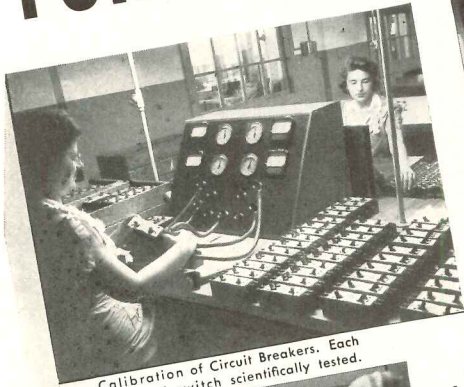

Calibration of Circuit Breakers. Each individual switch scientifically tested.



Synthetic load equipment for testing the load limit of T-rated Switches.



Left: Electric oven for temperature tests. Right: Calibrating first production samples of Circuit Breakers.

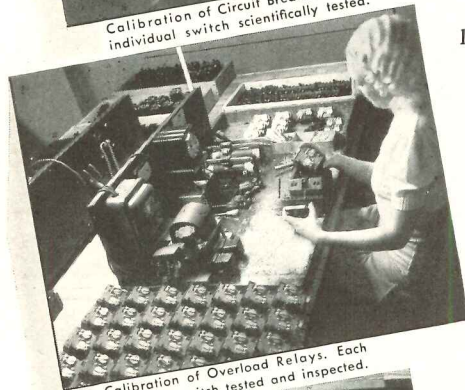

Calibration of Overload Relays. Each individual switch tested and inspected.

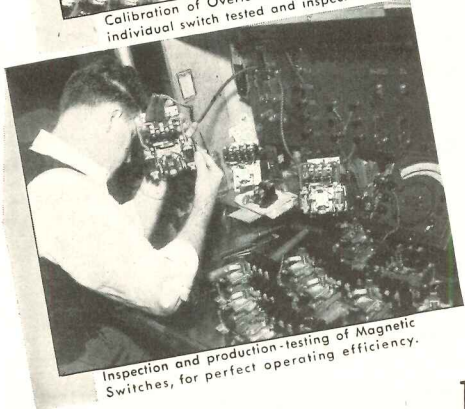

Inspection and production-testing of Magnetic Switches, for perfect operating efficiency.

If you look for **RELIABILITY** in Switches, look for it first in the records of testing machines! Here, Reliability is measured in terms of load limits, cycles of operation with load, mechanical life-tests.

Reputation is built on the tests of *USE*. But these tests of the Laboratory are still more severe; more exacting than any Underwriters or Federal requirements.

Just as the *past* reputation of H & H Switches is a known quantity to you, here its *future* is a known quantity too, predictable from our test findings. Your complete satisfaction with every switch is pre-established by overload, heating, insulation and mechanical life-tests.

H & H Switches, you see, are not just sent out into the world with our best wishes for a long life. Their long life is **PRE-DETERMINED**, as your confidence in them is assured-in-advance, *in the laboratory.*



Testing-machines for endurance and life tests, with and without load; Tumbler and Snap Switches.

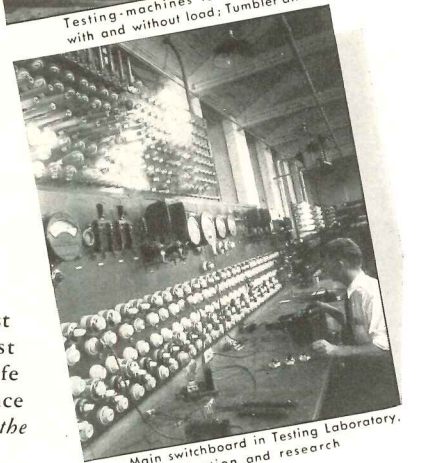

Main switchboard in Testing Laboratory, for production and research tests under overload.

HART & HEGEMAN DIVISION
THE ARROW-HART & HEGEMAN ELECTRIC COMPANY, HARTFORD, CONN.

(continued from page 82)



Substitute for Copper Flashing

THE OPM ruling that no sheet copper may be used for flashing in building construction led to development of a new through-wall flashing, now announced. The flashing comprises a ferrous metal core completely enclosed in a baked-on coal-tar pitch enamel. The product is also available in regular sheet form for use as

counterflashing, gutters, down spouts, gravel stops, termite shields, ducts, etc. Cheney Company, Ardmore, Pa.

New Water Service Medium

MORE THAN 150 cities, it is announced, have now formally approved a product introduced over a year ago as a water service pipe. The manufacturers claim that the new

product offers the endurance and corrosion-resistance of lead but is superior in strength, ductility and creep rate. Installation is said to be simple and the cost no greater than that of any other acceptable water service medium. It is said the product is available for relatively prompt delivery. American Smelting & Refining Co., 120 Broadway, New York.

New Lining Felt for Linoleum

ADVANTAGES of both dry and saturated felts are attributed to a new semi-saturated lining felt. The product is said to have unusually high resistance to splitting caused by seasonal subfloor movements. The fibres are partially impregnated with asphalt, according to the manufacturer, so that linoleum paste can penetrate only deep enough to assure a maximum bond, helping to save paste. Other advantages claimed are flexibility, excellent resistance to disintegration and bunching, and ease of handling. Armstrong Cork Co., Lancaster, Pa.

Deodorized Paint

A DEODORIZED PAINT is now being offered which, the manufacturer claims, can be applied without discomfort with windows closed. Available in flat, eggshell and gloss finishes and may be used on plaster, wallboard, wood, cement, brick or metal. Coverage 700 sq. ft. to the gallon. Dries in 12 to 15 hrs. Washable. American-Marietta Co., 43 E. Ohio St., Chicago, Ill.

Low-Cost Cooking Unit

DESIGNED FOR, and available only for, low-cost housing projects is a new electric roaster-hotplate-cabinet unit that will do the basic cooking job for a small family electrically and economically. The unit is not available to individuals but may be obtained in quantity orders at an extremely low price. The manufacturer states that a 15-gallon electric

(continued on page 90)



**A standard of living
you helped to create**

OUT of the estimated 24 million bathtubs in the world, about 18 million are right here in the United States — one example of the world's highest standard of living.

Architects have contributed much to this standard by designing attractive, *livable* homes. Here at ARMCO we are proud to have helped you by our part in the development of *Formed Iron Plumbing Ware* — made possible by ARMCO Ingot Iron — the pioneer enameling iron, now used by most leading manufacturers

for bathtubs, lavatories and sinks.

Because *Formed Iron Fixtures* are designed to be light without loss of strength, they conserve iron for Defense — are being used increasingly in Defense housing. They are easy to install and their high-luster porcelain enamel is easy to clean.

If you do not have adequate data on *Formed Iron Plumbing Ware*, just write and we'll be glad to see that you get it. Write to The American Rolling Mill Company, 101 Curtis Street, Middletown, Ohio.



TRANE

QUENCHING OIL COOLER

Does Double Duty

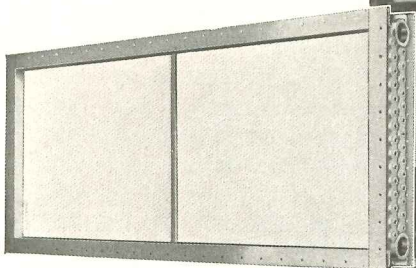
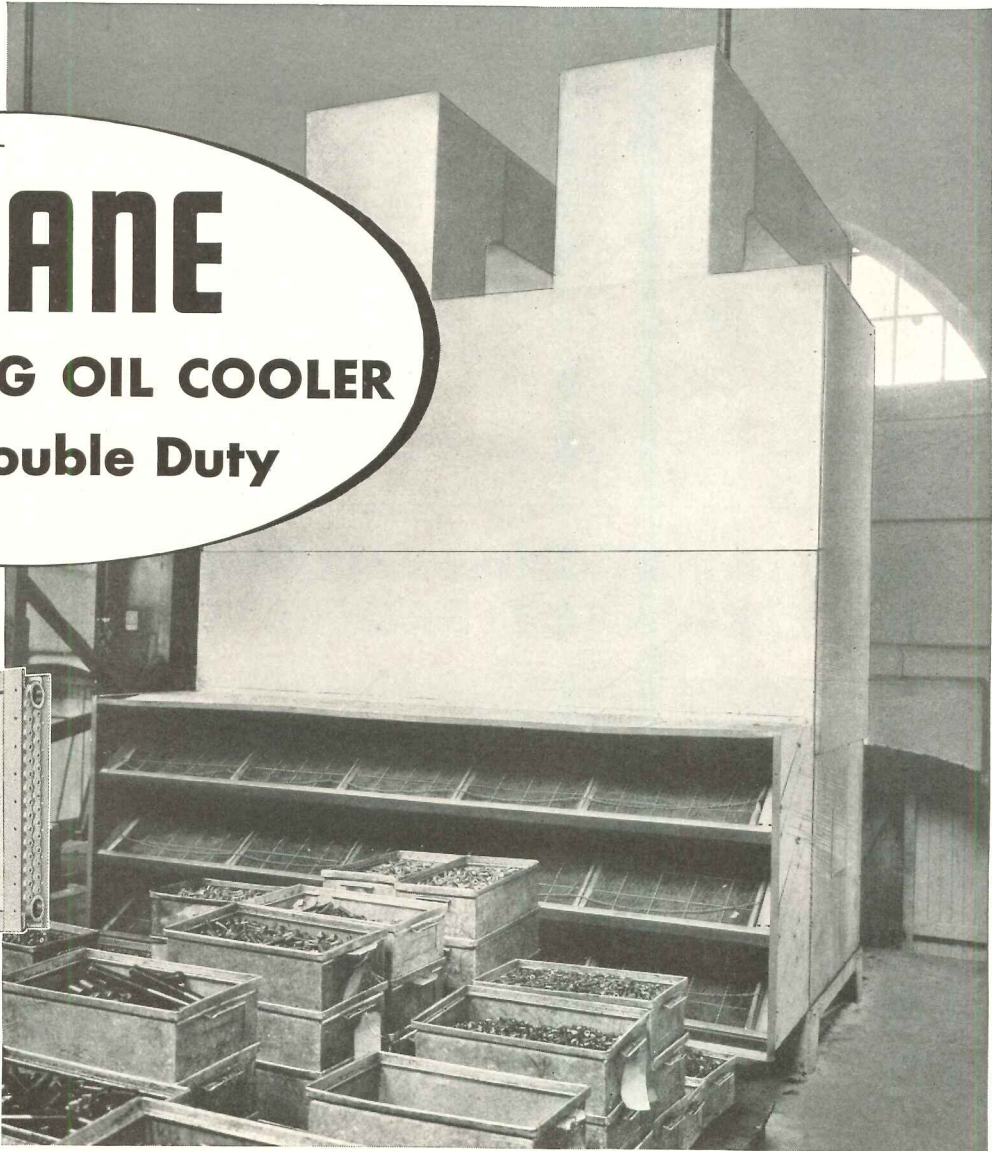

Trane Heating Coil

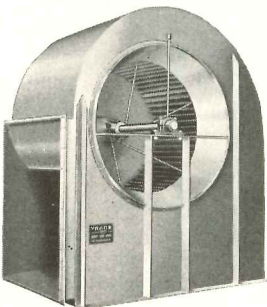

Trane Blower Fan

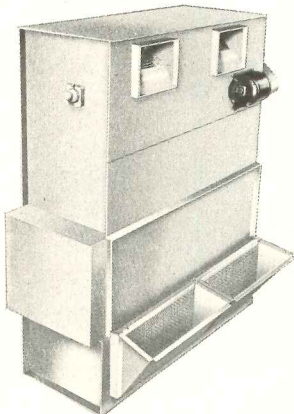

Trane Evaporative Cooler

**Cools 2000 pounds of bolts and screws per hour;
warms factory with salvaged heat**

THE Trane Quenching Oil Cooler in this national defense plant serves a dual purpose—and an economical one! The unit is used by an important manufacturer of bolts and screws for cooling quenching oil and for heating the plant with the air from this quenching oil cooler. The bolts and screws come from a gas furnace at a temperature of around 1600° to 1700° and are dumped into oil vats at the rate of 2000 lbs. per hour. The Trane Quenching Oil Cooler cools this oil and maintains it at 140° while, at the same time, salvaging the heat for warming the factory.

This is an example of the multitude of industrial process applications possible with Trane's complete line of heating, cooling and air conditioning equipment. Trane Climate Changers,

Heating and Cooling Coils, Evaporative Condensers, Evaporative Coolers, Turbo-Vacuum Compressors and other products are playing an important role in the vital operations of defense plants throughout the country.

In many cases, like the one cited here, it is possible to "kill two birds with one stone" and select equipment which will both assist a plant production process and provide healthful comfort as well.

"Production For Defense" is the Trane watchword. To that end there are, from coast to coast, 85 Trane offices prepared to serve you. A Trane representative near you is ready to discuss your industrial heating and air conditioning problems.

TRANE



TORONTO, ONTARIO

THE TRANE COMPANY, LA CROSSE, WISCONSIN • Also TRANE COMPANY OF CANADA, LTD.,

MANUFACTURERS OF HEATING • COOLING • AIR-CONDITIONING EQUIPMENT • 85 BRANCH OFFICES

(continued from page 88)

water heater may be added to the combination on future orders. Installation requires less than 4 sq. ft. and no special wiring is required. General Electric Company, Bridgeport, Conn.

Heavy Duty Cooking Equipment

FOR EXPANSION of large-kitchen facilities, two additions are announced

to a line of heavy-duty gas cooking equipment. These units are designed as auxiliary to batteries already in operation, to provide extra top cooking capacity. Four models in two styles are offered: two fry-top and two grate-top units, for use with 35-in. and 42-in. deep ranges. American Stove Company, 4301 Perkins Ave., Cleveland, Ohio.

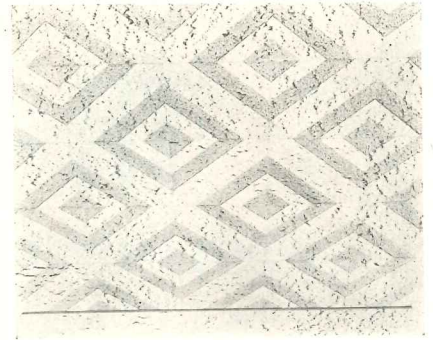
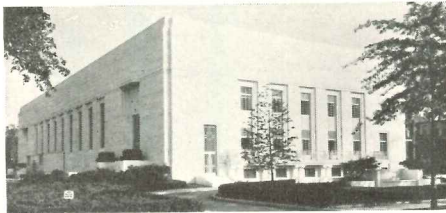

Figure 3

FAMOUS NATIONAL BUILDINGS HOLTZER-CABOT PROTECTED



Above, Department of Commerce Bldg., Washington, D. C. Equipped with HOLTZER-CABOT Fire Alarm, Watchmen's Patrol, and Other Signaling Systems.



Above, Washington District Post Office; Left, Folger Shakespeare Library, Washington, D. C. (Architect: Paul P. Cret, Phila.) Both equipped with HOLTZER-CABOT Fire Alarm and Other Signaling Systems.

Photos copyright by Harris & Ewing

The public buildings illustrated are but a few of the many in the nation's capital protected against fire and sabotage by Holtzer-Cabot Fire Alarm and Watchmen's Patrol Systems. New buildings under construction will also be Holtzer-Cabot Protected.

Government specifications for this specialized equipment demand the best. Engineering skill and reliable construction are vital.

Architects, in planning future buildings, whether public, industrial, or institutional, will find the experience of Holtzer-Cabot Sales Engineers of great help in insuring maximum, long-life protection.

The Holtzer-Cabot Electric Co.

125 AMORY STREET

BOSTON, MASS.

Branches In Principal Cities

Decorative Acoustical Ceilings

DECORATIVE effect for acoustical ceilings, in offices, restaurants, stores, etc., is achieved by one manufacturer by etching patterns on a sound-absorbent ceiling material. Architects and designers may design their own or choose from basic patterns. Units of this acoustical tile are 12 by 12 in. United States Gypsum Co., 300 W. Adams St., Chicago, Ill. (Fig. 3.)

Heating System Regulator

SUITED to multiple-occupancy buildings down to two-family apartments is a new heating system regulator which is said to provide in one instrument all the controls and switches necessary for automatic heat regulation based on outside temperature. Included are such features as a hold-fire switch, automatic cut-off and a four-position switch that is said to provide flexibility for buildings which require varied heating programs. Marsh Tritrol Company, 600 S. Michigan Ave., Chicago, Ill.

Safety Valve for Large Boilers

FOR hot water heating boilers with a gross BTU output up to 350,000 per hour is a new snap-action safety relief valve just added to a well known line. The manufacturer calls attention to the flexible, leakproof bellows in place of the usual diaphragm, and the stainless steel metal-to-metal valve that replaces the usual composition disc. McDonnell & Miller, 1310 Wrigley Building, Chicago, Ill.

school at Frostburg, Maryland, practically disaster-proof. Robert Holt Hitchins of Cumberland, architect. J. J. Bendik of Uniontown, Pa., contractor.

4 good reasons for choosing ARCHITECTURAL CONCRETE

ADAPTABILITY—concrete gives the architect wide freedom in selecting forms, shapes, textures; lends added distinction to his finest designs.

AVAILABILITY—architectural concrete requires a minimum of critical materials—aggregates, cement, water and forming material are readily available.

SPEEDY CONSTRUCTION—man-hours of labor are more precious now than ever. Rapid construction with concrete saves days and dollars.

ECONOMY—concrete saves on first cost by permitting frame and floors to be cast integrally with walls and ornament; insures lowest annual cost through decades of service.

Ask your architect or engineer about concrete. Literature upon request, or see Sweet's Catalog, Section 4/45.

PORTLAND CEMENT ASSOCIATION
Dept. 1-8, 33 W. Grand Avenue, Chicago, Ill.

A national organization to improve and extend the uses of concrete . . . through scientific research and engineering field work

Architectural Concrete

. . . combining structural and architectural functions in one firesafe, enduring material



TRENDS IN BRIEF

(continued from page 24)



Horn AUTOMATIC DOORS

When it gets right down to the problems of efficiency, of smart planning for today and the future, in new defense plants and army and navy buildings—Horn Automatic Folding Doors and Partitions are getting the call.

That's because Horn engineers come up with a solution to every problem that involves openings—no matter how large or how small—that must be closed and opened, often or occasionally.

For interior partitions or outside openings, in wood, steel, wood and steel, fire proof, glazed or unglazed, sound proof or not, for factories, plane hangars, barracks, schools, offices—Horn can supply the closure to fit the needs of the building.

Mechanical details are shown in Horn Catalogs in Sweets. Refer to them. But, each Horn installation is a separate custom-designed job. Before you get into the details of planning—either new constructions or remodeling—call the Horn representative near you—or write.

* Sorry, no pictures. Defense plant interiors are frowned upon. And besides, what's the use. Your installation probably would be different, anyway.

World's Largest Manufacturers of
Automatic Folding Doors

HORN
MANUFACTURING COMPANY
Dept. A-1 Fort Dodge, Iowa

are covered with moss and lichen, stone shells that have every appearance of being the genuine thing from outside, or boardings where perhaps a block of flats, a theater, or a church would have stood if war had not come. And so on.

While at first sight all this clamping down might appear to have in it the elements of a first-class disaster for those fifteen thousand architects and their assistants who depended on architecture for their livelihood, actually things did not turn out so badly. True there was a period in the very early days of the war when nearly everyone, from the most eminent principal to the most junior assistant, felt the uncertainty of the trend of affairs, but this mood passed as the gargantuan machinery of war got under way and it became apparent that architects were wanted, and wanted badly.

Naturally, the Government was the principal employer, and under the flags of such Ministries as Works and Buildings, Supply, Health and Home Security, besides various departments of the armed forces, many thousands of architects and assistants went to work. Among some well-known names are those of T. P. Bennett, successful London architect, specialist in flats and theaters, and now Director of Works, who is responsible for the wartime buildings of the Ministry; and Thomas Tait, architect to the Glasgow exhibition of 1938, and virile designer of many well known hospitals, flats, schools and banks, now Director of Standardization of the same Ministry.

The main bulk of the work of these Ministries is, of course, directed to the erection of those buildings which are necessary to the prosecution of the war-factories, houses and hostels for industrial and agricultural workers, food stores, temporary hospitals and camp buildings of all descriptions. A large amount of the actual executive work is carried out directly by the staff of the Ministries, but the Ministry of Works and Buildings and

also the Ministry of Supply have instituted a procedure which has been favorably received by the larger organizations of private architects. Jobs are now carried out in the offices of these architects under general guidance of the respective Ministry. The principal of the office is directly responsible for the work and he employs his own staff. An advantage attached to the scheme is, of course, that the private architects retain their organizations while the Ministries get the work done without having to extend their own staffs to enormous dimensions.

* * *

Other architects were, of course, engaged upon shelters both for local authorities and private clients, and then as the war progressed and we found it right on our doorsteps, with the Luftwaffe flying overhead dropping all the bombs it could, more work came along in the way of assessing the damage that had been done to buildings. Also the opportunity was presented of getting down to the problems of replanning; and that great subject is occupying some of the best brains in the country at this moment.

Left until last is a mention of another group of architects, who, like those thousands who have joined the armed forces, are doing a magnificent job of work, though it is well away from architecture, or even common building. I refer to those architects who were responsible for the initiation and now control that important branch of Civil Defence, the Rescue Service. In London it is the architectural staff of the London County Council who do this, and in some respects their task is about the most unenviable of them all. During the blitzes they go out with the squads (who are mostly building tradesmen, by the way) and share the common danger. Then, in between times, they have to share the common boredom of the lulls. And how hard that part of the job can be you do not know until you have tried it.

LOOK TO *Speakman* FOR QUALITY

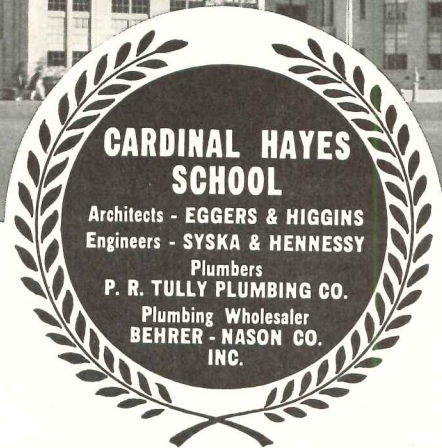

SPEAKMAN Showers and Fixtures Chosen for CARDINAL HAYES MEMORIAL SCHOOL

THE selection of Speakman Mixometer Showers, "SI-FLO" Flush Valves and other Speakman Fixtures for the new magnificent Cardinal Hayes School, Grand Concourse and 153rd Street, New York City, is typical of the high favor in which these dependable, efficient Speakman products are held.

For over 70 years the name "Speakman" has been synonymous with life-time service and economical maintenance in plumbing fixtures. As a result, you can know when you specify Speakman Showers, "SI-FLO" Flush Valves or other Speakman fixtures that you are providing your clients with products that possess these vital essentials: beauty of design; faultless operation; lasting service.

See Sweet's Catalog for additional information or write SPEAKMAN COMPANY, WILMINGTON, DELAWARE

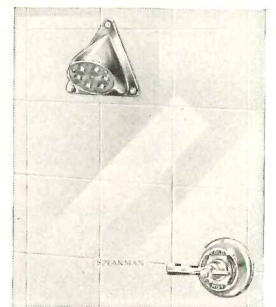

S-1110 Speakman Century Built-in Mixometer Shower with Wall Type Any-Stream Self-Cleaning Shower Head.

SPEAKMAN "SI-FLO" The Original Quiet-Operating Flush Valve

For ten years "SI-FLO" has proved its outstanding superiority through satisfactory performance in thousands of installations. Its features include:

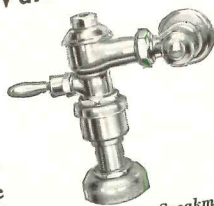

K-9000 BSP - Speakman "SI-FLO" Closet Flush Valve with Back-Syphon Preventer.

1. Quiet operation.
2. Low maintenance cost.
3. Easily and quickly repaired.
4. Low installation cost.
5. Long wearing piston.
6. Self-cleaning by-pass.
7. Adjustable connection between valve and stop.

SPEAKMAN

SHOWERS & FIXTURES

Since 1869

TIMBER DOES IT *Again!*

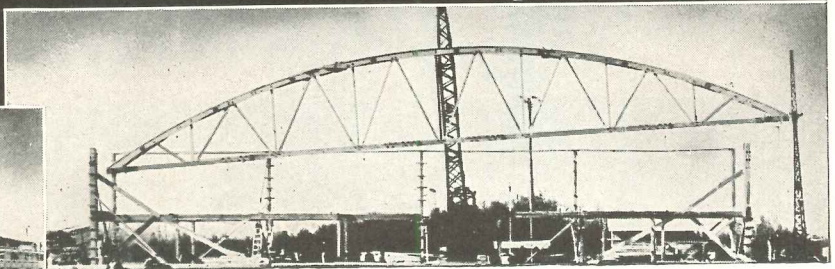
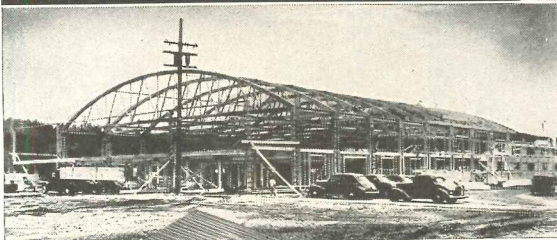

In Only 4 EIGHT-HOUR SHIFTS

THE first prefabricated, Teco connected 130' roof truss swung into place Thursday, March 13th, 3:00 P. M. All 12 were in place Monday, March 17th, 4:30 P. M., and Oregon Shipbuilding Corporation had its new mold loft building well on the way to completion.

The **TECO** CONNECTOR SYSTEM

of engineering, applied to this job by Timber Structures, Portland, Oregon, has created a wide range of design possibilities in timber construction. Mail the coupon—get this new engineering picture COMPLETELY before you—meet the need for speed with timber's new design opportunities.

TIMBER ENGINEERING COMPANY, INC.
Dept. P-1, 1337 Connecticut Avenue, Washington, D. C.

Mail Coupon
Today!

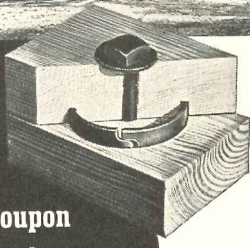

Timber Engineering Company, Inc.
Dept. P-1, 1337 Conn. Ave., Washington, D. C.
Please send us full technical information on the
TECO Connector System, including new 24-page
book "Designing Timber Connector Structures."

Individual.....
Firm.....
Street.....
City..... State.....

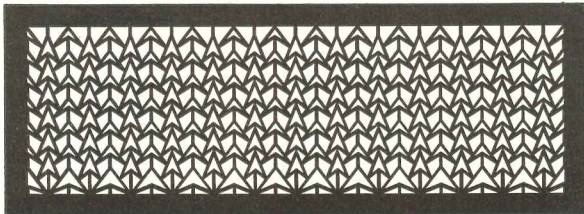

THE POPULAR FIR

One of the most frequently specified grilles among the more than one hundred designs illustrated in the Hendrick Grill Book is The Fir. With an open area of 50%, The Fir is as practical as it is pleasing.

If you buy or specify grilles, write on your letterhead for the 196 page Hendrick handbook, "Grilles."

Hendrick Manufacturing Co.

20 Dundaff Street, Carbondale, Pa.

Offices and Representatives in principal cities. See 'phone book.
Mfrs. of Mitco Open Steel Floorings, Mitco Shur-Site Treads
and Mitco Armorgrids, Hendrick Perforated Metals and Screens.

SAFE WATER

for Swimming Pools



BEGINS HERE

The responsibility for safe, sanitary pool water begins with the architect who designs the pool. You'll be better equipped to fulfill this responsibility with the help of informative, illustrated booklets offered by Wallace & Tiernan, dealing specifically with the following types of pools:

1. Outdoor Commercial Pools
2. Outdoor Municipal Pools
3. Town and Country Club Pools
4. High School Pools
5. College Pools
6. Hotel and Apartment Pools
7. "Y" and Club Pools
8. Private Estate Pools

Copies of any or all of these booklets will be sent on request. Remember, too, that the unmatched experience of Wallace & Tiernan in safeguarding swimming pool water is always "on call" to help you when the need arises.

S.P.69

"Swim in Drinking Water"

WALLACE & TIERNAN CO., INC.

Manufacturers of Chlorine and
NEWARK, NEW JERSEY



Ammonia Control Apparatus
REPRESENTED IN PRINCIPAL CITIES

An Engineer reviews 20 years experience with OIL BURNING SYSTEMS

Alfred L. Jaros, Jr., is a member of the well-known New York firm of Jaros, Baum and Bolles, Consulting Engineers. For more than a quarter of a century, this firm has acted as designing engineers for over a thousand buildings of all types. Mr. Jaros speaks here of his experience with oil heating systems:

"For over twenty years we have used oil burning systems in many types of buildings. Where Petro equipment was installed, we have found that it has lived up to its qualities of sturdiness, economy and efficiency. Particularly in the war building era ahead of us, such efficient operation and absolute dependability are essential requirements.

"I can speak highly of the Petro equipment and the Petro service organization, and my recollection is that Petro was the first oil burner we installed. This installation is still operating, and has given satisfaction to our clients and to us."

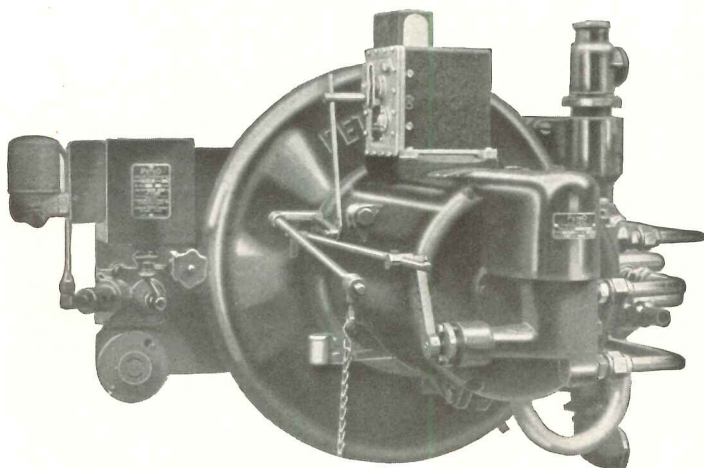

That burner installed 20 years ago has many counterparts still operating around the country. The 20 years of satisfactory performance are evidence of sound design and operating principle, and those are still basic in today's Petro burners, plus two decades of continuous scientific advance and refinement.

Today's marked professional preference for Petro equipment—its specification in so much Defense construction—and the wide-flung, isolated locations of many of these Petro installations—are, in themselves, impressive evidence of Petro's recognized dependability.

CAPACITIES: to 145 gal. per hr.—487 boiler h.p.—68,000 sq. ft. steam E.D.R.



Petro Industrial Burners for Automatic operation with preheated No. 6 oil, or with No. 5 or lighter oils, are available in eight sizes, Models W-2½ to W-9 inclusive. Each burner is a self contained assembly of motor, fan, pump, rotary cup atomizer and interlocked air and oil adjustments.

In the use of preheated No. 6 oil, the Petro Thermal Viscosity System is an integral part of a Petro installation,

insuring reliability of operation and fuel economy.

Semi-Automatic and Manually controlled Model W Burners and "Mechanical" type units are also available to meet circumstances which do not require automatic operation.

To the Architect in domestic building, Petro offers a complete line of burners for use with existing heating plants and complete oil fired boilers and winter air conditioners.

See our Exhibit, International Heating and Ventilating Exposition—Philadelphia—Jan. 26-30—Booths 265 and 266

Petro's Engineering Division will gladly answer questions. The Petro Industrial Equipment Catalog will be sent promptly on request.



PETRO

Cuts Steam Costs



PETROLEUM HEAT AND POWER COMPANY

STAMFORD

—Makers of good Oil Burning Equipment since 1903—

CONNECTICUT

SOMETHING TO TALK ABOUT

LOOK JOE, HOW THEY'VE IMPROVED THE GRAND RAPIDS INVISIBLE

BOSS, THAT'S SOMETHING, THERE'S THE BALANCE I GO FOR!



SIMPLIFIED TOP FASTENER
Easier to install. Permanent rigidity with one screw. Eliminates "play." Smoother, quieter operation.

"SPRING-FLEX" BEARING ARM
Spring steel arm adjusts automatically to different degrees of sash fit. Practically eliminates wood chatter. Always smooth, quiet, snug.

CHATTER-PROOF GUIDE BRACKET
Guide bracket opening exact diameter of balance bottom, giving close, chatter-proof fit without binding. Many other important superiorities. Send for new 1942 catalog.

Specify



the Balance that has met Every Test

WRITE FOR NEW 1942 CATALOG No. 42-SB-2

GRAND RAPIDS HARDWARE COMPANY
GRAND RAPIDS • MICHIGAN



Is your Business carrying a fever?

Check the temperature at which your place operates with those on this chart. See what can be done with proper refrigeration. Perhaps your business should be carrying a lower temperature.

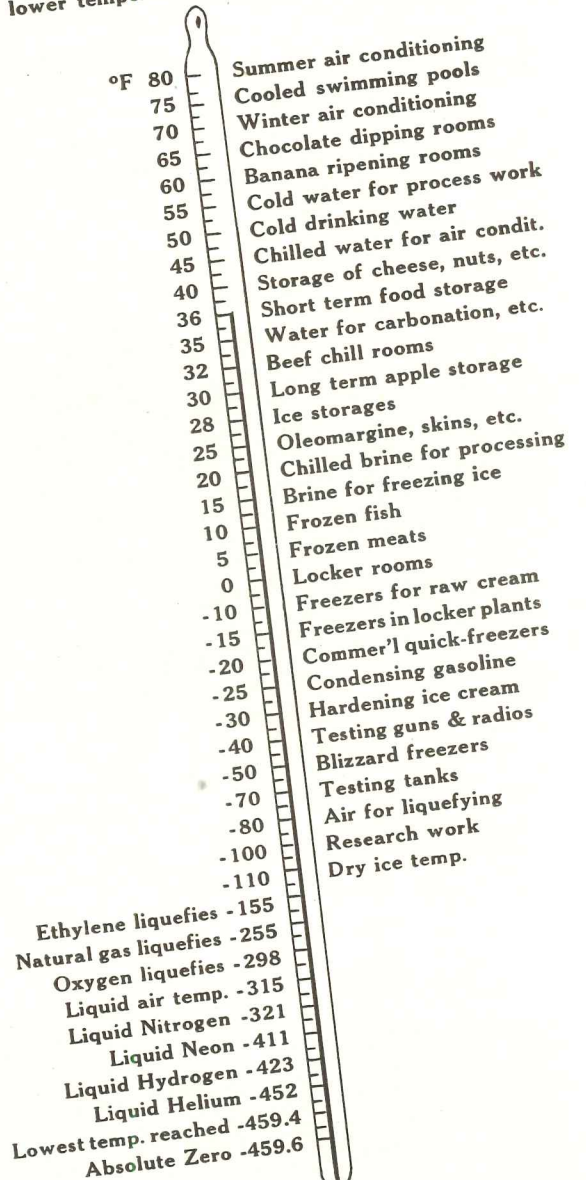

Refrigeration

Is the answer to your cooling needs.

Write Frick Co., Waynesboro, Pa.

NEW LOW-COST G-E GAS FURNACES FOR DEFENSE HOUSING

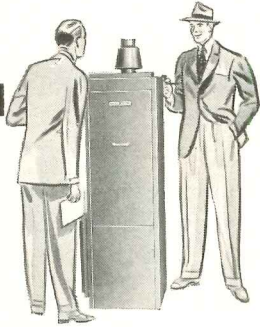

LOOK AT THESE FEATURES

- One compact unit. Smallest size occupies only 3½ square feet floor space.
- Corrosion - resistant cast iron heat transfer surface assures high transfer efficiency.
- Comes to you in one "package," factory wired and assembled for installation by any sheet metal contractor.
- Underwriters' Laboratories, Inc., approved for installation with only 2 inch wall clearance.

For defense housing and remodeling requirements, consider the General Electric series of new gas furnaces ranging from 48,000 to 96,000 Btu per hour output. These units will meet any of the heating requirements that may be encountered in defense housing projects utilizing forced warm air heating. For further data write to General Electric, Division 2441, Bloomfield, N. J.

TURN TO



For radiator or warm air heat, using oil or gas

G-E Oil Furnaces in 7 different sizes for various heating capacities. Year 'round domestic hot water coil. Also G-E Gas Furnaces.

G-E Winter Air Conditioners (Oil or Gas Fired) circulate *conditioned* warm air heat—filtered and humidified.

GENERAL  ELECTRIC

*Working against time in
Defense Plant Expansion?

Use
FERRO-METAL
Partitions!

FOR Wartime Plant Expansion, you'll save valuable time, make more attractive installations—at less labor cost—with FERRO-METAL PARTITIONS!

FERRO-METAL PARTITIONS are "Custom-Built" to your specifications . . . delivered in baked enamel finish all ready to assemble in place quickly and easily . . . for high-quality, modern-styled lavatories, showers, dressing rooms, or for factory offices, stockrooms.

Write for new Catalogs on:
FERRO-METAL PARTITIONS
BATHE-RITE Factory Shower Cabinets

MILWAUKEE STAMPING COMPANY
814 South 72nd Street Milwaukee, Wis.

Write **FERRO-METAL PARTITIONS**
into **YOUR** building or remodelling
specifications

FLUSH TOP
Partitions . . .

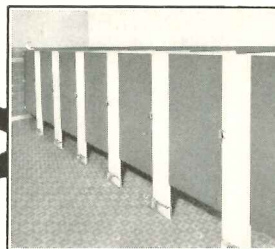

PANEL STEEL
Partitions . . .

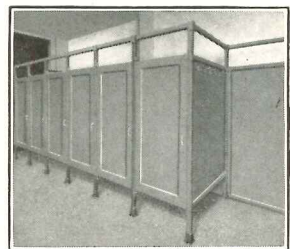

CUBICLE
Partitions . . .

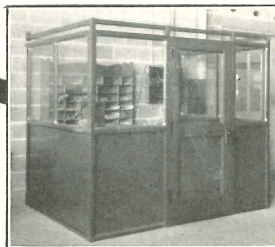

FLUSH STEEL
Partitions . . .

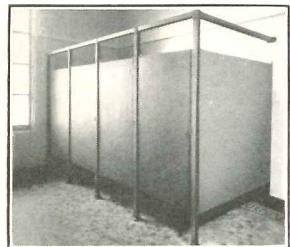

-protection in the public interest

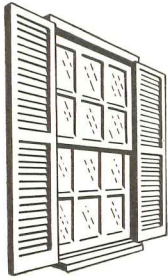

to preserve the
full beauty of
**wood
shutters**

—to help them withstand the rigors imposed by today's severe service requirements—research scientists have developed minimum standards of *toxic preservation*, a treatment that assures wood products an increased resistance against possible deterioration.

NATIONAL DOOR MANUFACTURERS' ASSOCIATION
McCORMICK BUILDING · CHICAGO, ILLINOIS

Seal of Approval—The Identification of a Product Meeting N. D. M. A. Preservative Minimum Standards



FOR FURTHER INFORMATION SEE OUR CATALOG IN SWEETS

WHEN an architect writes specifications, he is underwriting with his reputation the items he specifies. That is why architects generally so definitely specify — "windows to be hung with Samson Spot Sash Cord . . ." — they know that sash hung with weight, pulley and Spot Cord give long trouble free service — permanently satisfactory.

SAMSON CORDAGE WORKS
BOSTON, MASS.



REG. U.S. PAT. OFF.

**SAMSON
SPOT**



SASH CORD

5 USES on every job . . .

Specify this rugged
"All-Purpose"
BUILDING PAPER . . .

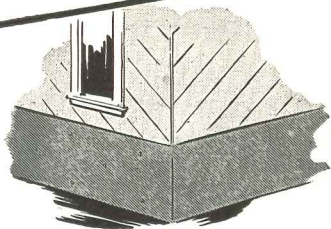

SISALKRAFT was developed as the BEST building paper that could be made—amazingly tough, air and moistureproof—resistant to shrinkage and dry rot. Specify it for these 5 uses on every job — it gives greater satisfaction to the owner.

The SISALKRAFT Co.
205 W. Wacker Dr., Chicago, Ill.
New York San Francisco



Over Sheathing



Under Roofing



Under Floor



Protecting Concrete



Covering Materials

SISALKRAFT

**AUER
METAL
GRILLES**

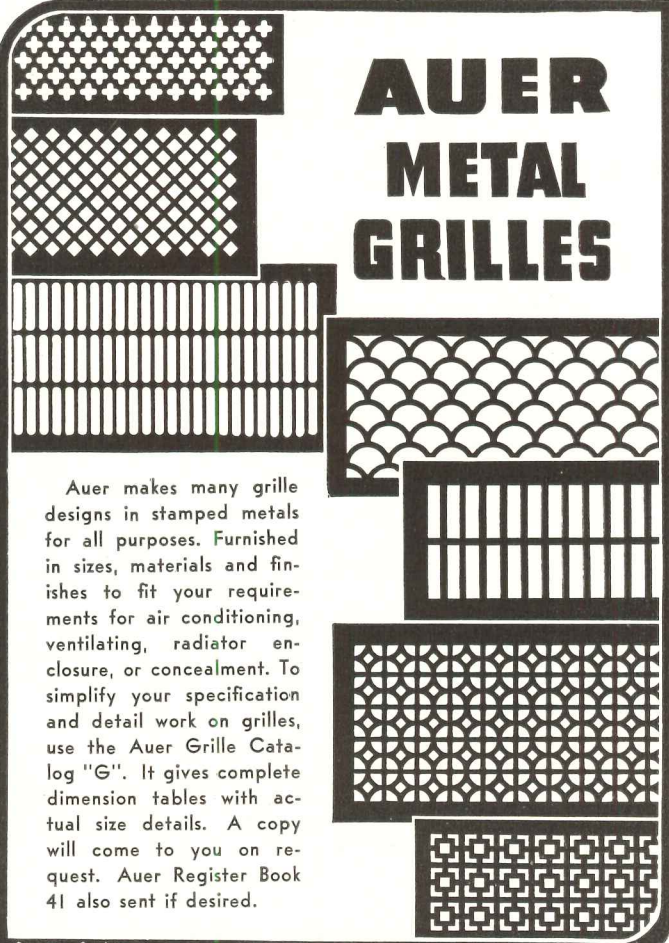

Auer makes many grille designs in stamped metals for all purposes. Furnished in sizes, materials and finishes to fit your requirements for air conditioning, ventilating, radiator enclosure, or concealment. To simplify your specification and detail work on grilles, use the Auer Grille Catalog "G". It gives complete dimension tables with actual size details. A copy will come to you on request. Auer Register Book 41 also sent if desired.

THE AUER REGISTER CO. CLEVELAND, O.

Floors that take PUNISHMENT OUGHT TO BE MAPLE

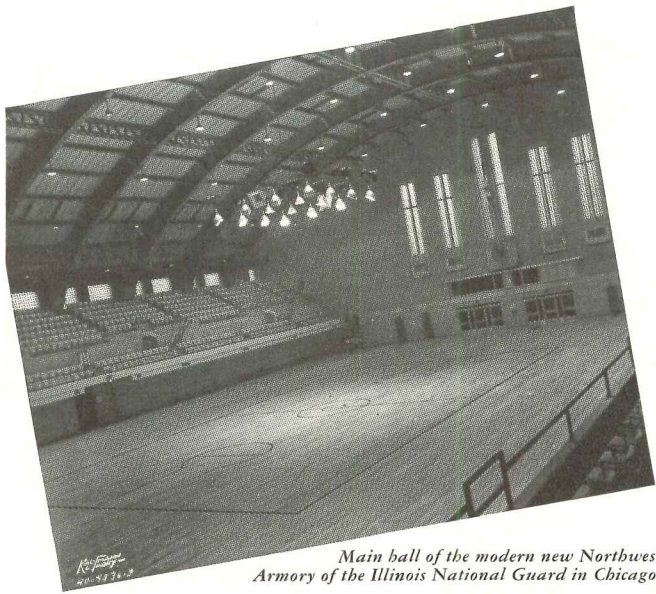

Main hall of the modern new Northwest Armory of the Illinois National Guard in Chicago.

Drills, games, gym work, dances, and assemblies—they're all "work" to an armory floor—punishment that soon shows in all but the toughest floorings. And so this Armory, like many, is floored with Hard Maple.

Northern Hard Maple is "made" for punishment. Its peculiar characteristics come from Nature itself. It grows in our Northern forests where winters are long, and slow growth gives it tough fibre and close grain that have remarkable resistance to abrasion. It tends to "polish" rather than wear—and because wear is slow, its cost is startlingly low when years of service are counted.

And during those years, Maple gives the more satisfactory service of wood—affords warmth, dryness, resilient comfort and sanitation. It lowers maintenance costs, simplifies alterations, and properly finished, is cleaned by brushing alone.

So when floors must take punishment, floor with Maple—trademarked MFMA Northern Hard Maple, in strips or blocks. See Sweet's, Sec. 11/82.

MAPLE FLOORING MANUFACTURERS ASSOCIATION
1782 McCormick Building, Chicago, Illinois

Floor with
MFMA Maple
REG. U. S. PAT. OFF.
(NORTHERN HARD)

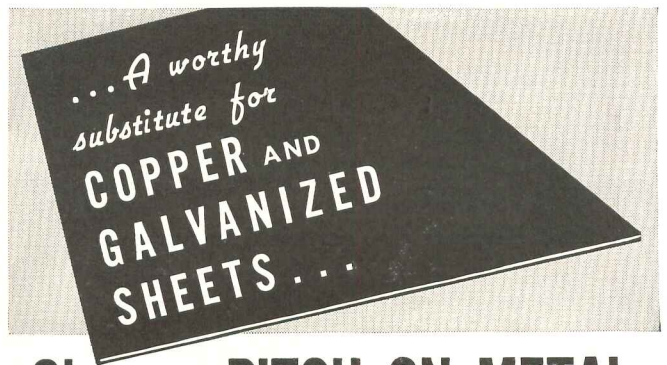

Cheney PITCH-ON-METAL

This newly developed material consists of ferrous sheet metal which is completely protected by a heavy baked-on coating of coal tar pitch enamel. CHENEY PITCH-ON-METAL has the strength of steel and the flexibility of copper. It is not affected by weather, moisture, lime, or cement mortar and is resistant to most acid conditions.

Our experiments carried on with the government departments at Washington and with the Bureau of Standards definitely convinces us that our new product, CHENEY PITCH-ON-METAL, will prove a worthy substitute during the emergency.

CHENEY BLACK FLASHING is a new product identical in shape and form with the original Cheney Copper Flashing except that it is made of CHENEY PITCH-ON-METAL instead of copper.

CHENEY BLACK REGLET is made of CHENEY PITCH-ON-METAL and costs of both Black Flashing and Black Reglet are much less than copper.

CHENEY PITCH-ON-METAL SHEETS made in 24 x 96, 30 x 96, and 36 x 96 only, for use as counterflashing, downspouts, gravel stops, valleys, termite shields, ducts, etc.

CHENEY PITCH PAINT is necessary as a field coat after shop fabrication of CHENEY PITCH-ON-METAL SHEETS to seal any damage to the PITCH-ON coating.

We are now in production and complete stocks will soon be available at warehouses of Sheet Metal Distributors throughout the United States. Get in touch with your sheet metal distributor and if he has not yet received his stock and price information, communicate direct with us.

SPECIFICATIONS (Private Work)

THRU-WALL FLASHING shall be provided below parapet copings, for counterflashing in masonry parapets, where low roofs abut the superstructure, wherever flashing is set between two courses of masonry, and elsewhere as indicated on drawings. Thru-wall flashing shall be placed in the wall with mortar below and on top of flashing so that a mechanical bond is obtained both vertically and horizontally. All counterflashing shall be bent to shape by the manufacturer. These flashings shall be CHENEY BLACK FLASHINGS and shall be furnished and installed according to the standard specifications of THE CHENEY COMPANY, ARDMORE, PA.

After all roofing and sheet metal work is completed this contractor shall paint all exposed thru-wall flashing with one brush coat of CHENEY PITCH PAINT.

FLASHING REGLET (for flashings in concrete) shall be CHENEY BLACK REGLET as manufactured by THE CHENEY COMPANY, ARDMORE, PA. The counterflashing locked into the reglet shall be CHENEY PITCH-ON-METAL.

SHEET METAL. CHENEY PITCH-ON-METAL 26 (or 24) gauge shall be used for counterflashing, gravel stops, valleys, downspouts, facias, termite shields, ducts, roof pans, roof scuttles, and for all sheet metal work that can be formed by locking or riveting. All sheet metal shall be painted with one field coat of CHENEY PITCH PAINT after fabrication to seal any damage to the Pitch-On coating.

Pitch-On-Metal can be satisfactorily painted any desirable color provided one coat of shellac is applied after all fabrication is completed.

SPECIFICATIONS (Public Work)

THRU-WALL FLASHING shall be provided below parapet copings, for counterflashing in masonry parapets, where low roofs abut the superstructure, wherever flashing is set between two courses of masonry, and elsewhere as indicated on drawings. Thru-wall flashings shall be formed with dovetail or undercut sawtooth corrugations spaced three inches apart, and shall be placed in the wall with mortar below and on top of flashing so that a mechanical bond is obtained both vertically and horizontally. All counterflashing shall be bent to shape by the manufacturer. Thru-wall flashing shall be formed of 26-gauge Pitch-On-Metal.

FLASHING REGLET (for flashings in concrete) shall be formed of 26-gauge Pitch-On-Metal with groove at not less than a rising 45 degree angle with serrated cross section for locked insertion of a Pitch-On-Metal counterflashing.

SHEET METAL. Pitch-On-Metal shall be used for counterflashing, gravel stops, valleys, downspouts, facias, termite shields, ducts, roof pans, roof scuttles, and for all sheet metal work that can be formed by locking or riveting. All sheet metal shall be painted with one field coat of coal tar pitch paint after fabrication to seal any damage to the Pitch-On coating.

PITCH-ON-METAL shall be 26 (or 24) gauge iron or steel and shall be factory coated with a baked-on coal tar pitch coating compounded to proper viscosity with suitable bituminous solvents. The coating shall be such that it will thoroughly bond to the metal, not run at summer temperatures, or crack at winter temperatures. The coating shall be such that the metal can be bent at a 180 degree angle around the circumference of a lead pencil without cracking.

METAL PAINT shall be a coal tar pitch paint homogeneous, free from water, extraneous matter, or sediment which cannot be readily incorporated by stirring, and shall be of such composition that, when brushed to a thin film on a metal plate, and exposed at a temperature of not less than 60 degrees F. it will dry to a glossy black surface in not more than six hours.

Pitch-On-Metal can be satisfactorily painted any desirable color provided one coat of shellac is applied after all fabrication is completed.

THE CHENEY CO. ARDMORE, PENNA.

In the BETTER BUILDINGS ZONOLITE does double duty

HERE'S another triumph in modern building design; another addition to the fast growing list of the blue chip jobs in which ZONOLITE insulation has contributed much to construction economy and maintenance efficiency.

Beneath this classic exterior is the lasting charm of *maximum economy!* . . . because ZONOLITE Concrete roof and floor fill permit the dual savings from decreased dead-load weight, plus greatly increased thermal and sound insulation values.

May we send you the ZONOLITE *Insulation Handbook for Architects?* This outlines ZONOLITE's multiple efficiencies for house fill, structural concrete, and all-purpose plaster.



**UNITED BENEFIT LIFE
INSURANCE BUILDING,
Omaha**

Architects: Tinsley, McBroom & Higgins.
Contractors: Peter Kiewit & Sons Co.
ZONOLITE Insulating Concrete Roof and Floor Fills.

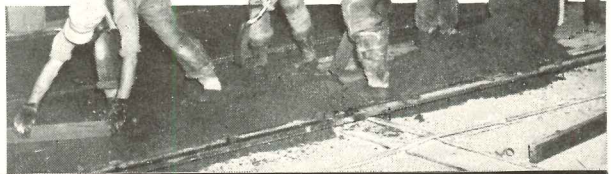

UNIVERSAL ZONOLITE INSULATION CO.

Plants In Principal Cities

Dept. 41 • 135 South La Salle Street • Chicago



Since 1910, nearly five million feet of Ric-wil Underground Steam Systems of *all types* have been installed. In the past year, over 500,000 feet of Ric-wil Insulated Pipe Units have been required for government-directed projects alone.

Ric-wil is exceptionally equipped, in engineering and plant facilities, for fast and large-scale production of all the various types of underground systems . . . Pre-Sealed Pipe Units, Tile, Cast Iron, etc. Today defense needs have precedence, but we believe Ric-wil facilities are large enough to handle a reasonable volume for private demands. *Write for latest Ric-wil Bulletins.*



Ric-wil
PRE-SEALED
INSULATED
PIPE
UNITS

RIC-WIL

CONDUIT
SYSTEMS



THE RIC-WIL COMPANY, CLEVELAND, OHIO
AGENTS IN PRINCIPAL CITIES

For 20 Years LEADING ARCHITECTS AND BUILDERS HAVE REPEATEDLY SPECIFIED *Evans* VANISHING DOOR WARDROBES FOR SCHOOL PROJECTS AND *Evans* HAS NEVER DISAPPOINTED THEM.

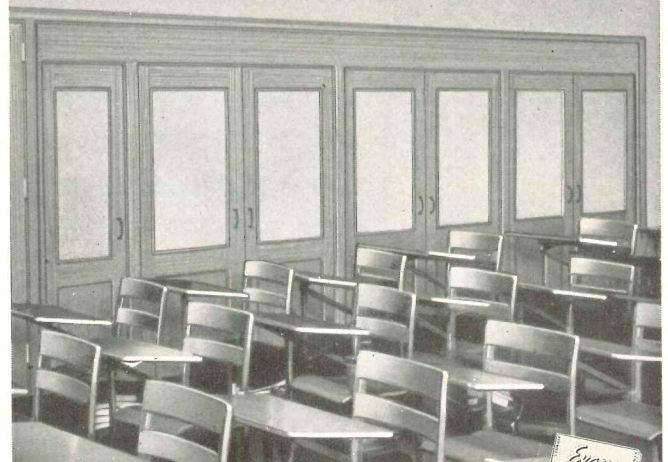

WRITE FOR NEW CATALOG AND DETAILS →



Evans VANISHING DOOR WARDROBES
W. L. EVANS COMPANY • WASHINGTON, INDIANA

A FELLOW CAN'T BUILD PLANES ON THE KITCHEN FLOOR



SOME day this husky designer of miniature dive-bombers will have a real place to work. And he'll keep the "Home Building" idea alive until he gets it. His pa and his ma, and his sister, too, have their pet ideas which they want to include in the home they plan to build.

That is why so many leading firms are including the complete stories of their products and services in *Home Owners' Catalogs*. Here they can be read and studied while dreams are being dreamed and plans are being made.

Architects who ask us to send *Home Owners' Catalogs* to clients interested in home building can be sure that the desire for a home will be maintained. This valuable book is filled with comprehensive information, beautifully illustrated, about home building materials and modern equipment which they frequently recommend. We'll send *Home Owners' Catalogs* by mail, prepaid to those who comply with the restrictions in the coupon below.

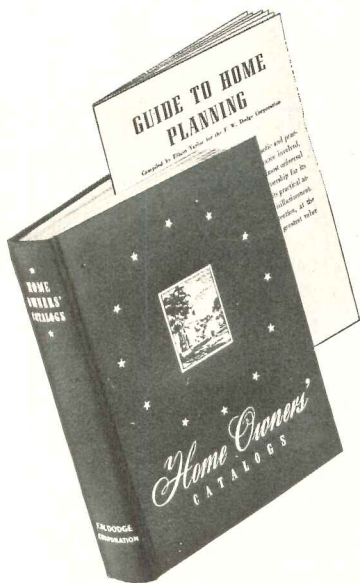

Home Owners' CATALOGS

Published by F. W. DODGE CORPORATION
119 West 40th Street, New York, N. Y.

FREE! Use the coupon or your own stationery to request a free copy of Home Owners' Catalogs, including the "Guide to Home Planning," for your home building clients who comply with our restrictions covering distribution.

RESTRICTIONS — Home Owners' Catalogs will be sent only to owners who plan to build homes for their own occupancy, within 12 months, in the 37 states east of the Rocky Mountains, costing \$4,000 or more for construction, exclusive of land. EVERY APPLICATION WILL BE VERIFIED BY A DODGE REPRESENTATIVE.

F. W. DODGE CORPORATION
119 West 40th Street, New York, N. Y.

In accordance with these restrictions, please send a copy of Home Owners' Catalogs to:

Name
Address
City State
Signed Architect, of

AR-1-42

NORTON DOOR CLOSER

Cut
Maintenance
Time
and Expense

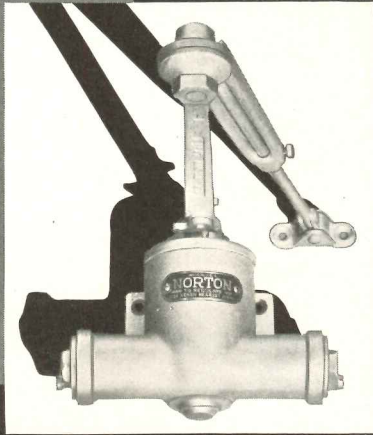

One job for the architect in National Defense is to specify building equipment that will save maintenance time and expense. Norton Door Closers aid defense production because Positive Control and Leakproof Mineral Oil Lubrication add years to the life of the closer and maintenance time and expense.

FOR FURTHER
INFORMATION



SECTION 16
CATALOG 27

NORTON DOOR CLOSER COMPANY

Division of the Yale & Towne Mfg. Company
2900 N. Western Ave. Chicago, Ill.

HOW COUNTRY KITCHENS CAN HAVE "CITY WAYS"

Building homes with modern kitchens beyond the gas mains is no problem today. These kitchens can have all the convenience, cleanliness and economy of real city gas service. Just install "Pyrofax" Gas Service!

"Pyrofax" Gas burns just like city gas—and uses the same type of appliances. There's no soot, no dirt, no smelly fumes. Cooks a meal for the average family for about 3 cents! Dependable supply assured by more than 20 years of unflinching service by one of the world's largest manufacturers of compressed gases.

Send for Don Graf's Data Sheets. These authoritative specifications folders on "Pyrofax" Gas Service for homes beyond the gas mains are available. Write to Dept. C, "Pyrofax" Gas Division, Carbide and Carbon Chemicals Corporation, 30 E. 42nd St., New York, N. Y.

PYROFAX

TRADE-MARK



SUPERIOR GAS SERVICE

COOKING • WATER HEATING
REFRIGERATION
BEYOND THE GAS MAINS

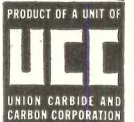

Sarcotherm HOT WATER CONTROL BY THE WEATHER

This simple, mechanical system provides continuous circulation of hot water at temperatures varied automatically in accordance with changes in outside temperature.

The gradual modulation of radiator temperatures is accomplished by blending a varying portion of the boiler water with the return. Sarcoflow balancing fittings in individual radiator connections balance the system.

In factories and apartments it provides de luxe modulated heat with reduced fuel costs. Ideal for modernization of institutions and homes.

Ask for Catalog No. 175.

128

SARCO
SAVES STEAM

SARCO COMPANY, INC.
475 Fifth Avenue, New York, N. Y.
SARCO CANADA LTD., FEDERAL BLDG., TORONTO, ONT.



THE VENETIAN VACATION WITH VACATIONERS

Favorite of vacation-minded visitors who seek congenial companions for Miami's many playtime pleasures. A true "resort" atmosphere, "share the fun" guest-entertainment program, social directress. Ideal location: closest Miami hotel to bay, beaches, recreation centers. Matchless views. Quiet, parklike surroundings, restful evenings after play-filled days. Excellent cuisine. Ample free parking. Restricted clientele.

WRITE for details of remarkably low rates—especially attractive for extended stays.

ON BISCAYNE BAY AT 15TH STREET
SEASON: NOVEMBER TO MAY

For Every Door . . .

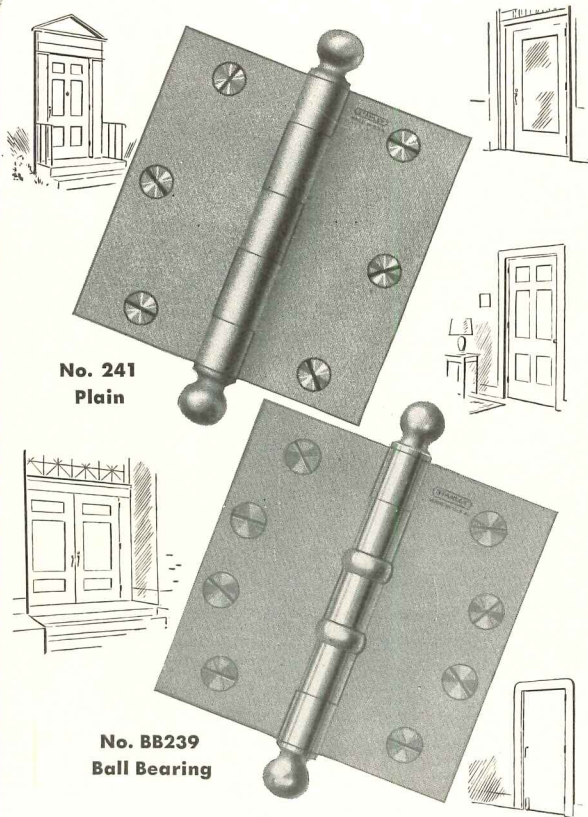

No. 241
Plain

No. BB239
Ball Bearing

STANLEY BUTTS

There is a Stanley Butt suited for every residence door, exterior or interior; for doors in commercial buildings, schools, hospitals and factories . . . any door anywhere.

For long time, trouble-free use specify Stanley Ball Bearing Butts.

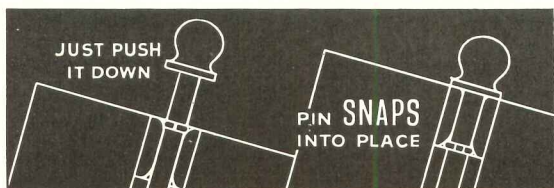

New exclusive Non-Rising Pin stays down.



Stanley Hardware Catalog No. 61 illustrates and describes the complete line - use it for ready reference. A copy will be gladly sent on request. The Stanley Works, New Britain, Conn.

STANLEY
TRADE MARK
HARDWARE

JANUARY 1942

Engineers Recommend
ANEMOSTATS
For Leading Installations
To Assure the Ultimate In
**DRAFTLESS
AIR DIFFUSION**

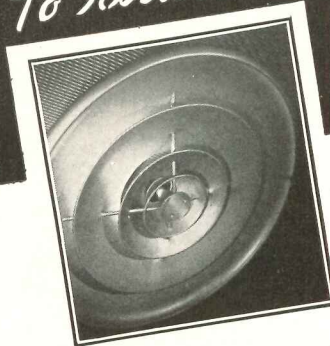

ENGINEERS throughout the industrial world realize the extreme importance of faultless air distribution.

This accounts for the widespread usage of ANEMOSTATS, Draftless Air Diffusers, in foremost factories, offices, theaters, stores, etc.

Faultless Air Distribution means draftless distribution of the heated, cooled or ventilation air, the equalization of temperature and humidity and the prevention of stale pockets in which the air is either too hot and too dry, too cold and too humid.

If you have faulty air distribution, the objectionable conditions are definitely overcome by the use of ANEMOSTATS.

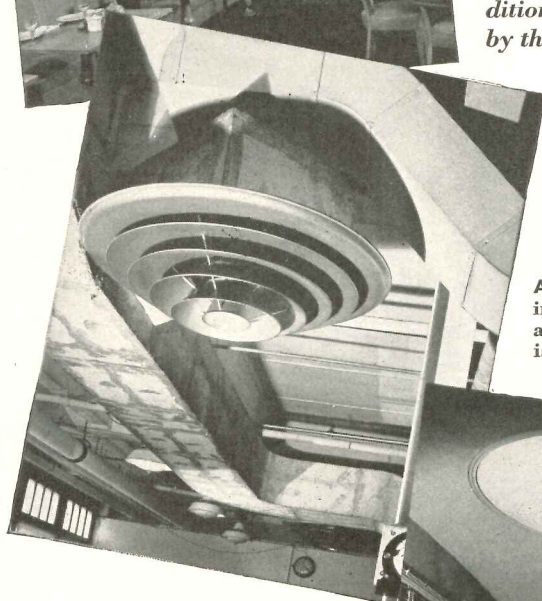

ANEMOSTATS can be installed inexpensively and quickly. They are ideal for use on new or existing installations.



ANEMOSTATS produce these unparalleled results because they are the only air diffusers which operate on the following interdependent principles:

- 1 Air Expansion within the device, which reduces velocity instantly
- 2 True Aspiration, which causes room air to be drawn into the device where it is mixed with the supply air.
- 3 Creation of a multiplicity of air currents and counter-currents at low velocities, which causes slow but adequate secondary air motion.

ANEMOSTAT
CORPORATION OF AMERICA
10 East 39th Street • New York, N.Y.

REPRESENTATIVES IN PRINCIPAL CITIES



DAYLIGHTING

plus Insulation

● THERMAG semi-vacuum glass blocks, with "Magnalite" lenses give complete 4-way light diffusion through an entire room. Total solar heat transmission per square foot of skylight area is under 50% by test. Airtight construction virtually eliminates thermal heat loss.

● THERMAG's *rigid*, insulated reinforced concrete grid construction is designed to withstand all snow loads and foot traffic. THERMAG's smooth surfaces clean easier. Its design and insulation guard against condensation.

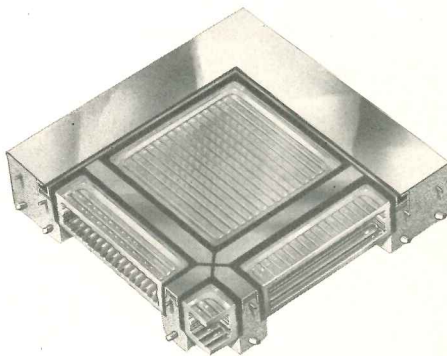

● THERMAG's even diffusion of mellow white daylight over wide room areas keeps skylight areas at a minimum. The soffit is highly ornamental. For details, see Sweets. For prompt engineering service without obligation, write direct to 2139 West Fulton Street, Chicago.

Light Up—the AMERICAN Way!



AMERICAN *3way-Luxfer* PRISM CO.
CHICAGO NEW YORK

INDEX TO ADVERTISEMENTS

Catalogs of concerns marked (s) are filed in Sweet's Catalog File (1941)

	Page		Page
Air Reduction Sales Co.....	29	s Mahon, R. C., Company.....	15
s Aluminum Company of America.....	32	s Maple Flooring Manufacturers Association.....	99
s American Air Filter Company, Inc.....	11	s McQuay, Inc.....	27
American Rolling Mill Company.....	88	Miller Company.....	2nd Cover
American Smelting & Refining Company.....	2	s Milwaukee Stamping Company.....	97
s American 3-Way Luxfer Prism Co.....	106	s Minneapolis-Honeywell Regulator Company.....	36
s Anemostat Corporation of America.....	105	National Bronze & Aluminum Foundry Co.....	108
s Arrow Hart & Hegeman Electric Company.....	87	s National Door Manufacturers Association.....	98
s Auer Register Co.....	98	s National Gypsum Company.....	83
s Bethlehem Steel Company.....	3rd Cover	s Norton Door Closer Company.....	104
Boeckh, E. H., & Associates.....	100	s Ohio Rubber Company.....	20
s Bradley Washfountain Co.....	28	s Owens-Illinois Glass Company.....	3
s Byers, A. M., Company.....	4	s Payne Furnace & Supply Co., Inc.....	19
s Cabot, Samuel, Inc.....	101	s Petroleum Heat & Power Company.....	95
s Carbide & Carbon Chemicals Corporation.....	104	s Pittsburgh Plate Glass Company.....	21
s Cheney Co.....	99	s Portland Cement Association.....	91
Crane Co.....	31	Prometheus Electric Corp.....	100
s Day-Brite Lighting, Inc.....	17	s Pyrofax Gas Division.....	104
s Dixon's Typhonite Eldorado Pencils.....	1	s Raymond Concrete Pile Company	4th Cover
s Douglas Fir Plywood Association.....	25	Ric-wil Company.....	102
s Evans, W. L., Company.....	102	s Robertson, H. H., Company.....	22-23
Faber, A. W., Inc.....	108	s Ruberoid Co.....	35
s Frick Co.....	96	s Samson Cordage Works.....	98
s General Electric Co.—Air Conditioning.....	97	Sarco Company, Inc.....	104
s Grand Rapids Hardware Company.....	96	s Sisalkraft Co.....	98
s Hart & Hegeman Division.....	87	s Sloan Valve Company.....	8-9
s Hendrick Manufacturing Co.....	94	s Speakman Company.....	93
s Holophane Company, Inc.....	6	s Spencer Turbine Company.....	30
s Holtzer-Cabot Electric Co.....	90	s Stanley Works.....	105
s Home Owners' Catalogs.....	103	s Sweet's Catalog Service.....	112
s Horn Manufacturing Company.....	92	s Taylor, Halsey W., Co.....	100
s Imperial Brass Mfg. Co.....	107	s Timber Engineering Company, Inc.....	94
s Josam Manufacturing Co.....	81	s Trane Company.....	89
s Koppers Company.....	13	Universal Zonolite Insulation Co.....	102
s LCN 466 Door Closers.....	100	Venetian Hotel.....	104
		s Wallace & Tiernan Co., Inc.....	94
		s Webster, Warren, & Co.....	14
		s York Ice Machinery Corporation.....	101

New York—General Manager: H. Judd Payne. Advertising Manager: Tom Tredwell. B. B. Orwig, 119 West 40th Street. Boston—Robert Marshall, 855 Park Square Bldg.; Chicago—C. B. Riemersma, F. H. Bowes and H. Neville Taylor, 700 Merchandise Mart; Cleveland—Homer Andrews, 321 Hanna Bldg.; Los Angeles—W. R. McIntyre, 400 East Third St.; Philadelphia—Tom Tredwell, 1321 Arch Street.

HELPFUL DATA

on modern flush valve installation practice in INDUSTRIAL PLANTS

SPEED is so important in the selection of every item for present day industrial plant work that we have developed this brief summary of installation practice on flush valves. These combinations have been widely used by well known industrial organiza-

tions in recent plants after careful study by the architectural firms, contractors and industrial executives responsible. We believe that you, too, can be safely guided by this data in selecting flush valves for both office and factory toilet fixtures in industrial plants.

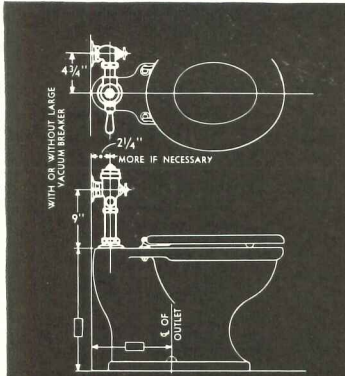

MOST POPULAR closet combination is that for top spud bowls. Neat in appearance. Moderate in cost. Watrous combinations of this type used by plants of General Motors, Northrop Aircraft, Tuthill Pump, T.V.A. and others.

Specify: Watrous Comb. M-532-VB (for diaphragm type valves); Comb. M-632-VB (for piston type valves). These combinations include vacuum breakers; meet all code requirements.

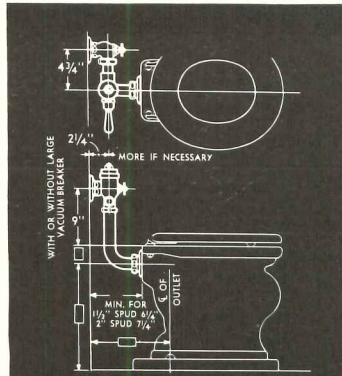

LOW UNIT COST and wide adaptability make this combination for rear spud bowls popular for industrial plants. Watrous combinations of this type used by such prominent industrials as Eastman Kodak, International Shoe, Imperial Tobacco, Kraft Phenix Cheese.

Specify: Watrous Comb. M-533-VB (for diaphragm type valves); Comb. M-633-VB (for piston type valves). These combinations include vacuum breakers; meet all code requirements.

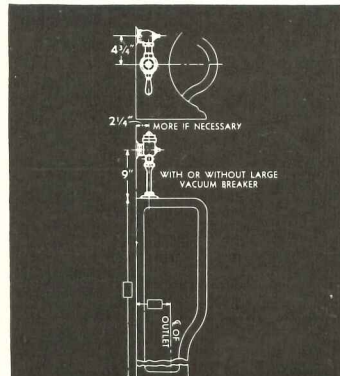

FOR MEN'S URINALS this combination offers many advantages. A real water-saver. Low in cost. Fits either wall hung or stall urinals. Phelps Dodge, Northrop Aircraft, Eastman Kodak, Frankford Arsenal are users of Watrous combinations of this type.

Specify: Watrous Comb. M-549 (for diaphragm type valves); Comb. M-649 (for piston type valves.) Usually used without vacuum breaker.

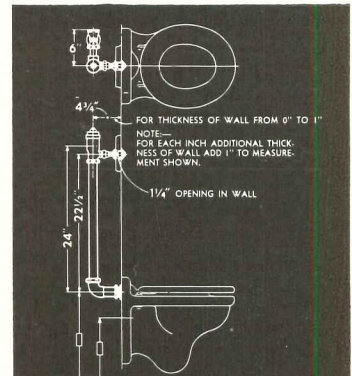

TAMPER-PROOF, attractive and easy to keep clean is a concealed flush valve installation of this type. Nothing but push button exposed—and button is high above floor to prevent damage from kicking. Recommended for industrial plants.

Specify: Watrous Comb. M-548-VB (for diaphragm type valves); Comb. M-648-VB (for piston type valves). These combinations include vacuum breakers; meet all code requirements.

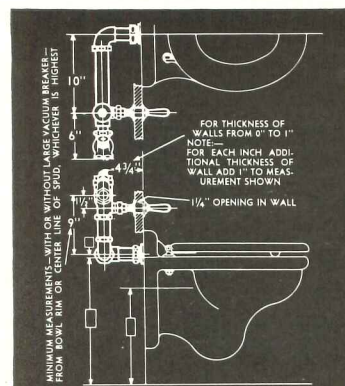

CONCEALED and out of the way of any tampering or abuse is this combination. Nothing exposed except lever for operating. Makes a very attractive installation. This Watrous combination used by General Electric for new Chicago plant.

Specify: Watrous Comb. M-539-VB (for diaphragm type valves); Comb. M-639-VB (for piston type valves). These combinations include vacuum breakers; meet all code requirements.

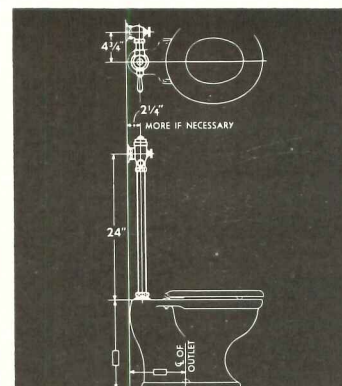

NON-KICKABLE and convenient is this high combination. Flushing handle is about 38" above floor. This eliminates possibility of damage due to kicking. This Watrous combination selected by Cincinnati Milling Machine, Corn Products Refining and others.

Specify: Watrous Comb. M-553-VB (for diaphragm type valves); Comb. M-653-VB (for piston type valves). These combinations include vacuum breakers; meet all code requirements.

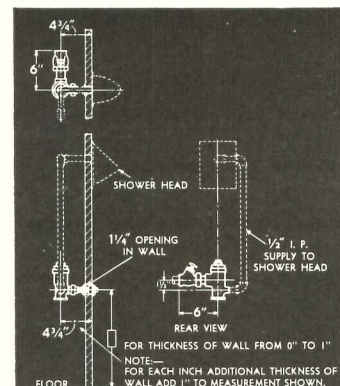

SHOWER OPERATION in industrial plants can be controlled in no more efficient way than by this new Watrous Shower Head Combination. A push on the button and water flows a given length of time. No possibility of anyone leaving shower running. Pays for itself quickly in savings.

Specify: Watrous Comb. M-666 (Shower head and concealed piping not included). No vacuum breaker required.



HERE ARE TWO REASONS WHY WATROUS FLUSH VALVE!

- 1. SAVE WATER.** A simple adjustment makes it possible to regulate any Watrous valve so minimum amount of water will be used for each fixture.
- 2. ELIMINATE MAINTENANCE TROUBLES.** By-pass has patented, mechanically operated self-cleansing device which prevents clogging—keeps valve working properly.



FOR ADMINISTRATION BLDGS., and offices where silent operation is desirable, the use of Watrous SILENT-ACTION Flush Valves is recommended. To specify, simply add words "SILENT-ACTION" after combination number.

THE IMPERIAL BRASS MFG. CO., 1240 W. Harrison St., Chicago, Ill.

Watrous Flush Valves

THEY PAY FOR THEMSELVES IN THE WATER THEY SAVE

For **ANTI-SLIP**
Qualities and Permanence



into the Specifications

TEN-LOX is a cast alloy imbedded with large and small abrasive grits and furnished in seven different styles of stair treads and two thicknesses of floor tile. Numerous tests have proven that TEN-LOX will outlast other materials of the same structure. The reason being that TEN-LOX is the only anti-slip material with abrasive grits extending clear through the casting. In addition to this exclusive feature fine grits are also imbedded to about 1/16" of the depth of the casting from the top. With this combination it is practically impossible for any slippage to occur and tests made by Underwriters' Laboratory show TEN-LOX to have a greater coefficient of friction when oily than it has when wet or dry.

Hundreds of architects are giving serious consideration to eliminating accidents caused from slipping — that's why so many of them are writing TEN-LOX into their

specifications. Literature and complete information on TEN-LOX will be gladly sent to interested parties.



THE NATIONAL BRONZE & ALUMINUM FOUNDRY CO.
Specialties Division
8900 LAISY AVENUE CLEVELAND, OHIO

"13"

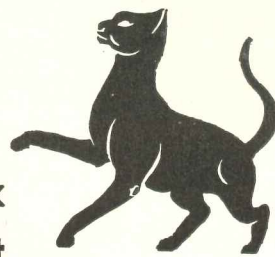

may be a Jinx on Friday but it stands for the **"TOPS"** in **DRAWING PENCILS!**

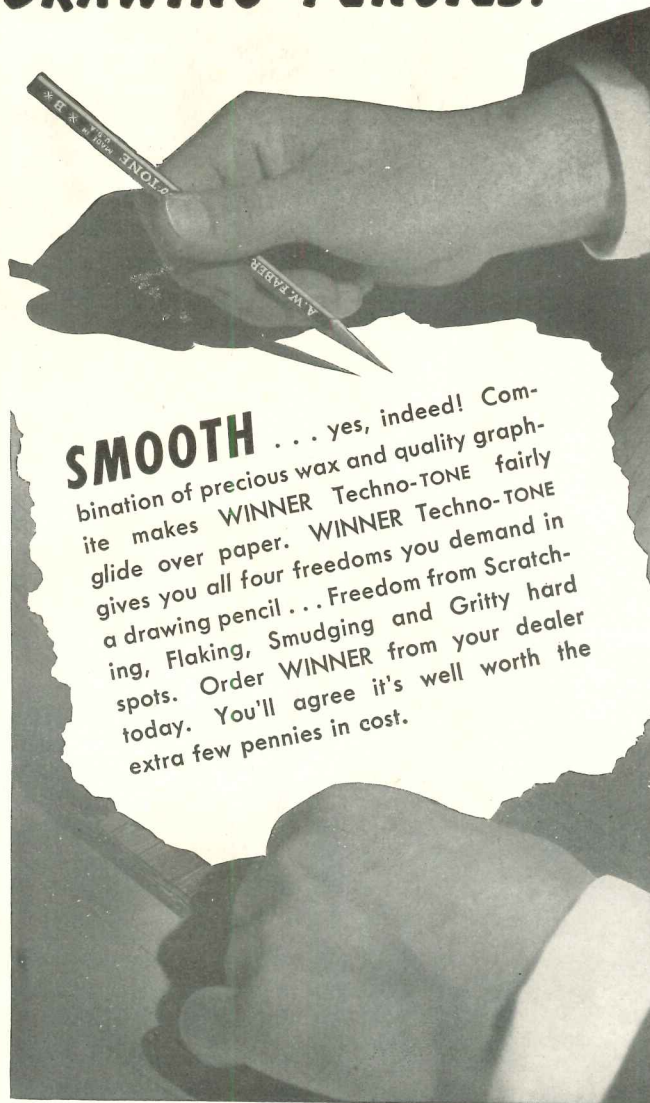

SMOOTH . . . yes, indeed! Combination of precious wax and quality graphite makes WINNER Techno-TONE fairly glide over paper. WINNER Techno-TONE gives you all four freedoms you demand in a drawing pencil . . . Freedom from Scratch- ing, Flaking, Smudging and Gritty hard spots. Order WINNER from your dealer today. You'll agree it's well worth the extra few pennies in cost.

WINNER Techno-TONE
DRAWING PENCIL

13¢ 2 for 25¢

translates
GRAY MATTER
into **BLACK MATTER**

Made in U.S.A. Polished rich green. Packed in metal box.

WINNER Techno-TONE
17 Degrees—6B to 9H
"It has the A. W. FABER name on it."

A.W. FABER Inc. NEWARK, N. J.