

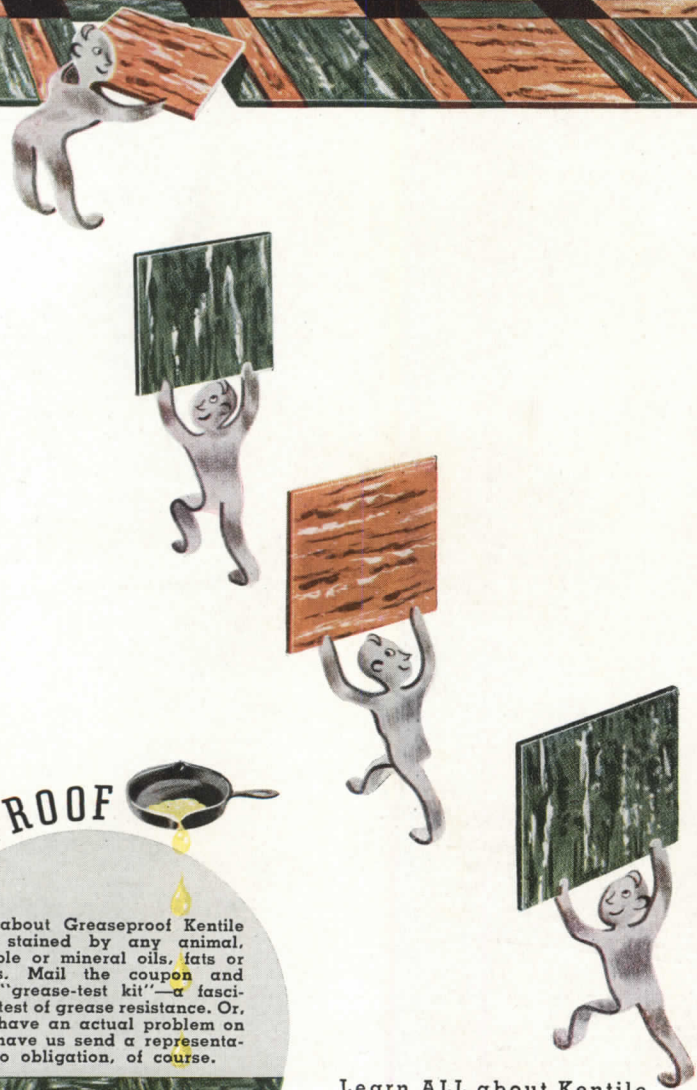

for  
IMPROVEMENT  
*today!*

Today you are searching for better ways to improve interiors—with greater economy, practicality and the added beauty that attracts business. Now Kentile, the new low cost floor that is so speedily laid piece by piece, answers every requirement. Here are just a few of Kentile's advantages:

1. Kentile, although resilient underfoot, is one of the most durable floorings made — practical even in heavy duty plants.
2. Kentile is one of the lowest cost floors made.
3. Kentile is moistureproof — perfect even on basement concrete in direct contact with earth.
4. Kentile resists almost any kind of staining.
5. Kentile is laid with amazing speed—is available immediately—is installed by authorized contractors in any part of America.
6. Kentile offers a million patterns—any design you conceive with its 44 colors, 15 tile sizes.
7. A Kentile floor can be altered in any part—without disturbing the other areas.



**GREASEPROOF**



Learn about Greaseproof Kentile —isn't stained by any animal, vegetable or mineral oils, fats or greases. Mail the coupon and check "grease-test kit"—a fascinating test of grease resistance. Or, if you have an actual problem on hand, have us send a representative. No obligation, of course.

Learn ALL about Kentile NOW! The list above gives only a few of Kentile's advantages. Without any obligation send for our big, fully detailed, full color catalogue. Mail the coupon now.



**KENTILE**  
*Asphalt Tile*  
Trade Mark Reg



DAVID E. KENNEDY, Inc., Dept. A., 66 Second Ave., Brooklyn, N. Y. Without obligation, please send

Catalogue NAME .....

Grease Tester ADDRESS .....

Representative CITY, ETC. ....

# If we're only $\frac{3}{5}$ right

## here's the best fluorescent buy

YOU'RE interested, we take it, in getting your client the most light for the least money in the long run.

We say Hygrade Fluorescent Lamps give you that for five reasons:

Because of finer coating texture, which you can see for yourself;

Because Hygrade Fluorescent Lamps give more light—more lumens per watt;

Because they are more even in color—every lamp alike, also obvious to the eye—and an assurance of uniformly high quality;

Because Hygrade lamps are "bright to the last inch"—early end-darkening no longer cuts down the light-casting length of the lamp;

Because Hygrade lamps last longer; tests show demonstrably more life than others; ask Hygrade users and see what they say.

If this were so on only three of these points, or even two, your customer will be money ahead, better off, because he'll get *more light and better light than he can get elsewhere.*

But plenty of Hygrade Fluorescent users say we're right on all five points.

Especially those using Hygrade Packaged Lighting—complete, guaranteed fixtures with all elements unit-engineered to work together—know the superior quality of Hygrade lighting.

That is "fluorescent at its finest"—*better* lamps in *better* fixtures kept performing at their peak by *better* accessories.

So you'll find it pays to specify Hygrade when you recommend fluorescent lighting. Your client will be getting the best there is—and not a little of the credit will be reflected on you.

If you haven't yet received our free file-size kit—containing catalogs, prices and complete technical specifications on all Hygrade Fluorescent Lighting Equipment—write for it today. Dept. AR2.

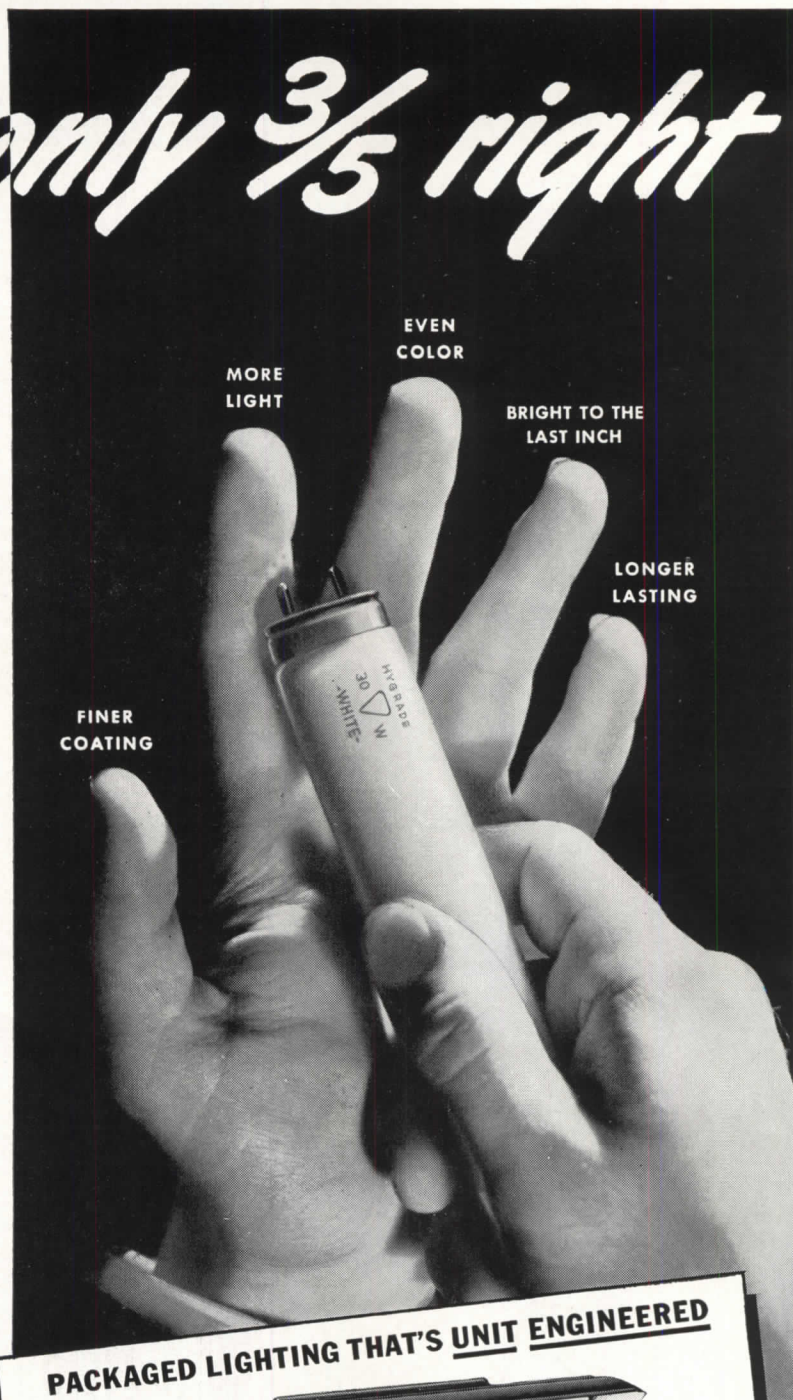

### PACKAGED LIGHTING THAT'S UNIT ENGINEERED

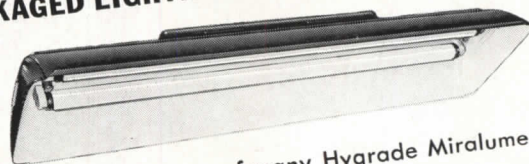

**MIRALUME F-240**, one of many Hygrade Miralume fixtures for every industrial need.

Good lamps are the heart of good fluorescent lighting. But good HYGRADE lamps are at their best in this Packaged Lighting that is engineered as a unit. Lamp, fixture,

starter and ballast are designed and built to *work together*, all held to uniformly high standards—there are no "weak spots" anywhere to limit the performance of any part.

## HYGRADE SYLVANIA CORPORATION

SALEM, MASS.

*Also makers of Hygrade Incandescent Lamps and Sylvania Radio Tubes*



# Windows

## ... THAT FIT YOUR PLANS TODAY

● *Improved*, "insulated," trouble-free wood windows help you specify extra value and greater economy for your jobs.

*Silentite Windows* are more important to you now than ever before! They'll help your builders cut installation costs and save time. For the "pre-fit" *Silentite*, by long experience and unbiased tests, actually saves *as much as half* the cost necessary to install ordinary windows!

*Silentite* comes to the job in dustproof cartons. There are no weights, cords or pulleys to install—just simple "life-time" springs. You may choose narrower, more modern trim, like Curtis Mitertite, for all interiors.

*Silentite* is fully weather-stripped! Owners report as much as 25% fuel savings. This wood window is

made of Ponderosa Pine and treated with a toxic preservative (a special Curtis formula). *Silentite* won't rattle, stick or jam! It's trouble-free! That means lasting window satisfaction!

To make it easy for you to figure installation and fuel savings with *Silentite Windows*, we have prepared an "Economy Calculator." It's a simple slide rule; easy to use.

Let us send you an "Economy Calculator" so you can figure installation and fuel savings for every job. We'll also send you information on the *Silentite* Window family which includes Double-Hung Windows, Casement Windows, Basement Sash, Circle Sash. Just mail the coupon. If you live in Canada, write to W. C. Edwards & Co., Ltd., 991 Somerset Street, West, Ottawa, Canada.

*When in New York, visit the Curtis Woodwork display at Architects' Samples Corporation, 101 Park Ave.*



CURTIS WOODWORK IS SOLD BY  
RELIABLE DEALERS EVERYWHERE

Curtis Companies Service Bureau  
Dept. AR-2, Clinton, Iowa

Please send me a Curtis Silentite "Economy Calculator" and information on Silentite Windows.

Name.....

Address.....

City.....State.....

# "Price Ceilings" on Defense Housing can apply to **MAINTENANCE**, also

Even under the cost limitations of the defense housing program, the sound policy of building for permanence need not be compromised—as this Glen-Hazel Heights Project shows. Built under FWA and the Pittsburgh Housing Authority, the estimated cost for 1001 units is \$3,700,000. Hot and cold water lines, and vent lines 2" and smaller, are Byers Wrought Iron. The unusual resistance of wrought iron to the corrosive conditions involved is indicated by the many wrought iron water lines and vent lines installed during the 90's which are still on the job.

Architects are successfully applying wrought iron to so many different uses (heating, plumbing, air conditioning and

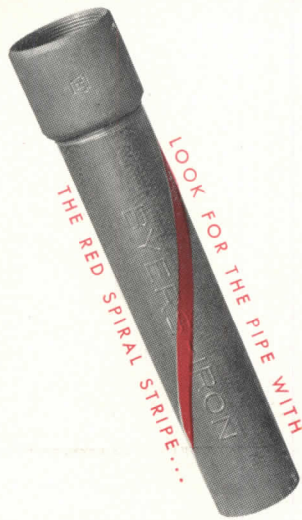

**BYERS  
WROUGHT  
IRON**

process piping, tanks, stacks, fuel handling equipment, flashing, lintels, and nails) that no list can completely indicate its possibilities. If you care to write us about any particular job, our Engineering Service Department will be glad to indicate, on the basis of actual past performance, the places where wrought iron might be profitably used. Ask, also, for our latest catalog, just produced, which gives full information on Byers Wrought Iron and Steel products. A complimentary copy will be sent immediately.

A. M. Byers Company, Pittsburgh, Pa. Established 1864. Boston, New York, Philadelphia, Washington, Chicago, St. Louis, Houston, Seattle, San Francisco.

USED IN HOT AND COLD WATER LINES AND SMALL VENT LINES IN THIS PROJECT

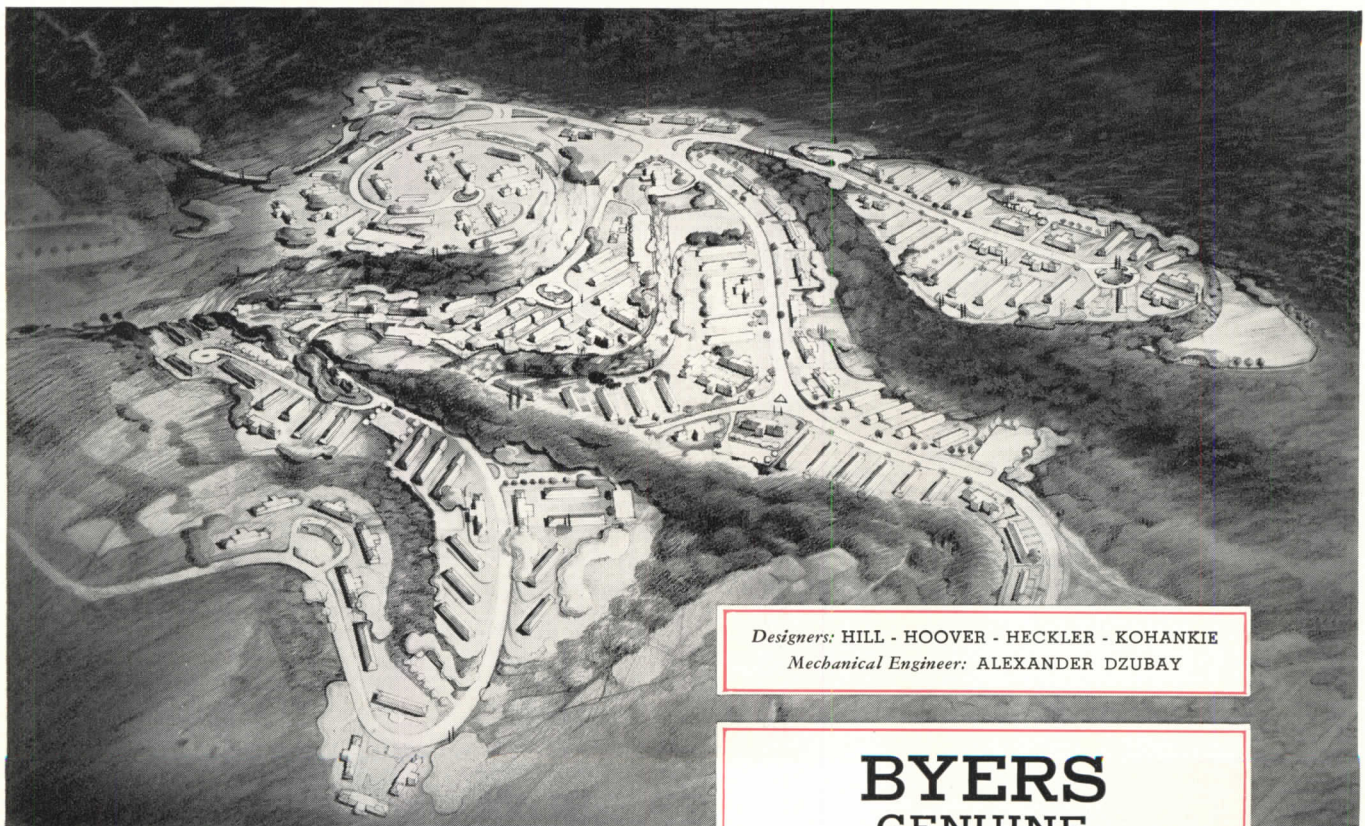

Designers: HILL - HOOVER - HECKLER - KOHANKIE  
Mechanical Engineer: ALEXANDER DZUBAY

**BYERS  
GENUINE  
WROUGHT IRON**

Tubular and Hot Rolled Products  
Steel Tubular Products

*Corrosion costs you more  
than Wrought Iron*

FEBRUARY 1942

# record

ARCHITECTURAL

COMBINED WITH  
AMERICAN ARCHITECT AND ARCHITECTURE

## BUILDING NEWS

REMODELING—A WARTIME MANDATE ..... 37

House Remodeling ..... 38  
By Morris Lapidus

Remodeled Farm House, Wilton, Conn. 40  
Country House, Bedford, N. Y. .... 41  
Two Built-In Units ..... 41  
City House—Apartments, New York City 42  
Hotel, St. Louis, Mo. .... 42  
Store Remodeling ..... 44  
By Dale Stetson

Department Store, Atlanta, Ga. .... 45  
Specialty Shop, New York City. .... 47  
Store, Los Angeles, Calif. .... 48  
Low-Cost Private Office, Des Moines, Ia. 48  
Office Building, San Diego, Calif. .... 50  
Factory Offices, Racine, Wis. .... 50  
Bank, Evansville, Ind. .... 51  
Church, Tiffin, Ohio ..... 51

TIME-SAVER STANDARDS ON REMODELING CONSTRUCTION  
DETAILS ..... 52

NEW WAYS TO SAVE STEEL IN CONCRETE ..... 59

SPECIFICATION STANDARDS FOR GOVERNMENT WORK—PART II 61

## RESTAURANTS . . . A BUILDING TYPES STUDY 65

Familiar Form Is a Trademark. .... 69  
Night Club Is Added to a Southern  
Restaurant ..... 70  
St. Louis Hotel Remodels Roof Bar and  
Dining Space ..... 72  
Roof Remodeled Around Existing Struc-  
ture ..... 75

BEHIND THE RECORD ..... 5

WITH RECORD READERS ..... 10

NEWS FROM WASHINGTON ..... 18

TRENDS IN BRIEF ..... 24

REVIEWS OF CURRENT LITERATURE ..... 30

NEWS OF MATERIALS AND EQUIPMENT ..... 78

ARCHITECTURE MEETS ADVERTISING ..... 80

INDEX TO ADVERTISEMENTS ..... 102

Copyright, 1942, by F. W. Dodge Corp. All rights reserved.

Editorial Director: Thomas S. Holden. Managing Editor: Roger Wade Sherman, AIA. Associate Editors: Frank G. Lopez, Jr., George A. Sanderson, Emerson Goble. Art Director: Gene Hawley. Desk Editor: Catherine Woolley.

ARCHITECTURAL RECORD (combined with American Architect and Architecture) is published monthly by F. W. DODGE CORPORATION, 119 West 40th Street, New York. Thomas S. Holden, Pres.; Howard J. Barringer, Vice Pres. and Treas.; Irving W. Hadsell, Vice Pres.; H. Judd Payne, Vice Pres.; Chauncey L. Williams, Vice Pres.; Sanford D. Stockton Jr., Secy.; Walter F. De Saix, Assl. Treas.; Edwin H. Freed, Asst. Treas. Member Audit Bureau of Circulations and Associated Business Papers, Inc. ARCHITECTURAL RECORD is indexed in Reader's Guide, Art Index, and Industrial Arts Index. Subscription rates: United States and Possessions, Canada, Cuba, Mexico, Central and South America, \$3 the year, \$5 for two years, \$6 for three years; elsewhere, \$5 the year; single copy, \$1. Circulation Manager: Robert C. MacDougall.

Manuscripts, photographs, and drawings which conform to RECORD'S editorial aims are welcomed. Every effort will be made to return material (if accompanied by stamped, addressed envelopes); but the editors will not be responsible for losses.

Other Dodge Services: REAL ESTATE RECORD AND BUILDERS' GUIDE, SWEET'S CATALOG FILES, HOME OWNER'S CATALOGS, DODGE REPORTS, and DODGE STATISTICAL RESEARCH SERVICE.

## BEHIND THE RECORD



### PREFABRICATION—1942 WAR BABY?

Walter Dorwin Teague, industrial designer, said recently, "What the vast shifting wage earning market needs is a modern house; a bright, shining, completely equipped, up-to-date house costing between \$1,000 and \$2,000; a house a man can alter or enlarge easily by buying spare parts; a house he can take with him when he shifts his job; a house he can turn in on a new make when it becomes obsolete; a house he can buy on the installment plan and pay for in two or three years without a lot of red tape."

Realization of Mr. Teague's description may come sooner than most of us think if the current FWA housing program goes through smoothly. With \$153,000,000 now available for the immediate construction of 42,000 "demountable" houses a new industry for the mass production of factory-made houses may spring up almost over night. At least the proponents of "prefabrication" (see Mr. Corbett's comments AR 12/41) are having a new war-born opportunity for some visionary prognosticating. And perhaps there is something in it, for prefabricators will have a good taste of solid food. Thus nourished they may take on a stature that will be worth watching in the unpredictable post-war period.

(continued on page 7)



## *RIGHT is RIGHT, We Always Say*

YOU CAN DO your full duty by *any* industrial air conditioning problem when you rely on York.

We say "any" because York installations include some of the largest and some of the smallest ever made, and more particularly because the range of York equipment is so comprehensive as to require no compromises.

You can do the job *right* because York places at your disposal chilled water or direct expansion systems, reciprocating or turbo compressors from ¼ ton to 1200 tons capacity for steam turbine, electric motor or gas engine drive; Freon 12 or ammonia refrigerant; air-cooled or water-cooled condensers.

We shall be glad to tell you just what you can expect from air conditioning in your plant. York Ice Machinery Corporation, York, Pennsylvania.



# YORK REFRIGERATION AND AIR CONDITIONING

*"Headquarters for Mechanical Cooling Since 1885"*

\*\*\*  
"KEEP'EM FLYING!"  
\*\*\*\*\*

A FEW OF THE MANY NATIONALLY-KNOWN USERS OF YORK EQUIPMENT—American Cyanamid • American Optical • Bendix-Westinghouse  
Bethlehem Shipbuilding • Bethlehem Steel • Consolidated Aircraft • Curtiss-Wright • Douglas Aircraft • du Pont • Eastman Kodak  
Firestone • Ford • General Motors • Goodrich • Gulf Oil • Hercules Powder • Jones & Laughlin Steel • Norton Company • Owens-  
Illinois • Republic Steel • Shell Oil • SKF • Socony Vacuum • Studebaker • Texas Company • U. S. Army • U. S. Navy.



(continued from page 5)

REMODELING IS HERE AGAIN

Remodeling as a pot-boiler is not entirely strange to architects and builders. But this time remodeling and modernization are not *just* pot-boilers for the architectural office; at least in defense-booming centers they have their own function in the all-out war effort. For the provision of industrial buildings and industrial housing can be in part accomplished through rehabilitation and conversion of existing structures. The merits of this scheme, which has received priorities blessing and other official support, are obvious, but important: 1. speed in meeting the need, 2. saving of critical materials, 3. avoidance at least in part of the inevitable over-building. And for non-defense centers, remodeling may turn out to be the only available means of satisfying building demand that cannot claim priorities. Remodeling has advanced, too, since depression days, as this issue of the RECORD should demonstrate, and it may rate new space in the office files.

NOW THEY HAVE STREETS

When Dorothy Rosenman made her timely plea for better coordination in the planning of defense housing projects (AR 11/41) there was general agreement that she had put her finger on a weak spot in the relations between Federal bureaus and local authorities. Even in taking exception to one of her for-instances, Seward H. Mott, Director of FHA's Land Planning Division, agrees with the general tone of her message.

His letter reads in part:

From its inception this Administration has cooperated closely with local planning commissions and municipal and county officials, and we are in hearty accord with Mrs. Rosenman's statement that housing problems must be worked out on the ground and with a consideration of local needs rather than from a desk in Washington.

Mrs. Rosenman refers to FHA activities in Newport News, Va., and we are gratified with the comments regarding the appearance of the FHA financed homes, but I wish to point out that the statement in regard to these houses being located on dirt streets and that the FHA has imposed no obligation on the developer to pave the

streets, is in error. It is a minimum FHA requirement that every house, either on an individual lot or in a development of homes, must be served with an adequate paved street as well as other utilities. We take particular pride in the character of the street improvements we are securing in the Newport News area as every one of our developments is served with bituminous bound macadam streets of a minimum width of 26 ft. This applies even to developments of homes in the \$3,000 price range. In higher priced developments such as Stuart Gardens concrete curbs and gutters and sidewalks are installed. No doubt the error was due to seeing these projects before the street construction was completed. The developers seldom install the paving until sewer and water ditches have settled and heavy hauling is over.

And for her part Mrs. Rosenman finds gratification in a note of all's-well-that-ends-well. She replies:

It is gratifying to know that the FHA projects at Newport News have been served with adequately paved streets.

When many of the FHA developments were completed, the people and officials of Newport News, the state planning officials and representatives of the National Re-

sources Planning Board, working in the area, did not know that FHA required the developers to pave the streets. They were concerned because there were no plans for street paving in evidence, because the locality had no ordinances which required street paving, and because the small taxes paid by these little houses could not possibly begin to defray the cost of paving the streets.

Had there been a mechanism established in the locality through which the various local agencies could have been kept *au courant* with the plans and action of Federal agencies operating there, the energy lost in speculation, meetings, discussions, time-consuming conferences, might have been used for more constructive purposes.

There is an understandable reason for this particular omission. The local FHA man was probably rushed from critical area to critical area. *He did his work*, and made his report to *his* office. There was no mechanism at that time for contact with the locality. They were left guessing, tried to get the facts, and, evidently, did not get them. However, all is well that ends well. It is good to know that the streets are paved, that the FHA office is on the alert and that there is an operating coordination of local and Federal housing functions in this area now.



"Why not remodel it? All you'll need is venetian blinds."

—Drawn for the RECORD by Alan Dunn

# THE *Story* BEHIND



**WALTER HESSE**, of the firm of Bloch and Hesse, well-known New York architects, is the designer of this new Schrafft's, as well as many other Schrafft restaurants and stores in Manhattan and other eastern cities. The firm has long been known for their outstanding work in the institutional and public building fields. Mr. Hesse is shown here examining the samples of Alexander Smith Carpet used in Schrafft's.



The burgundy Alexander Smith Carpet in this Cocktail Lounge sets off the walnut wainscoting and bar and the collection of unusually fine English coaching prints.



A rose-colored Alexander Smith Carpet was used in the Audubon Room (Ladies' Dining Room), accentuating the green leather chairs and the colorful twenty-foot Punch and Judy mural.



# THE CARPET

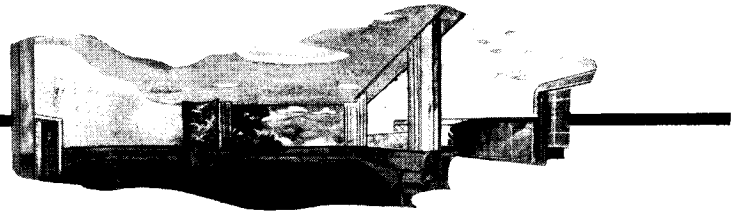

## SCHRAFFT'S

### New Times Square Restaurant

(Broadway at 43rd Street)

#### Mr. Hesse has this to say of his use of carpets:

"The fine food served by Schrafft's is worthy of a harmonious setting, and I consider carpet an important component of such a setting. Alexander Smith Carpets qualified for use here; aesthetically because of their beautiful colors and patterns, and practically because they resist the terrific wear to which they are subjected in this restaurant which seats 500 people.

"Our plans called for the use of carpets throughout the Ladies' and Men's Dining Rooms on the second floor and in the Cocktail Lounge on the first floor and even in the entrance to the Lounge from Forty-third Street where traffic is heaviest.

"Delivery dates were essential to open the restaurant on time. Alexander Smith were ahead of schedule. After my client and I had personally visited the Alexander Smith show-

rooms, their Contract Department furnished various samples for color and design. These greatly facilitated selection by the owners and myself, and resulted in a carpet which combines beauty of pattern and texture.

"Their agents were on the job from the minute the carpet was delivered until it was laid and even until the decorations and dining equipment were put into place. During the progress of the job the services and advice of their Contract Department were constantly helpful; and very important, too, was that they assisted us in keeping carpet costs within the budget.

"Guests have made many flattering comments on the new interiors of this Schrafft's. I am well satisfied, and do not hesitate in saying that the assistance of Alexander Smith was of inestimable help."



In the Grill on the second floor — famous for its permanent collection of original Currier and Ives prints — the same burgundy-colored Alexander Smith Carpet with a leaf design is used as in the Cocktail Lounge. Mr. Thomas M. Nelligan, Manager of the restaurant, is shown here. He says that the carpets add comfort and beauty to the dining rooms and help create that pleasant, homelike atmosphere which brings customers into Schrafft's.

★ ★ ★

For information about Alexander Smith Carpet and for complimentary copy of our comprehensively illustrated book, "Nearly Right Won't Do in Contract Carpets," write Alexander Smith & Sons Carpet Company, 295 Fifth Ave., New York, N. Y.



## ALEXANDER SMITH CARPET

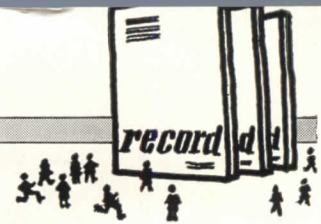

A COMMUNITY NURSERY IN FLORIDA 10

This design of "A Community Nursery in Florida," by Jane M. Dorsey of the New York School of Fine and Applied Arts, one of 65 entries, was awarded first prize by the American Institute of Decorators in its sixth annual Rorimer Design Competition

**AIA Notes**

A NEW Metropolitan Chapter of AIA will be organized if the Brooklyn and Westchester County Chapters accept an invitation proffered by New York Chapter to unite as nucleus of such a group. The Metropolitan Chapter will then invite as members individual members of New York, Brooklyn, Bronx, Queens, Staten Island, Long Island and Westchester architectural societies and all unaffiliated registered architects.

The movement follows a survey, by a committee headed by *Lewis Greenleaf Adams*, of architects in New York State (AR 11/41, p. 12), the majority of whom favored a central organization. Based on ratio of replies received, membership of the proposed chapter would reach, 1,136.

\* \* \*

DEAN WALTER R. MACCORNACK of Massachusetts Institute of Technology has been appointed chairman of the Committee on Urban and Rural Land

Use of AIA, succeeding *Frederick Bigger* of Pittsburgh.

\* \* \*

SAMUEL E. LUNDEN succeeds *Sylvanus B. Marston* as president of Southern California Chapter of AIA.

**Gold Medal**

PRINCETON University has been awarded the 1941 gold medal of the American Group of the Société des Architectes Diplomes par le Gouvernement, it is announced by *Julian C. Levi*, president of the Group. The medal goes annually to the "architectural department of that college or university having the best record of accomplishment in the teaching of architecture on the general principles of the Ecole des Beaux Arts in Paris."

A gold medal and a prize of \$50, bestowed every year upon the student obtaining the greatest number of values in the national competitions of the Beaux Arts Institute of De-

sign, was won by *Glen Paulsen* of the University of Illinois. *J. C. Tighe* of the University of Pennsylvania received the silver medal.

\* \* \*

DR. FREDERICK ERNST GIESECKE, Professor Emeritus, Heating, Ventilating and Air Conditioning, at A. & M. College of Texas, has received the F. Paul Anderson Gold Medal awarded by the American Society of Heating and Ventilating Engineers for distinguished scientific achievement. Dr. Giesecke was honored for his contributions to the advancement of heating based on his research work in the fields of heat transfer and hot water heating.

**Design Competition**

CASH AWARDS totaling \$500 are offered professional interior decorators in a national competition for the best plans for arrangement and furnishings of interiors in 200,000 U. S. Government defense houses as well as an estimated 200,000 privately built defense homes. Sponsors are PBA and *Interior Design and Decoration*, which announced the competition in its January issue, in cooperation with the American Institute of Decorators. A typical defense house floor plan was selected, and awards will be made for the best arrangements of interiors that can be obtained at the lowest cost by defense workers.

The contest runs until March 15. Judges include: *Nancy V. McClelland*, president, AID, *Edward Rowan*, Assistant Chief, Fine Arts Section, PBA, Commissioner *Reynolds*, PBA, *Gladys Miller*, interior designer and consultant on defense housing, *Gilbert Stanley Underwood*, architect, *Spence Wildey*, industrial designer, a housewife and wife of a construction worker.

**Defense Reference Center**

TECHNICAL material on public, domestic and industrial air raid precautions, as well as general instruc-

(continued on page 12)

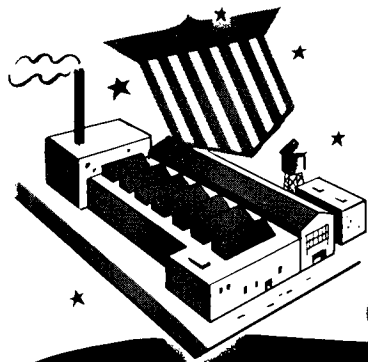

# ANNOUNCING KITCHEN MAID

# War-Time Cabinetry

## UPPER CABINETS

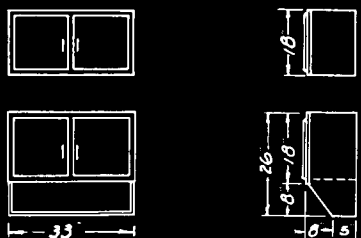

Available in 24", 30", 33", 36", and 42" widths—with or without doors and open lower shelves.

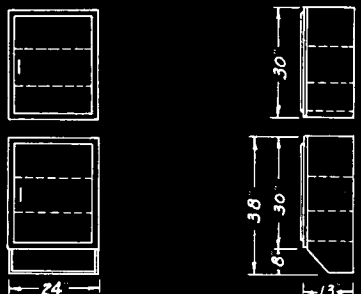

Available in 15", 18", 21", 24", 30", 36", 42", 48", 60", and 72" widths—with or without doors and open lower shelves.

## BASE CABINETS



Available in 15", 18", 21", 24", 30", and 36" widths.

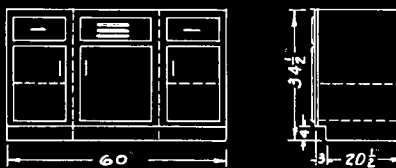

Available in 42", 48", 60", and 72" widths as package units.

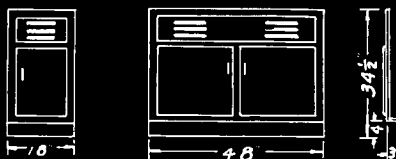

Available in following widths: 18", 24", 30", 36", 42", 48", 50".

## BROOM CLOSETS

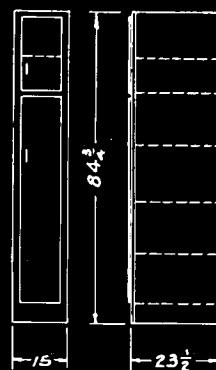

Width, 15". Also available with shelves in lower section—for dish cupboards.

## SINK FRONTS

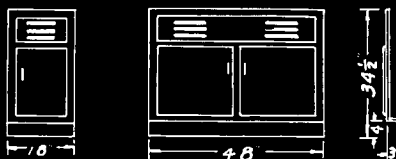

Available in following widths: 18", 24", 30", 36", 42", 48", 50".

**H**ERE is Kitchen Maid's answer to the challenge of war-time housing—an additional line of standard cabinet units, broad enough to meet any architectural requirement, yet simplified and standardized to permit substantial reductions in manufacturing costs. Such well known Kitchen Maid features as smooth surface, warp-proof doors, non-sticking drawers, dowel joints, hardwood frames, and factory-sealed finishes are found in this *new* line—yet a minimum of critical material is used. And Kitchen Maid's large productive capacity promises rapid delivery in quantities. Investigate before planning your next house or project. Mail coupon now.



Shelves are seated in special mouldings and securely glued.



Smooth surface, dust-proof doors cannot warp, swell, or shrink.



Frames are securely joined by hardwood dowel construction.

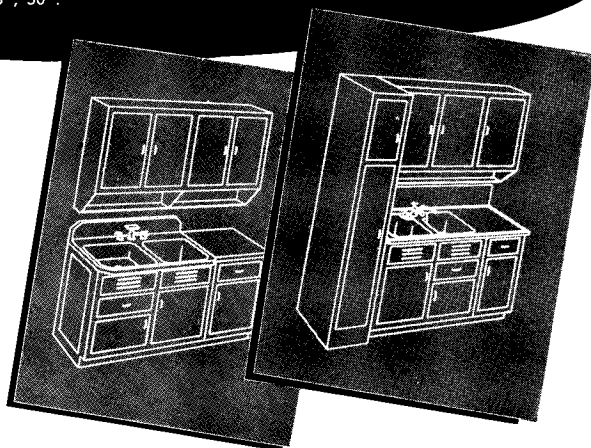

An attractive combination of upper cabinets, sink front, and base cabinet—available in sizes to fit practically any space.

Another practical combination of standard units with the additional convenience of broom closet or dish cupboard.

The Kitchen Maid Corporation, 821 Snowden St., Andrews, Indiana.  
Please send catalog on your new "War-Time Cabinetry."

Name \_\_\_\_\_

Address \_\_\_\_\_

Architect  Builder  Dealer  Owner

# KITCHEN MAID



# How to Save Vital War Materials When You Specify WIRE

(and probably make  
its delivery to your client  
faster and more certain)

WATERTITE--12--RW--600V---HAZARD-

**FOR WET LOCATION WIRING** . . . specify Hazard Watertite, Type RW. Its submarine rubber insulation requires no lead sheath protection and saves this vital material. Meets all code requirements. Ask for Bulletin 168A.

HAZAKROME--12--SN--600V--SYNTHETIC-

**FOR REWIRING**...specify Hazard small diameter wires, Type RHT or SN. They permit more and larger capacity wires to be installed in original conduit, eliminating the need for new conduit and thus save steel. Ask for Bulletin 200.

PERFORMITE-12-RHT-600V-HEAT RESISTING-

**FOR NEW WIRING** . . . in place of code wire, specify Hazard Performite, Type RH or RHT. Its extreme heat resistance means greater load capacity with the same amount of copper . . . or the same capacity with less copper. Precious copper . . . especially in the case of larger sized wires . . . is thereby conserved and smaller conduit requiring less steel can be used. Ask for Bulletin 118.

All of these Hazard Insulated Wires are fully approved by the National Electrical Code and are carefully built to deliver the continuous, trouble-free operation you and your clients want. For assistance we can give you in planning jobs these days, call upon our experienced engineering department. It is there to help you without obligation.

**HAZARD INSULATED WIRE WORKS**  
DIVISION OF THE OKONITE COMPANY  
Wilkes-Barre, Pa.—Offices in Principal Cities

**HAZARD**  
Building Wires for Every Purpose

## WITH RECORD READERS

(continued from page 10)

tions for the lay public, may be found in the Civilian Defense Reference Center which has been established in the library of Cooper Union, New York City. Installed at the request of OCD, according to *Harold Lancour*, head librarian, the collection includes books and articles dealing with the application of fluorescent and phosphorescent materials to civilian defense, protection of air filtration plants, use of reinforced concrete in wartime manufacturing plants, mechanical aids for moving traffic in the absence of street lighting, flexible substitutes for glass, clearance of debris, protective planning and camouflaging of large structures, economics of steel in large-scale construction, installation of bombproof shelters and air raid signal devices.

### Courses

AN evening course in Camouflage, under the direction of *George Kepes*, is offered by the School of Design in Chicago to begin Feb. 9. The program includes research in nature and

animal camouflage; surface covering; mimicry; visual illusions; geometrical optics; basic photography; investigation of camouflage technique with smoke, gas, mercury vapor, neon lights, light rockets, etc.

A second course, directed by *Robert J. Wolff*, will cover Visual Propaganda in Wartime. It will include research in posters and lectures by experts on physiology of the eye, atmosphere, landscape problems, optics, etc.

### Library Volume Available

ARCHITECTS concerned with post-war civic planning programs may be grateful for word that the 500-page volume "The American Public Library Building," by *Joseph L. Wheeler* and *Alfred Morten Githens*, is being sold from the Enoch Pratt Free Library of Baltimore, Md.

### Personal

KNOWN as Associated Landscape Architects, with offices at 664 N. Michigan Ave., Chicago, six landscape ar-

(continued on page 14)

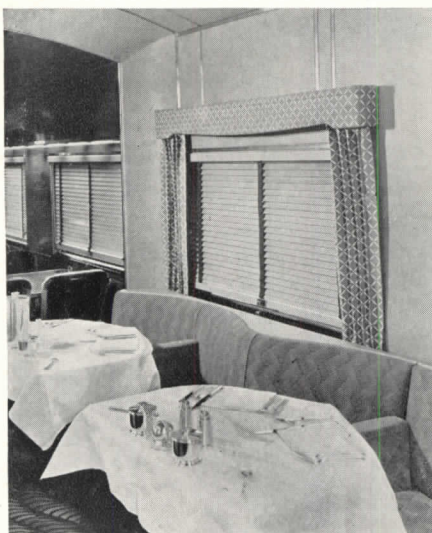

PAUL CRET designed the interiors for the cars of New York Central's new Empire State Express, built by the Edward G. Budd Manufacturing Company of Philadelphia. The view of the central section of the dining car shows "banquet type" seats, pigskin covering on walls and ceiling. The valance boxes from which the curtains are hung serve as baffles for air conditioning cur-



rents from the aerofuse outlets in the ceiling. Unbreakable glass is used at the door of the parlor car, which makes it possible to see down the passage from the car and into the car from the passageway. The glass panel is framed in stainless steel and the fin partition on which it rests has a stainless steel corner and a stainless steel base and a panel of bright color

# Inner defense for war-vital plants



**Rugged, reliable Anaconda electrical wires and cables, carriers of vital power, keep steady production in...shut-down losses out!**

THERE'S more to war than the equipping of bombers and battleships. The plants and shipyards that make them, the factories and mills turning out thousands of large and small parts, must be powered through wires and cables that can stand the pace of 3-shift operation.

Anaconda research has developed scores of product improvements and many completely new products that are today meeting these critical de-

mands. They are fitted for the job . . . their improved constructions deliver greater capacities with less power loss, their insulations can withstand high heat, corrosion, abrasion.

The research that built these wires and cables continues at a fast pace. Now in addition to delving into experiments for improvements in industrial products, Anaconda is devoting much of its research to wiring for residential and commercial building.

**When peace returns, adequate commercial and residential wiring will need your attention**

The electrical future will place greater demands than ever before on those in a position to make wiring selections. Anaconda will cooperate with architects with information and with products measuring up to their specifications.

ELECTRICAL WIRES AND CABLES OF COPPER ARE THE LIFE LINES OF OUR NATION

## ANACONDA WIRE & CABLE COMPANY

*Subsidiary of Anaconda Copper Mining Company*

GENERAL OFFICES: 25 Broadway, New York City

CHICAGO OFFICE: 20 North Wacker Drive

Sales Offices in Principal Cities



# " SPECS "

## FOR SUPERIOR SUBFLOORS



**Lumber treated with CZC, as in this housing project, means longer life by protecting against decay and termite damage**

**H**ERE'S ANOTHER housing project designed for low maintenance costs and long amortization. In this Georgia project, they've assured protection against decay and termites by treating subfloors, first floor joists, plates and bridging with Du Pont CZC. It's an economical way to avoid high maintenance costs caused by decay.

Lumber treated with Du Pont CZC is multiplied in life many times because it is decay resistant and termite repellent. And this treatment gives the plus advantages of lumber that's fire retardant, resistant to abrasion, and clean, odorless, paintable. CZC also provides an added Factor of Safety because the full strength of lumber is extended over a long term of service.

Write for locations of plants supplying this service. E. I. du Pont de Nemours & Co. (Inc.), Grasselli Chemicals Dept., Wilmington, Delaware.

**SPECIFY LUMBER TREATED WITH**



**CZC**

**CHROMATED ZINC CHLORIDE**

## WITH RECORD READERS

(continued from page 12)

chitectural firms have merged personnel, office facilities and equipment and will specialize in site and town planning, camouflage, defense housing, airports, recreation areas and defense industrial plants. In the group are C. B. Andrews, Fitzgerald & Atkinson, Robert Bruce Harris, Ralph Rodney Root, Simonds, West & Blair and F. A. Cushing Smith & Associates.

\* \* \*

E. E. ROBERTS AND ELMER C. ROBERTS INC. announce removal of their offices to 22 E. Huron St., Chicago, Ill.

\* \* \*

THE architectural firm of Austin & Shambleau, South Bend, Ind., has been dissolved. Mr. Shambleau has retained his office in the J. M. S. Building, *Ennis R. Austin* is at 1414 E. Michigan Ave., South Bend.

\* \* \*

NEW ADDRESS of *Harold H. Ehlert*, formerly of Detroit, is 7380 Franklin Rd., Franklin, Mich.

\* \* \*

ARCH ALBERT of St. Louis, Mo., is now at 1914 South 39th St.

### Died

FREDERIC CHARLES HIRONS, 59, in New York City. Mr. Hirons, a founder and former president of the Beaux Arts Institute of Design, had been named a Chevalier of the French Legion of Honor in recognition of his services for architectural education. Among his best known works are the George Rogers Clark Memorial at Vincennes, Ind., the Worcester (Mass.) War Memorial Auditorium, the Rockland County Court House in New City, N. Y., the Beaux Arts Institute of Design Building, New York City, and the Davidson County Court House at Nashville, Tenn.

\* \* \*

WILLIAM LOCKE, 69, at Charleston, S. C. Mr. Locke, an architect and engineer with offices for many years in St. Petersburg, Fla., at his death was Senior Engineer in the Planning Division at the U. S. Navy Yard in Charleston. He designed industrial plants, churches, schools and hotels throughout the South.

# SPEED UP PRINT PRODUCTION ... CUT PRODUCTION COSTS

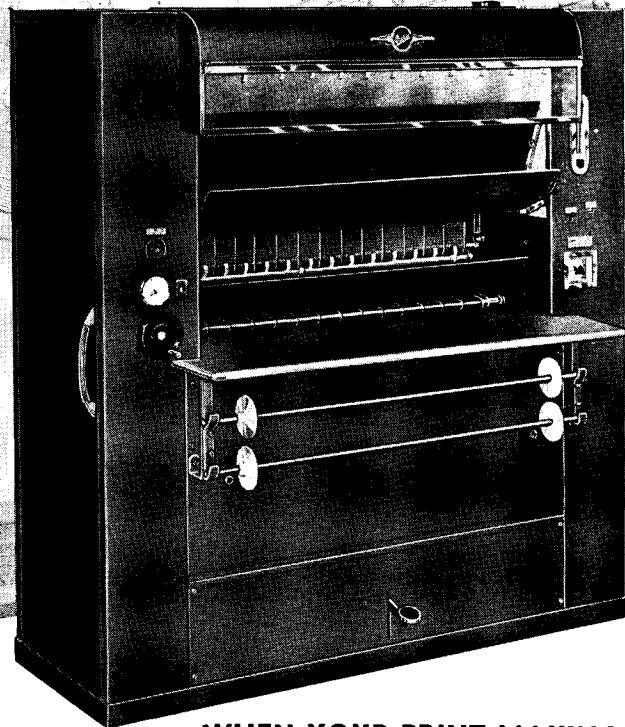
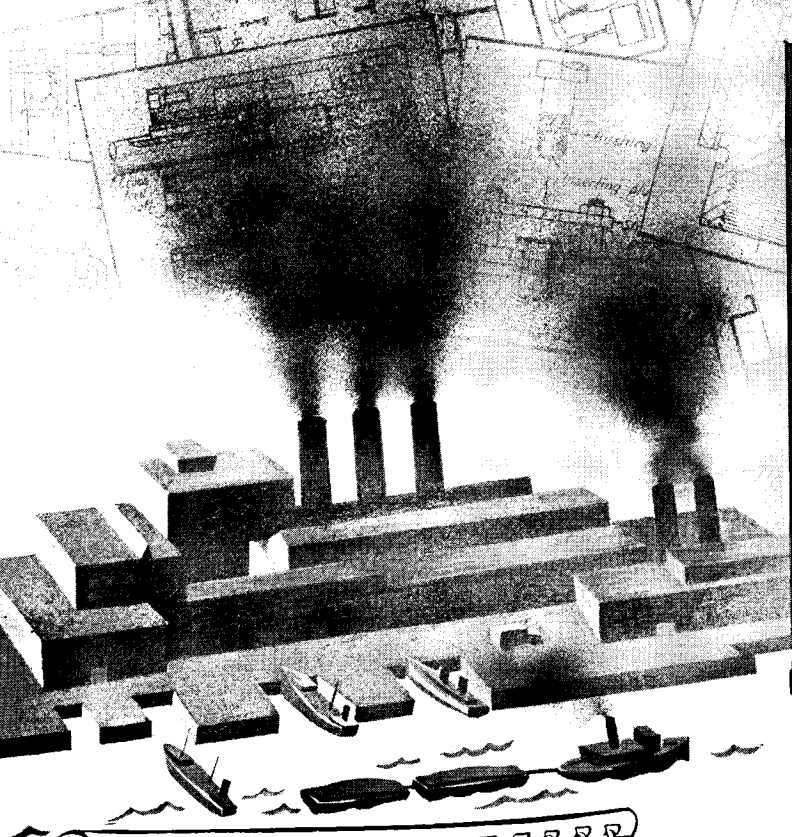

**WHEN YOUR PRINT MAKING** is complete—

all purpose — economical — that's when you increase print production — reduce print making costs.

With the Ozalid Process your prints are made at savings in time—labor—materials—because Ozalid is the only complete reproduction process.

Positive-type whiteprints having blue, black or maroon lines are made simply by using Ozalid sensitized materials in any of its whiteprint machines. They are printed and dry developed in one compact unit.

This process is time saving because prints are made in two easy steps, exposure and dry development . . . the finished prints are dry, ready for instant use . . . duplicate originals are made quickly just as whiteprints . . . changes, additions and corrections can be easily made on transparencies without altering the original drawing.

Production costs are cut because only one person is needed to operate any Ozalid machine . . . the use of cut sheets eliminates trimming waste . . . and uniform printing qualities of Ozalid materials lessen the possibility of over-exposure and subsequent waste of materials.

Write today for information describing how easily you can make prints at great saving with the Ozalid process.

SPECIFY **Ozalid**  
WHITEPRINTS

## BASIC FACTS ABOUT PRINT MAKING YOU SHOULD KNOW

OZALID STANDARD WHITEPRINTS OFFER A VARIETY OF EITHER BLUE, BLACK OR MAROON LINES ON A WHITE BACKGROUND . . . whereas blue prints offer no choice of color.

This variety of Ozalid color lines enables you to assign an identifying color to the office, another to the field, another for filing . . . distinguish checked prints from unchecked prints . . . lessen the possibility of errors.

These Whiteprints are permanent, true-to-scale of the original, and will not wrinkle or curl. They are easier to read, write on and check than negative prints.



This is the third of a series of facts on modern print making. Watch for Fact No. 4.

**OZALID PRODUCTS DIVISION**  
GENERAL ANILINE & FILM CORPORATION  
JOHNSON CITY, N.Y.

Ozalid in Canada • HUGHES OWEN CO. LTD., Montreal

# BETHLEHEM OPEN-WEB STEEL JOISTS

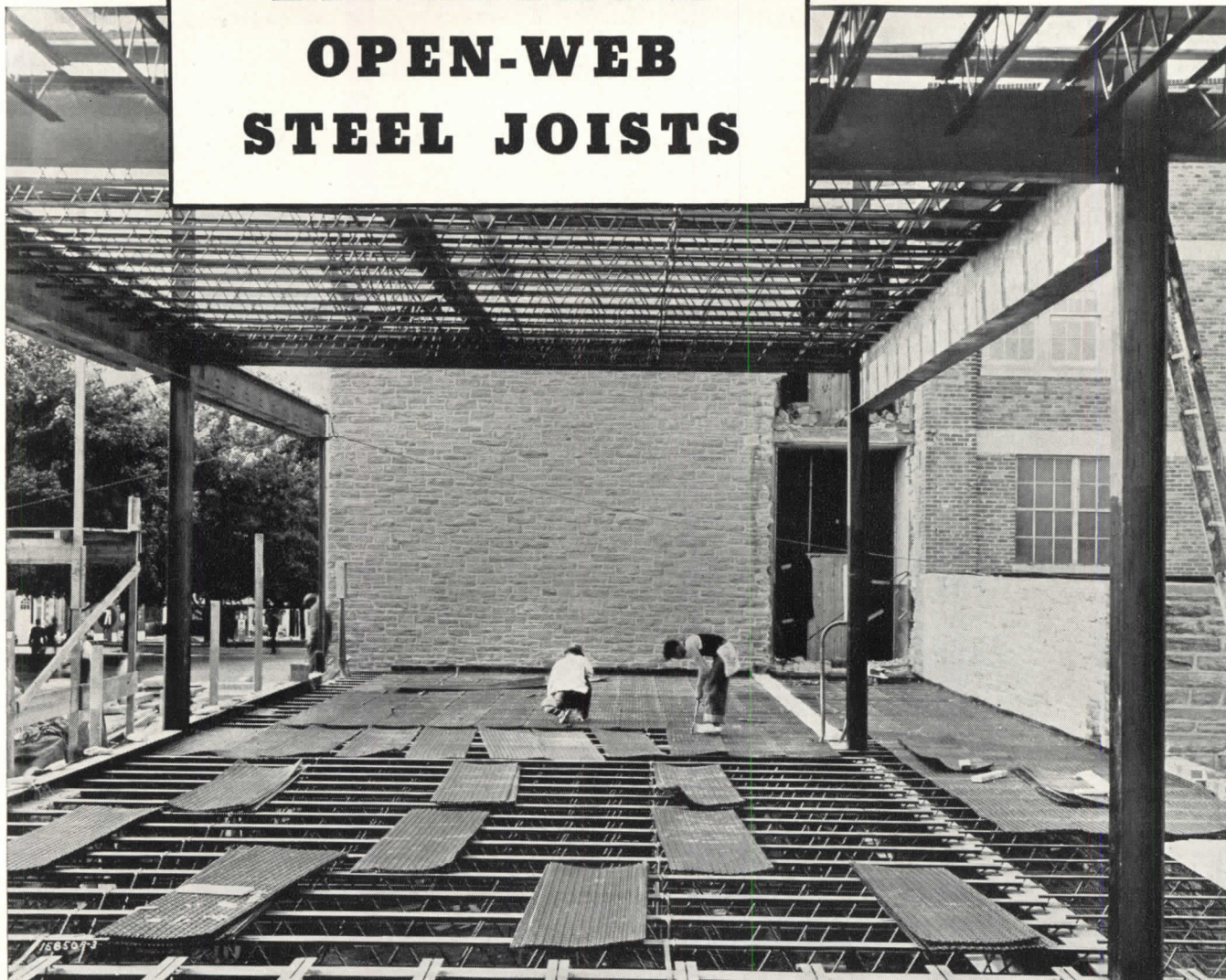

Bethlehem Joists used in construction of addition to the Weldon Junior High School, Glenside, Pa.

## Right for all types of light construction

Bethlehem Open-Web Steel Joists offer important advantages to designers of all types of light-occupancy structures.

Using them, it is possible to obtain a concrete floor with a plaster ceiling that combines ample strength with a weight of 40 lbs. per sq. ft. Bethlehem Joists 30 feet long, spaced 18 in. apart, will support a safe dead and live load of 139 lbs. per sq. ft. They are rigid, too. They cannot sag or shrink, thus eliminating a

major cause of cracks, open baseboards, and squeaky floors. They are termite proof. And, when used with a concrete floor slab and a plaster ceiling, they are sound-resistant and can provide up to 2 $\frac{1}{2}$ -hour fire safety.

Bethlehem Steel Joists also save money on construction. They arrive completely fabricated, clearly marked for instant placing. No falsework is necessary. One or two men can place them with the aid of a light gin pole.

### USE BETHLEHEM STEEL JOISTS IN DESIGNING:

Small apartment houses  
Small stores and office buildings  
Dormitories Hotels Hospitals  
Private homes Schools



# BETHLEHEM STEEL COMPANY



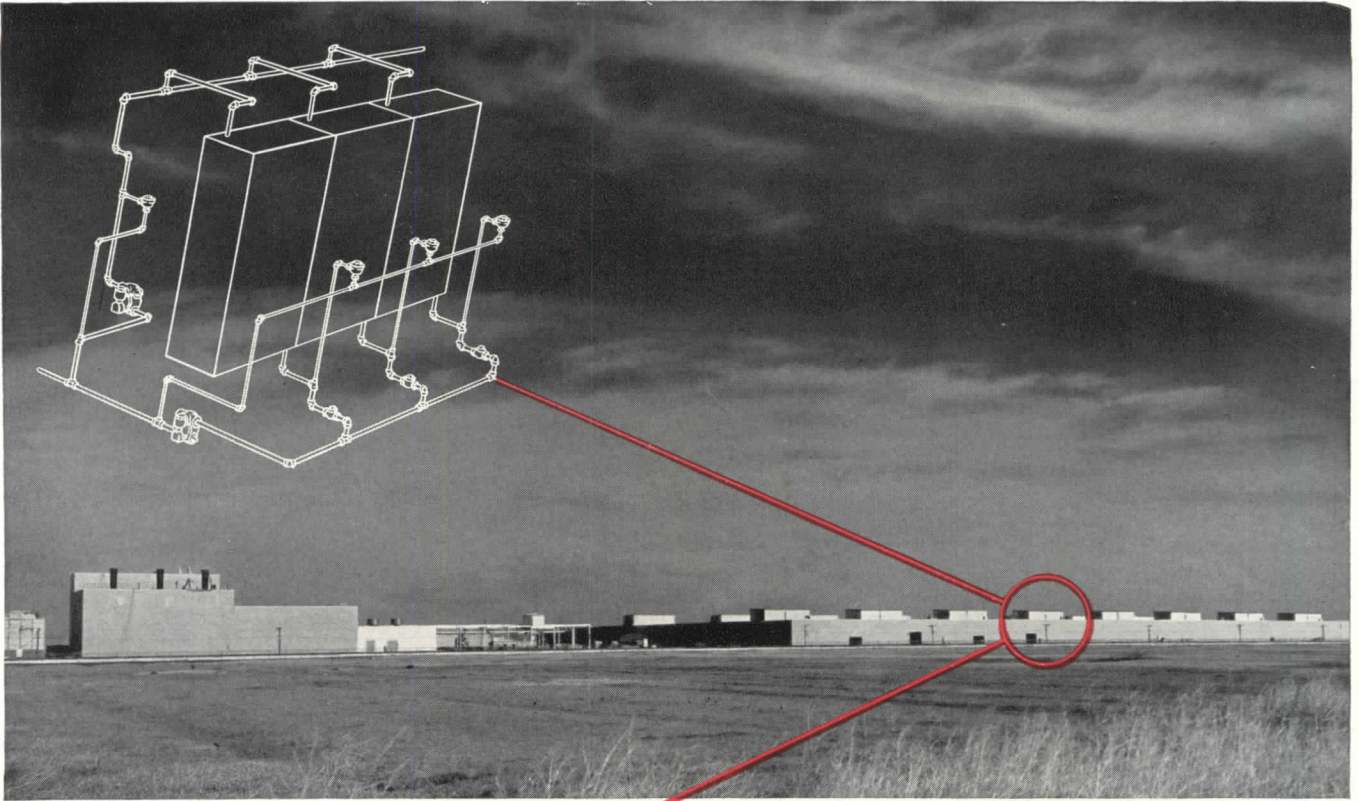

The new plant of the Studebaker Corp.—Aviation Division.  
Arch. & Engrs., Giffels & Vallet, Inc.—L. Rossetti

# Upside-Down HEATING

CLEAR S THE PATH FOR DEFENSE PROGRESS

As important a defense conservation as any other is that of manufacturing *space*! Here at the new Studebaker airplane motor plant is a notable example... engineering skill in providing clear spans and unobstructed floors is ably seconded by a heating method which wastes not an inch of productive area.

Each of the penthouses on the roof of this modern factory conceals a heating unit of novel design. Air is directed over steam heated coils and passed through ducts to the shops below. *Upside-down heating*, in the interests of space conservation!

Hoffman Steam Specialties play a strong part in this ultra-modern application of a soundly practical heating idea. Hoffman High Pressure Traps keep the heating coils at top efficiency by assuring thorough drainage of the large volumes of water created by condensing steam. The known quality of Hoffman Specialties dictated their selection for this job, where any equipment failure means slowing up the flow of vital war material!

Many similar defense projects today depend upon Hoffman Valves, Traps and Pumps for *more heat from less fuel!*

If you are now planning enlargement or modernization of your manufacturing facilities, ask your engineers about Hoffman Controlled Steam or Hot Water Heating Systems. Or write to us for counsel on your particular heating problem. Hoffman Specialty Company, Dept. AR2, Indianapolis, Ind.

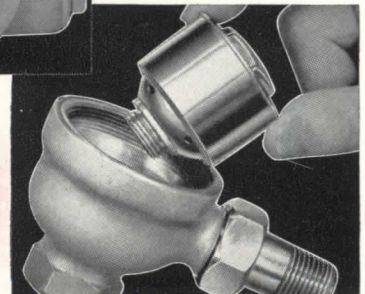
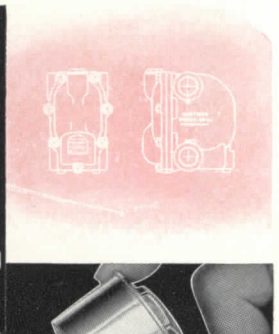
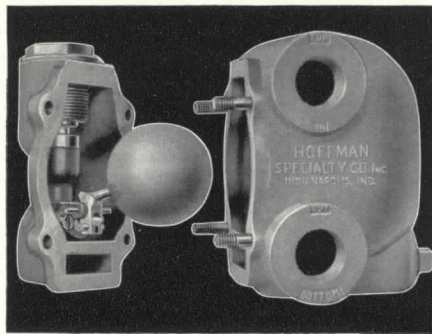

Hoffman 50 Series Heavy Duty and No. 20H High Pressure Traps are used to drain and vent the huge heating units of the Studebaker plant. Both are distinguished by constructions which give easy access to all working parts.

## HOFFMAN

*Controlled Heating*

VALVES, TRAPS, VACUUM AND  
CONDENSATION PUMPS, FORCED  
HOT WATER HEATING SYSTEMS



STEAM / HOT WATER



By KENDALL K. HOYT and RAYMOND R. DICKEY

## FREEZING ORDER IS IMMINENT FROM WAR PRODUCTION BOARD

War Production Board . . . New Freezing Order Imminent . . . Modernization Opportunities . . . Shelter for War Workers . . . Lanham Act Passed . . . Priorities and Housing

CREATION of the new War Production Board means far more than a mere shifting of agencies. Its significance is the tremendous power that it delegates to the Chairman of the Board.

Among the very first to feel the heavy hand of this Board will be the construction industry. A drastic freezing order which would stop all but certain classes of construction is now imminent. Already this order has been considered twice by the Clearance Committee which checks all potential priorities orders for unanimity of policy prior to final OK by the Director of Priorities. In each case, the order has been sent back for change. But as this is being written the present draft of the order provides for immediate cessation of all construction *not* falling within one of the following classes:

1. Any construction bearing a priority rating may be completed or begun.
2. Any building essential to the public health and welfare (such as hospitals) may be completed, whether or not it has a rating. In the case of new buildings of this type, clearance must be effected before commencing construction.
3. Where building foundations have been finished, the general rule will be to allow completion.
4. Certain types of farm buildings will be permitted.
5. Repair and modernization, where not using critical materials beyond certain amounts, will be permitted—even encouraged.

In all other cases, building will be permitted only through special dispensation.

The original draft of the order also provided that new construction which did not use more than 2,500 pounds of critical materials would be allowed. As a clear indication of the new "tough minded" administration of war production and civilian curtail-

ment to facilitate war production, the Clearance Committee returned the draft containing this provision with instructions to eliminate it entirely.

In the low-cost housing field there is still a tremendous opportunity for privately financed construction in defense areas. Banks and other lending institutions are being pressured by the FHA to put some of their huge amounts of funds into low-cost housing of a defense type. The FHA is urging the use of Title VI of the National Housing Act and is pointing out the marketability of mortgages insured under that title. The whole low-cost housing job cannot be done by public funds alone.

### FHA changes regulations

In an effort to step up private building to house war workers—especially rental properties—FHA has changed some of its regulations and procedures. Adjustments are being made immediately in FHA construction cost estimates in local areas, in relation to actual building costs, where increases in costs are stabilized and adjustments justified.

Monthly payments on loans insured under Title VI (defense housing insurance) are being reduced by about 11 per cent through elimination of the so-called accelerated amortization provision. Effective Feb. 15, the sum of principal and interest payments on new loans will be substantially the same each month. Up to this time, payments in the first five years have been greater than in the following 15 years. Adoption of a level repayment provision will enable more defense workers to purchase or rent homes constructed with mortgages insured under Title VI. Builders may either sell or rent such properties, and since the FHA is urging the construction of more homes under Title VI for rent, this change in the regulations will reduce the carrying cost for builders and the rent.

The new Lanham Act, which in-

creases the defense housing appropriation to \$600,000,000 and the Community Housing Program appropriation to \$300,000,000, has been sent to the President for signature as this is being written and will undoubtedly be signed. In addition to the increase in appropriation, the Act, as it finally got through Congress, extended the defense housing program to include living quarters for single persons engaged in national defense activities; increased the average unit cost of family dwelling units from \$3,000 to \$3,750 for construction types located within the continental United States, and to \$4,250 for other locations except Alaska where a \$7,500 limit was fixed. It also gives the Administrator discretionary authority to build temporary units where he believes there is not a reasonable prospect of disposing of houses built for defense purposes after the emergency. Houses built with funds appropriated under the Act may not be conveyed to any public or private housing agency engaged in slum clearance or subsidized housing for low income groups without express authorization of Congress. Rentals will be fixed in relation to the value of the property. In case of Army and Navy personnel, the Secretary of War and Secretary of Navy will name rentals.

Special authority is given to the Administrator to adjust rentals to incomes during the emergency. Contracts for the housing will be awarded by competitive bidding.

### Priorities

Supplies of plumbing, heating, and electrical equipment for maintenance and repair will continue to be available through the usual wholesale and retail channels, according to OPM's Priorities Division. Under a new suppliers' order, M-67, suppliers may accept deliveries of plumbing, heating and electrical supplies—and other suppliers, producers, or other persons may make deliveries of such supplies—if the supplier to whom delivery is being made has less than his maximum permissible inventory, and the delivery is of the minimum quan-

(continued on page 20)

This is one of a series of advertisements telling what leading Consulting Engineers think of modern steam heating.



Frank Sutton, New York Consulting Engineer. Member of American Society of Mechanical Engineers, American Society of Heating & Ventilating Engineers and the Society of Consulting Engineers. B.A., E.E., Columbia University.

UNDERWOOD & UNDERWOOD  
STUDIOS, N. Y.

“In my opinion,” writes Frank Sutton, “steam is the most flexible medium for heating large groups of buildings because with it you can obtain everything required for many varied types of service. Complete control over each building can be obtained with modern central steam heating control, with or without extensive zoning. Comfortable heating is provided at an enormous saving by comparison with earlier uncontrolled and now obsolete installations. By the use of appropriately located pressure reducing valves, steam is made readily available for laboratories, clinics and similar facilities and for heating domestic hot water.”



Frank Sutton designed and specified a “Controlled-by-the-Weather” Webster Moderator System of Steam Heating to improve the heating of fifteen buildings on the campus of Alfred University, Alfred, N. Y. It is an outstanding example of the heating improvements and economies that can be effected by modernization of the older-type low pressure steam heating systems.

WARREN WEBSTER & COMPANY, Camden, New Jersey  
Pioneers of the Vacuum System of Steam Heating  
Est. 1888 : : Representatives in 65 U. S. Cities

**STEAM** Heats  
America . . . .

©1940

## NEWS FROM WASHINGTON

(continued from page 18)



tity commercially procurable.

For a supplier located in the Eastern or Central Standard time belts the term "maximum permissible inventory" means that he cannot have *on order or in stock* more supplies, in total dollar value, than one-sixth of his total 1941 sales in dollar value. A supplier located elsewhere in the United States cannot have on order or in stock more than one-fourth his total 1941 sales in dollar value.

It is important to note that the M-67 does not guarantee delivery of any material. Delivery to a supplier depends upon the manufacturer being able to get the necessary materials to fabricate or manufacture plumbing, heating, or electrical supplies. Manufacturers of such supplies may get priority assistance by making application on Form PD-25a addressed to the Production Requirements Branch of OPM.

There has been a change in pro-

cedure for manufacturers who are supplying building materials for defense housing projects. Preference rating order P-55 was amended on Jan. 13 and provides that such manufacturers should, after that date, apply for priority assistance under the Production Requirements Plan. Under the former procedure, building materials manufacturers could extend project ratings to speed up their own purchase orders for necessary materials. Under the new procedure, however, these manufacturers may not extend ratings assigned to projects, but must apply on Form PD-25a for priority assistance.

When a project rating has been given to a particular housing project, the builder may extend that rating to a supplier if the supplier has "not in whole or in part manufactured, produced, assembled, or otherwise physically changed" the materials to fill a rated order. If the supplier has not

changed the materials, he may apply the rating carried by the project to his own purchase orders for finished items, but when the supplier extends the rating to a manufacturer for the finished item, the manufacturer cannot extend the project rating further to get raw materials but must apply for a rating to get his raw materials under the Production Requirements Plan.

The amended order P-55 also requires suppliers to sign an acceptance of P-55 amended before applying its rating to their orders, as well as to get each extension of the order authenticated by an agent of FHA.

One change of considerable value to a supplier is that the amendment allows him to defer application of the ratings assigned to orders filled by him until he can place a purchase order with a manufacturer for the minimum quantity procurable on customary sales terms.

Once an  
UGLY DUCKLING →



# NOW

A BEAUTY IN BOTH DESIGN AND ACTION →

At long last, awkward, unsightly overhead door checks need no longer be accepted as a necessary evil. They can be displaced by the specification of Rixson UNI-CHECK — at about the same cost level. UNI-CHECK is installed in the floor, practically out of sight. It enhances the appearance of a fine door with its small top

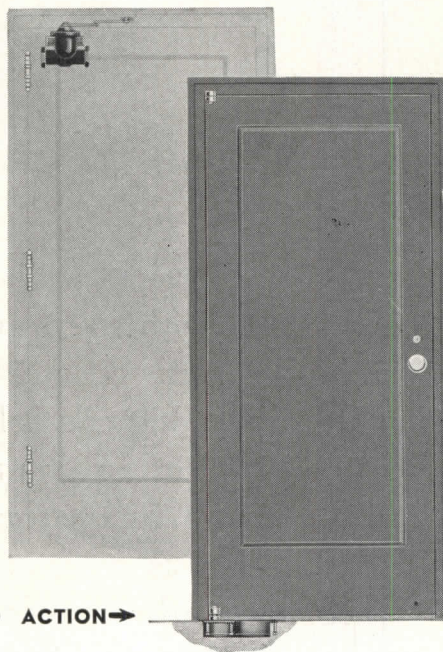

and bottom pivots instead of bulky hinges.

UNI-CHECK requires only 2 <sup>9</sup>/<sub>16</sub> inches of floor depth: Can be readily installed in any type of floor with or without a threshold. It closes the door gently and positively. There are only six sturdy moving parts and no complicated adjustments to make.

## RIXSON

### Uni-Check

FOR SINGLE ACTING  
INTERIOR DOORS

UNI-CHECK is suitable for any single swing interior door, wood or metal, and no unsightly arms project whether the door is open or closed.

Made in four capacities. Write for data sheet.

Your nearest Rixson representative will gladly demonstrate UNI-CHECK to you.

**THE OSCAR C. RIXSON CO.**  
4448 Carroll Avenue Chicago, Illinois

Rixson Representatives at:  
NEW YORK: 2034 Webster Avenue  
PHILADELPHIA: 211 Greenwood Avenue,  
Wyncote, Pa.  
ATLANTA: 152 Nassau Street  
NEW ORLEANS: 2630 Jefferson Avenue  
SAN FRANCISCO: 116 New Montgomery  
Street  
SEATTLE: 4012 East 38th Street  
LOS ANGELES: 909 Santa Fe Avenue  
LONDON, ONT., CANADA: Richards-  
Wilcox Co., Ltd.

**MAKE THIS TEST -**  
*Prove* **BRIXMENT** *is* **BEST!**



**1**

Slap a small amount of Brixment mortar, and an equal amount of 50-50 lime and cement mortar, on a brick. Wait a minute, then feel each mortar.

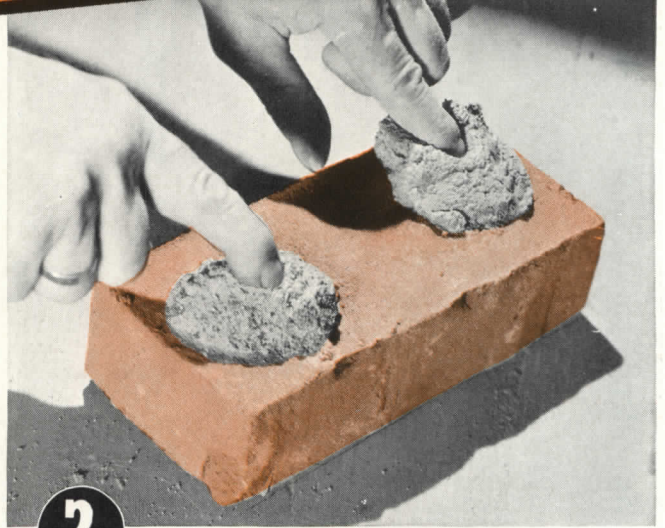

**2**

Test each mortar. You will find that the Brixment mortar stays plastic *far longer* than the other mortar. This proves *greater water-retaining capacity*.

## **BRIXMENT Mortar Has** **Far Greater Water-Retention!**

WATER-RETAINING CAPACITY is the ability of a mortar to retain its moisture, and hence its plasticity, when spread out on porous brick.

High water-retaining capacity is of *extreme importance* in mortar. If the mortar does not have high water-retaining capacity, it is too quickly sucked dry by the brick; the mortar stiffens too soon, the brick cannot be properly bedded, and a good bond cannot be obtained.

Brixment mortar has extremely high water-retaining capacity. It strongly resists the sucking action of the brick. Brixment mortar therefore stays smooth and plastic when spread out on the wall.

*This permits a more thorough bedding of the brick, and a more complete contact between the brick and the mortar. The result is a better bond, and hence a stronger and more water-tight wall.*



# **BRIXMENT**

## **For Mortar and Stucco**

*Louisville Cement Company, Incorporated, Louisville, Kentucky. Cement Manufacturers for Over a Century.*

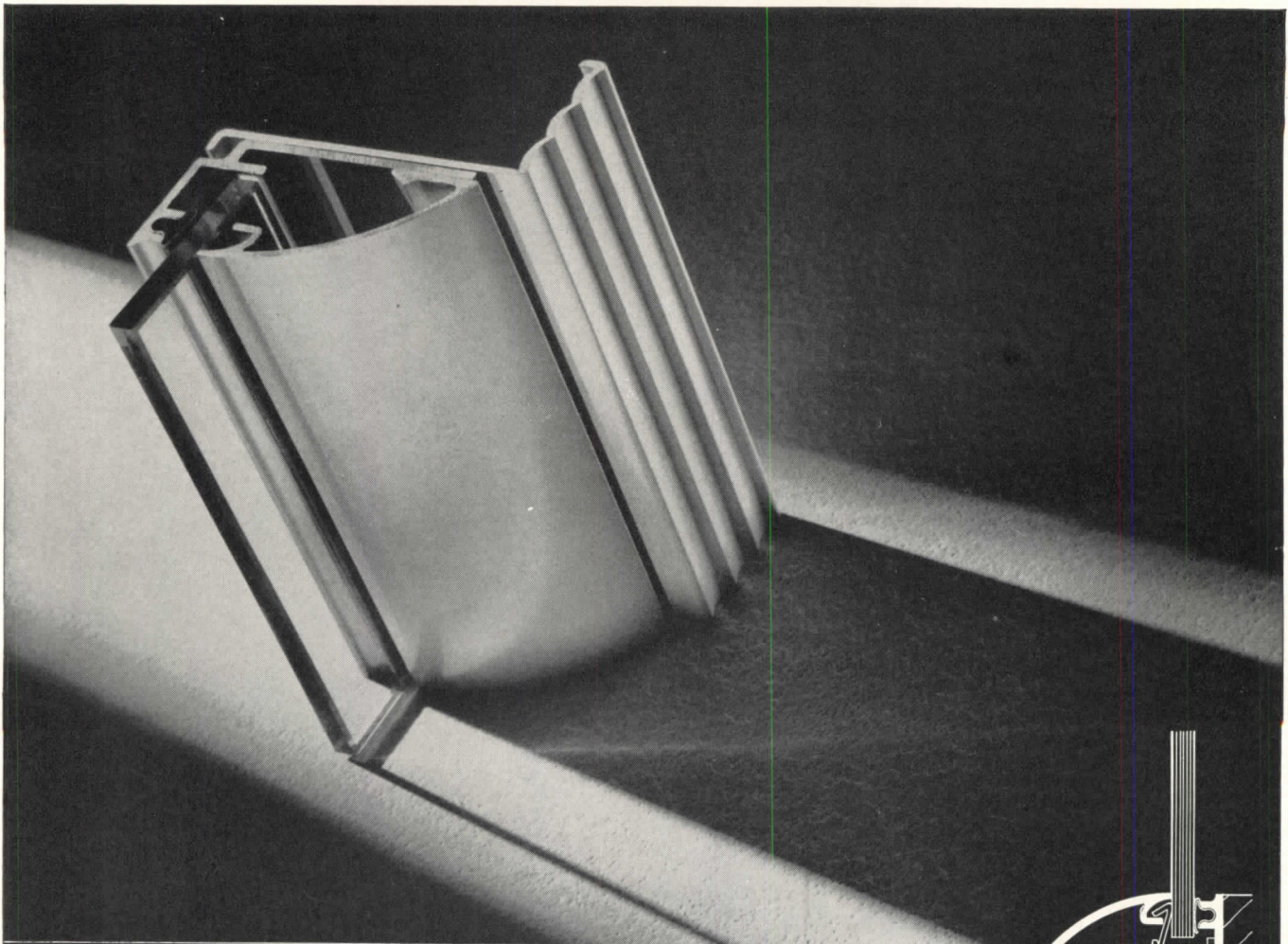

## COMPLEMENTARY CONTOURS

THE wide variety of units composing the Pittco Store Front Metal line affords the architect an opportunity to achieve unusually pleasing combinations of members. Each unit in the line bears a definite design relationship to all other units which may be combined with it in actual store front work. The effective contrast between smooth, sweeping surfaces and adjacent surfaces which are interrupted by beading or sharp contours, is a design element provided generously by Pittco Metal. This quality is exemplified in the sash shown above. Whatever problems of metal construction may confront you in designing quality store fronts, you will find a distinguished answer to them in the varied bars, mouldings and sash of the Pittco Metal line. Pittsburgh Plate Glass Company, Grant Building, Pittsburgh, Pennsylvania.

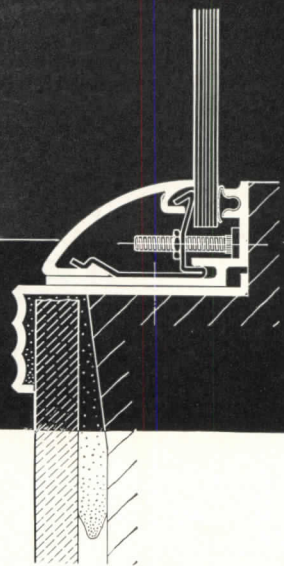

### DETAIL:

In the above combination, the clean arc of the sash faceplate enhances and intensifies the fluted jamb moulding. Sash: 12-A. Jamb: PX-195

**PITTCO STORE FRONT METAL**  
PITTSBURGH PLATE GLASS COMPANY

*"PITTSBURGH" stands for Quality Glass and Paint*

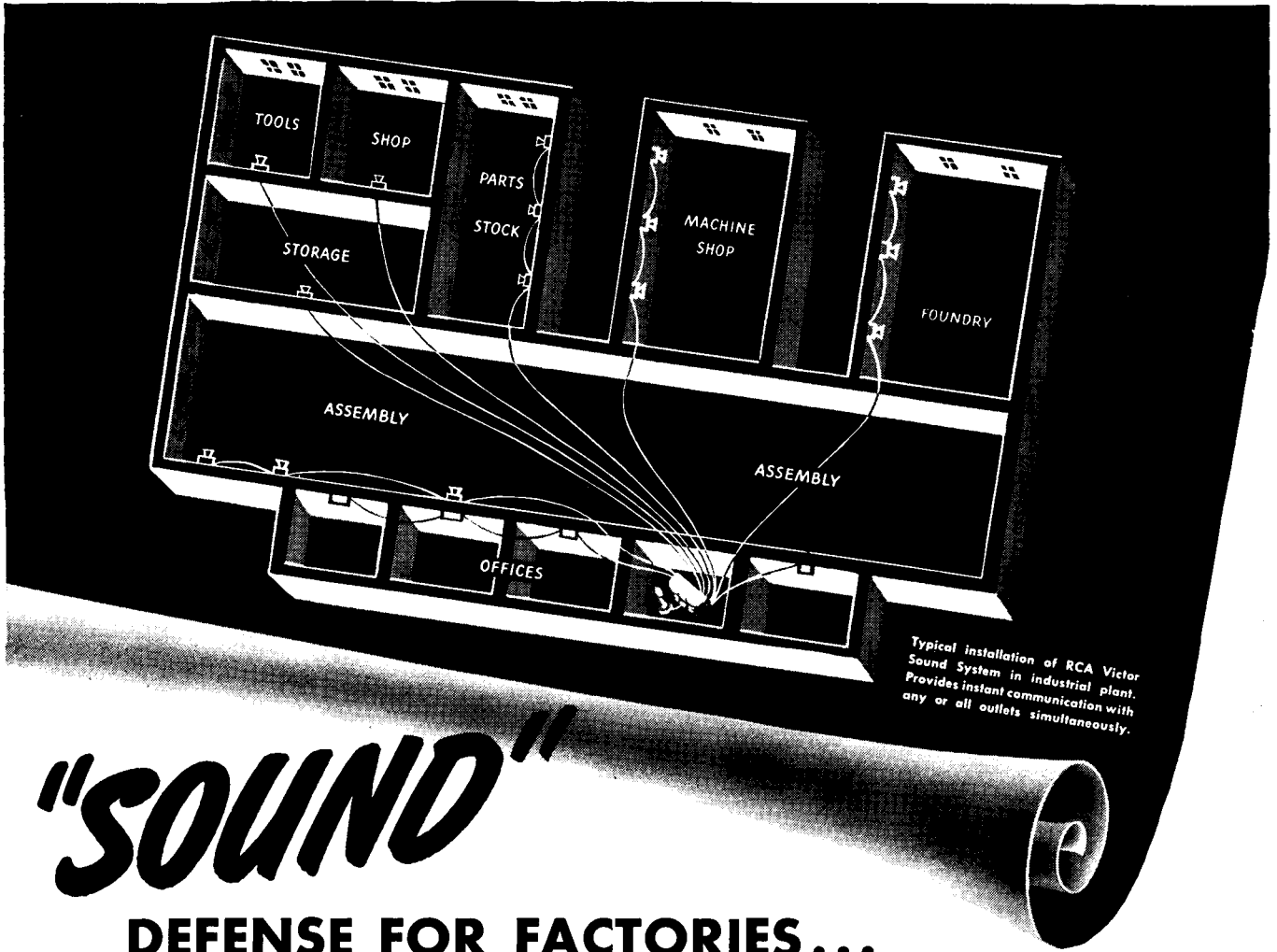

# "SOUND"

## DEFENSE FOR FACTORIES...

# RCA Victor Industrial Sound Systems!

**For Air Raid Alarms . . . Inter-Plant Communication . . . Emergency Instructions . . . Executive Announcements . . . Radio News Programs . . . Fire Drills or Alarms . . . Music!**

**I**N TIMES like these communication is especially vital! That's why the RCA Victor Industrial Sound System should be considered now by every plant designer and superintendent! RCA Victor Sound Systems put executives in instant communication with any or every department, or any individual, thus speeding production and increasing plant efficiency.

In addition, facilities for air raid alarms, emergency instructions, announcements to employees, and music during fatigue periods are

of tremendous importance to every factory producing war material. All these can be handled quickly and effectively with an RCA Victor Industrial Sound System.

Write or send coupon for full details about this important time-saving defense aid. Scores of defense plants are already using RCA Victor Sound Systems. We will be glad to furnish names upon request.

Trademark "RCA Victor" Reg. U. S. Pat. Off. by RCA Manufacturing Co., Inc.



**Of Vital Importance to Every Factory**

**DEFENSE**—Instant communication along production lines, between control positions, between floor and moving cranes, between office and warehouses. Provides instant warning or emergency instructions. Facilitates movement of material. Intelligible above extreme noise level in mills, shops and foundries.

**ADMINISTRATIVE CONTROL**—Paging system to locate executives, key men, visitors . . . Time, fire and safety signals . . . Instant contact for air alarms and emergencies.

**PERSONNEL RELATIONS**—All employees or groups of employees can be reached at once. Permits safety talks and instructive talks to improve efficiency. Music during lunch or fatigue periods increases defense production. Useful for recreational and social functions.



## RCA Victor Industrial Sound Systems

**MUSIC • PAGING • COMMUNICATING**

RCA Manufacturing Co., Inc., Camden, N. J. • A Service of the Radio Corporation of America • In Canada: RCA Victor Co., Ltd., Montreal

Commercial Sound Division (5-7)  
 RCA Manufacturing Co., Inc., Camden, N. J.

Please send me more information about RCA Victor Industrial Sound Systems.

Please have sound engineer call on me.

Name .....

Company .....

Address .....

City ..... State .....

RE-2



## DEMOUNTABLE HOUSING INDUSTRY TO BUILD 42,000 DEFENSE HOMES FOR FWA

DEMOUNTABLE housing, given a big boost last month with huge Government orders, moves suddenly into a significant position on the housing front. With FWA programming 42,000 demountable houses, to be paid for with a \$153,000,000 allocation from the President's emergency

funds, the prefabricating industry gets its first taste of mass production volume. While it can hardly be said that 42,000 units spread over 50 plants represents the long-heralded arrival of mass-produced housing, it can well prove sufficient volume to short-circuit much of the painful process of developing markets, and to establish at least a few companies in a strong position.

Thus, if for no other reason, the Government's acceptance of the demountable houses holds interesting potentials for architects and engineers. For the enthusiastic predictions of a few years back are again being freely offered, with a new post-war twist like this: 1. Many prefabricators will have a running start into peace-time production; 2. What happens then will be largely dependent on the designers.

The first announcement came early in January and the tempo increased through the month, until the wording was "the entire production capacity of the country's prefabricated house building industry will be used and manufacturers will be required substantially to increase their output." Concurrently the FWA whipped up some suggested floor plans and planning standards to guide prefabricators and site planners, and announced that orders for 35,000 units would be placed during January.

Then, while FWA field men were busy selecting sites in most of the 50 areas, came an announcement of a new scheme contemplating the construction of all types of defense homes in small groupings within a

defense area, instead of concentrating them in large numbers.

FWA reports 200 mills and wood-working plants have also indicated a willingness to take part in the program. Site fabrication will also be employed. The announcements promise a two-shift, seven-day-week production, and the 35,000 units in the first orders are to be ready by July 1.

## FLAMEPROOFING STRUCTURAL MATERIALS WITH BOROPHOSPHATE RESIN

By C. A. Crowley, Ph.D.\* and J. B. Mullen, M.S.\*\*

SHOULD AN ENEMY decide to bolster his own morale and impress us with a bombing attack, our chief danger would be from fire. Incendiary bombs by the hundreds can be carried in a plane which can transport only a few explosive bombs. So we should do what we can to increase the fire-resistance of wood structures, particularly those of military significance such as wood hangars, barracks, etc.

Some work has been done with ammonium salts of phosphoric acid and salts of boric acid, but these materials have shortcomings. A recently developed material with few if any defects is a sodium borophosphate polymer, commercially called *Abopon*.

This material is being satisfactorily used in fireproofing textiles, theater drops, etc. Its properties for application to structural materials has been the subject of study. Various commonly used panels were impregnated with 25, 50 and 75 per cent solutions of *Abopon*. They were then tested with a blowtorch adjusted so that the flame was 1 in. from the panel, with the blast continued for exactly 30 seconds after the material began to flame, and then shut off. Times required after that for flames to cease, and for afterglow to cease, were recorded (see p. 26). Superiority of the treated panels is apparent from these figures. Light, porous

\* Consulting Engineer, Chicago, Ill.  
\*\* Chief Chemist, Technical Service Bureau, Inc., Chicago, Ill.

(continued on page 26)

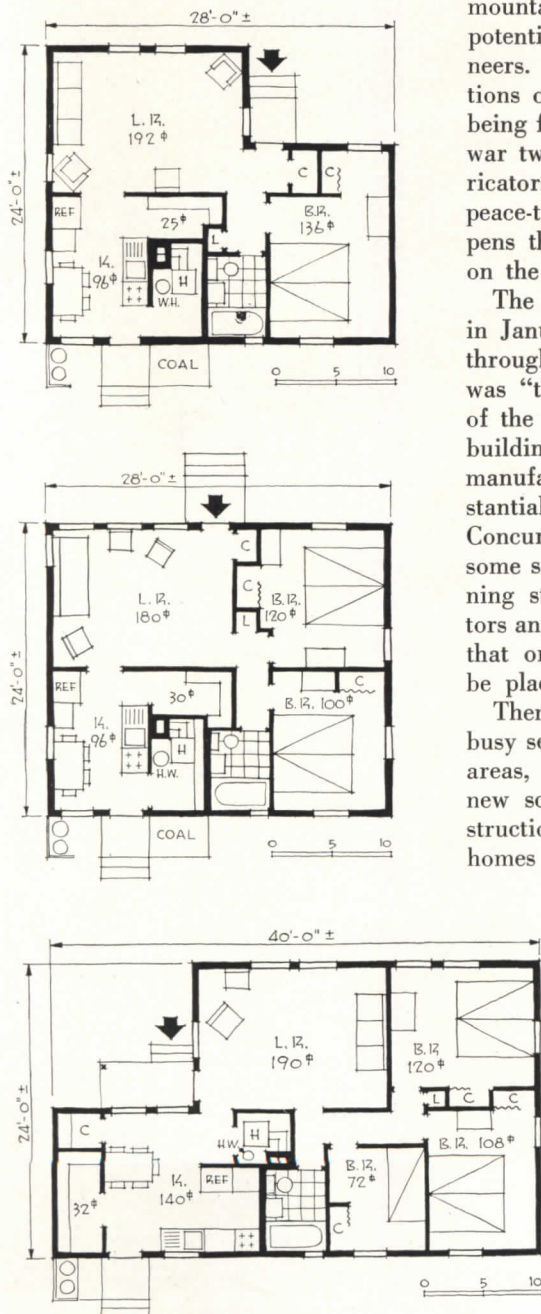

PLANNING MATERIALS issued for the guidance of prefabricators by FWA include a dozen floor plans, with elevations showing both gable and flat roofs. Because of the urgency, however, prefabricators were asked to concentrate on the three floor plans shown here, and to consider only gable roofs. The standards given for layout, construction and equipment for the demountable houses correspond quite closely with Lanham Act standards issued by USHA.





*Lives Saved! Battles Won!*  
**by a BRAIN and a PENCIL...**

A man hunched over a drawing board broods darkly as he sketches odd shapes on layout tissue . . . .

Suddenly an excited gleam comes into his eyes. His pencil moves feverishly, bringing forth a graphic design, translating his brain child into a new device to serve his Nation in the arsenal of production. A device that will speed Victory, save lives and achieve a quicker peace.

Men engaged in vital defense projects gladly pay a few extra pennies for A. W. Faber's WINNER Techno-TONE, America's standard of excellence in drawing pencils. You, too, will find that ideas come more readily, more smoothly with a WINNER Techno-TONE.

Try WINNER Techno-TONE at our expense. Write for free sample of your favorite degree on your business letterhead.

WINNER Techno-TONE guarantees all 4 Freedoms — Freedom from Scratching, Smudging, Flaking and Gritty Hard Spots. 17 scientifically graded tones — 6B to 9H. Polished rich green. Packed in metal box. Made in U. S. A.

**WINNER** *Techno-TONE*  
**DRAWING PENCILS**

**13c each    2 for 25c    \$1.25 dozen**

At all Drawing and Artists Material dealers and leading Stationers.

Write Dept. AR-2, A. W. Faber, Inc., Newark, N. J.

Companion Pencil — WINNER Thin Colored Checking — Superb colors and strength. Choicest for all prints: 2381 Red; 2382 Blue; 2383 Green; 2385D Yellow; 2437D Orange. 10¢ each. \$1.00 dozen. Would you like a sample?



**A.W. FABER Inc.** NEWARK, N. J.

## TRENDS IN BRIEF

(continued from page 24)

insulating boards show striking results.

Material	Treatment	Time in Seconds		
		to flame	to end of flame	to end of after-glow
Masonite	None	4	3	6
	25%	35	0	3
	50%	60	1	2
	75%	75	0	1
5 Ply Fir Board (3/4")	None	5	2	3
	25%	10	1	3
	50%	12	0	1
	75%	20	0	1
Celotex	None	3	167	over 300
	25%	10	1	3
	50%	150	1	2
	75%	over 300	..	2
Nu-Wood	None	2	35	over 300
	25%	37	0	3
	50%	78	0	3
	75%	over 300	..	2
Upson Board	None	2	2	over 300
	25%	12	1	4
	50%	18	1	2
	75%	31	0	2
White Pine	None	7	20	24
	25%	10	1	5
	50%	12	0	2
	75%	14	0	1

Untreated panels were badly burned over the entire upper two-thirds of the piece. (Each panel was clamped at bottom, and torch flame was directed at a point 2 in. from top and

4 in. from bottom of panel.) In sharp contrast, a round charred area not more than about 2 in. in diameter, and generally smaller, is the extent of damage to panels impregnated with *Abopon*. Also, exposure to the torch flame was greater for treated than for untreated specimens, since it took longer for treated pieces to flame.

Resistance of treated materials to fires caused by incendiary bombs, glowing sparks or the like was tested by means of hot blocks. A steel block  $3/4 \times 3/4 \times 4 1/2$  in., weighing approximately  $10 1/2$  oz., heated to  $1500-1600^\circ$  F., was laid on a test panel for exactly one minute. Treated panels, without exception, ceased to flame or glow within 20 seconds after removal of the block; untreated panels, in every case, continued to glow for over a minute and had to be quenched. Treated panels were charred only in an area roughly outlining the place where the block lay; the others were charred over virtually their entire

area. Furthermore, actual penetration was markedly less in all treated panels. These tests prove that while treated material may char, and may even flame while in actual contact with the hot object, flames will stop and charring will cease almost at once when the hot object cools or is removed.

Treated materials were also tested for possible loss of the fireproofing agent due to rain. The test was more severe than ordinary exposure. At its conclusion, the average loss of *Abopon* by weight was approximately 30 per cent. The materials tested were not painted. Yet, *Abopon* is not soluble in alcohol or oils and therefore can be easily covered by paint or lacquer to protect surface, so that loss due to rain could be made negligible. In fact, cost of painting *might be* reduced because borophosphate resins seal the porous surfaces of the materials, and prevent raw wood from "sucking in" paint.



## EXPERIENCE COUNTS—ALWAYS!

Our 50 years experience produces cold storage doors which efficiently protect the contents of refrigerated rooms.

JAMISON-BUILT DOORS—always essential to the best protection of perishable products—are today a vital link in national defense. For NO FOOD MUST BE WASTED.

Why call for anything less than the best—at no extra cost? Specify JAMISON-BUILT DOORS.

Consult nearest branch or address

**Jamison Cold Storage Door Co.**  
Jamison, Stevenson and Victor Doors  
HAGERSTOWN - - - MARYLAND

You can't buy  
EXPERIENCE,  
but JAMISON  
builds it into  
EVERY  
DOOR

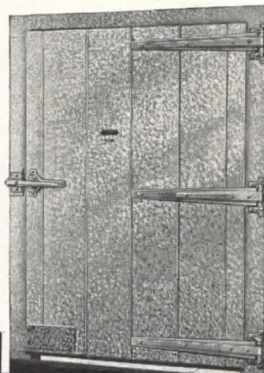

Jamison Metal Cold Door  
Send for Bulletin No. 127

A typical example of  
how Jamison creates  
doors to meet all needs

**JAMISON-**  
BUILT COLD STORAGE DOORS

### COMPETITION FOR AIRPORT BUILDING at Fitchburg, Massachusetts

The Fitchburg Municipal Airport Commission, George R. Wallace, Chairman, announces an architectural competition for the design of an administration building at the Municipal Airport.

Copies of the program may be obtained from Joseph Hudnut, Professional Adviser, Robinson Hall, Harvard University, Cambridge, Massachusetts.

See our catalog in Sweet's Catalog Files

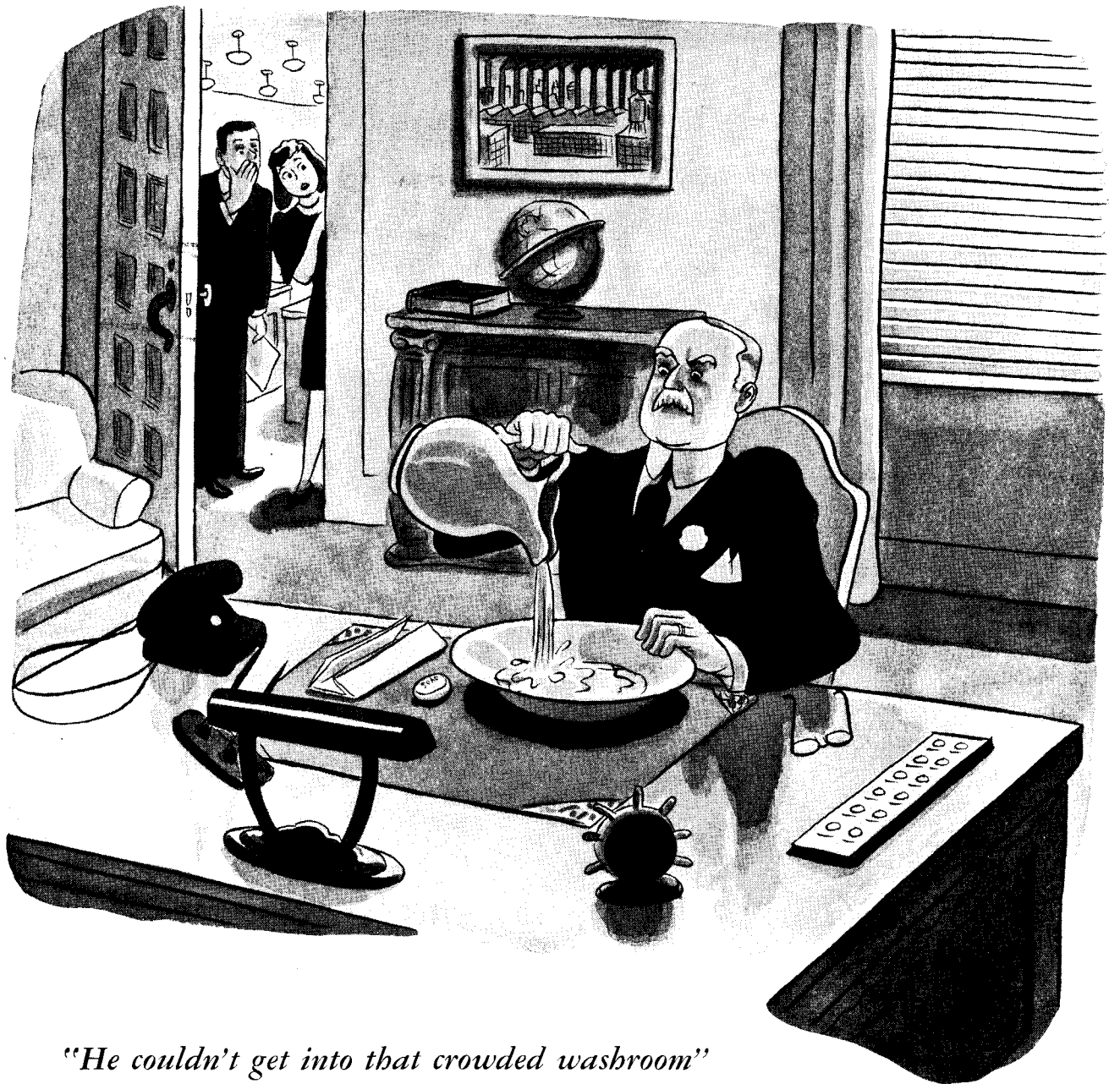

*"He couldn't get into that crowded washroom"*

Maybe it *is* stretching a point to think the boss would use his own office for a washroom.

But there are plenty of washrooms where the traffic jams are enough to make him want to.

Today, such conditions can easily be avoided with the planning help of the Scott Washroom Advisory Service.

This free service offers new technical data on traffic flow, fixture arrangements and sanitary needs . . . the assistance of trained staff members to provide material you need to plan washrooms for efficiency, comfort and economy in *use*.

For details, and for a set of Don Graf Data Sheets on washroom planning, write Scott Paper Company, Chester, Pa.

See our listing in  
Sweet's Catalog

## SCOTT WASHROOM ADVISORY SERVICE

offered by the makers of the famous  
new "Soft-Tuff" ScotTissue Towel and ScotTissue Service Roll

Trade Marks "Soft-Tuff," "ScotTissue" Reg. U. S. Pat. Off.  
Trade Mark "Washroom Advisory Service" Reg. Applied For.

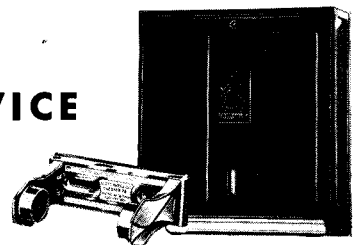

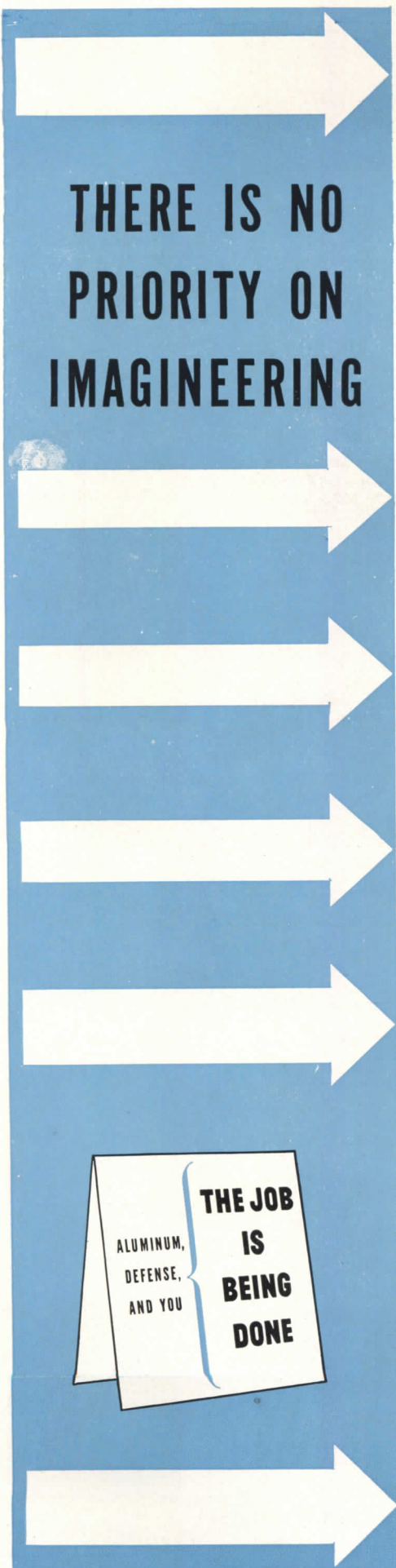

# THERE IS NO PRIORITY ON IMAGINEERING

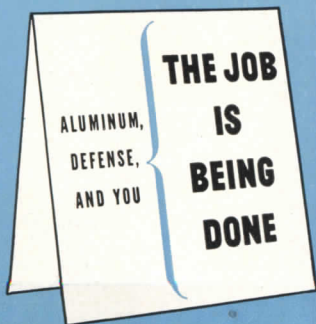

**EVERY INDUSTRY**, every responsible man in industry, has the present duty of answering two questions.

**FIRST ONE IS:** Are we, am I personally, doing everything within my power for the war? Our answer here at Alcoa is a plain, unqualified, yes.

**NEXT QUESTION IS:** What are we doing about the day when we will all need business, which is the polite way of saying, when millions of jobs will be needed for the boys who come back, and for the boys who stayed back to make the weapons.

**IMAGINEERING**, you know, is the word we have coined to define what we business people have all got to do about the future; about the products we are going to make and the services we are going to be able to offer when this war is over. Imagineering is imagination plus engineering.

**HOW DO YOU DO IT?** One way would be to figure out, now, how to take advantage of all the aluminum that is going to be available.

**QUICKEST WAY TO GET AT IT** is to take one of your products or a piece of equipment that "just couldn't" be made of aluminum, and ask yourself, Why not?

**MEANING, OF COURSE**, why not light; why not stronger for the same weight; why not resistant to corrosion, and so on, ad infinitum. The first man in any line of business who calls tradition a liar, and things-as-they-are a millstone, is the man who is going places; the man who is going to make peacetime pay rolls.

**THAT'S IMAGINEERING AT WORK.** We've got some ideas here at Alcoa. We're trying to pass them out. We are looking for men who have made themselves receptive by doing some solid Imagineering on their own hook, in their own fields.

Aluminum Company of America, 2167 Gulf Building, Pittsburgh, Pennsylvania.

## ALCOA ALUMINUM



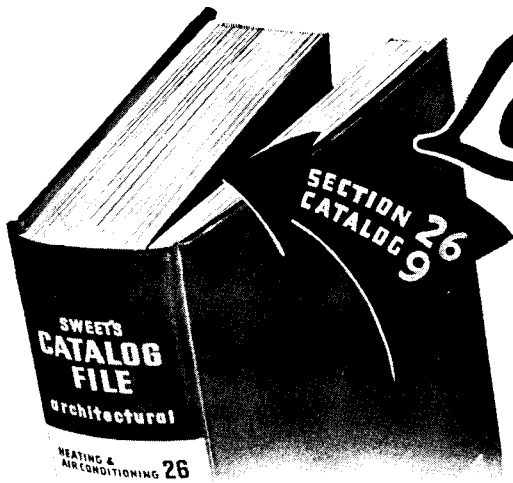

# Look in "Sweet's"

for full specifications on these  
**FITZGIBBONS**  
 units for heating defense homes

**80 FWA WARM AIR CONDITIONER**

Automatically controlled blower provides forced circulation of warmed air. Designed in accordance with the specifications set up by the Procurement Division of the U. S. Treasury Department, meeting the requirements of FWA, USHA, PBA and FSA for Defense Housing. Fitzgibbons "Weldseal" construction positively insures against leakage of flue gases. For hand firing with coal. Also available for use with oil or gas burner.

They already have an outstanding performance record in scores of projects, these steel boilers and warm air conditioners for defense housing. Designed in complete accordance with government specifications, and constructed with the sterling workmanship of Fitzgibbons — which means snug fits, close joints, fuel-saving operation, as well as quick installation and easy servicing.

## FITZGIBBONS 400 Series STEEL BOILER

The choice of architects and builders wherever low cost heating in small homes is needed. Beautifully adapted to defense housing using radiator heat with oil, gas or stoker firing, or with coal hand firing. Built-in copper coil provides domestic hot water. All the advantages of Fitzgibbons steel boiler construction in an attractively jacketed unit priced for the field it serves.

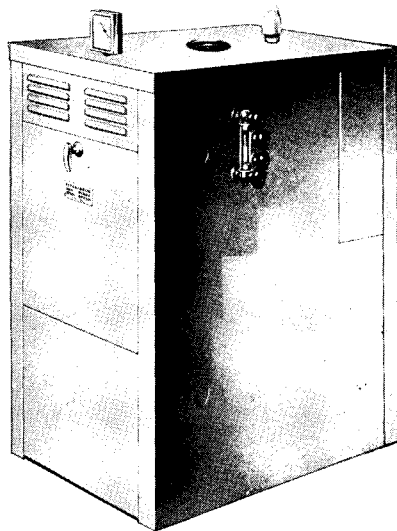

## FITZGIBBONS 65 DA—80 DA—100 DA

A distinctly small home air conditioner which has every Fitzgibbons advantage of welded steel construction, and extremely low fuel consumption. Warms, humidifies, filters and circulates the air. Quiet in operation, beautiful in appearance.

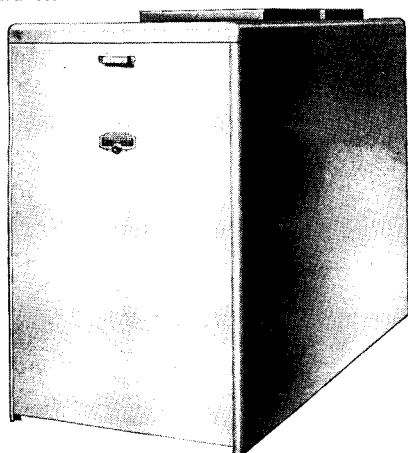

Fitzgibbons Service to Architects stands ready at all times to cooperate with you in the solution of your heating problems. Just say the word.

**Fitzgibbons Boiler Company, Inc.**

101 PARK AVENUE, NEW YORK, N. Y.  
 Branches and Representatives in Principal Cities

By ELISABETH COIT, AIA

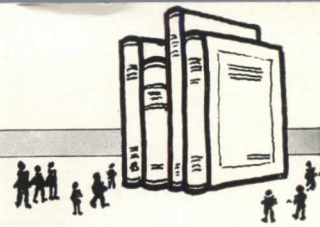

**THE EARLY ARCHITECTURE OF NORTH CAROLINA: A Pictorial Survey** by Frances Benjamin Johnston, with an Architectural History by Thomas Tileston Waterman. Foreword by Leicester B. Holland, FAIA. Chapel Hill, Univ. of North Carolina Press, 1941. 290 plus xxxv pp., 9¾ by 12¾ in., illus. \$10.00

**HOUSES OF OLD RICHMOND.** By Mary Wingfield Scott. Richmond, Va., The Valentine Museum, 1941. 332 plus xii pp., 7¾ by 10½ in., illus. \$5.00

"COLONIAL COLONIAL" is Professor Holland's name for North Carolina's land-borne style of the period covered in this book—"early 18th Century" to about 1850—as distinguished from the Spanish, French, English, or other sea-borne colonials which adorn the other North Atlantic tidewater states.

From one skillful hand come all the photographs, totalling about 330, and within a suavely harmonious frame showing great variety—with a staircase upside down to add piquancy. The chapters on the churches and on the domestic architecture of the tidewater and the foothills will be to all but the most initiated an astonishing delight.

Acknowledgments are made to the Carnegie Corporation, the H.A.B.S., and Colonial Dames.

Dr. Scott's interest and emphasis are on the side of local history in her story of Richmond's rise from village to commercial and social capital during 1737-1860, as expressed in over a hundred of the homes erected during that period. Short readable accounts of the families concerned and of the later happenings to their homes are supplemented by references to source material; and the pictorial record is the more valuable because it includes about fifteen houses no longer standing.

**BUILDING CONSTRUCTION: Materials and Types of Construction.** By Whitney Clark Huntington. New York, Wiley, 1941. 674 pp., 6 by 9 in., illus. \$6.00

THIS is a thorough revision of a standard work by the head of the University of Illinois Civil Engineering Department, made to include the past decade's developments in materials, construction types, insulation and acoustics.

The work, designed for students of engineering and architecture and for graduates of limited or specialized practical experience, is in textbook form and cyclopedic in scope, including industrial, scientific and technological aspects of the subject. The well written text, clothed in one of Wiley's best bold-face, roman and italic ensembles, defies fatigue and misunderstanding in the reading and forgetting in the sequel. Of the figures, numbered 237, a high proportion consists of full page groups of diagrams containing from half a dozen to three times that number of well drawn, well captioned drawings from which a child or the merest of laymen could get a good idea of cavity brick, hollow tile, steel column, stone masonry, glued-laminated truss, and other construction types. References at the chapter ends run from two or three to three score and ten. The index takes all the space it needs both for quick reference and for a legible summary of the contents.

**THE PUEBLOS: A Camera Chronicle.** By Laura Gilpin. New York, Hastings House, 1942. 124 pp., 7 by 9¼ in., illus. \$3.00

THIS CHRONICLE, twenty years in the making, is primarily authored by a photographer, who acknowledges in generous detail contributions by archaeologists and others to the quite superlatively well organized, attention-compelling text, consisting partly of a short introduction, partly of longish captions immediately adjoining the 75 fine photographs they complement.

While the latest period naturally shows more strictly architectural photographs, pictures of earlier periods powerfully present the extent and settings of dwelling groups, dance piazzas, "castles" protecting water sources, and other communal structures, holding their own in their unimaginably gigantic natural surroundings. Among the later dwellings one recognizes with a start that neither the one-family, compact, dazzling, white-walled, flat-roofed Acoma dwelling with its 12-paned double hung

sash, nor the terraced group of apartments of similar construction with outside stairs is not just plumb "modern."

**EARLY CHURCHES IN PALESTINE.** By J. W. Crowfoot. New York, Oxford Univ. Press, 1941. 166 pp. plus 31 plates, 6 by 9½ in., \$3.50

OF MAINLY archaeological interest, this book by an author long resident in the near East—at the Sudanese and Egyptian Ministries of Education and as director of the British School of Archaeology at Jerusalem—continues the record of churches cleared since 1920. Those of the fourth to the seventh century—the period which opened Europe's dark ages but which was bright with the architectural record of Christian achievement from Constantinople to Africa—forming the subject of the 1937 Schweich Lectures of the British Academy are here shown, the fragmentary finds being described and illustrated by some fifty detail photographs and a score of plans.

**THE ST. MARK'S NEIGHBORHOOD: A Study of Housing and General Property Conditions in a Congested Urban Area.** New York, Community Service Society, 1941. 43 mim. pp., 8½ by 11 in., diagrams. \$0.50

THIS SURVEY of 95 acres containing 22 blocks in Manhattan's Lower East Side tells in competent prose and 11 maps of the "improvement" of Peter Stuyvesant's orchard with reference to historic development, population changes, vital statistics, land values, building values, age and type of structure, parks, playgrounds and other communal facilities, alterations to buildings during the last decade, tax arrears and zoning regulations. Recommendations are made for the various parts of the area with respect to the recent New York State Urban Redevelopment Act. The Society's Housing Committee, which made the study in cooperation with New York University's School of Commerce and the Real Estate, Accounts and Finance Departments, plans to take the necessary steps for putting its recommendations into action.

(continued on page 32)



# *helping* - BUILD A STRONGER DEFENSE A BETTER-HOUSED AMERICA

Day and night Carey plants hum with activity, speeding production of materials needed in America's all-out war effort.

Carey Heat Insulation for power plants and aviation gasoline refineries . . . Carey Shingles and Roll Roofing for housing from barracks to defense workers' homes . . . Carey Built-Up Roofs for machine tool and aeroplane engine plants . . . Careystone Corrugated Siding and Roofing for munition plants, boiler houses, etc. . . . Elastite Expansion Joint for roads and runways . . . Carey-Miami Bathroom Cabinets and Accessories for public and private housing projects . . . these but highlight the unending stream of Carey Products going into America's vital construction program.

While Carey has thus been doing its utmost to help meet America's war needs, civilian requirements have not been forgotten. There are legitimate demands for repairs, remodeling and new construction in every community—needs that can and will be met by the building industry.

Meanwhile Carey research continues unceasingly to seek improvement—to check and recheck raw materials and formulas—to subject every product to gruelling tests . . . all to the end that the architect may specify CAREY Products with the sure confidence that they will render outstanding service. For catalog and details, address Dept. 21.

*Illustrations above represent the following: Underground steam lines at ordnance plant insulated with Carey Pipe Covering; Power Plant operating with boiler and turbine pressure of 2500 lbs. at 940° F.—Carey Heat Insulation used; Carey duct used in air conditioning system of engineering laboratory at air field; Carey Sub-grade Felt used in construction of runways at airport; Careystone Siding and Carey Asphalt Roofing Shingles used on F.W.A. housing project; Corrugated Careystone Siding and Roofing used on boiler house of oil refinery; Carey Elastite Industrial Flooring in plant of aluminum producer; Carey Built-Up Roof on large aeroplane engine plant.*

**THE PHILIP CAREY MFG. CO.**  
Dependable Products Since 1873  
**LOCKLAND...CINCINNATI, OHIO**  
IN CANADA: THE PHILIP CAREY COMPANY, LTD.  
Office and Factory: LENNOXVILLE, P. O.

## REVIEWS OF CURRENT LITERATURE

(continued from page 30)

**HOW TO DESIGN AND INSTALL PLUMBING.** By A. J. Matthias, Jr. Chicago, American Technical Society [c. 1941], 442 pp., 5½ by 8½ in., illus. \$3.00

A SLIGHTLY ENLARGED edition of a practical handbook first published less than two years ago, written by a

technician and teacher for student, tradesman and home owner. The material ranges from rural waste disposal to institutional plumbing; both the text and illustrations—these chiefly diagrammatic—are clear and informing; there are questions for

test and revision purposes and a serviceable index. Readers will wonder now and again: at inclusion, for example, of several non-essential full-page indistinct half-tones; at the post-dating in the imprint; at finding the portable bathtub among historic "installations"; at the statement that the bidet, "at one time used in residences," is "a form of bath used in hospitals to wash the lower extremities of the body."

### PERIODICAL LITERATURE

**TREND OF AMERICAN ARCHITECTURE.** By Talbot F. Hamlin. Harper's Magazine, New York, Jan., 1942. pp. 164-171

A SYMPATHETIC EXPOSE of the parts played by business, by tradition, by snobbery, and by free imagination in the making of buildings which are good or bad because "within the terms of each problem involved they are a good or a bad answer to it." Home building continues to show little progress, although California homes and even a few of the latest experimental defense houses show originality and spontaneity. On the other hand, where tradition has little say American architecture combines service and beauty, solidity and economy of line and material: witness the San Francisco and Bronx-Whitestone bridges, schools of different types, outdoor recreation areas such as Jones Beach, complicated express highways and the TVA dams.

**NEWS ITEMS FROM ATHENS.** By Elizabeth Pierce Blegen. American Journal of Archaeology, Concord, N. H., Oct.-Dec., 1941. pp 631-2

ASTONISHINGLY LITTLE known damage to works of art in Greece is reported as a result of the war. Delphi and Olympia were not under fire; destruction surrounds the Heraklion Museum in Crete but the Museum escaped; a bomb exploding in the Museum garden at Thebes did no harm to the exhibits; explosions at Eleusis broke the Museum windows and shook some of the mended pottery to pieces; some of the Acropolis

(continued on page 34)

## HERMAN NELSON hijet HEATERS INSTALLED AT WESTOVER FIELD ARMY AIR BASE

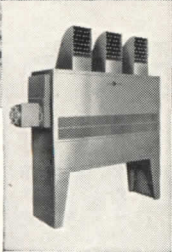
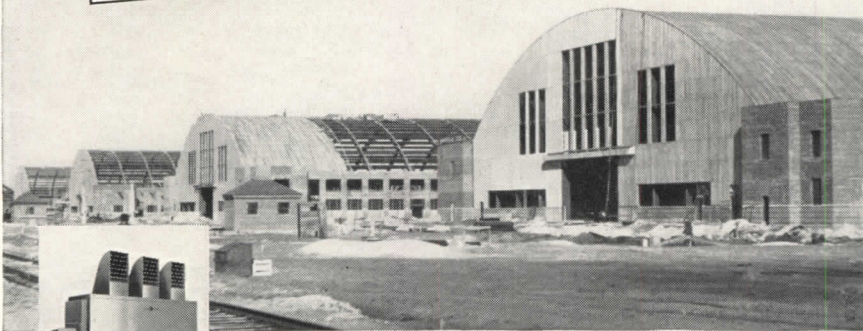

Fifty Herman Nelson Blower-Fan and ninety-five Propeller-Fan Type hijet Heaters have been installed in the hangars of Westover Field Army Air Base at Chicopee Falls, Massachusetts. These heaters are large enough to heat 550 average size homes.

Herman Nelson hijet Heaters have been installed in hundreds of buildings at Air Bases, Navy Yards, Arsenals, Camps and Forts vital to National Defense. The complete line of hijet Heaters includes Horizontal Shaft Propeller-Fan, Vertical Shaft Propeller-Fan, Blower-Fan and De Luxe Types. There are 263 models, sizes and arrangements, so you can select the exact unit to solve practically any heating problem most satisfactorily and economically.

### AUTOVENT FANS AND BLOWERS

have also been installed in many Defense Projects. This quality equipment is manufactured by the Autovent Fan and Blower Division of The Herman Nelson Corporation. All Autovent Products are tested and rated in accordance with the Standard Test Code as established by the National Association of Fan Manufacturers and the American Society of Heating and Ventilating Engineers.

Autovent  
Type HB  
Blower

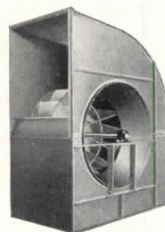

## THE HERMAN NELSON CORPORATION

MOLINE, ILLINOIS

MANUFACTURERS OF QUALITY HEATING, VENTILATING AND AIR CONDITIONING PRODUCTS



# MAHON Rolling Steel DOORS

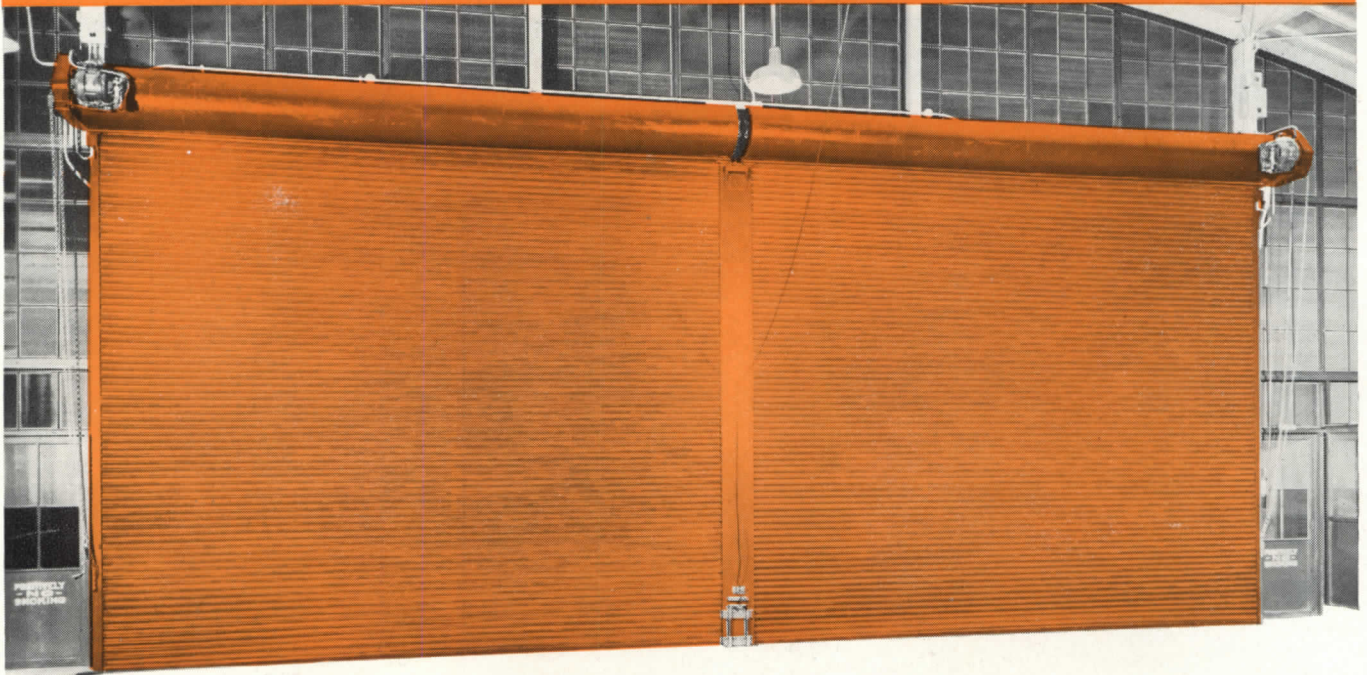

## MULTIPLE DOORS . . .

### *The Practical Installation Where the Door Opening is Extra Wide*

Where an unusually wide door opening is to be fitted, as pictured above, and the entire opening is used only occasionally, the practical and economical installation is two Mahon Rolling Steel Doors with an intermediate hinged or removable center post, which forms the center guide channels in which the door curtains operate.

This post can be released at the floor and either swung up out of the way or removed altogether, thus clearing the entire door-

way for unobstructed passage when desired. The doors can be fitted with either chain-gear or power operating mechanisms and can be raised or lowered individually or in unison.

Complete particulars of this and other installations will be found in Sweet's or in the NEW Mahon Rolling Steel Door catalog, just issued. If you have not yet received your copy, send for it at once.

**THE R. C. MAHON COMPANY • DETROIT • CHICAGO**

Manufacturers of Rolling Steel Doors, Shutters and Grilles, Steel Roof Deck, Kalamein Doors, Tin Clad Doors, Cast Iron Roof Sumps and Roof Sump Recesses.

**MAHON  
ROLLING STEEL DOORS  
OFFER THESE ADVANTAGES**

Protection from Fire,  
Weather and Intrusion.  
Light tight for Blackouts.  
Modern, Attractive Appearance.  
Smooth, Certain, Simple,  
Easy and Dependable  
Operation. Rigid Construction.  
Unobstructed Door  
Openings. A Labeled or  
Non-Labeled Type for Any  
Opening, Exterior or Interior,  
in Any Building, old or new.

# MAHON

# REVIEWS OF CURRENT LITERATURE

(continued from page 32)

and Kerameikos Museums' treasure had been removed to safety, and in the National Museum smaller objects stored in the basement of the new wing were protected by five stories of reinforced concrete construction above; Corinth's earthquake-proof

Museum with doors and windows sandbagged is better able to withstand explosion than any other in Greece: here smaller pieces were stored, and sand was laid deep in the sculpture gallery to provide a soft bed for statues left standing.



**MONOGRAPHS.** Oculus. New York (New York Chapter of AIA), December, 1941, p. 1

IN REPLY to a member's question as to the appropriateness of the Monograph series "Architecture and Design" as a vehicle for the work of AIA members, the Chapter Committee on Professional Practice records its opinions: "The . . . system of publishing the work of individual firms is a valuable contribution to the public relations of the profession. . . . To make such publication commercially possible, it must be supported as are other architectural magazines by advertising matter. Provided pressure methods in soliciting advertising are not used, and provided the space to the advertiser is reasonably equivalent to the price . . . no objection to this method of publication."

**OXALIC ACID . . . [and Other Products from Wood Waste].** Michigan Architect and Engineer, Detroit, Nov., 1941. pp. 97-8

NEW PLASTICS, comparable in price with today's cheapest, are promised for the near future by a new process producing lignocellulose from wood waste. This material, combined with a fraction of the phenol-formaldehyde-resin now used in making plastics, will make a plastic suitable for articles required by defense programs. Oxalic, acetic and formic acids as well as wood alcohol are also reclaimable by improved processes from sawdust.

**RAISING THE ROOF IN MISSOURI.** United Roofer, Philadelphia, Dec., 1941. p. 15, illus.

THE KANSAS CITY Building Commission proposes for the City Building Code measures estimated to reduce by a fourth or more tornado damage, such as that sustained last fall. Rafters should be anchored to the studs by strap iron instead of nailed; substantial rod braces should be provided for all chimney breasts; diagonal sheathing from sills to plates should be well nailed to all parts of the frame; bottom sills to be bolted to the foundation.

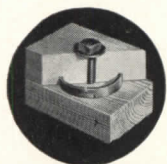
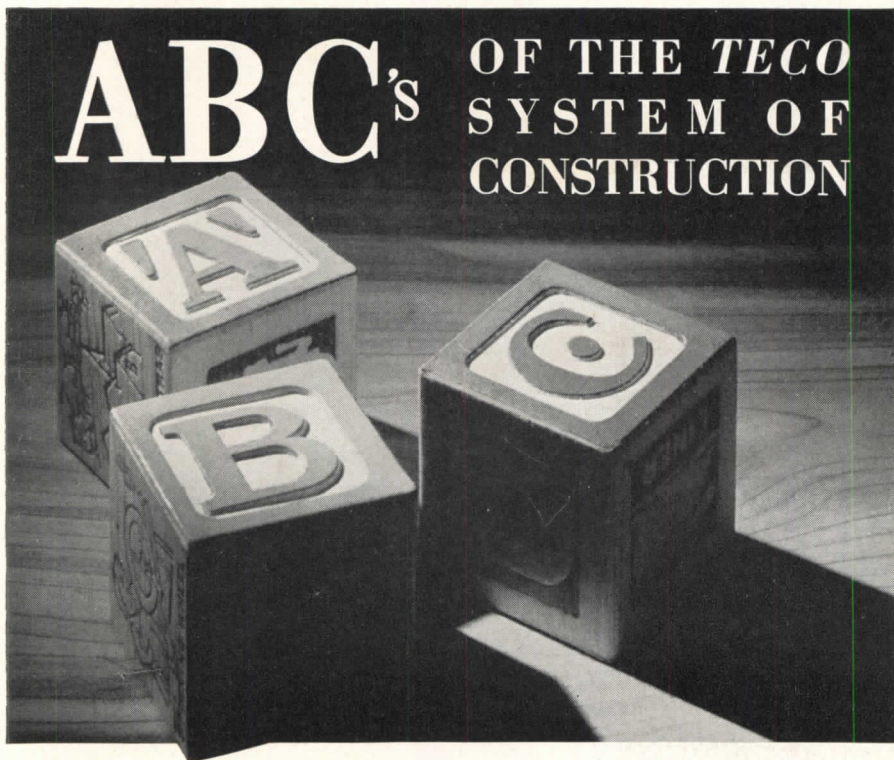

**TECO CONNECTORS**

spread the load on a timber joint more equally over the cross-section of the wood.

- The TECO CONNECTOR SYSTEM IS . . . . .**  
 . . . a new method of structural engineering in timber that strengthens joints and permits lighter members to do work that formerly required heavier timber.
- The TECO CONNECTOR SYSTEM HAS . . . . .**  
 . . . reduced man hours on the job by complete prefabrication of truss and frame assemblies.
- The TECO CONNECTOR SYSTEM OFFERS . . . . .**  
 . . . a typical design service and technical engineering data which has already aided hundreds of architects and engineers. Timber can do the job—write today!

**TIMBER ENGINEERING COMPANY**  
 Dept. P-2, 1337 Connecticut Avenue  
 WASHINGTON, D. C.

**TIMBER ENGINEERING COMPANY, INC.** Dept. P-2, 1337 Connecticut Avenue, Washington, D. C.

Please send me without cost or obligation complete information on the TECO Connector System of construction.

Individual \_\_\_\_\_ Firm \_\_\_\_\_  
 Street \_\_\_\_\_ City \_\_\_\_\_ State \_\_\_\_\_

THE SKY AND THE SEA—

...AND A FLOOR OF FINE Terrazzo!



Florida's alive with lovely colors, but the Hotel Whitman, in Miami Beach, has scenery all its own—a floor of FINE TERRAZZO made with Atlas White Cement.

The architect chose wisely when he chose FINE TERRAZZO made with Atlas White Portland cement. He knew it would reproduce any pattern, and reproduce it well. He knew its fresh and vivid colors would last a lifetime. And in addition, he knew upkeep

would be practically nil, except for regular cleaning.

Next time you plan a floor, plan on FINE TERRAZZO. And just to be sure its colors glow brightly—plan on using Atlas White Portland cement. It comes both plain and waterproofed. See Sweet's Building File, Section 11/24 for further details, and 24 full-color illustrations of FINE TERRAZZO. Or write us for free book. Universal Atlas Cement Company (United States Steel Corporation Sub-

sidary), Chrysler Building, New York City; OFFICES: New York, Chicago, Philadelphia, Boston, Albany, Pittsburgh, Cleveland, Minneapolis, Duluth, St. Louis, Kansas City, Des Moines, Birmingham, Waco.

*This FINE TERRAZZO floor made with Atlas White cement was designed for the Hotel Whitman by Architect Roy F. France, Inc., Miami Beach. Installation by the Venetian Art Marble & Terrazzo Co., Miami. Colors were: Red Champlain Marble; Belgian Black Marble; Yellow Verona Marble; Royal Green Marble.*

ATLAS WHITE CEMENT FOR FINE TERRAZZO





in 1919

UNIQUE RECONSTRUCTION

BOSTON CUSTOM HOUSE  
was described as "notable  
usage of historic edifice as  
base for new tower." Peabody  
& Stearns, Architects.

IN THAT YEAR, TOO, PAYNEHEAT  
MADE BUILDING NEWS

With constantly improved design, based on sound research, PAYNE has led the Industry in pioneering gas heating progress. ☆ Now, as America's largest manufacturer of gas heating equipment, PAYNE never relaxes this constant insistence on better engineering, better materials, better performance. With 69 double-tested styles and sizes, there's a PAYNE unit for every heating need. Investigate PAYNEHEAT thoroughly – and you'll specify it firmly! ☆ See Sweet's, Western States AEC, our convenient AIA file . . . or ask your PAYNEHEAT Contractor or Gas Company.

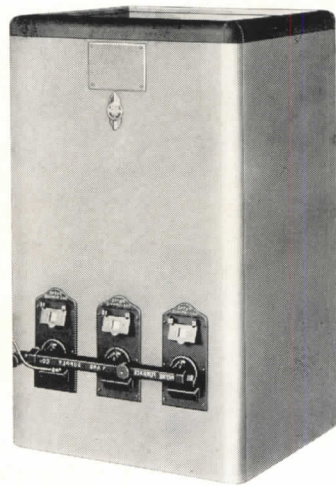

Above: PAYNE Gravity Unit. Also: Modern Console, Zoneair, Floor Furnace, Duplex Furnace, Space-saver Unit, Sentry Forced Air Unit, Industrial Units.

**PAYNEHEAT**

MORE THAN A QUARTER-CENTURY OF



SPECIALIZATION

Payne Furnace & Supply Co., Inc., Beverly Hills, California



## REMODELING—A WARTIME MANDATE

WITH THE PINCH of priorities getting painful, as forecast by ARCHITECTURAL RECORD (AR 11/41, 1/42), and in view of the President's recent galvanic call for war production, the rehabilitation of existing structures is increasingly indicated.

Reasons for modernization are impelling: 1. Speed and more speed is the cry that accompanies every order for industrial buildings or defense housing; 2. Utilization of existing buildings saves critical materials for still more urgent use. The call comes clearly from Washington, implemented with the assurance of priorities assistance for every directly essential modernization project.

The professional aspects of modernization should need no belaboring. While many firms of architects and engineers are swamped with war work, their offices crowded with new personnel and lighted into the wee hours, others find themselves becalmed in non-defense areas. To these, modernization may prove the only means of providing for civilian building needs. And the most-nearly-priorities-proof means of keeping the office intact until the mushrooming defense program calls for its talents, or even until the post-war period opens the door to manifold new opportunities.

As to industrial buildings, a recent survey of the National Association of Real Estate Boards indicates that when the United States entered the war there was usable space in 76 per cent of the cities of the country, but that in half of them there was already a practical need for modernizing industrial space. Every movement since then to intensify the war effort adds to this need, as it broadens the list of items required for military operations.

In housing, the push for conversion and alteration has been on for some months. Even before the famous "SPAB-9" order, FHA had begun its "Repair for Defense" program, giving every encouragement in financing to such rehabilitation as would create new housing units in defense areas. Priorities aid carries higher ratings than new construction for defense workers. And such modernization is specifically exempt from Federal Reserve Board restrictions on credits. FHA Title I has been amended to give additional inducements. Finally, automobile and tire restrictions will inevitably put a premium on close-in locations, giving a further competitive advantage to large old houses that are simply crying for improvement.

HOLC, too, has joined in the campaigning, and has undertaken to supply free advice to property owners. HOLC has a \$100,000 appropriation from the President's emergency funds to hire fee architects and technicians to supplement its own staff. This agency has gone so far as to suggest mass modernization much along the lines of slum clearance.

"Intelligent leadership combined with exceptional vision and technical skill will be necessary," says Howard Leland Smith, chief of the architectural section of FHA, "if real and lasting benefits are to be obtained. It seems logical, therefore, that the architect, by reason of his experience and training, should assume a large share of this leadership."



Plywood and paint clean up an old building in Hoquiam, Wash. H. K. Wilson, architect. Other Hoquiam store remodeling on page 44



Refurbished offices in the Studebaker plant, South Bend, Ind. W. L. Brunner, architect; Frank Wright and Charles Roessler associated

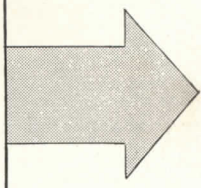

RENOVATED EXTERIOR. White composition shingles resurface the first floor; terrace of brick and slate

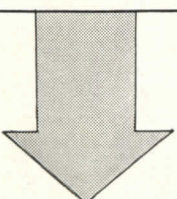
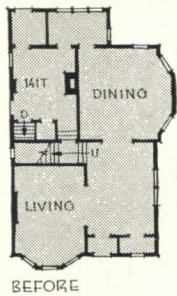

- REMOVE EXISTING WINDOW AND CLOSE UP OPENING
- DROP CEILING OVER CABINETS AND SINK TO 7'-0" ABOVE FLOOR
- REMOVE PRESENT CEILING AND LEAVE EXPOSED WOOD BEAMS
- REMOVE WOOD BASE; CONTINUE PRESENT WALL PLASTER FOR NEW COVE BASE
- CUT OPENING FOR RECESSED RADIATOR
- FACE EXISTING DOOR ON KITCHEN SIDE WITH PRESSED WOOD
- HANG NEW DOOR
- REMOVE PLASTER AND LATH FROM THIS WALL. NEW FINISH BY OWNER
- CUT DOWN EXISTING WALL TO RAKE OF RAIL
- CUT OUT CONSOLE AND PATCH WITH PLASTER
- NEW METAL LINED FLOWER BOX.
- REMOVE EXISTING WINDOWS AND REPLACE WITH NEW CASEMENT WINDOWS
- NEW FLAGSTONE TERRACE WITH NEW IRON RAILING AND NEW BRICK STEPS TOPPED WITH FLAGSTONE
- REMOVE EXISTING WINDOW AND CUT DOOR OPENING 6'-0" WIDE AND AT PRESENT HEIGHT. SET THREE NEW DOORS 2'-0" x 7'-10"
- CLOSE UP OPENING AND RESET WINDOW AT BAY WINDOW
- 8'-0" PLASTER, RECESS
- REMOVE PLASTER CEILING AND LEAVE BEAMS EXPOSED
- 8'-0" PLASTER OPENING
- REMOVE WOOD BASE; CONTINUE PRESENT WALL PLASTER FOR NEW COVE BASE
- 3" LALLY COLUMN
- CONTINUE PLATFORM AND BUILD NEW STEPS
- EXISTING CEILING BEAMS CARRIED BY METAL HANGERS FROM NEW 10'-33" GIRDER
- REPLACE PRESENT SHINGLES WITH NEW SIDING
- NEW ENTRANCE TO BE PROVIDED BY OWNER AND INSTALLED TO CENTER UNDER WINDOW ABOVE. REMOVE ALL DOOR AND WINDOW TRIM THROUGHOUT. STOOLS AND APRONS ARE TO REMAIN. APPLY NEW WINDOW TRIM TO BE PROVIDED BY OWNER
- FUR DOWN CEILING UNDER BEAMS
- SLIDING DOOR
- PRESSED WOOD
- 3" LALLY COLUMN

# HOUSE REMODELING

By MORRIS LAPIDUS, *Architect*

WARTIME PRIORITY LIMITATIONS and mounting costs are a serious deterrent to the construction of new private homes today. But in most communities, there are many outmoded houses, purchasable at reasonable cost, which can be advantageously remodeled according to modern standards with materials that are readily available. Frequently these houses contain heating and plumbing systems that need little or no change. In the following notes, based on my experience with my own house, shown on these two pages, I have attempted to point out a few considerations and rules of thumb which are pertinent to any such work undertaken today.

**EXTERIOR.** The most everyday house can be considerably improved in appearance by slight additions to and deductions from the original structure. The "style" of the house, set by the original structure, need not obviate achieving a modern character—which derives largely from simplification and designing interior areas to serve their functions more logically. Super-imposition of "modern" features results only in banality and superficiality. To keep costs down, minimize exterior alteration work, and avoid actual structural change wherever possible. Instead of tearing out side walls and roof, resurface with available, durable materials. Retain present fenestration as far as is compatible with the new interior living spaces. Judicious landscaping will increase the apparent size of the plot and help overcome the stilted appearance of many of these older houses.

**PLAN.** In securing an open, modern plan within the old framework at moderate cost, leave exterior walls as they are and re-use as much existing interior partitioning as possible. Throw unused hall space, small parlors and music rooms into one sizable general living area, adapted to many uses and furniture arrangements. If the house has an unnecessarily large kitchen, rearrange for a compact modern kitchen, plus a breakfast room or dining alcove. Make use of left-over areas for new closets, a lavatory or powder room.

**INTERIOR MATERIALS.** Select available materials for long life and low maintenance cost. Several modern panel or roll surfacing materials are available that can cover over old walls and ceilings and unify the different areas. Replace heavy molded trim with simple, flat trim. Use light fixtures solely as light sources and not as points of decoration.

Before ARCHITECT MORRIS LAPIDUS remodeled this Brooklyn, N. Y., house for his own use, it was an undistinguished, wasteful type that is found in almost every American community. With relatively simple changes, a house with completely modern living facilities has resulted. At right Mr. Lapidus discusses remodeling in wartime



LIVING AREA. A fabric-surfaced wall covering is used on walls; the ceiling is of compressed wood panels



BAR DETAIL (shown closed below)

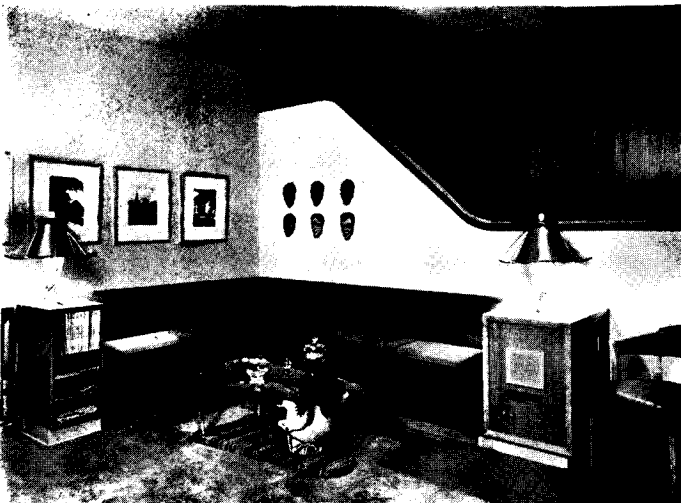

STAIR CORNER. Built-in furniture flanked by cabinets of rift-sawn oak



TOWARD DINING ROOM. A card table and cabinets line the wall



DINING ROOM. One wall is mirrored; the floor is linoleum



KITCHEN-BREAKFAST ROOM

Photos by Gottsche



FRONT (Before, above; after, at left)

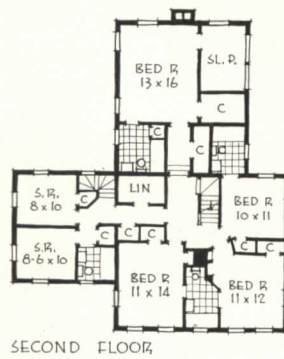
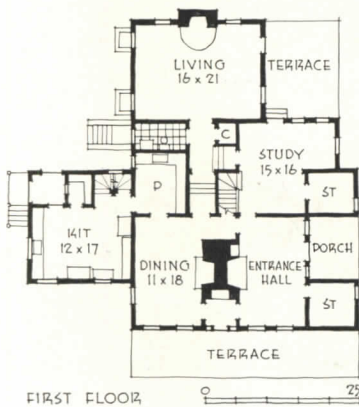

SECOND FLOOR

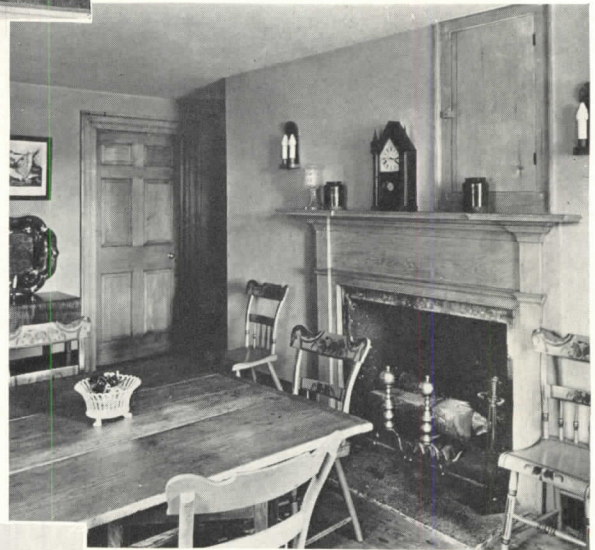

DINING ROOM



REAR (Before, above; after, at left)

## REMODELED FARM HOUSE

**WILTON, CONN., FARM HOUSE. POLHEMUS & COFFIN, ARCHITECTS.** A good example of the type of residential remodeling which has been widely practiced in the older sections of the country. The process includes both retention and renovation of admired period characteristics and addition of modern living comforts. In this case, two wings were added—one at the side, one at the rear—and the old central structure was reconditioned and replanned to fit in with a contemporary scheme of living. In the old portion, original woodwork which existed under numerous layers of paint was brought back to the natural wood and waxed. In addition to modern heating and plumbing, new facilities include insulation in all attic and new wing walls. The contractor for the job was H. C. Atwater, Inc.



# TWO BUILT-IN UNITS

PAUL BROMBERG,  
DESIGNER

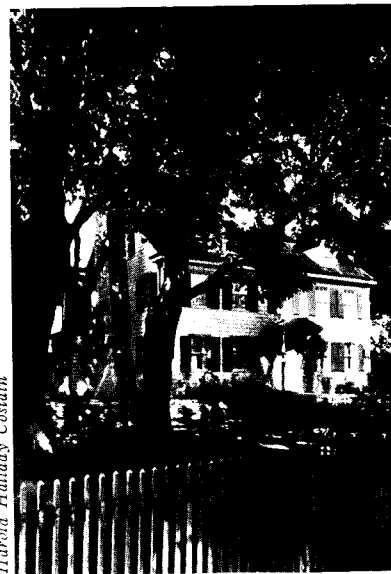

Harold Holiday Costain

## COUNTRY HOUSE

BEDFORD, N. Y. JAN VINK, ARCHITECT

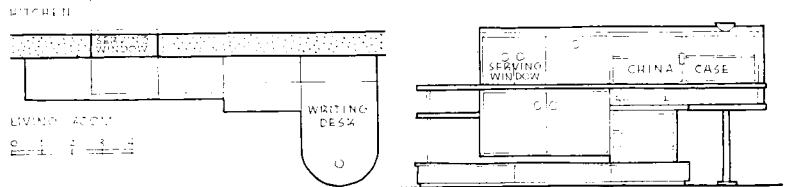
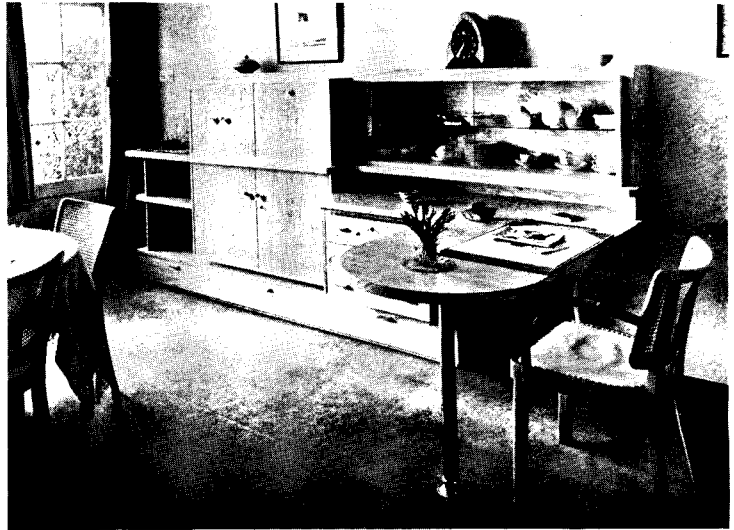

**THIS PIECE OF FURNITURE**, worked out in birch, combines cupboards, drawers, a glass-front china case and a writing table. The cupboards are accessible from both the kitchen and the dining room. The writing table is well adapted for use as a sideboard or as a serving bar for informal entertaining.

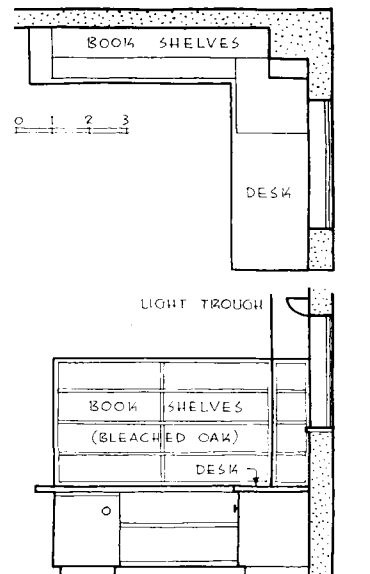

**IN THIS CORNER UNIT**, a desk and bookcase are joined to form a study area in what was formerly unused space. The desk surface is flush with and an extension of the top of the bookcase base. Both natural and artificial light come from the same direction. The entire unit is of bleached oak.

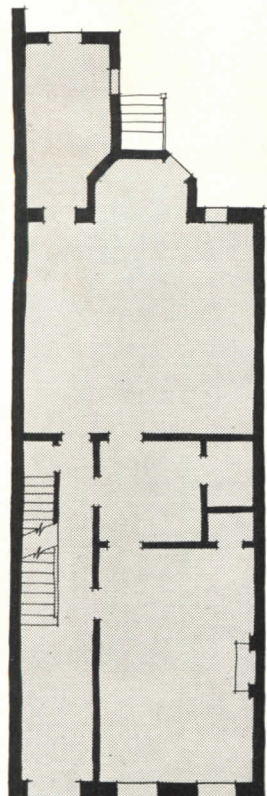

BASEMENT BEFORE

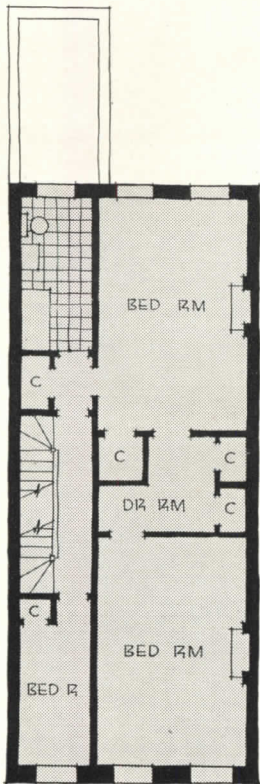

TYPICAL BEFORE

# CITY HOUSE— APARTMENTS



**NOS. 9 AND 11 PARK AVE., NEW YORK CITY. JAMES E. CASALE, ARCHITECT.** One owner acquired the two adjoining brownstone houses shown in the photographs. The one on the left was remodeled as the owner's home; the other (see plans) was converted into six house-keeping apartments—five of which were rented from the plans; the sixth by the time the remodeling was completed. Almost all of the original structure and materials were either salvaged and reused or renovated in their existing locations. Entrances were lowered to the basement level and new windows replaced the former doors. The facade was surfaced with imitation limestone. The architect reports: "The apartment rentals will, from present indications, exceed the cost of the entire job in less than three years."



The Taylor Photographers

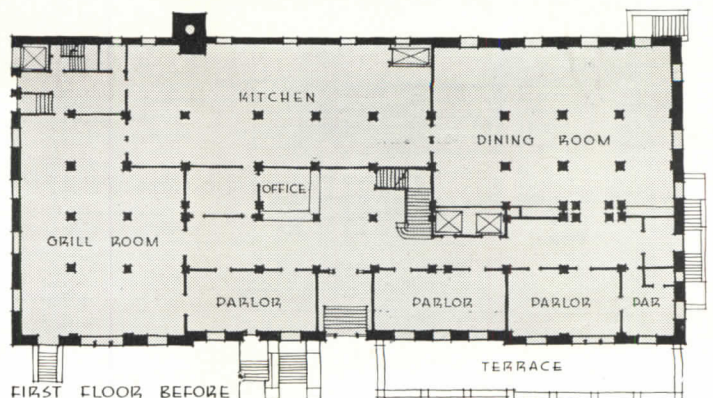

FIRST FLOOR BEFORE

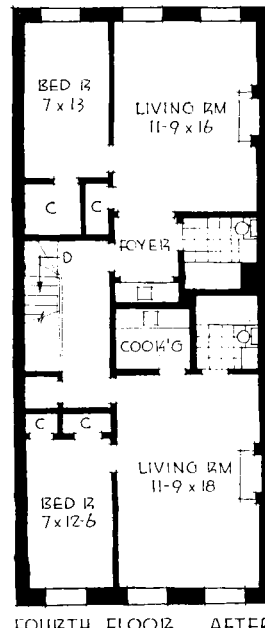
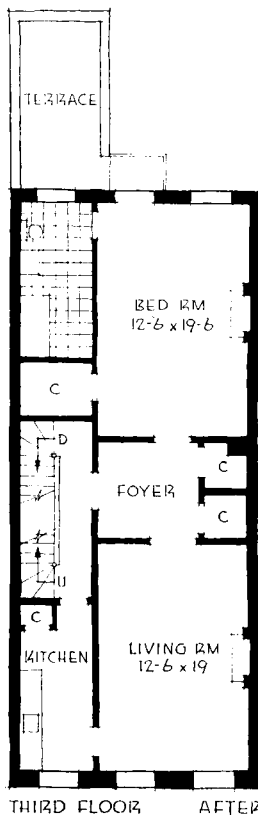
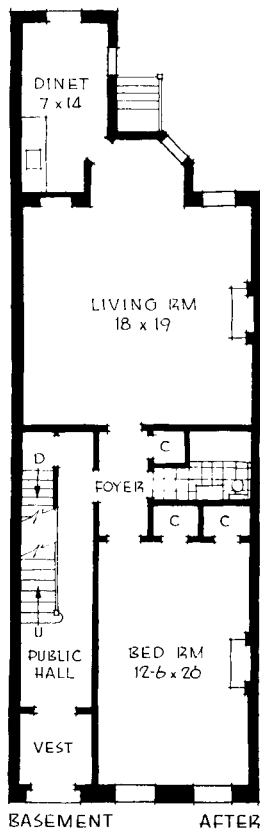
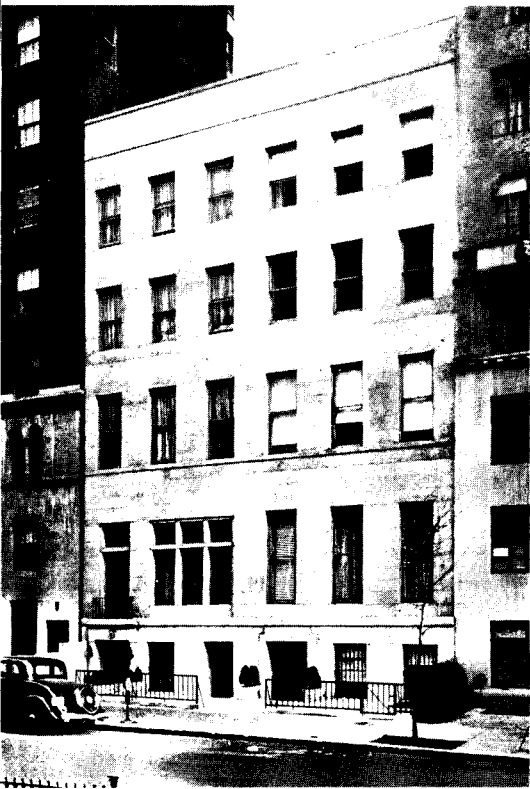

# HOTEL

**THE GEORGE WASHINGTON HOTEL, ST. LOUIS, MO. FRANK CANN, ARCHITECT.**  
 This is the fourteenth building that the owners have taken over as a liability, remodeled and changed into an asset. And one of the chief factors in its success, they emphasize, is that the existing structure was used as far as possible. Practically all partitions, window and door openings, heating and plumbing lines and wiring were reused. Before renovation, the 1903 wall-bearing structure contained 165 hotel rooms and large (unprofitable) lobbies and dining rooms. Today there are 72 apartments, 66 hotel rooms and five stores—almost always 100 per cent rented.

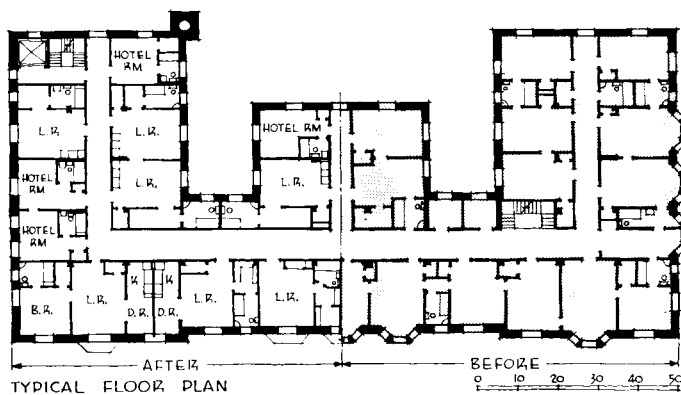
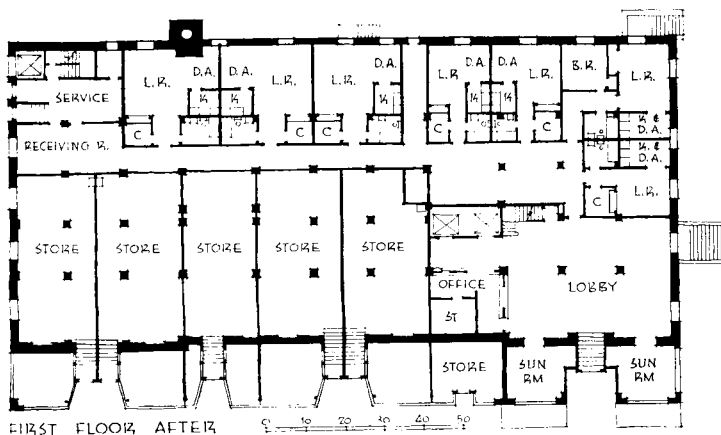

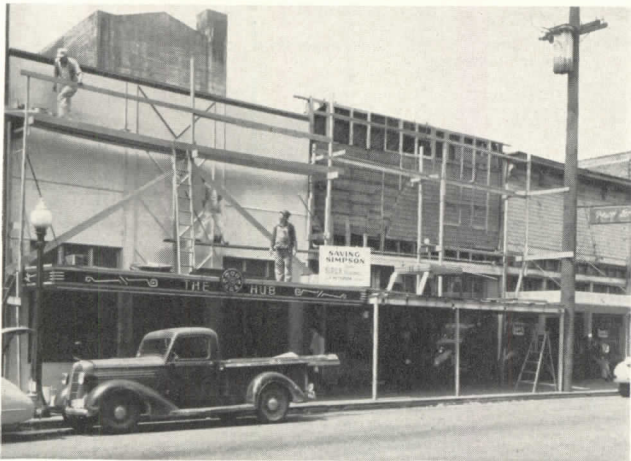

The Jones Photo Co.

**FACE LIFTING OF SIMPSON AVE., HOQUIAM, WASH.**  
**HAROLD K. WILSON, ARCHITECT.** Old fronts were trued up with nailing strips. Following line production methods, exterior plywood was applied in various patterns, and fresh coats of paint completed the job—with minimum use of “short” materials. The project took 30 days; its cost was \$1,200

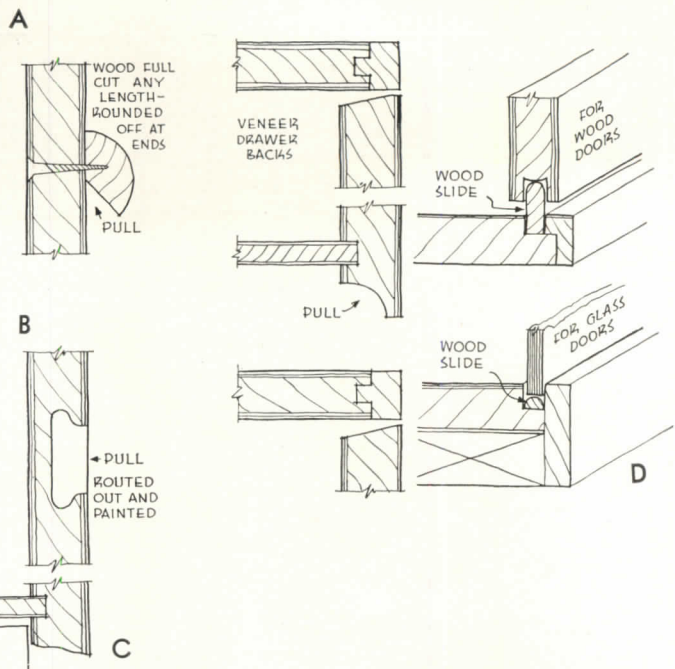

## STORE REMODELING

By DALE STETSON, Designer of the remodeled Davison Paxon Store, Atlanta, Ga., shown on the opposite page and on page 46

DUE TO PRESENT CONDITIONS, many materials customarily used in store remodeling have become scarce, prohibitive, or off the market. Under the worst conditions, however, we will probably still have left the two most important materials—wood and paint. A lot can be done with these alone.

Confronted with this situation, store designers can do one of two things—change details where possible, or make no change and use temporary substitutions where necessary. For example, certain items of hardware such as *drawer pulls* can be eliminated without sacrifice of design standards, as indicated in sketches A, B and C. Small *sliding doors* will function acceptably on a rounded wood track as shown in sketch D. Old *hang rods* can often be reused. If they cannot be plated now, paint them a bright color as often as necessary.

If fluorescent *wall case lighting* is not available, most old stores have plenty of used incandescent equipment that can be reused.

Many pieces of old *fixture cabinet work* which were formerly discarded because of labor expense involved in modernizing them, can now be reused at a saving due to advances in the price of materials over labor.

It is possible that present conditions should change the designer's and store owner's approach to current modernization. Instead of thinking in terms of fine cabinet work and permanent installation, it might be wise—and profitable—to think in terms of temporary large-scale display, using display techniques—wall board and batten construction, with water color paint to dress up existing interiors. In other words, this would amount to a sort of masquerade, in which the boldest of colors and conceptions can be executed because they are not permanent, and because they are not expensive.

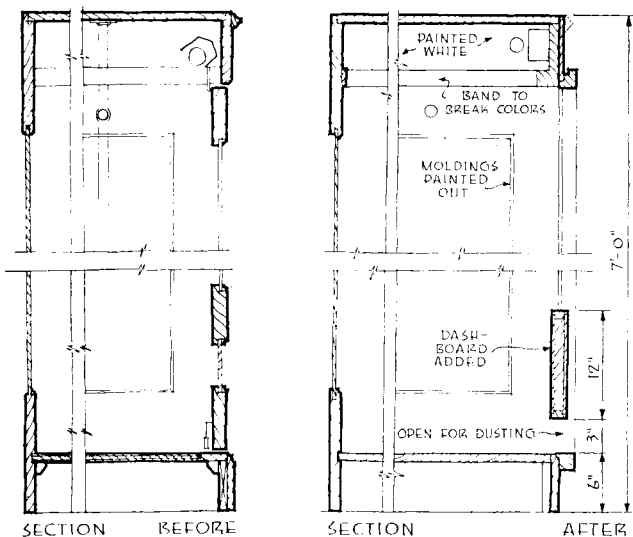

TYPICAL REMODELED CASE (above). Almost as much material was removed as was added. Receding wood and glass doors with their mechanisms and tracks were removed. A new cornice was added with a groove provided for cut-out letters. A dash board just above the base gives an even hem for dresses on display, conceals lighting and facilitates dusting

THIS MEMBER REMOVED  
 3/8" VERTICAL GRAIN VENEER, WALNUT  
 DOCKET FOR CUTOUT LETTERS  
 1/2" SOLID WALNUT  
 THIS MEMBER ADDED

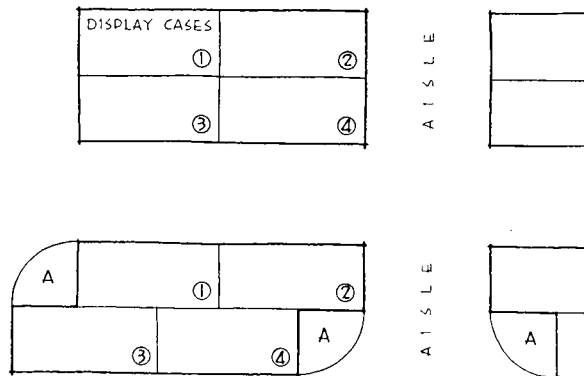

A = DISPLAY PLATFORMS

90 PER CENT REARRANGEMENT. Typical display cases, staggered on off-center alignment, with low display platforms added at the corners

Store owners frequently write off the expense of modernization in 10 years, charging the department involved so much per year—let's say \$1,000 a year for 10 years. Using this technique, an owner could change his department twice a year for about \$200, always have a store with a fresh appearance and still save \$800 a year toward the kind of modernization that is eventually desired.

The alternate theory is to do the best possible under existing difficulties, building well and planning well. One thing is certain. There will be no priority on the time and talents of those whose business it is to give intelligent study to store conditions and plans for the future.

## DEPARTMENT STORE

**DAVISON PAXON DEPARTMENT STORE, ATLANTA, GA. DALE STETSON, DESIGNER AND SUPERVISOR.** In remodeling this department store, the problem was to reassemble and modernize each department following a preconceived plan for the whole store. A typical "before" and "after" plan is shown at right. As cost was a controlling factor, all existing equipment was re-used; the work on both renovating of old equipment and construction of new backgrounds—cabinets, cases, etc.—was handled in the store's own carpenter and paint shop under the direct supervision of the designer, who pro-tem was employed by the store in an executive capacity. By this means, new fixtures were manufactured at cost, and knotty problems of how to use all salvageable materials were handled with least possible delay. In round numbers, the cost averaged about \$1 per square foot of floor space. The details at the top of the page illustrate a few of the more adroit improvements which were made at low cost.

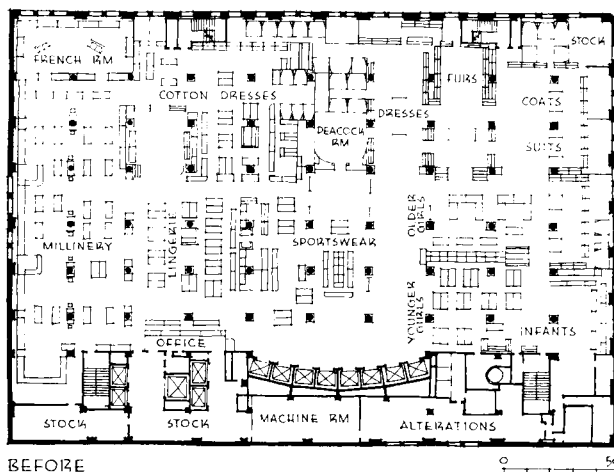

BEFORE

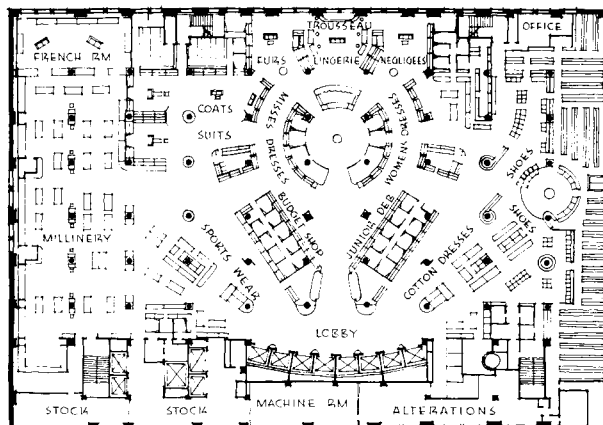

AFTER

TYPICAL BEFORE AND AFTER PLAN. Originally the plan was the typical "block plan" layout of display areas and departments. The rearranged plan is based on the fact that customers land on this floor from a single bank of elevators at one side. Hence the new traffic lanes radiate from this source. Departments located in rear corners gain in visibility and accessibility and the radiating scheme means minimum traveling distance for both customer and sales clerk in consummating a sale. Fitting rooms adjoin selling cases, and wrapping rooms are near by.

NOTE: The designer tells us that the inspiration for this unconventional layout was a pin ball machine. Imagine the customer to be the ball. She can easily reach many departments but instinctively aims for the bullseye—which, in this case, is where the more expensive clothes are sold



Photos by Taylor Photo Service

NEW BOOK DEPARTMENT



BOOK TABLE—BEFORE AND AFTER  
Doors removed; shelves added; more merchandise displayed



ABOVE, the birdseye view of the ground floor book department illustrates the planned organization that governs the whole store. The process involved remodeling of existing units (see above), construction of new cases and units, and rearrangement of elements to form an effective and inviting department

AT RIGHT are three details. The top one shows a variation on the remodeled cases detailed on the preceding page. Here, with the cases used for children's clothes, two drawers are incorporated at the base

THE MIDDLE PHOTO shows extremely inexpensive new display cases in the basement store. Built entirely of 3/4-in. pine, they are finished with half-round trim. Paint and good lighting do the rest

AT BOTTOM is the second-floor shoe shop, separated from the main floor physically but not visually by a low partition just out of the photograph at left

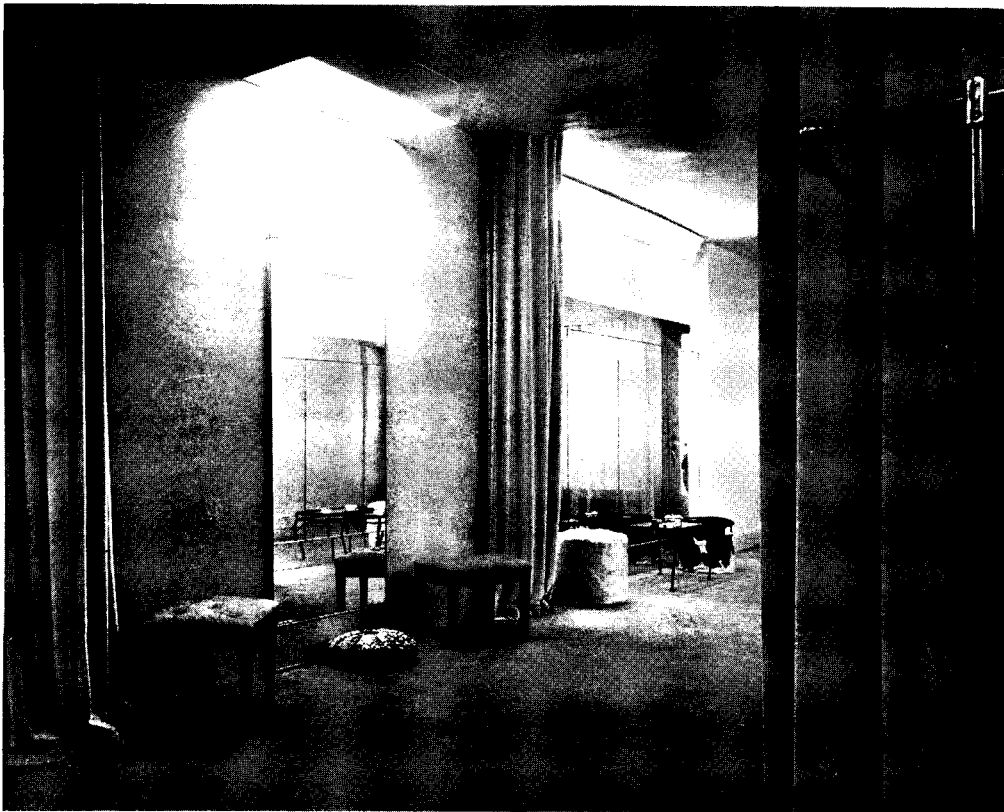

INTERIOR

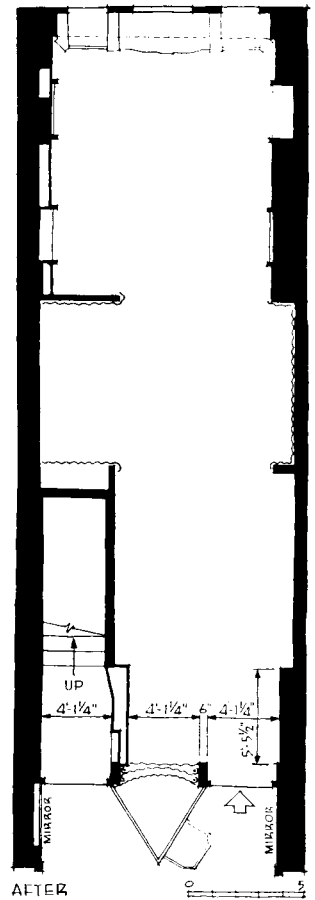

AFTER

## SPECIALTY SHOP

**FUR SHOP, NEW YORK CITY. PAUL BRY, DESIGNER.** The problem was to separate the apartment house and shop entrances, provide direct access to the shop from the sidewalk, dramatize a specialized display case, and to improve the design generally. The interior finishes of mirror, fabrics and glass have special news significance in the face of current priority limitations.

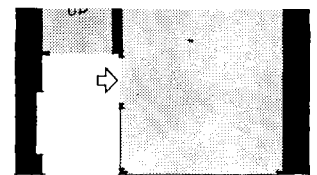

BEFORE

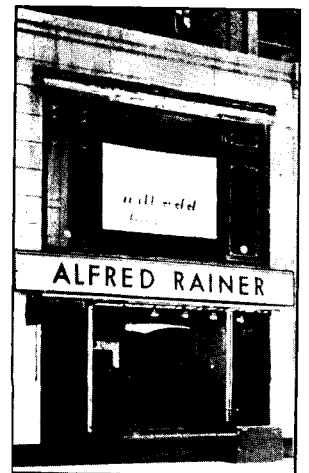
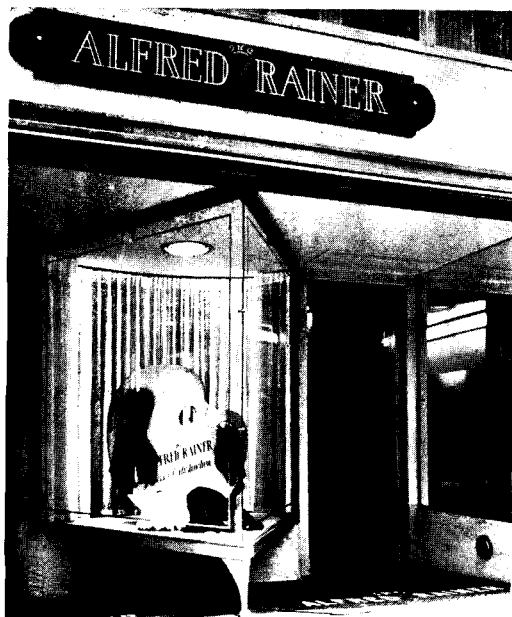

**EXTERIOR.** Business expansion to include the second floor space is architecturally expressed in the unified "after" scheme. The central, triangular display case is reflected in wall mirrors at either side of the entrance recess which are fully visible to those approaching the store from either direction



# STORE

**PARMELEE-DOHRMANN STORE, LOS ANGELES, CALIF. HARBIN F. HUNTER, ARCHITECT.** Although the new store occupies the upper floors and basement of this 4-story building, skillful planning called for only two bays plus a rear entrance corridor on the first floor. By this device, a minimum of expensive ground floor space was required; yet the building elevators are part of the store, and there is valuable direct access from the large parking lot at the rear. The new store front is faced in ceramic veneer and glass block. Trim and letters are of nickel silver. The general contractor was C. W. Driver, Inc.

FTER



BEFORE

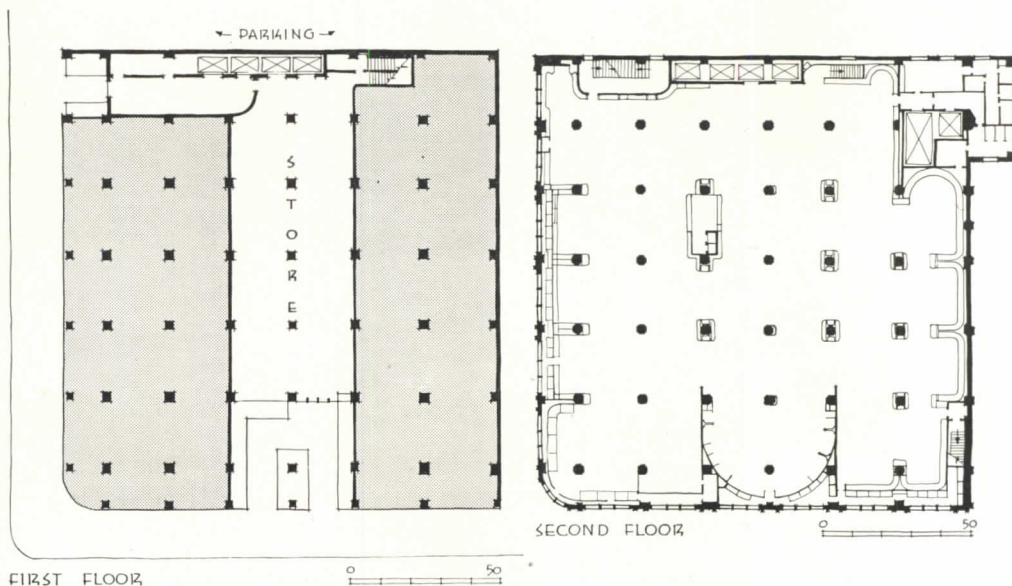

# LOW COST PRIVATE OFFICE

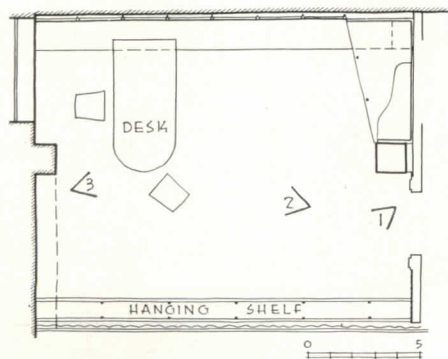

**SUPERVISOR'S OFFICE, IOWA WPA ART PROGRAM, DES MOINES. WILLIAM FRIEDMAN, DESIGNER.** The problem was to design inexpensive interior and furnishings, to be executed by unskilled or semi-skilled labor, for a typical office space with a wall-to-wall window facing west. The ceiling was furred down and covered with painted corrugated board. The east wall was furred and finished in 3-ply fir squares with pickled finish.



1. WEST (WINDOW) WALL. The plant shelf is supported by braces and ceiling wires, providing clearance for full-length draperies



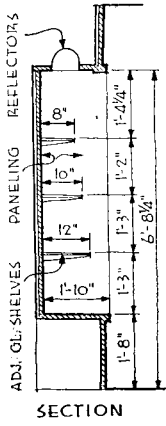

SECTION

ABOVE is a detail of wall case unit shown in the photo (at right) of the first floor, rear. Typical of most of the fixture work, the case is of lath, plaster and wood. BELOW are three schemes developed to give structural columns a useful and effective merchandising task

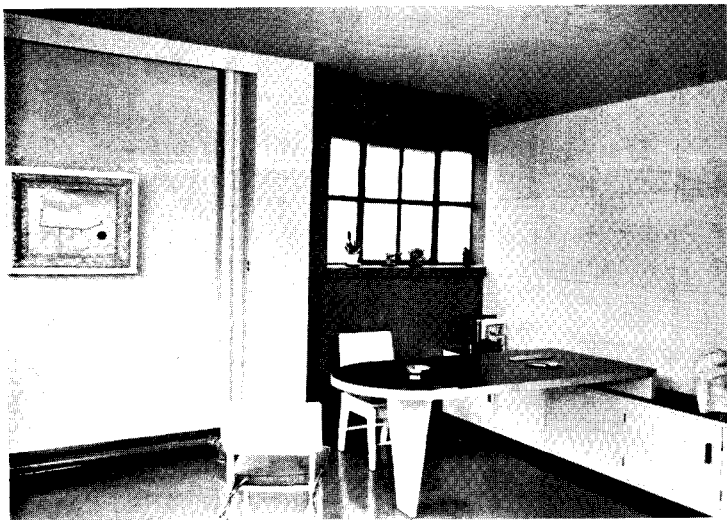
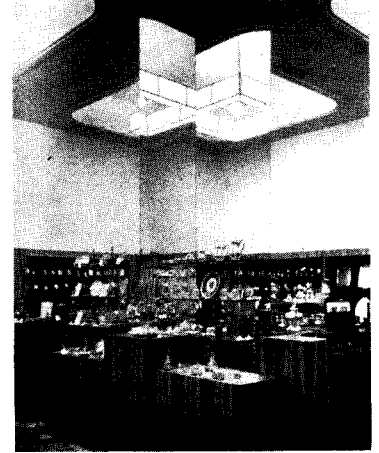
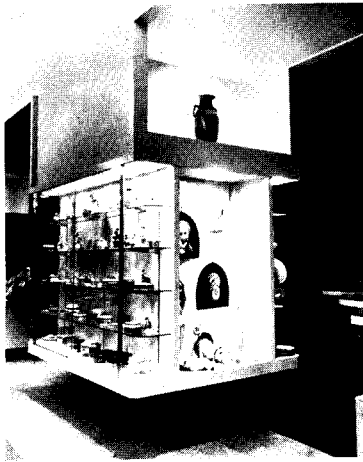
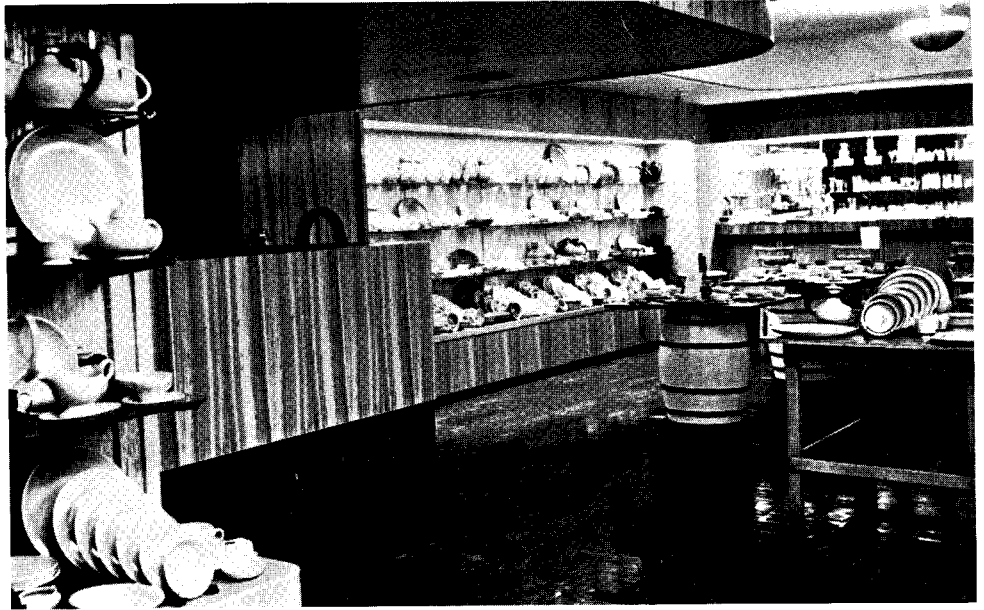

2. FURNITURE and cabinets of plywood with pressed wood work surfaces

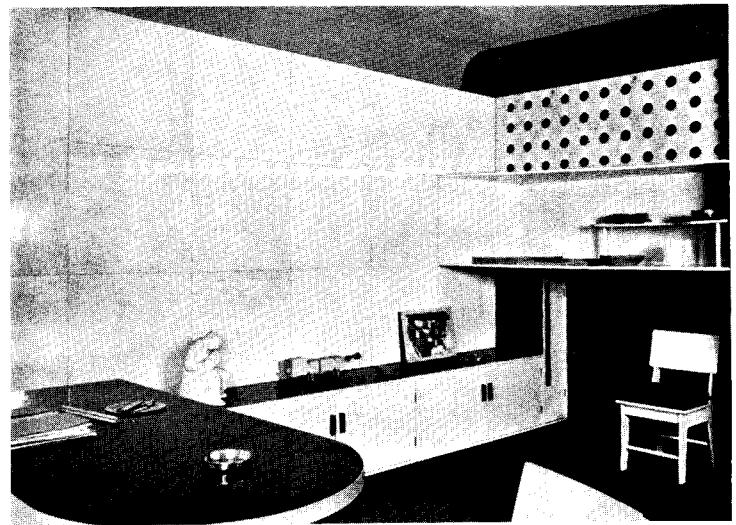

3. EAST WALL covered in plywood. Vents conceal exhaust fan

Herbert R. Fitch



## OFFICE BUILDING

**FIRST NATIONAL BANK BUILDING, SAN DIEGO, CALIF. FRANK L. HOPE JR., ARCHITECT.** From this 30-year-old building, the projecting cornice and belt courses, engaged columns and arches were removed. The bottom two floors were resurfaced with bronze-colored terra cotta units above a black granite base. The upper wall surfaces of buff glazed brick were retained and cleaned, and where elements had been removed the new surfaces are of glazed tile, specially fabricated in color and size to match the existing face brick. Cost: \$60,000. The general contractor was Walter Trepte.

Les May Studios

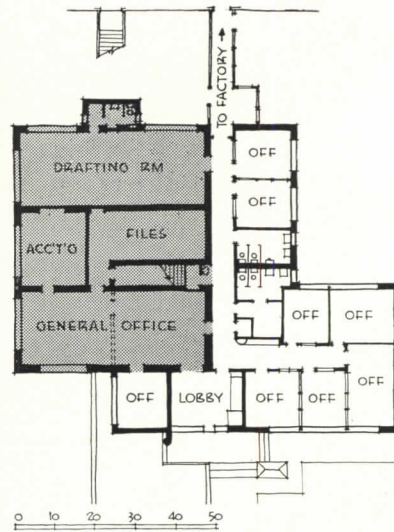

## FACTORY OFFICES

**GORTON MACHINE COMPANY OFFICE BUILDING, RACINE, WIS. FRANK J. HOFFMAN, ARCHITECT.** The enlarged office building is an extension of the first floor level beyond the confines of the old building (at right). The drafting room and chief engineer's office are at the rear, nearest the factory; purchasing department and general offices are logically nearest the main lobby. On the second floor are air supply and exhaust fans and compressor equipment. Control of air for both ventilation and cooling is individual with each office. There is a complete intercommunicating system between offices and factory building. The general contractor was Johnson and Henrickson.

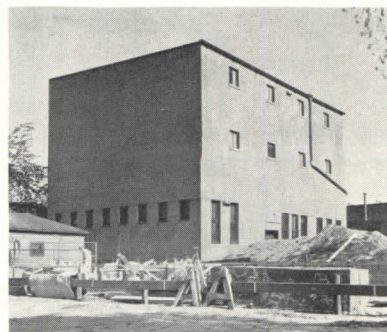

BEFORE



# BANK

**UNION FEDERAL SAVINGS AND LOAN BUILDING, EVANSVILLE, IND. RALPH LEGEMAN, ARCHITECT.** The problem was to convert a 25-year-old building into offices for the association and a related insurance agency. Columns were removed from the public space and replaced by reinforced concrete columns (and attendant new second-floor framing) at the four corners of this area. Plate glass is used on the front of the building; glass block elsewhere. Ventilation is accomplished by fan circulation; the building is year-round air conditioned. Interior walls are surfaced in plaster, oak plywood or flexible wood veneer. Contractor for the job was J. Bippus & Son.



Ed Reck's Studio

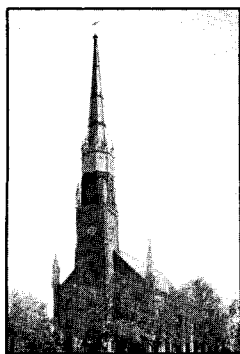
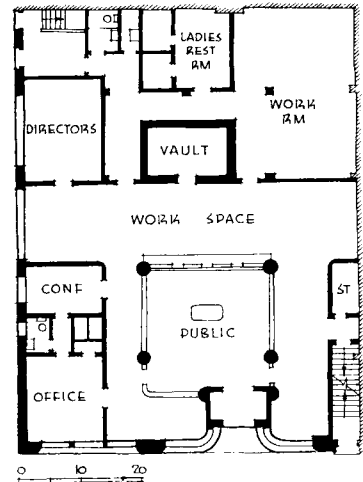

ORIGINAL 1862 church

**ST. JOSEPH'S CHURCH, TIFFIN, OHIO. ALOYS FRANK HERMAN, HOWARD THOS. SIMONS, ARCHITECTS.** General contractor, Hossler Brothers.

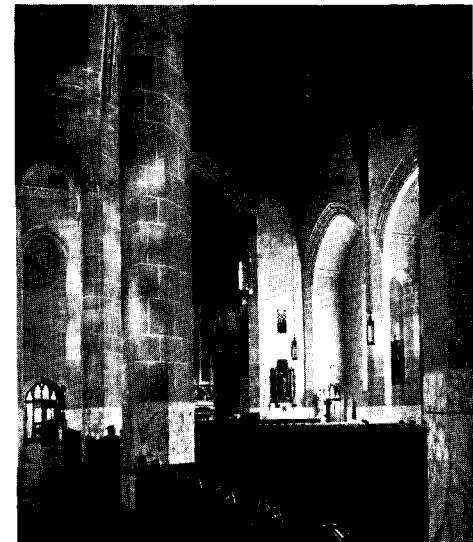
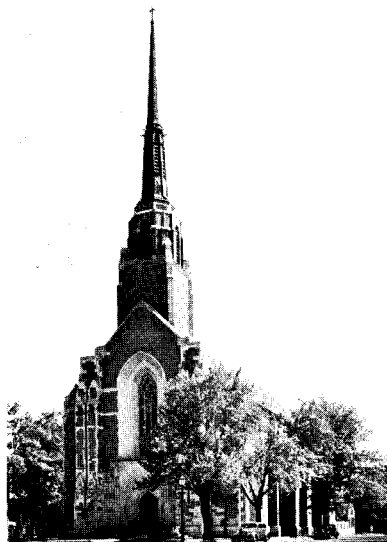

RECONSTRUCTED after a damaging fire, the new church was awarded an Ohio Architects Society medal for excellence of design. The new spire is of fireproof construction

# STRUCTURAL ECONOMIES IN REMODELING

AS MATERIALS for normal types of new construction become more and more scarce, the technical as well as the economic justification for remodeling becomes increasingly apparent. "Doing the most with the least" is more than ever a mandate that controls wartime building. Thus, ingenious construction economies in remodeling operations become of first importance in overcoming the limitations of a wartime emergency.

Phrased differently, this means that critical materials *must* be conserved in remodeling as in new construction. This is fundamental to any building operation today—whether or not the structure rates priority assistance. And the extent to which technical ingenuity can achieve sweeping conservation of scarce building materials may determine—now and in the foreseeable future—whether or not a project will go forward beyond the stage of plans and specifications.

Following paragraphs—and the Time-Saver Standards details that accompany them—are notes that will be found useful in designing for the "war economy construction" of remodeling projects. They have been adapted from a wide number of reliable technical sources and are applicable to a wide variety of building types and structural conditions.

**Foundations:** It is fair to assume that foundation remodeling problems will be comparatively simple, primarily because elaborate alterations or complicated underpinning operations will probably prove too expensive in both effort and material in the majority of cases. But however simple they may be, foundations justify the greatest care in design, specifications and field supervision. Particularly important points to check are:

1. *Type of structure.* If reinforced concrete is indicated steel should be figured at the minimum (see pp. 59 and 60 of this issue) and the concrete mix carefully adjusted to it so that stability, continuity of bearing and anchorage and waterproofness are assured. The use of mass concrete with a less-than-usual proportion of reinforcing is a possibility that de-

serves investigation in each case.

Timber supports—particularly where re-spanning is indicated—may be applicable depending upon local conditions. But not all grades or species of timber are equally good for such application. Recommendations of such agencies as the U. S. Forest Products Laboratory and the National Association of Lumber Manufacturers should be followed. And in virtually all cases foundation timbers of any sort should be treated with a wood preservative approved by the same technical authorities.

2. *Waterproofing.* This is partly a matter of providing adequate surface drainage and partly a question of flashing. It involves also the construction of the foundation walls and sub-surface floors. In concrete construction both integral and membrane waterproofing may be necessary. Dense concrete made with a water-cement ratio not exceeding 1 to 6, properly placed and cured, is inherently water-tight. But unit masonry walls will usually require two exterior skim coats  $\frac{3}{8}$  in. thick, using a proportion of 1 part cement to 2 parts sand and embodying a stearate or some other type of integral waterproofing compound. Usual types of metal flashing use critical materials and will be increasingly scarce. But new types made of corrosion-proofed sheet steel and asphalt coated flexible membranes are appearing in place of copper, zinc and lead sheets.

**Floors.** Most remodeling complications relative to floors involve either waterproofing or heat losses in sub-surface floors on fill or methods to prevent sound transmission between floors. The waterproofing problem can be variously solved by measures similar to those used in sub-grade walls to accomplish the same purpose. To reduce heat losses and prevent condensation some sort of insulation must usually be employed—either as surfacing or as a part of the floor construction itself.

For example, with a 4-in. concrete slab poured on earth, about 74 per cent of heat loss can be stopped by installing a yellow pine sub-floor on

sleepers and surfacing with maple or oak flooring. Where a concrete floor already exists, an even more efficient method is to install a 1-in. layer of rigid insulation board protected on both sides with membrane waterproofing and then pour an additional concrete slab on top. Even without additional surfacing this construction effects about a 67 per cent reduction in heat loss compared with a double-slab floor minus the insulation. And if the wood flooring just described is added, the heat loss is reduced an additional 12 per cent.

The problem of controlling sound transmission through floors also may involve use of a double-membrane floor with a "sandwich filling" of insulation blanket. Suggested details of such constructions are shown in the Time-Saver Standards on page 55. Although these do not, by any means, exhaust the structural possibilities, they emphasize two cardinal principles of sound transmission control: one, development of a relatively great mass in material; and second, dampening of sound vibration through use of dissimilar materials in close association.

**Walls.** Graphic suggestions in Time-Saver Standard details do not include several excellent construction methods that involve extensive use of metal—particularly the use of metal studs for hollow partitions and solid partitions formed by plastering on both sides of metal lath. They do, however, reflect the wide adaptability of masonry and wood frame construction to remodeling problems.

Material in the following six pages of Time-Saver Standards was compiled and drawn by Carl T. Sigman. Sources included a large number of building material manufacturers, practicing architects and engineers and the technical staffs of a number of trade associations. Among these particular credit is due the following: Portland Cement Association, Structural Clay Products Institute, National Association of Lumber Manufacturers, the National Lime Association and the United States Gypsum Co.

# REMODELING CONSTRUCTION: 1—Foundation Details

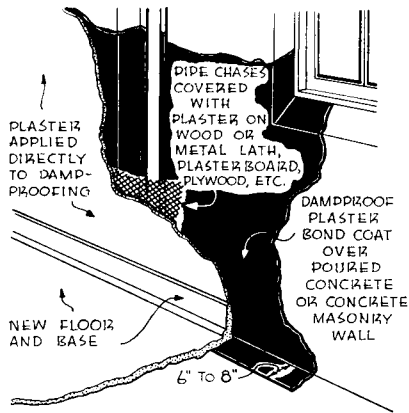

PLASTER OVER BASEMENT WALLS

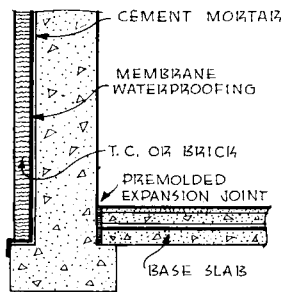

WATERPROOFING AGAINST GROUND-WATER PRESSURE

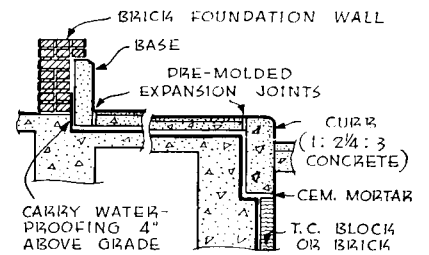

WATERPROOFING DETAIL FOR VAULTS AND TUNNELS

RECOMMENDED CONCRETE MIXTURES FOR FOUNDATION WALLS AND BASEMENTS

KIND OF WORK	STRENGTH AT 28 DAYS	GALLS OF WATER TO ADD TO EACH 1-SACK BATCH IF SAND IS:			TRIAL MIX FOR 1ST BATCH	MAXIMUM AGGREGATE SIZE		
		DAMP	WET	VERY WET				
BASEMENT FLOORS, STEPS, CORNER POSTS, PIERES, COLUMNS	3,000 $\frac{lb}{sq\ ft}$	5 1/2	5	4 1/4	1	2 1/4	3	1 1/2 in.
FOUNDATION WALLS WHICH NEED NOT BE WATER-TIGHT, MASS CONC. FOR FOOTINGS, RETAINING WALLS, ENGINE BASES.	2,000 $\frac{lb}{sq\ ft}$	6 1/4	5 1/2	4 3/4	1	2 3/4	4	1 1/2 in.

(ABOVE FROM "FOUNDATION WALLS AND BASEMENTS" - PORTLAND CEMENT ASSOCIATION)

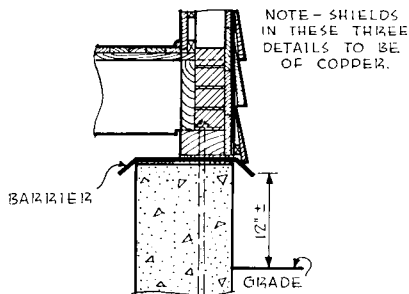

Barrier shield applied to frame construction

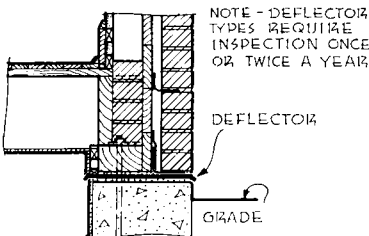

Deflector shield applied to brick veneer construction

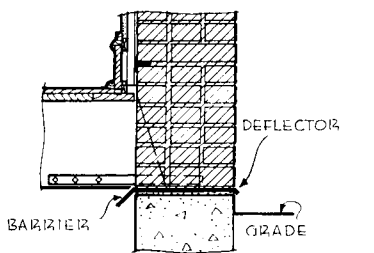

Combination shield applied to solid masonry construction

TERMITE SHIELDS  
Scale 1/2" = 1'-0"

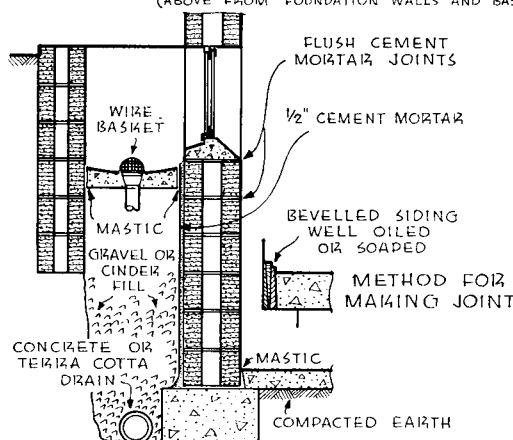

Waterproofed concrete block foundation wall

NOTE - FOR CEMENT MORTAR, WHEREVER SHOWN ON THIS PAGE, USE ONE PART CEMENT TO THREE PARTS SAND.

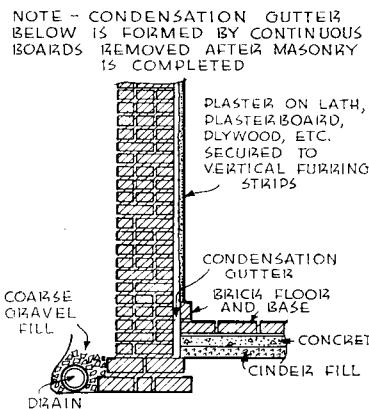

Brick foundation and basement floor  
Scale 1/4" = 1'-0"

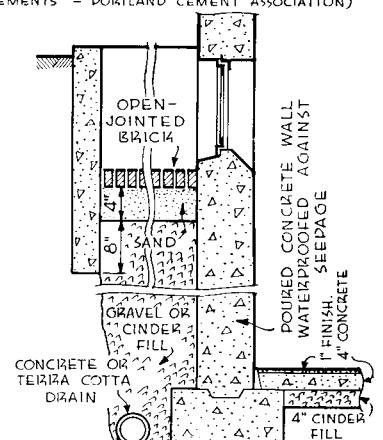

Concrete foundation wall with area

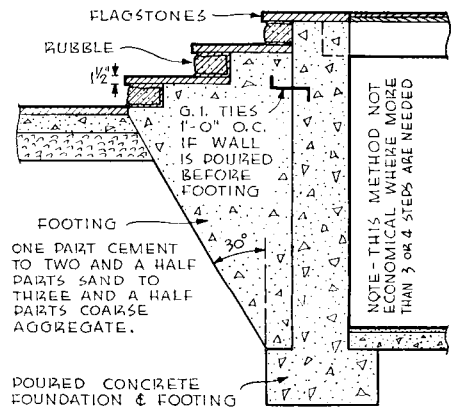

Concrete foundation and footing for steps

# REMODELING CONSTRUCTION: 2—Concrete Floors

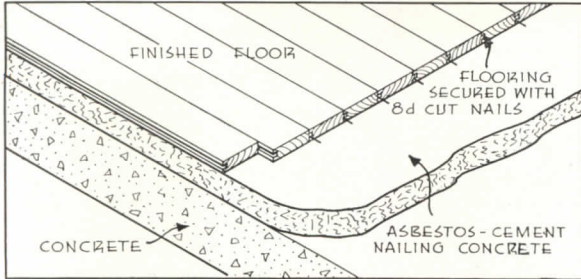

WOOD FLOOR OVER CONCRETE WITH UNDERLAYER OF NAILING CONCRETE

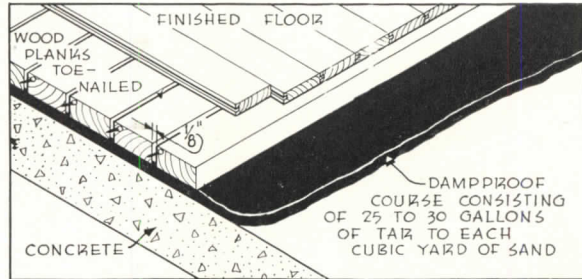

WOOD FLOOR OVER CONCRETE

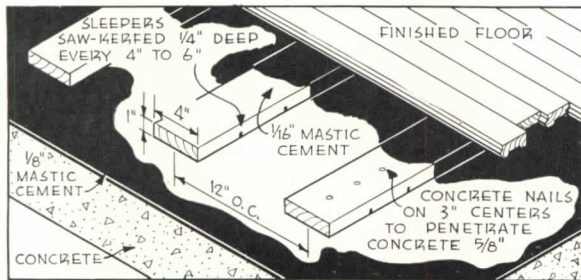

FINISHED FLOOR DIRECTLY ON SLEEPERS SET IN MASTIC CEMENT & NAILED TO CONCRETE

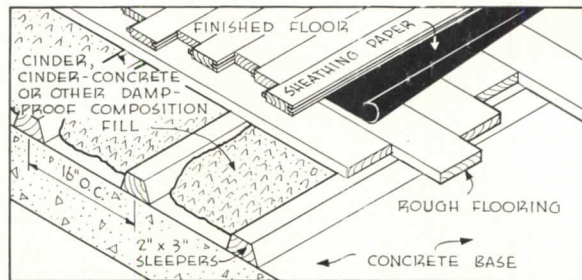

WOOD FLOOR OVER CONCRETE WITH SUB-BASE OF SLEEPERS & SLEEPER FILL

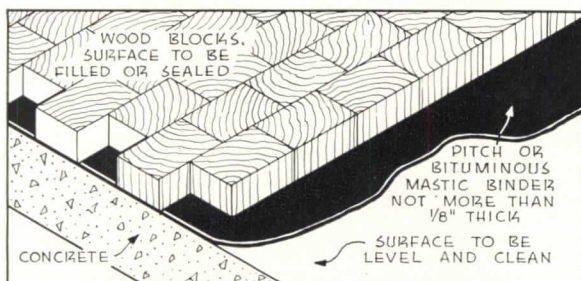

WOOD BLOCK FLOOR OVER CONCRETE

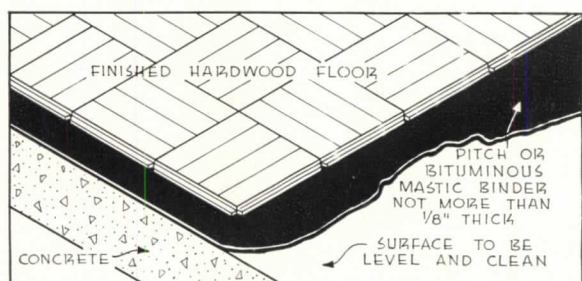

WOOD FLOOR OVER CONCRETE IN MASTIC

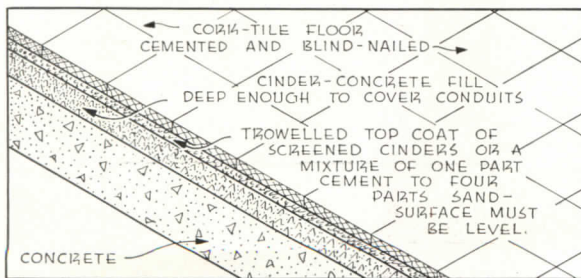

CORK TILE FLOOR OVER CONCRETE

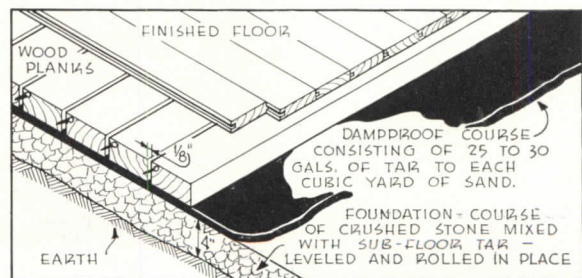

WOOD FLOOR APPLIED OVER EARTH

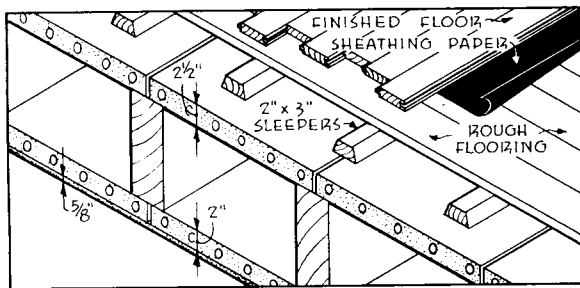

WOOD FLOOR OVER PRE-CAST GYPSUM BASE AND CEILING — WOOD JOISTS

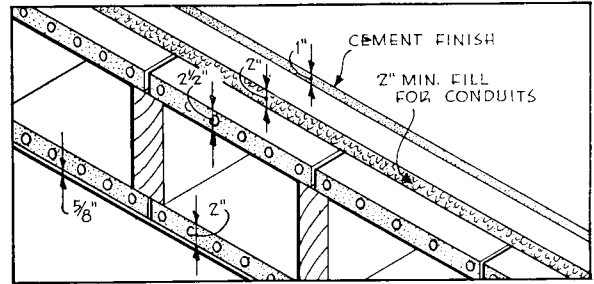

CEMENT FLOOR OVER PRE-CAST GYPSUM BASE AND CEILING — WOOD JOISTS

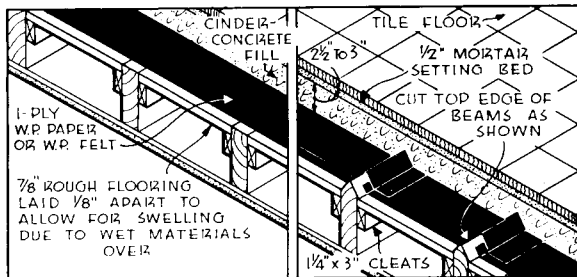

TILE FLOOR ON FLAT-TOP AND BEVELLED WOOD JOISTS

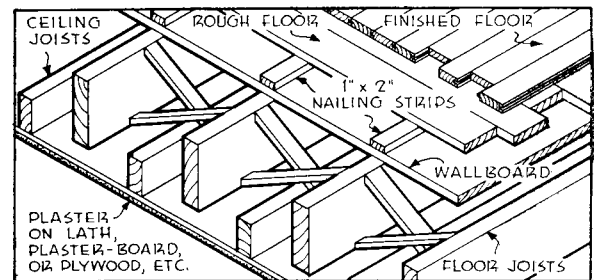

SOUND-CONTROL WITH STAGGERED JOISTS AND SUB-FLOORING

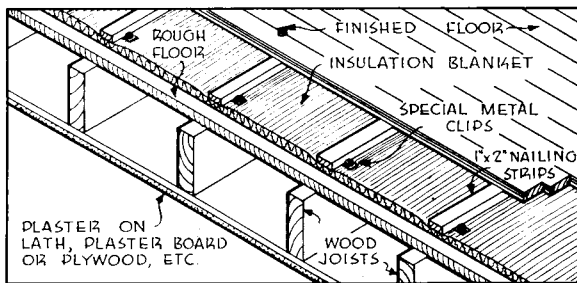

SOUND-CONTROL WITH INSULATION BLANKET BETWEEN ROUGH AND FINISHED FLOORING

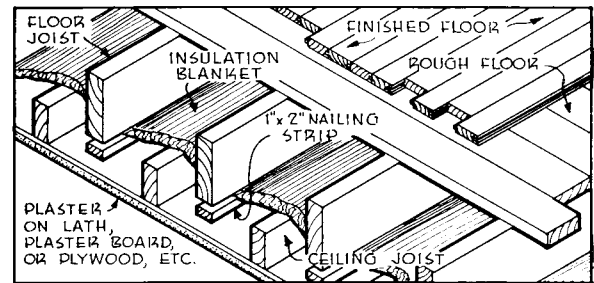

SOUND-CONTROL WITH STAGGERED JOISTS AND INSULATION BLANKET

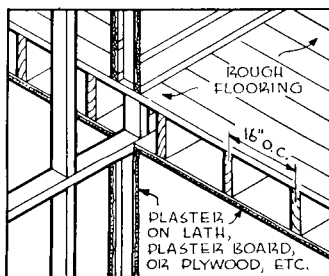

PARTITION OVER PARTITION PARALLEL WITH JOISTS

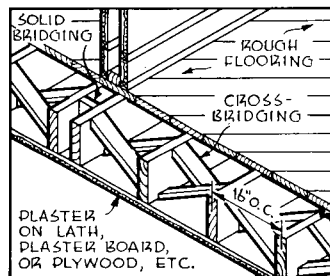

PARTITION NOT OVER PARTITION — ON DOUBLE JOISTS

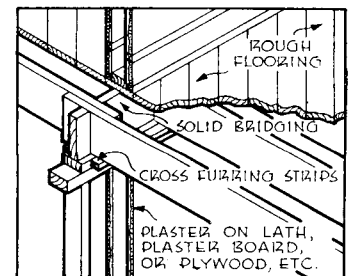

PARTITION OVER PARTITION AT RIGHT ANGLES TO JOISTS

# REMODELING CONSTRUCTION: 4—Exterior Walls

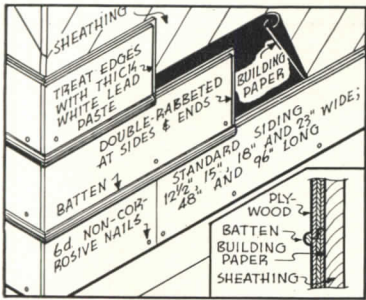

PLYWOOD SIDING  
 NEW CONSTRUCTION

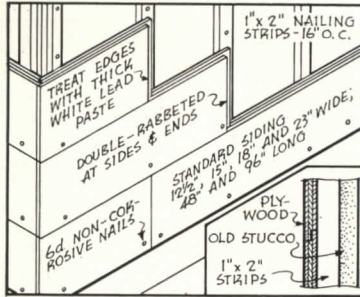

PLYWOOD SIDING OVER  
 OLD STUCCO OR BRICK

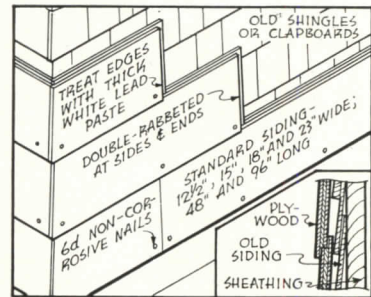

PLYWOOD SIDING OVER  
 OLD SHINGLES OR CLAPBOARDS

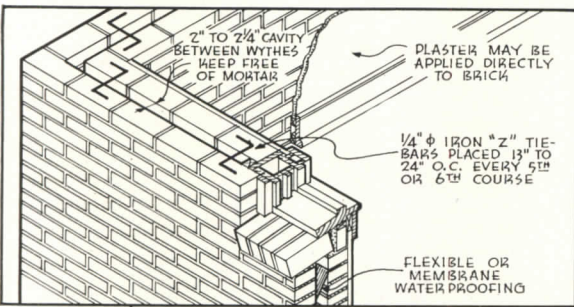

BRICK CAVITY WALL -  
 CORNER AND DETAIL AT WINDOW

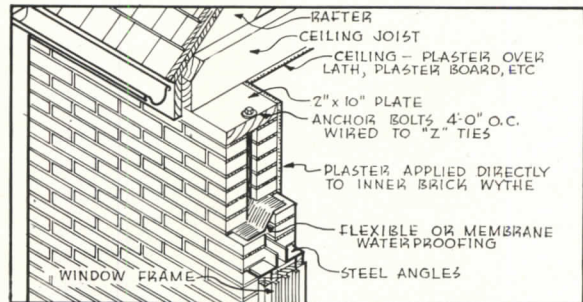

BRICK CAVITY WALL - SECTION THROUGH  
 PLATE AND WINDOW HEAD

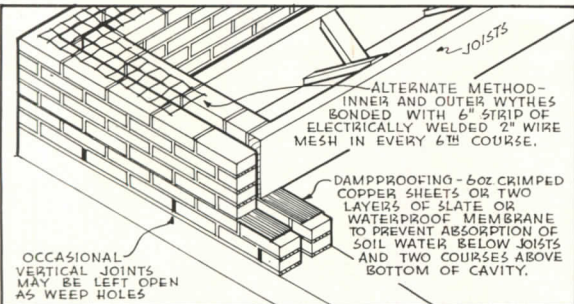

BRICK CAVITY WALL -  
 CORNER AT FOUNDATION WALL

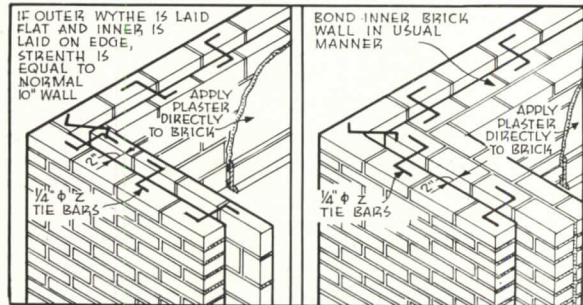

8" NON-BEARING BRICK CAVITY WALL      14" BEARING BRICK CAVITY WALL

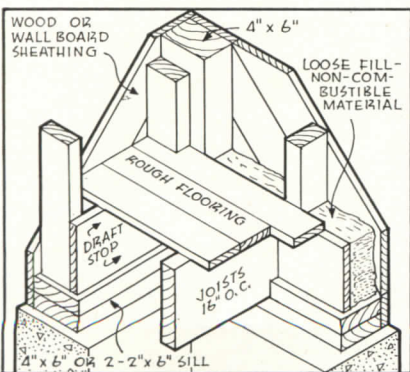

BRACED FRAME CONSTRUCTION  
 OUTSIDE CORNER

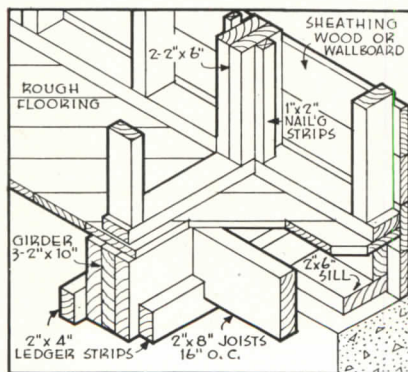

FRAMING A BEARING PARTITION  
 AT OUTSIDE WALL

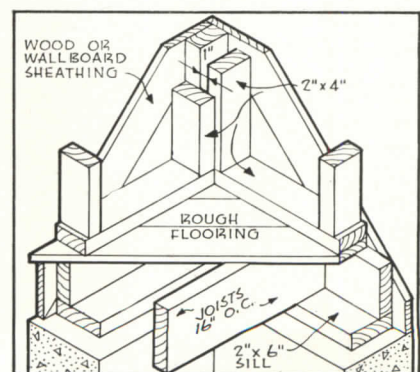

WESTERN FRAME CONSTRUCTION  
 OUTSIDE CORNER



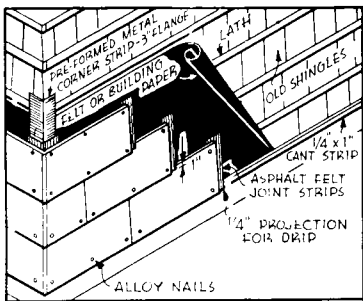

ASBESTOS CEMENT SHINGLES OVER OLD WOOD SHINGLES

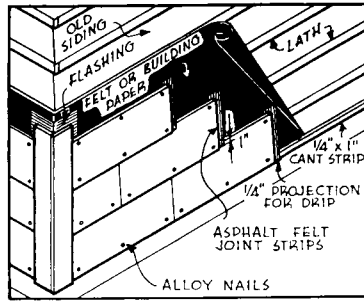

ASBESTOS CEMENT SHINGLES OVER OLD CLAPBOARDS

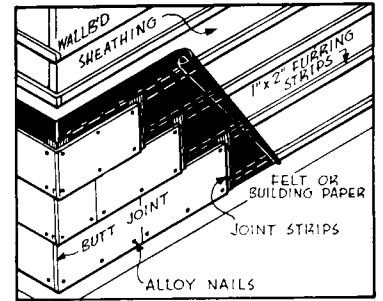

ASBESTOS CEMENT SHINGLES—NEW CONST. OR OLD STUCCO

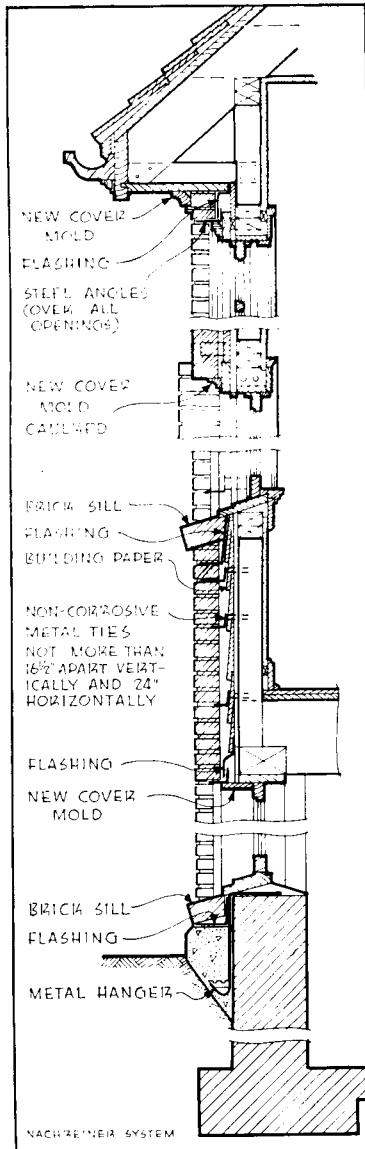

NEW BRICK VENEER OVER OLD CONSTRUCTION

**ASBESTOS CEMENT SHINGLES**  
 NOTE THAT NAILS THROUGH BUTT OF SHINGLE REST ON TOP EDGE OF SHINGLE BELOW, GIVING PROPER ALIGNMENT OF COURSES. ALL EXPOSED NAILS MUST BE ALLOY RUST-PROOF. JOINT STRIPS MUST OVERLAP SHINGLE BELOW BY 1".

LENGTH OF SHINGLES	EXPOSURE OF SHINGLES	
	SINGLE COURSE	DOUBLE COURSE
16"	6" TO 7 1/2"	8" TO 12"
18"	6" TO 8 1/2"	8" TO 14"
24"	8" TO 11"	12" TO 16"

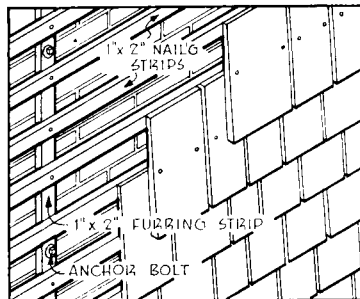

WOOD SHINGLES OVER OLD BRICK CONSTRUCTION

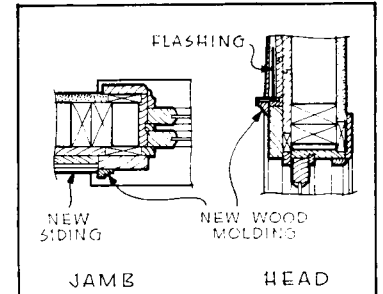

NEW MOLDING AND FLASHING FOR USE WITH NEW SIDING

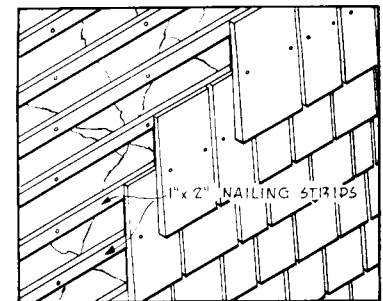

WOOD SHINGLES OVER OLD STUCCO CONSTRUCTION

NOTE — CENTER TO CENTER OF NAILING STRIPS = SHINGLE EXPOSURE.

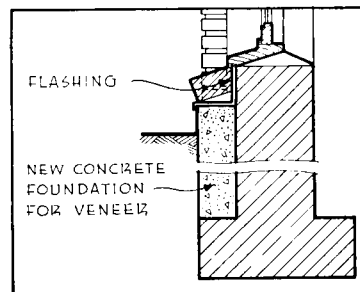

NEW BRICK VENEER—ALTERNATE FOUNDATION METHOD

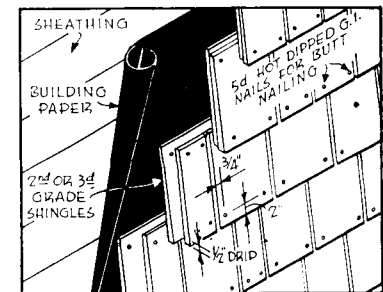

DOUBLE COURSING FOR NEW OR OLD CONSTRUCTION

# REMODELING CONSTRUCTION: 6—Interior Partitions

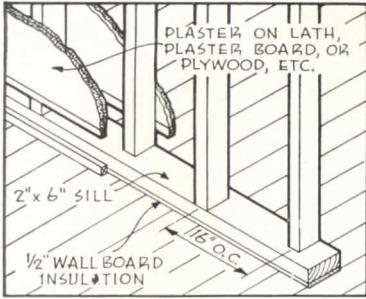

SOUND CONTROL BY STAGGERED STUDS

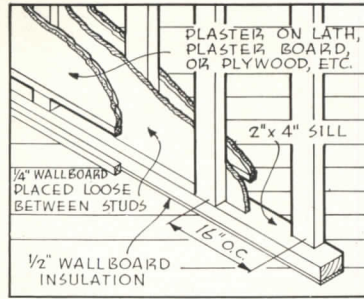

SOUND CONTROL—STAGGERED STUDS AND WALL BOARD

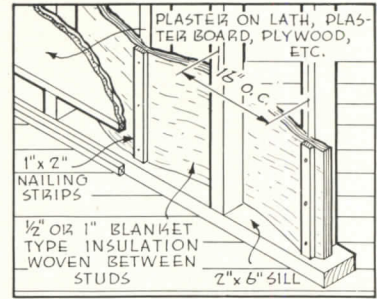

SOUND CONTROL—STAGGERED STUDS AND BLANKET CENTER

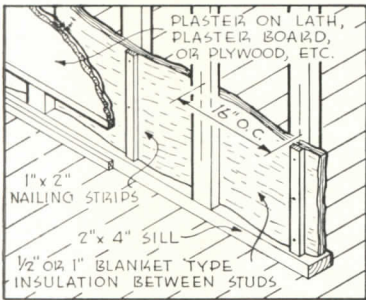

SOUND CONTROL—SIDEWISE STUDS AND BLANKET CENTER

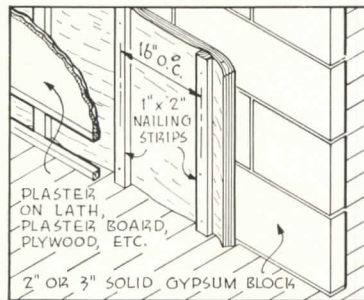

SOUND CONTROL—BLANKET OVER GYPSUM BLOCK

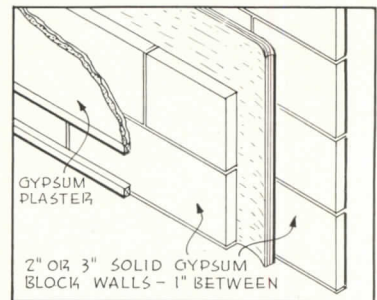

SOUND CONTROL—BLANKET BETWEEN GYPSUM BLOCK

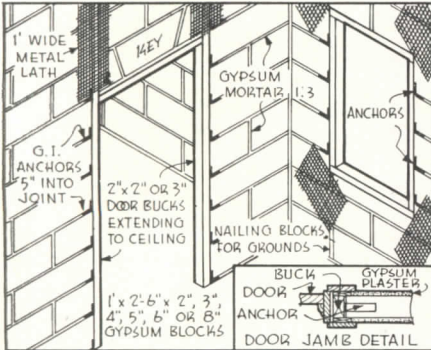

GYPSUM SOLID OR HOLLOW PARTITION TILE-1

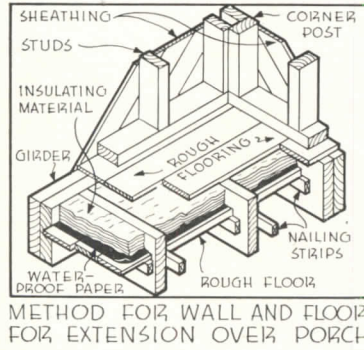

METHOD FOR WALL AND FLOOR FOR EXTENSION OVER PORCH

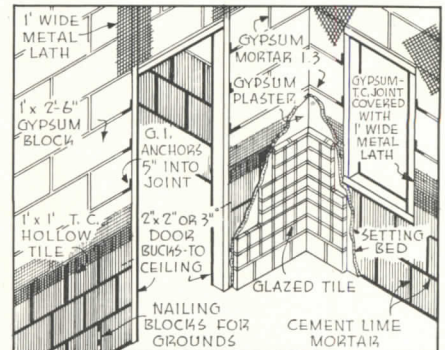

TERRA COTTA BLOCK PARTITION TO HEIGHT OF GLAZED TILE

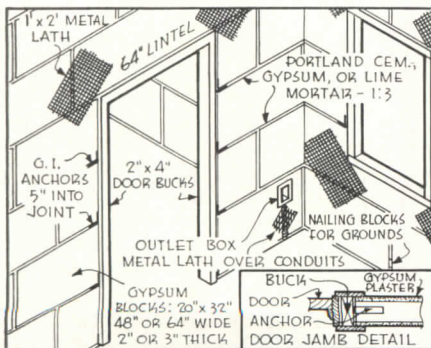

GYPSUM SOLID OR HOLLOW PARTITION TILE-2

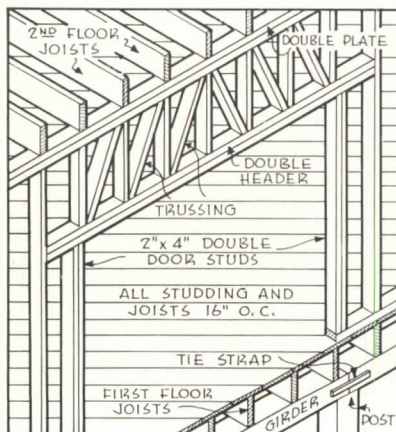

FRAMING FOR WIDE OPENING ABOVE SUB-STRUCTURE

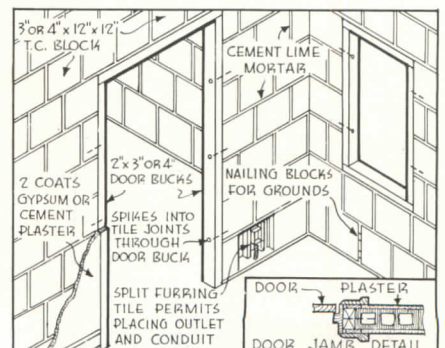

TERRA COTTA HOLLOW PARTITION TILE

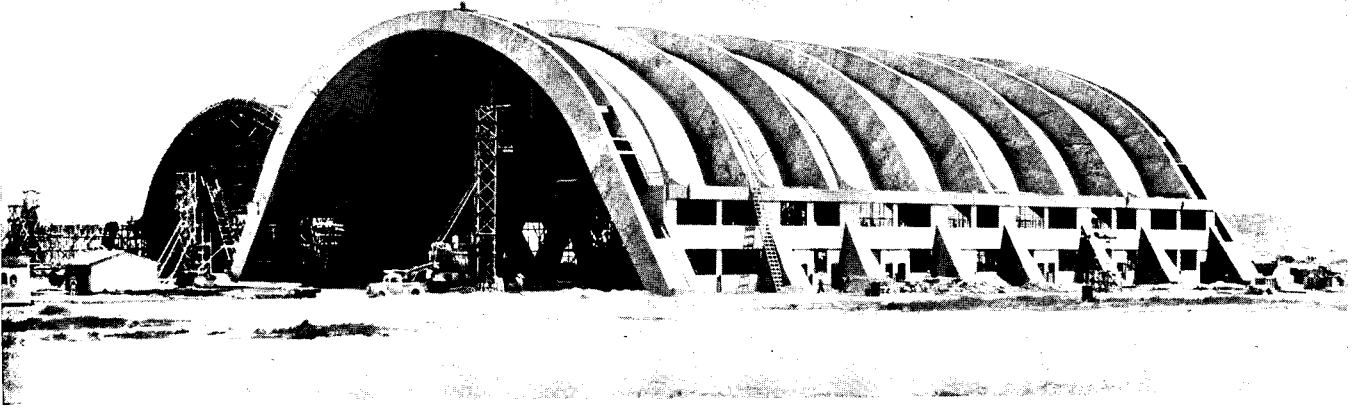

TYPICAL OF NEW WAR-TIME USES to which concrete is now being put is this hangar for Navy airplanes. It was designed by the engineering firm of Roberts and Schaefer, with a thin-shell four-unit arch without interior framing members. Exposed arch ribs are of 294 ft. span and 81 ft. rise

# NEW WAYS TO SAVE STEEL IN CONCRETE

WITH A HUGE BUILDING PROGRAM still ahead, and with metals becoming almost daily more critical, architects and engineers are looking more and more to such non-critical materials as concrete. Concrete specialists have been no less active in attempting to simplify design technique to conserve reinforcing steel.

Recent statements from two authorities point the way ahead. Carried to a logical conclusion the comments of Dr. Hugh L. Dryden, Bureau of Standards, and studies by engineers of the Portland Cement Association would imply a revision in both the theory and practice of concrete design. At least they offer specific suggestions for conserving steel.

## Steel in concrete floors

The comparison of steel requirements in various floor construction systems is by no means a simple subject, and authorities do not always agree. Dr. Dryden wrote recently: "The amount of steel needed in two-way reinforced slabs usually is considerably less than that needed in one-way reinforced slabs. The amount of reduction depending on the ratio of width to length of slab, the span, and the loading. In general, the steel reinforcement needed in reinforced

concrete slabs may be reduced by the use of light-weight fillers of structural clay tile or hollow concrete blocks."

Offering disagreement on some points are the results of some recent studies of specific designs, by the Portland Cement Association (see chart, page 60). P. C. A. engineers report: "In 1940, before the steel shortage became acute, seven types of concrete floor systems were designed including the supporting beams.\* The studies included three live loads—50, 100, 150 p.s.f.—and three span lengths—15, 20, 25 ft. At that time, comparative cost was the object, but today, while cost is still a vital problem, it is the steel quantities that are of special interest. The following steel quantities in lb. per sq. ft. of floor area for seven types of floors are taken from these design studies for 20-ft. span and 100-lb. loading.

1. 20-in. metal pans	2.77
2. 30-in. metal pans	2.58
3. 12-in. masonry filler	3.54
4. 16-in. masonry filler	3.43
5. One-way slab	3.01
6. Two-way slab	3.70
7. Flat slab	2.13

\*By the Structural Bureau of the Portland Cement Association. Design based on A.C.I. Code 1936 with  $f_s = 20,000$  p.s.i.,  $f_c' = 2,500$  p.s.i.

"One point that stands out is the superiority of the flat slab\*\* design, which requires only 2.13 lb. of steel per sq. ft. The designs that have most steel are types 3, 4 and 6—floors with masonry fillers and the two-way solid slab. The floors with metal pans and the one-way slab are between the extremes . . .

"Neither flat slab nor solid slab ceilings need metal lath or plaster. Ceilings that require suspended ceilings with metal lath should have approximately one-half pound added to their steel factors. Types 1 and 2, with suspended ceiling included, will then require approximately 3.2 p.s.f., and compared with this figure both flat slab and solid slab show a definite margin of saving.

"Flat slab construction has been regarded as suitable especially for heavy warehouse loads. Actually, flat slab will often show a saving both in cost and steel for light load construction such as apartments, and it deserves consideration in many other occupancies.

"Increasing the load increases all steel factors, but the smallest increase in steel is in the flat slab, the superi-

\*\*Flat slab here means girderless solid slab with drop panels, column capitals and two-way reinforcements.

ority of which becomes more marked the greater the load."

### Lowering live load estimates

Steel conservation possibilities in reinforced concrete columns, as given by the P.C.A., are put in tabular form on this page. The data compare tied and spiral columns for different column sizes, different concrete strengths, according to four different design codes. The column load assumed is 500 kips, and the steel weights are given per column with 12-ft. story height.

Several conclusions are cited: 1. For ordinary-strength concrete it is advantageous to use tied columns, that is, in normal column sizes. 2. In small-sized columns, and ordinary-strength concrete, spiral columns take a little less steel than tied columns. 3. The opposite is true where the design is based on 5,000-lb. concrete. 4. When loads are large and column sizes small, a great deal of steel may be saved by using high-strength concrete.

The P.C.A. goes on to point out: "Laps used for splices of vertical bars consume a considerable amount of steel. . . . Except for unusual cases in which comparatively large bending moments create tension in the columns, the vertical bars could still be butt-spliced and the steel now used in laps conserved. Attention should be given to welding ends of bars to be spliced in columns, especially when the bars are large. . . ."

### Reinforcement in columns

Codes of many city building de-

partments force a waste of structural materials by requiring inordinately high live loads for many types of occupancy. "It is clear," reports the P.C.A., "that many buildings designed under present building codes may be drastically over-designed and that such practice involves an amount of waste of materials which must cause concern. The live loads recommended by the U. S. Department of Commerce Building Code Committee should be adopted universally because their use will conserve building materials.

"Another source of waste originating in many city building codes is their tendency to require columns to be designed for excessive loads. It is generally recognized that for many types of occupancies the columns need not be designed for the full live load when there are several stories above the column considered. The committee's recommendation is that 'except in buildings for storage purposes, the following reductions in assumed floor live loads are permissible in designing all columns, piers or walls, foundations, trusses and girders.'

"Reductions of total live load carried:

Carrying one floor	0
" two floors	10
" three floors	20
" four floors	30
" five floors	40
" six floors	45
" seven or more floors	50

"For illustration, a column supporting eight levels (one of which presumably may be a roof) need not be designed for more than one-half of

the live load on all eight levels. Not taking full advantage of the reductions means that columns are over-designed and material wasted.

### Allowable working stresses

"The allowable stress in column bars in both J.C. 1940 and A.C.I. 1941 is 40 per cent of the yield point stress with an upper stress limit of 30,000 p.s.i. That means 16,000 on intermediate and 20,000 on hard grade. It is not customary to go any higher, and the fact seems to be ignored that the top limit in the codes is 30,000 p.s.i. which, of course, would be permitted only on steel with a minimum yield point of 75,000 p.s.i. Here is an untapped source of saving steel which deserves attention especially under the present conditions.

"Allowable concrete stresses are in general given in percentage of concrete strength, and increasing the latter may therefore be an important source of saving material. With present-day cements, a strength of 3,000 p.s.i. is a conservative value and designers could well adopt much higher strengths, all the way up to 5,000 p.s.i. In columns, loads should be carried by concrete rather than by steel, a subject that has already been discussed. Using a higher concrete strength for design purposes will go a long way toward reducing reinforcement in beams for compressive stresses, diagonal tension and bond. It will also be helpful in regard to reducing dead load, which is another source of saving, especially in long-span construction."

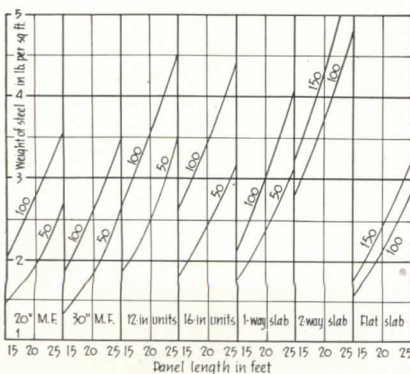

RELATIVE WEIGHTS of reinforcing steel in seven types of floor construction, from studies by the Portland Cement Association. The flat slab, the report indicates, requires the least steel, its superiority increasing with larger loads

Col. load: 500 k A structural column of equal capacity would weigh 1300 lb. per 12 ft. story height	$f_c' = 3000$					$f_c' = 5000$				$f_c' = 3750$	
	1	2	3	4	5	6	7	8	9	10	
	Minimum Tied	Steel Spiral	Same size as 2 Tied	Size reduced compared with 2, 3 Tied	Size reduced compared with 2, 3 Spiral	Minimum steel Tied	Size reduced compared with 6 Tied	Size reduced compared with 6 Spiral	Size reduced Tied	Size reduced Spiral	
Col. size	Reinf. lb.	Col. size	Reinf. lb.	Col. size	Reinf. lb.	Col. size	Reinf. lb.	Col. size	Reinf. lb.	Col. size	Reinf. lb.
J. C. 1940	28 387 25 630	25 643	22 937	22 788	22 257 20 545	20 653	22 681	22 630			
A C.I. 1936	30 444 25 630	25 944	.. .. .	22 812	22 574	.. .. .	20 677	22 984	22 658		
N. Y. 1938†	26 174 25 448*	25 212	22 916	22 723	.. .. .	.. .. .	.. .. .	.. .. .	.. .. .		
Chi. 1937	26 347 25 517*	25 464	22 782	22 695	22 249	20 374	20 536	22 507	22 569		

† $f_c' = 3400$  is max allowed. \*These values are close to min. steel.

Notes: Weight of reinforcement is in lb. per 12 ft. story height. 24 dia. added for lapped splices. 15 lb. added for ties per column. 15 lb. added for spiral spacers. Spirals assumed 11 ft. high. Hot rolled spirals.

Steel conservation possibilities in reinforced concrete columns, as tabulated by the Portland Cement Association, giving weights of reinforcement for tied and spiral columns of various sizes and various strengths of concrete. Conclusions of P.C.A. engineers are: 1. For ordinary-strength concrete it is advantageous to use tied columns; 2. In small sizes spirals take less steel; 3. The opposite is true with 5,000-lb. concrete; 4. When loads are large and column sizes small, much steel may be saved with high-strength concrete.

# SPECIFICATION STANDARDS FOR GOVERNMENT WORK

## PART 2

By HAROLD R. SLEEPER, AIA

Private architects who are now or will soon be engaged in work for the Federal Government will find the following lists, continued from the January issue of the RECORD, of invaluable assistance.

## DIVISION 4. STRUCTURAL STEEL

FED. SPEC.	A.S.T.M. SPEC.
<p><b>Steel, Structural; (for) buildings (includes rivets)</b>  <small>FED. SPEC. QQ-S-721a</small></p> <p>Specify Class:            Class A—Structural steel.            Class B—Structural steel, copper-bearing            Class C—Rivet steel.            Class D—Rivet steel, copper-bearing.</p>	<p><b>Steel for Bridges and Buildings</b>  <small>(Replaces A 9.)</small>  <small>(Includes references to:)</small>            Structural Rivet Steel.            Carbon-Steel Castings            For miscellaneous Industrial Uses.            Tentative Carbon-Steel Forgings for            Industrial Use</p>
	<p style="text-align: right;"><small>A.S.T.M. A 7-39 ASA G24-1939</small></p> <p style="text-align: right;"><small>A.S.T.M. A 141-39 ASA G21-1939</small></p> <p style="text-align: right;"><small>A.S.T.M. A 27-39 A.S.T.M. A 235-40 T</small></p>

### OTHER REFERENCES

"Specification for the Design, Fabrication and Erection of Structural Steel for Buildings."

Published by American Institute of Steel Construction. This may form the basis of Structural Steel Specification with the addition of several items required for the specific project such as

- Type of Paint. Type of field connections.
- Planing and milling of columns and stiffeners.
- Special holes in steel for attachment of other materials or passage of pipes, etc. Architectural clearances.
- Separators for double beams.

Bearing plates, gussets, lintels. Limitations of job cutting and drifting. Plumbing and levelling tests and shop drawings.

Simplification of structural steel shapes.  
 OPM Regulations, issued by American Iron and Steel Institute, Oct. 22, 1941. Effective Feb. 1, 1942.

Copies may be secured from the Steel Institute, 350 Fifth Ave., New York, N. Y.

The types of structural steel shapes have been reduced by this "simplification" and only those listed will be rolled.

## DIVISION 5. ROOFING & SHEET METAL

FED. SPEC.	A.S.T.M. SPEC.												
<p><b>Lead; Sheet</b>  <small>FED. SPEC. QQ-L-201</small>            Specify Grade A (purest) or Grade B; and weight per square foot. Weights in lbs. and approximate thicknesses are: 1 (1/16"), 1½, 2 (1/32"), 2½, 3 (3/64"), 3½, 4 (1/16"), 5, 6 (3/32"), 8 (¼"), 10 (5/32"), 12 (3/16"), 14, 15 (¾"), 16, 20, 24, 30 (½"), 40, 60 (1").</p>	<p><b>Lead-Coated Copper Sheets</b>  <small>A.S.T.M. B 101-40</small>            Specify type of application: Type I molten lead; Type II electro-deposited lead.            Specify Class      <i>Weight of lead, both sides, 100 sq. ft.</i></p> <table border="0" style="margin-left: 20px;"> <tr> <td></td> <td style="text-align: center;"><i>Min.</i></td> <td style="text-align: center;"><i>Max.</i></td> </tr> <tr> <td>Class A standard</td> <td style="text-align: center;">12</td> <td style="text-align: center;">15</td> </tr> <tr> <td>Class B</td> <td style="text-align: center;">20</td> <td style="text-align: center;">30</td> </tr> <tr> <td>Class C</td> <td style="text-align: center;">40</td> <td style="text-align: center;">50</td> </tr> </table> <p>Specify: If one side only is to be coated, if special textures are required.</p>		<i>Min.</i>	<i>Max.</i>	Class A standard	12	15	Class B	20	30	Class C	40	50
	<i>Min.</i>	<i>Max.</i>											
Class A standard	12	15											
Class B	20	30											
Class C	40	50											
<p><b>Copper; bars, plates, rods, shapes, sheets and strips</b>  <small>FED. SPEC. QQ-C-501a</small>            Specify: Forms and temper:            Rods—soft and hard.            Bars—soft and hard.            Shapes—soft and hard.            Sheets—soft, hard and light cold-rolled (latter for gutters, leaders, cornices, etc.)            Strips—soft, hard and light cold-rolled (latter for gutters, leaders, cornices, etc.)</p>	<p><b>Soft Solder Metal</b>  <small>A.S.T.M. B 32-40 T</small>            Specify Grade: Tin-lead solder A &amp; B grade.            Tin-lead-antimony solder, A &amp; B grades.</p>												
<p><b>Solder; tin-lead</b>  <small>FED. SPEC. QQ-S-571</small>            Specify Grade: A, B or C for galvanized iron or zinc. Fed. Spec. E-QQ-S-571, Aug. 16 '41 suggests use of Lead-silver solder in place of above.</p>	<p><b>Silver Solder</b>  <small>A.S.T.M. B 73-29</small>            Specify grade (1 to 8.)</p>												
<p><b>Solder; Silver</b>  <small>FED. SPEC. QQ-S-561b</small></p>	<p><b>Zinc-coated (galvanized) Iron or Steel Sheets</b>  <small>A.S.T.M. A 93-27 ASA G861-1931</small>            Specify class of coating and gauge of sheet:            Class A—Extra heavily coated (no forming except corrugating).            Class B—Heavily coated (not intended for forming except corrugating and curving to large radii).            Class C—Moderately heavily coated (moderate bending).            Class D—Ordinary, for general utility (not for long life).            Class E—Light, tightly adherent coating for severe forming.</p>												
<p><b>Iron and Steel; sheet, black and zinc-coated (Galvanized)</b>  <small>FED. SPEC. QQ-I-696</small>            Specify: Iron or steel; type, gauge, class and weight of coating; state if to be oiled.            Types I Flat black sheet.                  II Flat zinc coat sheets.                  III Corrugated zinc coated sheets.            Classes: A—Extra heavily coated.                  B—Heavily coated.                  C—Moderately heavily coated.                  D—Ordinary coated.                  E—Lightly coated for severe forming.            Fed. Spec. E-QQ-I-696, Sept. 12, '41. Alternates for light metal coating and other protective coatings such as paint, enamels, lacquers, asphalts, porcelain-enamelled specified.</p>													

**FED. SPEC.**

**Lead Calking** FED. SPEC. QQ-L-156  
Specify Type: Type I calking lead,  
Type II lead wool.

**Terne-plate (roofing tin)** FED. SPEC. QQ-T-201  
Specify: Material, iron or steel; trade symbol IC or IX;  
and weight of coating, 8, 15, 20, 25, 30, or 40 lbs.  
Fed. Spec. E-QQ-T-201, Sept. 12, '41 suggests use of steel,  
cement or asbestos shingles, asphalt roofing, slate roof-  
ing. Contains spec. for iron and steel sheets with sur-  
faces prepared for painting, and porcelain enamelled.

**Slate; roofing** FED. SPEC. SS-S-451  
Specify if other than 3/16" slate is required. Specify  
Grades: A highest, B & C. If special slate such as  
unfading or weather is required, so state. In accord  
with Simplified Practice Recommendation R 14-28.

**Fiber-board; Insulating** FED. SPEC. LLL-F-321a  
Specify Class C—roof boards.

**Terne-plate (Long ternes)** FED. SPEC. QQ-T-191  
Specify: whether steel or iron; type and class, grade;  
weight and finish. Type I for general use such as cor-  
nices, kalamein, doors, etc. Types II and III for uses  
where drawing or forming operations are severe for  
standard type. Class A only temporary protection, Class  
B, C, D for permanent protection.  
Classes are weights of coating per double box as fol-  
lows: Class A standard, Class B—12 lbs., Class C—15  
lbs., Class D—40 lbs. Grades: 1—Primes only, 2—  
Primes with up to 20% of seconds.  
Fed. Spec. E-QQ-T-191, Sept. 12, '41, suggests use of  
light coating of tin and specifies other protective steel  
coatings such as paint, enamels, lacquers, asphalts, etc.

**Roofing and shingles; asphalt-prepared, mineral surface** FED. SPEC. SS-R-521  
Specify Type: Type I. Ready or Roll roofing (80 lbs.)  
Type II. Shingles (83 lbs.)  
Specify color and any special desired texture or edging.

**Shingles, roofing, cement-asbestos** FED. SPEC. SS-S-291

**Pitch; coal-tar (for) mineral-surfaced built-up roofing, waterproofing and dampproofing** FED. SPEC. R-P-381  
Specify Type: (Both types to be used with coal-tar saturated felt.)  
Type I for use with felt for roofing and waterproofing with slope not over 1" per foot.  
Type II for use with felt for roofing and waterproofing as ply cement in membrane waterproofing or alone as dampproofing. Use in locations where temperature will not exceed 100° F.

**Cement, bituminous, plastic** FED. SPEC. SS-C-153  
For use with plastic flashing used with bituminous roofing. Specify: Type I for use with flashing felt. Type II or III (coal tar base) may be used on coal tar pitch for repair of metal roofing or as expansion joint material for concrete or masonry.

**Felt; coal-tar saturated (for) roofing and waterproofing** FED. SPEC. HH-F-201

**Asphalt-Primer; (for) roofing and waterproofing** FED. SPEC. SS-A-701

**Asphalt; (for) built-up roofing, waterproofing and damp-proofing** FED. SPEC. SS-A-666  
Specify Type and Class and Grade:  
Type I for surfaced, built-up roofing.  
Class A free from organic matter.  
Class B contains finely divided mineral matter.  
Type II for unsurfaced, built-up roofing.  
Grade I for inclines not over 6" to 12" over boards, and not over 3" to 12" over concrete.

**Roof-coating; asphalt, brushing consistency** FED. SPEC. SS-R-451  
For repair and coating of asphalt and metal roofing and for application to concrete, masonry and steel as dampproofing (use over primer).

**Felt; asphalt-saturated (for) flashing, roofing and waterproofing** FED. SPEC. HH-F-191  
Specify Type I for use with asphalt on built-up roofs, and Type II for flashing with such roofing.

**Roofing; asphalt, prepared, smooth-surfaced** FED. SPEC. SS-R-501  
Specify Grade A—Heavy (weight 50 lbs.) or  
Grade B—Medium (weight 40 lbs.) (intended primarily for temporary buildings.)  
Fed. Spec. E-SS-R-501, Oct. 21, '41 increases weight of both grades of roofing by increasing asphalt coating

**A.S.T.M. SPEC.**

**Zinc-coated (galvanized) Iron or Steel Sheets** A.S.T.M. A 93-38 T  
Zinc coated sheets for general use.  
Specify gauge of sheets and weight.

**Zinc-coated (galvanized) sheets, wrought iron** A.S.T.M. A 163-39  
See Miscellaneous Metals

**Asphalt Shingles surfaced with Coarse Mineral Granules** A.S.T.M. D 225-41 T  
Specify form, size, color and any special edging.

**Coal-Tar Pitch for Roofing, Dampproofing and Waterproofing** A.S.T.M. D 450-41  
For use as a mopping coat in built-up roofs with slag or gravel, as a mopping coat in dampproofing or as a plying or mopping cement in membrane waterproofing. Specify Type: Type A mopping coat for built-up roofs; mopping coat in dampproofing or as a plying cement in membrane waterproofing above ground when not exposed to temperatures over 125° F; Type B mopping coat in dampproofing, or as a plying cement in membrane waterproofing below grade (moderate tempera-  
ture.)

**Coal-tar Saturated Roofing Felt for use in waterproofing and in constructing Built-up Roofs** A.S.T.M. D 227-41

**Asphalt for use in Constructing Built-up Roof Coverings** A.S.T.M. D 312-41  
Specify Type:  
(a) For use in slag or gravel surfaced roofing on in-  
clines up to 3" per ft.  
(b) For use in unsurfaced on inclines up to 3" per ft.  
(c) For inclines between 3" and 6" per ft.  
Specify whether roofing is over boards or concrete.

**Asphalt-Saturated Roofing Felt for use in waterproofing and in constructing Built-up Roofs** A.S.T.M. D 226-41 T  
Specify: 32" or 36" widths; 15 lb. or 30 lb. type.

**Asphalt Roofing Surfaced with Powdered Talc or Mica** A.S.T.M. D 224-41 T  
Specify 32" or 36" width; 65 lb. grade or 55 lb. grade. Specifications for nails and lap cement included.

**Asphalt Roofing Surfaced with Fine Mineral Granules** A.S.T.M. D 248-41 T  
Specify width of 32" or 36" and grade, 65 lbs. or 55 lbs.

**FED. SPEC.**

**Roofing; asphalt ana asbestos-prepared, mineral surfaced**  
 Specify color. FED. SPEC. SS-R-511

**OTHER REFERENCES**

**Sheet Copper Handbook** (second edition) Copper & Brass Research Association, 420 Lexington Avenue, New York City.

**simplified Practice Recommendations**

Asphalt	R 4
Structural slate	R 13
Roofing ternes	R 30
Iron and steel roofing	R 78

**A.S.T.M. SPEC.**

**Asphalt Roofing Surfaced with Coarse Mineral Granules**  
 Specify: 32" or 36" width. Specify color. Specifications for nails and lap cement included. A.S.T.M. D 249-41 T  
A.S.T.M. D 371-41 T

**Wide Selvage Asphalt Roofing Surfaced with Coarse Mineral Granules**  
 Specify: 32" or 36" width. Specify 45 lb. or 55 lb. grade and color. This material is used as cap sheet. A.S.T.M. D 371-41 T

**Asphalt-Saturated Asbestos Felt for use in Constructing Built-up Roofs**  
 Widths 32" or 36". (This material may also be used for membrane waterproofing.) A.S.T.M. D 250-27

**DIVISION 6. MISCELLANEOUS METALS**

On account of scarcity of certain metals, reference to such metals and alloys of same have been omitted (such as aluminum, chromium, nickel, manganese.)

Note where "E" is used in front of Fed. Spec. symbol it denotes Emergency specification, such as E-QQ-B-601.

**FED. SPEC.**

**Copper; bars, plates, rods, shapes, sheets and strips**  
FED. SPEC. QQ-C-501a

**Lead; sheet**  
 For lead-coated copper see "Roofing and Sheet Metal." FED. SPEC. QQ-L-201

**Brass, commercial; bars, plates, rods, shapes, sheets and strips**  
 Specify types and compositions. Fed. Spec. E-QQ-B-611a, Sept. 6, 1941 suggests steel as substitute for brass. FED. SPEC. QQ-B-611a

**Brass; commercial, and naval castings**  
 Specify composition A to D. FED. SPEC. QQ-B-621

**Brass; castings (to be brazed)** FED. SPEC. QQ-B-601

**Bronze Castings; Specify Grade A or B** FED. SPEC. QQ-B-691a  
 Specify Type I and composition 1 to 10.  
 Fed. Spec. { E-QQ-B-601, Sept. 16, 1941  
 { E-QQ-B-691a, Sept. 16, 1941  
 { E-QQ-B-621, Sept. 16, 1941  
 Suggests use of cast iron or malleable iron-castings in lieu of the above brass and bronze castings.

**Iron; Gray, castings** FED. SPEC. QQ-I-652

**Steel; Castings** FED. SPEC. QQ-S-681a

**Iron; malleable; castings** FED. SPEC. QQ-I-666

**Iron, wrought (refined); bars** FED. SPEC. QQ-I-686a

**Steel; carbon and alloys, bars** FED. SPEC. QQ-S-671

**Steel, carbon (Low carbon), Sheets and Strips** FED. SPEC. QQ-S-636

**Treads; safety, metallic** FED. SPEC. RR-T-661  
 Specify Type and Class

Type A, Filled	{ Class 1 Brass with lead ribs. Class 2 Brass with abrasive ribs. Class 3 Aluminum alloy, with lead ribs. Class 4 Aluminum alloy, with abrasive ribs.
Type B, Cast	{ Class 5 Aluminum alloy Class 6 Cast iron Class 7 Alloy, as specified

**A.S.T.M. SPEC.**

**Copper Rods, Bars and Shapes**  
 Specify Type A or Type B—unless otherwise noted, Type A will be supplied. A.S.T.M. B 133-40 T

**Brass sheet and strip**  
 Specify: Alloy, temper, grain size of annealed tempers. A.S.T.M. B 36-41 T

**Copper-Base alloys in ingot forms for Sand Castings**  
 Specify alloy (25 listed) A.S.T.M. B 30-41 T

**Lightweight and Thin-sectioned gray iron castings**  
 Prime consideration of such castings is appearance and machinability. A.S.T.M. A 190-40

**Gray Iron Castings** A.S.T.M. A 48-41  
 Specify class: (Classes are in accord with tensile strength).  
 These castings are for use where strength is a consideration.

**Malleable Iron Castings** A.S.T.M. A 47-33

**Alloy-Steel Casting for Structural Purposes** A.S.T.M. A 148-36  
 Specify Class.

**Common Iron Bars** A.S.T.M. A 85-36

**Refined Iron Bars** A.S.T.M. A 41-36  
ASA G12-1936

**Single and Double Refined Wrought-Iron Bars**  
 Specify Grade A—Double refined or Grade B—Single refined. A.S.T.M. A 189-39 T

**Rolled Wrought Iron Shapes and Bars** A.S.T.M. A 207-39

**Wrought-Iron Plates** A.S.T.M. A 42-39

**Uncoated Wrought-Iron Sheets** A.S.T.M. A 162-39  
ASA G23-1939

**Strip Steel, Cold-Rolled**  
 Specify tempers, grades. A.S.T.M. A 109-38

**Mild Steel Plates** A.S.T.M. A 10-39  
ASA G 20-1939

**Carbon-steel and alloy-steel blooms, billets and slabs for forgings**  
A.S.T.M. A 17-29  
ASA G9.1-1933  
A.S.T.M. A 248-41 T

**FED. SPEC.**  
**Calking Lead** FED. SPEC. QQ-L-156  
 Specify Type I for calking lead and Type II for lead wool.

**For Structural Steel**  
 See Structural Steel Division.

**OTHER REFERENCES**

**Sheet Steel—**  
 Simplified Practice Recommendation (Second Edition) R 28-29

**Metal Partitions for Toilets and Showers—**  
 Simplified Practice Recommendation. R 101-40

**Hardware and Fittings; (for) lavatory-partitions and inclosures** FED. SPEC. FF-H-136

**A.S.T.M. SPEC.**  
**Zinc-coated (Galvanized) Wrought-Iron Sheets** A.S.T.M. A 163-39  
 ASA 68.8-1937  
 Sheets used for roofing, siding, culverts.  
 Specify Class:  
 Class A and B Extra-heavy and heavy coated (not for forming except may be corrugated).  
 Class C Moderately heavy coated (moderate bending).  
 Class D For general use.  
 Specify weight of coating.

**Zinc-coated Iron or Steel Sheets** A.S.T.M. A 93-38 T  
 A.S.T.M. A 93-27  
 ASA 68bl-1931

**DIVISION 7. METAL WINDOWS & DOORS**

**MISCELLANEOUS REFERENCES**

**Steel Windows and Industrial Doors (Solid Section Steel Windows)**  
 Simplified Practice Recommendation. R 72

**Hollow Metal Doors**  
 Simplified Practice Recommendation. R 82

**Kalamein Doors**  
 Simplified Practice Recommendation. R 83

**Fire Protection of Openings in Walls and Partitions against Fire**  
 National Board of Fire Underwriters.

**DIVISION 8. CARPENTRY**

**FED. SPEC.**  
**Wall-board; gypsum** FED. SPEC. SS-W-51a  
 Specify:  
 Type A with square edges, with or without recess, or Type B with rounded edges for filled joints; Standard thickness 3/8", special 1/4" and 1/2".

**Fiber-board; hard-pressed, structural** FED. SPEC. LLL-F-311  
 Specify: Class A—untreated  
 Class B—treated  
 Specify thickness: 1/8", 3/16", or 1/4".  
 (4' wide x 5', 6', 8', 9', 10' or 12').

**Fiber-board; insulating** FED. SPEC. LLL-F-321a  
 Specify: Class A—Building Board or Class C—Roof Board and finish desired.

**Millboard, asbestos** FED. SPEC. HH-M-351  
 Specify: Grade A medium, or Grade B hard and thickness, 1/8", 1/4" or 1/2".

**Paper; sheathing; waterproof** FED. SPEC. UU-P-536  
 Specify: Grade A for permanent structures and Grade B for temporary structures.

**Cord, sash, cotton, braided** FED. SPEC. T-C-571a  
 Specify: Type A unfinished  
 Type B polished  
 Specify that size shall be as required by pulleys and load.

**Bolts, lag, steel (lag screws)** FED. SPEC. FF-B-561

**Screws, Wood** FED. SPEC. FF-S-111

**Nails, spikes, staples and tacks** FED. SPEC. FF-N-101  
 Fed. Spec. E-FF-N-101, May 15, 1941, allows substitutions for certain finishes.

**Wood Treatments and Preservatives See "Painting"**

**Glue, casein, type, water-resistant** FED. SPEC. C-G-458

**A. S. T. M. SPEC.**  
**Gypsum Wall Board** A.S.T.M. C 36-34  
 Specify thickness 1/4", 3/8" or 1/2".  
 Specify if special joint is required.  
 Nominal widths 32", 36" or 48".  
 Lengths 4'0" to 12'0".

**Gypsum Sheathing Board** A.S.T.M. C 79-34  
 Specify thickness 1/2" or 3/4".  
 Nominal widths 24" or 32".  
 Length 6'8" or 8'0".  
 (May be secured with one or both faces covered with aluminum foil.)

**Structural Wood Joist and Plank, Beams and Stringers and Posts and Timbers** A.S.T.M. D 245-37  
 also ASA 07-1939

**NOTE: Specification Standards will be continued in the March issue of ARCHITECTURAL RECORD.**



# R E S T A U R A N T S

A survey of the problems of restaurant design based upon recent examples,  
and including both economical roadside establishments and more formal types

## A B U I L D I N G T Y P E S S T U D Y

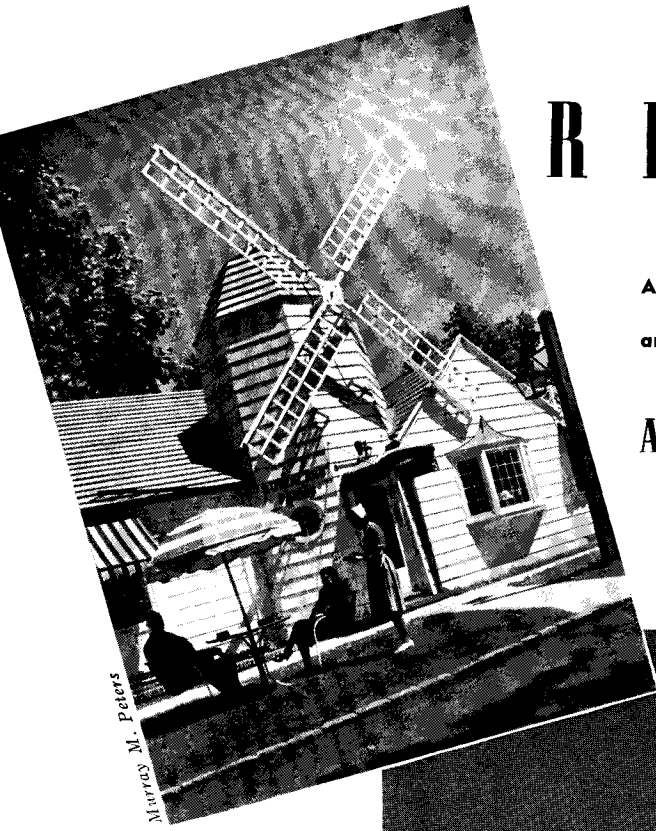

Murray M. Peters



Richard Averill Smith, Courtesy Alexander Smith and Sons

ABOVE, Dutchland Farms, Great Neck, N. Y. Joseph Waterson, architect.  
RIGHT, the new Schrafft's, New York City. Bloch and Hesse, architects

Courtesy "Masonite Corp."



**HOWARD JOHNSON RESTAURANT, CAMBRIDGE, MASS. JOSEPH MORGAN, ARCHITECT.** Even this well-established chain needs its face lifted periodically, as witness this example which has recently been entirely resurfaced, on the exterior, with weather-resistant fiberboard.

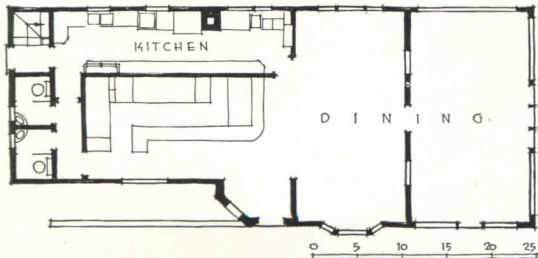
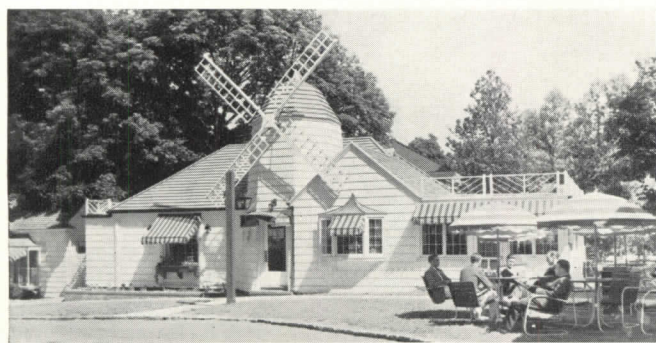

**DUTCHLAND FARMS RESTAURANT, GREAT NECK, N. Y. JOSEPH WATTERSON, ARCHITECT.** One of a row of quaint shops lining a lane, this unit was built and is owned by the Sedlmayr Realty Co.; is leased by Dutchland Farms. As originally built, the right-hand dining room was a dining terrace, but demand soon caused it to be enclosed. Total seating: 75 people.



ICE CREAM BAR makes most profits, is centrally located

# R E S T A U R A N T S

SOONER OR LATER the hot dog stand was bound to become big business. That was in the cards, as the saying goes. The public took to traveling independently of railroads, in many cases independently of hotels. The public wanted a bite to eat, informally because travel by car often left it feeling somewhat disheveled, quickly because it often wanted to get on in a hurry. And the family out for a breath of air on a hot day wanted some ice cream; or, hungry of an evening, a hamburger. So of course our highways became lined, first with dining cars, then with hot dog stands.

But the businesses were, as a whole, inefficient. Further, even a disheveled motorist wants a pleasant, clean place to stop—and most of them weren't clean.

Thus the "food-for-travelers" industry was ripe for organization, and we now have numerous chains, of which two are illustrated on these pages, making handsome profits. Individual operators lease rights to a name and an organization's advice—upon certain stipulations—from one chain. Another chain reverses the process, leasing and operating restaurants from individuals who put up the buildings. Whichever the method, operation of the chains, and of successful privately-owned-and-operated establishments as well, reflects a uniform basic conception.

The fundamental sources of profit are ice cream and soda-fountain business, frankfurters, hamburgers, sometimes sandwiches. Thus the soda fountain and the hamburger counter are the focal points in plan; the restaurants literally revolve about them. Ice cream in 28, 30, 40 flavors is advertised to the zenith.

Yet even Mrs. Smith, though slightly disarranged, wants the satisfaction which comes from soft roseate lights, suave service, acoustic plaster, spotless tile, and a passable meal now and then. So the satellite restaurants, which have to be carefully laid out on the basis of expected trade, to seat enough to make money but not enough to lose it, must be swank in a subdued way. And here commerce says: "They *must* be economically built!"

The gasoline scare a few months back cut down business in these establishments tremendously. What the war-necessary rubber and new car curtailments will do, no one can guess. Such problems, of course, do not affect the cocktail-lounge, night club type of restaurant, shown also in this issue, as directly. In times like these, people seem to feel the need of relaxing somewhat violently.

*Photos by Murray M. Peter*

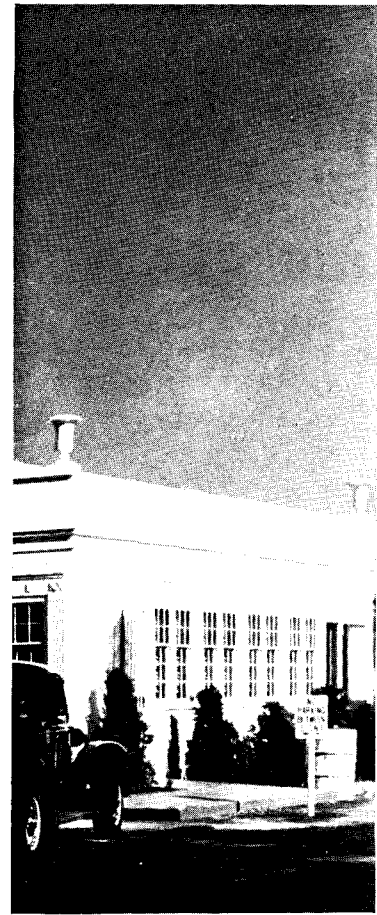

DINING ROOM, inexpensively designed, has blond maple furniture

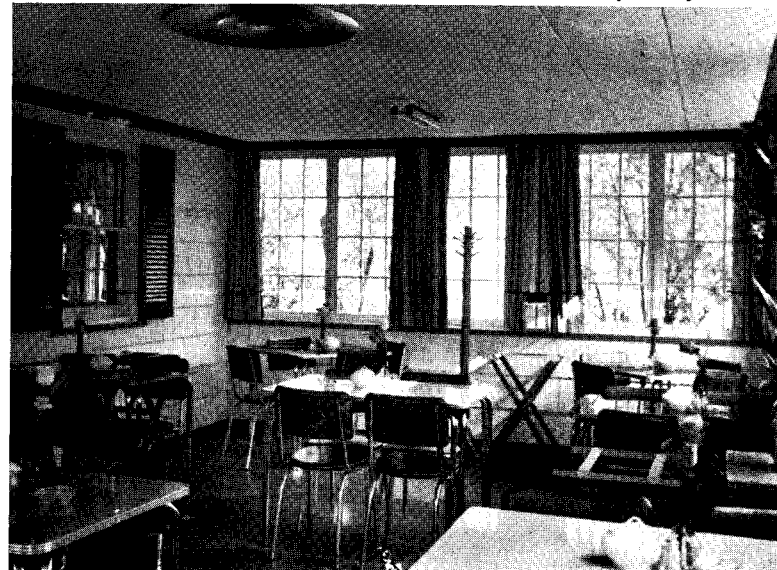

ENCLOSED TERRACE, like Dining Room, is finished in plywood and fiber board

Photos by Murray M. Peters

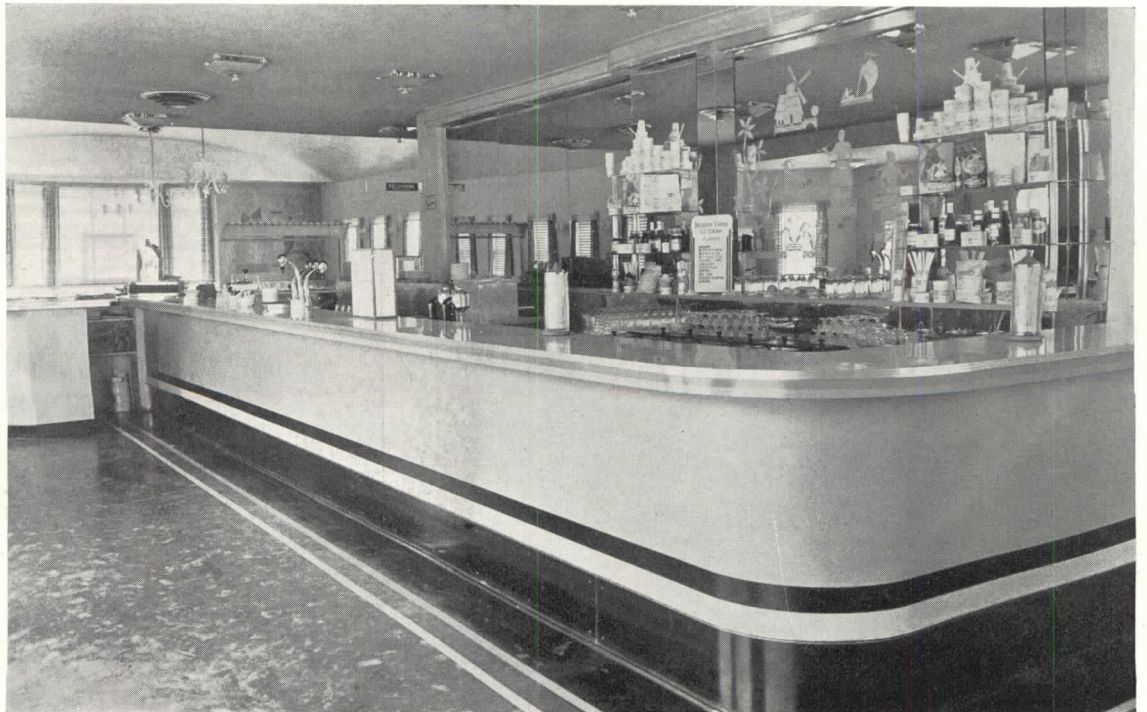

ICE CREAM BAR

# FAMILIAR FORM IS A TRADEMARK

**DUTCHLAND FARMS RESTAURANT, ROCKVILLE CENTER, N. Y. JOSEPH WATTERSON, ARCHITECT; S. TYSON HALDEMAN, ASSOCIATE ARCHITECT.** Here the problem was to design a building which would retain the characteristic Dutchland Farms form with its windmill so familiar to travelers, yet which would be smart and reasonably modern. Being a roadside restaurant, ample parking space was important. Sales of ice cream are the principal source of revenue, so the soda fountain had to dominate the interior, yet be somewhat dissociated from the dining room.

Sandwiches are featured as well; hence the sandwich maker is displayed in an alcove to the rear of the dining room. At the same time, seats for over 100 had to be provided in the dining space, so located that waitresses might have free access to soda fountain, sandwich counter and kitchen.

Above all, the building had to be exceedingly economical in construction; yet substantial enough to create a satisfactory impression. There is a partial cellar; walls are 8-in. brick; roof is tile. Floor and roof framing, doors and windows, are all wood. Floors are covered with linoleum except in kitchen, which is maple. Building is winter air conditioned; lighting is fluorescent. Ceilings are of acoustic plaster, walls painted plaster with Primavera plywood wainscot. Building was built and is owned by Gepo Realty Co.

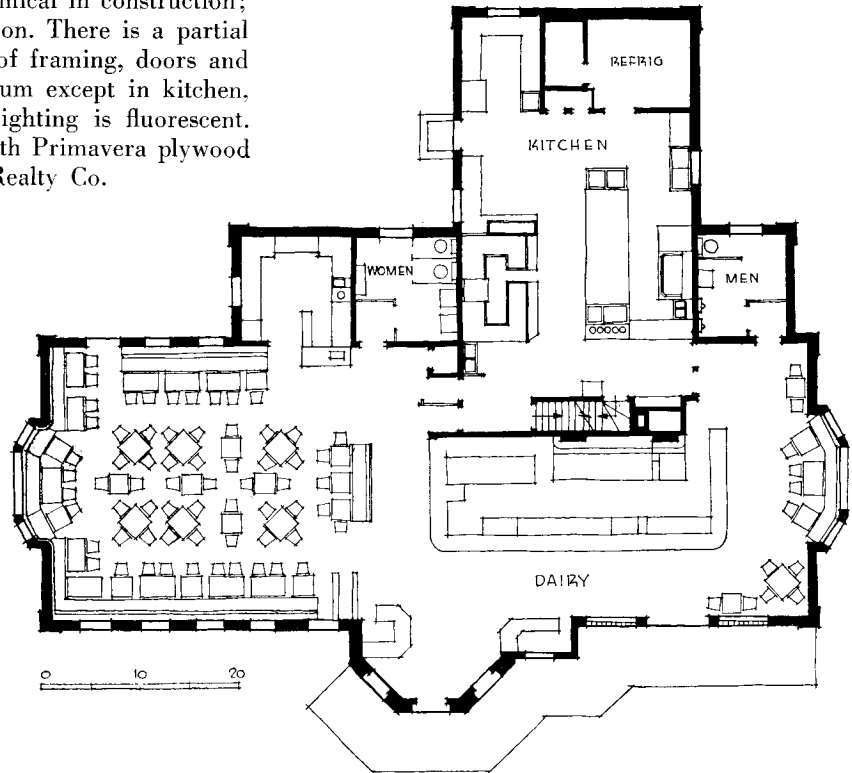

MAIN DINING AREA. Murals and an etched-glass back bar design are by Karl Drerup

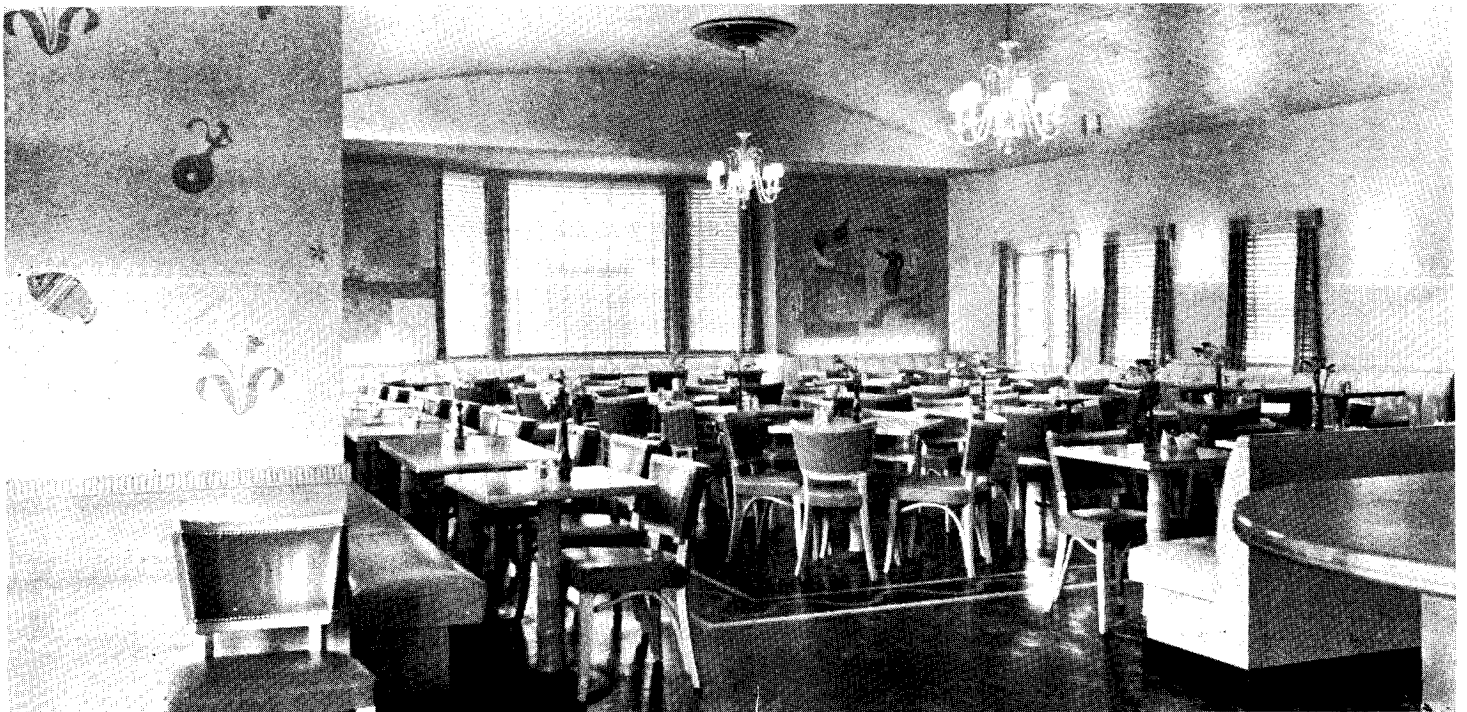

# NIGHT CLUB IS ADDED TO A SOUTHERN RESTAURANT

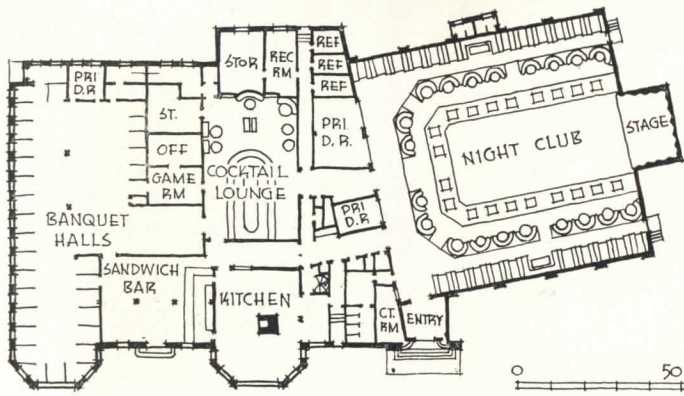

EXTERIOR of completed structure

## REMLER'S NIGHT CLUB, SAVANNAH, GA. LEVY and CLARKE, ARCHITECTS.

The existing portion of this restaurant consisted of the banquet hall, sandwich bar and kitchen; additions include the cocktail lounge and night club. Thus the restaurant's range embraces all types of food service, from a sandwich to a banquet, with or without entertainment.

The night club floor is tiered, with a maple dance floor in the center, and successive terraces occupied by free-standing tables, semi-circular booths, and wall booths. Construction is of steel frame with brick veneer curtain walls. Ceiling is of insulation board with a plastered center feature lighted by multicolored intermittent lights. Walls are of insulating tile and plaster.

Cocktail lounge has a U-shaped bar, is wainscoted in Harewood, and has a plastered ceiling. The building is air conditioned. L. D'Englere was the decorator. Contractor was Walter Strong.



DANCE FLOOR in night club portion is surrounded by terraced tables



ENTRANCE



COCKTAIL LOUNGE is in the center of the building



## ST. LOUIS HOTEL REMODELS ROOF BAR

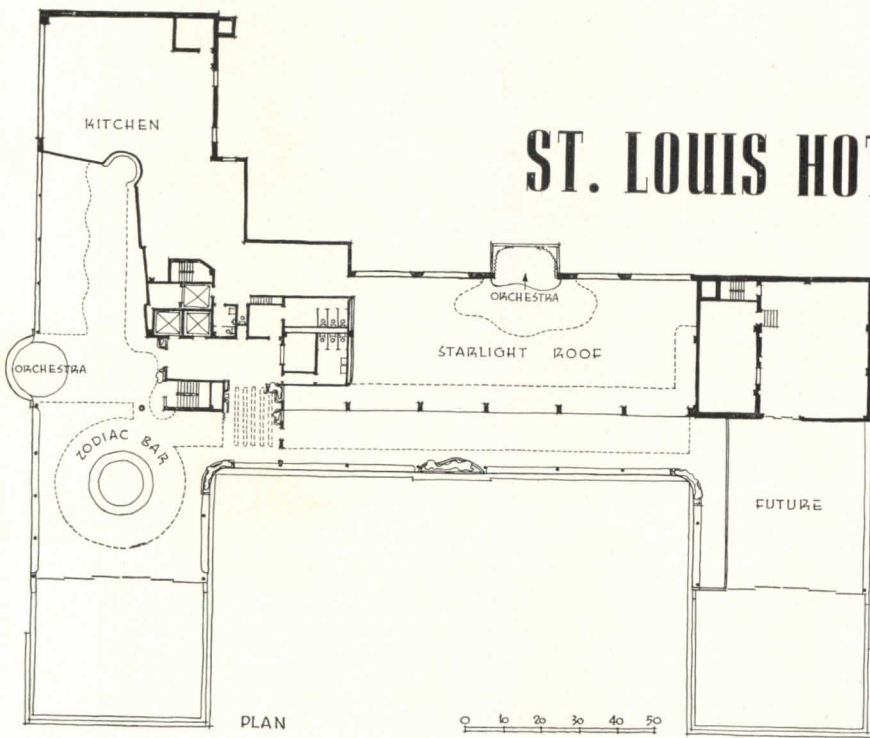

**CHASE HOTEL COCKTAIL LOUNGE and STARLIGHT ROOF, ST. LOUIS, MO. HAROLD KOPLAR, ARCHITECT.** To increase the hotel's convention and transient business, the management decided to add facilities. Only the roof—partially enclosed and hence subject to vagaries of weather—was available. The existing outdoor dining space and wasteful kitchen on the roof have been completely revamped.

Structurally, this involved several problems. Existing concrete columns and footings were examined to determine their suitability for carrying the added loads to be imposed. A high coping, which incidentally interfered with patrons' views of the city, was cut down to seat height, and new 6-in. H-columns were anchored to tops of old columns. Steel trusses spanning from wall to wall carry a new



ZODIAC LOUNGE: bar is portable. Roof is partially enclosed.



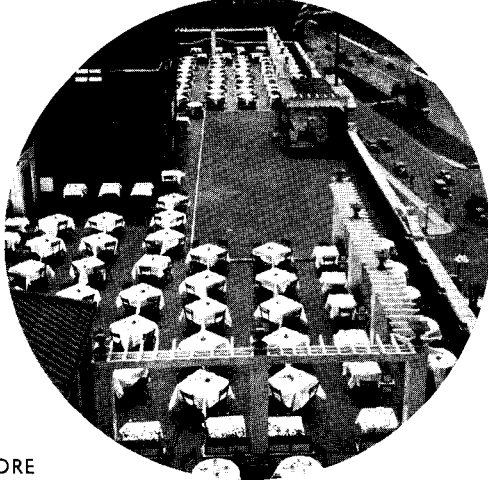

BEFORE

## AND DINING SPACE

roof of lightweight precast concrete slabs. New columns are fire-protected by concrete poured into stainless steel forms which remained in place as the permanent finish.

In both Zodiac and Starlight rooms are orchestra bays supported by cantilevers extending out from the roof framing. The bar itself is on casters, in two sections, which can be moved out to the remaining outdoor dining terrace or into the Starlight room to permit use of the Zodiac room for banquets or similar functions.

Both rooms are air conditioned and seat a total of 550 patrons. Lighting is both indirect (from cove lights) and direct (from directional flush lights). Construction was done by the hotel management. Structural engineers were Brussel and Viterbo.

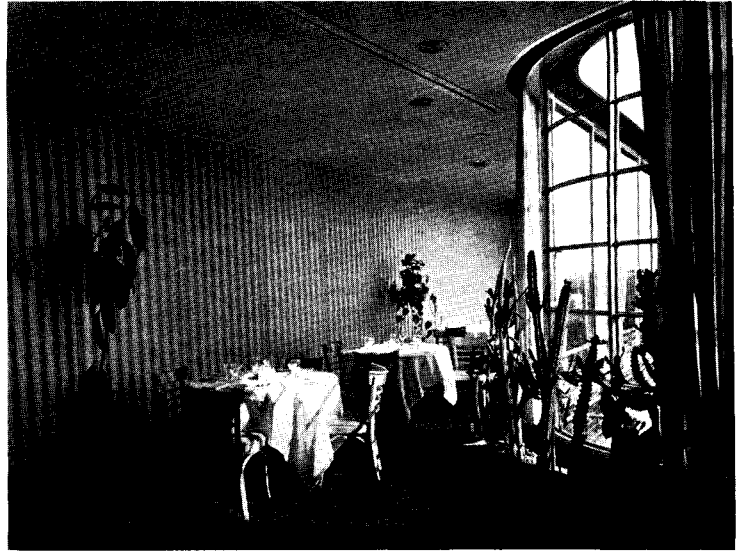

ASBESTOS-CEMENT partition shuts off space for future expansion



PLANTING SPACE in Starlight Roof dining room



STARLIGHT ROOF; orchestra occupies a balcony hung on the side of the building. Murals by Eric Mose

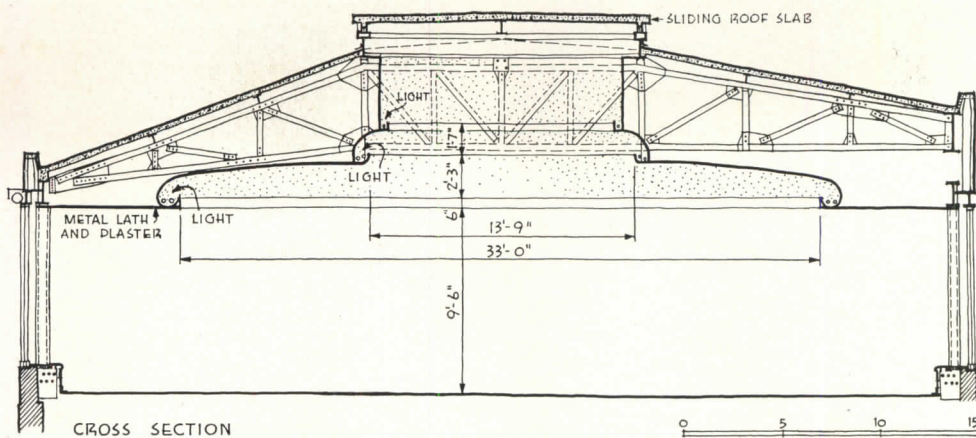

SECTION at right shows sliding roof directly over the circular Zodiac bar, and illustrates design of the trusses used to span from wall to wall. In addition, it demonstrates the way in which changes in ceiling level, etc., delimit various areas without using actual partitions

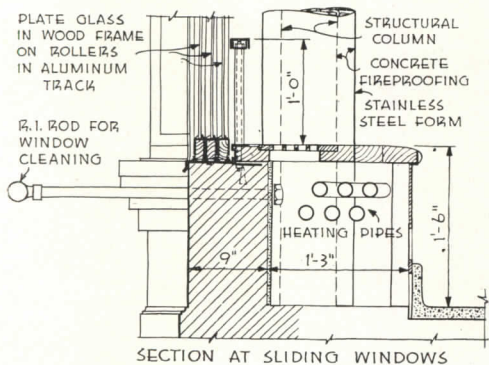

WINDOW DETAIL: remaining portion of parapet wall is capped with a 10-in. channel to which are attached the window tracks, made of aluminum channels and angles. Two out of each three windows slide horizontally. All are weatherstripped with refrigerator gaskets, and have concentric sash locks to strengthen their frames against wind pressure when closed

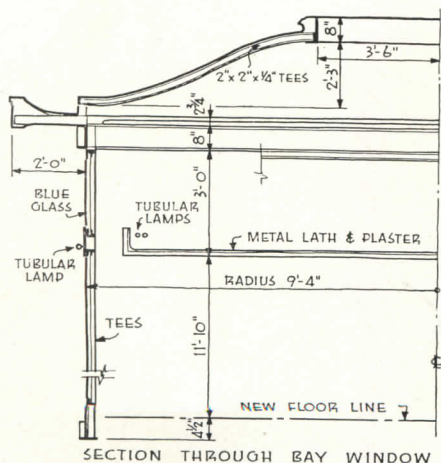
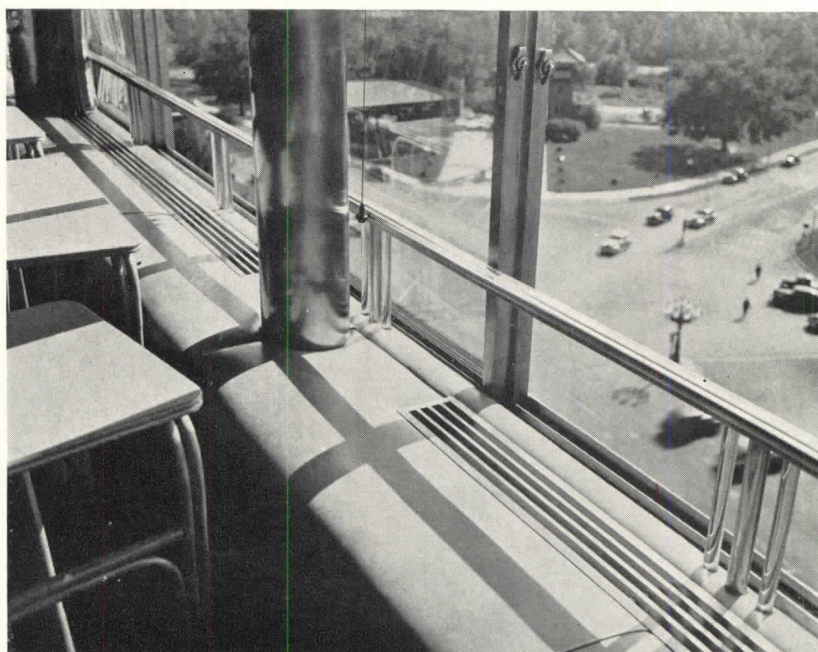

ORCHESTRA BAY in Zodiac room is suspended from an 18-ft. diameter steel ring cantilevered from the roof trusses, and projected 7 ft. beyond the building line. From the ring hang 3-in. steel tees which support the floor of the bay. Bay in Starlight room is similar, though rectangular and consequently simpler to fabricate



Photos by Joseph Molitor, Charles Trefis

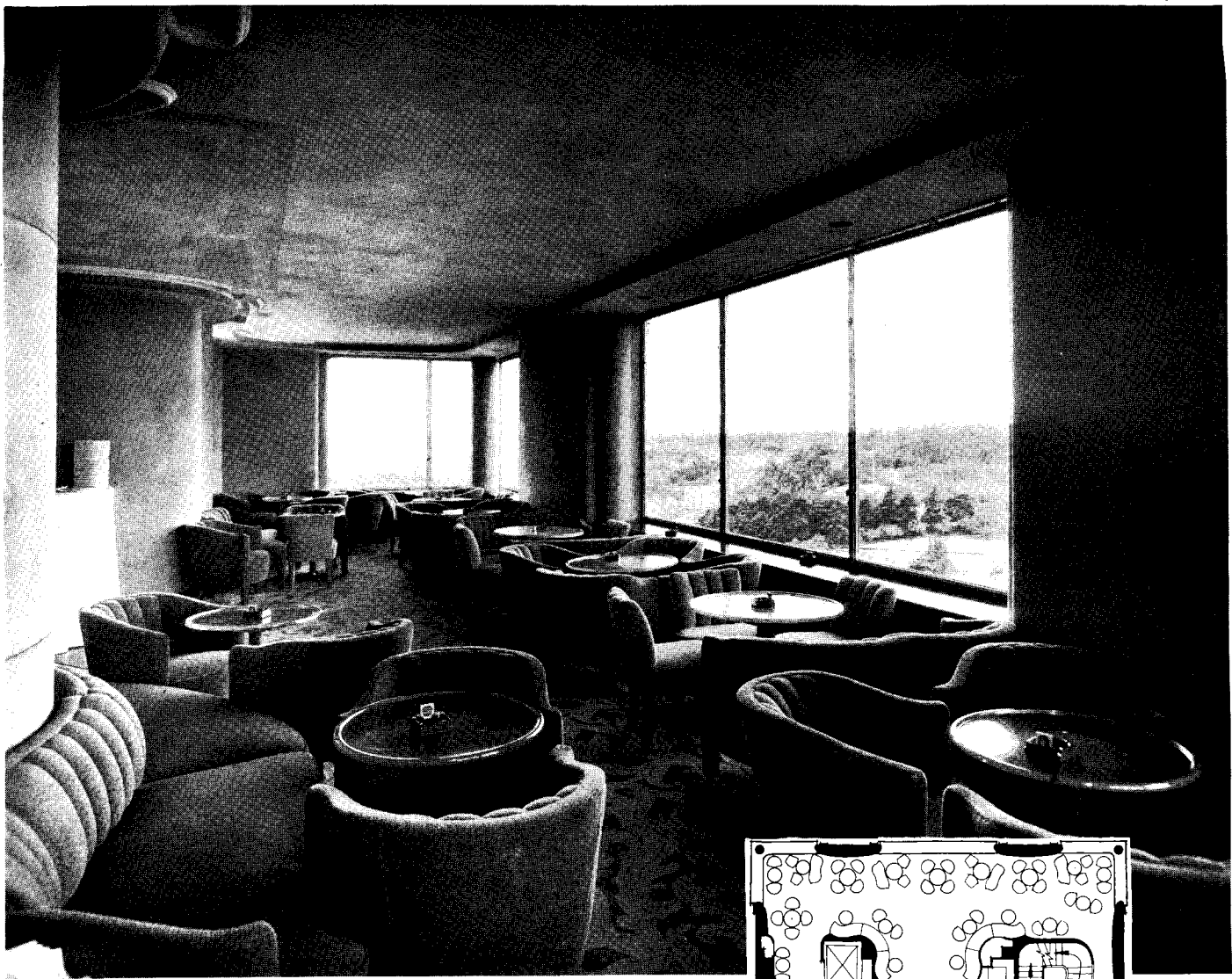

## ROOF REMODELED AROUND EXISTING STRUCTURE

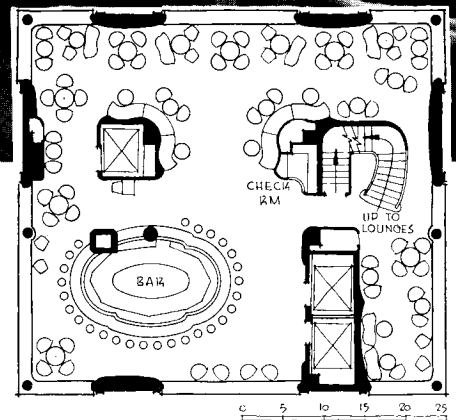

**SKY ROOM, EL CORTEZ HOTEL, SAN FRANCISCO, CALIF. HERTZKA and KNOWLES, ARCHITECTS.** In this remodeling job, certain structural elements could not be changed. The problem thus became one of designing as spacious a cocktail lounge as possible and minimizing columns, elevator shafts, etc. Windows are large in order to capitalize on the spectacular view. Construction is of reinforced concrete, with furred metal lath and plaster walls and ceilings, and carpeted floors. The lounge is air conditioned, with ceiling supplies, and an exhaust, decorated with a Lucite floral sculpture, over the bar. Fans, condensers, etc., are on the floor above. Ducts are lined with soundproofing material.

A difficult problem in this case arose from the fact that the room is used at night, and the windows ordinarily would mirror reflections of people and of the ceiling, obscuring the view of the city's lights which is one of the Sky Room's main attractions. After some experimentation, the architects found that putting the light source behind the person looking out the window eliminated reflections. Indirect coves, lighted by neon tubes, were designed to keep light off the ceiling, so that it would not be mirrored either.





BAR; air is exhausted through grille in the Lucite sculpture and gunmetal mirror overhead. Table tops are plastic



ABOVE, stairs to lounge. Rail is bronze with sand-blasted Lucite panels which house fluorescent lights. RIGHT, lounge interior. General contractor was M. H. Golden. Windows in Sky Room have heat-absorbing glass to reduce sun heat load



# For control of the air... in Blackout Plants

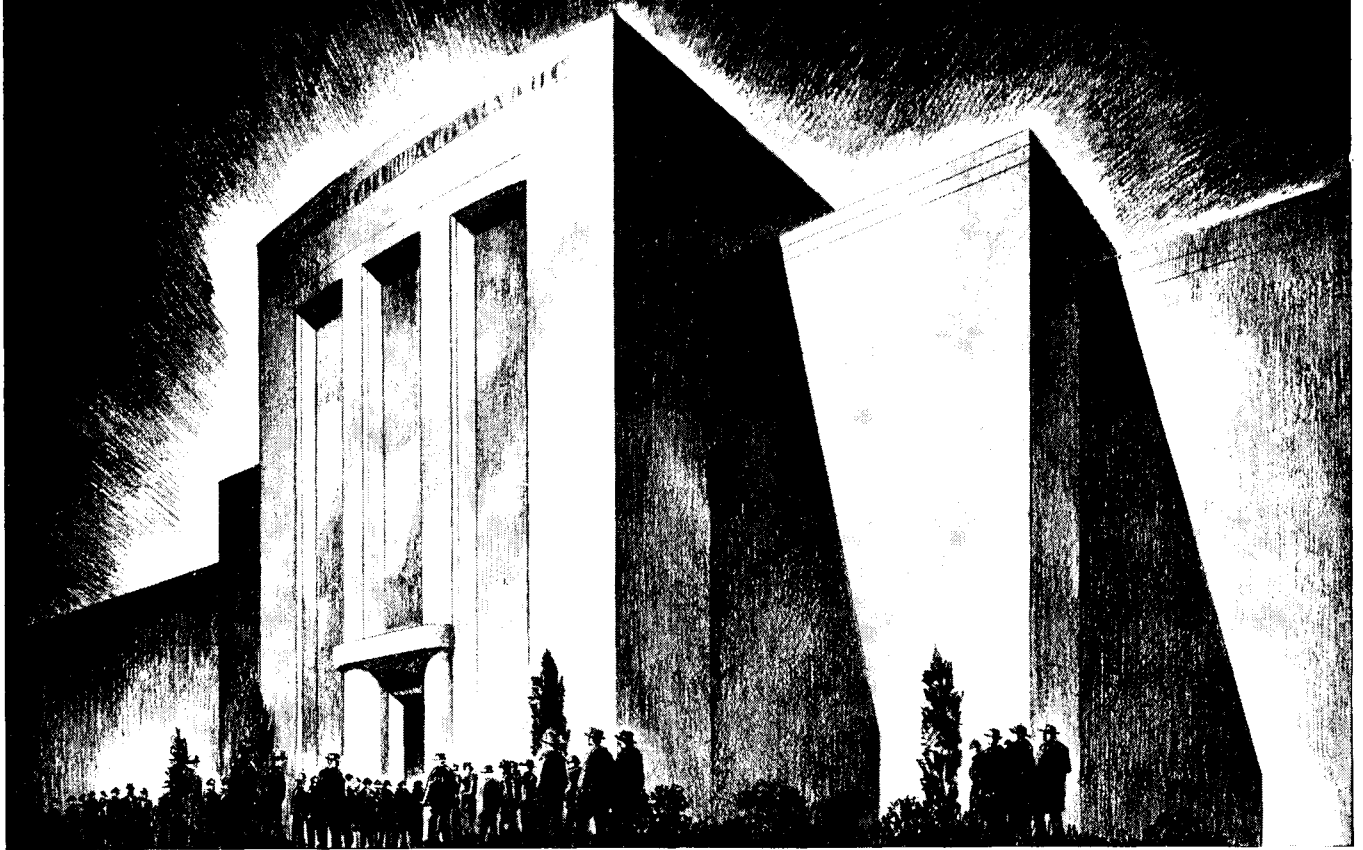

IN TODAY'S NEW WINDOWLESS FACTORIES, complete air conditioning equipment stands high on the list of "musts." All the familiar air conditioning problems are there—but with more stringent requirements, demanding new applications and closer control.

SUCH PROBLEMS faced General Electric engineers recently in planning the air conditioning system for a plant making vital aviation devices.

SUFFICIENT FRESH AIR to provide four complete air changes per hour was needed.

HEATING AND COOLING were major problems, for the internal heat released under normal operating

conditions was sufficient to heat the building with outside temperature at 15° above zero.

PRECISION MACHINING PROCESSES demanded unusually close control of temperature and humidity. Six independently controlled conditioning zones were necessary to provide the required flexibility.

THESE PROBLEMS WERE SOLVED by the installation of a complete system using G-E refrigeration and air conditioning equipment. The wide range of G-E products—plus G-E experience and engineering ability — can help to solve *your* problems.

General Electric Co., Div. 2442, Bloomfield, N. J.

## GENERAL ELECTRIC

FOR THE COMPLETE REFRIGERANT CYCLE

... TURN TO

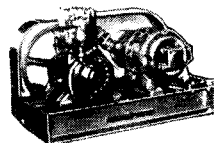

*G-E Condensing Units* ("Scotch Giant"), water or air cooled, are available from 1 to 60 hp. May be used in multiple when a larger cooling effect is required.

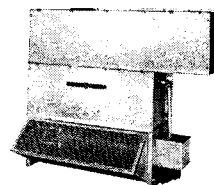

*G-E Evaporative Condensers* often save 90% or more in water costs. Available in a full range of sizes from 5 to 50 tons of refrigerant capacity.

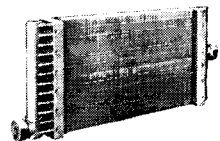

*G-E Coils* are available in all stock sizes for every heating and cooling need. Also "tailor-made" sizes to meet your specifications.

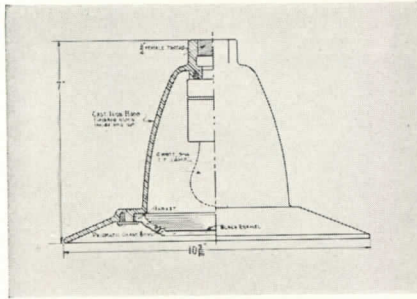

Figure 1

### Blackout Light

NOW AVAILABLE for shipment is a blackout lighting unit that follows requirements of the British Air Raid Precaution Specification. This is a suspension fixture with over-all depth of 7 in. Intensity of illumination secured on the ground is .0002 to .0004 foot candles, equivalent to starlight. Usual spacing between units 100 ft. The manufacturer says there can be no detection or identification of the units or surrounding area from hostile planes. Holophane Co., Inc., 342 Madison Ave., N. Y. C. (Fig. 1.)

### Blackout and Camouflage Paint

A COMPLETE LINE of blackout and camouflage paints is announced, for domestic and commercial use in areas subject to possible air raids. In black, smoke grey, earth drab and neutral brick, they obscure interior illumination when applied to windows, skylights and other glazed openings, and also effect a partial camouflage in daytime. Pittsburgh Plate Glass Company, Pittsburgh, Pa.

\* \* \*

ANOTHER line of blackout paint, which meets requirements of the Office of Civilian Defense, is said to give excellent results in opacity, weather-resistance and non-reflective properties when used on either inside or outside of the glass. These paints can be applied by brush, or by spray when reduced with petroleum thinners. Sherwin-Williams Company, Cleveland, Ohio.

\* \* \*

A NEW TYPE of low visibility paint has just been offered commercially. When properly selected, the manufacturer says, it will meet the requirements of good camouflage in any sort of terrain. A special advantage stressed is its heat-deflecting quality, which promises to be of particular value to public utilities, oil producers, refineries, etc. The Arco Company, Cleveland, Ohio.

\* \* \*

A BLACK-OUT paint for darkening windows and skylights of industrial plants is being marketed in paste form and is cut with water to be sprayed or brushed on. Coverage 800 sq. ft. to the gal. American-Marietta Company, 43 East Ohio St., Chicago.

### New Construction Material

SOMEWHAT in the nature of a plastic is a new construction material made of wood wool "excelsior," water, silicate of soda, soy bean protein and quicklime. Relatively strong, with low conductivity of heat, low manufacturing cost, good resistance to fire and good appearance, it is said to be applicable for molded products, insulating building boards, doors, sash, moldings, gutters, veneer cores, air ducts, stove pipe board liners, roofing, etc. The manufacturer claims it can be transported without breakage, sawn or nailed, and will not swell, bulge, warp or check. Designers for Industry Inc. of Ohio, 426 Terminal Tower, Cleveland, Ohio.

### Furnace-Water Heater

COMBINATION furnace and water heater, for low-cost housing projects and trailers, is announced. The lower half of this model comprises oil heating unit, combustion chamber and blower; the upper half consists of hot water tank and stack. A spring-mounted fan is installed at the bottom rear to force the heat out through louvres at floor level. There are controls for automatic water heating and semi-automatic house heating. Evans Products Company, Detroit, Mich.

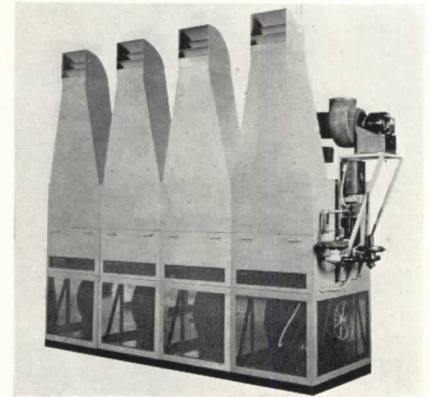

Figure 2

### Heavy Duty Unit Heater

FOR HEATING large buildings such as airplane hangars, skating rinks, locomotive shops, etc., there is a new heavy duty unit heater which delivers air at velocities of 1,500 to 2,500 ft. per minute and raises air temperature sufficiently to give a 100 to 125 degree temperature rise. The unit is built up of complete sections, each having an input rating of 250,000 Btu per hour. Surface Combustion Corporation, Toledo, Ohio. (Fig. 2.)

### Automatic Heat for Defense Homes

A BIN-FEED stoker-fired furnace is being offered at a low price which makes it suitable for defense homes. Over-sized fan and motor are employed and a minimum of ductwork is necessary. Filters are spun glass, stoker and fan are automatically controlled. The baked enamel jacket has a steel inner lining. Bonnet capacity 30,000 Btu; fan capacity 1,000 Cfm; heating surface 3,360 sq. in. Anthracite stoker has capacity of 108,000 Btu. Cooper & Cooper, Inc., Pittsfield, Mass.

### Five New Paints

A LINE of five new paints, designed to provide civilian markets with products to replace now unavailable aluminum paints, has been announced. A tank white can replace aluminum

(continued on page 84)

# "Why settle for 75¢ when you can have \$1.00?"



It gives you something to think about when you compare the advantages of Nairn Linoleum with other floor materials. For Nairn Linoleum alone meets *all four* of the basic specifications for the modern floor.

1. **EYE APPEAL**—Unequaled beauty and wide variety of color offer unlimited freedom of design. Patterns that are Color Correlated—with each other and other decorating materials.
2. **LONGER WEAR**—Nairn commercial linoleums not only meet, they *exceed* U. S. Government specifications on *every* point. Built-in ruggedness that spells long-range economy.
3. **RESILIENCE**—Quiet, "foot-easy" Nairn Floors are sound absorbing, sound deadening . . . "comeback" with a minimum of marring after indentation.
4. **CLEANLINESS AND EASY MAINTENANCE**—One-piece construction leaves no dirt-catching cracks and joints . . . reduces maintenance time and cost to a minimum. Positive germicidal properties. No splinters! No "dusting"!

Why be satisfied with a floor that gives you only two or three of these advantages—a 50% or 75% value for your money? In times like these especially—it's important to get "all 4"—100% for every dollar you spend—with Nairn Linoleum!

**EXTRA VALUE IN NAIRN WALL LINOLEUM, TOO.** It lasts as long as the building. It won't fade, crack, discolor, stain or dent. And—with its amazing variety of patterns and colors— it offers more decorating possibilities than any other permanent wall material. Both Nairn Floor and Wall Linoleum are fully guaranteed when installed in accordance with specifications.

**FREE—200 PAGE BOOK** of installation aids and specifications—for architects, contractors, builders. Write on your letterhead to Congoleum-Nairn Inc., Kearny, N. J.

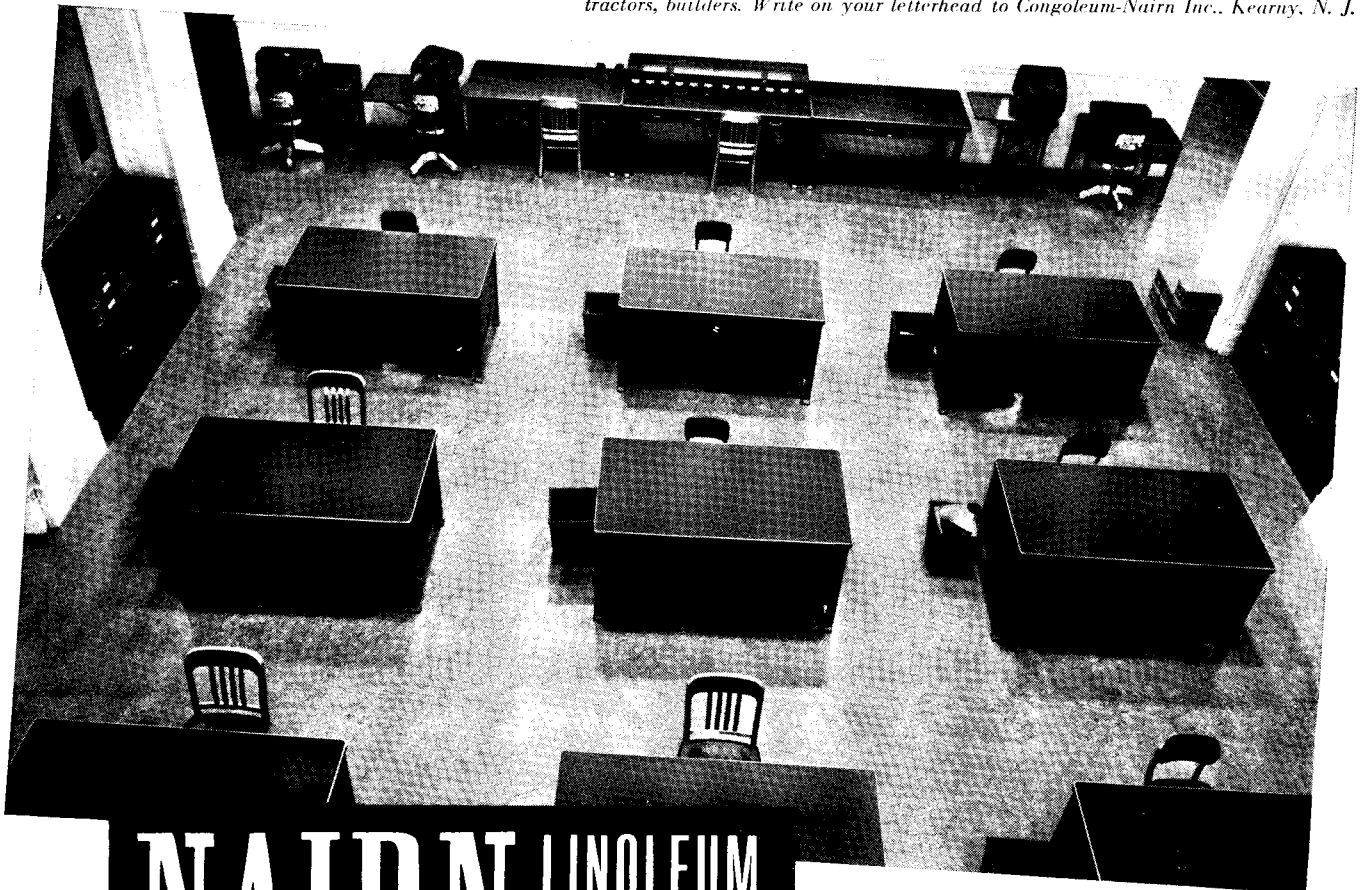

**NAIRN LINOLEUM**  
FLOORS AND WALLS

*The Federal Reserve Bank of Atlanta, Atlanta, Ga., used a handsome Nairn Veltone pattern. An ideal choice—for quiet, comfortable Nairn Linoleum hushes footsteps—lessens nerve strain.*

**Nairn Linoleum—the floor that gives you "all 4"**

# ARCHITECTURE

★ The fact that a number of building products and materials will not be generally available for the duration of the war has created an advertising situation that many manufacturers of items in this classification have not solved. They would like to prepare for the day when peace comes, when architects have returned to normal practice and construction for living and luxury is again in full swing.

These manufacturers are vitally interested in keeping the architect aware of the desirability of their products, because they know that the acceptance they have gained for them now might not hold at the war's end unless they do. With the advertising pages of the architect's journal of professional practice generally accepted as the ideal medium for carrying out this task, the problem is not so much one of "how" as it is "what" to tell the architect.

What the architect would like to know from the advertising of such products depends, of course, on the relation of his work to the national defense program, but by and large the big question that comes to his mind must be, "Is the item available?"

If the product is available, its advertisement should be "keyed" to current problems. The architect would like to know, for instance, the restrictions (if any) regarding the use of the product. He would like to have suggestions that would make for faster delivery, or save material, and otherwise assure the best job in terms of the national interest.

If the product cannot be obtained the architect would like to hear about improvements and new developments. He is also interested in knowing where and how it is now being used—which not only makes attractive reading but impresses the features of the product on the architect's mind.

In the final analysis, both the architect who is engaged in defense work and the architect who is striving to maintain his private practice realize that beyond the clouds of war is a bright future for building. The manufacturer whose advertising is usefully attuned to the emergency now will be foremost in the architect's mind when the time for rebuilding America comes.

—RONALD ALLWORK

## COMPANIES WITH NOTHING

PRACTICING ARCHITECTS recognize that a change in present-day advertising is necessary—in fact, they have some pretty definite ideas on the subject as the following quotations will testify.

**JOSEPH HOLTON JONES** says, "We feel manufacturers' advertisements should now fulfill two functions: Continue to keep the manufacturer's name and product before the profession, and keep the profession apprised of all new materials and methods which manufacturers may develop to meet war needs and which, after the war, may be used to advantage by architects in the building program which is bound to come."

**FRANCIS BENEDICT JACOBBERGER** suggests "information as to why these materials have no adequate substitute, or why they are not making a substitute material."

In this connection **JAMES C. MACKENZIE** asks for "a brief circular mailed out supplementing suitable advertisements in the magazines."

**PARTNERS FOR THE EMERGENCY...**

In the industries, aircraft, and other uses, INCO Nickel Alloys have long been used for vital parts of equipment. Strong, tough, resistant to heat, corrosion, and wear, these metals assure reliability, performance, and long economical life. As a result, INCO Nickel Alloys are now in regular demand—working with former peacetime industries at "Partners For The Emergency."

**PROPERTIES:** For their strength, ductility, and resistance to corrosion, INCO Nickel Alloys are used in the manufacture of aircraft engine parts, turbine engine parts, and other vital parts of equipment. They are also used in the manufacture of valves, pumps, and other parts of industrial machinery.

**ADVANTAGES:** INCO Nickel Alloys are used in the manufacture of aircraft engine parts, turbine engine parts, and other vital parts of equipment. They are also used in the manufacture of valves, pumps, and other parts of industrial machinery.

**PROPERTIES:** For their strength, ductility, and resistance to corrosion, INCO Nickel Alloys are used in the manufacture of aircraft engine parts, turbine engine parts, and other vital parts of equipment. They are also used in the manufacture of valves, pumps, and other parts of industrial machinery.

**ADVANTAGES:** INCO Nickel Alloys are used in the manufacture of aircraft engine parts, turbine engine parts, and other vital parts of equipment. They are also used in the manufacture of valves, pumps, and other parts of industrial machinery.

**PROPERTIES:** For their strength, ductility, and resistance to corrosion, INCO Nickel Alloys are used in the manufacture of aircraft engine parts, turbine engine parts, and other vital parts of equipment. They are also used in the manufacture of valves, pumps, and other parts of industrial machinery.

**ADVANTAGES:** INCO Nickel Alloys are used in the manufacture of aircraft engine parts, turbine engine parts, and other vital parts of equipment. They are also used in the manufacture of valves, pumps, and other parts of industrial machinery.

**THE INTERNATIONAL NICKEL COMPANY, INC.**  
87 Wall Street, New York, N. Y.

**INCO NICKEL ALLOYS**  
NICKEL • "N" NICKEL • "C" NICKEL • "K" NICKEL • "R" NICKEL • "M" NICKEL • "S" NICKEL • "T" NICKEL  
NICKEL • "N" NICKEL • "C" NICKEL • "K" NICKEL • "R" NICKEL • "M" NICKEL • "S" NICKEL • "T" NICKEL



# MEETS ADVERTISING

## TO SELL NOW SHOULD LOOK AHEAD

While **WILLIAM I. HOHAUSER** believes that information on unavailable products "that are improved upon during this period" is desirable.

To this **GORDON B. KAUFMANN** adds "Our own personal feeling in the matter is to suggest either 'name advertising' on a somewhat reduced scale or practically none at all. For your own purposes, articles on the critical list have no interest for us. We are so busy trying to find substitutes."

**J. LINERD CONARROE** asks advertisers. "Why not be frank about the materials and state if they can or cannot be had or if they can be had with priorities and on what types of buildings?"

And **PHILIP IVES** thinks that "new developments, which I could look forward to taking advantage of when private practice is resumed, are what I'd like to read about in advertisements."



IT'S LOOKING PRETTY FAR AHEAD to talk about Christmas gifts in 194—, the year the war ends. But that's just what this steel company is doing in the above ad directed to the layman. "We continue to advertise steel products for civilian use . . ." writes an official of the company, because "we are *looking ahead*. The acceptance of steel products is not something you can turn off and on at will. It must be created and maintained by *continuous efforts*."

THE ADVERTISEMENTS BELOW are examples of what well known manufacturers in the building field are doing to meet the present situation. These ads are of the present, and because they are informative, useful and interesting, their sponsors will be remembered

**An important announcement to all users of structural steel**

**BETHLEHEM STEEL COMPANY**

**A tremendous trifle trebles power cable life . . .**

**An achievement of Anaconda research benefiting both American Industry and Defense**

**ELECTRICAL WIRES AND CABLES OF COPPER ARE THE LIFE LINES OF OUR NATION**

**ANACONDA WIRE AND CABLE**

**ALUMINUM, DEFENSE, AND YOU**

**SIX MORE PLANTS IN SIX STATES ON THE WAY**

**UNION PLANT CORPORATION OWNS THEM**

**HOW DOES CONSTRUCTION?**

**WE'VE ASSIGNED**

**EVERY KNOWN IMPROVEMENT**

**DEFENSE GENTLEMEN**

**ALUMINUM COMPANY OF AMERICA**

*For Every Garage Door...*

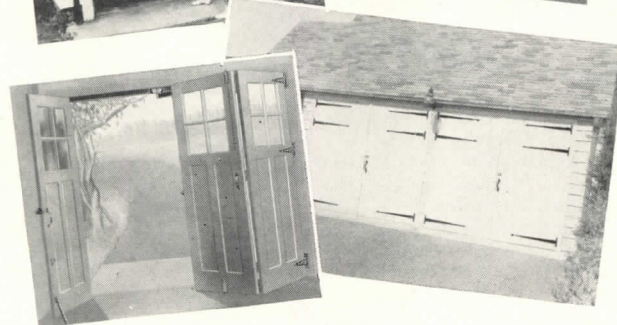
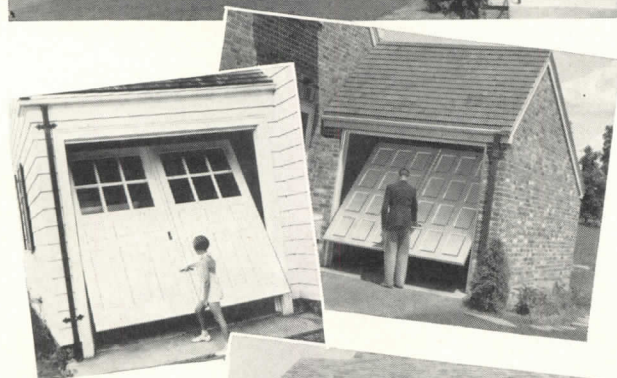

## STANLEY GARAGE DOOR HARDWARE

Do you know what Stanley has to offer for long-wearing, smooth-operating garage door equipment?

You'll find exactly what you want in Stanley's No. 61 Catalog. It is a handy reference book. A copy will be sent on request. The Stanley Works, New Britain, Connecticut.



# STANLEY HARDWARE

## Books on WAR TIME BUILDING AND AIR DEFENSE

The books listed below are especially recommended for architects and engineers who wish to specialize in solving the many technical problems pertaining to wartime construction and the protection of the civilian population.

1. **PLANNED A. R. P.**, by Tecton, Architects. 138 pages — extensively illustrated with photographs, diagrams and maps — Price \$2.50.
2. **CIVIL AIR DEFENSE**, by Lt. Col. Augustin M. Prentiss, U.S.A. A 334-page illustrated treatise on the protection of the civil population against air attack — Price \$2.75.
3. **BOMBS AND BOMBING**, by Willy Ley. 124 pages — A brisk, popular survey explaining how the several kinds of bombs are made and their probable effect on buildings of different types and on air raid shelters — Price \$1.25.
4. **WARTIME BUILDING CONSTRUCTION** — 1st American Edition 1942 — This book reviews the general principles of wartime building. There is a special section devoted to the construction of single-story buildings to provide living quarters for armed forces, also for temporary office accommodation and hospitals; a section devoted to the methods used for the application of reinforced concrete construction — Price \$4.00.
5. **CIVIL DEFENSE**, by C. W. Glover. Over 900 pages — fully illustrated, revised and enlarged. The most complete and authoritative book on the subject. This volume discusses in detail the precautions necessary for the protection of the civilian population — Price \$16.50.
6. **AIR RAID PRECAUTIONS — 1941**. An authoritative book compiled by various British experts based on actual experiences during air raids. It contains the best available scientific data pertaining to shelters, emergency watch towers, respiratory equipment, etc. — Price \$3.00.
7. **AIR RAID DEFENSE**, by Dr. Curt Wachtel, 1941. The purpose of this book is to convey the many and varied aspects of Air Raid Defense. All measures and methods discussed or recommended in this book are practiced somewhere in Europe — Price \$3.50.

ARCHITECTURAL RECORD  
119 West 40th Street, New York, N. Y.

Please send      1.       2.       3.   
   4.       5.       6.       7.

Check or money order for ..... is enclosed.

Name .....

Address .....

City and State .....

AR 2-42

Check the numbers of the books you want, and mail to Architectural Record with your remittance—no extra charge for postage

# RAMONA VILLAGE

(LOS ANGELES)



*More than 100 tons of NATIONAL PIPE installed in the 610 dwelling units of this new low-rent housing project.*

IT'S no accident that NATIONAL Steel Pipe has been chosen for a large majority of America's big scale housing projects. Architects and plumbing and heating contractors have long recognized the fact—that for general all-round building purposes, NATIONAL Steel Pipe gives the greatest service for the least investment. Owners can depend on the efficient, trouble-free operation of their piping systems when NATIONAL is on the job. Workmen tell us they like to work with NATIONAL Pipe because it's easy to install, profitable to use. It's clean, inside and out, strong and ductile, and uniform in every property. Bends, cuts and threads with ease.

NATIONAL quality never varies—NATIONAL Steel Pipe is always the same—no other pipe has been able to offer greater value in strength, durability and ease of installation at low cost. Write for data.

**it's NATIONAL PIPE  
again...in one of the  
country's large  
housing projects**

**RAMONA VILLAGE HOUSING PROJECT  
CONTAINS 610 DWELLING UNITS...  
ONE OF THE COUNTRY'S FINEST!**

Ramona Village is owned and operated by the Housing Authority of the city of Los Angeles, California. The 110 separate buildings are all two stories in height, and are of five different types, containing four, six and eight families each. The total number of rooms is 2679.

An administration building houses the administrative offices, maintenance shop, club and social room, and day nursery. The dwelling units contain from one to three bedrooms in addition to a living room and kitchen.

The architects for the work are known as the Housing Architects Associated, consisting of: George J. Adams, chief architect; Walter S. Davis, Ralph C. Flewelling, Eugene Weston, Jr., Lewis Eugene Wilson and Lloyd Wright. General contractor, Baruch Corporation. Mechanical engineer, Ralph E. Phillips.

## NATIONAL TUBE COMPANY

PITTSBURGH, PA.



Columbia Steel Company, San Francisco, Pacific Coast Distributors

United States Steel Export Company, New York

# UNITED STATES STEEL

(continued from page 78)

where it is desirable to cut evaporation losses and reduce inside temperatures. A metal lead paint is said to provide a protective lead-colored metal coating for all metal surfaces including new or old galvanized metal. Two grays are offered affording protection and durability on exposed metal surfaces; and an enamelled

yellow metal primer is for all types of metal surfaces, especially where subjected to damp, wet or foggy conditions. American-Marietta Company, 43 E. Ohio St., Chicago, Ill.

### Asphalt Mastic Board

HIGH melting point asphalt in combination with fine mineral aggregate,

sealed between dry non-bleeding liners, provides a new asphalt mastic board said to be waterproof, rigid, non-warping. The product is designed for application where a shortage of some fiber boards and sheet metal threatens. Acid- and alkali-resistant, it may be formed into various shapes or corrugated. Suitable for roofing, siding, duct work in heating, air conditioning and industrial air blower systems. Keystone Asphalt Products Co., 43 E. Ohio St., Chicago, Ill.



# PAGE FENCE

*America's First Wire Fence - Since 1883*

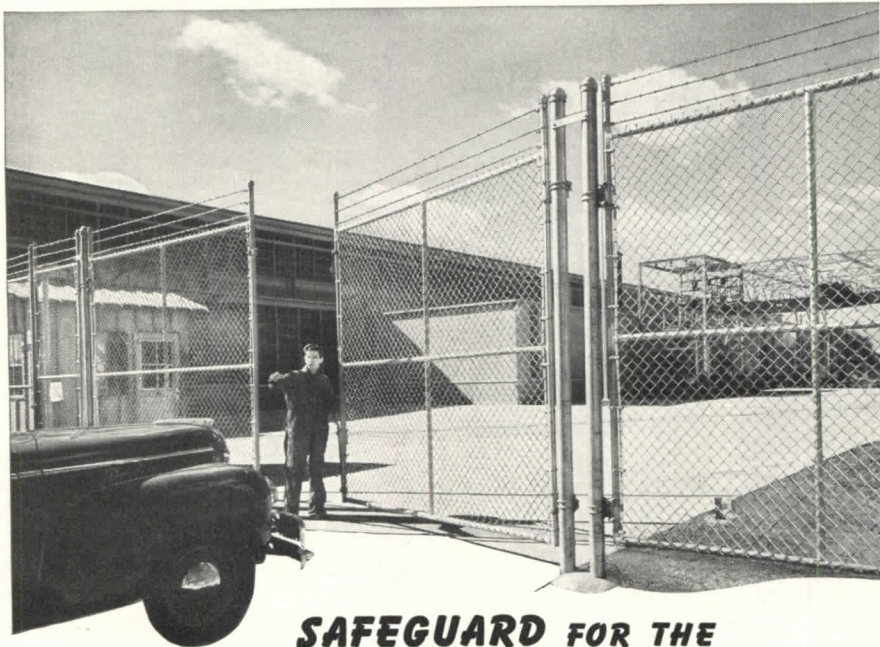

## **SAFEGUARD FOR THE OPERATIONS THAT WILL MAKE AMERICA SAFE**

● To make America safe, its production plants must be protected against all with malicious intent. On its service and quality records, Page Industrial Fence is recommended for trustworthy duty at property boundary lines. ● Woven wire fence was originated by J. Wallace Page in 1883, and the company which he founded has been a leader in every major development for 59 years. ● Page Fence distribution is unique and extensive. This service is performed by more than 100 local, responsible firms having technical training and fence erecting experience. These fence experts comprise the PAGE FENCE ASSOCIATION, Headquarters: Monessen, Pennsylvania.

**VICTORY FIRST**  
At the Page mills, men, machines and materials are on an all-out schedule for production of fence to protect plants working on Government orders

PRODUCT OF PAGE STEEL & WIRE DIVISION—AMERICAN CHAIN & CABLE COMPANY, INC., BRIDGEPORT, CONN.

### Plastic Strips for Terrazzo

PLASTIC tenite is being used to block off sections of terrazzo in the flooring of large buildings. Strips of tenite attached to ribbons of galvanized iron outline the design to be followed in laying the floor, and the plastic edge remains visible after the terrazzo has been polished. The tenite comes in a variety of colors. Extruded Plastics, Inc., Norwalk, Conn. (Fig. 3.)

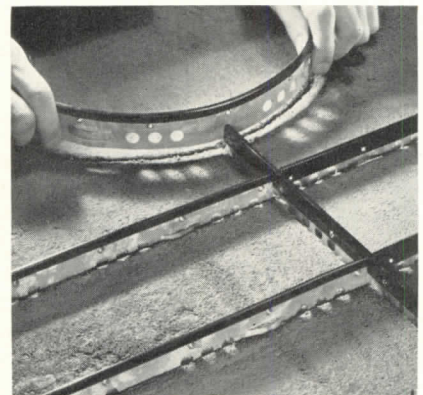
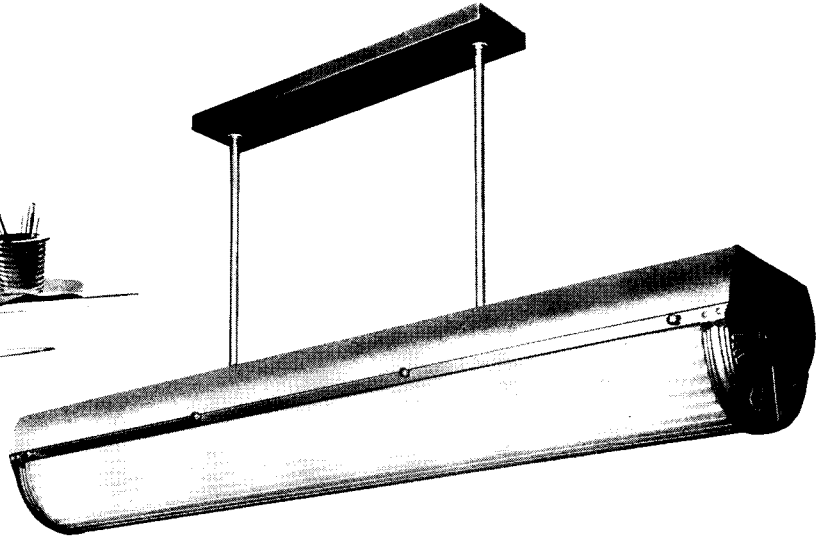

Figure 3

### Cleaning Air Conditioning Equipment

A CHEMICAL process of cleaning, dustproofing and fireproofing air conditioning or kitchen equipment, including ducts, fans, heating coils, filters and controls, grease ducts, chutes, etc., is guaranteed to keep the equipment cleaned for a year. The treatment is adapted to hotels, restaura-

(continued on page 86)



## HERE'S ONE FLUORESCENT UNIT FOR EVERY OFFICE LIGHTING NEED

The Westinghouse CL-110 fluorescent luminaire may be suspended from or mounted flush on the ceiling, as an individual unit or end-to-end in continuous strips.

When the luminaire is suspended from the ceiling, both direct and indirect lighting is provided. Light from one 30-watt lamp is directed upward and two or three 40-watt lamps, depending on the unit selected, are arranged to direct their light downward. When the luminaire is mounted directly on the ceiling, the 30-watt lamp is not used.

Regardless of mounting or number of lamps, high power factor and minimized flicker are assured. Maintenance is simplified on glass enclosed units by a hinged door assembly that facilitates cleaning and relamping. Units are also available without the diffusing glass.

Effective lighting is obtained today with CL-110 fixtures in industrial offices, drafting rooms, factory engineering and purchasing departments. This is Westinghouse *engineered seeing*—a lighting technique that may help you with your own illumination problems. Ask your nearest Westinghouse Lighting Distributor today for Folder 8655. Or, write Westinghouse Electric & Mfg. Co., Edgewater Park, Cleveland, Ohio.

### For Continuous Strip or Individual Mounting

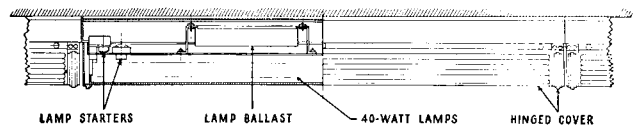

Knockouts for end-to-end mounting and straight-through wiring permit continuous lines of light.

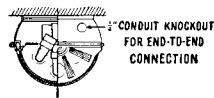

CL-110 units utilize either two or three 40-watt lamps when mounted flush on the ceiling.

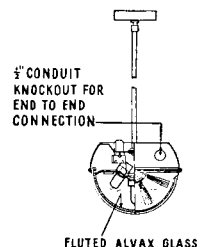
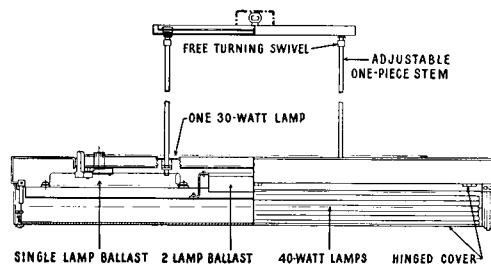

Both direct and indirect lighting is provided when CL-110 units are suspended from the ceiling.

Light from one 30-watt Mazda F lamp is directed to the ceiling, and two or three 40-watt lamps are arranged to direct their light downward.

*Engineered seeing* is available through 117 Westinghouse Electric Supply Company offices and Independent Lighting Distributors.

# Westinghouse

LIGHTING  
EQUIPMENT



(continued from page 84)



rants and office buildings, is applied by factory-trained service men without interrupting business and is said to solve the problem of dirty walls and ceilings in conditioned rooms as well as foul odor from equipment. Speed-D Chemical Systems, Cincinnati, Ohio.

## Emergency Lighting Units

FOUR new emergency lighting units are offered as protection against interruption of the normal source of power in manufacturing plants. According to the manufacturer they give "split-second emergency lighting pro-

tection" with absolute reliability. Each unit consists of a battery of either the chloride or the flat plate type, automatic switches which transfer the battery to the emergency lighting circuits upon failure of the a. c. supply, and an automatic charging device. When the a. c. service is restored the emergency lighting circuits are transferred back to the a. c. supply. No separate battery is required. Operating and maintenance costs are said to be extremely low and battery life is said to range from 8 to 14 yrs. Electric Storage Battery Co., Philadelphia, Pa.



You helped make American living more comfortable

**H**OT WATER on tap is a little-known luxury to most of the world. Here in American homes are some 15 million hot-water tanks — many of them specified by architects.

Today more and more tanks are being porcelain enameled inside. This glossy, flint-hard mineral surface has proved its durability over the years. And a porcelain enameled tank saves the 5 pounds of zinc or 55 pounds of copper that other tanks would require. These metals are vital to our war needs.

Most manufacturers use ARMCO Ingot Iron for their porcelain enameled tanks. The first enamel-

ing iron developed, it is now recognized as the "world's standard enameling iron."

If you do not have adequate data on porcelain enameled tanks, just write and we'll be glad to see that you get it. The American Rolling Mill Company, 371 Curtis Street, Middletown, Ohio.



## American Fabric Wall Covering

AMERICAN SUCCESSOR is announced to a well-known fabric wall covering. The fabric consists of a canvas foundation with a pyroxylin coating on which lacquer paints have been fused to make the surface light-resistant and capable of withstanding hard usage. According to the manufacturer, the tensile strength prevents plaster cracks, binds weakened plaster and gives permanent structural protection. The fabric is presented as non-porous, waterproof, vermin-, odor-, dust- and soot-proof. Plain, texture and pattern effects. Recommended for institutions and homes, remodeling and new construction. Frederic Blank & Co., Inc., 230 Park Ave., New York City.

## New Wood Weatherstrip

A WELL-KNOWN WINDOW is now employing a wood weatherstrip. Laboratory tests have indicated the new weatherstripping is tighter in high winds than the one formerly used, that high humidities do not affect its operation. The manufacturer also offers as advantages the fact that the wood weatherstrip will not corrode; long life; quicker installation; better balance. All items in this window line can be used with the new weatherstrip. Curtis Companies Incorporated, Clinton, Ia.

**WALLS, PARTITIONS and stiles of White Carrara Structural Glass, with Black Carrara trim, bring beauty and permanence to this toilet room in the University of Pittsburgh's Cathedral of Learning. Architect: Charles Z. Klauder.**

# Precision-made Carrara Glass keeps toilet rooms young!

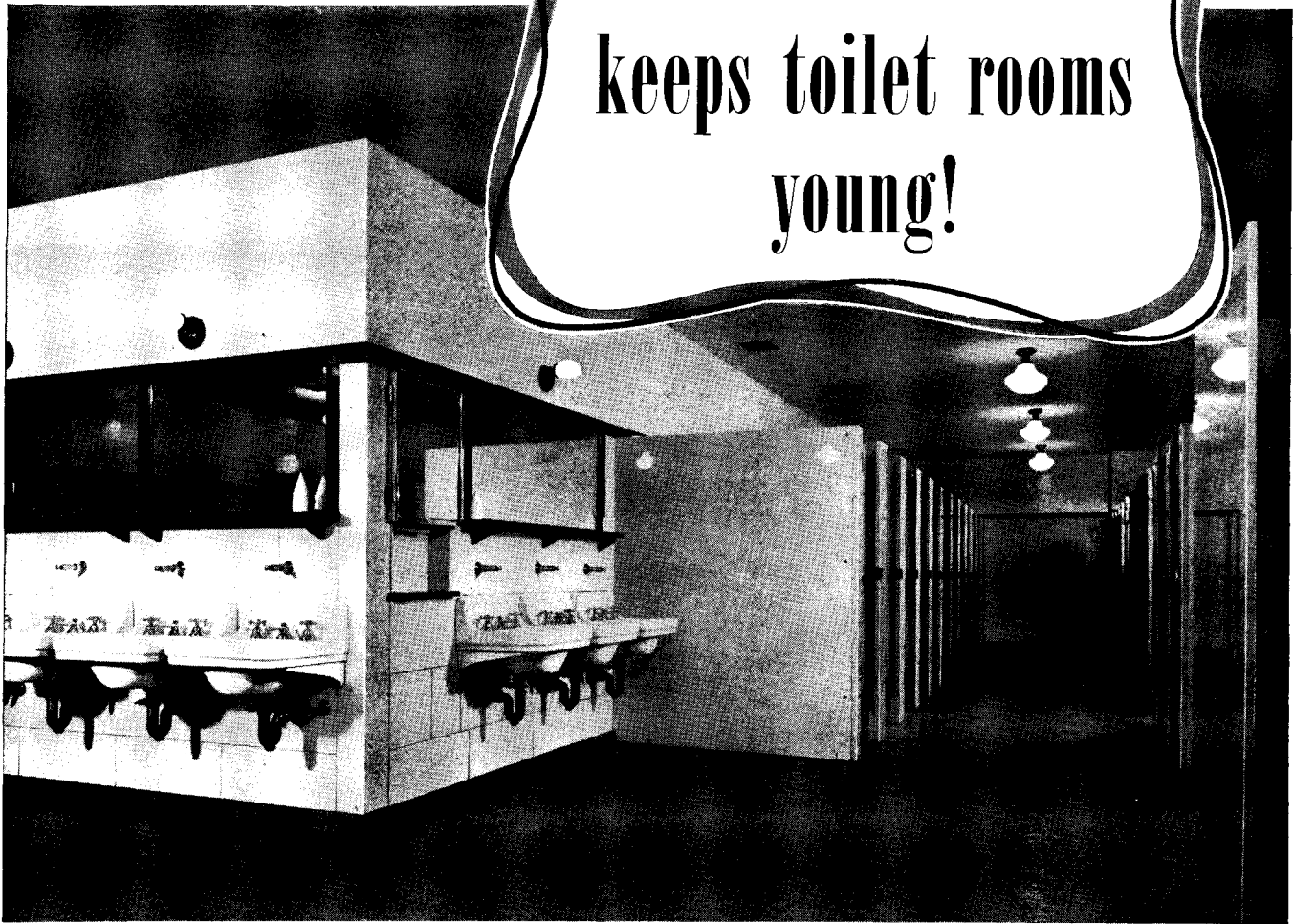

**WHEN** Carrara Structural Glass is made, every piece of it is mechanically ground and polished to a true, flat surface. This precision method of manufacture imparts to Carrara the high degree of excellence and quality found only in a finely-machined product.

Thus, Carrara has a smoothness and reflectivity of surface, a depth

and uniformity of color found only in a glass so made. Carrara joints are true and even, without lippage. Carrara never warps with age. It won't check, craze, stain, absorb odors or fade.

This glass can be decorated in various ways to achieve unusual architectural effects. It is available in a special Suede-finish for use where a soft, vel-

vety-surfaced glass is desired. And there are no construction delays with Carrara — its application involves little, if any, use of critical materials.

Send the coupon . . . today . . . for our free booklet on Carrara. It is profusely illustrated, and contains full information on Carrara's physical characteristics, the colors available, construction details, and other data.

## CARRARA

*The modern Structural Glass*

PITTSBURGH PLATE GLASS COMPANY

Pittsburgh Plate Glass Company  
2014-2 Grant Building, Pittsburgh, Pa.  
Please send me, without obligation, descriptive literature on Carrara Structural Glass.

Name.....

Address.....

City..... State.....

Show your clients how easy it is to  
**GIVE EMPLOYEES  
THIS PROTECTION**

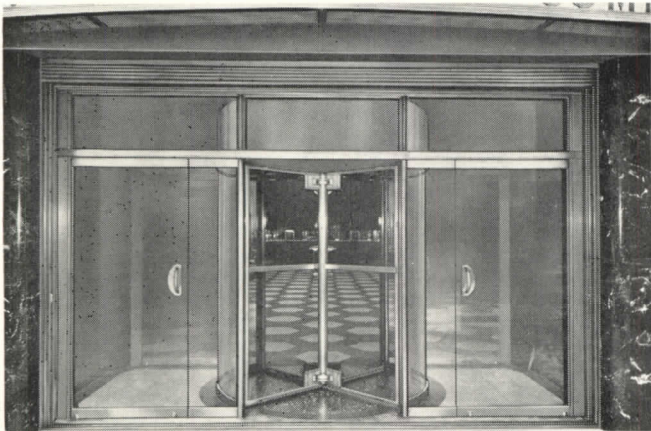

CHEMICAL BANK & TRUST COMPANY (New York) safeguards employees' health and customers' comfort with this draft-proof Revolving Door. In accord with new architectural needs, the "all-glass" construction of the door provides maximum light admission areas. Architects: Walker and Gillette.

★ When chilly blasts blow into your clients' business places—what happens? Employees shiver and shudder. They suffer from frequent colds. Even if they don't stay home from work, sneezing, sniffing employees can't render the efficient service the public expects.

Show your clients how they can safeguard employees' health and efficiency from the "blitz" of open doors. Tell them how easily they can install draft-proof Revolving Doors—and thus shut out winter's icy blasts, enjoy even heat distribution, and cut fuel bills as much as 25%.

For complete technical data, phone your local Revolving Door representative. Or write to the factory for a free A. I. A. Data Folder, containing photographs and descriptions of new installations in banks, office buildings, restaurants, hotels and stores.

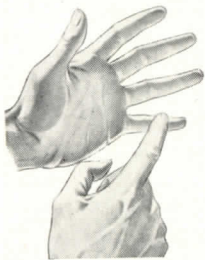

**5 Ways a Revolving Door  
Pays for Itself—**

- 1—Cuts heating and cooling costs.
- 2—Increases usable floor space.
- 3—Reduces damage from dust and dirt.
- 4—Assures customers' comfort.
- 5—Safeguards employees' health.

**Revolving Door**

★INTERNATIONAL  
★VAN KANNEL  
★ATCHISON

DIVISION of  
**INTERNATIONAL  
STEEL COMPANY**  
EVANSVILLE  
INDIANA

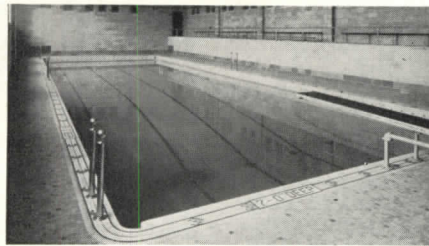

**W & T**

**Electrolytic Chlorinator  
for Sterilization of Swimming Pool Water**

**T**HIS equipment is designed to produce the actual sterilizing agent at the point of use. The Electrolytic Cell manufactures sodium hypochlorite solution from such readily available materials as common salt, water and electric current, and the new **W & T Electrolytic Chlorinator** can readily be operated at any point where these are available.

The new **W & T Electrolytic Chlorinator** can be used for most types and sizes of swimming pools. It justifies your specification by giving years of accurate, dependable service at minimum maintenance expense.

Copies of the folder on the **W & T Electrolytic Chlorinator** will be sent on request. Ask for Technical Publication 201. The unmatched experience of **W & T** representatives is at your service. They will explain how to

**"SWIM IN DRINKING WATER"**

**WALLACE & TIERNAN CO., Inc.**

Manufacturers of Chlorine and  
**NEWARK, NEW JERSEY**



Ammonia Control Apparatus  
**REPRESENTED IN PRINCIPAL CITIES**

*Welcome*

**to PITTSBURGH'S  
NEWEST HOTEL**

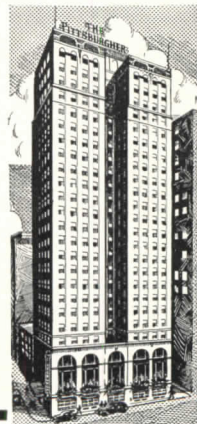

400 rooms, all with radio  
at no extra cost, outside  
view and bath.

★

**RATES**

Singles . . . . . \$3.30 to \$4.40  
Doubles . . . . . \$5.00 to \$6.50

★

*Most Conveniently Located Hotel  
in Downtown Pittsburgh*

**Hotel Pittsburgher**

— A KNOTT HOTEL —

Joseph F. Duddy, Manager



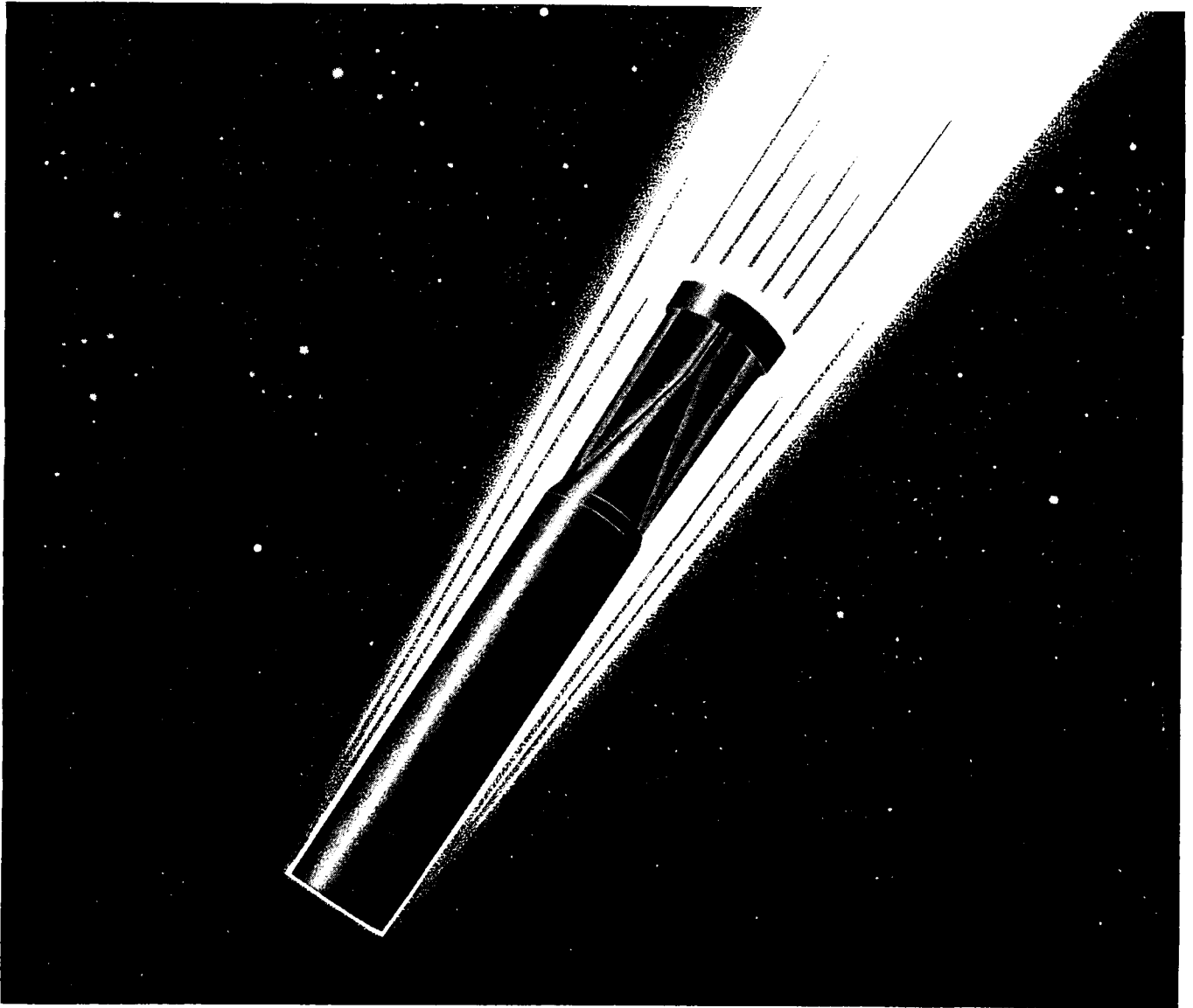

## **A LESSON ABOUT FIRE...FROM LONDON**

If ever there was a bit of hell with wings, it's an incendiary bomb! Yet from London . . . where bombs have rained alike on buildings with and without sprinkler protection . . . comes this word: *In no single known instance has a sprinkler-protected premise been destroyed by fire caused by incendiary bombs!*

Here's positive fire protection that every building owner would be especially glad to have called to his attention in these days of wartime hazards and replacement difficulties. Grinnell Automatic Sprinkler Systems are a vital safeguard to the building, its stocks of precious defense materials and irreplaceable equipment. You can trust them to control fire of *any* origin, automatically, at the source!

Make this efficient fire protection a blended part of your original designs. Over 50 years of intensive fire protection engineering enables Grinnell engineers to assist you with complete understanding of your problems and your clients' needs. Phone the Grinnell office near you for advisory interview. Grinnell Company, Inc., Executive Offices, Providence, R. I. Branch offices in 34 principal cities.

# **GRINNELL**

**Automatic Sprinkler Fire Protection**

**A BLENDED PART OF YOUR BUILDING'S DESIGN**

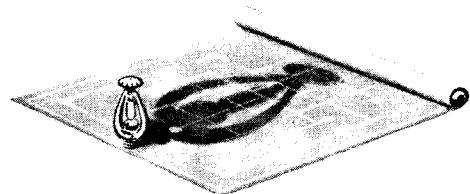

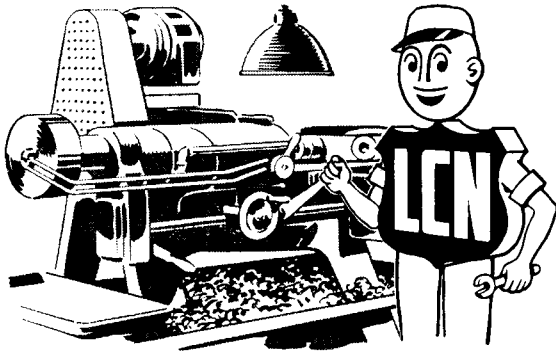

## "Enlisted . . . . for the Duration"

Today, when everybody should be at his post of greatest usefulness, we're at ours — turning out door closers and other goods marked "rush," with all the skill and speed we can muster!

## War Building Projects Need Reliable Door Control

All buildings have to have doors, and each important door needs a closer that can be relied on to work, to take punishment, day

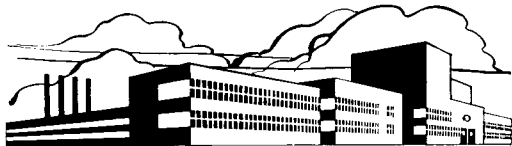

in, day out, for years without attention. Every workman, from the General or the Chairman down, has to use those doors. Better be sure they have the best of control.

## At Uncle Sam's Service . . . and Yours

The LCN organization, inside and out, has been carefully built over the years to do a superlative job in this field. We've taken on other work demanding precision, too, and our wheels turn day and night so that these two essential needs will be taken care of — well. LCN, 466 West Superior St., Chicago.

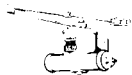

**To be Sure—Specify  
DOOR CLOSERS BY** 

## "Automatic" CONCRETE CURING

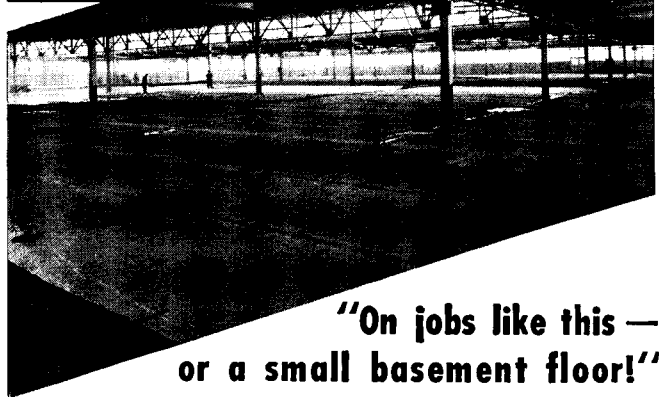

"On jobs like this —  
or a small basement floor!"

On ANY job, thorough curing under waterproof SISALKRAFT assures maximum hardness, density and strength. This method is simple, positive and economical. Once the paper is laid over a freshly finished slab, no further attention is required. No sand, bur-lap or sprinkling. No human element. SISALKRAFT for concrete curing is becoming the standard specification.



Write for complete data file.

**The SISALKRAFT Co.**

205 W. WACKER DRIVE • CHICAGO, ILLINOIS  
NEW YORK • SAN FRANCISCO



**THE VENETIAN**  
VACATION WITH VACATIONERS

Favorite of vacation-minded visitors who seek congenial companions for Miami's many playtime pleasures. A true "resort" atmosphere, "share the fun" guest-entertainment program, social directress. Ideal location: closest Miami hotel to bay, beaches, recreation centers. Matchless views. Quiet, parklike surroundings, restful evenings after play-filled days. Excellent cuisine. Ample free parking. Restricted clientele.

WRITE for details of remarkably low rates — especially attractive for extended stays.

**ON BISCAYNE BAY AT 15TH STREET  
SEASON: NOVEMBER TO MAY**

# BOX MOUNTING DEVICES



**Ideal for modern, efficient Surface Wiring  
IN INDUSTRY OR IN THE HOME**

Durability and long life in everyday service are built into all types of Bryant Box Mounting Devices. Their high-quality and master workmanship assure complete satisfaction, whether installed in factories or in the home.

You choose the application. Bryant has the Box Mounting Device which we feel sure you will agree meets the need "right on the nose."

*Metal Covers:* Switches, Outlets and Lampholders for 3¼" and 4" boxes. Covers are cadmium plated to resist corrosion.

*All Porcelain:* Lampholders only. Keyless and pull types with or without side outlet. Made with large diameter bases. 4⅛" diameter for 3¼" boxes, 5⅛" diameter for 4" boxes.



Catalog will be sent to you on request. Write for your copy today. The Bryant Electric Company, Bridgeport, Conn.

*Sold Through Electrical Wholesalers Nationally*



**EVERY OUTLET DESERVES A BRYANT DEVICE**



WAR OR NO WAR, Johnny's sister wants a room of her own. Month by month, the need for this extra room will worry Johnny's parents. Temporary arrangements may have to be made, but they will build that home of their own just as soon as they possibly can.

Meanwhile, they will be thinking and planning. They will appreciate ideas and information that will help them crystalize their home building requirements. They will need a book like *Home Owners' Catalogs* and its "Guide To Home Planning."

*Home Owners' Catalogs* does three specific things for prospective home owners. It helps them make detailed inventories of family needs. It provides room by room check lists and furniture cut-outs with which to determine adequacy of space and convenience of arrangement. And, through a product and brand selector, it enables them to list first and second choices of materials, equipment and furnishings suitable for their new homes.

But, perhaps most important to architects--and manufacturers of home building products as well--*Home Owners' Catalogs* "keeps 'em sighing" for the time when they can proceed with their home building plans.

## It's FREE . . . don't let them miss it!

Those who are planning to build homes for their own occupancy, costing \$4000 or more for construction, exclusive of land--and those who expect to modernize at a cost of \$2000 or more-- in any of the 37 states east of the Rocky Mountains, within 12 months, are entitled to receive a free copy of *Home Owners' Catalogs*, without obligation of any kind. We send this attractive cloth bound volume--with its hundreds of beautiful illustrations and comprehensive descriptions of reliable home building products--by mail prepaid, to all who meet these restrictions.



# Home Owners'

## CATALOGS

Published by F. W. DODGE CORPORATION, 119 WEST 40TH STREET, NEW YORK, N. Y.

AIR BASES

ARSENALS

CHEMICAL  
PLANTS

HOSPITALS

NAVAL BASES

INDUSTRIAL  
PLANTS

ORDNANCE  
PLANTS

## Defense against power failure . . .

## EXIDE EMERGENCY BATTERIES

**W**ITH defense industries working overtime, thousands of plants must have light all night long. And in many of these plants, essential processes must be operated continuously . . . even a temporary power failure would be disastrous.

And yet, because of storms, floods, fires and even street accidents . . . events which no utility company can possibly control . . . power failures do occur.

To forestall such risks, many architects and engineers have

installed Exide Emergency Power Units in industrial and chemical plants, Naval Bases, hospitals, ordnance plants, arsenals, and air bases. These Exide Units have "earned their pay" in many an emergency, because they operate instantaneously and automatically upon any interruption of the normal electric supply.

Also, they are easily maintained and economical to install and operate.

In providing for this vital protection in your plans for buildings, we can be helpful. Write us.

**Exide**  
EMERGENCY BATTERIES

THE ELECTRIC STORAGE BATTERY COMPANY, Philadelphia

*The World's Largest Manufacturers of Storage Batteries for Every Purpose*  
Exide Batteries of Canada, Limited, Toronto

# Time Is Short... America's Great

## WAR CONSTRUCTION PROGRAM

### Must Be Kept In High Gear!

**W**AR doesn't wait for those who aren't ready. Potential planes can't carry bombs and potential factories can't produce munitions and armaments. Our government, its War and Navy Departments, the Defense Plant Corporation and the Housing agencies have a stupendous responsibility and task to perform in properly equipping and implementing our field forces. The first step must be that of marshalling private enterprise to construct additional military installations and manufacturing buildings to produce munitions. And this first step, unless accomplished in the shortest possible space of time, may mean the difference between victory or defeat on many battle fronts.

Success in marshalling the building industry to perform its duty to the nation is dependent on a reliable and timely flow of information on projected war construction to those directly interested and in a position to contribute to our all-out construction effort. And *speed* in the flow of news, as well as in actual construction, *remains the essence*.

Complete cooperation and coordination of effort among owners, architects, engineers, contractors, subcontractors, sub-subcontractors and manufacturers is also essential to the successful execution of this all-out program. Timely and reliable information is needed so that the right men, the right materials, and the right equipment may be available at the right place at the right time.

Now, as for more than 50 years, the information provided through Dodge Reports is functioning on a confidential basis to coordinate the activities of those who can supply products and services to new construction projects . . . to tell them what is to be built — where — and when — and the responsible officials who must be served.

Dodge, working closely with officials of the War and Navy Departments, and conforming with the rules of censorship, will help keep America's great war production program in high gear. Each hour — each day — Dodge Reports help the industry to construct war projects on time, whether they be new industrial plants; new housing projects for industrial workers; new warehouse buildings; new commercial and community undertakings necessary to the health and safety of the public; or bridges, roads or other types of construction required for all-out prosecution of the war.

The continued cooperation of architects, engineers and contractors with Dodge Reporters in the field will contribute materially to the final victory.

## DODGE REPORTS



Issued by **F. W. DODGE CORPORATION**, 119 West 40th Street, New York, N. Y.



## *Who Has a Better Right to this Security?*

**Today The American Workman Has The Greatest Need For Home Equipment That Will Serve Him Well And Long AT LOW OPERATING COST!**

When a wage earner buys a house, financial consideration goes beyond a choice of land and structure. For it's the monthly cost *to live* which determines whether he can continue to afford the security of a home of his own.

Give him home operating equipment that will keep on giving good service at low cost. Give him an efficient and adequate heating plant and wiring system,

and money-saving kitchen appliances. These can contribute more in operating economies than any



slight increase they may cause in monthly payments under a long term mortgage.

And at the same time *you* can profit by specifying General Electric home equipment, because *the homes you design and build today are the homes that will build your reputation for tomorrow.*

★ ★ ★ ★

*Write us for the complete story . . . how G-E Equipment can lower living costs for your customers!*



WIRING • REFRIGERATOR • RANGE • FURNACE • WASHER • IRONER • CABINETS • DISPOSALL and DISHWASHER • WATER HEATER

# GENERAL ELECTRIC

HOME BUREAU, BRIDGEPORT, CONN.

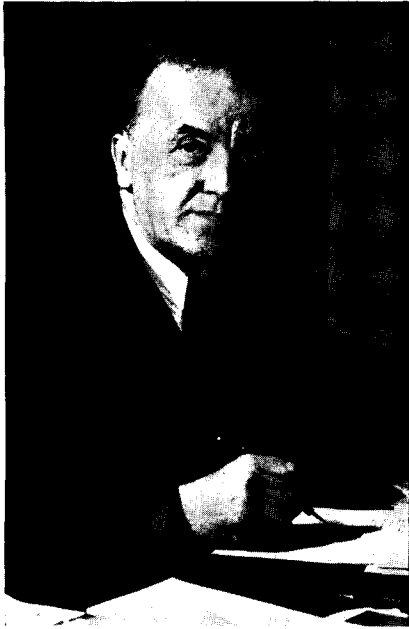

Mr. Rodney Derby

# YOUR NEW SWEET'S IS ON THE WAY!

**D**ISTRIBUTION of the 1942 Sweet's Catalog File is now under way. Your new file will be delivered to your office with the least possible delay. This is the thirty-sixth in an unbroken annual series of Sweet's files. It contains more than a thousand new and up-to-date manufacturers' catalogs—useful information on all kinds of building materials and equipment for all types of buildings.

Sweet's Catalog File enables you to compare and select products or services to meet your requirements. If it is difficult to get what you want from accustomed sources, use Sweet's as a means of finding reliable alternative sources. Sweet's gives you quickly and in convenient form, the product information you must have.

## FEWER ARCHITECTS MOVED OFFICES LAST YEAR

Comparison of Sweet's distribution lists for 1941 and 1942 shows less tendency on the part of practicing architects to move their offices.

"It is true that a good many architects closed up in 1941 because they were called into service," observes Mr. Rodney Derby, manager of the Distribution Department, Sweet's Catalog Service, New York. "But among other thousands of architectural offices a smaller proportion than heretofore reported a change of address. There may be several reasons for this: Many designers are temporarily working full time on rush jobs in big consolidated offices, but won't risk closing their own offices; others not so employed are sitting tight waiting to see what's going to happen; a large majority of course are too busy to take time to move.

"The urgency of defense and war time construction is such that many enormous consolidated offices have been set up both by architects and by contractors," Mr. Derby continues. "Advance notice of such establishments reaches us frequently, accompanied by an urgent request for Sweet's, and because we try to maintain a supply of Sweet's Catalog Files in several parts of the country, ready for delivery, we can usually respond to these emergency calls in very short order."

Mr. Derby's department compiles, checks and maintains the list of architects, engineers, general contractors and others qualified to receive Sweet's Catalog File. In addition to lists and records to which a staff of clerical workers devote their full time, the Distribution Department keeps in touch with users of Sweet's through the corps of 750 Dodge Reporters (as Sweet's is a division of F. W. Dodge Corporation). Traffic experts direct the actual delivery of twenty car-loads of five-volume Files, needed to supply applicants for the 1942 issue.

## MOST OF 'EM HAVE AN "S"

In the RECORD's Index to Advertisements on page 102 of this issue, an "S" preceding a company name indicates that the concern has one or more catalogs filed in the 1941 Sweet's Catalog File. You will note that most of the RECORD advertisers have adopted this modern, efficient and economical method of filing detailed information for your convenience. Thus, when a RECORD advertisement awakens your interest you can instantly turn to Sweet's "for further information." No writing. No waiting. No expense to you.

## USED SWEET'S 29 YEARS

McKim, Mead & White, Holabird & Root, Maybeck & White and Myron Hunt remind us they have been continuous users of Sweet's for twenty-nine years or more. Does any practicing architect recollect being a user longer than that? The first Sweet's file was issued in 1906, under the title, *Sweet's Indexed Catalogue of Building Construction*.

## CONSULTING STAFF

To interpret the professional viewpoint to manufacturer-clients, and to assist them in the selection and formulation of information for their catalogs, Sweet's has a full-time staff of consulting architects.

46 FIRMS IN SWEET'S  
FOR FIRST TIME

Accurate Mfg. Works, American Skein & Foundry Co., Anson & Gilkey Co., Arcade Mfg. Co., Auburn Central Mfg. Co., Robert N. Baltz & Co., Bart Laboratories, Biesanz Stone Co., Edward Cahill, Carilli System, Clark Door Co., C. R. Daniels, Inc., Drilled-In Caisson Corp., Federal Flooring Corp., J. J. Fisher Co., Inc., Fleur-O-Lier Manufacturers, Fort Schott Hydraulic Cement Co., Walter Haertel Products Co., Haley-Warren Inc., H. M. Harper Co., Hollaender Hanger Co., Hydrozo Products Co., Industrial Silica Corp., Industrials, Inc., International Bronze Tablet Co., Inc., Kedmont Mfg. & Waterproofing Co., Leslie Welding Co., Maid-O'-Mist, Inc., Martin-Parry Corp., National Bronze & Aluminum Foundry Co., National Cinder Concrete Products Assn., Outside Venetian Blind Co., Peerless Steel Shower Co., Propellair, Inc., Pro-Tect-U Awning-Shutter Co., R.O.W. Sales Co., Redstone Properties Inc., Frank C. Snedaker & Co., Inc., Thilman Pulp & Paper Co., Trinity Portland Cement Co., Ultimate Corp., Vaccinol Products Corp., Joseph Vasconcellos Inc., R. D. Werner Co., Inc., West Virginia Brick Co., Wood Treating Chemicals Co.

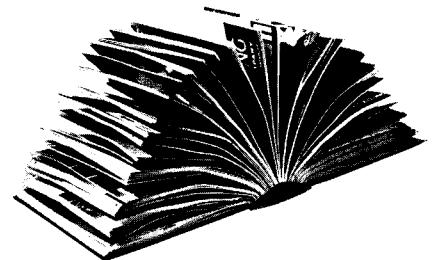



# Never before has FIRE-PROTECTION been so important!



**\*BUILT TO LAST 30 YEARS PLUS**, the new J-M American Colonial Roof Shingles combine beauty, firesafety, low upkeep. \*30 years is underestimating their life. Thousands of the very first J-M Asbestos Shingles are still going strong after more than 30 years.

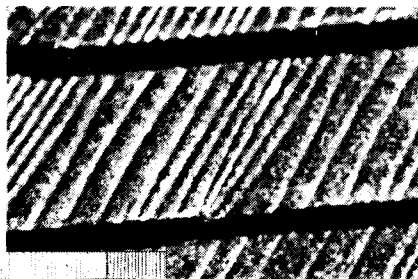

**BEAUTIFUL J-M Cedargrain Textured Siding Shingles** faithfully reproduce the pleasing grain of sawed wood. Fireproof and rot-proof, they assure permanently low maintenance. Never need preservative treatment. Unusually economical and easy to apply.

**Johns-Manville Asbestos Shingles for roofs and sidewalls are FIREPROOF . . . cost less in the long run . . . Why gamble?**

Every architect can help eliminate fire hazard by specifying J-M Asbestos Shingles. Made of asbestos and cement, they simply cannot burn!

*For roofs*, the new J-M American Colonials provide American Method beauty, the texture of weathered wood, handsome color blends, freedom from rot and decay. Any carpenter can apply them. *And the finished roof costs but little more than roofs of far less lasting materials.* In fact, based on their life expectancy\* the cost per year of a J-M Asbestos Shingle roof is, we believe, less than for any other roof.

*For sidewalls*, J-M Asbestos Siding Shingles offer equal protection against fire, weather, wear. Never require preservative treatment.

For details, just mail the coupon.



## JOHNS-MANVILLE

*Asbestos Shingles*

JOHNS-MANVILLE, Dept. A.R. 2,  
22 East 40th Street, New York, N. Y.

Please send me your latest brochures on J-M  
Asbestos Roofing and Siding Shingles.

Name \_\_\_\_\_

Address \_\_\_\_\_

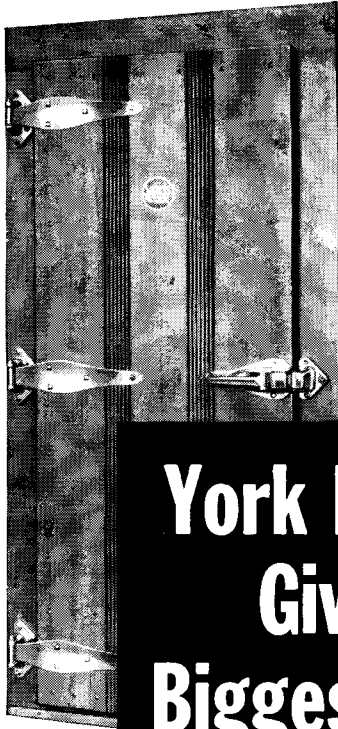

## York Features Give the Biggest Future

When you buy refrigerator doors, you expect them to last a long time. York doors stand up, retain original insulating, sealing and operating efficiency longer because of correct design, generous use of top-grade materials, rugged hinges, skilled craftsmanship . . . and these exclusive York features:

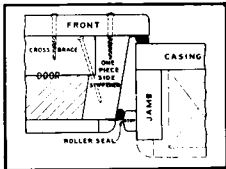

**PATENTED ROLLER-SEAL.** The York double seal provides two tough, pliable gaskets with sponge rubber cores and moisture-proof, grease-proof, wear-resisting coverings.

The outer gasket overlaps and compresses tightly against the face of the door-frame. The Roller-Seal or inner gasket is brought to bear against a wood sealing strip with a rolling and wedging action that insures a leak-proof seal through the years.

**ROLLER-SEAL LATCH.** A new latch combines finger-tip control with extreme ruggedness and modern styling . . . easy to operate and good looking . . . all exposed parts subject to wear made of stainless steel.

York Roller-Seal Doors are available for every type of refrigeration service, cooler, freezer and sharp freezer doors, vestibule doors, track doors.

York Ice Machinery Corporation,  
York, Pennsylvania.



# YORK

REFRIGERATION AND  
AIR CONDITIONING

"Headquarters for Mechanical Cooling Since 1885"

"KEEP'EM FLYING!"

For 20 Years LEADING ARCHITECTS AND BUILDERS HAVE REPEATEDLY SPECIFIED *Evans* VANISHING DOOR WARDROBES FOR SCHOOL PROJECTS AND *Evans* HAS NEVER DISAPPOINTED THEM.

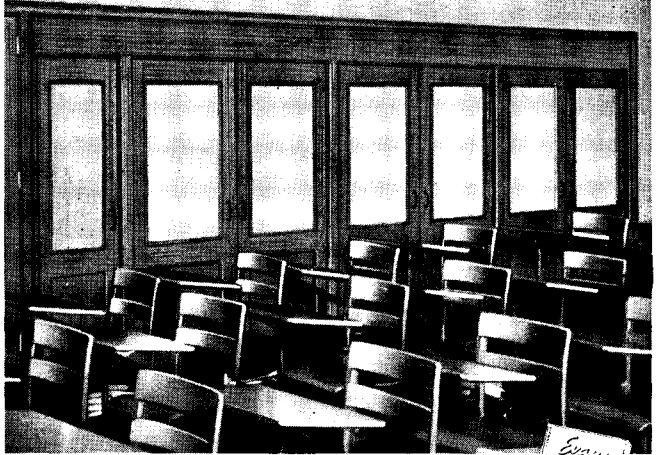

WRITE FOR NEW CATALOG AND DETAILS



*Evans* VANISHING DOOR WARDROBES  
W. L. EVANS COMPANY • WASHINGTON, INDIANA

## A Short Cut to Your CONSTRUCTION COST PROBLEMS FOR PRELIMINARY ESTIMATES

Boeckh's Manual contains cubic and square foot costs on approximately 500 types of buildings with a total of over 7,000 specific base cost figures and, in addition, thousands of specific cost variations.

All costs are keyed to local construction cost conditions through exclusive index conversion formulas—Boeckh's Manual never gets out of data if used with the conversion Index.

Boeckh's Manual of Appraisal is now used by over 8,500 firms, among which are hundreds of architects and builders. This Manual is nationally recognized by Fire Insurance Companies and Mortgage Loan Agencies as a standard of Building Construction Costs.

Boeckh's Manual of Appraisals and Pad of Work Sheets. Price shipping prepaid. . . . . \$6  
Local Current Index Conversion Factors (each location). Price shipping prepaid. . . . . \$1

Order now, examine it for 10 days, then if you are not completely satisfied return the Manual and your money will be refunded.

**E. H. BOECKH & ASSOCIATES**  
Consulting Valuation Engineers

903 TIMES-STAR BUILDING, CINCINNATI, OHIO



# THIS FREE BOOK HELPS Speed Construction for Victory

Here's the latest news about the advantages of Toncan Iron Sheets over other ferrous sheet materials—contained in a new 16-page edition published especially for architects and engineers.

"A Few Facts about Toncan Iron" presents valuable information to help you serve clients better, save them money, and increase your prestige. It will help you get the facts *straight* about Toncan Iron and how it differs from other ferrous metals—facts written by a producer of both iron and steel sheets.

Toncan Iron is *not* a copper-bearing steel. We make copper-bearing steel sheets—but we *also* make Toncan Iron Sheets. Toncan Iron is made from *open-hearth iron*—a highly-refined, exceptionally pure iron which is more resistant to the attack of rust and corrosion, more ductile than open-hearth steel.

With this finer base metal is alloyed the *exact proportion* of copper and molybdenum to produce a metal with greater rust-resistance than any ferrous material in its price class—a metal having *twice as much copper* as the best copper-bearing iron or steel.

Toncan Iron Sheets are easier to work, speed construction, reduce waste, stand up longer without repairs—all important in *Construction for Victory*.

*Get a copy of "A Few Facts about Toncan Iron" and see why it pays to specify Toncan Iron for sheet metal work. There's much of interest, too, in Sweet's—27/3 and 13/6 on pipe and sheets—23/5 on Steel and Tubes—9/1 and 21/2 on Berger—15/18 on Truscon.*

## REPUBLIC STEEL CORPORATION

General Offices: Cleveland, Ohio

Berger Manufacturing Division • Culvert Division  
Niles Steel Products Division • Steel and Tubes Division  
Union Drawn Steel Division • Truscon Steel Company

# REPUBLIC *Toncan Iron* SHEETS

Reg. U. S. Pat. Off.

An alloy of refined open-hearth iron, copper and molybdenum—that grows old slowly



# CONFIDENCE!



# KOH-I-NOOR

We Americans have confidence in our ability to maintain democracy and our present mode of living.

In our efforts to provide defense materials to protect these ideals, a pencil is inevitably used to transcribe our ideas into working designs on the drafting boards of America.

That KOH-I-NOOR Drawing pencils are so often the choice of draftsmen who know pencils best, cannot be chance alone, but must be based on practical experience gained by these men over a period of years.

Try KOH-I-NOOR today and see for yourself just what difference does exist. For sale at the better Stationery, Drawing Material and Art Material Stores.

★

MEPHISTO BLUE PRINT CHECKING PENCILS in six colors, are made expressly for use on blue prints. Their strong, smooth, full colored leads are also suitable for coloring maps, charts and for general checking purposes.

★

SEND FOR FREE BOOKLET No. 3

**KOH-I-NOOR**  
**PENCIL COMPANY INC.**  
 373 FOURTH AVENUE • NEW YORK

# NORTON DOOR CLOSER

Cut  
 Maintenance  
 Time  
 and Expense

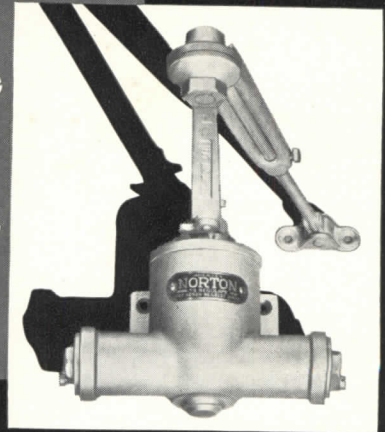

One job for the architect in National Defense is to specify building equipment that will save maintenance time and expense. Norton Door Closers aid defense production because Positive Control and Leakproof Mineral Oil Lubrication add years to the life of the closer and cut maintenance time and expense.

FOR FURTHER INFORMATION



SECTION 16  
 CATALOG 27

**NORTON DOOR CLOSER COMPANY**

Division of the Yale & Towne Mfg. Company

2900 N. Western Ave.

Chicago, Ill.

## THE RESTORATION OF COLONIAL WILLIAMSBURG

*A Reprint of the December, 1935, Issue of ARCHITECTURAL RECORD. 104 pages, bound in cloth. \$1.50 per copy.*

The Colonial Williamsburg Number of ARCHITECTURAL RECORD—issue of December 1935—was sold out soon after publication but the entire editorial contents have been reprinted and bound in permanent book form with blue cloth covers.

Many thousands of these Williamsburg reprints have been sold but the demand continues unabated.

ARCHITECTURAL RECORD  
 119 W. 40th St., New York, N. Y.

Enclosed is \$..... for which send ..... copies of your reprint, *The Restoration of Colonial Williamsburg*, bound in cloth, at \$1.50 per copy.

Name.....

Address.....

City and State..... A. R. 2-42

# An Architect Reports

on oil burning systems in

## SMALL COMMERCIAL BUILDINGS

Joseph Watterson, of Mineola, Long Island, has designed many fine residences and small commercial buildings on Long Island. Among the large number of jobs for which he has specified the Petro Oil Burning System are the attractive Dutchland Farms Restaurants in Great Neck and Rockville Centre which are published in this issue of the RECORD. S. Tyson Haldeman was associate architect on this latter job. Mr. Watterson has this to say about Petro:

"From my experience I know that an architect can safely specify Petro for the smaller commercial structure -which will be important in our defense building- as well as for the bigger jobs. In the Store or Restaurant where the basement is planned for use by customers, this area is rendered free from noise and dirt where oil systems are used. Overhead is cut down because a janitor is not needed to check an oil burner, and I believe that oil heating systems provide the clean, quiet, pleasant surroundings which add comfort for the customer and guest.

"The Petro System has proved highly dependable and economical in the Dutchland Farms Restaurants. The owners and guests are well-pleased, and I can endorse them one hundred per cent."

Mr. Watterson's opening sentence above contains a very well taken point. His experience with Petro equipment in small and average sized buildings agrees with the experience of many other architects and engineers who have used the smaller Petro systems.

Professional preference for Petro is based chiefly on Petro's performance record of high efficiency and low operating costs. But a second factor is the wide range of applications included in this record—everything from a small residence or store using "light" fuel oils to multi-unit, high pressure boiler rooms using pre-heated "Bunker" fuel oils.

To have such a range of equipment available at

one source is, in itself, an advantage to the architect. If he desires to check his own opinion, or the recommendation of his engineer, he can ask for a Petro recommendation. Since Petro has equipment in all sizes and for every commonly used fuel oil, the Petro engineer has no reason for bias in submitting his opinion.

The men quoted monthly in these pages in recent years have been noted for big structures. Their offices, however, have also directed a huge total of smaller projects, and their approval of Petro Systems reflects their total experience with Petro Systems of all sizes and the uniformly excellent performance Petro delivers regardless of size.



**CAPACITIES (single burners): to 145 gal. per hour—487 boiler h.p.—68,000 sq. ft. steam E. D. R.**

**FOR FURTHER  
INFORMATION**



Innumerable Petro Systems in daily Commercial use are fired with light "Domestic" oils, at firing rates from 2 to 18 gallons per hour.

Petro Industrial Burners for Automatic operation with preheated No. 6 oil, or with No. 5 or lighter oils, are available in eight sizes, Models W-2½ to W-9 inclusive. Each burner is a self contained assembly of motor, fan, pump, rotary cup

atomizer and interlocked air and oil adjustments.

In the use of preheated No. 6 oil, the Petro Thermal Viscosity System is an integral part of a Petro installation, insuring reliability of operation and fuel economy.

Semi-Automatic and Manually controlled Model W Burners and "Mechanical" type units are also available to meet circumstances which do not require automatic operation.

*Petro's Engineering Division will gladly answer questions. The Petro Industrial Equipment Catalog will be sent promptly on request.*



**PETRO**  
*Cuts Steam Costs*



**PETROLEUM HEAT AND POWER COMPANY**

**STAMFORD**

—Makers of good Oil Burning Equipment since 1903—

**CONNECTICUT**

# Specify **ALL-OUT PROTECTION**



An **ANCHOR FENCE** says

**KEEP OUT**

to Saboteurs / Troublemakers

Manufacturers on "All-Out" Defense production schedules require "all-out" protection, too. An effective way to *keep out all undesirables* is to install an Anchor Fence around the plant—and special Anchor enclosures *within* the plant, to keep all but the most trusted employees away from power stations, laboratories, chemical and material stocks and other vital points.

An Anchor Fence permits storage of materials outdoors—cuts expense for guards to a minimum. Anchor Fences can be quickly erected in any soil, in any weather, even when the ground is frozen. The exclusive driven "Anchors" hold the fence erect and in line, resist terrific force, yet can be moved in case of plant expansion.

There's an Anchor engineer near you, ready to consult with you at any time. Write for his address and a copy of Protective Fence Catalog No. 110. Anchor Post Fence Co., 6635 Eastern Ave., Baltimore, Md.

**NATION-WIDE SALES AND ERECTING SERVICE.**



## INDEX TO ADVERTISEMENTS

Catalogs of concerns marked (s) are filed in Sweet's Catalog File (1941)

	Page		Page
s Aluminum Company of America	28	s Kennedy, David E., Inc.	1
s American Chain & Cable Company	84	s Kitchen Maid Corporation	11
American Rolling Mill Company	86	Koh-I-Noor Pencil Company, Inc.	100
Anaconda Wire & Cable Company	13		
s Anchor Post Fence Co.	102	s LCN 466 Door Closers	90
		s Libbey-Owens-Ford Glass Company	104
Benjamin Electric Mfg. Co.	4th Cover	s Louisville Cement Company, Inc.	21
s Berger Manufacturing Division	99		
s Bethlehem Steel Company	16	s Mahon, R. C., Company	33
Boeckh, E. H., & Associates	98	Miller Company	2nd Cover
s Brixment	21	s Modine Manufacturing Company	103
s Bryant Electric Company	91		
s Byers, A. M., Company	4	s National Tube Company	83
		Nelson, Herman, Corporation	32
s Carey, Philip, Mfg. Co.	31	s Norton Door Closer Company	100
s Celotex Corporation	3d Cover		
s Congoleum-Nairn, Inc.	79	Okonite Company	12
s Curtis Companies Service Bureau	3	Ozalid Products Division	15
s Dodge Reports	94	s Page Fence Association	84
s Du Pont, E. I., de Nemours & Co., Inc.	14	s Payne Furnace & Supply Co., Inc.	36
		s Petroleum Heat & Power Company	101
Electric Storage Battery Company	93	s Pittsburgh Plate Glass Company	22-87
s Evans, W. L., Company	98		
		R. C. A. Manufacturing Co., Inc.	23
Faber, A. W., Inc.	25	s Republic Steel Corporation	99
Fitchburg Municipal Airport Commission	26	s Revolving Door Division	88
s Fitzgibbons Boiler Company, Inc.	29	s Rixson, Oscar C., Co.	20
General Aniline & Film Corporation	15	s Scott Paper Company	27
s General Electric Co.—Air Conditioning	77	s Sisalkraft Co.	90
General Electric Home Bureau	95	Smith, Alexander, & Sons Carpet Company	8-9
s Grasselli Chemicals Dept.	14	s Stanley Works	82
s Grinnell Company	89	s Sweet's Catalog Service	96
Hazard Insulated Wire Works	12	s Timber Engineering Company	34
s Hoffman Specialty Company	17		
s Home Owners' Catalogs	92	s United States Steel Corp. Subsidiaries	35-83
Hotel Pittsburgher	88	s Universal Atlas Cement Company	35
s Hygrade Sylvania Corporation	2		
		Venetian Hotel	90
s International Steel Company	88	s Wallace & Tiernan Co., Inc.	88
		s Webster, Warren, & Company	19
s Jamison Cold Storage Door Co.	26	s Westinghouse Electric & Manufacturing Co.	85
s Johns-Manville	97		
		s York Ice Machinery Corporation	6-98

New York—General Manager: H. Judd Payne. Advertising Manager: Tom Tredwell. B. B. Orwig, 119 West 40th Street. Boston—Robert Marshall, 855 Park Square Bldg.; Chicago—C. B. Riemersma, F. H. Bowes and H. Neville Taylor, 700 Merchandise Mart; Cleveland—Homer Andrews, 321 Hanna Bldg.; Los Angeles—W. R. McIntyre, 400 East Third St.; Philadelphia—Tom Tredwell, 1321 Arch Street.

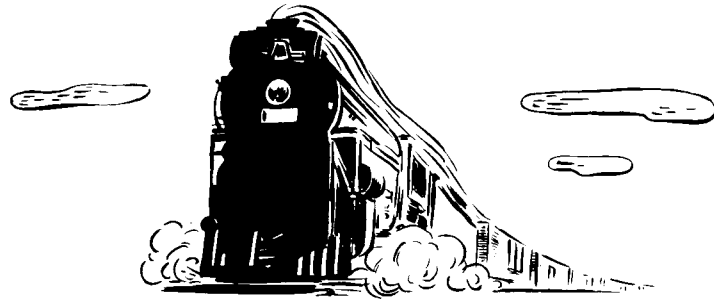

YOU CAN *Get 'em just as soon* AS YOU  
CAN ANY UNIT HEATER...MAYBE SOONER...AND

# modines can be Installed Faster



Horizontal Delivery Model

Vertical Delivery Model

● New buildings... industrial or governmental... must be designed to make manpower, as well as machinery, most productive. That means you must get adequate, effective heating in that new building of yours. With a war to win you can't afford to specify heating equipment that hasn't already proved its performance. Modine Unit Heaters *have!*

And now every single day counts! You want to get those unit heaters *in*—"all set" for quick, automatic heating. Modine Unit Heaters *are* faster and easier to install. With *Modine-patented* direct-from-branch-supply-pipe suspension, units attach directly to steam or hot water line. No brackets, pipe rods or straps. Supply connection is only support needed. Less material, less labor—\$3 to \$8 less cost per unit to install.

Modine *delivery is as prompt as any in the industry.* Get the latest catalogs.



Look in your phone book for Modine representative's name—"Where to Buy It" section under Heating Apparatus.

**MODINE MANUFACTURING COMPANY**  
1773 RACINE STREET • RACINE, WISCONSIN

**modine**  
THE *Unit Heater* WITH  
DIRECT-FROM-PIPE SUSPENSION

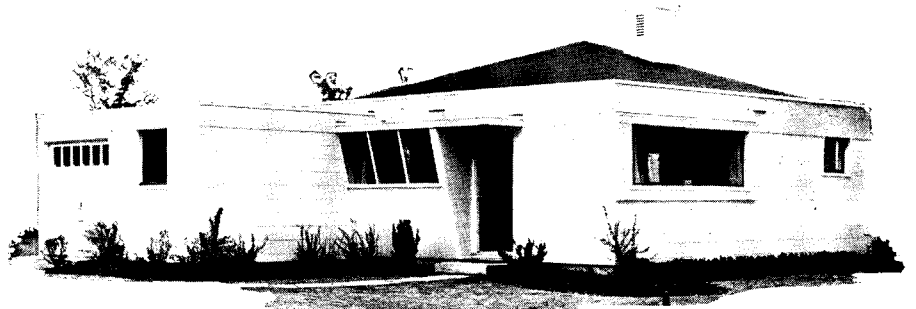

# 9 WAYS to brighten A \$4,200 HOME!

● Generous window areas are a pleasing feature of this \$4,200 home designed by Architect D. Kenneth Sargent for Milo D. Folley, Syracuse, N. Y. Note the slanting window treatment.

## HOW ARCHITECT SARGENT DID IT

WITH  Glass

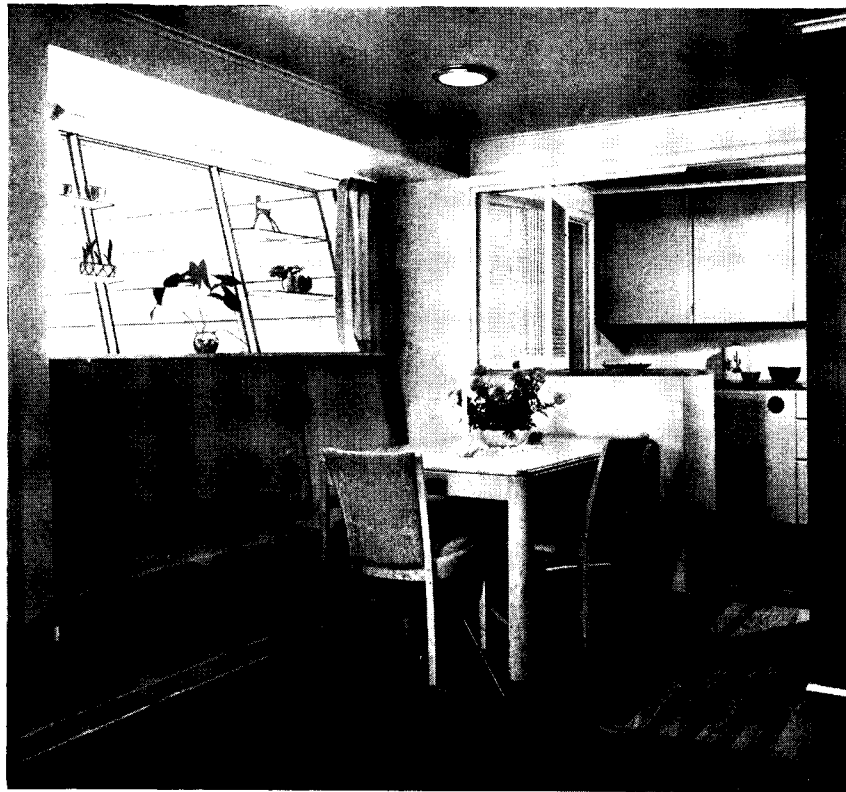

● Folding doors of decorative Flutex Glass are used over service counter between dining wing and kitchen. Plate glass shelves break up the window area without obstructing light.

- 1 Used large window areas for abundant natural light.
- 2 Placed a plate glass mirror over mantle.
- 3 Framed the fireplace with mirror panels.
- 4 Used Flutex decorative glass folding doors between dining wing and kitchen.
- 5 Placed plate glass shelves in windows.
- 6 Used Vitrolite on walls over bathtub.
- 7 Used fixed lights of Flutex above bathtub.
- 8 Placed generous size mirror over wash bowl.
- 9 Put full-length mirror on bedroom closet door.

When designing small homes or defense housing projects, remember that flat glass products can brighten them in many ways... add to comfort and convenience... actually help build morale.

The fact that glass is thoroughly in keeping with modern architecture is another point to keep in mind.

An important consideration these days is the ready availability of practically all types of Libbey-Owens-Ford flat glass. No priority headaches.

See Sweet's for full information or write for architect's catalog. Libbey-Owens-Ford Glass Company, 1221 Nicholas Building, Toledo, Ohio.

*You can GET  
Glass!  
Design for it!*



**LIBBEY · OWENS · FORD GLASS COMPANY**  
*Glass Designed for Happiness*