

ARCHITECTURAL

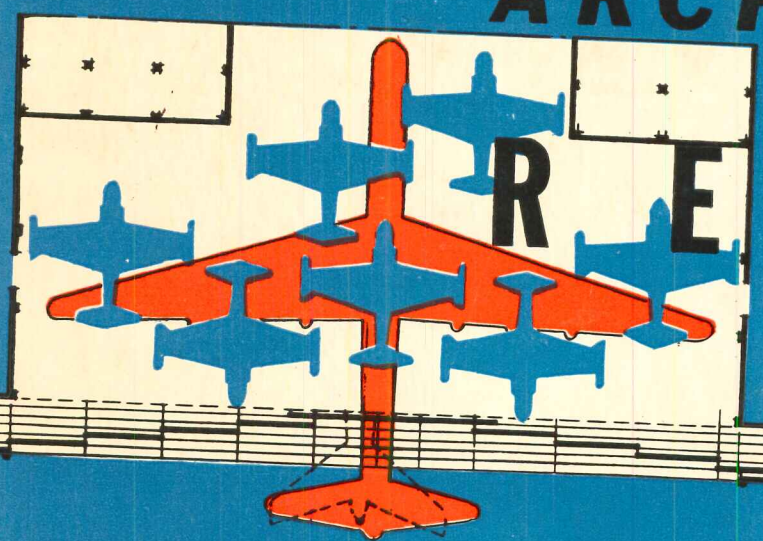

R E C O R D

JANUARY 1952

BUILDING TYPES STUDY NUMBER 182

AIR FORCE BUILDINGS

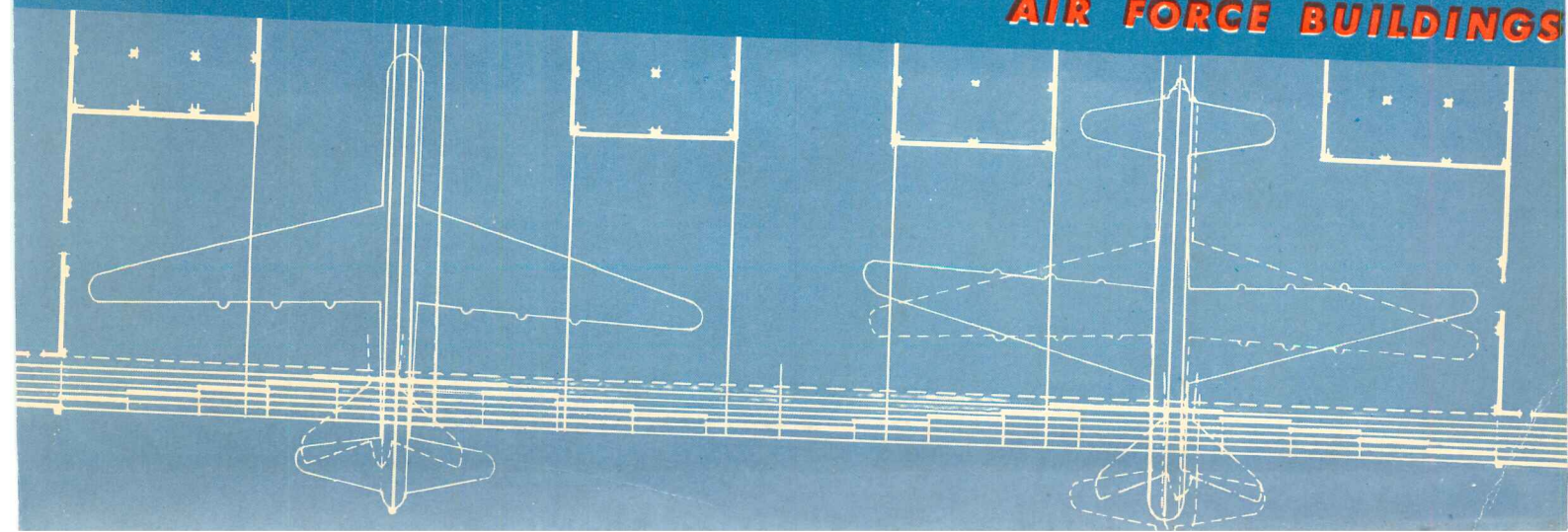



▲ PAUL DUNCAN, A.I.A. Architect for Lakewood Park Mutual Homes.



◀ J. S. KUSTER, Co-partner Kuster-Wetzel Electric Company, Wiring Contractors.

7,000 Homes Choose NuTone

The fabulous Lakewood Park subdivision . . . the dream of builder Ben Weingart . . . has chosen NuTone . . . to help make each house a HOME.

This development . . . the world's largest of its kind . . . with a total of over 17,000 homes when completed . . . was planned by architect Paul Duncan and is being equipped with NuTone Door Chimes and Transformers by Kuster-Wetzel Electric Company of Los Angeles, in co-operation with their supplier, Elm Wholesale Electric Company.

All over the U.S., leaders in the building industry choose

NuTone . . . because NuTone Door Chimes, NuTone Ventilating Fans, and NuTone Heat-A-Lite add so much more value and comfort to every home.

Now, more than ever . . . whether you are planning one home . . . or thousands . . . you can include all three NuTone Products without any strain on your budget. Specify NuTone Ventilating Fans . . . NuTone Door Chimes . . . and NuTone Heat-A-Lites . . . for easiest installation . . . low cost . . . trouble-free performance . . . and real client satisfaction.

NUTONE VENTILATING FANS

. . . Eliminate kitchen grease and banish cooking odors with NuTone's exclusive, quickly removable patented grille . . . easiest to clean . . . highest air delivery . . . quieter operation. Lower in cost . . . easier to install. Choose from 9 wall and ceiling models—\$24.95 to \$39.95.

NUTONE DOOR CHIMES

. . . Get rid of "Noisy Bells and Buzzers." Give your home a friendly, musical welcome at the front door. 14 smartly styled models for kitchen, hallway, or living room . . . harmonize perfectly with any interior. \$4.25 to \$82.50.

NUTONE HEAT-A-LITE

U. S. and Foreign Patents Pending

. . . Warm up "Cold Spots" in hard-to-heat rooms. A revolutionary new electric ceiling heater and overhead light. Saves valuable wall space. Easy to install . . . no pipes . . . no ducts. Safer than wall heaters. 6 models . . . \$49.95 to \$64.95



make
a House a Home
with

NUTONE
TRADE MARK

Write for Free Literature to NUTONE, Inc. Dept. AR8, Madison and Red Bank Roads, Cincinnati 27, Ohio

NUTONE, INC.— Cincinnati • New York • Chicago • Los Angeles • Seattle • Dallas • Montreal

ARCHITECTURAL RECORD



Copyright 1952 by F. W. DODGE CORPORATION, with all rights reserved • Publishing Director, Magazine Division, H. Judd Payne • Business Manager, Robert F. Marshall • EDITORS: Executive Editor, Joseph B. Mason; Managing Editor, Emerson Goble; Senior Associate Editor, Frank G. Lopez, A.I.A.; Associate Editor, Florence

A. van Wyck; Associate Editor (Engineering), Robert E. Fischer; Western Editor, Elisabeth Kendall Thompson; Assistant Editor, Herbert L. Smith, Jr., A.I.A.; Assistant Editor (News), Jeanne M. Davern; Contributing Editors, Ernest Mickel (Washington), Frederic A. Pawley, John Caulfield Smith, M.R.A.I.C. (Canada); Editorial Assistant, Jeanne G. Whitbeck • DESIGN: Consultant, M. Peter Piening; Director, Frances Torbert; Drafting, Sigman-Ward • CONSULTANTS: Industry Relations Consultant, Thomas S. Holden; Statistical Consultant, Clyde Shute; Field Research Consultant, Clifford Dunnels, Jr.; Public Relations Consultant, Samuel C. Pace.

Architectural Record (combined with American Architect and Architecture) is published monthly by F. W. Dodge Corporation, 10 Ferry St., Concord, N. H., with Editorial and Executive Offices at 119 West 40th Street, New York, N. Y. Western Editorial Office, 2877 Shasta Road, Berkeley 8, Calif. Chairman of the Board, James McV. Breed; Vice-Chairman of the Board, Paul Abbott; President, Thomas S. Holden; Vice-President and Treasurer, Howard Barringer; Secretary, Sanford D. Stockton, Jr.; Vice-Presidents, Irving W. Hadsell, Chauncey L. Williams, H. Judd Payne, T. Oliver Morgan; Assistant Secretaries, George W. Morgan, William C. Breed, Jr.; Assistant Vice-Presidents, Clyde Shute, Clifford G. Dunnels, Jr., Howard M. Thompson, Marc Wayne, Robert F. Marshall; Assistant Treasurers, Walter F. DeSaix, Edwin H. Freed, Irving B. Satin; Regional Vice-Presidents, Carl S. Bennett, Ralph M. Hairston, Julius T. Little, Richard H. Ray. Member Audit Bureau of Circulation and Associated Business Papers Inc. Architectural Record is indexed in Reader's Guide, Art Index, Industrial Arts Index and Engineering Index. Subscription rates: United States and Possessions, Canada, Cuba, Mexico, Central and South America, and Spain, \$4.50 the year, \$7.50 for two years, \$9 for three years; elsewhere, \$6.50 the year, \$11.50 for two years, \$15 for three years. Single copy \$2. Circulation Manager: Marshall T. Ginn. Every effort will be made to return material submitted for possible publication (if accompanied by stamped, addressed envelope), but the editors and the corporation will not be responsible for loss or damage. Other Dodge Services: Real Estate Record & Builders' Guide, Sweet's Files, Home Owners' Catalogs, Dodge Reports & Dodge Statistical Research Service.

| | |
|---|-----|
| THE RECORD REPORTS | 11 |
| News from Washington. By Ernest Mickel | 17 |
| News from Canada. By John Caulfield Smith | 18 |
| Construction Cost Indexes | 38 |
| REQUIRED READING | 42 |
| | |
| BUILDING TYPES STUDY NO. 182 . . . AIR FORCE BUILDINGS | 95 |
| PLANNING BUILDINGS FOR THE U.S. AIR FORCE | 96 |
| ALERT HANGARS | 98 |
| READINESS HANGARS | 99 |
| DOUBLE CANTILEVER HANGARS | 100 |
| EXTENSIONS OF DOUBLE CANTILEVER HANGAR | 102 |
| NOSE HANGAR | 103 |
| TECHNICAL TRAINING BUILDINGS | 104 |
| CELESTIAL NAVIGATION TRAINER BUILDING | 106 |
| MOTOR POOL BUILDINGS | 107 |
| AIRCRAFT MAINTENANCE — ENGINE BUILD-UP BUILDING | 108 |
| ARMAMENT AND ELECTRONICS BUILDING | 109 |
| COMMUNICATIONS BUILDINGS | 110 |
| OPERATIONS BUILDINGS | 112 |
| OPERATIONS BUILDING, SMALL | 114 |
| HEADQUARTERS BUILDING | 115 |
| HEADQUARTERS FOR AIR BASE GROUP | 116 |
| HEADQUARTERS AND OPERATIONS BUILDING, COMBAT SQUADRON | 117 |
| DORMITORIES | 118 |
| MESS HALLS | 120 |
| CHAPELS | 122 |
| READINESS BUILDING | 124 |
| GUARD HOUSES | 125 |
| THEATERS | 126 |
| | |
| AN ARCHITECTURE OF ENERGY | 127 |
| Cooperative Dormitory, Vassar College, Poughkeepsie, New York. Marcel Breuer, Architect | |
| YMCA-YWCA OFFICE AND ACTIVITY BUILDING | 135 |
| North Hollywood, Calif. Smith and Williams, Architects | |
| SCHOOL DESIGN IN 1952 | 138 |
| WHAT IS THE MATERIALS SITUATION, AND HOW CAN WE MEET THE CRISES? By Frank G. Lopez, A.I.A. | |
| HOUSE FOR MR. AND MRS. CHAUNCEY RILEY | 142 |
| New Canaan, Conn. Chauncey W. Riley, Architect | |
| RESIDENCE OF MR. AND MRS. E. J. GREANEY | 147 |
| Honolulu, T.H. Vladimir Ossipoff, Architect; R. O. Thompson, Landscape Architect; Robert Ansteth's Ltd., Interior Decorator | |
| WINDOWLESS OFFICE FOR AN ENGINEER | 152 |
| P. L. Davidson Office Building, Greensboro, N. C. Charles C. Hartmann, Architect | |
| OFFICE BUILDING FOR SÃO PAULO, BRAZIL | 154 |
| Rino Levi, Architect; Roberto Cerqueira Cezar, Associate Architect | |
| | |
| ARCHITECTURAL ENGINEERING | |
| TECHNICAL NEWS AND RESEARCH | |
| ARCHITECTURAL PROBLEMS IN ATOMIC LABS | 159 |
| By A. D. Mackintosh | |
| CHECK LIST TO SAVE METALS IN HOUSES | 165 |
| By Leonard G. Haeger | |
| PRODUCTS . . . For Better Building | 167 |
| LITERATURE FOR THE OFFICE | 168 |
| TIME-SAVER STANDARDS | 171 |
| Radiant Heating Systems For Houses, 12-15: Hot Water Systems. By William J. McGuinness | |
| INDEX TO ADVERTISING | 6 |

THE RECORD REPORTS

HIGH QUALITY BUILDINGS TAKE CALIFORNIA AWARDS AS 114 ENTRIES COMPETE

32 Projects in Seven Groups Honored in A.I.A. Program

ARCHITECTS, owners and contractors shared the honors when the awards were given for 32 building projects in a competition sponsored by the Southern California and Pasadena chapters of the American Institute of Architects.

The first architectural competition in the area in three years drew 114 entries in seven categories; but its success didn't have to be measured by size, as the quality of the buildings shown here and on the next two pages testifies.

Besides the two Distinguished Awards and 11 Honor Awards, there were 18 Honorable Mentions and one Special Citation. The competition was open to all members of the sponsoring chapters, about 500 in all. Buildings erected since 1946 were eligible for submission.

A three-man jury spent four days screening the entries. Jurors were Dean William Wurster of the University of California's School of Architecture; Harris Armstrong of St. Louis; and Lawrence B. Perkins of Chicago.



Distinguished Awards: Children's camp for City of Los Angeles Department of Recreation and Parks—Whitney Smith, A. Quincey Jones and Edgardo Contini, architects, engineers and site planners; U.C.L.A. Elementary School—Robert E. Alexander, architect. Photo above shows play area in camp's main building and twin fireplace dividing it from dining area. Below: U.C.L.A. school entrance; use of outdoor area was commended



Distinguished Award winners with Southern California A.I.A. President John Landon and President Thomas S. Holden, F. W. Dodge Corp., special guest at presentation banquet. L. to r.: Whitney Smith; Mr. Landon; A. Quincey Jones; Mr. Holden; Robert E. Alexander; Edgardo Contini

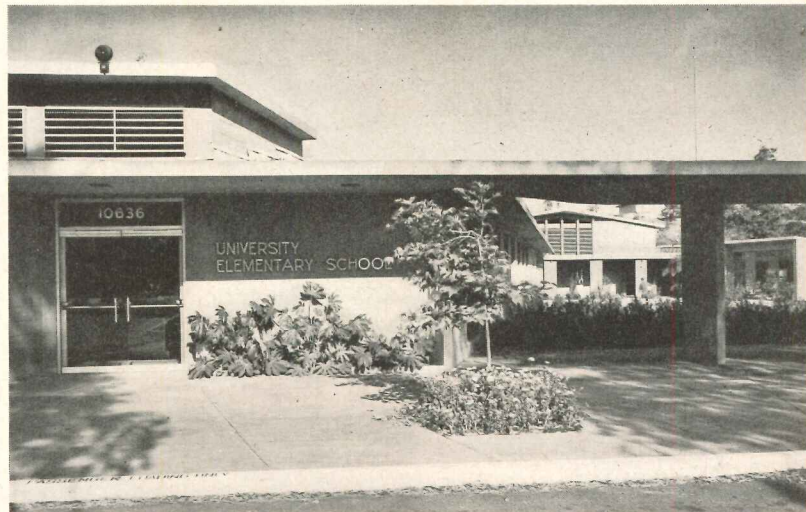

Julius Shulman photos

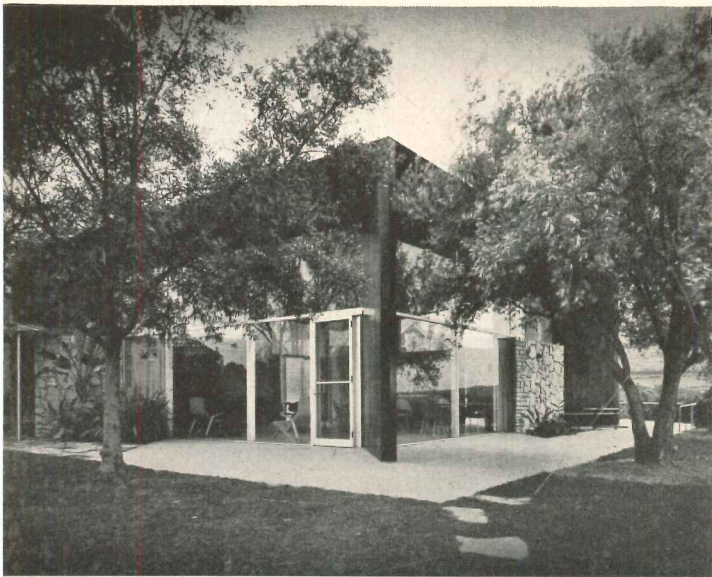

Residence of stone, redwood and glass for Mr. and Mrs. Arch Ekdale, San Pedro. Architects: Summer Spaulding and John Rex

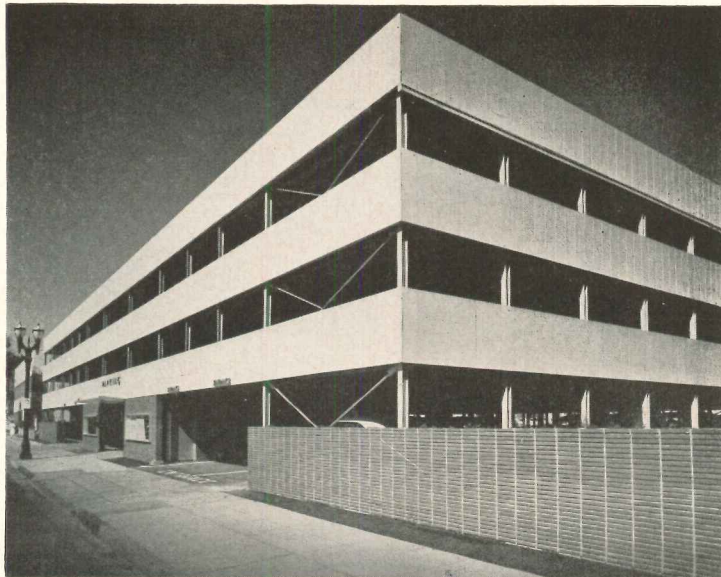

Multi-deck structure for Beverly Medical Center parks 400 cars in 94,848 sq ft. Architects and engineers: Pereira & Luckman

THE RECORD REPORTS: CALIFORNIA HONOR AWARDS

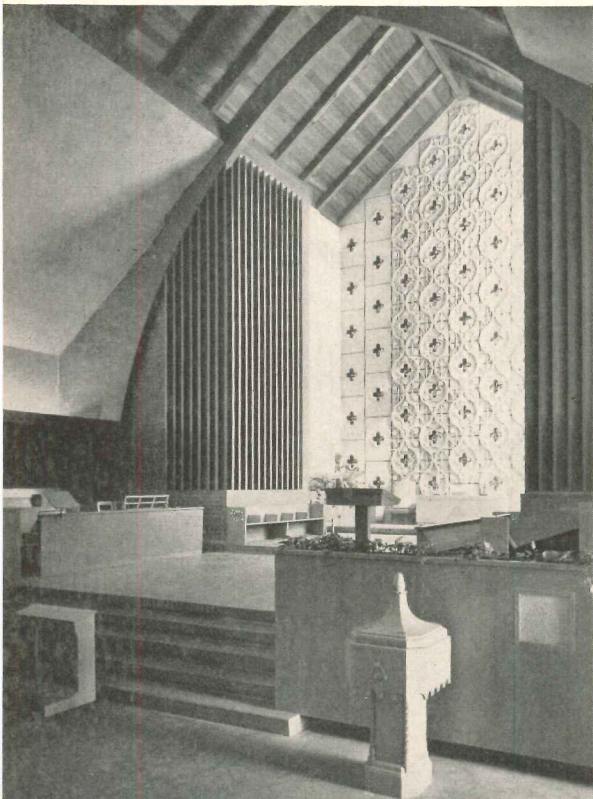
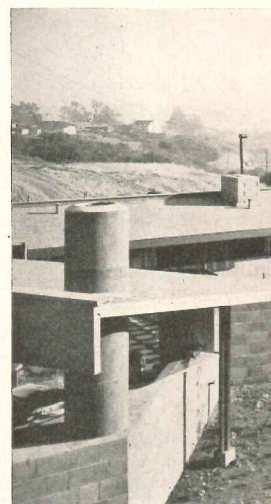

Oneonta Congregational Church, South Pasadena, brick and redwood. Architects: Marsh, Smith & Powell



Residence of redwood and natural stone for Miss Zona Hall, West Los Angeles, has outdoor pool. Architect: Edla Muir

Julius Shulman photos



Mid-Wilshire Medical Building for Pacific Projects, L. A. Architect: Victor Gruen; associate: R. L. Baumfield



Administration Building, Culver City Unified School District, Culver City, Cal. Exterior walls are brick and copper. Architects and engineers: Daniel, Mann, Johnson and Mendenhall

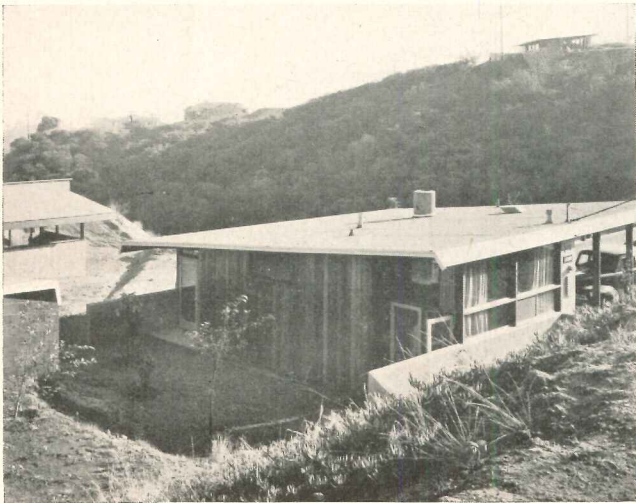

500-family community for Mutual Housing Association, Brentwood. Architects, engineers and site planners: Whitney Smith, A. Quincey Jones, Edgardo Contini



Residence and office for Mr. and Mrs. John E. Baird. Cost: \$6800 for 742 sq ft, including blacktop, paving of brick, curbs, fill planting and draperies. Architect: Edward Killingsworth



Residence of stone and redwood for Mr. and Mrs. Arthur Hanisch, Pasadena. Architect: Henry Eggers; assoc., Walter Wilkman



Residence of reinforced concrete, aluminum and glass for Mr. and Mrs. Warren Tremaine, Montecito, Cal. Architect: Richard Neutra

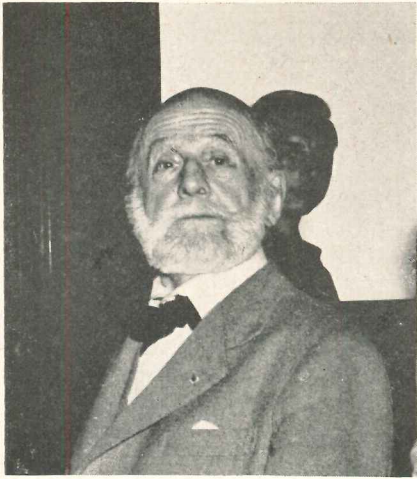

AUGUSTE PERRET NAMED FOR A.I.A. GOLD MEDAL

77-Year-Old French Architect Chosen for 1952 Award

AUGUSTE PERRET, 77-year-old French architect whose eminence has been little recognized outside the profession in this country, will receive the Gold Medal of the American Institute of Architects at the national convention of the A.I.A. in New York next June.

The Institute's highest professional honor has been awarded in recent years to Bernard Maybeck (1951), Sir Patrick Abercrombie (1950) and Frank Lloyd Wright (1949).

M. Perret, whose design of buildings in reinforced concrete has brought him worldwide recognition in the field, last visited this country in 1949. An exhibition of his work was shown in New York and Chicago in 1950.



Julius Shulman Photo

Another of the Honor Awards in the California program went to the Lea County Hospital, Hobbs, N. Mex., 80 beds, public and private. Architects and engineers: Pereira and Luckman; associate: Truman J. Mathews



A.I.A. President Glenn Stanton, in Charleston for last month's Craftsmanship Award meeting of the West Virginia Chapter, paid a visit to Governor Patteson at the same time. Above: L. D. Schmidt, chapter president; Walter F. Martens, president of the West Virginia State Board of Architects; Mr. Stanton; and the governor

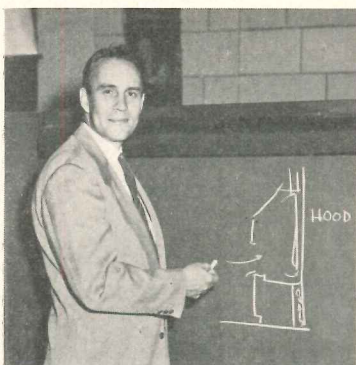

Alexander Macintosh, A.I.A., superintendent of New Facilities, Design and Construction at A.E.C.'s Oak Ridge National Laboratory, was one of the speakers at the BRAB conference. His article on radiochemical laboratories appears on pages 159-164 of this issue



At the recent Washington conference on design of laboratories to handle radioactive materials, jointly sponsored by the American Institute of Architects and the Building Research Advisory Board: A.I.A.'s Walter Taylor; Dr. W. N. Witheridge of General Motors; Bernis E. Brazier, architect; Charles Haines, of the architectural firm of Voorhees, Walker, Foley and Smith; and Thomas K. Fitzpatrick, chairman of the A.I.A. Committee on Atomic Design

METALS ARE THE BEST INSULATORS

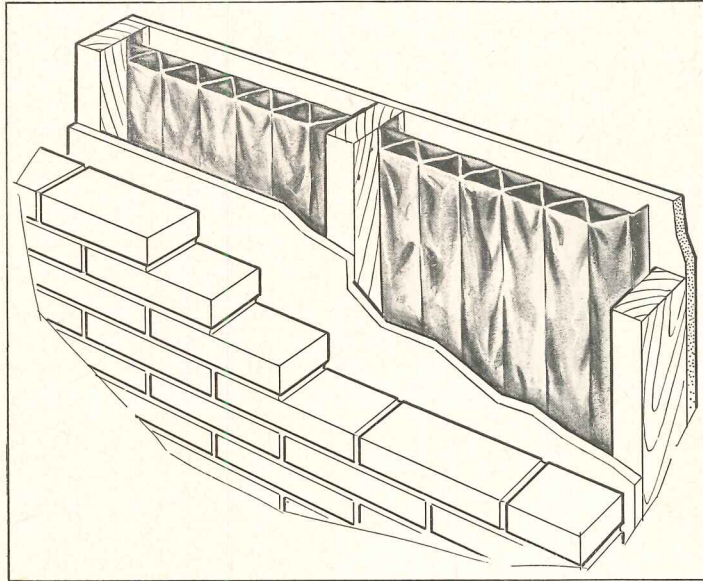

AGAINST HEAT AND COLD IN BUILDING SPACES

Ordinary iron is about 4 times better insulation in an air space than sheeps-wool, rockwool, asbestos, asphalt paper, brick, plaster, wood, marble, slate, tile, enamel. *Aluminum, brass, gold, silver, and many other metals are 40 times better.*

SPACE has slight density, therefore heat flow by CONDUCTION is slight. CONVECTION, which causes 15%-20% heat flow in space sideways, and 25% to 40% upwards, is BLOCKED by metals in space. RADIATION, responsible for 65% to 85% heat flow in space sideways and 55% to 75% upwards, is absorbed and emitted least by metal surfaces; from 1% to 5% with aluminum, brass, gold, silver; but over 90% with most building materials, including ordinary insulations.

Multiple sheets of metal, suspended in space, and spaced apart, make the supreme heat and cold insulation. One commercial form of this construction is Infra Accordion Aluminum Insulation, Types 4, 6, and 4 Jr.

*Write for interesting, informative, newly compiled, free
RADIATION AND ABSORPTIVITY CHART OF MOST BUILDING MATERIALS AND METALS
The facts contradict most people's preconceptions.*

INFRA THERMAL FACTORS, TYPE 4
Up-Heat C.134, R 7.46 = 3" dry rockwool
Wall-Heat C.107, R 9.34 = 3¾" dry rockwool
Down-Heat C.065, R 15.38 = 6" dry rockwool

INFRA INSULATION, INC.
525 Broadway, New York, N. Y.
PHONE: WO 4-2241

INFRA INSULATION, INC.
525 Broadway, New York, N. Y. Dept. R-1
Send FREE Radiation & Absorptivity Chart.

Name _____
Firm _____
Address _____

Send Prices of Infra Insulations Send Sample

Fine Flush Valves for Fine Buildings

For complete information on Watrous Flush Valves write for catalog No. 449-A.

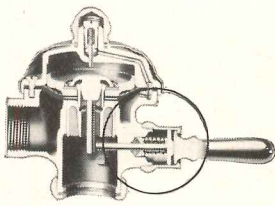

Among Watrous Fine Features

Self-Tightening Handle Packing

The spring-loaded packed stem in Watrous Flush Valves automatically maintains proper tension on the packing at all times. Provides real protection against leakage, yet requires no periodic tightening.

SAKOWITZ BUILDING,
Houston, Texas Dept. Store
One of the many fine buildings equipped with
Watrous Flush Valves

ALFRED C. FINN, F.A.I.A.
Architect

REG. F. TAYLOR
Mechanical Engineers

BARBER PLUMBING COMPANY
Mechanical Contractors

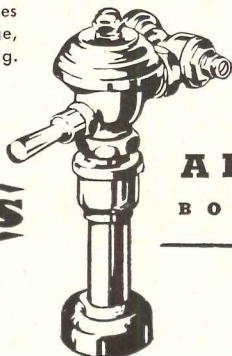

Watrous

ADJUSTABLE FLUSH VALVES
BOTH DIAPHRAGM AND PISTON TYPES

THE IMPERIAL BRASS MANUFACTURING COMPANY

1240 W. Harrison Street

Chicago 7, Illinois

NEWS FROM WASHINGTON *by Ernest Mickel*

Fleischmann Promises Materials Allocations by Project, Not by Quarter; End-Use Orders Expected for "B" Product Manufacturers; Shelter Design Manuals Coming March 1; Coogan Heads Housing for Armed Forces; Industry-Wide Session on Controls Set February 12

THE CONSTRUCTION INDUSTRY for the most part began its 1952 operations in an atmosphere of little optimism. The truce talks had bogged down in Korea during December. Defense agency officials had said repeatedly that settlement of the Korean conflict would have little effect (immediate effect) on the country's ever-accelerating mobilization program. Mounting, rather than diminishing, controls faced builders, large and small.

The possibility of one change in administration of controls appeared in Manly Fleischmann's "promise" to the Executive Committee of the American Institute of Architects of allocations of controlled materials for building on a project, rather than a quarterly basis.

Such a system would insure that what's started can be completed, and the A.I.A. hailed the statement as "the first major indication that the stream of critical evaluations of CMP . . . is having some effect on NPA policies."

When and how the statement would be implemented was not immediately apparent, but some amendments were expected early in the new year. Mr. Fleischmann acknowledged that the quarterly system had caused many difficulties in building, with its long-term commitments.

There was strong talk — and it was not without foundation — that new conservation orders would be applied soon to manufacturers; the "B" product producers who turn out thousands upon thousands of items that wind up as components, or finished products themselves, in completed equipment and projects. This talk was not new to the architects who, in a sense, had led the way toward greater conservation of scarce materials in their design practices.

While Defense Production Administration declined to confirm the reports as of mid-December, informal statements by defense agency officials indicated that the orders were being prepared to be in readiness for application when

circumstances demanded them. When might this be? The most reasonable guess being made was right after the first of the year. Certainly, if the conservation regulations were to be applied, they could not wait until after exhausted inventories emptied the pipelines of supply and sent the plans for controlling the economy into a tailspin.

Inventory Trouble Coming

Inventories were fast becoming objects of greater concern at the turn of the year. In the building materials line, both DPA and National Production Authority spokesmen warned that things had been running fairly smoothly up to January 1, but that trouble from dwindling stocks could be expected in the first quarter of 1952. This was hammered out at every opportunity with special emphasis on the condition of copper and

brass supplies. Here, DPA and NPA frankly looked for trouble to develop rapidly; trouble so severe that many producers, mainly smaller ones, might be thrown out of business altogether.

The plan to inaugurate the conservation (or limitation) orders was being devised as a supplementary assistance to the Controlled Materials Plan. It was believed the system could work as a prop to aid in keeping many firms in business that might otherwise have to fold, or at least turn to other lines that did not use the scarcest materials.

Standardization Tied In

Tied in with the conservation plan was a program of standardization and simplification conceived to throw available material into the production of more goods without actually depriving the manufacturer of any of his allocation. This apparently anomalous plan sought to force a simplification of design for many end items — such as door handles, locks, gears and a large array of construction products — resulting in the output of more of these without any increase in the quantities of material assigned to the manufacturer. In short, cutting out the frills and non-utilitarian features that consume any steel, copper, aluminum, nickel, etc. in the present processing can bring much larger numbers of needed goods for construction as well as durable goods production.

(Continued on page 26)



— Drawn for the RECORD by Alan Dunn

"Now the next move is up to Mrs. Truman . . ."

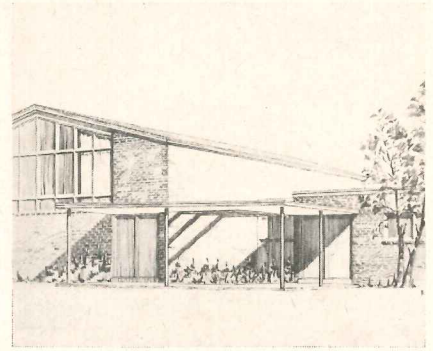
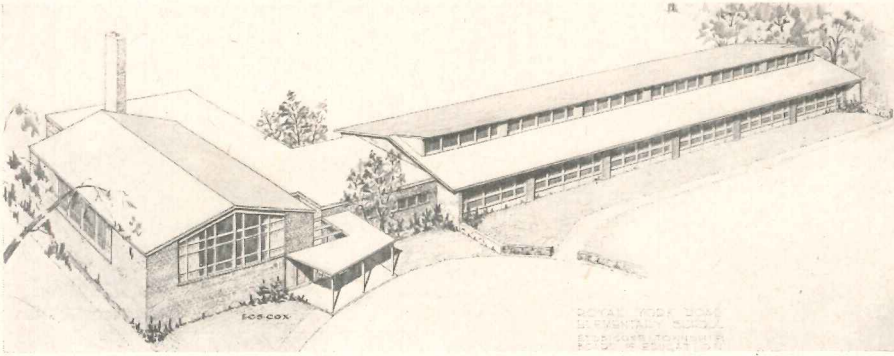

Royal York Road Elementary School, Etobicoke, Ont., features clerestory lighting on same side of room as conventional lighting. Architect: E. C. S. Cox, Islington

NEWS FROM CANADA by John Caulfield Smith

Architects and Engineers Reported Top Earners

ARCHITECTS AND ENGINEERS led all other Canadian earners in 1949, according to a government statistical report published in November.

Together they edged out lawyers and doctors, who in 1948 held first and second places respectively.

The tax collector counted 1210 architects and engineers. They had an average income of \$10,248, were the only group whose average topped the \$10,000 mark. Their average income tax amounted to \$2460.

Wanted: A Company to Build New Cities

CANADA'S SHIFT from an agricultural to an industrial economy has been dramatically emphasized by the Ford Company's decision to build a multi-million

dollar plant on 427 acres of farmland outside Oakville, Ont.

The new plant will employ 5000 workers. With their families, they'll constitute a town of 20,000 people. Since many of Ford's suppliers are expected to follow the company to Oakville, the population may actually be closer to 40,000 or 50,000. Present population is 7000.

Challenge to Planners

Obviously, comments *The Financial Post*, a leading business newspaper, here is a great opportunity for constructive community building. Conjured up is the vision of a thoroughly modern city with wide, well-laid-out streets, handsome schools and other public buildings, shopping centers with ample parking areas, clean industries, and quiet, attractive residential sections.

"In its way," the *Post* observes, "it could be as far in advance of the con-

glomeration of ugly chaos that characterizes most of our urban settlements as today's Ford is ahead of the Model T."

Zoning Safeguards Provided

The problem is how to make the dream come true. Local municipal authorities have had the foresight to draft zoning bylaws to guide the future development of the Oakville district. But zoning is necessarily restrictive rather than creative.

What is needed, says the *Post*, is something that doesn't exist. There is no community building agency in Canada with sufficient authority and capital to assume control of a new city site, plan it, build on it and turn the result into a happy, safe, rewarding place to work and live. Despite the possibilities for profitable, long-term investment that exist when the preservation and appreciation of realty values are assured, there's no organization to do the job that should be done for prospective residents of new cities and towns.

One Way to Do It

Precedents in the way of community building exist in U. S. and Britain, but they are public, not private. Perhaps a joint effort could be worked out in Canada.

The province of Ontario possesses the legislation, including the right to expropriate, to assemble land without paying speculators' profits. At the same time, life insurance companies have tremendous sums to invest. Some of them, notably Sun Life, have been active in financing new U. S. communities like Park Forest, outside Chicago. They might welcome a chance to do as much in Canada.

(Continued on page 288)



St. Louis-Marie de Montfort Hospital, Ottawa, will provide 218 beds and 67 nursery cubicles, four major operating rooms, two delivery rooms and emergency operating suite as well as the usual diagnostic facilities. The top floor has accommodations for 50 nuns and nursing sisters. There is also a chapel seating 200. Kitchen and dining facilities are in the basement. Substructure is reinforced concrete; superstructure steel frame; exteriors will be cream brick. Architects: LeFort & Gilleland, Ottawa

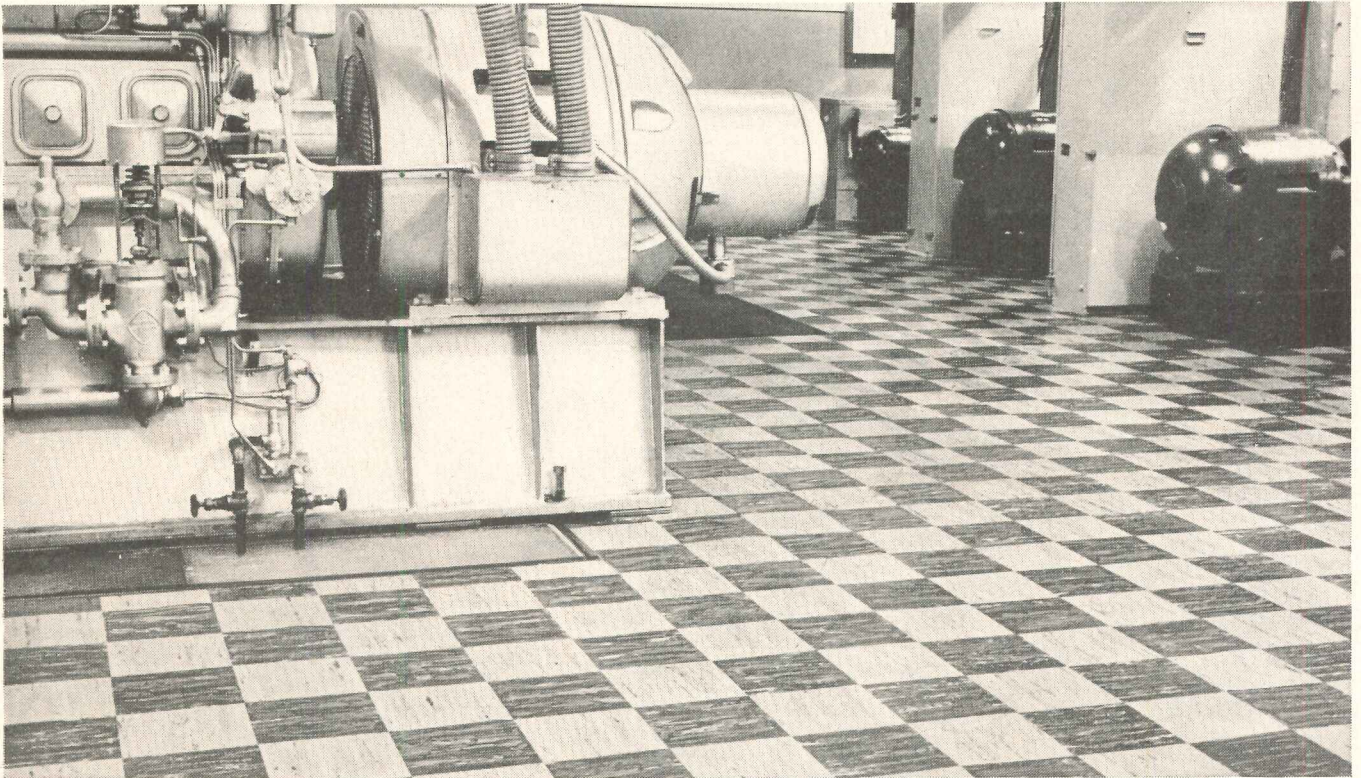
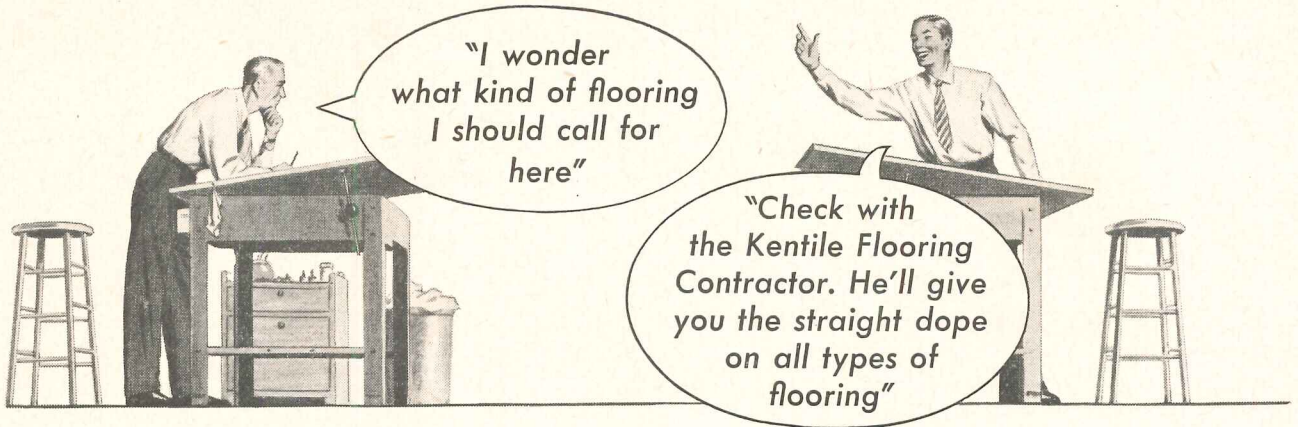

Special Kentile (greaseproof) is ideal for power rooms, machine shops, restaurants . . . wherever greases, oils, alcohol, alkalis, most acid solutions, or extra heavy traffic present a maintenance problem.

The practical and time-saving solution to any flooring problem is a call to the local Kentile Flooring Contractor

THE OBVIOUS advantages of a certain kind of flooring in a certain installation are often outweighed by disadvantages that can be foreseen only by the expert. To keep posted on the great number of products and materials available today would be so time-consuming

that busy specifiers everywhere are learning to count on specialists for accurate and up-to-date information. Such a man is the Kentile Flooring Contractor. Call on him as often as you wish... you'll find his extensive background makes him a valuable addition to your "staff."

KENTILE • SPECIAL KENTILE • KENCORK • KENTILE RUBBER TILE



KENTILE INC.

KENTILE, INC., 58 Second Avenue, Brooklyn 15, New York • 350 Fifth Avenue, New York 1, N. Y. • 705 Architects Building, 17th and Sansom Streets, Philadelphia 3, Pennsylvania • 1211 NBC Building, Cleveland 14, Ohio • 225 Moore Street, S.E., Atlanta 2, Georgia • 2020 Walnut Street, Kansas City 8, Missouri • 1440 11th Street, Denver 4, Colorado • 4532 South Kolin Avenue, Chicago 32, Illinois • 1113 Vine Street, Houston 1, Texas • 4501 Santa Fe Avenue, Los Angeles 58, California • 95 Market St., Oakland 4, Calif. • 452 Statler Building, Boston 16, Mass.

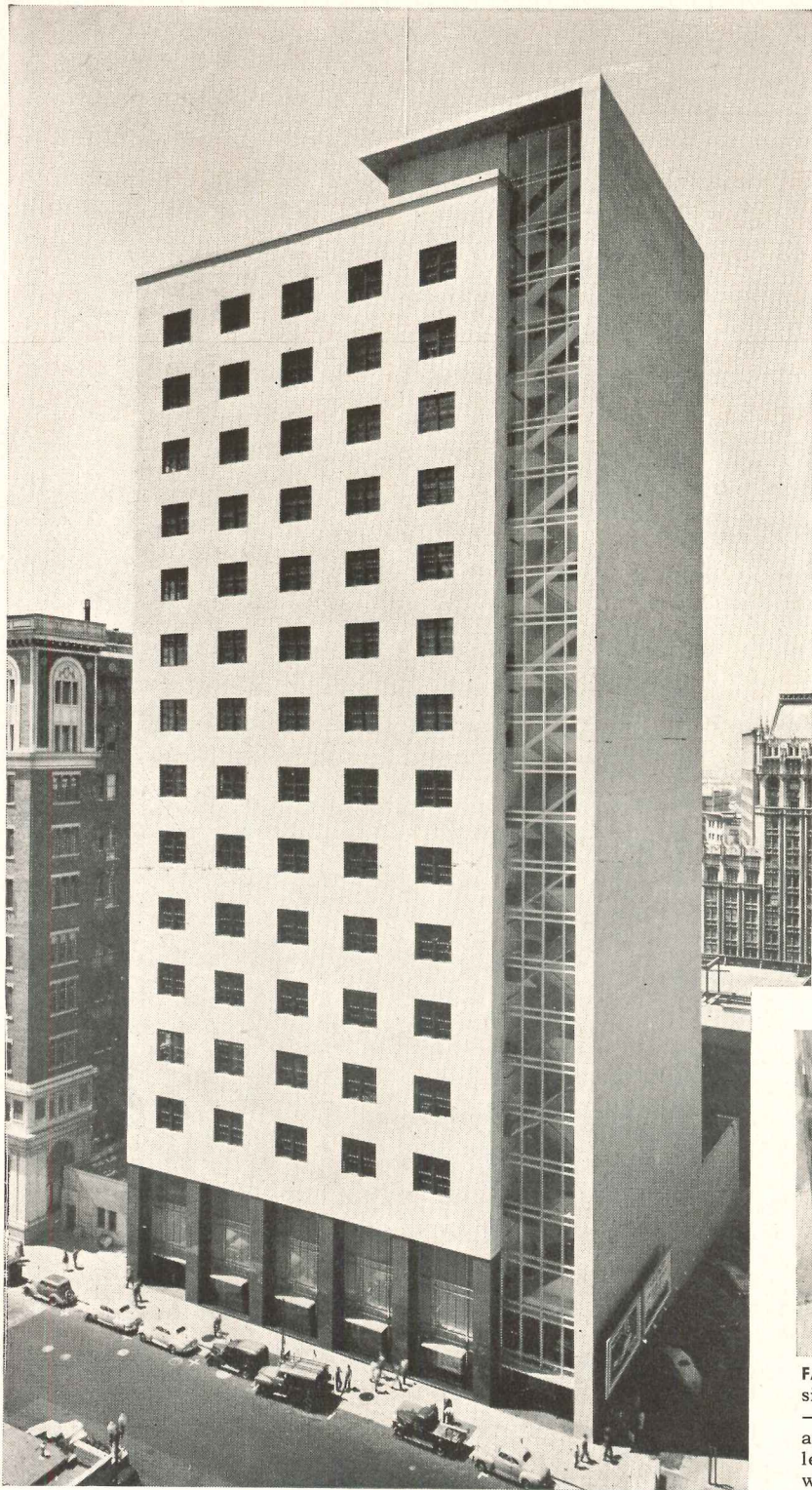

PACIFIC TELEPHONE & TELEGRAPH Company's Oakland, California, building used 49 tons of aluminum ducts in the heating and ventilating system. More than 90 per cent of it is *Kaiser Aluminum*.

ARCHITECTS: Thomsen & Wilson,
San Francisco

BUILDER: Dinwiddie Construction
Co., San Francisco

**HEATING AND VENTILATING
CONTRACTOR:**
Scott Company, San Francisco

LIGHT, STRONG, corrosion-resistant *Kaiser Aluminum* is installed faster with less worker fatigue than heavier materials. Without insulation, it delivers as much heat as insulated galvanized steel—a fact proved in engineering tests.

ALUMINUM...



KAISER ALUMINUM SIDING, installed vertically in *The Cotton Shop*, Chicago, gives effect of height, fits curved surface, hides heavy columns. Baked-on enamel coat is smooth, easy to clean, lasts longer. Architects: Walter H. Sobel, J. Stewart Stein. Contractor: Lee Construction Co., Chicago.

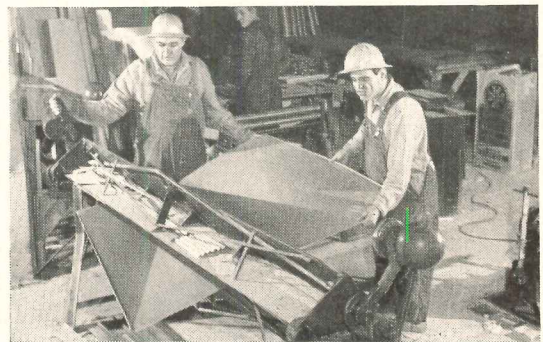

FABRICATING KAISER ALUMINUM into ductwork is so simple the contractors set up shop right on the job—and eliminated several steps in handling, trucking and storing assembled sections. *Kaiser Aluminum* is less wearing on shop equipment, can be fastened with rivets, by welding or with sheet metal screws.

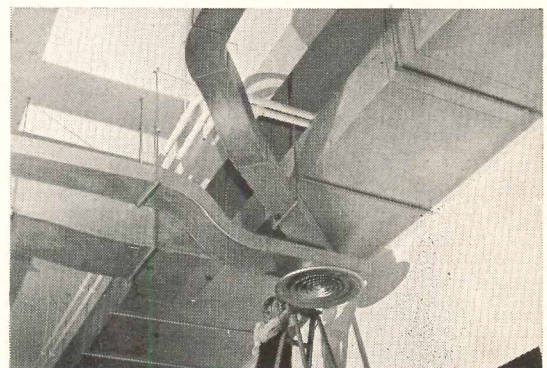

BUILDING MATERIAL OF THE FUTURE!



TEST: Glaring, direct rays of the sun made west rooms of Tulsa's Alvin Hotel uncomfortable, caused requests for space changes. Kaiser Aluminum Shade Screening was tested for a full summer on a few west windows and proved it blocked the sun without blocking light and air.



RESULT: Kaiser Aluminum Shade Screening was applied to *all* west windows. Now the Alvin's west rooms are always cool and inviting, easy to rent. The hotel management reports Kaiser Aluminum Shade Screening has improved the exterior appearance, too, with its modern, gray-green alodized finish.



KAISER ALUMINUM ROOFING makes an attractive, modern store facade. Used as a remodeling material, it gives older buildings new sparkle, fresh appearance. Lower in cost than most architectural specialties, it needs minimum of maintenance because it's *solid* aluminum, not clad or veneered.

Aluminum will be among the most plentiful of metals when the present industry-wide expansion program is completed.

The building industry will see many new uses of this versatile metal as supplies increase.

So keep aluminum in your plans. Use it whenever and wherever you can. Be prepared to use it in a wider variety of applications in the future.

Check the Advantages of Aluminum

Attractive, modern aluminum offers a unique combination of advantages found in no other metal.

It is light in weight, yet strong enough for rugged service. Corrosion and rust-resistant, it gives long life with minimum maintenance.

On the job, aluminum keeps cost down because it is

easy to handle and to fabricate. And it is lower in cost than most architectural specialties.

Heavy demands of the national security program limit the availability of aluminum. But before you specify less-satisfactory substitutes, check your dealer's supplies. You may still be able to give your clients the best: *Aluminum!*

Typical examples of Kaiser Aluminum

Building materials made of Kaiser Aluminum offer exclusive advantages in design, beauty and quality. Representative applications shown here prove *today* they're the building materials of the future.

For full information about any Kaiser Aluminum building product—and for AIA files—write: Kaiser Aluminum & Chemical Sales, Inc., Oakland 12, California. Sales offices in principal cities.

Kaiser Aluminum

*A major producer of
building materials for home, farm and industry*

HOW GOOD IS GOOD DESIGN? CONSUMERS SPEAK



Most liked by consumers: oak frame chair with reed seat. Designer: Hans Wegner

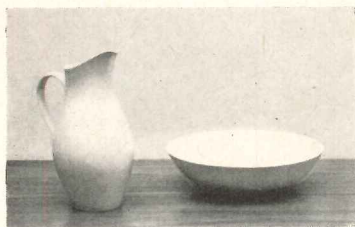

Porcelain pitcher by Trude Petri-Raben, one of three much liked by consumer voters

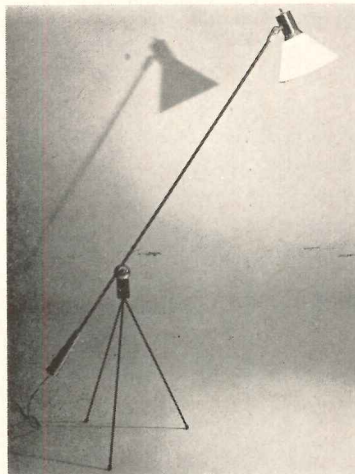

Gilbert A. Watrous' metal tripod floor lamp was another highly popular item

THE 1951 GOOD DESIGN EXHIBITION at the Museum of Modern Art was the springboard for a spirited discussion at the second of the Museum's current series on "The Related Arts of Today."

Basis of the discussion, "How Good Is Good Design," was a collection of objects from the exhibition which a poll of consumer visitors had indicated were "most liked" and "most disliked."

On this occasion the "experts" and the consumers were not as far apart as is sometimes suggested. The simplest designs met with warmest approval from the consumers; and the professionals



A wooden chair with a flavor of "traditional" was among consumer "dislikes"

liked their choices, but were equally pleased with more complicated designs.

Members of the panel differed among themselves on some points, leading one of them, Ceramic Designer Eve Zeisel, to provide a useful summary statement with the reminder that "love is a very personal thing."

Others on the panel were: Christine Holbrook, editor of *Better Living*; Lasette van Houten, fashion editor of *Retailing Daily*; Paul McCobb, furniture designer; and Russel Wright, home furnishings designer. Edgar J. Kaufman, director of the Museum's Good Design project, was moderator.

Gropius Wins Howard Myers Award

DR. WALTER GROPIUS of Harvard has received the first Howard Myers Memorial Award of \$500 for the "best written, most progressive and most influential" architectural writing in periodicals.

The award was given for Dr. Gropius' article "Not Gothic but Modern for Our Colleges," published in *The New York Times Magazine*, October 29, 1949.

There were two honorable mentions: Walter L. Creese, for his article "Architecture and Learning," *Magazine of Art*, April 1950; and Jean Murray Bangs for "Prophet without Honor," *House Beautiful*, May 1950.

The award is administered by the Committee on Scholarships and Special Awards of the Architectural League of New York.

New Honors for FLW

FRANK LLOYD WRIGHT was among six Americans recently elected to membership in the American Academy of Arts and Letters. The Academy, which has a life membership limited to 50, chooses each new member as "a creative artist whose works are most likely to achieve a permanent place in American culture."

Mr. Wright has recently been named for another award — he was one of 100 persons to get "Centennial Awards for the Northwest Territory" at the Centennial Convocation of Northwestern University on December 2.

Architectural League Honors Sculptors

THREE AMERICAN SCULPTORS, Henry Kreis, Helen Wilson and Koren der Harootian, received honorable mentions for their entries in the Gold Medal Sculpture Show of the Architectural League of New York, this year holding its 55th annual Gold Medal Exhibition series. The jury felt that no entry merited the Gold Medal.

TOP AWARDS: AMERICAN SCULPTURE, 1951

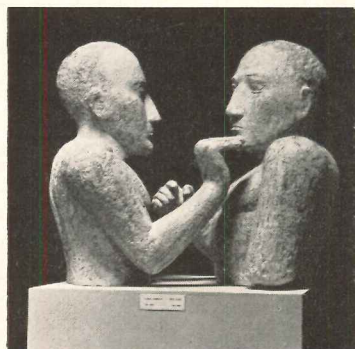

For her cast stone statue "Two Men" (photo far left), New York Sculptress Minna Harkavy has won the \$3500 first prize in the nationwide competitive sculpture exhibition sponsored by the Metropolitan Museum of Art. Rhys Caparn, also of New York, won the \$2500 second prize for her hydrocal "Animal Form I" (photo at left). Other awards: third prize, \$1500—Abbott Pattison, Chicago, for the bronze "Striding Man"; fourth prize, \$1000—Joseph J. Greenberg Jr., Huntingdon Valley, Pa., for the bronze "Eve"; Honorable Mention—Emil Lazarevich, Palo Alto, Cal., for the cast stone "Woman with Lyre."

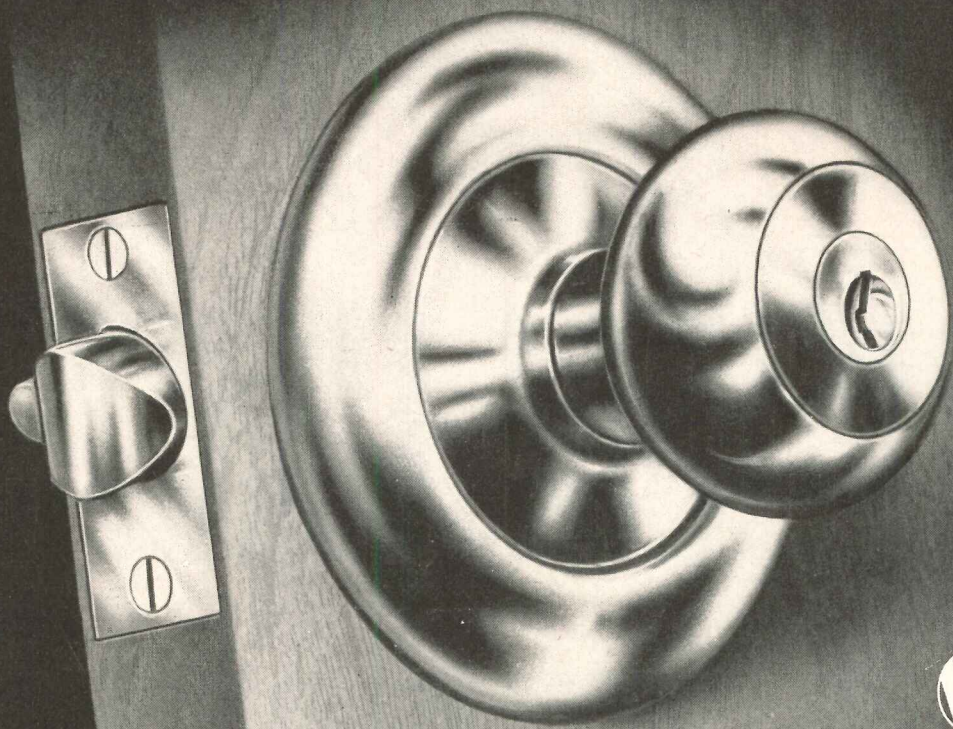

WESLOCK

CYLINDRICAL LOCKS

Melody design

large escutcheon No. 256 shown
with WESLOCK No. 240 five-
pin tumbler entry lock set.



New heights in style

Accepted by Architects and Builders as one of the most modern lock set accessories, the WESLOCK Melody escutcheon is the only design of its type available in any line. Although budget-priced, WESLOCKS are of the highest quality and unconditionally guaranteed. Send for a catalog of the complete WESLOCK line which is the best at *any* price.

WESTWOOD

MANUFACTURING CO.
1420 South Evergreen Avenue
Los Angeles 23, California



Another WESLOCK installation,
Richlee Gardens, Mineola, New York,
204 apartment units—FHA insured.

Architects: Samuel Paul Associates,
Jamaica, New York

Builder: Silbert Construction Co.,
Great Neck, New York

Hardware Contractor: Samuel
Golden, Brooklyn, New York

Another Herman GERMICIDAL LAMPS

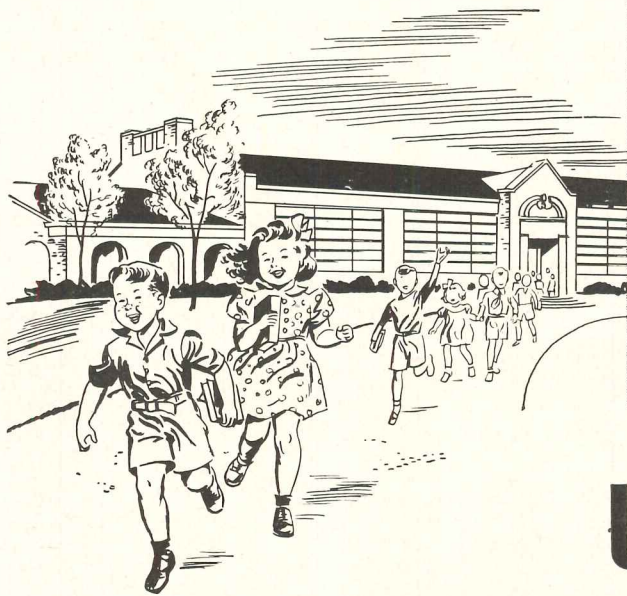

DRAFT

UNIT VENTILATORS

In 1918 Herman Nelson pioneered the first of a new type combined heating and ventilating unit for schoolroom use—UNIVENT. **In 1930** Herman Nelson Engineers produced the first unit ventilator which recirculated a portion of the air in the room as well as bringing in fresh air from the outside. **In 1950** Herman Nelson introduced the radically improved DRAFTSTOP system to solve the problem of drafts created by the larger window areas of modern schools.

Now Herman Nelson has done it again! In cooperation with the engineers and scientists of the General Electric Company DRAFTSTOP units are now available with germicidal tubes within the unit.

Out-of-doors as a result of the rays of the sun and air dilution the air is relatively germ free. But indoors, air

sanitation is needed, particularly in areas with high occupancy such as schoolrooms. The remarkable germ-killing effect of ultraviolet rays on airborne germs is well known. Now these rays generated by germicidal ultraviolet tubes are put to work purifying the air as it passes through the unit ventilator. Germ kill is high and as a result the treated air carries fewer respiratory infections. That means better pupil and teacher health for the air within the school becomes equivalent to outdoor air.

If you are responsible for the building or remodeling of school buildings you should have full information about this newest Herman Nelson advance in schoolroom ventilation. Write Dept. AR-1 today for complete information.

Nelson First

NOW AVAILABLE IN

STOP

THE MODERN
HEATING-VENTILATING
UNIT FOR SCHOOLROOMS

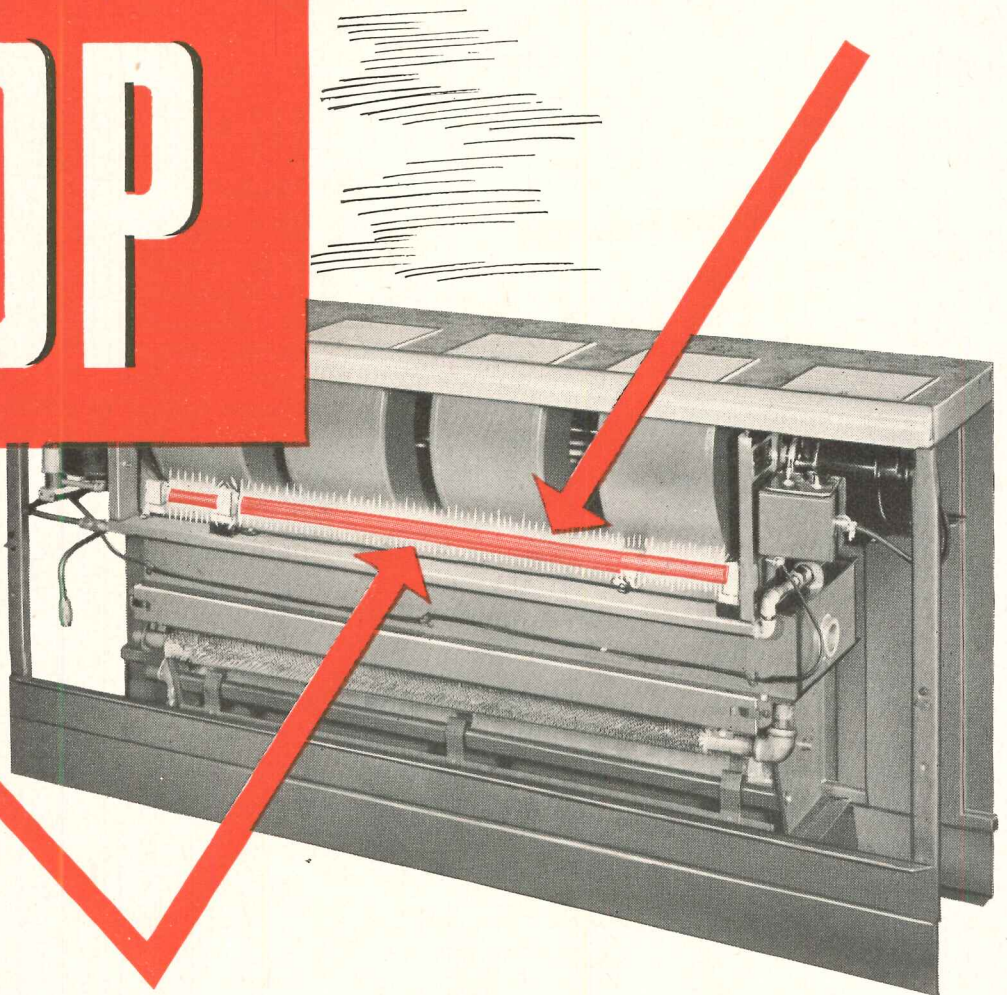

HERMAN NELSON

Division of AMERICAN AIR FILTER COMPANY, INC.

MOLINE, ILLINOIS

THE RECORD REPORTS

Officials are not fooling themselves into thinking that the implementation of this plan will result in saving any steel, copper or aluminum at the source, they say. But they remain convinced that something must be done if and when inventories dwindle too far, and they feel it's better to be prepared in advance. As one said: "If nothing is done, there just won't be enough to go around."

WASHINGTON (Cont. from p. 17)

Their answer, then, lies in revising specifications, reducing the size and varieties of manufactured items in the hope that this will bring a multiplication of finished products rolling off the assembly lines.

More than CMP

The CMP has been content with apportioning estimated available supplies of steel, copper and aluminum. The use

of this material, once it reached the producer, was largely up to him. Conservation orders would change this in that manufacturers would be told how and just to what extent the materials could be used in each product processed. Labor, production and handling costs would be saved at the same time.

There already is much activity along these lines — all of a voluntary nature. This was inevitable, say the planning officials, with allotments of scarce materials being cut so drastically. When a producer's "take" on copper drops to only 40 per cent of his base period use, for example, he's going to begin to think in terms of conserving that supply and stretching it into the production of more items. But the whole scheme apparently is not moving fast enough on the voluntary basis to suit the federal officials. They want to forestall trends that developed in World War II when some producers went the other way; dressed up their products with needless metal-consuming features to put them in a better competitive position. Limitation orders stopped the practice then; conservation orders might nip it now before it gets started on a broad basis.

Producers May Resist

Industry reaction, aside from patriotic motives, can be expected to be resistance. There will have to be assurance that the metal saved by design simplification can be used by the producer to further his output. This promises to be one of the knottiest problems in the proposal.

During the past few weeks some DPA officials have expressed their conviction that much improvement in the supplies of controlled materials could result from the application of a simplification and standardization system.

Follin Group for Program

Conservation in the use of controlled materials (principally metals) in the supplies for building purposes is being promoted every day by the construction subcommittee of DPA's Conservation Coordinating Committee. This group, headed by James W. Follin, is going to resist any move that might be made toward the substitution of ersatz products such as the plumbing fixtures turned out during World War II, but it will favor just as strongly the saving of metals through standardization and simplification. It points out that simplification cuts down the number of product lines at once and reduces inventory take while permitting usage to stay at the

(Continued on page 28)

NOW! SKYLIGHT WITH RESOLITE



Resolite is shatterproof. It can be worked, sawed, drilled with ordinary tools, and its installation ease is economical of man-hours.

TRANSLUCENT STRUCTURAL PANELS

Resolite makes large skylight and wallight areas economical for corrugated industrial buildings because no special framing is required, either for support or weatherproofing — it nests with any standard corrugated sheet. Resolite permits substantial savings in plant lighting by its efficient diffusion of daylight through the building interior.

Structurally rugged, chemically immune to weather extremes, and most industrial fumes, Resolite gives long life without protective treatment. Resolite is molded in standard sheet sizes and corrugations, made of polyester resins, reinforced with fiberglass mat — a quality product with controlled uniformity of thickness for strength and durability.

SPECIAL ARCHITECTURAL USES, TOO!



Interior and exterior decorative beauty is easy to obtain with Resolite's wide variety of colors and corrugated patterns. Store fronts, marquees, bar facings and patio covering are simplified in structure and assembly. While transmitting light freely, Resolite is impervious to vision, making it ideal partitioning for offices, shower stalls and toilet compartments.

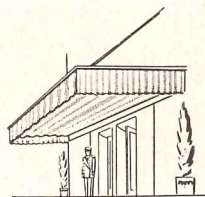

Write for free literature

RESOLITE CORPORATION

ZELIENOPLE, PA.

Like an
ENTIRE CITY
UNDER ONE ROOF

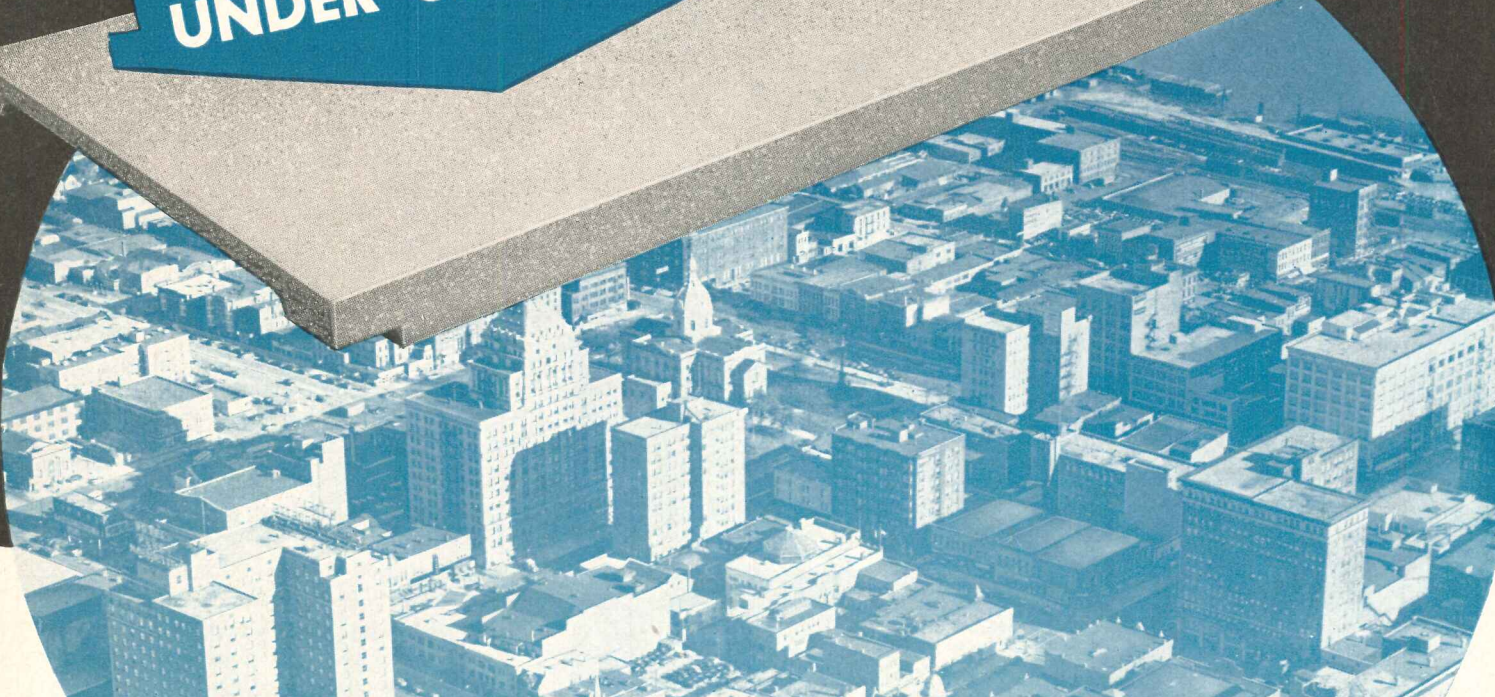

**THE TREMENDOUS NUMBER OF
FEDERAL ROOFS IN SERVICE TO-
DAY WOULD ALMOST COVER AN
ENTIRE CITY THE SIZE OF PEORIA,
ILLINOIS. (POPULATION OVER 110,000)**

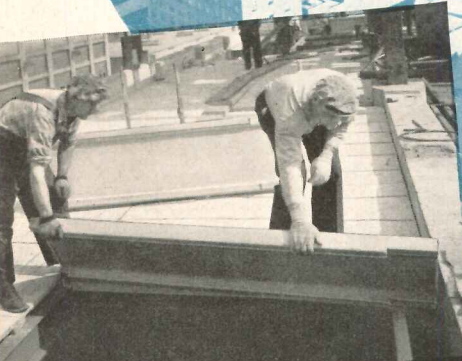

This vast expanse represents the thousands of Federal Roofs furnished over the past 45 years, for buildings of every size, shape and purpose. Yet this area is more than just a figure, because every contract has carried with it the responsibility of providing a roof to meet fully the individual requirements of each one of these thousands of purchasers.

It is an accomplishment and a real tribute to the sustained high quality of Federal's Structural Concrete Precast Roof Slabs under all kinds of conditions. For they must serve as well for the most exacting and rigorous industrial and railroad service as for the school or church or other public building.

The record has one common denominator—the consistent demand for the only type of lightweight, permanent, firesafe roof deck available, requiring no painting, repairs or replacements . . . FEDERAL.

CATALOG ON REQUEST

FEDERAL-
Featherweight
**PRECAST
STRUCTURAL
CONCRETE
ROOF SLABS**

Caterpillar Tractor Co., Peoria, Ill. Building KK roofed with almost 850,000 sq. ft. of Federal-Featherweight Precast Concrete Slabs. Archt. Giffels & Vallet, Inc., Detroit; Contr. S. N. Nielsen Co., Chicago. Over 2,000,000 sq. ft. of Federal Roofs have been installed at this plant during the past 35 years.



ANY BUILDING — INDUSTRIAL OR INSTITUTIONAL — is a BETTER BUILDING WITH A FEDERAL ROOF

MADE, LAID AND GUARANTEED BY

FEDERAL CEMENT TILE COMPANY

EXECUTIVE OFFICES: 608 SOUTH DEARBORN STREET • CHICAGO 5, ILL.

FOR FORTY-FIVE YEARS

SALES OFFICES IN PRINCIPAL CITIES

New BETTER WAY TO FASTEN CURTAIN WALLS

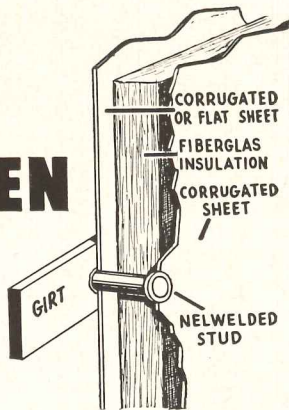

**SOUNDER CONSTRUCTION
NEATER APPEARANCE
WITH NELWELD METHOD**

1 in a split second, a Nelson granular flux-filled stud is end-welded to the girt with the Nelwelding gun. Only one type and size stud is required.

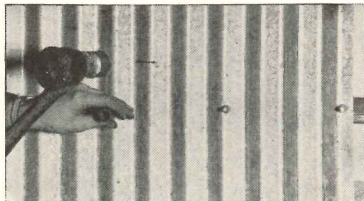

2 Inner sheet (corrugated or flat) is impaled over stud rivet extensions.

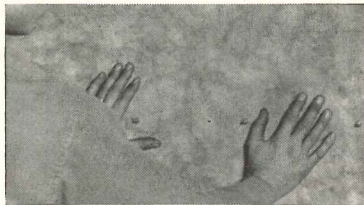

3 Insulation is quickly installed by impaling it over studs.

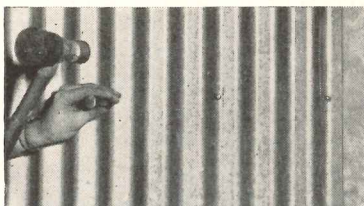

4 Outer corrugated sheet is impaled over stud rivet extensions and secured by riveting over burrs placed on stud extensions.

Nelson construction fasteners are distributed by United States Steel Supply Co., Reynolds Metals Co., Aluminum Company of America, Johns-Manville, Philip Carey Mfg. Co., Armstrong Cork Co., Southern States Iron Roofing Co.

When planning curtain wall, or sandwich type, construction, it will pay you to investigate and specify the Nelweld method of fastening. Used on such outstanding projects as the new Fairless steel plant, Morrisville, Pa., and the Lincoln Electric building, Cleveland, this method provides these advantages:

GREATER STRENGTH—Nelwelded studs become an integral part of the structure. The drilling (and weakening) of the structural steel is eliminated.

ONE-SIDE APPLICATION—Inside scaffolding is completely eliminated. All fastening is accomplished outside the structure. Application is safer.

FINE APPEARANCE—Positive alignment of sheets is provided by the Nelweld method. In addition, there are no exposed fasteners inside the building, resulting in neat appearance and easy painting maintenance.

COST-SAVINGS—Simplicity of the Nelweld application method results in fast erection and lower installation costs.

Full information and Nelweld Engineering Service are available to show the advantages of Nelweld methods as applied to your specific construction problem. Write Dept. A-O.

Nelson Approved Applicators throughout the country can bid and install your corrugated roofing and siding with the high-quality Nelweld method . . . Nelweld equipment is available for rental or purchase from Authorized Dealers.

Fasten it Better...at Less Cost, with

NELSON STUD WELDING

DIVISION OF GREGORY INDUSTRIES, INC., LORAIN, OHIO



THE RECORD REPORTS

WASHINGTON

(Continued from page 26)

same level. This, in turn, reduces the demand for raw materials.

One Opinion on Copper

Mr. Follin has summed up the copper situation as follows:

"The greatest question respecting construction in 1952, particularly in the latter half of the year, is the doubtful adequacy of many building supplies for the finishing of structures of various kinds. This refers particularly to plumbing, heating, electrical and hardware supplies. Copper allocations to these segments of manufacturing have been greatly reduced in the third and fourth quarters of 1951 and further reduced for the first quarter of 1952. Copper allocation to plumbing brass manufacturers for the first quarter is only about 35 per cent of the usage during the base period, which was the first part of 1950.

"It is difficult to see how an adequate number of necessary items can be manufactured from the greatly reduced metal supply, and conservation measures are very much in line here.

"The Industry Advisory Committee has recommended the adoption of a conservation program which would modify specifications, requiring substitutions where practicable, but also simplify production by reducing the variety of sizes and types. The latter move would make a one-time heavy reduction in metal use by reducing the amount tied up in inventories.

"Conservation can help close up the large gap between supply and demand. The pipe line of such products is still running fairly full and the real shortages may not be felt until the first or second quarter of 1952."

Design Effects: Now and Later

The architect is among the first to realize the effect of material shortages and to do something about it. In house design his influence already has been felt to a marked degree and will be increasingly shown in the months ahead. The private home builders recognize this when they say that the need for conservation of critical materials is going to stimulate many new ideas in home planning and in design and specification of materials in 1952.

(Continued on page 30)

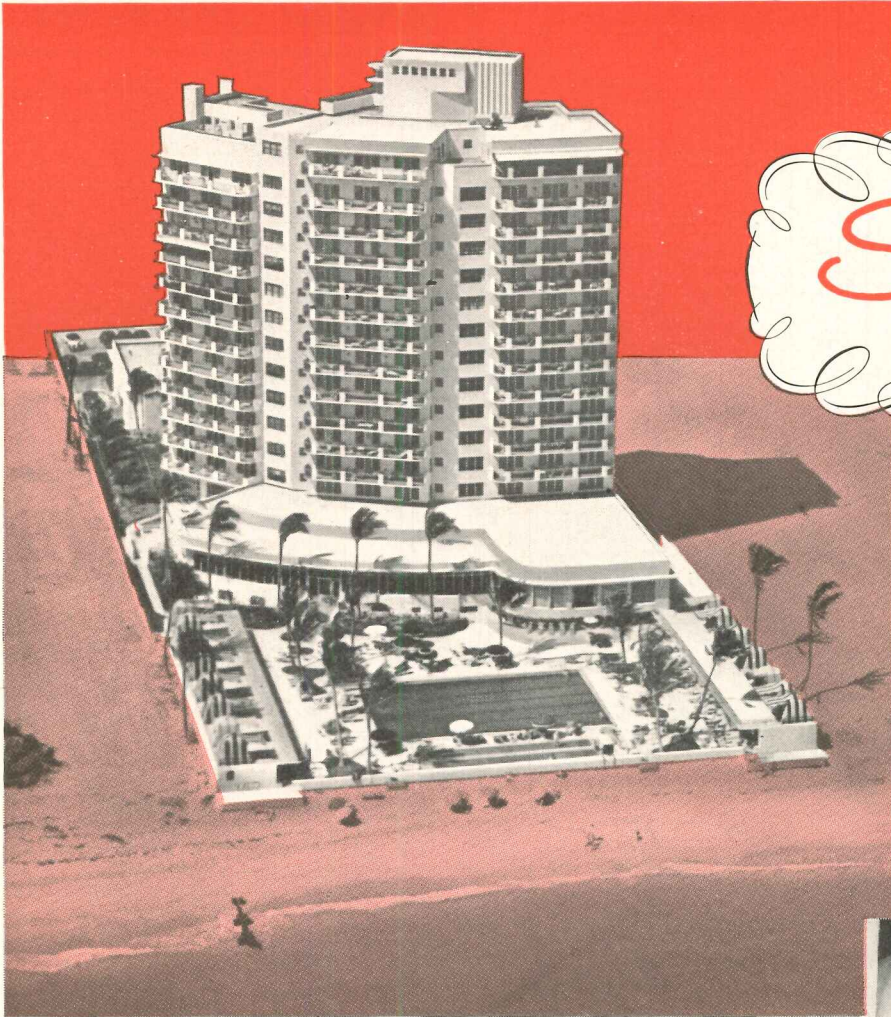

*Nothing but the best
for the beautiful*

Sea View
HOTEL
MIAMI BEACH, FLA.



Architects
Roy France and Sons, Miami Beach, Florida
Consulting Engineers
Jorgensen & Schreffler, Miami, Florida
Contractor
Feldman Building Corp., Miami Beach, Florida

Another Prominent Florida Hotel Reports—

**"NO HOT WATER COMPLAINTS
WITH POWERS CONTROL"**

Preventing OVER-heated water supplied to plumbing fixtures and reducing the consumption of high cost fuel make POWERS automatic temperature regulators a highly profitable investment. Fuel savings alone often pay back their cost several times a year.

Better Control—Less Maintenance assured by durable construction and these features: Overheat protection; temperature adjustment has OILITE thrust bearing; valve stem lubricator and SILICONE grease provide more accurate control and minimum of maintenance. Bulletin 329 gives full information. May we send you a copy?

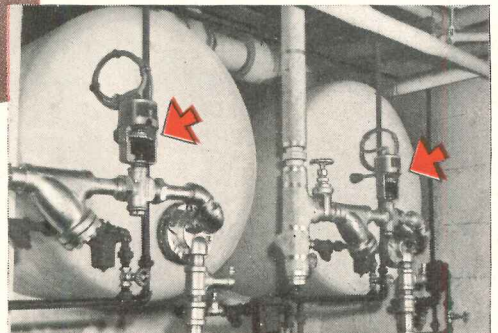

**POWERS NO. 11
REGULATORS**
Control temperature of
Water Storage Heaters at
Sea View Hotel. They're self-
operating, economical and un-
surpassed for—
DEPENDABILITY.



Modern Plant at SKOKIE, ILL. • Offices in Over 50 Cities
Chicago 13, Ill., 3819 N. Ashland Ave. • New York 17, N. Y.,
231 East 46th Street • Los Angeles 5, Cal., 1808 West 8th Street
Toronto, Ont., 195 Spadina Ave. • Mexico, D. F., Apartado 63 Bis.
Honolulu 3, Hawaii, P. O. 2755—450 Piikoi at Kona

THE POWERS REGULATOR COMPANY

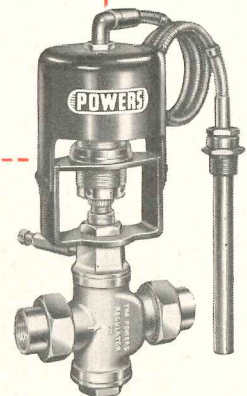

(a67)

WASHINGTON

(Continued from page 28)

Carl G. Lans, former director of the Technical Service Dept. of the National Assn. of Home Builders (now with Earl Smith, builder, El Cerrito, Cal.), calls attention to the testing of many materials designed to take the place of steel and copper. Some of them, Mr. Lans says, will receive limited acceptance by local and state authorities, and federal officials; but most of them will be forgotten because of the short time they will be needed. Critical metals are widely expected to be in better supply in 1953, leaving a relatively short time to force acceptance of substitutes, he points out, even though the alternate materials might be satisfactory in performance.

Lans Notes Some Trends

Mr. Lans suggests that the principal contribution to conservation will be in the planning stage. He looks for kitchens and baths to move to the front of the house, back-to-back, where the shortest possible utility connection will be required. This automatically places the living room toward the garden, where Mr. Lans says it ought to be.

Other trends seen coming from steel shortages: increased use of wooden kitchen cabinets painted in a variety of colors; plastics in doorknobs, escutcheon plates, parts of faucets and other trim; standardization of plumbing layouts; and the casting of large soilpipe fittings to combine several fittings now used. Exterior design trends are seen heading for the "rational contemporary" in most parts of the country.

Long-Delayed FCDA Manuals Now Promised for March 1

An early December meeting in Washington helped pave the way for publication of the long-awaited shelter construction manuals of the Federal Civil Defense Administration. These now are scheduled to appear by March 1.

At the December meeting, industry representatives were introduced to the contents of the proposed publications and agreed they would be useful tools from the practical standpoint. These manuals follow the first in a series, which defined a technique for deter-

(Continued on page 32)

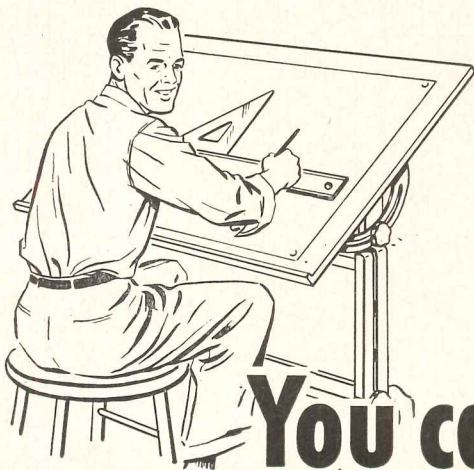

You can't miss
when you Specify
ALLENCO

1st* in Interior Fire Protection

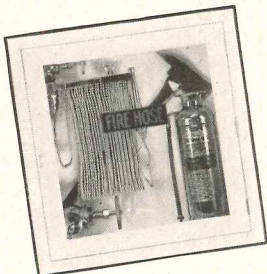

★ **Voted first choice by architects and engineers**

Annual surveys show ALLENCO is preferred 3 to 2 over next leading brand.

★ **Complete line, to meet every requirement**

Fire-fighting cabinet units and equipment, each in many forms.

★ **Easier selection of just what you want**

Each product, and its multiple forms, clearly defined to save your time.

★ **Proved reliability, known to all concerned**

Oldest line, probably most widely installed; well known by contractors, distributors, even "owners."

Ready Reference—12 page section in Sweet's

Consulting Service—gratis from 25 Sales Offices

A.I.A file 29e2—write for your copy, now

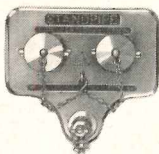
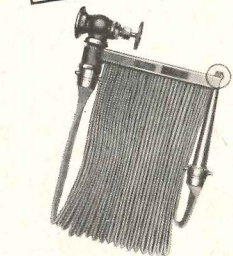

Established 1887

W. D. ALLEN Manufacturing Co.
 CHICAGO 6 • NEW YORK 7

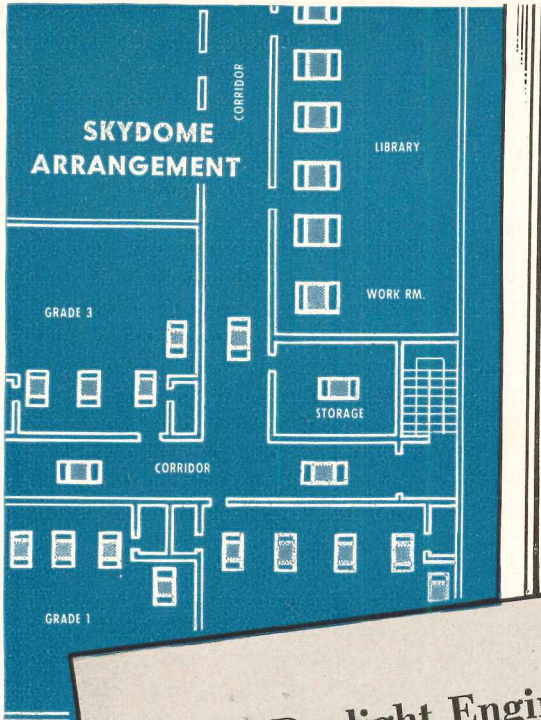

First Step to Better Daylighting:

A Wasco Daylight Engineering Study

Daylight Engineering Study

For: Clays Mill Elementary School,
Fayette County, Ky.

Arch't: John F. Wilson, Lexington, Ky.
Date: November 10, 1951

Prepared by
Daylight Engineering Dept.
Wasco Flashing Company
Cambridge 38, Mass.

A Wasco daylight engineering study of your building project is now available without cost or obligation. This study will show the correct number, size, type and spacing of Wascolite Skydomes . . . the illumination level maintained . . . other vital data. *Result:* superior daylighting at lower cost. Just send blueprint and illumination requirements; our daylight engineers will prepare recommendations promptly.

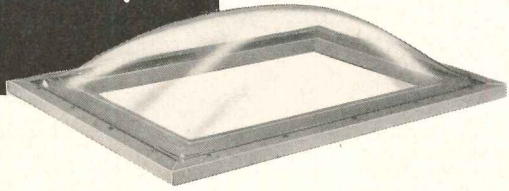
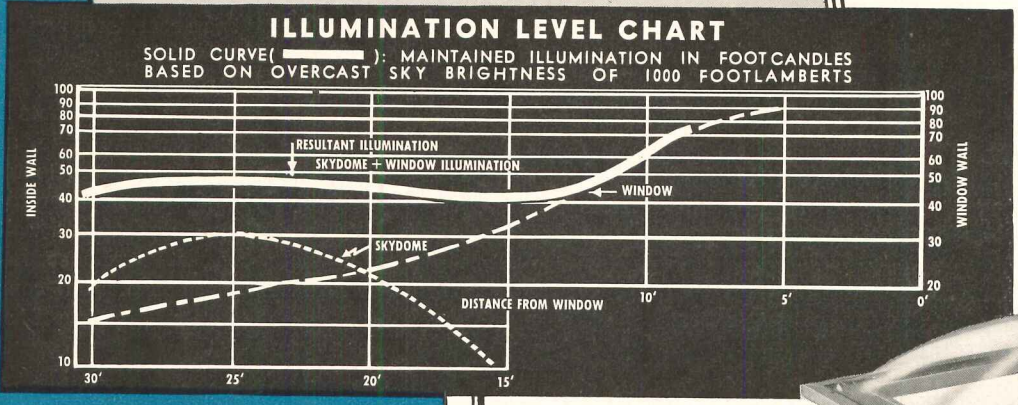

Prefabricated Wascolite Skydomes transmit 62% more daylight than conventional skylights . . . are weather-proof, shatter-resistant and maintenance-free . . . come in three basic shapes and with clear colorless or white translucent acrylic domes.



WASCOLITE SKYDOMES®
PATENT PENDING
"62% More Light On The Subject"
WASCO FLASHING CO., 82 FAWCETT ST., CAMBRIDGE 38, MASS.

THE RECORD REPORTS

WASHINGTON (Cont. from p. 30)

mining what shelter is needed in terms of number of persons to be protected. The first manual was published some months ago and dealt primarily with the identification of existing structures as bomb shelter types. One of the forthcoming manuals, which actually will be a second part of the survey treatise, will suggest proper structural changes to bring existing buildings into the category one classification as bomb shelters.

Design Criteria for Shelters

The third publication, considered by some in the FCDA shelter division to be the most important in the series, will deal forthrightly with design criteria. The agency describes it as an interim guide for the design of buildings exposed to atomic blast load.

Contents of these forthcoming booklets was reviewed at the December sessions by the several representatives

of industry (selected by the National Industrial Conference Board), by those who contributed material to the books, and by FCDA design engineers. The contents had been "cleared" earlier with architects and engineers.

Some in attendance asked if they should incorporate protective construction in new building activity immediately. FCDA, while not discouraging any effort toward bombproof design, explained that it would issue definite recommendations at the time the manuals appear. The location of the proposed structure, or of a present structure to be remodeled, is a strong determining factor in the treatment, architecturally, that it should be given, FCDA personnel say. The agency earlier sent states a list of supposed target areas. This document is still classified, but industries can go to their state civil defense offices and learn whether or not their plants and proposed plant locations are in the so-called target regions.

FCDA now is in the process of defining the "twilight zones," those areas not directly in the center of targets and yet where there should be an element of protection from bomb blast.

Coming: Textbook on Blast

All this leads to the future publication of a complete textbook on exposure of structures to A-bomb blast load. There's no indication of when this will come at the present time. The survey and improvement texts stand by themselves, but the No. 3 publication — on design criteria — is to be considered an interim guide pending printing of the more comprehensive report.

It sums up to this: FCDA wants those private concerns that know they are in the center of potential targets to get busy immediately on their protective construction plans; others can wait for the more complete guidance in the manual. As one official said, common sense should dictate the course of action.

New Moves on Housing: Eyes on Cost and Design

At long last some order was developing in military housing programs at the administration level. The Armed Forces Housing Agency created in September by the Department of Defense got a director last month — Thomas P. Coogan of Miami, former president of the National Association of Home Builders. An outgrowth of the old military construction commission, this new agency will have a broader field of operation. It goes

(Continued on page 264)

Ask for this credential when you buy concrete

The Bureau rating plate is available to all manufacturers who meet its quality standards and requirements.

However sympathetic you may be to the profit motive, you don't want *your* jobs served by truck mixers that are too small to properly mix a standard batch.

Deficiencies in drum cubics cannot be measured by the eye. *But you can instantly detect the absence of this rating plate.*

This rating plate on a truck mixer guarantees that it has the proper design and *full amount of free mixing space* needed to produce quality concrete. Look for it whenever you approve or buy concrete ready-mixed.

Affiliated with The National Ready Mixed Concrete Association

Truck Mixer Manufacturers Bureau

BLAW-KNOX DIVISION
Pittsburgh, Pa.
CHAIN BELT COMPANY
Milwaukee, Wis.

CONCRETE TRANSPORT MIXER CO.
St. Louis, Mo.
THE JAEGER MACHINE COMPANY
Columbus, Ohio

THE T. L. SMITH COMPANY
Milwaukee, Wis.
WORTHINGTON PUMP & MACHINERY CORP.
Dunellen, N. J.

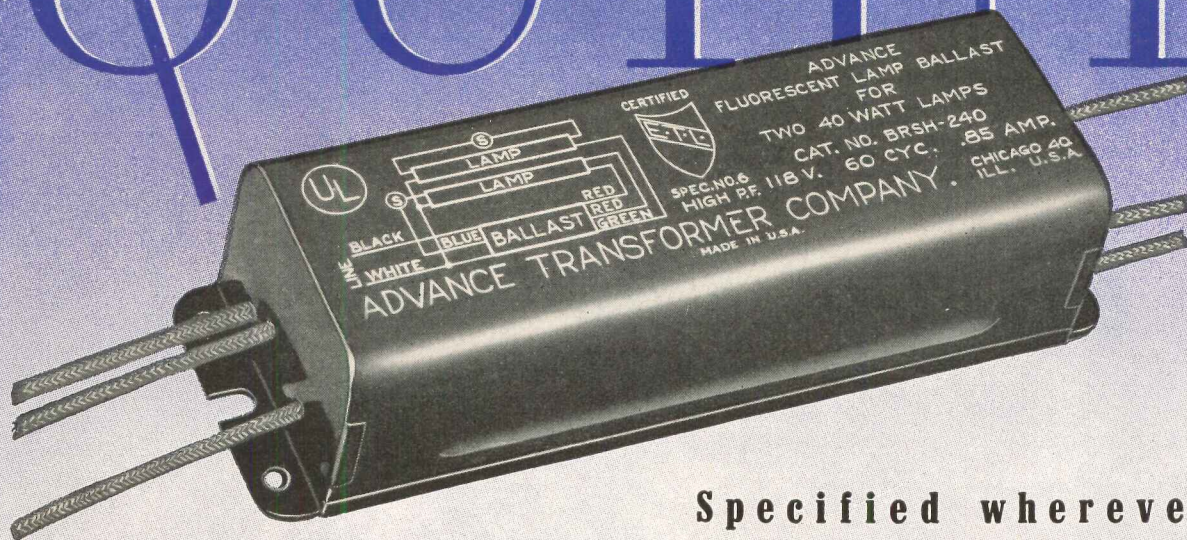

Specified wherever
 quiet, efficient
 operation
 is demanded

**ADVANCE
 TRANSFORMER
 CO.**

The Best Ballast Buy

CABLE ADDRESS:
 ADTRANS

1122 W. CATALPA AVE., CHICAGO 40, ILL., U.S.A.

The most important announcement ever made
in prefinished wallpanel history!

New for '52

TWO SENSATIONAL, NEW

MARLITE WALLPANELS

at new low prices!



**FOR HIGH QUALITY
AT LOW COST—
USE VERSATILE MARLITE**

1

VELWOOD

Now you can offer your clients the richness and warmth of fine finished woods at a price far below the cost of comparable wood paneling. Marlite Velwood, a completely new plastic-finished wall and ceiling panel, authentically reproduces beautiful wood grains. Made possible only through revolutionary new manufacturing techniques, Velwood is the perfect solution for creating beautiful low-cost interiors in your building and remodeling projects.

Ask your local lumber and building materials dealer for complete details, or write MARSH WALL PRODUCTS, INC., Dover, Ohio, Subsidiary of Masonite Corporation.

2

Coming Next Month

A second exciting new Marlite panel. Watch for it!

Make the most of *Marlitz*

"Where's our heat **come from** Daddy?"

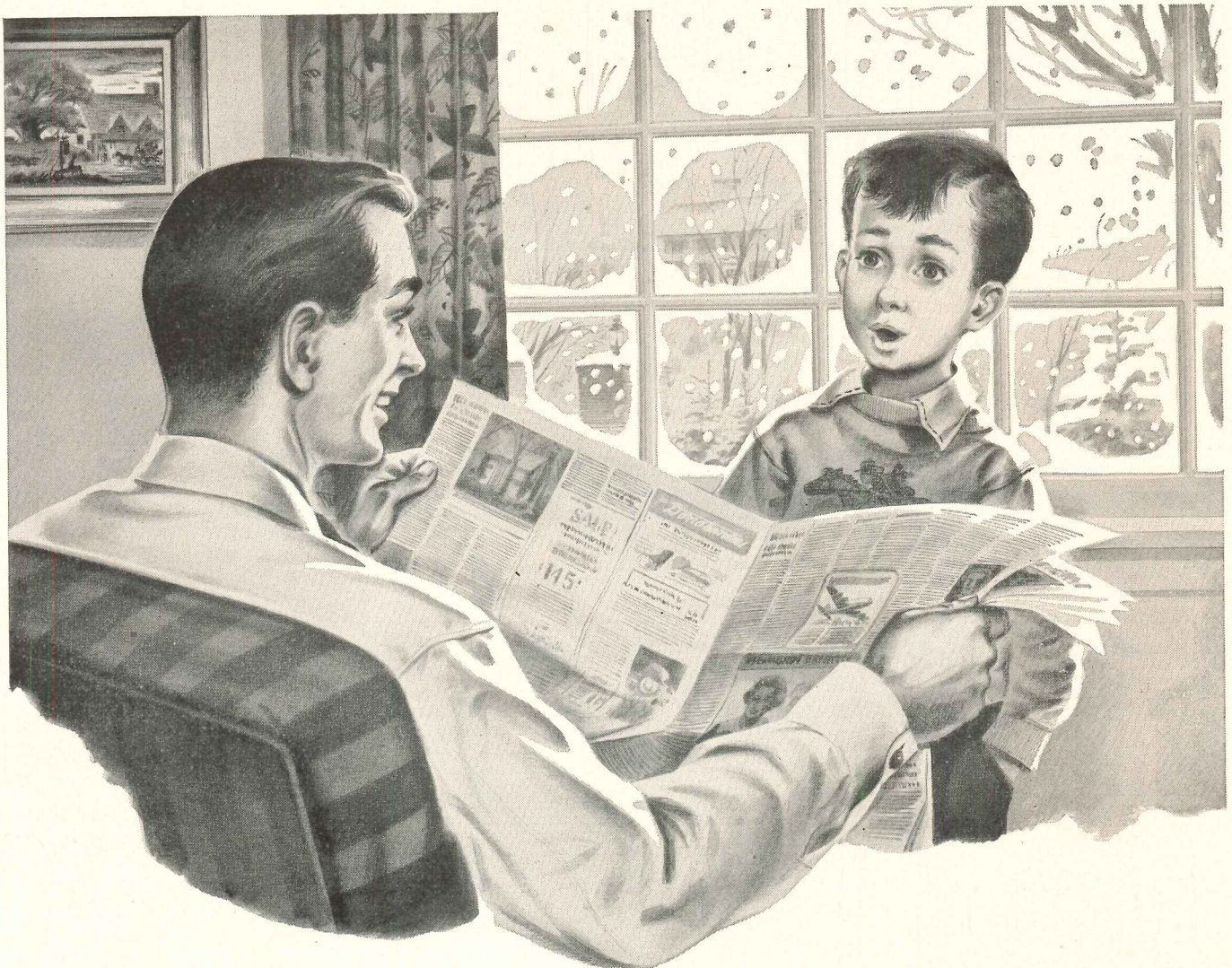

Steel pipe radiant panels provide "invisible heat"

Parents whose questioning children persistently ask for answers to such stumpers as "What keeps an airplane up?", may sometimes regard the conveniences of modern living as a mixed blessing! For what 6-year-old, snug and comfortable in a radiant-heated home, wouldn't wonder about and ask "where the heat is coming from?"

"Invisible heat" . . . the spring-like warmth from radiant panels concealed in floors, ceilings or walls . . . is here to stay, and its growing popularity will soon make it as understood by our children as was the polished

parlor stove by our grandfathers.

Reliable steel pipe, proved in over 60 years of service in hot water and steam heating systems, is, of course, the first choice for these radiant panel heating systems. For it embodies every necessary characteristic—economy, formability, and weldability, and, durability that is satisfying beyond the life-span of the structure.

That's why those who design, specify, sell or install steel pipe radiant panel heating and snow melting systems are assured satisfied customers!

Write for a copy. A free 48-page color booklet "Radiant Panel Heating with Steel Pipe"

**Steel Pipe
is First Choice**

COMMITTEE ON STEEL PIPE RESEARCH

AMERICAN IRON AND STEEL INSTITUTE

350 Fifth Avenue, New York 1, N.Y.

softly-shaded and functionally correct . . .

the new, beautiful *Suntile* colors

increase the efficiency of any **HOSPITAL INTERIOR!**

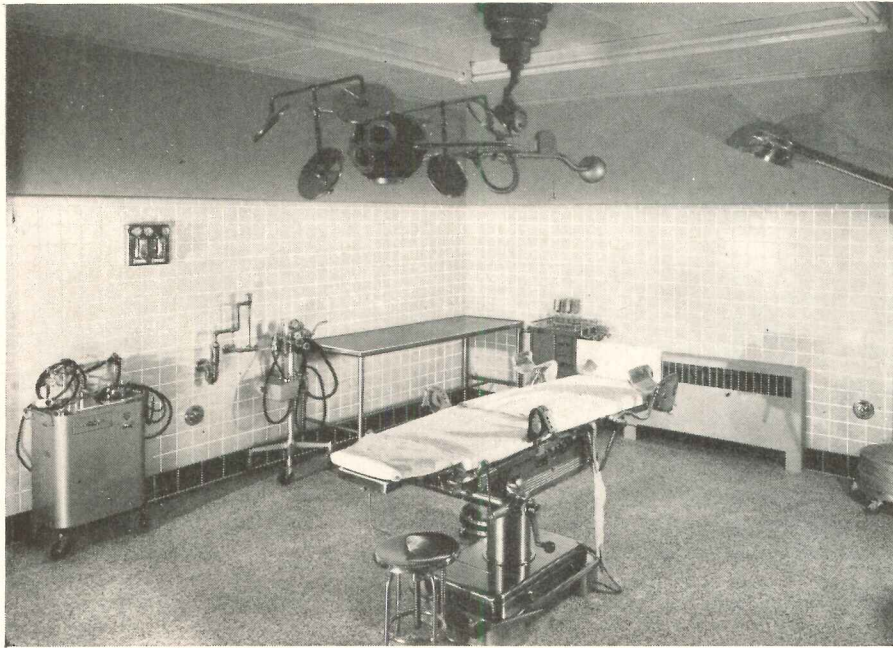

*you get the right color
plus the permanence
of real clay **TILE!***

Can color help hospital interiors fulfill their functions *better?*

Color authorities say "yes."

There's a *right* color—a most suitable, most beneficial color—for surgeries, wardrooms, corridors, and cafeterias . . .

The *right* color can relieve eye strain of doctors—impart visual and emotional benefits—provide a restful and cheerful environment for both patients and staff.

Suntile's beautiful new line of softly shaded colors has been scientifically developed to *fit the function of interiors*—not only in hospitals but in schools, institutions, commercial and industrial buildings.

This "color-fitted-to-the-function feature" gives you another reason for selecting color-balanced Suntile for walls and floors. Other well-known reasons for choosing this *real* clay tile are: permanence, ability to withstand heavy use, sanitation, ease of cleaning, low maintenance!

Write Dept. AR-1 for our new color booklet "Suntile Functional Color Recommendations." See your local Authorized Suntile Dealer. The Cambridge Tile Mfg. Co., P.O. Box 71, Cincinnati 15, Ohio.

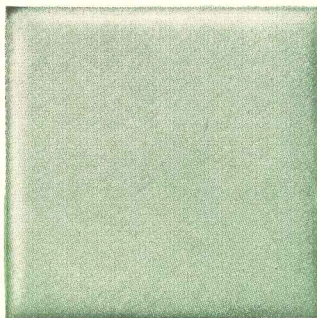

Sea Green 511

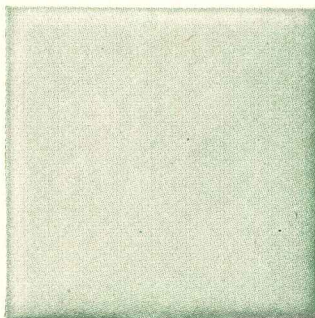

Light Sea Green 513

Suntile SEA GREEN, LIGHT SEA GREEN

Recommended for hospital surgery

Shown above are two tones of Suntile Sea Green—an original and modern color designed by Suntile with the aid of Faber Birren, nationally known color authority. The soft tone Sea Green is recommended for surgeries and operating rooms; the bright tone Light Sea Green for other service areas. Both of these are carefully balanced green tints with a special satin finish. The tint is complementary to the color of human tissue and complexion—and will aid vision and reduce ocular fatigue for the surgeon. Both of these Suntile backgrounds present a dignified appearance, are visually restful and physically durable. These are only two of a complete Suntile line of 12 functional colors, adaptable to all parts of a hospital.

WEST COAST OFFICES

The Cambridge Tile Mfg. Co.
470 Alabama Street
San Francisco 10, California

The Cambridge Tile Mfg. Co.
1335 S. La Brea
Los Angeles 19, California



SUNTILE OFFERS YOU BOTH • BETTER TILE • BETTER INSTALLATION

THE RECORD REPORTS

CONSTRUCTION COST INDEXES

Labor and Materials

United States average 1926-1929 = 100

Presented by Clyde Shute, manager, Statistical and Research Division, F. W. Dodge Corp., from data compiled by E. H. Boeckh & Assocs., Inc.

NEW YORK

ATLANTA

| Period | Residential | | Apts., Hotels Office Bldgs. Brick and Concr. | Commercial and Factory Bldgs. Brick and Concr. | | Brick and Steel | Residential | | Apts., Hotels Office Bldgs. Brick and Concr. | Commercial and Factory Bldgs. Brick and Concr. | | Brick and Steel |
|------------|----------------------|-------|--|--|-----------------------|-----------------------|----------------------|-------|--|--|-----------------------|-----------------------|
| | Brick | Frame | | Brick and Concr. | Brick and Steel | | Brick | Frame | | Brick and Concr. | Brick and Steel | |
| 1925 | 121.5 | 122.8 | 111.4 | 113.3 | 110.3 | | 86.4 | 85.0 | 88.6 | 92.5 | 83.4 | |
| 1930 | 127.0 | 126.7 | 124.1 | 128.0 | 123.6 | | 82.1 | 80.9 | 84.5 | 86.1 | 83.6 | |
| 1935 | 93.8 | 91.3 | 104.7 | 108.5 | 105.5 | | 72.3 | 67.9 | 84.0 | 87.1 | 85.1 | |
| 1939 | 123.5 | 122.4 | 130.7 | 133.4 | 130.1 | | 86.3 | 83.1 | 95.1 | 97.4 | 94.7 | |
| 1940 | 126.3 | 125.1 | 132.2 | 135.1 | 131.4 | | 91.0 | 89.0 | 96.9 | 98.5 | 97.5 | |
| 1946 | 181.8 | 182.4 | 177.2 | 179.0 | 174.8 | | 148.1 | 149.2 | 136.8 | 136.4 | 135.1 | |
| 1947 | 219.3 | 222.0 | 207.6 | 207.5 | 203.8 | | 180.4 | 184.0 | 158.1 | 157.1 | 158.0 | |
| 1948 | 250.1 | 251.6 | 239.4 | 242.2 | 235.6 | | 199.2 | 202.5 | 178.8 | 178.8 | 178.8 | |
| 1949 | 243.7 | 240.8 | 242.8 | 246.4 | 240.0 | | 189.3 | 189.9 | 180.6 | 180.8 | 177.5 | |
| 1950 | 256.2 | 254.5 | 249.5 | 251.5 | 248.0 | | 194.3 | 196.2 | 185.4 | 183.7 | 185.0 | |
| Aug. 1951 | 272.3 | 269.8 | 264.5 | 266.3 | 263.2 | | 212.6 | 214.3 | 204.9 | 203.7 | 206.8 | |
| Sept. 1951 | 273.7 | 271.6 | 264.8 | 266.5 | 263.6 | | 213.0 | 214.8 | 205.0 | 203.7 | 206.9 | |
| Oct. 1951 | 274.4 | 272.5 | 264.9 | 266.6 | 263.8 | | 214.6 | 216.4 | 206.6 | 204.7 | 208.3 | |
| Oct. 1951 | % increase over 1939 | | % increase over 1939 | | % increase over 1939 | | % increase over 1939 | | % increase over 1939 | | % increase over 1939 | |
| Oct. 1951 | 122.2 | 122.6 | 102.7 | 99.9 | 102.8 | | 148.7 | 160.4 | 117.2 | 110.2 | 120.0 | |

ST. LOUIS

SAN FRANCISCO

| | | | | | | | | | | | | |
|------------|----------------------|-------|----------------------|-------|----------------------|--|----------------------|-------|----------------------|-------|----------------------|--|
| 1925 | 118.6 | 118.4 | 116.3 | 118.1 | 114.4 | | 91.0 | 86.5 | 99.5 | 102.1 | 98.0 | |
| 1930 | 108.9 | 108.3 | 112.4 | 115.3 | 111.3 | | 90.8 | 86.8 | 100.4 | 104.9 | 100.4 | |
| 1935 | 95.1 | 90.1 | 104.1 | 108.3 | 105.4 | | 89.5 | 84.5 | 96.4 | 103.7 | 99.7 | |
| 1939 | 110.2 | 107.0 | 118.7 | 119.8 | 119.0 | | 105.6 | 99.3 | 117.4 | 121.9 | 116.5 | |
| 1940 | 112.6 | 110.1 | 119.3 | 120.3 | 119.4 | | 106.4 | 101.2 | 116.3 | 120.1 | 115.5 | |
| 1946 | 167.1 | 167.4 | 159.1 | 161.1 | 158.1 | | 159.7 | 157.5 | 157.9 | 159.3 | 160.0 | |
| 1947 | 202.4 | 203.8 | 183.9 | 184.2 | 184.0 | | 193.1 | 191.6 | 183.7 | 186.8 | 186.9 | |
| 1948 | 227.9 | 231.2 | 207.7 | 210.0 | 208.1 | | 218.9 | 216.6 | 208.3 | 214.7 | 211.1 | |
| 1949 | 221.4 | 220.7 | 212.8 | 215.7 | 213.6 | | 213.0 | 207.1 | 214.0 | 219.8 | 216.1 | |
| 1950 | 232.8 | 230.7 | 221.9 | 225.3 | 222.8 | | 227.0 | 223.1 | 222.4 | 224.5 | 222.6 | |
| Aug. 1951 | 251.3 | 246.9 | 240.2 | 243.2 | 240.6 | | 245.7 | 240.2 | 240.3 | 244.1 | 244.2 | |
| Sept. 1951 | 253.5 | 249.5 | 241.4 | 243.8 | 241.4 | | 248.1 | 243.0 | 242.0 | 244.9 | 245.4 | |
| Oct. 1951 | 255.6 | 252.4 | 241.2 | 243.9 | 241.6 | | 248.5 | 243.5 | 242.1 | 244.9 | 245.5 | |
| Oct. 1951 | % increase over 1939 | | % increase over 1939 | | % increase over 1939 | | % increase over 1939 | | % increase over 1939 | | % increase over 1939 | |
| Oct. 1951 | 131.9 | 135.9 | 103.2 | 103.6 | 103.0 | | 135.3 | 145.2 | 106.2 | 100.9 | 110.7 | |

The index numbers shown are for combined material and labor costs. The indexes for each separate type of construction relate to the United States average for 1926-29 for that particular type — considered 100.

Cost comparisons, as percentage differences for any particular type of construction, are possible between localities, or periods of time within the same city, by dividing the difference between the two index numbers by one of them; i.e.:

index for city A = 110
index for city B = 95
(both indexes must be for the same type of construction).

Then: costs in A are approximately 16 per cent higher than in B.

$$\frac{110-95}{95} = 0.158$$

Conversely: costs in B are approximately 14 per cent lower than in A.

$$\frac{110-95}{110} = 0.136$$

Cost comparisons cannot be made between different types of construction because the index numbers for each type relate to a different U. S. average for 1926-29.

Material prices and wage rates used in the current indexes make no allowance for payments in excess of published list prices, thus indexes reflect minimum costs and not necessarily actual costs.

These index numbers will appear regularly on this page.

another **HOMASOTE FIRST**— designed to reduce the cost of building

Announcing
the **NEW** /

**Weatherproof
HOMASOTE
UNDERLAYMENT**

Specifically designed for
use under
**WALL-TO-WALL CARPETING
and 1/8" LINOLEUM**



Photo by G. Barrows—Executive Office for INTERIORS designed by Knoll Associates, Inc.

• Greater resilience and longer life for the floor covering—a substantial saving in cost—these are the gains you get with this revolutionary new product.

Homasote Underlayment — integrally waterproofed throughout—is nailed directly to the rough flooring. The pieces—normally 4' x 6'—are simply butted together; they require no joining.

When used with 1/8" linoleum, the linoleum is cemented directly to the Underlayment; no felt is required. This saves the cost of both the felt and one cementing operation. When used with wall-to-wall carpeting, no pad is needed under the carpeting, saving both material and labor.

Along with a major improvement in floor-covering method, you save 1/3 to 1/2 the cost of the materials usually used for 5/8" underlayment. (The 5/8" Underlayment brings the floor covering up to the normal height for 25/32" hardwood flooring.)

For combination awning and storm shutters—Florida tested—here are the ideal thickness and strength in a low cost material that is *completely weatherproof*. In Big Sheets—up to 8' x 14'—you have the perfect answer for protecting store windows and fronts.

Let us send you samples and full details. Please give us the name of your lumber dealer!

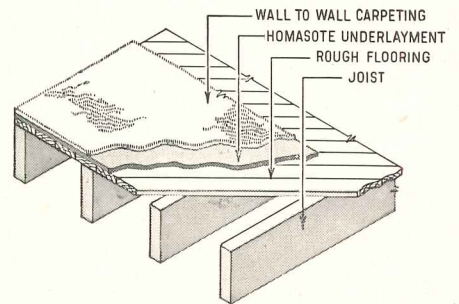

Nova Sales Co.—a wholly owned Homasote subsidiary—distributes the Nova Roller Door, Nova-I. P. C Waterproofing Products, Nova Sidewalls and the Nova Loc-Nail. Write for literature.



**HOMASOTE
COMPANY
TRENTON 3, N. J.**



— makers of the oldest and strongest
insulating-building board on the market

Homasote Company, Trenton 3, N. J. Dept. 75

Send samples and full details on Homasote Underlayment.

NAME.....

ADDRESS.....

CITY & ZONE.....STATE.....

My lumber dealer is.....



**COMPLETELY
REVISED!**

Here's helpful data

that simplifies electrical planning

for Architects and Engineers

The completely new edition of the famous Westinghouse Data Book is ready now! Prepared especially for Architects and Engineers, it contains valuable planning help on everything electrical. A truly complete electrical reference source.

It aids in selecting and specifying . . . quickly and conveniently. It is accurate, up to date. The data will enable you to apply electrical equipment to the very best advantage. Here all in one place is the latest factual information on every electrical product made by Westinghouse for the Construction Industry. It is your authoritative guide on electrical application. The presentation is simple and slanted to your needs and methods.

Distribution is being limited to those directly concerned with electrical planning. If you need the material and have not already received a copy, please contact your Westinghouse representative.

J-94893

YOU CAN BE **SURE**...IF IT'S
Westinghouse

**EQUIPMENT FOR THE
CONSTRUCTION INDUSTRY**





Beauport from the air. Lower terrace, center, commands sweep of Gloucester Harbor. Steps of landing lead under water to the habitat of lobsters

REQUIRED READING

BEAUPORT

Beauport at Gloucester. Pictures by Samuel Chamberlain; text by Paul Hollister. Hastings House (41 E. 50th St., New York, N. Y.), 1951. 7 by 9¼ in. 88 pp., illus. \$3.75.

REVIEWED BY KENNETH REID

Beauport is a house — a most remarkable house, put together by a remarkable man, who made its building almost literally a life's career. It started modestly enough as a bachelor's three-room cottage on the rocky shore of Cape Ann at Eastern Point and finally became a forty-room mansion, housing what must be one of the finest collections of early American interiors in existence. It is now owned by the Society for the Preservation of New England Antiquities.

Henry Sleeper, the creator and lifetime owner of Beauport, was, as a young man, possessed of a dream. His dream

was to make a house "in which each room could recapture some of the spirit of a specific mood or phase or 'period' of our American life from the time of Plymouth down through the Revolution and the early Republic." Granting the validity of his objective, he attained something not far short of perfection. For the house he made was no dry-as-dust, pedantic restoration of existing precedent, meticulously copied from measured drawings. On the contrary, it had life and warmth and richness and humanity because it was the expression of the spirit of an individual man. He was an eclectic, as were most of his contemporaries, and was thus true to his times. The house, as shown by Chamberlain's admirable photographs and described by Mr. Hollister's playful text, is evidence enough of Sleeper's love for fine form, color, and texture and of his

understanding of their significance in environment.

We do not design that way today; we like to think of ourselves as more creative. In our "creations," however, we often fail to achieve the emotional satisfactions we set out to produce in the minds and hearts of our clients. Someday we will reach our goal, let there be no doubt of it. In struggling towards it we can be helped rather than hindered by unbiased contemplation of such a thing as Beauport, which does contain qualities that are sorely needed in much contemporary work.

The pity of it is that Beauport will be seized upon by many as a justification for another wave of "period" interiors, and the antique ensemble will find renewed public favor. Ah well, we'll just have to give them something they'll like better! (Reviews continued on page 46)



Far left: the Pembroke Room. "Probably nowhere on earth will you find a more sympathetic reconstruction of the heart of the pioneer home, family, community than here in the room which Sleeper reassembled from the oak-and-pine house of his forbears at Pembroke"

Near left: the Mariner's Room—a pine attic-room—bespeaks the salty simplicity of an early New England seafaring existence

Rolling Steel DOORS

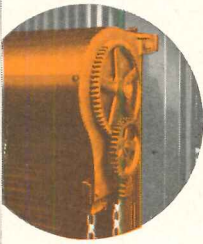
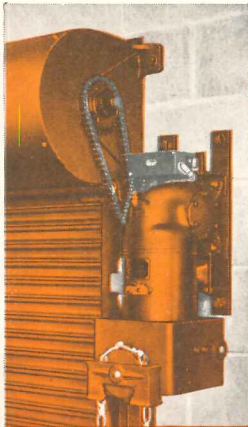

MAHON
CHAIN-GEAR
OPERATOR

MAHON STANDARD
POWER OPERATOR 920-P

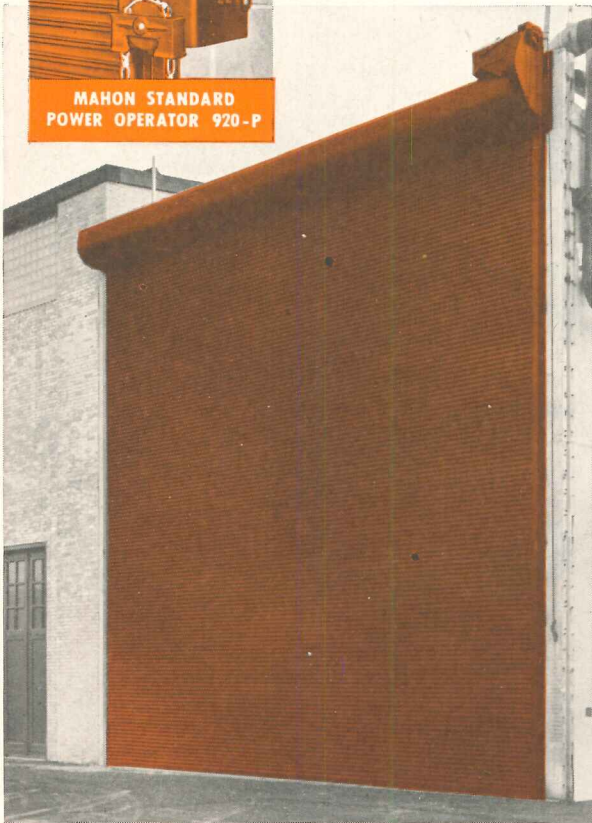

Manually, Mechanically, or Power Operated

The advantages of a rolling steel door are manifold . . . most important of these are economy of space, and the permanent all-metal construction which provides greater protection against intrusion and fire. Their vertical roll-up action requires virtually no clearance inside or outside the opening—occupies no usable space, and, when equipped with power operators, their quick-opening, quick-closing operation reduces heat loss and saves valuable time, particularly in loading dock operations. Like other things, there is a vast difference in the quality of rolling steel doors on the market today—a careful check of specifications will reveal this. For instance, the galvanized steel, from which the interlocking curtain slats of Mahon Rolling Steel Doors are rolled, is chemically cleaned, phosphatized and chromated to provide paint bond, and the protective enamel coating is baked on at 350° F. prior to roll-forming, thereby protecting the entire metal surface of the slat—including the inside of the interlock roll. This is just one of the extra value features of Mahon Rolling Steel Doors—you will find others. See Sweet's Files for complete information including Specifications, or write for Catalog No. G-52.

THE R. C. MAHON COMPANY

Detroit 34, Michigan • Chicago 4, Illinois • Representatives in Principal Cities
Manufacturers of Rolling Steel Doors, Grilles, and Automatic Closing Underwriters' Labeled Rolling Steel Doors and Fire Shutters; Insulated Metal Walls; Steel Deck for Roofs, Partitions, and Permanent Concrete Floor Forms.

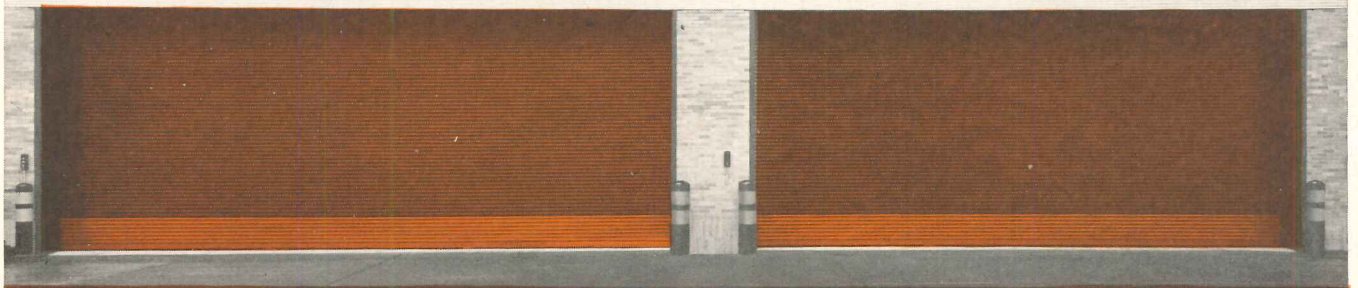
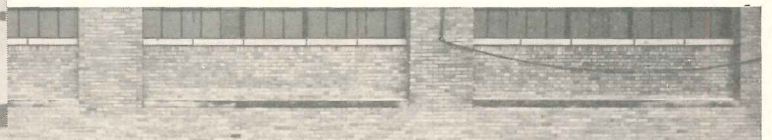

ROLLING STEEL DOORS, SHUTTERS AND GRILLES TO MEET EVERY REQUIREMENT

Top Illustration: One of Two Mahon Power Operated Rolling Steel Doors 30'-0" x 30'-0" Installed in a General Electric Test Cell. Bottom: Two Mahon Power Operated Rolling Steel Doors 37'-0" x 14'-9" and 33'-0" x 14'-9" Installed in Openings of an Enclosed Loading Dock.

MAHON



... and for the temperature control, we'll insist on Honeywell!

You'd think cartoonist Tobey's famous couple would be discussing something else in a setting like this!

However, the *one* thing the gentleman above wants to make sure of, in planning his new home, is *comfort!* And he knows that the best way to get it is to ask his architect or heating engineer to specify Honeywell temperature controls.

If *you* have a control problem, Honeywell can help provide the proper thermal environment for any client—anywhere—in any kind of structure.

A large staff of well informed control engineers—in 91 different Honeywell offices across the nation—are experienced in doing just that. Or—there's a lot of literature that's yours for the asking—on the automatic control of heating, ventilating and air conditioning.

So, why not *talk to Honeywell?* Why not *write to Honeywell* about *your* control problem? And why not do it *now?*



For help with any control problem, talk to Honeywell

Specify Honeywell Electronic Air Conditioning Control!

*Give your clients the ultimate in comfort—
and increased efficiency, lower maintenance costs*

Here's an entirely new type of air conditioning control! Its many new features make it *easy* to achieve results never before possible.

You see, this new Honeywell system electronically "feels" temperature changes as they occur and then gives *fast*, accurate modulating control over heating and air conditioning dampers or valves.

And because it is *electronic*, it's 100 times more sensitive than conventional systems! This means faster reaction to changes in load; no temperature "overshoot"; no waste of either warm or cool air.

Honeywell electronic thermostats are greatly simplified for lasting service with little or no maintenance costs, for they have no moving parts to wear or get out of adjustment.

So be sure to specify the new Honeywell electronic air conditioning control to give your client the ultimate in comfort. At the same time you'll be giving him a system that helps pay for itself through increased efficiency and lower maintenance costs.

MINNEAPOLIS
Honeywell 

First in Controls

*...and for help with the temperature control,
we'll talk to (your firm name)*

FREE — personalized cartoon. For your 8½" x 9" reproduction of this Tobey cartoon (incorporating the name of your firm), fill out and mail coupon today.

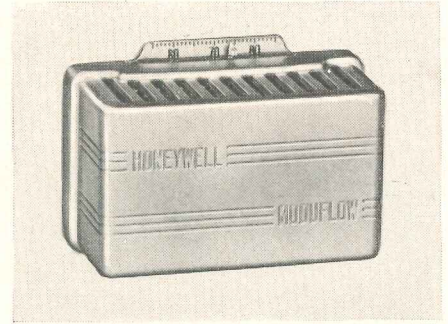

*Space
Thermostat.
No moving parts to
wear out or get
out of adjustment.*

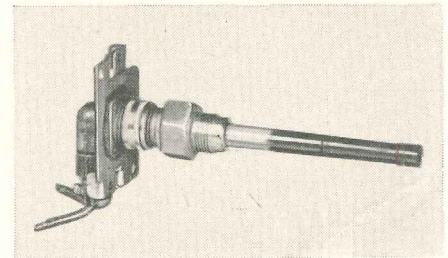

*Duct and
Immersion
Thermostat.
Measures tempera-
tures accurately
from -50 degrees to
300 degrees F.*

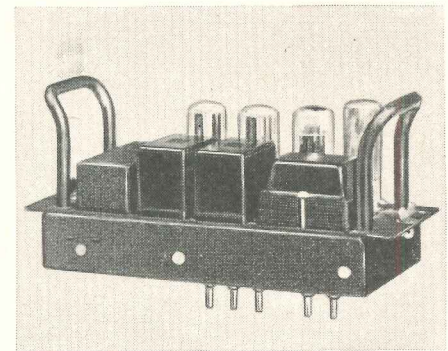

*Electronic Relay.
Here's the famous
"brain" that
measures thermo-
stat signals,
operates the valves
and dampers.*

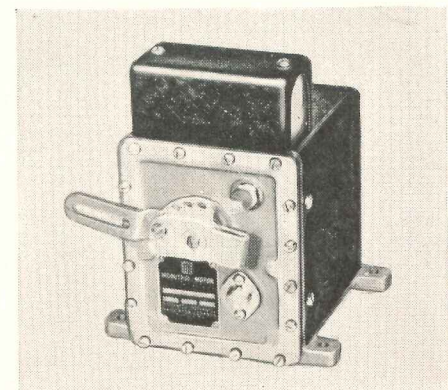

*Modulating
Motor.
Slightest tempera-
ture fluctuation
causes motor to
change valves or
dampers.*

MINNEAPOLIS-HONEYWELL REGULATOR CO.

Dept. AR-1-05, Minneapolis 8, Minnesota

Gentlemen:

- Please send me your booklet "New Horizons of Comfort with Honeywell Electronic Air Conditioning Control."
- Please send me a free personalized reproduction of the Tobey cartoon.

Name _____

Firm Name _____

Address _____

City _____ Zone _____ State _____

WHEN AIR



IS BAD

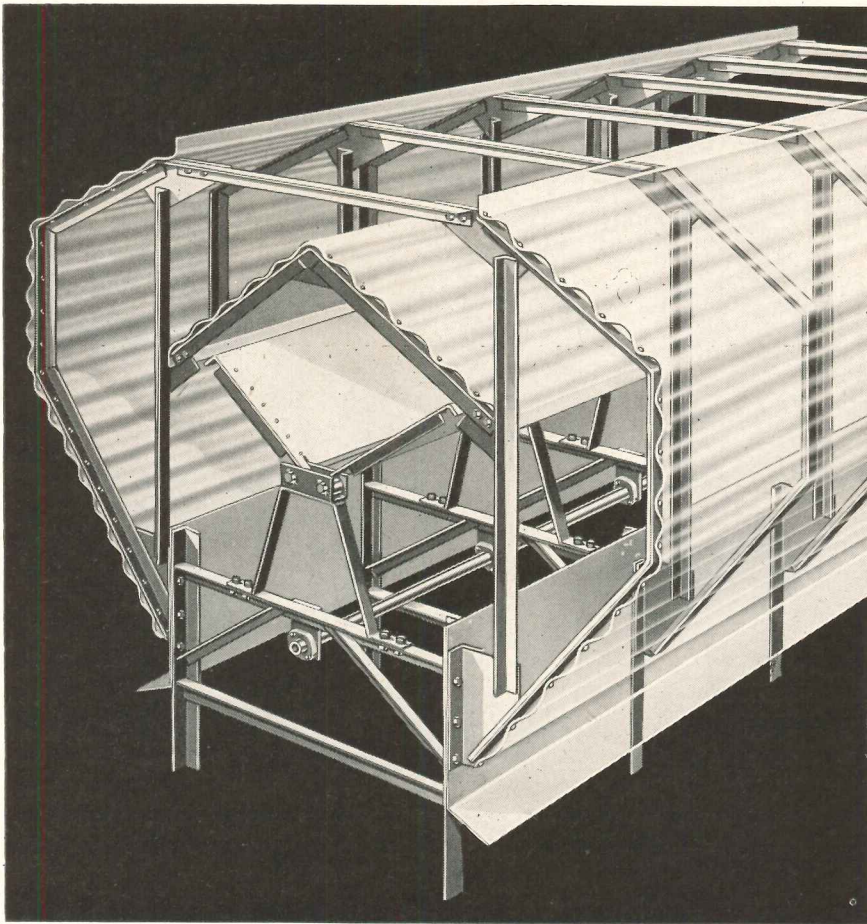

REMOVE FUMES, SMOKE AND HEAT WITH BURT MONOVENT

The Burt Monovent Continuous Ridge Ventilator is particularly efficient in heavy industry — for steel mills, foundries, forge shops, etc.

Installed as a continuous unit the entire length of the building, Burt Monovent converts the roof line to a giant valve that exhausts bad air rapidly from the whole structure. Standard production sizes from 4" to 96" widths handle almost any application.

The Monovent is remarkably efficient. It can be installed on any type roof. And, its simplicity and heavy construction assure long, trouble-free life with almost no maintenance. See Sweet's for further details or write for Bulletin S.P.V.6.

FAN & GRAVITY VENTILATORS • LOUVERS • SHEET METAL SPECIALTIES

The Burt Manufacturing Company

48 E. South Street • Akron 11, Ohio

REQUIRED READING

(Reviews continued from page 42)

LATROBE'S THOUGHTS ON EARLY NEW ORLEANS

Impressions Respecting New Orleans — Diary & Sketches 1818-1820. By Benjamin Henry Latrobe. Edited with an introduction and notes by Samuel Wilson, Jr. Columbia University Press (2960 Broadway, New York 27, N. Y.), 1951. 8 $\frac{1}{8}$ by 11 in. xxiv + 196 pp., illus. \$8.75.

Mr. Wilson has brought together in a handsomely presented volume the existing diaries of Latrobe covering the last years of his life, which were spent in New Orleans. Although parts of these journals were published in 1905, it is the first time the original manuscripts have been presented in their entirety or with any number of the neat sketches drawn by Latrobe during this period.

The vivid descriptions contained in the diaries present precise and revealing pictures both of early New Orleans and of Latrobe himself. His comments run the gamut from philosophical and moral questions, the state of society, and the style of buildings to Negro music, flora and fauna. The value of the book probably lies more in these varied observations and thoughts of the man referred to by many as the father of the American architectural profession, than to any extensive material on his architectural techniques.

The introduction by Mr. Wilson includes a brief biography of Latrobe's life, and a review of his work in Louisiana. This is frequently spiked with examples of the difficulties and frustrations which pursued Latrobe's career, and which, it would appear, are not new to the profession.

RELIGIOUS ARCHITECTURE

A History of Religious Architecture. By Ernest Short. Third revised edition. W. W. Norton Co. (101 5th Ave., New York, N. Y.), 1951. 7 $\frac{3}{4}$ by 5 $\frac{5}{8}$ in., 306 pp., illus. \$6.00.

As a comprehensive history of religious building for the general reader, this is a volume which certainly has much to recommend it. At the same time, although it covers the field more than adequately, the book cannot escape from the inevitable characteristic quality of the generalized history, and in its very sweep tends to be at times somewhat cursory. Thus although all the usual high spots are hit, one finds that buildings of such importance as

(Reviews continued on page 50)

Springfield, Missouri, hospital chooses Modine

At St. John's Hospital, nearly 1000 Modine Convectors provide patients and staff with healthful, floor-to-ceiling heat. Architects: Maguolo & Quick, St. Louis. Engineer: Harry F. Wilson, St. Louis. General Contractor: McGough Bros., St. Paul, Minn. Heating Contractor: C. Wallace Plumbing Company, Inc., Dallas, Texas.

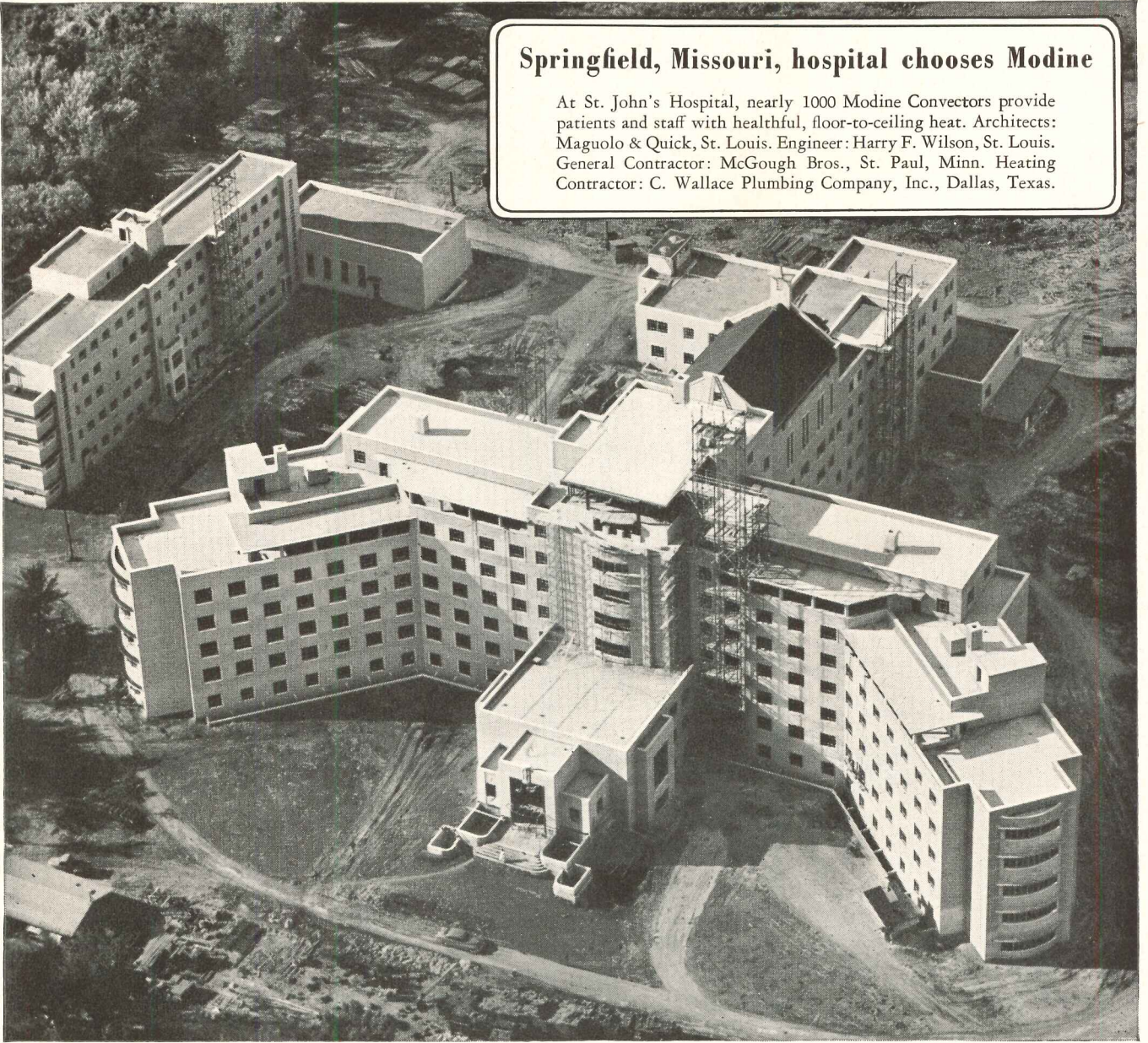

*America's finest buildings
use America's finest convectors*

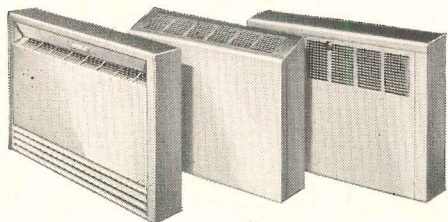

Choose from three enclosure types in Standard and heavy-duty Institutional models for free-standing, recessed or wall-hung installation

FOR today's hospitals, superior heating performance must be teamed with subtle styling and long-life construction. On all counts, Modine Convectors meet exacting professional standards. That's why more and more Modine Convectors are being specified by leading architects and engineers. For full information on heating at its finest, call your Modine representative. You'll find him listed in your classified phone book. Or write Modine Mfg. Co., 1510 DeKoven Ave., Racine, Wis.

***Modine* CONVECTORS**

Architect shushes in new apartments with



Build and insulate with double duty

INSULITE

MADE OF HARDY NORTHERN WOOD



"neighbor-noise" split-plate wall and Insulite Lok-Joint Lath



Sibley Manor, St. Paul, Minnesota

Architect: *Tecnico*

General Contractors: *Sauers Construction Company and Johnson, Drake & Piper, Inc.*

Lok-Joint Lath

Problem. How to reduce noise transmission in party walls and still keep costs in line.

Solution. A low-cost split-plate wall lathed with sound-deadening INSULITE LOK-JOINT LATH!

Does it work? Sauers Construction Company, co-builder of St. Paul's new Sibley Manor says *yes!* So far, Sauers Construction Company has used this novel wall on three projects and claim it is superior to the staggered-stud wall with blanket wool insulation! And far less costly . . . *4¢ per square foot less!*

One reason: LOK-JOINT LATH not only deadens sound, but provides an ideal plaster base plus effective insulation in one operation.



For complete facts on INSULITE LOK-JOINT LATH, see Sweet's File. For samples of LOK-JOINT LATH and other INSULITE products, write Insulite Division, Minnesota and Ontario Paper Company, Minneapolis 2, Minnesota.

FROM THE
**INSULITE
IDEA FILE**

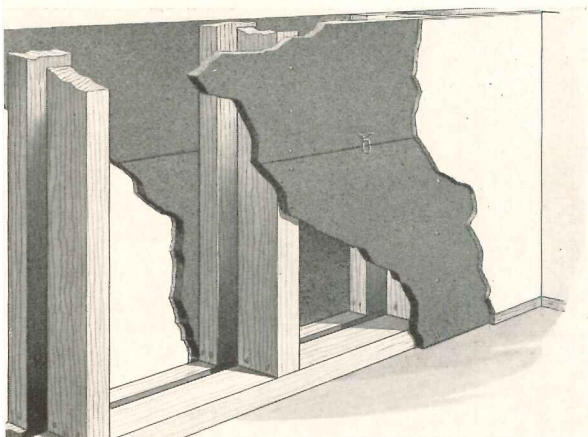

Noise stops here. The standard wall is framed with 2 x 4's on a 2" x 4" plate. Secondary wall is framed with 2 x 4's turned flatwise on a 2" x 2" plate with a half-inch space between plates. Both walls are lathed with sound-deadening INSULITE LOK-JOINT LATH.

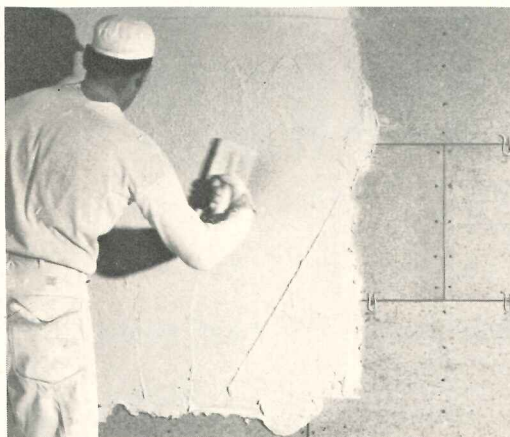

Bonding Power of plaster to LOK-JOINT LATH is more than *twice* that required by the commercial standard for structural fiber board. Exclusive rigid metal "Loks" stop annoying "yield-and-snap-back" at joints. Large units lay up quickly; save time.



Insulite Bildrite Sheathing on exterior wall saved Sauers Construction Company hundreds of dollars on every Sibley Manor U because no corner bracing was required. BILDRITE has twice the bracing strength and insulation value of horizontally applied wood, yet applied cost is far less!

**OF 488 ENGINEERS, DRAFTSMEN,
ARCHITECTS, PURCHASING AGENTS**

94% Certify

The New **MICROTOMIC**
'more uniform' than the pencils
they were then using!

Last year, we asked 488 drawing pencil users—a representative cross-section—to test 3 MICROTOMICS (of any degree of their choice) against 3 other drawing pencils of the same degree.

459 (94% of those who made the test) found MICROTOMIC grading definitely "more uniform" by unbiased comparison.

In fact, about a month later, 185 said they were already using MICROTOMICS . . . and another 199 said their next drawing pencil order would be for MICROTOMICS.

free! Try the
3 against 3 test yourself

**EBERHARD
FABER** SINCE 1849

Mail for FREE test pencils!

- EBERHARD FABER Pencil Co., Dept. AR-1
- 37 Greenpoint Avenue, Brooklyn 22, N.Y.
- *I want to test MICROTOMIC uniformity vs. my present pencils. Send... degree MICROTOMICS please.*
- NAME _____
- FIRM _____
- STREET _____
- CITY _____
- DEALER'S NAME _____

REQUIRED READING

(Reviews continued from page 46)

St. Denis and Cluny are either brushed off with a brief note or not mentioned at all. Still, considering its scope, the book is remarkably inclusive. An American reader is particularly aware, however, of some notable omissions such as the New England Meeting House and Richardson's Trinity Church.

The book's ending is somewhat disappointing, too, in view of Mr. Short's avowed purpose. This—in his own words—is "to show how the chief manifestations of religious art are connected with outstanding social, political and geographical circumstances; to gauge the emotions and thoughts embodied in various types of buildings, and the actions and reactions which created the different national styles; always striving to penetrate through the artistic production to the intellectual and emotional circumstances which shaped and vitalized it." In terms of such a broadly human and intelligent intention, it seems a little strange that the author should devote his attentions in discussing the 20th century to such contemporaneous but non-contemporary structures as the Cathedral of St. John the Divine and Liverpool Cathedral; buildings which, whatever else they may be, can hardly be said to be a direct or honest expression of our time and place in the vital manner in which Mr. Short would like us to think of religious architecture—as an index of a culture's essential spirit.

ART CRITICISM

The Works of Man. By Lisle March Phillipps. *The Philosophical Library, Inc.* (15 E. 40th St., New York, N. Y.), 1951. 5½ by 8½ in. 330 pp., illus. \$4.75.

This is the second edition of a well-known work on art criticism. The first edition appeared in 1911 and has been out of print for eighteen years.

For those who haven't read the book, Mr. Phillipps' main concern is to discover in art, more particularly in architecture which he considers the most broadly human of all the arts, the distinguishing characteristics of man in each historical epoch.

The author believes that art is most significant when it finds expression in definite styles. Art, he says, cannot be inspired only by individual caprice. Another of his theses is that art and

(Reviews continued on page 302)

SELECTING ACOUSTICAL MATERIALS

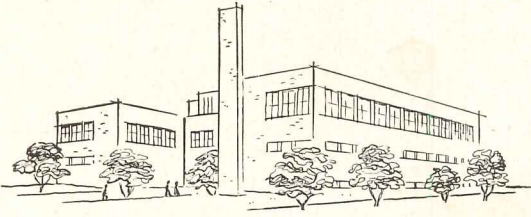

A RECREATION CENTER: Bronx, N. Y.

Architects: Brown, Lawford, & Forbes

General Contractor: Rubin Construction Co.

Acoustical Contractors: Hannam & Schede, Inc.

Other factors besides acoustical efficiency dictated the choice of acoustical materials for the swimming pool of St. Mary's Recreation Center. This area required a material that could withstand extreme moisture conditions, help to protect lighting and ventilating equipment above the ceiling, and bend to fit the ceiling curve.

Armstrong's Corkoustic was chosen because it has high natural resistance to moisture. The pure cork composition of Corkoustic gives it a flexibility unusual in acoustical materials, and its textured surface provides both efficient sound absorption and architectural beauty.

The complete line of Armstrong's Acoustical Materials offers you a wide range of special features. Your Armstrong Contractor is ready to give you expert advice without obligation. Write for free booklet, "How to Select Acoustical Material." Armstrong Cork Company, 24 Stevens Street, Lancaster, Pennsylvania.

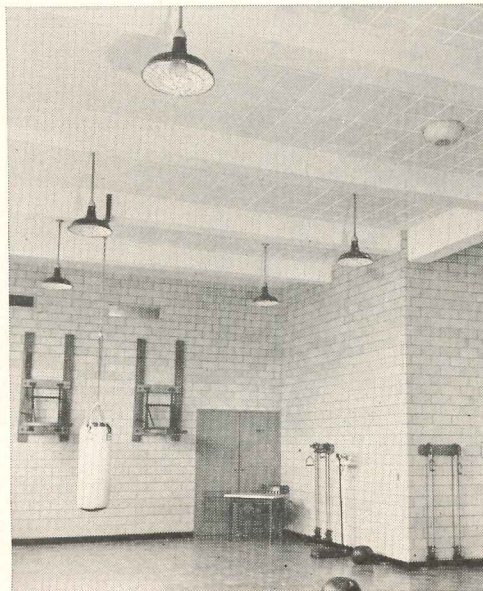
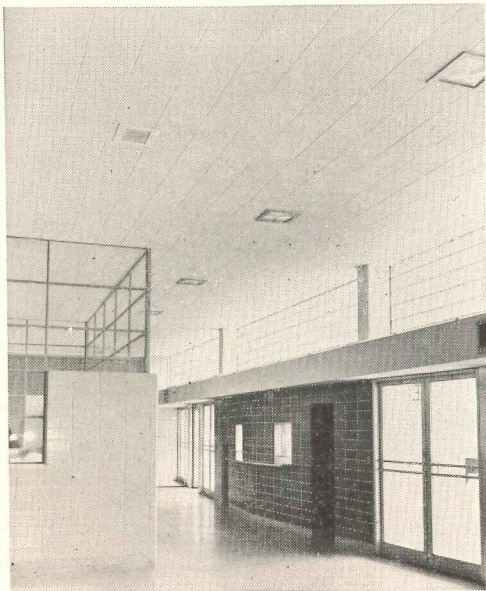

The lobby, gymnasium, and other rooms of St. Mary's are sound conditioned with Armstrong's Cushiontone, a wood fiber acoustical material. It was chosen for its low cost, high sound absorption, and clean, smart appearance. Cushiontone has neatly drilled perforations, and its washable white paint finish is high in light reflection.

ARMSTRONG'S ACOUSTICAL MATERIALS

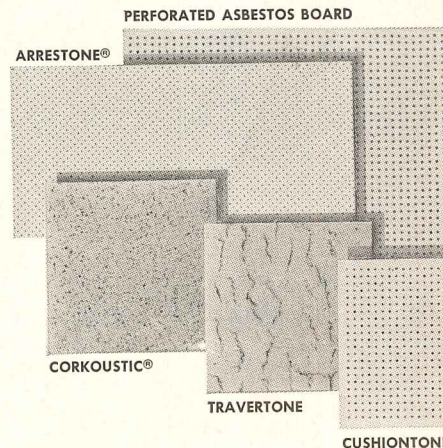



Andersen WINDOWALL in home by Humphrey & Hardenbergh, Inc., architects

**BREEZE-CONDITIONED
BEDROOM with . . .**

ANDERSEN
Windowalls *



CORNER WINDOWALLS add spaciousness, plenty of sunshine and a view to this bedroom during the day. At night they glide easily open, catch every breeze that stirs. Open these three Andersen Gliding Window

Units, and you have 45 square feet of wall open for ventilation. Close them, and you have a highly weathertight picture wall. More than windows, more than walls, these are WINDOWALLS.

*TRADEMARK OF ANDERSEN CORPORATION

Andersen Corporation BAYPORT • MINNESOTA
FAMOUS FOR COMPLETE WOOD WINDOW UNITS

Write for Detail Catalog or Tracing Detail File; or see Sweet's files for specification data. WINDOWALLS sold by millwork dealers.

Low-cost heat for any size space

Specify Carrier to heat big buildings or small, efficiently, economically

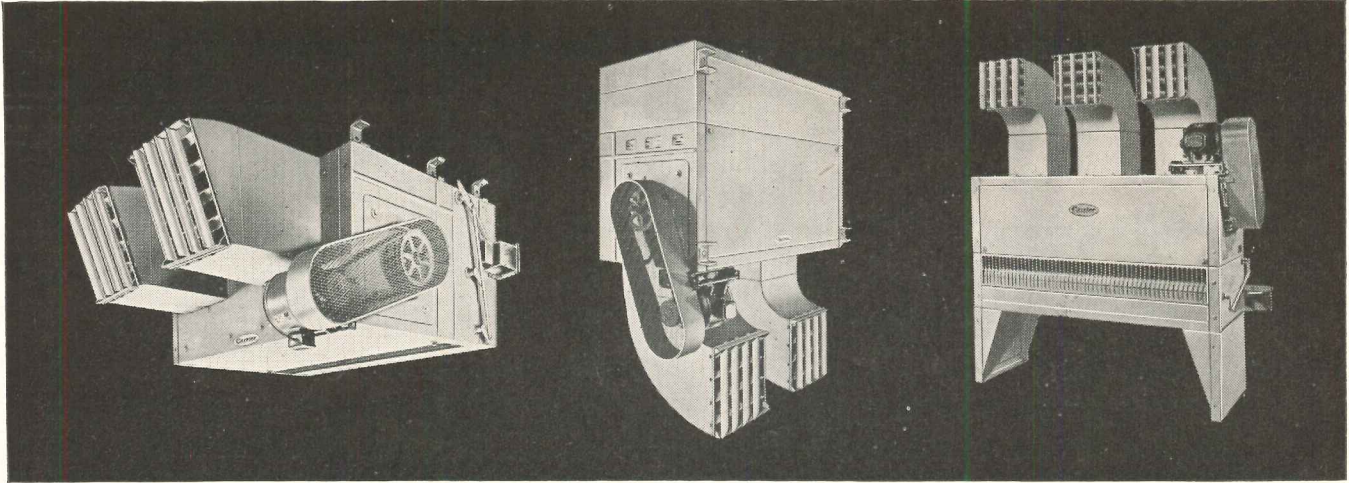

CARRIER BLOWER-TYPE HEAT DIFFUSERS 46P,Q,R heat and ventilate large enclosed areas in factories, warehouses, hangars, garages, etc. Floor, wall or ceiling mounted. Sectionalized for easy handling. Quickly altered to fit changing needs. Multiple discharge outlets with adjustable lou-

vers deliver air in practically any direction. For use with steam or hot water. Available in 7 sizes, to 1,720,000 Btu's, they offer air-handling capacities from 4000 to 25,000 cfm. *We have a catalog, "Carrier Heat Diffusers," that's yours for the asking.*

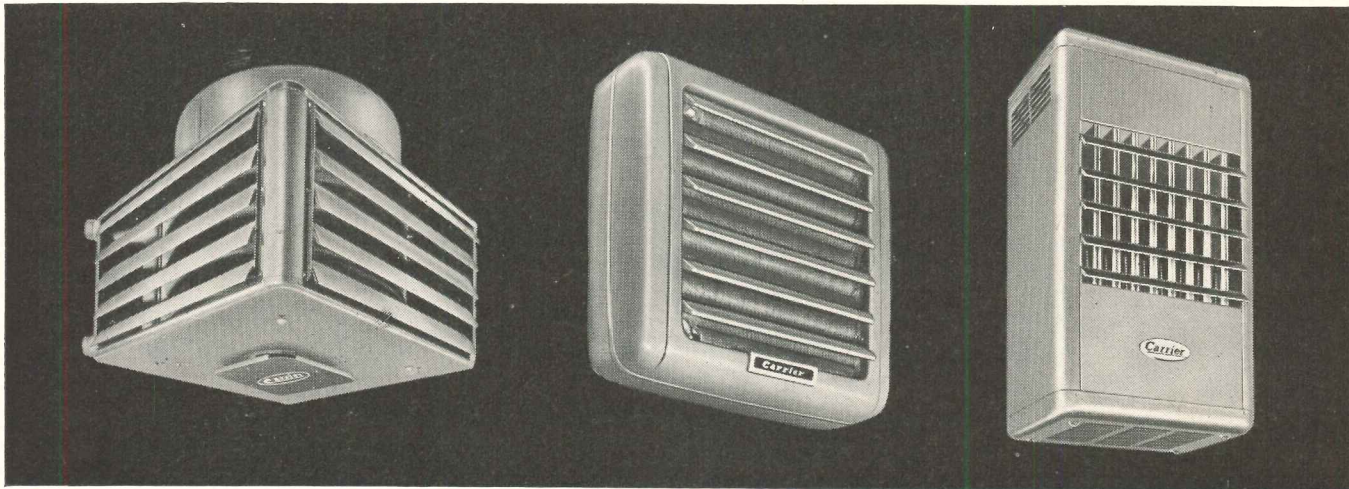

CARRIER PROPELLER-FAN TYPE UNIT HEATERS. *Four-way Directed-flo vertical model 46S* gives quick heat from higher ceilings. Discharges in four directions, at any angle, in any quantity. Steam or hot water. 7 sizes: 82,000 to 500,000 Btu's. *Horizontal model 46U* directs warmed air from heights of 15 to 18 feet. Attractive, quiet, rugged. Single-row Aerofin heating coil with

widely spaced fins offers less air resistance, makes cleaning easier. Steam or hot water. 10 sizes: 21,000 to 200,000 Btu's. *Gas-fired models 46T, shown, and 46TD (duct type)* give clean, economical heat wherever gas is available. Both feature one-piece heat exchanger and combustion chamber of Aluminized Steel. AGA-approved for all types of gas. 7 sizes: 70,000 to 230,000 Btu's.



The Unit Heater Industry is proud of the recognition accorded it by the armed services and procurement departments of the United States Government. Proven in grueling use during World War II, unit heaters are now standard equipment in ships, plane hangars, living quarters, garrison buildings—wherever reliable, efficient heat is necessary for the completion of a task or the well-being of our fighting forces. On the home front, unit heaters serve equally important roles in industrial plants producing war material supplying the needs of the allied forces.

AIR CONDITIONING • REFRIGERATION • INDUSTRIAL HEATING

A note to Carrier Corporation, Syracuse 1, New York, will bring you a free, valuable, complete Industrial Heating Manual.

*Easy, Low-Cost Solution To Every Architect's
Public Seating Problems*

Samson Folding Chairs



Congregation Beth Yeshurun, Houston

Handsome Appearance . . . Posture-Designed For Comfort . . . Ruggedly Built For Low Upkeep And Long Life!

ARCHITECTS everywhere are finding that Samson Folding Chairs allow quick, easy conversion of almost any room to a variety of uses—with complete seating comfort and at low cost.

Strong enough to stand on! Tubular-steel construction, cross-braced and electrically welded, means long life, low upkeep. (Gauge of steel meets U. S. Bureau of Standards specifications.)

Comfortable! Generously proportioned seats. Posture-curved backs. Noiseless, cushioned rubber feet.

Safe! Perfectly balanced—won't tip, tilt or wobble. Safety-guard seat hinge prevents finger injuries.

Easy handling! Samson Chairs open and fold as easily as a book. They stack compactly, conserve storage space.

Special low prices on quantity purchases. Ask your Samson distributor for quotation, or write us direct.



FREE TRIAL! Write us on your letterhead, describing your public seating problem. We will send you, express prepaid, for examination *in your office*, the Samson series 2600 folding chair—America's number one public seating buy!

**Leading Users Of
Public Seating
Everywhere Choose
Samson Folding Chairs!**

Carl Schurz High School
Chicago, Illinois
Pan American World Airways
System
Claremont Hotel
Berkeley, California
Columbia Broadcasting
System, Studio 21
New York City
Veterans Memorial Building
Detroit, Michigan
Wanamaker's
Philadelphia, Pennsylvania
Dinner Key Auditorium
Miami, Florida
Harvard University
Cambridge, Massachusetts
Indiana State Teachers College
Terre Haute, Indiana

THERE'S A **Samson** FOLDING CHAIR FOR EVERY PUBLIC SEATING NEED

Shwayder Bros., Inc., Public Seating Division, Detroit 29, Michigan

ALSO MAKERS OF THE FAMOUS SAMSON FOLDAWAY FURNITURE FOR THE HOME AND SMART SAMSONITE LUGGAGE FOR TRAVEL

how an Architect found the

COURT HOUSE KEY TO KITTANNING

through

Auto-Lok

PATENTED

the perfect window





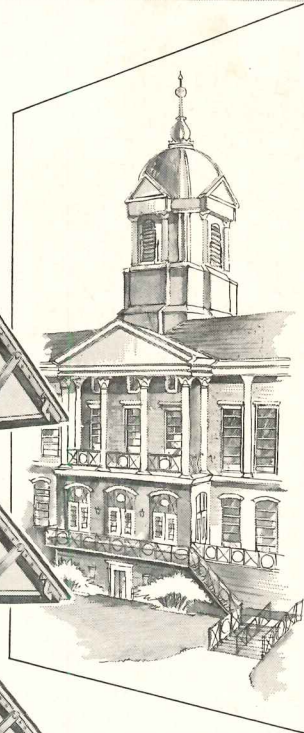
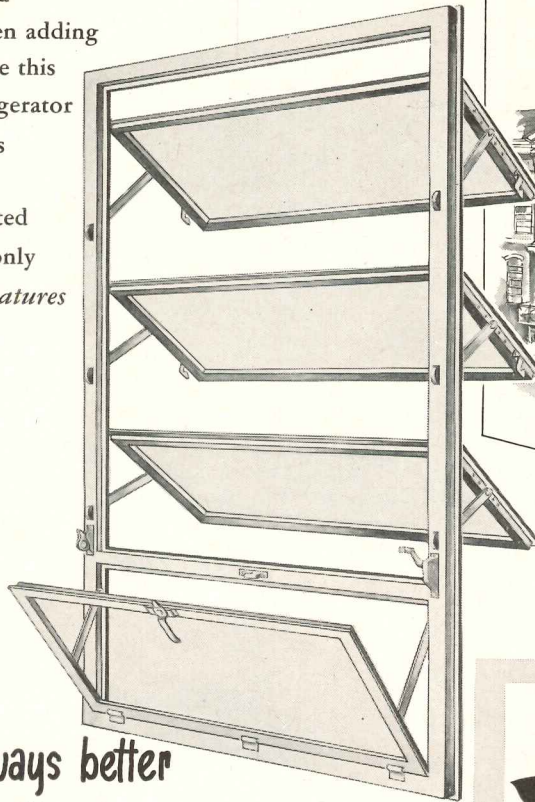









Over in Kittanning, Pennsylvania, residents of Armstrong County point to their court house with added pride today. Something new has been added to the charming old structure to make it a modern, more practical building without sacrificing its period personality. . . . Architect Charles J. Marr specified Auto-Lok aluminum Windows when adding and remodeling . . . not alone because this is the window that seals like a refrigerator when closed . . . or because it affords ventilation even when it's raining. Like many other architects, he selected Auto-Lok because Auto-Lok is the only window which combines the *best features of all window types!*



For further details on Auto-Lok -- The Perfect Window -- see SWEET'S and, by all means, write for the name of your nearest distributor and a copy of the free booklet, "WHAT IS IMPORTANT IN A WINDOW?" Address Dept. AR-1.

Auto-Lok is twelve ways better

-  Tightest closing -- sealed like a refrigerator.
-  Widest opening -- 100% ventilation.
-  Ventilation -- even when it's raining.
-  Fingertip control . . . as easy to open as to close.
-  Automatic locking thwarts intruders -- vents cannot work loose or be jimmied.
-  Draft-free ventilation -- air scooped in and upward.
-  Delayed Action Opening -- 100% control of ventilation.
-  Clean the outside from the inside.
-  Removable inside screens and storm sash.
-  Unobtrusive operator -- no interference with blinds, drapes, etc.
-  Precision balanced hardware eliminates need for periodic adjustment, absolute minimum of maintenance.
-  Skyscraper to cottage, Auto-Lok meets every requirement.

Architect:
Charles J. Marr,
New Philadelphia, Ohio

Associate Architects:
Scheeren & Rittenhouse,
Kittanning, Pa.

Contractor:
Fred Lundgren,
Kittanning, Pa.

*Tightest
Closing
Window
Ever Made*

Auto-Lok

PATENTED

WINDOWS

aluminum or wood

SEALED LIKE A REFRIGERATOR

LUDMAN

Corporation

BOX 4541 • MIAMI, FLORIDA

Certified Capacities... Guaranteed Performance!

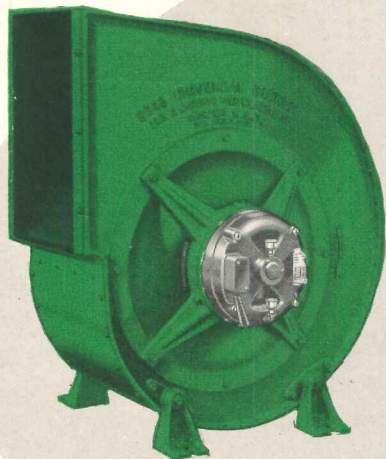

Direct-Drive or Belted
Centrifugal Fans

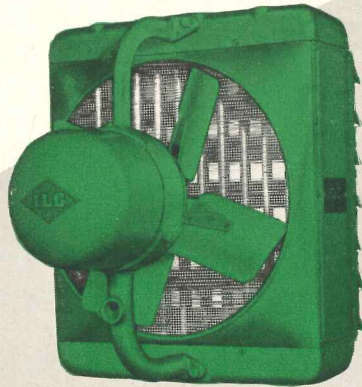

Steam, Hot Water, Gas,
Electric Unit Heaters

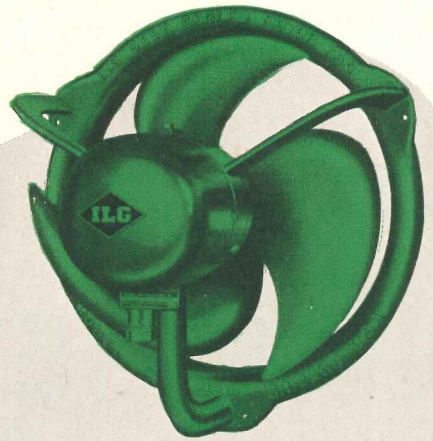

Self-Cooled Motor
Propeller Fans

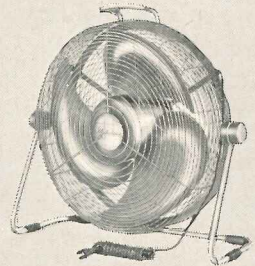

Home Cooling Fans



"PRV" Power Roof Ventilators

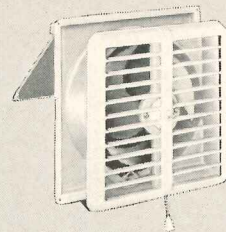

Kitchen Ventilators



Quietest, most dependable equipment you can specify

For your protection, every piece of ILG equipment bears the "One-Name-Plate" Guarantee. This means that each complete unit, including the motor, is covered by a single responsibility. ILG is able to offer this exclusive, broad guarantee only because ILG products are designed and built RIGHT to perform RIGHT.

Direct-connection of motor and wheel, special characteristics incorporated into ILG-built motors, electrical balancing of all rotating parts, scientific streamlining, unusual design features determined by laboratory research, testing of each assembled unit before shipment—add up to exceptionally high quality and remarkably long life. Capacity ratings of each unit are certified according to standard test codes of ASHVE, NAFM, PFMA, and IUHA. Decibel ratings verify quietness of operation.

All these advantages are yours when you specify ILG equipment. Get latest data by phoning nearby Branch Office (consult classified directory) or sending coupon.

VENTILATING, HEATING EQUIPMENT

Ilg Electric Ventilating Co.
2818 N. Crawford Ave., Chicago 41, Illinois
Offices in more than 40 Principal Cities

Send latest data on:

- | | |
|--|---|
| <input type="checkbox"/> Propeller Fans | <input type="checkbox"/> Centrifugal Fans |
| <input type="checkbox"/> Unit Heaters | <input type="checkbox"/> Power Roof Ventilators |
| <input type="checkbox"/> Kitchen Ventilators | <input type="checkbox"/> Night Cooling Fans |

Firm Name _____

Individual _____

Address _____

City _____ State _____



It's **YALE** exclusively for **NEW JERSEY TURNPIKE**

ACROSS NEW JERSEY as across the Nation, the first choice in quality hardware is YALE! What better recommendation can any hardware offer than this outstanding vote of approval by America's leading architects and contractors.

And, a well-earned endorsement it is! For, it is only by making maximum use of research, engineering skill and progressive design methods that YALE has been able to produce the quality

products of today—products that mean greater security...rock-bottom maintenance costs and extra years of dependable service.

See for yourself how easy and inexpensive it is to apply these advantages to your next scheduled job. For complete details, write, today, to The Yale & Towne Manufacturing Company, Dept. S-441, Stamford, Connecticut.

(In Canada, St. Catharines, Ont.)

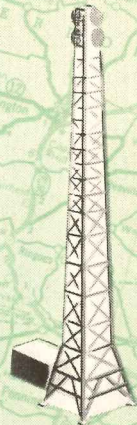

**SHORT WAVE STATION
AND TOWER**

YALE & TOWNE

LUNCHROOM

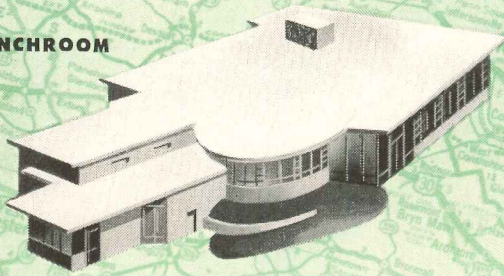

TOLL BOOTH

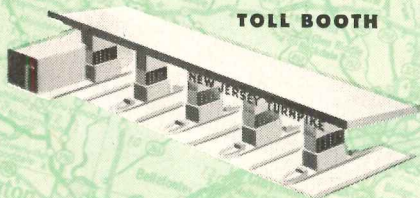

ADMINISTRATION BLDG.

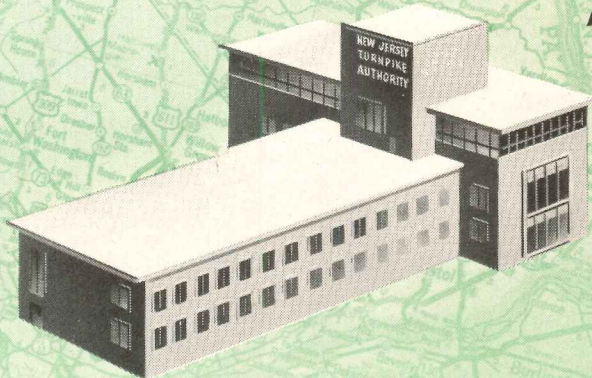

RESTAURANT

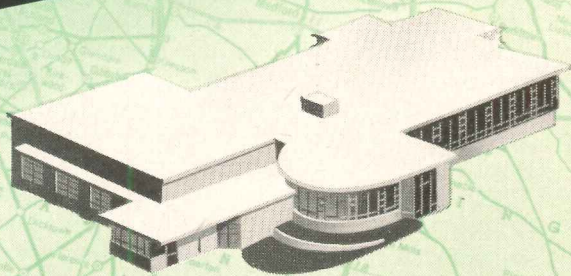

all 43 buildings of the

..America's newest, safest speedway!

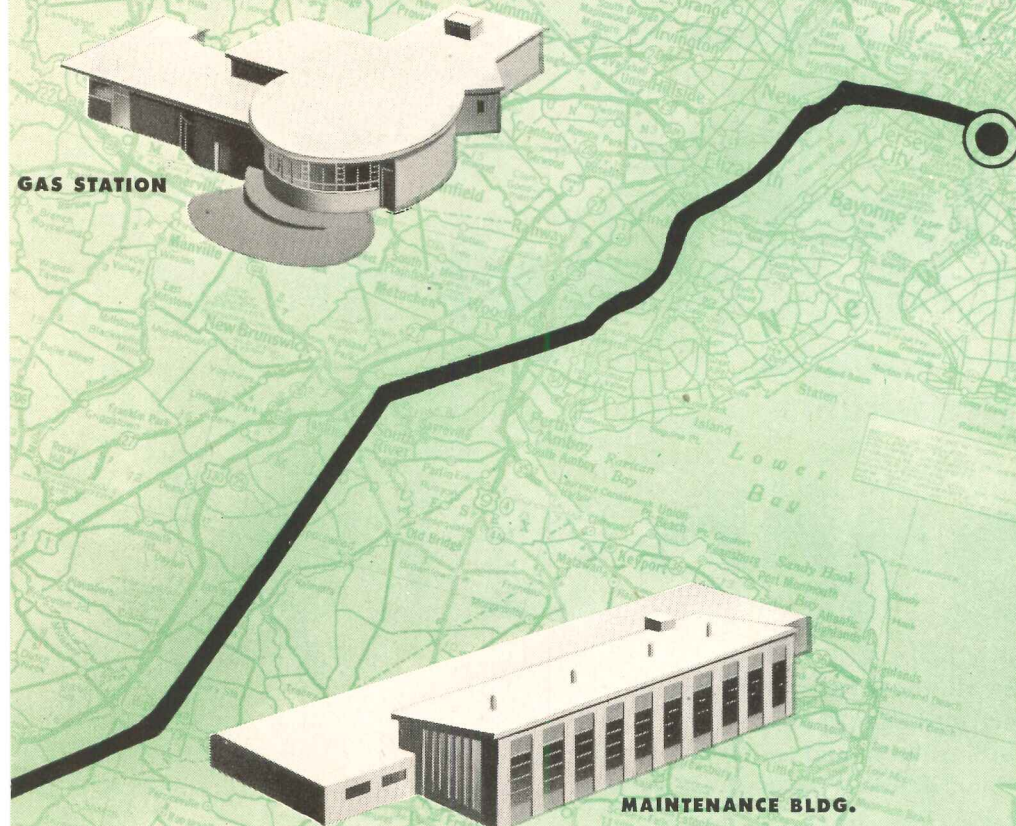

118 MILES . . . 255 MILLION DOLLARS

Running from Delaware to the approaches of Manhattan, the 118 mile New Jersey Turnpike was constructed at an estimated cost of 255 million dollars. It boasts six lanes and forty-three service buildings, all exclusively equipped with YALE hardware. The entire system is Grand Master-keyed!

Architects:

Fellheimer & Wagner
New York, N. Y.

Associate Architects:

Frank Grad & Son
Newark, New Jersey

Contractors:

A. A. LaFountaine &
George Arace
Hackensack, New Jersey

Hardware Supplier:

New Jersey Hardware
Company
Newark, New Jersey

Base Map Copyright by Rand McNally & Company, Chicago R.L. 5152.

And, heres the Yale hardware specified...

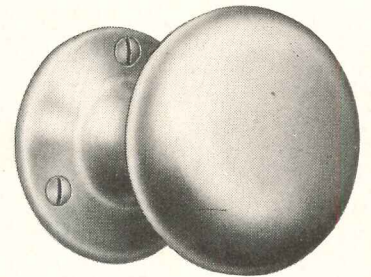

YALE knobs and roses, #D35 and G222

A knob within a knob, the #D35 has a bronze finish spun over an inner shell of steel. Result — beauty with strength and resistance to indentation. The perfect companion, rose #G222 is finished in bronze as well.



YALE Compact door closers — series 90

Available in many sizes and models, these famous YALE door closers work quickly, quietly and firmly. Smart-looking, they combine low installation costs with minimum upkeep.

YALE Builder's locks #8656

With self-lubricating latchbolt and armored front, this Builder's lock offers extra years of service and top security. Bronze fronts.

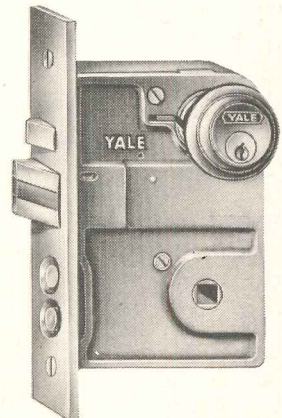

YALE is a registered trademark



It's the **newest**
laminated wood paneling
... unlike anything you've ever seen!

It's the **flattest**

paneling yet developed
—virtually warp-free

It's **novoply***

—revolutionary, new all-wood material. Light. Strong. Spectacularly beautiful. Easily fabricated. Has excellent insulating and sound reduction qualities. Remarkably low priced.

Novoply has qualities superior to those of any wood product yet developed!

It challenges the imagination... offers unlimited possibilities for spirited, distinctive wall and ceiling paneling, for furniture and fixtures. It is the ideal material for cabinet and sliding doors—won't warp or jam. Just the thing for built-ins. In fact, you'll find scores of uses for this exciting new material.

Seeing is believing—write today for free sample of NOVOPLY and descriptive folder.

*Trade-mark registered.
Patented : other patents pending.



Made by **UNITED STATES PLYWOOD CORPORATION**

Manufacturers and Distributors of
Weldwood Plywood, Weldwood Doors
and Other Specialties.

..... AR-1-52

..... UNITED STATES PLYWOOD CORPORATION, 55 West 44th Street, New York 18, N. Y.

..... Please send a sample of NOVOPLY and descriptive booklet.

..... Name.....

..... Address.....

..... City..... Zone..... State.....



Architectural Service

Attractive Awnings

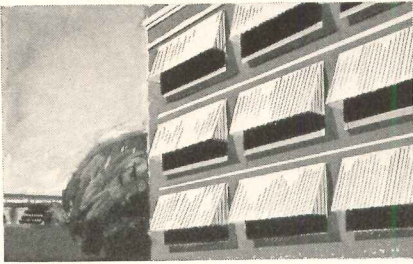

Rapidly increasing use of aluminum awnings is due to their advantages in all types of structures—institutional, commercial, industrial and residential. Besides providing desired shading, aluminum awnings reflect sun's heat—do not absorb and hold it against the building. Maintenance is never a problem with fireproof, rustproof, permanent aluminum . . . either in natural finish or one of the unlimited number of color combinations that are available. Fixed or roll type awnings made from Reynolds Aluminum are sold by many reliable manufacturers. We'll be pleased to send you their names.

Better Ductwork

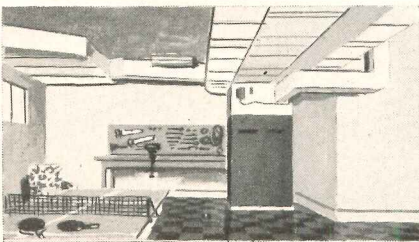

A fast-moving trend to aluminum for heating, ventilating, and air conditioning ducts will soon make it the accepted material standard. Aluminum makes neater installations—an important factor in such places as game rooms. Rust problems are eliminated in laundry areas or wherever moisture is a consideration. Finished costs for aluminum ductwork are comparable to those with less permanent materials because lightweight aluminum is easier to handle, fabricate and install. For completely satisfied clients specify aluminum ductwork.

Modern Fire-Escapes

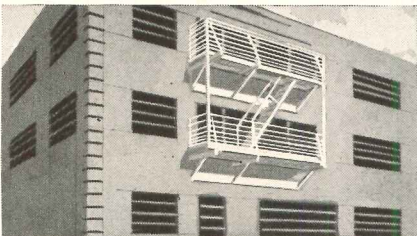

Rust will never stain the buildings you design when you specify fire escapes made of always attractive Reynolds Aluminum. Painting expense is eliminated for the building owner, too . . . especially important where corrosive industrial fumes are encountered. Savings made possible by the lighter structural load and easier erection frequently offset the small added material cost. A Reynolds architectural aluminum specialist will work with you on fire escape or any other aluminum design problem.

(Advertisement)

Measure
ALUMINUM
by these yardsticks

✓ UTILITY
✓ APPEARANCE
✓ INVESTMENT VALUE

You can get these advantages *plus* specialized help from the Reynolds Architectural Service

When planning your next design, stop and ask yourself what other metal offers the advantages that you find in aluminum. Unlimited design flexibility . . . widest range of finishes . . . light weight . . . great strength . . . rust and corrosion resistance. All these factors mean aluminum is the ideal material for *your* specifications.

Even though the supply of aluminum for building is limited now, the assistance of Reynolds Architectural Service is still yours for the asking. This service is an efficient and economical solution to your design problems. For complete information, call the Reynolds office listed under "Aluminum" in your classified telephone directory.

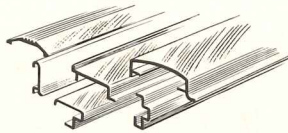

EXTRUDED SHAPES

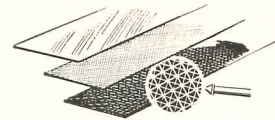

SHEET

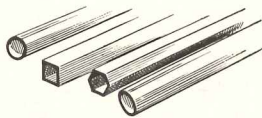

TUBULAR PRODUCTS

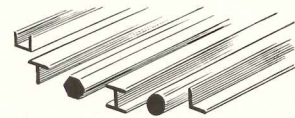

STRUCTURALS

FREE BOOKLET!

Send for your copy of Reynolds Architectural Folio today! A complete, up-to-date kit on architectural aluminum. In loose leaf form with drawings for direct tracing. Free when requested on business letterhead. Write to Reynolds Metals Company, 2572 South Third Street, Louisville 1, Ky.

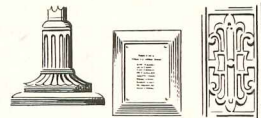
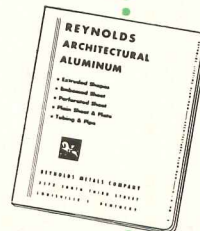

ORNAMENTAL CASTINGS produced to your specifications by independent foundries from Reynolds Aluminum ingot.



REYNOLDS ALUMINUM

MODERN DESIGN HAS ALUMINUM IN MIND

fedders

A GREAT NAME IN COMFORT

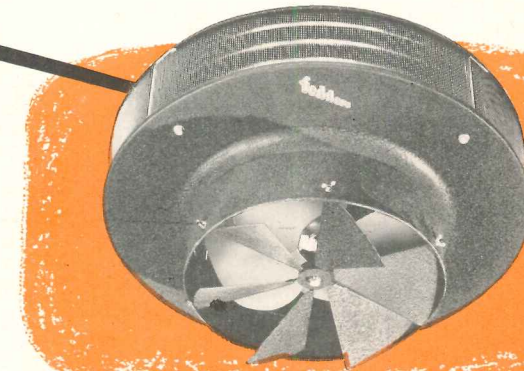

Fedders Series 16 Downblow Unit Heaters are designed for installations involving high ceilings, craneways, frequently opened factory and garage doors.

Fedders Series 15 Horizontal Unit Heaters are widely used in factories, stores, service stations.

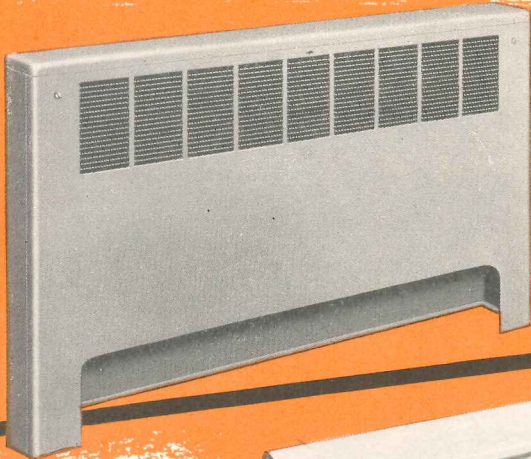

Fedders code rated Convector-Radiators with compact, high efficiency heating elements are made in a wide range of free standing and semi-recessed models. Ideal for new and replacement work.



Fedders Baseboard Radiation with exclusive directional louvers and anti-streak covers are welcomed by architects, decorators and home owners.

Miles of Fedders all-steel Wall Radiation are being used for commercial, institutional, industrial and residential heating. Available with or without covers.

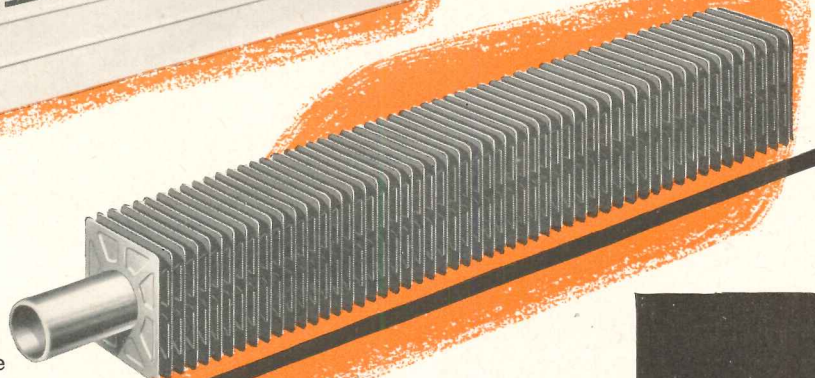

THE QUALITY LINE

for **1952**

• Architects, interior decorators, contractors and home owners approve the Fedders line of modern quality radiation and unit heaters.

*Making Warm Friends for every Man
who Designs, Specifies, Sells, Installs
and Uses Heating Equipment*

They combine every advantage and economy of handsome appearance, cleanliness, uniform heating, easy stocking and installation.

Fedders complete line of Convect-Radiators, Baseboard Radiation, Wall Radiation and Unit Heaters offer well-graduated, standardized sizes and capacities. They meet a wide range of requirements for residential, institutional, industrial and commercial installations.

Complete design and specification data are yours for the asking. Write:

FEDDERS-QUIGAN CORPORATION
57 TONAWANDA STREET • BUFFALO 7, N. Y.

ONLY ***KENNATRACK***
HAS SLIDING DOOR HARDWARE

**Specially Designed and
 Engineered for every
 interior application**

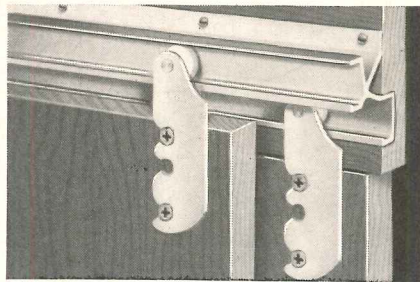

SERIES 250—For by-passing ¾" to 1½" doors on cabinets, wardrobes and fixtures. Hanger permits mounting doors flush with cabinet face.

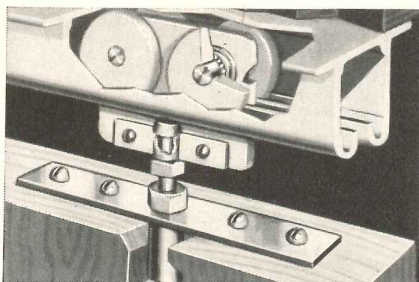

SERIES 400—For heavy closed pocket installations. This is generally considered the finest sliding door hardware obtainable. Allows vertical door adjustment. Ball bearing hangers.

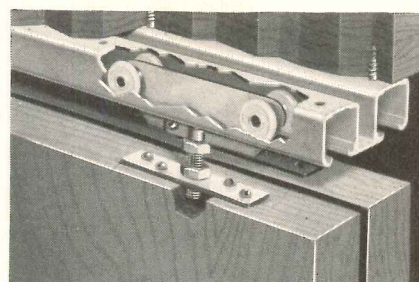

SERIES 600—A new double track designed for 1¾" by-passing wardrobe and closet doors. Has newly designed adjustable hanger providing convenient means of aligning door to side jamb. Allows ½" vertical adjustment.

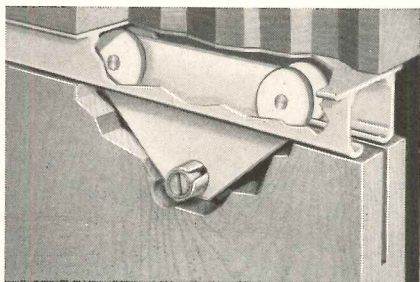

SERIES 300—Kennatrack's most popular hanger. Series 300 is for converging doors, closed and open pocket installation. Has exclusive mounting plug feature requiring minimum headroom of only one inch.

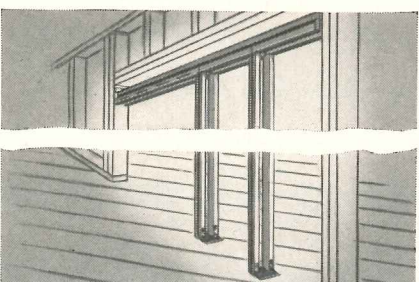

SERIES 800—Metal Sliding Passage Door Frame. Prefabricated. Complete with famous SERIES 400 heavy duty track attached to header at factory. Eliminates all warpage. Easily installed by anyone. Vertical and horizontal ADJUSTMENT features. Wood filler strips permit plaster base, trim and stops to be nailed or screwed to frame.

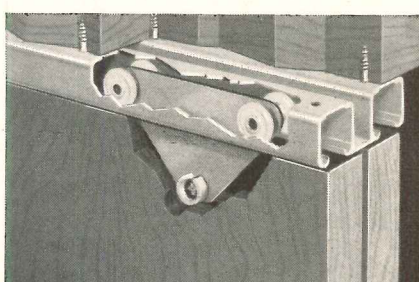

SERIES 650—Exclusive expansion-sleeve mounting plug feature requires minimum headroom space of only 1". Easily installed—just screw track to header! Acceptance of these features is proven by world-wide demand.

At McKenna we specialize in only *one* thing . . . sliding door hardware. As a result the KENNATRACK line is the most comprehensive and versatile line of sliding door hardware ever available. There is a KENNATRACK for every purpose. Each track is specially designed and engineered for a particular interior use. Each door slides smoothly not on two, not on four, but on EIGHT nylon wheels except on Series 250.

In addition there is a KENNATRACK Series 800 METAL PASSAGE DOOR FRAME.

It comes prefabricated and complete with SERIES 400 ball bearing heavy duty track attached to header at the factory. Can be assembled on the job in about 20 minutes.

Features of the KENNATRACK line are too numerous to mention. Moreover, you get all your sliding door hardware from one source. Ask any KENNATRACK jobber about KENNATRACK'S record for fast delivery, prompt service! Specify KENNATRACK for the plus in value.

Write Department 464 for full details.

SEE US



IN BOOTH 96

JAY G. McKENNA, INC.

ELKHART, INDIANA

JAY G. McKENNA (Canada) Ltd., 104 Jarvis St., Toronto, Canada

SPECIALIZING EXCLUSIVELY IN THE MANUFACTURE OF SLIDING DOOR HARDWARE

Aerofuse

IN BOSTON

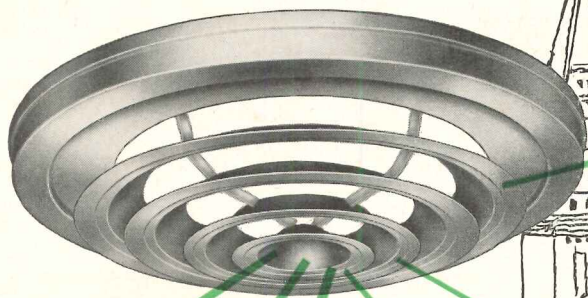

S. S. PIERCE COMPANY

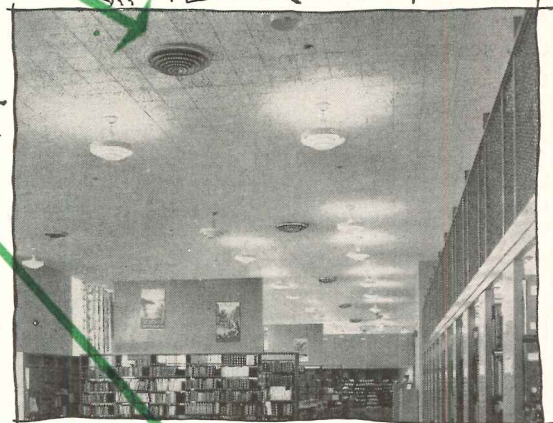

CHARLES HAYDEN MEMORIAL LIBRARY
MASSACHUSETTS INSTITUTE OF
TECHNOLOGY



R. H. STEARNS COMPANY

In the shadow of Bunker Hill ... Old North Church ... and the many other historic landmarks here ... busy Boston enjoys the comfort and convenience of modern air conditioning in its up-to-date commercial, industrial and institutional buildings.

As is the case in other cities from coast to coast, important air conditioning jobs in Boston are Aerofuse Diffuser jobs. Selected on the basis of efficient, dependable performance ... and smart styling that blends architecturally with modern interiors ... Aerofuse Diffusers meet the most exacting requirements at the *vital point of air delivery*, the point at which the success of an air conditioning installation is measured.

There's a complete Aerofuse line ... a type and style to meet every job specification. For complete details, size selection information and engineering data, write for Catalog 104.

TUTTLE & BAILEY inc
NEW BRITAIN, CONNECTICUT

Other Typical
Aerofuse Installations
in the Boston Area

Peter Bent Brigham Hospital Public Service Building

Veterans Hospital
Roxbury, Mass.

Brookline Trust Co.
Brookline, Mass.

Junior High School
Somerset, Mass.

ENGINEERED PRODUCTS FOR HEATING, AIR CONDITIONING AND VENTILATING

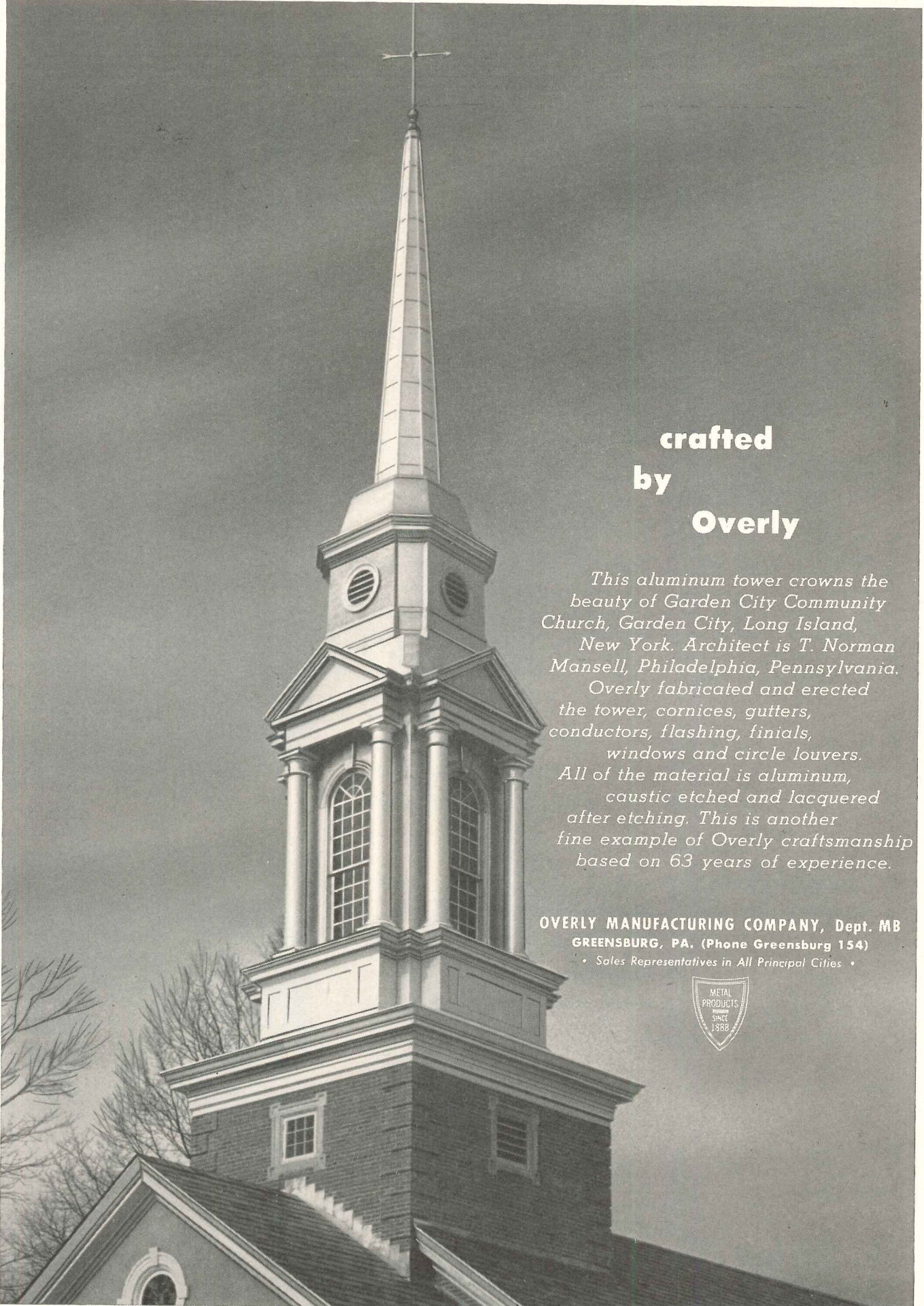

**crafted
by
Overly**

This aluminum tower crowns the beauty of Garden City Community Church, Garden City, Long Island, New York. Architect is T. Norman Mansell, Philadelphia, Pennsylvania.

Overly fabricated and erected the tower, cornices, gutters, conductors, flashing, finials, windows and circle louvers. All of the material is aluminum, caustic etched and lacquered after etching. This is another fine example of Overly craftsmanship based on 63 years of experience.

**OVERLY MANUFACTURING COMPANY, Dept. MB
GREENSBURG, PA. (Phone Greensburg 154)**
• Sales Representatives in All Principal Cities •



This is NEVAMAR[®]

THE LAMINATE THAT BUILDS BEAUTY AND DURABILITY INTO ANY SURFACE



Write For This Free Booklet

It gives you all the facts about NEVAMAR, plus actual applications in full color.

This is NEVAMAR[®]

... a high-pressure laminate surface, designed for long life and lasting beauty. Nevamar is not affected by grease, alcohol, fruit acids, ammonia, bleach, ink or similar substances. It will not craze, crack or peel. Nevamar is resistant to cigarette burns and withstands boiling water. Nevamar may be cleaned with soap and water.

● To keep your Nevamar surface beautiful... Don't use abrasive cleansers. A protective pad should be used beneath hot vessels, electric toasters and similar appliances. Don't use your Nevamar surface as a cutting or chopping board.

TESTED BY 1000S OF WOMEN
Guaranteed by
Good Housekeeping
IF NOT AS ADVERTISED THEREIN

THE NATIONAL Plastic Products Company
ODENTON, MD. • NEW YORK, N. Y. • LOS ANGELES, CAL.



NEVAMAR high-pressure laminates conform to NEMA specifications.

NEVAMAR is a surfacing material that's a natural for livable interiors. Its wide range of colors and patterns—particularly the newer wood grains—gives the decorator and architect free reign in planning original color schemes and decorative effects.

NEVAMAR offers unlimited latitude, too, because it is adaptable to every purpose. Use it on tops for custom-built furniture, on surfaces of cabinets and doors, for wall panels in offices, on store fixtures in modern shops.

NEVAMAR is so easy to care for—it never needs painting or refinishing. It's always a standing tribute to the architect's skill.

SOLE DISTRIBUTORS: THE NEVAMAR COMPANY, BALTIMORE-30, MD.

 *The NATIONAL Plastic Products Company*

Manufacturers of Nevamar Decorative and Industrial Laminates • SARAN FILAMENTS • Wynene Molded Products

ODENTON, MARYLAND • NEW YORK EMPIRE STATE BUILDING • LOS ANGELES 2252 EAST 37th STREET



he's free of concern . . . his plant won't burn

Going home . . . relaxing after a day of high-g geared activity is no trouble for this executive! His mind's at ease about fire . . . a short circuit, a stray spark, a forgotten cigarette or spontaneous combustion . . . all these and many more are definitely under control 24 hours a day, thanks to efficient, quick-acting C-O-TWO Fire Protection Equipment.

You, too, can have this same peace of mind . . . this same positive protection from costly fires by installing complete, approved C-O-TWO Fire Protection Equipment. For instance, at many locations, with today's high costs and delayed replacements, a C-O-TWO Combination Smoke Detecting and Fire Extinguishing System is a "must." The first trace of smoke in a protected area sounds an alarm . . . then fast, clean, non-damaging, non-conducting carbon dioxide blankets the fire, put-

ting it out in seconds, before it spreads and causes extensive damage . . . no after-fire mess, no water damage with carbon dioxide.

Also, C-O-TWO Portable Fire Extinguishers . . . either carbon dioxide type or dry chemical type . . . render fast, positive action for extinguishing fire during the incipient stage. C-O-TWO Portable Fire Extinguishers are designed to take abuse . . . rugged construction, no extra gadgets protruding or complicated operating parts . . . built to rigid specifications to assure you of lasting, efficient fire protection.

Remember . . . you can't put fire off . . . fire doesn't wait! For expert advice, let a C-O-TWO Fire Protection Engineer help you in planning complete and up-to-date fire protection facilities now. Write us for free information . . . our experience is at your disposal.



C-O-TWO FIRE EQUIPMENT COMPANY NEWARK 1 • NEW JERSEY

*Sales and Service in the Principal Cities of United States and Canada
Affiliated with Pyrene Manufacturing Company*

MANUFACTURERS OF APPROVED FIRE PROTECTION EQUIPMENT

**Squeeze-Grip Carbon Dioxide Type Fire Extinguishers • Dry Chemical Type Fire Extinguishers • Built-In Smoke and Heat Fire Detecting Systems
Built-In High Pressure and Low Pressure Carbon Dioxide Type Fire Extinguishing Systems**

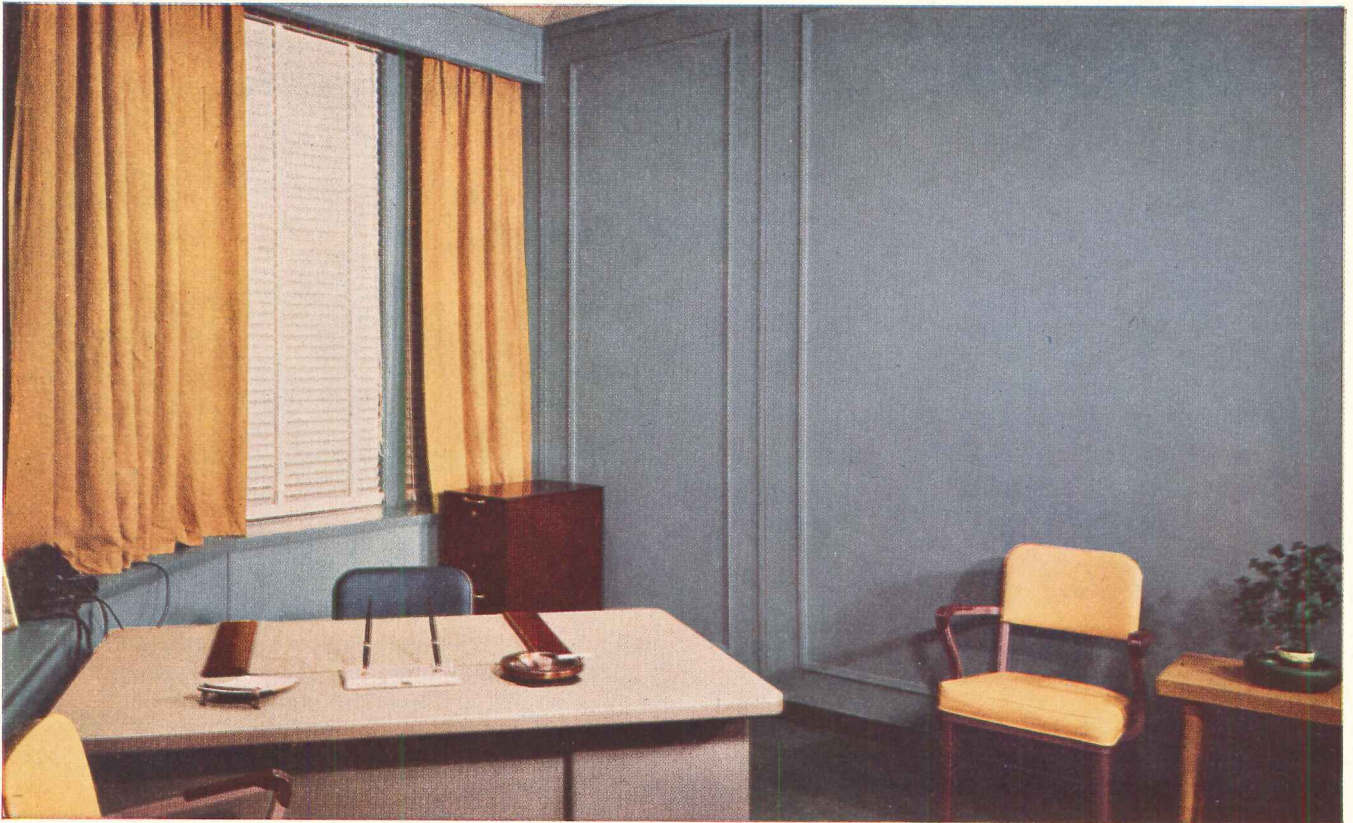

● One of the handsome offices of The Upson Company, Lockport, N. Y., after decorating according to COLOR DYNAMICS.

Pittsburgh COLOR DYNAMICS contributes to greater office efficiency these four ways . . .

1. lessens eye fatigue
2. stimulates concentration and improves efficiency and morale
3. reduces absenteeism
4. simplifies housekeeping problems

NEXT TIME you select color discard old-fashioned methods and do it the up-to-date way — with Pittsburgh COLOR DYNAMICS.

● Pittsburgh has kept pace with modern advancements in office architecture, equipment and management by perfecting this new system of painting which is based upon the *energy in color*. Science has shown that color has a psychological and physical influence upon those who come in contact with it. Some colors cheer or stimulate, others soothe and relax, still

others fatigue, depress and irritate.

● Pittsburgh has put this knowledge to practical use in COLOR DYNAMICS. With this method you can choose color arrangements that are more than just pleasing to the eye—you select colors that improve efficiency and morale, build loyalty, inspire confidence and trust.

● With COLOR DYNAMICS you select the right colors for all types of offices in keeping with their purposes, their exposure to sunlight and their natural and artificial lighting.

● You lessen eye-strain, stimulate concentration, promote the comfort and well-being of those who work in these offices. Because of the greater pride workers take in such surroundings they take extra pains to keep their quarters neat and clean, thus reducing housekeeping and maintenance problems.

● Why not discover for yourself how you transform the offices you plan or build into a business asset that lends prestige to their tenants and the goods or services they sell?

LET US MAKE A COLOR DYNAMICS ENGINEERING STUDY FOR YOU—FREE!

● For a complete explanation of COLOR DYNAMICS and what it can do for the offices you plan or build, send for our free booklet containing many practical suggestions. Better still—we'll gladly make a color engineering study of your building, or any portion of it, *without cost or obligation*. Just call your nearest Pittsburgh Plate Glass Company branch and arrange to have one of our trained color experts see you at your convenience. Or send this coupon.

SEND FOR A COPY OF THIS BOOK!

Pittsburgh Plate Glass Co., Paint Div.,
Dept. AR-12, Pittsburgh 22, Pa.

Please send me a FREE copy of your Booklet "Color Dynamics."

Please have your representative call for a Color Dynamics Survey without obligation on our part.

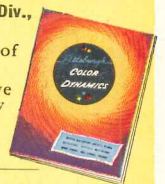

Name _____
Street _____
City _____ County _____ State _____



PITTSBURGH PAINTS

PAINTS • GLASS • CHEMICALS • BRUSHES • PLASTICS

PITTSBURGH PLATE GLASS COMPANY

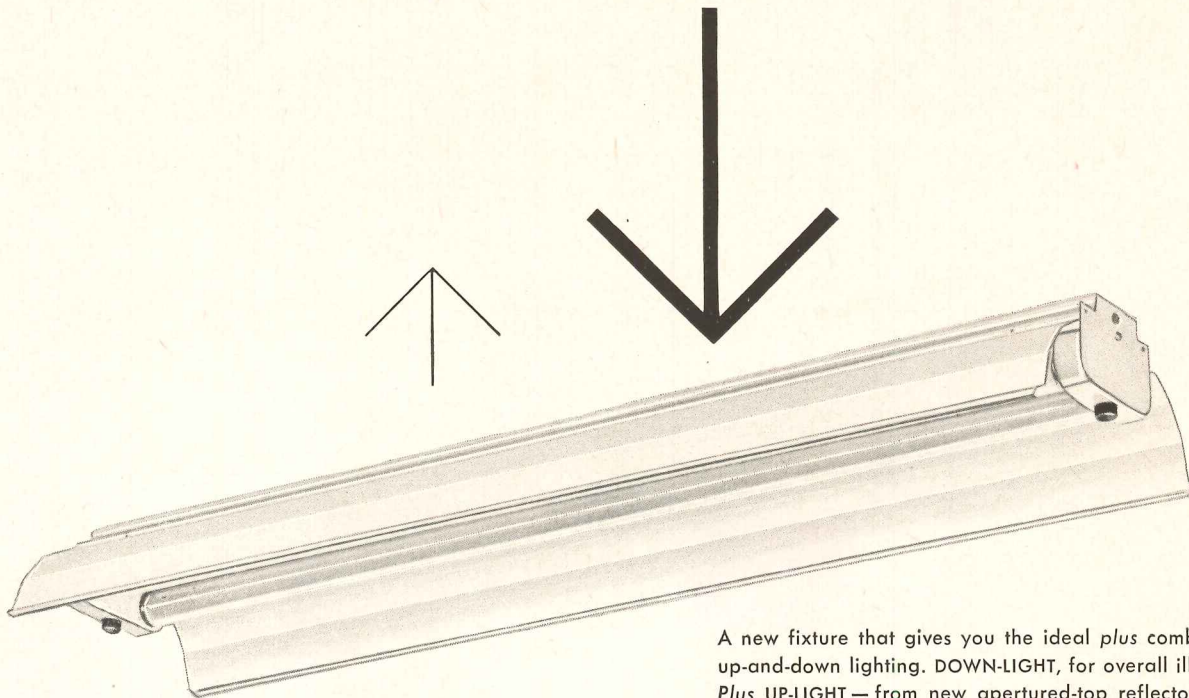

A new fixture that gives you the ideal *plus* combination of up-and-down lighting. DOWN-LIGHT, for overall illumination. *Plus* UP-LIGHT — from new apertured-top reflector, new all-white finish inside and out — to minimize brightness contrast (and give sufficient light for overhead maintenance). Result — a new high standard of illumination that enables workers to see easily and work better.

A more compact fixture, too, made possible by the use of the new G. E. small cross-section ballast. Long life assured by rigid adherence to the Miller 8-Point QUALITY standard. Engineered for easy installation and maintenance. Carries RLM label. Can be mounted individually or in continuous rows. Delivery — excellent.

a new plus in industrial lighting

millier 50 FOOT CANDLER JR.

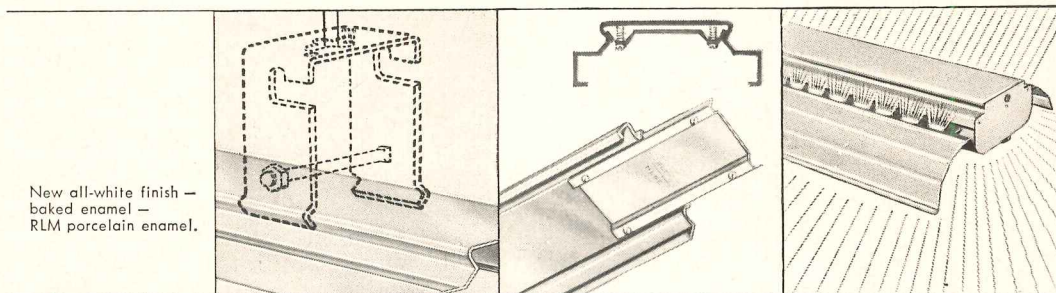

New all-white finish — baked enamel — RLM porcelain enamel.

Flanged-top wireway channel permits clamp hanger mounting anywhere along entire length — simplifies installation.

New pressure-type connector for joining luminaries for continuous rows. No holes to drill.

New apertured-top reflectors, minimize brightness contrast — give sufficient up-light for overhead maintenance.

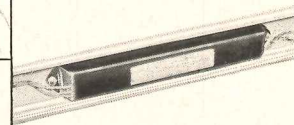
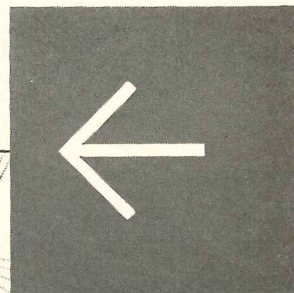

New small cross-section G.E. #89G343 ballast — streamlined wireway.

This, the husky son of our famous 50 Foot Candler, is the newest of a complete line of Fluorescent, Filament and Mercury fixtures for a wide range of industrial and commercial lighting requirements. Miller field engineers and distributors are conveniently located for nation-wide service.

THE millier COMPANY MERIDEN, CONN.
SINCE 1844

ILLUMINATING DIVISION:

Fluorescent, Incandescent, Mercury Lighting Equipment

HEATING PRODUCTS DIVISION:

Domestic Oil Burners and Liquid Fuel Devices

ROLLING MILL DIVISION:

Phosphor Bronze and Brass in Sheets, Strips and Rolls



New STEELCRAFT INDUSTRIAL PIVOTED STEEL WINDOWS

Stronger-Durable!

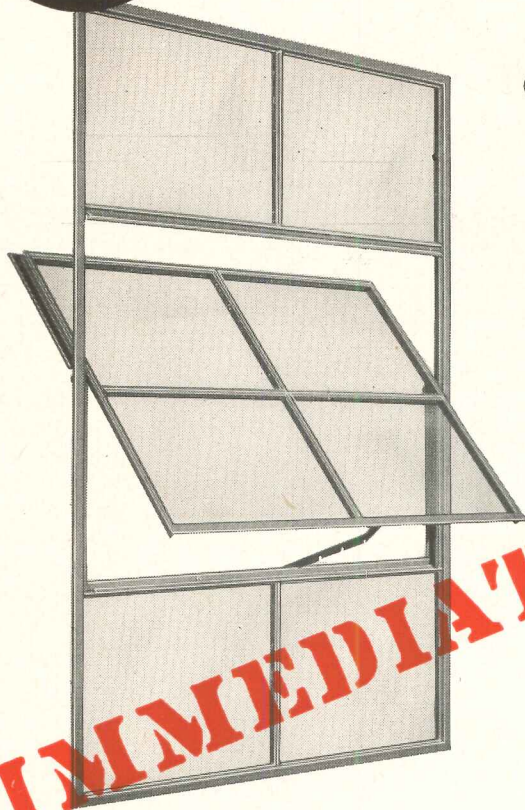

- HOT ROLLED NEW BILLET STEEL
- STURDY HEAVY DUTY CONSTRUCTION
- DOUBLE CONTACT WEATHERING
- BUILT-IN BEARING TYPE PIVOT
- EASILY INSTALLED

IMMEDIATE DELIVERY

Especially designed for Factories, Warehouses, Garages, Stores and other Industrial and Commercial installations.

Typical Installations

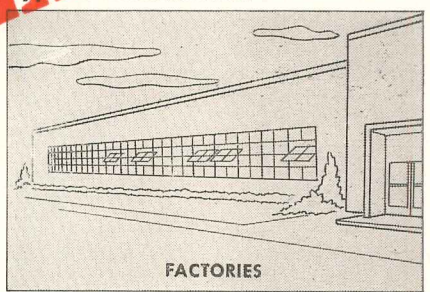

FACTORIES

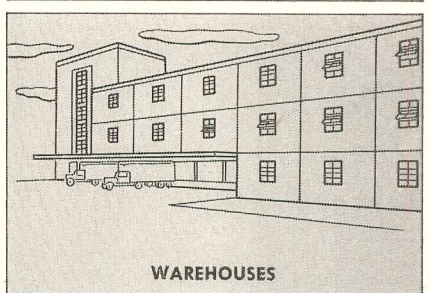

WAREHOUSES

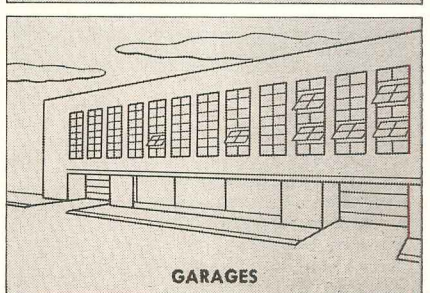

GARAGES

... and they're BONDERIZED for Protection.

When daylight, ventilation and economy are the primary considerations in planning a new building, Steelcraft Industrial Pivoted Steel Windows are the answer. With Steelcraft Industrial Pivoted-Type Windows you can plan continuous walls of glass or use them as units.

Made of hot rolled new billet steel, Steelcraft Windows are strong and rugged yet designed for maximum light. Steelcraft pivoted windows are engineered for permanent, easy operation of the vented section. They cannot stick, warp or shrink and always operate easily under all weather conditions. The outside sections are angle shaped to provide firm anchorage in the masonry or mullion connection. Double Flat contact weathering is provided on all four sides of the ventilator.



FREE CATALOG

Write today for complete information on Steelcraft Pivoted-Type Industrial Windows. Mail the coupon now.



MAIL COUPON NOW

STEELCRAFT MANUFACTURING COMPANY, DEPT. AR-152
9017 Blue Ash Road, Rossmoyne, Ohio

Please send me complete information on Steelcraft Industrial Windows.

Name.....Title.....
 Company.....
 Business Address.....
 City.....Zone.....State.....

STEELCRAFT
 MANUFACTURING COMPANY
 ROSSMOYNE, OHIO (IN GREATER CINCINNATI)

marble

beauty
and
sanitary
cleanliness

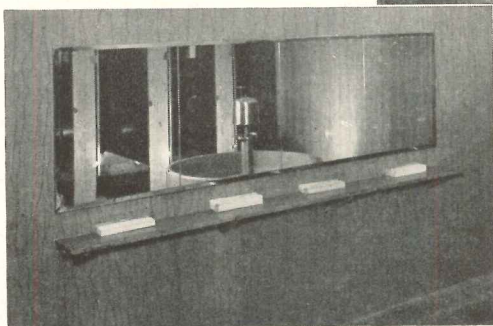
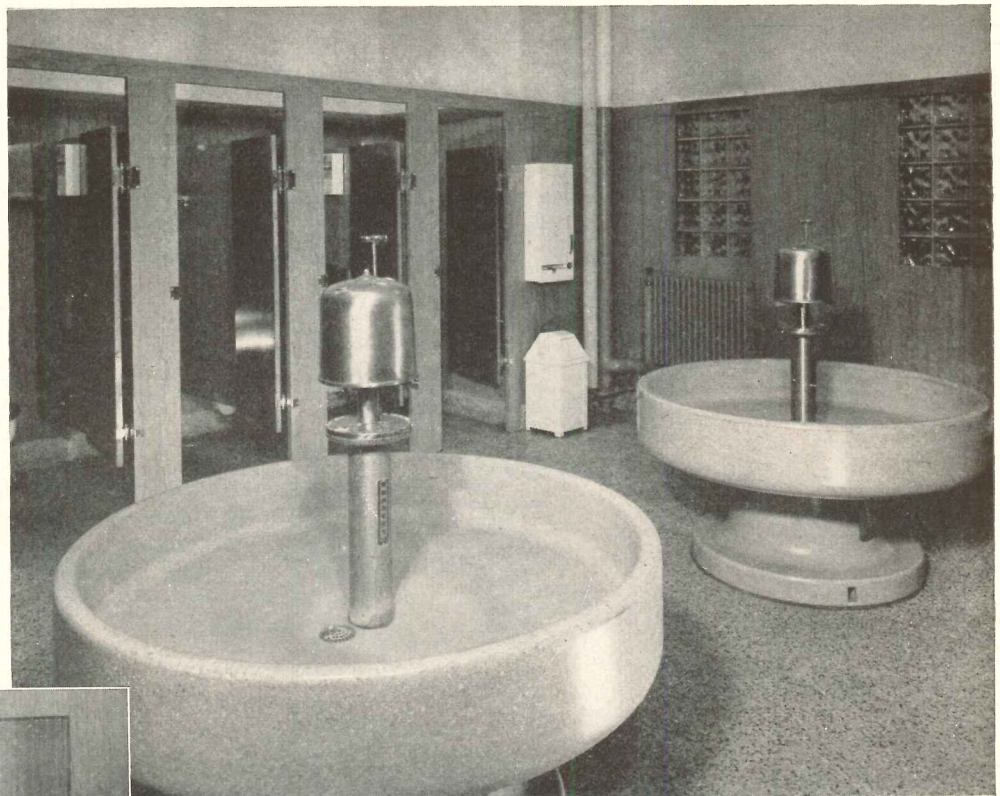

• Fitzhugh Scott, Sr. & Jr., Architects.

Membership in the M.I.A. is your guarantee that materials and methods used in Marble installations conform to the highest standards. Patronize your local M.I.A. member.

FREE LITERATURE: "The Care and Cleaning of Marble" will be sent on request. Write to:

You can wash your hands and *know* they're clean. Isn't it just as important to *know* that the materials you provide to maintain cleanliness *do* inhibit the growth of germs and bacterial organisms — more dangerous than the dirt you can see?

Marble is one material which is by nature *an aid* to sanitary cleanliness. It can be maintained hospital-clean with only the simplest daily attention. And Marble is always beautiful to look at, bright and cheerful to live with.

MARBLE



INSTITUTE OF AMERICA, INC.

108 FORSTER AVENUE, MOUNT VERNON, NEW YORK

Now—**RICHMOND** Vogue Lavatory comes complete with the



THE VOGUE
 plate G-141
 (10" punching)
 plate G-143
 (4" punching)

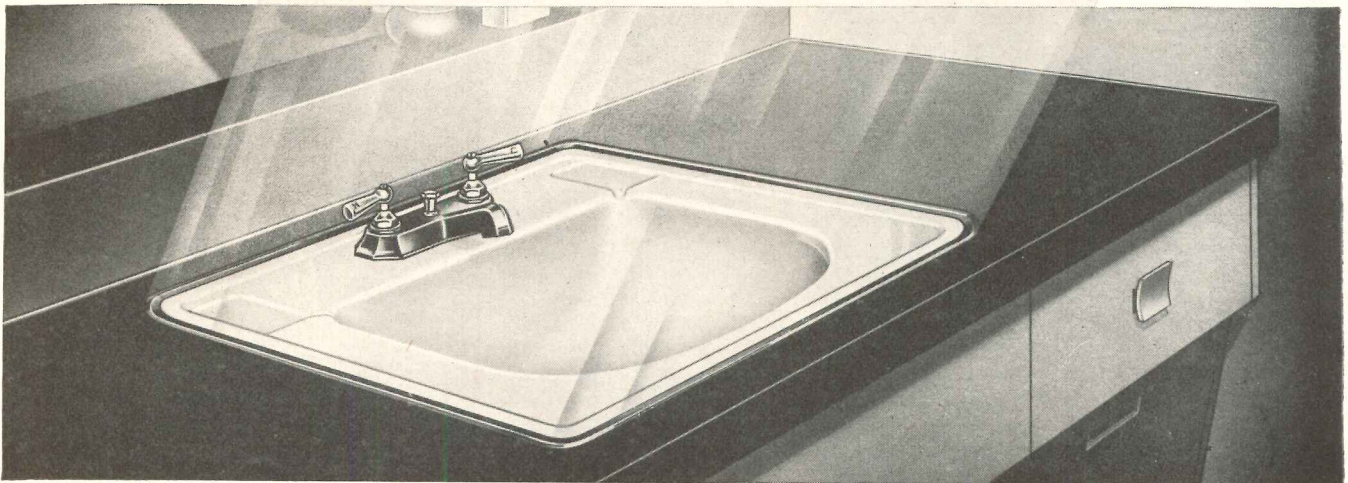

When you use the *Vogue*, you're sure of a top-quality vitreous china lavatory, that is easily installed with the special Richmond "F-543" Rim, which comes complete with special mounting lugs and bolts.

The fashionable *Vogue* is ideal for counter-top installations using plastic, linoleum or wood dressing table materials. It comes in "Whiter-White",

Bermuda Coral, Azure Blue, Fern Green, Oriental Ivory and Mellow Red . . . with recessed soap dishes, rectangular bowl, spacious slab, and built with concealed front overflow.

Remember—whenever you use a Richmond fixture, you're sure of outstanding beauty of design and finish—plus the trouble-free service that builds complete and lasting customer satisfaction.

See your wholesaler or Mail Coupon Today:



RICHMOND

RICHMOND RADIATOR CO.—AFFILIATE OF REYNOLDS METALS CO.

Richmond Radiator Company AR-1
 19 East 47th Street, New York 17, New York
 Please send me additional information and literature on the Richmond Vogue Lavatory with "F-543" Rim. No obligation, of course.

NAME.....

COMPANY.....

ADDRESS.....

CITY.....ZONE.....STATE.....

We are plumbing wholesalers plumbing contractors building contractors.

Specify Goodall Seamloc* Carpeting

for these 4 plusses

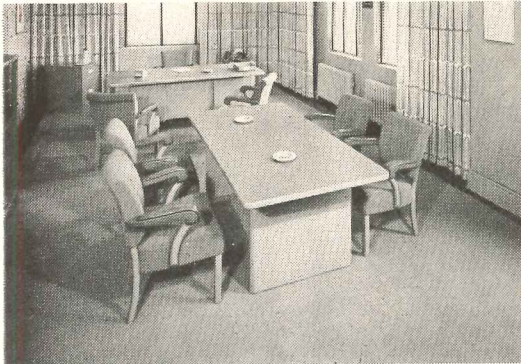

Remington Rand, Inc., New York, carpeted the office of A. N. Seares, Vice-President with Goodall *Sampson* in harmonious Taupe.

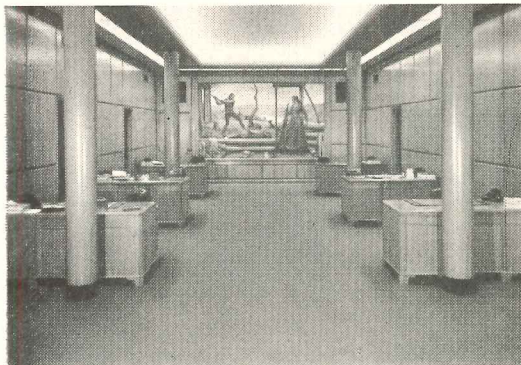

The Fidelity Trust Company, Pittsburgh, achieves elegance in this office with Goodall *Sampson* ... the color, Turquoise.



The California Packing Corp., San Francisco, color-keys the office of its Vice-President with Goodall *Sampson* in Willow Green.

1. Wide Color Range:

You'll marvel at the richness, softness, and clarity of Goodall Seamloc's colors. Colors with the subtle variations you need for true decorator beauty. Goodall's Luxuria, Araby, and more than any other wool carpeting. Every Goodall quality, of course, comes in a wide range that meets every decorating theme.

2. Velvet, Hard Twist and Loop Pile Qualities:

Seamloc is available in many qualities. Your dealer will help you select the one that is exactly right for your particular job.

3. Easier Installation:

Seamloc comes in 4½' widths to fit rooms of every size with less waste. Special seam construction allows practically invisible seams. Seamloc makes special insertions of design or color possible without custom-weaving. Seamloc can be moved elsewhere ... re-cut and re-show. And the "welded" seams have a tensile strength of 70 pounds to the square inch ... 2½ times stronger than sewn seams.

4. Long Wear:

Goodall Seamloc is *Blended-to-Perform* of selected all wool yarns. That means long wear, greater resilience, greater luxury. Double backing holds the rich pile *in* and *up* ... allows Seamloc to be washed right on the floor. See any of the dealers listed below ... get the right Seamloc carpeting for office, store, institution, and housing project installations.

© 1952, Goodall Fabrics, Inc. Subsidiary, Goodall-Sanford, Inc.
(Sole Makers of World-Famous PALM BEACH* Cloth)

GOODALL FABRICS, INC. • NEW YORK • BOSTON
CHICAGO • DETROIT • SAN FRANCISCO • LOS ANGELES

*Registered Trade Marks

• These key distributors will supply you with Goodall Seamloc Carpeting immediately!

ATLANTA: Vol T. Blacknall Co. BOSTON: Ben Elfman Carpet Co., A. J. Wallace Mfg. Co. BUFFALO: Bickford Brothers Co. CHICAGO: American Rug & Carpet Co. CUMBERLAND: Felix Half & Brother, Inc. DALLAS: American Rug & Carpet Co. DENVER: McGranahan Brothers. DETROIT: Edson Moore & Co. FRESNO: D. N. & E. Walter & Co. KANSAS CITY: American Rug & Carpet Co. LOS ANGELES: D. N. & E. Walter & Co. MILWAUKEE, MINNEAPOLIS: American Rug & Carpet Co. NEW ORLEANS: Brown & Demaré. NEW YORK, PHILADELPHIA: American Rug & Carpet Co., Inc. PITTSBURGH: Felix Half & Brother, Inc. PORTLAND, SALT LAKE CITY, SAN DIEGO, SAN FRANCISCO, SEATTLE, SPOKANE: D. N. & E. Walter & Co. ST. LOUIS: American Rug & Carpet Co. WASHINGTON, D. C.: American Wholesalers.



Bottom left, South wall exterior, lounge in foreground, McCormick Theological Seminary of the Presbyterian Church, Chicago, Ill. Architects: Edwin H. Mittelbush and Edward M. Tourtelot, Jr. Consulting Engineer: Frank W. Riederer. Heating Contractor: Advance Heating & Air Conditioning Corp. General Contractor: A. L. Jackson Co.

Bottom right, Detail showing Walvector on end connecting with Hi-Cap Webster Baseboard Heating under large windows.

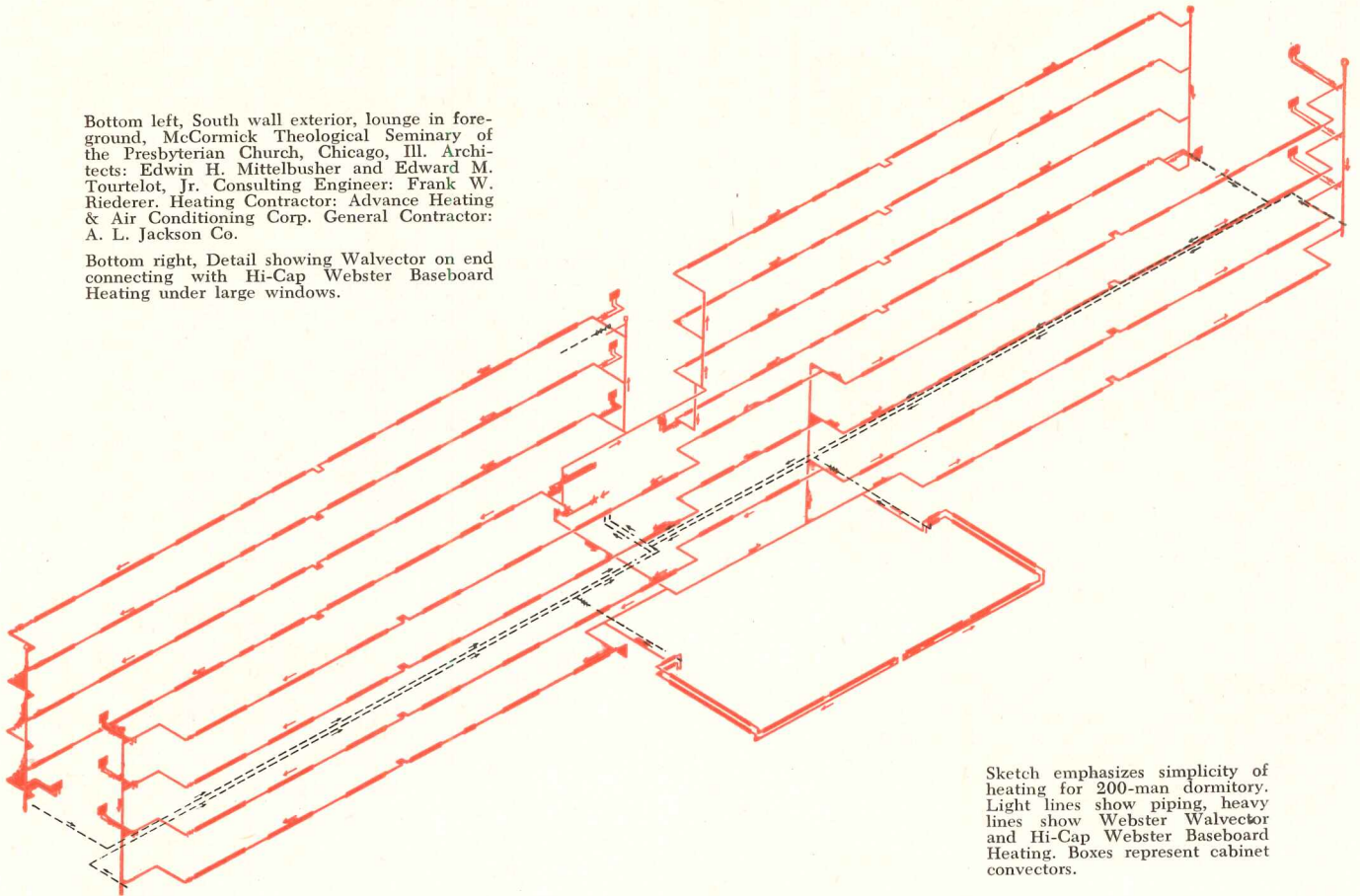

Sketch emphasizes simplicity of heating for 200-man dormitory. Light lines show piping, heavy lines show Webster Walvector and Hi-Cap Webster Baseboard Heating. Boxes represent cabinet convectors.

Perimeter Heating for a Dormitory

True perimeter forced hot water Webster Heating was provided for the new dormitory building at McCormick Theological Seminary.

Continuous Heating Elements connected in series blanket the windows . . . spread the heat uniformly on every floor.

Consulting Engineer Frank W. Riederer says:

"The continuous radiation design contributed to economy of first cost. It eliminates exposed piping, leaves more usable room space, produces uniform heating.

"Steam from the Seminary's central heating plant is converted to hot water in a heat exchanger. In this design, the hot water system proved less expensive and more satisfactory than a system using steam."

Call the Authorized Webster Factory Representative or write us for his name.

Address Dept. AR-1

WARREN WEBSTER & COMPANY
Camden 5, N.J. Representatives in Principal U.S. Cities
In Canada, Darling Brothers, Limited, Montreal

Webster
WALVECTOR
REG. U. S. PAT. OFF.
For Steam or Hot Water Heating

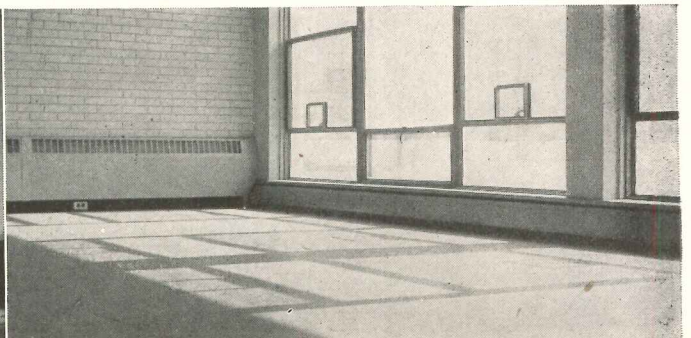
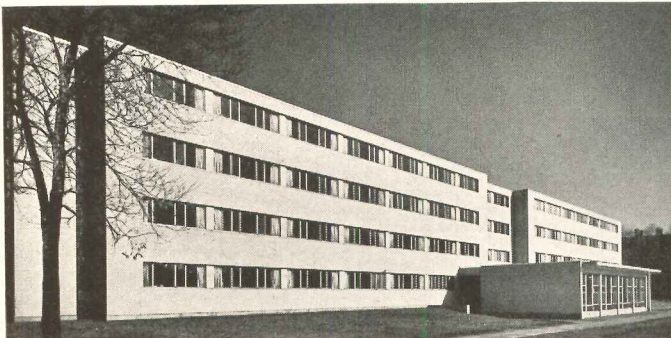

WEST COAST HOSPITAL illustrates flexibility of Frigidaire air conditioning and refrigeration units

LOCATION: Yakima, Washington
OWNER: Yakima Valley Memorial Hospital

The maintenance of proper temperatures in a large hospital—near zero for frozen-food storage to comfort air conditioning for patients and staff—presents many an engineering problem—and calls for a variety of specialized equipment. The architects and engineers of the Yakima Valley Memorial Hospital knew that this equipment must be dependable, too—to provide not only a wide range of temperatures, but precise control of these temperatures at all times, under all conditions.

Like many modern hospitals, Yakima Valley Memorial Hospital is equipped throughout with Frigidaire Air Conditioning and Refrigeration. The following is quoted from a letter written by George V. Rankin, Chairman of the Building Committee.

“Our hospital is 100% equipped with Frigidaire Air Conditioning and Refrigeration, including kitchen and food storage equipment as well as biological and blood bank refrigerators. One full year of most satisfactory operation indicates that we made a wise selection when we chose Frigidaire.”

For expert help in planning installations of this kind—or in solving any air conditioning or refrigeration problem—call the Frigidaire Dealer, Distributor or Factory Branch that serves your area. Look for the name in the Yellow Pages of your phone book. See Frigidaire catalogs in Sweet's Files or write Frigidaire Division of General Motors, Dayton 1, Ohio. In Canada, Leaside (Toronto 17), Ontario.



Frigidaire Air Conditioning and Refrigeration throughout.



Frigidaire Reach-In Refrigerators and Ice Cream Cabinets match the modern efficiency of this carefully planned hospital kitchen.

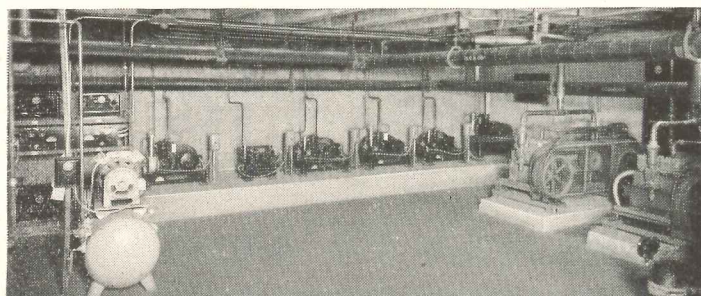

12 Frigidaire Compressors serve the food refrigeration and air conditioning requirements of the entire hospital.

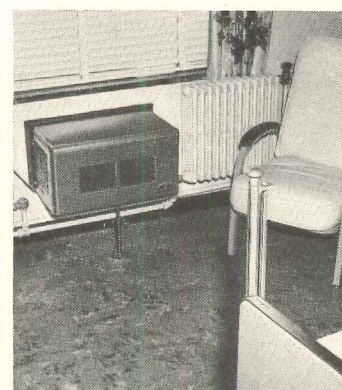

Individually controlled Frigidaire Room Air Conditioners provide cool, filtered air in many hospital rooms.

FRIGIDAIRE Appliances — Refrigeration and Air Conditioning Products

Frigidaire reserves the right to change specifications, or discontinue models, without notice

Refrigerators • Electric Ranges • Home Laundry Equipment
Food Freezers • Water Coolers • Electric Water Heaters • Air Conditioning
Electric Dehumidifier • Commercial Refrigeration Equipment

Save Critical Steel...

with **STRUCTURAL FACING TILE**

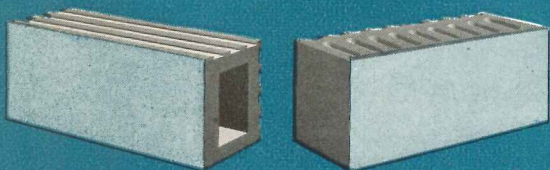
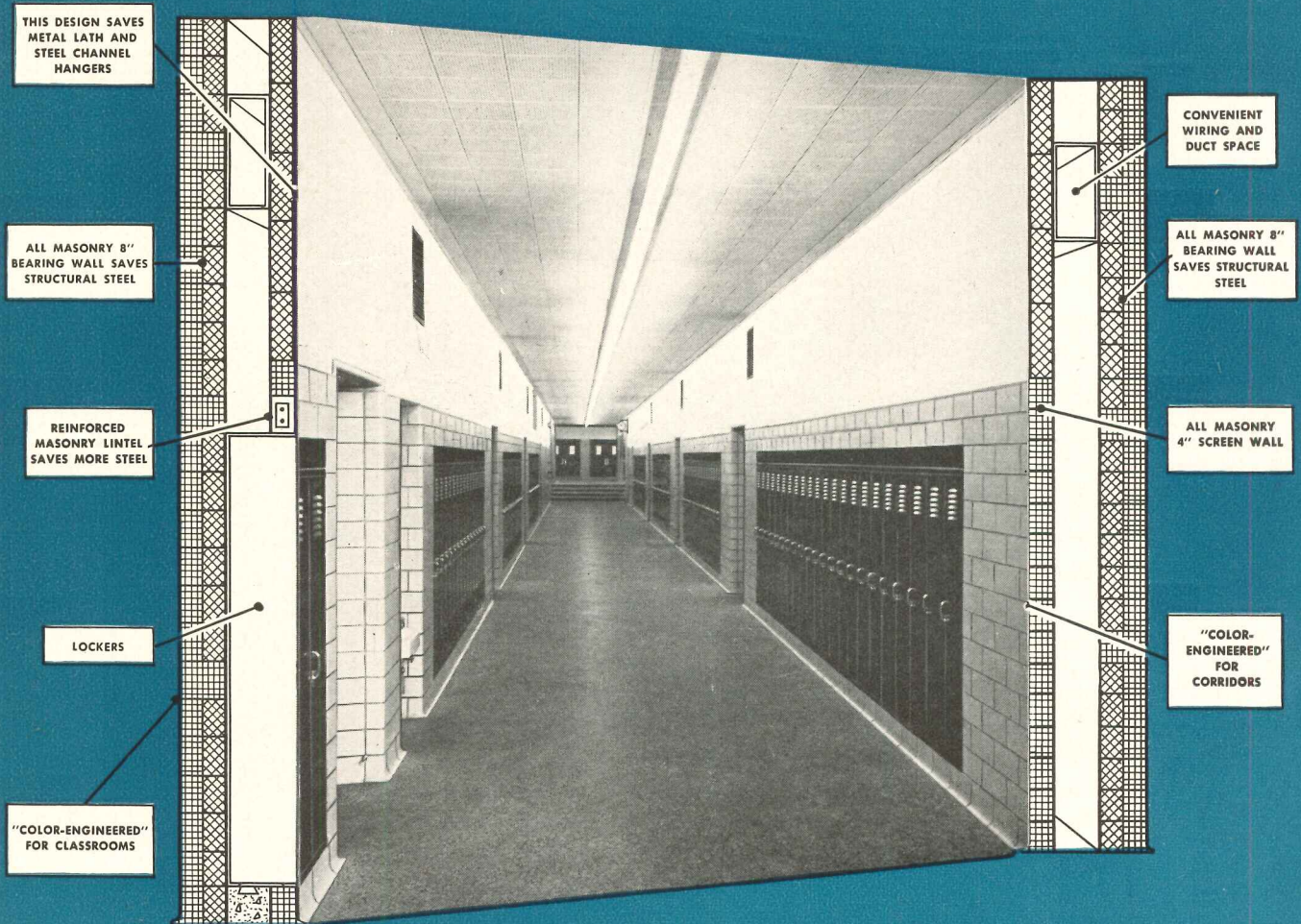

FACING TILE GIVES YOU MORE FOR YOUR DOLLAR THAN ANY OTHER SINGLE BUILDING MATERIAL!

- IT'S A WALL AND FINISH IN ONE
- IT GOES UP FAST
- FIRST COST IS LAST COST
- IT'S LOAD-BEARING
- IT'S "COLOR-ENGINEERED"

...and it's available!

LOOK FOR THIS SEAL

It is your assurance of highest quality Facing Tile



LEARN HOW TO GET MORE FOR YOUR BUILDING DOLLAR. Take this first step now. Send for our 3 free booklets on glazed or unglazed Facing Tile, "The Scientific Approach to Color Specification," "Catalog 52-C," "Facing Tile Construction Details." Address your request to any Institute Member or to our main office, Dept. AR-1.

This seal is used only by members of the Facing Tile Institute, these "GOOD NAMES TO KNOW" . . . BELDEN BRICK CO., Canton, Ohio • CHARLESTON CLAY PRODUCTS CO., Charleston 22, West Virginia • THE CLAYCRAFT CO., Columbus 16, Ohio • HANLEY CO., New York 17, New York • HOCKING VALLEY BRICK CO., Columbus 15, Ohio • HYDRAULIC PRESS BRICK CO., Indianapolis, Indiana • MAPLETON CLAY PRODUCTS CO., Canton, Ohio • METROPOLITAN BRICK, INC., Canton, Ohio • McNEES-KITTANNING CO., Kittanning, Pennsylvania • NATIONAL FIREPROOFING CORP., Pittsburgh 22, Pennsylvania • ROBINSON BRICK & TILE CO., Denver 9, Colorado • STARK CERAMICS, INC., Canton, Ohio • WEST VIRGINIA BRICK CO., Charleston, West Virginia • **FACING TILE INSTITUTE**, 1520 18th Street, N. W., Washington 6, D. C.



**ASK THE
AEROFIN MAN**

*For the Practical Answer to
Your Heat-Exchange Problem...*

Aerofin is sold only
by manufacturers
of nationally adver-
tised fan system
apparatus. List
on request.

There is a competent Aerofin heat-transfer engineer near you, qualified by intensive training and long experience to find the *right* answer to your own particular heat-exchange problem.

This specialized knowledge is there, ready for you to use to your greatest advantage. Ask the Aerofin man — and be right.

AEROFIN CORPORATION
410 South Geddes St., Syracuse 1, N. Y.

NEW FRONTIERS
For NEW SCR Insulated Cavity Wall Construction!
FOR BRICK AND TILE

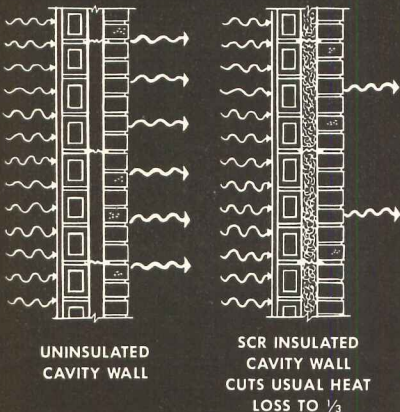
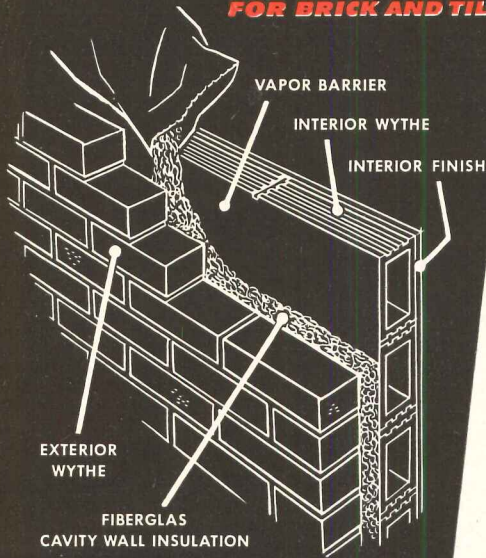

OWENS-CORNING FIBERGLAS
U.S. PAT. OFF.

CAVITY WALL INSULATION

POURING TYPE
Pour in place... do not tamp

APPROVED FOR:
SCR Insulated Cavity Wall

OWENS-CORNING FIBERGLAS CORPORATION
 TOLEDO 1, OHIO

MADE IN U.S.A. PRINTED IN U.S.A.

Specify this **New Fiberglas* Insulation**
Designed and Approved for the Job

FIBERGLAS CAVITY WALL INSULATION—Pouring Type is especially designed to meet the rigid requirements of SCR Insulated Cavity Wall—the latest development in masonry construction. It is approved by Structural Clay Products Institute as the only material that performs satisfactorily.

IT'S THERMALLY EFFICIENT—Like other Fiberglas Insulations, this new insulation offers the highest resistance to passage of heat economically feasible for its intended use. It provides this construction with a "U" value of .12, or less than one-half that of conventional uninsulated cavity walls.

IT'S MOISTURE SHEDDING—Made of fibers of glass, low in moisture pickup and of selected size and uniformity, it does not interfere with the function of weep holes—permits adequate drainage of the cavity.

IT'S EASY TO POUR—Only Fiberglas Cavity Wall Insulation, in the form of tufted nodules, is prepared in the

low density that assures easy, satisfactory pour into the cavity. Also, the non-settling, highly resilient fibers of glass expand under vibration and tend to fill any voids in the construction.

For complete specification information, contact the Fiberglas Branch Office nearest you, your regional office of the SCR Institute OR write to: Owens-Corning Fiberglas Corporation, Department 68-A, Toledo 1, Ohio.



*Fiberglas is the trade-mark (Reg. U. S. Pat. Off.) of Owens-Corning Fiberglas Corporation for a variety of products made of or with fibers of glass.
 SCR—trade-mark property of Structural Clay Products Research Foundation.

You can see
 why ENDURO-
 ASHLAR
 Architectural
 Terra Cotta
 is specified
 more than
 ever before!

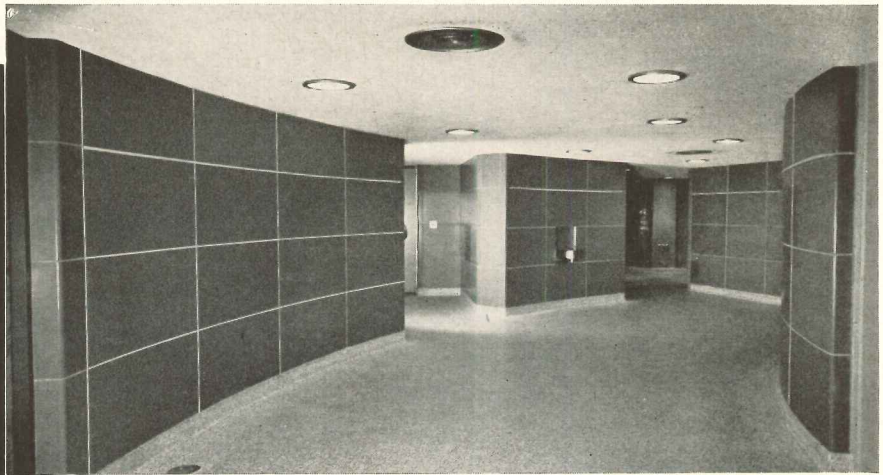

CHEMICAL ENGINEERING BUILDING

Wilson Dam, Alabama

Designed by TVA Engineers and Fellheimer & Wagner

Built by Southern Fireproofing Co., Inc.

Enduro-Ashlar Architectural Terra Cotta, in blue glaze, provides an unusually pleasing interior in this handsome building. Units are 24 x 42 inches.

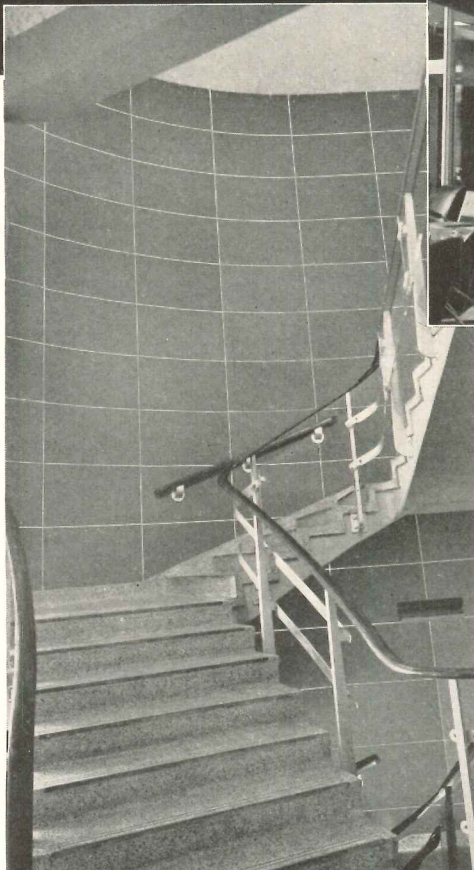

It's as easy as ABC or TVA to design impressive interiors of correct color and texture when you specify Enduro-Ashlar Architectural Terra Cotta. It is tailor-made to meet your most exacting requirements—individual units large or small, plain surfaces or decorative sculpture, brilliant colors or delicate tints. This time-proved building material is *available* as well as *versatile* . . . for it is not classified as critical. Moreover, the original richness and beauty of its glazed finish can be retained indefinitely by simple soap-and-water washings. Without obligation we will gladly send you many striking examples of how Enduro-Ashlar Architectural Terra Cotta is featured in all major types of construction.

Construction detail, data, color samples, estimates, advice on preliminary sketches will be furnished promptly without charge. Send your inquiry today.

FEDERAL SEABOARD TERRA COTTA

C O R P O R A T I O N
 10 EAST 40TH STREET, NEW YORK 16, N. Y.

Plants at Perth Amboy and South Amboy, N. J.



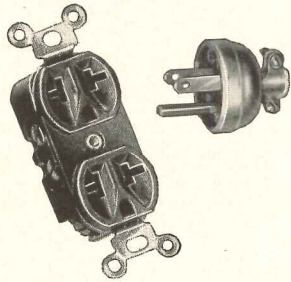

GROUNDING TYPE DEVICES, 2-3 WIRE. Here is the newest development to provide positive identification of grounded circuits. This is the most complete line of standard items available anywhere.

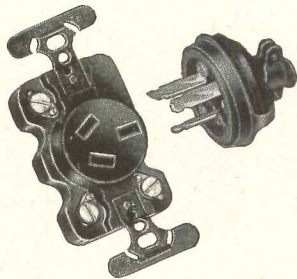

POLARIZED DEVICES, 2-3 and 4 WIRE. Protects valuable equipment by maintaining polarity at all times. Ideal for such portable equipment as power tools, heating and lighting units and many other applications. 10 to 50 ampere capacity.

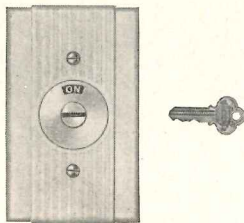

CORBIN ROTARY LOCK SWITCHES

This is the only switch that gives absolutely foolproof protection against the unauthorized operation of vital safety lights and other circuits. Can be actuated only by turning the proper key in the Corbin Pin Tumbler Lock. Features Uniline plate design.

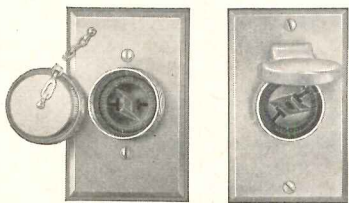

WEATHERPROOF RECEPTACLES

The complete H&H line includes outdoor receptacles for every circuit requirement. Single and duplex models with self-closing or screw-on cover caps are available.

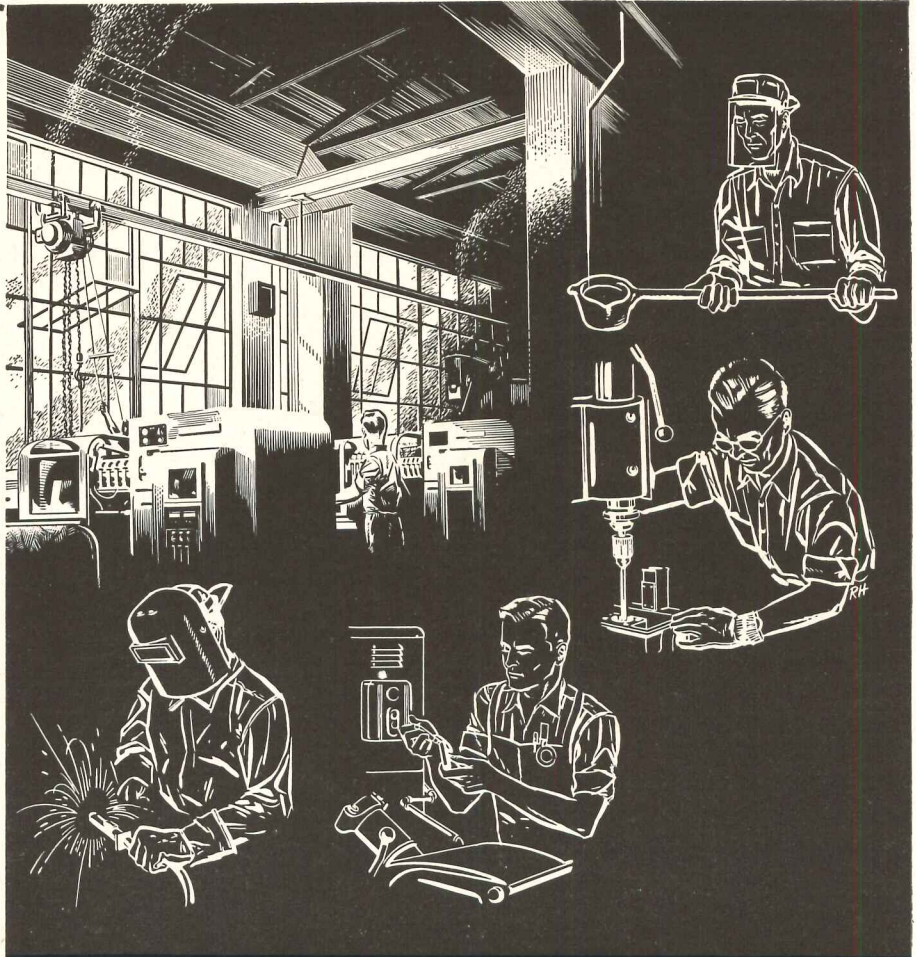

**ELECTRICAL AVAILABILITY
IMPORTANT
TO INDUSTRIAL PLANTS**

Modern industry depends more and more on an ever increasing variety of portable and semi-portable electrical tools and equipment. Carefully planned electrical availability is more important now than ever before. Make sure that your electrical specifications allow for today's needs and tomorrow's expansion. To help you give your client truly modern electrical convenience in his plant, look to the complete H & H line. You'll find there's an H & H wiring device for every circuit requirement. The big, fully illustrated H & H catalog can really make your electrical planning job easier — and better. Send for your copy today; just write to 1901 Laurel Street, Hartford 6, Connecticut.



Wiring Devices
AND ENCLOSED SWITCHES

THE ARROW-HART & HEGEMAN ELECTRIC CO., HARTFORD, CONN.

Branches in: Boston, Chicago, Dallas, Denver, Detroit, Los Angeles, New York, Philadelphia, San Francisco, Syracuse. In Canada: Arrow-Hart & Hegeman (Canada) Ltd., Mt. Dennis, Toronto.

Never have cost comparisons been so favorable to this permanently beautiful wall material



Roddiscraft
Hardwood
Plywood

Central display panel of Quilted American Walnut in the beautiful new Furniture Club of America Dining Room, Chicago Furniture Mart — designer, Chicago Architect Philip West.

...BEAUTY THAT OFTEN OUTLIVES THE BUILDING

Today's dollars invested in walls of Roddiscraft Hardwood Plywood yield a substantial return—enduring beauty and value—service that often outlives the building—walls requiring the least in maintenance man-hours to keep always attractive.

Roddiscraft Plywood is manufactured from the best veneers. It is available in a wide variety of native and foreign hardwoods—fabricated to exacting standards by expert workmen who take pride in an established tradition of craftsmanship.

Ask to see the Roddiscraft Veneer Sample Book . . . 51 different veneers from Ash to Zebrawood. Available on loan from your nearest Roddiscraft warehouse whenever you need it for client consultation.

Roddiscraft

RODDIS PLYWOOD CORPORATION
Marshfield, Wisconsin

NATIONWIDE Roddiscraft WAREHOUSE SERVICE

Cambridge, Mass. • Charlotte, N. C. • Chicago, Ill. • Cincinnati, Ohio • Dallas, Texas • Detroit, Michigan • Houston, Texas • Kansas City, Kan. • New Hyde Park, L. I., N. Y. • Los Angeles, Calif. • Louisville, Ky. • Marshfield, Wis. • Milwaukee, Wis. • New York, N. Y. • Port Newark, N. J. • Philadelphia, Pa. • St. Louis, Mo. • San Antonio, Texas • San Francisco, Calif.

THE FORESTS...THE FACILITIES...THE EXPERIENCE TO PRODUCE THE FINEST

INSTALL *Custom Designed* CONVECTOR GRILLES

without increasing your building costs

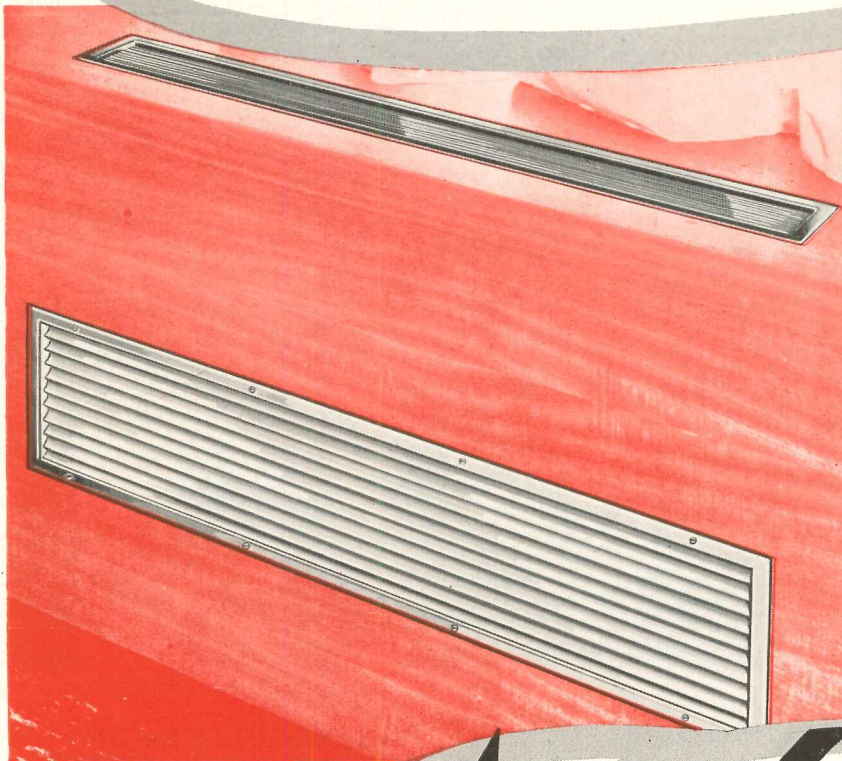

- **EXTRA RUGGED**
Made to *withstand heaviest use and abuse* which lower wall grilles must take.
- **TAMPER PROOF**
No "see-thru". Extra-close spacing of louvers prevents gum wrappers—waste paper from being dropped between louvers.
- **EXTRA-HEAVY SUPPORT BARS**
Heavy-duty steel bars on 6" centers give added strength where it is most needed.
- **MADE TO ANY SIZE**
- **OVER 70% FREE AREA**
- **EASILY INSTALLED**
Precision built to fit snugly. Can be installed in marble, tile or other special surfaces.
- **EXTRA-WIDE BLADES FOR MOST EFFICIENT DEFLECTION OF AIR**
- **EACH DEFLECTING BLADE "HEMMED" FOR ADDED STRENGTH —ADDED SAFETY**
- **ALSO AVAILABLE WITH DAMPER AND KNOB CONTROL**

Above
Photo shows AIRFOIL convector grilles installed in John Hancock Building.

Architects—
Crame & Ferguson,
Boston, Mass.

Gen. Contractors—
Turner Const. Co.,
Boston, Mass.

Heating & Ventilating Engineers—
Buerkel & Co., Inc.,
Boston, Mass.

Sheet Metal Contractors—
Stanley E. Priggen Co.,
Boston, Mass.

Airfoil

AIR CONDITIONING OUTLETS

AIRFOIL CUSTOMED CONVECTOR GRILLES are built above and beyond average demand. Give air distribution performance that's above and beyond average—YET COST IS KEPT AT STANDARD PRICES.

Superior construction and performance usually reserved for the highest-priced grilles are incorporated as standardized features of this great new line of convector grilles. *They meet the most exacting specifications of architects and engineers.*

AIRFOIL CONVECTOR GRILLES are better designed—more durable. Feature for feature, dollar for dollar—they cannot be duplicated. Made with a "decorator's touch," they add new beauty to any installation.

Free



CHECK TYPE OF GRILLE ON WHICH INFORMATION IS DESIRED

- | | |
|---|--|
| <input type="checkbox"/> Air conditioning outlets | <input type="checkbox"/> Perforated metal and ornamental grilles |
| <input type="checkbox"/> Return air grilles and registers | <input type="checkbox"/> Door ventilators |
| <input type="checkbox"/> Volume controllers | <input type="checkbox"/> Special made-to-order grilles |

TITUS MANUFACTURING CORP., WATERLOO, IOWA

- RUSH information on Convector Grilles.
- Send complete catalog.
- Send literature on above checked items.

NAME _____
ADDRESS _____
CITY _____ STATE _____

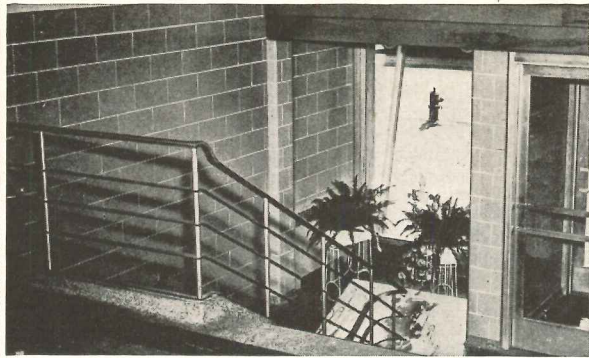

Interior views showing NATCO Ceramic Glazed Structural Facing Tile (Vitritle) used in LLOYD ST. JOSEPH HOSPITAL, Menominee, Michigan. Architect—Harry W. Gjelsteen, Menominee, Michigan. Contractor—Proksch Construction Co., Iron River, Michigan.

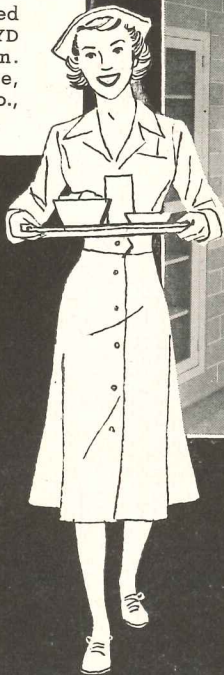
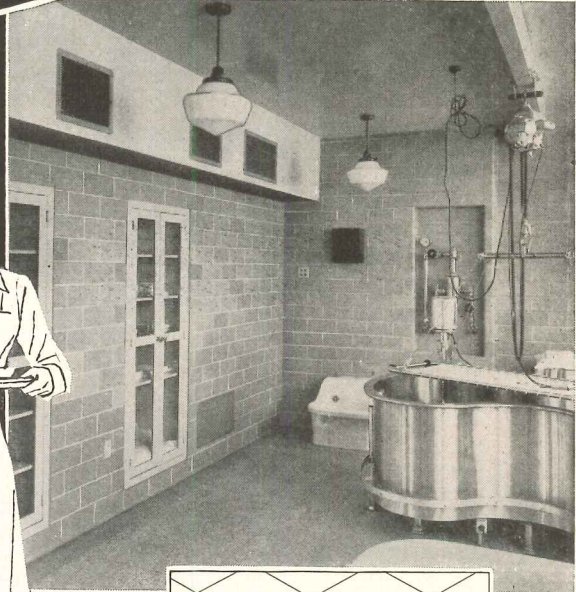

LLOYD ST. JOSEPH HOSPITAL
*walls are permanently
 cheerful and colorful
 because they are* **NATCO**
 GLAZED STRUCTURAL FACING TILE

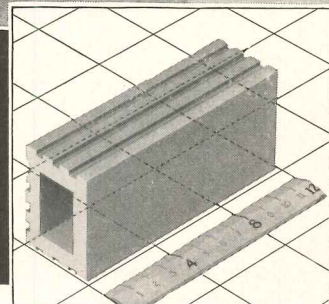

Health stimulating attractiveness with hygienic cleanliness was achieved by the functional use of green and ivory Natco Ceramic Glazed Structural Facing Tile for the interior walls of this modern Michigan hospital. And with this enduring beauty, there is no need for future painting or refinishing—there is no maintenance expense other than occasional washing with soap and water. Besides, the walls are structurally strong, germ proof and firesafe.

MODULAR COORDINATION
 Tile and 12 inch ruler at right are laid on grids made up of 4 inch squares. The 4 inch module unit of measure is the basis of modular coordination for all building materials and equipment.

In addition to Natco Ceramic Glazed Structural Facing Tile, Natco Clay Backup and Partition Tile were used throughout the building. Write for a copy of Natco Catalog S-52, just off the press. This describes the many Natco Clay Products that are being used so extensively for interior and exterior walls, floors and for a great many other uses demanded by modern hospital and other building construction.



NATIONAL FIREPROOFING CORPORATION

GENERAL OFFICES: 327 FIFTH AVENUE • PITTSBURGH 22, PA.

Branches: New York • Syracuse • Detroit • North Birmingham, Alabama
 Chicago • Philadelphia • Boston • Toronto 1, Canada

"The Quality Line Since 1889"

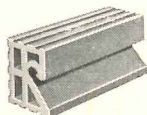

Raggle Blocks
 Prevent Water Seepage
 4" x 5 1/2" x 12" Nom. Size

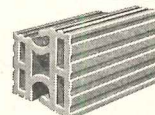

Speed-A-Backer Tile for
 Backing Brick Faced Walls
 12" long Varying Heights

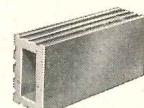

Ceramic, Clear
 Glazed Vitritle 5 1/3" x 12"
 Nom. Face Size

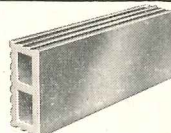

Ceramic Glazed Vitritle
 8" x 16" Nom. Face Size



Non-Loadbearing Tile, Scored
 and Unscored, 12" x 12" Face
 In Standard Wall Thicknesses

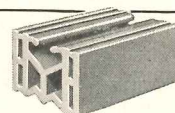

Buff Unglazed, Manganese
 Spot, Salt Glazed, Red
 Textured Dri-Speedwall Tile,
 5 1/3" x 12" Nom. Face Size

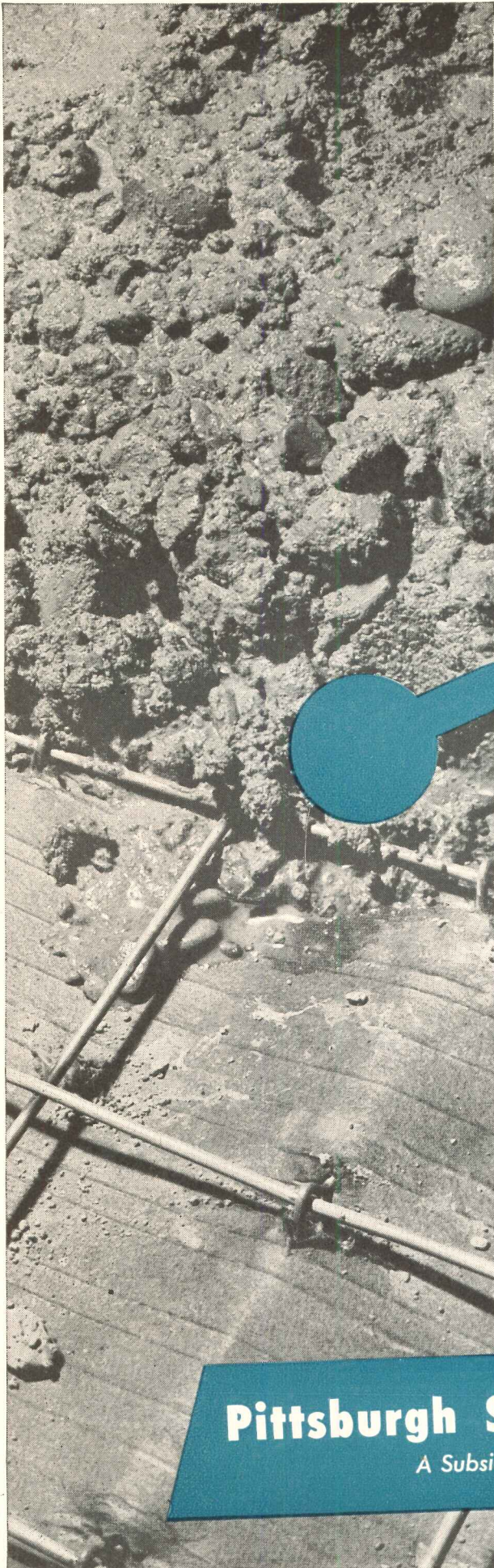

Look how the strong
welded mesh of
**Pittsburgh
Steeltex**
Floor Lath
assumes its proper
position in a
concrete slab

You can readily see why a slab poured over Pittsburgh Steeltex Floor Lath means a better, stronger floor. It is properly reinforced with embedded galvanized welded wire mesh and properly cured because moisture is retained by tough waterproof backing. Furthermore, construction costs can be cut since work may continue on the floor below while pouring is in progress. For further good reasons to specify Steeltex, see Sweet's or write for our catalog D.S. 133, Dept. AR, Pittsburgh Steel Products Co., Grant Bldg., Pittsburgh 30, Pa.

Pittsburgh Steel Products Company

A Subsidiary of Pittsburgh Steel Company

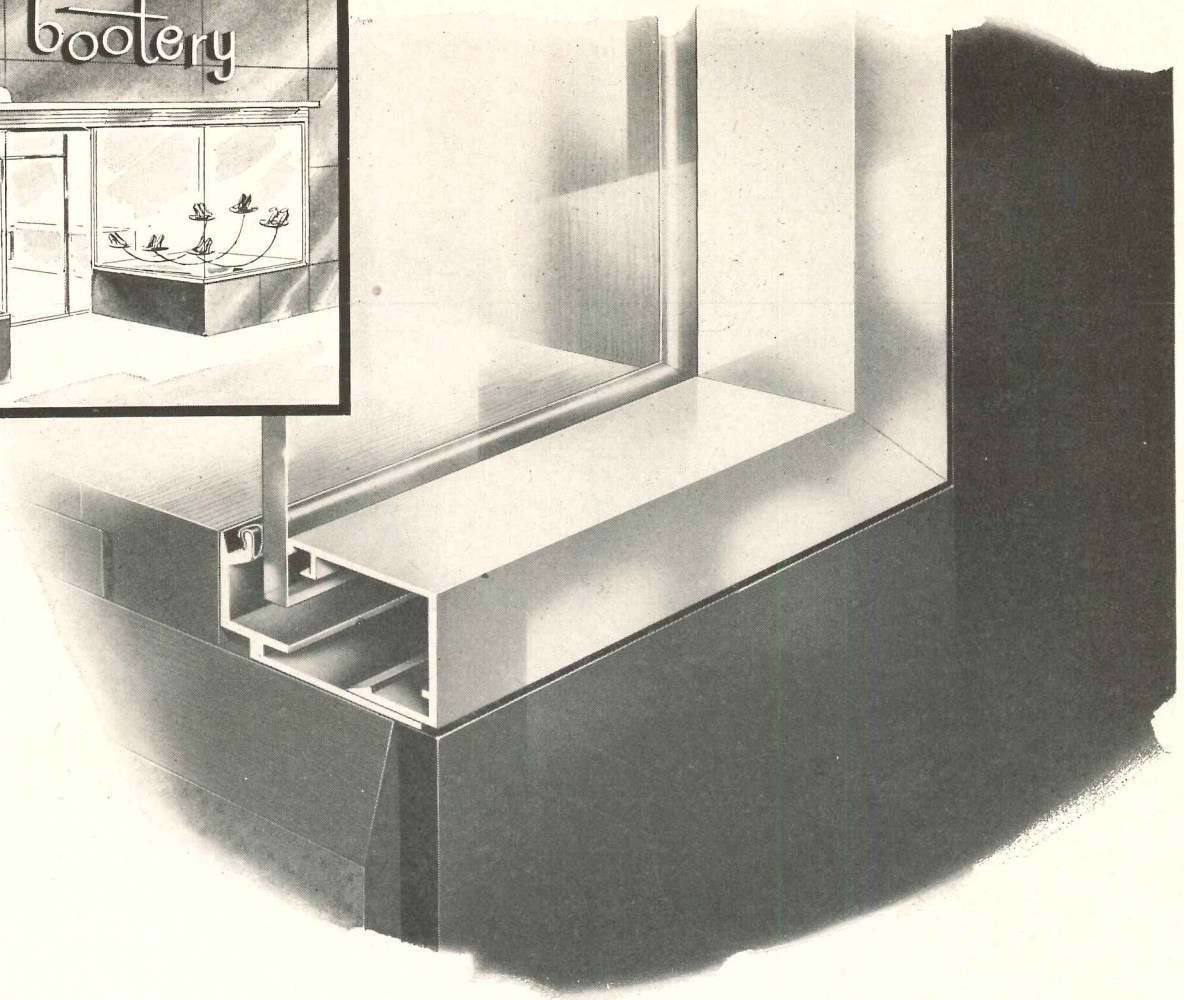
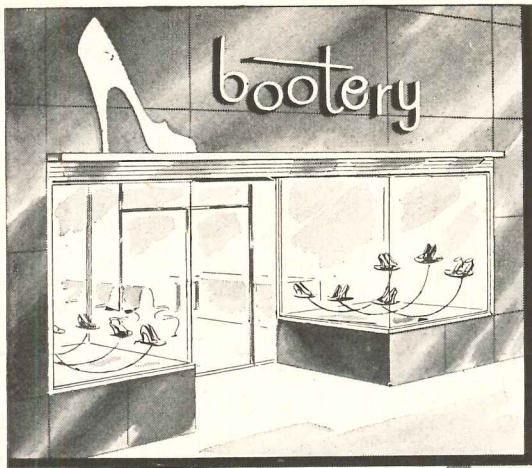

***Always a winning combination
but especially valuable today...***

● In the face of today's metal shortages, this combination of store front materials is receiving more attention than ever from architects.

Typical of the Pittco Store Front Metal line is this single-faced rectangular sash (Pittco De Luxe 12-C). Its plain surface—rich in tone and gloss—and clear, sharp profiles make it extremely popular.

Used in conjunction with Carrara Structural Glass, this beautiful and practical Pittco Metal Sash produces an effect of rich-

PITTCO METAL SASH AND CARRARA STRUCTURAL GLASS

ness, elegance and distinction on the modern store front.

Both Pittco Metal Sash and Carrara Structural Glass are available to you today. Both are the products of Pittsburgh's continuing research.



PITTCO STORE FRONT METAL

PAINTS · GLASS · CHEMICALS · BRUSHES · PLASTICS

PITTSBURGH PLATE GLASS COMPANY

Intermediates that last like photographs

... produced at low cost

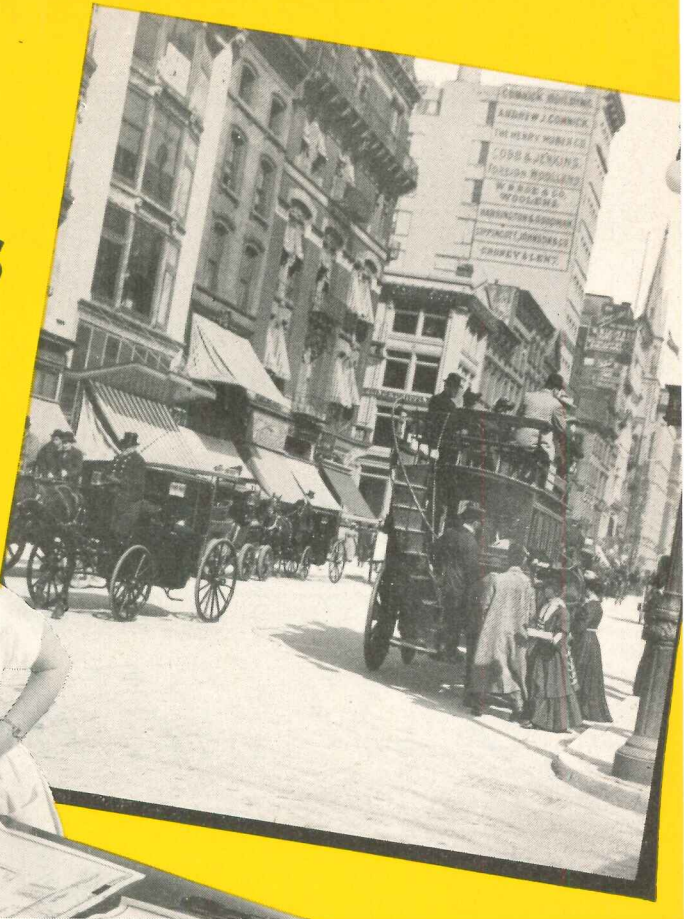

A case history based on the experience of the Hyster Company, Portland, Oregon

By reproducing its engineering drawings on Kodagraph Autopositive Paper, the Hyster Company gets intermediates which have dense black photographic lines on a translucent, highly durable paper base. Intermediates which will remain intact in the files year after year . . . and produce sharp, legible blueprints and direct-process prints whenever needed.

And the cost is surprisingly low because Kodagraph Autopositive Paper boasts unique photographic properties which cut production costs *substantially*. It can be handled in ordinary room light . . . and it produces positive copies *directly*—without a negative step.

Furthermore, existing equipment can be utilized—Autopositive can be exposed in any blueprint or direct-process machine . . . and processed in standard photographic solutions. Hyster uses a blueprint

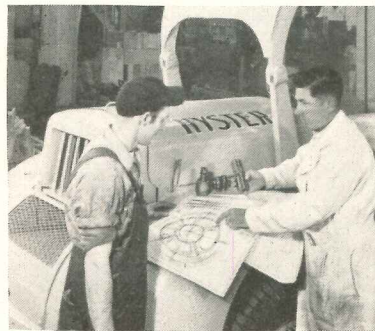

machine which has also been designed to produce Autopositive intermediates in a continuous flow.

How The Hyster Company Uses Autopositive

For All Print Production. Autopositive intermediates are used instead of valuable and perishable original drawings. Producing sharp, legible blueprints and direct-process prints time after time, they greatly reduce the possibility of reading errors in the shop.

For "Permanent" Files in its home office . . . and branches in the United States and abroad. "Photolasting" Autopositive intermediates eliminate the costly delays experienced in the past when intermediates faded, turned yellow, or became brittle.

For Drafting Room Short Cuts. Autopositive Paper is used to reclaim old and weak-lined drawings . . . and to duplicate standard designs which will be incorporated in new drawings. *All of which saves hours of creative drafting time.*

Kodagraph Autopositive Paper

"THE BIG NEW PLUS" in engineering drawing reproduction

Learn in detail all the ways you can use Kodagraph Autopositive Paper — the revolutionary photographic intermediate material which you, or your local blueprinter, can process *quickly . . . economically . . . at a low cost.*

EASTMAN KODAK COMPANY
Industrial Photographic Division, Rochester 4, N. Y.

Gentlemen: Please send me a copy of "New Short Cuts and Savings" . . . describing the many savings Kodagraph Autopositive Paper is bringing to industry.

Name _____ (please print) Position _____

Company _____

Street _____

City _____ Zone _____ State _____

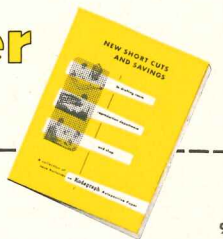

95

Kodak
TRADE-MARK

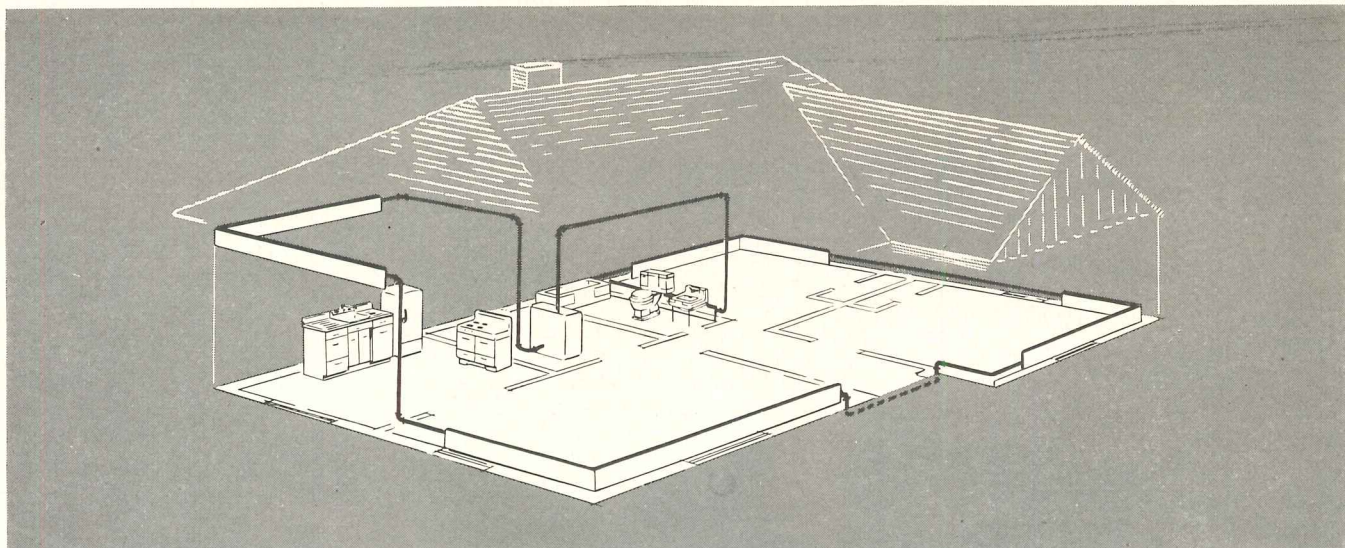

for SURE heating comfort...

CRANE *Radiant* BASEBOARD PANELS

*Provide adaptable, clean,
amazingly efficient heat...*

On the floor, rule a straight line *just 1 7/8 inches in* from the finished wall. That is all the room space this highly efficient form of modern radiant heat requires!

That perspective above, those photos at the left show how easy it is to plan, how easy to build a hot water or steam system with Crane Baseboard Panels.

They leave more space for *living*. Their cast-iron construction is best for radiation, proof to hard knocks, and can be painted any color without reducing heating efficiency.

The large volume of hot water held in Crane Baseboard Panels means extra heating capacity always in reserve and maximum heat conservation.

Floor-level drafts and ceiling-level layers of static hot air are eliminated by the clean, modern combination of radiant and convection heating Crane Baseboard Panels provide.

Consult your Crane Branch, Crane Wholesaler or Plumbing Contractor for complete technical data.

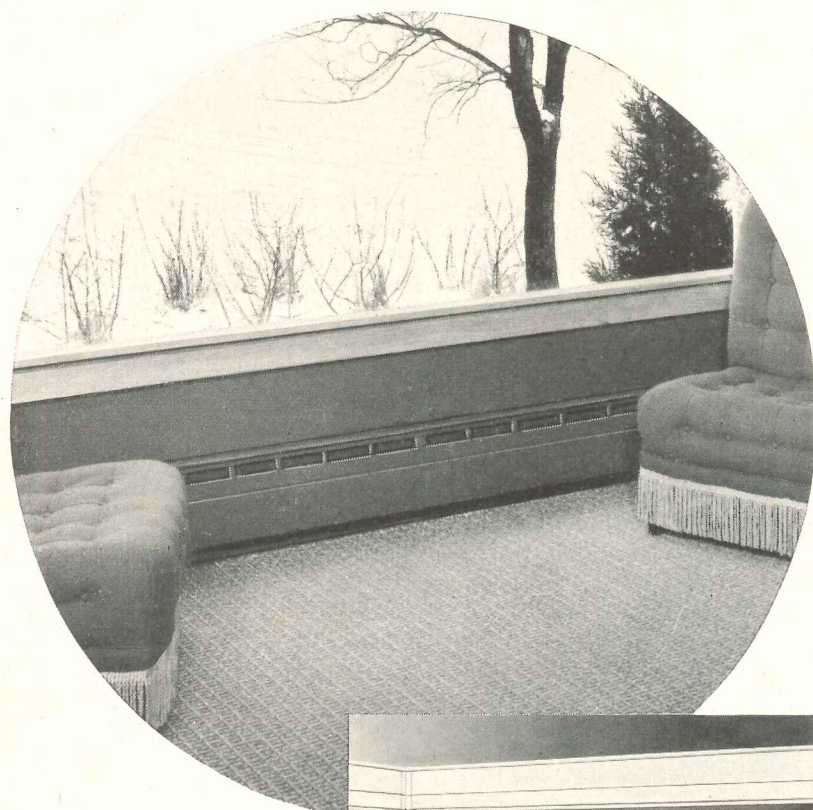

Crane Radiant Baseboard Panels, in two types, provide versatile, *efficient* modern heat. Use type "RC" (in living room above) at the baseboard only. Specify type "R" for floor-level, ceiling-level, or vertical installation. (Shown at ceiling level in kitchen.) Ideal for either new construction or remodeling.

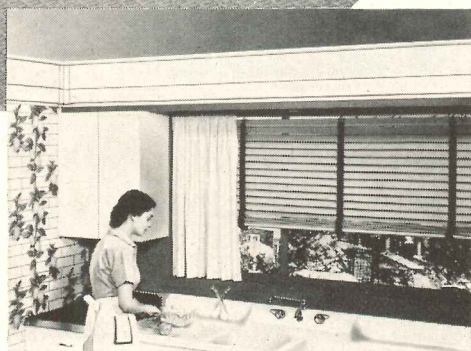

CRANE CO.

GENERAL OFFICES: 836 SOUTH MICHIGAN AVE., CHICAGO 5
VALVES • FITTINGS • PIPE
PLUMBING AND HEATING



movability pays in offices ... factories ... schools ... hospitals ... laboratories

change characterizes the modern building
 When business, education, industry, building changes or office or industrial purposes, the building, when used for space requirements, can change the change in organization or reorganization. New departments, personnel, products, and methods constantly demand that small offices be made into large ones or the reverse.

moving masonry walls
 When it is necessary to move a masonry wall, there is a lot of approximately 50% of the total cost of the wall, and it must be knocked down and a new wall built. Hence, from the old wall. The only materials salvagable exceeds the value of moving the debris. The dirt, and that of the job usually necessitates cleaning the tops, drains and office machines.

moving Mills partitions
 On the other hand, moving a steel wall is a simple and rapid procedure. All panel units and accessory parts are made in one piece. These may be added without dismantling the panels. New layouts can be made overnight or during a weekend. Mills movable partitions make hazardous, divided changes in space subdivisions possible because they can be easily and moved.

speed and facility of erection
 In covering the and plastic walls, laborers, masons, plasterers, carpenters and painters are involved. There are usually three or four subcontractors. On the other hand, when movable partitions are erected, there is one

subcontractor who arrives with the completely fabricated and factory-finished panels, doors and frames. With field dimensions previously checked, the erection quickly follows pre-measured layouts. Movable metal partitions are installed in one-third to one-half the time required for wet systems of construction. As a result, buildings are occupied sooner with reduced interest and carrying charges.

low maintenance cost
 Yearly maintenance of masonry walls is expensive with the necessity of repointing, filling cracks and cleaning. The steel surfaces of Mills partitions, however, require only the regular upkeep for they have hard, smooth, occasional ordinary washing surfaces. In fact, Mills Partitions are important.

some recent Mills installations
 U. S. Naval Reserve Laboratory, 3000 York, Md.
 Dept. of Law Library, Iowa City, Iowa
 Pacific Telephone & Telegraph Co., Oakland, Calif.
 E. R. Smith & Sons, Hamilton, N. Y.
 Building Energy Products Co., Detroit, Mich.
 Dept. National Gas Co., Philadelphia, Pa.
 State Office Building, Jackson, Miss.
 Chicago-Sears & Co., Chicago, Ill.
 State Office Building, Montpelier, Vt.
 E. J. Harlow & Son, Inc., Camden, N.J.
 General Cable Building, New York, N.Y.
 Service Pipe Line Building, Tulsa, Okla.
 Capital Publishers, Inc., Kansas City, Mo. and Denver, Colo., New Jersey
 Penn Home Insurance Co., Indianapolis, Ind.
 Transamerica Building, Inc., Cleveland, Ohio
 John Harlan Insurance Co., Cleveland, Ohio
 Dan. E. Campbell Co., Madison, Wis.
 First National Bank Building, Tulsa, Okla.
 American Gas Co., Baltimore, Md.
 National Office Building, San Francisco, Cal.
 National Cash Register, Dayton, Ohio
 National Electric Co., Cleveland, Ohio
 Detroit-Campbell Electric Corp., Newark, Ohio
 East Standard Oil Co., Baton Rouge, La., and Memphis, Tenn.
 International Paper Co., Cincinnati, Ohio



executive office
 Mills Partitions provide handsome, unobstructed office work, reconfigurable, movable with minimum expense and inconvenience.



commercial office
 Mills Partitions may be easily and quickly moved to meet changing conditions.



school room
 Mills Partitions provide flexibility in room changing also for re-arranging.



industrial plant equipment room
 Mills Partitions may be economically changed to provide for expanding equipment.

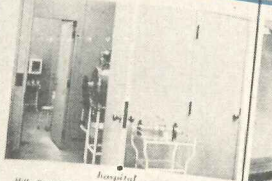

hospital
 Mills Partitions permit immediate substitution of another or other hospital space.



laboratory
 Mills Partitions allow for change or expansion with minimum loss of time.



Changing the location of a tile and plaster wall is a slow, expensive work, while hundreds of pounds of tiles are carried out and wet concrete materials brought in.

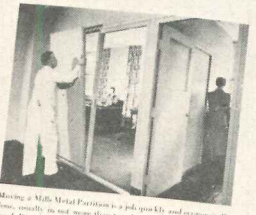

Moving a Mills Metal Partition is a job quickly and economically done, usually in not more than ten days. Because partitions are Panel units are taken down and reerected with no structural waste, debris or dirt.

Mobilized interiors solve your layout problems today and tomorrow

... this Book of Facts shows you how

● No matter how perfectly your layout meets present needs, it will be truly efficient only if it can be quickly, easily and economically adapted to changes in space requirements. Such changes are inevitable—and they occur far sooner and much more frequently than is generally realized.

Mills Movable Metal Walls, for over thirty years the demonstrably superior system of flexible interiors, are today's efficient answer to this problem. Attractively modern in design and finish, of all-welded steel construction, they are structurally strong, completely incombustible, fully insulated and thoroughly soundproofed. Yet they are easily installed and can be quickly moved to fit new layouts—frequently in a matter of only a few hours—at very low cost.

THE MILLS COMPANY, 950 WAYSIDE ROAD, CLEVELAND 10, OHIO

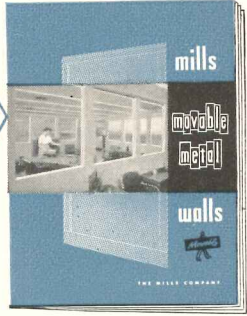

A PRACTICAL BOOK for BUILDING PROFESSIONALS

We'll be glad to send you a free copy of this 48-page book. Just ask for Mills Movable Metal Walls Catalog No. 52.

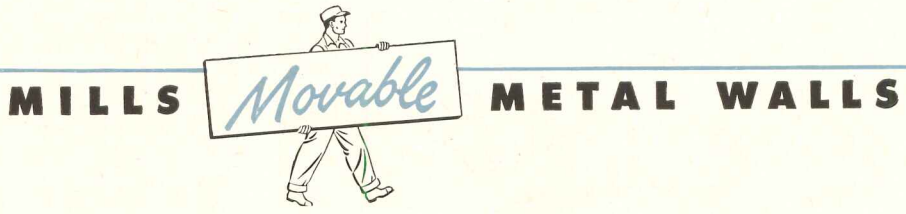

... You'll also find this catalog in Sweet's File, Architectural, for 1952.

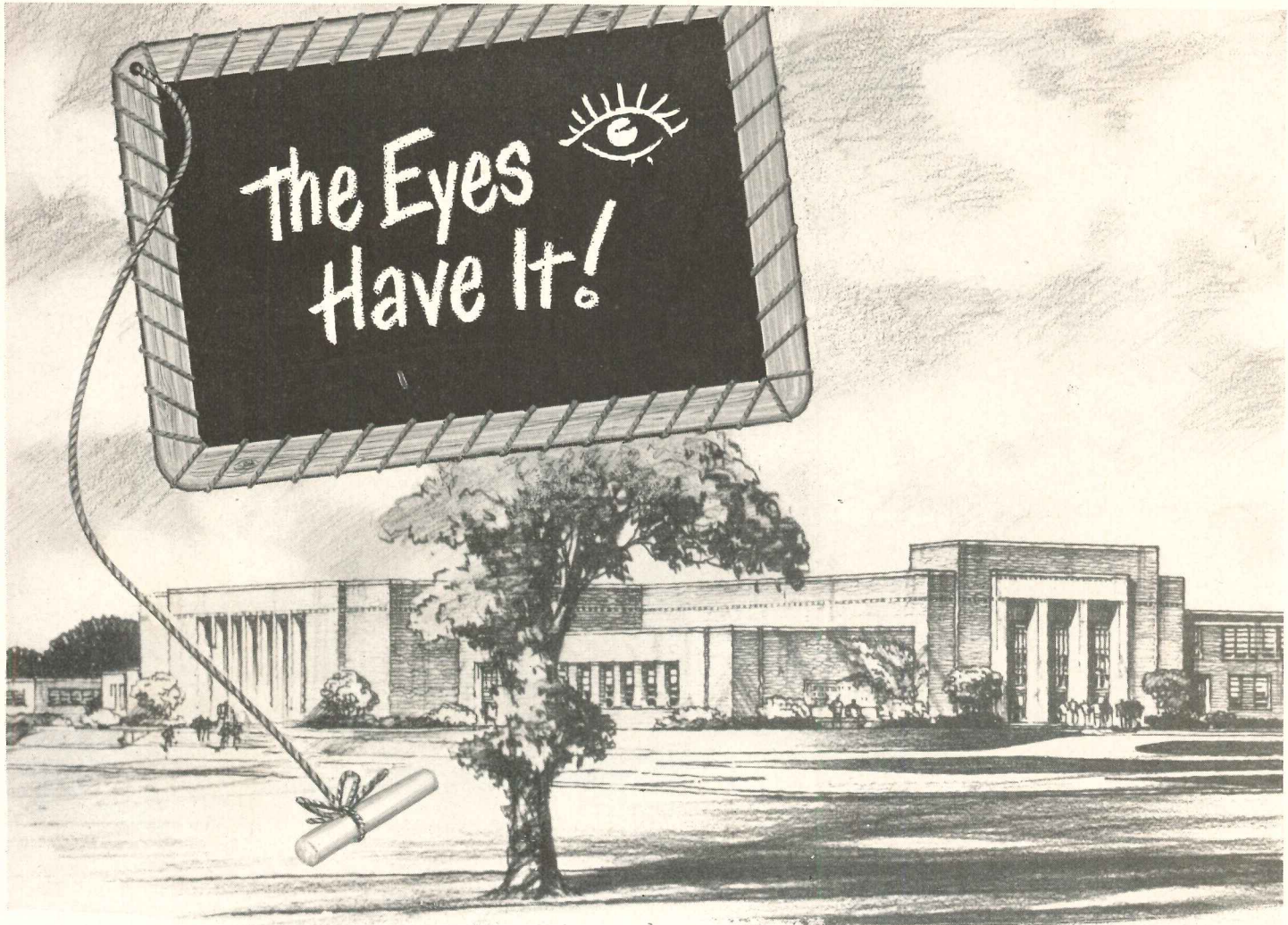

HINSDALE HIGH SCHOOL, HINSDALE, ILLINOIS • CHILDS & SMITH, ARCHITECT • E. H. MARHOEFER JR. COMPANY, CONTRACTOR

...with CECO Metal Windows for schools

As you read this your eyes are doing more than seeing—they are bringing into action your entire body—nerves, muscles, circulation.

And you are burning up energy—piling up fatigue in direct proportion to the amount of light available for vision.

Medical science has proved eyestrain has a marked effect on the well-being of all. So it's necessary then that seeing be done with ease and in comfort. That's why proper illumination is all-important and there's

where metal windows come in, for they admit more daylight than any other window.

Add to that fact, most days in most of the country are overcast in winter. Here again metal windows meet the need because only metal windows provide enough daylight for good vision on overcast days.

So there's good reason for the swing to Ceco Metal Windows in modern school construction. Besides giving more light for better sight, they permit

**CECO
STEEL**

In construction products **CECO ENGINEERING**



distant vision so vital for relaxing young minds.

There are other advantages in Ceco Metal Windows—such as controlled ventilation—won't rot or warp—cost less to install, clean and maintain. And because Ceco Windows are better engineered they fit better—last longer. That's why we say—"When you use Ceco Windows you know you use the very best—you're sure of savings, too."

CECO STEEL PRODUCTS CORPORATION

General Offices: 5601 W. 26th St., Chicago 50, Illinois
Offices, warehouses and fabricating plants in principal cities

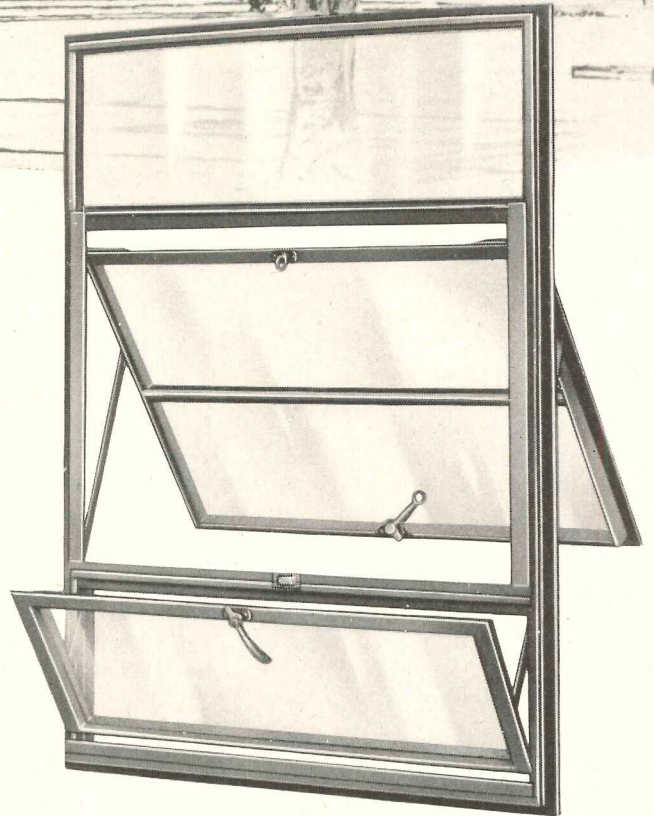

makes the big difference

Steel Windows and Doors • Steel Joists and Roof Deck
Steelforms • Reinforcing Steel • Metal Frame Screens
Aluminum Storm Windows • Combination Windows
and Doors • Metal Lath • Roofing Products

Johns-Manville

PERMACOUSTIC* —An Acoustical Unit

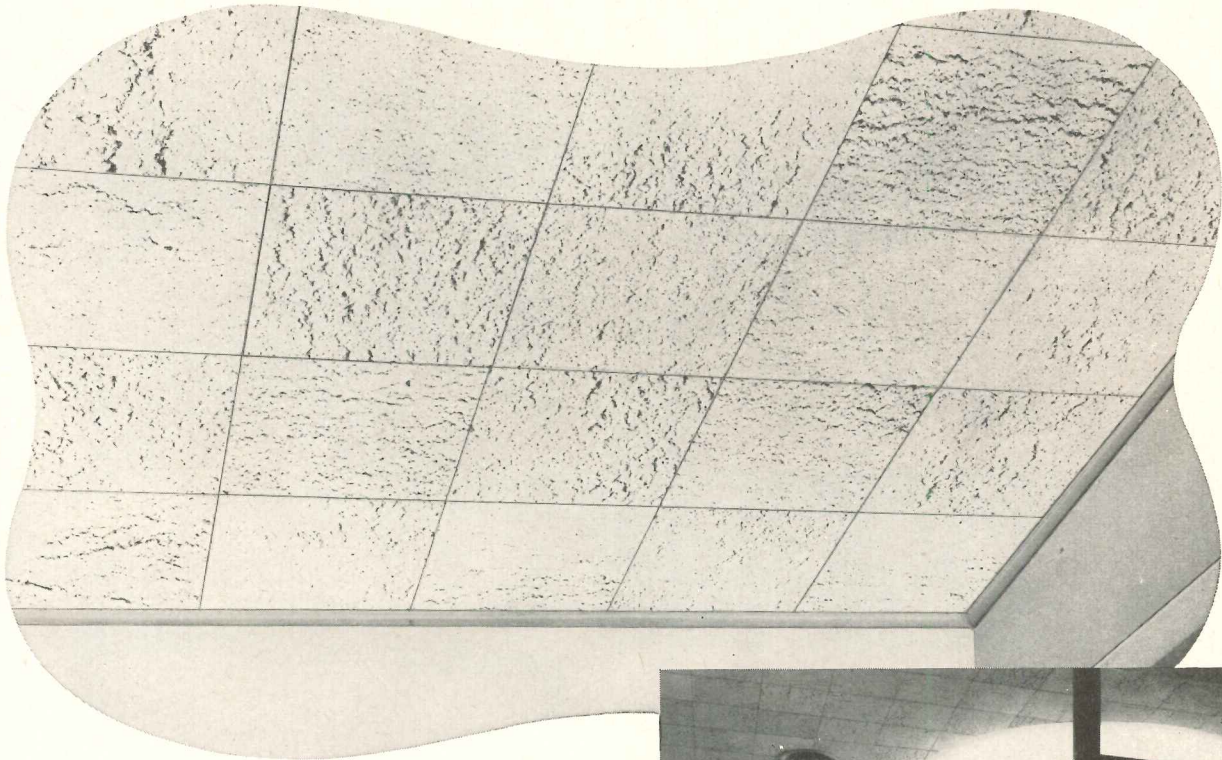

**For a non-combustible,
noise-quieting ceiling of
unrivalled architectural appeal**

- **UNUSUAL BEAUTY**—The attractive fissured surface of J-M Permacoustic avoids mechanical monotony. Distinctive and pleasing in appearance, Permacoustic is ideal for hospitals, schools, offices, dining rooms, lobbies, etc.
- **NON-COMBUSTIBLE FIRE RATING**—Made of fire-proof rock wool, Permacoustic meets building codes which specify the use of non-combustible acoustical materials to minimize fire hazard in critical areas and in certain types of buildings.
- **HIGH ACOUSTICAL EFFICIENCY**—Permacoustic consists of 12" square panels of moulded and baked rock wool fibers. The fissured surface adds additional acoustical efficiency to a material which is in itself inherently sound absorbent. Noise reduction coefficient is 65% to 70% depending on method of application.



- **READILY AVAILABLE**—Because Permacoustic is made of non-critical materials, you can plan present and future construction without fear of shortages. Stocks are carried in all the principal cities of the United States.
- **EASILY APPLIED**—Permacoustic is easily installed by application to existing ceiling slabs or it can be suspended using a spline system of erection.

For a new free brochure about Permacoustic, write Johns-Manville, Box 158, New York 16, N. Y. In Canada write 199 Bay Street, Toronto 1, Ontario.

*Reg. U. S. Pat. Off.



Johns-Manville Acoustical Materials

Permacoustic*—Fibretone*—Sanacoustic*—Transite*

Sanymetal*

ACADEMY TOILET COMPARTMENTS FOR AIR BASE BUILDINGS

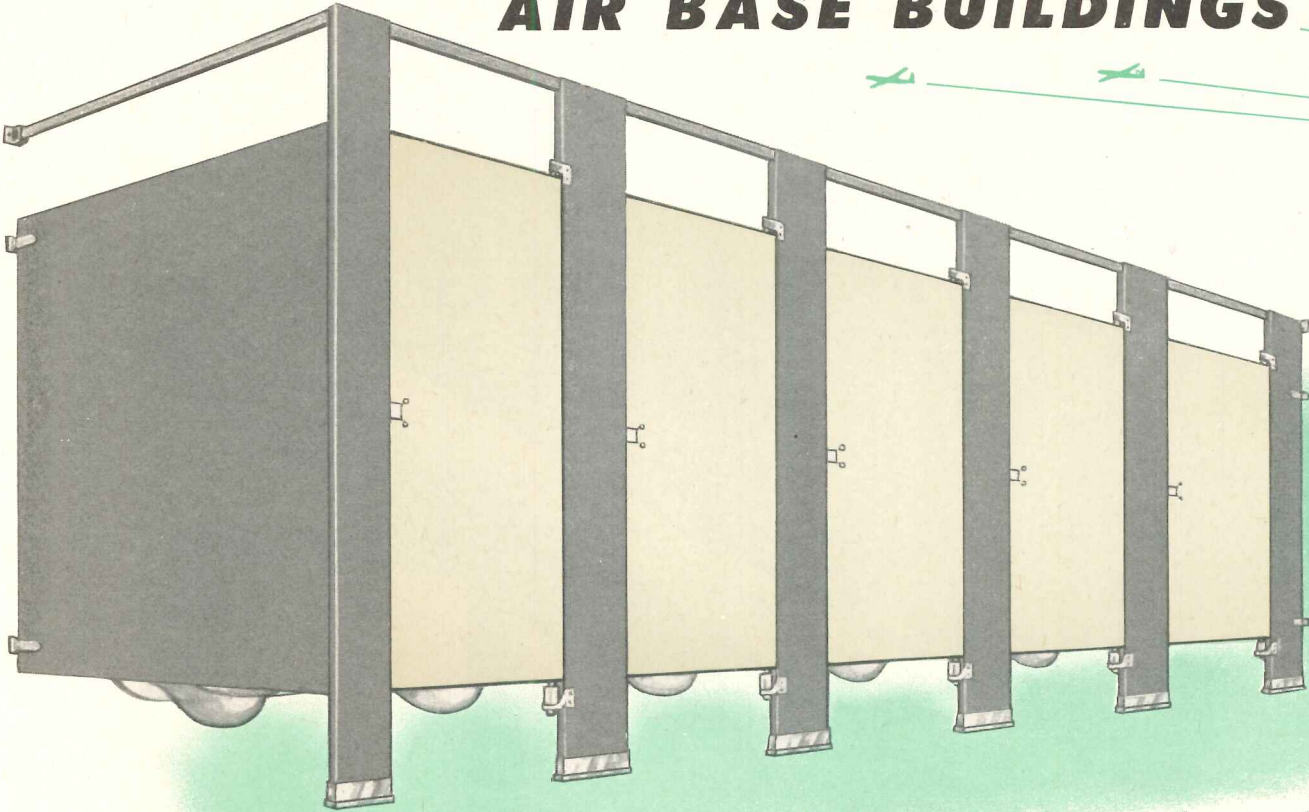

Toilet compartments usually dominate a toilet room, influencing the toilet room environment. Sanymetal offers several types of toilet compartments suitable for different types of air base buildings. The Sanymetal Academy Type elevates the toilet room environment into harmony with other modern environments of a building—an environment that is certain to continue to be appropriate over a long span of service life.

Sanymetal Academy Type Toilet Compartments provide the utmost sanitation, combined with convenience, and reduce the cost of maintenance to an all-time low. These toilet compartments are fabricated of Galvanized, Bonderized* Steel (when specified), that has a neutral film which insulates the baked-on paint enamel from the zinc that grips it tenaciously. This insulation lengthens the life of the baked-on paint enamel finish. This material affords four-way protection against corrosion and other processes of depreciation. The smooth lustrous protective finish assures long lasting newness. It has a hard non-porous surface that absorbs neither odors nor moisture and, like the enamel surface of an automobile, may be washed, waxed, or simonized.

Ask the Sanymetal Representative in your vicinity (See Partitions in phone book) for complete information regarding details of construction and availability. Catalog No. 89, available on request, gives complete description of this and several other types of Sanymetal Toilet Compartments.

*Treated with "BONDERITE", a product of Parker Rust Proof Company.

THE **Sanymetal***

* Trade Mark Registered

PRODUCTS CO., INC.

1689 URBANA ROAD • CLEVELAND 12, OHIO

**WE'RE OLD ENOUGH
TO KNOW BETTER...**

and we do!



"MANHATTAN HOUSE"
Architects
Skidmore, Owings and Merrill



Aetna started fabricating hollow metal doors and frames over 50 years ago.

Since then, the hollow metal door and frame industry has become of prime importance in the building field.

Aetna's expansion has paralleled that of the industry, and today, Aetna is the country's leading producer of hollow metal doors and frames.

We owe our growth and leadership to architects, designers, specification writers and builders, who know that Aetna products are of high quality and that Aetna engineering and follow-through on specifications are painstaking, accurate, dependable.

AETNA STEEL PRODUCTS CORPORATION

730 FIFTH AVENUE, NEW YORK 19, NEW YORK

MANUFACTURERS OF STANDARDIZED STEEL DOORS AND FRAMES FOR HOUSING UNITS.

FABRICATORS OF QUALITY HOLLOW METAL PRODUCTS FOR SCHOOLS, HOSPITALS, OFFICE BUILDINGS, ETC.

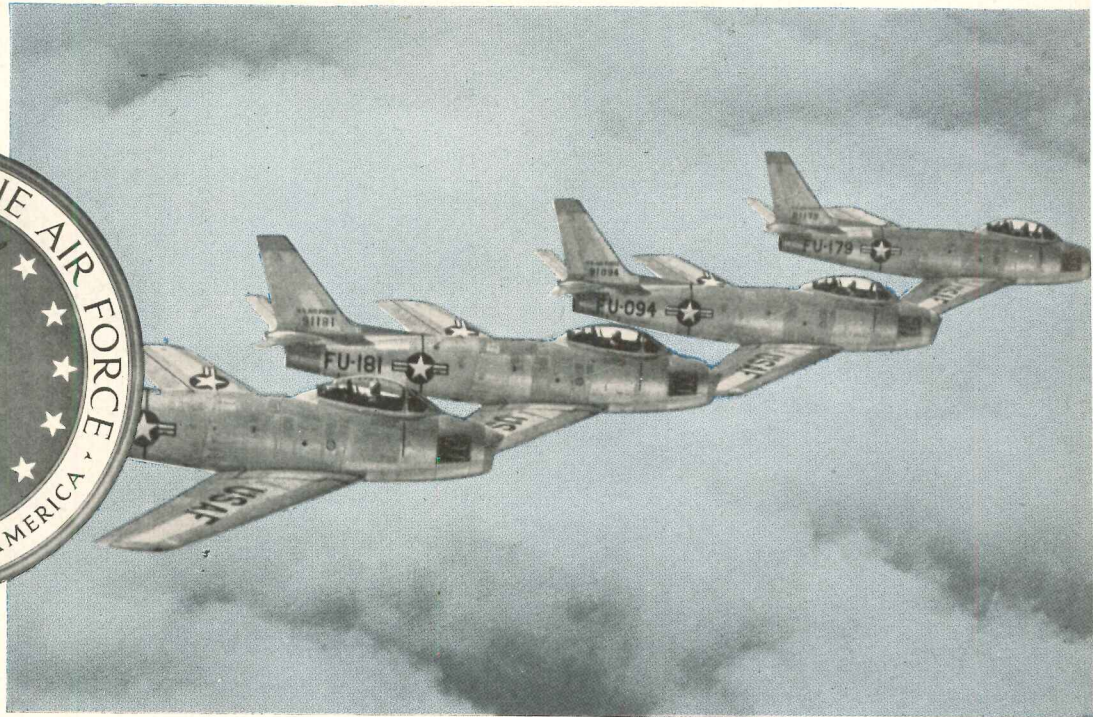

NUMBER 182

ARCHITECTURAL RECORD'S BUILDING TYPES STUDY

AIR FORCE BUILDINGS

ARCHITECTS anxious to turn their talents to buildings for the Air Force will find a well formulated program, complete with planning criteria, awaiting them. Architect-engineer contracts are given out by the Division and District offices of the Army Corps of Engineers (see ARCHITECTURAL RECORD, March, 1951, for directory), where full instructions and basic planning aids are available. While the background planning study for various types of buildings, from barracks to celestial-navigation-trainer buildings, was done by a central architectural unit for the Air Force, all of the prototype plans are given out to participating architects through the decentralized offices of the Corps of Engineers. No Washington contact is necessary.

Planning aids take the form of "definitive drawings" for various types of buildings (there are more than two hundred drawings), plus a set of outline specifications. The definitives are basic plans, similar to the usual preliminaries, for various sizes and types of dozens of specialized buildings. They are not working drawings, and they leave a good deal of scope to individual architects.

The definitives are the result of intensive field surveys of the special requirements of Air Force buildings by staff architects of the Architectural Services Branch of the Directorate of Installations. Through such study, criteria have been developed for all standard types of buildings, to insure functional adequacy, economy of construction and speed of execution. Participating architects, then, are presented with a prepared parti for each building and outline instructions as to specifications, from which to complete an architectural design suited to local conditions, final plans and working drawings, detailed specifications and contract documents.

Architects are called upon to work to rigid dictates of economy, in fact the word "austerity" is heard frequently in the Pentagon. In spite of the ease with which Washington talks about billions — and the Air Force building program does run into billions — military architects are extremely sensitive to murmurs of extravagance. The American airman, like the American foot soldier, will be the best housed and best fed in the world, but there will be no fanciness in his buildings.

Directorate of Installations

Major General Patrick W. Timberlake
Brigadier General C. M. Myers

Architectural Services Branch

Colonel Stewart A. Marshall, Jr., Military Chief
Lt. Col. Edwin M. Loye, Deputy Military Chief
Carl C. Sanford, Civilian Chief

Drafting of Definitive Drawings by Mills & Petticord

Drawings by Marilyn Miller

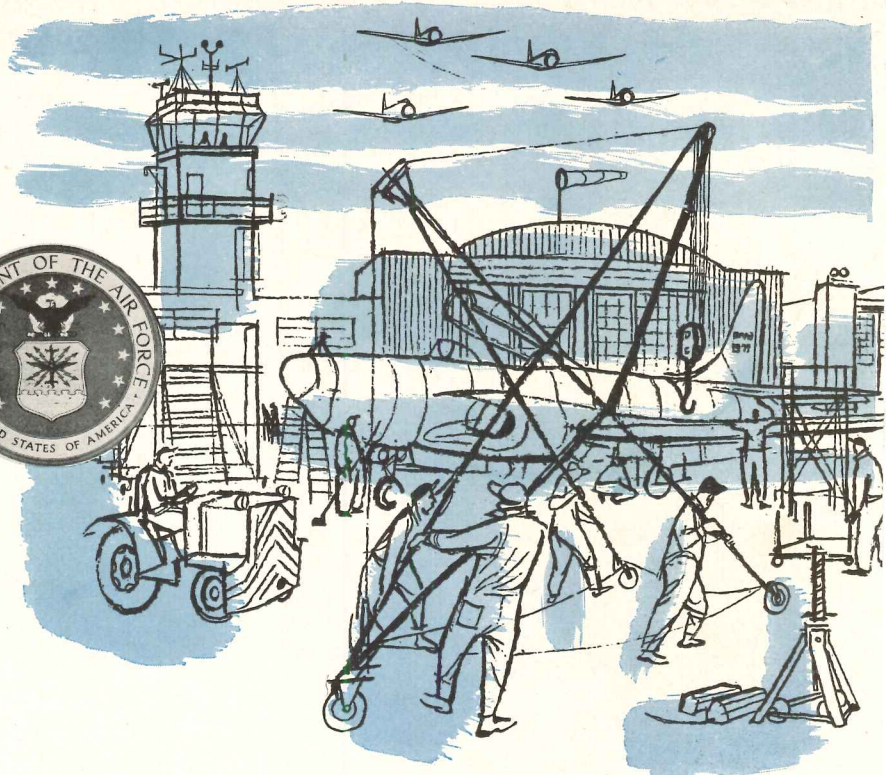

Selected Plans from "Definitive Drawings, 1951" and "Definitive Drawings, 1952," prepared by the Architectural Services Branch, Directorate of Installations, U. S. Air Force

PLANNING

| | |
|--|-----|
| Planning Buildings for the U. S. Air Force..... | 96 |
| Alert Hangars..... | 98 |
| Readiness Hangars..... | 99 |
| Double Cantilever Hangars..... | 100 |
| Extensions of Double Cantilever Hangar..... | 102 |
| Nose Hangar..... | 103 |
| Technical Training Buildings..... | 104 |
| Celestial Navigation Trainer Building..... | 106 |
| Motor Pool Buildings..... | 107 |
| Aircraft Maintenance—Engine Build-up Building..... | 108 |
| Armament and Electronics Building..... | 109 |
| Communications Buildings..... | 110 |
| Operations Buildings..... | 112 |
| Operations Building, Small..... | 114 |
| Headquarters Building..... | 115 |
| Headquarters for Air Base Group..... | 117 |
| Headquarters and Operations Building, Combat Squadron..... | 117 |
| Dormitories..... | 118 |
| Mess Halls..... | 120 |
| Chapels..... | 122 |
| Readiness Building..... | 124 |
| Guard Houses..... | 125 |
| Theaters..... | 126 |

ARCHITECTS undertaking commissions to plan buildings for the Air Force will be expected to produce final plans, working drawings and contract documents expeditiously, and they may expect to adhere to the strictest dictates of economy. They are not asked, however, to put aside imaginative urgings or common-sense inventiveness; they are, in fact, expected to exhibit their usual design ingenuity within the requirements of function and budget. Of course, should the design urge run to useless embellishments or nostalgic doodads, the Engineer Corps, which makes contracts for the Air Force, will give it all a crisp veto. But the whole Air Force building program is designed to utilize the services of private architects, local architects wherever possible, and to exact full performance.

Most of the background thinking has already been done by the Air Force Architectural Services Branch, Directorate of Installations, and is available to participating architects in the books of definitive drawings which may be reviewed at the various offices of the Engineer Corps. These show the requirements, space allotments, and policies of the Air Force for a great variety of more or less standard building types. These drawings, with the Outline Specifications, become virtually the Air Force instructions to the Corps of Engineers, and thence to commissioned architects. They are essentially diagrammatic floor plans; the architect is then to develop site plans, provisions for utilities, working drawings, detailed specifications and contract documents.

Air Force buildings for the current emergency are assumed for a 10-year life, though in some for permanent use the specifications are drawn for a 25-year

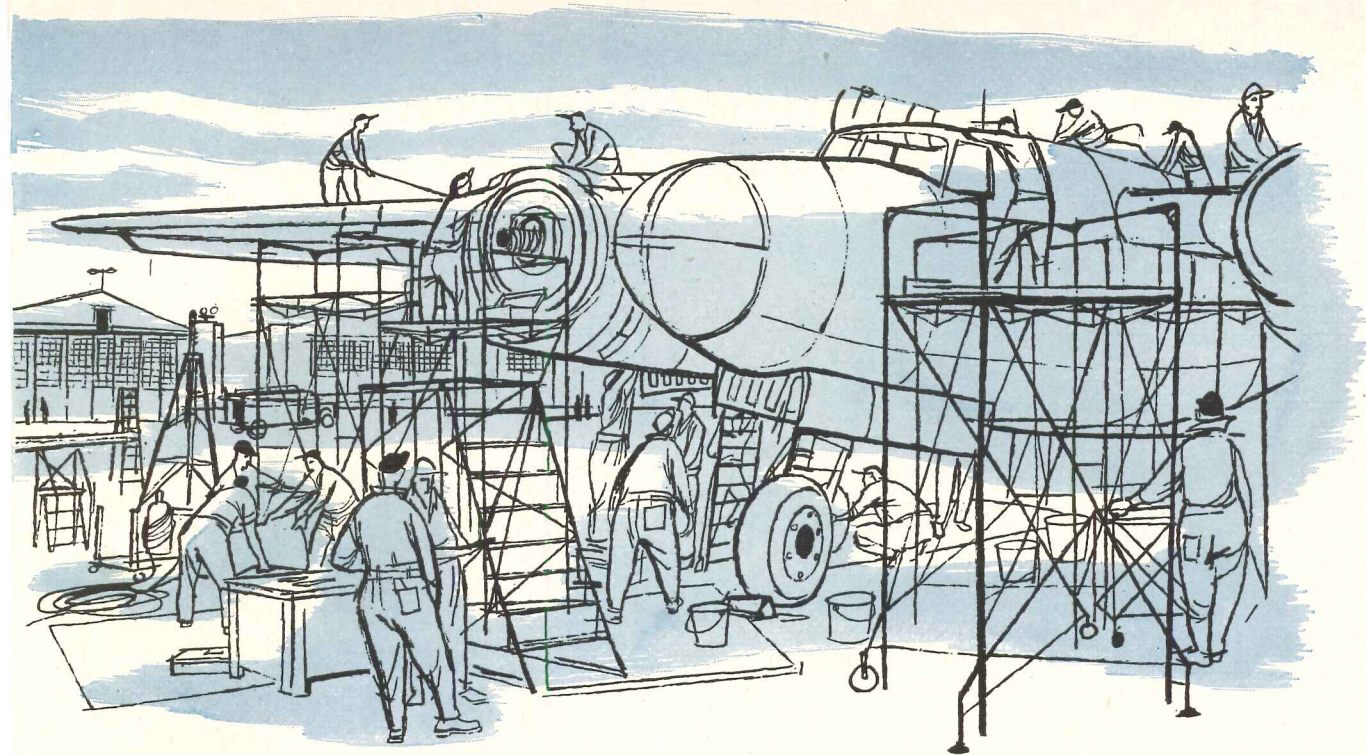

BUILDINGS FOR THE U. S. AIR FORCE

life. And the 10-year buildings are so designed that with some refinements in finishes, siding, roofing and so on they will meet the 25-year specifications if these are required for longer use.

The 10-year description comes from the assumption that in general new installations will be semi-permanent, as part of a preparedness program of unpredictable duration. Some bases, on the other hand, are planned as part of a permanent, or 25-year, standing defense installation. It is assumed, too, that some of the semi-permanent bases may later be designated permanent, and the 10-year buildings brought up to 25-year standards. In any case, the policy is to anticipate the dismantling of most bases and building installations, and hold investments to a minimum.

Actually the savings represented by the differences in specifications are not up to expectations at the time the policy was laid down by Congress, when the savings were lightly assumed in the neighborhood of 20 per cent; life expectancies for buildings are pretty vague calculations, and for any building it is necessary to use a sound structural system and a certain minimum of equipment. The area for savings then is limited to such minor items as siding material, roofing, floor and wall finishes. Nevertheless there is some saving, and if the building is dismantled according to plan, the savings hold, for the experience of wartime shows that virtually nothing is salvaged when military buildings are junked.

The difference in planned life is, usually, merely a matter of specifications, not of plan. In other words, the floor plans in the definitive drawings hold, no matter what the assumed life.

Specifications are given in fairly general terms in the

“Outline Specifications for Standard Air Force Buildings,” for the two major categories, which are usually referred to as Type C (combustible) and Type N (non-combustible). Type C is, of course, normal wood frame construction, and the specifications assert that this “will be accepted from the standpoint of longevity and should be considered in every case except where combustible materials are specifically prohibited or where more durable and satisfactory construction is obtainable at a cost no greater than that of wood frame.”

Also, “These specifications are not intended to preclude the use of new materials and construction methods if they are comparable in cost and equally suitable.”

Prefabricated construction is encouraged, with the usual stipulations as to cost and suitability.

Of especial interest to architects is this paragraph: “It is not considered essential that new structures conform with the established style of architecture at existing installations. It is desirable instead that the designs be consistently economical and generally in harmony with the simple contemporary architectural trends, devoid of any details or ornamentations, applied purely for the sake of embellishment. Full advantage should be taken of the use of the natural textures and color of the materials employed as well as of the variety afforded by the properly selected color schemes where paint is applied.”

In other words, even though he may be called upon to follow floor plans with near exactness, he must determine architectural styling, must adapt plans to local climate, and will find considerable range in fenestration, overhang, materials and colors. He is still expected to be an architect, and to think as such.

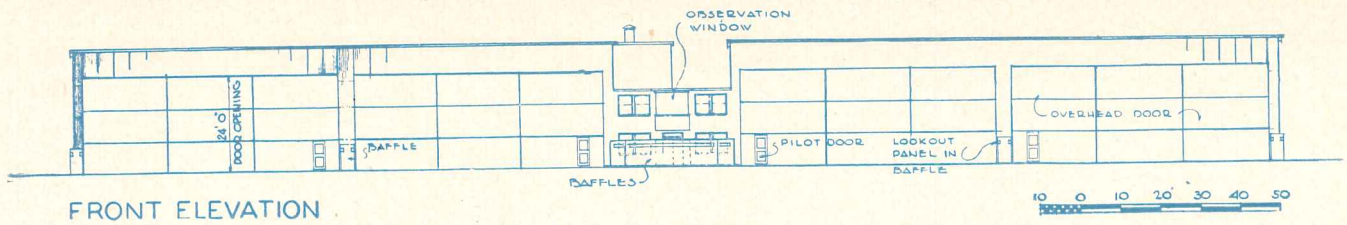

FRONT ELEVATION

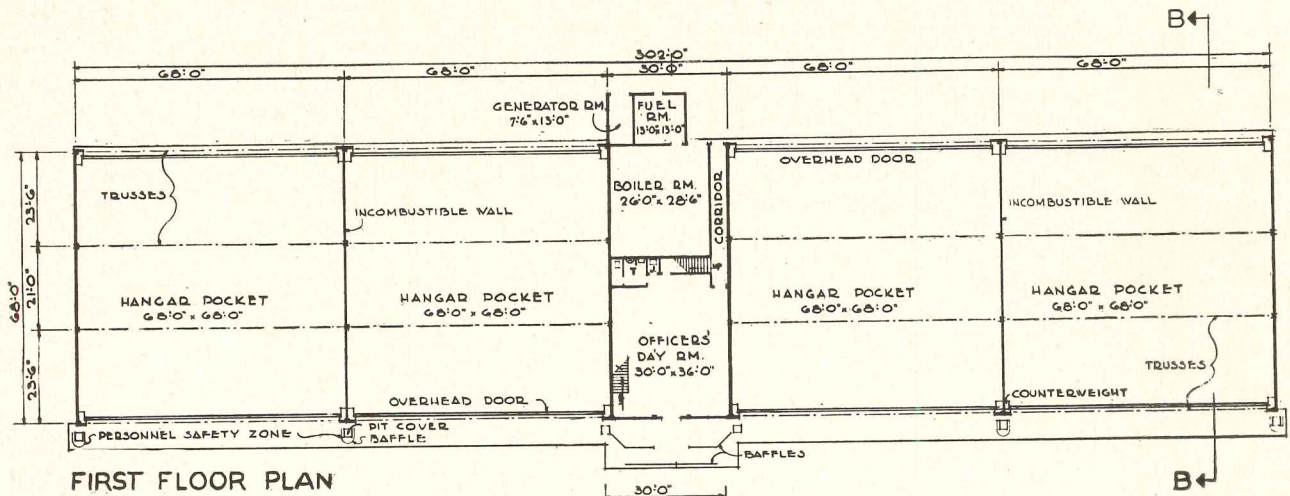

FIRST FLOOR PLAN

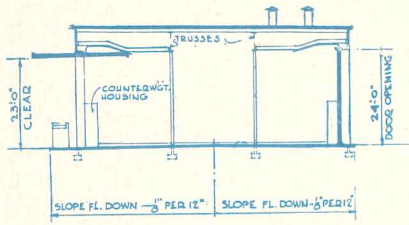

SECTION B-B

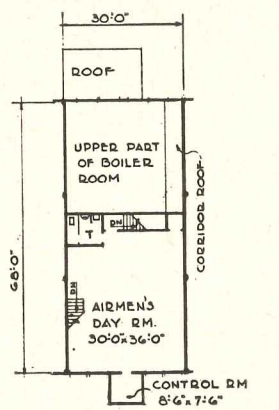

SECOND FLOOR PLAN

ALERT HANGARS

THE AIR FORCE "alert hangar" represents a new concept of defensive preparedness, in which fighter planes are to be air borne within 90 seconds. Such fast action imposes a number of requirements which, in the first place, necessitate keeping the alerted planes in hangars, and also then dictate the design of the hangar. Planes must be under cover so that they can be kept warmed up, manned, and ready to fly.

Actually the planes must take off right from the hangar; there is no time in the 90-second schedule for wheeling them out. A hangar which is actually a take-off point must, then, fulfil some special requirements. In the first place, the hangar must have quick-operating doors, both front and back, so that the plane can move quickly, and so that its power will not blow the building apart. The requirement is for vertical-operating doors to achieve full opening within 30 seconds. The hangar form must be narrow, with one pocket for each plane. It must be fire-resistant, of course, and heated. It must also have accommodations for airmen, comprising a day room for officers, on the ground floor, and one for

airmen on the second floor. Note also on the plan the baffles at the personnel entrance and at the pocket partitions; these are for protection against the air blast, or jet blast. The individual baffles between pocket doors protect the man operating the doors when the plane takes off.

Each alert hangar is arranged for four alerted planes. The scheme is to have sufficient hangar pockets, in several hangars, for the first flight of fighter planes to take off during an alert. Other fighters might be kept in a "readiness hangar," as a second line. These planes would have some more time than the first flight; the normal plan would be for them to take the places of the first flight in the alert hangars to await signals to take off.

The alert hangar might appear at any base from which fighter planes would operate, whether an advanced base or an "aircraft control and warning station." So, while this is a new type of hangar, it is expected to be built in large numbers, so that the Air Force is never caught with its fighters on the ground.

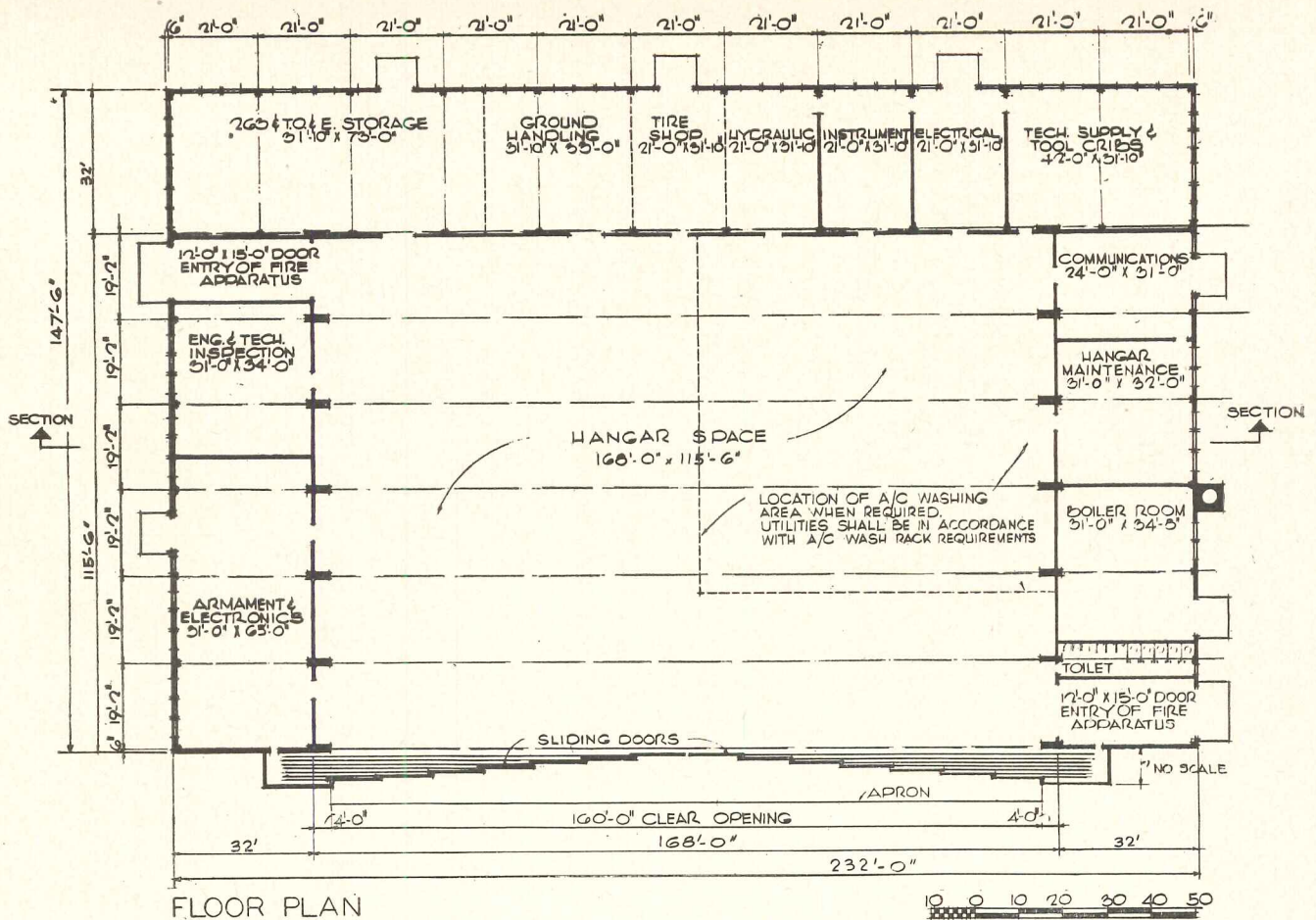

FLOOR PLAN

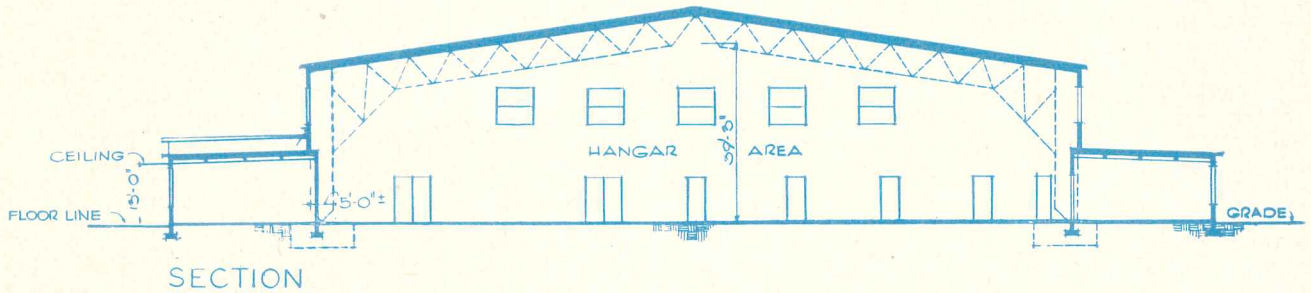

SECTION

READINESS HANGARS

THE READINESS HANGAR is one of the Air Force hangar designs that uses the conventional form so familiar in the last war. It is really a multiple-purpose hangar, without the highly specialized requirements of the alert hangar, but useful in many ways.

For planes kept "in readiness" it provides a place where fighter planes, or even larger ones, can be parked under cover, kept warm, and can be taken out with reasonable despatch, either to use or to the alert hangar. Thus the long-span, completely open interior is desirable. There is no thought, however, that planes would be kept lined up for instant service, or that they would actually be flown out of the hangar.

The readiness hangar is also a maintenance shop for anything short of major overhaul. It is quite possible to use the hangar for both readiness and service at the

same time. Or, of course, for almost any hangar service in case the operations of the base should change. It is useful also for many different types of planes, short of the largest bombers. It is in many respects an old-fashioned type of hangar, as succeeding pages will show, but still a very useful one.

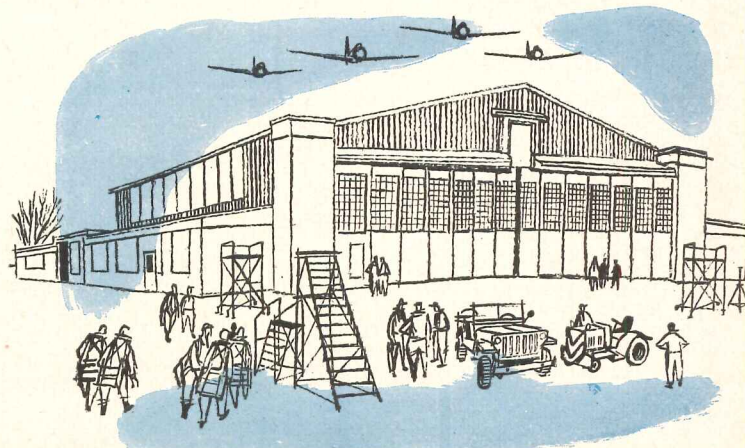

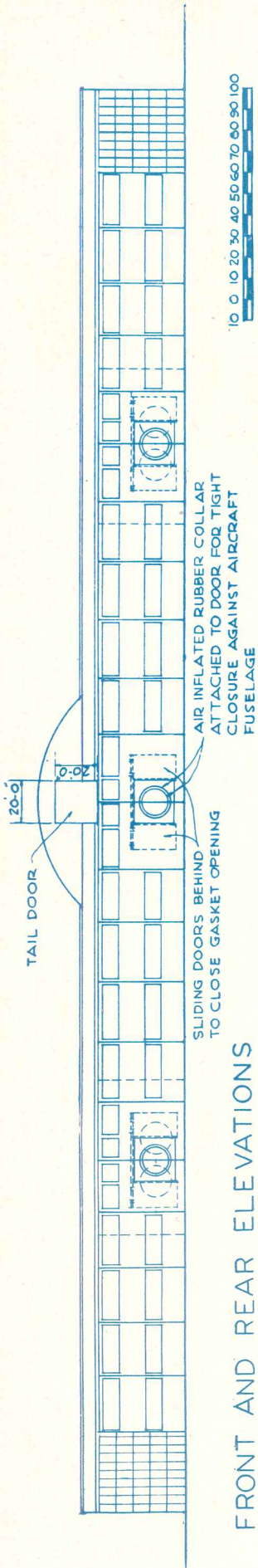

FRONT AND REAR ELEVATIONS

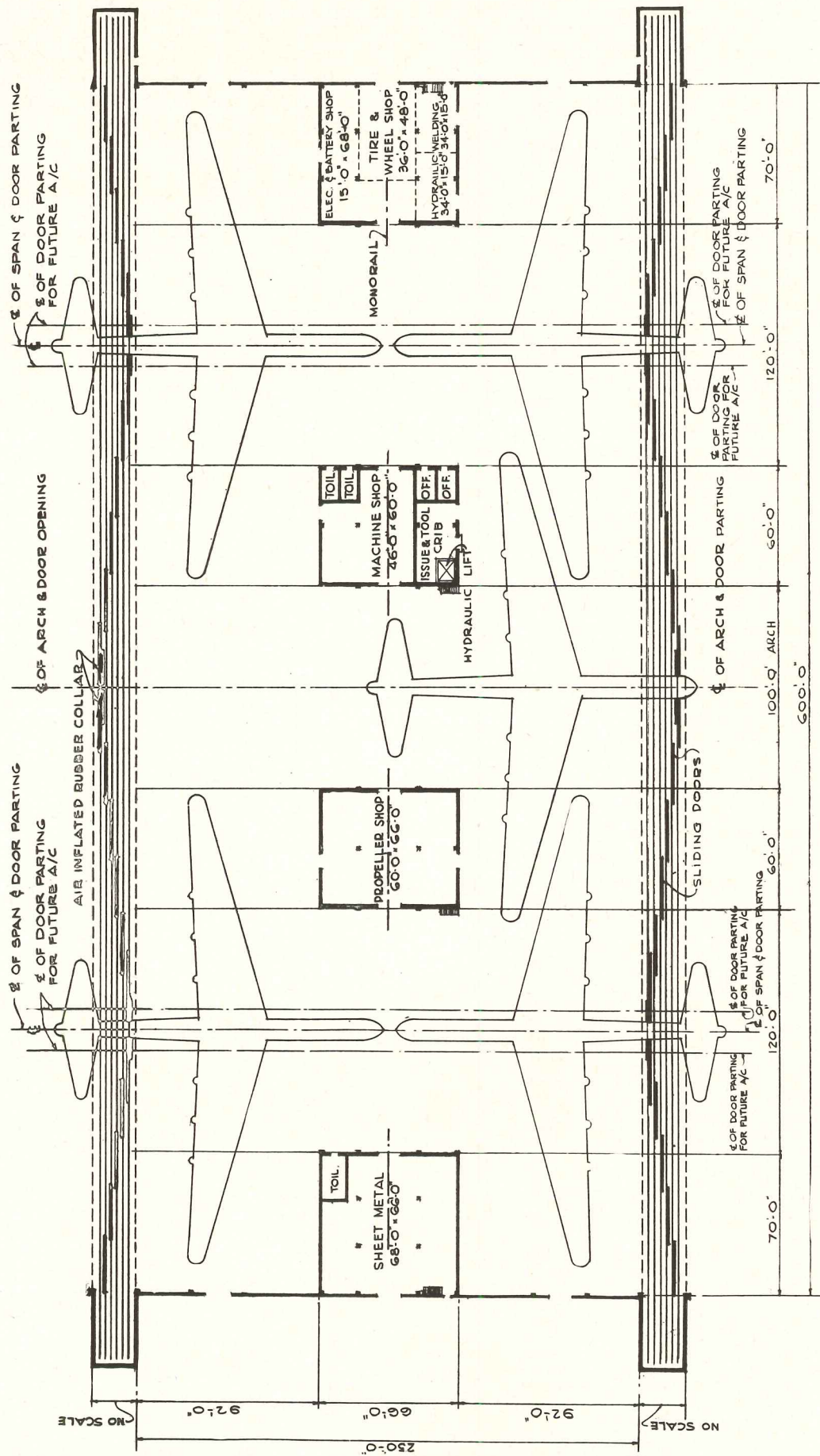

GROUND FLOOR PLAN

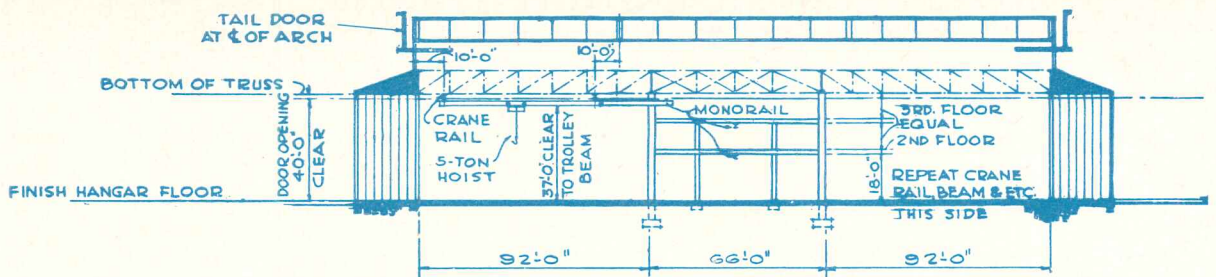

DOUBLE CANTILEVER HANGARS

ONE of the most interesting hangars is the new double-cantilever type now under development by the Air Force. It promises to change the form of long-span hangars in the future, through one of those simple switches in concept which makes one say, "Why didn't I think of that?"

In principle it amounts to turning the structure sideways, so that the distance spanned is toward the hangar doors and away from the center of the hangar. Thus, in theory, the hangar dimension corresponding to the wing spread of the plane is completely unlimited.

The structural system is a double row of large columns, each two columns supporting a huge truss which cantilevers to the front and to the rear. As the diagrams show, it is possible to service a large plane with either its nose or its tail projecting out of the hangar; the critical dimension, then, is something less than the length of the plane — the wing spread does not matter.

The double cantilever idea developed, of course, as wing spread grew increasingly long, making the arch-type hangar awkward and expensive. The spans were working up toward 300 ft, and there was also the problem of overlapping planes to get more than one in a hangar. Turning the span require-

ment sidewise promises, therefore, to be a bright idea.

It is not all quite so simple, however, for the swept-back wing arrived and accordingly increased the necessary depth of the cantilever. Early designs for the double-cantilever hangar put this dimension at 80 ft; now it is up to 92 ft. Truss designs are now in process for this 92-ft cantilever, with the central supporting columns 66 ft apart. The trusses must also support five-ton cranes which must operate almost to the end of the cantilever.

Early designs called for 40-ft-high doors (see section and elevation) with one higher bay for the tail section of large planes. New designs (now being developed by the Kaljian Corporation in an architect-engineer contract) indicate that it is just as economical to have 60-ft doors throughout, since the necessary depth of the truss is such as to permit that height almost automatically.

In such a hangar the shops come at the center, not strung out along the sides. Various shops come in square spaces, three stories high, between the columns. This arrangement, by the way, substantially shortens the distances over which heavy parts must be transported from plane to shop, and utilizes space that would be largely wasted in the old single-span hangars.

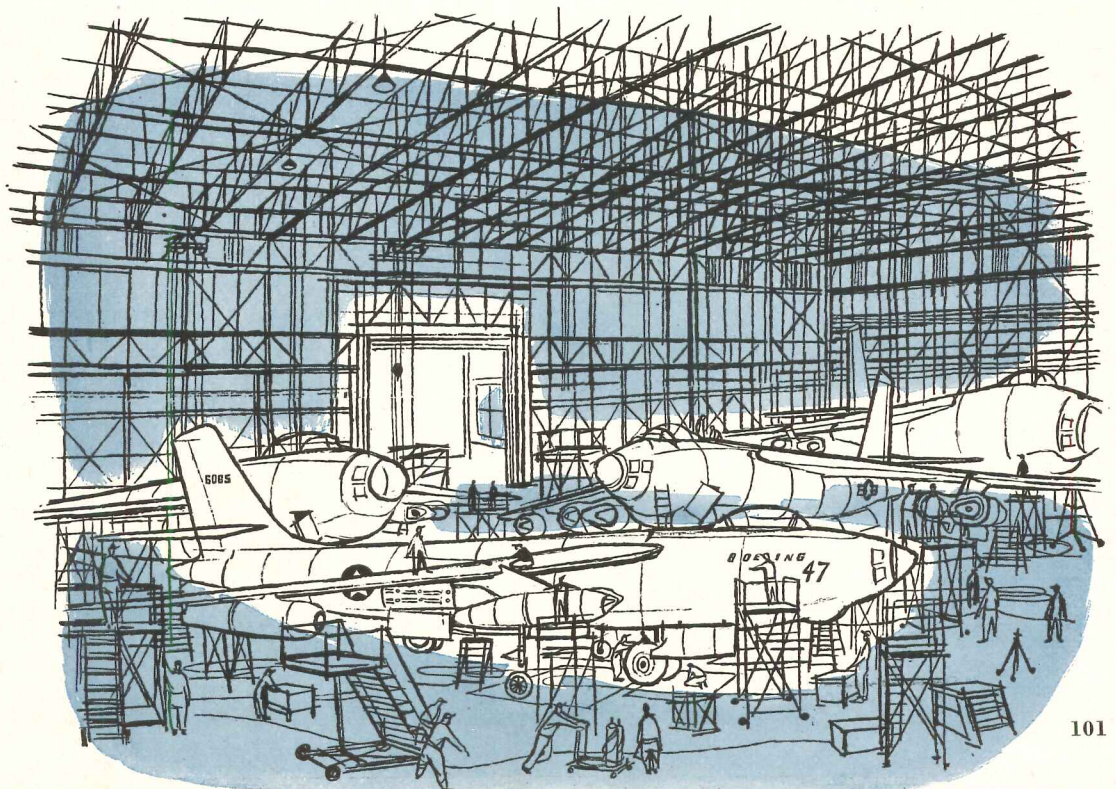

EXTENSIONS OF DOUBLE CANTILEVER HANGAR

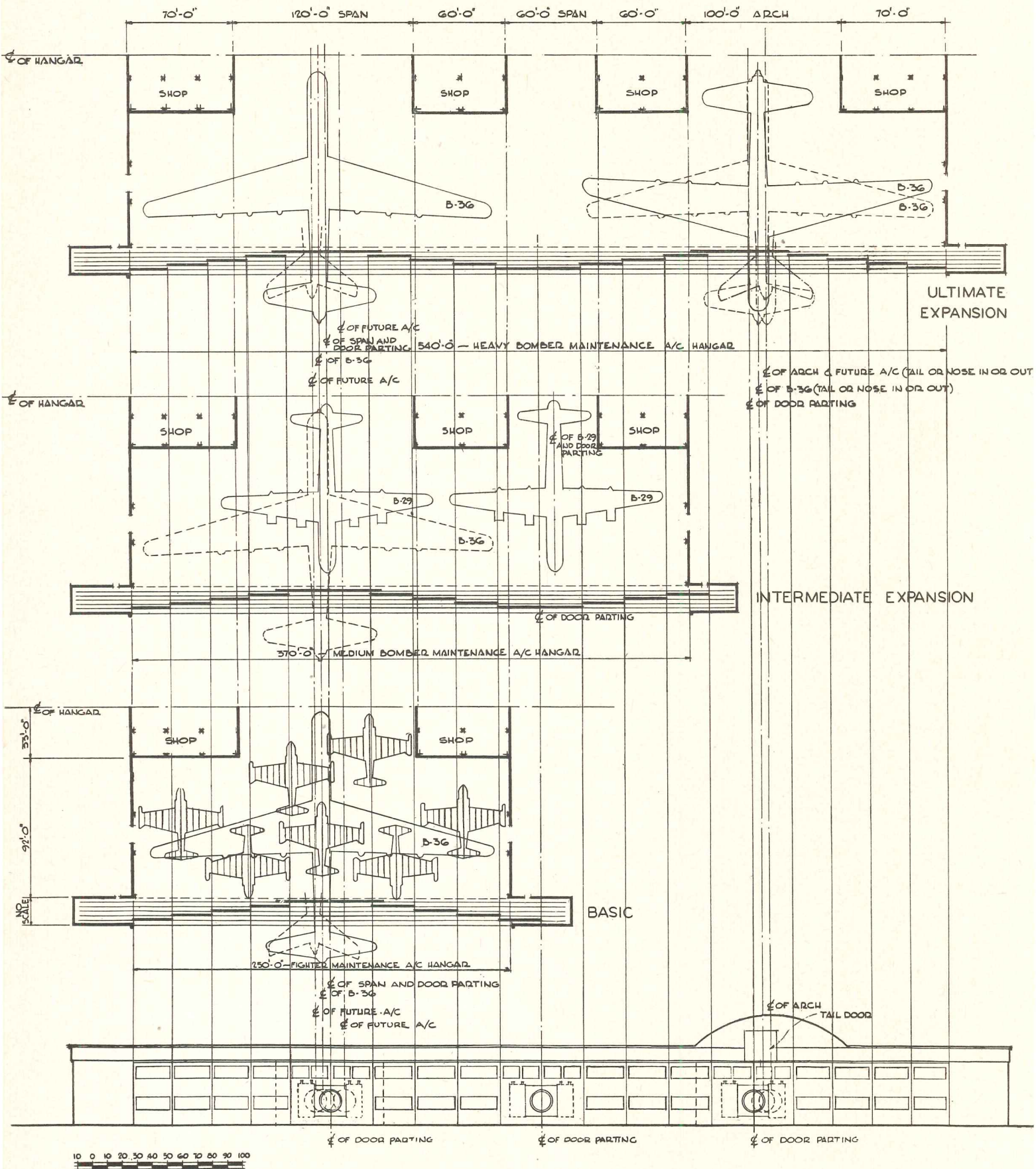

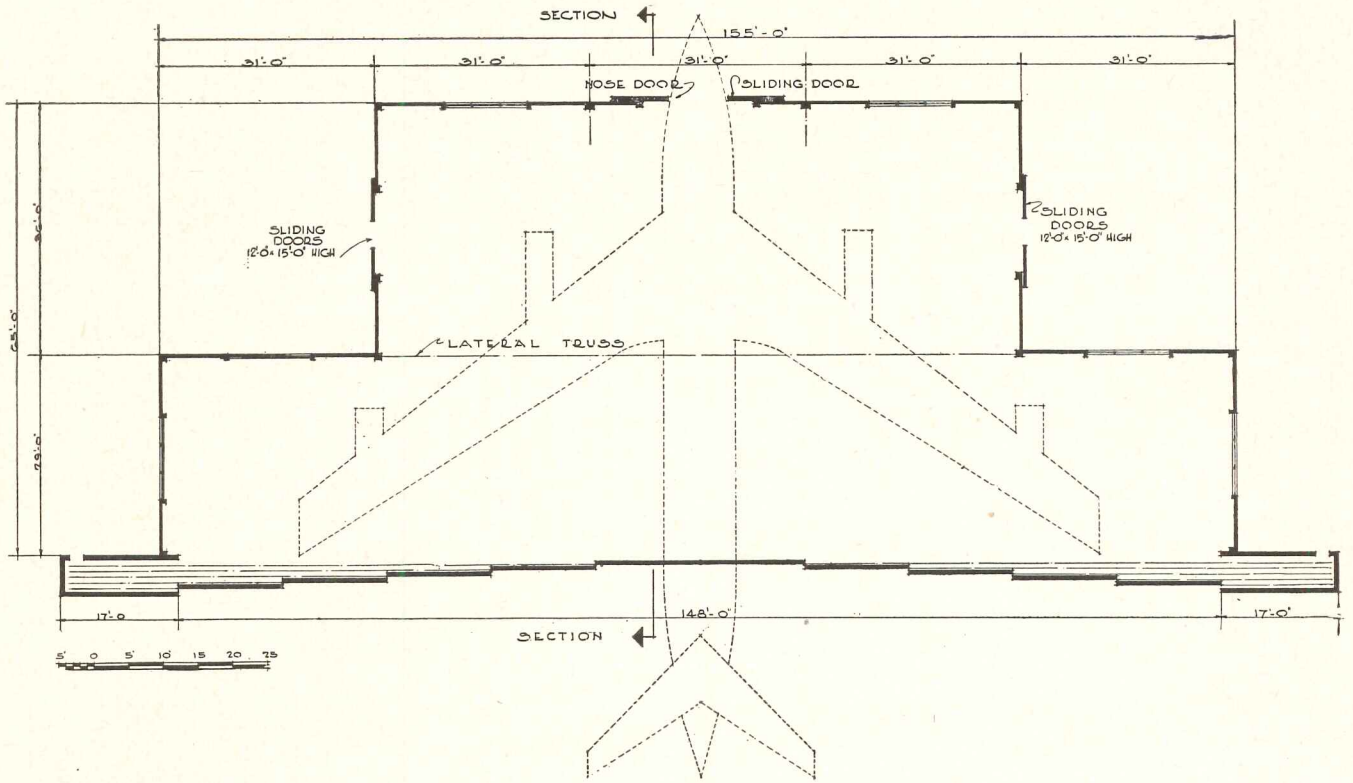
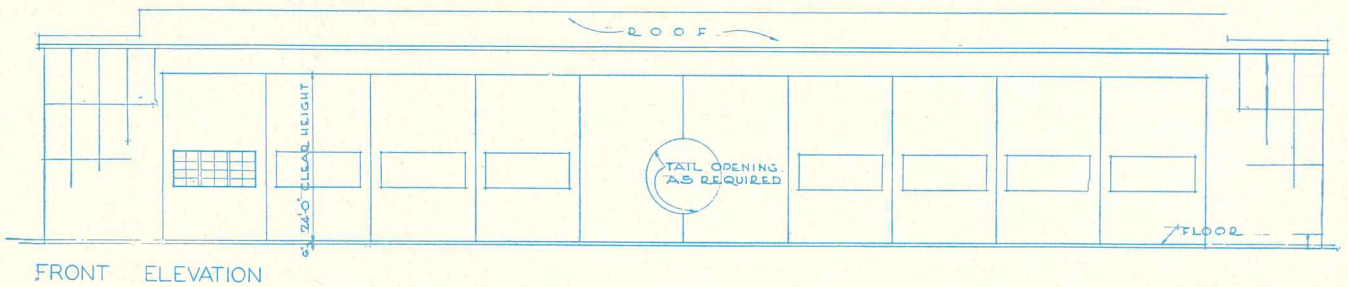

NOSE HANGAR

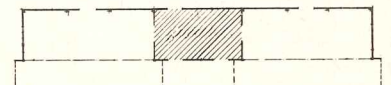
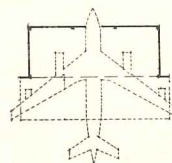
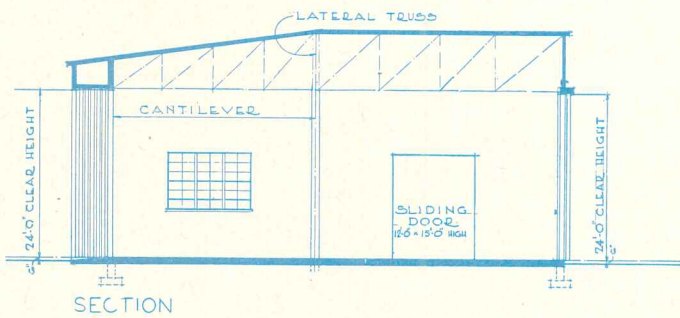

0' 0" 10' 20' 30' 40' 50' 60' 70' 80' 90' 100' 110' 120'

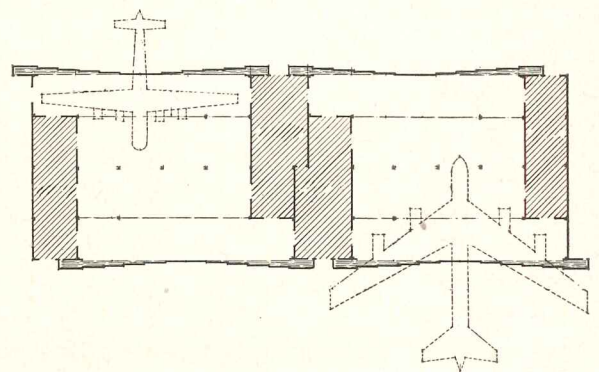
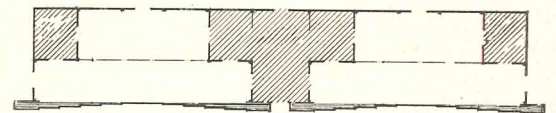

AN OLD IDEA IN HANGARS for large planes appears here in new form. The large plan shows its simplest form, a sort of minimum hangar for the occasional large plane. Diagrams at the right show how the same general idea might be used in various combinations, with shop areas included, for different types of planes. All of these assume that the whole plane need not be in the hangar. Canvas drops are used in many.

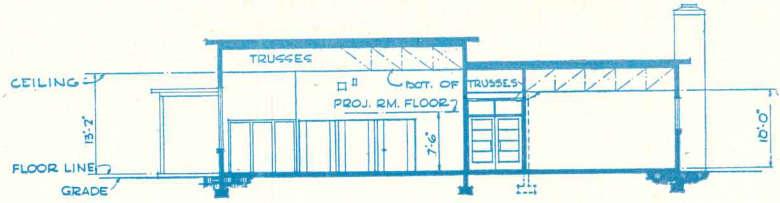
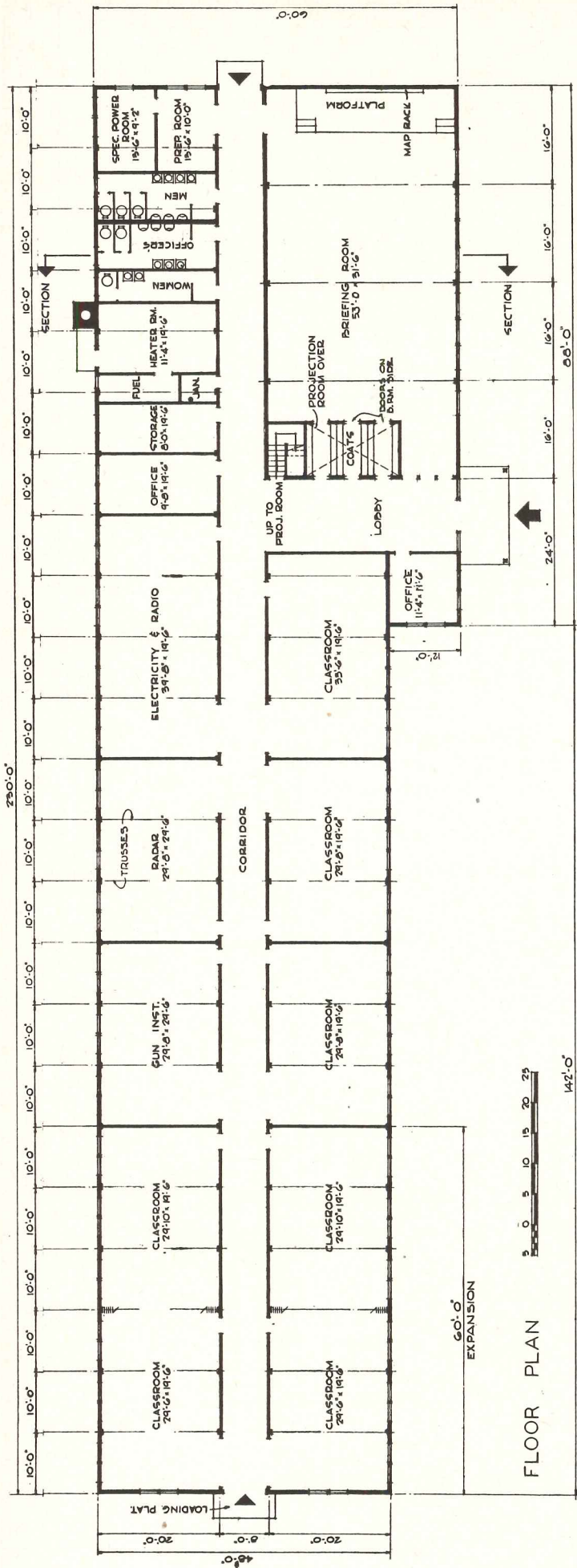

SECTION

TECHNICAL TRAINING BUILDINGS

IN THE AIR FORCE TECHNICAL TRAINING is perhaps the major activity from the standpoint of hours spent. Naturally then training buildings occur everywhere, in wide variety. The one shown on this page is one of the smaller ones, with more or less standard classrooms, plus one typical briefing room. A few classrooms are specially equipped for gun instruction, radio, radar. As the technical training buildings get larger more spaces are specially planned and equipped. Some, for such highly technical procedures as celestial navigation training, or flight simulators, get rather involved as to design.



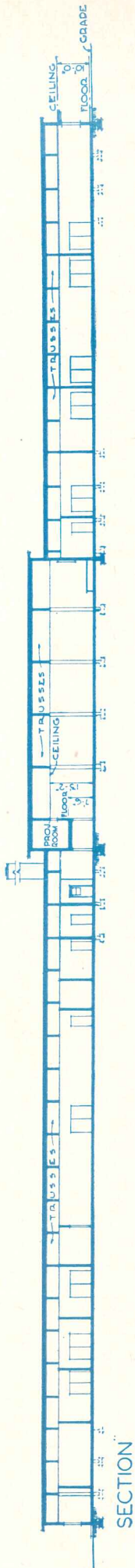

SECTION

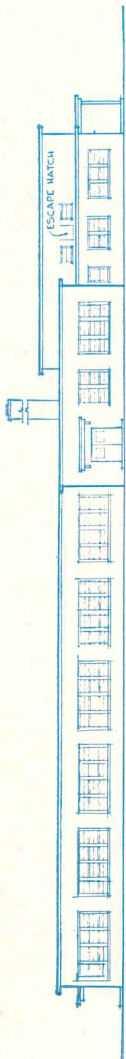

SIDE ELEVATION

This building for technical training gets considerably more complicated, with most of its space arranged for individual procedures, including Link trainers and bomb training. This building is large enough so that circulation becomes a problem; the briefing room is centrally located with easy access from either inside or outside the building. While the briefing room may be used for its stated purpose, it is actually a small auditorium, with many uses

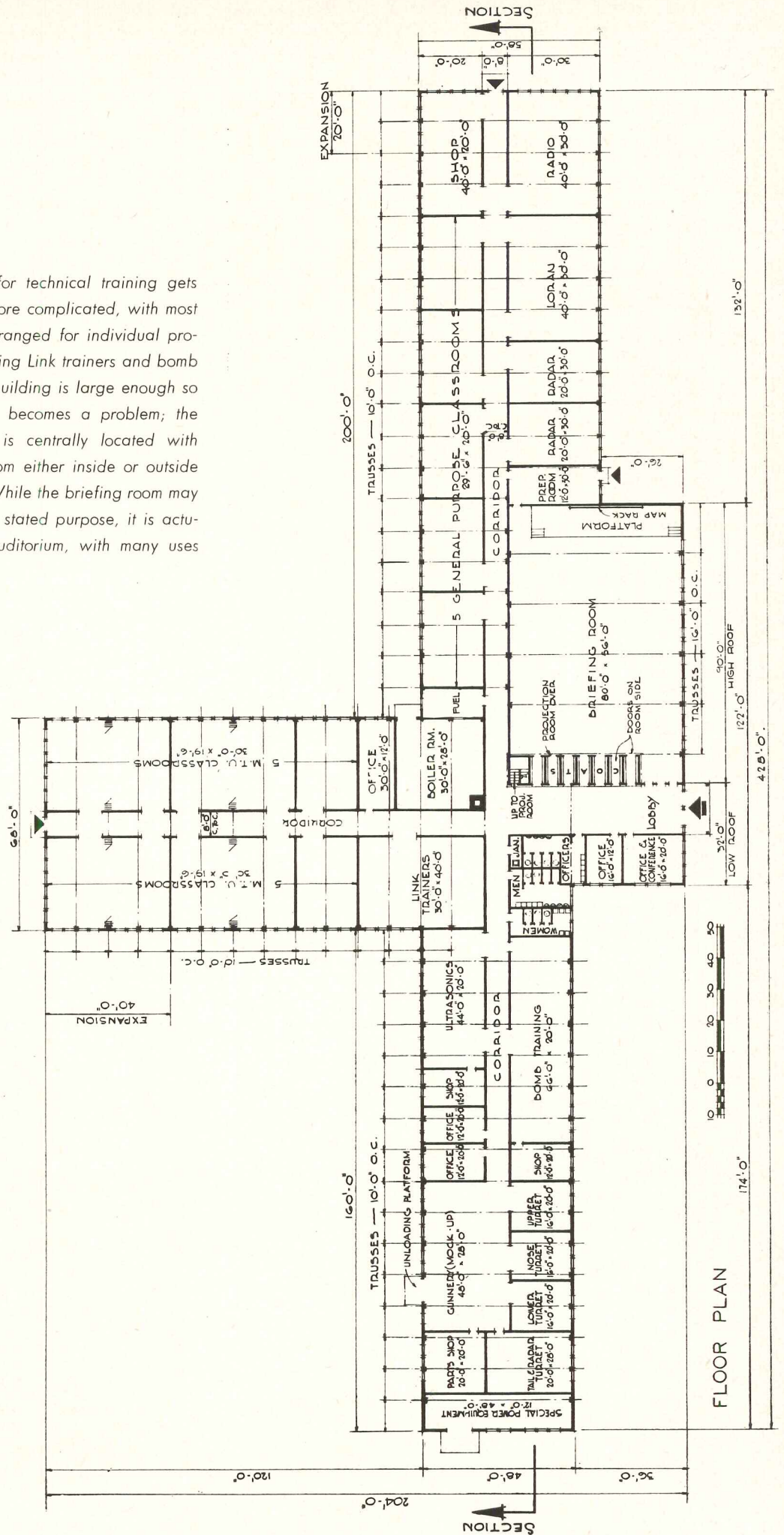

FLOOR PLAN

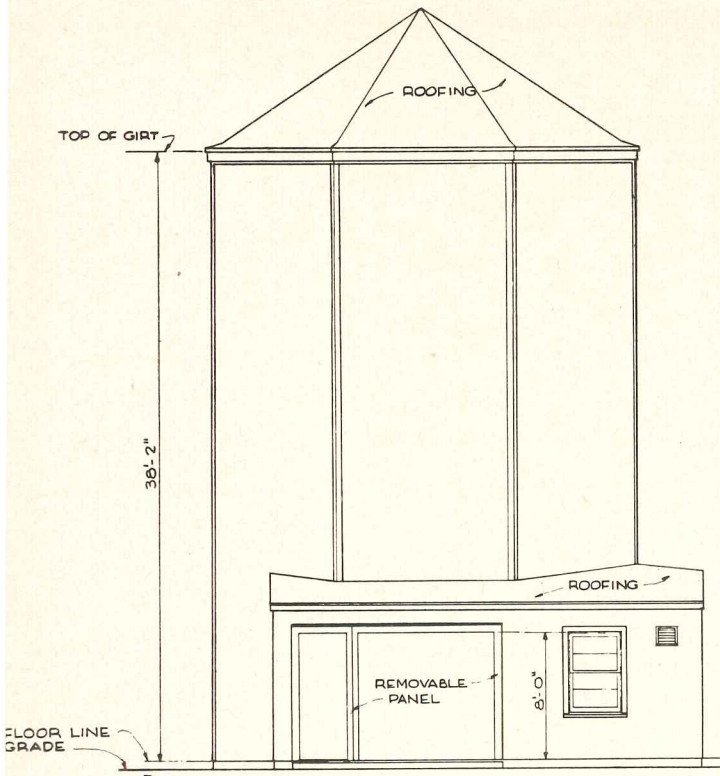

FRONT ELEVATION

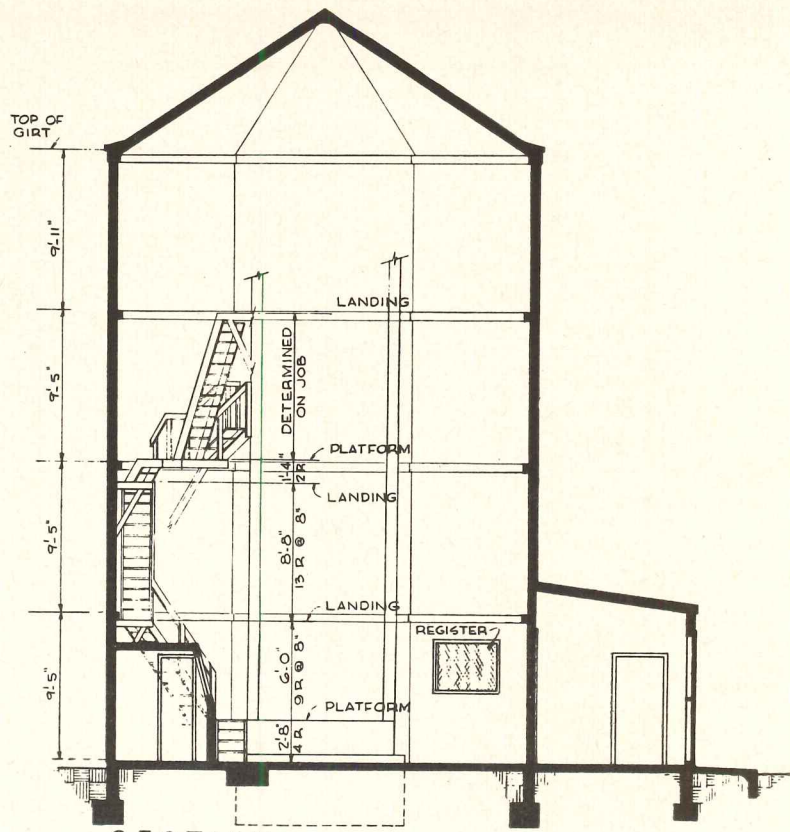

SECTION

CELESTIAL NAVIGATION TRAINER BUILDING

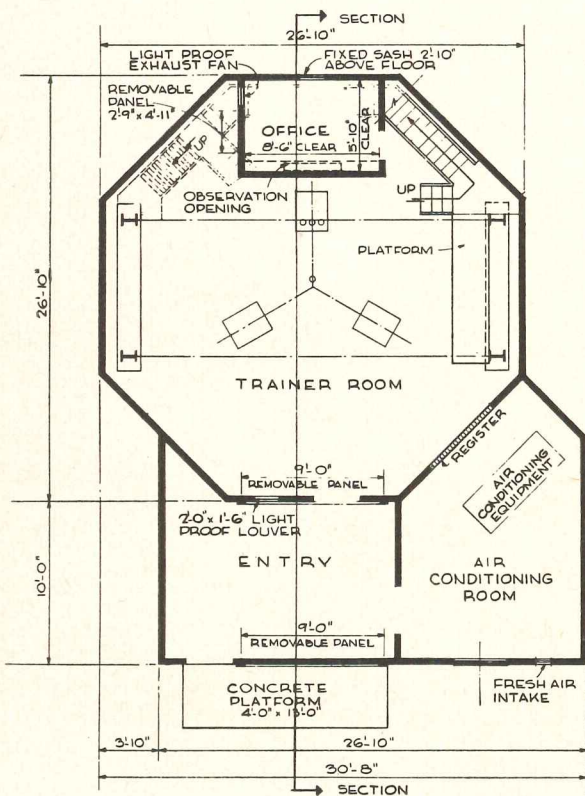

FLOOR PLAN

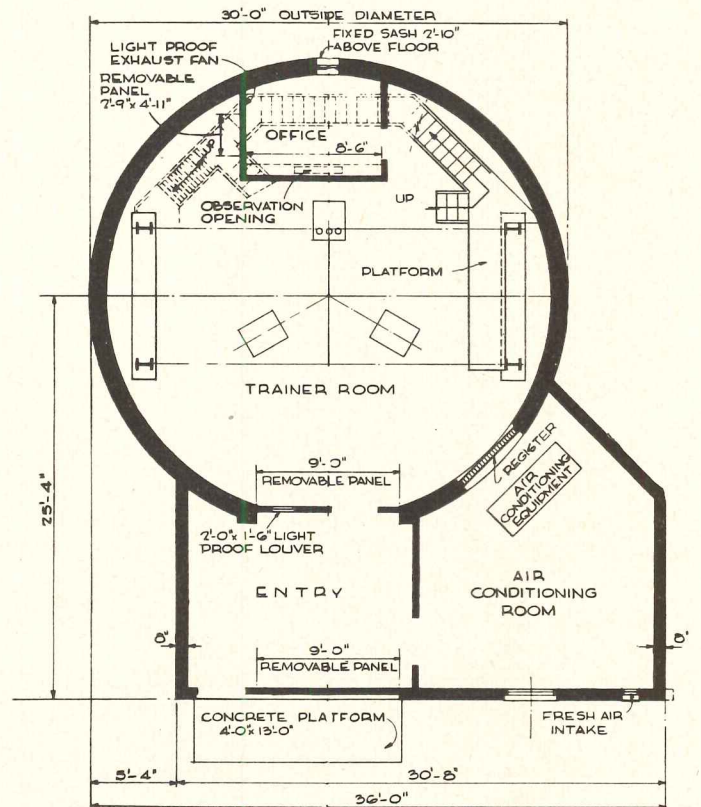

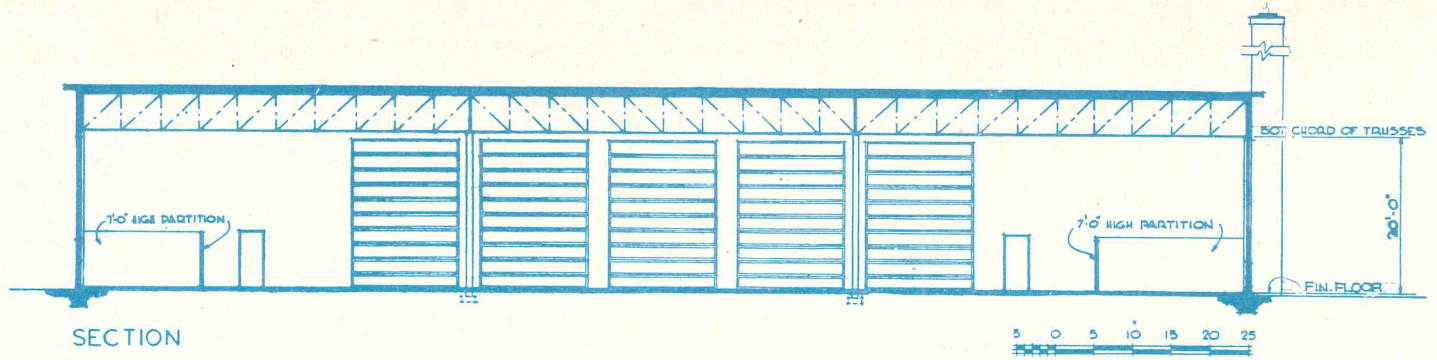

SECTION

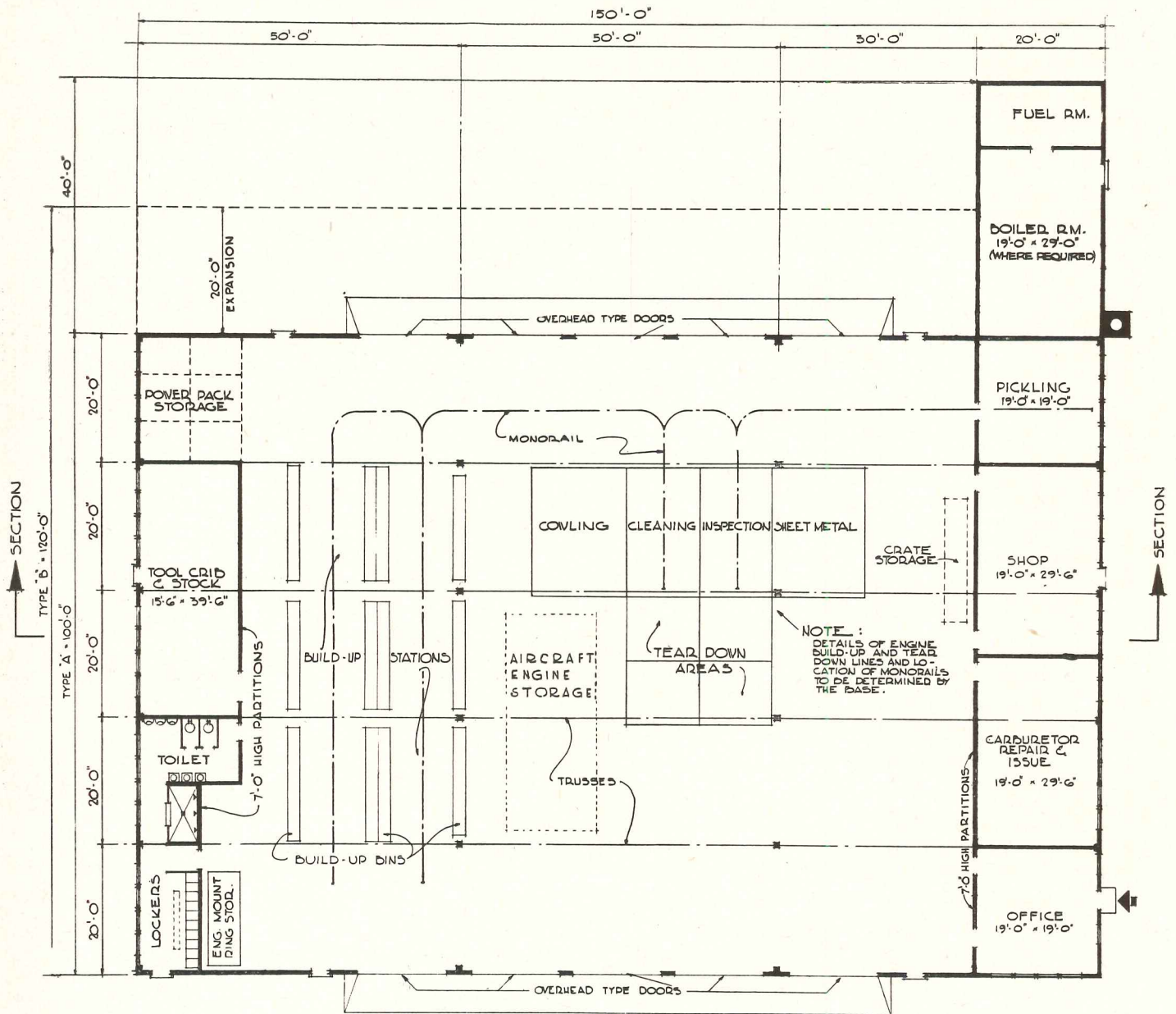

AIRCRAFT MAINTENANCE—ENGINE BUILD-UP BUILDING

AIRCRAFT MAINTENANCE becomes a highly complicated procedure in the Air Force, including everything from routine tune-up to tear-down and rebuilding. Simpler conditioning is done by flight squadrons on their own fields, but for major overhauls the planes would go to a maintenance group for the base. Thus there is a differ-

ence between a maintenance hangar, which handles a wide variety of tasks, and a central group consisting of four principal buildings: Fabrication, Engine Build-up, Armament and Electronics and Parachute and Dinghy Shop. The Engine Build-up building, shown here, is not a hangar, but a complete shop for rebuilding engines.

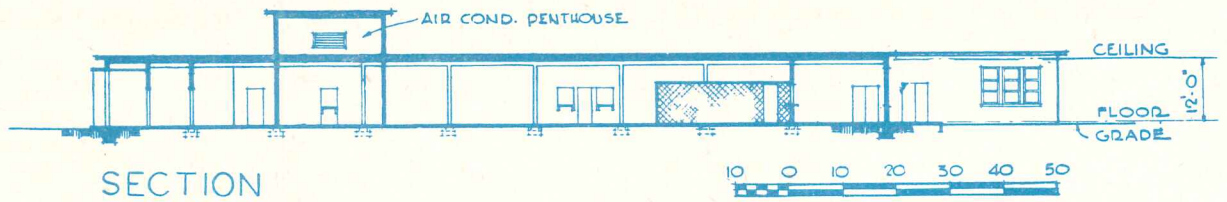

SECTION

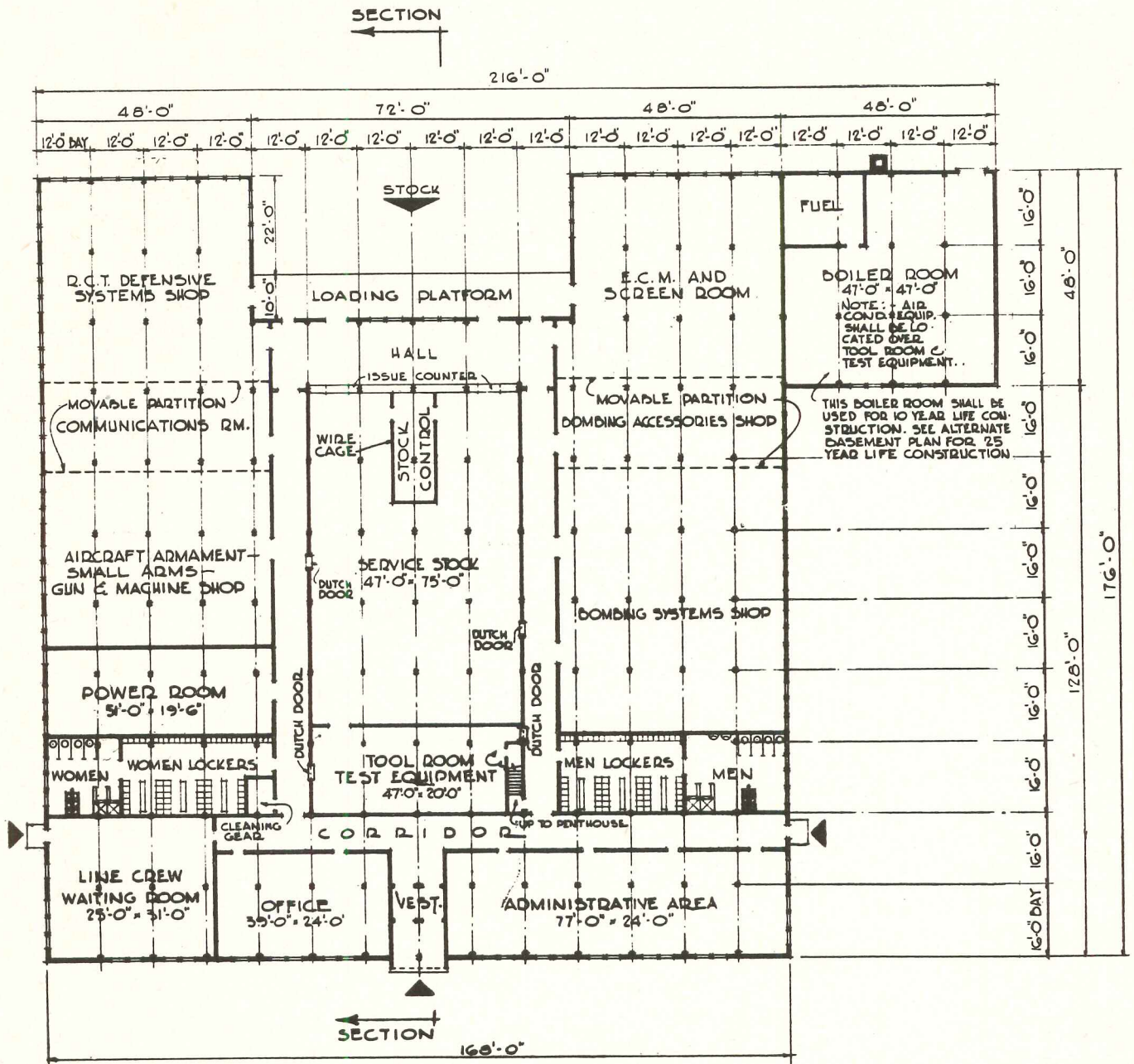

ARMAMENT AND ELECTRONICS BUILDING

ANYBODY who has ever been to the movies knows that military planes are loaded down with the most glamorous and complicated electronic equipment, guns, bomb-sights, and other wonderful secrets. All of it has to be serviced, and this is the standard building for that. Again it is not a hangar, but a fairly simple shops build-

ing with various arrangements of spaces in 12-ft modules for small-equipment repairs. The work here would be done on equipment taken out of planes, but a line crew is kept here for service calls to various hangars for such checking and repairs as could be done in place, or for removing the equipment from planes for later servicing.

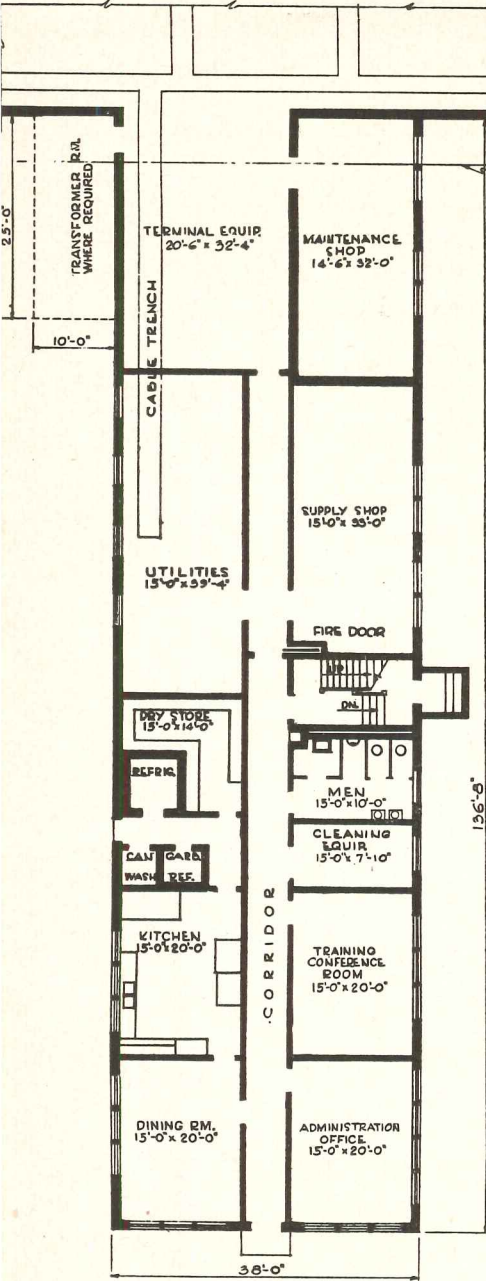

FIRST FLOOR PLAN

Remote Transmitter Building

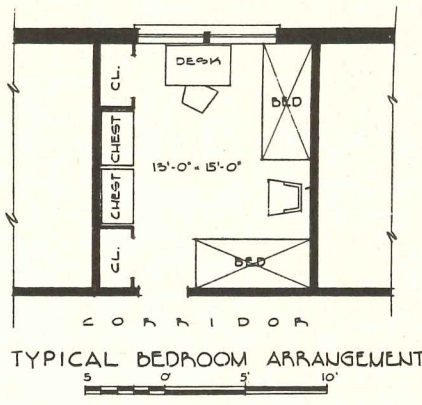

TYPICAL BEDROOM ARRANGEMENT

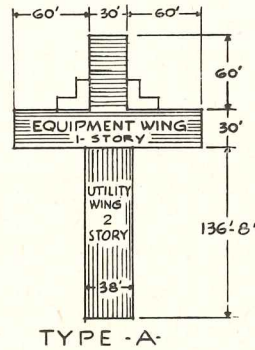

TYPE -A-

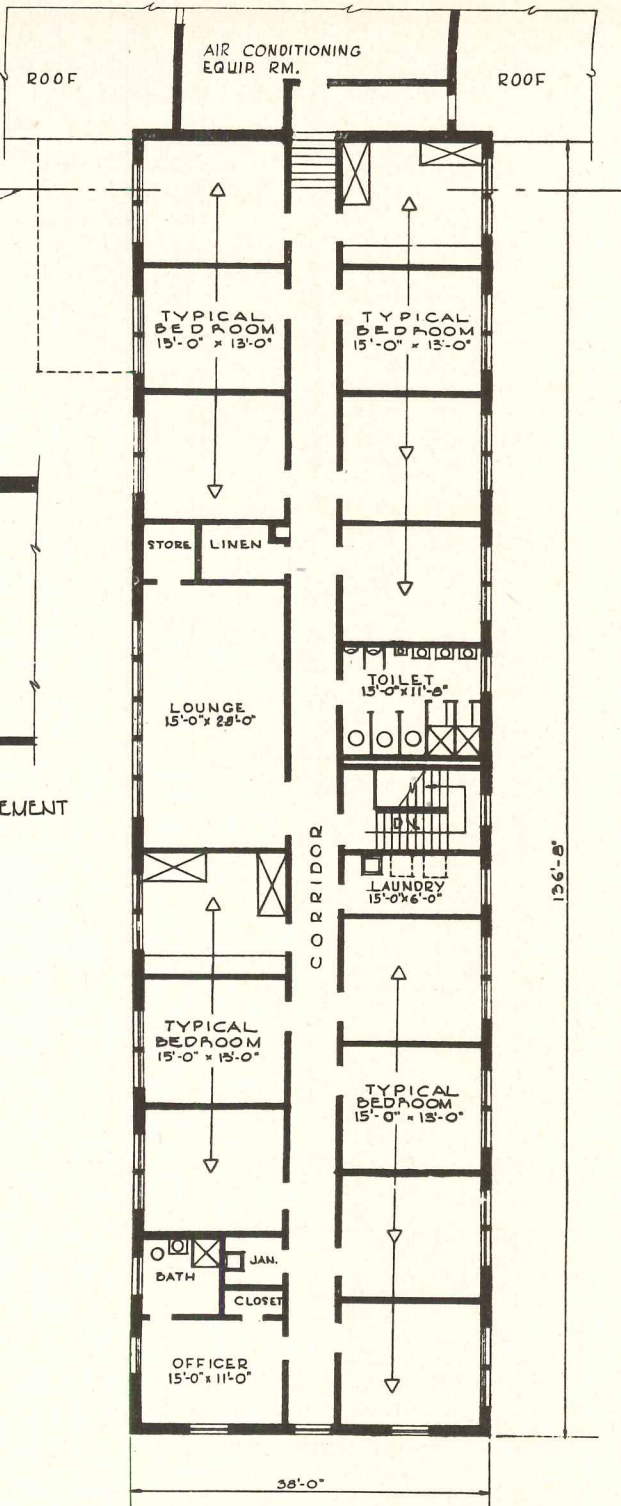

SECOND FLOOR PLAN

COMMUNICATIONS BUILDINGS

COMMUNICATIONS MAKES UP another category of highly specialized buildings for the Air Force. There are three general classifications: Receiving, Transmitter and Communications Center. The equipment wings call for no comment here; they are full of esoteric and classified equipment which can be left to the Air Force personnel. The Communications Center (opposite page) is a

strictly equipment building, simple in design and construction, with 16 by 30 ft bays for economy. The other two types (Transmitter above; Receiving Building opposite page above) are different in that they must also house the operating personnel. So they have bedrooms, lounges, kitchen and dining rooms. There are variations on the basic schemes shown.

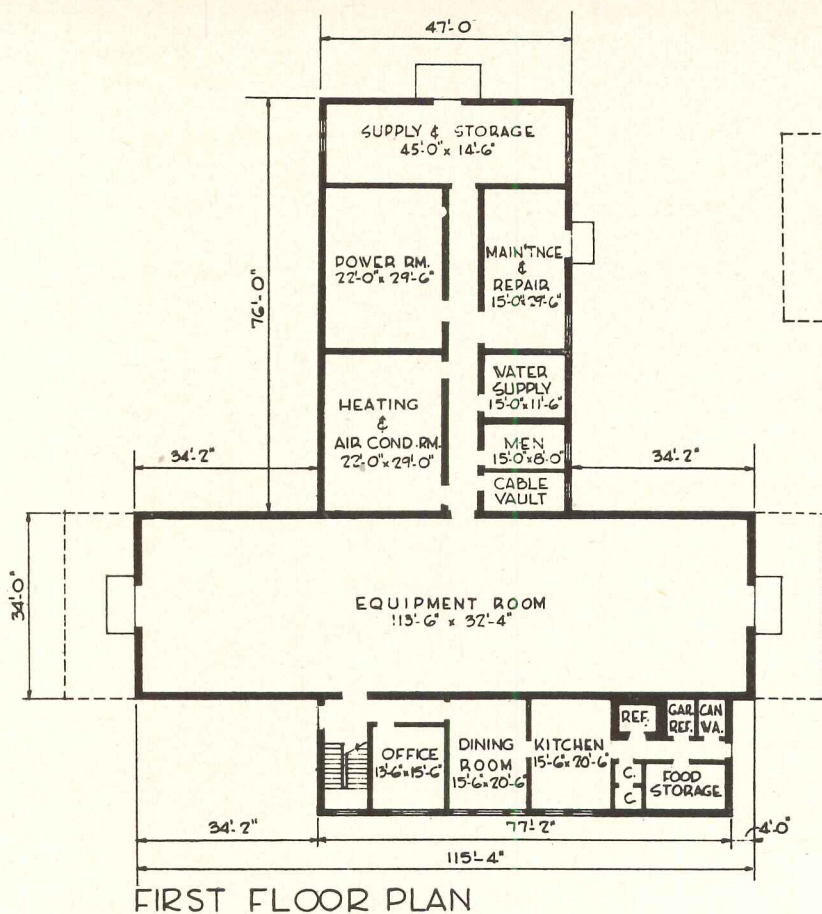

FIRST FLOOR PLAN

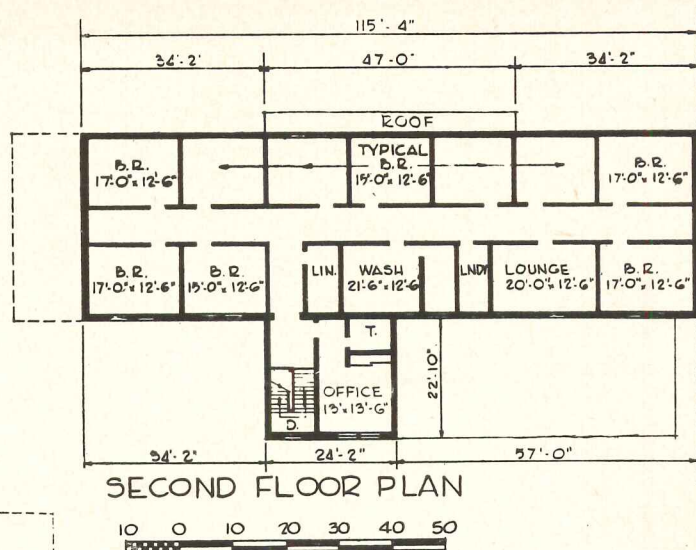

SECOND FLOOR PLAN

Remote Receiving Building

Communications Center

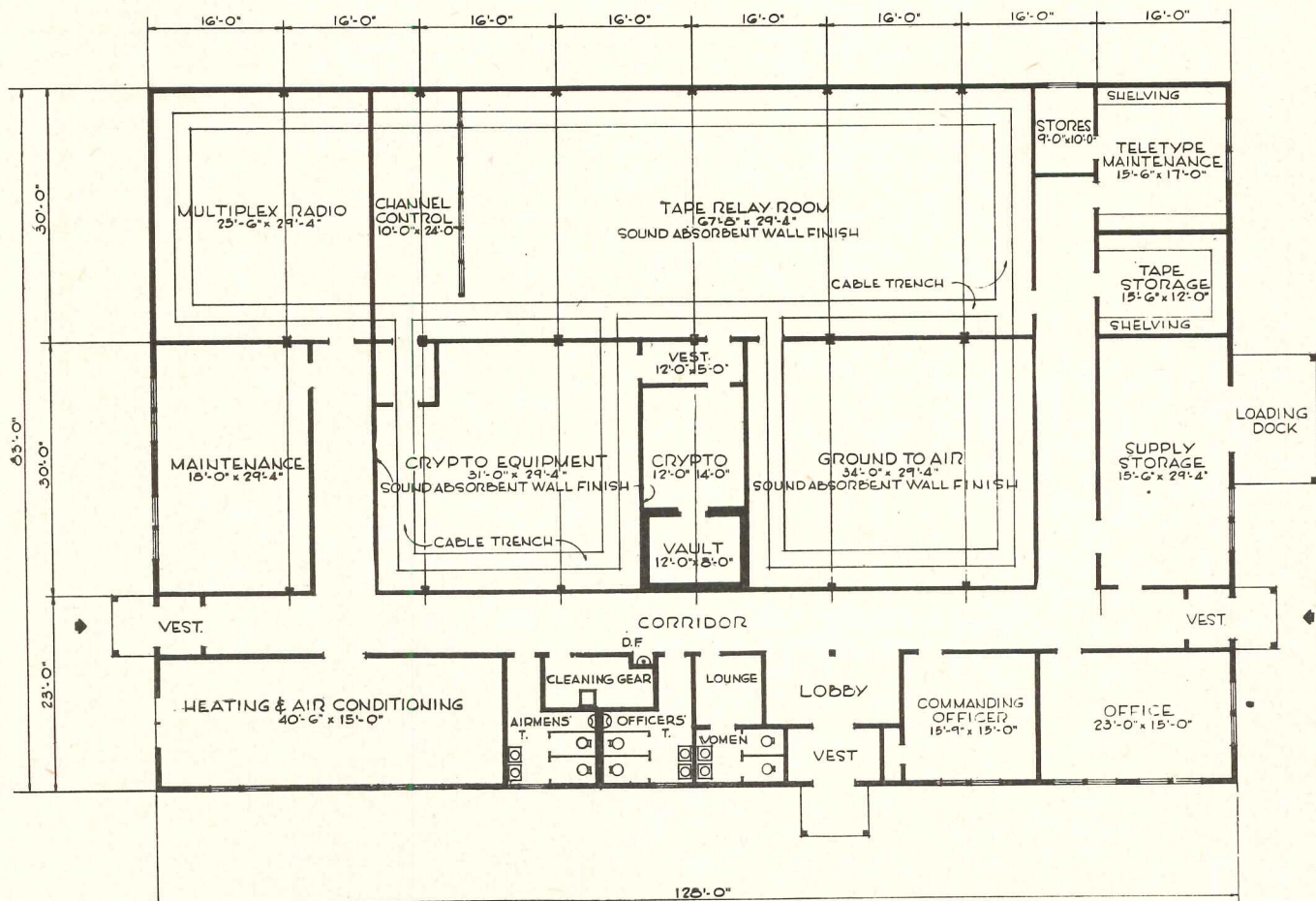

FLOOR PLAN



OPERATIONS BUILDINGS

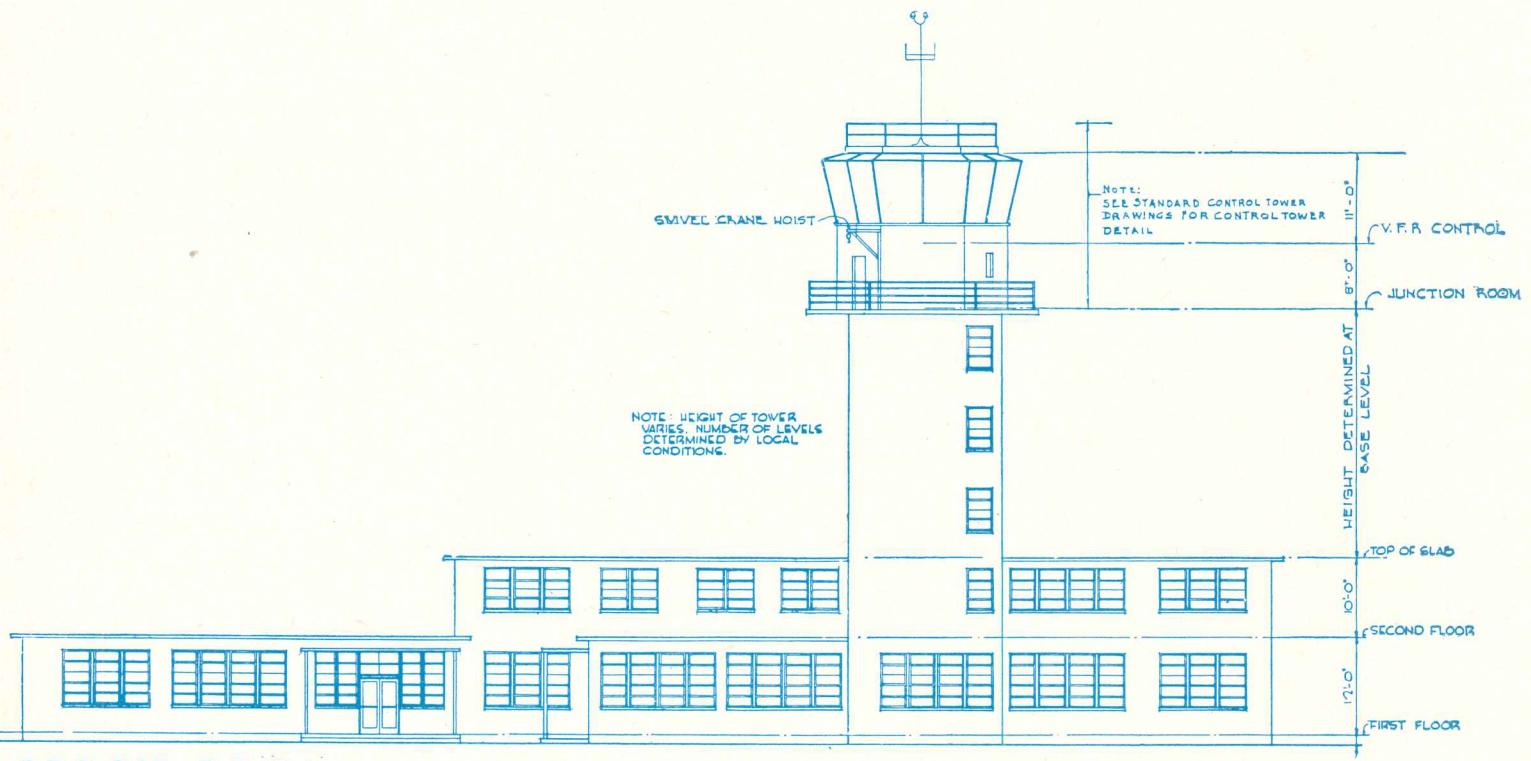

FIELD SIDE ELEVATION

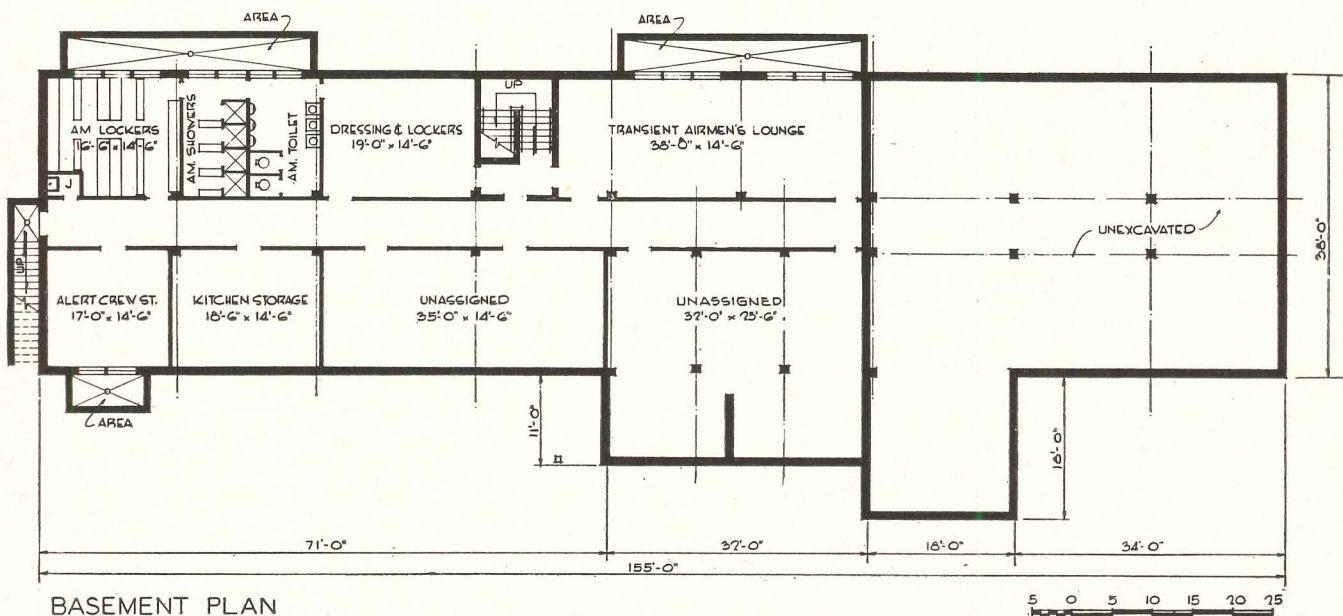

BASEMENT PLAN

THE OPERATIONS BUILDING of an air base corresponds to the terminal building of a civilian airport. It has the control tower, from which is controlled all of the flying to and from the field, just as in an ordinary airport. Aside from the flying control center, however, the operations building is virtually apart from the rest of the base, having virtually no other function in the base operation. It does, however, serve virtually all functions for flights and personnel in transit. This might

involve anything from the visit of some brass on tour to considerable operational flights from other bases. The plans themselves give a good summation of the several functions this building serves for its visitors; notice the briefing room, again for personnel not normally assigned to the base. Like other buildings, operations buildings are large or small depending on local conditions. This is a fairly large one; a smaller type is shown on page 114.

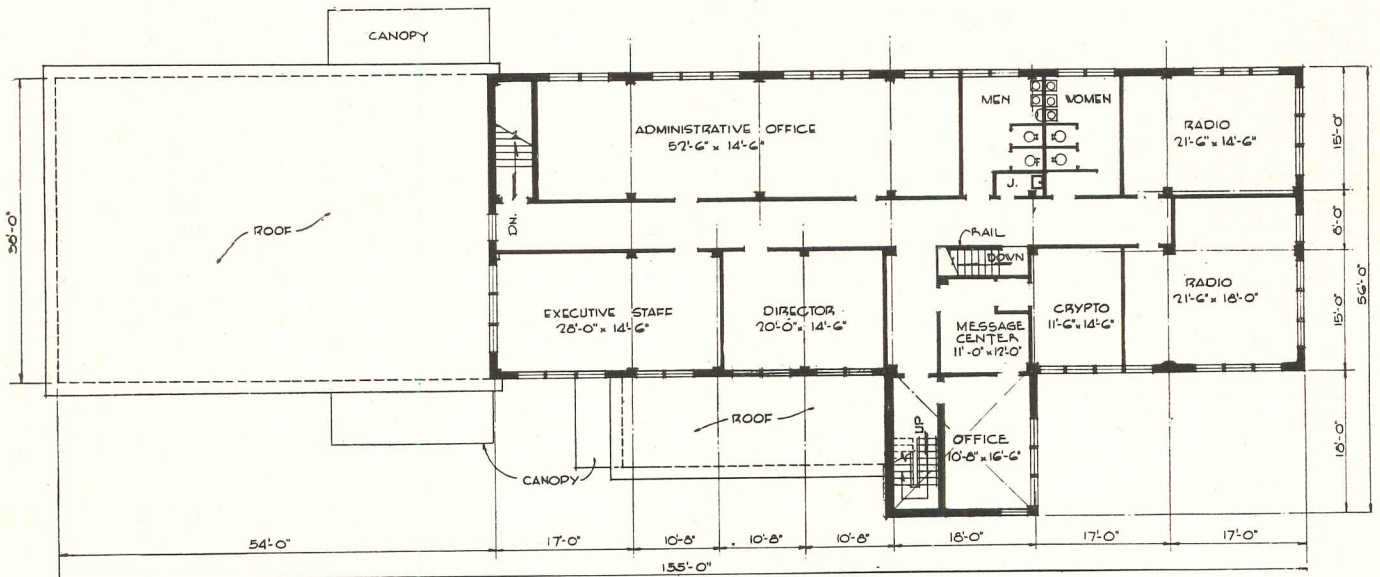

SECOND FLOOR PLAN

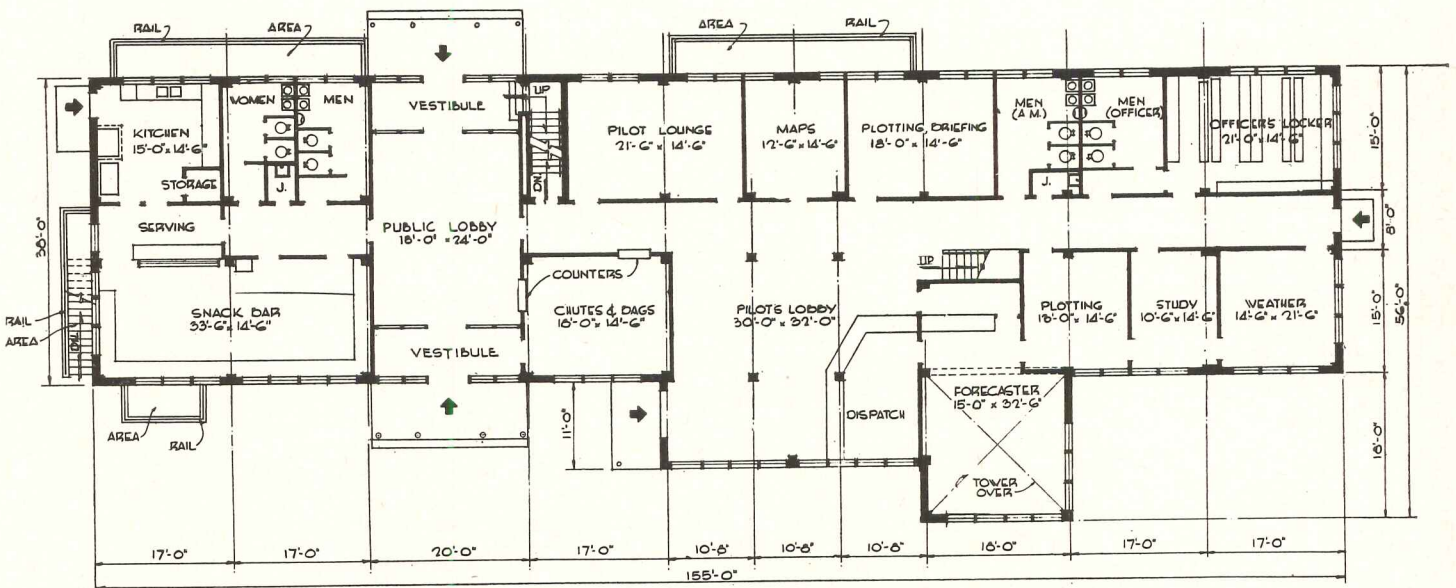

FIRST FLOOR PLAN

FIELD SIDE ELEVATION

OPERATIONS BUILDING, SMALL

At a small field the functions of the operations building are in general those of the corresponding building on a large base, but cut down in space requirements much as in a small civilian port. This building is the smallest one to require a control tower, though there is a still smaller one in the definitive drawings

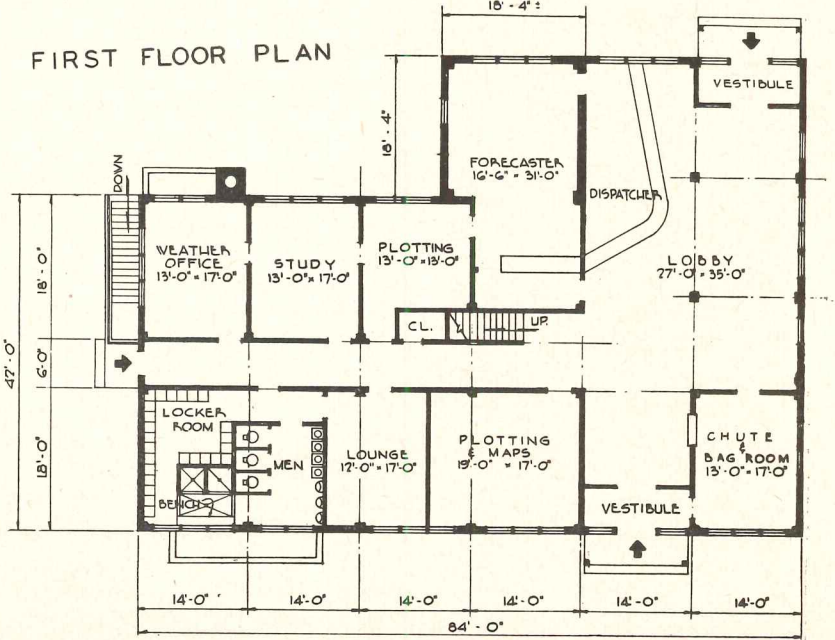
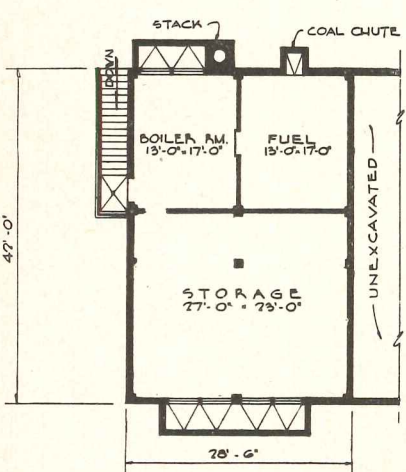
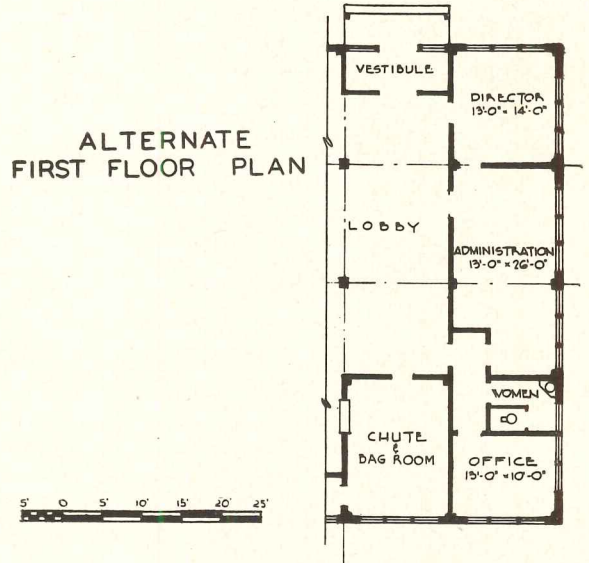
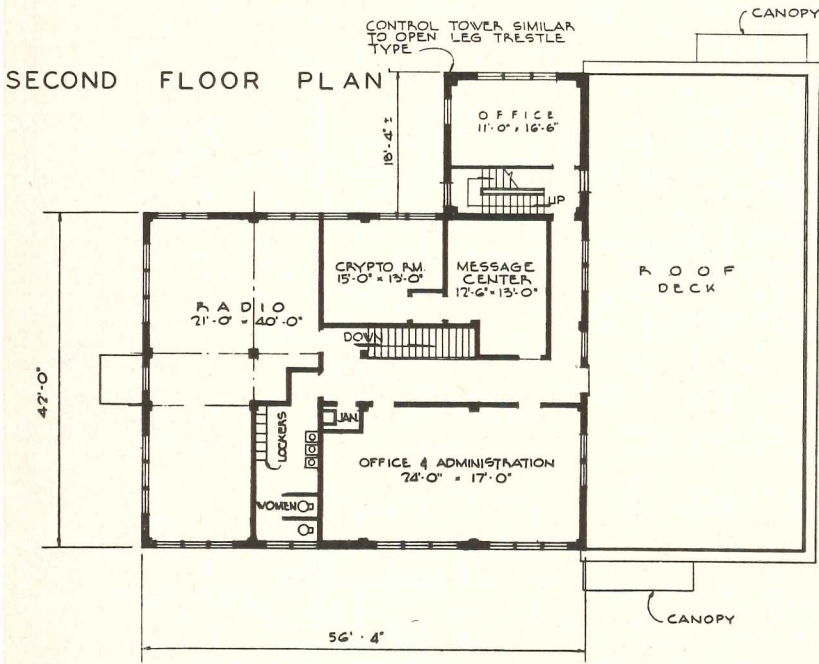
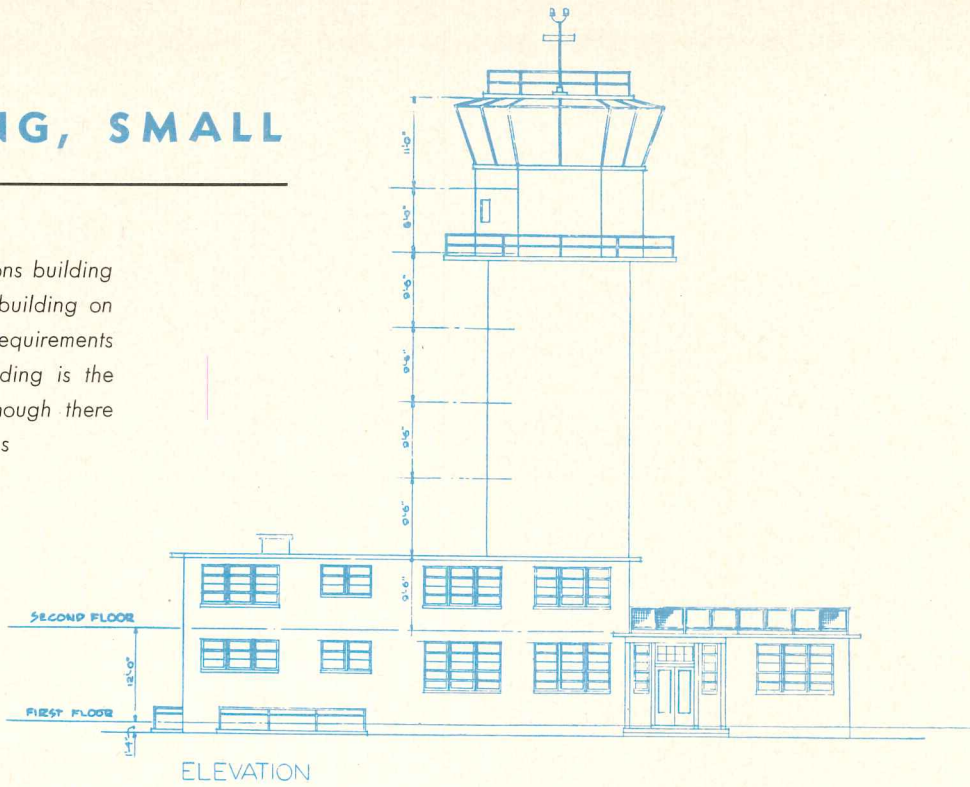

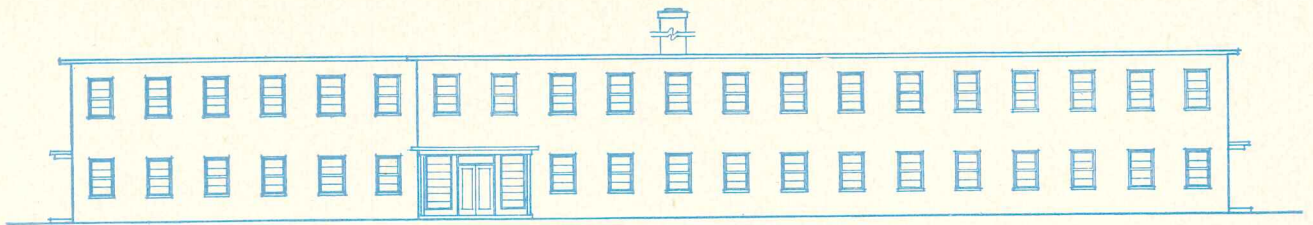

FRONT ELEVATION

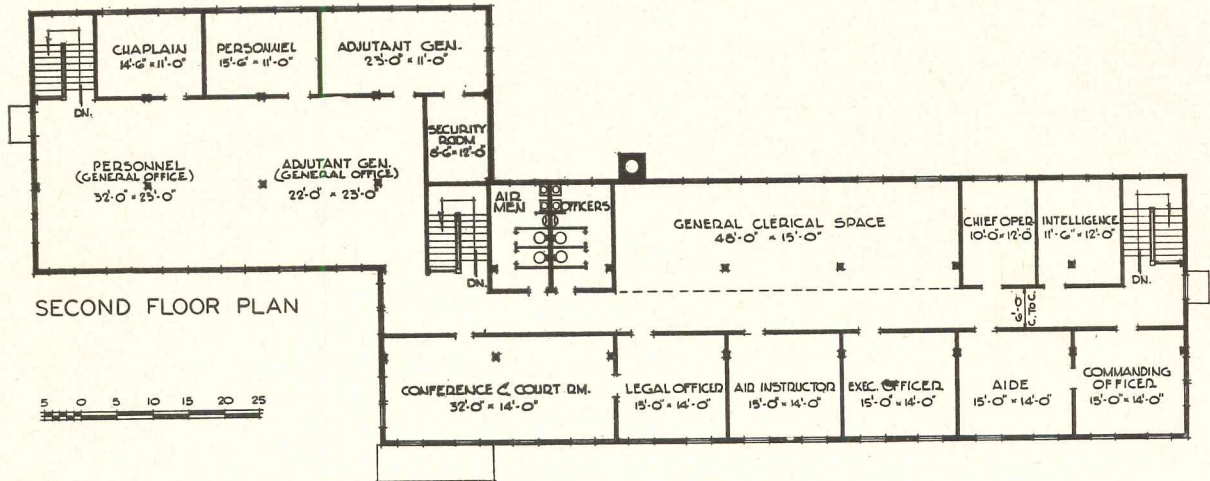

SECOND FLOOR PLAN

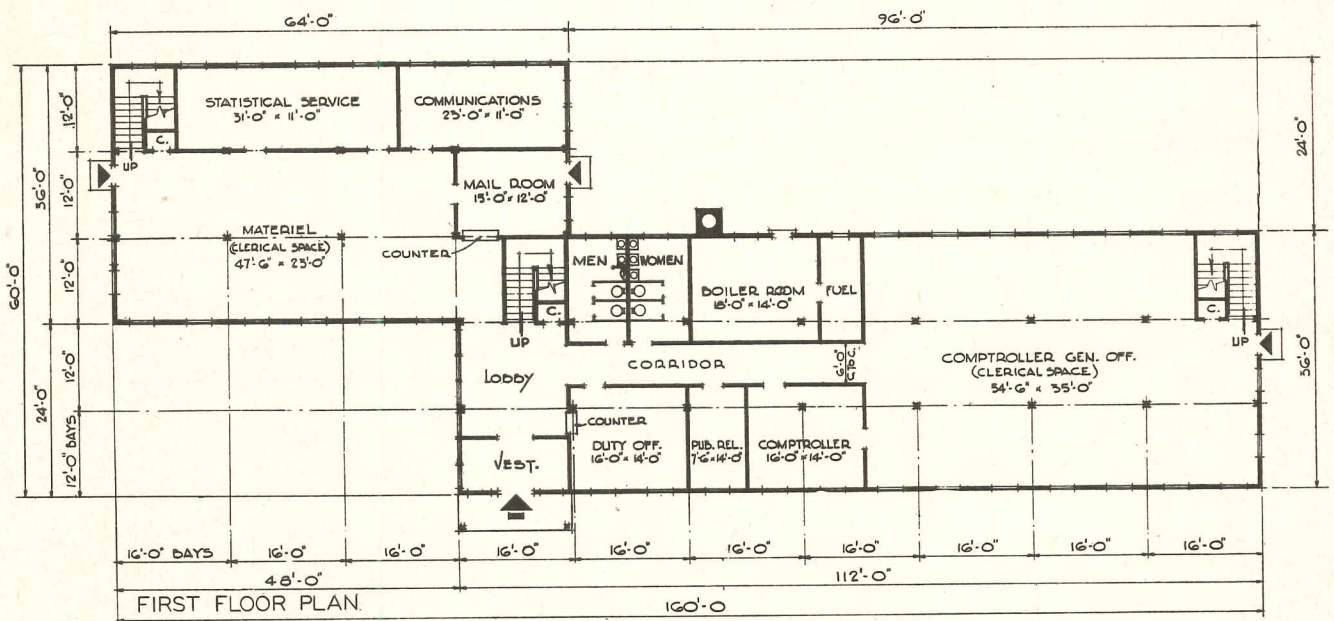

FIRST FLOOR PLAN

HEADQUARTERS BUILDING

THE HEADQUARTERS BUILDING of an Air Force base is its office building. Its planning problems are quite similar to those of designing any office building for an individual client, and the building will be simple and small, or large and involved, as any other office building might. It is not, however, like an industrial office building, in that this is the headquarters only of the base commander and his staff, who operate the base as

such. They may have little to do with flight operations from the base, or training or what not, which would be under squadron or group commanders. There would, then, be other places where office space would be used.

In general, however, this is office use, including in its general requirements the purchasing, public relations, accounting, legal, statistical and other like functions. The building here shown is one of the smaller ones.

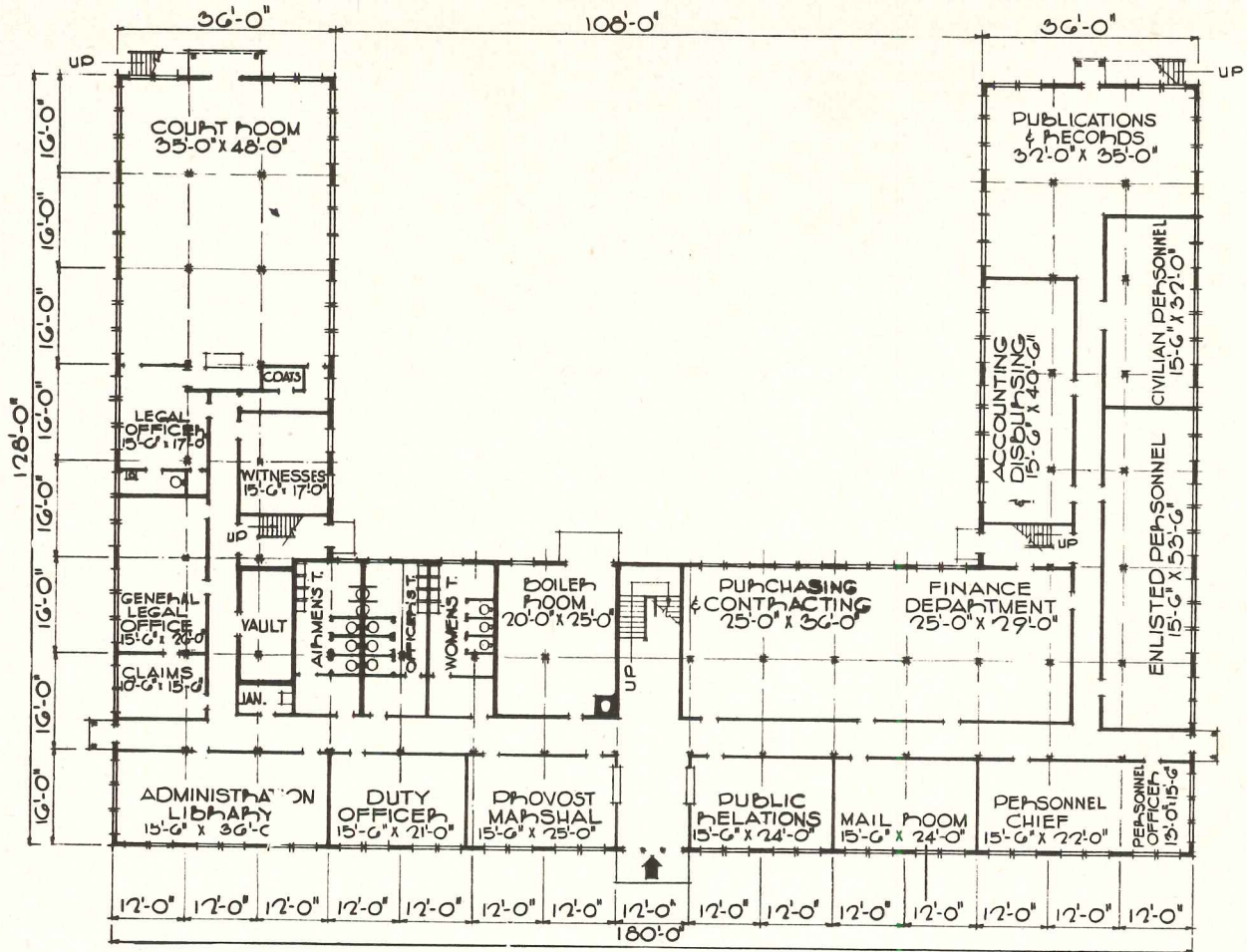

FIRST FLOOR PLAN

For a large airbase the headquarters, or office building, becomes a real city hall, for a large base might have as many as 30,000 men. It won't look much like the usual city hall, however, for this two-story building will have no trace of monumentality.

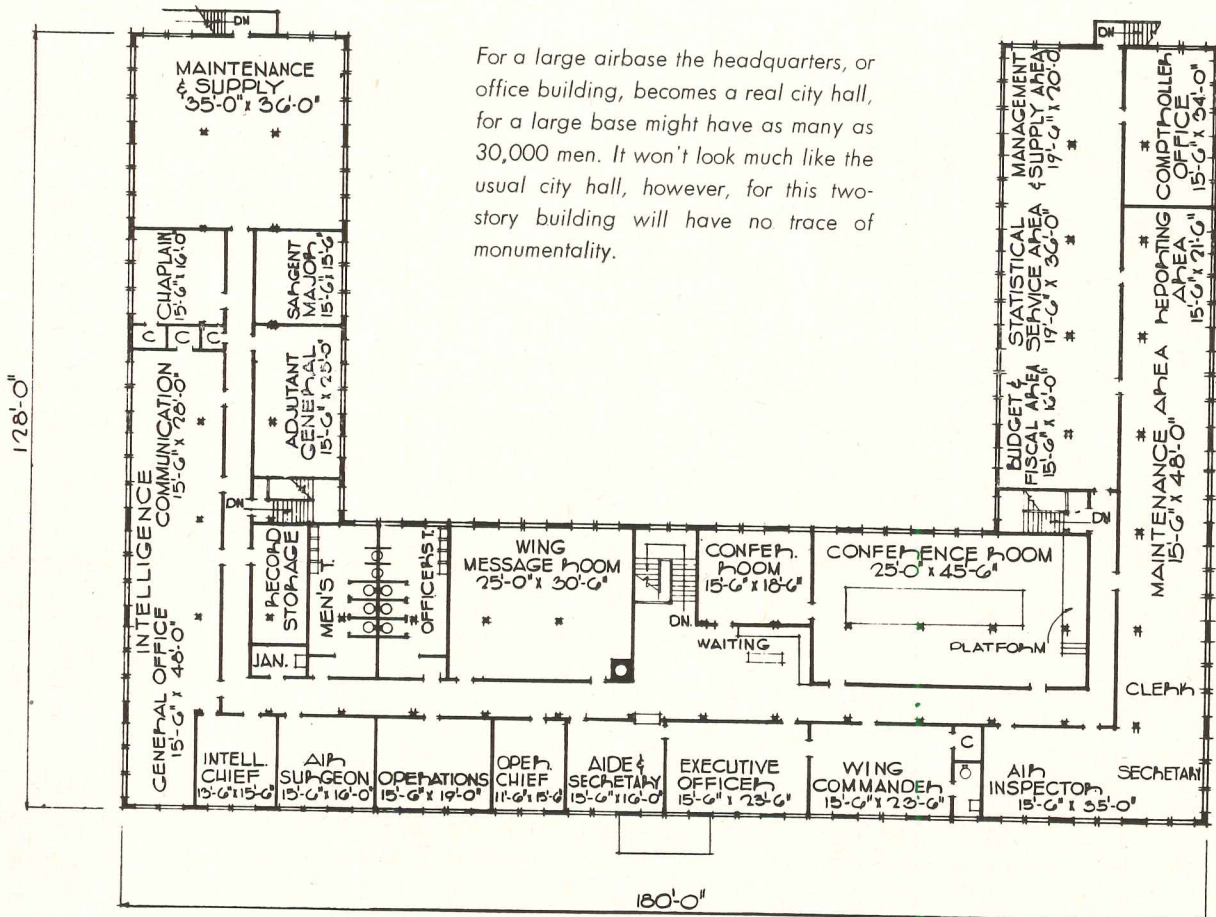

SECOND FLOOR PLAN

HEADQUARTERS FOR AIR BASE GROUP

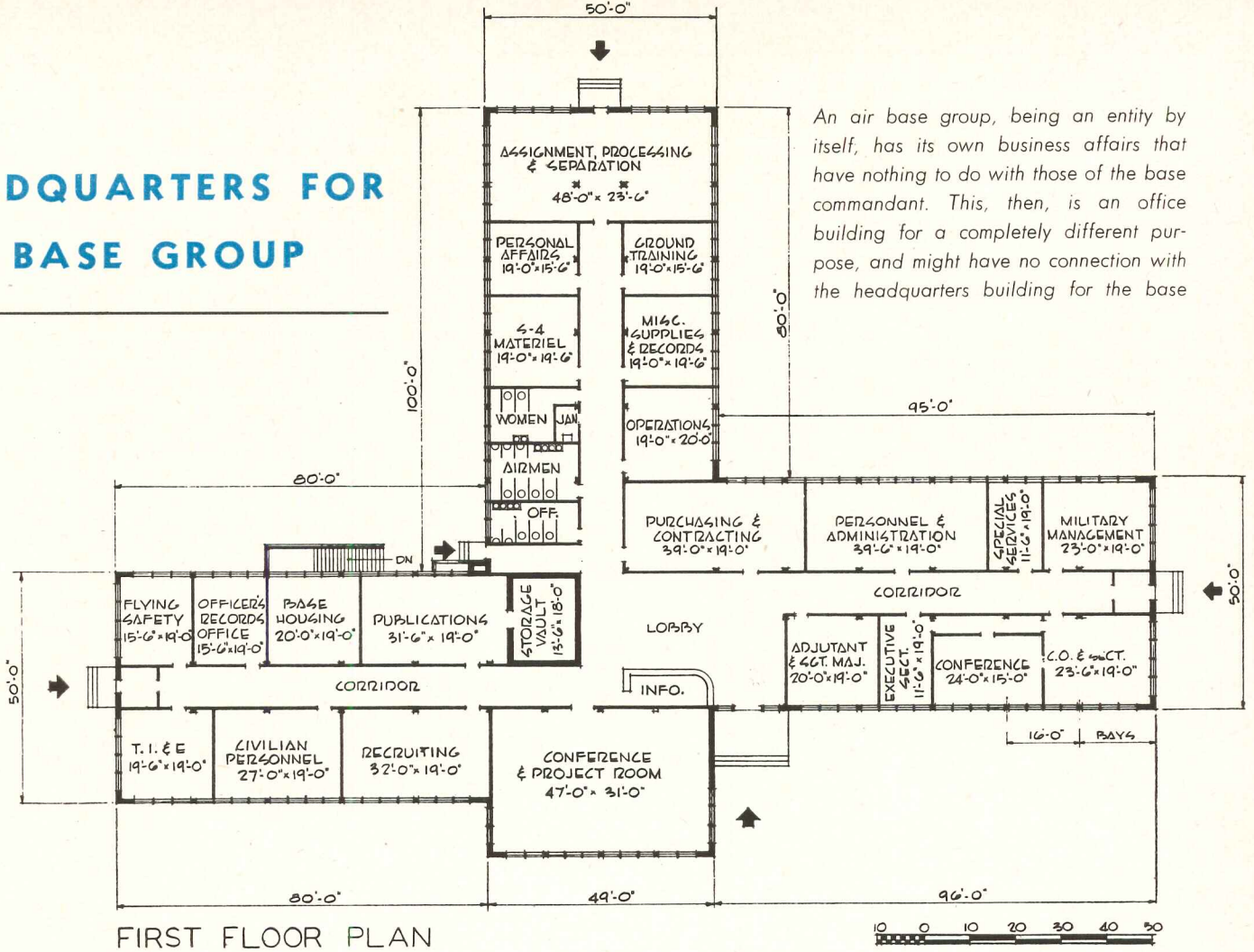

FIRST FLOOR PLAN

An air base group, being an entity by itself, has its own business affairs that have nothing to do with those of the base commandant. This, then, is an office building for a completely different purpose, and might have no connection with the headquarters building for the base

HEADQUARTERS AND OPERATIONS BUILDING COMBAT SQUADRON

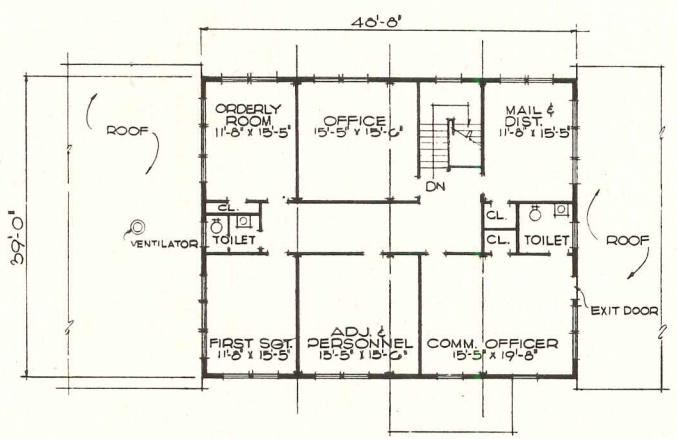

SECOND FLOOR PLAN

When a squadron gets into actual combat, in some distant battle area, its routine operations are naturally quite different from those of a training base. It still has its office problems, however, so in this building office space is combined with operational needs, making a combination headquarters and operations building

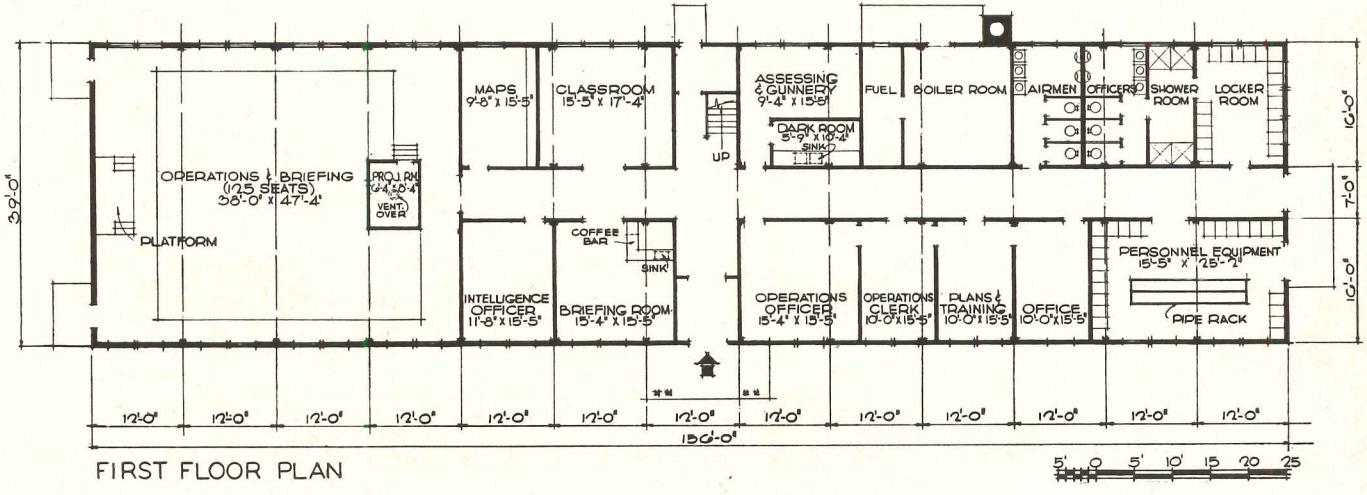

FIRST FLOOR PLAN

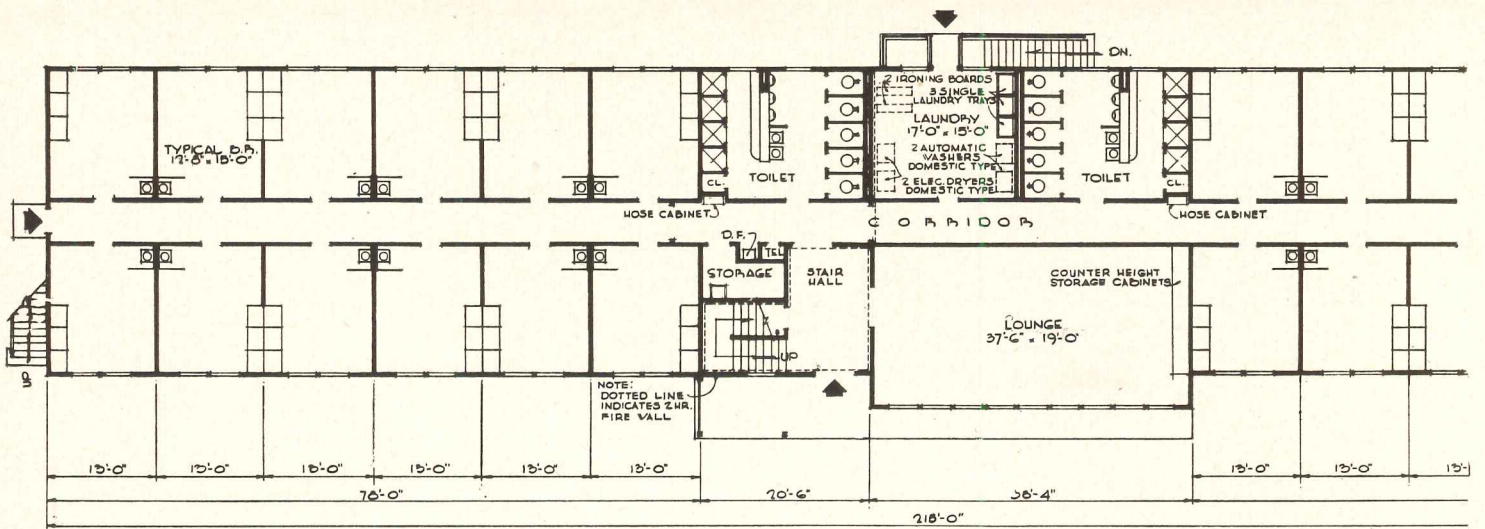

FIRST FLOOR PLAN

NOTE: WASHERS AND DRYERS ARE SHOWN FOR LOCATION AND ROUGHING IN PURPOSES ONLY.

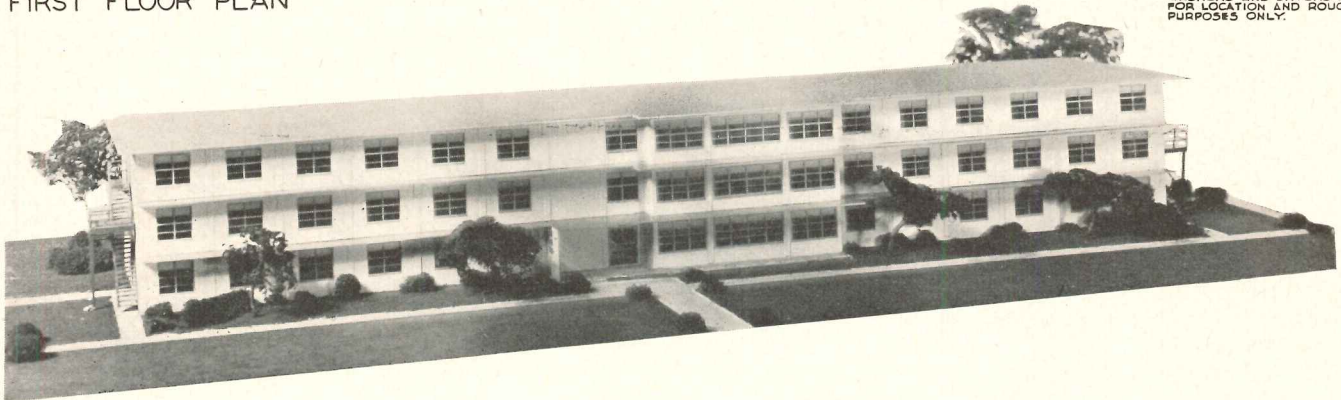

DORMITORIES

OF ALL OF THE TYPES of Air Force building, probably none has had such intensive study as barracks or dormitories. Here the need for economy is especially great, since naturally dormitories are everywhere and extras in the cost would be multiplied over and over again at every Air Force base. So these buildings have been studied and re-studied and are still being discussed.

On the functional side, they are not to be regarded as the barracks buildings of the last war or the war before that, for airmen in training must study just as assiduously and as frantically as college students. They must, in fact, absorb technology at a rate that would give pause to college engineering students. Thus the studies center around a dormitory type of building, in place of the barracks kind of squad room accommodations, with at least some provision for study. There is also the problem, worse than in college dormitories, of some men studying while others are sleeping, for Air Force shifts usually go around the clock, some men being assigned to night operations which may or may not be part of their training.

The problem, then, was to develop dormitory-type accommodations that would come within the prescribed limit of 72 net sq ft per man in bedrooms.

The design here shown is the 1952 model, which is in many respects more economical than the 1951 plan. The men are housed in rooms, with cot-type or bunk beds, a

study table, a straight chair for each man, and a storage closet. In a college such a room would be considered small for two students, and each would expect his own study desk and certainly some easy chairs. In the Air Force the rooms are designed for either two or three men. To meet the 72-sq-ft limit it is necessary to put three men in many of the rooms, though not all of them. Then at least one two-deck bunk would be used, and the closet space would be divided for three men each to have his own space.

Another problem, in half-war half-peace times, is to encourage reenlistment, and this is largely a matter of giving the men decent living accommodations. Training of airmen is frightfully expensive, and base commanders have called vociferously for all possible means to keep men for more than just the first hitch. It doesn't matter much whether they are pilots or ground crew men, their training is still long and painful, and to keep them from leaving for good paying jobs in private industry requires at least livable quarters.

The plan shown is more economical than earlier schemes. Storage space is provided above the individual closets in the room, whereas in previous schemes there was a central storage room; the newer arrangement not only saves space but also makes storage easier to control. The new model also uses outside stairs for fire exits, a further saving in space.

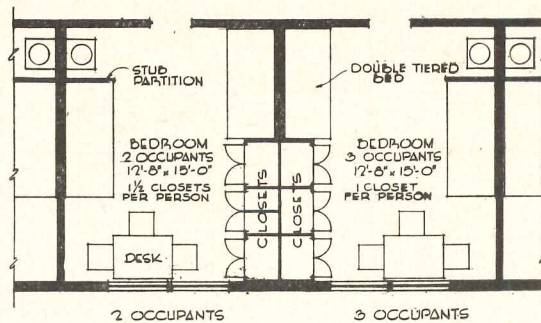
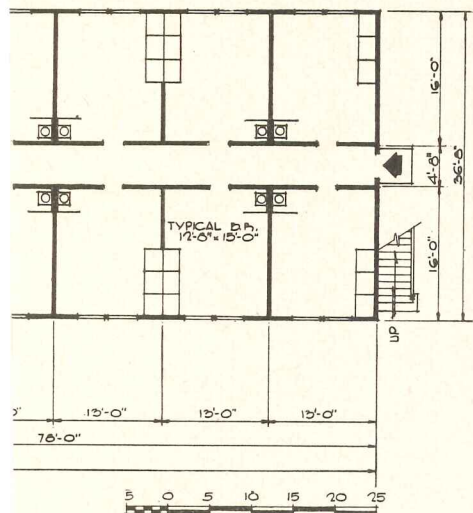

TYPICAL ROOM LAYOUT

Each typical room has three closets, full ceiling height, with built-in drawers and upper storage compartments. For two-man occupancy, center closet is cut in half

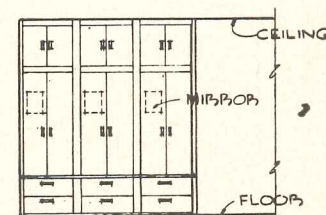
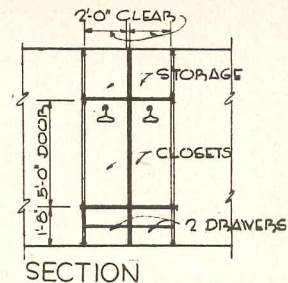

ELEVATION

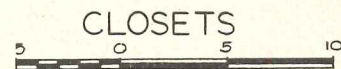

CLOSETS

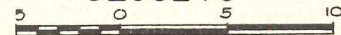

The plan shown would be identical for first, second or third floor, except that the laundry room would not occur on the third floor. The laundry, by the way, has proved an appreciated convenience; it is surprising how much of their own washing the men will do. The equipment is actually paid for by the men, out of their welfare fund.

Notice that the lounge room does not connect directly to corridors; it may be used for entertaining guests not permitted in the rest of the building. This is especially

necessary in women's dormitories. Incidentally, the plan would be virtually identical for use by women, with only minor changes in facilities, and with the addition of a small kitchenette in the lounge.

Normally the dormitories would be three stories high, in "25-year" construction — concrete frame, masonry walls, fire-resistant design. This would compare in cost with wood construction, two-story buildings with "10-year" finishes. They are usually built in groups of four buildings, with mess hall, in a rough quadrangle scheme.



| Item No. | Item | Size | No. Req'd | Fuel or Power | Item No. | Item | Size | No. Req'd | Fuel or Power |
|------------|---------------------------------------|-------------------|-----------|---------------|------------|--|---------------------|-----------|--------------------------|
| K-4-1 | Cabinet, ice cream 4 hole, 20 gal. | 53" x 31" x 34" | 2 | Elect. | K-21 | Slicer, meat—pedestal or table mounted | 26" x 20" | 1 | Elect. |
| K-5 | Chest, ice crushed— 200 lbs. | 32" x 32" x 32" | 2 | | K-22 | Steamer, veg., 6 bu. | 36" x 36" x 66" | 1 | Elect. |
| | Dishwasher | | 2 | | K-24-1 | Table, work | 72" x 36" | 1 | |
| K-9-2, or | Fryer, deep fat—68 lbs. | 21" x 36" x 34" | 2 | Gas | K-24-2 | Table, work | 96" x 36" | 2 | |
| K-9-3 | Fryer, deep fat—90 lbs. | 27" x 34" | | Elect. | K-24-4 | Table, cook's w/pan rack | 96" x 36" | 2 | |
| K-10-1 | Griddle (type A) | 34" x 18" | 2 | Elect. | K-25-1, or | Toaster, conveyor— 360 slice | 16" x 18" x 28 1/2" | 2 | Gas |
| K-12-4, or | Kettle—Jacketed— 60 gal. | 30" OD | 2 | Steam | K-25-2 | Toaster, conveyor— 360 slice | 16" x 18" x 28 1/2" | | Elect. |
| K-12-5 | Kettle—Jacketed— 60 gal. | 35" OD | | Gas | K-26-2 | Urn, coffee, twin w/stand 6/34/6 gal. | 48" x 33" x 64" | 2 | Elect., gas, or steam |
| K-13-2 | Mixer—Vertical—30 OT. | 23" x 39" | 1 | Elect. | C-3 | Sink, glass wash | 24" x 20" | 2 | |
| K-14-1, or | Oven bake, 3 deck (tile) | 55" x 48" | 1 | Gas | C-3-2 | Sink, cook's, 1 comp. | 30" x 24" x 14" | 1 | |
| K-14-2 | Oven bake, 3 deck (metal) | 60" x 44" | | Gas | C-3-4 | Sink, soaking, 1 comp. | 36" x 24" x 16" | 1 | |
| K-16-1 | Peeler, veg.—30 lb. | 40" x 30" | 1 | Elect. | C-3-5 | Sink, scullery w/steam jet, drain boards | 108" x 26" x 20" | 1 | |
| K-18-1, or | Range, H.D. hotel type | 36" x 42" | 4 | Gas | C-4 | Table, steam | 61" x 28" | 2 | Steam, Gas, or elect. |
| K-18-2 | Range, H.D. hotel type | 36" x 36" | | Elect. | SC-1 | Cold pan Prewash salvager | 46" x 28" | 2 | |
| K-19-4 | Refrigerator, 65 cu. ft. | 90" x 42" x 74" | 3 | Elect. | | | | | |
| K-20-3 | Refrigerator, prefab., 1310 C.F. | 120" x 288" x 94" | 1 | Elect. | | | | | |

Note: Item numbers preceded by K are centrally procured, government furnished and contractor installed.

Item numbers preceded by C are contractor furnished and contractor installed.

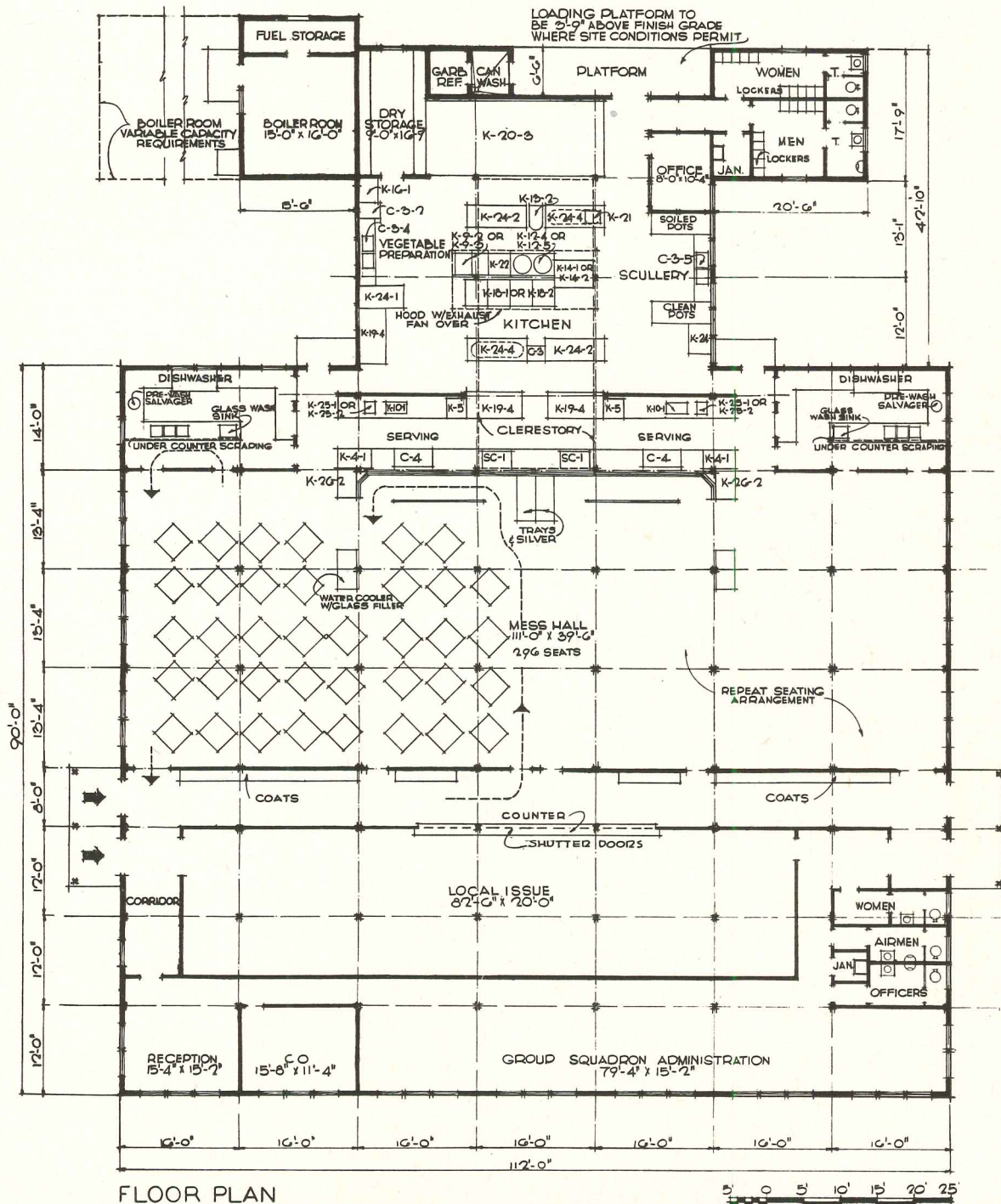

FLOOR PLAN

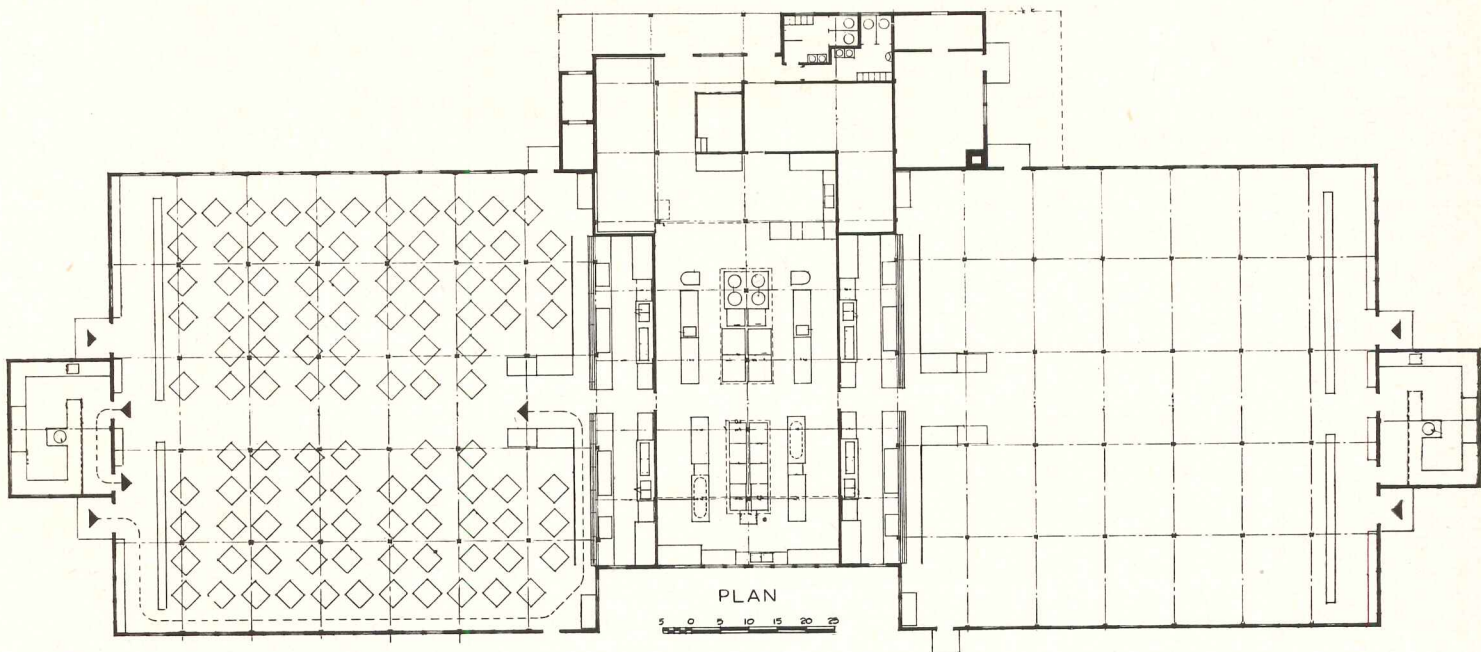

MESS HALLS

THE MESS HALL shown in plan on the opposite page is the one used most frequently. Its normal capacity is 500 men, but it will serve up to 750 without overloading. Normally such a mess hall serves four dormitory buildings, which would be arranged around it. Serving is handled in a double cafeteria arrangement, with double entrance, double dishwashing scheme. The plan pretty well explains itself, except for the lower part of the drawing. The building actually serves the double pur-

pose of serving food and issuing it, for various operational maneuvers which involve feeding away from the base. In the scheme shown the same corridor serves both the cafeteria and the issue counters.

The plan above is a larger variation of the double cafeteria scheme, for 1200 men. It is not normal to the dormitory grouping mentioned above, and so would not be frequently used, but is available in case a larger group of living quarters were found more practical.

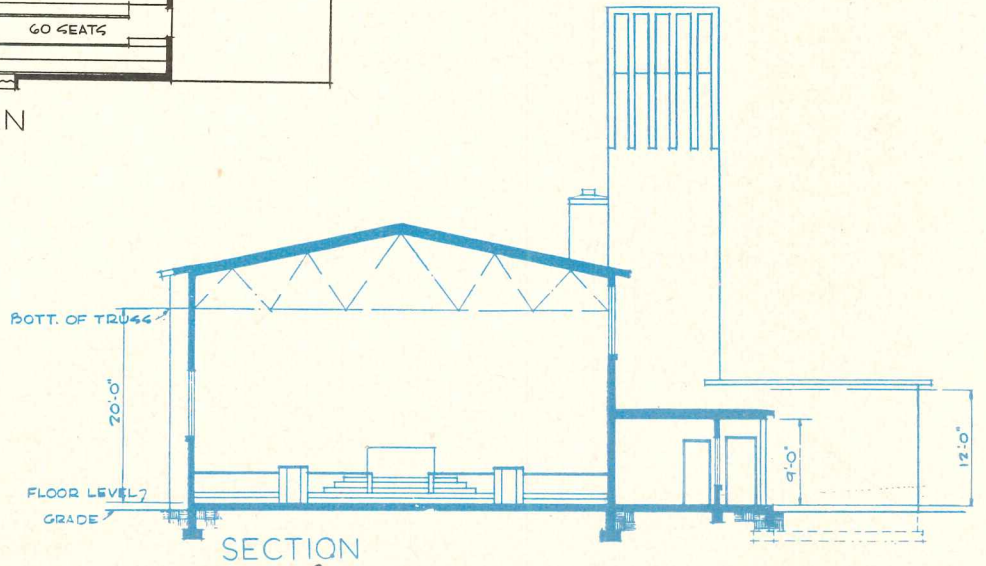
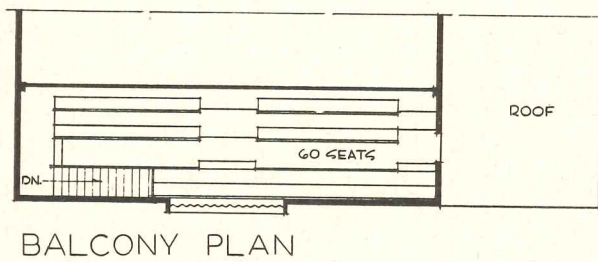
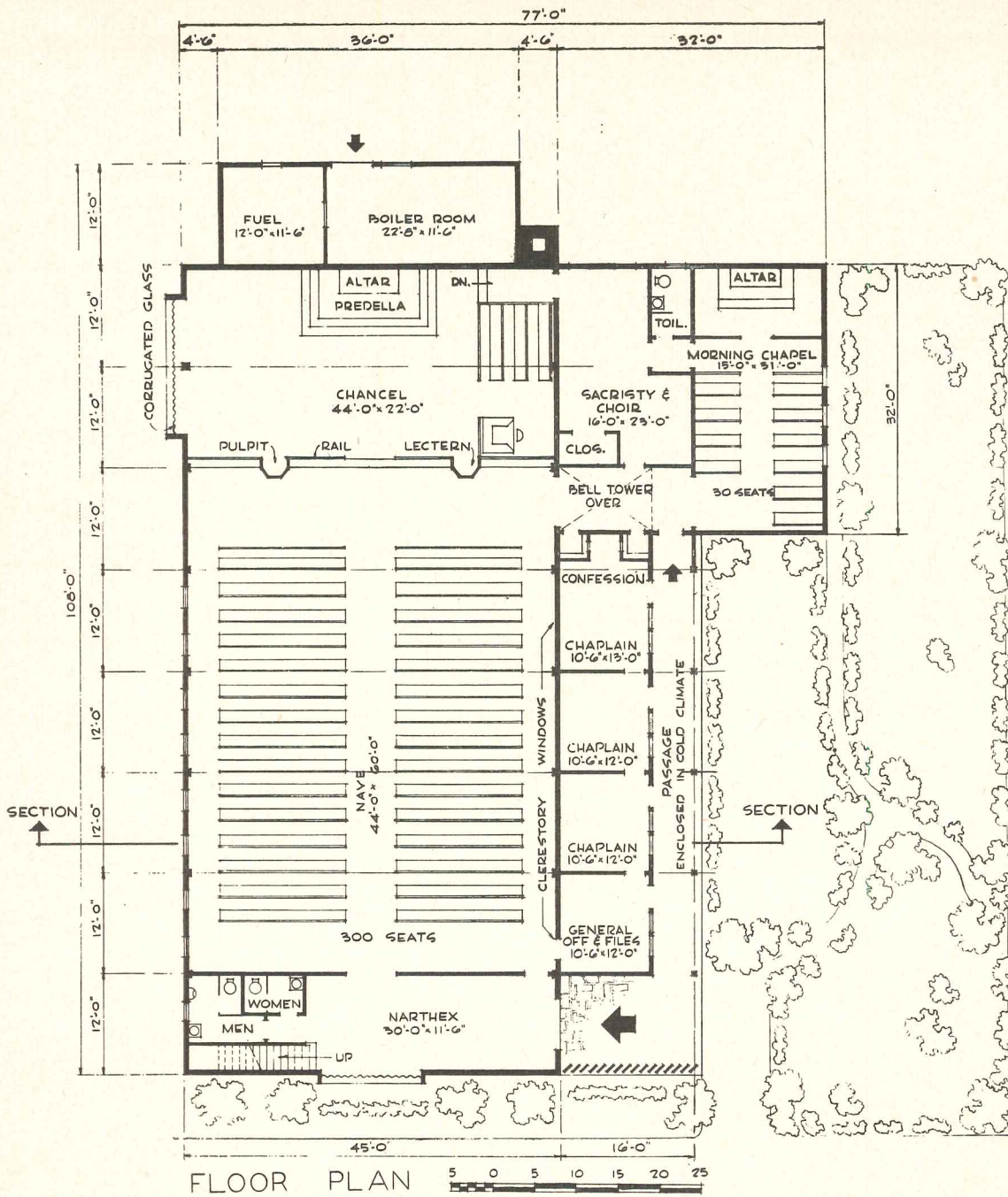

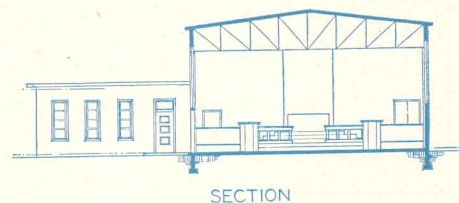
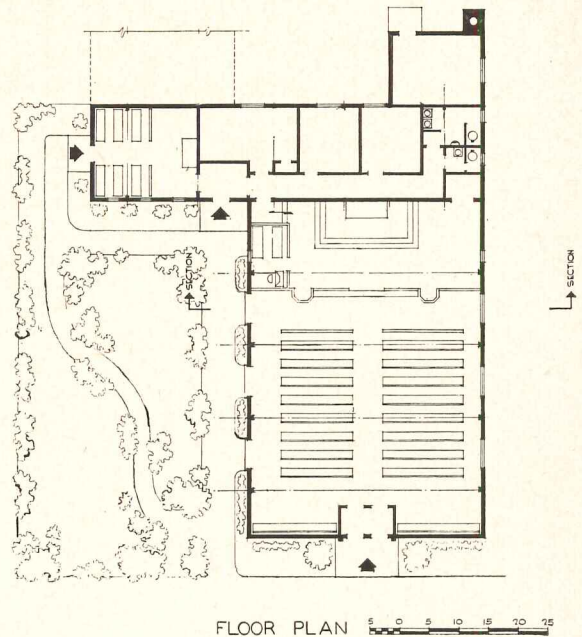
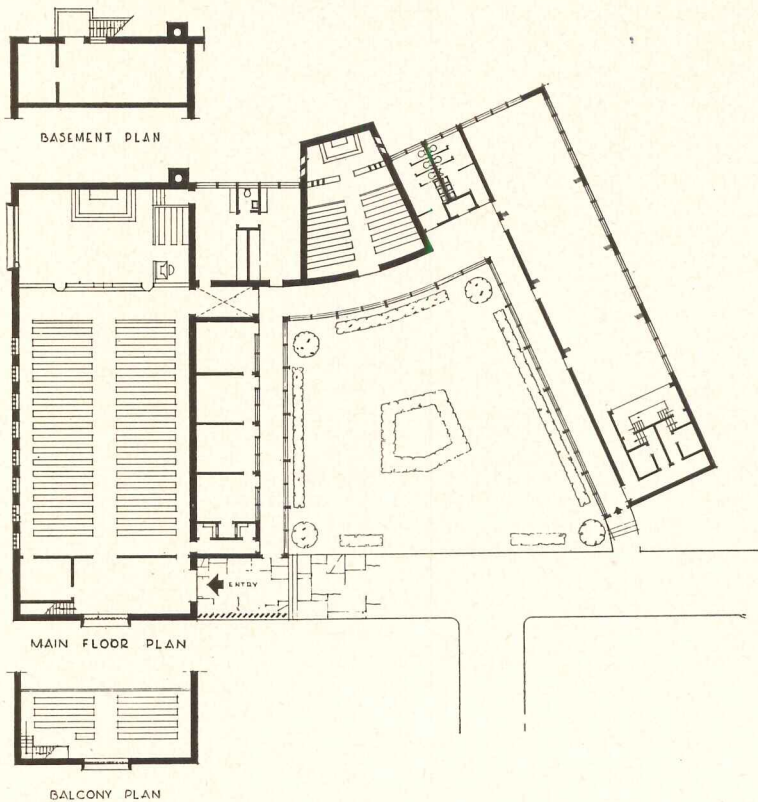

CHAPELS

CHAPELS FOR AIRMEN are, of course, non-sectarian, will serve equally well for any religious group. The basic chapel is shown opposite, with all of the principal requirements, but without classrooms for religious teaching. The 300-seat chapel is the most common one, but there are also definitive designs for smaller and larger buildings. The morning chapel is considered a firm requirement, the classrooms desirable. Thus the morning chapel is set to the side so that the classroom wing can be added, if not during original construction, at a later time. Where the classroom is part of the first construction it might well be angled as shown above, if for no other reason than relief from the cumulative rectangularity that might begin to seem regimented when an air base grows quite large. While the 300-seat chapel is considered the regular size, it is possible to put all necessary requirements in a small chapel, without bell tower, as shown at the right above.

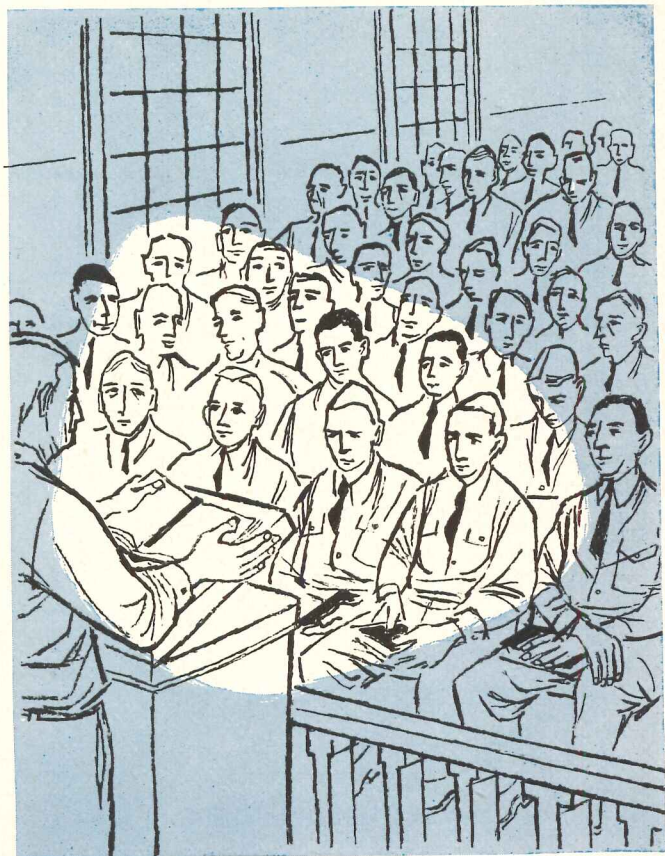

READINESS BUILDING

THE NAME OF THIS BUILDING and its plan pretty well describe its functions. It is an advanced base dormitory for flying personnel, where normal activities may be hurried at times. So briefing room is attached, as are also certain operational functions for this particular group, and a few training facilities for boning up on new equipment, or perhaps for the final training of replacement personnel.

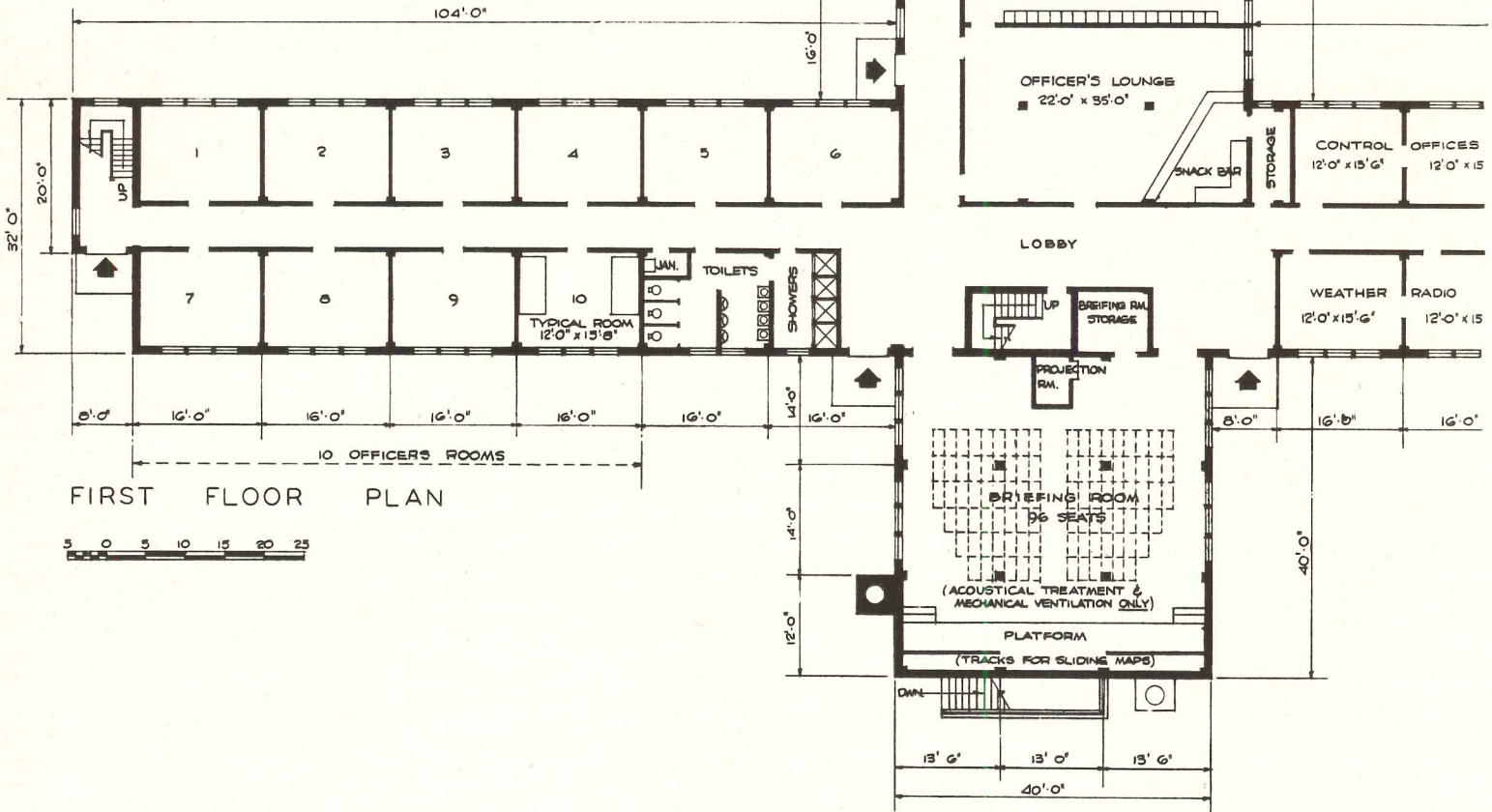

FIRST FLOOR PLAN

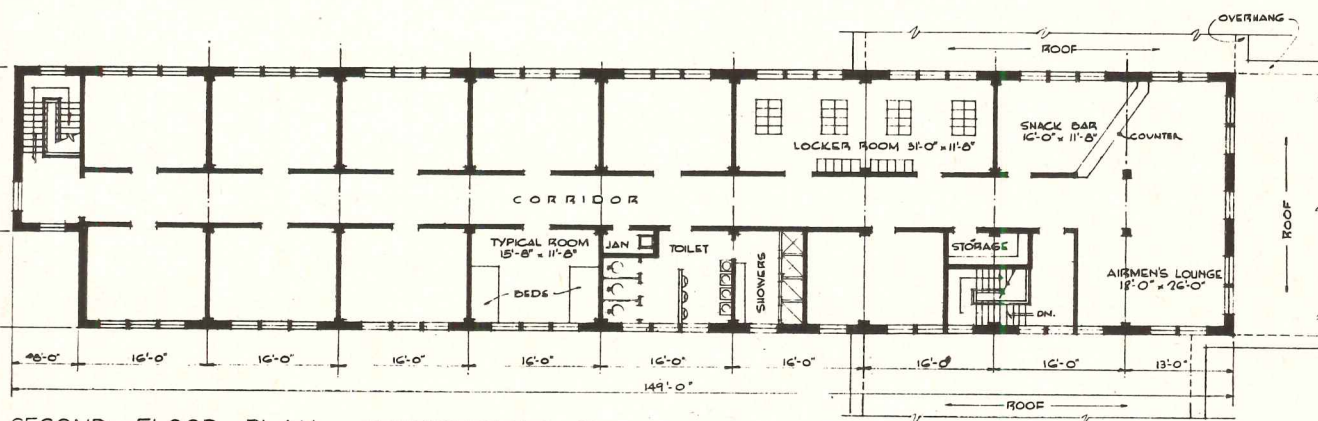

SECOND FLOOR PLAN 10 AIRMENS ROOMS x 2 = 20

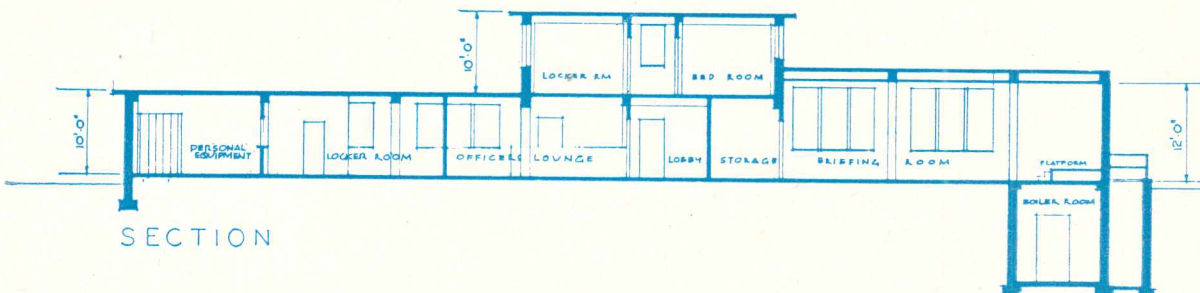

SECTION

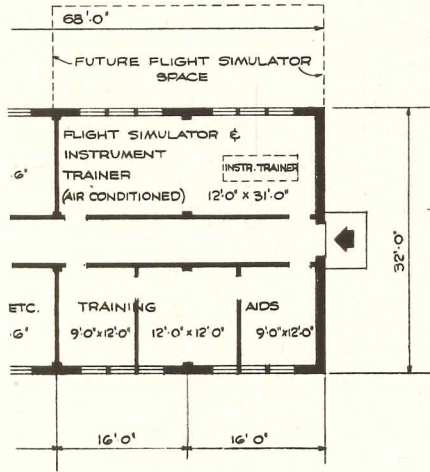

GUARD HOUSES

AND, of course, the inevitable guard house. This scheme represents fairly normal prison design as adapted to Air Force needs. There is an isolation block, for the infrequent crack-up case. But the normal assumption is that the guard house is for temporary detainment of a few "good kids" who get too boisterous once in a while.

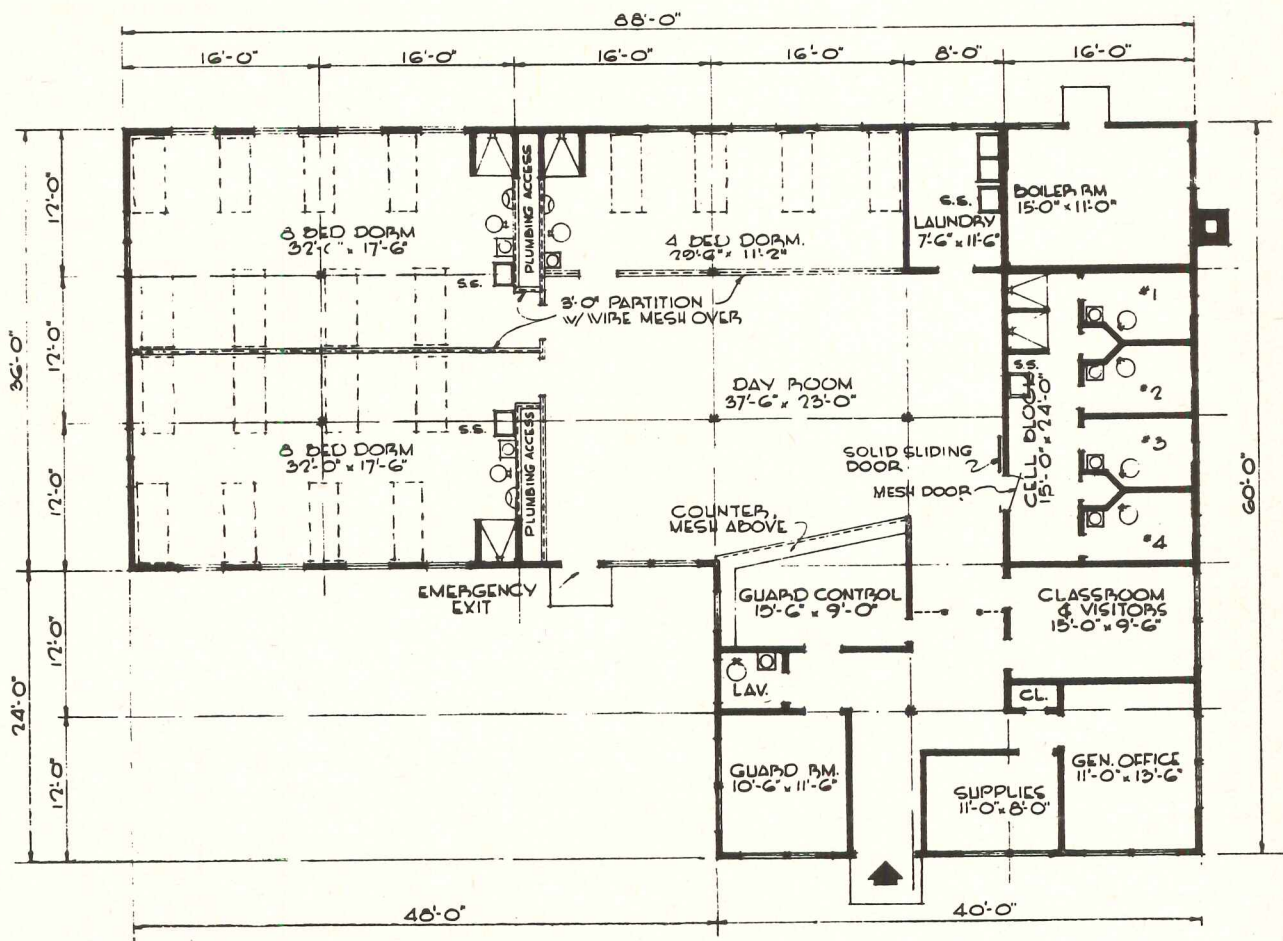

FLOOR PLAN

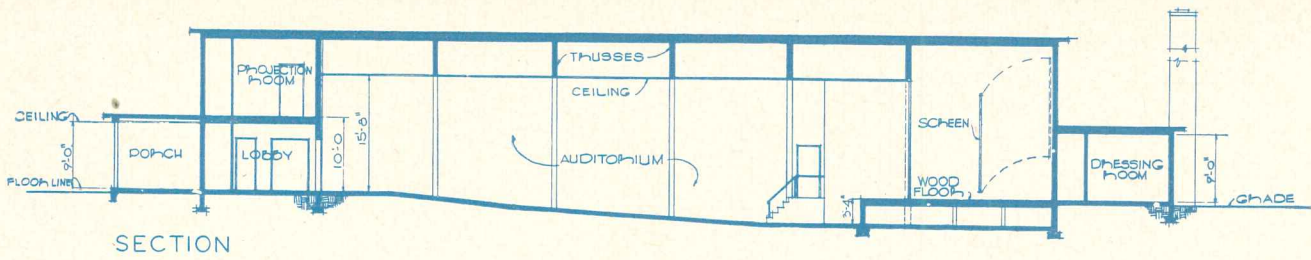

SECTION

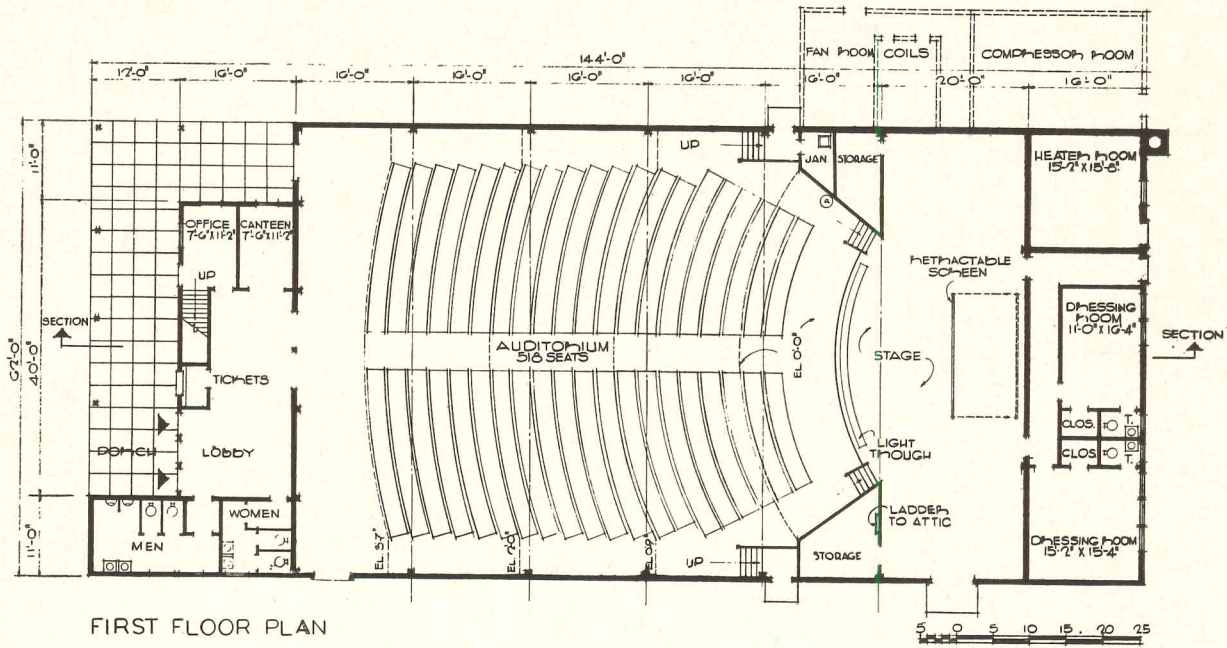

FIRST FLOOR PLAN

THEATERS

THIS is one of a considerable group of theater designs for the Air Force, this one having some 500 seats. All plans are basically alike, differing mainly in size, somewhat in facilities. Most of the entertainment will be movies, but in all theaters there should be some provision for live-talent shows. Some sort of theater is considered a must at every air base. In a normal base of, say, 6,000 men, a 1,000-seat theater would be used. A training base, which might run up to 30,000 men, would have several theaters. All are pared down to bare essentials. Working drawings are available for certain of the theater designs, done by John and Drew Ebersson.

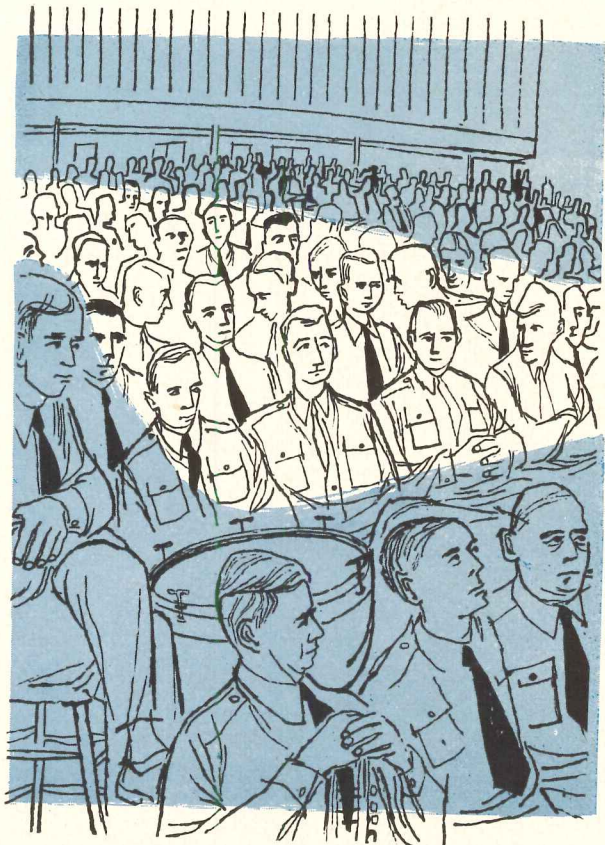

Marcel Breuer, Architect

Joseph Molitor Photos



*Cooperative Dormitory
Vassar College
Poughkeepsie, New York*



AN ARCHITECTURE OF ENERGY

IN AN OLD COLLEGE SETTING, with its venerable buildings, this new dormitory has a quality that almost makes it jump. There was no attempt here to make it blend with its ancient neighbors, not even any urging that it do so. The desire was rather to assert the "floating, still uncrystallized energies" of a college group, to create something felt, not merely seen.

Breuer has taken pains with laymen to explain that form-follows-function is inadequate explanation of this particular form, though hastening to add that the functional approach is assumed to be a simple necessity in any building problem, up to a certain point.

In this instance the analysis went: there should be privacy for the bedrooms; one way to achieve this is to elevate them from the ground. Two gains follow: covered outdoor areas for ping-pong tables, games, bicycles, and uninterrupted views, so that the building does not split its site quite so sharply, or seem to crowd its campus.

The living-dining portion does sit on the ground, giving the dormitory a binuclear scheme that separates, actually and psychologically, the noise, music and traffic of this area from the relative quiet of the study-bedrooms.

Bedrooms, besides being elevated, should be sunny: thus the orientation of windows is east-west. There should be protection from hot midday sun, hence the sunshades. Office, utility room, upstairs lounge, telephone booth and bathrooms should be along the central path of traffic, to reduce disturbance and nervousity as well as mere number of steps.

Most of the bedrooms are for double occupancy, though they are partially compartmentalized so that one girl may sleep while the other studies.

If this analysis determines form, how say what determines esthetics? Breuer has made a thrust at it in this (his first and only poem):

"Often you ask: where and how and what are esthetics, beyond functions needed?
Colors which you can hear with ears,
Sounds to see with eyes,
The void you touch with your elbow,
The taste of space on your tongue,
The fragrance of dimensions,
The juice of stone."

Which is probably as good a way as any to explain an architecture that is not to be seen in one plane, but must be experienced.

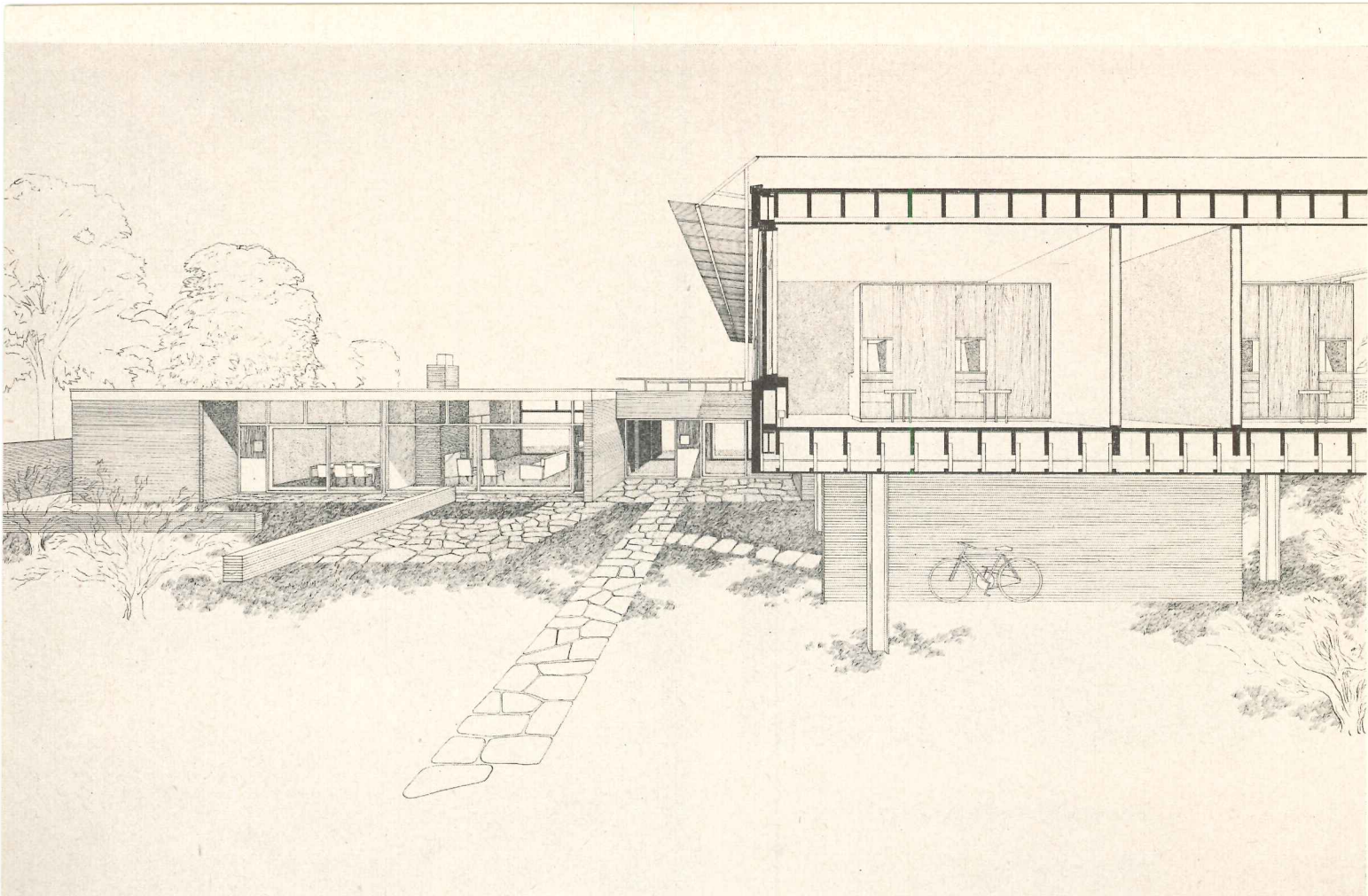

Whether Breuer builds into his site or onto it is a question that will not be settled by the Vassar Dormitory, for this building has the familiar Breuer low-seat walls to merge site and building, also the frank elevation of one portion above ground. Maybe this building suggests an answer to a current academic argument which has generated many thousands of words



Joseph Molitor Photos

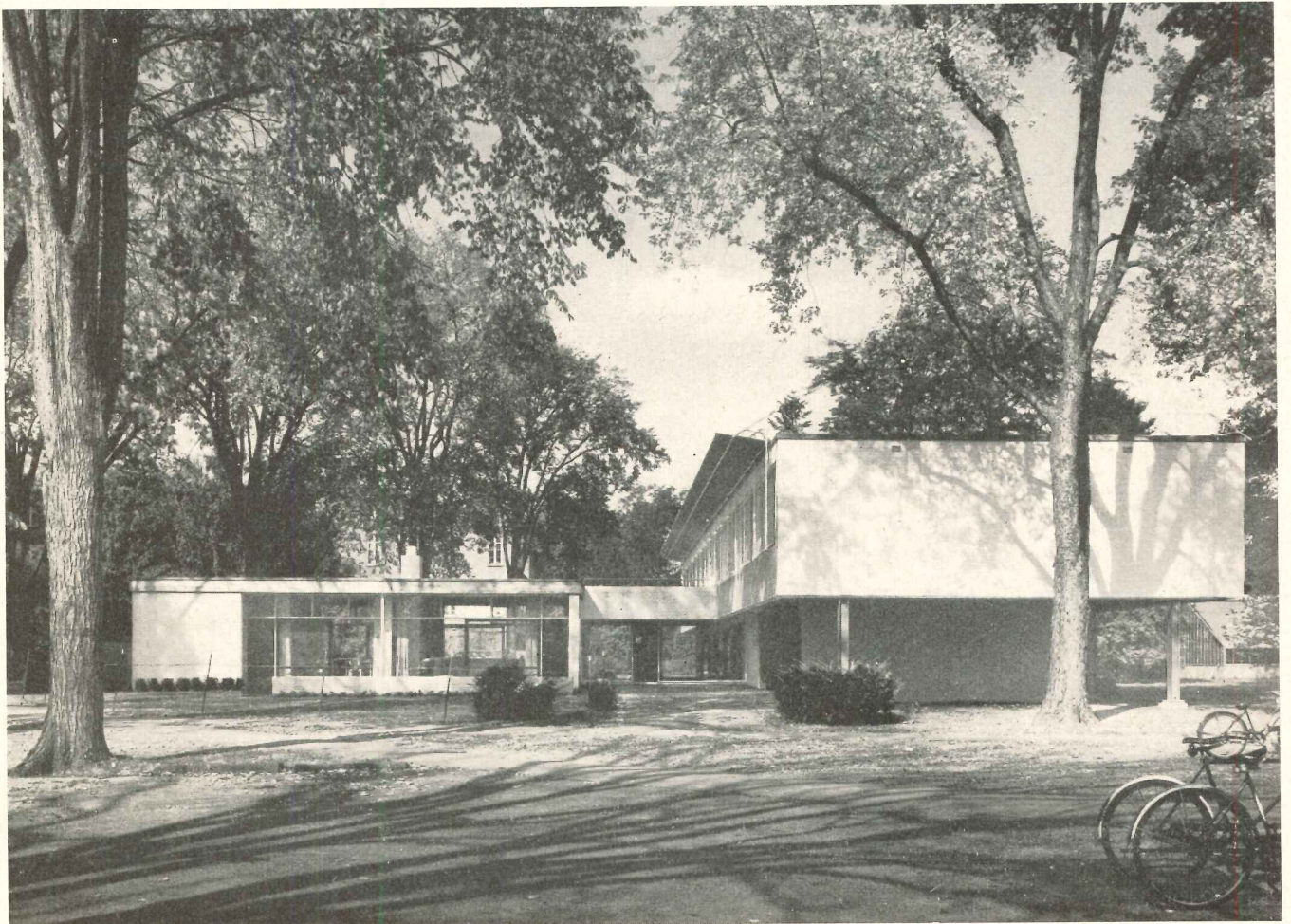
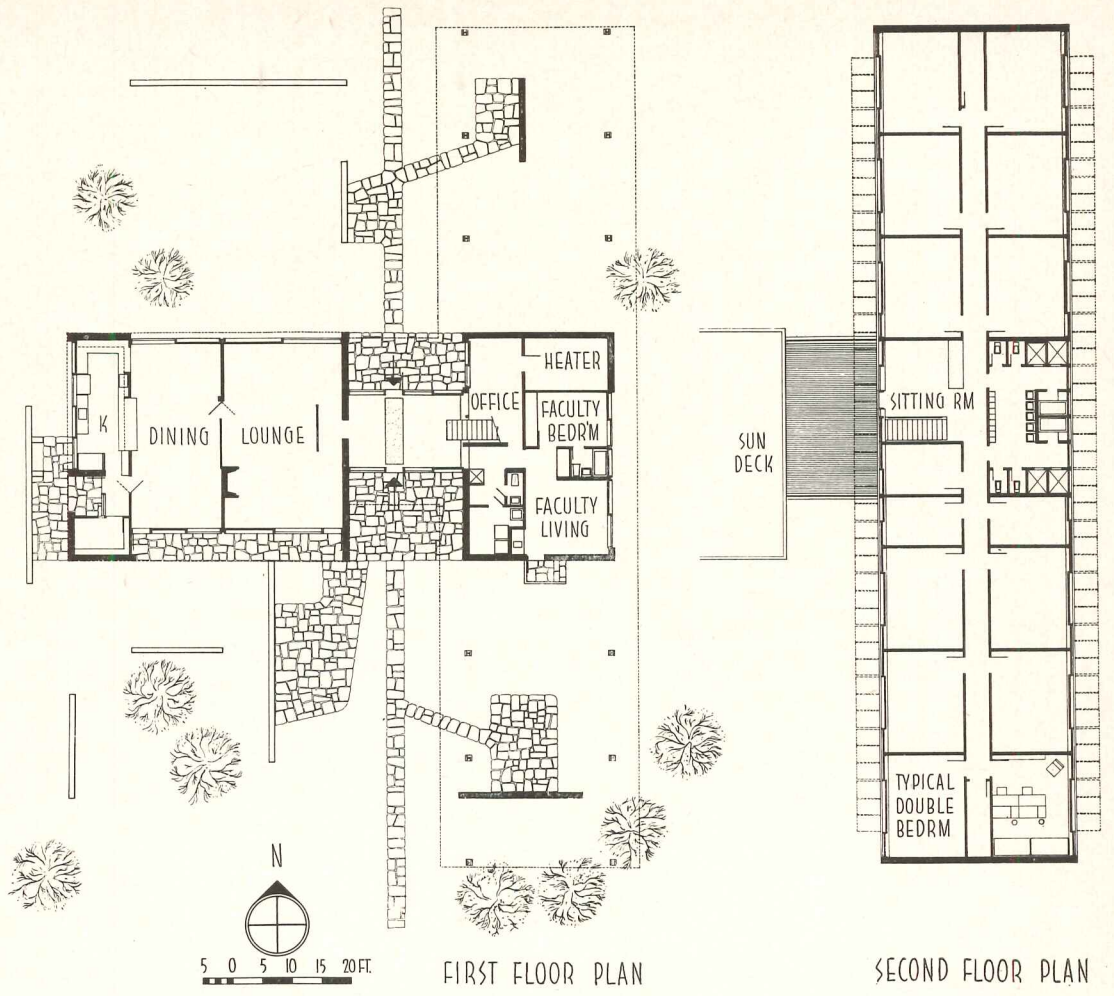
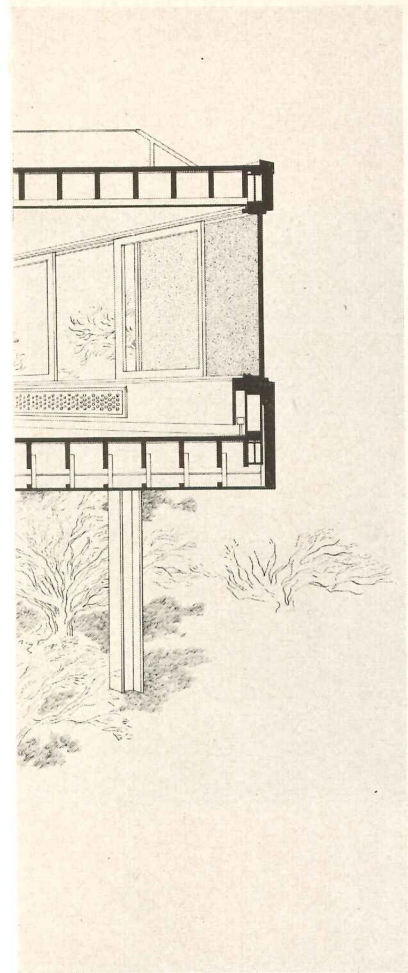



Joseph Molitor Photos

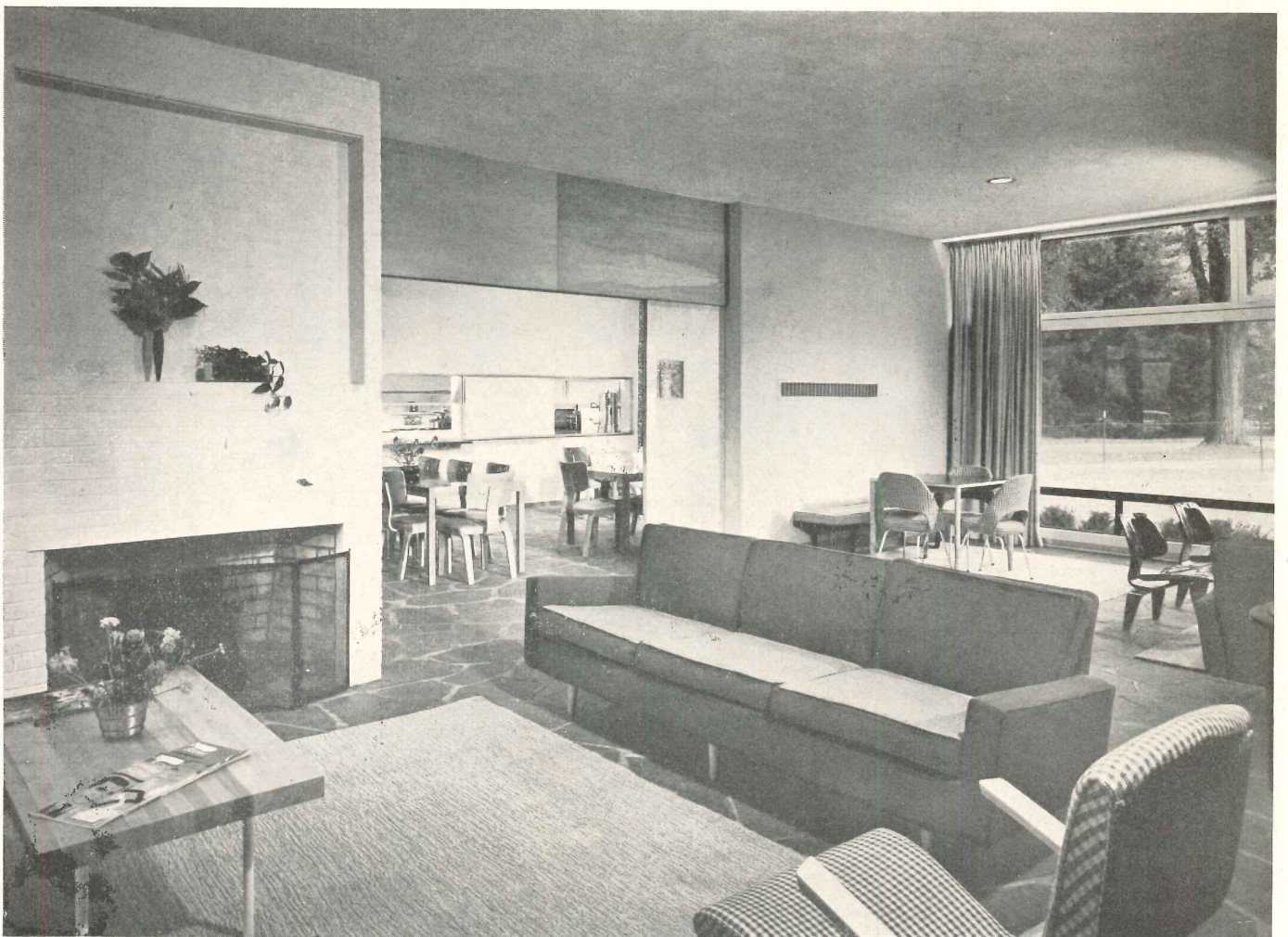



Breuer's Vassar Dormitory is a cooperative house in which the girls do their own work, even the cooking. Efficiency exhibits itself in kitchen and serving arrangements, but by no means dominates the interiors. The living-dining area presupposes a good measure of energy and noise, and is set apart from the strictly dormitory portion so that exuberance need not be inhibited. The glass walls do more than "bring the outside in;" there is perhaps a suggestion of letting the inside out. At any rate, these interiors are designed to be open, with a calculated note of gaiety

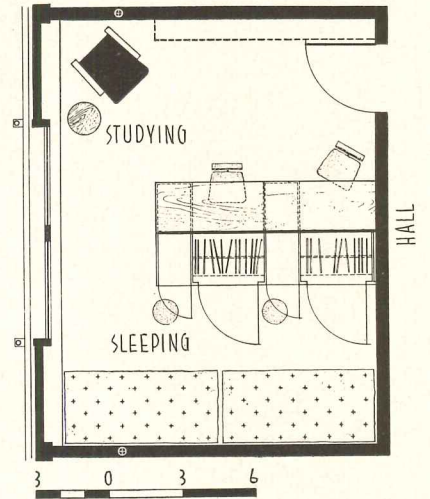
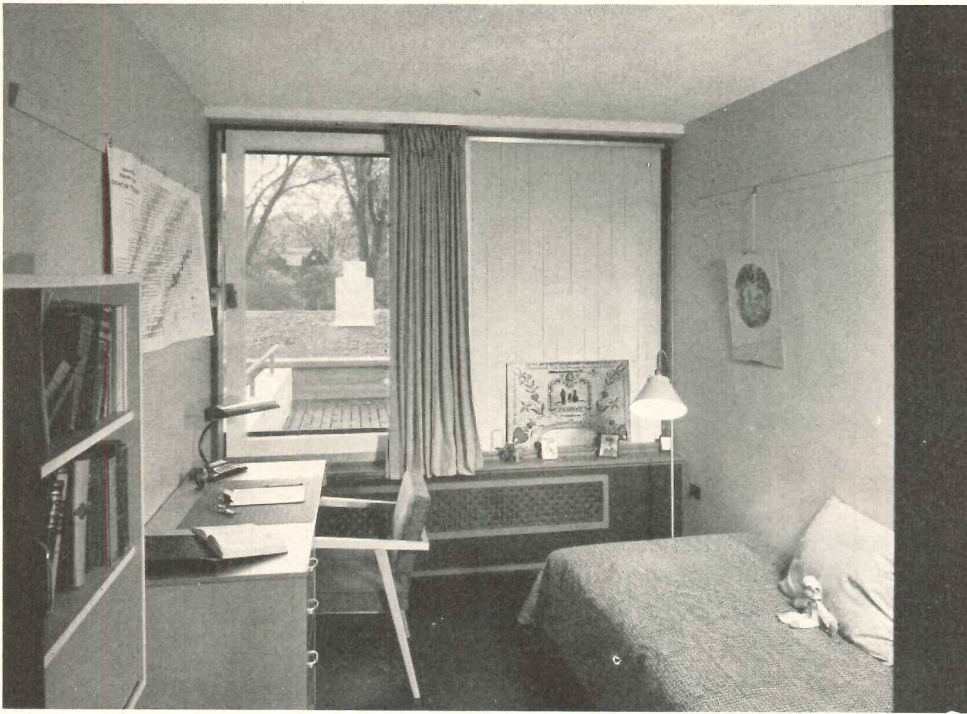
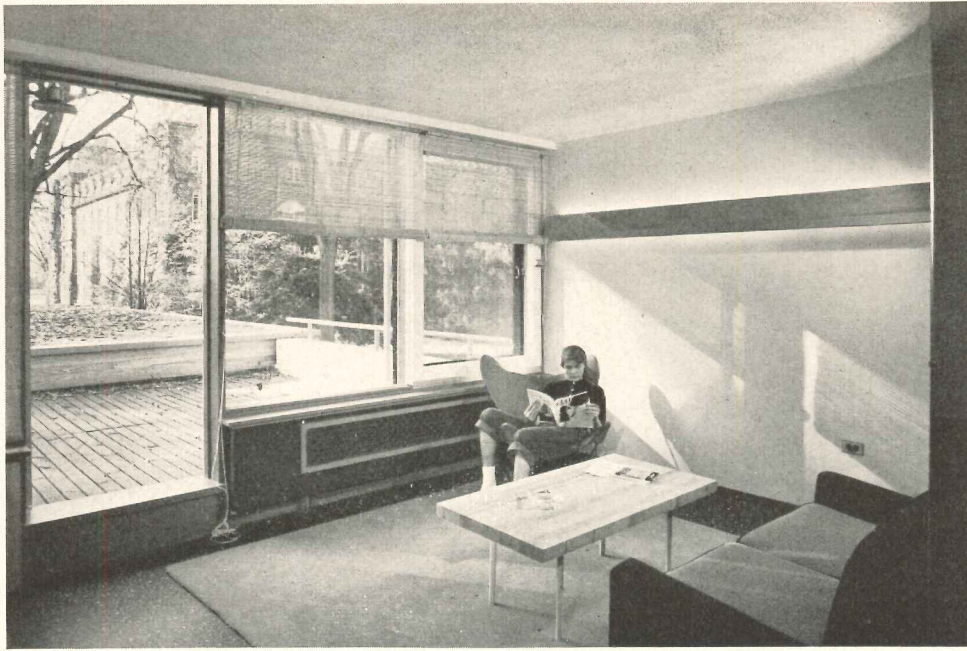

Upper photograph shows the up- stairs lounge where the girls may break the grind for that all-impor- tant chatter. It is located right at the head of the stairs, opens to roof deck beyond. View in center is one of the single rooms; note the panel in the convector cover; holes may be closed for heat control by just sliding the panel. Photograph at left shows living room of special apartment for the faculty adviser



Joseph Molitor Photos



Typical double bedroom is divided into sleeping space and study space by head-high cabinet partition. On one side are aligned two study desks, each with inset lighted panel. Other side of this same fixture lights dressing table in sleeping portion



The fun of structural things in tension here comes out in a cable stabilizer for the pipe-supported sunshades. Shade itself is sections of corrugated asbestos cement, with small spaces between sections to make light stripes across the building



Joseph Molitor Photos

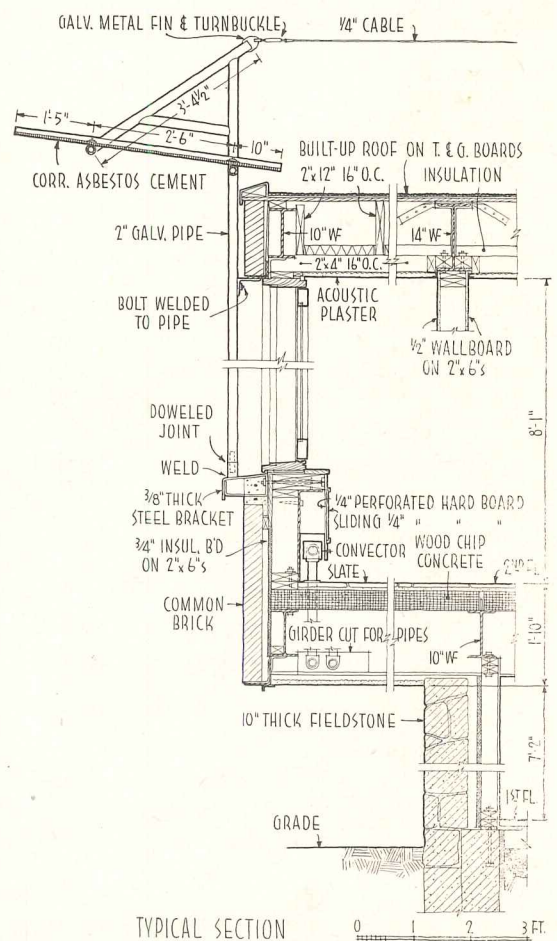

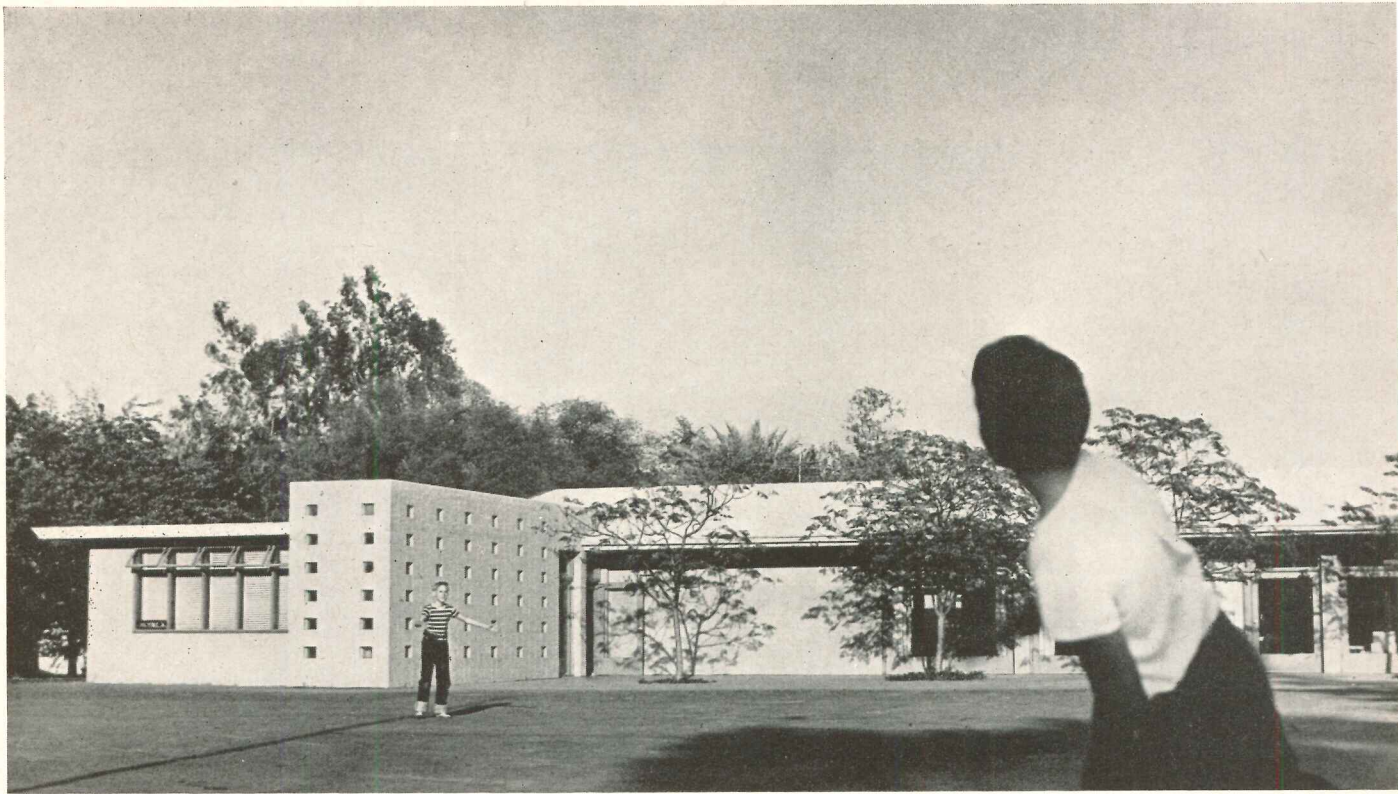

Garber Sturges Photo

YMCA-YWCA OFFICE AND ACTIVITY BUILDING

North Hollywood, California

Smith and Williams, Architects

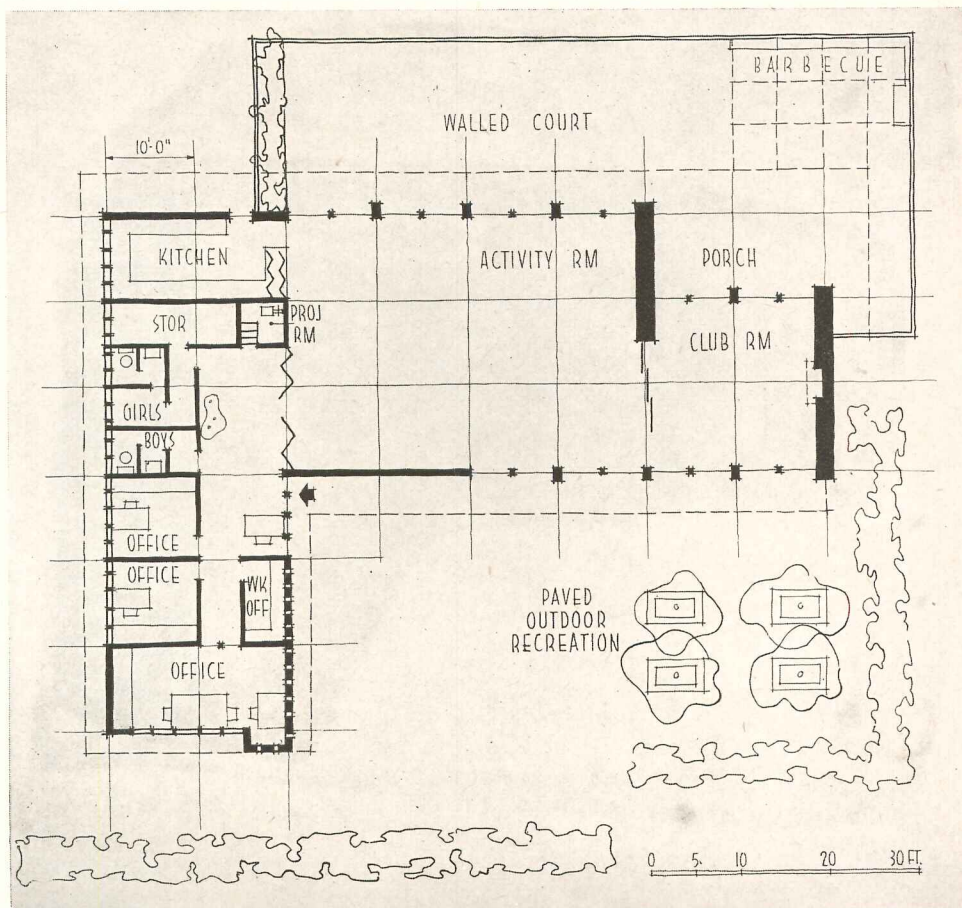
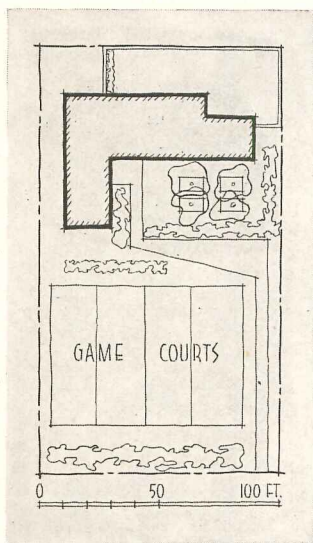

YMCA-YWCA BUILDING

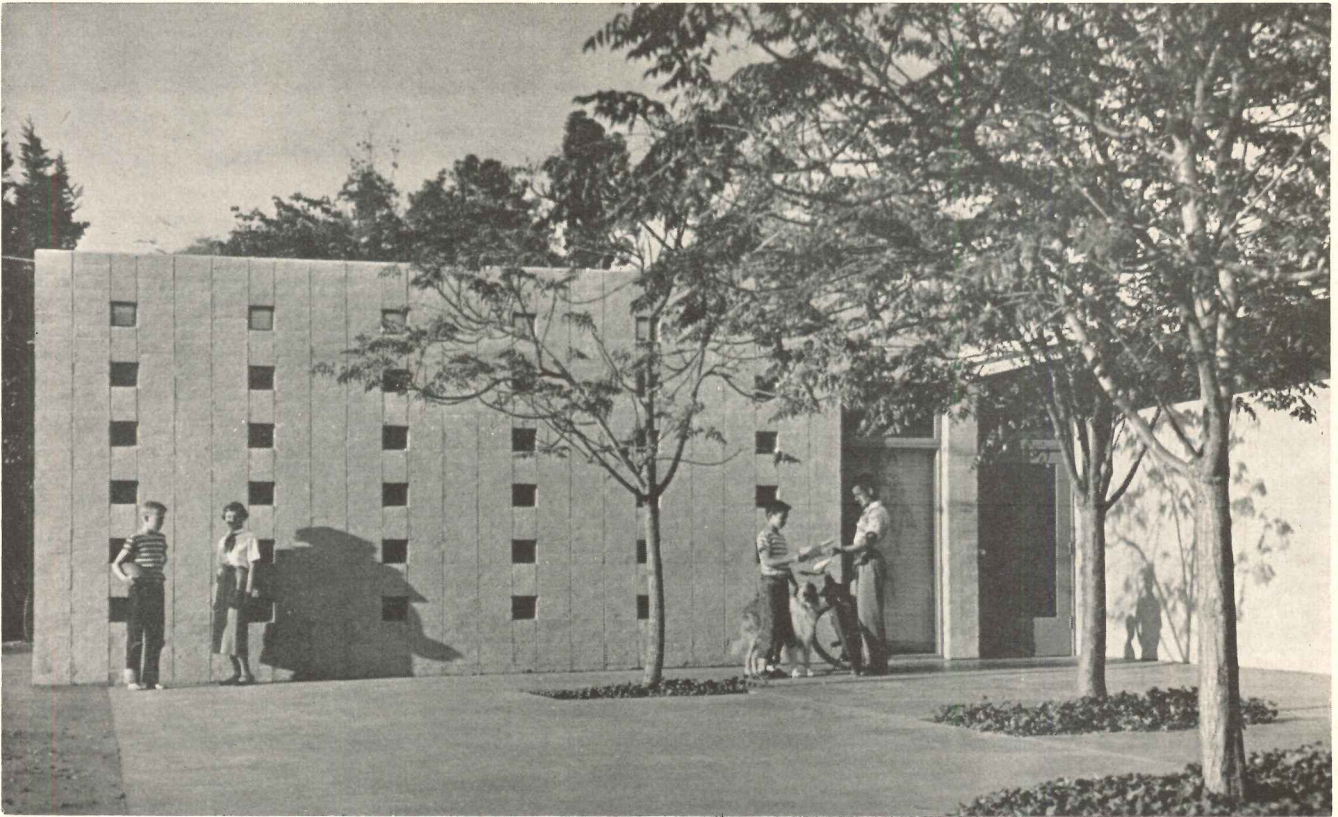

Known as the "Y" youth center, this activities building was constructed at $\frac{1}{3}$ to $\frac{1}{2}$ the comparable cost of conventional Y buildings in California. Modular construction, elimination of much plaster, articulation of plan and similar factors are credited with keeping cost to \$29,000

BETWEEN 1940 AND 1944 the San Fernando Valley gained 59,000 residents; "Y" boards and supporters started a drive for funds when the need for facilities became apparent. The budget, based on what the community could raise, was one factor behind the decision to share YM and YW facilities. In certain respects this decision satisfied social needs that might not otherwise have been met; and it also introduced a new group of design problems. A multi-use, mixed occupancy building cannot be compared with the typical, single-use "Y" building. The demands which joint scheduling made on space and facilities tended to increase, not decrease, cost per square foot.

The plan had to be flexible. Either the club room or the activity room had to be usable as an isolated social room with access to the outdoor barbecue. Construction is concrete block finished with an exterior cement brush coat; the roof is of solid wood sheathing with a white top surfacing to reflect heat. Floors are stained concrete. Sash are wood; heating is provided by individual space heaters.

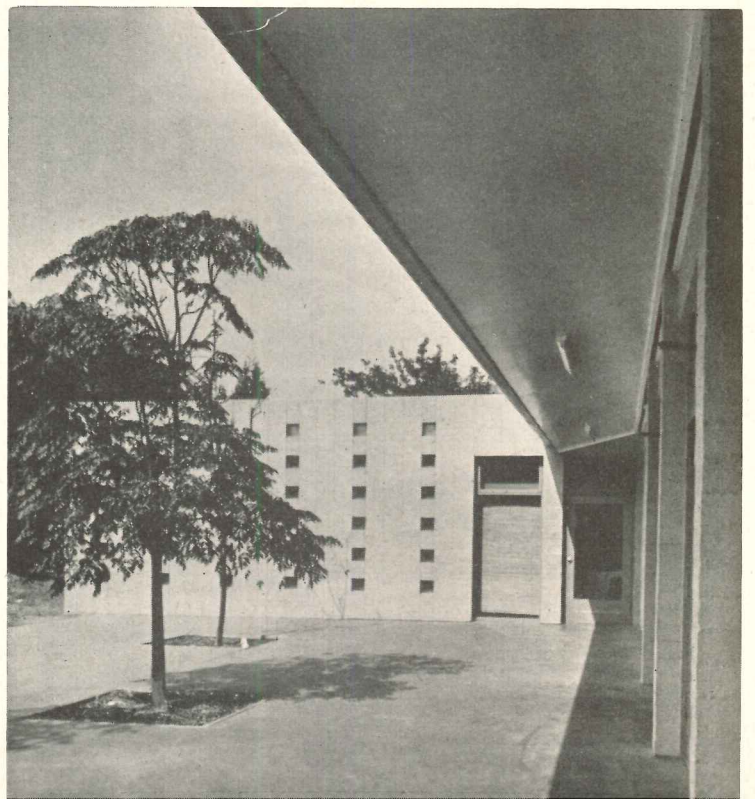

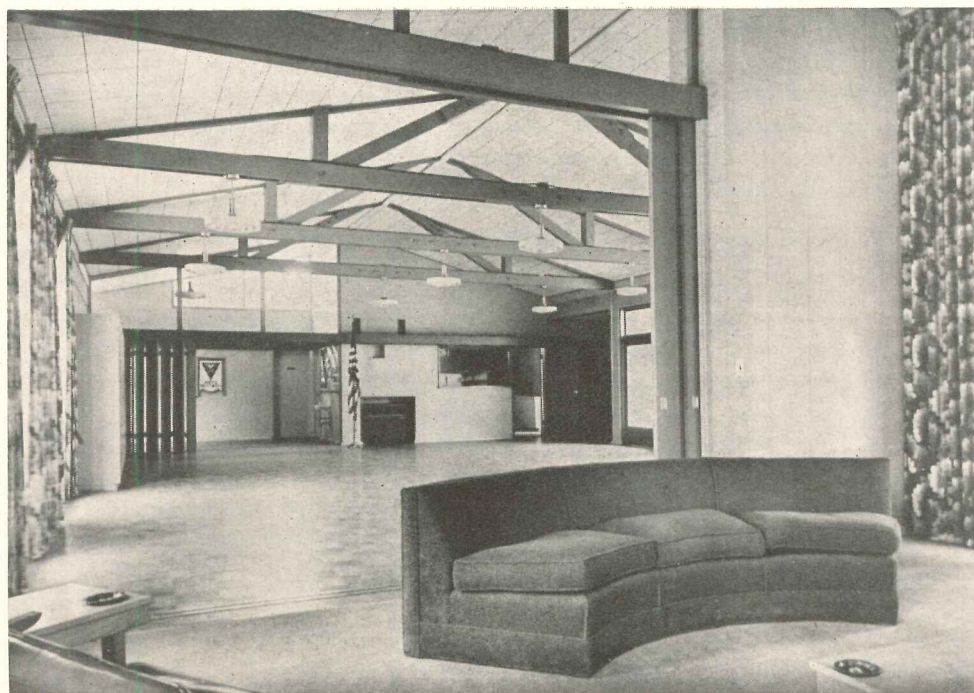
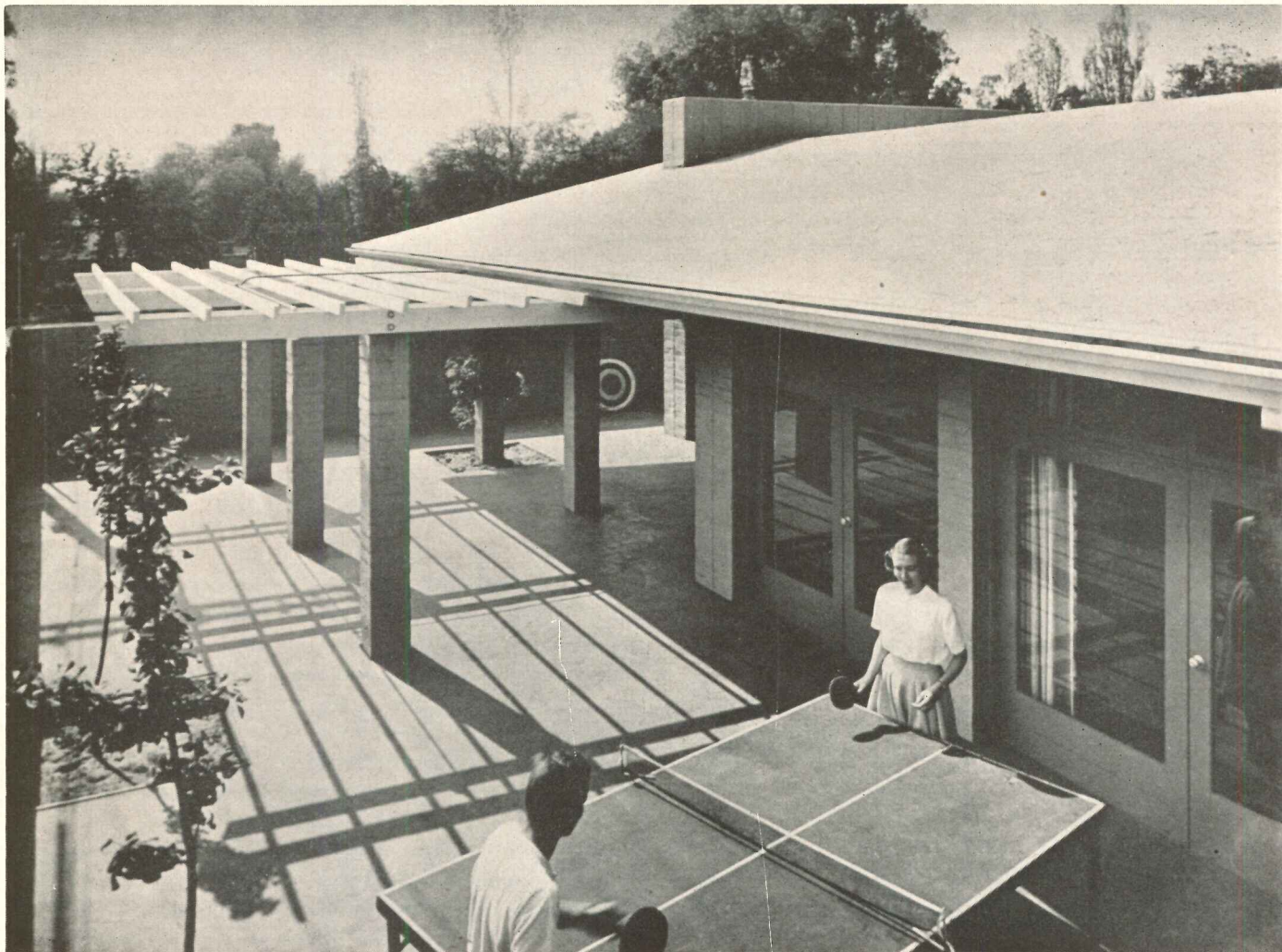

Garber Sturges Photos

Top of page, game area in walled court; bottom, 30 by 40-ft activity room seen from 20 by 20-ft club room. Ceiling between the exposed wood trusses is acoustical tile

SCHOOL DESIGN IN 1952

What Is The Materials Situation, And How Can We Meet The Crisis?

ESTIMATED PUBLIC ELEMENTARY AND SECONDARY SCHOOL CLASSROOMS NEEDED, BY YEARS*

| School year | Estimated public elementary and secondary enrollment | Classrooms needed | | | |
|--------------|--|-------------------|-------------------------|-------------------|-------------------|
| | | To house increase | For normal replacements | To reduce backlog | Total annual need |
| 1950-51 | 26,259,000 | | | | |
| 1951-52 | 26,907,000 | 24,000 | 18,000 | 36,000 | 78,000 |
| 1952-53 | 28,329,000 | 53,000 | 18,000 | 36,000 | 107,000 |
| 1953-54 | 29,610,000 | 47,000 | 18,000 | 36,000 | 101,000 |
| 1954-55 | 30,722,000 | 41,000 | 18,000 | 36,000 | 95,000 |
| 1955-56 | 31,484,000 | 28,000 | 18,000 | 36,000 | 82,000 |
| 1956-57 | 31,966,000 | 18,000 | 18,000 | 36,000 | 72,000 |
| 1957-58 | 32,251,000 | 11,000 | 18,000 | 36,000 | 65,000 |
| 7-year total | | 222,000 | 126,000 | 252,000 | 600,000 |

By Frank G. Lopez
A. I. A.

* Source: Ray L. Hamon, Chief, School Housing Section, U. S. Office of Education; published in "School Life," November 1951

WHEN you get right down to cases, this crisis in school construction is nothing new, except as it has been accentuated by the concurrent and continuing mobilization crisis. The causes are now of a different nature, more acute and possibly more drastically limiting to architects, educators, and material or equipment suppliers; but the end result is actually just the addition of another — though a very serious — set of obstacles in the way of designing adequate schools.

To be specific: almost never since the tag end of the depression, when schools began again to be built, has an architect had a free hand in design, or has the educator gotten built all the space he needed. School boards or building committees have seldom been able to get either all the money or all the public comprehension of their aims they have wanted. We have had constantly to hunt for less expensive structure, materials and equipment; mounting construction costs have forced school design into this channel. The School Building Type studies published in ARCHITECTURAL RECORD in 1949, 1950 and since have emphasized economy as much as pedagogical demands.

ALMOST, BUT NOT QUITE, THE SAME

The differences, of course, are that now we must economize in two ways, in dollars *and* in certain types of materials; that economies of cost may at times have to give way to saving materials. If we can't save materials we are to be prevented from building enough schools. We are no longer at liberty to choose freely among steel, reinforced concrete or wood for framing systems, to determine which will do a given job most cheaply in view of a local set of conditions. Add copper and aluminum to the materials on which we must economize, and you have a great part of the picture.

There are a lot of other factors. For instance, designing a school takes many months. It is far too costly for an architect to redesign so that out of the intimately and intricately related spatial-framing system-equipment complex of a modern school is squeezed every possible ounce of critical material; he can't afford it,

and his client can't pay him for the extra work involved. Again, a tremendous backlog of needed construction has been building up since 1930, and our feverish school building pace since 1945 has done little to reduce it (see table). Still again, schools wear out and, though they aren't replaced often enough, some need for their replacement does have to be acknowledged. Worst of all, perhaps, is the biological fact that wars cause increased birth rates. World War II babies are now at the doors of the schools to which the law says they must be admitted, and shortly these children will be entering secondary schools (which have been built in far smaller numbers than elementary schools). The present mobilization is eventually going to increase the clamor at the school gates. Just to complicate matters, add this item: the school building problem cannot be solved by any sweeping national dictum. It is a grass-roots problem, each individual case differing from every other in respect to financing, educational demand, and suitability of materials and equipment. In this, perhaps, lies salvation.

O.E., A.I.A., D.P.A., AND CONGRESS

The United States Office of Education, though neither set up nor equipped to act as a traffic cop controlling materials flow, has had to assume exactly that function for school construction. There have been the inevitable inequities in its processing of applications; for these USOE can hardly be blamed. They would have existed to a greater degree in an agency of lesser integrity and sincerity. USOE has considered every means of improving the situation. As far as it could it has battled vigorously for more material. The American Institute of Architects' Committee on School Buildings, composed of several of the nation's ablest school architects (who have labored long and at some personal sacrifice), has been trying to formulate a technical basis on which to proceed. The public, meaning local parent-teacher groups as well as boards and committees, has made its complaints heard even in Congress (which is not surprising in a pre-election year).

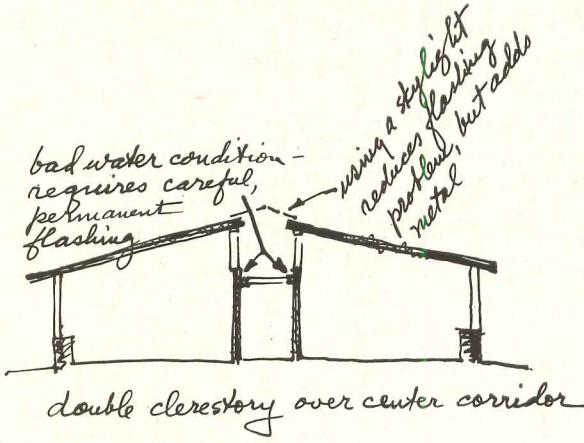

2

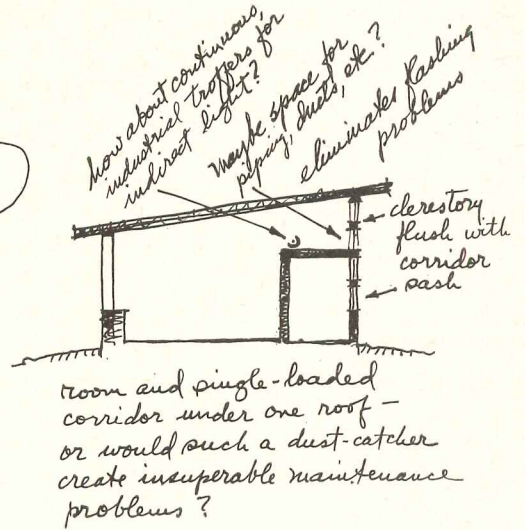

3

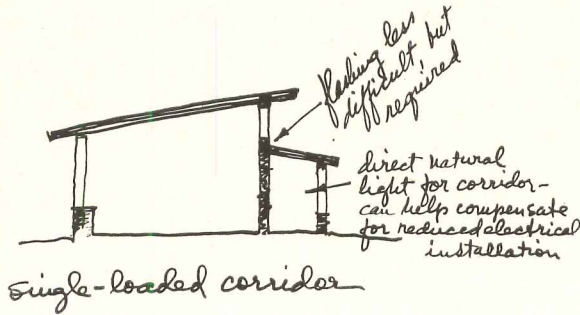

4

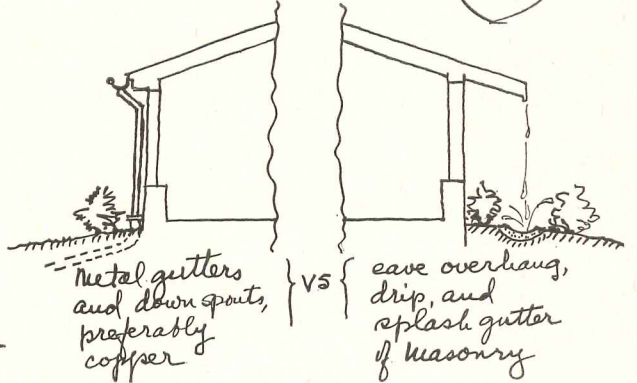

Classroom concepts can complicate - or simplify - flashing problems

gutters and leaders

and structural framing

5

6

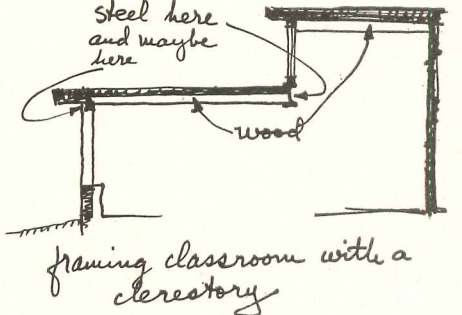
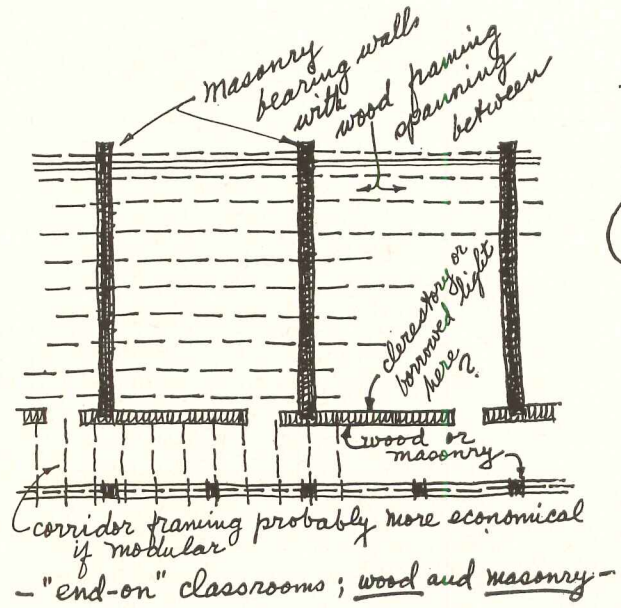

Merely to state a sequence of facts, the steel allocation has been increased by 15,000 tons for the first quarter of 1952. Though this is far from enough, it carries with it an extension of 60% of the same amount for the next quarter, 50 and 20% for each of the following quarters. Thus, approval of an application carries some assurance of sufficient materials for completing a project once it has been started. The system can cause some complications; for one thing, the advance commitments can pile up to more than 100% of future quarterly allocations, unless these are increased.

There are other straws in the wind. There is talk of, possibly, applying the self-certification principle to school jobs, up to, say, 25 tons of steel per project. This might enable architects to negotiate for local warehouse stocks, or to adapt their designs to what was locally available. On the other hand, though it might get many schools built, it might, if completely unregulated, prove too great a drain on the supply of materials; and if it were to be hedged about with regulatory measures, difficulties of operation might become greater than they are now. Also, a very serious case can be made against self-certification as a virtual opening of the flood gates; one might as well have no controls at all. There is, too, a considerable opinion, which can be persuasively argued, to the effect that by mid-1952 the steel shortage will be easing off. Proponents of this point of view cite increasing production coincident with a leveling off of abnormal demands; its opponents, not as optimistic about production, indicate also the possible changes for the worse in the international situation.

ALUMINUM AND COPPER, TOO

While there is every sign that aluminum production, now being increased as fast as possible, will in time catch up with demand, not so much can be said for copper. The United States does not produce enough copper, we hear, and that is a most serious limitation on school work. Reportedly, aluminum wire can be substituted for copper as an electrical conductor only in the larger gauges; wire sizes normally used for lighting and convenience circuits appear to demand copper. Considering the emphasis placed on high-level artificial illumination, the need for current for audio-visual aids, and the like, this becomes an onerous shortage.

It has been hopefully suggested that perhaps one row of lighting fixtures, that nearest a window wall, could be temporarily omitted from each classroom. The problem is not as simple as that. Can standards be so arbitrarily lowered? Would it be better to wring out of all circuits every possible surplus bit of precious copper? To insist that circuits be run in the most direct fashion, not bothering to "square" the corners of runs? To reduce the number of convenience outlets? To explore potential savings in such devices as remote-control switch-wiring between switch and outlet? The same reasoning might be applied to layout of piping systems. A short supply of copper means a shortage of brass goods, and this in turn means a shortage of hardware. Anything that can be done to reduce the hard-

ware required will help decrease the difficulties.

A copper shortage also affects spatial and structural design concepts. One can so organize space within a school building, and so devise structural overhangs, clerestories, corridor roofs, etc., that a minimum of flashing is required. One can design in wood, even to employing wood sash superlatively well. This may not always be a totally satisfactory solution, but we are going to have to do more of such things. We are going to have to explore fully the potentialities of utilizing a room shape which may induce natural ventilation, with the object of reducing the load on artificial ventilation equipment. We are going to have to study the advantages and disadvantages of using small boilers, for instance, to heat each of several groups of rooms, one, two or three to a group, rather than one large installation to heat an entire school.

In all of this we are inevitably going to find ourselves, at times, in conflict with codes and prejudices. Not many codes are flexible enough to admit all these practices. Yet, curiously, many state school building authorities are willing to accept one-story, semi-fireproof or non-fireproof buildings (provided there are direct exits from classrooms); while local building committees will insist upon structures more costly in money and critical materials because they think them proper.

SOME PROPOSALS ARE REALISTIC

Other suggestions besides the omission of some lighting circuits have been proposed, some of them realistic and some betraying ignorance. If we eliminate gymnasiums and auditoriums (and by inference cafeterias), we hear, we may be able to build as many classrooms in 1952 as in our peak year, 1951. Well, the gym is not a luxury, it's an instructional space. The cafeteria is a necessity in any school which has a bus transport system. The object of the suggestion, one would guess, is to save framing steel. What about the use of wood trusses, prefabricated or job-fabricated, of solid timbers, or laminated, or with a stressed plywood skin? These need virtually no metal! A great deal can be done, and undoubtedly will, in the way of remodeling or renovating existing structures, and of building additions to schools in such fashion as not to require the full amount of wiring, piping, ductwork, etc., which a completely new structure would demand. If work of this nature can be done in such a way that it does not saddle a community for another quarter century with a perpetuation of a long-since outmoded building, remodeling or additions can help alleviate conditions.

We intimated previously that in the fact that each school building presents its individual problems, and that each architect of a school building has his individual method of attacking them, might lie salvation. Certainly no agency is going successfully to promulgate a set of rules for school design. We know of architects who have recently built schools which are good in the light of their own circumstances for as little as \$4.50 to \$7.50 per square foot. If architects can economize on dollars so well, they can surely economize on steel, copper and aluminum.

Structural devices

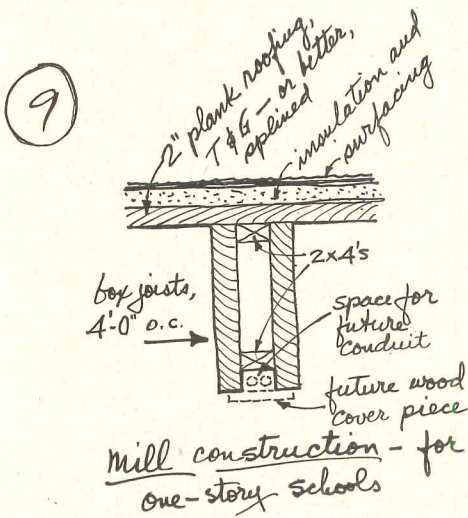
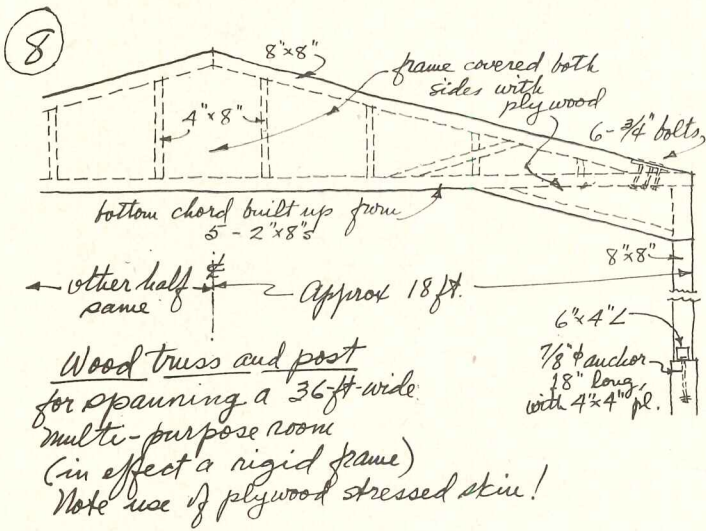
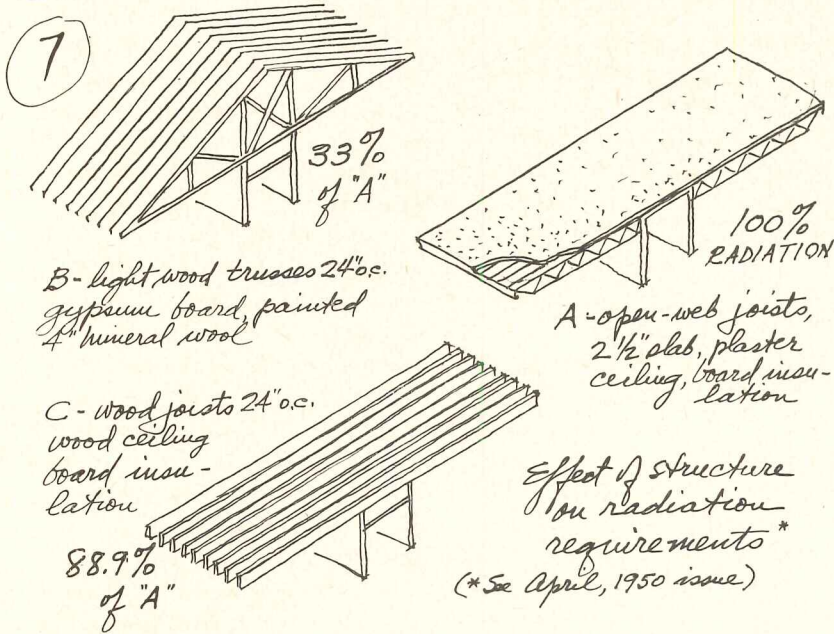

Equipment

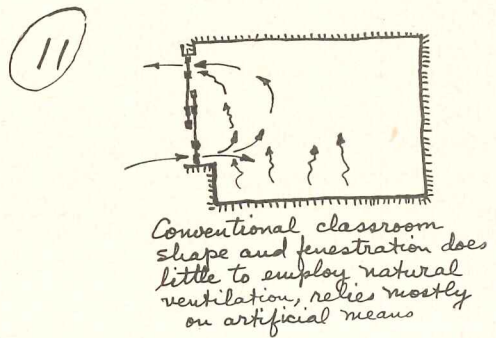
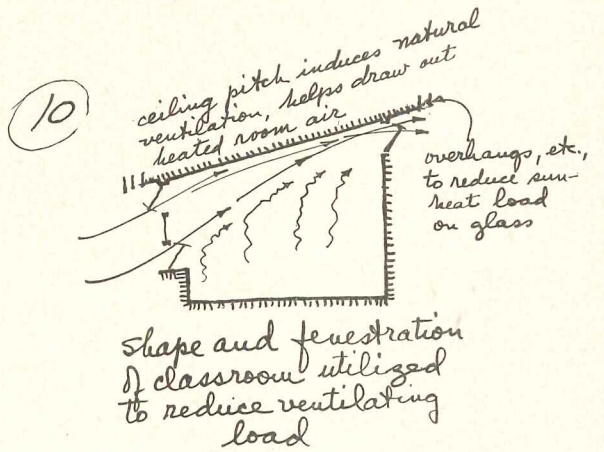

Hardware etc.

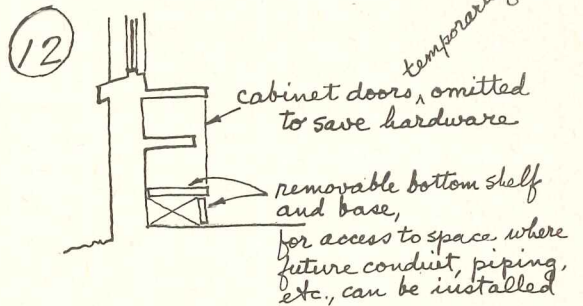

Hardware difficulties -

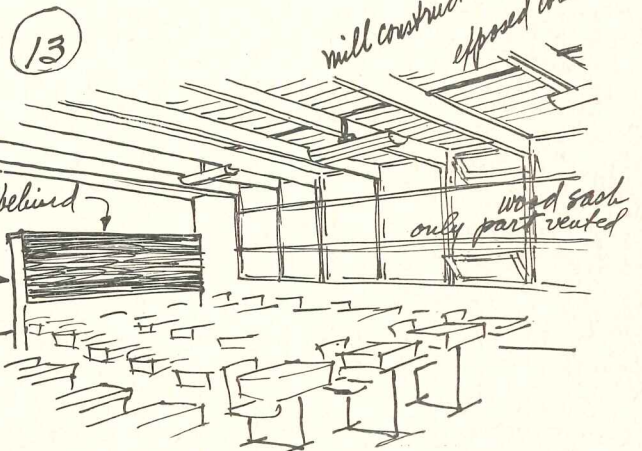

Several means of cutting use
of metals
(See April 1950 issue)

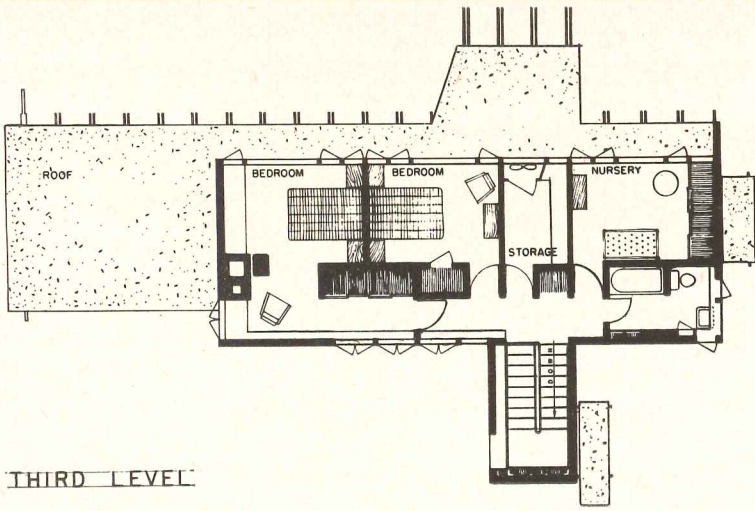

THIRD LEVEL

The steep site, with its one location precisely right for overlooking the southerly view of meadows, small pond and distant hills, dictated a vertical house. Small photo taken from end of garage shows main entrance at left, and outdoor stair to service porch which doubles for outdoor dining and nursery

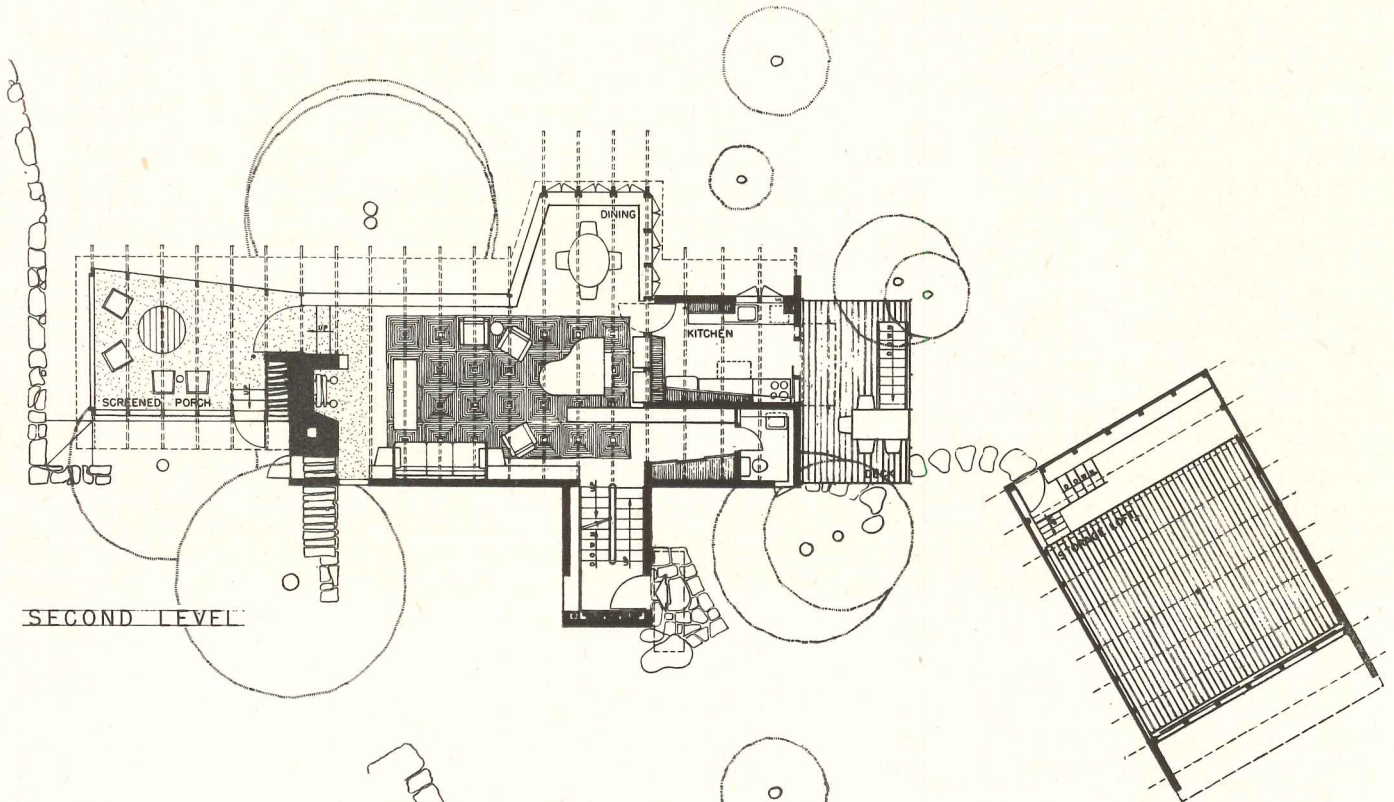

SECOND LEVEL

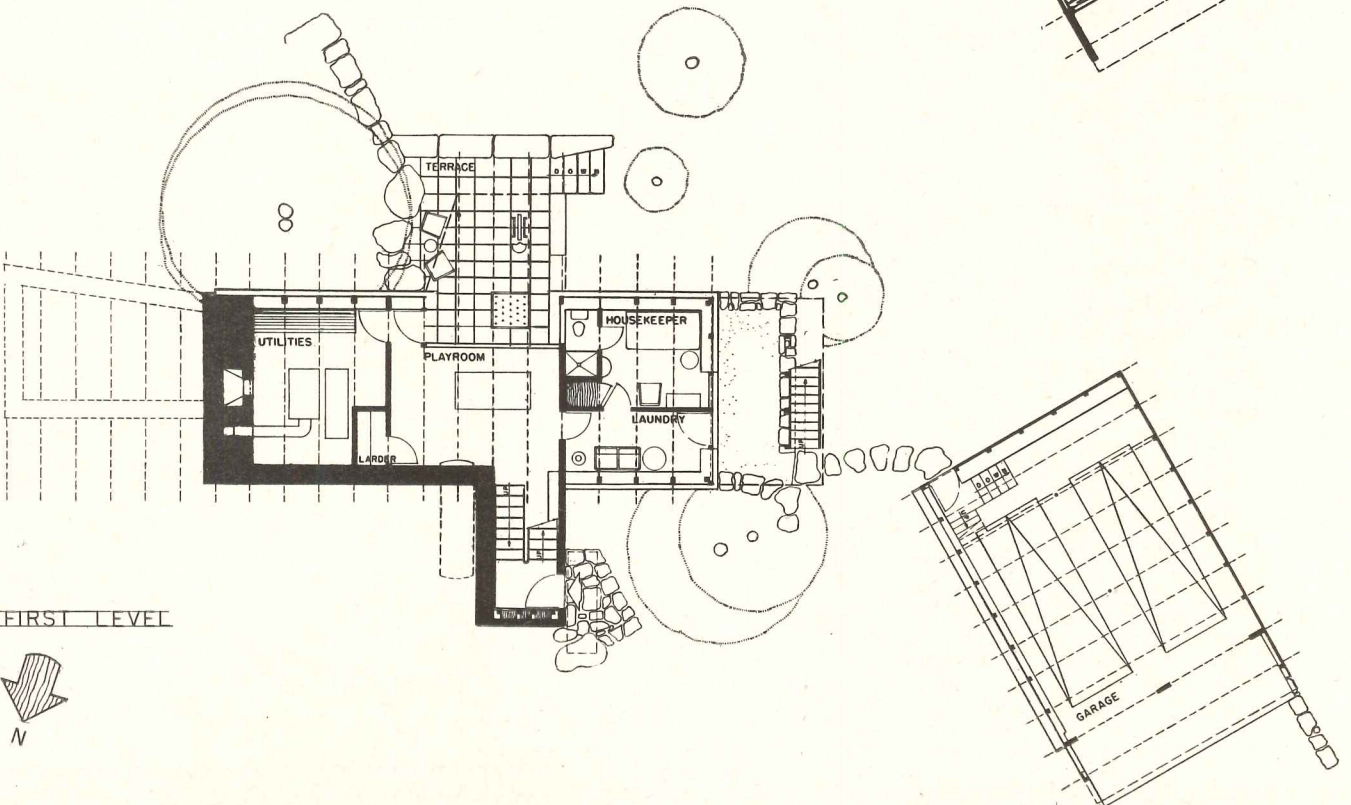

FIRST LEVEL



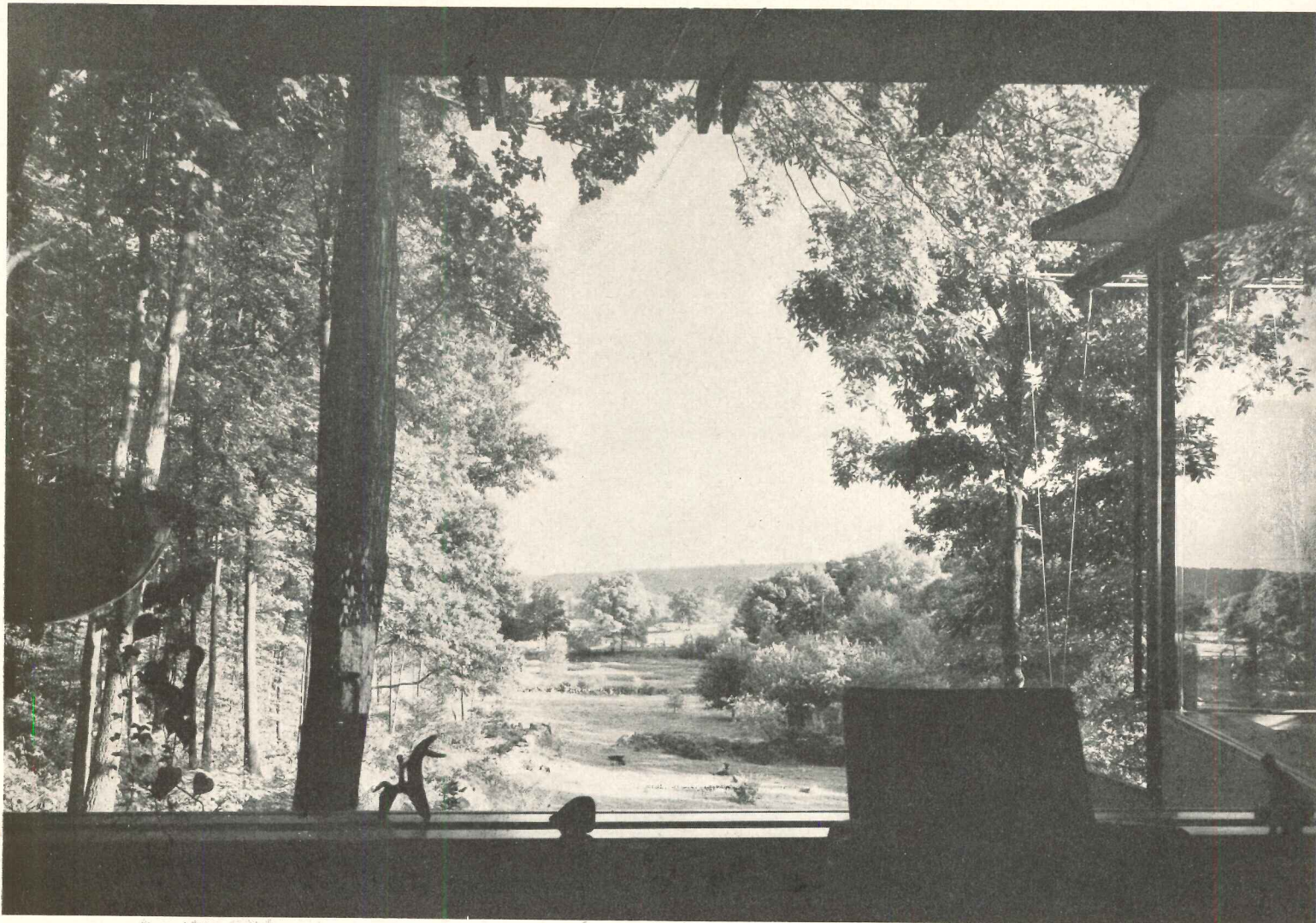

Ezra Stoller: Pictor

**HOUSE FOR
MR. & MRS. CHAUNCEY RILEY
NEW CANAAN, CONNECTICUT**

*Chauncey W. Riley
Architect*

JANUARY 1952

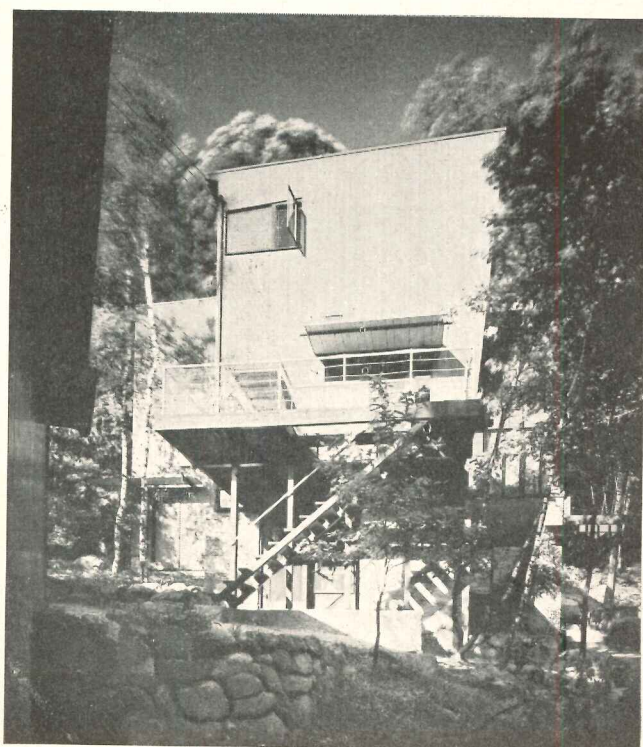

RILEY HOUSE

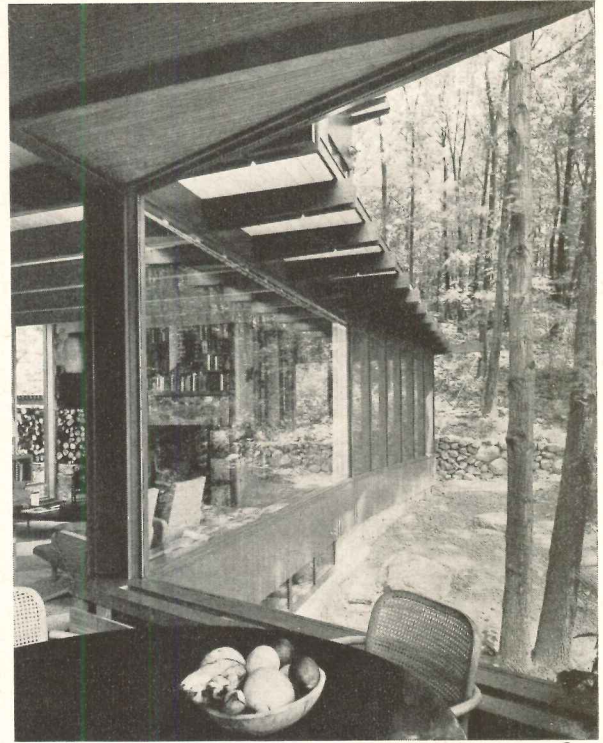
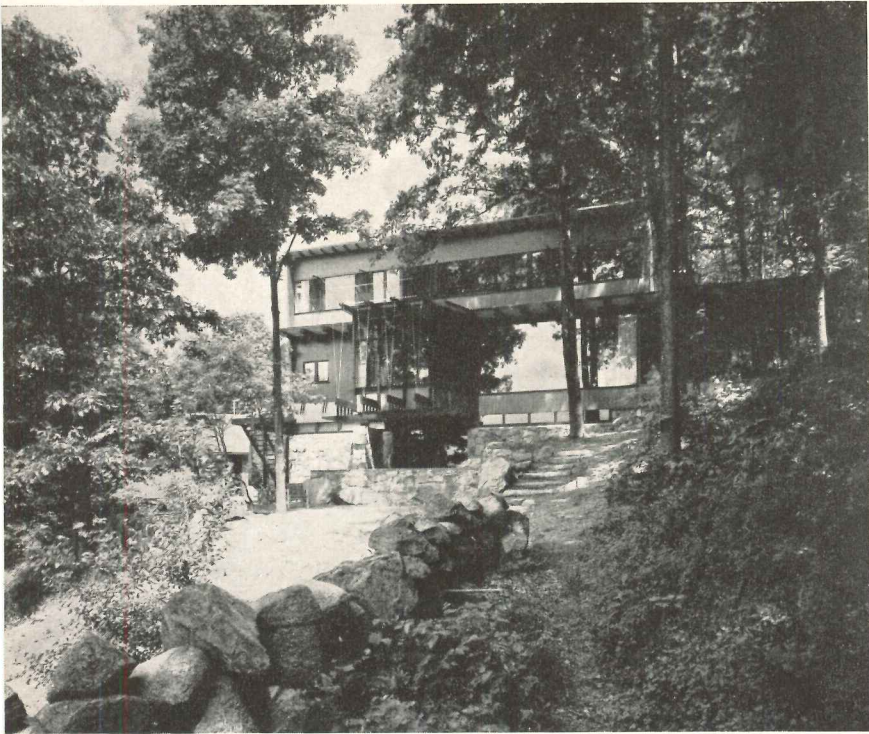

Above, left, exterior from south showing screened porch at east end under trees; center, dining bay, looking along glass wall of living room; right, dining bay and wall beneath shelter the terrace. Below, left, living room with screened porch beyond; center, kitchen; right, looking toward dining bay and kitchen



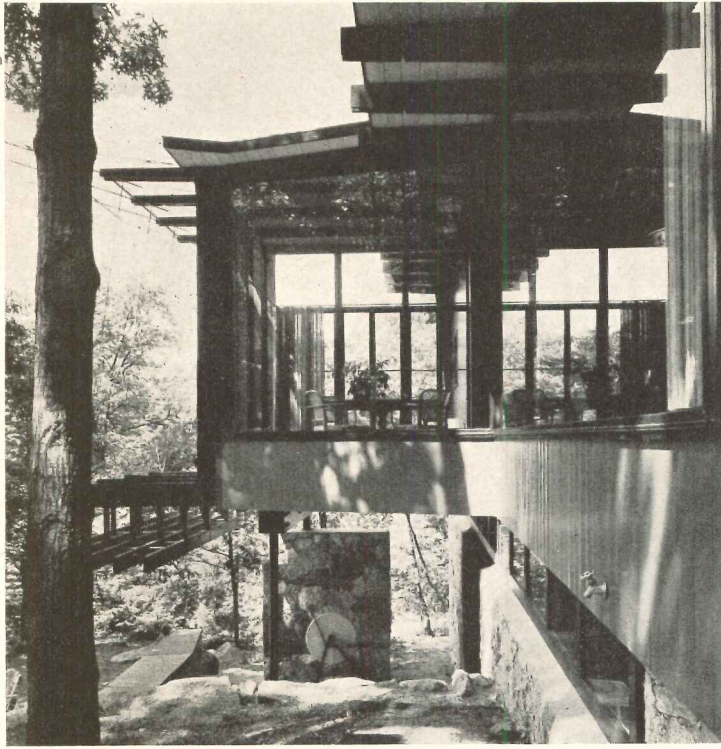

Ezra Stollen: Pictor

MY CLIENT," says Chauncey Riley, the architect of this house, "was Mrs. Riley." She and Mr. Riley both commute to New York, which rendered essential quick access to the garage and thence to the highway. Although the site and view demanded a vertical house, the ease associated with one-floor houses was appreciated, and so the stairs were designed to attain complete comfort. This is the reason the stair hall (see next page for details) was taken outside the house proper.

Woody growth on the site was carefully thinned so the deciduous trees would provide summer shade but not obstruct winter sun; the moon, the Rileys discovered, is highest in midwinter, lowest in midsummer, and this reverse of sun positions makes moonlit evenings enjoyable all year. On summer evenings, also, there is constant movement of air down the hillside toward the pond below; air flowing through the screened north-south walls of the porch — its east wall is glass to keep out damp east winds — makes it a pleasant, insectless sitting place. In daytime the prevailing summer breeze is southwest, so the two walls of the dining bay facing in this direction have operating sash.

The interior was thoughtfully studied to capture within the character of the countryside. Some plywood finish was used (for instance, all kitchen cabinet work is mahogany plywood); but flooring, exposed framing members and trim are all unfinished solid fir, whose color is deepening in the sunshine. Doors are mahogany, simply waxed. Much furniture is built in; all this was thoroughly detailed. Stone found on the site forms the chimney. Exterior materials are vertical fir siding painted russet, dark green fir trim, and the same stone masonry so disposed as to blend the house into the land and its traditional stone fences.

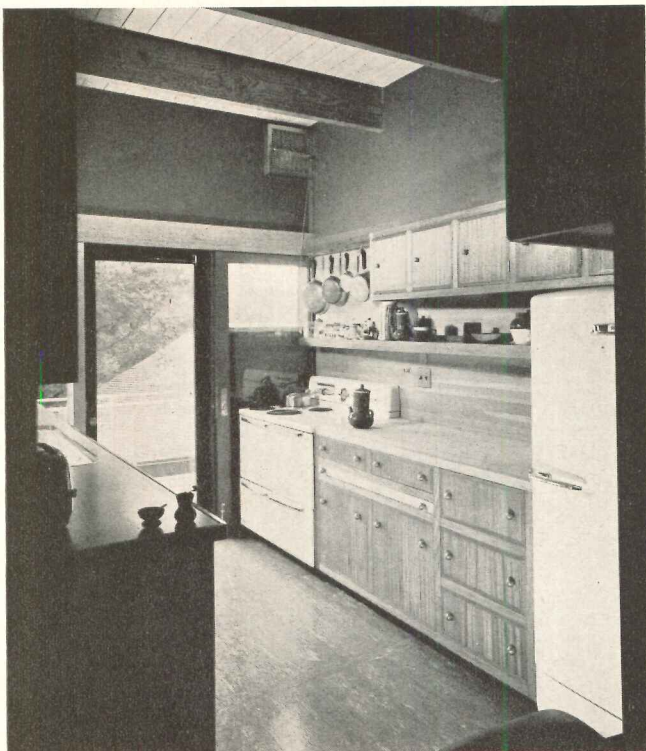

RILEY HOUSE

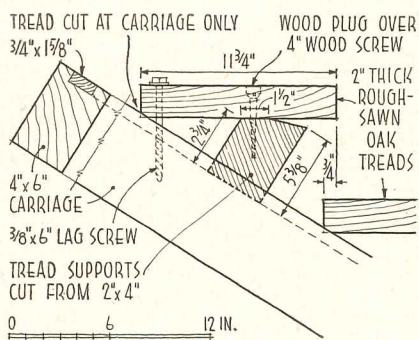

Stair hall was disengaged from other elements so easy stair proportions would not be cramped. As wood adjusts to atmospheric moisture, lag screws are taken up to eliminate squeaking treads. Cantilevered nosings add to stair's resiliency. Rail is 1-in. round iron; balustrade, wire rope. Garage, below, has vertical lift doors; old architectural documents are stored on upper level

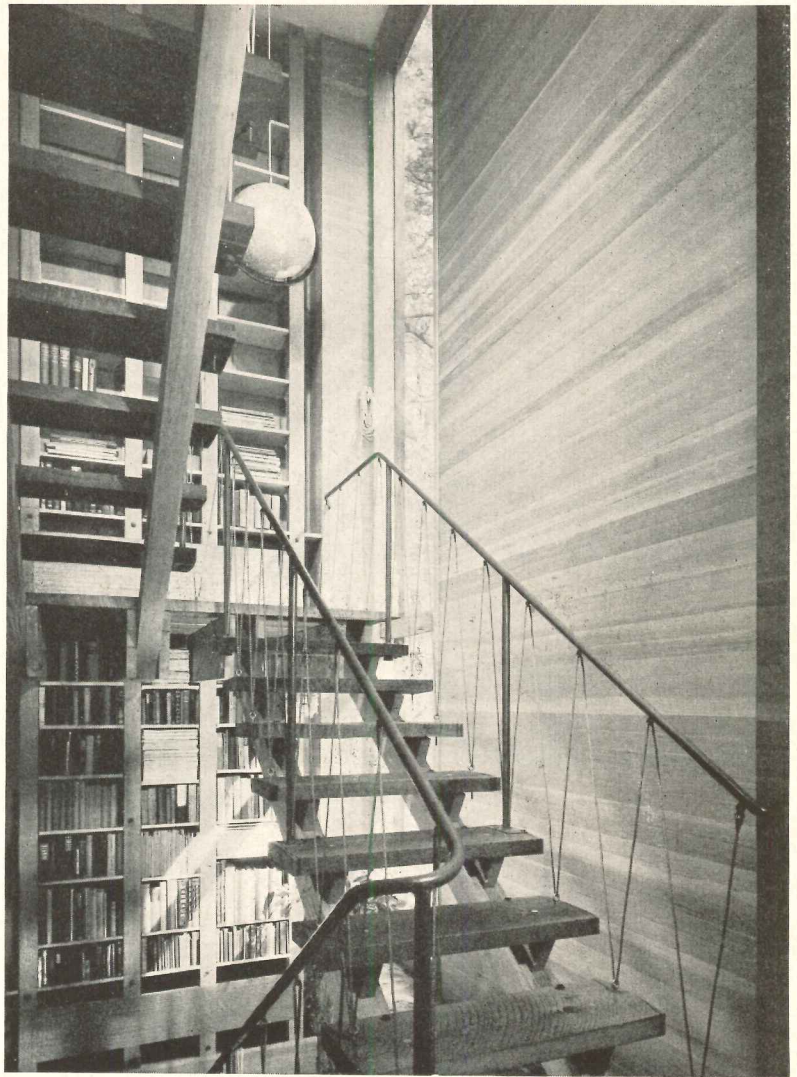

Ezra Stoller: Pictor

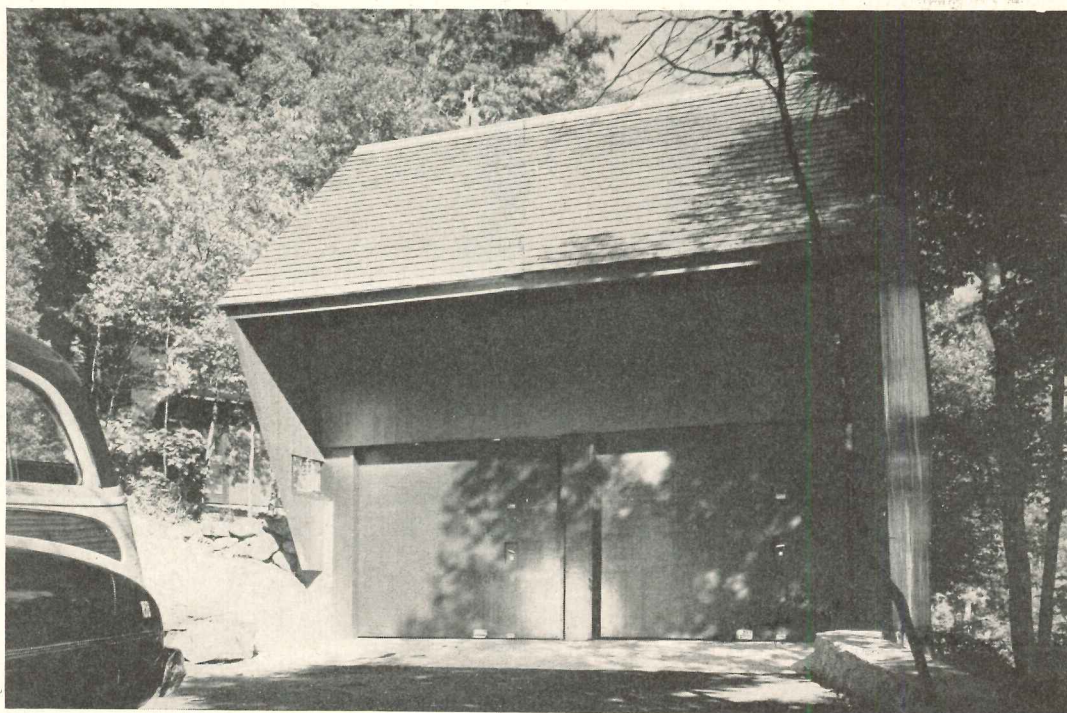

RESIDENCE OF MR. AND MRS. E. J. GREANEY

Honolulu, T.H.

Vladimir Ossipoff, Architect

R. O. Thompson, Landscape Architect

Robert Ansteth's, Ltd., Interior Decorator

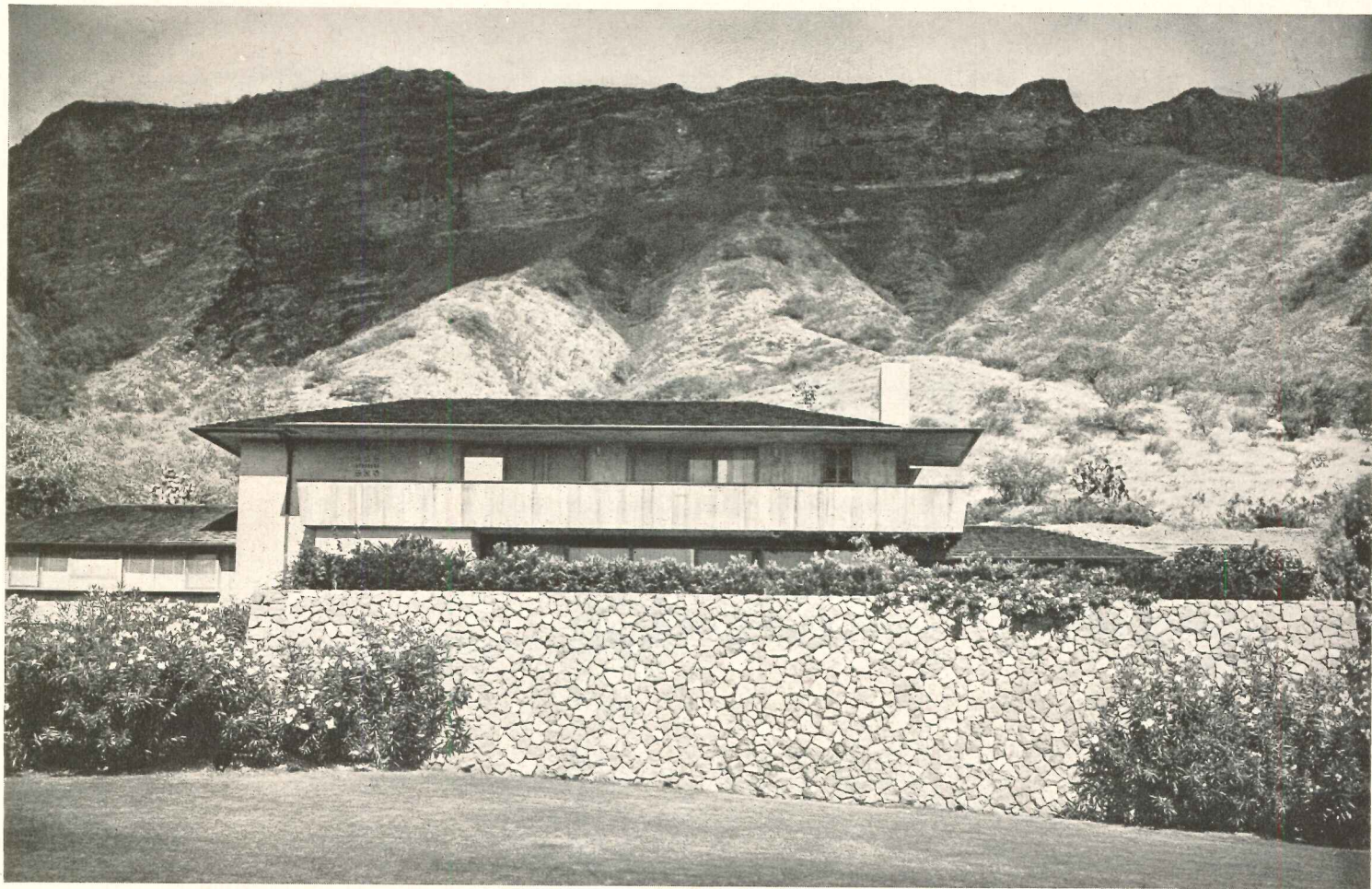

R. Wenkam Photos

IN PLAN, this house is characteristic of Hawaii, with sliding glass doors opening the main living area to surrounding lanais, or terraces. At first glance, however, it does not seem at all typical of the open architecture of the Islands. True, it has a balcony, but the high stone wall gives it a closed-in look which is surprising, particularly as the house faces the ocean. The reason is this: the house is situated on the slopes of the famous Diamond Head — slopes so steep that retaining walls were required along two sides of the property. (The stone used for the walls was excavated on the site, and the excavation in turn was used to form the lanai at the rear of the house.)

The architect obviously gave considerable thought to how the house would look against its background. As the photo shows, the horizontal emphasis, the varied levels, and the low hipped roof echo the contours of the mountain itself.

Exterior of the house is hollow cement block and rough Northwest pine which has been given a weathered finish; the tan of the pine blends with the warm dark brown of the stonework. The roof is cedar shakes, the foundation masonry and concrete. Ceilings are acoustic plaster and, upstairs, a local cane fiberboard with a pleasant texture and both thermal and acoustic insulating qualities.

GREANEY HOUSE

The site is both steep and irregular, sloping from 132 to 116 ft along northern edge and from 138 to 106 ft along southern. Elevation of the turnaround is 118 ft, that of the house and terraces 126. Garage is under the service wing

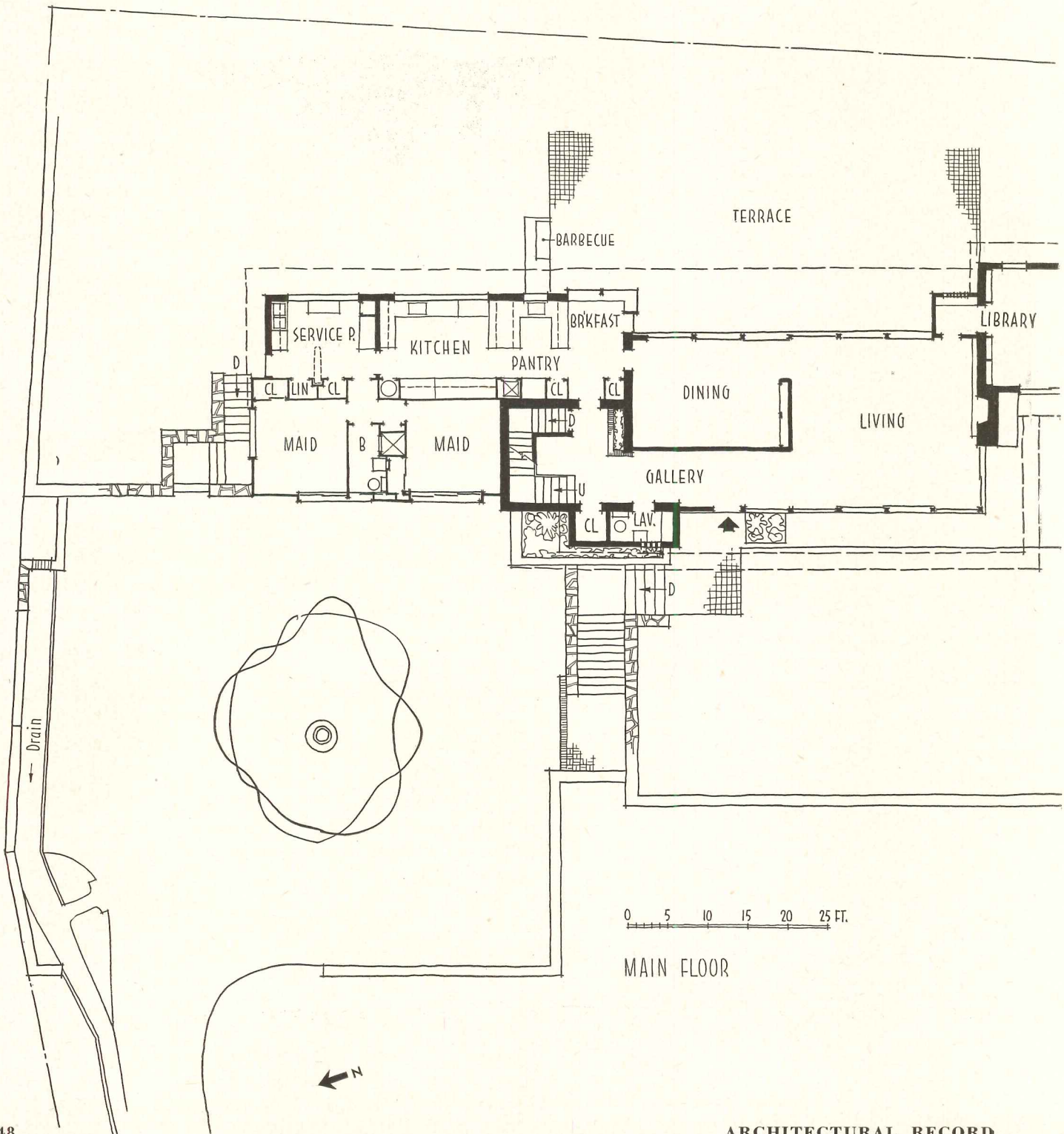
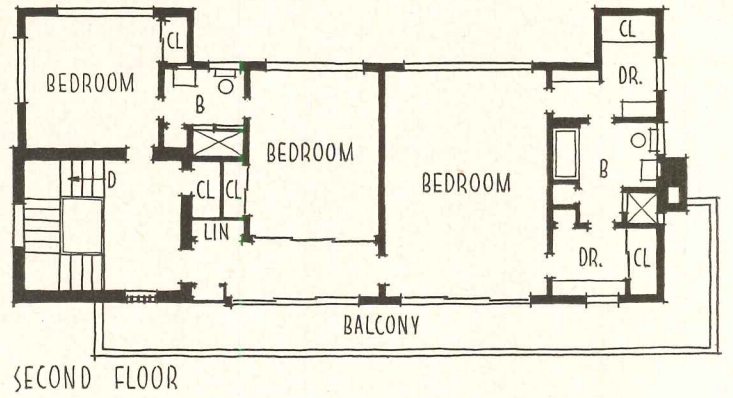

Right: barbecue is at one end of rear lanai, out of the way, but handy to kitchen. It serves effectively to terminate sitting area and shut off service wing from terrace

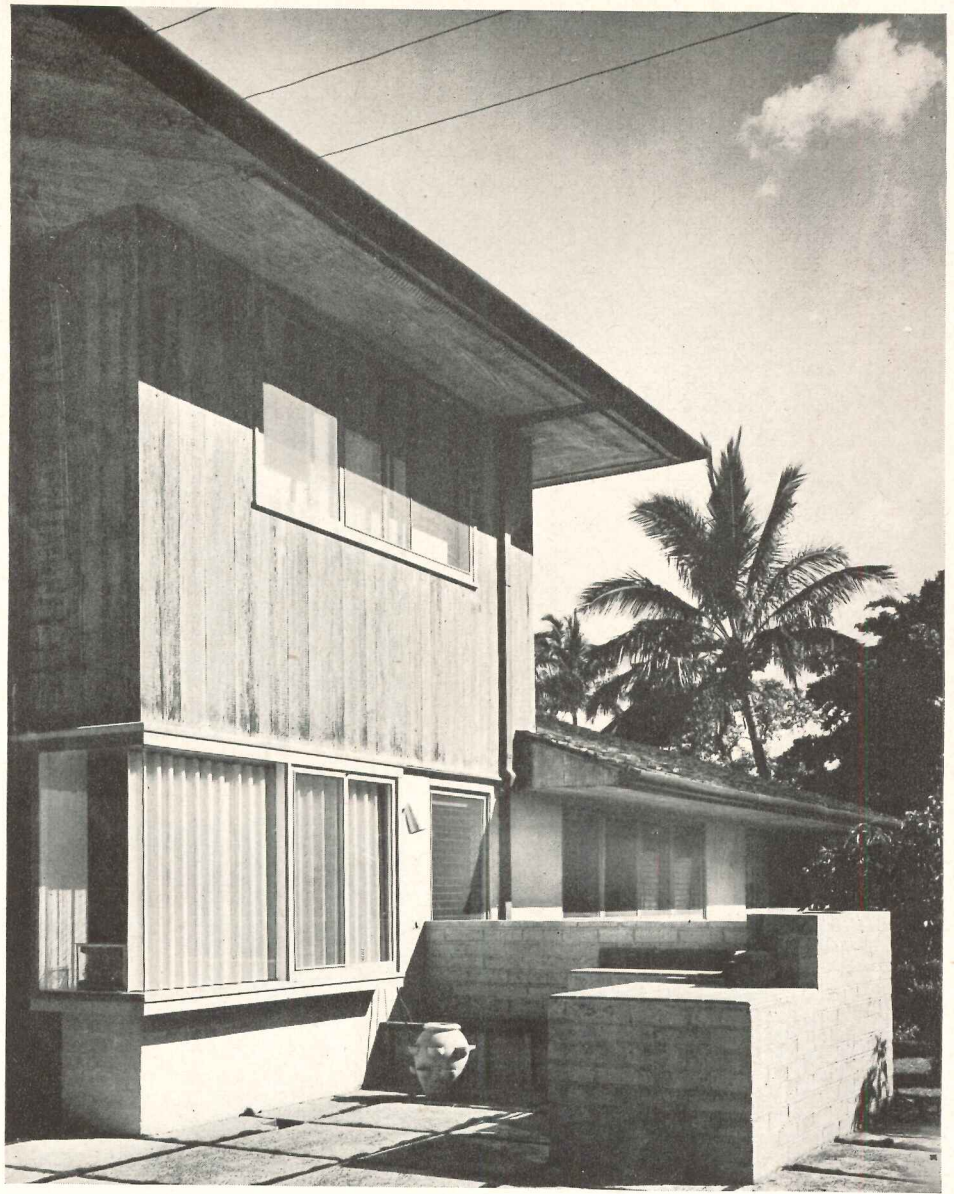

R. Wenkam Photos

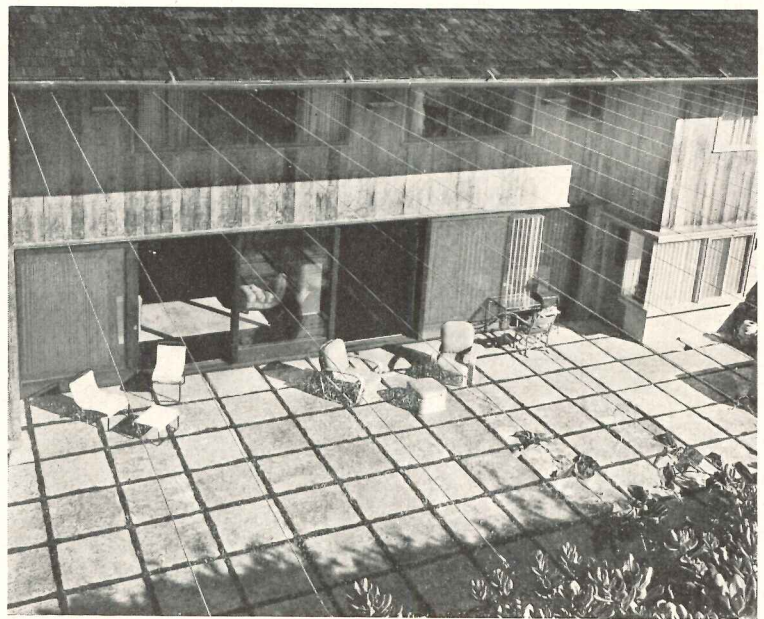

Upper or rear lanai is paved with concrete blocks using a coral aggregate; joints are planted with a Japanese moss grass. Wires above are to carry vines to provide needed shade in middle of day

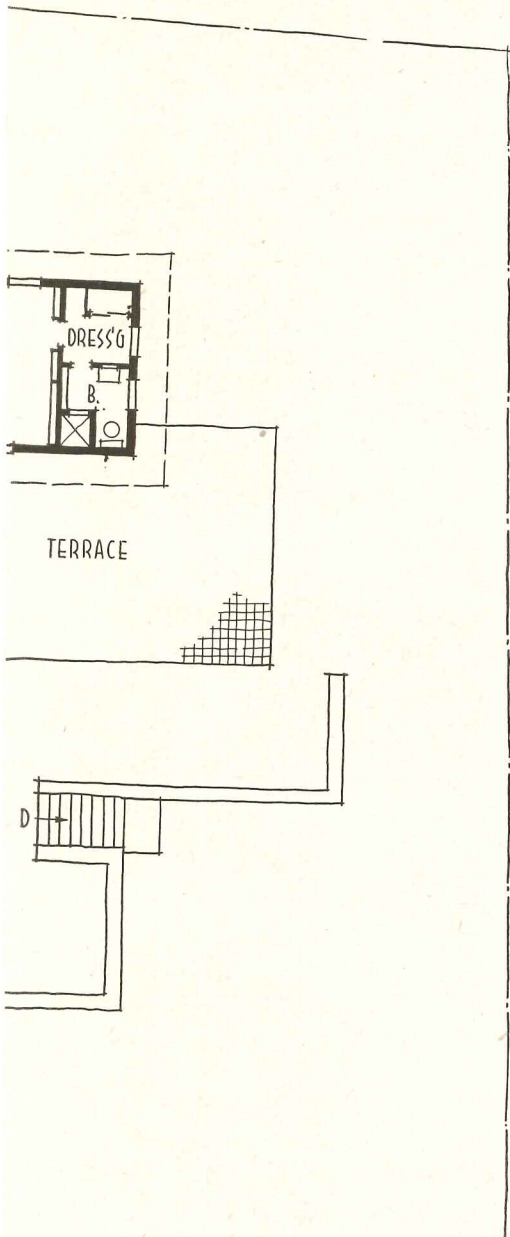

GREANEY HOUSE

Sliding glass doors in library (right) and elsewhere throughout house are hung with split Hong Kong reed. Floors are ohia, a Hawaiian hardwood. Below: another view of upper terrace, with living room at left and library at right

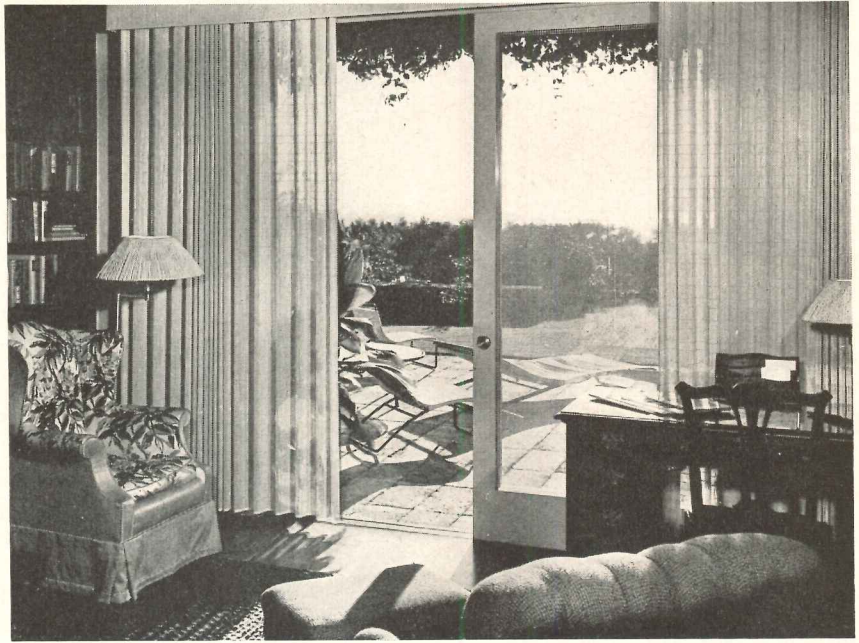

R. Wenkam Photos



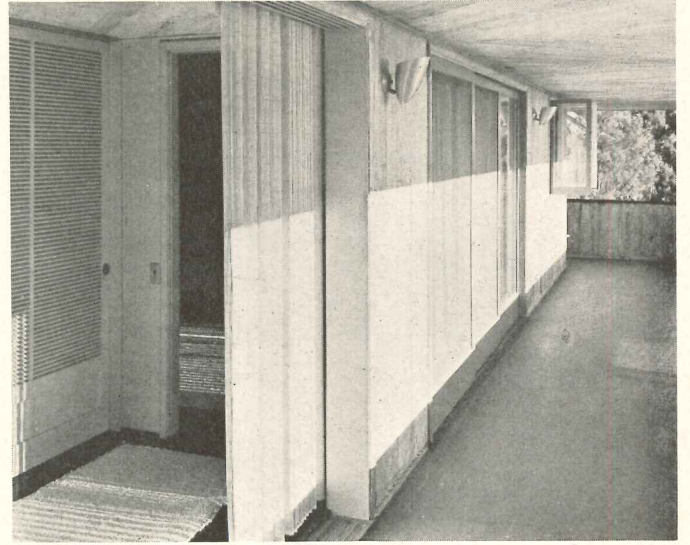

Above, left: stairs to main entrance. Below, left: living room from entrance hall; floor here is black rubber tile, fireplace is gray marble. Above and below, second floor hall has sliding doors to balcony. Note louvered sliding doors of center bedroom, which has only one exposure

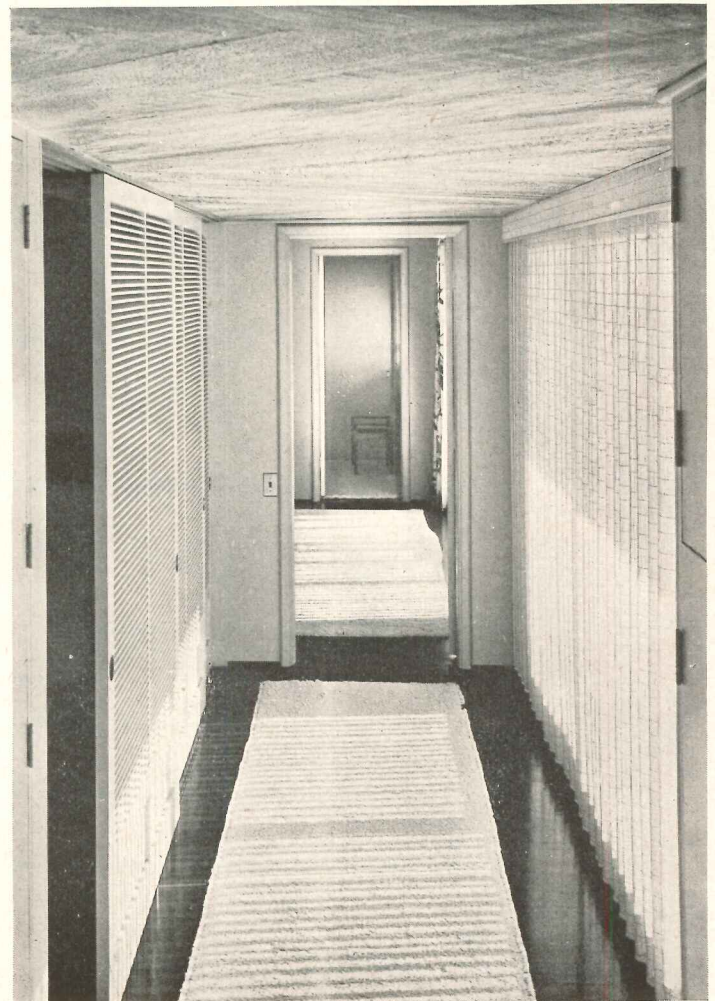



WINDOWLESS OFFICE FOR AN ENGINEER

P. L. Davidson Office Building, Greensboro, North Carolina

Charles C. Hartmann, Architect

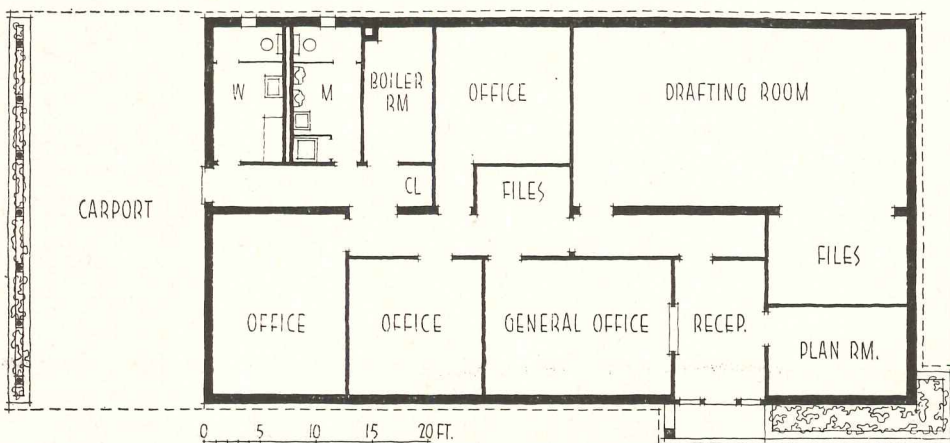

The omission of windows in this compact, trim office building serves both to reduce costs and lessen distraction from outside noise, and also permits flexibility in the placement of furniture along walls. Openings in toilets on plan are exhaust louvers



Joseph Molitor Photos

The only glazing used in the building is at the front door (left), where it serves to make the entrance more open and inviting. It is sheltered by a marquee and side louvers of redwood painted white

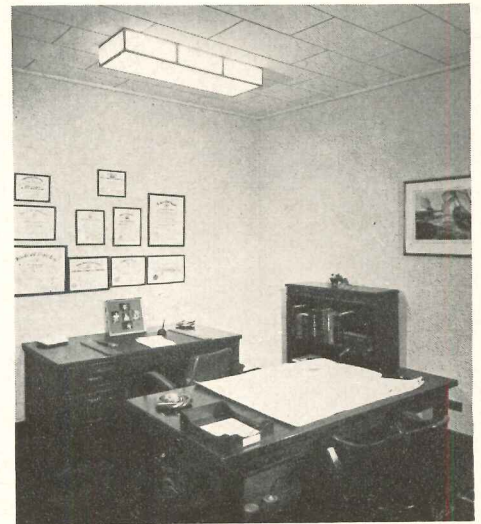

All interiors have year-round air conditioning, fluorescent lighting and acoustical tile ceilings. Partitions are painted slag block, doors and trim are metal. Above: private office. Left: drafting room



LONG AN ADVOCATE of windowless manufacturing areas, P. L. Davidson, a consulting engineer who specializes in the design of air conditioning systems, requested that his theory of a closed-in, artificially ventilated and lighted structure be applied in the design of a new branch office building for his firm in Greensboro.

The resulting windowless building has had favorable reaction from both personnel and visitors, and demonstrates a number of economies in construction and operation, a high degree of quietness and lack of outside distraction in the offices, and a considerable amount of flexibility in the placement of furniture and equipment. The office is constructed of concrete block, painted to match the brick veneer facade. The floor is a 2-in. rein-

forced concrete slab, laid over clay tiles set in alternate directions, and finished with rubber tile. A foamglass cold barrier goes around the slab perimeter. The use of modular planning and omission of windows in such a structure combined to give a relatively low first cost. Further savings were effected in the air conditioning and heating system — a simple one-zone system made of standard components, which uses city water for condensing purposes without evaporative condenser or cooling tower. Main ducts in furred-down corridor ceilings lead to ceiling diffusers in each room. Maintenance problems are simplified by the durable materials used, and by the lack of dust on the interior, so often introduced by open windows in standard buildings.



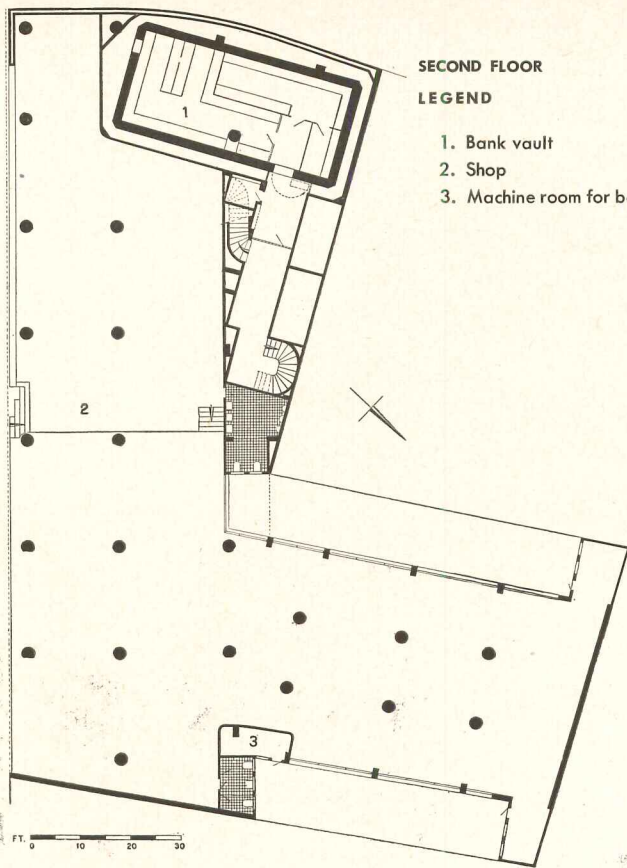

SECOND FLOOR
LEGEND

- 1. Bank vault
- 2. Shop
- 3. Machine room for bank's elevator



THIRD FLOOR
LEGEND

- 1. Building entrance
- 2. Electrical equipment
- 3. Public lobby
- 4. Tellers' cages
- 5. Stair to vaults
- 6. Banking area
- 7. Executives
- 8. Telephone switchboard
- 9. Accountants

LADEIRA PORTO GERAL

OFFICE BUILDING FOR SÃO PAULO, BRAZIL

Rino Levi, Architect

Roberto Cerqueira Cezar, Associate Architect

ALTHOUGH it stems from a concept similar to that of many recent structures, this glass-walled, fifteen-story office building in São Paulo introduces several well thought out planning factors which distinguish it from the average example.

The program requirements were familiar ones: a simple, easy-to-maintain building that would fill the maximum building envelope allowed by the city, and whose structure would give great flexibility in arrangement of office areas in the top eleven floors. These floors were to be subdivided and sold as cooperatives after completion of the building. A steep site which permitted street access to three floor levels led to the allocation of the two lowest for shops, and the combined third and fourth for the Paulista Bank of Commerce and the building lobby, each with main street entrances.

Unlike the more usual solution, glass curtain walls were used only on the sunless southern facades; walls to the sunny north are completely blank except for a section with wide overhangs in the ell. The fenestration of each floor is divided into three bands, with the lower one of fixed obscured glass protected by a wide interior baseboard which also serves as an electrical duct. The upper panes are clear and open independently for ventilation. Deft use of glass block gives privacy to the banking floor, yet preserves continuity of glazed facade.

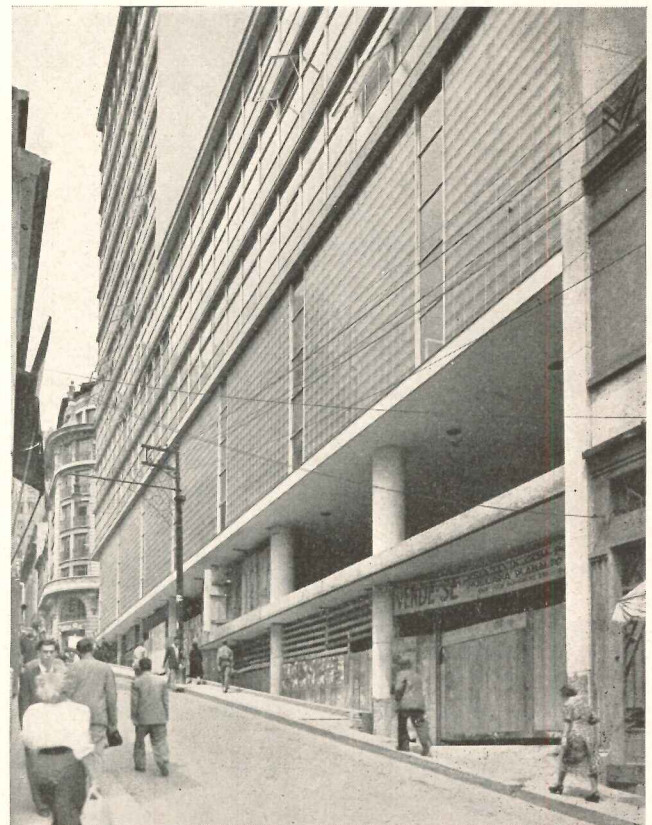

Peter Scheiler Photos



Peter Scheier Photos

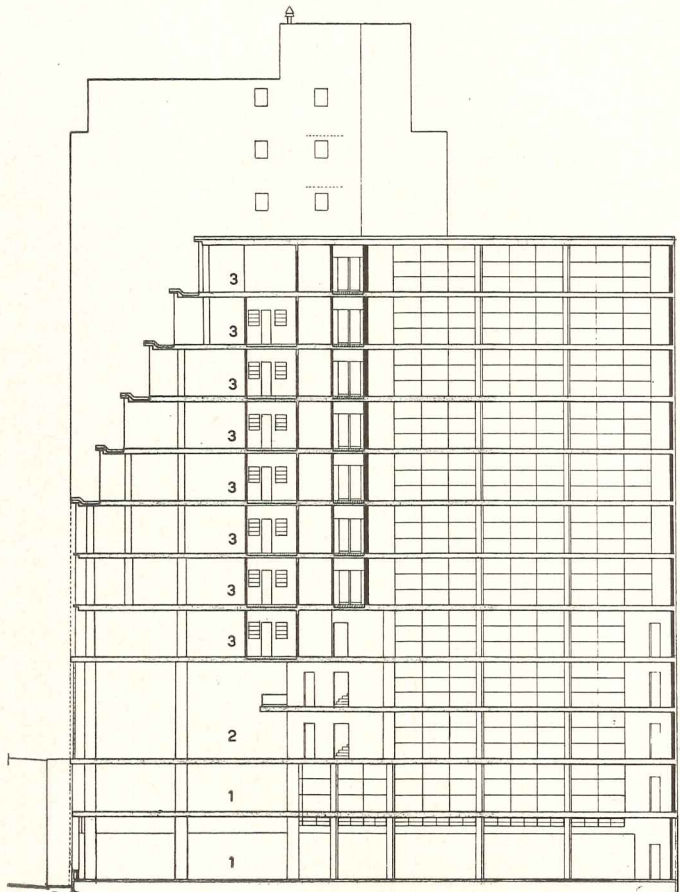
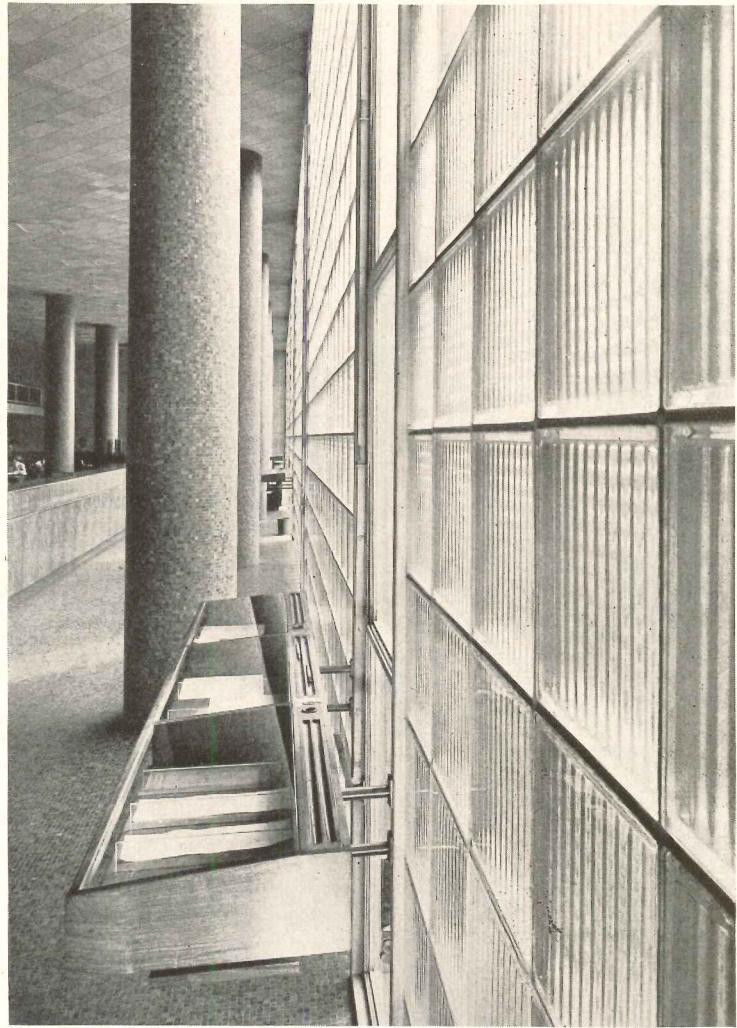

13TH TO 15TH FLOORS
LEGEND

- 1. Elevator hall
- 2. Office space—to be divided with partitions

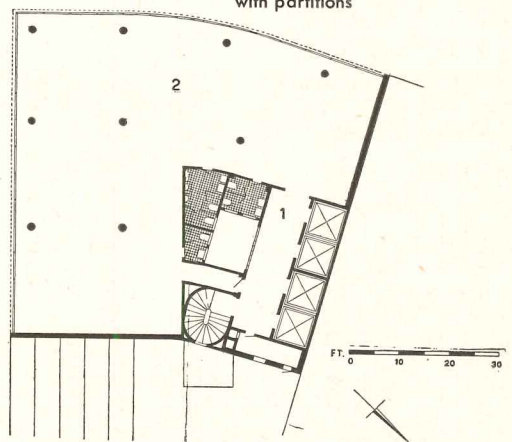

Setbacks of the building follow city regulations. The structure is of reinforced concrete, with brick used in dark areas of section shown left. Numbers indicate floor use: 1. shops; 2. bank; 3. offices. The three top floors follow plan shown above. Utilities are dispersed on each of lower floors to aid in office rearrangement

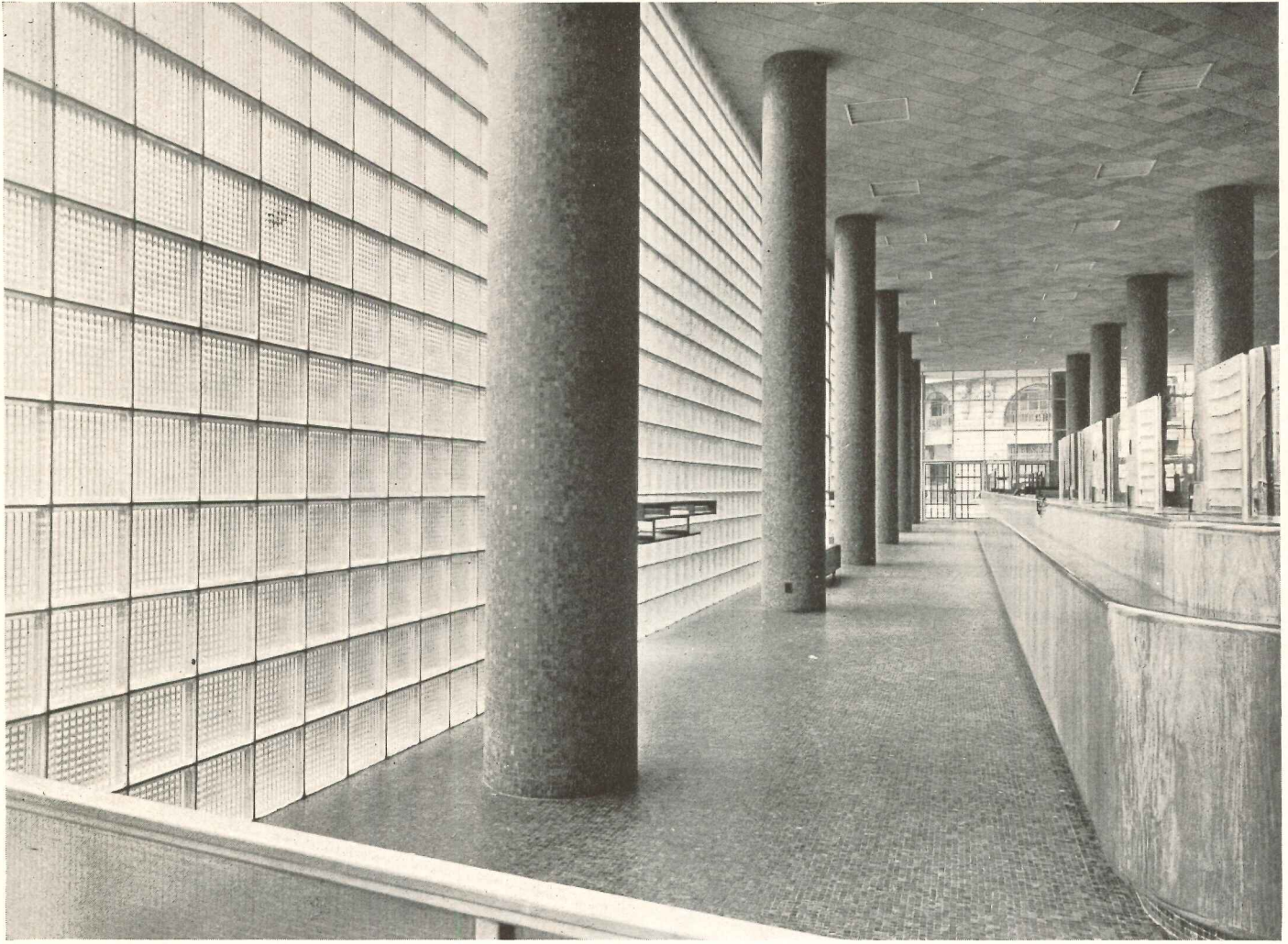

A slight extension of floor slabs on the exterior (above left) subtly emphasizes the building's structure without destroying the unity of design. The bank interior is richly finished in glass and ceramic mosaic on floors and columns; forthright screen of glass block with window insets gives privacy. Below right: mezzanine office corridor

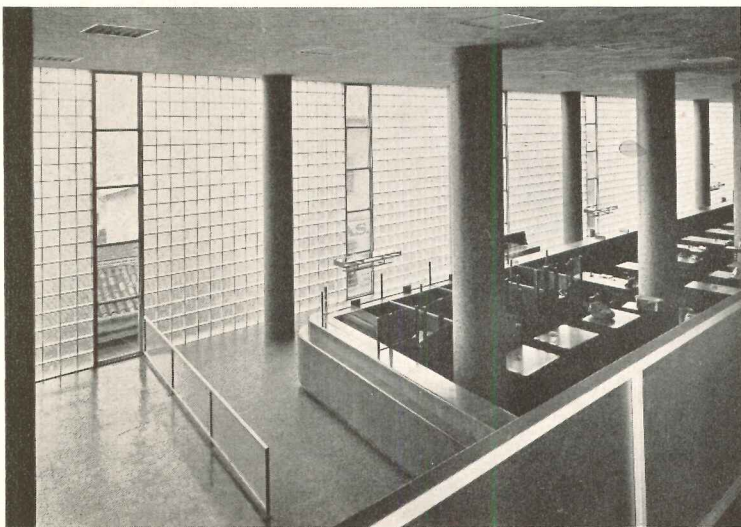

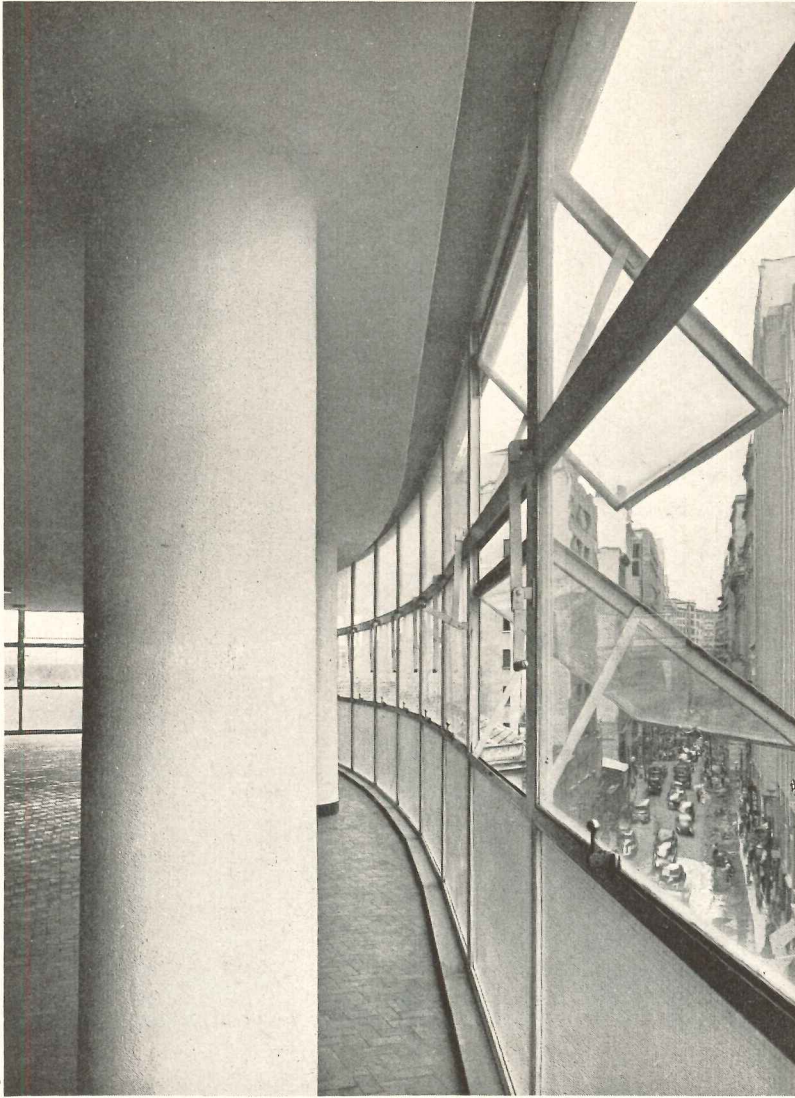

Peter Schieler Photos

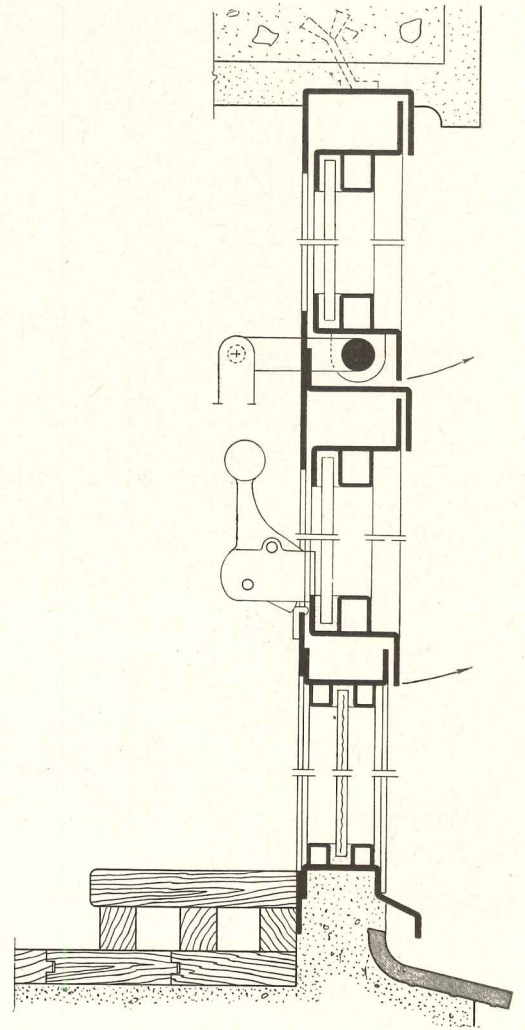

Above left: typical office floor. Above right: section through window wall; bottom pane is fixed obscured glass. Below: baseboard detail showing use as electrical duct

The eleven office floors are planned to be as open as possible, with utilities and toilets ranged along the blank walls to the north. A number of features were incorporated to facilitate the partitioning off and selling of individual office spaces. These include use of regular, short spaced divisions in the windows, and the lack of projecting beams on the ceilings. As it was assumed that most desks would be placed near the window walls, electrical and telephone conduits were run through the protective baseboard, and vertically through the hollow metal window columns. The curve of the front wall follows the bend of the street below. Ceramic tile sills below the windows also serve as finishing caps for the projecting edges of the floor slabs to the exterior. All the office floors are 3.15 meters (about 10 ft 3 in.) high. Flooring is wood parquet glued directly to the concrete slabs with a special mastic.

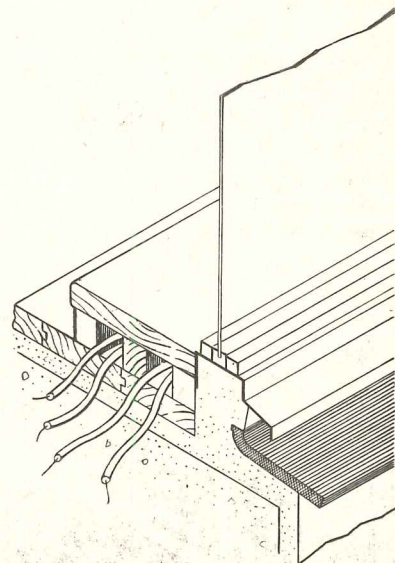

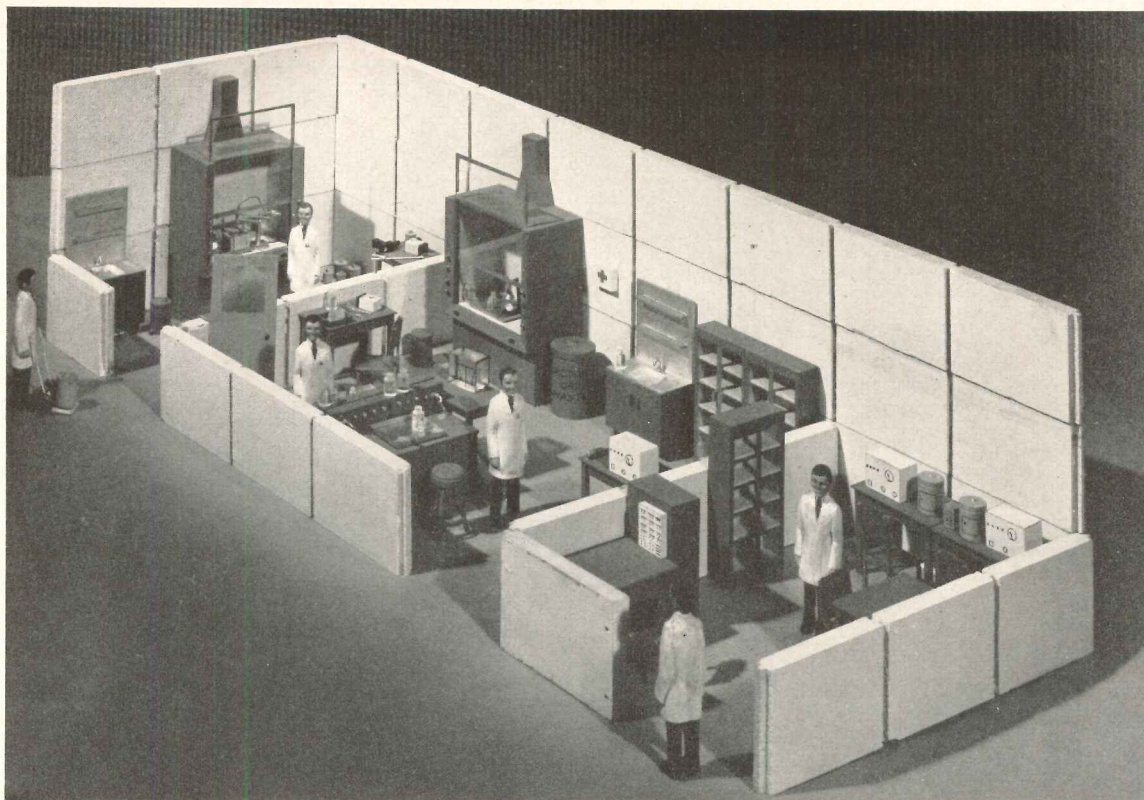

U. S. Atomic Energy Commission, Isotopes Division

Model of a three-room laboratory to handle beta- and gamma-emitting materials. Rooms are, from left to right: high level lab, low level lab, and counting room. This plan prevents random radiations from the high level lab from registering false "counts" on the counting room instruments and minimizes the possibility of contamination

ARCHITECTURAL PROBLEMS IN ATOMIC LABS

By A. D. Mackintosh, A.I.A.

The author is Superintendent of the Department of New Facilities Design and Construction in the Division of Engineering and Maintenance at Oak Ridge National Laboratory

PEACETIME APPLICATIONS OF ATOMIC energy are coming along much faster than many people expected. Probably the most rapid development of interest to the architect is the demand for radiochemical laboratories for industrial, agricultural and medical applications. Although there is a great deal of similarity between conventional chemical laboratories and those handling radioactive materials, the concepts of laboratory design, from site planning to selection of interior finishes, have to be revised in terms of protecting personnel and equipment from radioactivity: areas have to be shielded with lead and concrete, causing heavier and more concentrated floor loads than commonly encountered; some highly radioactive wastes must be buried; large quantities of air must be drawn in through fume hoods to be sure that radioactive particles are not inhaled; finish materials must be easily decontaminated if radioactive materials are spilled.

Location of Radiochemical Labs

For low level radioactive laboratories, site problems are minor; in fact, they are no different from those encountered in conventional chemical laboratories.

For high level work, the site selection and orientation of buildings is of great importance. Prevailing winds will govern locations of the hotter facilities and their

vent stacks. These stacks must be placed down-wind from the areas of lower activities, to prevent contamination of the areas of less than normal background.

Normal Activity (background) refers to the level of radiation ordinarily encoun-

Brookhaven National Laboratory Photo

Research is being conducted in "hot" labs throughout the country to discover how radioactivity* effects plant life

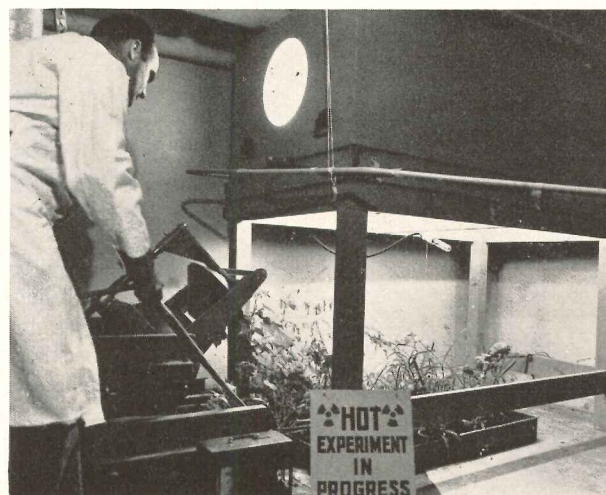

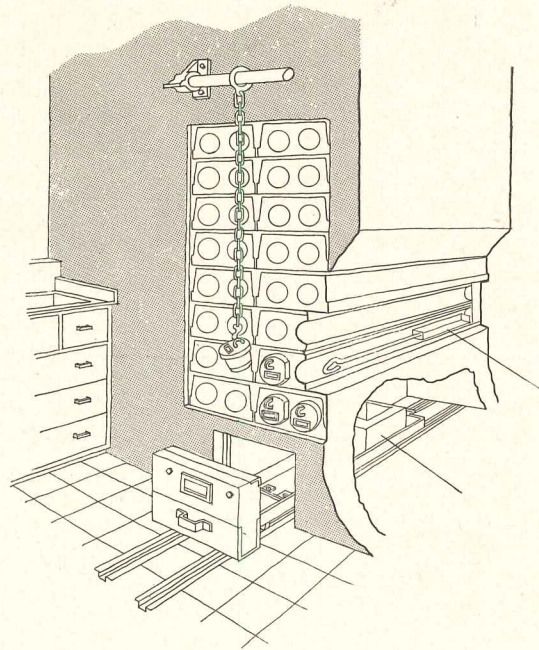
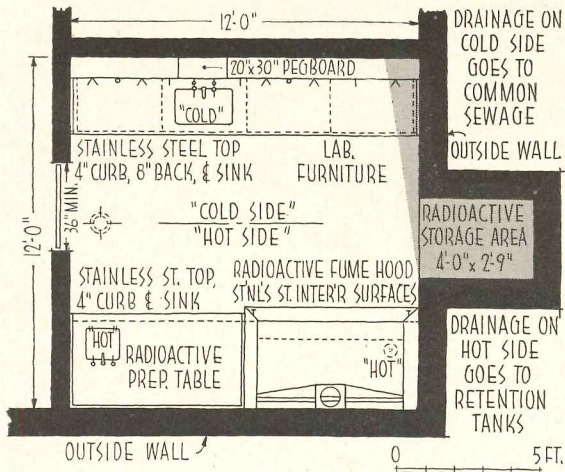

Above: plan of a typical, small radioisotope laboratory. Shading indicates the area covered by the perspective of the radioactive storage vault at right. A vertical section through the storage vault is shown across the page

Drawings Courtesy Kewaunee Mfg. Co.

tered from natural sources and from cosmic rays that reach the earth's surface. "Hot" (high level activity) is used when referring to anything contaminated by, or possessing properties of, radioactive materials. Likewise, "cold" is used when something is not "hot," and "warm" indicates a low level of activity. The word *activity* refers to various types of radiation.

Ground slope must be kept in mind in order that surface waters will not carry possible contamination, deposited by foot traffic, from the areas of higher activity to areas of lower activity. The water table flow should not be permitted to carry any possibly "warm" waste toward the water supply. These comments, of course, do not apply to work dealing with any of the lower levels of activity.

In all cases contamination must be localized. Potential spread of activity must be reduced by avoiding the placement of hot facilities directly adjacent to cold facilities whenever possible. "Hot" processing areas should be grouped together to simplify waste handling and to prevent accidental contamination of normally "cold" areas. It is not desirable practice to place a "hot" working unit in a "cold" laboratory.

Building Layout

When considering interior layout, a similar approach must be made with

regard to all levels of activity. As far as possible all areas should be kept free and open, through the use of movable partitions, so that complete flexibility is possible with regard to initial layout, future revisions, and later readjustments. A modular principle should be adopted in order that services may be placed as indicated later.

As in considering the site layout, one should first enter into the "cold" areas and then go progressively to the "warmer" ones.

Location of Lab Equipment

In considering the location of laboratory equipment within the building, the greatest flexibility is achieved when working on a modular basis. It has been found that bays about 24 ft sq lend themselves more readily to subdivisions which will be most useful. This 24 ft chief module is subdivided easily into a lesser module of 4 ft and combinations of it.

Washroom and locker facilities frequently need provision for both "warm" and "cold" use, when serving areas of highest activity. It is recommended by most health authorities that one area be provided for the storage of street clothing, and that the work clothes and coveralls which are used on the job be stored separately, in an adjacent area.

For the "low activity" level, housing work dealing with microcurie, amounts of radioactivity, it is found that very

little provision must be made for these laboratories beyond that normally used in any chemical laboratory, with the exception that hoods must be available to exhaust contaminated airborne particles.

For "middle activity" laboratories, some attention should be given to isolating areas where radioactivity is handled, mainly to provide for centralized waste gas and liquid handling facilities. Traffic patterns do not necessarily have to be rigidly controlled, although "built-in" means of preventing excessive and unnecessary traffic between "cold" and "hot" areas should be provided. It will be necessary now to introduce at least local shielding, which will be placed around the equipment within the hoods; this is usually an enclosure of lead bricks, 2 by 4 by 8 in. in size.

Laboratories in which work of a "high level" activity is carried on frequently need to be surrounded by massive shielding, in addition to the local shielding in the hoods. This general shielding may take the form of 1- or 2-ft thicknesses of solid concrete blocks; these units are usually 4 by 8 by 16 in., laid dry. The use of block is more desirable than a monolithic pour, for flexibility as well as for decontamination purposes. High activity areas must be isolated from areas of lower activity.

The areas for alpha particle operations need special attention paid to

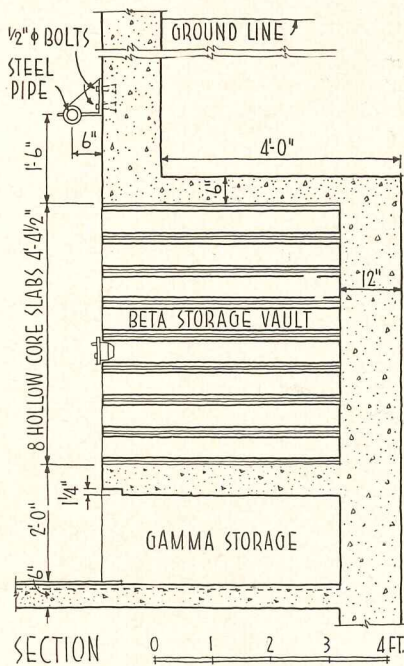

ventilation. Here dry boxes should be used wherever possible.

Radiation is the collective term for the rays and particles released by radioactive materials. When radiation passes through other materials, such as air, metal, or animal tissue, it has the property of electrifying the materials along its path. This process is called "ionization." In living tissues the ionizing effect of radiation causes the injury and death of cells. Ionizing radiation, if applied in large amounts, can do great harm to a plant, an animal, or a human being.

We are familiar with three common types of nuclear ionizing radiation: *alpha particles*, *beta particles*, and *gamma rays*. All three produce ionization when passing through other materials. Each **alpha particle** bears a positive electric charge and is the nucleus of an ordinary helium atom. **Beta particles** — which are electrons — are very much lighter and have a negative, rather than positive, charge. **Gamma radiation**, unlike alpha and beta particles, is radiant energy similar to light or X-rays. There is no associated particle and no electrical charge.

Dry Box is a term now applied to a completely enclosed work surface, which may or may not be vented by a small flow of air. Glove ports permit an operator to work through attached rubber gloves.

In alpha laboratories considerable danger lies in the possible contamination of personnel; the alpha particles

are not sufficiently potent to get through even a sheet of paper, but their great ionizing power can cause heavy damage inside the body. One must be extremely careful not to inhale or ingest this type of radiation, nor should one permit any of this material to pass through an incision or abrasion of the skin surface. Beta particles, although they do not penetrate deeply, can cause burns if in sufficient concentration. Gamma rays penetrate deeply into the body and can cause enough damage to make a person ill, or even cause death.

It can be seen that the "warmer" the use to which the facility is to be applied, the more careful must be the approach directed toward the equipment layout and design. Not only does the shielding for instrumentation become progressively more necessary, but also the traffic pattern, shielding, and biological protective measures become more important.

In placing equipment within the laboratories the factor of safety should always govern layout, in order not to bottle any personnel into an area from which no escape would be available in event of some disaster. Likewise, it should be kept in mind that persons entering or leaving the laboratory space should not have to make their way between rows of equipment where others are carrying on their operations.

Interior Finishes

Movable metal partitions with baked enamel finish make a very satisfactory enclosure.

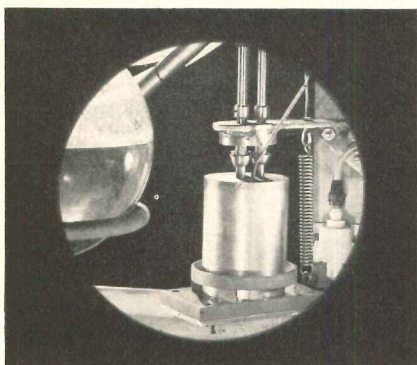

Experiments dealing with very high levels of radioactivity are conducted in steel "hot" cells behind 1-ft solid steel doors. The inside of the cell is painted with a strippable coating to facilitate decontamination. Remote controls are used and progress is observed through a periscope which gives a picture as shown above. The metallic vessel will be removed by remote control and placed in a special shipping shield

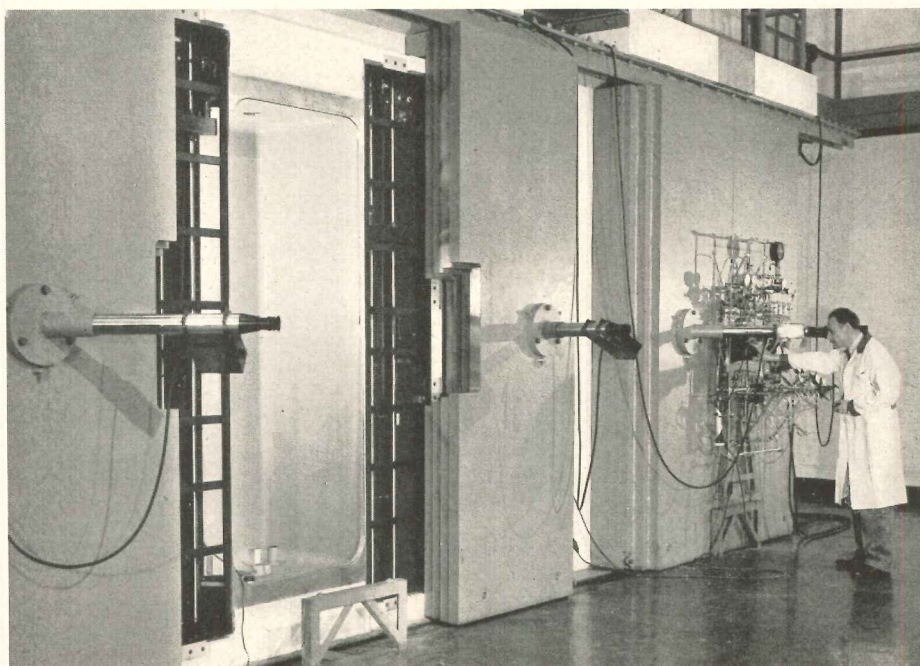

Brookhaven National Laboratory Photos

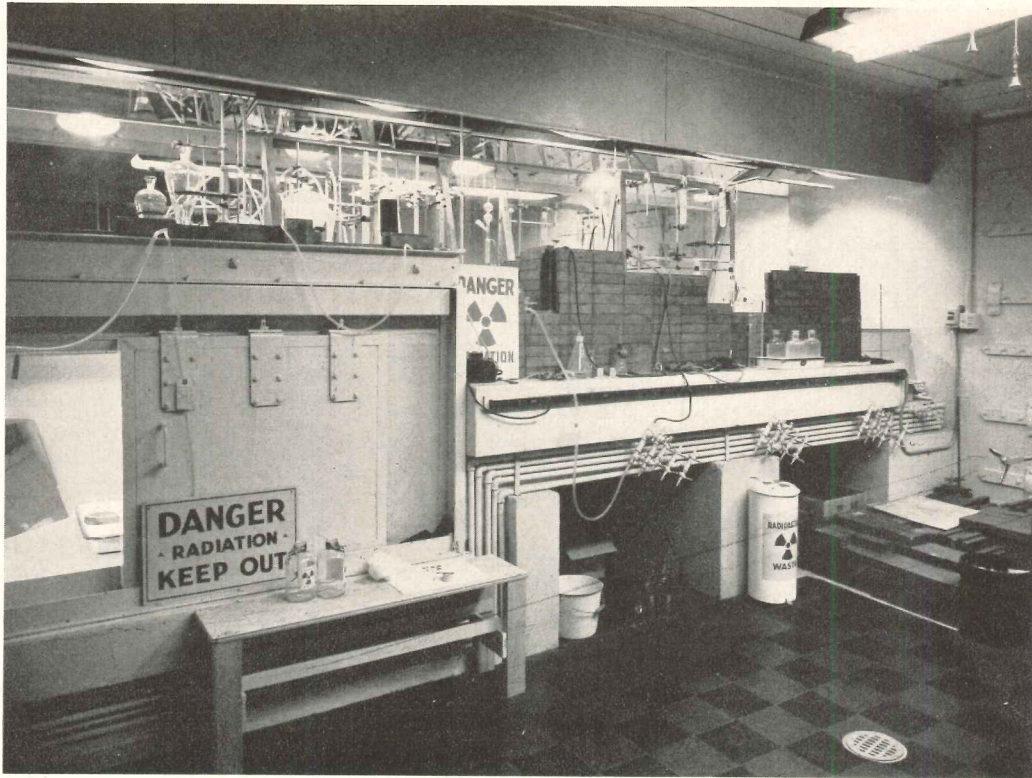

In this semi-hot laboratory at Brookhaven National Laboratory, two types of shielding are provided. The sliding lead door provides easy access in setting up an experiment. A barrier of lead bricks can be adjusted to suit the experiment. Mirrors along the back wall enable technicians to observe and operate equipment at a safe distance

Electronic counters are provided in "hot" labs to detect contamination and prevent it from being carried beyond lab exits

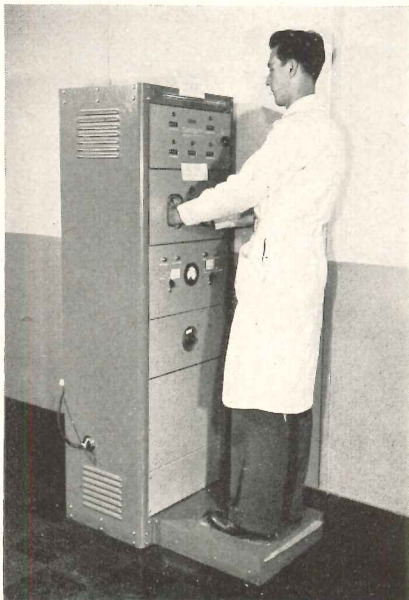

It is generally agreed that the floor covering should be of asphalt tile, or some similar material in small square sections. Although some people favor large, continuous sheets, small squares are more readily replaced when decontamination becomes necessary. Large sheets present fewer cracks through which contamination may find its way down to the concrete floor slab, but these large sheets are more difficult to cut and patch, while the cracks of the small squares may be further backed up by an undermat of paper with applied metallic foil.

Hung ceilings, with a uniform height throughout, also lend themselves to better flexibility with regard to partition location; at the same time they cover the maze of ductwork, electrical conduit, and other services.

Shielding

This is a problem the architect does not encounter in other work, with the exception of X-ray facilities for hospitals or doctors' offices. Safety is maintained by: (1) shielding, (2) distance of workers from the radioactive source and (3) time limits of exposure. Shielding is always important because the entire layout of facilities is dependent upon what materials are used, and how they are employed. There are, broadly, two approaches to shielding: "local" and "general." Local shielding means a restricted, local application of protection, confining one or two specific instru-

ments or vessels. General shielding embraces an entire cell, room, or area.

Cell is the term applied to an area, surrounded by adequate shielding, within which highly radioactive operations may be performed by remote control.

A rough approximation as to the shielding needed may be "guesstimated" by using tables and graphs (see the graph on page 164.) Permanent shielding (dead loads) and movable shielding (live loads) may be figured with fair precision. These load figures will then indicate the positive, or negative, desirability of single-story vs. multi-story layout of various units to be incorporated.

Some shielding will probably be needed for "hot" drain lines. Vertical risers must be protected as they pass rooms below. Tanks or other storage vessels must be enclosed.

Having been introduced to the basic problems which must be kept in mind during preliminary sketch stages, we should examine more carefully the steps to be followed for installing shielding. First, one must determine the most desirable technique to be used. For small operations which may be closely confined, or for protection of instruments, local shielding will probably be used.

For more extensive assemblies of equipment, or to enclose a large number of instruments, general shielding, surrounding an entire cell or room should

be used; the cells (and even the rooms) might need labyrinthal entrances to protect against direct passage of radiation through the hatch or doorway.

Depending on the thickness of shield required, storage vaults for "hot" materials can be enclosed either by local or general shielding, or even a combination of the two.

With regard to laboratory equipment, it is well to enclose as much alpha work as possible in dry boxes; this will save much cost when considering volumes of air needed for ventilation. Beta and gamma work, which is not so "hot" as to require remote control in a cell, will be done inside ventilating hoods; a barrier of lead may be needed in the hood, behind which the work will be carried on.

Floor and ceiling slabs must be checked to see that areas below and above receive protection. Adding to the thickness of concrete slabs is the most economical way to provide this general shielding. It may be found that it is more economical to relocate certain facilities on grade because of excessive loads, especially when the movement of portable shielding is added into calculations.

Determination of Specific Shielding Needs

Let us now examine the method of determining "what" thickness is required, and of "which" material. The scientist will determine for us the level of radioactivity with which we shall be dealing.

Alpha Protection. The equivalent thickness of a sheet of writing paper will usually provide sufficient mass shielding to block the particles.

Where the dry box does not permit the operator sufficient flexibility of movement for alpha work, it is sometimes necessary to use hoods.

Beta and Gamma Protection. In providing for beta or gamma work, hoods will normally enclose the operations. The beta radiations usually may be reduced by using a transparent lucite shield of about $\frac{1}{4}$ in. thickness. Gamma rays, however, require far more mass to stop them; lead bricks are stacked between the source and the operator, with control of operations being conducted by means of bent handling devices, around or over the lead, the work being viewed by mirrors.

Local shielding is used to protect individual units within cells and rooms, or instruments outside. This is usually of lead, but might also be of iron.

General shielding is frequently placed around a laboratory in order to protect persons and instruments in adjacent areas. This is ordinarily of concrete; solid concrete blocks 4 by 8 by 16 in. give better flexibility for later revision than is permitted by the use of poured walls. Likewise, the blocks may be more readily removed when decontamination is necessary. Most shields are built to provide a radiation level of about 6.5 mr (milliroentgens) per hr.

If the level of activity is as high as one curie, or greater, the work is ordinarily carried on within a "cell," by remote control. The cell walls may be poured with a multitude of sleeves, or laid up of solid concrete block. As in hood work, the process system is vented.

Curie: an amount of radioactive material in which 37 billion nuclear disintegrations per second occur. This is approximately the number of disintegrations that takes place each second in one gram of radium. A millicurie is one-thousandth of this amount, and a microcurie is one millionth of this amount.

Roentgen: measures the amount of energy absorbed by material receiving radiation. It is a unit based on the amount of X-rays or gamma rays required to produce ions equivalent to one electrostatic unit of charge in one cubic centimeter of air under standard conditions.

Waste Disposal

Waste disposal, with regard to vapors

and liquids, varies considerably depending on the type of site which is being developed, and the level of activity. Waste gases from chemical experiments will usually originate in hoods, from which three types of exhaust are possible:

Normal Hood Air taken in through the hood door. In low activity areas, need for filtration of this air is questionable. Where only a few millicuries of activity are handled, filtration is unnecessary. However, in densely populated areas, filters may be desirable to provide "legal insurance." Gases from hoods using "tracer" quantities of activity (small amount of radioactive material added to a larger quantity of inert material of the same nature) can be discharged to the atmosphere using standard precautions for laboratory hood exhaust.

Equipment Ventilation Air. Each hood can be provided with a small ($\frac{1}{2}$ to $\frac{3}{4}$ in.) low vacuum line through which vent gases from sealed process units can be discharged. For higher levels of work, this line provides a small volume collection system for all corrosive and possibly radioactive gases. If cleaning is required, only a small installation for all hoods in an entire lab building is then needed. The system should be constructed of stainless steel for corrosion resistance.

Laboratory High Vacuum. Discharge of gases from this system can be accomplished in a manner similar to the

Brookhaven National Laboratory Photo

Very "hot" materials are stored beneath the floor in special shielded containers at one of the national laboratories. Other materials not quite as "hot" are placed in locker compartments

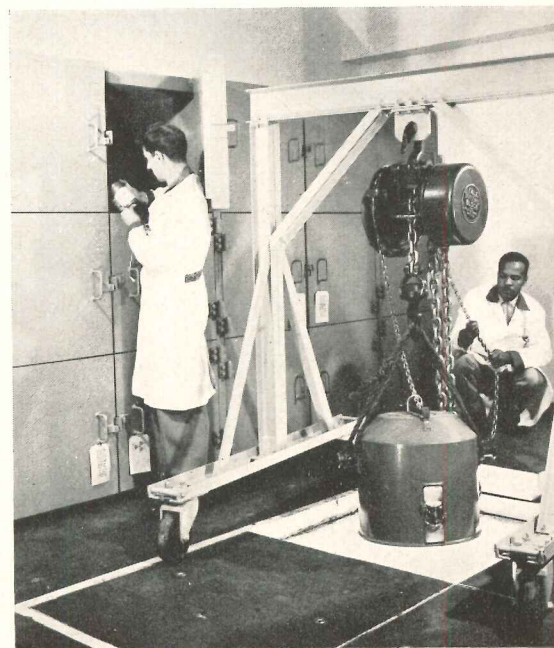

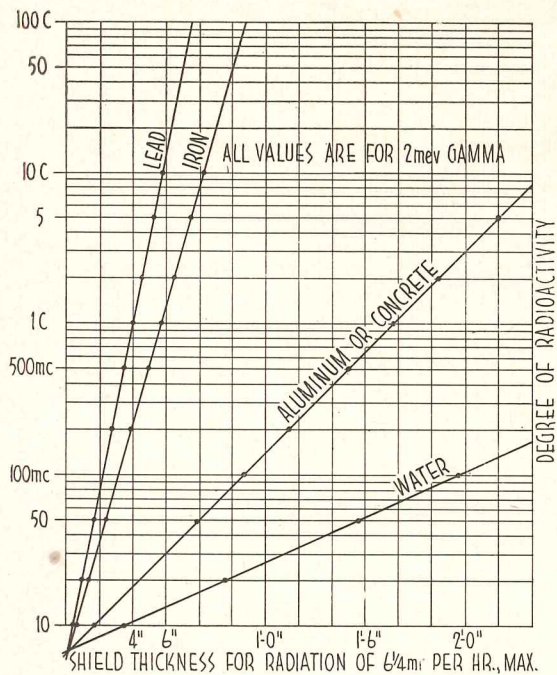

Graph gives thicknesses of shielding for various materials to reduce gamma radiation having a potential of 2 million electron volts (mev) and a given intensity in curies (vertical scale, mc is millicuries) to a recommended safe level for personnel

parts: one "cold," and one "warm." The warm process waste would then need to be retained in a bottle or tank until analysis would indicate what manner of disposal would be considered necessary.

"Hot" Drain Line. Should always be of stainless steel. There should be no traps in these lines, because of the build-up of "activity" which would take place in any traps. Therefore, all such drains should be located within hoods where they will be adequately vented. The hot drain lines will lead to a hot storage tank.

Solid Waste

Solids which become contaminated with radioactivity must either be decontaminated chemically, or collected and disposed of in a safe burial ground. Non-combustibles which cannot be decontaminated are usually buried. Combustibles can be burned provided a safe incinerator is available.

Laboratory glassware used with radioactive solutions can be washed in a normal manner, provided the waste solutions are sent to the "hot" drain system and are properly monitored before either collection or disposal.

Ventilation Supply

Heating and ventilating of the areas for radiochemical work possesses certain unique characteristics. The major portion of air to be introduced is fed directly into the laboratories. The travel of air from one space to another should always be calculated so that it moves from "cooler" areas, through "warmer" ones to the "hot" facilities.

Supplementary air to the laboratories is usually introduced first to the office areas, from which it passes into the hallways, and then on into the laboratories through the louvered slots in doors. The laboratory must have a slightly negative pressure differential in order to guarantee air movement in that direction.

No recirculation of air in occupied areas is possible, except in separate administrative and service parts of the building. Hence, hood design is most important in order to effect greatest reduction to air demand, while remaining within safe limits.

Air conditioning will be mandatory only in certain special areas where process and instrumentation considerations govern. In some climates it is needed to help prevent workers from picking up radioactivity.

low vacuum system with manner of cleaning to be determined by the hazard involved.

Liquid Disposal

There are usually three main liquid disposal systems:

Normal Sanitary System. Waste from washrooms and kitchen facilities. The treatment will be quite traditional, except for hospitals using "tracers" in

patients, where careful analyses must be made of waste material.

Process Waste. Essentially a normal, neutralized, chemical waste system. In the very low level tracer work, there will be no need to consider this to be more of a problem than the chemical waste from a normal laboratory. In dealing with radiochemicals in the higher levels of activities, however, process waste might be subdivided into two



A technician stands behind a barrier and uses a long pole to lower a sample by remote control. The health physicist (right) uses a survey meter to make sure that the technician is not exposed to dangerous amounts of radiation

CHECK LIST

TO SAVE METALS IN HOUSES

By Leonard G. Haeger, A.I.A.

Building Materials Expediter,

National Association of Home Builders

The NPA method of controlling housing construction through a limitation on the delivery and use of controlled materials (steel, copper and aluminum) on a functional basis, rather than on a dollar or area limitation, marks a milestone in the writing of regulations by the Federal Government. Since the weights of these materials allowed per structure is limited, it is squarely up to the designer and his own ingenuity to stretch these amounts of materials to the utmost; at the same time, the Federal Government's objective of conservation is accomplished best.

While many of the methods of saving metals are well known, designers have made little effort to follow them in the face of liberal supplies of metals.

Here are nineteen practical methods to save metals which should be investigated by every architect and designer of residences during the planning stages.

√ **1. Steel in footings can be reduced and sometimes eliminated.** Local practice and regulations frequently require reinforcing steel in footings of small structures, regardless of soil conditions. Engineering evaluation will indicate that in many cases reinforcing of footings can be reduced considerably and frequently eliminated.

√ **2. Reinforcing mesh may not be necessary in slabs.** Local prejudices frequently require reinforcing mesh to be placed in the slabs of small houses built on the grade. Analysis will indicate that in most cases slabs can be installed without it. Perimeter insulation of the slabs and provisions to insure against capillarity are usually more important than reinforcing.

√ **3. Wood girders can replace structural steel framing.** For many years completely adequate small structures have been built without structural steel beams. As a matter of fact, the use of wood girders in basement framing in place of steel girders will tend to equalize shrinkage in those jobs in which no wood plate is used over the beam. A wood plate installed on the masonry exterior foundation wall without a similar wood plate on the steel girder is definitely poor practice.

√ **4. Reinforced masonry lintels easily supplant structural steel angles, used as lintels in masonry construction.** In most residences, two ¼ in. round reinforcing rods will be sufficient.

√ **5. Gutters and downspouts can be eliminated.** With the NPA prohibiting the use of copper for gutters and downspouts, many designers will turn towards galvanized sheet metal and aluminum. Since so many gutters are installed incorrectly, causing clogging with leaves, debris and ice and snow, the architect should consider the complete elimination of gutters and the installation of a wider hanging eave. In residential structures this practice is completely consistent with the trend toward simple, modern design. Unsightly soiling of the wall from the splash of the drip can be prevented by the use of gravel and by planting splash areas under the eaves.

√ **6. Additional insulation will keep in heat and thus save metal in the heating system.** While our designers of houses in recent years have tended towards the greater use of insulation, additional insulation will further reduce the heat loss and may make possible the use of smaller furnaces, along with less duct work or pipe.

√ **7. Crawl space heating eliminates metal ducts.** The use of the crawl space in the winter as a plenum chamber for the heating system has been successfully demonstrated. Where this type of heating system is feasible, almost all duct work can be eliminated.

√ **8. Warm air perimeter heating systems operate successfully with non-metallic ducts.** There have been many installations of perimeter heating in which

(Continued on page 166)

CHECK LIST TO SAVE METALS IN HOUSES

warm air is carried to and around the perimeter of the structure in glazed ceramic pipe, glazed tile, fiber tubing and similar products. The use of non-metallic duct work in these systems eliminates most of the metal.

✓ **9. Metallic flashing can be eliminated.** Simple, straight-forward design of roofs can eliminate the need for flashing of valleys, hips and "trick" intersections. Obviously, much copper flashing can be eliminated by thoughtful design. Where valley flashing is absolutely required, self-flashing of roofing can be employed. The use of copper flashing of extremely long life in conjunction with roofing materials of much shorter life expectancy is wasteful practice.

✓ **10. Intelligent planning can reduce plumbing.** The opportunities of planning for the conservation of materials should be first on the list of every designer. In the case of plumbing in the small house, these are: the concentration of utilities, back to back plumbing, and the location of the plumbing on the side of the house nearest the utilities (when the utilities occur in the street, place the kitchen and bathrooms on the street side of the house).

✓ **11. Low voltage wiring uses less copper.** It is now generally believed that low voltage wiring saves small amounts of copper when compared to conventional wiring systems. For large houses, low voltage wiring systems definitely provide the opportunity for more utilities and switches than would be possible with the houses conventionally wired.

✓ **12. The National Electric Code describes and accepts the use of non-metallic-covered wiring systems.** The steel used in armoring the cable, and the steel used in outlet and switch boxes, can be conserved. Switches and outlets in kitchens and bathrooms can be grounded for safety without grounding the entire system.

✓ **13. Research back of the National Plumbing Code indicates that a high degree of safety can be obtained with much less piping.** The new National Plumbing Code, the result of research at the National Bureau of Standards and other laboratories, and written in cooperation with all elements of the plumbing industry, is a potent means of conservation. Recent studies by the Housing and Home Finance Agency indicate that the use of the plumbing code, with its simplified installation of drainage and vent piping, would conserve in terms of 100,000 small homes as much

as 21,800 tons of cast iron and 3,200 tons of steel. These savings would be possible without in any way reducing the health and sanitation requirements.

✓ **14. Non-metallic sewers have worked satisfactorily for many years.** The use of clay pipe, fiber pipe and cement asbestos pipe for sewerage systems outside of the house is a well established practice in many areas, yet many areas of this country require cast iron.

✓ **15. Better nailing means fewer nails.** While the average house requires something like 400 lb of nails, it is believed that considerable quantities of nails could be saved each year by a simple understanding of good practice in frame construction. Frequently more nails are used than are needed and, more frequently, nailing is done incorrectly. A splendid reference on house nailing is "The Technique of Nailing," published by the Housing and Home Finance Agency and available from the Government Printing Office for 20 cents.

✓ **16. Plastic pipe and tubing have potentialities.** The tremendous progress made by the plastics industry since World War II is currently being reflected in the limited use of plastic tubing in housing in some areas for water and gas service. While not all of the plastic tubings obtainable have been completely tested, some already have good installation records.

✓ **17. Septic tanks need not be made of steel.** Much steel can be conserved by the use of compartmented septic tanks made of large sections of clay pipe. The United States Public Health Service studies indicate that successful septic tanks can be made out of materials other than steel and reinforced concrete.

✓ **18. Temporary plastic coatings on bathtubs save metal by preventing damage to them during house construction.** Coatings, applied at the shop before the bathtub is taken to the job, will greatly lessen loss from chipping of the surface.

✓ **19. Modular Coordination means less waste of materials.** Much has been written about modular coordination, and it still is one of the most promising approaches to substantial conservation. Through the standardization of dimensions of building material and equipment on a uniform basis of measurement, small savings can be achieved in each of a multitude of items with the complete house a conservation project throughout.

PRODUCTS for Better Building

Right: lighting levels in various parts of room as afforded by new system in typical installation. Below, top: lighting fixture comes compactly packaged. Center: lighting fixture installed, showing central channel and extensions connected by wires enclosed in tubing. Bottom: installation with baffles partly hung in place beneath lamps at back

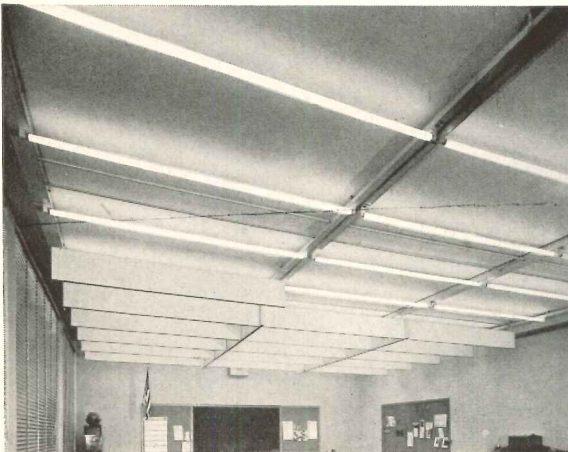
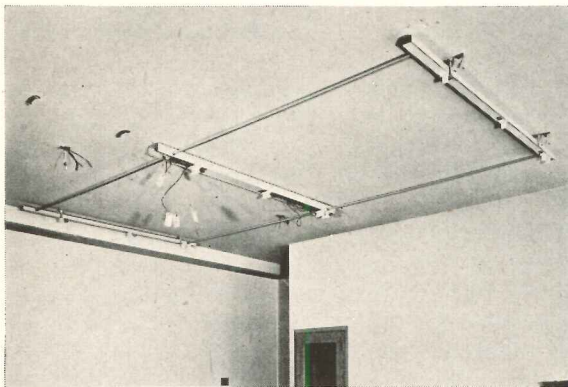
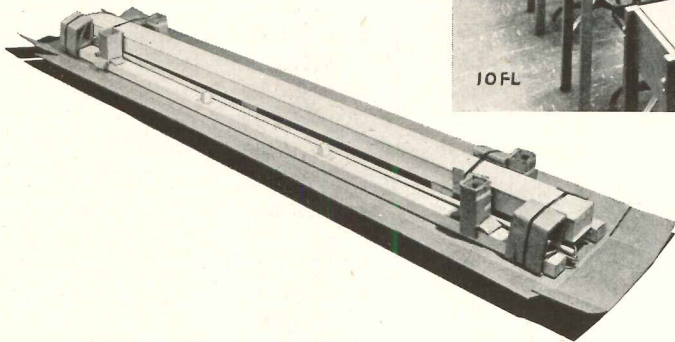
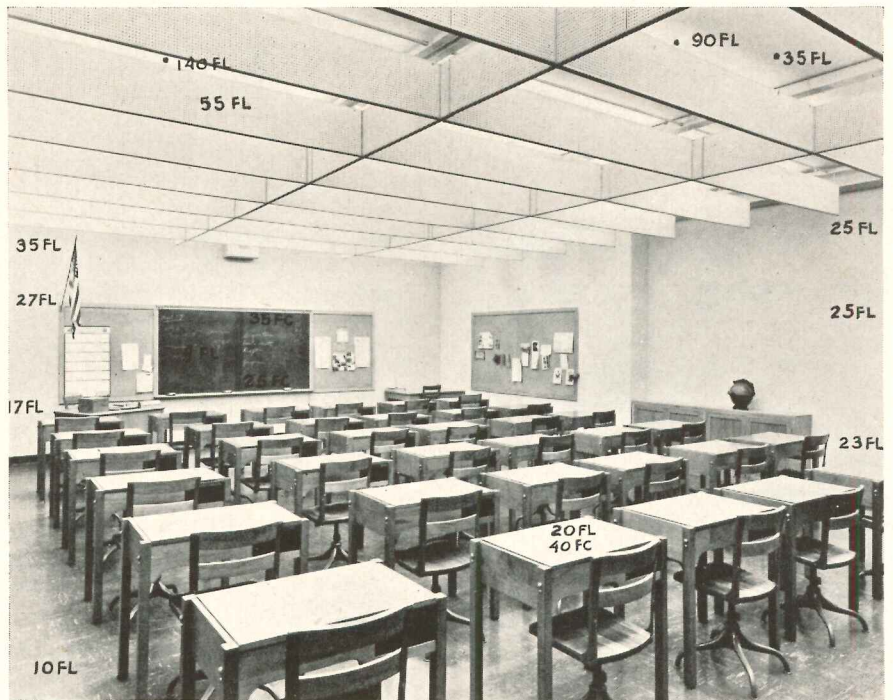

Acoustical Ceiling Lighting System

Reported to provide both effective lighting and acoustical control in a single combined installation, a new ceiling system introduced by Curtis Lighting, Inc., employs luminaires consisting of three parallel sections of channel, interconnected by four lengths of $\frac{1}{2}$ in. tubing and supporting baffles for light and sound control. The central channel, which encloses the ballasts, is larger than the others, which are extensions from it connected by wiring enclosed in the tubing. This method of installation, besides providing for more effective illumination, is said to lower costs of electrical contracting work. The tubing sections require no threading and are secured by a simple turn of the fittings at the channel sides. They establish lampholder spacing, provide closed passage for wiring and unify the assembly for electrical grounding.

The sound-and-light-conditioning baffles are hooked onto hangers which are in turn connected to the channel sections by hooks. These baffles consist of 1 by 8 ft metal frames, into which are fitted acoustical panels, the exposed surfaces of which are perforated. The panels are $\frac{5}{8}$ in. thick and are placed back to back in the frames. Curtis Lighting, Inc., 6135 W. 65th St., Chicago, Ill.

(Continued on page 230)

LITERATURE FOR THE OFFICE

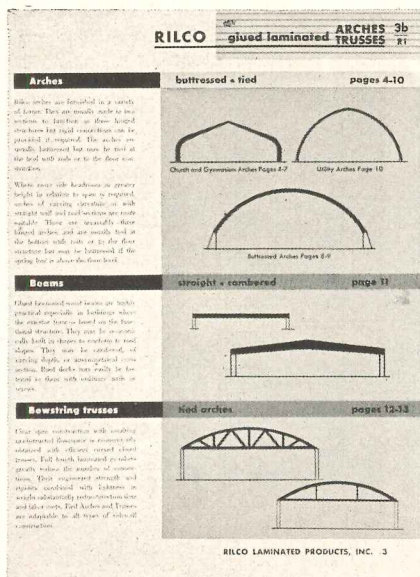

Booklet shows use of many laminated forms

Laminated Arches

Rilco Glued Laminated Wood Arches, Beams and Trusses. Diagrams and photographs of construction details and typical installations illustrate this catalog of the manufacturer's line of laminated wood structural members. Included are descriptions of church and gymnasium arches, utility arches, buttressed arches, straight and cambered beams, bowstring trusses and tied arches. Dimension tables, details and information concerning determination of design adaption, and complete specifications are given, together with a full description of advantages of the members in design and construction. 15 pp., illus. Rilco Laminated Products, Inc., 1670 First National Bank Bldg., St. Paul 1, Minn.*

Face Brick

Stone Creek - Ava Face Brick. In this catalog of the manufacturer's line of face brick shades and textures, 21 different varieties are illustrated in full color reproductions. In addition, photographs of more than 50 buildings, including houses, which employ face brick are included to illustrate the

*Other product information in Sweet's File, 1951.

adaptability of the product to a variety of construction types. Examples of exposed masonry interior walls and construction details concerning bonds and mortars have also been incorporated into the booklet. 27 pp., illus. Stone Creek Brick Co., Stone Creek, Ohio.

Heating for Small Houses

Heating the Home. A revision of a circular by the same title issued by the University of Illinois in 1945, this pamphlet incorporates advances made in heating systems for small houses in the last six years. Prominent attention is given to heating basementless houses, particularly with the forced hot-water and forced warm-air systems. Authors are Professors S. Konzo, W. S. Harris, and R. W. Roose, members of the staff of the Engineering Experiment Station at the University. 12 pp., illus. Price, 10 cents. Small Homes Council, University of Illinois, Urbana, Ill.

Floor Treatment and Maintenance

Floor Facts. This booklet contains specifications for the manufacturer's line for use in original treatment and maintenance of floors — asphalt tile, rubber tile, linoleum, cork, terrazzo, wood, cement, marble and tile. In each case there are recommendations for cleaning, conditioning and finishing, and cautions to be observed for the particular kind of floor. 17 pp., illus. Vestal, Inc., 4963 Manchester Ave., St. Louis 10, Mo.

Cooling—Heating Systems

Application Engineering Data on G-E Personal Weather Control Systems. This pamphlet provides extensive technical information on the design of weather control systems and on the application of room air-conditioning units and other equipment to such systems. There are notes on the selection of a system, the application of this particular system to various types of buildings (with examples cited), system design considerations, and application data. 60 pp., illus. Price, 50 cents. Air Conditioning Division, General Electric, Bloomfield, N. J.*

New Government Documents

• *Simplified Practice Recommendation R243-51, Unorificed Radiator Supply Valves.* Proposed by the Steam Heating Equipment Manufacturers Association, the recommendation lists the sizes, patterns and capacities of unorificed radiator supply valves for use in two-pipe, low pressure steam heating systems that currently are in use and demand, and are regarded as affording an adequate selection for ordinary use and stock. General provisions are included as related and useful information concerning these valves. Price, 5 cents.

• *Simplified Practice Recommendation R244-51, Low Pressure Thermostatic Radiator Traps and Float-and-Thermostatic Traps.* Also relating to steam heating systems that currently are in use and demand, and proposed, again, by the Steam Heating Equipment Manufacturers Association, this recommendation lists sizes, patterns and capacities of the specified traps. Price, 5 cents.

• *Fixture Unit Ratings as Used in Plumbing System Design: Housing Research Paper No. 15.* By Herbert N. Eaton and John L. French. A comprehensive treatment of the subject which briefly but adequately deals with the material outlined in the authors' statement of purposes. These are (1) to relate briefly the derivation of the terms "fixture unit" and "fixture unit rating;" (2) to indicate in simplified form the mathematics of the probability relations associated with them; and (3) to clarify the significance and use of these terms in the determination of design flow rates for water supply systems in buildings containing large numbers of fixtures. According to the authors, the procedures indicated in the booklet can also be utilized to determine drainage flow rates, provided the proper unit ratings are assigned to the fixtures. Price, 15 cents.

All three publications available from Superintendent of Documents, Government Printing Office, Washington, D. C.

(Continued on page 260)

For the
Dun
&
Bradstreet
Building

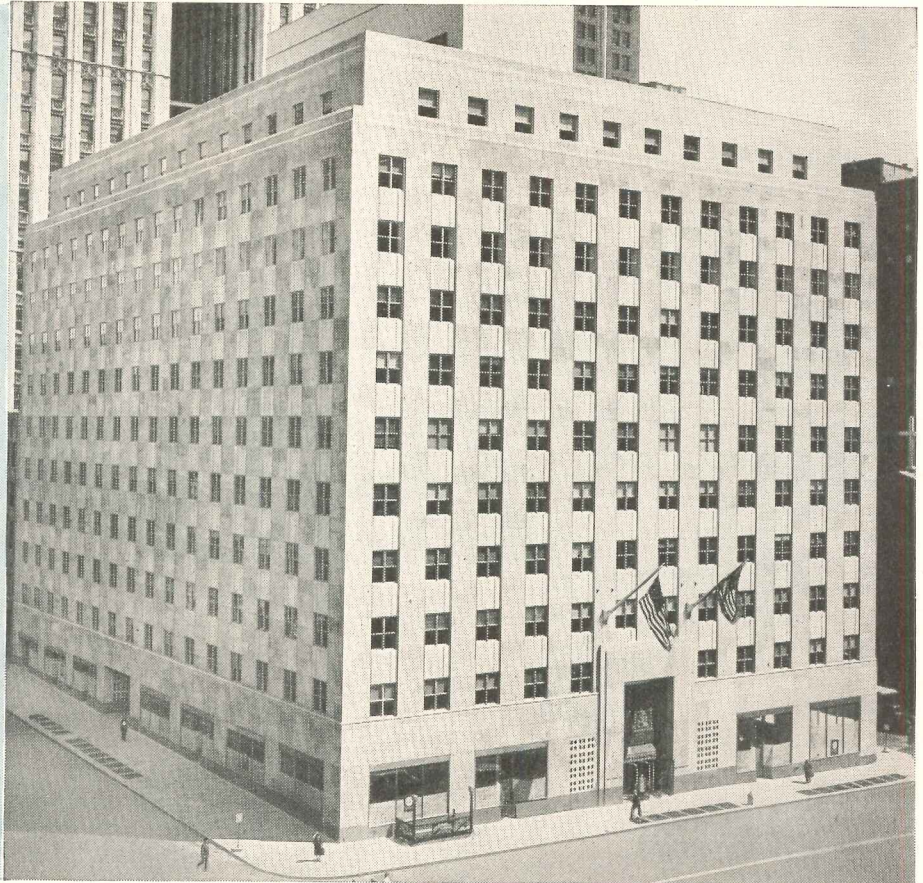

Dun & Bradstreet Building, New York City Architect: Reinhard, Hofmeister & Walquist Contractor: George Fuller Company

Adlake aluminum windows

The woven-pile weather stripping and exclusive patented serrated guides that are a vital part of ADLAKE Aluminum Windows mean complete weather protection for Dun & Bradstreet's new New York offices. Wind, rain and cold will not penetrate their positive weather seal.

What's more, these ADLAKE Aluminum Windows will ultimately pay for themselves by eliminating

all maintenance costs except routine washing. They'll never warp, rot, rattle, stick or swell, and they will keep their weather seal, beauty and finger-tip operation for the life of the building!

Let us show you how ADLAKE Aluminum Windows will guarantee continuing satisfaction to your clients, while they save them money! ADLAKE Representatives are in all principal cities.

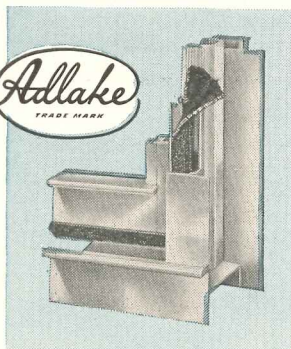

every Adlake window gives you these "plus" Features:

- Woven-pile Weather Stripping and Exclusive Patented Serrated Guides
- Minimum Air Infiltration
- Finger-tip Control
- No Painting or Maintenance
- No Warp, Rot, Rattle, Stick or Swell



THE **Adams & Westlake** COMPANY
Established 1857 ELKHART, INDIANA New York • Chicago

"College-Requisite" Elevating

ALVERNO COLLEGE
Milwaukee, Wisconsin

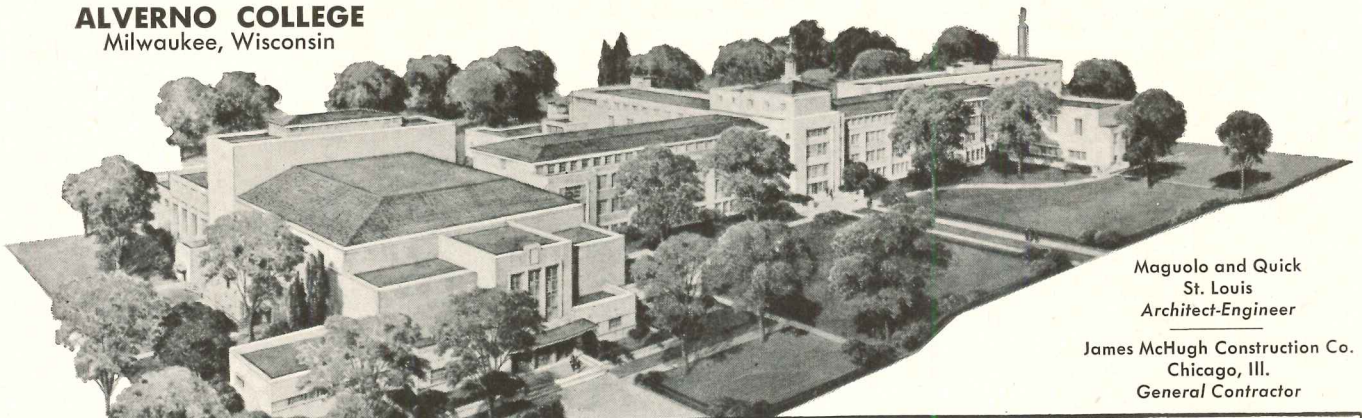

Maguolo and Quick
St. Louis
Architect-Engineer

James McHugh Construction Co.
Chicago, Ill.
General Contractor

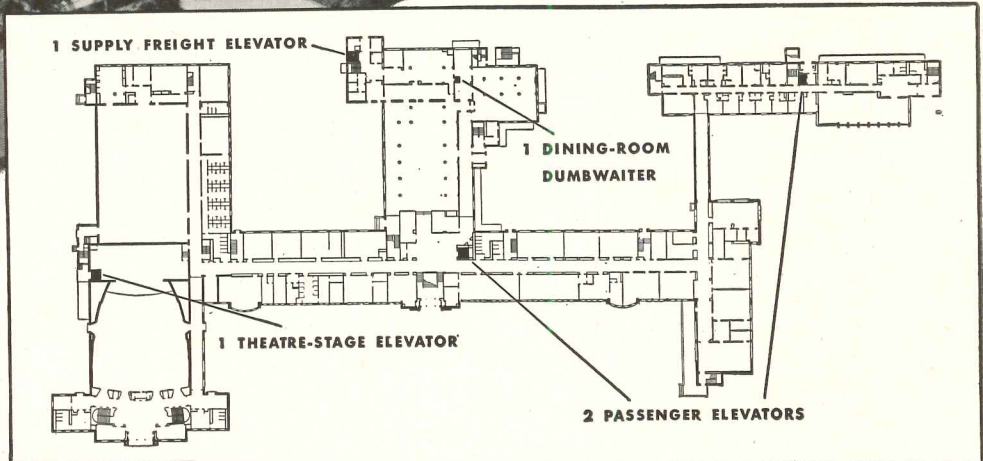

2 PASSENGER ELEVATORS



1 THEATRE-STAGE ELEVATOR



1 DINING-ROOM DUMBWAITER



1 SUPPLY FREIGHT ELEVATOR

Better elevating
is the business of



The new Alverno College for Women, being erected for the School Sisters of St. Francis, was designed by Maguolo and Quick, Architect-Engineer. Planned for 800 students, the main building will consist of five units: The chapel, administration offices, classroom and convent, library, auditorium and gymnasium; the project also includes a residence hall and a service building.

OTIS ELEVATORING meets all college requirements. 2 collective-control Passenger Elevators will handle student traffic; 1 plunger-electric Freight Elevator will lift the theatre stage apparatus; 1 call-and-send Electric Dumbwaiter will serve food from the kitchen to the dining room; 1 electric Freight Elevator will carry incoming supplies and food.

WHY DID ALVERNO COLLEGE BUY OTIS? OTIS was able to design, manufacture and install all of the required vertical transportation under a single responsibility. OTIS had a proven record of performance of many years standing in Milwaukee's Sacred Heart Sanitarium and St. Mary's Convent. Local OTIS service has always been prompt and courteous. All of which confirmed the fact that, "Better elevating really is the business of Otis."

For further details of OTIS vertical transportation equipment, including escalators, see SWEET'S Architectural File. Or, call your local OTIS office. Otis Elevator Company, 260 11th Avenue, New York 1, N. Y.

RADIANT HEATING SYSTEMS FOR HOUSES—12: Hot Water Systems

By William J. McGuinness

Professor of Architecture, Pratt Institute

The fourth installment in a series on radiant heating, the following pages present a typical example using floor panels, and worked out by simplified methods presented in the Time-Saver Standards for August and September 1951. A similar example for a ceiling panel installation appeared in the October 1951 issue.

Example 2 — Floor Installation

This example illustrates the design of a system of floor coils for the heating of the same house (Fig. 12) as shown in Fig. 7, TSS, Oct. 1951, Sheet 8. The house is still assumed to be fully insulated and double glazed. Carpets may, in this case, be eliminated with some advantage to the operating economy.

1. Layout

The available panel areas are shown in Fig. 13. Coils should not be run below any fixed equipment such as kitchen floor cabinets. The bathroom panel might have been made smaller to avoid the area of bathtubs, although they are good transmitting surfaces and some piping below them assures comfort while bathing. Fig. 14 is a final summary of the design. Preliminary sketches resembling Fig. 14 should be made to study the possible location of coils and equipment and the routing of mains.

2. Net Hourly Heat Losses

Column 1, Table 6, lists the heat losses from the several rooms. For the use of floor coils, they include the losses through glass, walls and ceilings as well as infiltration of air. Perimeter floor loss is not included. The reverse flow from the pipes to the ground is later added to establish the gross heat loss (column 7, Table 6) from which the linear feet of pipe is selected for the coils.

3. Adjustment

Because this is a one-story house, there is no gain in any heated space from heat flowing in by reverse loss from a panel in a room above or below. Adjustment is not needed.

4. Net Output

It is well to keep the net output in Btu per hr per sq ft of panel below 55 in floors. Columns 1, 3 and 4 (Table 6) establish this output in the case of

each room. The dining room is critical at 55 and should be considered first.

5. Gross Output

The water circulated through the pipes must bring in enough heat to make up the net heat loss from the rooms and also the reverse loss to the ground. Fig. 1, TSS, Aug. 1951, Sheet 2, expresses the approximate reverse loss for various floor coverings. Columns 5, 6 and 7 of Table 6

Fig. 12. Plan, Example 2.

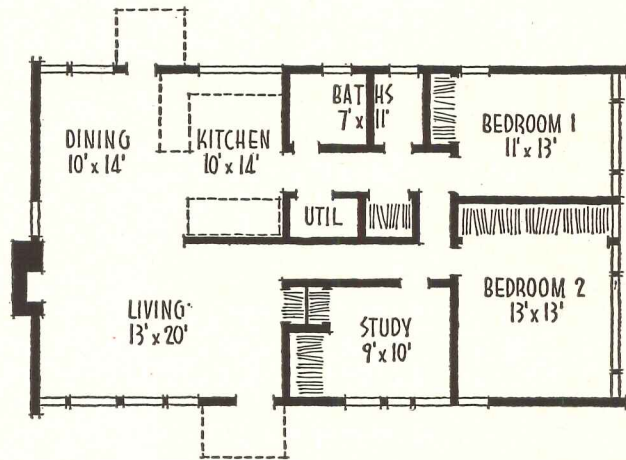
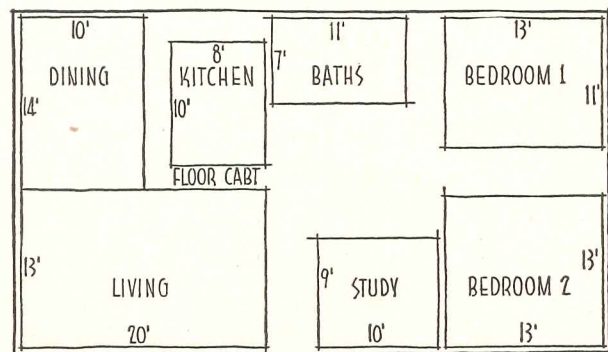

Fig. 13. Panel Areas Available, Example 2.



TIME SAVER STANDARDS

This lighting installation WILL PAY FOR ITSELF IN 3 YEARS!



Photographic record shows why Sylvania Fluorescent Lighting speeds production ... saves big money for Southern Mill

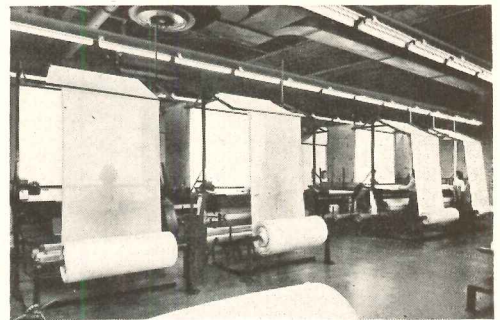

\$1500 Saved Here. This unique inspection method uses 24 forty-watt Sylvania fluorescent tubes and a luminous panel. Mill engineers estimate this Sylvania-designed unit provides a saving of \$1500 per year.



Inspection speeded here. Excellent use is made of the flexibility of Sylvania Fixtures. Hung at an angle over the cloth they eliminate need for slow, costly hand portable droplights and greatly speed inspection. Another big saving with Sylvania.

Looking for ways to cut costs? Here's a Sylvania Fluorescent Lighting Installation that does just that for the Deering-Milliken Mills in South Carolina.

Note the clean, clear lighting atmosphere in the above photo. Sylvania tubes and fixtures furnish a lighting level practically triple that obtained from former lighting units. As a result, mill authorities estimate, the saving realized in production costs, time, and the elimination of waste will completely pay for this efficient installation in just three years time.

cient installation in just three years time.

In addition, Sylvania fixtures offer the lowest possible maintenance costs. Hard durable porcelain reflectors resist the dampness caused by humidification necessary in textile mills. Turned down fixture lips prevent accumulation of dust or lint.

Sylvania now offers fixtures for every industrial need ... equipped with 2, 3, or 4 tubes ... standard or instant start. Ask your secretary to mail the coupon for full information TODAY!

Architects, Engineers, and General Contractors! make a note of this sign! It's your guide to a qualified Lighting Contractor who is fully equipped to give you full cooperation in working out your lighting plans. He'll take over a thousand and one details ... save you many lighting headaches and provide the latest Sylvania Fixtures and long-life tubes.

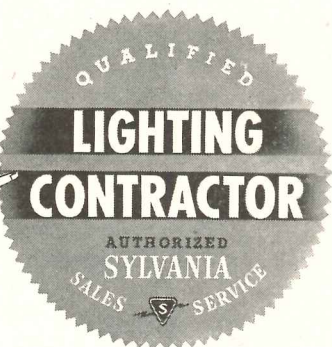

SYLVANIA

FLUORESCENT TUBES, FIXTURES, SIGN TUBING, WIRING DEVICES; LIGHT BULBS; RADIO TUBES; TELEVISION PICTURE TUBES; ELECTRONIC PRODUCTS; ELECTRONIC TEST EQUIPMENT; PHOTOLAMPS; TELEVISION SETS

Sylvania Electric Products Inc.
Dept. L-1401, 1740 Broadway, New York 19, N. Y.

Please send me new folder describing the full line of Sylvania Industrial Fluorescent Fixtures.

Name _____
Street _____
City _____ Zone _____ State _____

RADIANT HEATING SYSTEMS FOR HOUSES—13: Hot Water Systems

By William J. McGuinness

Professor of Architecture, Pratt Institute

Fig. 14. Coil Layout, Example 2.

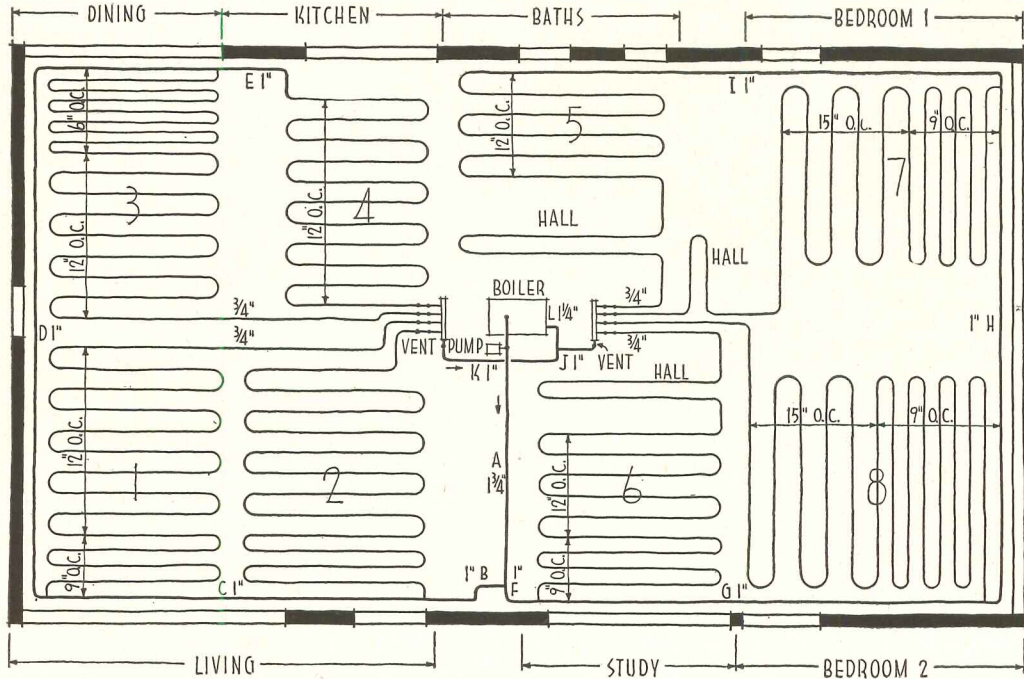

TABLE 6. Design Work Sheet, Example 2 House shown in Fig. 12

| General Design Data | | Coil Location—Floor | | Gross Unit Output, Btu/hr/ft or pipe—53†† | | | | | | | | |
|---------------------|--------------------------------|---|----------------|--|------------------------|----------------------------------|-------------------|-----------------|-------------------------------|-----------------|-------------------|--------------------|
| | | Pipe Size 3/4 in. wrought iron or steel | | Avg. Water Temp. 130° F Temp. Drop in System 10° F | | | | | | | | |
| Col. Nos. | 1 | 2 | 3 | 4 | 5 | 6 | 7 | 8 | 9 | 10 | 11 | 12 |
| Net Room Heat Loss | Available Panel | Unit Output of Panel | Floor Covering | Reverse Flow | Gross Heat Loss | Pipe Req'd. Per Room | Sinuous Coils | Identification | Approximate Pipe Spacing | | | |
| | | | | | | | | | Dimensions | Area | Material Selected | % of Gross |
| Btu/hr | Feet | Sq Ft | Btu/hr/s.f. | Material Selected | % of Gross | Btu/hr | Feet | Number Per Room | Coil Numbers | Inches c. to c. | Inches c. to c. | |
| Living | 11,440 | 13 x 20 | 260 | 44 | Carpet | 20 | 14,350 | 270 | 2 @ 135 | 1, 2 | 11 | 9 & 12 |
| Dining | 7,700 | 10 x 14 | 140 | 55† | Asphalt Tile | 10 | 8,550 | 160 | 1 | 3 | 9 | 6 & 12 |
| Kitchen | 3,250 | 8 x 10* | 80 | 41 | Asphalt Tile | 10 | 3,620 | 68 | 1 | 4 | 13 | 12 |
| Baths | 2,740 | 7 x 10 | 70 | 39 | Ceramic Tile | 10 | 3,050 | 58 | 1 | 5 | 12 | 12 |
| Study | 3,760 | 9 x 10 | 90 | 42 | 1/4 in. wood in mastic | 20 | 4,700 | 88 | 1 | 6 | 11 | 9 & 12 |
| Bedroom 1 | 6,300 | 11 x 13 | 143 | 44 | Asphalt Tile | 10 | 7,000 | 132 | 1 | 7 | 12 | 9 & 15 |
| Bedroom 2 | 8,100 | 13 x 13 | 169 | 48 | Asphalt Tile | 10 | 9,000 | 170 | 1 | 8 | 11 | 9 & 15 |
| Totals | 43,290 | | | | | | 50,270 | 946 | 8 | | | |
| Notes | Not incl. floor perimeter loss | *Exclusive of floor cabinets | | Col 1 ÷ Col 3 | | See Fig. 1 TSS Aug. '51 Sheet 2. | Col—by .80 or .90 | †† Col 7 ÷ 53 | L.R. Divided for equalization | See Fig. 13 | See Text | See Layout Fig. 13 |

† Critical output, (not to exceed 55 for floors)

†† From Table 1, TSS, Aug. '51, Sheet 4. 57 x .93 = 53 Btu/hr/ft of pipe

TIME - SAVER STANDARDS

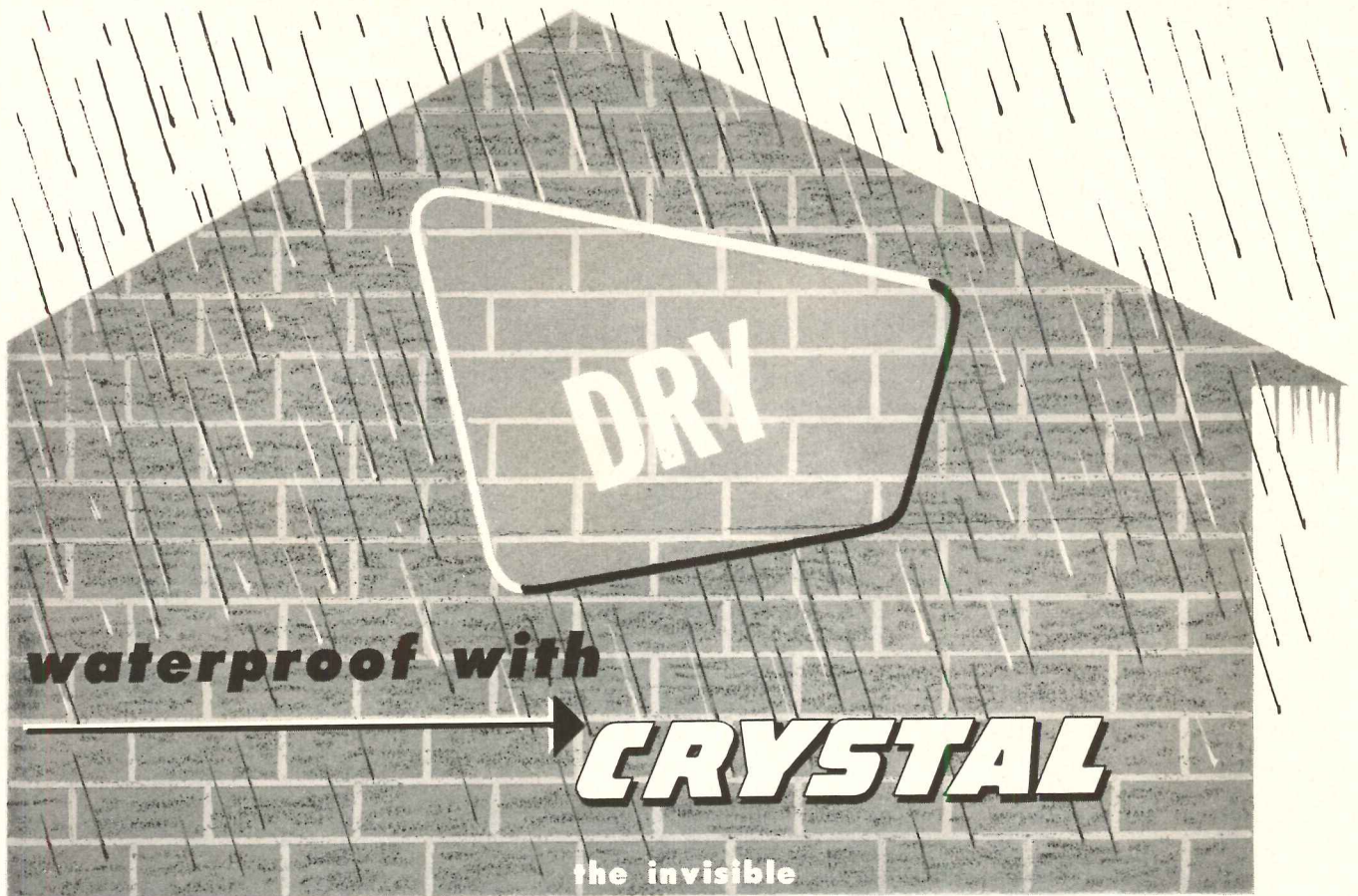

**the invisible
silicone masonry
water repellent
even in freezing weather**

CRYSTAL, the original silicone water repellent may be effectively and easily applied at low cost at any season—regardless of temperature. When its solvents evaporate, every masonry pore and hair line crack is lined with 100% pure transparent silicone to the full depth of its penetration... keeping walls lastingly dry... protecting masonry joints and preventing stains and efflorescence.

Important Information



Wurdack Chemical Company pioneered the use of silicones as a masonry water repellency. It has been granted a United States Patent No. 2,574,168 covering the application of silicones on masonry structures. All users of CRYSTAL are licensed under this patent. Applicators of any other silicone masonry water repellent must obtain a license and are invited to make application to the Wurdack Chemical Company for same.

Wurdack Chemical Company will protect its patent rights and all licensed applicators.

Write for specifications

**There is
no masonry
water repellent to
equal time-tested**

CRYSTAL

**NONE...NONE IN ALL
THE WORLD**

WURDACK

CHEMICAL COMPANY

4952 FYLER AVENUE, ST. LOUIS 9, MO.

RADIANT HEATING SYSTEMS FOR HOUSES — 14: Hot Water Systems

By *William J. McGuinness*

Professor of Architecture, Pratt Institute

show the method of arriving at the gross heat loss for each space.

6. Temperature Drop in the System

Pipes of wrought iron or steel $\frac{3}{4}$ in. in diameter will be used for the coils. In these relatively large pipes the friction is small and the water can be pumped through them quite rapidly. A small temperature drop can be expected and 10 deg is chosen.

7. Average Water Temperature

A trial computation was made using 110 F as the average water temperature, and it was found that the pipe spacings in the dining area were too small. A temperature of 130 F was then chosen and is used here. Table 1, TSS, Aug. 1951, Sheet 4, gives the output per ft of $\frac{3}{4}$ in. pipe as $57 \times .93 = 53$ Btu/hr at 130 F.

8. Critical Panel

If the gross heat loss of the dining area be divided by the output per ft of pipe (53 Btu), it is found that 160 ft of pipe are required. This works out to an average spacing of 9 in. on center. This is in accord with suggested spacings in Table 1, TSS, Aug. 1951, Sheet 4. To overcome the greater loss near glass, the pipes will be spaced 6 in. on center near the glass and wider as the coil recedes from the glass. 6 in. is greater than the closest possible spacing of $\frac{3}{4}$ in. pipe as determined by the minimum bend radius. Comments under the item "Critical Panel", TSS, Oct. 1951, Sheet 10, may be helpful in layout and study.

9. Other Panels

Columns 8 through 12 in Table 6 are a summary of the trial and final spacings based upon the required total linear footage for all coils. Coils up to 350 ft in length are permissible

using $\frac{3}{4}$ in. wrought iron or steel pipe. It will be seen that all of the proposed coils are less than this length, resulting in a simpler coil layout than that of Example 1. In that example, 12 coils were used instead of 8 because of the smaller tubing chosen. The living room requirements are met by two coils or lengths comparable to those in other rooms.

10. Size of Mains

Mains A and L convey more than 35,000 Btu per hr. Reference to Table 2, TSS, Sept. 1951, Sheet 6, results in the selection of $1\frac{1}{4}$ in. mains at these two points. All other mains can be 1 in. because their capacities are less than 35,000 Btu. The mains are shown in heavy lines on Fig. 14.

11. Water Flow

Sufficient water must be pumped to make up the gross heat loss. Dividing the gross heat loss of 50,270 Btu

by the factor 5000 for a 10 deg drop, 10 gallons per minute is found to be the necessary rate.

12. Selection of a Pump

The pump size will depend upon the rate of pumping and the friction head through the longest circuit (Coil 3) expressed in ft of water. The path of the water and the friction of each pipe length may be traced in Table 7. The resulting head of 2.38 ft of water makes no allowance for fittings and equipment for which 50% is commonly added. $2.38 \times 1.50 = 3.57$ ft of water, total friction head. If these coordinates (10 G.P.M. & 3.57 ft) are plotted on Fig. 6, TSS, Sept. 1951, Sheet 7, it will be seen that in this small system the usual minimum pump size of 1 in. is adequate.

13. Boiler

The hourly requirement of this house under design performance is 50,270 Btu for the gross connected heating load. A boiler must be se-

TABLE 7, Friction in the longest run (Coil 3)

| Pipe Identification | Heat Conveyed | Pipe Size | Actual Length | Friction Ft/100 ft Pipe | Friction Head, Ft |
|---------------------|-------------------|---------------------------------|------------------------|-------------------------------|-------------------|
| A | 50,270 Btu | $1\frac{1}{4}$ in. | 19 ft | 1.8 ft | .34 ft |
| B | 26,520 | 1 | 5 | 2.0 | .10 |
| C | 19,350 | 1 | 18 | 1.2 | .22 |
| D | 12,180 | 1 | 36 | .4 | .14 |
| Coil 3 | 8,550 | $\frac{3}{4}$ | 170* | .8 | 1.37 |
| K | 26,520 | 1 | 8 | 2.0 | .16 |
| L | 50,270 | $1\frac{1}{4}$ | 3 | 1.8 | .05 |
| Total | | | | | 2.38 ft |
| Notes | Fig. 13 & Table 6 | Table 2, TSS Sept. '51 Sheet 6. | *160 + 10 ft to header | Fig. 5, TSS Aug. '51 Sheet 5. | |

fuel savings WITH WOOD WINDOWS



Research has proved it—a 2'4" x 5'2" window with well-fitted storm sash is estimated to save 100 lbs. of coal per year—8½ gallons of oil—or 12 therms of gas per year. That's *one* reason why wood windows assure important fuel savings to home owners. Wood window units make possible a weather-tight fit on every window because wood storm sash are readily fitted to any window—even one which has settled out of square. And all wood windows provide *extra* insulation because wood is a non-conductor, high in insulating value. Wood Window Program, 38 South Dearborn Street, Chicago 3, Illinois.



wood windows

for modern beauty and modern performance

RADIANT HEATING SYSTEMS FOR HOUSES — 15: Hot Water Systems

By William J. McGuinness

Professor of Architecture, Pratt Institute

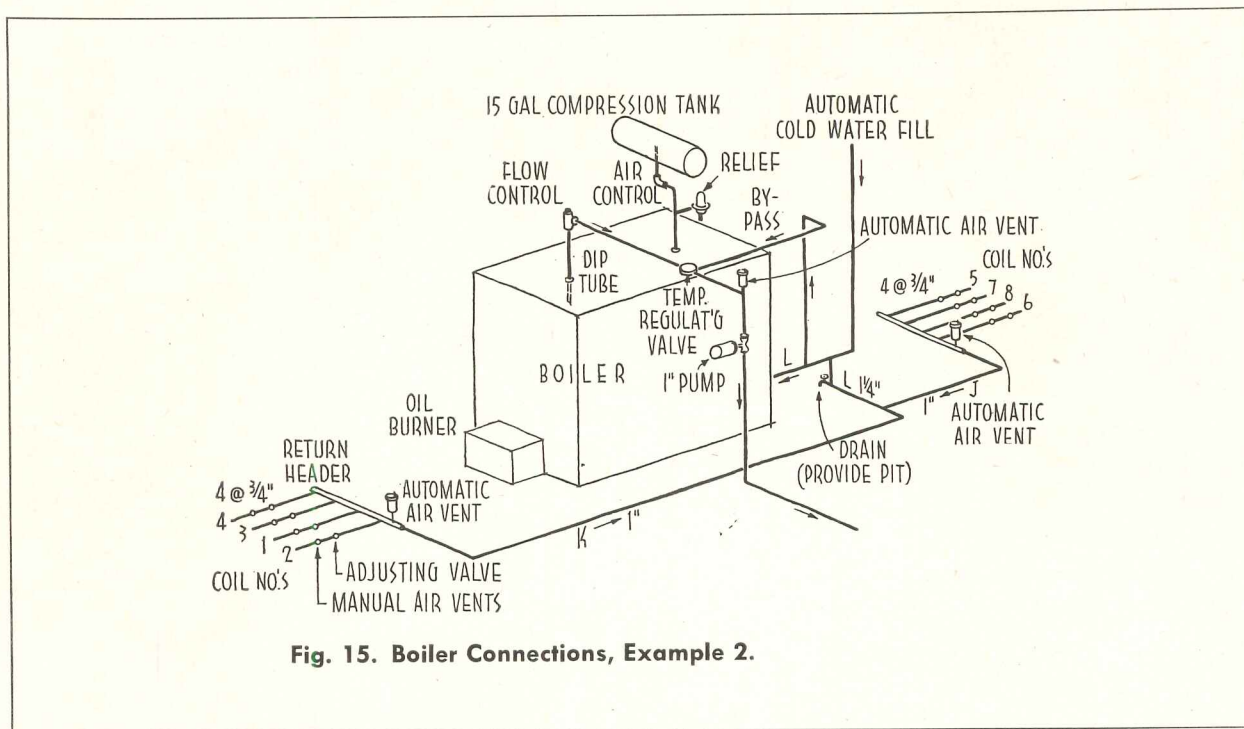

Fig. 15. Boiler Connections, Example 2.

lected to carry this load and also meet the demand for domestic hot water.

14. Compression Tank

A 15 gallon tank will permit the required expansion of the water in this system according to Table 3, TSS, Sept. 1951, Sheet 6, since the net heat loss is less than 50,000 Btu/hr.

Boiler Connections

The piping arrangements at the boiler are pictured in Fig. 15. For simplicity, some of the boiler controls, valves in the piping and domestic hot water connections have been omitted. The boiler will deliver water through main A at 135 F and it will return through L at 125 F. This is necessary to achieve the 130 deg average water temperature and the 10 deg drop. The bypass from the

return line and the temperature regulating valve permit the boiler to operate at 180 deg or more, assuring a temperature high enough for domestic hot water (135 is not enough). The hot water of the boiler is mixed with the cooler return water to produce the supply water at 135. This mixing arrangement is needed in most cases where domestic hot water is generated by the same boiler. It would have to be used if domestic hot water were desired from the boiler in Example 1, Fig. 11, TSS, Oct. 1951, Sheet 11. The actual piping might be a good deal more compact than that shown in Fig. 15 resulting in the inclusion of the vents and adjusting valves within the utility room. Otherwise, the adjusting valves would have to be in a recess in the floor covered by an access plate. The automatic vents would have to be above the floor in a partition or utility space.

All vents and controls must be accessible.

Venting and Adjustment

The dip tube prevents air from favoring a path through the main. It collects in the air chamber of the compression tank. Entrained air in the supply and return mains is exhausted by the automatic air vents at high points in the supply main and return headers. The manual air vents are petcocks which can be opened and the air purged from one circuit by closing off the others and pumping through the open circuit only until the air is driven out. This may have to be done at the beginning of operations. The adjusting valves may be used to cut down the flow to coils which are overhot. Care should be taken not to constrict the general flow too much, but only to equalize or balance it.

TRANE ADDS 4 NEW PLANTS...

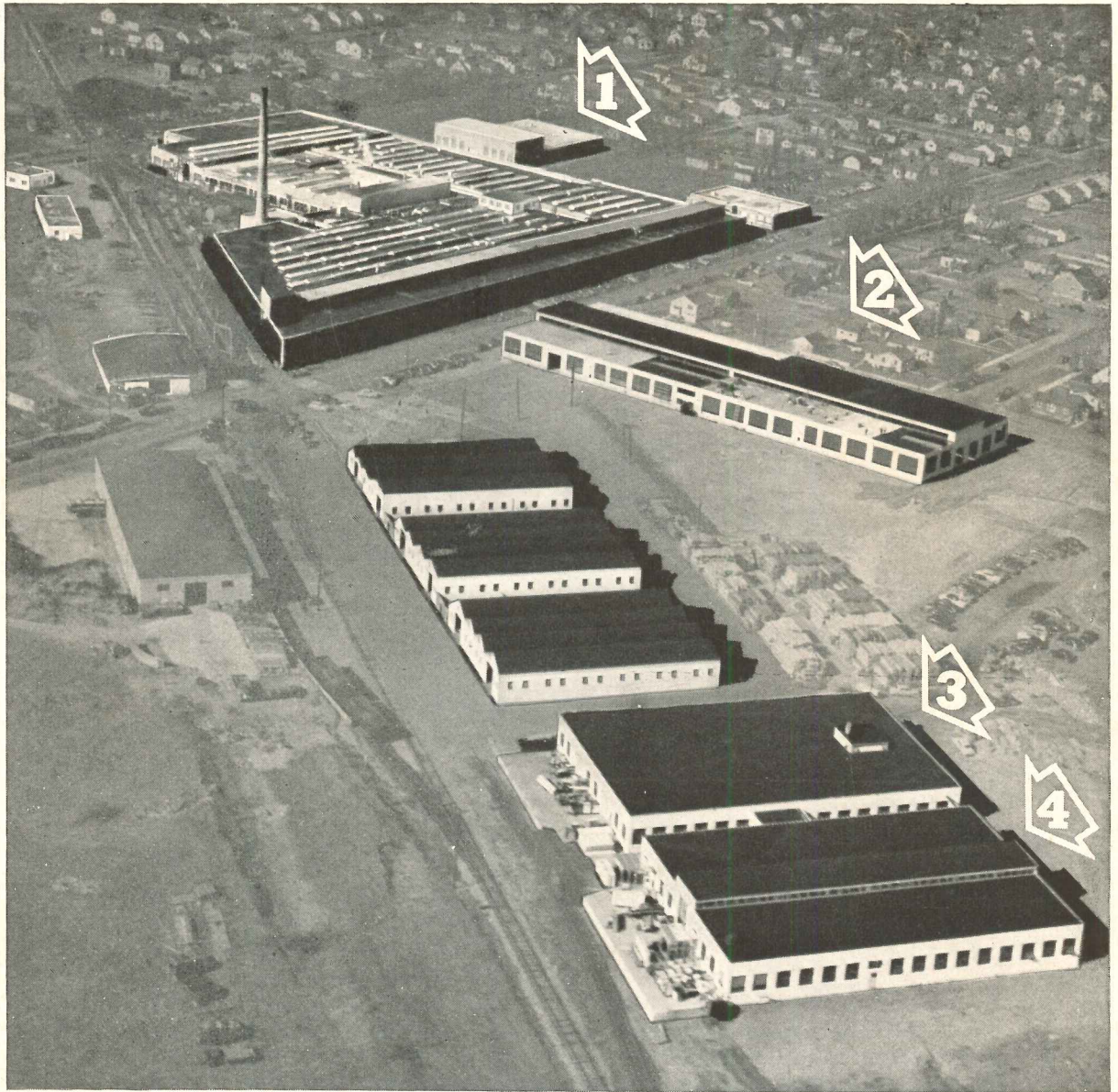

New buildings completed in recent Trane construction program. Arrows indicate: 1) Tool Building, a separate unit immediately north of the Main Plant, 2) a complete plant for assembly of standard heat transfer surface, 3) Brazed Aluminum Plant, 4) Special Heat Transfer Products Assembly Building.

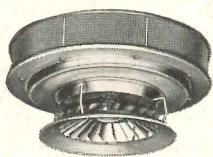

More Unit Heaters—Plant additions permit expansion of unit heater assembly lines—more heat for army camps and defense plants.

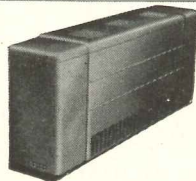

More Unit Ventilators—With more schools being built, demands are high for the warm, fresh air produced by Trane Unit Ventilators.

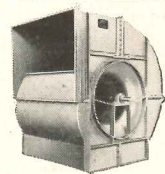

More Fans—Trane introduced a new line of centrifugal fans recently. Popular acceptance and increased sales make more manufacturing space necessary.