

ARCHITECTURAL

RECORD

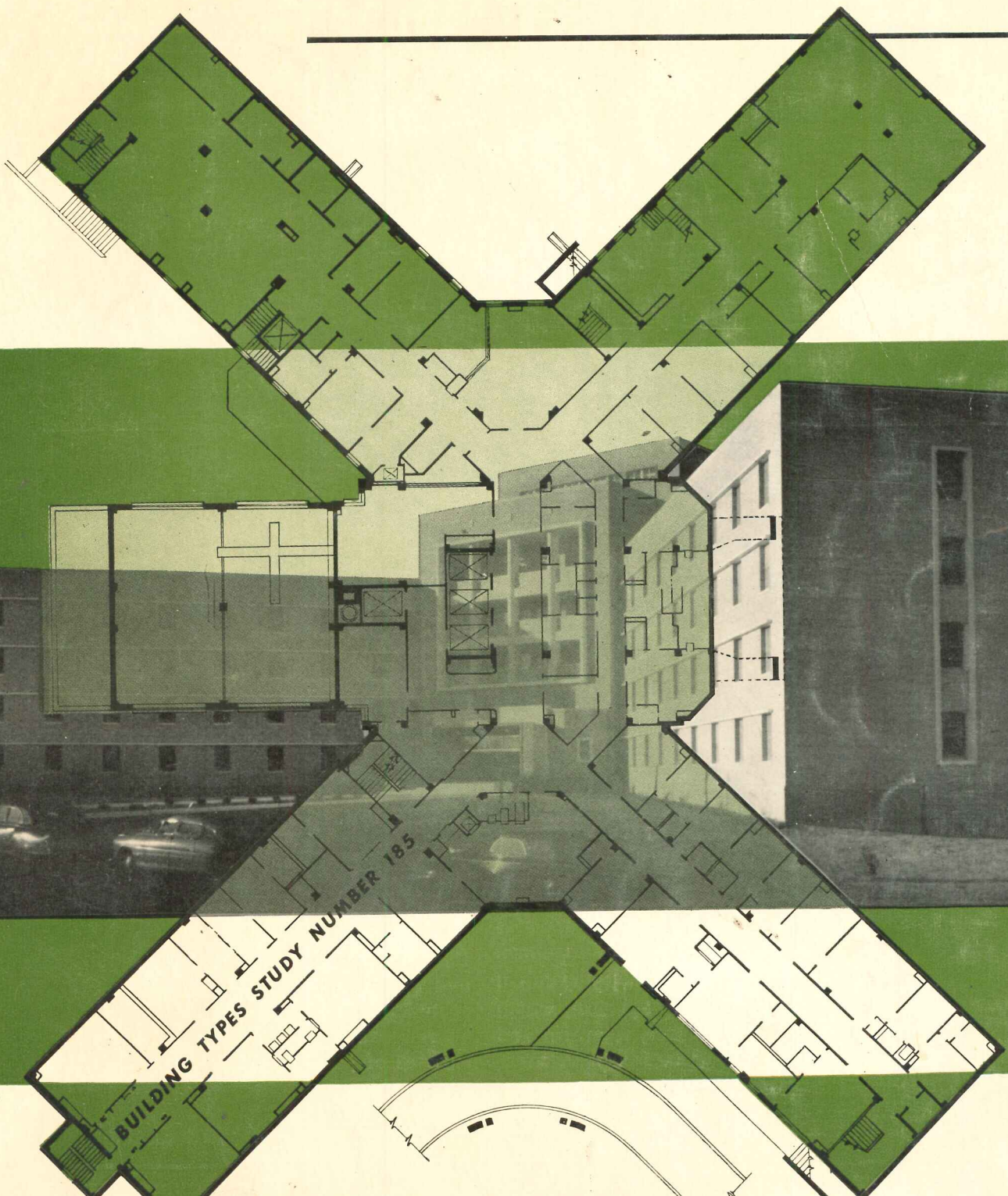

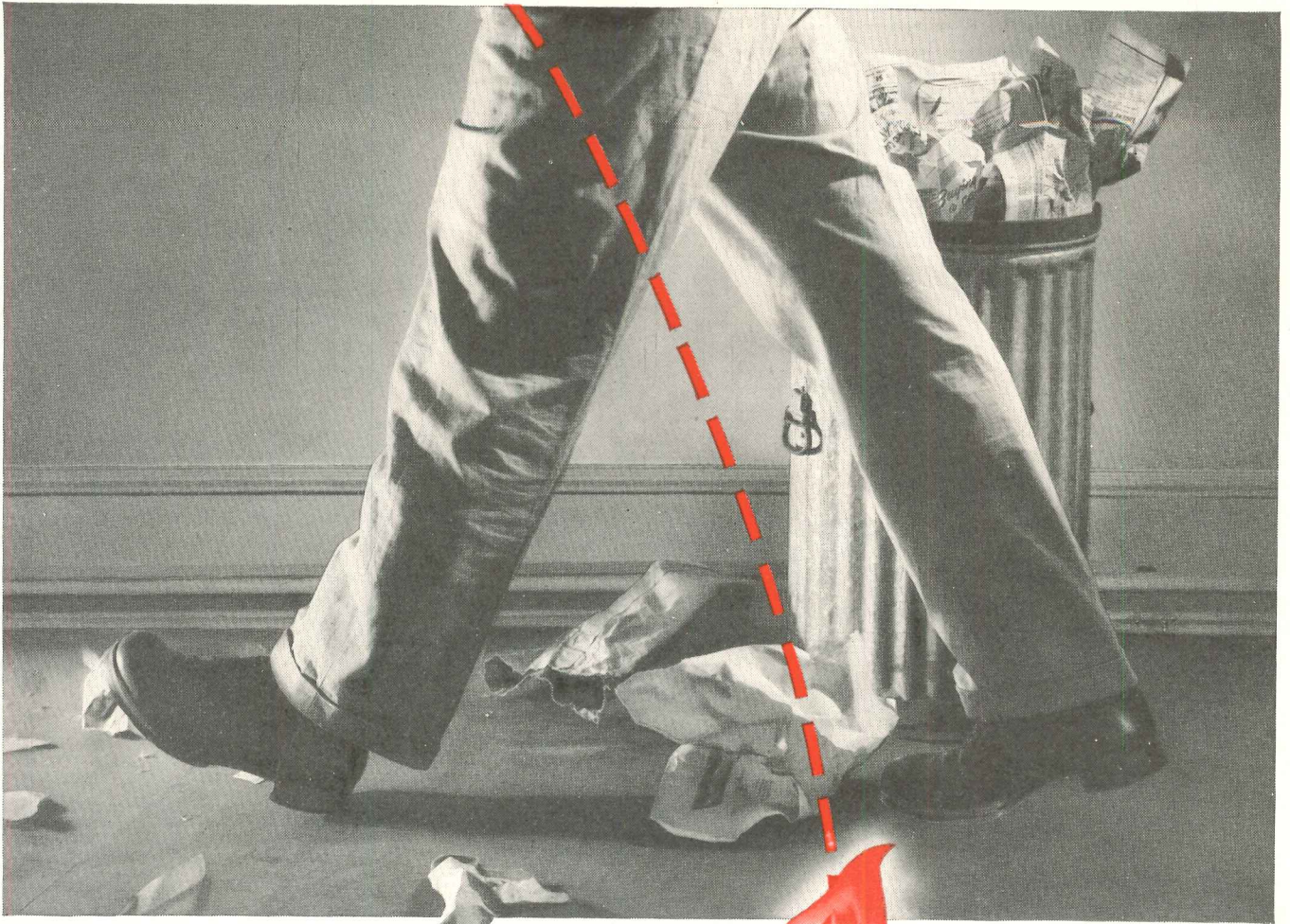

How Fires Start . . .



Carelessness

Top-of-the-list cause of fires, according to study after study, turns out to be just plain human carelessness.

Under the heading "Careless smoking habits" you'll find such oddities as the

waitress who cleaned *hot* ash trays with napkins destined for the laundry chute, and the mechanic who tossed a match into a puddle of gasoline. But far, far more frequently it's simply the ordinary guy who unthinkingly tosses away a lighted match.

How Fires Are Stopped . . .



Grinnell Sprinklers

Education does a world of good to prevent fires from *starting*. But until human behavior is perfect, your best protection lies in *automatic control*.

The surest control is with Grinnell Automatic Sprinkler Systems, which check fire at its source, wherever and whenever it may strike, with auto-

matic certainty. In factories, hotels, hospitals, schools and theatres, there is a moral obligation upon architects and management to provide the utmost protection of life and property.

For your own sake, be sure the lives and property for which you are responsible are protected with Grinnell automatic sprinkler heads — your assurance of positive fire protection.



GRINNELL FIRE PROTECTION SYSTEMS

GRINNELL COMPANY, INC., PROVIDENCE 1, RHODE ISLAND • BRANCH OFFICES IN PRINCIPAL CITIES

ARCHITECTURAL RECORD (Vol. 111, No. 4, April, 1952) is published monthly by F. W. Dodge Corp., 10 Ferry Street, Concord, N. H., with editorial and executive offices at 119 W. 40th St., New York 18, N. Y. \$4.50 per year; Foreign, \$6.50.

Entered as second-class matter at the Post Office, Concord, N. H. March 16, 1946, under the Act of March 3, 1879.

ARCHITECTURAL RECORD



Copyright 1952 by F. W. DODGE CORPORATION, with all rights reserved • Publishing Director, Magazine Division, H. Judd Payne • Business Manager, Robert F. Marshall • EDITORS: Executive Editor, Joseph B. Mason; Managing Editor, Emerson Goble; Senior Associate Editor, Frank G. Lopez, A.I.A.; Associate Editor, Florence

A. van Wyck; Associate Editor (Engineering), Robert E. Fischer; Associate Editor, Herbert L. Smith, Jr., A.I.A.; Western Editor, Elisabeth Kendall Thompson; Assistant Editor (News), Jeanne M. Davern; Contributing Editors, Ernest Mickel (Washington), Frederic A. Pawley, John Caulfield Smith, M.R.A.I.C. (Canada); Editorial Assistants, Carl Scarenco, Enid Belding, Elizabeth Davey, Jeanne G. Whitbeck • DESIGN: Consultant, M. Peter Piening; Director, Frances Torbert; Drafting, Sigman-Ward • CONSULTANTS: Industry Relations Consultant, Thomas S. Holden; Statistical Consultant, Clyde Shute; Field Research Consultant, Clifford Dunnells, Jr.; Public Relations Consultant, Samuel C. Pace.

Architectural Record (combined with American Architect and Architecture) is published monthly by F. W. Dodge Corporation, 10 Ferry St., Concord, N. H., with Editorial and Executive Offices at 119 West 40th Street, New York, N. Y. Western Editorial Office, 2877 Shasta Road, Berkeley 8, Calif. Chairman of the Board, James McV. Breed; Vice-Chairman of the Board, Paul Abbott; President, Thomas S. Holden; Vice-President and Treasurer, Howard Barringer; Secretary, Sanford D. Stockton, Jr.; Vice-Presidents, Irving W. Hadsell, Chauncey L. Williams, H. Judd Payne, T. Oliver Morgan; Assistant Secretaries, George W. Morgan, William C. Breed, Jr.; Assistant Vice-Presidents, Clyde Shute, Clifford G. Dunnells, Jr., Howard M. Thompson, Marc Wayne, Robert F. Marshall; Assistant Treasurers, Walter F. DeSaix, Edwin H. Freed, Irving B. Satin; Regional Vice-Presidents, Carl S. Bennett, Ralph M. Hairston, Julius T. Little, Richard H. Ray. Member Audit Bureau of Circulation and Associated Business Papers Inc. Architectural Record is indexed in Reader's Guide, Art Index, Industrial Arts Index and Engineering Index. Subscription rates: United States and Possessions, Canada, Cuba, Mexico, Central and South America, and Spain, \$4.50 the year, \$7.50 for two years, \$9 for three years; elsewhere, \$6.50 the year, \$11.50 for two years, \$15 for three years. Single copy \$2. Circulation Manager: Marshall T. Ginn. Every effort will be made to return material submitted for possible publication (if accompanied by stamped, addressed envelope), but the editors and the corporation will not be responsible for loss or damage. Other Dodge Services: Real Estate Record & Builders' Guide, Sweet's Files, Home Owners' Catalogs, Dodge Reports & Dodge Statistical Research Service.

Cover: Providence Memorial Hospital, El Paso, Texas. Carroll and Daeuble, Architects. Photo by F. Wilbur Seiders

THE RECORD REPORTS	11
News from Washington. By Ernest Mickel	11, 38
News from Canada. By John Caulfield Smith	28
Construction Cost Indexes	42
REQUIRED READING	46
THE HUMANIZATION OF URBAN LIFE	121
By S. Giedion	
ADDITION TO WASHBURN SCHOOL, AUBURN, MAINE	130
Alonzo J. Harriman, Inc., Architects and Engineers	
SMALL OFFICE BUILDINGS	
OFFICE FOR BESSEMER IMPROVEMENT CO.	138
Greensboro, N. C. Edward Loewenstein, Architect	
MEDICAL BUILDING FOR PAUL C. BLAISDELL, M.D.	142
Pasadena, Calif. Smith and Williams, Architects	
LIBRARIES	
HAYWARD PUBLIC LIBRARY	147
Hayward, Calif. John Carl Warnecke, Architect; Thomas D. Church, Landscape Architect	
HARMON PARK LIBRARY	152
Phoenix, Arizona. Guirey and Jones, Architects; Alfred Morton Githens, Consulting Architect	
MIDWEST INTER-LIBRARY CENTER	157
Chicago, Ill. Shaw, Metz and Dolio, Architects	
KALIHI-PALAMA BRANCH, LIBRARY OF HAWAII	160
Honolulu, T. H. Fisk, Johnson, Ossipoff and Preis, Architects; Vladimir Ossipoff, Coordinator	
HOUSES	
SIMPLE DESIGN FOR SOUTHERN LIVING	165
Residence for Dr. Ann Stuckey, Griffin, Ga. Aeck Associates, Architects	
VICTORIAN STABLE BECOMES MODERN HOUSE	168
House for Mrs. Alma Morgenthau, Lattingtown, Long Island, N. Y. Herman Herrey, Architect	
MAXIMUM USE OF ODD-SHAPED 2-LEVEL SITE	174
Residence for Mr. and Mrs. Elliot Handler, Los Angeles, Calif. Kenneth N. Lind, Architect	
ISLAND WEEK-END HOUSE FOR ALL-YEAR USE	178
Country House for Mr. Richard Lea, Lopez Island, San Juan Group, Washington. Lionel H. Pries, Architect	
BUILDING TYPES STUDY NO 185 . . . HOSPITALS	
INTRODUCTION	181
NEW AND REVISED ELEMENTS OF THE GENERAL HOSPITAL	182
By Division of Hospital Facilities, U. S. Public Health Service, Federal Security Agency	
MENTAL HOSPITAL PLANNED TO MAINTAIN MORALE	194
Administration and Receiving Buildings, State Hospital, Hastings, Minn. Thorshov and Cerny, Inc., Architects	
FIRST UNIT OF NEW MEDICAL CENTER	200
Providence Memorial Hospital, El Paso, Texas. Carroll and Daeuble, Architects	
60-BED HOSPITAL ON 100-BED CHASSIS	204
Flow Memorial Hospital, Denton, Texas. Bennett and Crittenden, Architects	
SMALL, COMPACT ONE-STORY HOSPITAL	208
Perry County Hospital, Marion, Ala. Sherlock, Smith and Adams, Architects and Engineers	
54-BED HOSPITAL FOR RURAL AREA	210
Wood County Hospital, Bowling Green, Ohio. Strong, Strong and Strong, Architects	
ARCHITECTURAL ENGINEERING	
TECHNICAL NEWS AND RESEARCH	
MOVING STAIRWAYS FOR TALL BUILDINGS	213
By G. B. Gusrae. Voorhees, Walker, Foley and Smith, Architects	
HOW SOILS AFFECT FOUNDATION DESIGN	218
By S. D. Teetor. Seelye, Stevenson, Value and Knecht, Consulting Engineers	
PRODUCTS . . . For Better Building	223
LITERATURE FOR THE OFFICE	224
TIME-SAVER STANDARDS	
METHODS OF FASTENING TO MASONRY WALLS, 1-4	227
TECHNICAL NEWS	240
INDEX TO ADVERTISING	6

INDEX TO ADVERTISEMENTS

MANUFACTURERS' PRE-FILED CATALOG
 Symbols "a", "b", and "e" indicate that catalogs
 of firms so marked are available in Sweet's Files
 as follows:

- a—Sweet's File, Architectural, 1952
- b—Sweet's File for Builders, 1952
- e—Sweet's File, Engineering, 1952

a Accurate Metal Weatherstrip Co., Inc.	262	a Formica Company	420	ab Paine Lumber Co., Ltd.	64
abe Adam, Frank Electric Co.	59	ae Frankl Foundation Company	410	a Penberly Injector Co.	404
a Adams & Westlake Co.	39	ae Fremont Rubber Company	75	ae Pennsylvania Wire Glass Co.	34
ae Advance Transformer Co.	249	a Frick Co.	391	ab Pittsburgh Plate Glass Co.	88-238-239
Aerofin Corporation	74	General Aniline & Film Corp.	318	a Pittsburgh Reflector Company	345
Air Devices, Inc.	33	General Electric Co., Air Conditioning	306	ab Pittsburgh Steel Products Company	404
Alan Wood Steel Company	322	a General Electric Co., Construction Materials	10-400	Pittsburgher, Hotel	395
a Albenene Stone Corporation	104	General Electric Co., X-Ray	84	a Portland Cement Association	401
a Allen, W. D. Manufacturing Co.	419	a General Portland Cement Co.	321	ae Potter Fire-Escape Co.	32
Aloe, A. S. Co.	393	a Getty, H. S. & Co., Inc.	381	Powers Regulator Co.	20-21
Alysynite Company of America	37	a Glide Windows Inc.	310	Preferred Utilities Manufacturing Corp.	409
a Alumilux Corporation	396	ae Globe Hoist Company	314	ab Pryne & Company, Inc.	242-243
Alumiseal Corporation	254	Glynn-Johnson Corporation	324	RLM Standards Institute	289
ae American Abrasive Metals Co.	36	a Goodyear Tire & Rubber Co., Inc.	23	a R.C.A. Rubber Company, The	51
a American Air Filter Company, Inc.	246-247	ae Granco Steel Products Co.	341	Radio Corporation of America	358
American Bleached Shellac Manufacturers Assn., Inc.	413	abe Great Lakes Steel Corporation	237	a Republic Steel Corporation	58-361
ae American Blower Corporation	344	ae Grinnell Company, Inc.	2nd Cover	abe Revere Copper & Brass, Inc.	369
a American Brass Company	109	a Gruber Lighting Inc.	343	ae Reznor Manufacturing Co.	395
ab American Hardware Corporation	252-253	a Guth, Edwin F. Company	112-113	abe Reynolds Metals Company	303-383
a American-Olean Tile Company	257	a Hachmeister, Inc.	375	Richkraft Company	418
b American Radiator & Standard Sanitary Corp.	417	a Haertel, W. J. & Company	373	Richmond Radiator Co.	115
American Steel & Wire Division	259	a Hager, C. & Sons Hinge Mfg. Co.	305	ae Roberison, H. H. Co.	335
American Sterilizer Company	57	Hamilton Manufacturing Company	388-399	ab Roddis Plywood Corporation	98
ab American Telephone & Telegraph Co.	72	Hart & Hegeman Division	408	Roebling, John A. & Sons	279
a Anemostat Corp. of America	225	a Haws Drinking Faucet Co.	416	ae Rohm & Haas Company	273
Angel Novelty Co.	298	ab Healtrol Inc.	371	a Rotary Lift Company	398
Arabol Manufacturing Co.	389	a Herring-Hall-Marvin Safe Company	370	ab Russell & Erwin Division	252-253
Architectural Record	308-309	a Hoffman Specialty Co.	245	ae Rust-Oleum Corporation	287
Ardmore Products Co.	382	ae Hogan & Co., C. T. Inc.	255	a Sarco Company, Inc.	409
ae Armsstrong Company	398	ab Homasote Company	43	a Sarcotherm Controls, Inc.	283
abe Armstrong Cork Company	60-120	Home Owners' Catalog	380	a Schlage Lock Company	7
Arrow-Hart & Hegeman Electric Co.	408	ae Hope's Windows, Inc.	300	ae Scott Paper Company	412
Art Metal Company	50	a Horn, A. C. Company	71	a Seaportel Metals, Inc.	330
abe Asbestone Corporation	267	ab Hunter-Douglas Corp.	70	a Security Fire Door Co.	38
ab Associated Plywood Mills, Inc.	79	ab Hunter Fan & Ventilating, Co., Inc.	377	a Sedgwick Machine Works	394
ab Atlas Plywood Corporation	102	abe Ilg Electric Ventilating Co.	413	a Serviced Products Corp.	400
a Auth Electric Company, Inc.	116	a Imperial Brass Mfg. Co.	16	Sharon Steel Corporation	419
a Babcock & Wilcox Co.	387	ae Infra Insulation, Inc.	15	Sheldon, E. H. Equipment Company	351
a Bar-Ray Products, Inc.	408	ab Inland Steel Products Company	226	Shwyder Bros., Inc.	367
abe Barrett Division, The	325	ab Insulite Division	234-235	a Simpson Logging Company	414-415
ae Bayley, William Company	27	abe Insulux Glass Block	331	ab Sisalkraft Co.	405
Bel Electric Company	405	International Nickel Company, Inc.	118	Sjostrom, John E. Co.	407
ab Bell Telephone System	72	a Jackson & Church Co.	3rd Cover	Skylike Lighting, Inc.	348
Benjamin Electric Mfg. Co.	76-77	Jenkins Bros.	111	ae Sloan Valve Co.	4th Cover
ae Bethlehem Steel Company	80-315	ae Johns-Manville	78-333	a Smith, H. B. Co., Inc.	386
Bigelow Rugs & Carpets	304	Johnson, S. T. Co.	412	Solar Light Manufacturing Co.	411
abe Bilco Co.	390	ae Josam Manufacturing Co.	397	a Soss Manufacturing Company	272
Bituminous Coal Institute	292	a Just Manufacturing Co.	299	a Speakman Company	316
Blank, Frederic & Company, Inc.	117	Kaiser Aluminum & Chemical Sales Inc.	40-41	Square D. Company	91
abe Blue Ridge Sales Div.	353	ae Kalmor Floor Company, Inc.	413	Stainless Steel	52-53
Books	384-392-403	ae Kaylo Division	93	ab Standard Dry Wall Products	368
Bostwick Steel Lath Company	29	a Kennecott Copper Corp.	337	a Standard Electric Time Co.	105
a Bradley Washfountain Co.	266	ab Kentile, Inc.	19	a Steel & Tube Division	361
ab Brainard Steel Division	419	Kent-Moore Organization, Inc.	408	ab Sterling Hardware Company	401
Briggs Manufacturing Co.	49	ae Kewanee Boiler Corporation	334	abe Stran-Steel Division	237
ae Brown Company	419	ae Kinnear Mfg. Co., The	286	Struthers Wells	390
ae Bruce, E. L. Co.	67	a Knapp Bros. Mfg. Co.	119-418	ae Swartwout Co.	378
Bryant Heater Division	54	Koh-I-Noor Pencil Co.	395	Sweet's Catalog Service	284-285
Bulldog Electric Products Co.	99	Kohler Co.	319-391	a Symmons Engineering Co.	108
a Bundy Tubing Company	241	ab Kohket Sales and Service Company	1	ab Thrush, H. A. & Company	399
Burnham Corporation	405	a LCN Closers, Inc.	364	a Tile Council of America	103
ae Burt Manufacturing Co.	402	Laclede Steel Co.	354	Tile-Tex Division	275
a Byers, A. M. Company	4	abe Libbey-Owens-Ford Glass Co.	353-356	Timber Engineering Company	362
a Cabot, Samuel, Inc.	258	a Litecontrol Corp.	96	ab Timber Structures, Inc.	389
a Caldwell Manufacturing Co.	410	a Lockwood Hardware Manufacturing Co.	87	a Titus Mfg. Corp.	397
a Cambridge Tile Mfg. Co.	85	a Lorio Iron Works	393	Titusville Iron Works Company	390
Cannon Electric Company	338	ab Louisville Cement Company, Inc.	277	Trade-Wind Motorfans, Inc.	406
Canvas Awning	83	a Ludowici-Celadon Co.	317	ab Trane Company, The	107-250-44-45
ae Carrier Corporation	66-307	ae Macomber, Incorporated	352	a Tremco Mfg. Co.	400
ae Cast Iron Soil Pipe Institute	332	a Mahon, R. C. Co.	47	a Trinity Division	321
ae Caco Steel Products Corp.	68	a Marble Institute of America, Inc.	396	a Tuttle & Bailey, Inc.	2-3
abe Calolux Corporation	301	Masonite Corp.	35	United States Hoffman Machinery Corp.	342
a Century Lighting Inc.	280	McKenna, Jay G., Inc.	108	United States Motors Corporation	388
Certified Ballast Manufacturers	65	McQuay, Inc.	269	ab United States Plywood Corp.	313
a Chase Brass & Copper Co.	337	a Medart, Fred Products, Inc.	263	a United States Quarry Tile Co.	326
a Chicago Hardware Foundry Co.	399	Medusa Portland Cement Co.	355	ae United States Steel Corp. Subsidiaries	52-53-259-288-372
a Cincinnati Time Recorder Company	411	ab Metal Tile Products Inc.	407	a Universal Atlas Cement Company	288
Cipco Corporation	416	a Michaels Art Bronze Co., Inc.	350	a Universal Bleacher Company	106
ae Cleaver-Brooks Company	411	a Miller Company	407	b Universal-Rundle Corp.	90
Committee on Steel Pipe Research	320	ae Mills Company	69	a Upco Co.	278
a Concrete Reinforcing Steel Institute	385	a Minneapolis-Honeywell Regulator Co.	260-261	a Valley-Metal Products Company	73
Congoleum-Nairn, Inc.	30-31	ab Minnesota & Ontario Paper Co.	234-235	Van-Packer Corporation	374
Connor, W. B. Engineering Corp.	63	a Minwax	386	ae Viking Corporation	276
Connors Steel Company	327	ae Mississippi Glass Company	256	Vilter Refrigeration & Air Conditioning	389
a Consolidated Water Power & Paper Co.	228	ae Mitchell Mfg. Co.	396	Versen, Kurt Company	406
a Corning Glass Works	339	ae Modine Mfg. Co.	311	ae Wakefield, F. W. Brass Co.	408
a Coyne & Delany Co.	82	ae Moore, P. O. Inc.	416	Wallace, William Company	270
C-O-Two Fire Equipment Company	365	Morgan Company	359	ae Wasco Flashing Co.	232
b Crane Co.	379	ab Mosaic Tile Company	294-295	a Waylite Company	297
abe Crawford Door Co.	328	ab Mueller Brass Co.	55	a Wayne Iron Works	412
ae Crucible Steel Co. of America	97	a Natcor Store Fronts	404	ae Webster, Warren & Co.	394
a Curtis Companies Service Bureau	349	a National Gypsum Company	357	a Weis, Henry Manufacturing Co., Inc.	268
a Curtis Lighting Inc.	89	ab National Lath Company	366	a Wesco Waterpaints	296
a Curtis Manufacturing Co.	329	ab National Oak Flooring Mfrs. Assn.	56	a Wesix	400
a Cutler Mail Chute Co.	412	abe National Steel Corporation	237	a Westinghouse Electric Corp., Apparatus	107-250-251-281
a Day-Brite Lighting, Inc.	8-9	ae National Tube Division	372	a Westinghouse Electrical Appliance	264-265
Detroit Steel Products Co.	110-347	e Nelson Herman Division	246-247	a Westinghouse Electrical Corp.—Elevator Division	293
Dodge, F. W. Corporation	284-285	a Neo-Ray Products, Inc.	323	a Wiggins, H. B. Sons Co.	401
a Douglas Fir Plywood Association	94-95	a New Castle Products	81	Will-Burt Company	416
a DuPont de Nemours E. I. & Co.	100-101	Norman Products Company	106	Wilnot Castle Co.	376
Duriron Company, Inc.	346	ab Nova Sales Co.	43	Wing, L. J. Mfg. Co.	403
Eberhard Faber Pencil Co.	302	ab NuTone, Inc.	393	Wiremold Company, The	48
Edwards Company, Inc.	336	Onan, D. W., & Sons, Inc.	402	Wood Window Program	62
Electric Storage Battery Company	114	a Oregon Lumber Company	86	a Worthington Pump & Machinery Corp.	92
a Ellison Bronze Co.	274	a Otis Elevator Company	340	ae York Corporation	360
Employment Opportunities	396	abe Owens-Corning Fiberglas Corporation	363	abe Zonolite Company	291
a Erie Enameling Company	290	abe Owens-Illinois Glass Company	93-331	ae Zurn, J. A. Mfg. Co.	61
ae Executone, Inc.	388	Oxford University Press	404		
Faber, A. W. Castell Pencil Co.	382	Ozalid Division	318		
a Fedders-Quigan Corporation	24-25				
ae Federal Cement Tile Company	397				
Federal Seaboard Terra Cotta Corp.	312				
ae Fenestra Building Products	110-347				
ab Fiat Metal Manufacturing Company	282				
Fiske Iron Works, J. W.	409				
a Fitzgibbons Boiler Company	230				
Fleur-O-Lier Fixtures	271				
Flint & Wallina Mfg. Co., Inc.	415				

NEW YORK—H. Judd Payne, Publishing Director; Robert F. Marshall, Business Manager; Tom Tredwell, Advertising Mgr.; Benton B. Orwig, Creative Service Manager; M. A. Murphy, Advertising Production Manager, 119 West 40th Street; BOSTON—Harry M. Horn, Jr., 855 Park Square Bldg.; CHICAGO—C. B. Riemersma, Robert T. Franden, David K. Bortz, 700 Merchandise Mart; CLEVELAND—John C. Jackson, Joseph F. Palmer, John W. Setear, 321 Hanna Bldg.; DALLAS—Joe Sanders, 2909 Maple Ave.; LOS ANGELES—Rob. Wettstein, 672 South Lafayette Park Pl.; PHILADELPHIA—Tom Tredwell, 1321 Arch St.; PORTLAND—Rob. Wett-

THE RECORD REPORTS

THE WORST IS OVER: MOST NON-DEFENSE BUILDING IS PROMISED NPA APPROVAL FOR THIRD-QUARTER STARTS

Fleischmann Can See "Near Normal" Construction Operations by Last Quarter; End of Controls on Some Types of Steel and Aluminum Not Far Off; Producers Reiterate Reports of Easing Supply Outlook; Official Attitude on Homebuilding Unchanged

BUILDING TYPES that for the last year have provided more headaches than business for architects and engineers will be on the boards again in increasing numbers as the effect of moves by the Defense Production Administration that indicate increasing recognition of the easing in supplies of "critical" metals.

An important green light flashed with the announcement by DPA Administrator Manley Fleischmann on March 17 that practically all pending applications to start non-defense commercial and industrial buildings and most new applications will be approved for the second half of the year.

Projects that do not get metal rations for the third quarter will get advance allotments for the fourth quarter, Mr. Fleischmann said, so that planning and site preparation can go ahead.

Amusement and recreation buildings, and structures the DPA considers a "frivolous" use of metal, were not included; but the go-ahead for commercial construction generally relaxed a ban that had held up virtually all non-defense building in that field since February 1951.

Fowler Lists Criteria

National Production Authority Administrator Henry Fowler named two important criteria to be used by the government in approving construction applications.

First, the project must be in a state of "engineering readiness" — that is, it must be ready to absorb metal rations as soon as they are issued; and second, all non-essential use of copper must be held to the absolute minimum.

Selective Decontrol Forecast

Mr. Fleischmann said he is considering methods of removing controls on

certain types of steel and aluminum — the first official recognition of the validity of cries from producers of the metals that oversupply was becoming a problem in some lines.

Carbon steel, except for bars, plate, tubing and certain other forms which may still be scarce, might be removed from CMP by the fourth quarter, the DPA chief indicated, and aluminum may be decontrolled in the first quarter

of 1953. Copper would still remain under tight government curbs.

Before Mr. Fleischmann's statement, the mobilizers' position had been that shape-by-shape decontrol would only lead to confusion.

More Schools, Hospitals

Major increases in allotments will go to schools, hospitals and highway construction, Mr. Fleischmann said, but there was no indication that the relaxation would be extended to home building.

Another type that appeared sure of materials by the end of the year: television stations. The Federal Communications Commission was expected to lift its ban on new TV stations.

(Continued on page 26)

M-100: SCHEDULE I

Quantities of controlled materials which may be obtained under the self-authorization procedure and which may be used in 1-through-4 family residential structures, the construction of which is commenced after Mar. 5, 1952.

Type of Construction	Carbon Steel (excluding structural shapes)	Copper and Copper Base Alloys
Residential structures using steel pipe water distribution system, per dwelling unit.	Not more than 1800 lbs. per dwelling unit.	Not more than 35 lbs. per dwelling unit.
Residential structures using copper pipe water distribution system, per dwelling unit.	Not more than 1450 lbs. per dwelling unit.	Not more than 135 lbs. per dwelling unit.
Residential structures using steel pipe for interior water supply pipes where local building code requires Type B or K copper tubing for underground water service connections, per dwelling unit.	Not more than 1635 lbs. per dwelling unit.	Not more than 80 lbs. per dwelling unit.
Residential structures using copper pipe water distribution system where local building code requires Type B or K copper tubing for underground water service connections, per dwelling unit.	Not more than 1450 lbs. per dwelling unit.	Not more than 145 lbs. per dwelling unit.
Residential structures using sheet metal ducts for heat distribution.	In addition to the amounts of controlled materials allowed above, not more than 500 lbs. of carbon steel per dwelling unit.	
Residential structures using electrical energy heating systems.		In addition to the amounts of controlled materials allowed above, not more than 15 lbs. of copper per dwelling unit.

Structural shapes (except foreign, as noted above), alloy and stainless steel A products may not be used for the above types of construction. However, aluminum may be used for the conduction of electricity in place of copper on the basis of one pound of aluminum for each two pounds of copper. In such event, the allowable quantity of copper is to be reduced accordingly.

FIVE SCHOOL BUILDINGS CITED FOR "OUTSTANDING DESIGN"

School Executive Magazine's First Annual Competition Draws 186 Entries

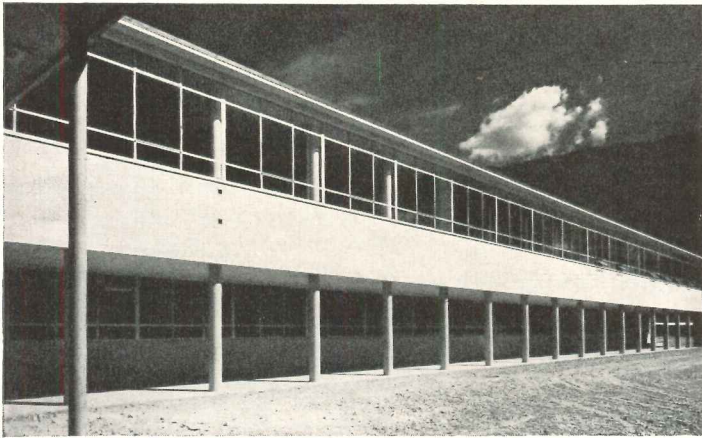

Varley

Stanley Humphries School, Castlegar, B.C.; Sharp & Thompson, Berwick, Pratt, Architects

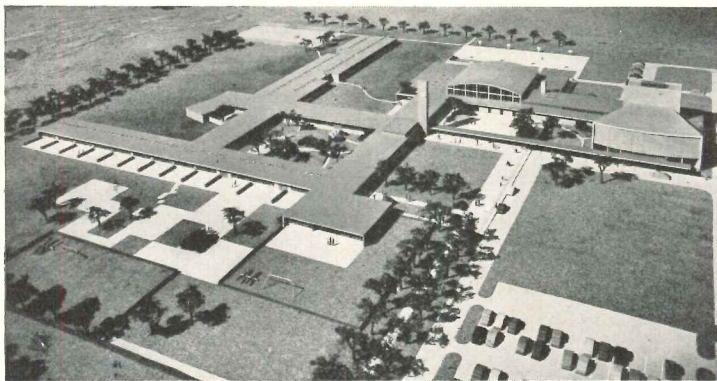

Lou Checkman

Long Beach Elementary-Junior High School, Long Beach, N. Y.; Reisner & Urbahn, Architects



Ruth Gray

Vine Street School, Bangor, Maine;
Eaton W. Tarbell, Architect

AWARD WINNERS in the first annual Competition for Better School Design sponsored by *School Executive Magazine* were exhibited at the regional convention of the American Association of School Administrators February 23-27 in St. Louis. Also on exhibit were the winners in the A.A.S.A.-A.I.A. Regional Competition for school buildings.

The five winning entries and one Canadian school which won a special award in the *School Executive* Competition are shown on these pages. In addition, there were 15 Honorable Mentions and four Special Mentions.

One hundred eighty-six approved entries were received; 109 projects were actually submitted. The competition was open to all architectural firms in the United States and Canada which during 1951 designed or constructed a new school building in whole or in part.

Morris Ketchum, of Ketchum, Gina, and Sharp, Architects, New York, was chairman of the panel of judges chosen by *The School Executive* in cooperation with the A.I.A. Committee on Competitions.

Other judges were: Robert Hutchins, Moore and Hutchins, Architects, New York; Walter Kilham Jr., O'Connor and Kilham, Architects, New York; Ray L. Hamon, Chief of the School Housing Section, U. S. Office of Education; and Benjamin C. Willis, Superintendent of Schools, Buffalo.

Honorable Mentions were given to the following architectural firms: Aeck Associates, Atlanta; Clark and Beuttler, Robert Evans, San Francisco; Warren S. Holmes and Company, Lansing, Mich.; Johannes and Murray, Silver Springs, Md.; Kelly and Gruzen, New York; Lyles, Bissett, Carlisle and Wolff, Columbia, S. C.; McLeod and Ferrara, Washington, D. C.; Perkins and Will, Chicago.

Also Sharp and Thompson, Berwick, Pratt, Vancouver, B. C.; Sibley and Sibley, West Hartford, Conn.; Spaulding-Rex-Deswarte, Los Angeles; and Weiler and Strong, Madison, Wis.

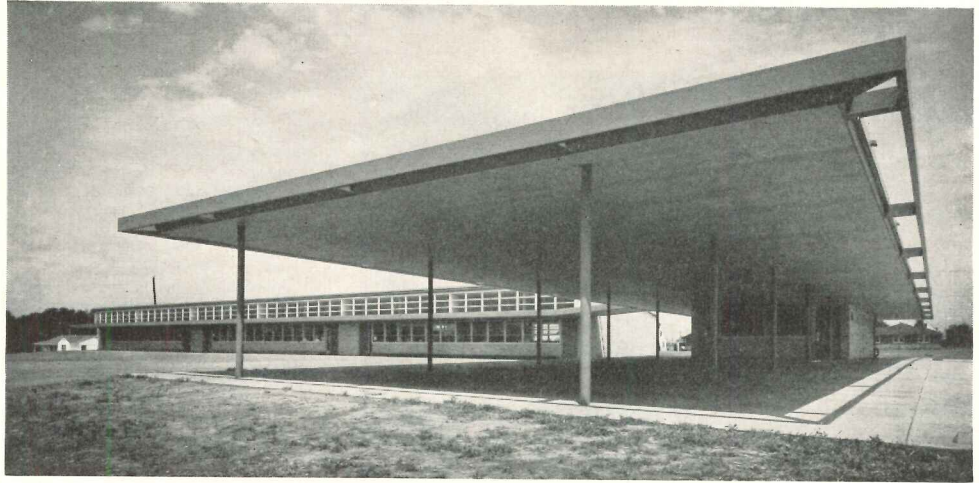

Hedrich-Blessing

Westwood Elementary School, Stillwater, Okla.; Caudill, Rowlett, Scott & Associates, Architects



Colonial Heights Elementary School, Yonkers, N. Y.; Edward Fleagle, Architect

Richard Garrison

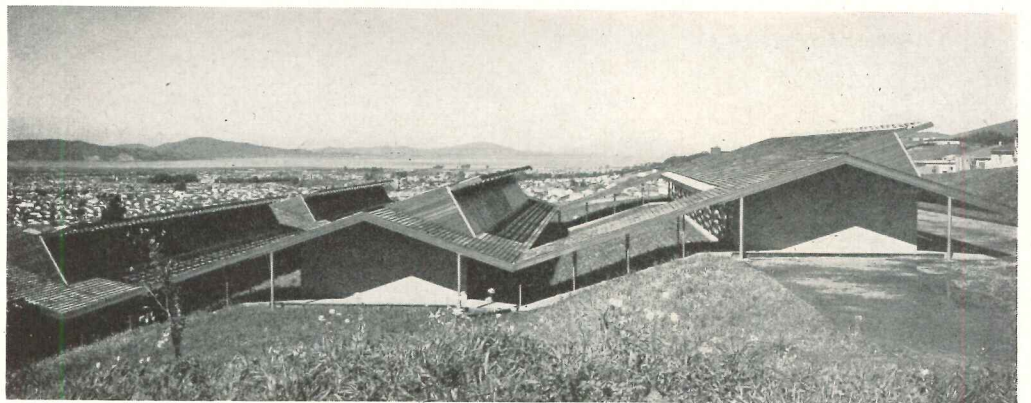

Rondal Partridge

Mira Vista Elementary School, El Cerrito, Cal.; John C. Warnecke, Architect

MICHIGAN ARCHITECTS HOLD BIG AND BUSY MEETING



Jury members in Small House Competition look over the exhibit. Standing: Clair W. Ditchy, F.A.I.A., A.I.A. secretary; Jean Hebrard, F.A.I.A.; Suren Pilafian, A.I.A.; front row: A.I.A. Regional Director John Richards; Alden Dow, A.I.A.

William E. Bradley

AWARDS in a small house competition sponsored by the Michigan Society of Architects and supported in prize money by a real estate developer were presented at the Michigan Building Industry Banquet which closed the Society's 38th annual convention at Detroit March 5-7.

Howard T. Keating of Birmingham, Mich., who contributed \$1400 to the prize fund, made the presentations.

First prize went to Gordon A. Sheill,

A.I.A., and Harold Binder, designer, both of the office of Albert Kahn Associated Architects and Engineers, Inc. Second prize was won by Charles D. Hannan, A.I.A., and Herbert L. Hawthorne, designer; and third prize by Morris Jackson of Smith, Hinchman and Grylls, Architects and Engineers.

Close to 400 members and guests attended the convention, and more than 1000 people were at the Industry banquet.

MEMORIAL DESIGNS EXHIBITED AT VIRGINIA CONVENTION

THE NINETEEN ENTRIES in last winter's Virginia World War II Memorial Competition were on exhibit as one feature of the annual meeting of the Virginia Chapter of the American Institute of Architects February 15-16 in Richmond.

Construction is expected to begin next spring on the memorial, which will be erected from the winning design (photo of rendering below) by Samuel J. Collins

of Staunton, in collaboration with his nephew, Richard F. Collins of Silver Springs, Md.

The annual banquet and some of the other sessions were held jointly with the Virginia Society of Professional Engineers, which was meeting at the same time. Highlight of the joint sessions was the seminar on prestressed concrete, at which Beanie Miesal, Jack Lacey, Bill

Blanton and Phil Melville, researchers and engineers, were among the speakers. One Virginia example of prestressed concrete construction, Sullivan's, Inc., Store in Kilmasnock, came in for discussion.

Louie L. Scribner of Charlottesville was reelected president of the Society.

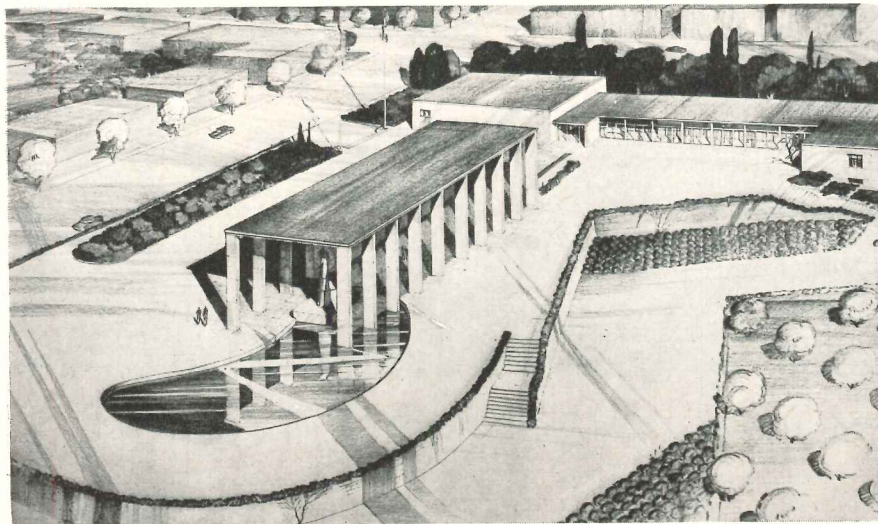

A.I.A. MOUNTAIN REGION HOLDS FIRST CONFERENCE

THE FIRST ANNUAL CONFERENCE of the Western Mountain District of the American Institute of Architects last month drew 225 architects from four of the district's five states to Colorado Springs for a highly stimulating and eventful session.

Seminars on urban redevelopment, prestressed concrete and landscape architecture were outstanding.

W. Gordon Jamieson of Denver was nominated by acclamation to be a candidate for regional director at the A.I.A. convention in June.

There was much indignant protest over the news that the School of Architecture at Denver University might be closed as "unprofitable."

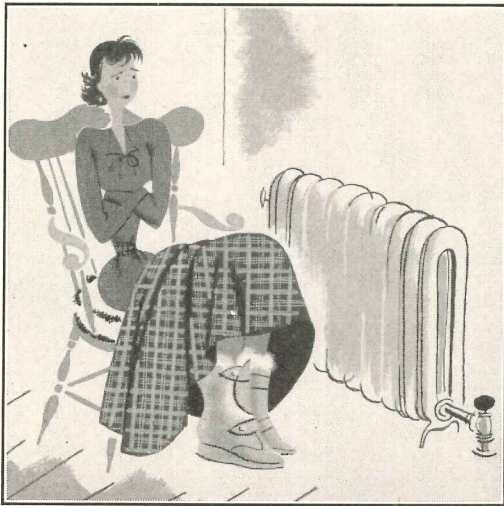

COLD FEET...

Dampness, Tremendous Heat Loss, Peeling Paint, Timber Rot, are the Products of Usual Crawl Space Construction

Nature's Law: Heat flows to cold in any direction by Radiation and Conduction.

So warm walls, ceilings, furniture, people, even dust particles, transmit downwards invisible energy rays through the air to a cold floor where they are absorbed, turned into heat, and conducted down. Also, heat flows down by direct conduction through solids, wherever walls, furniture and people touch the colder floor.

How to prevent condensation and timber rot, conserve heat and create foot comfort, are explained by the National Housing Agency. Its "Technical Bulletin No. 38" reports numerous tests in which the National Bureau of Standards subjected multiple aluminum surfaces in crawl spaces to dampness from below, deliberate fogging, and tremendous temperature drops. To quote some of the findings:

DEWPOINT NEVER REACHED

"The temperature of these surfaces was observed to be above the dew point of the contacting air under all test conditions."

"With average outside air temperatures between 30.9 and 32.2 degrees F., the temperatures of the upper surface of the insulation remained above the dew point of the air to which it was exposed by 12.5 to 15.7 degrees F.," with only 2 layers having 4 aluminum surfaces, forming 3 reflective spaces.

"When the outside temperature dropped from 56.3°F. to 31.4°F. in six hours, the insulation temperatures remained above the dew point by 14.6 to 10.3°F. When the ambient temperature was dropped from 39.2°F. to 9.2°F. in 24 hours, the insulation temperatures remained above the dew point by 12.9 to 5.8°F.," with only one layer of insulation, two reflective surfaces and spaces.

CONDENSATION CANNOT OCCUR

"As a further indication of lack of condensation, the upper surface of the upper layer of insulation was deliberately fogged during several of the tests. Each time the surface of the insulation was so fogged, the condensed moisture disappeared within 5 to 10 minutes."

"The results indicate that condensation would not occur between the floor and the insulation or between the two layers of insulation during any probable winter conditions."

"Reflective insulation produces a marked rise in the temperatures of the floor surface."

ORDINARY INSULATIONS SPILL OUT

Vapor flows from areas of greater density to those of lesser. The lower its temperature, the less vapor can air retain in suspension.

Ordinary insulations, including asphalt paper covered ones (asphalt is not impervious to vapor, only to moisture), get soaking wet in crawl spaces, because of condensation on the fibres from ambient vapor, and vapor flow from the earth below and the building

above. So they tear at the staples and elsewhere because of wetness and added weight, and spill their contents to the earth, unless a costly support is built underneath, in which case timber rot is fostered by the wet mass.

Multiple accordion aluminum sheets weigh less than 1 oz. per sq. ft., are impervious to vapor, are non-condensation-forming, do not absorb nor retain any moisture, need only staples for support. They bar heat flow by RADIATION with their 3% absorptive and 3% emissive surfaces. Practically no heat flows by CONDUCTION through their multiple air spaces for air is a poor conductor. There is no CONVECTION heat flow downwards.

NON-CONDENSATION FORMING INSULATION

One commercial form of multiple accordion aluminum, Infra Insulation Type 6, is pre-fabricated with three sheets of tough aluminum and two separating fibres to automatically form six reflective spaces, six fully reflective surfaces, as it is stapled in place, simply and speedily. Infra Type 4 provides 4 reflective spaces. For shallow structural spaces (less than 2") especially under floors, Type 4 Jr. is suggested.

For a more detailed discussion of the principles of heat and vapor flow and their practical application to the prevention of heat loss, discomfort and destructive condensation, consult "Technical Bulletin No. 38" and Alexander Schwartz's "Simplified Physics of Vapor and Thermal Insulation." Copies of either or both sent FREE.

INFRA THERMAL FACTORS, DOWNHEAT

Type 6 C.044 R22.72 = 9" Dry rockwool

Type 4 C.065 R15.38 = 6" Dry rockwool

Type 4 Jr.* C.097 R10.30 = 4 1/8" Dry rockwool
*In 1" space.

INFRA INSULATION, INC.

525 Broadway, New York, N. Y.—WORTH 4-2241

INFRA INSULATION, INC., 525 Broadway, N. Y. C. Dept. R4

Please send FREE "Technical Bulletin No. 38." Send FREE "Simplified Physics of Vapor and Thermal Insulation," new revised edition. Send Prices of Infra Insulations. Send Sample.

Name _____

Firm _____

Address _____

Fine Flush Valves for Fine Buildings

For complete information on Watrous Flush Valves write for Catalog No. 449.

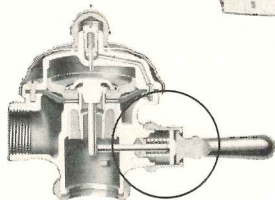
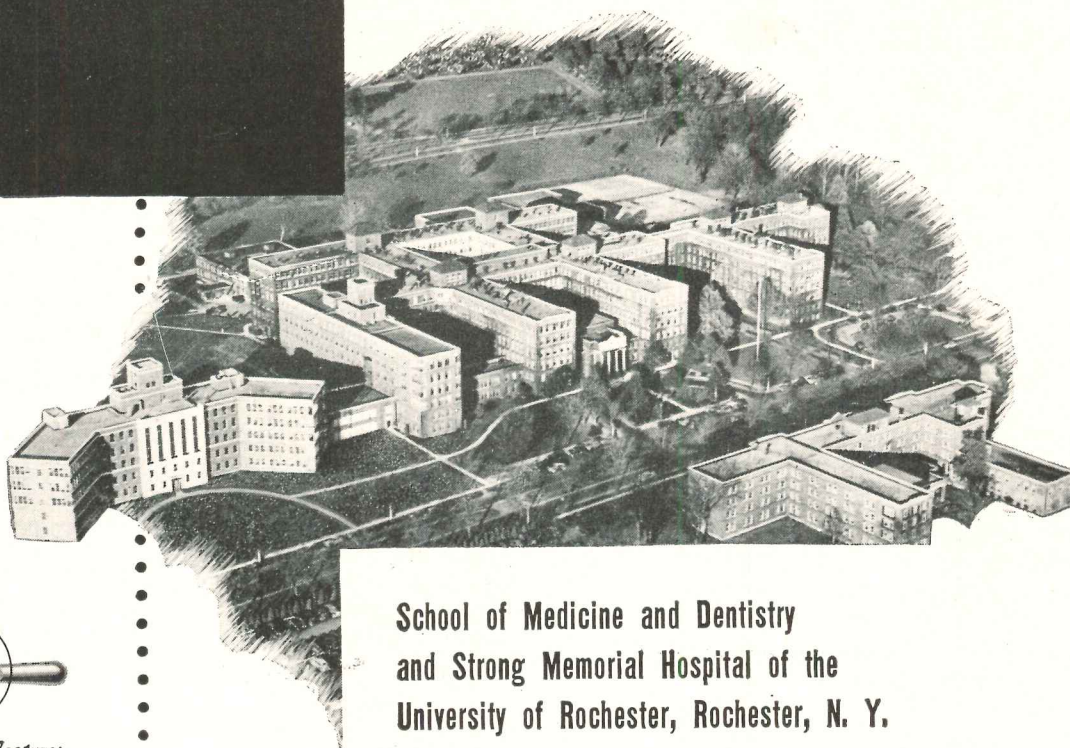

Among Watrous Fine Features

Self-Tightening Handle Packing

The spring-loaded packed stem in Watrous Flush Valves automatically maintains proper tension on the packing at all times. Provides real protection against leakage, yet requires no periodic tightening.

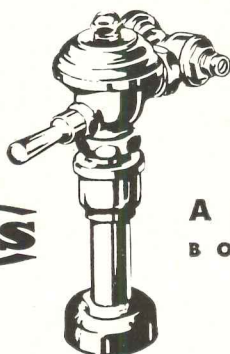

Watrous

School of Medicine and Dentistry and Strong Memorial Hospital of the University of Rochester, Rochester, N. Y.

Shown at left in this aerial view is New Psychiatric Clinic. This outstanding Medical Center is typical of the many fine buildings in which Watrous Flush Valves are installed.

KAELBER & WAASDORP

Architects

A. W. HOPEMAN & SONS CO.

General Contractors

WRIGHT & ALEXANDER CO.

Plumbing Contractors

**ADJUSTABLE FLUSH VALVES
BOTH DIAPHRAGM AND PISTON TYPES**

THE IMPERIAL BRASS MANUFACTURING CO.

1240 W. Harrison Street, Chicago 7, Illinois

BRAB CONFERENCE ATTACKS CONDENSATION PROBLEMS

René



At the BRAB conference: Paul Cadwallader, Bennington, N. J., lumber dealer; Prof. of Architecture Kenneth Sargent, Syracuse; Leonard Haeger; Alfred Ebert, Cleveland painting contractor

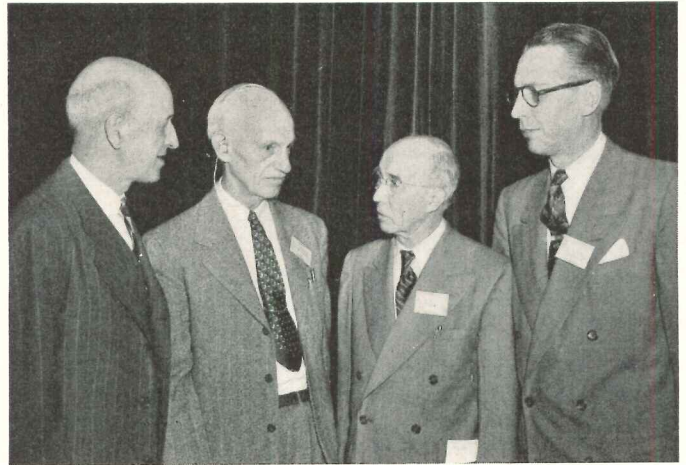

Conference Chairman Tyler Stewart Rogers; L. V. Teesdale, U. S. Forest Products Lab.; Frank Rowley, Minnesota professor-emeritus; C. E. Lund, Minn. Engineering Experiment Station

ONE OF THE KNOTTIEST problems in current construction — condensation control — came in for thorough probing and discussion at the latest technical conference of the Building Research Advisory Board in Washington late in February. The conference was held at the National Academy of Sciences and was arranged by William H. Scheick, executive director of BRAB. The conference chairman was Tyler Stewart Rogers. An impressive group of technical experts presented papers covering condensation problems as related especially to paint problems and insulating materials.

To open the discussion a lively panel had been arranged to present the practical aspects of the problem. Here the down-to-earth views of an architect, a merchant builder, a lumber dealer and a painting contractor were aired. Thus, right at the start, the scientists and technicians were presented with a definite statement of condensation problems from the viewpoint of men in the field.

Moderator of this opening panel was Leonard Haeger, Research Director of the National Association of Home Builders.

Following the discussion of practical problems, Professor C. E. Lund of the University of Minnesota Engineering Experiment Station presented a paper on technological aspects of the problem. This was followed by "Mechanics of Moisture Movement," a study by J. D. Babbitt of the Canadian Scientific Liaison Office.

In the field of current technical progress, which was the subject of the afternoon session of the first day of the con-

ference, another panel discussion was staged devoted to paint films. The subject was introduced by E. J. Dunn, Jr., of the National Lead Company, and members of the panel were W. G. Vannoy, E. I. duPont deNemours & Co.; G. G. Sward, National Paint, Varnish & Lacquer Assn.; and W. A. Gloger, National Lead Company. The moderator was J. S. Long, Devco and Reynolds.

Other subjects covered were paper and foil films, Floyd Newkirk moderator; insulation and construction prob-

lems, L. V. Teesdale, speaker and moderator. Members of the panel devoted to this subject were R. S. Dill, Bureau of Standards; Frank Rowley, University of Minnesota; Frank Parsons, National Mineral Wool Assn.; and A. S. Bull, Insulite Div., Minnesota & Ontario Paper Co.

The final session of the conference was devoted to future technical and educational opportunities with a panel presided over by Professor E. R. Queer of Pennsylvania State College.



— Drawn for the RECORD by Alan Dunn

"I was their coordination specialist — and then they asked me to decentralize —"

FOUR HOUSING PROJECTS IN CALIFORNIA CALLED BEST DEVELOPMENTS OF 1951

FOUR HOUSING DEVELOPMENTS in California have been cited by the Architectural Board of Review of Southwest Research Institute's Quality House Program as the best builders' developments approved by the Institute during 1951.

Frederick E. Emmons and A. Quincey Jones, Anshen and Allen, were architects and Eichler Homes, builders, for all four projects — Charleston Meadows, Channing Park and Fairmeadow, all in Palo Alto, and Ladera, in Menlo Park.

Second honors went to Robert Morris Park, Morristown, N. J., a project approved late in 1950 and considered with this year's projects in accordance with a decision of the Board at the time last year's award was made. Nemeny and

Geller were architects, Lynch and Kline, site planners. Owner is Standard Holding Company and Edward S. Klausner is the builder.

The Board also recommended a special mention for Conantum on the Sudbury River, Concord, Mass., which was commended for "superb" site planning. Carl Koch and Associates were the architects, Conantum Realty Trust, the builder.

12 Projects Considered

Of the 20 projects approved during 1951, the Board gave serious consideration to 11 and the Morristown project from last year made the total reviewed for the award 12.

The effort of the Board in selecting the

award winner was to cite the project which best exemplified the aim of the Quality House Program — to make houses of high quality available to the public at moderate prices.

Honorable Mentions Given

Three honorable mentions were given by the Board:

Vista Val Verde Ranches, Provo, Utah; W. Rowe Smith, architect; Delmar C. Kenner, builder.

Orchard Hill, Branford, Conn.; Peter Powers Hale, architect; The Builders Corporation, builder.

Holmes Run, Fairfax County, Va.; Keyes, Smith and Satterlee, architects, Francis D. Lethbridge, associate; Luria Brothers, Inc., builder.

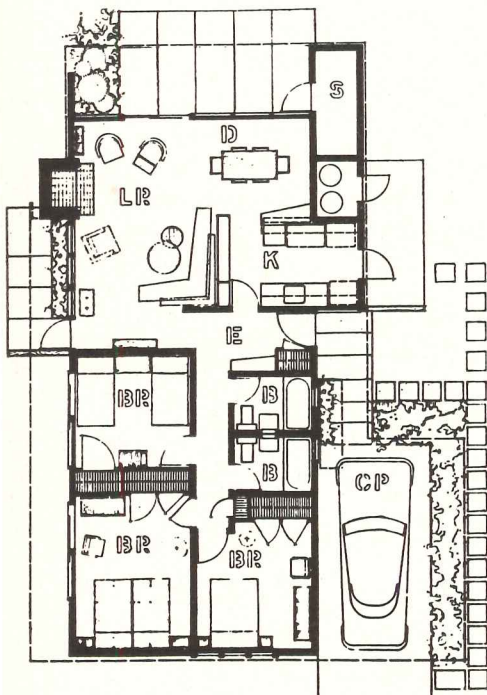
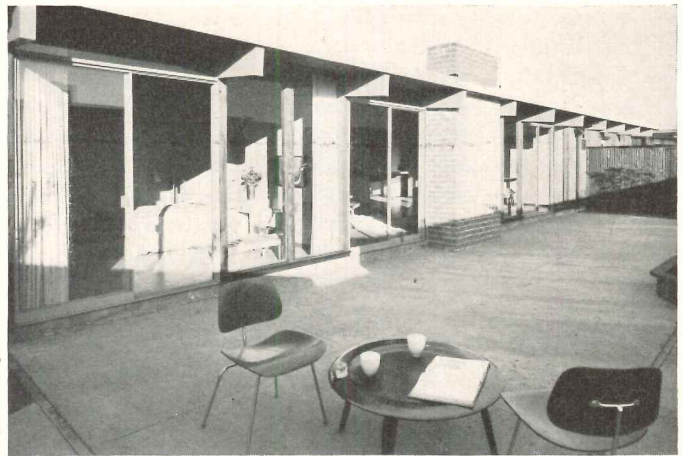

House in the Fairmeadow development is shown in photo (at left above) and plan (left). Price: \$14,750. House in Channing Park: photo at right above; plan below. Price: \$19,750-\$20,750. Units in all the

California projects were commended for good design, skillful use of plank and beam roof construction, good circulation, paved terraces, service courts and fences for privacy. All have radiant heating

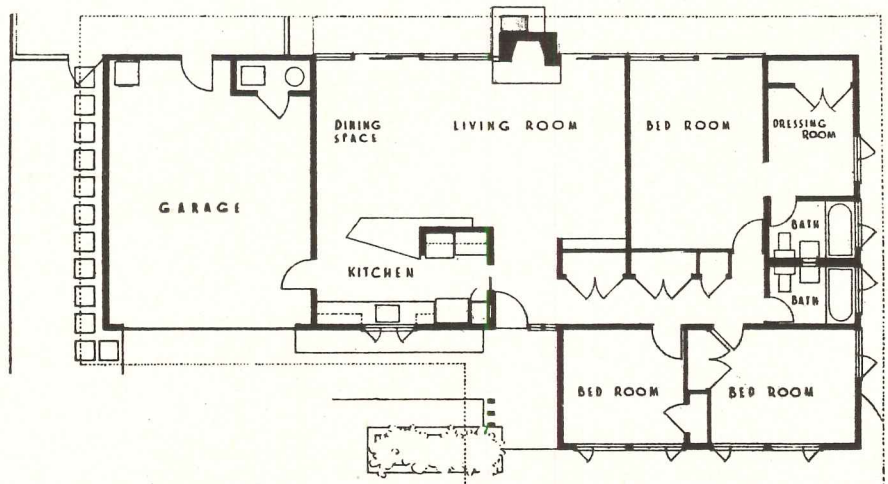

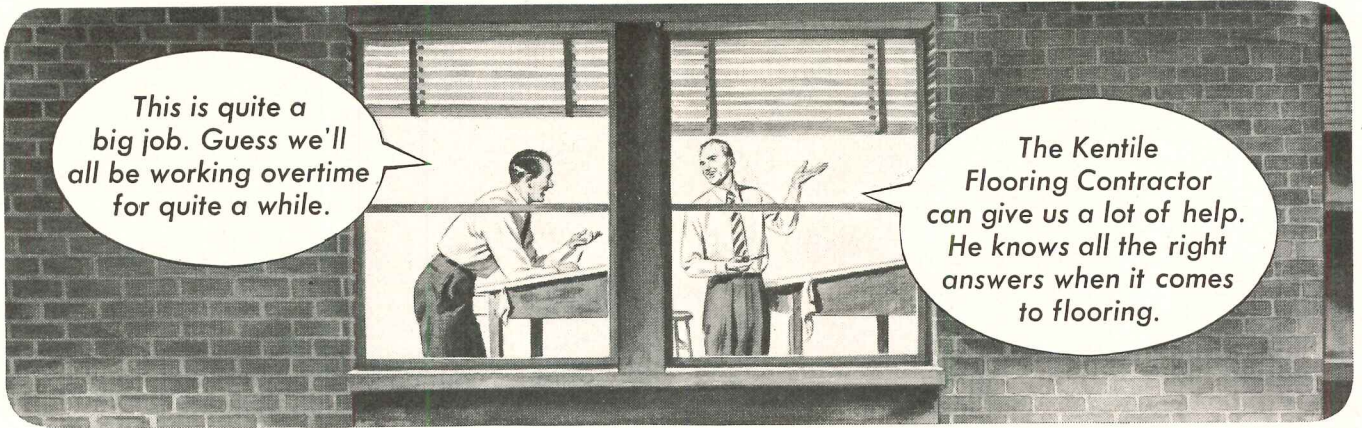

This is quite a big job. Guess we'll all be working overtime for quite a while.

The Kentile Flooring Contractor can give us a lot of help. He knows all the right answers when it comes to flooring.

Consider the Kentile Flooring Contractor a willing addition to your staff

DUE to the complexities of modern flooring materials available today, selection is increasingly a job for trained flooring experts... men like the Kentile Flooring Contractor whose years of study and experience qualifies him to choose the right floor for every installation... the one floor that has most to offer in appearance, durability,

and economy in the use to which it will be put.

Whether the problem is one of new construction or the remodeling of existing facilities, the Kentile Flooring Contractor is available night and day to help you select the floor that will give you the most for your money. Call on him as you would any member of your actual staff.



KENTILE Asphalt Tile is preferred for commercial and industrial installation, large and small, because it always looks fresh and new in spite of constant daily traffic... resists dirt, stain and wear for long years of easy, inexpensive cleaning... retains its original, locked-in colors with only an occasional no-rub waxing. And, Kentile's low initial cost plus speedy, tile by tile installation over any smooth, firm surface provides money-saving advantages where business must continue without cost-consuming delay.

KENTILE • SPECIAL (Greaseproof) KENTILE • KENTILE RUBBER TILE • KENCORK



KENTILE INC.

KENTILE, INC., 58 Second Avenue, Brooklyn 15, New York • 350 Fifth Avenue, New York 1, N. Y. • 705 Architects Building, 17th and Sanson Streets, Philadelphia 3, Pennsylvania • 1211 NBC Building, Cleveland 14, Ohio • 225 Moore Street, S.E., Atlanta 2, Georgia • 2020 Walnut Street, Kansas City 8, Missouri • 1440 11th Street, Denver 4, Colorado • 4532 South Kolin Avenue, Chicago 32, Illinois • 1113 Vine Street, Houston 1, Texas • 4501 Santa Fe Avenue, Los Angeles 58, California • 95 Market St., Oakland 4, Calif. • 452 Statler Building, Boston 16, Mass.

PROMINENT CONTEMPORARY HOSPITALS USING

POWERS

Pneumatic Temperature
and Humidity Control



A Temperature Reaction is one of the first events in the life of a new born child—and throughout life temperature and humidity affect its comfort and health.

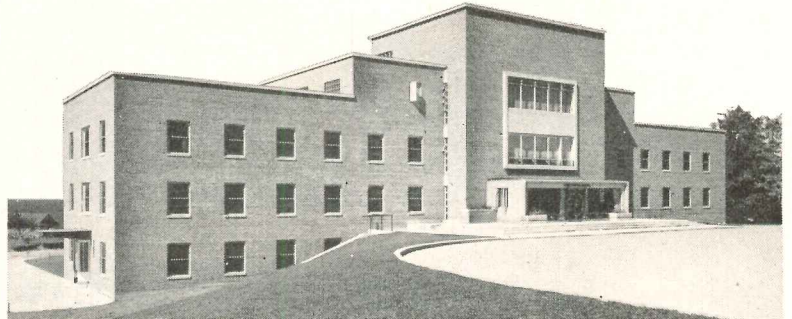

Little Traverse Hospital, Petoskey, Mich.
Architects: Skidmore, Owings & Merrill, Chicago
Consulting Engineer: Samuel R. Lewis, Chicago
Contractor: Lansing Heating & Ventilating Co., Lansing, Mich.

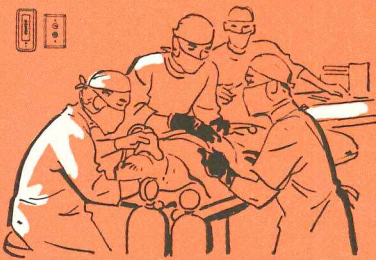

Powers control provides optimum temperature and humidity for patients, doctors and nurses, in operating and recovery rooms, delivery and X-ray rooms and nurseries, private rooms and wards.

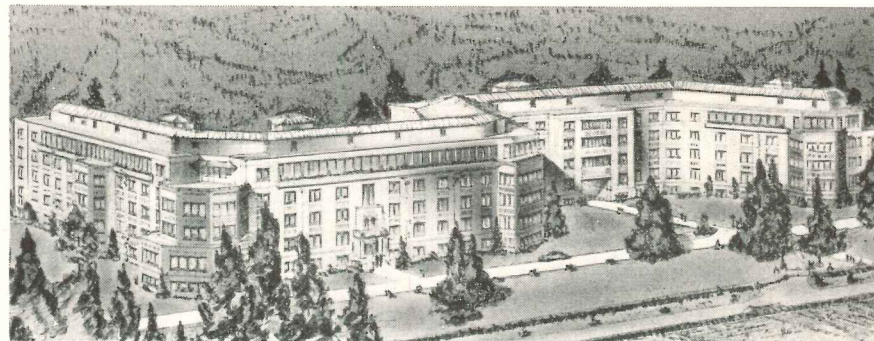

Male Ward Building, Western State Hospital, Fort Steilacoom, Wash.
Architect: A. Gordon Lumm, Tacoma, Washington
Engineer: James B. Notkin, Seattle, Wash.
Contractor: P. S. Lord, Portland, Ore.



Proper Temperature—external and internal, hastens recovery of patients.

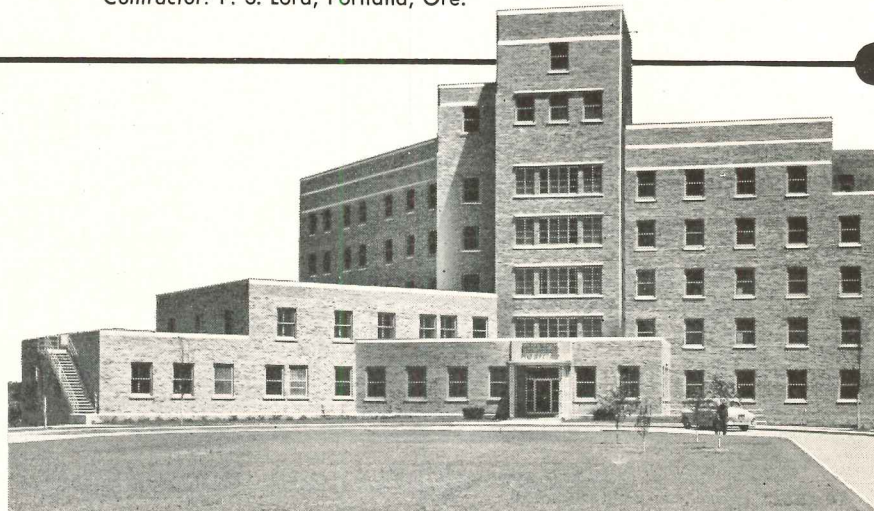

St. Joseph-Benton Harbor Memorial Hospital, St. Joseph, Mich.
Architects: Fugard, Burt, Wilkinson & Orth, Chicago
Contractor: Northwestern Heating & Plumbing Co., Evanston, Ill.

For Greatest Comfort and Lowest Maintenance Cost Use POWERS Control

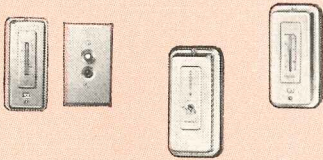

POWERS

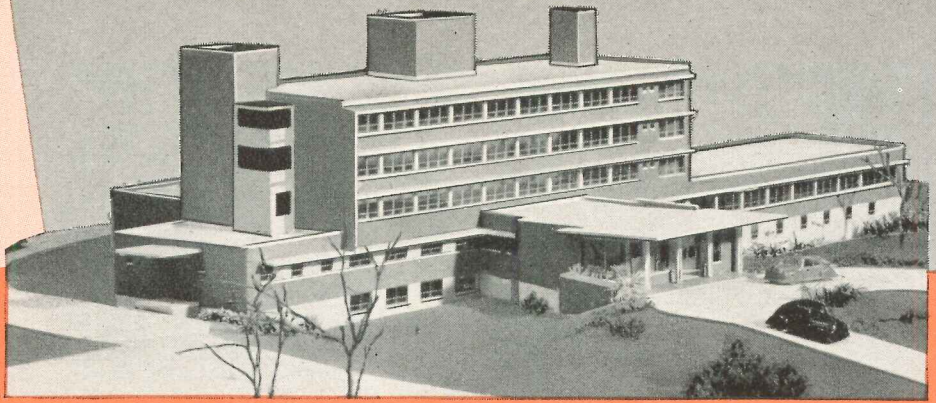
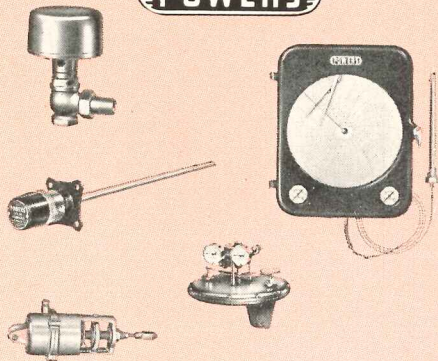

Comanche County Memorial Hospital, Lawton, Okla.
Architect: Paul Harris, Chickasha, Okla.
Paul H. Fesler, Hospital Consultant
Engineers: Carnahan & Thompson, Oklahoma City, Okla.
Contractor: Ray F. Fischer Co.

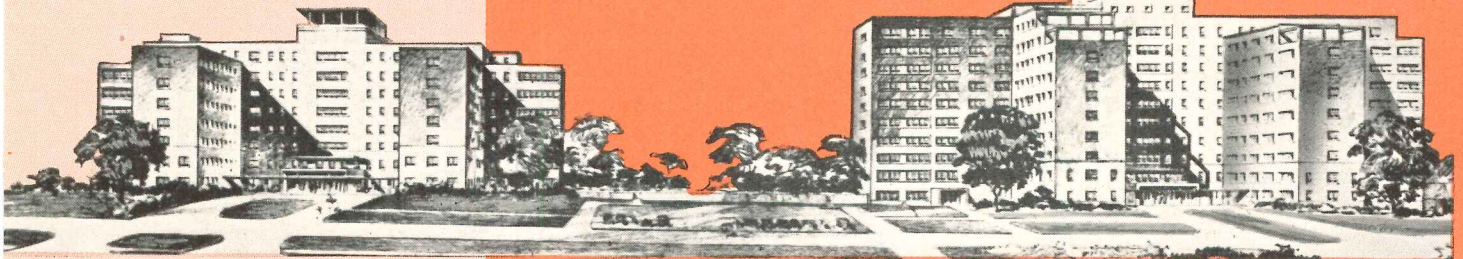

Veterans Administration Hospital, West Haven, Conn.
Left: 400 bed Tuberculosis Bldg.; Right: 500 bed General Medical & Surgical Bldg.
Architects: Curtin and Riley, Boston, Mass.
Engineers: Corps of Army Engrs., Boston District
Contractor: Raisler Corp., New York City

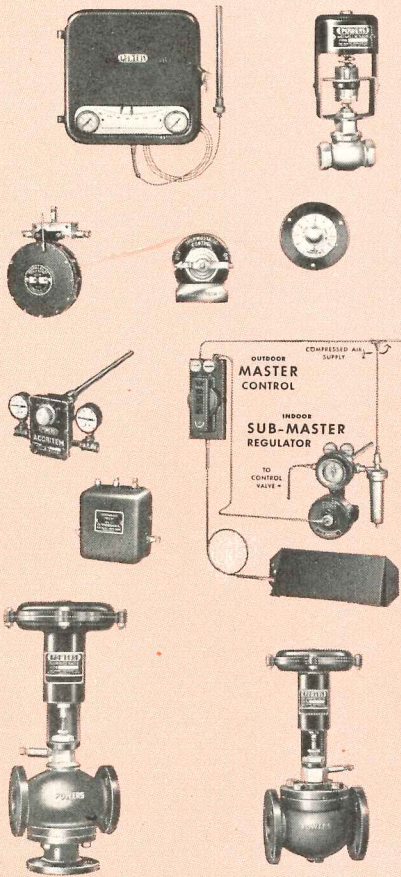

Morristown Memorial Hospital, Morristown, N. J.
Architects: John H. & Wilson C. Ely, Newark, N. J.
Hospital Consultant: Gerhard Hartman, Ph. D., New York City
Mechanical Engineers: Meyer, Strong & Jones, New York City
Contractor: August Arace & Sons, Inc., Elizabeth, N. J.

(a75)

THE POWERS REGULATOR COMPANY

Established 1891 — Offices in Over 50 Cities — See Your Telephone Directory
 GENERAL OFFICES AND FACTORY—SKOKIE, ILLINOIS





MEMORIAL LIBRARY IN BERLIN

The first American-type open-stack free library in Germany will be built in Berlin with American funds as a memorial to airmen who died in the airlift. The final design was developed from four chosen in a competition open to all architects in West Berlin and West Germany under the guidance of Francis Keally as consulting architect and Charles Mohrhardt as library consultant. The German architects whose designs were used were Gerhard Jobst, Willy Kreuer, Hartmuth Wille and Fritz Bornemann. The building, of gray Bavarian stone, will have bronze ventilation grills lighted from behind at night.

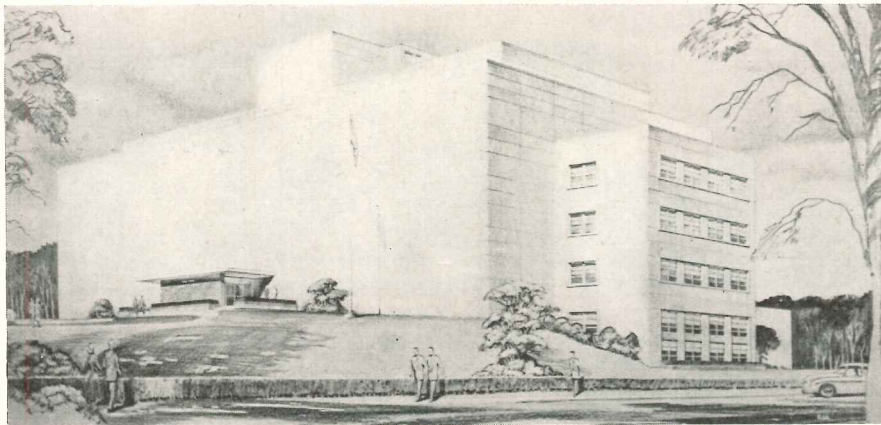

"PROTECTIVE" CONSTRUCTION

The new pathology hospital to be constructed at the Army's Walter Reed Hospital in Washington will feature the first "protective" construction in the Washington area — exterior walls of reinforced concrete 12 in. thick, designed to withstand an atomic bomb blast up to half a mile away. Building will have 3,221,900 cu ft, cost \$7 million. Architects: Faulkner, Kingsbury and Stenhouse; engineer, Guy D. Panero; structural engineers, Marshall and Gongwer.

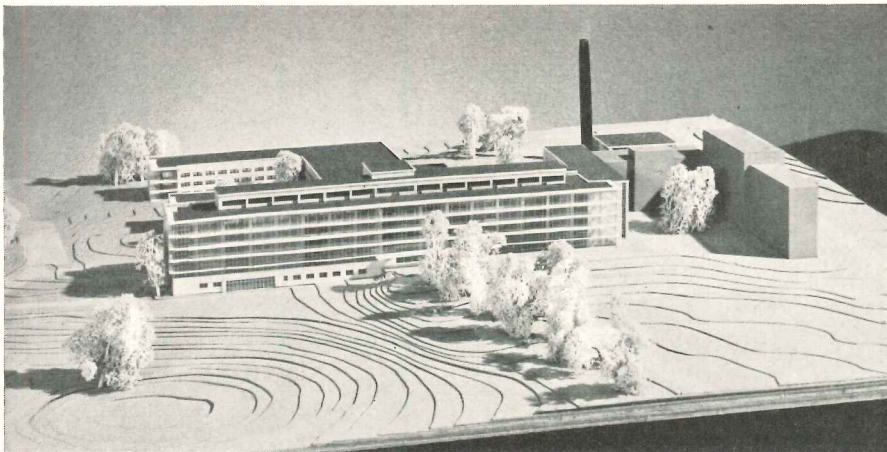

George M. Cushing Jr.

HOSPITAL FOR THE INDIGENT

Coolidge, Shepley, Bulfinch and Abbott are architects for the new buildings to replace the old Springfield, Mass., Municipal Hospital, which is operated for indigent patients without charge by 70 volunteer doctors. There will be a six-story main building containing children's rehabilitation center, operating and laboratory rooms, and two wards for 234 patients. Attached two-story building will house 204 aged patients and their own rehabilitation center.

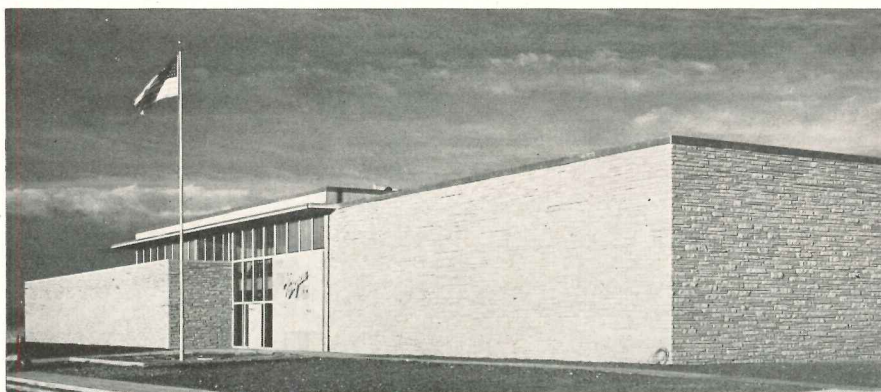

PNEUMATIC PRODUCTS PLANT

C. A. Norgren Company plant in Englewood, Colo., a suburb of Denver, is pleasantly located near a city park and has a magnificent view of the Rockies. The 60,000-sq-ft building is a steel frame structure, except for the west wall, a cavity-bearing wall with outer diaphragm of red flagstone. Elsewhere walls are curtain type to simplify future expansion. Stanley Morse, architect; Jared Morse, designer.

Maxwell, Masmy Studio

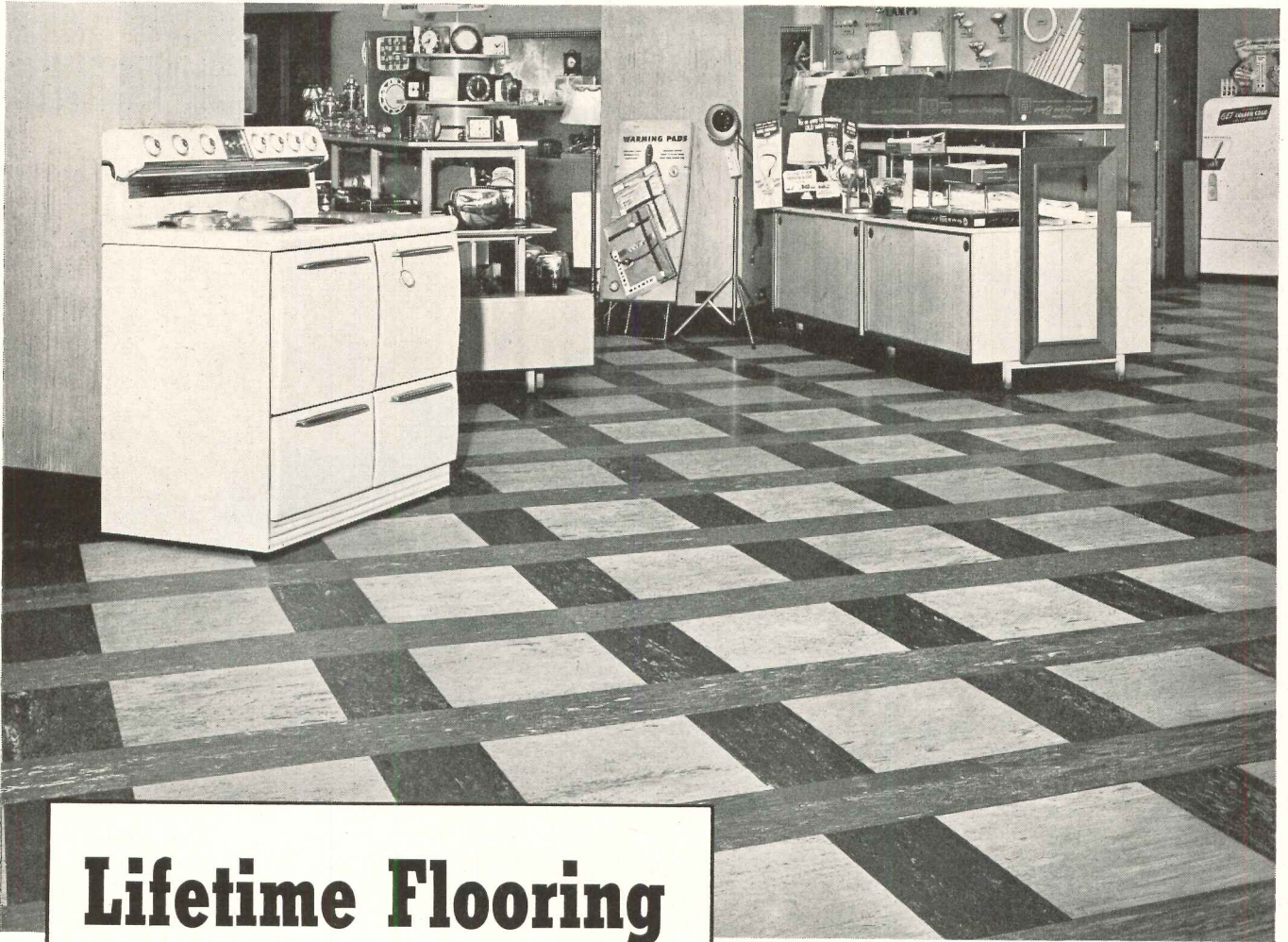

Lifetime Flooring -Lifetime Beauty!

*Wingfoot Rubber is enduring
testimony to your sound
judgment*

YEARS from now, this wonderfully rich, smooth, lustrous flooring will still be saying fine things about your wisdom in specifying it.

Years from now, your client will still be enjoying the like-new beauty, resiliency, comfort and quiet of this remarkable flooring.

LASTING BEAUTY—Choose from 16 attractive, durable marbled colors that never fade or “walk off” because they are an integral part of the flooring.

DURABILITY—Goodyear’s Wingfoot Rubber Flooring resists fire, stains, alcohol, inks, most acids, cigarette burns. The smooth, resilient surface defies time and wear!

EASE OF MAINTENANCE—Because dirt doesn’t penetrate its surface, Wingfoot Rubber Flooring keeps its brand-new look with minimum maintenance cost.

ADAPTABILITY—Available in either continuous sheet form or 9” x 9” tile, Wingfoot Rubber is favored by architects, builders and owners for both commercial and residential installation.

AND ECONOMY! Long after conventional floorings need replacement, Goodyear’s Wingfoot Rubber Flooring retains its just-installed look!

See Wingfoot Rubber, specify it at flooring dealers’ and contractors’. For specification data, write to Goodyear, Flooring Dept., Akron 16, Ohio.

Wingfoot—T. M. The Goodyear Tire & Rubber Company, Akron, Ohio

WINGFOOT *Rubber* FLOORING { SHEET
by and
GOODYEAR TILE
Makers of VINYL • TILE Flooring

OVER 2

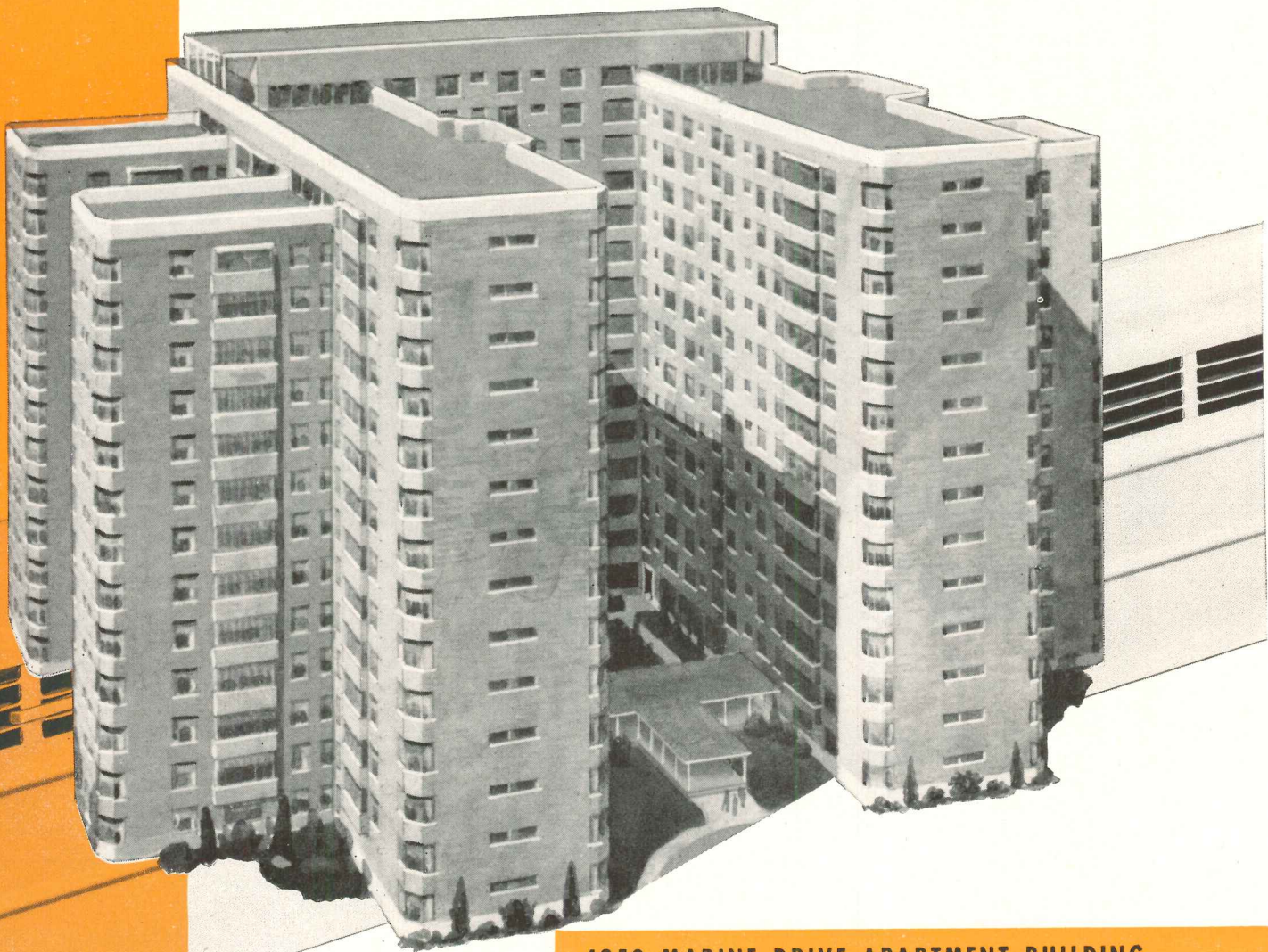

4950 MARINE DRIVE APARTMENT BUILDING

ARCHITECT—Dubin & Dubin, 140 North Dearborn, Chicago, Illinois.

ENGINEER—H. S. Nachman & Associates, 179 West Washington, Chicago, Illinois.

GENERAL CONTRACTOR—Peter Hamlin Construction Co., 9 South Clinton Street, Chicago, Illinois.

HEATING CONTRACTOR—Davis Construction Co., 18 West Kinzie, Chicago, Ill.

FEDDERS-QUIGAN CORPORATION

MILES *of* ***fedders***

Baseboard Radiation

Heating New Chicago Apartment

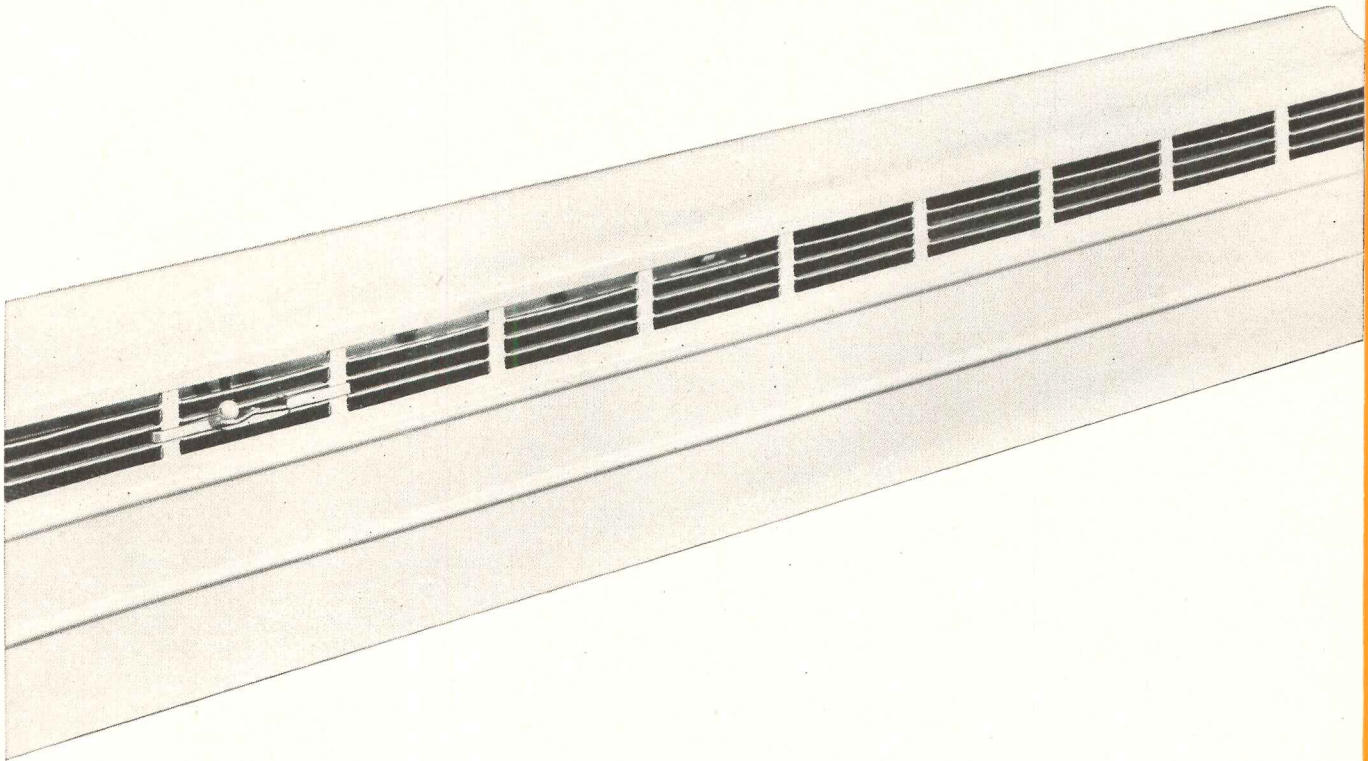

Men who design and build modern American housing are turning to Fedders Baseboard Radiation for efficient, economical heating.

This ultra-smart apartment building located at 4950 Marine Drive is another example of how men of the profession and the industry are providing new comfort, new cleanliness and new decor with Fedders Baseboard Radiation.

Taking the place of ordinary baseboards, Fedders Baseboard Radiation saves space, facilitates furniture arrangement and simplifies picture

window installations.

Fedders Baseboard Radiation has specially designed anti-streak covers (patent applied for) which reduce cleaning and maintenance costs.

They are light in weight, easy to stock and install. They give instant response to thermostatic control thus conserving fuel by eliminating necessity to "force the fire" or open windows to cool off.

Fedders representatives are located in every major city. You will find their names in your classified telephone directory.

57 Tonawanda Street • Buffalo 7, New York

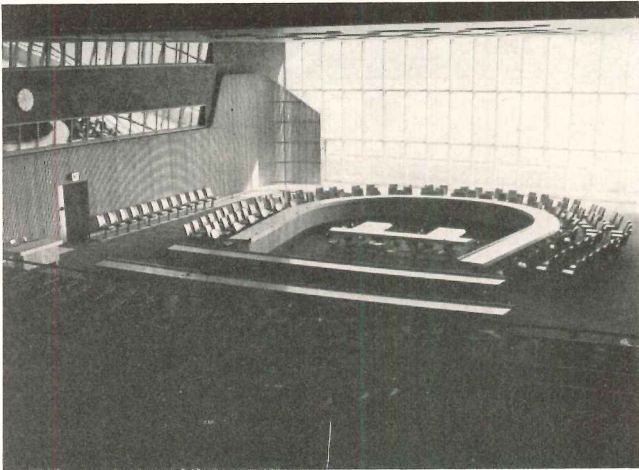

UNations

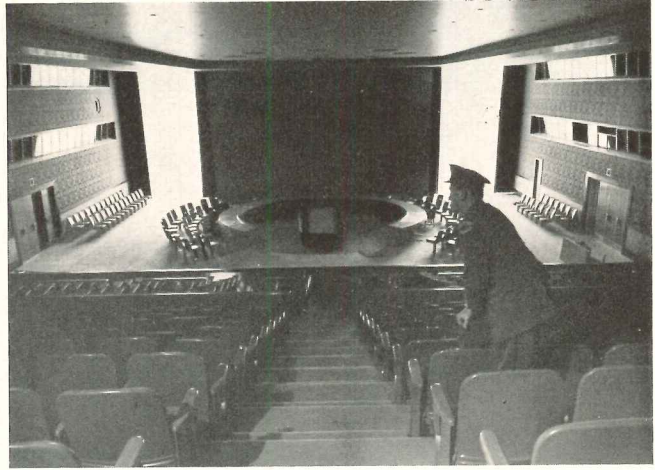

UNITED NATIONS CONFERENCE BUILDING OPENS

THE \$11 MILLION United Nations Conference Building was opened at the end of February and the three Council rooms shown here held major interior interest.

All three were outfitted by the Scandinavian nations. For the Security Council (above right), Arnstein Arneberg directed the decorating for Norway. Walls are done in a tapestry pattern that repeats the design of the draperies; doors are of Scandinavian pine with inlaid designs.

Sweden was the sponsor and Sven Markelius the designer for the Economic and Social Council Chamber (left above), where the treatment of the ceiling is

notable for its straightforward showing of metal struts and lighting fixtures.

In the Trusteeship Council Chamber (left), Designer Finn Juhl, for Denmark, has used Danish birch in woodwork and horse-shoe-shaped tables. Walls are gray acoustical plaster; ceiling has rectangular blocks of yellow, green, rust and black, colors repeated in alternating bands on the gray rug.

Contemporary furnishings, used throughout, include chairs from England, tables from Canada, leather divans from the United States, rugs from Scotland, and woodwork from the Netherlands or the Far East.

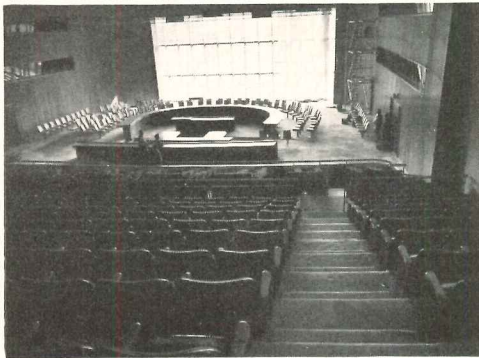

NPA APPROVAL (Cont. from page 11)

Long-Awaited Orders Issued

Issuance of the new construction control orders on March 6 was already almost incidental in the general stream of NPA announcements loosening the reins on construction.

By the time it issued its revised CMP Regulation 6 and the new housing order, M-100, NPA had: (1) lifted the ban on 646 community projects previously denied approvals; (2) allowed completion of 186 other commercial-type projects previously halted; and (3) granted permits to 105 new commercial building projects in six metropolitan areas where building curbs under the defense program have brought about serious unemployment.

The revised edition of Regulation 6 consolidated all the controls formerly grouped under M-4A; and M-100 was the new order covering housing.

Even structural steel was favored, though not so much as carbon steel of other types, in the new orders. Self-

authorization was applied to 2300 lb of carbon steel per housing unit per quarter; and in Regulation 6 the self-authorization provision for permitted types of commercial construction was raised to five tons, including two tons of structural steel.

It was a different story for copper; but even there the housing order issued was more liberal than the original draft which drew such strong protest from the industry. The threatened bathroom limitation was entirely removed and the order permits adequate wiring facilities for new homes; the original proposal had cut close — too close, the industry insisted — to the "safe" level. Area limitations on housing likewise had been dropped.

Major drawback from builders' point of view: the new order set up a *use* limitation, instead of a *delivery* limitation, on controlled materials. That meant that whatever a builder used from his own inventory must be counted as part of his self-authorization maximum; it drew immediate protest from home builders.

HOUSING FOR SERVICEMEN; COOGAN REVIEWS PROGRAM

By Ernest Mickel

THINGS ARE NOT RUNNING AS SMOOTHLY as they might be in the Armed Forces Housing Agency. Director Thomas P. Coogan, the Miami home builder and former president of the National Association of Home Builders, is having trouble in laying the groundwork for a solid approach to construction of adequate shelter space for U. S. servicemen.

Interservice Differences

Differences in attitude of the various branches of service toward their own housing — its volume and characteristics — hinder the attempts of AFHA to develop uniform types of housing.

For example, the Air Force actually can afford better accommodations than the Navy and the Army. One of the immediate goals of the new agency is to establish in drawings and specifications a standardized house for similar grades

(Continued on page 398)

Where the *other* services also count - it's always BAYLEY WINDOWS

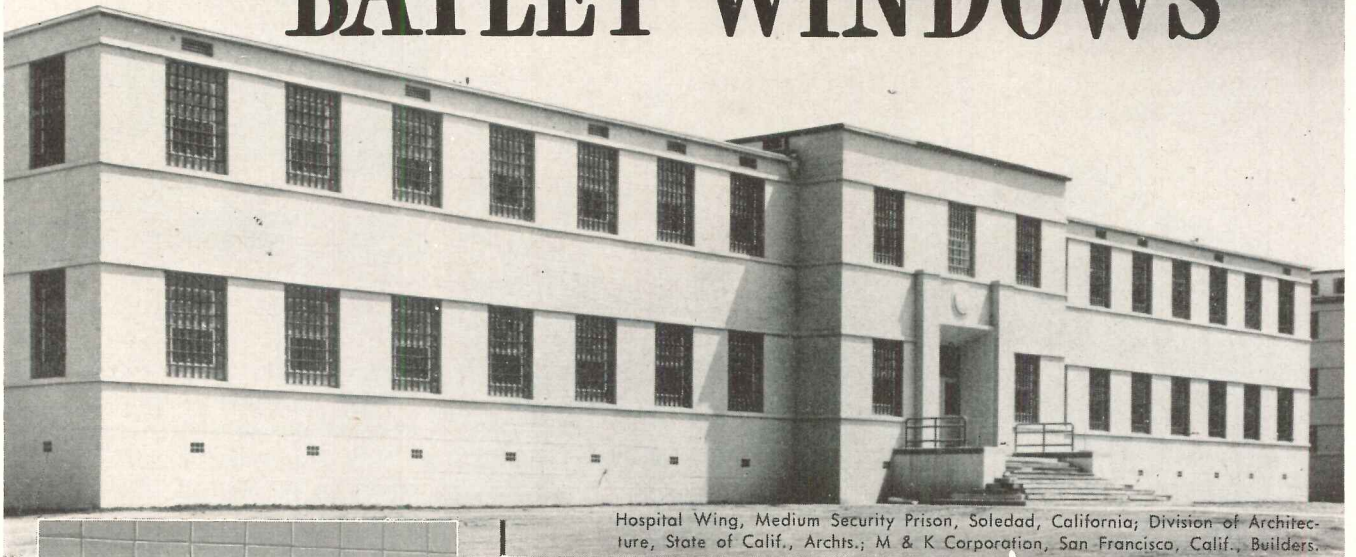

Hospital Wing, Medium Security Prison, Soledad, California; Division of Architecture, State of Calif., Archts.; M & K Corporation, San Francisco, Calif., Builders.

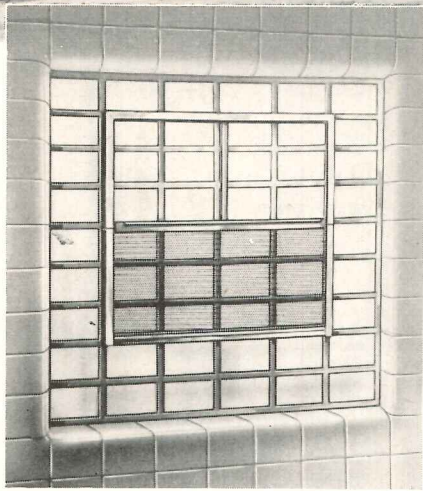

Highlights of this New Exclusive BAYLEY Product

- Safeguards against escape ● Better daylighting ● Controlled ventilation ● Large areas of clear vision ● Minimizes self injury ● Working parts concealed ● Clear glass ● GLAZ-WEDG secures glass ● Sanitary—screens removable, easy to clean ● Glass washed from inside ● Noncorrosive metals throughout ● Reduces maintenance and interference with hospital routine

73 Years of
RELIABILITY



New Bayley SAF-T-GARD Window *Scientifically Developed for Mental Hospitals*

To be known for a fine quality product is only the *first* essential. Much more is required from a truly satisfactory relationship. Full understanding of this fact is the foundation of Bayley's policy—and why Bayley has been so widely preferred for so many years by discriminating Building Designers.

Bayley's endeavor to better serve through all the building stages—from recognition of need to building occupancy—is further exemplified in the new Bayley Saf-T-Gard Window. This window is the result of Bayley's close collaboration with Doctors and officials of mental institutions. Not only does it efficiently meet the demands of modern mental hospitals but it also incorporates construction features made possible by Bayley's years of specialized window experience.

Regardless of window requirements, you too will find extra values in discussing your needs with Bayley. Write or phone.

See Bayley in Sweet's. Complete catalogs on Aluminum Windows, 17a/BA; Steel Windows, 17b/BAL; SAF-T-GARD Hospital Detention Window, 17b/BAY.

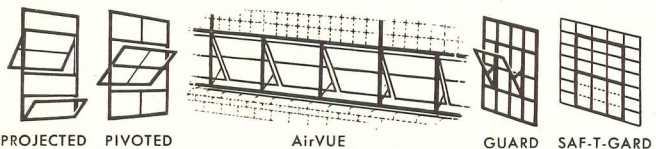

THE WILLIAM BAYLEY COMPANY
Springfield, Ohio

District Sales Offices:

Springfield, Ohio

Chicago 2

New York 17

Washington 16

A demonstration wood house has been designed for construction on the grounds of the Canadian International Trade Fair. Preliminary plans show a 1000-sq-ft house with living-dining room, den or guest room and two bedrooms. The design by Fred S. Brodie shown here was selected in a competition sponsored by the architectural firm of Sharp & Thompson, Berwick, Pratt, of Vancouver, who had been asked to prepare preliminary sketches. Requirements included compliance with National Housing Act provisions, use of western red cedar lumber, and approximate cost of \$12,000

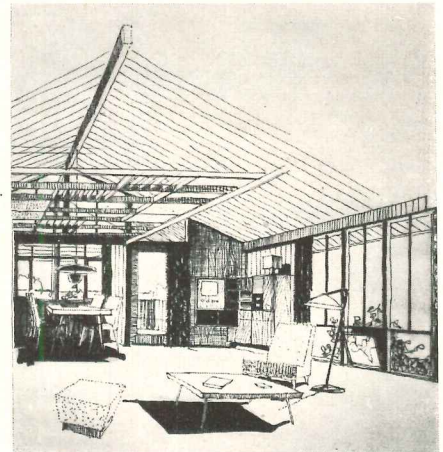
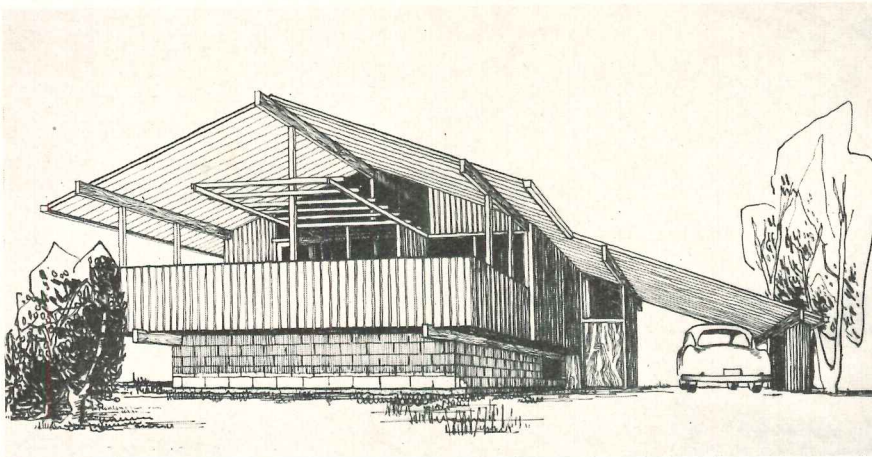

NEWS FROM CANADA by John Caulfield Smith

More Steel Is Permitted For Commercial Building

UP TO TWO TONS of steel may now be used to build commercial structures of some types, according to a recent announcement by D. C. Beam, steel construction adviser to the Department of Defense Production.

Mr. Beam's announcement was made at the Toronto convention of the Canadian construction Association, and it salved a sore spot of long standing.

The C.C.A. has repeatedly pointed out that many defense and defense-supporting projects require less field labor and a lower content of other construction materials per ton of steel than is normally the case. Yet it is to these projects that the bulk of all steel available for building has been diverted. The Association has urged that restrictions be relaxed to permit worthy construction projects requiring relatively small amounts of steel to go ahead.

Some Types Excluded

The relaxation of the steel ban applies to such buildings as stores, warehouses, garages, banks, motels. Not included are amusement and recreational buildings, or buildings for the storage of tobacco, liquor or beer.

Mr. Beam stressed that the permits are merely "hunting licenses" and it is

still necessary to obtain the steel on the open market. He noted that pipe less than 4 in. in diameter has also been removed from federal control, but indicated that no further relaxations can be expected for the present.

January Building Total Off; Housing Up from Last Year

CONSTRUCTION CONTRACTS awarded in January came to \$151.3 million, as against \$159.1 million for the same month in 1951. Impact of winter on the building industry varies from year to year, so this five per cent drop is not considered a reliable indicator of what may lie ahead.

Analysis of award totals compiled by MacLean Building Reports Ltd. shows an extremely sharp drop in industrial work and a substantial decrease in commercial volume. Housing contracts rose 25 per cent; but the biggest gain was made in the engineering category, largely because of the letting of the Edmonton-Burnaby pipeline contract at \$82 million.

Other large jobs were the Toronto-Montreal TV relay system; railway improvements at Port aux Basques; a power station in Vancouver; factories at Thorold and Cowansville; hospitals in London and Montreal; a telephone ex-

change in Ottawa; barracks in Esquimalt; defense married quarters in Comox; and various housing projects.

Here is a summary of the MacLean report on January (in millions of dollars):

Classification	1952	% change from '51	% change from Dec.
Residential	20.0	+ 25	- 26
Commercial & Institutional	24.2	- 35	- 46
Industrial	6.2	-911	- 78
Engineering	100.9	+164	+400
Totals	151.3	- 5	+ 26

Quebec Architects Elect Maurice Payette as Head

Maurice Payette of Montreal has been elected president of the Province of Quebec Association of Architects.

Other officers of the 1952 P.Q.A.A. Council are: H. Ross Wiggs, Montreal — past president; John Bland, Montreal — first vice president; Lucian Mamguy, Quebec — second vice president; E. J. Turcotte, Montreal — honorary treasurer; Henri Mercier, Montreal — honorary secretary.

Councillors are: H. A. I. Valentine, Montreal; S. A. Cyr, Montreal; Georges de Varennes, Montreal; F. J. Nobbs, Montreal; Gerard Benne, Quebec; R. C.

(Continued on page 32)

Supply Outlook

The outlook for supplies of building materials as reported in a recent survey is reported in an article that begins on page 382.

BOSTWICK DIAMOND MESH METAL LATH

more meshes per sheet...



George Washington University's new hospital. Faulkner, Kingsbury and Stenhouse, Architects. Charles H. Tomkins Company, General Contractors.

freedom of design for the architect with Bostwick Metal Lath

● George Washington University's new \$5,000,000 hospital, designed by Faulkner, Kingsbury and Stenhouse (Washington architects), exemplifies the functional benefits of Bostwick diamond mesh metal lath and cold rolled channel. Bostwick lath, channel and expanded corner bead fit the design . . . no adjustments in dimensions were required by limitation of the lath or corner bead. Both met modern architectural requirements, providing reinforce-

ment, long life, cleanliness, and low maintenance in the finished walls.

Metal Lath has always met the structural and decorative demands of every decade. That is why Bostwick Metal Lath has always been used during the past half-century in America's fine structures.

As a pioneer in manufacturing all types of Metal Lath, casings and accessories, Bostwick will gladly help you with specification data.

The **Bostwick** Steel Lath Company
105 HEATON AVE. • NILES, OHIO

NAIRN

TRADE-MARK ®

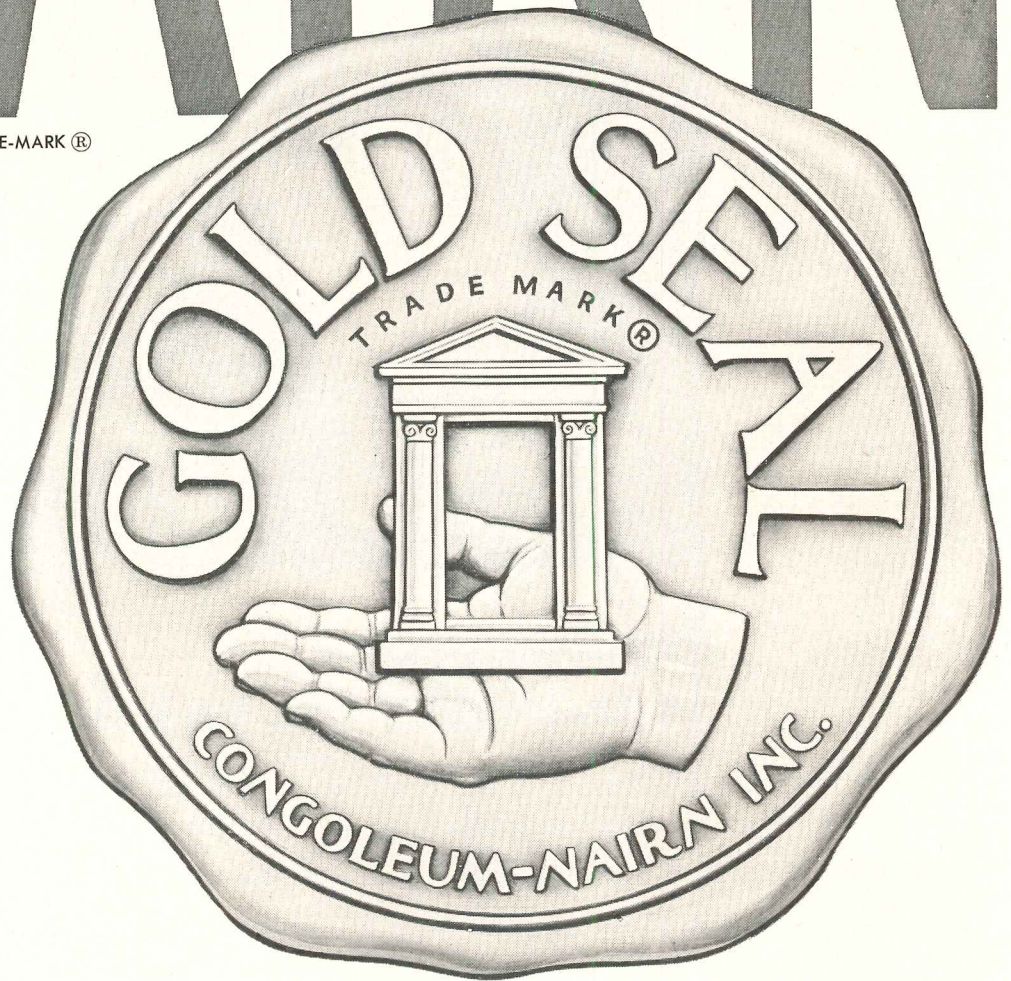

This Gold Seal, designed by a famous American sculptor, is an impressive and unique rendering of a time-honored trademark. It now identifies all the principal floor and wall coverings of Congoleum-Nairn.

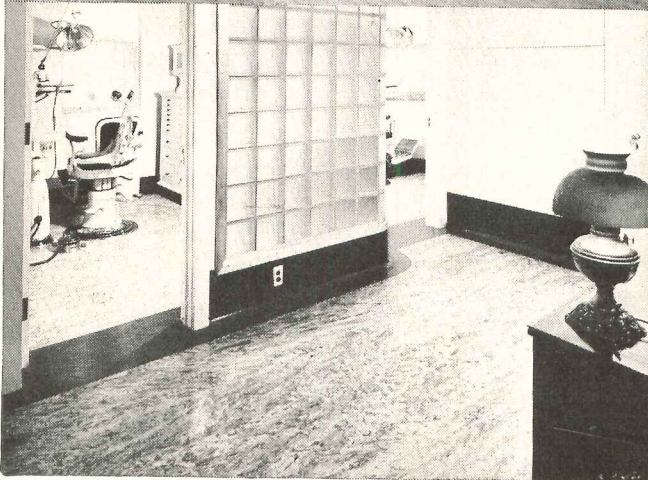
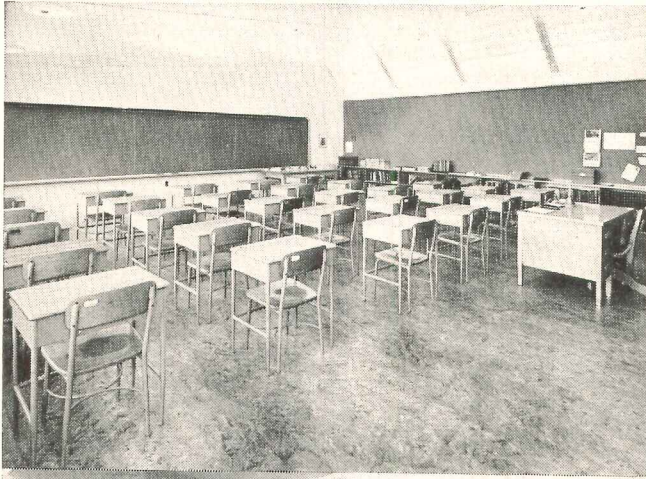

GOLD SEAL NAIRN LINOLEUM

presenting
a distinctive symbol
for a distinguished product

The Gold Seal has long been associated with certain products of Congoleum-Nairn Inc.—one of the oldest manufacturers of smooth-surface floor coverings to consistently employ trade-mark identification for the protection of its customers. In a distinctive form, this Gold Seal now unites all major Congoleum-Nairn products under one widely recognized and respected symbol of quality.

With Gold Seal Nairn Linoleum, as with the rest of the Nairn line, just a name has been added—nothing of their quality or performance has been taken away. These products will continue to be specified wherever the best in floor coverings is desired.

*The Gold Seal is your
money-back guarantee of
satisfaction from the
makers of the finest floor
coverings in the world:*

GOLD SEAL NAIRN LINOLEUM
GOLD SEAL ASPHALT TILE
GOLD SEAL VINYL INLAIDS

"Gold Seal" and "Nairn" are registered trade-marks.
© 1952, Congoleum-Nairn Inc., Kearny, N. J.

THE RECORD REPORTS

CANADA (Continued from page 28)

Betts, Montreal; Alphonse Belanger, Sherbrooke; Gerald Leger, Montreal; R. E. Bolton, Montreal; and P. E. Samson, Quebec.

Active in Civic Affairs

The Association's new president has been extremely active in civic as well as professional areas. A Fellow of the Royal Architectural Institute of Canada since 1946, Mr. Payette has been a mem-

ber of the City Planning Committee, the Committee on Housing and the Building Code Committee, all of Montreal.

Mr. Payette, who is equally at home in speaking French and English, was admitted to architectural practice in 1929. He has designed, alone or in partnership, a large number of residential, religious, educational, commercial and industrial buildings. He is now in practice under his own name.

Mr. Payette has been a member of the P.Q.A.A. Council since 1932 and has served as both honorary secretary and honorary treasurer.

Expect Acceptance of Building Safety Code

Acceptance of the newly drafted section on Construction Safety Measures for the revised National Building Code is now expected by officials of the Division of Building Research of the National Research Council.

Over 900 copies of the draft have been distributed across Canada. While there has been no official expression of opinion from municipal councils, Building Research spokesmen say there is reason to believe the new regulations will be acceptable, since they are comparable to those already in force "in several jurisdictions."

Comments made by municipal officials, builders and material suppliers indicate there is general agreement the provisions are appropriate for the purpose. There appears to be no conflict with similar provisions in force in various provinces under the supervision of such agencies as Workman's Compensation Boards, etc., and that no indication the enforcement of such regulations would not add to construction costs.

When it is approved, it is expected that this section of the National Building Code will be issued in separate booklet form for the use of foremen, superintendents and others.

Defense Building Under Way Totals Over \$235 Millions

Though only 18 months old, the Canadian Government's Defense Construction Ltd. has chalked up an impressive record of achievement.

During 1951 this crown company awarded contracts totaling \$183 millions; and including carryover from previous years, it is now administering over \$235 millions in 700 contracts.

D.C.L. reports that when the fiscal year ended March 31, it had awarded in the 12-month period about \$250 millions in contracts and had spent approximately half that amount.

The carryover into the 1952-53 program will be slightly over \$100 million and contracts in the 1952 calendar year may total about \$200 million.

Double Spending Expected

Cash expenditure in the calendar year 1952 is likely to run from \$180 to \$200 millions, roughly double the expenditure

(Continued on page 34)

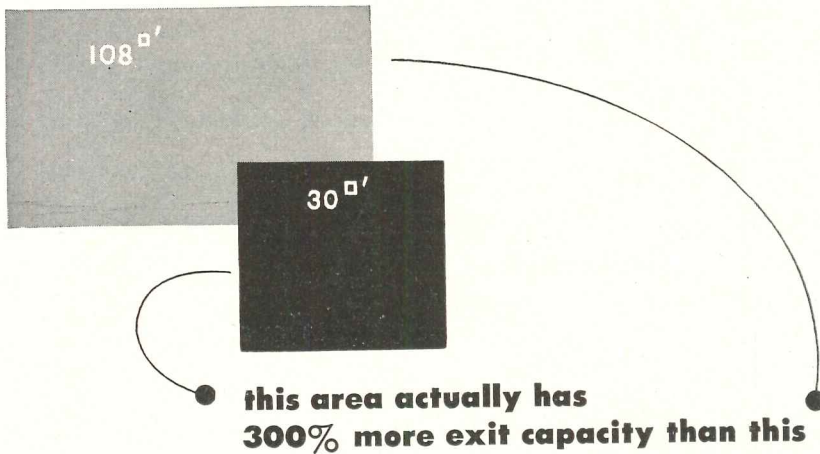

Architect:

"The most efficient fire escape on the market!"



Fire Chief:

"We heartily approve of the Potter Fire Escape, recommend it to anyone."

A Potter interior Spiral Escape requires only 30 square feet of floor area and will evacuate 3 times as many people safely, under emergency conditions, than a typically enclosed stairway requiring 108 square feet of floor area.

The Potter Slide Escape listed by the Underwriters Laboratories as standard offers, in multi-storied buildings, the fastest means of evacuation for the lowest initial cost and the lowest of maintenance cost. It has no equal for the handling of hospital and institutional patients and school children.

Plan to incorporate this modern emergency escape, with a 20 year record of successful use, in your next project.

Potter's Slide Escapes may also be installed economically on the exterior of old buildings.

POTTER FIRE ESCAPE CO.

We make this product only

POTTER FIRE ESCAPE CO.
6107 No. California Ave.
Chicago 45, Illinois

Gentlemen:

Please send us specifications and details of the Potter Spiral Escape for both exterior and interior installation.

Name _____

Address _____

City _____

Send the coupon for full information. See our catalog in Sweets.



AGITAIR[®]
WORLD'S MOST WIDELY USED
SQUARE & RECTANGULAR
AIR DIFFUSERS

... and no wonder. AGITAIR Type R is the only diffuser to assure 100% air distribution in any shape area ... from any location ... without blank-offs or oversized outlets. Tailor-made for each application.

Write for Complete Data

Air Devices Inc.

17 East 42nd St. • New York 17, N. Y.
Air Diffusers • Air and Grease Filters • Exhausters

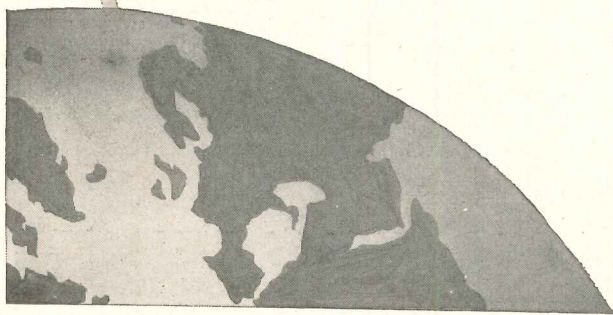

THE RECORD REPORTS

CANADA

(Continued from page 32)

Lanor Avenue Elementary School, Etobicoke, Ont., now under construction, has colored wall panels under all exterior windows. The building has nine classrooms, two kindergartens and a general-purpose room. Architect: Gordon S. Adamson of Toronto

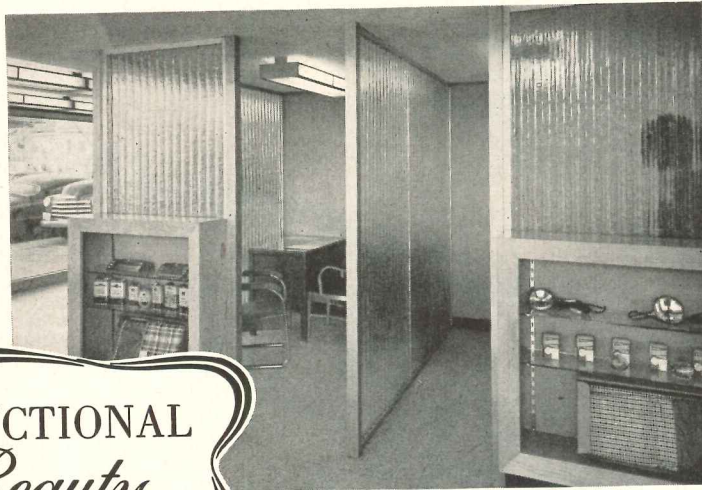
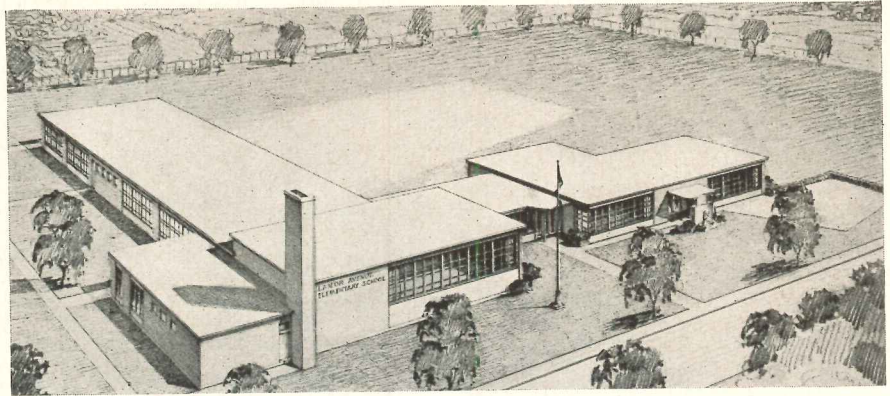

FUNCTIONAL
Beauty

PARTITIONS & SCREENS of PENNSYLVANIA CORRUGATED GLASS

Without Wire

Also Manufacturers of Original CORRUGATED Wire Glass (with wire netting encased). Use coupon below to check off the catalog for your needs.



Interior design achieves striking functional styling with light-diffusing partitions and screens of Pennsylvania CORRUGATED GLASS without wire. For home and institutional decor, sparkling, easy-to-clean CORRUGATED GLASS provides, with amazing economy, divisional effects of simple, pleasing and utilitarian design. Commercial uses are varied—from reception and office partitions to back-bars, counter fronts and illuminated fountain centers. There is no end to the flexible design of CORRUGATED GLASS and its advantages for inviting more and better business. There is no better way to let in light without sight. You specify minimum maintenance, easy installation, and lifetime beauty when you include CORRUGATED GLASS without wire for redecoration, and new room planning.



**PENNSYLVANIA
WIRE GLASS
COMPANY**

1612 Market Street
Philadelphia 3, Pennsylvania
REPRESENTATIVES IN PRINCIPAL CITIES

PENNSYLVANIA WIRE GLASS COMPANY R

1612 Market Street, Philadelphia 3, Pa.

Please send me the following FREE illustrated catalogs:

- GENERAL CATALOG SIDEWALL CATALOG
 PARTITIONS and SCREENS CATALOG
 BROCHURE ON FACILITIES FOR GLASS AND METAL WORKING FOR DEFENSE PRODUCTION
 PENGLASS VENTILATOR CATALOG

NAME _____

ADDRESS _____

CITY _____ ZONE _____ STATE _____

DEFENSE BUILDING (Continued)

on direct defense construction in 1951.

There are three classes of construction for which this money pays. Class I consists of permanent buildings of solid masonry at long-established naval, military and air force bases, camps and naval stations. Class II is made up of buildings having a structural steel or concrete frame with wooden partitions and outside walls. Class III refers to structures which are entirely wooden, except for concrete foundations and ground floor.

Private Firms Employed

A feature of the defense building program is its employment of private architectural and consulting engineering firms.

In the early stages of the program, much of the designing was carried out by consultants in Ontario and Quebec. This was done because of their proximity to defense headquarters and the necessity for close liaison in the design of standard buildings, whose construction was to be started as quickly as possible and repeated from coast to coast.

As the program got under way, however, every effort was made to employ consultants in all regions of the country. Central Mortgage & Housing Corp. usually supervises construction in the field, but in the case of special buildings the knowledge of the consultant is of particular importance. Then he is employed on supervision.

Firm Bids Preferred

In addition to supervising defense construction projects, C.M.H.C. acts as agent for the calling of tenders. Preference is given to contractors and suppliers quoting on a firm basis.

"It would appear that insistence on firm prices by general and subcontractors is in many cases a matter of per-

(Continued on page 36)

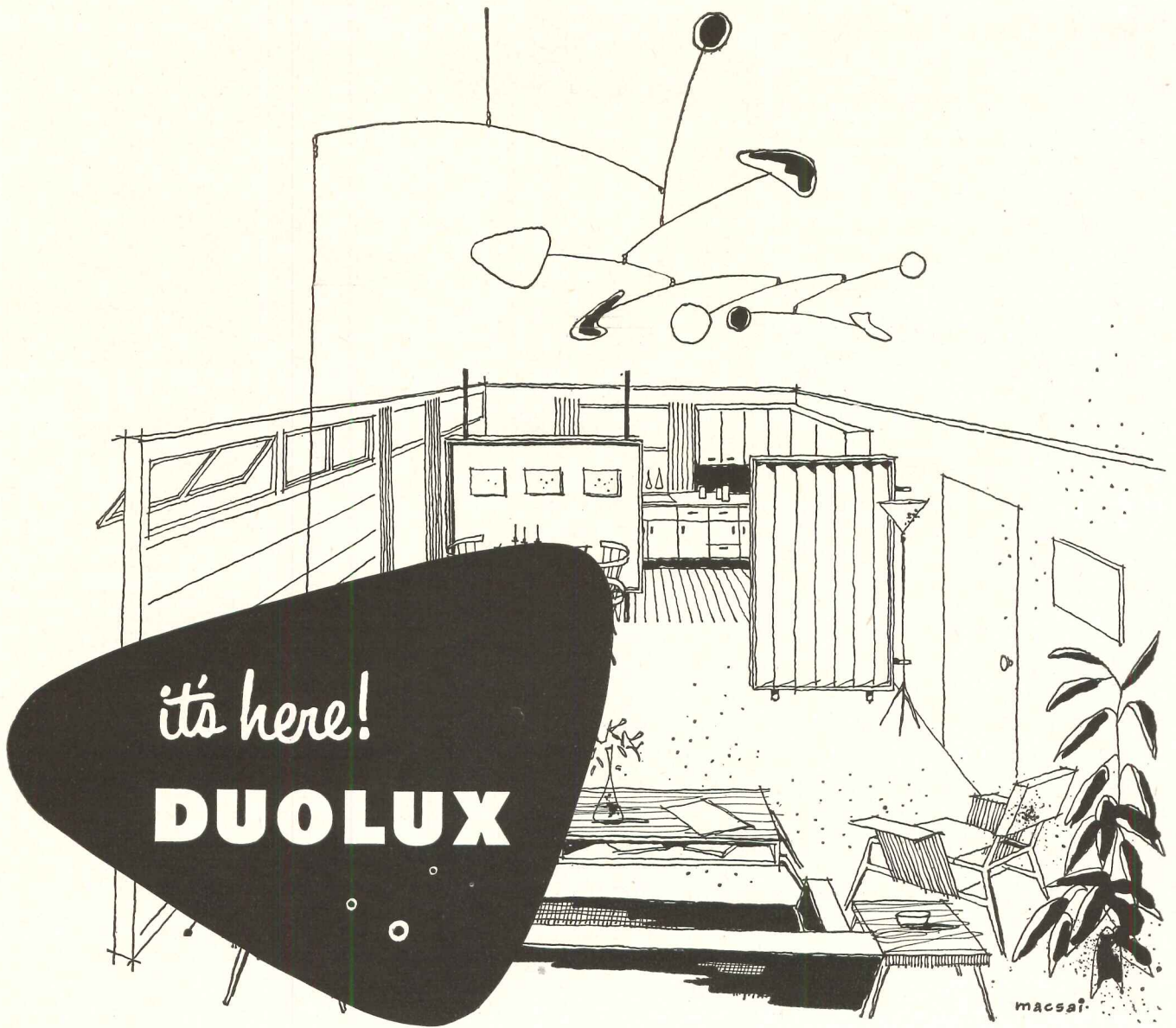

a new MASONITE PRESWOOD
smooth on both sides!

BETTER HARDBOARDS FOR BETTER LIVING

Dozens of Applications!

- In Homes*, new or remodeled. Cabinets, flush doors, partitions, dividers, curtain walls, valances, etc.
- In Stores*. All types of fixtures, partitions, curtain walls, valances, room settings, cut-outs and displays.
- In Institutions*. Flush doors, partitions, cabinets, curtain walls, valances, all types of built-in equipment.
- In Factories*. Partitions, cabinets, bin dividers, time-card racks, office decor, etc.

DUOLUX—Wherever you want to see both sides!

Now! New help for you in working out design problems.

With Masonite Duolux you can specify a strong, rigid, durable panel material that's *smooth on both sides!*

And it's really smooth! Its glass-like surface takes beautifully smooth finishes in paint, enamel, lacquer and other materials.

Building materials dealers everywhere now carry this new member of the Masonite Presdwood® family. Use Standard Duolux for normal interior applications. Whenever exposure to high humidity or heavy surface wear is expected, and for all exterior purposes, specify Tempered Duolux. Both available in 1/8" and 3/16" thicknesses.

For more information about any of the 23 types and thicknesses of all-wood Masonite Presdwood, write:



"Masonite" signifies that Masonite Corporation is the source of the product.

MASONITE®
CORPORATION

DEPT. AR-4, BOX 777, CHICAGO 90, ILL.

FERALUN

- takes punishment
- gives years of safety service

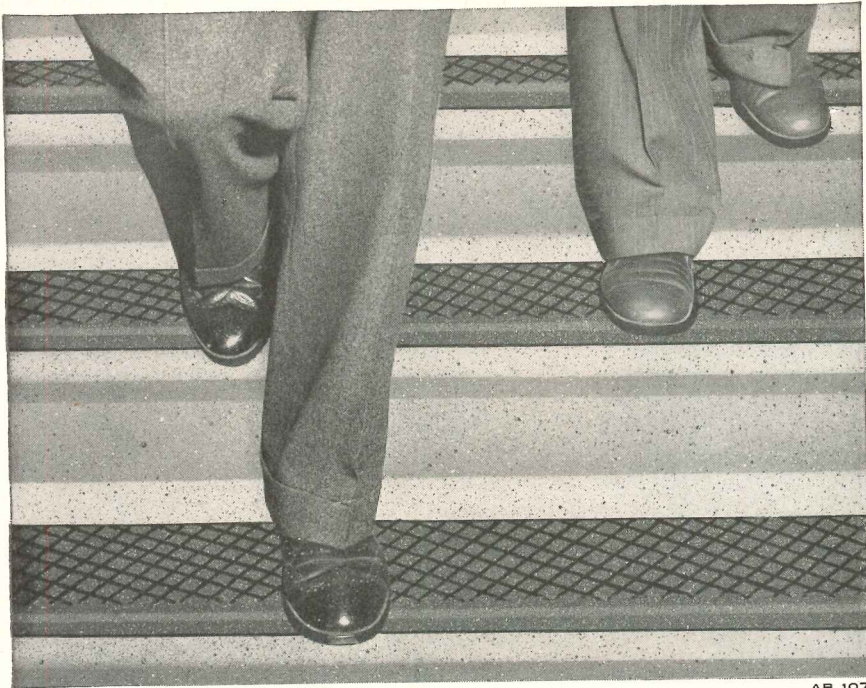

AB 107

Yes, Feralun treads, floor plates and thresholds take the pounding of heavy traffic in stride because this economical flooring material is *cast to last!* No matter where you put Feralun—on stairs, steps, walkways or ramps—it assures two-fold benefits:

- 1 It protects against slips and falls.
- 2 It keeps doing this vital safety job for the life of the building.

Reason? Feralun consists of a special cast iron matrix with a diamond-hard abrasive imbedded in the walking surface.

Gripping action is provided by the abrasive, not by the scoring or indentations in the metal. ● Get the full story on Feralun. Find out why millions of feet of this long-lasting anti-slip flooring are now in use.

BULLETIN 4k
Am
contains
complete data
WRITE TODAY
for your copy

AMERICAN ABRASIVE Safety Floorings

AMERICAN ABRASIVE METALS CO.
460 COIT STREET, IRVINGTON 11, NEW JERSEY

THE RECORD REPORTS

CANADA

(Continued from page 34)

sistent effort," says D.C.L. President R. G. Johnson. "An escalator clause is an easy answer; but experience indicates that firm prices can be obtained when a real effort is made."

Ontario City Plans to Build Big Downtown Parking Garage

It looks as though London, Ont., a city of 120,000, will beat its larger colleagues to the draw in providing downtown parking facilities.

Plans are well advanced for erection of a \$2 million, two-and-a-quarter-acre market and parking garage to replace the city's present Covent Garden and open-air public market. Architect is Victor J. Blackwell, London.

The capacity of the garage will be 2200 passenger cars. Some concept of the size of this structure may be gained from the fact that it has very nearly the combined capacity of *all* public parking garages in the city of Toronto.

Design Kept Simple

The building is to be of simplest possible design, and will be constructed of reinforced concrete.

The glass-fronted market area is on the ground floor. Parking floors are above, alternately arranged in bays five and six stories in height. This staggering of floor levels permits maximum use of space, both in relationship to the ramps and the storage of the cars themselves: the front ends of cars on a higher floor project over the trunks of those on the floor below.

Sides of the building are left open, with protection provided by low parapets.

Shift in Building Emphasis Reflected in 3-Year Totals

How much the construction picture has changed as the nation presses its defense program is demonstrated by a table showing percentage comparisons by categories of building for the last three years.

Category	1951	1950	1949
Residential	19.0	35.5	40.7
Commercial	23.9	28.9	28.4
Industrial	19.7	9.2	9.1
Engineering	37.4	26.4	21.8

DOUGLAS AIRCRAFT INSTALLS SHATTERPROOF *Alsynite*

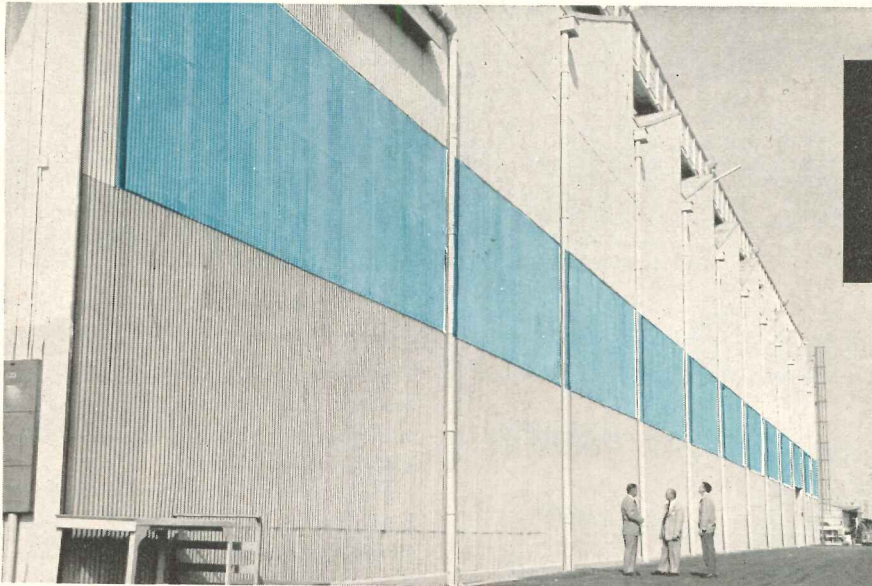

SIDEWALL INSTALLATION at Douglas Aircraft Plant, El Segundo, Calif.—corrugated metal siding was removed and replaced with Alsynite panels. No additional framing required. Lap-joints sealed with mastic. Light diffusion throughout interior greatly increased due to refractive action of Alsynite.



ALSYNITE DECORATIVE PARTITION is shown above. Alsynite has unlimited possibilities for practical use in homes, offices, stores, as well as for industrial "daylighting."



Corrugated and flat panels.

Seven colors for decorative uses.

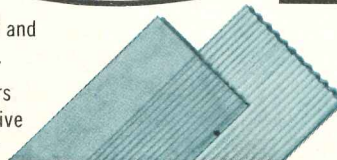

The sensational new material for shatterproof skylights, windows, walls and partitions

Costs less to install!
Cuts lighting costs!

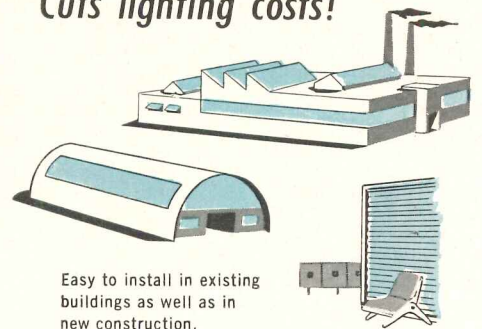

Easy to install in existing buildings as well as in new construction.

ALSYNITE MAKES new and unlimited daylighting possible for buildings of all types. Alsynite is a new kind of structural glass made by combining glass fiber with resin. It is shatterproof, permanent and feather-light (8 oz. per sq. ft.). It can be sawed, nailed, drilled ... installs exactly like corrugated metal. Like patterned glass, Alsynite lets the light through but can't be seen through. It has a higher light diffusion factor. *Corrugated Alsynite* nests with all standard corrugated roofing and siding. *Flat Alsynite* substitutes for glass in standard windows. Now let daylight in wherever you want it with *shatterproof Alsynite*. Plants in California and Ohio.



CUTS WITH SHEARS
OR SAW

FREE SAMPLE!

ALSYNITE COMPANY OF AMERICA
Dept. A, 4670 De Soto St., San Diego, Cal.
Please send free sample of Alsynite with complete info. & name of nearest distributor.

NAME _____
COMPANY _____
ADDRESS _____
CITY _____ STATE _____
DISTRIBUTORS IN PRINCIPAL CITIES

Operation Trade Secrets in session in Washington: Wallace E. Johnson, Memphis, Tenn.; Frank Burns, Denver, Colo.; Andrew Place, South Bend, Ind.; Leonard G. Haeger, N.A.H.B.; Richard G. Hughes, Pampa, Tex.; W. Hamilton Crawford, Baton Rouge, La.; and C. W. Smith, Southwest Research Institute, San Antonio. Object of all eyes is Mr. Place's central plumbing stack for multiple tie-ins



Why **SLAM** the Door...

...on greater

- Economy!
- Eye-Appeal!
- Extra Protection!
- Ease of Operation!

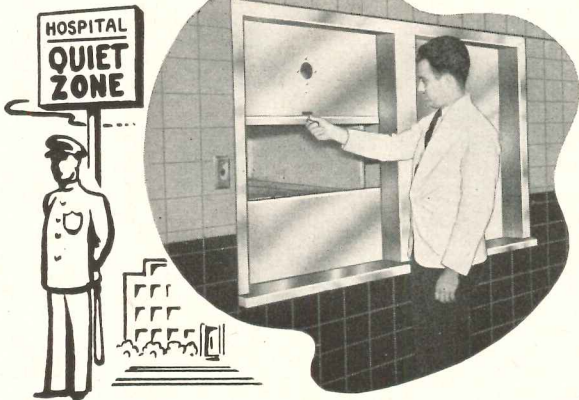

SECURITY *Uni-Bilt* DUMBWAITER DOOR UNITS

... vastly different from other makes—Security Door Units are doing a smoother, quieter, better job for America's most progressive hospitals and restaurants.

Although frequently overlooked, proper construction and design of Door Entrance Units is essential to any Dumbwaiter, trayveyor, or subveyor installation. No part receives more wear or is subject to as much damage or abuse.

Factory-assembled as a complete door with frame and trim as a unit, these easily installed doors must be set before walls are erected. Constructed to give **LASTING** trouble-free service, Security Doors provide improved operation with their adjustable **ANTI-FRICTION GUIDE SHOES** and rugged, easy action **THUMB-OPERATED POSITIVE LATCHES**. **ELECTRIC INTERLOCKED** for Safety with Security's own sturdy switches, these doors are usually furnished with **INSULATED PANELS**, and may be **UNDERWRITERS LABELED** for complete fire protection.

For over 30 years Security has specialized in, developed, and built unsurpassed Dumbwaiter and Freight Elevator Door Entrance Units

A FEW OF THE MANY HOSPITALS USING SECURITY UNITS

- St. John's, Detroit • Cedars of Lebanon, Los Angeles • Blodgett, Grand Rapids
- U. of Cal., Moffitt Hospital, San Francisco • Good Samaritan, Los Angeles
- Grace-New Haven, New Haven



Counter Door Units at F. W. Woolworth's largest store in Houston are typical of Security installations in Woolworth stores throughout the country.

S. H. Kresge, Sears Roebuck and W. T. Grant are other chains that have many Security installations.

Write for Catalog

Security Fire Door Co.

3047 LAMB DIN AVE., ST. LOUIS 15, MO.

Better Homes for Less Money: Trade Tips at N.A.H.B. Parley

THE ARCHITECT and the home builder continue to join hands in the effort to provide the buying public with better and less costly housing.

This mutual effort finds its latest public expression in what the National Association of Home Builders has termed its "Operation Trade Secrets."

The project is an attempt on the part of the industry to give John Public a better house for less money.

The reasoning is simple: if one builder develops a better way of incorporating a product into his units, or finds a better plan for his houses, sharing the information with other tradesmen will broaden the field for all.

Field Sessions Inaugurated

So last year the N.A.H.B. decided to share members' interests in a big way. A series of field meetings were held under

(Continued on page 314)



A jovial group at Washington session of Operation Trade Secrets: Sen. A. S. ("Mike") Monroney (D-Okla.); Raymond M. Foley, Housing and Home Finance Agency administrator; N.A.H.B. President Alan E. Brockbank; Sen. Robert S. Kerr (D-Okla.); Emanuel Spiegel, New Brunswick, N. J., N.A.H.B. first v.p.

only

Adlake

aluminum windows

offer these two
weather-protection
features:

1. woven pile
weather stripping
and
2. exclusive
serrated guides

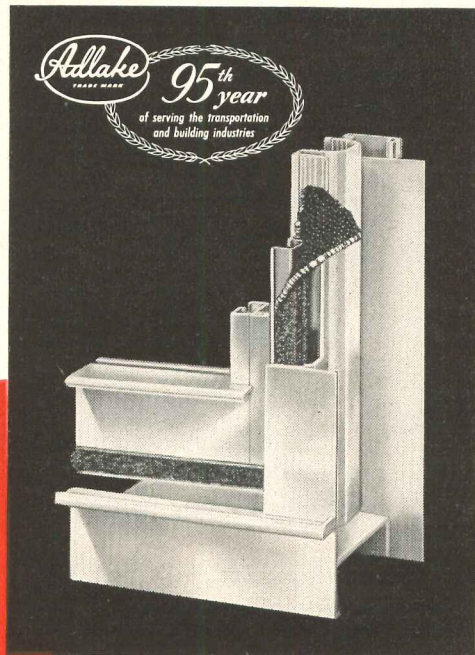

When you install ADLAKE Aluminum Windows, you can count on a perfect weather seal. Wind, rain and cold drafts are baffled by ADLAKE's exclusive combination of snug woven-pile weather stripping and patented serrated guides —and this protection, together with ADLAKE's famous finger-tip control, will last through the entire life of the building!

Because they eliminate all maintenance costs, and keep their beauty and efficient operation with only routine washing, ADLAKE Aluminum Windows ultimately *pay for themselves!* Yes, for economy . . . for performance . . . for

lasting good looks . . . ADLAKE Windows set the standards, in both replacement and original installations.

Get the whole story on ADLAKE's advantages today! ADLAKE Representatives are in most large cities.

ADLAKE ALUMINUM WINDOWS GIVE YOU ALL THESE "PLUS" FEATURES, TOO:

- Minimum Air Infiltration • Finger-tip Control • No Warp, Rot, Rattle or Stick • Ease of Installation • No Painting or Maintenance

THE Adams & Westlake COMPANY

Established 1857 • ELKHART, INDIANA • New York • Chicago

PLAN FOR TOMORROW

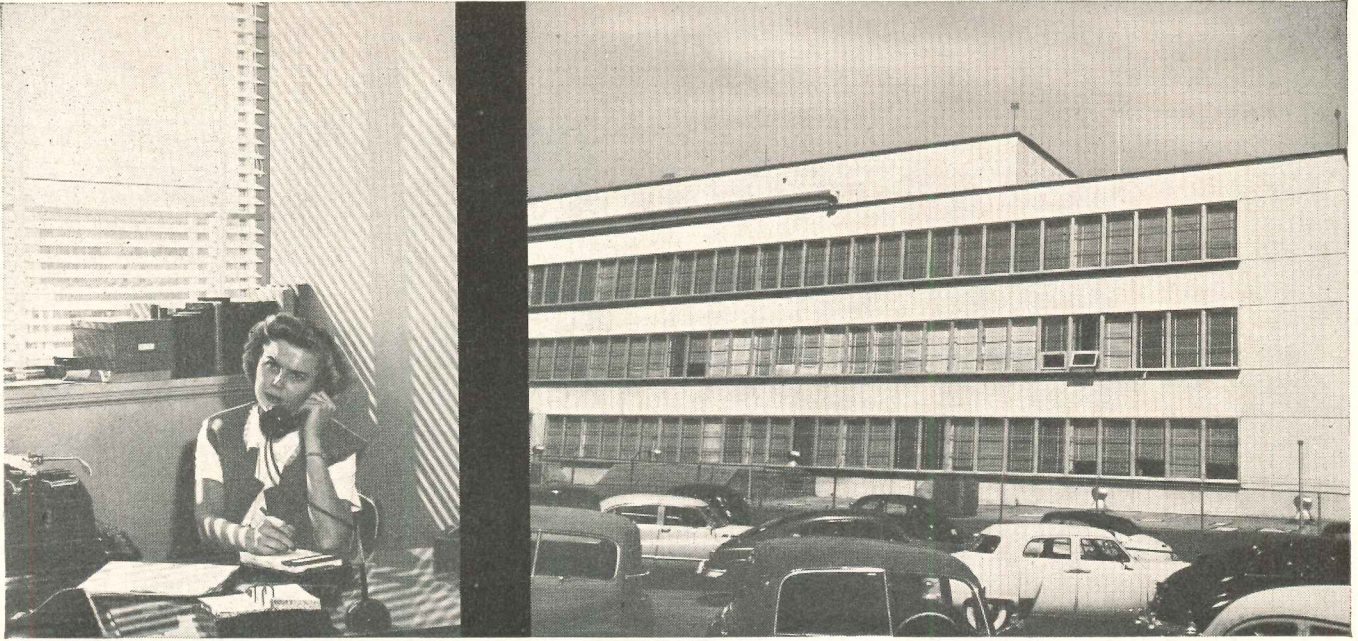

BEFORE

Sun-struck Windows of Lockheed Aircraft Corporation's Burbank, California plant created eyestraining glare, allowed heat rays to penetrate glass, caused uncomfortably high inside temperatures. Appearance of building exteriors was spoiled by unevenly adjusted blinds and the open and closed windows.

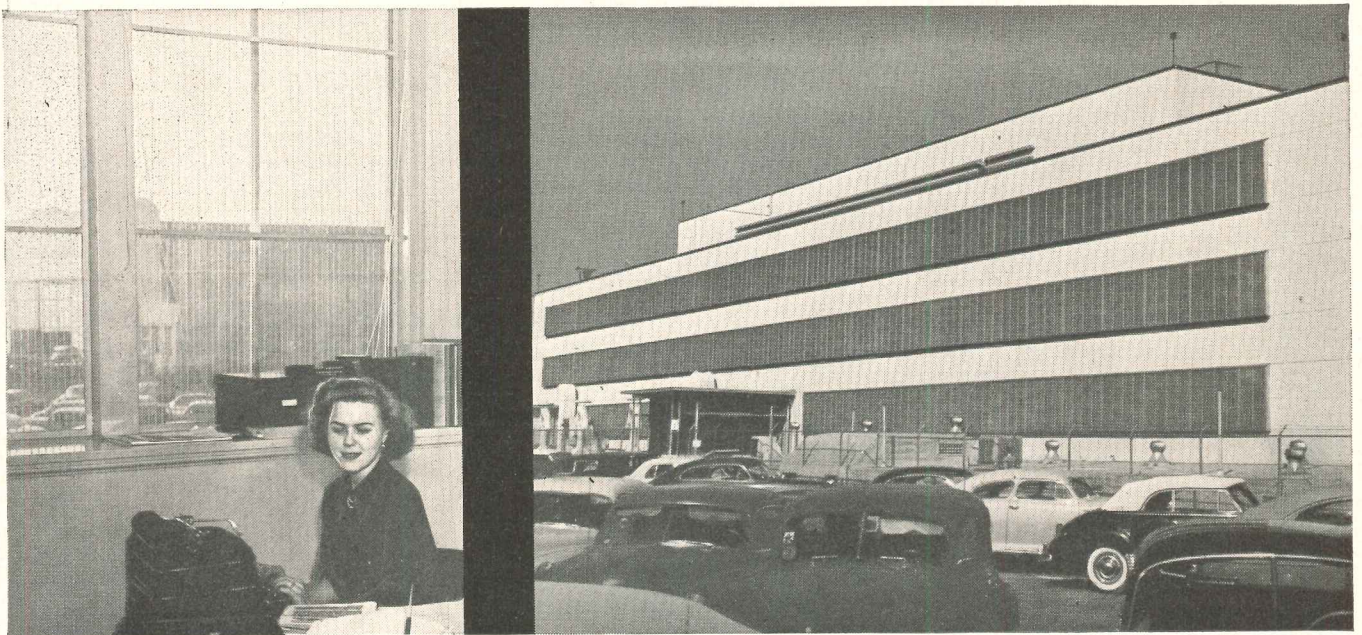

AFTER

Kaiser Aluminum Shade Screen now covers 10,000 square feet of windows on 7 buildings of the Lockheed plant. Thousands of tiny louvers deflect hot rays *before* they hit glass. Result: Glare eliminated. Interiors up to 15% cooler, more comfortable for work. Exteriors dramatically improved by uniformity of windows—emphasis of modern, horizontal lines.

WITH ALUMINUM

THERE'LL BE plenty of aluminum available for tomorrow's building requirements as a result of today's industry-wide expansion.

Kaiser Aluminum alone is building new facilities which will increase its pre-Korea production of primary aluminum by 132 per cent!

So make your plans now to utilize the many advantages of light, strong, corrosion-resistant aluminum.

Check Before You Substitute

Most Kaiser Aluminum today goes to help meet the needs of the national security program. That's why it is not always readily available.

However, before you specify less-satisfactory substitute materials, ask for Kaiser Aluminum.

You may still be able to give your clients the best—Aluminum!

A Few of Today's Modern Aluminum Applications

Building materials made of Kaiser Aluminum offer exclusive advantages in design, beauty, and quality. Shown here are a few recent applications that prove aluminum is your best building material for tomorrow's plans.

Write for Information

Write for full information about any Kaiser Aluminum building product—and for AIA files. Kaiser Aluminum offices in principal cities. Kaiser Aluminum & Chemical Sales, Inc., Oakland 12, California.

Kaiser Aluminum

Building materials for home, farm and industry

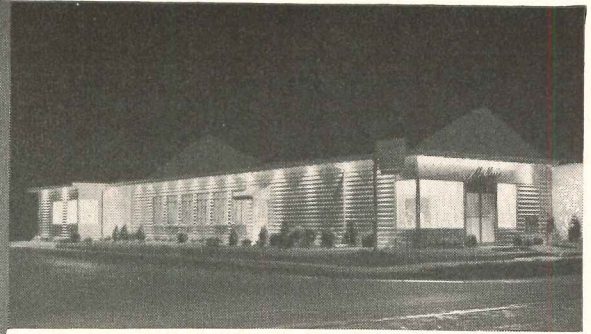

Kaiser Aluminum Siding, ideal for building or remodeling, gives sparkling modern look to Malley's Candy Shop, Cleveland. Weatherproof, rotproof, rustproof, aluminum siding lasts for generations. Baked-on enamel coat gives smooth surface that looks better, is easy to clean. Designed and erected by Lumi Land Distributing Co., Rocky River, Ohio.



Kaiser Aluminum Roofing on these Liggett & Myers tobacco warehouses is strong, *solid* corrugated aluminum. Bright surface reflects sun's rays—helps maintain uniform inside temperatures, often so important in warehousing goods. Specified by owner W. O. Crombie of Paris, Ky., because of aluminum's "complete lack of maintenance requirements."



Kaiser Aluminum Ductwork used in Los Angeles Times Building was fabricated *right on the job*, eliminating costly handling, trucking, storing of bulky pre-assembled sections. Easily fastened with rivets, by welding, or with sheet metal screws. Installed faster with less worker fatigue. And uninsulated aluminum delivers as much heat as insulated galvanized material at lower cost.

CONSTRUCTION COST INDEXES

Labor and Materials

United States average 1926-1929 = 100

Presented by Clyde Shute, manager, Statistical and Research Division, F. W. Dodge Corp., from data compiled by E. H. Boeckh & Assocs., Inc.

NEW YORK

ATLANTA

Period	Residential		Apts., Hotels Office Bldgs. Brick and Concr.	Commercial and Factory Bldgs. Brick and Steel		Residential		Apts., Hotels Office Bldgs. Brick and Concr.	Commercial and Factory Bldgs. Brick and Steel	
	Brick	Frame		Brick and Concr.	Brick and Steel	Brick	Frame		Brick and Concr.	Brick and Steel
1925	121.5	122.8	111.4	113.3	110.3	86.4	85.0	88.6	92.5	83.4
1930	127.0	126.7	124.1	128.0	123.6	82.1	80.9	84.5	86.1	83.6
1935	93.8	91.3	104.7	108.5	105.5	72.3	67.9	84.0	87.1	85.1
1939	123.5	122.4	130.7	133.4	130.1	86.3	83.1	95.1	97.4	94.7
1940	126.3	125.1	132.2	135.1	131.4	91.0	89.0	96.9	98.5	97.5
1946	181.8	182.4	177.2	179.0	174.8	148.1	149.2	136.8	136.4	135.1
1947	219.3	222.0	207.6	207.5	203.8	180.4	184.0	158.1	157.1	158.0
1948	250.1	251.6	239.4	242.2	235.6	199.2	202.5	178.8	178.8	178.8
1949	243.7	240.8	242.8	246.4	240.0	189.3	189.9	180.6	180.8	177.5
1950	256.2	254.5	249.5	251.5	248.0	194.3	196.2	185.4	183.7	185.0
1951	273.2	271.3	263.7	265.2	262.2	212.8	214.6	204.2	202.8	205.0
Nov. 1951	274.4	272.5	264.9	266.6	263.8	214.6	216.4	206.6	204.7	208.3
Dec. 1951	274.4	272.5	264.9	266.6	263.8	216.1	219.0	207.9	205.0	208.9
Jan. 1952	278.5	275.3	270.3	274.2	270.0	217.5	219.8	210.1	208.1	211.5
Jan. 1952	125.5	124.9	106.8	105.5	107.5	152.0	164.5	120.9	113.7	123.3

ST. LOUIS

SAN FRANCISCO

1925	118.6	118.4	116.3	118.1	114.4	91.0	86.5	99.5	102.1	98.0
1930	108.9	108.3	112.4	115.3	111.3	90.8	86.8	100.4	104.9	100.4
1935	95.1	90.1	104.1	108.3	105.4	89.5	84.5	96.4	103.7	99.7
1939	110.2	107.0	118.7	119.8	119.0	105.6	99.3	117.4	121.9	116.5
1940	112.6	110.1	119.3	120.3	119.4	106.4	101.2	116.3	120.1	115.5
1946	167.1	167.4	159.1	161.1	158.1	159.7	157.5	157.9	159.3	160.0
1947	202.4	203.8	183.9	184.2	184.0	193.1	191.6	183.7	186.8	186.9
1948	227.9	231.2	207.7	210.0	208.1	218.9	216.6	208.3	214.7	211.1
1949	221.4	220.7	212.8	215.7	213.6	213.0	207.1	214.0	219.8	216.1
1950	232.8	230.7	221.9	225.3	222.8	227.0	223.1	222.4	224.5	222.6
1951	252.0	248.3	238.5	240.9	239.0	245.2	240.4	239.6	243.1	243.1
Nov. 1951	255.6	252.4	241.3	243.9	241.6	248.5	243.5	242.1	244.9	245.5
Dec. 1951	255.4	252.0	241.8	244.3	242.0	246.9	241.3	242.4	245.3	245.5
Jan. 1952	256.1	252.9	241.9	244.4	242.2	248.0	242.7	242.6	245.4	245.8
Jan. 1952	132.4	136.4	105.0	104.0	103.5	134.8	144.4	106.6	101.3	111.0

The index numbers shown are for combined material and labor costs. The indexes for each separate type of construction relate to the United States average for 1926-29 for that particular type — considered 100.

Cost comparisons, as percentage differences for any particular type of construction, are possible between localities, or periods of time within the same city, by dividing the difference between the two index numbers by one of them; i.e.:

index for city A = 110
index for city B = 95
(both indexes must be for the same type of construction).

Then: costs in A are approximately 16 per cent higher than in B.

$$\frac{110-95}{95} = 0.158$$

Conversely: costs in B are approximately 14 per cent lower than in A.

$$\frac{110-95}{110} = 0.136$$

Cost comparisons cannot be made between different types of construction because the index numbers for each type relate to a different U. S. average for 1926-29.

Material prices and wage rates used in the current indexes make no allowance for payments in excess of published list prices, thus indexes reflect minimum costs and not necessarily actual costs.

These index numbers will appear regularly on this page.

More proof

TRANE

great reciprocating

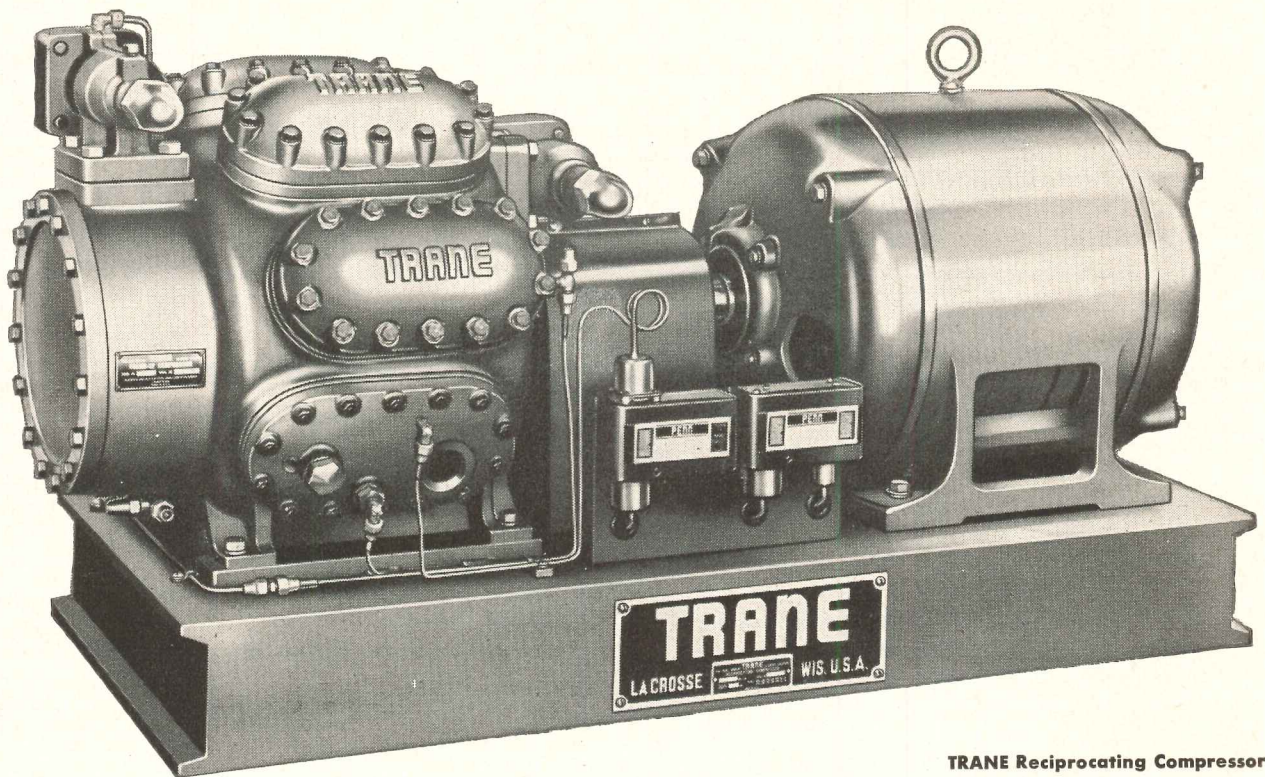

TRANE Reciprocating Compressor

Complete air conditioning from a single, easy-to-install TRANE unit

A MARVEL IN COMPACTNESS!

TRANE SELF-CONTAINED AIR CONDITIONER. Here's a year-round air conditioning unit that takes a minimum of space for the job it performs — a boon for stores, restaurants, offices.

From 3- to 20-ton sizes, with built-in evaporative condenser optional in 15- and 20-ton models. Easy to install. Heating coil optional. For more information see TRANE Bulletin DS-362 and 362-A.

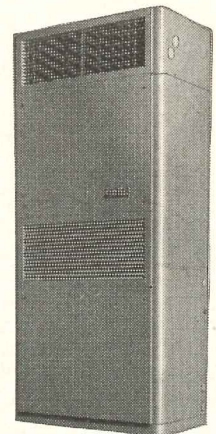

makes a compressor!

More evidence appears daily that the new TRANE Reciprocating Compressor is living up to the greatest expectations. You want modern design—TRANE Reciprocating Compressor delivers it! You must have efficient performance—TRANE delivers it! You expect long life, quieter operation, simplified installation and maintenance—TRANE has delivered that too, on the line!

No other compressor offers all these features!

- **UNLOADED STARTING** . . . permits use of normal torque motor.
- **FOAM BREAKER** . . . reduces loss of oil from crankcase when oil foams from start-up.
- **OIL PRESSURE PROTECTION SWITCH** provides a second guard against lubrication failure.
- **QUIETER OPERATION** because of dynamically balanced construction and direct drive.

- **SIMPLIFIED INSTALLATION** with fewer connections to make on job—it's factory assembled!
- **MODERN DESIGN** with two piston sizes, 2, 4 and 6 cylinders, 10- to 50-ton capacity. Available with shell-and-tube condenser above compressor.
- **SMOOTHER OPERATION** because of carefully balanced lightweight aluminum pistons and connecting rods.

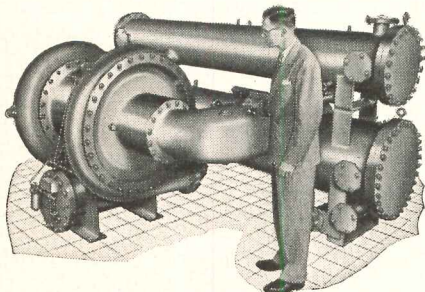

TRANE CenTraVac. A complete water-chilling system, hermetically sealed. Capacities as low as 45 tons! Power consumption very closely proportionate to load through entire range. Saves power. Saves money. TRANE Bulletin DS-399 provides complete data.

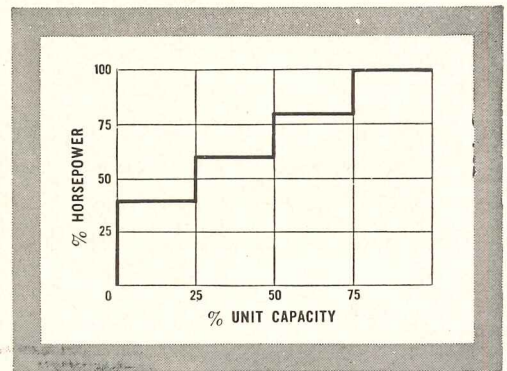

PROOF: More Power Saving When Loads are Reduced! TRANE hydraulic cylinder unloader reduces horsepower when cooling load is reduced. It's completely automatic and internal—suction pressure controlled, oil pressure actuated.

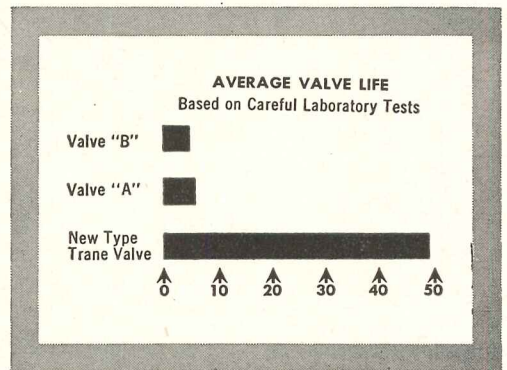

PROOF: More Hours of Operation from Valves! That's because TRANE ring plate valves have a special surface treatment for long life. Tests prove TRANE valves have up to 8 times the life of other valves tested under the same conditions.

For FULL INFORMATION about the TRANE Reciprocating Compressor and these other great TRANE refrigeration products, contact the TRANE representative in your area, or write the main office, La Crosse, Wisconsin.

TRANE

THE TRANE COMPANY, LA CROSSE, WIS.
Eastern Mfg. Division, Scranton, Pa.
Trane Company of Canada, Ltd. . . . Toronto
Offices in 80 U. S. and 14 Canadian Cities

MANUFACTURING ENGINEERS OF HEATING, VENTILATING
AND AIR CONDITIONING EQUIPMENT

REQUIRED READING

HOUSING

Two-Thirds of A Nation. A Housing Program. By Nathan Straus. Alfred A. Knopf (501 Madison Ave., New York, N. Y.), 1952. 5½ by 8½ in. 291 pp. \$4.00.

REVIEWED BY ELISABETH COIT, A.I.A.

Nathan Straus, first administrator of the United States Housing Authority and long a dedicated friend of economical shelter, follows THE SEVEN MYTHS OF HOUSING with a book of broader scope. The former volume focused on public housing; the present one serves as well the income group that needs help short of subsidy: families who have been forced to buy when it might have been wiser to rent, who have been offered shoddy, ill-planned houses, and who have been subject to misleading advice. Advertised monthly financing payments, priced apparently for their benefit, rarely have included costs of utilities and maintenance that might add as much as forty-five per cent to the obligation.

The work proposes several corrective measures: one is Connecticut's venture into the moderate-rental field, using short-term, low-cost state financing. Middle-income families approved by the state may buy state-approved houses, borrowing low-interest state housing funds through local banks. Rental housing for families above the subsidized range may be sponsored by local authorities using state loans. The "Straus Plan" would use municipal credit to acquire capital by selling local housing authority bonds, two-thirds of which would be secured by a mortgage lien on the project, amortized by the rent roll. The remaining third would be guaranteed by the city, covered by a special tax, which, however, would normally not be collected after the first year, Mr. Straus believes, since rents would pay yearly charges. Some features of this plan were used by the New York City Housing Authority for its unsubsidized program of 1948-1950. A third

hope for moderately-priced homes lies in cooperative housing ventures. These should be aided by informed technical and administrative guidance, by low-cost financing and by local cooperation in site selection, utility provision and basic design data. A small grant from a philanthropic foundation establishing a guiding central bureau would approach the help that Sweden and Denmark, for example, have given to their successful cooperatives.

Other chapters on government-aided housing give us facts, philosophy and forecast, together with a discussion of urban redevelopment schemes and their effect on low- and modest-rental housing. Special assignments are contributed by guest authors. Eric L. Bird, editor of the Journal of the R.I.B.A., writes of British policies and accomplishments, including aid to middle-income families. Chester Bowles charts the state's responsibilities working with federal and city agencies. Charles Abrams' chapter on segregation in housing traces its background and analyzes present tendencies and future opportunities that a federal program can offer to dissolve enforced segregation. Mr. Abrams also points out how housing shortages encourage segregation. Lee F. Johnson supplies a useful account of the Housing Act of 1949 and its possible effect on communities. In addition, the author supports his well-organized text with quotations from many other authorities.

There are two appendixes to the book. One, by William C. Vladeck, describes the use of a housing-rent chart for quick analysis of the relation of land cost, density and other factors to rentals. The other (from notes of Raymond Unwin) treats of land values and densities.

Perhaps the work's most likable quality is its candor about sore subjects—real estate lobbying against aided housing, canned anti-housing propaganda distributed country-wide, brazenly inaccurate claims of speculative builders, and the double standard of criticism

given to private and public construction. Mr. Straus feels that FHA has been converted to a mechanism for providing high-rent housing and fantastic profits for speculative builders.

TWO-THIRDS OF A NATION will be sought by anyone who wants to know about advances in urban redevelopment and housing, both British and American. The few charts, tables and illustrations add to the text. The volume is well documented, and there is a full index.

SIR CHRISTOPHER WREN

Wren: His Work and Times. By John Lindsey. Philosophical Library, Inc. (15 E. 40th St., New York 16, N. Y.), 1952. 5½ by 8½ in. 256 pp., illus. \$6.00.

As more than two-thirds of this book is devoted to a discussion of the historical background surrounding Sir Christopher Wren, the "Work" and "Times" order of importance in the title might well be reversed.

If, like this reviewer, one likes to refresh his college history courses, he should find this book most enjoyable. If, on the other hand, a detailed explanation of Wren's work is sought, I am afraid that its contents might prove disappointing. A better or more accurate title would undoubtedly improve the book's popular appeal.

Mr. Lindsey's main interest appears to be in Wren as a man. As a consequence it is apparent that the author has done much constructive research on affairs of state that had a great influence on Wren's work. While all this is educational, and it is fascinating to follow the development of Wren's interest in mathematics to a compelling absorption in architecture as Surveyor-General to the Crown, one does wish that the author had covered Wren's techniques, methods and architecture in the same thorough manner.

In the pages of this book one meets again with Charles II, Pepys, Evelyn and Grinling Gibbons, not to mention those less scrupulous dealers in archi-

(Reviews continued on page 48)

INSULATED METAL WALLS

for INDUSTRIAL and COMMERCIAL BUILDINGS
ALUMINUM, STAINLESS or GALVANIZED STEEL

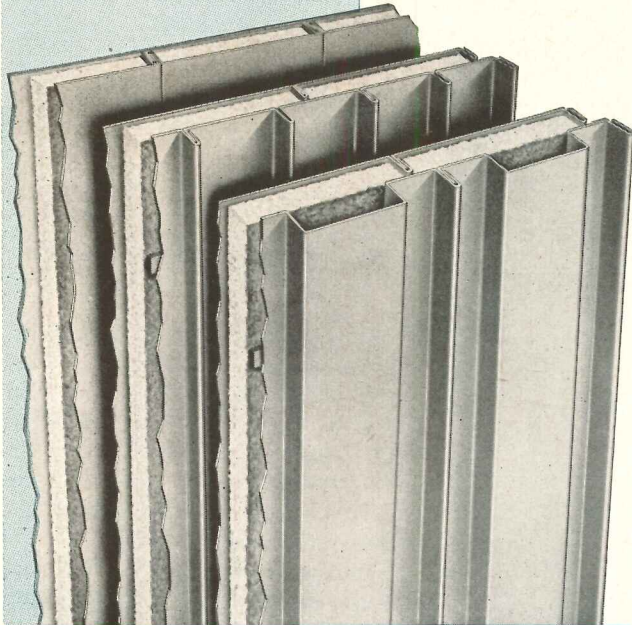

FLUSH, RIBBED, or FLUTED
Over-all "U" Factor of Various Types is Equivalent to or Better than Conventional 16" Masonry Wall

As further evidence of the trend to Insulated Metal Walls in modern construction, the new plant recently built for Quaker Oats in Omaha, Neb., is presented. A second plant for Quaker Oats is now nearing completion in Chattanooga, Tenn. Mahon Insulated Metal Walls with Aluminum exterior wall plates, coping, flashing, etc., and Mahon Steel Deck Roofs, were employed to good advantage in the construction of both of these completely new and modern plants. Mahon Insulated Metal Walls can be furnished in the three distinct exterior patterns illustrated at left . . . they are available in two "Field Constructed" types, and in two types of "Prefabricated Panels". Walls of the "Field Constructed" type can be erected up to fifty feet in height without horizontal joints—a feature of Mahon walls which is particularly desirable in power houses or other buildings where high expanses of unbroken wall surface are common. For complete information on this modern, permanent, firesafe Wall and Roof Construction see Sweet's Files, or write for Catalogs No. B-52-A and B.

THE R. C. MAHON COMPANY

Detroit 34, Mich. • Chicago 4, Ill. • Representatives in All Principal Cities
Manufacturers of Insulated Metal Walls; Steel Deck for Roofs, Partitions, and Permanent Concrete Floor Forms; Rolling Steel Doors, Grilles, and Underwriters' Labeled Rolling Steel Doors and Fire Shutters.

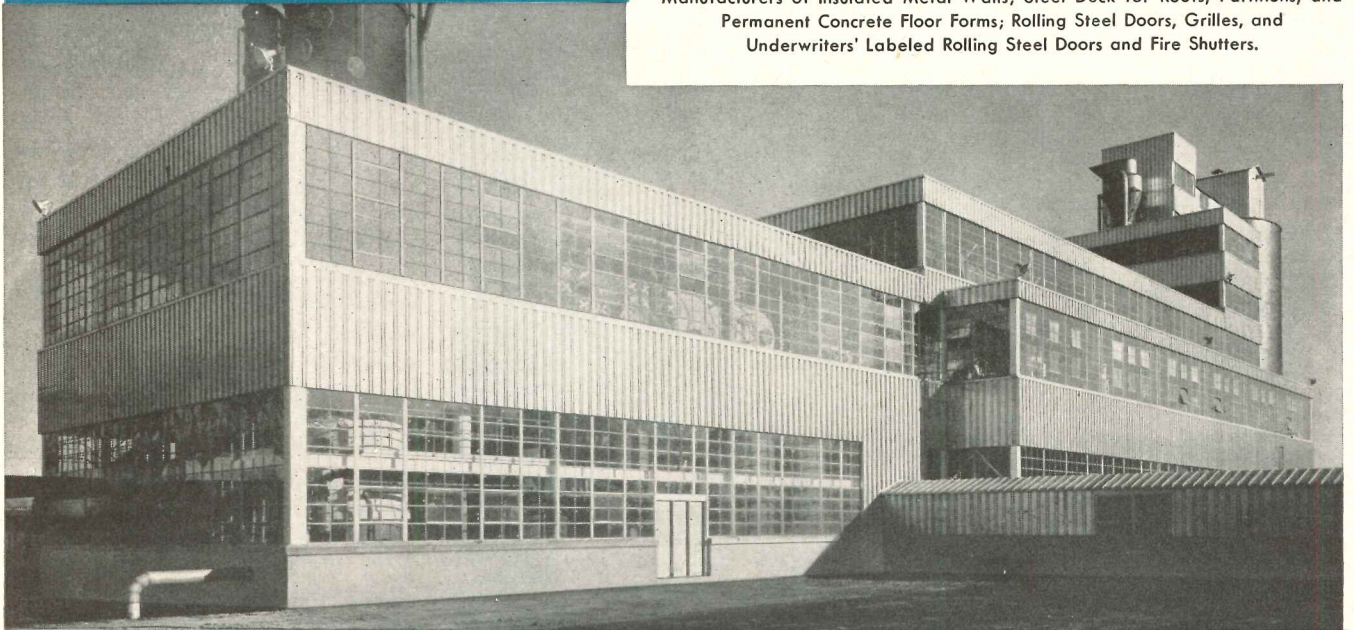

Mahon Aluminum Insulated Metal Walls and Mahon Steel Deck Roofs were employed in the construction of this new plant for Quaker Oats at Omaha, Neb. Verne E. Alden Company, Chicago, Ill., Architects and Engineers. Parsons Construction Co., Omaha, Neb., General Contractors.

MAHON

No. 1 on your wiring Hit Parade



The Plugmold TRIO

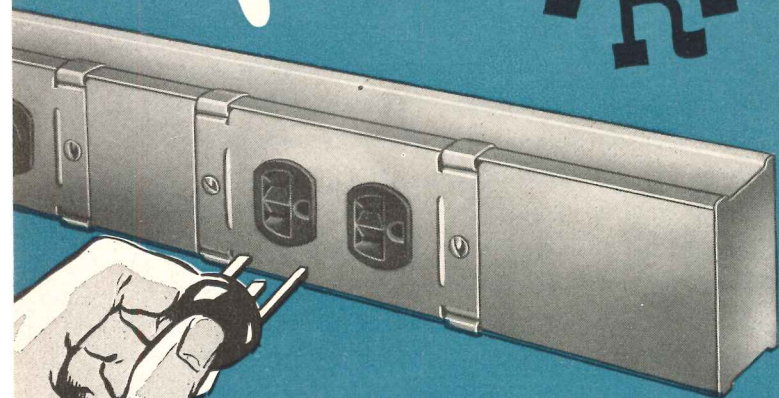

The safe, efficient way to provide closely-spaced, correctly-located outlets for the convenient plug-in-anywhere of electrically-operated machines and equipment on assembly lines, work benches, inspection tables, in laboratories, engineering departments, offices . . . wherever it is essential to have all the outlets you need when you need them, where you need them.

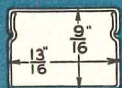

1900 PLUGMOLD

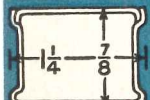

100 PLUGMOLD

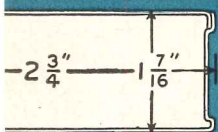

3000 PLUGMOLD

HERE'S THE TRIO!



WHEN YOU PLAN OUTLETS... PLAN ENOUGH OUTLETS... PLAN TO PLUGMOLD IT!

Send today for this new bulletin describing in detail the PLUGMOLD trio.



THE WIREMOLD COMPANY

HARTFORD 10, CONN., DEPT. F

Please send me a copy of the PLUGMOLD bulletin.

Name _____

Company _____

Address _____

THE WIREMOLD COMPANY
HARTFORD 10, CONN.

REQUIRED READING

(Reviews continued from page 46)

ecture that include Mr. Barebone. Over all of these men falls the shadow of St. Paul's, for its history and shape are inseparable from the period and the leading figures of the time.

If one is planning to visit any of the fifty-two city churches designed by Wren, or is simply interested in his work and the period in which he lived, this book should be of interest.

"THAT THE PRESENT MAY LEARN FROM THE PAST"

Willow Run: A Study of Industrialization and Cultural Inadequacy. By Lowell J. Carr and James E. Stermer. Harper & Brothers (49 East 33d Street, New York, N.Y.), 1952. 5½ by 8½ in. 406 pp. \$5.00.

This investigation of a sociological disaster should scare the wits out of anyone involved in industrial expansion in this latter day of defense mobilization. What happened at Willow Run from 1941 to 1945 can happen this year or the next or the next in practically any "decentralized" industrial area.

What happened at Willow Run was that the world's largest bomber plant, set up in the open fields near a quiet village, attracted tens of thousands of workers but made no provision for their housing or community needs until the plant had been in operation over a year. While plant operators, the U.A.W., the government housing authorities, and local real estate people and builders argued among themselves, the workers and their families crowded into trailers, shanties, and even tents. Housing, schools, and shopping centers finally arrived, but were never adequate to meet the social problem. Ironically, designs for an integrated community were completed by the architectural faculty at the University of Michigan, but, the authors note, "no one was interested."

Professors Carr and Stermer, both well known sociologists, actually worked at the plant while gathering material for this study. Their conclusions are supported by their own diaries, those of trailer dwellers and office workers, and many other convincing human interest anecdotes, as well as graphs, charts, tables, statistics, and photographs.

No smug hindsight solution is offered for the Willow Run problem. The authors place the blame with no particular individuals or groups. "The social fiasco

(Reviews continued on page 415)

SCIENCE DEVELOPED **FORMED STEEL**



BRIGGS *Beautyware*

proved it the ideal base for porcelain enamel!

**AND BRIGGS VITREOUS CHINA FIXTURES
ARE TOPS FOR QUALITY, TOO!**



Like the famous formed steel fixtures, Briggs Beautyware vitreous china lavatories and closets are products of the finest craftsmanship and designing skill to be found in the plumbing ware industry. The permanent luster and attractive pastel colors of the sparkling Briggs Beautyware fixtures are well known among architects alert to the advantages of modern materials and methods.

Forward-looking architects specify Briggs Beautyware formed steel plumbing fixtures today because *they look new longer*—because they are scientifically engineered to provide a maximum of durability as well as beauty. The thickness of the porcelain enamel is rigidly controlled to ensure that it will fuse perfectly with the etched surface of the metal. On Briggs Beautyware, even unexposed surfaces have porcelain enamel protection.

When the Briggs Manufacturing Company first began producing bathtubs and lavatories of porcelain enameled formed steel, it was a revolutionary development—the first major design improvement in years. Tremendous and ever-growing acceptance has established Briggs Beautyware as an outstanding triumph.

This truly modern metal—light yet strong and rigid—has made possible important changes in the construction of plumbing ware and many other products. Briggs engineers discovered that *there is no more perfect base* for porcelain enamel. Down through the years, Briggs Beautyware fixtures have proved it in thousands upon thousands of American homes. Briggs formed steel construction means outstanding quality in your homes—and lasting satisfaction for your clients!

BRIGGS MANUFACTURING COMPANY • 3001 MILLER AVENUE • DETROIT 11, MICHIGAN

© 1952



EVERYONE LIKES BRIGGS COLOR!

The four famous Briggs Beautyware colors are truly beautiful—and so reasonable! When your clients find that they can have non-fading colored fixtures in complete sets for only a very little more than plain white, they're delighted!

ART METAL releases

the **SECOND** of its NEW ideas in

INCANDESCENT LIGHTING

ADVANCED DESIGN

ART METAL
ASYMMETRIC (corridor-type) and SYMMETRIC LIGHT DISTRIBUTIONS
Surface and Recessed (150-W) Types

NEW PRODUCT RELEASE



No. 3355—Surface type. Holophane Prismatic Glass Refractor provides a widespread symmetrical pattern light distribution. Spacing up to 2.0 times the mounting height above surface to be lighted provides uniform illumination.



No. 3353—Surface type. Holophane Prismatic Glass Refractor provides an Asymmetric (corridor-type) light distribution. Spacing up to 2.5 times the mounting height above the floor provides uniform floor illumination.

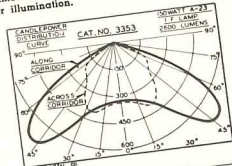
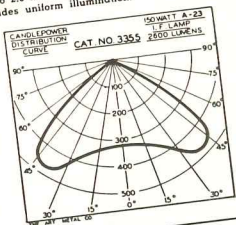

Room Index	COEFFICIENTS OF UTILIZATION				
	50%	75%	30%	50%	30%
J	.32	.30	.31	.30	.30
I	.40	.37	.40	.39	.36
H	.43	.40	.43	.43	.39
G	.46	.44	.44	.44	.40
F	.47	.46	.47	.48	.43
E	.50	.48	.49	.49	.46
D	.51	.50	.50	.50	.48
C	.52	.50	.50	.50	.49
A	.52	.52	.51	.50	.50

No. 3355. Maintenance Factors—.85 Clean .75 Average.

SPECIFICATIONS

Socket is wired with 12" No. 18AF wire leads for easy splicing. Relamping is accomplished by loosening two thumb screws permitting the glass in its supporting ring to swing downward on the hinge. Approved by Underwriters' Laboratories, Inc. Finish is Brushed (Satin) Aluminum.

Cat. No.	Distribution Characteristic	Refractor Size	Max. Watts	Dia.	Depth O. A.	Std. Pkg.	App. Wt.	List Price
3353	Asymmetric	10" x 3 1/4"	150W A.23	13"	5 3/4"	1	9	7.40
3355	Widespread	10" x 2 1/4"	150W A.23	13"	5 3/4"	1	9	7.40

THE ART METAL CO.
CLEVELAND 3, OHIO

RECESSED ASYMMETRIC (corridor-type) AND SYMMETRIC LIGHT DISTRIBUTIONS



No. 3335—Recessed type. Holophane Prismatic Glass Refractor provides a widespread symmetrical pattern light distribution. Spacing up to 2.0 times the mounting height above surface to be lighted provides uniform illumination.

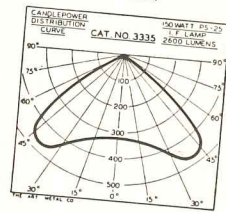

Room Index	COEFFICIENTS OF UTILIZATION				
	50%	75%	30%	50%	30%
J	.32	.30	.31	.30	.30
I	.40	.37	.40	.39	.36
H	.43	.40	.43	.43	.39
G	.46	.44	.44	.44	.40
F	.47	.46	.47	.48	.43
E	.50	.48	.49	.49	.46
D	.51	.50	.50	.50	.48
C	.52	.50	.50	.50	.49
A	.52	.52	.51	.50	.50

Maintenance Factors—.85 Clean .75 Average.

Complete with Adjustable Plaster Ring and a 4" Underwriters' Laboratories, Inc.

WRITE
for these releases and the leather-bound catalog
INCANDESCENT UNIFIED LIGHTING
Unified in Design
Characteristics
Engineered for application performance

THE ART METAL COMPANY
CLEVELAND 3, OHIO

Manufacturers of Engineered Incandescent Lighting



She knew what she wanted

.. BUT WAS LOOKING FOR IDEAS

.. and ideas backed by sound knowledge and experience are your stock in trade. You have the know-how to select and adapt specific materials to the best solution of your client's problem.

Flexi-flor and Wall-flex deserve an important place in your specifications. The exclusive advantages of these RUBBER floor and wall materials — cushioned resilience, exceptional color and design range, low maintenance and lifetime durability — not only handle requirements but turn an ordinary job into one of outstanding success and satisfaction.

We want to be sure your files contain complete pertinent information for your quick reference on Flexi-flor and Wall-flex, and trim accessories — R.C.A. is the *only* line for *complete* rubber installations.

WALL-FLEX

walls of rubber. New—exclusive—flexible 1/16" gauge fabric-back rubber in 28 colors. Simple, quick, one-man installation with the advantages of continuous corners and curved surfaces, sanitation, low maintenance and economy. You'll want to include the versatility and colorful beauty of Wall-Flex in your plans.

FLEXI-FLOOR

floors of rubber. Available in 28 colors, sheet or tile form, 3/32", 1/8" and 3/16" gauges. This complete range meets a diversification of uses in addition to floors—counter tops, display tables, drainboards, desk tops, counter facings, etc.

ACCESSORIES

design-planned to complete the ensemble. Feature strips—borders—cove base—corners—and tread runners in the same 28 colors, stair treads for residential and commercial use — all of the same dependable R.C.A. rubber. Everything you need for complete planning.

Time-tested for:

- HOSPITALS
- OFFICES
- APARTMENTS
- HOTELS
- BANKS
- SCHOOLS
- STORE
- CHURCHES
- RESTAURANTS
- RESIDENCES

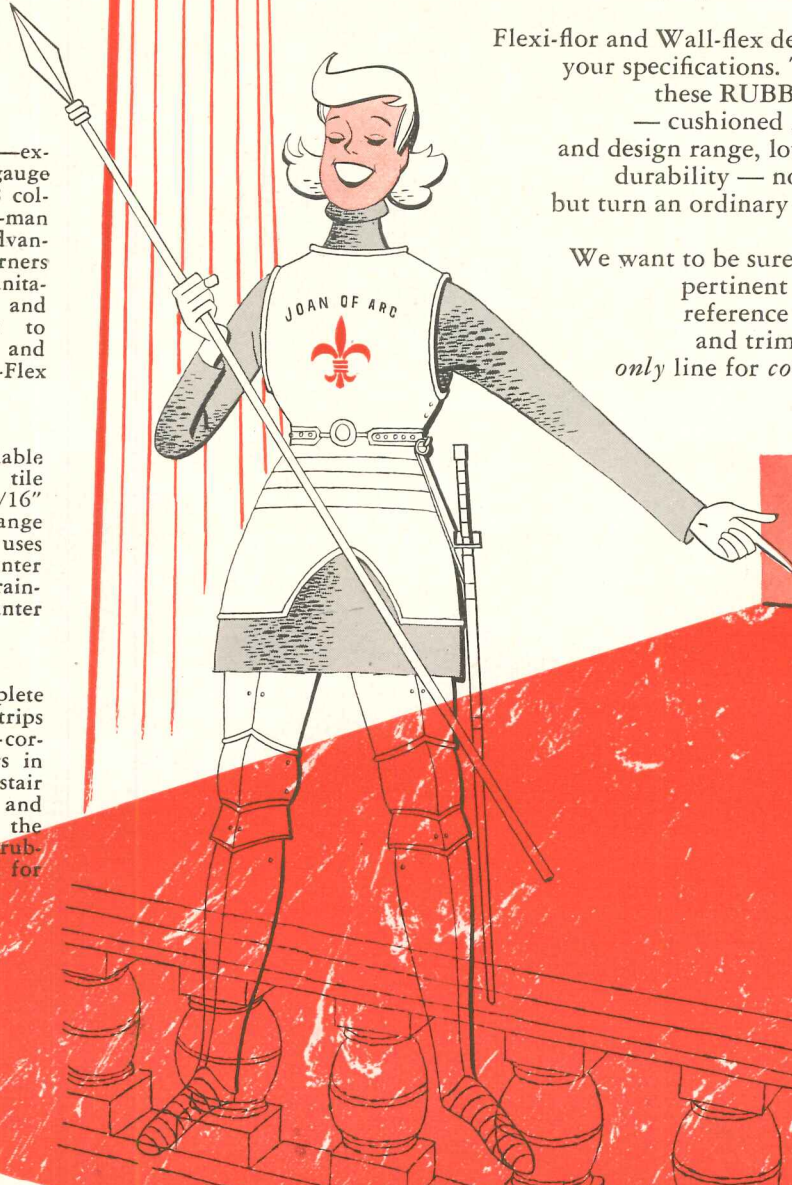

RUBBER

FLEXI-FLOOR

FLOORS of RUBBER

WALL-FLEX

WALLS of RUBBER



"the more we're together

..the happier you'll be"

CONSULT SWEET'S Architectural File — or write for full color brochure, samples and installation folder.



THE R. C. A. RUBBER COMPANY 1849 E. MARKET STREET AKRON 5, OHIO

The wall is available to

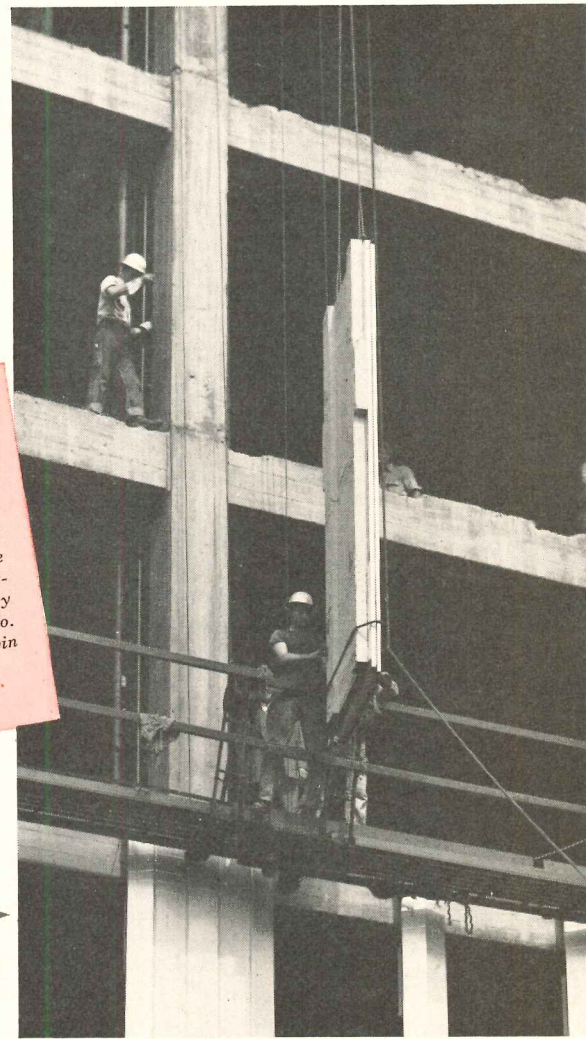

In Cleveland

Below, you see how a plant was enlarged with Stainless Steel wall panels in its original size. The photograph shows the partially completed addition with panels removed from the original structure being reused. The photograph above shows work in progress. Owner: The E. F. Hauserman Company.

In Pittsburgh

A 48" spandrel of Type 430 Stainless Steel backed with approximately 4½" of light-weight concrete is being guided into place on one of the three buildings in the new Gateway Center project, Pittsburgh, Pa. Panel weight is one ton. Owner: Equitable Life Assurance Society of the United States. Builder: Starrrett Bros. & Eken, New York. Panels by United Steel Fabricators, Wooster, Ohio. Architects: Eggers & Higgins and Irwin Clavan.

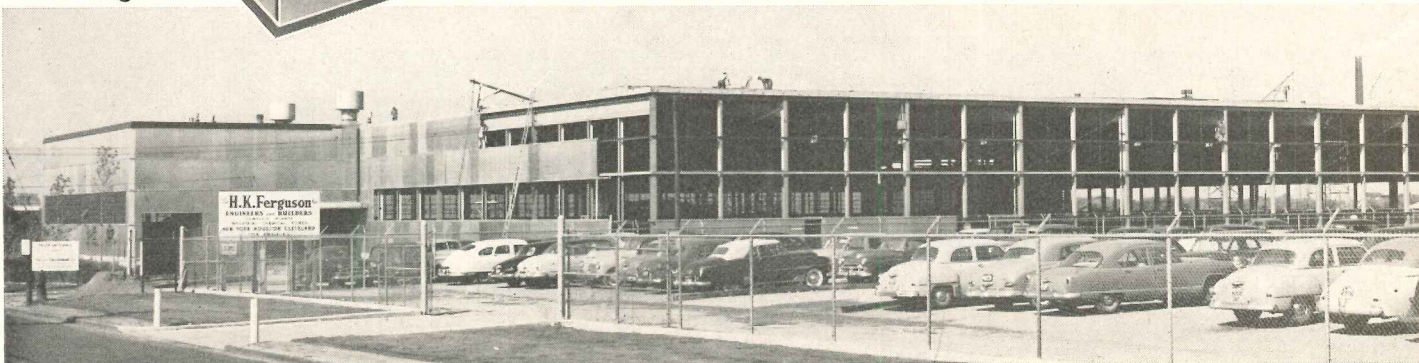
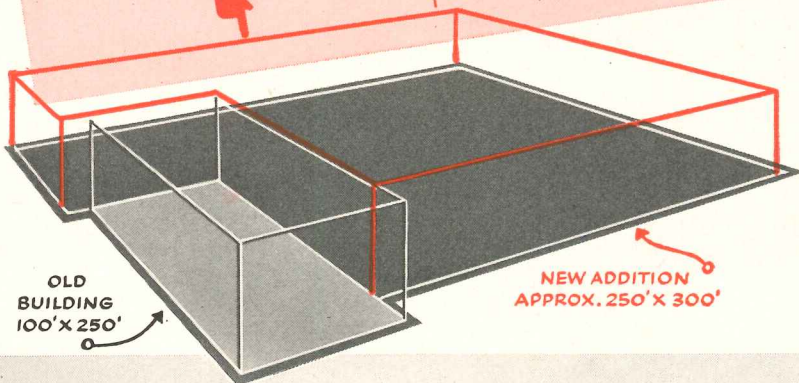

material of tomorrow

you today—*U.S.S. 17 (TYPE 430)*

Stainless Steel

Architects must consider U.S.S. 17 (Type 430) Stainless Steel when searching for the most practical, economical and available exterior panel wall material.

This grade of stainless steel has proved to be suitable for insulated and non-insulated panels on many types of buildings, including office buildings, plant office buildings, warehouses, and power plants. U.S.S. 17 (AISI Type 430) is available today; it is not affected by the nickel shortage that limits the current use of some other grades of Stainless Steels.

An outstanding example of the use of insulated panels of U.S.S. 17 Stainless Steel are three multi-story office buildings now under construction in Pittsburgh's new Gateway Center. Here panel installation was accomplished at the almost unbelievable rate of 17 floors in 15 working days. And Stainless Steel's permanence and ease of maintenance will be reflected throughout the life of these buildings.

The versatility of Stainless panels was demonstrated effectively on a plant of the E.

F. Hauserman Company in Cleveland, Ohio. Here a building constructed with Stainless Steel walls was enlarged by removing panels, adding a wing larger than the original structure and then using both the old panels and additional new ones to enclose the new wing.

Our new booklet contains full details on Stainless Steel panels and their use. You'll find it valuable in planning your current work as well as future projects. Use the coupon to obtain your copy and indicate if you would like additional information direct from panel manufacturers. Remember that United States Steel only produces the Stainless Steel; it does not fabricate panels.

No CMP tickets needed

Effective January 28, 1952, the NPA has removed all straight-chromium Stainless Steels from CMP controls. This includes U.S.S. 17 (Type 430). Purchasers no longer need CMP tickets; they simply order from their steel supplier.

AMERICAN STEEL & WIRE . . . COLUMBIA-GENEVA STEEL . . . NATIONAL TUBE . . . TENNESSEE COAL & IRON
UNITED STATES STEEL SUPPLY, WAREHOUSE DISTRIBUTORS . . . Divisions of **UNITED STATES STEEL COMPANY, PITTSBURGH**
UNITED STATES STEEL EXPORT COMPANY, NEW YORK

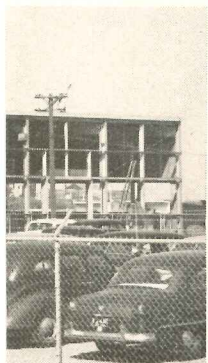
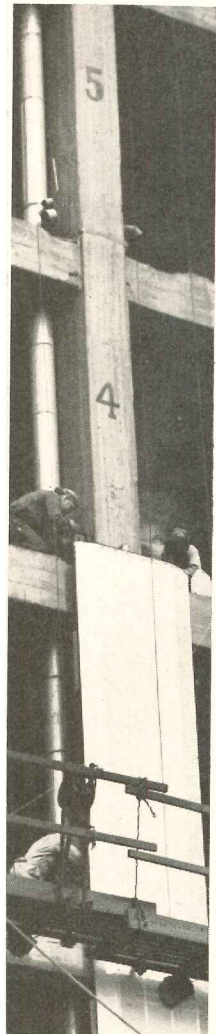

United States Steel Company
Room 2802D, 525 William Penn Place, Pittsburgh 30, Pa.

Please send me your booklet "U.S.S. 12, U.S.S. 17 Stainless Steel Walls and Roofs for Industrial Buildings."

Please arrange to have fabricators of Stainless Steel wall panels send me literature on their particular type of construction.

Name..... Title.....

Address.....

City..... State.....

UNITED STATES STEEL

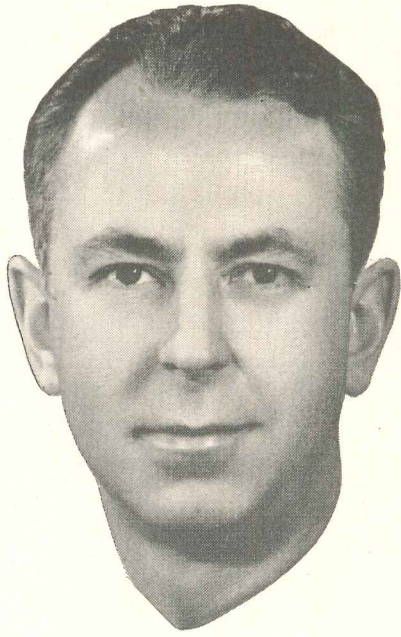

"More living room
is no problem with
this hideaway furnace"

says Phil Hedback,

Bryant-Hedback Co., Indianapolis, Ind.

With useable space at a premium, it is little wonder that the Bryant *Hideaway* Gas Furnace is proving so popular. Architects and builders say it not only saves valuable space, but the furnace, itself, is a real selling feature.

Tucked away in the attic—or suspended from the ceiling or under the floor—this dependable forced-air furnace provides a world of comfort for householders while releasing *extra space* for storage, utility purposes or plain *living*. The *Hideaway* is a true Bryant product—long on dependability and gas economy, and with positive automatic control. Naturally, the casing temperatures are low. You'll also like the way it goes in—structural steel mounting channels come with it and can be used to suspend the unit when it is so installed.

Yes, you'll like this Bryant *Hideaway* Forced-Air Furnace that gives you both added living space and better heating.

Why not ask your Bryant Distributor for full details? Or write Bryant Heater Division, Dept. 213, Affiliated Gas Equipment, Inc., 17825 St. Clair Ave., Cleveland 10, Ohio.



**Bryant Model 324
Hide-away Gas Furnace**

Can be tucked away in the attic, or suspended from ceiling or under the floor. Fully automatic, forced-air unit with *Hevigage* heat exchanger. Available for all gases. AGA inputs: 65, 85, 100 and 125 thousand Btu per hour.

bryant *best buy*

IN HEATING,

AIR CONDITIONING,

WATER HEATING

that
Streamline[®]
 copper plumbing
 sure stands up!

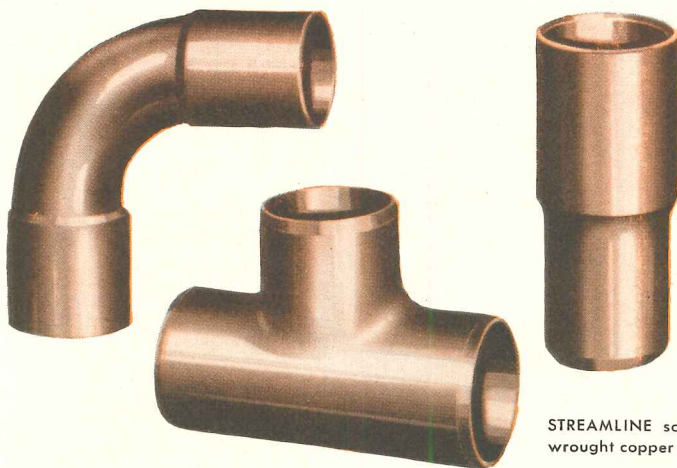
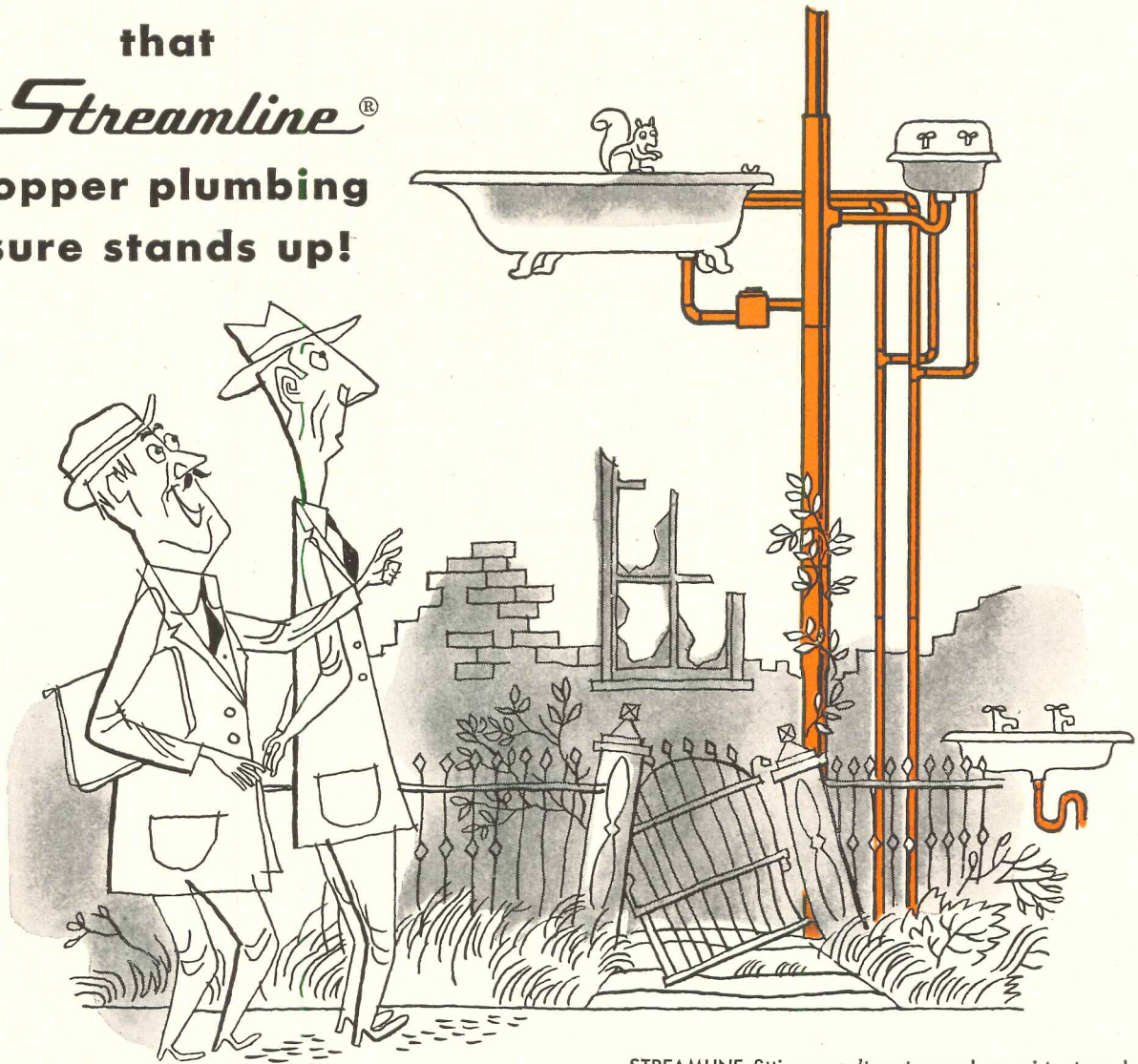

STREAMLINE solder type wrought copper fittings.



STREAMLINE threaded cast bronze fittings.

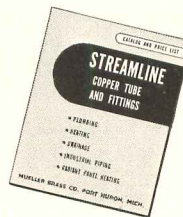

See your jobber for further information or write for catalog S-352 describing our complete line of STREAMLINE wrought copper and cast bronze fittings.

76



MUELLER BRASS CO. PORT HURON 7, MICHIGAN

LOW-COST HOMES, TOO, CAN HAVE THE BENEFITS OF OAK FLOORING

Grades of oak for low-cost budgets and laying oak over concrete make a cost-cutting combination.



Prospective homeowners want, and should get, *all* the basic fundamentals in their new, low-cost homes. These fundamentals, which include "healthfulness," durability and economy, need not be sacrificed.

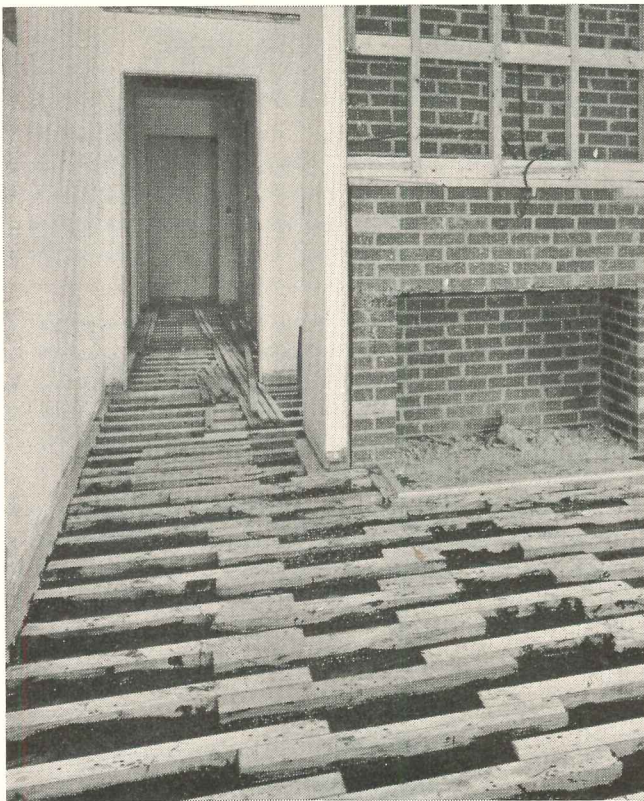

Oak flooring is one material that provides the basic fundamentals and one which *can* be included in even the lowest cost homes.* It is now possible to lay oak over concrete slab, using screeds set in mastic.



Oak is the only flooring material, in any price range, that keeps that "just-installed" look for a lifetime—with a minimum of upkeep. That's one reason 85% of all prospective homeowners demand oak flooring.

*WRITE TO NATIONAL OAK FLOORING MFRS. ASS'N, STERICK BLDG., MEMPHIS 3, TENN., FOR FREE, FHA-APPROVED INSTRUCTIONS ON LAYING OAK OVER CONCRETE.

HOSPITAL	LOCATION	ARCHITECT
Univ. of Arkansas Hospital	Little Rock, Arkansas	Erhart Eichenbaum & Rauch
St. Vincent's Infirmary	Little Rock, Arkansas	Brueggeman, Swain & Allen
Atascadero State Hospital	Atascadero, California	Ralph E. Phillips
Peninsula Hospital	Burlingame, California	Stone & Mulloy
Seneca District Hospital	Chester, California	Stone & Mulloy
Coronado Hospital	Coronado, California	
Student Health Center	Davis, California	
Imperial Valley Mem. Hosp.	El Centro, California	Frank Hyde
Children's Hospital	Fresno, California	William Hastrup
Napa State Hospital	Imola, California	
LaMesa Com. Hospital	LaMesa, California	
Good Samaritan Hospital	Los Angeles, California	Samuel E. Lundon
St. Francis Hospital	Lynwood, California	
Beverly Hospital	Montebello, California	A. E. Harvey
Needles Mun. Hospital	Needles, California	
Children's Hospital	Oakland, California	Stone & Mulloy
Institution for Epileptics	Porterville, California	
Cascade Sanitarium	Redding, California	Goeffrey Banks
W. Contra Costa Hospital	Richmond, California	Stone & Mulloy
Sacramento Co. Hospital	Sacramento, California	George C. Sellon
San Diego Hospital Assn.	San Diego, California	
Children's Hospital	San Francisco, California	Skidmore, Owings & Merrill
University of California	San Francisco, California	
San Jose Hospital	San Jose, California	Stone & Mulloy
Eden Township Hospital	San Lorenzo, California	
Stockton S. Hospital	Stockton, California	
Norwalk General Hospital	Norwalk, Connecticut	York & Sawyer
Milford Mem. Hospital	Milford, Delaware	Morris G. Whiteside
Home for Aged and Infirm	Blue Plains, Wash. D. C.	
De Land Mem. Hospital	De Land, Florida	Mr. G. M. Peek
Bacon County Hospital	Alma, Georgia	Gregson & Ellis
Georgia Baptist Hospital	Atlanta, Georgia	Stevens-Wilkinson
Habersham Co. Gen. Hosp.	Demorest, Georgia	H. H. Beckanstin
Douglas Coffee Co. Hosp.	Douglas, Georgia	Wm. J. J. Chase & Assoc.
Tri-County Hospital	Fort Oglethorpe, Georgia	
Children's Mem. Hospital	Chicago, Illinois	
Galesburg S. Res. Hospital	Galesburg, Illinois	West, Weber & Armstrong
Hinsdale San. and Hospital	Hinsdale, Illinois	Fugard, Burt & Wilkinson & Orth
Marion Mem. Hospital	Marion, Illinois	
Moline Public Hospital	Moline, Illinois	Wm. F. Bernbrock & Assoc.
Oak Park Hospital	Oak Park, Illinois	Schmidt, Garden & Erikson
Methodist Hospital	Peoria, Illinois	James & Harrison
Swedish American Hospital	Rockford, Illinois	Gilbert Johnson
St. Anthony's Hospital	Rock Island, Illinois	Schmidt, Garden & Erikson
Bartholomew Co. Hospital	Columbus, Indiana	J. M. Rotz Eng. Co.

HOSPITAL	LOCATION	ARCHITECT
Mayo Memorial Hospital	Minneapolis, Minnesota	C. H. Johnson Co.
St. John's Hospital	St. Paul, Minnesota	
University of Minnesota	St. Paul, Minnesota	
Independance San. & Hosp.	Independance, Missouri	
Burge Hospital	Springfield, Missouri	Hawkins & Esterly
City Hospital	Springfield, Missouri	Hawkins & Esterly
Roundup Mem. Hosp. Assn.	Roundup, Montana	Jos. W. Pahl, Jr.
Calloway Mun. Hospital	Calloway, Nebraska	
Douglas Co. Hospital	Omaha, Nebraska	
Overbrook Hospital	Cedar Grove, New Jersey	Epple & Seaman
St. Clare's R. C. Hospital	Denville, New Jersey	A. J. DePace
Burlington County Hospital	Mt. Holly, New Jersey	Mr. George Von Uffel
Perth Amboy Gen. Hospital	Perth Amboy, New Jersey	
Princeton Hospital	Princeton, New Jersey	York & Sawyer
S. Amboy Mem. Hospital	S. Amboy, New Jersey	Pierson & MacWilliam
Binghamton City Hospital	Binghamton, New York	
Brooklyn Women's Hospital	Brooklyn, New York	
Frederick Ferris Thompson	Canandaigua, New York	Cannon, Thiele, Betz, Cannon
Cuba Memorial Hospital	Cuba, New York	Will Alban Cannon
Dansville Mem. Hospital	Dansville, New York	Kaelber & Waasdorp
Beekman Hospital	New York City	Eggers & Higgins
Hospital for Spec. Surgery	New York City	Rogers & Butler
Clifton-Fine Hospital	Star Lake, New York	Granger & Gillespie
Jones Memorial Hospital	Sellsville, New York	Duane, Lyman & Assoc.
DeGraff Memorial Hospital	Tonawanda, New York	Green James Meadows
St. Elizabeth's Hospital	Utica, New York	John B. Peterbin
N. C. T. B. Sanatorium	Chapel Hill, N. C.	F. Carter Williams
Univ. of N. C. Infirmary	Chapel Hill, N. C.	
Watts Hospital	Durham, North Carolina	George Watts Carr
North Carolina Sanatorium	McCain, North Carolina	F. Carter Williams
Union County Hospital	Monroe, North Carolina	J. N. Pease
Eastern N. C. Sanatorium	Wilson, North Carolina	Walter Hook
Ellendale Hospital	Ellendale, North Dakota	Latensar & Son
Turtle Lake Com. Hospital	Turtle Lake, North Dakota	Thorsen & Thorsen
Wishek Hospital Clinic	Wishek, North Dakota	Ursa Louis Freed
Good Samaritan Hospital	Ashland, Ohio	
Bellevue Hospital	Bellevue, Ohio	
Cincinnati General Hospital	Cincinnati, Ohio	
Benjamin Rose Chronic Case	Cleveland, Ohio	Garfield, Harris, Robinson & Schaefer
Summit Co. Rec. Hospital	Cuyahoga Falls, Ohio	
St. Elizabeth Hospital	Dayton, Ohio	Schmidt, Garden & Erikson
Miami Valley Hospital	Dayton, Ohio	
Holzer Hospital	Gallipolis, Ohio	
Lancaster Mun. Hospital	Lancaster, Ohio	D. Carmichael

- Manufacturers of*
- Sterilizers
 - Bed Pan Washers
 - Stills
 - Flasking Equipment for Sterile Water
 - Solution Preparation Equipment
 - Surgical Lights and Tables

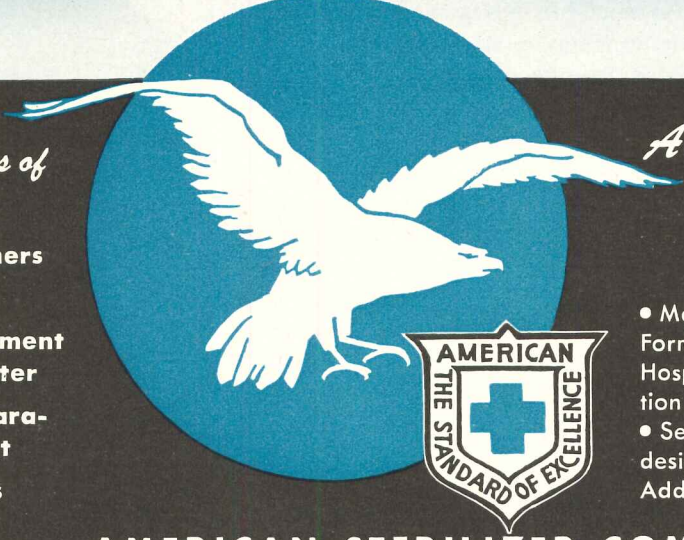

A Partial List of Hospitals selecting
American Sterilizer Company
equipment
in their 1951 building program

- Many of the Central Sterile Supply Departments, Milk Formula Laboratories and Parenteral Solutions Rooms in the Hospitals listed were planned by architects in close cooperation with our Planning Department.
- Send us your plans—we will be glad to assist you with the design of these specialized departments—no obligation. Address Department AR-4.

AMERICAN STERILIZER COMPANY • ERIE, PENNSYLVANIA

Clinton County Hospital	Frankfort, Indiana	Mr. Rodney Leonard
Freeman-Greene Co. Hosp.	Linton, Indiana	
Woodlawn Hospital	Rochester, Indiana	
Jane Lamb Mem. Hospital	Clinton, Iowa	Morrell & McCann
Finley Hospital	Dubuque, Iowa	Weherral & Harrison
Mercy Hospital	Oelwein, Iowa	Maguolo & Quick
Hamilton Co. Public Hosp.	Webster City, Iowa	W. Beuttler-R. C. Treeves, Associate
Ellinwood Dist. Hospital	Ellinwood, Kansas	Mr. Jos. Radotinsky
St. Elizabeth's Mercy Hosp.	Hutchinson, Kansas	
Univ. of Kansas Med. Cen.	Kansas City, Kansas	
Ransom Mem. Hospital	Ottawa, Kansas	Radotinsky
St. John's Hospital	Salina, Kansas	
St. Elizabeth Hospital	Covington, Kentucky	Potter, Tyler & Martin
Kentucky Baptist Hospital	Louisville, Kentucky	
Hayswood Hospital	Maysville, Kentucky	Mr. Albert La Feber
Franklin Foundation Hosp.	Franklin, Louisiana	Fuhrmann & Geier
Jewish Medical Center	Baltimore, Maryland	
Eastern Shore State Hosp.	Cambridge, Maryland	
Kent & Queen Ann Hospital	Chestertown, Maryland	
Memorial Hospital	Frederick, Maryland	
Hartford Memorial Hospital	Haver DeGrace, Maryland	
Calvert County Hospital	Prince Frederick, Md.	Edmunds
Boston City Hospital	Boston, Massachusetts	James Ritchie & Assoc.
N. E. Deaconess Hospital	Boston, Massachusetts	Coolidge, Shepley, Bulfinch & Abbott
New Carney Hospital	Dorchester, Mass.	Maginnis & Walsh
Holyoke Hospital	Holyoke, Massachusetts	Ritchie & Assoc.
St. Luke's Hospital	New Bedford, Mass.	Curtin & Riley
Fernald School	Waverly, Massachusetts	
University of Michigan	Ann Arbor, Michigan	
Grace N. W. Hospital	Detroit, Michigan	Smith-Hinchman & Grylls
Jewish Hospital	Detroit, Michigan	J. A. Kahn & Assoc.
United Memorial Hospital	Greensville, Michigan	Gennett & Straight
Marlette Comm. Hospital	Marlette, Michigan	St. Clair Pardee
Northville State Hospital	Northville, Michigan	
St. Francis Hospital	Breckneridge, Minnesota	Mr. Frank W. Jackson
Community Hospital	Madison, Minnesota	Hubert H. Swanson

Mansfield General Hospital	Mansfield, Ohio	
Township Mem. Hospital	St. Mary's, Ohio	Strong, Strong & Strong
Providence Hospital	Sandusky, Ohio	Conrad, Hays, Simpson & Ruth
St. Charles Hospital	Toledo, Ohio	Robert J. Reiley
Toledo State Hospital	Toledo, Ohio	
Western Okla. S.T.B. Hosp.	Clinton, Oklahoma	Coston & Frankfurt
St. Mary's Hospital	Enid, Oklahoma	Smith, McVey & Peddie
Woodward Mem. Hospital	Woodward, Oklahoma	Jos. R. Koberling
Bryn Mawr Hospital	Bryn Mawr, Pennsylvania	Scott, Smith & Erikson
Butler Co. Mem. Hospital	Butler, Pennsylvania	Samuel Hannaford & Sons
J. Lewis Crozier Hospital	Chester, Pennsylvania	G. W. Pepper
Easton Hospital	Easton, Pennsylvania	Mr. William Lee
Erie County T. B. Hospital	Erie, Pennsylvania	Meyers, Krider, Werle & Ellenberger
Westmoreland Hospital	Greensburg, Pennsylvania	Jan. B. Ritchie Assoc.
Greenville Hospital	Greenville, Pennsylvania	Echles
Grove City Hospital	Grove City, Pennsylvania	Echles
F. W. Black Hospital	Lewistown, Pennsylvania	Dean Kennedy
Lewistown Hospital	Lewistown, Pennsylvania	
McKeesport Hospital	McKeesport, Pennsylvania	
Muncy Industrial Home for Women	Muncy, Pennsylvania	
Misericordia Hospital	Philadelphia, Pa.	Thomas Early
Philadelphia Con. Hosp.	Philadelphia, Pa.	M. Beaverbach
St. Margaret Mem. Hospital	Pittsburgh, Pennsylvania	Wm. York Cocken
Torrance S. Hospital	Torrance, Pennsylvania	Kuhn & Newcomer
Our Lady of Fatima Hosp.	N. Providence, R. I.	
Charleston Co. T. B. Hosp.	Charleston, S. C.	Simons & Lapham
Toumey Hospital	Sumter, South Carolina	James & Durant
Driscoll Foundation Hosp.	Corpus Christi, Texas	C. H. Page & Sons
John Sealy Hospital	Galveston, Texas	Edward H. Page
M. D. Anderson Cancer Res.	Houston, Texas	MacKie & Kanrath
Brattleboro Mem. Hospital	Brattleboro, Vermont	James Ritchie & Assoc.
Fairmont General Hospital	Fairmont, West Virginia	Louis D. Schmidt
St. Joseph's Hospital	Hillsboro, Wisconsin	Durrant & Berquist
St. Luke's Hospital	Racine, Wisconsin	Schmidt, Garden & Erikson

27 years
and no repairs!

... because the roofing and siding were **TONCAN IRON**

● In 1924, the tall building shown in the photo—a soy bean processing plant located on the shore of Lake Erie at Fairport Harbor, Ohio—was roofed and sided with rust-resisting Toncan Iron. 15 years later, when an addition was necessary, the trouble-free performance of Toncan Iron recommended that it be used a second time.

Last year, in 1951, the building was demolished—but in spite of lake front service in smoke and fume-laden atmosphere, the Toncan Iron Sheets were still in good condition.

Service like this is typical wherever Toncan Iron is used for the sheet metal work. It is an *ALLOYED IRON*, containing twice the amount of copper ordinarily used in copper-bearing steels or irons—plus just the right amount of molybdenum to make the copper most effective. That's why it resists rust—outlasts other ferrous materials in its price class—saves money in the long run.

Read more about Toncan Iron in Sweets'—or write for literature.

REPUBLIC STEEL CORPORATION
GENERAL OFFICES • CLEVELAND 1, OHIO
Export Department: Chrysler Building, New York 17, N. Y.

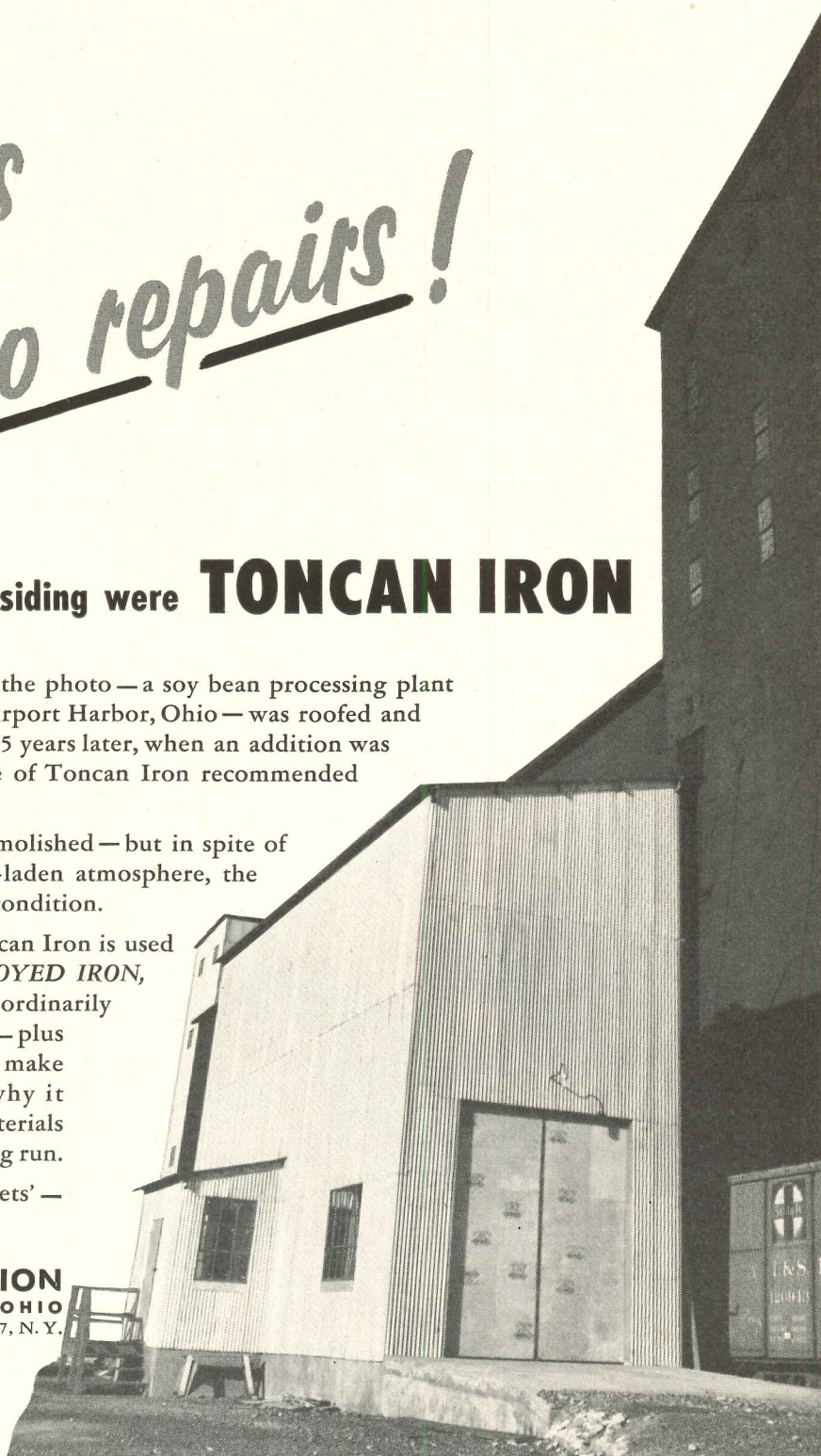

FOR MORE THAN 40 YEARS . . .
HIGHEST RUST-RESISTANCE OF ALL
FERROUS MATERIALS IN ITS PRICE CLASS



Republic

TONCAN **COPPER** **IRON**
MOLYBDENUM

— for ducts, gutters, conductor pipes, roofing, siding, tanks, ventilators, skylights, hoods and other sheet metal applications requiring rust-resistance — and for corrugated metal drainage products.

For Hospitals and Other Institutions

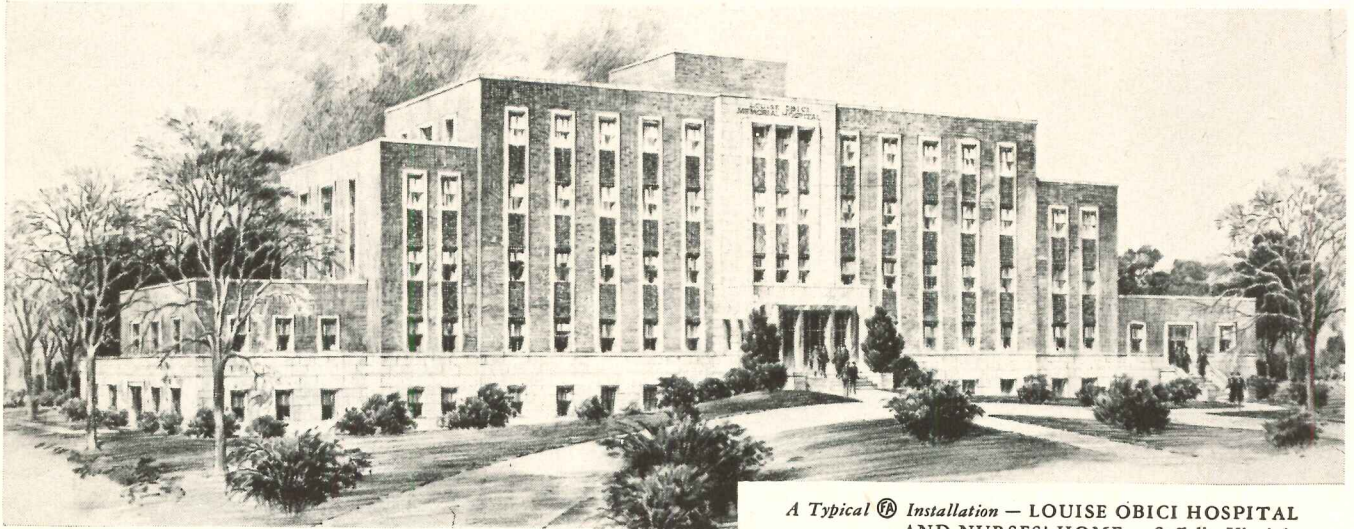

A Typical **FA** Installation — LOUISE OBICI HOSPITAL AND NURSES' HOME — Suffolk, Virginia

BASKERVILLE & SONS, Architects and Engineers, Richmond, Va.

SAMUEL HANNERFORD & SONS, Consulting Architects, Cincinnati, O.

Specify . . . **FA**

Electrical Products

Adequate power and light is vital, not only to hospitals and other institutions, but to modern industry. That's why **FA** products are being installed in more and more institutions and industrial plants.

Architects, engineers, contractors, builders and industrialists know from years of practical experience that **FA** is a symbol of quality — that its power and light distribution systems, and other products are safe, dependable, efficient, and economical . . . and will provide years of trouble-free service.

The next time you are confronted with a power and light distribution problem, do as so many others are doing; contact your nearest **FA** representative (he's listed in Sweet's) or write for complete information.

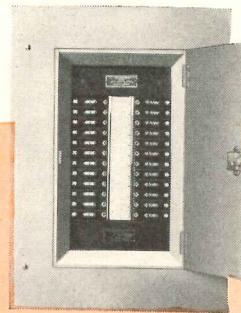

FA Circuit Breaker Panelboard similar to that installed in Louise Obici Memorial Hospital and Nurses' home. Capacities, 15 to 50 amperes, single and double pole, 120—240 volts, three wire, or 120—208 volts, 4 wire main, 42 circuits and less.

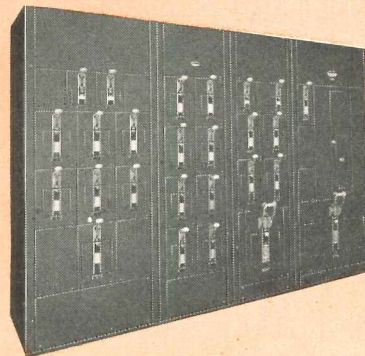

FA Shutbrak Switchboard which has proven extremely popular and practical for hospitals and other institutions. Designed for main feeder and branch circuits. Capacities 30 to 1200 amperes, 250 volts AC or DC and 600 volts AC 2, 3 and 4 pole types.

Frank Adam Electric Co.

P. O. BOX 357 ST. LOUIS 13, MISSOURI

Makers of BUSDUCT • PANELBOARDS • SWITCHBOARDS • SERVICE EQUIPMENT • SAFETY SWITCHES • LOAD CENTERS • QUIKHETER



ACOUSTICAL
MATERIALS
WORK



CHURCH OF ST. ALICE, Upper Darby, Pa.

Architect: Henry D. Dagit & Sons

General Contractor: McCloskey & Company

Acoustical Contractor: Berger Acoustical Company

In addition to being one of the first air-conditioned churches in the North-Atlantic area, St. Alice's was the nation's first church to use the new Embossed Travertone acoustical tile. This unique material enabled the architects to work a pleasing, unobtrusive design into a ceiling spotted with lighting and air-conditioning fixtures.

The regular Armstrong's Travertone, which covers most of the ceiling area, is attractive in itself. Made of mineral wool with a beautifully fissured surface, Travertone imparts an added grandeur to the church interior.

Other factors which recommended Travertone were its incombustibility and its exceptionally high absorption of middle- and high-frequency sounds. Your Armstrong Contractor will give you the full details on the complete Armstrong Line. For free booklet, "How to Select an Acoustical Material," write Armstrong Cork Company, 2404 Stevens Street, Lancaster, Pennsylvania.

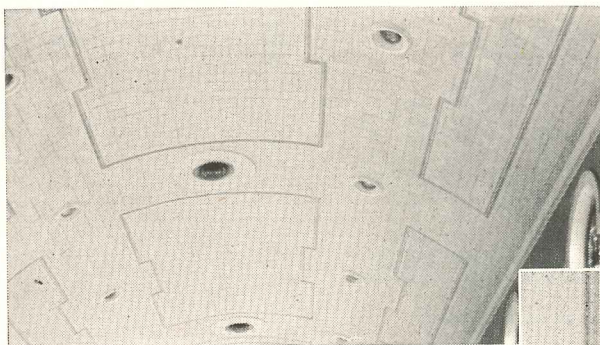

The new Armstrong's Embossed Travertone, made with scored lines on its surface, is used to create border and panel designs.

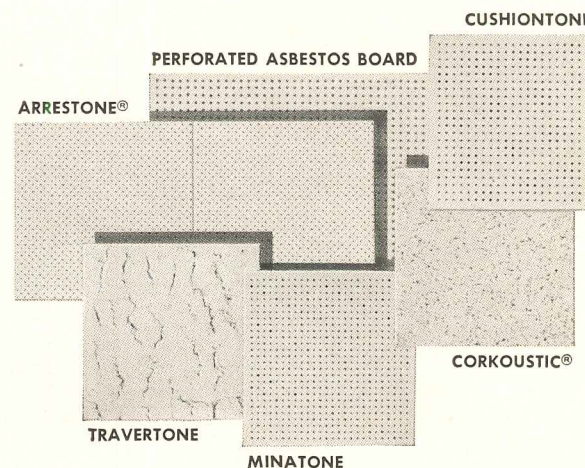
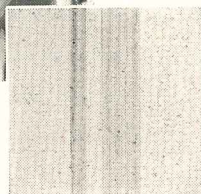

ARMSTRONG'S ACOUSTICAL MATERIALS

Your decision on rest rooms

can have an influence far reaching in its

effect on the **TOTAL COST OF A BUILDING**



This booklet just off the press, is about rest rooms and the sanitary equipment that is installed in them. It shows how different types of plumbing fixtures affect the over-all cost of a building, and the day-to-day cost of maintenance of sanitary facilities. It contains numerous illustrations and details of construction of rest room facilities. The ideas presented in this 32 page booklet are the result of experiences of engineers, architects, general contractors and plumbing and heating contractors. Many of these ideas are presented in this booklet for the first time.

These ideas lead to a reduction in the use of building materials—eliminate the need of suspended ceiling construction—save time and labor and protect rest rooms from premature obsolescence. Write today for your copy of this booklet

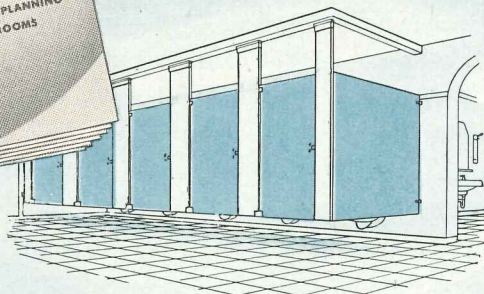
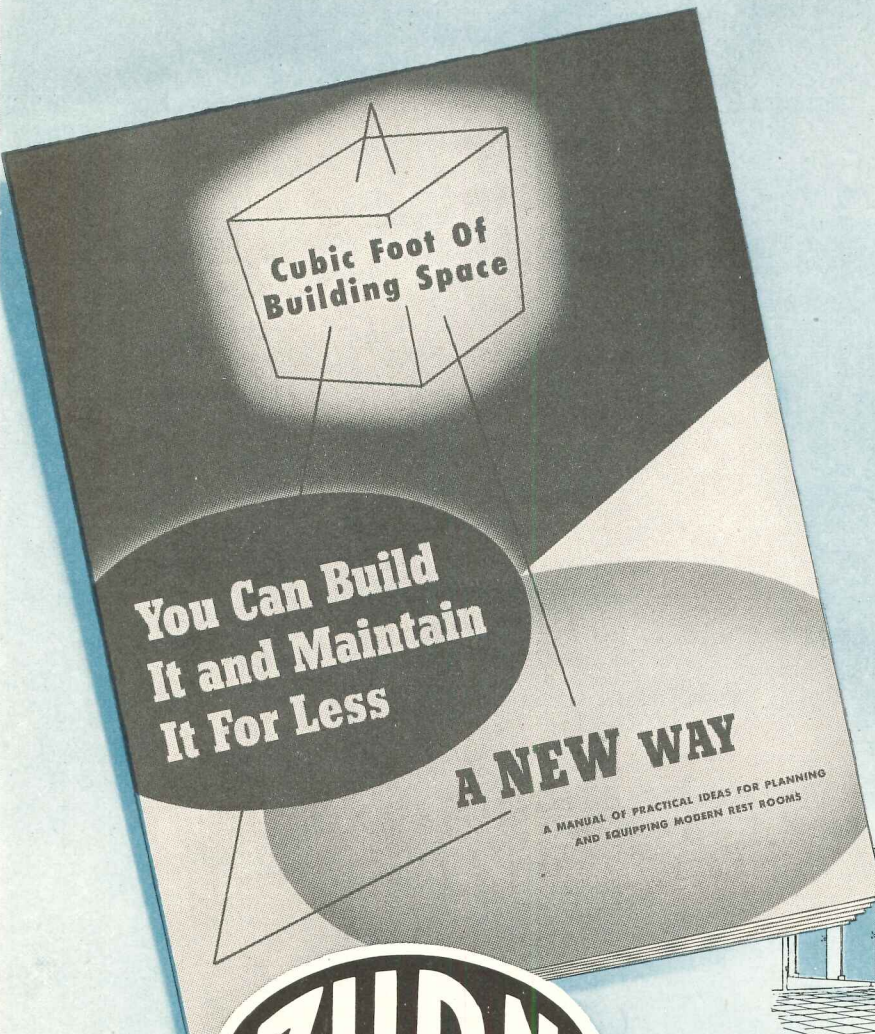

-type rest rooms have fixture-bare floors!



Our 50th Anniversary

J. A. ZURN MFG. CO. PLUMBING DIVISION • ERIE, PA., U.S.A.

Sales Offices in All Principal Cities
Pre-eminent Manufacturer of Sanitary Products for the Protection of Human Health and Modern Structures

J. A. ZURN MFG. CO. • Plumbing Division
Erie, Pa., U. S. A.

I want to know more about the influence rest rooms have on the total cost of a building. Please send booklet entitled, "You Can Build It (Cubic Foot of Building Space) For Less A New Way."

Name and Title

Company

Street

City and State

Please attach coupon to your business letterhead. Dept. AR.

versatility **WITH WOOD WINDOWS**

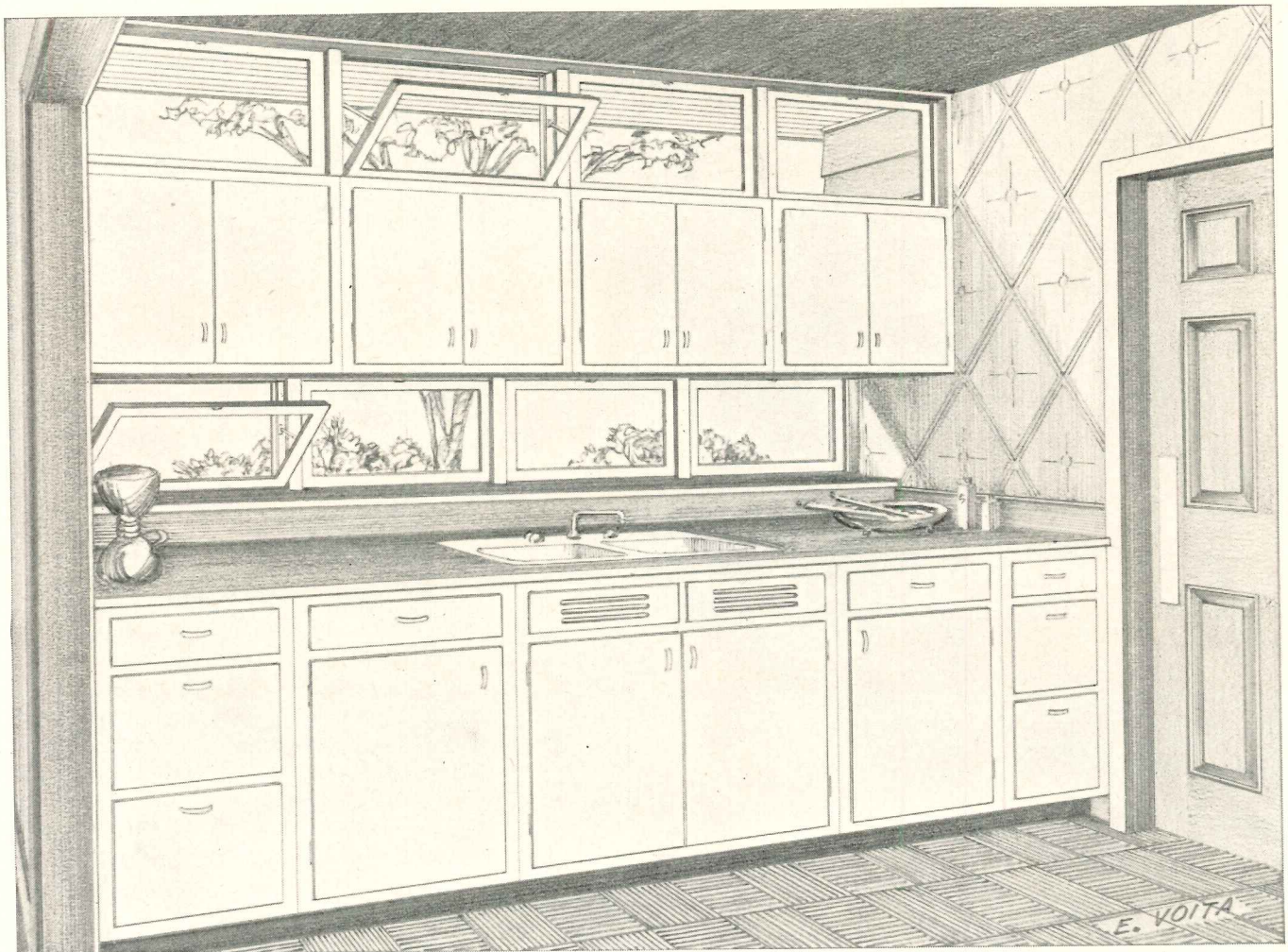

There's practically no limit to your designing scope when you use wood windows. You can create an effective "window wall"—at modest cost—by combining stock design units. You can have large, single-pane glass areas—attractive bays—unusual corner window groups. Because of their variety, modern design and versatility in use, wood windows enable you to provide the generous window areas which today's home owners want—at a cost which fits their pocketbooks. Wood Window Program, 38 South Dearborn Street, Chicago 3, Illinois.

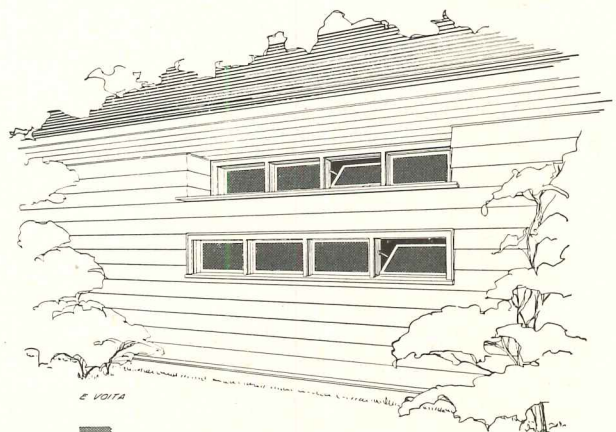

wood windows
for modern beauty and modern performance

1
PLANT:

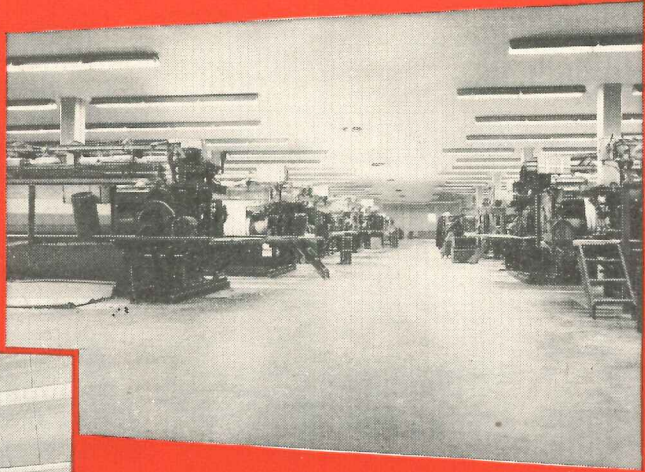

2
REASONS

Asten-Hill Manufacturing Co., Philadelphia, Pa., The Ballinger Co., Architects and Engineers.

for choosing **kno-draft** adjustable air diffusers

Office space and manufacturing areas in this new asbestos dryer felt plant posed separate problems in air conditioning. In the manufacturing section, the vital factor in diffusion was the *even distribution* of the thoroughly conditioned air. Kno-Draft *Adjustable* Air Diffusers got the call because of their demonstrated efficiency in similar critical installations.

In offices and other employee quarters, beauty as well as efficiency had to be considered. Here again, Kno-Draft *Adjustable* Air Diffusers were selected. In addition to their unobtrusive harmony with any surroundings—from severely plain work areas to paneled directors' rooms—they assure the comfort of *draftless* air distribution.

Another big reason for choosing Kno-Draft *Adjustable* Air Diffusers for every job is their adjustability *after* installation. This means exactly the right balance of temperature and air distribution throughout the area for user comfort . . . and saves engineer and installer a vast amount of preliminary figuring. There are types and sizes of Kno-Draft *Adjustable* Air Diffusers to meet all requirements.

NEW EDITION! KNO-DRAFT DATA BOOK now in new 32-page format. Complete up-to-the-minute engineering and installation data on Kno-Draft *Adjustable* Air Diffusers. Bring your files up to date. Mail coupon today.

TRADE MARK "KNO-DRAFT" REG. U. S. PAT. OFF.

W.B. CONNOR ENGINEERING CORP.

Danbury, Connecticut

Air Diffusion • Air Purification • Air Recovery

In Canada: Douglas Engineering Co., Ltd.,
190 Murray Street, Montreal 3, P. Q.

W. B. CONNOR ENGINEERING CORP.
Dept. E-42, Danbury, Connecticut

Please send me the *new edition* of the Kno-Draft Data Book—without obligation, of course.

Name.....
Position.....
Company.....
Street.....
City..... Zone..... State.....



P A I N E

REZO

T. M. REGISTERED

D O O R S

**built up to a standard
not down to a price**

There is no substitute for
experience in establishing and
maintaining quality.

Over five million Paine Rezo
doors are in use since 1935.

Manufactured by the

P A I N E L U M B E R C O . , L T D .

*Oshkosh
Wisconsin*

ESTABLISHED 1853

To get efficient fluorescent lighting ... insist on *This Shield* on your ballast

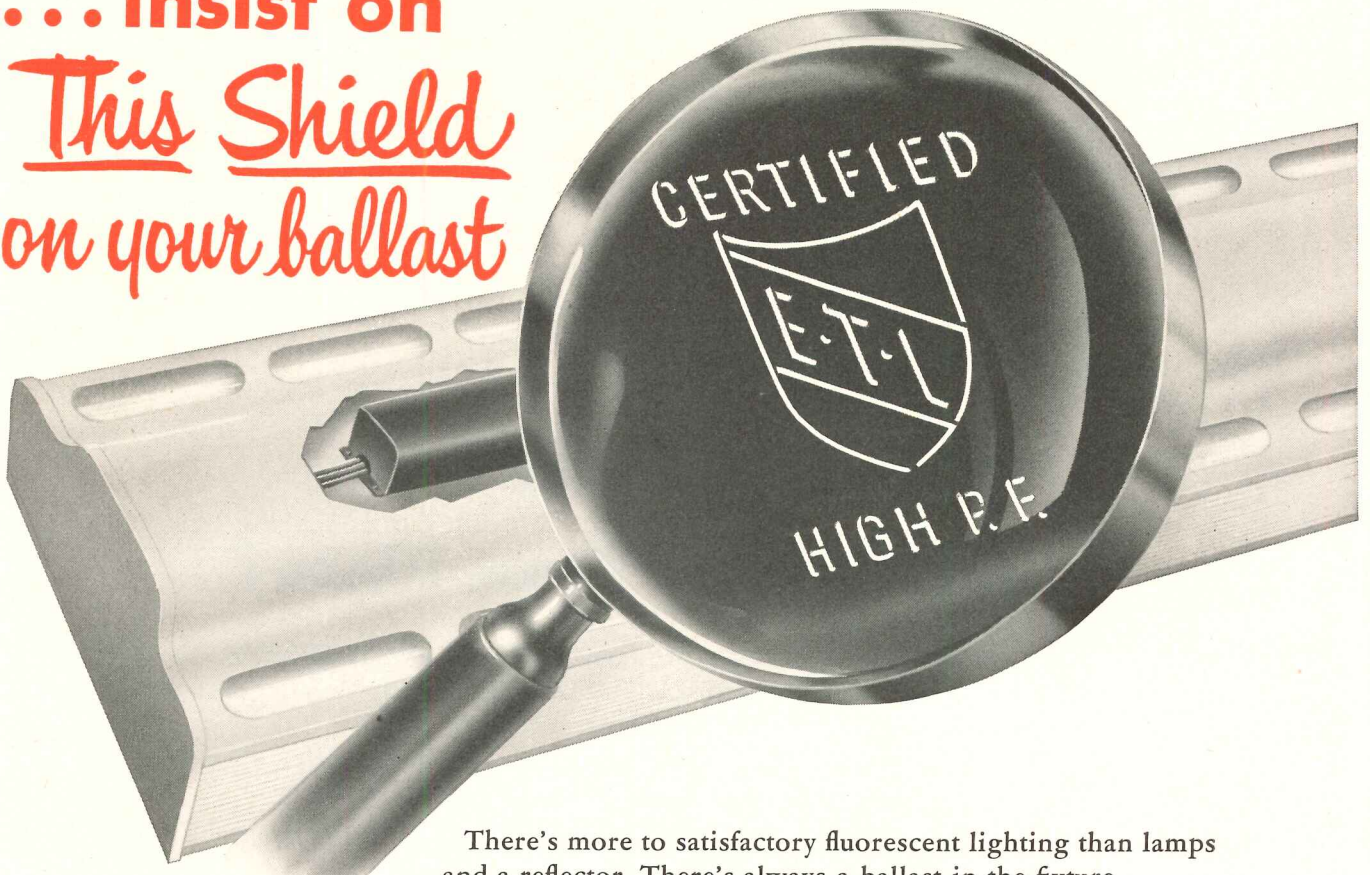

There's more to satisfactory fluorescent lighting than lamps and a reflector. There's always a ballast in the fixture . . . and the way it performs determines whether you'll get *full lamp life, rated light output and satisfactory performance.*

Only CERTIFIED BALLASTS carry the shield that assures best lighting. That's because CERTIFIED BALLASTS are made to precise specifications, then tested by Electrical Testing Laboratories, Inc., which certifies they conform to these high standards.

There's no excuse for inefficient, unsatisfactory fluorescent lighting when CERTIFIED BALLASTS are available.

Be sure every fixture you get has CERTIFIED BALLASTS . . . the ones with the shield.

● Complete information on the types of CERTIFIED BALLASTS available from each participating manufacturer may be obtained from Electrical Testing Laboratories, Inc., East End Ave. at 79th St., New York, N. Y. Participation in the CERTIFIED BALLAST program is open to any manufacturer who complies with the requirements of CERTIFIED BALLAST MANUFACTURERS.

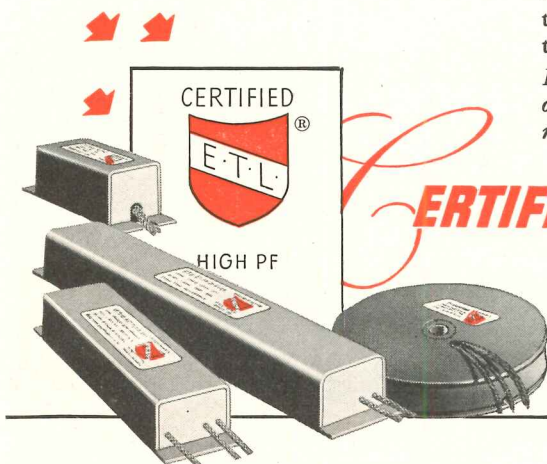

CERTIFIED BALLAST MANUFACTURERS

Makers of Certified Ballasts for Fluorescent Lighting

2116 KEITH BLDG., CLEVELAND 15, OHIO

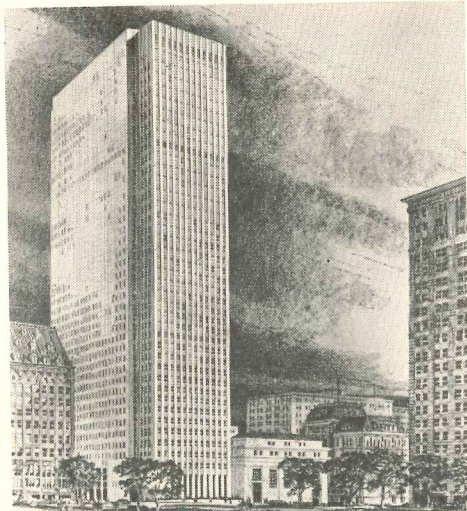

Architects,
Harrison & Abramovitz;
consulting engineers,
Meyer, Strong & Jones;
mechanical contractor,
Dravo Corporation.

Which was best for William Penn Place?

The newest and largest skyscraper in Pittsburgh is 525 William Penn Place. This 40-story office building is occupied by U. S. Steel Corporation and Mellon National Bank and Trust Company.

Four Carrier Centrifugal Refrigerating Machines provide refrigeration for the Conduit Weathermaster* Air Conditioning System.

These machines have no equal in their field. They represent thirty years of experience in manufacture and application.

They have set a record that no other machine can match — two thousand three hundred of them are *on the job!*

They are backed by the largest, most experienced national service organization in the centrifugal field. Carrier experts are stationed in cities across the country . . . always ready to serve . . . seldom called.

Carrier Centrifugal Refrigerating Machines have the finest shaft seal ever designed. It's the Carrier automatic all-metal, non-friction oil seal. Other advantages include easy installation on simple foundations, the smallest dimensions per ton of capacity.

They're available in a full range of sizes up to 2500 tons. Want complete information? Call the nearest Carrier office. Or write Carrier Corporation, Syracuse 1, New York . . . *for 50 years—the people who know air conditioning best.*

*REG. U. S. PAT. OFF.



AIR CONDITIONING
REFRIGERATION
INDUSTRIAL HEATING

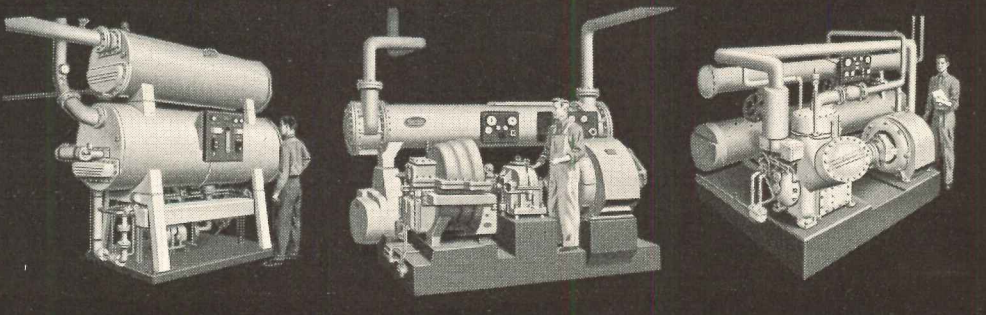

Your particular needs might best be served by a Carrier Absorption Machine which makes cold from steam.

525 William Penn Place uses four of these Carrier Centrifugal Refrigerating Machines.

In many applications, this Carrier Reciprocating Refrigerating Machine is the most economical choice.



Biggest value in hardwood floors

■ Specify *prefinished* Bruce Strip Floors to give owners more value for less money.

The factory-applied finish brings out all the natural beauty of the wood . . . doesn't cover up or discolor the grain. Tests have proved it will outwear surface finishes at least 3 to 1. And housewives find their *prefinished* Bruce Hardwood Floors far easier to keep clean and beautiful.

The cost of this modern hardwood flooring is usually less than the same grade of unfinished flooring plus the expense of on-the-job finishing. There's a saving of 3 to 5 days' time on every house because there's no sanding and finishing, no holding up the work of other trades. Write for complete information on *prefinished* Bruce Strip Floors. See our section in Sweet's File.

Bruce
 *Prefinished*
STRIP FLOORS

PRODUCT OF E. L. BRUCE CO., MEMPHIS 1, TENN.

*World's largest maker of
hardwood floors*

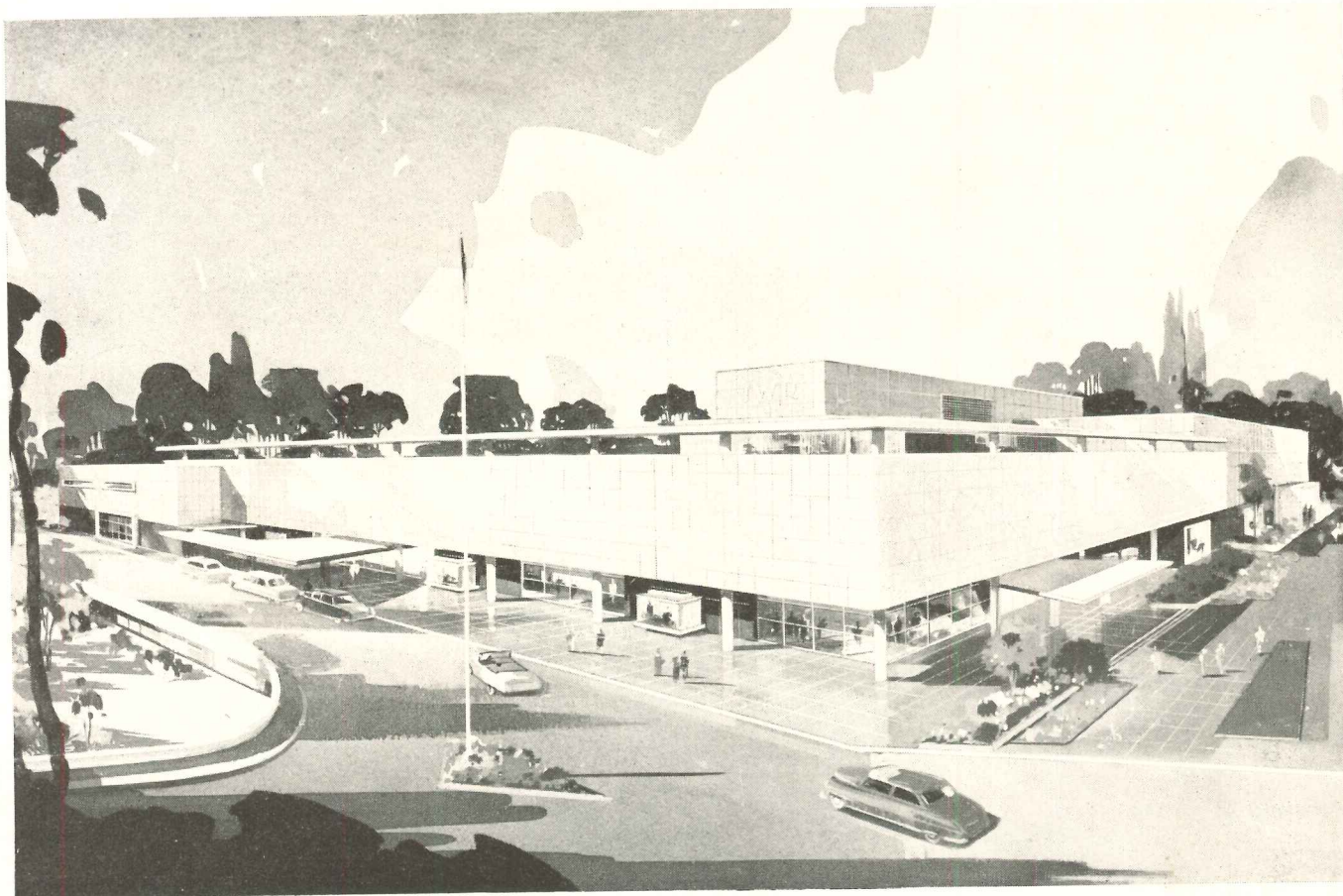

DESIGNER: WILLIAM T. SNAITH OF RAYMOND LOEWY ASSOCIATES
 ARCHITECTS: PEREIRA & LUCKMAN AND CHARLES O. MATCHAM
 GENERAL CONTRACTOR: THE WILLIAM SIMPSON CONSTRUCTION COMPANY

CECO *first choice*

in another great building project

The J. W. Robinson Company's new Beverly Hills Department Store — built with Ceco Reinforcing Steel and Windows for truly modern design.

In creating the J. W. Robinson Company's new Beverly Hills department store, the architects and contractors recognized the need for expert fabricating service on reinforcing steel and precision in steel windows. Here Ceco's 40 years of on-the-job experience offered unmatched facilities and Ceco's windows met all requirements

because they are manufactured on an engineering principle backed by research and constant in-the-field testing.

Ceco detailed the drawings for the Reinforcing Bars, Welded Wire Fabric, Architectural Projected Windows and Security Windows and erected the windows.

Here's an example of how Ceco's broad service benefits designer, architect, contractor and owner — for they know "In construction products CECO ENGINEERING makes the big difference."

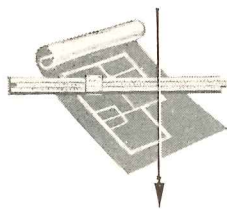

More and more architects count more and more on Ceco for the best in building products.

CECO STEEL PRODUCTS CORPORATION

General Offices: 5601 W. 26th St., Chicago 50, Illinois
 Offices, warehouses and fabricating plants in principal cities



In construction products **CECO ENGINEERING** *makes the big difference*



Research Laboratory
Corridor

The *unseen*
beauty of these
walls is their

Adaptability

We'll be glad to send you an easy-to-read 48-page booklet that will give you all the details. Just ask for Mills Catalog No. 52.



Will your hospital meet tomorrow's needs as well as it meets today's?

It will if you specify Mills Movable Metal Walls. Mills Walls can be moved quickly, easily and at very low cost, to fit any new layout dictated by changing requirements for the areas within a hospital structure. The walls shown above can be dismantled, moved and rearranged in a matter of hours by only two workmen—without dust, debris or commotion, with practically no interruption of normal hospital routine.

Mills Walls combine maximum mobility with structural solidity and beauty of appearance. They are insulated and soundproofed. Their baked-on enamel surfaces will not chip or mar and are specially treated to eliminate all harsh light reflection. They require no maintenance other than occasional ordinary washing to keep them clean and looking fresh and new.

THE MILLS COMPANY • 953 WAYSIDE ROAD • CLEVELAND 10, OHIO

MILLS

Movable

METAL WALLS



announcing
a new high
in window
treatments



the revolutionary all-*Flexalum*[®] blind

Never before...a blind so far *above* the rest in quality and beauty...so far *below* in cost of upkeep! Here's what the remarkable new all-Flexalum blind gives you:

9 important advantages:

- plastic tape wipes clean, won't fade, shrink, stretch
- spring-tempered aluminum slats snap back to shape, won't chip, peel, crack
- new plastic cords: easy to clean, won't fray!
- precision-built mechanism: easy-to-operate, lubricated for life
- unbreakable, noiseless tassels
- minimum cord travel eliminates fraying, or strain on mechanism
- slim, trim all-metal top bar
- cords locked in place, can't slip
- rigid tubular bottom bar

plus uniform quality in every blind...every time.

All parts are Flexalum: your assurance that every blind you buy... no matter *where*, no matter *when*...will be of the same superior quality.

Write for free 8-page catalogue containing complete details on all-Flexalum blind.

HUNTER DOUGLAS CORP., Riverside, California and 150 Broadway, New York 38, N. Y. • HUNTER DOUGLAS LIMITED, Montreal, Que.

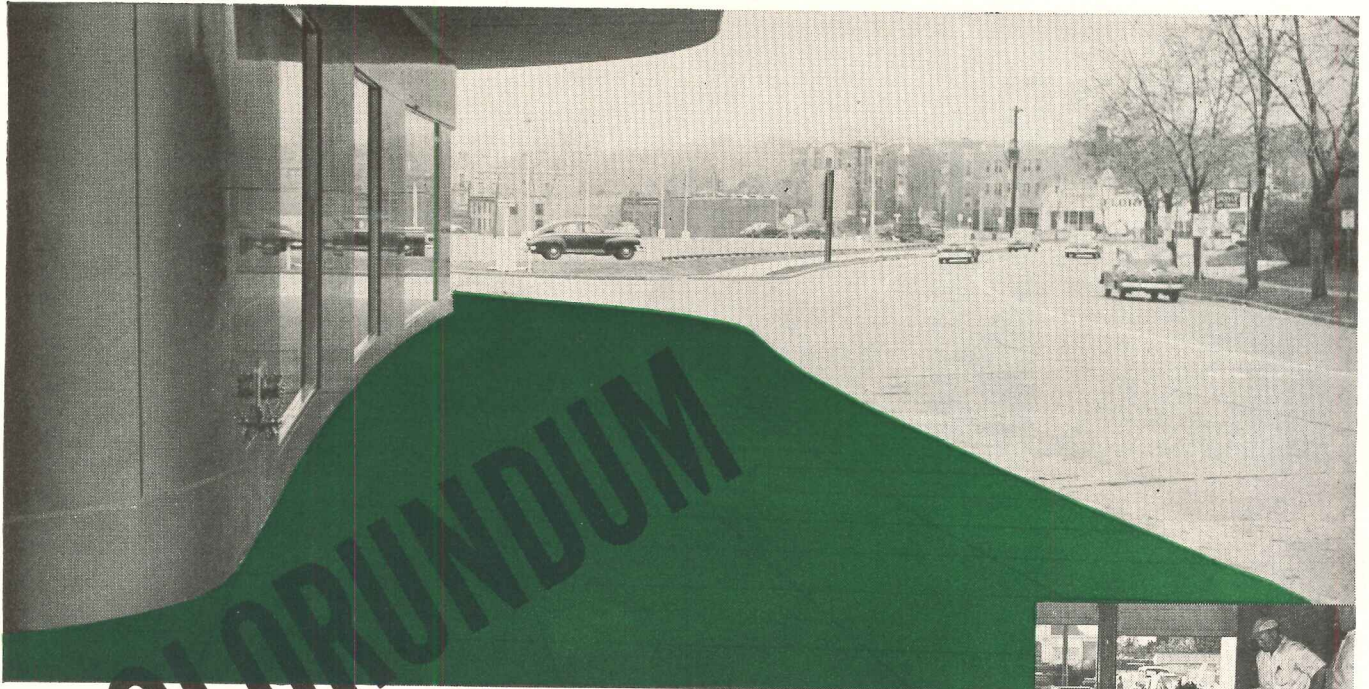

COLORUNDUM

**for colored concrete floors
and sidewalks use COLORUNDUM**

All over the nation modern building design now includes the use of Colorundum in colored concrete floors, sidewalks, roof decks, industrial and other walkways and driveways. Colorundum is used widely in exteriors or interiors . . . as a wear-resistant and colorful concrete topping of long life . . . at practically the average cost of ordinary concrete. Decorative color combinations are often employed of red, maroon, brown, green, dark green, french grey, black. Colorundum is a dry powder ready for use, composed of coloring mediums, fused aggregates, water-repellent and hardening elements. Colorundum is dusted on and floated and trowelled into the fresh concrete topping. The non-slip, non-metallic surface makes it an ideal flooring on new concrete or when replacing old concrete floors or sidewalks.

trowelled into the fresh
concrete topping

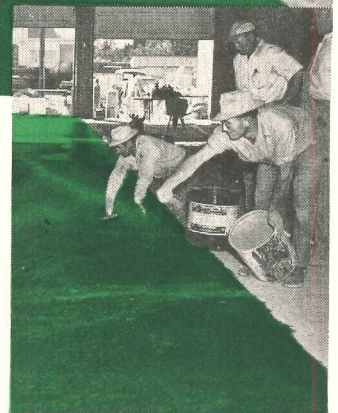

Colorundum central fire station floor

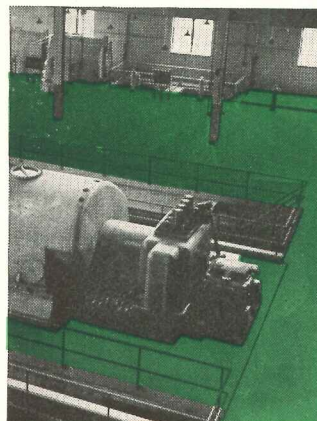

Colorundum power plant floor

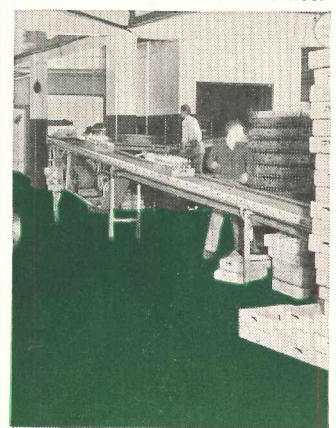

Colorundum industrial floor

HORN

A. C. HORN COMPANY, Inc. est. 1897

Manufacturers of materials for building maintenance and construction
LONG ISLAND CITY 1, N. Y. • Los Angeles • San Francisco • Houston
Chicago • Toronto **SUBSIDIARY OF SUN CHEMICAL CORP.**

A. C. HORN COMPANY, INC.,
Long Island City 1, N. Y.

Please send me complete data on
COLORUNDUM



free copy of your
96-page Construction
Data Handbook



AR-2

NAME _____ TITLE _____

FIRM NAME _____

ADDRESS _____

CITY _____ STATE _____

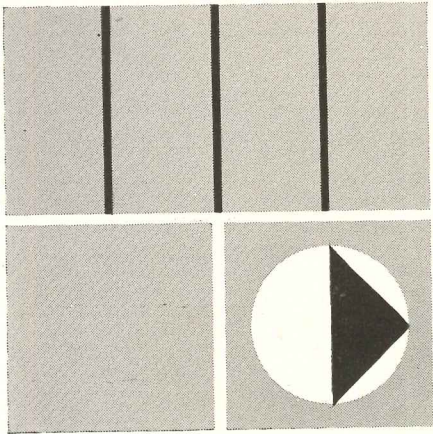

*as fundamental as
kitchen cabinets...*

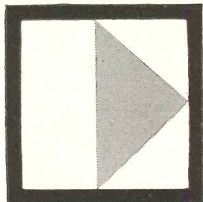

*A good plan
is always better
when it includes
symbols for
telephone outlets.*

To be really complete in every detail, a house needs cabinets in the kitchen — *and telephone raceways in the walls.* For conduit is your only guarantee that telephone wires can be concealed, that the beauty of thoughtfully planned interiors will be fully protected.

Your Bell Telephone Company will be glad to help you work out economical telephone conduit installations. Just call your nearest Business Office.

BELL TELEPHONE SYSTEM



VAMPCO ALL-ALUMINUM WINDOWS

Another **LIFETIME**
"VAMPCO" Installation

Mr. Pleasant State Hospital
Mt. Pleasant, Iowa
Architects: Arthur & Seth Temple
Contractor: Carl A. Nelson

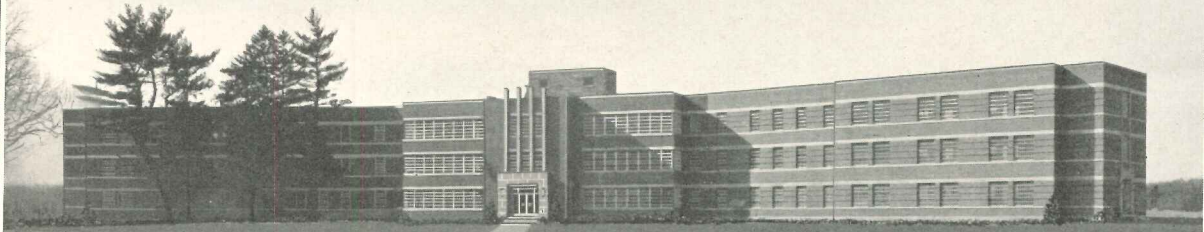

ERECTION *Economy...*
MAINTENANCE *Economy*
YOU PLAN FOR BOTH WHEN YOU PLAN WITH VAMPCO

MORE ECONOMICAL INSTALLATION — No costly "on the job" fitting . . . no wasted man hours. VAMPCO all-aluminum windows are shipped complete — hardware in place — precision assembled. They fit your openings and install in a matter of minutes.

MAINTENANCE ELIMINATED — No rust, no corrosion, never the touch of the paint brush. VAMPCO aluminum keeps its beauty and integrity for the life of the building.

TROUBLE-FREE FOR LIFE — Rigidity and load-bearing strength are first essentials of VAMPCO extrusions and assemblies. The VAMPCO name guarantees free, easy and trustworthy operation without time limit.

LOOK TO **VAMPCO** FOR *Engineering* SERVICE

VAMPCO'S engineering department is maintained and keyed to serve the architect. You are invited to write them — without obligation — for suggestions and cooperation.



FOR ALL THESE WINDOW TYPES — IN LIFETIME ALUMINUM

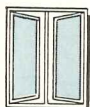

CASEMENT

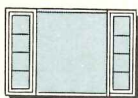

PICTURE



BASEMENT

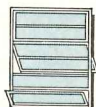

INTERMEDIATE
PROJECTED

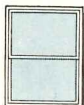

DOUBLE HUNG



WINDOWS FOR
GLASS BLOCK

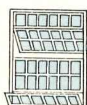

PSYCHIATRIC



COMBINATION
CASEMENT AND
PROJECTED

Write

Dept. AR 4-2,
our Engineering
Department,
for money-sav-
ing suggestions
Consult
SWEET'S for
standard sizes and
specifications.

VALLEY METAL PRODUCTS COMPANY - PLAINWELL, MICHIGAN

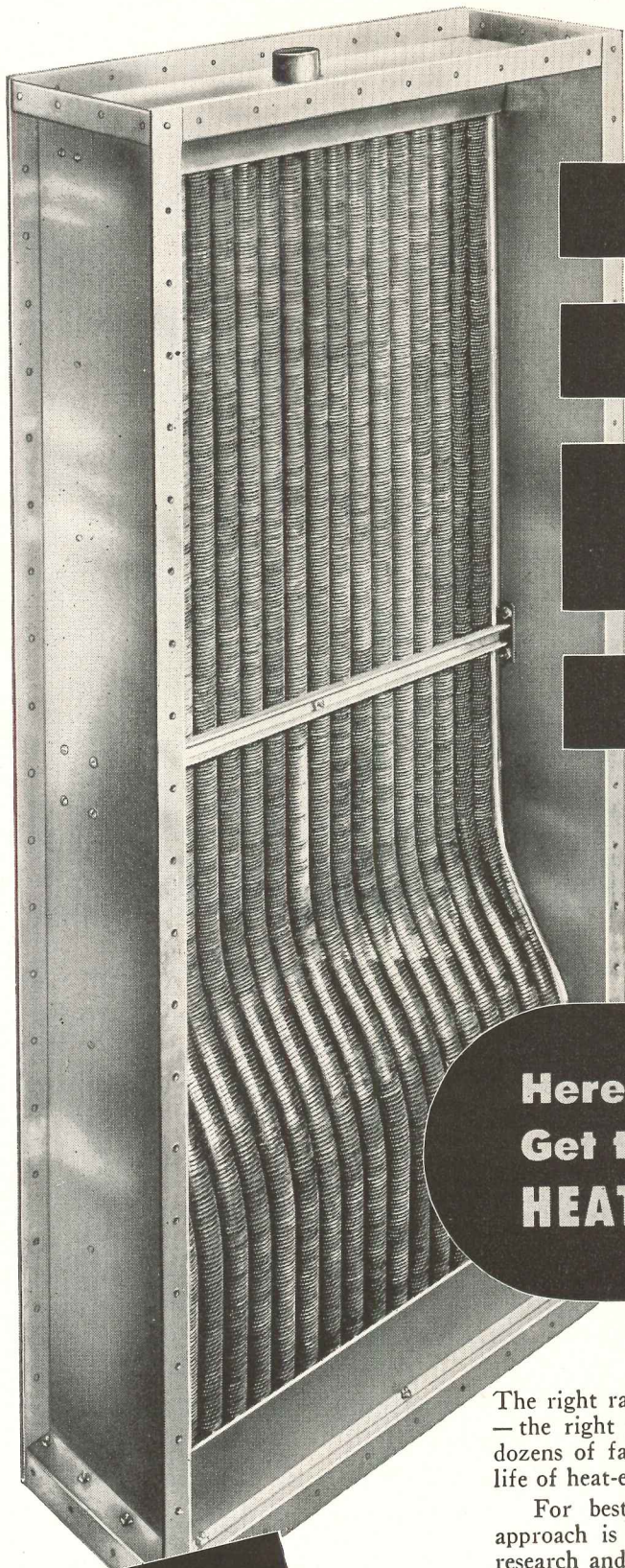

Heating?

Cooling?

**Air
Conditioning?**

Process?

**Here's How to
Get the RIGHT Answer to your
HEAT-EXCHANGE PROBLEMS**

The right ratio of surfaces—the right materials—the right velocities—the right proportion between coil area and depth . . . there are dozens of factors that affect the efficiency, maintenance and service life of heat-exchange coils.

For best performance in your own application, the practical approach is to take full advantage of the unequalled engineering, research and design skill—the unequalled manufacturing and testing facilities—which Aerofin offers you.

To get the *right* answer—ask the Aerofin man.

Aerofin is sold only by manufacturers of nationally advertised fan system apparatus. List on request.

AEROFIN CORPORATION

410 South Geddes St. SYRACUSE 1, N. Y.

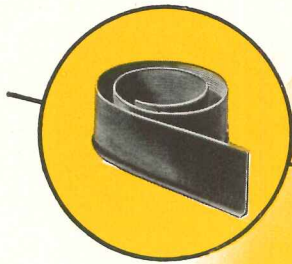

VINYL PLASTIC
COVE BASE

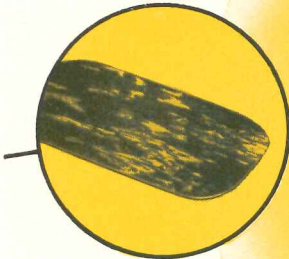

FATIGUE RUGS

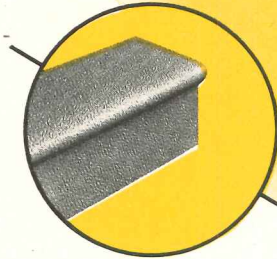

RUBBER
STAIR TREADS

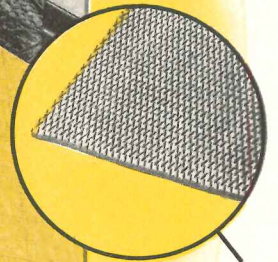
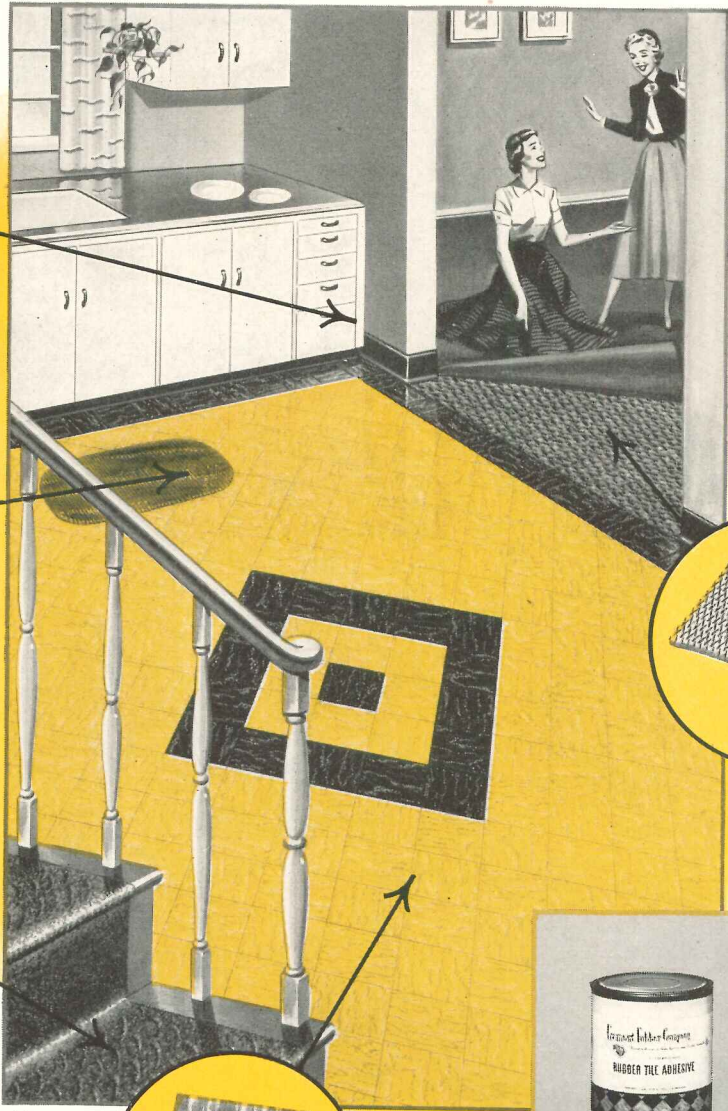

SPONGE RUBBER
RUG CUSHION

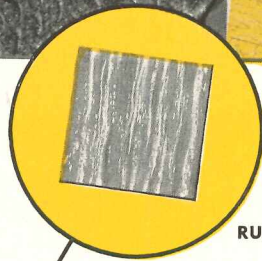

RUBBER TILE



ADHESIVE

*Your Prestige
brand...*

THE **Fremont** FLOOR FAMILY!

Planning, designing, or specifying — you add both color and comfort to the entire home at surprisingly low cost when you use Fremont flooring products everywhere.

COVE BASE in 1½" and 4" heights, continuous lengths, 10 smart colors.

FATIGUE RUGS in oval shape, 18" x 30" and 24" x 36", six decorator colors.

RUBBER STAIR TREADS in three colors, 18" and 24" widths, carpet-like finish.

RUBBER TILE in 6" x 6" and 9" x 9" sizes, three gauges — ¼" in 17 colors, ⅜" and Styrene Plastic Standard Gauge in 8 colors.

ADHESIVE in quart, gallon and five-gallon sizes for proper installation of both Rubber Tile and Cove Base.

SPONGE RUBBER RUG CUSHION in endless rolls, 36" x 53" widths, ⅜", ¼" and ⅜" gauge.

For prices, literature, and free samples, write the Sales Department.

Fremont Rubber Company

309 McPherson Highway, FREMONT, OHIO

WATCH FOR FREMONT'S NEW PRODUCTS



by all **LIGHTING** standards

by all **ELECTRICAL** standards

by ANY Quality Standard

by all **LIGHTING Standards** . . . When compared with the most approved standards in the science of illumination, "Magna-Flo" systems excel: in *high lighting efficiency*, because these units are specifically designed for maximum utilization of the highly efficient T12 Slimline Lamp; in *high light output*, providing high footcandle readings on vertical surfaces and horizontal levels; in *proper brightness balance*, to provide maximum visual comfort and seeing efficiency; in *elimination of direct glare*, to reduce eye fatigue and interference with vision.

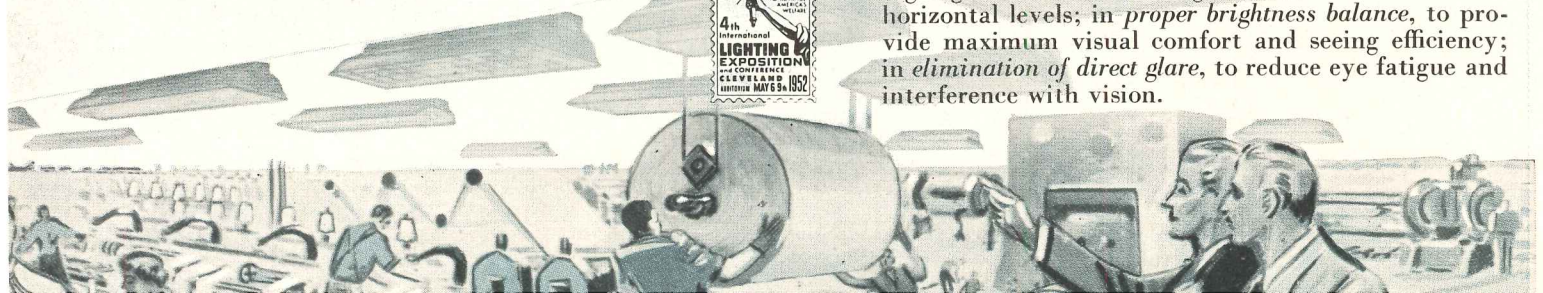

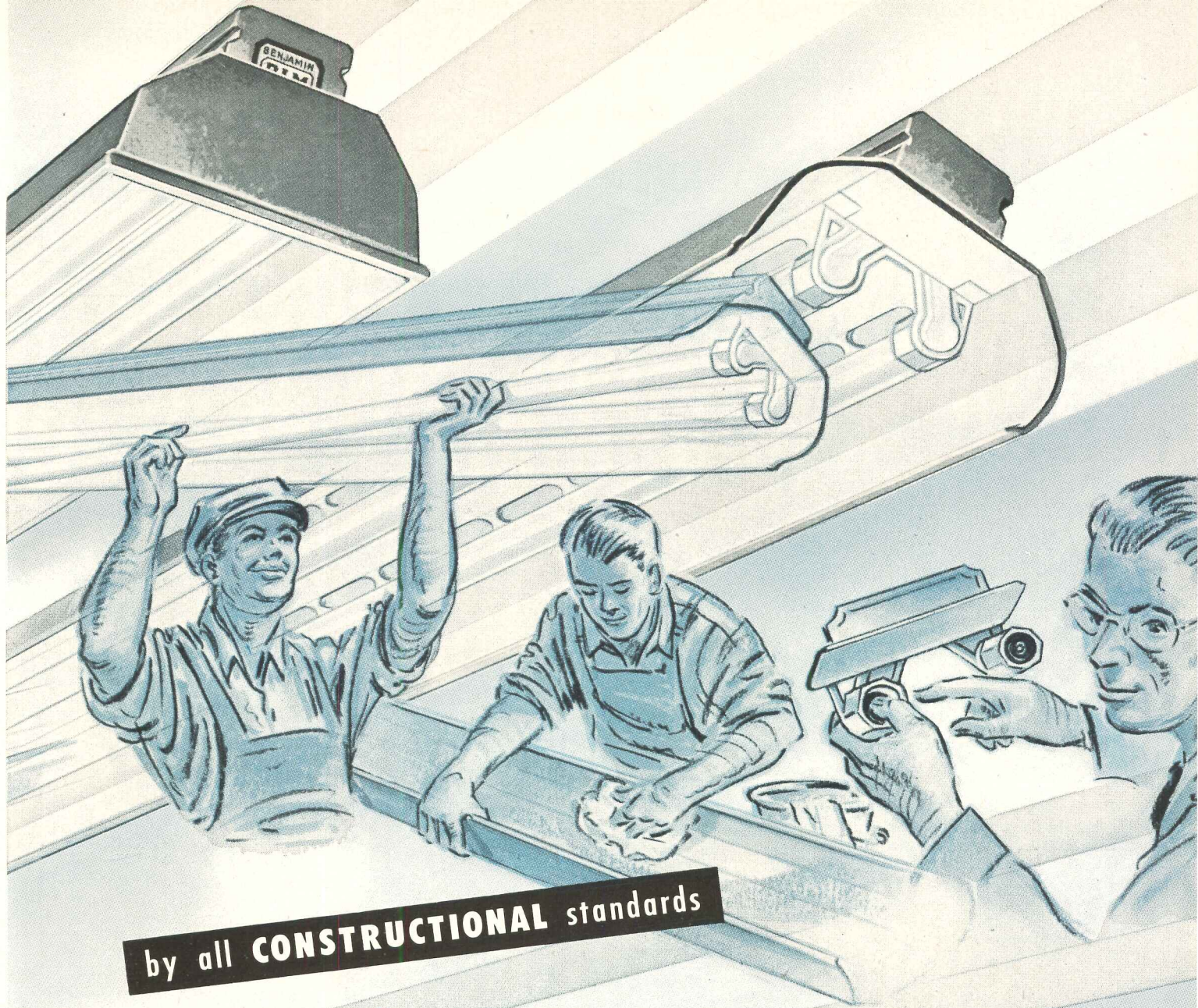

by all **CONSTRUCTIONAL** standards

BENJAMIN "Magna-Flo" Excels!

Compare Benjamin "Magna-Flo" Industrial Lighting Systems with *all* established quality standards. You'll easily see why "Magna-Flo" units excel *all* ways! The "Magna-Flo" line is **SO COMPLETE** that over 300 combinations are possible from just 4 basic reflectors and 3 channels. This completeness makes possible **TASK-MATCHED** installations for the proper lighting of practically all types of industrial seeing tasks. In addition, "Magna-Flo" excels:

by all ELECTRICAL Standards . . . In "Magna-Flo" units you get equipment that meets the maximum established electrical standards to assure simplified installation, high efficiency and dependable operation. Top-of-channel knockouts provide handy line-wire entrances. Channel caps are easily fastened to the channel by two screws. For maximum efficiency and continuously-cool operation only high-power factor "ETL"-approved ballasts are standard equipment on "Magna-Flo" lighting units.

by all CONSTRUCTIONAL Standards . . . You'll find "Magna-Flo" excels in all ways to assure longer life and quicker, simplified maintenance. Reflecting surfaces are genuine "Life-Time" Porcelain Enamel, which does not discolor, scratch or become dull. Year after year, original light-reflecting efficiency can be sustained by simple soap-and-water cleaning. Further, "Magna-Flo" excels *because ONLY* "Magna-Flo" has "Springlox". This all-metal lampholder speeds up re-lamping, improves lighting equipment maintenance.

Write for Bulletin AD-5705; Benjamin Electric Mfg. Co., Dept. Q-1, Des Plaines, Ill.

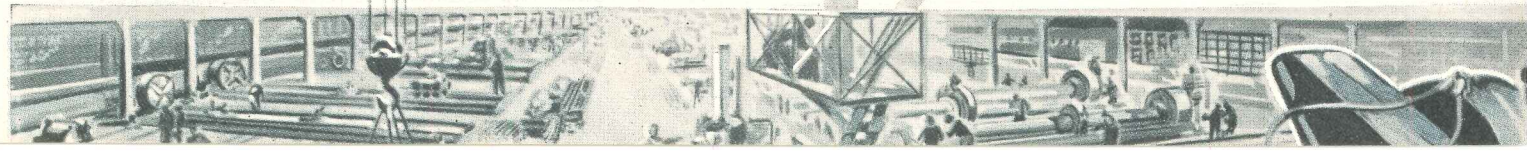

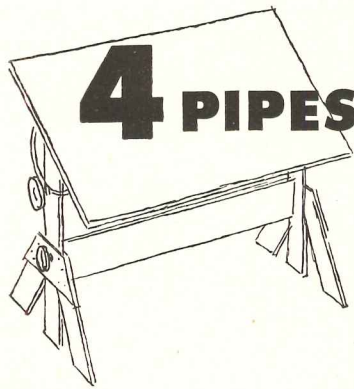

4 PIPES *Designed* TO DO 4 JOBS BETTER

... each one a Johns-Manville quality asbestos-cement product

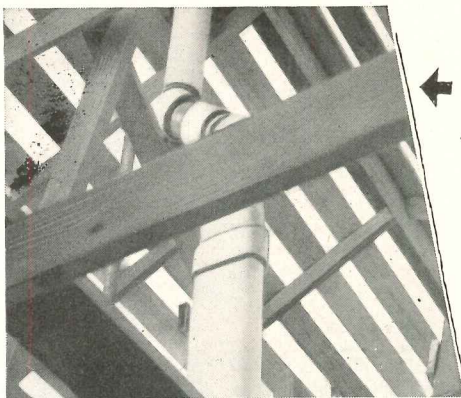

← TRANSITE FLUE PIPE

A favorite with both architects and installers for venting gas-burning appliances, more than 65 million feet of this popular pipe are now in service. It cannot rust, is tough and strong, easy and economical to install. Made in round and oval shapes with a complete line of fittings. Transite Flue Pipe has been listed by UL continuously since 1932. Ask for Brochure TR-13A.

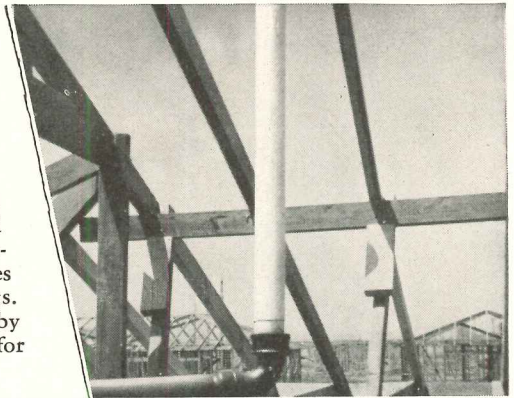

↑ TRANSITE PLUMBING VENT PIPE

Specifically designed for the dry vent portions of building plumbing systems. Its strength, durability and inherent corrosion-resistance assure lasting serviceability. Ten-foot lengths reduce number of joints, facilitate installation. On many jobs, a single length is all that's required. Installed in accordance with standard plumbing practices. Ask for Folder TR-107A.

TRANSITE HOUSE CONNECTION SEWER PIPE →

Specify this pipe for the most economical performance in house sewer line service. Its Ring-Tite Couplings are specially designed to safeguard against root-clogging; its long 10-foot lengths and wide choice of fittings simplify installation. Tough, strong, corrosion-resistant, it provides a lasting, dependable connection between house and street sewer or septic tank. Ask for Brochure TR-82A.

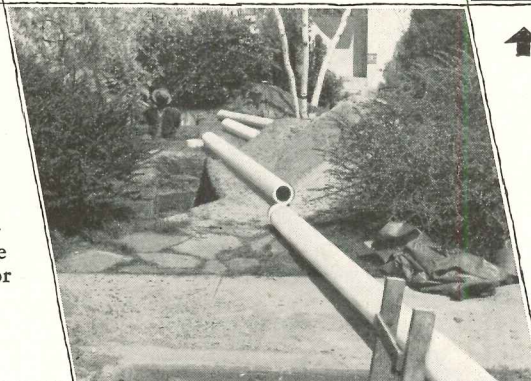

← TRANSITE WARM AIR DUCTS

The modern duct for perimeter and radial heating systems. Made of time-tested Transite for strength and corrosion-resistance — can't rust or scale. Their long lengths, light weight and easily assembled joints simplify handling, cut installation time to a minimum. Ask for Folder TR-111A.

Each of these is a Transite* product made of the Johns-Manville asbestos-cement material widely known for its durability and resistance to corrosion. Each provides dependable, economical

service on the job for which it was designed. For further information, write for literature mentioned above. Address Johns-Manville, Box 290, New York 16, N. Y.

*Reg. U.S. Pat. Off.



Johns-Manville TRANSITE PIPE

Designed for Better Home Construction

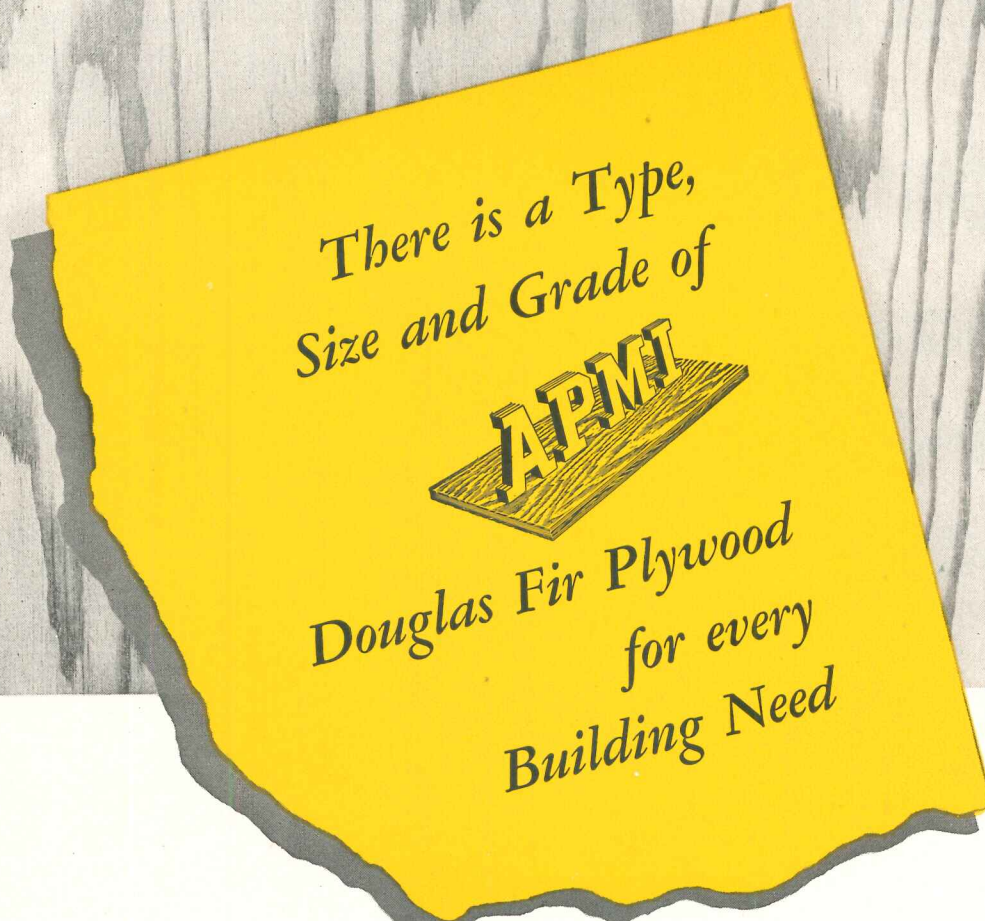

There is a Type,
Size and Grade of

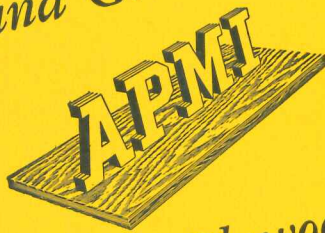

Douglas Fir Plywood
for every
Building Need

As one of the oldest and largest producers in the industry, Associated makes a type, size and grade of Douglas fir plywood for every building need:

Interior-type: For walls, ceilings, cabinets, built-ins; for sheathing and subflooring.

Exterior-type: For siding, outdoor signs, farm structures, boats of all sizes and shapes.

Sea Swirl (interior and exterior). A beautiful decorative plywood for remodeling and new construction.

Plastic surfaced plywood (exterior-type): For concrete forms, siding for commercial and industrial buildings.

Plyron (interior and exterior). Plywood core between hardboard surfaces. For all types of construction; built-ins, furniture.

All APMI plywood is manufactured in the heart of the Douglas fir region of Oregon; is grademarked and trademarked; is available through branch sales warehouses in major building cities, sold by experienced plywood men. Your inquiries are invited.

BRANCH SALES WAREHOUSES:

4268 Utah Street, St. Louis, Missouri
4814 Bengal Street, Dallas, Texas
4003 Coyle Street, Houston, Texas
1026 Jay Street, Charlotte, North Carolina
111 Welborn Street, Greenville, South Carolina
925 Toland Street, San Francisco, California
Eugene, Oregon

SALES OFFICES:

31 State Street, Boston, Massachusetts
Los Angeles, California

**ASSOCIATED PLYWOOD
MILLS, INC.**

General Offices:
Eugene, Oregon

Plywood plants at Eugene and Willamina, Oregon
Lumber mill at Roseburg, Oregon

Tallest in Philadelphia

**WITH
OPEN-WEB
JOISTS**

The new Rittenhouse-Claridge, a 25-story apartment structure facing fashionable Rittenhouse Square, is Philadelphia's tallest building with steel-joist floor construction.

Code requirements in Philadelphia call for floors that can withstand fire for at least two hours. Bethlehem Open-Web Joists, combined with 2½-in. concrete floors and 1-in. sanded gypsum ceiling, give the Rittenhouse-Claridge fire-safety to meet these requirements. 530 tons of Bethlehem Joists were supported by a steel framework fabricated and erected by Bethlehem.

Economy, fast construction and sound-resistance were additional factors in the selection of Bethlehem Open-Web Joists for this large apartment building. These joists reach the job fabricated and marked, ready for placing without falsework or special equipment. Pipes and conduits are run right through the open webs. Finished floors are stiff and solid, resistant to vibration and noise.

If you're planning any type of light-occupancy building, consider using

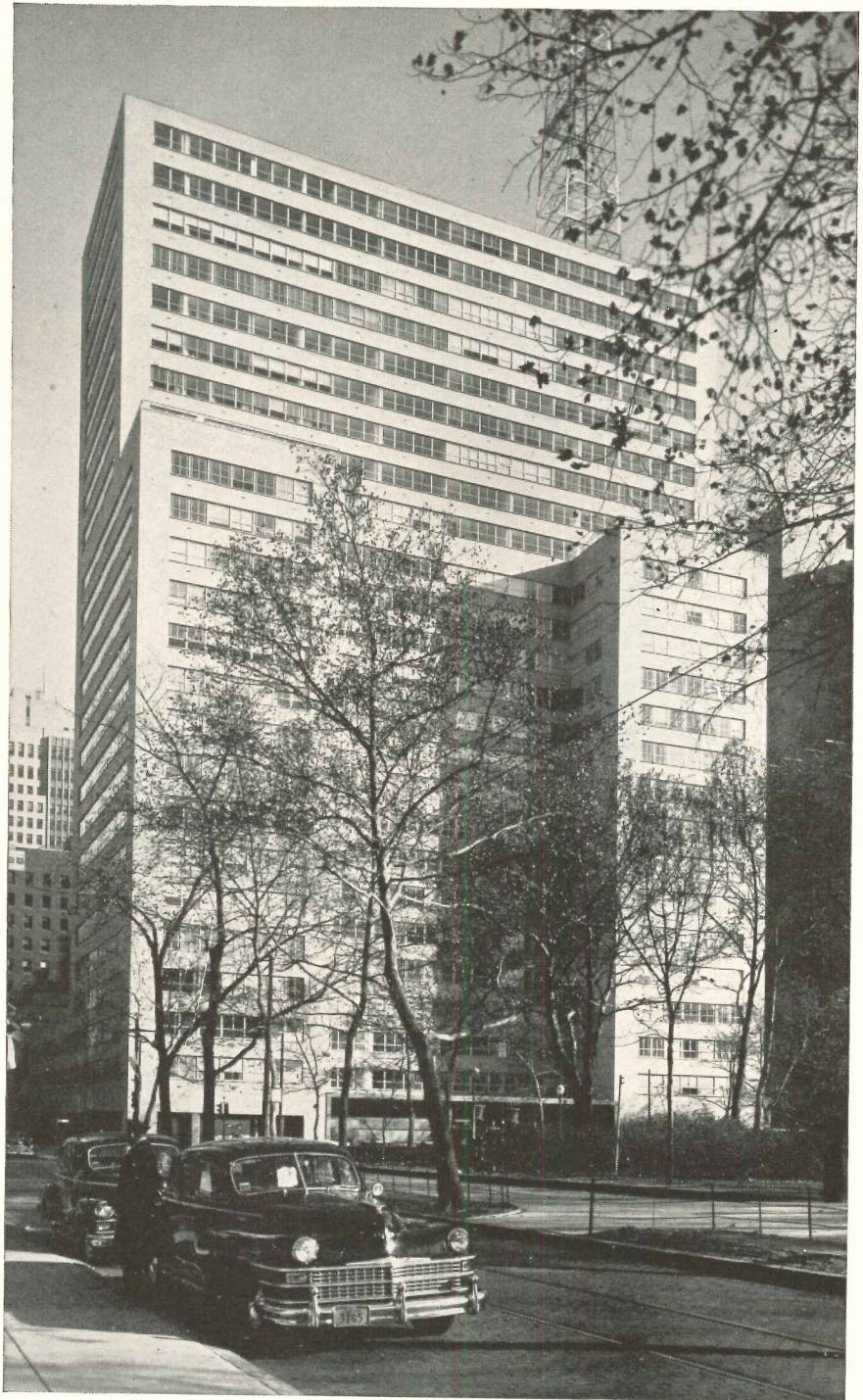

Bethlehem Open-Web Joists. The nearest Bethlehem sales office will be glad to give you further information. Or write to us at Bethlehem, Pa.

BETHLEHEM STEEL COMPANY
BETHLEHEM, PA.

On the Pacific Coast Bethlehem products are sold by Bethlehem Pacific Coast Steel Corporation. Export Distributor: Bethlehem Steel Export Corporation

▲ Philadelphia's Rittenhouse-Claridge, containing 482 apartment units of from 1½ to 7½ rooms. Owners: M. H. McCloskey and Key K. Kaiserman, Philadelphia; Builders: McCloskey and Co., Philadelphia; Architects: J. Raymond Knopf, Samuel I. Osbiver, J. Ethan Fieldstein, Philadelphia; Structural Engineer: Robert E. McLaughlin, Philadelphia.

BETHLEHEM OPEN-WEB JOISTS

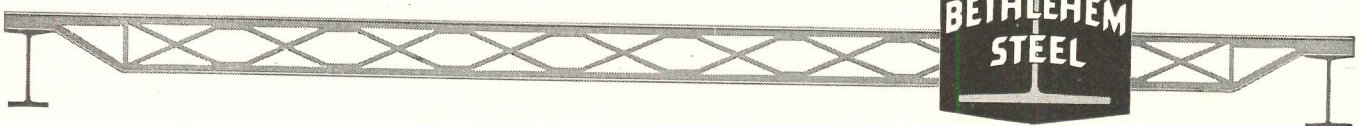

**Out of Sight . . .
Out of Mind!**

Kitchen work area disappears in a second when you close this handsome "Modernfold" door. When the "Modernfold" door is open the entire area is free for big family dinners—informal entertaining.

Here's how builder George M. Holstein III combines *ideas* and "Modernfold" doors to build more room for living into his low cost "Westmont Tract" homes in Los Angeles. Reports Mr. Holstein, "Our homes with "Modernfold" doors sell faster than those without."



**Your ideas come to life . . . for life
with "MODERNFOLD" doors**

You're sure to keep clients happy when you specify "Modernfold"—the original folding door. Why? Because no other folding door *anywhere* equals "Modernfold" for quality of design . . . for quality and strength of materials.

Your clients will like space-saving "Modernfold" doors because they last longer, look better, operate easier. You'll like specifying "Modernfold"—because the line is so complete. You can get exactly what you need in a "Modernfold" door for every closure or space division problem.

Sold and Serviced Nationally

NEW CASTLE PRODUCTS, NEW CASTLE, INDIANA
In Canada: Modernfold Doors, 1315 Greene Ave., Montreal

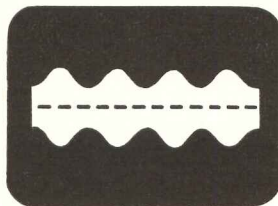

Only "MODERNFOLD" Doors
have center-line design—the same number, same type, same size binges . . . both top and bottom . . . on both sides of the track.

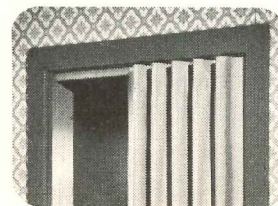

Better Looking
Fabric covering completely conceals all operating mechanism—no cornice needed to hide track, trolleys and binges.

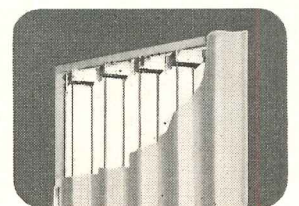

Longer Lasting
"Modernfold" doors have more steel binges both at top and bottom; more steel in each bingie more vertical steel rods.

YOU CAN'T GET MORE IN A FOLDING DOOR



the doors that fold like an accordion

**modernfold
DOORS**

by NEW CASTLE

COPYRIGHTED NEW CASTLE PRODUCTS 1952

New Castle Products
Box 813
New Castle, Indiana

Gentlemen:
Please send me full details on "Modernfold" doors.

Name.....

Address.....

City..... County..... State.....

And in Clemson - A FUTURE OF FAULTLESS SERVICE

Largest of its kind in the world—
 that describes this gigantic new Utica-Mohawk
 cotton mill, equipped throughout with DELANY
 FLUSH VALVES, as specified by the architects and
 engineers. Combining 14 acres of plant under a single
 roof, fine quality goods will be produced in
 uninterrupted flow from bale cotton to finished sheets
 and pillow cases. Equally uninterrupted will be the
 flawless operation of the COYNE & DELANY
 diaphragm type FLUSH VALVES and
 VACUUM BREAKERS—unmatched in design
 and virtually maintenance free.

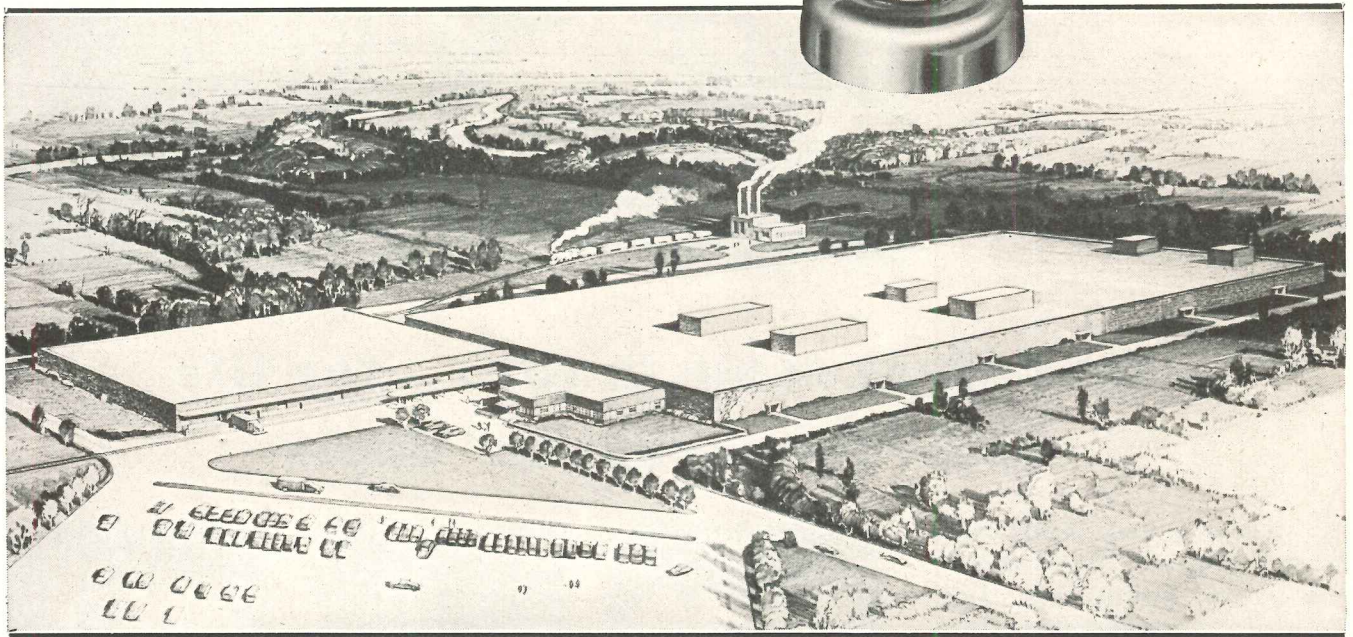
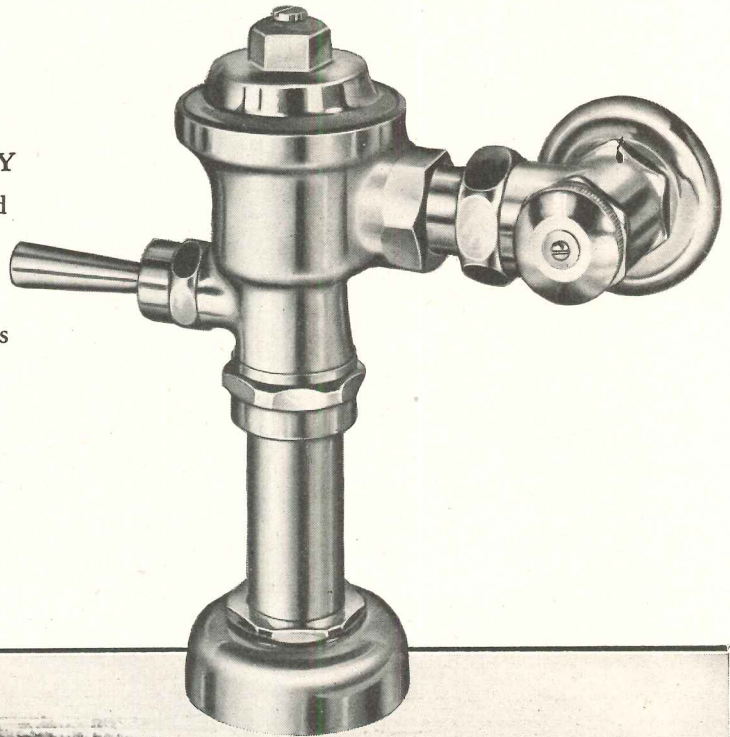

UTICA & MOHAWK COTTON MILLS
 Division of J. P. Stevens & Co., Inc.
 Clemson, South Carolina
 LOCKWOOD GREENE ENGINEERS, INC.
 architects & engineers
 DANIEL CONSTRUCTION CO.
 contractor
 STEWART SUPPLY CO.
 wholesale distributor

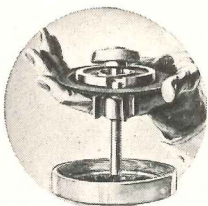

For those who have lived with COYNE & DELANY there is no other
 valve. Shown at left is a deciding factor—the interior working assembly
 of a DELANY valve. Only six working parts comprise this assembly—less
 than any other valve offers today. Removing the valve cover immediately
 identifies any source of difficulty, and replacements, if necessary, are
 accomplished inexpensively, instantaneously—and infrequently.

DELANY
Flush
VALVES

COYNE & DELANY CO. • 834 KENT AVE. • BROOKLYN, NEW YORK

Since 1879

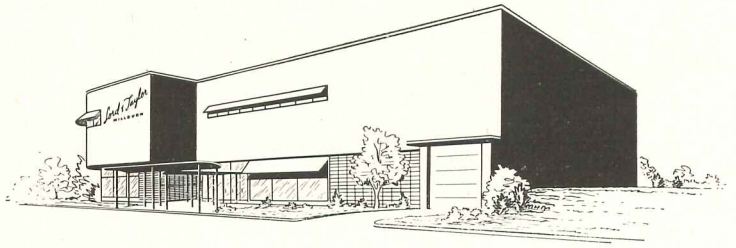

Lord & Taylor's Suburban Store, Millburn, New Jersey

Designers: The Raymond Loewy Corporation



"From the viewpoint of the building designer, canvas is another of the adaptable materials which can be integrated into a total design to provide color, texture, grace. As I use it, canvas is not seasonal or demountable; it is part of the architecture. Although alternate materials may seem to have greater durability, I doubt if canvas can be matched for economy. Primarily, I like the variety of applications it allows me and the fact that it introduces a note of lightness, delicacy to offset the weight of a building mass."

William T. Snaith, President
The Raymond Loewy Corporation



modern design and Canvas

Among the materials which help contemporary architecture achieve its purpose of combining function with beauty, none can match CANVAS in providing maximum design flexibility. Awning fabrics lend color and texture to both interiors and outer features, permit greater freedom in the use of glass by economically solving problems of solar heat control.

The Loewy Corporation chose Canvas Awnings to meet the Lord & Taylor standard for fashion and decor, blending them gracefully into an outstanding modern store design.



CANVAS AWNING INSTITUTE
and NATIONAL COTTON COUNCIL
P. O. BOX 18 MEMPHIS, TENN.

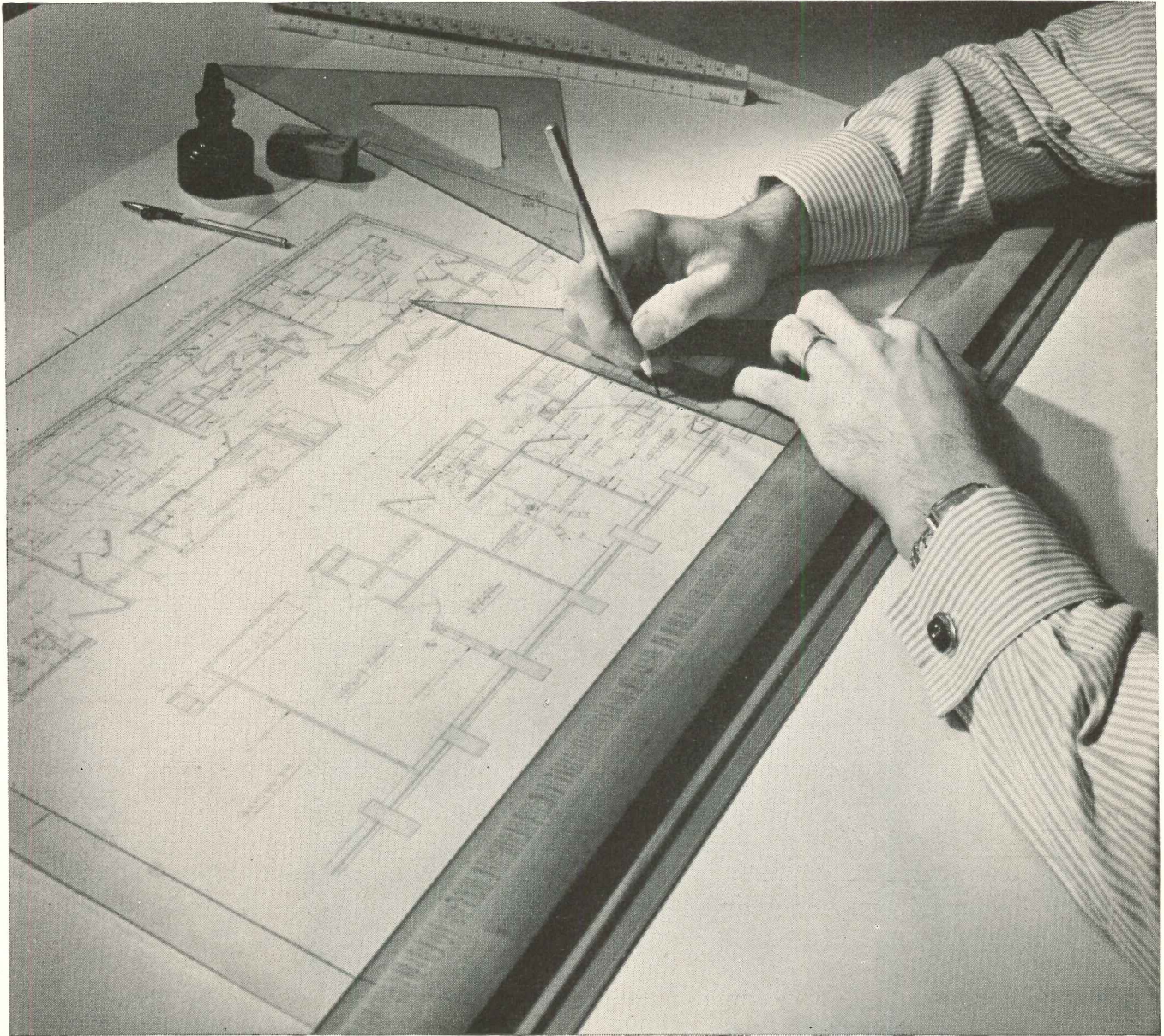

We'll give you a hand...

Enlarging, remodeling, building? If x-ray facilities are involved, you can use these hands and the years of experience behind them. The X-Ray Department, General Electric Company maintains a large staff of full-time specialists in the design and layout of x-ray departments. They'll gladly give you a hand in planning a layout that works.

You can put your confidence in —

GENERAL  **ELECTRIC**

Ceratile

an exciting new medium
of creative design

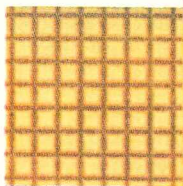
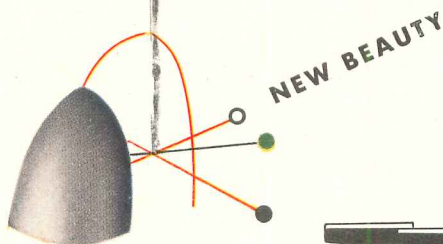

SAND CHECK
In 4 1/4" or 6" tiles

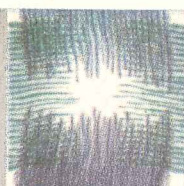

BASKET WEAVE
In 4 1/4" or 6" tiles

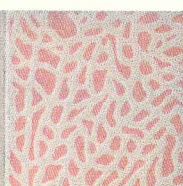

CORAL
In 4 1/4" or 6" tiles



ARAGON
In 4 1/4" or 6" tiles

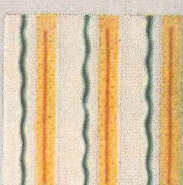

REGENCY
In 4 1/4" or 6" tiles

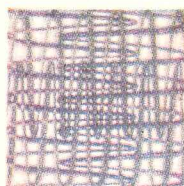

SOUND WAVES
In 6" tiles only



LATTICE
In 4 1/4" or 6" tiles



HARLEQUIN
In 4 1/4" or 6" tiles



GINGHAM
In 4 1/4" or 6" tiles



TEAR DROP
In 4 1/4" tiles only

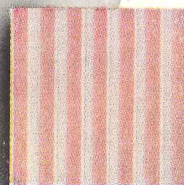

CANDY STRIPE
In 4 1/4" or 6" tiles

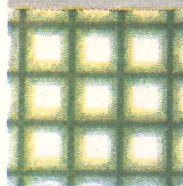

WINDOW PANE
In 4 1/4" or 6" tiles

Shown here are typical designs from the standard Ceratile group of 34 patterns, fast becoming the most accepted line of decorative tile in the country. Each is a wholly new concept in tile design, texture and color combination. Each is available now. You can get frostproof Ceratile for exterior use in freezing climates. We welcome your request for full information. Just write to Dept. AR-4.

THE CAMBRIDGE TILE MFG. CO. Authorized Distributors of Ceratile, P. O. Box 71, Cincinnati 15, Ohio
WEST COAST OFFICES • The Cambridge Tile Mfg. Co., 470 Alabama Street, San Francisco 10, California
• The Cambridge Tile Mfg. Co., 1335 South LaBrea, Los Angeles 19, California



allwood *
HARDBOARD

for the men who build America

a new quality Douglas fir hardboard from the world's newest and most efficient plant. ALLWOOD hardboard... amazingly tough... amazingly versatile... challenging comparison as a new leader in quality hardboard. Produced in the mountain forests of Oregon. Distributed nationally by SIMPSON LOGGING COMPANY, Seattle, Washington.

Write for FREE booklet: The ALLWOOD Story

*Trade Mark of the
Oregon Lumber Co.

**OREGON
LUMBER
COMPANY**

ALLWOOD DIVISION

Dee, Oregon

Manufacturers of Lumber
and Lumber Specialties
since 1889

Sound Choice!

LOCKWOOD HEAVY DUTY KEY 'N KNOB LOCKS OFFER

Heavy Brass Forgings for the important structural and functional parts. Brass is of course, the time proven material best suited for lock manufacture. Forging it to shape however, is a superior method of fabrication comparatively new to builders' hardware. A denser granular structure is achieved, increasing toughness and reducing wear and breakage in service.

Permanently Aligned Assembly when installed is another bonus feature of the rugged structural members. All functional parts are rigidly held in proper relationship. Binding of parts, with resultant sluggishness or failure in action is eliminated . . . wear is further minimized.

Quick Installation . . . reversing of hand is a simple matter requiring only seconds . . . changing cylinders (on the job, to change keying) is an extremely easy matter.

Specify either HATTEN or HOLBROOKE Design for your most prideful works and you can be sure you have made a SOUND CHOICE!

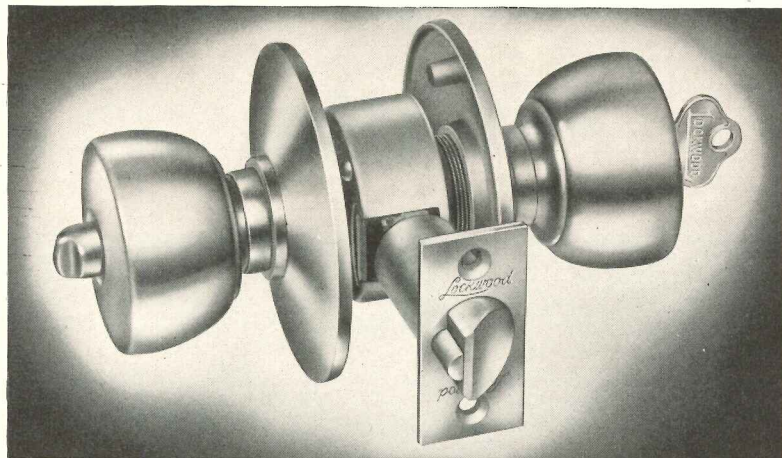

Hatten Design

Contemporary lock design at its enduring best . . . its urn-shaped knobs are comfortable to grip, yet offer a pleasing diversion from the traditional elliptical profile. The 3½ inch roses give the appearance of extra ruggedness and provide extra protection for the door finish. Made in cast brass, bronze or aluminum . . . a SOUND CHOICE for the finest structure.

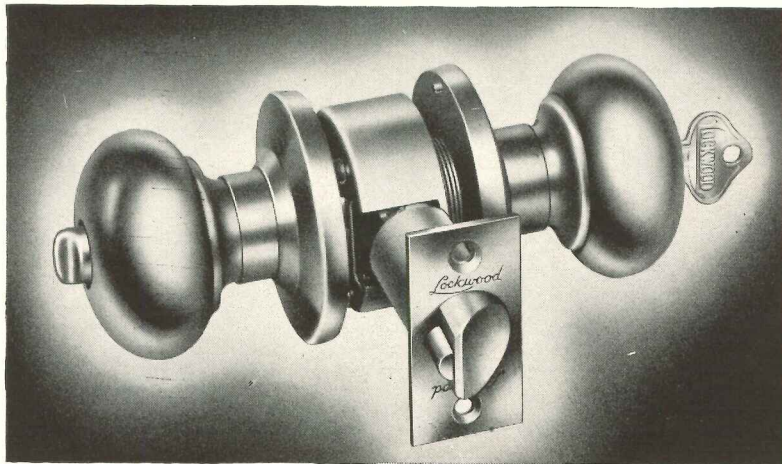

Holbrooke Design

Simpler perhaps than the Hatten, and with its knob and rose patterned more closely after the traditional, HOLBROOKE is designed to give the smooth, enduring performance of the Lockwood Heavy Duty Series at lower cost. It is made of wrought brass, bronze and aluminum. Where the allowance does not permit specification of Hatten . . . HOLBROOKE is a SOUND CHOICE!

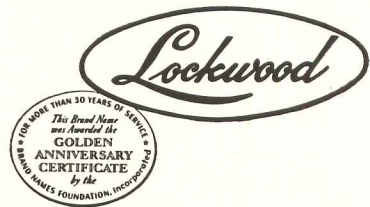

FOR USE ON SCHOOLS, HOSPITALS, HOTELS, COMMERCIAL,
INSTITUTIONAL AND INDUSTRIAL BUILDINGS.



LOCKWOOD HARDWARE MANUFACTURING COMPANY
FITCHBURG, MASSACHUSETTS

To cut on-the-job costs . . . choose **precision-built** **Pittsburgh Doorways**

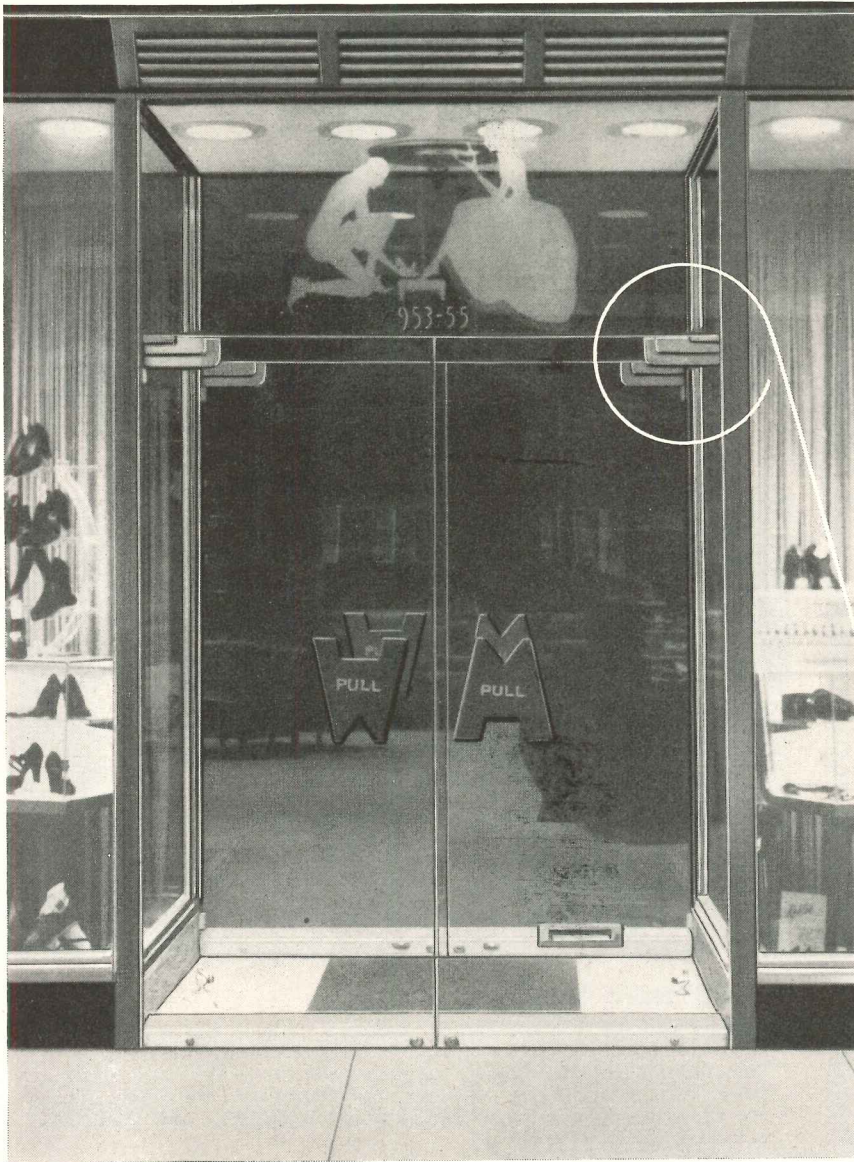

Architects: Solomon Kaplan & J. Joshua Fish, Philadelphia, Pa.

- When you specify factory-assembled, precision-manufactured Pittsburgh Doorways, you get units that cut labor costs substantially. For they eliminate time- and labor-consuming details of calculating, fitting and locating at the site. All that is involved is the unpacking of the frame, bolting it into the building opening and hanging the sturdy Herculite Doors, for whose strength the frames have been especially engineered.

Consider the high quality of Pittsburgh Doorways—their *total-installed cost*, not the list price—and you will find them your logical choice. We should like you to have our descriptive, fully illustrated booklet on Pittsburgh Doorways. Why not send for it now? There is no obligation. Write to Pittsburgh Plate Glass Company, 2103-2 Grant Building, Pittsburgh 19, Pa.

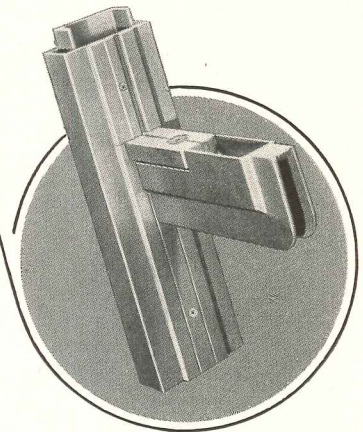

SUPPORTING the top pivot bearing, as well as the Herculite Door and Herculite transom glass, are sturdily-built transom brackets, as shown here. Eliminating the transom bar, they provide the maximum in open-vision, giving full view from floor to ceiling. Standard frames may be modified at the factory to include transom brackets instead of transom bars. For full information, see Sweet's Section 16b.

Pittsburgh DOORWAYS



PAINTS • GLASS • CHEMICALS • BRUSHES • PLASTICS

PITTSBURGH PLATE GLASS COMPANY



CURTIS
DUA-LITE

DIRECT — INDIRECT
INCANDESCENT
LUMINAIRE

*and most important of all
a wonderful room with
the most marvelous light
over my bed!
love
Betty*

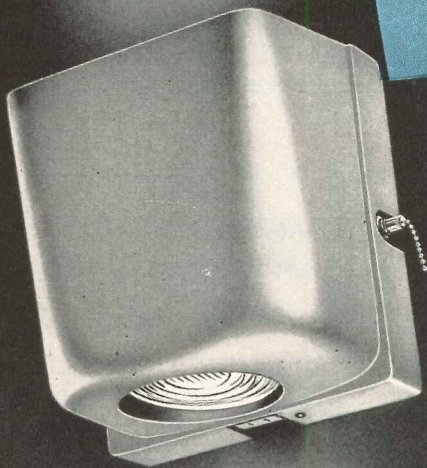

Listed by Underwriters'
Laboratories, Inc.

Many hospitals are providing better and more convenient lighting for their patients and conserving personnel time by installing the Curtis "Dua-Lite". The newly designed Curtis "Dua-Lite" is the ideal hospital lighting unit for installation in private rooms or multi-bed wards. The "Dua-Lite" provides indirect illumination for general hospital room lighting as well as direct illumination for the patients' reading light. A Fresnel lens is utilized to control distribution of the 75-watt lamp used for the direct component. A diffusing heat-resistant cover glass is used above the indirect component. This cover glass, together with an efficient Alzak Aluminum reflector, softly diffuses the light from a 150-watt lamp throughout the room. There is an individual levolver switch control and a convenience outlet built into each "Dua-Lite". The housing is cast aluminum which is readily painted after installation to blend with the room interior. Write Dept. L37-16 for Bulletin 2416.

CURTIS LIGHTING, INC.,
Dept. D3-16, 6135 West 65th Street
Chicago 38, Illinois

CURTIS
LIGHTING, INC.

6135 West 65th Street Chicago 38, Illinois

Name _____
Company _____
Address _____ State _____
City _____

Look to Universal-Rundle

for the latest in style and performance



For 51 years, Universal-Rundle has searched for and found better ways to make bathroom fixtures more beautiful, more efficient, more lasting.

Today, you can look to Universal-Rundle for the newest in smart, modern design that will sell your customers. And you can look to Universal-Rundle for long-lasting, unobtrusive performance that will build good-will for you.

To help you sell, there are full-color Universal-Rundle advertisements in leading magazines such as *The Saturday Evening Post* and *Better Homes & Gardens*. These advertisements are telling your customers about these U/R features:

Whitest white—by actual scientific tests!

Matched colors—by U/R, first maker of colored fixtures. Lovely colors, matched closer than the human eye can see!

Strongest bond between surface glaze and body gives highest resistance to chipping!

"Harder than steel" surfaces that are easy to keep clean, scratch-free, sparkling bright!

Write today for the new U/R catalog, showing the complete line of bathroom and kitchen fixtures—plus plans, drawings, specifications and helpful information. (See the U/R line in *Sweet's Builders File*, also.)

FAMOUS "FIRSTS" From UNIVERSAL-RUNDLE!

FIRST—with colored fixtures!

FIRST—with the one-fire Hi-fired process which gives harder-than-steel surfaces and lifetime bond between surface glaze and body!

FIRST—with the patented Rim - Jet flushing principle!

FIRST—with concealed front overflow!



Universal-Rundle

The World's Finest Bathroom Fixtures

UNIVERSAL-RUNDLE CORPORATION, DEPT. 37, NEW CASTLE, PENNSYLVANIA
Plants in Camden, N. J.; Milwaukee, Wisconsin; New Castle, Pennsylvania; Redlands, California; Hondo and San Antonio, Texas

Which

Square D Control Center will do *Your* job best?

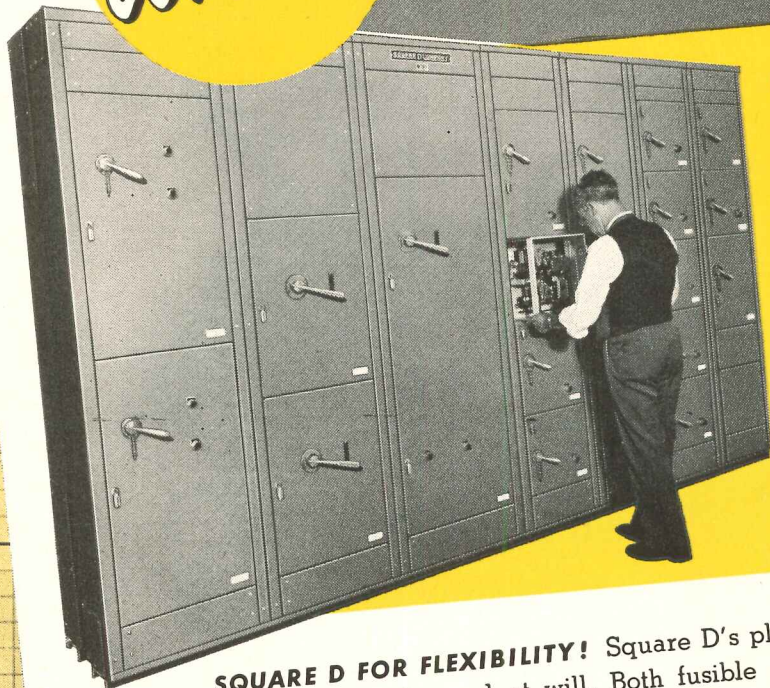

- 1 STANDARD
- 2 BACK-TO-BACK
- 3 DUST-TIGHT
- 4 WEATHER-PROOF
- 5 FILTERED AIR

1 Standard Square D Plug-in Control Centers in Nema I enclosures are designed for the majority of installations.

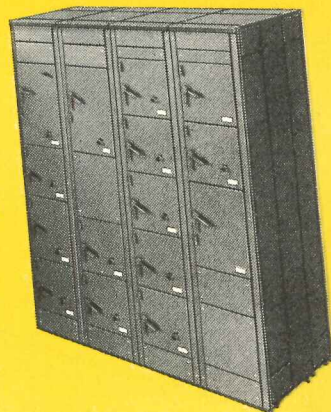

SQUARE D FOR FLEXIBILITY! Square D's plug-in units can be removed, added, or exchanged at will. Both fusible switch and circuit breaker types available. Standardized sections and units are 100% reusable after plant conversions or rearrangements.

Write for Bulletin 8938. Address Square D Company,
4041 North Richards Street, Milwaukee 12, Wisconsin.

2 Space an Important Factor? Back-to-back Nema I enclosures provide maximum concentration of control in limited space.



3 for Excessively Dusty Locations — felt-gasketed, dust-tight, Nema V enclosure. A "natural" for foundries, smelting and refining plants.

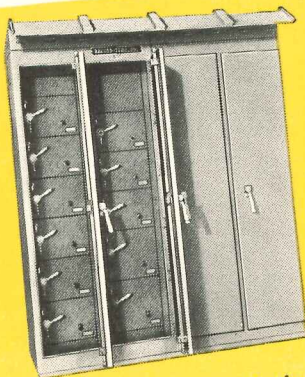

4 for Outdoor Installations — rubber-gasketed, Nema III enclosure protects equipment from weather. Special rust-proof, vinyl-clad finish.

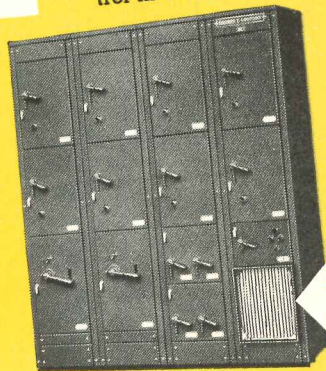

5 Need Filtered Air Protection? Built-in fan and filter combination pressurizes enclosure for moderately dusty or certain types of corrosive atmospheres.

ASK YOUR ELECTRICAL DISTRIBUTOR FOR SQUARE D PRODUCTS

SQUARE D COMPANY

DETROIT

MILWAUKEE

LOS ANGELES

SQUARE D COMPANY CANADA LTD., TORONTO • SQUARE D de MEXICO, S.A., MEXICO CITY, D.F.

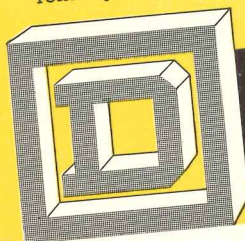



Famous Labels suggest the choice



Many of the big textile mills . . . names your wife will recognize . . . "air-control" many of their manufacturing operations with Worthington air conditioning and refrigeration.

And many of the famous shops where the mills' products are sold . . . Saks Fifth Avenue, The Higbee Company, J. L. Brandeis, Lane Bry-

ant, many Sears Roebuck Stores . . . are air-conditioned by Worthington.

No other manufacturer makes so complete a line. A Worthington system is all Worthington-made — not just Worthington-assembled — assuring you of perfectly balanced operation and unit responsibility.

Worthington Pump and Machinery Corporation, Air Conditioning and Refrigeration Division, Harrison, New Jersey.

America's Leaders... in Many Businesses... Select

WORTHINGTON



A.2.9

AIR CONDITIONING AND REFRIGERATION

The Most Complete Line... Always the Correct Recommendation

This Roof Deck Forms a Completed Ceiling

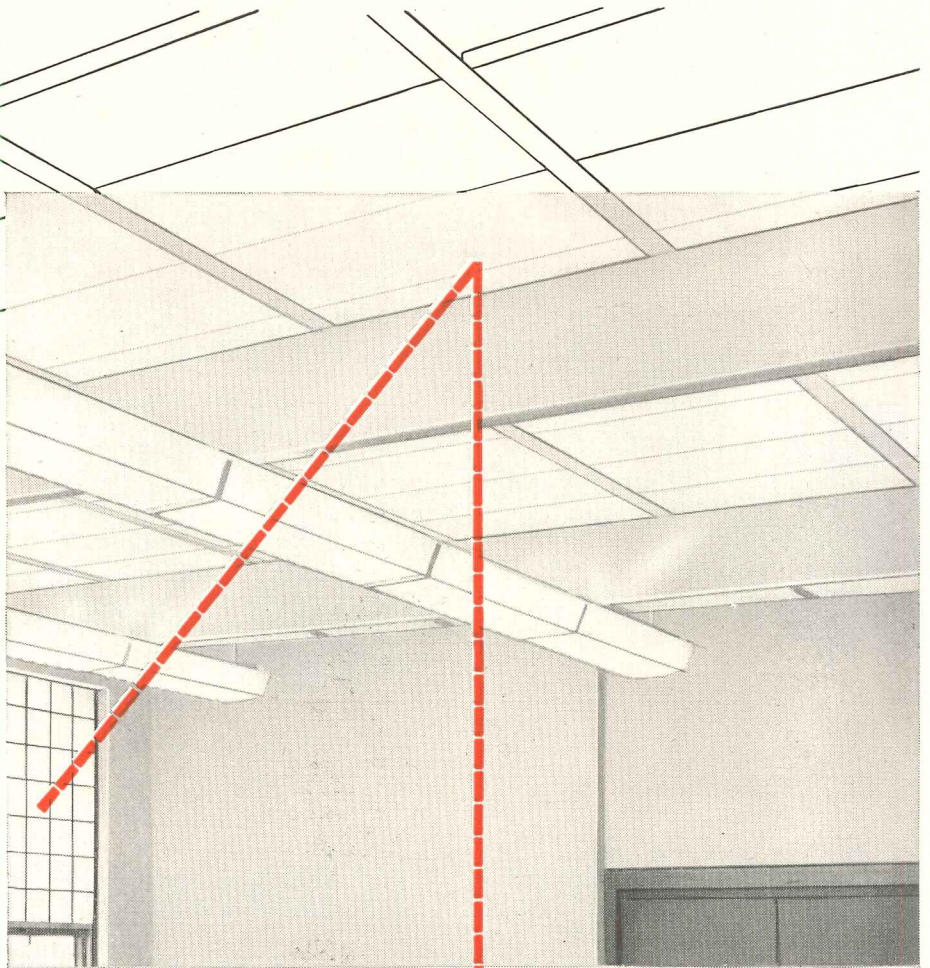

Kaylo Insulating Roof Tile **Reflects Light**

... Requires No Painting or Other Treatment!

Kaylo Roof Tile provides a lightweight, insulating roof deck and at the same time forms a *completed* ceiling. For Kaylo Tile's smooth, near-white under-surface has a light reflection factor of approximately 80 per cent—and the tile need not be painted. Thus, a Kaylo roof deck makes it possible to save the cost of constructing a ceiling.

A Kaylo roof deck weighs only 6 pounds per square foot, yet the tile has more than sufficient strength for typical roof loads. This means that a lighter structure readily supports the lightweight

Kaylo deck—and permits important savings of steel.

Kaylo Roof Tile saves on insulation costs, too. Because Kaylo Tile, a hydrous calcium silicate, has insulating value equal to one and one-half inches of standard insulation board—adequate for usual installations. Kaylo Roof Tile is incombustible; it resists water damage and is rot and vermin-proof.

The ease and speed with which Kaylo Insulating Roof Tile can be handled and placed also contribute to economical construction—forming a roof deck with advantages you will appreciate over the years.

WRITE FOR FREE BOOK—"Kaylo Insulating Roof Tile." Address: Dept. N-213, Owens-Illinois Glass Company, Kaylo Division, Toledo 1, Ohio.



KAYLO® ... first in calcium silicate

... pioneered by OWENS  ILLINOIS Glass Company

MAIN OFFICE: TOLEDO 1, OHIO — KAYLO SALES OFFICES: ATLANTA • BOSTON • CHICAGO • CINCINNATI • CLEVELAND • DETROIT
HOUSTON • MINNEAPOLIS • NEW YORK • OKLAHOMA CITY • PHILADELPHIA • PITTSBURGH • ST. LOUIS • WASHINGTON

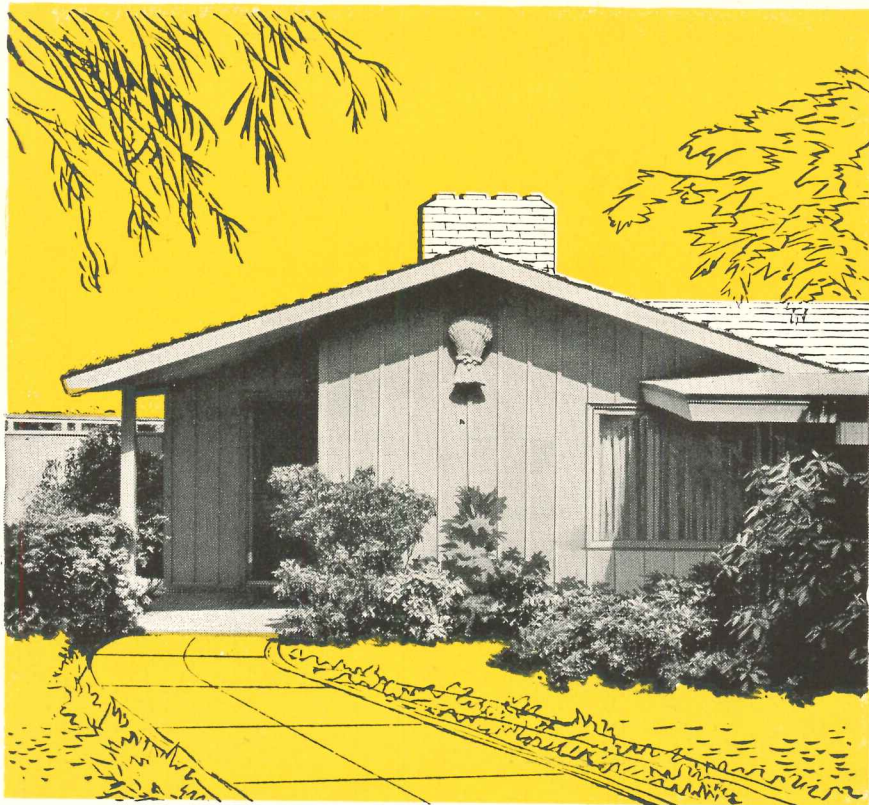

Beauty, Adaptability, Economy— Get All 3 With Plywood Siding*

OF ALL SIDING MATERIALS, Exterior plywood is the most adaptable to various design treatments. It can be used to create board and batten siding . . . flush surface . . . or cut in third or half panel widths and applied as extra-wide lapped siding. It can be used in combination with other materials such as brick or masonry to achieve interesting texture contrasts.

And of all *quality* siding materials, Exterior plywood is least expensive. Least expensive in two ways: first, Exterior plywood actually costs the same or *less* per square foot than other quality materials; second, plywood's large size and easy workability speed work, cut labor and application time and costs up to *one-third!*

Exterior plywood siding is durable, too. It won't shatter, split, or puncture. And the completely waterproof adhesives used between plies are *more durable* than the wood itself!

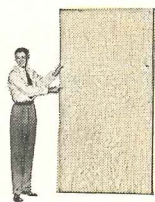

Douglas Fir
Plywood

AMERICA'S BUSIEST BUILDING MATERIAL



*PlyShield® is the siding grade of waterproof-bond Exterior-type plywood. One side is of highest appearance; for economy, limited defects are permitted in back. For use as siding, gable ends, etc. Other Exterior grades with 2 faces of highest appearance are available for single wall partitions, fences, etc.

PANEL DISCUSSION

FHA Accepts 3/8" Plywood Over Rafters 24" O. C.

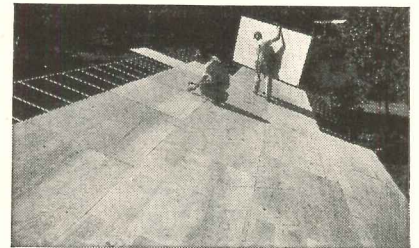

On the basis of recent tests and experience data, Federal Housing Administration now accepts plywood 3/8"-thick as roof decking over rafters spaced 24" on centers, according to a letter from Curt Mack, assistant commissioner of the FHA underwriting office, to Douglas Fir Plywood Association.

A revision of FHA Minimum Property Requirements is planned; meanwhile, FHA at Washington (Underwriting Office) will advise any insuring office upon inquiry that 3/8" plywood over rafters 24" on centers will be accepted. Plywood roof deck thicknesses now accepted by FHA are shown below in tabular form.

Roofing Material	Max. Rafter Spacing	Min. Plywood Thickness
Wood, Asphalt Shingles	16"	5/16"*
	24"	3/8"*
Slate, Tile, Asbestos-Cement	16"	1/2"
	20"	1/2"
	24"	5/8"
Flat Roofs	16"	3/8"
	20"	1/2"
	24"	5/8"

*Under wood shingles: If plywood is less than 1/2" thick, apply 1" x 2" nailing strips.

A folder giving information regarding use and acceptance of fir plywood in homes built under FHA financing may be had free of charge from Douglas Fir Plywood Association, Tacoma 2, Wash.

Plywood Builds Band Shell

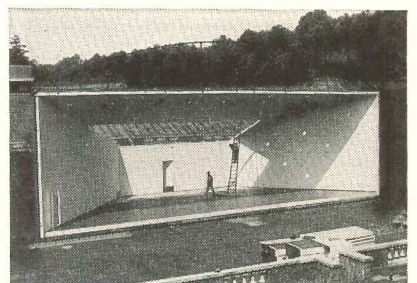

The problem was to design a symphonic band shell for the University of Virginia that would be, as nearly as possible, acoustically perfect, light and easily erected, yet amply strong and rigid. To meet these requirements, Architect Floyd E. Johnson, Charlottesville, Va., chose Exterior fir plywood framed with lumber, fir and light steel bow string trusses.

Floor of the structure is 3/4" Exterior plywood, supported by 2x10 joists over

large oak timbers. Wall sections are of $\frac{1}{4}$ " plywood framed on all four sides by 2x4s. Roof panels are $\frac{1}{4}$ " plywood secured to 2x6 framing members. Wall and ceiling panels are bolted together. Self-opening plywood blow panels, 4'x4', relieve air pressure. Acoustical qualities of the shell have been favorably commented upon by performers and audience alike.

Plywood Catalog Available

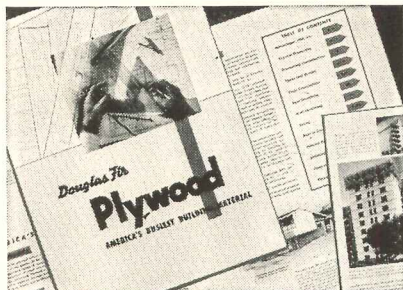

The 1952 Basic Plywood Construction Catalog, a reprint of the 20-page insert for Sweets File, Architectural, is now available free of charge to architects, engineers, builders and dealers. It contains plywood grade-use data, finishing information, suggested details and plywood construction techniques. Order from Douglas Fir Plywood Association, Tacoma 2, Washington.

Garden-Room Addition Uses Single Wall Construction

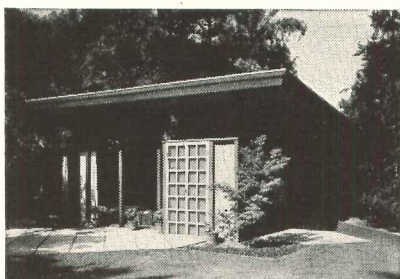

Faced with the problem of creating extra living space to accommodate the needs of his growing family, Architect Whitney R. Smith combined Douglas fir plywood, plate glass and considerable skill to add this large multi-purpose garden-living room to his Los Angeles country home.

Situated in an April-like garden planted 40 years ago, the striking plywood addition creates an intimate link between indoors and out. Physically, this is accomplished by having the floor of the room at the same level as the garden which surrounds the room on four sides. Visually, the slender supports combine with high ceiling windows to permit a smooth, unbroken flow of plywood ceiling paneling outward into the broad plywood soffits.

Architect Smith used a single thickness of $\frac{1}{2}$ " Exterior plywood secured to the inside of 4"x4" posts, 4' o.c. Interior ceiling paneling is $\frac{3}{8}$ " Interior plywood; soffits are $\frac{3}{8}$ " Exterior. Both interior and exterior walls are painted a pleasing grey-green; ceiling and soffit are light-stained.



Plywood Built-Ins Often Mean The Difference Between and

No DOUBT about it, plywood built-ins have buy-appeal. Space-thrifty plywood storage wall, built-in dining bar or crisp kitchen cabinets can often mean the difference between a house that's snapped up the minute it's offered and one that's a drug on the market—an important fact to consider as selling becomes more and more competitive.

And it's so easy to add client and customer-winning distinction to your homes with plywood built-ins. For no other material is so adaptable to specific design and space requirements. With plywood, you can make the built-in fit the house—*exactly*. No bothersome juggling of "stock size" units. No limit to size, design, finish or color. Plywood works quickly, easily with ordinary tools. It is equally adaptable for construction of shop-fabricated units. Plywood won't split, chip or puncture. *It's the logical material for every built-in.*

Douglas Fir
Plywood

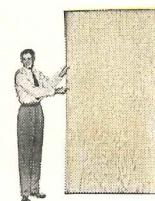

AMERICA'S BUSIEST BUILDING MATERIAL

Portfolio of Prize-Winning Built-Ins. Valuable collection of designs that will serve as a springboard for your own imagination. Contains over 50 designs judged best in the national "Better Living Home" architectural contest. For your free copy write Douglas Fir Plywood Association, Tacoma 2, Washington.



Art Museum

Chooses Lighting Artistry by LITECONTROL



JOB: Art Museum of New Britain Institute, Stanley Wing, New Britain, Conn.
ARCHITECT: Delbert K. Perry & Associate, John Perry, New Britain, Conn.
ELECTRICAL CONTRACTOR: Peterson Electric Co., New Britain, Conn.
FIXTURES: 30 Special No. F74 4-lamp fixtures.
 4 Special 4-lamp corner mitred fixtures.
LAMPS: Standard warm white fluorescent.
AREA: 32' x 60' x 12' ceiling height — 1,920 square feet.
WATTS: 6,500.
WATTS PER SQUARE FOOT: 3.3.
AVERAGE INTENSITY ON PAINTINGS, vertical plane (outside row of lamps only) 20 footcandles in service. (With all lamps on) 32 footcandles in service.

Here paints the magic brush of light . . . custom-tailored by LITECONTROL . . . by the ingenious modification of standard Litecontrol fixtures.

But because they are crafted by lighting artisans . . . and made in many styles and designs . . . LITECONTROL fixtures provide installations which are "standard" in price only, definitely custom in appearance and performance.

Problem here was to enable paintings on wall to be featured or, when desired, to permit featuring of floor

displays (see small photo). *Planned Lighting by Litecontrol* provided fixtures with outside lamps operating independently of inside lamps, with light shielded by a vertical baffle. Thus, the outside row alone evenly illuminates the paintings around the

walls, or the inside row alone can be used to highlight center displays. Note how the fixture row follows the room contour, even at the mitred walls, for evenness of illumination.

On your next lighting problem, call in LITECONTROL — and save.

LITECONTROL *Fixtures*
 KEEP UPKEEP DOWN
 See You at Booth 102, Lighting Exposition

LITECONTROL CORPORATION, 36 Pleasant Street, Watertown 72, Massachusetts

DESIGNERS, ENGINEERS AND MANUFACTURERS OF FLUORESCENT LIGHTING EQUIPMENT DISTRIBUTED ONLY THROUGH ACCREDITED WHOLESALERS

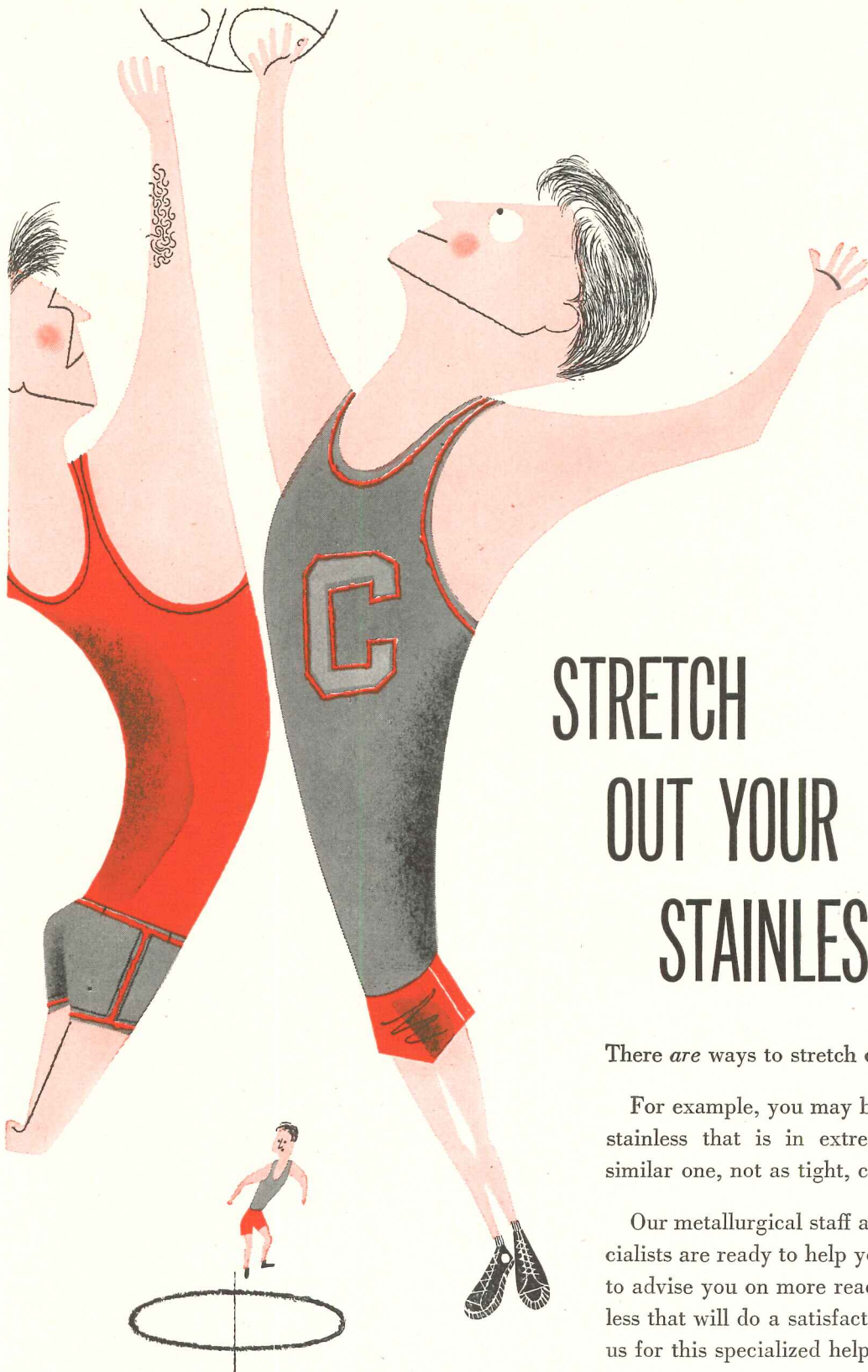

STRETCH OUT YOUR STAINLESS, TOO

There *are* ways to stretch out your supply of stainless.

For example, you may be using a grade or finish of stainless that is in extreme demand when another similar one, not as tight, could do the job adequately.

Our metallurgical staff and stainless fabricating specialists are ready to help you look into this matter and to advise you on more readily-available types of stainless that will do a satisfactory job. Feel free to call on us for this specialized help.

CRUCIBLE

first name in special purpose steels

52 years of *Fine* steelmaking

STAINLESS STEEL

CRUCIBLE STEEL COMPANY OF AMERICA, GENERAL SALES OFFICES, OLIVER BUILDING, PITTSBURGH, PA.
REZISTAL STAINLESS • REX HIGH SPEED • TOOL • ALLOY • MACHINERY • SPECIAL PURPOSE STEELS

Roddiscraft Solid Core Flush Veneered Doors

An Institution with Institutions

For nearly two generations Roddiscraft Doors have been standard equipment in hospitals, schools, hotels, churches and other institutions. Roddiscraft standard construction incorporates all the features demanded by institutional installations — fire protection, sound resistance, ability to take rough treatment. Roddiscraft standard 5-ply construction — core, crossbandings and faces welded into a single unit — builds in all the strength and stability of plywood construction.

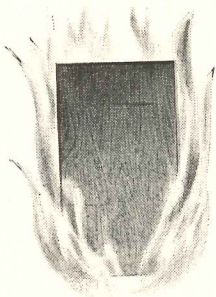

SAFE — Standard 1-3/4" construction withstands independently conducted fire tests in excess of 40 minutes.

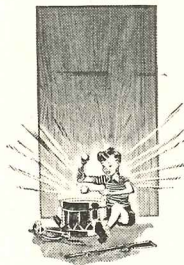

SILENT — Standard 1-3/4" construction develops a sound transmission loss of 30.9 decibels.

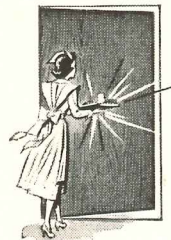

STURDY — Solid core and strong 1/10" crossbandings give complete support to the faces — absorb shock.



WATERPROOF — Two complete waterproof glue lines deny entrance to moisture.

Standard Thickness Face Veneers* Out-Look and Out-Last Thick Veneers

The thinner the face veneer, the less wood exposed outside the waterproof glue line. That's a self-evident fact — and that's why Roddiscraft Standard Thickness Face Veneers — *1/28" for most woods — are best. Exposure tests show checking patterns become coarser and more conspicuous as the face thickness increases. Thin veneers also

permit better matching, are more resistant to abuse because of the tough hardwood crossbandings to which they are inseparably bonded.

Roddiscraft construction utilizes 1/10" thick hardwood crossbandings . . . sure protection against core pattern showing through face veneers after finishing.

FOR SPECIAL INSTALLATIONS

FLUSH VENEERED FIRE DOORS FOR INTERIOR USE...

Advanced safety features that guard life and property are built into Roddiscraft Protex Doors. That's why these doors are so often specified in plans for hospitals, hotels, schools and apartment buildings. They are built to withstand the 60-minute fire test, including the hose stream test. Independent laboratories show they have a safety margin well above the prescribed minimum. Identical in appearance to other Roddiscraft Flush Doors.

FLUSH VENEERED DOORS FOR X-RAY PROTECTION...

The Roddiscraft X-Ray Door matches regular Roddiscraft Flush Doors in appearance. It is equipped with a continuous sheet of lead set midway between a divided wood core. Otherwise, it is identical in all respects to the Roddiscraft Solid Core Door. Roddiscraft X-Ray Doors are manufactured only on special order. Any thickness of lead may be specified, according to the amount of protection required.

Roddiscraft

RODDIS PLYWOOD CORPORATION
MARSHFIELD, WISCONSIN

NATIONWIDE Roddiscraft WAREHOUSE SERVICE

Cambridge, Mass. • Charlotte, N. C. • Chicago, Ill. • Cincinnati, Ohio • Dallas, Texas • Detroit, Michigan • Houston, Texas • Kansas City, Kan. • New Hyde Park, L. I., N. Y. • Los Angeles, Calif. • Louisville, Ky. • Marshfield, Wis. • Milwaukee, Wis. • New York, N. Y. • Port Newark, N. J. • Philadelphia, Pa. • St. Louis, Mo. • San Antonio, Texas • San Francisco, Calif.

Now . . . "individually engineered" panelboards . . . in minutes!

BullDog's new principle of standardized units gives architects new flexibility in planning, simplifies specification of panelboards up to 42 circuits

Here's news that architects will welcome. By standardizing on component parts, BullDog has engineered 5 basic panel devices that can handle any requirement up to 42 circuits.

These basic units can meet your circuit and rating specifications *exactly*, and, in effect, be "individually engineered" to your plans . . . yet your contractor or client can get them *immediately* from local BullDog Distributor stocks.

BullDog panelboards are highly flexible, too. Individual Pushmatic circuit breakers are interchangeable, and available in a wide range of ratings to meet present *and future* circuit requirements. Where circuit spaces aren't utilized immediately, filler plates may be used; and your client can add as many as 36 extra circuits later, as needed.

Forget about costly, custom-built panels that often cause construction delays, that won't adapt to changing electrical needs. Specify BullDog Pushmatic Electri-Center Panelboards. They're mass produced and cost your customers *less* at no sacrifice in quality . . . but at a definite gain in flexibility, speedy procurement and convenience.

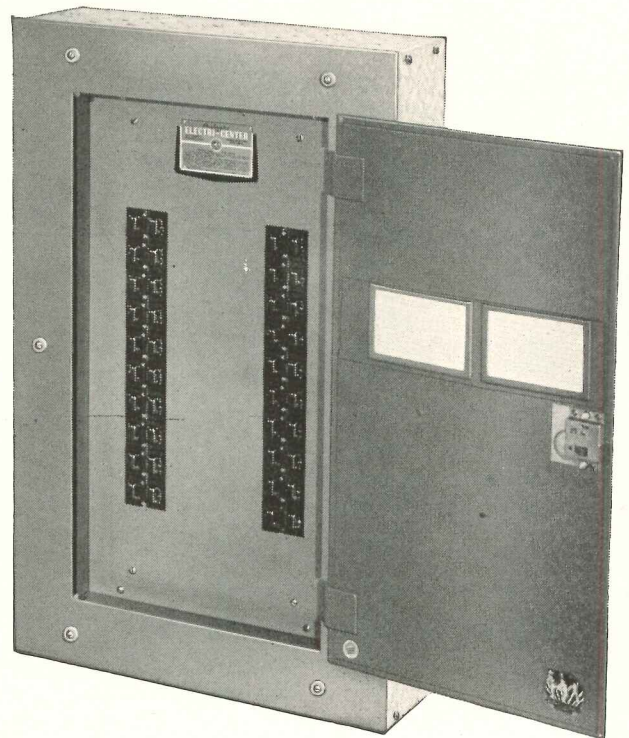

BullDog Pushmatic Electri-Center Panelboards. For complete details, send for free Bulletin 513.

BULLDOG Pushmatic Electri-Center Panelboards

- For plants, commercial buildings, institutions.
- Underwriters'-listed up to 42 circuits.
- Individual Pushmatic units (Thermal Magnetic) rated 15, 20, 30, 40 and 50 Amps.; quick-mounting, fully interchangeable
- Meet Federal Specifications WP 131a Class A
- Push-button switching and automatic circuit protection. No reset position.
- Code Gauge steel fronts, flush or surface type.
- Code Gauge steel boxes with ample knockouts in removable ends.
- 4"-wide gutters for easy wiring.
- Provision for Main Lugs at top or bottom.
- Flexible from every standpoint.



BULLDOG

BULLDOG ELECTRIC PRODUCTS COMPANY
DETROIT 32, MICHIGAN • FIELD OFFICES IN ALL PRINCIPAL CITIES
IN CANADA: BULLDOG ELECTRIC PRODUCTS OF CANADA, LTD., TORONTO
PIONEERS IN FLEXIBLE ELECTRICAL DISTRIBUTION SYSTEMS

1902-1952 . . . SERVING INDUSTRY FOR 50 YEARS WITH FINER ELECTRICAL PRODUCTS

One of a series of papers prepared by leading authorities on air conditioning. The opinions and methods presented are those of the author and are not necessarily endorsed by the Du Pont Company. Reprints of this and other articles in the series may be had free upon request.

AIR CONDITIONING

THE MODERN HOTEL

By Guy B. Panero—Consulting Engineer



GUY B. PANERO, whose firm has offices in New York and Washington, has practiced as a professional engineer both in this country and abroad over a 25-year period. His organization has specialized in the design of air conditioning systems for commercial, institutional and industrial buildings, and has been responsible for mechanical engineering on numerous large hotels—among them the Waldorf-Astoria and the new Hotel El Panama. His firm is presently serving as consultants for a new hotel in Italy and has recently completed work on a luxury residential hotel in Bogota, Colombia.

Today's hotel structure is essentially a group of special occupancies housed under one roof. In a modern hotel of medium size, for example, there will be guest rooms, a cocktail lounge and bar, dining rooms, coffee shop, ball-room, various private dining rooms, stores and offices. For both business and competitive reasons, all these spaces should be air conditioned.

Each area, however, presents a special problem. To illustrate, air conditioning for the dining room, cocktail lounge and bar will differ little from that of restaurants and bars of the luxury type discussed previously in this series.

In the hotel, however, judgment is required in grouping similar types of occupancies and load demands to obtain highest efficiency from the installed system.

GUEST ROOMS

The largest part of the load demand in any hotel, of course, is that supplied by the guest rooms. These rooms can be served by a central system or one based on the unit-system plan. Let us first consider the central-station system. This can be one of two designs, although, basically, both use a central air conditioner with a supply fan or blower to deliver conditioned air through the air-distribution system or ducts.

The central-system design, using zones, will have areas of similar load conditions grouped together; each with its own air distribution and its own fan or blower. Volume control has been used but is not the writer's recommendation. Control by temperature is preferred.

A central-station system can also be part of a design that uses two separate ducts to convey air to the rooms. One duct transports cool and dehumidified air when cooling is required; when heating is necessary, it has air from the return system. The other line carries heated and humidified air when it is necessary to supply heat, or by-passed air for cooling. In this way, the two lines can be used summer and winter for supplying air at different temperatures. Automatic dampers take care of the air mixing problem to provide the proper room conditions, although the total air volume delivered is fixed.

Air from these two systems can be supplied to the rooms through cabinet units placed at windows, or, where a less conspicuous location is desired, ceiling outlets may be used.

Air conditioning through the unit system can be by:

1. Self-contained units.
2. Fan units.
3. High-pressure induction units.

Although there are many trade names for unit systems now available, they can be grouped into three classifications:

Self-contained units are boxes installed outside windows and connected to the nearest appropriate inside electrical outlet. They contain a compressor or air conditioning unit, cooling coil, filter, fan, motor and the necessary controls.

Fan units can be set in a cabinet placed at a window, or

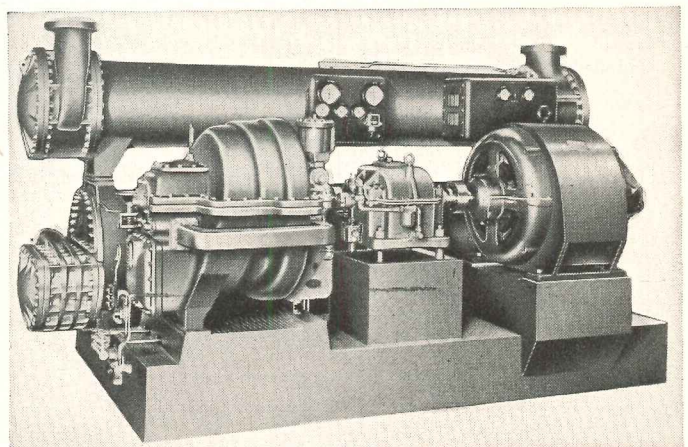

Carrier Compressor of type similar to that installed in Waldorf-Astoria.

ceiling-mounted and installed over a door or in a closet. The cabinet contains a fan and motor, cooling or heating coil, condensate pan, filters and controls. Such units are commonly served from a central system supplying chilled water or refrigerant. With a central system, the fan only handles recirculated air, although some outside air can be brought in. When heating is required, hot water is circulated through the cabinet coil.

High-pressure induction units consist of a cabinet that contains a coil used for cooling or for heating, a condensate pan and controls. Conditioned outside air is delivered from a central station at high velocity. As the air emerges from the cabinet, it causes a secondary flow of room air over the coil. From 75% to 80% of the room air is recirculated.



The Waldorf-Astoria in New York . . . famed for comfort and hospitality... makes extensive use of modern air conditioning.

NOISE IN ROOMS

Guests demand an air conditioning system that is quiet in operation. Whether self-contained units, fan units, induction units or a central-station system is selected, precaution must be taken to keep the noise level at a minimum in the guest rooms or conditioned spaces.

VENTILATION

In addition to conditioned air normally supplied, a large amount of outdoor air may be necessary to dilute smoking and other odors. In between cooling and heating seasons, there may be a period when it is desirable to deliver 100% outside air.

The central-station systems described can supply 100% outside air when necessary. However, the self-contained units and the induction units are limited to the delivery of about 25% outside air. Although fan units can deliver an amount larger than this, they cannot approach the quantity of outside air that can be supplied by a central system.

The three unit systems continuously recirculate the same room air. Central-station systems mix return air from all rooms and in that way dissipate smoking and other odors.

AIR SUPPLY AND DISTRIBUTION

The successful system must properly condition air supplied. The air must be delivered evenly over the entire conditioned area so that there is an absence of drafts, and air quantity will remain constant with varying loads. How the air should be distributed calls for good engineering.

GROUPING OF LOADS

Systems serving the hotel lobby and guest rooms are

designed to function 24 hours a day. Public dining rooms, cocktail lounge, barber and beauty shops, stores and offices, however, are in use only part of the day. Since barber and beauty shops and stores have the same operating characteristics, they may be grouped and served by one system. A ballroom has a high heat load but is only used occasionally. Considerable attention must be given the occupancy and use factors before determining the grouping of areas to be served by one system to cut down operating costs.

MAINTENANCE

Central-station systems can be serviced easily because the equipment is installed in a few locations. Such equipment is more conveniently attended, and better maintenance becomes possible at lower cost. Although central systems may be costlier, savings in operation generally help offset initial expense.

Equipment located in guest rooms may frequently be difficult to service because of room occupancy. Self-contained and fan units have filters that must be changed periodically, and both fan and induction-type units have pans that may become clogged. For best results at all times, the hotel should have an effective maintenance schedule for servicing all units of the systems.

In the foregoing paper, Mr. Panero has presented a working approach to the complicated problem of air conditioning today's hotel structure. There are, of course, many details which could not possibly be covered in so brief a report. However, it is believed that this outline of the various types of air conditioning systems available will prove helpful in determining how best to meet specific requirements.

Each of the systems mentioned above is of a type operated with "Freon" refrigerants. Obviously, the factor of safety is a prime requisite in any hotel air conditioning installation. Because "Freon" refrigerants are safe . . . noncombustible, nonexplosive, virtually nontoxic, harmless to fabrics and finishes . . . they are ideal for hotel systems which serve the public. In addition, the chemical purity of "Freon" refrigerants—rigidly maintained by laboratory-controlled methods of manufacture—contributes to the dependable, economical operation of the equipment over long periods. "Freon" refrigerants help protect the owner's original investment—an excellent reason for your recommendation of systems using them. E. I. du Pont de Nemours & Co. (Inc.), "Kinetic" Chemicals Division, Wilmington 98, Del.



150th Anniversary

BETTER THINGS FOR BETTER LIVING . . . THROUGH CHEMISTRY

"FREON" SAFE REFRIGERANTS



"Freon" is Du Pont's registered trade-mark for its fluorinated hydrocarbon refrigerants

The internal construction of ATLAS FLUSH DOORS

means
lasting beauty and
lasting strength

The exterior beauty of an Atlas Flush Door rests not alone on the simplicity of its lines and the superior quality of its surface panels . . . Its engineered, internal construction is a major factor that assures permanently fine appearance.

Whatever you choose for surface panels — Northern Hardwoods, Southern Gum, Western Fir or rarer imported woods: Avodire, Mahogany, Prima Vera and the like—the principles of construction remain the same.

There is an Atlas Flush Door to fit every architectural scheme and every budget. If the door is to be painted, less expensive paint grade veneers are available. Similarly, stains on gum offer a choice of Mahogany, Walnut and other "furniture" finishes—with economy.

Every Atlas Flush Door is the product of a single, wholly integrated organization. From standing tree to completed door, there is one standard of control and inspection — one responsibility. We'd like you to know more about Atlas Hollow Core and Solid Core Flush Doors. For illustrated literature, kindly address your request to Department 64.

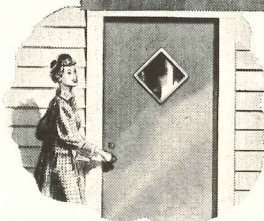
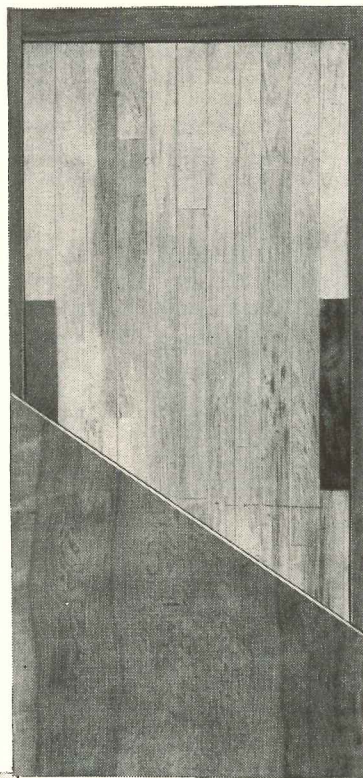

SOLID CORE

The core material of the Atlas Solid Core Flush Door is Balsa Wood — inert, proof against stress and warpage. With the same K factor as cork, Balsa has important sound-deadening qualities. Its low thermal conductivity means efficient insulation. Its light weight means light weight for the finished door. The core blocks are positioned within a kiln-dried frame. Lock blocks on both sides permit the door to be hung from either right or left.

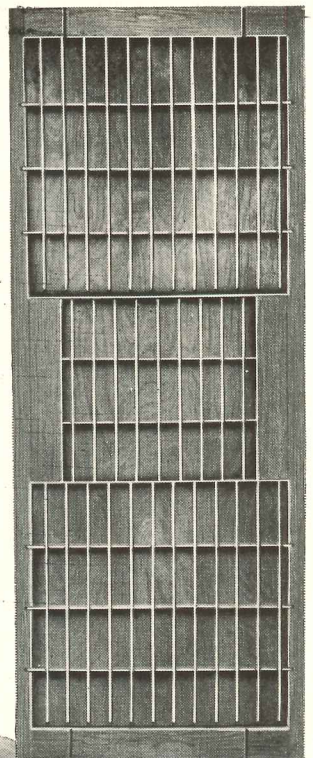

HOLLOW CORE

In the Atlas Hollow Core Flush Door, kiln-dried soft wood struts —running both laterally and perpendicularly—interlock to form a grid. Wherever two struts interlock, the outer corners are beveled to permit free air circulation. The carefully machined frames are of kiln-dried White Fir or Ponderosa Pine. Lock blocks on each side permit hanging from either right or left. Before the surface panels are bonded to core and frame, the interior surfaces have been completely sized, to counter-balance the pull of the final exterior finish.

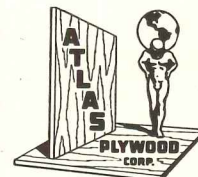

18 MANUFACTURING PLANTS

Anderson, Cal.	Gladstone, Mich.
Crescent City, Cal.	Munising, Mich.
Laurel, Del.	Goldsboro, N. C. (2)
Brunswick, Ga.	Plymouth, N. C.
Houlton, Me.	Klamath Falls, Ore. (2)
Greenville, Me.	Portland, Ore.
Patten, Me.	Williamsport, Pa.
Cadillac, Mich.	Newport, Vt.

PANEL AND DOOR DIVISION

ATLAS

PLYWOOD CORPORATION

24 SALES OFFICES AND WAREHOUSES

Boston, Mass.	New York, N. Y.
Los Angeles, Cal. (2)	Goldsboro, N. C.
Oakland, Cal.	Cleveland, Ohio
Sacramento, Cal.	Dayton, Ohio
San Francisco, Cal.	Oklahoma City, Okla.
Denver, Colo.	Tulsa, Okla.
Chicago, Ill.	Portland, Ore.
Evansville, Ind.	Pittsburgh, Pa.
Detroit, Mich.	Corpus Christi, Tex.
Gladstone, Mich.	Houston, Tex.
Grand Rapids, Mich.	San Antonio, Tex.
	Tacoma, Wash.

STATLER BUILDING, BOSTON 16, MASS. • Telephone: Hancock 6-0016 • Teletype: BS-644

LEADING DESIGNERS SPECIFY GENUINE CLAY TILE

Clay Tile again proves to be an exciting, modern material as used by Muller-Barringer, one of America's leading firms of designers. Dramatic focal point of this room is a striking clay tile fireplace. The decorator colors of the textured hearth are locked for life in its kiln-fired surface . . . cleaning like a charm . . . never to be refinished. Note, too, the practical use of stainproof clay tile on coffee table and service chest . . . the warm inviting red of the easily-cleaned quarry tile floor. Clay Tile offers your clients rich color and design potential, the twin factors of extremely long life and very low maintenance plus an unmatched resistance to wear, staining, moisture and scratching. It will pay you to study this versatile material. *Tile Council of America, 10 East 40th St., New York, or Room 433, 727 W. Seventh St., Los Angeles, Calif.*



GENUINE CLAY

tile

The Modern Style is

PARTICIPATING COMPANIES: American Encaustic Tiling Co. • Architectural Tiling Co., Inc. • Atlantic Tile Mfg. Co. • B. Mifflin Hood Co. • Cambridge Tile Mfg. Co. • Carlyle Tile Co. • General Tile Corp. • Gladding, McBean & Co. • Mosaic Tile Co. • Murray Tile Co., Inc. • National Tile & Mfg. Co. • Olean Tile Co. • Pacific Clay Products • Pacific Tile and Porcelain Co. • Pomona Tile Mfg. Co. • Robertson Mfg. Co. • Summitville Tiles, Inc. • United States Quarry Tile Co. • Winburn Tile Mfg. Co.

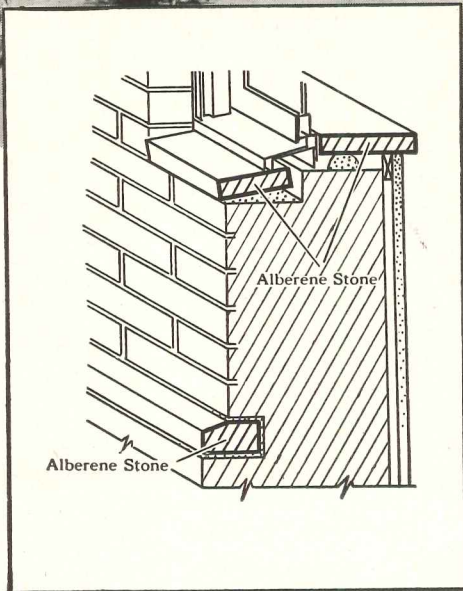
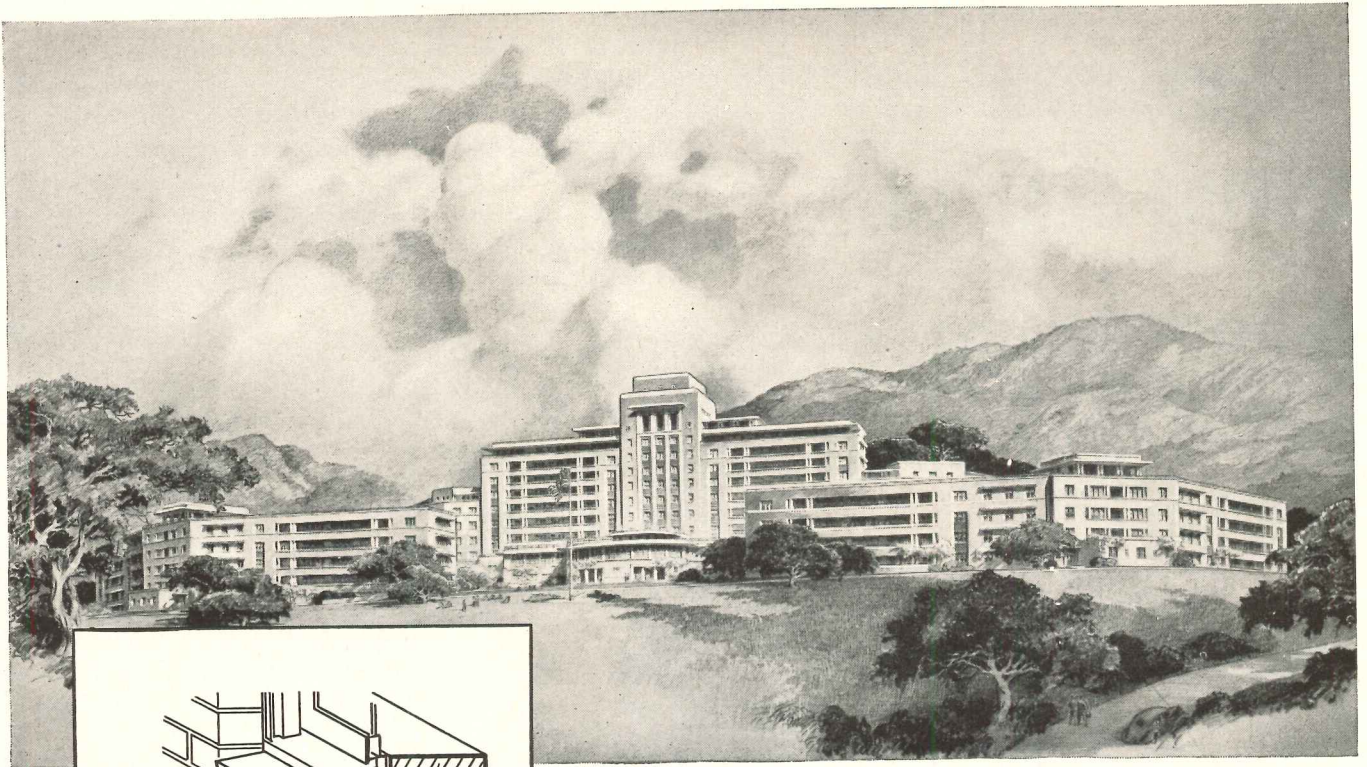

Detail showing $1\frac{1}{2}$ " thick slip sill with $1\frac{1}{4}$ " stool and $2\frac{1}{4}$ " belt course.

*Tripler General Hospital, U. S. Army Medical Dept., Hawaii
— Architects: York and Sawyer, New York City. $1\frac{1}{2}$ "
Alberene slip sills.*

sills, stools, and trim
of **ALBERENE** stone are
DURABLE and ECONOMICAL

Regular Grade Alberene Stone is an ideal material for exterior trim because it can be cut into thin sections, permitting substantial economies. It offers freedom to the designer—by making possible greater reveal, to give just one example.

The stone has no cleavage planes, is dense, non-absorbent, and chemically-resistant. It is free of maintenance cost. Its color—silver gray in rubbed finish and a pleasing blue gray when honed—harmonizes well with almost any color scheme.

Where a darker color is desired, we suggest

Alberene Serpentine. It is a darker gray in rubbed finish, blue-black when honed, and blue-black or black when polished.

The high chemical resistance of both stones, which has made them favorites for use in laboratory equipment, also makes them ideal for *window stools* in laboratory buildings.

Since there is a decided difference in price between Alberene *Regular Grade* and *Serpentine*, architects' specifications should be carefully worded so as to clearly call for the type desired. Ample supplies of both materials are available.

ALBERENE STONE CORPORATION

419 Fourth Avenue, New York 16, N. Y.

Branches in Principal Cities

BOY • IT'S A GIRL • IT'S A BOY • IT'S A GIRL • IT'S A BOY • IT'S A GIRL • IT'S A

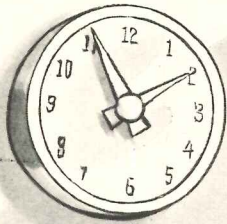

**we'll even signal
the
expectant father**

B-L-U-E *~~~~~*

~~~~~ **P-I-N-K**

**ARCHITECTS KNOW
NO ANXIOUS MOMENTS
WHEN THEY SPECIFY STANDARD
HOSPITAL SIGNAL AND CLOCK SYSTEMS**

Nurses' Call Systems

Doctors' Paging Systems

Staff in-and-out Registers

STANDARD

Since 1884

THE STANDARD ELECTRIC TIME COMPANY

81 LOGAN STREET • SPRINGFIELD 2, MASSACHUSETTS

Norman* Three-Sixty

The Unit Type Gas Heater
For Modern Store Interiors



Patent No. 2519496
Other Patents Applied For

for natural, mfgd., or mixed gas



New symmetrical design harmonizes perfectly with attractive store interiors. New comfort for customers and clerks. No hot spot blasts or cold corners. Heat is gently diffused by fan and convection in a full 360° radius. Fully automatic, quiet operation. Forced draft simplifies venting problem—assures expulsion of flue gases to outside. *Get the facts now.* Send for descriptive literature, specifications and name of nearest representative or distributor.

	SMART FASHION SHOPPE —Trim lines of the Three-Sixty harmonize beautifully with store interior.
	GROCERY STORE —Gently circulates warm air in all directions. No withering blasts to shrivel produce.
	FURNITURE STORE —Full 360° heat distribution with 5 units serving large glassed-in area.
	DRUG STORE —New heating comfort for customers and clerks. Notice shallow mounting.

Made by the makers of the famous Norman Southerner Horizontal Gas Furnace



Norman products company 
1160 Chesapeake Ave., Columbus 12, O.

Please send full details on the Norman Three-Sixty Unit Type Gas Heater.

Your Name _____

Firm Name _____

Address _____

City _____ Zone _____ State _____

Copyright 1952 by Norman Products Co. *Trade Mark Registered

For Large Seating Capacity
Or Small . . .

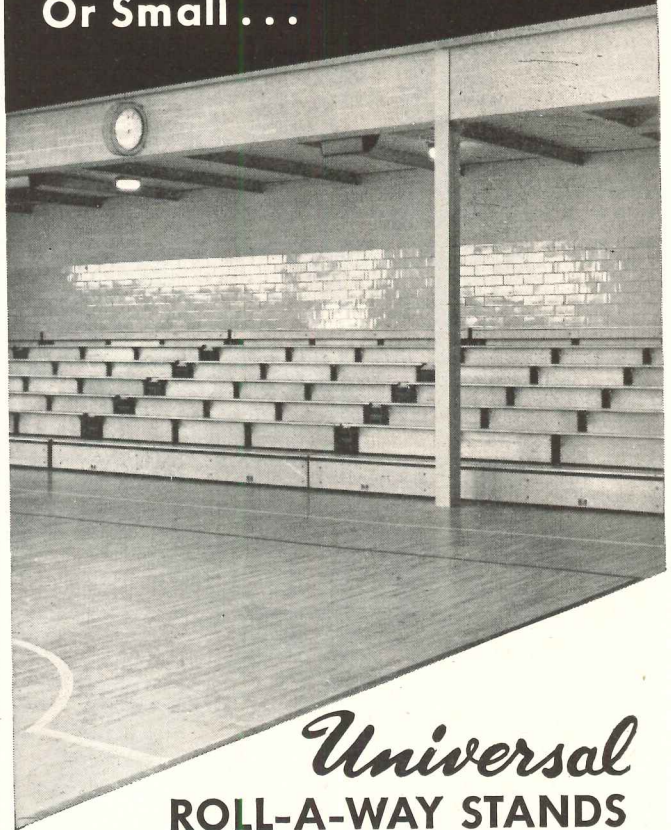

Universal ROLL-A-WAY STANDS MEET ALL GYMNASIUM DEMANDS

Carefully engineered and custom built to meet the requirements of individual installations, *Universal* Roll-A-Way Stands offer the ideal solution to practically any gymnasium seating problem . . . large capacity or small. They are compact, yet roomy and comfortable; neat and attractive; exceptionally strong and safe. When not in use, they may be rolled back to the walls, providing approximately 70% more floor space for regular gymnasium activities. Improved vertical filler boards enclose

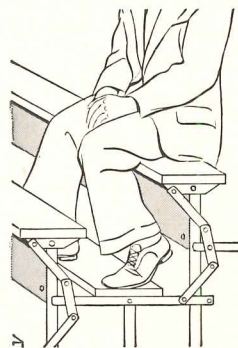

the entire understructure from front view, add more rigidity to seat boards, make the complete stands even stronger and more substantial. Thanks to their centered positions, these filler boards do not interfere with spectators' leg room . . . permitting normal positions of feet drawn back under seats, as illustrated at left. Write today for catalog, prices and complete list of *Universal* installations.

Universal BLEACHER COMPANY

606 SOUTH NEIL STREET • CHAMPAIGN, ILLINOIS

Bleacher Experts for Over 30 Years

Save with SAFER...SURER
AB BREAKERS

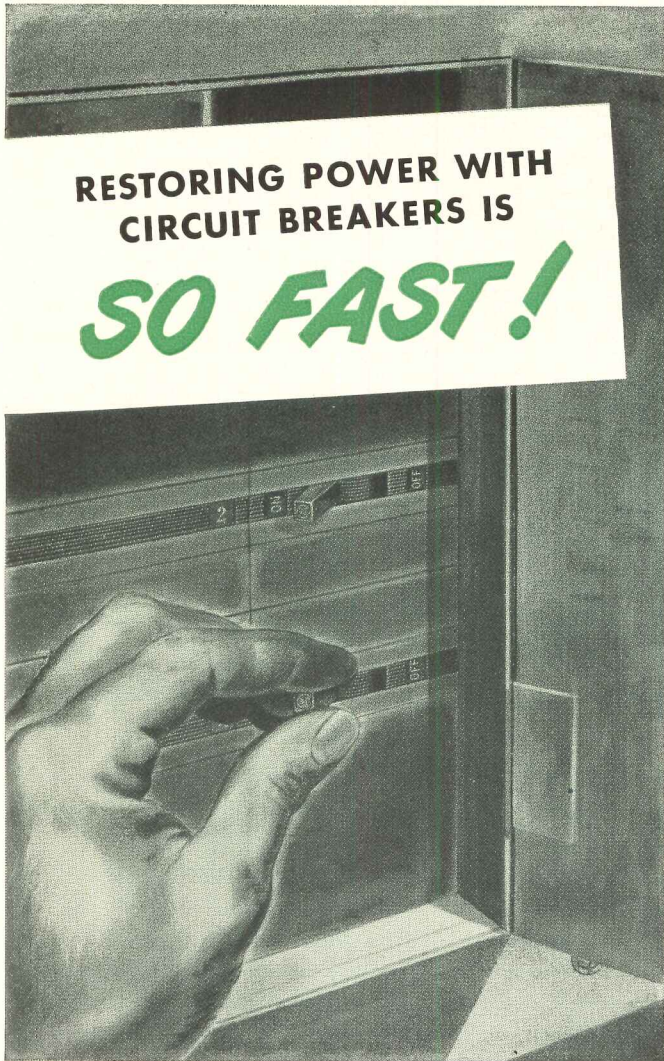

The blow that often hurts worse than a power outage is inability to get back into production. With one investment you can have reliable circuit control and protection, and help in eliminating road blocks to capacity production—with Westinghouse Circuit Breakers.

On short circuits, Westinghouse Breakers trip instantly, yet provide a time lag on temporary, harmless overloads to minimize circuit interruptions. As soon as trouble is cleared on the line, flip the handle back to "on" position and power is restored—just as quick as that. No need to chase fuses, no costly maintenance time to install them. In addition, Westinghouse Breakers are

tamperproof—provide you dependable protection for years and years without attention.

Westinghouse has a complete line of Circuit Breakers for industrial and commercial applications in ratings from 5 through 600 amperes. For complete information, call your nearest Westinghouse office, or write for Bulletin D. B. 29-060, Westinghouse Electric Corporation, P. O. Box 868, Pittsburgh 30, Pennsylvania.

J-30052

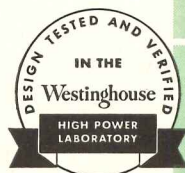

YOU CAN BE SURE.. IF IT'S
Westinghouse

AB CIRCUIT BREAKERS

THE COMPLETE LINE



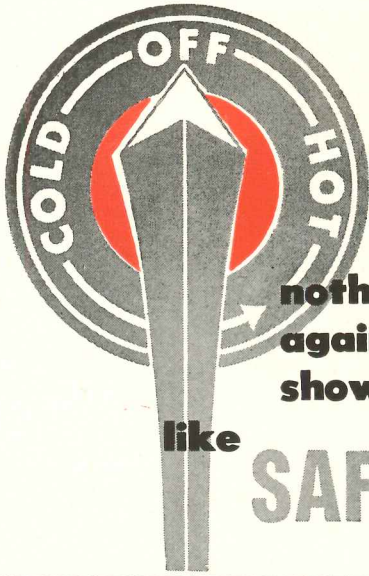

nothing protects
against sudden
shower scalds

like

SAFETYMIX



GIVE THEM THIS EXTRA SHOWER SAFETY
... AT NO EXTRA COST!

SHOWER SAFETY

... No scalds ... no chills. Protects against both sudden scalds and chills. Even with pressure fluctuations up to 85%, Safetymix keeps shower temperature constant. Automatically shuts down flow when either hot or cold water fails.

LIFETIME QUALITY

... Only one moving part. Designed and manufactured by engineers and approved by architects, pressure-actuated Safetymix is the most rugged shower control valve made. Only Safetymix has the patented Flow Control Spindle with but one moving part to control all valve functions.

FREE FROM MAINTENANCE

... Easy to fix as a faucet. Safetymix is designed with self-cleaning action to prevent clogging. Saves water. All parts accessible from front.

COSTS NO MORE

Because it costs no more than ordinary shower valves and is guaranteed to be entirely as represented, architects specify Safetymix and engineers recommend it. Safetymix gives the extra safety and satisfaction that builds better reputations. Safetymix is used in thousands of schools, colleges, hotels, industrial plants, institutions and better homes from coast to coast.

See Sweets Architectural File or your Domestic Engineering Catalog.
Send for bulletin and prices.

Symmons
ENGINEERING COMPANY

791 TREMONT STREET, BOSTON, MASS.



KENNATRACK

leads again!

Amazing new Series 800 metal sliding passage door frame gives you advantages never before available!



saves time
saves labor
eliminates warp

Builders, architects and owners from coast to coast are demanding the Kennatrack Series 800 Metal Frame for sliding passage doors. This frame saves time ... saves labor ... eliminates warpage, and can easily be installed by anyone. Treated for rust resistance. Multiple adjustment features make fit and plumb child's play. Designed for all standard 2 x 4 walls. Frames come in standard door widths. Secure complete facts ... then you can see more clearly just what these advantages mean.

Write Dept. C4

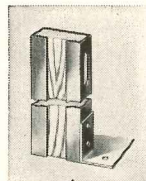

Prefabricated and complete in one package. Includes famous Kennatrack Series 400 heavy duty track assembled to header at factory, with hangers in place. Can be installed on the job in 25 minutes.

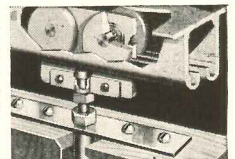

Door rolls smoothly, quietly on not two ... not four ... but on EIGHT Nylon wheels. Ball bearing axles.

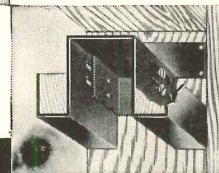

Left: Header adjustable two ways: (1) Pocket end allows 3/4" horizontal adjustment to fit rough opening; (2) Jamb end permits 3/4" vertical adjustment.

Above: Wood filler strips in metal frame allow plaster base, stops and trim to be nailed or screwed in usual manner.

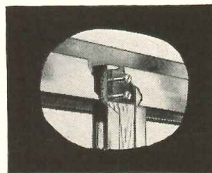

Left: Split jambs and supports also provide 1" adjustment for height.

C 4

JAY G. McKENNA, Inc.

ELKHART, INDIANA
Jay G. McKenna (Canada) Ltd., 104 Jarvis St., Toronto
SPECIALIZING EXCLUSIVELY IN THE MANUFACTURE OF SLIDING DOOR HARDWARE

use **copper** wisely

this **way** – not **this**

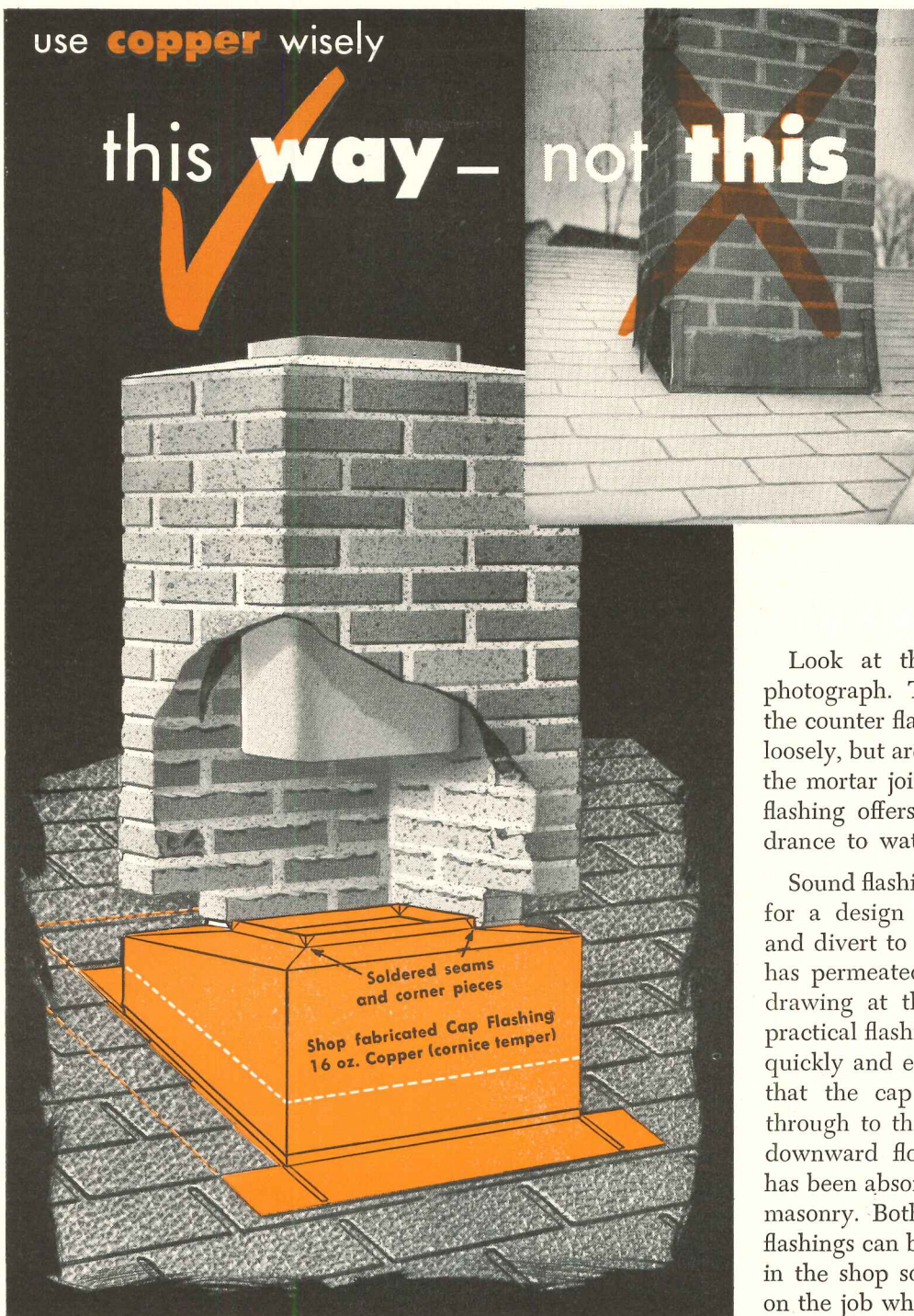

Look at the flashing in this photograph. The pieces forming the counter flashing not only hang loosely, but are simply tucked into the mortar joints. As a result, the flashing offers little, if any, hindrance to water penetration.

Sound flashing of chimneys calls for a design that will intercept, and divert to the roof, water that has permeated the masonry. The drawing at the left illustrates a practical flashing method which is quickly and easily installed. Note that the cap flashing, extended through to the flue, will stop the downward flow of water which has been absorbed by the exposed masonry. Both the cap and base flashings can be readily fabricated in the shop so as to be available on the job when needed.

5238

WRITE FOR DETAIL DRAWINGS

The purpose of recent research and investigation by Anaconda building specialists has been to develop methods of using a minimum of sheet copper for maximum results in the protection of buildings from weather.

This work has resulted in a series of drawings which show suggested detail of new applications and improved methods for sheet metal work. These drawings, including the ones shown here, are available in a complete portfolio on 8½" x 11" sheets convenient for filing. Send for your set now. Ask for Portfolio S. Just write to The American Brass Company, Waterbury 20, Conn.

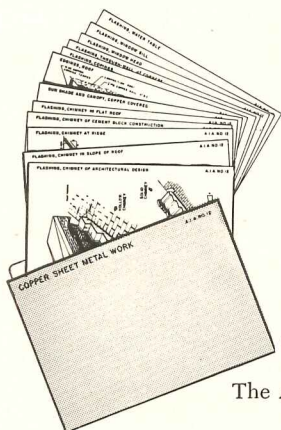

for better sheet metal work — use

ANACONDA[®]
copper

Lick Your Window Maintenance Problems

... get *Fenestra* Super-Galvanized Steel Windows

Steel windows have the strength and rigidity that no other windows can match. And now Fenestra has even eliminated maintenance *painting!* Insist on Fenestra* Super Hot-Dip Galvanized Steel Windows.

Here's why they are called *Super Galvanized*: Fenestra has developed a Hot-Dip Galvanizing system designed specifically for steel windows and built a special plant around it. It is the only one of its kind in America.

In Fenestra's new plant, completely automatic controls move Fenestra window assemblies through a series of special tanks where they are cleaned and pickled, rinsed, fluxed, dried, galvanized and Bonderized. Timing, temperatures—every step—is laboratory controlled.

So add Super Hot-Dip Galvanizing to your present list of Fenestra advantages . . . such as integral ventilator butts that increase window strength, precision machining of window bars for perfectly uniform window size, automatic

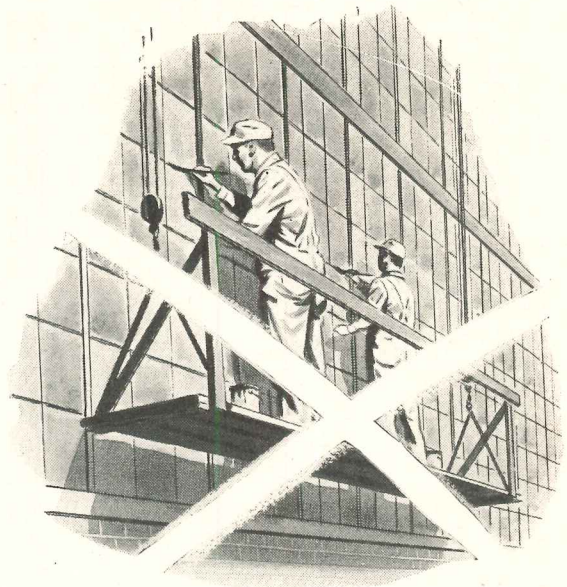

assembly of ventilators for perfect permanent fit, continuous double contact for weather-tightness all around vent openings, rigid *interlocking* muntin joints.

And, remember, Fenestra's volume production, permitted by standardization of types and sizes, gives you high-quality Fenestra Steel Windows at remarkably low cost.

Call your Fenestra Representative or write Detroit Steel Products Company, Dept. AR-4, 2252 East Grand Blvd., Detroit 11, Michigan. *®

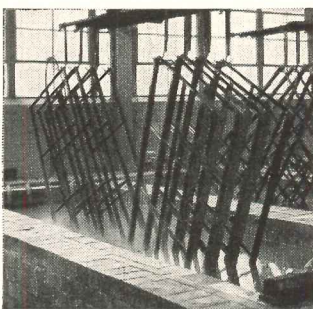

FLUXING. After cleaning, pickling and rinsing, Fenestra Windows dip into a flux bath that provides a film to prevent contamination of the cleaned steel as it passes to galvanizing tank.

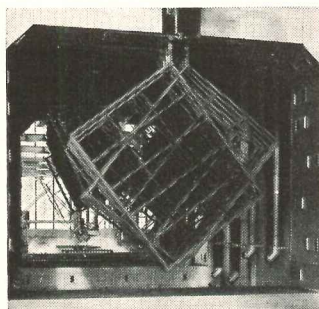

DRYING. In this oven, the flux is dried on. Of course, in the galvanizing tank, this protective coat of flux volatilizes on contact with the molten zinc to permit a strong zinc-iron bond.



GALVANIZING. Assemblies dip deep into molten zinc, and come up with a thick, smooth, uniform coating. Temperature and timing are automatically controlled with laboratory accuracy.

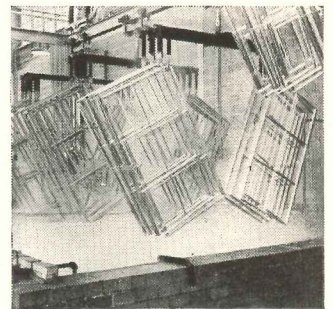

BONDERIZING. Here you see the galvanized assemblies being Bonderized to give the surface a soft silver color and to provide a holding surface for decorative paint, if it is ever desired.

Fenestra

SUPER HOT-DIP GALVANIZED STEEL WINDOWS
from America's first plant especially designed to galvanize steel windows

... at its new \$5,000,000 oil research center

UNION OIL COMPANY planned for lasting economy ... installed JENKINS VALVES

Architects

AUSTIN, FIELD & FRY, LOS ANGELES

General Contractors

P. J. WALKER CO., LOS ANGELES

Mechanical Contractors

S. GLEN HICKMAN CO., LOS ANGELES

Consulting Mechanical Engineer

SAMUEL L. KAYE, LOS ANGELES

The new 14-building research center of the Union Oil Company of California is unique in many features of design. Here, a research staff of 250 will have every modern facility for developing products that will shape the company's future progress.

The same future-minded attitude was maintained toward plant operating costs by the architects and engineers who specified equipment. To insure lasting efficiency and maintenance economy, they chose Jenkins Valves for more than 3,000 control points on the miles of steam, water, sanitation, fire-control, and other pipelines essential to operations.

Like so many of the nation's top-flight building specialists, these men have confidence in the *extra measure* of efficiency and endurance built into Jenkins Valves.

Despite this extra value, *you pay no more* for Jenkins Valves. For new installations, for all replacements, let the Jenkins Diamond be your guide to lasting valve economy. Jenkins Bros., 100 Park Avenue, New York 17; Jenkins Bros., Ltd., Montreal.

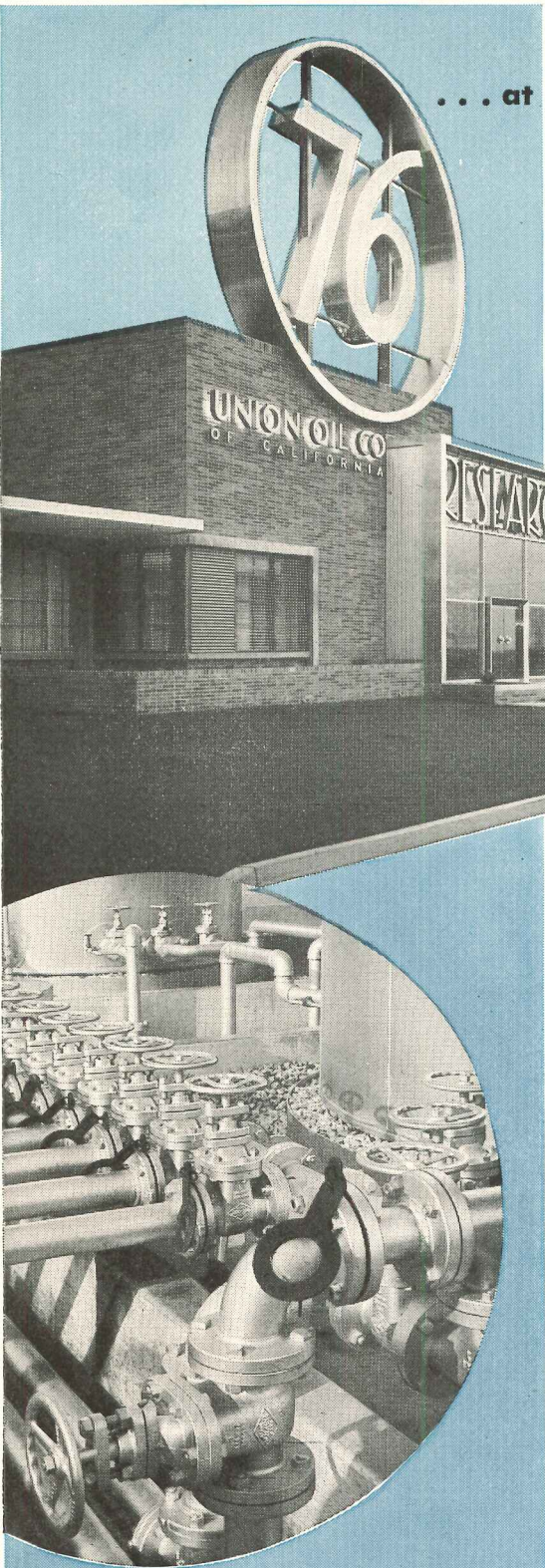

SOME OF THE 3000 JENKINS VALVES installed at the new research center. Many structural innovations, designed to simplify maintenance, are unique in this plant. Tunnels between buildings carry all pipelines; make them readily accessible. Air-conditioning system supplies 100% fresh air to laboratories at all times. The administration building, shown above, is one of 14 major buildings on a 100 acre site.

JENKINS
LOOK FOR THE DIAMOND MARK
VALVES



Jenkins Bros.



*A man's work
is his Cathedral*

Edwin F. Guth, Sr., has given fifty years of his life to his work with almost religious devotion. His efforts have been rewarded.

His company, now celebrating its Golden Anniversary, is recognized as one of the leaders in the lighting industry. He has achieved fame for his contributions to the betterment of lighting. We at GUTH pause to honor this man who has shaped the past and future of our company.

Thanks, E. F. Guth, Sr. And thanks to all of you who have been so wonderful to us during this past half-century.

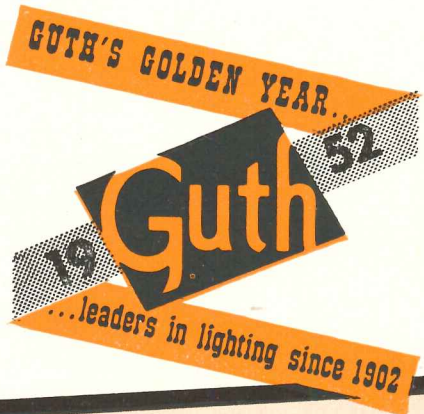

THE EDWIN F. GUTH CO. / ST. LOUIS 3, MO.

"...his deeds have made us what we are today"

In devoting a half-century to his work, Edwin F. Guth, Sr., has built a record of accomplishments that stands as a monument to his untiring spirit:

*F*ounded our company April 22, 1902.

*I*nvented over 150 patented lighting devices.

*D*esigned the world-famous BRASCOLITE.

*I*ntroduced the first "Packaged" Lighting Fixtures for distribution through wholesalers.

*D*esigned and manufactured cast bronze lighting equipment for many state capitols and other public buildings all over the world.

*P*roduced the finest reflector finishes as they were developed — Alzak Aluminum, Porcelain Enamel, 300° White, and Electroplated Finishes.

*C*reated the famous GUTHFAN—the first improved fan over a 30-year period.

*D*esigned and manufactured lighting equipment through all stages of lighting development— Gas Fixtures, Gas Mantles, Combination Gas & Electric, Carbon, Gem, Tantalum, Tungsten, Mercury, Fluorescent, and Germicidal—from 1902 to the present.

*H*onored by the National Association of Manufacturers which named him, "A Modern Pioneer on the Frontier of American Industry".



THE EDWIN F. GUTH CO. / ST. LOUIS 3, MO.

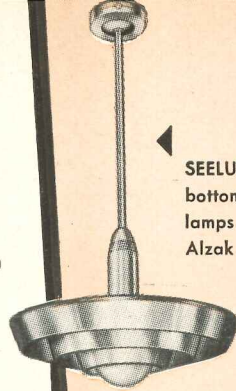

SEELUX* 3-ring, open-bottom for silver bowl lamps with heatproof Alzak louvres.

WYTE-LINER the new idea for factory lighting: white inside and out. Results: lessens contrasts — lifts ceiling gloom.

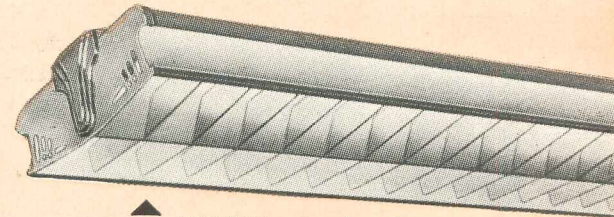

GUTHLITE* swings down for easy maintenance. 43% uplight, 57% downlight.

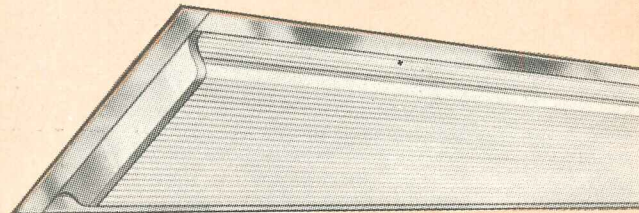

LITE-BLOX TROFFER comprehensive line — ribbons of light — super constructed.

ARISTOLITE* hinged glass panels swing apart for easy cleaning from floor.

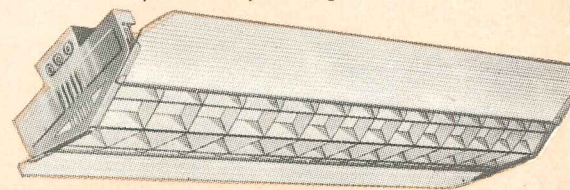

INDUSTRIAL INCANDESCENT reflectors for better light control at the working plane.

* © and Patents Pending

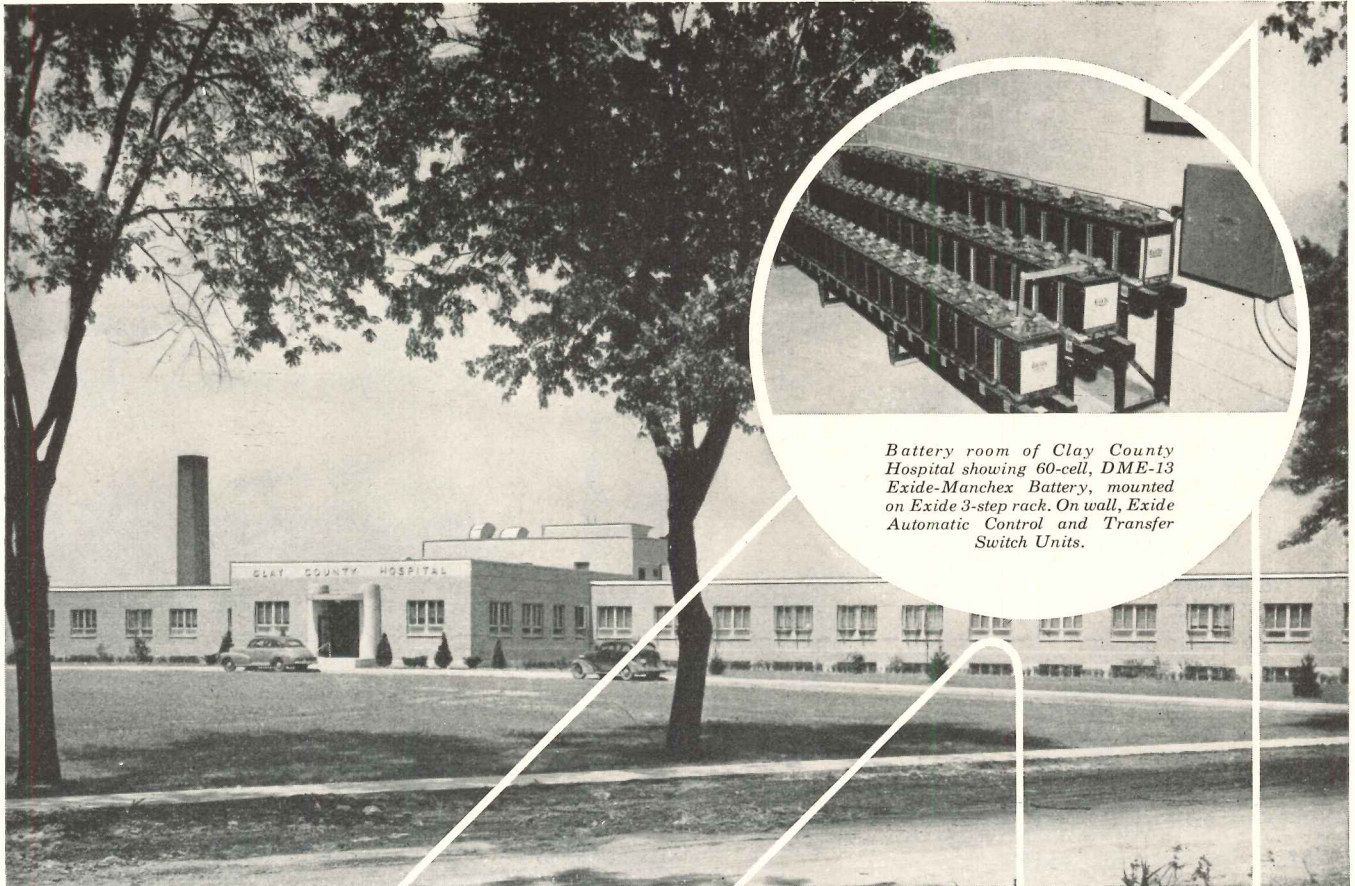

Attractive, modernly-equipped Clay County Hospital, Flora, Illinois, protected from lighting failure by Exide Emergency Lighting.

Battery room of Clay County Hospital showing 60-cell, DME-13 Exide-Manchex Battery, mounted on Exide 3-step rack. On wall, Exide Automatic Control and Transfer Switch Units.

PROVIDE LIGHTING PROTECTION FOR THE HOSPITALS YOU DESIGN

Despite all precautions of utility companies, storms, fires, floods and accidents beyond their control can interrupt normal supply of electric current.

Such interruptions are frequent. But they are no threat to the Clay County Hospital or to the many other hospitals that are safeguarded by Exide Emergency Lighting. This dependable, modern protection is safe, sure, economical. It's ready to take over the lighting load, instantly and automatically, when needed.

You can install Exide Emergency Lighting as an integral part of the building—in new construction, in remodeling. Units and systems can be supplied for any need—for a few lights or many, for a single building or large group.

Safeguard the buildings you design. Specify

Exide Emergency Lighting for hospitals, schools, theaters, stores, factories, churches, religious and public buildings.

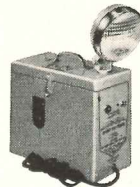

EXIDE LIGHTGUARD

Here's a portable, low cost unit that can be plugged into any A.C. lighting socket. When normal current is cut off, a built-in relay instantly and automatically turns on the powerful floodlight. After normal service is restored, the relay shuts off floodlight and turns on charging current. The Exide Battery is always fully charged ready for immediate action.

THE ELECTRIC STORAGE BATTERY COMPANY
Philadelphia 2

Exide Batteries of Canada, Limited, Toronto

"Exide" and "Manchex" Reg. Trade-marks U.S. Pat. Off.

Exide

EMERGENCY LIGHTING

1888 . . . DEPENDABLE BATTERIES FOR 64 YEARS . . . 1952

...in Key West

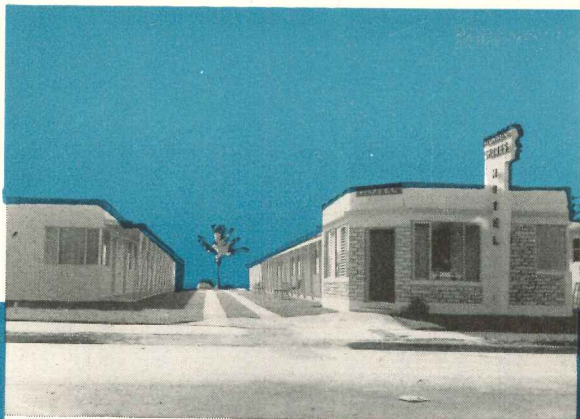

ATLANTIC SHORES

Wholesaler: Bond Plumbing Supply Co. • Pl. Contractor: John Curry • Architect: Gerard Pitt.



KEY AMBASSADOR

Wholesaler: Bond Plumbing Supply Co. • Pl. Contractor: Superior Plumbing Co. (Ed Murray) • Gen'l Contractor: Superior Home Builders • Architect: Edwin T. Reeder • Engineers (Pool) Riley & Ross • Owner: Charles Helberg & B. G. Kilpatrick.



KEY WESTER

Wholesaler: Bond Plumbing Supply Co. • Pl. Contractor: Superior Plumbing Co. (Ed Murray) • Gen'l Contractor: Superior Home Builders • Architect: Edwin T. Reeder • Engineers (Pool) Riley & Ross • Owner: Charles Helberg & B. G. Kilpatrick.

it's RICHMOND

Just recently these 3 motels opened in Key West, Florida. These are the last word in beauty...superbly designed...beautifully furnished...magnificently landscaped.

And all 3 installed Richmond plumbing fixtures.

You'll find this happening from coast to coast. Whenever quality and

beauty are desired, wherever economy and efficient operation are demanded, more and more Richmond is the choice.

Remember Richmond when you buy or specify any type of plumbing fixtures. You'll find the Richmond line of vitreous china and cast-iron fixtures is complete, and you're assured of customer satisfaction every time in every way.



RICHMOND

RICHMOND RADIATOR CO.—AFFILIATE OF REYNOLDS METALS CO.

See your wholesaler or Mail Coupon Today:

Richmond Radiator Company AR/4
19 East 47th Street, New York 17, New York
Please send me more information and literature on the Richmond Plumbing Fixtures. No obligation, of course.

NAME.....

COMPANY.....

ADDRESS.....

CITY.....ZONE.....STATE.....

We are plumbing wholesalers plumbing contractors building contractors.

AUTH'S "whisper-control" Nurses' Call System—

a brilliant new aid to

HOSPITAL EFFICIENCY

*"Like having a private nurse"
says the patient!*

*"Like having one private patient"
says the nurse!*

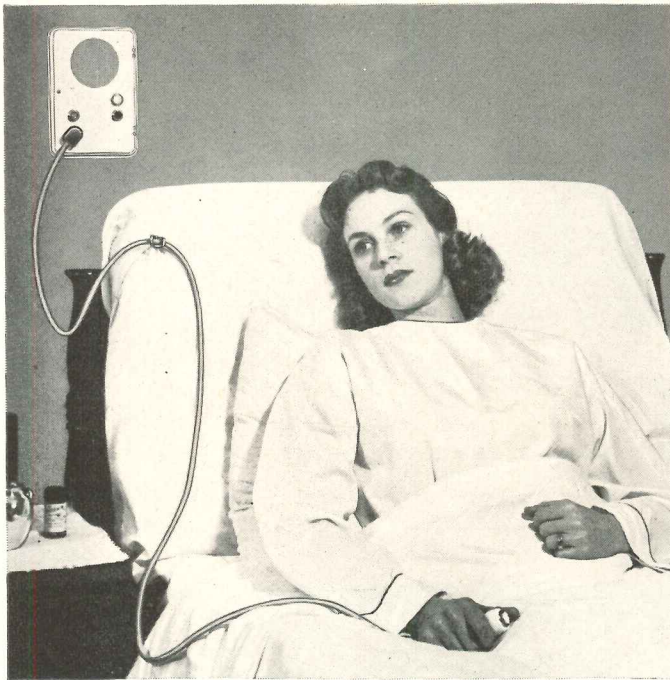

Yes, they're both happier—and with good reason. The patient has the psychological advantage of knowing that her smallest need will get immediate attention. She knows she will be heard when she wants to be heard even if she whispers, no matter in what direction she faces. So long as she can move her thumb and make a sound, she's sure of attention. Knowing this, she is less demanding, more relaxed.

And the Nurse? Well, she's actually been multiplied several times. Her energy and time are conserved, her spirits improved, her efficiency immeasurably increased. And so is the efficiency of the whole hospital. For that's the wonder of the new AUTH Vokalcall. It's the finest single aid to hospital efficiency that was ever devised.

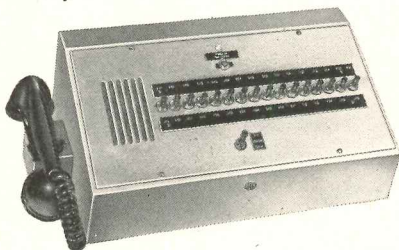

Nurses' control available in two styles: With speaker-microphone and telephone handset for auxiliary use . . . or with telephone handset only.

In addition to Vokalcall Systems for hospitals Auth also produces standard visual nurses' call systems, doctors' paging and in-and-out systems, clock systems and operating room timers, intercom telephone and fire alarm systems, and night lights.

More information? Write for complete descriptive literature to Auth Electric Company, Inc., 34-20 — 45th Street, Long Island City 1, New York.



FOREMOST IN THE DESIGN AND MANUFACTURE OF ELECTRICAL
SIGNALING, COMMUNICATION AND PROTECTIVE EQUIPMENT

AT LAST!

after years of research,
the makers of FABRON*
present:

Permon

TRADE MARK REGISTERED

—developed especially
for wall surfaces
subject to hard usage

*Use both!

For interior walls exposed to average wear, FABRON is still the most decorative and economical wall treatment available. PERMON was developed especially for areas subjected to heavier than average abuse: lower sections of corridor walls, service rooms, etc.

You'll want to use both together . . . for the colors of both are coordinated to produce combinations in perfect harmony—with PERMON for the wainscot and FABRON for the upper wall.

Yes, here it is—the wall covering made to fit your own specifications—a *plastifused fabric wall covering* . . . with a plastic armor permanently fused to fabric to provide advantages never before combined in a flexible wall covering.

You specified durability—the strength to withstand the abuse to which corridor walls, for example, are subjected. PERMON has it—and then some!

You specified beauty—colors of decorative quality and diversity. PERMON has them—and then some!

You specified easy application . . . no shrinkage after installation . . . washability . . . moderate cost. PERMON meets the specifications in every respect—and to a degree unmatched by any other flexible wall covering available today.

Reason? PERMON was built to *your* specifications by the *only firm specializing solely in plastifused fabric wall coverings for the institutional field.*

You asked for it—and now it's here! May we send you further details via the coupon below?

FREDERIC *Blank* & COMPANY, INC.

ESTABLISHED 1913

The institutional field's only specialists
in plastifused fabric wall coverings.

230 PARK AVENUE, NEW YORK 17, N. Y.

Represented in Canada by the Robert Simpson
Company, Ltd.—Special Contract Division

Frederic Blank & Company, Inc.
230 Park Avenue, New York 17, N. Y.

Please send me complete information about PERMON

Name _____

Title _____

Just fill in, clip to your letterhead and mail

AR 4-52

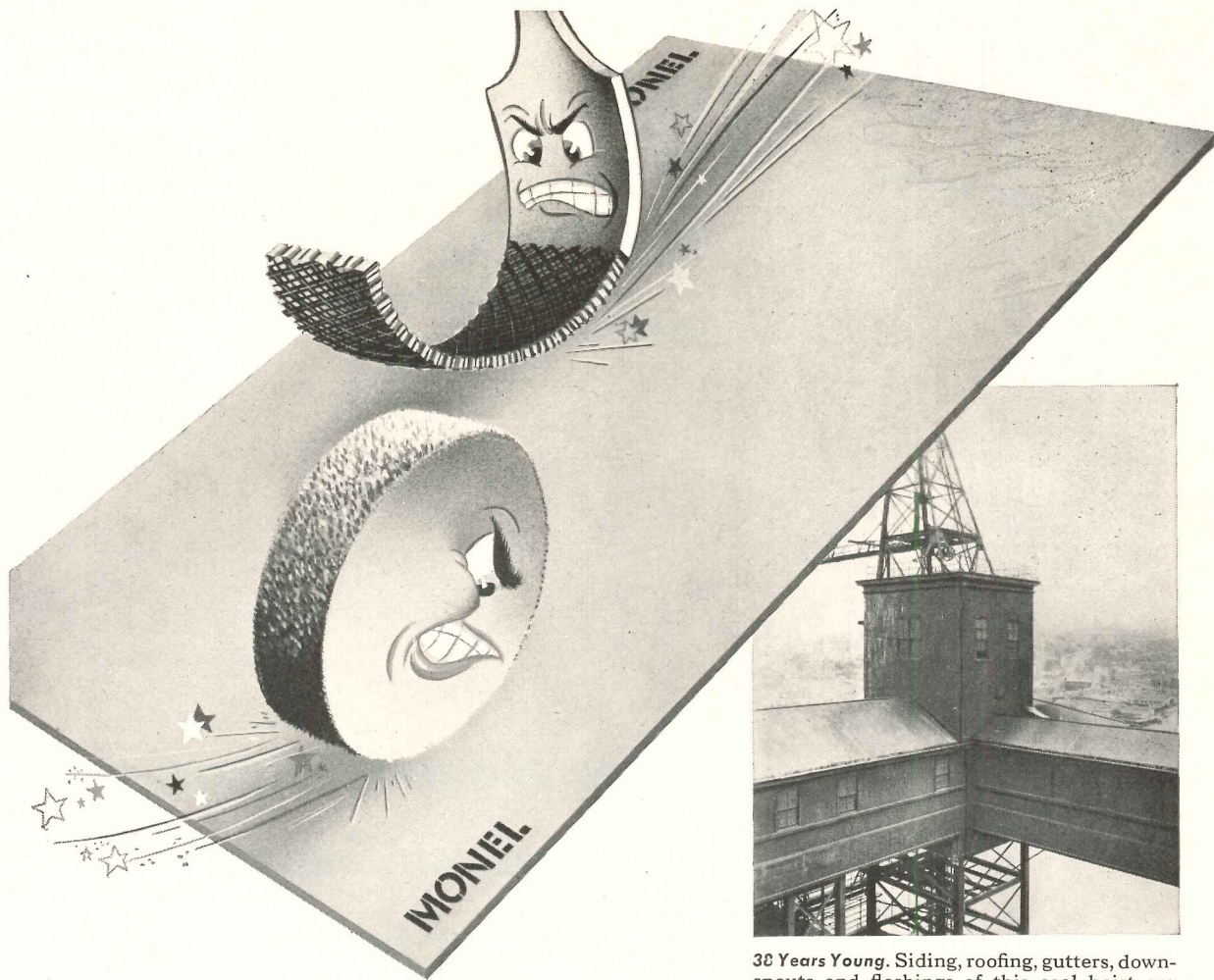

A roofing sheet to remember...

38 Years Young. Siding, roofing, gutters, downspouts and flashings of this coal hoist are Monel. Installed in 1913 at a riverside power plant, the metal is still in excellent condition.

for protection against wear and abrasion!

Look out! There's trouble in the air!

Maybe it's dust or dirt. Maybe it's cinders or fly ash.

Whipped in by wind — and washed around by rain — these trouble-makers gang up on a roof.

But they don't get far against roofs made of Monel®!

For Monel is stronger and tougher than structural steel. It can *never* rust. Its smooth, hard surfaces not only resist erosion; they withstand even the abrasive, wearing action of sliding snow and ice.

Right now — because of the demand for nickel and nickel alloys in the defense program — Government orders prohibit use of Monel for building applications.

But the time will come again when there is enough Monel available for normal roofing needs! Meanwhile, let INCO help you in planning for the future. Call on our Architectural Section for the latest technical information and literature.

THE INTERNATIONAL NICKEL COMPANY, INC.

67 Wall Street, New York 5, N. Y.



MONEL ... "For the Life of the Building"

for low-cost hospital maintenance



Southeast Louisiana State Hospital, Mandeville, La.

Architects: Wogan, Bernard & DeLaVergne and, Andre & Feitel
 Consulting Engineer: Alvin M. Fromberz
 Plastering Contractors: B. E. King & Sons

... architects specify

KNAPP METAL BASE AND CHAIR RAIL

In hospital design where sanitation, appearance, fire resistance and low cost maintenance are the deciding factors, Knapp Metal Trim has been the first choice of architects for more than a half century.

Knapp Brothers' standard of quality is always the highest. For more than fifty years, they have taken pride in their ability to produce precision metal trim products that meet the most exacting specifications. Knapp Metal Trim is the recognized standard for schools, hospitals, public and institutional buildings. No matter how large or how small, each job is handled with the utmost care and efficiency.

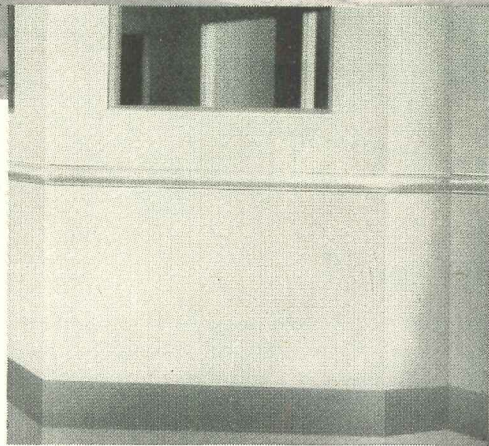

Knapp No. 202 Metal Base and No. 300 Chair Rail were used throughout the rooms and corridors of this hospital. The durability and sanitation of Knapp Metal Trim make their use essential in modern hospital construction as typified by this building.

Write today for complete details.

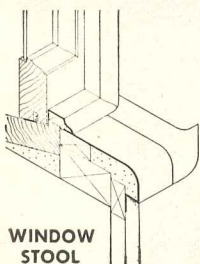

WINDOW STOOL

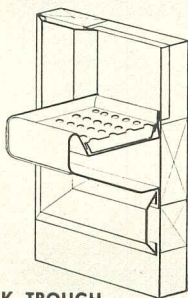

CHALK TROUGH

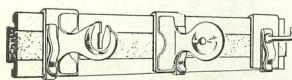

MAP AND DISPLAY RAIL

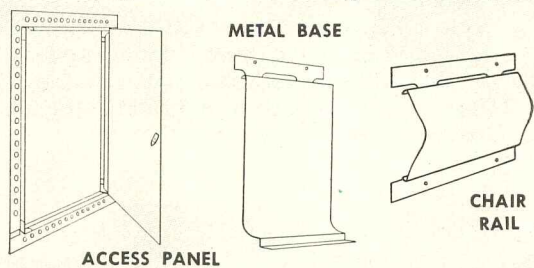

ACCESS PANEL

METAL BASE

CHAIR RAIL

Mail This Coupon Today!

Knapp Bros. Mfg. Co. Dept. AR-452
 16 E. 72nd St., Cincinnati 16, Ohio

Please send me complete information on Knapp Metal Trim Products.

Name _____ Title _____

Company _____

Address _____

City _____ Zone _____ State _____

KNAPP BROTHERS MANUFACTURING CO., CINCINNATI 16, OHIO

Which insulation for this roof?

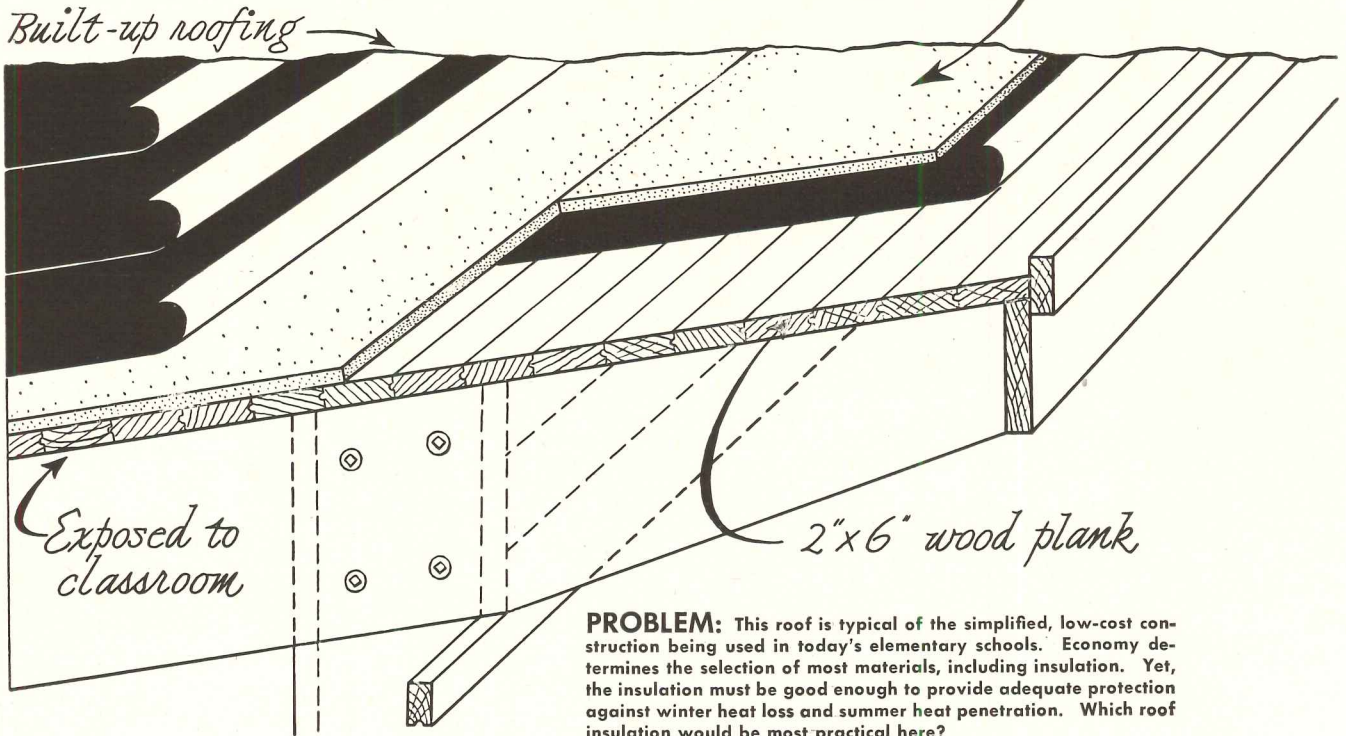

PROBLEM: This roof is typical of the simplified, low-cost construction being used in today's elementary schools. Economy determines the selection of most materials, including insulation. Yet, the insulation must be good enough to provide adequate protection against winter heat loss and summer heat penetration. Which roof insulation would be most practical here?

SOLUTION:

Since this job doesn't require a costlier heavy-duty material, a wise selection would be Armstrong's Temlok®. Combined with the 2" wood plank roof, 1" of Temlok will give the entire structure a "U" factor of .17. This provides sufficient insulation for year-round comfort, and to hold fuel bills in line.

Whenever you have to keep one eye on cost and the other on efficiency, Temlok is a safe choice. Armstrong's Temlok is made of sturdy, low-cost pine fibers, processed into strong boards. The tiny dead air spaces between these fibers give Temlok its high insulation efficiency. It has good strength to provide a rigid base for built-up roofing and can be nailed in place where roof pitch is over 3" per foot.

Temlok's strength also makes on-the-job handling fast and easy. A sizing solution in the board gives it good water resistance.

Naturally, each job must be carefully studied before specifying a roof insulation. Where you need added moisture resistance, you can use Armstrong's Asphalt-Impregnated Temlok. For those rugged jobs where maximum serviceability is demanded, you may choose Armstrong's Corkboard. Call the nearest Armstrong Office for full details or write Armstrong Cork Company, 2404 Concord Street, Lancaster, Pennsylvania.



**ARMSTRONG'S
ROOF INSULATIONS**

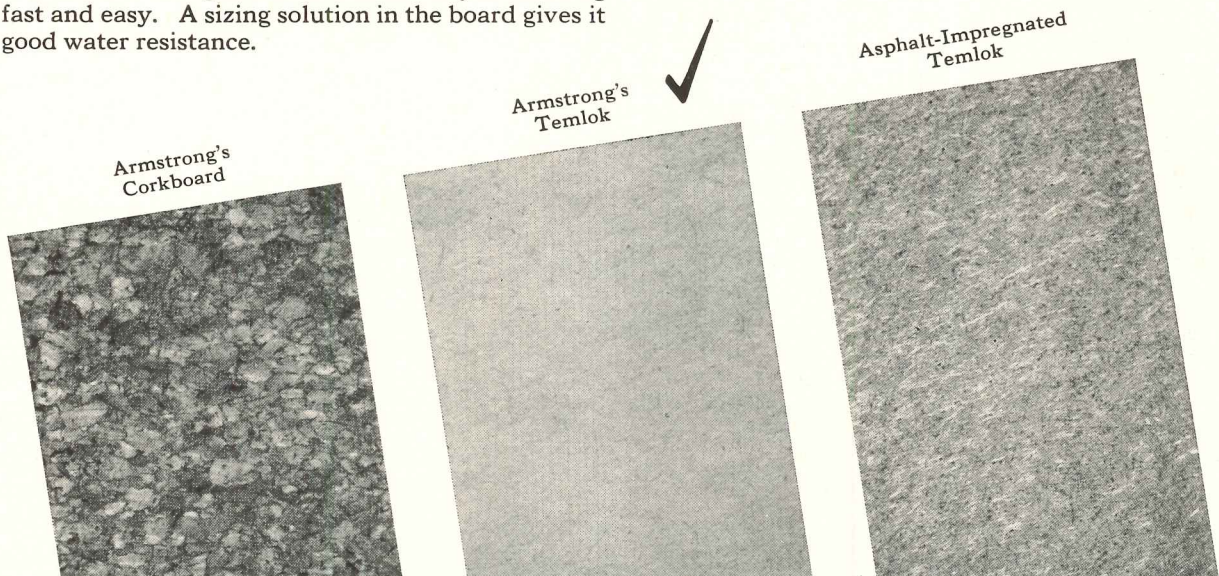



"Monumentality is only for the gods. The Acropolis was never a gathering place." Temple of Zeus Olympios, Athens

THE HUMANIZATION OF URBAN LIFE

By S. Giedion

IF WE EXAMINE, from a human point of view, the road that architecture has been obliged to follow during this century in order to come to terms with its own period, we shall find this divided into two distinct stages.

The development started as a fight against an "infected atmosphere and as a moral revolt against the falsification of forms" (Henry van de Velde). It began far back in the nineteenth century with William Morris's purification of the immediate human environment by giving dignity of form to objects of daily use. From here it passed on to architecture, nowhere more markedly than in the single-family houses built around 1900 by Frank Lloyd Wright and others in the suburbs of Chicago. The American spark reached Europe. The work of the Stijl Group in Holland, Mies van der Rohe's projects for a country house, Le Corbusier's first Paris house in reinforced concrete, were all produced early in the century and all were single-family houses. A study of the single-family house —

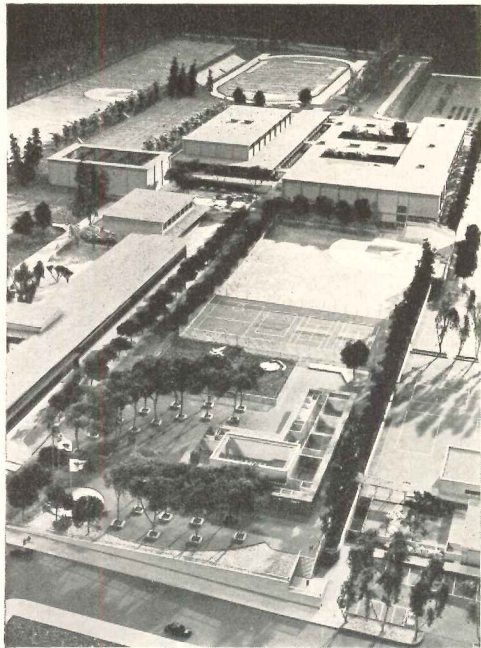

A gathering place for an American city, Sunset Community Center for San Francisco. Wurster, Bernardi & Emmons, coordinating and master plan architects

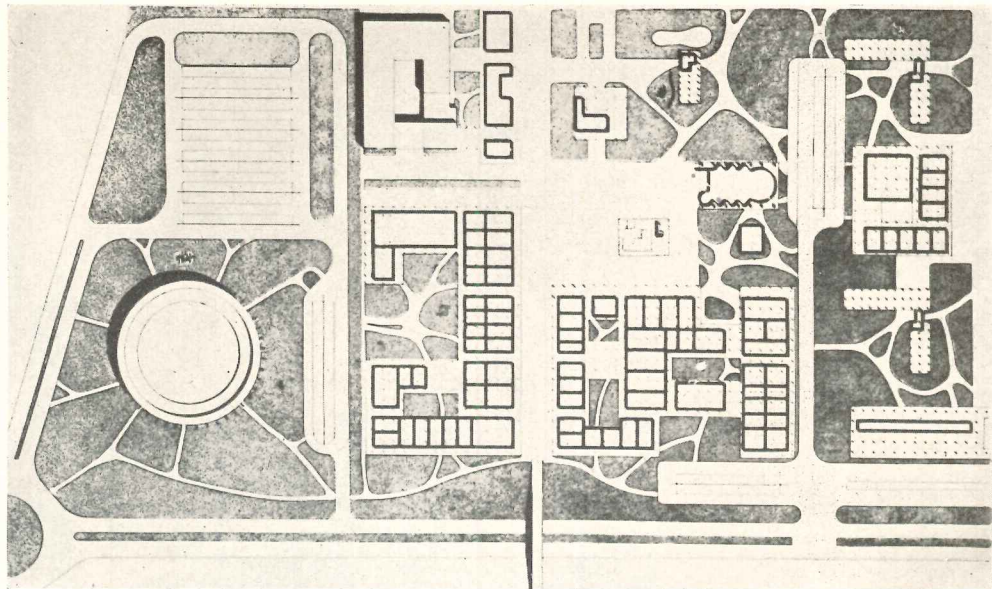

A gathering place for a South American city, Civic and Commercial Center for Chimbote, Peru, featuring an open square surrounded by church and commercial buildings, by Paul Lester Wiener and José Luis Sert

man's most intimate environment — enables one to understand better than anything else whether a man really knows how to build. The climax of this development came later in California. (I was able to develop this observation when editing a volume of the works of CIAM architects from 22 countries — "A Decade of Contemporary Architecture," Zurich 1952.)

The family cell was still the motif of the different forms of multi-storied dwellings that were developed parallel in time, including three-story row houses and skyscrapers. The so-called "tower" houses that have been particularly developed in Sweden are a compromise between high and low forms of housing and, for several reasons, they may be discarded sooner than expected.

The beginning of a link between social and esthetic aspects of the housing movement was marked by J. J. P. Oud's Rotterdam worker settlement (Tusschendyken 1919/20). Today it has reached an experimental climax in Le Corbusier's *Unité d'Habitation* at Marseilles which, by reason of its esthetic importance as well as its internal organization, is as much a contribution to urban design as it is an agglomeration of family dwellings.

This has been the first part of the route. The second stage of contemporary architecture is more concerned with the humanization of urban life. The relation of the parts to the whole, the contact between the individual and the community, has to be restored.

A glance at the big cities, whose functioning has become paralyzed by the impact of mechanization, gives rise to scepticism. Where in a "megapolis" does one

find any trace of community life, or of enjoyment based upon spontaneity and social intercourse, other than in passive observance of a movie or a football match?

Absolutely true. Yet the suppressed demand for social contact, which has lived on imperishably in the human soul ever since men first met in caves during the ice ages and left their ritual symbols on the walls, breaks out spontaneously when man is shaken by some great event. I remember the gathering that collected at the tiny Rockefeller Center at the end of the second World War, when the voice of Lily Pons suddenly arose and gave expression to the emotion that moved the masses.

It is one of the curious features of present day civilization that the contemporary creative focus can no longer be traced to a single center. Today creative impulses within the same movement arise all over the earth.

The Heart of the City

The endeavor to re-establish an equipoise between the individual and the collective sphere is proceeding today throughout the world. This may have been the underlying reason for the selection of the *Core of the City* as the theme for the 8th congress of CIAM (Hoddesdon, England, July, 1951). The term "core" which was introduced by the MARS group of London in the place of "civic center" (whose meaning has become too closely restricted to administrative buildings) may soon come into general use.* Since 1300, according to the Oxford

* The whole problem will be developed in "THE HEART OF THE CITY" edited by E. Rogers, J. L. Sert, J. Tyrwhitt (Lund Humphries, London, 1952).

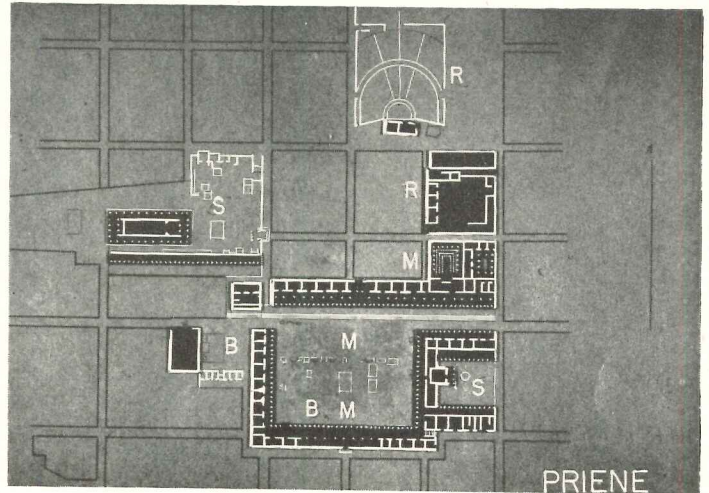
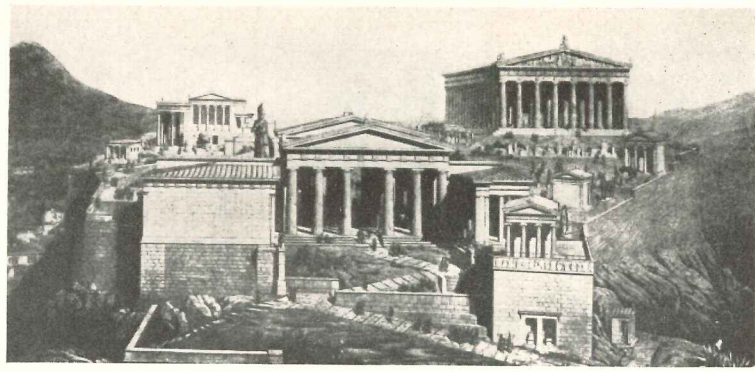
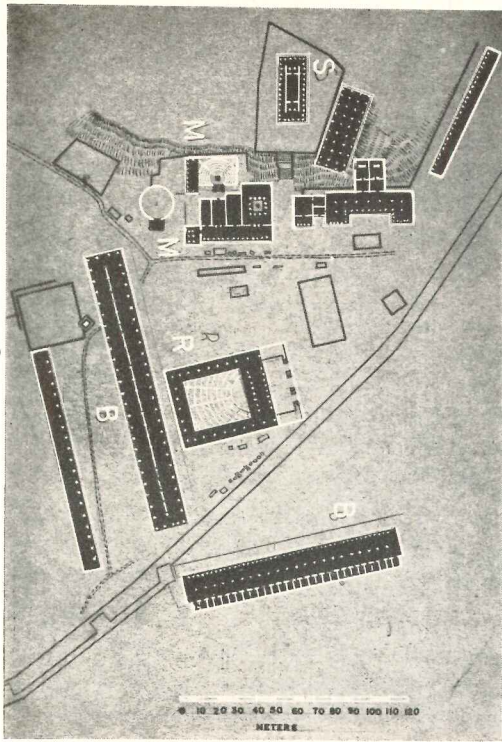

Agora of Athens was an exception in that it had a temple — "the Acropolis was never a gathering place." Right: the agora of Priene, an example of the final status of the agora of old Greek cities

English Dictionary, the word core has meant "the central innermost part, the heart of anything" and it was defined by the MARS group as "the element which makes a community a community and not merely an aggregate of individuals."

Contemporary interest in the core is part of a general humanizing process; of a return to the human scale and the assertion of the rights of the individual over the tyranny of mechanical tools. It seems possible that this demand for the re-establishment of community life is likely to be satisfied sooner in the new town cores that are now coming into being in Peru, Colombia and India than in the highly mechanized cities of the USA.

Is it possible, in our western civilization, to build functioning city cores in the absence of a well-defined structure of society? In contemporary art — poetry, music, painting, architecture — we can see that during the last forty years a new language has been evolved out of our own period by artists who themselves seldom adhere to a formal religious creed or well-defined political convictions.

This development is not without an inner significance. It seems that a new stage of civilization is in formation in which the human being as such — the bare and naked man — will find a direct means of expression. We do not know consciously, for instance, why certain forms or symbols which have no direct significance appear again and again in the works of the most diverse painters. All of these forms are somehow bare and naked as yet. They are, at any rate for the present, symbols

without immediate significance. As Sartre once wrote, "we need today signs and symbols which spring directly to the senses without explanation." He then strengthened this statement by reference to experiments that have been carried out by certain psychologists.

The problem of the core is a human problem. The extent to which it will be fired with life will depend on the people themselves. Architects and planners know that they cannot solve this problem alone and that they need the cooperation of sociologists, doctors, historians. For example, no one at the CIAM 8th congress was listened to with greater attention than Dr. G. Scott Williamson, founder of the Peckham Health Center in London, which was indeed a "core" based on the spontaneous activities of people of all ages. Then the historian was asked to present the historical background of the core, because our period has lost so many of the formerly accepted norms of human behavior and human relations that a special interest has arisen in the continuity of human experience. We are vitally concerned to know how those who came before us handled certain like problems. For instance, how did they develop social intercourse and community life? There is, of course, no suggestion that we should imitate our forebears, but I believe (and here I come back to the symbol of the bare and naked man) that there are certain continuous features running through human history — certain experiences which appear and are lost and then come up again.

To take only a very simple example: the right of the pedestrian in the center of community life — in the core.

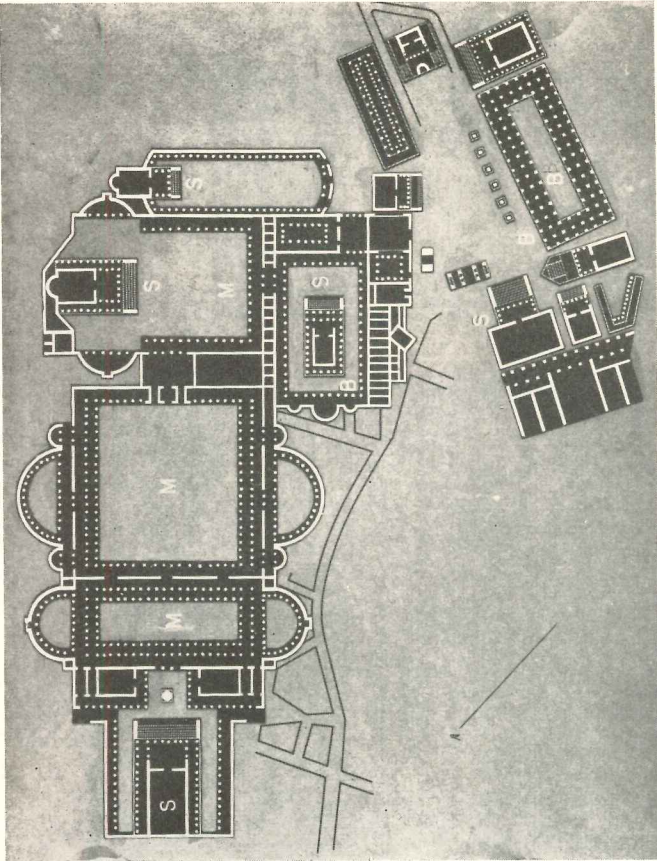

The Roman Forum and the Imperial Fora differed from the Greek agora; the "Forum Romanum was a completely disordered place," intermingling business, religion, justice and public life, impossible to the Greeks

This was carefully respected, and indeed self-evident, in all former civilizations. Today this right of the pedestrian — this human right — has been over-ridden by the petrol engine, and so the gathering places of the people — the places where people can meet together without hindrance — have been destroyed. Today one of our hardest tasks is the reestablishment of this human right, which is not merely imperiled but has been destroyed altogether.

So, when we look back into history we wish to pose very human questions such as, "What is still the same and what is quite different between us and you?" Or, in this particular case, "Is there still today a need for the core?"

Does this question really need an answer? There are many architects and planners who are at this moment engaged in the actual work of construction and reconstruction of city centers; who are in the midst of the practical problems of realization of their plans for the core. Besides this there are also other anonymous signs of interest in this question, which are, from the point of view of the historian, just as important. These are direct impulses that are arising from the general public.

Spontaneity

The man in the street — and that means each of us — has undoubtedly an urgent desire to get away from his purely passive position as an onlooker at a football match. Today he wants — and this is different from the nineteenth century — to act his own part in social life.

In June, 1951, we had a festival in Zurich to celebrate the 600th anniversary of the entrance of Zurich into the Swiss Confederation. The streets of the medieval city center were closed for two days to all traffic, and benches were spread over the tracks of the tramways. It poured with rain, and yet one couldn't chase the people away from the streets. Everywhere there was music and throughout the whole night people danced in the streets under umbrellas, and medieval nooks and squares were used as open air theaters. The festival was a reunion of people from the whole canton of Zurich. Those who came from the different parts of the canton gathered spontaneously together and performed their own plays. We had been very much afraid that the medieval core of Zurich had been altogether destroyed. Suddenly we discovered that something still remains and that — given the opportunity — people will dance and play theater in these open spaces.

Everybody was astonished at the spontaneity of the public. To be actor and spectator in one person, that's what is wanted! It is clear that the public is ready. The question is whether we are! Let us not wait for a structurally well-defined society to arise. Let us just ask what is alive in the bare and naked man and needs to be given form and expression. Let us just ask what there is that lives in the bare and naked man, who is not just a symbol but is us, ourselves.

I had another experience recently in Amsterdam. I saw a number of childrens' playgrounds that have been created under the guidance of van Eesteren and designed

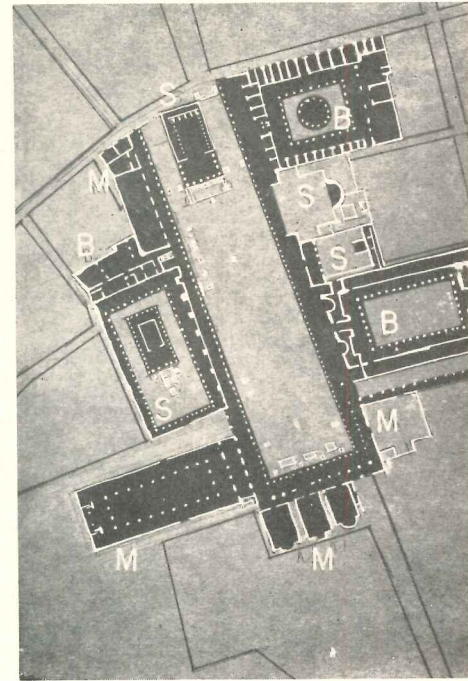
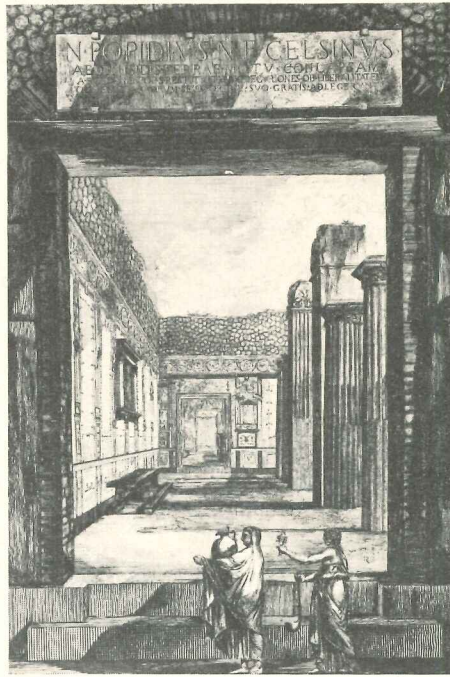
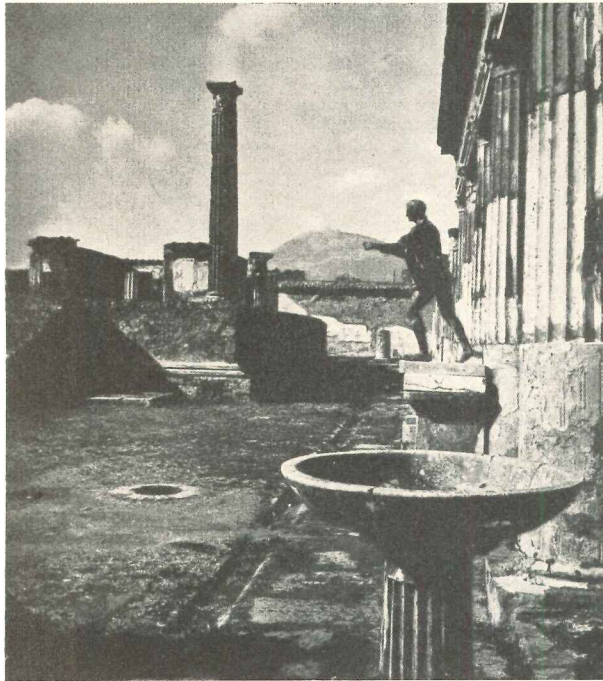

Pompeii with its temples (and with stepping stones at openings) barred wheeled traffic from the public square

by a young Dutch architect Aldo van Eyck. These have been made from very simple elements — a circular sand pit, some upright steel hoops, a parallel pair of tree trunks lying horizontally. But these simple elements are grouped so subtly — with a background of the Stijl movement and modern art which injects some kind of vitamin into the whole performance — that they act as fantastic starting points for the child's imagination. These playgrounds also, simultaneously, fulfill another function. The careful design of their layout has transformed useless pieces of waste ground into active urban elements. One needs only to provide the opportunity and we, the public, who are also maybe children of a kind, will know how to make use of it.

The Core in Greece and Rome

Like plants, human settlements require certain conditions for growth, though human community life depends upon far more intricate conditions than the plant. What is common to both however is that there are certain periods which favor growth and other periods which hinder it. There are periods in which many new cities are founded, and hundreds of years during which no new cities are started at all.

A city is the expression of a diversity of social relationships which have become fused into a single organism. The conditions which influence its growth can be of a widely dissimilar nature. New cities have arisen in periods of dictatorship, when the despot has had power to compel everyone to build in conformity with a single

design. They have also arisen in periods of purposeful communal energy. The despot has the advantage of his capacity for rapid and ruthless action; but, as his sovereign will is bound to ignore the imponderable laws which stimulate human cooperation, a city built under a dictatorship can never acquire that essential quality of organic diversity. In cities that have been developed by the united efforts of their citizens, everything — even to the last detail — is permeated by a marvelous strength.

Never since the Fifth Century B.C., when the democratic way first found expression, has so much loving care been lavished upon the gathering places of the people, or space been so amply provided for them. Nor has the place where the decisions of the people have been enunciated ever dominated the physical and moral structure of the town so effectively as the agora of these Greek cities.

When I was in the United States I felt very conscious of the absence of places where one could stand about — to rest, to stop, to speak, just to move about in. To make the future generation of architects consciously aware of this absence, I conducted a seminar on "civic centers and social life" first at Yale in 1942, then in both Zurich and M.I.T., where some of the illustrations to this article were made by the students. These illustrations follow the normal methods of CIAM in that each city is represented in the same manner and upon the same scale.

A sociological question came up immediately: "What was the relation between the plan of the city and its



The City of Berne, an example of one of the planned towns of the 12th century

social life?" and we were plunged at once into this curious experiment of Greece — the most exciting that mankind has ever experienced — this sudden awakening of the individual mind with, behind it, the enormous background of Oriental and Egyptian tradition.

The gridiron system is an oriental invention. This is clear, not only from recent discoveries in the Valley of the Indus, but — above all — in the work of the only Egyptian revolutionary, the Pharaoh Akten-Aton, who in the 14th century B.C. built, within twenty-five years, a city on the Nile (on the site of the present village of Tel-el Amarna), which is an absolutely clearcut gridiron. But the Greek gridiron of Hippodamus is something quite different from the gridiron of Akten-Aton (and also completely different from the gridiron of Manhattan). In both Egypt and the culture of the Near East the gridiron had within its center either the palace of the king or the temple. In Greece it was completely different. Here the core of the gridiron was the agora — the gathering place of the people.

What is the agora? It is now established that in the beginning the agora was above all the gathering place of the people and not just a market. It was only with increasing trade and wealth in the fifth century B.C. that the agora became more intermingled with commerce. The agora in principle is an open space — a square — surrounded loosely by simple buildings intended for public use. In the Hellenistic period the agora came to be bounded by standardized elements, still very simple in form — columns, porticos and an entablature — that

formed the stoa, a covered way protected against rain and sunshine which served above all as a meeting place for the formation of public opinion. Sociologically it is especially interesting that no buildings faced directly upon the agora itself. The stoa was supreme. The public buildings — Prytaneum*, Buleuterion**, etc., were in close contact with the agora, but stood behind the stoa. The agora itself was for the community: not for the council, not for anyone else, but only for the people, and exclusively for the people. On the inner wall of the stoa and in the square itself objects were placed in memory of those who had worked well for the community.

Priene is one of the best examples for study because of the excellence of its excavation, and it is interesting to notice here the lack of direct relation between effect and cause. Here, as in so many other cities, the final status of the agora only appeared after the Greeks had in fact lost their liberty. Agoras in their final form were made at the time of Alexander or later, very few before. But the idea of the agora is inherent in the democratic conception of Greek life.

One thing more. In the Greek cities there is a clear classification of functions. Monumentality is only for the gods. The Acropolis was never a gathering place. First it was the quarters of the king, then, when he was eliminated, it became the quarters of the gods, the consecrated area with the temples. Recent American excavations have shown that there was a temple on the

* Public building enclosing the eternal hearth, mystical court and the assembly of the elders.
** Council Hall.

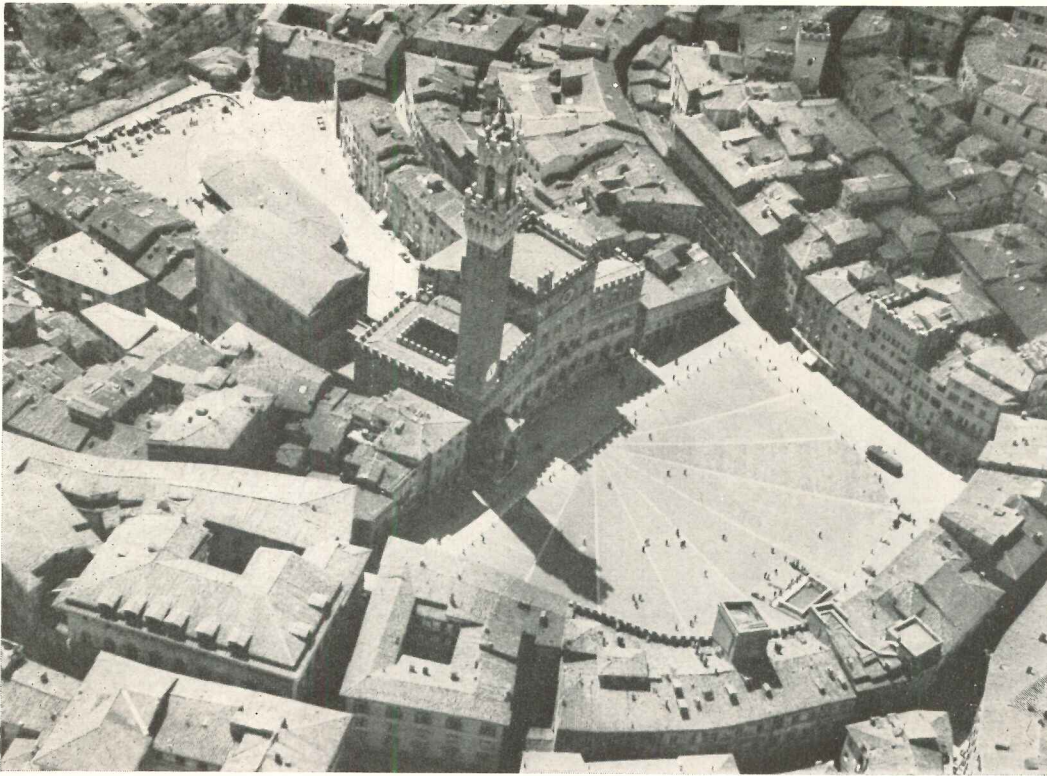

The main square of Siena, all lines as well as the formation of the square, pointing to the town hall

agora at Athens, but this agora, which was gradually built throughout centuries, was an exception. The agora is a community place, well defined and very nicely arranged, but very simple. Finally there is the private life. By the law of Athens any citizen who had too large a private house was chased out from the city. Private life was very humble. These three degrees — first the gods, then community life, then private life — were never again distinguished so clearly. Even in medieval cities — the only period in which we can see a continuation of antiquity — different functions were intermingled.

Now the Romans. What is the difference between the Forum Romanum and the agora? It is very clear and very great. The Forum Romanum was a completely disordered place. It would have been impossible in Greece to place the prison, the *carcer*, next to the *rostrum*, the people's platform. *Carcer*, *rostrum*, temples, treasure houses and *comitium* (the patrician's stronghold): this was the nucleus of the Roman Forum Romanum. The Romans from the beginning intermingled business, religion, justice and public life. But this does not mean that the Romans did not understand how to build cities. It is true that Rome itself never had a plan. All failed who made the attempt — Julius Caesar, Nero, the Antonins. The city of Rome was so much a disorder that traffic had to be forbidden in the streets during the day by law. The rich lived in the best places on the hills and the poor in squalor in buildings of five to eight stories.

But there are small Roman cities such as Ostia or

Pompeii where the urban development becomes more evident. In both of these — in contrast to the Greek practice — there is a temple dominating the forum.

But besides differences between Greece and Rome, which reveal divergent conceptions of community life, common features prevail. The right of the pedestrian is regarded as sacrosanct in both the agora and the forum. For instance, the surface of the main forum of Pompeii was depressed: "stepping stones" and columns made it impossible for wheeled traffic to enter.

One word about the Imperial Fora of Rome, which were built over a relatively short period — 50 B.C. to 115 A.D. — from Julius Caesar to Trajan. The Imperial Fora in their sterile pomp are, for me, the beginning of academic architecture. They somehow foreshadowed the nineteenth century.

The Core in the Gothic Period

What happened through the medieval period? Decay, decay, decay, through centuries. The standard of life sank rapidly. Existing cities became depopulated and hung heavily, like an over-large garment, upon the shoulders of their shrunken inhabitants. Then came a sudden awakening. In the eleventh and twelfth centuries new cities were founded all over Europe. I may have a certain prejudice, but I find the most interesting are those in South Germany and Switzerland. The normal view of the romantic medieval city is here entirely debunked. These new towns were not in any way haphazard foundations. As a consequence of the low stand-



Michelangelo's Capitol in Rome, "a comprehensive development in depth"

ards of living that had prevailed through centuries, these new medieval cities, in contrast to the cities of Greece and Rome, show an intermingling of public and private life. The market place, whether bordered or not by arcades, is surrounded by the private houses of the citizens. Also, in contrast for instance to Pompeii with its stepping stones, no care is taken to see that traffic is kept out of the public square. On the other hand, the street — the shopping street — acquired a new and much more intense significance.

The city of Berne may be taken as an example of one of the planned towns of the 13th century (and also to destroy the romantic conception of the medieval cow-path city). Berne was laid out in regular and equal ground plots, 100 x 60 feet, along three parallel streets. These plots determined the whole construction of the town. The front length of 100 feet could be subdivided in 4, 5, 6, or 8 parts — a system which still prevails today. The streets and the porticos which stood in front of the houses, were owned by the protector of trading rights, the emperor or his representative. Both street and porticos were therefore *res publica* destined for the market, for public affairs and for justice. The life of the city took place along the street: the town hall with its square was not built until the fifteenth century.

The Core and the Artists

Finally we may come back to our question: How can we build the core in the absence of a well-defined structure of society? There is certainly some relationship

between the social structure of a city and the physical structure, or urban form, of its core. But one must issue a warning that this is not always strictly true.

It was all so easy in the old days — even in the nineteenth century! History was simple and so was physics: effect and cause in history, effect and cause in physics, effect and cause in psychology. It was the physical sciences that first abolished this rule, and today we are forced to recognize that the relation between the core of the city and the social structure of the city is not at all so simple and so rational as we once thought. It does not always obey the law of effect and cause.

Let me finish with a single example. It is a tragic example: Michelangelo's Capitol in Rome. The *Area Capitolina* occupies one of the hilltops of ancient Rome. It is composed of a complex of the square itself (which is not a real square, but more of a trapezoid); a broad ramped stairway (the *Cordinata*), and three buildings (the Senatorial Palace or town hall in the background, the Palazzo dei Conservatori on the right and the Capitoline Museum on the left).

The architectural composition of the Capitol can be rapidly summarized as a comprehensive development in depth: piazza, stairway and the relation with the old medieval city of Rome.

In 1530 the city-republic of Florence lost its independence to the Medici despot, Cosimo the First. Michelangelo came from an old Florentine family and, in 1534, he left Florence forever and spent the remaining thirty years of his life in voluntary exile in Rome. Here

he gave concrete reality to what he had derived from his youthful democratic experiences in Florence. Here, in the Rome of the Counter-Reformation, a Rome in which there was no freedom and no democracy, Michelangelo's Capitol — a very perfect expression of the core — was a symbol of the vanished liberties of the medieval city-republic that he held in his heart. It was, at the same time, a memorial to the tragic dreams of its creator.

The lack of imagination usually shown today (though there are a few exceptions) in our attempts to devise new

city centers — new city cores — is invariably excused on the ground that we no longer have a way of life that it is possible to express. What Michelangelo has mirrored in his Area Capitolina is the baffling irrationality of historic events and the enigmatic omission of any direct relation between effect and cause.* Once more we realize that a great artist is able to create the artistic form for a phase of future social development long before that phase has begun to take shape. This is our task today!

** In the forthcoming 9th printing of Space, Time and Architecture this problem is treated more extensively.*

The square at St. Peter's, completed by Bernini, who erected the colonnades enclosing the piazza

Black Star



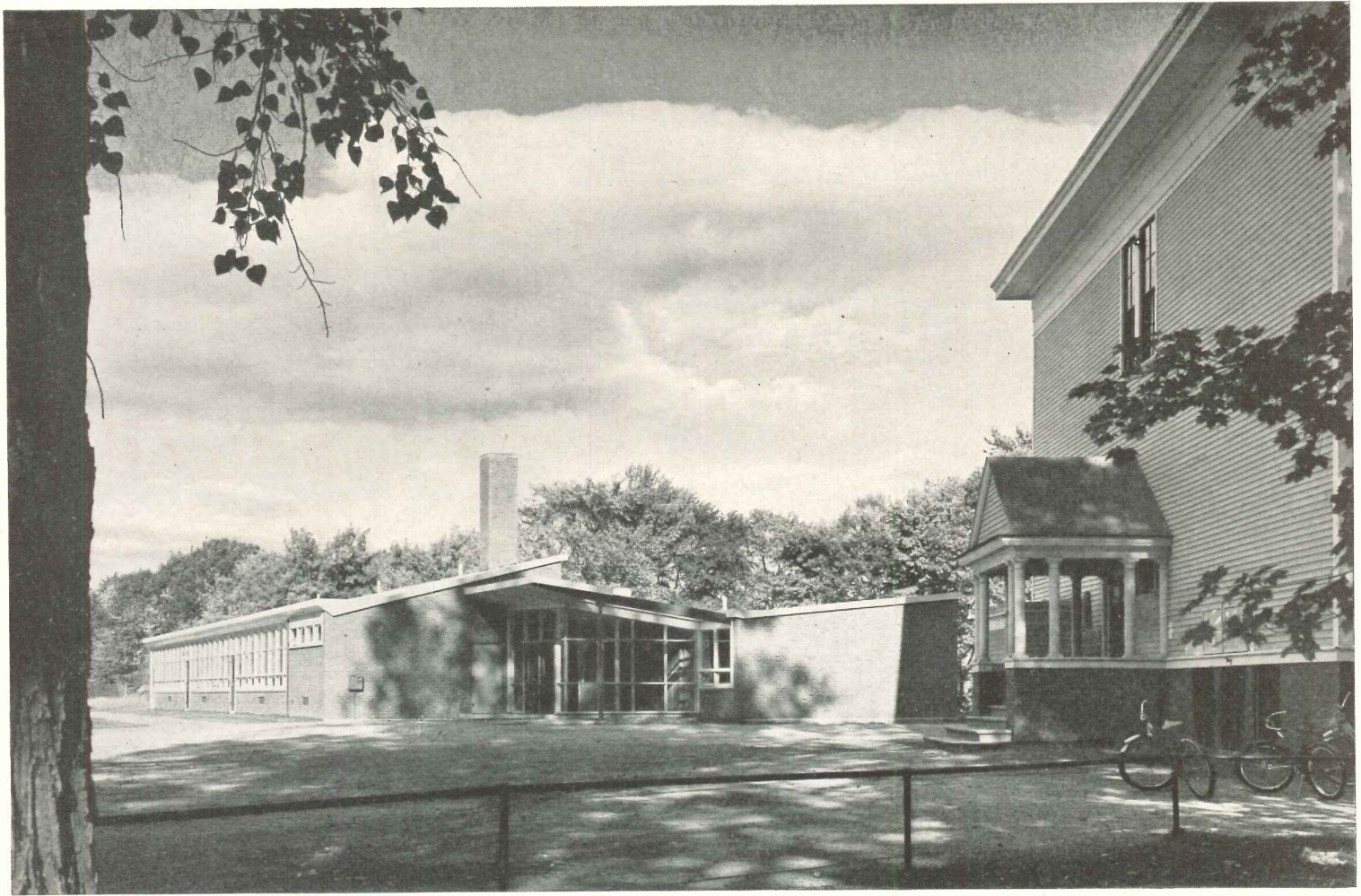

Joseph W. Molitor

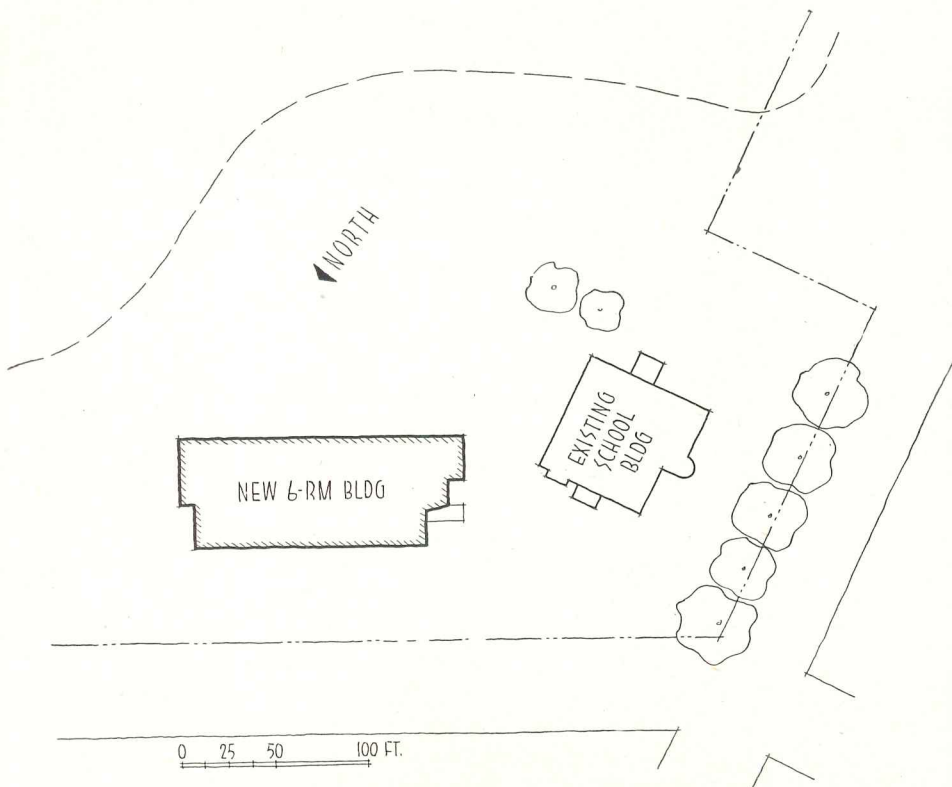

ADDITION TO

Facing page: northeast facade and old building. Sketch: west end is wood to simplify work of adding future classrooms. Right: lower panels of vestibule walls are safety glass

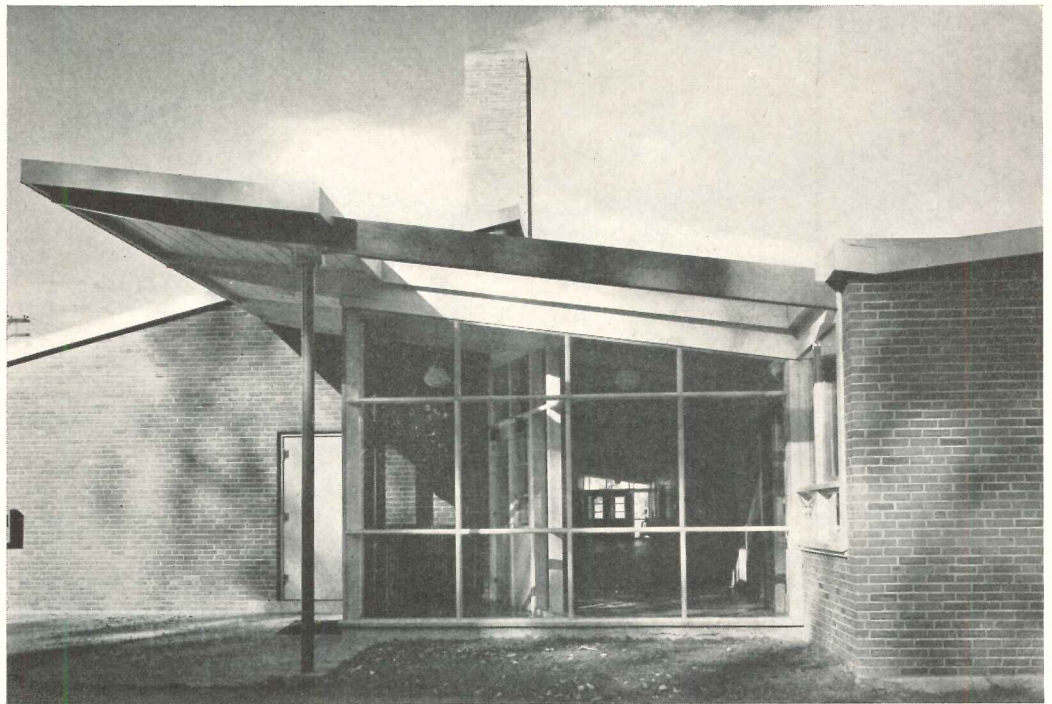

WASHBURN SCHOOL, AUBURN, ME.

Alonzo J. Harriman, Inc.

Architects and Engineers

IN DESIGNING this school building the architects and engineers translated advanced architectural and educational thinking into a building for a specific climate and location. Maine has real winters. Folks there are traditionally cautious about spending money. The natural environment had to be controlled and a building and classrooms which would stimulate both children and teachers had to be produced without wasting money. The cost per classroom for this six-room structure was \$13,861; per student, the cost was \$462. Construction is simple: steel columns, with walls continuous outside them; open-web joists fully exposed, supporting an insulated wood-plank roof; and a concrete slab on grade.

WASHBURN SCHOOL

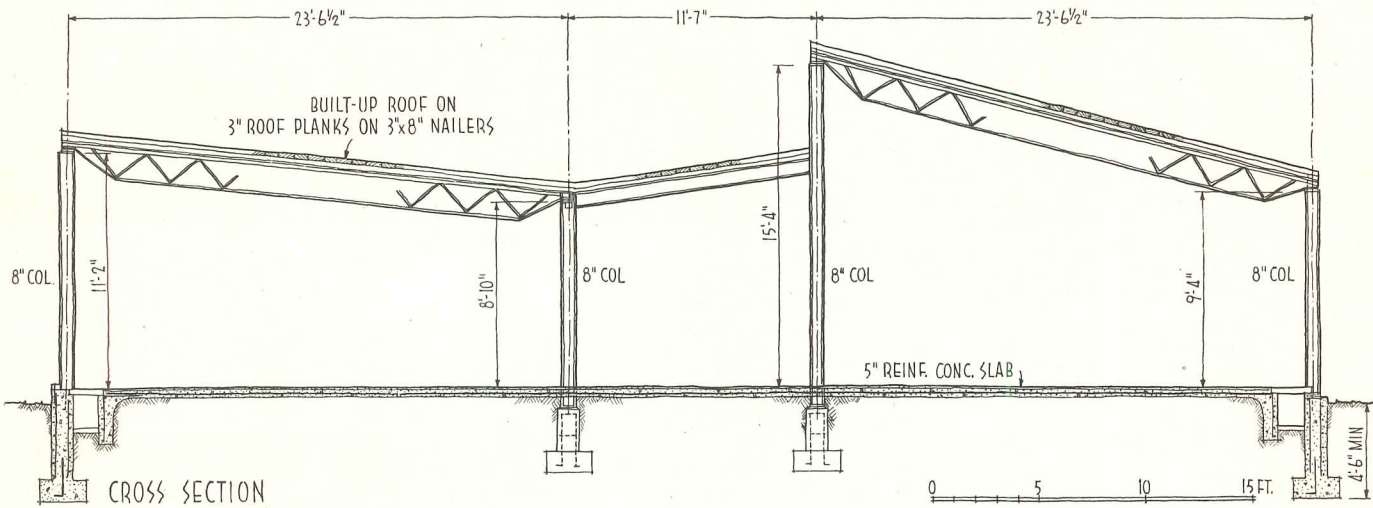
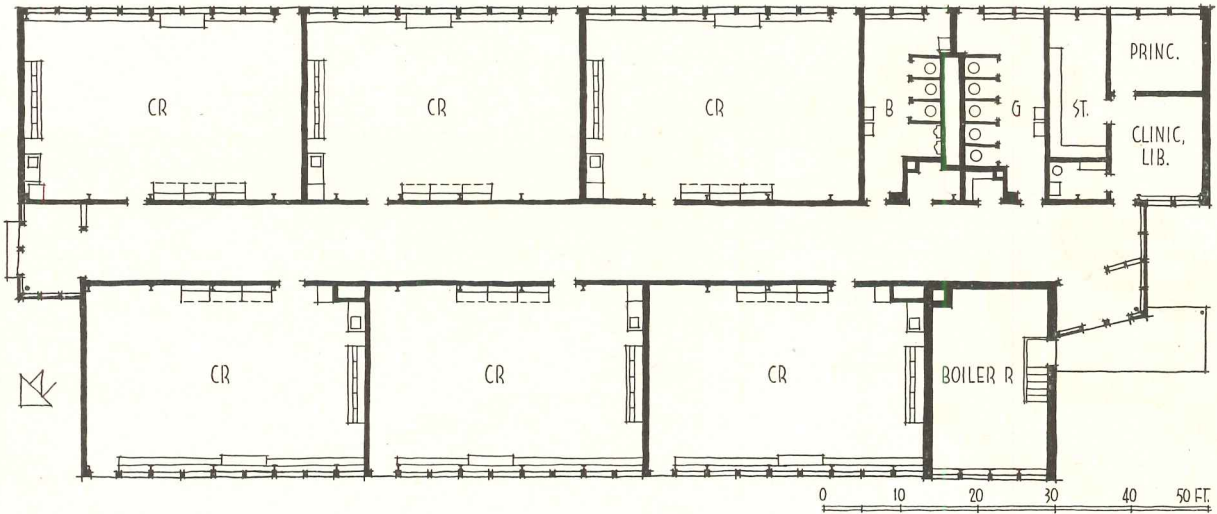

Section above and photos at right show use of clerestory to admit sunlight to all rooms, even those which face almost due north. Entire structure can be comprehended at a glance; disposed in an orderly fashion, structural elements and mechanical and electrical runs are visible to a degree as satisfying as the vaulting of a cathedral, the half timber of medieval houses, or a beamed colonial ceiling



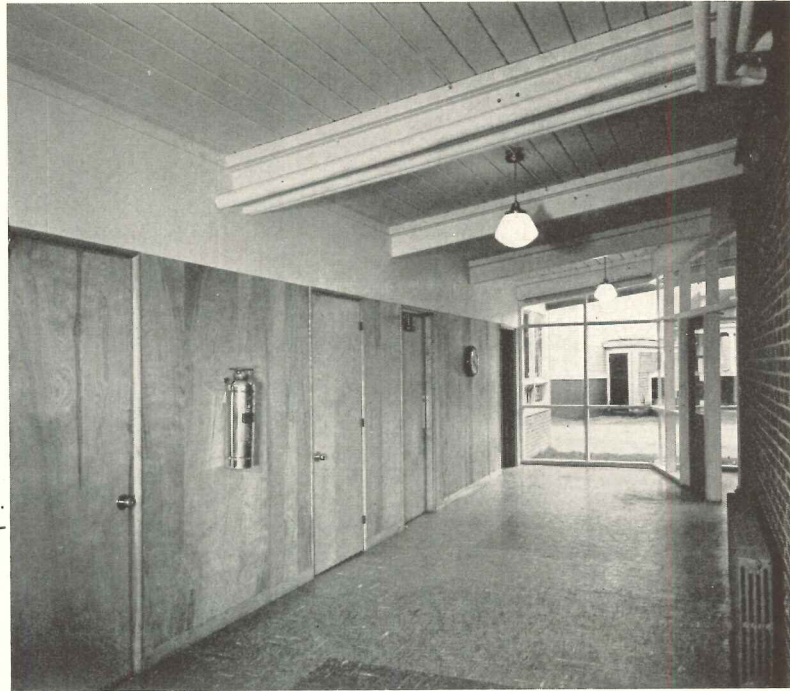
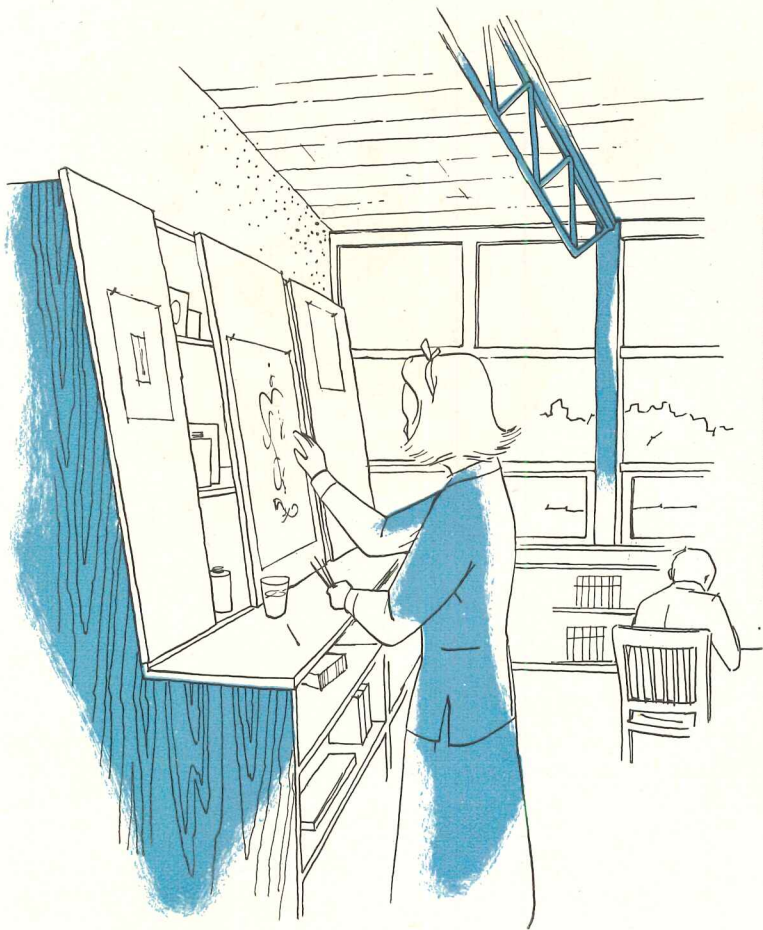

Joseph W. Molitor

Easel units, one for each classroom, were built locally for \$500 each. See details on following pages

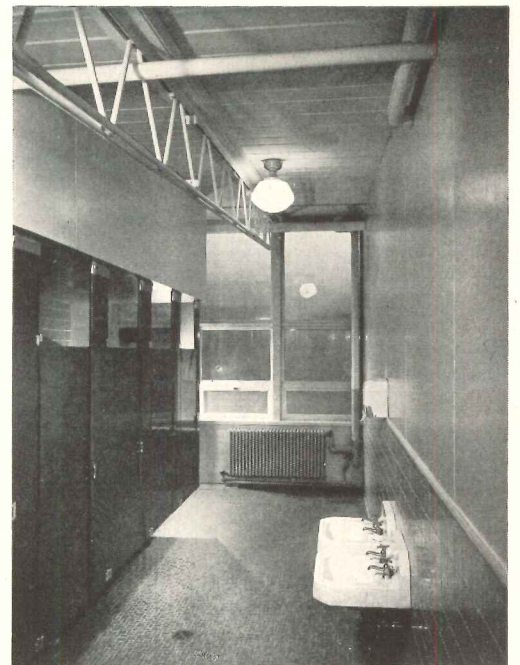

Toilets are blue and yellow, have ceramic tile floors and wainscots, wall-hung fixtures to facilitate cleaning

WASHBURN SCHOOL

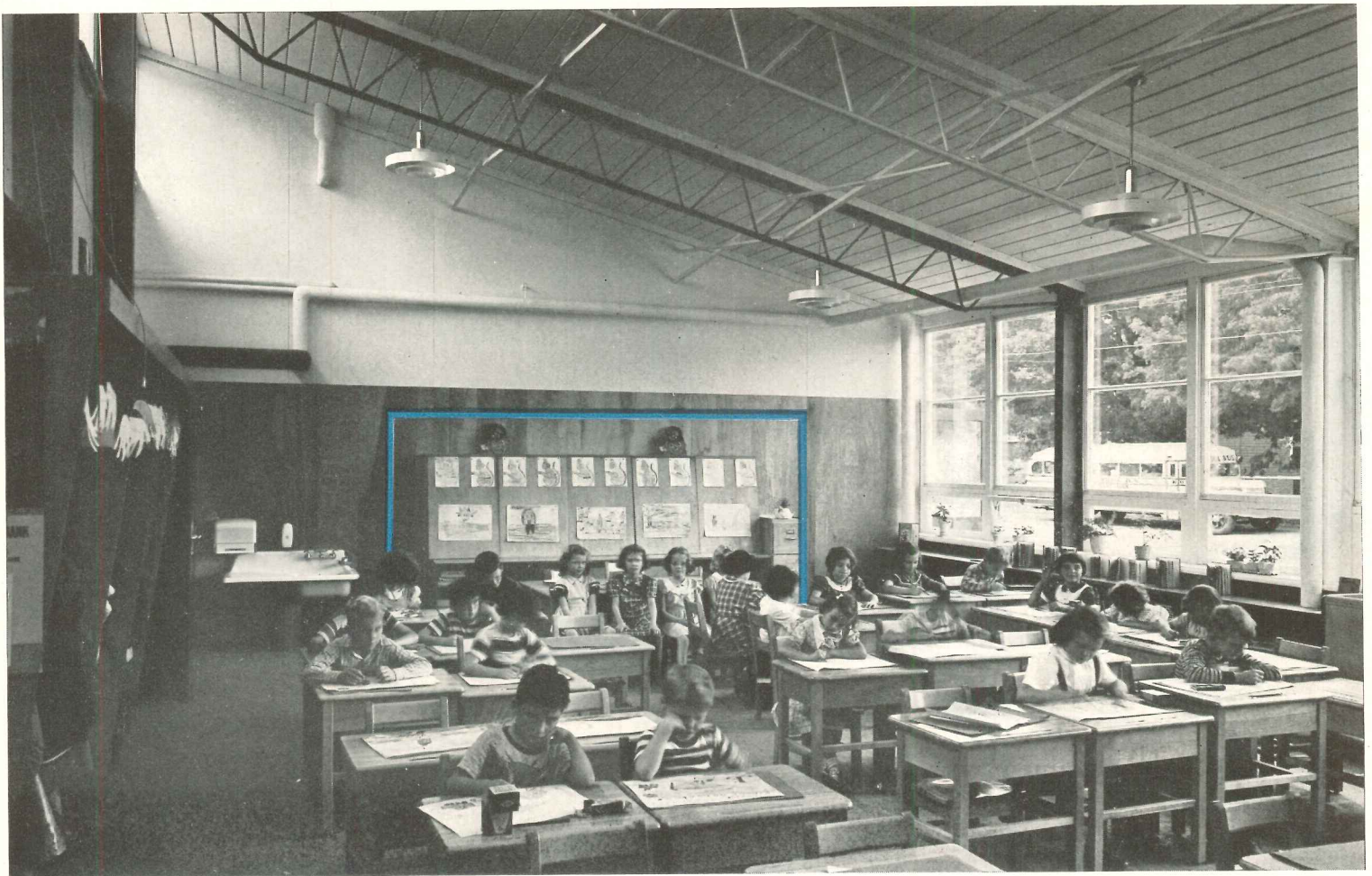

In photo and details on this page, note classroom easel units

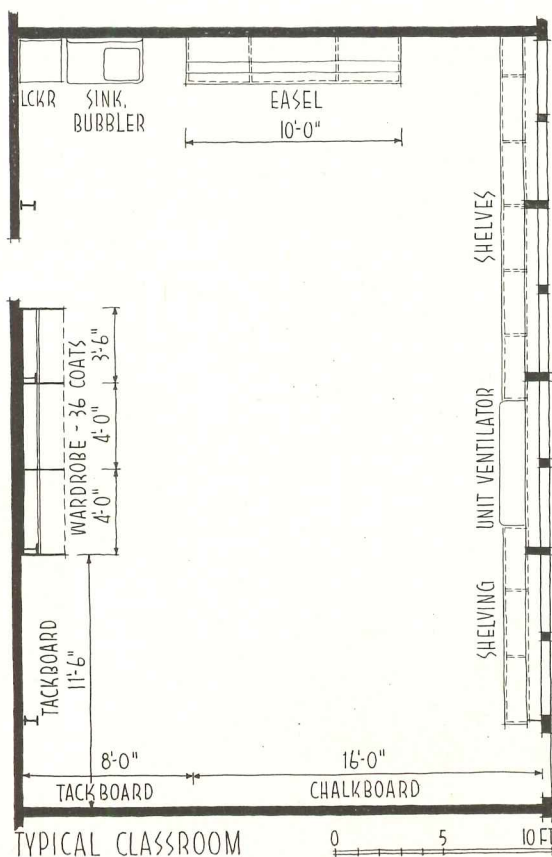

TYPICAL CLASSROOM

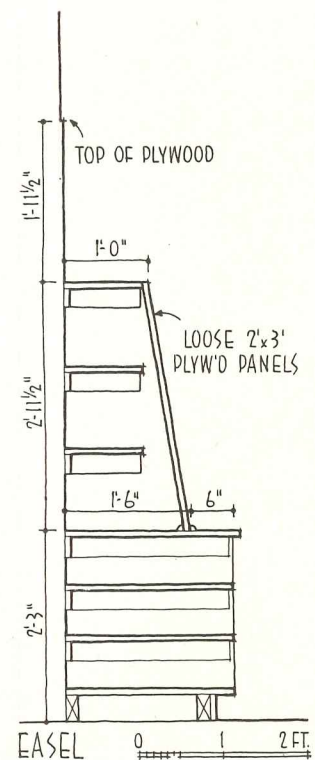

ARCHITECTURAL RECORD

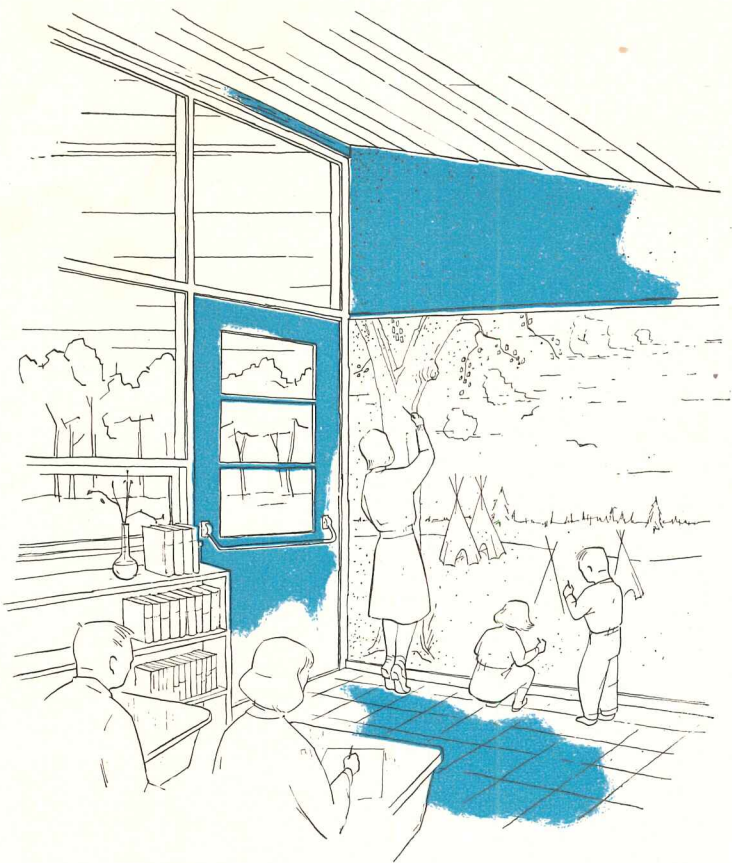

Joseph W. Molitor

Numerous things were done in Washburn School to make it a children's building. Children in the elementary grades which it houses have a love for strong color. At the same time optimum visual conditions demand light, highly reflective wall and ceiling colors which are, to children, scarcely color at all. Here, brilliant color is used sparingly against a light background. In each room one ceiling joist and column are painted a strong primary color; besides satisfying a psychological need, the color serves to delimit the portion of each room used as an

activity area. Ceiling and upper walls are white. Floors are concrete covered with gray asphalt tile. Wainscot, of light-toned hardwood plywood, and tackboards and chalkboards, are carried to the top of the door trim. Chalkboards, as shown in the sketch above, are carried from door-head full to the floor. At this age, children vary somewhat in height, and whatever their height they often sprawl on the floor to draw. Lengths of chalk tray are inserted into the board at convenient intervals. Tackboards also extend to the floor.

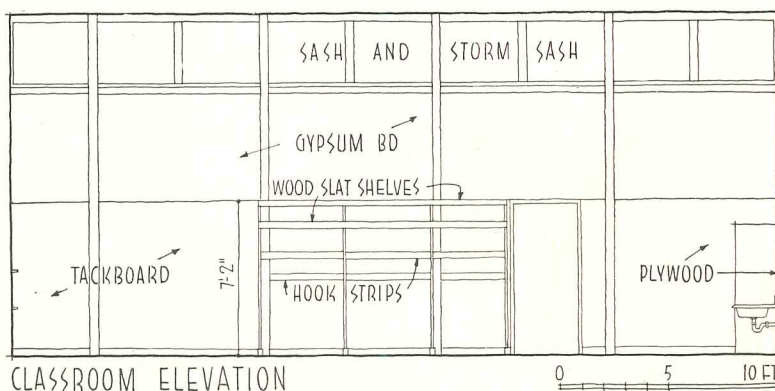
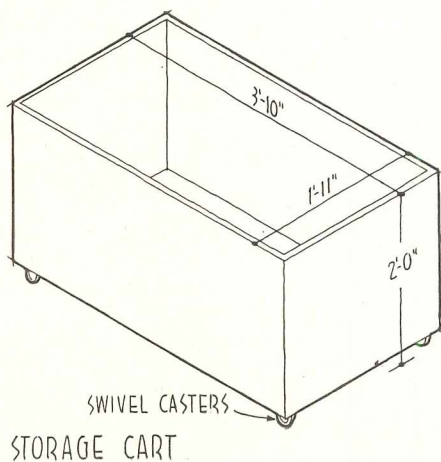

WASHBURN SCHOOL

Artificial lighting is incandescent, with photo-electric cell controls which switch them on whenever daylight provides too little interior illumination. This relieves the teacher of the chore — often neglected — of controlling lights manually. Heating and ventilation are supplied by units under windows. Stale air is vented through the roof. The main steam supply, often buried in a floor trench, is here suspended on the wall of the north bank of classrooms beneath the clerestory. In this position its unavoidable emission of some heat is employed to minimize cold downdrafts from the high windows.

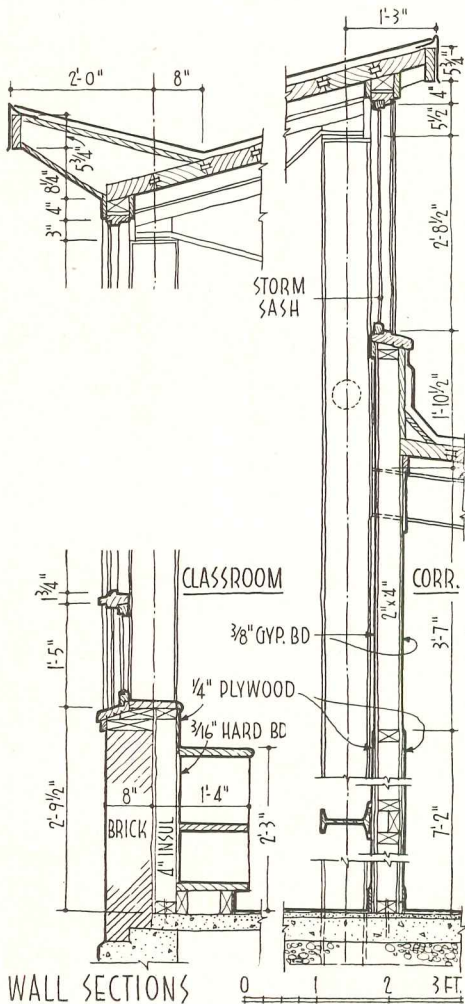
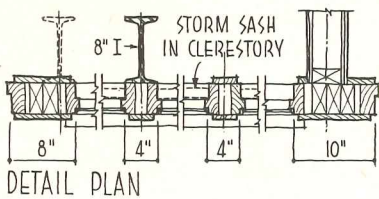
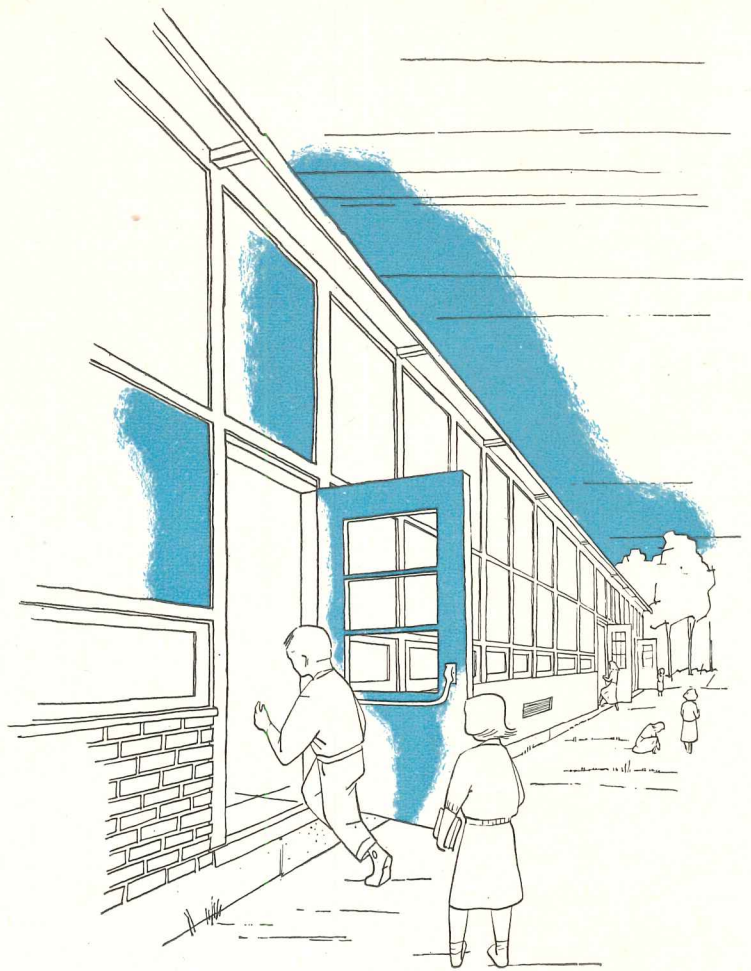

Exterior classroom doors are painted different primary colors, keyed to colors used inside. This helps each child identify himself with his room, and achieves the gaiety and brilliance of a toy

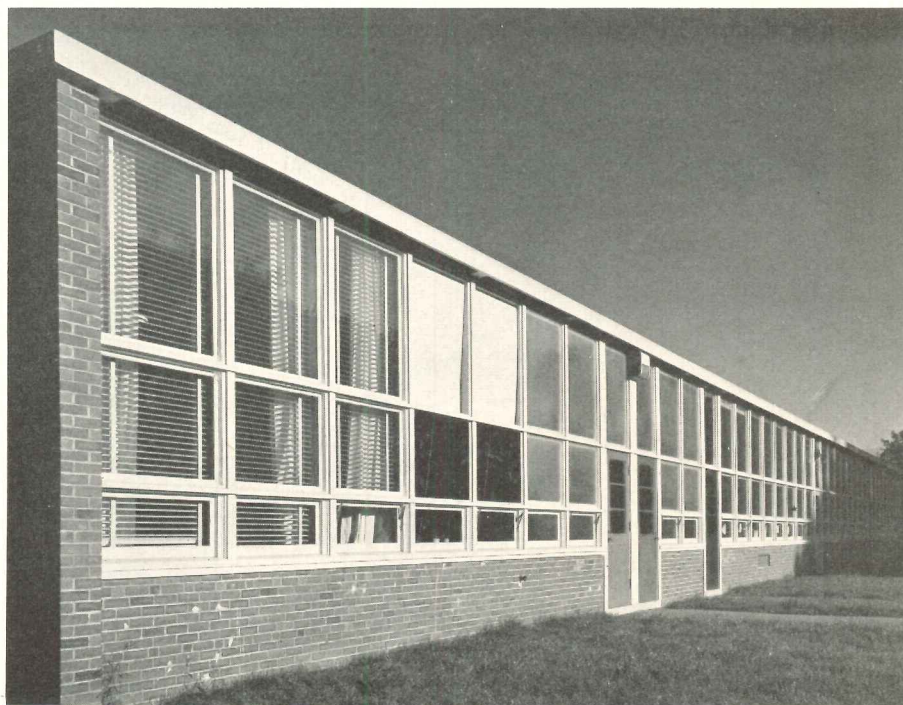

Joseph W. Mollitor

UNIT COSTS

Contract Price _____		\$83,169.
sq ft 8,560 _____	cost/sq ft _____	9.71
cu ft 115,594 _____	cost/cu ft _____	.71
Plumbing, Htg., Vent. _____	\$1.99/sq ft	
Electrical _____	.322/sq ft	
Cost per Classroom _____		\$13,861.
Cost per Pupil _____		462.

COST ANALYSIS

COSTS PER SQ FT

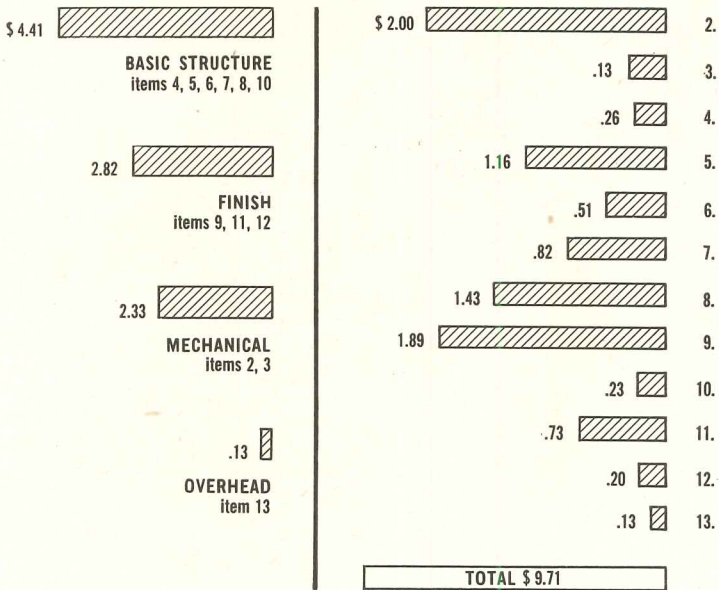

- | | | |
|-----------------------------|---------------------|-------------------------|
| 2. Plumbing, Heating, Vent. | 6. Masonry | 10. Roofing |
| 3. Electrical | 7. Struc. Steel | 11. Painting—Floor—Wall |
| 4. Site Preparation | 8. Rough Carpentry | 12. Allowances |
| 5. Concrete Work | 9. Finish Carpentry | 13. Temp. Office, Bond |



Library-clinic anteroom (above) and principal's office are treated with color and furnishings to induce relaxation



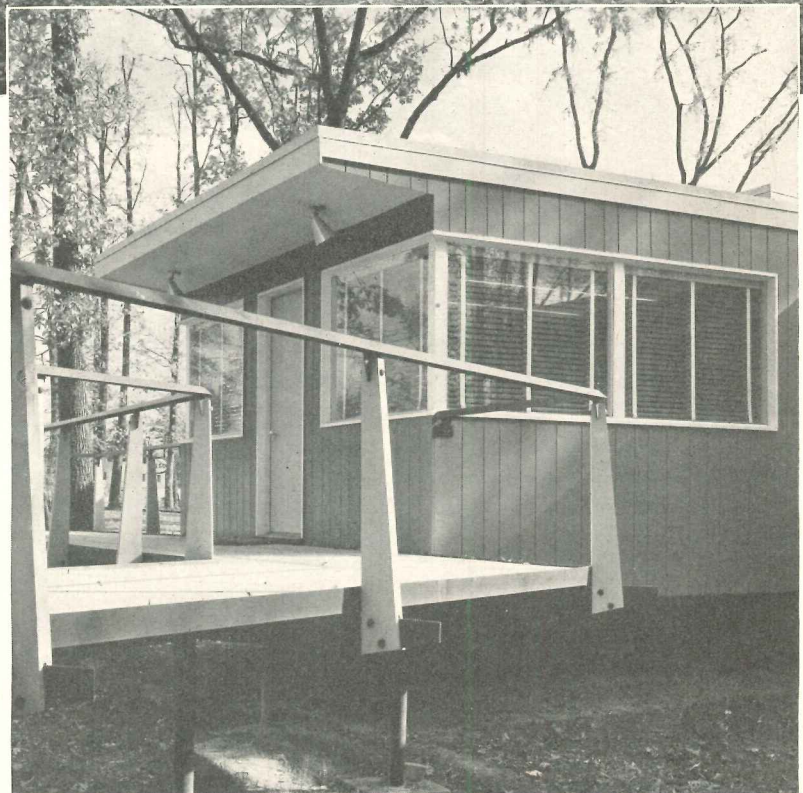



Joseph Molitor

OFFICE FOR BESSEMER IMPROVEMENT CO.

Greensboro, North Carolina

Edward Loewenstein, Architect

WHEN THE REAL ESTATE and development company which owns this building chose the site for the project, it had two main goals in mind: to provide offices away from the center of town and to prove that low, swampy property could be used to good advantage. The site is in the midst of a large area owned by the Bessemer Company. Most of it was 8 ft below the street and several feet below existing sewers; it was partially wooded and generally under water during rainy seasons. Similar sites on the property were not saleable until this building had been completed and it had been proved that construction was possible without great expense and filling.

The original plan was to place the building on a single, central column enclosing the services. The owner considered this too radical, however, and suggested four

columns. A block foundation finally was adopted after it had been decided to provide space for heating and air conditioning, plus a garage-work shop at ground level. The original contours of the site were preserved, which is expected to permit easy landscaping and planting in the future.

Half of the building is given over to a private office suite which includes the owner's office, storage space, lounge and light lunch facilities, and a screened sun deck where business may be transacted in good weather. The other half of the building consists of offices for the development company's staff.

Foundation is concrete block, framing is wood stud. Exterior walls are random width pine, painted. Interior walls are plywood, floors are rubber tile over wood, ceilings are acoustical cane fiber tile.

OFFICE FOR BESSEMER IMPROVEMENT CO.

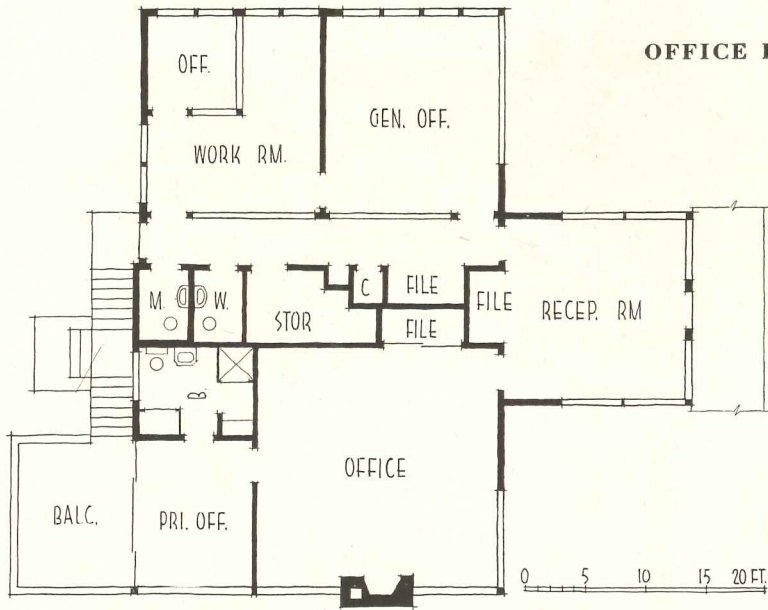

In both plan and section the building is refreshingly simple and well adapted to its swampy site. Opposite page: offices are well lighted and airy; windows are shaded with venetian blinds (top) or split bamboo (bottom). Fireplace wall has marble inserts

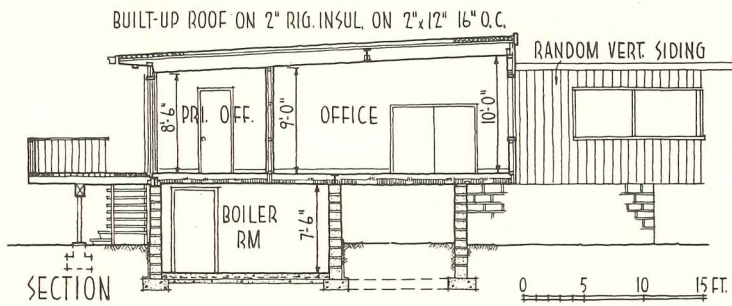

Joseph Molitor

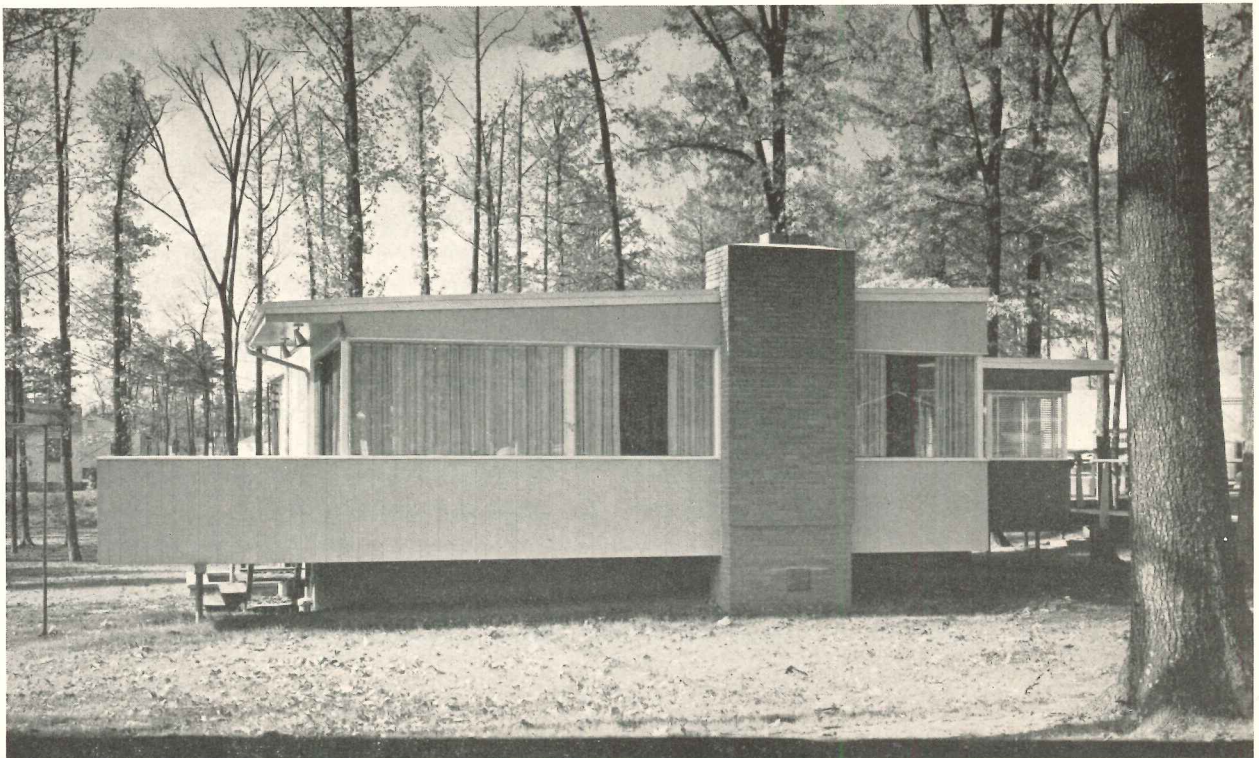

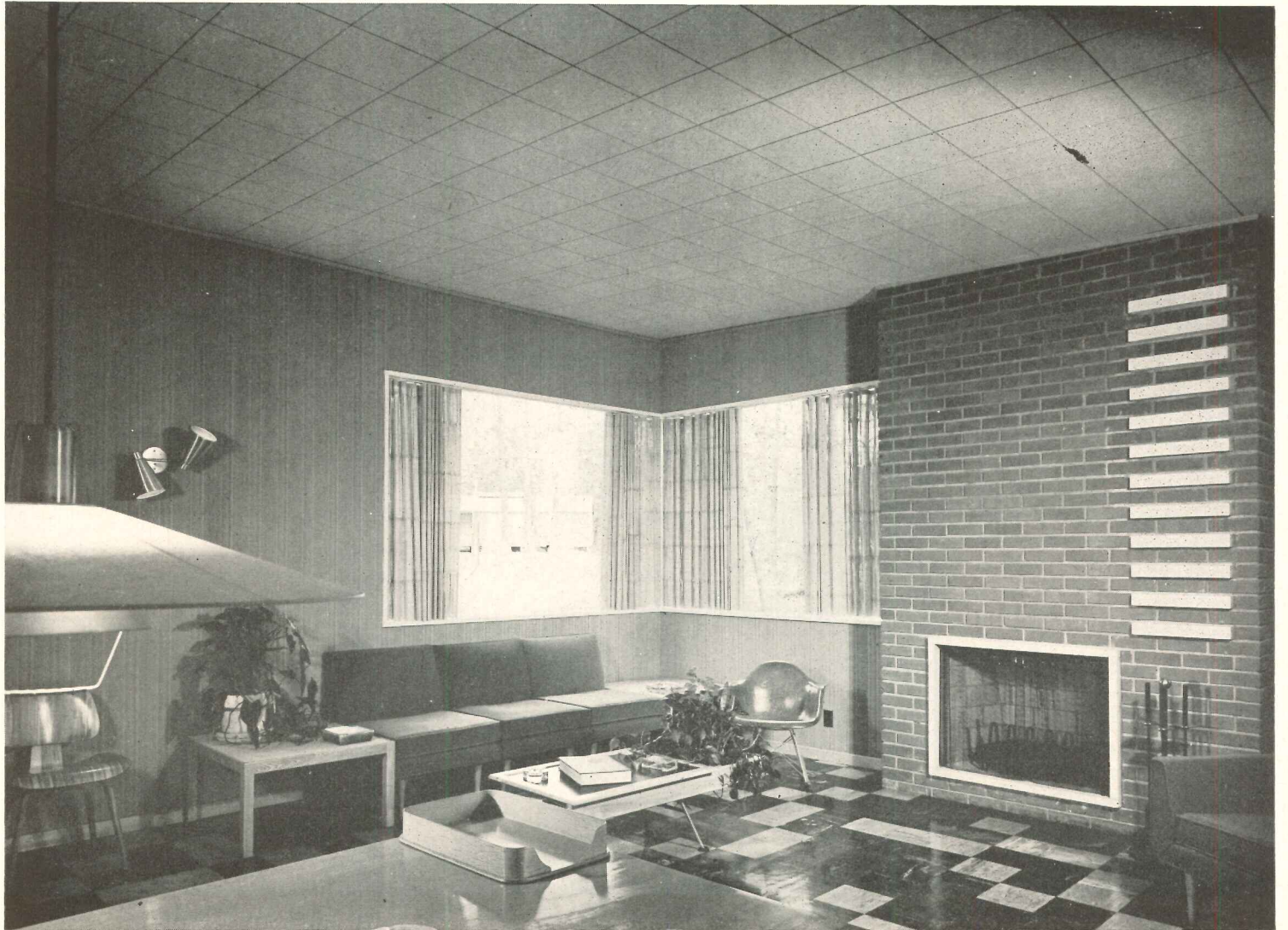

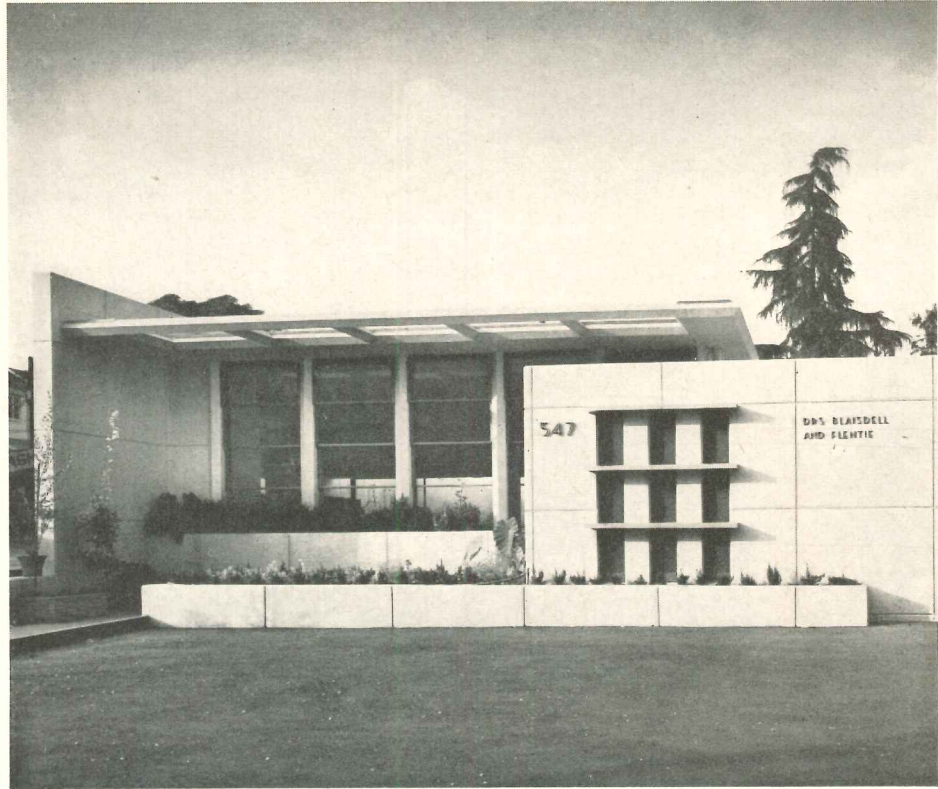
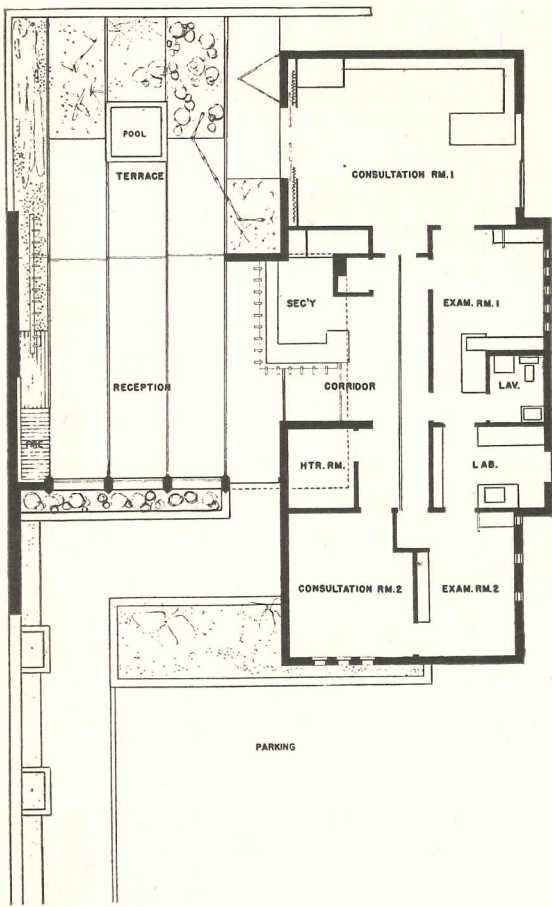

Julius Shulman



MEDICAL BUILDING FOR PAUL C. BLAISDELL, M.D.

Pasadena, California

Smith and Williams, Architects

THE TWO DOCTORS who share this building are specialists who spend about half the day in hospitals, and the other half in their own offices and consultation rooms. For their non-hospital hours they were anxious to secure as pleasant and relaxing an environment as possible.

Thanks to Pasadena's mild climate, a good part of the reception area could be in a walled garden, outside the building proper. Identical paving, plaster soffit wall finish and lattice work were used in both the garden and the indoor reception room to make them visually one continuous area.

The architects tried consciously to express on the

exterior of the building the difference in use and character between the reception and consultation wings. The former is almost wholly of glass, the latter is almost solid masonry, with natural light filtered into the examining rooms through grills formed by glass brick spaced separately in a pattern on the concrete walls.

The building is located in the center of a busy medical district and for that reason was set far back from the street to permit on-site parking for five cars. Air conditioning is controlled by both clock and thermostat, and music is piped to all rooms from an LP record player located near the secretary's desk (photo, page 145).

MEDICAL BUILDING



Screens, glass block and clear glass are used as interior partitions wherever possible throughout the reception area; ceilings are high, furniture arrangement is informal. Within the limits of the local fire code, this entire area is a glass enclosure, contrasting strongly with the privacy of the examination and consultation rooms. The "cold, clinical look" has been avoided everywhere, despite the fact that the entire building was planned for the efficient use of the latest developments in medical equipment and technique.

Informality of reception area is accentuated by corner fireplace in enclosed portion (above), small pool and cloth "ceiling" in garden portion. The larger of the two consultation rooms (page 146) opens to garden





Julius Shulman

Secretary's office is at almost dead center of the building, between reception area and consultation rooms. Location permits secretary to keep her eyes on entire building, and be instantly available to both patients and doctors; screening of her cubbyhole makes her presence unobtrusive



MEDICAL BUILDING



Julius Schulman

Larger consultation room (above) opens to garden, has built-in desk and cabinets. Examination rooms (one at right) are day lighted by glass block, separated by lavatory and laboratory

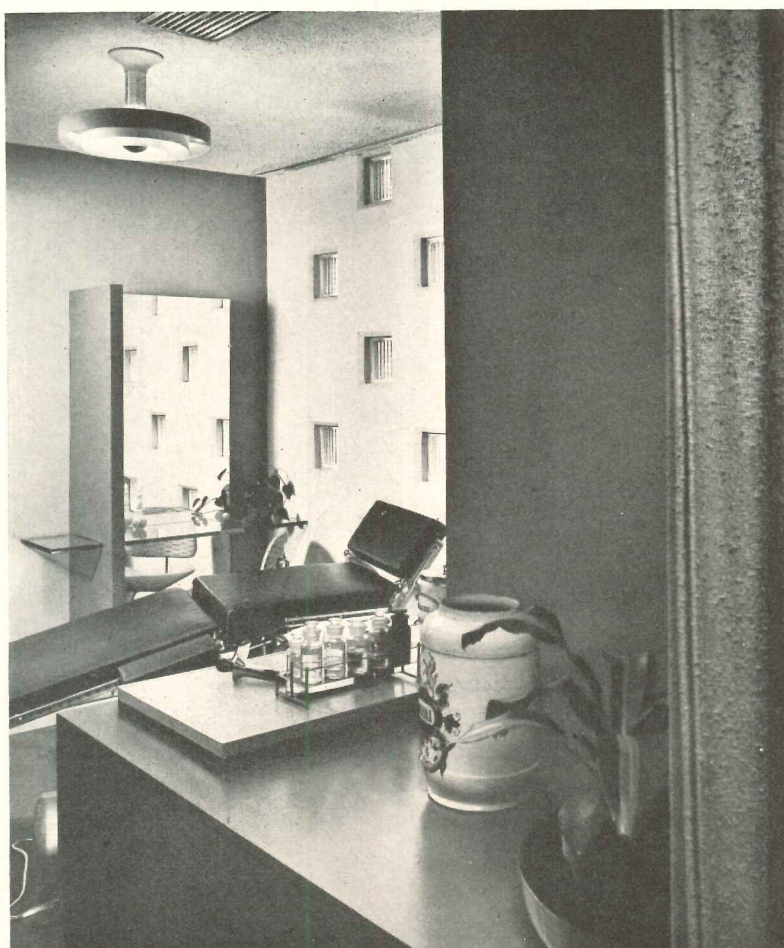

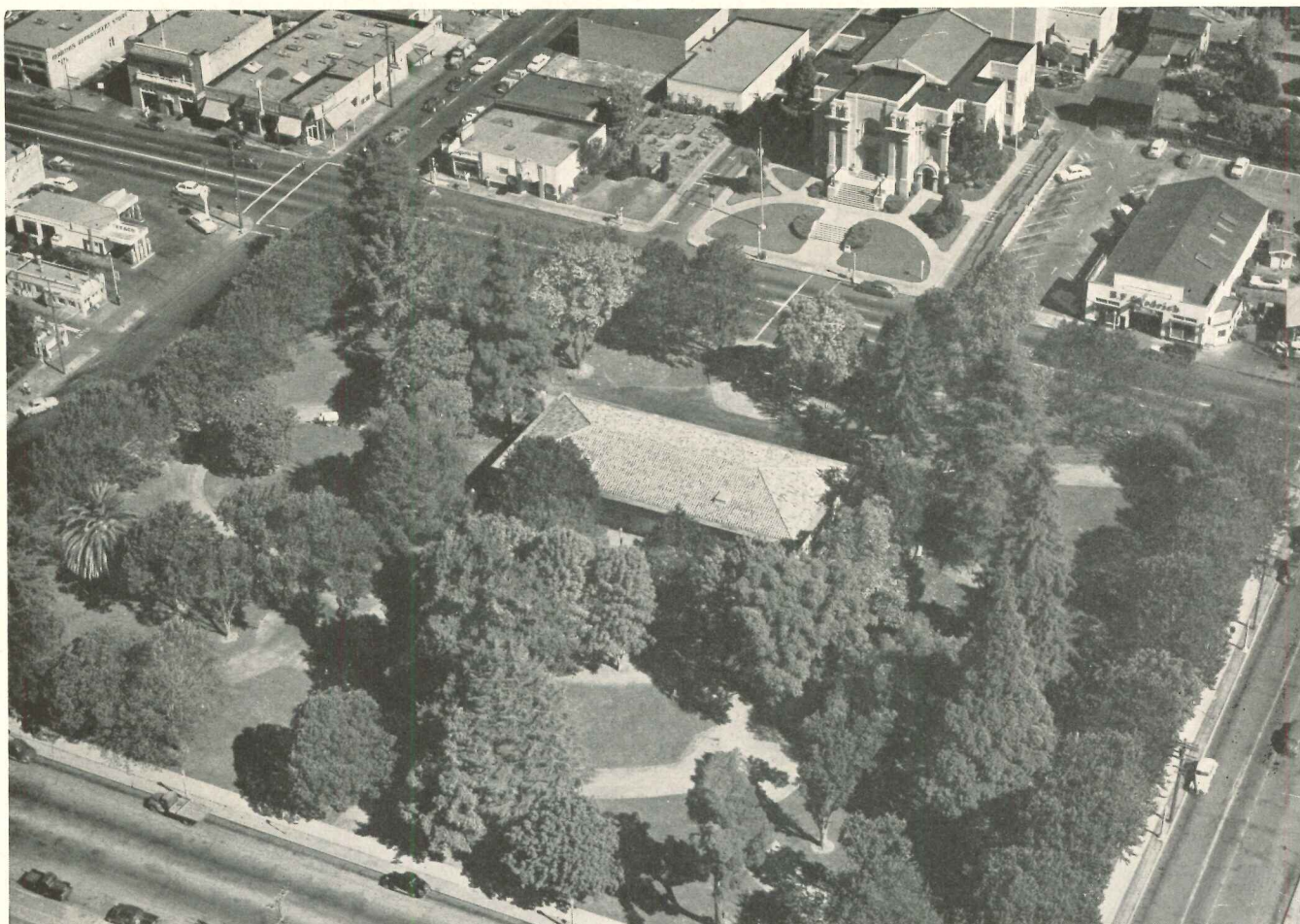

R. L. Copeland

HAYWARD PUBLIC LIBRARY

Hayward, California

John Carl Warnecke, Architect

Thomas D. Church, Landscape Architect

ON APRIL 7, 1951, the town of Hayward, California, proudly dedicated its new Public Library "to enrich personal life and enlighten the citizens." The library, as an institution, was then some 55 years old: it was started as a reading room back in 1896; two years later it was formally established as a library in a small storeroom in the center of what was then the village of Hayward; by 1905 it was supported by the town and had a building of its own — a building which served the community until the end of 1948.

The new library was planned as part of the City Hall Plaza. Because its site is in a public park opposite the City Hall, the architect felt that the exterior design must blend well with a park setting. That it does exactly that is apparent in the air view above. The hip roof, with a 5-ft overhang, is of red mission tile, chosen for its rich color and texture; beneath it is a thoroughly modern library designed on modular lines.

The structural frame is steel and concrete, spanning the full width of the building; with the exception of



Courtesy Remington-Rand Inc.



Ronald Partridge

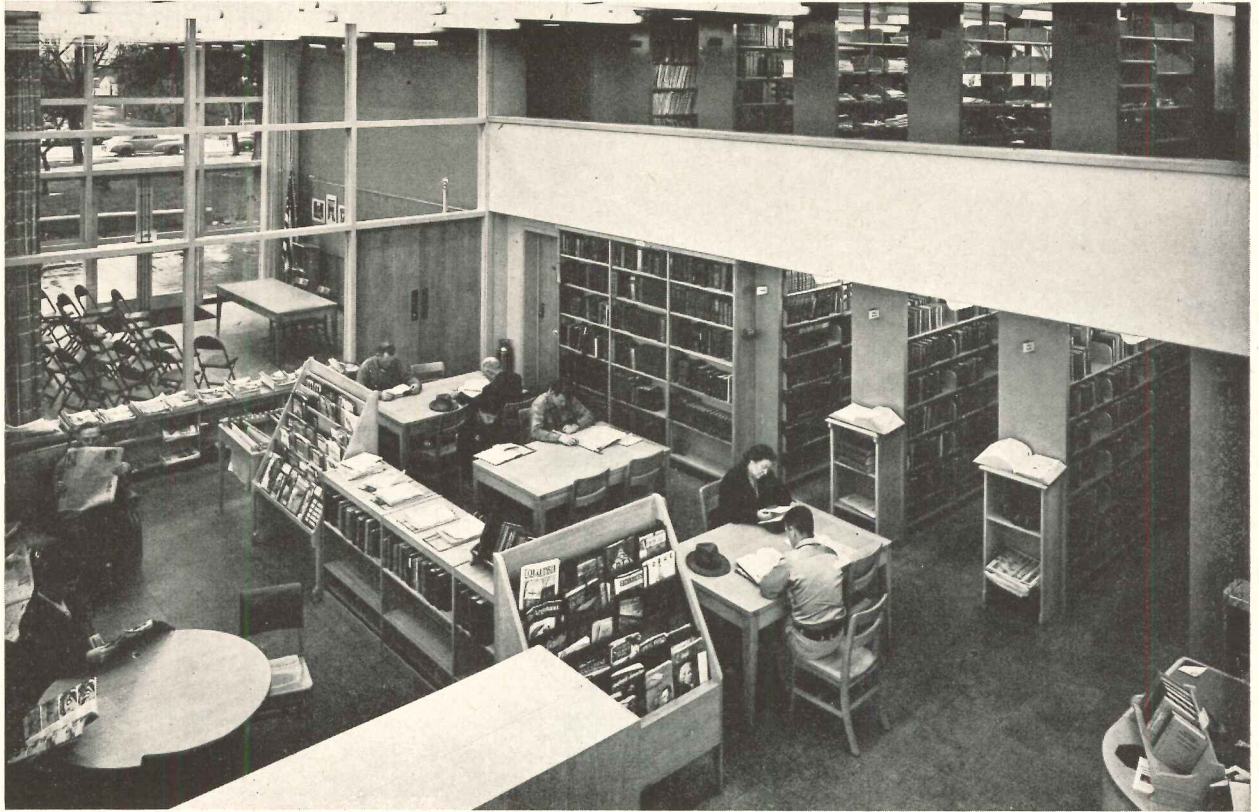

Main reading room (opposite) lies between lecture room (background, above) and children's reading room (background, below). Charge desk is strategically located for control of entire building



HAYWARD PUBLIC LIBRARY

the mezzanine, all partitions are non-bearing to provide almost complete flexibility in plan. At each end of the building is a floor-to-ceiling window approximately 24 by 16 ft in size; these huge windows, plus the clear glass of interior partitions, bring a view of the park to every part of the building.

Furniture and draperies were carefully planned to harmonize with the interior color scheme. Furniture is of light bleached oak to blend with the buff walls; arm and side chairs are upholstered in olive green leather; the floor-to-ceiling curtains between lecture room and main reading room are a light olive green.

The lecture room was one of the main requirements of the library board and the librarian: needed for lectures and showings of movies and slides, it had to be completely cut off from the adult reading room. Both it and the children's room at the opposite end of the building have separate entrances.

The building is concrete and brick on concrete foundation. Floors are cork and asphalt tile, ceilings are acoustic tile.

Courtesy Remington-Rand Inc.

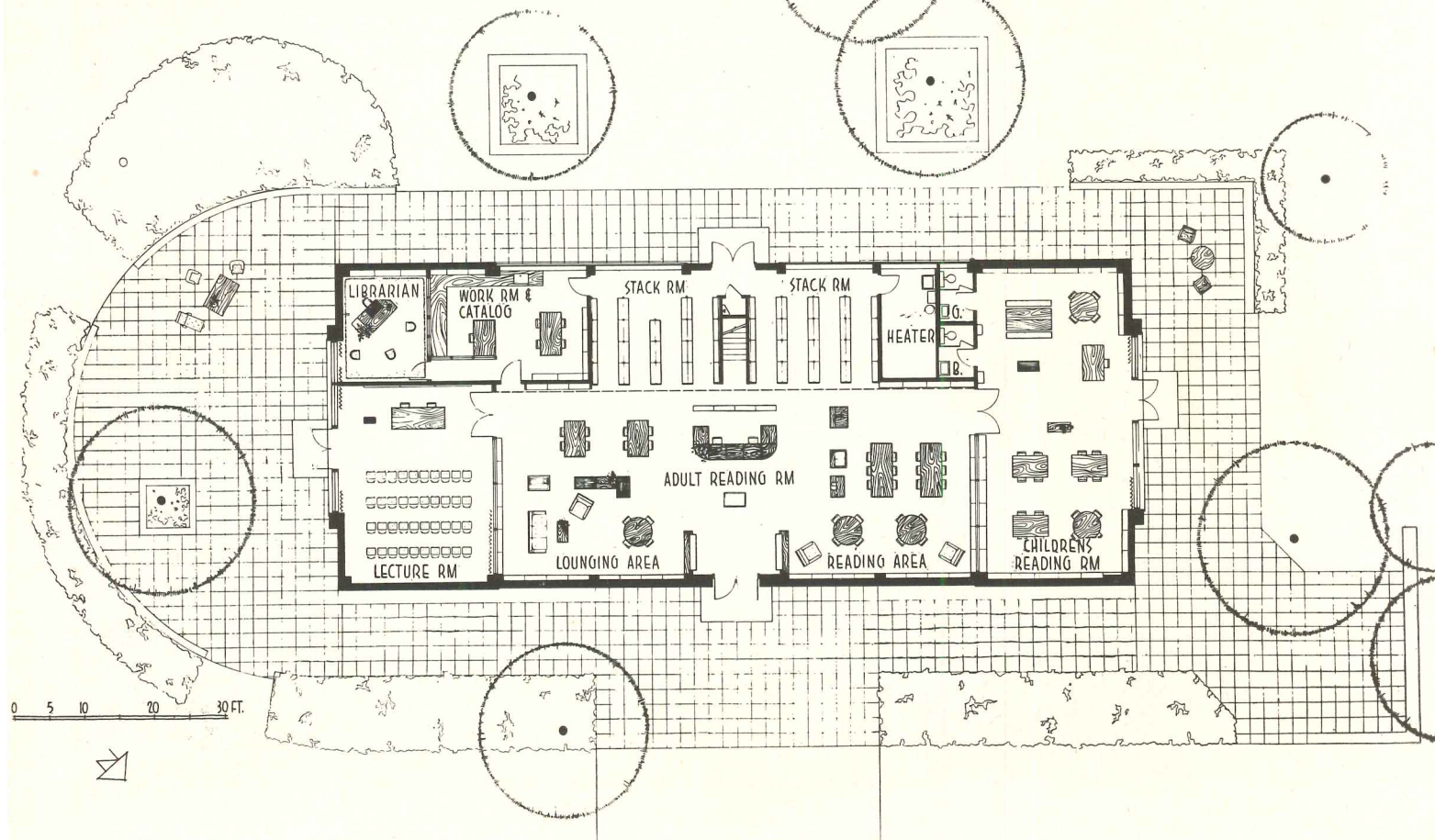



Courtesy Remington-Rand Inc.

Children's reading room (above) has low shelves, generous bulletin board space, and informal arrangement of furniture

Rondal Partridge



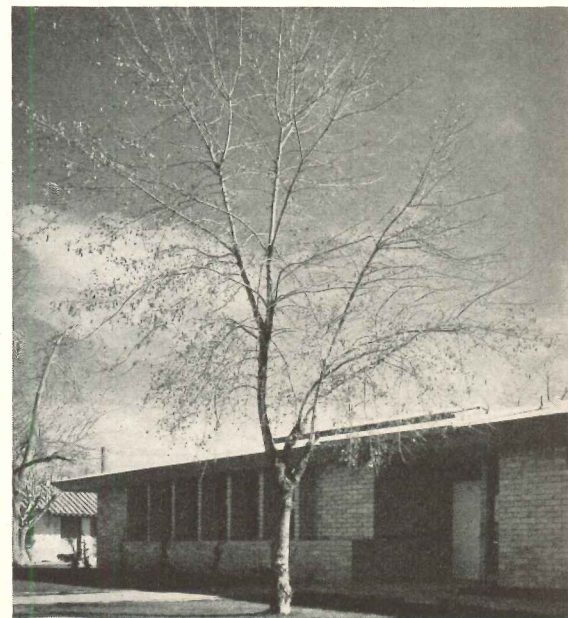
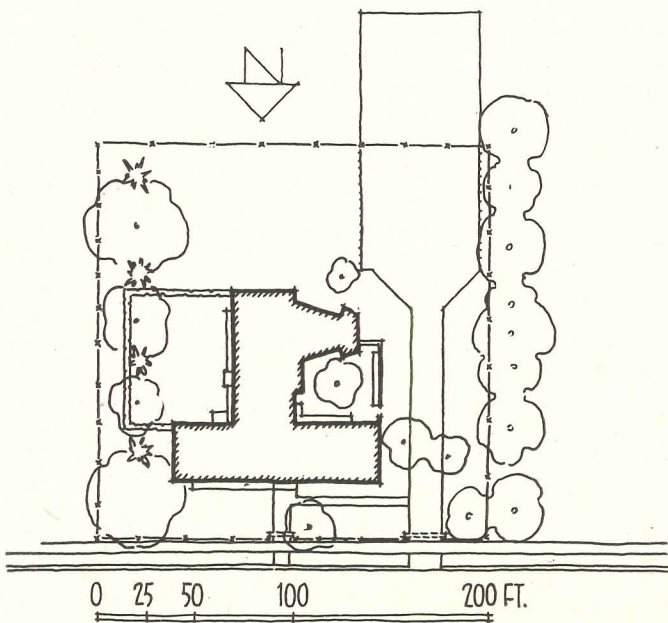
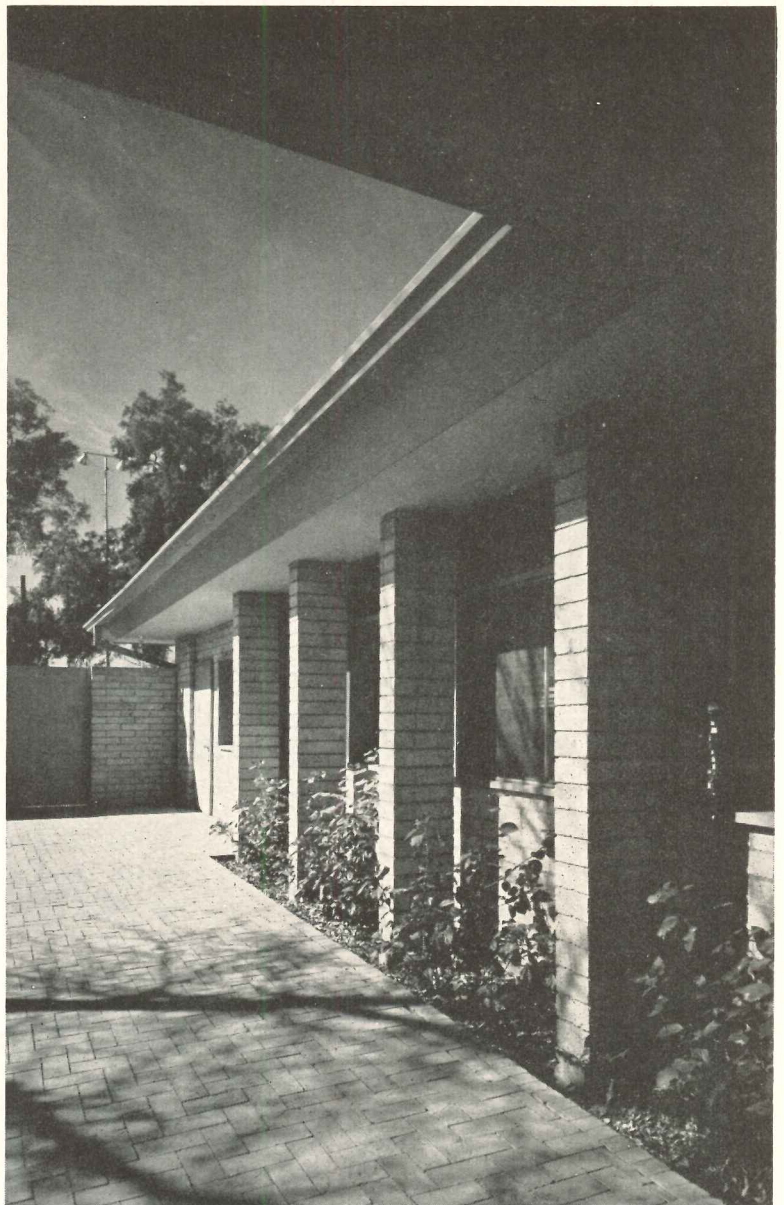

Stuart A. Weiner

HARMON PARK LIBRARY

Phoenix, Arizona

Guirey & Jones, Architects

Alfred Morton Githens, Consulting Architect

BECAUSE THE SITE of this small library is in a municipal park, the owner specifically requested that the building be kept informal in character and residential in scale. Facilities required were: adult and children's reading rooms, each with an outdoor patio; a record-playing room; a meeting room for book discussions and movies; a work room; a staff room which could also be used for small group meetings; and a kitchen to serve both the staff room and the children's patio. The meeting room was to be so located that its capacity could be considerably enlarged by opening it

to the children's reading room. These various facilities, furthermore, plus the washrooms, must all be within visual control of a single librarian.

Around these exacting requirements the architects designed a simple and pleasing building, one story in height, with hipped roof and wide overhang to keep out the hot Arizona sun. Walls are reinforced pumice block masonry carrying a rigid frame; roof is exposed steel bents. The reading rooms are tri-laterally lighted, with shaded skylights. The building is fully insulated, and air cooled.

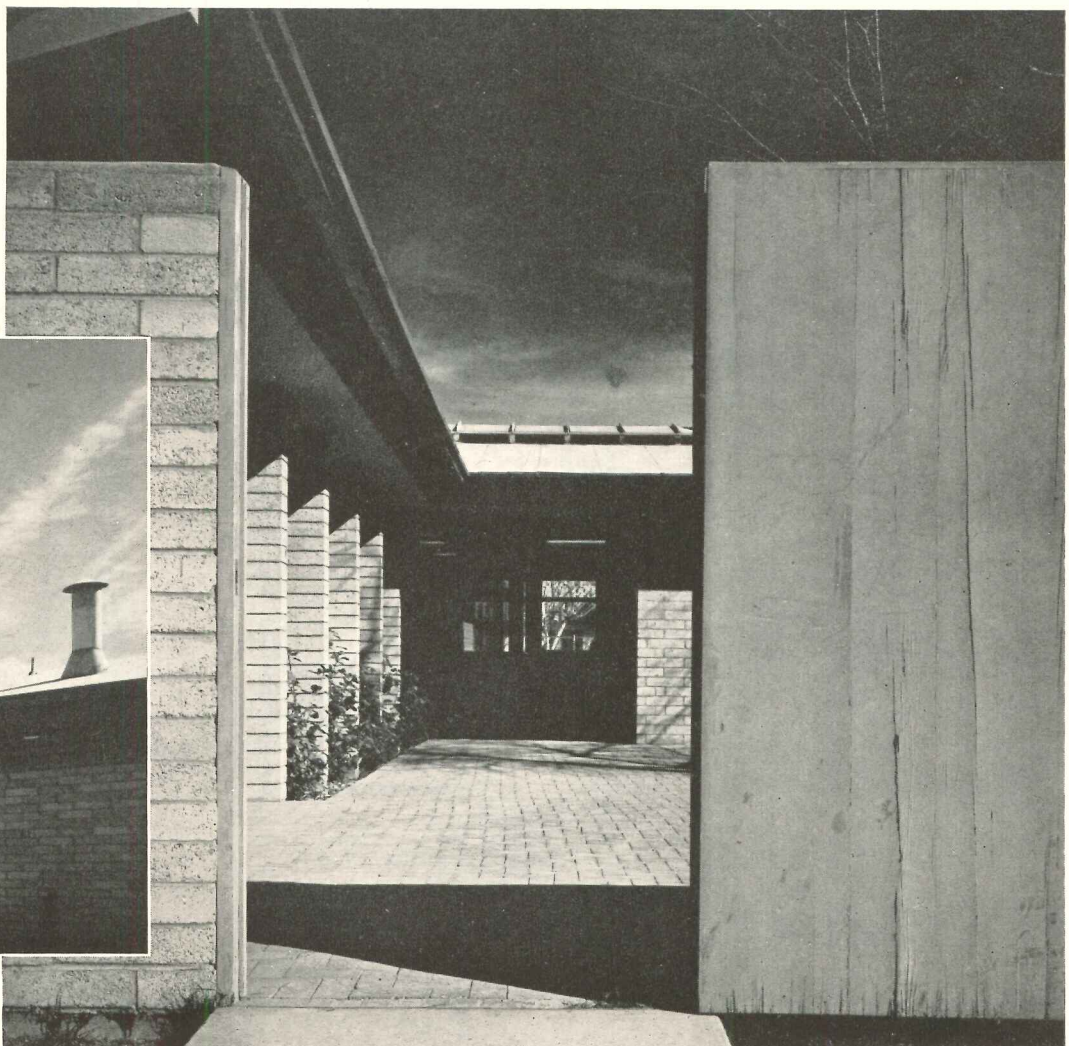

HARMON PARK LIBRARY

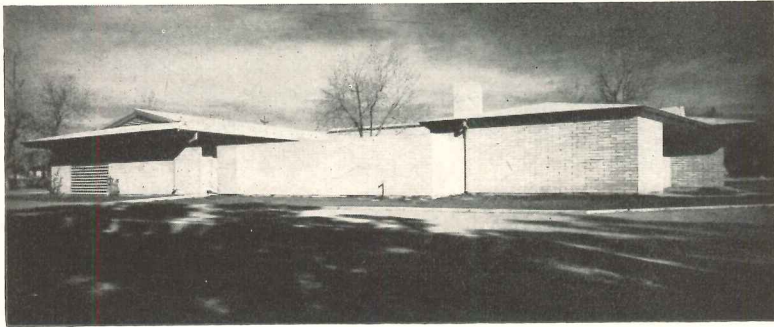
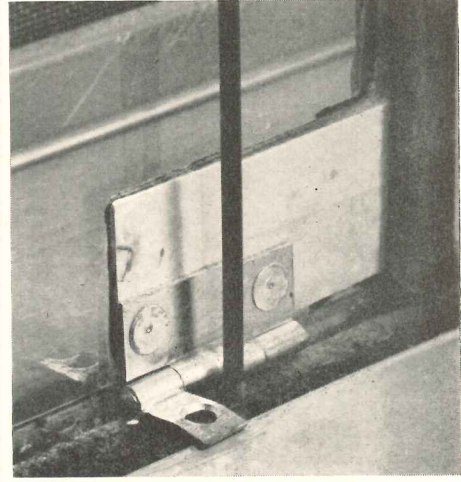
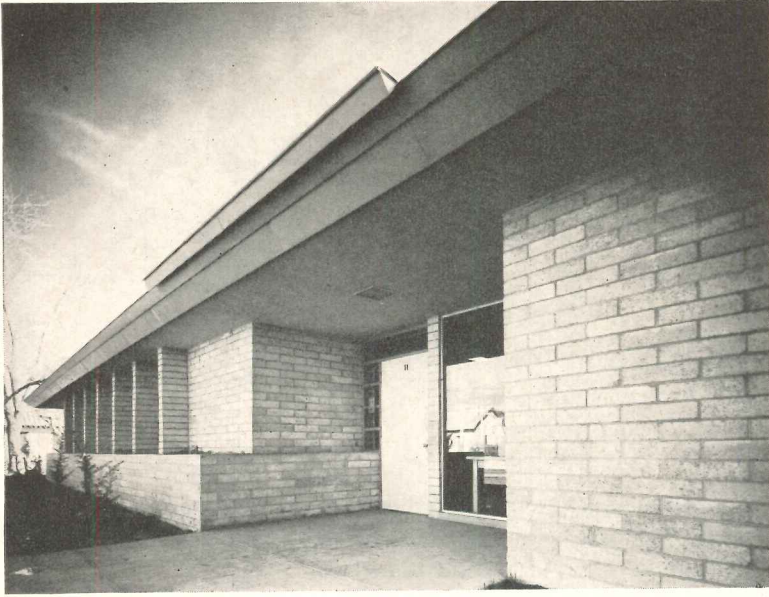

Stuart A. Weiner

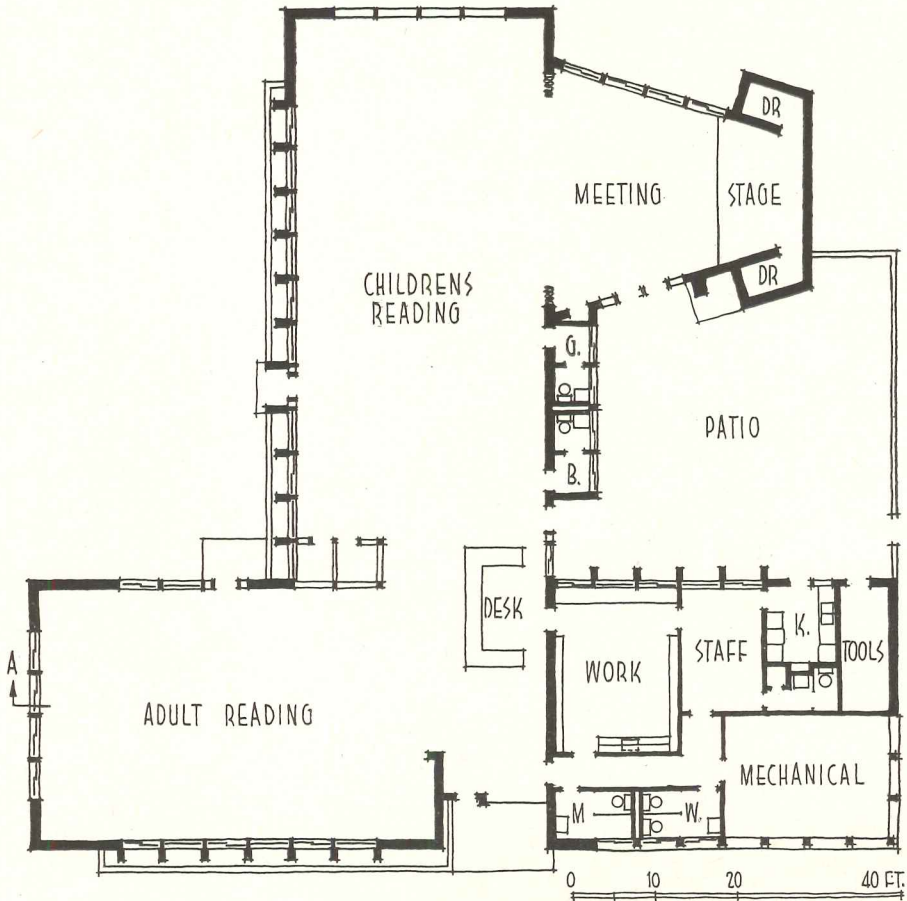

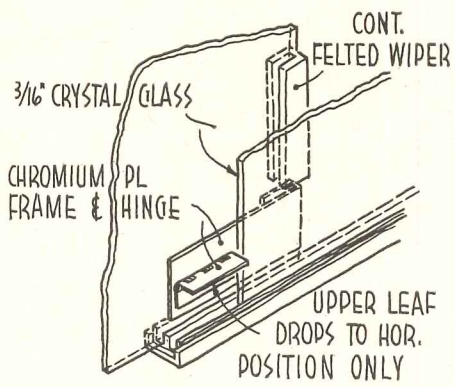

Capacity of meeting room (above) can be about doubled when folding doors between it and children's reading room are opened. Charge desk (below) is close to main entrance, and so located that from it the librarian can watch over entire building — patios included. All windows have movable panels (photo and detail above left) with metal inserts and drop-hinges which double as stops and handles



HARMON PARK LIBRARY

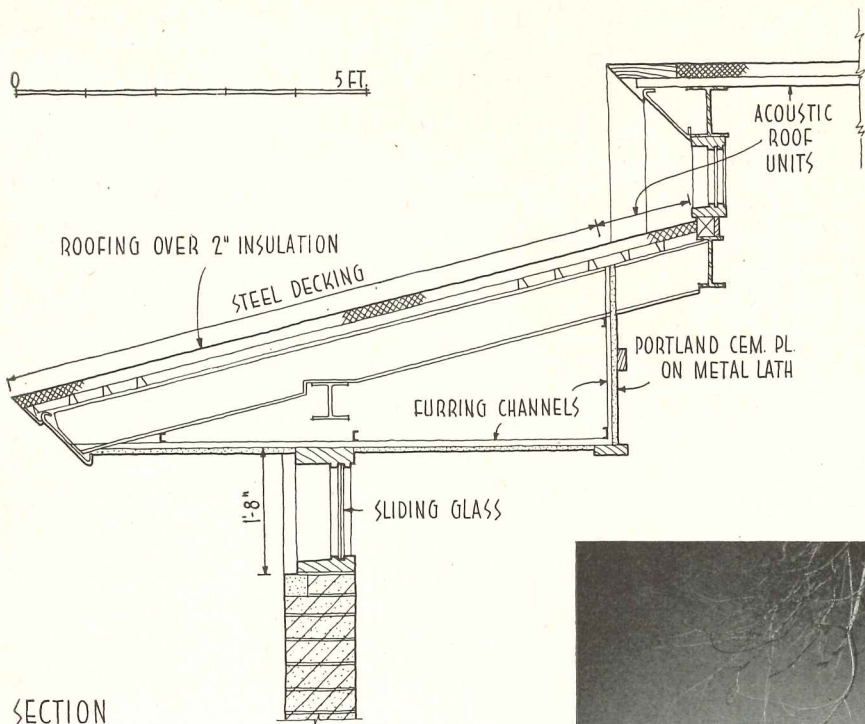

Stuart A. Weiner

SECTION

Reading rooms receive more than usual amount of daylight, but are kept cool nonetheless: skylights are shade-screened, and glazed with heat-resistant glass; roof is insulated with 2 in. of glass fiber and topped with white asbestos. Roof decking is of acoustical units in reading rooms, standard steel elsewhere

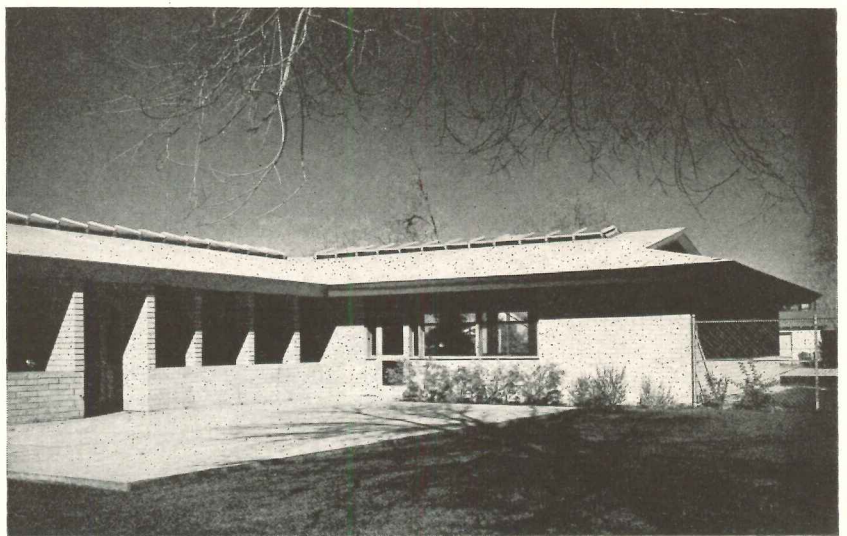

Chicago, Illinois

Shaw, Metz and Dolio,
Architects

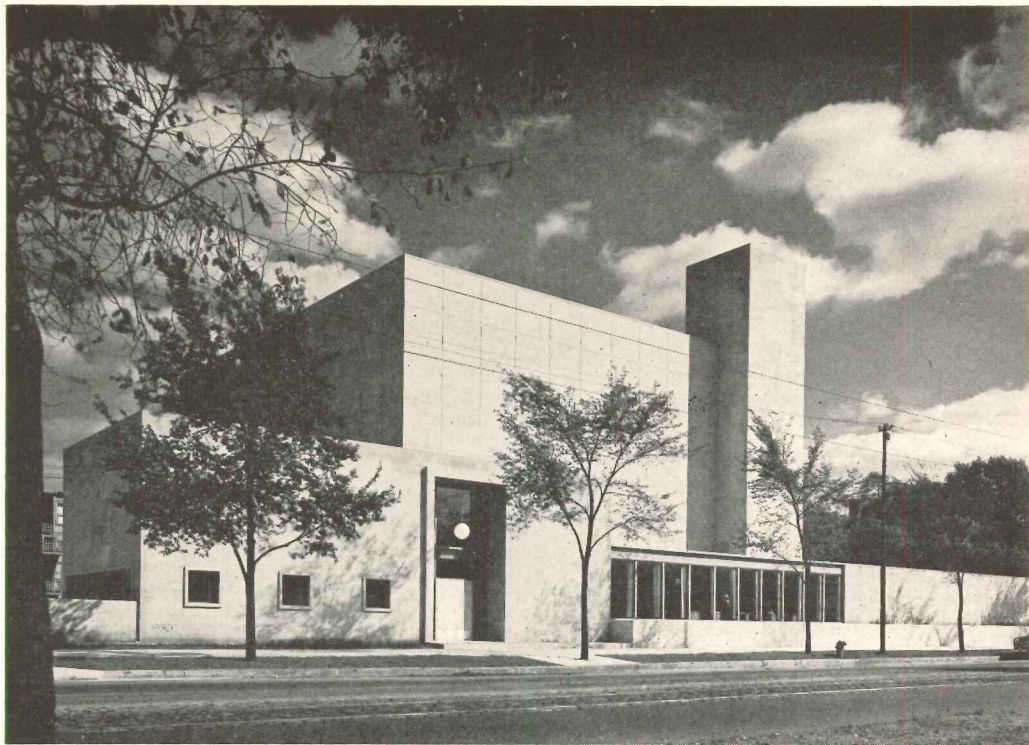

Hedrich-Blessing

MIDWEST INTER-LIBRARY CENTER

NOT IN THE STRICT SENSE OF THE WORD a library, this unusual building was sponsored by a group of mid-western universities as a cooperative deposit and research center (ARCHITECTURAL RECORD, June 1950, pp. 143-145). The University of Chicago contributed a 320 by 130 ft site on the edge of its Chicago campus; the Carnegie Corporation and the Rockefeller Foundation provided grants for the first unit of the project.

The building is predominantly a gigantic stack area.

In its present phase it can accommodate 2¼ million volumes; the addition of three similar stack areas eventually will bring its capacity up to 10 million. Service facilities adequate for the entire project are provided in the two-story service wing. These include: provision for truck transport of incoming and outgoing books for the member universities; work areas for receiving, cataloging and filing; offices; carrels or study-cubicles; teletype room and microfilm laboratory.

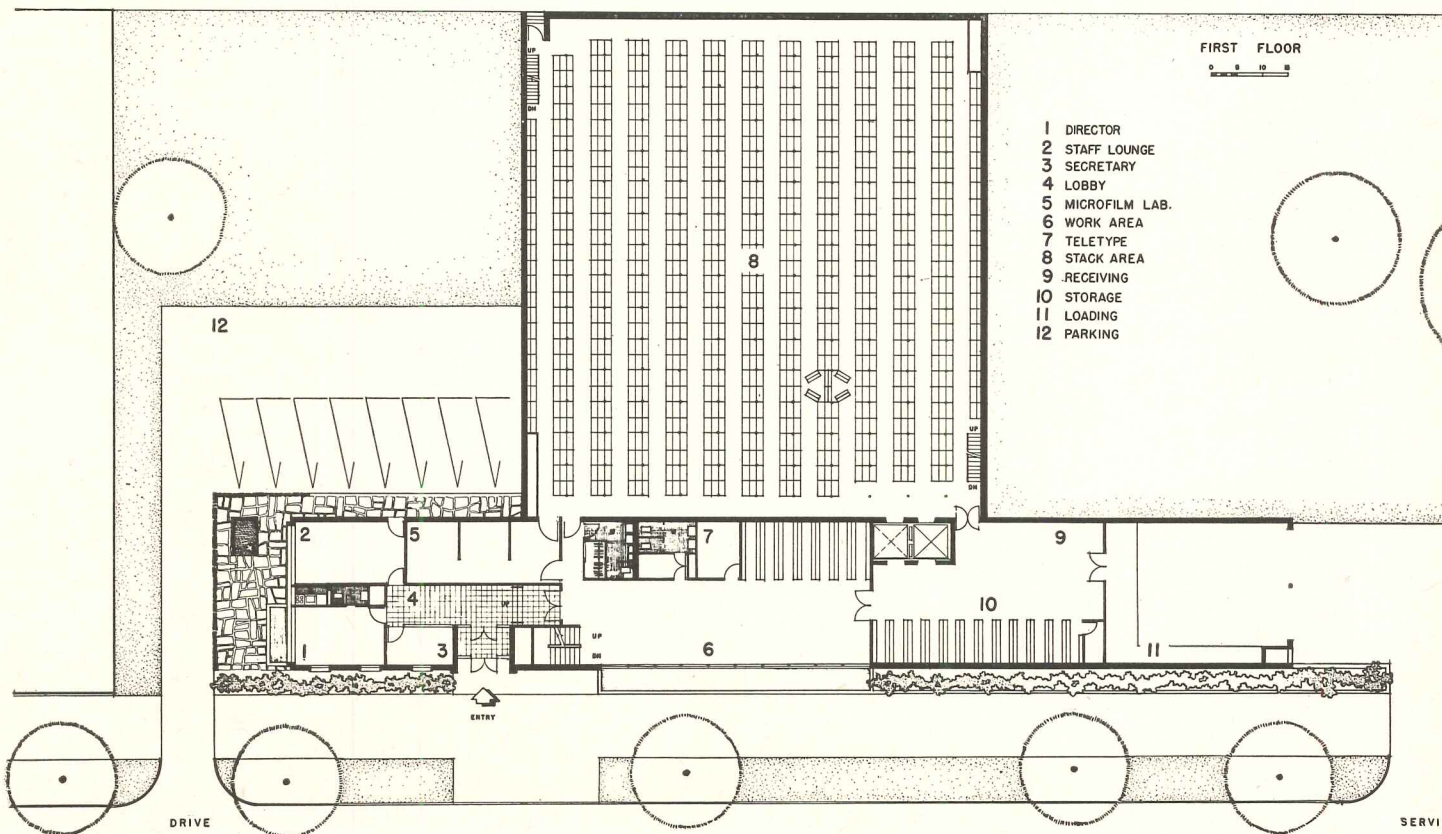

MIDWEST INTER-LIBRARY CENTER

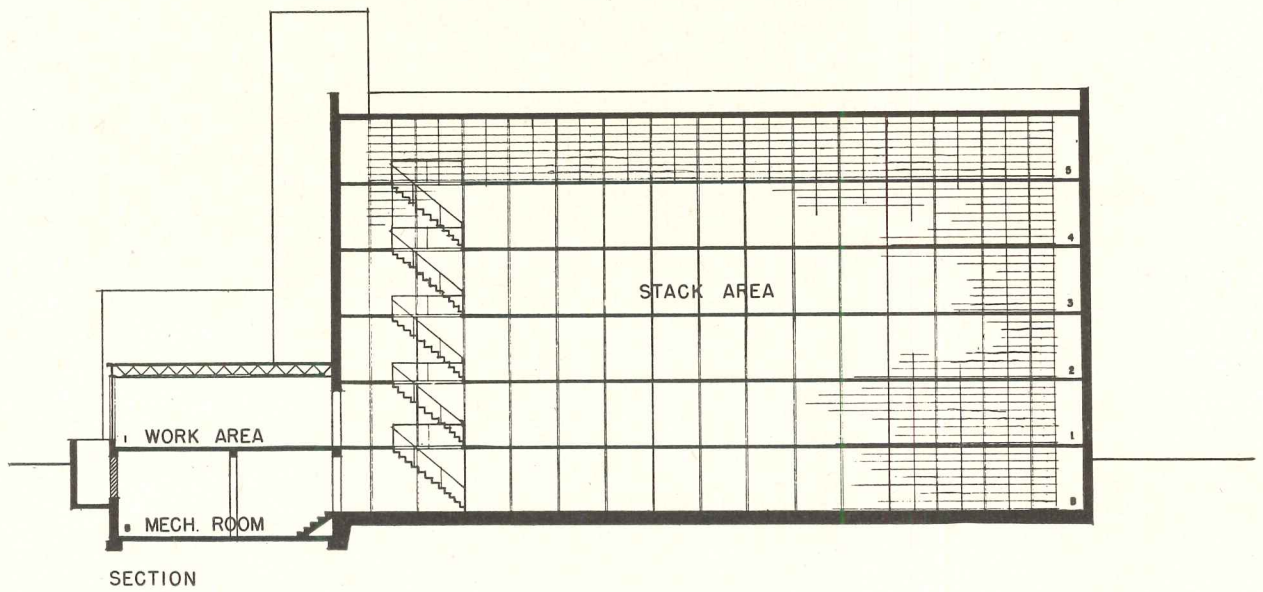

A unique feature of the building is the "triple sandwich stack" scheme shown below and top opposite. Three double-faced stacks are placed together, the center one fixed and the two exterior ones pivoted. This system, possible because general public does not enter the area, greatly increased the volume-per-cubic-foot ratio and permitted wide 3 ft 4 in. aisles. Elevators servicing the stacks are outside the stack area; access corridor will connect them with future parallel stack areas

- 13 STUDY CUBICLES
- 14 LOUNGE
- 8 STACK AREA

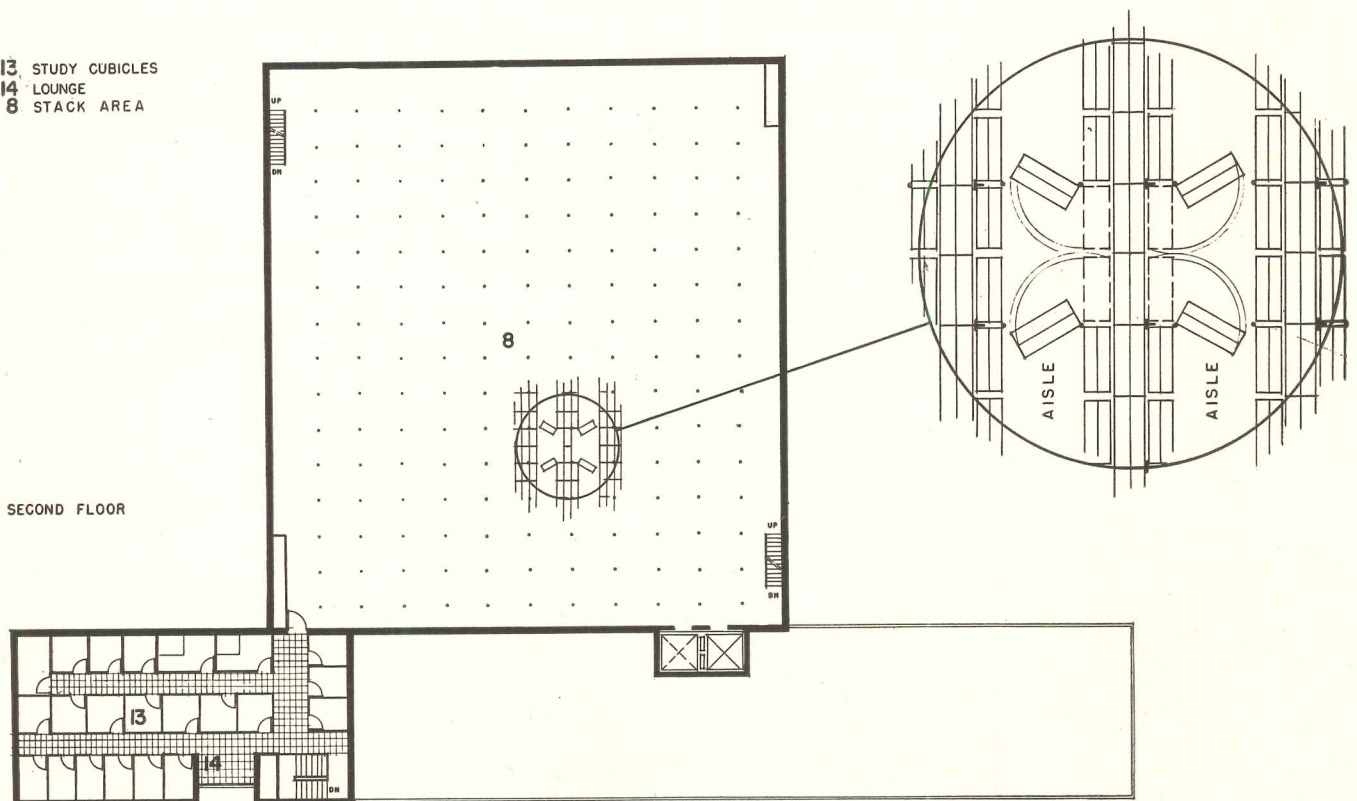



Hedrich-Blessing

Service wing is entirely air conditioned; stacks are not cooled, but conditioned with filtered air kept at comfortable temperature and book-preserving humidity



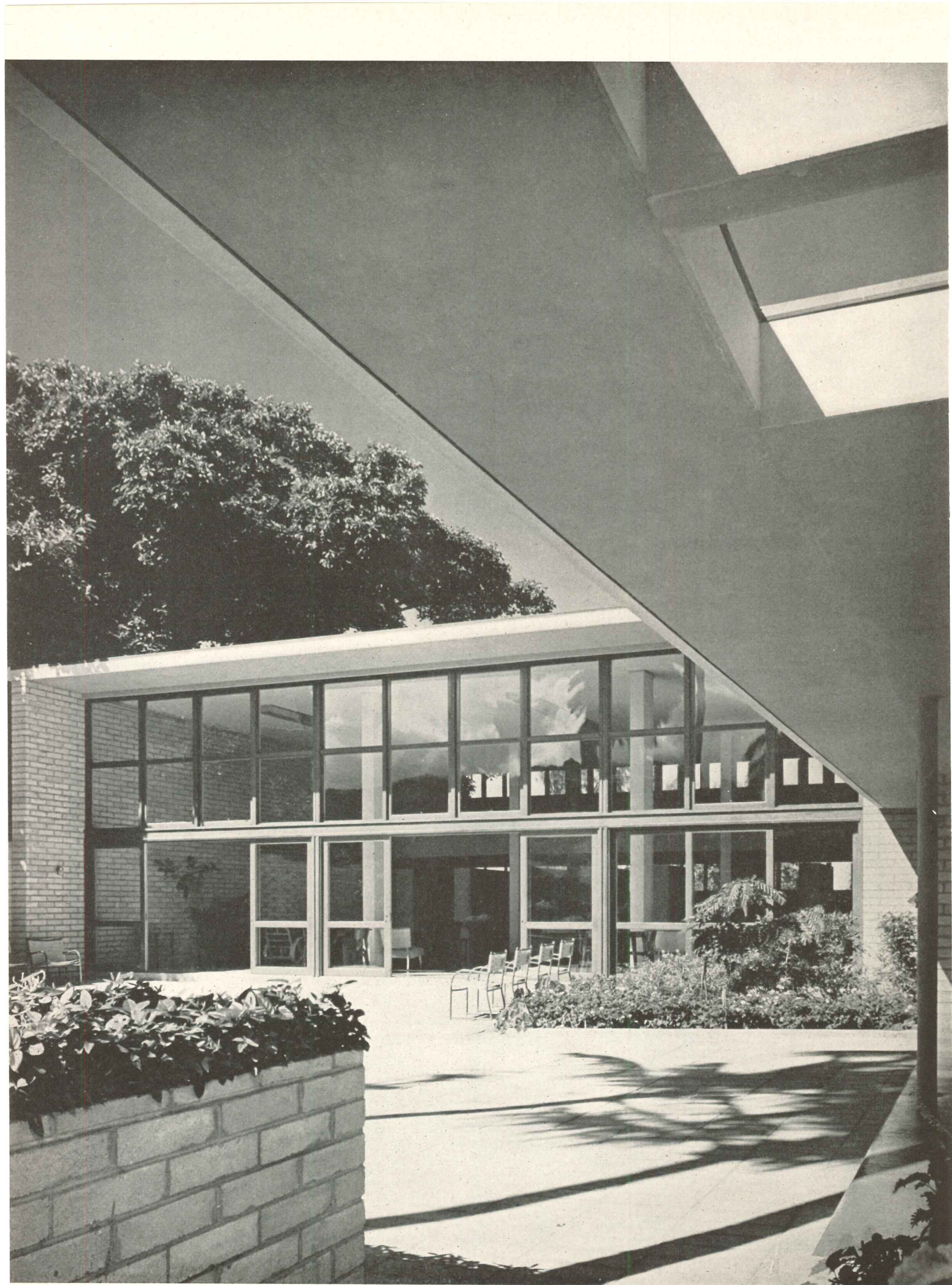



KALIHI-PALAMA BRANCH, LIBRARY OF HAWAII

Honolulu, T.H.

Fisk, Johnson, Ossipoff & Preis, Architects

Vladimir Ossipoff, Coordinator

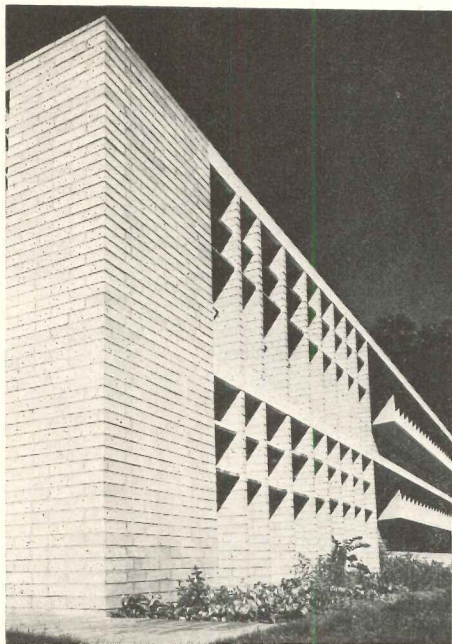

R. Wenkam

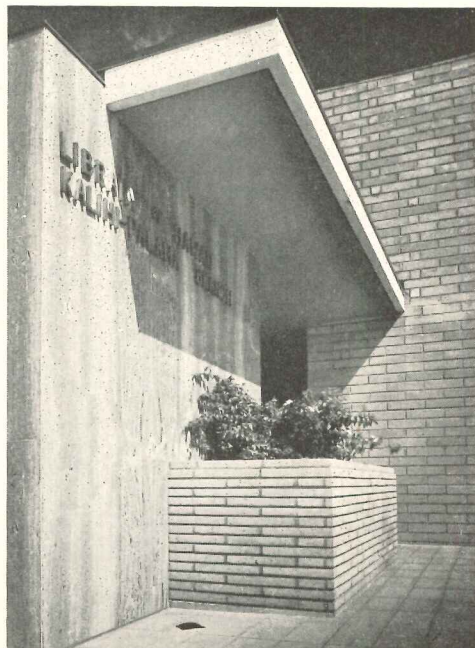

KALIHI-PALAMA BRANCH, LIBRARY OF HAWAII

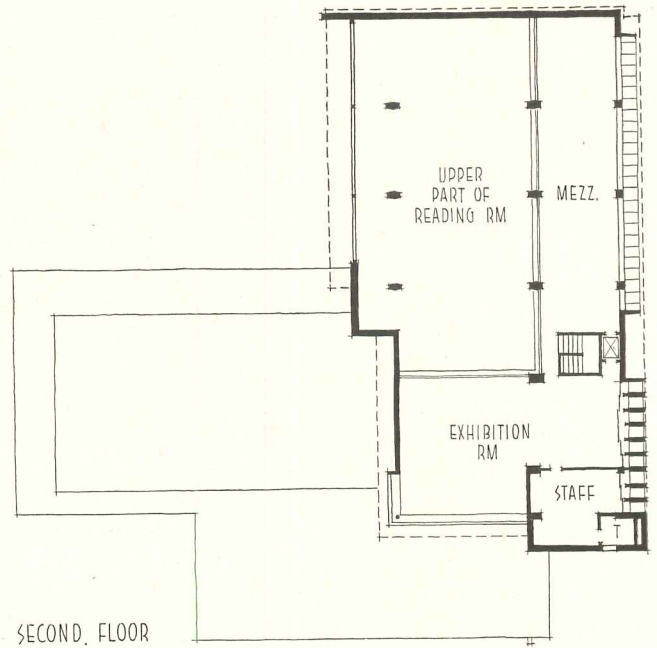
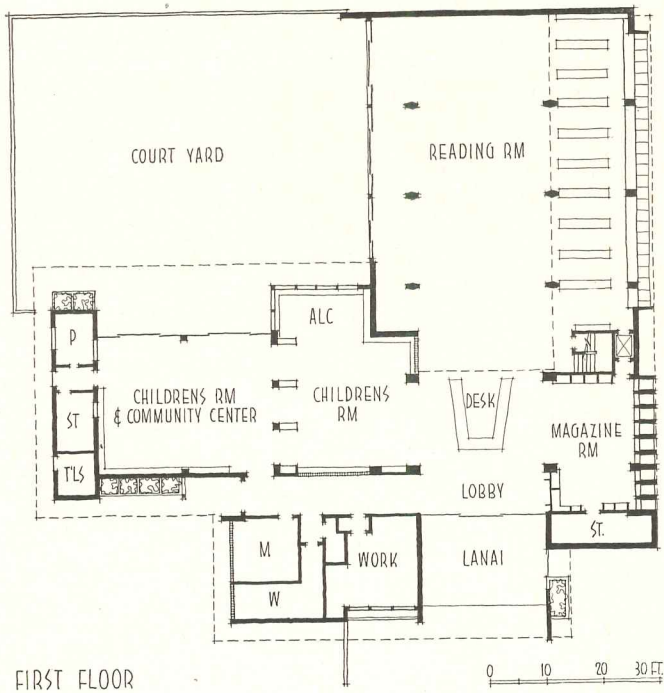

EVERYTHING about this branch library in Honolulu suggests coolness and pleasant informality. As few partitions as possible are used to separate the various departments; the high-ceilinged main reading room and the combination children's room-community center both open to the patio. The cement block and brick of the interior are cool materials both visually and actually.

Bright colors are used throughout, particularly in the upholstered furniture, tables and lamps in the main reading room. The patio — an outdoor reading room — is gay with colorful umbrellas and chairs, a fish pond, and tropical planting.

Sun control was a vital part of the planning, since during the spring months the sun would shine through

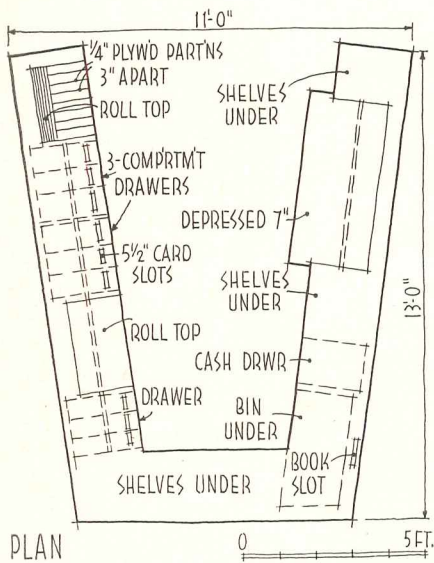

R. Wenkam

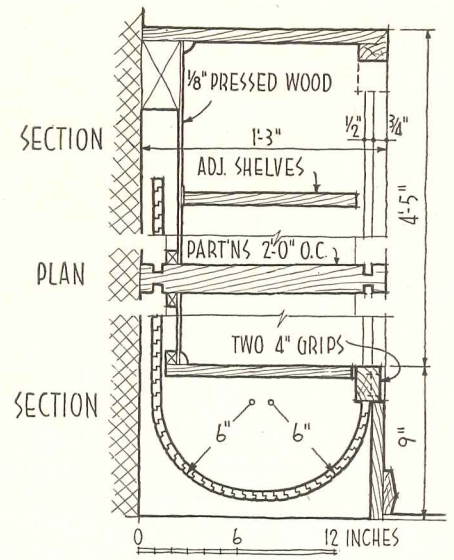
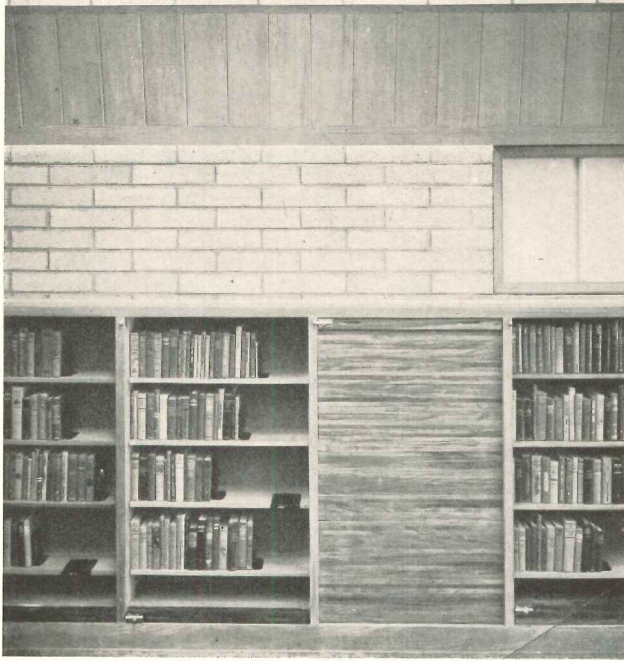

The architects designed much special furniture for the library, such as the spacious and efficient charge desk (opposite page), and the rolltop book and storage shelves (left and above)



KALIHI-PALAMA BRANCH, LIBRARY OF HAWAII

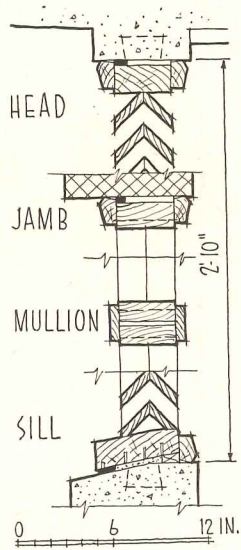

Fixed louvers at windows (above) and adjustable shutters along east wall provide ventilation and sun control. Floors throughout are cement and cork; ceilings are acoustic plaster

the building on an almost horizontal line after three in the afternoon. The east wall, therefore, has adjustable wood louvers along its entire length (detail below). Louvers are used also for ventilation above the doors between the main reading room and the patio, and above and below many of the windows.

Interestingly, the unbroken expanse of exterior wall was planned as an outdoor exhibit area.

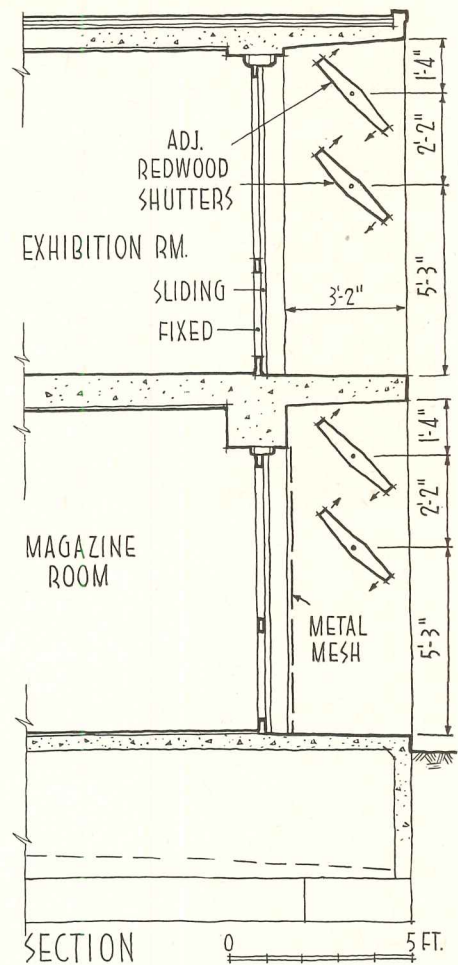

R. Wenkam

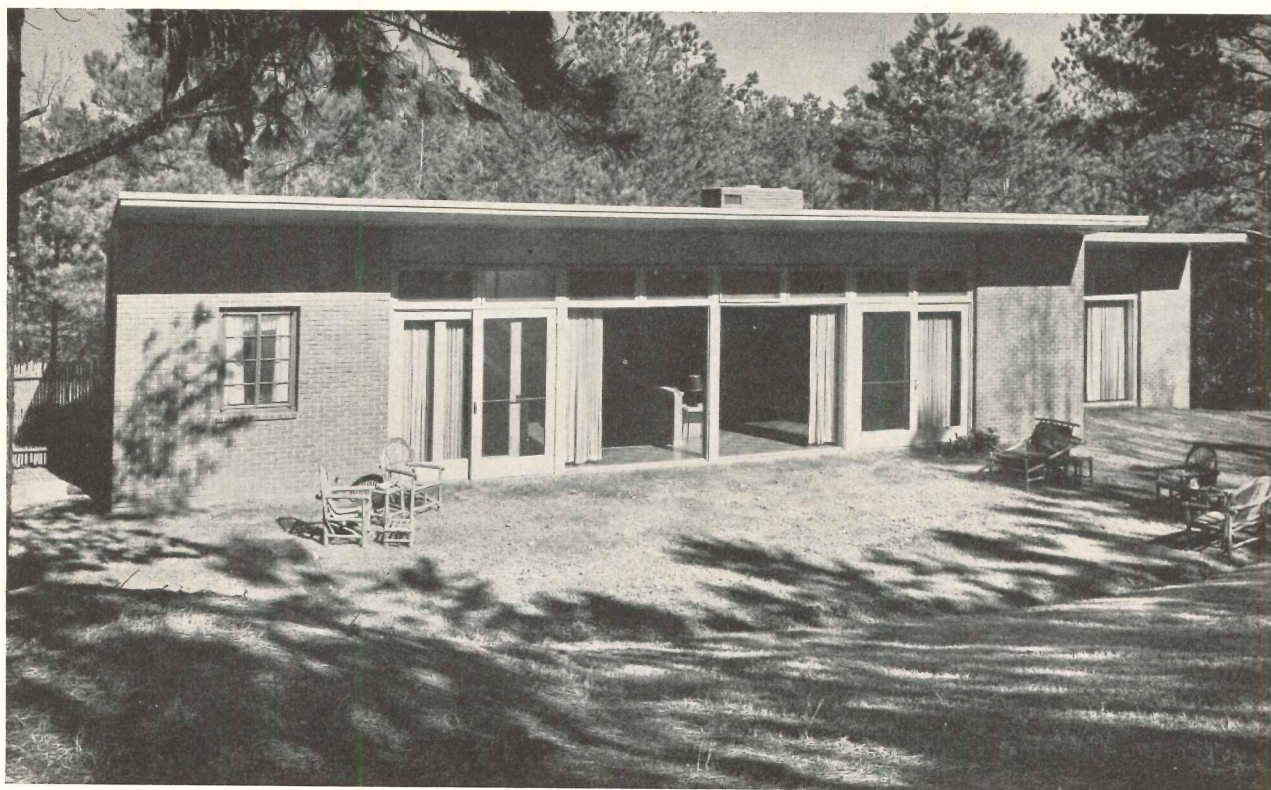

SIMPLE DESIGN FOR SOUTHERN LIVING

Residence for Dr. Ann Stuckey

Griffin, Georgia

Aeck Associates, Architects

THE QUIET, UNOBTRUSIVE CHARACTER of this house set in a grove of pines somewhat belies a skillful handling of its structural and design elements. Use was made of the sloping site to divide the plan into three sections: on the lower level are the utility areas — boiler room, storage, carport, entry — and a short flight of outside steps to the kitchen; on the main level are the living areas, flanked by kitchen and guest room; at the top level is a suite for the owner which can be closed off for privacy and a sense of security. All levels are connected by ramps, frankly used to provide a gracious entrance, and in this case fitted in without an extravagant waste of space. The structure uses brick in all lower sections, with lighter-weight pine boards on second floor exteriors and above most of the window openings. The butterfly roof with its wide overhangs permits larger, and protected, fenestration for major rooms.

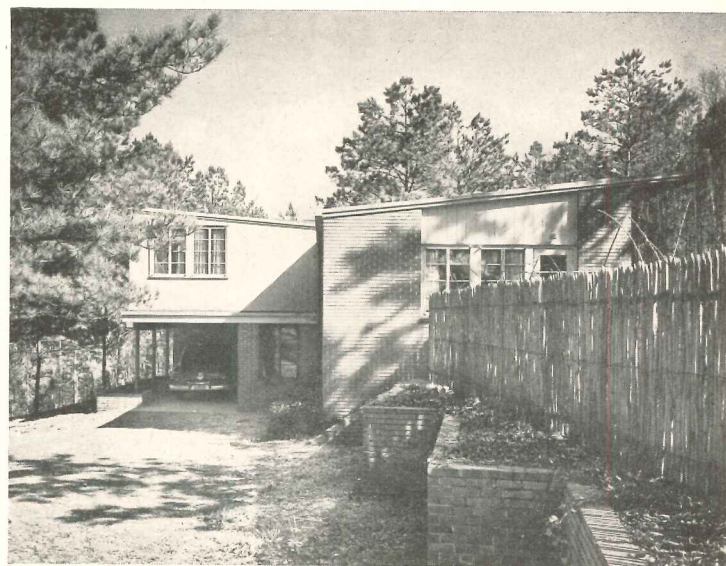



DR. ANN STUCKEY RESIDENCE

The property slopes up a half-story in the width of the house, gives ground level entrance to all rooms but owner's suite. Heating is by a hot water radiant system in the ceilings

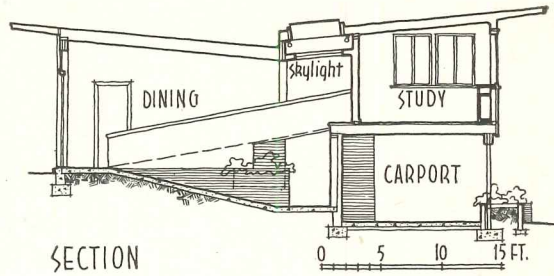

SECTION

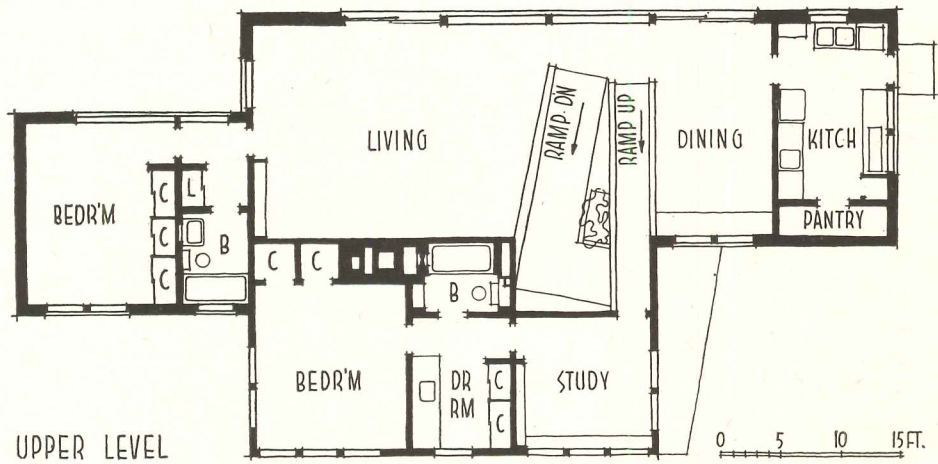

UPPER LEVEL

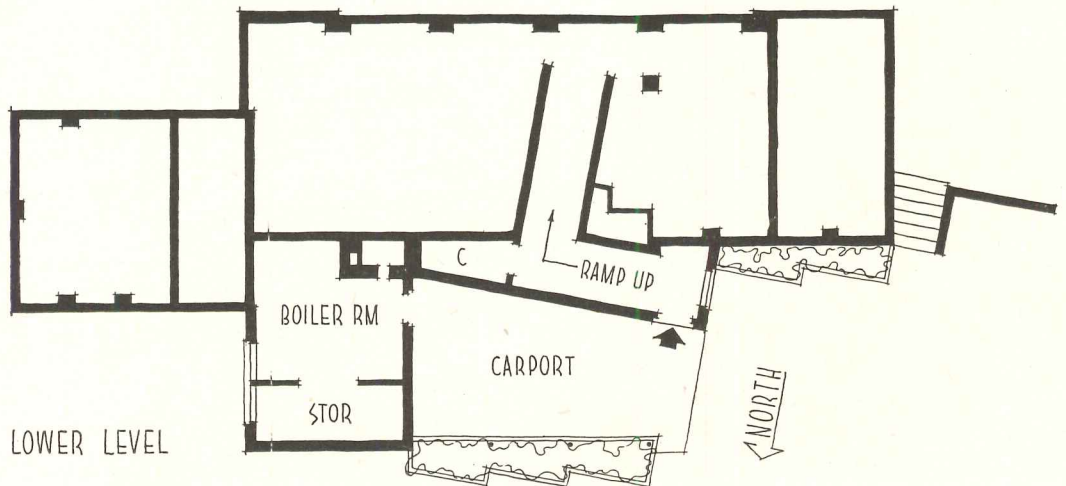

LOWER LEVEL

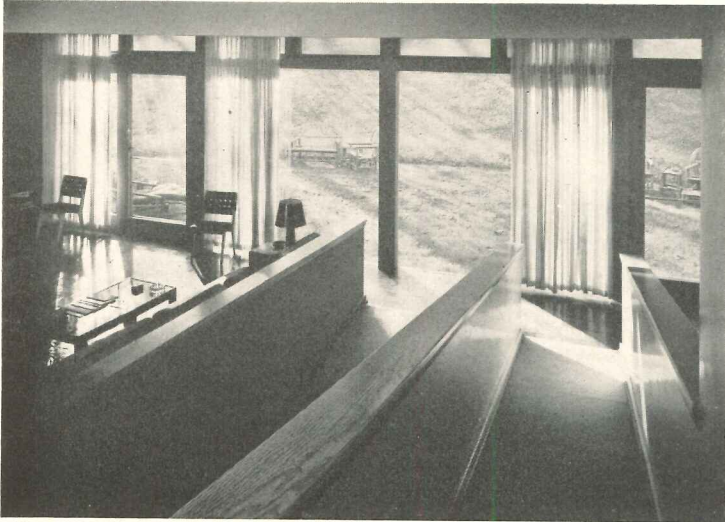

Living area (below) has generous scale, great sense of spaciousness. Ramps have skylight above, serve to separate sitting and dining areas. Interior walls are painted plaster

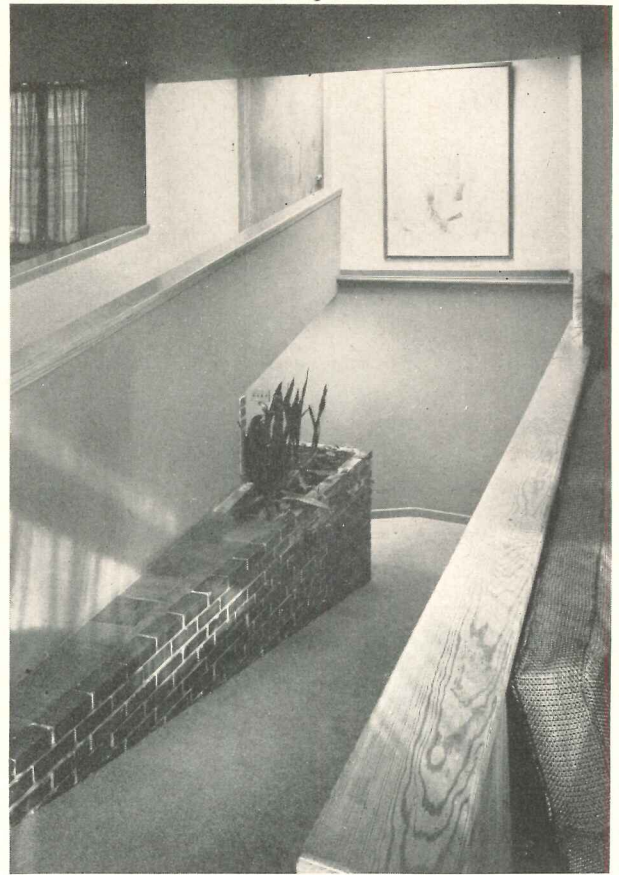

Richard Garrison



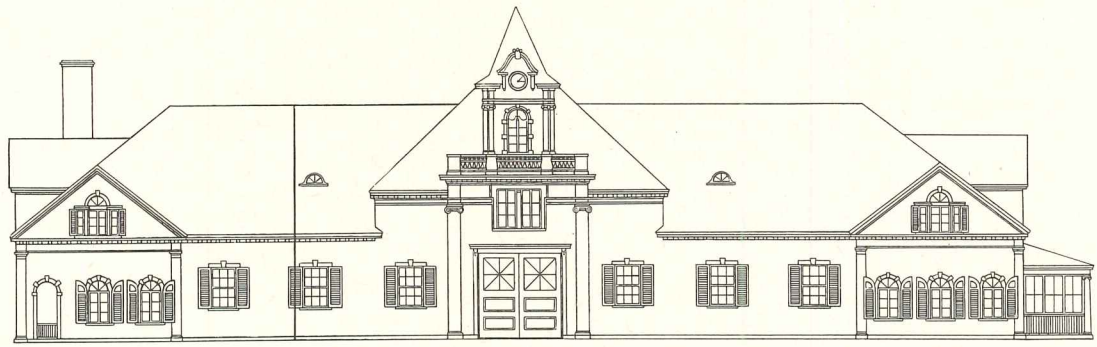

VICTORIAN STABLE BECOMES



Ben Schnall

House for Mrs. Alma Morgenthau

Lattingtown, Long Island, N. Y.

Herman Herrey, Architect

MODERN HOUSE



THIS STRIKING ADAPTATION of part of a Victorian stable for contemporary residence is the result of a series of carefully considered compromises between the qualities of the original building and those desired in the remodeled house. At the beginning of the project, the architect found himself confronted with sections of a dilapidated but still pretentious stable- and carriage-hall building, located in the midst of a lovely old park. The land had been divided through the center of the building, and the middle hall demolished. Both architect and client felt that the original structure had a pleasant

mellowness, "a composite of age, weather, wear and patina that can go far in compensating for architectural deficiencies in an old house." It was reasoned that this quality "explains why sensitive people accept as greatly pleasing things that they might not tolerate in a fairly new building." Thus a conscious, deliberate effort was made to preserve this atmosphere — especially in the choice of materials and finishes — without any sacrifice of plan or design efficiency. The result is a fresh design that should not have to depend on a state of newness for effect.

Only the southern wing of the stable (portion to left of vertical line in sketch) was used in final house; photo at upper right is from same angle as the drawing

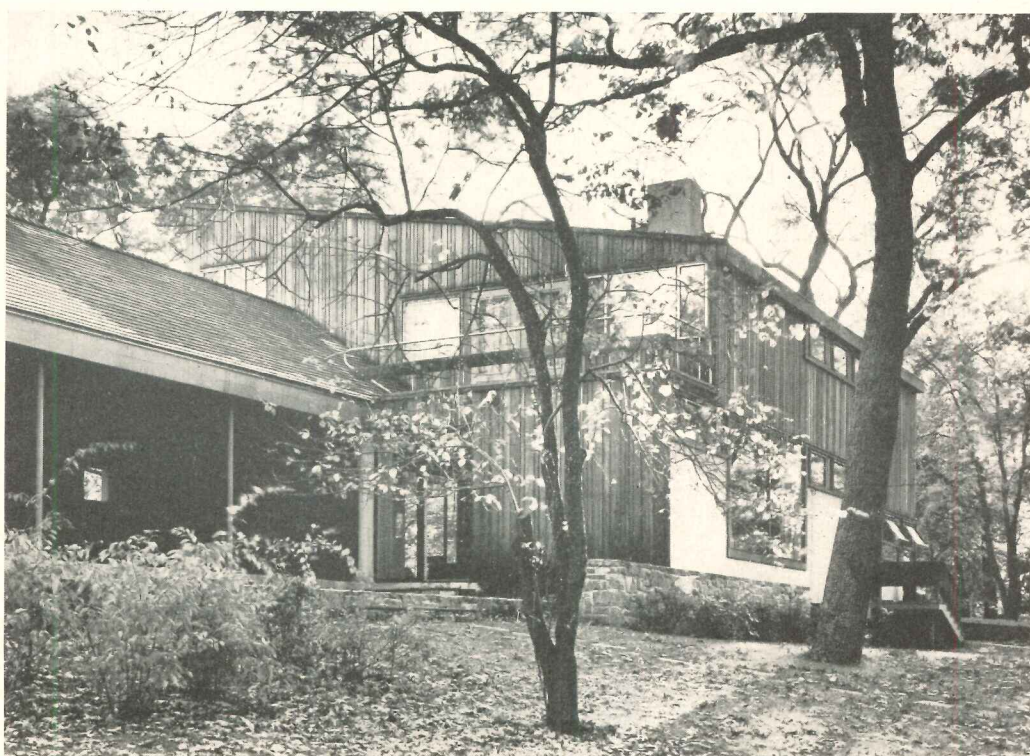

REMODELED HOUSE

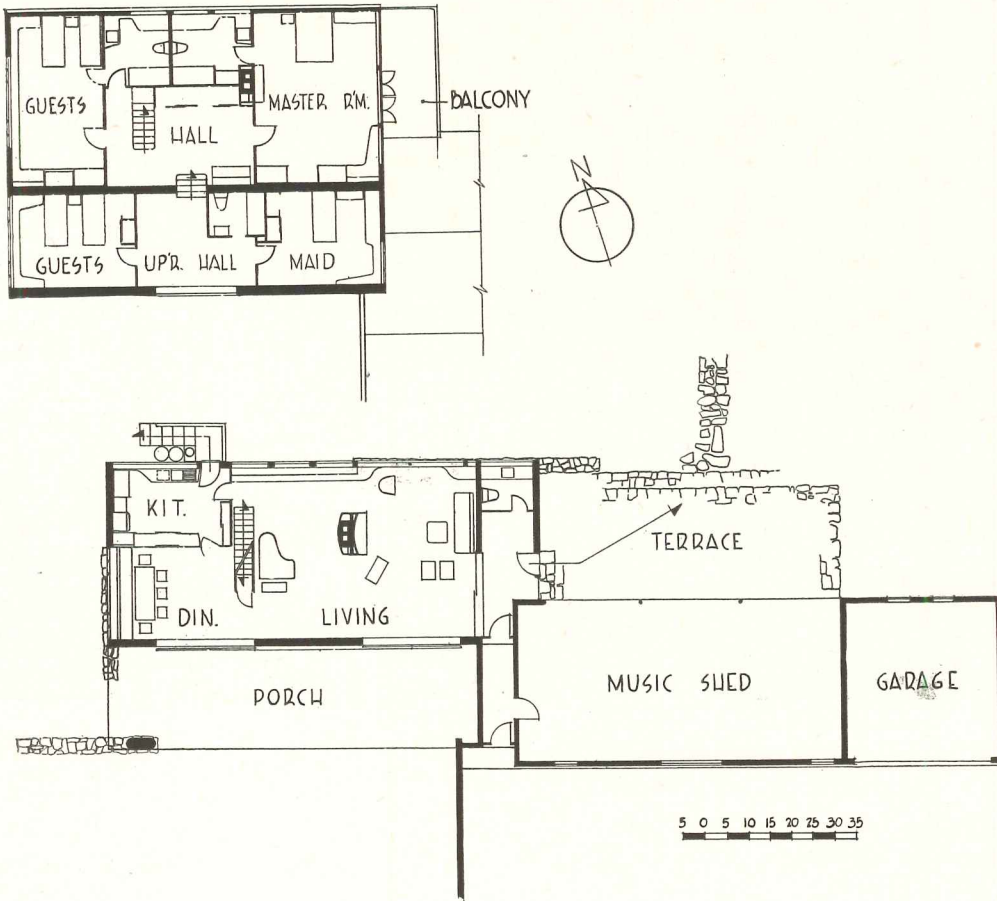

The main portion of the house was adapted from the carriage hall, retained only major parts of structure. Music shed and garage were transformed with only minor alterations from stable wing. House is site of annual Locust Valley Music Festival

Ben Schnall

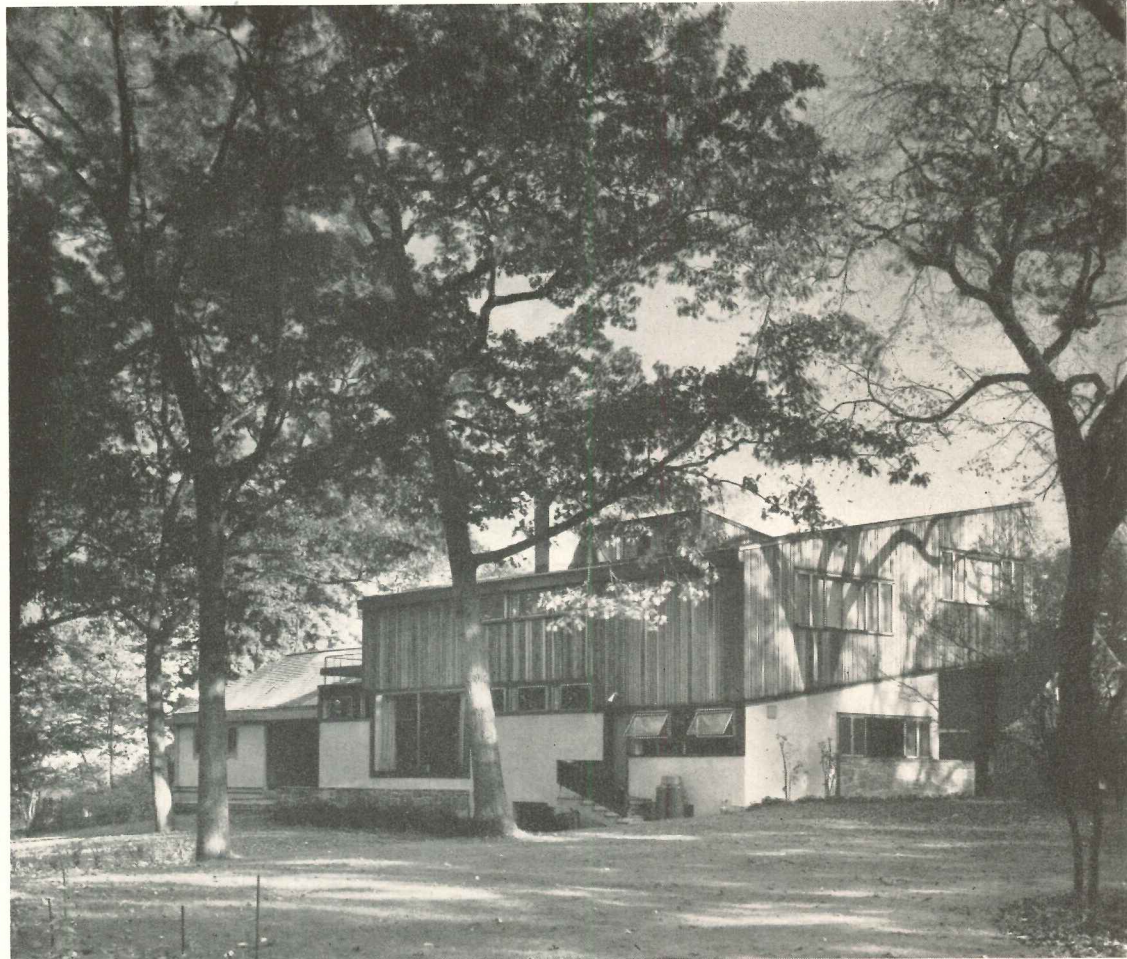

It was desired to save as much as possible of the original structure for economy. The complicated roofs, however, were completely out of scale with the revised design, and were removed except for one large truss on the south. This was refashioned into a rectangular truss, and a simple built-up roof was sloped from it down to the north (see eave details at right — scale is in inches). Problems were also posed by the existence of four different floor levels. These were solved by converting the high-ceilinged, concrete-floored space to the south into an open porch, and by sloping the redwood siding of the upper story to conform with the 3 ft difference in floor level. The lower floor exterior was left stuccoed as it had been before. Interior partitions were rearranged to provide a convenient plan. All mechanical equipment is new, and is kept simple and unobtrusive.

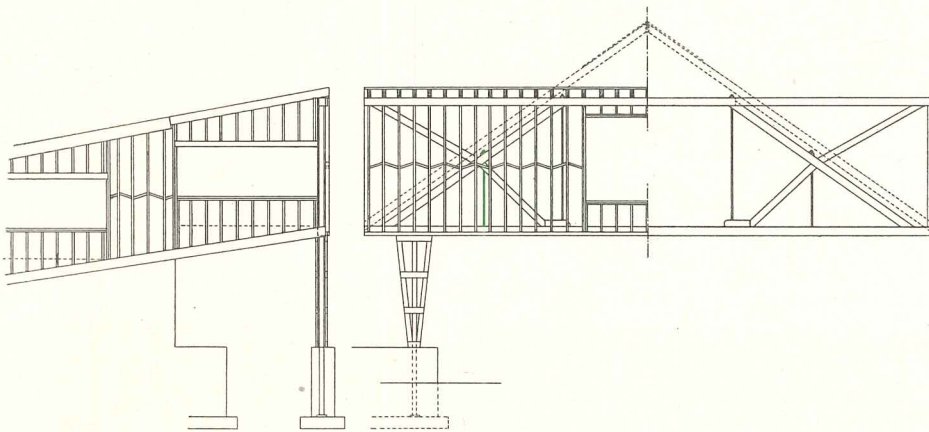
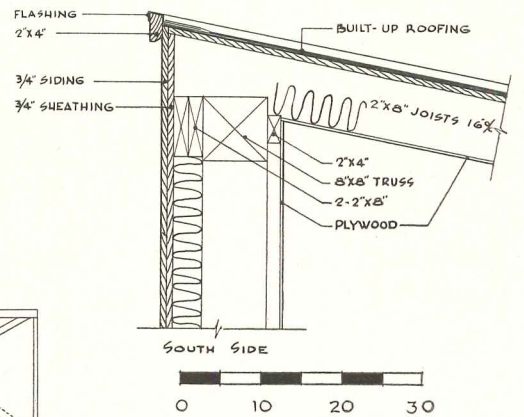
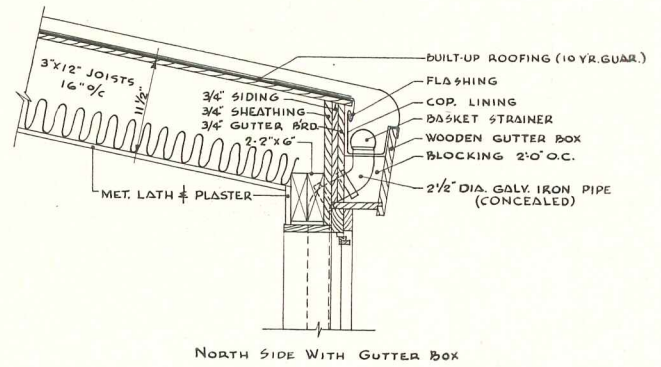

The original variations in floor levels were retained for economy. West elevation of upper floor was sloped to unify the two different levels. A rectangular truss, refashioned from an existing truss, spans new porch

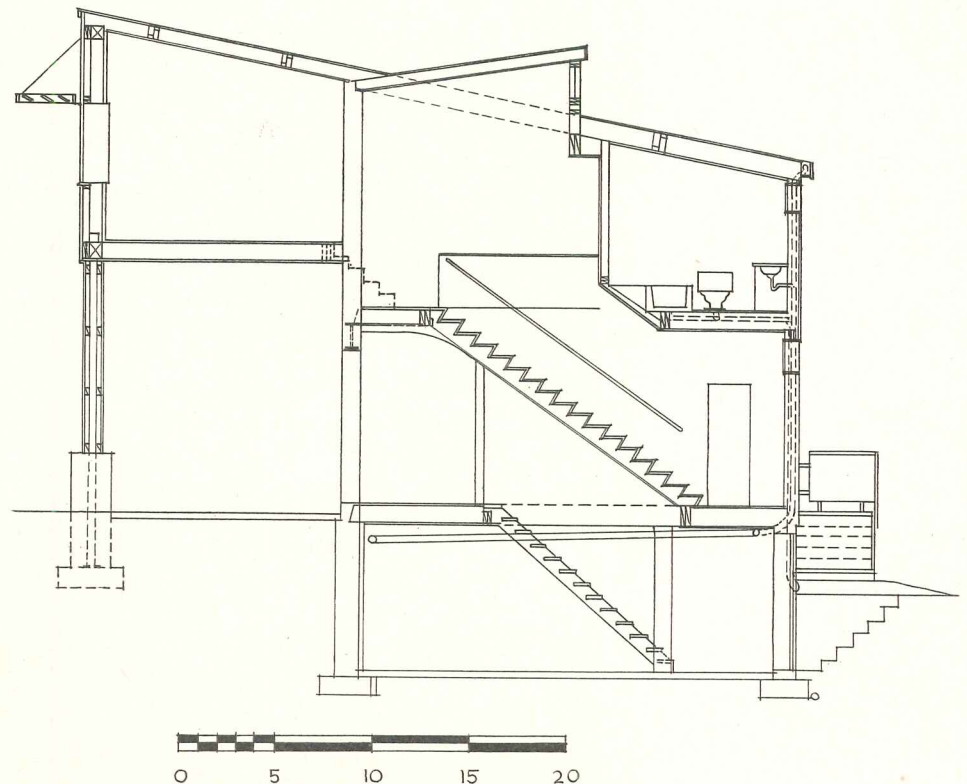

REMODELED HOUSE

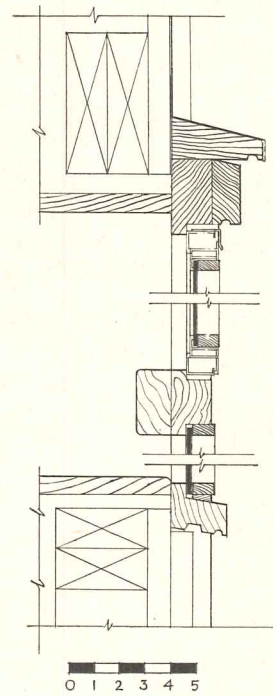
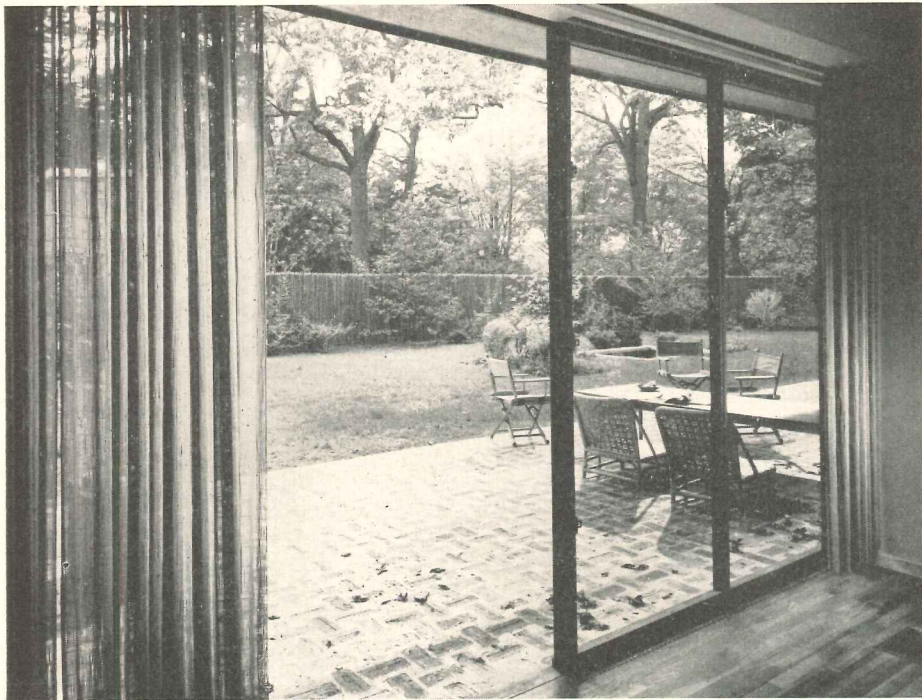

The living area (above and below) was planned to permit entertaining of large groups; broad windows open on park. Both fixed and metal casement windows have wood surrounds for uniformity, as in kitchen window detail above right (scale is in inches)



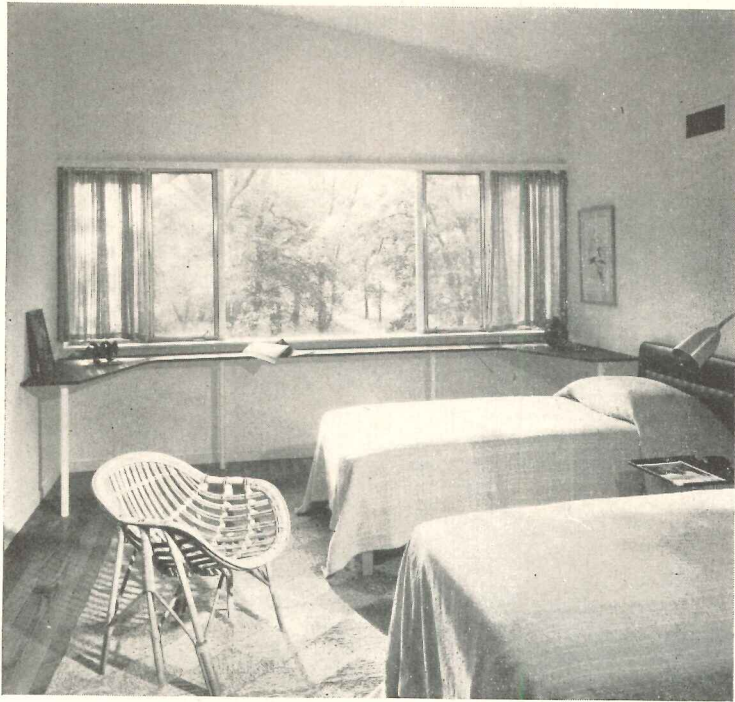

The existing stairs were opened up toward living and dining spaces, with a new railing planned to make rooms seem as open as possible. Large central hall on second floor (right) is lighted by dormer windows, has bank of storage closets. Interior walls are plaster, floors maple

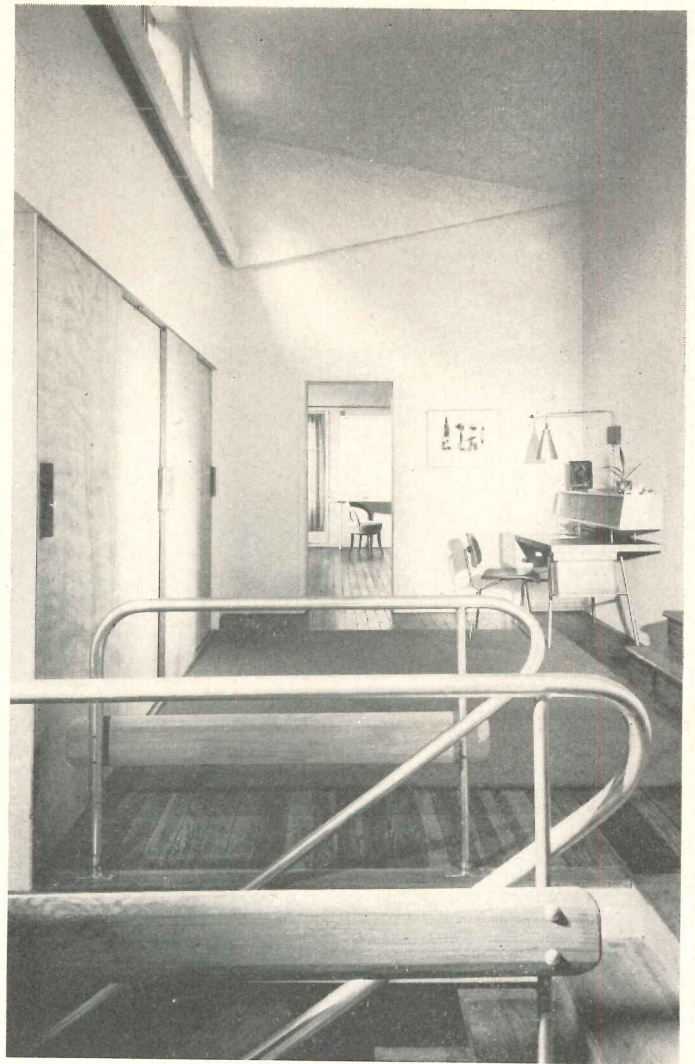

Ben Schnell

MAXIMUM USE OF ODD-SHAPED



Residence for Mr. and Mrs. Elliot Handler, Los Angeles, California

Kenneth N. Lind, Architect

2-LEVEL SITE

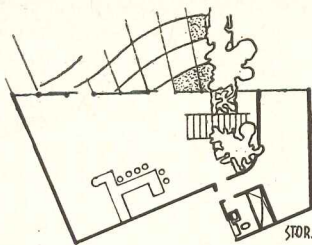

Main floor plan is shown below, lower level recreation room plan at left. Staggered walls extend vistas from dining area and kitchen

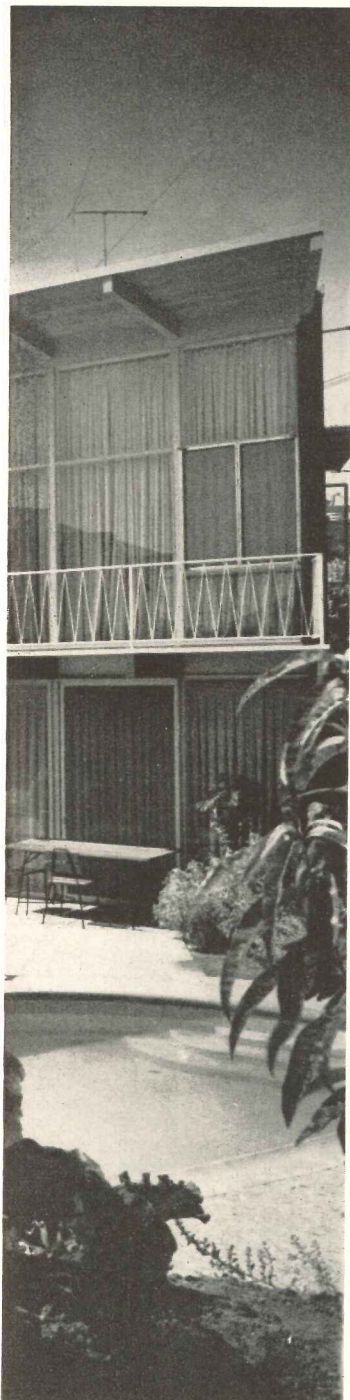
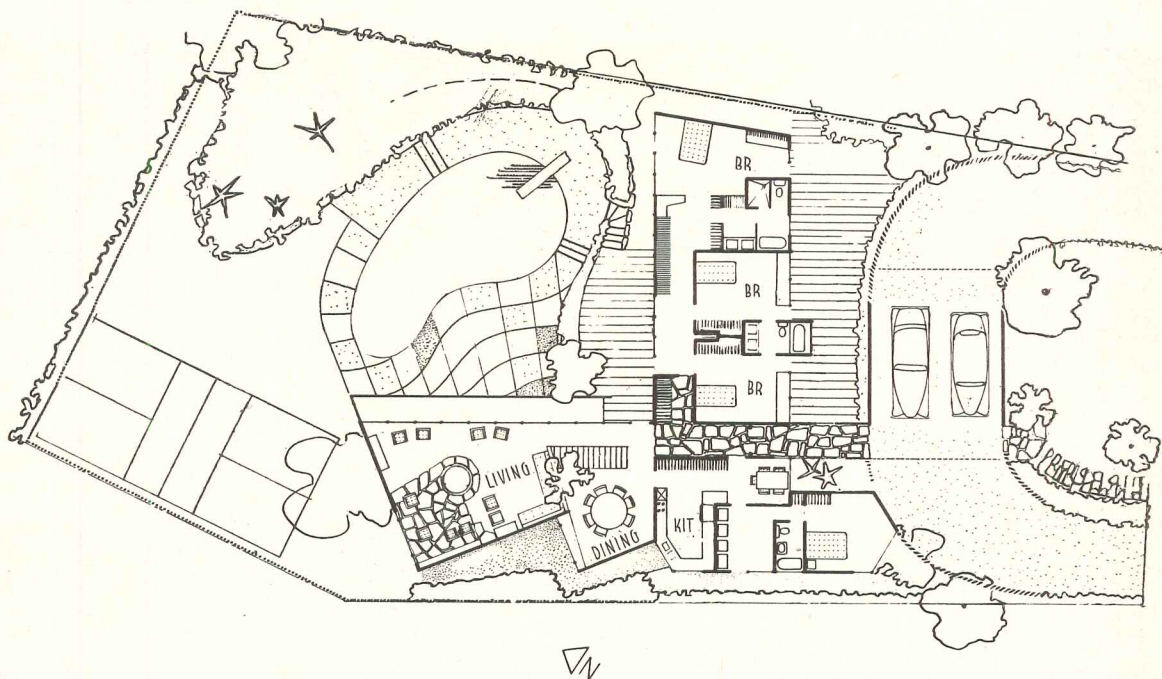

A LOT of ingenuity was used in planning this house for its odd-shaped, two-level site in a rather crowded residential area. The clients wanted as much space and privacy as possible, both indoors and outdoors, for the family activities, and space for entertaining business associates. To achieve these objectives, the architect used the natural drop in site level to divide the one-story sleeping and service section from the two-floor living wing. It also serves as an exterior transition from the upper levels to the walled-in garden below. All major rooms open directly to the outside, and have windows shielded from immediately adjoining properties.

Julius Shulman

The entire site is walled-in, used as living areas. Walls of entrance court (right) screen bedroom terraces from street. Main garden provides for such space-taking sports as tennis, swimming



HANDLER HOUSE

The structure of the house is wood frame on concrete foundations. Exterior walls are stucco, or redwood stained and oiled; the roof is surfaced with 2½- to 3-in. terra-cotta-colored granules. Considerable use is made of rough stone for walls and terraces, and the stone is continued into the recreation room together with planting (see photo below) to visually tie it in with outdoor areas. Interior walls are plaster, mahogany plywood or random pine strips. Ceilings are lightweight aggregate plaster or exposed tongue-and-groove sheathing. Roof areas over exposed beamed ceilings are thermally insulated with a 2-in. layer of poured lightweight aggregate.

Heating is by a hot water radiant system installed on top of wood floor framing. Coils are imbedded in a 1½-in. layer of concrete, separated from the wood by a membrane. The concrete also stiffens floors, reduces squeaks and spring.

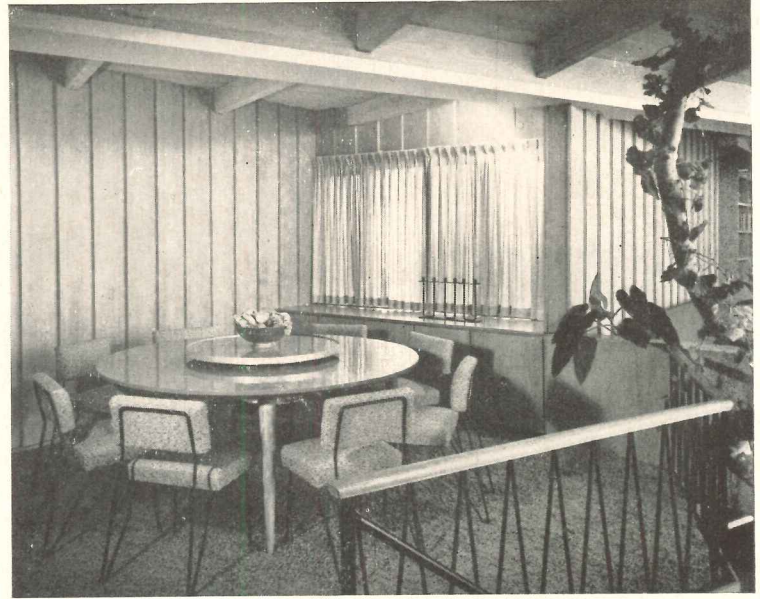

Julius Shulman





Living areas on the upper level form large, open room with suggested divisions: general sitting area (above) is separated from book area by raised stone floor flanking central fireplace; from dining area (above left) by stairwell and railing. All rooms open to out of doors, including bedrooms and kitchen





Charles R. Pearson

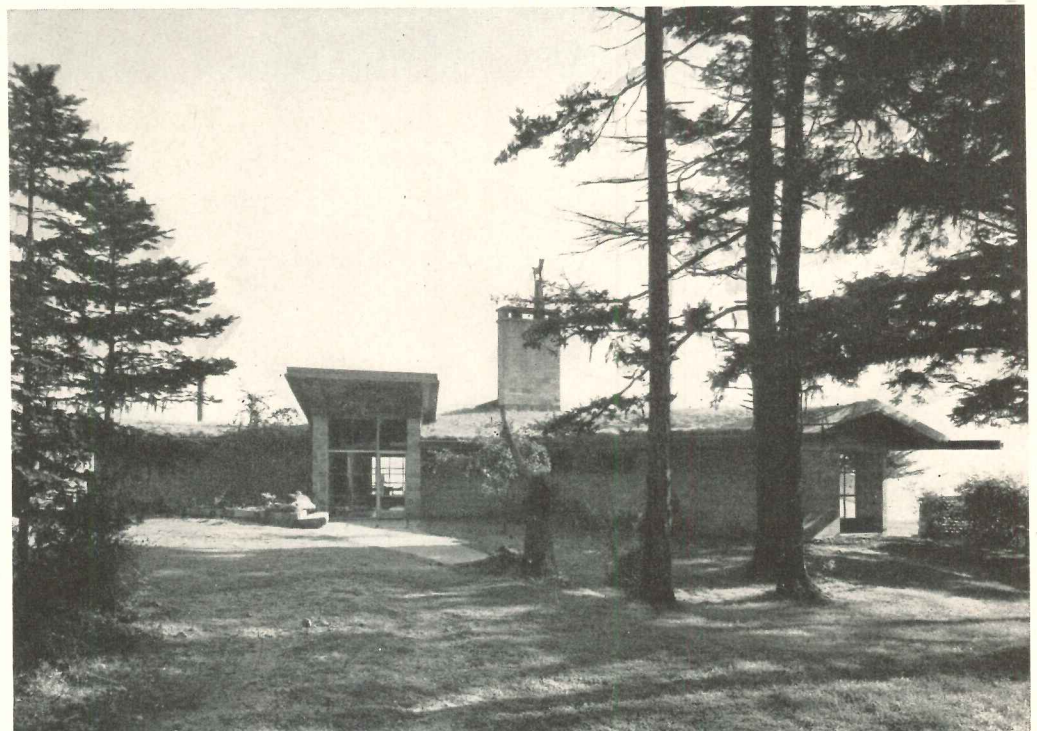

ISLAND WEEK-END HOUSE FOR ALL-YEAR USE

*Country House for Mr. Richard Lea
Lopez Island, San Juan Group, Washington
Lionel H. Pries, Architect*

A **DRAMATIC**, isolated site which faces an often-stormy strait affords the owners of this house a retreat from the bustle of Seattle, 100 miles away. Designed for year-round week-end occupancy, the house is set off by half-mile stretches of beach on either side and by heavy woods behind. It is constructed of concrete block, clear-finished on the exterior, painted on the interior. Floors are tobacco-brown concrete and ceilings are clear-lacquered cedar. The sodded roof, which helps tie the low-spreading house to its setting, never needs trimming, since salt spray breaking over it stunts the native grasses and Japanese Iris with which it is planted.

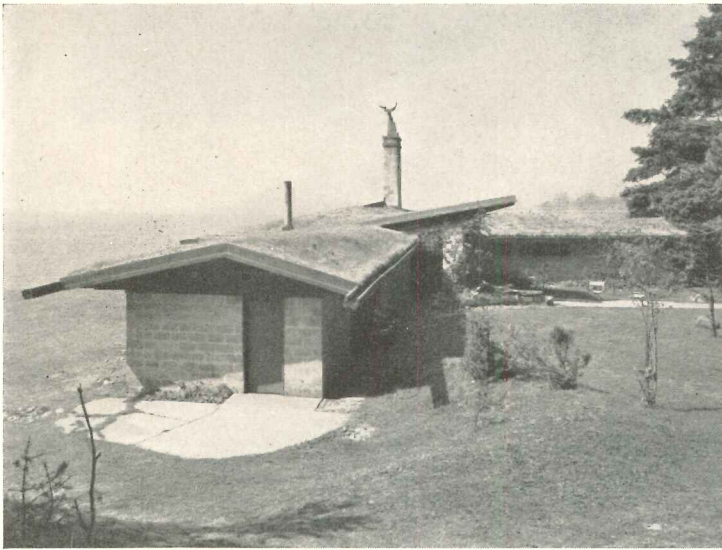

Casual nature of house is pointed up by decorative effects, including painted motif on underside of entry and copper "thunderbird" sculpture atop chimney

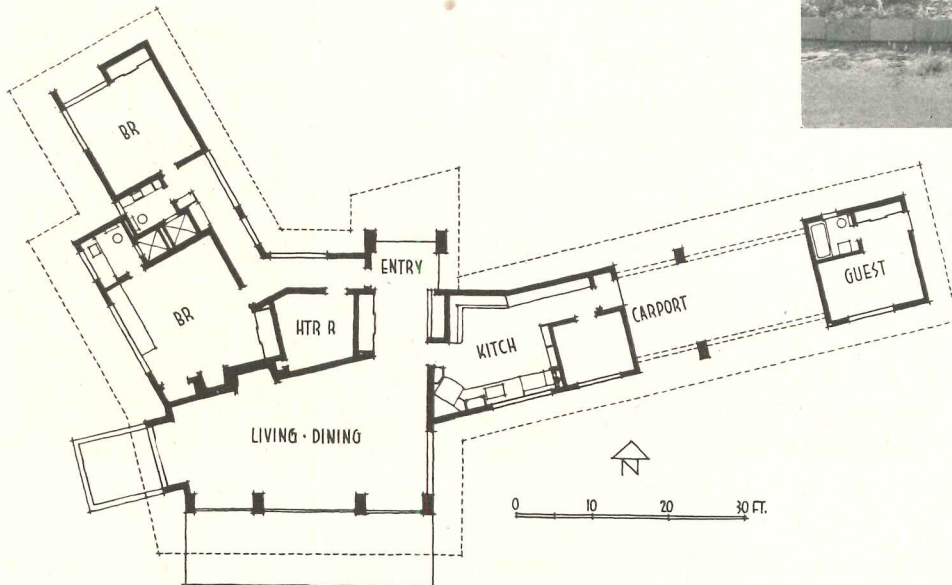

ISLAND WEEK-END HOUSE

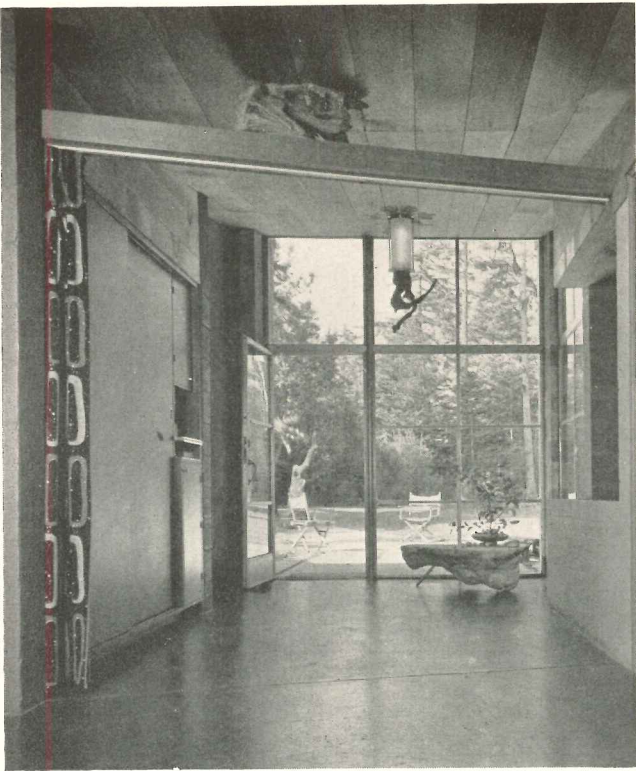

Charles R. Pearson

Simplicity of interior offers pleasant, effective contrast to the dramatic site, as in entry, above. Living room, above right and below, has glass doors leading to terrace, can be thrown open to breezes from the sound

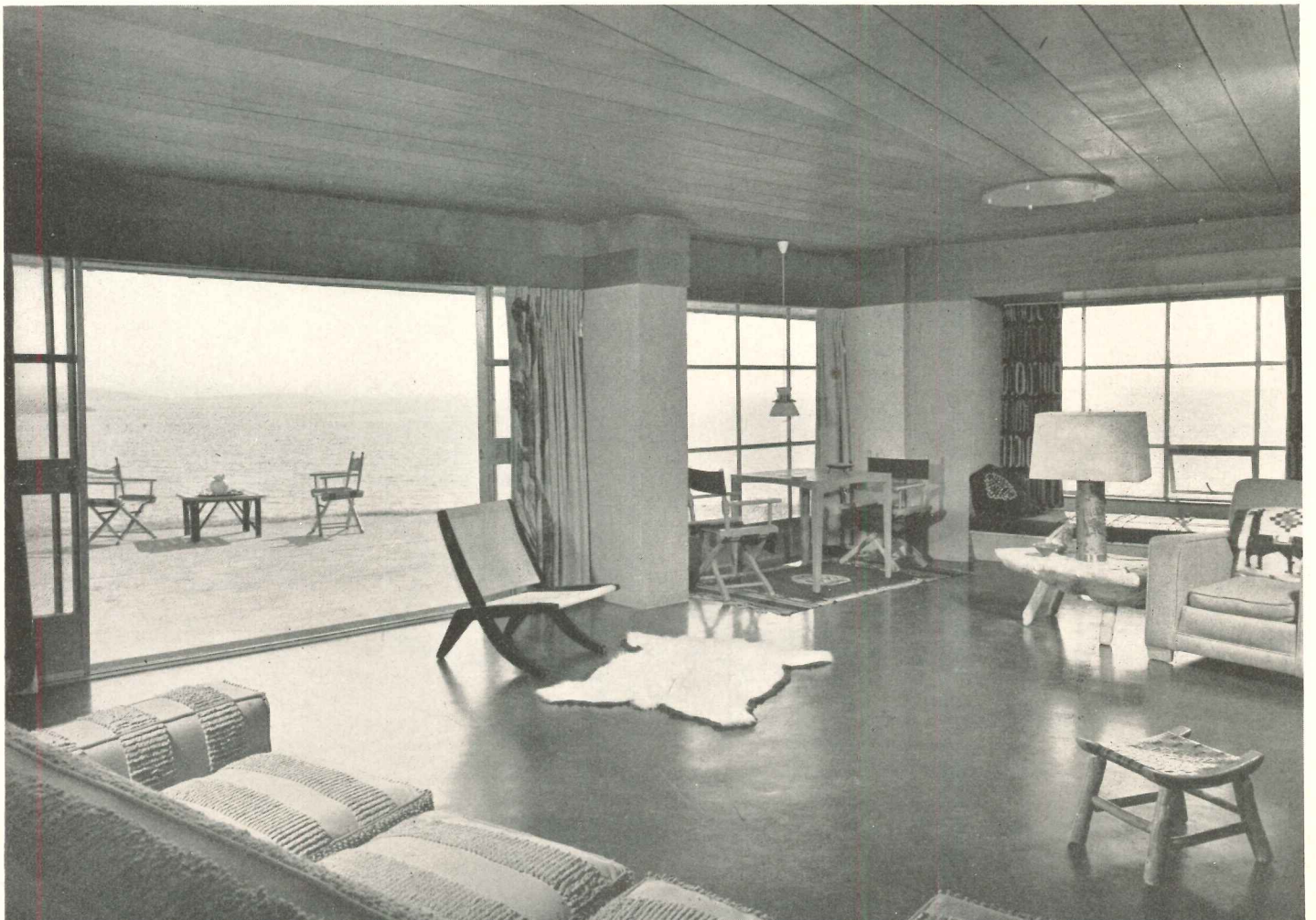

HOSPITALS

TEN BILLION DOLLARS worth of hospital construction is still required to satisfy the nation's needs for medical care. According to the U. S. Public Health Service, we now have around a million acceptable hospital beds, with 874,000 beds still needed. At current per-bed costs, \$10,000,000,000 is probably conservative.

Since 1947, when the Hospital Survey and Construction (Hill-Burton) Act became effective, a systematic state-by-state inventory of hospital facilities has been taken, and a sizeable start made on building of needed hospitals and public health centers. The chart below shows what proportion of total bed requirements have been met, and how much building remains to be done.

In terms of new hospital construction yet to come, the chart figures mean that there is still much to be done in general hospitals, especially in small communities, but the program will gradually shift toward mental hospitals, then later toward chronic disease hospitals.

New and Revised Hospital Elements

"Elements of the General Hospital," a series of planning aids prepared for hospital architects by Marshall Shaffer and his staff at the U. S. Public Health Service, was published in ARCHITECTURAL RECORD in 1946; since then something like fifty thousand reprints have been distributed. In intervening years many of the elements have been revised in accordance with changing hospital practice, and many new plans have been added. The first dozen pages of this Building Types Study bring the series up to date, include all of the revisions and additions. As before, these are not intended to be arbitrary or restrictive; rather they represent a convenient method of showing important planning considerations, not forgetting major items of equipment shown in place.

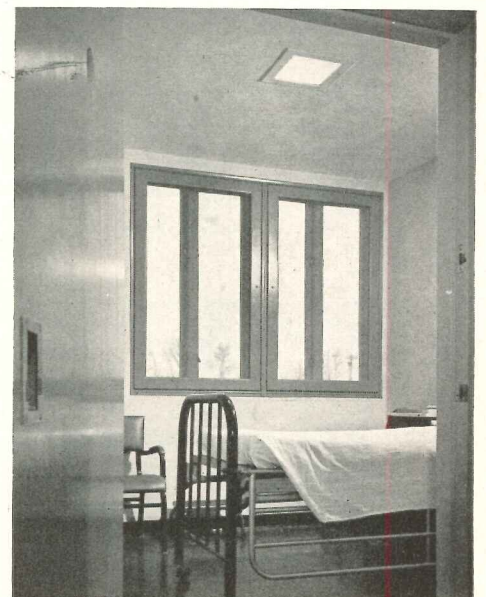
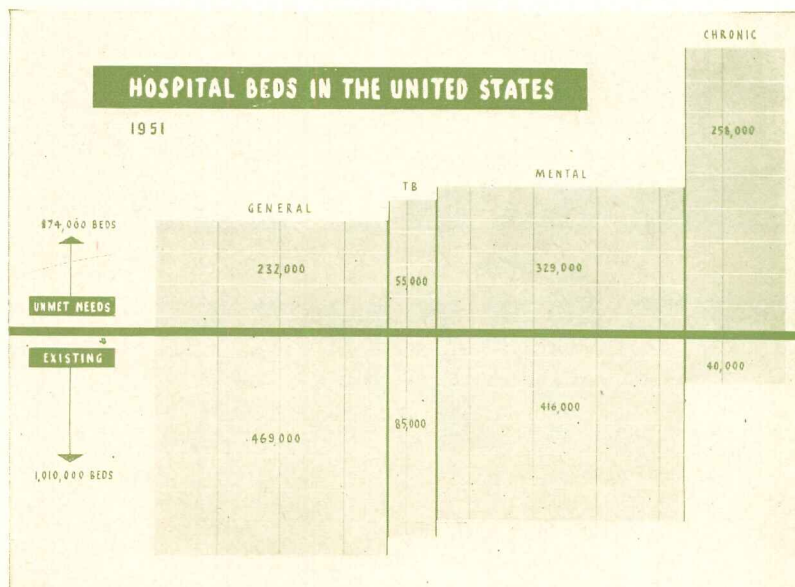

NEW AND REVISED ELEMENTS OF

By Division of Hospital Facilities

U. S. Public Health Service

Federal Security Agency

NURSING DEPARTMENT

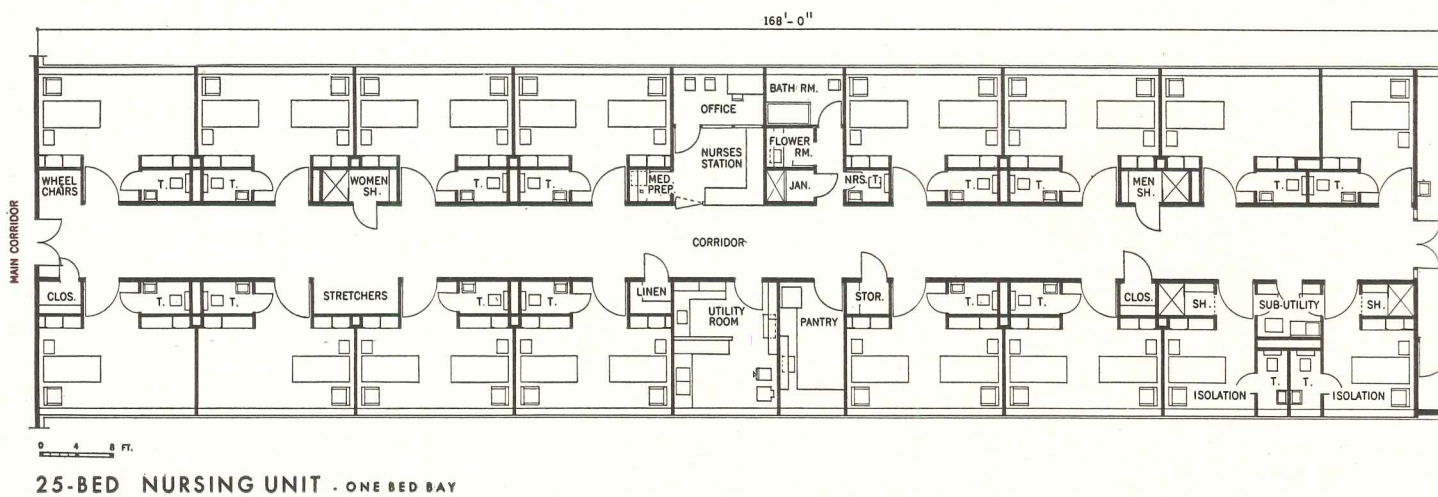
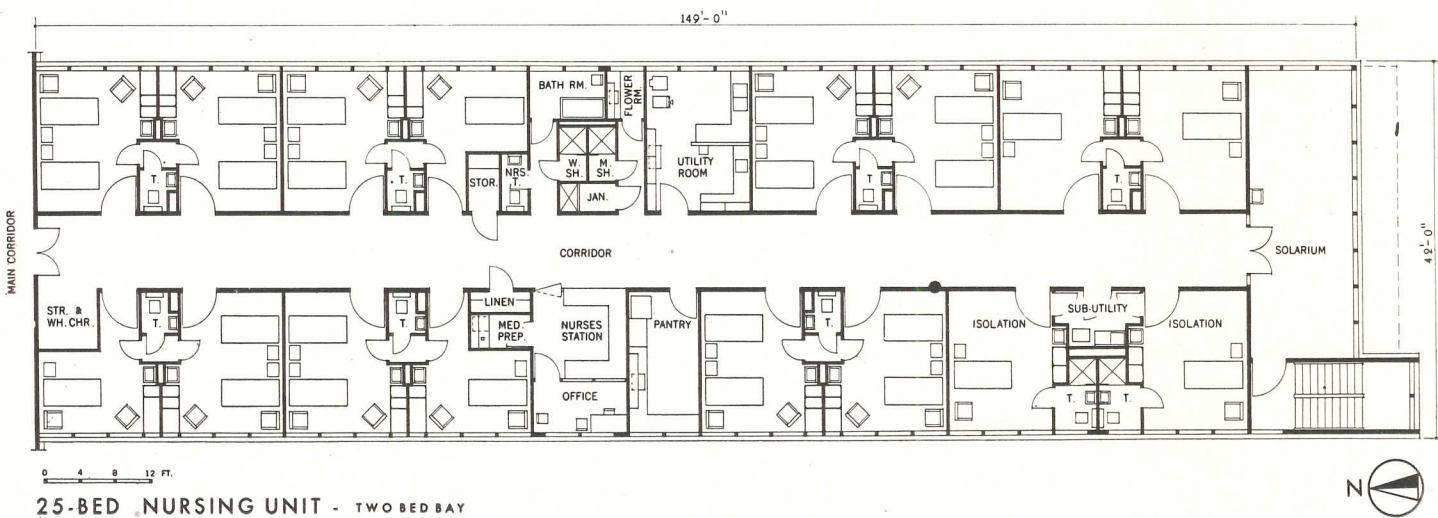

THE GENERAL HOSPITAL

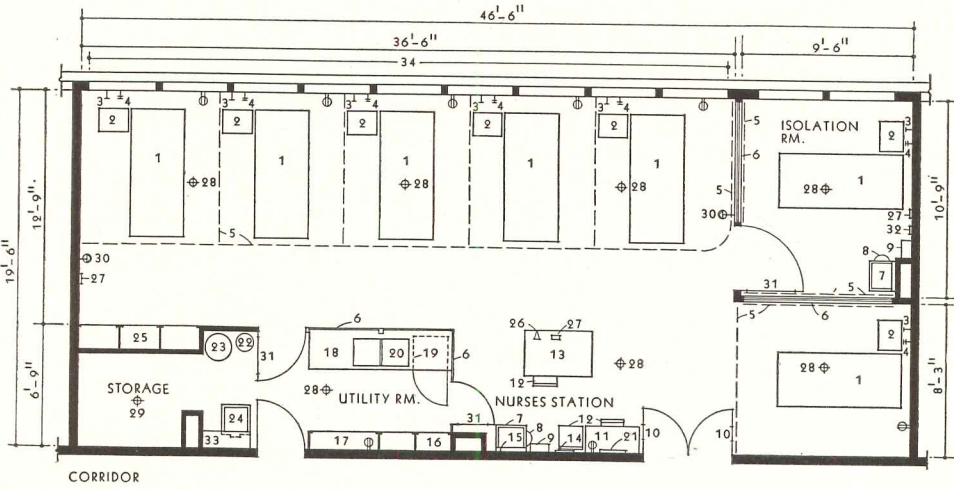

SURGERY RECOVERY ROOM FOR A 200-BED GENERAL HOSPITAL

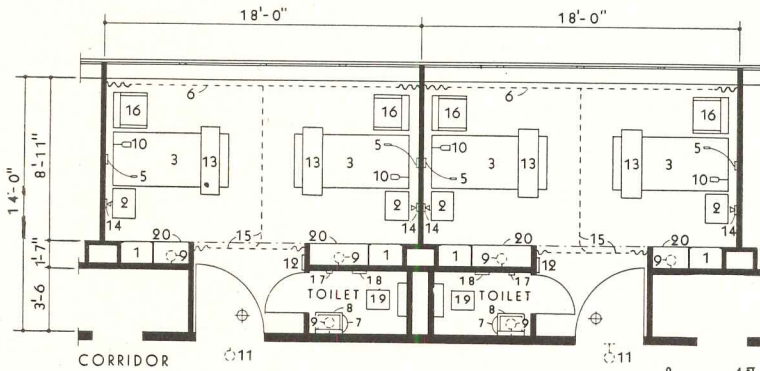

TYPICAL PATIENTS' ROOMS (TWO-BED BAY)

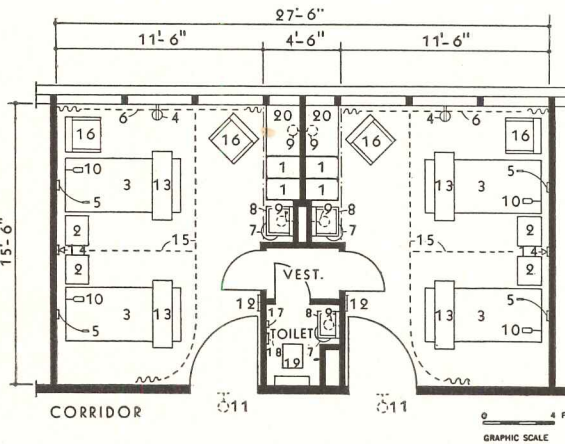
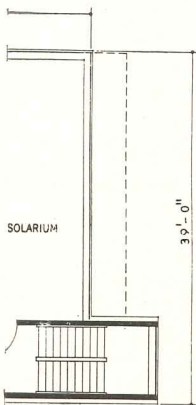

TYPICAL PATIENTS' ROOMS (ONE-BED BAY)



SURGERY RECOVERY ROOM

1. Adjustable hospital bed
2. Bedside cabinet
3. Oxygen outlet, 5 ft 3 in. above floor
4. Suction outlet, 5 ft 3 in. above floor
5. Cubicle curtain
6. Partition to ceiling, glass 40 in. above floor to 7 ft above floor
7. Lavatory with gooseneck spout and knee or elbow control
8. Waste paper receptacle
9. Paper towel dispenser
10. Vision panel
11. Table
12. Straight chair
13. Executive type desk
14. Clock
15. Mirror
16. Locked wall cabinet with inner locked narcotic compartment and inside light
17. Shelf 12 in. wide, 38 in. above floor with cabinets above and below
18. Work counter 2 ft 4 in. wide, 38 in. above floor
19. Refrigerator under counter
20. Double compartment sink, one comp. 6 in. deep, the other 10 in. deep, gooseneck spout
21. Bulletin board
22. Sanitary waste receptacle
23. Laundry hamper
24. Clinical sink with bed pan flushing attachment
25. Storage cabinet
26. Telephone outlet
27. Nurses call with emergency call button with duplex receptacle
28. 500 watt indirect lighting units
29. 200 watt semidirect lighting unit
30. Single receptacle 30 amp
31. Glazed door
32. Hook strip
33. Shelf 48 in. above floor
34. Window sills approximately 6 ft above floor

TYPICAL PATIENTS' ROOMS

1. Built-in locker
2. Bedside cabinet
3. Adjustable hospital bed
4. Duplex convenience outlet
5. Nurses' calling station with duplex receptacle
6. Sliding window curtain
7. Waste paper receptacle
8. Lavatory with gooseneck spout and knee or elbow control
9. Wall bracket light, switch controlled
10. Bed light
11. Corridor dome light
12. Night light, switch controlled
13. Over bed table
14. Telephone outlet and duplex receptacle
15. Cubicle rod and curtain
16. Easy chair
17. Nurses calling station (push button type)
18. Grab rail
19. Water closet with bed pan lugs and bed pan flushing attachment
20. Built-in dresser

NURSING DEPARTMENT

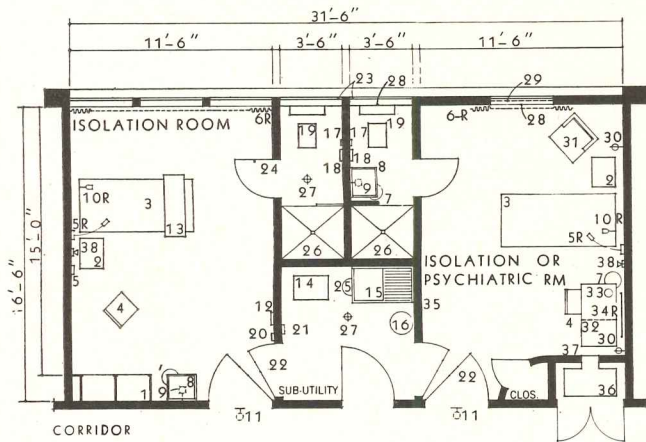

ISOLATION AND PSYCHIATRIC ROOMS

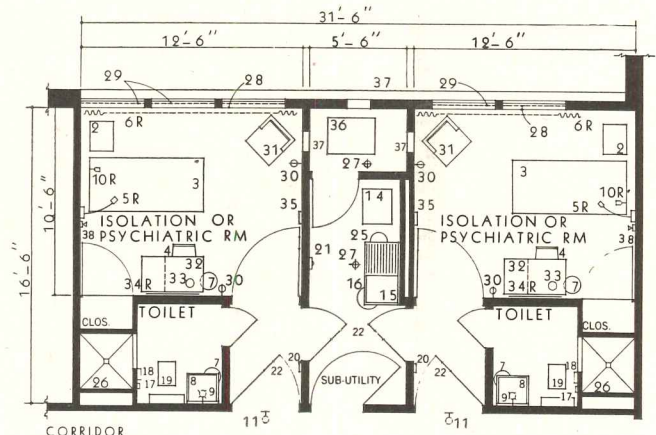

ISOLATION AND PSYCHIATRIC ROOMS

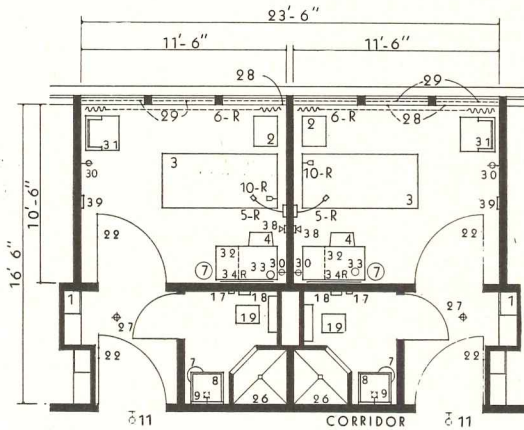

PRIVATE SPECIAL TREATMENT ROOMS

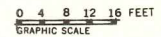
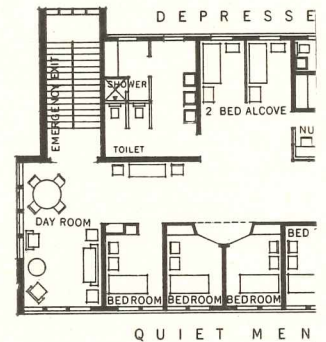

ISOLATION AND PSYCHIATRIC ROOMS

Note: All numbers noted with "R" denote that the items shall be removable.

1. Built-in lockers
2. Bedside cabinet
3. Adjustable hospital bed
4. Straight chair
- 5R. Nurses calling station with duplex receptacle, contagious type
- 6R. Sliding window curtain
7. Waste paper receptacle
8. Lavatory with gooseneck spout and knee or elbow control
9. Wall bracket, switch controlled
- 10R. Bed light
11. Corridor dome light
12. Night light, switch controlled
13. Over bed table
14. Utensil sterilizer 20" x 20" x 24"
15. Sink and drainboard
16. Linen hamper
17. Nurses calling station (push button type)
18. Grab rail
19. Water closet with bed pan lugs and bed pan flushing attachment
20. Hook strip
21. Dome light and buzzer, 5' 6" above floor
22. View panel with heat tempered glass approx. 8" x 12" and 4' 6" from floor
23. Obscure glass
24. Coat hook
25. Sanitary waste receptacle
26. Shower
27. Ceiling light
28. Detention screen
29. Shutter
30. Duplex receptacle
31. Easy chair
32. Desk
33. Desk lamp
- 34R. Mirror
35. Night light with heat tempered glass and switch controlled from sub-utility
36. Air-conditioning unit.
37. Supply and exhaust openings with grille
38. Telephone outlet and duplex receptacle

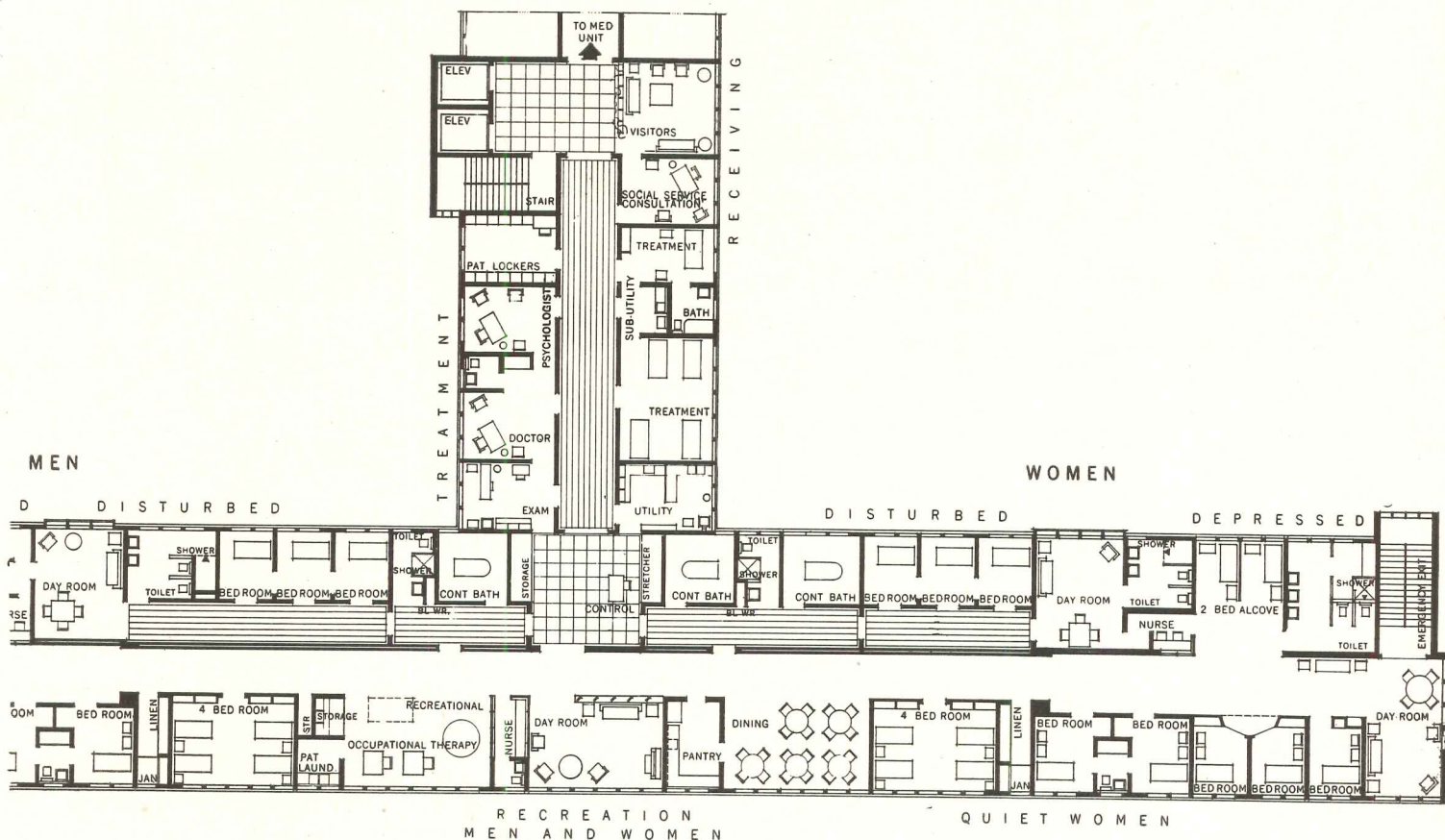

SUGGESTED PLAN OF PSYCHIATRIC WARD FOR THE GENERAL HOSPITAL
 FOR DISTURBED, QUIET AND DEPRESSED (MEN AND WOMEN) CAPACITY 30 PATIENTS

WING 1

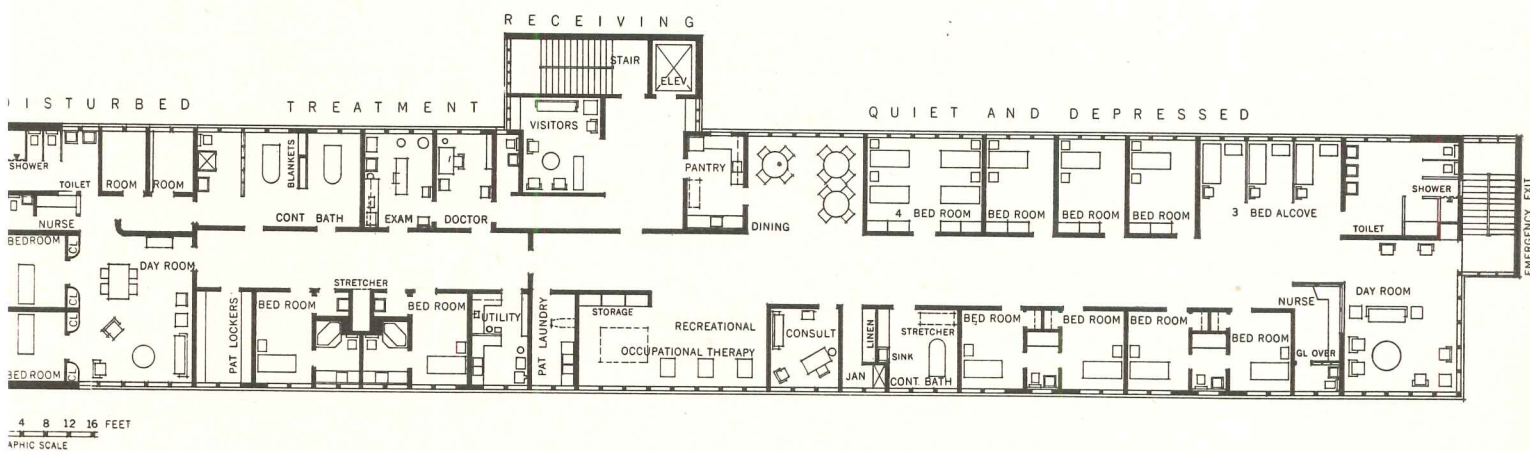

4 8 12 16 FEET
 GRAPHIC SCALE

SUGGESTED TYPE PLAN OF PSYCHIATRIC WARD FOR THE GENERAL HOSPITAL
 FOR DISTURBED, QUIET AND DEPRESSED (MEN OR WOMEN) CAPACITY 20 PATIENTS

WING 2

NURSING DEPARTMENT, TUBERCULOSIS HOSPITAL

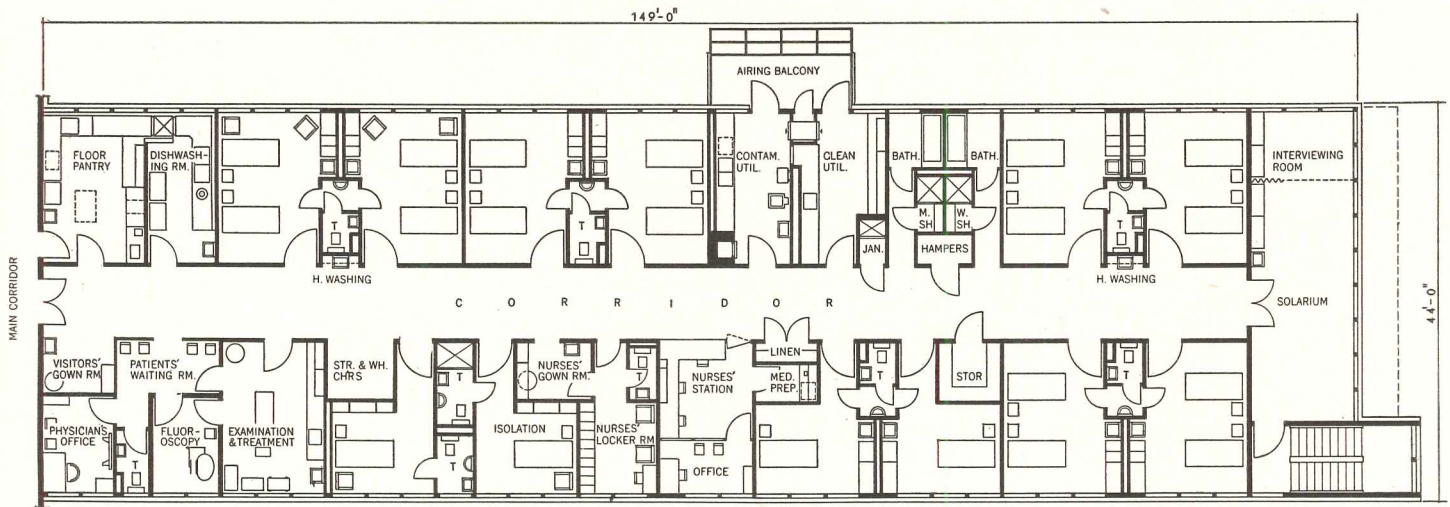

20-BED TUBERCULOSIS NURSING UNIT FOR A GENERAL HOSPITAL

PRIVATE AND SEMI-PRIVATE ROOMS WITH CONNECTING TOILETS - TWO BED BAY

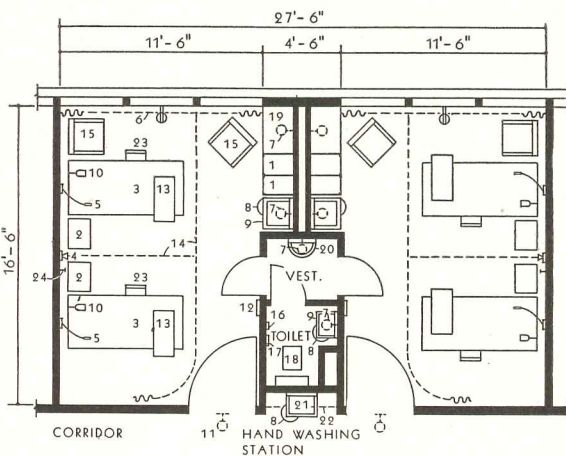
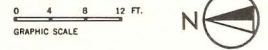

TYPICAL SEMI-PRIVATE ROOMS WITH CONNECTING TOILET

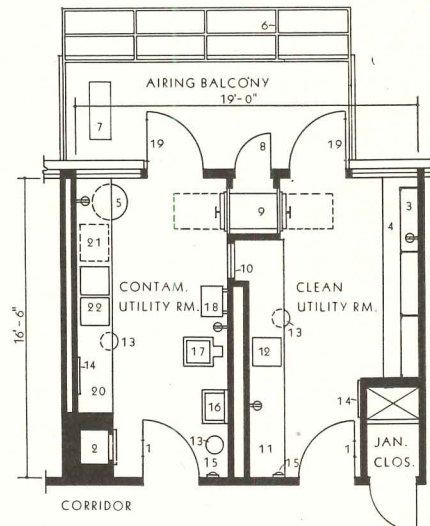

UTILITY ROOMS

TYPICAL SEMI-PRIVATE ROOMS

1. Built-in locker
2. Bedside table
3. Adjustable hospital bed
4. Telephone outlet and duplex receptacle
5. Nurses' calling station with duplex receptacle
6. Sliding window curtain
7. Wall bracket light, switch controlled
8. Waste paper receptacle
9. Lavatory with gooseneck spout and knee or elbow control
10. Bed light
11. Corridor dome light
12. Night light, switch controlled
13. Over-bed table
14. Cubicle rod and curtain
15. Easy chair
16. Nurses' calling station (push button type)
17. Grab rail
18. Water closet with bedpan lugs and bedpan flushing attachment
19. Built-in dresser
20. Dental lavatory
21. Scrub-sink with gooseneck spout and knee or foot control
22. Shelf above scrub sink
23. Straight chair
24. Oxygen and suction outlets, 5 ft 6 in. from floor

UTILITY ROOMS

1. Vision panel
2. Incinerator
3. Wall cabinet

4. Counter, 36 in. high, with cabinets below
5. Laundry hamper
6. Mattress airing rack
7. Drying rack
8. Access door
9. Sterilizer with double doors, 24 by 36 in.
10. Pass window
11. Counter, 36 in. high, with open shelf below
12. Sink in counter with gooseneck spout and foot or knee control
13. Waste paper receptacle
14. Bulletin board, 26 by 24 in.
15. Domelight and buzzer set, 5 ft 6 in. from floor
16. Scrub sink with gooseneck spout and foot or knee control
17. Clinical sink
18. Hot plate, double element, on bracket
19. Glazed door
20. Counter, 36 in. high with open shelf below
21. Cracked ice bin (for external use only)
22. Built-in double compartment sink

NURSES' GOWN ROOM, ETC.

1. Counter 36 in. high with shelving under sink for medicine trays
2. Medicine sink in counter with gooseneck spout
3. Refrigerator under counter
4. Instrument sterilizer, 3 by 3½ by 8½ in.
5. Wall cabinet with inner locked narcotic compartment and inside light
6. Counter, 30 in. high, open below
7. Dutch door with lock
8. Straight chair
9. Waste paper receptacle
10. Domelight and buzzer set, 5 ft 6 in. from floor
11. Pigeon-hole form rack
12. Chart rack

13. Bulletin board, 26 in. by 24 in.
14. Glazed door
15. Glazed partition
16. Desk
17. Lavatory with gooseneck spout and knee or elbow control
18. Easy chair
19. Counter with mirror above
20. Water closet
21. Lockers, full length
22. Scrub sink with gooseneck spout and foot or knee control
23. Soap dispenser with foot control
24. Hook strip with name plates above hooks
25. Wall cabinet for clean gowns
26. Shelf for clean mask container and forceps jar, mirror above shelf
27. Laundry hamper
28. Telephone outlet
29. Receptacle for contaminated masks
30. Trimmed opening

EXAMINATION AND TREATMENT ROOM, ETC.

1. Domelight and buzzer set, 5 ft 6 in. from floor
2. Telephone outlet
3. Counter, 36 in. high, with cabinets below
4. Wall cabinet
5. Instrument sterilizer 17½ by 7½ by 6 inches
6. Built-in instrument sink, with gooseneck spout and foot or knee control
7. Scrub sink with gooseneck spout and foot or knee control
8. Soap dispenser, single, with foot control
9. Waste paper receptacle
10. Clean-up table, 18 by 30 in.
11. Instrument table, 18 by 33 in.

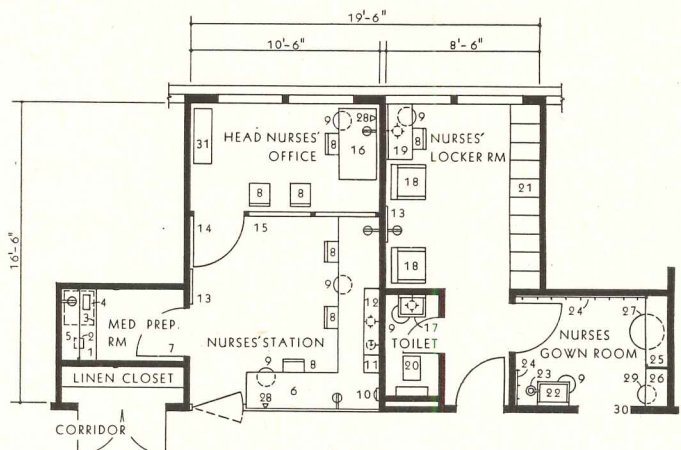

NURSES' GOWN ROOM, NURSES' LOCKER ROOM, NURSES' STATION, OFFICE AND MEDICINE PREPARATION ROOM

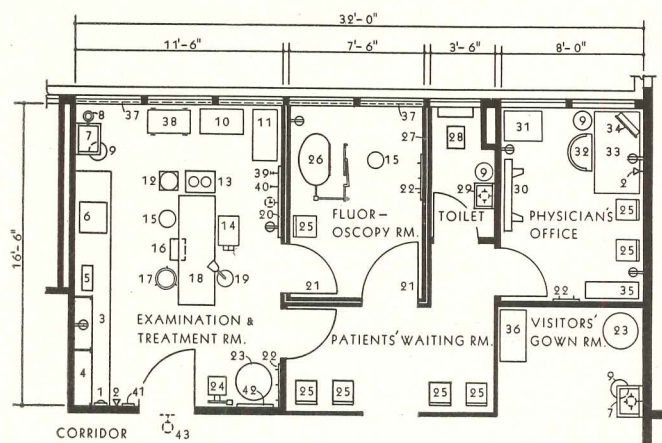

EXAMINATION AND TREATMENT ROOM, FLUOROSCOPY ROOM, PHYSICIAN'S OFFICE, PATIENTS' WAITING ROOM AND VISITORS' GOWN ROOM

- | | | |
|---|---|---|
| <ul style="list-style-type: none"> 12. Single basin stand 13. Pneumothorax apparatus with stand 14. Mayo table 15. Adjustable stool 16. Footstool 17. Kick bucket 18. Examination table 19. Examination light 20. Film illuminator, 2 units of 3 each, built-in 21. Lead lined door 22. Hook strip | <ul style="list-style-type: none"> 23. Laundry hamper 24. Clinical scale 25. Straight chair 26. Fluoroscope 27. Lead lined walls 28. Water closet 29. Lavatory with gooseneck spout and foot or knee control 30. Mobile film illuminator stand 31. Film file 32. Desk chair | <ul style="list-style-type: none"> 33. Executive type desk 34. View box 35. Bookcase 36. Table for clean gowns 37. Light-proof shades 38. Dressing cart 39. Suction outlet, 5 ft. 6 in. from floor 40. Oxygen outlet, 5 ft. 6 in. from floor 41. Nurses' call (connected to nurses' station) 42. Bulletin board, 26 by 24 in. 43. Corridor domelight |
|---|---|---|

ADJUNCT DIAGNOSTIC AND TREATMENT FACILITIES— PHARMACIES

- | | | |
|--|--|---|
| <ul style="list-style-type: none"> 1. Executive desk 2. Executive chair 3. Straight chair 4. 4 drawer file 5. Writing table 6. Waste paper receptacle 7. Book case 8. Magazine rack 9. Telephone outlet 10. Glass panel 11. Carboy rack 12. Sanitary waste can 13. Sink with gooseneck spout and drain-board, graduate rack above, cabinets below 14. Glass tank, distilled water, 12 gallon 15. Cabinets, adjustable shelves 16. Drug cabinet, sectional type, with shelf above counter 17. Drug cabinets, sectional type 18. Prescription counter, cabinets and drawers below 19. Counter, cabinets and drawers below | <ul style="list-style-type: none"> 20. Dispensing window 21. Adjustable open shelves, starting 18 inches above counter 22. Shelf above counter 23. Prescription file 24. Refrigerator with biological drawers, 32 cubic feet 25. Dumbwaiter 26. Narcotic safe under counter 27. Prescription scale, class A 28. Prescription scale, heavy duty 29. Counter scale 30. Heat outlet grill, inlet grill in base of cabinet 31. Guards, at all windows 32. Mixing or storing tank, 20 gallons, mounted on stand with casters 33. Portable electric mixer 34. Filter press, suction-pressure type, mounted on casters 35. Hot and cold water outlets 36. Filter rack 37. Colloidal mill 38. Two compartment sink with drainboard, gooseneck spout, cabinets below 39. Still, 2 gallon per hour | <ul style="list-style-type: none"> 40. Double element hot plate 41. Vent outlet, 8 inches above floor to atmosphere 42. Vent inlet, near floor to atmosphere 43. Shelves, starting 42 inches above floor 44. Adjustable open shelves, 12 inches wide 45. Counter, 24 inches wide, 36 inches high, adjustable open shelf below 46. Barrel rack 47. Clothes locker 48. Radiator, above shelving 49. High windows 50. Bottle rack 51. Bottle cleaner, pressure type 52. Sink with gooseneck spout 53. Sink with distilled water rinser, omit hot and cold water supply 54. Drip pan with waste connection in counter top 55. Suction and pressure pump 56. Still, 10 gallon per hour 57. Gas outlet 58. Sterilizer carriage, under counter 59. Sterilizer, 24 x 36 x 48 inches 60. Hot air oven, 24 x 14 x 14 inches, on counter 61. Counter, open below 62. Storage cabinet, open adjustable shelves |
|--|--|---|

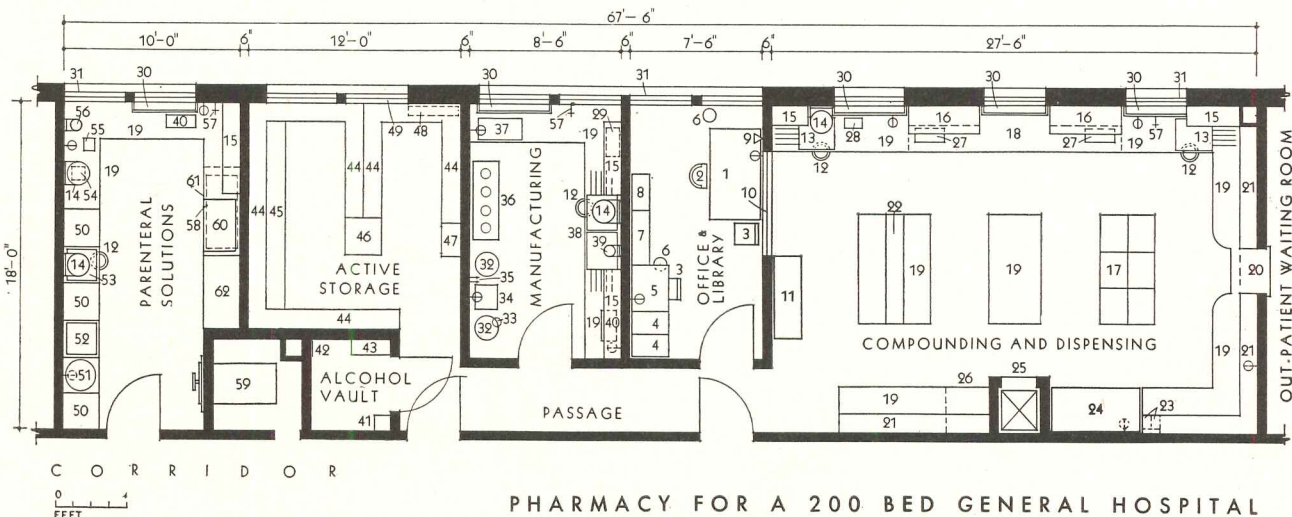

PHARMACY FOR A 200 BED GENERAL HOSPITAL

ADJUNCT DIAGNOSTIC AND PHARMACIES

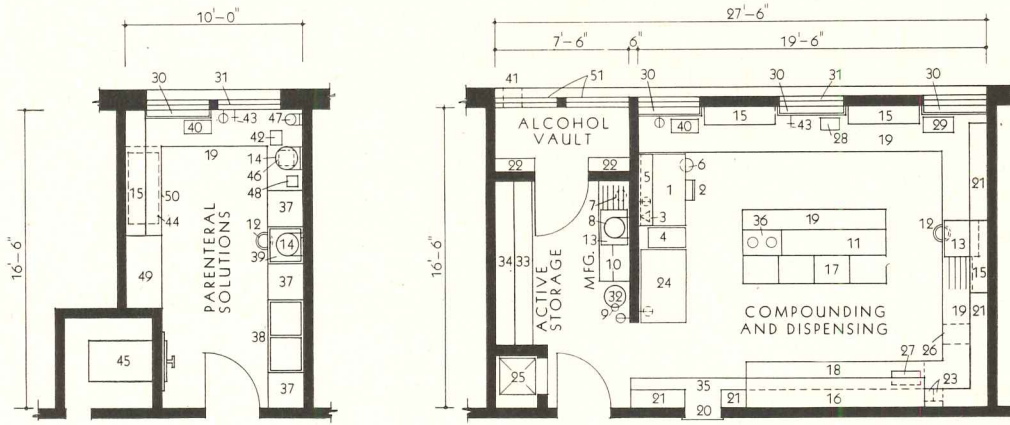

C O R R I D O R
0 4
FEET

PHARMACY FOR A 100 BED GENERAL HOSPITAL

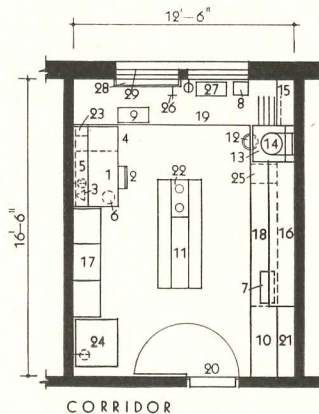

0 4
FEET

C O R R I D O R

PHARMACY FOR A 50 BED GENERAL HOSPITAL

PHARMACY FOR A 100 BED GENERAL HOSPITAL

1. Desk
2. Chair
3. Telephone outlet
4. File, 4 drawer
5. Book shelves over desk
6. Waste paper receptacle
7. Still, 2 gallon per hour. Required if par-enteral solution room is omitted
8. Glass tank, distilled water, 5 gallon
9. Portable electric mixer
10. Counter, cabinets below, shelves above
11. Carboy rack above counter
12. Sanitary waste can
13. Sink with gooseneck spout and drainboard, graduate rack above, cabinets below
14. Glass tank, distilled water, 12 gallon
15. Cabinet, adjustable shelves
16. Drug cabinet, sectional type, with shelf above counter
17. Drug cabinets, sectional type
18. Prescription counter, cabinets, sectional type drawers below
19. Counter, cabinets and drawers below
20. Dispensing window
21. Adjustable open shelves, starting 18 inches above counter
22. Shelves, starting 42 inches above floor
23. Prescription file
24. Refrigerator, 16 cubic feet, with biological drawers
25. Dumbwaiter

26. Narcotic safe, under counter
27. Prescription scale, class A
28. Prescription scale, heavy duty
29. Counter scale
30. Heat outlet grill, inlet grill in base of cabinet
31. Guards, at all windows
32. Mixing tank, 20 gallons, mounted on stand with casters
33. Counter, 24 inches wide, 36 inches high, adjustable open shelves below
34. Adjustable open shelves, 12 inches wide
35. Counter, 18 inches wide, adjustable shelves below
36. Filter rack above counter
37. Bottle rack
38. Two compartment sink, gooseneck spout, cabinets below
39. Sink with distilled water rinser, omit hot and cold water supply, cabinets below
40. Double element hot plate
41. Vent at ceiling and floor
42. Metric solution scale
43. Gas outlet
44. Sterilizer carriage under counter
45. Sterilizer, 24 x 36 x 48 inches
46. Drip pan with waste connection in counter top
47. Still, 5 gallon per hour
48. Suction and pressure pump
49. Storage cabinet, open adjustable shelves
50. Counter, open below
51. High window

PHARMACY FOR A 50 BED GENERAL HOSPITAL

1. Desk
2. Chair
3. Telephone outlet
4. 2 drawer file
5. Book shelves
6. Waste paper receptacle
7. Prescription scale, class A
8. Prescription scale, heavy duty
9. Counter scale
10. Counter, open adjustable shelves below
11. Carboy rack, above counter
12. Sanitary waste can
13. Sink with gooseneck spout and drainboard, graduate rack above, cabinets below
14. Glass tank, distilled water, 5 gallon
15. Cabinet, adjustable shelves
16. Drug cabinet, sectional type, with shelf above counter
17. Drug cabinets, sectional type
18. Prescription counter, cabinets and drawers below
19. Counter, cabinets and drawers below
20. Dutch door
21. Open adjustable shelves, starting 18 inches above counter
22. Filter rack, above counter
23. Prescription file, on desk
24. Refrigerator, 8 cubic feet, with biological drawers
25. Narcotic safe
26. Gas outlet
27. Double element hot plate
28. Heat outlet grill, inlet grill in base of cabinet
29. Guards, at both windows

TREATMENT FACILITIES

PHYSICAL THERAPY SUITES

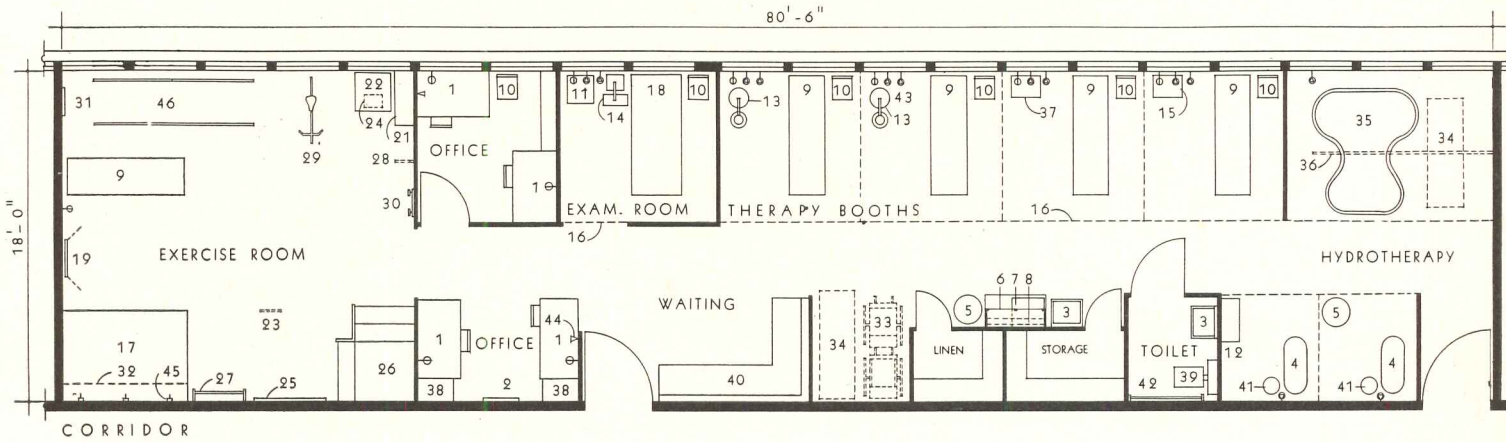

SUITE FOR A 200 BED GENERAL HOSPITAL

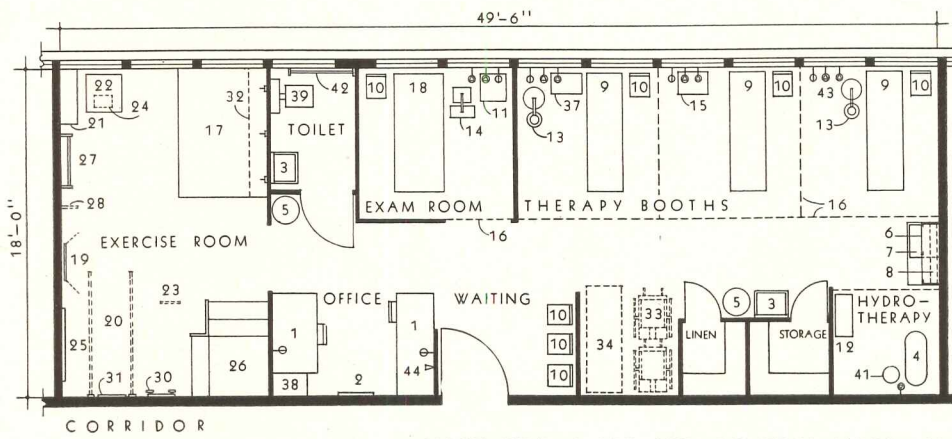

SUITE FOR A 100 BED GENERAL HOSPITAL

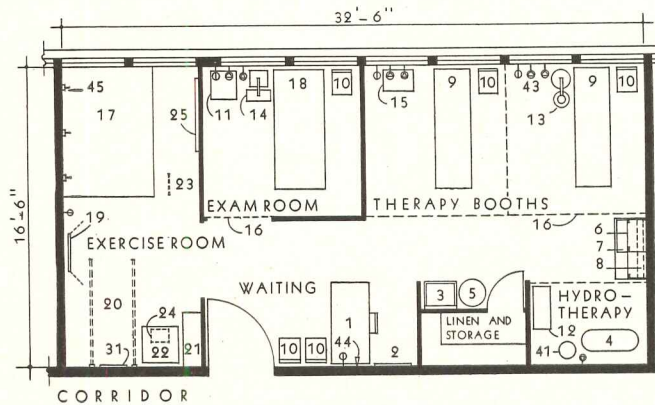

SUITE FOR A 50 BED GENERAL HOSPITAL

PHYSICAL THERAPY SUITES

1. Desk
2. Bulletin board
3. Lavatory with gooseneck spout
4. Whirlpool bath
5. Laundry hamper
6. Wall cabinet
7. Sink with drainboard
8. Glass shelf over sink
9. Treatment table with storage space below
10. Chair
11. Bedside table
12. Paraffin bath
13. Infrared lamp
14. Ultraviolet lamp
15. Short wave diathermy unit
16. Rod and curtains
17. Gym mat
18. Examination table with storage space below
19. Posture mirror (triple, portable)
20. Parallel bars, folding type
21. Three shelves, 6, 27, and 48 in. above floor
22. Table, 24 by 24 in.
23. Sayre head sling attached to ceiling
24. Foot rest
25. Shoulder wheel
26. Steps
27. Stall bars
28. Shoulder abduction ladder arch type
29. Stationary bicycle
30. Pulley weights
31. Wall mirror
32. Shelf 6 ft above floor
33. Wheel chair
34. Wheel stretcher
35. Hubbard tank; a therapeutic pool 8 by 12 ft may replace the Hubbard tank by increasing length of suite
36. Monorail over
37. Direct current generators
38. File cabinet
39. Water closet
40. Bench
41. Adjustable stool
42. Hand rail
43. Three single outlets on separate branch circuits, 1 outlet 2-pole, 2 outlets 3-pole
44. Telephone outlet
45. Gym mat hooks
46. Parallel bars

SERVICE DEPARTMENT

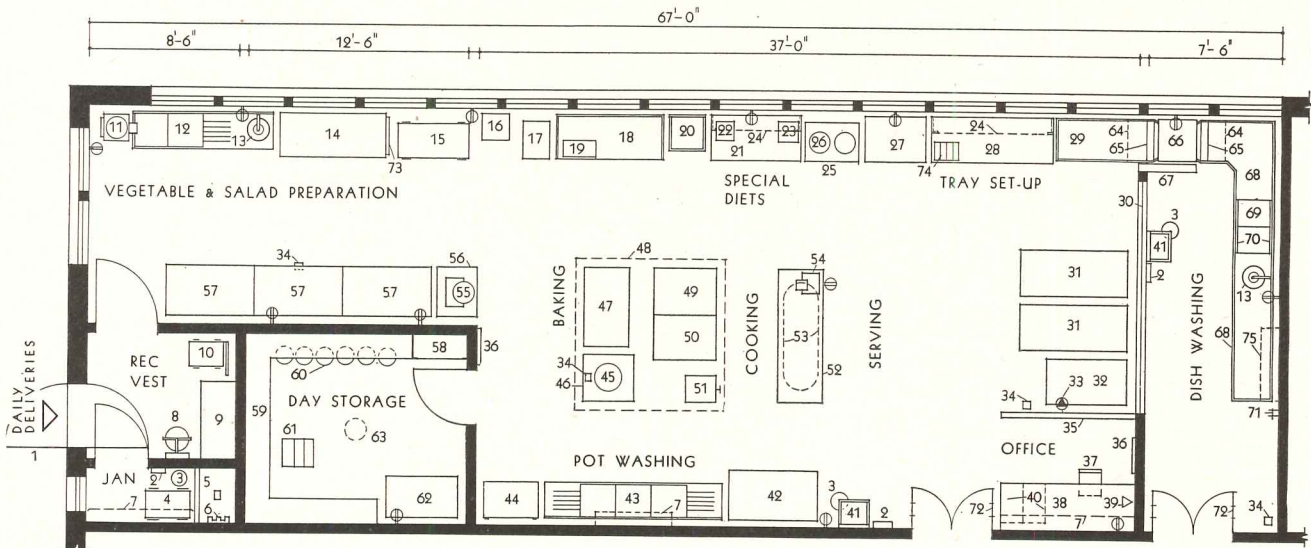

KITCHEN FOR A 50 BED GENERAL HOSPITAL USING CENTRALIZED BULK FOOD SERVICE

NOTE IF FOOD WASTE GRINDERS ARE NOT USED GARBAGE REFRIGERATOR AND CAN WASHING ROOM SHOULD BE PROVIDED.

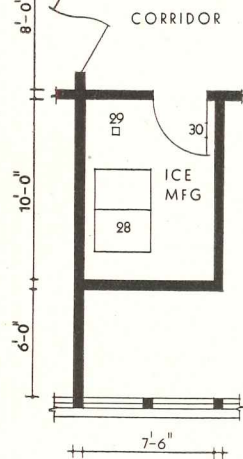
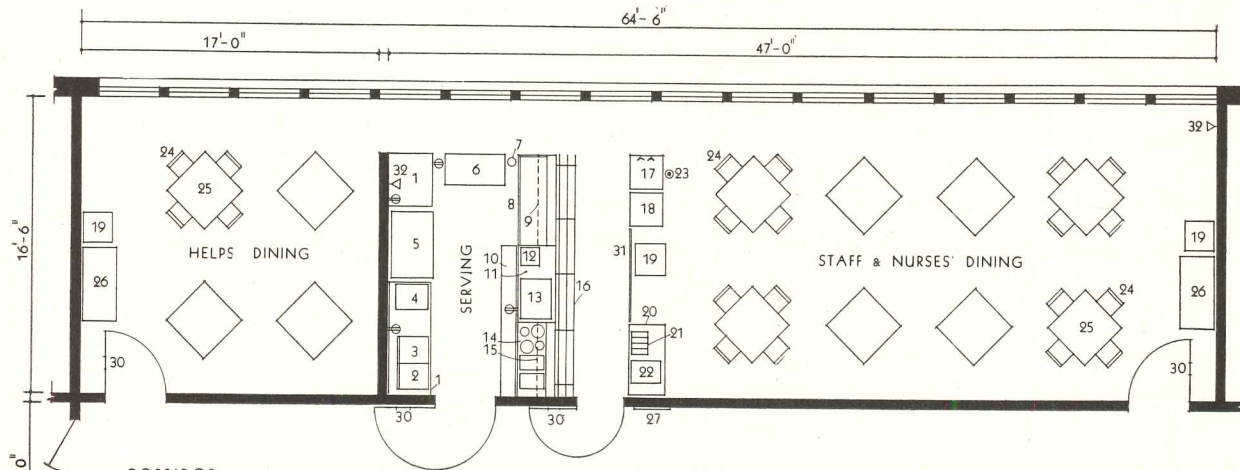

CAFETERIA FOR A 100 BED GENERAL HOSPITAL

KITCHEN FOR 50 BED GENERAL HOSPITAL

1. Screen door
2. Paper towel cabinet
3. Waste paper receptacle
4. Mop truck
5. Curb and receptor or sink
6. Mop rack
7. Shelf over
8. Hanging scale with pan, dial face, 60 lb. x 1 oz.
9. Counter, for checking deliveries
10. Platform scale

11. Peeler, 15 lb. capacity, pedestal type with peel trap
12. Double compartment sink, each compartment 24 x 24 x 14 inches, one drainboard
13. Food waste grinder, institutional size, with pre-rinse spray
14. Preparation table, 30 x 72 inches, with 2 drawers and undershelf
15. Utility truck
16. Water cooler
17. Cooling rack, 24 x 18 x 72 inches, on casters
18. Baker's table, 30 x 72 inches with 2 drawers and overshelf
19. Baker's scale
20. Single compartment sink, 24 x 24 x 14 inches
21. Counter, 30 x 60 inches, cabinets below
22. Dietetic scale, gram
23. Toaster, electric, 4 slice, heavy duty
24. Wall cabinets
25. Coffee urn stand
26. Coffee urn (battery), one 5 gallon coffee urn, one 10 gallon boiler
27. Ice cream cabinet, 15 gallon capacity. Provide running water dip well if bulk ice cream is used
28. Counter, 30 x 84 inches, open shelves below
29. Clean dish table with up-turned edge
30. Glass partition above wainscot
31. Tray truck, open, approximately 25 tray capacity (tray size approximately 14 x 18 inches)
32. Food conveyor, 50 patient capacity
33. Electric outlet
34. Floor drain
35. Partition 3 feet high
36. Bulletin board, 26 x 24 inches
37. Straight chair
38. Built-in desk
39. Telephone outlet
40. File cabinet, 2 drawer
41. Lavatory (hand washing)
42. Refrigerator (salad and cook's), 40 cubic foot capacity
43. Three compartment sink, each compartment 24 x 24 x 14 inches, one compartment with dial thermometer, two drainboards
44. Pot cabinet, 24 x 36 x 72 inches, adjustable open shelving, on casters

45. Kettle, steam jacketed, 10 gallon capacity
46. Floor depression
47. Roasting oven, two sections, each with additional removable shelf for baking (deck 33 x 22 inches)
48. Hood
49. Range, oven below
50. Range, one section griddle, and one section hot top, broiler below
51. Steamer, one bushel capacity
52. Cook's table, 30 x 90 inches, with plate warmer section below
53. Pot rack, over cook's table
54. Meat slicer, motor driven
55. Mixer, bench type, 20 quart capacity with 12 quart bowl, meat and food chopper attachments
56. Cabinet stand for mixer
57. Refrigerator, 40 cubic feet capacity
58. Locked cabinet
59. Shelves, 16 inches deep, first shelf 36 inches from floor
60. Storage can, mounted on casters
61. Step ladder, pantry type
62. Frozen food cabinet, vertical type, 18 cubic feet capacity
63. Ventilator at ceiling
64. Hood
65. Dish table drain
66. Dishwashing machine, single tank, floor model, vertical sliding door, approximate capacity 1250 pieces per hour, automatically timed
67. Rack return
68. Soiled dish table with 3-inch up-turned edge
69. Double compartment soak sink
70. Slide rails (for conveying dish racks)
71. Hot and cold water outlet
72. Vision panel
73. Kitchen tool rack
74. Silver box, 4 compartment
75. Shelfover for soiled glasses

CAFETERIA FOR 100 BED GENERAL HOSPITAL

1. Back bar, open shelves below
2. Hot plate, counter type, 2 element, electric, 3 heat control, heavy duty

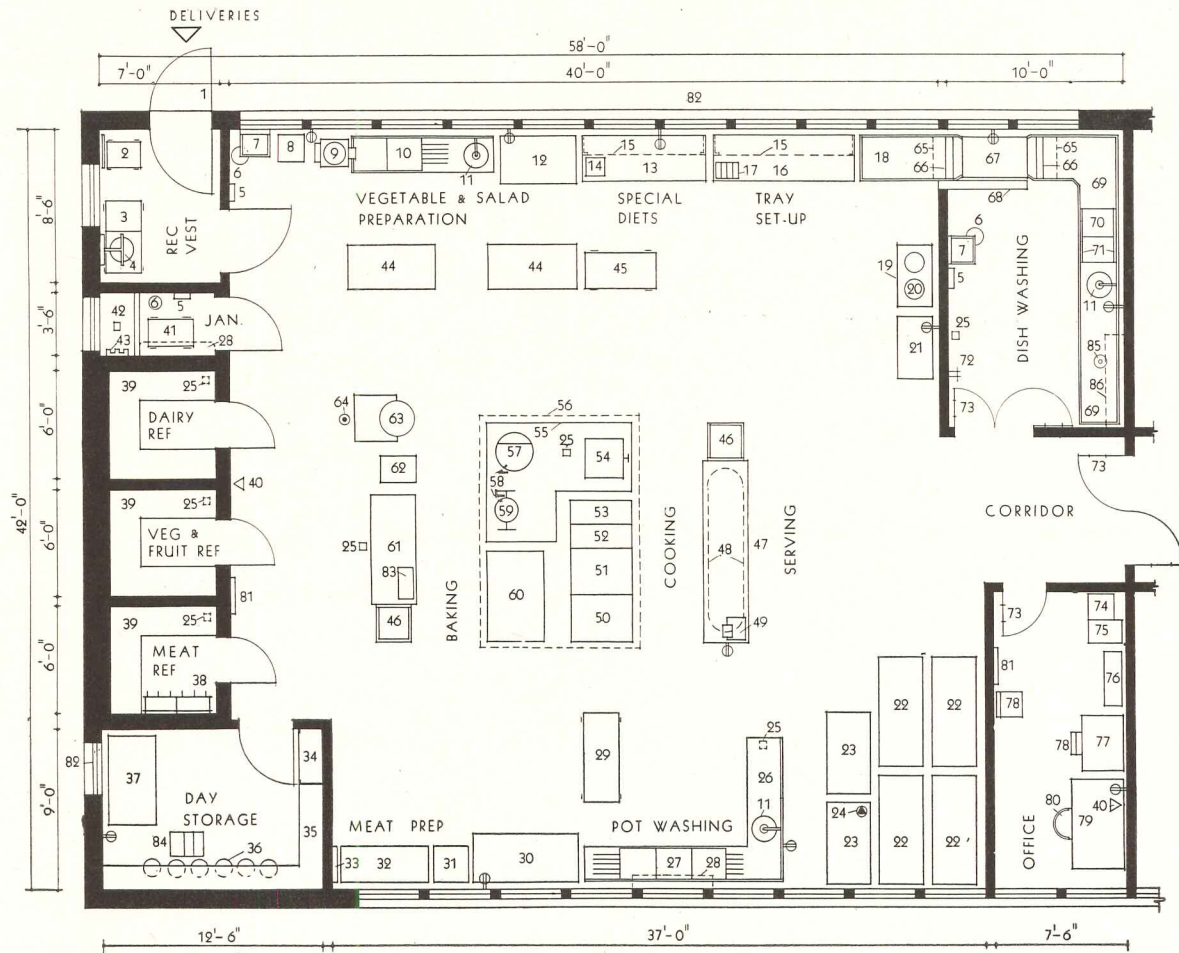

**KITCHEN FOR A 100 BED GENERAL HOSPITAL
USING CENTRALIZED BULK FOOD SERVICE**

NOTE IF FOOD WASTE GRINDERS ARE NOT USED GARBAGE REFRIGERATOR AND CAN WASHING ROOM SHOULD BE PROVIDED



3. Griddle, counter type, electric, 3 heat control, heavy duty
4. Sink, in counter, open shelves below
5. Refrigerator, 20 cubic feet capacity
6. Ice cream cabinet, 10 gallon capacity
7. Ice cream dip well
8. Cold pan unit
9. Glass display shelves
10. Serving shelf
11. Counter, cabinet below with one shelf, sliding doors
12. Toaster, electric, 4 slice, heavy duty
13. Coffee maker, vacuum type, 5 elements
14. Hot food table with interchangeable panel inserts, and dish warmer below
15. Shelf and glass protector panel
16. Tray slide
17. Water cooler
18. Glass rack
19. Folding tray stand
20. Table, 24 x 48 x 30 inches high
21. Silver box, 4 compartment
22. Trays (approximately 14 x 18 inches)
23. Electric outlet at floor
24. Dining chair
25. Dining table, 36 inches square
26. Tray truck, open
27. Menu board
28. Ice making machine
29. Floor drain
30. Vision panel
31. Railing
32. Telephone outlet

**KITCHEN FOR
100 BED GENERAL HOSPITAL**

1. Screen door
2. Platform scale, 1000 lb. capacity, drop lever
3. Platform truck
4. Hanging scale with pan, dial face, 60 lb. x 1 oz.
5. Paper towel cabinet
6. Waste paper receptacle
7. Lavatory (hand washing)
8. Water cooler
9. Peeler, 30 lb. capacity, pedestal type with peel trap
10. Double compartment sink, each compartment 24 x 24 x 14 inches, one drainboard

11. Food waste grinder, institutional size, with pre-rinse spray
12. Refrigerator (salad) 30 cubic feet capacity
13. Counter, 30 x 84 inches, cabinets below
14. Dietetic scale, gram
15. Wall cabinets
16. Counter, 30 x 96 inches, open shelves below
17. Silver box, 4 compartments
18. Clean dish table with up-turned edge
19. Coffee urn stand
20. Coffee urn (battery) one 5 gallon coffee urn, one 10 gallon boiler
21. Ice cream cabinet, 10 gallon capacity. Provide running water dip well if bulk ice cream is used
22. Tray truck, open, approximately 25 tray capacity (tray size approximately 14 x 18 inches)
23. Food conveyor, 50 patient capacity
24. Electric outlet, ceiling drop, 2 receptacles
25. Floor drain
26. Table with up-turned edge
27. Three compartment sink, each compartment 24 x 24 x 14 inches, one compartment with dial thermometer, two drainboards
28. Shelf over
29. Pot cabinet, 24 x 60 x 72 inches, adjustable open shelving, on casters
30. Refrigerator (cook's) 50 cubic feet capacity
31. Meat block
32. Table, 24 x 60 inches
33. Kitchen tool rack
34. Locked cabinet
35. Shelves, 16 inches deep, first shelf 36 inches from floor
36. Storage can, mounted on casters
37. Frozen food cabinet, vertical type, 30 cubic feet capacity
38. Meat hooks and rail
39. Refrigerator shelving, 18 inches deep, first shelf 36 inches from floor
40. Telephone outlet
41. Mop truck
42. Curb and receptor or sink
43. Mop rack
44. Preparation table, 30 x 60 inches, with drawer and undershelf
45. Utility truck
46. Single compartment sink, 24 x 24 x 14 inches

47. Cook's table, 30 x 120 inches, with 2 drawers and undershelf
48. Pot rack over cook's table
49. Meat slicer, motor driven
50. Range, oven below
51. Range, broiler below
52. Spreader plate
53. Deep fat fryer, approx. 25 lb. capacity
54. Steamer, 2 compartment, 4 bu. capacity
55. Floor depression
56. Hood
57. Kettle, steam jacketed, 30 gallon capacity
58. Swinging water spout over steam kettle (hot and cold water)
59. Kettle, steam jacketed, trunnion, 10 gallon capacity
60. Roasting oven, two sections, each with additional removable shelf for baking (deck 42 x 32 inches)
61. Baker's table, 30 x 72 inches with 2 drawers and overshelf
62. Cooling rack, 24 x 18 x 72 inches, on casters
63. Mixer, 60 qt capacity, with 30 qt bowl, meat and food chopper attachments
64. Electric outlet at floor
65. Hood
66. Dish table drain
67. Dishwashing machine, single tank, floor model, vertical sliding door, approximate capacity 3000 pieces per hour, automatic
68. Rack return
69. Soiled dish table with 3-inch up-turned edge
70. Double compartment soak sink
71. Slide rails (for conveying dish racks)
72. Hot and cold water outlet
73. Vision panel
74. Locker
75. File cabinet
76. Bookcase
77. Table, 30 x 36 inches
78. Straight chair
79. Desk
80. Swivel chair with arms
81. Bulletin board, 26 x 24 inches
82. High windows
83. Baker's scale
84. Step ladder, pantry type
85. Glass washing brush
86. Shelf over for soiled glasses

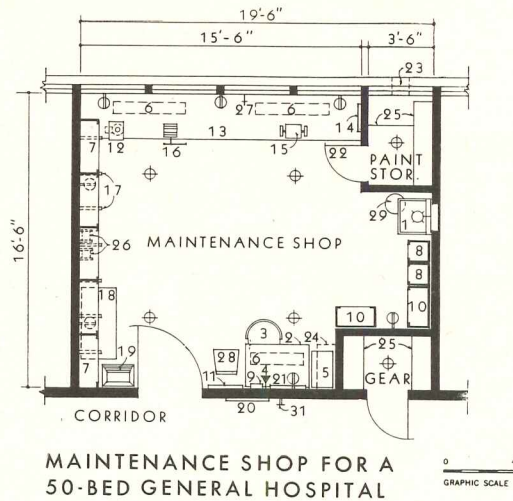
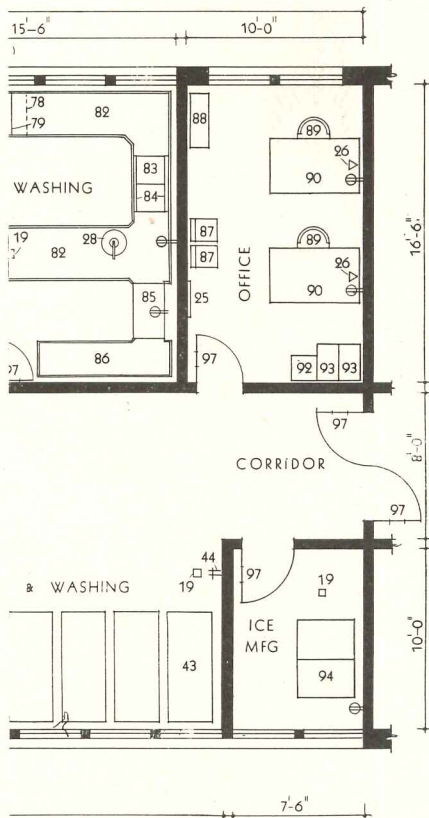

MAINTENANCE SHOP FOR A 50-BED GENERAL HOSPITAL

GRAPHIC SCALE

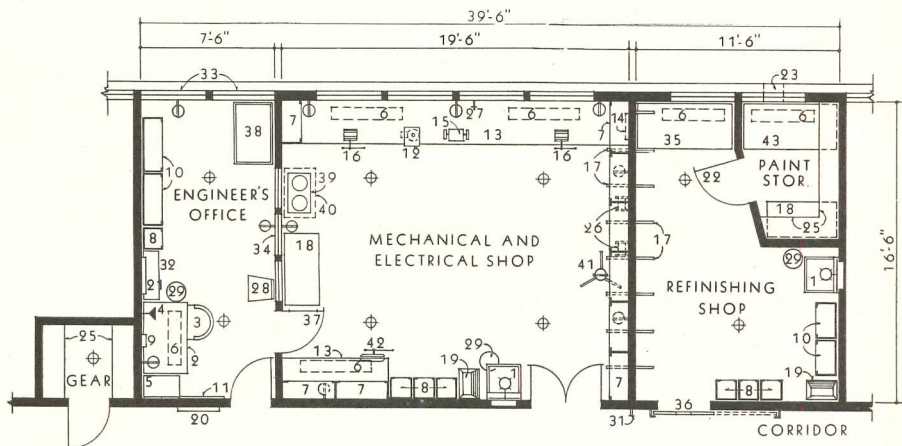

MAINTENANCE SHOPS FOR A 100-BED GENERAL HOSPITAL

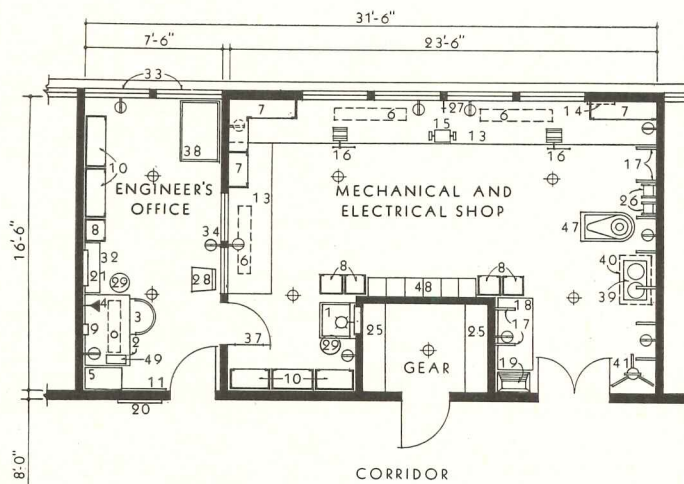

CORRIDOR

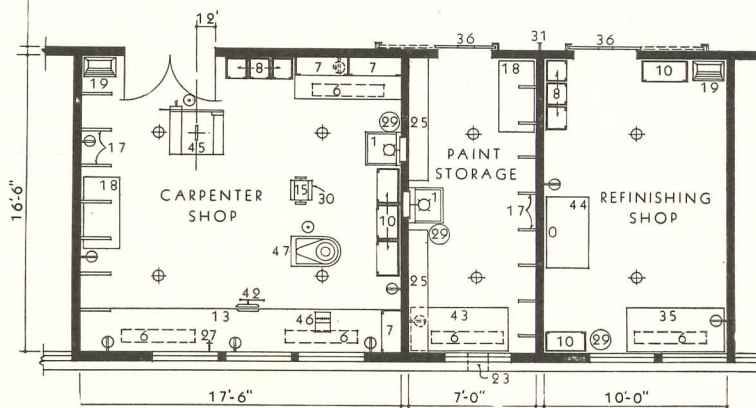

MAINTENANCE SHOPS FOR A 200-BED GENERAL HOSPITAL

MAINTENANCE SHOPS

1. Service sink with grease trap and medicine cabinet above
2. Desk
3. Desk chair
4. Telephone outlet
5. Legal size, 4-drawer filing cabinet
6. Fluorescent light, 7 ft above floor
7. Wall cabinet
8. Steel clothes locker, 15 x 15 x 60 inches
9. Master clock
10. Steel cabinet with shelving and doors
11. Bulletin board, 26 x 30 inches
12. Frame for portable drill press
13. Work bench, 36 inches high with heavy plank top, slide drawers and cabinets below
14. Test board with lamp and bell transformer
15. Electric buffer and grinder
16. Machinist's bench vise
17. Wall racks
18. Four wheel truck especially equipped for each shop
19. Step ladder, 8 ft high
20. Fire alarm board
21. Heating and ventilating control board
22. Automatic closing, metal covered fire door
23. Wall vents at floor and ceiling
24. Book shelf
25. Steel shelving
26. Extension cord reel, attached to wall
27. Compressed air outlet
28. Straight chair
29. Waste paper receptacle
30. Pedestal stand
31. Watchman's station
32. Sectional bookcase
33. Window blinds
34. Clear glass, beginning 40 inches above floor
35. Glass cutting table, 30 x 64 x 36 inches high with glass rack below
36. Automatic closing, metal covered sliding door with glass view panel
37. Door with upper panel of clear glass
38. Plan rack, 26 x 42 x 50 inches high, open top and bottom
39. Portable welding outfit
40. Portable ventilator hood
41. Portable pipe vise
42. Woodworker's vise
43. Work table, 30 x 64 x 36 inches high
44. Vapor tight spray hood with exhaust fan and hinged panels front and sides
45. Electric rip saw and jointer combination, 10" diam.
46. Key cutter
47. Drill press
48. Steel storage bins
49. Intercommunication, remote station



Photography, Inc.

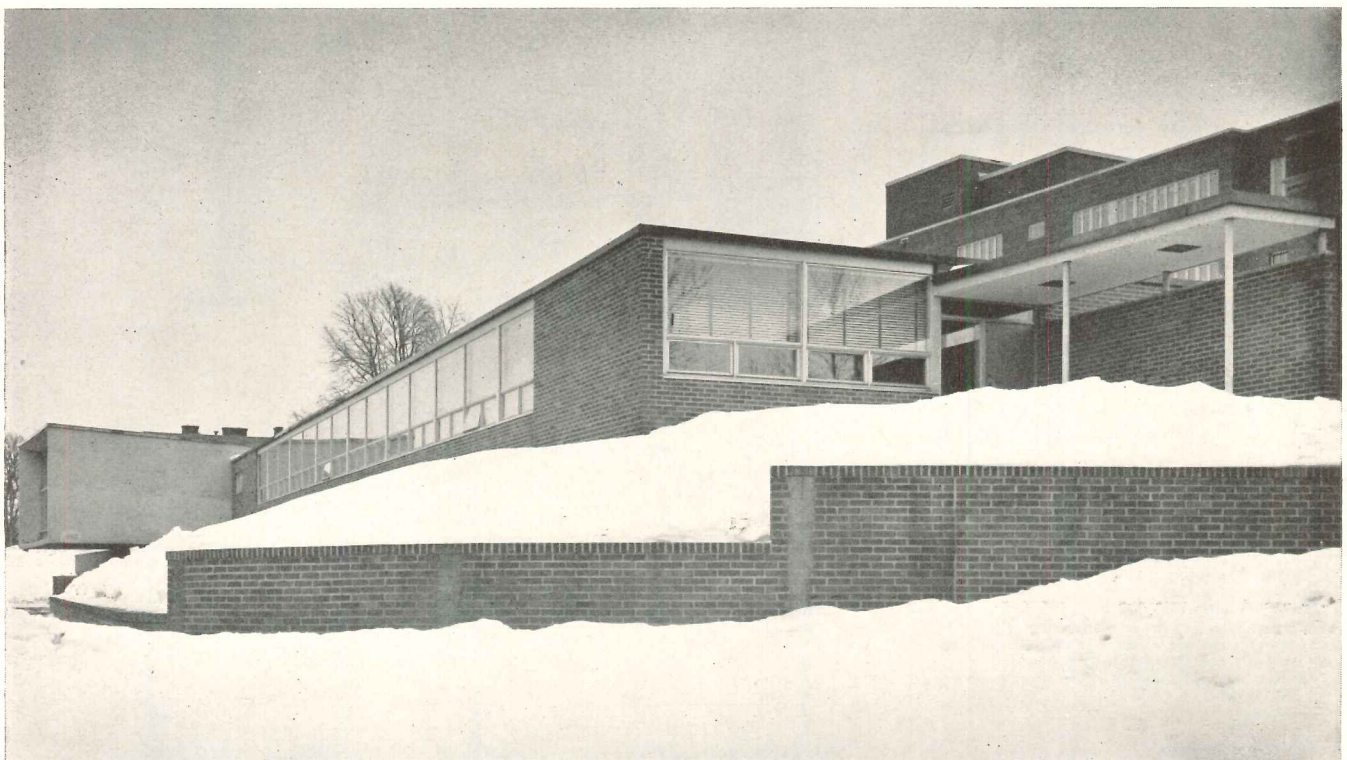

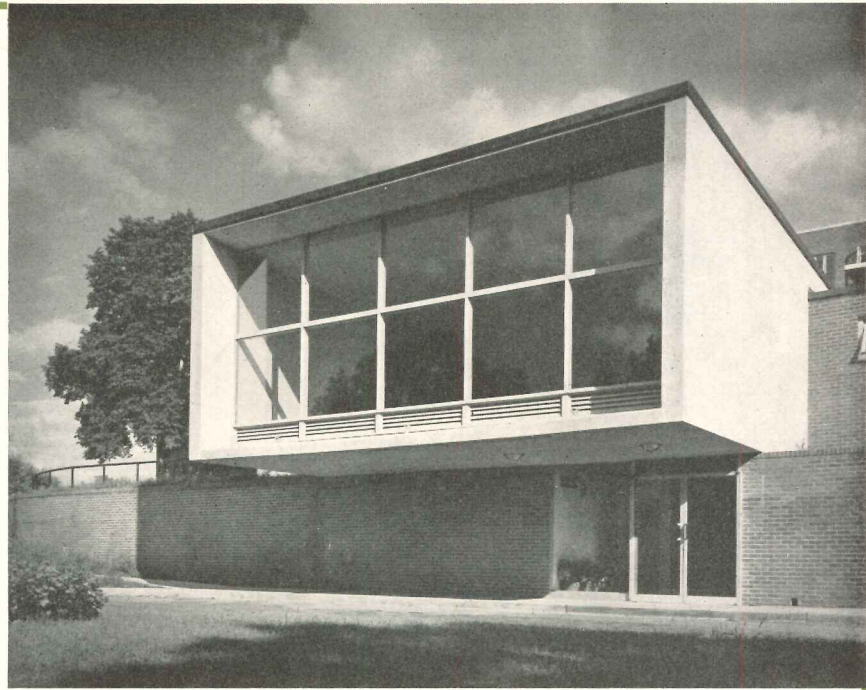
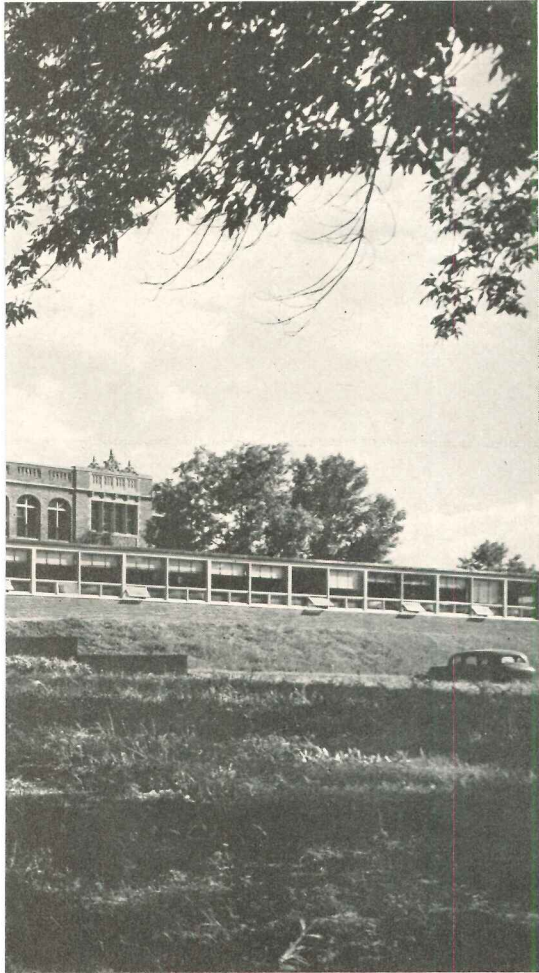

MENTAL HOSPITAL PLANNED TO MAINTAIN MORALE

*Administration and Receiving Buildings, State Hospital, Hastings,
Minn.*

Thorshov & Cerny, Inc., Architects

THE ENLIGHTENED PROGRAM of mental care in Minnesota takes another step forward with this addition to the State Hospital at Hastings. The enlightenment is plainly evident in this building, the feature of which is the several provisions for maintaining patient morale. The architects have done everything possible to obviate an institutional atmosphere, and to provide an array of lounges, visiting rooms, canteens, beauty shops, recreational facilities to cheer patients and to encourage visits of friends and relatives.

The addition is really two separate buildings, the Administration Building at the lower level and the Receiving Unit placed between wings of existing buildings. The Administration Building contains offices for medical, business and supervisory personnel, with a private entrance and an adequate parking space before it. Thus natural topography was utilized to give a nice separation of administrative and hospital functions, especially desirable to encourage visiting. The large visitors' lounge, the dominating mass in this building, projects out over the main entrance drive to provide a shelter. The large glass wall overlooks a beautiful valley, offering a restful scene to ease many an awkward interview.

A separate patient receiving entrance (ground floor of Receiving Building) makes it easy to arrange a carefully handled reception, to reduce the gravity of the situation and avoid emotional trauma.

From then on every effort is made to maintain the dignity of the patient and encourage him to share in normal activities. Thus there are beauty shop, barber shop, library, gymnasium, auditorium, canteen area, and other facilities for a continuous program of physical therapy, social dancing, games, movies, church, theater and concerts. Emphasis in the design has been on a gay residential character. Color is liberally used, furniture carefully chosen, for safety as well as esthetics. Detention at windows is maintained by a sturdy stainless steel screen visually similar to insect screening. A soft low night light is contained in the recessed ceiling fixtures.

The four-story Receiving Building has a reinforced concrete frame and slab construction, with brick veneer exterior walls. Positive ventilation and humidity and heating control is provided throughout. Heating is by ceiling radiant panels in nursing floors, floor panels elsewhere, radiators being considered a hazard.

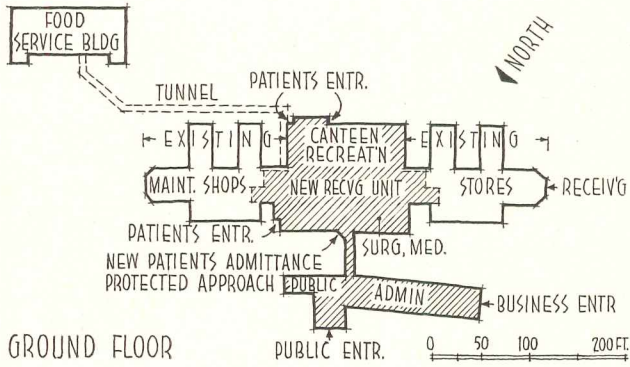
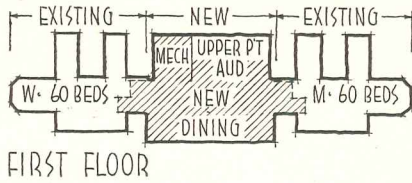
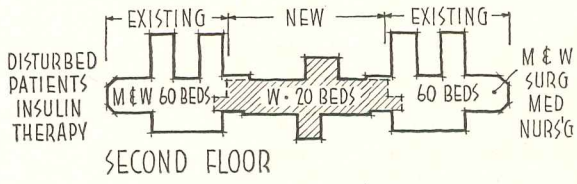

Photography, Inc.

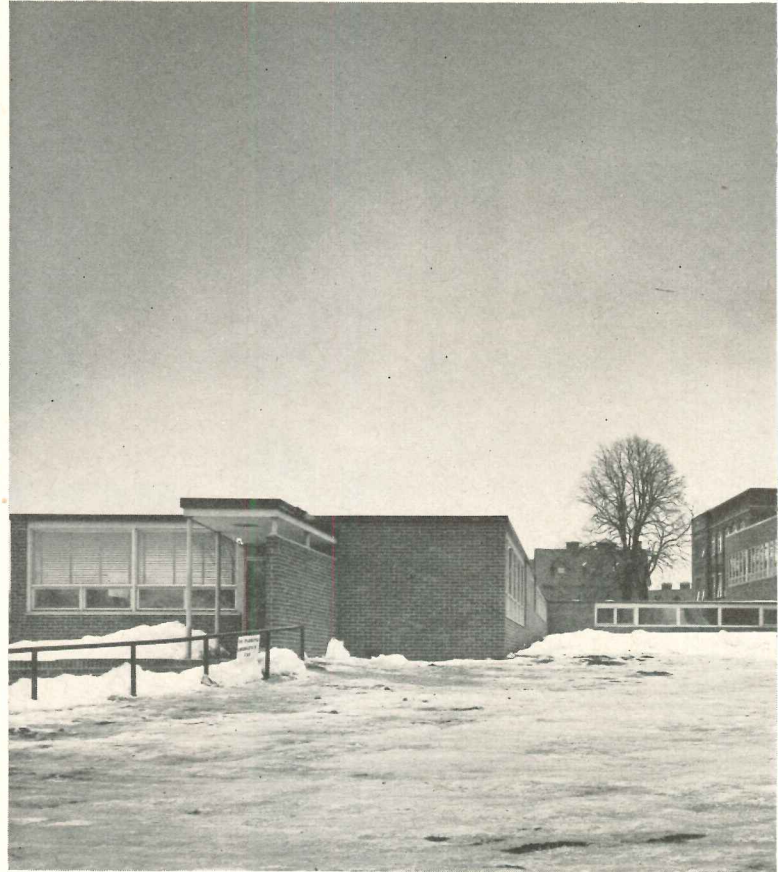

GROUND FLOOR

One-story Administration Building occupies lowest level of hilly site, is thus nicely separated from hospital functions. Receiving Building, at higher level, connects with nursing wings in existing buildings, and by covered passage to Administration Building

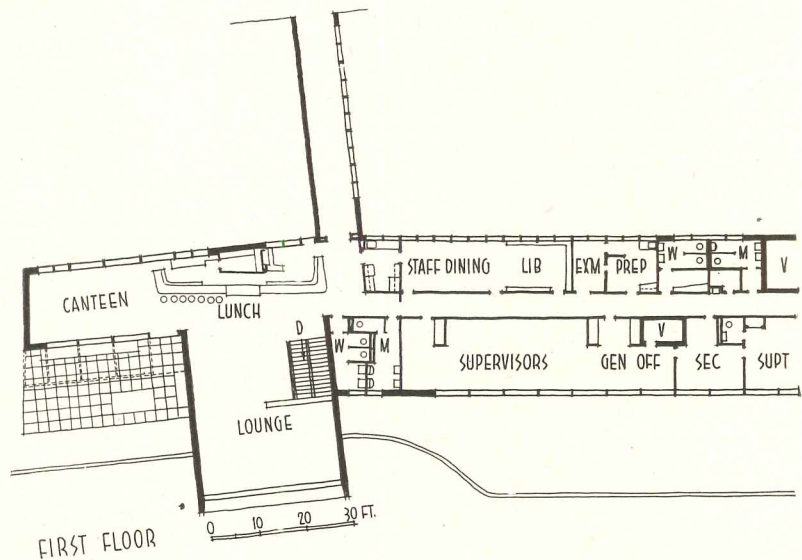

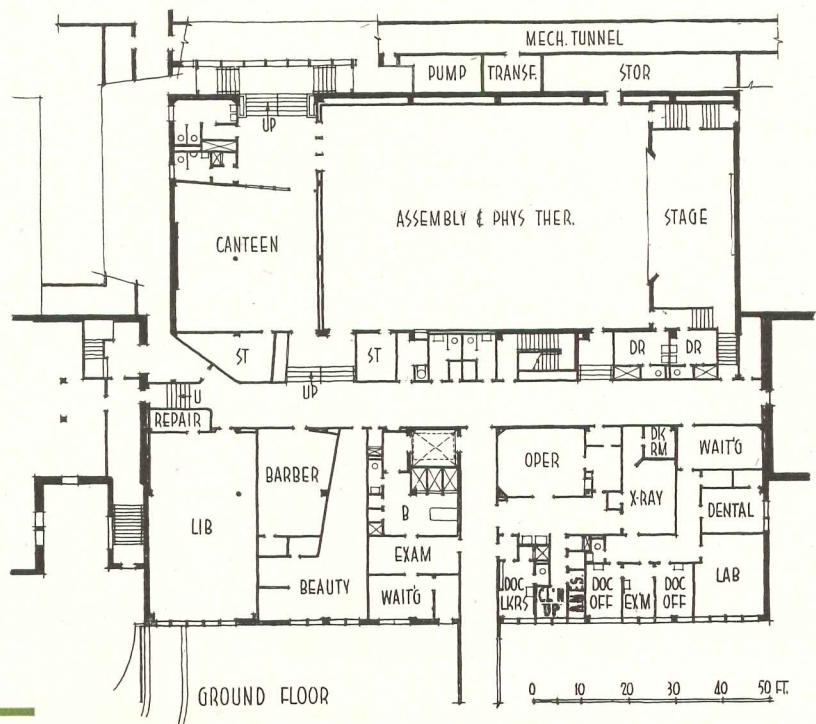
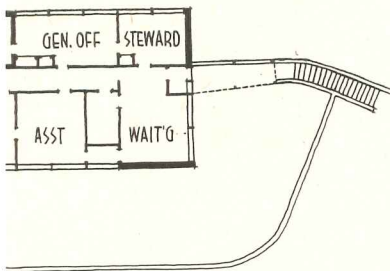
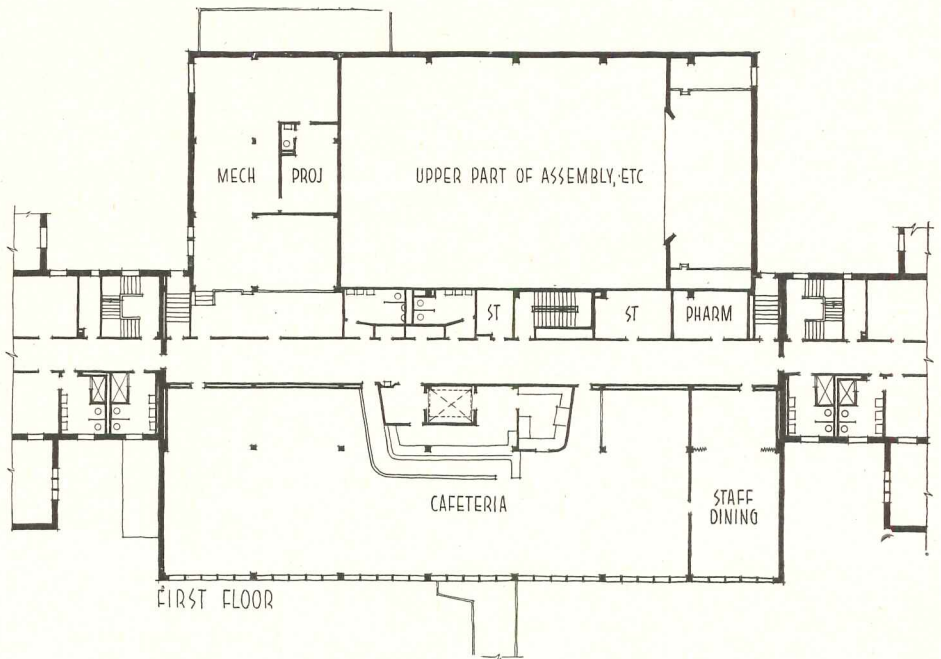
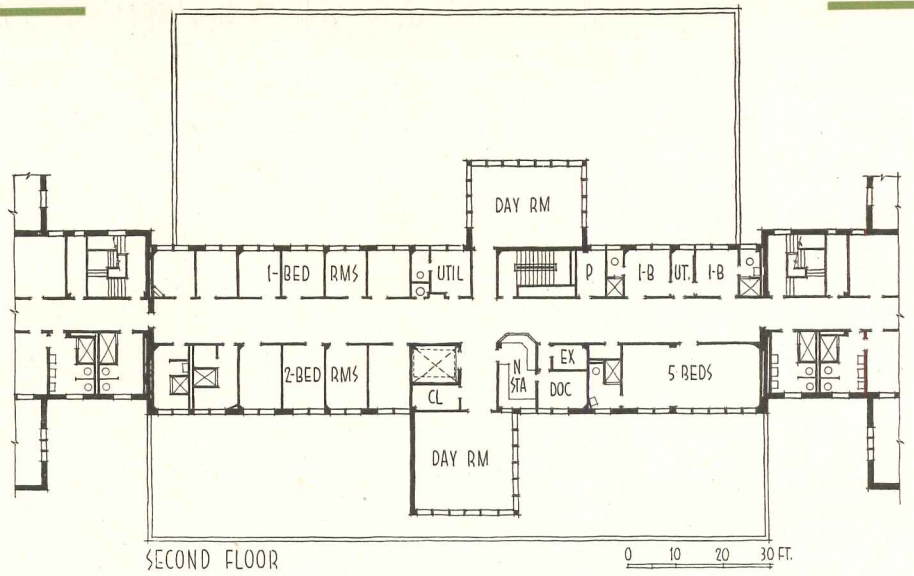
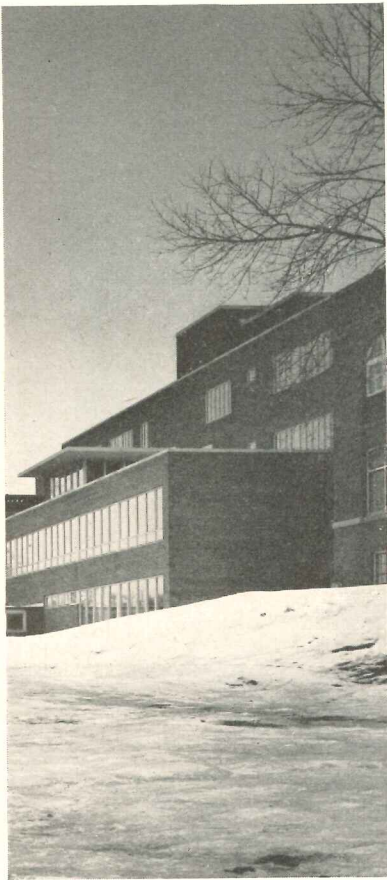

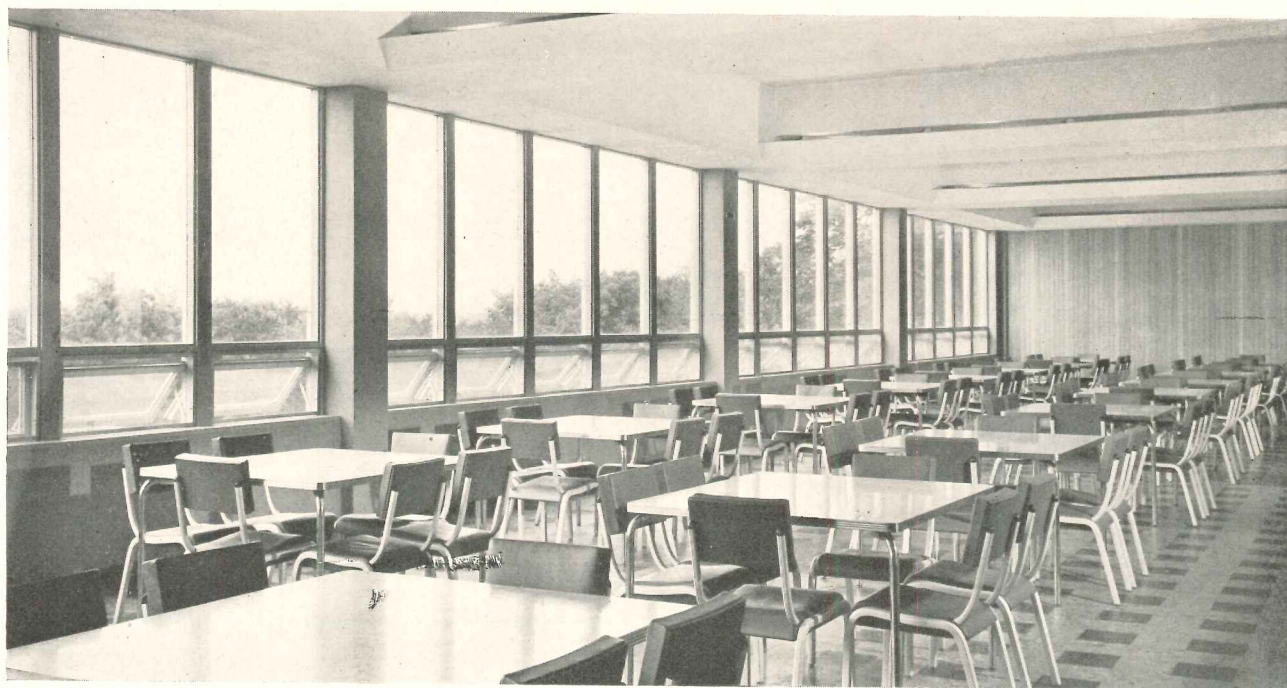

Some of the morale-building facilities at Minnesota State Hospital — on this page: dining room, beauty shop, dayroom and canteen; opposite page: auditorium-gymnasium, staff dining room and library and patients' library. Such elaborate rooms and equipment, gaily and colorfully done, have high therapeutic value, for morale is the primary objective in every mental hospital

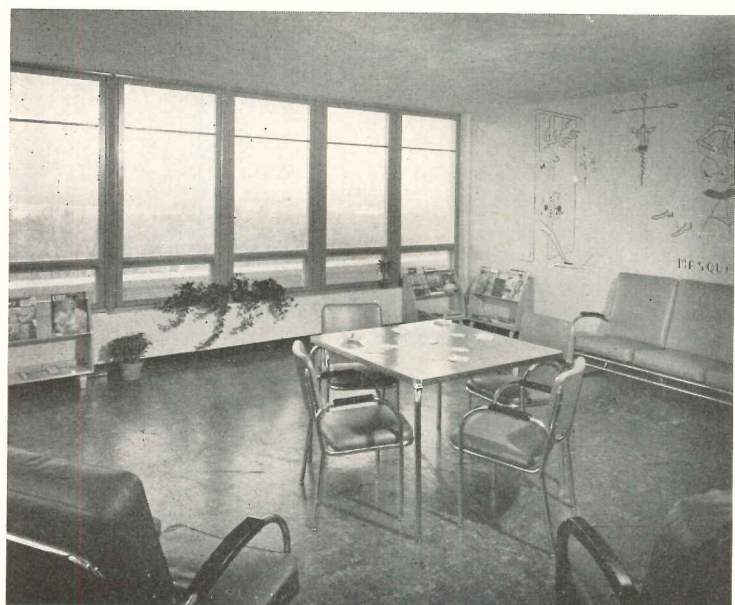



Photography, Inc.



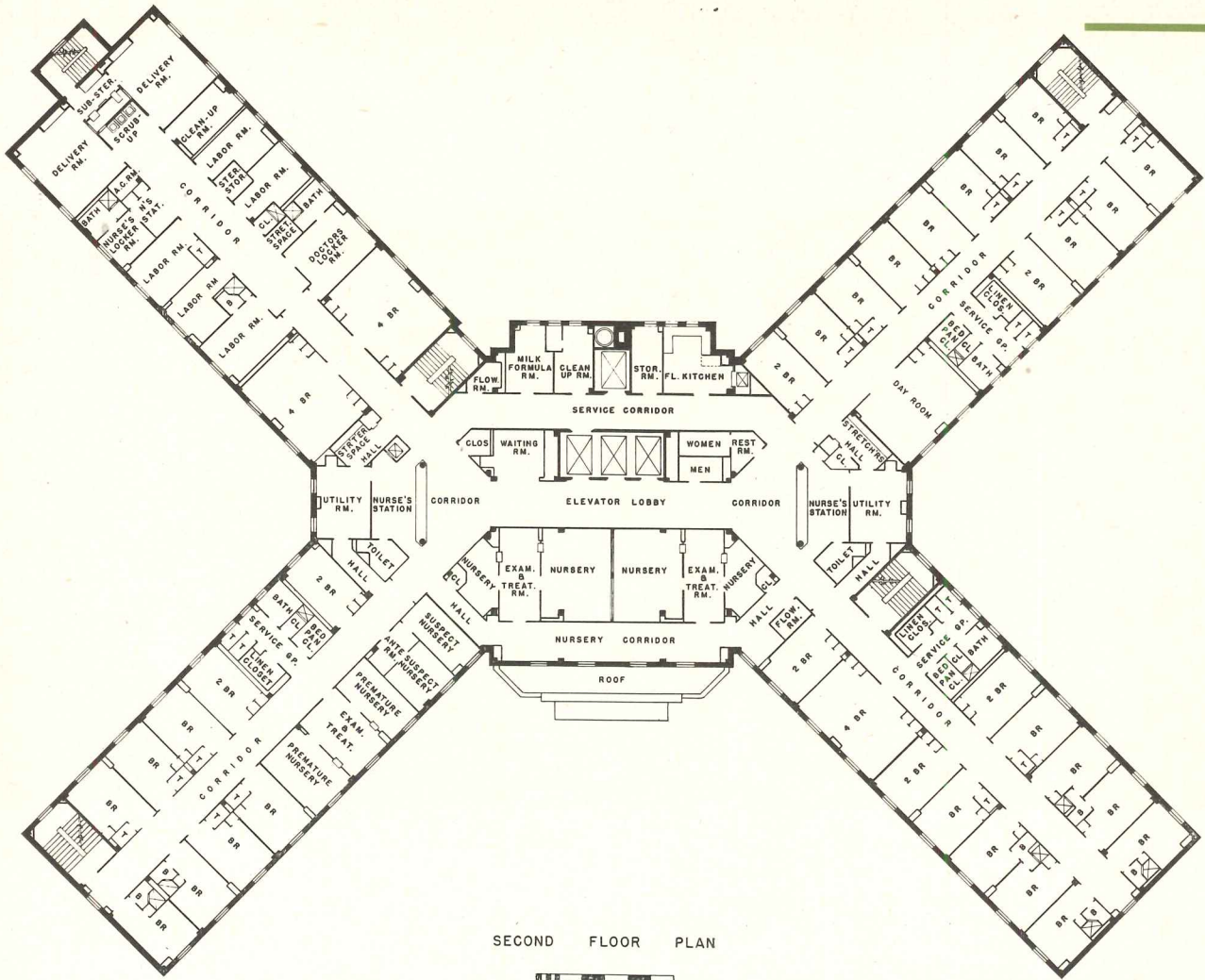

SECOND FLOOR PLAN

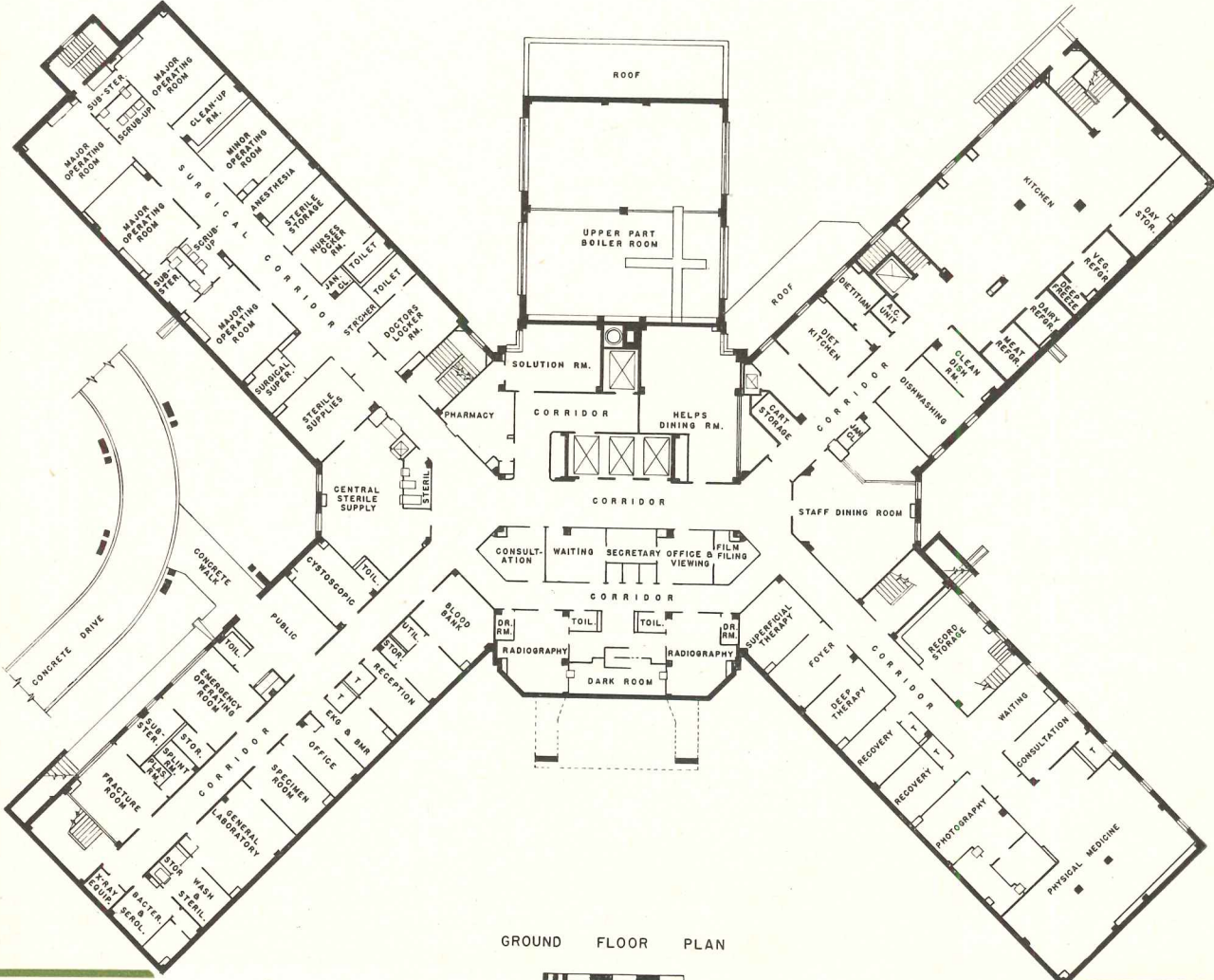
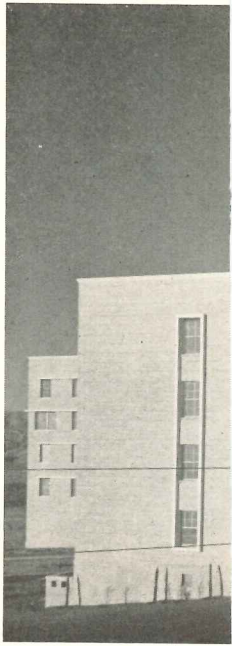

GROUND FLOOR PLAN



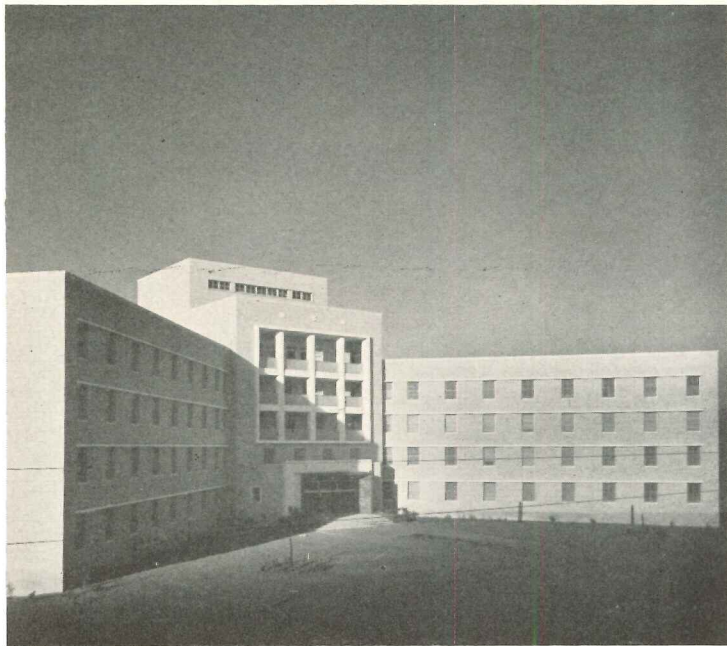

FIRST UNIT OF NEW MEDICAL CENTER

IN THE TEXAS STATE PLAN for hospital facilities, El Paso is slated to be a regional center for 10 counties, with this hospital as the first unit in a teaching center, hence so large a building, with its 272 beds. It is a good example of the cruciform plan, with large central core and radiating wings giving good isolation to nursing units and various medical and surgical departments. Nurses' stations are at central angles, for good super-

vision in all directions; utility rooms are centrally located in nursing wings to save nurses travel. The two plans shown indicate how the cruciform scheme works out; other floors repeat in general the nursing wings shown here. The hospital, with all Class I equipment but not including movable Class II equipment, cost a total of \$2,427,300; this comes out at \$1.19 per cu ft, \$15.10 per sq ft, or \$10,846 per bed.

*Providence Memorial Hospital
El Paso, Texas*

*Carroll and Daeuble
Architects*

*Norman B. Roberts
Consultant-Administrator*

*Landauer, Guerrero and Shafer
Consulting Engineers*

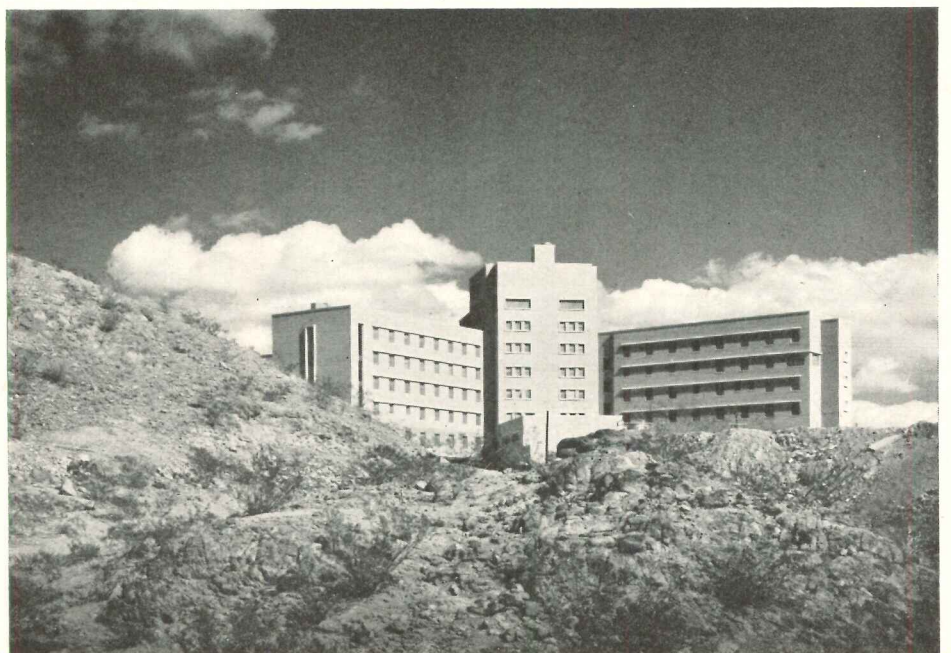

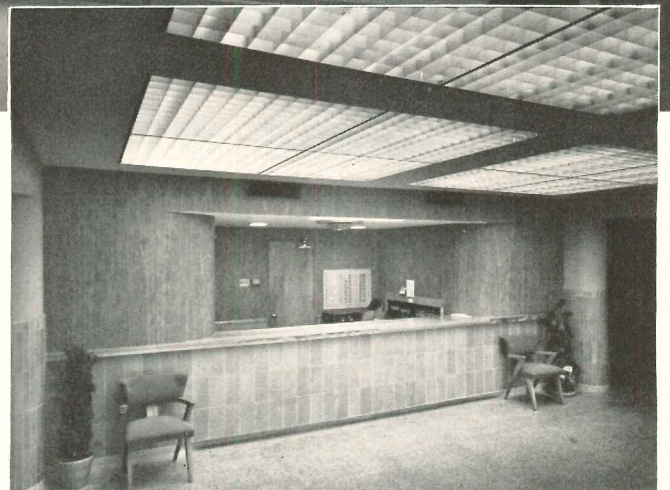
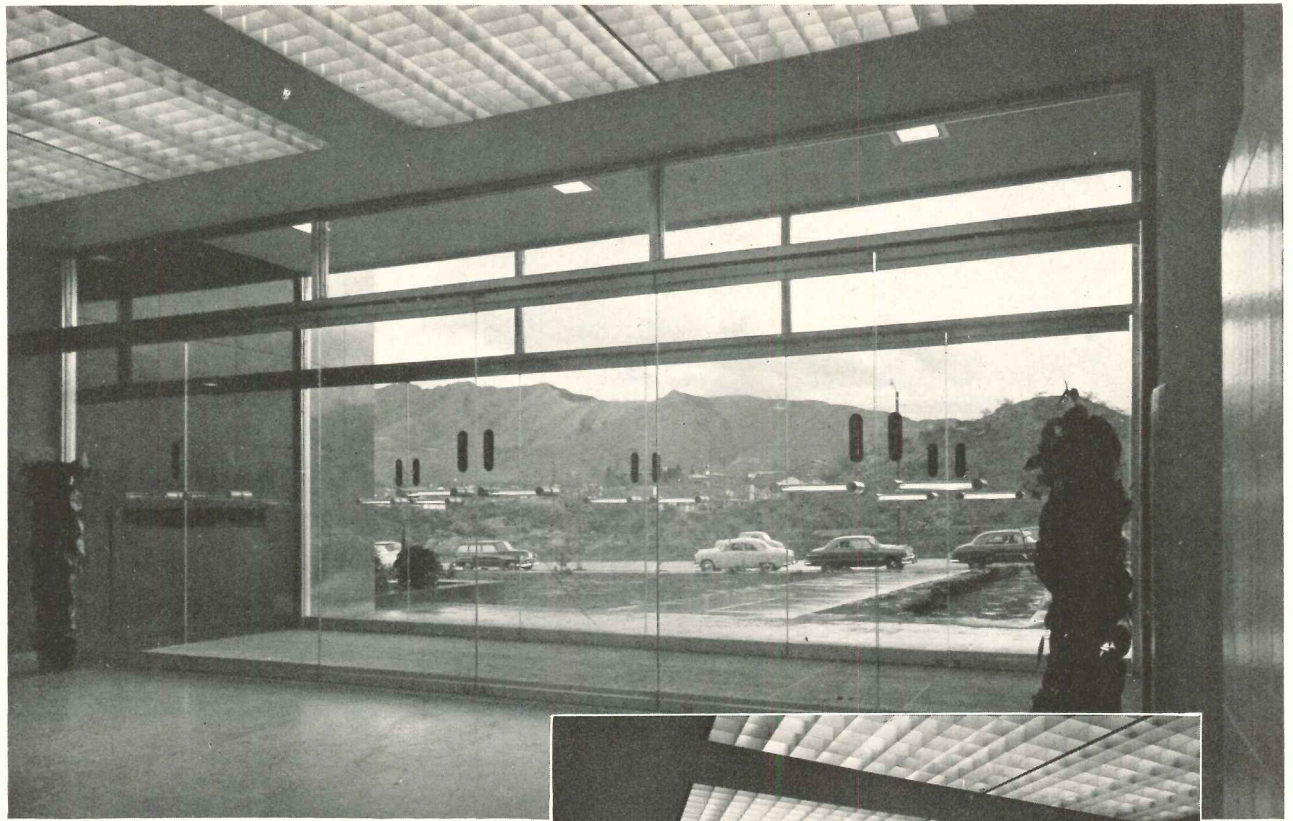

Providence Memorial Hospital is fully air conditioned for summer and winter. More than half of patients' rooms have access to private toilet and bath facilities; each room is piped for oxygen, has telephone jacks, radio and nurses' call of latest type. Building is a concrete frame, fireproof structure, with adequate fire towers and fire doors in all corridors to permit transfer of patients from wing to wing in case of emergency

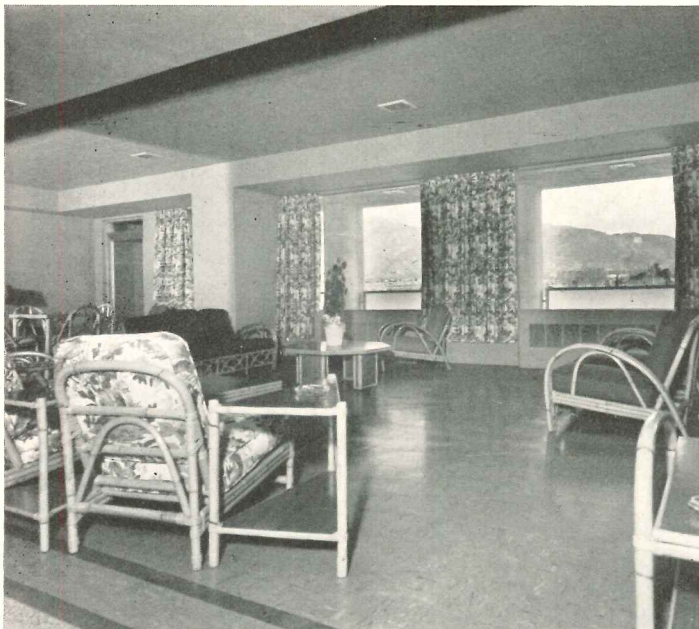

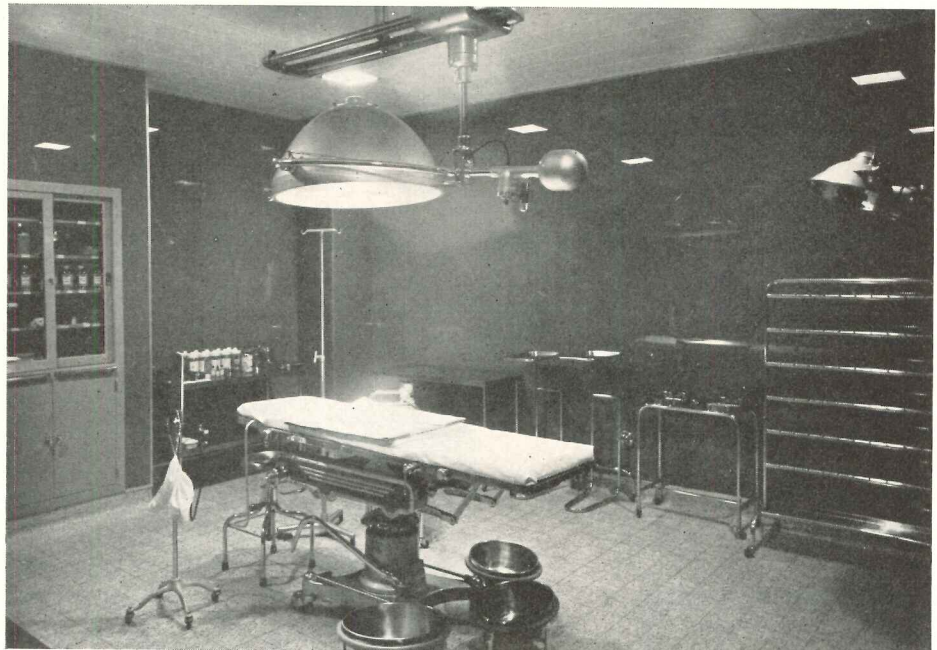
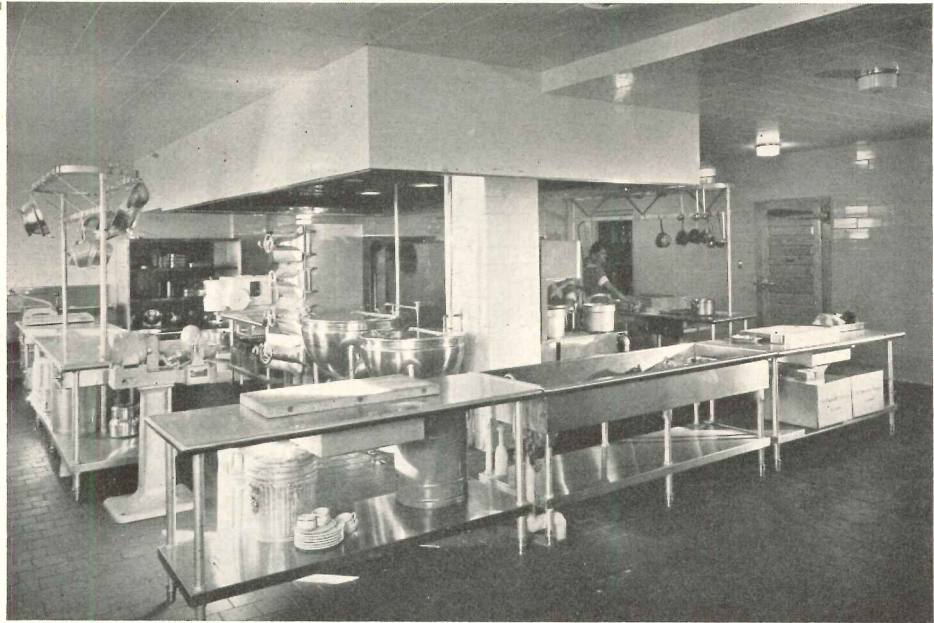

F. Wilbur Seider



*Flow Memorial Hospital
Denton, Texas*

*Bennett and Crittenden
Architects*

*Mullen & Powell
Structural Engineers*

*Landauer, Guerrero & Shafer
Mechanical and Electrical
Engineers*

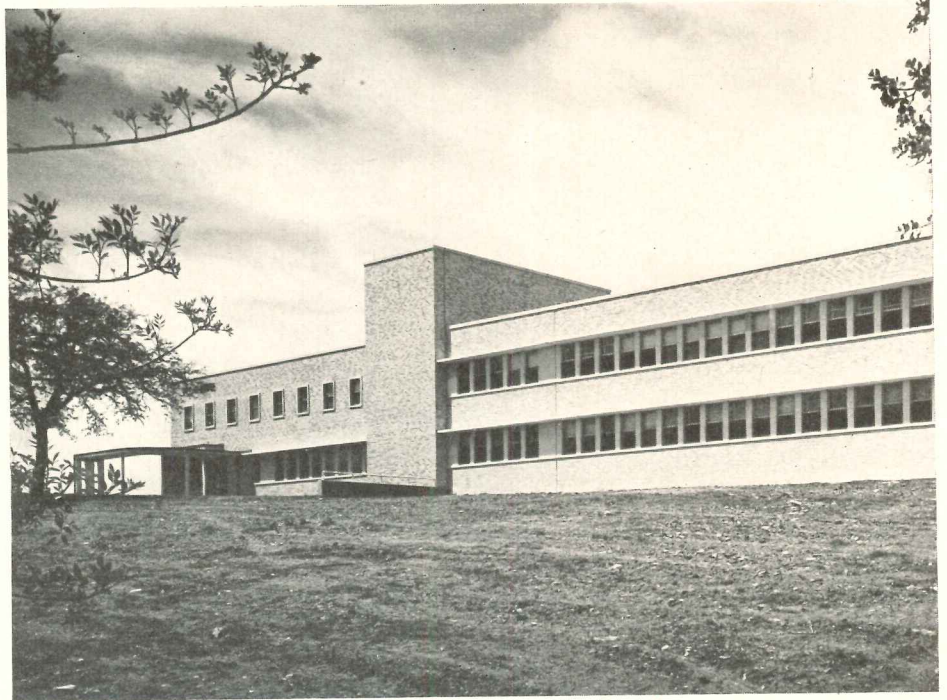

60-BED HOSPITAL ON 100-BED CHASSIS

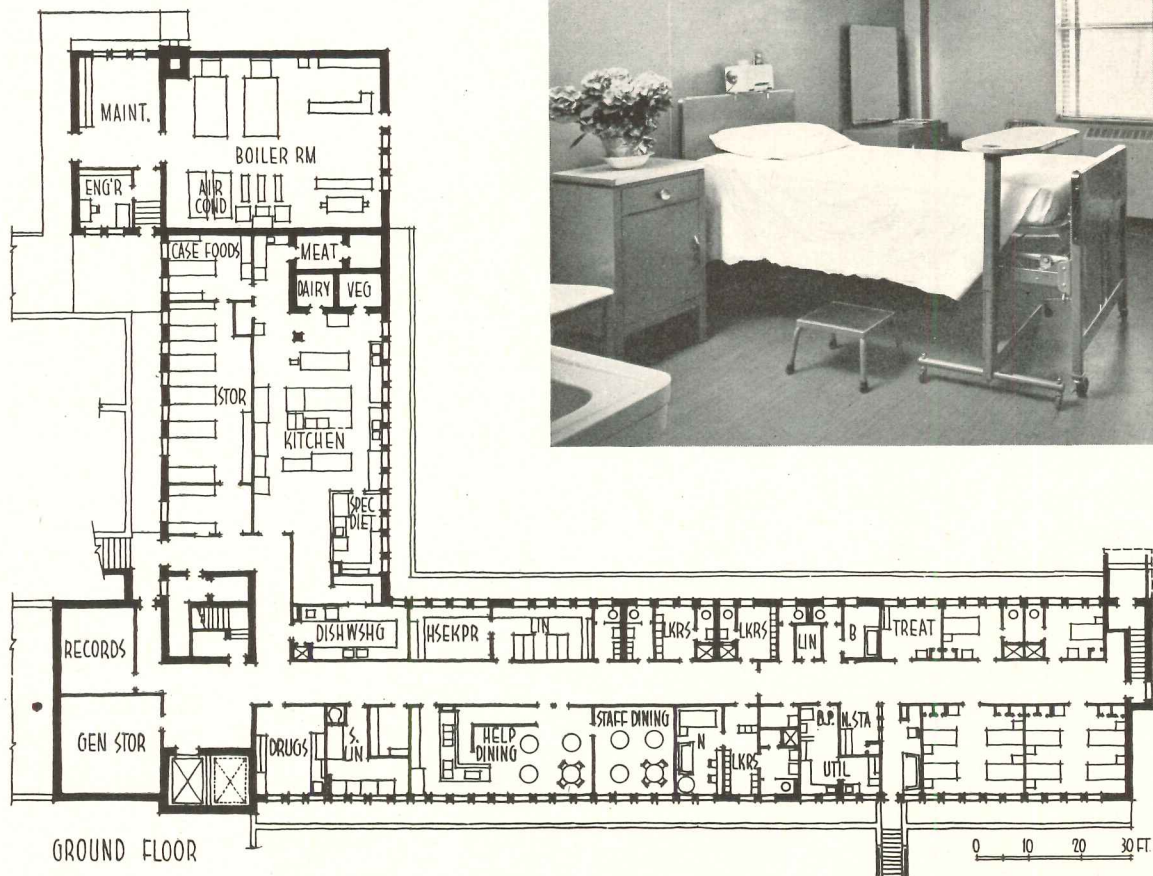

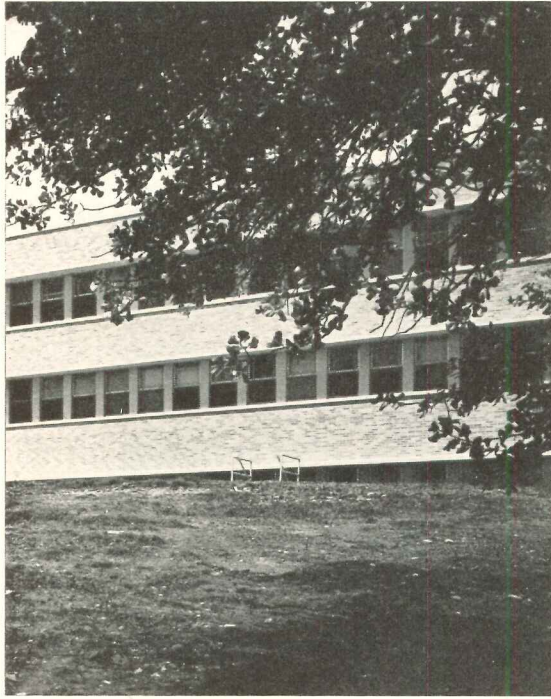

Ulric Meisel

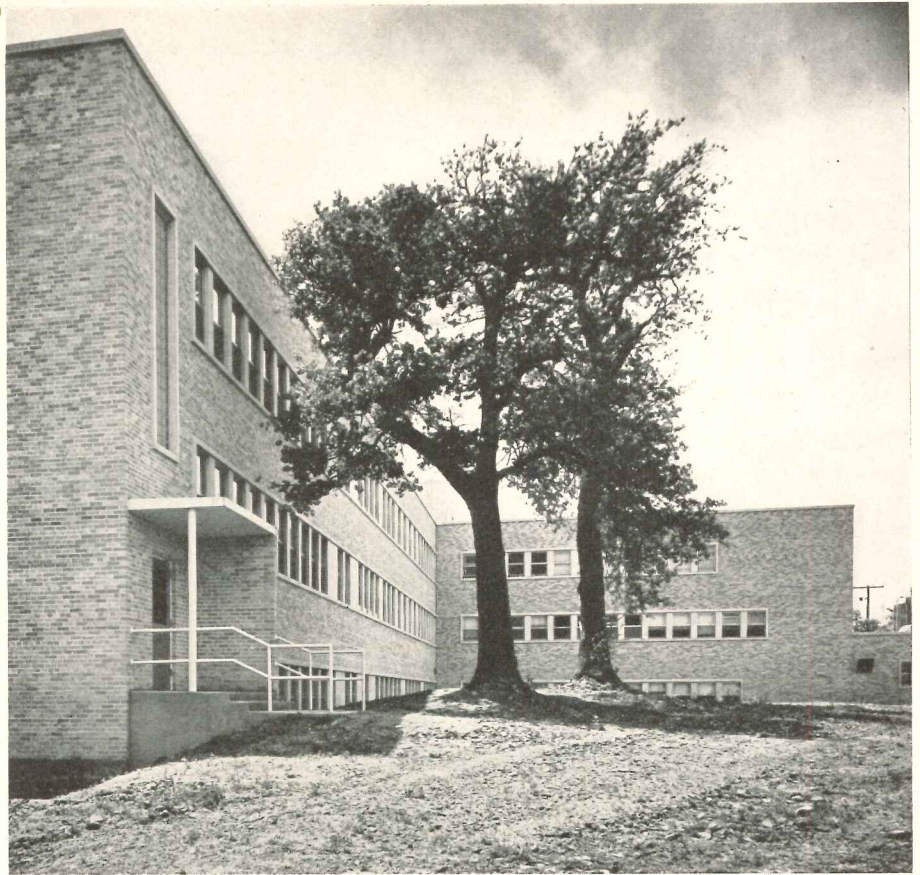

ACCORDING to the survey of needs, this hospital should have 100 beds, but needs and funds did not quite match, so it became a 60-bed hospital on a 100-bed chassis. Actually its facilities will accommodate 120 beds, and it can be enlarged to that size.

It is a hospital well worthy of study. Departmentalization is well worked out, with separate wings giving cul-de-sac locations for office, diagnostic (plus emer-

gency suite), operating, obstetrical departments, and good privacy for nursing units. This last has been the subject of especially favorable comments. Ground floor has a 10-bed nursing unit with its separate entrance.

The hospital won an award of merit at the Texas State Hospital Association convention in 1951. It was constructed and equipped, including its oversize chassis, for a total cost of \$809,725.

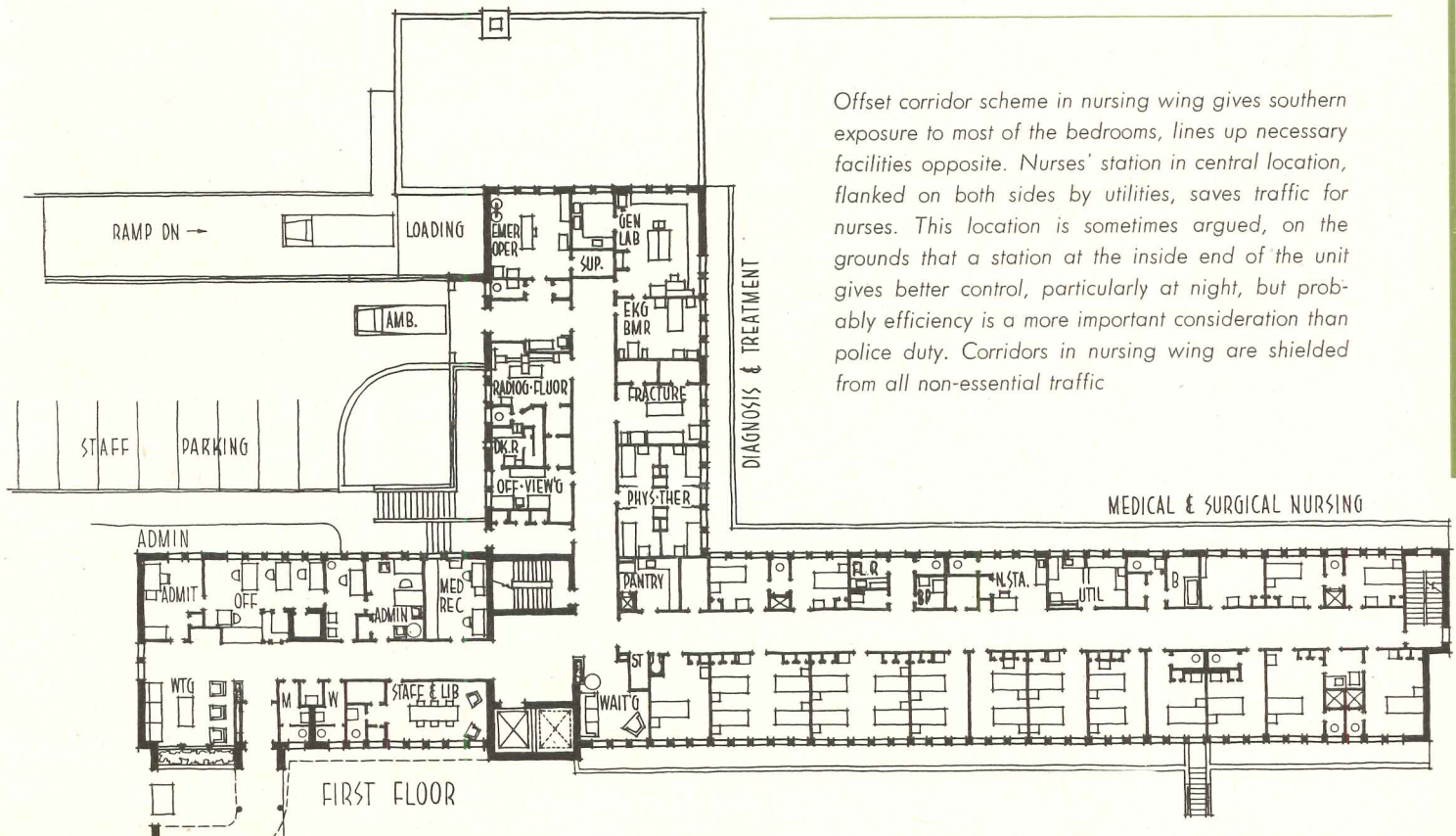

Offset corridor scheme in nursing wing gives southern exposure to most of the bedrooms, lines up necessary facilities opposite. Nurses' station in central location, flanked on both sides by utilities, saves traffic for nurses. This location is sometimes argued, on the grounds that a station at the inside end of the unit gives better control, particularly at night, but probably efficiency is a more important consideration than police duty. Corridors in nursing wing are shielded from all non-essential traffic

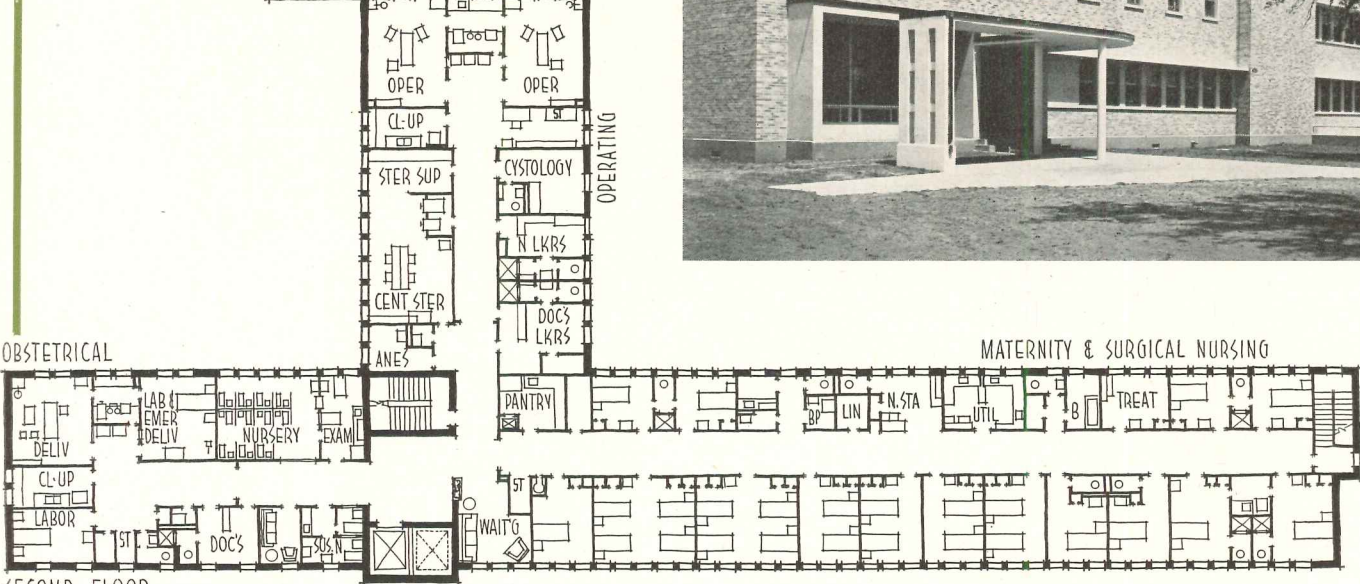
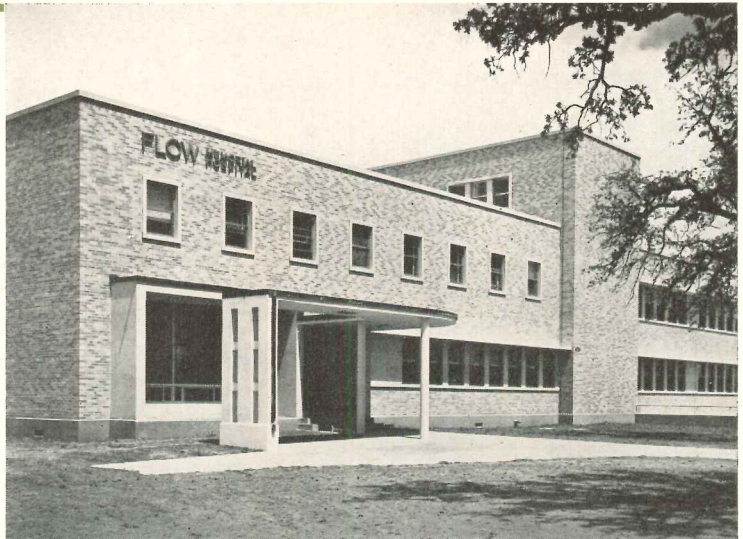
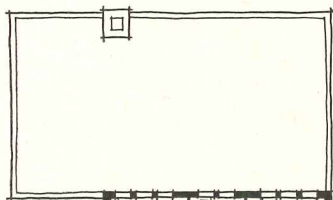

Obstetrical and operating departments each have dead-end locations in separate wings. Both departments, with their supporting facilities, are large enough for double the present bed capacity of the hospital, need not be disturbed when additional nursing units are added to building

Entrance lobby and waiting room get attention in the modern hospital. Planting box inside and planting strip just beyond big windows may ease the tension of visitors



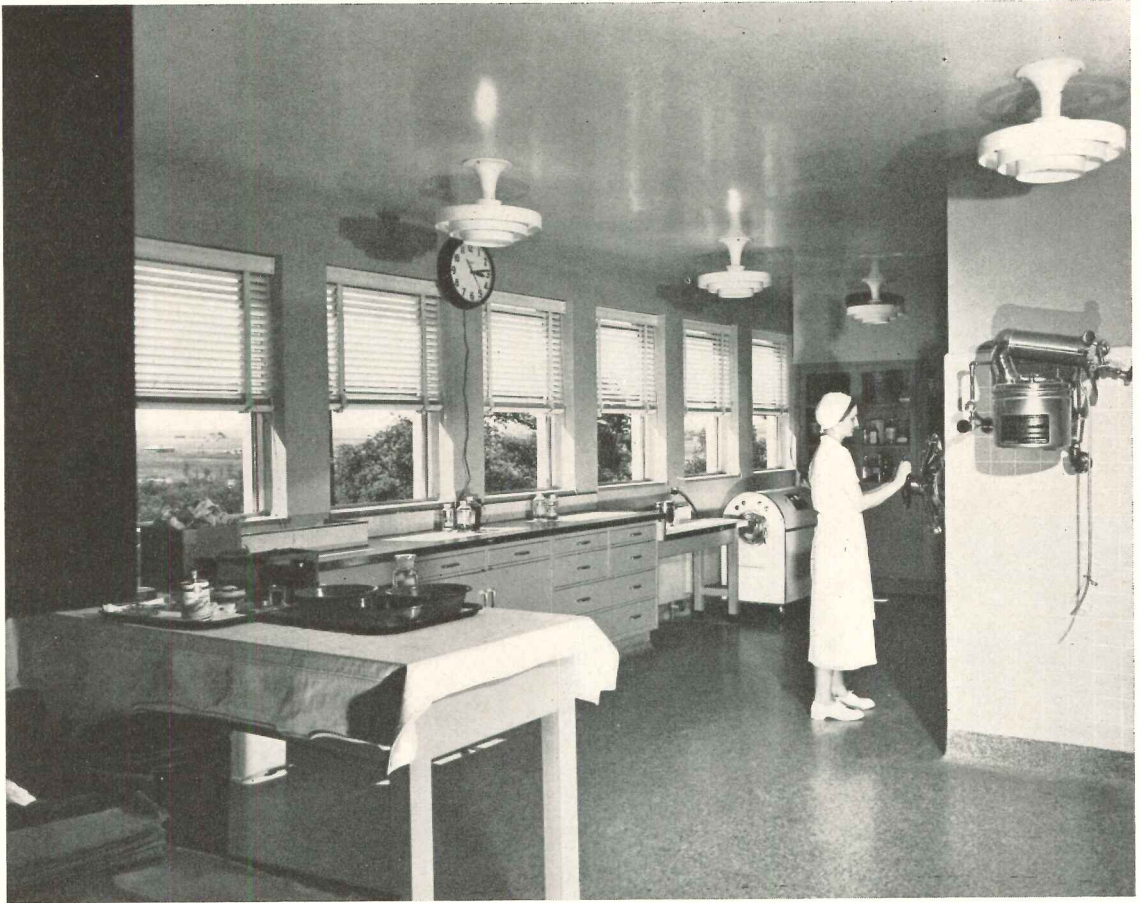

Central sterilizing, above, is well placed near operating suite, not too far from obstetrical department. Below, one of major operating rooms



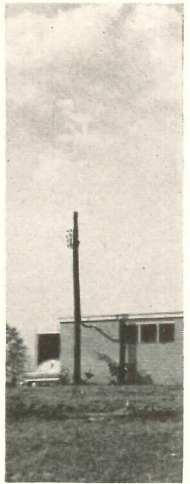
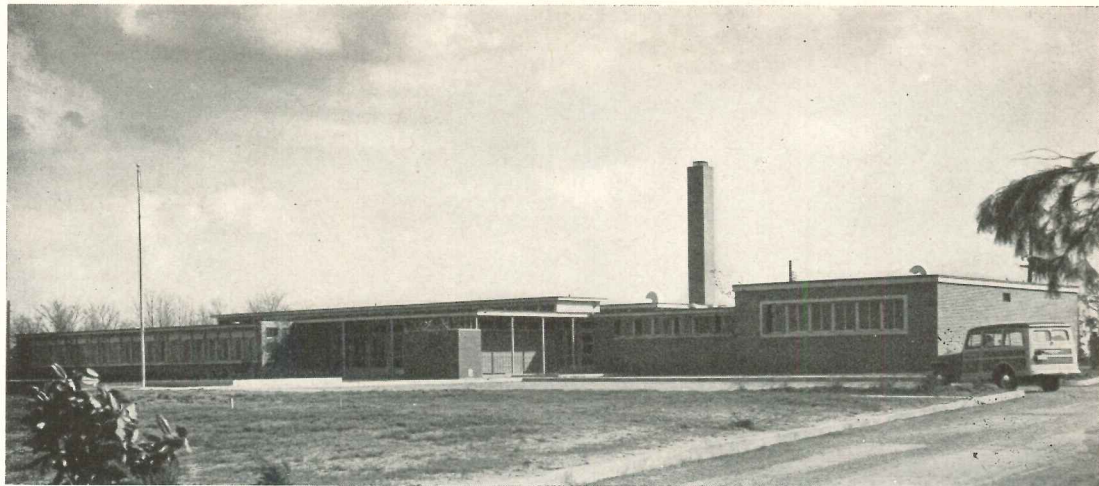

SMALL,

IN THE very small hospital — this one has but 20 beds — functions begin to flow together, and the various departments cannot be so nicely isolated. This one represents clever manipulation in keeping separations that are necessary (isolation of operation, obstetrical and emergency) and in separating traffic. A double corridor scheme helps in this regard, also serves to keep the building compact and economical. The plan even manages to have separate entrances as in a larger hospital,

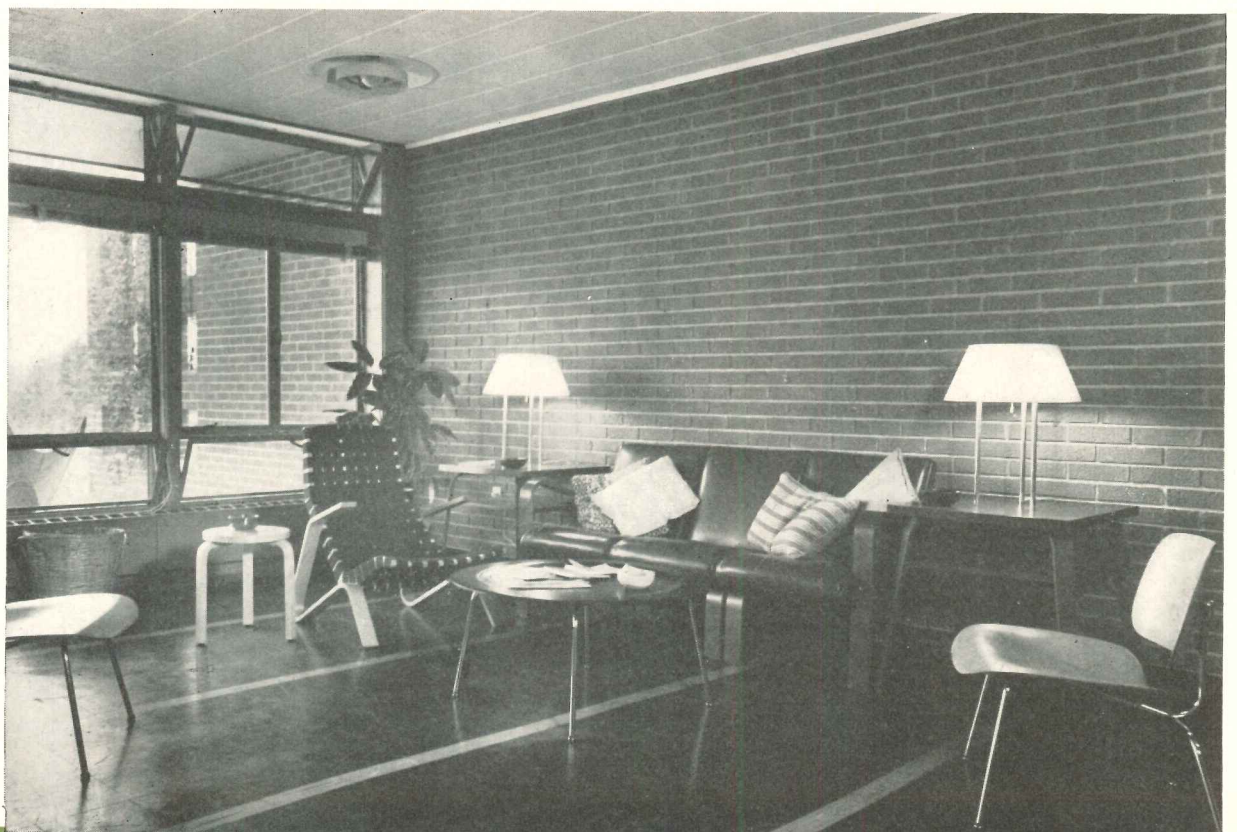

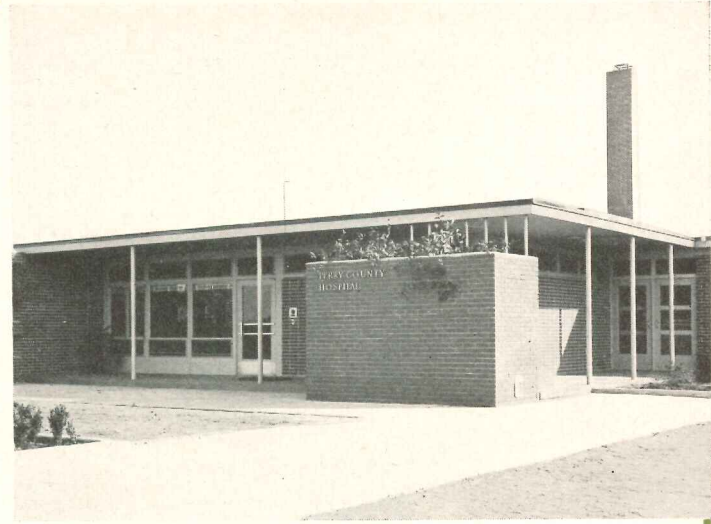
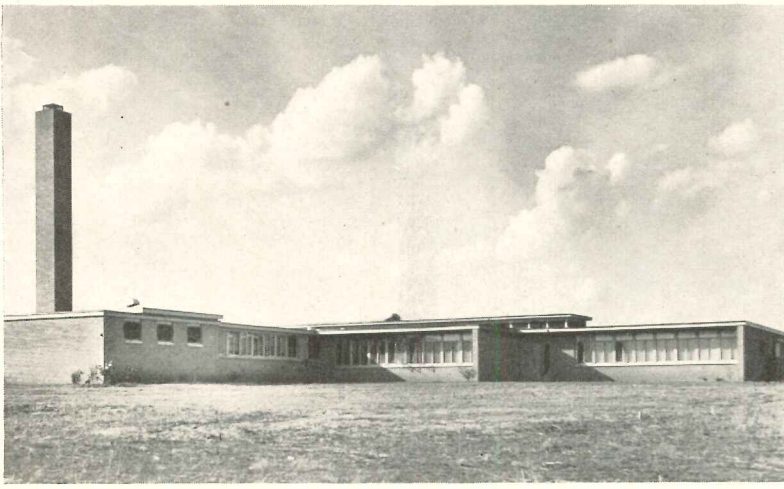

Betty Baldwin

COMPACT ONE-STORY HOSPITAL

and to keep nursing units separated from service traffic and noise. The scheme also assures good control at all times, and makes it possible to maintain supervision with a minimum number of employees. The nurses' station permits supervision of waiting room and of outpatient facilities too, if that should be necessary. Nursery is close to nurses' station, to save steps for nurses, especially during night shifts. The plan also is arranged for expansion of the nursing unit as required later.

Perry County Hospital, Marion, Ala.

*Sherlock, Smith & Adams
Architects and Engineers*

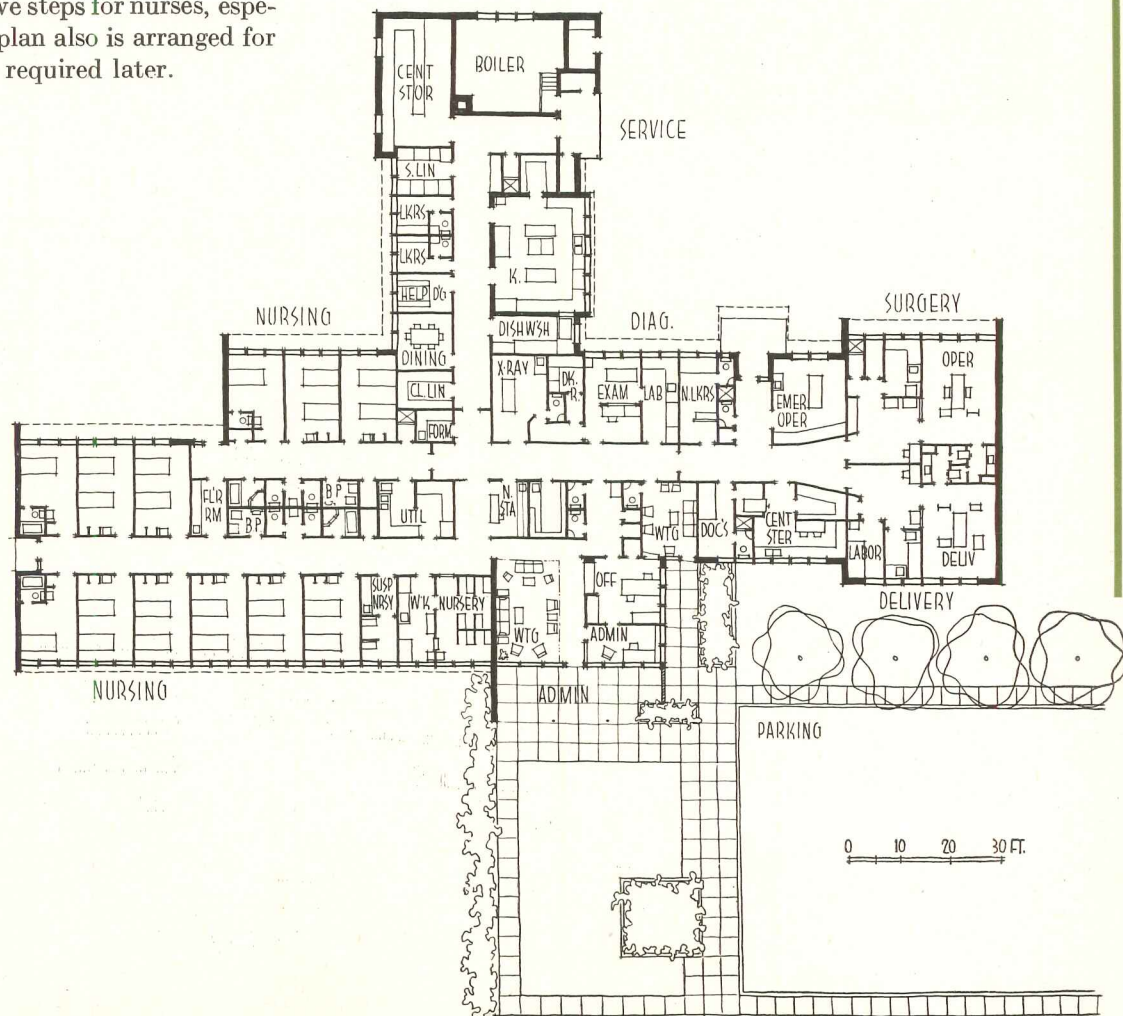

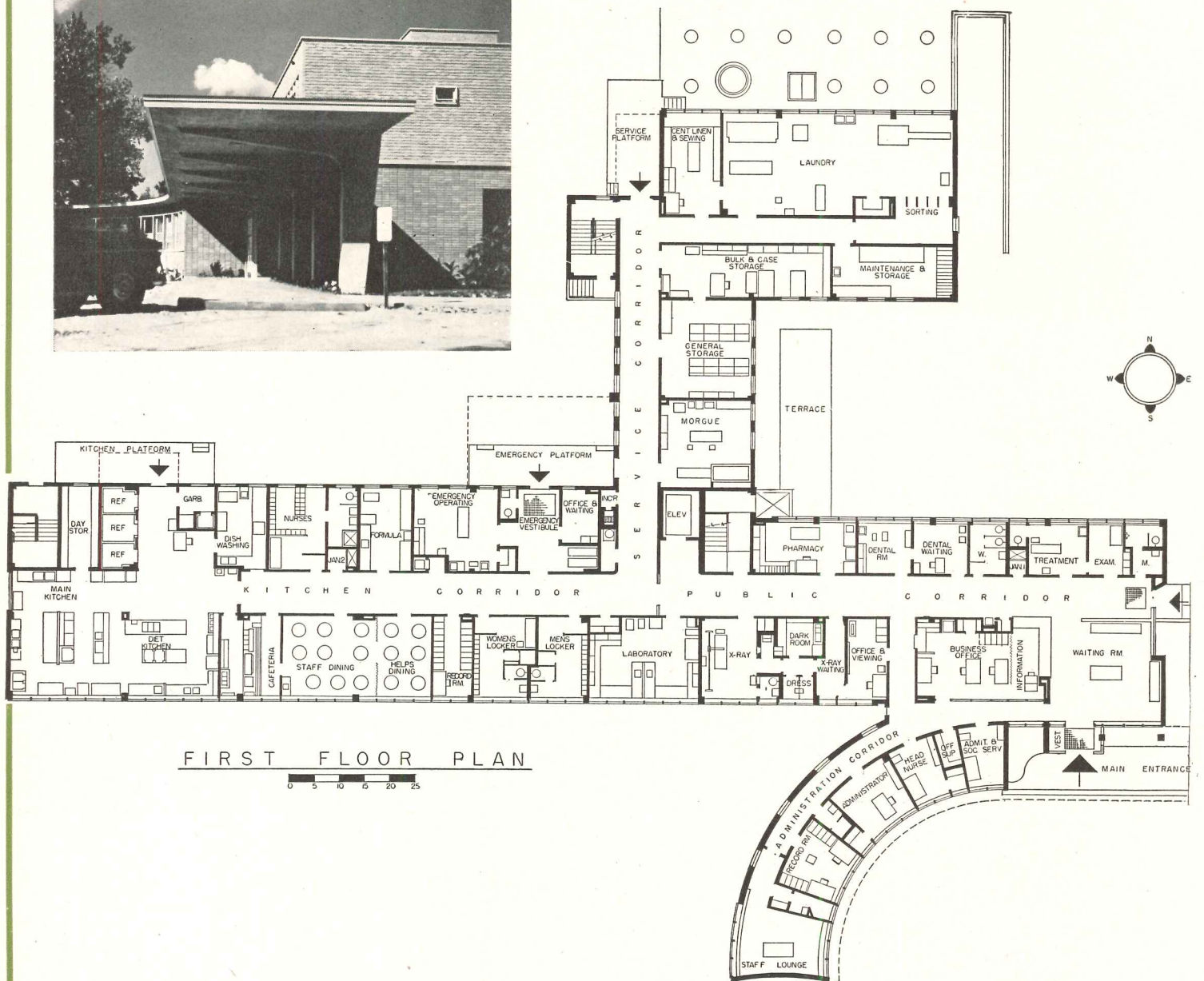
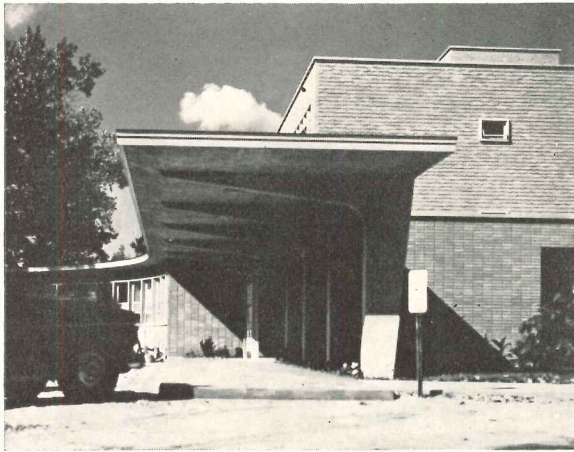

54-BED HOSPITAL FOR RURAL AREA

Wood County Hospital, Bowling Green, Ohio

Strong, Strong and Strong, Architects

A 54-BED HOSPITAL is just about large enough to require full facilities, not quite large enough to allow full departmentalization. Here the separations are maintained quite well; only medical and surgical nursing beds are put together. A small separated wing at the back keeps the laundry and service operations well

away from the rest of the hospital, and gives an isolated location for the surgical suite. Perhaps the most noteworthy feature of the plan is the development of the offset corridor scheme to give the good southern exposure to most of the bedrooms and still utilize to the full the opposite side of the corridor. Actually the corridor

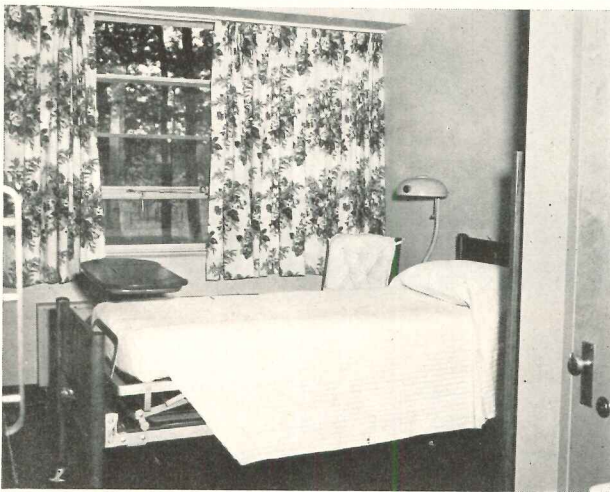

SECOND FLOOR PLAN

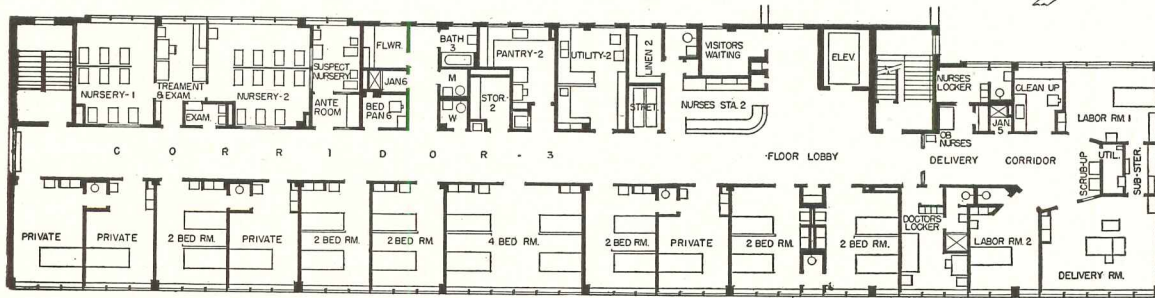
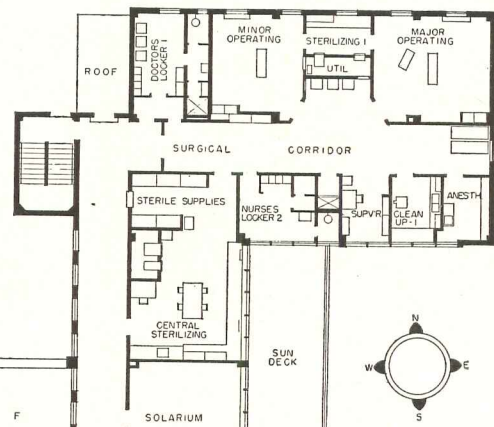
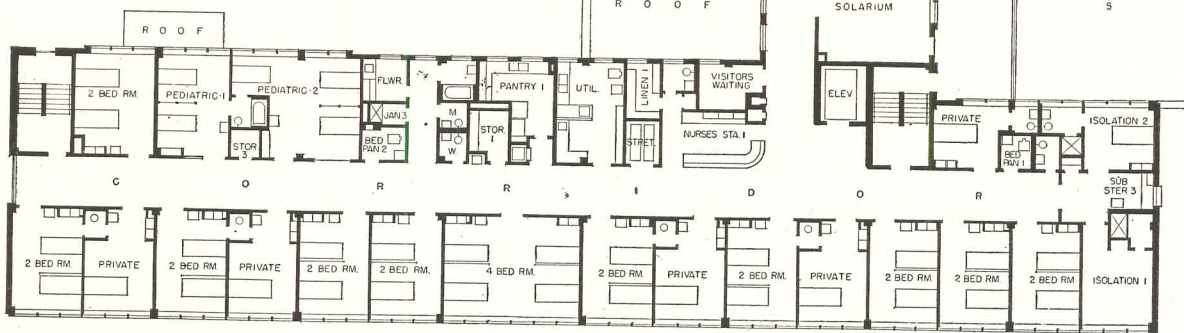
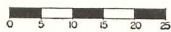

THIRD FLOOR PLAN



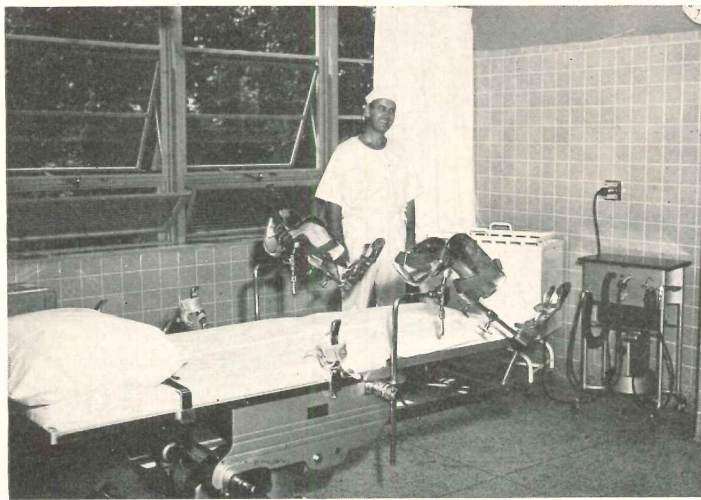
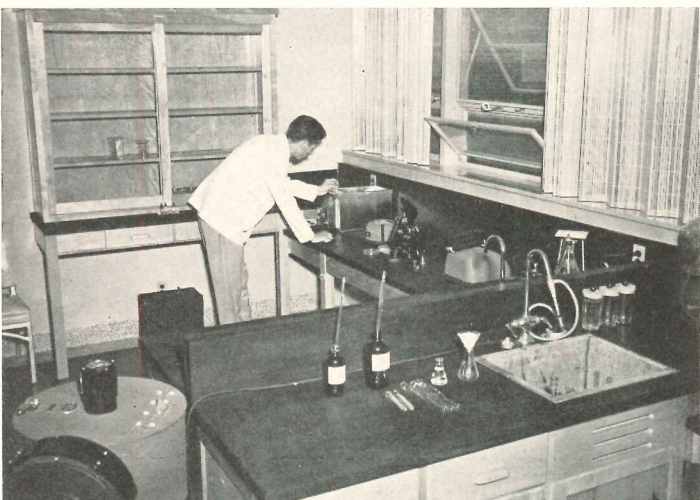
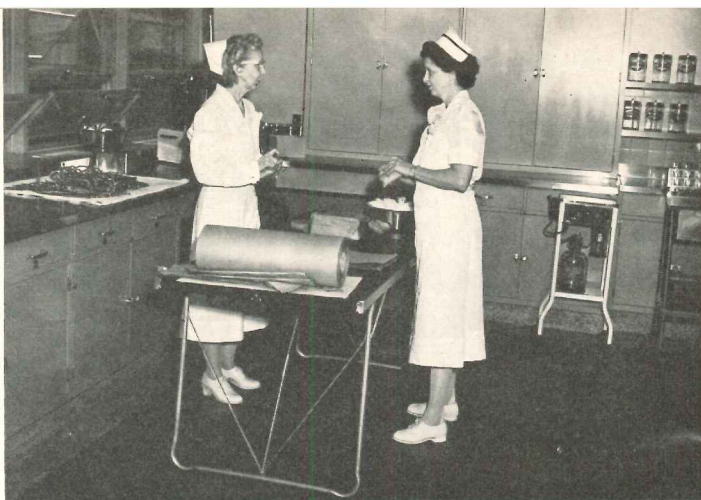

is offset for only a small portion of its length, but the general development of the floor follows the "offset corridor" idea in that only nursery, pediatrics section and a couple of isolation rooms get the northern exposure. The nurses' station with its utilities seems to be an exceptionally workable layout, with the possible exception of the location of the linen room. The nurses' station

is well placed and the utility space both adequate and centrally located. The hospital serves an essentially rural area which was badly in need of hospital facilities. There was plenty of difficulty in fund raising, in the face of low average income and rising costs, but with Hill-Burton aid the total cost of \$840,000 was finally met. Per bed cost is given at \$15,555.

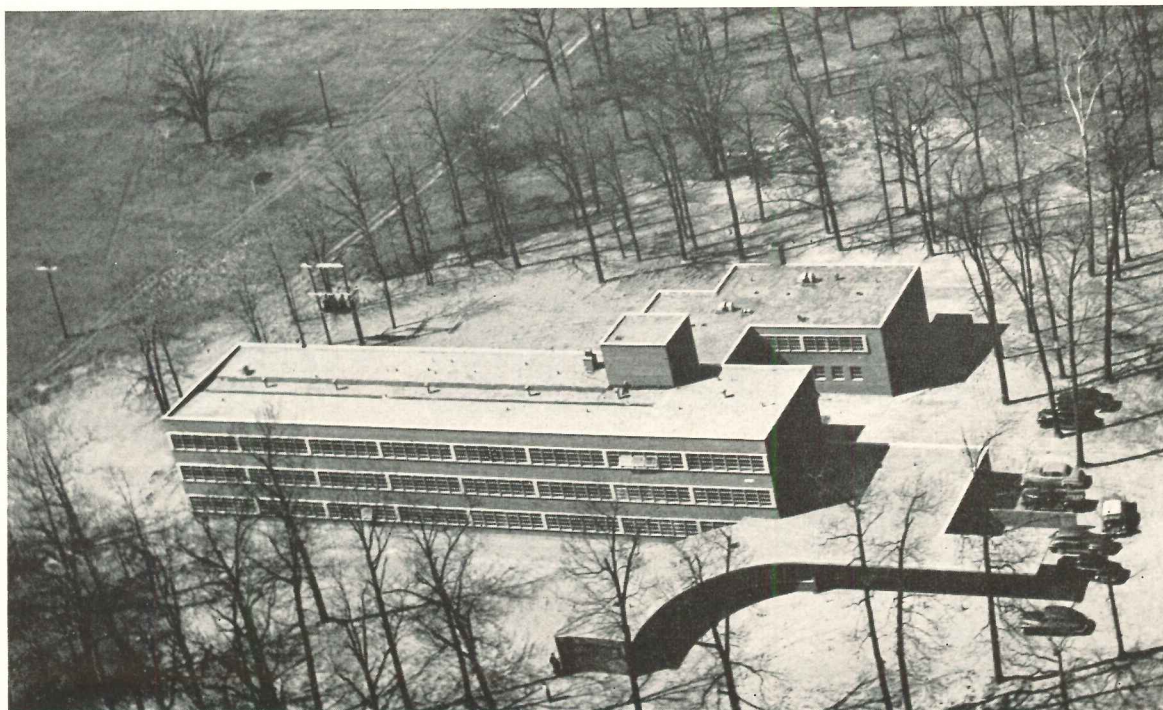

MOVING STAIRWAYS FOR TALL BUILDINGS

By G. B. Gusrae

Voorhees, Walker, Foley & Smith, Architects

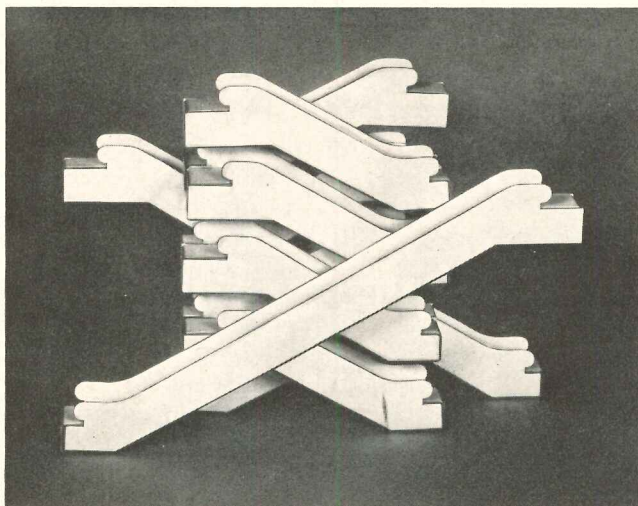

The relative costs and advantages of moving stairways and elevators in office buildings were analyzed by Mr. Gusrae in the December, 1950, issue of ARCHITECTURAL RECORD. He concluded that moving stairways could transport many more people than the number of elevators that could be provided at the same cost. But, because of the slower speed of moving stairways and the walking time required between them at each floor, they were deemed most practical for heights up to 6 stories, with 8 stories being the absolute limit. Elevators would be used to reach any remaining floors.

(Continued on page 214)

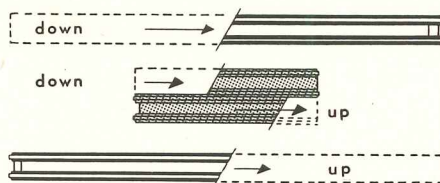

Moving stairways traveling a vertical height equal to that of a 5-story building are a familiar sight in New York City subway stations. The author proposes to use three-floor express units in a 10-story office building. There is considerable recoverable cubage under the express units which could be inside offices or storage. The model and drawing have different arrangements of one-floor units just to show what can be done

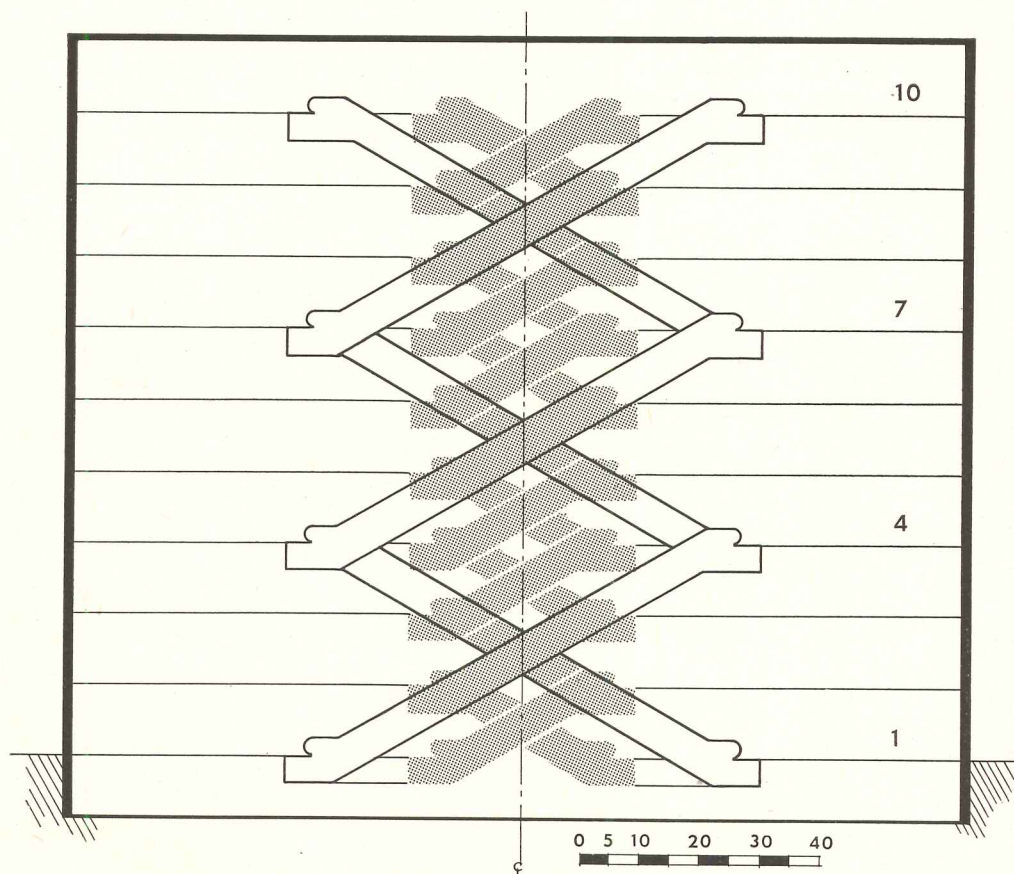

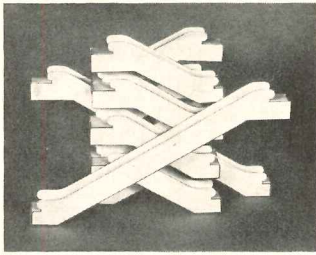

MOVING STAIRWAYS FOR TALL BUILDINGS

They Cost Less

Still, Mr. Gusrae reasoned, moving stairways are cheaper to install and operate than a comparable elevator installation. Their speed can be increased only slightly, so the big obstacle to their total use in tall buildings is the time consumed in changing from one stairway to another. When he was asked to design a moving stairway system for a proposed 10-story building, he hit upon the idea of using express moving stairways together with local (floor-to-floor) units. In this article, he reviews some of the background information presented in the first article and then discusses the possible solutions for moving stairways in a 10-story building.

Below is a cost comparison of moving stairways and elevators in a 6-story building. The author said in his previous article that this height was about the practical limit for "local" (floor-to-floor) moving stairways. The example, however, is indicative of costs for an express system

EXAMPLE

6-story building Population: 4000	
Vertical Transportation Required	Daily Cost
15 elevators (\$30,000 class)	\$423.00
10 moving stairways (5 up, 5 down)	91.50

IN TODAY'S modern commercial buildings with large populations, we must seriously consider the use of moving stairways in place of elevators — even in buildings up to 20 stories and perhaps higher. Often their application offers the only successful solution to the involved transportation problems, economically and functionally as well.

Advantages of Moving Stairways Reviewed

Five-hundred persons can board a single moving stairway, traveling upward or downward, in any 5 min. interval. A moving stairway "run" (up and down) can successfully serve a building with a population up to 4000 persons. An equivalent elevator installation, capable of transporting 500 persons in any 5 min. interval, would consist of at least thirteen 3000 lb or fifteen 2500 lb elevators. This is based on the average 5 min. carrying capacity of a 3000 lb elevator of 40 persons and that of a 2500 lb elevator of 32 persons. (Usually elevators are designed to make about two round trips in 5 min. Of course this time varies with building heights so as to be within practical limits. In taller buildings, elevators are made to run faster in order to obtain about two trips in 5 min., and cost more. For instance, an elevator traveling at a rate of 200 fpm might cost \$15,000 to \$20,000. If the speed is increased to 350 fpm, the same type of elevator will cost \$25,000 to \$30,000.)

Bearing in mind that an up-down moving stairway "run" (spanning one story at a time) occupies little more than the space of just three elevators (See Fig. 2), that it is always available for immediate use, and that it does not require a machine room, pit, or attendants, its advantages are self-evident.

Cost Comparisons

It has been shown that the daily cost of elevators is considerably higher than

that of moving stairways. The daily cost of a single moving stairway unit running between two floors, including all factors, is about \$9.15.

A 6-story building about 350 ft wide and 250 ft deep may have a population of 4000 persons, based on one person per 100 sq ft of net area. A moving stairway installation for such a building would consist of 5 up and 5 down units or a total of 10 units. In a single-purpose building, it must be assumed that at least 20% of the people will be able to obtain transportation in any 5 min. period at the beginning and end of the day. Both runs of moving stairways then will be operated in the same direction. This doubles the capacity so that 4000 people can be transported up or down in 20 min. The daily cost of the entire moving stairway installation, including capital recovery, liability insurance, electric power and maintenance, would be about \$92.

The daily cost of an equivalent elevator installation based on fifteen \$30,000 elevators manned with elevator attendants, would be \$423. In other words, for the above condition, the daily cost of elevators is nearly 4½ times that of the moving stairways.

In view of the obvious economic advantage, the convenience of immediate availability, the superior functional value, and simpler installation requirements, moving stairways will tend to displace elevators where warranted.

Limitations

Moving stairways are, however, subject to certain limitations and, consequently, cannot be used indiscriminately. They cannot transport disabled persons; nor can they move freight such as office furniture. Most of all, they are limited in speed. The fastest moving stairways in the United States are rated at 125 linear fpm. Some 150 linear fpm moving stairways have been installed in

... and Take Less Space

England. In any event, at 125 linear fpm, the vertical speed is limited to 60 fpm or 1 ft per second.

An average moving stair unit (1 story span) in a building has a vertical rise of about 15 ft. At the rate of one fps, this distance requires 15 sec. to complete. Since an additional 5 to 8 sec. are required for walking between stairway units, the addition of the walking time to the moving stairway time indicates that the equivalent continuous vertical speed obtained with a 125 linear fpm moving stairway is only about 40 fpm.

For that reason, a 6-story building is about the tallest suitable for a standard, floor to floor, moving stairway installation. Taking an extreme case, i.e. a floor height of 15 ft, the overall traveling height of a 6-floor building would be 75 ft, and a passenger would require about 2 min. to complete this trip. It is generally recognized that, although there are 480 min. in an 8-hr working day, 2 to 3 min. appear to be as long as a passenger is willing to wait to reach his destination.

The problem is to find a way of taking advantage of the functional and economic superiority of the moving stairways in applying these to buildings over 6 stories in height.

Solution

The great disadvantage in using standard floor to floor moving stairway

These sketches give some idea of the space saved by using moving stairways. For example, a moving stairway system may take only a little more cubage than three elevators (Fig. 2), although it would take many more elevators to transport the same number of people. Fig. 1 shows relative amounts of lobby space required for each. These figures apply only for one run of moving stairways

FIG. 1

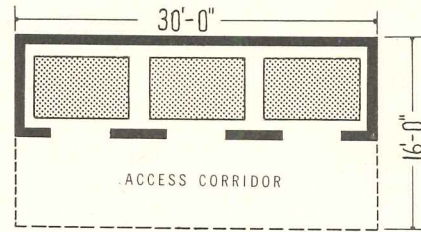

AREA REQUIRED FOR 3-3000 LB ELEVATORS: 480 SQ FT

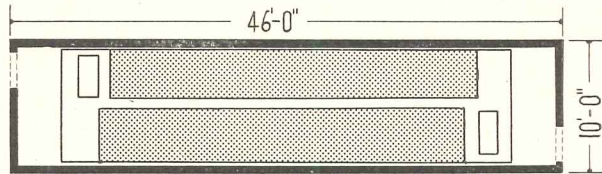

AREA REQUIRED FOR 2 MOVING STAIRWAY UNITS: 460 SQ FT

FIG. 2

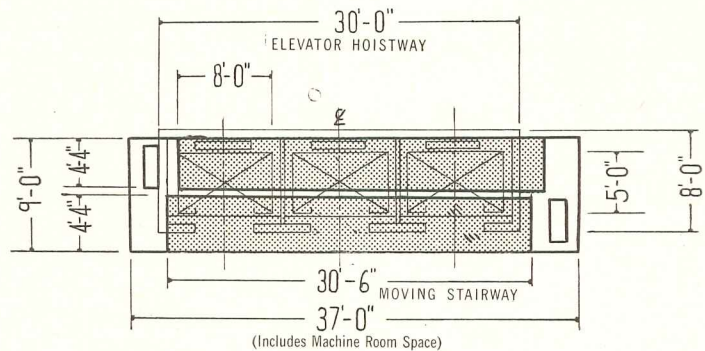

PLAN

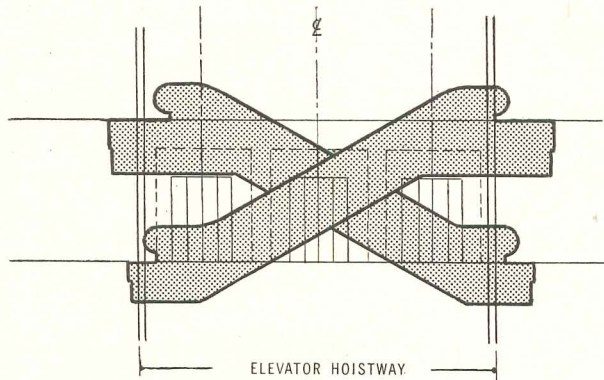

ELEVATION

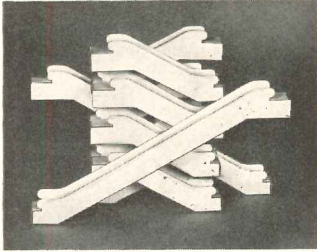

MOVING STAIRWAYS FOR TALL BUILDINGS

How They Could Be Used in a 10-Story Building

DESIGN NO. 1

Local stairway system only (single floor units)

Floors	Number of Changes	Travel Time
1 to 2	none	15 sec.
1 to 3	1	38 sec.
1 to 4	2	61 sec.
1 to 5	3	1 min. 24 sec.
1 to 6	4	1 min. 47 sec.
1 to 7	5	2 min. 10 sec.
1 to 8	6	2 min. 33 sec.
1 to 9	7	2 min. 56 sec.
1 to 10	8	3 min. 19 sec.

DESIGN NO. 2

Express stairway 1st to 10th floor (9-floor unit)
Local stairways floor to floor (single floor units)

This system has very little to offer since it will benefit only those at the 10th floor and, therefore, need not be further considered.

DESIGN NO. 3

Express stairway 1st to 5th floor (4-floor unit)
Express stairway 5th to 9th floor (4-floor unit)
Local stairways floor to floor (single floor units)

Floors	Use	No. of Changes	Travel Time
1 to 2	Local	none	15 sec.
1 to 3	Local	1	38 sec.
1 to 4	Local	2	61 sec.
1 to 5	Express (1-5)	none	60 sec.
1 to 6	Express (1-5) and local	1	1 min. 23 sec.
1 to 7	Express (1-5) and local	2	1 min. 46 sec.
1 to 8	Express (1-5) and local	3	2 min. 9 sec.
1 to 9	Express (1-5), (5-9)	1	2 min. 8 sec.
1 to 10	Express (1-5), (5-9) & local	2	2 min. 31 sec.

DESIGN NO. 4

Express stairway 1st to 4th floor (3-floor unit)
Express stairway 4th to 7th floor (3-floor unit)
Express stairway 7th to 10th floor (3-floor unit)
Local stairways floor to floor (single floor units)

Floors	Use	No. of Changes	Travel Time
1 to 2	Local	none	15 sec.
1 to 3	Local	1	38 sec.
1 to 4	Express (1-4)	none	45 sec.
1 to 5	Express (1-4) & Local	1	1 min. 8 sec.
1 to 6	Express (1-4) & Local	2	1 min. 31 sec.
1 to 7	Express (1-4), (4-7)	1	1 min. 38 sec.
1 to 8	Express (1-4), (4-7) & Local	2	2 min. 1 sec.
1 to 9	Express (1-4), (4-7) & Local	3	2 min. 24 sec.
1 to 10	Express (1-4), (4-7) & (7-10)	2	2 min. 31 sec.

DESIGN NO. 5

Express stairway 1st to 3rd (2-floor unit)
Express stairway 3rd to 5th (2-floor unit)
Express stairway 5th to 7th (2-floor unit)
Express stairway 7th to 9th (2-floor unit)
Local stairways floor to floor (single floor units)

Floors	Use	No. of Changes	Travel Time
1 to 2	Local	none	15 sec.
1 to 3	Express (1-3)	none	30 sec.
1 to 4	Express (1-3) & Local	1	53 sec.
1 to 5	Express (1-3), (3-5)	1	1 min. 8 sec.
1 to 6	Express (1-3), (3-5) & Local	2	1 min. 31 sec.
1 to 7	Express (1-3), (3-5), (5-7)	2	1 min. 46 sec.
1 to 8	Express (1-3), (3-5), (5-7) & Local	3	2 min. 9 sec.
1 to 9	Express (1-3), (3-5), (5-7) & (7-9)	3	2 min. 24 sec.
1 to 10	Express (1-3), (3-5), (5-7), (7-9) & Local	4	2 min. 47 sec.

units in taller buildings is the necessity, on the part of the passenger, of being subjected to the constantly recurring cycles, each consisting of (1) a brief period of relaxation, (2) the anticipation of required alertness in approaching the landing, (3) the actual alertness in leaving the unit, (4) the competition with other passengers in approaching the next unit, and (5) the final alertness required in boarding the next unit. Any system which cuts down the number of cycles would stimulate a more ready acceptance by the public of moving stairways, even though the time required for the arrival to the destination exceeds that of the speedier elevators by as much as one minute.

The means for obtaining a superior moving stairway system would be to employ "express" moving stairways. This means stairway units traveling more than one floor as contrasted with "local" units traveling from floor to floor.

Moving stairway units traveling a vertical height equal to a 5-story building are commonplace. Many have been and are being installed in various New York City subway stations, and all have been readily accepted by the public. Often the moving stairway of this type is considered superior compared with elevators, primarily due to its immediate availability, less competition in obtaining transportation, and complete absence of uncomfortable jostling and packing in the confined spaces of elevator cabs.

Four 5-story moving stairway express units could easily serve a highly populated 21-story building. Those who have had the experience of traveling on any high rise moving stairway would, most likely, admit that the use of four units for traveling to the 21st floor would be quite acceptable, even though the traveling time would be in the range of $4\frac{1}{2}$ min. The trip to the 11th floor in such a building would require the use of only two units, take about $2\frac{1}{4}$ min., and would certainly be superior to any elevator arrangement.

Design

Two factors that influence the design of a system of express and local moving stairway units, are (1) the travel time and (2) the number of changes from unit to unit.

There is not much that can be done to reduce the travel time. The maximum speed of moving stairways is limited by the average human reaction time re-

quired for boarding or for leaving a unit. The speed of 150 linear fpm, used successfully in England, could easily be adapted to express stairways.

A change from one local unit to another takes about 8 sec. Consequently, any express unit by-passing two floors saves about 16 sec., or the average time required for a local unit for floor to floor transportation. In other words, when the local passenger would be getting off at the 3rd floor, an express passenger on a 5-floor express unit would be getting off at the 5th floor.

Any attempt at equalizing time intervals within local and express zones, as is being done with elevators, is not feasible. Further increase in the speed of moving stairways, would be too small to alter the situation much.

Of the two factors influencing design, the number of changes from unit to unit is the one that can be controlled. The underlying principle of the system of express and local moving stairway units is the deletion or reduction of the number of annoying changes normally required by standard floor to floor units.

Example of Express Units

Let us assume a 10-story office or department store building with a 15-ft story height from floor to floor (again extreme, but assumed as the worst possible case). A quick analysis indicates that there are five possible basic designs. (Same size express stairways are used in each design, i.e., all 2-floor, all 3-floor, or all 4-floor units.) Other designs are possible, using different size units in different zones of the building. These will not be considered.

The analysis of designs Nos. 1 to 5 indicates that two designs would provide the most satisfactory results: design No. 3 using 4-floor express units, and design No. 4 using 3-floor express units. In these designs there would be the least number of changes and about $2\frac{1}{2}$ min. of traveling time to the top (10th) floor compared with about $1\frac{1}{2}$ min. required by a modern elevator.

Design No. 4 is, however, more desirable than design No. 3 because it occupies less floor space, requires a smaller hoistway, and uses less supporting steel.

The installation would have three express stairway "runs": 1st to 4th, 4th to 7th, and 7th to 10th floors. In each "run" would be one "up" and one "down," 3-floor express unit. The total express system would consist of six 3-floor units.

The local stairway "runs" would consist of one "up" and one "down" unit for each floor, or a total of 18 single floor units. The entire system would be enclosed in a common hoistway, and the units in each "run" would be arranged in a scissor type grouping. (See Fig. 2). The linear speed of the units would be 125 fpm. This system would be capable of clearing 1000 persons in 5 min. and could easily serve a population of 5000 people distributed evenly through the 9 floors of the 10-floor building.

An equivalent elevator installation, capable of clearing the same number of people in 5 min., would have to consist of at least thirty 2500-lb passenger elevators. (Such an installation would be very impractical, taking entirely too much cubage, in relation to the size of the building, and being expensive to operate and maintain. Actually, if elevators were selected, fewer than 30 would be used, and the flow of traffic would have to be staggered.)

Economics

The initial cost of the stairway system as described would probably not exceed \$900,000. The initial cost of the equivalent 30-elevator installation would be about \$1,500,000.

The daily cost of the stairway system, including capital recovery, liability insurance, electric power, and cost of maintenance, would probably be \$325. The daily cost of the equivalent elevator installation, including cost of elevator attendants, would be \$1000, or about three times that of the moving stairway system.

Conclusion

Benefits besides lower daily cost are obtained with moving stairways. They do not require penthouses, pits and complicated controls, and occupy considerably less floor space. Breakdowns affect only one unit at a time with the parallel unit always available as a spare for upward travel. The equipment is simpler and easier to maintain. Its life is equal to and often longer than that of elevators. Initial cost of moving stairways will no doubt continue to decrease in proportion to the increasing demand.

Their use is justified in department stores and office buildings with large populations. The system described, employing express and local moving stairways, will easily provide an acceptable form of vertical transportation for buildings up to 20 stories or even higher.

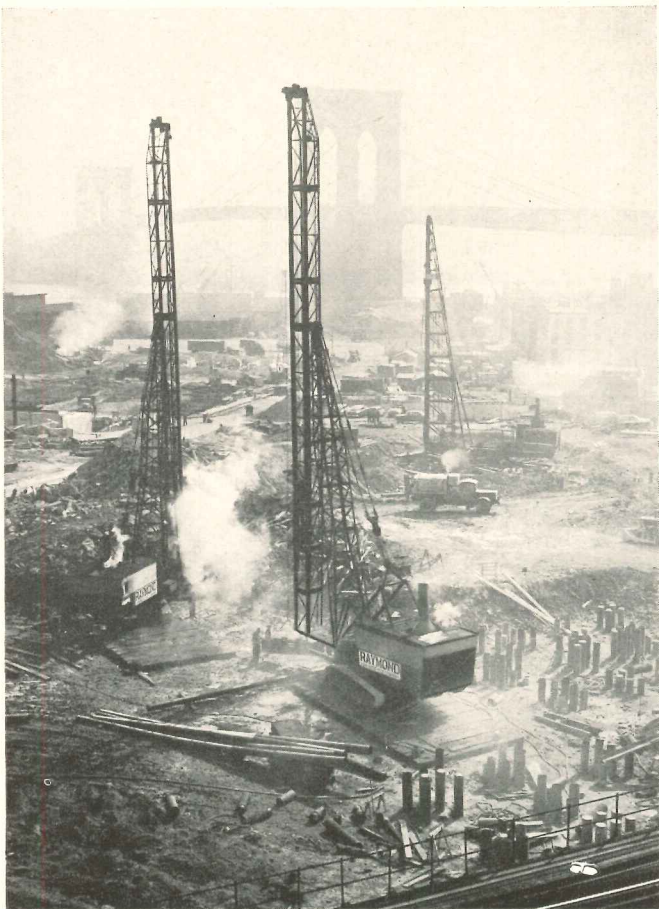

Many of New York City's buildings stand on solid rock, but now that marginal areas are being developed, piles must be driven in silt to support buildings such as those in the Governor Alfred Smith housing project along the East River

HOW SOILS AFFECT FOUNDATION DESIGN

By S. D. Teetor, Supervising Engineer

Seelye Stevenson Value & Knecht

Consulting Engineers

Simple and inexpensive to use, an auger can determine if there are any layers of soft soil under the proposed foundation of a house. The man in the middle is twisting an auger into the ground. The man at right holds one attached to several lengths of pipe, showing how deep it goes; pipe is added as needed

WHETHER A PARTICULAR SOIL is good or bad depends on how it is to be used. For example, a plastic clay makes excellent earthenware; gravel does not. But a clay soil underneath a building may mean that piling is necessary for support, rather than footings which can be placed safely on gravel, and are simpler and cheaper to construct.

Mapping The Soil

The first step in determining the type of foundation required for a building is to have soil borings made. From them two types of information can be learned: (1) a picture of subsurface conditions (just as a topographic survey describes the surface of the soil), and (2) the physical properties of the various layers of soil found in the soil survey.

Borings ascertain whether there are any layers of soft soil, and if so, if piles are necessary. Borings also disclose whether the soil is suitable for footings. The footings can be designed after a safe load bearing value is determined from tests on boring samples. Depending on



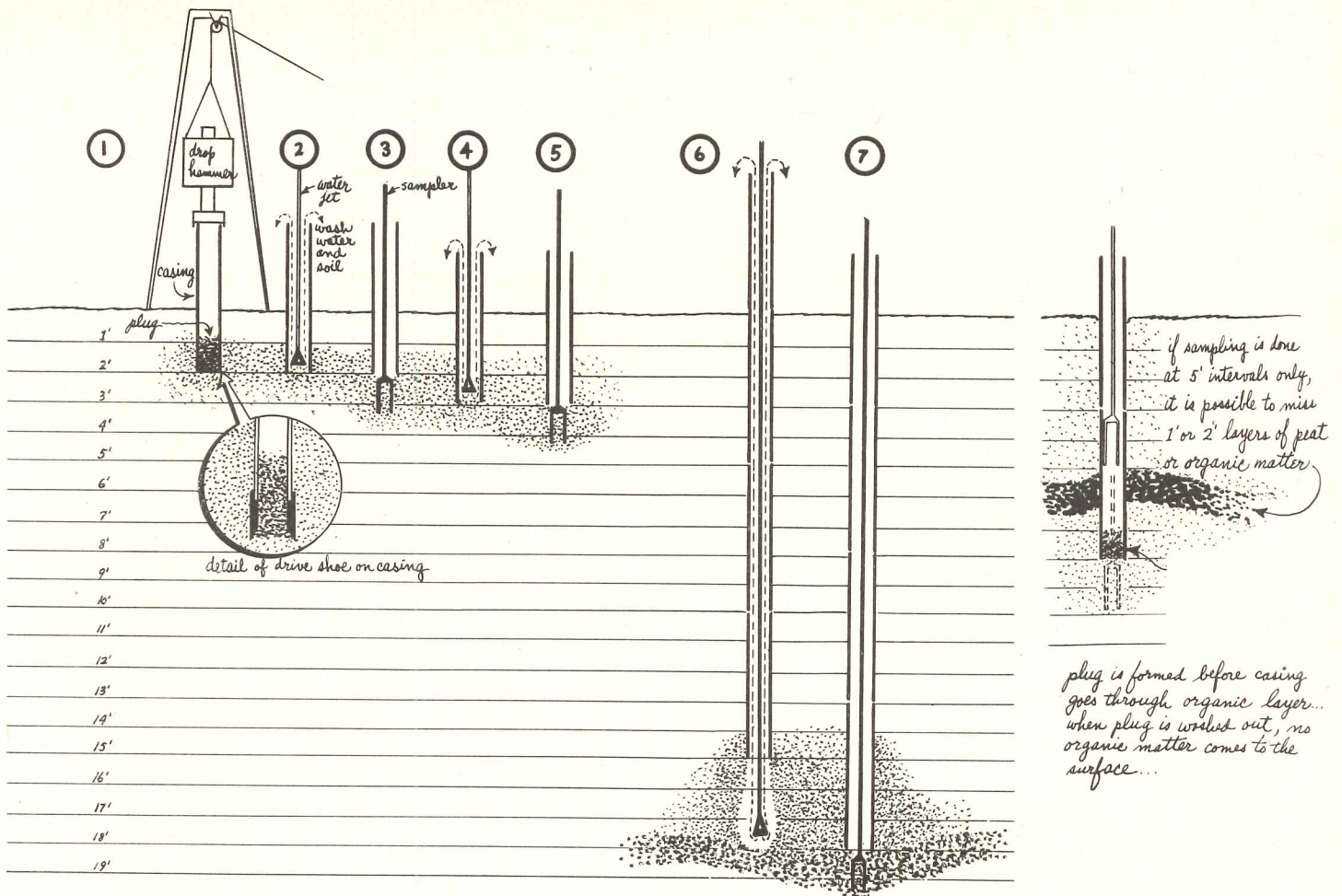

Soil sampling followed by testing gives two types of information: (A) what kind of soil lies under the surface and (B) the physical properties of this soil. Continuous sampling, as diagrammed above, means that one sample is taken each foot for the first 15 ft, then every 5 ft. Sketch at right shows how a treacherous layer of soil might be missed if samples are taken only once every 5 ft, as is sometimes

specified. How it's done: (1) 5-ft length of casing is driven down by drop hammer; (2) water jet washes out casing until plug is removed; (3) sample spoon is driven by lighter drop hammer and then withdrawn; (4) jet washes below casing; (5) another sample is taken a foot lower; (6) wash water shows new type of soil, so a sample is taken (7)

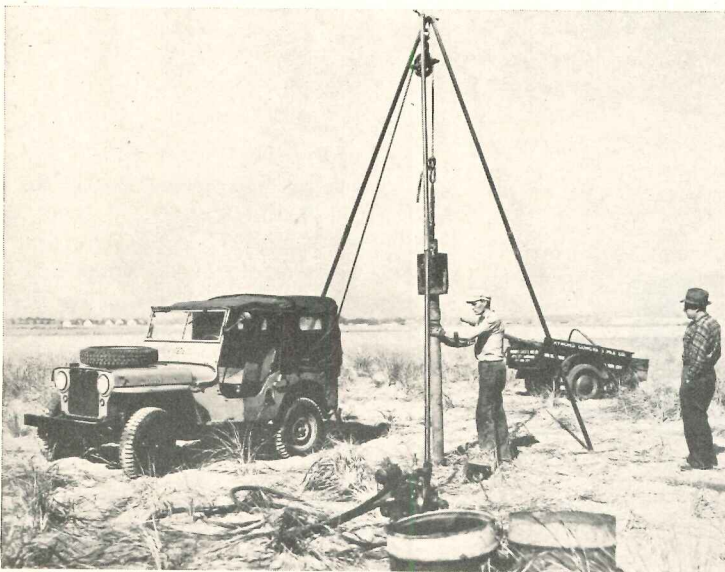

Soil investigations for heavy structures call for more complicated equipment than the auger. Casing is being driven into the ground by the "standard boring" method prior to taking a sample. The steps are outlined above

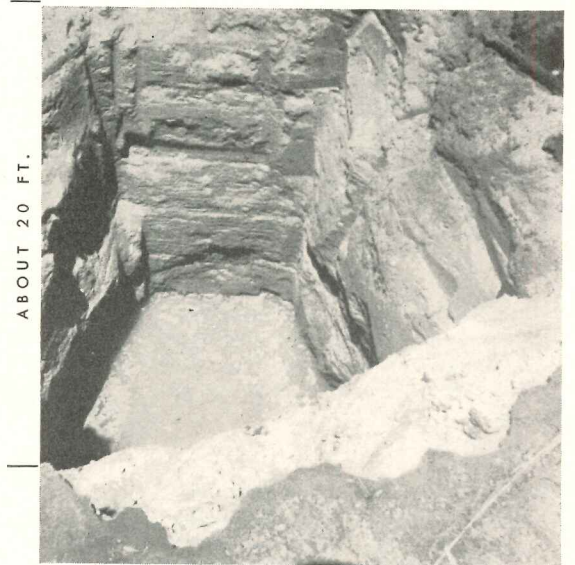

If a power shovel is on the job, test pits may be dug to show soil as it exists. The shovel digs the hole fast enough so that the soil can be examined before the pit collapses

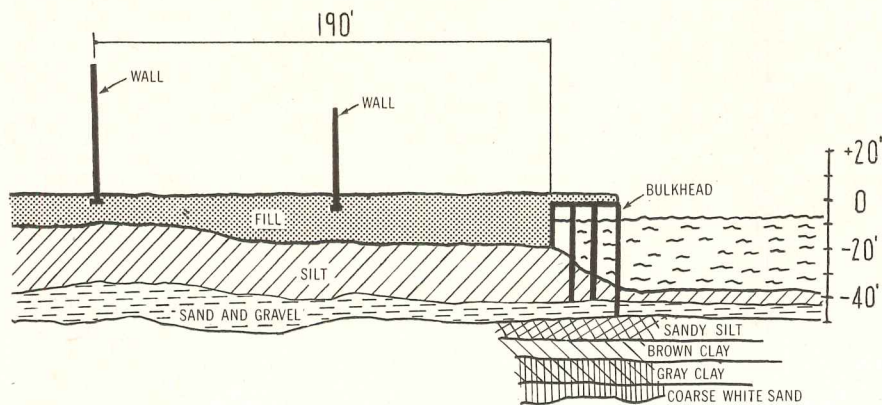

Soil profile drawing for sugar refinery in Philadelphia, plotted on basis of soil borings

HOW SOILS ARE TESTED

Consolidation Test—Simulates the loading that new construction will impose on subsoil. A vertical load is applied to the soil sample, and the amount the sample decreases in height is measured. By applying the results to the actual thickness of the soft subsoil layers, one can estimate the amount that the new construction will settle.

Unconfined Compression Test—This is very easy to make and can be done in the field with portable apparatus. The apparatus measures the amount of vertical load per sq in. that the sample will carry before it fails. One-half of this load is equal to the shearing strength (cohesion) of the soil.

Liquid Limit and Plastic Limit Tests—These tests show the approximate amount of clay in the soil. The higher the clay content, the more settlement to be expected.

Unit Weight and Moisture Content Tests—These are determined by measuring the volume and weight of a sample before any of the moisture has evaporated. The sample is then placed in an oven and dried, then weighed a second time. These tests are necessary to know the wet and dry weight per cu ft of soil in order to make settlement computations.

what the first set of borings shows, the investigation may be kept simple, or may become very complex.

If any compressible or suspicious layers are disclosed by the first set of borings, then additional borings must be made, and undisturbed samples taken and tested. Typical tests are: *Consolidation, Unconfined Compression, Liquid Limit, Plastic Limit, Unit Weight, and Moisture Content.* By use of complex formulas and analyses, the behavior of soil layers may be predicted under the proposed building load, i.e., the amount of settlement, and the factor of safety against a *mud wave*.

Even for as simple a structure as a house, borings should be made when the

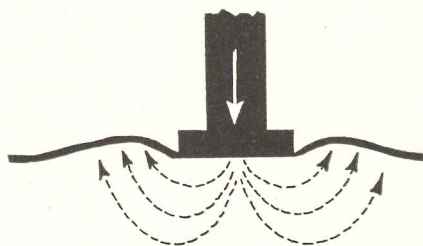

Weight of the column tries to push the footing down into the soil. If over-stressed, the soil will bulge upward alongside the footing, allowing it to sink. This is called a "mud wave"

foundation conditions are unknown. Probably, it will not be necessary to hire any high-priced boring equipment. In certain soils, the needed information (whether there are any soft layers from 10 to 20 ft under the foundation) can be learned by using a post hole auger. With larger buildings, when a crane is available, a few test pits are a good supplement to borings because one can see what the soil looks like — under a proposed footing, for example.

When standard borings are made using *wash water*, a *casing* and a *dry sample spoon*, then it is of the utmost importance that *continuous samples* be taken for a depth of at least 15 ft below footing level. (See p. 219.) If this is not done, usually the borings only show accurately what is in the soil every 5 ft. In fact, I have been at sites where borings had been made, and later I found soft layers of clay or peat never shown by the borings.

Piles

Now, knowing what should be learned about subsurface conditions, their effect on design of building foundations will be discussed. Starting with a plastic clay, there is no such thing as a cure-all; one professor used to propose, "When in doubt, use piles."

Have you been sold on the idea of using piles for a building and then, after construction has started, found that you had quite a problem? Perhaps a pile is "hung up" above an adjacent pile (cannot be driven any further and sticks up above the other pile) in the same group. There could be several reasons. Perhaps the pile has hit solid rock; it will be a firm pile because of its solid base. The pile may come to rest on the edge of a rock cliff, or on a compact layer of gravel overlaying rock. If, however, the pile hits a boulder that may have a soft, compressible soil under it, the pile will probably settle. This possibility can't be discounted because piles wouldn't have been driven in the first place if the soils had not been found treacherous.

One of the most displeasing experiences in foundation work is to find that a group of piles has ended up bearing on a 45 degree slope. In the trade we say that the piles "walked" before they "fetched" (hit a solid bearing surface). This occurs because a layer of rock underground slopes at this angle.

If borings indicate a layer that will cause hard driving, underlaid by a soft soil, one must be careful about the type of pile used. A thin-wall, closed-end pipe

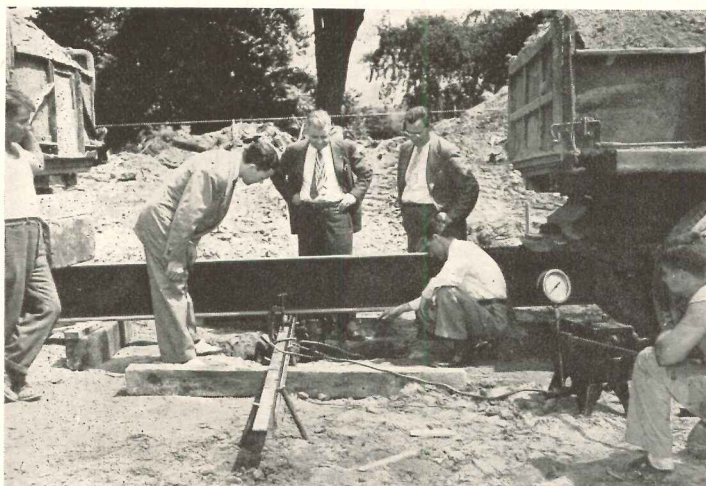

Above: field test simulates the load of a proposed structure. Weight of the trucks presses down on the ends of "I" beam while a hydraulic jack in the center pushes up on the "I" beam and down on a 2 ft sq steel plate on the ground. Hydraulic pressure and amount plate sinks are measured. Right, top: apparatus for measuring shearing strength (cohesion) of soil samples. Right, bottom: typical samples

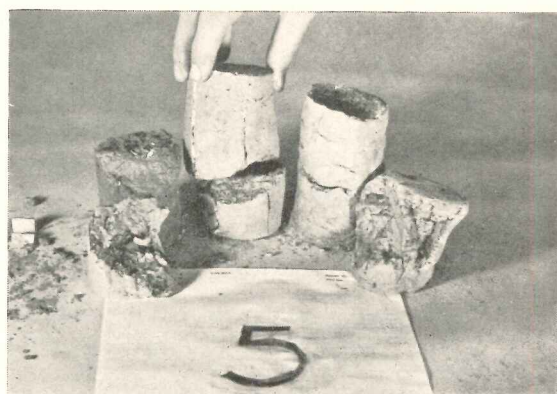
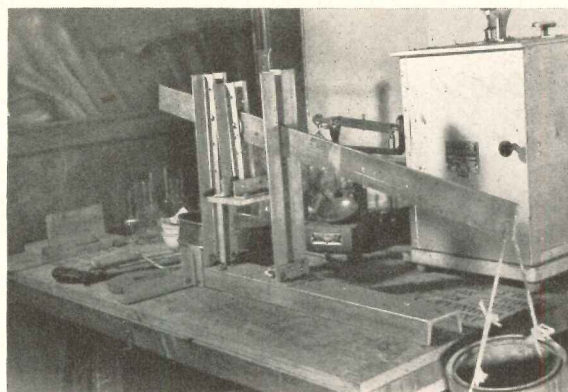

may collapse when being driven through the hard layer, so a thick-wall pipe pile or H-pile should be used.

When a pile is difficult to drive, it is safe to *jet the pile down* if it is not near any existing footings. With this method, two water pipes are put down with the pile; and while the pile is being driven, water is forced out of the pipes under high pressure, loosening the soil. If a footing were nearby, this action would undermine it. Jetting is usually done when a pile must penetrate a dense

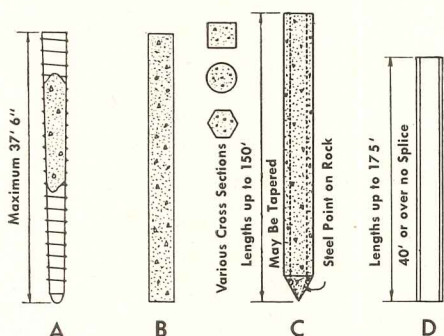

Typical piles: A — metal shell and mandril driven, mandril removed, concrete poured; B — pipe driven, concrete poured; C — precast concrete; D — steel "H" piles

layer of gravel overlaying a layer of soft soil. If the piles are stopped above this soft soil, it will consolidate later, causing the building to settle. The piles must be driven through the soft layer to a firm layer underneath.

When short, end-bearing piles (tubular steel piles with plates covering the bottom) are driven through soft silt, nothing is more annoying than seeing some of the piles, already down, "heave" when the last pile in the group is driven. By "heaving" is meant that the piles pop up out of the ground. This happens because the piles displace the soil when driven and cause an upward pressure on both tapered and closed-end pipe piles. (See p. 222.) Careful analysis of borings would have uncovered this condition, indicating that H-piles or open-end pipe piles should have been used.

Even though the pile contractor may not have to be paid extra for re-driving the piles, the job takes longer and costs the client more money.

Although there is a multitude of jobs where piles not only are proper, but are mandatory, still there are other types of foundations that can be employed on soft clay.

Basement Foundations

When the building is an isolated structure, the simplest foundation is a

deep basement with the floor slab designed as a foundation mat under the building. Naturally, the depth of the basement and the amount of mat overhang depend on the softness of the clay and the weight of the building. (See p. 222.)

One doesn't need to abandon all hope for an inexpensive foundation if the site for a house or small apartment house is underlaid by organic silt or even peat which is below the water table. First, he must make certain that there is no

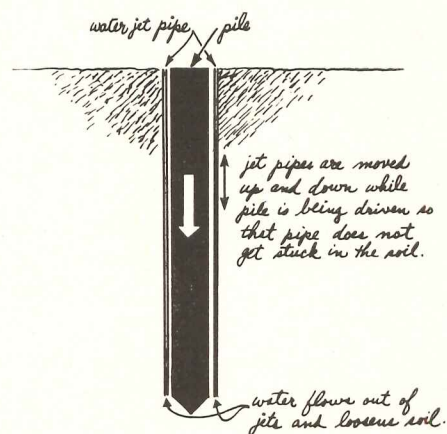

Two water pipes are sometimes put down alongside a pile to help loosen the soil and make pile driving a little easier

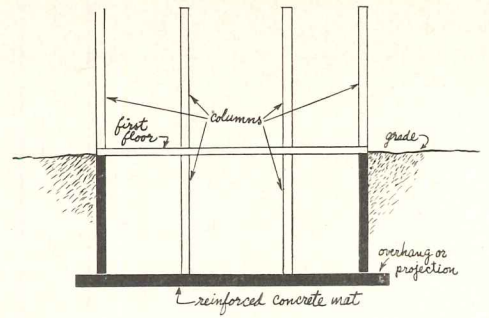
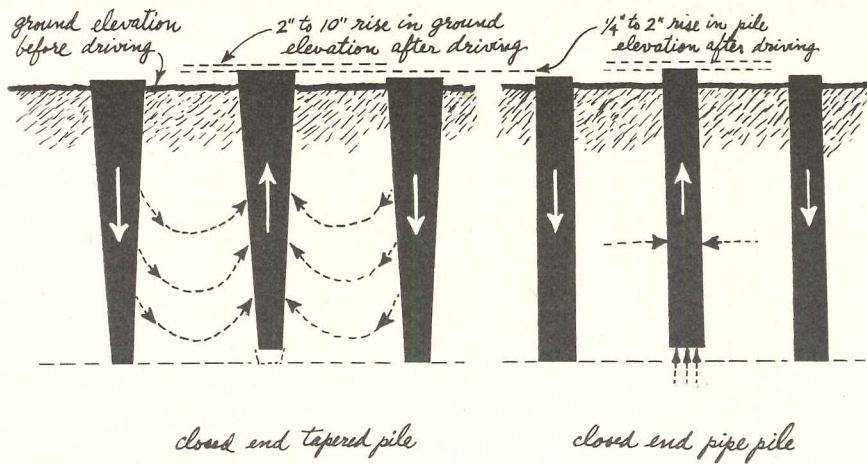

Reinforced concrete footing mats with overhangs decrease the load per sq ft on the soil. When the soil pressure on the mat must be as low as possible, the basement walls are moved outward (see below)

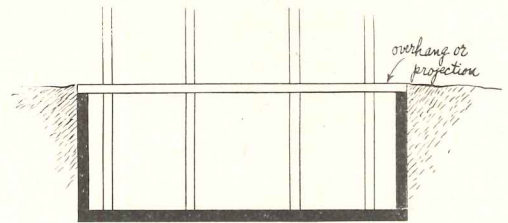

Pile Heaving. Tapered Piles: after the first pile is down, the additional piles displace more soil. This soil tends to move upward, causing the ground surface to rise. It also pushes up on the sides of the pile, which may lift (heave) the pile an inch or so. **Pipe Piles:** vibration of pile driving makes the soil temporarily semi-liquid. The piles are hollow until all are driven; then they are filled with concrete. The "soupy" soil tries to float the pile, exactly as a body of water would buoy up a hollow drum. Therefore, the pile may heave about an inch

possibility of the groundwater table being lowered. If it ever is lowered, the organic silt or peat will dry out and disintegrate, causing the structure to settle. Secondly, if the groundwater level is lowered, the buoyant effect of water on the soil (62.4 lb per cu ft) will be lost for whatever depth the water table is lowered. The result would be an increased load on the compressible layers of peat.

This phenomenon explains why the ground level of a swamp settles when a sewer is constructed through it. The joints in the sewer pipe usually allow leakage of groundwater into the pipe.

This lowers the water level and increases the net weight on the compressible soil because the buoyant effect is lost.

With most house basements, the weight of the soil removed will be more than the weight of the structure — so it won't settle very much. There are houses in Binghamton, New York, in very good condition that are built over beds of peat.

In areas of Norfolk, Virginia, the soil is a very loose alluvial silt, so houses set on footings will surely settle. Therefore, the houses are built with poured reinforced concrete basement walls so that

the walls act as distributing beams: if the soil sinks under one part of the footing, the concrete wall can transfer the load of the house to another section. By making the basement a strong enough box to keep the settlement fairly uniform, the foundation is safe, economical, and cracks are prevented from occurring in the superstructure.

A Mixture of Theory and Practicality

When I first started to work, I was imbued with the theory of soil mechanics

(Continued on page 236)

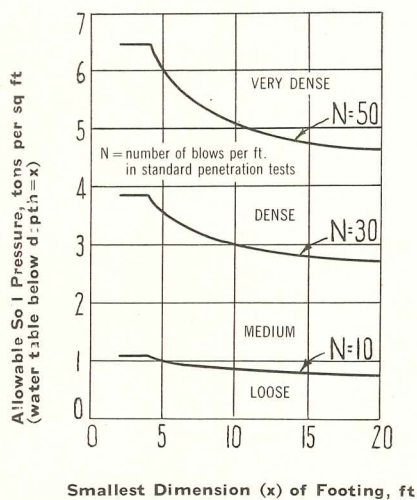

To give 1 in. settlement if water table is at footing elevation, cut allowable load 50 per cent

Above: chart for estimating allowable footing loads on sand. Right: table for determining allowable footing loads on clay

PROPOSED ALLOWABLE BEARING VALUES FOR CLAY						
Description of Clay	N	C	C ₁		C ₂	
			Square Footing 1.2 x C	Continuous Footing 0.9 x C	Square 1.8 x C	Continuous 1.3 x C
Very soft *	Less than 2	Less than 0.25	Less than 0.30	Less than 0.22	Less than 0.45	Less than 0.32
Soft *	2 to 4	0.25 to 0.50	0.30 to 0.60	0.22 to 0.45	0.45 to 0.90	0.32 to 0.65
Medium	4 to 8	0.50 to 1.00	0.60 to 1.20	0.45 to 0.90	0.90 to 1.80	0.65 to 1.30
Stiff	8 to 15	1.00 to 2.00	1.20 to 2.40	0.90 to 1.80	1.80 to 3.60	1.30 to 2.60
Very stiff	15 to 30	2.00 to 4.00	2.40 to 4.80	1.80 to 3.60	3.60 to 7.20	2.60 to 5.20
Hard	Over 30	Over 4.00	Over 4.80	Over 3.60	Over 7.20	Over 5.20

N = number of blows per ft in standard penetration test (140 lb weight, 30 in. drop, 2 in. o.d. sampler)
 C = unconfined compressive strength in tons per sq ft
 C₁ = proposed normal allowable bearing value in tons per sq ft
 C₂ = proposed maximum tolerable bearing value in tons per sq ft
 Table and chart from **Soil Mechanics in Engineering Practice** Karl Terzaghi and Ralph B. Peck, John Wiley and Sons, 1948.

PRODUCTS for Better Building

Precast Insulated Sandwich Walls

A newly developed, insulated sandwich wall panel for commercial, industrial and residential use is reported to help lower costs in masonry construction. Designed by Ford, Bacon and Davis, Architects, the development can be used as a curtain wall to be attached to structural steel, or as a load-bearing wall. Installations to date have been successful enough to encourage the Marietta Concrete Corp., Marietta, Ohio, to build a plant especially for the manufacture of the panels, which consist of a layer of *Fibreglas* insulation between two layers of concrete. The panels are made in slabs of from 8 by 8 ft to 8 by 30 ft, all 5 in. thick. Edges of the standard panels are tongue-and-groove to provide an interlocking joint.

In the construction of the panels, illustrated at right, concrete is placed in a steel form which has muslin stretched tautly over the bottom form plate. The concrete is vibrated, following which a panel of pre-formed fibreglas insulation is placed over the first concrete pour and held in position by more reinforcing mesh.

The new sandwich wall is reported by the manufacturer to receive favor among contractors because of the speed with which it can be erected. It is also said to save up to 40 per cent in masonry costs and to be very durable because of its fewer number of joints. The wall is further reported to help cut the expenses of insulating and heating large industrial buildings. It is described as resembling natural Indiana limestone, but may be painted if desired with regular cement paint on the exterior and rubber-base paint on the interior. Owens-Corning Fibreglas Corp., Toledo 1, Ohio.

(Continued on page 252)

In first step of process, facing cloth, reinforcing mesh, inserts and perimeter shear ties are inserted into form

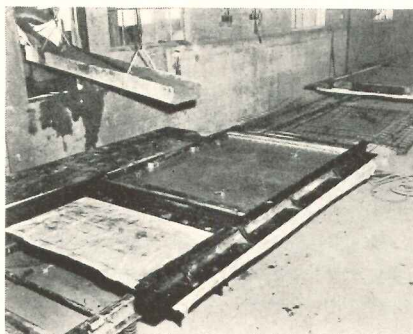
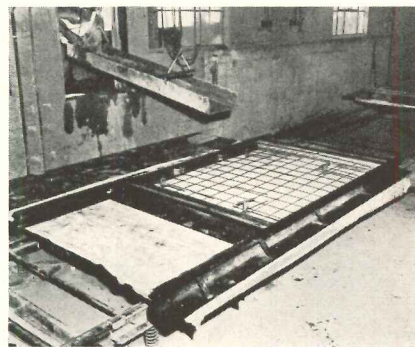

Concrete is poured into form and vibrated for 2 minutes

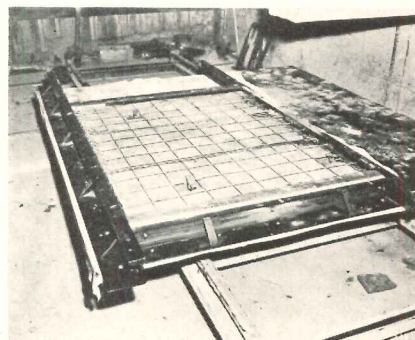

Next, insulation panel is placed over the first concrete pour and held in position by more reinforcing mesh

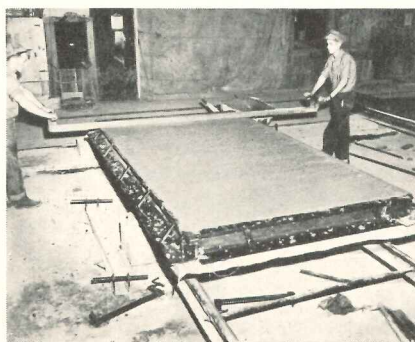

Second concrete layer is poured over insulation, vibrated again, then screeded to a finish and sent for curing

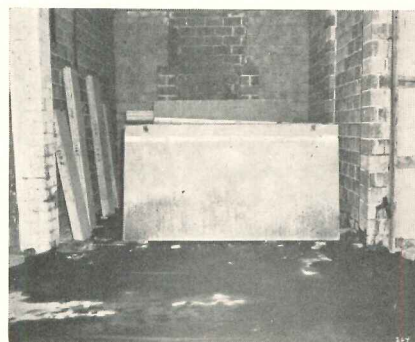

Panels are placed in steam curing room for minimum of 48 hrs., then stored in open for 10 days minimum

LITERATURE FOR THE OFFICE

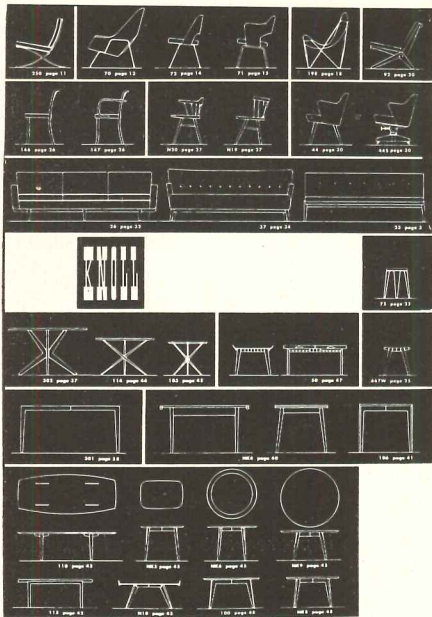

1952 Knoll catalog has illustrated index; is quick guide to individual sections

Handsome New Catalog Presents Furniture and Textile Designs

Knoll Index of Contemporary Design. Suited to industrial, commercial, institutional, educational (dormitories, etc.) and residential requirements, the line of furniture and textiles illustrated in this attractive book is presented with detailed drawings and many photographs. The book contains a color-keyed and cross-referenced index and is grouped into five sections—each flagged with color separators. Included in the furniture group are chairs, sofas; tables; beds, chests, cabinets; desks and office accessories. Dimensions are given for all furniture shown and interior settings are illustrated. The section of the catalog devoted to textiles contains photographs which point out in detail the various patterns and weaves available. A separate brochure of Knoll's new price list may also be obtained with the catalog. 80 pp., illus. Knoll Associates, Inc., 575 Madison Ave., New York 22, N. Y.

*Other product information in *Sweet's File, 1952.*

Flue Pipe For Venting Domestic Gas Appliances

Johns-Manville Transite Flue Pipe. Folder describes the manufacturer's asbestos-and-cement flue pipe especially designed for venting domestic gas-burning appliances. Features are noted and fittings are illustrated with photographs and drawings. Tables of dimensions and weights are given and are keyed to a chart of round and oval pipe and fittings. 4 pp., illus. Johns-Manville, 22 E. 40th St., New York 16, N. Y.*

Plumbing Fixture Color Kit

Kohler Plumbing Fixture Colors. Kit contains color samples of vitreous china in four colors in which the manufacturer's plumbing fixtures are made. It is designed to help eliminate guesswork in planning wall, floor and ceiling colors where colored plumbing fixtures are employed. Kohler Co., Kohler, Wis.

Split-Level Houses

14 Split-Level Houses Designed for Solid-Fuel Heat. Booklet lists the advantages of a house containing three basic floor elevations, from the standpoint of solid-fuel use, from a livability point of view and from a cost standpoint. Containing floor plans and sketches of 14 different "staggered" level houses, this booklet is attractively laid out and numbers 16 pages. Price: 50 cents. Small Homes Council, Mumford House, University of Illinois, Urbana, Ill.

Lumber

Sugar Pine—The King of Pines. Booklet describes all of the characteristics of sugar pine, including the botanical classification, appearance, structure, weight, etc. The manufacture of this pine is clearly defined—giving information on the seasoning, milling and grading. Building and industrial uses are listed, and photographs illustrate siding, sheathing, subflooring, roof decking, concrete forms, paneling, architectural woodwork, and other installations in actual use. Recommended grades are

shown for construction uses in residences, garages, multiple dwellings and large buildings. 52 pp., illus. Western Pine Assoc., 510 Yeon Building, Portland 4, Ore.

Paneling

Barclay Plasticated Paneling and Barclay Paneling. Both folders point out varied uses for panels, illustrating with colored photographs, typical installations in a bathroom, kitchen and store, and listing many other examples of its use. All available colors are given—both standard and special—and complete information on grades, standard sizes, metal moldings, putty, touch-up and waterproof cement is included. A description of the three surface designs is given and an actual sample of the plasticated paneling is contained in one of the folders. Short form specifications give instructions for preparation of surfaces on both old and new walls, and application details are shown with drawings. Each folder is 4 pp., illus. Barclay Mfg. Co., Inc., 385 Gerard Ave., New York 51, N. Y.*

Theatrical Lighting

Stage Lighting Artistry with the Davis Dimmer. Booklet explains how dramatic lighting effects may be obtained in the theater, school, church and auditorium with the use of a lighting control. The basic requirements for flexible stage lighting are given and a typical floor plan shows the proper installation locations of the whole lighting system. The features of the portable and the master dimmers are described and wiring diagrams are included. The booklet contains complete specifications for the various models of the panel, and photographs and technical drawings illustrate how the panels operate and obtain results. Contained in the booklet is a dealers' layout and quotation sheet, giving a description of the component parts and the list prices—for "not wired" and for "wired and assembled." 35 pp., illus. Ariel Davis Mfg. Co., Provo, Utah.

(Continued on page 302)

Now Ready for You!

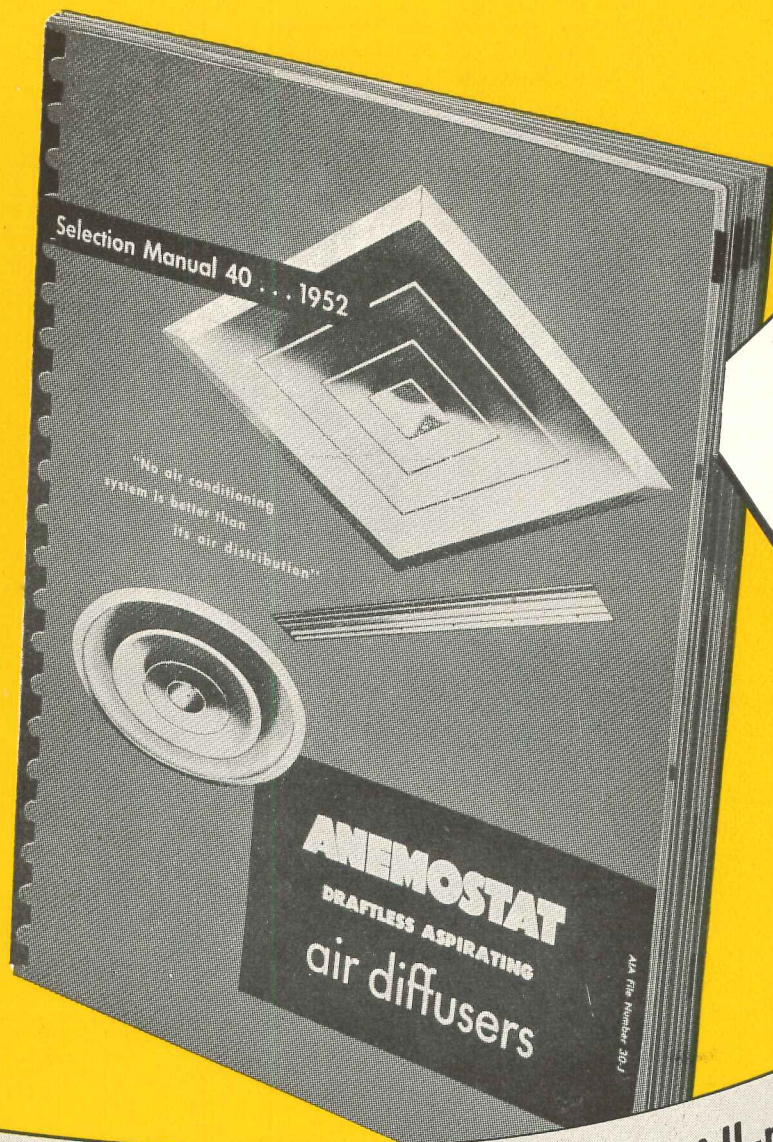

OF SPECIAL INTEREST! All-new section on
Anemostat High Pressure units for
high pressure, high velocity systems.

ANEMOSTAT® **DRAFTLESS Aspirating AIR DIFFUSERS**

Anemostat Corporation of America
10 East 39th Street, New York 16, N.Y.
Representatives in Principal Cities

*"No Air Conditioning System Is Better
Than Its Air Distribution"*

The new 1952, 64-page Anemostat Selection Manual 40 gives you complete, up-to-the-minute information on Anemostat air diffusers. Ask your Anemostat representative for your copy, or write for it on your business letterhead today.



MILCOR
REG. U. S. PAT. OFF.

50TH
Anniversary

MILCOR *Solid Partition Systems*

speed the erection of fire-resistant non-bearing walls

Reinforced monolithic slab construction — The Milcor Solid Partition is a steel-reinforced vertical slab of plaster, 2" thick. Milcor Metal Lath serves as plaster base — reinforces the partition horizontally and diagonally.

Only 3 units needed to support the metal lath — Slotted ceiling runner, standard $\frac{3}{4}$ " cold-rolled channels and easy-to-use Milcor Housing Base or slotted floor runners.

Practical advantages — (1) Quick, simple erection; (2) Saving of floor space; (3) One-hour fire rating; (4) Reduced sound transmission; (5) Resistance to impact; (6) Reduced dead floor load; (7) Unexcelled sanitation; (8) Adaptable to metal or wood trim.

Check the branch nearest you regarding deliveries of components for Milcor Solid Partitions.

*Reg. U. S. Pat. Off.

INLAND STEEL PRODUCTS COMPANY

4035 WEST BURNHAM STREET • MILWAUKEE 1, WISCONSIN
BALTIMORE 24, MD. — 5300 Pulaski Highway • BUFFALO 11, N. Y. — 64 Rapin St. •
CHICAGO 9, ILL. — 4301 S. Western Blvd. • CINCINNATI 25, OHIO — 3240 Spring Grove Ave. •
CLEVELAND 14, OHIO — 1541 E. 38th St. • DETROIT 2, MICH. — 690 Amsterdam Ave. •
KANSAS CITY 8, MO. — South West Blvd. and State Line • LOS ANGELES 58, CALIF. — 4807
E. 49th St. • NEW YORK 17, N. Y. — 230 Park Ave. • ST. LOUIS 10, MO. — 4215 Clayton Ave.

METHODS OF FASTENING TO MASONRY WALLS: I

The following sheets, presented through the courtesy of Structural Clay Products Institute, contain many of the current methods in general use of fastening to masonry walls. Other methods, including more data on the use of powder-driven tools, will be covered in subsequent installments of Time-Saver Standards.

Introduction

When other materials, fixtures, etc., are to be attached to brick or tile walls, the procedure is relatively simple if planned and executed during the construction of the walls. Usually the necessary anchors, nailing blocks, etc., can be properly located and built in by the mason as his work proceeds. The designer or builder has a wide variety of anchoring methods and products from which to select and the final selection will depend largely upon the type of fixtures or material to be attached and the type of masonry to which those fixtures will be affixed.

Attaching Wood Trim

The most common method of anchoring such items as baseboards, chair rails, picture moldings, etc., to masonry walls is by the use of wood nailing blocks placed in vertical mortar joints by the mason as he builds the wall. These blocks should be of seasoned soft wood and creosoted to prevent shrinkage or rot. They should never be placed in the horizontal joints, but only in the vertical mortar joints.

Metal nailing or "wall" plugs provide better construction. Fig. 1 illustrates a typical wall plug. These are made of galvanized metal, either with or without a wood or fiberboard insert. Like the wood nailing blocks,

Fig. 1. Typical Wall Plug To Attach Wood Trim

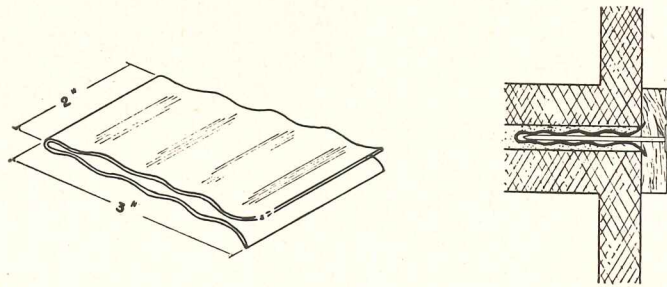
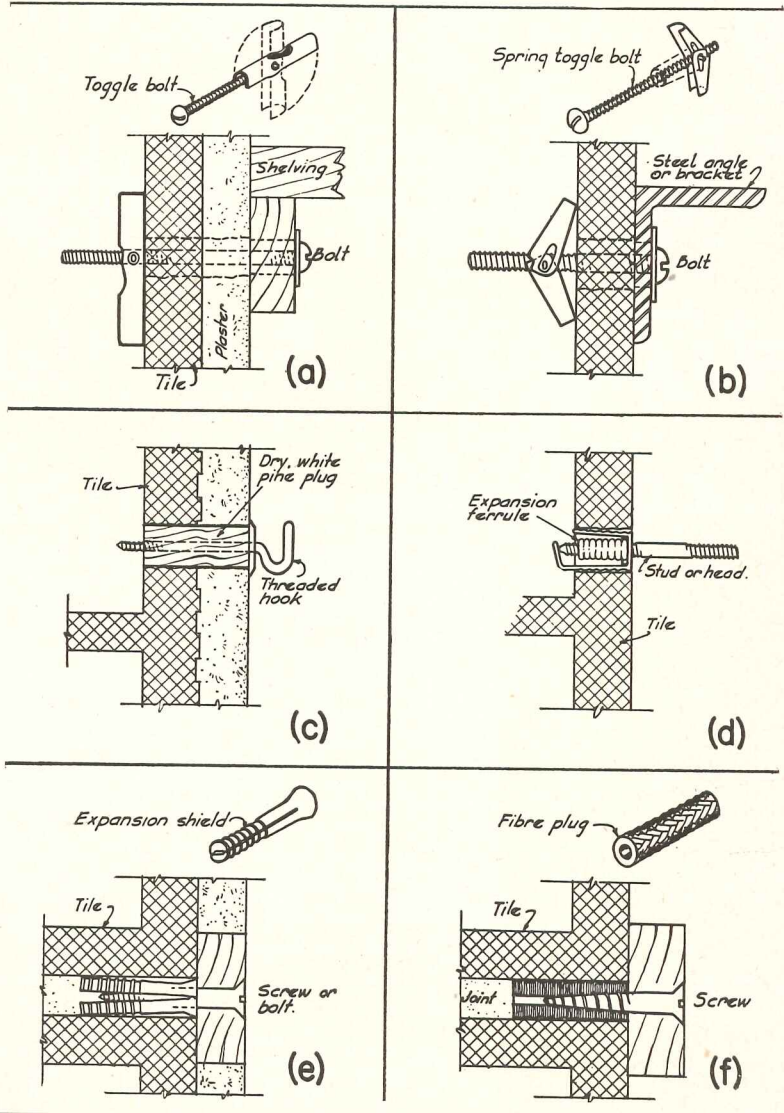
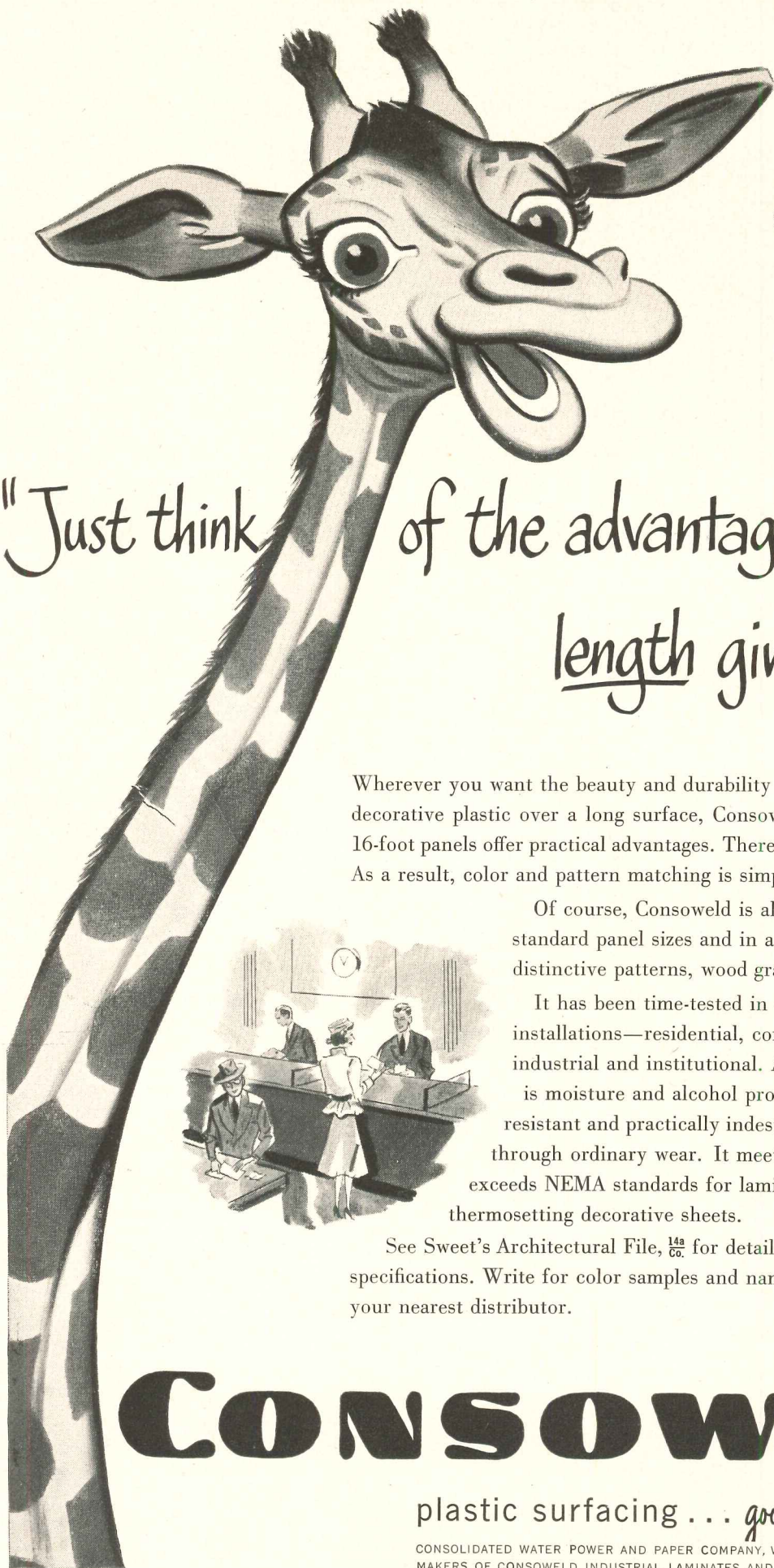

Fig. 2. Methods Of Attaching Fixtures



Architectural Engineering
TIME - SAVER STANDARDS



"Just think of the advantages
length gives you!"

Wherever you want the beauty and durability of a decorative plastic over a long surface, Consoweld's exclusive 16-foot panels offer practical advantages. There are few or no seams. As a result, color and pattern matching is simplified.

Of course, Consoweld is also available in all standard panel sizes and in a wide range of distinctive patterns, wood grains and solid colors.

It has been time-tested in all types of installations—residential, commercial, industrial and institutional. And Consoweld is moisture and alcohol proof, burn resistant and practically indestructible through ordinary wear. It meets or exceeds NEMA standards for laminated thermosetting decorative sheets.

See Sweet's Architectural File, ^{14a}/₆₀ for details and specifications. Write for color samples and name of your nearest distributor.

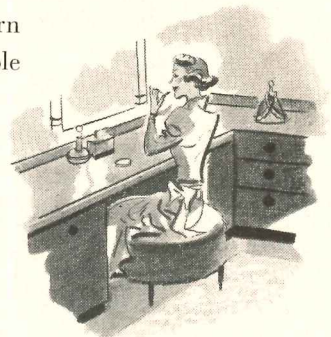
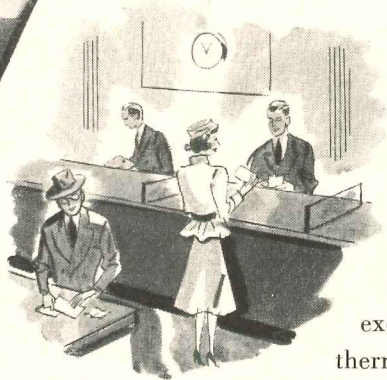

CONSOWELD

plastic surfacing . . . *good for a colorful lifetime*

CONSOLIDATED WATER POWER AND PAPER COMPANY, WISCONSIN RAPIDS, WISCONSIN
MAKERS OF CONSOWELD INDUSTRIAL LAMINATES AND IMPREGNATED PAPERS

METHODS OF FASTENING TO MASONRY WALLS: 2

the metal wall plugs are built into the joints as the masonry is erected. Their exact location is not a serious problem when used to fasten baseboards, chair rails, etc., but it may be difficult to predetermine their location for fixtures, cabinets, shelving, etc.

Attaching Fixtures, Cabinets, Etc.

Several methods of attaching fixtures, cabinets, shelving, trim, etc., are shown in Fig. 2. The methods illustrated in Fig. 2(a), (b) and (d) can be used only with structural clay tile walls and are installed after the walls are built and the exact location of the fixture is determined.

Fig. 2(c) illustrates a method of fastening that can be used with either brick or tile construction, by building the wood plug in as the wall is built, or by driving it into a hole drilled into the masonry after it has been erected.

Fig. 2(e) and (f) show two methods which may be used with either brick or tile construction. Usually, the expansion shields or fiber plugs are placed in holes drilled in the mortar joints. As required, such holes may be drilled through the face shells of tile, or into the mortar joints with hard steel or carbide tipped drills. In some cases where softer tile are used, as in plastered partitions, small holes may be made by the use of an ordinary 1/8-in. punch and hammer.

A relatively new method of attaching to solid masonry walls has been developed which consists essentially of using a power-actuated tool which, in effect, "rams" or drives an anchor or pin into the masonry instantaneously. There are suitable pins for almost any type of anchorage desired. Three typical pins are illustrated in Fig. 3.

Fig. 3.
Typical Pins Used For Anchorage

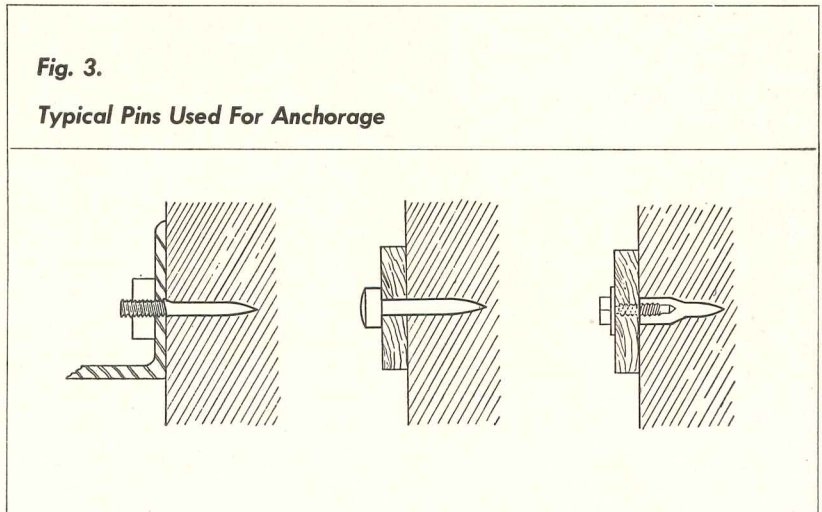

Furring Applications

Although there are many examples of brick, structural clay tile and composite brick and tile walls with plaster finish applied directly to the interior masonry surface, furring on 8-in. walls is recommended, particularly in northern areas and for residential construction. In southern areas, an 8-in. vertical cell tile wall is often satisfactory with no interior finish other than paint or with the plaster applied directly to interior surface.

Furring may be of wood, metal, or hollow tile, depending upon the type of construction and the local building requirements.

In Fig. 4 are shown several typical methods of attaching wood furring. The wood furring strips are either 1 x 2" or 2 x 2" and are applied vertically to the wall at intervals usually 16 in. on center. The wood strips may be attached by nailing into wood

nailing blocks or metal wall plugs as shown in 4(c), or directly into the mortar joints by the use of case-hardened "cut" nails or special spiral-threaded masonry nails as shown in 4(d). Special anchor nails fastened to the masonry wall with an adhesive cement is a recent development for installing furring and is illustrated in 4(a). Such fastenings are easily and quickly installed without drilling, plugging or nailing. Brick-size porous clay nailing blocks are available in some areas. Since such blocks are completely inert, there is no danger of nail disintegration from chemical reaction. The use of such blocks is illustrated in 4(b).

Metal furring strips consist of standard light steel channels fastened by either tie wires built into the mortar joint or by special clips designed for this purpose.

Tile furring may be either attached or free-standing. Hollow or cored

Completely Water Jacketed...

FOR BIG SAVINGS IN FUEL AND INSTALLATION

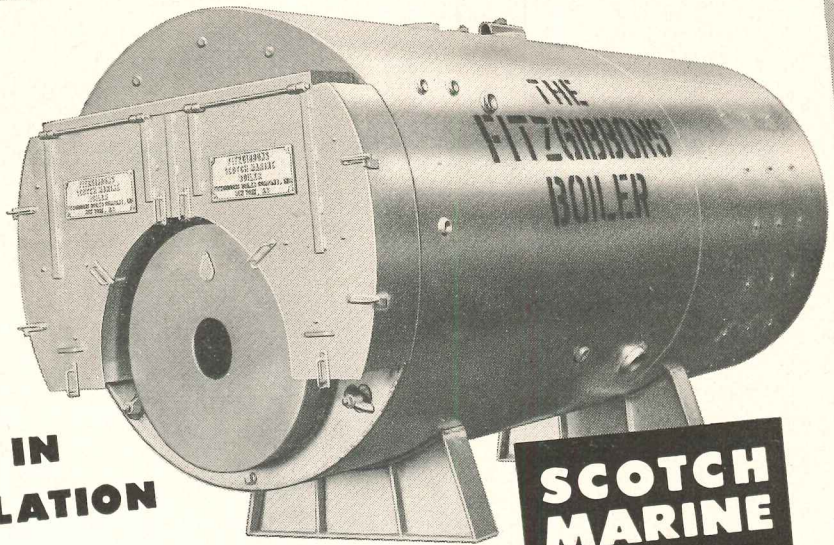

SCOTCH MARINE

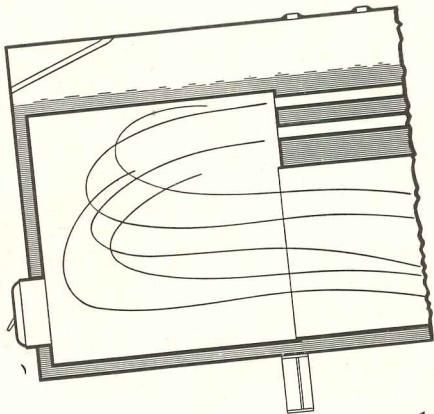

The entire rear wall of the combustion chamber is water-jacketed. No brick work to burn out or radiate heat into the boiler room. Rear access door in water wall facilitates cleaning.

Low Pressure Heating Boiler

All heating surfaces, including the rear furnace wall, are water jacketed in this popular Fitzgibbons steel boiler. As a result, there is greater heat transfer, flue gas temperatures are lower, fuel consumption is reduced and the usual rear dry wall refractory lining is eliminated. The low water line and corresponding low head-room further simplify installation where conditions require this type of boiler. Catalog AR-4 gives complete details. Write for it today.



Fitzgibbons Boiler Company, Inc.

General Offices: 101 PARK AVENUE, NEW YORK 17, N. Y.
 Manufactured at OSWEGO, N. Y. • Branches in Principal Cities



A steel boiler is a lifetime investment
—sell "the best in steel boiler heat"—
THE FITZGIBBONS BOILER®



"200" SERIES

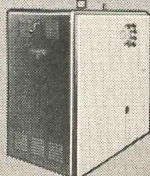

"400" SERIES



"80" SERIES



"RZU" JUNIOR

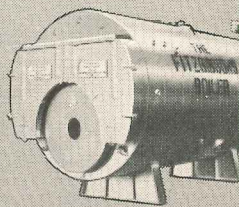

"SCOTCH MARINE"

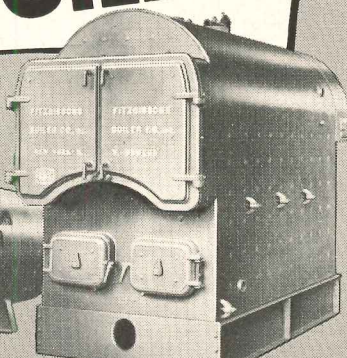

"D" TYPE

METHODS OF FASTENING TO MASONRY WALLS: 3

structural clay units when used as attached furring may be 2, 3 or 4 in. in nominal thickness. The 2-in. thickness is available either as a solid back unit or as "split" furring. The split units should always be applied directly to the wall without mortar on the back of the ribs, thus providing an uninterrupted air space. Since the solid back furring tile have one or more air cells through their thicknesses, the space between the units and the wall may be filled with mortar, if desired for greater rigidity or where exterior wall parging is specified. Fig. 5 illustrates typical method of applying split furring tile.

A number of different methods of attaching tile furring to masonry walls may be used. Table 1 gives the proper spacing of anchors or ties for attached furring, together with height and length limitations of the furring itself.

Nailing

Typical 12 x 12-in. face size structural and split furring tile may be attached to walls by driving 10d nails into the mortar joints of the main wall and clinching the heads of the nails down into the cells of the tile or over the ends of the split tile as shown in Fig. 5.

Wire Ties

Heavy wire ties may be built into the mortar joints of the wall as the masonry is erected. These ties should not be less than No. 11 gauge and bent down into the cells of the furring tile as they are erected. If No. 13 gauge wire is used, it should be doubled and looped through the mortar bed to form a secure bond.

Corrugated or Crimped Metal Ties

The most common type of metal

Fig. 4. Typical Methods Of Attaching Wood Furring

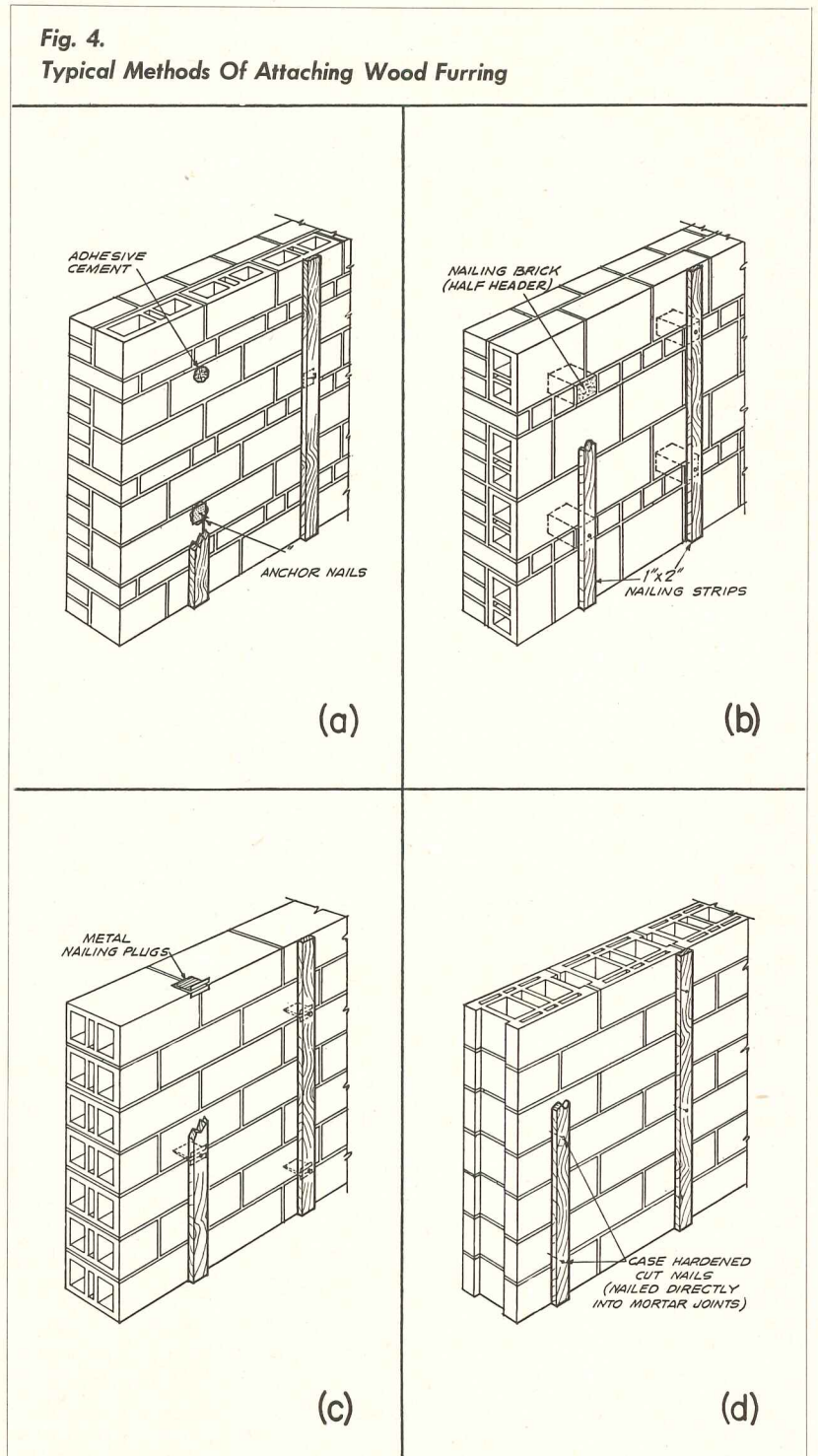

TIME SAVER STANDARDS Architectural Engineering

First Step to Better Daylighting at Lower Cost:

A Wasco Daylight Engineering Study

BETTER DAYLIGHTING . . . A properly engineered Wascolite Skydome installation provides glare-free, evenly distributed daylight for the interior of *any* structure. Wasco Daylight Engineering Studies, available without obligation, show:

- 1 The correct size, type, number, spacing and above-floor height of Wascolite Skydomes.
- 2 Illumination curves . . . reflection and climatic factors considered.
- 3 Task brightness ratios as required.

LOWER COST . . . A Wascolite Skydome daylighting system permits lower ceilings and walls with consequent savings in steel, other critical materials and labor. *Maintenance-free* Skydomes also pay dividends by eliminating upkeep costs usual with other bilateral lighting schemes.

Fill in and mail this coupon today with your Floor Plan and Lighting Requirements.

Wascolite Skydomes[®]
PATENT PENDING

WASCO FLASHING COMPANY
82 FAWCETT ST., CAMBRIDGE 38, MASS.

- I am interested in a Daylight Engineering Study. I enclose a floor plan and specific lighting requirements.
- Please send Skydome folder and prices.

NAME _____
TITLE _____
ORGANIZATION _____
ADDRESS _____
CITY _____ STATE _____



Prefabricated Wascolite Skydomes are installed in *minutes* . . . are weather-proof, shatter-resistant and maintenance-free . . . come in three basic shapes and with clear colorless or white translucent, light-diffusing acrylic domes.

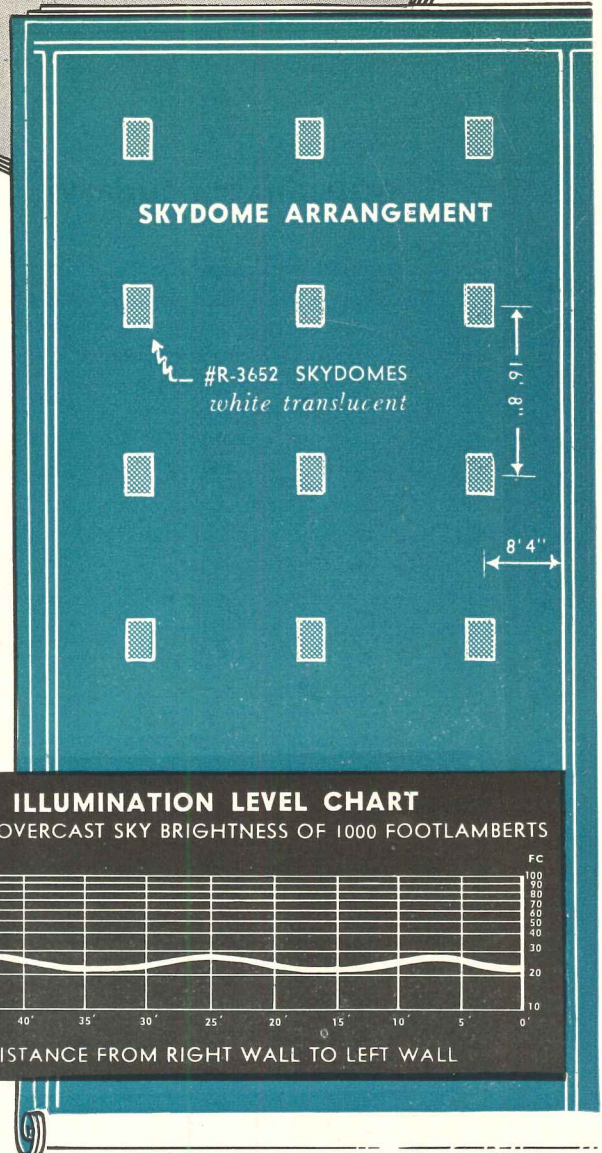
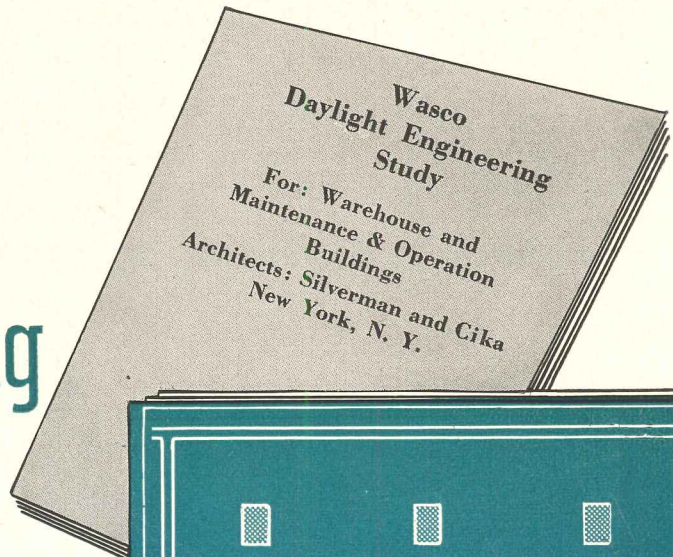
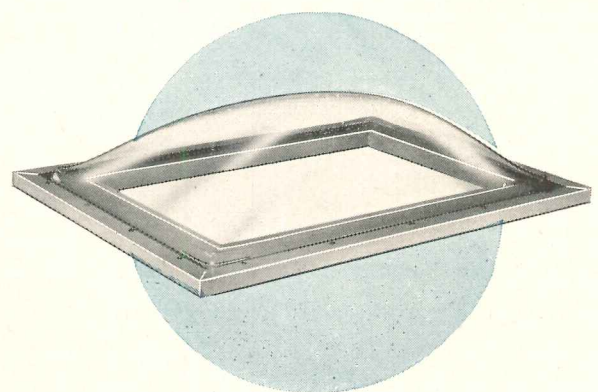

METHODS OF FASTENING TO MASONRY WALLS: 4

tie used in furring is the galvanized corrugated or crimped type. These ties should be at least 7/8 in. wide and not lighter than No. 22 gauge.

Wire Mesh

Where wire mesh or hardware cloth ties are specified, they should be at least 4-in. wide strips of 1/2-in. mesh, No. 20 gauge galvanized wire fabric. These ties should extend at least 3 in. into the masonry wall and to within 1/2 in. of the face of the furring.

Anchors

Tile furring is attached to concrete by the use of dovetail anchors inserted into metal slots embedded in the concrete. These anchors should be at least 7/8 in. wide and not lighter than No. 16 gauge. Wire ties not lighter than No. 9 gauge may be used in place of the dovetail anchors. The wire is hooked into the slots or inserts cast in the concrete.

Grout or Adhesives

When using solid-back hollow units, they may often be applied directly to the structural wall without metal anchors or ties by utilizing the high adhesive bond obtained by filling the back space with cement grout. Experiments conducted on reinforced grouted brick masonry indicate that adhesion of cement grout to natural masonry surfaces is very effective.

Recent developments in self-bonding and waterproof adhesives indicate that metal furring anchors or ties may also be omitted for certain types of construction when using this method of attachment. Such adhesives are usually heavy-bodied solvent-type mastics which set without heat or pressure.

Fig. 5.

Typical Methods Of Attaching Furring Tile

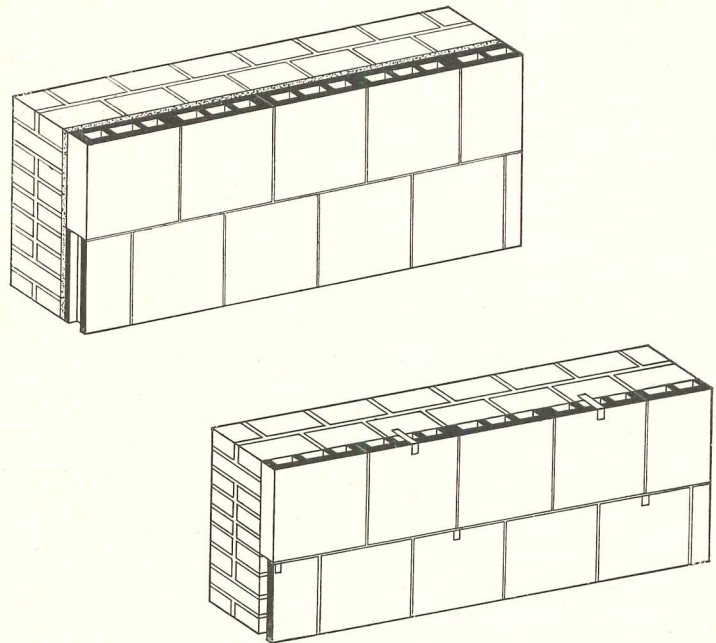

Table 1

Height and Length Limitations For Attached Furring Tile and Spacing of Metal Ties and Anchors

Type and Thickness of Furring	Maximum Allowable Spacing of Ties		
	No Ties Required	24" Vertical 24" Horizontal	16" Vertical 24" Horizontal
2-in. Split	—	Up to 14 ft.	14 to 35 ft.
2-in. Hollow	9 ft.*	9 to 14 ft.	14 to 35 ft.
3-in. Hollow	12 ft.	12 to 18 ft.	18 to 35 ft.
4-in. Hollow	15 ft.	15 to 22 ft.	22 to 35 ft.

* Not over 6 ft. in length.

What do you in roof insulation?

Economy? Inch for inch of thickness no other type of roof insulation can compare with Insulite's low cost for adequate thermal insulation value! *Nothing* takes the place of Insulite for *quality* and *price!*

Proof of performance? The first fiberboard roof insulation jobs in the world were applied with Insulite. Many of them are now nearly forty years old and appear just as sound as the day they were applied!

But these are only two of the advantages to be gained in specifying Insulite Roof Insulation. Here are some other reasons why we think you'll like Insulite best:



Withstands traffic. See for yourself. Ask your Insulite sales representative for a sample. Then test it. See how strong and rigid it is! That's because Insulite, the original fiberboard roof insulation, is made only from hardy Northern wood fibers!



Handles without breaking. This is one of the big reasons roofers like Insulite Roof Insulation. The strong, rigid sheets are built to withstand the rough handling they are subjected to under actual job conditions! There's no fear of breakage with Insulite on the job!

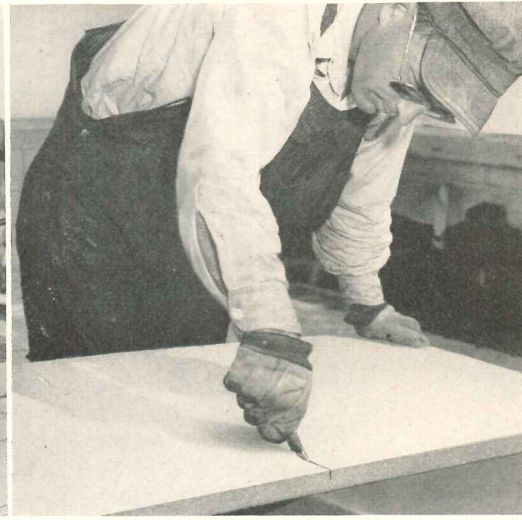

Cuts cleanly and easily. Next time you're out on a job, see how quickly and easily the roofer cuts Insulite. If you have time, talk to him... chances are he'll tell you that cutting ease is one of the reasons he likes to work with Insulite Roof Insulation.

Build and insulate with double-duty

INSULITE

MADE OF HARDY NORTHERN WOOD

INSULITE, INS-LITE AND GRAYLITE ARE REG. T.M., U.S. PAT. OFF.



want most



Free roofing facts. Here's the most complete book of its kind! Contents include: (1) Coefficients of Heat Transmission (U) and Thermal Resistance (R) of Various Types of Flat Roofs Covered with Built-up Roofing, (2) Condensation Chart and (3) Fuel and Radiation Requirements Chart. Write for your copy today.



INSULITE DIVISION
MINNESOTA AND ONTARIO PAPER COMPANY
MINNEAPOLIS 2, MINNESOTA

PRODUCT DESCRIPTIONS

INS-LITE

1. Made from strong wood fibers, treated for high resistance to moisture.
2. Color: Natural wood.
3. Edges: Square, except in thicknesses greater than $\frac{1}{2}$ " , in which case they may be square or offset.
4. Size: 23" x 47".
5. Thickness: $\frac{1}{2}$ " , 1" , $1\frac{1}{2}$ " , and 2".
6. Fabrication: Glued to 2" , stapled to 2" , integral to 1" .

GRAYLITE

1. Made from strong wood fibers, integrally treated with asphalt for increased strength and high resistance to moisture.
2. Color: Gray-brown.
3. Edges: Square, except in thicknesses greater than $\frac{1}{2}$ " , in which case they may be square or offset.
4. Size: 23" x 47".
5. Thickness: $\frac{1}{2}$ " , 1" , $1\frac{1}{2}$ " , and 2".
6. Fabrication: Glued to 2" , stapled to 2" , integral to 1" .

ics, and didn't have too much regard for the "practical" foundation engineers. But I have found that it takes a mixture of both theory and practicality to build an economical foundation. The soil table and graph included in this article are quite a step forward from the old "rule of thumb" days. At the same time, they should be used with caution; more as a trial balloon. As an example if the soil is so dense that 20 blows on the sample spoon are required to make it penetrate one foot, then there is no need for the architect to consult a foundation engineer. Conversely, if five, or only three, blows on the sample spoon make it penetrate one foot, it isn't always necessary to discard the site or to use piles. The table and graph indicate that a building should never be built on a five-blow soil. Yet, several buildings have been constructed on spread footings bearing on five and even three-blow soil (non-plastic silt — a very fine sand). Of course, this was done only after a very thorough soil study had been made. In these borderline cases, large sums of money usually can be saved by calling in a foundation engineer.

Can You Build on Fill?

There is still considerable debate about the question of putting up a building on fill. However, a clean, coarse sand which has been flooded deliberately to compact it, and has been in place for several years provides a satisfactory house foundation. Examples can be found at many seaside towns. The houses have been up for years and are still in excellent condition.

But building on top of an ash dump — then look out! The odds are against a satisfactory foundation. I have seen several buildings, ranging from a one-

story manufacturing plant to a school building, with sections of each built on dumps. Objectionable cracks have opened up, the walls have gone out of plumb, and eventually the building has had to be underpinned.

To be fair, I should say that I also have seen a 25-ft high storage building located on 12 ft of cinder fill, underlaid by 30 ft of organic silt. Even with this condition, the subsoil was so uniform that no cracks occurred when the building settled.

Sand, Gravel, Silt and Rock

It has been mentioned that clays and silts are the least desirable soils, and that sand and gravel are the best. Yet, there are still problems to worry about with them. They are caused by water and lots of it. If the excavation goes below groundwater level, it will be necessary to use pumps and a sump or well points, depending on subsoil conditions.

Either a good or bad foundation might be built on non-plastic silt (very fine sand or rock flour) depending on how closely the soil is examined. People on a foundation job sometimes think that piles should be used because the surface of this silt may appear muddy. If laborers are allowed to trample up and down in the footing bottom when the soil is full of water, they start the soil quaking, and it looks like a "mud pie." Trampling on this soil vibrates the top layers and tends to cause them to consolidate. The soil voids are full of water, impeding this process, so the soil temporarily acts like a sponge. This is still a good soil, but some people are ready to call for a pile driver. The secret is to keep the soil well drained and to prevent laborers from making it muddy.

Then there are the difficulties with

rock as a foundation. Whenever a hole is excavated in rock, there must be some provision to drain the hole, or else the basement must be designed to resist the water pressure, and this is expensive. In addition to the possibility of an underground stream flowing in the rock which will not show up until spring, the hole will act as a cistern for any rain or surface water. If no outlet is provided, the water pressure will build up, crack the basement slab and walls, and then water floods the basement.

When rock has been formed in layers, such as shale, precautions must be taken that there are no slip planes in the rock (See below); or, if so, that there are no columns next to excavations. Otherwise, the weight of the column load may push a plane of rock into the excavation, and the column will sink.

When some sections of a building are on rock, and others on soil, several precautions must be taken, depending on what type of soil is adjacent to the rock. If the footings are near rock, but resting on hardpan or a very stiff clay, no precautions are necessary. If they are on

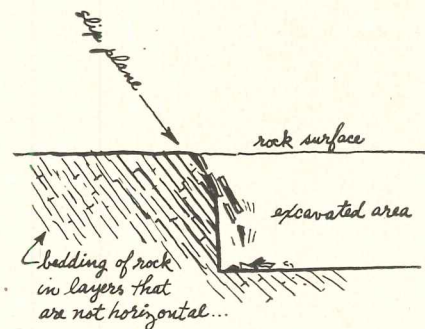

If a column must be set on rock formed in sloping layers such as shale, it should not be near any excavation

sand, then the customary procedure of using one-half the standard soil pressure for the footings adjacent to the rock will be satisfactory.

If the soil adjoining rock is a medium clay, then it may be necessary to provide a settlement joint between the footings on rocks and those on soil. Whether this settlement joint is a permanent one (something like an expansion joint between roof sections) or only open during the construction period will depend on whether the soil consolidates quickly or slowly. Settlement joints are quite often very tricky architectural details.

When building on rock, the actual elevations of rock layers should be located by soundings. This reduces the possibility of extra costs for excavations.

Here is a good-sized footing being poured from a transit-mix truck

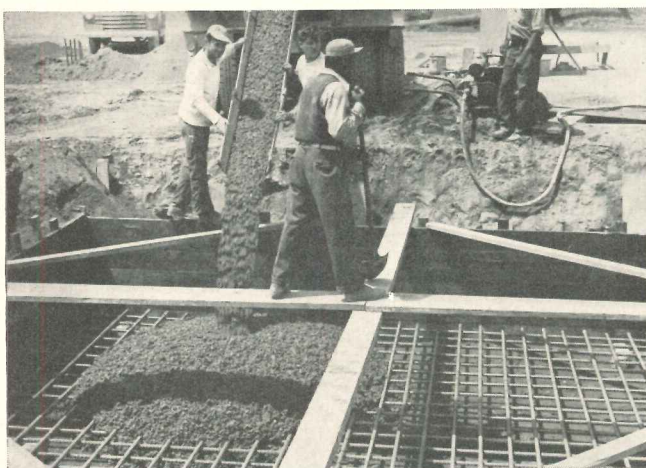

Glass in commercial buildings

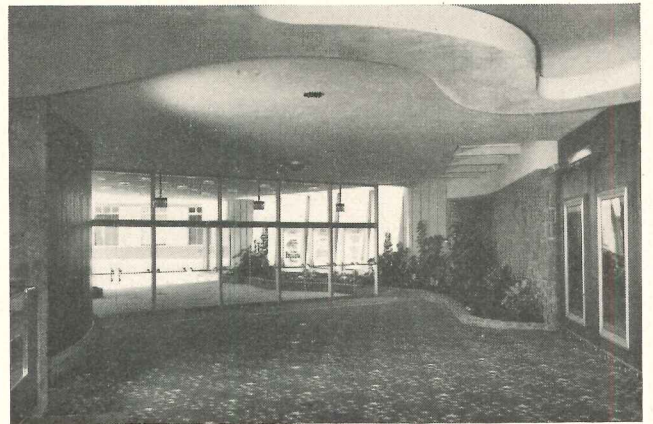

AT THIS THEATRE in Los Angeles, California, Pittsburgh Products bring more beauty to the exterior, more comfort to the interior. Herculite Doors, as shown here, were chosen for the entrance. Additionally, Pittsburgh Polished Plate Glass was installed on the outside. And inside, Pittsburgh Mirrors, Heavy Plate Glass and Carrara Structural Glass rounded out a practical, well-thought-out-plan of glass utilization. Architects: Arthur Froehlich (Beverly Hills, Calif.) & T. Rogvov, Detroit, Mich.

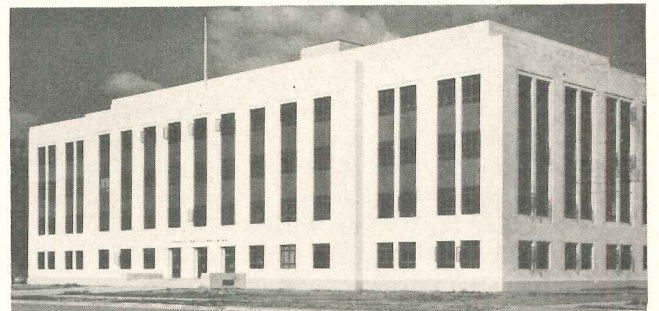

SOLEX—"the best glass under the sun"—was selected for glazing all the windows of this handsome building at Salem, Oregon. This heat-absorbing Plate Glass keeps rooms ten to twenty degrees cooler than the outside temperature. It reduces the strong heat and brightness of intense sunlight, while admitting soft, natural daylight into the room. It transmits 70% to 75% of the sun's total light, but admits less than 45% of the total solar heat. Sorex has proved its exceptional worth—in homes, schools, office buildings, factories, stores, airport control towers, solariums. Architects: Church, Newberry & Roehr, Portland, Oregon.

Design it better with **Pittsburgh Glass**



Your Sweet's Catalog File contains detailed information on Pittsburgh Plate Glass Company products.

PAINTS • GLASS • CHEMICALS • BRUSHES • PLASTICS

PITTSBURGH PLATE GLASS COMPANY

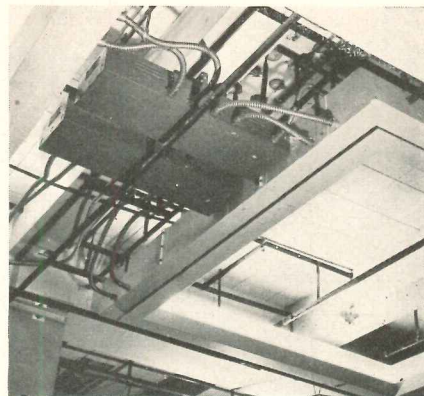

Left: remodeled offices of Sperry & Hutchinson Co. have 7 by 7 ft coffers. Above: unfinished ceiling. Below: detail

**COVE LIGHTING, UNUSUAL FOR OFFICES
PROVIDES HIGH QUALITY ILLUMINATION**

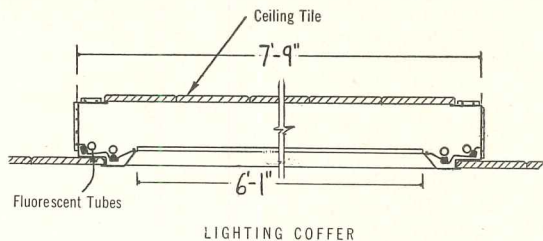

A SPECIAL SYSTEM OF COVE LIGHTING — unusual for an office — which combines a high quality of illumination with low surface brightness has been developed for the remodeled offices of Sperry & Hutchinson Company in New York City by Guy B. Panero, Engineers.

The offices occupy two floors in which the floor beams drop below the ceilings, so lighting fixtures and air conditioning ducts were designed to fill the spaces between beams, and a hung ceiling of acoustical metal tile was used.

The client asked that the lighting conform to the following conditions: (1) optimum illumination, (2) low surface brightness, (3) no long, narrow lines of light (precluded troffers), (4) no surface mounted or suspended lighting units, and (5) no sacrifice of lighting quality.

One lighting scheme considered was 4 by 4 ft squares in the ceiling, with rows of fluorescent tubes behind a glass screen, thus making use of standard lighting equipment. This, however, would result in a number of high intensity sources of direct light, with long, dark lines in between. Also, it would have been extremely difficult to avoid a high surface brightness; therefore, it was decided to use indirect light.

Since suspended fixtures were not to be used, the only other practical method of indirect light was cove lighting. A standard cove around the perimeter of the room would not provide a high intensity illumination and good quality at the same time. However, it was possible to use a coffered ceiling. These coffers could be illuminated, to almost any level.

The coffers needed to be as large as possible, so that most of the ceiling would be lighted. A 7 by 7 ft square opening in the ceiling tile was finally decided upon since four of these could be placed in a bay, with the air conditioning duct running between them.

A lip was provided around the coffer to make room for the fluorescent tubes and, also, to shield the tubes from view.

In order to throw more light to the center and away from the backwall, a vertical backwall and asymmetrical reflectors were used.

After one week of operation, the maximum light was 44 footcandles. The illumination close to walls dropped to a minimum of 32 footcandles due to the high absorbency, and low reflectivity, of the wall finishes used.

Wood Arches Span 180 Feet in Private Hangar

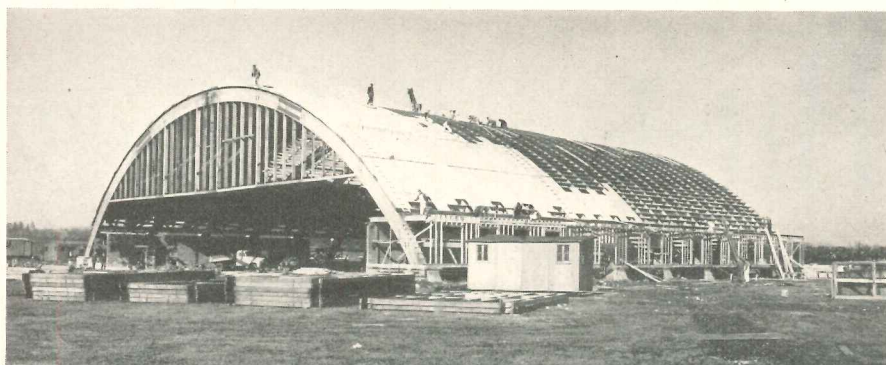

NINE, THREE-HINGED, laminated wood arches, believed the largest to have gone up during the current steel shortage, have been used in a \$250,000 private hangar for the Continental Can Co.

The hangar is 180 ft long, 160 ft wide and 25 ft high. Constructed almost entirely without strategic materials, the hangar features an asbestos shingle exterior and doors covered by hardboard. Designers and builders are the Wigton-Abbott Corp. of Plainfield, N. J.

(Technical News continued on page 244)

Make Buyers Out of Shoppers With

Value... Quality

Survey after survey has shown that there is a market for approximately 1,000,000 houses a year for the next several years . . . BUT, all building trades are faced with keener competition than ever before.

Because . . . People who buy, build or remodel are more discerning—they are demanding VALUE and QUALITY when they invest, *even before price*. That is when the reputation of Blo-Fan electric exhaust ventilators and Pry-Lite recessed lighting fixtures is an important factor for architects, builders, and electricians to consider. The reputation of Blo-Fan and Pry-Lite names is built on value and quality. Skilled craftsmanship plus quality material from reputable sources have been important in building the Blo-Fan and Pry-Lite names and what they stand for—just as your name and reputation are made and recognized through the products you use and the way you use them.



Remember the old adage, "Quality is remembered long after price is forgotten." Remember, too, that when you specify or install Blo-Fan electric exhaust ventilators and Pry-Lite recessed lighting fixtures...

"their reputation will guard yours"

PRYNE AND COMPANY

BOX R-42, POMONA, CALIFORNIA

EASTERN FACTORY: 124 Adams Street, Newark, New Jersey

Warehouses: Los Angeles, San Francisco, Chicago, Atlanta

Stocked by more than 700 wholesalers in over 350 cities.

"The hottest news
in heater history!"

THE NEW PRYNE

Glomaster

INFRA-
RED

RECESSED WALL HEATER

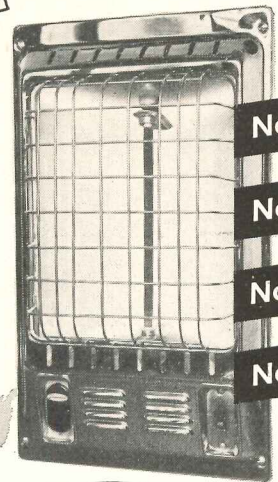

No Smoke

No Flame

No Fumes

No Draft

It's *Safe!*

EASY TO INSTALL

In new or old construction. On remodel jobs, merely cut a hole between studs . . . There's no plastering to do . . . The attractive heater front covers the rough plaster edges . . . "Rough-in" box mounts flush with flanges against the wall, has two knock-outs in bottom, and no extra pull box is required . . . Heater assembly is secured to "rough-in" box with four machine screws, thus eliminating the need for drilling extra holes in finished walls.

MORE HEAT WITH LESS CURRENT

Real economy is provided by the Glomaster auxiliary heater . . . Uses no more electricity than an iron . . . Radiates heat from floor to head with absolute safety . . . There are no flames to ignite clothing or towels . . . Modern wire grille remains at safe temperature—will not burn the skin if touched . . . Heating element is non-metallic—will not transmit shock . . . Choice of chrome or baked white enamel finishes . . . U. L. APPROVED!

AMAZING HEAT ELEMENT NEVER BURNS OUT!

Sintered carbide compound heating element is not affected by splashed water and will not corrode.

If local stocks are not available, ask your Blo-Fan or Pry-Lite distributor to order Glomaster for you.

PRYNE AND COMPANY

Pomona, California

Newark, New Jersey



RADIANT HEATING PIPES IN DETROIT BUS GARAGES PROTECTED FROM CORROSION AFTER EARLY TROUBLE

MOST RADIANT HEATING SYSTEMS in service for a number of years have performed satisfactorily, but in a few cases they have been designed and installed in such a way that trouble is inevitable. First of all, the slab must be designed properly, waterproofed, and underlaid with a recommended fill.

There are times when still further precautions must be taken — electrolytic protection, for example. A case in point was the problem at three terminal garages built for the Detroit Department of Street Railways four years ago, each building covering 250,000 sq ft and with a capacity of between 450 to 500 buses.

To melt the accumulation of snow and ice the buses pick up — as much as one ton each during one “trick” — and to provide comfortable working conditions,

radiant heating systems were installed in each garage, with pipe coils laid on sand fill. The radiant heating systems operated satisfactorily until the second heating season, when deterioration from corrosion of the pipe coils became so severe that the system in one garage had to be abandoned, and leaks were developing at an alarming rate in the other two.

What happened, according to engineers who were called in to determine whether cathodic protection would save the remaining two heating systems, was that the pipes were eaten away by a salt solution. Salt came from two sources. The snow-ice mixture picked up by buses from the streets is saturated with salt used to melt snow. This drops off the buses and leaks through the slab joints

Radiant heating pipes in garage floors corroded because of contact with salt. Below: rectifier used with cathodic protection systems which will halt further corrosion

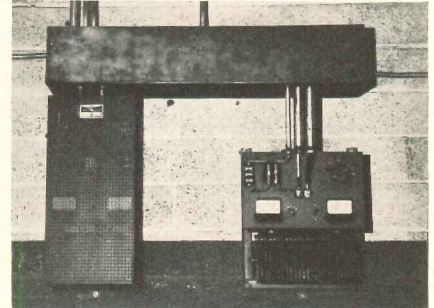

and other cracks in the floor, and eventually seeps through to the sand fill. Also, the soil, itself, around Detroit is notorious for its saline content.

Cathodic protection was found practicable, costing approximately \$15,000 for each garage, in contrast to \$80,000 each to replace the radiant heating by space heaters. Cathodic protection in effect reverses the flow of electrical current that originally caused the pipes to oxidize, so no further corrosion occurs. Under the floor of each of the two garages were installed 68 graphite anodes, buried 8 ft down. The series of anodes (called ground beds) are electrified by 12-volt rectifiers (for direct current). The protection systems were designed and installed by the Hinchman Corp. of Detroit.

Southwest Research Institute Suggests New Floor Slab Design

RESULTS OF 18 MONTHS STUDY of structural concrete floor slabs for houses by Southwest Research Institute indicate that deep foundations under the perimeter probably are not needed. Conducted by the Housing Research Foundation of the Institute, the studies show that perimeter foundations or grade beams contribute little strength or stiff-

ness to floor slabs laid on grade.

To cope with the problem of soil movement, attempts have been made in recent years to design “floating” slabs which offer no resistance to the soil’s horizontal movement, but which can be reinforced economically against unevenly distributed vertical movement. One type, accepted by FHA in San

Antonio, consists of perimeter grade beams and intermediate beams spaced on 12 to 16 ft centers. Most of the load is transmitted to the ground through these beams, but the slabs have not been entirely satisfactory for supporting heavy masonry walls.

Many models of slab designs were built and tested, and it was found that a slab of inverted pyramid design yielded the greatest strength and stiffness for the same estimated cost as the FHA design. The steel was placed diagonally in the slabs instead of parallel with the sides to increase strength and stiffness.

It is somewhat difficult to place steel in the inverted pyramid, but almost as good is a 10⁵/₈-in. slab, with the same amount of steel placed 12 in. on centers diagonally top and bottom. The flat slab is easier to place and waterproof.

(Technical News continued on page 248)

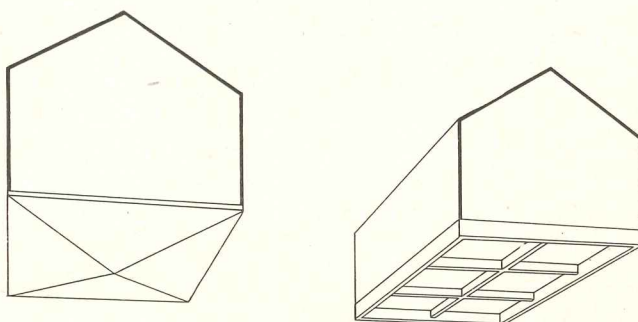

Lesson...



Is it a fact that loss to cold classroom windows a significant one scarcely, if ever. Herman Nelson school laboratory have shown that Skyshine—radiant heat from the sky—actually balances any excessive body heat loss in this direction.

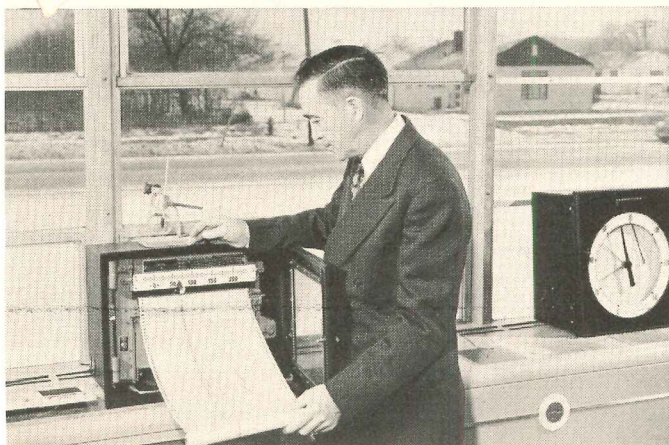

Write today for your free copy of the new Herman Nelson DRAFT|STOP Catalog and schoolroom heating-ventilating guide.



DRAFT STOP

HERMAN NELSON

SYSTEM OF CLASSROOM
HEATING AND VENTILATING

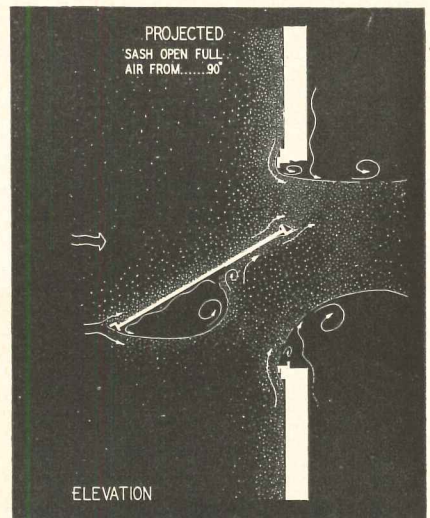
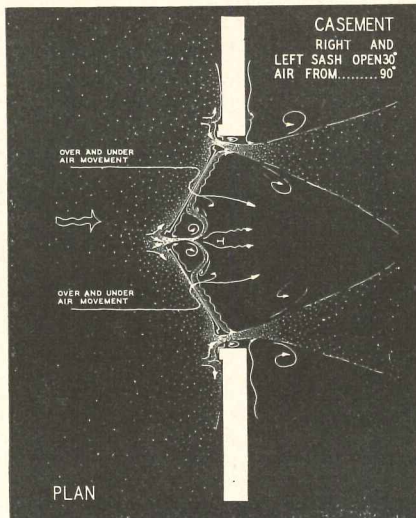
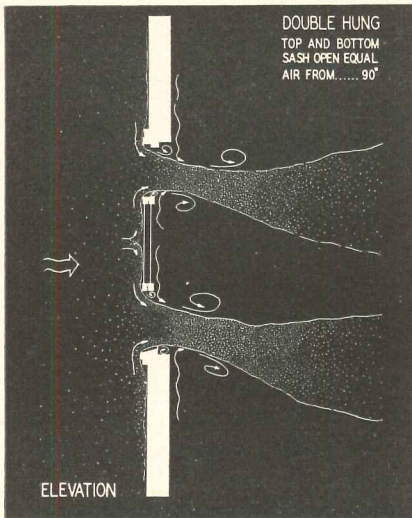

TEXAS A & M REPORTS ON AIR FLOW THROUGH CONVENTIONAL WINDOWS

AIR FLOW PATTERNS through a variety of conventional windows is the subject of a recent report by the Texas Engineering Experiment Station of Texas A & M (Research Report No. 33). Its purpose is to promote improved window designs as well as better selections of windows for particular applications. The researchers noted that in many cases the stress on window design is for draft-free ventilation in winter without much thought to summer cooling.

Three classes of windows were studied: *simple openings* (double-hung, horizontal

sliding); *vertical vane openings* (casement); *horizontal vane openings* (projected, awning, jalousies).

Tests with manufacturers' windows were first conducted in a full-scale experimental building mounted on wheels (so that orientations could be varied). Then model windows were set in a model building and tested with a wind tunnel, the reason being that experiments could be controlled better. Acid smoke from titanium chloride blown through the windows by the tunnel's fan was used to show the air patterns, from which

drawings, such as the three above, were made, covering 24 separate tests; the closer the dots, the faster the air flow.

Some conclusions were: *Simple Openings*. Window does not change vertical direction, nor alter speed much. *Vertical Vanes*. Folding windows spread air wide into the interior (perhaps fewer windows can be used than with other types). *Vertical pivot windows* have extreme air directing characteristics. *Horizontal Vanes*. Jalousies direct air up and down, allowing installation at different heights with little change in ventilation.

Engineer Discusses Hospital Electrical Requirements

PRINCIPAL REQUIREMENTS for electrical distribution systems in hospitals is the subject of a recent article in *The Construction Specifier*, by Noyce L. Griffin of the Division of Hospital Facilities. The article covers power demands, major equipment, wiring in hazardous locations, and emphasizes emergency power systems.

Engineer Griffin says that, as a minimum, the emergency system should be on the site, and should serve at least the operating and delivery rooms, nurseries, stairs and partial lighting for corridors. He lists three acceptable systems, but believes that combinations may be desirable; these are: connection with separate generating plant, internal combustion engine, and storage battery. Generators starting cold require some time for warming up, so it is advisable to add a light duty storage battery system.

