

JANUARY 1955

A detailed architectural floor plan of a college building interior, rendered in blue ink on a white grid background. The plan shows a central rectangular room with a desk, two chairs, and a telephone. To the left and right are smaller rooms with desks and chairs. At the bottom, there are two large rectangular areas, possibly storage or utility rooms, with racks and shelves. The drawing uses fine lines and cross-hatching for shading and texture.

ARCHITECTURAL
RECORD

BUILDING TYPES STUDY NUMBER **218**
COLLEGE BUILDINGS



New Arrow Park plant of The Parker Pen Co., Janesville, Wisconsin. Archt.—John J. Flad & Son, Madison, Wisconsin; Contr.—T. S. Willis, Janesville, Wisconsin; Pozzolith Ready-Mixed Concrete supplied by Janesville Sand and Gravel Co., Janesville, Wisconsin.

POZZOLITH*...an aid here to better quality concrete

Better quality spells better performance, whether applied to the Parker Pens made in this beautiful new plant, or to the Pozzolith Concrete used in building it.

For the *contractor*, better quality concrete with Pozzolith means easier placeability, even though water is reduced as much as 15%, less bleeding, no segregation.

For the *architect and engineer*, concrete produced with Pozzolith assures minimum shrinkage, low permeability, increased bond-to-steel, great durability.

These results are obtained with Pozzolith because, through cement dispersion, it is the key to *lowest unit water content*—most important basic factor affecting the quality of concrete. See Bureau of Reclamation's current Concrete Manual, Pg. 130.

Full information on Pozzolith and demonstration kit sent on request.

* **POZZOLITH**... reduces unit water content (water required per cubic yard of concrete) up to 15% for a given workability, and fully complies with the water-cement ratio law. Adaptations of Pozzolith permit rigid control of entrained air. Produced in three standard formulations—Normal Pozzolith, High Early Pozzolith and Low Heat Pozzolith—to give, with maximum economy, the results required under varying job conditions.

Non-shrink, ready-to-use
EMBECO PRE-MIXED GROUT
and
EMBECO PRE-MIXED MORTAR
provide these advantages:

- Convenience and ease of use (add only water)
- Time and labor savings
- Assurance of uniformly superior results.

Do jobs like these better with —
NON-SHRINK EMBECO PRE-MIXED GROUT:

Grouting Machinery
Grouting Anchor Bolts
Grouting Building Columns

NON-SHRINK EMBECO PRE-MIXED MORTAR:

Patching Concrete Floors and Steps
Repairing Wall Seams and Cracks
Grouting Around Pipes Through Walls
Repairing Joints of Brick Floors
Tuck Pointing Masonry
Caulking Joints Between Floor Slabs and Basement Walls
Caulking Joints of Bell and Spigot, and Tongue and Groove Pipe
Grouting Steel Sash and Jambs

Write for information and where to buy in your area.

The

MASTER



BUILDERS

CLEVELAND 3, OHIO • TORONTO, ONT.

Subsidiary of American-Marietta Company

Cable Address, Mastmethod, Ne

ARCHITECTURAL RECORD

January 1955 Vol. 117 No. 1

Copyright 1955 by F. W. Dodge Corporation, with all rights reserved. ARCHITECTURAL RECORD (combined with AMERICAN ARCHITECT and ARCHITECTURE) is published monthly by F. W. Dodge Corporation, 10 Ferry Street, Concord, New Hampshire, with editorial and executive offices at 119 West 40th Street, New York 18, New York. Western editorial office, 2877 Shasta Road, Berkeley 8, California.

STAFF OF ARCHITECTURAL RECORD



H. Judd Payne, Publishing and Editorial Director; **John Knox Shear, A.I.A.**, Editor-in-Chief; **Robert F. Marshall**, General Manager; **Marshall T. Ginn**, Circulation Manager. . . . **Emerson Goble**, Managing Editor; **Frank G. Lopez, A.I.A.**, Senior Editor; **James S. Hornbeck, A.I.A.**, Senior Associate Editor; **Elisabeth Kendall Thompson**, Senior Associate Editor and Western Section Editor (Berkeley, California Office); **Robert E. Fischer**, Associate Editor (Engineering); **Florence A. van Wyck**, Associate Editor; **Jeanne M. Davern**, Associate Editor (News); **Daniel M. Kelley**, Associate Editor (Engineering Assistant); **Ernest Mickel**, Dan Street (Washington); **John Caulfield Smith, M.R.A.I.C.** (Canada); Contributing Editors; **Marjorie Blake**, **Grace M. Anderson**, Assistant Editors; **Ruth P. Watson**, **Helen E. Cook**, Editorial Assistants; **Peter Piening**, Consulting Design Director; **Eugene H. Hawley**, **Alfred Petersen**, Design; **Sigman-Ward**, Drafting Consultants; **Thomas S. Holden**, Industry Relations Consultant; **Clyde Shute**, Statistical Consultant; **George Cline Smith**, Economics Consultant; **Clifford Dunnells, Jr.**, Field Research Consultant; **Samuel C. Pace**, Public Relations Consultant.

TABLE OF CONTENTS

The Record Reports

Perspectives	9
"Center of the Americas." Miami Finds New Support of Old Dream	10, 11
News from Washington. <i>By Ernest Mickel</i>	12, 38
Meetings and Miscellany	15, 16
Periodical Reports	20
Opinion	24
News from Canada. <i>By John Caulfield Smith</i>	26
Construction Cost Index	42
Required Reading	46
Current Trends in Construction	298

Building Types Study Number 218 — College Buildings

It's not exactly news that college buildings are very active, will get progressively more active, no doubt, as the famous crop of wartime babies begin to reach college age, in five or six years. Glancing through this Building Types Study you may get the impression that the biggest news is that college buildings are beginning to show some collegiate erudition.

Campus Development for Illinois Institute of Technology, Chicago, Ill.; Ludwig Mies van der Rohe, Architect 126

The University of Michigan, Ann Arbor, Mich.; Lynn W. Fry, Supervising Architect 132

North Campus Plan, Eero Saarinen and Assoc., Archts.; Central Service and Stack Bldg., Albert Kahn Assoc., Archts. and Engrs.; Addition, Couzens Hall, Ralph R. Calder, Archt.; Addition, Michigan Union, Eberle M. Smith, Archts. and Engrs.; North Campus Apt. Housing, Leinweber, Yamasaki & Hellmuth, Archts.; Proposed School of Music, Eero Saarinen and Assoc., Archts.; Phoenix Project, Giffels & Vallet, Inc., L. Rossetti, Archts. & Engrs.; Automotive Engineering Bldg., Giffels & Vallet, Inc., L. Rossetti, Archts. & Engrs.; Women's Swimming Pool, Lee Black & Kenneth C. Black and Alden B. Dow, Archts.; Children's Hospital; Psychiatric Unit, Swanson Assoc., Inc., Archts.; Kresge Medical Research Bldg., Giffels & Vallet, Inc., L. Rossetti; Skidmore, Owings & Merrill, Archts.; Outpatient Clinic, Giffels & Vallet, Inc., L. Rossetti; Skidmore, Owings & Merrill, Archts.

The Australian National University, Canberra, Australia; Prof. Brian B. Lewis, Consulting Architect 139

Cover: Typical dormitory room, Young, Richardson, Carleton & Detlie, Architects and Engineers

Continued on next page

Building Types Study Number 218 — College Buildings (Continued)

Physical Education Center, Northeastern University, Boston, Mass.; Shepley, Bulfinch, Richardson & Abbott, Archts.	142
Oberlin Inn, Oberlin College, Oberlin, Ohio; Eldredge Snyder, Archt.	145
Alms Memorial Bldg., University of Cincinnati, Cincinnati, Ohio; James E. Allan, Archt.-Engr.	146
Men's Dormitory, University of Washington, Seattle, Wash.; Young, Richardson, Carleton & Detlie, Archts. and Engrs.	147

What's New in Dormitories

What's new in college dormitories is, of course, more college kids, more and more of them, with their younger brother expected to follow soon. The FHA has been doing something about it, and a good job, too, judging by what architects say about the program. Here is a quick review of typical buildings by private architects, who were allowed considerable freedom. 151

Glare-Less Daylighting in Hawaii

Hawaiian Life Insurance Co. Building, Honolulu, T. H.; Vladimir Ossipoff, Architect 155

Amenity Values in a Small Factory

Additions to Plant of Avery Adhesive Label Corp., Monrovia, Calif.; George Vernon Russell, Architect 161

Houses

House for Mr. and Mrs. Harry E. Ormston, McLean, Va.; Harry E. Ormston, Archt. 164

House for Mr. and Mrs. C. B. Fox, New Orleans, La.; John W. Lawrence and Sam T. Hurst, Archts. 166

House for Dr. Clara Tucker, Baton Rouge, La.; John W. Lawrence and Sam T. Hurst, Archts. 168

Architectural Engineering

Feeding college youngsters by the thousands is one of the big tasks that is being handled as big business. Scientific food management has developed a number of ideas that will be important to all architects doing college buildings that will involve any food facilities. This article presents the thinking of several specialists from universities which have instituted modern systems.

Food Service Planning in Colleges 170

Roundup 175

Product Reports: Gymnasium and Library Equipment 176

Office Literature 178

Time Saver Standards — Engineered Wood Design: Plank and Beam Construction. By William J. LeMessurier and Albert G. H. Dietz 181

Index to Advertising

300

OFFICERS OF THE F. W. DODGE CORPORATION

James McV. Breed, Chairman of the Board; Paul Abbott and Thomas S. Holden: Vice Chairmen of the Board; Howard Barringer, President; Irving W. Hadsell, Chauncey L. Williams: Executive Vice Presidents; Howard M. Thompson, Vice President and Treasurer; Julius T. Little, Robert F. Marshall, T. Oliver Morgan, H. Judd Payne: Vice Presidents; Carl S. Bennett, Ralph M. Hairston, O. O. Paulsell, Richard H. Ray: Regional Vice Presidents; Edwin H. Freed, Assistant Vice President and Comptroller; George Cline Smith, Assistant Vice President and Economist; Walter F. DeSaix, Clifford G. Dunnells, Jr., Clyde Shute, Marc Wayne: Assistant Vice Presidents; Sanford D. Stockton, Jr., Secretary; William C. Breed, Jr., George W. Morgan, Jr.: Assistant Secretaries; Irving B. Satin, Assistant Treasurer.

OTHER F. W. DODGE SERVICES:

Dodge Reports and Dodge Statistical Research Service — Sweet's Files — "Planning Kit for Our New Home" — Chicago Construction News — Daily Pacific Builder — Denver Daily Journal — Real Estate Record & Builders' Guide.

Member of Audit Bureau of Circulations and Associated Business Publications. Architectural Record is indexed in Readers' Guide to Periodical Literature, Art Index, Industrial Arts Index and Engineering Index.

Every effort will be made to return material submitted for possible publication (if accompanied by stamped, addressed envelope), but the editors and the corporation will not be responsible for loss or damage.



Subscription rates in U. S., U. S. Possessions, and Canada: \$5.50 for one year, \$9.00 for two years, \$11.00 for three years. Elsewhere, subscriptions from those who by title are architects or engineers, \$6.50 for one year, \$11.50 for two years, \$15.00 for three years; subscriptions from all others outside U. S., U. S. Possessions and Canada, \$20.00 a year. Single copy price, \$2.00. Circulation Manager: Marshall T. Ginn. Change of Address: Subscribers are requested to furnish both old and new addresses, sending if possible the stencil impression from magazine wrapper. Allow four weeks for change.

THE RECORD REPORTS

P E R S P E C T I V E S

ASHVE TO ASHACE: The American Society of Heating and Ventilating Engineers has voted to change its name to American Society of Heating and Air-Conditioning Engineers Inc.

ATOMIC POWER will fuel half the electric power plants being built by 1976, President Ralph J. Cordiner of General Electric told the recent 59th annual Congress of American Industry. Mr. Cordiner said the survival of freedom is likely to depend on the kind of planning business men do and especially on whether they have the imagination to convert atomic fission from "our major source of fear into one of our major sources of fuel energy in the next century." The development of "automatic factories" was seen by Mr. Cordiner as another potential for raising living standards and increasing freedom. Defeat of the Soviet challenge, Mr. Cordiner said, can best be achieved by developing "a philosophy, a program and a passion" toward a richer life for all mankind.

CONSTRUCTION LEADS THE U. S. in number of new businesses formed, according to the latest report by the U. S. Department of Commerce. The Department's study of the U. S. business population covering the year 1953, and released late in 1954, showed the contract construction industry added 14,000 more companies between January 1 and December 31 of 1953, an increase of about three per cent and the biggest of any business category. Of the U. S. total of 4,185,300 businesses, 466,667 were recorded for construction.

YOUNG IS A CIRCUMSTANCE: The advent of a new year seems to offer a suitable occasion for quoting the dean of American architects on the

subject of old age. The following essay appeared under the byline of Frank Lloyd Wright in the very interesting 1954 annual report of the New York State Joint Legislative Committee on Problems of the Aging: "It seems to me the best thing ever said concerning old age was said by Oscar Wilde: 'The tragedy of old age is that it is not old.' As an experienced builder of homes I should say that most needed by the aging is more realization that young is a circumstance and youth is a quality. And more needed is less accent by society on maturity as a disability. If it is not an asset, then our civilization passes into failure. Also — no retirement, less segregation; rather more privileges as reward for wisdom and achievement. In short, age should be treated as a qualification that ought to be — not as now, be a disqualification. Also, I think old age needs a greater range of activity, not less, and needs more rewards of the kind development covets. Like for instance, a beautiful environment — the high quality we call a work of art in nearly everything from here to heaven." At 85, Mr. Wright has just announced that the adverse decision of a Wisconsin tax court will make it necessary for him to abandon Wisconsin and the Taliesin Fellowship (rudely described in court argument as his "design business"). He has opened a new "office" at the Hotel Plaza in New York.

DON'T ANYBODY make a mistake about this: In the automotive field "styling" and "design" are two separate procedures. One of the auto manufacturers explained this very carefully, said it had been a source of much confusion. "Styling" and "Body Engineering" are in fact two different buildings. A car body is

designed by Body Engineering, then the design goes to Styling where the important work is done. The two departments are not presumed to have any business in common; if a clash should develop, it is referred to top management, but this is sort of academic — in practice it would be rare, so well are the two functions understood.

AUTO DESIGNERS joined with other designers serving the mass market at the recent Ann Arbor Conference, sponsored jointly this year by the Michigan University College of Architecture and Design and the Institute of Contemporary Arts, of Boston. The chronic unhappiness of designers cropped out frequently — the designer must not only please the fickle public (beware of consumer research, by the way, it can throw you) but also the president, the board of directors, not to mention the sales manager and the advertising agency. One story at the conference dealt with the unhappy fate of the designer who for once was given his head: no opposition, no doubts, no question; he was the boss and could do anything he chose. Oh, what misery! Think of the responsibility. Perhaps a better story was told by one designer who came originally from Europe. He was much impressed, he said, to learn about that favorite of American burlesque, the striptease act. He kept thinking in terms of design — after all the coverings come off, and the natural design is all that is left, well, you just have to start putting things back on again.

LET'S HANG TOGETHER is the title of the monthly news sheet published by the National Metal Awning Association.

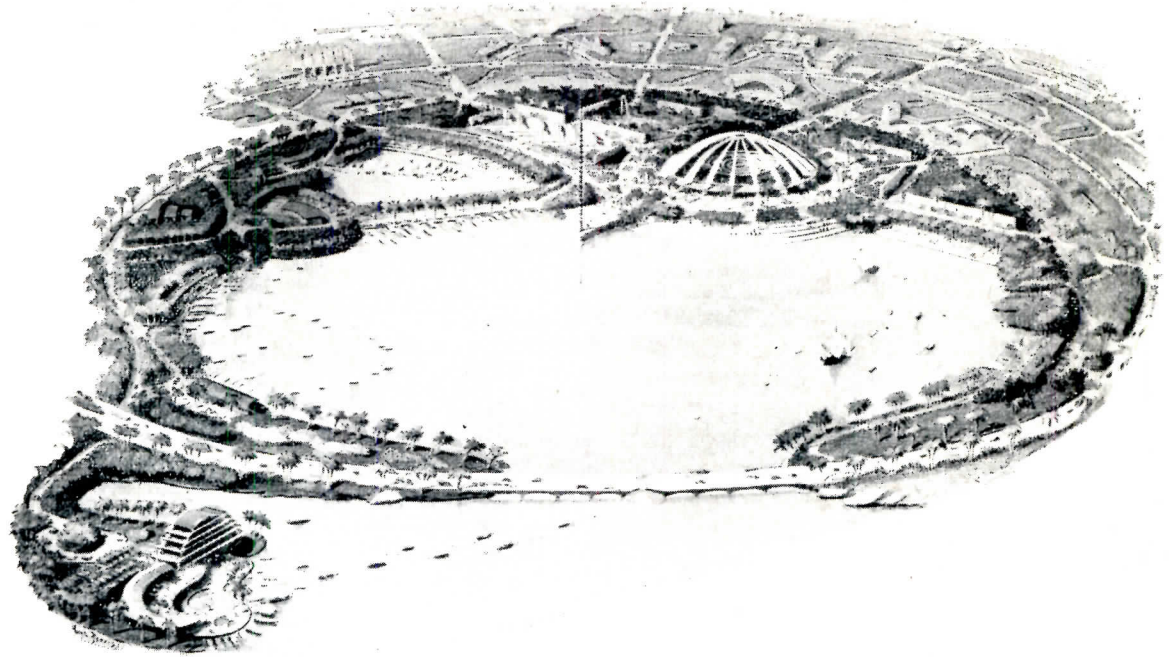

“CENTER OF THE AMERICAS”:

A \$200 MILLION PERMANENT EXPOSITION and recreation center on an 1800-acre site ten miles north of Miami is now proposed by Florida's Inter-American Center Authority as a new and expanded version of Miami's perennial dream of creating a center of trade and cultural relations for the western hemisphere. Financing is still to be found: but two New York investment houses, Lehman Brothers and Van Alstyne Noel, have agreed to underwrite the public offering of the requisite initial \$60 million bond issue next spring; and the project has received high marks for commercial feasibility in the report by Ebasco Services Inc. of New York on an intensive business study.

Architects have played a key role in developing not only planning and design concepts to implement a program but the basic program itself. Early in 1950 Dr. D. H. Walker, chairman of the Authority and very much the genie of the project, asked Robert Fitch Smith, then president of the Florida South Chapter of the American Institute of Architects, to name an advisory group of architects. The resulting Architectural Board of Design has worked closely with the Authority ever since and now begins the intensive phase of basic design; it is also expected to function as a board of control to review the work of other architects who may be commissioned to design individual exhibition buildings.

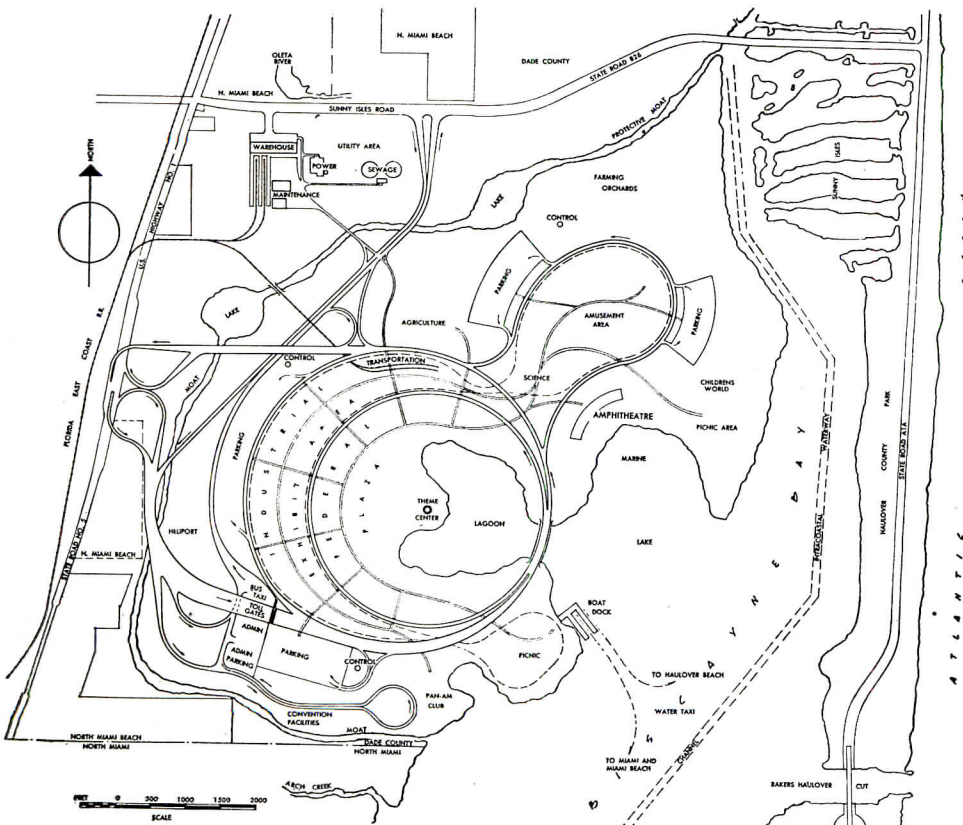

Although members of the Board of Design emphasize that they have been concerned with basic concepts and not even preliminary building designs, the renderings by Hugh Ferriss hint at architectural themes to be developed. Top of page: overall view; across-page top, “theme center”

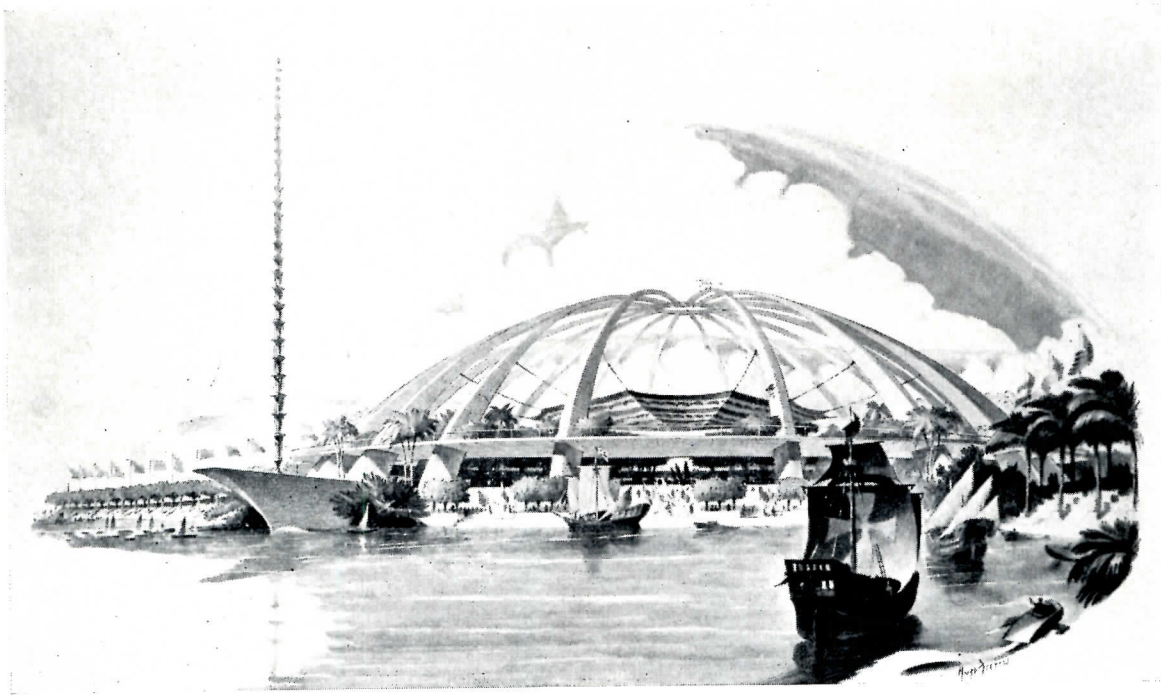

MIAMI PLUGS NEW VERSION OF A BIG DREAM

Members of the Board are: Russell T. Pancoast of Miami Beach and Alfred B. Parker, John E. Petersen, Robert Fitch Smith and Robert Law Weed, all of Miami; associate architects are: William K. Jackson of Jacksonville, Arthur Gale Parish of St. Petersburg and James Gamble Rogers of Winter Park. Hugh Ferriss of New York has been associated with the Board in visualizing the developing concepts of the project. Mr. Smith has served as Board chairman.

The center is regarded by the architectural board as an unparalleled opportunity for a regional architectural expression indigenous not only to the site itself but to the areas from which many of the Latin American visitors will come. The setting is envisioned as a

subtropical garden with a "theme center" consisting of a lagoon area with a multipurpose amphitheater surrounded by circular levels of exhibition buildings. A canal system will wind through the grounds as the lowest of three levels of circulation, with sidewalks on the next level and roadways on top; buildings will be between the sidewalk and roadway levels, permitting them to be viewed from either one.

A simple human fact — that touring feet get tired — and an economic one — that exhibitors must be satisfied their displays will be seen by the maximum number of people — have been dominant in the evolution of the circular plan and other basic concepts. Item: a one-way road system will pass all exhibition

buildings and "points of interest" so motorists get an overall view before parking. Item: resting places will be located not in vacant spaces but within view of the exhibitions. Item: relationship of gardens, buildings and walkways will be planned to give the weary visitor as little "not one more building!" feeling as possible.

Estimating an average annual attendance of 10 to 12 million, Ebasco forecasts an annual operating profit of \$20 million. On the basis of the experience at recent World's Fairs, Ebasco recommends shorter hours (only one shift of employees) and design of facilities for much lower peak attendance — 100 per cent instead of 600 per cent above the anticipated daily average.

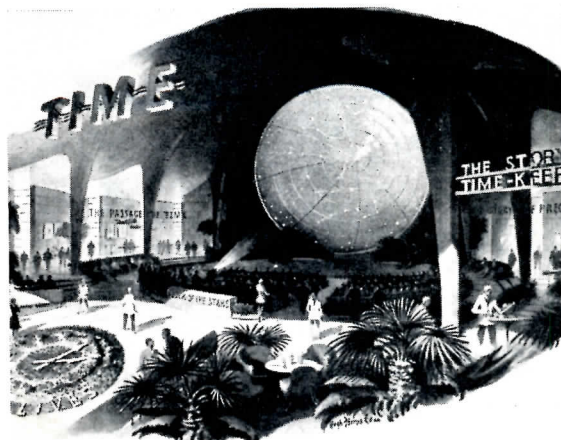

ENROLLMENT BOOM SPURS NEED FOR COLLEGE HOUSING

U. S. Office of Education Estimates Present Backlog

At \$6 Billion, Needs for Next Decade at \$2 Billion

COLLEGE HOUSING CONSTRUCTION costing \$6 billion would be required to erase the present backlog of need, according to the latest estimates by the U. S. Office of Education. Just to cope with enrollment increases of the next decade, without respect to obsolescence, is estimated to require expenditures for construction averaging \$200 million a year.

An even greater expenditure would be required to enable institutions of higher learning to meet the increasing demand by students for on-campus housing and to replace substandard housing presently in use. A steady decline in the number of students housed in private homes is being noted; and while only 26 per cent of today's students are housed by the colleges and universities, the Office of Education believes the demand might reach 50 per cent by 1965-70. And 13 per cent of the students housed on-campus today live in "temporary" dormitories erected to meet the post-World War II rush to the colleges under the GI Bill of Rights.

Estimated enrollment for 1965 is 3.5 to 4 million, or a whopping 94 per cent over the pre-1941 figure. Actual figures place the 1954-55 enrollment at the all-

time record high of 2,472,000 students, ten per cent over 1953 and six tenths of one per cent over the previous high reported in 1949.

Commenting on Fall 1954 enrollment figures, Dr. J. Kenneth Little, deputy commissioner of education, noted that college and university enrollments showed an increase for the third consecutive year. "Except for the years immediately following World War II, when large numbers of veterans were attending college under the GI educational benefits, the ten per cent increase in number of students this fall over last fall is the largest single-year increase since the mid-Thirties. The estimated 636,000 new students enrolled this fall [1954] is the second highest enrollment of new students in the nation's history."

One out of three of these students lives on campus; the other two out of three either live at home or compete in declining numbers for the private housing that is becoming less and less easily available in campus vicinities.

Back in 1947 the Office of Education and the Federal Works Agency conducted a study of higher education facilities. This turned up 119 million sq

ft of residence space. Two thirds of it was for single students, one sixth for married and one eighth for faculty occupancy. Later, a check on a sampling basis indicated that 95,559,000 additional sq ft were required, or 80 per cent of the total square footage then available.

Between mid-1951 and mid-1953, colleges built living space for 66,715 students. The cost was placed at \$207,338,888 or \$3108 per student.

One spokesman said that all the housing constructed at colleges and universities since 1947 fails to go beyond the urgent and emergency needs as expressed in that year. That was when the authorities were predicting declining enrollments.

If \$2 billion worth of college housing can be erected in the next 10 years, and the enrollment estimate of 3.5 to 4 million students in 1965 is substantiated, the Office of Education believes about one half of the anticipated enrollment increase could be housed in new structures, though it doubts the percentage of total students being housed could be significantly increased. Even excluding needs forced by obsolescence, the outlay of \$200 million per year will be required to provide adequate housing for 25 to 30 per cent of anticipated enrollments.

Financing is, of course, the key to how much of the needed construction can be accomplished; and on this point the Office of Education warns that unless new resources for financing are developed there will, in fact, be less institutionally owned and operated housing in relation to increasing enrollments each year for the next decade. Local resources for providing the needed shelter are close to being exhausted, say the Office of Education spokesmen. Federal scholarships, a part of which could go to building purposes, are being talked of. Any diversion of scholarship funds for construction now is prohibited. Student migration is still another problem to complicate the building picture. Junior colleges are being suggested in some quarters as a possible temporary answer since students would be kept in their own home towns for an additional two years after high school.

(More news on page 15)

EDUCATOR WARNS: EXPANSION IS NOT ENOUGH

STATES must apply to the development of facilities for higher education the kind of comprehensive long-range planning local communities now bring to consideration of elementary and secondary school needs, according to Dr. John Perkins, University of Delaware president.

Writing in the October 1954 issue of *State Government*, Dr. Perkins notes that the anticipated 70 per cent increase in college-age population by 1970 implies an enormous expansion of facilities: "It has been estimated that in the next 15 years as much floor space will have to be provided for higher education as was built in the 300 previous years."

But the Topsy-like growth of the past will no longer be tolerable: "To

make it financially possible for the commonwealths to fulfill their responsibility to the larger student bodies of the future, the entire state structure of higher education should be subjected to the closest scrutiny and, when needed, generally overhauled." Overlapping and duplication of programs at several institutions within a state probably can no longer be afforded; on the graduate and professional level inter-state cooperation may be required. Existing organizations in the South and the Rocky Mountain area are cited as examples of regional coordination; Florida and Illinois are given as examples of states which have already established long-range planning programs.



Aluminum angels heralded Christmas in Rockefeller Plaza this year. The 9-ft figures, designed by sculptress Valerie Clarebout, had brass trumpets and aluminum robes and wings sprinkled with tiny light bulbs. Architect Robert I. Carlson is in charge of the Center's yearly display

Hard Work at Palm Beach

FOR AN OCCASION billed as a "fun convention" — and held against the alluring background of the fabulous new resort La Coquille at Palm Beach — the 40th annual convention of the Florida Association of Architects was a pretty hard-working affair. Most important of the proposals acted on were two which represent major steps in the effort by Florida architects to take the lead in development of closer coöperation in the building industry. One of these, embodying recommended bidding procedures, was adopted by the convention on

the recommendation of the Joint Co-operative Committee of the F.A.A. and the Associated General Contractors. The other, representing an effort by a joint architect-engineer committee to provide a basis for agreement on areas in which architects and engineers might admit each other as prime design professionals, is to be sent all members for further study and comment before consideration by the Executive Committee at its next meeting. Clinton Gamble of Gamble, Pownall and Gilroy, Fort Lauderdale, was elected F.A.A. president to succeed Igor Polevitzky of Miami; Edgar S. Wortman of Palm Beach is the new secretary-treasurer. In the large and varied architectural exhibit held at the Norton Gallery in West Palm Beach, award-winners were Robert M. Little and Watson & Deutschman; William B. Harvard, architect, Blanchard Jolly, associate; Paul E. Kohler Jr. and David Shriver; and (for scale models) Alton C. Woodring Jr., (for delineation), J. N. Smith, and (for ink-traced working drawings) Philip Julien.

Public Relations In '55

A TEACHERS MANUAL and a film strip figure in the A.I.A.'s public relation pro-

gram for 1955. The manual, "At Home With Architecture," was prepared to help elementary and junior high school teachers in the presentation of architecture; it was produced by the A.I.A.'s Public Relations Committee, the Octagon staff and Ketchum Inc., public relations counselors to the Institute. The film strip, "Architecture — U.S.A." will include colored slides of contemporary American architecture, and is now being edited by architect Ralph Myers, of the Kansas City firm Kivett and Myers, on the basis of his research under the Brunner Scholarship. Members of the A.I.A.'s public relations committee include John Root, chairman, Chicago; William Stephen Allen, San Francisco; Karl F. Kamrath, Houston; Harold Sleeper, New York; Harold Spitznagle, Sioux Falls, S. D.; G. Thomas Harmon III, Columbia, S. C.; Leon Chatelain Jr., Washington, D. C.; and the Institute's executive director, Edmund R. Purves.



With the A.I.A.

EDWIN BATEMAN MORRIS JR. has been appointed Director of the Department of Public and Professional Relations of the American Institute of Architects. Mr. Morris comes to the A.I.A. from the Public Health Services' Division of Hospital Facilities, where he was assistant to Marshall Shaffer, chief of the Technical Services Branch. He assumed his new duties at the beginning of this month. The previous incumbent was Harold D. Hauf, who left the Institute to become head of the Department of Architecture at Rensselaer Polytechnic Institute.

1955 Honor Awards

SIMPLIFIED ENTRY REQUIREMENTS are part of the A.I.A.'s 1955 Honor Award Program — judgment will be made on

(Continued on page 16)

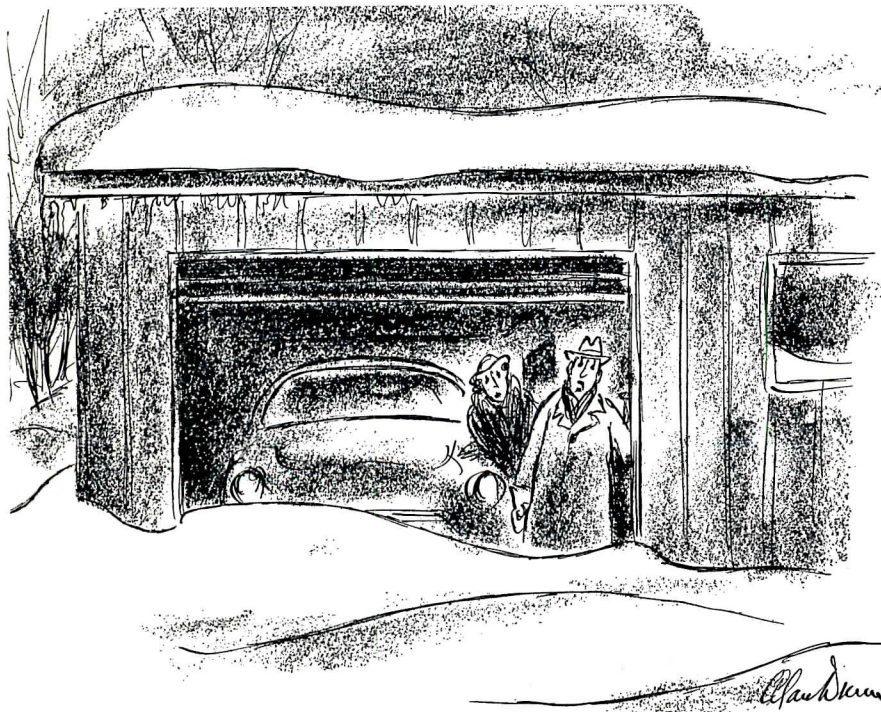

—Drawn for the RECORD by Alan Dunn

"Well, there goes our new electrically-heated driveway! I forgot how whenever it snows the power lines go out."

(Continued from page 15)

photographs and other material fixed in transparent binders, eliminating the requirement for presentation boards for preliminary submissions. This year's program is open to buildings of all classifications completed since January 1, 1950. A \$10 registration fee must be submitted before Feb. 15, 1955, while the deadline for material is April 1. Information is available from the Committee on Honor Awards, The American Institute of Architects, 1735 New York Avenue, N.W., Washington 6, D. C.

and Mrs. Pearson. The A.I.A. hopes to sign up a total of 20 or 30 architects and their wives.

Scholarships and Contests

THE Rotch Travelling Scholarship, open to American citizens who have studied or practiced in Massachusetts, will be awarded this April for the 66th year; information is available from William G. Perry, Secretary, Rotch Travelling Scholarship Committee, 955 Park Square Bldg., Boston 16, Mass. . . . **The Cranbrook Academy of Art**, at Bloomfield Hills, Mich., is offering four scholarships of \$1320 each to architects as well as to other artists and craftsmen; applications are due March 1. . . . Graduate fellowships offered by the **University of Pennsylvania** include the Albert Kahn Memorial Fellowship, \$1100; Ellen L. Matlock Fellowship, \$1200; four Theophilus Parson Chandler Fellowships, each for \$1200; three Graduate Tuition Scholarships, each \$700; the Albert F. Schenck Memorial Traveling Fellowship; and a number of graduate assistantships in the history of art; applications should be addressed to the Dean of the School of Fine Arts at Philadelphia 4. . . . **Princeton University** announces the following architectural scholarships for the academic year 1955-56: Voorhees Walker Foley

and Smith Fellowship, \$2000; Emil Buehrer Foundation Fellowship, \$1500; Lowell M. Palmer Fellowships, each \$1100; Henry N. Young III Scholarship, \$500; D'Amato Prize, \$500; assistantships in instruction and in research, each \$1500; applications should be made before March 1 to the Secretary, School of Architecture, Princeton, N. J. . . .

The Kansas Team (Contd.)

THE SIXTH ANNUAL MEETING of the Kansas Builders Forum, an organization composed of members of the American Institute of Architects, Associated General Contractors, the Master Plumbers Association and the National Electric Contractors Association (ARCHITECTURAL RECORD, September 1954, p. 16), was held in Topeka at the end of September. Delegates to the two-day meeting participated in discussion groups covering various angles of the architect-contractor relationship; each of the component organizations also held its own meeting. Awards for good design and construction were made to six architect-contractor-client teams. Contractor Clarence Vollmer was elected to succeed Charles L. Marshall, A.I.A., in the presidency. Other officers elected were Roy Calvin, A.I.A. — vice president; and P. A. VanEs — treasurer.

(More news on page 20)

TOPPING-OUT CEREMONIES:

Flag-raising for (above) Mid-America Home Office Building, Prudential Insurance Company, Chicago — Naess and Murphy, architects; George A. Fuller Co., builders. Left: tree-raising for Martland Medical Center, Newark, N. J. — Ziegler, Childs & Paulson, architect; Walter Kidde Constructors

Saludos, Amigos

THE 1955 Architects' Trek "Round South America" is scheduled to visit Panama, Peru, Chile, Argentina, Uruguay and Brazil; trekkers will meet their fellow architects in each of these countries. The trip, which will be led by Clyde C. Pearson, regional director of the A.I.A.'s Gulf States District, was arranged, as usual, by the United Travel Agency; the travelers will leave Miami on February 1 and the trek will end a month later at the same place. Already planning to go on the trip: Cecil C. Briggs, Peoria, Ill.; Mr. and Mrs. Kenneth Black, Lansing, Mich.; Mr. and Mrs. J. A. Brennan, Miami Beach, Fla.; N. W. Overstreet, Jackson, Miss.; Mr. and Mrs. Jerome L. Schilling, Miami Shores, Fla.; Mr. and Mrs. Fred B. Dudley, Great Falls, Mont.; Mr. and Mrs. Gerald A. Barry, Chicago; and Mr.

Marking the American Institute of Architects' recent gift of a stained glass window for Chartres Cathedral, the A.I.A.'s Chartres Cathedral committee presented French Ambassador Henri Bonnet with a parchment bearing a tribute from American architects to the builders of the cathedral. Right: A.I.A. president Clair W. Ditchy, Julian Levi, Harold B. Willis, M. Bonnet and Ralph Walker



At the convention of the Structural Engineers of California, left: new officers Charles M. Herd, Sacramento—vice president; G. A. Sedgwick, San Francisco—president; and James L. Stratta, San Francisco—secretary. Right: Lynn Beedle, Assistant Director of the Fritz Laboratory at Lehigh University and Harold King, the retiring president

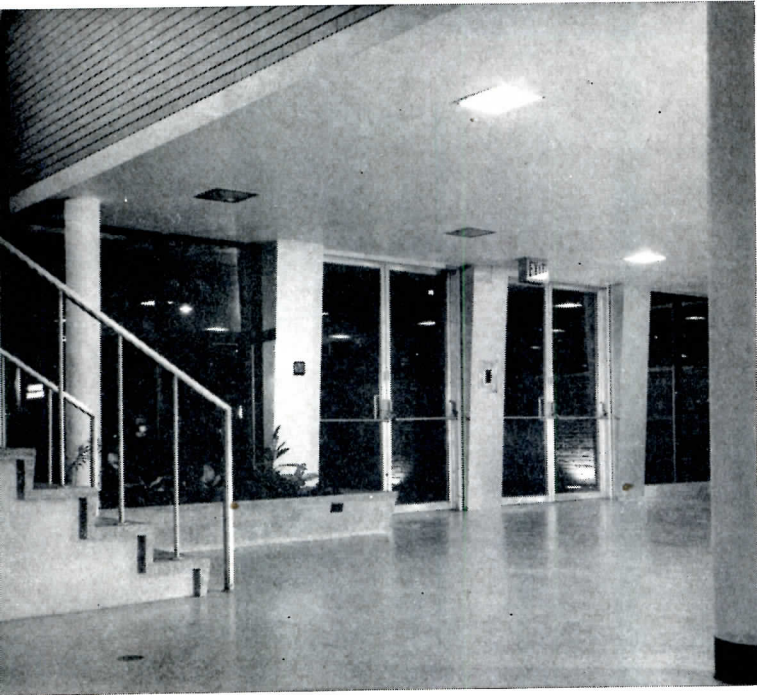

**The startling simplicity of
modern architecture . . .
unmarred by exposed
arms and mechanisms**

Only by the smooth, quiet, automatic door closing action is there any evidence that these doors are equipped with closers. The trim lines . . . especially those of the handsome flush, wood doors . . . are unbroken by any protruding arms or exposed bulky mechanisms.

And there are many functional advantages of firmly installing these closers in the rigid floor. They are out of the way . . . cannot be tampered with, work loose, or gather dust or dirt. RIXSON floor type closers cost no more installed and are simple to adjust and maintain.

There is a size and style of RIXSON closer for every door closing need, from the heaviest entrance door to the light interior room door.

It's the modern trend to . . .

"Conceal the closer and expose the beauty of the door".

specify **RIXSON** throughout

concealed closers

*Entrance doors and all interior room doors.
Vestibule, stairwell, cafeteria, gymnasium, classroom,
toilet and all doors leading from the corridors.*

THE OSCAR C. RIXSON CO.

9100 w. belmont ave. • franklin park, ill.

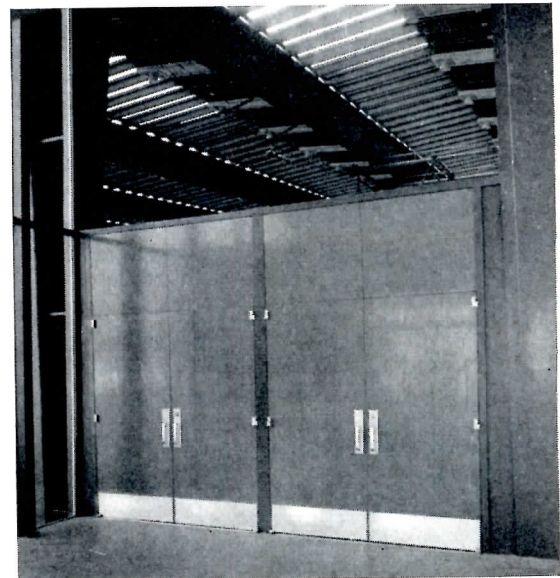
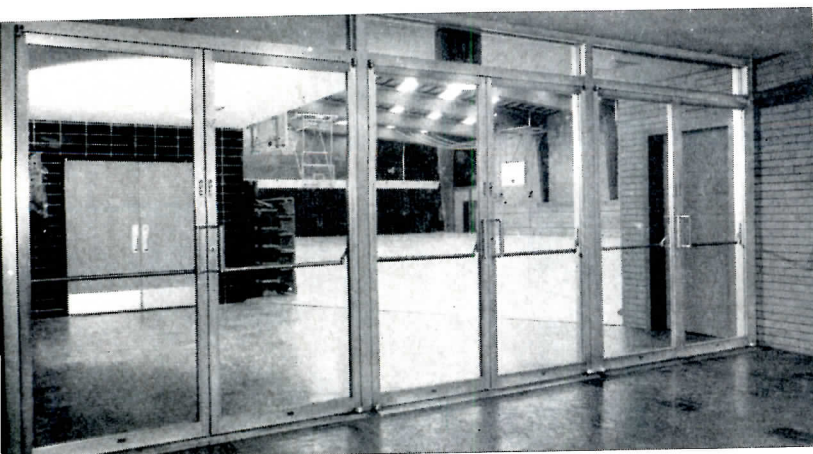

ARCHITECTURAL DESIGN, November 1954. This issue of the British monthly is devoted entirely to the problem of cladding framed buildings. Architect Edward D. Mills, the issue's guest editor, contributes an introduction in which he reviews recent strides made in the utilization of new light materials for cladding. He also discusses new developments in heavier traditional materials. The introduction is followed by a number of case histories covering the use of stone, brick, slate, concrete, ceramics, timber, asbestos and glass. In the next issue of the magazine the uses of aluminum, steel, plastic and glass curtain-wall techniques were to be studied. Right: molded pre-cast concrete blocks are bolted to steel clips hooked on to steel frame; school in Hertfordshire, C. H. Aslin, architect

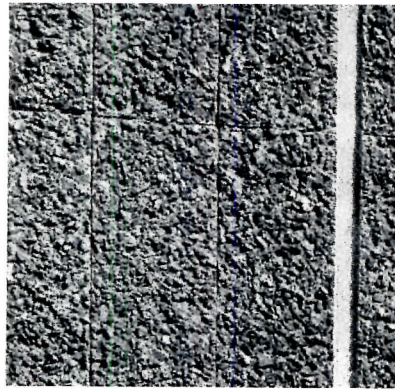
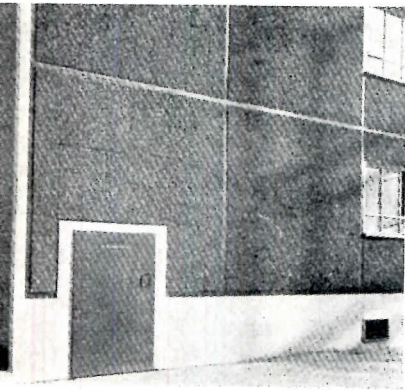
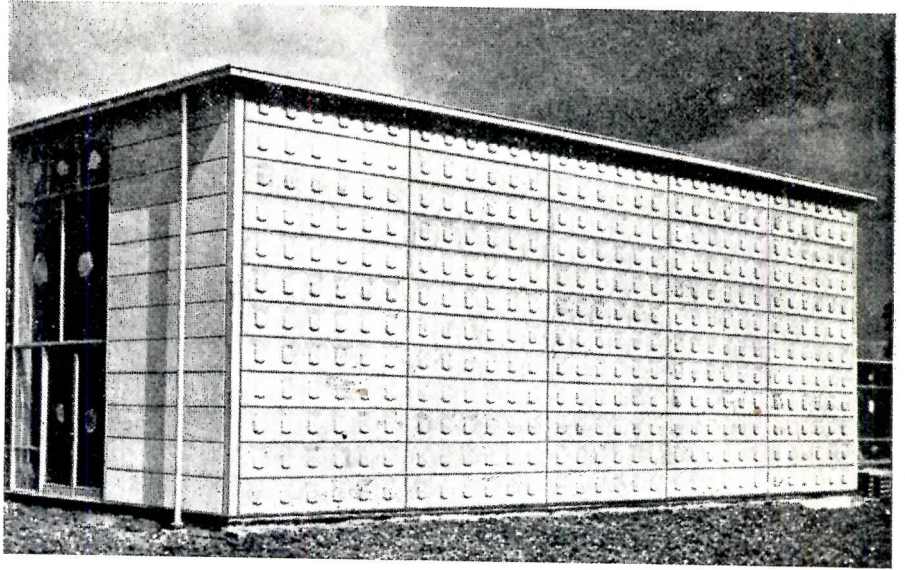

BYGGMÄSTAREN, B2, 1954. Cladding again — this time in a discussion of the finishing of concrete surfaces; the Swedish journal provides an English translation of the article by J. G. Wilson, who suggests that the dull gray appearance of concrete buildings can be avoided by the use of aggregate finishes, which give a variety of possibilities in the way of textures and colors. Other suggestions for varying the pattern of a concrete wall include the use of slabs of different sizes and of patterned slabs. The author also maintains that rough aggregates are more resistant to weathering. Elsewhere in the article he discusses the problems of fastening slabs. Left: photos of British example of the use of aggregate finish; Hening & Chitty, architects

L'ARCHITECTURE FRANÇAISE, Nos. 147-148. For those who like the drama but not the exertion of deepsea diving, French architect J. Ph. Valois has designed a bar to be built under the Mediterranean. A vertical passenger conveyor belt will carry visitors to the air conditioned bar, which can be approached by land or by sea (a small port is planned for sailors). Each of the small port-hole tables will be provided with its own movable spotlight. No mention was made of construction plans

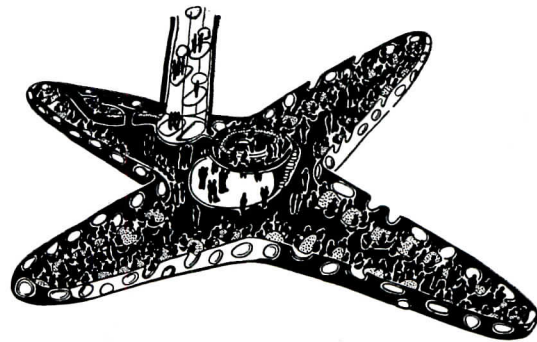

THE INDIAN BUILDER, July 1954 (Special Architecture Number). A review of current trends in Indian architecture is introduced by editor Patwant Singh, who describes India as "reluctant to tear herself away from the powerful influence of architectural tradition, yet beckoned inevitably onwards by the intriguing vistas of contemporary assertiveness." To the "reluctant" architects he says: "India owes its present entity to its revolutionaries. But what it needs today . . . is a revolutionary in the field of architecture." He is encouraged, however, by such buildings as West Bengal's Supplementary Secretariat (left) — H. Rehman, architect, and International Students House, University Enclave, at Delhi (right) — J. M. Benjamin, architect

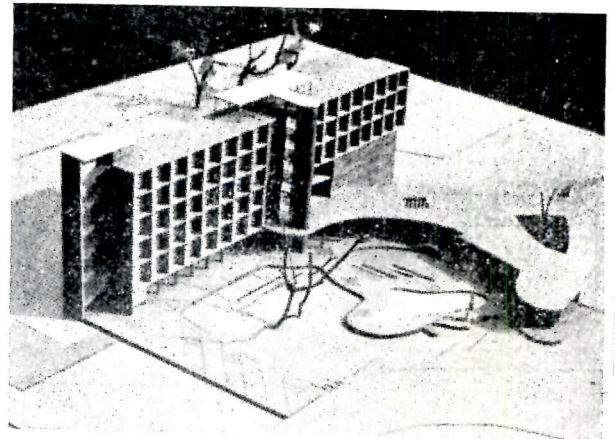



ALDRICH HALL Harvard Graduate School of Business Administration

One of the 17 unique classrooms shown at left seats 158 students; three others seat 80; and 13 accommodate 102 each. The rooms have been arranged to provide an intimate relationship between instructor and student in the give-and-take discussions by the case method generally used throughout the Harvard School of Business Administration.

Below: GORDON McKAY LABORATORY

Interior photo shows two-story room with important features, a high door and removable intermediate floor to permit varying uses. Research in this laboratory is conducted in mechanical engineering, electronics, electrical engineering and the properties of matter.

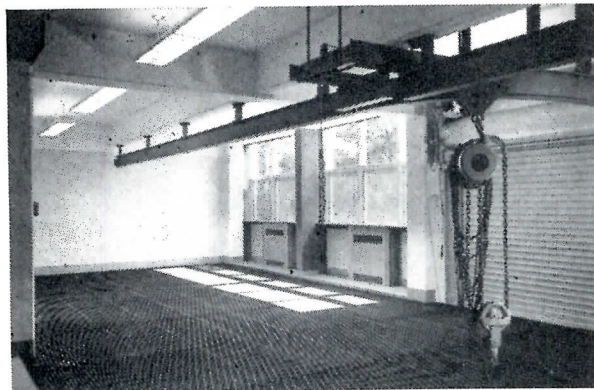
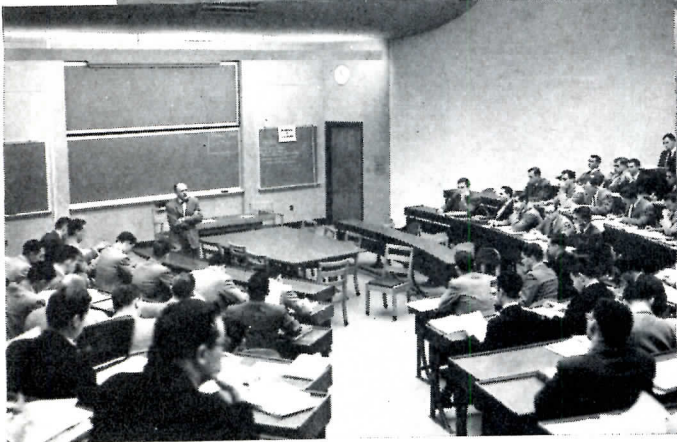

POWERS

AUTOMATIC SYSTEMS OF

Temperature Control

On the Harvard campus are to be found some of America's most beautiful buildings. A few of them which benefit from the maximum thermal comfort and fuel savings assured by POWERS control are illustrated here.

For more than half a century POWERS control has been renowned for its matchless ability to give many years of efficient economical service. Users often report 25 to 50 years of reliable control with a minimum of repairs.

Experience gained here and in thousands of other famous buildings qualifies POWERS to help you select the most economical and efficient temperature control for your buildings. When problems of temperature control arise, call our nearest office or write us direct.

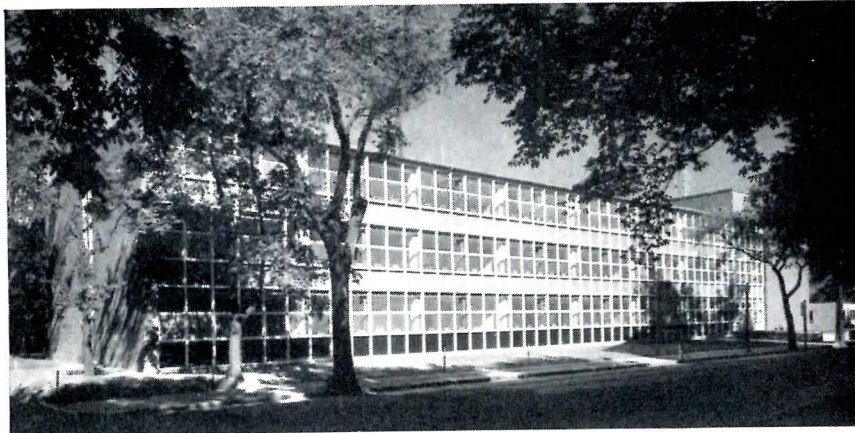

THE POWERS REGULATOR COMPANY

SKOKIE, ILLINOIS | Offices in 60 cities in U. S. A., Canada and Mexico



Over 60 years of Automatic
Temperature and Humidity Control

O P I N I O N

Design freedom, within obvious and necessary economic limits, appears to set the architectural context for the HHFA college housing program (see pages 151-154). The RECORD asked 15 architects who have worked on projects financed under the program for their comments on the relationship between HHFA and the architect; comments of the ten who replied are printed in full below

I have worked with the officials of Housing and Home Finance Agency, Fort Worth, Texas, for the past two years. Our relations with this branch have been most pleasant. The freedom for design and construction under this branch has been most refreshing. I can only say that other branches of our Federal government need to take a lesson from the HHFA in giving more freedom to the architect or engineer.

— Kenneth Easterwood
Waco, Tex.

It has been a pleasure to work with the HHFA on this project. They have been extremely cooperative in expediting the necessary approvals and gave the architects and the college practically complete freedom of design within the financial limitations established. It has thus been possible to develop a solution suitable to local problems and conditions and to achieve a contemporary building compatible with the surrounding traditional college architecture.

— John Merrill Jr.
Belluschi and Skidmore,
Owings & Merrill, Architects
Portland, Ore.

From an architect's standpoint our relationship with this agency was in all respects most satisfactory. We were given complete latitude to develop plans which were tailored to suit the needs of our client. The HHFA was most cooperative and did not in any way dictate the policy of planning or choice of materials. The Housing and Home Finance Agency accepted our preliminary plans for these dormitory units when first submitted to them as a development which had been especially created to satisfy the needs of a particular college in a particular geographical area. They

at no time questioned the planning or the selection of materials.

The offices of the HHFA were consulted during the early stages of planning and their first suggestion to this office was that we concern ourselves with the primary fact that their program was based on economy and the careful consideration of not only good basic materials but the cautious use of square foot areas. It was our feeling from the inception of the project that square foot area per student must be carefully considered in order to arrive at a solution acceptable to both client and agency.

Our earlier school dormitory work proved that the use of sturdy indestructible materials, although not always the cheapest, was the best investment when maintenance is to be considered. Therefore, concrete and masonry walls, with paint applied direct, were selected over plastered stud walls which tend to have a high casualty rate in college dormitory buildings. All this basic thinking was favorably looked upon by the HHFA and no major changes in either basic specifications or plans were proposed by the agency.

The HHFA cooperated most enthusiastically in all respects and from an Architect's point of view working with the agency of the Federal Government has been a most happy experience. The cooperation which they gave this office during all phases of both planning and construction would make most architects' hearts glow with new enthusiasm. I say this because I commenced this program with the firm conviction that I was to be hogtied and hobbled at every stroke of the pencil and every clause of the specification.

This was not the case in any respect. Instead of red tape and ultimatums we received encouragement and helpful consideration. The final results speak

for themselves. The owners have the kind of buildings that best fit their requirements and it has been publicly stated that the HHFA is pleased with the final results. The architect is happy — what more can one wish.

— Kingsford Jones
Menlo Park, Cal.

It was indeed pleasant to work with the various members of the staff of the Housing and Home Finance Agency. Their technical knowledge together with their sympathetic understanding of the architect's problem enables them to give assistance far beyond that which could be normally expected. The freedom of design which they permitted and their recognition of existing and local conditions eliminated the necessity of producing a stereotyped stock plan defined by minimum standards. We have at Tufts a structure that truly reflects the desires of the college authorities.

— Arland A. Dirlam
Boston, Mass.

In matters of design HHFA has been very cooperative and in no sense have they been dictatorial about the design of the building. They gave me to understand, and I believe they were sincere, that their interest simply lay in seeing that their mortgage was well secured by a building which would last the term of the mortgage, that the project be financially sound and that no money be wasted in "plush items." They have adhered to this policy completely and have been very cooperative. My relationship with them has been most pleasant, and their local representative, Mr. Sandquist, has been very fine to work with.

— James M. Hunter
Boulder, Colo.

We concur in your impression that HHFA has allowed us the greatest freedom in developing the plans. The Philadelphia Regional Office was most cooperative in guiding us through the few Federal requirements. We were allowed to design the buildings to conform in plan and elevations to existing buildings on the campus. The contract documents were reviewed promptly, and, as timing was of great importance, the contractor was allowed to proceed at once with the work. Field inspection by the HHFA was prompt and directives were few. The financial procedures were also held to a minimum. Documentation was reasonably simple and funds

(Continued on page 246)

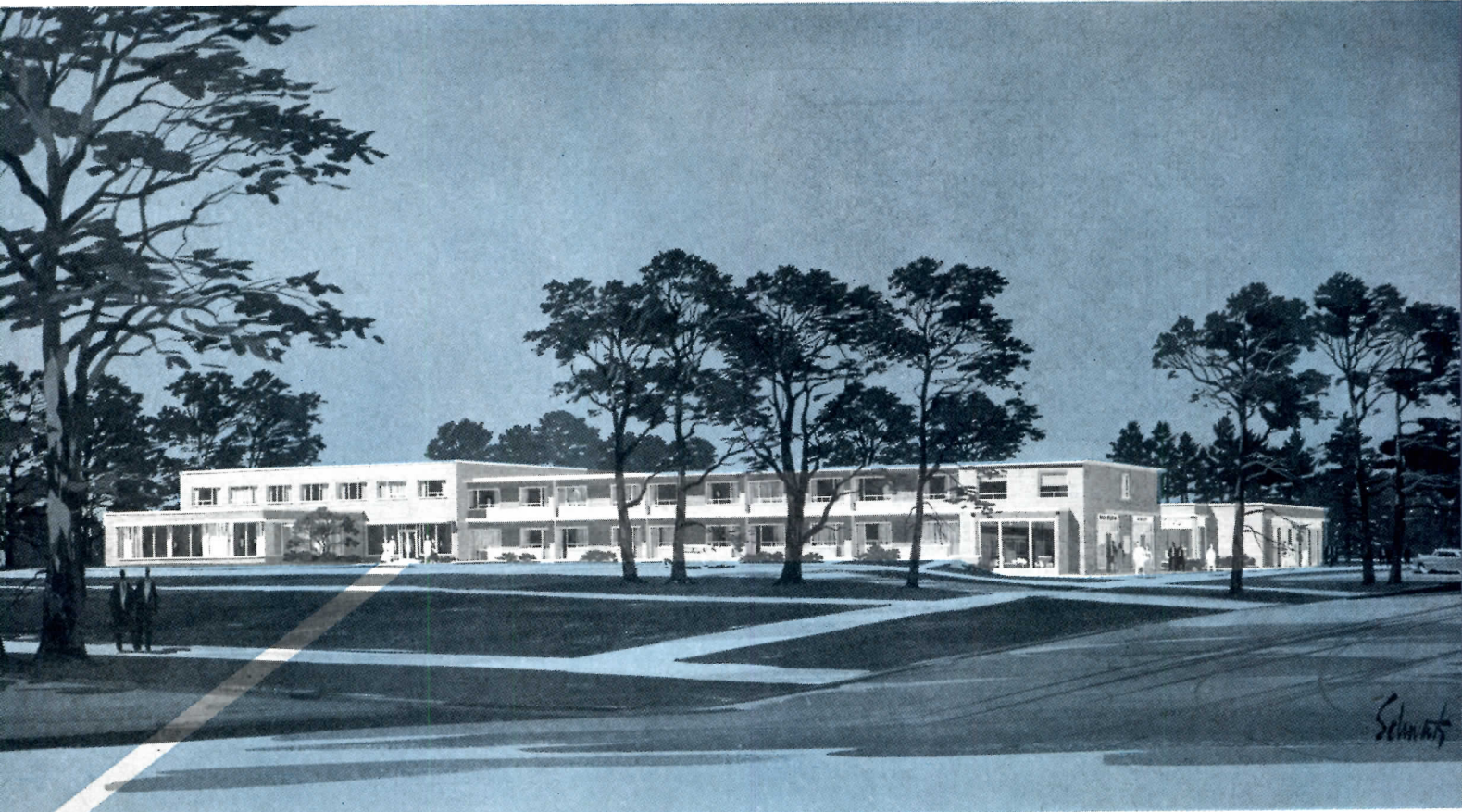

Inviting entrances by *Amarlite*

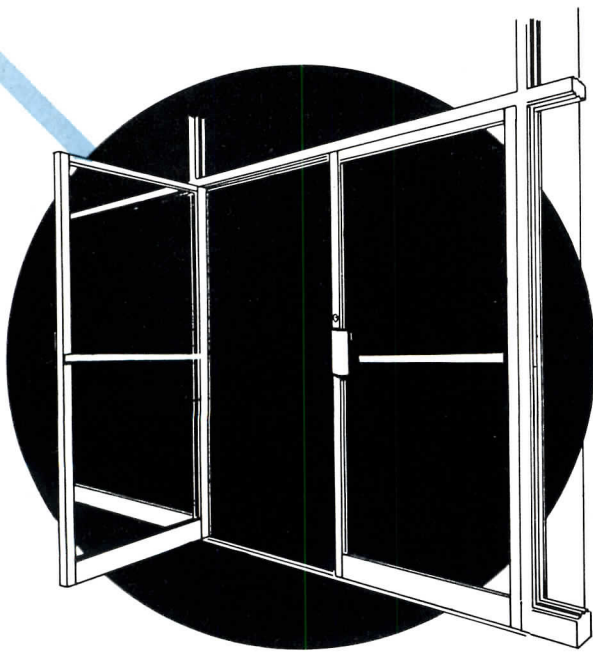

These smart (yet unobtrusive) aluminum doors are the logical choice in more and more new buildings—public, industrial, commercial. Amarlite Entrances are specified by architects because of these six points of leadership:

- 1 Quality — (always)
- 2 Strength plus rigidity
- 3 Finish — (incomparable)
- 4 Development of new features
- 5 Distribution for prompt service
- 6 Consistent price policy.



For full information on Amarlite Aluminum Entrances, ask a glass dealer or write for your copy of the 1955 Amarlite Catalog.

American Art Metals Company,
433 Bishop Street, N.W.
Atlanta, Georgia

AMARLITE®

aluminum entrances |

• ATLANTA, GEORGIA • BROOKFIELD, ILLINOIS
• DALLAS, TEXAS • ENGLEWOOD, NEW JERSEY

NEWS FROM CANADA *By John Caulfield Smith*

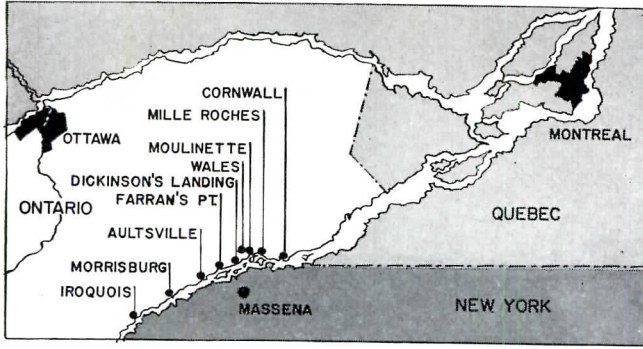

At left: the area to be affected by the St. Lawrence power development, showing the towns involved in Hydro's plan. Below: a detail of the International Rapids Section of the river as it will look after inundation, showing locations of the projected new towns and of the power construction planned by Ontario Hydro and the New York State Power Authority

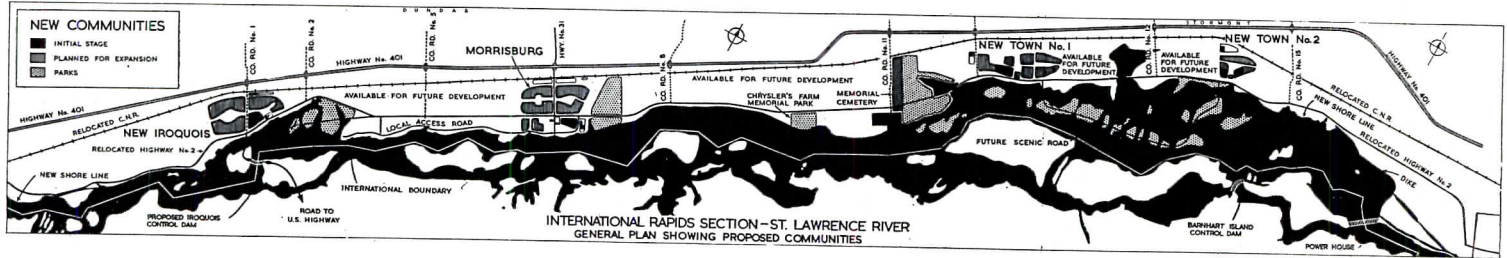

ST. LAWRENCE POWER PROJECT PRODUCES THREE NEW TOWNS

WHEN THE BANKS OF THE ST. LAWRENCE are flooded, three years hence, as a result of power construction in the International Rapids section of the river, residents of the eight towns to be inundated will already have moved into the new towns planned by the Hydro-Electric Power Commission of Ontario, Canadian agent for the international power project; the American agent is the New York State Power Authority. Some 18,000 acres on the Ontario side — a 39-mile strip between Cornwall and Cardinal — will be flooded.

Hydro's general plan for the area, as conceived by H. D. Rothwell, liaison engineer for Hydro, and Kent Barker, professor of architecture at the University of Toronto serving as consultant to Hydro, calls for three entirely new towns and part of another: two new towns incorporating several villages which will be flooded, a new site for the town of Iroquois and a subdivision to replace about one-third of Morrisburg, which will be only partially flooded.

The regional plan, which Hydro says is "only a suggested pattern for land use," is set out in two phases — the immediate replacement of the affected towns and the possible future expansion of the area.

New Town No. 1 will incorporate the villages of Aultsville (pop. 350), Far-

ran's Point (pop. 350), Dickinson's Landing (pop. 200) and Wales (pop. 150); it can expand if necessary to a population of 7000. New Town No. 2 will replace Moulinette (pop. 300) and Mille Roches (pop. 1100), with an expansion limit of 3000. Iroquois, a town of 1100, will be moved to a site north of its present location, and could eventually handle a population of 10,000. A 100-acre subdivision is planned for Morrisburg, which now has 1800 people and could grow to 12,000.

For the time being, about 95 per cent of the land involved will be left in agricultural use.

Industry's place in the plan is provided in a limited amount of space in each community and in larger areas tentatively set aside for large-scale industrial development outside the towns — a 6000-acre tract between Morrisburg and Aultsville has been mentioned for this purpose. The planners have also taken into account the region's potentialities as a tourist attraction and have selected, again tentatively, sites for natural parks and recreational areas.

Originally, plans for housing under the rehabilitation program called for the construction of "hundreds" of new homes, and architectural designs had been proposed by Hydro. These would have been financed by the owners after

compensation payments had been made. Subsequent surveys among the home owners, however, have indicated a rather widespread preference for bodily relocation of the houses, and Hydro accordingly is considering moving these houses wherever possible or desired.

The power construction planned by the St. Lawrence project which will principally affect this area will consist of a control dam near Iroquois Point, a dam in Long Sault Rapids at the head of Barnhart Island and two powerhouses, one on either side of the international boundary, at the foot of Barnhart Island, as well as dikes and navigation canals.

Hydro and Human Relations

Hydro's policy in planning for persons displaced by the power project has been one of continual consultation with the towns' planning boards or similar groups. Although there has been some disagreement over compensation arrangements, the only objection to Hydro's town planning scheme came from Iroquois, which had chosen a different site at the suggestion of its own consultant, British town planner Dr. Wells Coates. The argument, though prolonged, was quickly resolved when the Caldwell Linen Mills, Iroquois's only industry, accepted Hydro's site; the town followed suit.

(Continued on page 30)



• John Bennett
H. L. McMURRY & CO.
Caribbean Rep.



• Geo. F. Bertrand
GEO. F. BERTRAND CO.
Philadelphia, Pa.



• J. M. Bird
GENERAL
EQUIPMENT LTD.
Vancouver, B. C., Canada



• Eugene Bolstad
EUGENE BOLSTAD LTD.
Edmonton, Alberta, Can.



• E. B. Boston
AIR PRODUCTS
EQUIPMENT CO.
Chicago, Illinois



• J. H. Christman
THE THERMAL
PRODUCTS CO.
Akron 2, Ohio



• S. S. Colle
AIR CONDITIONING
ENG. CO.
Montreal, Quebec, Canada



• John A. Cooper
FLINN ENGINEERING CO.
Little Rock, Ark.



• D. J. Crawley
CRAWLEY GORBANDT CO.
Atlanta, Ga.



• E. H. Crawley
CRAWLEY GORBANDT CO.
Atlanta, Ga.



• George S. Flinn
FLINN ENGINEERING CO.
Memphis, Tenn.



• F. R. Foote
F. R. FOOTE CO., INC.
Albany, N. Y.



• R. A. Frey
FREY EQUIPMENT CO.
Dayton 2, Ohio



• J. L. Frisse
THE THERMAL
PRODUCTS CO.
Cleveland, Ohio



• R. N. Gates
D. E. McCULLY CO.
Omaha, Neb.



• I. M. Golan
I. M. GOLAN COMPANY
Fort Worth, Texas



• E. T. Gorbandt
CRAWLEY GORBANDT CO.
Atlanta, Ga.



• Harry E. Gray
GRAY EQUIPMENT
SALES CO.
Toledo, Ohio



• John B. Hewett
JOHN B. HEWETT CO.
New York 17, N. Y.



• R. B. Hudson
AIR PRODUCTS
EQUIPMENT CO.
Chicago, Ill.



• Jim Hutsinpler
R. E. CHASE & CO.
Spokane, Washington



• J. G. Johns
J. G. JOHNS & CO.
Ablene, Texas



• H. Dewey Jones
H. DEWEY JONES CO.
Columbus, Ohio



• Margaret Lancaster
LANCASTER, MAY & CO.
Baltimore 18, Md.



• John J. Landers
LANDERS
ENGINEERING CO.
Buffalo, N. Y.



• W. L. Lashley
W. L. LASHLEY & ASSOC.
Houston, Texas



• L. F. Luchner
L. F. LUCHNER CO.
Boston, Mass.



• N. H. Malcolm
AIR PURIFICATION CO.
Denver, Colorado



• C. E. Malone
C. E. MALONE CO.
St. Louis, Mo.



• Robert E. Mason
ROBERT E. MASON & CO.
Charlotte, N. C.



• Clarence L. May
LANCASTER, MAY & CO.
Baltimore, Md.



• H. L. McMurry
H. L. McMURRY & CO.
Jacksonville, Fla.



• Walter B. Moses, Jr.
ENGINEERING SALES CO.
New Orleans, La.



• George Q. McNamara
GEO. Q. McNAMARA CO.
Detroit, Mich.



• D. C. Murphy
D. C. MURPHY CO.
Des Moines, Iowa



• W. R. Ousley
H. L. McMURRY & CO.
Miami 2, Fla.



• Frank S. Ozanne
R. E. CHASE & CO.
Seattle 1, Washington



• Gus Pailet
ENGINEERING SALES CO.
Baton Rouge, La.



• Ben Paller
PALLER
ENGINEERING CO.
Indianapolis, Ind.



• George Richardson
THERMAL
ENGINEERING CO.
Boise, Idaho



• A. Q. Roberts
I. M. GOLAN CO.
Dallas, Texas



• R. E. Sanford
SANFORD MECHANICAL
EQUIPMENT CO.
Oakland, Calif.



• R. A. Sansing, Jr.
S. C. BRATTON SALES
ENGINEERS LTD.
Birmingham, Ala.



• J. W. Snyder
SNYDER EQUIPMENT CO.
Cincinnati, Ohio



• R. E. Stallings
PALLER
ENGINEERING CO.
Fort Wayne, Ind.



• James R. Teed
COOLING & HEATING
ENGINEERS
Los Angeles, Calif.



• Hobart Teneff
R. E. CHASE & CO.
Spokane, Washington



• Laurence Trant
LAURENCE TRANT & CO.
Norfolk, Va.



• Vernon Tupper
VERNON S. TUPPER CO.
Nashville, Tenn.



• H. F. Warren
R. E. CHASE CO.
Tacoma, Washington



• S. S. Webb
HEAT TRANSFER
EQUIPMENT CO.
Oklahoma City, Okla.



• Charles D. White
LANCASTER, MAY & CO.
Washington, D. C.



• J. M. McWilliams
ARTHUR R. LEITCH CO.
LTD.
Toronto, Ont., Canada



• W. G. Woolley
R. E. CHASE & CO.
Portland, Ore.



• L. W. Worthington
L. W. WORTHINGTON CO.
Billings, Mont.



• R. F. Zimmerman
R. F. ZIMMERMAN & CO.
Shreveport, La.

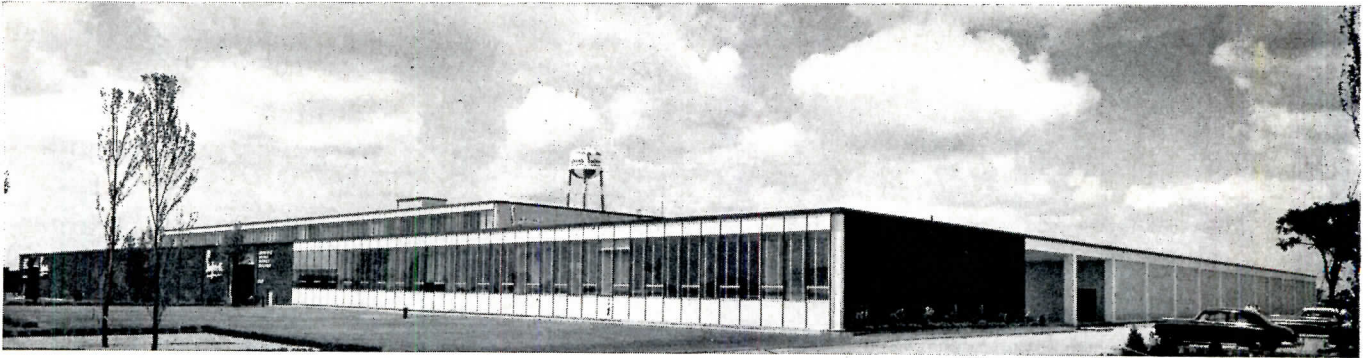

Warehouse for Robert Simpson Co. Ltd., Toronto, was designed by Toronto firm John B. Parkin Associates

Beauty
that outlasts the building

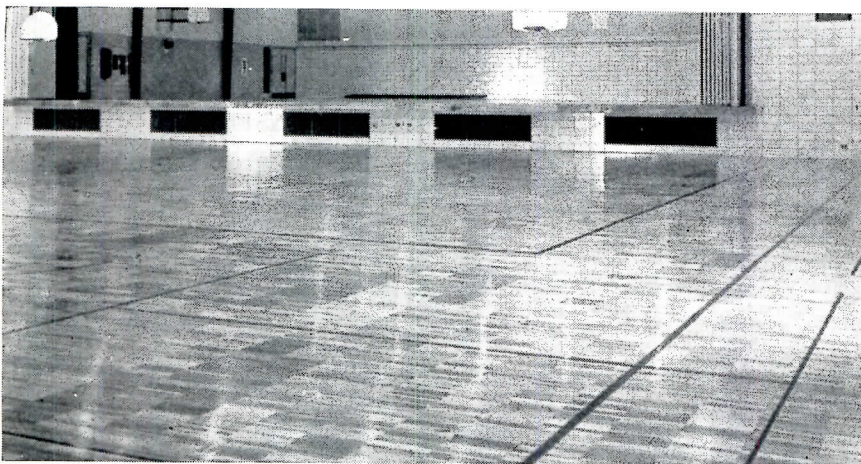

Gymnasium, Alexander Ramsey Senior High School, St. Paul, Minn. Arch.: Magney, Tusler & Setter, Minneapolis. Installed by: Chas. H. Anderson Floors, Inc., Minneapolis.

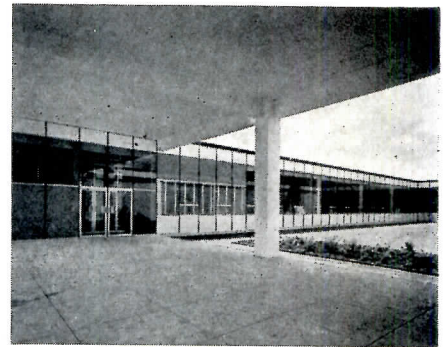

**ARCHITECTS, ENGINEERS
DRAW HIGHEST EARNINGS**

Architects and engineers were Canada's top income group in 1952, according to the latest tax statistics released by the Department of National Revenue. The architect-engineer average income of \$12,266 was not only the highest of any group, but was the highest any group had ever recorded.

Doctors and surgeons, the second highest group, reported an average income of \$10,522, while lawyers, who led the field in 1951, were third in 1952 with \$9,222. In the last five recorded years, architects and engineers have topped the list three times; the lawyers led twice.

**FLOOD CONTROL REPORT
PROMPTED BY HURRICANE**

Prompted by the disastrous effects on Toronto of last October's Hurricane Hazel, which cost the unprepared city 73 lives and \$25 million in damages, Prime Minister Louis St. Laurent appointed engineer J. B. Carswell and investment banker D. Bruce Shaw to a special investigating commission to suggest flood control measures for the area.

(Continued on page 32)

**... ROBBINS IRONBOUND* CONTINUOUS STRIP*
MAPLE FLOORING**

You're looking at a gymnasium floor designed to "take it"! Uniformly resilient, tight grained and splinter resistant, it will still be smoothly beautiful for generations to come.

To achieve this happy combination of beauty and long run economy Robbins uses finest strips of Northern Maple, laid in mastic and interlocked with saw-tooth steel splines at the end of each strip. That's why a Robbins IRONBOUND CONTINUOUS STRIP floor stays tight and smooth so many times longer.

If you are planning a school job you can find information and general specifications on Robbins Ironbound Continuous Strip floors in Sweet's File 19 E-92, or better still, write Robbins Flooring Company, Reed City, Michigan, for name of your nearest Robbins Ironbound contractor.



ROBBINS FLOORING COMPANY

WORLD'S LARGEST MAPLE FLOORING MANUFACTURER

*T.M. Reg. U.S. Pat. Off.

Reed City, Michigan

Ishpeming, Michigan

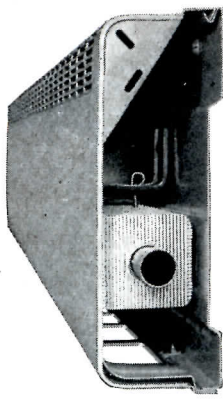

IN the Institutional Picture . . .

Nesbitt Sill-line Radiation demonstrates its effectiveness in the new Hospital Pavilion of Jefferson Medical College

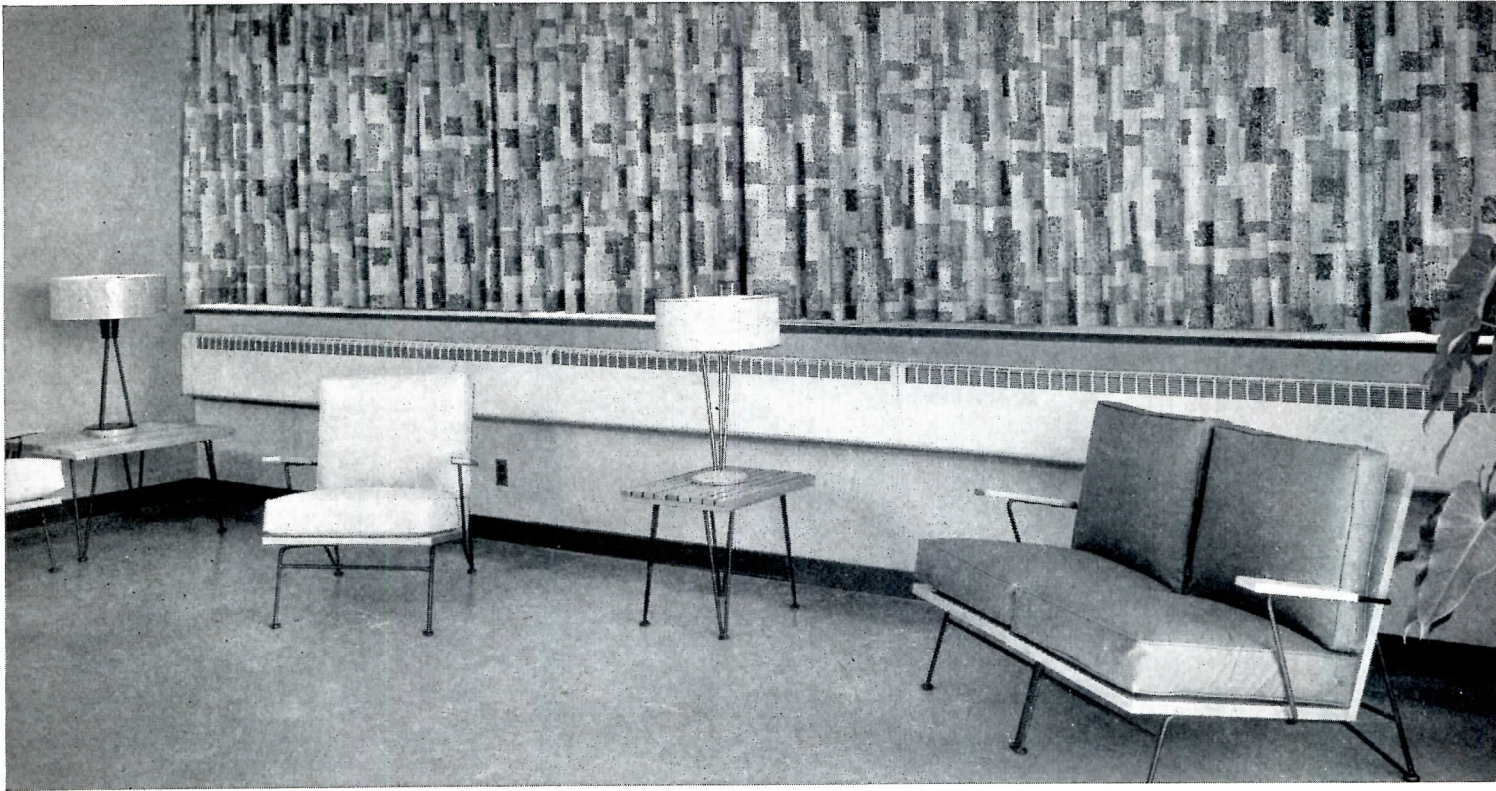

THE rapid development of modern institutional design calls for a conformable means of heating. Nesbitt provides this most acceptably in *Sill-line*, a perimeter type of high capacity fin-and-tube radiation housed in a beautiful casing that enhances the appearance of any modern interior.

In addition to its radiant heat, *Sill-line* provides a curtain of convected warm air along cold walls and windows, overcoming downdraft and giving the uniform comfort so desired in today's offices, classrooms, and hospitals.

Constructed for permanence and ingeniously designed for quick and easy installation without cutting, Nesbitt *Sill-line* is ideally suited to modern building production.

Sill-line sections are immediately available in protective cartons: four cabinet sizes; seven standard lengths; heating capacities from 700 to 2675 Btu per lineal foot; and all needed accessories. It may be used with any hot water or steam system. Write for Publication 102.

Nesbitt

SILL-LINE RADIATION

Made and sold by John J. Nesbitt, Inc., Philadelphia 36, Pa.

Vincent G. Kling, *Architect*
A. E. D'Ambly, *Engineer*
W. M. Anderson Co.,
Heating Contractor

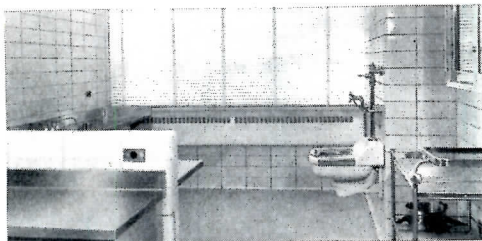

Sill-line conforms in a utility room (above)

Its functional beauty graces a semi-private room (right)



CANADA

(Continued from page 30)

The Carswell-Shaw report blames the extent of the disaster on public laxity, which permitted building in dangerous river-bank areas, and calls for a \$5 million program to prevent a repeat performance.



Recently completed in Calgary, Alta.: a new office and warehouse for the Lennox Furnace Co. (Canada) Ltd., designed by architects Rule, Wynn & Rule of Calgary and Edmonton

Simplicity... the keynote of MODERN design

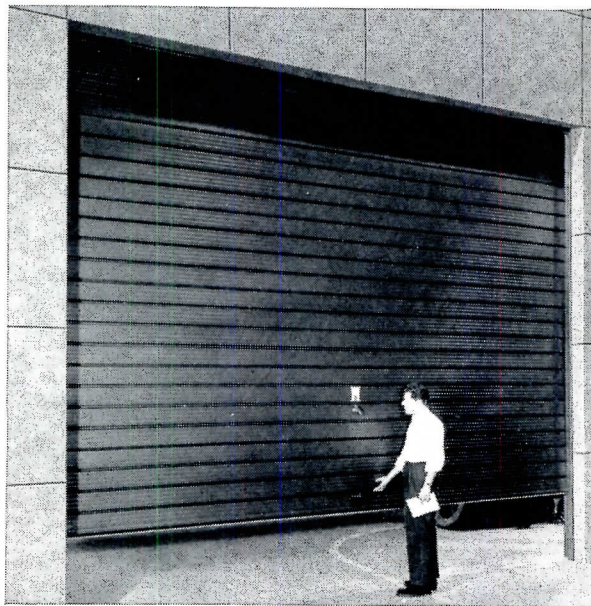

MORRISON

Roly-Door steel sectional doors

RESIDENTIAL • COMMERCIAL • INDUSTRIAL

CLEAN, MODERN FUNCTIONAL SIMPLICITY that blends with all types of architecture is the hallmark of Morrison Roly-Doors.

SIMPLIFIED DESIGN ensures safe, easy, trouble-free installation and operation... manual, electrical and by remote control.

BONDERIZED, ALL-STEEL, WELDED CONSTRUCTION provides lasting good looks and a durability that defies the weather and years of hard use.

ECONOMICAL INSTALLED COST made possible by sound engineering and modern, precise, mass production... Roly-Doors cost

no more than ordinary wood or metal doors for the same purpose.

OVER 100 STANDARD SIZES ready for immediate delivery and facilities to produce special sizes to individual specifications provide a Roly-Door for every overhead door requirement.

NATIONWIDE SALES AND SERVICE... prompt delivery and expert installation service are offered by Roly-Door Distributors and Dealer-Installers located in the principal cities of the U.S. and Canada. They are listed in classified telephone directories.

Complete Roly-Door Specifications are available in Sweet's Architectural File or from:

Roly-Door Division

MORRISON STEEL PRODUCTS, INC.

651 Amherst Street, Buffalo 7, New York

Also manufacturers of MOR-SUN WARM AIR FURNACES and MORRISON SERVICE BODIES
In Canada, Roly-Door Distributors, Ltd., 1330 Bloor Street W., Toronto 4, Ont.



Major recommendations of the commission include: the expropriation of land lying below flood level and the prohibition of further building in these areas; the removal to higher ground of houses already standing in some of these areas; the conversion of grounds below flood level into protective green belts; raising and widening a 17-mile dyke surrounding Holland Marsh; and cleaning and straightening the bed of the Humber River.

OPTIMISTIC OUTLOOK HELD FOR HOUSING THIS YEAR

A high volume of housing construction in 1955, at least for the first half of the year, was predicted by Gordon S. Shipp, president of the National House Builders Association, in a recent speech at Hamilton, Ont. A comparison of the number of housing starts in the first nine months of 1953 and of 1954 indicates, he reported, a carryover of 65,000 uncompleted units into 1955, in contrast to the 59,967 carried into 1954.

As for the last half of 1955, Mr. Shipp wasn't sure. On the optimistic side, he noted the continuing high birth rate, the need of many families for larger quarters, and the more generous financing offered by the revised National Housing Act. On the pessimistic side, he observed that the rate of family formation shows signs of slackening, that immigration and employment prospects have dropped slightly, and that increasing availability of rental accommodations may retard house sales in some areas. All in all, however, Mr. Shipp concluded that Canada's high level of house production would continue in 1955.

(Continued on page 36)

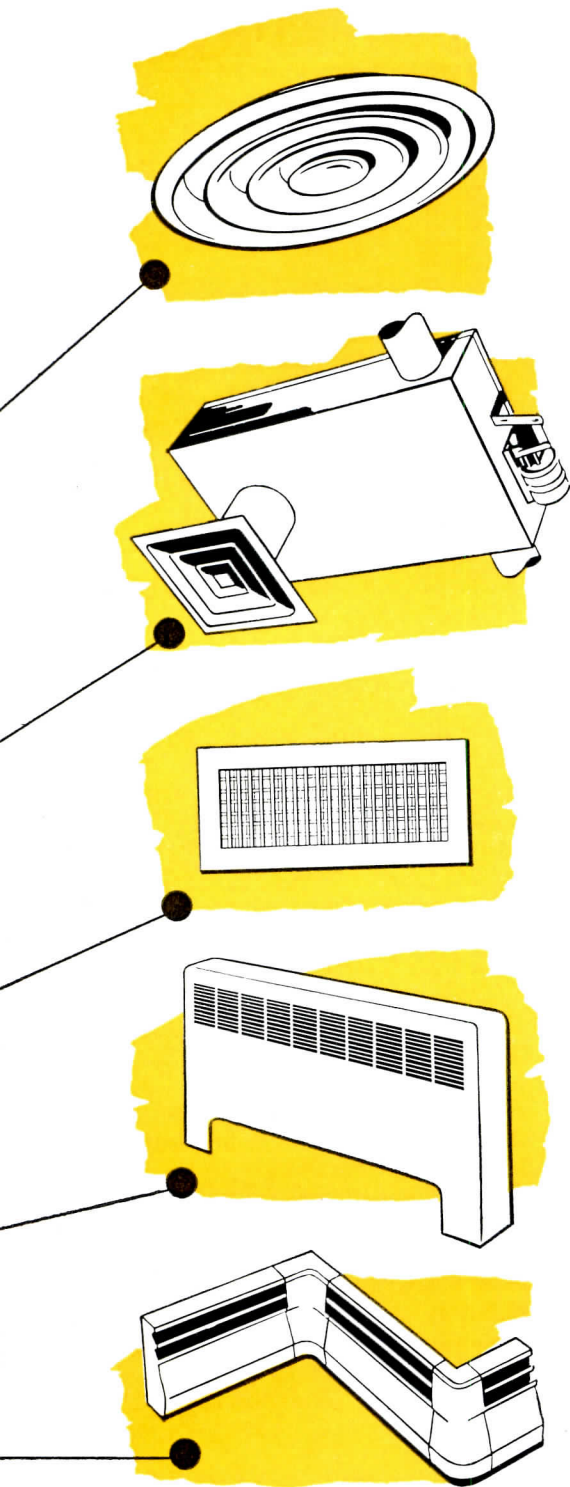

Aerofuse Ceiling Diffusers are available in a wide selection of types and sizes, styled and engineered to meet the most rigid requirements of appearance and performance at the point of air delivery.

T & B High Pressure Diffuser Units are the result of many years of laboratory experiment and practical experience in the field. Units now in operation handle branch duct velocities up to 4000 FPM, discharge air without noise or drafts.

Tri-Flex Supply Air Grilles and Registers . . . Aerovane Return Air Grilles and Registers. Standard sizes for economy and prompt delivery. Individually adjustable face bars. Registers equipped with opposed blade dampers.

T & B Convectors are widely used in homes and apartments. Two types are available . . . Type R for recessed installation . . . Type F for free standing installation. Styled for beauty, engineered for comfort.

T & B Baseboard combines the heating comfort and smart appearance essential in the modern home. Two types . . . recessed . . . free standing . . . both designed for ease of installation.

See the
TUTTLE & BAILEY
 EXHIBIT
 ASHVE Show, Booth 31

TUTTLE & BAILEY inc

NEW BRITAIN, CONNECTICUT

There is no "or equal" for

FERALUN

ABRASIVE TREADS

Here's ★
the proof of
FERALUN
superiority



★ Here is an unretouched photograph of a *Feralun* tread taken after acid treatment. (Paint is removed and acid is used to eat away the metal base so as to isolate the actual abrasive content of the tread.) Note the full and even distribution of abrasive—for greater safety, longer wear.

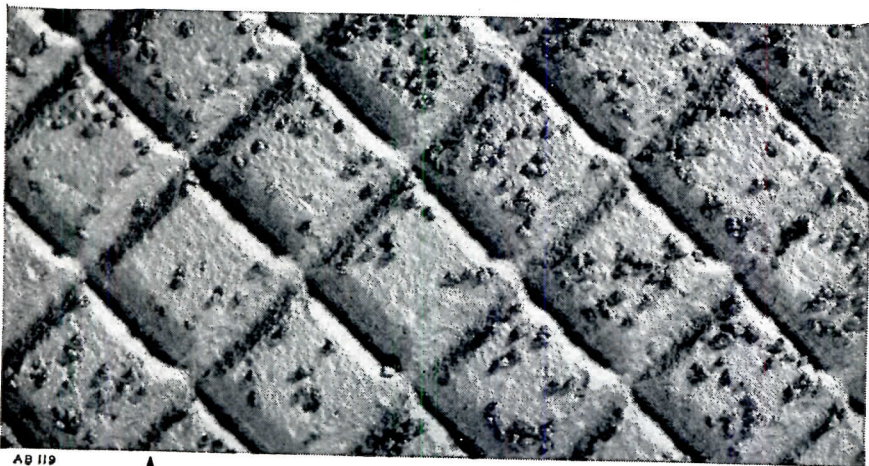

★ Here is an unretouched photograph of an abrasive tread, purchased on the open market of the type often offered as an equal of *Feralun*, after the identical acid test. Note the meager amount of abrasive and spotty distribution.

The life and non-slip effectiveness of any abrasive tread is approximately proportional to the amount of abrasive embedded in the surface. *Feralun* has provided lasting safety—free from maintenance—for the past 35 years.

Feralun is available as treads, thresholds, floor plates and elevator sills. Also in Bronzalun, Alumalun and Nicalun. See Sweet's Catalog 1954—12b/Am.

AMERICAN ABRASIVE METALS CO. • IRVINGTON II, N. J.

THE RECORD REPORTS

CANADA

(Continued from page 32)

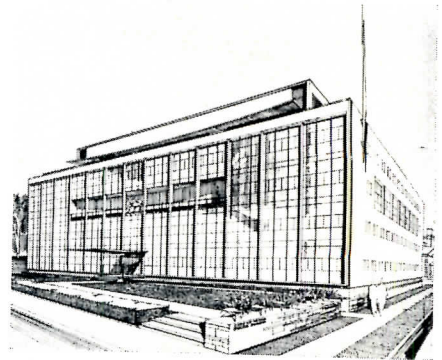

COMPETITION HELD FOR OTTAWA POLICE BUILDING

First place in the recent architectural competition held by Ottawa to select a design for its new Police Building went to Peter Dickinson, A.R.I.B.A., M.R.A.I.C., who was awarded the commission for the building. Mr. Dickinson is a partner in the Toronto firm of Page & Steele, which will serve as associate architects for the building, shown in the rendering above.

Runners-up in the competition, which attracted 37 entries, were Hart Massey and Leo Dirassar, Ottawa, who were awarded \$500; Guy Desbarats and Ray Affleck, Montreal, \$300; and Fred Lelensold, Montreal, \$200.

Members of the Board of Assessors were Magistrate Glenn E. Strike, Q.C., chairman of the Board of Commissioners of Police; Watson Balharrie, Ottawa architect; and C. Maxwell Taylor, the city's building inspector and supervising architect.

(More news on page 38)

Contracts Awarded: Comparative Figures Compiled by MacLean Building Reports (in \$ million)

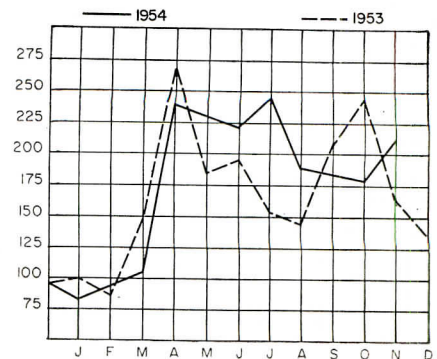

Q ...*WHAT* is the Foremost Institutional Project in America?

A The Multi-Billion-\$ EDUCATIONAL BUILDING PROGRAM

Q ...*WHO* are Recognized Authorities on Educational Lighting?

A Unquestionably, the HOLOPHANE ENGINEERING STAFF

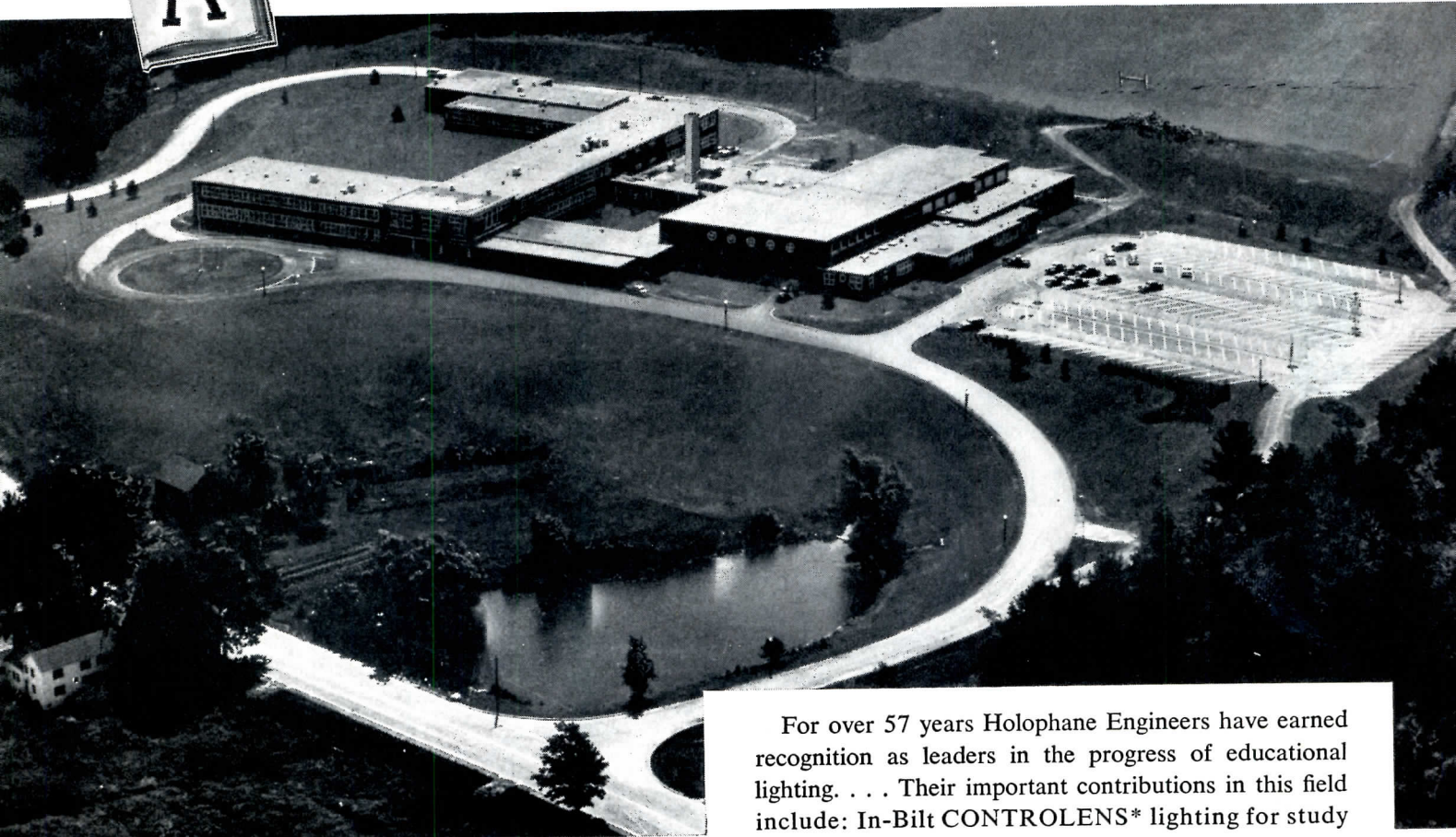

Regional Educational Center, Holden, Mass.

For over 57 years Holophane Engineers have earned recognition as leaders in the progress of educational lighting. . . . Their important contributions in this field include: In-Bilt CONTROLENS* lighting for study rooms, assembly halls and blackboards; HIBAY*, LOBAY* and REFRACTOLENS* lighting for recreational areas, and many other major developments.

Today, with this unique experience and specialized skills, Holophane is finding new and better ways to meet the lighting needs of expanding educational facilities—in colleges, as well as secondary schools.

Architects, engineers and educational administrators are invited to call in Holophane Engineers—at headquarters or in the field—for consultation without obligation.

Write for "Guide to Lighting Educational Institutions"

HOLOPHANE COMPANY, INC.

Lighting Authorities Since 1898 • 342 MADISON AVENUE, NEW YORK 17, N.Y.
THE HOLOPHANE COMPANY, LTD., THE QUEENSWAY, TORONTO 14, ONTARIO

*For Better Lighting
Be Specific . . .*

H LOPHANE



**PANEL NAMED TO REVIEW
PBS PLANNING STANDARDS**

TWO ARCHITECTS AND THREE ENGINEERS have been named by the Public Buildings Service of the General Services Administration to an eight-man advisory committee set up to review PBS planning standards. The committee's recommendations could result in significant revisions of the technical handbooks

supplied by PBS to architects and engineers engaged in Federal building construction.

Earl H. Lundin of New York and George M. Ewing of Philadelphia are the architects on the panel; engineers are Albert L. Baum, Rage Pearson and Archie N. Erickson, all of New York. Other panel members: N. J. Pescatore, New York, and John J. McDermott, Washington, D. C., contractors; and —

as a representative of building management — Earle Schultz of Chicago, former president of the National Association of Building Owners and Managers. W. E. ("Bert") Reynolds, who retired last year after many years as Commissioner of Public Buildings, is serving as consultant.

The committee is expected to submit its recommendations "by the middle of March" — which should mean they will be in hand before the first batch of projects under the government's new lease-purchase program actually gets under way.

PBS Commissioner Peter Strobel has outlined the purposes of the review as follows:

"Essentially, we are taking a long, hard look at our standards. We are getting set, by searching for whatever improvements prove necessary, to meet the pressing needs of the future with economical and efficient construction practices.

"In view of the 15-year ebb in construction of Federal buildings, the government obviously has both worn out and grown out of its clothes. The everyday business of government has created a huge backlog of building needs awaiting the time when large-scale costs will not unduly burden the Federal budget.

"Meanwhile, we are planning limited construction under the new lease-purchase authority to satisfy most urgent requirements. With the competent advice of private industry, we will be able to keep down the cost of our lease-purchase program. Moreover, it will give us the chance to test our improved standards for the larger needs of the future.

Dignity — and Function

"Present practices base the architecture of public buildings on simplicity and dignity. Cornices, elaborate mouldings, and other embellishments have been eliminated in general from Federal architecture largely because they add to construction and maintenance costs. The end product is building designs which are adapted to functions. This basic principle involves policies regarding overall design as well as standards and details employed in carrying out these policies. The consulting group will review both."

The effort is assisted by L. L. Hunter, supervising architect of PBS, and its chief estimator, C. G. Palmer, who act as liaison with GSA.

(Continued on page 250)

"If theyda specified Monoxivent we wouldn't be havin' this kinda trouble!"



IT PAYS TO *Specify* KENT-MOORE
MONOXIVENT
EXHAUST ELIMINATING FIXTURES

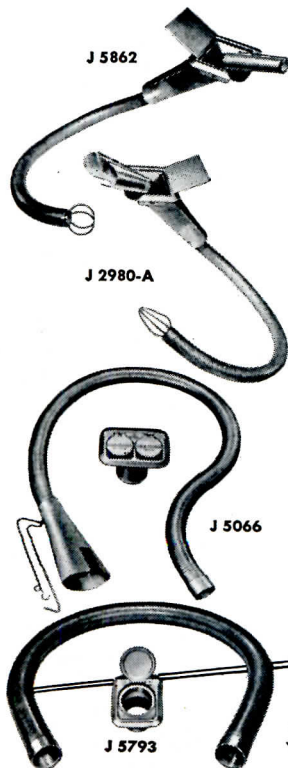

Nothing matches modern Monoxivent Fixtures for effectively ridding service departments and garages of carbon monoxide fumes! In fact, Monoxivents offer all the advantages "most wanted" in exhaust eliminating systems . . . installation economy, operating efficiency, long, trouble-free life . . . and no unsightly hoses hanging from overhead, either! Models available to meet your every requirement, too. Want the convenience of underfloor hose storage, for example? Two Monoxivent Sets offer this outstanding feature . . . J 2980-A and the new J 5862 "Twinstallation" model that services both single and dual exhaust cars! Looking for economy? Then you can't beat the low-cost J 5066. Or, if trucks are to be serviced, there's the J 5793 . . . a special new fixture designed to service all trucks!

What's more, as the pioneer in the exhaust eliminating field, Kent-Moore offers you FREE technical engineering services to assure proper installation and efficient operation of every Monoxivent fixture. See your nearby Kent-Moore jobber, or write direct for complete information today!

KENT-MOORE ORGANIZATION, INC.

Engineers and Manufacturers of
Special Automotive Service Tools and Equipment
5-105 General Motors Bldg. • Detroit 2, Mich.

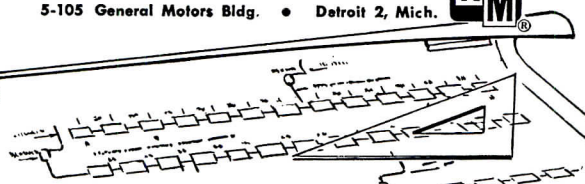

CRANE CRANE CRANE
 CRANE CRANE CRANE
 CRANE CRANE CRANE

WHEN YOU
 MAKE UP YOUR
 MIND TO REMODEL

CRANE

**When you're in the market
 for a new house**

Look in the bathrooms for the answer to these questions:

"How well built is this house?"

"What will it be worth 10 years from now?"

Because—the bathrooms are where a house first shows its age. If the name on the fixtures is Crane, you have design that is advanced today and modern tomorrow—thanks to famed designer, Henry Dreyfuss.

So Crane bathrooms are more than the most desired in beauty and good taste. They are "value insurance" that will help keep your new home looking new longer.

Ask your Crane Plumbing and Heating Dealer about the wide selection of fixtures in the Crane line.

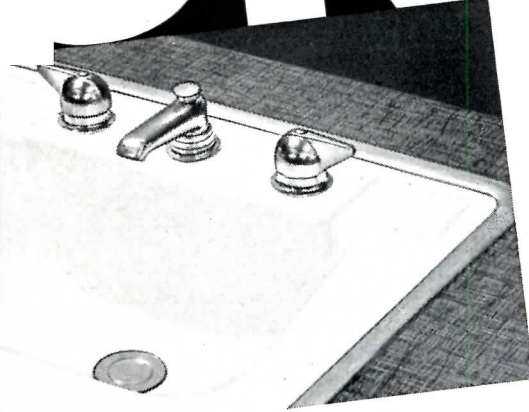

COUNTERTOP. READY TO INSTALL. PRICES START AT \$39.45 (Suggested Consumer Price)

"CRITERION" LAVATORY EITHER FITS INTO COUNTERTOP OR STANDS ALONE. READY TO INSTALL. PRICES START AT \$104.90 (Suggested Consumer Price)

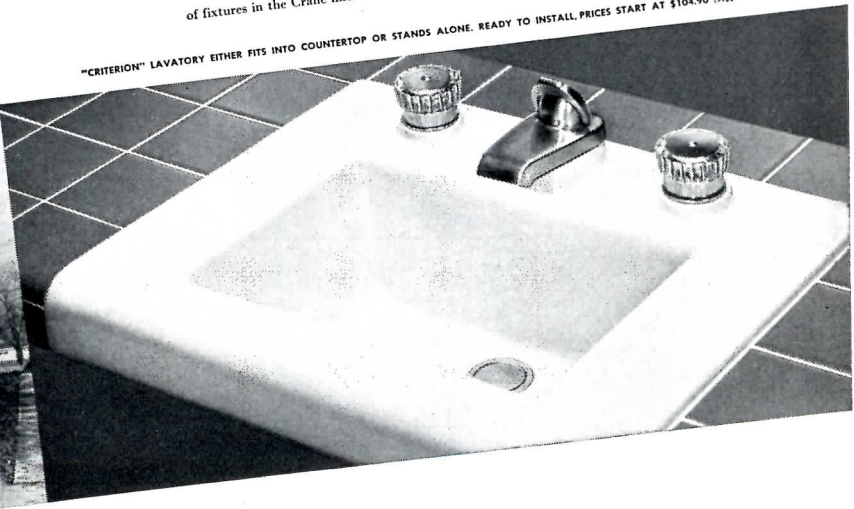

Crane's Centennial Advertising Campaign in Life Magazine is one of the largest in plumbing history. More than 65,000,000 people will read about Crane in 1955.

**CRANE STARTS
 ITS SECOND CENTURY
 OF QUALITY
 Founded July 4, 1855**

CONSTRUCTION COST INDEXES

Labor and Materials

U. S. average 1926-1929 = 100

Presented by Clyde Shute, manager, Statistical and Research Division, F. W. Dodge Corp., from data compiled by E. H. Boeckh & Assocs., Inc.

NEW YORK

ATLANTA

Period	Residential		Apts., Hotels Office Bldgs. Brick and Concr.	Commercial and Factory Bldgs. Brick and Concr.		Residential		Apts., Hotels Office Bldgs. Brick and Concr.	Commercial and Factory Bldgs. Brick and Concr.	
	Brick	Frame		Brick and Steel	Brick	Frame	Brick		Frame	
1930	127.0	126.7	124.1	128.0	123.6	82.1	80.9	84.5	86.1	83.6
1935	93.8	91.3	104.7	108.5	105.5	72.3	67.9	84.0	87.1	85.1
1939	123.5	122.4	130.7	133.4	130.1	86.3	83.1	95.1	97.4	94.7
1940	126.3	125.1	132.2	135.1	131.4	91.0	89.0	96.9	98.5	97.5
1946	181.8	182.4	177.2	179.0	174.8	148.1	149.2	136.8	136.4	135.1
1947	219.3	222.0	207.6	207.5	203.8	180.4	184.0	158.1	157.1	158.0
1948	250.1	251.6	239.4	242.2	235.6	199.2	202.5	178.8	178.8	178.8
1949	243.7	240.8	242.8	246.4	240.0	189.3	189.9	180.6	180.8	177.5
1950	256.2	254.5	249.5	251.5	248.0	194.3	196.2	185.4	183.7	185.0
1951	273.2	271.3	263.7	265.2	262.2	212.8	214.6	204.2	202.8	205.0
1952	278.2	274.8	271.9	274.9	271.8	218.8	221.0	212.8	210.1	214.3
1953	281.3	277.2	281.0	286.0	282.0	223.3	224.6	221.3	221.8	223.0
Aug. 1954	285.4	278.0	294.1	302.3	296.7	219.3	218.5	224.1	226.1	226.5
Sept. 1954	285.4	278.0	294.1	302.3	296.7	219.7	218.9	224.6	226.5	226.9
Oct. 1954	285.4	278.0	294.1	302.3	296.7	220.2	219.7	225.0	226.6	227.1
Oct. 1954	% increase over 1939			% increase over 1939		% increase over 1939			% increase over 1939	
Oct. 1954	131.0	127.1	125.0	126.6	128.0	155.1	164.3	136.5	132.6	139.8

ST. LOUIS

SAN FRANCISCO

1930	108.9	108.3	112.4	115.3	111.3	90.8	86.8	100.4	104.9	100.4
1935	95.1	90.1	104.1	108.3	105.4	89.5	84.5	96.4	103.7	99.7
1939	110.2	107.0	118.7	119.8	119.0	105.6	99.3	117.4	121.9	116.5
1940	112.6	110.1	119.3	120.3	119.4	106.4	101.2	116.3	120.1	115.5
1946	167.1	167.4	159.1	161.1	158.1	159.7	157.5	157.9	159.3	160.0
1947	202.4	203.8	183.9	184.2	184.0	193.1	191.6	183.7	186.8	186.9
1948	227.9	231.2	207.7	210.0	208.1	218.9	216.6	208.3	214.7	211.1
1949	221.4	220.7	212.8	215.7	213.6	213.0	207.1	214.0	219.8	216.1
1950	232.8	230.7	221.9	225.3	222.8	227.0	223.1	222.4	224.5	222.6
1951	252.0	248.3	238.5	240.9	239.0	245.2	240.4	239.6	243.1	243.1
1952	259.1	253.2	249.7	255.0	249.6	250.2	245.0	245.6	248.7	249.6
1953	263.4	256.4	259.0	267.6	259.2	255.2	257.2	256.6	261.6	259.7
Aug. 1954	265.5	258.8	265.1	274.9	268.2	259.9	251.7	266.4	275.7	269.5
Sept. 1954	265.5	258.8	265.1	274.9	268.2	259.9	251.7	266.7	275.9	270.1
Oct. 1954	265.5	258.8	265.1	274.9	268.2	260.6	252.6	266.8	276.0	270.3
Oct. 1954	% increase over 1939			% increase over 1939		% increase over 1939			% increase over 1939	
Oct. 1954	140.9	141.8	123.3	129.4	125.3	146.7	154.3	127.2	126.4	132.0

The index numbers shown are for combined material and labor costs. The indexes for each separate type of construction relate to the United States average for 1926-29 for that particular type — considered 100.

Cost comparisons, as percentage differences for any particular type of construction, are possible between localities, or periods of time within the same city, by dividing the difference between the two index numbers by one of them; i.e.:

index for city A = 110
index for city B = 95
(both indexes must be for the same type of construction).

Then: costs in A are approximately 16 per cent higher than in B.

$$\frac{110-95}{95} = 0.158$$

Conversely: costs in B are approximately 14 per cent lower than in A.

$$\frac{110-95}{110} = 0.136$$

Cost comparisons cannot be made between different types of construction because the index numbers for each type relate to a different U. S. average for 1926-29.

Material prices and wage rates used in the current indexes make no allowance for payments in excess of published list prices, thus indexes reflect minimum costs and not necessarily actual costs.

These index numbers will appear regularly on this page.



**"UNI-FLO"
ENGINEERED**

Air Distribution

**... modern, versatile
... for better jobs**

What happens when conditioned air enters a room marks the difference between success and failure of a complete job. If there are drafts, uneven distribution, or noisy operation at point of room entry, the entire system is condemned. On the other hand, if air is delivered efficiently, unobtrusively, quietly, the whole job is lauded. The one way to write an insurance policy on satisfaction with each job is to specify the finest available air distribution equipment. Then you know you will get the best possible results from the entire system, free from troublesome and costly service calls. At the same time, you assure yourself of proved designs which are easier to install, harmonize beautifully with modern surroundings, last a lifetime. In the Uni-Flo line you get all these advantages, plus many exclusive developments. Choose from this wide selection:

<p>GRILLES, REGISTERS—available with a wide variety of frame styles and core designs to meet all wall and door installation requirements. Wide selection of finishes.</p>	<p>CEILING DIFFUSERS—Venturi-Flo units provide adjustable air patterns in a complete range of sizes. Minimize ceiling smudge. Available with integral lighting.</p>	<p>SQUARE, RECTANGULAR DIFFUSERS—to match acoustical ceiling designs. Adjustable air patterns . . . exclusive with Uni-Flo. Surface or recessed types. Minimize ceiling smudge.</p>
<p>HIGH VELOCITY UNITS—control units and air valves reduce high velocity, high pressure air to conventional flow. Available with sidewall or ceiling diffusers and to supply air to branch ducts.</p>	<p>UNI-FLO ACCESSORIES—unique Uni-Flo developments for more efficient handling of air in ducts, grilles, registers, diffusers. Assure even air distribution, easier system balance.</p>	<p>LINE-O-FLO CEILING DIFFUSERS—provide uniform air distribution over entire length of linear units. Supplied with or without integral fluorescent lighting fixtures.</p>

BLAZING THE TRAIL TO BETTER AIR DISTRIBUTION

When Barber-Colman entered the air distribution field, almost twenty years ago, we found meager and incomplete selection data. Up to then, rule-of-thumb methods were in common use. "Guesstimating" was accepted practice in determining sizes and proportions of the opening; the grille in most cases was added merely for decorative purposes.

In our research laboratory, every possible condition of air distribution was simulated. Results were tabulated and compiled into usable application data bulletins. Today, this time-proved information is used by architects, engineers, and contractors to determine

exact requirements for each application.

From our research laboratory, too, come such outstanding "firsts" as opposed-blade volume control and air flow balancing devices; air turning equipment; adjustable ceiling outlets; high velocity air valves . . . to mention only a few.

Today, Barber-Colman's certified data is available to you from our nearby Field Office. Phone or write us for information on any type of air distribution device, or for engineering help. Specify Barber-Colman and *be sure!*

BARBER-COLMAN COMPANY, Dept. M, 1104 Rock Street., ROCKFORD, ILLINOIS

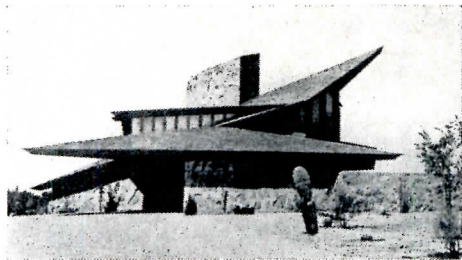

FLIW TELLS HOW TO BUILD YOUR OWN

The Natural House. By Frank Lloyd Wright. Horizon Press (New York, N. Y.) 1954. 223 pp, illus. \$6.50

By EMERSON GOBLE

In this book the master turns his ingenuity to the small house, the economical house. Wright calls it the Usonian Automatic; a newspaper reporter calls it the U-Drive-it house. The book, incidentally, is timed to coincide with the opening by Wright of a New York office for the purpose of pushing his pour-it-yourself scheme.

Along with the ingenuity the author dispenses the expected quantity of pronouncements, naturally the same pronouncements long familiar to avid Wright readers (like me). Much of the material is, in fact, taken from earlier writings. There are, however, new portions, particularly those presenting the Usonian Automatic.

More importantly, the book presents a number of houses, some not previously published, and all carefully chosen to show how the talents are used in the low-cost house. Houses are shown in plan and photograph, and captioned with cost and date.

One of them is the Jacobs House, prototype for the Usonian, built in Madison, Wis., in 1937, for \$5,500 including architects fee of \$450. This, incidentally, is the first house to have Wright's "gravity" heat, the system commonly known today as "radiant" heating. Wright objects, you know, to its being called radiant — "it was simply gravity heat — heat coming up from beneath as naturally heat rises." He tells an interesting story of how he came upon the principle in Japan, when he was entertained in a "Korean" room, which had tile ducts under the floor through which heat from an outside fire was circulated.

In a rambling, Wrightian way the book follows a topical outline, covering the elements of house planning in small individual pronouncements — roof, basement ("a noisome, gaseous damp place"), attic ("never plan waste space"), orientation, sunlight, space, — pretty much right through the usual list. A list of his own inventions in the house field would be

long. Even the typical Wright outburst on furnishings and decorating. He is frank about chairs — "all my life my legs have been banged up somewhere by the chairs I have designed. But we are accomplishing it now. Someday it will be well done."

The organic theme runs through the book, the integral ornament — "imagination giving natural pattern to structure itself." But the book doesn't devote much space to the tilting at favorite enemies; there are only casual slaps at "the machine for living" or the "boxment." There are some jabs at "the expedient houses built by the million, which journals propagate, and government builds. . . . To me such houses are stupid makeshifts, putting on some style or other, really having no integrity. Style *is* important. A style is not. There is all the difference when we work *with* style and not for a style."

Perhaps what is most admirable about Wright in his books is his stout affirmation of architecture. This makes you forget his dramatics, forgive his arrogance. Very few sell architecture like he does.

One of several diagrams showing how the "Usonian Automatic" is built

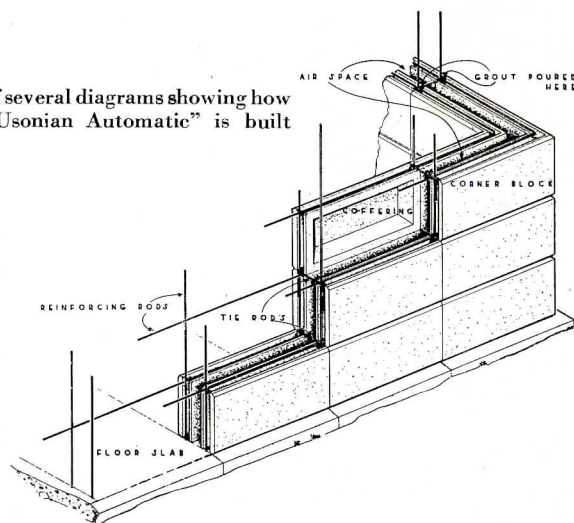

THE WORK OF ALVAR AALTO

Finnish Architecture and Alvar Aalto. By Ed. and Cl. Neuen-schwander. Frederick A. Praeger (105 W. 40th St., New York, N. Y.) 1954. 192 pp, illus.

A series of historical and cultural sketches by Kaarlo Olsonen, Paul Bernoulli and the Neuen-schwanders about the origins of Finnish architecture along with examples of outstanding buildings done by various architects, prefaces the main part of this instructive book. The primary concern is with the presentation of the great works and projects completed by Alvar Aalto from 1950 to 1952 as well as numerous of his

earlier buildings. With a brief text (the commentary is in English, French and German) and through many excellent photographs, sketches and plans the authors have shown how Aalto's creative power has put its imprint on the Finnish landscape and Finnish living.

"Water and rocks, boats, the huts of the fishermen, the daily means of getting food and preparing it are a constant emotional stimulus to the imagination."

This ever-present stimulus is shown to provide basic in-

Continued on page 288
More books on page 48

Rolling Steel Doors

Manually, Mechanically, or Electrically Operated

Here is another shipping dock application in which no other type of door could meet the operating space requirements. In three openings, 38'-0" x 14'-0", at the entrance to an enclosed subterranean shipping dock located off a vehicular tunnel under "Northland"—Hudson's fabulous new shopping center in Detroit's northwest section—three Mahon Power Operated Rolling Steel Doors provide the quick, timesaving operation, the permanence, the firesafety, the security, and the space conservation demanded in this unusual motor freight handling facility. The quick, vertical roll-up action of rolling steel doors occupies no usable space either inside or outside the opening—floor space is usable to within a few inches of the door curtain on either side . . . and, there are no overhead tracks or other obstructions to interfere with crane handling adjacent to the door opening. The permanent all-metal construction of rolling steel doors means less maintenance, provides greater protection against intrusion and fire, and assures you a lifetime of trouble-free service with convenient local or remote electrical control stations. When you select a rolling steel door, check specifications carefully . . . you will find in Mahon Rolling Steel Doors some exclusive and very desirable features in operating mechanisms, bearings, and other parts and materials which add up to a greater over-all value. See Sweet's Files for complete information, or write for Mahon Catalog No. G-55.

T H E R . C . M A H O N C O M P A N Y

Detroit 34, Michigan • Chicago 4, Illinois • Representatives in all Principal Cities
Manufacturers of Rolling Steel Doors, Grilles, and Automatic Closing Underwriters' Labeled Rolling Steel Fire Doors and Fire Shutters; Insulated Metal Walls and Wall Panels; Steel Deck for Roofs, Partitions, and Permanent Concrete Floor Forms.

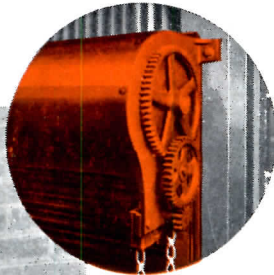

MAHON
CHAIN-GEAR
OPERATOR

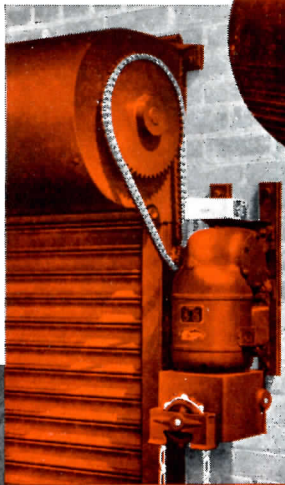

MAHON STANDARD
POWER OPERATOR 920-P

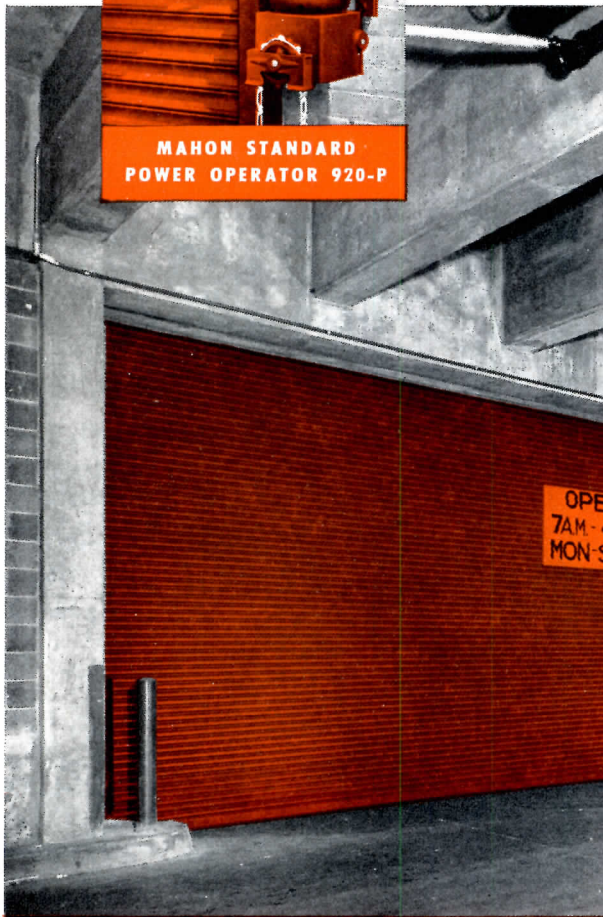

ROLLING STEEL DOORS, SHUTTERS AND GRILLES TO MEET EVERY REQUIREMENT

Three Mahon Power Operated Rolling Steel Doors, 38'-0" x 14'-0", at the entrance to an enclosed subterranean shipping dock off a vehicular tunnel under "Northland"—The J. L. Hudson Company's new shopping center, Detroit. Victor Gruen & Associates, Architects. Bryant & Detwiler, General Contractors.

MAHON

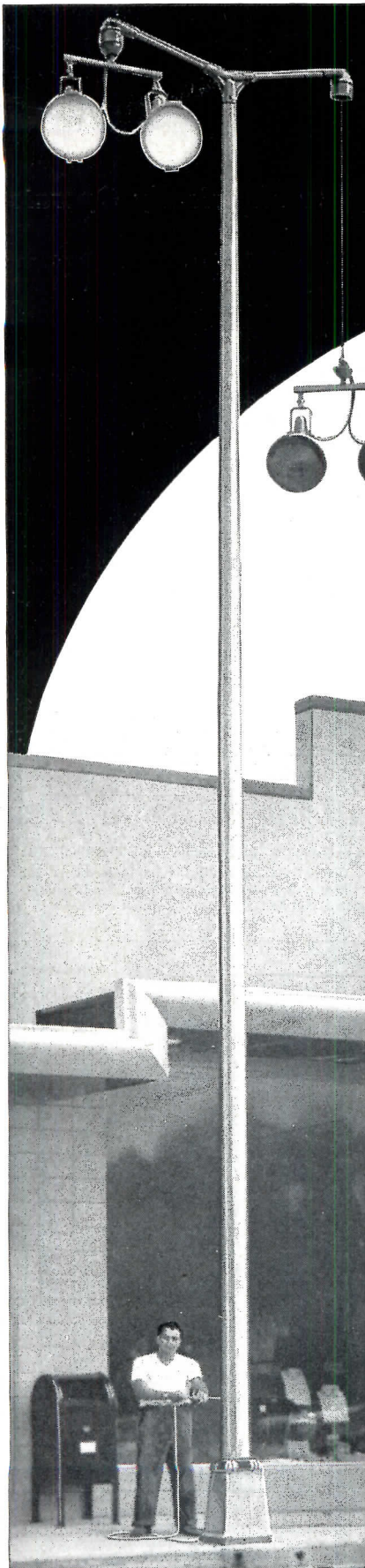

THE FACTS OF LIGHT

and THOMPSON *Servisafe* POLE UNITS

FACT NO. 1: ONLY "SERVISAFE" UNITS PERMIT GROUND LEVEL MAINTENANCE FOR POLE-MOUNTED LUMINAIRES. A disconnecting and lowering hanger mechanism allows workman to lower luminaire for servicing and then reposition it with minimum effort and complete safety.

FACT NO. 2: ALL SERVICING HAZARDS ARE ELIMINATED. Workman has both feet on the ground and both hands on the job at all times. In addition, lowered fixture is "dead" because live contacts remain at pole top.

FACT NO. 3: SERVICING TIME AND COSTS ARE REDUCED TO MINIMUM. One man, using only a light vehicle, now can maintain pole-mounted luminaires in a fraction of the time formerly required. Faster servicing and elimination of costly auxiliary equipment assures substantial savings as well as increased lighting efficiency.

FACT NO. 4: "SERVISAFE" POLE UNITS ARE SUPPLIED AS COMPLETE PACKAGES READY FOR WIRING AND ERECTING. Featuring decorative as well as functional qualities, both single and double-arm models can be furnished with a variety of new steel and aluminum poles. "Servisafe" Bracket Units for wall and wood pole mountings also are available.

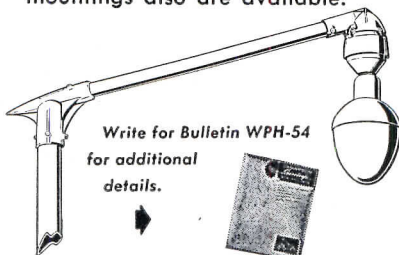

Write for Bulletin WPH-54
for additional
details.

5030-TE

THE THOMPSON ELECTRIC CO.

1199 POWER AVENUE • CLEVELAND 14, OHIO

REQUIRED READING

(Continued from page 46)

WALTER GROPIUS

Walter Gropius. By S. Giedion. Reinhold (New York, N. Y.) 1954. 8 in. by 10 in. 250 pp, illus. \$10.00.

SIGFRIED GIEDION HAS WRITTEN a biography of Walter Gropius. The author of the architectural students' manual "Space, Time and Architecture" has treated the story of his friend with characteristic thoroughness. It is a good book: easy and interesting to read, well indexed and documented, with many illustrative photographs.

The conclusion to be drawn from the biography of Gropius is that he was one of the leaders in interpreting the impact of the industrial revolution in terms of architecture. It becomes evident that Gropius is a man of big ideas that cover many facets (education, theater, industry, housing, prefabrication, slab apartment blocks and city planning) and that although he instinctively perceives the solutions to the problems, he laboriously works them out by means of painfully exact calculations. He is more interested in achieving a result than in seeing his name in lights — teamwork is a result of his philosophy and the basis of his developments.

The development of the Bauhaus at Dessau was explained by Mies van der Rohe as "an idea" — and Giedion elaborates — "an attempt to bridge the gulf between the world of the spirit and the world of every day, between art and industrial production. The whole endeavor of the Bauhaus was to discover similarities between the two conflicting spheres and to make them generally known . . ." In spite of great opposition the team of Gropius (the leader), Albers, Klee, Kandinsky, Itten and Moholy-Nagy have spread the work throughout the world.

Giedion writes a nice piece on City Planning too — asserting that "Town Planning and Democracy have a common basis: the establishment of an equilibrium between individual freedom and collective responsibility." He presents Gropius' major projects for Berlin and Boston's Back Bay as examples.

But to this reviewer the most exciting aspect of Gropius' biography comes with the realization that the characteristics of this man's creative development are only a part of the whole creative development of our age — that at the same time men like Wright, Corbusier, Mies, Nowicki and Buckminster

(Continued on page 288)

COLLEGE BUILDINGS

THE SPATE OF STUDENTS that has been flooding our elementary and secondary schools has already begun to affect our institutions of higher education. The U. S. Office of Education has released current statistics: 2,472,000 students (total) in the fall of 1954 — nearly 1 per cent more than the previous all-time high, 2,457,000 in 1949, when the G. I. educational program's influence reached its peak; 11 per cent more new students last fall than in 1953, more than any previous year except 1946 when new G. I. enrollees were at a maximum. What we are now experiencing is the normal result of population growth in a period of economic well-being.

Those are the present facts. Possibly the most reliable future estimate is made by Ronald B. Thompson, Registrar of Ohio State University, in the August, 1954 issue of *College and University Business*: "It is now generally accepted among those in higher education that college and university enrollments will approximately double in the next 15 or 16 years." The National Association of Manufacturers, quoting the Council for Financial Aid to Education, estimates enrollments for 1965 at 4,000,000; for 1975, at 5,000,000.

Against these statistics are arrayed some facts that cause serious concern: low salaries and shortages of faculty personnel; dwindling revenue, particularly among our historically dominant private institutions whose endowments have shrunk; co-existing obsolescence of many facilities and imperative demand for more and new types of space. In the following pages is a brief report of the building programs several institutions have set up to cope with their individual situations (and, lest we think the phenomenon peculiarly American, one from abroad); and a sampling of the results of the Housing and Home Finance Agency's College Housing Program, an ably administered, highly successful example of Federal aid.

Old and new together, Illinois Institute of Technology; Ludwig Mies van der Rohe, Architect

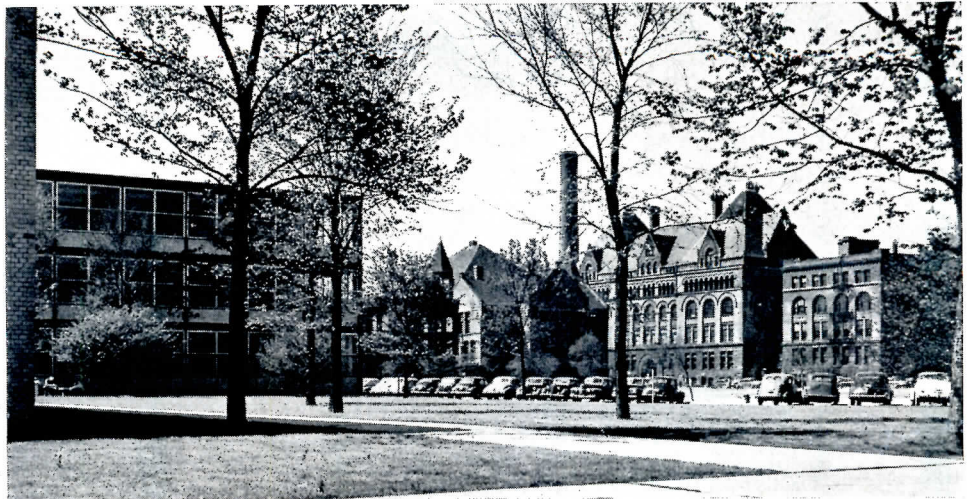

Joseph L. Lucas, Jr.



Technology Center, IIT campus; cross is site once proposed for nuclear reactor, now relocated in center of area

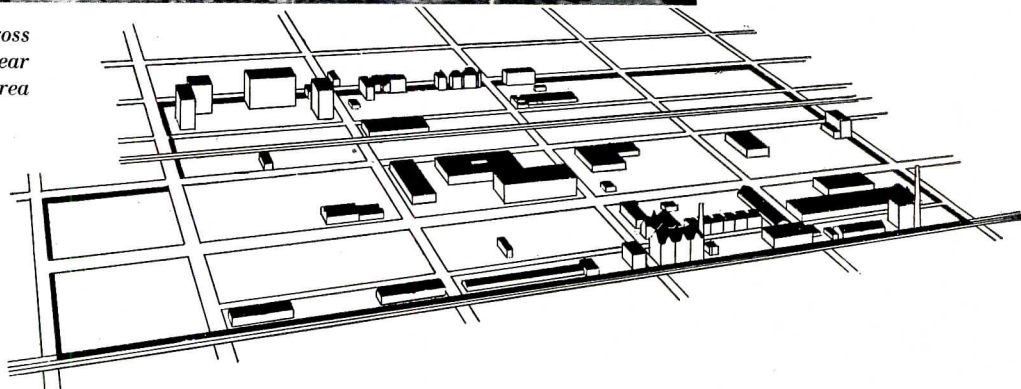

ILLINOIS INSTITUTE OF TECHNOLOGY, CHICAGO, ILL.

DR. JOHN T. RETTALIATA, President of Illinois Tech, pointed out in the course of an address last June that Chicago's mid-America location, in addition to making it the world's greatest industrial city, had in the past enabled it to lead the country architecturally; he suggested that the city's vitality as well as its situation could attract talent and patrons of all the industrial arts. Illinois Tech's newly developed 110-acre campus in Chicago's industrial south side thus has a positive goal and a continuing philosophy. The view of IIT's residential area (right) shows several apartment buildings for students and faculty. Reading clockwise they are: Carman Hall (completed 1953); Bailey and Cunningham (under construction); Gunsaulus Hall.



RESIDENCE HALLS

*Ludwig Mies van der Rohe,
Architect*

*Pace Associates,
Associated Architects*



Carman Hall, recently completed student-staff apartment building

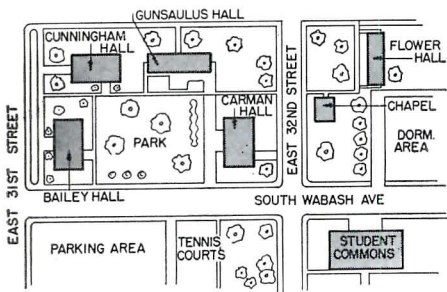

Plot plan shows residential campus; right, part typical plan, Cunningham and Bailey Halls; layouts vary slightly. Cunningham will have 6, 5 and 2-room units (total, 56), Bailey, 4, 3 and 2-room units (total, 88), for married students and staff

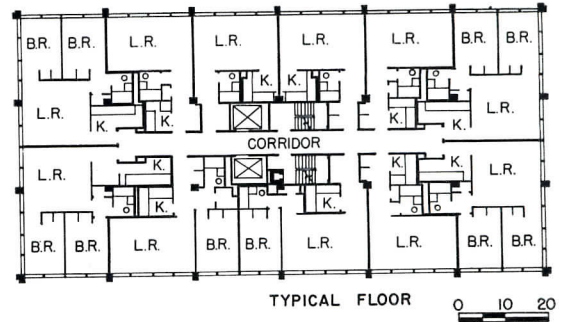

Lobby, Carman Hall



Typical apartment, Carman Hall

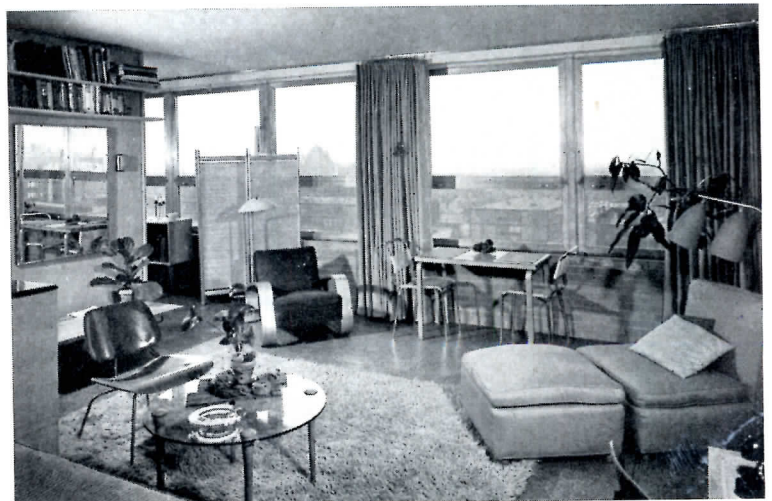

COMMONS BUILDING

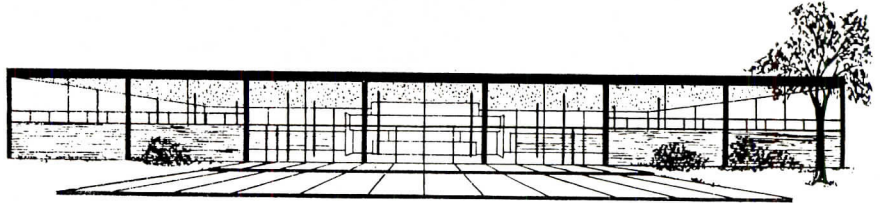

Hofrich-Blessing

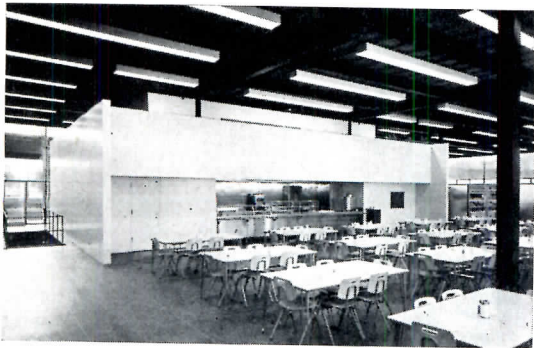

Above, front view, and left, student dining room, new Illinois Tech Commons Building. All of Tech's new buildings are designed by Mies van der Rohe. Commons serves both as dining room for resident students and as shopping center for faculty and staff members living in campus *apartment buildings*. Upper half of all exterior and interior walls is clear glass. Building was completed in the Spring of 1954. In the basement are a recreation lounge and bowling alleys.

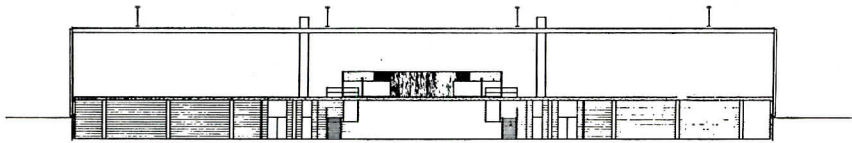

*SCHOOL OF
ARCHITECTURE, DESIGN,
AND CITY PLANNING*

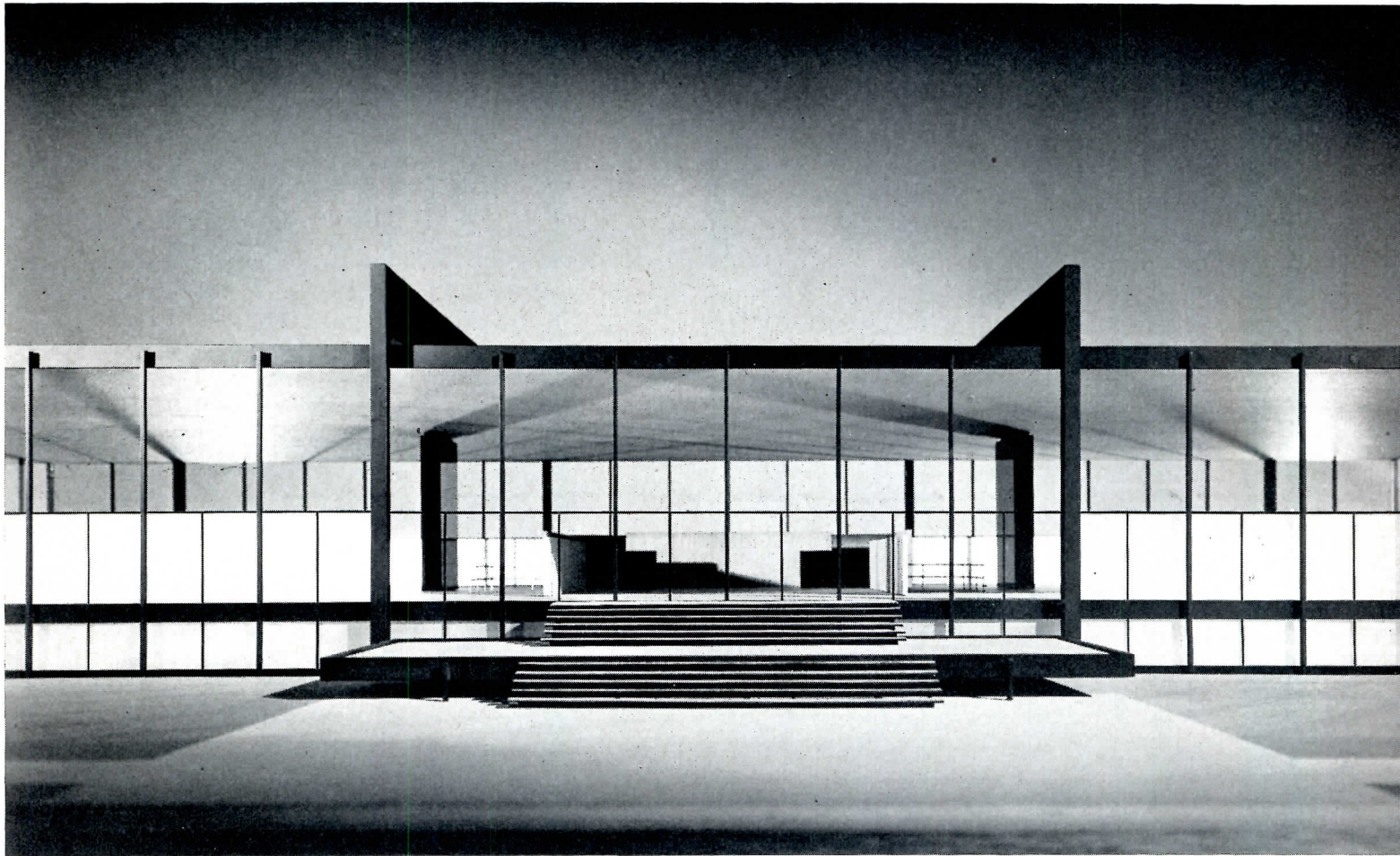

This will be the twentieth modern building on Tech's campus. Of steel and glass (lower sections opaque), it will contain a large, column-free main hall; its concrete roof will be hung from four exposed girders. Main floor, 120 by 220 ft., will have two drafting rooms. Basement will house studios, lecture rooms, other facilities

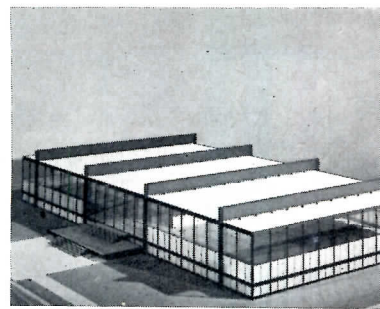
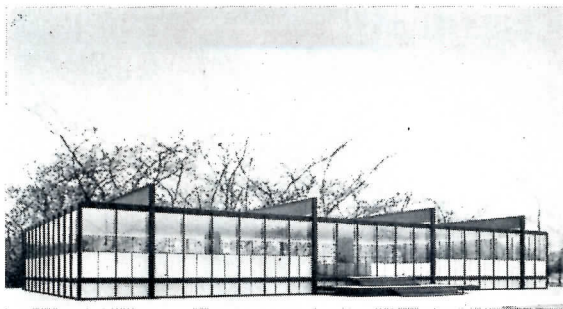
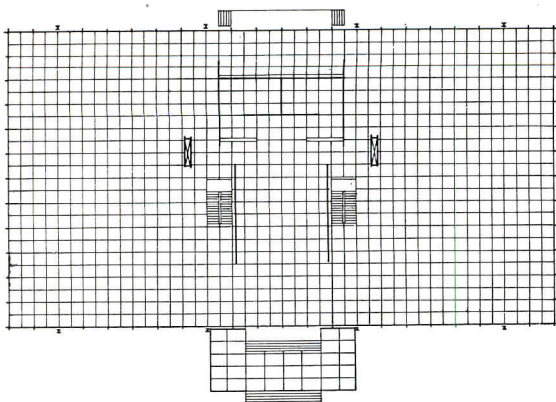

**CLASSROOM BUILDINGS:
ALUMNI HALL; METALLURGICAL
AND CHEMICAL ENGINEERING;
CHEMISTRY BUILDING**

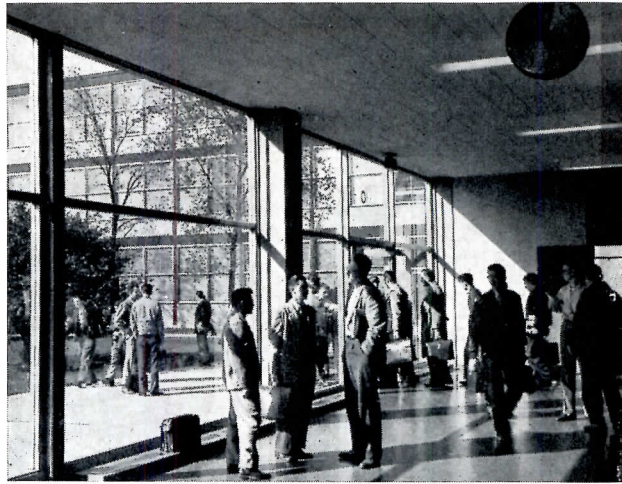

Joseph J. Lucas, Jr.

Foyer, Metallurgical and Chemical Engineering

Hedrich-Blessing

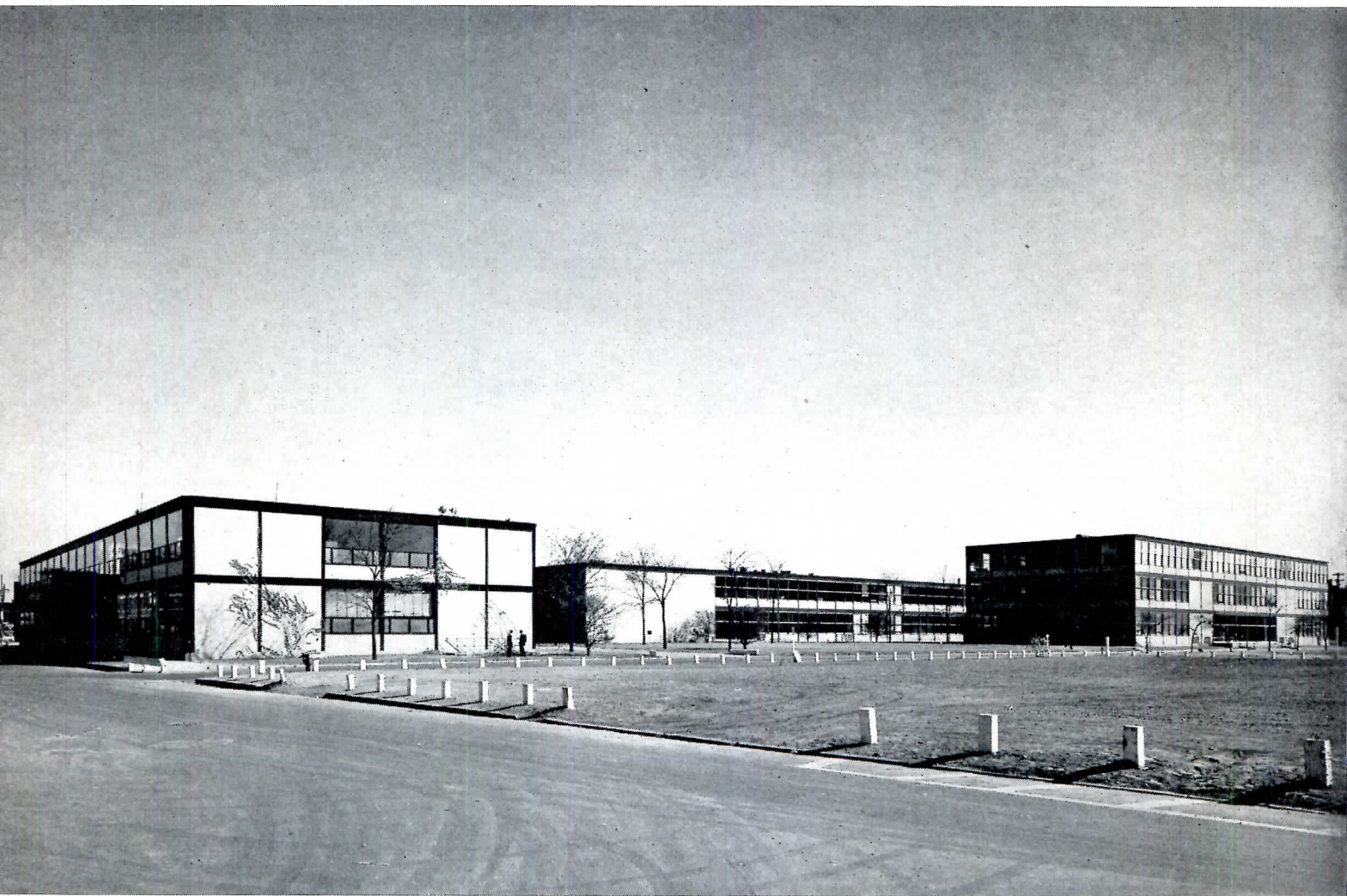

Alumni Hall

Metallurgical and Chemical Engineering

Chemistry Building

ST. SAVIOUR'S CHAPEL

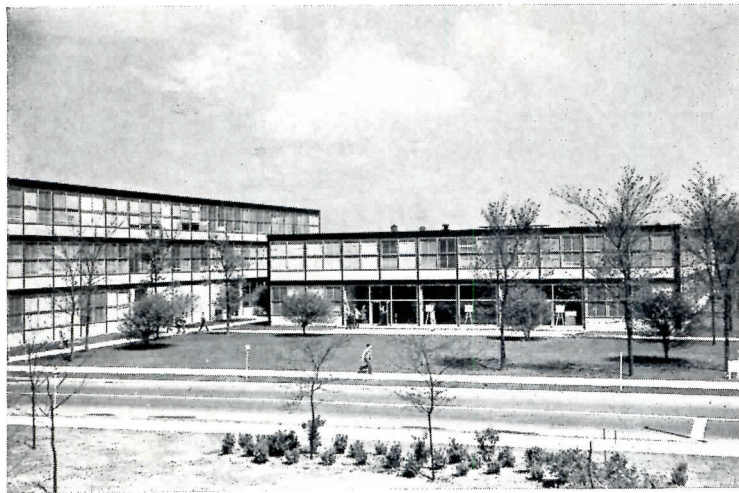

Joseph J. Lucas, Jr.

Chemistry, and Metallurgical and Chemical Engineering

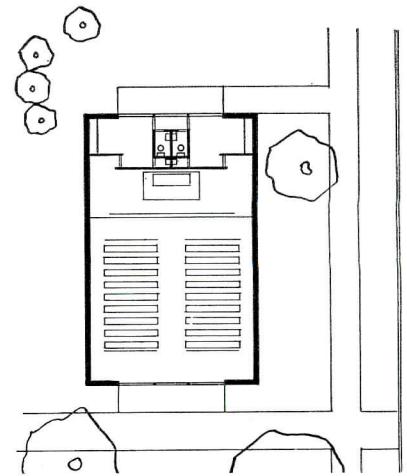

Hedrich-Blessing

Like most of the country's colleges and universities, Illinois Institute of Technology is crowded. Until the new Architecture, Design and City Planning Building (see preceding page) is built, architecture classes are being taught in Alumni Hall. The crowding is a symptom, not of an ailment but of fundamental soundness which has attracted unprecedented numbers of students. Starting in 1940 with a few old buildings and seven acres of land, Illinois Tech embarked on its bold program under Mies van der Rohe's architectural guidance. Carman Hall (preceding pages) was the fifteenth new building on the campus; Commons, the sixteenth; more are needed. Architecture and Design, Liberal Arts, the Student Union, Library and Administration, more engineering buildings, gymnasium, swimming pool and field house, and research facilities for IIT's affiliates, all remain to be built.

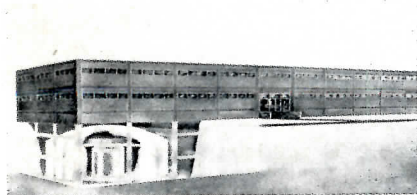

Sketch above is one conception of the Armour Research Foundation Nuclear Reactor to be housed below ground in a new building

Hedrich-Blessing

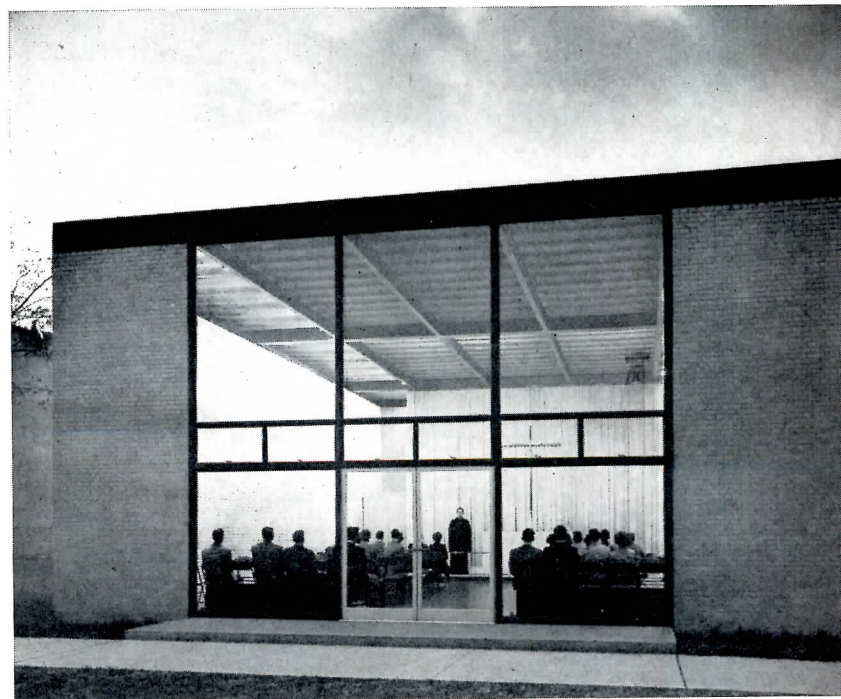

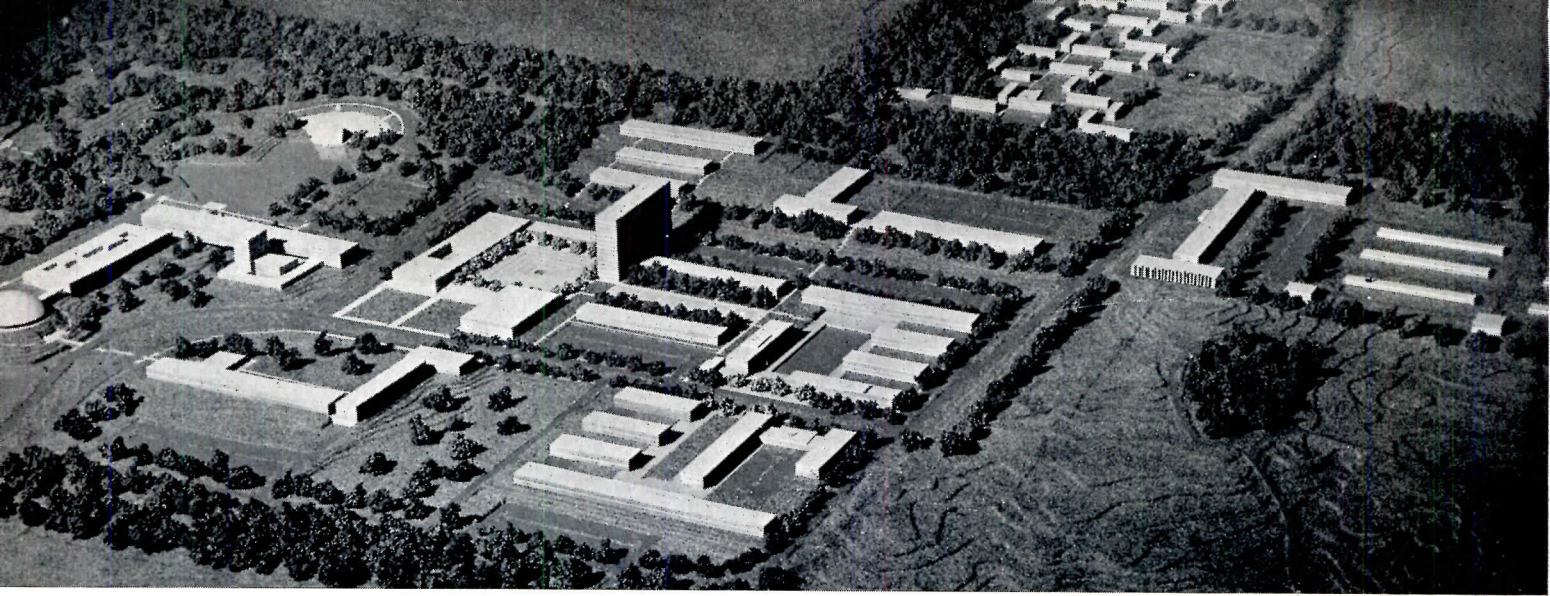

The city of Ann Arbor hems in Michigan's main campus, necessitating development of new North Campus laid out by Eero Saarinen and Associates (model above, plan below)

THE UNIVERSITY OF MICHIGAN

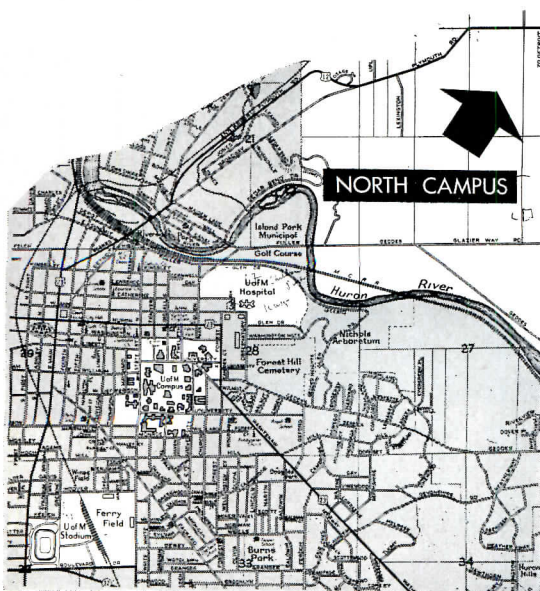
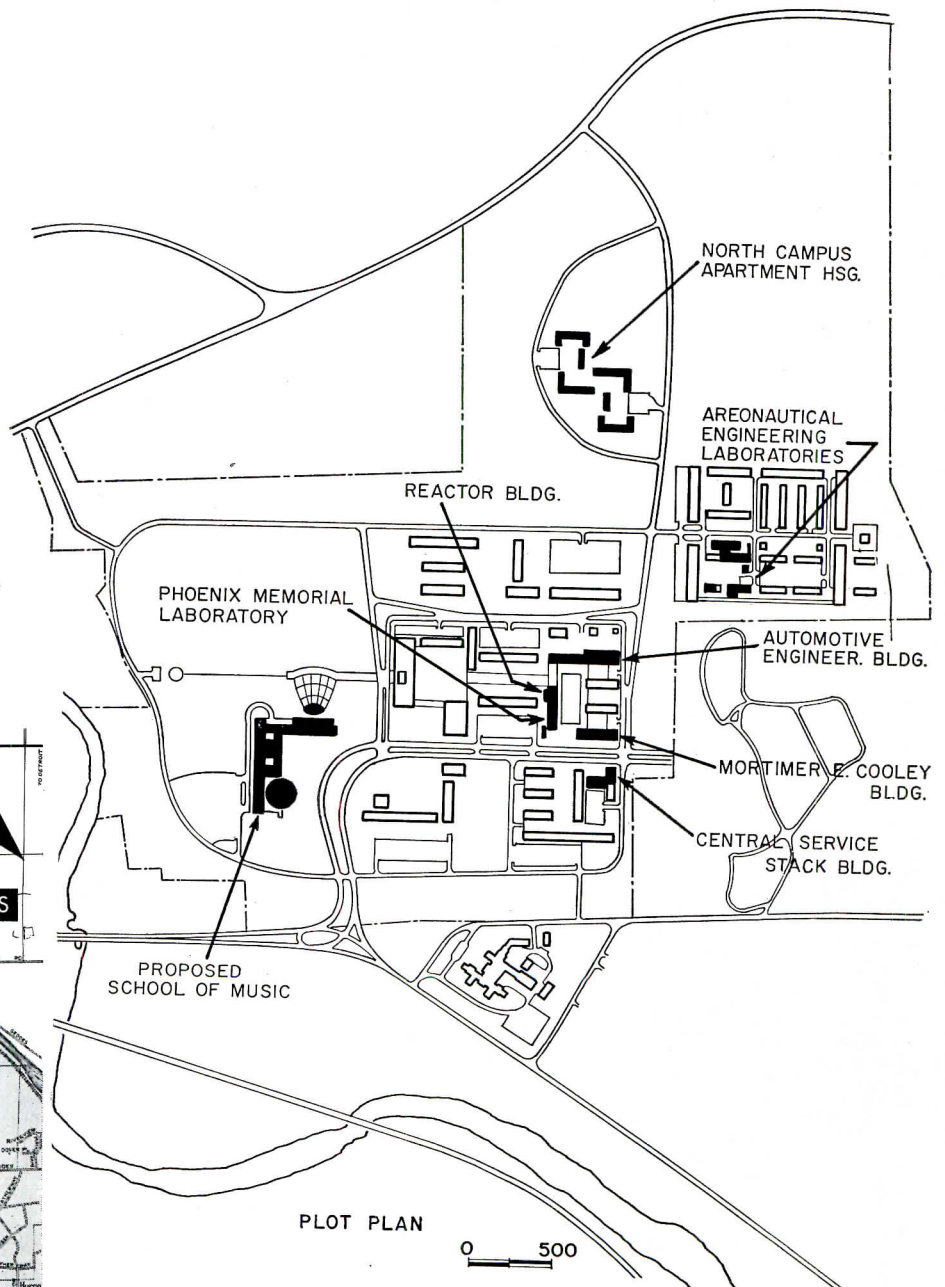

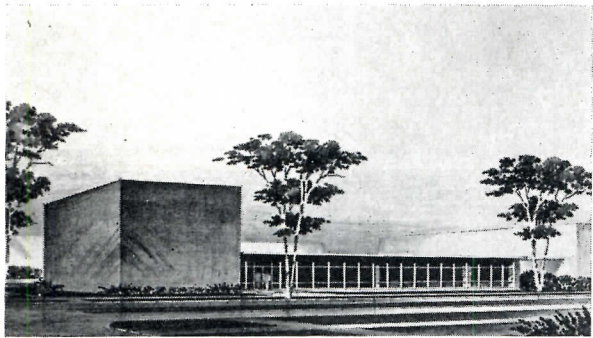

CENTRAL SERVICE AND STACK BLDG.
Albert Kahn Assoc. Archts. and Engrs.

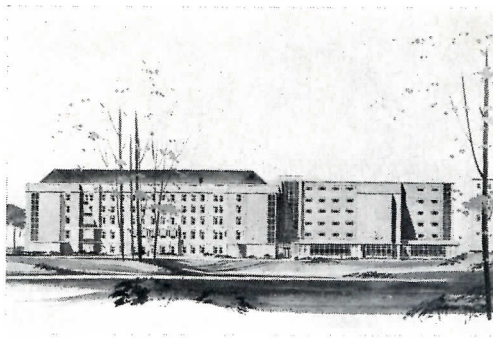

ADDITION, COUZENS HALL
Ralph R. Calder, Archt.

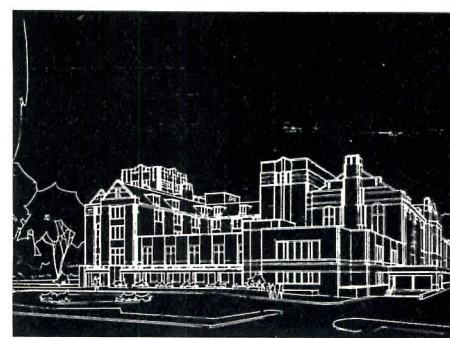

ADDITION, MICHIGAN UNION
Eberle M. Smith, Archts. & Engrs.

OUTGROWS ITS CAMPUS, ANN ARBOR, MICHIGAN

THE UNIVERSITY OF MICHIGAN has a long-range development program designed to meet present and future needs. Appropriations are expected from the 1955 session of the State Legislature for construction immediately required and to make a significant start on the 5-year expansion program, which involves new construction, remodelling and additions with work

scheduled on a year-by-year basis. In presenting its request the Michigan Board of Regents states: "It is urged that adequate appropriations be made. . . . The period of expanding enrollment is already at hand. . . . Action is imperative if the growing number of Michigan's young men and women are to receive the college training and later, the professional training they

NORTH CAMPUS APARTMENT HOUSING

*Leinweber, Yamasaki
& Hellmuth, Architects*

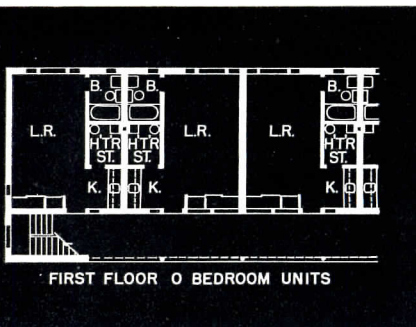
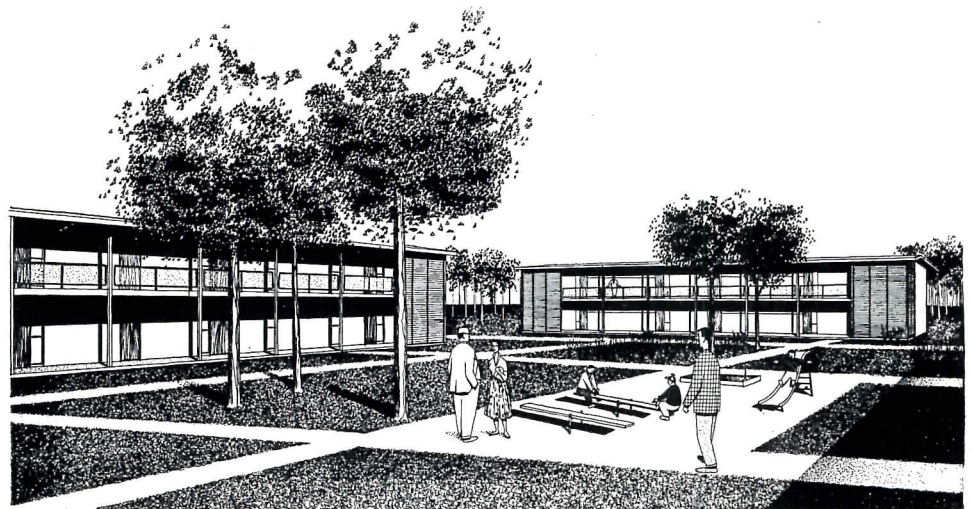

FIRST FLOOR 0 BEDROOM UNITS

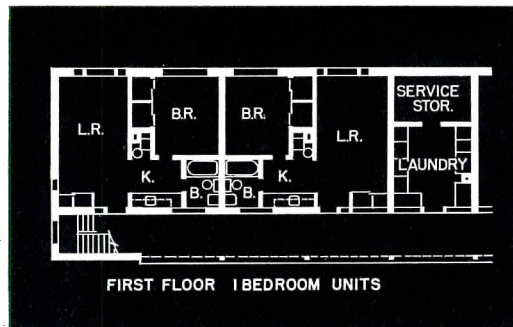

FIRST FLOOR 1 BEDROOM UNITS

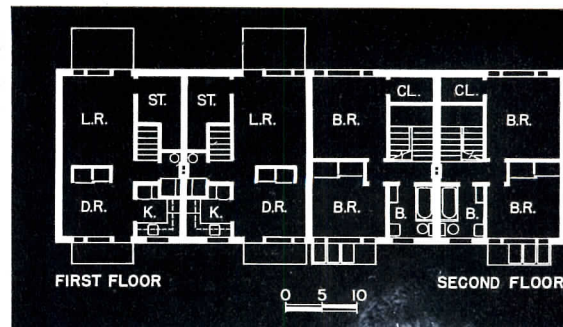

FIRST FLOOR

SECOND FLOOR

0 5 10

Typical apartments: 0 bedrooms

One bedroom

Two bedrooms

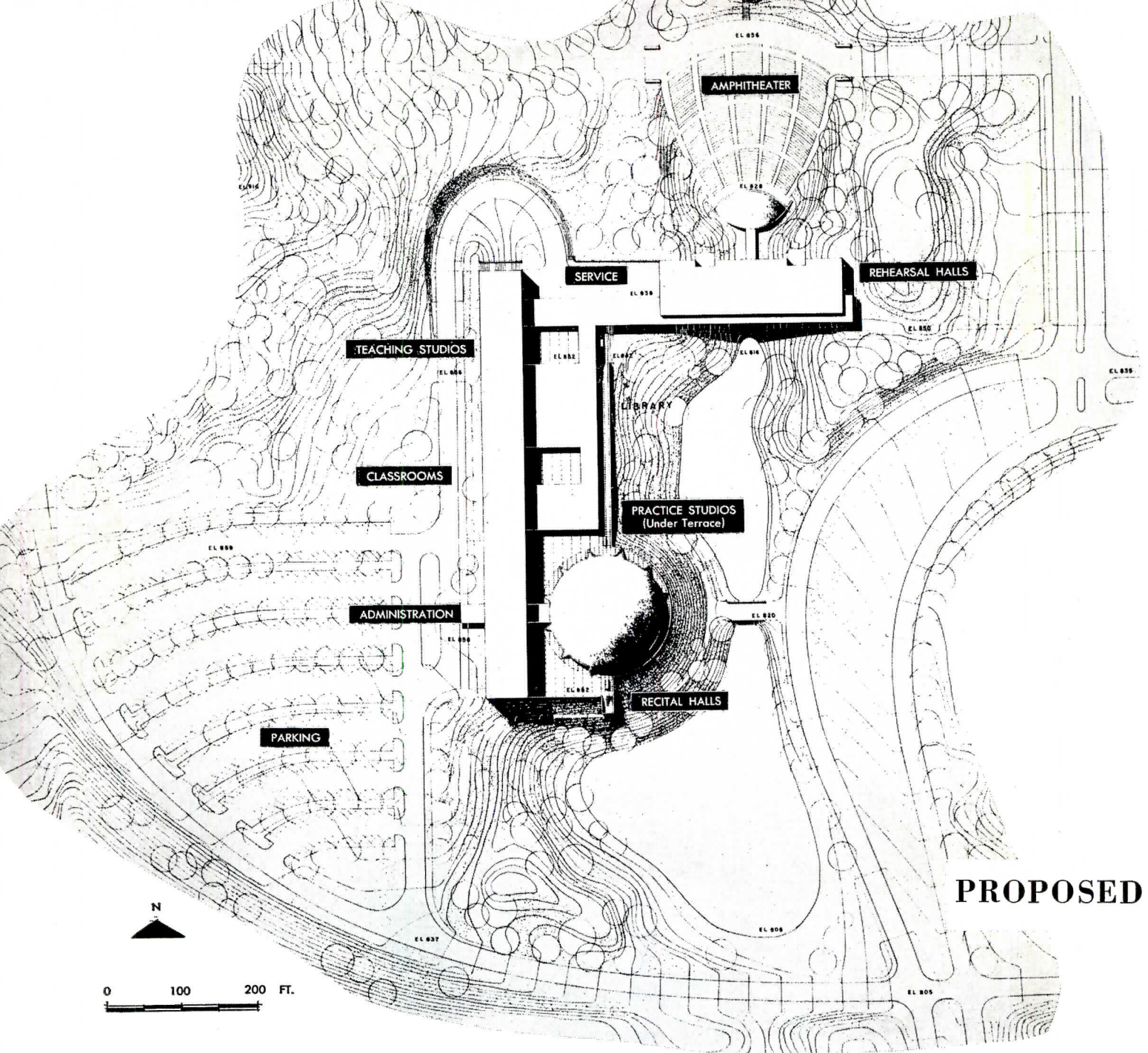

must have if we are to achieve continued improvement in the welfare and standard of living of all citizens." The University is asking \$9,061,000 for new construction, \$2,320,000 for remodeling and additions in 1955, \$704,000 for planning funds.

Unlike some other institutions of higher learning, the University of Michigan is employing many different architectural and engineering firms to develop the individual buildings which are fulfilling its master plan. As of June 1954 there were some seventy building projects, on the Main and North Campuses and at the Medical Center, in different stages of progress. These were designed by some 28 firms of architects and engineers, individually and in various combinations. Obvi-

ously the work of only a few can be shown here; the entire list of designers reads like a roster of the Michigan Society of Architects, with some out-of-state firms for good measure and some of the normal alteration, addition and engineering work handled by the University's Plant Department or Supervising Architect's Office. Lynn W. Fry, Supervising Architect, has charge of developing building programs, of correlating the work of individual architects, and of supervising construction. One instance of this cooperative procedure is the proposed School of Music, shown on these pages. Its thin-shell concrete dome will house two recital halls, one of 400, the other of 1200 seats. Both will have suspended acoustical ceilings.

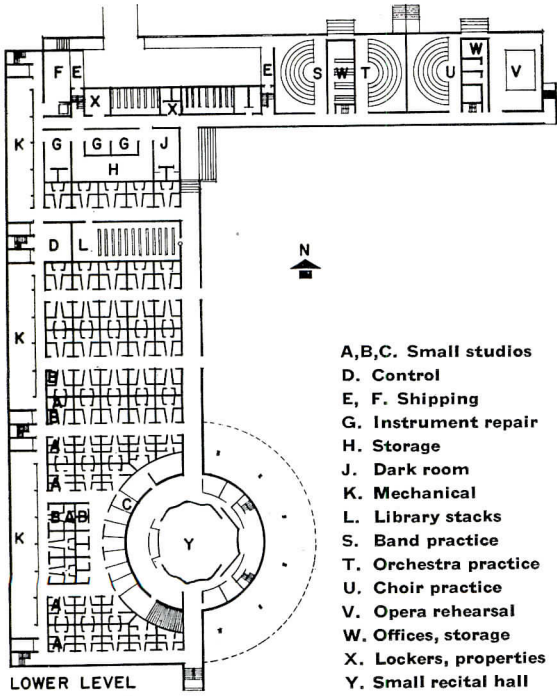

- A, B, C. Small studios
- D. Control
- E, F. Shipping
- G. Instrument repair
- H. Storage
- J. Dark room
- K. Mechanical
- L. Library stacks
- S. Band practice
- T. Orchestra practice
- U. Choir practice
- V. Opera rehearsal
- W. Offices, storage
- X. Lockers, properties
- Y. Small recital hall

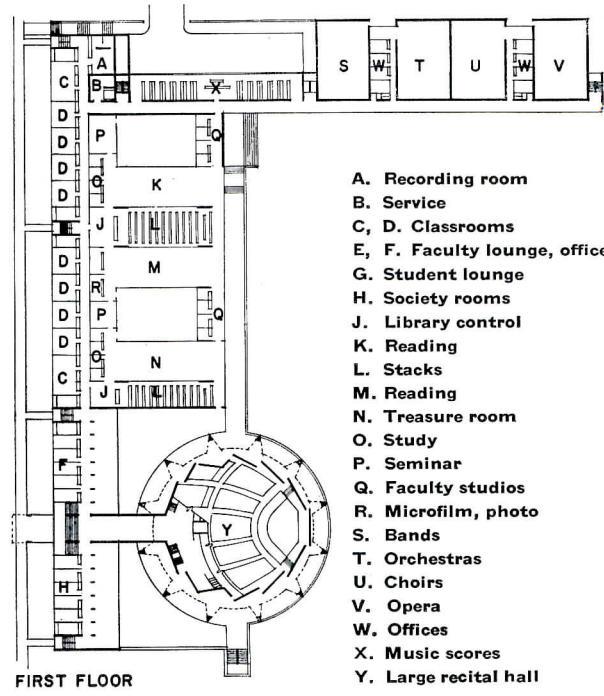

- A. Recording room
- B. Service
- C, D. Classrooms
- E, F. Faculty lounge, offices
- G. Student lounge
- H. Society rooms
- J. Library control
- K. Reading
- L. Stacks
- M. Reading
- N. Treasure room
- O. Study
- P. Seminar
- Q. Faculty studios
- R. Microfilm, photo
- S. Bands
- T. Orchestras
- U. Choirs
- V. Opera
- W. Offices
- X. Music scores
- Y. Large recital hall

0 100FT.

Second floor, above classroom wing, contains administrative offices; third floor, classrooms, large and small studios, and faculty offices

SCHOOL OF MUSIC

Eero Saarinen and Associates, Architects

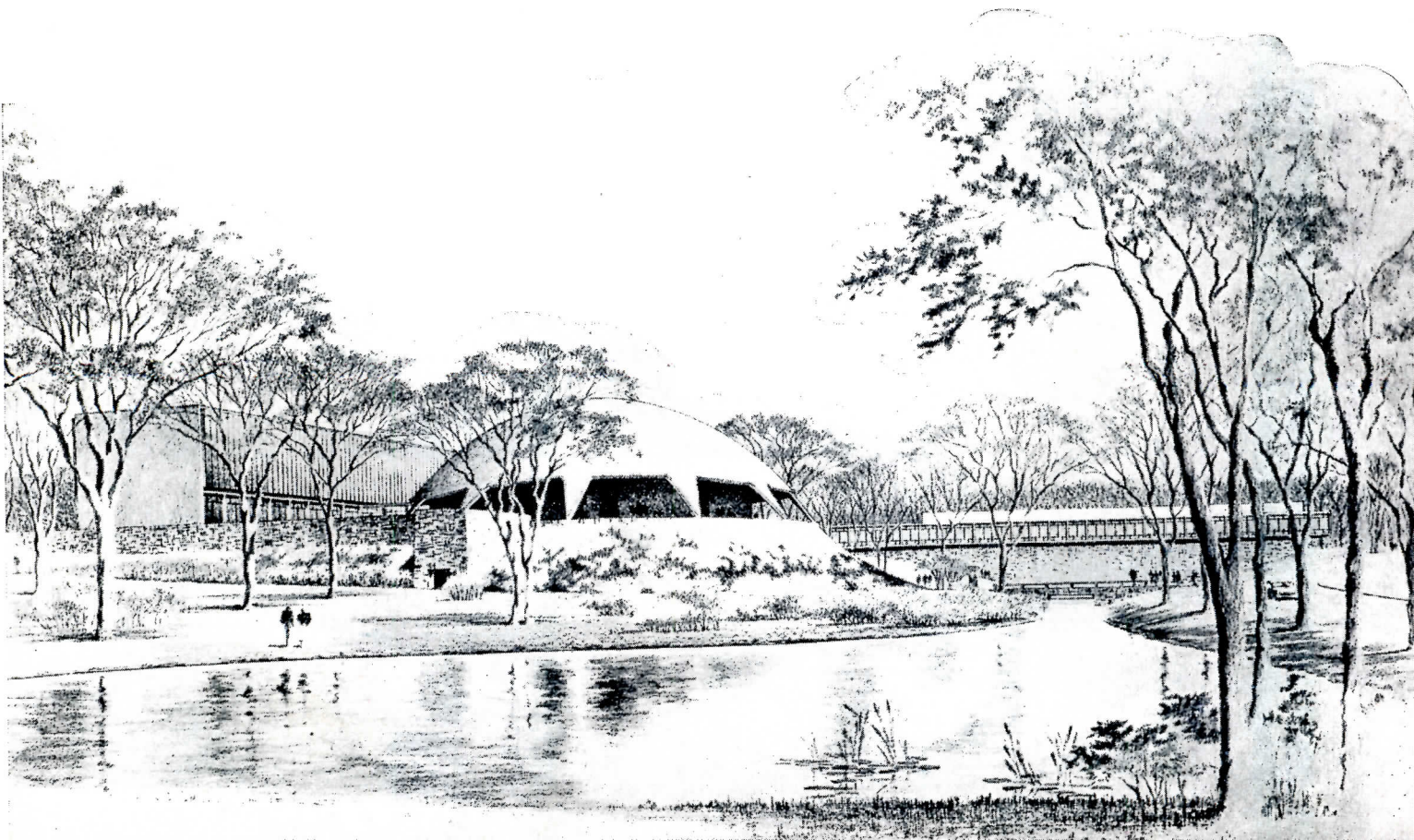

PHOENIX PROJECT (PROPOSED NUCLEAR REACTOR)

Giffels & Vallet, Inc., L. Rossetti, Archts. & Engrs.

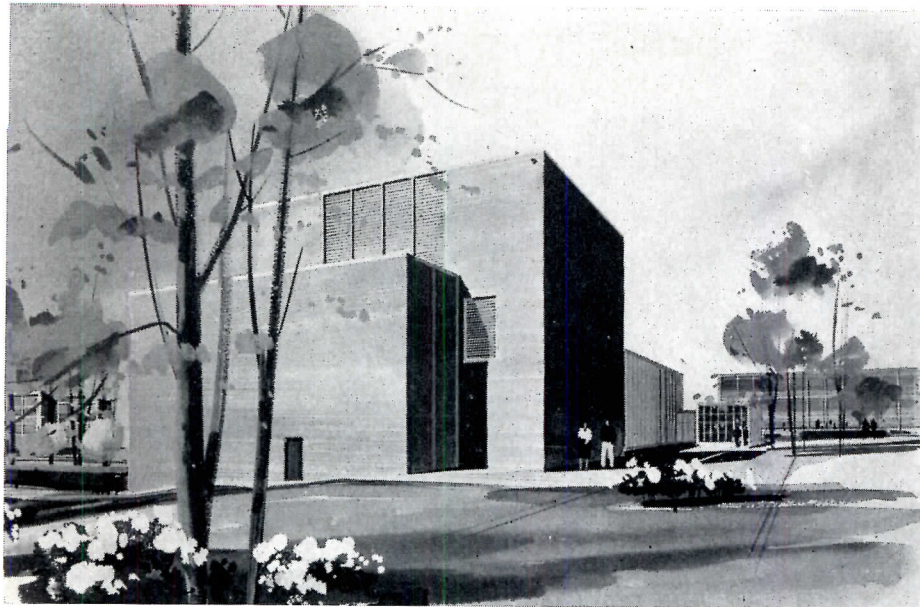

On the North Campus, this building and reactor pool will house a relatively high-powered research thermal reactor. It is windowless, gas-tight; its pool has 6-ft-thick "heavy" concrete walls whose barytes aggregate yields 50 per cent greater density than ordinary concrete. Upper floors carry loads of one ton per sq ft. Normal heating, ventilating and plumbing facilities were modified to meet requirements for safe operation, including protection against radiation, air leakage, and disposal of contaminated wastes

Photos of Women's Swimming Pool building show exterior, student's lounge, and pool. Ground floor contains lockers, mechanical equipment

AUTOMOTIVE ENGINEERING BUILDING

Giffels & Vallet, Inc., L. Rossetti, Archts. & Engrs.

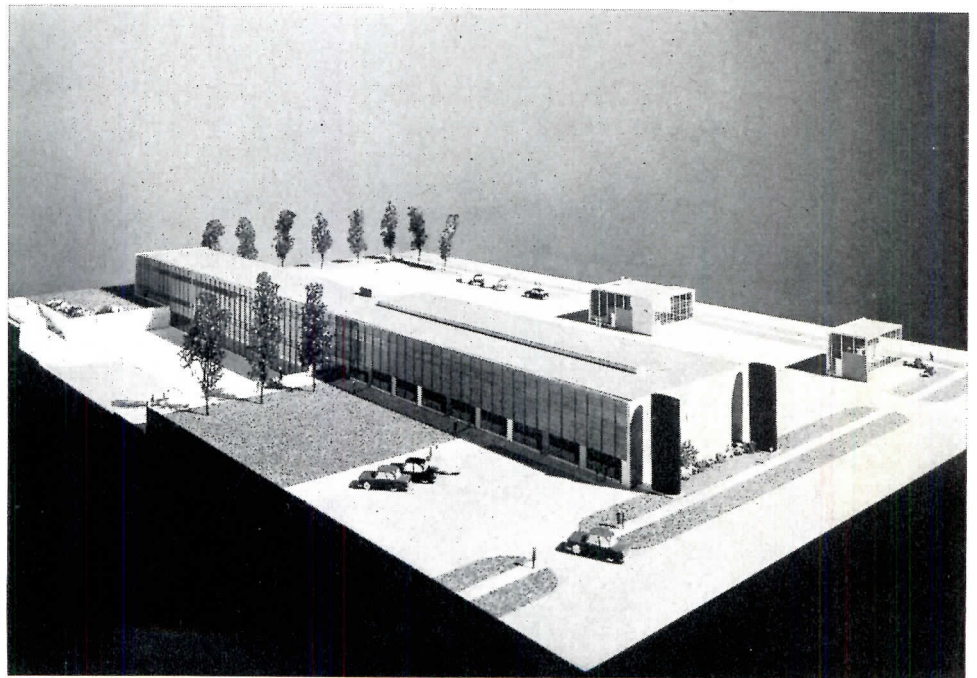

Lens-Art

Construction has started on the Automotive Engineering Building; photographs show the model. Exhaust stacks indicate position of dynamometer rooms. In the building will be testing laboratories for research, classrooms, faculty offices





Hedrich-Blessing

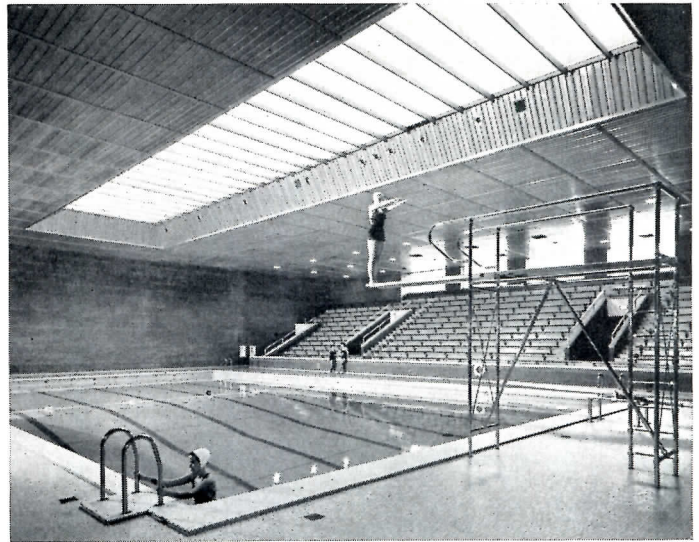
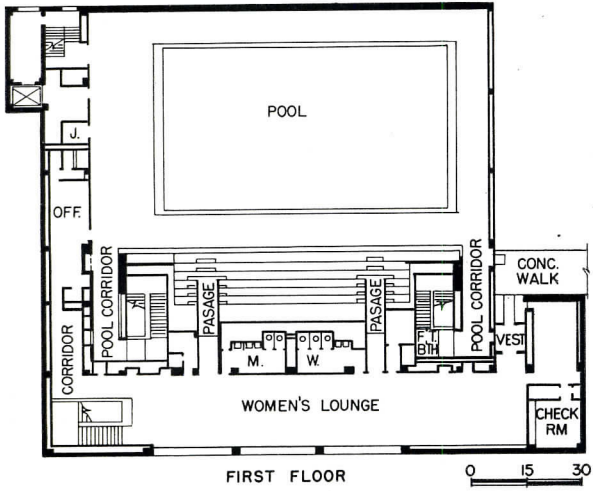

WOMEN'S SWIMMING POOL

Lee Black & Kenneth C. Black and Alden B. Dow, Architects

Lens-Art

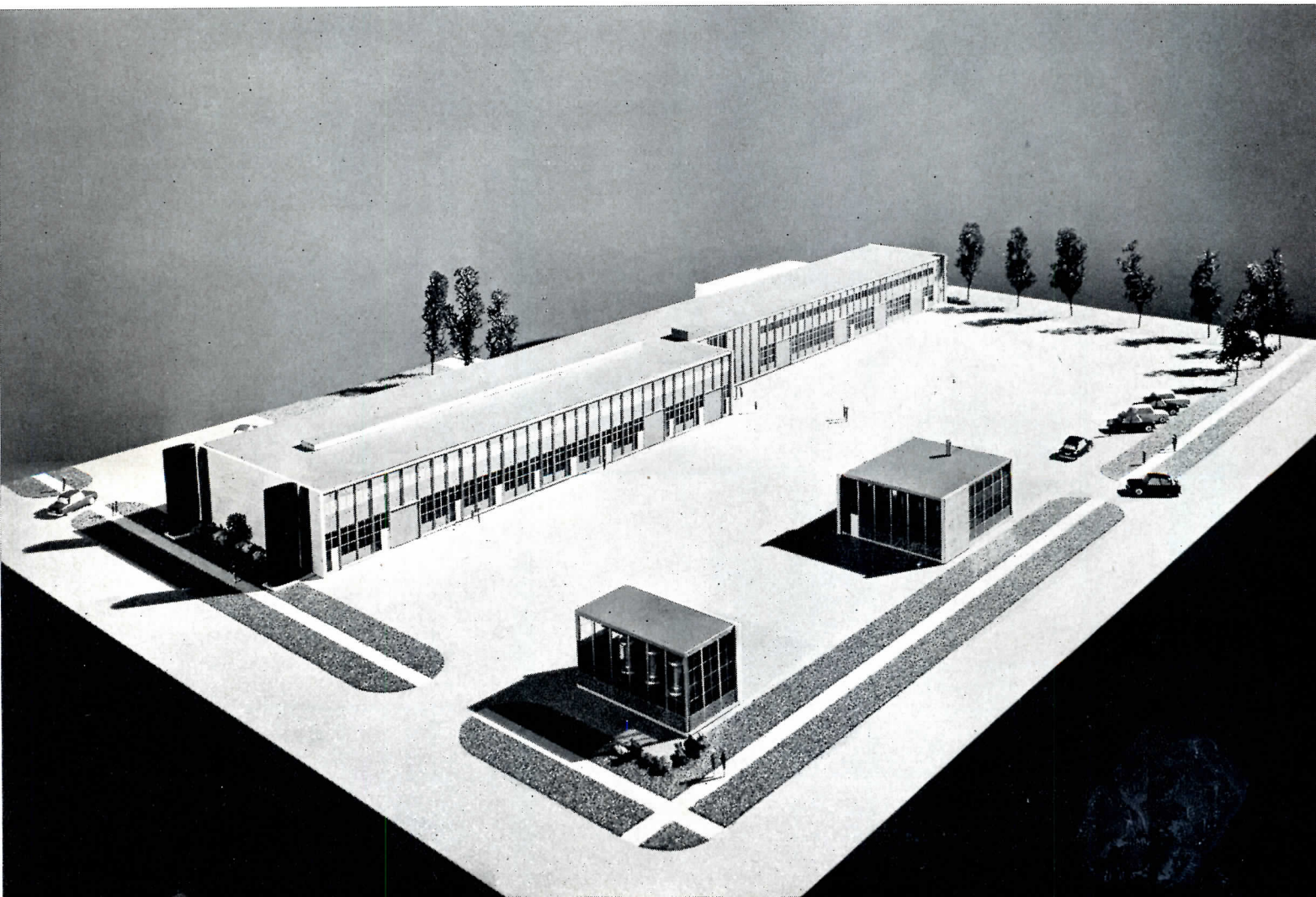

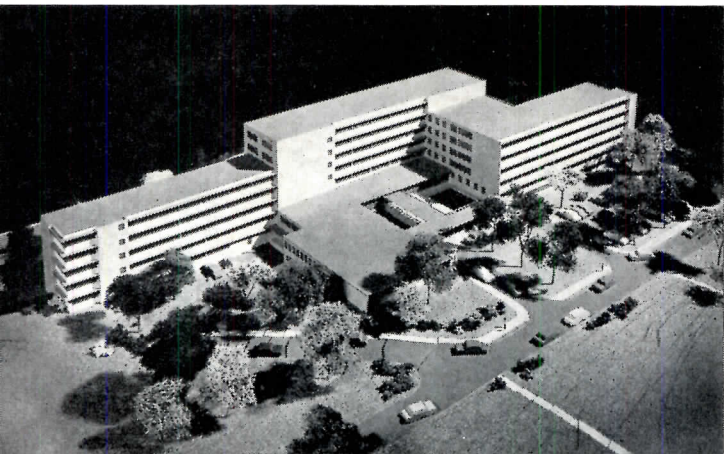

Richard Shirk

CHILDREN'S HOSPITAL; PSYCHIATRIC UNIT
Swanson Associates, Inc., Architects

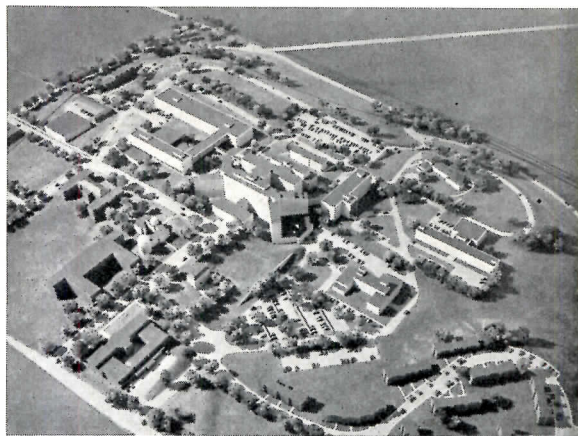

The University of Michigan medical center contains a number of existing buildings as well as several under construction or contemplated. The group (model photo above is situated between the Main and North Campuses

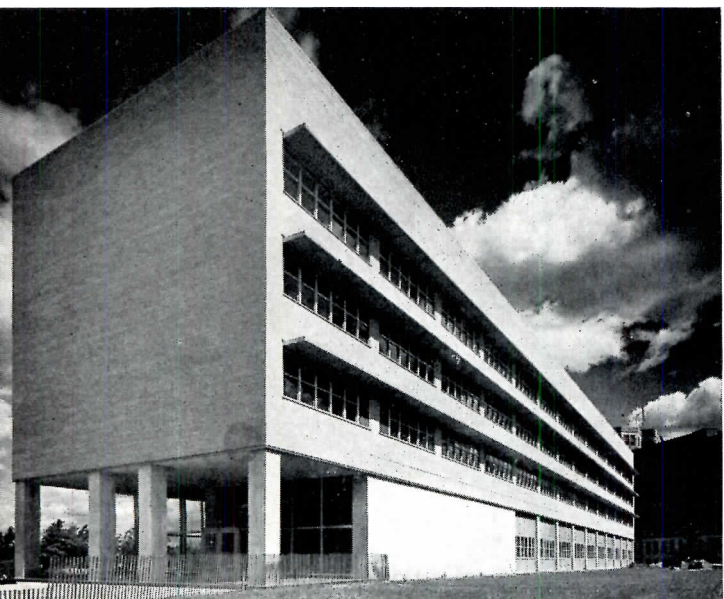

Lens-Art

KRESGE MEDICAL RESEARCH BUILDING
Giffels & Vallet, Inc., L. Rossetti; Skidmore, Owings & Merrill, Architects

The Psychiatric Unit of Children's Hospital is a complete hospital in itself. The Kresge Medical Research Building has a basement containing mechanical equipment and shops, four floors of offices and laboratories, and a fifth floor enclosed in an almost solid wall containing more mechanical equipment. The Outpatient Clinic, with an interior service-core scheme, has seven floors housing the following departments in addition to those indicated on the third-floor plan: heredity, pediatrics, pharmacy, dermatology, gynecology, orthopedics, surgery, urology, neurology, otolaryngology, ophthalmology, endocrinology and metabolism, dietetics, thoracic surgery, psychiatry

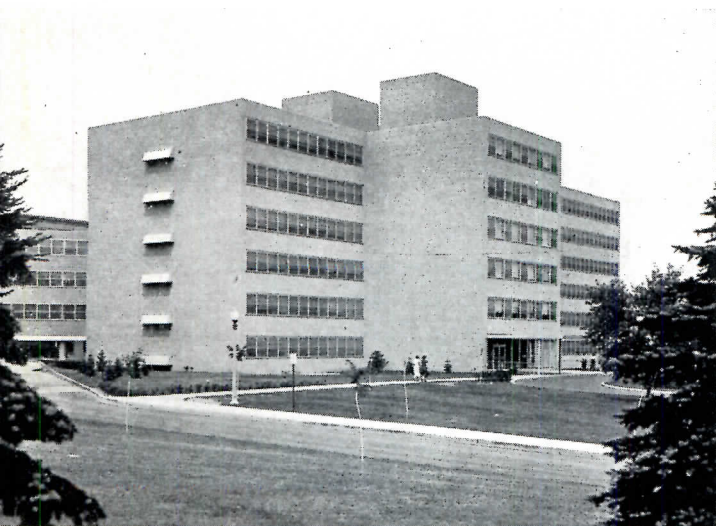
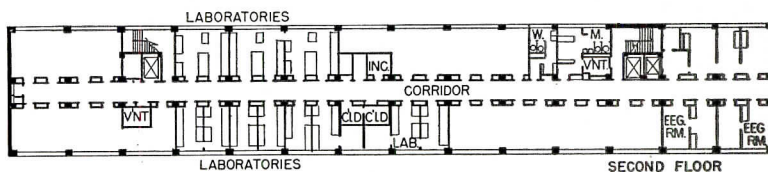

OUTPATIENT CLINIC
Giffels & Vallet, Inc., L. Rossetti; Skidmore, Owings & Merrill, Architects

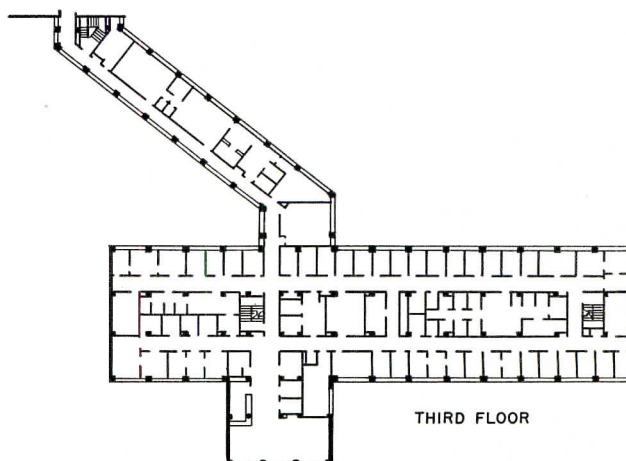



Ritter-Jeppesen Studios

THE AUSTRALIAN NATIONAL UNIVERSITY

CANBERRA, AUSTRALIA

Prof. Brian B. Lewis, Consulting Architect

In 1911 an international competition for the plan of Canberra, Australian federal capital, was won by American architect Walter B. Griffin of Chicago. The area then reserved for a university, although modified by unfortunate early changes, is now occupied by the Australian National University. Established since World War II, it is a post-graduate school devoted principally to non-clinical medicine, nuclear physics, Pacific studies and social sciences. The 200-acre site, mostly low and undulating, has a marked ridge, one determinant of Griffin's plan, on which the central University buildings are now being placed

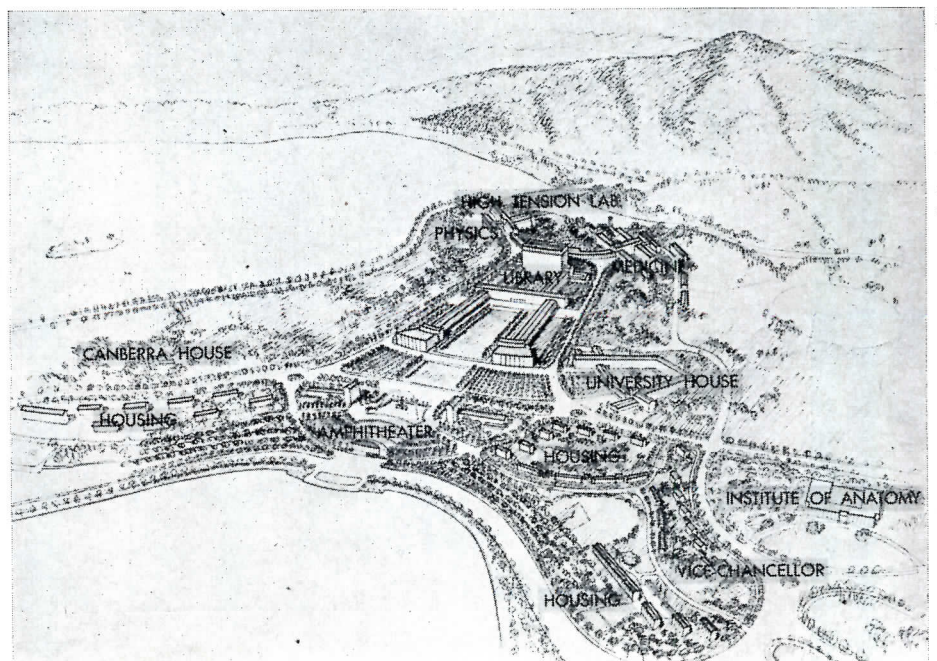

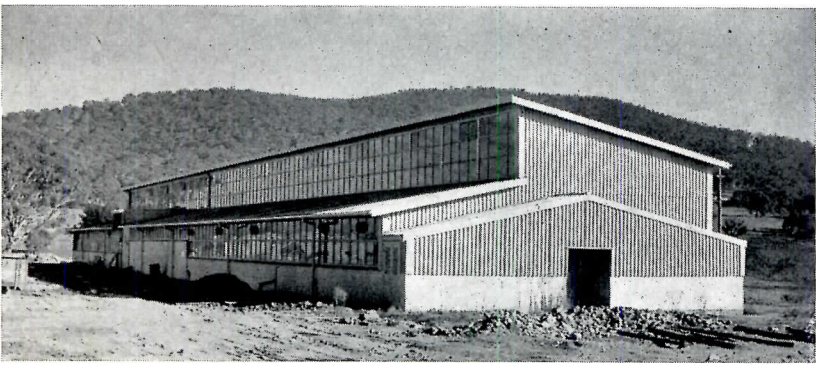
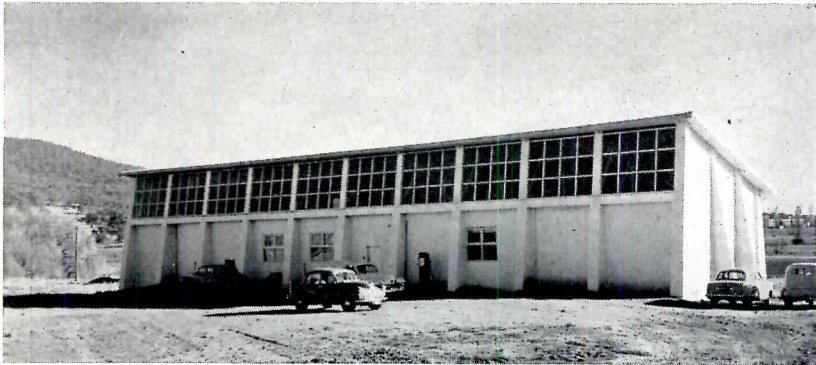
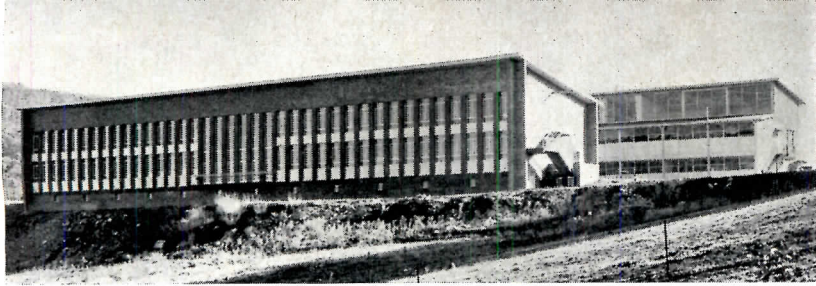

Top photo: Physics School (plan at right); administrative unit in foreground; vertical supports 5 ft o.c., U-shaped in plan, carry vertical services to small labs facing south away from sun. Center, Physics Workshop, built during steel shortage; bottom, Medical School Workshop, steel framed, first of several medical units

The building program at Australian National University includes an Institute of Physical Research, now completed and occupied; Institute of Medical Research (workshops completed, main building started); Departments of Social Studies and Pacific Studies (nothing built; these occupy existing temporary structures); University House, social and residence center (completed); Library (not started); Housing (five buildings completed); workshops and storage buildings (one complete). Professor Brian Lewis of the University of Melbourne was retained to develop the site plan and design most of the buildings. Architects Mussen & Mackay of Melbourne designed the Medical Research group.

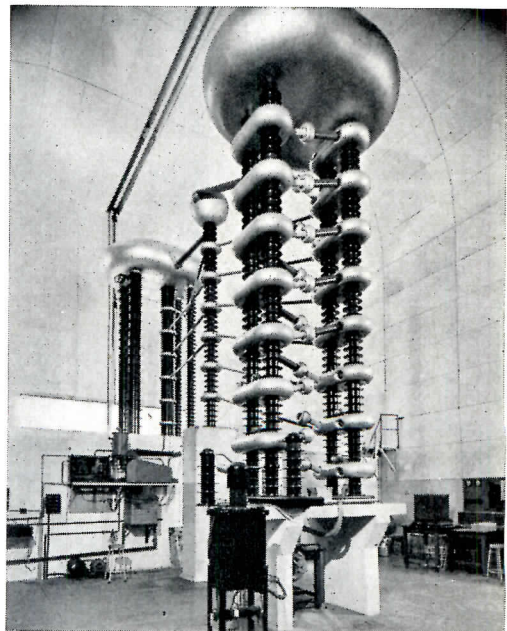
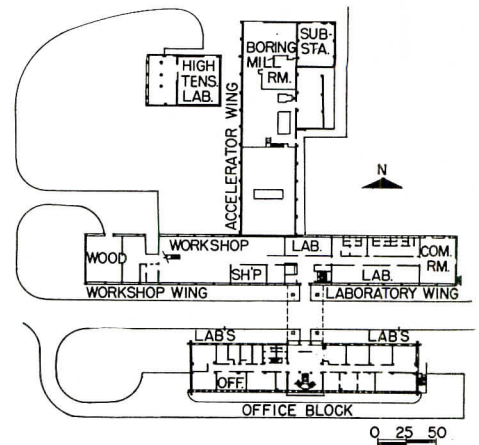

Physics School Workshop (left), upper level; walls are 3-in. insulation blocks against asbestos cement sheets; right, High Tension Laboratory

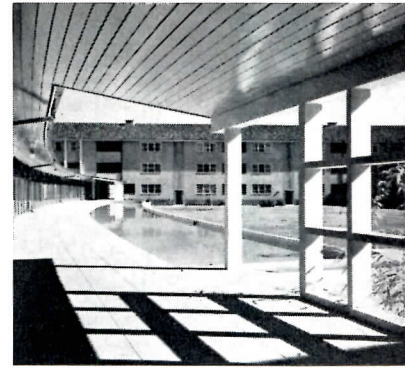
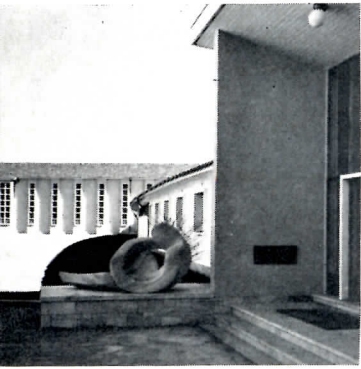

University House is the social center, contains 96 apartments for students and special guests, 30 student dormitory rooms and 30 for domestic staff, a 250-seat refectory, two suites of private dining rooms; and a separate suite of public rooms with its own entrance and garden for staff wives. Construction: brick cavity walls, wood floors on panel-heated concrete slabs. Above, left to right: Entrance with wood sculpture, "Repose," by Gerald Lewers; balconied north (sunny) façade; lounge wing with 5-ft overhang above insulating glass walls; courtyard has reflecting pool to temper the north sun

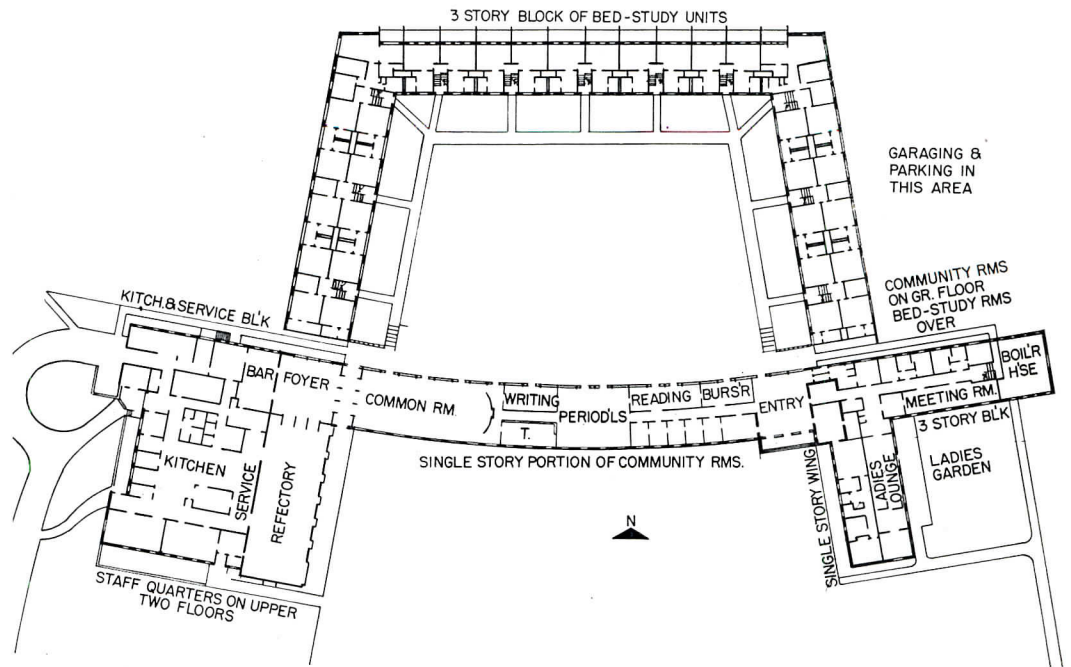

Ritter-Jeppesen Studios



Above, foyer to refectory; right, refectory, in which a large mural is to be executed on the end wall; ceiling is Indian red, walls light gray, verticals white

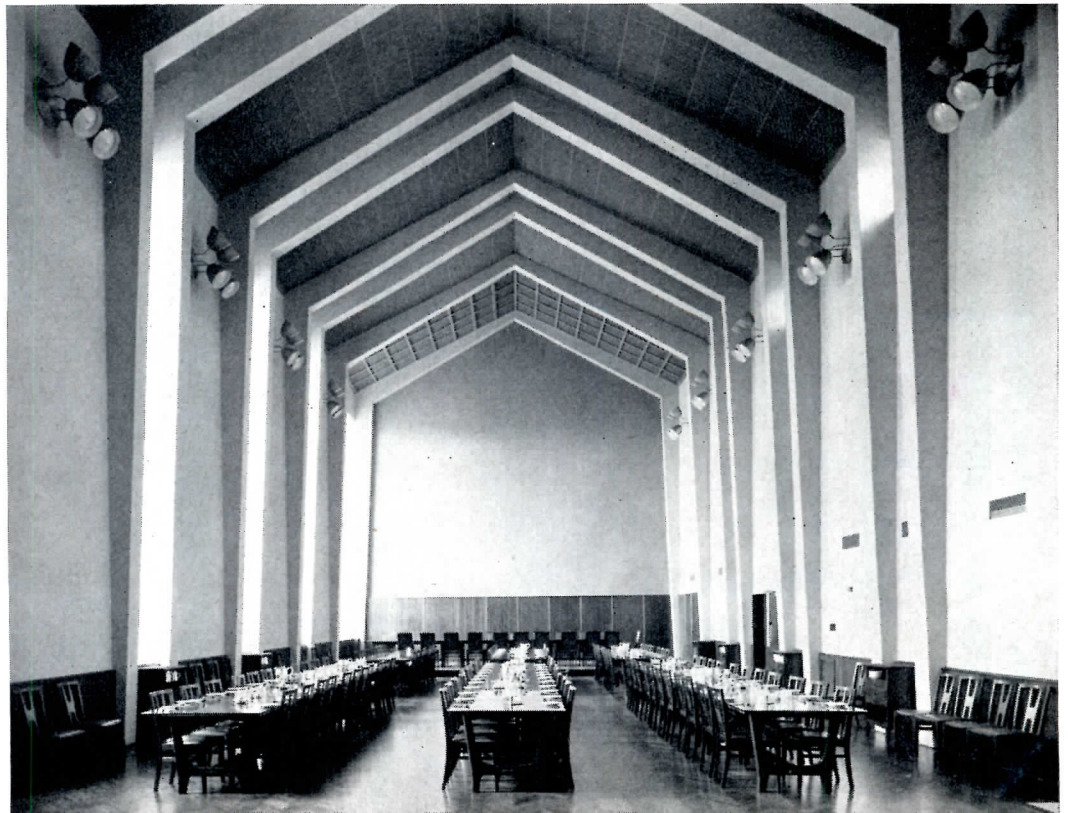

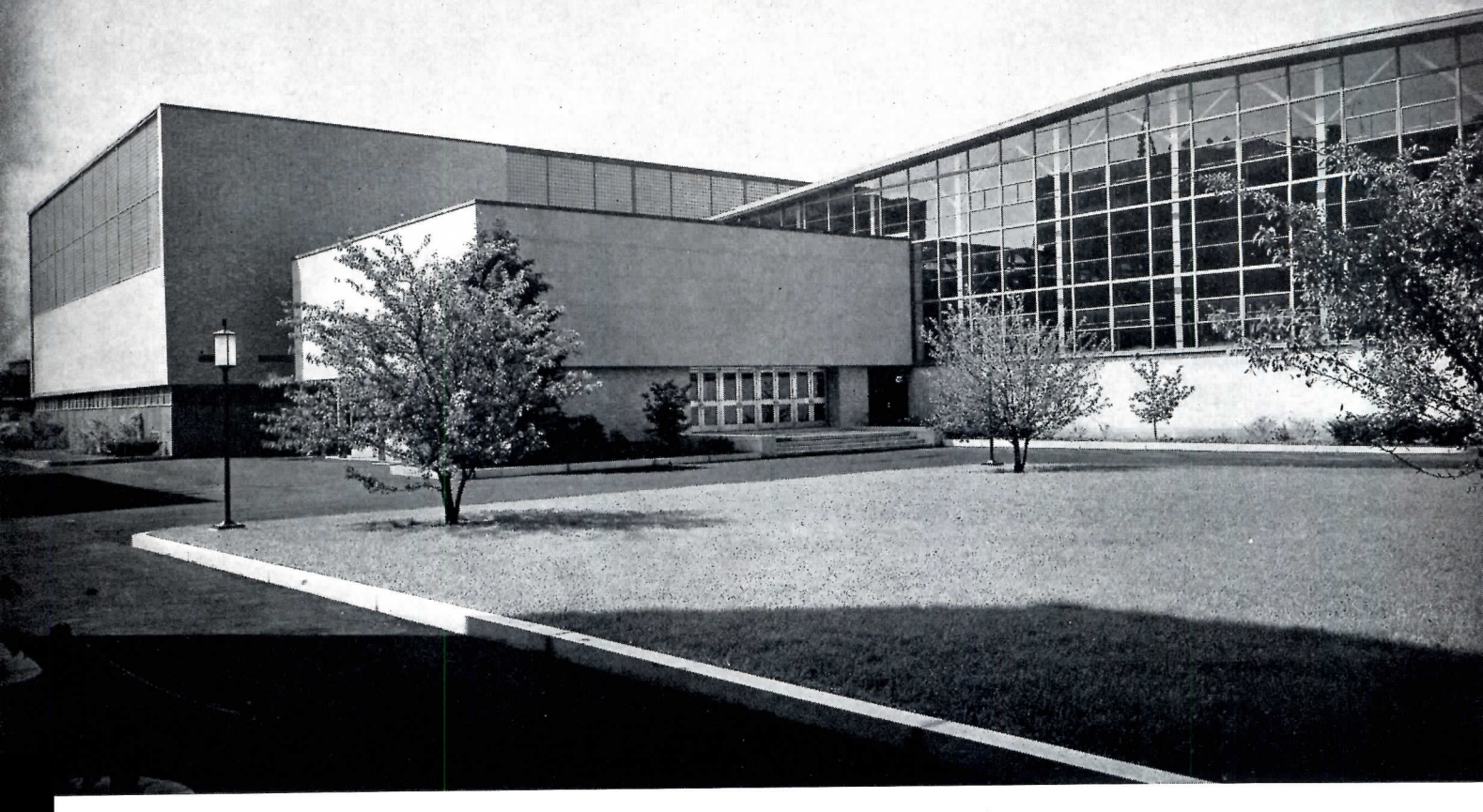

NORTHEASTERN UNIVERSITY, BOSTON, MASS.

Main gymnasium is 110 by 156 ft, has 25-ft headroom, stands for 1700, temporary seats for 1300 more. Women's gym, not shown, is 51 by 103 ft. Rifle range is 50 ft, has 5 firing points. Boxing room is one of several special facilities

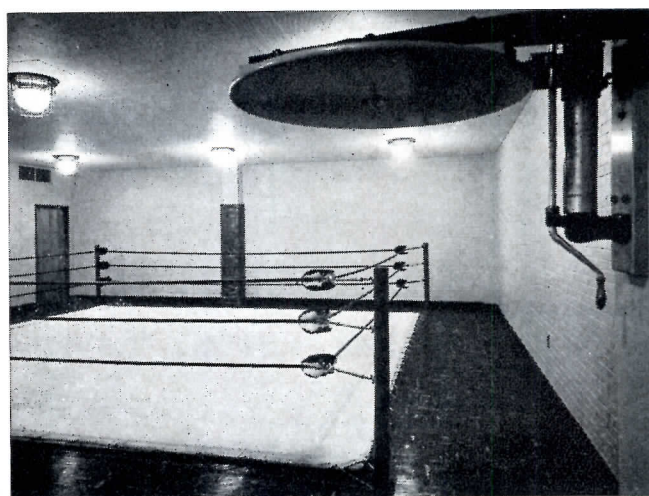
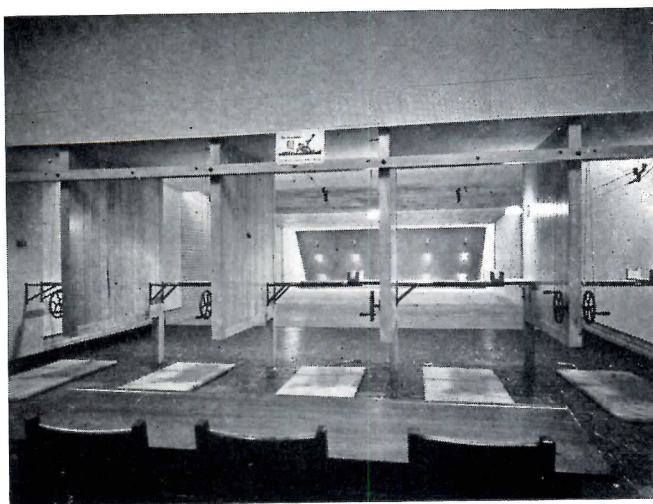

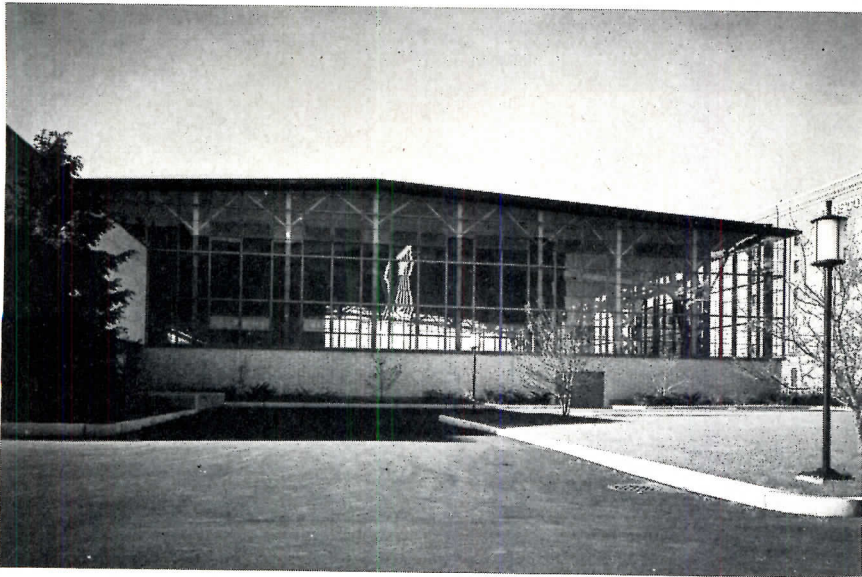

Joseph W. Mellior



Above, exterior, cage at right; and rear of building. Below, interior of cage; trussed rigid frames, substituted for steel plate frames due to steel shortage, employ standard structural H-sections. Clear span is 159 ft, height at center, 42 ft. Floor is resilient mixture of clay and peat moss. Total cost of Center: \$1,602,690 or \$0.57 per cu ft

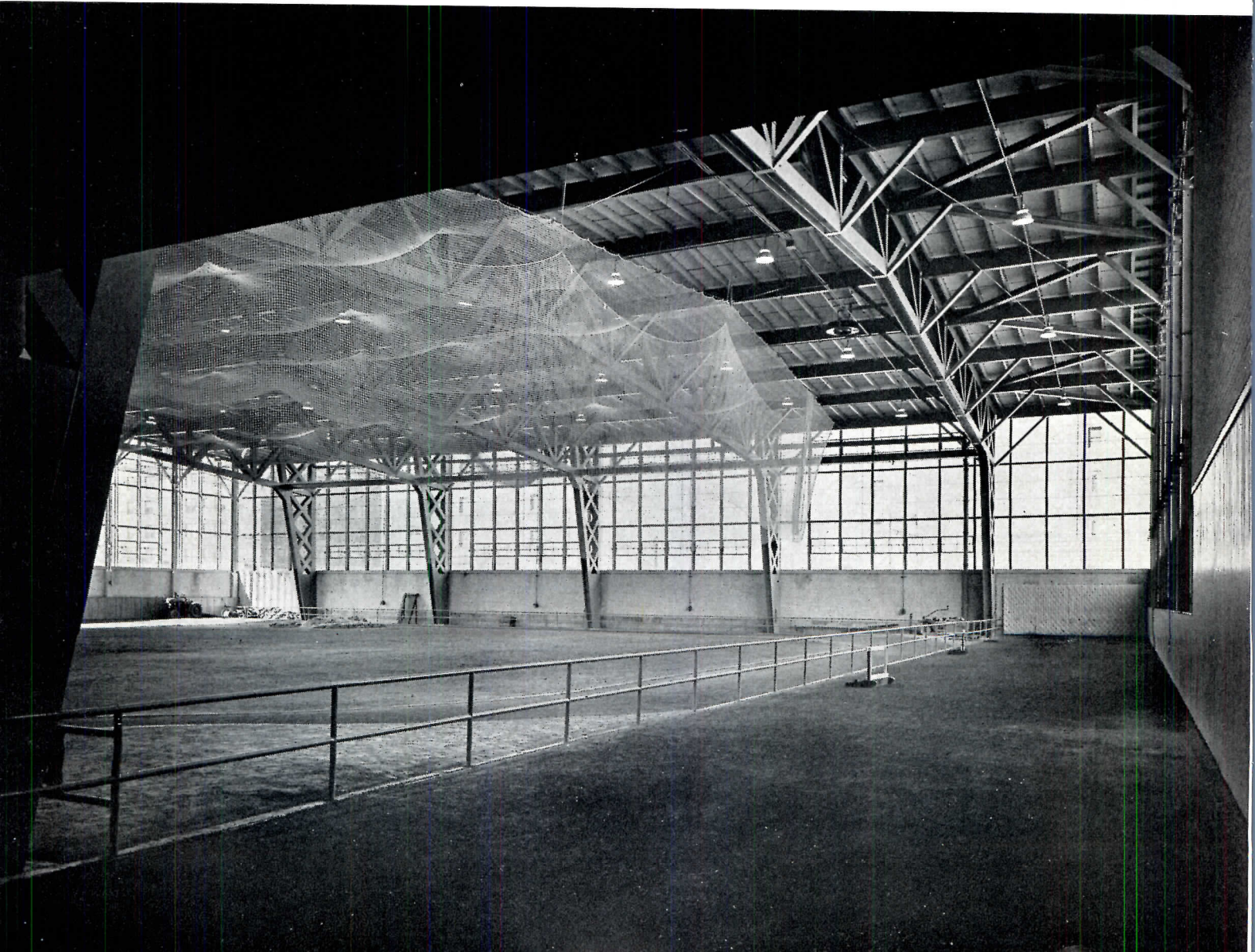

COLLEGE HOSTELRY: OBERLIN INN

OBERLIN COLLEGE, OBERLIN, OHIO

Architect, Eldredge Snyder; Landscape Architect, W. H. Lavery; Structural Engineers, Barber & Magee; Mechanical Engineers, Adache & Case

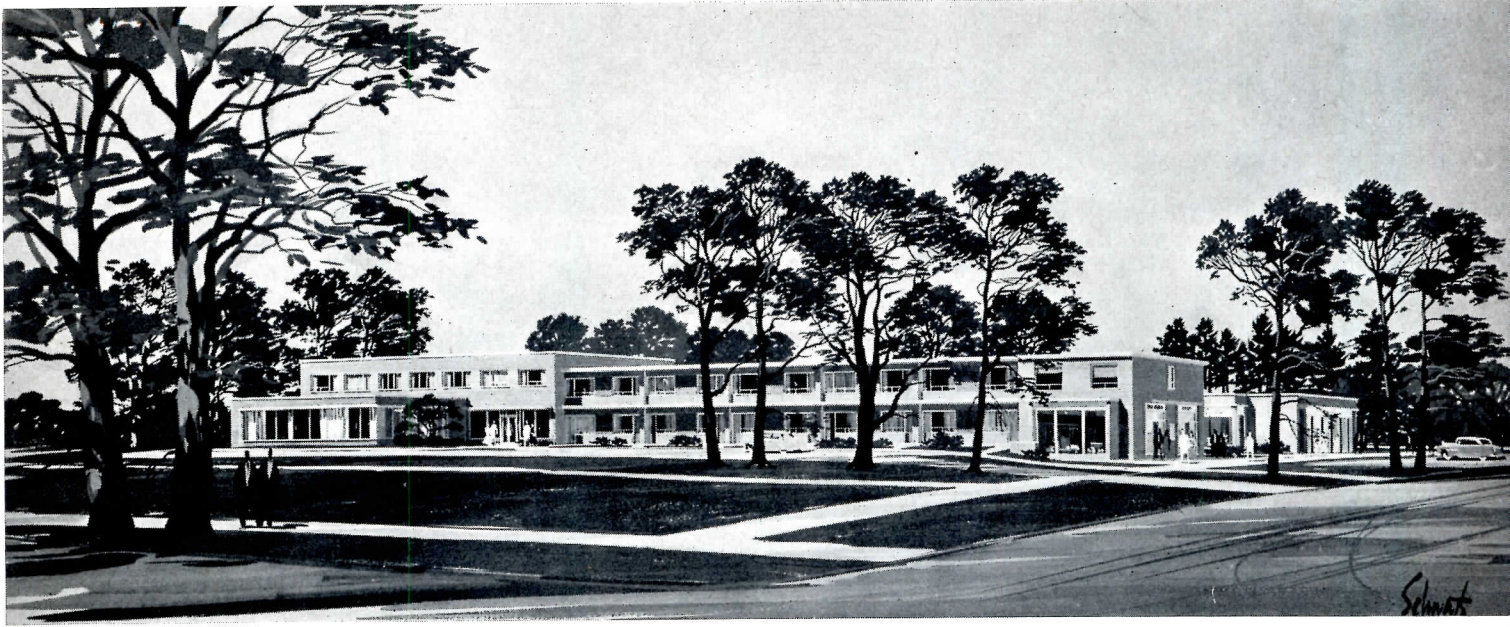

IN 1867, 34 years after Oberlin was founded on empty, rural acreage, the first Oberlin Inn was built at the small crossroads center which by then had begun to develop. It is now being replaced with the buildings shown on this page; completion is scheduled for this month. Financing the new work partly determined its nature, since a donor was thought to be unlikely and a hotel chain would have little interest in operating an inn in a "dry" town served by no railroad. Hence the combination of hotel and motel-like accommodations: 48 bedrooms, two restaurants, private dining rooms, kitchen to serve 200 at a sitting (all rooms combined); and the adjacent shopping center unit. Patronage is expected from College and business sources, visiting musical and theatrical organizations, and tourists.

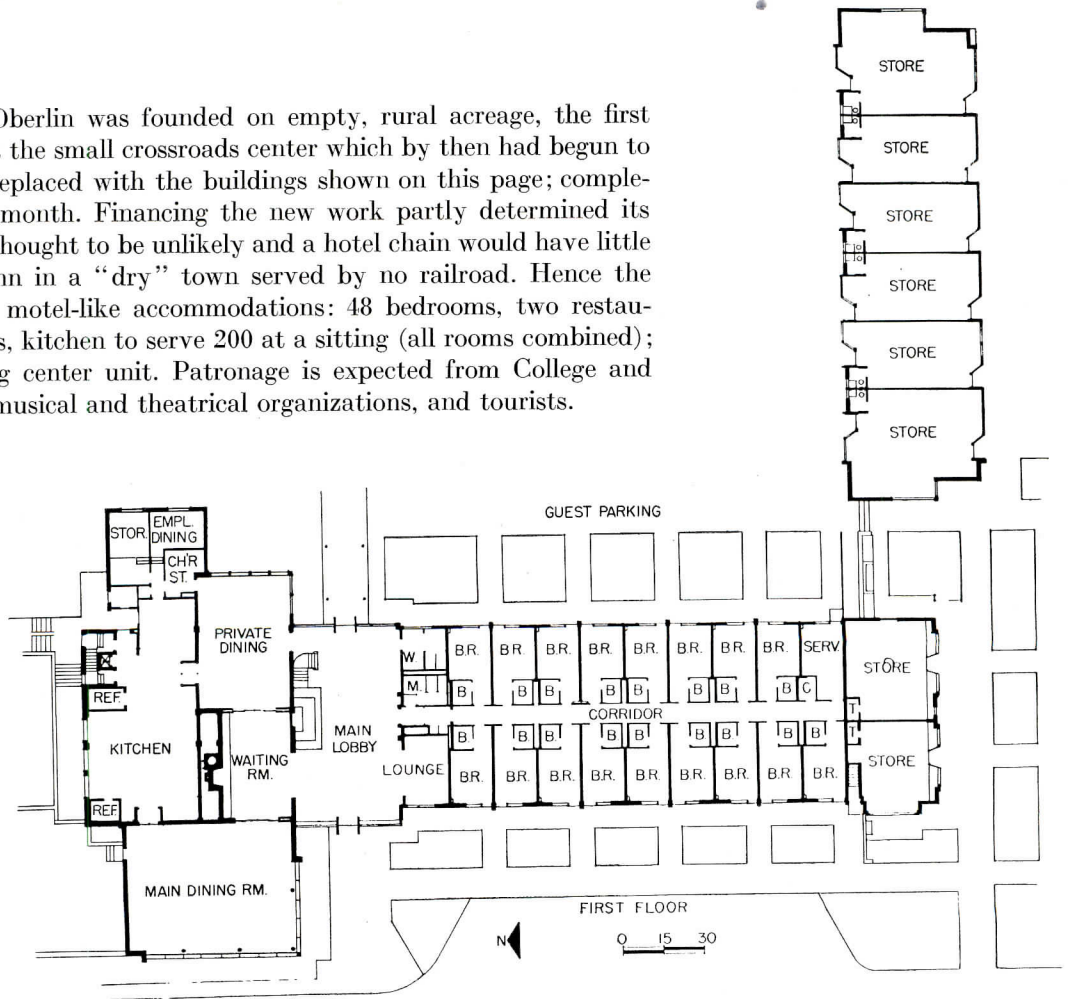

Herman Kroll



Herman Kroll



Wm. R. Whitaker Studios

BUILDING FOR COLLEGE OF APPLIED ARTS

THE UNIVERSITY OF CINCINNATI dedicated, late in 1953, the first unit of its new building for the College of Applied Arts: Alms Memorial, named for the late Mr. and Mrs. Frederick H. Alms who willed the University \$200,000 for the purpose. The building is of reinforced concrete with an exterior of brick, glass and stone trim. Second and third floors are similar in general plan to first floor (below). The large, open interiors are at present partly occupied by teaching areas (studios, etc.) which are likely to be redistributed when the eventual scheme, shown in model photograph (right) is fulfilled.

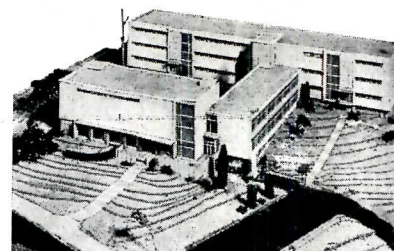

Herman Kroll

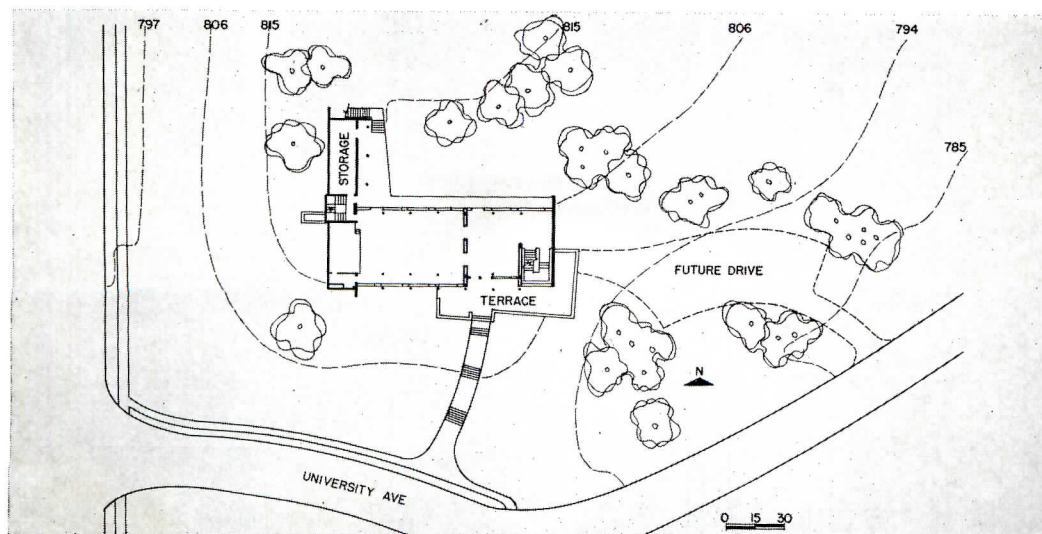

**ALMS MEMORIAL
BUILDING,
UNIVERSITY OF
CINCINNATI,
CINCINNATI, OHIO**

**James E. Allan,
Archit.-Engr.**

**George Frederic Roth,
Consultant**



Charles. R. Pearson

MEN'S DORMITORY, UNIVERSITY OF WASHINGTON

STUDENT HOUSING at the University of Washington is expected to develop as a series of tower dormitories in pairs connected by separate dining halls and lounges and joined in the middle with a common kitchen. The high cost of urban land dictated the tall-building scheme. The buildings, eventually lining Campus Parkway, will be enhanced by reorganization of the automobile approaches and by landscaping. Of these the Men's Residence Hall shown here is the first. It houses 600 students and guests as well as dining, kitchen and recreation facilities. The first floor contains entrance, administration, mail and toilet rooms. Below is a garage for approximately 70 student cars; and under the dormitory proper are service and storage areas, music practice rooms, etc.

SEATTLE, WASHINGTON

*Young, Richardson,
Carleton & Detlie,
Architects and Engineers*

*John Paul Jones,
Supervising Architect*

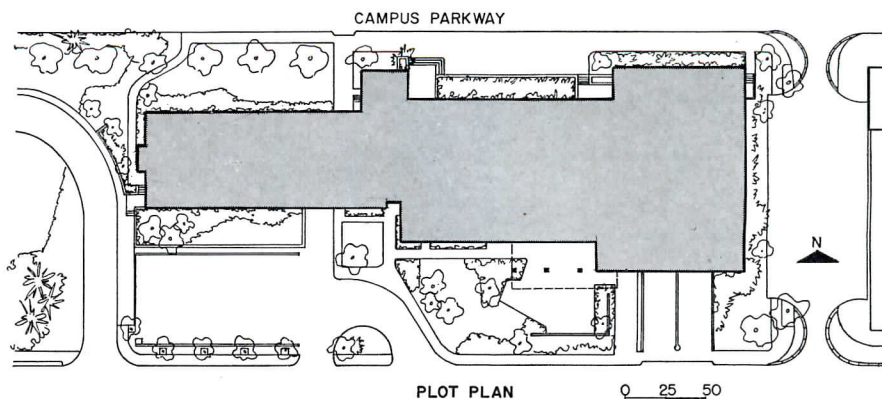



Food is served cafeteria-style; kitchen has room for more equipment so it can serve planned additional dining areas

Charles R. Pearson

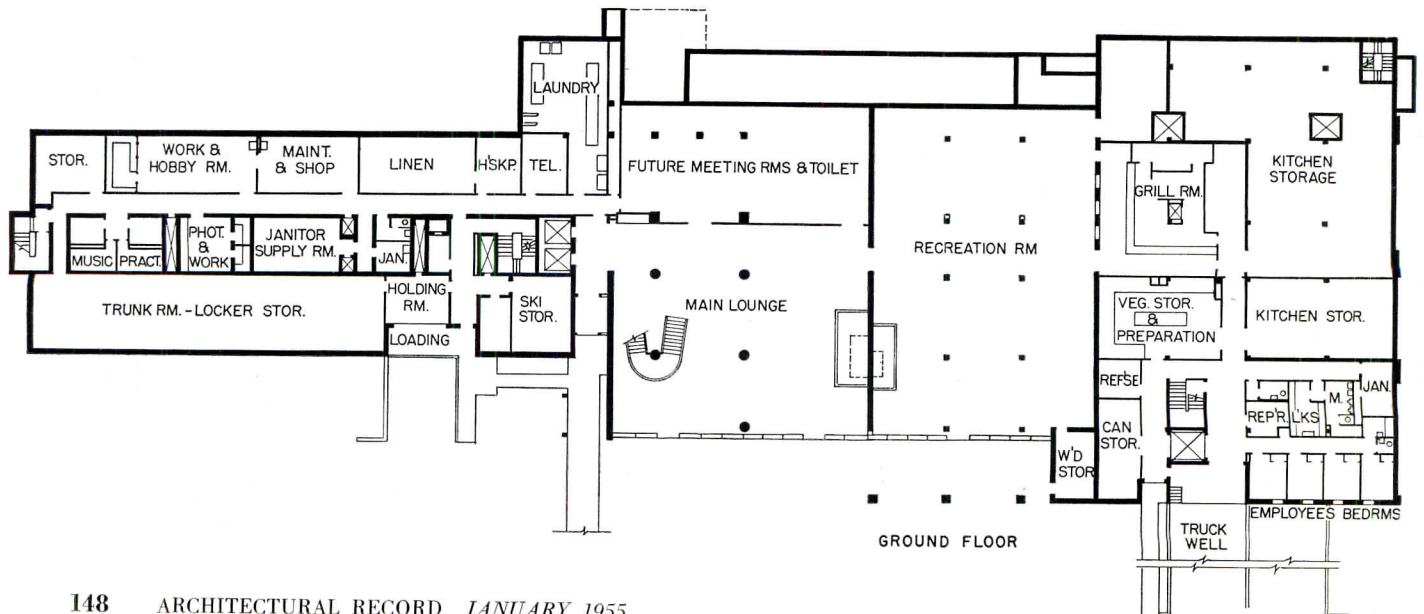



Building is organized into dormitory units of approximately 100 students each, housed on pairs of floors with a two-story lounge for each unit. Every floor has a Proctor's room, linen rooms, quiet study rooms, kitchenette facilities, storage for athletic equipment. High-speed, duplex control elevators and ample stairs afford access between floors

Main lounge on first floor is also a two-story room, notable for its huge fireplace and sculpture of the University's Husky mascot as well as the cantilevered stair connecting it with a balcony. Adjoining are a recreation room and a grill room containing a soda fountain

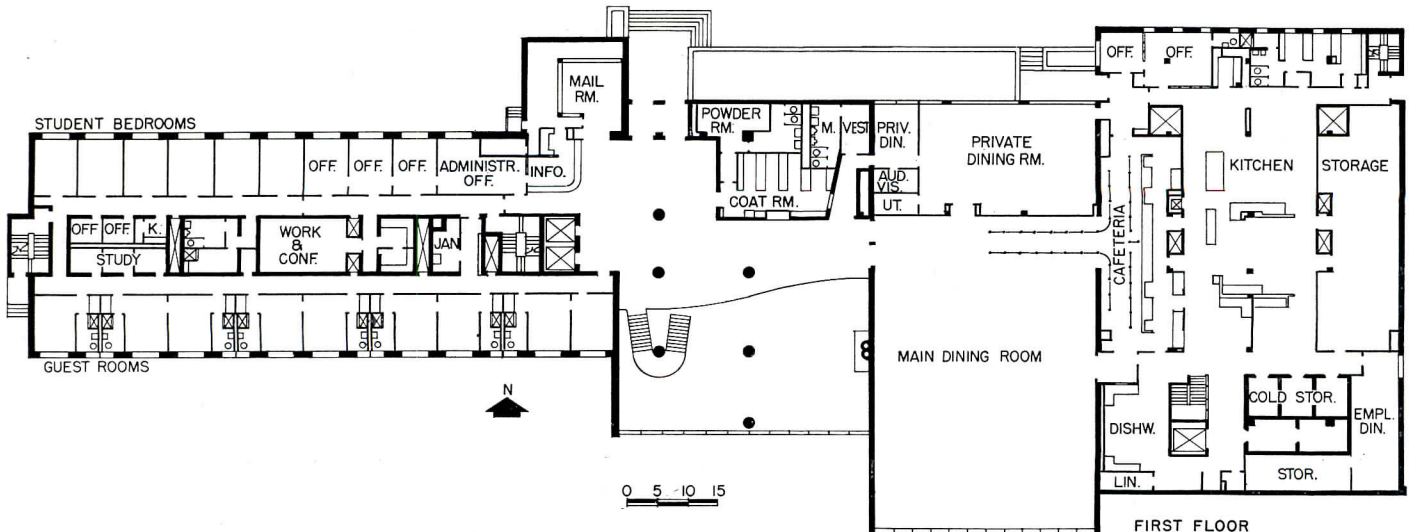
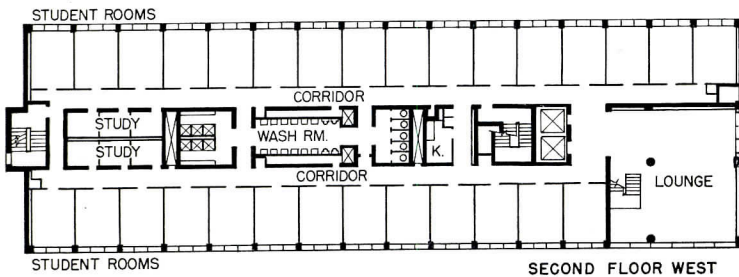

COLLEGE BUILDINGS: UNIVERSITY OF WASHINGTON DORMITORY

Each room has been designed for maximum efficiency, to provide ample storage, sleeping, social and study space compactly arranged. Yet, while economy was undoubtedly the controlling factor, nothing reasonable has been omitted that would contribute to an atmosphere suitable for study and relaxation. Frequently admired though inexpensive is the use of draperies, sun-yellow in rooms exposed to the north and blue in windows with southern exposure. Furniture, including wardrobes, bookcases, desks and built-in bolsters at the studio couches, was not only simply detailed for assembly on the job; drawings were also made to show how the mill-fabricated parts went together. Examples are the wardrobe assembly drawings below

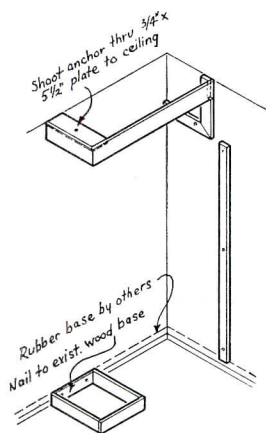
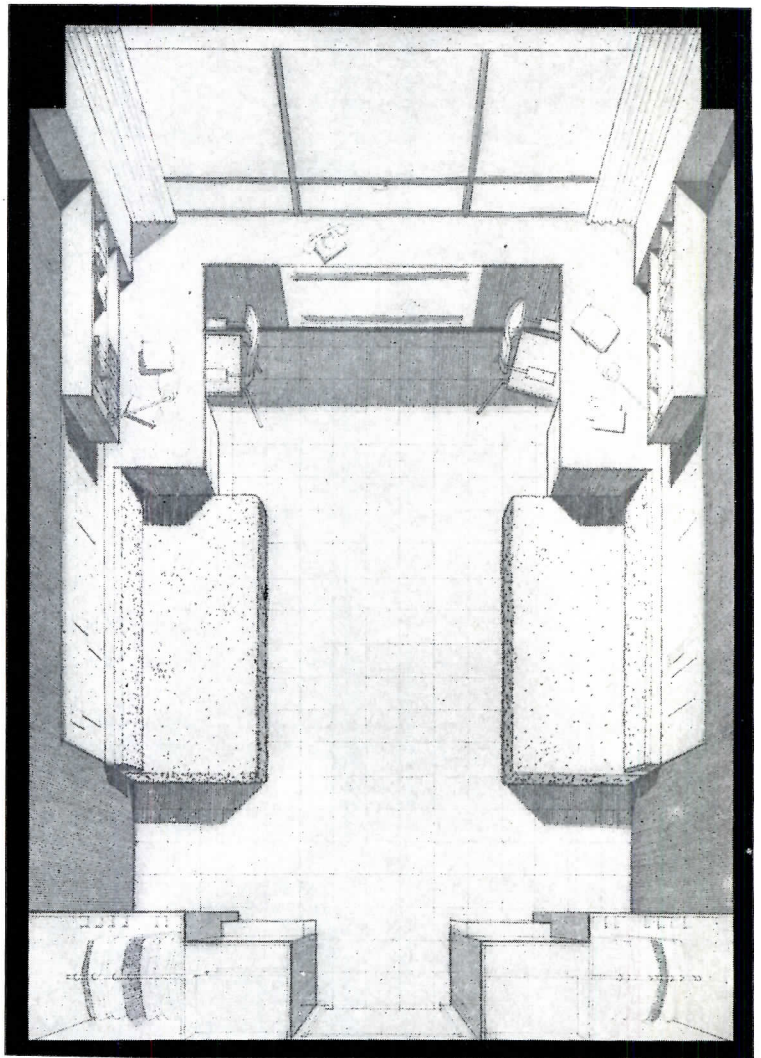
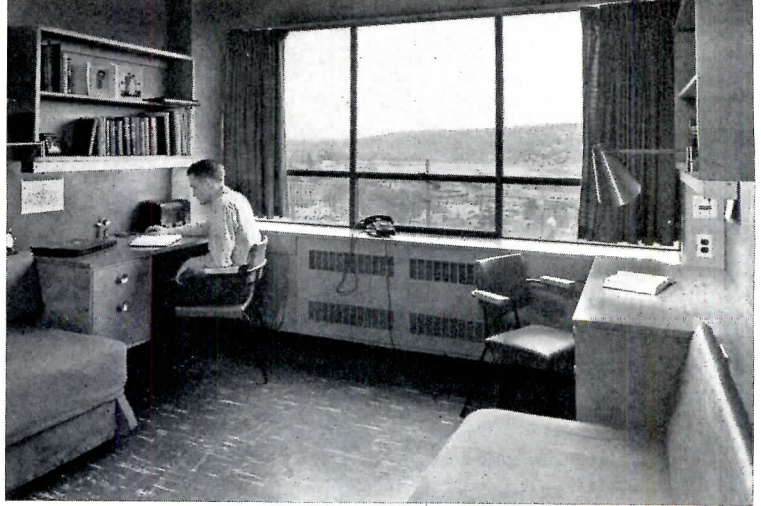

STAGE 1

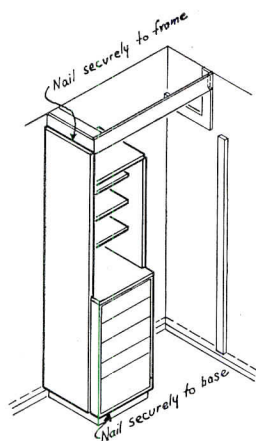

STAGE 2

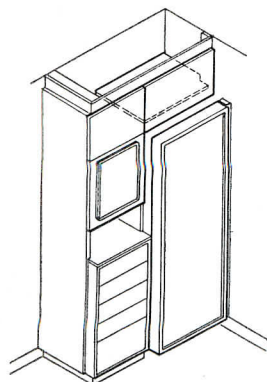

STAGE 3

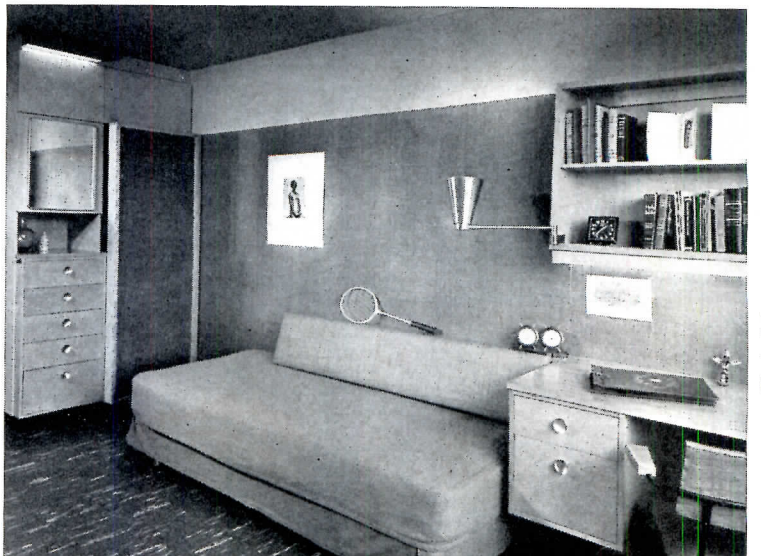

THE COLLEGE HOUSING THAT HHFA LOANS BUILD

The college housing loan program administered by the Housing and Home Finance Agency under Title IV of the Housing Act of 1950 has already helped 226 institutions provide housing for 48,377 students; and only a little more than half the amount of the original authorization of \$300 million has been spent. Architecturally the results are most notable for their diversity — a circumstance stemming from an operating philosophy which puts a high premium on freedom for the individual institution and its architect. Architects have high praise for the operation of the program (see page 24), which

has been the responsibility of the College Housing Branch (Jay du Von, Director) of HHFA's Division of Community Facilities and Special Operations (John C. Hazeltine, Commissioner). On this and following pages, a progress report including representative examples of projects financed under the program . . . See Building Types Study No. 218 (pp. 125-150) for additional examples of HHFA-financed projects: North Campus Housing, University of Michigan; Men's Dormitory, University of Washington; Illinois Institute of Technology housing

By Albert M. Cole, Administrator
Housing and Home Finance Agency

EARLY IN 1950 representatives of American colleges and universities presented to the committees of the Congress of the United States a plan for long-term Federal loans at reasonable rates of interest which would enable these institutions to construct urgently needed permanent housing for students and faculty. The spokesmen for these institutions pointed out that the high costs of construction, the undesirability of increasing students' rentals beyond their capacity to pay, and the difficulty of securing long-term funds at reasonable rates of interest all combined to block their efforts to provide housing for present enrollments as well as for the increasing demands of the future. They also cited the deterioration of temporary barracks which had been provided with Government assistance for the short-term use of veterans enrolled under the G.I. Bill of Rights.

Congress adopted an amended form of the proposal in Title IV of the Housing Act of 1950 which authorized \$300 million in borrowings from the United States Treasury to finance such college housing loans for institutions unable to secure such loans from private sources at comparable rates. The legislation provided for a differential between the interest cost of borrowings from the Treasury and the interest rate to be charged to the colleges for the purpose of defraying the cost of administration of the program and making possible its operation without eventual loss to the Federal Government.

Spending at Midpoint

After a year's delay due to the outbreak in Korea, the first loan under the program was made in July 1951. Since that date a total of 144 loans in the amount of \$112.8 million have been ap-

(Continued on page 240)



Reynolds Photography Inc.

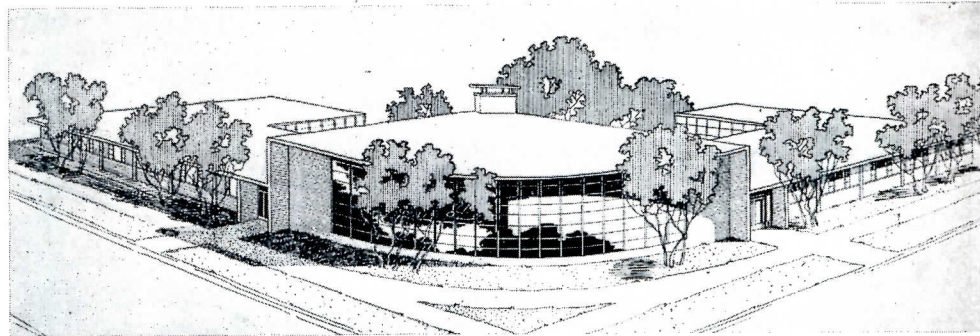

Top: men's dormitory, Colorado A & M — four three-story dormitory wings with central two-story lounge-dining unit; capacity 400, cost \$1.5 million, area per occupant 248 sq ft; architect, James M. Hunter.
Above: women's dormitory, Upper Iowa University — two one-story L-shaped wings joining central high-ceilinged lounge; capacity 54, cost \$238,000, area per occupant 265 sq ft; architect, William A. Lockard.
Below: men's dormitory, Tufts College (Mass.) — three- and four-story, includes dining facilities; capacity 280, cost \$1,065,000, area per occupant 239 sq ft; architect, Arland A. Dirlam

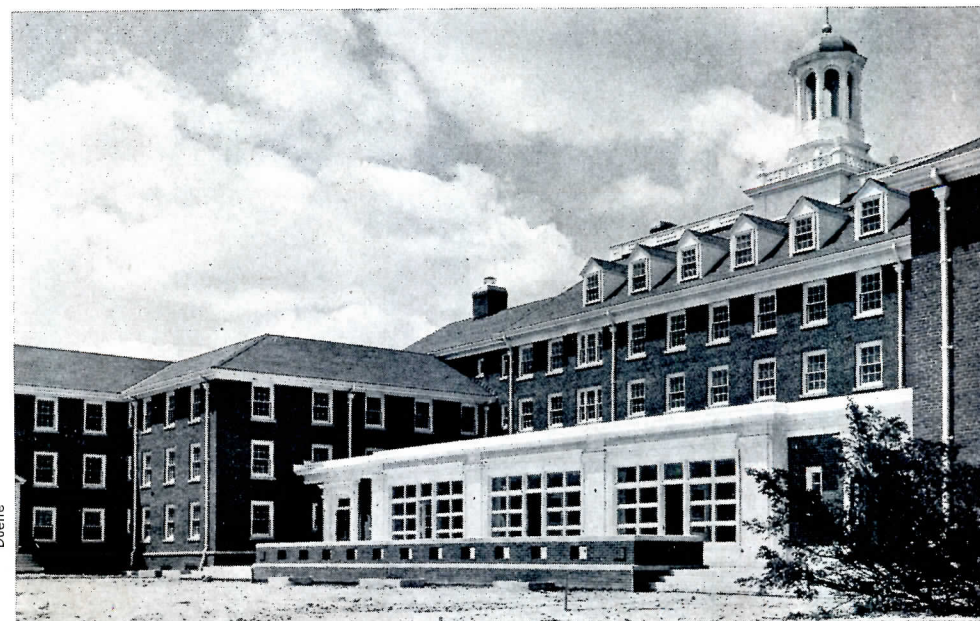

Duette

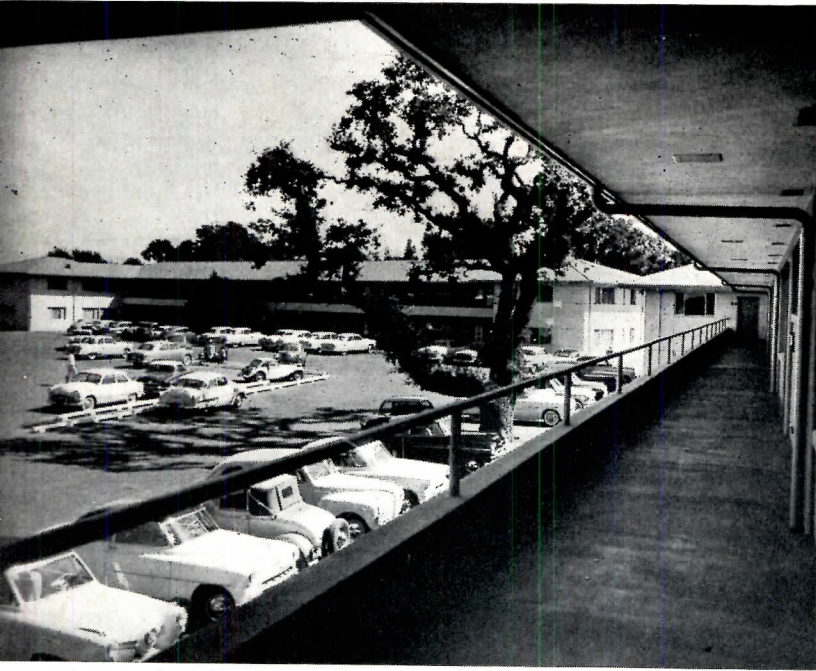

Ingersoll Studio

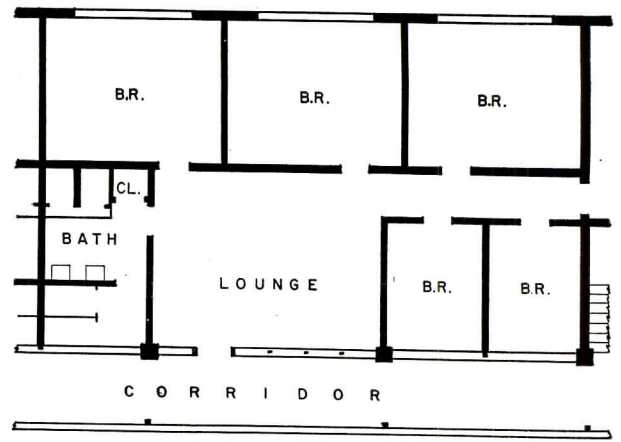

Two men's dormitories for Menlo (Junior) College (Cal.)—two-story units provide for 128 students and eight faculty apartments; cost \$520,000. Typical living arrangement (sketch) provides lounge and washroom for each eight students. Area per student, 204 sq ft; study-bedroom per student, 107 sq ft; toilet-shower per student, 15 sq ft. Architect: Kingsford Jones

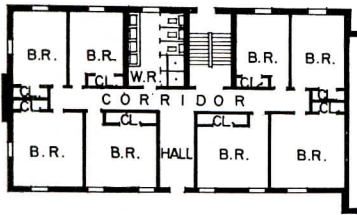

Women's dormitory, University of Maryland—nine connected four-floor units; capacity 488. Sketch shows typical living unit. Architect: Ted Englehardt. This plus a dormitory for 448 men by Mr. Englehardt and another for 368 men by Walton and Madden (see page 242) cost \$2,350,000, for lowest per-bed cost in HHFA program. For all three: average area per occupant, 156 sq ft; study-bedroom, 100 sq ft; toilet-shower, 13 sq ft



Feet-Melbrook Inc.

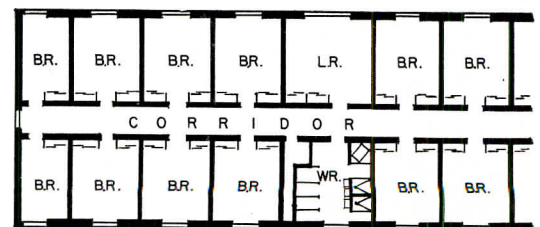
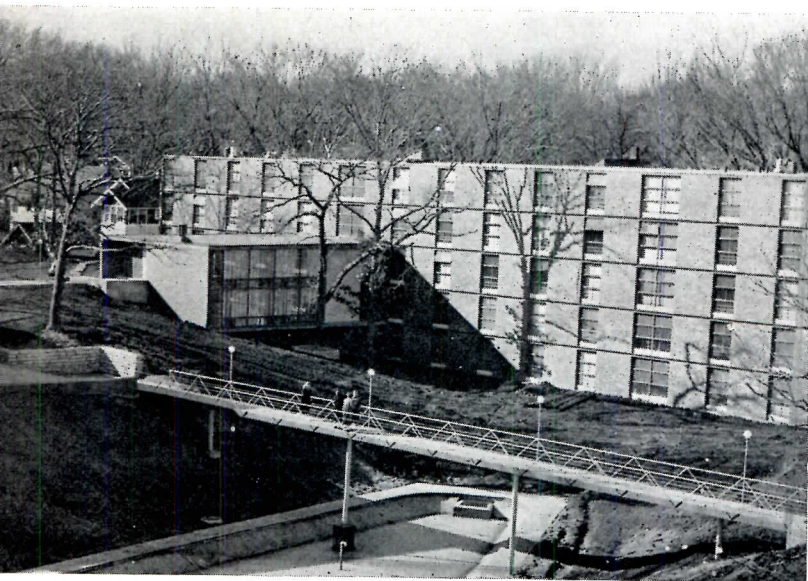

Women's dormitory at Drake University (Iowa) is one of three new dormitories which were completed last year at cost of \$1,648,000 to house 384 women and 201 men. This unit accommodates 152; typical floor has 22 bedrooms (double 16 x 13 ft, single 16 x 9 ft), two washrooms, living room. Architect: Eero Saarinen

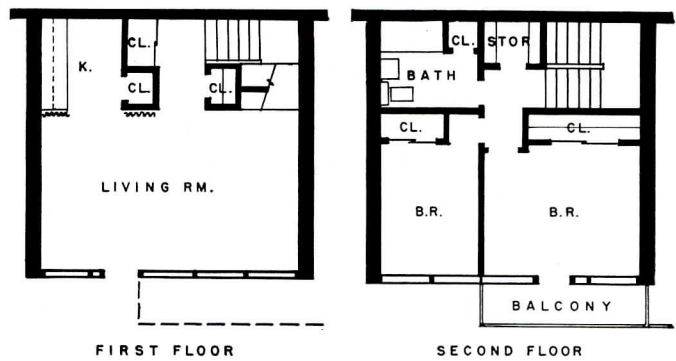
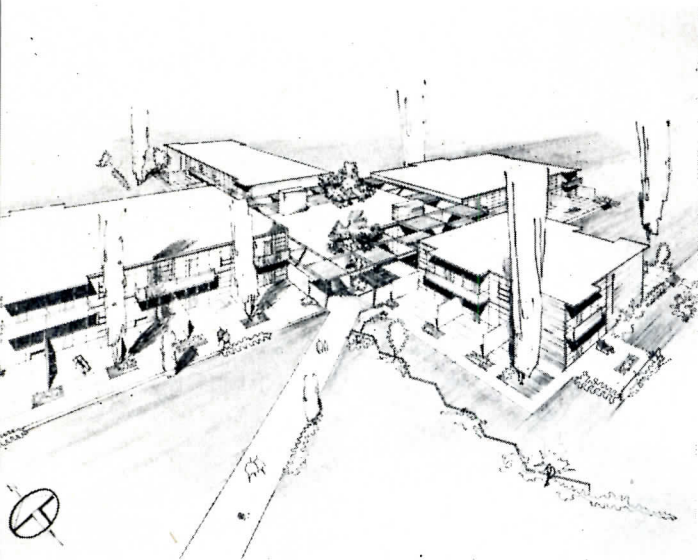

One of four separate two-story units containing a total of 92 apartments for married students and 52 for faculty at Indiana University. Total cost, \$2,050,000; average area per student apartment, 615 sq ft; average area per faculty apartment, 1140 sq ft. Two of the units have duplex apartments — sketches show typical plans in this one. Architect: Edward D. James

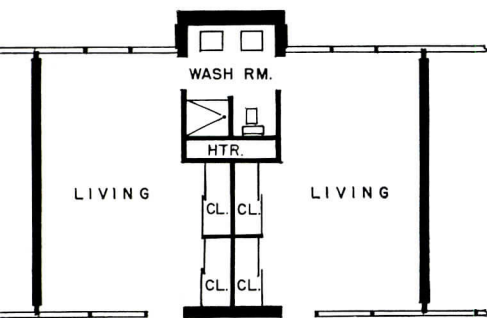

Men's dormitory, Trinity University (Houston) — two three-story units of lift-slab construction; capacity 150, cost \$480,000. Sketch shows typical four-student accommodation. Total area per student, 255 sq ft; study-bedroom-toilet-bath per student, 170 sq ft. Architect: O'Neil Ford

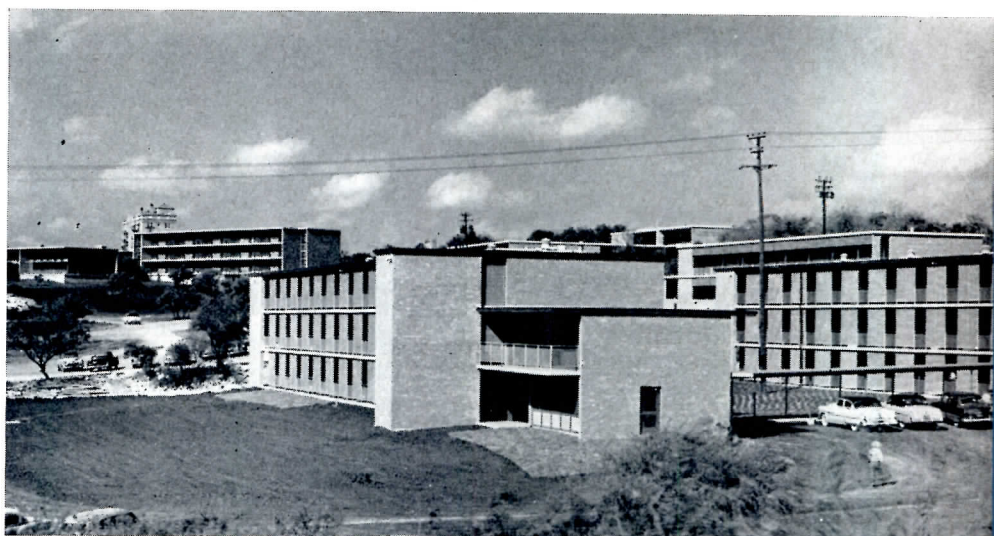

Clarence John Laughlin

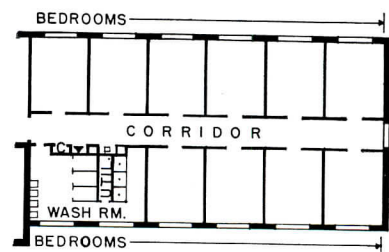

Women's dormitory, University of Southern Illinois — three connected four-story units, dining facilities included; capacity 422, cost \$2,059,000. Sketch: typical living arrangement in one unit; lounge adjoins with another 12 bedrooms beyond. Total area per student, 255 sq ft; study-bedroom per student, 90 sq ft; toilet-shower per student, 12 sq ft. Architects: Shaeffer, Hooton & Wilson

HHFA COLLEGE HOUSING PROGRAM



Williams & Meyer Co.

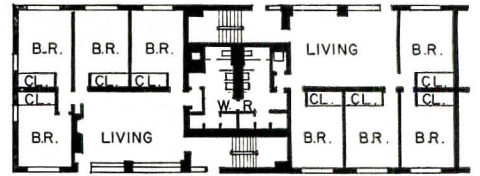

Men's dormitory, Knox College (Ill.) — first of three units to be built had eight men to one living room suite (new ones have 12); capacity 96, cost \$443,000. Sketch shows typical living arrangement. Area per occupant, 235 sq ft; study-bedroom per occupant, 111 sq ft. Architects: Skidmore, Owings & Merrill

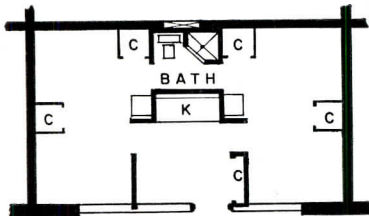

Men's dormitory, College of Southern Utah — capacity 200, cost \$230,000. Apartments are designed primarily for four men but with a view to married student occupancy as needed. Gross area, 21,449 sq ft. Architect: Robert Gardner

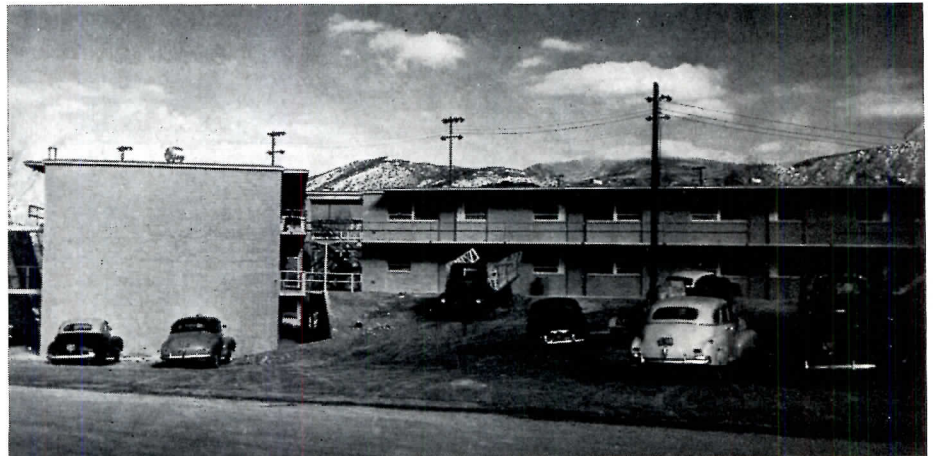

Northwest Photographic Illustrators



Photo: Women's dormitory, Reed College (Ore.) — capacity 72, cost \$230,000. Architects: Belluschi and Skidmore, Owings & Merrill. Sketch: plan of typical wing in projected dormitory for 101 men designed for Reed by same architects; to have two three-story dormitory wings with one-story lounge section; cost \$300,000. Area per student, 239 sq ft; study-bedroom area per student, 20 sq ft; toilet-shower area per student, 20 sq ft

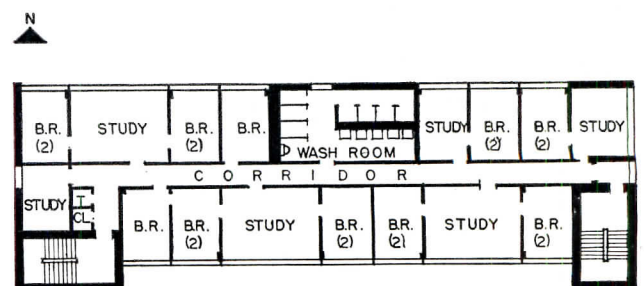



GLARELESS DAYLIGHTING IN HAWAII

Hawaiian Life Insurance Co. Building, Honolulu, T. H.

Vladimir Ossipoff, Architect

GOOD DAYLIGHTING without sun glare is always a problem in a climate such as Hawaii's, and architects in such areas are constantly coming up with new solutions to that problem. This new office building, located midway between downtown Honolulu and Waikiki, uses vertical fins, supplemented on the southwest side with sun baffles; there are no windows to the west.

Since the building fronts on busy Kapiolani Boulevard and houses the Internal Revenue offices and a restaurant in addition to the Hawaiian Life Insurance Company and other offices, parking space was also a major problem.



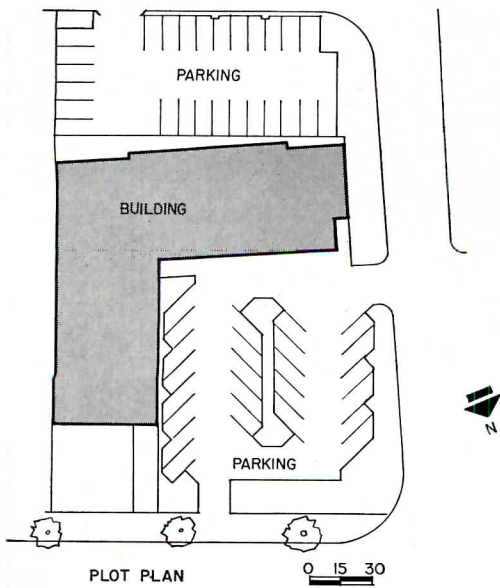

The long wing of the L-shaped building is six stories in height, the shorter wing only two stories. Construction is concrete, on a pile-driven foundation; exterior frame is steel, interior frame is open with joists and cellular steel decking. Concrete is painted white; vertical sun fins are aluminum, enameled a pale blue-gray-green; spandrels are painted dark brown. Ceramic tile on exterior is variegated rust-brown. The restaurant, on the ground floor of the two-story wing, fronts on Kapiolani Boulevard; its long west wall, facing the parking area, is entirely of glass, protected from the sun by the second floor extension.

Position of building on lot provides two separate parking areas, one for restaurant patrons and other transient visitors, and one at the rear for building occupants. Above: northeasterly elevation, with restaurant at left and roof of penthouse just visible. Below: opposite facade; exterior fire stairs are at extreme left of photo





Main entrance (above) is at end of covered walk flanking restaurant. Lobby (below) has direct access to both front and rear parking lot. Internal Revenue Department occupies all office space on first floor and has separate entrance; (see page 160). Hawaiian Life has second floor of both wings

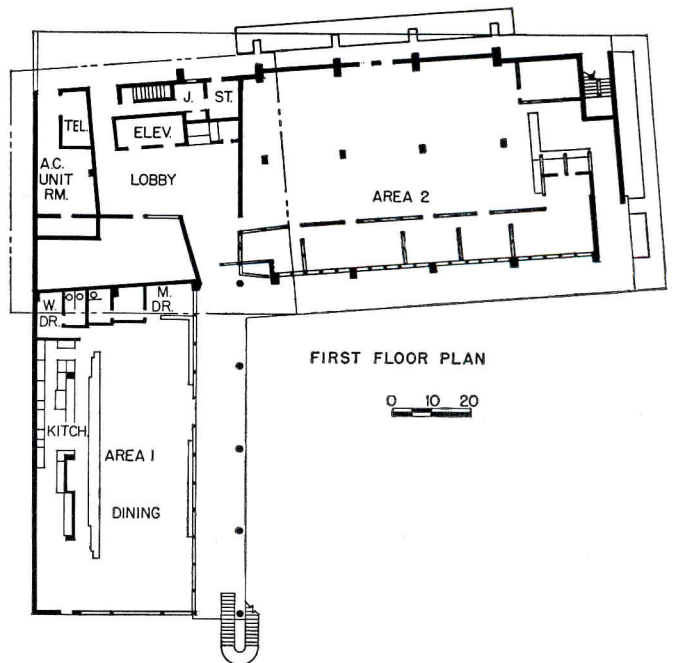
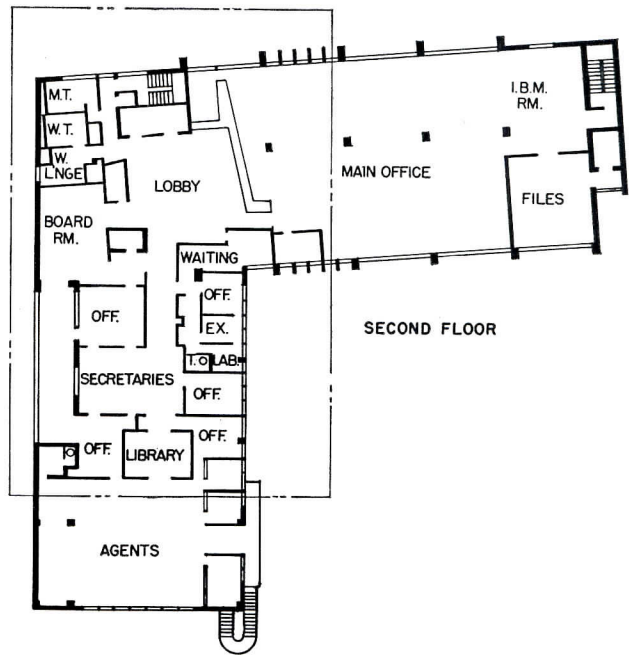
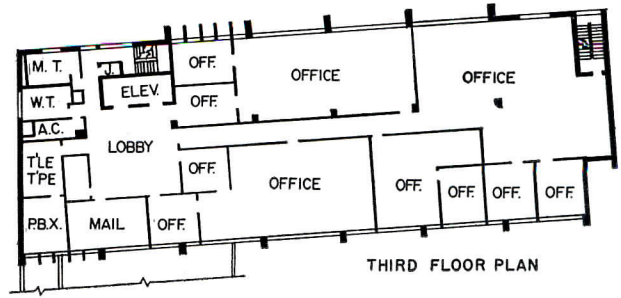



Woody's-on-the-Boulevard Restaurant occupies entire first floor of two-story wing. Architect explains that what looks like cotton in the window (above, left) is reflection of clouds over the mountains. Cantilevered stairs lead to agents' room in Hawaiian Life offices, reducing interior traffic



Hawaiian Life Insurance premises on second floor: above left, reception desk in elevator lobby; above right, agents' room; opposite, main office

Sun fins differ on two sides of building, and many studies were made of their effectiveness. On south, sloping baffles were used between vertical fins, but on north vertical fins alone were found to be adequate (right)

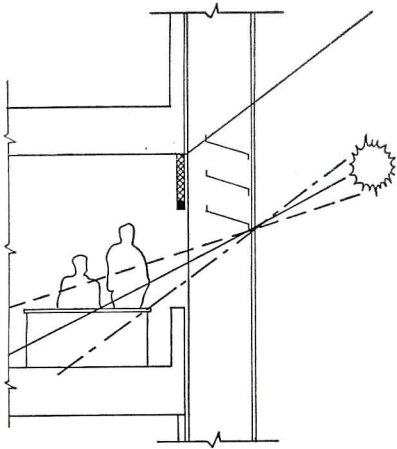

SOUTH FACE

- SUN AT 4 P.M.
- SUN AT 9 A.M. & 3 P.M.
- · - SUN AT 10 A.M. & 2 P.M.

R. Wenkam

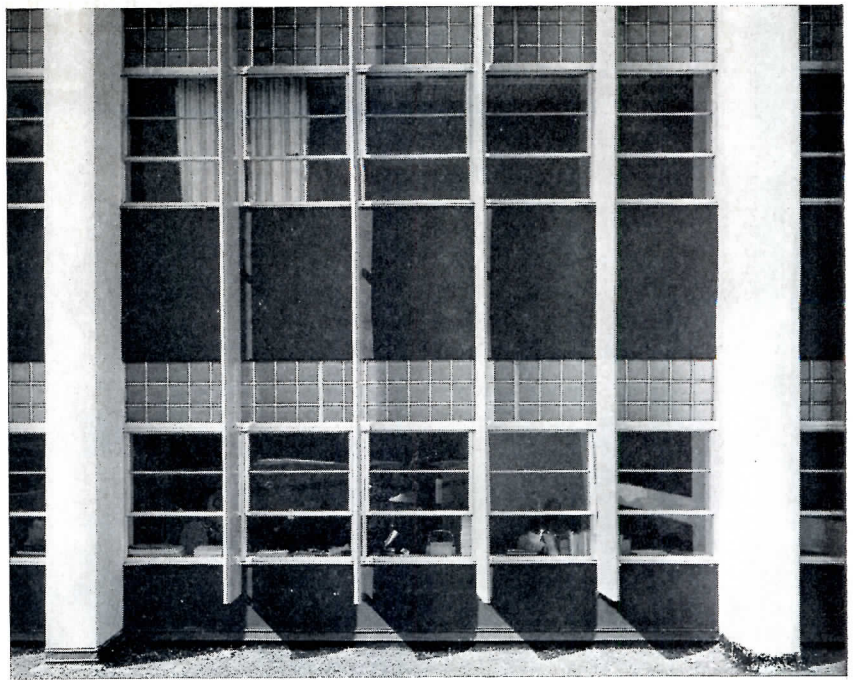

Right: Internal Revenue Department premises on first floor; Departmental requirement for solid walls 8 ft high resulted in less open facade than originally planned. Below: entrance to Internal Revenue; concrete slab outside fire stairs is faced with Cremona Italian tile

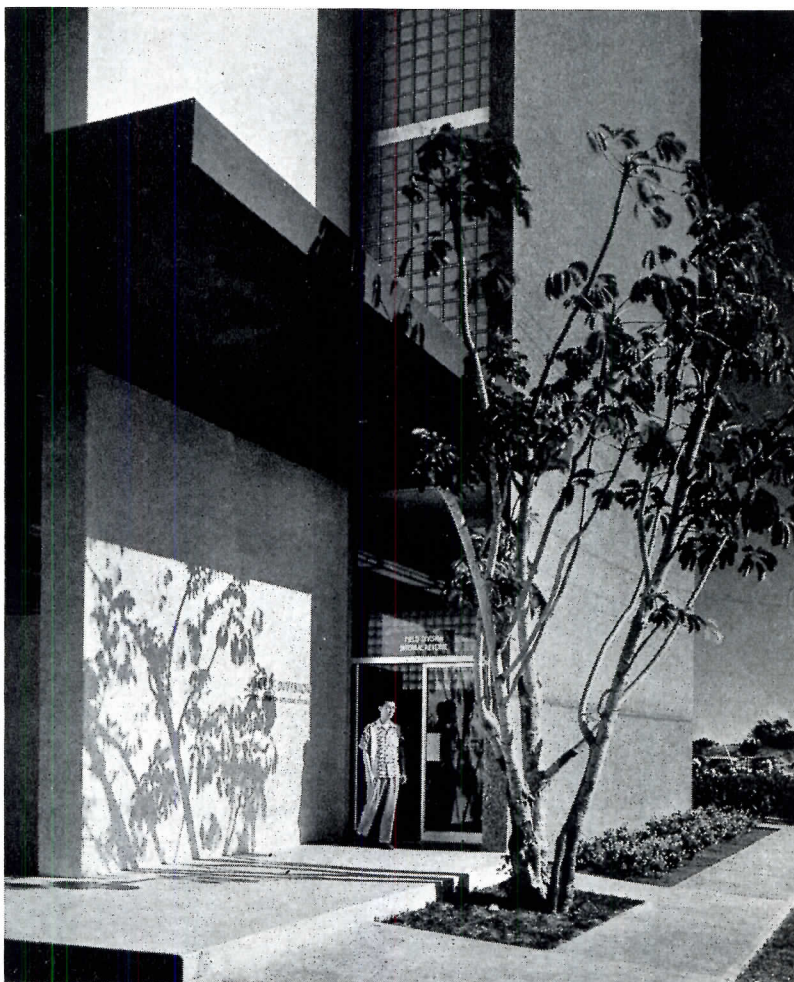

R. Wenkam

Mr. Ossipoff's office in the penthouse (right) is in tones of dark eggplant and white. Window drapery is vertical and horizontal split bamboo, desk is Janizero. Egg-crate ceiling has concealed lighting

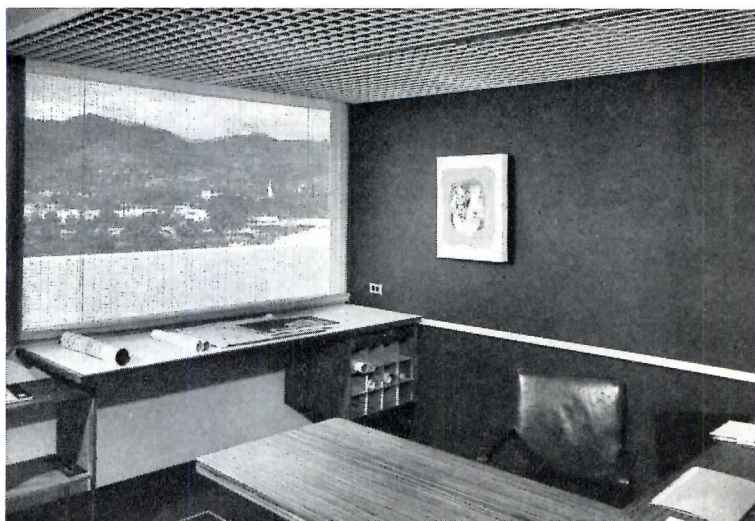

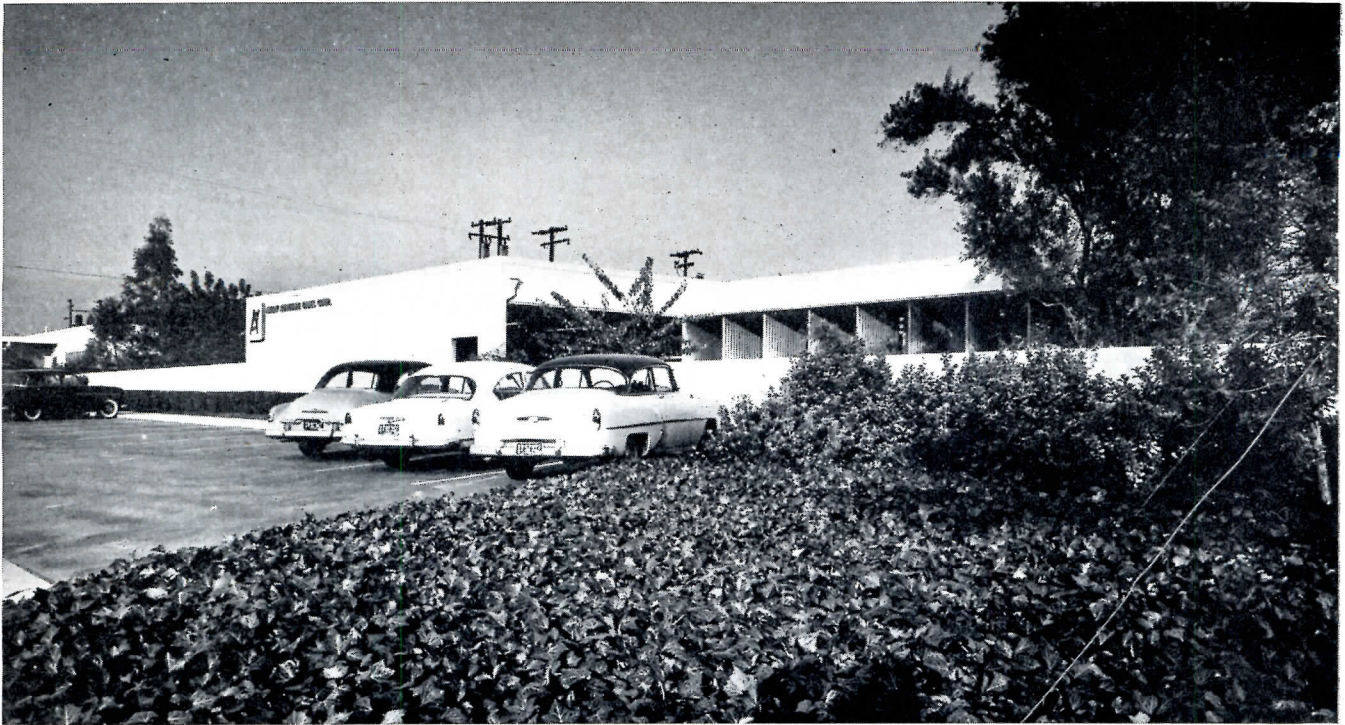

AMENITY VALUES IN A SMALL FACTORY

*Additions to Plant of Avery Adhesive Label Corp.
Monrovia, Calif.*

George Vernon Russell, Architect

Julius Shulman

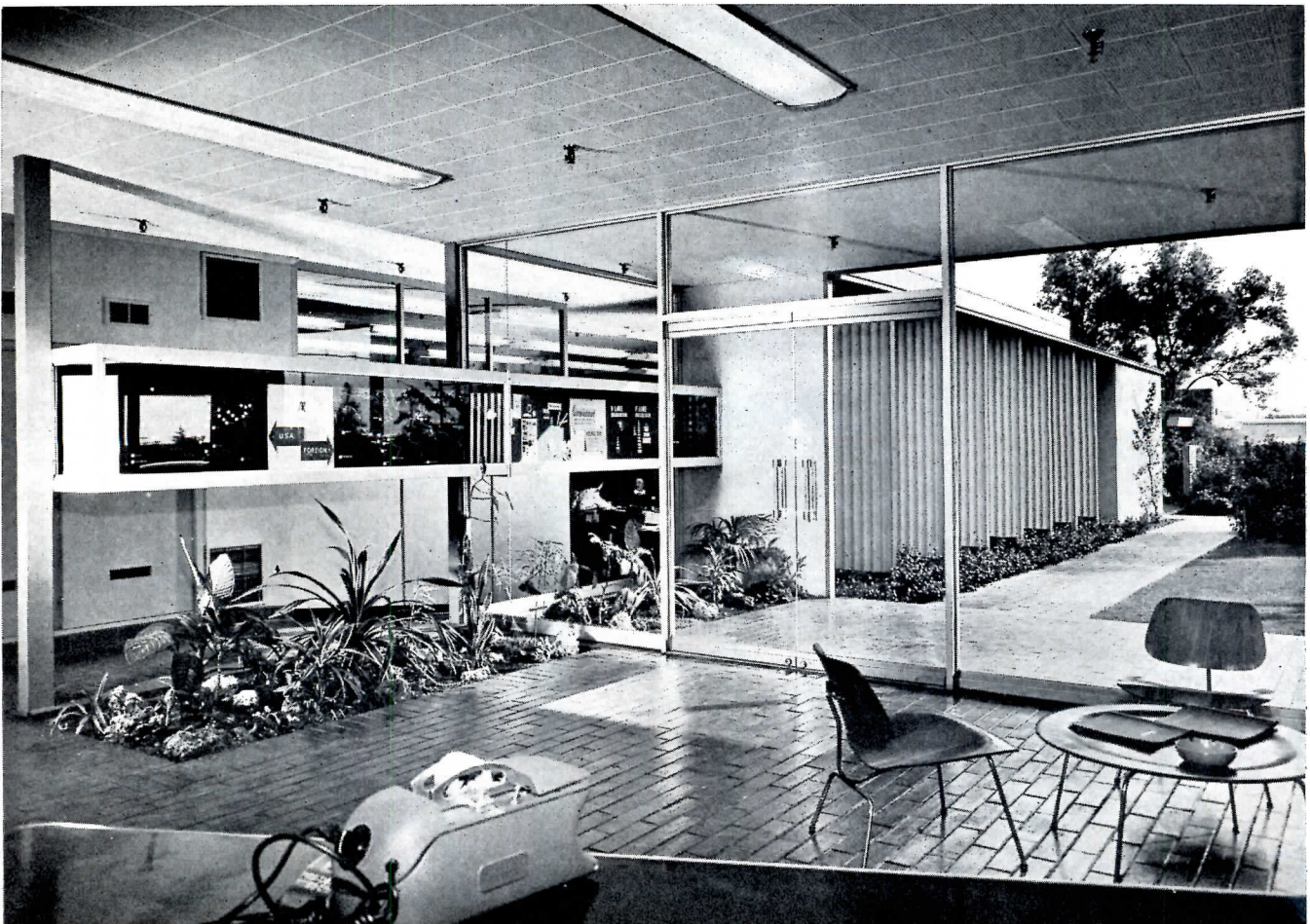

AVERY ADHESIVE LABEL CORPORATION

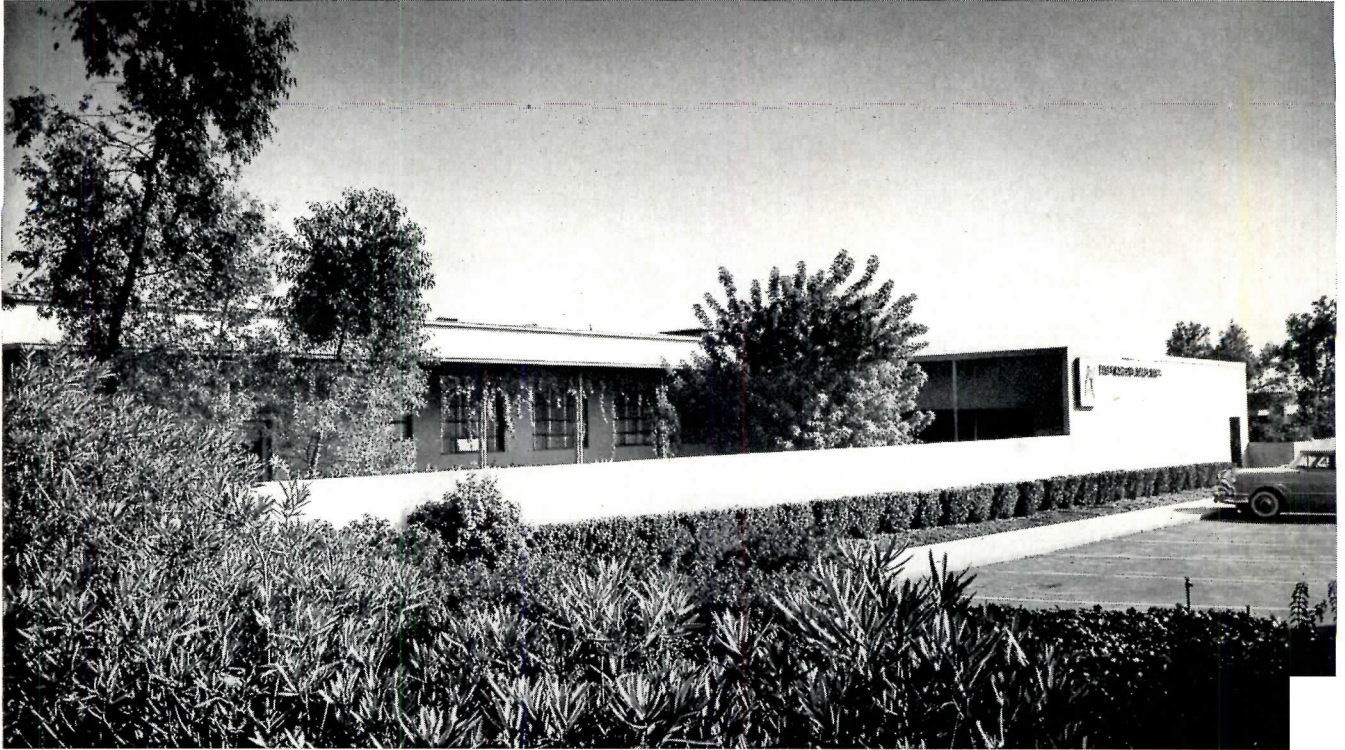

AMENITY VALUES"—a vague term for some pleasant plusses—are strongly developed in this small factory and office building. Notice, in the photo above, the walled-in garden which protects executive offices from street noises and confusion, also from dirt. There is also the pleasant entrance garden, with glass-walled reception space, with displays and planting tying indoors with outdoors. Employees have a large recreation room, with sliding glass panels opening to another garden; hiring offices open to this same terrace (photo opposite). Costs for these "extras" could not be large.

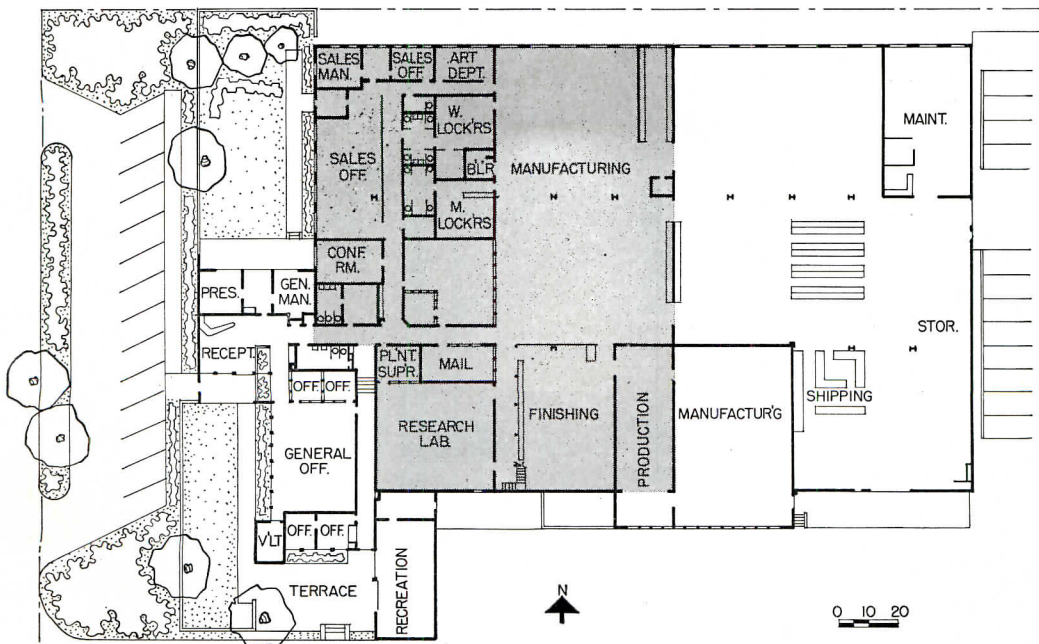

The alteration adds office space to one side of an older building (shaded area in plan), more production space to the other. The garden walls tie old and new together, and help somewhat in the process of absorbing the old with the new. The architect expresses his conviction that "alterations which disregard the existing building . . . are as wrong as a zoot suit on Discobolus"

One can imagine that the strains of being a president are considerably eased by the pleasant outlook from this office (below, left). Production area (right, below) is well lighted and not crowded. Certain adhesive rooms are designed for minimizing possible blasts from volatile materials

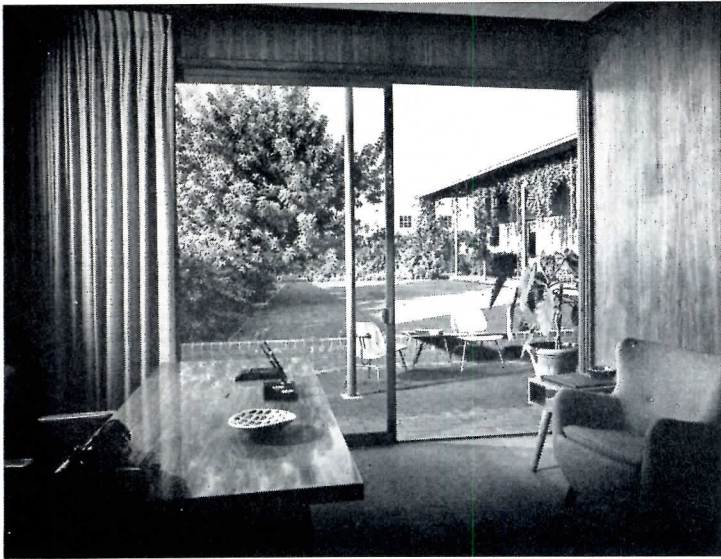

Lunch time is a pleasant hour for employes in the room shown below. Large sliding glass panels open the room to the brick-paved terrace. Walls in this section of the building are of a tilt-up panel system largely developed by the architect, permitting continuous fenestration

Julius Shulman



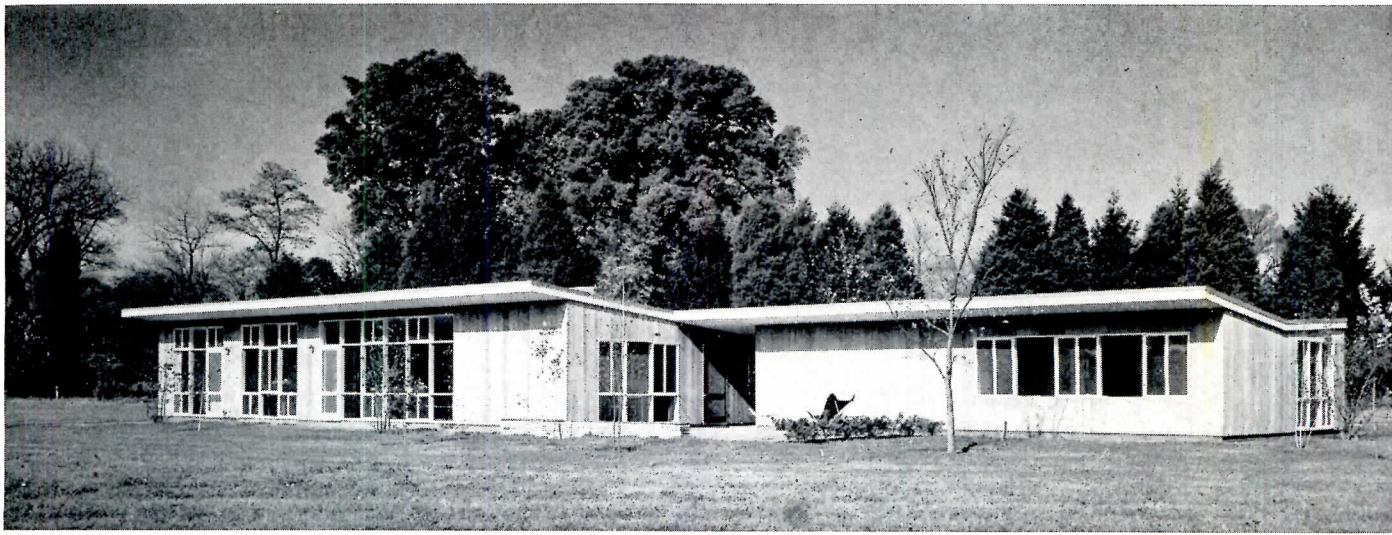

ARCHITECT'S STUDIO-RESIDENCE IN VIRGINIA

*House for Mr. and Mrs. Harry E. Ormston
McLean, Va.*

Harry E. Ormston, Architect

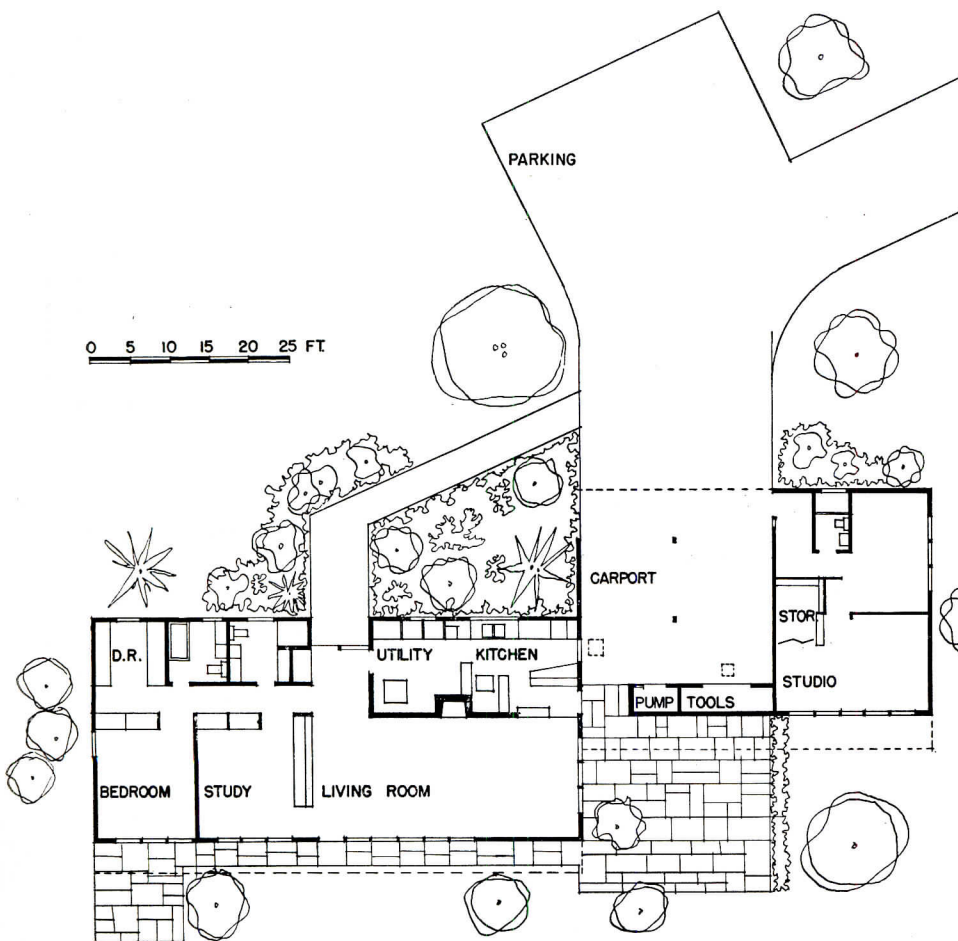

THIS STUDIO-RESIDENCE was planned by the architect-owner for maximum separation of home and office, with both under one roof. The carport was used as the divider, and the terrace was made the visual link between the two units.

Owner's requirements were: a one-level plan with principal rooms oriented to view at south; a minimum of fixed partitions and a maximum of movable head-high storage-type room dividers to assure privacy without limiting interior spaciousness. The 2½-acre site, originally a flat open field without any trees, has been transformed with the planting of over 500 trees and shrubs.

Exterior of house is natural redwood vertical siding; interior walls are plaster and birch plywood, oil painted and waxed.

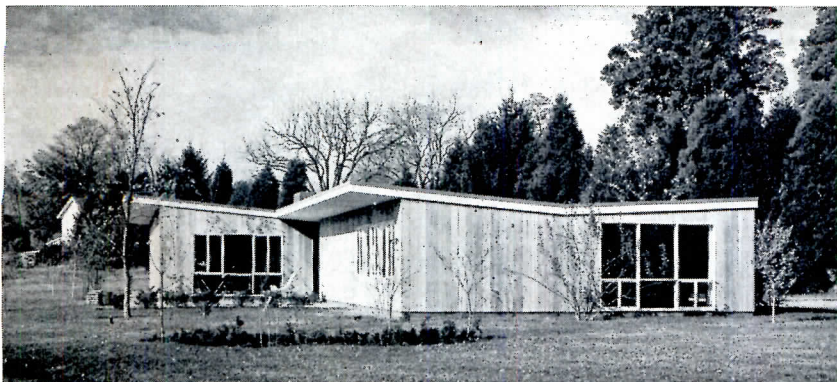

Architect-owner's studio is virtually a separate building, linked to house proper only by carport roof and rear terrace. Studio has own entrance adjacent to driveway for business visitors, but connects through carport with kitchen, living area

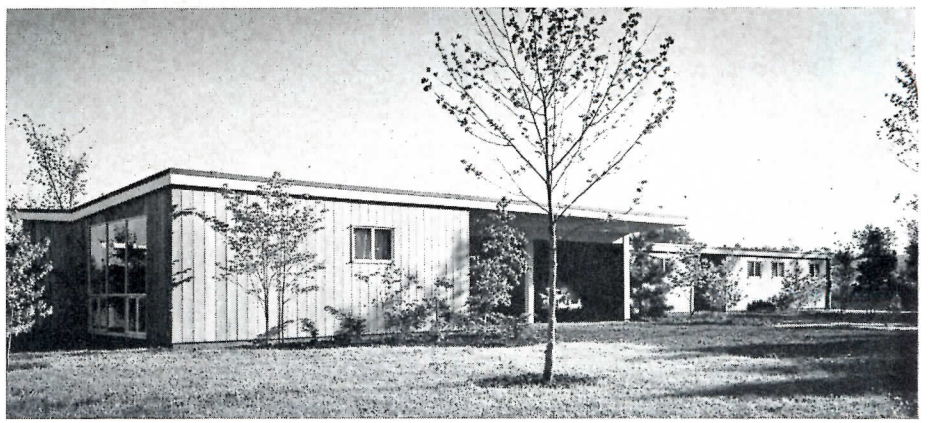

Windows on front of house (right above) are small and high to insure privacy. Rear walls (right and below) are largely of glass to take advantage of view; wide roof overhang controls sun penetration. Opposite page: top, rear elevation, with living quarters at left, carport in center, studio at right; bottom, end of studio wing, living room wing, in background. Below: living room and study are separated by book shelf unit which does not reach to ceiling; draw curtain provides privacy when needed. All built-in furniture such as book cases, storage cabinets and desks were designed by architect and constructed on site of birch and fir plywood. Recessed ceiling lights also were designed by architect

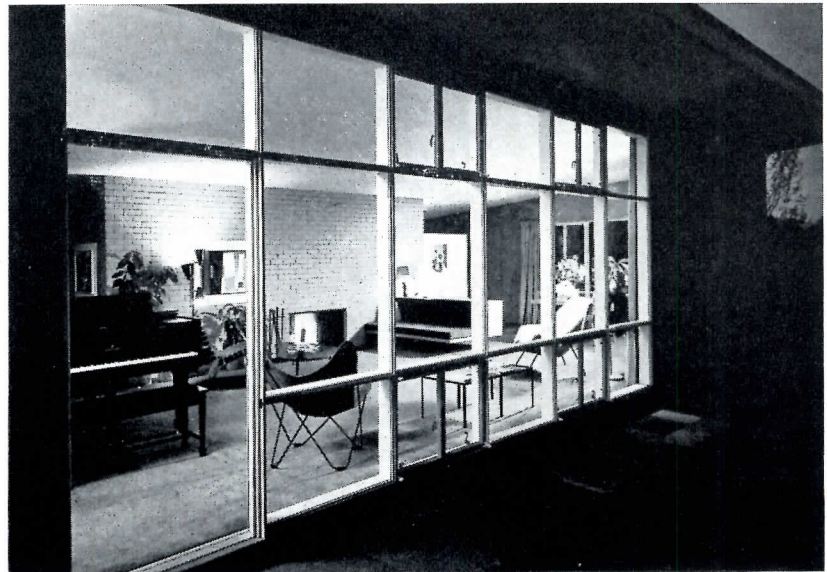



CONSERVATIVE CONTEMPORARY IN NEW ORLEANS

House for Mr. and Mrs. C. B. Fox

*John W. Lawrence and Sam T. Hurst
Architects*

Wm. R. Allen, Jr., Collaborating Architect



Main entrance (above and opposite) is connected with carport by covered walk with pond to right of entrance; site was left as natural as possible, with landscaping used only to enhance shady and cool effect of existing trees, light brush, saplings and moss

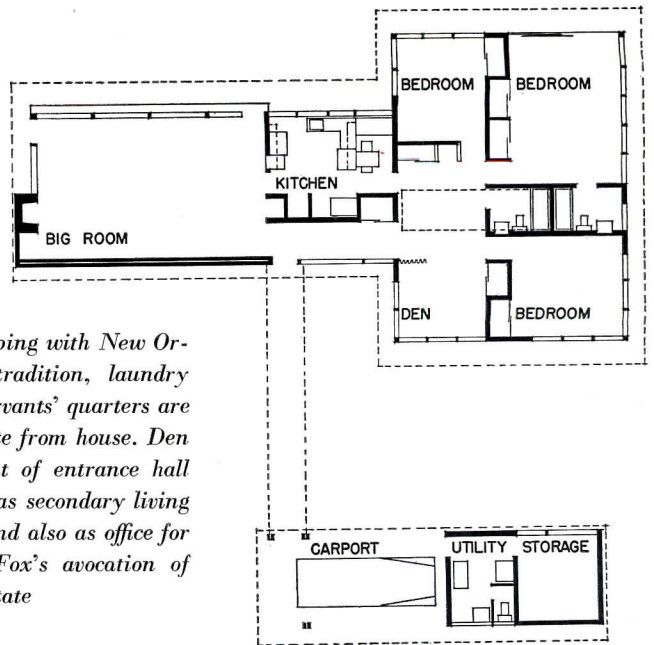

In keeping with New Orleans tradition, laundry and servants' quarters are separate from house. Den to right of entrance hall serves as secondary living area and also as office for Mrs. Fox's avocation of real estate

0 5 10 15 20 25 FT.

THE OWNERS of this house were torn between traditional and contemporary design when they first talked with their architect. They knew that they would not be content with traditional, but they "couldn't quite bring themselves to live in a house with that 'stark' look," the architect reports, and "they definitely didn't want a flat roof." They *did* want an informal living area, which they always referred to simply as "the big room," and insisted that the bedrooms have direct access to the kitchen out of the living room line of vision. And they put a firm tabu on both a separate dining room and a dining alcove.

Joseph W. Molitor



C. B. FOX RESIDENCE

Wood and brick were used in Fox house specifically to add warm look. Brick is light pink mixture; board and batten exterior is rough-sawn, painted a dark green. Interior walls are brick in natural finish and cypress, painted or natural

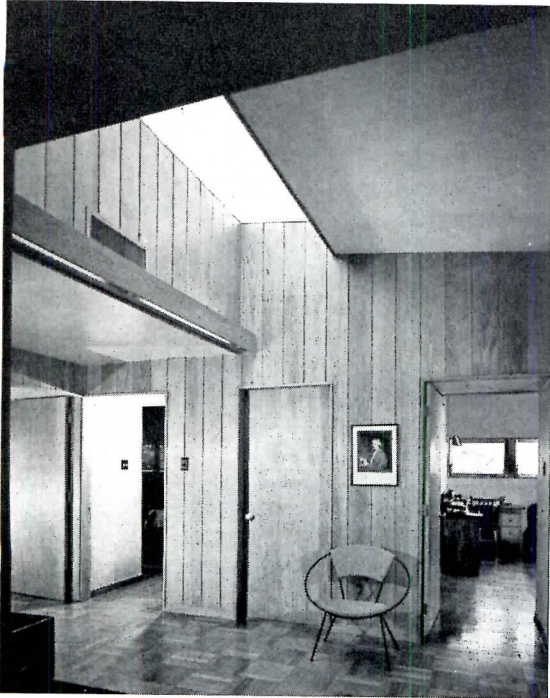

Joseph W. Mollitor

SMALL HOUSE MADE TO LOOK LARGE

*House for Dr. Clara Tucker, Baton Rouge, La.
John W. Lawrence and Sam T. Hurst, Architects*

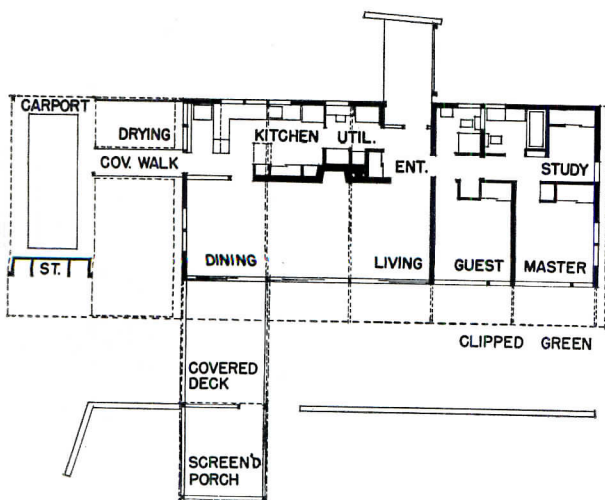

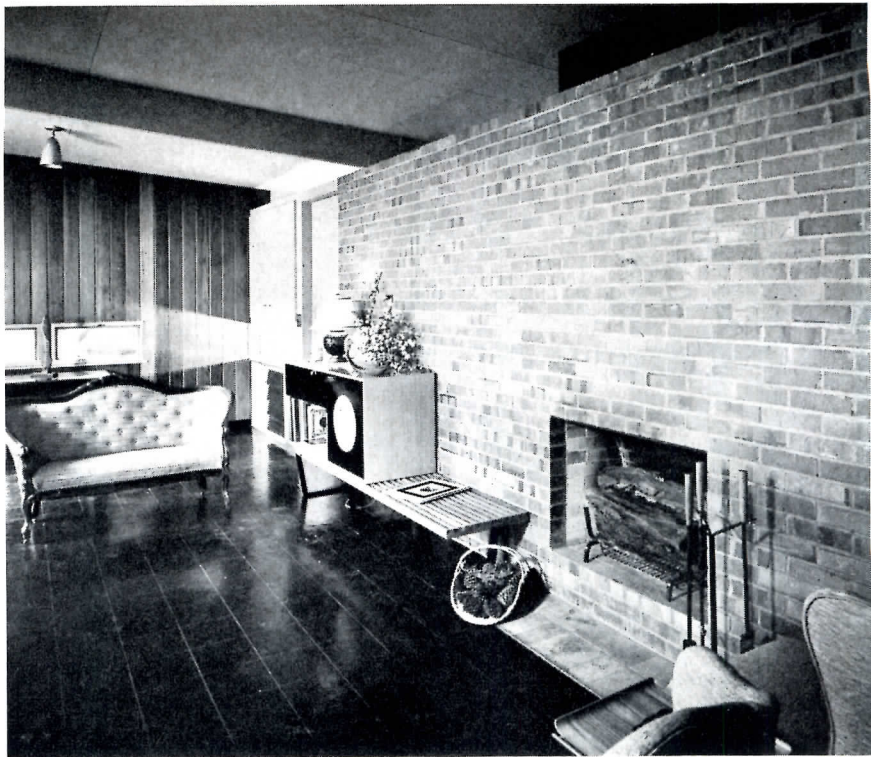
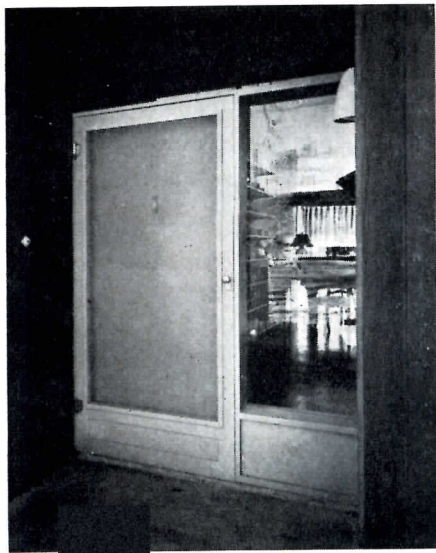

THE PROBLEM here was to make a small house (1200 sq ft) look large enough to fit its 100-by 300-ft site. The solution: a rectangular screened porch, quite separate from the house except for overhead beams which form the frame for a sliding canvas roof over an intervening terrace. Owner is head of Home Economics Department at Louisiana State University, so kitchen (below) came in for special study.

Joseph W. Mollitor

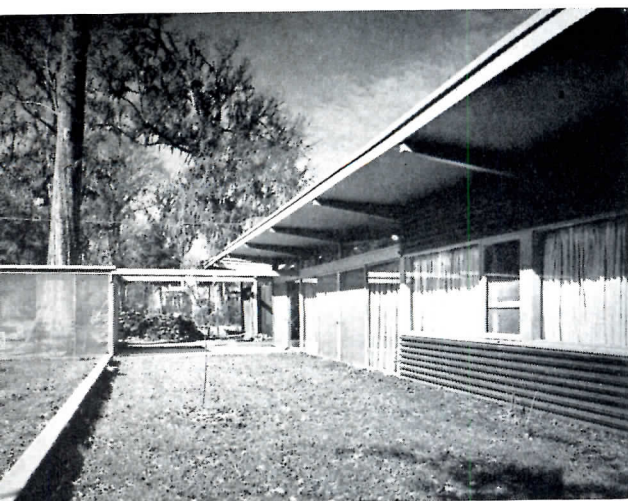

FOOD SERVICE PLANNING IN COLLEGES

Centralized systems are the trend. Cafeteria service is on the increase, even though college administrators emphasize the educational value of more formal dining. Cost is the determining factor

COLLEGE FEEDING is "big business" today. Enrollments are higher than ever before, and are expected to go higher, and costs of all services and supplies have mushroomed. Faced with these facts, and the necessity of serving as many as 40,000 or 50,000 meals a day on some campuses, college authorities realize that food handling facilities must be designed for maximum productivity.

In the planning stage, close cooperation is essential between the architect and food service consultant, whether they be on the college staff or retained by the college. Most experienced food service directors have developed ideas from practical usage of equipment and layouts, and they are familiar with trends in the use of new food materials and appliances and modern cooking methods. They know that a solution to the college cost problem lies in a centralized feeding system. The nucleus of this system is a central stores building with facilities for storage and basic preparation of food for all outlets on the campus. It is operated like a business, with customers billed for cost of supplies ordered plus a prorated carrying charge for overhead, labor, plant depreciation, etc. Shipments from wholesale suppliers are received by rail and truck, stored in designated areas under controlled temperatures and then trucked to campus kitchens on a regular delivery schedule.

The advantages of operating a plant of this nature, as listed by Garner G. Collums, Director of University Housing at the University of Oklahoma, are that it —

1. Eliminates the necessity for large storerooms and warehousing expense in the kitchens of the residence or eating halls, since daily deliveries are made from the commissary.
2. Provides better storage facilities than could be afforded in each unit.
3. Cuts loss of perishable items because of better storage.
4. Makes possible closer stock control.
5. Centralizes purchases and payments.
6. Permits buying for future use when market conditions are favorable.
7. Permits buying of "specials" from companies which are long in certain items or which desire an inventory reduction.
8. Reduces labor in processing meats because of extensive use of labor-saving equipment such as power saws, grinders, tenderizers, patty machines, etc.
9. Eliminates waste in processing.
10. Permits centralized baking of pastry and eliminates the need for large ovens, mixers, sifters, etc., in kitchens.
11. Aids in the use of standard menus in all feeding areas.
12. Assists in unit food cost control by providing uniform servings of processed foods.
13. Provides cheap ice as a by-product of the refrigeration system.

Miss Mildred A. Baker, Director of Food Service at The Pennsylvania State University, believes that extensive facilities for both quick-freezing and deep-freeze storage of fruits, vegetables and meats (1) make it possible to utilize the labor force and equipment more fully during summer and holiday vacation periods when dining halls are closed and (2) assure an adequate supply of products during bad weather when deliveries might be delayed.

Trucks bringing supplies from distributors are unloaded at receiving docks usually by either a conveyor system or a system that uses pallets and fork-lift trucks. When the Food Service Building at the University of Michigan was occupied in 1948, it featured an elaborate conveyor system. Today it uses a pallet and fork-lift system, which has proved to be both fast and practical. In the new Food Service Building at Michigan State College a combination system has worked. A conveyor system relays stores from the loading platform to storerooms located directly below, and pallets and fork lifts carry stores on elevators to aboveground storage areas. Meat is usually attached to hooks on an overhead track, at some point of which is a scale for checking its weight before it reaches the refrigerator.

One of the major advantages of a central storage system is the savings resulting from basic preparation of food before delivery to campus kitchens. Most central stores buildings have butcher shops in which meat is prepared according to orders from food outlets. The prepared meat is packed into pans, covered with wax paper, tagged with order, weight and destination and then stored in refrigerators until delivery. The butcher shop is best located adjacent to meat refrigerators.

Some food services have found that it is more practical to order bread from outside suppliers than to bake it themselves. However, many central storage areas have bake shops in which all other baking is done. The bake shop should be planned so that it is close to the storage area for flour — or under it, as at the University of Michigan, where large sifters measure the flour and drop it through chutes to mixing bowls in the bakery below.

Generally the storerooms for meat and fresh products should be located as close to receiving docks as possible, because these are the supplies which will be ordered most often. Frozen foods and canned goods are usually ordered only once a year and such supplies as flour and sugar only once a month.

Some colleges maintain that an experimental kitchen in the food service building pays off in food savings. Such a kitchen-laboratory duplicates in size and kind each piece of equipment used in unit kitchens. Specifications for foods purchased are checked here, and formulas for large-quantity cookery are standardized to ensure correct preparation of food in all units.

An intercommunication system is a vital part of a modern food service plant. It is important both in the central stores building and in the kitchens and dining rooms of residences and eating halls. In the central stores building outlets should be connected from the large storage areas and butcher and bake shops to a control station in the manager's office. In eating halls, communication is advisable between all



Food Service Building, University of Michigan — Louis C. Kingscott & Associates, Architects; Lynn W. Fry, Supervising Architect. Rails lead to loading dock, far right. Overhead door raises to admit trucks

sections of the kitchen and the scullery, serving line, manager's office and eating areas.

Student Feeding Facilities

Of the satellites dependent on the central stores building, the largest and most important are the student feeding facilities. These vary in type according to the following general breakdown prepared by Theodore W. Minah, Director of Dining Halls at Duke University:

Cafeteria Service

1. Pay-as-you-go service, with multiple-choice menus.
2. Multiple-choice menu combined with menu combination intended to encourage the student to buy complete, well-balanced meals.
3. Board, or contract, type feeding where students pay for their meals in advance; cafeteria type service with little or no menu selection.
4. Hollow square, or colonnade, system of cafeteria service planned for speedy service.



Duke University—Horace Trumbauer Co., Architects. Receiving platform, rear of Graduate Center

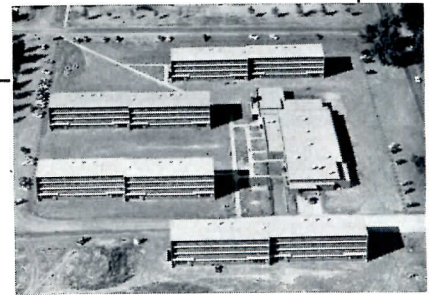

University of Oklahoma—Sorey, Hill and Sorey, Architects. Central dining hall serving four residences

Table Service

5. Board type of feeding; family style or plate service (usually a dining room built as a part of the dormitory).
6. Waiter service; pay-as-you-go, with menu selection and provision for cooking to order.

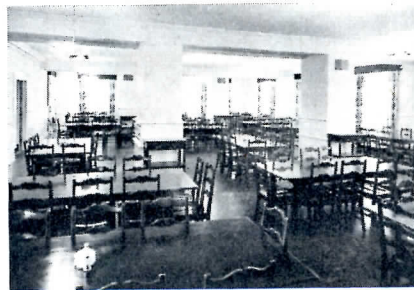

University of Arkansas—Dining room at Holcombe Hall, women's residence. Breakfast and lunch cafeteria style, dinner served

Ideally, table service is most suitable if the dining operation is to be an integral part of college training. However, the cost factor has caused many colleges to compromise, since cafeteria service is most practical from the aspects of speed, staff, economy and space. M. R. Shaw, Director of Residential Halls at Cornell University, explains, "Paradoxically the trend of thinking by educators and personnel administrators on college campuses during the past decade has been to emphasize the educational value of dormitory living and dining operations. We here at Cornell have wanted to develop more leisurely dining for all students under gracious

University of Michigan—Folding doors open to enlarge hall in men's residence. Cafeteria style



San Francisco State College—Part of main dining room in College Union. Cafeteria style, but can be converted to table service



Duke University—Coffee lounge in Men's Graduate Center

The second floor of Brody Hall at Michigan State College serves six residence halls (three completed, three proposed). Students enter through lobbies to separate serving lines for each of four dining rooms. An accordion-type partition between Dining Rooms A and B folds back to provide one large room. Food is taken from the delivery entrance directly to storage areas on the second floor by elevator at times that do not conflict with food preparation and serving. Flow lines from storerooms to preparation areas and then to serving lines are shown by dotted and solid paths, respectively. Equipment is arranged so that as few steps as possible need be taken. Salads and fruits are taken to refrigerated wall compartments and warm foods to heated compartments and are passed through them to serving lines. Dirty dishes from Dining Rooms A and B are bussed directly to dish washing rooms. Dishes from Dining Rooms C and D are taken first to pre-wash rooms and then carried to washing machines on conveyor systems. *Ralph R. Calder, Architect, Emery G. Foster, Manager, Dormitories and Food Services*

Keyed areas on the plan:

- | | |
|--|--------------------------------------|
| 1. Elevator | 15. Roasting ovens |
| 2. Milk refrigerator | 16. Work tables |
| 3. Meat refrigerator | 17. Pot racks |
| 4. Deep freeze | 18. Dry bread cabinet |
| 5. Cook's refrigerator | 19. Pot washing area |
| 6. Potato storage | 20. Bakery storage |
| 7. Vegetable refrigerator | 21. Cook's refrigerator |
| 8. Peeler | 22. Baker's refrigerator |
| 9. Work tables | 23. Salad refrigerator |
| 10. Vegetable and salad preparation area | 24. Pre-wash room |
| 11. Fryers | 25. Dietitian's office |
| 12. Kettles | 26. Glass dispenser and water cooler |
| 13. Steam cookers | 27. Accordion-type folding partition |
| 14. Grills | |

Garbage disposal units located at 8, 9, 10 (two), 19 and dish washing room (two)

living conditions but, like the rest, have been forced to develop informal eating facilities in order to control the costs of space, equipment, and staff."

Many colleges offer a combination system, with two meals under Plan 3 and the evening meal under Plan 5. Some colleges use Plan 5 in women's residence halls and a combination in other dining areas. On many campuses undergoing building programs a main dining hall is being planned to serve a number of residence halls. In such large dining halls, with as many as four separate dining areas, Plan 4 is popular. Brown University's main dining room will seat 800 students, all served by student waiters. Around the perimeter of this area are 18 private dining rooms, 17 of which are used by fraternities and the other for special

functions. This is an unusual feature, since central feeding plans on most campuses do not include fraternity and sorority groups. Student Union buildings, and oftentimes residence halls, have grills or snack bars operated on either Plan 1 or Plan 2.

Kitchen Design

The design of the kitchen and dining areas depends, of course, on the type of service planned. Flow charts are helpful in integrating food facilities areas so that as many bottlenecks as possible are eliminated. Time is saved if steps are saved, and confusion is obviated if lines of flow do not cross.

Stainless steel kitchen equipment is preferred above all others for ease of maintenance. Sectional planning is desirable, with ranges, ovens, grills, fryers,

kettles and steam cookers in separate locations. Drainage should be adequate under kettles and steam cookers. Grills should have grease troughs with some provision for disposal of scrapings. A ventilation hood over the area in which this equipment is located should have enough power to exhaust all odors. If it is furred in, difficult cleaning of the top surfaces of the hood and pipes is eliminated. Removable, easily washed filters facilitate maximum sanitation. A further boon to odorless kitchens is equipment mounted on legs, which can be easily cleaned and which allows air circulation along the floor. Equipment which stands away from the walls and the edges of which are rolled smooth but not closed prevents the accumulation of dirt and insects.

Well-defined, open aisles are essen-

KITCHEN



Vegetable and potato preparation area in South Quadrangle, University of Michigan. Kettles, steam cookers in background; ovens left. Air diffusers in ceiling

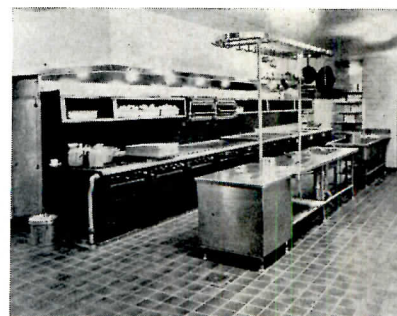

Closer view of kettles and steam cookers shows removable drains in stainless steel gutter and powerful furred-in exhaust hood above

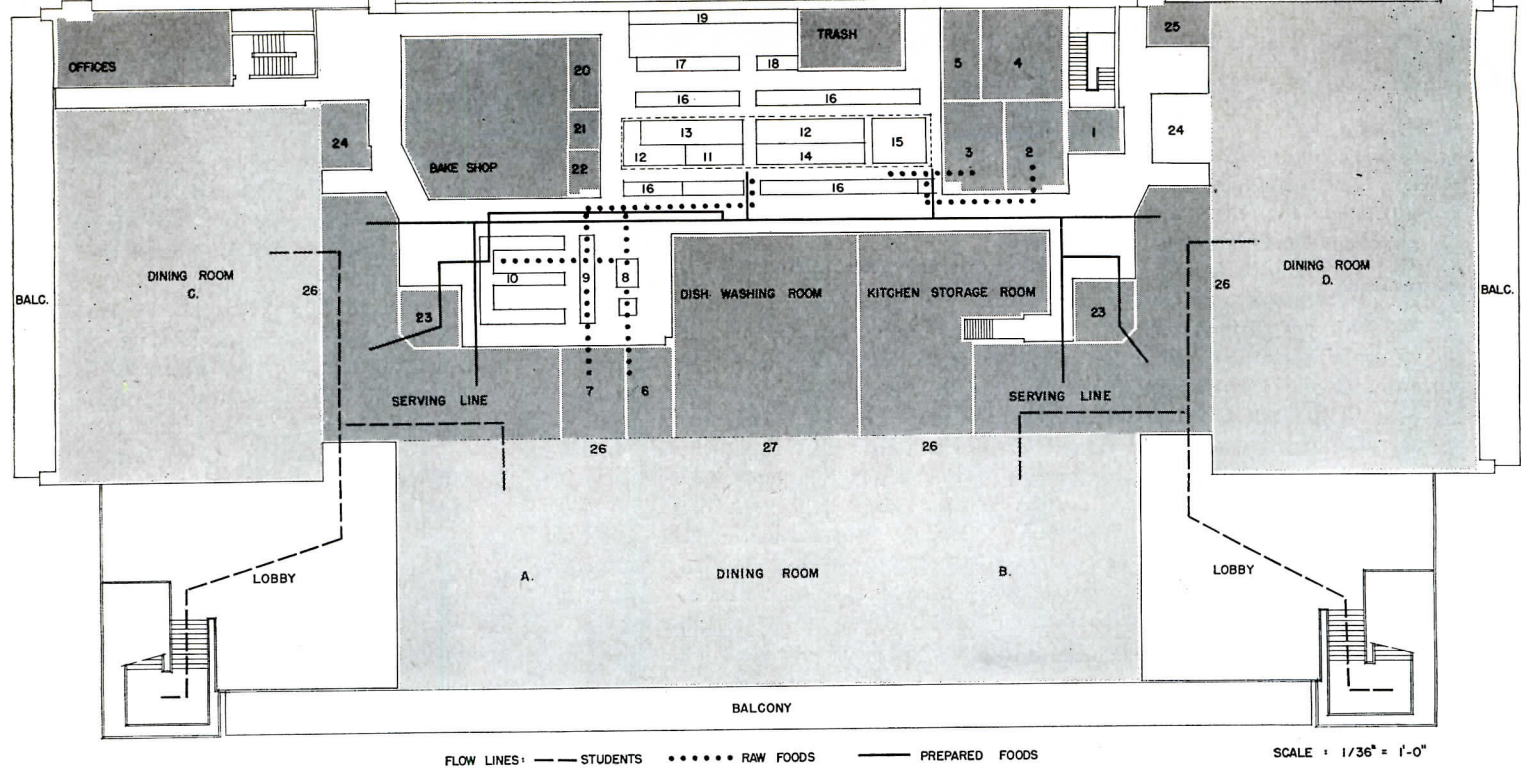

Ranges, grills and fryers are in one line behind ovens, also under exhaust hood. Tile floor is well supplied with drains



tial in a food preparation area to maintain unobstructed traffic from one unit to another. Wheeled carts and equipment are moved easily if all floors are flush. A tile floor well equipped with drains has been found to be most satisfactory to meet sanitation requirements.

Food Serving Area

A food serving area, whether for cafeteria or table service, is most productive if it is supplied from outside, so that there is no need for either carts or personnel to enter. The medium most effective here is the "pass-through" compartment, located in the wall between the service area and the kitchen. Warm food is passed through a food warmer to the serving line, and salads and fruits are passed through refrigerated compartments. As the serv-

ing line needs replenishing, counter servers re-stock from the wall compartments, which are, in turn, restocked from the other side by kitchen attendants. Warming tables, either steam or electric and deep enough for flexibility of fractional pans, keep foods warm while they are on the counter. Spring-loaded dispensers supply dinner plates at working height for serving. Tables, either refrigerated from below or supplied with crushed ice, cool salads and fruit. Even with ice, a certain amount of refrigeration is desirable, and drains are necessary. Milk and juices are displayed on crushed ice or served from dispensers. Coffee is often a serve-yourself operation. Some colleges have found that a combination of self-service and attendant service at coffee urns avoids bottle-necks in the serving line.

Dishwashing

Dishwashing is a key operation in college feeding because dishes must be kept moving so that they can be used more than once at each meal. Automatic operation becomes almost a necessity. "Cleaning rooms" should be designed so that trays of dirty dishes, glasses and silver can be delivered from each dining area to a receiving counter. A minimum of workers in the cleaning rooms can scrape plates, put dishes and glasses in respective washing machines and handle the silver. If one kitchen area provides for a number of dining halls, a central washing room is practical, with dishes carried from the separate cleaning rooms on a conveyor network. At Michigan State College a conveyor system carries dishes from cleaning rooms through the space above a hung ceiling.

SERVING LINE



At San Francisco State College hot foods are taken from ovens and grills and placed in pans on steam table before being passed along to serving area



Warm foods are passed through warming compartments to steam table at right; salads and fruits through refrigerated compartments in South Quadrangle

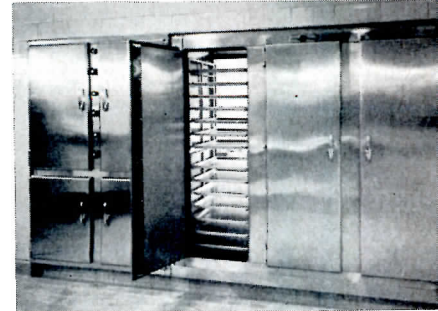

Trays of salads and fruit are placed in racks of refrigerated wall compartments, The Pennsylvania State University

After washing, rehandling of dishes can be avoided by loading them directly onto trucks for return to service areas.

Garbage should be disposed of promptly and completely. Where the sewage system is adequate, automatic waste disposers are practical. At Michigan State College all waste is disposed of at point of origin. Seven waste disposers are located throughout the food preparation and cleaning areas, so that all waste from peelings, cuttings and plate scrapings is disposed of directly. In areas where sewage is already overloaded, waste should be collected in covered trash cans, and special refrigerated rooms should be planned in which they can be stored until daily collection.

Dining Areas

In order to compensate for the sacrifice of social graces resulting from the introduction of cafeteria-style eating, college authorities insist upon attractive as well as practical dining areas. In graceful surroundings, they assert, the student will maintain a certain dignity of manner even though he carries his own tray of food. With the variety of easily maintained wall and floor materials available today, a comfortable dining area can be provided without any sacrifice in practicality. Well-designed yet sturdy furniture complements an attractive interior. Diffuse lighting and an acoustically treated ceiling make the room more pleasant. If the serving line is separate from the dining area, it is not in evidence when table service is offered.

A public address system adds to the usefulness of the dining hall areas for functions such as conferences, society meetings and even dances. It can also be used to pipe in music during meal-

times. Accordion-type folding partitions can divide one large area into smaller rooms for teas and small gatherings.

Space Requirements

In planning spaces, the ideal is to arrange them so that the food gets from the point where it is prepared to the customer in the shortest possible time. Theodore Minah lists ten factors which have a bearing on space requirements: (1) standards of service; (2) time allowed for serving; (3) peak loads; (4) location of college (city or country); (5) warehousing space; (6) availability of markets; (7) extent of menu selection; (8) number of floors allotted; (9) labor union demands; (10) fire and health codes. He goes on to enumerate, in *College and University Business*, October 1954, minimum requirements to be used as a guide with which to begin:

1. Dining room: 14 sq ft per person.
Banquet hall: 10 sq ft per person.
2. Food preparation area (precooking and cooking): 45 per cent of dining room area. When only a single menu is prepared, a kitchen could be as small as 30 per cent of dining room area.
3. Storage and refrigeration: 25 per cent of dining room area (based upon the assumption that the activity will carry an inventory of about one-third of one month's requirements).
4. Dishwashing area: 20 per cent of food preparation area.
5. Baking area (if all baking is done on premises): 50 per cent of food preparation area or 15 per cent of dining room area.
6. Serving area (cafeteria line or serving counter): 20 per cent of dining room.

7. Receiving offices, employe restrooms: 15 per cent of dining room area.

In figuring capacity of the dining room, lunch should be considered the meal of peak load. The number of students expected to eat the noon meal divided by the anticipated turnover of each seat during the meal period ($2\frac{1}{2}$ to 3 times in 2 hr is a good average) will give the necessary seating capacity. This figure multiplied by 14 sq ft will give the number of square feet which should be allowed for in the dining room.

Another method of finding the seating requirement is to multiply the number of students expected to file through the line in one minute (7 is average for a cafeteria in which a selective menu is offered, but some one-meal lines have reached 10 or 12) by the number of minutes it will take each student to eat (20 or 30 min, counting on a smoke after the meal). Larger occupancies have to be planned in dining areas of colleges in which students are encouraged to linger after meals.

A survey of some colleges and universities with new or recently modernized feeding facilities has indicated that the architect's degree of responsibility in planning food service areas varies. In some colleges, such as the University of Texas, the staff architect did the complete job of layout and specifications with assistance from the food service staff. At other colleges, such as Northwestern University, the architect retained by the school only designed the building after actual space requirements were determined and specified by the food service personnel. However, no matter how extensive the architect's role may be, it is fast increasing in complexity and scope.

DISH WASHING

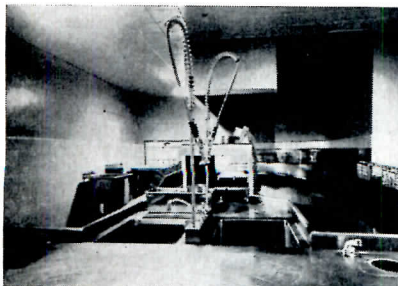

Dishes are bussed to receiving counter, scraped into disposers (left and right), pre-washed in sinks and placed in washer at San Francisco State College

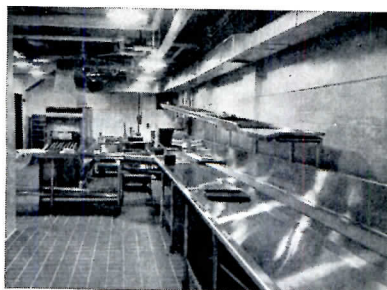

Conveyor system carries dishes away for washing after pre-wash at Duke University

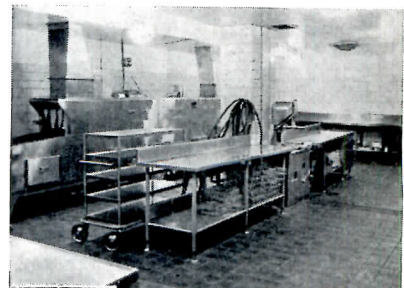

At University of Michigan dishes are scraped and placed in washer (rear); glasses are washed semi-automatically. Clean utensils are taken away on carts

CLASSROOM TV | *Experiments Prove Its Worth As Teaching Medium*

Television as a classroom audio-visual aid is arousing more and more interest among school administrators and educators. As a result, many architects and engineers are planning new buildings with provision to include or add a television distribution system.

Experiments conducted at Chicago Teachers College reveal that closed-circuit TV used in the classroom has many advantages over centralized or classroom film showing. It brings to the classroom "live" demonstrations, performances and lectures from internal camera cable setups as well as from local stations, thus saving the setting up of film equipment for individual classrooms and the need for students to move to a main projection room.

According to officials of the Jerrold Electronics Corp., systems can be in-

stalled with little inconvenience and cost. Many schools have been designed with extra conduit capacity or with easily accessible shafts and ducts. Amplifiers can be used to receive signals from antennas, one for each channel, and boost signal strength to desired levels for distribution throughout the building.

Closed circuit TV is being used as a standard teaching medium in Army classrooms at Fort Monmouth, N. J., and will be installed in the Case School of Applied Science in Cleveland. It also has application in hospitals and was displayed for hotel interests at the National Hotel Exposition. Signal Corps teachers at Fort Monmouth claim that TV teaching is better than movies because ventilation is better and rooms are not darkened, so students stay awake and can take notes.

DRIVE-IN BANK | *Picture Window And Wind-proof Deposit Box Used*

The latest in "drive-in" banking utilizes a picture window and an automatic "wind-proof" deposit receptacle to cut a motorist's transaction time to a minimum and to eliminate parking problems.

The customer drives up to the window of bullet-proof glass framed in stainless steel and speaks to the teller through a two-way speaker system. The teller's finger-tip pressure on a pushbutton electrically controls the wind-proof deposit receptacle, which moves from the window to within easy reach of the driver. If the teller does not press the "return" button within 15 sec, the receptacle will automatically retract. The entire transaction is within view of the customer.

The new unit, styled by industrial designer Henry Dreyfuss for the Mosler Safe Co., was introduced at the American Bankers Association Convention. It can be clamped into place quickly by means of removable rear flanges.

AIR CONDITIONING for Hospitals | *Specified in Defense Dept. Directive*

A directive setting forth the conditions under which air conditioning may be provided for permanent and semi-permanent hospitals and other medical facilities has been issued by the Defense Department. The directive specifies that consideration be given to all design factors, such as siting and the relative values of insulation, shading, size of glass areas and double-glazing, to establish an optimum balance between costs of these details and savings anticipated from installation of the air conditioning system. The order is applicable to all new construction, and may apply to major alterations in existing structures to an extent authorized by the Secretary of Defense.

HHFA | *Two Research Papers*

Results of two comprehensive studies made by the Housing and Home Finance Agency have been published in two research papers:

The Thermal Insulating Value of Air-spaces, Housing Research Paper 32. Housing and Home Finance Agency. U. S. Government Printing Office (Washington 25, D. C.) 32 pp, illus. 25¢.

Shrinkage Characteristics of Concrete Masonry Walls, Housing Research Paper 34. Housing and Home Finance Agency. U. S. Government Printing Office (Washington 25, D. C.) 60 pp, illus. 40¢.

COLORED ALUMINUM PANELS*Impregnated Electrochemically*

Aluminum panels in which color has been impregnated by an electrochemical process cover the front and rear walls of a new two-story sales office of the Aluminum Company of America in Cincinnati.

The extruded, interlocking panels, gold on the front elevation and blue on the rear, are expected to start a new trend in commercial architecture, say Alcoa officials, since they do not require exterior maintenance, nor will their integral color chip, peel or rust. Additional shades, including gray, brown and yellow, are available, and others are being developed.

The panels measure 4 ft in width and range from 8 ft 5 $\frac{3}{4}$ in. to 17 ft 8 in. in length, many including one or two aluminum windows. They were secured to the lightweight steel frame by bolts and spaced between natural finish aluminum mullions. The entire wall thickness, including aluminum exterior, 1 $\frac{1}{2}$ -in.-thick fibreglas back-up wall and interior finish, measures only 6 in. Aluminum enclosed windows pivot in mechanically operated frames for inside cleaning.

The ends of the 134- by 51-ft building are of dark granite, with marquees faced with colored aluminum sheet front and rear. All offices face outside. Flexibility of design will permit the addition of a third floor with a minimum of alteration. The building was designed by Paul Schell, Pittsburgh architect. General Bronze Corp. fabricated the aluminum walls, which were colored by the Stolle Corp.

(Roundup continued on page 188)

PRODUCT REPORTS

Materials / Equipment / Furnishings / Services

GYMNASIUMS AND LIBRARIES: A SURVEY OF NEW EQUIPMENT

Gymnasiums and libraries have taken on a "new look" — and a new meaning. Today they are vital parts of the community, whether it be a college campus or a town or village, and as such are designed for maximum usefulness and eye-appeal. Equipment has become so important and such an integral part of the interior that some manufacturers offer consulting services to advise on the technical aspects of laying out the areas.

Gymnasiums are used not only for physical education and team practice, but also for competitions between college, school, industrial and club teams. Space becomes an important consideration in gymnasiums with such varied activities, and here rolling, or folding, bleachers fulfill every requirement. Basketball backboards can also be folded up and away. For important games almost every gym of any size is equipped with an electric scoreboard.

Libraries, which used to be dreary and uninviting, today are community centers. Brightness and cheery colors entice young and old to come in and browse around. Books are stacked practically and are handled easily. Records, tape recordings and films are often available in well-catalogued systems. In many libraries special rooms are planned, and so suitable furniture is necessary, for children's programs, group meetings and special readings. Study areas are quiet and well-lighted.

On these pages ARCHITECTURAL RECORD presents a survey of some of the newest equipment for gymnasiums and libraries. More gymnasium equipment starts on page 214, and more library equipment on page 200.

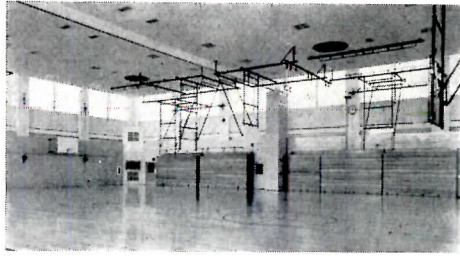

Installations of Medart gymnasium equipment show Telescopic Gym Seats closed up in a one-level gym (above) and partly open on the balcony of a three-level gym (below). The two stands to the left of the folding partition (above) are movable. Basketball backboards, except those that are wall-braced, can be swung up when necessary. Note gymnastic equipment supported from overhead. Electric scoreboard features automatic timing, pushbutton scoring. Fred Medart Products Inc., 3535 De Kalb St., St. Louis 18, Mo.

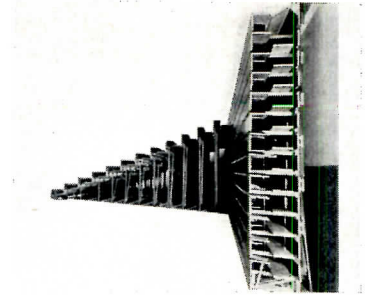
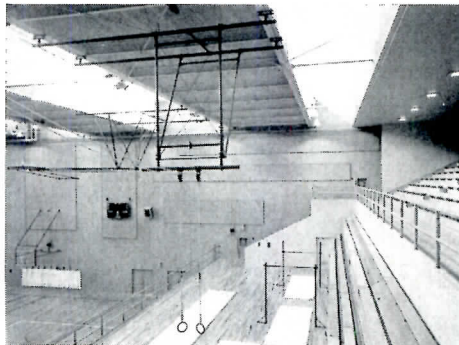

Wayne Rolling Gymstands have wheels that travel in parallel paths instead of the same plane to prevent grooving of gym floor. Standard wall-attached models and recessed models are made. Wayne Iron Works, Wayne, Pa.

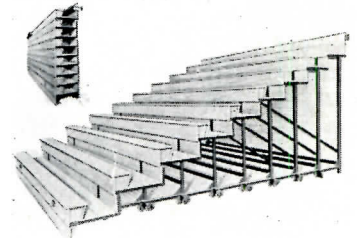

Hussey "Roll-Out" Gym Seats are closed in to prevent litter; forward plate is inverted for feet. Hussey Mfg. Co., Inc., No. Berwick, Me.



The Catawba College Library in Salisbury, N. C. (John Hartledge Associates, Architects) is bright and airy. Round and rectangular tables are apronless and have adjustable glides for leveling on uneven floors. Book shelves are supplemented by feature book tables, dictionary stand and reference book study tables (background). Close-up of front and back of charge-out desk (left) shows chute for book returns. Books are dropped through chute into book truck with a mechanical platform that gradually descends as books pile up. Myrtle Desk Co., High Point, N. C.

BLEACHERS are one of the most important elements in a gym in which spectator sports are scheduled. Stands which can be pushed back against the wall when not in use are fairly standard. Most of them are basically the same, with special features offered by different manufacturers. Many are available with end panels, end rails, aisle treads and scorers' tables. Loads are important; an average live load figure is 120 lb per linear foot, and this load is usually taken by the supports to the floor rather than the wall. Adequate bracing under the stands prevents side sway. Standard length of sections is 16 ft. Depth of stands, from seat to seat, is usually about 22 in.; rise from seat to seat is about 9 in.; and rise from footboard to seat is about 16 or 18 in. Locks ensure stability of stands when they are open, either fully or partially, or closed. Cleaning is usually easy, since the bottom plate of most stands can be lifted while they are closed. Some points to be considered in specifying bleachers are (1) safety, (2) comfort, (3) adaptability, (4) space requirements, (5) visibility, (6) design and construction, (7) operation, (8) maintenance, (9) appearance, (10) exclusive features, (11) service offered and (12) insurance rates.



Universal Roll-A-Way Gymnasium Stands are installed on balcony and main floor of this gym. Universal reference table gives room and basketball court dimensions corresponding to number of seats desired. Universal Bleacher Co., Champaign, Ill.

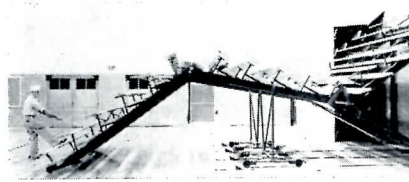

Amweld Easi-Fold Bleachers come in single or double folds, have floor plates to protect gym floor. The American Welding & Manufacturing Co., Warren, Ohio.

La Salle Electrical Gym Seats are operated by pushbutton. Basketball backstop is by La Salle also. La Salle Engineering Co., 139th and Antioch Rd., Olathe, Kan.

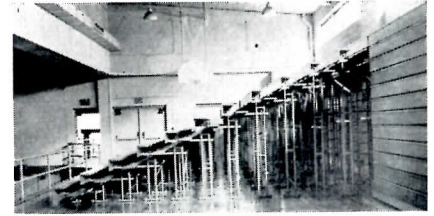

Leavitt Telescoping Bleachers feature a wheel movement under the foot and seat boards as well as at floor level. Leavitt Bleacher Co., Urbana, Ill.

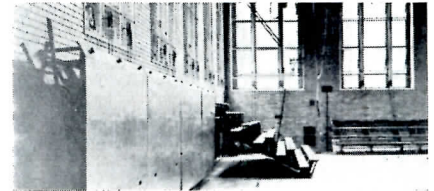

Long Island Jack Knife Bleachers, supported by steel bearing plates, fold away. Long Island Bleacher Co., Inc., 33-35 Ninth St., Long Island City 6, N. Y.



Shelving Inserts can be attached to aluminum clips stripped inside both high- and medium-height shelves. In the display shown above two bulletin boards and magazine and newspaper racks have been inserted in the shelves. The exhibit case is 61 in. long by 29 in. wide by 36 in. high, with 9-in.-high case. John E. Sjoström Co., 1717 N. Tenth St., Philadelphia 22, Pa.



Conference-type table is comfortable and roomy for modern library. Herman Miller Furniture Co., Zeeland, Mich.

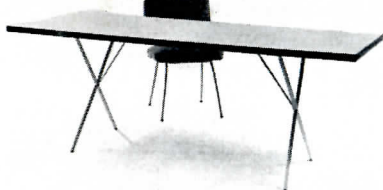

Compo Stacks slide on nylon-tired ball bearings to provide extra capacity in a space made easily accessible. Stacks can be adjusted vertically for different book sizes. Hamilton Mfg. Co., Two Rivers, Wis.

Book Charging Recorder automatically prints date of withdrawal and a transaction number on a loan slip, thus saving the librarian much writing and accounting. International Business Machines Corp., 590 Madison Ave., New York 22, N. Y.

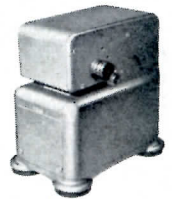

Card Catalog Cabinet has 60 interchangeable drawers with capacity for 72,000 medium-weight cards. Three maple shelves in the middle are convenient for writing or as drawer rests. Gaylord Bros., Inc., 155 Gifford St., Syracuse 1, N. Y.





ELECTRICAL DISTRIBUTION SYSTEMS

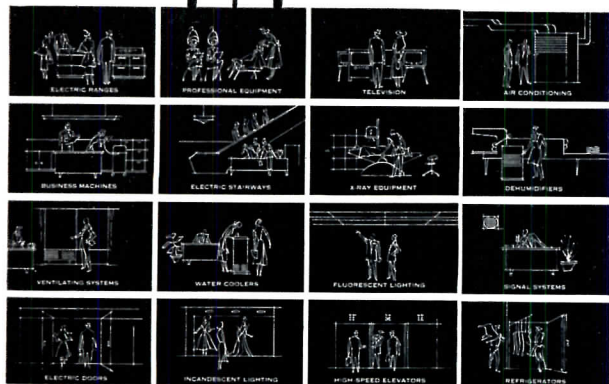

• *Cornerstone — or Tombstone* describes the basic elements of electrical distribution systems for commercial buildings. Service continuity, good performance, safety and flexibility are stressed. Four typical systems are presented: low-voltage radial, high-voltage radial, spot network and distributed network, with simplified sketches of basic layouts. 20 pp, illus. *Westinghouse Electric Corp., Box 2099, Pittsburgh 30, Pa.**

STONES, BRICK AND TILE

- *A Portfolio of Detail Plates and General Information* on Indiana Limestone has been compiled by the *Indiana Limestone Institute, P. O. Box 471, Bedford, Ind.**
- *Brick and Tile Walls Reduce Air Conditioning Loads*, 8 pp, is available from *Structural Clay Products Institute, 1520 18th St. N.W., Washington 6, D. C.**
- Twelve plans of granite entrance features, presented in file form, and also a four-page folder giving structural details and orthographic cut-away illustrations of standard and stock granite sills are available from the *Cold Spring Granite Co., Cold Spring, Minn.**
- *Quarry Tile Data File* includes specifications and photos of typical installations. *Summitville Tiles, Inc., Summitville, Ohio.**

WINDOWS

- *Bulletin No. A-531* contains details, engineering data and design characteristics of tubular sections for mullion construction. *Bulletin A-532* illustrates the Kawneer 10-350 Sash and includes installation instructions. *Bulletin A-533* gives details, engineering data and design characteristics of #16-1050 heavy duty stiffener for division bars. *The Kawneer Co., Niles, Mich.**
- *Window Planning Principles* gives information on the selection and placement of windows from the standpoints of daylight, ventilation, view and appearance. *University of Illinois Small Homes Council, Urbana-Champaign, Ill.*

STEEL

- *Why Structural Steel Is Best for Schools* illustrates how steel framing has been successfully used in different types of school structures and in various geographical locations where physical requirements differ. *American Institute of Steel Construction, 101 Park Ave., New York 17, N. Y.*
- *A Guide to Future Uses of Stainless Steel in Architecture and Building* describes the composition and characteristics of stainless steel as well as suggesting its uses and applications of stainless steel tubing. *Crucible Steel Co. of America, Henry W. Oliver Bldg., Pittsburgh 22, Pa.*

• A 20-page booklet describes and illustrates the uses of light steel structural beams for floor and roof construction as well as for truck and trailer frames, ship building and grandstand construction. *Jones & Laughlin Steel Corp., 3 Gateway Center, Pittsburgh 30, Pa.**

PORCELAIN ON STEEL

• An illustrated brochure describing the factors involved in architectural porcelain-on-steel construction may be obtained without charge from the *Erveen Corp., 4000 W. Ridge Rd., Erie, Pa.*

LITERATURE INDEX

• *Classified Index of Literature* (Bulletin 100-C) lists all current Honeywell Industrial Division literature. 12 pp, illus. *Minneapolis-Honeywell Regulator Co., Industrial Div., Wayne and Windrim Aves., Philadelphia 44, Pa.**

AUTOMATIC EQUIPMENT

- *The Electronic Control Story* explains the fundamentals of electronic temperature controls and their application. 24 pp, illus. *Barber-Colman Co., Rockford, Ill.**
- *Modulite* pulsed-beam photo-electric relays for industrial use are described in a 4-page illustrated booklet published by *Electronic Control Corp., 1573 E. Forest Ave., Detroit 7, Mich.*
- *More Dollars from Less Space* tells about the Alden Work Center System. 32 pp, illus. *Alden Systems Co., Alden Research Center, Westboro, Mass.*

• The new low-voltage wiring system for the central and remote control of multiple circuits is described and illustrated in a bulletin available from *The Bryant Electric Co., Dept. L-263, Bridgeport 2, Conn.**

• *Just As the Doctor Looks Inside* lists advantages of a business telephone system. *Automatic Electric Sales Corp., 1033 W. Van Buren St., Chicago 7, Ill.*

PRODUCT BULLETIN

• *Technical Bulletin Number 70* gives manufacturer's technical information on 37 products. *The Producer's Council Inc., 1001 15th St. N. W., Washington 5, D. C.*

WALL AND FLOOR AGGREGATES

• A 12-page illustrated booklet includes a description of the physical characteristics, design data, construction features and details of Waylite Aggregates for walls and floors. *The Waylite Co., P. O. Box 30, Bethlehem, Pa.**

FIBERGLASS PANELS

• Fiberglass-reinforced translucent structural panels are illustrated in a folder released by *Resolite Corp., Zellenople, Pa.**

DRAFTING ROOM EQUIPMENT

• A 32-page illustrated catalog of modern drafting room equipment has been released by the *Hamilton Mfg. Co., Two Rivers, Wis.*

(Continued on page 228)

*Other product information in *Sweet's Architectural File, 1954*

ENGINEERED WOOD DESIGN-4: PLANK AND BEAM CONSTRUCTION

By William J. LeMessurier and Albert G. H. Dietz

Plank and Beam Tables

These sheets present tabular data and details to facilitate the design of plank and beam roofs and floors for houses. Three different ways of using the planks are possible (see figure below), but the type which is continuous over two spans will give greatest span lengths. Simple spans or semi-continuous spans with alternately staggered joints may be used in special cases.

The lumber chosen for the planks must have minimum strengths as indicated, but satisfactory appearance may require lumber of higher grade. 2-in. nominal planking (1 5/8 in. actual size) generally will give more economical designs than 3 in. (2 5/8 in. actual size), which should be used only for special cases.

The table on this page gives the plank spans possible (same as beam spacing) for three roof loads and for the standard floor load of 40 lb

per sq ft. Three wood groups are included for wide selection.

Together there are 12 beam tables which give considerable freedom in design. For each roof or floor load and each of three different wood groups, three beam choices may be made. The first beam listed uses the least lumber; the second beam gives the most headroom; the third beam is built-up of two pieces to provide a concealed space for electrical conduit.

Basis For Tables

The plank tables are based on ordinary design formulas for bending and deflection. For roofs, total deflection is limited to 1/240 of the span, and the load is considered uniformly distributed. For floors, live load deflection is limited to 1/360 of the span, and total deflection to 1/300. Floor live loads are assumed on one span only for continuous spans when this condition

is more critical than fully uniform loads.

Beam tables are based on moments, deflections and shears computed for simple spans. Roof deflections are limited to 1/240, and floor deflections are limited to 1/300 of the span. Maximum shearing stresses were computed by the formula:

$$H = \frac{3wSL}{4bh} \left(1 - \frac{h}{6L} \right)$$

where H = shearing stress in lb per sq in., w = load in lb per sq ft. S = spacing in ft, L = span in ft, and b and h = width and depth of the beam, respectively, in in. This method is recommended by the National Lumber Manufacturers Association. In no case should beam be notched without special investigation of shearing stresses.

Sample Design

A typical design for the roof of a house measuring 28 by 48 ft with a 30 lb per sq ft live load might be made as follows:

(Text continued on page 183)

Planking continuous over two spans gives greatest span lengths.
Next in order is alternate planking method followed by simple span

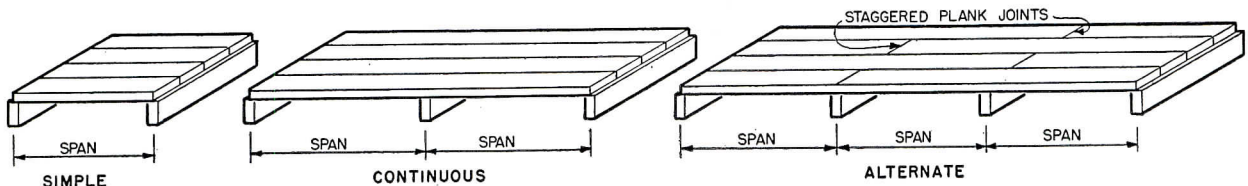

MAXIMUM PLANK SPANS FOR VARIOUS FLOOR AND ROOF LOADS
1 5/8 in. and 2 5/8 in. planking (actual dimensions)

TYPE OF WOOD	GRADE	MODULUS OF ELASTICITY, PSI	MAX. FIBER STRESS, PSI	ROOF						FLOOR					
				LIVE LOAD—20 Lb/Sq Ft			LIVE LOAD—30 Lb/Sq Ft			LIVE LOAD—40 Lb/Sq Ft			LIVE LOAD—40 Lb/Sq Ft		
				SIMPLE	CONT.	ALT.	SIMPLE	CONT.	ALT.	SIMPLE	CONT.	ALT.	SIMPLE	CONT.	ALT.
HEMLOCK	UTILITY STRUCTURAL	1,100,000	950	6'-8"	8'-11"	7'-6"	6'-2"	8'-3"	6'-11"	5'-7"	7'-8"	6'-5"	5'-6"	6'-3"	5'-10"
				10'-9"	14'-6"	12'-1"	9'-11"	13'-4"	11'-1"	9'-3"	12'-5"	10'-5"	8'-10"	10'-2"	9'-5"
CYPRESS	1300f			6'-10"	9'-3"	7'-8"	6'-4"	8'-6"	7'-1"	5'-11"	7'-11"	6'-7"	5'-8"	6'-6"	6'-0"
PINE, NORWAY	PRIME STRUCTURAL	1,200,000	1200	11'-1"	14'-11"	12'-5"	10'-3"	13'-8"	11'-5"	9'-7"	12'-10"	10'-8"	9'-2"	10'-6"	9'-8"
REDWOOD, CALIF.	HEART STRUCTURAL														
SPRUCE, EASTERN	STRUCTURAL, 1200f														
DOUGLAS FIR, COAST REGION	1100f, No. 2														
PINE, SOUTHERN	No. 2	1,600,000	1100	7'-7"	10'-2"	8'-6"	6'-11"	9'-4"	7'-10"	6'-6"	8'-9"	7'-3"	6'-3"	7'-2"	6'-7"
PINE, SOUTHERN	No. 2 LONGLEAF			12'-3"	16'-5"	13'-9"	11'-3"	15'-1"	12'-7"	10'-6"	14'-1"	11'-9"	10'-1"	11'-6"	10'-8"

Note: First rows for wood groups are 1 5/8" planking; second rows are 2 5/8" planking.

from **A**rchitecture to **A**coustics

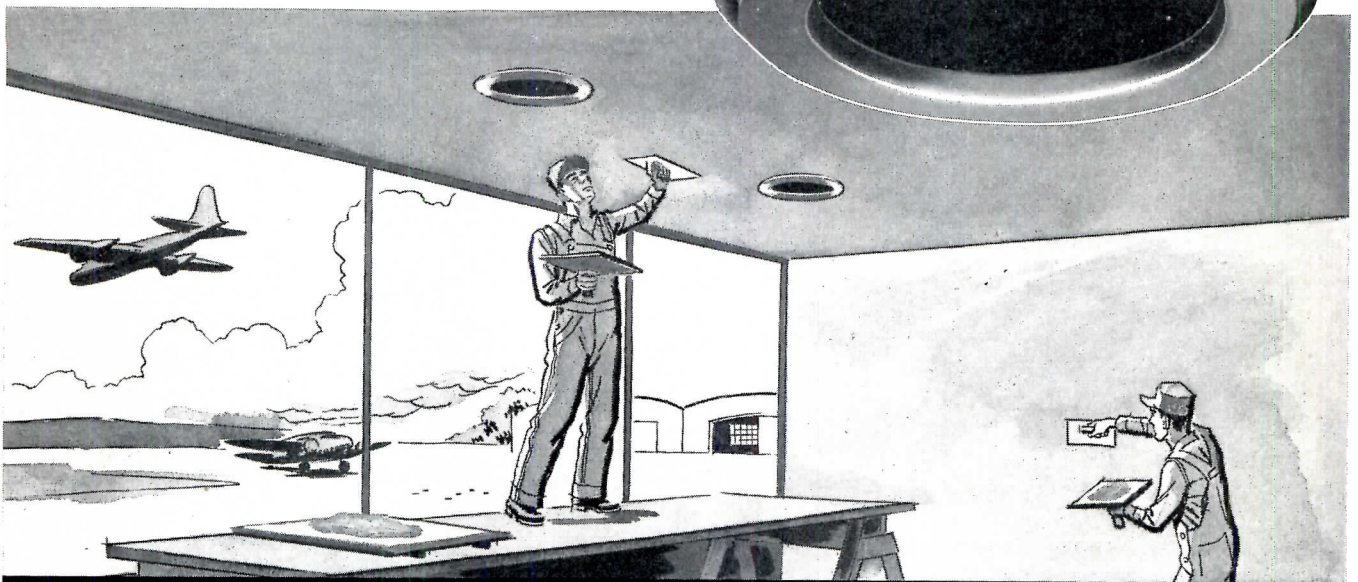

LOWELL Is Preferred for Profitable Sound Installation

When you specify Lowell—the *complete* line of “ear level” sound equipment—you are recommending the line *preferred* by architect and acoustical engineer alike wherever clarity of sound reproduction is essential.

Only Lowell offers:

One source for one complete line. Over 100 models of: Ceiling Baffles • Wall Baffles • Speaker Grilles • Speaker Enclosures • Combination Speaker Baffle and Circline Fluorescent Light Fixtures • Mounting Accessories • Intercom Systems.

Leader in the field, Lowell ear-level sound equipment has proven superior for new and existing construction in more large installations such as airports, railroad stations, hospitals, schools, and factories than any other make.

Lowell Recessed Protective Speaker Enclosures

The Lowell Round Type (CP Series) protective enclosures (illustrated above) are designed for quick, labor-saving installation in wall or ceiling in *new construction* ready for plastering. Speakers are fully protected from fire, dust, falling mortar and rodents. All steel, spot welded construction—with plaster ring attached—is of 22 gauge metal, the exterior rust proofed and interior heavily

undercoated to prevent metallic resonance. Sufficient speaker back pressure relief assures high speaker efficiency. Four models in the series to accommodate speakers from 6” to 15” in size.

For *existing construction* the Lowell Round Type (XCP Series) protective enclosure offers identical superiority in enclosure design. Both CP and XCP Series may be used in suspended ceilings by the use of Lowell Type SS Support Channels.

Lowell Ceiling Type Baffles with “Floating Conical Action”



Low Ceiling Type Baffle (AL Series)

Lowell AL Series Baffles are especially designed for low ceiling areas or any area where concealment of speaker is required. Lowell “Floating Conical Action” distributes *controlled* sound uniformly throughout a full 360°. They are constructed entirely of 18 gauge aluminum. The diffusing cone is supported through rubber grommets by four ¼” formed aluminum rods eliminating metallic resonance. Lowell Type AL Baffles are extremely attractive and are available in natural satin finish or in a variety of colored lacquer finishes.

Complete information regarding the Lowell line—**world’s largest-used line of sound installation equipment**—will be sent immediately upon request.

HEARD EVERYWHERE
Lowell MANUFACTURING COMPANY
3030 LACLEDE STATION ROAD, ST. LOUIS, MO., U.S.A.

IN CANADA: ATLAS RADIO CORP.

560 KING ST., WEST, TORONTO, CANADA



ENGINEERED WOOD DESIGN-5: PLANK AND BEAM CONSTRUCTION

By William J. LeMessurier and Albert G. H. Dietz

1. Eight bays at 6 ft or six bays at 8 ft could be used to frame the length of the building. With 6-ft bays, any arrangement of 1 5/8 in. planking could be used with any wood group listed. For 8-ft bays, 1 5/8 in. planks must be continuous over two spans. Note that other plank arrangements will not span 8 ft regardless of the wood used (table on Sheet 4).

2. For beams spaced at 8 ft on center, and with posts assumed at the centerline of the house giving two 14-ft spans, 4 x 12 beams of No. 1 Southern Pine would be most economical (Table 2, sheet 6). If shallower beams were desired, to save headroom, 6 x 10's could be used. With posts placed to give 12-ft and 16-ft spans across the width of the house, 4 x 10's and 4 x 14's respectively, could be used for these two spans.

3. With beams spaced 6 ft on center 4 x 10's of 1700f Dense No. 1 Douglas Fir, Coast Region, would span 14 ft (Table 3). 4 x 10's and 4 x 12's of No. 1 Douglas Fir, Coast Region, respectively, could be used for spans of 12 ft and 16 ft (Table 2).

Design Guides and Details

1. Insulation of a plank and beam roof is ordinarily required in cold climates. Rigid insulation laid over the planks and a vapor barrier be-

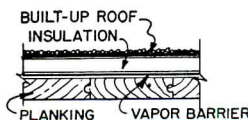

tween planks and insulation are essential where condensation may be a problem.

2. Where concentrated loads of partitions occur on plank and beam floors, special beams may be required.

3. Provisions should be made for electrical conduit in planning the

structure. Built-up beams may be used to provide overhead conduit.

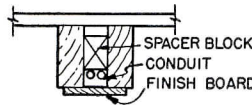

4. Careful attention should be given to wind bracing for a plank and beam house. This may be provided in the form of solid partitions and exterior walls in at least two perpendicular plans. Additional stiffness may be developed by using rigid beam to post connections.

5. Posts or columns should be proportioned to carry axial loads safely. The minimum size for a free-standing, solid post should be a 4 x 4. A 4 x 4 post, 8 ft high, with

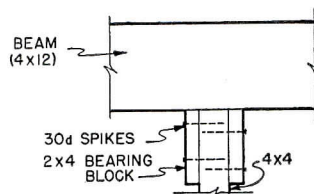

lumber having a modulus of elasticity of 1,200,000 psi may safely carry a load of 6750 lb. This would be just adequate as an interior column with 8-ft beam spacing, 16-ft beam span, and a 30 lb per sq ft live load.

The bearing stress perpendicular to the grain of a beam is also governed by the column size. A larger post may be required to control this stress unless bearing blocks are provided. Bearing stresses at the ends of beams should be limited at 300 to 450 psi depending on the grade of wood used. For example, the total load on a 4 x 4 post as limited by a beam bearing stress of 400 psi would be 5250 lb, which is less than the column capacity. This load may be increased by adding bearing blocks securely

fastened to the top of the column as shown.

It is often desirable to use built-up columns made from smaller sections to give more lightness to the design or to make a more rigid connection of columns to beams. Several possible arrangements are shown with their capacities calculated for a height of 8 ft and with wood having a modulus of elasticity of 1,200,000 psi. (For other woods the allowable load will be proportional to the modulus of elasticity.) The strengths shown assume that the elements are connected together only by nails.

Examples of built-up columns

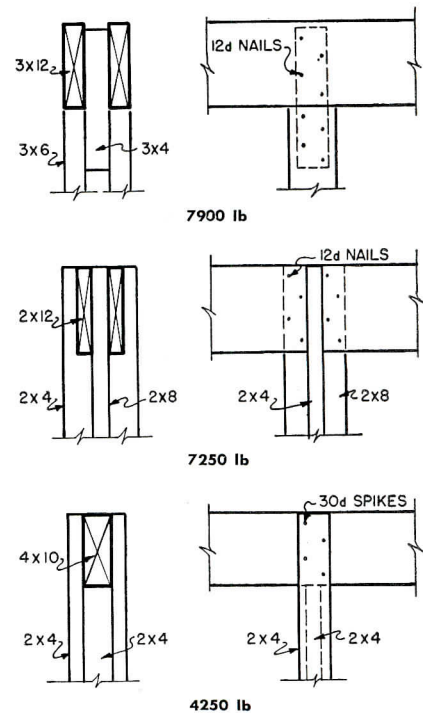

Beam to column connections may be made in a variety of ways with built-up columns. Connections for the three columns designs are shown above. It will be noted that beam reactions are partially carried by nails in each of these cases.

6. All planks should be tongue-and-grooved or splined to distribute concentrated loads.

The most convincing stamp of user satisfaction

9
repeat
orders
for Sarco
Heating
Specialties



Engine factory of Caterpillar Tractor Co., Peoria, Ill. Architects & Engineers: Giffels & Vallet Inc., L. Rossetti Assoc., Detroit. Heating Contractor: The Stanley-Carter Co., Detroit. Sarco heating specialties also are providing trouble-free service in Caterpillar's Joliet and Decatur, Ill. and York, Pa. plants.

... won by past performance at Caterpillar Tractor Co.!

SARCO heating specialties were first installed in a Caterpillar plant back in 1947.

Since that first order, Sarco heating specialties have been ordered an *additional nine times* for four Caterpillar plants — each repeat order is indicative of the confidence Caterpillar has in Sarco performance.

Today, more than 1800 Sarco steam traps in addition to other heating specialties give trouble-free

service at four Caterpillar Tractor Co. plants.

Architects, engineers and heating contractors appreciate this kind of dependability. It assures them complete user satisfaction, protects reputations, eliminates trouble-some call-backs. Why not specify Sarco on *your* next job?

For full information on all Sarco products, write Sarco Co., Inc., Empire State Bldg., New York 1.

**America's
 Industrial Leaders
 Repeatedly Order Sarco
 Heating Specialties**

- Aluminum Co. of America
- Bethlehem Steel Co.
- Caterpillar Tractor Co.
- Ford Motor Company
- Lederle Laboratories
(Div. of American Cyanamid Co.)
- United Aircraft Corporation
- U. S. Steel Company
- Western Electric Company

2102-B

SARCO *saves*
steam

STEAM TRAPS • TEMPERATURE CONTROLLERS • HEATING SPECIALTIES

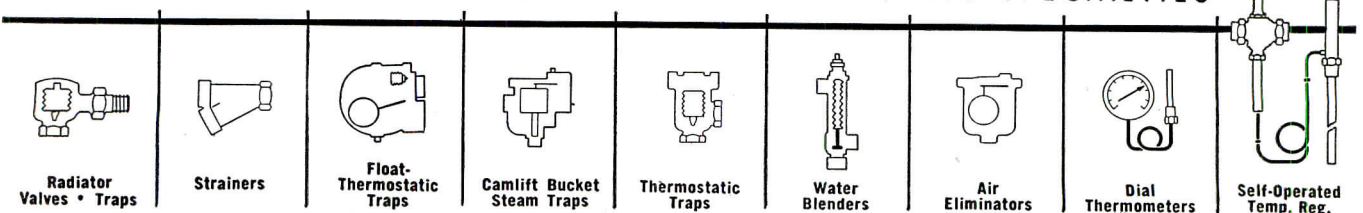



ENGINEERED WOOD DESIGN-6: PLANK AND BEAM CONSTRUCTION

By William J. LeMessurier and Albert G. H. Dietz

Key to tables
 Columns A—Maximum economy
 Columns B—Minimum depth
 Columns C—Built-up beams

BEAM DESIGN TABLES
Roofs, 30 lb/sq ft live load
 (To be continued)

Span	4'-0"			4'-6"			5'-0"			5'-6"			6'-0"			7'-0"			8'-0"			9'-0"			10'-0"		
	A	B	C	A	B	C	A	B	C	A	B	C	A	B	C	A	B	C	A	B	C	A	B	C	A	B	C
8'-0" 4x6	—	2-2x6	4x6	—	2-2x6	4x6	—	2-2x8	3x8	3x8	6x6	2-2x8	3x8	6x6	2-2x8	3x10	6x6	2-2x8	3x10	6x6	2-2x8	3x10	6x6	2-2x8	3x10	6x6	2-2x8
9'-0" 4x6	—	2-2x8	3x8	6x6	2-2x8	3x8	6x6	2-2x8	3x8	6x6	2-2x8	3x8	6x6	2-2x8	3x8	3x10	6x6	2-2x8	3x10	6x6	2-2x8	3x10	6x6	2-2x8	3x10	6x6	2-2x8
10'-0" 3x8	6x6	2-2x8	3x10	6x6	2-2x8	3x10	6x6	2-2x8	3x10	6x6	2-2x8	3x10	6x6	2-2x8	3x10	3x10	6x6	2-2x8	3x10	6x6	2-2x8	3x10	6x6	2-2x8	3x10	6x6	2-2x8
11'-0" 3x10	4x8	2-2x8	3x10	4x8	2-2x10	3x10	6x8	2-2x10	3x10	6x8	2-2x10	3x10	6x8	2-2x10	3x10	4x10	6x8	2-2x10	4x10	6x8	2-2x10	4x10	6x8	2-2x10	4x10	6x8	2-2x10
12'-0" 3x10	4x8	2-2x10	3x10	6x8	2-2x10	3x10	6x8	2-2x10	3x10	6x8	2-2x10	3x10	6x8	2-2x10	3x10	4x10	6x8	2-2x10	4x10	6x8	2-2x10	4x10	6x8	2-2x10	4x10	6x8	2-2x10
14'-0" 4x10	6x8	2-2x10	4x10	8x8	2-2x12	4x12	8x8	2-2x12	4x12	8x8	2-2x12	4x12	8x8	2-2x12	4x12	4x12	6x10	2-2x12	4x12	6x10	2-2x12	4x12	6x10	2-2x12	4x12	6x10	2-2x12
16'-0" 4x12	6x10	2-2x12	4x12	6x10	2-2x12	4x12	6x10	2-2x12	4x12	6x10	2-2x12	4x12	6x10	2-2x12	4x12	4x14	8x10	2-2x12	4x14	8x10	2-2x12	4x14	8x10	2-2x12	4x14	8x10	2-2x12
18'-0" 4x12	6x10	2-2x14	4x14	8x10	2-2x14	4x14	8x10	2-2x14	4x14	8x10	2-2x14	4x14	8x10	2-2x14	4x14	4x14	8x12	2-2x14	4x14	8x12	2-2x14	4x14	8x12	2-2x14	4x14	8x12	2-2x14
20'-0" 4x14	6x12	2-2x14	4x14	6x12	2-2x14	4x14	6x12	2-2x14	4x14	6x12	2-2x14	4x14	6x12	2-2x14	4x14	6x14	8x12	2-2x14	6x14	8x12	2-2x14	6x14	8x12	2-2x14	6x14	8x12	2-2x14

Span	8'-0"			9'-0"			10'-0"		
	A	B	C	A	B	C	A	B	C
8'-0" 3x6	—	2-2x6	3x6	—	2-2x6	3x6	—	2-2x6	3x6
9'-0" 4x6	—	2-2x6	4x6	—	2-2x8	3x8	—	2-2x8	3x8
10'-0" 4x6	—	2-2x8	3x8	6x6	2-2x8	3x8	6x6	2-2x8	3x8
11'-0" 3x8	6x6	2-2x8	3x10	6x6	2-2x8	3x10	6x6	2-2x8	3x10
12'-0" 3x10	4x8	2-2x8	3x10	4x8	2-2x10	3x10	4x8	2-2x10	3x10
14'-0" 3x10	6x8	2-2x10	4x10	6x8	2-2x10	4x10	6x8	2-2x10	4x10
16'-0" 4x10	8x8	2-2x10	4x10	8x8	2-2x12	4x12	8x8	2-2x12	4x12
18'-0" 4x12	6x10	2-2x12	4x12	6x10	2-2x12	4x12	6x10	2-2x12	4x12
20'-0" 4x12	8x10	2-2x12	4x12	8x10	2-2x12	4x12	8x10	2-2x12	4x12

Span	8'-0"			9'-0"			10'-0"		
	A	B	C	A	B	C	A	B	C
8'-0" 3x6	—	2-2x6	3x6	—	2-2x6	3x6	—	2-2x6	3x6
9'-0" 3x6	—	2-2x6	4x6	—	2-2x6	4x6	—	2-2x6	4x6
10'-0" 4x6	—	2-2x8	3x8	6x6	2-2x8	3x8	6x6	2-2x8	3x8
11'-0" 3x8	6x6	2-2x8	3x10	6x6	2-2x8	3x10	6x6	2-2x8	3x10
12'-0" 3x8	—	2-2x8	3x10	—	2-2x8	3x10	—	2-2x8	3x10
14'-0" 3x10	6x8	2-2x8	3x10	6x8	2-2x10	3x10	6x8	2-2x10	3x10
16'-0" 4x10	8x8	2-2x10	4x10	8x8	2-2x10	4x10	8x8	2-2x10	4x10
18'-0" 4x12	6x10	2-2x12	4x12	6x10	2-2x12	4x12	6x10	2-2x12	4x12
20'-0" 4x12	8x10	2-2x12	4x12	8x10	2-2x12	4x12	8x10	2-2x12	4x12

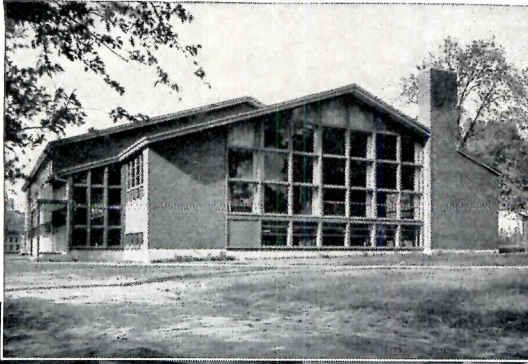

pride of the community!

Gentle Community Building, Houlton, Maine. Alonzo J. Harriman, Inc., Auburn, Maine, Architects and Engineers



foot-friendly NORTHERN HARD MAPLE

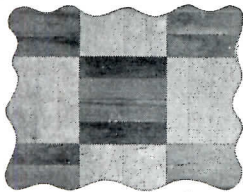

Cost is surprisingly low for the ultimate in luxury flooring—in blocks and modern patterned designs as well as the more conventional strip form. Readily laid in mastic, over concrete or softwood sub-flooring.

● The air of hospitality that beckons the townspeople of Houlton into their new Community House is repeated with cordial emphasis within. The warm, “foot-friendly” comfort of resilient, Northern Hard Maple Flooring extends its own invitation. Activities room, dance lounge and gymnasium-auditorium—all are maple-floored, for enduring, low-cost “housekeeping” and maintenance. We believe you’ll agree, the building’s low \$7.75 unit cost (\$123,750 for its 10,000 square feet) bespeaks to some degree the economy of “the finest floor that grows.” Write for latest literature, or consult Sweet’s (Arch. 12K-MA).

MAPLE FLOORING MANUFACTURERS ASSOCIATION

Suite 550, Pure Oil Bldg., 35 East Wacker Drive, Chicago 1, Ill.

FLOOR WITH **NORTHERN** HARD MAPLE
BEECH AND BIRCH



APARTMENTS

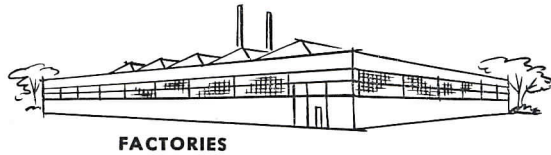

FACTORIES



RESTAURANTS



MOTELS

new!

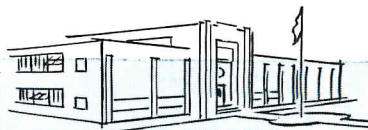

SCHOOLS



HOMES



LAUNDRIES

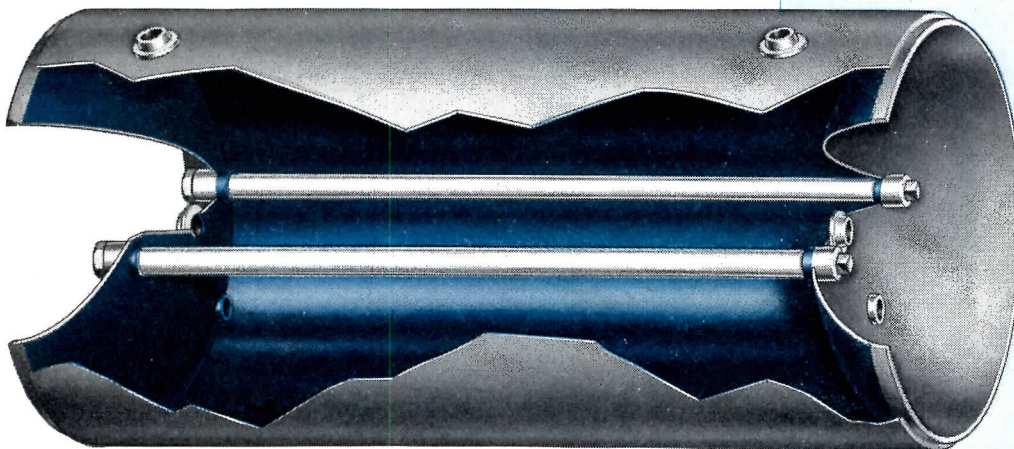

Cut-a-way view of concave type tank suitable for horizontal or vertical mounting.

● Here is a *glass-lined*, large volume water storage tank to meet your demands for the clean, rust-free storage of cold and hot water for your commercial or industrial jobs. Where rust and corrosion are annoying problems and where long tank life is desired these *new* glass-lined water tanks are the answer . . . and at reasonable cost.

The inside of this new tank, especially designed for the storage of water, is completely coated with special A. O. Smith ceramic glass, permanently fused to the steel. Stored water will stay as pure and clean as your water supply, and rust free, too, because the mirror-smooth, glass-surfaced steel tank can't rust or corrode under any water conditions. Ranging in size from 100 to 1,000 gallons, or larger on special orders . . . designed for horizontal or vertical mounting in the smaller sizes for installation flexibility . . . available for use in gas-fired Burkey hot water systems . . . or fitted with coils for steam systems . . . you have a proved line of water storage tanks to choose from.

See your nearest A. O. Smith distributor for full details about this quality line of Permaglas water storage tanks.

Permaglas[®]

**LARGE
VOLUME
WATER
STORAGE
TANK**

**for restaurants, plants, motels,
laundries, apartments, homes,
schools — or any place where
water rusts or corrodes tanks.**

Through research  . . . a better way

A.O. Smith
CORPORATION

PERMAGLAS DIVISION • KANKAKEE, ILLINOIS

write

Write for the new Permaglas Large Volume Water Storage Tank Specification Sheet . . .

TO: A. O. Smith Corporation, Kankakee, Illinois, ARCH R, 1-55.
Gentlemen: Please send me the above mentioned literature.

Name Title
Company
Address
City Zone State

(Continued from page 175)

RADIANT HEATING SYSTEMS Are Installed in Three Georgia Schools

A radiant heating system has been installed in three new school buildings in Miller County, Ga., at a cost low enough to be important in an area where initial heating system outlay costs have been extremely high in proportion to the amount of heat produced and the number of hours used.

Field prefabrication and standardization of pipe were major factors in saving both time and labor on the project. Bends in all Jol-Duct coils and mains were made on an electric Tal Bender, as shown in the first photo below, and then the bent pipes were shoved directly onto pattern tables for immediate welding connections. Sizes of coils were restricted to those easily handled by two men for faster stacking in stockpiles and to expedite movement to permanent positions when ready.

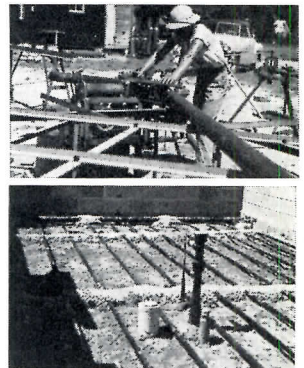

After the grading was completed in each wing or section of the buildings, mains and coils were laid dead level on grout concrete chair supports, as shown in photo 2 above. Supply and return mains were laid nearest outside walls and in all hallways and corridors. The tops of the coils in their permanent locations were positioned 2 in. under the top of the concrete floor, thus limiting the possibility of leaks and guaranteeing the highest amount of heat transfer from hot water to panel. Several types of floor coverings were laid over the system. Perimeter insulation was installed around the entire outside wall, using insulating blocks 1 in. thick and 1-ft wide. The heating is controlled by an automatic thermostat system.

Albany Architects and Engineers, Albany, Ga., were architects for the schools. Contractors and Equipment Co., Colquitt, Ga., were the heating subcontractors.

(Continued on page 193)

**THE REAL LOW-DOWN
ON
DOWNLIGHTING**

Here are the facts...

**A Comparative Study of
DOWNLIGHTING DEVICES**

THE SKYLIKE *Silver-spot* LINE

Provides these outstanding features

1/3 LAMP COST...

Lamp replacement costs for most popular types of downlights using reflectorized lamps will approximate three times the cost of lamp replacements for Silver-spot and Silver-dot units.

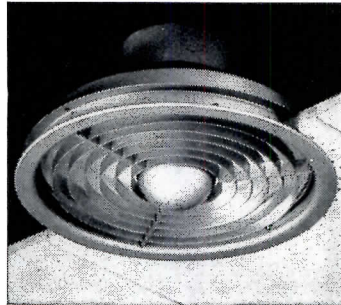

SILVER-SPOT

2/3 POWER COST...

Since many of the commonly used downlight devices employ 150 watt lamps, the 100 watt Silver-spot or Silver-dot units will cost only two thirds as much to operate.

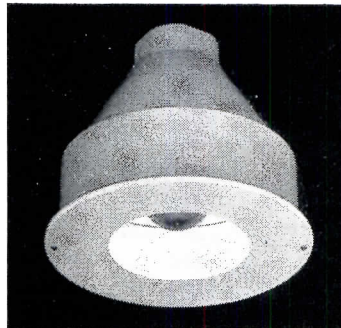

SILVER-DOT 113

3/TIMES LIGHT OUTPUT...

Performance of downlights varies greatly with design and light distribution. In general Silver-spot and Silver-dot produce more effective footcandles within the designed beam. This increase in illumination averages about three times that afforded by other devices but in some cases exceeds five times the illumination within specified zonal limits.

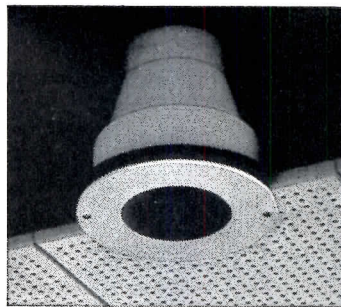

SILVER-DOT 110

THIS COMPLETE REPORT ON DOWNLIGHTING DEVICES yours for the asking

Proof of these facts is definitely established in a comprehensive study just completed. Charts of various types of downlighting devices are based on data taken from photometric tests conducted by Electrical Testing Laboratories, Inc., or from published photometric data. To obtain this report just write to...

Skylike LIGHTING, INC.

A SILVRAY ASSOCIATED COMPANY
BOUND BROOK • NEW JERSEY

for help on your
air conditioning or
refrigeration problems
phone your
Acme engineer



ALABAMA, Birmingham	Robert Sansing, Cecil Buck, 54-8534
ARIZONA, Phoenix	A. C. Baechlin, WH-5-6351
CALIFORNIA, North Hollywood	Dave Nurse, Erv Robart, Stanley 7-7131
CALIFORNIA, San Francisco	R. B. HollandSutter 1-6062
FLORIDA, Hollywood	Allen Dean2-4919
FLORIDA, St. Petersburg	C. W. McIntyre, 7-5778
GEORGIA, Atlanta	Walter Garrard, Leo Sudderth...Exchange 8664
ILLINOIS, Chicago	Acme Industries, Inc.MOhawk 4-6124
INDIANA, Indianapolis	Charles LugarBroadway 9323
IOWA, Des Moines	Anderson Bros. Engr. Co.Des Moines 5-5661
LOUISIANA, New Orleans	H. N. Stall, L. A. FlickCanal 9991
MARYLAND, Washington 7, D. C.	Stuart MitchellNational 8-4854
MASSACHUSETTS, Cambridge	Fred W. SmithTro 6-0080
MICHIGAN, Detroit	C. K. Carter, R. A. DayTrinity 1-5848
MICHIGAN, Leslie	W. N. Hart404-2346
MINNESOTA, Minneapolis	R. H. McGintyAtlantic 6878
MISSOURI, Kansas City	T. J. ManningBaltimore 4077
MISSOURI, St. Louis	Palmer StillWydown 1-2077
NEBRASKA, Omaha	Roger AndersonAT 3639
NEW YORK, Buffalo	J. Bert SlaterCleveland 6477
NEW YORK, New York	Acme Industries, Inc.Murray Hill 2-3423
NEW YORK, Syracuse	J. W. Stevens72-1071
NORTH CAROLINA, Charlotte	Robert E. Mason2-1903
NORTH DAKOTA, Fargo	John Holm2-2365
OHIO, Cincinnati	J. W. Snyder, George BullElmhurst 2505
OHIO, Cleveland	Wm. G. Mussun, John FordUtah 1-5244
OHIO, Columbus	Richard FarrKingswood 8757
OHIO, Toledo	J. F. GuestAdams 9516
OKLAHOMA, Tulsa	H. W. Meinholtz2-6976
OREGON, Portland	Wm. WoolleyBRoadway 3082
PENNSYLVANIA, Philadelphia	Harold Margulis, Marc Sheffler...Evergreen 2-4500
PENNSYLVANIA, Pittsburgh	E. J. BuschMuseum 3-2500
TENNESSEE, Memphis	T. J. O'Brien8-0339
TEXAS, Dallas	Leo J. FreitasDixon 9748
TEXAS, Corpus Christi	T. N. Inglis
TEXAS, Houston	Acme Industries, Inc.Keystone 1418
TEXAS, San Antonio	L. S. Pawkett, Louis HornorFannin 1291
UTAH, Salt Lake City	Ted Brown9-8677
VIRGINIA, Richmond	E. Glenn Breeden, Jr.88-1660
WASHINGTON, Seattle	Frank OzanneSEnea 2377
WASHINGTON, Spokane	Hobart TeneffMAdison 9052
WASHINGTON, Tacoma	H. F. WarrenMArket 4281
WISCONSIN, MilwaukeeBroadway 1-1414 or Contact the Chicago Regional Office
CANADA, Montreal	Blair LivingstonBEclair 6102
CANADA, Toronto	Bernard KaufmanMurray 18185

AEI ROUNDUP

(Continued from page 188)

NEW DEVELOPMENTS | Portable Air Meter and Bonding Material

Heating and air conditioning loads in buildings can now be determined more precisely than before by means of a portable air infiltration meter designed by C. W. Coblenz of the National Bureau of Standards. The new instrument, much less cumbersome than the equipment which has been restricted to laboratory installations in the past, will provide an improved means for determining the rate of air infiltration between different rooms of a building and the outside.

A new material consisting of a combination of metals and inorganic substances for bonding fiberglass is in the development stage by the U. S. Navy Bureau of Ordnance. The as yet unnamed material will produce laminates and tubular products of high strength, resistance to usual corrosive agents, and will be more suitable to higher temperatures than presently available fiberglass structural materials. John S. Nachtman, inventor of the material and Supervisor of Materials at BuOrd, indicated that it could be used in roofing, flooring, panels, beams and molding.

SANITARY PLUMBING | Standards

New rigid standards for quality, dimensions and dimensional tolerances for sanitary plumbing have been adopted recently by the Cast Iron Soil Pipe Institute. Member companies of the Institute, representing over 80 per cent of the industry, will be issued a seal for products that conform to the specifications for weights, dimensions and patterns of soil pipe and fittings. The seal will not only eliminate sub-standard pipe and fittings but will also promote interchangeability of cast iron soil pipe and fittings made by different member manufacturers, thus lowering the ultimate cost to builders and homeowners.

BUILDING RESEARCH | CIB Bulletin

The C. I. B. — International Council for Building Research, Studies and Documentation — is now circulating a bi-monthly bulletin as a means of achieving its aim: "to encourage, facilitate and develop international cooperation in building research, studies and applied research and documentation covering not only the technical but also the economic and social aspects of building."

(Continued on page 196)

when there's more
than one floor
.... think of
Sedgwick

IN COMMERCIAL AND INDUSTRIAL BUILDINGS



to move loads from floor to floor
and to make better use of space

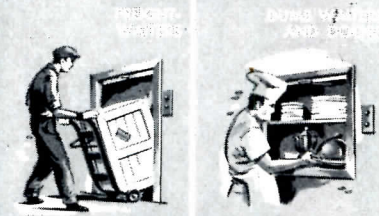

IN RESIDENCES

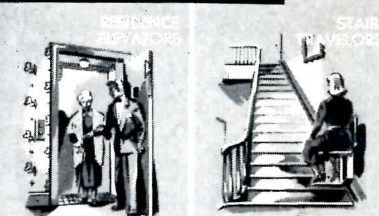

to add one-floor convenience

Sedgwick furnishes safe, modern vertical transportation equipment to fit in with your plans. Quality performance is assured by 60 years of constant improvements and engineering advances. Specified by three generations of architects. For free specification service and engineering recommendations, write:

Sedgwick

MACHINE WORKS

142 W. 15th St., NEW YORK 11, N. Y.

When it comes to **efficient**
kitchens ... nothing



Gas has speed, economy and flexibility—all the advantages that make it an extremely efficient fuel. Now you can get it — now you can offer it to your prospects — in the kind of appliances that spell immediate and recognizable efficiency to the housewife. The new Gas ranges light, time and cook automatically. The new Gas refrigerators have automatic ice-makers. Most important of all, you now have an excellent choice of automatic **Gas separate range units**.

Survey after survey proves women love these units. They love the no-bend, no-stoop of the oven. They love the usable under-the-counter space the range top gives them. They love the way the units become a built-in part of the kitchen. More and more builders are using such units to sell their medium-priced homes. Put *your* best foot forward by building New Freedom Gas Kitchens* with your choice of popular, automatic **Gas separate range units**.

*Reg. A. G. A.

makes as much sense as Gas

This New Freedom Gas Kitchen was especially designed for efficiency. Separate range units are made to "CP" standards by the **Caloric Stove Corp.** The noiseless **Servel Gas** refrigerator (with a 10-year warranty and no moving parts to wear) has the now famous automatic ice-maker. The **Republic Steel** cabinets house pots, pans and utensils in small, separate "work centers."

Don't miss the New Freedom Gas Kitchens in the Normandie Lounge and the lower exhibit level of the Conrad Hilton and the mezzanine of the Sherman at the NAHB Convention, Chicago, Jan. 16-20.

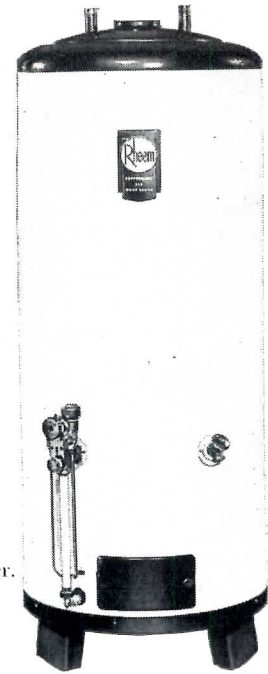

Rheem Coppermatic
automatic Gas water-heater.



Hamilton automatic Gas
clothes dryer with
matching automatic washer.

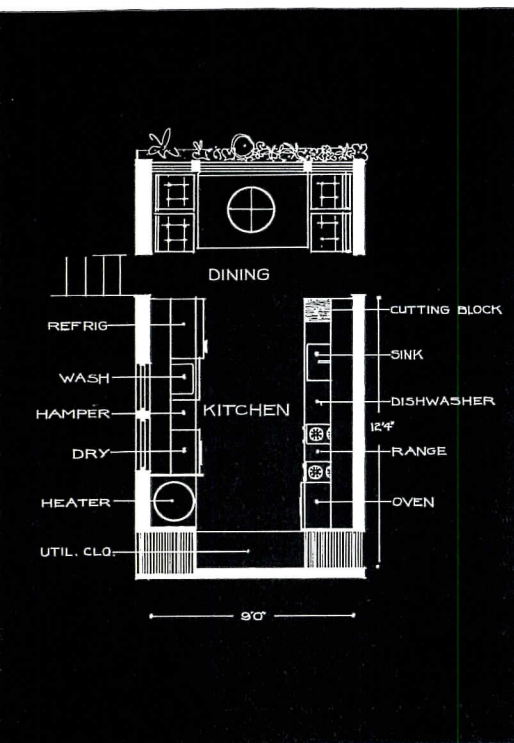

A fast-recovery water-heater is vital for today's homes . . . thanks to larger families, more bathrooms, automatic dishwashers and automatic clothes washers. (The latter uses 20 gal. of hot water for each washing cycle.) Gas water-heaters are 3 times faster than any other kind run by an all-automatic fuel. Another appliance that is getting more and more vital is the clothes dryer.

Many women even rate it ahead of the washer because it saves the hardest part of wash-day—the hauling and hanging. A number of manufacturers offer dryers in a choice of 2 fuels. However, professional laundrettes prefer Gas for its speed and economy 30-to-1. If you can't supply dryers, rough in the outlet and the vent and include feed lines so the customer can choose Gas. She'll thank you for it.

AMERICAN GAS ASSOCIATION

Your local Gas company will be happy to work with you on any problem.

Only Gas



does so much—costs so little

GAS—THE MODERN FUEL FOR AUTOMATIC COOKING...REFRIGERATION...WATER-HEATING
... HOUSE-HEATING . . . AIR-CONDITIONING . . . CLOTHES-DRYING . . . INCINERATION.



(Continued from page 192)

HANDBOOKS | And a Research Paper

IES Lighting Handbook, 2nd ed. Illuminating Engineering Society (1860 Broadway, New York, N. Y.) 1954. 1000 pp, illus. \$8.

This second edition is a 75 per cent revision and updating of the previous edition and represents two years' work by some 500 members and 37 IES technical committees. IES calls it a fulfillment of "the need for complete information on all aspects of the art and science of illumination."

Plastics Engineering Handbook, compiled by The Society of the Plastics Industry. Reinhold Publishing Corp. (430 Park Ave., New York 22, N. Y.) 2nd ed. 1954. \$15.00.

With contributions from over 200 engineers, technicians and other authorities in the plastics industry, this handbook is divided into five main sections covering materials and processes, design, finishing and assembly, testing, and SPI standards. Commercial standards are included for testing, rating, certification and labeling of plastics products.

Residential Wiring Handbook, compiled by the Residential Committee on Industrial Wiring Design (Room 2650, 420 Lexington Ave., New York 17, N. Y.) Revised edition, 1954. 32 pp, illus. 25¢.

This revised handbook offers the latest authoritative data on wiring for air conditioning and individual circuits for laundry and kitchen appliances. It foretells the probability of continued rapid increase of demand on home electrical systems and raises the standard for wiring adequacy to a minimum of 100 amp for service entrance capacity in compliance with the recommendation of the National Association of Home Builders.

The handbook is applicable to one-story open floor-plan houses as well as two-story and multi-family dwellings and covers the rewiring of older homes.

Fastening of Gypsum Wallboard with Threaded Nails, by E. George Stern, Research Professor of Wood Construction, Virginia Polytechnic Institute, Blacksburg, Va.

Threaded nails offer more holding power for fastening gypsum wallboard than do plain-shank nails, according to results of tests conducted by Prof. Stern and sponsored by the Independent Nail & Packing Co. of Bridgewater, Mass.



Designed for heavy traffic

In public places, under the daily pounding and traffic of thousands of feet, Wright Rubber Tile stands up like no other resilient flooring. It thrives on punishment—literally bounces back for more.

Wright resists indentation, cigarette burns and penetration by dirt. The proof lies in the many Wright floors installed over 30 years ago, which remain beautiful and serviceable today.

A complete description of all Wright products, together with color charts and specifications, is available in our new 8-page folder. A copy is yours for the asking.

WRIGHT MANUFACTURING CO., 5205 Post Oak Road, Houston, Texas

**WRIGHTEX
WRIGHTFLOR
VINYL TILE
ECONOTILE**

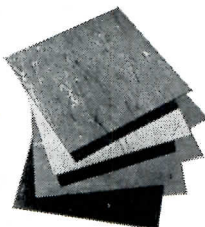

WRIGHT RUBBER TILE

The 100-Year Floor!



FACTORY WAREHOUSES

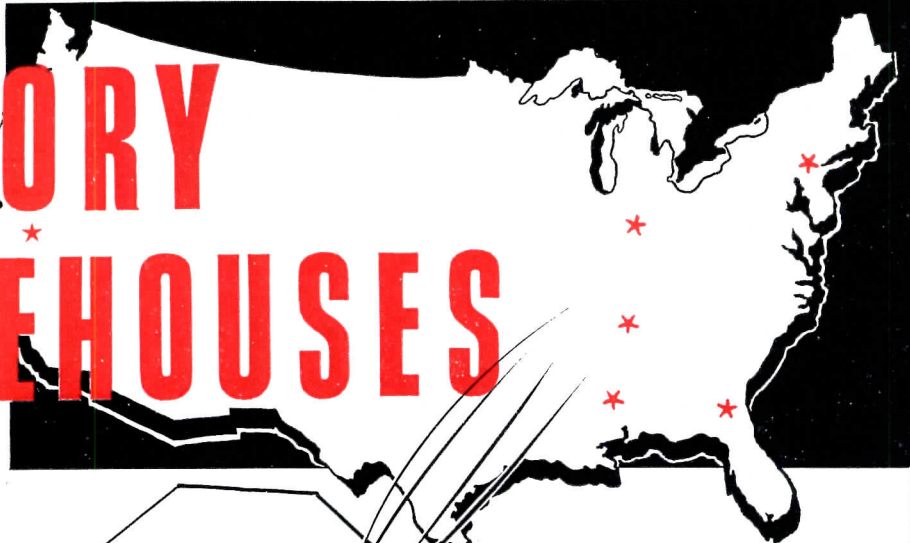

**NATION-WIDE
SERVICE
TO SUPPLY YOUR
SPECIFICATIONS!**



AWNING



AWNING
HOPPER



CASEMENT



HOPPER



JALOUSIE



DOUBLE
HUNG



TWINSUL



BASEMENT



RANCH
WALL



SELECT-
A-VENT



HORIZONTAL
SLIDING

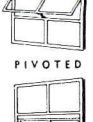

PIVOTED



PROJECTED



UTILITY

Look to Ualco!

Ualco manufactures the most *complete* line of aluminum windows in the field, the *only* complete line.

NOW—Ualco announces another great service to the building industry: *direct factory*

warehouses . . . strategically located . . . with full stocks . . . to give you fast, money-saving service on any style windows, in any quantities!

For windows *as you want them—when you want them*—look to Ualco, world's largest manufacturer!

(THE COMPLETE LINE)

SEE OUR CATALOG IN SWEET'S ARCHITECTURAL FILE 16A OR WRITE US FOR COMPLETE INFORMATION UN

SOUTHERN SASH SALES & SUPPLY CO. — SHEFFIELD, ALABAMA

WAREHOUSES AND SALES OFFICES: Canton, Ohio; Elizabeth, N.J.; Hialeah, Florida; Florence, Alabama; Montgomery, Alabama; Van Nuys, California; Greensboro, N. C.; Aurora, Illinois; Ruston, La.; Kansas City, Missouri.

ASK ABOUT OUR ENGINEERING PLANNING SERVICE to assist architects, engineers and contractors in making "take-offs" and solving window problems.

UALCO WINDOWS ARE UNCONDITIONALLY GUARANTEED AGAINST DEFECTIVE MATERIALS AND WORKMANSHIP

UALCO—WORLD'S LARGEST MANUFACTURER OF ALUMINUM WINDOWS

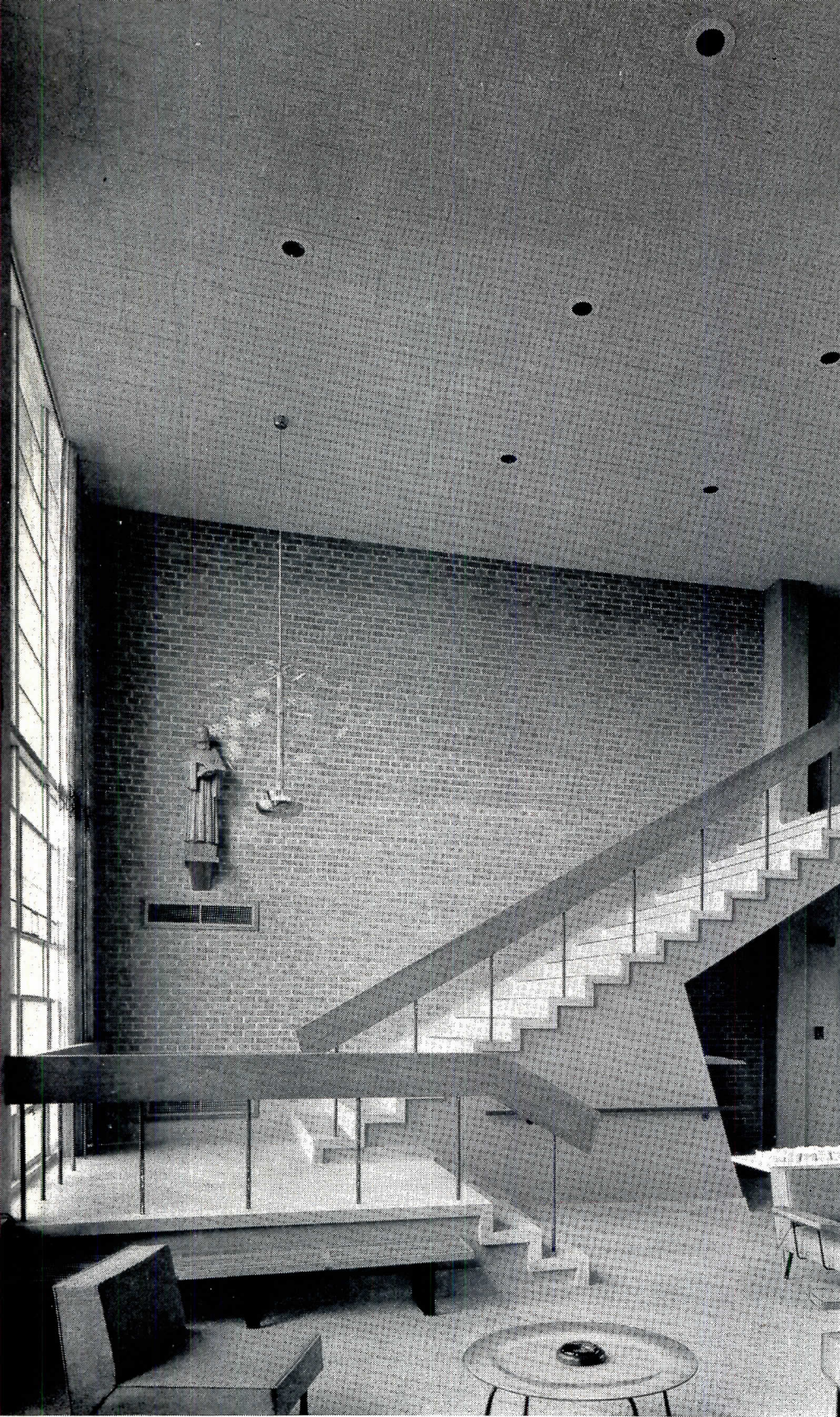

Echoes are absorbed by the Armstrong Travertone ceiling in this beautifully designed, two-story lobby. Travertone's attractive white fissured finish blends ideally with the handsome combination of buff colored brick walls and beige terrazzo floor.



**BELLARMINE COLLEGE,
Louisville, Kentucky**

Architect:

Thomas J. Nolan & Sons

General Contractor:

Al J. Schneider Company

Acoustical Contractor:

The Carrell-Rogers Co., Inc.

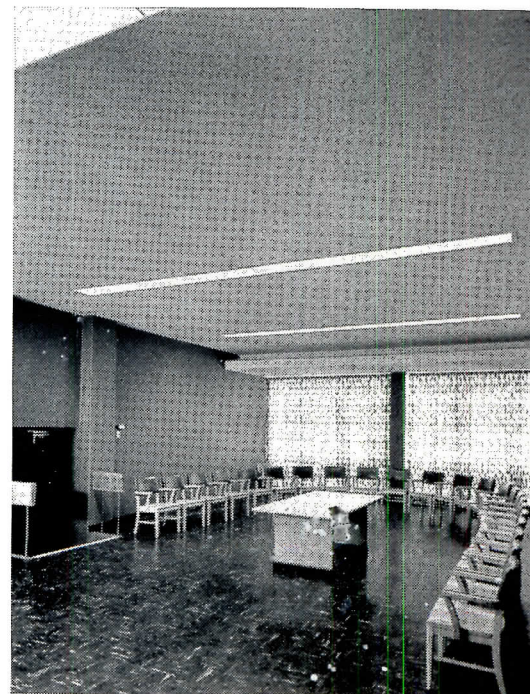

Discussions are free from distracting noise in this tastefully designed seminar room. The quiet, handsome Travertone ceiling muffles the sound of foot-falls, scraping chairs, and cuts down voice echo.

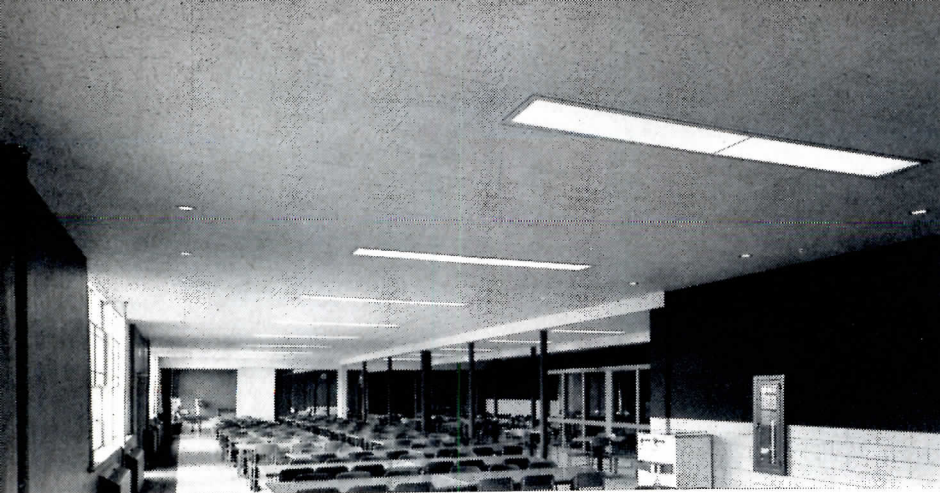

Quick, easy maintenance helps keep this cafeteria ceiling of Armstrong Travertone within the school's rigid standards of sanitation. Armstrong Travertone can be cleaned by vacuuming or washing with mild soap and water.

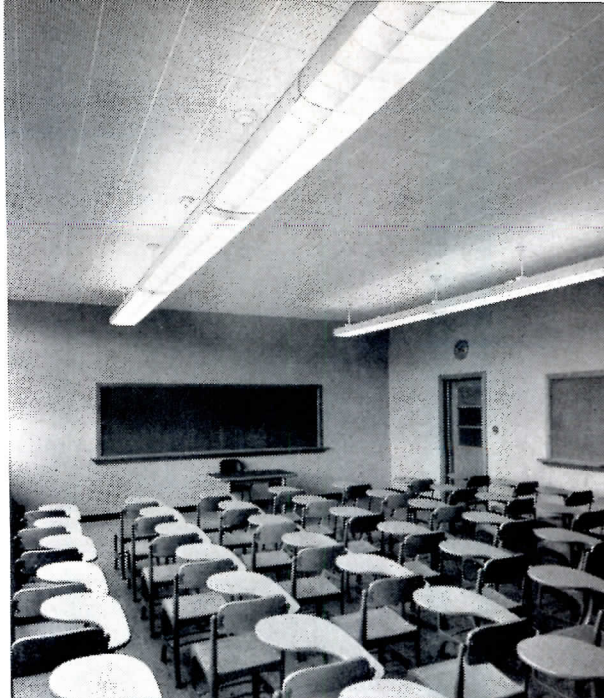

High light reflection from the acoustical ceiling in this classroom is due to Cushiontone's factory-painted white finish which reflects 79% of the light that strikes it. Cushiontone can be repainted without lowering its acoustical efficiency.

Sound conditioning helps college plan for future

Expansibility is a key design feature of the Administration-Library building at Bellarmine College. The new building's chapel-auditorium area can be converted to classrooms as soon as funds permit a separate chapel at the growing four-year-old school. The change will be simple because the architect provided all areas of this well-planned structure with forward-looking installations of the basic elements—including highly important sound conditioning.

Noise-absorbing ceilings of Armstrong acoustical materials were used throughout the building. For the artistically modern two-story lobby, as well as the library, student theater, business offices, corridors and cafeteria, the architect chose ceilings of Armstrong Travertone*. In addition to high noise absorption, Travertone gives a distinctive appearance which blends well with the exposed brick walls and terrazzo floor of the lobby. Travertone's mineral wool composition is incombustible, meeting all fire-safety regulations.

In the classrooms, ceilings of Armstrong Cushiontone prevent sound from reaching a disturbing level. Cushiontone, a wood fiber material, offers high sound-absorption efficiency. It absorbs up to 75% of the noise that strikes its surface. Low in

*Trade-Mark

both material and installation cost, Cushiontone ceilings permitted the architect to cover large areas economically. Ease of maintenance, repaintability, and high light reflectivity are other important Cushiontone features.

Travertone and Cushiontone are only two of six Armstrong acoustical products. Get full details on Armstrong's entire line of sound-conditioning materials from your Armstrong acoustical contractor. He'll be glad to give you more detailed product information and a free estimate, without obligation. For the free booklet, "How to Select an Acoustical Material," write Armstrong Cork Company, 4201 Rock Street, Lancaster, Pennsylvania.

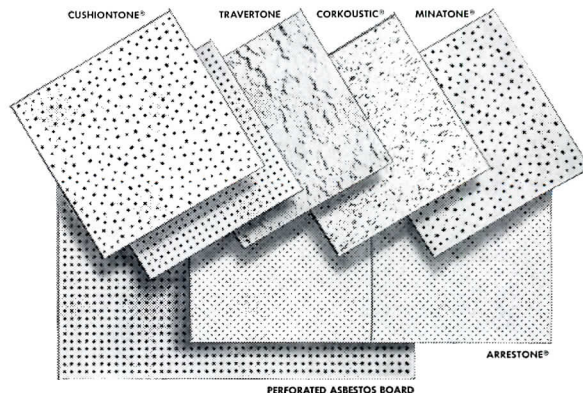

Armstrong ACOUSTICAL MATERIALS

(Continued from page 177)

MORE LIBRARY EQUIPMENT

BOOKSTACKS, one of the most important elements in a library, can fit into any type of library scheme. They can be multi-tier stacks, with shelf supports rising through two or more floors, or single-tier. Adjustable shelving is practical, and a variety of special shelf units are available. Flexibility is evident, so that libraries can be expanded when necessary.

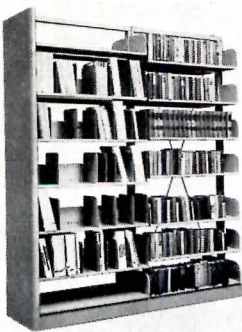

Divided shelves, interchangeable with standard bracket-type shelves to the right, have adjustable dividers which permit magazines and pamphlets to stand by themselves. *W. R. Ames Co., 150 Hooper St., San Francisco 7, Calif.*

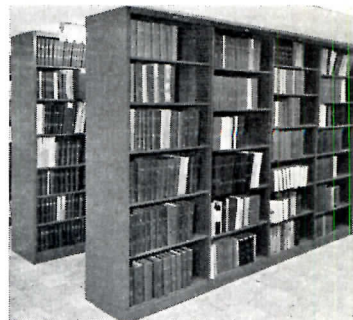

Free-standing bookstacks with double backs and adjustable shelves are manufactured by *The General Fireproofing Co., Youngstown 1, Ohio.*

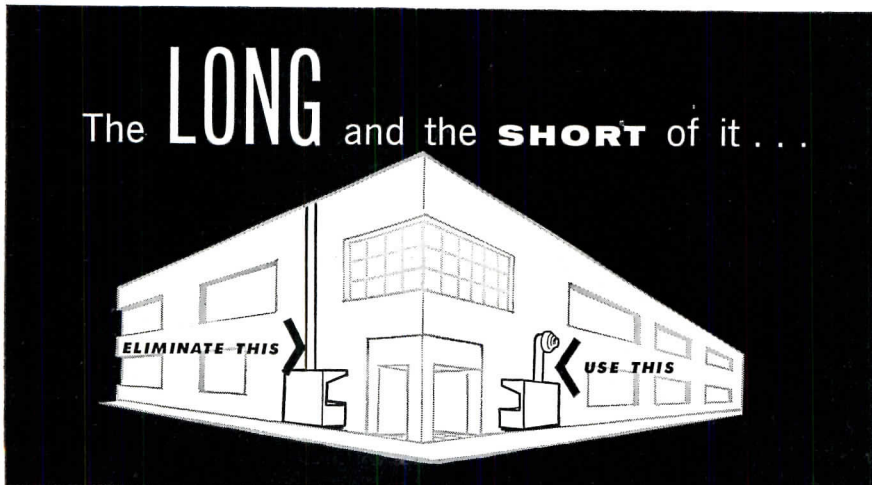

The **LONG** and the **SHORT** of it . . .

. . . HOW TO CUT DUCT COSTS

This is the story of how to save money on ventilating—the story of long duct runs vs. short ducts.

PROBLEM: To reduce long and elaborate duct runs connected to power exhausters—runs that often cost more than the heart of the system, the fan, itself. This problem is more acute in multi-story construction or existing structures where ducts are brought through upper floors to the roof.

SOLUTION: Use Jenn-Air Wall Exhausters . . . thus eliminating most duct work. One simple opening through the outer wall permits the Wall Exhauster to be connected directly to the area of ventilation. In this way valuable interior space is saved and installation costs are reduced.

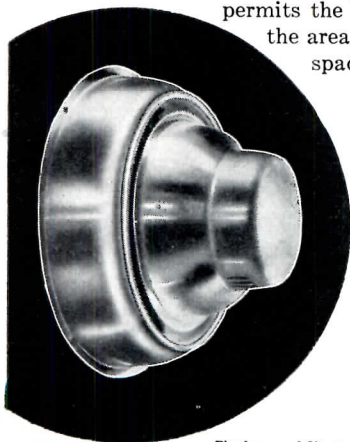

JENN-AIR
Wall Exhausters

Visit us in Booth 27 at the ASH & VE Show.

The Long and Short of It on the Roof

Jenn-Air Low-Contour Roof Exhausters
Design blends with today's buildings. Gone are unsightly penthouses, and gravity stacks. First with spun aluminum construction, Jenn-Air Exhausters are setting the trend in the field.

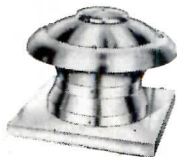

JENN-AIR PRODUCTS
COMPANY, INC.

Architects & Builders Building
Indianapolis 4, Indiana

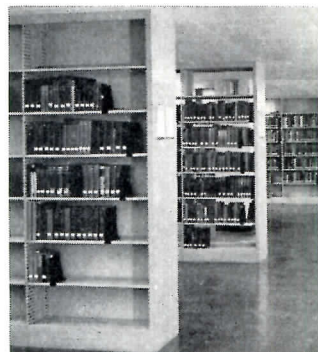

Standard single-tier bookstacks with adjustable shelves are part of the line of *Art Metal Construction Co., Jamestown, N. Y.*





Strong shelving for basement or back-room storage can be erected with single rows or double rows (by placing single rows back to back). Rows of any desired length can be built. *Edward Hines Lumber Co., 2431 So. Wolcott Ave., Chicago 8, Ill.*

(Library Equipment continued on page 204)

FLOOR DRAINS

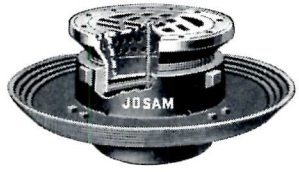
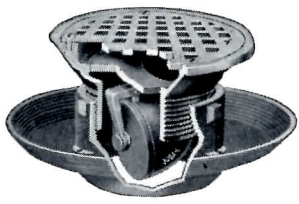
IN ANY TYPE OF BUILDING . . .

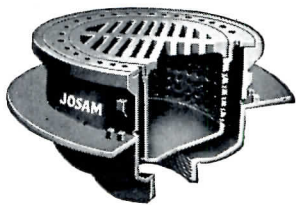
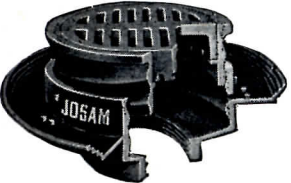
 <p>1 Josam Series No. 200 Floor Drain with integral drum-type "P" trap and adjustable strainer.</p>	 <p>2 Josam Series No. 300-35C Floor Drain with polished brass non-clog adjustable strainer.</p>	 <p>3 Josam Series No. 380-J Floor Drain with adjustable strainer and Back-water Control.</p>	 <p>4 Josam Series No. 610 Floor Drain with deep set tractor grate for locations subject to heavy trucking.</p>
 <p>5 Josam Series No. 860-V Floor Drain with brass back water valve caulked into trap and floor cleanout.</p>	 <p>6 Josam Series No. 810-V combined Floor Drain and trap with ball type back-water valve and internal brass cleanout.</p>	 <p>7 Josam Series No. 5040 Floor Drain with rectangular hinged grate, removable slotted sediment bucket.</p>	 <p>8 Josam Series No. 5440 Non-Clog Triple Drainage Floor Drain, removable perforated sediment bucket with auxiliary drain-age rim.</p>
 <p>9 Josam Series No. 3610 Leveze Floor Drain with adjustable collar to permit raising or lowering grate to meet finished floor level.</p>	 <p>10 Josam Series No. 5250 Floor Drain with bolted top section, removable sediment bucket and heavy duty grate.</p>	 <p>11 Josam Series No. 6800 Floor Drain with funnel shaped seal, sediment bucket and floor clean-out, for intercepting oils, gasoline and other volatile liquids.</p>	 <p>12 Josam Series No. 0370 Drain for draining excess water and slush at entrance of revolving doors.</p>

13 MATERIALS AND FINISHES. Drain bodies are regularly furnished in cast iron lacquer finish unless otherwise described but can be furnished galvanized or malleable iron, brass or everdur with polished brass, chromeplate, everdur or white metal top.

14 OUTLETS. Drains shown above with bottom outlets can also be furnished with side outlet. Bottom outlets available female threaded or inside caulk. Side outlets furnished threaded, hub or spigot.

For each of the many basic drain designs in the Josam line, there are scores of variations depending on the particular requirement. These are all clearly illustrated and described in the Josam Catalog "K" or Manual "SK" — the accepted authorities in the field. These are invaluable reference guides on all plumbing drainage problems. Send coupon if you do not have a copy of Josam Catalog "K" or Manual "SK".

JOSAM MANUFACTURING COMPANY
 Dept. AR • Michigan City, Indiana
 Please send free copy of Catalog "K"
 Manual "SK"

Name Profession

Firm

Address

City Zone..... State

COLLEGE HOUSING

(Continued from page 154)

proved for the construction of housing for 34,214 students, 260 married students and 467 faculty members. Funds have been reserved for an additional 61 projects, involving \$40.2 million, so that additional accommodations are now in sight for 9708 students, 366 married students, and 111 faculty members. A total of \$153 million has been com-



Men's dormitory for Baylor University (Texas) accommodates 340, cost \$700,000. Area per occupant, 176 sq ft; study-bedroom, 107 sq ft; toilet-shower, 10 sq ft. Architects: Easterwood & Easterwood

2

POPULAR SCHOOL *Combinations*

Halsey Taylor Counter-Type Fountain class-room unit, 20" x 30", with receptor of acid-resisting, gleaming porcelain cast iron or lifetime stainless steel. Chromium Plate Glass Filler and Fountain Head. All the usual Halsey Taylor sanitary features. Specify No. 4840.

This is an ideal combination for "gym" or athletic areas. The Halsey Taylor recessed Cuspidor, No. 4647, shown at right, is designed to be used with No. 4646 recessed wall type, shown at left. Special outlet supplies water to flushing jet of cuspidor. Semi-recessed models also available.

School boards and architects know that to specify Halsey Taylor drinking-water equipment is to provide the utmost in sanitation as well as trouble-free maintenance. Every Halsey Taylor product—whether fountain or cooler—is factory-tested for dependability in service . . . backed by years of specialization in manufacturing this type of equipment exclusively.

The Halsey W. Taylor Co., Warren, O.

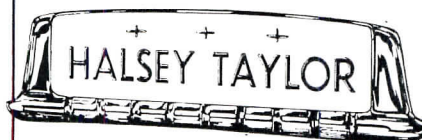

AS-40

mitted from the \$200 million thus far released from the authorization.

So much for the history and statistics of the program.

Diversity and Freedom

The provision of housing for students and faculty on the campus of a university presents unique and challenging problems to the university officials and their architects. Here, as in many other areas of American life, where its diversity is part of its brightest promise, it is difficult to generalize or to attempt to impose rigid, pre-conceived designs. Congress itself recognized this fact and required only that the Administrator find that the housing will be undertaken in such a manner that "economy will be promoted in its construction and that it will not be of elaborate or extravagant design."

Designs Vary Widely

Within this finding it has been possible for many different types of institutions and their architects to seek and to find widely varying solutions to meet the highly specialized housing needs of their campuses and their students. There appears to be no single or simple answer; on the contrary, the approaches which the colleges and universities have taken under the College Housing Program have all the variety which has characterized American higher education from its inception. The experience derived from these different approaches is available to colleges and universities and their architects in the Regional and Central Offices of the Housing and Home Finance Agency.

(Continued on page 240)

The right windows can make a REAL DIFFERENCE . . .

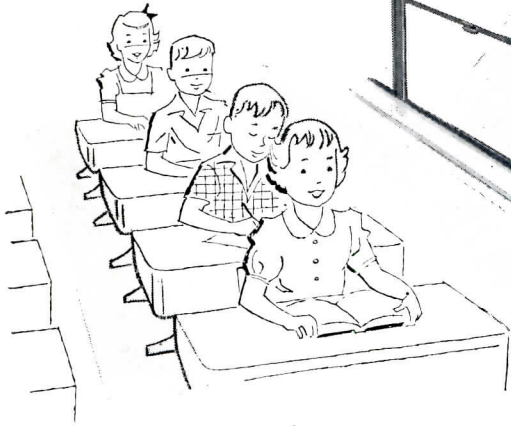

*Ask the
Teacher!*



The teacher sees the effect of good daylighting and good ventilation in a lot of ways. In a classroom filled with fresh air and daylight, her students are more alive and alert—more receptive to learning. There's none of that "closed-in" feeling. And needless to say, the teacher herself feels "more like teaching" in such a room. Fenestra* windows give you *more* daylight per opening because of their slender, but strong steel members.

There are practical, as well as psychological, advantages to the right windows. The teacher can operate the vents in Fenestra Intermediate Projected Steel Windows easily. Tilt-in vents protect her students from drafts, and like tilt-out vents, admit fresh air even on rainy days. And sill vents keep even the most rambunctious of small fry from tumbling out the windows.

They'll probably stay cleaner, too, because they can be washed (as well as screened) from the inside—with resultant savings in time, labor and cost. *And they'll never need painting if you specify Fenestra Super Hot-Dip Galvanizing.* It's a special process that protects your windows from rust and weather for life!

For complete information on these beautifully designed steel windows, call your Fenestra representative. He's listed in the yellow pages of your phone book. Ask for our authoritative booklet, called *Better Classroom Daylighting.* Or write Detroit Steel Products Company, Dept. AR-1, 2252 East Grand Boulevard, Detroit 11, Michigan. *®

Fenestra

**INTERMEDIATE
STEEL WINDOWS**

Architectural, Residential and Industrial Windows • Metal Building Panels
Electrifloor* • Roof Deck • Hollow Metal Swing and Slide Doors



MISSOURI. Fenestra Steel Windows in Willard Elementary School, Willard, Mo. Architect: I. Dale Allmon, Springfield, Mo. Contractor: DeWitt Construction Co., Springfield, Missouri.

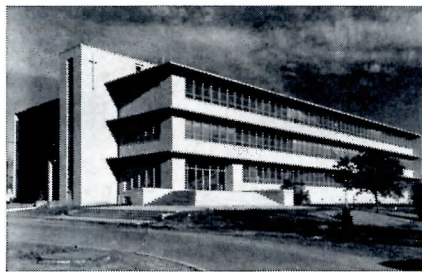

TEXAS. Fenestra Steel Windows in the Science Hall at St. Mary's University, San Antonio, Texas. Architect: Julian & White, San Antonio. Contractor: Lynn & Morse, San Antonio, Texas.

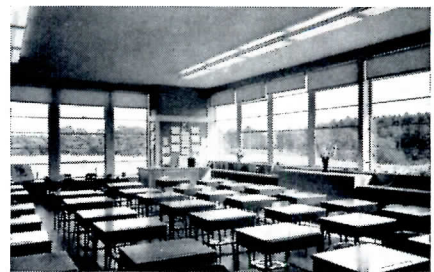

MASSACHUSETTS. Fenestra Steel Windows in the Elementary School at Kingston, Mass. Architect: Bogner & Richmond, Cambridge, Mass. Contractor: Blake Construction Co., Milton, Mass.

COLLEGE HOUSING

(Continued from page 238)

The Financial Equation

The housing problem at a college or university, in common with all housing problems, has at its base a financial equation. Charges for tuition and board and room have increased substantially since the war, but these charges can hardly be expected to keep pace with the increase in construction costs which

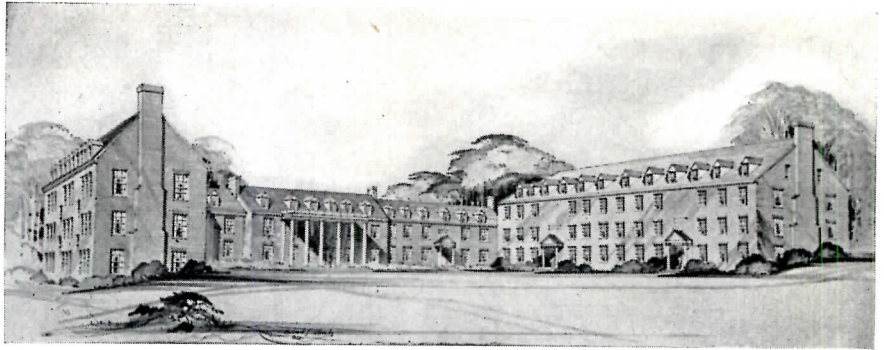

Men's dormitory, U. of Maryland — seven connected four-floor units; capacity 368 (on cost and areas, see Maryland women's dormitory, page 152). Architects: Walton and Madden



Now MY BOSS IS PROUD OF THE LETTERS I WRITE!

Since the Boss gave me an Underwood All Electric Typewriter, not only original letters, but carbon copies are sharp and clear. Just imagine you can make as many as you need with a light touch of your finger

... Because electricity does the fatiguing work.

See and try the sensational All Electric at your local Underwood Office.

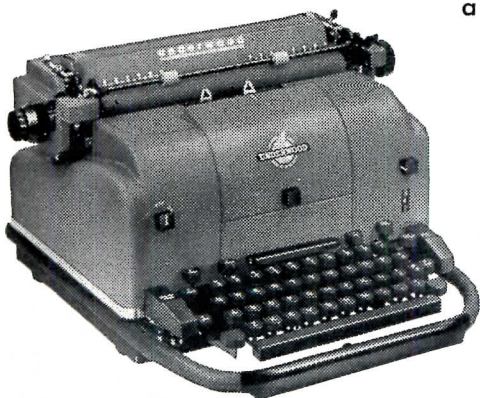

Underwood Corporation

One Park Avenue, New York 16, N.Y.
Underwood Limited, Toronto 1, Canada
Sales and Service Everywhere



TYPEWRITER LEADER OF THE WORLD

Sales and Service Everywhere

have doubled since 1941 and quadrupled since 1913. Even with the 40-year maximum amortization and the current three and a quarter per cent interest rate provided under the College Housing Program, it is almost impossible to work out projects which are completely self-liquidating from the moderate rentals which are economically feasible for college students today. Nearly every college housing loan requires additional revenues from other debt-free buildings, student fees or other sources. Thus, each institution must work out its own individual solution to a financial problem whose principal components are the construction cost per bed and monthly rent per student. It is not an easy equation to solve, for there is no magic about the College Housing Program. However, notwithstanding its lack of magic, the program has brought what seemed to be hopelessly impossible situations into the realm of the possible for some 226 institutions which are planning or constructing housing for 48,377 students.

Private Financing Spurred

While the College Housing Program is intended to operate on a self-liquidating basis without eventual cost to the Government, direct Federal loans do represent an immediate outgo of Federal funds from the overburdened Federal budget. Also, it is clear that if the colleges and universities are to be able to handle the mounting tide of enrollments, it will have to be done through sources other than the limited Federal program, which should be reserved for the more critical needs. The U. S. Office of Education estimates that the two million-odd students now in college will

(Continued on page 242)

Here's a steel panel roof with an acoustical treatment built right in . . .

WHAT COULD MAKE MORE SENSE?

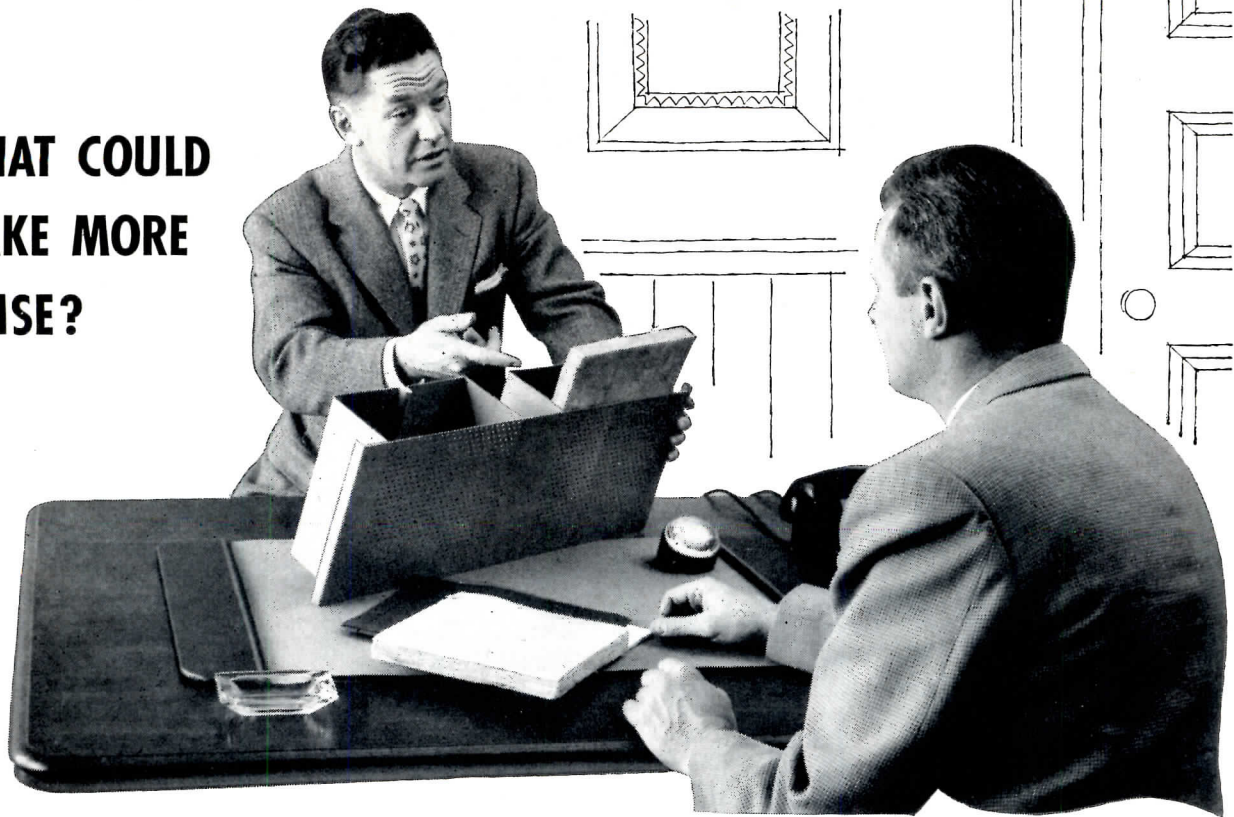

If you're looking for a really practical acoustical treatment for your new classrooms, gym or auditorium, look no further! For these Fenestra* Acoustical-Structural Building Panels form a beautifully finished structural ceiling, noncombustible acoustical treatment and a joist-system support for finished roofing—*all in one!*

No acoustical material has to be pasted on the ceiling surface. You pay no bills for special trades or extra labor. Maintenance washing or painting won't affect the acoustical efficiency. Bumps or knocks can't hurt this ceiling. And if your building has a second floor, your Fenestra ceiling forms a strong solid subfloor for rooms above.

This combination acoustical-structural ceiling goes up *fast*. The panels lock together simply and quickly, saving days of labor, giving you substantial cost savings. To see how much sense it makes in the building *you're* planning call your Fenestra Representative. And do it *before* your plans are on paper! Or write to Detroit Steel Products Company, Dept. AR-1, 2252 E. Grand Blvd., Detroit 11, Mich.

*Trademark

Fenestra | METAL BUILDING PANELS

Architectural, Residential and Industrial Windows • Metal Building Panels
Electrifloor† • Hollow Metal Swing and Slide Doors • Roof Deck

†®



PANELS are laid over the rigid steel frame during course of erection. It's a construction method that really pays off. Be sure to investigate *before* you plan your next building!

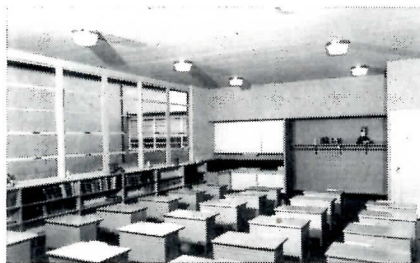

ACOUSTICAL PANELS in Willard Elementary School, Willard, Mo. *Architect:* I. Dale Allmon, Springfield, Mo. *Contractor:* DeWitt Construction Co., Springfield.



ANOTHER INSTALLATION at Converse County High School, Douglas, Wy. *Architect:* Hitchcock & Hitchcock, Laramie, Wy. *Contractor:* Speigelberg Lumber & Building Co., Douglas.

COLLEGE HOUSING

(Continued from page 240)

increase by more than 50 per cent, or to more than three million by 1960.

With these two considerations in mind, the Housing and Home Finance Agency has embarked on an aggressive program to stimulate a market for College Housing Program bonds. We have been referring to private investment as many as possible of these loans at all stages of the application process and

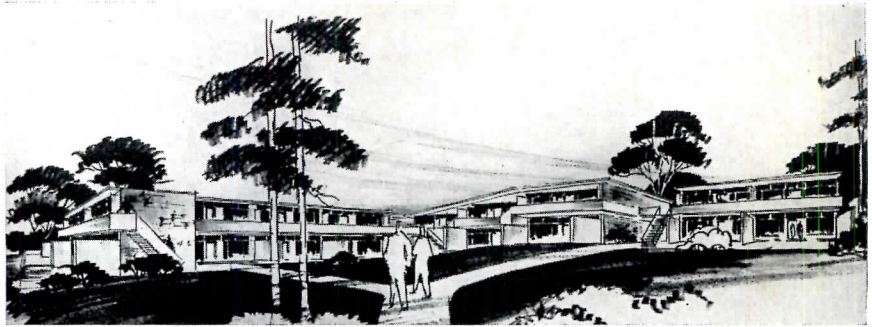

Married students' apartments, Indiana University — there are two units like this one with 46 one-story apartments each (see page 153 for Indiana duplex). Architect: Edward D. James

Michaels Quality Products

FOR YOUR BUILDING PROJECTS



Michaels produces aluminum, stainless steel and bronze products for the building industry. The bronze railing used in the Huber Mausoleum, New Orleans, is a typical example. And there are literally scores of other products for interior and exterior use.

Whatever you need, if it's made of stainless steel, aluminum or bronze, and irrespective of the size of the project, it will pay you to contact Michaels . . . a name well known among architects and builders for products of the highest quality. Michaels has the men and equipment to faithfully reproduce in metal the most intricate details of your designs.

Send us the specs. for your next job. We are confident you will find our prices right. And we'll be glad to refer you to any number of architects and contractors who have found Michaels a thoroughly reliable source of supply.

The Michaels Art Bronze Co., Inc.

234 Scott Street, Covington, Ky.

Manufacturers since 1870 of many products in Aluminum, Bronze and other metals



MICHAELS PRODUCTS

- Bank Screens and Partitions
- Bronze Doors
- Aluminum Doors
- Elevator Doors
- Store Fronts
- Name Plates
- Grilles and Wickets
- Kick and Push Plates
- Push Bars
- Cast Thresholds
- Lettering
- Check Desks (standing and wall)
- Lamp Standards
- Marquees
- Tablets and Signs
- Extruded Thresholds
- MI-CO Parking Meters
- Museum Trophy Cases
- Inurnment Urns
- Stair Railings

Literature on any or all Michaels products will be sent on request.

even after the projects are completed. Under this policy which I inaugurated shortly after becoming Administrator of the Agency, more than \$60 million in college housing loans have been rescinded or withdrawn in favor of private financing.

The application of this policy requires the borrowing institution to advertise its bonds for private sale and to accept private bids for all or part of the issue if the interest rate bid is not more than one fourth of one per cent higher than the college housing rate. During the last six months some 16 dormitory issues approved under the program have been purchased privately, in whole or in part, many of them at rates lower than the college housing rate. Three recent loans with maturities up to 40 years have been purchased by private investment groups — making the first time in the history of dormitory bond financing that bonds covering this span of years have found a market other than the Government. The College Housing Program is stimulating an awareness of the soundness of these loans and a market for this type of security seems to be in the process of creation. To the extent that this market develops, the need for direct Federal loans will diminish and a much broader program will come into existence which can tap private investment funds to provide many times the amount of housing possible under the College Housing Program.

I believe that the College Housing Program furnishes an opportunity for institutions of higher learning to analyze their needs, to crystallize their plans and to develop economically sound projects with assurance of reasonable financing.

Look at the amazing difference between new Libbey·Owens·Ford Parallel-O-Plate Glass and ordinary plate glass

Why does merchandise look better through a Parallel-O-Plate Glass storefront?

Why does your view look better through a Parallel-O-Plate Glass picture window?

Why do buildings look better with windows of Parallel-O-Plate?

Because this amazing new plate glass is *twin-ground*—the first and only *twin-ground* plate glass made in America!

At first this L·O·F glass was reserved for fine mirrors and military optical instruments. But now it is available for general use—and it will change the face of America.

Distortion in glass sometimes results from poor installation but most frequently is due to a lack of parallelism of its two surfaces.

At L·O·F, plate glass is run through massive new machines which *grind both sides simultaneously* for maximum parallelism. And Libbey·Owens·Ford is the only manufacturer of *twin-ground* plate glass in the U.S.

Be sure you specify Parallel-O-Plate Glass. Get it from your local L·O·F Glass Distributor or Dealer who is listed under "Glass" in the yellow pages of phone books. For further information, write to Dept. 7515, Libbey·Owens·Ford Glass Company, 608 Madison Avenue, Toledo 3, Ohio.

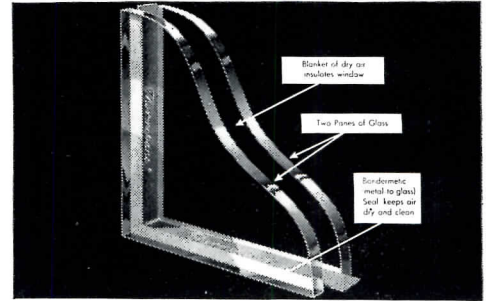

Parallel-O-Plate is doubly important for *Thermo-pane*® insulating glass because there are two panes to look through.

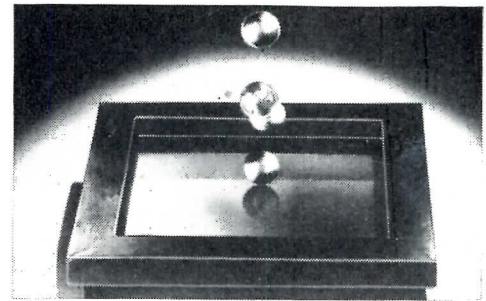

$\frac{1}{4}$ " *Tuf-flex*® is tempered Parallel-O-Plate Glass. A $\frac{1}{2}$ -lb. steel ball, dropped 10 feet, bounces right off $\frac{1}{4}$ "-thick *Tuf-flex*. For vulnerable windows.

Parallel-O-Plate Glass

Finest plate glass made in America...only by **LIBBEY·OWENS·FORD**
a Great Name in Glass

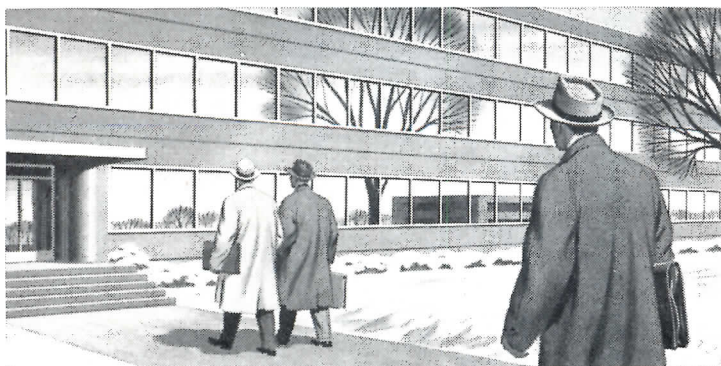

LOOKING AT windows of Parallel-O-Plate Glass you see how much its truer reflections mean to exterior appearance.



WASHINGTON

(Continued from page 38)

PBS handbooks serve as guides in preparing and carrying out Federal building plans. They carry basic design criteria setting out space requirements, mandatory architectural and engineering standards, and optional design data for construction elements such as floor plans, materials, finishes, and lighting fixtures. Optional data, most often in the form of sample drawings, are intended by PBS to permit flexibility to fit plans to size, location, supplies, and various combinations of agencies for which buildings are constructed. The agency also carries stock specifications of highly repetitive items such as hardware for doors and windows.

PBS supervises Federal building construction of all types: court houses, office buildings, hospitals, warehouses, border stations, and multipurpose buildings for postal, judicial, and office use.

ISSUE DESIGN DATA FOR NEW HILL-BURTON TYPES

New design standards for hospital types added to the Hill-Burton hospital construction program by 1954 amendments to the basic legislation have been issued by the U. S. Public Health Service of the Department of Health, Education and Welfare. Copies of the standards are available at the state agencies or from USPHS, Washington 25, D. C.

Diagnostic centers, chronic disease hospitals, rehabilitation facilities and nursing homes are the types covered by the new standards, which have been approved by the technical committee for architectural standards of the Federal Hospital Council, the full Council and the Surgeon-General.

The states are beginning to become active in developing their own state plans, which must be approved by the Surgeon-General before they can receive grants under the expanded program. USPHS reports that many states have already begun their inventories and the Federal agency expects to begin taking formal applications on the new types before the middle of next year.

In the 1954 legislation, Congress authorized expenditure each fiscal year for the remaining three years of the Hill-Burton Act of \$20 million for diagnostic
(Continued on page 254)

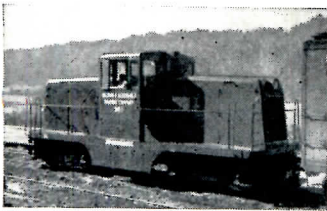

A completely dieselized transportation system serves the Alberene quarries and mills and connects with the C. & O. R. R. at Esmont, Va.

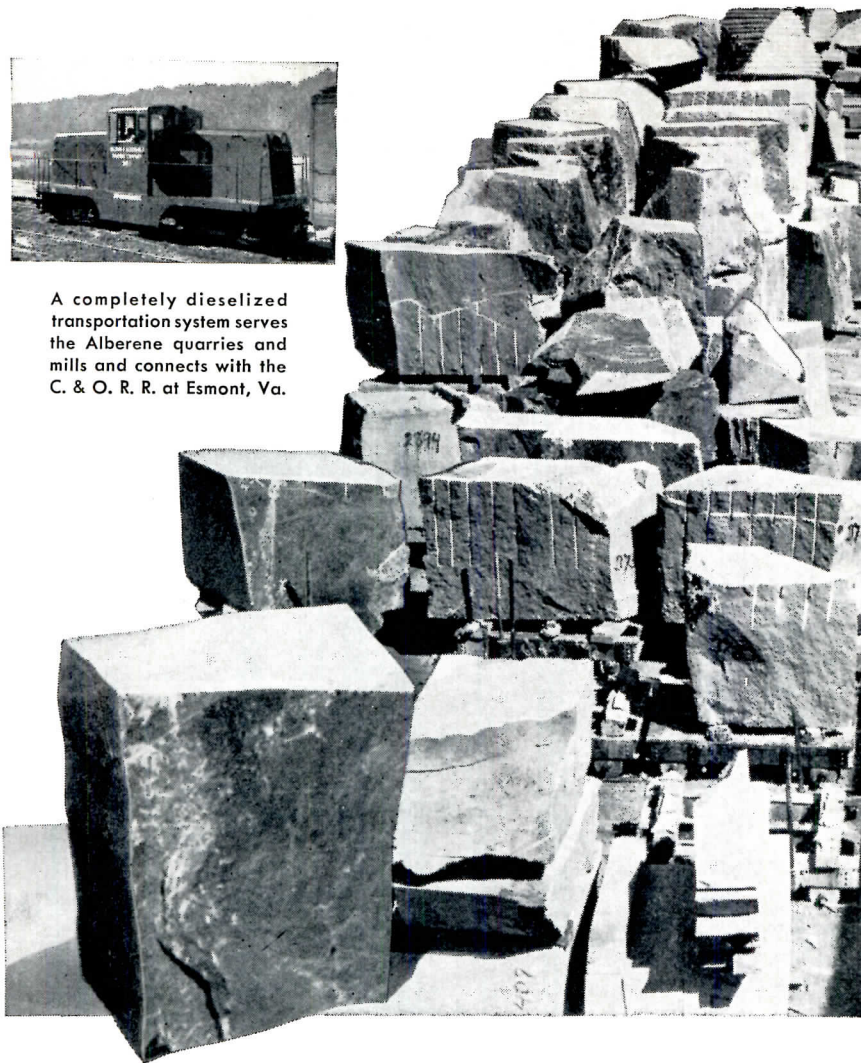

Let's talk "DELIVERIES!"

For practical purposes, the supply of Alberene Stone is inexhaustible. It is quarried, milled, and transported by the most modern and efficient methods.

With reasonable cooperation from the purchaser, we can schedule our production of stone to meet the requirements of contractors and laboratory equipment manufacturers.

There's no need to let deliveries interfere with getting Alberene Stone — *the natural silicate stone with the surface that goes all the way thru!* Only Alberene Stone can be cut, drilled, tongued and grooved, refinished and reused almost indefinitely.

For information and technical assistance, address: Alberene Stone Corporation, 419 Fourth Avenue, New York 16, N. Y.

ALBERENE STONE

provides LOW ABSORBENCY protection

Why have so many of America's largest, most famed buildings installed Yorkaire Systems of air conditioning?

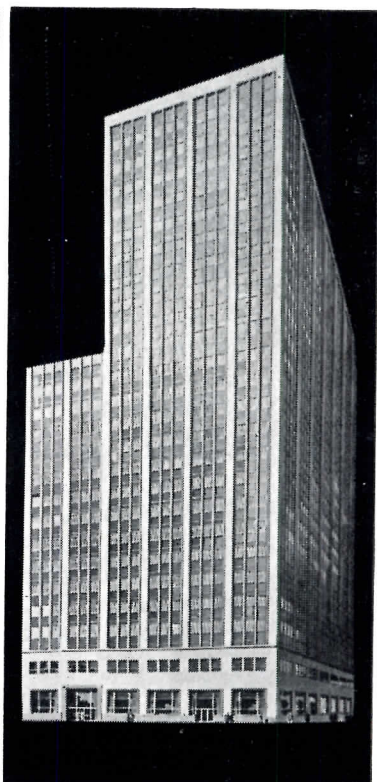
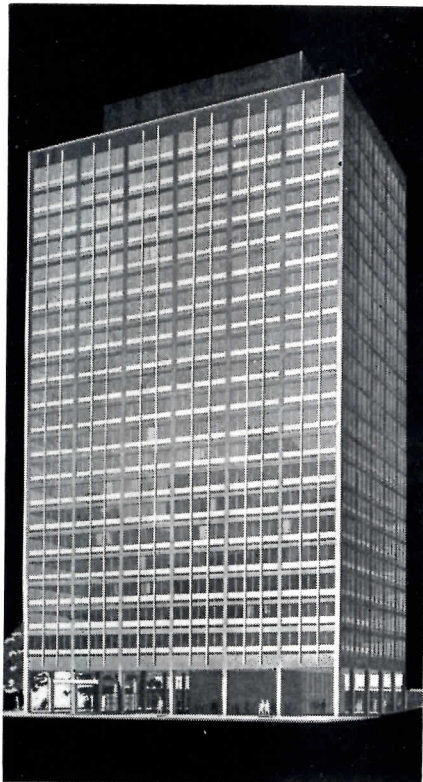
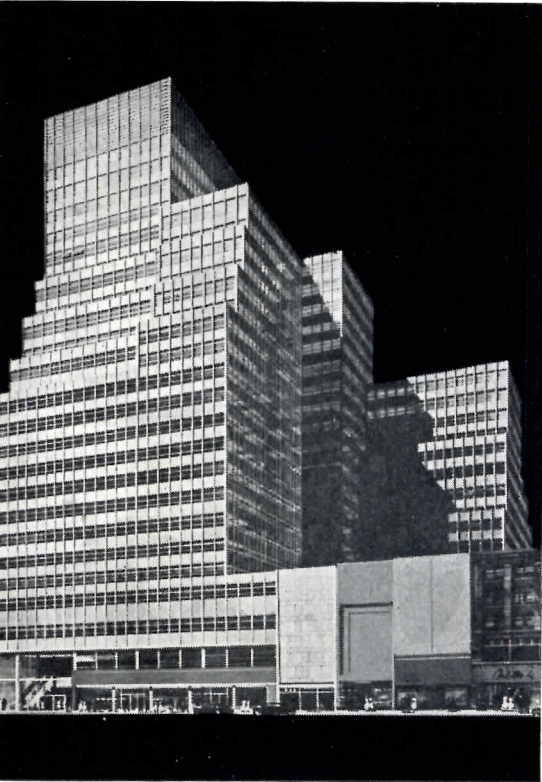

FROM PHILADELPHIA'S FABULOUS NEW PENN CENTER

to office buildings, hotels and hospitals in your own city, think for a moment how many of America's largest, most famed buildings have installed—or *are* installing—Yorkaire Systems of Air Conditioning!

And there is every good reason: a Yorkaire System is the *right kind* of air conditioning . . . precision-tailored to the building.

Since glass areas and heat loads and floor areas and numbers of rooms, economic considerations and taxes and depreciation and a score of other

factors vary from building to building, up and down the land, obviously no one system—or even two or three—can do the job best for every building. That's why York chooses and tailors each system to fit the particular building in which it is installed. And *that's* why so many of the "tough jobs" come to York.

Apply this knowledge and experience to your own building (old or new). Call your York District Office (located in principal cities and listed in the classified telephone directory). Or write to York Corporation, York, Pennsylvania.

Visit the York Booth (219-227) at the 12th International Heating and Ventilating Exposition

air conditioning and refrigeration

M E C H A N I C A L C O O L I N G S I N C E 1 8 8 5

WASHINGTON

(Continued from page 250)

The ARCHITECT knows that ALGRIP



—the *only* abrasive rolled steel floor plate in the world—means permanent safety against slipping accidents in any industrial plant . . . even on wet, greasy or oil-splashed floors or ramps.

He also knows . . .

—that ALGRIP's depth-controlled abrasive penetration of its rolled steel base . . . assuring a safety surface self-renewed against the hardest wear . . . means greater . . . constant . . . and lasting . . . safety of your workers' lives.

—that ALGRIP is approved for safety by the Underwriters' Laboratories.

A.W. ALGRIP Abrasive Rolled Steel Floor Plate *puts your business on a firm footing.*

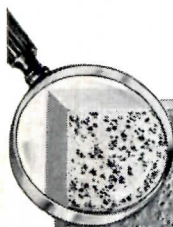

A.W. ALGRIP

ALAN WOOD STEEL COMPANY
Conshohocken, Pa.

Please send A.W. ALGRIP Booklet AL-2

Name _____

Title _____

Company _____

Address _____

City _____ Zone _____ State _____

Other products: A.W. SUPER-DIAMOND Rolled Steel Floor Plate—Plates—Sheets—Strip—(Alloy and Special Grades)

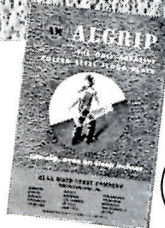

MAKE FIRST MOVE ON NEW MILITARY HOUSING UNITS

The Department of Defense has made what it calls a "line item certification" for approximately 40 per cent of the \$75 million Congress appropriated for the construction of military housing during fiscal 1955. This is the initial step toward provision of armed services housing under the direct appropriation method.

After need has been certified by the Secretary of Defense, the services must meet design and specification criteria outlined in the legislation. An additional 10 per cent of the appropriated funds is soon to be given line item certification, bringing to 50 per cent the amount of the fund placed in that category.

The 40 per cent certification covers about 2000 of the 11,000 units authorized by the 83rd Congress. This is described by Pentagon personnel as "drop-in-the-bucket" operations. Congress

(Continued on page 258)