

ARCHITECTURAL RECORD



BUILDING TYPES STUDY

RELIGIOUS
BUILDINGS

241

DECEMBER 1956



Hardly noticeable...always dependable

GRINNELL SPRINKLERS

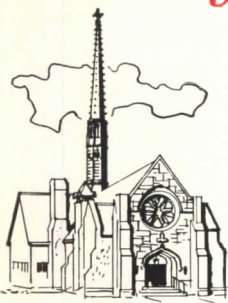

All Souls Church
Bangor, Maine

“You will find it difficult to get pictures of the Grinnell Sprinkler installation in the auditorium of our church”, states correspondence from All Souls Church, Bangor, Maine. “The pipes blend so well with the ceiling rafters that one hardly ever sees them, which, of course, is just what we wanted.”

“As to our reason for installing a sprinkler system”, continues the letter, “There was no fire or threat of fire. Our insurance committee simply wanted to protect our property more adequately and economically.”

Good reasons, too! With at least 8 church fires occurring *every day*, churches need positive pro-

tection to stop fire at its start. A Grinnell Sprinkler System provides this protection — stops fire at its source, wherever and whenever it strikes, night or day, *automatically*. Seventy-eight years experience proves this. Moreover, the cost of such protection is small compared to losses from fire, and especially since a Grinnell Sprinkler System reduces insurance premiums.

The best time to consider fire protection is at the planning stage. However, a Grinnell system can be installed in existing buildings with a minimum of inconvenience, and without disrupting normal procedure. Write Grinnell Company, Inc., 269 West Exchange St., Providence, R. I.



GRINNELL

PROTECTION AGAINST EVERY FIRE HAZARD

— Manufacturing, Engineering and Installation of Automatic Sprinklers since 1878 —

ARCHITECTURAL RECORD

December 1956 Vol. 120 No. 6

Copyright 1956 by F. W. Dodge Corporation, with all rights reserved. ARCHITECTURAL RECORD (combined with AMERICAN ARCHITECT and ARCHITECTURE) is published monthly, except May 1956 when semimonthly, by F. W. Dodge Corporation, 10 Ferry Street, Concord, New Hampshire. Editorial and executive offices: 119 West 40th Street, New York 18, New York Western editorial office, 2877 Shasta Road, Berkeley 8, California.

STAFF OF ARCHITECTURAL RECORD



H. Judd Payne, Publishing Director; Robert F. Marshall, General Manager; John Knox Shear, A.I.A., Editor-in-Chief; Marshall T. Ginn, Circulation Manager; Emerson Goble, Managing Editor; Frank G. Lopez, A.I.A., Senior Editor; James S. Hornbeck, A.I.A., Senior Associate Editor; Elisabeth Kendall Thompson, Senior Associate Editor and Western Section Editor (Berkeley, California, Office); Robert E. Fischer, Associate Editor (Engineering); Florence A. van Wyck, Associate Editor; Jeanne M. Davern, Associate Editor (News); Daniel M. Kelley, Associate Editor (Engineering Assistant); Herbert L. Smith, Jr., A.I.A., Associate Editor; Ernest Mickel, Dan Street (Washington), John Caulfield Smith, M.R.A.I.C. (Canada), Contributing Editors; Grace M. Anderson, Assistant Editor; Helen E. Cook, Editorial Assistant (Production); Dianne Thomas, Editorial Assistant; Eugene H. Hawley, Design Director; Thomas L. McArthur, Mary Ann Godfrey, Design; Sigman-Ward, Drafting Consultant; Thomas S. Holden, Industry Relations Consultant; Clyde Shute, Statistical Consultant; George Cline Smith, Economics Consultant; Clifford Dunnels, Jr., Field Research Consultant; Daniel J. Howe, Jr., Public Relations Consultant.

TABLE OF CONTENTS

The Record Reports

A New Editorial Partnership	9
Views of Current Periodicals: New Buildings Abroad	10
Buildings in the News	12
The Sullivan Centenary Exhibition: It Presents the "Rich Treasure" of His Work but wants Context and "Relevance." A Review by <i>Frederick Gutheim</i>	16
Perspectives	17
Meetings and Miscellany	21
A Washington Report: BRI's First Major Workshop Conference Yields Questions and Answers on Metal Curtain Walls. By <i>Ernest Mickel</i>	32
News from Canada. By <i>John Caulfield Smith</i>	36
Washington Topics. By <i>Ernest Mickel</i>	48
Construction Cost Index	54
Required Reading	58
Calendar and Office Notes	272
Reviewing the Record	316
Current Trends in Construction	332

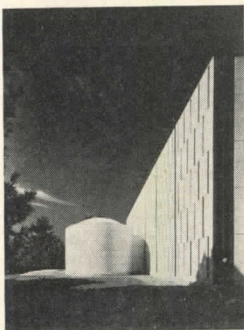

Cover: K. T. I. Synagogue, Port Chester, N. Y.; Philip Johnson, Architect; © Ezra Stoller photo

Building Types Study Number 241 — Religious Buildings

The architectural problems facing newly organized congregations are presented here with great understanding by Marvin Halverson, one of today's leading thinkers in this area; with a collection of most pertinent buildings.

K. T. I. Synagogue, Port Chester, N. Y.; Philip Johnson, Architect	123
"On Getting Good Architecture for the Church." By <i>Marvin Halverson</i>	130
St. Joseph's Church, Ft. Atkinson, Wis.; John J. Flad and Assoc., Architects	136
Emmanuel Presbyterian Church, Spokane, Wash., McClure & Adkinson, Architects	140
Temple Beth El, Gary, Ind.; Percival Goodman, Architect	144
Immaculate Conception Chapel, Jennings, La.; Burk, Lebreton & Lamantia, Architects	148
St. Martha's Mission, West Covina, Cal.; Carleton Winslow, Architect	152

Continued on next page

ARCHITECTURAL RECORD

Continued from page 5

Ponti and the Pirelli Building

"Out of a Philosophy of Architecture." An article by Gio Ponti, plus project presentation of the Pirelli Building now under construction in Milan, Italy

155

Bathrooms

165

A New Kind of Bearing Wall

Proposed United States Embassy Office Building, The Hague, Netherlands; Marcel Breuer, Architect

171

One Hundred Years of Significant Building

The churches grouped in this installment represent four uniquely individual statements concerning man's organization of his devotions in architectural form.

7. Churches

177

Bank and Rental Offices

City National Bank Building, Beverly Hills, Cal.; Welton Becket & Assoc., Architects and Engineers

181

Chandigarh in Photos

Supplementing recent coverage of this new city, the work of Le Corbusier, Pierre Jeanneret, Maxwell Fry and Jane Drew, now a photographic report by Ernest Scheidegger

187

Architectural Engineering

A Controlled Climate for Shopping 193

Ventilation of Commercial Kitchens. *By Jack A. Wunderle* 196

Technical Roundup 201

Product Reports 205

Literature 206

Time-Saver Standards: Determination of Exhaust Hood Requirements — 1, 2 & 3 209

Index to Advertising

336

OFFICERS OF THE F. W. DODGE CORPORATION

James McV. Breed, *Chairman of the Board*; Paul Abbott and Thomas S. Holden: *Vice Chairmen of the Board*; Howard Barringer, *President*; Irving W. Hadsell, Chauncey L. Williams: *Executive Vice Presidents*; Howard M. Thompson, *Vice President and Treasurer*; Julius T. Little, Robert F. Marshall, T. Oliver Morgan, O. O. Paulsell, H. Judd Payne, George Cline Smith: *Vice Presidents*; Carl S. Bennett, Clinton C. Bennett, Ralph M. Hairston, Roy J. Hard, Richard H. Ray, John M. Williams: *Regional Vice Presidents*; Edwin H. Freed, *Assistant Vice President and Comptroller*; Walter F. DeSaix, Clifford G. Dunnells, Jr., Clyde Shute, Marc Wayne: *Assistant Vice Presidents*; Sanford D. Stockton, Jr., *Secretary*; William C. Breed, Jr., George W. Morgan, Jr.: *Assistant Secretaries*; Irving B. Satin, *Assistant Treasurer*.

OTHER F. W. DODGE SERVICES

Dodge Reports — Dodge Statistical Research Services — Sweet's Catalog Services — Dodge Books — Dodge Mailing Service — Chicago Construction News — Daily Pacific Builder — Denver Daily Journal — Real Estate Record & Builders' Guide.

Members of Audit Bureau of Circulations and Associated Business Publications. ARCHITECTURAL RECORD is indexed in Art Index, Industrial Arts Index and Engineering Index.

Every effort will be made to return material submitted for possible publication (if accompanied by stamped, addressed envelope), but the editors and the corporation will not be responsible for loss or damage.

Subscription prices: Published monthly except May 1956 when semimonthly. U. S., U. S. Possessions and Canada: \$5.50 per year; other Western Hemisphere countries, Philippines and Spain, to those who by title are architects and engineers, \$9.00 per year. Single copy price except Mid-May 1956 issue \$2.00; Mid-May 1956 issue \$2.95. Beyond Western Hemisphere, excluding Philippines and Spain, to those who by title are architects and engineers, \$9.00 per year for 12 monthly issues not including Mid-May 1956 issue. Subscriptions from all others outside U. S., U. S. Possessions and Canada for 12 monthly issues, not including Mid-May issue, \$24.00 per year. Change of address: subscribers are requested to furnish both old and new addresses, sending if possible stencil impression from magazine wrapper; allow four weeks for change.



A NEW

EDITORIAL PARTNERSHIP

THROUGH ACQUISITION of the publications THE MODERN HOSPITAL, THE NATION'S SCHOOLS, and COLLEGE AND UNIVERSITY BUSINESS — leaders in their respective fields — the F. W. Dodge Corporation has extended its professional magazine horizon. Headquarters of these magazines will remain in Chicago. The strong publishing team and editorial staffs that have made these magazines dominant in the areas they serve will be retained.

We believe this acquisition is significant to those who read and use ARCHITECTURAL RECORD. We at F. W. Dodge who edit the RECORD hold to our conviction that architects and engineers have an increasing need for a professional magazine edited specifically in terms of their complex interests and problems. The RECORD's success supports this conviction. Equally, such client groups as hospital administrators, school administrators and college and university administrators have need for publications edited to serve them in terms of their special interests, of which building design is but one. The recognized strength of our companion magazines is based on meeting these needs effectively.

In serving you as our reader we have consistently sought to present the reasoning of educators with respect to what is asked of present-day schools. We have steadily presented findings of hospital specialists and of doctors in and out of government as to standards to be met in the design of many types of health facilities. And we have dealt in the same spirit with the complex family of structures requisite to college and university campus.

On many occasions the editors of THE MODERN HOSPITAL, THE NATION'S SCHOOLS and COLLEGE AND UNIVERSITY BUSINESS have collaborated with us in our efforts to serve RECORD readers well.

Clearly, under common ownership and joint publishing management, opportunities for useful coordination of efforts will multiply. To RECORD readers will come increasingly the fruits of the experience and special knowledge of editors who are leading the thinking of hospital, school and college administrators. To our affiliate publications' staffs will be added the knowledge and experience of the RECORD's editorial staff of twenty-four.

So we are very glad to broaden our horizon by joining forces with companion publications in areas which are vitally important to architects, engineers and our society as a whole.

John Knox Shear

NEW BUILDING ABROAD

ST. PAUL'S: Sir William Holford's plan for rebuilding the area of London around St. Paul's Cathedral has received plenty of attention from the British press, lay and architectural. It has also aroused some controversy, which The Architectural Review characterizes as a basic issue of principle between adherents of the "Grand Manner" (French) and the "Picturesque" (English). Sir William, according to the Review, considered the picturesque approach of "surprise and concealment" more appropriate to the site and to the cathedral. The plan had not, at the time of the June report, been adopted, but the Review had hopes that the preponderance of pro opinion, both public and professional, would outweigh the vocal minority opposed to Sir William's scheme

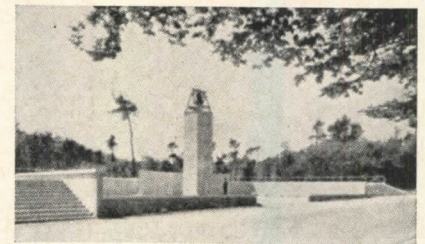
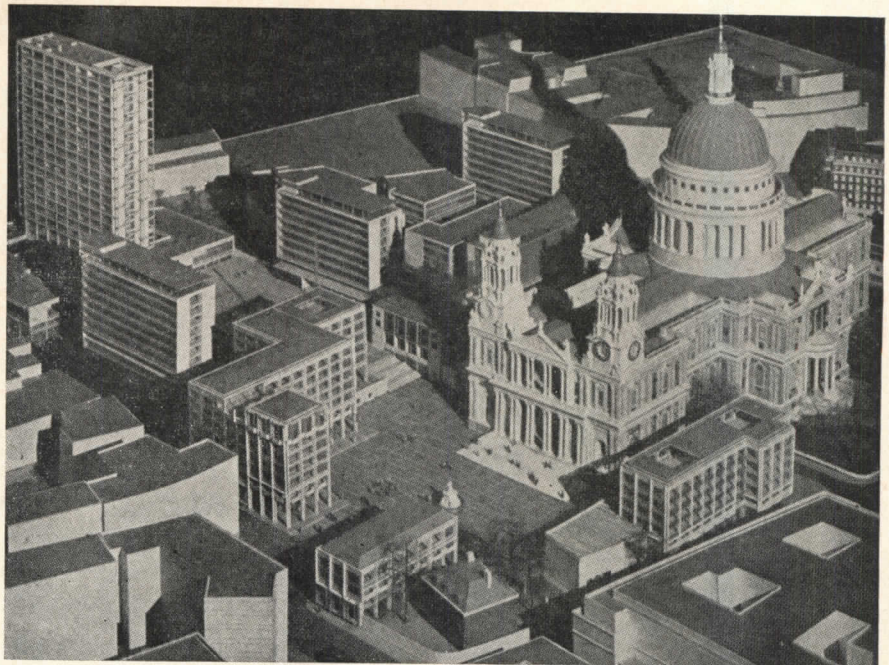

WAR MEMORIALS: designed and dedicated by architect Mario Labo to his architect son and to other Italians killed at Mathausen by the Germans, the monument above was reported in the Italian journals Casabella and L'Architettura. The memorial is composed of an iron cross by sculptor Mirko and a stone wall,

representing "a wall of sorrow, a wall for firing squads, a bastion and a sepulchre." In the same issue of L'Architettura, the postwar work of Netherlands Architect J. J. P. Oud was reviewed, including his 1949 monument for Amsterdam (top right) and the 1948 monument for Rhenen (bottom right)

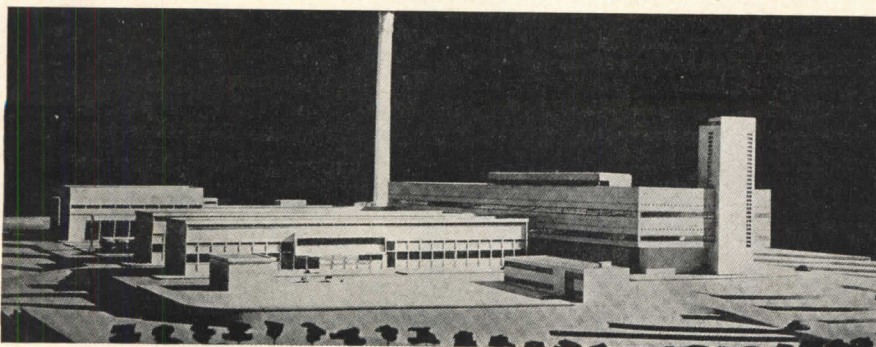

ENERGIE ATOMIQUE: the May issue of the French magazine Techniques & Architecture reported on the French Atomic Energy Commission's industrial center of Marcoule, now under construction at Gard, on the River Rhône. Major buildings at the center are the three reactors and (left) the plutonium "ensemble," containing laboratories, offices and, at right in the photo, the factory. The architects for the center are D. Badani and P. Roux-Dorlut

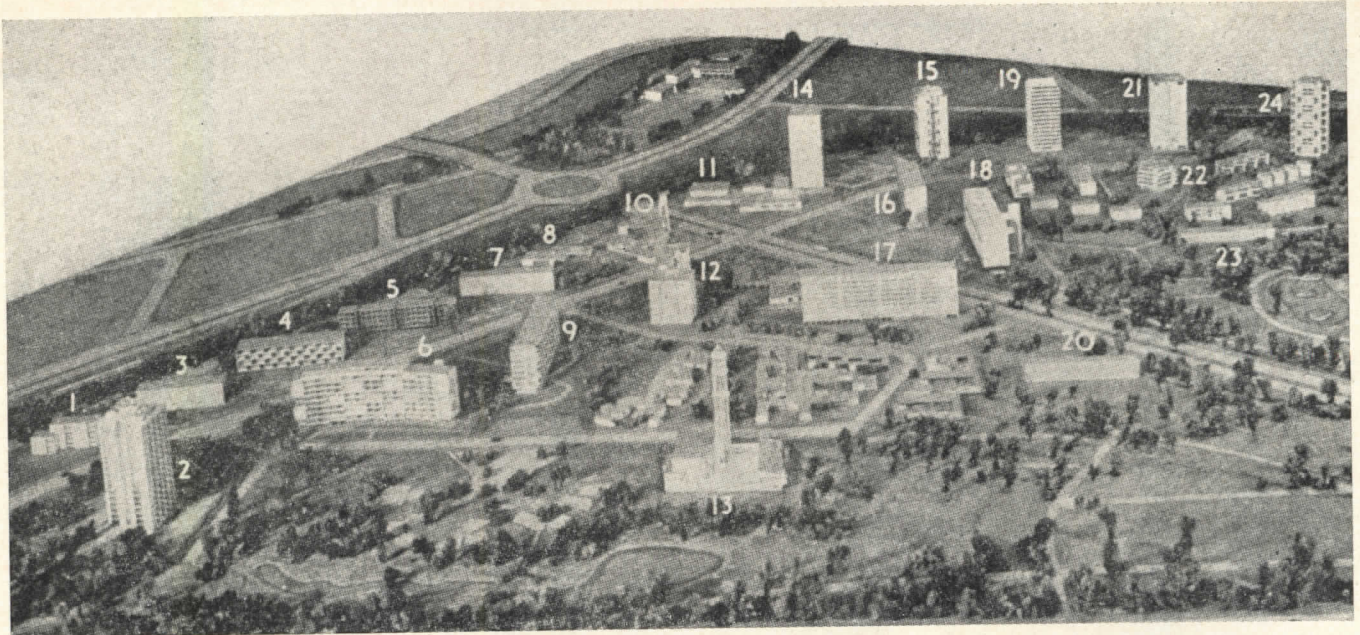

BERLIN INTERBAU: part of the International Building Exhibition being held in Berlin next year will be the new housing in the Hansa Quarter. Architects for the apartments, as reported in the August 9 issue of *The Architects' Journal*, include: 1. Alexander Klein, Israel; 2. Klaus Muller-Rehm and Gerhard Sieg-

mann, Berlin; 3. Richard Henning, Berlin; 4. Gunther Gottwald, Berlin; 5. Wassili Luckhardt and Hubert Hoffmann, Berlin; 6. Walter Gropius, U. S.; 7. Paul Schneider-Esleben, Dusseldorf; 9. Pierre Vago, France; 12. Alvar Aalto, Finland; 14. Luciano Baldessari, Italy; 15. J. H. van den Broek and J. B. Bakema,

Netherlands; 16. Egon Eiermann, Karlsruhe; 17. Fritz Jaenecke and Sten Samuelson, Sweden; 18. Oscar Niemeyer, Brazil; 19. Gustav Hassenpflug, Hamburg; 20. Paul G. R. Baumgarten, Berlin; 21. R. Lopez and E. Baudoin, France; 22. O. H. Senn, Switzerland; 23. H. Scharoun, Berlin; 24. H. Schwippert, Dusseldorf

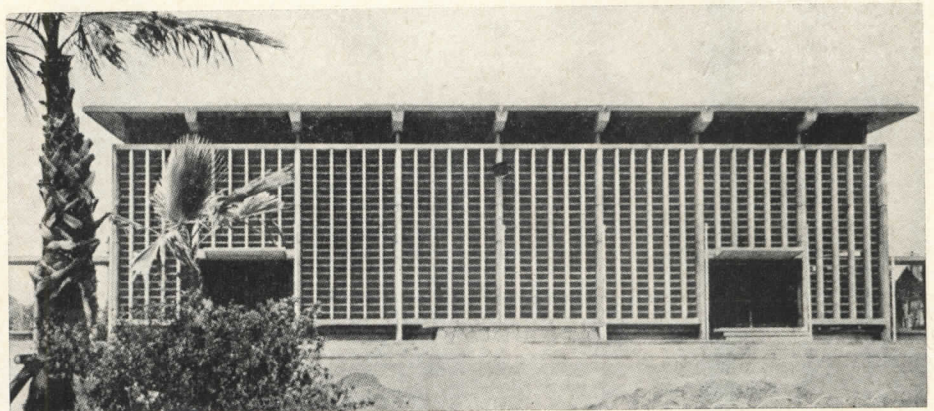
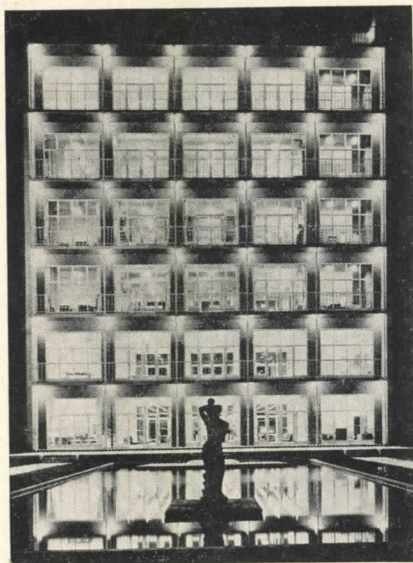

FOR WORLD PEACE: Japan, building an International Culture Center, located it symbolically at Nagasaki, the only city open to Westerners during Japan's isola-

tionist period. The center comprises two concrete buildings: a memorial hall, left, and an auditorium, above. Takeo Sato was the architect

HANGING ROOF: a model for a new stadium at Göteborg, Sweden, as reported in the October 1 issue of the German magazine *Bauwelt*, shows a roof suspended entirely around the stands by cables strung from four masts. The design was selected in a national competition won by architects Fritz Jaenecke and Sten Samuelson, with associate Torsten Hebrand. In addition to facilities for football and motor-cycle racing, the 52,000-seat stadium will contain also a swimming pool and, in the winter, a skating rink

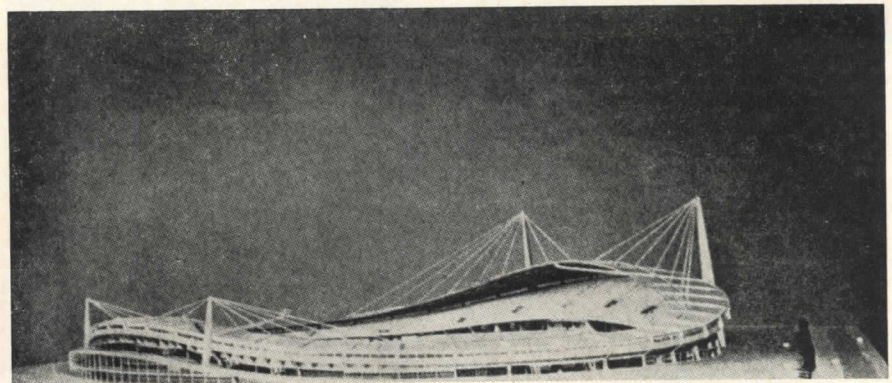

(More new buildings on page 12)

THE RECORD REPORTS

BUILDINGS IN THE NEWS

SOME CURRENT PROJECTS: 1. Central Engineering Laboratories are planned by American Machine & Foundry Company for Stamford, Conn. In designing the campus-type center, architects Perkins & Will strove to "attain an academic appearance" and to "assure privacy for the surrounding residences." Estimated cost is \$4 million. 2. The Mark C. Steinberg Memorial Ice Rink, donated to the city of St. Louis by Mrs. Steinberg, was designed for Forest Park by Frederick Dunn and Associates, in consultation with sculptor William Talbot of St. Louis. A fire pit has been added to the design, to be placed at the right end of the model as it appears in the photograph. 3. The Beverly Tower, a cooperative apartment house, will

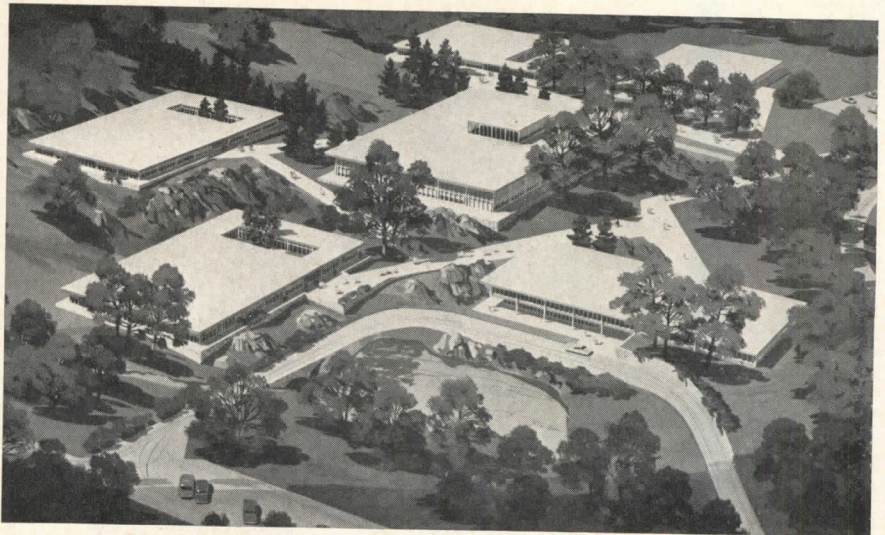

1

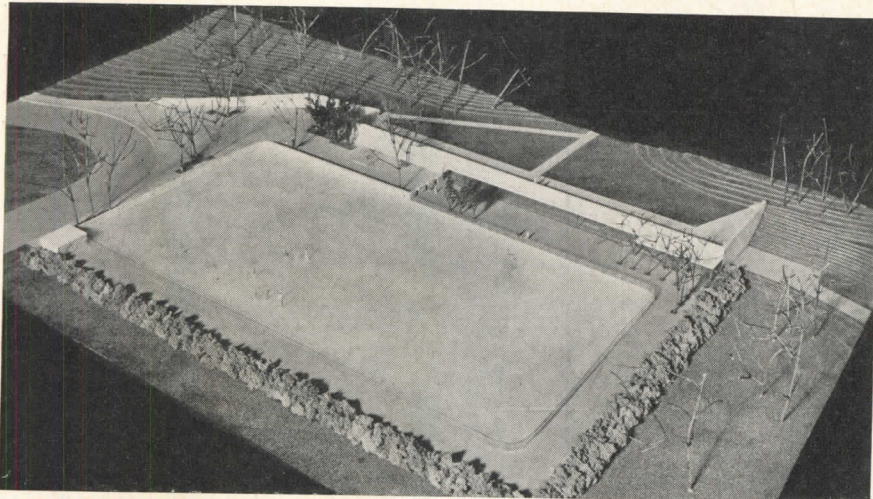

2

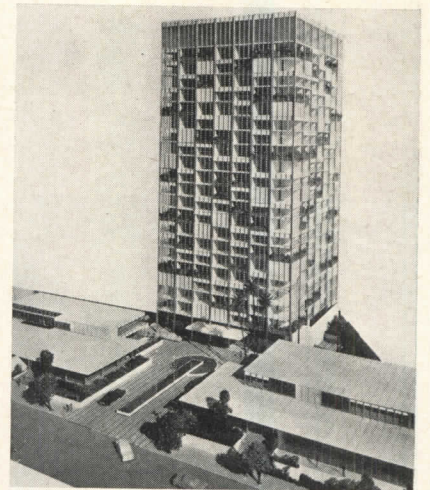

3

4

be built in Beverly Hills, Cal., at a cost of about \$10 million. It will provide, besides 102 apartments, a swimming pool, cabanas, private gardens and a health club, and a "Sky Club," with dining facilities, on the roof. The architects are Pereira & Luckman. 4. The various Commonwealth agencies in and around Philadelphia will be consolidated in the Philadelphia State Office Building now under construction. The 17-story building will have an exterior of white marble, a lobby of glass mosaic tile. The building, which will cost an estimated \$10,240,000, will contain 245,518 sq ft of space. In addition to the office building, plans also call for a garage to the west of the building handling 200 automobiles. The architects are Carroll Grisdale & Van Alen, Harbeson Hough Livingston & Larson, and Nolen & Swinburne



(More news on page 16)

TWO GREAT NAMES IN PLYWOOD AND DOORS

NOW ONE











WHEN Simpson acquired the properties of M & M Wood Working Company it was news—but the BIG news to architects is that the combined resources of Simpson and M & M now provide a single dependable source of fir and redwood plywoods, plywood specialties, and flush and panel doors.

This means that architects can specify Simpson-M & M plywoods and doors with assurance of the same uniform high quality that has characterized the products of Simpson since 1895 and M & M since 1905.

Rely on Simpson

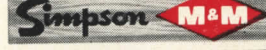
QUALITY • SERVICE • INTEGRITY
SINCE 1895

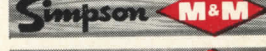
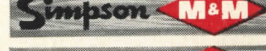
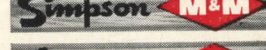
**FOR ASSURANCE OF HIGH QUALITY
SPECIFY THESE BRANDED PLYWOODS**

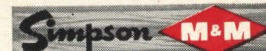
	FIR PLYWOOD
	FIGURED GRAIN REDWOOD
	RIFT GRAIN FIR AND REDWOOD
	FIR AND REDWOOD SHADOWOOD
	FIR AND REDWOOD PLYWEAVE
	REDWOOD RUSTICWOOD
	FIGURED GRAIN PHILIPPINE MAHOGANY
	RIBBON GRAIN PHILIPPINE MAHOGANY
	BIRCH AND KNOTTY PINE
	TEXTURE 1-II, LONG LENGTH, JUMBO AND BOAT PANELS
... AND THESE <u>BRANDED</u> DOORS	
	FLUSH AND PANEL DOORS

SIMPSON LOGGING COMPANY

SALES OFFICE, PLYWOOD AND DOOR PRODUCTS: 2301 N. COLUMBIA BLVD., PORTLAND 17, OREGON
REGIONAL SALES OFFICES IN NEW YORK, CLEVELAND, CHICAGO, MINNEAPOLIS, MEMPHIS, DALLAS, DENVER, LOS ANGELES, PORTLAND, SEATTLE
GENERAL OFFICES IN SHELTON, WASHINGTON

SLO-61C

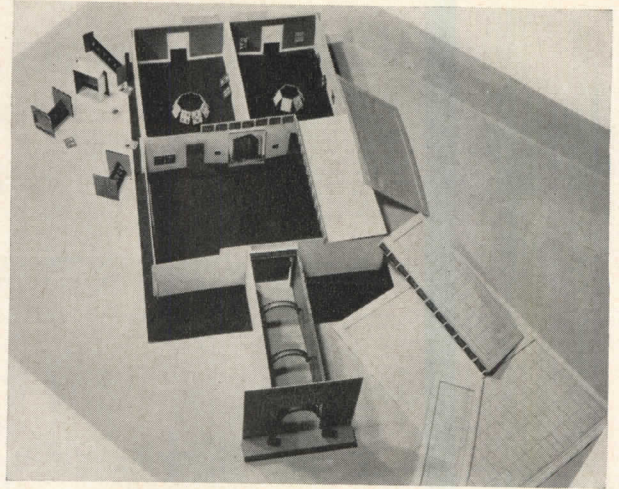

THE SULLIVAN CENTENARY EXHIBITION:

IT PRESENTS THE "RICH TREASURE" OF HIS WORK BUT WANTS CONTEXT AND "RELEVANCE"

A review by Frederick Gutheim

The Sullivan centenary exhibition in the Chicago Art Institute will be extensively circulated following its showing there, which ends December 2. Much of its news interest had been dissipated by the notices of John Szarkowski's picture book.* That the exhibition appeared as fresh as it did must be attributed to the efforts of its director, Edgar Kaufman.

From the entrance, where Sullivan-esque barrel arches faced with photographic reproductions of the architect's distinctive ornamental designs announce the intention to do more than mere photography can, one is prepared for an unusual exhibition. In later galleries use is made of elevator grilles, hardware, skylights, woodwork and other building elements. There are excellently installed small transparencies, essential to an understanding of the richness and colorful qualities of Sullivan as an *art nouveau* architect, and some unfortunate experiments in rear-projected color slides. The galleries of the Art Institute are painted and papered here and there with reproductions from Sullivan's work. But the result, in the end, is a predominantly photographic exhibition. But after all, outside a few blocks away, are the Sullivan buildings themselves.

Chicago and Sullivan was no love affair, as Frank Lloyd Wright has insisted for many years, most recently at the A.I.A. dinner preceding the opening of the exhibition. Sullivan's most typi-

cal buildings were built elsewhere — the Wainright and Guaranty office buildings, the mid-western banks. Apart from Max Dunning, Elmslie and a devoted handful, the city's architects' neglect was more remarkable than the city's own indifference. Outside Chicago Sullivan had many more contemporary admirers, and in 1923 at the time of his death his position in American architecture was secure. The profession itself had solicited "The Autobiography of an Idea," had published it in the *Journal of the American Institute of Architects* and as a book. But Sullivan drank himself to death in the Cliff Dwellers Club and was almost alone when the end came in a cheap hotel. If the preservation of an architect's buildings is a proper mark of the value we put on his work, there is small evidence that Chicago yet acknowledges Sullivan. It is impossible to accept the Sullivan exhibition as evidence of this. It is hardly expiation. Rather, like Sullivan's own experience in life, it is the creation of a handful of devoted admirers.

The enthusiasm of these devoted admirers sustains their excursions into Sullivan memorabilia. We are given childhood photographs, youthful drawings, the family album. But enthusiasts often forget that others do not know as much. The exhibition shows little of the general historical background. A few astonishing photographs of Chicago ruins after the great fire suggest what this might have contributed to the exhibition. But didactic portraits of Herbert Spencer, Richard Wagner and other "influences" show us little. The

resources of contemporary documentary photography, sampled in such work as the notable series of pictures J. W. Taylor took for the Chicago Architectural Photographing Company, are used only as they fall within the limited area of architecture. Nothing is done to create a general sense of the gas-lit, horse-drawn, sanctimonious and isolated city in which Sullivan chose to work, much less its cultural horizon and taste.

If the exhibit lacks a contest, it likewise lacks direct relevance. The effort to relate Sullivan's work to current practice is a failure. While it is certainly true that Sullivan's interest in structure, and his creation of architectural ornament and decoration, have parallels in the work of other architects, past and present, this is hardly a relationship, much less evidence of influence. The story of Sullivan and his clients, also a Szarkowski theme, is more successful. The architect's relationship with Dankmar Adler, his ideological debt to John Edelman, and other biographical enigmas are left in obscurity. But if this exhibition does not answer all the questions, it does succeed in dramatizing, presenting and emphasizing the rich treasure of Sullivan's work. Its medium is photography, and in the end one only wishes there were more of it.

The catalog† of the exhibition is of exceptional value to Sullivan students. It contains useful bibliographies, source lists, manuscript lists, photographic credits, and similar information, and is a worthwhile addition to the other Sullivan books due for publication this year, and to Hugh Morrison's standard work.

(More news on page 17)

*John Szarkowski, *The Idea of Louis Sullivan*. University of Minnesota Press, 1956.

†*Louis Sullivan and the Architecture of Free Enterprise*. Edited by Edgar Kaufman Jr. Chicago Art Institute, 1956.

HELPS THESE



Which **STRAND** should I use?



What **TENSION LOAD** should I use?



SEND THIS COUPON FOR A FREE COPY. This new 16-page booklet describes the complete line of high strength wire, high strength stress-relieved strand, and end fittings manufactured by American Steel & Wire. It contains stress-strain curves, typical tensioning loads and breaking strengths for American Super-Tens Wire and American High Strength Strand—quality products that are especially made for use in prestressed concrete. Send for your copy.

AMERICAN STEEL & WIRE DIVISION

United States Steel, General Offices: Cleveland, Ohio
 Columbia-Geneva Steel Division, San Francisco, Pacific Coast Distributors
 Tennessee Coal & Iron Division, Fairfield, Ala., Southern Distributors
 United States Steel Export Company, New York



STRENGTH STRAND

UNITED STATES STEEL

American Steel & Wire
 Dept. I-86, Rockefeller Building
 Cleveland 13, Ohio

Please send your new descriptive booklet on American Super-Tens Wire and American High Strength Strand for prestressed concrete. Also send information on these other products of American Steel and Wire:

- American Welded Wire Fabric for Portland Cement Concrete
- American Welded Wire Fabric for Asphaltic Concrete
- American Welded Wire Fabric for Airport Runways
- American Road Joints
- American Multisafety Highway Cable Guard
- American Beam-Type Highway Guard

Name

Firm

Address

City State

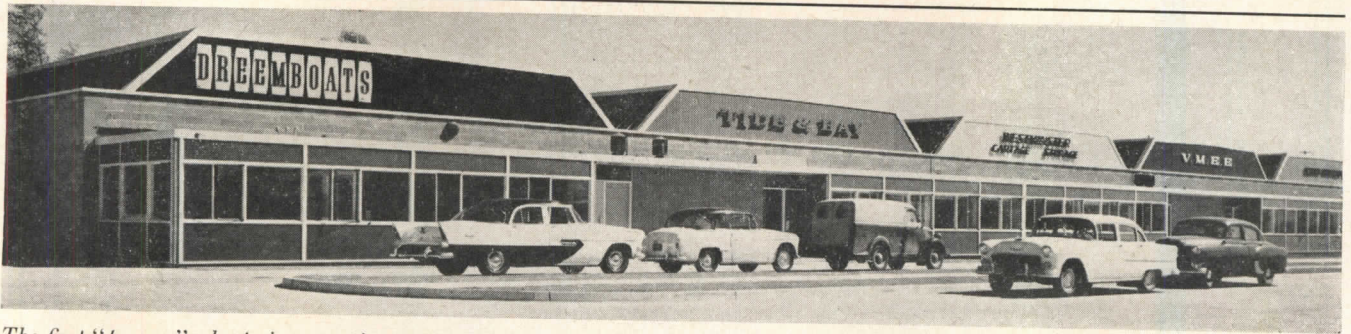

The first "terrace" plants in operation



Typical plant, for John Laing & Son

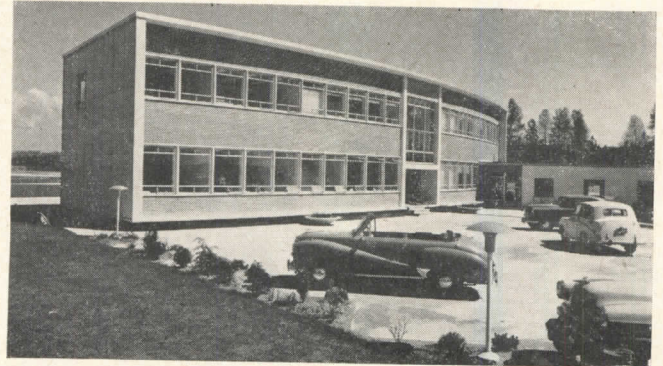

The administration building

DEVELOPERS SPECIFY GOOD DESIGN FOR ANNACIS INDUSTRIAL ESTATE

Good design, in the mind of the Grosvenor Estates, developers of an industrial site on Annacis Island in British Columbia, is not confined to "planning and zoning industries" and "ensuring that a good quality of building is maintained." They count on both of these requirements, but in their prospectus also promise to provide "attractive streets with pleasant landscaping and well-designed buildings and street furniture." Defining the architectural character of the Annacis Industrial Estate, the developers hope for "orderliness and efficiency by simple buildings grouped carefully with each other to avoid the clash of adjoining buildings which would tend to produce any restlessness to the street façade and overall planning." The Grosvenor Estates feel also that

their tenants should not be inflicted with "raucous advertisement" and that "the appearance of his factory with designed name signs will be his advertisement."

Progress so far on the 1200-acre island, which is being developed in 200-acre packages, includes the completion of the administration building, ten "terrace" plants, with another six under way, and eight factories and warehouses, as well as a ninth which was scheduled to be occupied in October.

Zoning of the island, which will have no building but industry, calls for, eventually, heavy industry on the perimeter, with cores of medium industry, surrounded by light manufacturing, in the center of the area. The geography of the island permits deep-sea shipping

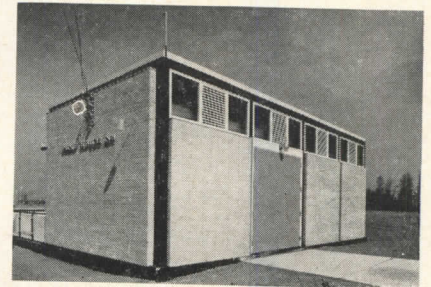

A designed pump house

as well as road and rail transportation.

The permanent architect for the development is Francis Donaldson, who has succeeded H. Keith Allen in the position. The builder is John Laing & Son (Canada) Ltd., which a few months ago merged with the Grosvenor Estates to form Grosvenor-Laing, Ltd.

N.R.C. COMPLETES LAST LINK IN RESEARCH STATION CHAIN

The last of the regional stations planned by the National Research Council's Division of Building Research has been opened in Vancouver, and will be known as the British Columbia Regional Station. Earlier, stations were opened at Halifax to serve the four Atlantic provinces, and at Saskatoon to serve the Prairie provinces; Ontario and Quebec are covered by the Division's head-

quarters at Ottawa. In addition, the division operates, during the summer months, its Permafrost Research Station at Norman Wells, where the new buildings were dedicated last June.

Heading the new Vancouver branch is Alan Veale, a 1955 graduate of the School of Architecture at the University of British Columbia.

The purpose of these regional stations is to provide liaison between the building industry and the engineering and architectural professions, and between

these groups and the Building Research Center in Ottawa. A special part of this function is in connection with housing development. The staffs in each of the stations are also in charge of the Division's regional exposure sites.

EARLY ESTIMATES INDICATE ANOTHER RECORD YEAR IN '56

According to *The Financial Post*, Canadian construction seems likely to reach a new high in 1956, and will have suffi-

(Continued on page 40)

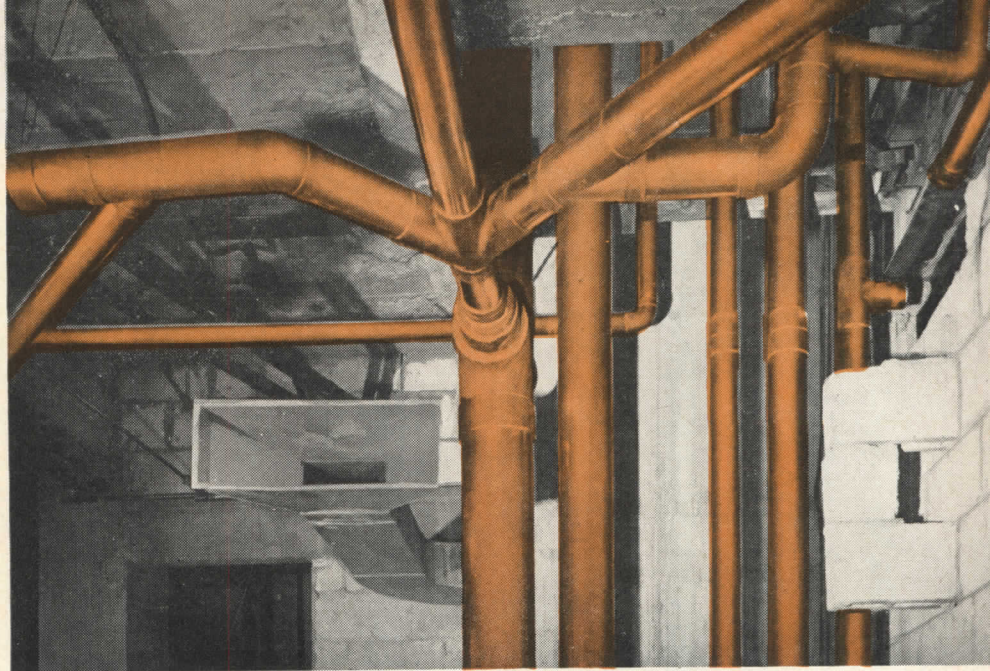

Tube and fittings fit in standard partitions. A 3" copper tube stack with fittings can be installed within a standard 4"-wide stud partition.

Save space and weight in all buildings—even skyscrapers. Copper tubes in main pipe shaft of a 43-story office building. Copper tube saves space because pipe shaft and furred spaces at columns and ceilings can be smaller. Light weight speeds installation.

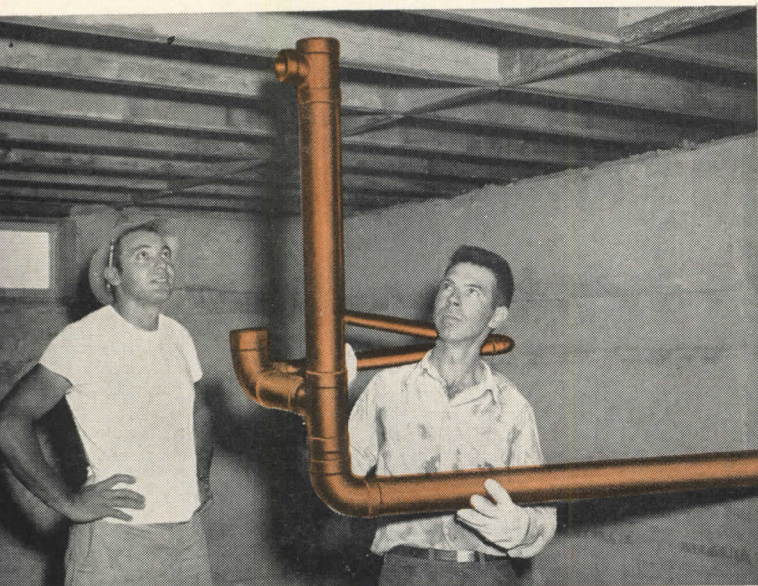

Lightweight for easy, fast handling. This preassembled section comprising about 13 feet of copper tube and 5 solder-joint fittings weighs only 35 pounds, is easily handled by one man.

Prefabrication speeds construction. Sections like this can be preassembled out in the open or at the shop where men can work easier and faster—no lost time waiting for construction.

Simplify remodeling jobs. Lightweight copper tube and solder-joint fittings made light work of an otherwise back-breaking job, in adding two baths in this remodeled residence. Note how little ceiling height was lost.

Trim, compact lines. In this remodeling job, two stud spaces served as the chase for the copper tube risers. The large tube is the soil stack; smaller tubes are water supply and heating lines.



THE RECORD REPORTS

NEWS FROM CANADA

(Continued from page 36)

cient work to carry over well into 1957.

This year's increase in volume of construction, said the *Post*, will be only about half the figure estimated on intention at mid-year by the Department of Trade and Commerce. At that time, construction spending planned was 23

per cent above the 1955 figure, which, in turn, was a record year. Now, it is believed, the increase will be between 11 and 12 per cent — about the same as the 1955 increase, and well above the less than two per cent increase registered in 1954.

The pattern of construction, however, has changed this year. Though the year has shown more housing completions than ever before, new residential starts have dropped off in the last few months. This may be reflected in a 13.5 per cent drop in residential carryover into 1957

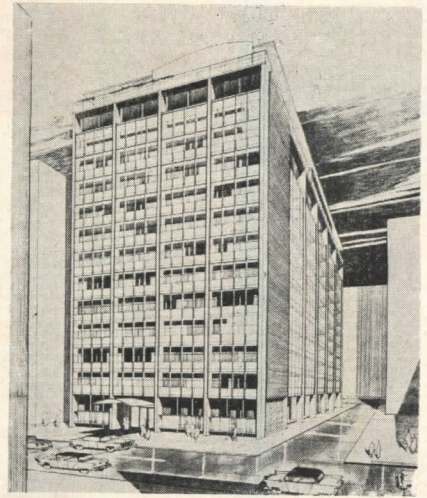

Offices for the Toronto Board of Trade, now under construction, will cost \$2.2 million; Bregman & Hamann are the architects

— still just a fraction above the 1954-55 carryover.

This year, the emphasis has been on engineering and industrial construction, expected to be substantially ahead of 1955.

NATIONAL COMMITTEE FORMED TO PROMOTE SLUM CLEARANCE

To combat the spread of slum areas, a national body, the Canadian Urban Renewal Board, has been formed. C. E. Campeau, director of planning for Montreal and vice president of the Community Planning Association of Canada, is the chairman.

The council will promote local efforts to stop deterioration, cut down the rate at which neighborhoods become slums, take measures to conserve areas which could deteriorate, rehabilitate rundown areas, and finally redevelop areas which are completely blighted. Work is expected to get under way early in 1957, and the council estimates that measurable results will appear within three years.

LENDERS SEEK HIGHER RATE ON HOUSING ACT MORTGAGES

Architects who have project builders for clients are affected by the squeeze on residential loans being applied by life insurance companies. The latter want the interest rate on National Housing Act mortgages raised from the current 5½ per cent.

Lending under the Act during the first nine months of 1956 dropped more than \$125 million below that of the same period in 1955. In terms of dwelling

(Continued on page 44)

Wood Beauty ARCHITECTURAL HARDWARE



Get this latest bulletin—see the colored illustrations of our newest Wood Beauties.

These are custom built to complement distinguished architecture and appointments. Your choice of selected hardwoods or Stratawood and metals, make design combinations that are almost endless. Metal parts are available in Aluminum, Brass, Bronze and Stainless Steel.

Architects desiring to design their own will receive complete production cooperation from us.

Write us for your copy of this beautiful 8 page bulletin



2200 COLE ST.
ST. LOUIS 6, MO.

DOOR

window shade

In addition to this "rolling door," many other types of doors take advantage of aluminum's efficiency and economy. The four types shown below are recommended for specific applications.

Kaiser Aluminum architectural representatives are ready to give you immediate assistance and counsel in your selection of aluminum for any architectural use.

* * *

Contact the Kaiser Aluminum sales office listed in your telephone directory, or write Kaiser Aluminum & Chemical Sales, Inc., *General Sales Office*, Palmolive Bldg., Chicago 11, Ill.; *Executive Office*, Kaiser Bldg., Oakland 12, Calif.

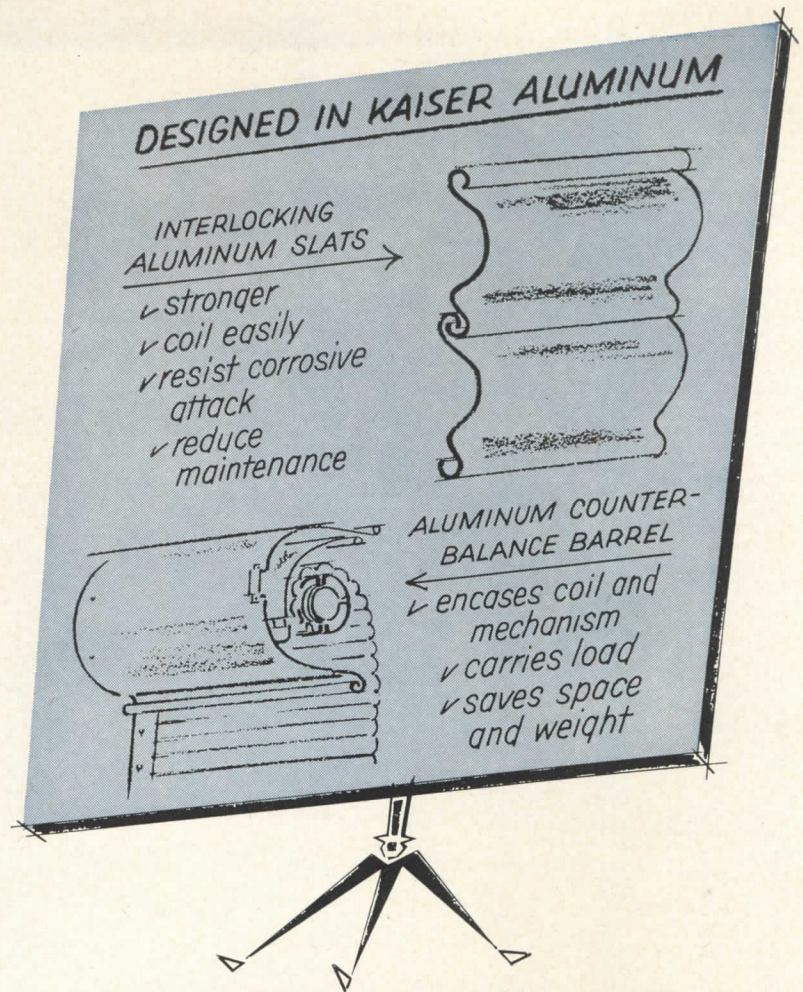

THESE DOORS ARE TYPICAL OF MANY NOW BEING PRODUCED AND OFFERED BY MANUFACTURERS USING KAISER ALUMINUM

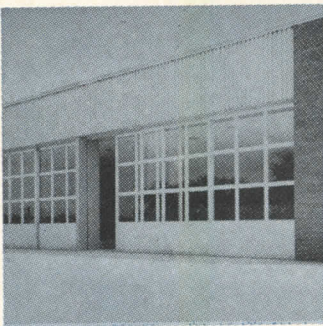

Sliding Doors of aluminum tubes and aluminum sheets roll sideways into compact pockets to allow maximum unrestricted indoor-outdoor space use.

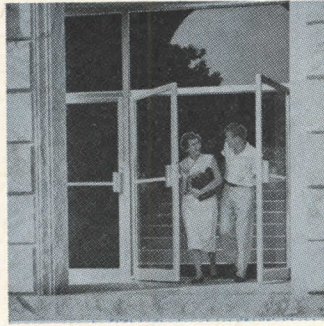

Entrance Doors of aluminum assure lasting strength and beauty . . . will never rust . . . cannot warp . . . require virtually no maintenance.

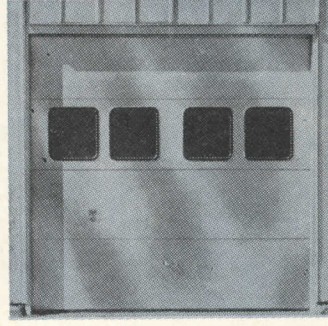

Overhead Doors of aluminum permit flush exterior design with strength and simplicity that assures trouble-free performance in all climates.

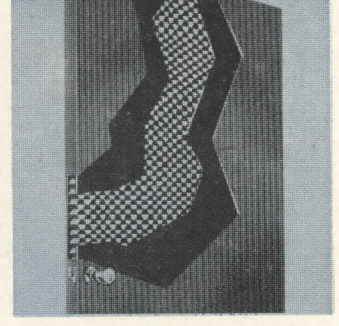

Flush Doors of embossed aluminum facings laminated to hardboard and honeycomb core are built on high-strength extruded aluminum frame.

Kaiser Aluminum

See "THE KAISER ALUMINUM HOUR." Alternate Tuesdays,
NBC Network. Consult your local TV listing.

KAISER ALUMINUM ARCHITECTS' SERVICE
919 N. Michigan Avenue
Chicago, Illinois

- Please send names of suppliers of aluminum doors. I understand there is no obligation for this information.
 Please have your Architectural Representative call.

NAME _____

ORGANIZATION _____

ADDRESS _____

CITY & STATE _____

THE RECORD REPORTS

NEWS FROM CANADA

(Continued from page 40)

units, the decrease was 28 per cent.

Largely because of the availability of conventional mortgages, which bear a higher interest rate than is permitted under NHA, total house production in Canada continues at a high level. In municipalities of 5000 population and over, Central Mortgage & Housing

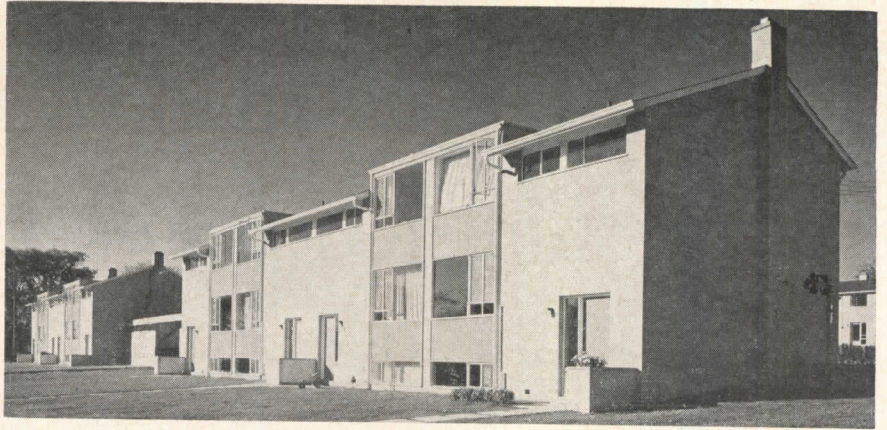

Southhill Village supplies needed rental accommodation in Don Mills, the planned community now nearing completion near Toronto. Henry Fleiss and James A. Murray of Toronto are the architects

Corporation reports that dwellings started for the nine-month period totaled 70,830, a decrease of only 4.9 per cent, while housing completions were up 4.1 per cent. Units under construction at the end of September totaled 57,725, a decrease of 6.9 per cent.

PARKIN CLAIMS NO LACK OF LEADERS FOR ARTS COUNCIL

Continuing pressure for the formation of a state-supported Canada Council of the Arts, architect John C. Parkin, president of the Canadian Arts Council, denied a statement by Prime Minister St. Laurent that delay in acting upon the 1951 recommendation was due to lack of leadership material. Said Mr. Parkin: "Men have been found of outstanding caliber to act as trustees of the National Gallery of Canada, the National Film Board and other government bodies, who, at the expense of personal time, give generously for the benefit of the country as a whole. They can be found just as readily for a Canada Council.

"Legislation for a Canada Council" he added, "would rank as one of the boldest and most imaginative acts of any government."

NEWS NOTES

A \$2000 fellowship has been established by the Canadian Construction Association for postgraduate studies at Canadian universities; the C.C.A. hopes to encourage the expansion of construction courses. . . . New and revised specifications issued by the Canadian Government Specifications Board dur-

(Continued on page 46)

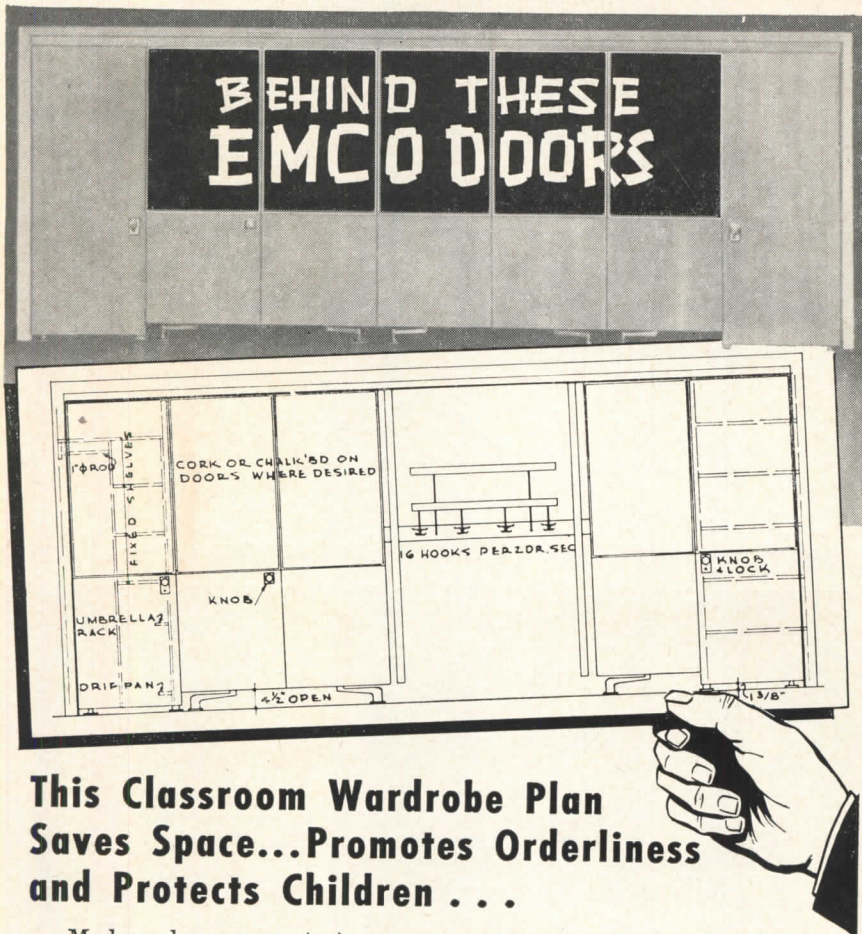

This Classroom Wardrobe Plan Saves Space...Promotes Orderliness and Protects Children . . .

. . . Modern day garment storage areas can not only complement the classroom, but they should be a *working part of it* for teacher and children alike.

The above EMCO plan tells a lot in this respect . . . but it cannot demonstrate the greatest EMCO refinements of safety and ease of operation. These are to be found in the exclusive patented EMCO hardware which eliminates dangerous overhead contrivances . . . prohibits injury to hands when opening doors . . . and allows the smallest child to open the multiple operated doors easily.

You cannot go wrong in specifying and insisting on EMCO—the design is right—the construction quality unmatched. Write today for brochure.



CLASSROOM WARDROBES

Manufactured by

Equipment Manufacturing Co., Inc.

1400 Spruce, Dept. AR

Kansas City, Mo.

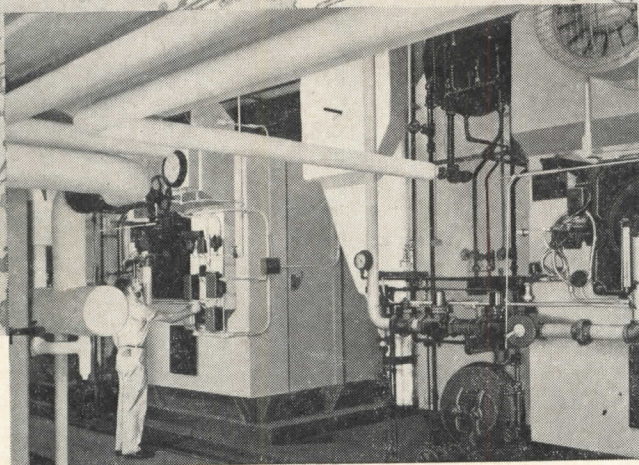

B&W FM units which provide steam for all requirements in the United Gas Building.

**HELPING TO SERVE
THE GULF-SOUTH**

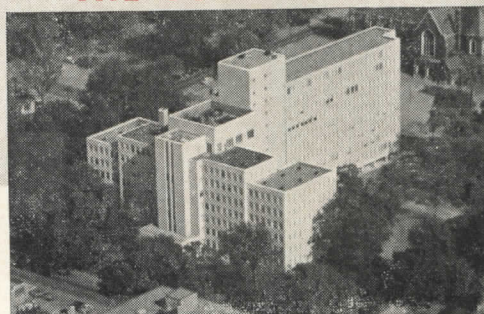

Headquarters for United Gas Corporation, the world's largest handler of natural gas.

B&W FM Boilers Provide Steam for AIR CONDITIONING • HEATING United Gas Building

United Gas Corporation and its subsidiaries of Shreveport, Louisiana, one of the largest systems of its kind in the world, supplies natural gas to a large and growing part of the southern section of the United States—the "Gulf South". And when the installation of modern heating and air conditioning facilities in the company's Shreveport headquarters building was being studied, the same careful consideration applying to other phases of the company's far flung operations was given to the selection of boilers. As other users have done, United Gas chose two B&W FM Units for a reliable and economical steam source.

In the newly enlarged United Gas Building, the FMs supply the heating load during the winter and

steam for the much heavier summertime air-conditioning load. They are gas-fired and designed for manual or semi-automatic operation. Each boiler is designed to generate up to 11,000 lb of steam per hr at an operating pressure of 160 psi. Since their installation in August 1953, the FM Units have provided completely satisfactory service, efficiently and economically.

B&W FM Boilers are available in standard sizes to 40,000 lb of steam per hr at pressures to 235 psi. Many are also in service at higher pressures and with moderate superheat. Write for Bulletin G-76 for complete details. The Babcock & Wilcox Company, Boiler Division, 161 East 42nd Street, New York 17, N. Y.

G-744

FMs Offer These COST-SAVING FEATURES

- Save Erection Time and Cost
- Meet Wide Range of Service
- Handle Quick Load Changes
- Suitable for Outdoor Service
- Safe, Automatic Operation
- Fast Steaming
- Low Maintenance
- Easy Accessibility
- Burn Oil and/or Gas
- Save Fuel
- Save Space

**BABCOCK
& WILCOX**



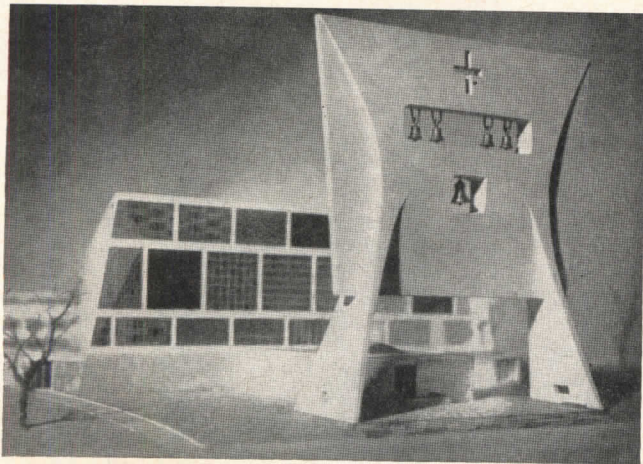

Left, Project for Abbey of St. John, Collegeville, Minn., by Marcel Breuer. Below, Catholic Church of St. Francis at Pampulha, Brazil, by Oscar Niemeyer

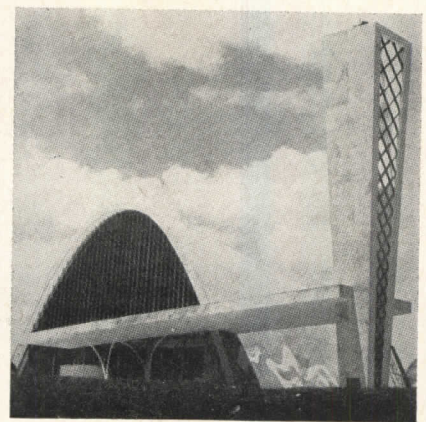

THE ROLE OF ARCHITECTURE IN CHURCH REVITALIZATION

BY THE VERY REV. DARBY W. BETTS

Dean of the Cathedral of St. John, Providence, R. I.

The Modern Church. By Edward D. Mills. Frederick A. Praeger, New York, Distributed in cooperation with F. W. Dodge Corporation 1956. 190 pp. Illus. \$9.75

AFTER A LAPSE of some fifty years, notable books dealing with the Church's use of architecture are beginning to appear. Their frequency and caliber lead us to hope that contemporary architecture is beginning to seek to serve the Church with a devotion that has not been known since the Victorian era. *The Modern Church* by Edward D. Mills, a well known practicing architect of England and an obvious expert on the subject, is a worthy addition to this growing library. The Foreword by Basil Spence and the Author's Preface amply demonstrate an allegiance to the conviction that the Church is a "Meeting House" where man meets God in the midst of the human community with all function and design centering upon and springing outward from this amazing

encounter. "Architecture in the service of the Church" becomes a live reality and is well illustrated in this most helpful book.

The sound historical introduction reminds us that the Church's use of architecture has played a vital role in the living expression of her doctrine and program. The exciting chapter on the Church and the Community drives home with great force the undeniable fact that architecture must play its part in the revitalizing of a Church which has tended to become separated from the secular community in its architecture as well as in many of its other manifestations. If the Church is to rediscover and continue its vital role of being the most direct line of communication between almighty God and his world, it must speak in the vernacular architecturally as well as in sermons and community service. *The Modern Church* is a good record of the architect's attempt to do this in many countries and over a

wide span of years in our own age. It properly relates architecture to the allied arts, and goes a long way in re-establishing architecture's position as the mother of man's outward manifestations of his artistic insights.

To be appreciated properly and to be of the richest value to the reader, this book must be seen as a whole rather than dipped into as a source for particular designs. Covering all sizes of buildings and a representative number of the divisions of Christendom, it is a fine display of what is being done through the renewed cooperation between architecture and the Church. Obviously aware of and in sympathy with the Liturgical Movement now firmly established as a cleansing and enriching element in all branches of Christendom, it will be of little comfort to those who seek safety in a status quo that has actually become past history. But to the clergyman, layman and architect who

(Continued on page 62)

RELIGIOUS BUILDINGS

BUILDING TYPES STUDY NUMBER 241

DECEMBER 1956 ARCHITECTURAL RECORD

A PLACE OF WORSHIP IS A PLACE OF LIGHT

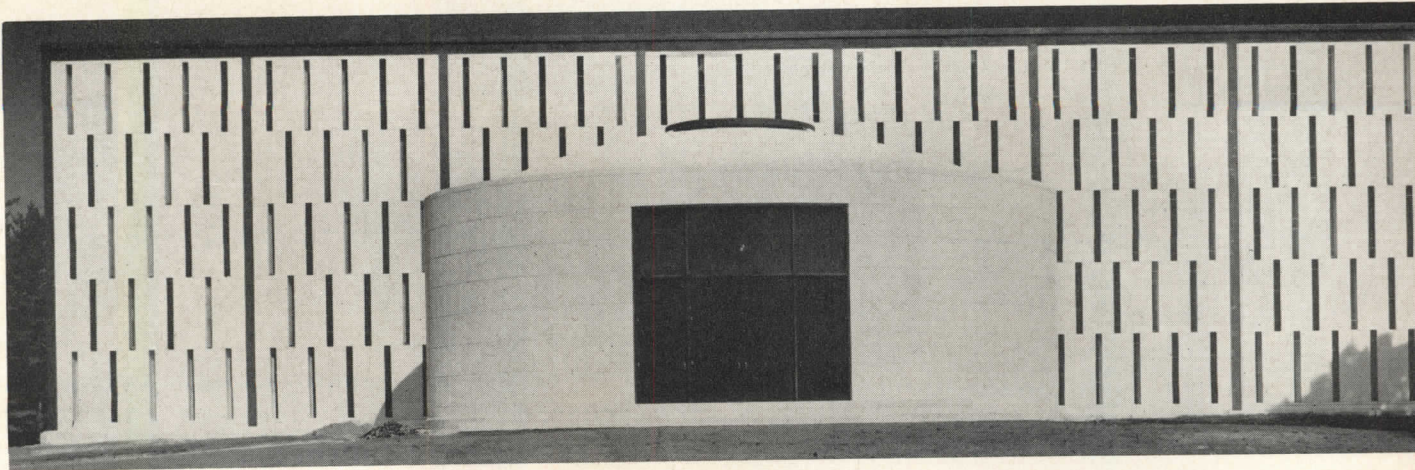

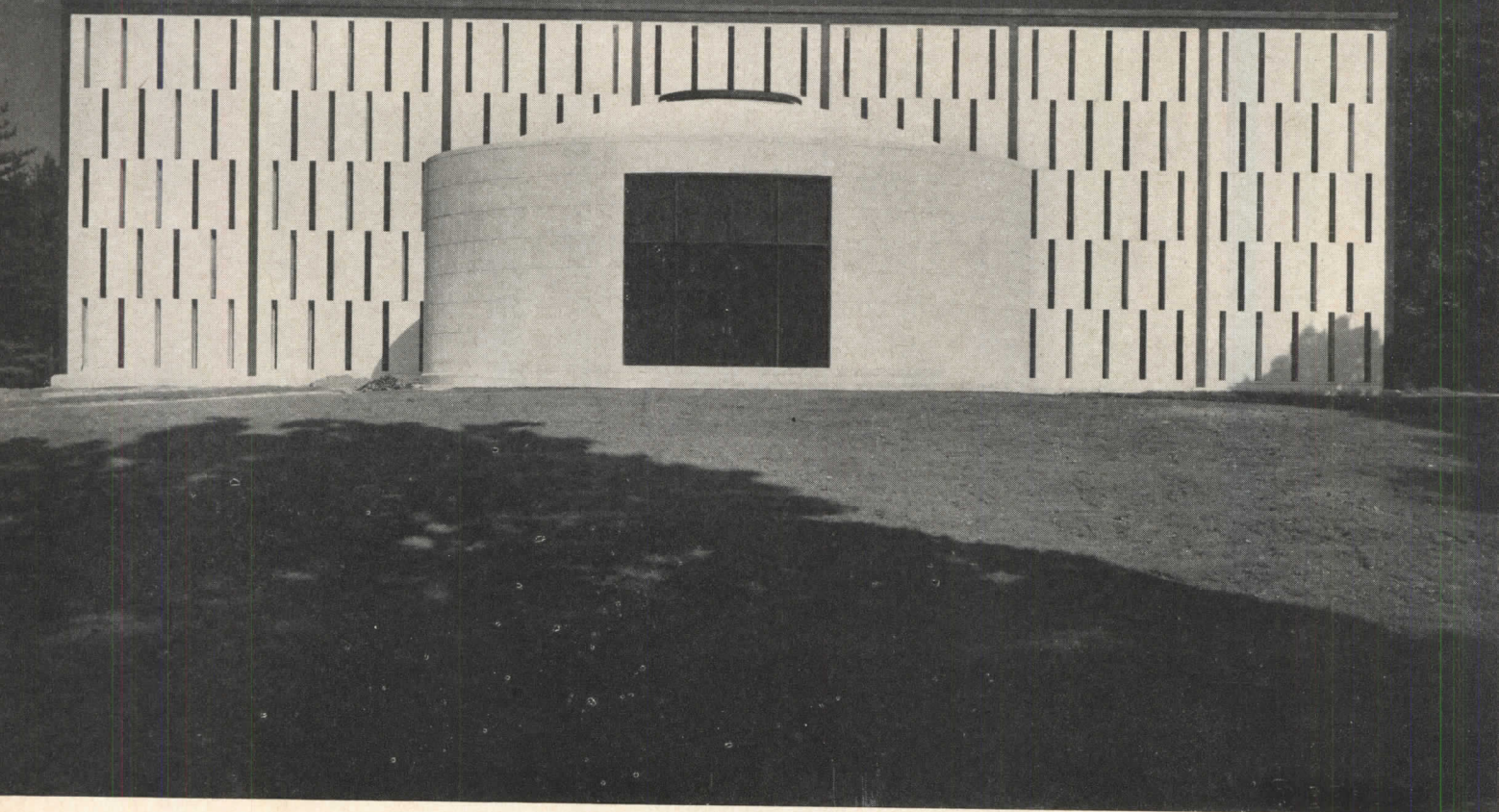

© Ezra Stoller

* K. T. I. SYNAGOGUE, PORT CHESTER, N. Y.

Philip Johnson, Architect
Marcello Mezzullo, Contractor
Eipel Engineering, Structural
Engineers

Charles Middleleer, Landscape
Architect

Ibram Lassaw, Sculpture

Richard Kelly, Lighting
Consultant

John Johansen, Stained
Glass Consultant

* *Kneses Tifereth Israel*

The intellectual appeal of clear, structural articulation and the sensual delights inherent in precise craftsmanship are real, though limited, satisfactions. In a time which often seems to have restricted its reverence to these particulars it is especially rewarding to find a building which provides in addition some positive and fruitful answers to problems of approach and scale and color and light. In this synagogue a full range of human and structural requirements has been accepted and organized into an instructive and inspirational example.

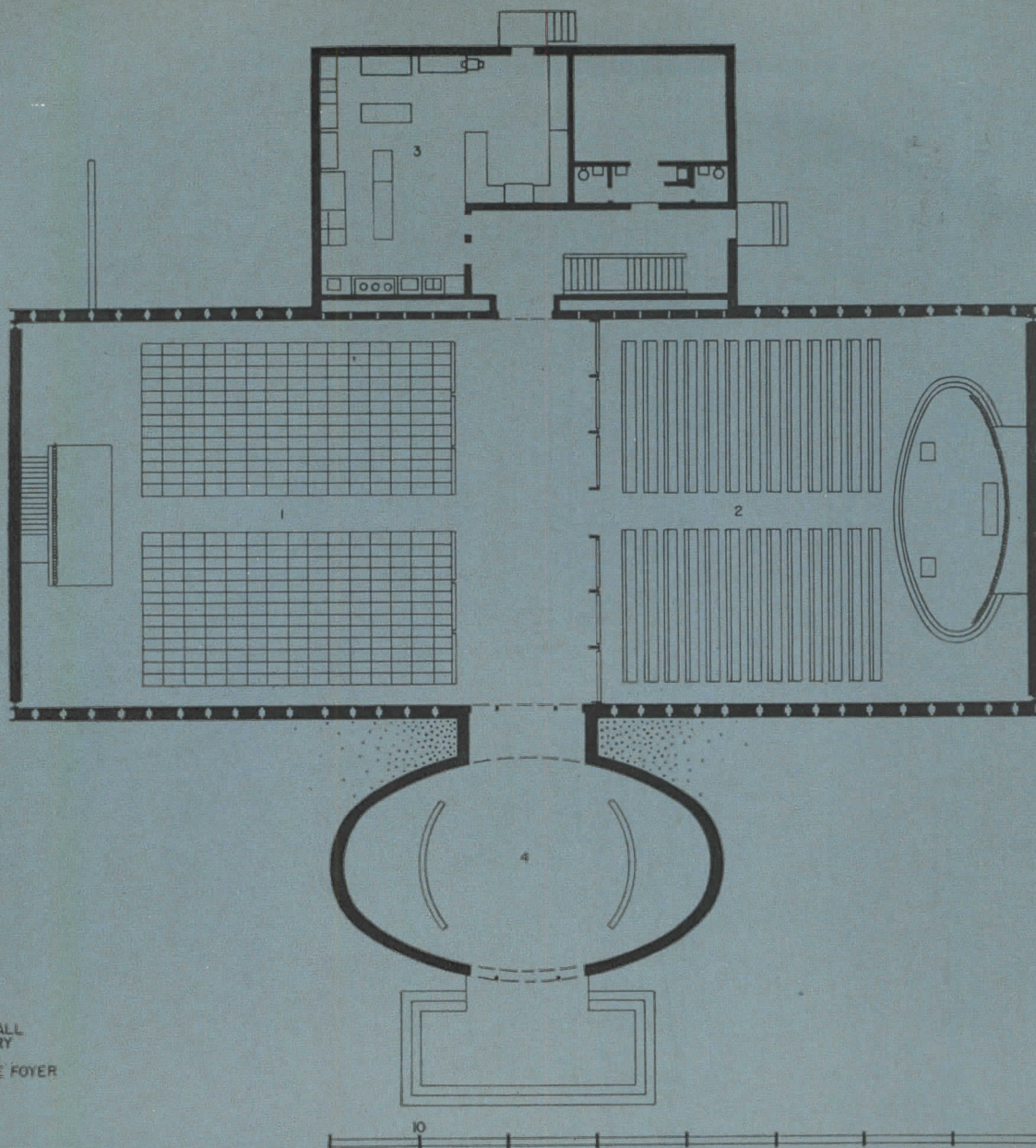

FROM THE APPROACH along Port Chester's King Street, the building is suddenly seen sitting high and very white against the trees. It is bigger than its pictures have suggested and this feeling is enhanced by the way in which the entrance drive, moving parallel to the south face of the building and then half-circling back to the doors, reveals progressively that essential relationship of the small oval entrance pavilion to the large rectilinear hall which has such powerful consequences in terms of scale.

This is a monumental building and its patterns and penetrations as well as its profiles are all arranged to make it so. The panels

are just over the height of a man and they, rather than the openings, afford the kind of human dimensional identification necessary to the sense of bigness which is achieved when they are multiplied into five ascending tiers.

From the first this building is revealed as an accomplished exercise in scale and the conviction grows as one moves from out under the sky through the large dark doors into the small compressive ellipse of the vestibule, and from there on into the expansive — almost explosive — space of a hall which seems higher than its thirty-seven feet. And light, which contributes in so many ways to scale, has

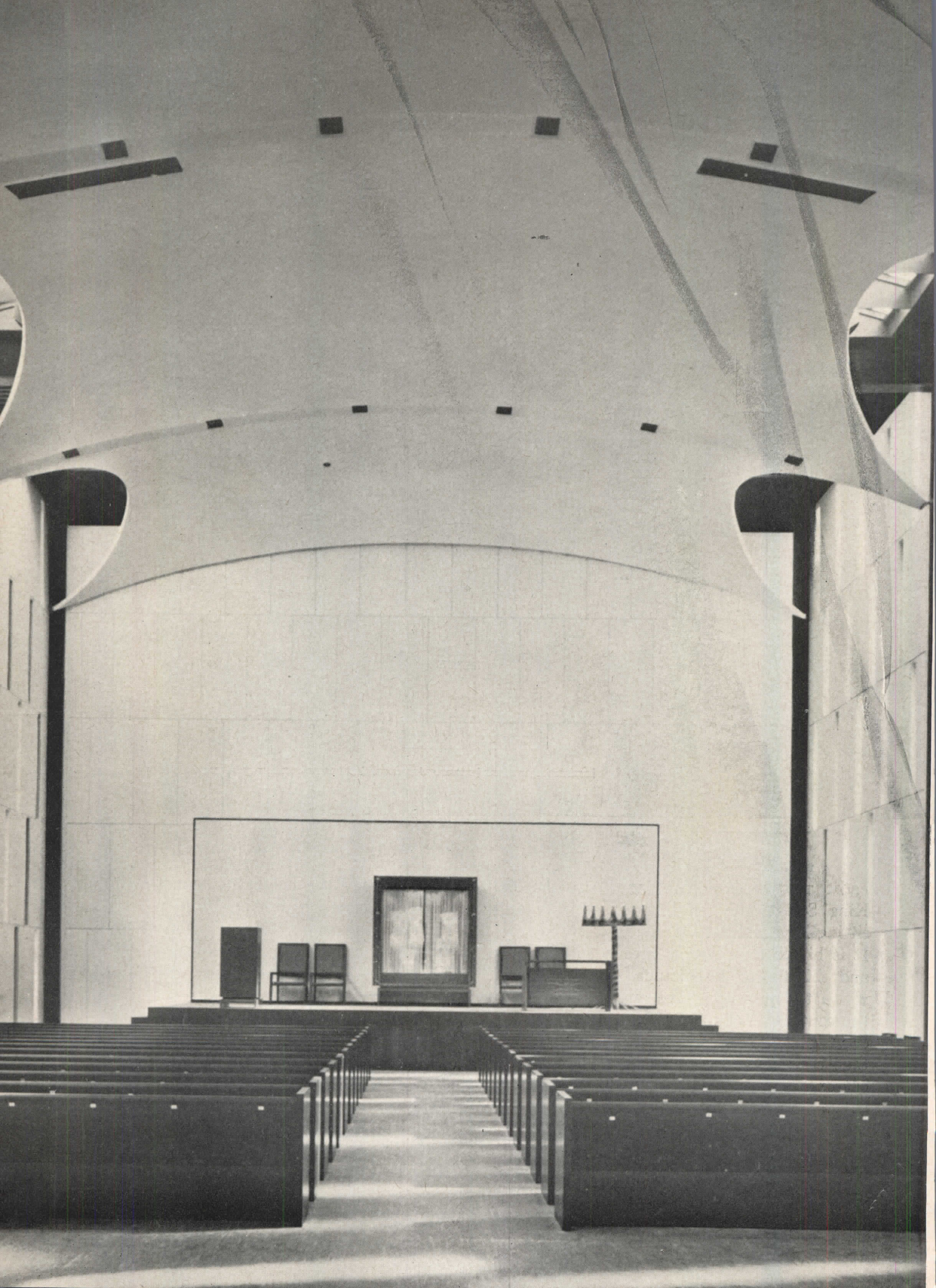

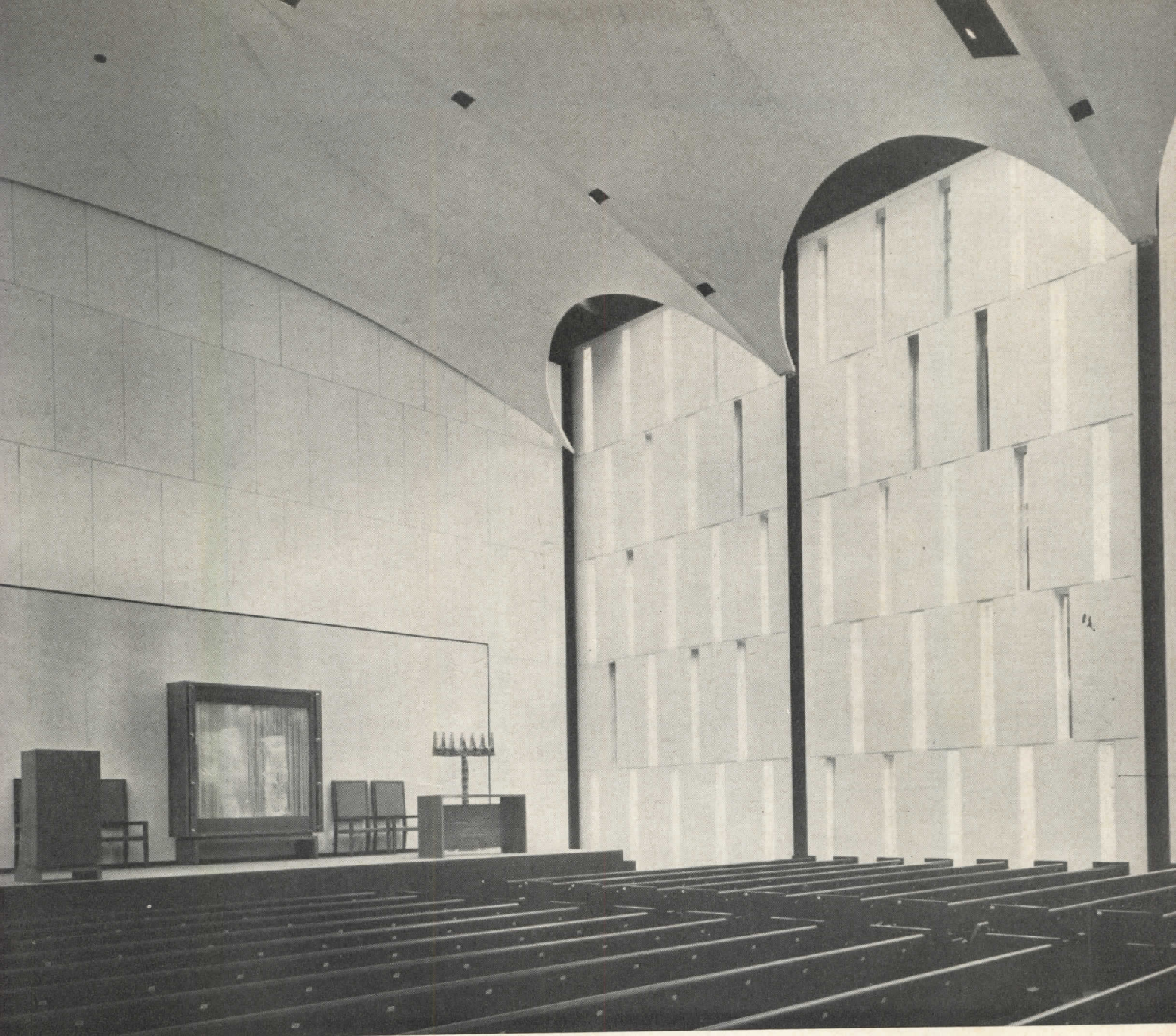

© Ezra Stoller

been manipulated equally well. The organization is the classic sequence of light to dark to light again in which the transition from outside to inside is prevented from robbing the windows of either dimension or brilliance. White — again inside — is a compelling impression but here it is subtly slashed from floor to ceiling and end to end with the Joseph's coat palette of the stained glass light slits. The colors have great clarity. Each is used separately in a single slit and there are just enough clear panels to fortify the lighter colors and to contrast the full richness of the dark reds and blues. The floor is a white-streaked, light gray asphalt tile; the straight

rows of three hundred theater seats in the sanctuary are upholstered in a light silver gray which picks up just a little of the blues and reds from the glass. The bema is covered in gold colored carpeting and the screen behind it is clad in a metallic white acoustic cloth.

Across the middle, dividing the sanctuary and the social areas, are the parallel lines of eight-foot partitions which, framed in aluminum and steel braced, are bolted to the floor for easy removal on the High Holidays when over 1000 must be accommodated. Above all sail seven gently curving suspended vaults of plaster, giving a particular sense of containment to this space through their spe-

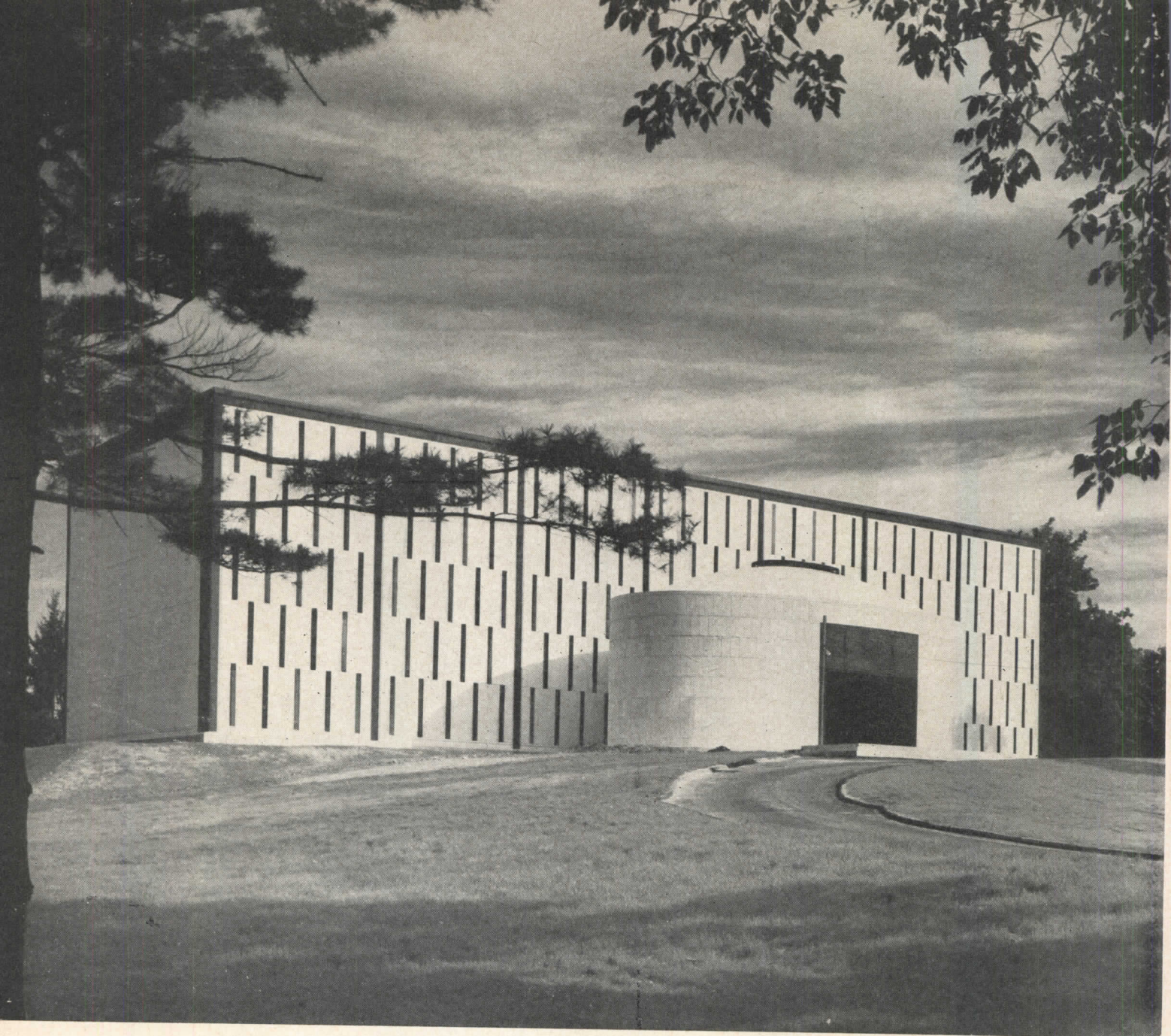

© Ezra Stoller

cial ability to modulate the daylight and serving themselves as both light sources and baffles. In each rib are the direct downlights — six dark piercings when unlit, and only partially concealed behind the sail's incurving sides are the dimmer-controlled lights which, directed toward the sidewalls, let the building glow at night like the "box of jewels" that had been promised even in its preliminary planning (ARCHITECTURAL RECORD, June 1955).

Perhaps only in the piercing of the plaster canopies does one find anything out of harmony in this inspirational space and even here it is difficult to find fault. The downlights and spotlights which undeniably re-

move some of the free-floating quality of the ceiling are nevertheless essential to the equally important control of illumination.

Here the architect has chosen the more difficult and more commendable path. He has been willing to admit into a kind of formal purity — even at the risk of its partial dilution — the means of a larger satisfaction. This may well be the most significant story of this rewarding building. To a structural system of great precision and beautiful proportions has been added a concern for light, and color, and the way people use and experience buildings: with *all* their senses *and* their intellects.

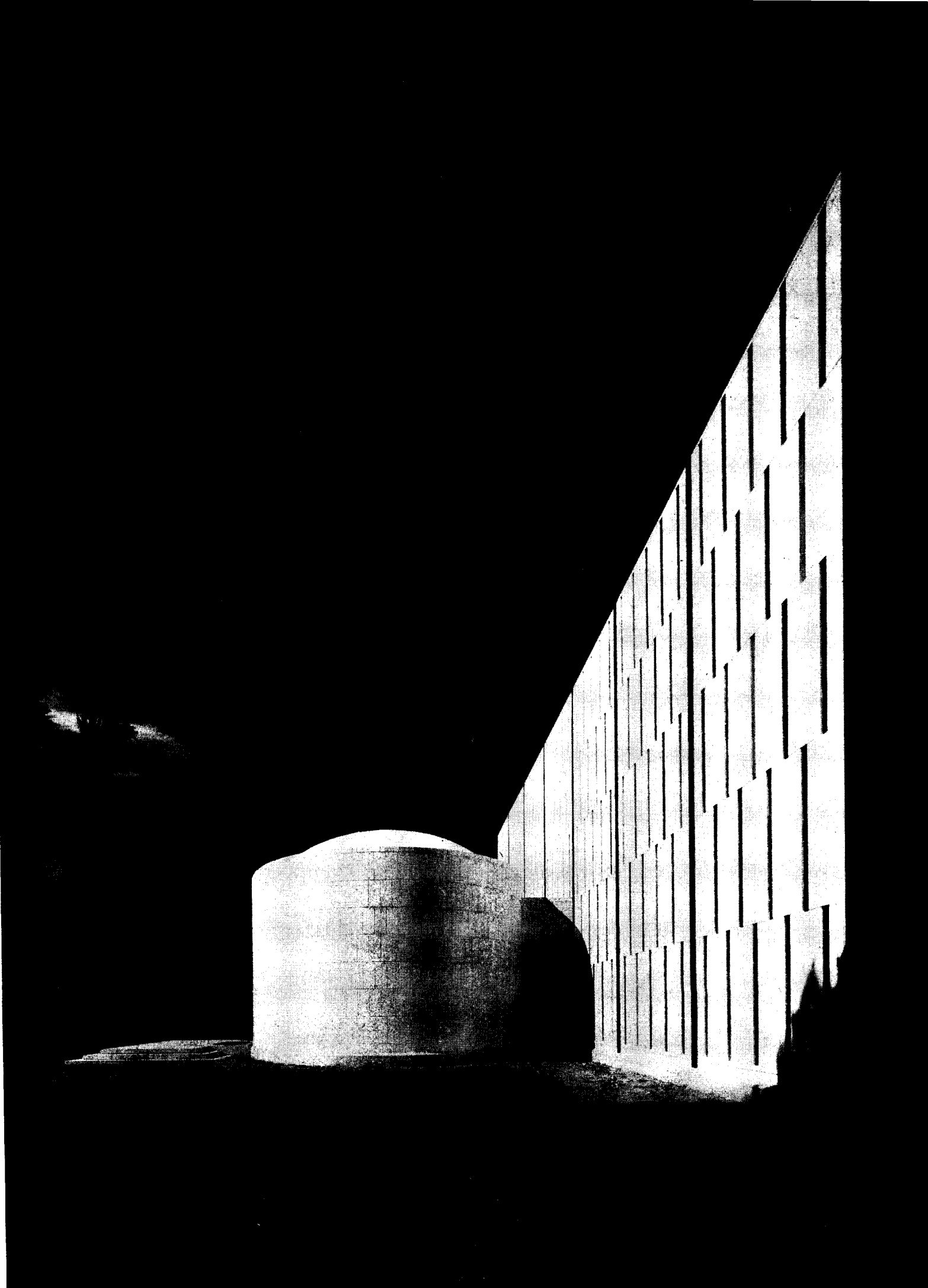

On Getting Good Architecture

BY MARVIN HALVERSON

Executive Director, Department of
Worship and the Arts,
National Council of Churches

HOW TO GET good architecture for the church is not an academic question. More church buildings are being erected than ever before and there is every prospect that the tempo of construction will increase. In being concerned with good architecture for the church, therefore, we are not dealing with a hypothetical issue. We are faced with immediate concerns — construction today which should have architectural and religious validity for tomorrow.

My interest in good architecture for the church derives from my concern that the Church truly witness its faith in the 20th century. While the Church has made enormous efforts in education, in social action, in psychology and pastoral care, the Church has been negligent in the arts and in worship.

Because we have allowed our best traditions in worship to decay and because our tradition with respect to the arts has been one of suspicion, Protestants, at least, have not had a living tradition on which to draw. Fortunately, growing interest in the arts and worship holds promise of renewal in the future. But these are years in which fateful decisions influencing future generations are being made. Although I do not write as a professional in architecture and the allied arts, I write out of a conviction that new insights in worship and the arts are already available to us. I write out of some awareness of the new directions in Christian thought and out of a concern that church architecture not shadow the past but anticipate the future.

Unfortunately, we are burdened in the churches with a baleful legacy of misunderstanding, romanticism, and ignorance about the question of architecture for the church. As far as I can recall, my instruction in one of the country's leading centers of theological training never dealt with the problem except insofar as we were led to believe that in the interests of worship the Congregational churches, for whose ministry we were preparing, should look to Episcopal churches as their architectural ideal. We were nurtured in the belief there was a "holy" style for the church and a "secular" style suitable for a factory or a school or even a home.

Double standard architecture

But one of the basic problems which confronts a local

church planning to erect a new building is the breach between architecture for the church and architecture for the rest of society. The hiatus between architecture for the church and architecture for other institutions and groups in society exposes the shallowness of our understanding of the Gospel and its relevance to all areas of our common life and all realms of society. The continuing penchant among many churches for Gothic and Renaissance denies their assertion that Christianity has significance for all aspects of man's life. It is an architectural denial of the meaning of the Incarnation and the belief that God continues to speak his Word in the language of each new age.

The failure to face architectural facts started in the 19th century. Soon after the Industrial Revolution and the emergence of new technological devices, eclecticism commenced to exert its influence. By returning to the past we shall be saved. The Oxford movement in England and the Cambridge Camden Society with its ritual and ceremonial concerns spurred the return to the past. The Gothic "style" came to be considered the only architecture consonant with the spiritual meanings perceived in the restoration of pre-Reformation ceremonial and ritual.

The Gothic mask

The early Victorians covered the machine in their shame. Perhaps they confused the ruthlessness of 19th-century industrial society with the new techniques and the new materials — concrete, cast iron, and later, steel. At any rate, it was not only the churches which were designed as miniature Gothic cathedrals, but factories, warehouses, and railroad stations were made to appear like medieval castles, fortifications, and cathedrals. The revival of Gothic architecture, I believe, enabled a people to ignore the injustices of a rapidly expanding empire by escaping romantically into a past which they neither understood nor could enter.

On the positive side, the vogue of Gothic in the Victorian era became a form of social protest by architects, poets, and seers. Their motivation was often religiously prophetic, but they failed to grapple with their age.

Despite the peril of appearing chauvinistic, I believe

for the Church

there is an American tradition in architecture from which the church can learn about its failure in the past and its present opportunity. Although modern architecture is indebted to many 19th-century Europeans and reached a degree of maturity in 20th-century Europe, modern architecture is strikingly indebted to American influences. Lewis Mumford has suggested that the Yankee clipper ship and the American ax, and I would add, the New England frame meeting house, were forms which in their honest treatment of materials and their direct relationship to purpose were things of beauty. This tradition of integrity flowered again when from 1880 to 1893 the Loop in Chicago was the center of architectural development for the whole world. In a brief period of time the immense architectural possibilities in structural steel were explored. "Form follows function," which Louis Sullivan gleaned from Horatio Greenough and reiterated in his *Kindergarten Chats*, became the key to understanding the relationship between function and material, making possible — making even morally necessary — new architectural forms.

But while a Louis Sullivan was designing the office buildings, the warehouses and the factories which shaped modern architecture, the churches imitated the past. The now unfashionable sections of the same city are dotted with vast church buildings, vain monuments to middle-class ecclesiastical pride and reminders that the church failed to understand the religious and social meaning of their buildings and their time. For they designed their church buildings in terms of the past rather than the living present anticipating the future.

I understand it is one of the axioms of the architectural profession that architecture always tells the truth about the society in which it takes form. However much an age may try to disguise itself, its real nature is disclosed because architecture is the most social of all the arts. Architecture, therefore, is one of the most significant indices of the spiritual climate of an age. Among the best architects today one finds a concern for the social and religious significance of architecture that is not matched by the churches. These architects are concerned with the importance of good design in man's total life and particularly with the importance of good

design for the church building and its allied arts. To these architects the restoration of spiritual health to present-day society involves the restoration to the church building of the symbolic and formative role which it once possessed in man's common life. No doubt many clergymen and churches would be surprised to learn that the best architects of our time, established ones and younger men launching their professional careers, are eager to design churches, and that many architectural students put their greatest effort and imaginative thought into church buildings. The best architectural talent is available to the churches. But Protestant churches for the most part have not faced as yet the fundamental task of freeing the architect from the fetters of style (whether it be Gothic, Renaissance, or modern) and giving the architect instead the ingredients for a sound exercise of his profession.

Church function and church form

The credo ascribed to Louis Sullivan, "Form follows function," points to the basic problem of good architecture for the Church. If this article were to have a text, it would be this: a church building which is effectively designed in terms of the function of the Church (and the particular congregation for which the building is erected) will have an appropriate form and thus the building may take on the nature of a symbol, saying to the world something of what the Church believes.

But before this can be achieved the Church must have a clearer understanding of its function, its vocation, in the world — in today's and tomorrow's world. In a sense architecture cannot reach its proper achievement until there has been a theological recovery within the Church of the meaning of the Church. Architecture is sometimes referred to as the queen of the arts and theology as the queen of sciences. They can never usurp each other's thrones, but unless their respective realms are in deep communication with each other, the one will thwart the other in the architecture and life of the Church. One of the important consequences of the ecumenical movement, represented institutionally in the World Council of Churches and in the National Council of Churches, is the growing awareness of the various traditions in the whole Church, and the rich

meanings in the Church's heritage and present life which point to its fundamental vocation and function in the world.

On the other hand, one of the difficulties of church architecture in the past has been frequently that architectural form has followed too closely an inadequately conceived function. An architect can design a building, to be sure, for a church needing units to house its diverse activities. While the architect must have data on religious education requirements and space needs for the various groups in the church, the architect's task demands more than this. Fundamentally, he must know the Church's *raison d'être*. This understanding of the Church's purpose must be discovered by the minister and the congregation. The architect cannot be the theologian for the Church, just as the minister and the congregation cannot be the architect. In fact, more architects should say "no" to a church until the church is ready to say "yes" to its responsibility of rethinking its faith and life and work. A wise and spiritually discerning architect can thereby be of inestimable service to the Church. His insistence on the Church fulfilling its responsibility can be the catalyst in the Church's reassessment of itself and rediscovery of the source of its life.

Nikolas Pevsner, in a speech a few years ago on the proposed new Coventry Cathedral, said, "the function of the Church building is to convert visitors into worshippers." A building does not have the power of converting a visitor into a Christian worshipper, perhaps, but a building can hinder and distort the worship of the Church. Worship is central to the life of the Church. It is the Church's primary function and what the Church has always done before it has done anything else. Long before there were church schools and youth programs and community service, long before these and the multitude of activities of a contemporary parish church, the Church engaged in corporate worship. For worship is the heart of the Church's life and work. In fact, it has been asserted that the entire program of religious education is preparation of young and old for participation in the corporate act of worshipping God. Corporate worship sums up all the activities and the meaning of the Church.

One of the distinctions between the Judaeo-Christian tradition, between the Church and eastern religions, is the existence of a community, a fellowship into which men enter. While personal devotion and private worship are not denied, worship in the Christian community is a communal act. Therefore a church building must be designed not for the worship of the individual alone *with the Alone*, but for a corporate fellowship called to a purpose in the world.

The building should be shaped by worship, and not worship by architecture. But for some time Protestants have been erecting buildings designed to achieve a "mood" in which an individual might have a "worship experience" rather than a setting for the activity of the Church in showing its Lord in worship before the world.

However, we are on the threshold of new insights into

worship as a result of the ecumenical movement. We are entering a period of rediscovery of the Church similar to other great periods in the history of Christianity. As in those times of renewal of life, the Church is reviving its historical memories, trying to find what has made the various denominations worship in different ways, and discover the unity which is higher and deeper than the differences. Architecture for the Church building, particularly the location of the altar, is a key to perceiving our differences.

"In the course of history, the Church has evolved three different types of altar, the mysterious, the dramatic, the ministerial. There is the altar of the eastern Christians, the mysterious altar hidden behind veils or the iconostasis; and frequently the Church in the west has tried to make the altar partially mysterious by the use of the chancel screen, the Lenten veil, the placing of the clergy and choir between the altar and the people. There is the dramatic altar, the altar of the baroque architects, of the Victorian ritualists, of numerous modern churches; an altar which by dramatic methods — ornament, the beauty of space, the manipulation of light and shadow — is made the showpiece of the church, and suggests to the worshipper the glory of the Sacrament. There is the ministerial altar, the holy table, a place of ministering, where our Lord perpetuates His ministry here on earth by the gift of heavenly food to the faithful gathered around it." (Addleshaw & Etchells, *The Architectural Setting of Anglican Worship*)

The mysterious altar is found without exception in Eastern Orthodox churches as well as in many of the Gothic buildings of Western Christianity. Eastern Orthodox churches continue to be constructed in such a way that the altar is hidden from the congregation. The dramatic altar is found in Baroque churches, whether they be Roman Catholic or Lutheran. And many contemporary Protestant church buildings are designed to make the altar spectacularly the object of attention in the Baroque manner. The ministerial altar is the Holy Table of the early Church and the Church of the first several centuries. In certain respects the Reformation was an attempt to restore the ministerial altar, the holy table.

The table and the pulpit

For example, as soon as the Reformation was established with some assurance of tenure, the reformed Church of England sought to accommodate its buildings to its new understanding of the Church. While practically no new church construction was undertaken until the last half of the 17th century, architectural changes were made in the existing buildings. The choir or chancel, which had been filled with stalls for monks or secular clergy, was cleared of its furniture and often the Table was moved forward or turned to extend lengthwise down the chancel. In the Book of Common Prayer order for Holy Communion at the point when the faithful were invited, "Ye that do truly and earnestly repent . . . draw near with faith," those who were to take communion came from the nave into the chancel and

gathered about the Lord's Table to celebrate as a community the communion of the Lord's Supper.

In other expressions of the Reformation, the entire building became the sanctuary as the belief in the priesthood of all believers extended participation in the liturgy to the entire people. The first church built in Scotland after the Reformation, St. Cuthbert's of Burntisland in 1592, constituted an attempt to reckon architecturally with the implications of the Reformation. The church was designed in the shape of a Greek cross, and the great pulpit was thrust from one of the arms of the cross into the heart of the congregation, and placed in front of it was a large Table, around which a host of persons might sit. Pulpit and Table, in classic Protestantism, are theologically and liturgically united, and early Protestantism was chiefly concerned that architecture reflect this basic conviction.

This tradition of pulpit and Table closely related continued for some time. In fact, there was a remarkable unity of architectural form in 18th-century colonial America. It arose out of a common understanding of the nature of the Church and its function. Thus one found Congregational churches in New England, Dutch Reformed churches in New York, Presbyterian churches in New Jersey, Lutheran churches in Pennsylvania, and Episcopal churches in Virginia, all having a large pulpit in the center and a Table of goodly proportions before it, emphasizing the centrality of the Word and the unity of the Word in its two forms of Scripture and Lord's Supper.

The architectural tradition of a meeting house for Protestant churches disappeared nearly a century ago. The great pulpit, designed in scale with the interior, shrank in the 19th century to a lectern, badly out of scale with the building, and placed on a platform or rostrum. The organ and choir, which in the meeting house were in the rear gallery, were moved to the dominating position in back of the generally tiny Table and spindly lectern. Out of this emerged the so-called Akron plan. Disastrous as it was architecturally, this much-derided pattern of church building was well designed for the church of its day. It was well planned for hearing a speaker and choir or quartet, for accommodating the extra crowds which would come to hear a striking address, and for the growing emphasis on religious instruction for young and old in the church rather than the home. The inadequacy of this kind of building for Protestantism, so apparent to us now, derived from the diminishing understanding of the full spiritual dimensions of the Church. It stands as an architectural reminder that before it builds the Church must think profoundly about itself and see its function in terms of the Bible, tradition, and the present world.

The emptiness of vacuity

Even so the Akron plan was designed for a church still nourished by evangelical roots. As these roots dried, however, there was confusion about the building and concern over its barrenness. With the increasing decay of preaching the room for worship became empty,

not in Professor Tillich's conception of "holy emptiness," but the emptiness of vacuity. Protestant churches sought to fill the emptiness by copying church traditions other than their own and by introducing pictures, crosses. Rather than looking to their own past they found an ideal in the Episcopal Church, in its worship, in its music, and above all in its architecture, generally Gothic in character with an altar, choir stalls, and the Bible no longer on the pulpit but on a lectern on the opposite side of the chancel. During recent decades when Presbyterian, Congregational, Methodist, and Baptist churches were appropriating architectural arrangements from them, Episcopalians were not yet conscious of how recent and unjustified was their introduction of medieval altars and monastic choir arrangements into their parish churches.

Thus the churches in America today find themselves confronted with liturgical and theological anachronisms. They are attempting to worship in buildings that imply beliefs they do not hold and patterns of worship they do not practice. Fortunately, immense resources of new thinking about these matters are available from the leaders of the Church. The most recent Biblical, theological, and liturgical works are in remarkable agreement. The Church, they say, is a family, a people, a community, called into being to serve a purpose. And the nature of its life, its worship, its vocation and its function in the world demands altogether new approaches to worship and architecture. There is recognition of the uniqueness of each denominational tradition and at the same time a growing understanding of the basic unity of the Church.

The free-standing altar

It is one of the ironies of history that the liturgical movement in the Roman Catholic Church is seeking to recover the ministerial altar at a time when Protestants have been approaching the architectural setting for worship in ways that the fathers of the Reformation rejected. In the Roman Catholic Church, the liturgical movement, for instance, has rejected the medieval altar in favor of a free-standing altar, sometimes even resembling a table. Several new churches designed with the altar in the center imply that the same currents are at work as are found in the ecumenical movement. The central position of the altar suggests that the Church is a family gathered for its Holy Meal. Such a central plan, which many Roman Catholic churches are adopting, is not easily arranged for Protestants because for them the liturgical orientation is not to an altar alone but to an altar (Table) *and* a pulpit and a font or baptism.

The architectural anachronisms of many Protestant church buildings will become even more apparent in the future as the confluence of Biblical, theological, and liturgical studies results in re-examination and renewal of worship. It has already commenced at the level of the World Council of Churches and in theological seminaries. When it becomes fully apparent, much of the church building of the last few decades will be seen to be

imitative, eclectic, and impressionistic.

Fortunately, there are several striking examples in the United States of serious reflection and fresh thinking by a local congregation engaged in an informed dialogue with the architect. Pietro Belluschi's design for the Presbyterian Church in Cottage Grove, Oregon, shows what can happen as a result of cooperation between minister, congregation, and architect. But this building is not to be imitated. The thorough exploration in the congregation of what it means to be a Church, what it means to belong to a particular tradition of the whole Church, and what it means for the Church to try to speak simply but directly in terms of our day — it is this exploration and reflection which should be emulated by all congregations preparing to erect a new house of worship. The building program then becomes not an expression of the Church's self-concern but the occasion of spiritual renewal.

A church building not only houses the public worship and related life of a religious community. It becomes a symbol to the secular community of what the Church is and what it believes. If architecture arises out of the faith and common life of the Church it can accentuate the religious apprehensions of the worshippers, reinforce the beliefs and memories which the Church shares. Manifestly, architecture cannot create faith, but it can express aspects of the faith which is given. A church building can express the transcendence and the immanence of God; it can suggest that the Church escapes from the world or that the Church lives in but not of the world; it can imply that the Church can speak only to those within it or that the Church speaks to the world it confronts.

The Judaeo-Christian tradition affirms that God is both transcendent and immanent. He is beyond space and time and cannot be confined to a particular place or moment, culture or age. On the other hand, God is present in the living Church, acting in the events of history and in our common life. In the Incarnation, the Church asserts, God entered our world at a particular place and time.

Space is the symbol of God

I believe that the transcendence and immanence of God can be expressed in church architecture today perhaps better than ever before. The concern of contemporary architects with space and the relationship and inter-penetration of interior and exterior space can be highly significant. Professor Tillich asserts that space is our most valid symbol of God. The God who cannot be contained or "spatialized" is represented by definition of space which covers man in his finitude. With today's building materials and techniques it is possible to achieve architectural space of symbolic power. I believe that the Church building of our day can best express God's transcendence of space and time as it also expresses the immanence of God in employing the space and time possibilities of modern architecture.

The plea, "I want a church building to look like a church," is not to be dismissed. A church building

should be a symbol of the Church. This is the problem faced by the Christian movement since its inception. How can the Christian message be expressed afresh in each new age, in cultures other than our own? Yet the Christian faith which derives from the Incarnation must become incarnate in each person, in each generation. As the Christian faith becomes manifest in flesh and blood, so it must become manifest in stone, concrete, glass, and steel.

Architecture for the Church, for this reason, becomes the highest challenge which confronts an architect. Equipped with a congregation's knowledge of itself, its history, and its present life, the architect must design a building that suggests the Church is a people with a history, whose source of life is beyond history, and whose work is in the present — the now that will be the history of tomorrow — and whose destiny is beyond history and this life.

The tent as a prototype

Daniel Jenkins, a Congregational pastor and theologian, has offered the interesting thought that the tent is the prototype of the ideal building for the Church. In connection with its Hebrew antecedents it suggests a building for a people on the march, the Church ready to move on to new frontiers. Paul Schweikher's design for a Methodist church, which is reminiscent of a circular tent, represents an interesting fusion of the tent motif, American religious history, and present-day design. The new circular chapel at M.I.T. is also an appropriation of an ancient religious form, the circle. Rudolf Schwarz has explored the symbolism of the different forms of the church building. His doubt of the religious validity of the circle in terms of the Christian faith suggests that no form in itself will answer the problem of church design. The forms of architecture arise at the intersection of God's action toward man and man's response to God in community with his fellows. Architectural symbolism must arise from the Church's life and a building appropriate to it, rather than by imposing a "universal" symbolic form on architecture.

Do our church buildings imply that the Church seeks to escape from the world or that the Church lives in but not of the world? Do the buildings suggest the Church has a message for the world or only for itself? Several churches built during the last few years illustrate the problem that every Church and architect must confront. In St. Clement's at Alexandria, Virginia, a church was designed with an altar in the center and the congregation on opposite sides, the choir over the entrance supposedly uniting the two parts of the congregation. This building represents a serious attempt to recognize the Church as a family gathered about its Holy Table. But there are no windows. Overhead pinpoints of light provide illumination in what might be a catacomb of darkness. Economy of construction prompted the use of windowless exterior walls, but the symbolism becomes a matter of importance. In obedience to its faith, can a Church shut out all evidence of

the world of nature? It has been suggested that this particular building points to a truth about the Church in our world. Despite its present outward success, this argument states, the Church is forced to withdraw within itself, cutting itself off from the world in order to renew its life and strength, that at the right time it may go forth and transform the world.

In contrast, St. Stephen's Church in Columbus, Ohio, makes interesting use of a glass wall which relates the church to the world. Numerous churches have been built in which the worshippers look across the "altar" through clear glass windows into a forest or a mountain view. In such churches the ultimate focus is the world of nature. St. Stephen's resisted both the temptation to nature worship on the one hand and complete withdrawal from the world on the other. Through windows at one side a garden court may be seen, but worship is oriented to a Holy Table above which is suspended a cross. The glass wall is at the entrance to the church building. While the church is worshipping in a building, the world may catch a glimpse of the mystery which the Church declares in its worship to the world. The congregation on leaving the building is conscious of the world to which the Church must witness. This building was designed for the function of the Church in the modern world. But it symbolizes a community which exists in the world, serves the community in which it lives in the name of a higher community from which it derives its life, and points to our ultimate fulfillment in that higher community.

A proper procedure

1. Before an architect is selected the church should engage in a thorough study of itself. Study your denominational heritage, its beliefs about the Church, its tradition of worship, its attitude toward the arts, its overall understanding of its function in the world and in the community. Review this study in the light of the Bible. One of America's outstanding laymen, an industrialist who wants good architecture for the church, suggests that a congregation study the New Testament before it decides to build. In this way tradition and the Church's present life will be brought together under the creative judgment of God's disclosure.

2. Because the minister has had theological seminary training it should not be assumed that he does not need personally to engage in even more thorough study. Having been a Dean of Students and Director of Studies in a theological seminary for several years, I know how the seminaries have failed to give adequate training in these matters. Let the minister be the first to submit himself to a discipline of study.

3. The church should review its program in the light of the fresh insights of these studies. Questions such as these might be asked: should the church building be designed in terms of the existing pattern of the Church's life, or should the building anticipate the changes in worship, religious education, and fellowship which a thorough study of the Church may suggest are God's will.

4. Look, then, for the best architect you can find. Some of the great buildings for the Church have been designed by comparatively young architects of outstanding ability or by architects who have never before designed a church building. When the church is ready to retain an architect, several architects may be interviewed. Not the architect who agrees most readily with what predilections may remain within a church after a thorough study, but the architect who challenges the church to further thinking, may well be the architect who will serve the larger purpose of the Church. If the local church fulfills its responsibility of developing a clear conception of itself, its nature and its function, the truly imaginative architect will draw upon all his talents. The result may be a building for which future generations will rise up and call you blessed!

5. The *Handbook of Architectural Practice*, published by the American Institute of Architects, 1741 New York Ave., N.W., Washington, D. C., will be of great help to the Building Committee. Several shorter documents can be obtained in quantity for a few cents each and will insure understanding on the part of the local church of its relationship to the architect. These are: A.I.A. Document #225, *Principles of Professional Practice*; A.I.A. Document #300, *The Selection of an Architect*; and A.I.A. Document #177, *Details of Service to be Rendered and Schedule of Proper Charges for Services*.

6. After you have selected an architect, proceed to selection of a site. The architect's advice can save a local church from grievous errors. There may be circumstances which necessitate procuring a site before an architect is retained. In all events it is assumed that a local church works in cooperation with its appropriate denominational agencies and with the council of churches in planning and comity.

7. If the church's study suggests that art properly may be used in the church building, make adequate provision to use the work of living artists rather than mass-produced liturgical arts. Make certain that the architect's plans include all the liturgical items appropriate to your church's way of worship. Many otherwise fine buildings have been disfigured by the intrusion of crosses, candlesticks, communion vessels, fabrics, and other items that violate the integrity of the architect's work. The director of the nearest art museum can put the church and architect in touch with competent artists. As with architects, the best artists may not be the ones who aggressively seek a commission from the church. The best artists of our day, however, will respond with enthusiasm to an invitation to do work for the Church. Let us use them.

8. While Protestantism has been negligent in the visual arts, it has employed and often fostered the musical arts. The budget for a church building should include provision for a pipe organ. A church building is not complete for worship without one. Again the church should turn for competent advice, for instance, to the head of the organ department in a leading college or university.



William Wollin Studio

ST. JOSEPH'S CHURCH, FT. ATKINSON, WIS.

*John J. Flad and Associates,
Architects
T. S. Willis, General Contractor*

At eighty-eight cents a cubic foot and on a congested corner site these architects have been able to create for a traditional liturgy and a conventional program of requirements a building of many positive architectural achievements. Most dramatic of these is the enormous stained-glass mural which dominates the entrance face and which — particularly at night — provides a rich tapestry of light as the focus of an ensemble which inevitably reveals the harsh demands of a rigidly restricted budget, but achieves distinction nevertheless.

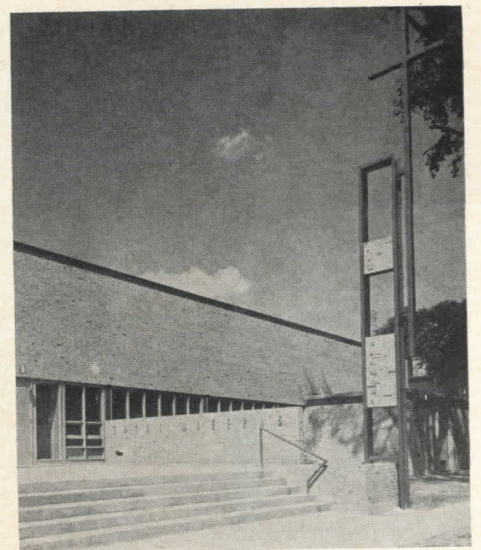
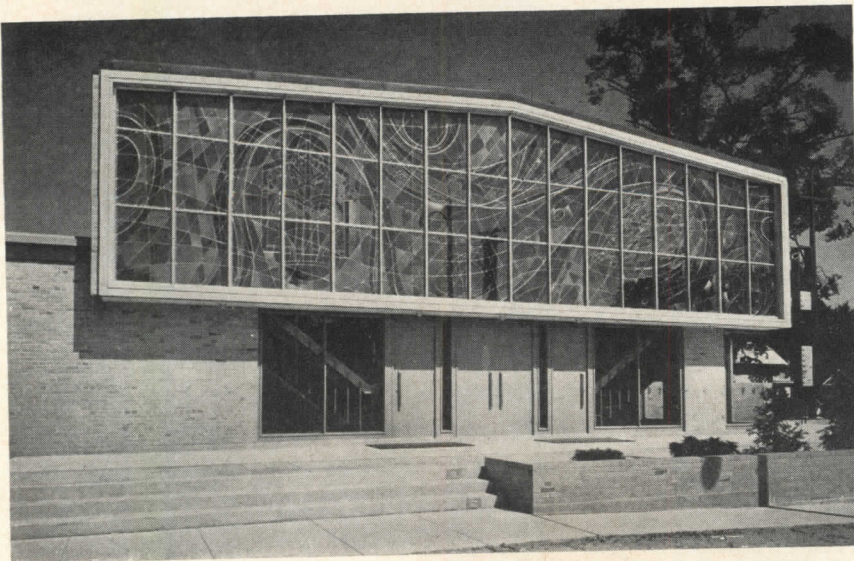
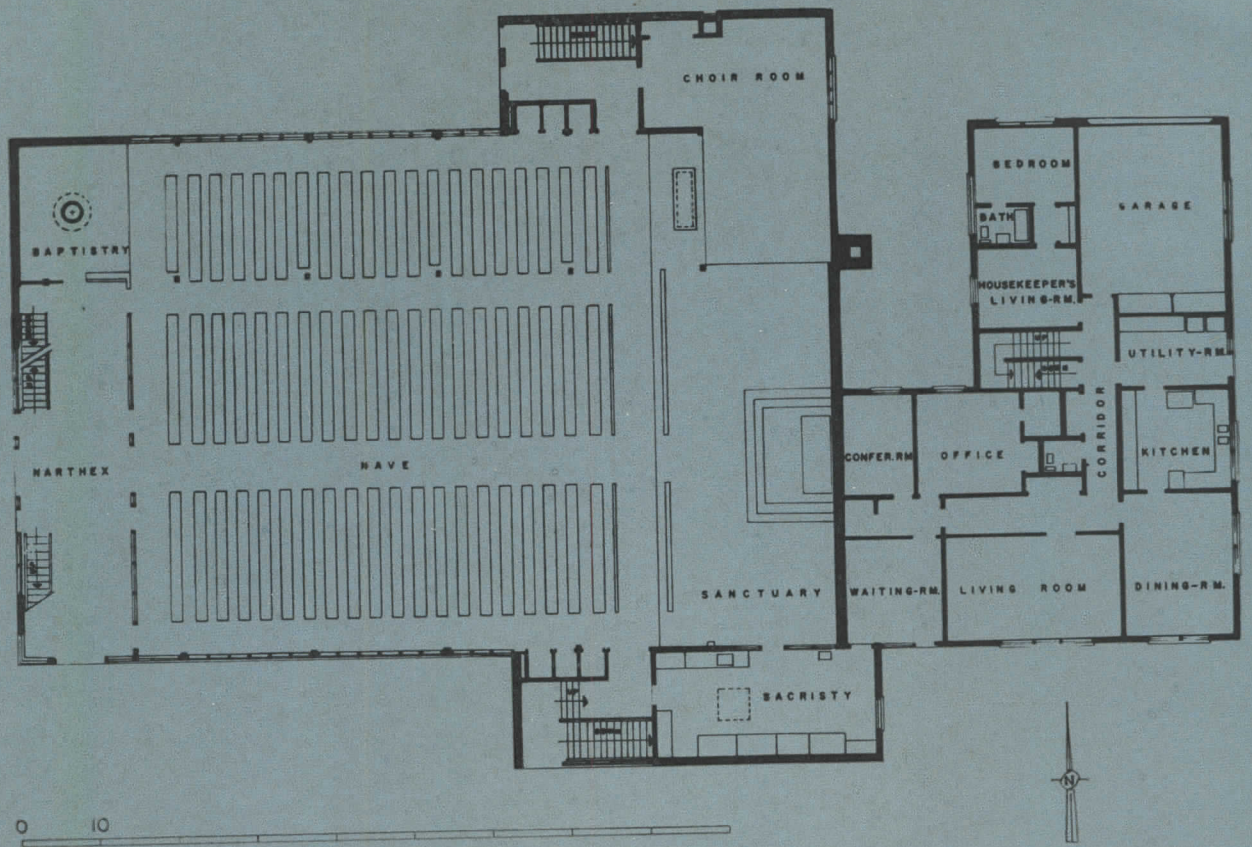



William Wollin Studio

NAVE, BALCONY, AND CHOIR can seat just over 700 on this site crowded with an existing two-story school and with the necessity of providing with the church a fairly elaborate rectory facility. Circulation between these elements was a primary problem and has been handled well along with the principal approach which is by means of an offset terrace.

Immediately off the narthex is a completely enclosed baptistery lighted through the low roof which, continuing over the side aisle, gives emphasis to the higher nave and acts as visual transition between church and school.

The principal material is a buff-range brick exposed throughout the interior and which —

both inside and out — serves as a neutral background for the two principal color foci. Of these the great window tells its story in blues and reds with minor accents. It was designed by Burckhard and executed by the Esser Studio of Milwaukee, as was the altar mural, which was designed by Erhard Stoettner in Venetian glass tile mosaic.

All major materials are in their natural colors. Pews and trim are in birch, and the rectory uses redwood siding.

A large parish hall with adjacent lounge, meeting rooms, and kitchen occupies the entire basement level. Total cost of building was \$295,000.

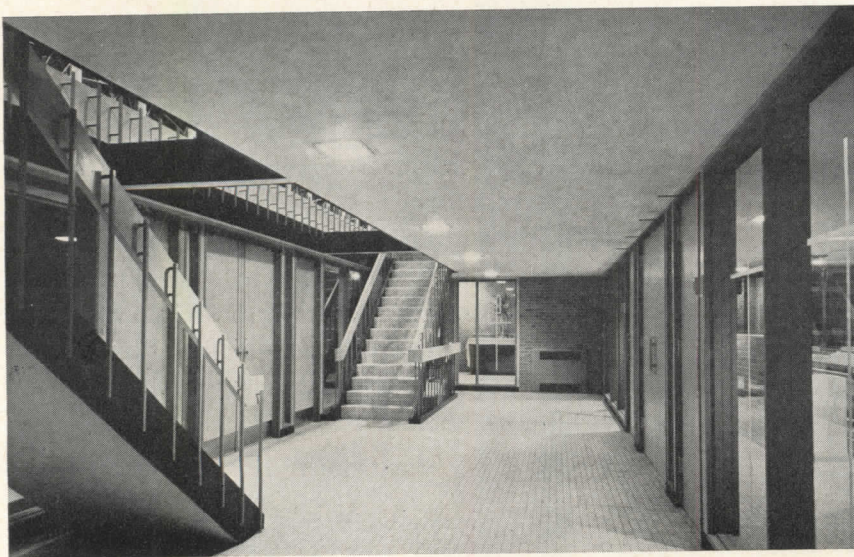
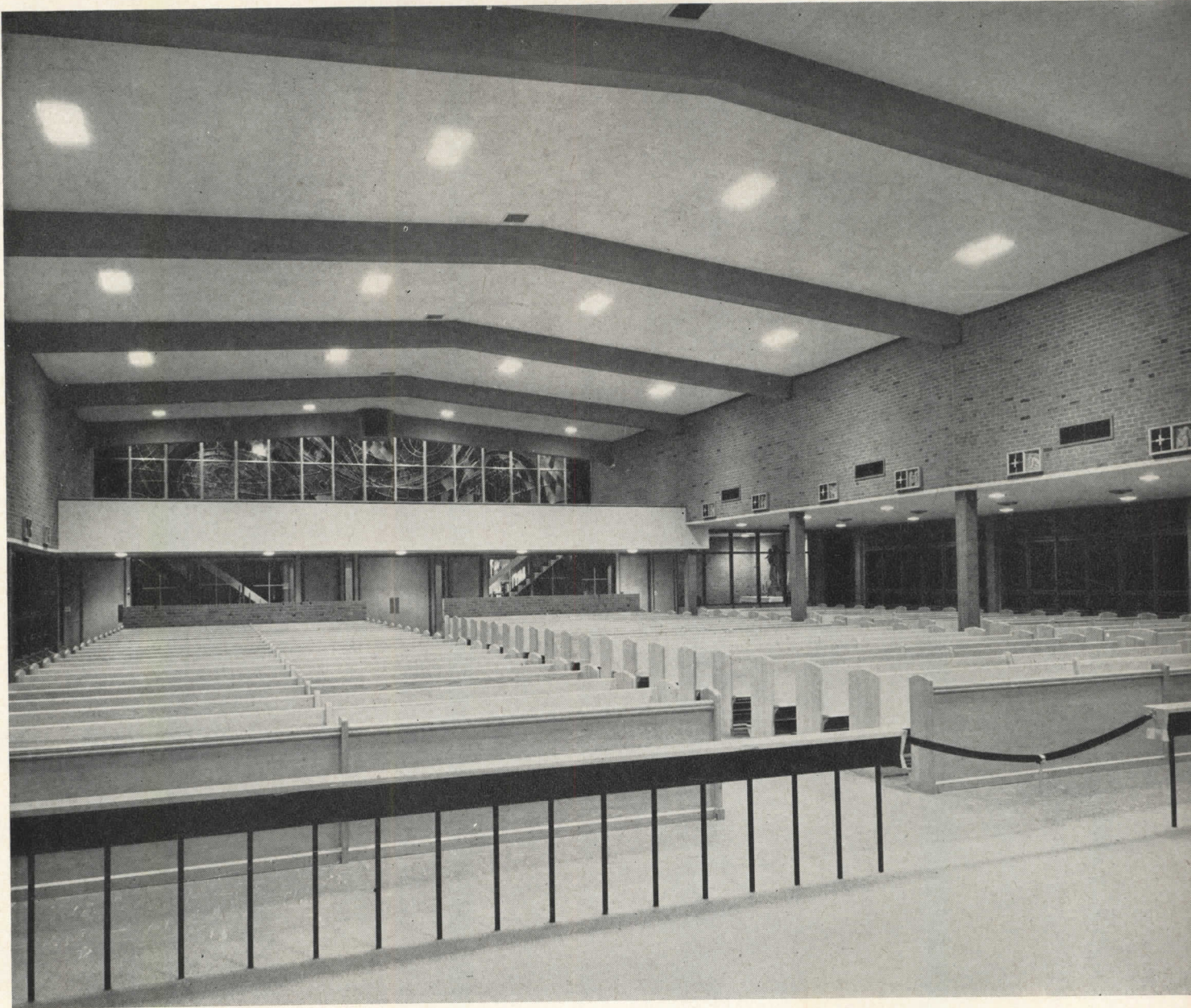



Dearborn-Massar

EMMANUEL PRESBYTERIAN CHURCH, SPOKANE

*McClure & Adkinson,
Architects*

*Lyle C. Campbell,
Structural Engineer*

*Kendall Wood & Associates,
Mechanical Engineers*

*Joseph Doyle,
Electrical Engineer*

Fine scale, the skillful use of a limited site, and a very positive expression of an invitation to withdrawal are the qualities which particularly recommended publication of this church. Of these the latter is almost unique today. Here a welcoming reach is made to the community through the covered entrance walk alongside the pleasantly placed tree and yet it is everywhere manifest that the community is being welcomed to withdraw in worship. Welcome and withdrawal are a difficult duality and in a small building are seldom achieved simultaneously.

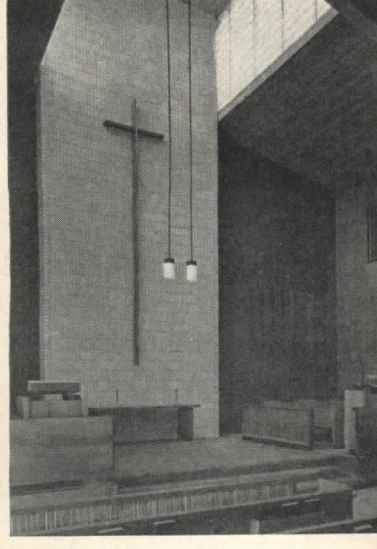
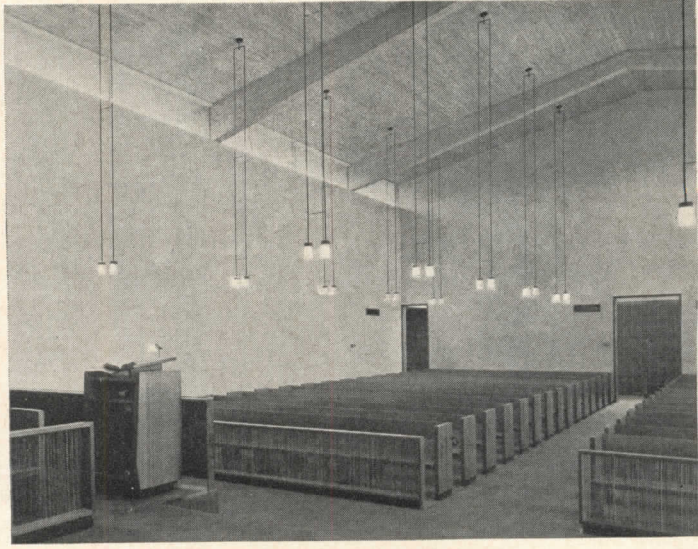
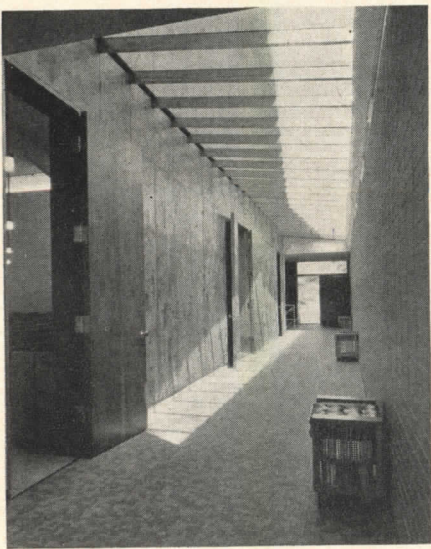
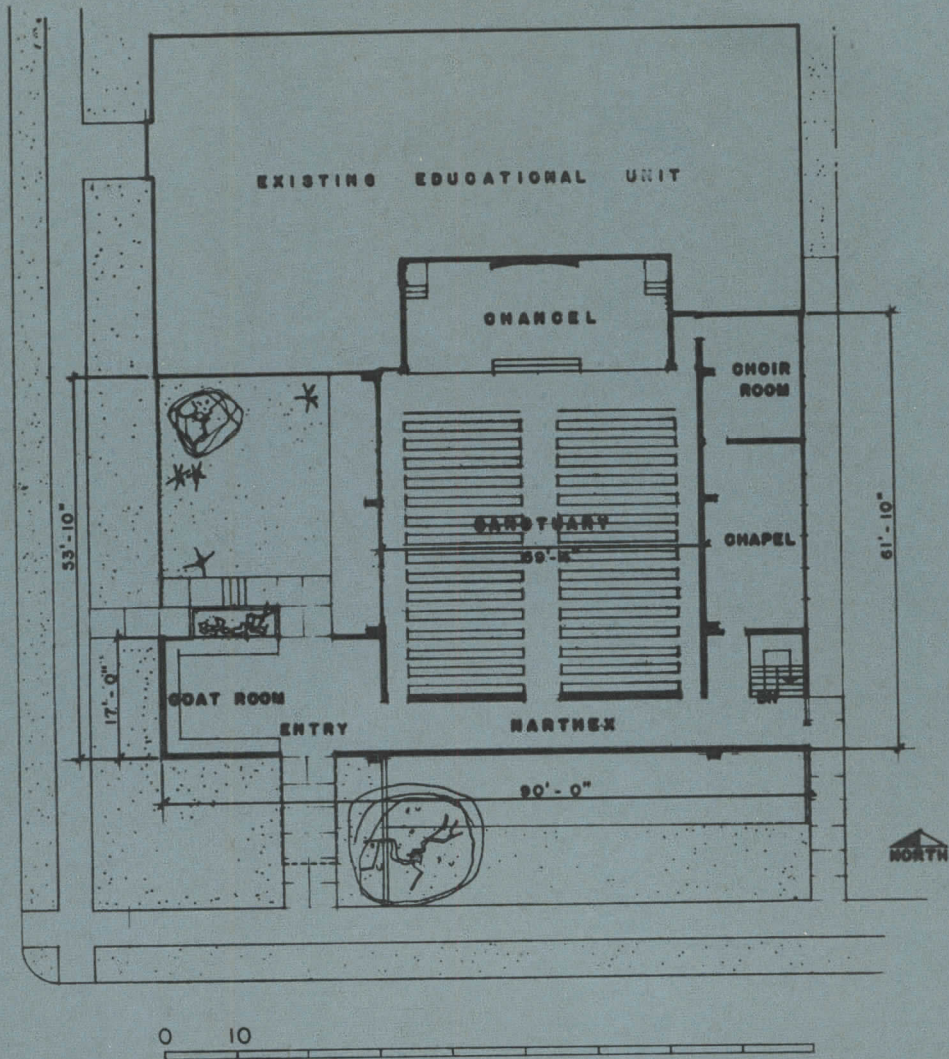



Dearborn-Massar

NO WINDOWS FACE THE STREET and once inside the natural light sources are arranged to enhance that sense of removal which is both theologically and sensuously effective. The hollowed recession of the first bay over the brick-screened, sky-lighted narthex contributes strongly to the visual pull and to the plastic participation of interior and exterior spaces. This recessed wall is clad in acid-treated copper and while for some there may be an overabundance of materials certainly no one would wish to delete this one which forms such a rich background for the white enamelled cross and which extends downward to form the interior narthex wall.

The program asked the architects for a sanctuary for 400, sympathetic to the already existing educational wing and within a hemmed in site. The side location of entry and coat area, which was in direct response to the property limitation, produces the useful court and partially contributes to the sense of retreat. Relationship of new and existing basement levels required the forward light well. Principal framing elements are the glue laminated arches. Exterior surfaces are brick, painted plaster and copper; interior repeats these plus walnut and asbestos cement panels, acoustic, ceramic and asphalt tile. All sanctuary furnishings were designed by the architects.

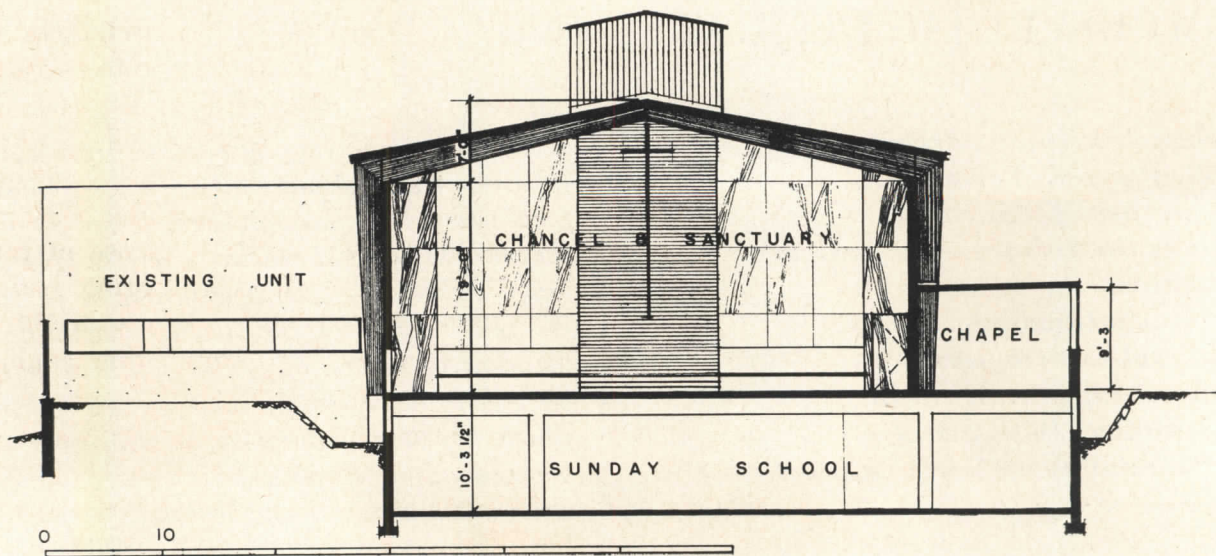

LATERAL SECTION

SCALE: 1/8" = 1'-0"



Hedrich-Blessing

TEMPLE BETH EL, GARY, IND.

Percival Goodman, Architect
Faioli, Blum & Yesselman,
Structural Engineers
William Dusenbury, Mechanical
Engineer
Gerometta Construction Co.,
General Contractors
Seymour Lipton, Sculptor
Hans Moller, Designer of
ark curtain

Historically the synagogue in the west has been relatively free of strong traditions in architectural form which have made modern design for Christian worship a most exacting exercise. The architect of talent has been able generally to express the relationship of the Jewish Community to the general community and nowhere has this been done more clearly than in this synagogue which has been fashioned in steel against the background of a steelworking city. Especially clear is the arrangement for the three part function of worship, study and social gathering,

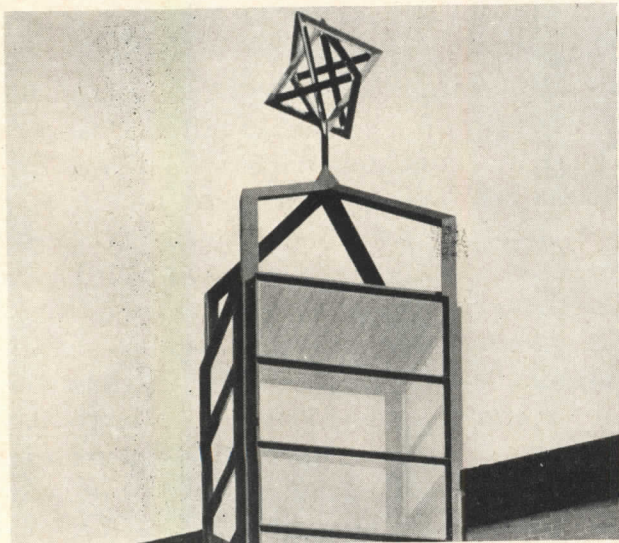
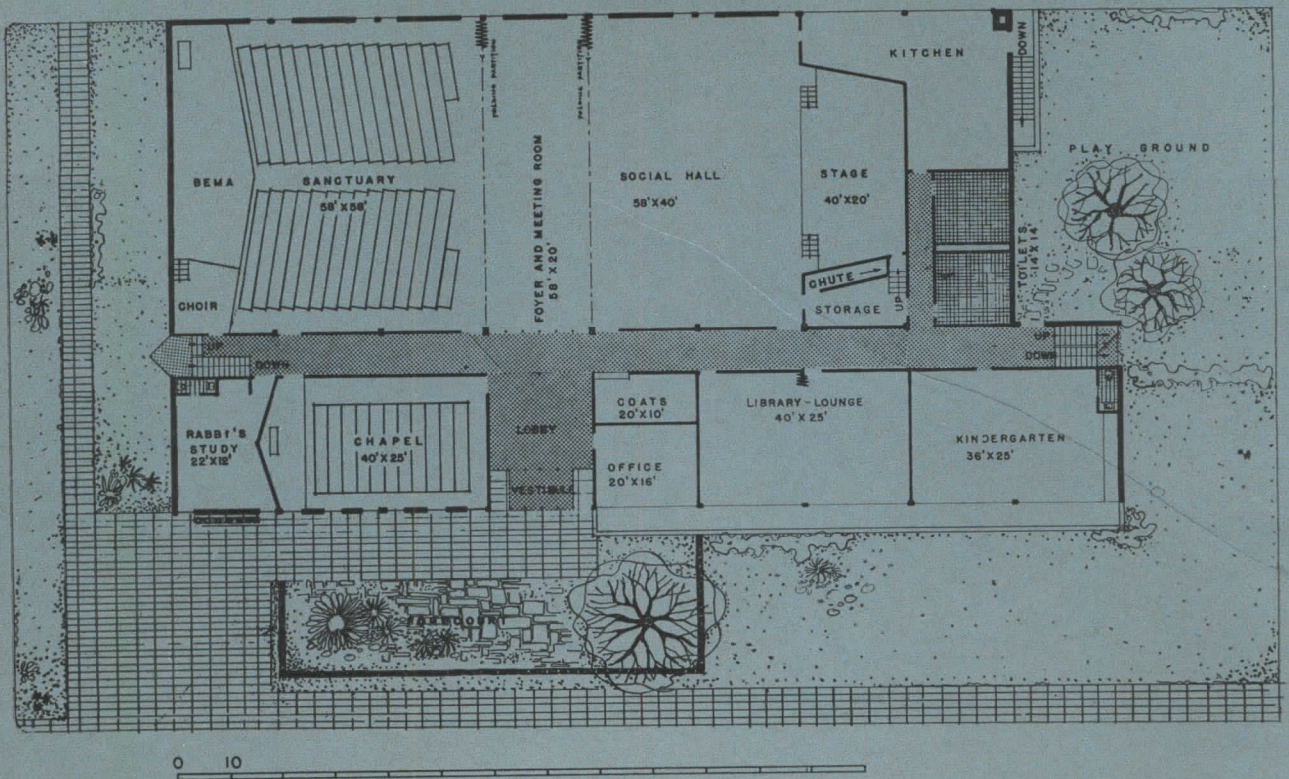



Hedrich-Blessing

which so characterizes the good synagogue today. In an orderly, economical, and direct architectural expression perhaps only the triangular stair tower projection will be questioned — and that for its proportion rather than intention.

IN THE OTHERWISE rectangular framework of exposed standard steel sections the architect has placed panels of brick, granite or glass. A projecting canopy covers the entrance from the gathering place within the walled forecourt. To the left the welded metal sculpture in the menorah theme is by Seymour Lipton. Directly ahead of the lobby is a central lounge whose partitions fold away on either side to open up the 22 ft high sanctuary and social

hall whose combined seating capacity is 1000. The ark which dominates the sanctuary is framed in black and white veined marble and is covered with a curtain in brilliant color designed by Hans Moller. The menorah and the eternal light over the ark are by Lipton.

A chapel for small weddings and services, a multi-use library, a well equipped kindergarten and administrative offices complete the main floor. Above are nine classrooms and the custodian's apartment and in the basement are several meeting rooms and a large play-room. All adjunct faculties are designed for the maximum flexibility demanded by the heavy and varied use of the building.

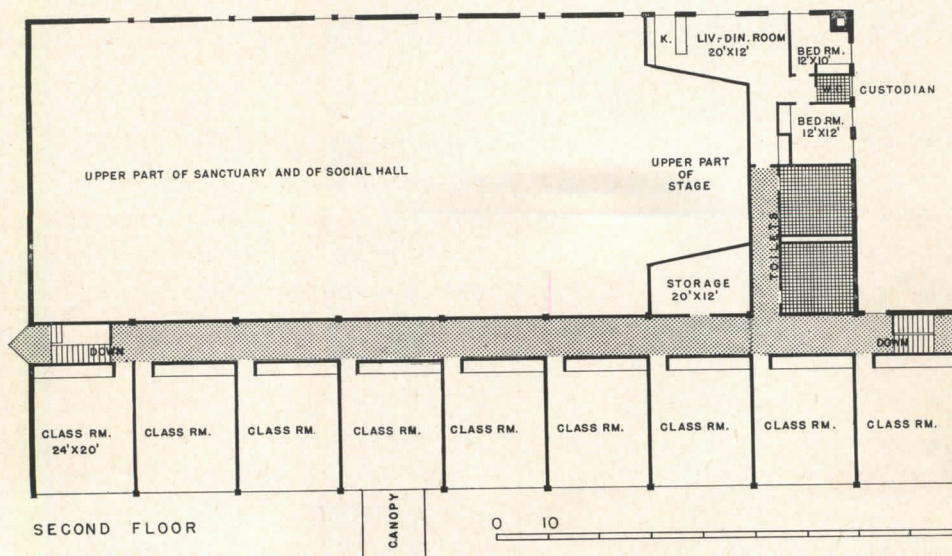
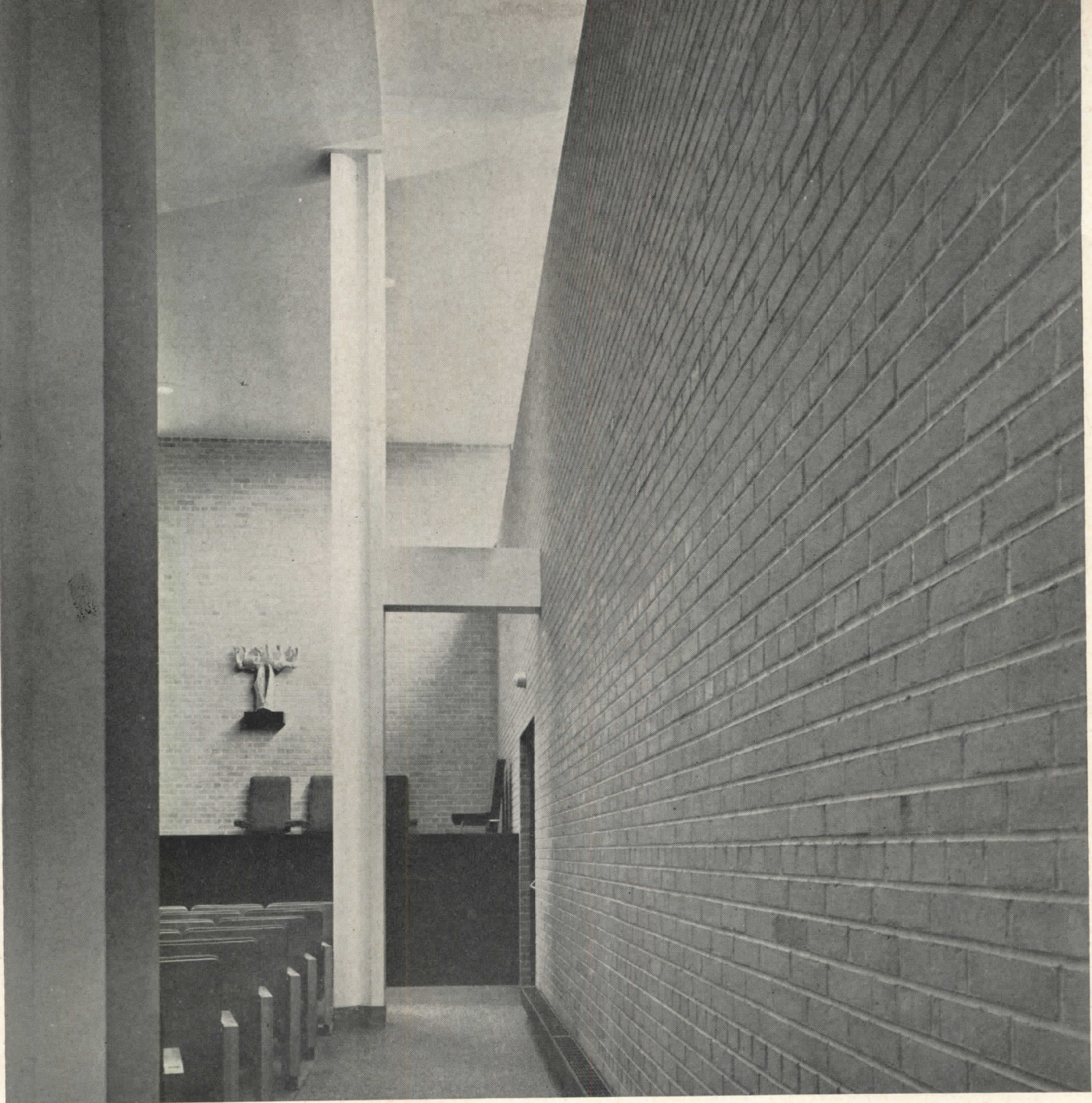

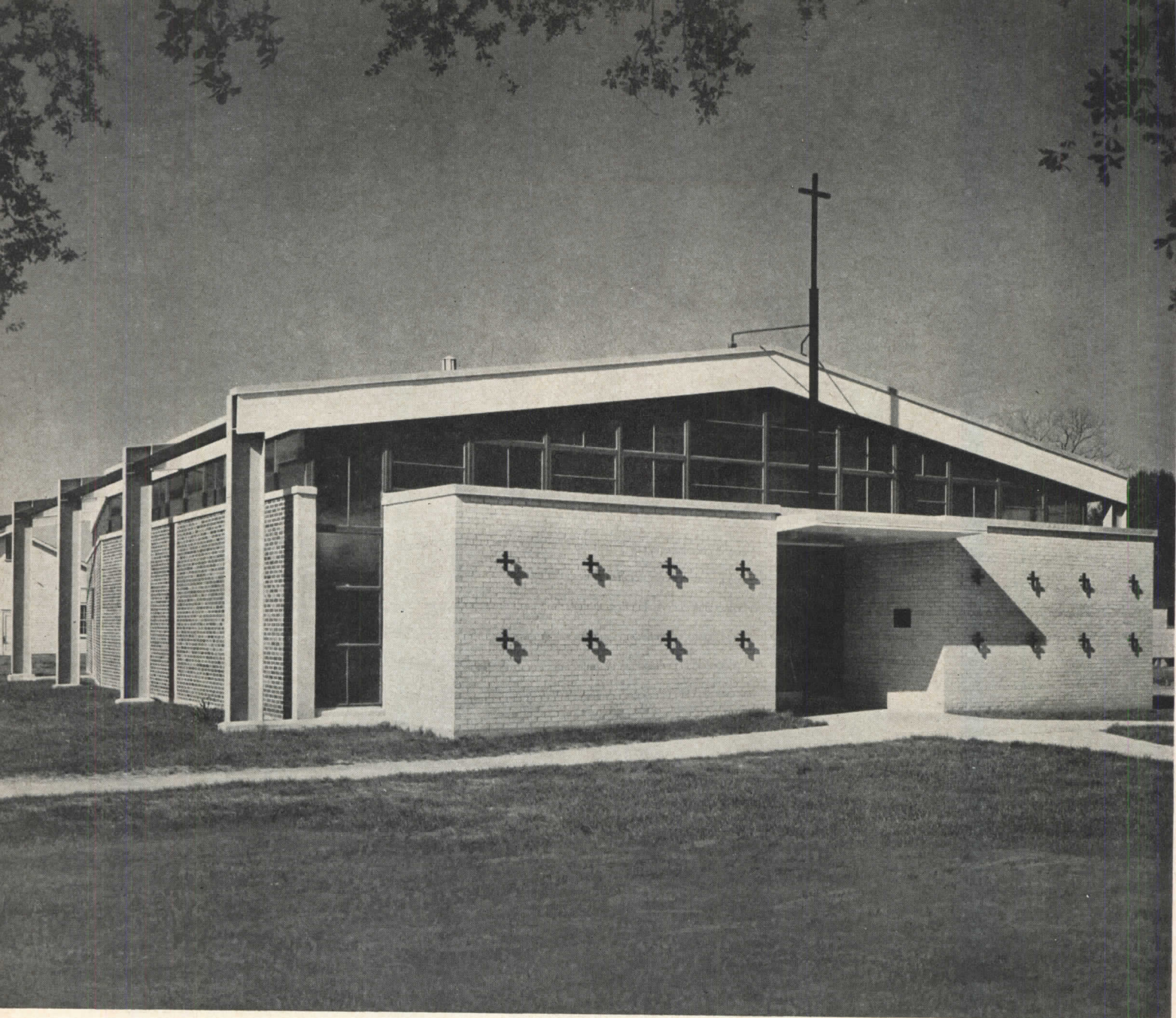

Frank Lotz Miller

IMMACULATE CONCEPTION CHAPEL, JENNINGS, LA.

*Burk, Lebreton & Lamantia,
Architects
Bartley & Binnings, General
Contractors*

On a budget of \$65,000 which rigidly restricted design to the manipulation of the shape and color of a few simple materials the architects have created for this outlying area of a Louisiana parish a chapel of real distinction. The building is carefully made and achieves its success through this as well as through an expansive quality of the interior space which is generated by the well arranged natural light sources and the flat-bowing of the non-loaded brick side walls.

The desirable sense of withdrawal has been almost fully attained without sacrifice of the sense

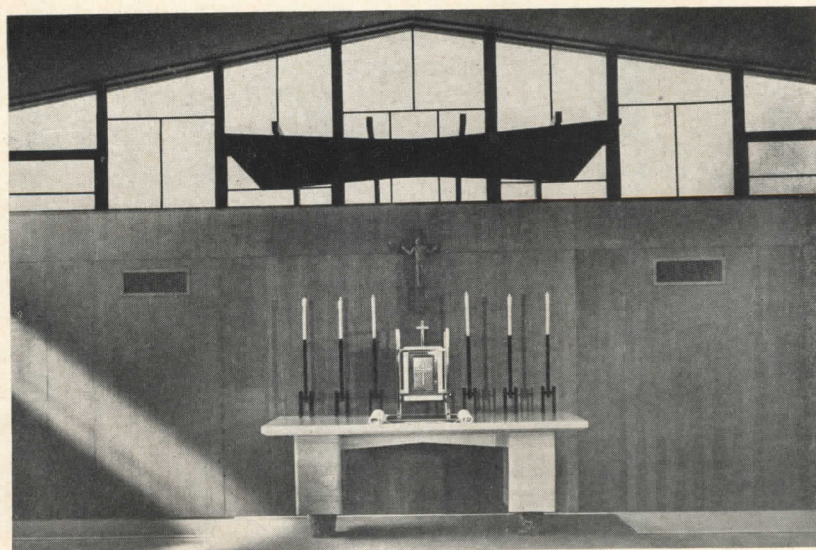
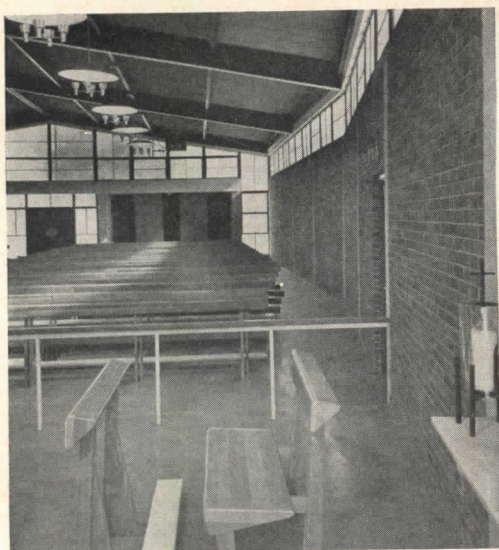
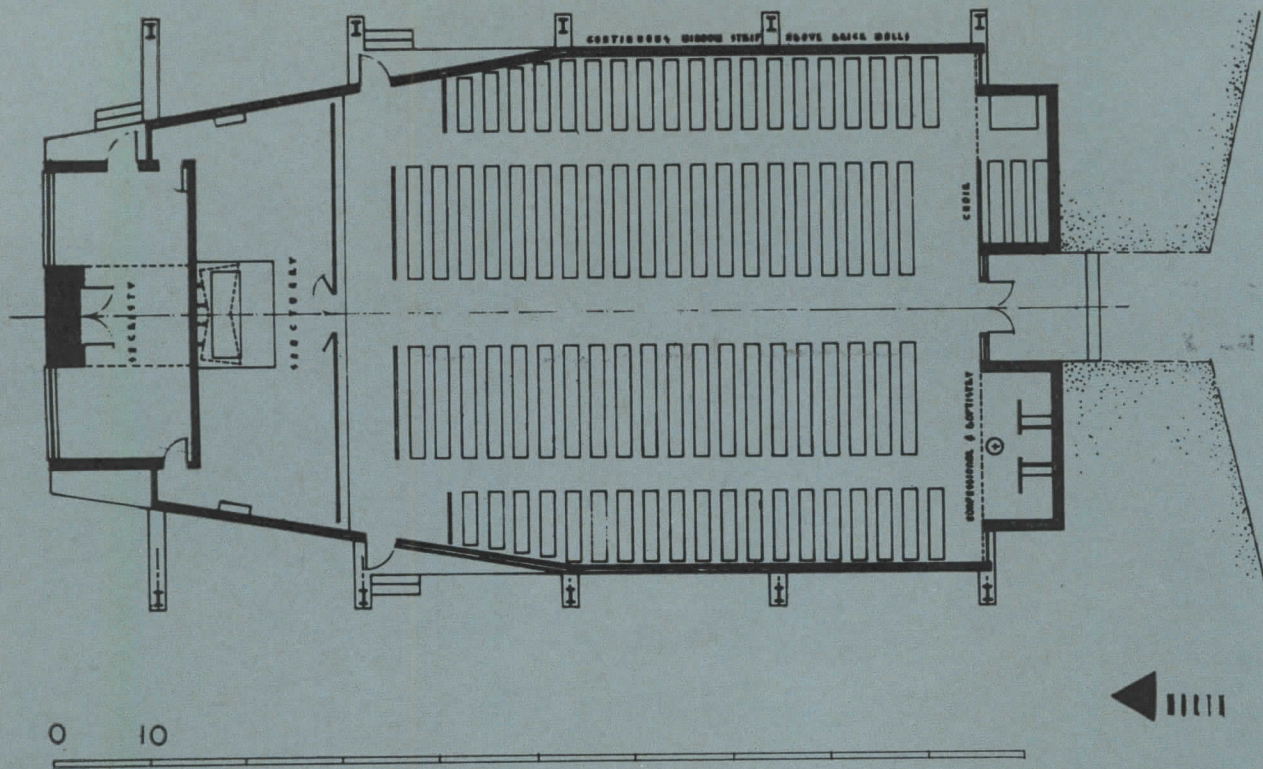



Frank Lotz Miller

of welcome which is afforded, in part, by the transitional spaces under the eaves and behind the rank of supports. The penetration of these 10-in. hollow core brick walls with exit doors seems an unhappy necessity in an otherwise splendid geometry of concrete stabilization posts, brick infilling, and steel sash patterns.

THESE LATTER ARE GLAZED in delicate tints of marine antique glass. Although the building is not constantly open regular services are offered for 400 people. The rigid steel frame carries a steel deck with built-up composition roof. The exposed deck constitutes the ceiling finish except over the chancel bay where an acoustical ceiling is hung to conceal electrical

work, reduce noise, and provide an accent over the altar as well.

The floor is of concrete on earth fill with an added surface that was hardened, colored and waxed.

The wall separating sanctuary and sacristy, the canopy over the altar, and confessionals are of white oak plywood. The custom built furniture includes oak pews, a communion rail in oak and steel, a marble altar with iron candlesticks. The crucifix is of wood with a terra cotta corpus. Tabernacle is a stock steel box painted and suspended by bronze bars. All furnishings are included in the total cost as stated.

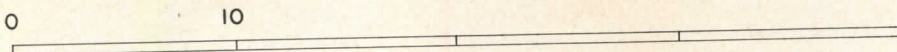
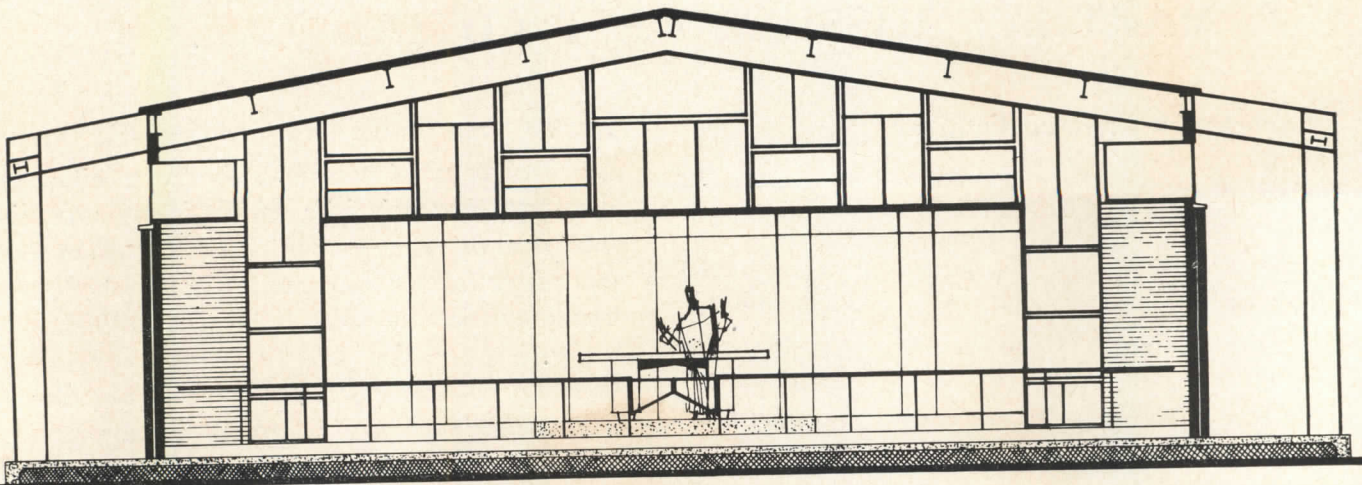

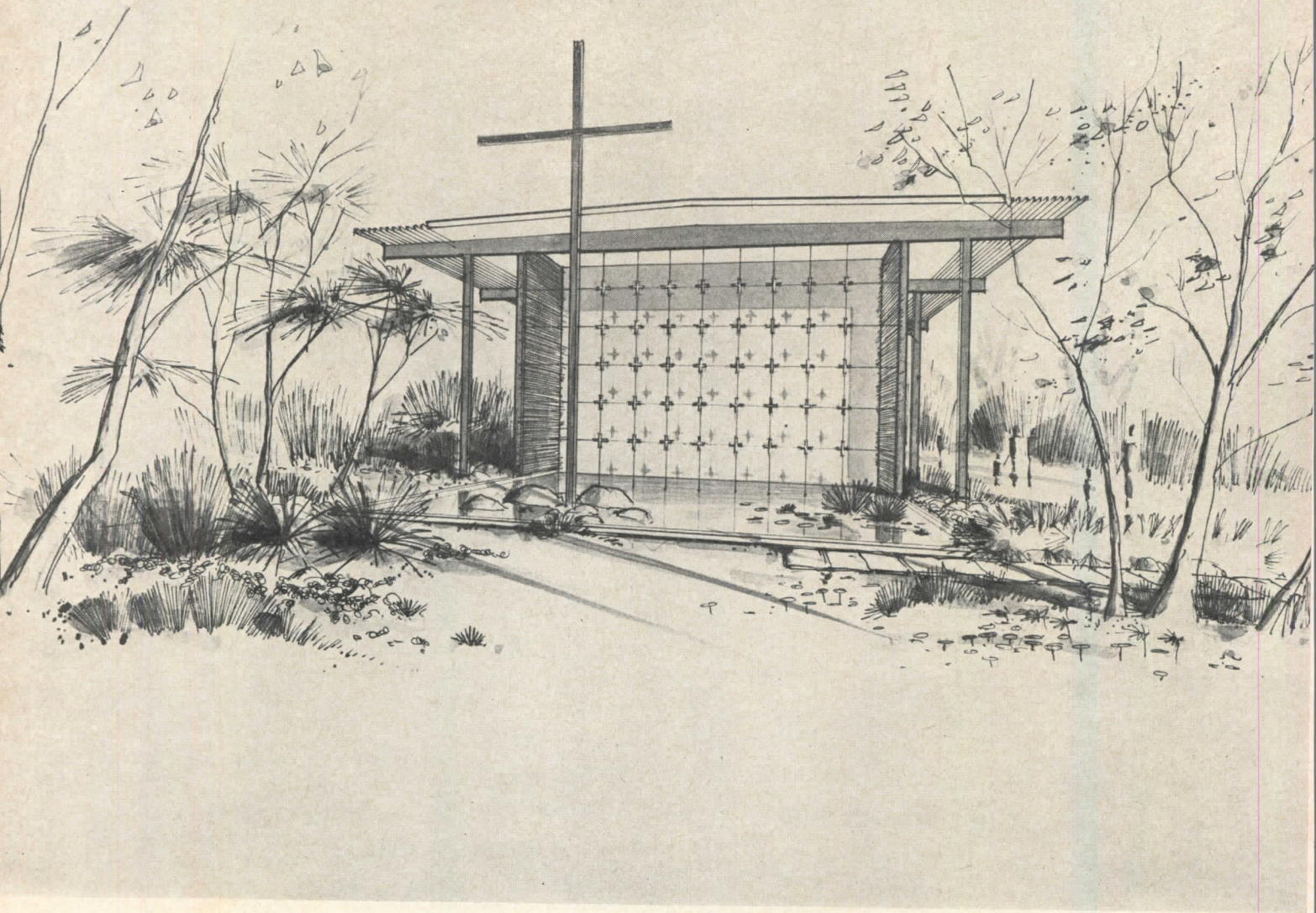

ST. MARTHA'S MISSION, WEST COVINA, CAL.

Carleton Winslow, Architect

In the final analysis instructive examples of architecture must possess and express either one dominant characteristic which is so appealing that it integrates — or at least overrides — all other aspects, or some combination of less forceful appeals which have been brought to unmistakable unity.

The proposal for St. Martha's Mission Church approaches such unity through employing in a simple constructional system a direct expression of a few modern materials, a rich color palette and a happy relationship of building to site.

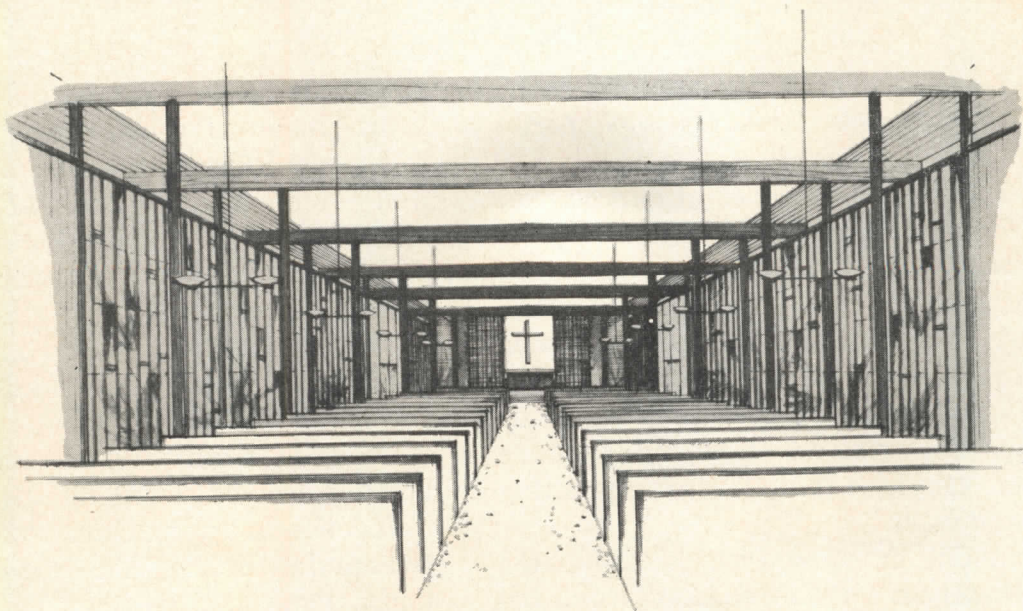
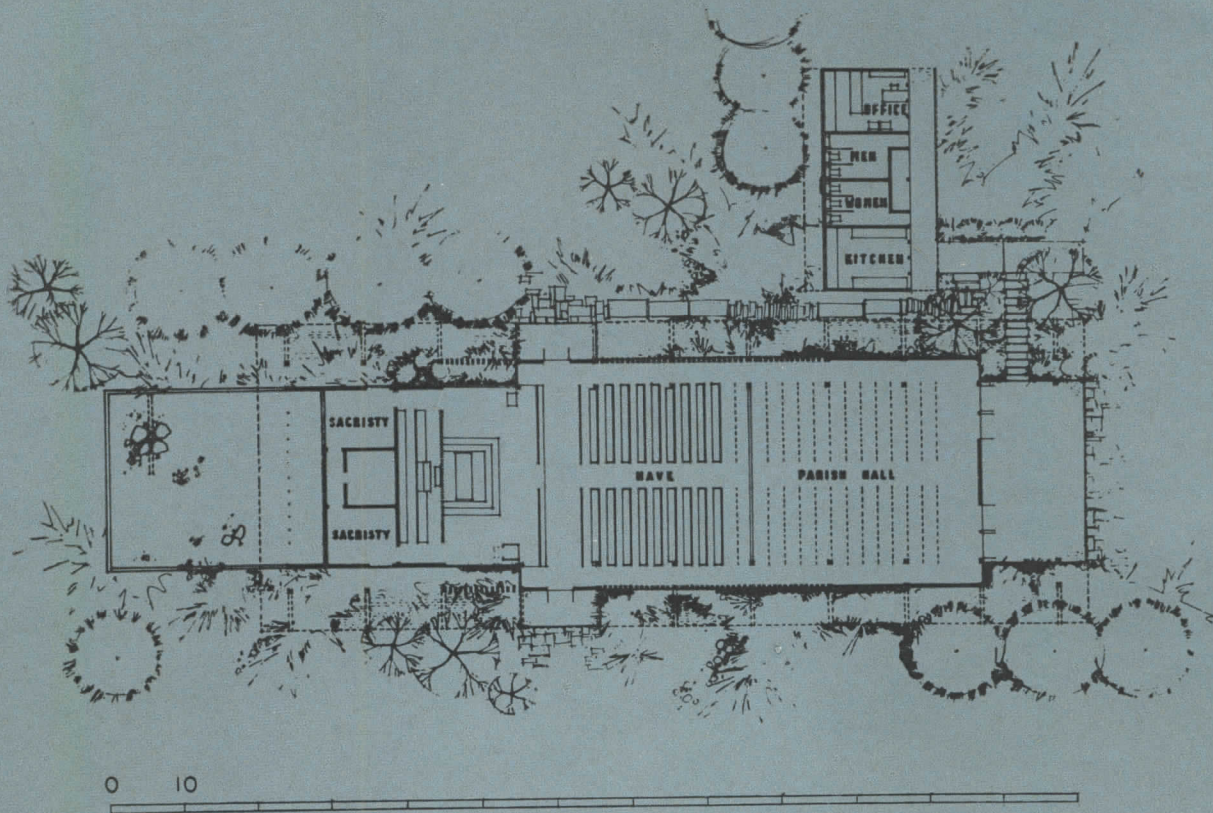

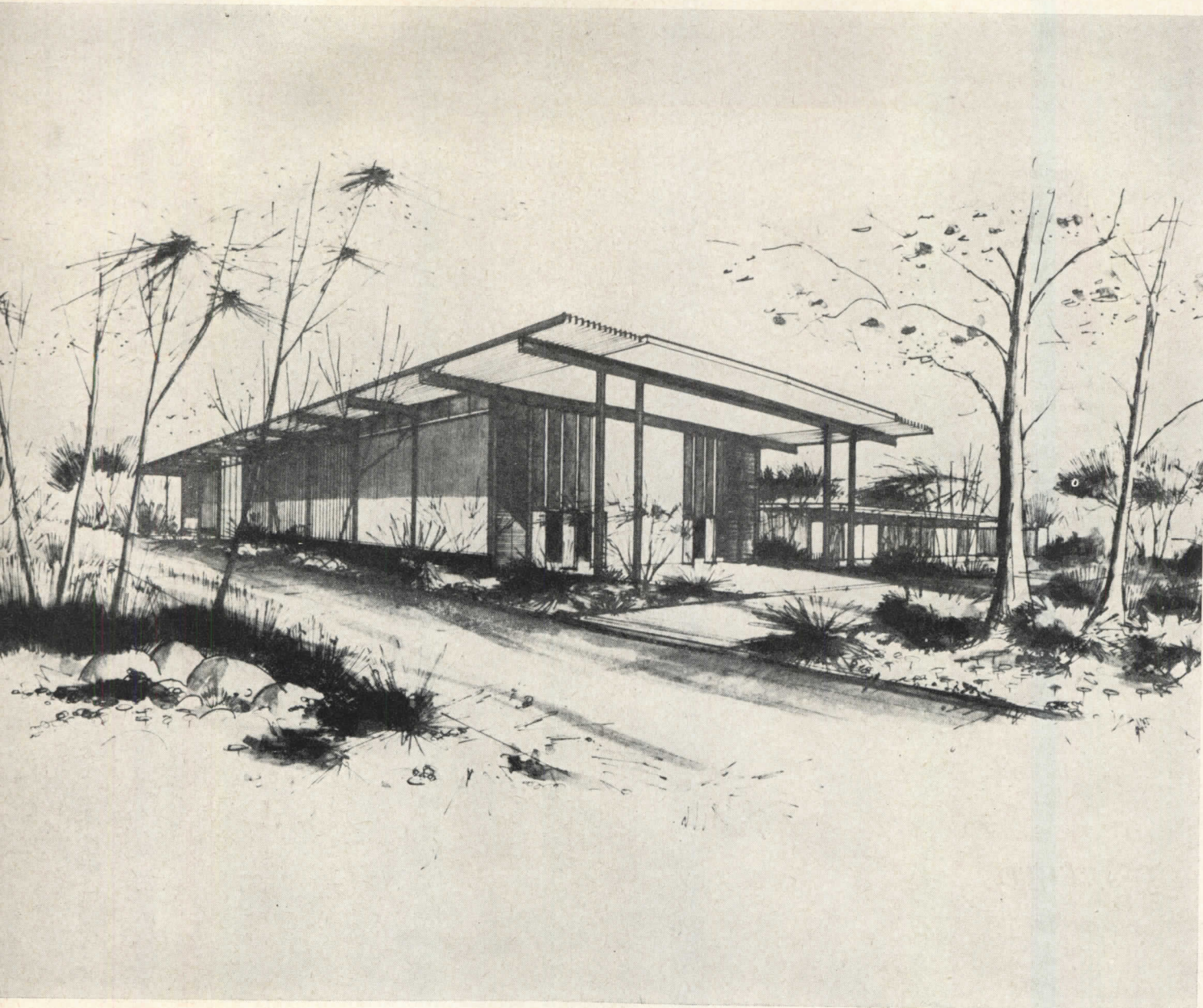

Beyond the question of the appropriateness of its Oriental character for an Episcopal parish in a Los Angeles suburb there is a quality here which recommends the attention of all who must build to limited budgets as well as to those more fortunately funded.

WHEN COMPLETED THIS BUILDING will stand in a grove of trees with a tall, white wooden cross rising from the side of a pool which has been arranged to reflect the end wall of the sanctuary. The wall, which is blue, will be lightly screened by a grid of wires supporting small gold crosses.

The building frame consists of laminated beams carried on square wood posts well be-

yond the side walls to keep out the direct sunlight. The broad overhangs are thus a response to a natural force in the region but provide as well — along with the range of supports which stand free of the building sides — an inviting cushion of space between the inside and the outside.

The side walls are to be entirely of burnt orange glass. Other colors are blue green, gray and royal blue.

Designed to seat 550, one end of the 150-ft. building can be closed off with sliding walls to function as a parish hall. The use of existing trees and the scaling of the building to them is unusual and rewarding.

PONTI AND THE PIRELLI BUILDING

The photographs and drawings that follow show the final revised scheme for the Pirelli office building, now under construction in Milan. The building is the combined work of two Milanese studios: the Studio Ponti, Fornaroli, Rosseli; and the Studio Vallolina dell'Orto, with whom Pier Luigi Nervi and Arturo Danusso worked.

In order to explain his philosophy of design and criticism for ARCHITECTURAL RECORD readers, architect Gio Ponti has composed a text to accompany the illustrations and has also written the captions.

Gio Ponti, widely known as editor and publisher of the magazine Domus, was born in Milan in 1891 and received his architectural degree from the Milan Politecnico in 1921. He has organized many of the Triennale exhibits; has written books on architecture and the arts; and painted the frescoes at the University of Padua. In addition to designing office buildings, villas, expositions, a college building and a mountain hotel, Ponti has designed furniture, various industrial products, and ship interiors.

OUT OF A PHILOSOPHY OF ARCHITECTURE

By GIO PONTI

Translated by Dr. Nathan H. Shapira, Architect

IN ASKING ME to state my "philosophy of architecture," ARCHITECTURAL RECORD does me honor, for surely one's philosophy is more important than his works. For many reasons, actual works involve circumstances beyond our control, and the architect has at his disposal only limited powers with which to oppose them. It is difficult for the designer in practice not to betray his ideas, and in the final analysis it is the observer (you, the reader) who must judge how faithfully the reality follows the thought. To me this appears the only correct basis for judgment: that the work be judged only after the ideas generating it have been evaluated.

These thoughts are limited to an attempt to clarify the judgment of the "new architecture" by relating it to several unchanging ethical terms.

Obviously, a new architecture exists: new in terms of materials, structures and techniques which determine new spatial relationships; new in terms of new purposes, new requirements, new sizes, new customs, new functions, new relationships to environment, new conditions. But the new architecture also has a constant basis: *man*.

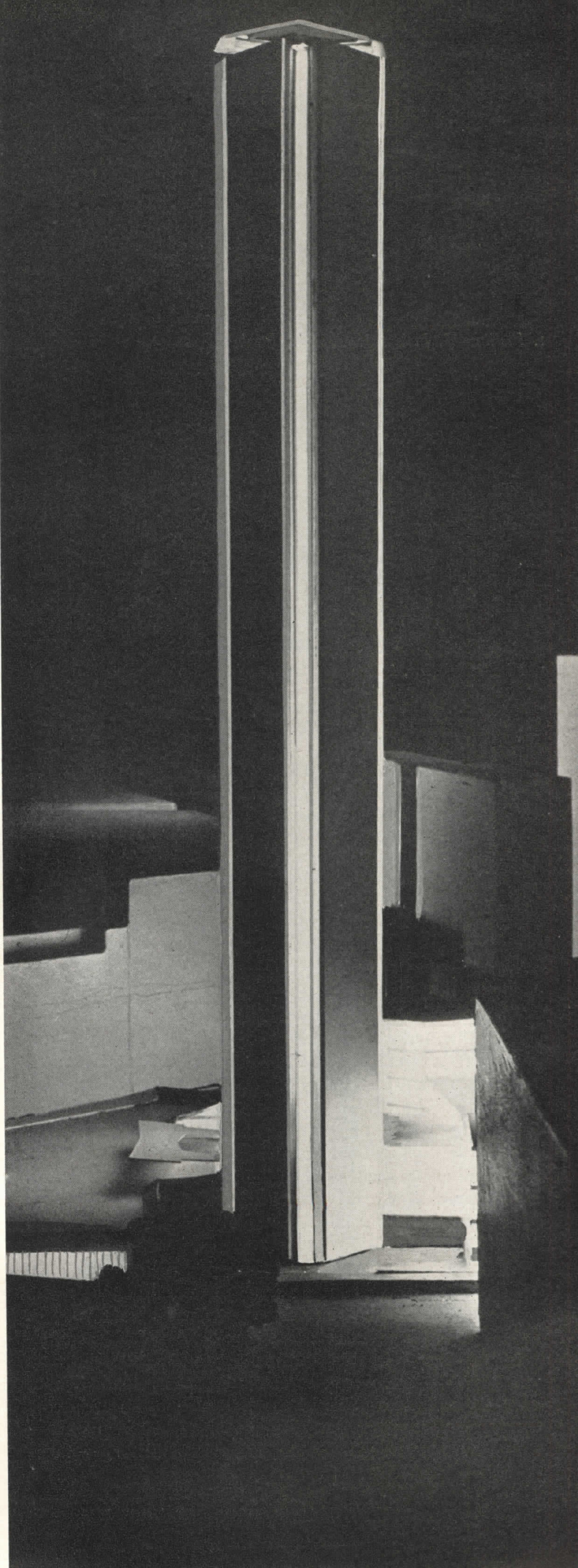

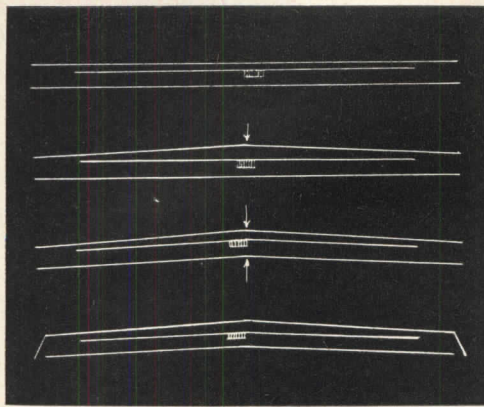

1. *Institute of Nuclear Physics, Sao Paulo*

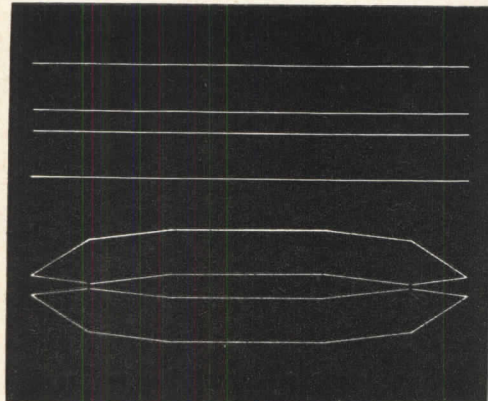
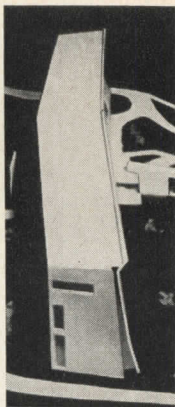

2. *Pirelli Building, Milan*

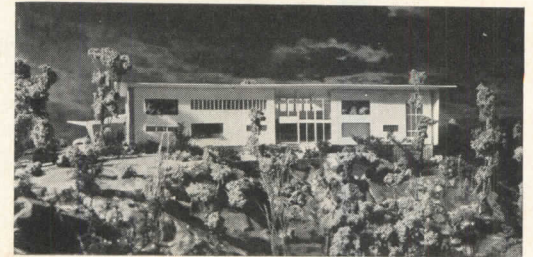
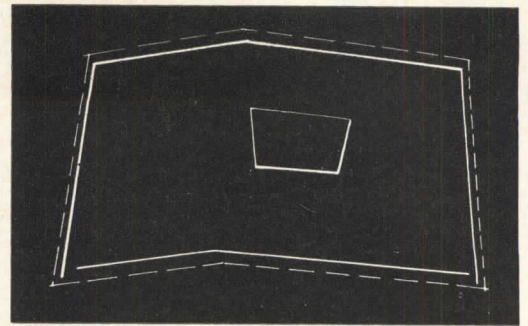
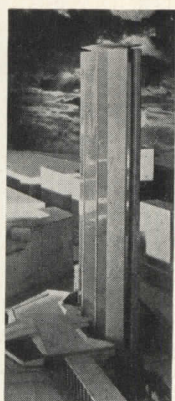

3. *Villa Planchart, Caracas*

THE SEARCH FOR FORM

1 & 2, transition from a parallel pattern *ad infinitum* to a closed or definitive pattern; 4, progressing from two prevalent aspects (frontal and symmetrical) through spatial composition to a design with multiple aspects — greater complexity with continuous change in form. 5, A complete or closed form within a grouping of diverse elements with differing functions — hotel element at left, foundation proper at right. 3, The final realization of a complete “closed” form

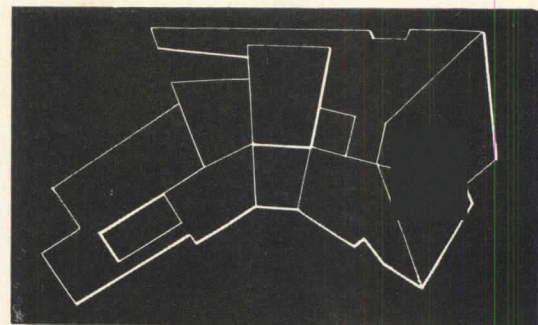

4. *Villa Arreaza, Caracas*

PONTI (continued):

There is also a new man. There is always a new man, but there is always *man*. And there is a universal condition, nature, which is never new, but constant.

It is equally obvious that the “past” and its formal tradition are no longer useful conceptually in designing this new architecture. In the context of all these new things, there is a genuine gap between the architecture of the past and our architecture. But — and here is the core of the issue — when the new architecture must be judged as a reality and a work of art, then the term “new” no longer exists, for we must evaluate it within a framework of universal and unchanging terms.

There is, of course, a type of judgment — the “historical” — which is extremely interesting and which vastly enlarges the boundaries of architectural study. Such a judgment considers “architecture” as the totality of all built things; it makes use of all those aspects listed above, and it considers esthetic value as *one* of these. But can this be the judgment of an architect? Is it not rather the judgment of an historian who — correctly enough for the purposes of history — takes

everything into consideration? The judgments of the working architect, who is active, and of the critic, his contemporary, are necessarily more restrictive. For the practicing architect and the critic, this historical enlargement of ideas and boundaries — which embraces and hence accepts everything on the same level — hardly clarifies the thinking that inspires art. Nor does it contribute — once these ideas have been defined — to the aim of clarifying and purifying the end product.

To relate the new architecture to *absolute* esthetic (i.e., ethical) values, and to consider this relationship *exclusively* in terms of architecture — or, to establish the condition of a work belonging to architecture, *which implicitly and necessarily gives us all the rest* — favorably limits one’s judgment. It excludes innumerable buildings old and beautiful, but it helps clarify evaluation.

In viewing architecture as “a work and creation of art” there is no past, because *in our culture everything is simultaneous*. There are no new ways of judgment; we must approach works of architecture on the level of

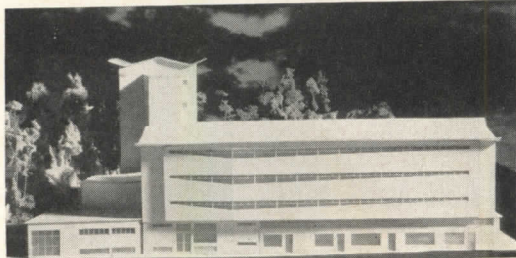
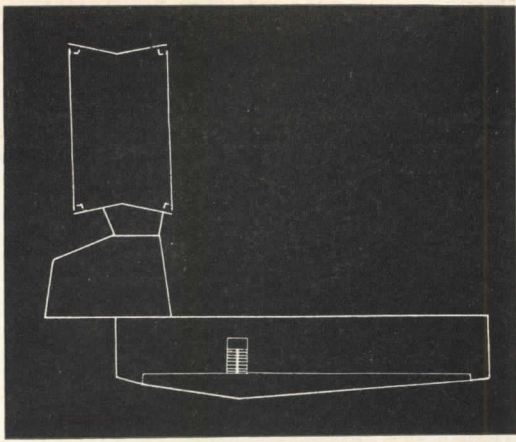

5. Garzanti Foundation, Forlì, Italy

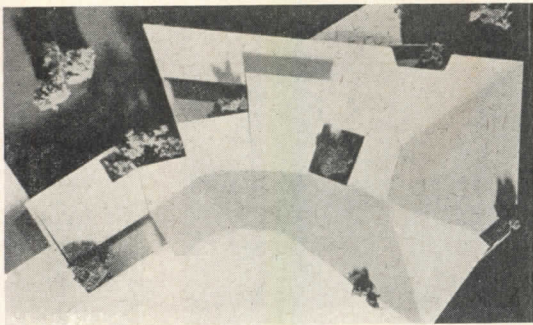

a pure and exclusive evaluation of art. Neither history nor new techniques, materials, structures, sizes nor new functions will alter the eternal and unique conditions of this judgment, because such conditions are moral. The pure judgment of art cannot alter these conditions; rather, it occurs after them. The architectural judgment of a work is unique and permanent, regardless of whether it is art, whether it is beautiful, or whether it delights us. And that judgment must be kept separate from everything else — use, purpose, material, technique, period, and so on. These latter considerations are implicit in the pure evaluation of any work, beautiful or ugly, but *they do not function on the level of art.*

Thus, when I admire Philip Johnson's steel and glass pavilion by saying it is an example of Attic, you will understand that my judgment transcends the work itself in one exclusively spiritual answer in the permanent and unchanging terms of thought. Thus, my notion of *the Attic* symbolizes a supreme degree of purity rather than a place or a period. The conceptual framework I use in approaching architecture as a work of art may be

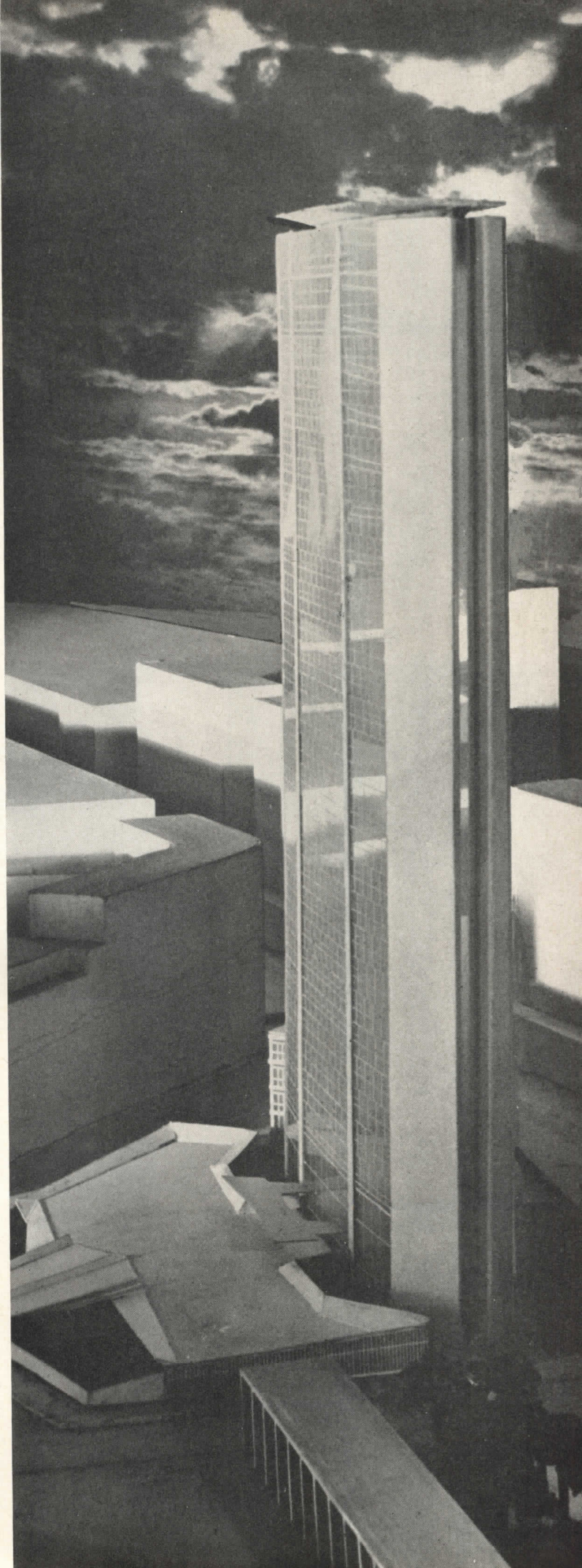

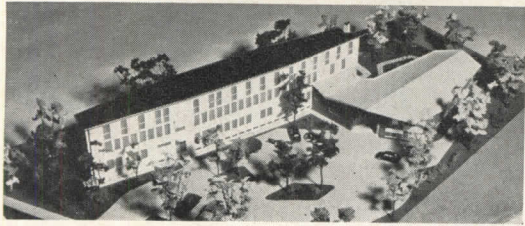
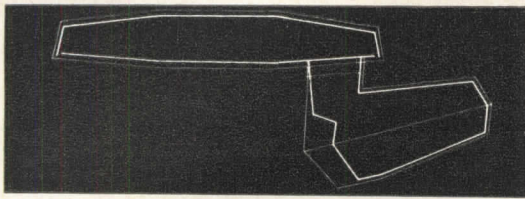

6. Institute for Italian-Swedish Culture, Stockholm

THE SEARCH FOR FORM

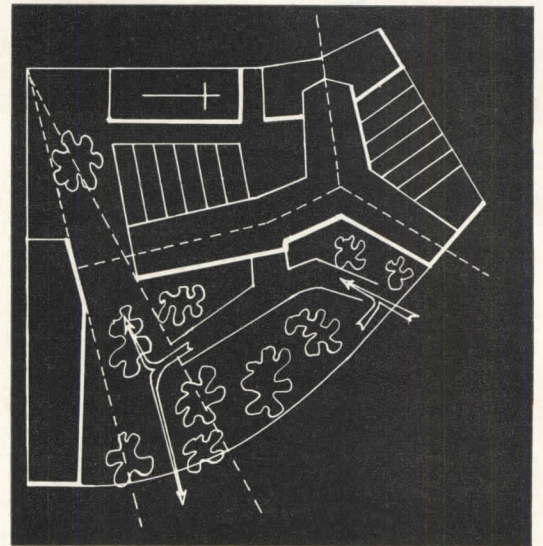

8. R. A. S. Building, Milan. Ponti, Ponti, Fornaroli, Rosselli & Portaluppi, Architects

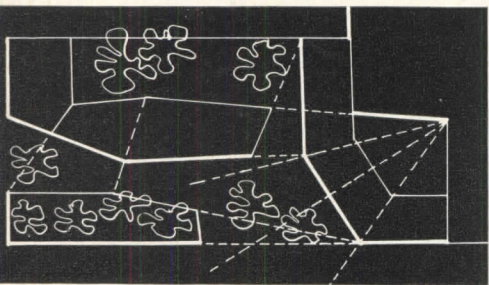

7. Gallini Center, Voghera, Italy

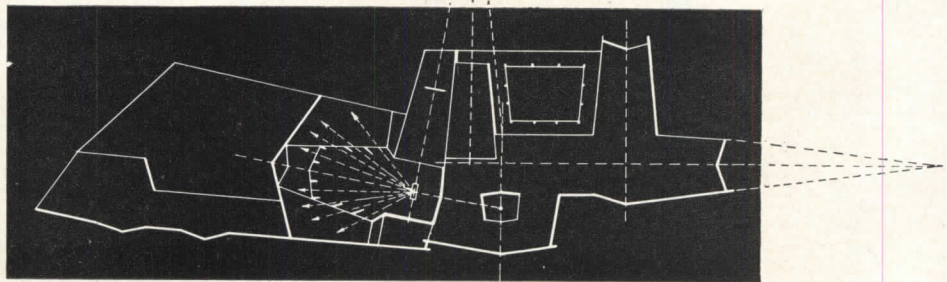

9. Monastery & Church, San Remo, Italy

PONTI (continued):

formulated in the following terms: (1) *Formal and Structural Inventiveness*, (2) *Essentiality*, (3) *Representativeness*, (4) *Expressiveness*, (5) *Illusiveness*, and (6) *Perpetuity*.

At the risk of repetition, let me say that I respect the historical judgment of an example of modern architecture as it relates to comparisons, documentations, and analogies; in relation to technology and its evolution; and in relation to changed social conditions or customs. Further, in terms of historical-critical evaluation, the search for similarities in the works of different creative minds will sometimes offer a superb testimony of culture. However, in the field of creation — in the field of architecture to be done — to evaluate architectural validity we must judge exclusively in universal and permanent terms. In such terms, the contingencies of periods and of places, of materials and of functions, count for nothing. One might even say that a work of art is entirely a matter of interior re-imagination, despite whatever similarities the thread of history might — by chance — show.

I do not underestimate the constructive values and the functional clarity of architectural drawings; all that is implicit in each sensible work of architecture. This was always so, especially in primitive works. But functionality is necessarily a constitutive term which has no importance in our judgment because we judge solely whether or not architecture is functioning on the level of a work of art. There are buildings that function admirably on the practical level, but which simply do not function on the artistic level.

There are so many examples of architecture that were brought into being for a specific purpose (a home, a palace, a church) which were preserved afterwards and remain valid for other functions because they are beautiful. They function now on the artistic level! Even ruins can function on this level when every other use has been lost; they speak forcibly to our minds in unchanging terms.

I believe that both in judging and in creating architecture as art, each work must stand alone before

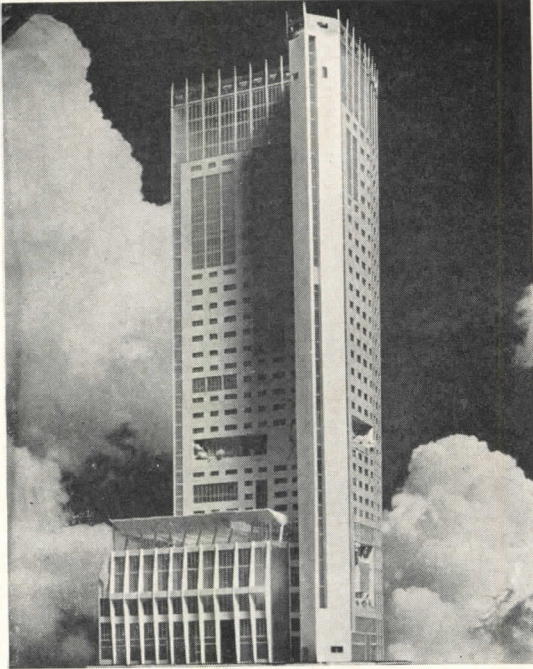
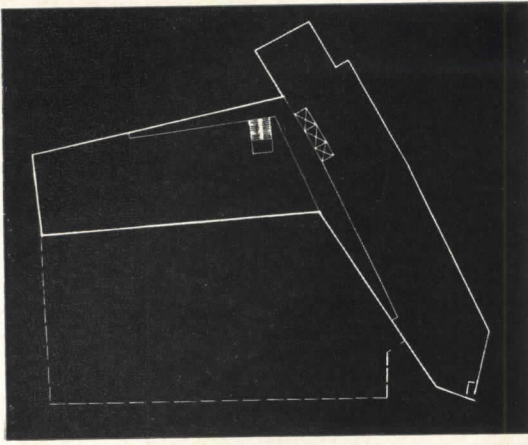

10. Project for Italy House, Sao Paulo

certain laws — universal and unchanging conditions. I have formulated these laws in my own way, and should like to explain how I justify them.

Formal and Structural Inventiveness

There is formal inventiveness, whether of unity or of composition, only if there is a form. When there is a form it can be only finite — i.e., closed — either materially or conceptually. A form is unchangeable, unrepeatable, unique, and coherent in each part. When there are forms whose structures are identified with architecture — this occurs markedly today and this is what I mean by structural invention — then there exists a *forma veritalis*, a truthful form, integrity of form. Formal and structural inventiveness is a term of judgment. It is judgment brought to bear on the facility of the architect's *imagination*. Even to make rational architecture we need architectural imagination.

Examples? In the Falling Water House and in the Ronchamp Chapel there is formal invention. In buildings where there is a simple repetition of elements there

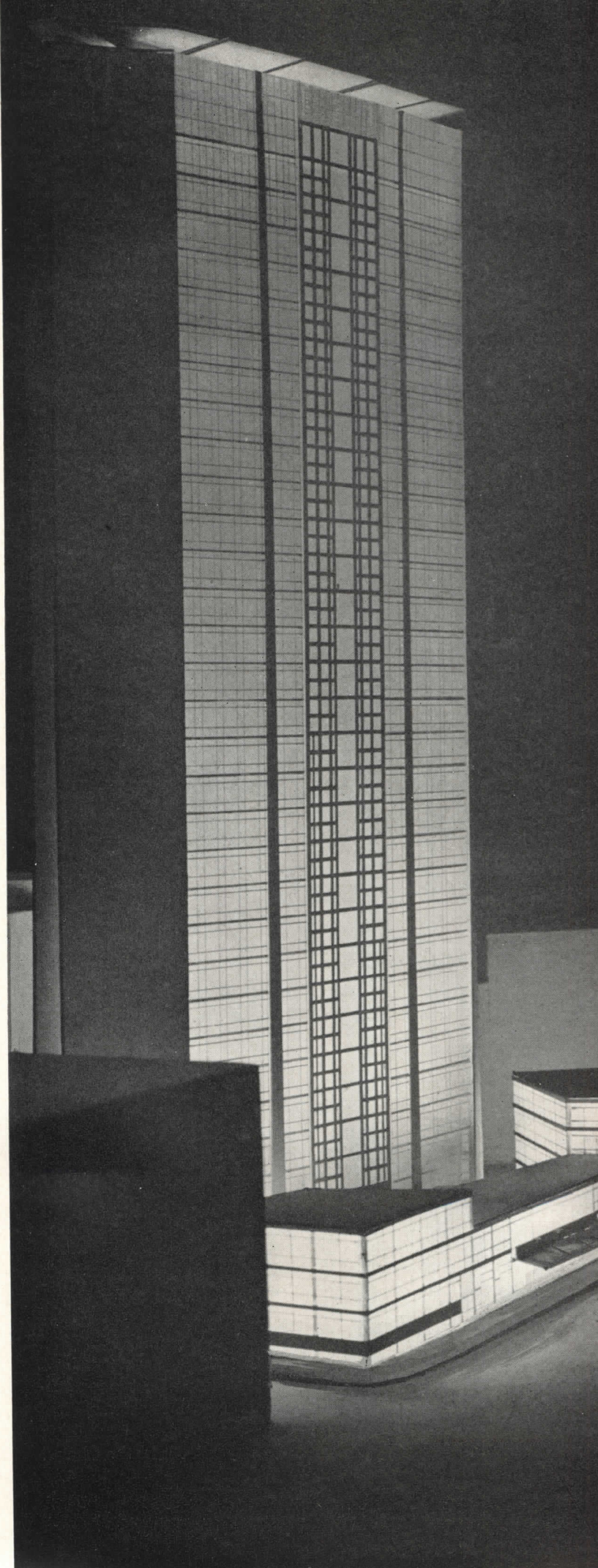

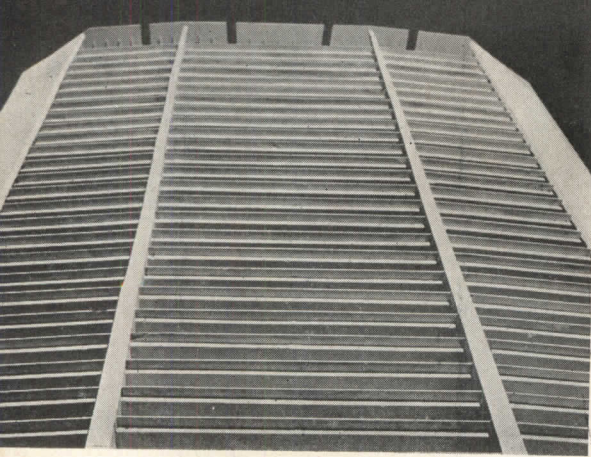

THE PIRELLI BUILDING

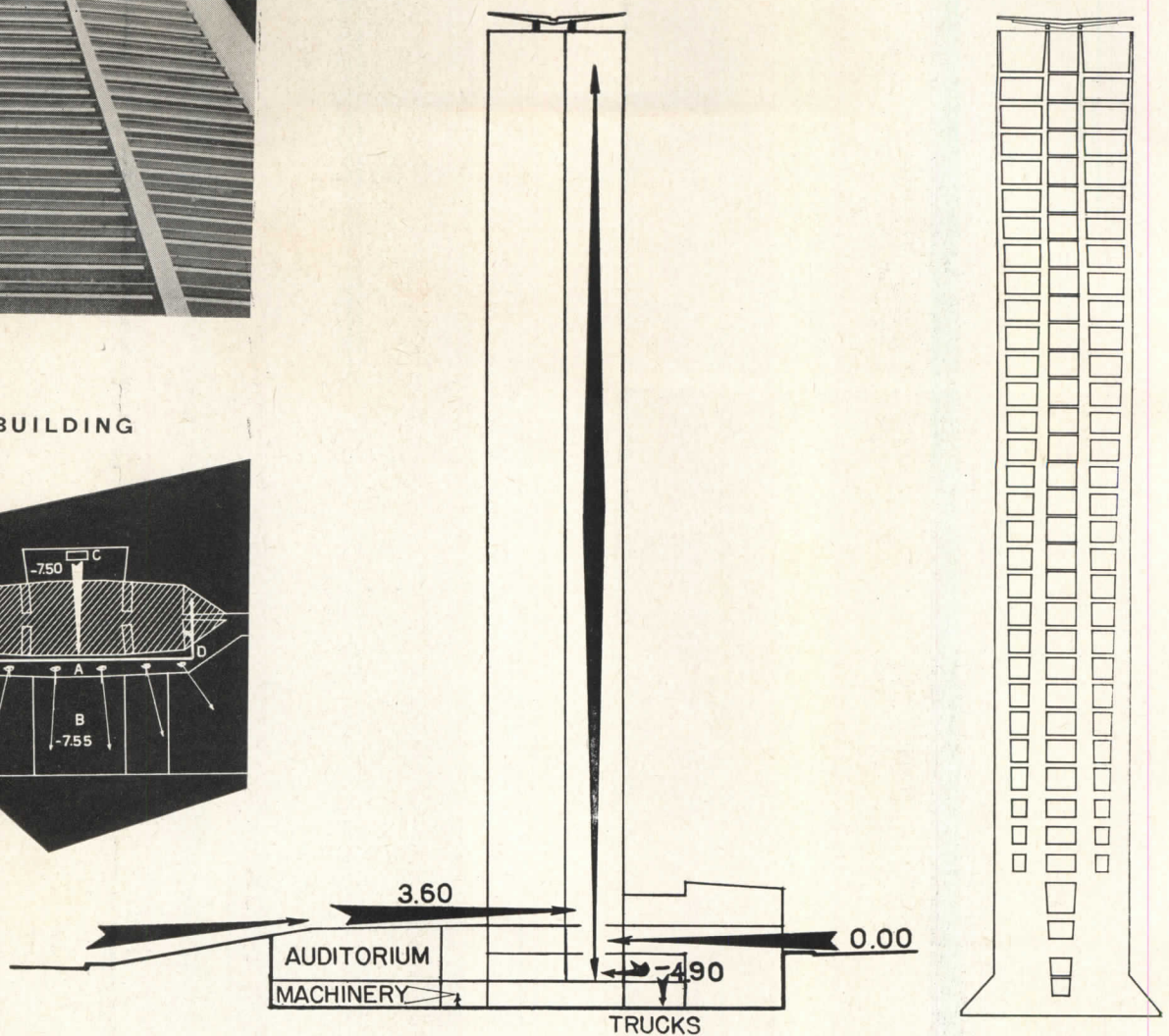
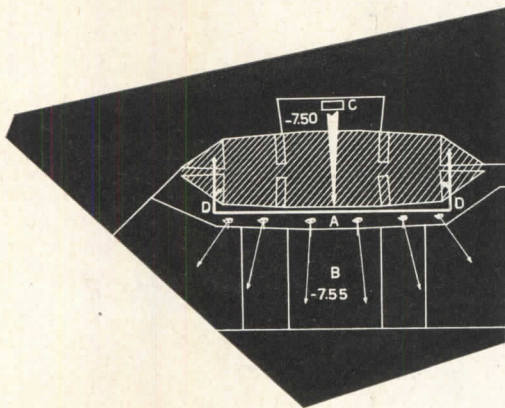

PONTI (continued):

is no formal invention. Consequently such elements are a matter of technique and not of art.

Essentiality

A construction is truthful if it is brought to its very essence, in opposition to any esthetic dogma, academic notions (whether traditional or modern), or the insistence upon decoration. Care must be taken, however, that the plasticity of the architecture of the past is not confounded with the function such architecture served in celebrating some person or event. The work must arrive at the point where nothing can be added or taken away; it must arrive at unity, essentiality. Essentiality is the term of judgment that *measures* a work.

Representativeness

A building must visually represent to the mind that purpose for which it was or is dedicated. In the masterpiece there is no equivocation. A palace is a palace; a temple is a temple; a house is a house. The Falling Water House by Wright is exactly what it is; the Chapel

at Ronchamp by Le Corbusier is no more or less than *une chapelle*. It is only during periods of decadence in creativity — periods when the academic has dominated, or when history has turned back on itself — that architecture has created sham and confusion, and has abandoned clarity. Such work is "*architecture d'apres l'architecture*," as Cocteau would say — to which I add, *et pas d'apres une creation*. It has created stock exchanges, railway terminals, parliaments, institutions, according to the design of Grecian temples. The representative aspect must be alive, rich in imagination, recognizable in the constitutive part of architecture.

The representative aspect characterizes the building and cannily brings it to popular understanding, to that *communication* which is one of the terms in the proof of the existence of art. This is the element of judgment brought to bear on the *character* of the building.

Expressiveness

This is that wisdom of an architect which knows how to make his building understood by the visual message of

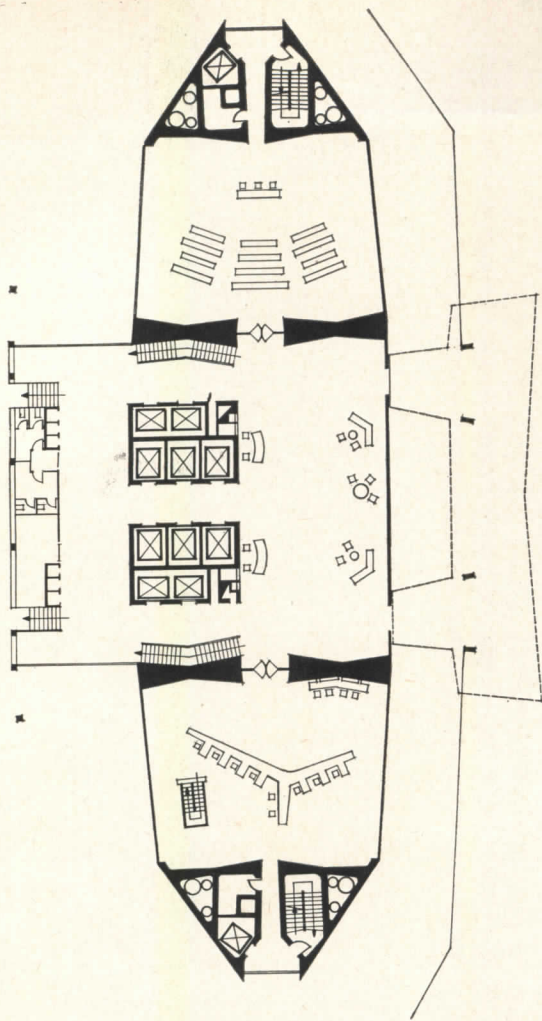

The plans make clear the manner in which the bifurcated columns diminish in area towards the building's summit. In the small plan, left page, C indicates the truck entrance and lift; D shows the glass-enclosed gallery where visitors may view mechanical and electrical equipment, located in the area noted as B

its elements. It is an interpretation of those elements in a way that makes them clear in the language of architecture and hence clear in the mind of the observer. It is the judgment of the architect's *acuteness*, of the manner in which his imagination *speaks*.

Illusiveness

This characteristic is one which transposes the building to a higher level — sheerly poetic and unreal — where a volume, a dimension, a weight, or a manner becomes meaningful. Without this quality of poetry, of unreality, the building is not a work of art; it remains in essence technique and engineering, not architecture.

According to Le Corbusier, a building "*doit chanter*." This song (*canto silenzioso*, if I may call it that) is the song of architecture, which abides in illusiveness. An example: the Ca d'Oro in Venice has weight, as do all other palaces, but how light it is! Remember that architecture is not only static but also ecstatic; its poetic unreality is its only true reality. This is to say that illusiveness is another term of judgment.

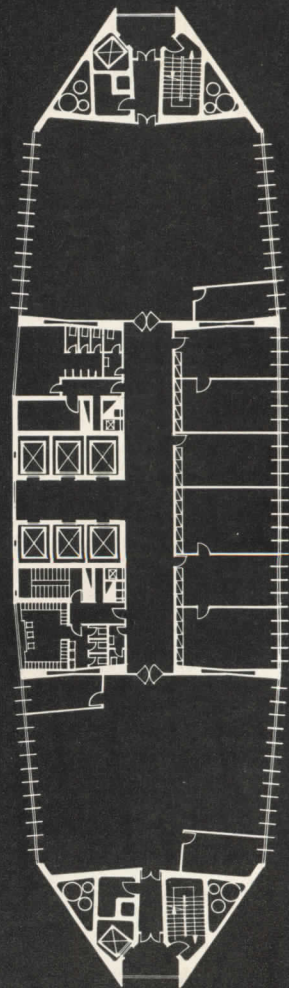
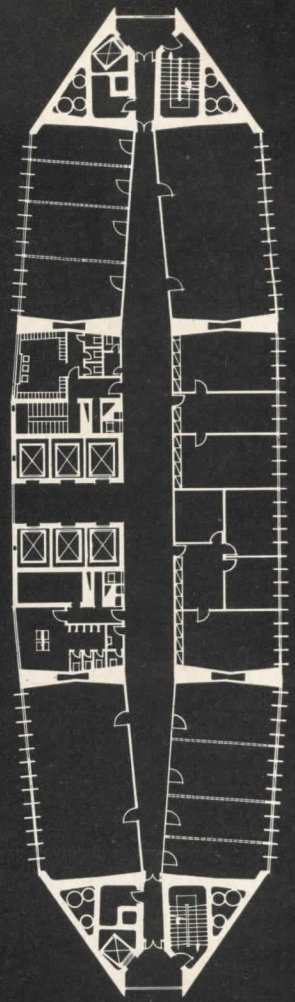

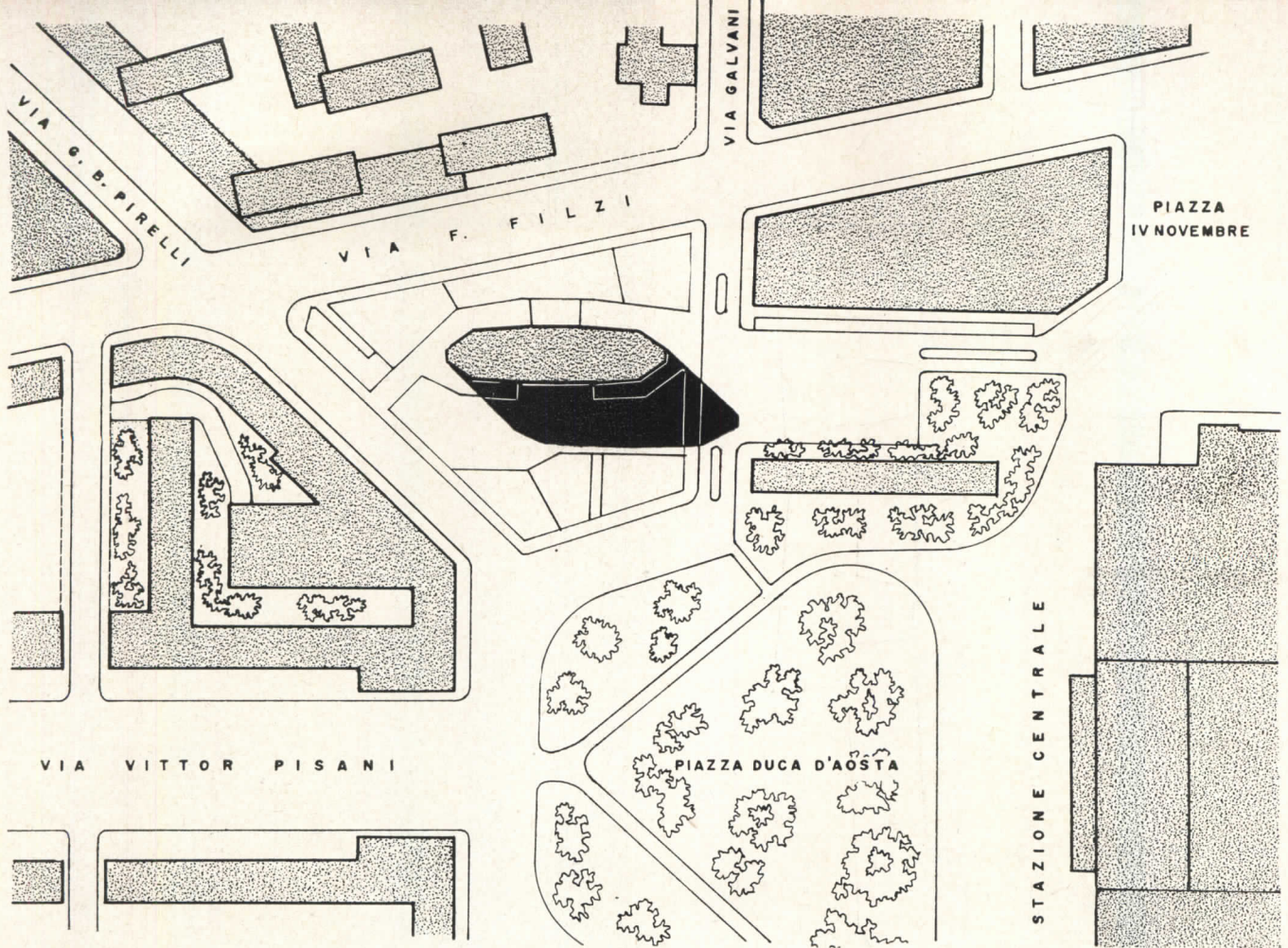

THE PIRELLI BUILDING AND THE CITY

Development in height is justified in a city when the ground area occupied by the building proper is small, so that the surrounding areas are freed for the movement of traffic and for parking. Based on a 20 minute time limit, the plaza between the bounding streets provides parking for over 2,000 cars during the working day. Inner truck road (dash line at right) descends 5 meters below street level

PONTI (continued):

Perpetuity

This derives from all of the foregoing terms because they are ideal terms, universal terms, and hence unbounded by any of the contingencies of time.

Can you conceive of architecture as a work of art when it does not contain formal and structural inventiveness, or when it does not possess its own finite, unchangeable and unrepeatable form? Its unchangeability lies in the perpetuity of its form. Buildings constructed with equal elements repeated vertically and horizontally, with parallelisms, and with no limitations which derive from a composition (form *is* composition) are admirably congenial, if you will, but they belong to technique — which functions on the level of pure utility — and to engineering — a wonderful discipline, but one which has nothing to do with architecture as art.

It is advantageous to distinguish clearly between technique and art; between engineering (even in cases where it is splendid) and architecture (even if it is simple); between that which grows and advances (as

engineering does) and that which possesses perpetuity (as Palladio says). If there is an architecture that interprets the social progress of civilization and which takes advantage of technological progress then, for me, such a progressive architecture cannot exist as a work of art.

Technology is progressive; art (and thus architecture as art) is not progressive, it is perpetual. Technical work is repeatable for it is a prototype and repetition does not falsify it. Each repetition of technology is authentic; each Cadillac is a Cadillac, each factory type bears repeating, as does a bridge. Each example of architecture — the work of art — is a monotype; it cannot be repeated; it is absurd to repeat it; the repetition would be a fraud. Would you duplicate the Falling Water House? The Chapel at Ronchamp? Would you make a row of Falling Water Houses, each repeating the other? The work of art is permanent — “perpetual” as Palladio says. Let us preserve it! It is always alive, even in ruins.

A work of technology dies by self-transformation be-

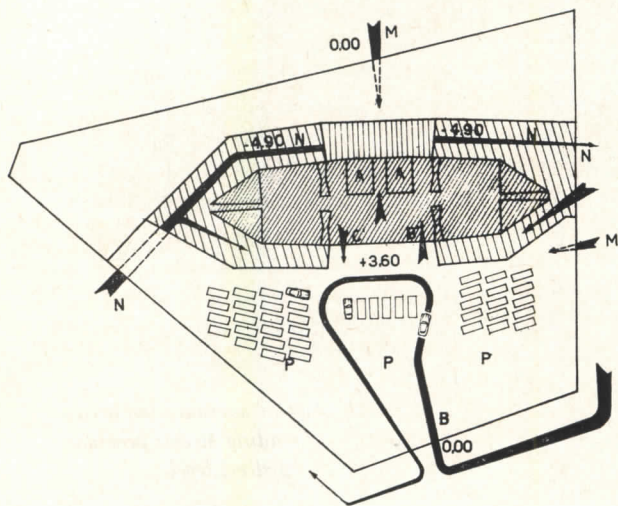
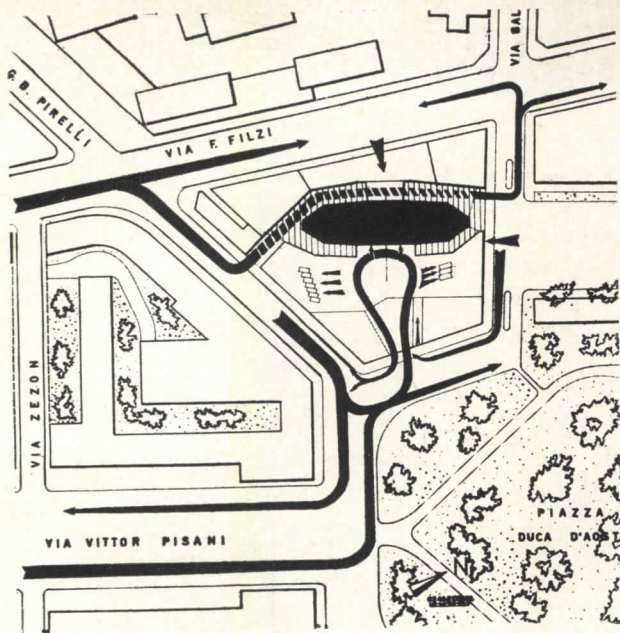

cause technology supersedes itself, is progressive. We do not preserve a worn out product of technology; its ruins are bits and pieces. An old car is grotesque, and so is an out-dated factory building. We can think in terms of permanent value and of full poetic and spiritual efficacy when we speak of any work of art, yet how can one conceive of the permanence of a car, a locomotive, or an airplane — even if they are beautiful?

So, for me, prefabrication and social architecture are works and technical services; works and social services. They are *historical architecture*. That is only by chance a work of art which, by its creation, generates models according to which things are prefabricated, for such is purely an historical and academic fact, not an artistic one; it is a transitory fact, not a perpetual one.

Conclusion

My understanding of these terms for judging and designing matured slowly, and any merit they may have is due others. To understand them is to feel their shock, even by contrast. I passed from buildings having

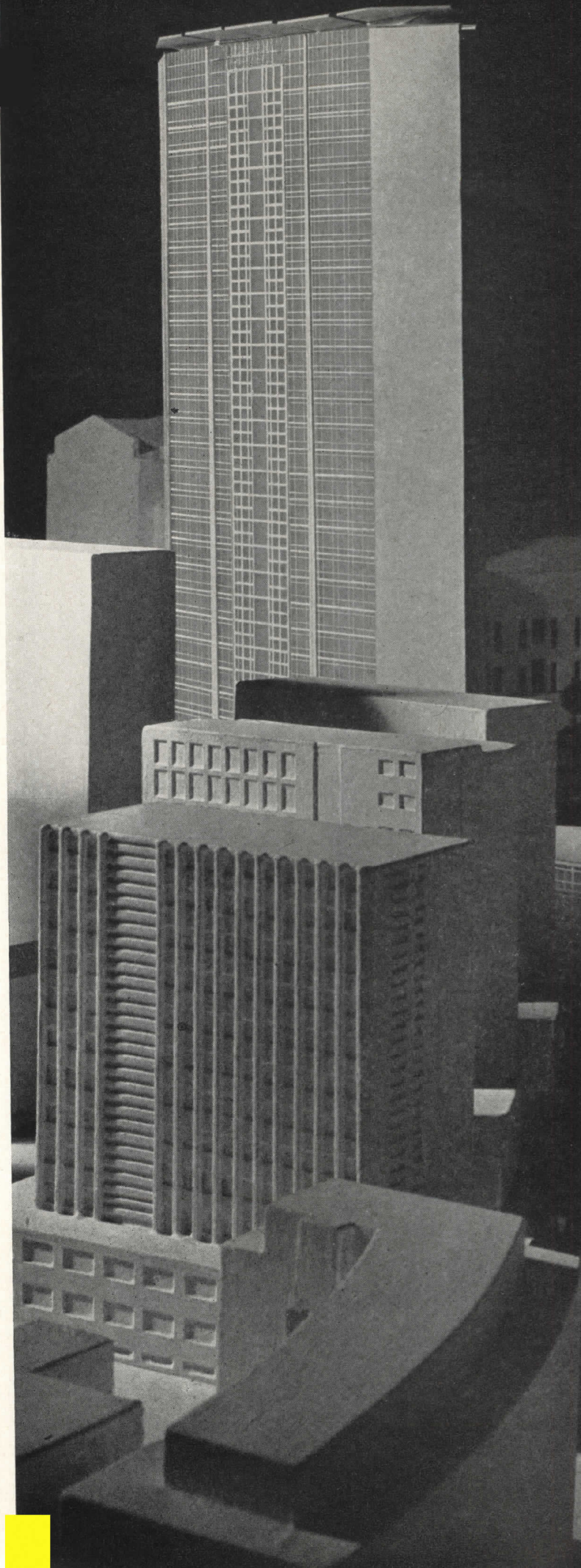

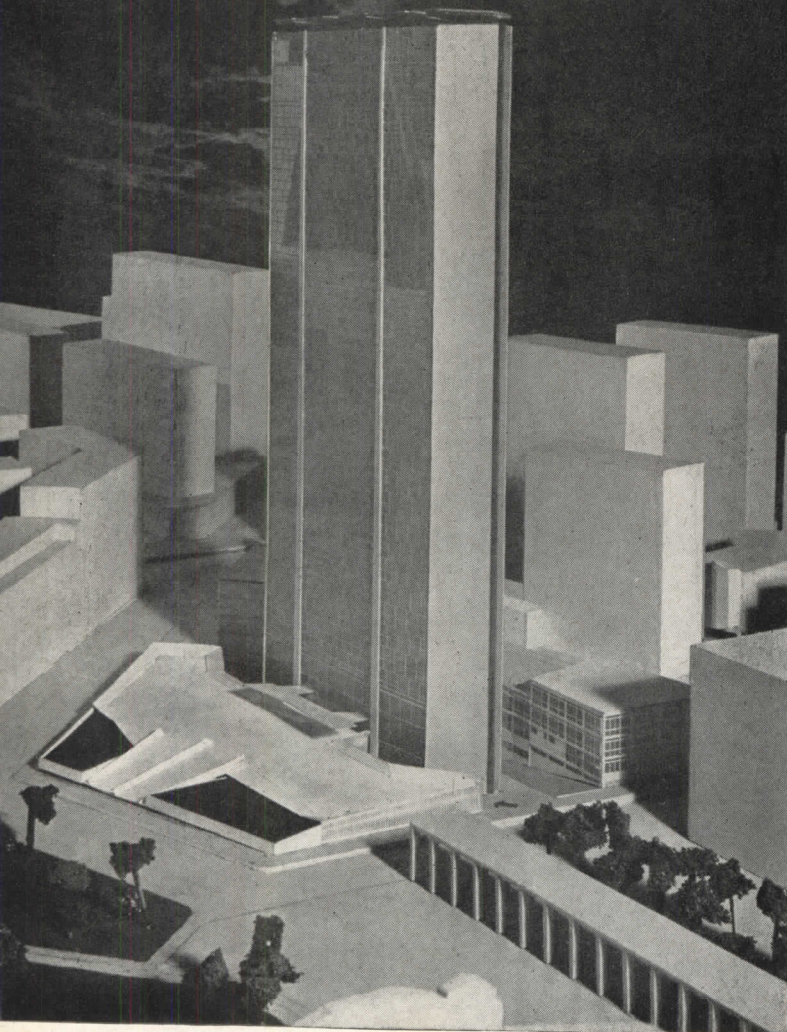

THE PIRELLI BUILDING DAY AND NIGHT

I should like to mention — as brief observations — some recent developments in modern architecture. These do, however, always enter into esthetic judgment in the terms I have mentioned.

First, it appears that our architecture is divorcing itself from the use of materials upon which time can act competitively. We are coming to use incorruptible materials; non-oxidizing metals, glass, ceramics, plastics — materials born of technology and not of nature; materials which do not become old. But when architecture does indeed become old, can we then say that its materials too have become old? That which has everlasting value can hardly be old.

Next, in addition to designing for daytime we must consider the night. Why not develop the possibilities illumination offers for obtaining a different optical effect that changes forms, distances, sizes, volumes, silhouettes, weights, and creates (or annihilates) spaces and spatial relationships? This can be a brand new dream for architecture. American architects: take this idea and let it revolutionize the aspect of your cities at night! Or, let me collaborate with you to create a building, even a small one, of two architectures — for the day and for the night!

— Gio Ponti

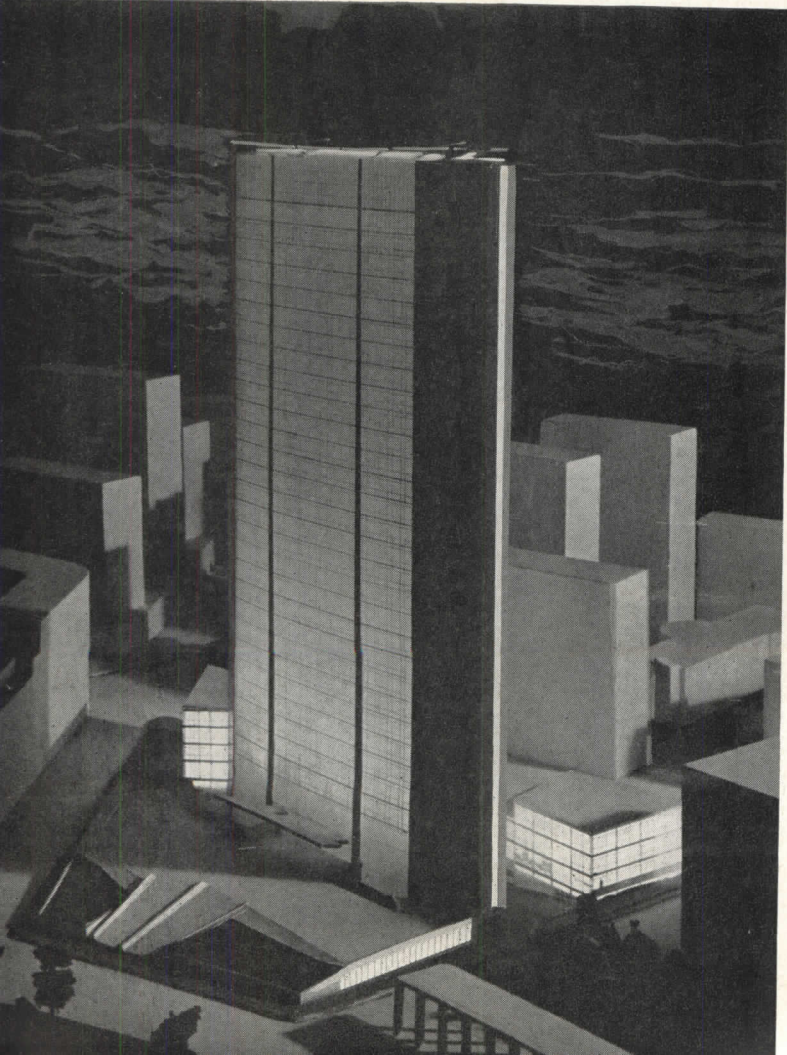

PONTI (continued):

parallelisms without finite form, or having only perspective variations — to the search for closed forms and for visual variations as one moves about them. I passed from closed buildings (volumes) to buildings penetrable visually (spaciousness). I passed from inexpressive to expressive buildings. And I will, if God permits, include light in architecture for the night.

In permanent terms, the result enters into the spirit of "classic without classicism" — i.e., becomes classic without classical elements. Paraphrasing the title Edgar Kaufman gave his article in *Art News* on the Pirelli building, "a new look in the old American art of the skyscraper . . ." I might say instead, "an old look in new American . . ." Why? Because, in effect, what we sought was an order for all time, not a new order. And because, in effect, the American art of the skyscraper is new; did not exist before historically modern times. This does not diminish the fact that the Pirelli building has a new look, despite its "obedient order." The novelty is that the new construction is reformulated in accordance with perpetual spiritual laws.

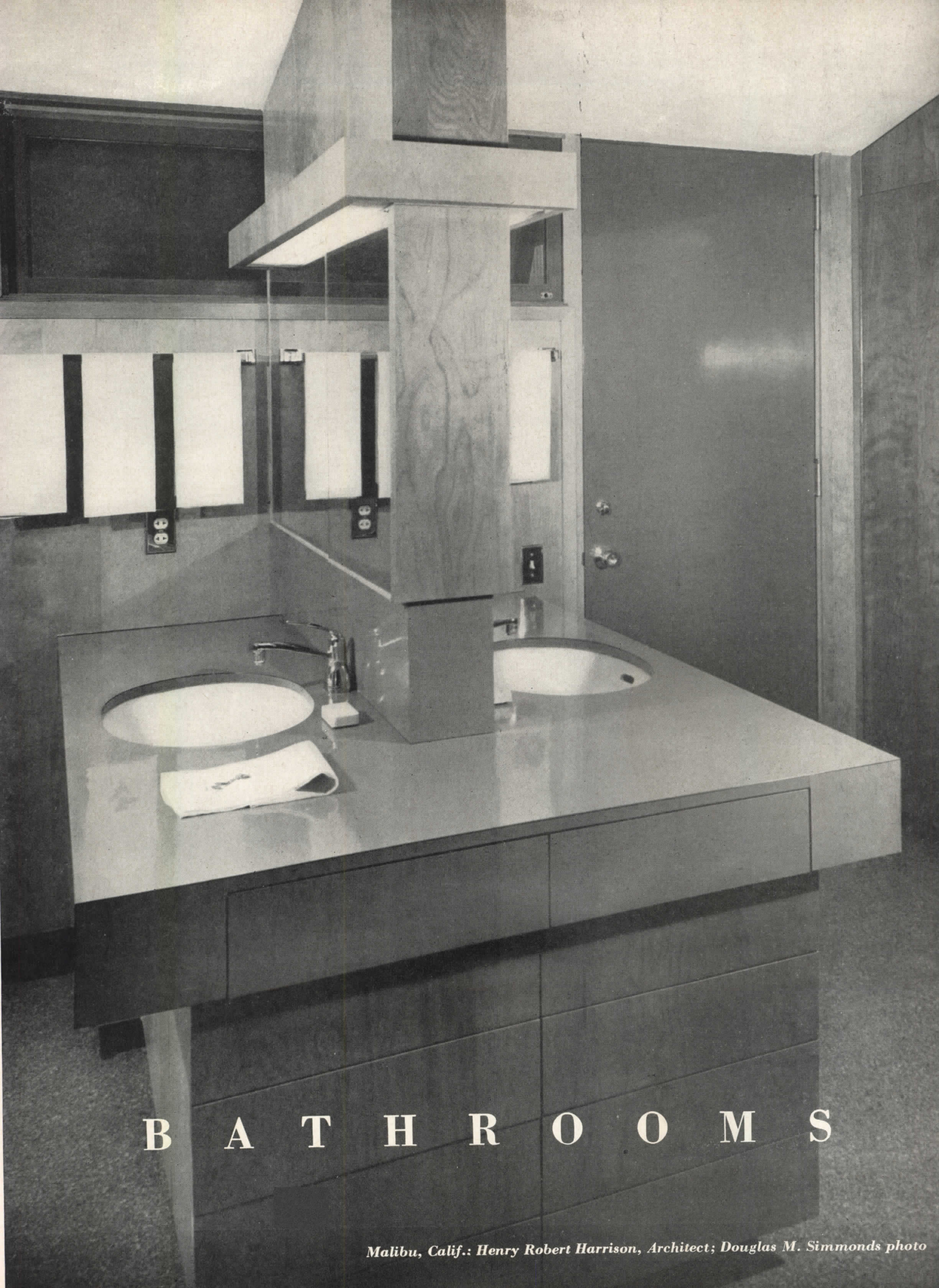

B A T H R O O M S

Malibu, Calif.: Henry Robert Harrison, Architect; Douglas M. Simmonds photo



Woodside, Calif.

*Clark & Beuttler
Architects*

Ernest Braun photo

B A T H R O O M S

Libertyville, Ill.

*Schweikher and Elting
Architects*

Hedrich-Blessing photo



North Muskegon, Ill.

*George Fred Keck and William Keck
Architects*

Hedrich-Blessing photo



Seattle, Wash.

*Paul Thiry
Architect*

Art Hupy photo

BATHROOMS

Tujunga, Calif.

*Richard J. Neutra
Architect*

Julius Shulman photo



Miami, Fla.

*Nims & Browne
Architects*

© Ezra Stoller photo

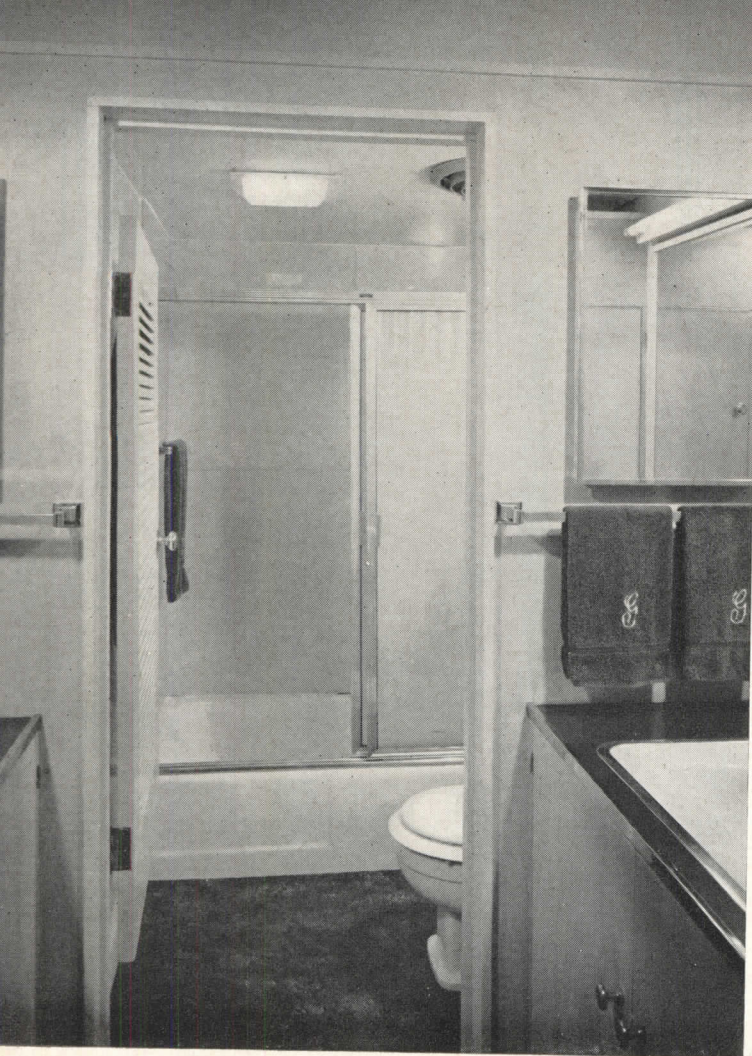

Mt. Airy, N. C.

C. D. Elliott

Architect

Joseph W. Molitor photo

BATHROOMS

South Pasadena, Calif.

Jean Roth Driskel

Architect

Douglas M. Simmonds photo





**A NEW KIND OF
BEARING WALL**

In his scheme for the United States Embassy Office Building to be built next year in The Hague, Netherlands, architect Marcel Breuer has devised an unusual solution to the ancient problems inherent in a fenestrated structural wall

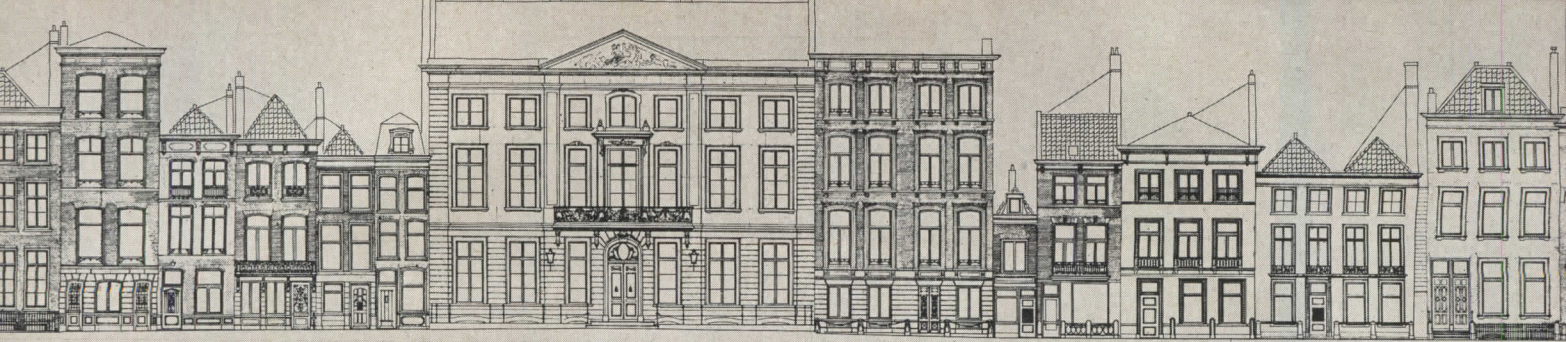

1. BUILDINGS ADJOINING THE SITE TO THE NORTH

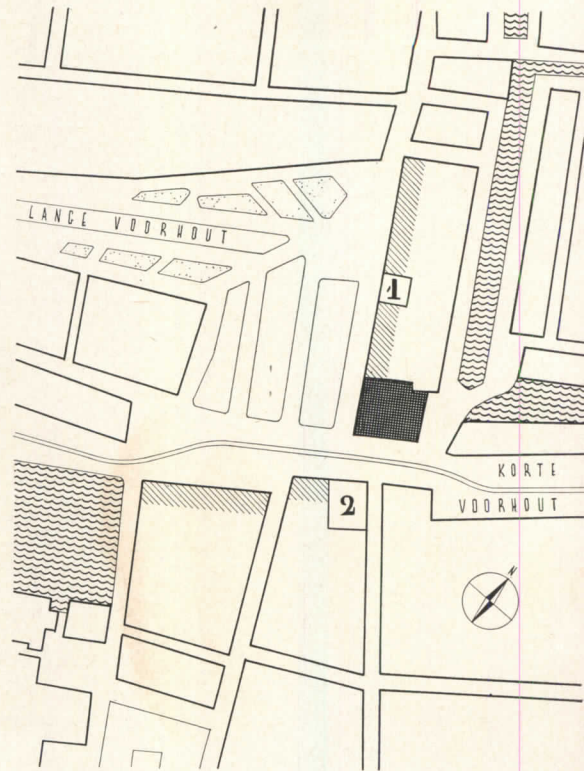

2. BUILDINGS FACING THE SITE FROM THE SOUTH

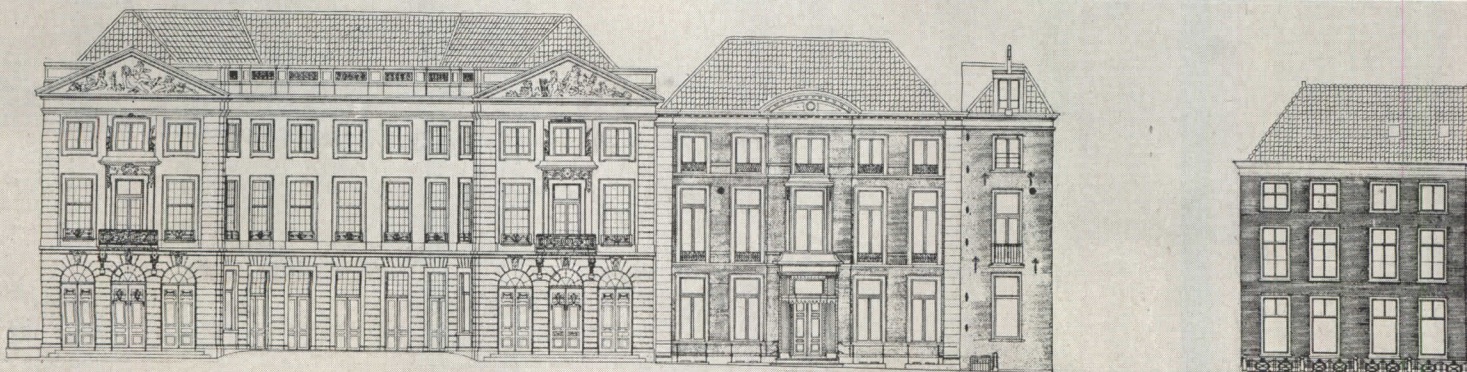

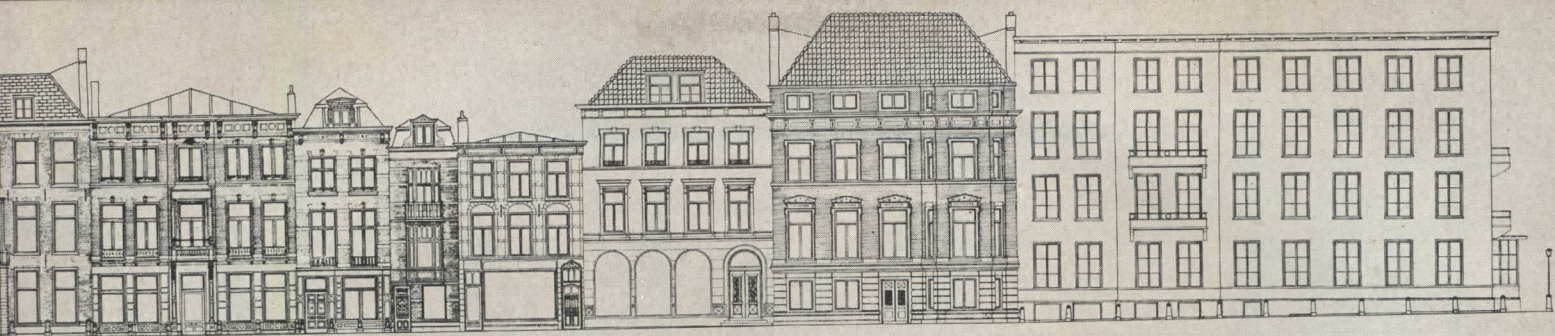

OFFICE BUILDING SITE

**U. S. EMBASSY
OFFICE BUILDING,
THE HAGUE**

*Marcel Breuer
Architect*

IN ANSWER TO THE QUESTION, "Why did you decide upon masonry construction for this building?" the architect replied that the answer could be found in tracing the development of the design and in following the thinking that went into its growth.

From the beginning the site, the city, and history weighed heavily in all the considerations. Tradition is not to be taken lightly in The Hague, historic seat of Dutch government. At the site proper, on Lange Voorhout, the street widens to form a small park, shown at left by the photo. Here one is in the midst of the buildings shown at top and bottom, which date variously from the 17th, 18th, and 19th centuries. Many are of a gray sandstone which, unhappily, slowly disintegrates in the weather, in much the same fashion as the old brownstone in New York. The use of this particular sandstone is now prohibited, but the important fact remains that here, on Lange Voorhout, the traditional manner of building is in *masonry*.

Breuer next called attention to the *scale* of the surrounding buildings, which is small — almost domestic in character — with two exceptions: the Queen's Palace, far left in the photo and shown also in the top strip; and the Queen's Theater, shown at the left end of the bottom strip.

Several design approvals were necessary. First, the actual space needs were studied and arranged in a manner satisfactory to the officials of the Foreign Buildings Operation and the Security Agency. Next, the drawings had to be reviewed by the Architectural Advisory Committee, consisting of Messers Shepley, Belluschi, and Bennett. In Holland, approval was required from: the City Building Department, concerned with structure, materials, etc.; the Art Commission; and the City Planning Office, concerned with building esthetics as well as street plans, traffic, etc.

In such a situation, where "new versus old" becomes a leading issue, Breuer contends "*there is no need to compromise; a modern design, if good, will be appropriate. For example, the buildings bounding St. Mark's Plaza date from several periods, yet what is important there is the over-all character and unity of the space. Here, in The Hague, small scale is important, and so is the dignity of the building — the creation of a proper presence. A steel and glass structure here might strike a jarring, aggressive note; masonry would seem to be more at home.*"

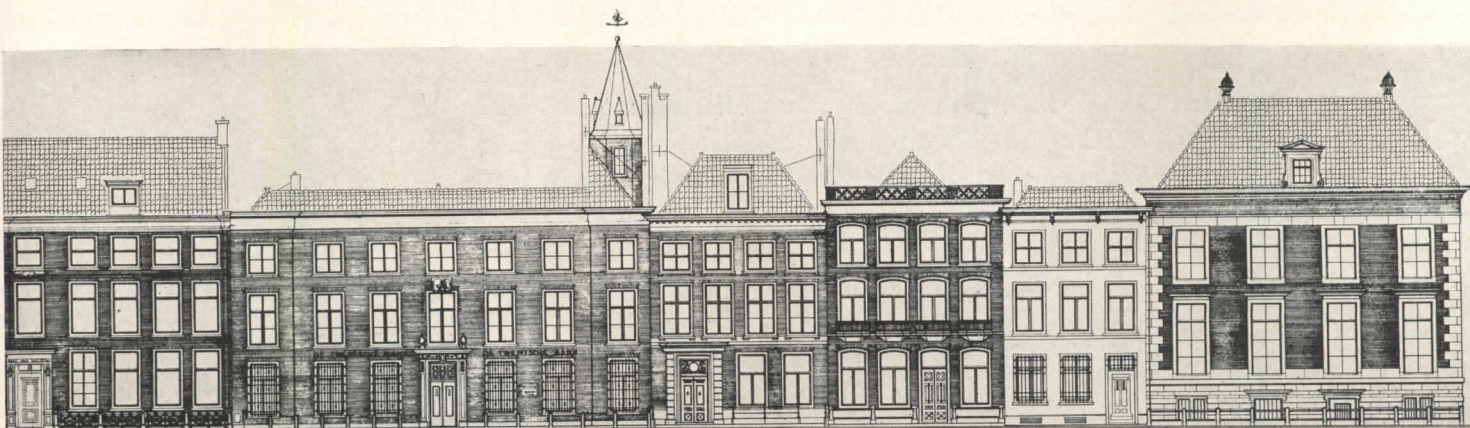

For flexibility of partitioning in the new building, a 5 ft module governs both plan and bearing wall. For the exterior, however, there was a desire to avoid the usual vertical and horizontal rows of windows that give the effect of holes in the masonry and transform the wall structurally into a series of vertical piers. The goal was the maintenance of both the visual and structural integrity of the wall; its expression as a single entity. Thus, the module spacing was staggered on alternate floors and

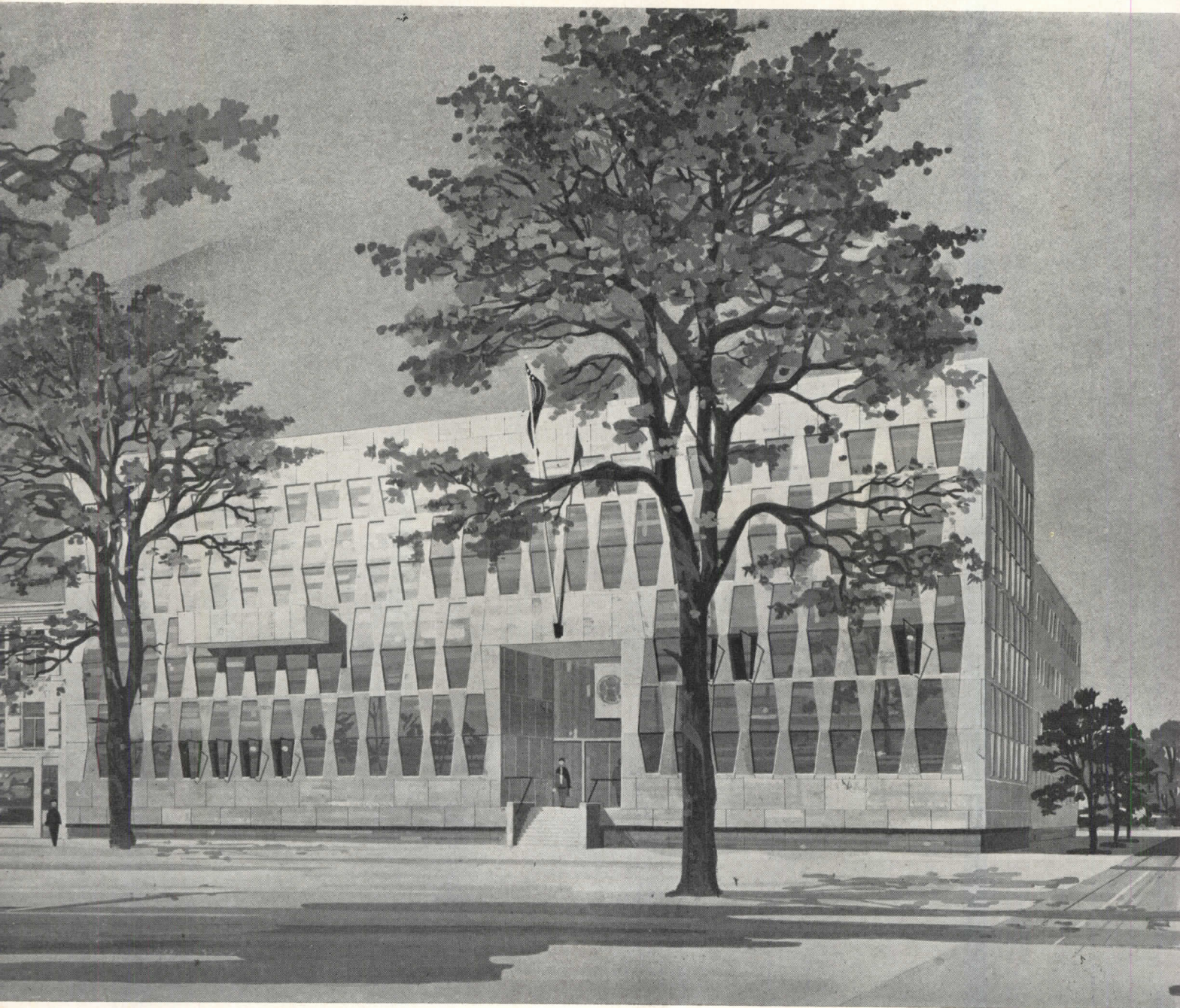

the sides of the openings were chamfered to ease the flow of diagonal stresses. The result is an over-all fenestration pattern in a wall that looks and acts like a unit. Also, there is now the opportunity to group the openings into plastic forms, as was done in the elevation at bottom right.

With scale in mind, the long elevation was divided into two units connected by a glass link, and the entrances were designed as penetrations through the solidity of

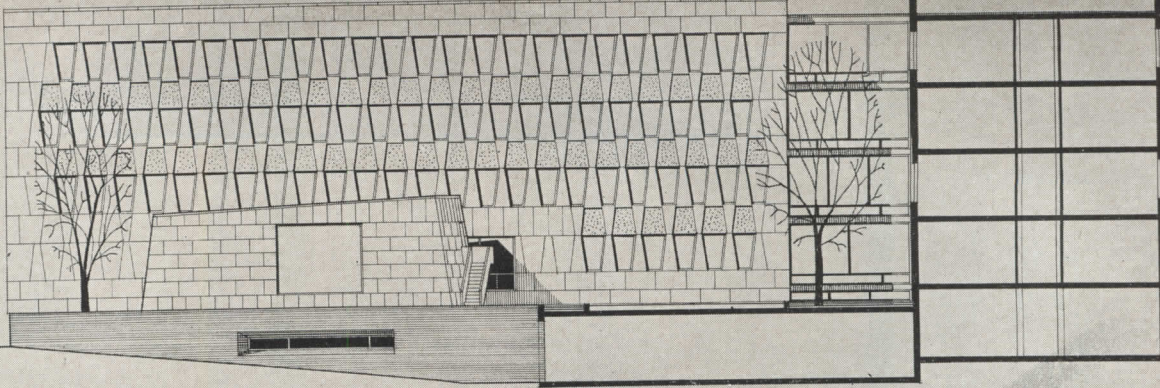

**U. S. EMBASSY
OFFICE BUILDING,
THE HAGUE**

Marcel Breuer
Architect

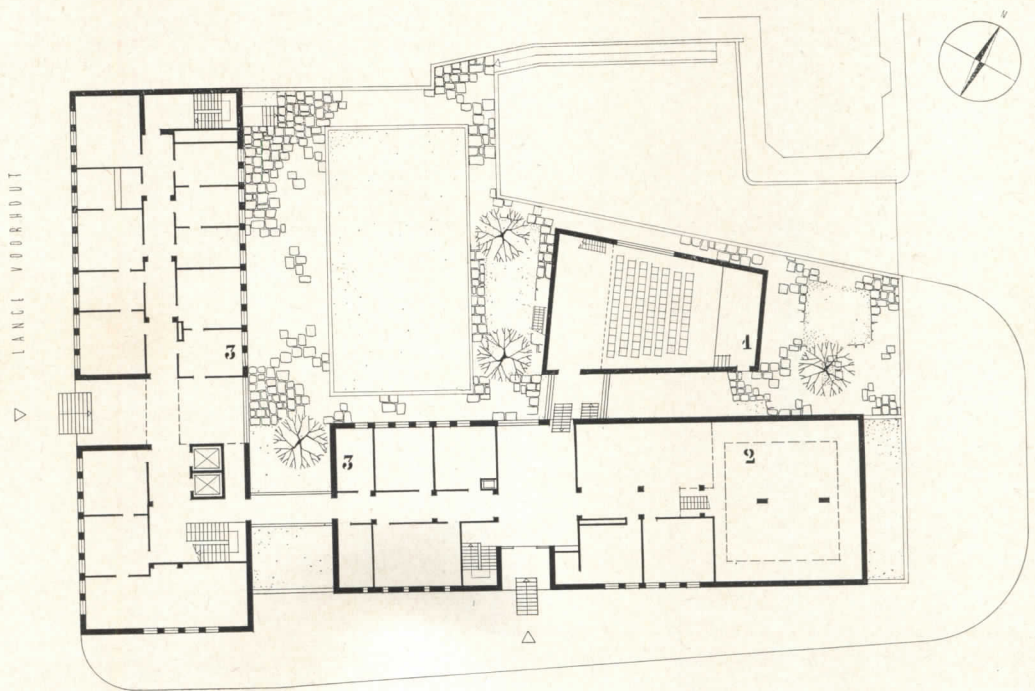

- 1 AUDITORIUM
- 2 LIBRARY
- 3 OFFICES

KORTE VOORHOUT

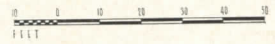

foody

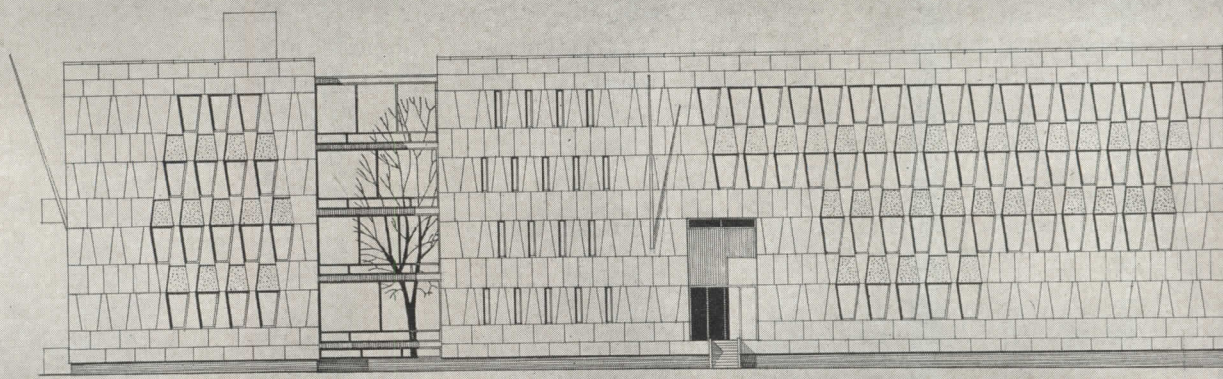

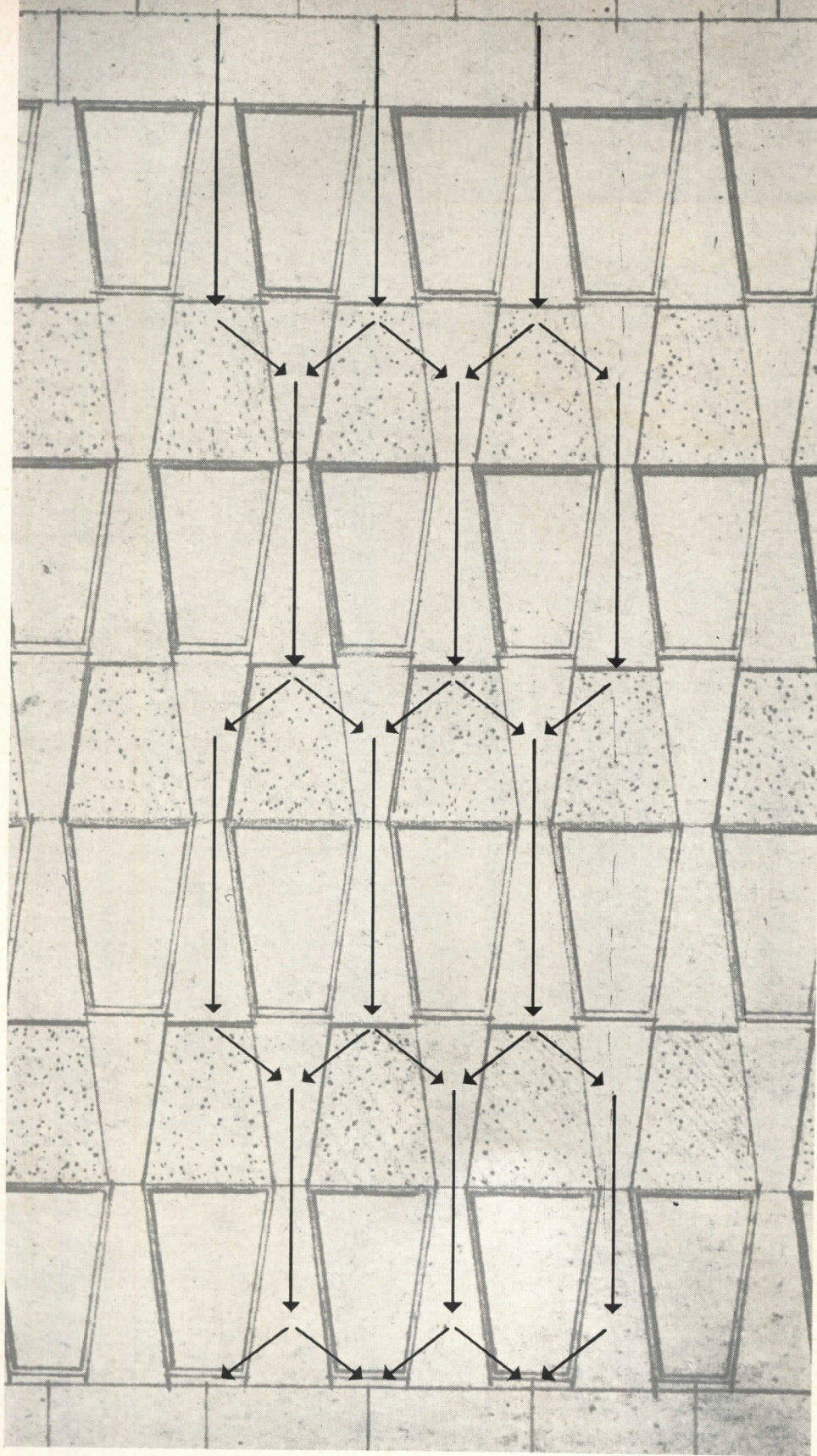

U. S. EMBASSY
OFFICE BUILDING,
THE HAGUE

Marcel Breuer
Architect

the building masses by means of large glass panels opening to the garden at the rear.

For textural interest in the wall, the upper half of the coffin-shaped openings will be faced with highly polished granite slabs; while the typical wall will be faced with imported limestone (not yet selected) with its surface roughened by means of striations. The striation pattern will vary from stone to stone — some vertical, others horizontal, the remainder diagonal in either direction.

WAINWRIGHT BUILDING, St. Louis
Louis Sullivan

CARSON PIRIE SCOTT STORE, Chicago
Louis Sullivan

ROCKEFELLER CENTER BUILDINGS, New York
Reinhard & Hofmeister; Corbett, Harrison
& MacMurray; Hood & Foulhouz

LEVER HOUSE, New York
Skidmore, Owings & Merrill

TRINITY CHURCH, Boston
H. H. Richardson

PHILADELPHIA SAVINGS FUND SOCIETY
BUILDING, Philadelphia
Howe & Lescaze

GENERAL MOTORS TECHNICAL CENTER, Detroit
Saarinen & Saarinen

LAKE SHORE DRIVE APARTMENTS, Chicago
Mies van der Rohe

S. C. JOHNSON & SON, INC., ADMIN. BLDG., Racine
Frank Lloyd Wright

MONADNOCK BLOCK, Chicago
Burnham & Root

DAILY NEWS BUILDING, New York
Hood & Howells

TVA NORRIS DAM & POWER HOUSE, Tennessee
Roland Wank, Architect-in-charge

BOSTON PUBLIC LIBRARY, Boston
McKim, Mead & White

STOCK PAVILION, Raleigh
Nowicki & Deitrick

CHRISTIAN SCIENCE CHURCH, Berkeley
Bernard Maybeck

WOOLWORTH BUILDING, New York
Cass Gilbert

CROW ISLAND SCHOOL, Illinois
Saarinen & Saarinen,
with Perkins, Wheeler & Will

MANUFACTURERS TRUST BUILDING, New York
Skidmore, Owings & Merrill

UNITY CHURCH, Oak Park
Frank Lloyd Wright

NEBRASKA STATE CAPITOL, Lincoln
Bertram G. Goodhue

S. C. JOHNSON & SON, INC.; LABORATORY, Racine
Frank Lloyd Wright

UNITED NATIONS SECRETARIAT, New York
Wallace K. Harrison & Consultants

LINCOLN MEMORIAL, Washington
Henry Bacon

M.I.T. AUDITORIUM, Cambridge
Eero Saarinen

EQUITABLE BUILDING, Portland
Pietro Belluschi

ALLEGHENY COUNTY BUILDINGS, Pittsburgh
H. H. Richardson

UNIVERSITY CLUB, New York
McKim, Mead & White

CRANBROOK SCHOOLS, Michigan
Elliel Saarinen

MINERALS & METALS RESEARCH BLDG., I.I.T., Chicago
Mies van der Rohe

ALCOA BUILDING, Pittsburgh
Harrison & Abramovitz

MUSEUM OF MODERN ART, New York
Goodwin & Stone

PENNSYLVANIA STATION, New York
McKim, Mead & White

EXPERIMENTAL SCHOOL, Los Angeles
Richard Neutra

DODGE TRUCK PLANT, Detroit
Albert Kahn

100 MEMORIAL DRIVE APARTMENTS, Cambridge
Kennedy, Koch, DeMars, Rapson & Brown

CENTRAL LUTHERAN CHURCH, Portland
Pietro Belluschi

HOUSES

F. C. ROBIE, Chicago
Frank Lloyd Wright

E. J. KAUFMANN, Pennsylvania
Frank Lloyd Wright

TALIESIN WEST, Arizona
Frank Lloyd Wright

HENRY VILLARD, New York
McKim, Mead & White

WATTS SHERMAN, Newport
H. H. Richardson

AVERY COONLEY, Illinois
Frank Lloyd Wright

W. W. WILLITTS, Illinois
Frank Lloyd Wright

D. R. GAMBLE, Pasadena
Greene and Greene

PHILIP JOHNSON, New Canaan
Philip Johnson

WALKER GUEST HOUSE, Florida
Paul Rudolph

ELLEN SCRIPPS, La Jolla
Irying Gill

WESTON HAVENS, Berkeley
Harwell Hamilton Harris

LOVELL "HEALTH HOUSE", Los Angeles
Richard Neutra

EDITH FARNSWORTH, Chicago
Mies van der Rohe

7: CHURCHES

WHEN ARCHITECTURAL RECORD'S PANEL of architects and architectural scholars nominated the buildings they deemed most significant during the one-hundred-year history of the American Institute of Architects, four churches led that building type in the balloting and are included among the fifty buildings being presented in this series.

It is a surprisingly large number of examples for a period that has not been distinguished for its religious buildings. By comparison, there were only three schools on the list, two apartment houses, one factory, and no hospitals or stores. Perhaps it may be concluded that although the level of quality in the design of the latter types was generally higher during this period, nevertheless a church program when in the hands of an architect of great talent offers challenges and satisfactions which evoke peak performance.

Certainly these four examples are acknowledged masterpieces. They have responded to the whole range of man's need which is nowhere more evident than in the requirements for a place of worship. The essentially one-story, one-space character of a church affords a high degree of plasticity in spatial organization, and the commonly shared desire that something beyond the ordinary be expressed there offers unusual freedom in manipulation of shape and surface. Any church offers rich opportunities for design, and in these churches the opportunities were richly fulfilled in ways which are thoughtfully spelled out on the following pages by a number of nominating-panel members who know the buildings and for whom the buildings have been "most significant."



Joseph W. Moffor

Trinity Church, Boston, 1873-77, H. H. Richardson. (Fourth)

"So great is the vitality of this building that it seems to escape the usual trivialities of derivative works. The bold structural conception; the delicate and rich detailing; the subtle play of the interior light and shadows; the sureness of its choice of materials and colors; and the scale, proportions, and unity of the whole make this church a very great example of what *architecture* can mean to mankind."

Pietro Belluschi

"In this his first major work, Richardson's extraordinary talent enabled him to integrate into a powerful expression the chief architectural currents of his eclectic day. For here the classic rationality of form and plan that he had learned so well at the Ecole de Beaux-Arts are fused with a post-Ruskinian free handling of chiefly medieval forms, and with a feeling for

the future and function of materials not unlike that of William Morris. It is no wonder that he is now so widely recognized as one of the chief founders of modern architecture."

Donald D. Egbert

"If Trinity Church on Copley Plaza were to be built today it would undoubtedly be considered anachronistic and extravagant. It belongs to a vanished past and is an example of unrestrained eclecticism that was natural at the moment of its creation. However, Richardson was not a strict revivalist. With Trinity Church and with most of his works he shows surprising originality as well as brilliance in composing building masses. The influence of Richardson on the architecture of his contemporaries was phenomenal. A review of the churches, schools and libraries that appeared in the American landscape



from 1885 to 1900 will convince us of the *virility* of Richardson as originator, and of the *servility* of the average architect as imitator.”

A. Lawrence Kocher

“Richardson brought a certain gentleness and poetry to the he-man Romanesque. This is especially true in Trinity Church. The Romanesque flavor is there; with the difference that while Richardson Romanesque had the Romanesque appeal, actual Romanesque was only Romanesque. It lacked Richardson.

There is some criticism of Trinity because it is held not to be all Richardson, since some of it is a later addition and much of it represents change from the original idea. But the Richardson compelling genius, in spite of change and addition, has resulted in an undying piece of architecture.”

Edwin Bateman Morris

First Church of Christ, Scientist, Berkeley, 1910, Bernard Maybeck. (Eleventh)

“This is my favorite church in America. Photographs give us no conception of the grandeur of its scale, the extraordinary qualities of space and light in the main meeting room, or the vigor of the colorful detail. Maybeck used Japanese, Provençal Romanesque, Gothic, and Art Nouveau elements in concrete, steel, and wood, and faced the exterior with common transite, proving that eclecticism in the right hands can produce miracles.”

James J. Ackerman



Bill Engvall, Hedrich-Blessing

**Unity "Temple," Oak Park, Illinois, 1905-08,
Frank Lloyd Wright. (Tied for thirteenth)**

"Wright's design for Unity Temple, in suburban Oak Park, was conceived with the prime objective of giving exterior expression to a room of worship. His chief problem lay in the subordination of the smaller rooms to the main temple. Many studies finally led to the skillful joining of these two elements, placing the entrance in between.

An early experiment in concrete, with the pebble aggregate exposed on the surface for texture, this church has a clearly defined exterior expression with its square stair towers at the corners giving an added emphasis to the importance of the main room, while the high windows, under the projecting roof slabs, separated by ornamented masonry piers, give to the whole a perfect sense of scale and a true indication of the actual size of the building."

Alan Burnham

"Although this church was the first major building to be constructed of cast concrete, it seems to me far more significant as a new "temple" form. Here, as in all really great architecture, the materials of the structure are subordinated to the subtleties of interior space and light. Unity Temple reveals itself as a symbol of its religious purpose through deeply felt inner space and thus to the inner man."

Buford Pickens



Roger Sturtevant

**Central Lutheran Church, Portland, 1951,
Pietro Belluschi. (Tied for twentieth)**

"In the aesthetic housecleaning necessary to end eclecticism in architecture, much of human value has often been discarded along with real rubbish. Religious atmosphere in churches has been proven by countless generations to be a truly needed quality in their design. Yet few present day architects have been brave enough to use the proper components of this quality — vertical lines, pointed arches and colored light — lest their buildings not be "modern."

Belluschi's Church is outstanding in that it makes frank use of these three design elements in a structure handsomely suited to contemporary life. The architect has composed his structure with vast understanding of the nature of his materials — again a quality inherent in fine buildings of any age — but his personal touch is everywhere evident. The relation to the domestic scale of the neighborhood lends humanity to the design without the loss of dignity. Only in the joining of the apse and nave is there a question of unity."

Leslie Cheek, Jr.

"The secret that distinguishes much of Belluschi's work — a relaxed simplicity — is nowhere better seen than in this modest yet impressive city church. Its elements are not in the usual vocabulary of city church designers. Nevertheless as Belluschi handles them they create a sense of community welcome and of religious honesty and directness which is remarkable and perhaps one of the most creative impressions of current Protestant church ideals."

Talbot Hamlin

BANK AND RENTAL OFFICES

*City National Bank
Building,
Beverly Hills, Cal.*

*Welton Becket & Associates
Architects and Engineers*

*Maynard Woodward
Design Director*

*Louis Nadorf
Project Designer*

*Clyde Whitlow
Project Architect*

*Murray Erick
Structural Engineer*

*Robert H. Carter
Landscape Architect*







Douglas M. Simmonds

CITY NATIONAL BANK

LOCATED IN Beverly Hills at the intersection of Roxbury Drive, Brighton Way and Wilshire Boulevard, this office building and bank strikes a new and colorful note in the city's skyline. The structure was conceived as a speculative venture, but when the National City Bank of Beverly Hills signed a 65 year lease and became the principal tenant, the building was named for it. The area is apportioned in such manner that 18,000 sq ft are devoted to the bank, 16,000 to underground parking, and 105,000 to rentable area. The bank occupies parts of three floors; basement, ground and second.

Architecturally, there is interest in the handling of the southwest façade of the building, shown on the left page. The structural uprights are concrete painted white, the spandrels are aqua-colored Italian glass mosaic tile, and the infilling panels at ground level are marbled pebbled tile in a soft beige color. For sun protection, there are projecting alumilited aluminum eyebrows which project 5 ft from the building line and which are terminated by aluminum drop curtains approximately 3 ft high. The awning type windows are aluminum with the top panel opening inward.



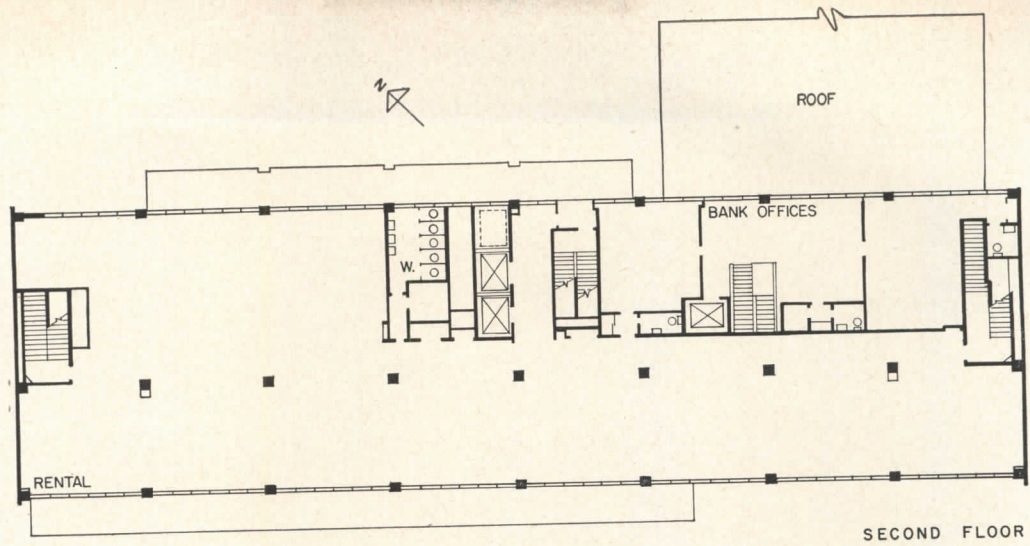

SECOND FLOOR

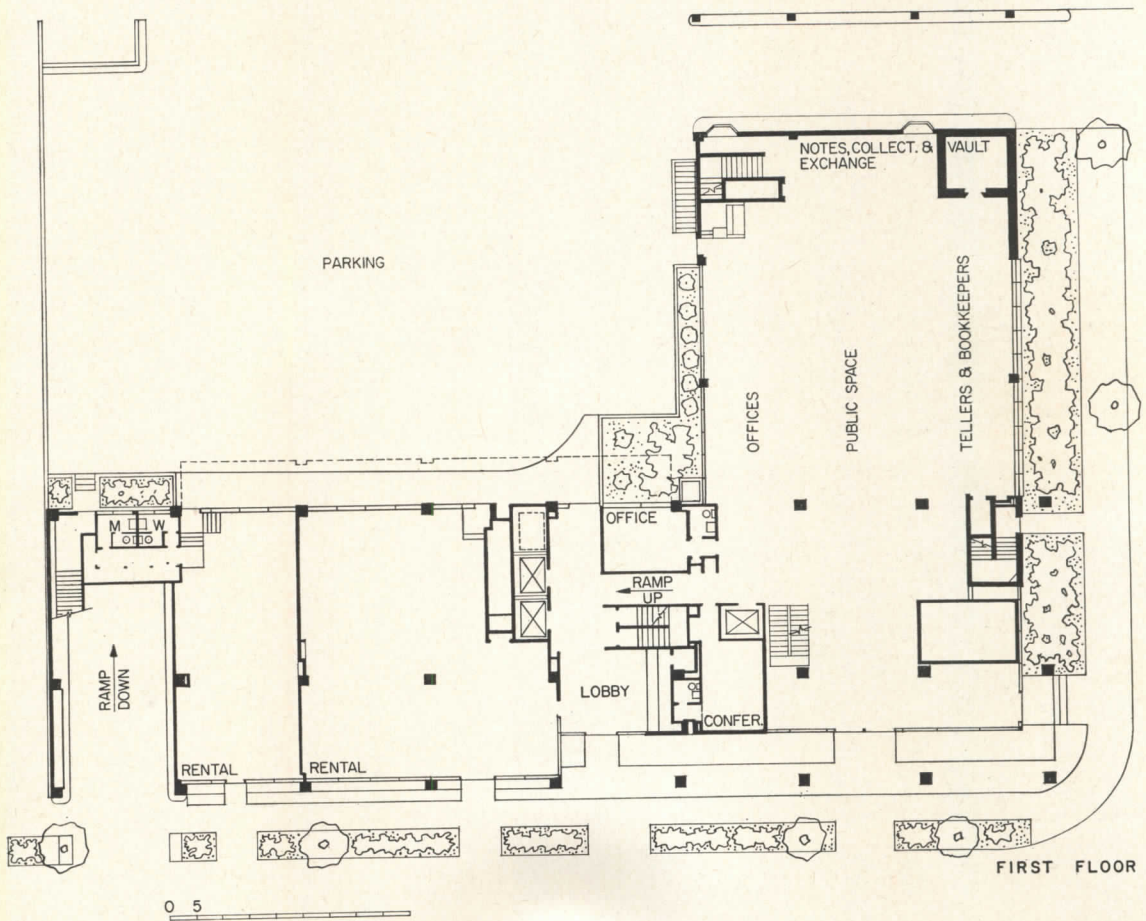

FIRST FLOOR

CITY NATIONAL BANK

Part of the second and all of the third to sixth floors are rental space, while the bank occupies most of the basement, ground and second floors. An open stair (left) connects the three banking levels. The vault, record storage, employee lounge and mechanical equipment are below ground; tellers, officers, and loan department are at ground level; executive offices, board room and accompanying reception space are on the second floor

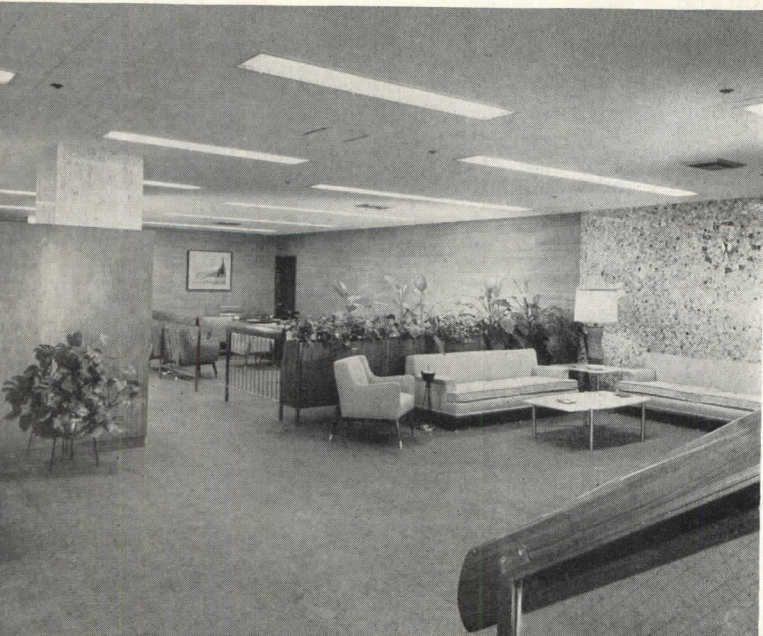

CITY NATIONAL BANK

The top photograph shows a typical executive office; note particularly the arrangement of lighting and the interesting use of contrasting materials.

The open stair (center, left) connecting the three-level banking space serves as a unifying element that, esthetically, "ties" them together.

At the lower level (bottom, left) the stairway ends in a reception area which serves the money vault and safe-deposit areas

CHANDIGARH

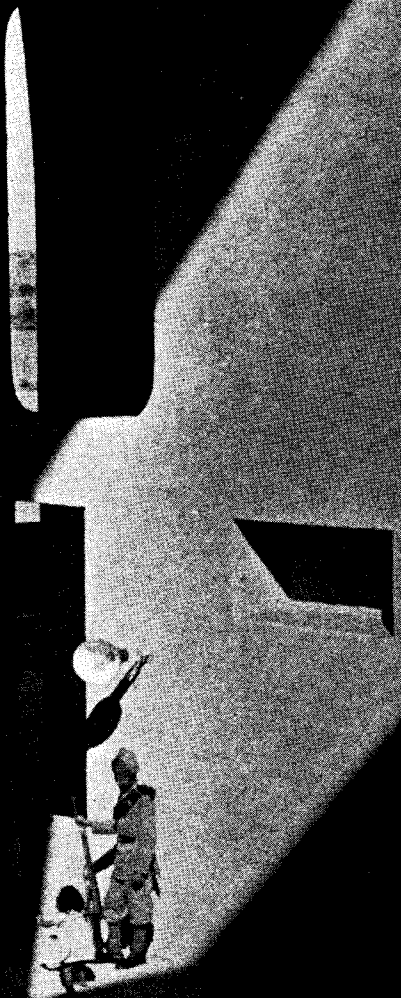

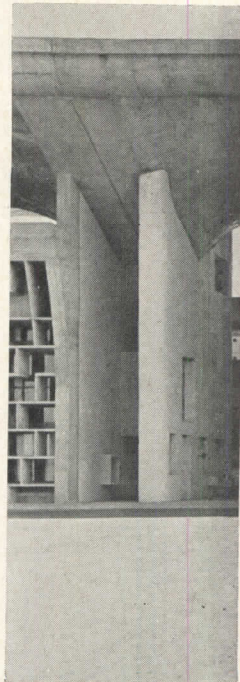
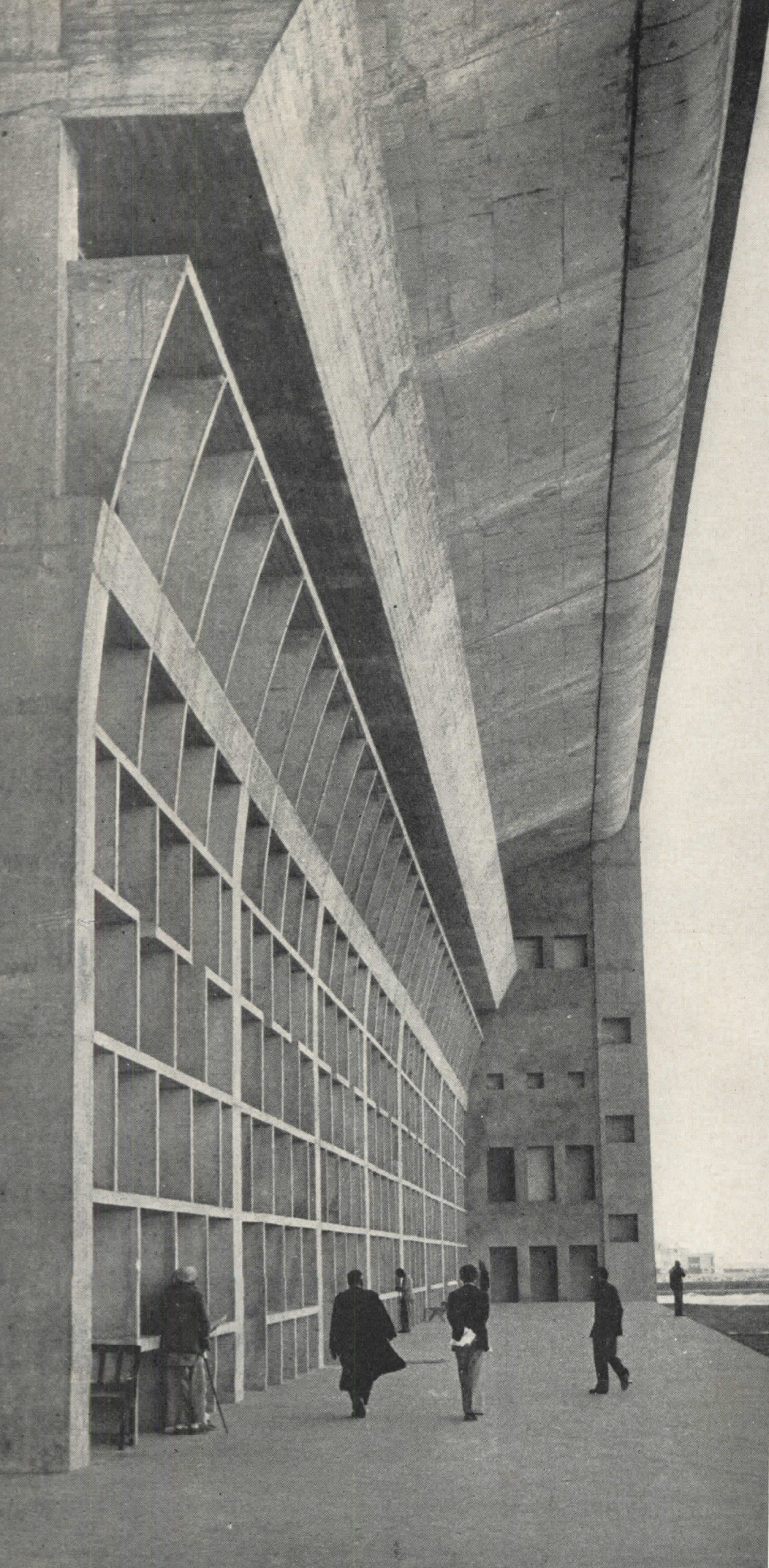

CHANDIGARH

The new capital of India's Punjab—one of the few total cities created in our time, and a symbol of Le Corbusier's new philosophy—is now taking firm shape. To supplement our previous coverage* on this work of Le Corbusier, Pierre Jeanneret, Maxwell Fry and Jan Drew, ARCHITECTURAL RECORD presents a recent photographic report by Ernst Scheidegger

Ernst Scheidegger — Magnum Photos, Inc.

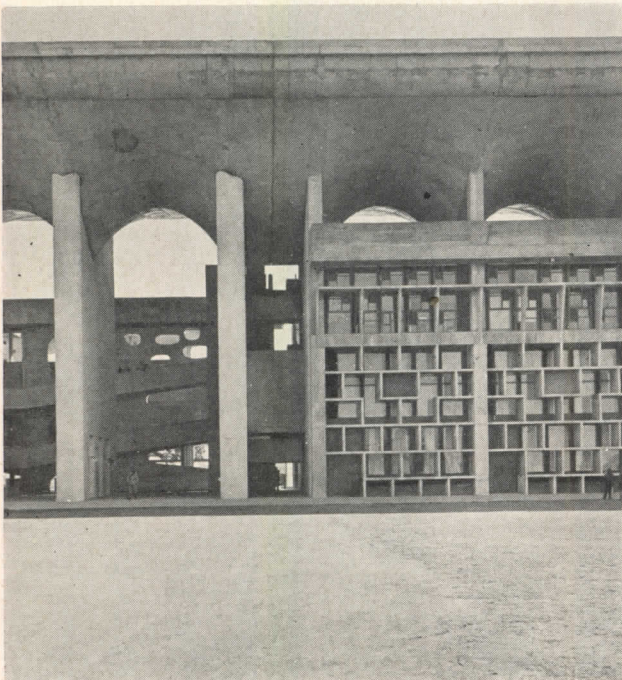
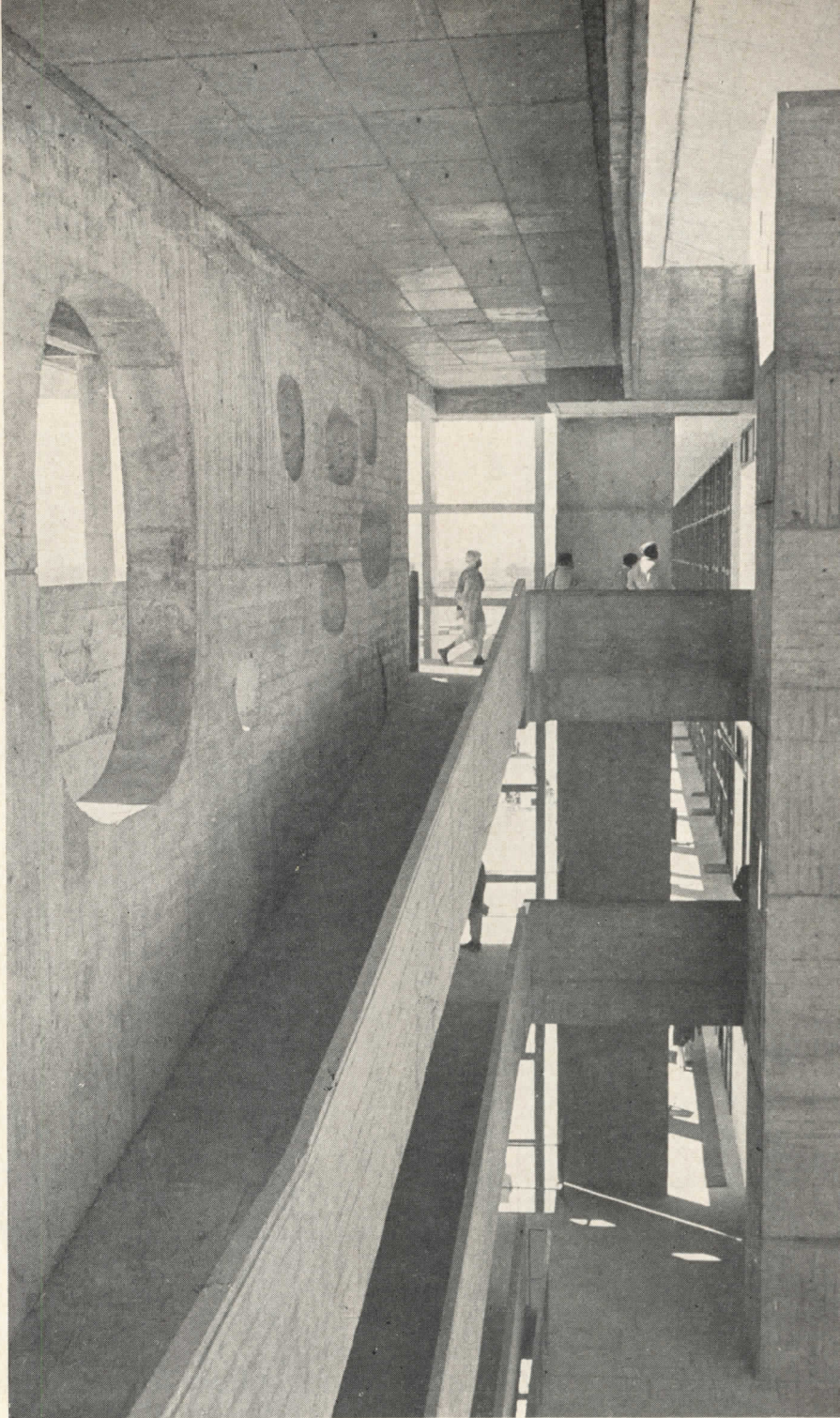

The enormous sculptured forms of the high court building bear the strong stamp of Le Corbusier's new and exuberant approach to design. The parasol-roofed, sun-baffled structure is the major building in the governmental center to be finished and put in use. Court rooms are approached via an open lobby and ramps (above); offices are to the back of the building (right)

* ARCHITECTURAL RECORD: Sept., 1954 by Lewis Mumford; June, 1955 by E. Maxwell Fry; Nov., 1955 by Frederick Gutheim

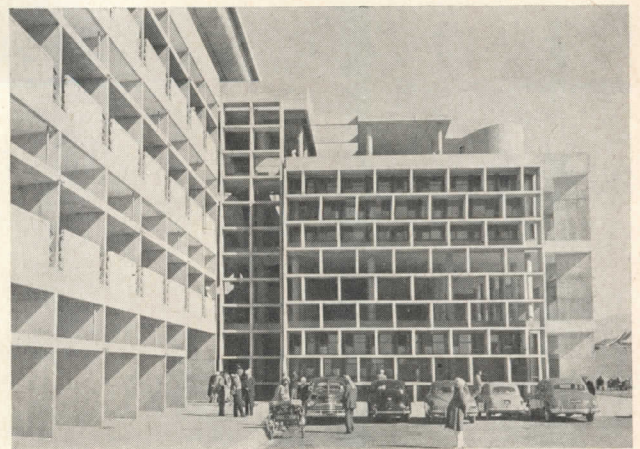



Ernst Scheidegger — Magnum Photos, Inc.

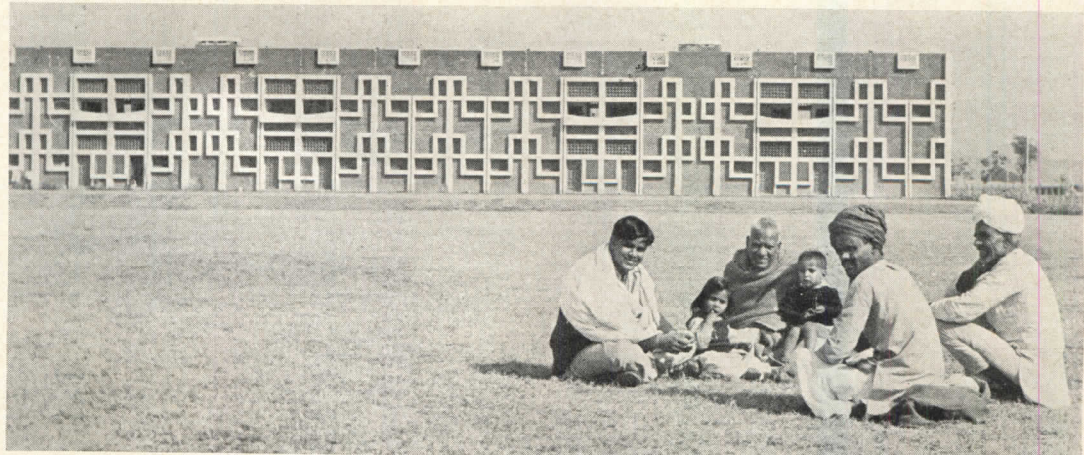

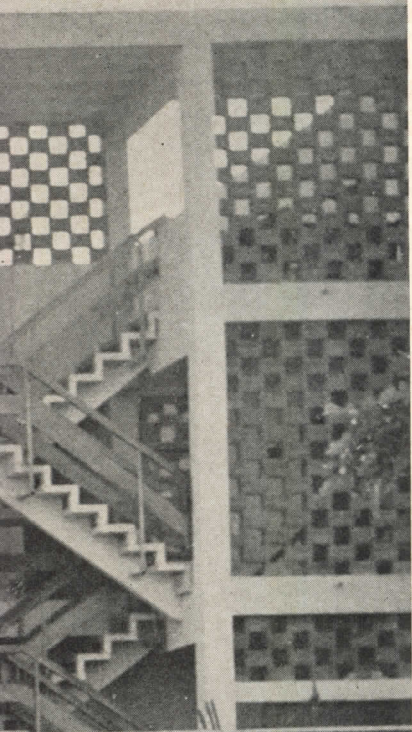

CHANDIGARH

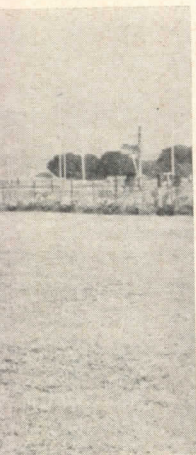
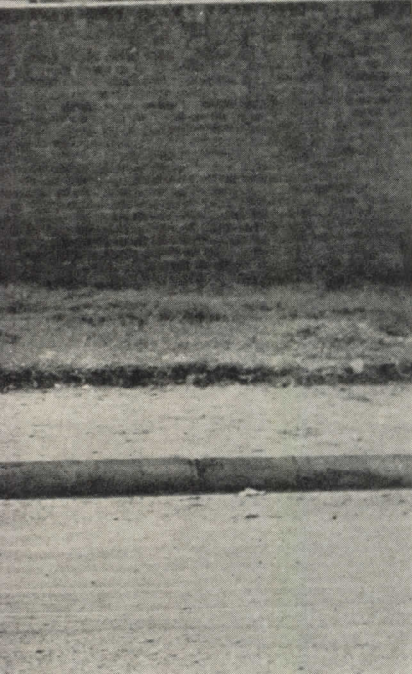

The housing units, three of which are shown here, reflect a great fusion of cultures. General acceptance by the inhabitants appears quite good, but there are a few interesting objections — they fear the sunbreakers are insufficient barriers against dust and burglars, and there is no space in the houses for the holy cows. With the new redivision of Indian states, Punjab and Chandigarh will be larger than anticipated

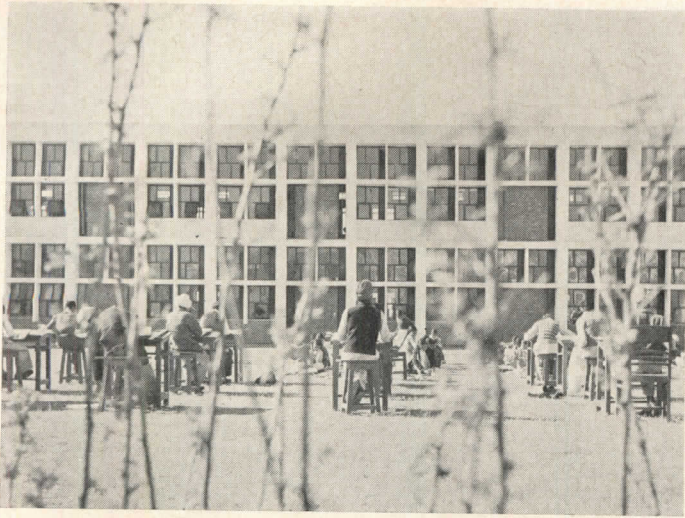

CHANDIGARH

Schools are already in full session — in and out of doors. The sector and traffic zoning plan of the city provides quiet zones suitable for open air classes, as at the elementary school shown above. An ornamental concrete grill screens the dramatic open entrance loggia of one of the colleges, shown in photo below

Ernst Scheidegger — Magnum Photos, Inc

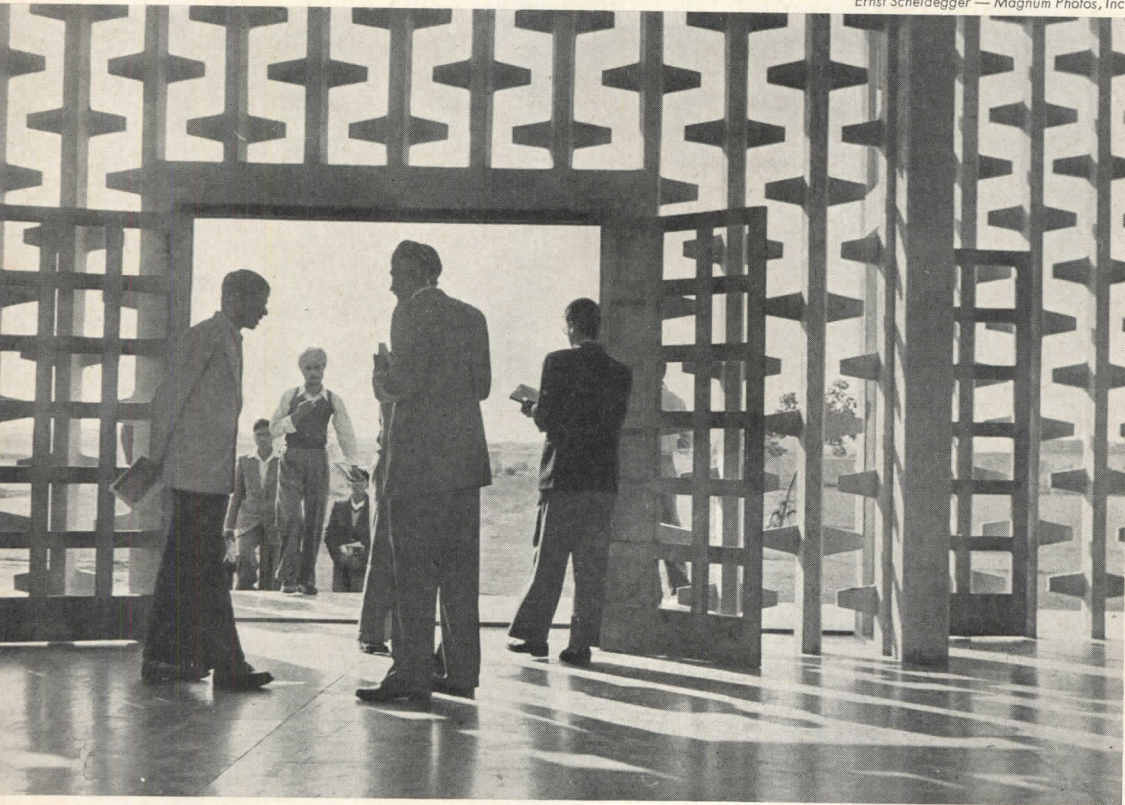



A CONTROLLED CLIMATE FOR SHOPPING

In Minneapolis' Southdale Shopping Center by Victor Gruen, stores face on an air conditioned Garden Court and can be heated and cooled simultaneously by a heat pump

SOUTHDALE'S AIR CONDITIONING system provides year-round comfort with amazing efficiency for several reasons. First, the architectural concept of stores faced inward upon a sheltered, central court reduces the outside wall exposure. Second, the court itself serves as a giant plenum chamber, providing tempered air to the stores. Third, conservation of energy in the air conditioning system cuts operating costs. (For example, the interiors of stores have to be cooled all year, due to lights and people, and in winter the rejected heat is distributed to the perimeter walls to negate the heat loss. Then, too, well water used for cooling in the summer becomes heated and is returned to a diffusion well. In winter, heat is taken from diffusion well water, and after being cooled it is returned to a deep well for reuse in the summer.)

Forgetting for a moment the rational aspects of Southdale's design, it does seem that the exterior, set amidst acres of blacktop, achieves a "single-building" unity at the expense of visual invitation to enter. Something is missing that might hint of the delights within. There are those who will agree with the idea of a non-committal exterior such as this.

Others will wish that a more open, "seeing-through" effect had been devised.

The Basic System

Southdale can expect a wide variety of weather, ranging from -30 F in winter to over 100 F in summer, so indoor climate control is a necessity. The centrally controlled air conditioning system heats and cools Dayton's — a branch of Minneapolis' largest department store, and owner of the shopping center — and a number of tenant stores. The other department store in the center, Donaldson's, which also has a downtown store, operates its own system.

As has been mentioned, the motivating principle behind the design was "conservation of energy." Merchandising areas are heat producing due to lights and people, and the interior zones are not affected by the weather outside. Such is the excess heat generated, that the outside temperature has to drop to five below before other heat sources must be called upon.

Thus no boilers are required for space heating. Instead the refrigeration equipment is designed as a heat pump, supplying hot water from condensers to

heat the building, to temper the ventilation air, to heat (partially) domestic hot water, to operate the snow melting system for the truck tunnel ramps, and to warm humidification water.

The cooling capacity of the system is about 2000 tons: 700 tons for pre-cooling ventilation air, 700 tons for tenant stores and 600 tons for Dayton's. Ventilation air is cooled by water pumped from a deep well, tenant stores are cooled by self-contained package units from 2 to 15 tons in size, and the Dayton store is cooled by a chilled water system. Condenser water for the tenant stores and Dayton's comes from two deep wells.

Ventilation Air

Two ventilation fans in the penthouse draw in 100 per cent outside air, temper it to approximately 70 F and discharge it into the court through a narrow grille that runs the length of the court. Pre-heating coils, filled with glycol to prevent freezing, can heat air at -20 to $+35$ F, after which the air passes over a second set of coils to be heated to 70 F. Heat for this tempering comes from condenser water of the tenant package air conditioners. If this is not sufficient,

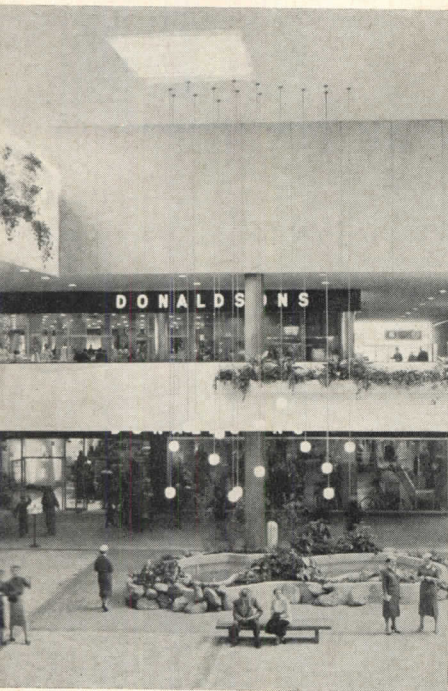

The Garden Court, 109 by 270 ft, acts as a plenum chamber to supply 70 F ventilation air to Dayton's store and tenant stores. Air enters

additional heat can be obtained from the central refrigeration condensers. Any heat loss of the Garden Court is compensated by recirculating the air over heating coils by means of a third fan. At other times this fan is used to provide excess ventilation air to Dayton's when crowds are at peak capacity.

On the cooling cycle, the water coils use 50 F well water directly, raising the temperature 10 to 12 F, whereupon the water is used for condenser cooling and finally cooling for the gas engines which drive the refrigeration compressors.

The ventilation fans provide a positive pressure within the court so that ventilation air pushes itself through continuous grilles in front of every tenant space. Then, there is a grille at the rear of the store connected by duct work to an exhaust fan which pulls the air down into the basement storage rooms. From here it is drawn into the truck tunnel to replace the stale air. The contaminated air is exhausted to the atmosphere by means of a large fan in the penthouse.

Dayton's Air Conditioning

Ventilation air is ducted to the intakes of a series of air handling units grouped around a centrally located moving stairway well on each of two levels. These units are primarily for cooling since the heat gain from lights and people would tend to overheat the area otherwise. Chilled water for cooling is supplied

from a refrigeration plant in the penthouse which includes five reciprocating compressors driven by five internal combustion natural gas engines. Two of the air handling units on the upper level are equipped with hot water coils to provide heat to the upper level during the night to offset the roof heat loss.

In the heating cycle, during the day, the heat gain from lights and people more than offsets roof loss. However, at the walls of the store, heat must be supplied day and night through small air handling units equipped only with heating coils. These run continuously during the day, and intermittently at night.

During the cooling cycle, these units are shut down, but cool air from the centralized fan coil units is diverted into the perimeter duct work to provide a curtain of cool air.

Tenant Stores

Self-contained package units handle the cooling load. Water from the central condenser system is piped around the building to remove heat from the package units. During cold weather, hot condenser water gives up its heat to the tempering coils of the ventilation air units in the penthouse. The package units do not run at night during the winter, and therefore are not producing heat. This causes no problem, because there is no ventilation air either. Roof heat loss in the tenant buildings is offset

in the daytime from the heat given off by lights and people. At night, however, fan and coil units located in the service cores force warm air into the stores.

Operation of Wells

Plenty of cold ground water is available in the region of Minneapolis. It is not cold enough (50 F), however, to do a complete job of air conditioning, because water of 40 to 45 F is needed for dehumidification. Therefore a split system was used. Well water cools ventilation air to 75 F, while mechanical refrigeration absorbs the heat within the various spaces. Sufficient water is pumped through the ventilation air coils to handle the load for the court as well as to provide for condenser and domestic water requirements.

Water leaves the ventilating coils at 60 F and passes through the central condensers, its temperature rising to 75 F. It then enters condensers of tenant spaces, removes heat and goes up to 90 F. Some of this water is used for roof flooding and/or lawn sprinkling while the balance passes through the gas engine radiators and exhaust mufflers, adding another 10 or 15 degrees to the water. This heated water is diffused into an underground storage basin, some 300 ft deep, where it can be kept until required for the heating season. The cold water used at the beginning is pumped from a different strata, 400 to 600 ft deep.

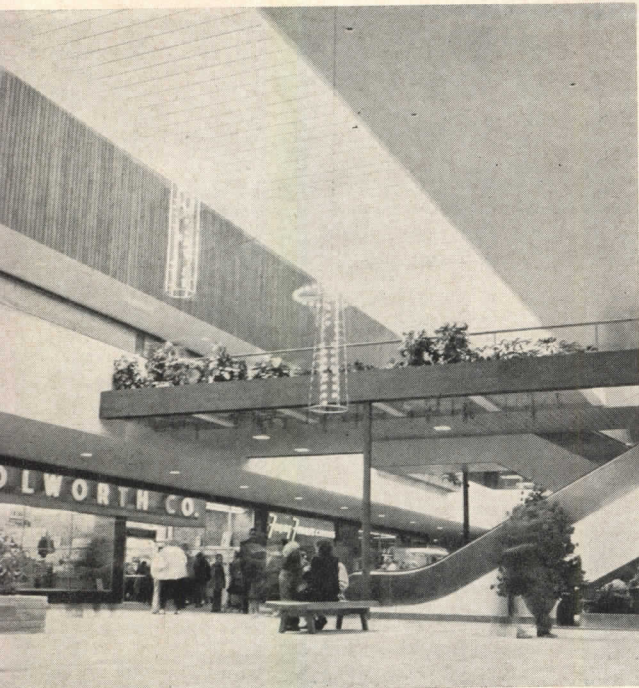

the court through a continuous slot above the wood screen

Air Conditioning Engineer: David Berks
of Victor Gruen & Associates

Heat Pump Consultant: J. Donald Kroeker

Hydraulic Consultant: Adolph Meyer

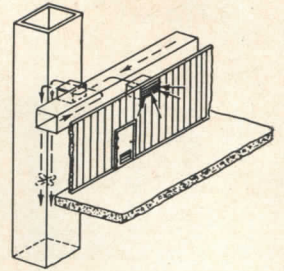

Detail "A"

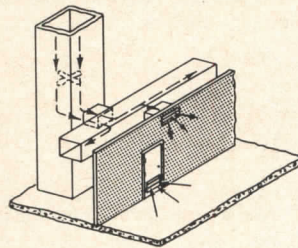

Detail "B"

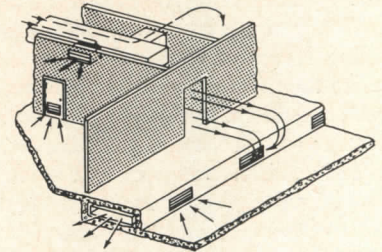

Detail "C"

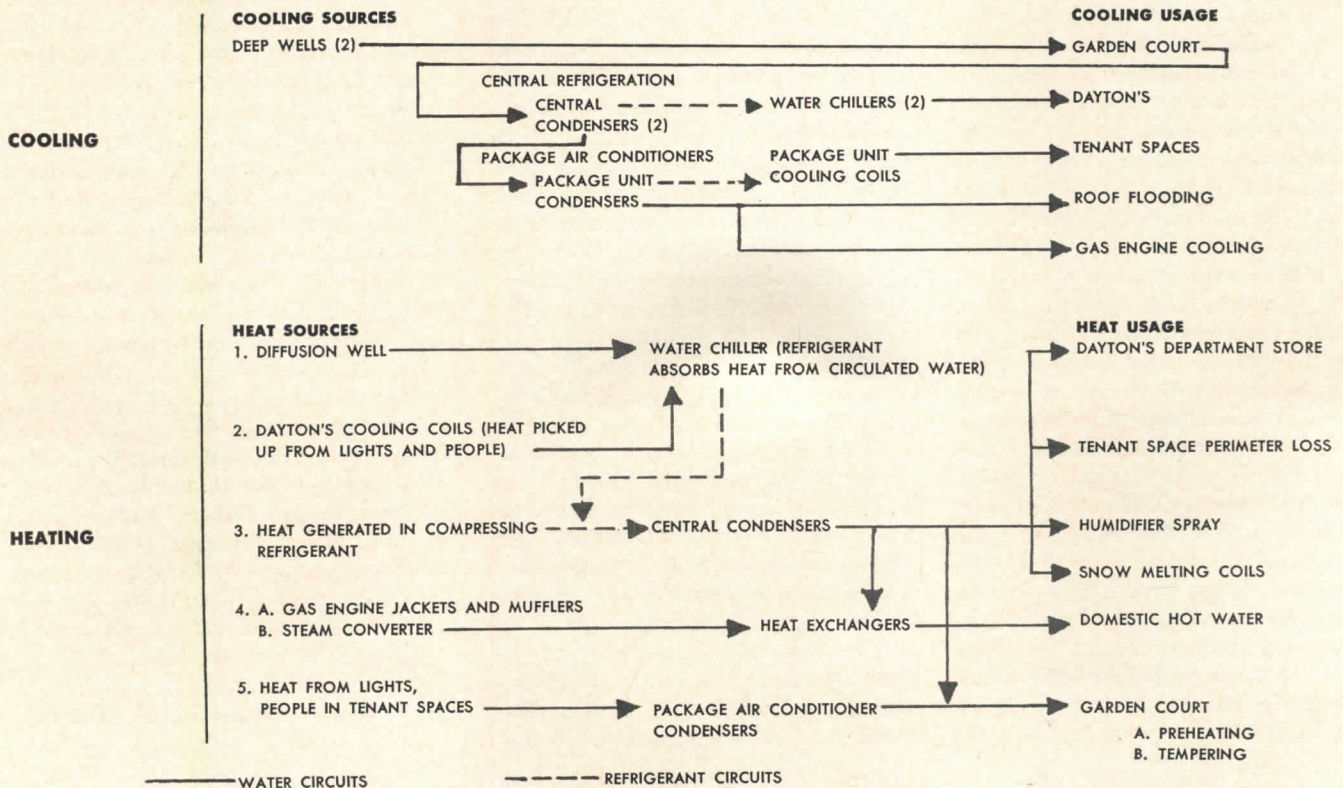
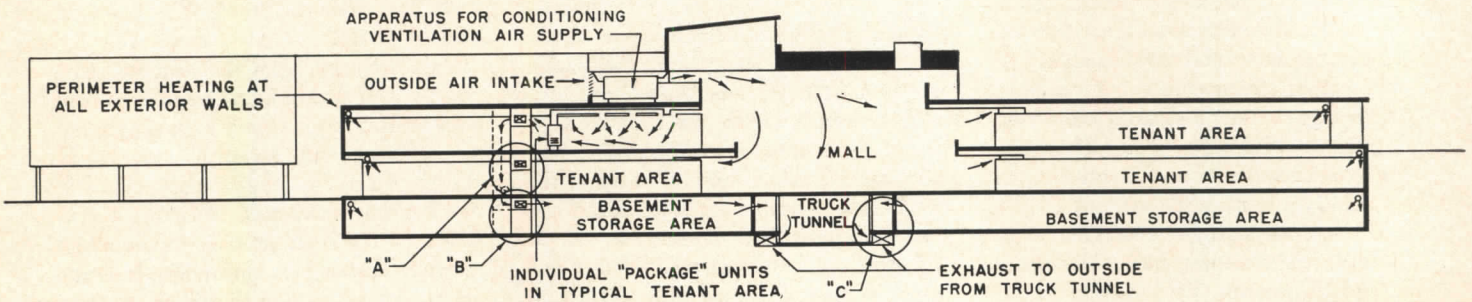

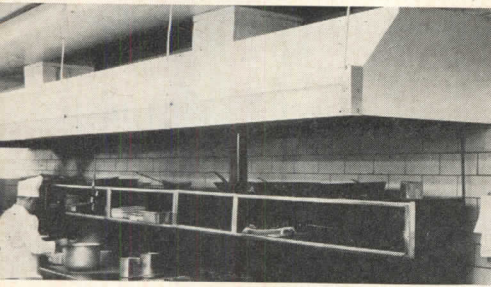

VENTILATION OF COMMERCIAL KITCHENS

Most state and local sanitation codes require that commercial kitchen and dining room ventilation be "adequate" — but they offer no hint as to what "adequate" is. Here is some basic information to guide the architect and engineer in designing efficient and economical kitchen ventilation systems

BY JACK A. WUNDERLE

Air Cleaning & Ventilation Engineer
Ohio Department of Health

GOOD VENTILATION is as integral and necessary a part of the kitchens and dining rooms of eating establishments as are the ranges, washers and even the walls and floors. It's the most important element to be considered in eliminating excessive heat, steam clouds, cooking odors, greasy vapors and even drastic temperature changes (particularly in winter if windows are used for ventilation). Without good ventilation, especially in kitchens, the resulting unfavorable working conditions decrease efficiency and increase irritability of employees, steam clouds hamper work in all departments and unpleasant cooking odors disseminated to the dining room promote customer dissatisfaction.

Ventilation may be defined as the process of supplying or removing air by natural or mechanical means to or from a space. There are two classes of ventilation: (1) general ventilation, which is the process of removing air from a general area, space, room or building; and (2) specific or local exhaust ventilation, by which a contaminant is captured at the source before it can be dispersed into the surrounding area.

General or dilution ventilation is customarily used for temperature, humidity, odor and comfort control. The standard for average conditions of ventilation has been commonly accepted as 10 to 30 cfm of outdoor air per person. ASHAE suggests that the minimum quantity of air required for spaces to be used for eating, recreation or manual work should not be less than 20 cfm per person. The Wisconsin Industrial Commission in their Heating and Ventilating Code, the Chicago Code and the Public Buildings Administration suggest 4 cfm per square foot of floor space as a minimum ventilation rate. Other sources base minimum rates on an air change basis; that is, the number of complete room volume changes per hour. Recommended figures vary from 15 to 40 air changes per hour.

Local exhaust ventilation is more effective than general ventilation. It requires less air movement and so results in less heat loss and lower power costs for the same degree of control. In addition to capturing the contaminants at their source, local exhaust acts also as a general ventilation system since the air to supply the exhaust hoods must come from the general room area. Usual practice is first to design the local exhaust system to control the contaminant sources and then to check the design volume against the general ventilation requirements. The exhaust requirements can be figured from the formula $Q = V_f \times A_h$, where Q is the exhaust volume required, V_f is the velocity of air at the face of the hood and A_h is the area of the hood opening. The proper fan size is selected on the basis of this Q value and the static pressure produced within the duct system (see discussion of Ductwork on page 198) — that is, unless a higher general ventilation rate than that produced by the exhaust volume is needed, in which case the higher rate should govern the fan size selected.

Unfortunately ventilating systems cannot be standardized, packaged and installed as a unit to do any and all jobs. The many variables — building dimensions, variety of kitchen equipment and equipment combinations, arrangement of equipment, building obstructions, local codes, etc. — dictate that the system be tailored for each application. Basically, a local exhaust system consists of hoods enclosing the source of contaminant generation, branch ducts connected to the hoods, one or more main ducts joining the branches, ductwork fittings, possibly a collector for contaminant removal in the exhaust air, and air-moving equipment to produce the necessary air flow through hoods and to overcome the resistance to the flow of air in the system. In the following paragraphs these various components of a typical kitchen ventilation

system are discussed. Methods of determining exhaust hood requirements are presented in the Time-Saver Standards on pages 209, 211 and 213.

Hoods

The purpose of all hoods is to capture contaminants in an air stream and to remove them from the working atmosphere. The hood exhaust volume must be sufficient to cause air flow into the receiving hood from all directions. It should produce an air current velocity which is adequate to control odors and vapors and which is unaffected by the cross-currents and drafts created by the opening and closing of doors and windows and by the operation of other mechanical ventilating equipment. Yet it should not itself produce unnecessary drafts. This air current or face velocity is the velocity of air as it enters the hood in the plane of the hood face. A number of factors enter into the selection of proper design face velocity, the most important of which are (1) the condition of contaminant release into the surrounding atmosphere and (2) the nature of the influencing zone of air surrounding the hood. If contaminants enter the surrounding air with high velocity, then the design face velocity will have to be high in order to trap them. As the contaminant velocity decreases to medium, low and zero, then the design velocity can also be lower. Likewise, if the body of air around the hood is relatively quiet, then the design velocity can be low. However, if it is in motion or composed of high-velocity cross-drafts, then the design velocity must be higher. Other factors which influence the selection of proper face velocities are the make-up air which is provided to the room and the use of side curtains along the hood parts not in use.

Most kitchen ventilation hoods are canopy hoods of two basic types: the freely suspended type and the shed type. The freely suspended hood is

supported (usually from above) over the surface to be controlled. All four sides are open to provide working space around the entire perimeter of the operating surface. The shed type generally extends outward from a wall and thus has three operating sides. Whichever type of hood is used, the distance X between hood bottom and work surface should be kept to the minimum possible without interfering with operations and still consistent with good appearance. The amount of this open area greatly affects the exhaust volume required.

The hood size should be such that its edges extend beyond the outer edges of the range, broiler, fryer, etc., over which it is to be installed. In some localities this is regulated by ordinance. Where such is not the case, a minimum overhang or hood projection R of 12 in. is considered necessary, and greater overlap is desirable. A common method of determining overhang is to multiply the distance X from hood bottom to work surface by 0.4. Another method is to increase the hood dimension by 2 in. for every foot of distance X . Regardless of the method used a minimum overhang of 12 in. should be maintained.

Where sufficient headroom permits, it is desirable to provide a hood height H of 2 ft. This plenum or chamber acts as a reservoir and prevents spillover by retaining excessive momentary puffs of smoke and steam until the exhaust system can handle them.

Aprons or sides extending from hood bottom to surface are often provided on those sides of the cooking units which are not in use. Use of such elements increases the effectiveness of the hood, decreases air requirements (face velocity and exhaust volume Q) and restricts carryout by cross-drafts. Oftentimes they are hinged or sliding to provide flexibility.

Obtaining uniform distribution of air inflow across the entire hood face is

a desired goal in any hood design. In smaller hoods (4 to 5 ft or less) there generally is no problem unless short-circuiting of inflow is caused by low headroom, duct take-offs at hood ends and/or low hood height. In larger hoods, which are more problematical, better flow distribution may be obtained by baffling, subdividing, including multiple take-offs or otherwise compounding the hood. All take-offs should be made at the top and rear of hoods. Where multiple take-offs are employed, they should be spaced on not more than 6-ft centers. Where space limitations do not allow take-offs vertically, and the main exhaust duct must extend horizontally from the hood end at hood level, the use of an adjustable baffle-manifold arrangement with multiple openings is often the solution. Grease filters also tend to promote uniform air distribution.

Slot Type Exhausts

Slot type exhausts, either of the straight lateral type or used in modified shed type designs, are not nearly so desirable as canopy type hoods. They increase cost of construction and cost of ventilation components, since the exhaust volumes required to control effectively a given operation are two to three times those necessary for the same operation with a canopy hood. They are not effective over distances of much more than 3 ft. In addition, slots are difficult to keep clean because of their inaccessibility. On those occasions when it may be necessary to use slot type exhausts (as in the case of overhead limitations), the slots should be made wide enough to permit access for cleaning. Grease filters should not be located near the slots if there is any danger of ignition, but should be placed at a safe distance along the exhaust duct yet still close enough so that the accumulated grease in the duct return preceding them cannot give trouble. Formulas for

determining exhaust volumes of common slot type exhausts are given on Time-Saver Standards page 213.

Deep Fat Fryers

Deep fat fryers, when not exhausted under the main range hood, may be exhausted locally by a branch duct from the main duct or by a separate system. Exhaust volumes can be determined, as in the case of range hoods, by using the formula $Q = V_f \times A_p$, where V_f is a recommended face velocity of 50 fpm and A_p is the peripheral area bounded by the forward corners of the exhaust hood and the fryer.

Steam Tables, Dishwashers

Hoods over steam tables and dishwashers do not require so calculated a design as those over ranges and other grease- and soot-producing appliances. They are provided to exhaust only steam and moisture, and so are not used in conjunction with such additional elements as grease filters.

Hoods over steam tables are generally of similar construction to range hoods. Exhaust volumes are calculated using the same formula: $Q = V_f \times A_h$. The recommended face velocity V_f is 60 to 70 fpm.

Separate and relatively small hoods and blowers are generally provided for mechanical dishwashers, with the air exhausted only at the ends of the washer, as shown in the drawing. These hoods exhaust steam and moisture which escape from the washer enclosure when dishes enter and leave. Exhaust volumes for dishwashers can be figured fairly generally, with no need for extended formula calculations. For a 9-ft dishwasher, exhaust volumes of approximately 1500 cfm are used; for 5-, 6- and 7-ft sizes, Q is about 1000 cfm; and for smaller washers, 750 cfm should be the volume used.

Shed type hood

Freely suspended hood

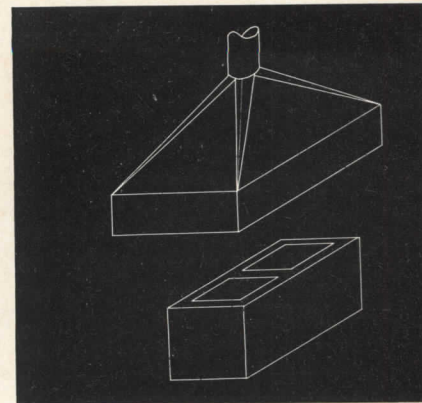
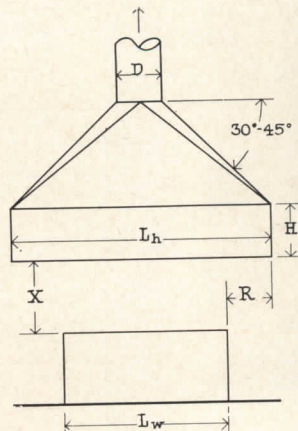
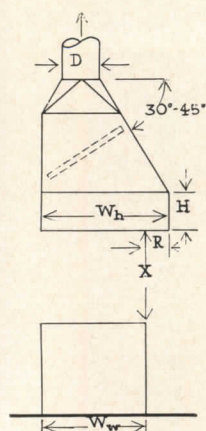
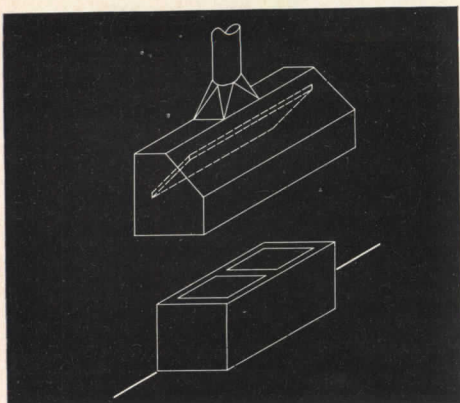

Grease Filters

Grease filters are desirable for large kitchen hoods for two reasons: (1) They remove oily vapors and droplets, thus preventing the accumulation of cooking greases in the ductwork, on exhaust fan blades, on building walls, etc. (2) They serve as diffusers and so tend to promote a uniform distribution of air over the hood opening. These filters must be changed or cleaned frequently, so they should be installed so that they can be removed easily. When they are heavily coated with grease, they not only drip excess grease, and increase measurably the system resistance, but they are also serious fire hazards. In some designs the filters are tilted slightly to permit drainage of excess grease and oil to drain channels and thence to a reservoir or container.

Where air exhaust volumes are so large that they cannot be handled by the filters, air noise can become a serious nuisance. To combat this, filters may be arranged in a V or W form, thus increasing the filter area and enabling larger air volumes to be handled.

Most grease filters are made to standard dimensions, varying from 1 to 3 in. in thickness, and are designed to handle from 150 to 250 fpm (low velocity type). There is also on the market a high velocity type which is said to work best at velocities of approximately 500 fpm. For good efficiency the velocity through any filter should be that recommended by the manufacturer. The grease filter area required (number of filters) is readily obtained by dividing the exhaust volume (cfm) by the filter manufacturer's velocity rating (fpm).

Ductwork

The correct design and competent installation of sheet steel ducts (and hoods) is of utmost importance for the proper functioning of any exhaust sys-

tem. Improperly laid-out ductwork often results in inadequate distribution of ventilation. Ducts should be as straight as possible. Where direction changes are necessary, they should be gradual rather than abrupt. Interiors of all ducts should be smooth and free of all obstructions, with joints either welded or soldered air-tight.

Round ducts are preferred over square or rectangular ducts and should be used wherever possible because of their lower perimeter per unit area ratio (lower friction loss per unit length) and because of their more uniform cross-sectional flow pattern. Where rectangular ducts must be used, they should be made as nearly square as possible.

For kitchen ventilation systems, an approved fire damper with fusible link in the ducts adjacent to the hoods is recommended to reduce the possibility of a grease fire spreading through the system. Access doors should be provided at the fire dampers to provide easy access for inspection, cleaning and replacement of the fusible link. Exhaust piping should be provided with tight-fitting clean-out doors of a size to permit easy cleaning of the grease ducts.

All exhaust systems should be constructed of approved materials, sizes and types, and installed in a permanent and workmanlike manner. Copper bearing steel is suggested by the Public Buildings Administration for reduction of corrosion effects in ducts, hood and fan. Aluminum, black iron, stainless steel and galvanized sheet steel are also used.

Duct sizes are determined by the quantity of air to be moved and the transport or carrying velocity to be maintained in the duct. Generally, to minimize the condensation of cooking by-products in the system, it is advisable to maintain a transport velocity of 1500 to 2000 fpm. See sample calculation on Time-Saver Standards page 211.

Fans and Motors

An exhaust fan is expected to establish and maintain a prescribed rate of air flow through the various elements of the exhaust system. In order to select the proper fan for an exhaust system, it is necessary to determine the amount of work the fan must do. This work takes the form of resistance to flow and is composed of hood entrance losses; friction losses due to the ductwork and fittings; resistance of make-up air inlets and wind back-pressure; shutter resistance at exhaust outlet; and resistance to collectors and grease filters (when filters are dirty, filter resistance may increase two or three times that of clean filters, and note of this should be taken in calculating the maximum system resistance for fan selection). Manufacturers' catalogs list static pressure ratings of fans (inches of water) and fan capacities (cubic feet per minute). The pressure-volume charts or curves in these catalogs should be used in fan selection to ensure that the required exhaust volume will be delivered even with conditions of maximum over-all system resistance.

In general, centrifugal fan blowers rather than propeller-type fans should be used, because they are designed to operate efficiently against the static pressure of duct systems. Propeller fans are highly sensitive to any change in resistance pressure and hence may exhaust considerably less if any increase in system resistance develops. The centrifugal blower overcomes this disadvantage and has an additional advantage over the propeller fan in that the motor is not in the smoke- and grease-laden airstream. (Some local city ordinances prohibit the use of propeller fans whose motors are in the airstream.)

As a rule, it is better to have blowers and motors slightly oversize. If blowers are too small, the motors must operate at high speed and usually with consider-

Biddles Restaurant, Columbus, Ohio

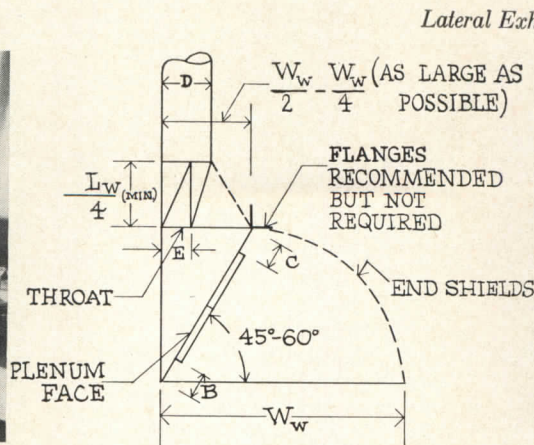
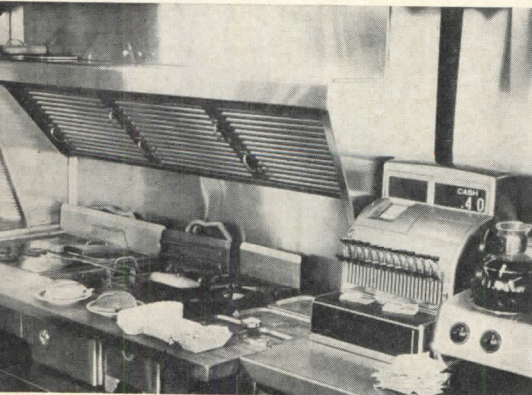

Lateral Exhaust (slant type hood)

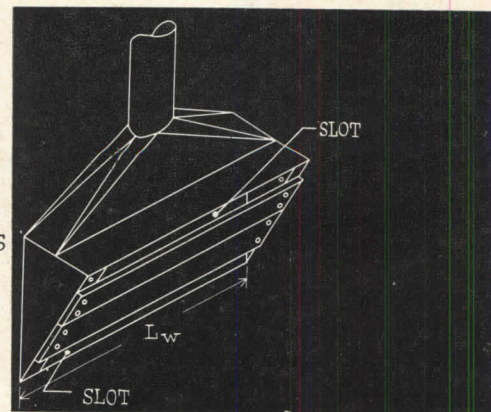

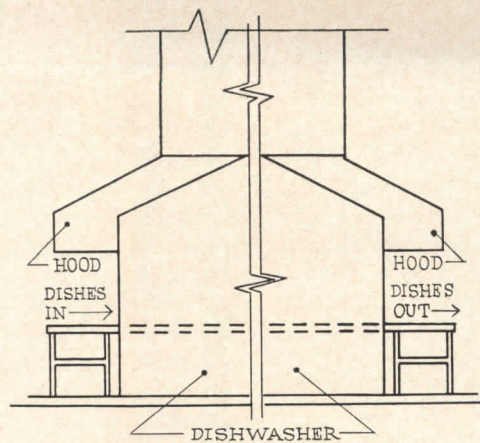

Dishwasher hood

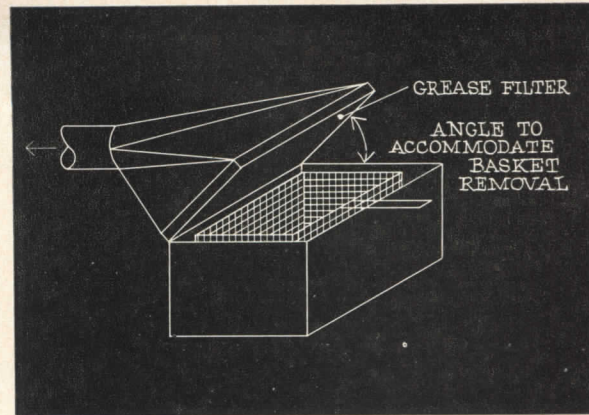

Deep fat fryer

able noise, and current consumption will in most cases exceed that of a larger blower running at a slower speed. Motor speed regulators are sometimes used where maximum ventilation is not required at all times. Their use saves electricity and reduces wear, tear and noise. Another desirable feature is the use of overload cut-outs to prevent overloading of drive motors should the system resistance be suddenly reduced (e.g., removal of grease filters for cleaning during fan operation).

Where flexible connections are made to the fan inlet and outlet, they should be of asbestos cloth for fire resistance. Fly screens are inadvisable on the outlet side of the fan since dirt, dust, grease, etc., soon clog the openings and prevent air passage. Doors should not be used since they may be blown or accidentally left shut. Automatic shutters which will open or close with fan operation and which will close with an excessive temperature rise (duct fire) are suggested.

Make-up Air

In the ventilation of any space it is a cardinal rule that not only must the contaminants be removed but a like quantity of fresh air must be introduced to replace that exhausted. There are a number of reasons for the provision of make-up air: (1) to insure proper operation of exhaust hoods; (2) to eliminate high-velocity cross-drafts through doors, windows or cracks into the zone of influence of the hood, thus nullifying the control exercised by a properly designed exhaust hood; (3) to eliminate cross-drafts on workers; and (4) to ensure the proper operation of natural draft stacks on fuel-burning appliances, etc.

Make-up air should not be introduced in such a manner as to create an undesirable draft or to interfere with the effectiveness of hood operation. It is desirable to locate the air supply openings so that cross-ventilation of the workroom is

obtained with no "pockets," "dead spaces" or short-circuiting. Properly located openings allow the air volume handled to be "used twice": first to supply general ventilation, and second to supply make-up air for the exhaust system.

In kitchens, replacement air is often brought from the dining area by placing registers or grilles in the partition separating the two areas. The slight static pressure thus developed in the dining room has the advantage of preventing kitchen odors from reaching the area, and in addition it helps to ventilate the dining area. Where such a method is used, there should always be two grilles of liberal proportions in the partition, preferably separated and located toward each side of the room.

The grille inlet velocities recommended by the American Standards Association are as follows:

Height of Inlet above Floor (ft)	Inlet Velocity (fpm)
Under 8	120
8-12	250
12-18	500
18 and over	1000

Knowing the permissible inlet velocity from the above table and the amount of air to be passed through the grilles (make-up volume), one can figure the necessary grille area ($A = Q/V$). The area so figured is the actual open area or "effective" area of the grille. One must add to this the area taken up by grille mesh in order to obtain the physical dimensions of the grille. In general, increasing the computed grille area by 50 per cent will approximate the proper over-all grille size.

Where dining spaces are air-conditioned, it may be desirable to reduce the amount of air taken from them in order to reduce the load placed on the refrigeration system and to provide the

remaining air directly from the outdoors. This air may be supplied through properly located windows (summer only) or through sized ductwork with adequately spaced openings. Regardless of how it is supplied, the flow of air into the building and out through the exhaust system should be orderly, providing a blanket sweep of the room with fairly uniform air movement.

During the winter season, it is necessary to temper the air drawn from the outside. Tempered fresh air may be provided through the main heating system, if such is feasible, or through unit heaters. It is wise to arrange the make-up system so that fresh air may be drawn from the outside and either passed directly to the room (non-heating season) or passed through the heating element (winter season). In installations using steam or hot water elements, freeze-proof coils and automatic controls should be specified if there is a danger of heating coils being subjected to freezing temperatures.

The intake for the air supply should be located remote from any contamination sources (exhaust discharges, etc.). Where air drawn in from the outside may contain objectionable foreign matter, filters may be advisable at the inlets to remove dust, soot, etc. This additional resistance plus that due to any heating elements in the make-up air stream must be added to the over-all system resistance when determining exhaust fan sizes.

Finally, a note of warning concerning appliance flues. Caution must be exercised where fuel-burning equipment requiring flue venting (such as a gas-fired, booster water heater) is located near powerful exhaust equipment, since the exhaust equipment may pull air (back-draft) through the appliance flue. This illustrates another and most important point in favor of the balanced make-up exhaust system.

CONSTRUCTION CONSIDERATIONS AND SPECIFICATIONS FOR LOCAL EXHAUST HOODS*

Competent design and correct installation is essential to proper functioning and satisfactory operation of any exhaust system. The following specifications are given as a guide to good construction and installation practice.

Materials

1. All construction should be of new and approved materials. Black iron welded, galvanized sheet steel riveted and soldered, copper clad steel, aluminum and stainless steel are materials suited for construction unless the presence of corrosive gases, vapors, mists or other conditions makes the use of such materials impractical. Galvanized construction is not recommended for temperatures exceeding 400 F.

2. For pipes or ducts used in the average exhaust system on non-corrosive applications, the following metal thicknesses are recommended:

Diameter of Straight Ducts (in.)	U. S. Standard Gauge
8 and less	24
Over 8 to 18	22
Over 18 to 30	20
Over 30	18

3. Ductwork should be located so as to require the minimum length of pipe and a minimum number of elbows and so as to be accessible yet protected from external damage.

4. Elbows, bends and angles should be a minimum of two gauges heavier than straight lengths of the same diameter.

5. Hoods should be a minimum of two gauges heavier than the straight sections of connecting branches and free of all burrs and sharp edges. Large hoods should be reinforced for rigidity, particularly along the edges, to prevent warping and buckling. If stainless steel is used, gauges may be reduced.

6. Use of flexible piping should be

kept to a minimum. Where used, a non-collapsible piping should be employed. Asbestos or fireproof materials are necessary on hot applications.

7. On corrosive applications consideration should be given to non-corrosive materials and corrosion-resistant paints or coatings. Even where corrosion is not considered a problem, it may be advisable to apply a corrosion-preventative coating to both the inside and outside of the system to minimize costly maintenance and repair work, since all ductwork and system components are not mass-produced but tailor-made for the job.

Construction

1. Duct joints should be smooth and free of obstructions or screens and of as near airtight construction as possible.

2. Longitudinal duct joints should be lapped and riveted or spot-welded on 3-in. centers or less.

3. For minimum resistance to flow and turbulence, the lap on girth joints should be made so that, in the direction of air flow, the downstream end of duct sections is inside the upstream end of the next section. A 1-in. lap is used for ducts 19 in. or less in diameter, and a 1¼-in. lap for larger ducts.

4. Slip joints should be reinforced and free of burrs, obstructions and sharp edges.

5. All bends should preferably have a centerline curvature radius of 2½ times the duct diameters and never less than 1½ duct diameters. Elbows (90-deg bends) of 6 in. diameter or less should be of at least five-piece construction; over 6 in. diameter, of at least seven-piece construction; other bends sectioned in proportion.

6. Transition pieces in mains and sub-mains should be tapered. Where possible, the taper should be approximately 5 in. long for each 1 in. change in diameter. In the design of ductwork, care should be exercised to make sure that in going from a small to a larger duct the conveying velocity is maintained in the larger duct.

7. Branch ducts should enter the main near the large end of transition pieces and at a maximum angle of 45 deg (30 deg or less is preferred) measured between the centerlines of the ducts. Connections to the mains should be on the top or sides, not on the bottom. Branch connections should be staggered, and the connection of two branches in the same section of the main should be avoided. If two or more branches must

enter in the same section, use an entrance angle of approximately 20 deg.

System Details

1. The main duct should be connected to the exhaust inlet by a split-sleeve drawband at least one pipe diameter but not less than 12 in. long. Approved flexible connections may be used for certain applications. The area of fan inlet and outlet should be at least equal to the area of the main pipe.

2. The duct system should be supported so that no weight is transferred to the connected equipment. Sufficient support should be provided so that the system will not collapse even though completely plugged with contaminant material. Recommended maximum supporting interval is 12 ft for ducts 8 in. or smaller and 20 ft for larger ducts.

3. A minimum clearance of 6 in. between ducts and ceiling, walls or floor is recommended.

4. Clean-outs or access openings should be provided every 10 or 12 ft, near each elbow, angle or duct junction and at damper locations. Dead-end caps are recommended within 6 in. from the last branch of all mains and sub-mains.

5. Where blast gates are used, they should be of sturdy construction and preferably placed near the connection of branch to main. A positive means should be provided for locking, bolting or otherwise permanently fastening in place to prevent manipulation after the system has been balanced.

6. Round ducts should be used wherever possible. Where clearances prevent the use of round ducts, rectangular ducts as nearly square as possible are permissible. Metal gauge, lap and other construction details should be equal to those of round ducts the diameter of which equals that of the longest side of the rectangular duct.

7. Automatic fire dampers should be provided where pipes pass through firewalls.

8. Ducts passing through non-fireproof roof or walls should have an outer sleeve with at least 1 in. air space. The sleeve should be not less than 2 in. from a wooden member.

9. Fire dampers, explosion vents, etc., should be installed in accordance with National Fire Protection Association Codes and/or local fire ordinances.

10. Electrical equipment and wiring should be installed in accordance with the National Electrical Safety Code. Electric wiring should be enclosed in metal conduits.

* Reprinted from "Industrial Ventilation Manual," by the American Conference of Governmental Industrial Hygienists, 1954.



POWER BUILDING WIRED FOR MAXIMUM INTERIOR FLEXIBILITY

FLEXIBILITY IS THE KEYNOTE of the new Department of The Interior Building in Portland, Ore. Designed by John Graham and Company, Architects-Engineers, of Seattle, the power building features an electrical system which makes possible arrangement of interior spaces for maximum utility.

The plan shown below of a typical floor in the office wing indicates the underfloor conduit system serving electric and telephone outlets. As can be seen, four branch panelboards and three telephone panels at either end and in the center of the building serve each floor. Electric and telephone conduits are run under each concrete floor slab from these panels. The 1-in. electric cable serves outlet boxes, one of which is centrally located in each bay. Additional outlet boxes, energized from these centrally located boxes, can be located anywhere in the floor slab. Two outlets are also wired into each of the 14 columns which are spotted along the center of each floor on 24-ft centers. In addition, a continuous electrical plug-in strip is recessed in the bottom of the continuous convector runs around the perimeter of each floor.

The telephone system is installed in a similar manner. A 2-in. conduit runs down the center of each floor to serve telephone outlet boxes at the top of

each column, just under the slab. Outlets run from these boxes can be located anywhere in the floor above. In addition, the bottom of the heating convector, just under the plug-in strip, affords approximately a 4- by 4-in. continuous raceway on the perimeter of the building for telephone wires.

The lighting system is planned so that tenants can install ceiling height partitions and not interfere with the lighting pattern even for small offices. Continuous troffers are hung from the floor slabs in rows that are 4 ft on centers. These troffers not only house lamps but also, as shown in the drawing at right, form hangers which support the acoustical tile hung ceiling. Each tile can be removed for access to the underfloor electrical conduit. In the initial installation each continuous troffer was divided into alternate 4-ft lamp sections and 4-ft empty sections. The empty sections were provided with blank covers which could be removed so that ballasts and lamps could be added to make a continuous run of fluorescent lamps. Likewise, lamp sections could be replaced with blank covers, if desired, for complete flexibility. The troffers, with louvered bottoms, were designed for two- or three-lamp operation, using standard 4-ft 40-watt fluorescent lamps.

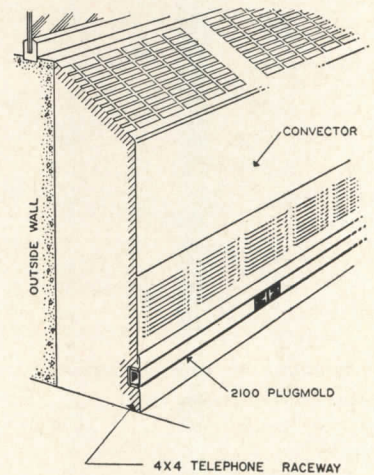

Continuous electrical plug-in strip and telephone raceway are recessed in bottom of perimeter convectors

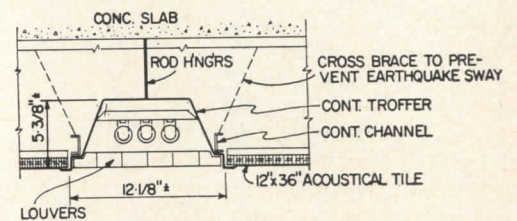

Continuous fluorescent troffers hung from floor slab support ceiling tiles

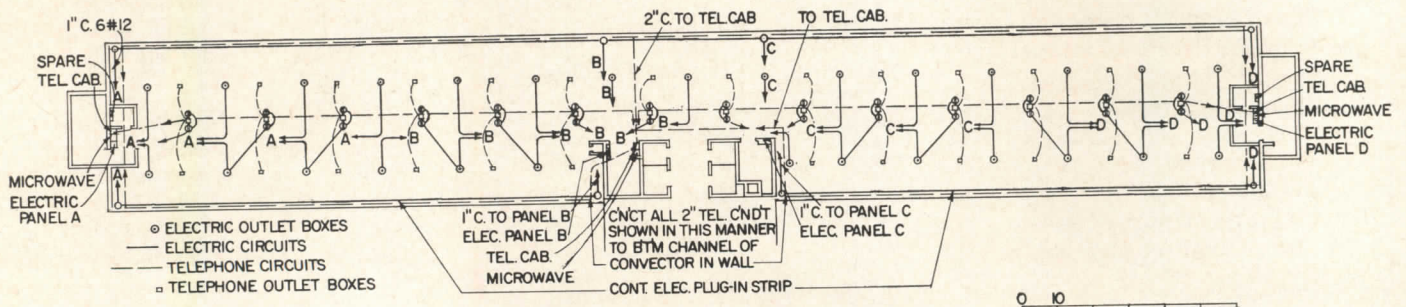

Typical floor in office building

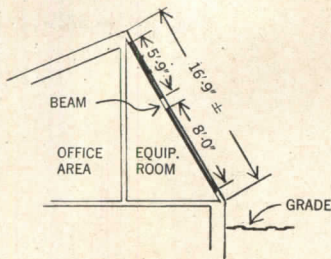

Photos by Rose Photo Studio, Albuquerque

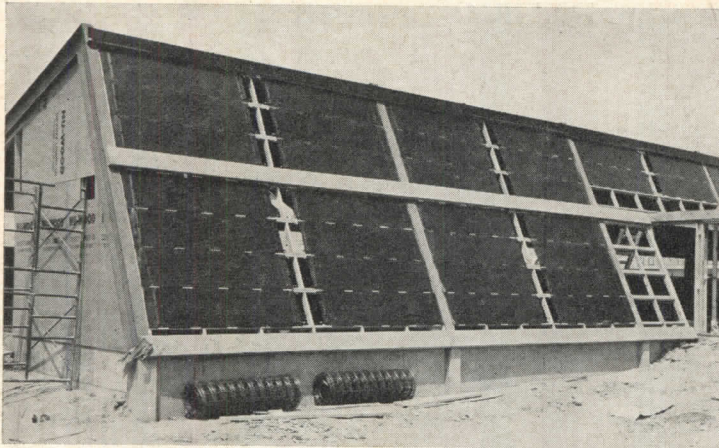

Black aluminum collector panels enclose integral water channels $\frac{1}{2}$ in. wide by $\frac{1}{8}$ in. deep

A section and a close-up of the network of pipes which carry heated water from the collector panels into the heating system. The tanks are the water chiller and condenser of the heat pump

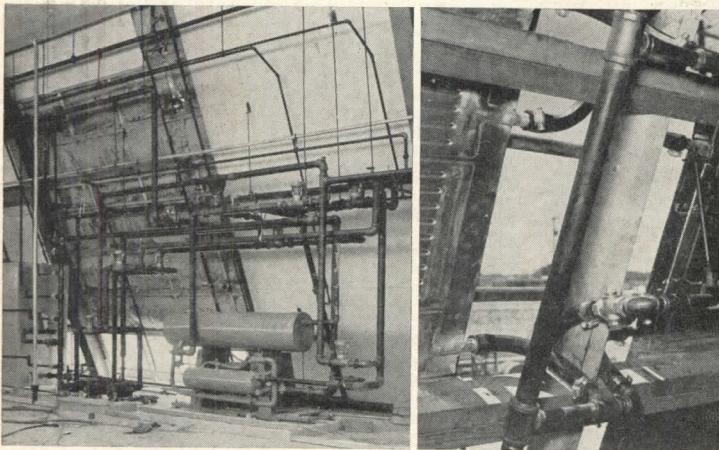

South wall separates office space from equipment room. Light from skylights bounces off wall and lights room

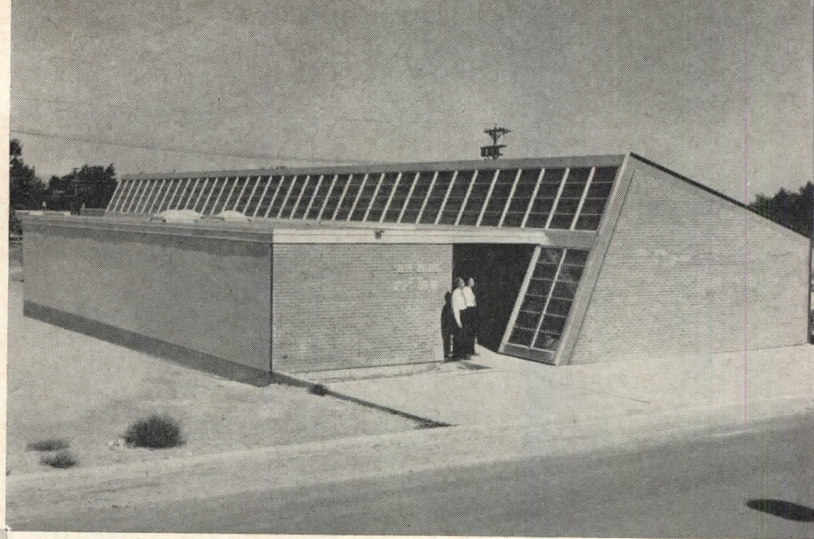
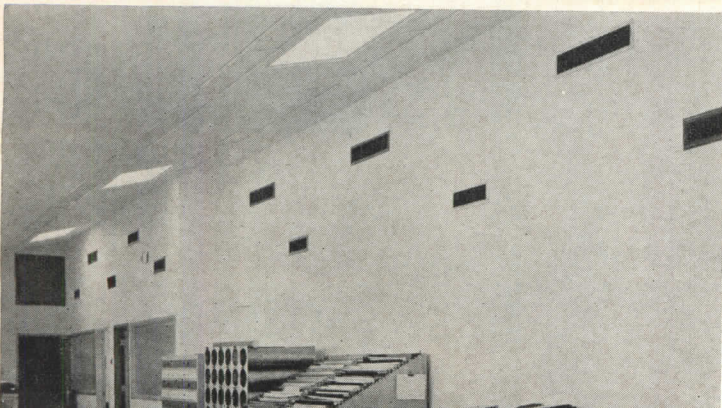

SOLAR-HEATED OFFICE BUILDING

SOLAR HEATING has graduated from the stage of research or use in "solar houses" to actual every-day commercial operation. Architects Stanley & Wright, AIA, of Albuquerque, N. M., have conceived a practical and attractive office building to house the solar heating system which was designed by the engineering firm of Bridgers & Paxton, who also own the building.

The system itself is based on a bank of collector panels composed of silk-screened aluminum sheets which are fusion-welded under pressure between platens and then "blown up" to form interlacing channels through which water can flow. These panels — 800 sq ft of them — are painted black with a specially prepared paint that has a reflectivity of almost zero. They face south, of course, and the heat that is absorbed by the water coursing through the channels is run through radiant-heating panels in the ceiling and floor.

An integral part of the system is a 6000-gal water storage tank which is

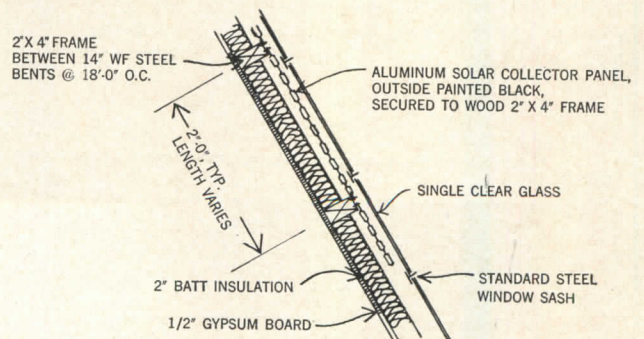

Engineers Donald Paxton and Frank Bridgers stand on the threshold not only of the office building which houses their solar heating system—but also of a challenging new era of heating and cooling

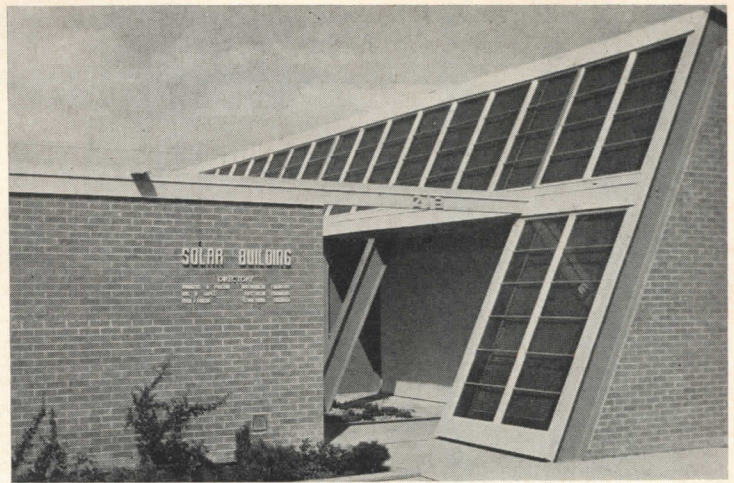

COMBINES GOOD ARCHITECTURAL AND MECHANICAL DESIGN

sunk underground and insulated with 4 in. of fiber glass block. This tank can store enough heated water from the collectors to heat the building for three days. If, however, dark, cold days continue for a longer period than three days, the system can be switched to activate a heat pump operation. The heat pump system extracts heat from the stored water (even when its temperature is as low as 35 F), compresses the heated refrigerant to an even higher degree of heat and then passes on this heat to the water in the radiant heating system. The heat pump is utilized without the solar collector in warm weather to provide cooling for the building. In this cooling cycle, heat extracted from water in the storage tank is passed along to an evaporative water cooler which discharges it to the outside. The subsequently cooled water in the storage tank is passed directly into the radiant panel system.

In the spring and fall, when heating is required during the night and early

morning in Albuquerque and cooling in the afternoon, a modulating valve can separate the radiant system from the collector-to-storage-tank system, and the tank can store up daytime heat for nighttime heating while the evaporative cooler cools the building. The evaporative water cooler can also be used in the summertime as the sole cooling medium if the cooling load is not too high (in which case the heat pump system would be used).

The building itself, with a gross floor area of 4300 sq ft, is framed with seven welded steel bents 18 ft on centers, with wood joists spanning between the bents. Most of the building was constructed on grade, except for a small basement of 200 sq ft. Cost of construction, including the heating system, was about \$13.60 per sq ft.

The drafting rooms of the three firms which occupy the building are spotted along the pitch-roofed section. Indirect lighting enters this section through skylights along the top and bounces off the

south wall to eliminate the need for artificial lighting during the day. The south wall is dropped vertically from the peak of the sloping roof, separating the office area from the equipment room. The offices of the three firms are in the flat-roofed section.

Bridgers & Paxton feel that the most important element in considering this type of building for other sections of the country is the amount of storage required. In Albuquerque, where the number of degree-days per year is 4389, a three-day storage period suffices. In other areas, such as New York, which has 4989 degree-days per year, a longer storage period might be necessary. Other factors would have to be considered also, such as the cost ratio of conventional fuels to electricity, the cost of materials and labor, the cost of the land itself—and, of course, sunlight. To ensure an unobstructed source of sunlight for this building, the lot to the south was purchased so that no future tall building could block the heat supply.

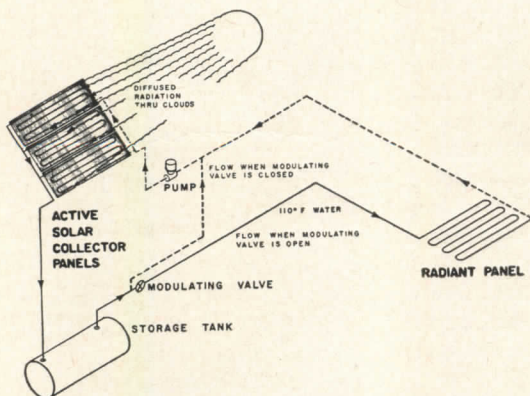

When modulating valve is open, 110F to 140F water from collectors flows directly through tank to heating system. When it is closed, water circulates from collectors to tank, storing heated water. Then cooled water can be used in the radiant panels

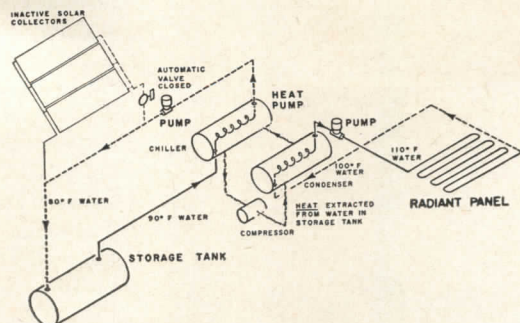

During extended dark days, heat pump heats building. Heat pump can also be used for summer cooling, with cooled water from chiller going directly into radiant system and extracted heat being discharged to the outside through evaporative water cooler

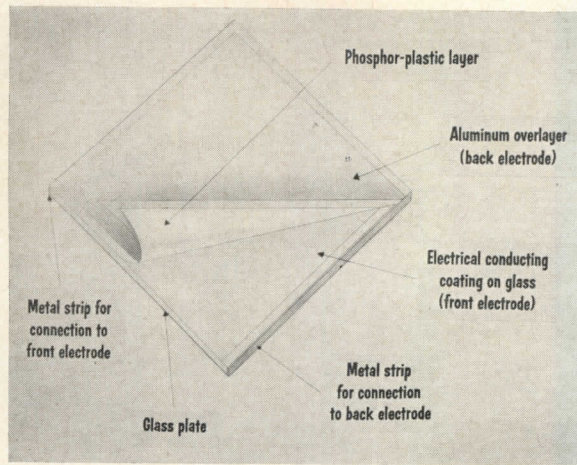

“ELECTROLUMINESCENT” GLASS PANELS PROVIDE INTEGRATED LIGHTING

ROOMS OF LIGHT — with walls, ceilings and possibly even floors as sources of illumination — may be part of the construction of tomorrow. This phenomenon will be realized by means of *electroluminescence*, which is a natural progression in sources of light from the familiar point (bulb) and line (tube) sources to panels of light. Introduced by Westinghouse after years of research, electroluminescent panels are still not ready for commercial use. However, it is expected that they may be ready for marketing after another two years of development.

The panels, shown above illuminating a room with shadowless lighting, consist of 1-ft square glass plates $\frac{1}{8}$ in. thick, each of which is coated with a transparent but electrically conducting film. Over this is spread a layer of polyvinyl choride plastic in which is embedded a zinc sulfide-type phosphor. An aluminum conducting coating completes the panel, which thus has two conducting layers separated by a dielectric. When electricity is applied, the phosphors in the phosphor-plastic layer give off diffused light through the glass plate.

Even a variety of color will be pos-

sible with electroluminescence. Since some phosphors have more than one emission band, frequency affects the color emitted. White is obtained by mixing together red, blue and green phosphors. It is entirely possible that rooms of the future will have two knobs for controlling complete electroluminescence. One will adjust voltage to regulate brightness, and the other will adjust frequency to regulate color emission. The illumination of the room illustrated is 50 ft-candles, the brightness is 100 ft-lamberts and the efficiency is 3 lumens per watt.

DECORATIVE LIGHTING EFFECTS FOR DALLAS STATLER HOTEL

SOME UNUSUAL AND DRAMATIC TECHNIQUES of lighting public spaces have been conceived by architect William B. Tabler for the Dallas Statler Hotel. Practical as well as decorative, they combine color and design in translucent

acrylic plastic in such a way as to relieve what otherwise might be a monotonous lighting pattern.

A basket-weave ceiling in the elevator lobby is fabricated from dozens of 2-in.-wide strips of $\frac{1}{8}$ -in.-thick translucent white Plexiglas woven around ovoid brass rods spaced at 6-in. intervals. The ends of the rods are supported in steel channels in 3-ft sections which are invisibly joined at the top. These sections, supported on wires, can be lowered for replacement of fluorescent lamps. To keep the fluorescent tubes invisible through the openings in the weave, 3- by 4-ft sheets of Plexiglas are mounted between the woven strips and the lights. The ceiling pattern is continued down the wall at the end of the corridor to provide backlighting for a silhouette of the State of Texas.

Strips and squares of colored translucent Plexiglas combined into abstract patterns of line and color add interest to the 40-ft expanse of corrugated white luminous ceiling above the cashier's

and registration desks. The plastic grill-work, which was assembled by cementing, is composed of gray translucent square rods punctuated at intervals with the squares and strips of yellow, red, blue, green and white.

(Continued on page 214)

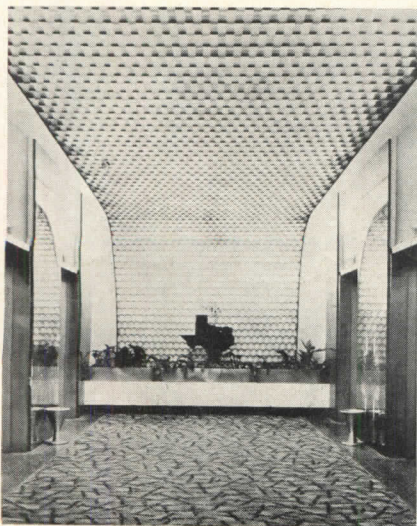

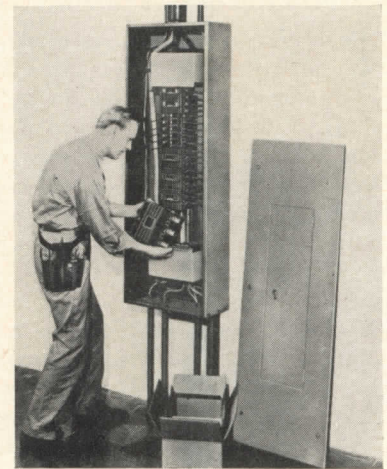
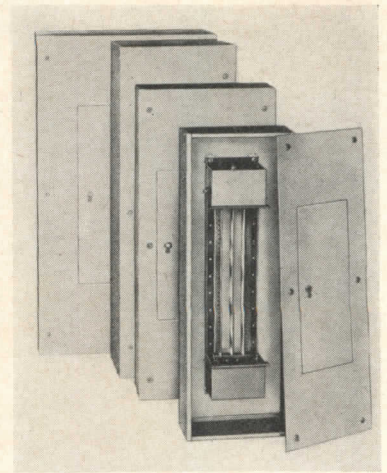
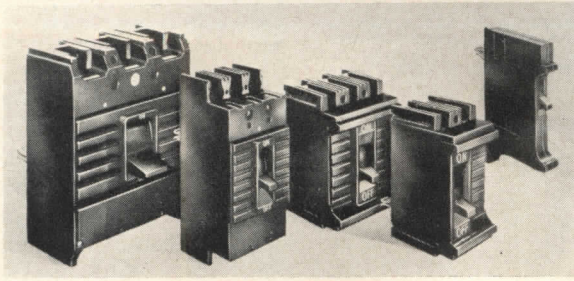

MODULAR CIRCUIT BREAKERS AND CASES

MODULAR-DESIGN MOLDED CASE circuit breakers which make possible flexibility and economy of installation have eliminated the need for custom-built panelboards. There are now four different standard panel assemblies available with single and double bussing to accommodate E, F and J frame StA-Breakers with main capacities up to 600 amp.

The complete line of StABreakers, shown above, ranges from a slim $1\frac{1}{16}$ -in. single-pole type E at the right to the 225-amp three-pole type J at the left. These breakers are simply "stabbed" into the appropriate panel for a job, as shown in the installation photograph at right, to provide the protection required. When modification of service is necessary, breakers can be removed easily and replaced by other units of the proper type or rating. With the selection of breakers available, compactness is assured within the rating limits, especially with the $1\frac{1}{16}$ -in.-

wide single-pole NE-S breakers. These narrow units are supplied with ratings from 15 to 50 amp to double the number of lighting circuits served by a single panel enclosure unit. Filler strips are supplied to assure dead front construction when panel space is reserved for future circuits.

The four panel assemblies, shown in the photograph at right, range from an enclosure 16 in. wide by 48 in. high for single-row bussing for 225 amp main to an enclosure $28\frac{3}{4}$ in. wide by 60 in. high for double-row bussing for 600 amp main. These panels make it possible to select and install the proper size panel at the beginning of a job according to the estimated amount of breaker protection required and then to order and install the exact number of StABreaker units, taking into account any last-minute circuit changes, when the building is ready. *Federal Pacific Electric Co., 50 Paris St., Newark 1, N. J.*

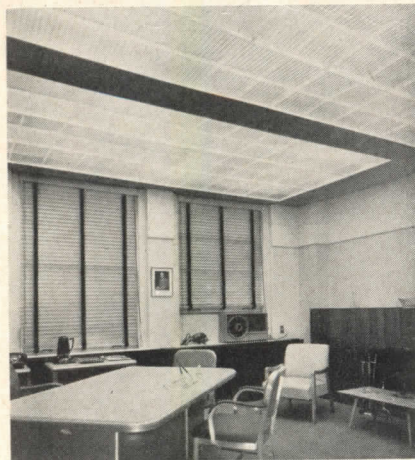
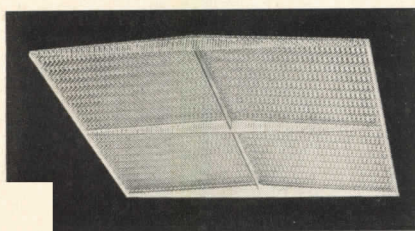

GLARELESS PRISMATIC CEILING LENS PLATE

A CEILING LENS PLATE has been introduced which is said to have a negligible glare factor and a visual comfort factor of 100 per cent for all room sizes and for all lighting levels. The *Prismalume Controlens No. 6024* is a lens plate of prismatic plastic which carries the claim of keeping the apparent brightness in any normal viewing angle, between 45 and 90 deg, below 200 ft-lamberts while distributing a generous amount of light to the work area. Average lighting levels up to 300 ft-c are said to be possible without discomfort from sidewise overhead glare.

The 2-ft-square lens can be used singly for two or three standard 20-watt

lamps; in combination for troffers or rectangles of any size with fluorescent lamps of 4, 6 or 8 ft; or to cover an entire ceiling. Each lens is slightly concave downward, with translucent struts and an edge flange which rests on any flat support. Adjacent edges butt together tightly. Transparent plastic T-bar strips provide shadowless supports for the lenses. Each unit weighs only $4\frac{1}{2}$ lb and can be cut or drilled. The prisms are on the underside; the upper surface is flat. The installation shown at left is in Holo-phane's New York office. *Holophane Co., Inc., 342 Madison Ave., New York 17, N. Y.* (More Products on page 225)

Excellent Wind Load Resistance



Limited Contraction and Expansion



High Moisture Resistance



Maximum Insulation Value

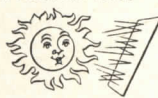

INSULATING STRUCTURAL PANEL

Asbestos Transitop (AIA 19-D) describes the construction of this insulating structural panel, made with an insulating board core faced on both sides with *Asbestos Flexboard*, for heavy and light construction. It covers the basic physical characteristics of *Transitop*, pictured at left, and follows with three sections on its use in curtain wall construction over either steel or wood framing, for roof decks and as interior walls. Design data together with specifications for painting and decorating are included. 36 pp. *Johns-Manville, 22 East 40th St., New York 16, N. Y.*

Modern Sheet Copper Practices

(AIA 12) Publication C-1 is a spiral-bound workbook of drawings and specifications intended as a guide to architects, specifications writers and sheet metal workers on the correct uses of sheet copper. 110 pp. *The American Brass Co., Waterbury 20, Conn.**

Architectural Metal Products

(AIA 15) This 4-page brochure announces the Flour City architectural metal products. More detail is offered in three other brochures: *Metal Windows* (AIA 16-E), 24 pp; *Curtain Walls* (AIA 17-A), 12 pp; *Metal Doors* (AIA 16-E), 12 pp. *The Flour City Ornamental Iron Co., 2637 27th Ave. So., Minneapolis, Minn.**

Custom Wallcovering

This catalog and price list of matching fabrics and wallpapers also includes a section on metal furniture. 26 pp. *Louis W. Bowen, Inc., 37-06 36th St., Long Island City, N. Y.*

Glass Mosaic

Presents architectural and decorative glass tile for floors, walls, ceilings, panels, murals, table tops, etc., manufactured by the Societa Anonima Italiana Del Vetro D'Ottica in Italy. 8 pp. *American Import & Export Co., 815 Land Tille Bldg., Philadelphia, Pa.*

Contemporary Lighting

File folder contains a complete line of commercial and residential lighting fixtures and portable lamps. *EJS Lighting Corp., 921 East Pico Blvd., Los Angeles 21, Calif.*

Brisk Metal Products

(AIA 14-B-4) Details extruded aluminum louvers, solar canopies and vent housings. 8 pp. *Brisk Metal Products, 103 Park Ave., New York 17, N. Y.*

Case Plumbing Fixtures

Leaflet catalogs plumbing fixtures and includes chips of 32 colors in which they are available. *Case Mfg. Corp., 33 Main St., Buffalo, 3, N. Y.*

Wiring Devices (AIA 31-C-7)

Catalog 29 lists and describes a complete line of wiring devices and enclosed switches. *Arrow-Hart & Hegeman Electric Co., Hartford, Conn.*

Window Washing Systems

Booklet 2022-A describes *Tramrail* window washing systems in different types of buildings, stressing their safety features. 16 pp. *The Cleveland Crane & Engineering Co., Cleveland Tramrail Div., Wickliffe, Ohio.*

The Massapequa Story (AIA 19-B)

Describes the use of the *Teco* system of engineered timber construction in providing modern educational facilities for the mushrooming school population of Massapequa, N. Y., at about a 35 per cent reduction in costs. *Timber Engineering Co., 1319 18th St., N.W., Washington 6, D. C.**

Rapid Combustion

Pressures Developed by Rapid Combustion is a report of investigations to determine the pressure effect of high combustion rates inside closed buildings. It develops a formula for determining necessary vent area to prevent damaging pressures. \$1. *Factory Mutual Engineering Div., 1151 Boston-Providence Turnpike, Norwood, Mass.*

General Purpose Circuit Breakers

Bulletin 3411 describes the principle, design, operation and application of the hydraulic-magnetic type of general purpose circuit breaker. 20 pp. *Heinemann Electric Co., 254 Plum St., Trenton 2, N. J.*

Foamglas Building Insulation

(AIA 37-B) Booklet FB-101 contains information on the latest recommended procedures for application of *Foamglas* cellular glass insulation on flat roofs, pitched roofs, parking decks, curtain walls, core walls, wall linings, ceilings and perimeters. 24 pp. *Pittsburgh Corning Corp., 1 Gateway Center, Pittsburgh 22, Pa.**

For Modern Exteriors (AIA 23-L)

Numerous color photos show various siding materials, including horizontal siding and vertical panel siding in various treatments and textures. 16 pp. *Masonite Corp., Home Service Bureau, 111 W. Washington St., Chicago 2, Ill.**

Man of Vision (AIA 20-B-1)

This booklet carries the development of metal lath from the first perforated sheets of Peter Naylor through the improved modern-day product, covering fire safety, design versatility, durability and economy. 16 pp. *Metal Lath Mfrs. Assn., Engineers Bldg., Cleveland 14, Ohio.**

Shopping Centers

... *Framed with Steel*. Presents the advantages of steel construction in shopping centers, stressing low cost, strength, flexibility, adaptability, appearance, safety and speed of construction. 16 pp. *American Institute of Steel Construction, Inc., 101 Park Ave., New York 17, N. Y.**

Unibestos Insulation

Catalogs *Unibestos* pipe insulation and presents a new way to specify proper thickness for pipe insulation. 40 pp. *Union Asbestos & Rubber Co., 111 West Perry St., Bloomington, Ill.**

*Other product information in *Sweet's Architectural File, 1056*.

(More Literature on page 260)

DETERMINATION OF EXHAUST HOOD REQUIREMENTS—1

By Jack A. Wunderle, Air Cleaning & Ventilation Engineer, Ohio Department of Health

FREELY SUSPENDED AND SHED TYPE HOODS

There are three basic methods of calculating exhaust requirements for freely suspended and shed type hoods: (1) the face velocity-area method, (2) the ACGIH method and (3) the capture velocity method. Following are an explanation and sample calculation of each. The sample calculations are based on an assumed kitchen which is 30 ft long by 25 ft wide by 10 ft high, in which are located two kitchen ranges, each 4 ft wide by 8 ft long. Two kitchen range hoods, one freely suspended and the other of the shed type, are each 5 ft wide by 10 ft long and located 4 ft above the work surface. These dimensions, it can be seen, fulfill better than the minimum overhang requirements outlined on page 197. The width overhang is exactly 12 in., and the length overhang, which is often proportionately larger, is 24 in. The symbols used in these calculations and on the diagrams are as follows:

- Q = exhaust volume, cfm
- V_f = face velocity, fpm
- V_v = average velocity in vertical plane under edges of canopy, fpm
- V_c = control velocity, fpm
- X = perpendicular distance from work surface to hood bottom, ft = 4 ft
- W_w = width of work surface, ft = 4 ft
- L_w = length of work surface, ft = 8 ft
- W_h = width of hood opening, ft = 5 ft
- L_h = length of hood opening, ft = 10 ft
- A_w = area of work surface, sq ft = $4 \times 8 = 32$ sq ft
- A_h = area of hood opening, sq ft = $5 \times 10 = 50$ sq ft
- P_w = perimeter of work surface, ft = $(2 \times 4) + (2 \times 8) = 24$ ft
- P_h = perimeter of hood opening, ft = $(2 \times 5) + (2 \times 10) = 30$ ft
- U = volume of kitchen, cu ft = $30 \times 25 \times 10 = 7500$ cu ft
- D = diameter of ductwork, in
- C = number of air changes per hour

Face Velocity-Area Method

This method is an easily used one for estimation purposes but possesses disadvantages for accurate design work. No provision is made in the calculations for various hood shapes, sizes and designs, nor is there account taken of the variable factor X (distance from hood bottom to work surface).

The volume Q of air to be exhausted is determined by multiplying the area A_h of the hood face (for both the freely suspended and shed type hood) by the face velocity V_f : $Q = A_h \times V_f$. The exhaust volume Q found in this manner is then checked to determine whether it is adequate to provide the

Hood sketches adapted from designs appearing in the ACGIH "Industrial Ventilation Manual," 1954, and ASA Code Z9.1-1951.

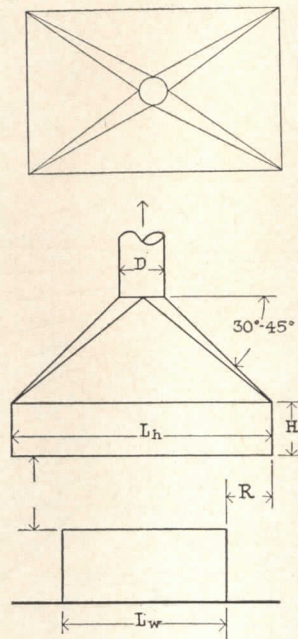

Freely Suspended Hood

minimum general ventilation requirements (e.g., 20 to 25 air changes per hour) figured on the entire kitchen room volume. Should the exhaust fan selected on the basis of the Q value not provide the required minimum air change rate, it should be increased in size to provide necessary air turnover. On the other hand, if the fan provides more than the minimum air change rate, its size would not be decreased, since the exhaust volume it provides has been calculated to be necessary for proper hood operation.

Example

$$Q = V_f \times A_h$$

Using a design face velocity of 55 fpm (recommended by the American Gas Association):

$$Q = 55 \times 50 = 2750 \text{ cfm}$$

For both hoods:

$$Q = 2 \times 2750 = 5500 \text{ cfm}$$

To check this figure against the minimum required rate of 20 to 25 air changes per hour, first change the total exhaust volume of the two hoods to cubic feet per hour:

$$Q = 5500 \text{ cfm} \times 60 = 330,000 \text{ cfh}$$

Divide this figure by the room volume to find the number of air changes per hour:

$$C = Q/U = 330,000/7500 = 44$$

This figure is well over the desired minimum of 20 to 25, and so the fan selected on the basis of $Q = 2750$ cfm for each hood will meet the requirements of the room.

ACGIH Method

The ACGIH (American Conference of Governmental Industrial Hygienists) method has a

distinct advantage over the face velocity-area method in that calculation of exhaust volumes may be suited, by selection of proper design velocity, to the two most common hood types. Actually, it is a modification of the face velocity-area method.

For shed type hoods, it is recommended that a design face velocity of 100 fpm be used and that the exhaust volume so calculated be checked to ensure that it is not less than:

$$Q = 50 P_h \times X$$

For canopy hoods, this formula is suggested:

$$Q = 1.4 P_w \times X \times V_v$$

Velocity V_v in this formula ranges from 50 to 250 fpm depending on cross-drafts, condition of contaminant release, etc.

Example

For the shed type hood:

$$\begin{aligned} V_f &= 100 \text{ fpm} \\ Q &= V_f \times A_h \\ &= 100 \times 50 = 5000 \text{ cfm} \end{aligned}$$

As a check, the exhaust volume must be greater than:

$$\begin{aligned} Q &= 50 P_h \times X \\ &= 50 \times 30 \times 4 = 6000 \text{ cfm} \end{aligned}$$

Since the exhaust volume calculated by the first method is less than that determined in the check method, the fan selected on the basis of $Q = 5000$ cfm should be increased in size to meet the requirements of 6000 cfm. For the canopy hood the lower velocity figure of 50 fpm will be used.

$$\begin{aligned} Q &= 1.4 P_w \times X \times V_v \\ &= 1.4 \times 24 \times 4 \times 50 = 6720 \text{ cfm} \end{aligned}$$

On this value of Q should be based the selection of a fan for the canopy hood.

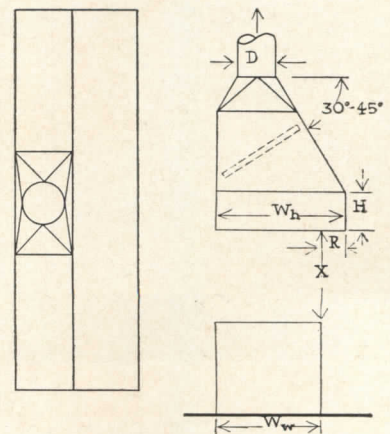

Shed Type Hood

beauty... service... imagination

combined in

stairwell of

STARK

glazed facing tile



This stairwell detail shows one of the many imaginative ways in which school architects are using Stark Glazed Facing Tile as a beautiful, economical interior finish.

So many of your design needs can be satisfied with this single versatile material—hard burned structural clay faced with ceramic glaze in pleasing colors. It builds quickly, defies hard usage, saves maintenance, eliminates painting.

Write for our new catalog showing colors, sizes, shapes. Address Dept. AR-126.

And to aid timely delivery, write Stark into your specifications early.

TYPICAL STAIRCASE AND DETAILS

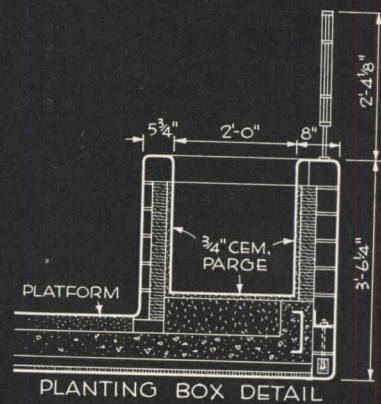
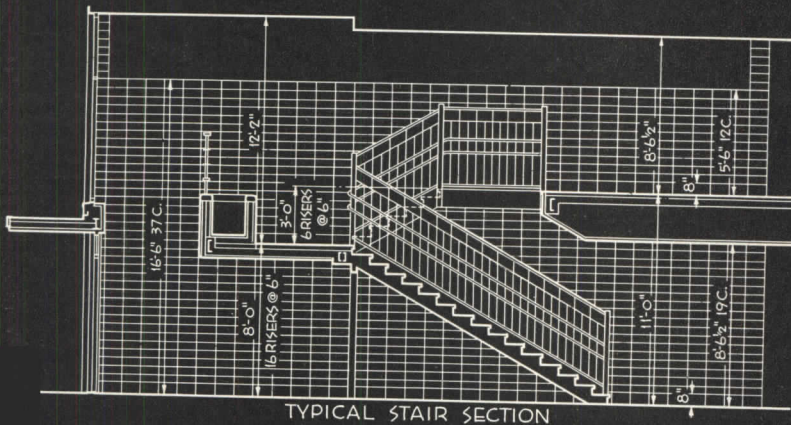

Elementary School, Ellenville, N. Y.
Howard C. Snyder, Reginald E. Marsh, Starett and Van Vleck,
Associate Architects.



Ceramics, Inc. • Canton 1, Ohio

14305 Livernois Avenue, Detroit 4, Michigan
15 East 26th Street, New York 10, N. Y.



DETERMINATION OF EXHAUST HOOD REQUIREMENTS—2

By Jack A. Wunderle, Air Cleaning & Ventilation Engineer, Ohio Department of Health

Capture Velocity Method

The third, and most accurate, method of calculating hood exhaust volume requirements is by the use of capture velocity—velocity contour principles. It is the preferred method of calculating exhaust hood requirements because it takes into consideration variable hood dimensions, variable hood to work surface distances and control velocities.

Capture velocity may be defined as the velocity at any point in front of a hood necessary to capture the contaminated air at that point and cause it to flow into the hood. This differs from face velocity, which is the velocity at the face of the hood. By the proper selection of capture velocity, the designer can ensure the removal of contaminants without outward escapement and with the minimum exhaust volume and power expended. Professor DallaValle of Georgia Tech, who is a respected authority in this field, proposes the use of 30 fpm as the capture velocity to be applied at the outer edge of the working surface of hooded kitchen appliances. This suggested velocity of 30 fpm has merit in that the human body is relatively insensitive to air movements less than 30 fpm, and hence, for worker comfort, it is advisable to keep cross-drafts below this amount.

The velocity contour concept states that the velocity distributions (expressed as percentages of the velocity across the hood open area) will be the same for geometrically similar hoods and obstructural arrangements. The importance of this velocity contour relation is realized when one considers that, regardless of the actual dimensions involved, the positions of velocity contours (lines of equal velocity) are the same for similar hood shapes. Thus, when velocities are expressed in terms of face velocity and distances in terms of hood dimensions, a single pattern of contours is representative of all hoods of the same general shape.

These principles are represented by two formulas:

For freely suspended hoods, either square or with side ratios of 1:2:

$$(1) \quad Q = 14.5 V_c \times W_h^{0.2} \times X^{1.8}$$

For rectangular shed type hoods:

$$(2) \quad Q = 8.5 V_c \times W_h^{0.2} \times X^{1.8}$$

To eliminate laborious mathematical calculations, DallaValle has represented these formulas graphically in the curves reproduced on this page. To further simplify matters, the units of measurement are in terms of hood width W_h . For example, a hood of length $2W_h$ is twice as long as it is wide. Similarly, if the distance from the work surface to hood bottom is $1.5W_h$, then it is one and one-half hood width. It will be noted that there are

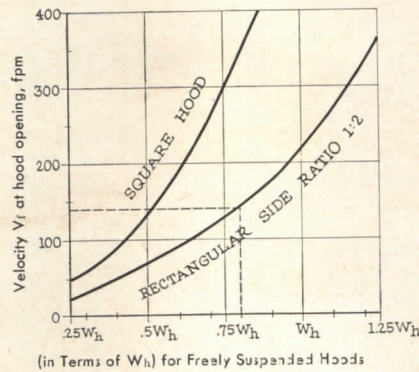

several curves on each of the graphs. These curves are labeled for different side ratios (hood width: hood length). A control velocity V_c of 30 fpm was used in calculation of these curves. Knowing the side ratio, hood width and distance X , the face velocity V_f can be found from the curves and the hood exhaust volume calculated using the formula $Q = V_f \times A_h$.

The hood exhaust volume thus calculated will provide a minimum control velocity of 30 fpm at the outer peripheral edge of the work surface. In fact, one may expect more than a 30-fpm velocity, since some contribution will be realized from the chimney effect generated by the hot surfaces. If higher or lower velocities are wanted, the values may be increased or decreased by the ratio of the desired velocity to 30 fpm. Where velocities are reduced, the hood should be lowered to the minimum distance from the work surface and the open areas not in use enclosed with suitable metal shielding.

Example

Using the graphical solutions to formulas (1) and (2), one can determine the hood face velocity which will provide a control velocity of 30 fpm at the edge of the range.

$$\text{Side ratio} = \text{hood width/hood length} = 5/10 = 1:2$$

$$X \text{ (expressed in terms of hood width)} = 4/5 W_h = 0.8 W_h$$

For the freely suspended hood:

$$V_f \text{ (from the graph)} = 142 \text{ fpm}$$

$$Q = V_f \times A_h = 142 \times 50 = 7100 \text{ cfm}$$

For the shed type hood:

$$V_f \text{ (from the graph)} = 88 \text{ fpm}$$

$$Q = V_f \times A_h = 88 \times 50 = 4400 \text{ cfm}$$

If a control velocity of 40 fpm is desired instead of the 30 fpm from which the curves were calculated, the values of Q should be increased by the ratio of 40 to 30:

$$Q = 7100 \times 4/3 = 9467 \text{ cfm}$$

$$Q = 4400 \times 4/3 = 5867 \text{ cfm}$$

DUCTWORK

One may determine the proper duct size (or check a proposed installation for proper duct size) by dividing the exhaust volume through the duct by the recommended transport velocity. As an example, suppose it were required to exhaust 4500 cfm with a transport velocity of 1800 fpm:

$$\text{Duct area} = \frac{4500 \text{ cfm}}{1800 \text{ fpm}} = 2.5 \text{ sq ft}$$

$$\text{Area of a circle} = \pi D^2/4$$

$$D = \sqrt{\frac{4 \times A}{\pi}} = \sqrt{\frac{4 \times 2.5}{3.1416}} = 1.787 \text{ ft}$$

$$1.787 \text{ ft} \times 12 \text{ in./ft} = 21.4 \text{ in.}$$

Therefore, a 20-in. duct should be used. Where the duct size calculated is an odd size or fraction, the next smaller available duct size should always be selected. The smaller size increases rather than decreases the duct velocity and thus prevents deposition or settling of entrained contaminants in the system as might be the case if a larger size duct and hence a slower velocity were used. If a 21-in. duct were available, it would be used. However, the usual sheet metal fabricator will have patterns in 1/2-in. steps for sizes through 5 1/2 in.; 1-in. steps for sizes 6 to 20 in.; and 2-in. steps for sizes 22 in. and larger.

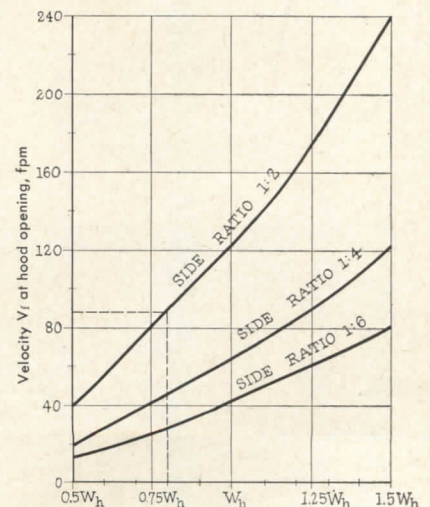

X (in Terms of W_h) for Rectangular Shed Type Hoods

Charts from "Design of Kitchen Range Hoods," by J. M. DallaValle, Air Conditioning, Heating and Ventilating, August 1953.



Piggly Wiggly, Inc. Supermarket, St. Louis, Mo. Owner and Operator: Wm. H. Brown

Skylike makes the most out of lighting in... SUPERMARKETS

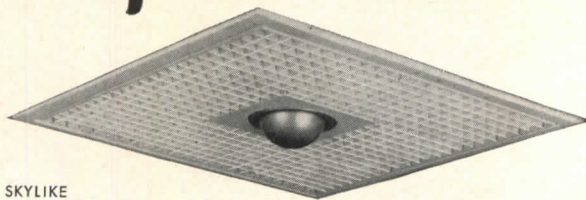

SKYLIKE

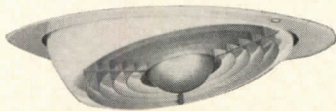

ADJUSTO SILVER-SPOT

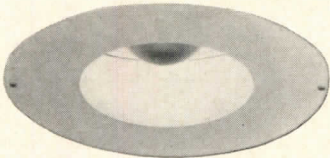

SILVER-DOT

Supermarkets have come a long way since the "box and crate days." Modern trends demand an unhurried atmosphere of cheerfulness, friendliness and pleasing color—to make shopping pleasurable—to increase buying moods. Skylike units supplemented by Silver-Dots are being used extensively by foremost designers to achieve this desirable result. Installations, as shown here, prove the effectiveness of their soft, glareless overall lighting combined with accent lighting in displaying foods at their tempting best and by inducing a leisurely selection of non-food, higher profit, traffic items.

If you are modernizing or planning new units it will pay to investigate the Silvray-Skylike line for supermarket lighting.

SKYLIKE LIGHTING, INC.
A SILVRAY ASSOCIATED COMPANY
RKO Bldg., New York • Bound Brook, New Jersey



DETERMINATION OF EXHAUST HOOD REQUIREMENTS—3

By Jack A. Wunderle, Air Cleaning & Ventilation Engineer, Ohio Department of Health

SLOT TYPE EXHAUSTS

For slot type exhausts the methods of calculating exhaust volumes vary depending on the design of the exhaust system. Ducts are usually sized to maintain a duct velocity of 1500 to 2000; slots sized to maintain a slot velocity of 2000 to 2500 fpm.

Lateral Exhaust (Slant Type)

Slots extend along the top and bottom of a plenum face, on which removable metal slats of various widths are adjustable for best control. Two types of construction are common: (1) transition piece tapered down to throat opening E; (2) duct is connected (as shown by dashed line) to top point of slant hood. Design proportions of E, B and C for these two styles are as follows:

	E	B + C
Type (1)	.05 W_w — .1 W_w	.1 W_w — .2 W_w
Type (2)	.1 W_w — .2 W_w	.05 W_w — .1 W_w

The formula used for determining Q is:

$$Q = V_m \times A_w$$

where V_m is the minimum ventilation rate in cfm per sq ft of hot surface, and A_w is the area of the work surface. The recommended values of V_m vary with the ratios between width and length of work surface, as follows:

W_w/L_w	V_m
0 — .09	100
.1 — .24	125
.25 — .49	150
.5 — .99	175
1.0 — 2.0	200

Lateral Exhaust (Rear or Side Draft)

The formula used for determining Q is:

$$Q = V_f \times A_w$$

where the recommended values for V_f are 150 fpm for hot surfaces with end shields and baffles, and 200 fpm without shields and baffles. The slot should be sized to maintain a slot velocity of 2000 to 3000 fpm. The length of the slot is the same as the length of the work surface, and the width can be determined, after Q is calculated, by substituting in the formula $W_s = Q/(V_s \times L_s)$, where V_s is the desired slot velocity and L_s is the slot length.

The exhaust hood should be extended out over the appliance as far as use permits, but not less than $W_w/4$. The maximum width of the appliance should be 4 ft, but ideally it should be only 3 ft. The maximum length of the transition piece should be 4 ft, using multiple take-offs for larger hoods.

Lateral Exhaust (Slot Type)

With the slots on a vertical surface, the formula for determining Q is:

$$Q = 2.8 V_f \times L_s \times W_w$$

where L_s is the slot length, W_w is the width of the work surface and the recommended values of V_f are 150 to 250 fpm depending on room conditions and degree of work surface enclosure. If the surface is enclosed, the slots can be sized for a slot velocity of 1000 fpm. However, if the surface is not enclosed, they should be sized to maintain a velocity of 2000 fpm or higher.

Lateral Exhaust (Enclosing Hood Type)

This type of enclosing hood, actually not a slot type exhaust but a combination of shed type hood and lateral exhaust, is designed to exhaust laterally across the work surface, giving essentially a horizontal air flow. To provide horizontal flow, air is drawn around and over a distributing or baffle plate. The formula used for determining Q is:

$$Q = V_c \times A_o$$

where V_c is the control velocity and A_o is the area of all openings into the hood. The recommended values for V_c vary depending on the number of sides which are enclosed:

- With only one open side, $V_c = 65$ fpm
- With two open sides, $V_c = 90$ fpm
- With three open sides, $V_c = 100$ fpm

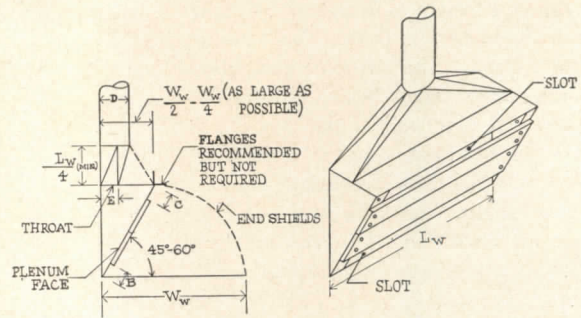

Lateral Exhaust (Slant Type)

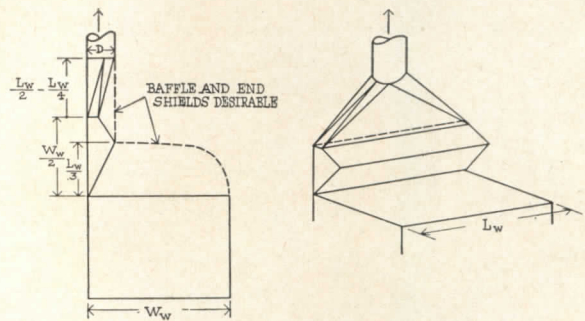

Lateral Exhaust (Rear or Side Draft)

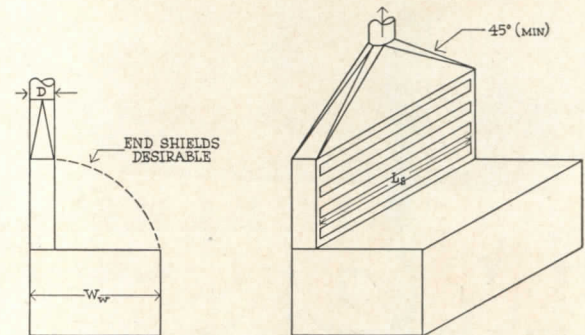

Lateral Exhaust (Slot Type)

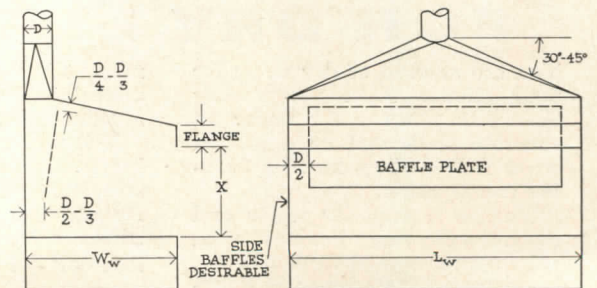

Lateral Exhaust (Enclosing Hood Type)

(Continued from page 204)

Dallas Statler Lighting (Continued)

Lighting treatment in the passenger elevators consists of hundreds of clear and colored acrylic buttons inserted on 2-in. centers in the 5-ft-wide perforated stainless steel panels which surface the ceiling and rear wall of the cars. Each car is lighted mainly by six fluorescent tubes over the rows of colorless buttons in the ceiling. The back wall has nine rows of amber-toned buttons which transmit a less intense light and, lower

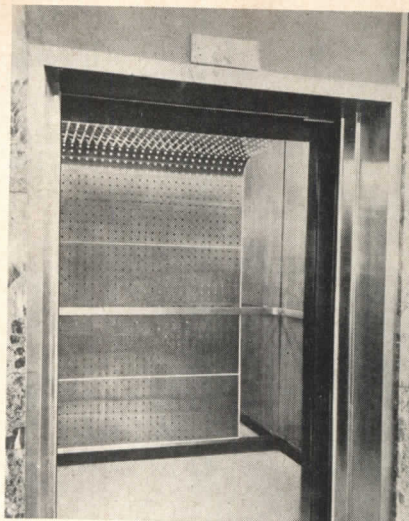

down, amber and red buttons inserted in a random pattern to pick up reflected light.

LOW-NICKEL ARCHITECTURAL STAINLESS STEEL ANNOUNCED

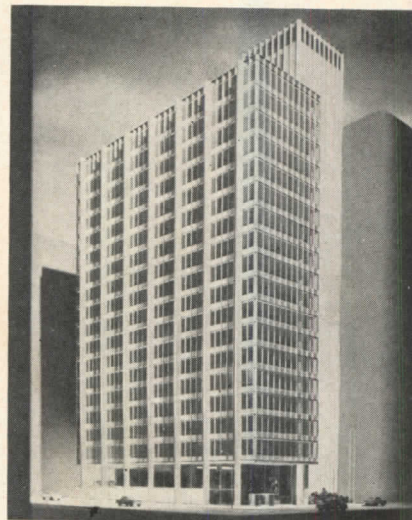

More than twenty years of research on austenitic stainless steels of the low-nickel, high-manganese types has resulted in the announcement by the American Iron and Steel Institute of its new "200 series" of low-nickel, austenitic stainless steels. The new steels are said to compare favorably in all essential characteristics with equivalent types in the higher nickel 300 series, and are expected to help meet the increasing demand for stainless steel for architectural purposes. Chicago's Inland Steel Building (Skidmore, Owings & Merrill, Architects), shown above, will use the new series throughout, and several other buildings still in design stages have tentatively designated these grades.



Announcing

**SISALKRAFT
MOISTOP**

Permanent Vapor Barrier

FOR DRY FLOORS

You are assured of dry floors for your clients when you specify Sisalkraft MOISTOP for under all concrete slabs and as a ground cover for crawl spaces in residential construction.

This is a superior water and moisture-proofing product with polyethylene backed to reinforced, impregnated kraft paper. It is per-

manent in its protection . . . it is unaffected by acids and alkalis, rot and mold.

You will want to specify Sisalkraft MOISTOP for all types of construction — there is nothing finer. Available in rolls up to 8 feet — meets FHA and VA minimum property requirements. AR-8

Other Quality Products in the SISALKRAFT Line:

- Sisalkraft** — Reinforced, water-proof building paper
- Copper Armored Sisalkraft** — Electro sheet copper for concealed flashing and water-proofing
- Sisalation** — Reflective insulation and vapor barrier
- Sisalkraft Vaporstop** — Rot resistant vapor barrier
- Sisalite** — Pure polyethylene film

ALWAYS USE *Genuine*
SISALKRAFT
PRODUCTS

American
SISALKRAFT
Corporation
Chicago 6 • New York 17
San Francisco 5

Sandwich Panels vs. Columns

Sandwich panels may soon take the place of columns and other supports in a number of different types of buildings, according to Edward Kuenzi, a scientist at the U. S. Forest Products Laboratory and chairman of the ASTM Committee on Structural Sandwich Panel Constructions. Speaking at a two-day conference on the design and use of sandwich panels sponsored by The Bettinger Corp. of Waltham, Mass., Mr. Kuenzi stated that sandwich panels are bound to become more and more important in building because of the increasing need for cutting building costs while still maintaining high standards.

(More Roundup on page 216)

HOW WOULD YOU DO IT?

... this way?

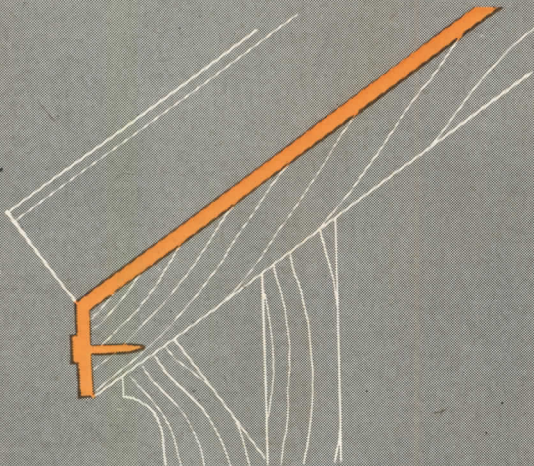

EDGE STRIP DETAIL
BATTEN SEAM ROOF
Fig 1

... or this way?



EDGE STRIP DETAIL
BATTEN SEAM ROOF
Fig 2

In the Fig. 1 detail the roofing pans are turned down over the cornice edge and secured by copper nails spaced about 3 inches on center.

In Fig. 2, along the cornice edge, a continuous edge strip made from 8'-0" long pieces, such as shown, is attached to the roof boarding before the roofing pans are placed. The lower edge of the roofing pans hook over this previously placed edge strip.

In Fig. 1 the exposed nails will work loose and draw out so they can be removed by the fingers. By nailing the sheets, expansion and contraction movement is restricted which

cause waves and buckles to form in the roofing sheets.

In Fig. 2, where the roofing pans are hooked over the edge strip, freedom of movement is provided for the necessary contraction and expansion of the metal. This also keeps the copper nails from being exposed, for a neater installation. A proper drip edge is also provided and the cornice edge of the roof can be finished in a workmanlike manner. Note that the edge strip should extend under the copper roofing pans at least 4" and the ends of each 8'-0" length butt together.

We do not wish to presume to tell you how to design your structures or dictate their construction. For there are many satisfactory methods of installing gutters, leaders, roofs, flashing, coping covers, etc., which, of necessity, change with the design and type of construction and materials used. The purpose of this advertisement is to point out the methods of installation that have been proved by many years of use, and backed by more than a century and a half of experience in working with copper, to be the most satisfactory techniques. You will find these methods in Revere's 110 page brochure, "COPPER AND COMMON SENSE." Send for a copy today. And remember: Revere has a staff of specialists known as Technical Advisors, whose experience qualifies them to render valuable service and advice regarding the use of metals in the building field. Feel free to consult with them at all times regarding the use of Revere Copper; you incur no obligation. Revere Technical Advisors may be contacted through the Revere Office nearest you.



REVERE COPPER AND BRASS INCORPORATED

Founded by Paul Revere in 1801

230 Park Avenue, New York 17, N. Y.

Mills: Baltimore, Md.; Brooklyn, N. Y.; Chicago, Clinton and Joliet, Ill.; Detroit, Mich.; Los Angeles and Riverside, Calif.; New Bedford, Mass.; Newport, Ark.; Rome, N. Y. Sales Offices in Principal Cities, Distributors Everywhere.

DIMENSIONAL STANDARDS FOR ROUGH WINDOW OPENINGS

Dimensional standardization of rough window openings is possible, according to a recent study conducted by Producers' Council, Inc. of installation details for all types of residential windows in frame, masonry and veneer construction. The study shows that details for a majority of available residential windows conform to a relationship between exterior and interior openings which could be proposed as an industry standard.

According to the Council's findings, when the exterior rough opening is modular and dimensioned in a multiple of 4 in. plus $\frac{3}{4}$ in., the width of the interior framing material should be the same multiple of 4 in. plus $\frac{3}{4}$ in. Similarly, the height of the exterior rough opening should be a multiple of 4 in. plus or minus 1 in. at the sill with the head on the modular grid line, while the height of the opening in interior framing materials should be the same multiple of 4 in. plus $\frac{3}{4}$ in. at the head with the sill placed on the modular grid line. (See drawings above right.)

The advantages of this common framing detail relationship, which is now standard for modular windows, could be greatly extended by the adoption of a similar uniform standard for dimensioning windows.

Architectural Lighting Awards

Awards were made at the 50th Anniversary National Technical Conference of the Illuminating Engineering Society in Boston to 14 students for designs which combine good illumination practice with architectural treatment. Part of the Allied Arts Program of the society, this competition serves to focus attention on light as an artistic design medium and on cooperation among young designers in the fields of architecture, industrial design and illuminating engineering.

Winners were Herbert D. Kosovitz, University of California, Berkeley; Delmer Beckhart, USC; John Jensen, Arizona State College; Mark H. Beck and Michael E. Graves, University of Cincinnati; Robert Blackford, Jerome Aidler, John R. Parks, David Simpson of Western Reserve University, Case Institute of Technology, Cleveland In-
(More Roundup on page 218)

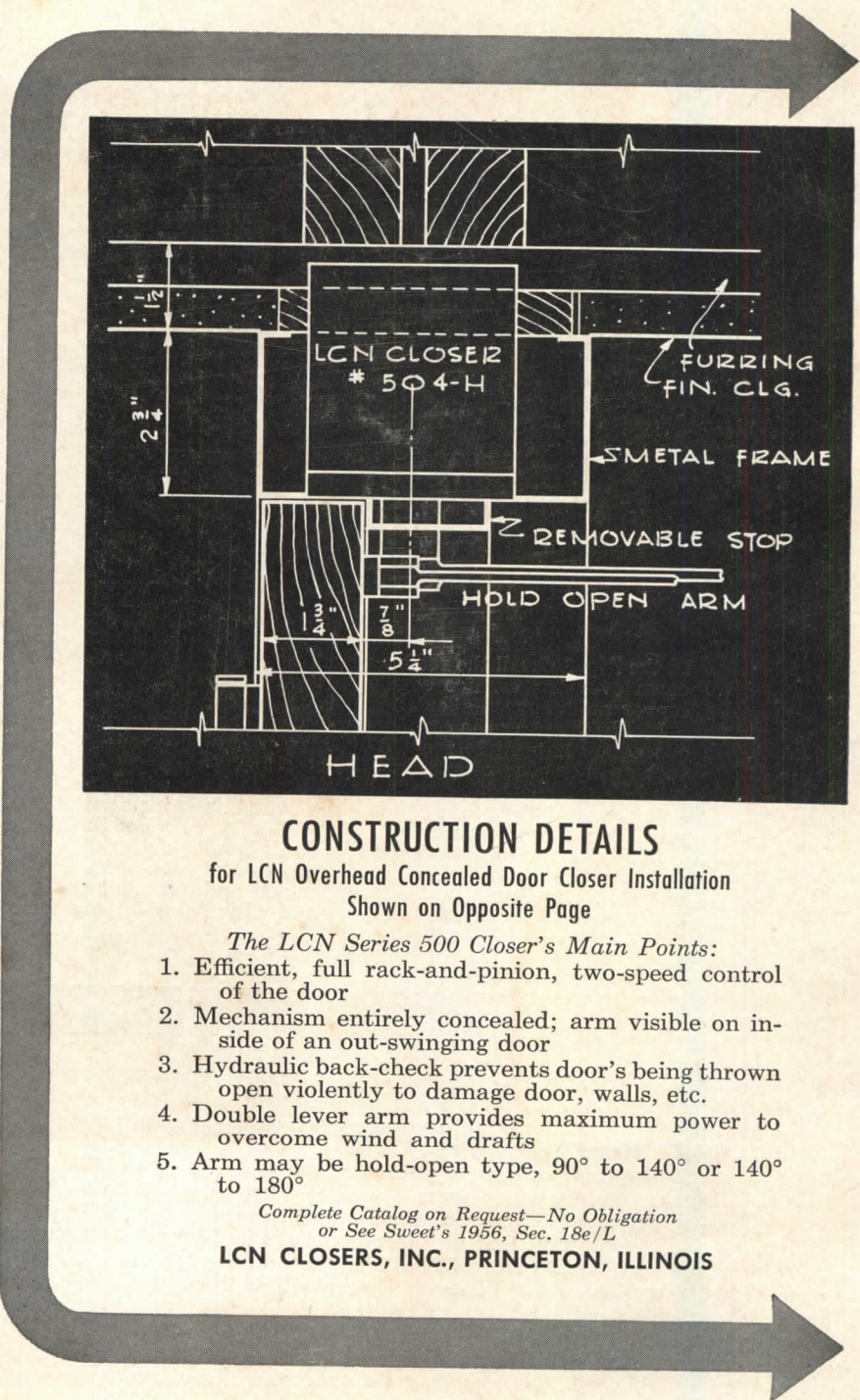
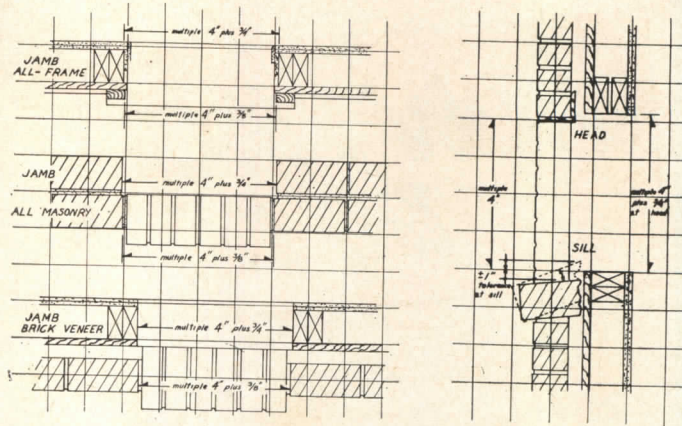

CONSTRUCTION DETAILS

for LCN Overhead Concealed Door Closer Installation
Shown on Opposite Page

The LCN Series 500 Closer's Main Points:

1. Efficient, full rack-and-pinion, two-speed control of the door
2. Mechanism entirely concealed; arm visible on inside of an out-swinging door
3. Hydraulic back-check prevents door's being thrown open violently to damage door, walls, etc.
4. Double lever arm provides maximum power to overcome wind and drafts
5. Arm may be hold-open type, 90° to 140° or 140° to 180°

Complete Catalog on Request—No Obligation
or See Sweet's 1956, Sec. 18e/L

LCN CLOSERS, INC., PRINCETON, ILLINOIS