

ARCHITECTURAL

RECORD

Business Design Engineering
A McGraw-Hill Publication, Six Dollars a Copy
April 1984



TYLER TAKES YOU INTO THE 21ST CENTURY IN STYLE.

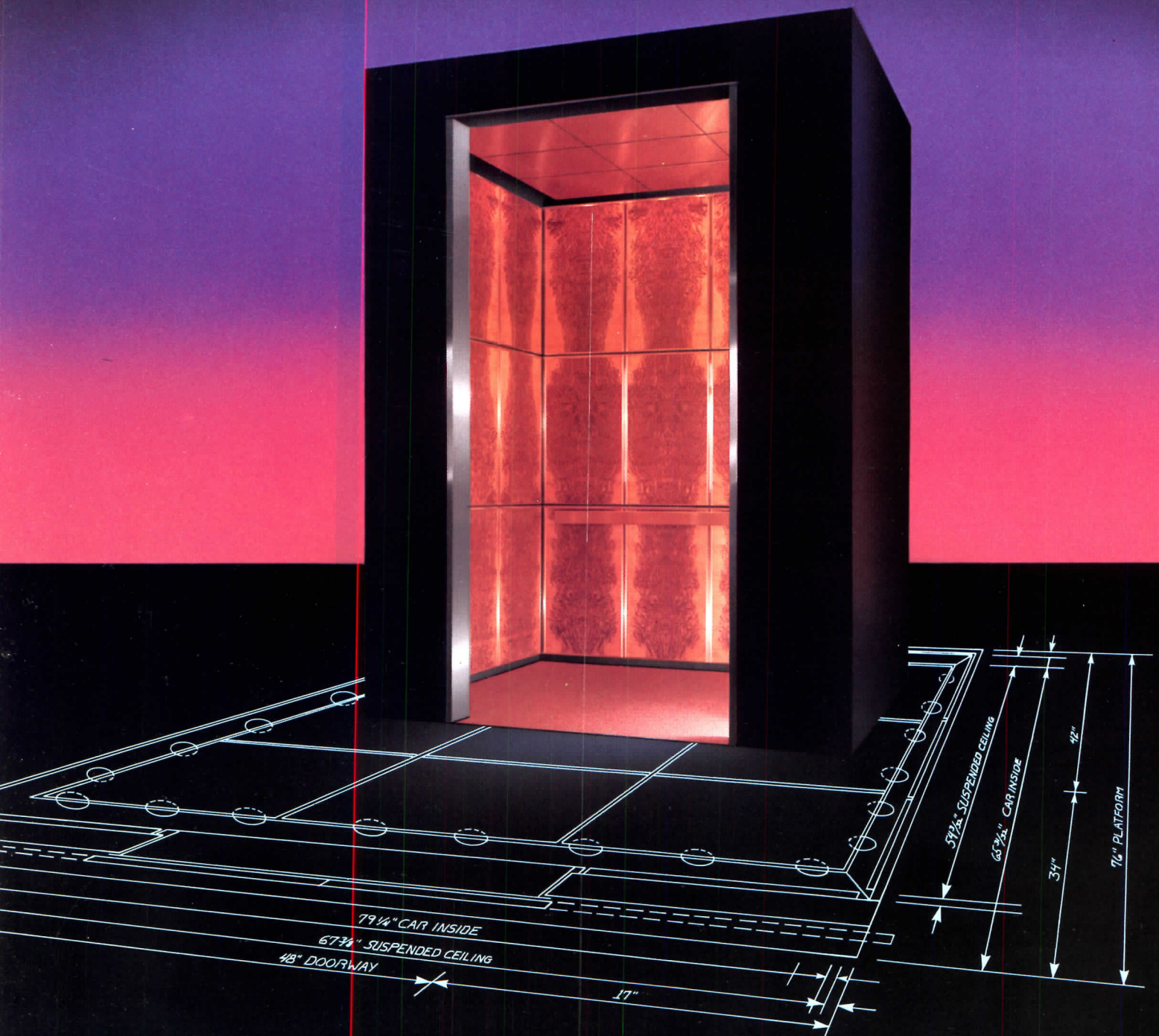

Tyler, with origins in the 19th century, approaches the 21st with design technology, unique materials and fine craftsmanship resulting in elevator cabs and entrances that surpass your highest expectations.

Let Tyler design custom cabs and entrances for your next project to reflect your architectural statement and create a memorable impression that reaches beyond the threshold of the new century.

For information call or write: Tyler Elevator Products, 3615 Superior Avenue, Cleveland, Ohio 44114; 216/361-8200 or 1-800-321-1344.

TYLER 
ELEVATOR PRODUCTS
A SUBSIDIARY OF KLECO

For New Concepts In Architecture.

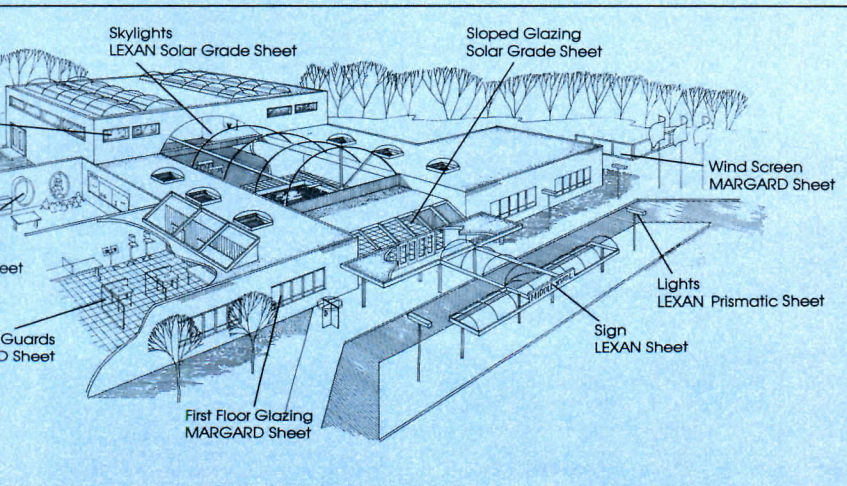
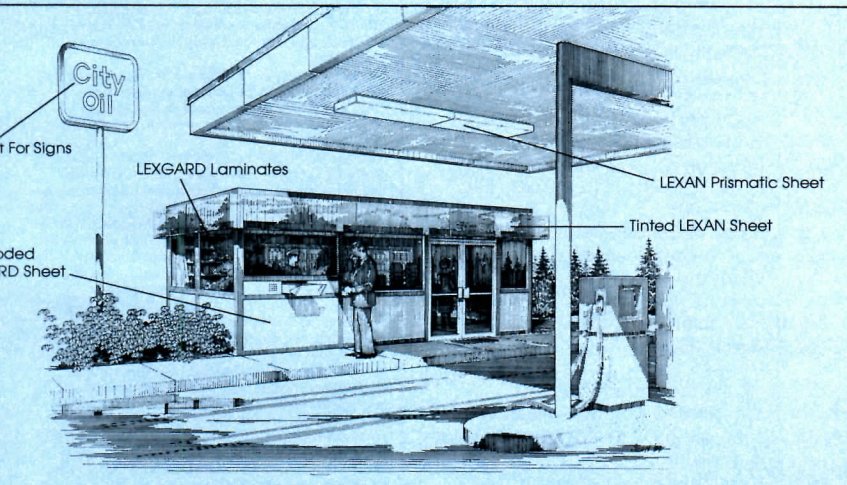
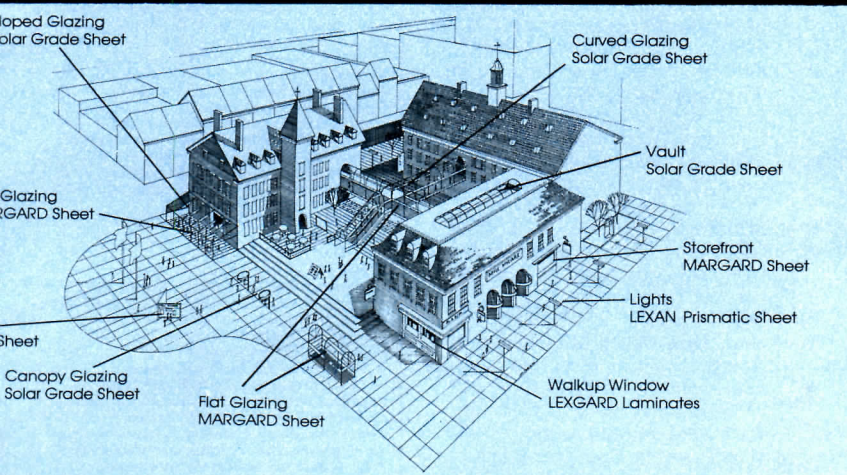

Only From GE.

LEXGARD® laminates: Ballistics and Containment Protection.

Designed for demanding security applications, this family of UL†-listed bullet-resisting materials offers no-spall, multiple-shot protection. LEXGARD laminates also stand up to physical attack better than any glass-clad material. And their mar resistance extends service life. Specify LEXGARD laminates for security applications in detention facilities, banks, gas station kiosks, convenience and retail stores.

Standard LEXAN glazing: Clear and Privacy Textures.

Standard LEXAN sheet products deliver excellent light transmission, impact and vandal resistance. They provide far greater toughness than glass or acrylic for primary or over-glazing while improving your building's security, appearance and energy efficiency.

LEXAN sheet for signs: For Your Corporate Image.

A family of products designed to preserve your image and stand up to vandalism and the elements. Their formability allows plenty of freedom to enhance your design.

More major corporations enjoy the long term economy of signs made from LEXAN sheet due to minimized damage and replacement costs.

LEXAN sheet. Guaranteed against breakage.* Guaranteed to do more.*

See your 1984 Sweet's Catalog, 8.26 a/Ge, for more ideas—plus all the technical information you need to specify LEXAN sheet. For quickest response to literature requests, call Toll Free 1-800-422-1600.



GENERAL ELECTRIC COMPANY
Plastics Group
Sheet Products Department
One Plastics Avenue
Pittsfield, MA 01201

We bring good things to life.
GENERAL ELECTRIC

A performance standard from the start



Introducing

the Echo Chair™

New thrust for professionalism at ACEC

If Shelby K. Willis has his way, American consulting engineers, including architectural/engineering firms, will soon begin looking over the shoulder of other consulting engineers, figuratively speaking, to tell them how to improve their operations.

Willis, a consulting engineer from Salina, Kansas, who is the current president of the American Consulting Engineers Council, is pushing hard for adoption of a new voluntary national program of organizational peer review to upgrade the quality of ACEC's member firms and to improve the image of engineers in general.

When Willis took office last spring, one of his first actions was to set up a new quality improvement committee within ACEC to look at ways of improving everything—"reports, design, specs, letters, finance." At the time Willis said he wanted to stress "creativity" aspects of engineering, something an earlier ACEC survey had indicated was associated more with architects than with engineers.

Since then the quality improvement committee has come up with the full program that it will present to ACEC's Board of Directors for adoption at the Council's annual meeting, to be held May 14 through 17 in San Francisco.

A system of peer review is not brand-new for engineers—the Association of Soil and Foundation Engineers initiated a similar plan in 1978. No other profession apparently has or is planning a system of reviews by fellow professionals that looks at all aspects of the operation. ACEC staffers hope that in addition to improving the general quality of operations and providing a partial answer to the proliferation of government regulations, such a program will ultimately help to lower the number of suits brought against engineers and reduce claims.

Beyond that, such a program would help to alleviate shortcomings in current engineering education. "Today's engineering graduates receive little formal training in drafting, detailing, surveying, construction inspection or other tasks essential to the performance of engineering services," Willis says. "While some firms provide excellent on-the-job training, others do not," he adds. "Without training, graduates entering the profession will never be capable of properly evaluating the job

performance of subordinates, technicians and contractors working on their projects."

The program will be completely voluntary. A review will be undertaken only if the chief executive of an ACEC-member firm makes a request to national headquarters, and the chief executive will have complete control over the selection of the review team. The requesting firm will be given a list of qualified reviewers but can also request others not on the list. The teams consist of one to four reviewers, depending on the size of the firm.

Under present plans the reviewers will volunteer their time, although payment of a small honorarium is still being considered. They will also be reimbursed for travel and expenses while they are at the requesting firm. One thought is that firms requesting review will thereby commit themselves to be a future peer reviewer, and it is expected that requesting firms generally will select reviewers located outside their normal areas of competition.

Firms requesting review will be asked to submit advance documentation relating to organization, business promotion and construction administration. They will also be asked for client-oriented materials such as recent samples of proposals, contracts, specifications, sets of plans, cost estimates, calculations and other data.

After interviews carried out during the on-site visit and completion of the review, the team will present a confidential verbal report to the firm's CEO. At present, there are no plans for a written report.

Before the May national conference, half a dozen firms in California will be matched with six review teams in a trial run. James L. Stratta, chairman of the quality improvement committee and a consulting engineer from Menlo Park, California, says the six firms selected will be of different sizes and disciplines, including architectural, electrical, civil and mechanical engineering firms. Stratta expects the program to be a success. "The soil foundation engineers have been extremely happy with this," he says. *Peter Hoffmann, World News, Washington, D.C.*

Construction cost-estimating references available

The Cost Information Systems Division of McGraw-Hill has released a four-volume series of cost-estimating guides for 1984 projects.

The guides, which provide architects, engineers and contractors with information covering 12,000 building materials, labor rates for 22 building trades and actual project listings among other data, may be updated quarterly, in part by reference to the regular *Costs* page in *RECORD* (see page 39). The information is derived from McGraw-Hill's F.W. Dodge database of construction cost information, the largest in the world.

The reference system includes the *Dodge Construction Systems Costs*, for estimating in the schematic and preliminary stages of design; the *Dodge Manual for Building Construction Pricing and Scheduling*, which gives labor and material costs, including productivity rates; the *Digest of Building Costs and Specifications*, which contains job-by-job listings of nearly 3000 actual projects in over 500 cities in the United States and Canada; and the *Dodge Guide to Public Works and Heavy Construction Costs*. Special features of *Pricing and Scheduling* are sections on remodeling and renovation and solar energy.

The volumes may be purchased as a slip-cased set or ordered separately. To order or to get more information, contact Percy Pereira, Chief Editor, Cost Information Systems, P.O. Box 28, Princeton, N.J. 08540 (800/257-5295).

ACEC annual meeting scheduled

The American Consulting Engineers Council will hold its annual meeting this year in San Francisco on May 14 through 17. The new voluntary program of peer review will be discussed and is expected to be adopted (see story this page). For more information, contact the office of the Council at 1015 15th Street, N.W., Washington, D.C. 20005 (202/347-7474).

How to make a dramatic exit.

Set the stage with the new Russwin 500 Series Designer Bolt.

When it comes to dramatic presence and performance, this new, heavy-duty push bar has it all. The clean, trim look of a new, low profile that adds a graceful touch to emergency doors.

The solid assurance of touch-and-go action with a recessed, perfectly positioned push bar to eliminate the worry of pinched fingers and bring user weight to bear at the point of maximum leverage.

Featuring tamper-resistant construction to guard against the insertion of damaging objects, the Russwin 500 Series is made to comply with applicable ANSI standards and is UL listed.

For your ordering and specifying convenience, the new Russwin 500 Series is now listed in our new specifications manual, *The Russwin Specifier*. Ask your Russwin Distributor or call for details. 1-203-225-7411. Russwin Division, Emhart Hardware Group, 225 Episcopal Road, Berlin, CT 06037. 

Circle 17 on inquiry card

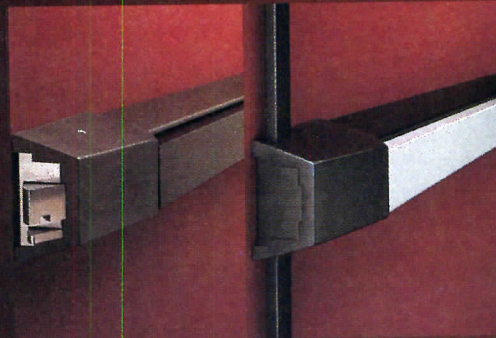
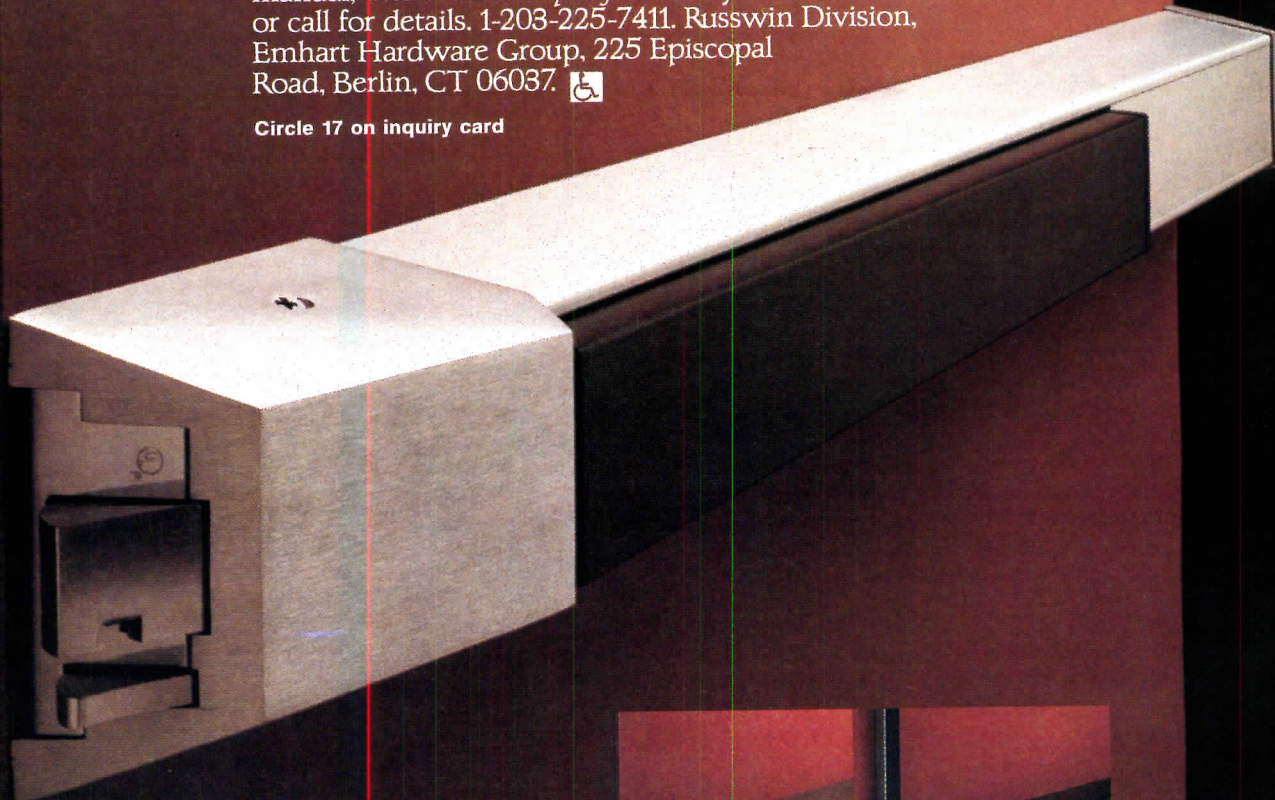

RUSSWIN
HARDWARE GROUP
EMHART



Construction economy update: A steady course with changing emphasis for 1984

By George A. Christie

Stability has replaced expansion as the word that best describes the present state of the building industry. The *Dodge Index* of total construction contract value, which is the leading indicator of building materials demand and construction put in place, has been doing no better than drifting sideways ever since it reached the lofty 140s last summer.

Not that 140 is a bad place to be, considering the depressed state of the construction market two years ago, when this index sank to its recent low of 92. The climb back to the current 140 level brought a welcome infusion of more than \$65 billion of new construction to the building market. Still, it's hard to avoid the reality that recovery, vigorous as it was between mid-1982 and mid-1983, has stalled. Is the building cycle experiencing burnout?

A glance over the shoulder shows how and when this cycle lost its momentum Recovery began in the spring of 1982, when interest rates broke. Housing starts surged in response. A year later, when interest rates stopped falling, housing activity plateaued. And that's almost all there is to it. Almost, but not quite.

During 1983, the second stage of recovery began to take hold on the nonresidential market. The stability of total contracting since mid-1983 conceals a trade-off: quarter-by-quarter improvement in commercial and industrial building has been taking up the slack left by the hesitant housing sector.

For 1983 as a whole, nonresidential building didn't look very strong with its square-footage gain of only 8 per cent. But between the first and fourth quarters of last year, the seasonally adjusted rate of nonresidential contracting improved by a respectable 17 per cent (from 935 million square feet to 1.1 billion). Housing starts, by contrast, were no higher at the end of 1983 than at the beginning. This transition from housing to nonresidential construction as the building market's driving force during 1983 opens an alternative path to renewed expansion in 1984.

It is by no means certain, however, that the housing cycle has reached its peak. Demand is strong (as indicated by January's spurt to 1.9 million units), and the potential exists for a modest further gain beyond 1983's volume of starts as long as mortgage rates are not driven up.

What happens next should be a big catch-up of nonresidential construction with housing...

A bigger potential remains to be realized in commercial and industrial building, which still has a long way to go to establish a normal relationship with the level of building already achieved in the housing market. Of course, it takes more than a housing recovery to stimulate nonresidential building. Commercial and industrial construction needs the support of a strong economy, and here too, the signs are generally favorable.

Last year's rebound of consumer spending has already set off a wave of contracting for stores and shopping centers. Rising employment supports most types of commercial building, but is particularly important to offices. Capacity utilization, which jumped from 69 per cent to 80 per cent over the past year, is the key to the turnaround of industrial construction. Meanwhile, the economy continues to race ahead, powered by the fiscal thrust of the huge Federal deficit. Unfortunately, the reluctance to come to grips with the deficit increases the risk of countervailing monetary restraint.

Most of the pieces seem to be falling into place for another good year for the construction industry, and 1984 can be thought of as an extension of the positive developments that have taken root since mid-1982:

- Commercial and industrial building—with the exception of offices—will be moving into the strongest phase of its cycle.
- Housing demand in 1984 will be as good as last year (or a bit better), reaching as high as 1.8 million units.
- Institutional building will continue to provide steady support in the future as it has in the past.
- Public works construction, enjoying the luxury of temporary Federal funding through the Surface Transportation Assistance Act, will comfortably exceed last year's record value.

In 1984, the construction market is positioned to follow up on 1983's outstanding 23 per cent contracting gain with a "second effort" that will boost total construction contract value another 9 per cent to \$211 billion.

Commercial and industrial building have lots of room for expansion

By the start of 1984, contracting for commercial and industrial building had already advanced 30

1984 National Estimates Dodge Construction Potentials

First Update
March 1984

Nonresidential Buildings		1983 Actual	1984 Forecast	Percent Change 1984/83
Floor Area (millions of square feet)	Office Buildings	281	236	-16
	Stores & Other Commercial	362	446	+23
	Manufacturing Buildings	107	140	+31
	Total Commercial & Manufacturing	750	822	+10
	Educational	73	64	-12
	Hospital & Health	84	79	-6
	Other Nonresidential Buildings	116	134	+16
	Total Institutional & Other	273	277	+1
	Total Nonresidential Buildings	1,023	1,099	+7
	Contract Value (millions of dollars)	Office Buildings	\$ 19,766	\$ 17,650
Stores & Other Commercial		13,798	17,225	+25
Manufacturing Buildings		5,080	7,525	+48
Total Commercial & Manufacturing		\$ 38,644	\$ 42,400	+10
Educational		\$ 6,157	\$ 5,750	-7
Hospital & Health		8,560	8,625	+1
Other Nonresidential Buildings		8,544	9,775	+14
Total Institutional & Other		\$ 23,261	\$ 24,150	+4
Total Nonresidential Buildings		\$ 61,905	\$ 66,550	+8
Residential Buildings				
Dwelling Units** (thousands of units)	One-Family Houses	1,000	1,125	+13
	Multi-Family Housing	719	675	-6
	Total Housekeeping Residential	1,719	1,800	+5
Floor Area (millions of square feet)	One-Family Houses	1,578	1,772	+12
	Multi-Family Housing	682	651	-5
	Nonhousekeeping Residential	78	75	-4
	Total Residential Buildings	2,338	2,498	+7
Contract Value (millions of dollars)	One-Family Houses	\$ 61,765	\$ 73,375	+19
	Multi-Family Housing	25,919	26,175	+1
	Nonhousekeeping Residential	5,517	5,675	+3
	Total Residential Buildings	\$ 93,201	\$ 105,225	+13
Nonbuilding Construction				
Contract Value (millions of dollars)	Highways & Bridges	\$ 15,219	\$ 17,200	+13
	Sewer & Water	7,536	7,450	-1
	Other Public Works	7,210	7,450	+3
	Total Public Works	\$ 29,965	\$ 32,100	+7
	Utilities	\$ 7,680	\$ 7,000	-9
Total Nonbuilding Construction	\$ 37,645	\$ 39,100	+4	
All Construction				
Contract Value (millions of dollars)	Total Construction	\$192,751	\$210,875	+9
	Dodge Index (1977 = 100)	138	151	

**F.W. Dodge basis.

Prepared February 1984
by the Economics Department
McGraw-Hill Information
Systems Company;
George A. Christie, vice president
and chief economist

"Gentlemen prefer Durasan."



Durasan. Anything else is just an imitator.



Durasan is the original predecorated gypsum wall panel. Save time and expense in commercial building or remodeling. Build with the long-acknowledged leader in quality, color and style: Durasan. To receive a complete pattern selector and detailed technical literature, send \$1.00 and your business card to Gold Bond Building Products, Dept. M, 2001 Rexford Road, Charlotte, NC 28211.



Harvest Barley—an original pattern by Durasan. Marilyn Monroe imitator provided by Ron Smith Celebrity Look-Alikes.

1984 Regional Estimates Dodge Construction Potentials

North-east	CT, ME, MA, NH, NJ, NY, PA, RI, VT			Percent Change 1984/83
		1983 Actual	1984 Forecast	
Contract Value (millions of dollars)	Nonresidential Buildings			
	Commercial and Manufacturing	\$ 5,972	\$ 6,625	+11
	Institutional and Other	4,160	4,225	+ 2
	Total	\$10,132	\$10,850	+ 7
	Residential Buildings			
	One-Family Houses	\$ 6,871	\$ 8,400	+22
	Multi-Family Housing	3,607	4,175	+16
	Nonhousekeeping Residential	986	1,125	+14
	Total	\$11,464	\$13,700	+20
	Nonbuilding Construction			
Highways and Bridges	\$ 2,387	\$ 2,775	+16	
Other Public Works	2,830	2,850	+ 1	
Utilities	313	500	+60	
Total	\$ 5,530	\$ 6,125	+11	
		\$27,126	\$30,675	+13

North Central	IL, IN, IA, KS, MI, MN, MO, NE, ND, OH, SD, WI			Percent Change 1984/83
		1983 Actual	1984 Forecast	
Contract Value (millions of dollars)	Nonresidential Buildings			
	Commercial and Manufacturing	\$ 7,314	\$ 8,125	+11
	Institutional & Other	4,513	4,675	+ 4
	Total	\$11,827	\$12,800	+ 8
	Residential Buildings			
	One-Family Houses	\$ 9,867	\$11,725	+19
	Multi-Family Housing	3,211	3,400	+ 6
	Nonhousekeeping Residential	683	675	- 1
	Total	\$13,761	\$15,800	+15
	Nonbuilding Construction			
Highways and Bridges	\$ 4,204	\$ 4,550	+ 8	
Other Public Works	3,011	2,975	- 1	
Utilities	1,376	1,200	-13	
Total	\$ 8,591	\$ 8,725	+ 2	
Total Construction	\$34,179	\$37,325	+ 9	

First Update
March 1984

South	AL, AR, DE, DC, FL, GA, KY, LA, MD, MS, NC, OK, SC, TN, TX, VA, WV			Percent Change 1984/83
		1983 Actual	1984 Forecast	
Contract Value (millions of dollars)	Nonresidential Buildings			
	Commercial and Manufacturing	\$15,575	\$17,150	+10
	Institutional and Other	8,941	9,200	+ 3
	Total	\$24,516	\$26,350	+ 7
	Residential Buildings			
	One-Family Houses	\$29,148	\$33,625	+15
	Multi-Family Housing	12,686	12,025	- 5
	Nonhousekeeping Residential	2,386	2,300	- 4
	Total	\$44,220	\$47,950	+ 8
	Nonbuilding Construction			
Highways and Bridges	\$ 5,798	\$ 6,525	+13	
Other Public Works	5,259	5,350	+ 2	
Utilities	2,151	2,700	+26	
Total	\$13,208	\$14,575	+10	
Total Construction	\$81,944	\$88,875	+ 8	

West	AK, AZ, CA, CO, HI, ID, MT, NV, NM, OR, UT, WA, WY			Percent Change 1984/83
		1983 Actual	1984 Forecast	
Contract Value (millions of dollars)	Nonresidential Buildings			
	Commercial and Manufacturing	\$ 9,783	\$10,500	+ 7
	Institutional & Other	5,647	6,050	+ 7
	Total	\$15,430	\$16,550	+ 7
	Residential Buildings			
	One-Family Houses	\$15,879	\$19,625	+24
	Multi-Family Housing	6,415	6,575	+ 2
	Nonhousekeeping Residential	1,462	1,575	+ 8
	Total	\$23,756	\$27,775	+17
	Nonbuilding Construction			
Highways and Bridges	\$ 2,830	\$ 3,350	+18	
Other Public Works	3,646	3,725	+ 2	
Utilities	3,840	2,600	-32	
Total	\$10,316	\$ 9,675	- 6	
Total Construction	\$49,502	\$54,000	+ 9	

per cent from its cyclical low point in the fourth quarter of 1982, to a seasonally adjusted rate of 824 million square feet. Most of this improvement took place in retail building (stores and warehouses), normally the first business-related category to recover.

Contracting for retail building has considerable room for improvement in order to match the spectacular achievement of the housing market between mid-1982 and mid-1983. Experience indicates that a rate of housing starts of 1.7 million units per year is capable of supporting approximately 400 million square feet of store and warehouse construction annually. Despite last year's encouraging recovery of retail building, the current rate of contracting is only a little over 300 million square feet.

To establish "parity" with homebuilding, there is potential for further improvement in retail building of at least another 20 per cent in 1984. Moreover, if housing starts reach 1.8 million this year as expected, the potential for stores and warehouses will be closer to a gain of 25 per cent.

The response of industrial building to 1983's economic recovery was, and continues to be, unusually strong. The most likely explanation for 1983's uncharacteristically early rebound of contracting for manufacturing buildings is that after a decade or more of underinvestment, much existing manufacturing capacity is obsolete. One reason why the rate of capacity utilization advanced so rapidly during 1983's recovery is that many idle plants have been closed forever.

As the point of departure for the future, the improvement in the seasonally adjusted rate of contracting for manufacturing buildings between the first and fourth quarters of 1983 needs to be put into perspective. Due to the extremely depressed state of this market at its cyclical low point in the first quarter of 1983, last year's quarter-by-quarter gains still left the full year's total square footage 10 per cent below 1982's volume—the fourth consecutive annual decline. And while 1983's developments were highly significant in turning that four-year decline around, the 122 million square foot rate of contracting reached by the fourth quarter was still far below the potential indicated by a capacity utilization rate of 80 per cent.

Considering that the rate of contracting had already passed

120 million square feet by the end of 1983, a forecast of 140 million in 1984 hardly stretches credibility, even though it implies a year-to-year gain of 31 per cent. It is worth remembering that 145 million square feet of industrial construction was contracted in the worst year of the 1975 recession.

The rebound in office construction in 1983 was a temporary aberration

The inevitable retreat from 1981's all-time peak of contracting for 325 million square feet of office buildings began in 1982 as newly started work settled back 20 per cent to 261 million square feet. That decline was temporarily reversed in 1983, however, when contracting rebounded to 281 million square feet.

The surprising "second life" of the office building boom may be the result of the accelerated depreciation provision of the 1981 tax legislation (ERTA). Whatever the reason, two critical numbers indicate the extent of the adjustment that lies ahead in order to restore supply/demand balance in the office building market:

- It is estimated that the national surplus of office space (both completed and under construction) exceeds 200 million square feet.
- Diminishing growth of the white collar labor force by the mid-1980s will require net additions of no more than 225 million square feet per year.

Taken together, these two limiting factors imply that the annual volume of building must be brought below 225 million square feet per year for as long as it takes to absorb the already existing surplus. After that, it should be possible to sustain an average rate of 225 million square feet per year of new construction. This compares with the 270 million per year average actually started during the past five years.

The continued subsidizing of office space through accelerated depreciation, as well as the regional concentration of the existing surplus, suggest a gradual market adjustment over several years rather than another crash like the one that followed the REIT-inspired office boom of the early 1970s. The forecast of 236 million square feet in 1984 (16 per cent below 1983's volume) will do little to clear the market of its surplus, and implies still lower rates for office building in the years that follow.



Robertson finishes.

Worlds of protection against all the world's atmospheres.

Whatever the climate, whatever the conditions, whatever the contaminant, Robertson's range of architectural finishes protects buildings from the world's worst. From the sun, sand and salt of desert and seacoast . . . to the humid tropics . . . to the worst pollutants in urban/industrial atmospheres . . . Robertson finishes endure. Beautifully! And have since 1906. With sales and production facilities strategically located worldwide, Robertson can design, engineer, manufacture and complete buildings literally anywhere. And our metal wall and roof panels, especially those protected by our multi-layered Versacor® (epoxy basecoat and silicone-modified polyester) and Vitralume® (porcelain enamel) finishes, can protect against practically anything. Your valuable structure deserves Robertson protection, wherever in the world you're building.



Robertson

400 Holiday Drive
Pittsburgh, PA 15220
U.S.A.
(TWX) 710-664-2051

50 Tuas Avenue 9
Singapore 2263
(Telex) 786-33696

Cromwell Road
Ellesmere Port
South Wirral L65 4DS
England
(Telex) 851-61605

Circle 19 on inquiry card

The Outlook

Nonresidential Building Contract Value

Seasonally adjusted annual rates, in billions of dollars

Year/Quarter	Total	Commercial/ Industrial	Institutional	
1983	I	\$59.5	\$37.2	\$22.3
	II	60.1	36.4	23.7
	III	63.1	40.2	22.9
	IV	64.8	40.6	24.2
1984	I	\$64.9	\$41.5	\$23.4
	II	65.4	41.7	23.7
	III	67.2	42.8	24.4
	IV	68.7	43.6	25.1
1983	\$61.9	\$38.6	\$23.3	
1984	\$66.6	\$42.4	\$24.2	
% Change	+ 8	+10	+ 4	

Residential Building Contract Value

Seasonally adjusted annual rates, in billions of dollars

Year/Quarter	Total	One Family	Multi-Family*	
1983	I	\$ 84.5	\$57.1	\$27.4
	II	92.7	63.9	28.8
	III	99.1	63.7	35.4
	IV	96.4	62.3	34.1
1984	I	\$ 98.3	\$67.2	\$31.1
	II	102.9	71.6	31.3
	III	109.9	77.6	32.3
	IV	109.7	77.1	32.6
1983	\$ 93.2	\$61.8	\$31.4	
1984	\$105.2	\$73.4	\$31.8	
% Change	+13	+19	+ 1	

*Includes Nonhousekeeping Residential Buildings

Nonbuilding Construction Contract Value

Seasonally adjusted annual rates, in billions of dollars

Year/Quarter	Total	Public Works	Utilities	
1983	I	\$31.8	\$25.8	\$ 6.0
	II	48.8	32.1	16.7
	III	38.8	32.3	6.5
	IV	31.2	29.6	1.6
1984	I	\$38.3	\$31.4	\$ 6.9
	II	38.7	31.9	6.8
	III	39.3	32.3	7.0
	IV	40.2	32.8	7.4
1983	\$37.7	\$30.0	\$ 7.7	
1984	\$39.1	\$32.1	\$ 7.0	
% Change	+ 4	+ 7	- 9	

Residential building will be only stable—assuming mortgage rates are

Recent experience seems to show that stable mortgage rates in the range of 12 to 13 per cent can continue to support a volume of housing starts in the range of 1.7 to 1.8 million units. To break out of that range—in either direction—requires a change in the level of interest rates.

In pursuit of its dual objectives of containing inflation while supporting the economy's growth, the Federal Reserve has little room to move toward either tightness or ease without

upsetting the economy's delicate balance. (The credit-induced recession of 1981 is an all-too-recent example of what "Fed-power" can do at this stage of the business cycle.) Since the immediate threat of inflation is considerably less urgent than the need to support economic expansion at least through 1984, sound central banking policy means holding a steady monetary course as long as the economy is not in danger of overheating, leaning as much as necessary in the direction of ease for the balance of the current year, and in the direction of restraint after 1984.

This scenario, which makes the case for a small (and temporary) decline in mortgage rates in the middle of 1984, allows room for a further modest improvement in housing starts this year. Compared with the dramatic rise from 1.1 million to 1.7 million in 1983, however, the remaining potential of the current housing cycle for 1984 is meager. With little likelihood that mortgage rates will fall below an average of 12.5 per cent for the year, the upper limit of housing starts cannot be much above 1.8 million.

Moreover, the probability that interest rates will begin rising again toward the end of 1984, and will march steadily upward in the post-election years, virtually establishes 1984 as the peak of the housing cycle. However, the expected quarterly pattern through 1984, rising to 1.85 million in the third quarter and then turning down, implies a reasonably strong beginning for 1985. If interest rates rise only gently next year (say, one-half per cent), 1985's volume could hold as high as 1.7 million units.

The remarkable strength of multifamily building in 1983 is giving the current housing cycle an unusual twist. Two things are responsible for boosting multifamily building to its highest volume since the HUD-subsidized era of the early 1970s: inflated costs have led to the substitution of condominiums for one-family homes, and ERTA's liberalized depreciation rules are diverting additional capital into apartment construction.

The 1983 share of multifamily units to total housing starts—an exceptional 42 per cent—isn't likely to be sustained for long once the "tax shelter motive" loses some of its initial appeal. In 1984, housing activity is expected to show a mix closer to the proportion of 60/40, as contracting for multifamily settles back to 675,000 units. When the housing cycle begins to

recede after 1984, however, the "affordability issue" will sustain the current strong demand for condominiums as an alternative to nonexistent "low-cost" one-family homes. Continued support from condos will help to keep the proportion of multifamily building close to 40 per cent of total newly built dwelling units for the foreseeable future.

The public works decline since 1979 reversed dramatically early in 1983

That was when budgetary restraint yielded to the more traditional use of public works as a means of helping the economy make its way out of deep recession.

Two Federal programs, the Emergency Jobs Act (EJA) and the Surface Transportation Assistance Act (STAA), were the vehicles for channeling extra billions of dollars into public works construction in 1983. The result: a record \$30 billion of contracting for highways and bridges, mass transit, water resources, waste-water treatment facilities, and other public projects.

Although EJA was little more than a device for speeding up the expenditure of already appropriated funds for already existing programs, STAA—through its new 5¢-per-gallon fuel tax—is now delivering upwards of \$5 billion a year of additional Federal funds, and the stream will continue for several years. Eighty per cent of these "user fees" is dedicated to highway and bridge construction; the balance is pledged to mass transit. By the time STAA expires, this program will be largely responsible for raising the annual value of contracting for public works construction from its current \$30 billion to a peak of \$35 billion in 1986.

In 1984, contracting for highways and bridges will enjoy a "built-in" gain owing to the timing of STAA. This year the program will be operative for a full 12 months, compared with its actual 9 months' effectiveness in 1983. The extra quarter's allocation will lift 1984's total highway/bridge contract value another 14 per cent to \$17.2 billion.

With contracting for most other public works projects holding close to their 1983 rates, total public works construction is forecast to increase by seven per cent in 1984.

Haworth provides lighting equal to the task.

Office tasks and the lighting to support them should not restrict interior design. TriAmbient™ Lighting by Haworth expands design options. Easily. Economically. Efficiently. Attractively. Fluorescent task and ambient fixtures; and High Intensity Discharge (H.I.D.) freestanding and panel-supported ambient lights allow tasteful, tailored solutions. For accent, vertical display, task or ambient illumination, all fully integrated with Haworth's TriCircuit ERA-1® pre-wired panels. For design options that are equal to any task, consider TriAmbient Lighting by Haworth.



Send for the "TriAmbient Lighting Package". Write: Haworth, Inc., One Haworth Center, Holland, MI 49423

HAWORTH®



Practice: Design quality is a central management issue

In this second part of his article, the author brings home his points about the need to change the way many offices are structured

By Bradford Perkins

In the first part of his two-part article last month, Brad Perkins set forth the basis for his argument that the way most offices approach design must change through the firm hand of organized management—as he puts it, “a muddling of traditional separations.”

He cited some obvious situations architects confront but often fail to recognize as the result of management failure—such as firms with established competence losing business because of dull design or design being carried out in large firms by a changing cast with no clear, consistent conviction.

Perkins stressed that—especially with larger projects—most design today is carried out by a team that must interact among its members and with a client—a team that must be “managed” effectively if quality design is to result.

Two specific areas in which management is crucial, in Perkin’s argument, were covered in the first part of the article: how the firm defines its goals, and what types of projects the firm secures.

In this concluding part of his article, Perkins discusses four other areas in which design management is, he argues effectively, a very important activity. C.K.H.

Design process here means how the firm allocates and controls its design resources (people, consultants, hours, etc.) and manages them to execute a project. To improve design quality and efficiency of the project team, as well as promote meaningful interaction between the client and the project team, time must be spent at the outset designing the design process.

A clear, well-documented and agreed-upon definition of this process will include for each of the participants (owner/architect/consultants) a definition of the scope of the work, a schedule and a work plan. Such a plan serves to organize the efforts of the team and is a vehicle for communicating the sequence of these efforts to the client.

There are major differences even between “design-oriented” firms in this area. Some of the typical ones are:

- *Length of time devoted to each phase.* For example, some firms spend far more time in program and site analysis than others; other firms allocate as much as possible to schematic design and design development; and still others are careful to allocate adequate resources to the late design-development, contract-document, shop-drawing, and field phases in the belief that truly “God is in the details.”
- *Who does what.* In any design-oriented firm, the proper matching of staff with projects is the critical first step in the proper execution of the project. Some people are good for small projects, others are best in design development, and still others are good working through complex problems.

The natural tendency, however, is to make do with the staff available. This can result, as one architect friend of mine claimed, in the most important projects often being assigned to the people no one knew what to do with since they were the ones who were available.

- *How each phase is carried out.* This means decisions about when engineers should be involved, what tools (models, renderings, etc.) will be used during the design phase to study and present key design decisions, and how design issues are studied and resolved.

Most architects will, when asked, say they like to involve their engineers at the beginning of design, but in reality many do not. Moreover, many engineers discourage such involvement since they want to do the job once. Still, failure to seek

creative engineering input early can significantly affect the development of a building design.

- *How progress is monitored.* At specific times during the development of a project, there is a need to pause for a review. The firm must decide when these reviews are needed, how they should be structured and who should participate. Sporadic reviews by poorly briefed principals that result in a lot of rework are too common and often give reviews a bad name.

Well-run design firms find some way to provide regular review and participation by the firm’s design leadership. In any event, these reviews should evaluate project progress against those management, design, and technical goals established for the project. They should suggest areas for further study and establish guidelines for further development.

- *How the firm deals with the problems of schedule and budgeting fee.* In an environment where clients want projects yesterday, it is tempting to cut out the soft parts of the design process. The design development phase is the most typical victim today, but it can be just an important detail that needs the extra time. I would hate to see a separate accounting for a chair rail detail that was a central theme in one of our interiors projects, because it took several weeks to resolve. These soft periods are often the gestation periods when the design concept matures. In still other situations, firms are faced with the need to re-think a design—a decision that cuts into fee budget, project schedule, and client patience.

The firms with design ambitions are careful to preserve their flexibility in all aspects of the process in order to bring additional skills, time, and effort to a project when necessary. These factors can all play a role in effectively focusing the resources of a firm so that the design concepts established by the principal designer can be developed into an excellent completed work of architecture.

- *How the firm deals with other members of the project team.* Over the last several decades, the size of teams has grown and the roles and responsibilities have changed. Now many specialist consultants, construction managers and others have direct access to the client. Almost every firm today has lost some important design decision because of the advice of one of these other team members. Conversely, in an era of skeptical

clients, a united front of architect and construction manager or other consultant can often resolve an important design issue. Therefore, how a firm controls the entire project team—and in particular its relationship with the source of such key owner concerns as cost and time—will have a great deal to do with the success.

Firm organization may take many forms, but the need to manage is always there

How the process works, of course, depends in large part on how the firm is organized and how design decisions are made.

Central to the effectiveness of each aspect of the process are communication and interaction.

In simpler times when the problems, the project, and the practice were all on a smaller scale, the practice of architecture could be based on individual intuition. Today, with larger projects, complex functional, technical and environmental problems, and larger groups of client/architect/consultant teams working to solve these problems, organized and effective communication and interaction are essential. Some options:

- Some firms—even some large national ones—try to centralize design in the hands of a single person. Management theory says that most individuals can only control the details of four to six complex issues (such as design projects) at a time. This, of course, has not deterred some architects from trying to handle more. Centralization of design decision-making is normally effective only in small firms.

- Medium- and large-size firms usually take one of three more decentralized options: departmental, project team, and studio. The first breaks the project into specialties—often with different specialists or departments doing the planning, programming, design, production, and construction administration. Under this option, a project manager provides the common thread for each project. The second option has a single team take the project from planning through construction with specialists and draftsmen added to the core team as required. The studio is an expanded team with most or all of the skills and personnel to handle several projects organized under a single design/management leadership.

Each of these options and their variants have their advantages and disadvantages. The central organizational issue, with respect to design quality within each

CRITERIA: ULTIMATE PERFORMANCE

TCS

Architects have become increasingly aware that a metal roof can become a welcome departure from the commonplace and an important aspect of contemporary expression.

When that departure is created by TCS, terne-coated stainless steel, as exemplified by the beautiful, new headquarters of Square D Company in Palatine, Illinois, this exciting new material permits the visually significant roof to become an important basic component of design.

TCS is unique among roofing materials. It has inherent adaptability to form and function, is maintenance free, and weathers to a predictable, warm gray. May we send you substantiating evidence?

Call us toll-free 800-624-6906

FOLLANSBEE

FOLLANSBEE STEEL CORPORATION
FOLLANSBEE, WEST VIRGINIA

Headquarters Building, Square D Company, Palatine, Illinois
Architects: Loeb, Schlossman & Hackl, Chicago, Illinois
Roofer: E. W. Olson, Chicago, Illinois

Circle 21 on inquiry card

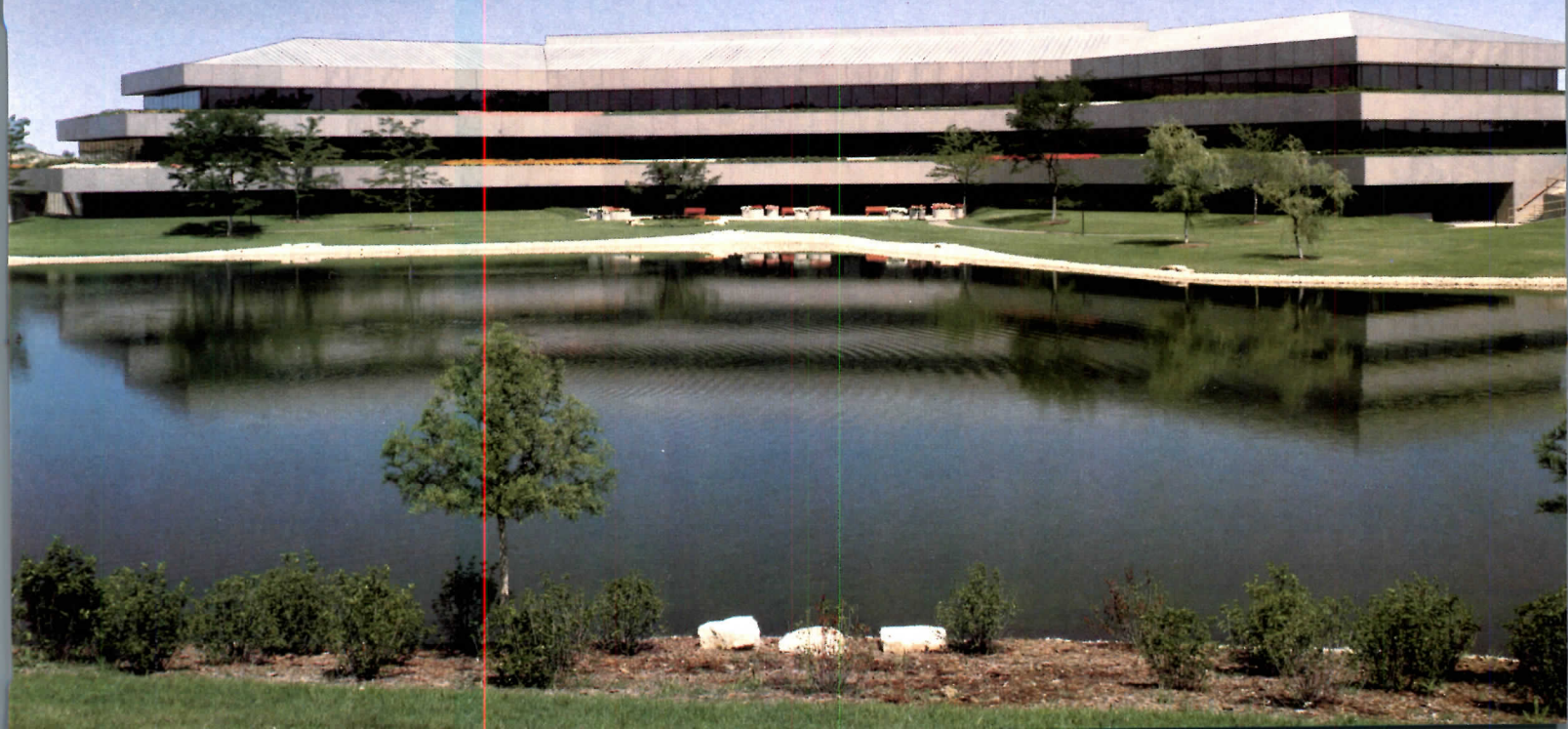

option, is the role of the principal designers. More specifically, do designers or managers control the project decision-making? On this point much blood has been shed. If it is not the designer, how do important design decisions get made? And is the principal designer involved throughout the process?

Firms that confine the principal designer to schematic design and design development have been compared to multi-stage rockets with each stage controlled by a different guidance system. The satellite may get launched, but not necessarily into the orbit intended by the first stage rocket. Peter Samton, director of design for The Gruzen Partnership, set out recently to answer some of these questions by reviewing how 10 of Gruzen's more respected competitors organized themselves to achieve design quality. While his sample was limited to relatively large firms (with over 100 on staff), his study supports several conclusions relevant for most firms:

- Design excellence is only achieved when there is effective design leadership at the principal level throughout the process.
- All firms studied were very concerned about process, organization, and most of the other issues covered in this article and were working to find the right approach for their firm.
- No two firms were identical in the way they achieved excellence, but all had found some way to address each issue.

Client management is different but may make the difference between good and bad design

A key figure in project organization—even if that person is not the principal designer—is the person who manages the client relationship. The design quality of many projects is often won or lost in this one area. In some projects it is easier to go along with a client's wishes than to defend a design solution the client does not support. But while it is easier to ride a horse in the direction it is going, such thinking can often lead to a compromised design concept.

Fewer owners today accept their architect's design decisions unchallenged. Often owner opinions intrude directly into key trade-offs of budget and esthetics. If there is no one on the architect's side who understands what is important in the design and who can sell it to the client, many of the firm's design ideas will fall prey

unnecessarily to unsupported arguments based solely on "taste" or budget. This does not need to happen. An understanding client is essential to a good result. It is part of the architect's job to impart this understanding. To quote Eero Saarinen, "Let's see if we can make this guy a great client."

There is a popular architectural argument that good design does not necessarily cost more. While this is true, sometimes, it is, unfortunately, more true that the heart of many designs has been cut out in last-minute budget reductions due to poor client and construction cost management. Many of the budget reductions also alienate clients because they feel misled by their architects and see the quality they, too, had hoped for cut back. Thus, the careful management of client expectations and project budget are critical to design.

Another essential part of the client management process is the effective communication of the design team's ideas and recommendations. The person(s) presenting the design must be supported with adequate visual and technical support to make his or her arguments. It is no coincidence that the best known design firms typically produce the most spectacular design presentations.

Your public image is another aspect of your practice you must manage

Obtaining client support for one's design proposals is easier, of course, if the firm has a strong reputation for design excellence. Clients are noticeably less sure of their own architectural judgment when dealing with a recognized design talent. Design image also has the more tangible reward of attracting clients and talented staff. This has always been true, but it appears to be even more important in recent years. The success of developers, such as Gerald Hines, in making good architecture pay, added to an increased public interest in architecture has made being a design celebrity an important competitive asset.

But, unfortunately, being a design celebrity is created, not just earned. Several of the best known design figures today were nationally known before they had completed more than a few houses and small interiors. A former Zeckendorf executive recounted how Zeckendorf promoted his young in-house architect, I.M. Pei, so effectively that he was listed among the nation's leading architects before

a single one of the projects that later earned him his well-justified reputation was off the drawing boards.

Others, far less worthy, are now striving to equal that remarkable public relations achievement. The lesson here is that even a local design reputation requires an active effort at self-promotion.

What is more, this self-promotion rarely can be based upon the reputation of an organization; today it must be tied to identifiable personalities. It is irrelevant that many of the buildings and designs attributed to some of the nation's most prominent design figures were, in reality, designed by someone else; the focus of the reputation is almost always an individual talent. This glorification of the individual—in spite of the reality—is one of the reasons the larger firms have had trouble building the type of multistar organizations common in other professions. It is also one of the reasons so few large firms have been able to achieve consistent design excellence. Architecture as art demands the identification of artists.

One of my father's favorite stories is that of Bill Caudill, who wanted to be pictured with his entire team—rather than alone—in a story in *Life* magazine. The editor said, "Bill, everyone knows the MGM lion, but no one thinks he made the movie all by himself."

The editor was right, of course, about the public's understanding about movies, but not about architecture. The film industry is careful to identify and reward the many different talents that go into the complex task of making a great movie. Such is not yet the case in the equally complex task of architecture.

The image-building methods employed vary considerably, but the ones most used today include:

- Cultivation of the press.
- Aggressive publication of the firm's work. (In more than one case this has involved subsidizing a publisher to put out a book on the firm.)
- Active participation in the design establishment's activities: teaching, speaking, preservation efforts, art openings, panel discussions, juries, etc.
- Organizing architectural exhibits or writing about architecture with inclusion of one's own work.
- Working to make the firm's office, graphics, and the other elements of its physical appearance consistent with the desired image.

Of course, the time-honored methods of entering and winning competitions or design award programs are still among the best approaches, but these, too, are frequently manipulated to reward those who have actively worked to become members of the design establishment. Far too many recent juries have given awards to friends rather than to design merit. One can object, but given the tangible and psychic rewards of being accepted by this group, image-building is an important priority.

Design talent cannot be grafted on, but needs to be made basic to the tree

The most important figures in the process, however, are the lead designer and the design team that work on each project. No matter how good the goals, the projects, the process or the salesmanship, great—or even good—design comes only from a good design team led by a superior design talent.

Firms that have strong reputations have little trouble attracting such talent, but building a new organization, or rebuilding an older tarnished one, is a far more difficult task. The firms that have done so have had to aggressively seek out, train, and integrate talent into organizations that may have had powerful antibodies to resist change. At the very least, this usually requires several years.

It is very rare to see a firm such as C.F. Murphy (now Murphy/Jahn) quickly emerge as a design leader, but the great Air Force Academy layoff at SOM, combined with the Richard J. Daley-directed load of public work gave that firm an opportunity for staff and projects with real design potential—an opportunity that it took and ran with. Some firms have tried the quick fix by importing outside talent to lead the design effort. More often than not this has failed because the effort stopped with the hiring of one or two stars. As many expensive free agents in baseball have proven, a few stars are not enough to make a successful team.

As with any other aspect of a successful architectural practice, consistent design excellence cannot be achieved by accident. It is the product of an intense, multifaceted effort. Having someone with design talent in a leadership role is the essential core of a successful effort to achieve consistently high design quality, but it is not enough. Because it is not enough, design is a central management issue.

RIXSON *Sets the Mark!*

Rixson sets the mark for life safety with its latest combination smoke detection/door control...the Heritage Smok-Chek.™

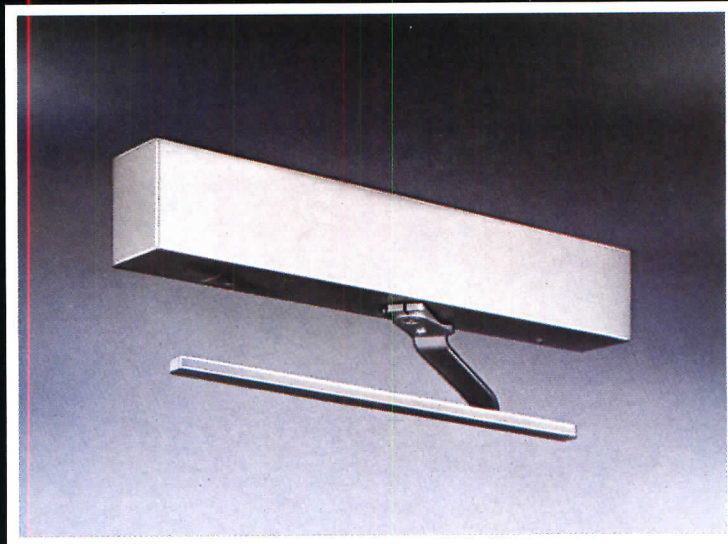

When smoke is detected by the built-in smoke detector, an alarm sounds and the door is closed automatically, preventing smoke from spreading. The fire's location is immediately signaled on an annunciator panel, allowing other alarms and Smok-Cheks to be activated.

The Heritage Smok-Chek...just one more fine product from Rixson-Firemark's quality line of fire/life safety products—including smoke detectors, door releases, annunciator panels and electromagnetic locks—plus security and door control products.

RIXSON-FIREMARK

9100 W. Belmont Ave., Franklin Park, IL 60131 Ph. (312) 671-5670

A DIVISION OF
CONRAC
CORPORATION

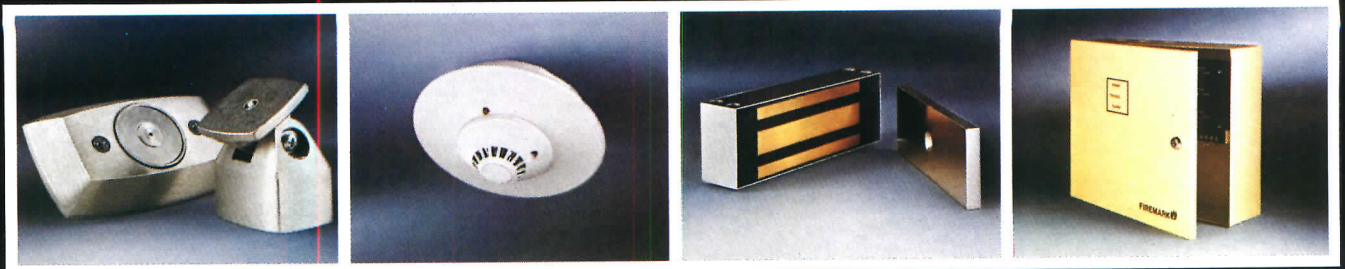

Finance: A stock market slump does not mean the end of the recovery

By Phillip E. Kidd

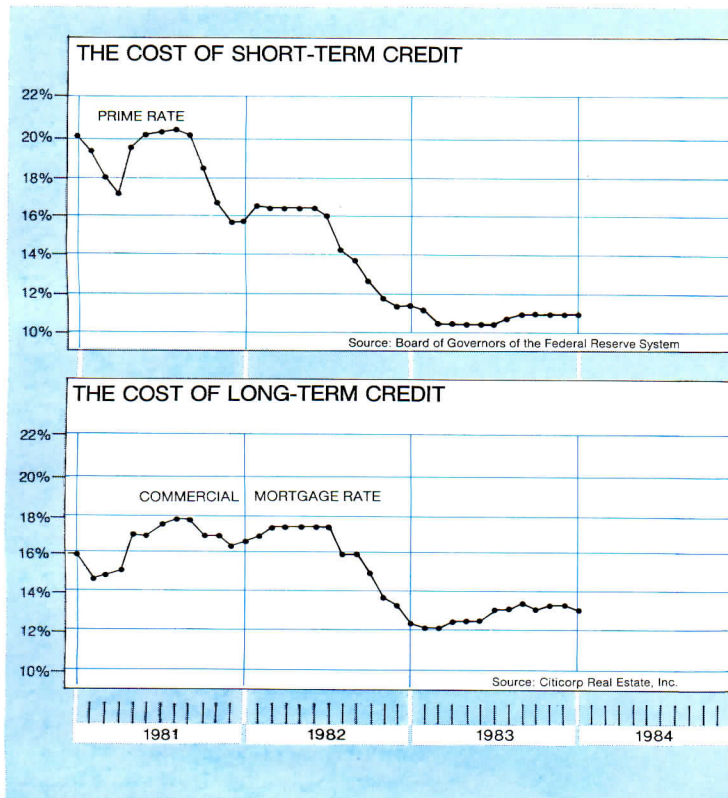

Behind the late-winter slump in the stock market were mounting investor fears that economic expansion could not be sustained this year without re-igniting significant inflationary pressures. Fueling such fears are massive, unending Federal deficits, which neither Congress nor the Administration seems willing to attack, and an erratic monetary policy.

Continued voluminous Federal borrowings were and are seen colliding with rising private-loan demand, with interest rates pushed up and some private sectors—especially interest-sensitive industries such as housing and automobiles—forced to reduce their credit demands, weakening their sales performance and in turn undermining economic growth.

In such a scenario, the Federal Reserve switches from restraint to aggressive ease that boosts economic activity, but also sets off inflationary forces. Later, to curb them, the Federal Reserve re-institutes a tight monetary policy, slowing economic growth. As a result of this start/stop process, the enormous economic momentum built up in 1983 is dissipated and by late 1984 or early 1985, the economy is settling back into another round of stagflation.

In effect, the financial markets are ignoring the past two years of low inflation

Instead, investors are nervously reacting to the upward creep of inflation in the second half of 1983. They have been there before. Vivid in their memories are more than a decade and a half of watching inflation erode the value of their stock, bond, and mortgage portfolios. During that span, fiscal policy was primarily stimulative and monetary policy was used as the swing factor to control the pace of economic activity. When monetary policy was easy, the economy boomed; when it was restrictive, the economy slumped.

Even worse, in each successive expansion/recession cycle the rate of inflation was ratcheted upward to a higher level than in the previous cycle. Now investors are becoming alarmed that this pattern is about to repeat itself.

Eventually, unchecked Federal deficits that consistently run in the hundreds of billions of dollars could overwhelm private credit demands, but this will not happen this year.

The Federal government is only one part of the government sector. In the early 1980s, state and local governments, the other part, were also experiencing significant revenue shortfalls. For the most part, they responded by curtailing spending and raising taxes, which acted as a drag on economic activity. In 1983, these actions, aided by a rapidly expanding economy that enhanced tax receipts, pushed state and local governments into the black. As a result, the combined government sector will be draining relatively fewer dollars from the financial markets this year than in the early 1980s.

Meanwhile, this sector's expenditures for military hardware and for the repair and rehabilitation of infrastructures—highways, bridges, etc.—will create jobs and income that will support economic growth.

And financial markets are ignoring their own influence in keeping inflation low

Perhaps the most crucial difference between today and the inflationary 1970s is the veto power that the financial markets are coming to exercise over monetary policy. In the past when monetary policy eased, interest rates were expected to fall in response.

Now, whenever there is the slightest hint that the Federal Reserve is trying to boost money

growth too fast, inflationary expectations are rekindled in the financial markets. Immediately, investors begin rearranging their assets, emphasizing shorter terms and equity participations. Interest rates start rising. Then, to quell these jitters, the Federal Reserve has to tighten the money supply, which pushes rates higher still.

Rates move up until the financial markets are satisfied that inflation will not flare up. When that happens, financial institutions and individuals energetically return to the markets to lock up attractive yields. As funds become more available, rates begin to subside.

The current slump will keep the economy down only as long as inflation jitters persist

Currently, the financial markets are preventing the Federal Reserve from aggressively using monetary policy to stimulate economic growth. Instead, investors are forcing the Federal Reserve to follow the economy, adding reserves only as they are needed, thereby tempering inflationary expectations.

Unfortunately, this is not a smooth process. Indeed, it is quite herky-jerky, as both the Federal Reserve and the financial markets frequently misread each other's signals. For the construction sector in 1983, that means dealing with long-term interest rates that bounce around between 11 and 14 per cent, with the tendency clearly toward the mid-to-upper-end of the range. For the second year of a recovery, those are extraordinarily high rates by historic standards. Nevertheless, the 1983 expansion indicates that the construction sector can handle such rates and still produce solid real growth.

Mr. Kidd is a prominent economic consultant and former director of Economics Research for the McGraw-Hill Information Systems Company.

You design environments that work.
We design tables that work.

Howe Furniture Corp. ©1983



Norman Cherner has designed a distinguished group of Howe tables. And he gave each a great pair of legs, so they'll work handsomely in environments for dining, conferencing and training. Some can even fold their legs or flip their tops for extra flexibility. The Cherner Group — tables that work by adapting to their environments. Ready when you are in rectangles, rounds or squares. And a variety of materials and colors.

HOWE, 155 East 56, N. Y., N. Y. 10022 (212) 826-0280

**TABLES
= HOWE**

Circle 23 on inquiry card

Costs: Despite all fears, costs continue stable

Summary of Building Construction Costs



Districts Eastern U.S.				
	Number of metro areas	10/83 to 1/84	1/83 to 1/84	1977* to 1/84
Metro NY-NJ	18	2.01	6.02	1579.76
New England States.....	33	1.09	4.97	1554.28
Northeastern and North				
Central States.....	120	-0.35	2.33	1580.61
Southeastern States.....	106	-0.39	4.36	1622.93
Average Eastern U.S.....	277	-0.04	3.66	1593.61



Western U.S.				
	Number of metro areas	10/83 to 1/84	1/83 to 1/84	1977* to 1/84
Mississippi River and West Central States.....	122	1.18	3.23	1596.50
Pacific Coast and Rocky Mountain States.....	106	1.39	4.12	1690.89
Average Western U.S.....	228	1.28	3.64	1640.39
United States: Average.....	505	0.56	3.65	1614.73

While the general trend of growing strength in construction over the last year or so has led to widespread speculation that material and labor costs would rise with demand, this has so far failed to happen. Based on a survey by the McGraw-Hill Cost Information Systems Division for the period October 1983 through December 1983, the following cost trends appeared: concrete was down .3 per cent; block, up .8 per cent; plywood, down 1.8 per cent; lumber, down .7 per cent; gypsum board, up 4.3 per cent; asphalt shingles, down 3.1 per cent; reinforcing steel, down 1.8 per cent; structural steel, up 1.9 per cent; conduit, up .2 per cent; and pipe, down 3.5 per cent.

All of these mixed risings and fallings seem to indicate an overall steady course, changing only with localized market conditions such as the amount of competition by suppliers in selling and buyers in creating demand. Announced price increases by major steel mills did not hit the market with full force due to the effect of inventory backlog and imported steel, although depleted backlogs, when they occur, will undoubtedly produce future upward adjustments. Rebar prices dropped in response to low

demand. Gypsum board prices are still under the effect of spot shortages.

Union wage settlements for 1983 were the lowest in the past decade. As with 1982, one-year contracts were the rule, as both sides attempted to protect their interest. The elimination of contract language that restricted work output continued strong in 1983.

The increase in other types of construction has helped to overcome pockets of office-space oversupply. Especially when housing starts are considered, the 1984 index *should* show a steady rise.

McGraw-Hill Information Systems Company studies are conducted quarterly by direct contact with union and nonunion sources, direct material suppliers, construction labor consultants, and both general and specialty contractors in each city. For a run-down on how the studies work, see RECORD January 1984, page 37.

James Stewart
Cost Information Systems
McGraw-Hill Information
Systems Company

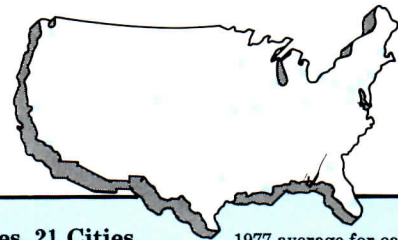

Historical Building Cost Indexes—Average of all Nonresidential Building Types, 21 Cities

1977 average for each city = 1000.0

City	1977	1978	1979	1980	1981	1982	1983	1984	1985	1986	1987	1988	1989	
Atlanta	1171.5	1712.6	1925.6	2098.6	2090.6	2078.0	2208.8	2212.2	2302.0	2360.6	2503.5	2421.4	2478.5	2456.7
Baltimore	1018.4	1107.7	1304.5	1446.5	1600.5	1544.9	1567.8	1603.3	1615.9	1639.5	1683.8	1702.4	1705.0	1689.7
Birmingham	1029.7	1142.4	1329.9	1407.2	1463.1	1469.9	1502.5	1490.1	1478.2	1468.1	1491.0	1518.9	1540.0	1535.7
Boston	1028.4	0998.6	1236.0	1283.7	1413.5	1432.5	1463.5	1508.3	1495.3	1502.0	1553.7	1547.7	1557.1	1563.9
Chicago	1007.7	1032.8	1199.7	1323.6	1342.7	1344.7	1343.0	1376.5	1413.9	1425.8	1415.6	1433.3	1459.0	1439.5
Cincinnati	0848.9	0991.0	1323.9	1385.2	1400.7	1350.4	1353.5	1349.9	1361.5	1362.6	1376.8	1445.3	1459.1	1430.8
Cleveland	1034.4	1040.8	1287.5	1388.2	1454.2	1459.5	1449.4	1469.9	1511.4	1511.4	1462.1	1523.2	1521.0	1475.9
Dallas	1042.4	1130.6	1431.9	1481.9	1693.9	1750.6	1740.8	1765.0	1777.3	1834.3	1816.9	1847.8	1892.8	1925.9
Denver	1038.8	1100.4	1495.6	1487.4	1587.6	1632.2	1709.7	1724.0	1715.2	1679.1	1684.6	1745.9	1755.7	1800.1
Detroit	1018.1	1087.3	1275.3	1447.4	1579.6	1580.3	1589.8	1604.6	1627.1	1638.0	1649.5	1654.4	1652.9	1672.1
Kansas City	1023.5	0951.5	1125.8	1233.2	1262.8	1323.4	1284.3	1336.9	1384.5	1381.8	1347.4	1390.8	1400.6	1407.5
Los Angeles	1022.5	1111.0	1255.3	1387.5	1473.3	1474.3	1491.6	1507.0	1500.9	1503.3	1506.0	1506.1	1501.4	1523.9
Miami	1004.5	1080.9	1330.1	1380.6	1387.5	1369.1	1350.7	1357.5	1375.1	1392.1	1429.6	1458.9	1473.5	1467.6
Minneapolis	1060.2	1196.8	1236.9	1327.7	1433.2	1442.6	1450.8	1540.8	1572.8	1576.8	1586.2	1631.8	1632.5	1624.6
New Orleans	1001.3	1138.8	1291.9	1505.7	1560.4	1572.7	1573.2	1626.4	1631.3	1616.9	1618.0	1624.8	1631.0	1650.5
New York	1005.4	1043.0	1247.1	1319.4	1397.3	1419.2	1417.8	1472.6	1497.7	1491.8	1563.7	1623.1	1622.3	1672.5
Philadelphia	1013.8	1074.2	1487.5	1539.5	1634.2	1660.7	1676.9	1755.7	1762.5	1769.4	1754.9	1759.7	1815.9	1819.5
Pittsburgh	1016.1	1015.0	1227.0	1341.7	1450.3	1493.2	1526.7	1487.4	1458.4	1479.5	1486.7	1491.6	1488.8	1497.2
St. Louis	1039.1	1198.8	1275.9	1320.0	1379.2	1397.3	1399.5	1436.3	1433.8	1451.2	1453.5	1498.1	1508.6	1524.9
San Francisco	1083.2	1326.8	1473.4	1644.8	1763.9	1776.4	1777.0	1804.5	1813.8	1810.1	1814.1	1851.9	1856.8	1856.8
Seattle	1142.5	1137.9	1373.4	1616.8	1685.9	1814.9	1905.5	1968.8	1940.9	1962.7	1986.6	1982.7	1974.5	1979.0

Costs in a given city for a certain period may be compared with costs in another period by dividing one index into the other; if the index for a city for one period (200.0) divided by the index for a second period (150.0) equals 133%, the costs in the one period are 33% higher than the costs in the other. Also, second period costs are 75% of those in the first period (150.0 ÷ 200.0 = 75%) or they are 25% lower in the second period.

Announcing a significant



Cot-R-Cap

Cot-R-Cap[®] has all the beauty and distinction of traditional batten seam roofing. But unlike traditional metal roofing systems, Cot-R-Cap is fabricated right at your jobsite.

Factories on Wheels

Our Factories on Wheels[™] employ modern roll-forming technology to produce roofing or siding components in unlimited lengths, quickly and to your exact specifications.

That's a significant advancement which can be a major advantage to you because site forming

eliminates most problems associated with old-fashioned metal roofing.

Significant Advantages

With Cot-R-Cap there is no shipping damage, no possibility of dimensional error or excess scrap. No work stoppages resulting from delayed or short shipments. And, because Cot-R-Cap is formed in unlimited lengths, leak-prone horizontal lap joints are eliminated.

Additional moisture barriers aren't needed with Cot-R-Cap. A concealed, engineered anchorage system permits thermal movement while it assures weather integrity. And Cot-R-Cap offers optimum design freedom: unbroken directional changes down fascias, over ridges, into soffits

Architectural education: ACSA—the member schools should celebrate their diversity

By O. Jack Mitchell



Last June, I completed my year as president of the Association of Collegiate Schools of Architecture, an organization representing 94 American schools and nine Canadian schools offering programs in architecture. The activities of this organization need to be better known to the profession because they are important and substantial. ACSA represents these schools and to some extent speaks collectively for them. It has two primary missions: (1) to work with the other professional organizations (AIA, NCARB, NAAB, ASC/AIA) on matters of mutual concern that transcend the responsibilities of any of the individual organizations, and (2) to work to enhance the quality of architectural education in general. In my view, the latter is by far the more important activity, but it varies with changing events. Let me elaborate briefly.

ACSA works closely with other architectural organizations

Currently, the five professional groups are discussing three important issues. The first is the Intern Development Program offered by NCARB. Who can quarrel with the intentions of this program? A thoughtful, structured program to enhance the required office internship years is a fine idea. As with many fine ideas, however, it may be difficult to implement in the "real world." It requires strong cooperation from architectural offices and, in the long run, may require the support of local AIA chapters to provide all of the special requirements in the NCARB list of skills. In my view, the intentions are proper but the capacity to effectuate the program has yet to be proved. Also, the requirements are extremely traditional in view of the changes taking place in the profession and the world. I hope that they will have a built-in capacity to evolve and change over time.

The second important issue is the degree requirement from an architectural program for NCARB certification. ACSA has endorsed this requirement as long as there is a satisfactory "loophole" for exceptional candidates. As reported by Robert Oringdolph in the February 1984 issue of *RECORD* (page 37), NCARB has formed a

O. Jack Mitchell, FAIA, is dean of the Rice University School of Architecture in Houston, Texas, and recent past president of the Association of Collegiate Schools of Architecture.

While certain new developments affecting education might seem to veer toward conformity, Dean Mitchell stresses that the individual schools forming ACSA are highly individual and should strive to remain so

committee to develop criteria for an alternative educational track—which would be one way of satisfying its constituency. One can only observe that with 91 accredited schools in the United States, and more than 20 others either in the process of or considering applying for accreditation, bringing into being yet another educational system may have questionable merits. However, the complete resolution of this problem remains in the future.

The third issue has to do with NAAB, and in some ways it is currently the most positive of the three. Over a year ago, a "blue ribbon" committee was put together by NAAB representing all of the organizations. Its purpose: to make recommendations for restructuring the accreditation process, as William McMinn described in *RECORD* (March 1984, page 51). This committee has recommended procedures for accreditation that are simpler and more specific. It also recommended restructuring the composition of the board of NAAB. These changes have been implemented, and their first test is currently taking place in selected school accreditation visits. NAAB, by necessity, needed a committee composed of its support (AIA, NCARB, ACSA) to recommend these changes. The quality of the committee, as well as its work, suggest this as a model for solving other important issues that affect more than one organization.

One interesting activity that occurs each year is a series of meetings of the "Five Presidents." The presidents of the five organizations get together—sometimes with staff, sometimes without—to discuss critical issues that the groups have in common. My experience with these meetings was extremely positive, as all of these organizations are extremely supportive of architectural education.

However, this group of five organizations, each with a different mission, represents a somewhat clumsy system for ordering and advocating the best interests of our profession, as well as improving the quality of the built environment. Other countries, such as the United Kingdom, deal with these issues more simply; still, I believe our system—clumsy as at times it may be—represents the plurality of interests and attitudes that is appropriate to the way this country operates.

ACSA stresses quality in architectural education

Improving the quality of the built environment begins by improving the quality of architectural education. This is the other main purpose of ACSA. Our most important event is the Annual Meeting, which gathers a broad representation of our constituency to hear appropriate keynote speakers and listen to juried papers presented by our members on a wide range of topics. More specific areas of concern are dealt with at other meetings oriented to administrators, or teachers of technology, or the older conference for teachers held annually at Cranbrook and funded in part by the AIA. These allow smaller groups to focus more closely on issues of special interest.

The reasonably new Design Conference held in San Francisco in July is attended by as many practitioners as it is by educators. There is also the Energy Institute held in the summer to teach teachers about issues in order to bring more information to the classroom. The bringing together of teachers to discuss and study issues of the built environment makes for better classroom and studio education.

Regional meetings and a journal add to exchanges

The additional individual meetings of the six regions represent something of the diversity of ACSA and allow a different focus. Last year the Northeast Region met jointly with the AIA Design Committee. Having groups such as these meet to discuss design issues of the profession should happen more often.

The *Journal of Architectural Education* is an example of ACSA working to improve quality in education. This long-time publication has undergone much more change in the last several years than just in its graphic format. With the addition of an executive editor, an excellent advisory board, and the reorganization of the selection process for articles, there is a clear sense of direction. The *JAE* is most important to ACSA and must represent the highest quality of which the organization is capable. I think we are close to accomplishing that. The comments about the *JAE* may be appropriate to ACSA as a whole, which also has changed greatly in the last five years or so. The quality of the organization and our capacity to

LCN understands the ins and outs of entrance accessibility.

LCN understands your need to provide entrance accessibility for people who are handicapped or frail. To help you solve accessibility problems, we offer a complete line of special purpose door closers. Our Entrance Accessibility brochure contains complete technical details. For your free copy, contact LCN Closers, Princeton, IL 61356; 815/875-3311. Ingersoll-Rand Door Hardware, Mississauga, Ontario, L5E3B6; 416/278-6128.



AUTO-EQUALIZER® AUTOMATIC DOOR OPERATOR opens door slowly to 90°. Adjustable control holds door open up to 30 seconds.

DELAYED ACTION SMOOTHIE® CLOSER makes safe, convenient passage possible. Adjustable delay holds door open from 15 seconds to one minute, then releases.



4041 SUPER SMOOTHIE® CLOSER permits door to open with a force of less than five pounds to meet many interior barrier-free requirements.

LCN CLOSERS

Part of worldwide Ingersoll-Rand

better serve our constituency have undoubtedly improved greatly. Architectural education is better because of these collective activities.

We should all celebrate diversity in our schools

In my travels among the schools last year, it was clear that we are a diverse group and that there is great diversity in architectural education. I have frequently heard my colleagues from AIA or NCARB say, "you educators don't do this" or "schools don't do that" or "educators only teach this." None of that is true. There are great differences in the schools, and I believe this to be good—no, even necessary—in the society in which we live. We at ACSA should celebrate this diversity amongst us. It is a strength of our organization.

The other organizations we deal with are trying to measure things—as well they must. NCARB is setting minimum standards and NAAB is looking at similar evaluation criteria. It is our strength that we are located in different parts of this country, we are composed of both public and private institutions, and we draw students from widely different backgrounds.

There is a wide range of choice, and students should take advantage of that for their best interests—and the best interests of practitioners as well. We represent diversity, as does our society, and we should all celebrate that.

Quality education is a function of the individual schools

This in part argues for the individual schools finding their own uniqueness—the thing that separates them from all others. A school has an obligation to its constituency. Who are its graduates? Where do the students come from and where do the graduates go? What is the character and mission of the parent institution? Where is the school located? This notion of "place" is important.

Notwithstanding the importance of ACSA and its collective activities, architectural education takes place in the individual schools, and this ultimately is where quality education must thrive. My major contribution will be made at Rice and not with ACSA.

Architectural education is the only form of professional education that has not decided when is the best time to educate future professionals. We begin architectural education immediately after high school in

the traditional five-year undergraduate programs; we provide a stronger general education with the four-year undergraduate, two-year graduate programs; and we have graduate programs lasting from three to three and one half years for students who come with a university degree.

This seems a bit muddled to those who need to quantify or who feel strongly about one or the other options. I am convinced, however, that the present options are appropriate, and that these options allow schools the flexibility of finding the proper time to teach. Given their special qualities, it also gives students a choice in the determination of their career patterns. We at Rice offer all three options, and I believe each group of students benefits because the others are there—the over-all quality of education is enhanced. I do not suggest that all schools should do this, but it seems right for Rice.

What to teach is of course a major question as well. I read with interest Lee Copeland's thoughtful remarks about architectural education and particularly his concern for balance between general education and technical education, but always viewed as a humanistic endeavor (RECORD, January 1984, page 45). Currently the faculty at Rice is grappling with directions for the future of our school. It is a stimulating, sometimes frustrating, experience in which we can agree to disagree. The one thing we do unanimously agree on is to try to make Rice the best architectural school we can, and to create our own model for doing so.

It is interesting to note that the time available for architectural subjects is very nearly the same whether one looks at five-year undergraduate programs (with some graduate work), the four-two undergraduate/graduate programs, or three-to-three-and-one-half-year graduate programs. We are dealing with a reasonably inelastic time frame.

Adding new technologies may require trade-offs

There has been a move "back to basics" in universities in the last several years, and there is a concern to teach new technologies as they emerge as powerful change agents in the practice of architecture. Currently the most potent example is computers. There is probably general consensus among educators on the above

ideas, but when we begin to look at specific curricula the debate commences. Also, where should special degree programs, such as urban design, fit into this framework? Some of our deliberations at Rice are centered on these issues. Obviously "trade-offs" must be made in what to teach. I would offer three observations to consider in these deliberations:

1. Certain things are better taught in a university setting, while other things can better be learned in practice. At Rice we require our five-year undergraduates to spend one year—between their fourth and fifth year—in a professional office situation, which we assign. We feel this experience is much better than trying to teach selected courses that may be too removed from the "real world" of practice.

2. As we know today, it is rare that we can have all the information we would like to have to make decisions at all levels. One must learn to make decisions on limited information. This realization helps us to determine how much of any given subject is necessary and, more important, it is an attitude that needs to be instilled in students.

3. Learning is a lifelong process. This is another idea we must instill in students. The notion of seeking further knowledge where and when required is important for them. They must realize that a professional degree is only a beginning.

Education must be a big concern of the profession

I advocate an even greater diversity in curricula among architectural schools than currently exists. There are too many forces in society pressing towards conformity. Our profession, and the schools in particular, need to explore and evolve new ways of dealing with the current forces of change in our society.

This is a time of great economic—if not social—change in our country, which affects our profession substantially. There is current thinking that suggests major structural changes have taken place, and continue to take place, in the productive life of this country. The prognosis is mixed. There is debate about whether or not we are equal to this challenge. Architects are important to the task. Can we understand these changes and build proper environments to accommodate society—and

encourage change to promote a more equitable social environment as well?

Architectural education is central to these issues. The students in our schools will be the leaders of the future; and our future, in large degree, is in their hands. Education has the obligation to commence the process of shaping our future, but the profession as a whole must ultimately be involved. Education, in the broadest sense, must be a principal concern of our profession, but with goals for quality, diversity, and the intellectual and economic wherewithal to support it.

Editor's notes:

• *The best existing guide to members and affiliates of the ACSA is Architecture Schools of North America (Peterson's Guides, Dept. 2605, P.O. Box 2123, Princeton, N.J. 08540), which gives considerable data about programs, faculty and costs of each school—plus pertinent introductory material on ACSA and architectural education, careers, and opportunities.*

• *All five major architectural organizations—ACSA, AIA, NCARB, NAAB, and ASC/AIA—share the same address: 1735 New York Avenue, N.W., Washington, D.C. 20006.*



Above, weekend overtime workers in various offices use local override controls to open own blinds to enjoy natural daylighting.

Large selection of colors offers alternative to dull, unattractive buildings and the sameness of standard dark glass vision bands.

free Daylighting ^{and} solar shading

“... the lowest life cycle cost and energy use were obtained with daylighting coupled with clear glazing and exterior sun-control blinds,” according to a study of life cycle costs and energy use analyzing various sun control and daylighting options on high rise office buildings, commissioned by the **Department of Energy.***

Consider these facts which affect office building operating costs:

FACT: 50% of the energy bill in a typical office is for artificial lighting.

FACT: 50% of office cooling energy is required just to remove heat generated by the artificial lighting.

FACT: 25–50% of the normally required tons of perimeter air conditioning can be eliminated by using Baumann Exsotrol™*** blinds.

FACT: 50% of a commercial building's electric bill represents “peak demand”—the 30 minute period in the year when the most electricity is used.

Solar control—outside blinds, “7 times better”... HUD***

The most effective way to stop solar heat gain is to block the sun before it strikes the glass. Exterior blinds are 7 times more effective for

cooling than interior window treatments. Clear glazing and Baumann Exsotrol blinds have a shading coefficient of 0.14—more protection from radiant and conductive heat than any tinted or reflective glazing and interior blind combination.

Daylighting—clear glass 10 times better

Clear glazing transmits 10 times more visible light than the best reflective glazing. With the blinds in their working position, every slat is a light shelf. Work stations 20 ft. from windows maintain an illumination level of 200–500 lux. Workstations near windows remain cool and glare free. Baumann blinds provide diffused “northlight” quality light on all elevations.

Using clear glazing alone as the daylighting concept only reshuffles the energy use ratio. Daylighting concepts are optimized when combined with Baumann Exsotrol blinds.

Flexibility—accept or reject the sun

Flexibility is the reason Baumann Exsotrol blinds are the most effective solar control product in the market today.

Just before the sun strikes the glass, the blinds can be lowered and adjusted to the proper angle to give 100% solar protection while allowing natural daylight to enter. The raising, lowering and adjustment of the blind slats may be motorized or manual. Motorized blinds can be computer controlled to respond to sun, wind, rain, time of day and weekend occupancy.

Having dark glass on a building is like wearing sun glasses 24 hours a day. Unlike fixed shading systems (including dark glass) Baumann Exsotrol blinds can be completely retracted when not needed on cloudy days, or when the sun is shining on other elevations. Blinds can be retracted on sunny winter weekends when solar gain is desirable, during window washing or window replacement.

Perfect protection for all seasons

Unlike overhangs, setbacks or fixed louvers, Baumann Exsotrol blinds provide 100% shading of the glass, regardless of season or elevation.

Overhangs are designed primarily for protection against the south summer noon sun. They are impractical on east and west elevations, and

ineffective against the glare and heat of low sun angles during fall, winter and spring.

Baumann blinds \$ave more than they cost

- Eliminate up to 50% of perimeter air conditioning.
- Eliminate need for costly special glazing.
- Eliminate need for most interior window treatments.
- Reduce perimeter lighting requirements.
- Lower “peak demand” and total electrical operating costs for the life of the building
- Provide excellent hurricane protection.
- When programmed as movable insulation, help stop winter nighttime heat loss.

Send for additional information. Also available from Baumann: rolling shutters and European Style awnings.

IF YOUR BUILDING HAS WINDOWS, IT NEEDS BAUMANN BLINDS.

Baumann, Inc.
111 North Avenue
Barrington, IL 60010
(312) 381-4924



Baumann
division of Air Vent Inc.

*Report LBL-12298 of DOE contract W-7405-ENG-48 with Lawrence Berkeley Laboratory.

***U.S. Department of Housing and Urban Development publication, “In the Bank or Up the Chimney?”

**Exsotrol = EXterior SOLar conTROL

Architectural education: A student's long path into Arcadia



By Robert D. Fox

If you walk into a design studio at almost any architectural school and ask a student for his or her view of architectural education, the answer you are most likely to receive will be idealistic—and more than likely will not give you a clear perception of what is being taught. Architectural studios are an “Arcadia” of architectural issues. Not only has the whole process of educating architects become very idealistic, but the entire profession of architecture as well is presented as such. While students begin to learn about conceptual development and solving architectural problems, they are just starting out on a quest that will take them through most of their professional lives. That quest, ingrained in the studio, is the search for design excellence—something every architect strives for, but few achieve. In the studio it is presented as an easily achievable goal; however, in order to achieve that goal the student must strive to uphold both the traditions of the profession and hard-to-maintain values.

To many students architecture is almost a cult. It becomes a new religion, a cause to devote one's life to—which is not all that far from the truth. But it is important for a student to keep a sensible view of reality, something that is not always presented clearly in an Arcadian atmosphere. Students are not always clear on the external forces that influence the design process, and often see compromises as disrespectful to architecture, a selling of one's soul. Academia rarely deals with an understanding of the values of society in the present day. As a result, students have little understanding of the reasons that shape buildings, and they continue to develop their design talents devoid of all outside influences. In order for us to better understand the students' view and the reasons for their feelings, we must go back and take a look at the whole educational process. It is necessary to try and begin to see what the student is taught from the very beginning.

Arcadia must be infused with some reality

Before a student decides to become an architect, he or she *must* have some outside contact with the profession. At that point most have very little real knowledge about architecture. They can easily identify with a certain phase of the profession,

Recent graduate Bob Fox draws from his own schooling, and from work with many students and schools as president of ASC/AIA, to depict a warmly idealistic—yet very practical—view of his new profession

but have no idea of all the aspects required to put a building together. Generally they look at the part of the profession they find most interesting and build their dream around that perception. That is good because it provides lots of inspiration and excitement. To get a little more specific, we can look at design—which is probably the strongest influence and attraction to the architectural profession.

Many students first coming into the profession are familiar with the names and work of a number of famous architects that they would like to emulate. Often these architects are pictured as idealists who often stood by their design decisions determined to build what they saw as the best solution—a goal that we all set for ourselves. Most students are taught that they should stand up for what they see as being the solution, and many wind up fighting for things that they like, and not for things that are needed to complete a series of architectural relationships or to improve the workings or esthetics of a space.

Please don't misunderstand my criticism of the educational system. School *should* be somewhat removed from the everyday world of building construction—but not totally. Too often a person graduates today from academic life and he or she is totally unprepared for what is to be encountered in the real world of architecture. Rarely is this put into perspective for the student, who is left struggling to relearn later how the profession operates. A good example of this can be found when recent graduates are assigned to a “real-life” design team. Many times they will defend what they have done, rather than work with the team to develop something better. A list of examples could go on, but my point is that somehow the schools should teach what exists outside—without overburdening the architectural Arcadia of the studio.

Learning design takes a new frame of mind

It is a huge burden for a school to try and train someone to completely understand the design process in a short five-year period of time. To many students five years is an eternity, and few understand the need for such a long program—especially to teach design. Think about what preparation we had before we entered an architectural program. We came from four years of secondary school, and of

the things we learned few, if any, provided a good base from which to learn design. In high school we typically learn the “three R's,” which are primarily a series of facts presented to a student. In most cases students are taught a process, formula or method to get *the* answer they need. In all other cases students memorize. Students are simply given facts and are tested on those facts. In very few places are they taught to think, or to solve problems that fall outside of the system. We all went through that system which will probably continue.

Thinking, solving problems, conceptual development and creativity are rarely touched on as subjects in secondary schools, yet these are all needed to solve problems that we encounter in our everyday lives. Students who can remember everything they were taught in high school will still have trouble solving problems that fall outside of those taught subjects or systems. Creative thinking is not even considered in most high schools, yet it is the fountain for advancement of our society and, in our case, the basis for education and advancement into the profession of architecture.

There are lots of factors in designing a building

Another problem with the high school educational system is that it tends to reinforce the notion that there is only one answer or solution to any problem. Architects know that a number of equally relevant solutions can exist. There was a student I went to school with who just could not comprehend that there was no right or wrong answer. He expected everything in architecture to be either black or white, and also expected that the program would teach him a set process for drafting up well-designed buildings. Anything less than this was unacceptable. He eventually decided that architectural education wasn't worth the trouble and has removed himself from that type of decision-making process. I'm sure that he is not alone. Possibly there are many architects who still don't understand. So you can see that five years is not long to retrain people how to think.

Typical programs start small and quickly augment

Architectural education deals with the complicated process of putting a building together. It tries to incorporate materials, systems, the environment, spatial uses and other relationships into

Robert D. Fox is president of the Association of Student Chapters/AIA, and graduated from Temple University, Philadelphia, in May 1983 with a Bachelor of Architecture.



The Pepperdine University Plaza building was designed by Landau Partnership and is managed by Murdock Development Company.

At Pepperdine, Laminated Glass gets high marks for noise control.

The beautiful, all-glass skin of Pepperdine University Plaza was all



that separated the university administrative offices from the roar of this busy LA freeway.

To meet STC requirements of 36-38 would have required $\frac{3}{4}$ -inch monolithic glass. However, that thick-

ness exceeded weight limitations of the building design.

So $\frac{3}{8}$ -inch laminated glass, with a Saflex® interlayer by Monsanto, was proposed as a solution. Laminated glass achieved the STC requirements of 36-38 with half the thickness and weight.

The configuration for the all glass building is detailed in the illustration:

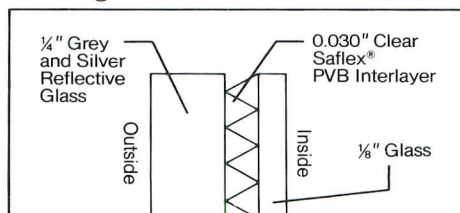

Circle 37 on inquiry card

And the Pepperdine University Plaza building went up quiet, beautiful...and *not* overweight.

If your building has a weighty sound control problem, write us for more information on laminated glass acoustical control. Monsanto Polymer Products Company, Dept. 804, 800 N. Lindbergh Blvd., St. Louis, Missouri 63167.

Saflex® is a registered trademark of Monsanto Company © Monsanto Company 1983

SAFLEX®
PLASTIC INTERLAYER BY **Monsanto**

a well orchestrated whole. Each of these areas requires special consideration and thought as to the interwoven sharing of space. All of this requires a special sensitivity that architectural schools assume can be taught. The architectural programs are as varied as the number of schools, but all are five to six years—with the exception of graduate programs. The subject matter also varies, but generally starts with simple problems and develops into more complex design projects.

The first year of a five-year program might deal with very simple designs that have little, if any, overlapping of systems—such as a simple study of the relationship of spaces and transitions. Second year might include environmental relationships—such as solar and wind orientation. Structural systems would be introduced and more complex spatial relationships studied. It is to be hoped that by this time the student would have a good grasp of the conceptual thought process. In the third year, structural and environmental systems would become important issues to be integrated with spatial relationships. Here the student would become aware of all the overlapping and integration of different systems that must take place within a building. Fourth year would take a close look at the details and how the building actually goes together. The use of materials would be studied as well as connections of various parts of the building, such as roofs and walls. Fifth year would be a culmination of everything that had been learned earlier—brought together into one final thesis project that, hopefully, would also allow the student to explore other related areas of interest as well.

Of course while this was being learned in the studio, the student would also be learning history, structures, professional practice, and more, in the classroom. At some point the student would become aware that there are other related professions architecture depends on in order to produce a complete building, but the total understanding and true relationships are left a mystery that only internship can answer.

A degree is just the beginning

Teaching design in and of itself requires a great deal of time, but architectural pedagogy goes far beyond the formal institution.

Most students feel that when they graduate they are prepared to practice architecture. Nothing could be farther from the truth. It only takes a short conversation with a practicing architect to confirm that fact. Architects expect to train a young graduate for several months, and possibly years, to assure themselves that the graduate is at a level that he or she can take on jobs of greater responsibility. It is in the best interest of any firm to do so, in order that the graduate will make a real contribution to the firm and not require constant guidance from others with greater experience. This leads to the great debate of whether graduates should be completely prepared to practice architecture upon graduation—and is that the schools' responsibility? I think that most upperclass students are aware of the situation, and fully expect to serve an internship. Students realize that some things can only be learned once they start working. They also must use the opportunity to find the exact kind of work that helps them to achieve their own personal goals.

Architecture can lead to many career paths

One of the most exciting things about architecture is the number of disciplines involved, and the number of them that the architect can participate in directly. Few other professions can offer the diversity of architecture. Today, architects are also finding related jobs outside of the traditional practice. The skills that architects learn lend themselves to many other areas within our economy. Industry planning, construction management, furniture design and interior design are just a few. The health care field is another good example; many hospitals, in order to obtain state funding, are required to submit 5-, 10-, and 20-year plans that include space planning needs and requirements. Many architects are also doing the same type of work for many areas of industry. Students should be aware of these opportunities, and begin to plan for a career in whatever area might interest them.

I believe the areas for architects to work in will continue to grow. It is just a matter of architects finding and creating the positions in areas they feel they can comfortably handle. Traditional practice will continue as long as architects desire—and can remain competitive with new ways to

produce a building. Most students are aware of the problems facing the profession and are preparing themselves to take on the challenge. It is probably safe to say that most architectural graduates will aim for traditional practice, at least in the near future.

Involved students work with the student organization

The students who are most active in this budding profession, and who stay on top of the current issues to help set policy and make decisions from the student position, work with the Association of Student Chapters of the American Institute of Architects. ASC/AIA is the national organization for architectural students. It is a publicly supported non-profit corporation that is run exclusively by students. The main purpose of ASC is to better prepare students to enter the profession of architecture—which is done by providing a forum for the discussion, presentation and understanding of architectural issues and ideas. ASC also provides its members with opportunities to become more closely associated with their particular areas of interest.

Architecture is by far the overriding concern of our members, but they tend to watch other related areas of the profession to see how the quality of the environment might be affected. Students feel very strongly towards ensuring the highest quality of the built environment. ASC also has two big programs, *CRIT* magazine and "Forum," which are specifically directed towards these concerns.

CRIT is published by ASC and deals with issues of greater intellectual value, often addressing highly theoretical and controversial issues. In the past it has covered such areas as architectural education, preservation, housing, and more. *CRIT* has earned a high level of respect within the student and educational community, and will continue to provide a current, timely response to relevant issues.

"Forum" is ASC's annual convention. It is traditionally held over Thanksgiving, since this is the one time of the school year when all students have the same time off. The purpose of "Forum" is to bring students together to discuss current issues in architecture, listen to lectures and seminars, and to participate in discussion sessions. It all adds up to a very intense week that

evaluates a special theme, as well as architecture in general. Students also have the opportunity to meet and discuss topics and problems with their peers from across the nation. "Forum" is hosted by a school chapter, and is planned, run and financed through the work of students. The experience of running an event like "Forum" helps students to get actual hands-on experience of running a business, and in developing the communication skills they will need throughout their professional careers.

Another one of ASC's programs is the administration of design competitions. Traditionally we sponsor two competitions a year, one in the spring or summer and one in the fall. The design competitions give students a chance to compare their design talents with those of students from across the country. The number of entries is generally over 300 from 130 school chapters. The jury for these competitions consists of well-known practicing architects from various parts of the country.

There are other programs as well that ASC runs and/or sponsors—many in cooperation with the AIA, with which ASC is closely associated. The president of ASC sits on the AIA Board of Directors and represents student views and opinions. He also sits on several AIA committees, and on the Membership Service Commission. This is done in an effort to keep students informed on what is happening within the profession so that they may adjust their career paths as they see necessary. The AIA provides strong support for students and is very willing to help in the development of new programs.

Internship program gives guidelines for experience

Once a student graduates, the educational part of the profession is far from over. Immediately following graduation there is internship—the part of a beginning architect's career where the technical aspects of the profession are used daily and new experience is gained. Students often look at the internship process as a long and tedious path, but realize the necessity of it in order to better understand the building process. Graduates are very aware of the knowledge of architecture they lack, and see internship as the place where they can gain and use that knowledge.

Continued on page 57

Light... Years Ahead.

P2 Parabolume® . . . For Maximum Efficiency

First introduced in 1980, the super-low brightness P2 features an optical system that maximizes lighting distribution and efficiency while retaining the high visual comfort levels that are the trademark of quality lighting.

Designed as an energy saver for the 80's, P2 has proven itself to be the most practical and reliable parabolic innovation since Columbia introduced the original Parabolume 18 years ago.

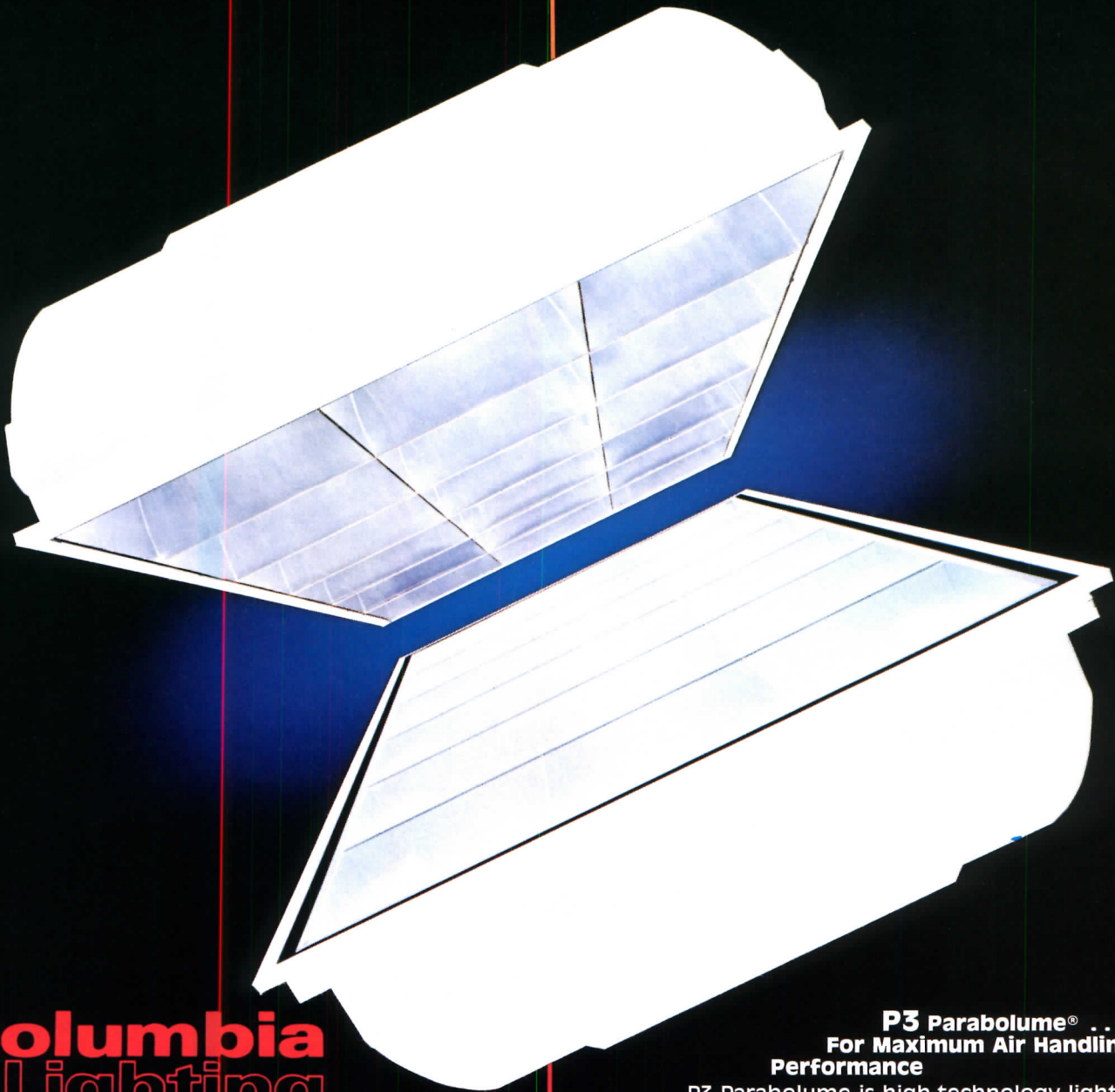

Columbia
Lighting
Inc

P.O. Box 2787
Spokane, WA 99220
(509) 924-7000

usi U.S. INDUSTRIES, INC.
A Subsidiary of

P3 Parabolume® . . . For Maximum Air Handling Performance

P3 Parabolume is high-technology lighting at its best. Combining the classic appearance of Columbia's 1965 original Parabolume with the advanced performance of P2 optics, the P3 is the latest in a long line of successful Columbia designs.

P3 matches aesthetics with optimum performance. For more information on the P2 or P3 Parabolumes, contact your Columbia Lighting representative or write us.

ASC has worked closely with AIA, NCARB and other organizations to develop the Intern Development Program, which gives a guideline for students to follow during their internship. IDP enables the student to chart the experience through internship, and will show what areas the intern is getting experience in—and those where he or she is not. This will help the intern get the most effective training during this period. IDP also is geared to those who want to practice outside of traditional practice, thus providing flexibility. IDP helps to assure the employer that a person who has successfully completed the IDP has a basic working knowledge of how buildings go together. An advantage for interns in states where IDP is mandatory—should they meet the minimum requirements before the traditional three years are up—is to be able to take the Architectural Registration Examination (A.R.E.) early.

Architecture is in an exciting new era
Students studying architecture today are in one of the most exciting times for the profession. With the advent of new technologies, it is hoped that more time will be spent on using them for the serious improvement of design. Students are also looking for new ways to handle the typical business aspects of the profession. And students will probably explore new territories of the profession that our ancestors would never have imagined. The profession of architecture has always advocated approaching problems with an open mind—and the architectural students of today *are* approaching architecture with an open mind. But they are approaching the everyday problems of running an office with that same attitude. They are more aware than ever that we are only limited by our own imaginations.

Even with all of the problems that the architectural education system has, it works incredibly well. The system is adapting to new technologies, and students—and architects—are more aware of them than they perhaps were in the past. There are also more services for the architect now, along with more special interest groups related directly to architecture. Architects of the future will have to work very closely with these groups and gain full advantage of their services and interests. It is a very exciting and promising time to be involved in architecture.

Engineering the world's most critical barriers:

SOUND

You build a test environment so carefully that nothing will break its integrity. You need a door engineered so well that only a continuation of the wall would be any better. Then

you face a special problem like accessing your test environment with an over-the-door conveyor system, while maintaining sufficient sound isolation. That's one of the reasons the doors you select will come from Jamison.

Because you know forty years experience in designing and building of specialty doors gives us a unique ability to solve your problems. And an R&D department that can come up with specialized solutions to special requirements. Backed with the service you expect from Jamison.

For sound, temperature, chemical reaction and atmospheric control, we don't just build doors. We build solutions. To learn how, contact us with your requirements. And we'll engineer your most critical barrier.

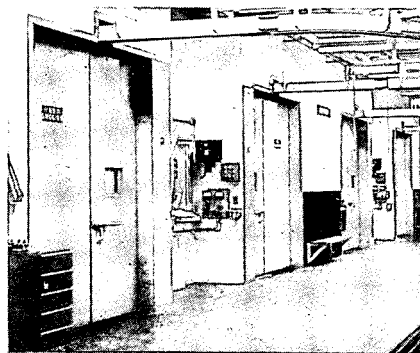

For Mack Trucks

Jamison STC 51 doors tame the roar of powerful truck engines in 36-cell dynamometer testing facility. Custom-engineered, switch-controlled "guillotine" mechanism seals around overhead conveyor track that carries engines in and out of cells.

SPECIALLY ENGINEERED DOORS BY
JAMISON

Jamison Door Co., P.O. Box 70, Hagerstown, MD 21740
Telephone (301) 733-3100, Telex #292336 JMSN UR

Any other door is second best

Circle 39 on inquiry card



Curtain wall

Thermalized windows

Sliding patio doors

Balcony railings

How aluminum keeps down the cost of keeping up the Devonshire.

Savings start with the Devonshire building's 230,000 square feet of low-maintenance aluminum exterior panels that make it a standout on Boston's skyline. They're coated with a new fluoropolymer finish in a shade of gray that matches across the entire facade.

Savings continue with 7,000 thermalized aluminum windows that reduce the likelihood of condensation, and reduce heating and cooling costs.

Exterior balconies on the 36 residential floors that rise above the

seven commercial floors of the Devonshire have sliding access doors and railings of aluminum for its durable and attractive finish with a minimum of maintenance.

Aluminum gives architects other opportunities to build-in operational and maintenance economies. For example, aluminum modular flooring systems to reduce the cost and disruption of installing and changing underfloor wiring and conduit. Aluminum ceiling systems for a rich choice of colors, styles and finishes as well

as easy access to overhead lighting and wiring. Even aluminum-louver solar control systems on windows to help control heat gain and reduce costs of cooling.

For more information write the Aluminum Association, Inc., Dept. B, 818 Connecticut Avenue, N.W., Washington, D.C. 20006.

Building owner: Devonshire Associates, New York; architect: Steffian/Bradley Associates, Inc., Boston; curtain wall fabricator and erector: Maddison Associates, Revere, Mass.



MAKE IT WITH ALUMINUM

Rekindling the Great White Way: A redevelopment proposal for Times Square

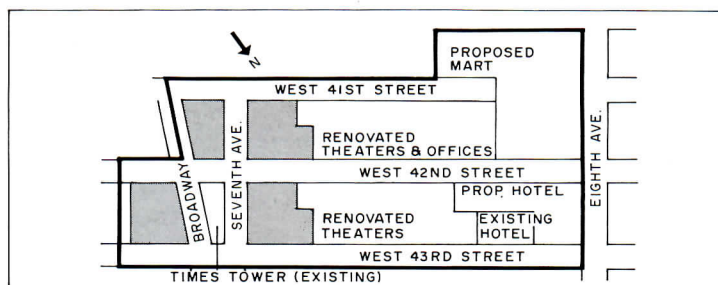

One of the most famous thoroughfares in New York City, West 42nd Street also ranks among the shabbiest. Anyone who has walked the seedy gauntlet that runs between Broadway and Eighth Avenue will likely welcome the major revitalization plans recently unveiled for the Times Square area by the New York State Urban Development Corporation and the City of New York. A key element of the 13-acre redevelopment project for 42nd Street will be four new office towers designed by John Burgee Architects with Philip Johnson. Grouped at the intersection of West 42nd Street, Seventh Avenue, and Broadway (shaded area map left), the proposed towers range in height from 29 to 56 stories. Imposing arched glass entryways visually link the four stone-clad buildings, while sleek glass mansard roofs mark the skyline with a dramatic combination of contemporary material and traditional form. A pedestrian tunnel, part of a larger redesign scheme for the Times Square subway station, will physically join the towers, which will contain more than four million square feet of office space. Other components of the planned Times Square redevelopment, scheduled to evolve over a seven-year period, include a wholesale mart for the computer and garment industries, a new 550-room hotel, and the renovation of nine theater buildings. The UDC predicts that the \$1.6 billion project will eliminate economic blight on 42nd Street and strengthen the Times Square area as a center of *legitimate* entertainment.

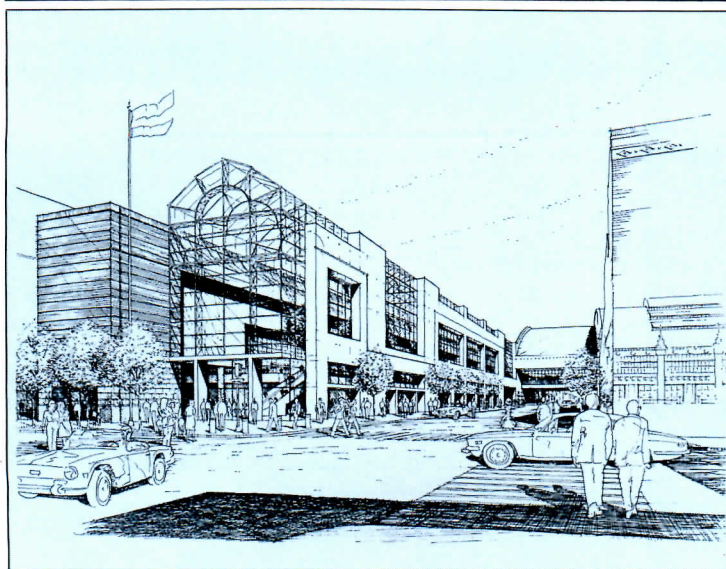

Philadelphia on the right track

The city of Philadelphia has chosen a schematic design for a redevelopment proposal that will integrate the historic 1893 Reading Terminal near City Hall into a vast convention center, hotel, and retail complex. Architects for the 12-block project are Thompson, Ventulett, Stainback & Associates in joint venture with the Vitetta Group and Cope Linder & Associates.



The Man in the Modernfold Wall

His products and performance have made Modernfold operable walls the #1 choice for facilities across the country.

Your local Modernfold distributor, The Man in the Modernfold Wall, has consistently provided the innovative products and conscientious service that so many architects and end-users have come to rely on. With a network of over 150 of these installing distributors, there's sure to be one near your next project. He can

be on site in a hurry to coordinate activities for a smooth, trouble-free installation. And he'll be there to handle the follow-up service that's so important to long-term customer satisfaction.

Most of our distributors have been with Modernfold for over 20 years. With this application expertise and

Modernfold

An American-Standard Company

our full line of products, your distributor can find the most effective ways to implement your solutions to tough designing problems.

You can count on The Man in the Modernfold Wall to come through for you with every installation. For the name of the one nearest your next project, contact Modernfold, P. O. Box 310, New Castle, Indiana, 47362. In Canada, contact P. O. Box 399-Station E, Toronto, Ontario, M6H9Z9, Telex: 27-2285.

Motor City rebirth?



A possible symbol of a city on the upswing after years of economic decline, Millender Center is a mixed-use development in downtown Detroit that includes a 30-story apartment tower, a 260-room hotel, a 1,850-car parking garage, leisure facilities, and 34,000 square feet of retail space. The complex will be clad in bands of exposed aggregate and

sandblasted precast concrete alternating with slate-colored metal spandrels. Two skywalks will link the nearby Renaissance Center to the project, which will also have a station on the city's downtown "people-mover" system. Architects for the development are The Ehrenkrantz Group.

The pavilions and pools of St. Petersburg

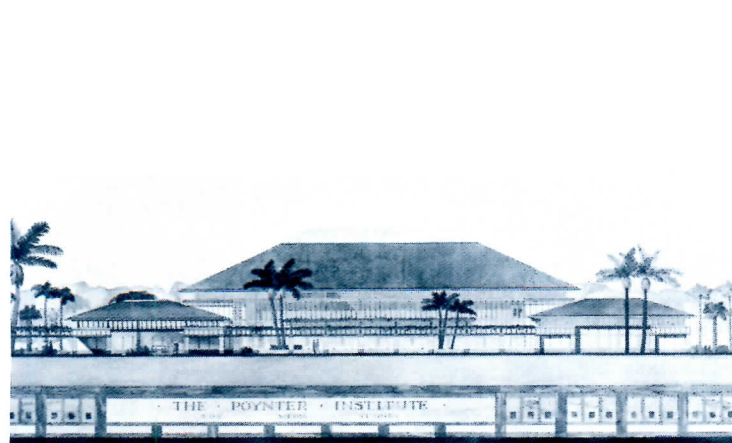

A careful relationship to site through both form and material characterizes the new Poynter Institute for Media Studies at the University of South Florida in St. Petersburg. Traditional tile hipped roofs with deep eaves crown a series of pavilions grouped around reflecting pools. Travertine, wood, glass, and local keystone will be used throughout the center, which will

accommodate an amphitheater, a design laboratory, classrooms, research facilities, and a 20,000-volume library. The transition from outdoor to indoor space will be eased by a 50-foot-high glass atrium and a system of covered walkways. Architects for the 31,000-square-foot project are Jung/Brannen Associates.

Pyramids-on-the-Seine: Pei's plan for the Louvre

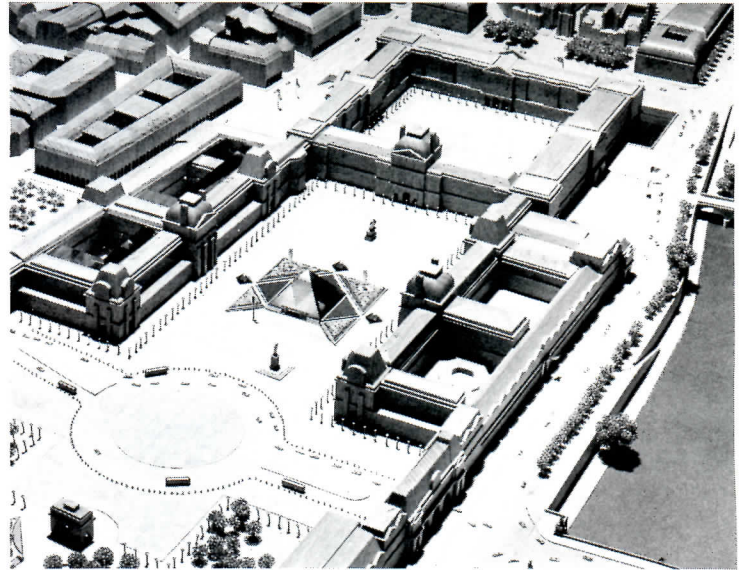

French President François Mitterrand has approved plans for the rebuilding of the Louvre that involve the renovation of space formerly occupied by the Ministry of Finance, the conversion of the palace basement into office and storage areas and, most significantly, the construction of a 65-foot-high, 100-foot-square glass pyramid in the Court Napoleon to serve as

the new main entrance to the museum. The project by I.M. Pei & Partners will incorporate still and bubbling water elements and three "baby" pyramids that will illuminate escalators leading down to a new visitor lobby. The plan also calls for terminating the use of a part of the courtyard as a car park and restoring some of the public space to its original layout.

San Francisco project banishes the glass box

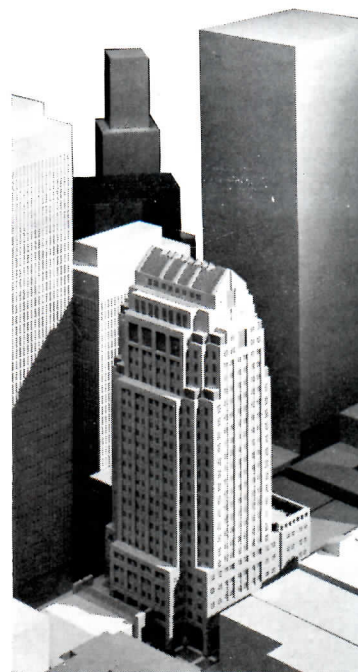

Stevenson Place is a 23-story office building in San Francisco designed to offset the more severe International-Style towers that have contributed to the so-called "Manhattanization" of the city's downtown area over the past three decades. The building will be sheathed in precast concrete and pink French marble, and will feature a series of stepped corner setbacks to increase sunlight penetration and to provide the maximum number of corner offices with multiple views of the city and the bay. Situated on the edge of the financial district and planned within the strict height limitations recently imposed by the City Planning Department, the tower will be crowned by a pedimented green copper roof that will add scale and visual interest to the building while incorporating the structure's mechanical system. In addition to 395,000 square feet of flexible lease space, the tower will also have a ground-floor restaurant and a through arcade linking Jessie and Stevenson streets. Architects for the project are Kaplan/McLaughlin/Diaz.

When your eye says beauty, but logic demands performance

Nail it down.

Don't guess about commercial carpet performance. Be sure. Specify Anso[®] IV HP nylon with HaloFresh[™]. The only antimicrobial 4th generation heavy-denier contract carpet fiber. The Multi-Task carpet fiber.

- Superior, multi-action protection against destructive bacteria, mildew and fungi is permanently built-in to last.
- Soil and stain resistance is chemically built-in. Proven effective and durable in demanding commercial use.
- Heavier denier fibers for greater strength and resiliency. Improved resistance to crushing and matting.
- Exciting styles tested to meet rigid construction specifications. Backed by a 10-year wear warranty (see label for details).

Write for Facts and Proof: J. Peters,
Allied Fibers & Plastics Company,
P.O. Box 31, Petersburg, VA 23804

ALLIED CORP. NYLON
Anso IV HP
with HaloFresh[™]

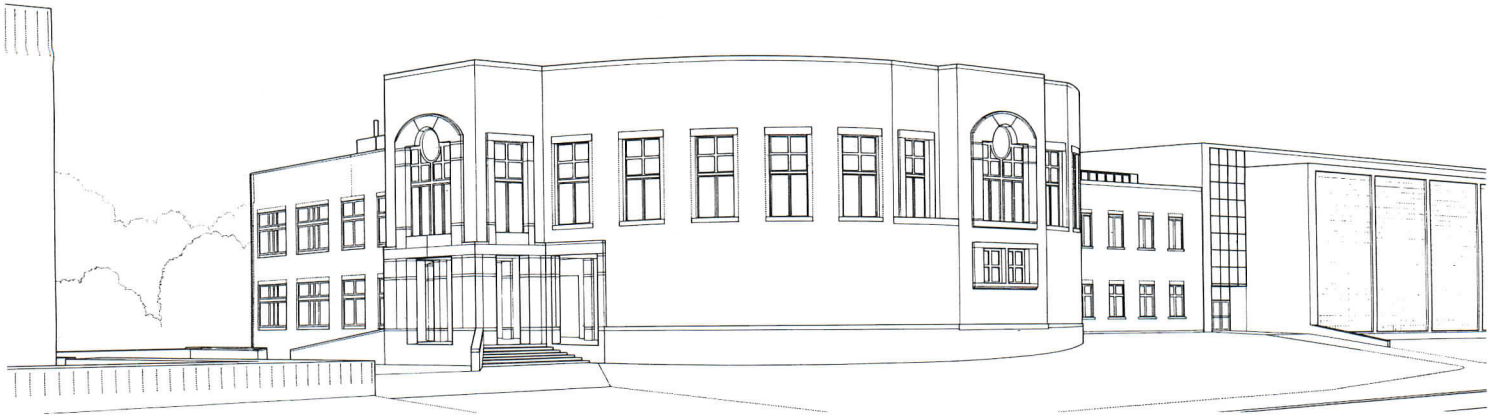

To accommodate the expanding departments of biology and psychology, the University of Virginia has planned a major addition to Gilmer Hall, a 1960s brick-and-concrete box located west of the Thomas Jefferson-designed complex for which the campus is best known. The addition comprises two major elements. A semicircular lecture hall and library (top) is

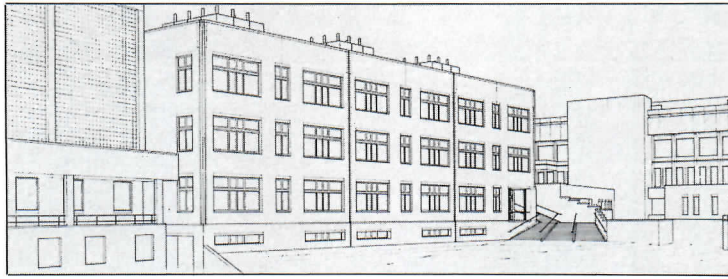

articulated by stylized limestone Palladian windows and closes the axis formed by a group of 1950s neo-Georgian dormitories. The rectilinear rear section of the addition, by contrast, is designed to reflect the utilitarian nature of the laboratories housed within (bottom). Architects are R.M. Kliment & Frances Halsband in joint venture with Wank Adams Slavin Associates.

First Wolf Prize in architecture awarded



The international Wolf Foundation Prize in architecture has been presented to Ralph Erskine of Sweden for "outstanding contribution to contemporary design." The \$100,000 prize is the first architecture award granted by the Israel-based foundation, which annually recognizes superior achievement in the arts and sciences. Considered one of the leading second-generation architects of the Modern Movement, the British-born Erskine has been widely acclaimed for particularly sensitive solutions to large-scale housing problems. Among his best known projects is the urban redevelopment of Byker, Newcastle-on-Tyne, England (1969), sometimes credited as one of the first "humanistic" housing projects in Great Britain.

Historic D.C. hotel gets new lease on life

In its heyday, the Willard Hotel was a favorite meeting place for Washington elite, who ate, drank, and otherwise made social and political merry in the ornate, turn-of-the-century rooms. After World War II, however, the hotel fell on hard times, but a sensitive renovation plan by architect Vlastimil Koubek will soon return the dog-eared building to its original elegance. In addition

to a full exterior facelift, the project calls for the restoration of the grand old lobbies, including the famed Peacock Alley. A luxury retail/office addition distinguished by a series of building setbacks and mansard roofs that complement the original 1904 design by Henry Janeway Hardenberg will also be constructed along the Pennsylvania Avenue facade.

Landmark office building becomes Buffalo hotel



Once scheduled for demolition, the 60-year-old landmark Genesee Building in downtown Buffalo has been transformed into the Hyatt Regency, a 400-room luxury hotel. The \$41 million project was designed by The Gruzen Partnership and required complete gutting of the old building and installation of new wiring, elevators, plumbing, and heating and cooling systems. The finished hotel opened in February and combines the 15-story Renaissance Revival office structure with a new 11-story addition and a contemporary glass atrium. The project is reportedly the first conversion of an office building into a hotel in this country.



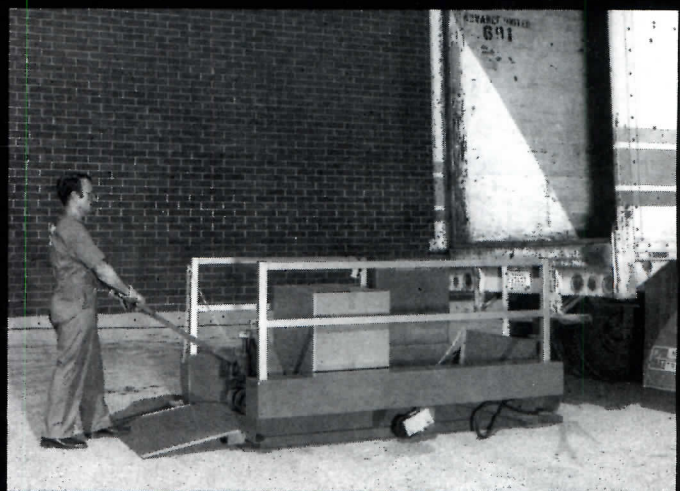
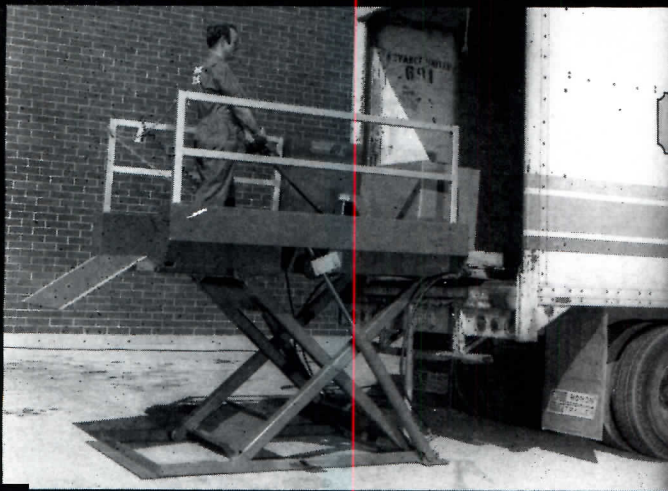

THE INEXPENSIVE TRUCK DOCK

- 1/4 the cost of a concrete loading dock, twice as useful
 - 80 models starting at \$3,975.00
- Call 1-800 THE DOCK In Illinois (312) 584-9881



ADVANCE LIFTS

Advance Lifts, Inc., 3575 Stern Ave., St. Charles, IL 60174 312-584-9881

Discover how easy it is to turn your shipping or receiving area into a profit center with an Advance Superdok. It adjusts to any truck height at the push of a button. A Superdok will increase productivity, improve safety, reduce damaged goods, improve employee morale and increase your profits. Call us today at 1-800 THE DOCK and we'll send you, FREE, all the super facts on Superdoks.

Circle 42 on inquiry card



PETER WITTER SPEAKS WITH AN ACCENT.

"This home's high country setting made Shakerstown's shingle siding a natural. But we wanted something extra; an accent of added interest. And so the strip of FancyCut Shingles. Their cost was surprisingly small, but not their contribution."

— Peter Witter AIA, Peter Witter Architects

SHAKERTOWN FANCY CUTS®

Send for free design ideas portfolio: Shakerstown, Box 400-AF4, Winlock, WA 98596

Circle 43 on inquiry card

THE RIBBON® RACK by brandir™

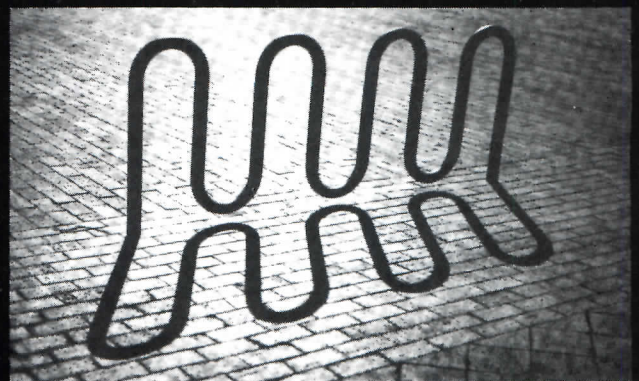

BRANDIR INTERNATIONAL, INC.
200 Park Avenue, Suite 303E
New York, NY 10166 (212) 505-6500

IDSA National Design Award Winner

Circle 92 on inquiry card

AIA names new executive vice president



The American Institute of Architects has announced the appointment of Louis Lawrence Marines as executive vice president and chief executive officer. A Phi Beta Kappa graduate of Washington and Jefferson College, Marines comes to the AIA with almost 20 years of management experience at design-related organizations. Since 1978, he has been general manager of Haines Lundberg Waehtler, a 300-person architectural firm based in New York City, where he was responsible for financial planning and communications and sales activities. Previously, he was vice president and general manager for the Detroit firm of William Kessler & Associates and a principal of the Coxe Group Inc., a Philadelphia consulting firm.

Competition calendar

- The Industrial Designers Society of America is sponsoring its fifth annual competition for the best achievements in industrial design of the past year. The deadline for entries is May 1, 1984. For more information, write to IDEAS4, IDSA, 6802 Poplar Place, Suite 303, Melean, Va. 22101 or call 703/556-0919.
- The best government-sponsored design projects completed between January 1, 1974 and January 1, 1984 are the target of the new Presidential Design Awards. Projects in the fields of architecture, planning and design are eligible. Entries are due by late spring. For more information, write to Mr. Robin Murphy, Design Arts Program, National Endowment for the Arts, 1100 Pennsylvania Ave., N.W., Washington, D.C. 20506.

Major London development slated for Thames River site

Although a familiar old nursery rhyme argues the contrary, a lot more is going up than falling down at London Bridge these days. According to the St. Martins Group, a British real estate concern, the south bank of the River Thames will be the site for one of the most comprehensive mixed-use developments ever constructed in the British capital. Dubbed London Bridge City, the project will combine offices, shops, leisure facilities, a private hospital, and a museum in a landscaped, traffic-free setting planned in two phases. The first, designed by architects Michael Twigg, Brown & Partners and John S. Bonnington Partnership, will extend east of London Bridge to Battlebridge Lane. A focal point of this phase is Hay's Galleria (below). Erected by

Thomas Cubitt in 1857, the building will be reconstructed to incorporate offices, apartments, and a dramatic public atrium. Here, a 100-foot-high vaulted glass roof will crown a gallery of shops, pubs, and coffee houses. The original Victorian facade (bottom) will remain intact. Another office complex, "Cottons," will house a swimming pool, a gymnasium, and squash courts. At the foot of London Bridge, twin office towers will serve as the gateway to the development and provide access to a riverside pedestrian walkway to run the length of the site. Phase II, still in the planning stages, will continue the project to Tower Bridge, and will include a three-acre public park, in addition to more housing, offices, and shops. A river taxi service is also proposed.

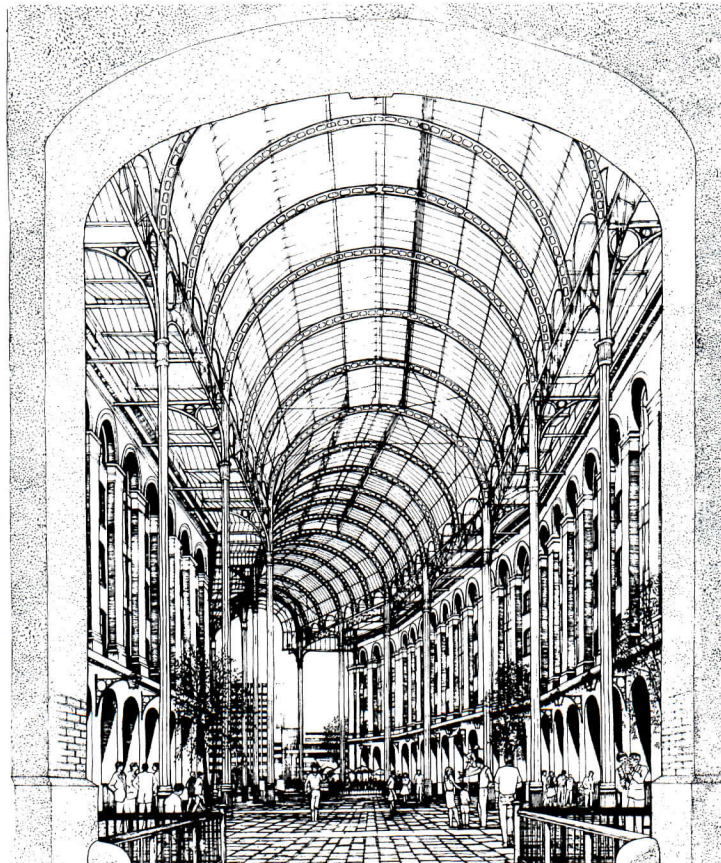

Banking on the Missouri

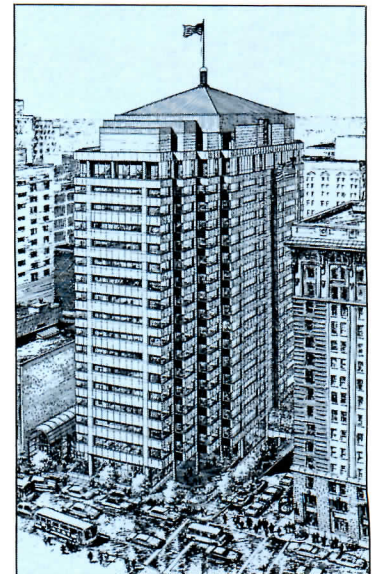

Conceived as a major step toward the revitalization of Kansas City's downtown financial district, the new Commerce Bank will house 378,000 square feet of office and retail space in a 19-story, rose-colored granite and aggregate precast tower that features corner setbacks and a block-long shopping arcade. Architects are Hellmuth, Obata and Kassabaum.

Play ball!

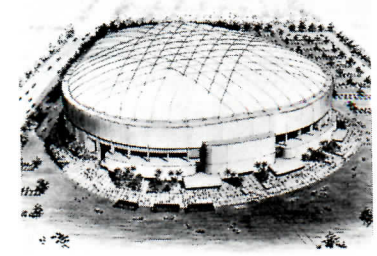

Seeking to enhance odds that the area will be awarded a major league franchise in 1986, Tampa will erect a 46,000-seat baseball stadium and crown it with an air-supported fiberglass roof. Designed by Ellerbe Architects & Engineers in association with Heery/Fabrap, the facility will assume a classic boomerang configuration—the architectural symbol of the nation's pastime.

The most complete
and versatile
line of metal
**Laboratory
Furniture
& Casework.**

Making an investment
in lab furniture
by Duralab
really pays dividends
. . . in years of service.



SEE OUR CATALOG IN
THOMCAT
and **SWEETS**

Constructed of superior materials, such as lead-coated sheet steel with baked-on enamel finish providing corrosion and acid resistance for the utmost in performance, durability and value.

Custom features include concealed hinges, double-panel insulated doors and drawers with removable panels for easy cleaning and decontamination. Get the full story from our engineering team.

DURALAB
EQUIPMENT CORPORATION
107-23 Farragut Rd., Brooklyn, NY 11236 / 212-649-9600

Circle 44 on inquiry card

Sun System. The Perfect Fit



SUN SYSTEM™
PREFABRICATED
SOLAR GREENHOUSES

for every Lifestyle, Building Style, and Budget.

Creating a building design that "works" demands harmony of form and function. SUN SYSTEM Prefabricated Solar Greenhouses complement any building style, enhance any decor, and can be tailored to fit any budget. SUN SYSTEM's state-of-the-art passive solar greenhouses combine elegant design and advanced technological know-how with superior construction—and the applications, both commercial and residential, are unlimited. **Call now for information or estimates on our standard or custom models.**

Copyright 1983 SUN SYSTEM Greenhouses

- 100% Thermally Broken
- Curved Tempered Glass
- Optional • Full Shading & Ventilation Systems • Quick & Easy Installation • Over 51 yrs. of construction experience

For our new color catalog and price list write to:

SUN SYSTEM Prefabricated Solar Greenhouses, Inc.
60H Vanderbilt Motor Parkway
Commack, New York 11725

See us in SWEET's Catalog
Section 13.2c Sty.

Circle 45 on inquiry card

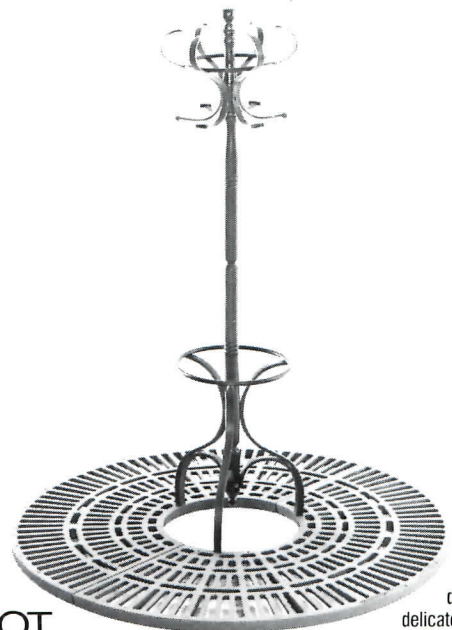

NOT
ALL TREES
NEED OUR
TREE GRATES!

Our tree grates are specifically designed to protect the delicate root systems of living trees while at the same time allowing moisture and fertilizers to reach the necessary areas. We offer over 65 geometric design opportunities for use in malls, sidewalks, parks and shopping areas to fit into your plans. Or, we will work with you to custom design according to your specifications.

NEENAH 
FOUNDRY COMPANY
Box 729, Neenah, WI 54956 (414) 725-7000

Write Dept. T for our Cat. R., 9th Ed.

Circle 46 on inquiry card

WHICH ONE?

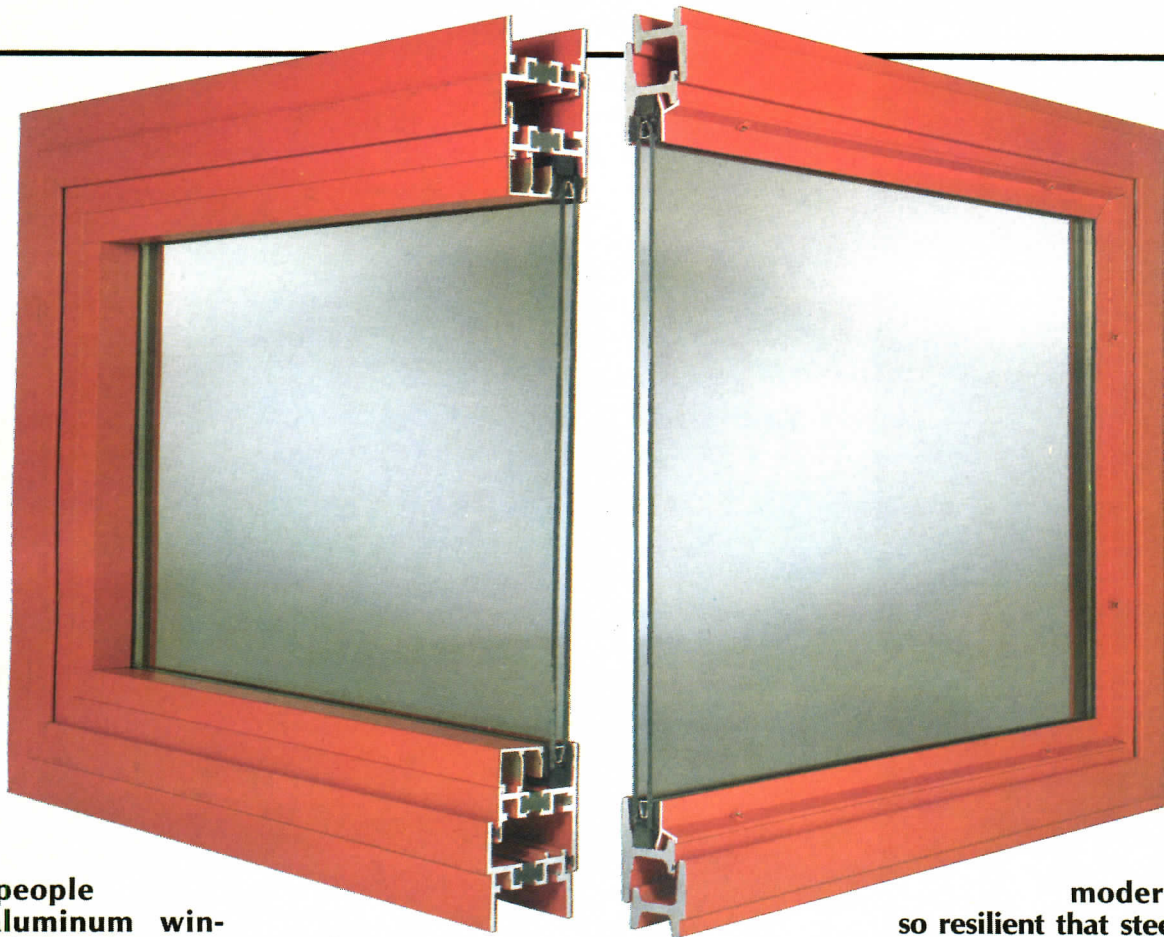

Some people make aluminum windows. A few make steel. But only Hope's manufactures both. That's very important because these two windows have little in common and getting straight facts could change the way you specify. The difference in sight lines and visual mass is obvious. What is not so obvious is just as important. For example, the steel window is three times stronger than the aluminum one. And there are differences in resistance to racking and durability. Both these windows have been finished with PVC, a

modern coating so resilient that steel windows can survive the harshest environments without surface degradation. What these windows do have in common that seems most surprising to so many is thermal performance. The steel window without thermal breaks delivers equivalent performance to the aluminum windows with thermal breaks. One company knows the real facts about both windows because one company makes both windows. Before you decide which one is right for your project, call Hope's.

HOPE'S ARCHITECTURAL PRODUCTS INC.

84 Hopkins Avenue/Jamestown, New York 14702-9990/716 665-5124

custom manufacturers of steel windows, aluminum windows, steel casement doors, security windows, fire rated windows and other architectural elements

**Design awards/competitions:
American Wood Council
1983 Design Awards**



**1. The Pilchuck School Office/
Gallery Building, Stanwood,
Washington;** Thomas L.
Bosworth, FAIA, Architect (First
Honor Award). Located at the
entrance of a rural summer
school, this 1,046-square-foot,
board-sided building houses
offices and a central gallery used
for the display of glass art
produced by students. The
gallery is illuminated by a high
triangular window at the gable
end and by clerestory
fenestration; its sense of privacy
and drama contrasts with
brightly lit office space that
opens to a central courtyard in
the rear. The jury praised the
architect's "skillful
interpretation of indigenous
materials" and noted how the
building "is at once ageless and
quite new."

**2. Farm Building
Reconstruction, Four-Mile
Historic Park, Denver,
Colorado;** Long Hoelt,
Architects (Honor Award).
Careful research on early
American building techniques
went into the reconstruction of
two c. 1860 barns and a corral
located outside Denver. The
architects retraced an old stage
coach route and surveyed
existing ranches to acquire
details for construction. Antique
tools were used, along with
native lumber and handmade
nails. Authentic carpentry
methods included board-on-board
roofing, board-and-batten siding,
half dovetail corner log work,
and mortised loft joist ends. The
completed structures
demonstrate, according to the
jury, "the power of primitive
buildings."

**3. The College Preparatory
School, Oakland, California;**
Dutcher & Hanf, Architects
(Honor Award). When a small
private high school moved to a
heavily wooded, six-acre site, its
administrators asked the
architects to develop a plan for a
low-cost facility incorporating
both portable, 1940-vintage
classrooms and new buildings.
The ingenious solution is a two-
level hillside campus that
consists of 16 classroom buildings
refaced with wood shingles and
raised above offices, small
seminar rooms, and bathrooms.
The jurors lauded the project as
"a total environment, a brilliant
site plan, and a compelling reuse
of existing structures."

**4. Deer Valley Resort, Park
City, Utah;** Esherick Homsey
Dodge and Davis, Architects
(Honor Award, see RECORD, May
1983, pages 92-97). The first
phase of a year-round resort
complex, these heavy timber and
stone buildings are updated
versions of the rustic wood
structures that the National
Park Service erected during the
1930s. The Deer Park lodges
incorporate log columns up to 42
inches in diameter, glued
laminated beams, and a variety
of exposed woods in the paneling,
flooring, and detailing.
"Beautifully finished,"
proclaimed the jurors. "The
facility feels exactly right as a
ski lodge at the base of a
mountain and creates a
handsome presence of the
landscape."

©Peter Aaron/ESTO

Established in 1981 to illustrate the applicability of wood construction to a variety of building types, the American Wood Council's 1983 design awards program for nonresidential architecture produced 17 winners selected from 261 national submissions. "The strongest entries," concluded the jury, "were the simplest expressions of wood design—basic buildings that reveal a clarity of focus, substantial energy, and a clear understanding of the materials." Jurors for the second biennial program were Don M. Hisaka (chairman), FAIA, of Cambridge,

Massachusetts; Thomas H. Beeby, AIA, of Chicago; Peter Q. Bohlin, FAIA, of Wilkes-Barre, Pennsylvania; Jaquelin T. Robertson, FAIA, of Charlottesville, Virginia; William Turnbull, Jr., FAIA, of San Francisco; and Tod Williams, AIA, of New York City.

Awards news continues on pages 78-79 with the architectural drawing competition sponsored by the Memphis Chapter of the AIA.

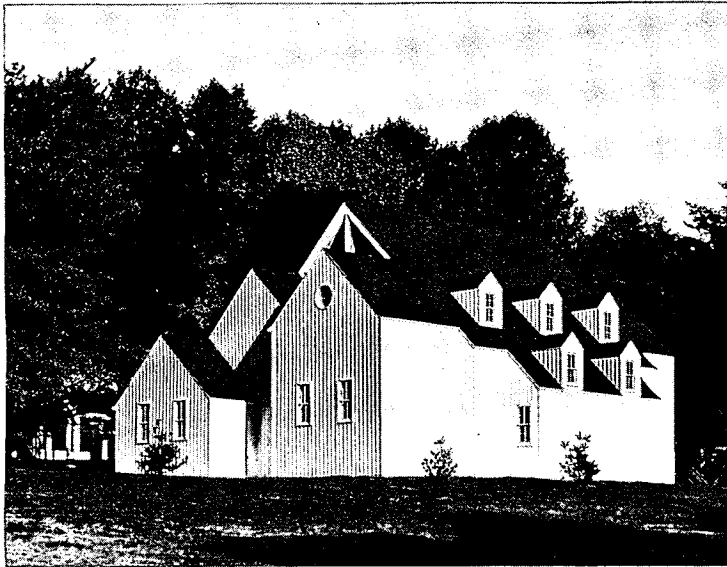

5

Robert Lautman

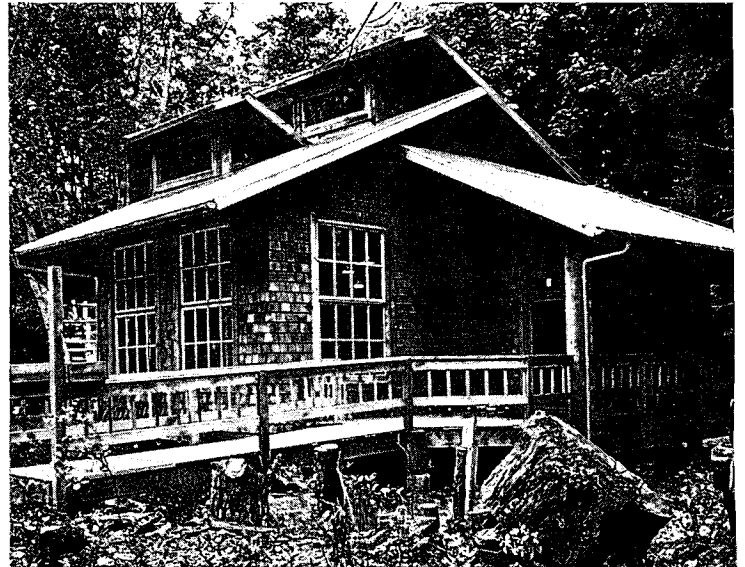

6

©Gary Vannest



7

Robert Lautman



8

5. Immanuel Presbyterian Church, McLean, Virginia; Hartman-Cox, Architects (Honor Award). Connected to an existing farmhouse by a covered arcade, a new church comprising a sanctuary and fellowship hall was called by the jury "an American archetype in its imagery—a clean wood composition that suggests a Shaker quality." The north side of the board-and-batten building faces the farmhouse and exhibits contemporary adaptations of the mullioned windows, fireplace, and dormers of the older structure. The south side, by contrast, is nearly windowless. Inside, a high, pitched ceiling and braced and tied timber framing articulate the formal sanctuary.

6. Stuart Island School, Stuart Island, Washington; Larsen Lagerquist Morris, AIA, Architect (Honor Award). This 1,000-square-foot, one-room schoolhouse on the northernmost island of the American San Juan chain responds to its forest setting with shingled siding, wooden posts, and light timber trusses and roof decking. The architect designed a fan-shaped floor plan that allows the classroom to double as a theater and community hall. Oversized south-facing windows and two clerestory tiers help maximize solar gain. The jury called the schoolhouse "very poetic and enormously evocative. It has a naive plan that is also sophisticated—a paradox appropriate for children."

7. The Hillwood Museum, Washington, D.C.; O'Neil & Manion, Architects (Honor Award). Built to house the collection of Indian artifacts that once belonged to Marjorie Merriweather Post, this small museum was designed to resemble a rustic Adirondack camp. Decorative and structural wood forms contributing to the picturesque theme include roughsawn roof timbers, split hemlock interior walls, bark-edged siding, a balcony rail of entwined branches, and oak tree trunks that appear to grow out of the floor. "Wood infuses the whole space with character," said the jurors, who also liked the architects' "unusual handling of scenographic, sculptural elements."

8. Cedar Hill Activities Building, Maple Valley, Washington; The Miller/Hull Partnership, Architects (Citation). The challenge: to design a 2,000-square-foot alcoholic treatment center on a budget of \$78,000. The architects' solution: exterior walls of 2x6 studs with plywood siding, builder's trusses spaced at two-foot intervals for the length of the building, and V-struts at the endwalls for over-all stability. The jury's conclusion: "a visually interesting, clean and simple building."

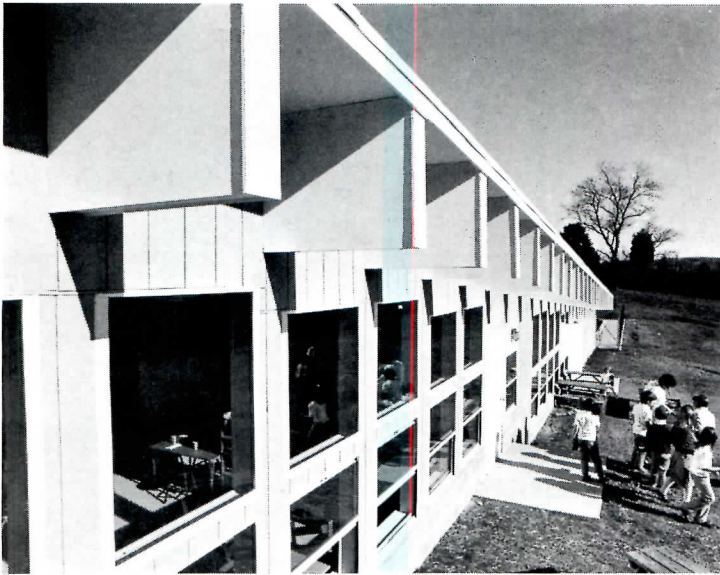

9 Linda Bartlett

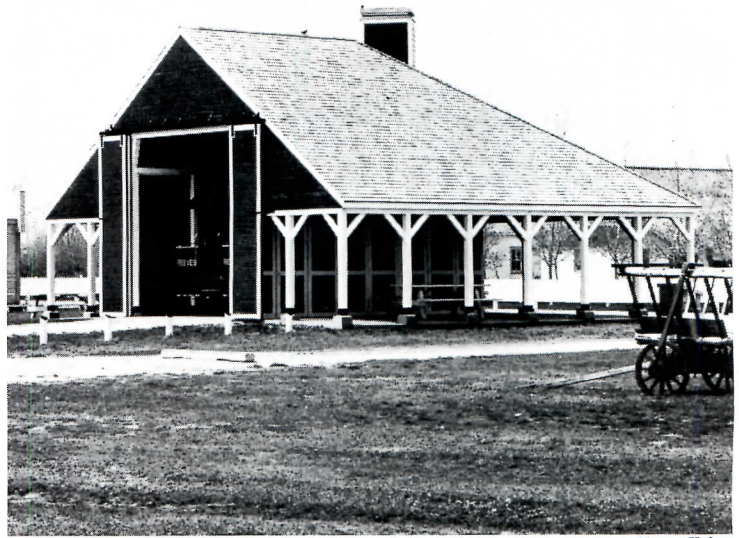

10 ©Henry Kalen



11 ©Robb Miller

9. Montessori County School, Darnestown, Maryland; Kerns Group, Architects (Citation). Nestled into a sloping site and constructed on a modest budget of \$35 a square foot, this rural two-room preschool exhibits a three-foot overhang that shields the classrooms from the summer sun but allows solar gain during the winter. The architects utilized exposed wood roof trusses and plywood sheathing—"a low-key solution that is deceptively simple in its modest scale and appropriateness," commented the jury.

10. Tractor Shelter, Mennonite Village Museum, Steinbach, Manitoba; Rudy P. Friesen & Associates, Architects (Citation). A restored 1904 steam tractor is housed in this wood frame structure, designed to complement existing historic buildings in a museum complex. The shelter exhibits farm-building vernacular in its red drop-board siding, steeply pitched shingle roof, and folding plywood partitions. A roof extension supported by wood posts forms a pavilion on three sides of the shelter to accommodate visitors during special events. The jury concluded that the structure was "full of joy and muscularity, highly evocative of a time when locomotives were in operation."



12

11. Descanso Education and Exhibition Complex, La Canada, California; Berkus Group, Architects (Citation). A 9,400-square-foot complex adjoining Los Angeles County's 158-acre Descanso Gardens is used as a horticulture education center. The series of pavilions has as its focus a large exhibit hall dominated by an exposed wood truss roof. Outside, a 3,200-square-foot covered beam structure extends the space for large events. With its heavy timber trusses, post-and-beam construction, clinker brick, and wood trim, the complex recalls the wood cottages popularized in the Pasadena area by Greene & Greene early in the 20th century. "An excellent example of the strength and intensity of that kind of regional detail," noted the jury.

12. Multipurpose Hall, Boys Town of Missouri, St. James, Missouri; Ittner & Bowersox, Architects (Citation). "An American classic" is how the jurors characterized a traditional frame structure that was conceived as a symbol for the warmth, stability, and openness of this institution's teaching program. Long covered porches trimmed with wood railings and latticework give the building a domestic quality and shield a mullioned window wall from the summer sun. The exposed roof system rests on heavy timber trusses.

13. Thousand Islands Shipyard Museum, Clayton, New York; Darrel Rippeteau, Architect (Citation). Budgetary limitations, a context of older industrial buildings, and harsh climatic conditions at the site of this

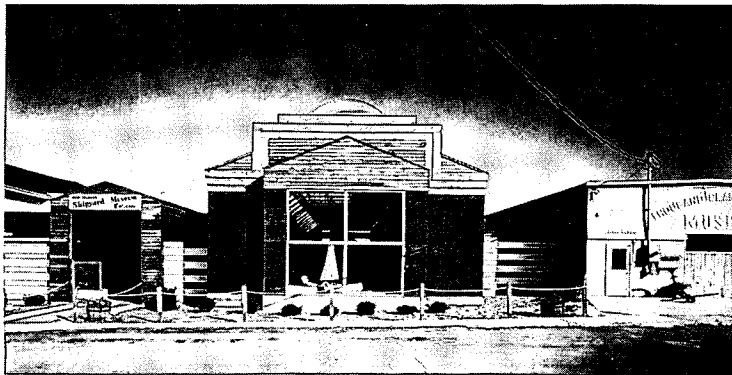

13 ©Harlan Hambricht

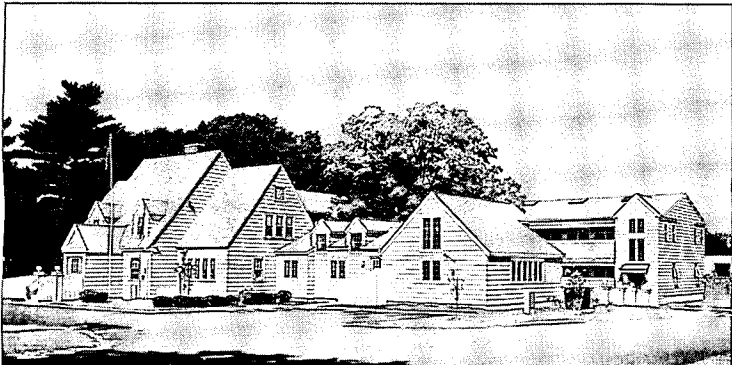

14 Norman McGrath

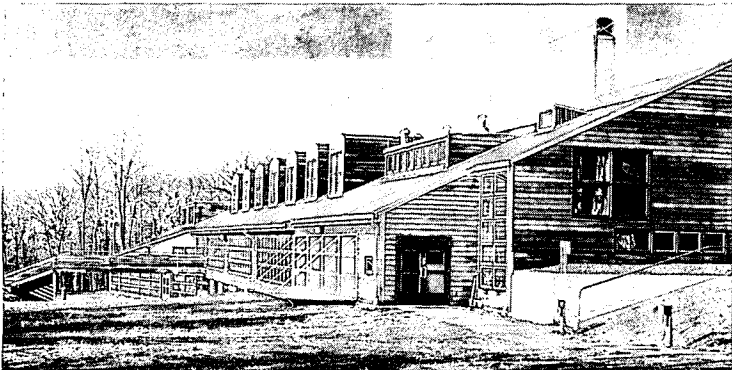

15 ©Robert Perron/Ron Ellis

antique boat museum on the St. Lawrence River helped determine the building's simple configuration and the use of readily available wood materials. Frame walls and plywood siding offer protection against high winds and moisture, and provide ample space for insulation. The modest interior features plywood paneling and exposed gang-nailed roof trusses from which boats are suspended. The jury's verdict: "a comfortable solution, totally appropriate to its function and the modest scale of the street."

14. Connecticut Water Company, Clinton, Connecticut; Moore Grover Harper, Architects (Citation). The architects adopted a traditional courtyard scheme for an 8,000-square-foot addition to a public utility company in a small New England shore town. On the

exterior, painted wood shingles and contrasting trim are purposely modest, while wooden trusses on the interior contribute to a cheerful, open ambience. "A thoughtful expansion of an existing complex that relates in scale and feeling to the original," noted the jurors.

15. Milford Reservation Solar Conservation Center, Milford, Pennsylvania; Kelbaugh & Lee, Architects (Citation). Intended as a model of energy conservation with six passive solar heating and cooling systems, this 16,000-square-foot educational center comprises a dormitory for 110 people, a dining hall, classrooms, a library, and offices. The structure's dormer windows, clapboard siding, and shed roof were designed to evoke images of nearby wood farmhouses. The



16 Norman McGrath



17 ©Gary Vannest

jurors praised the architects for developing "an energy-conscious building that is also rich architecturally—a difficult combination to find."

16. Lenz Winery, Peconic, New York; Mark Simon of Moore Grover Harper, Architect (Citation). The architect used a series of trellises as a unifying visual theme in the conversion of a Long Island potato farm complex into a winery. The trellising extends into a central courtyard to form a summer wine-tasting pavilion and arches in front of an existing barn to announce the public entrance to the winery. Two new cupolas, a bell tower, and wood sliding doors were added to allow more light into the barn. The jury particularly admired "the verve of light shearing through the trellis frames."

17. Tacoma Sports and Convention Center, Tacoma, Washington; McGranahan, Messenger Associates, Architects (Special Structural Citation). "A compelling image that imparts a sense of grace and beauty," proclaimed the jurors regarding a 530-foot diameter wood dome. Rising 152 feet above the stadium floor, the computer-designed, long-span structural system of intermeshing laminated members with tongue-and-groove wood decking encloses a 25,000-seat arena. The volume of lumber used—900,000 board feet of beams and 700,000 board feet of two-inch decking—would frame 160 average-size houses.

Memphis Chapter/AIA Architectural Drawing Competition

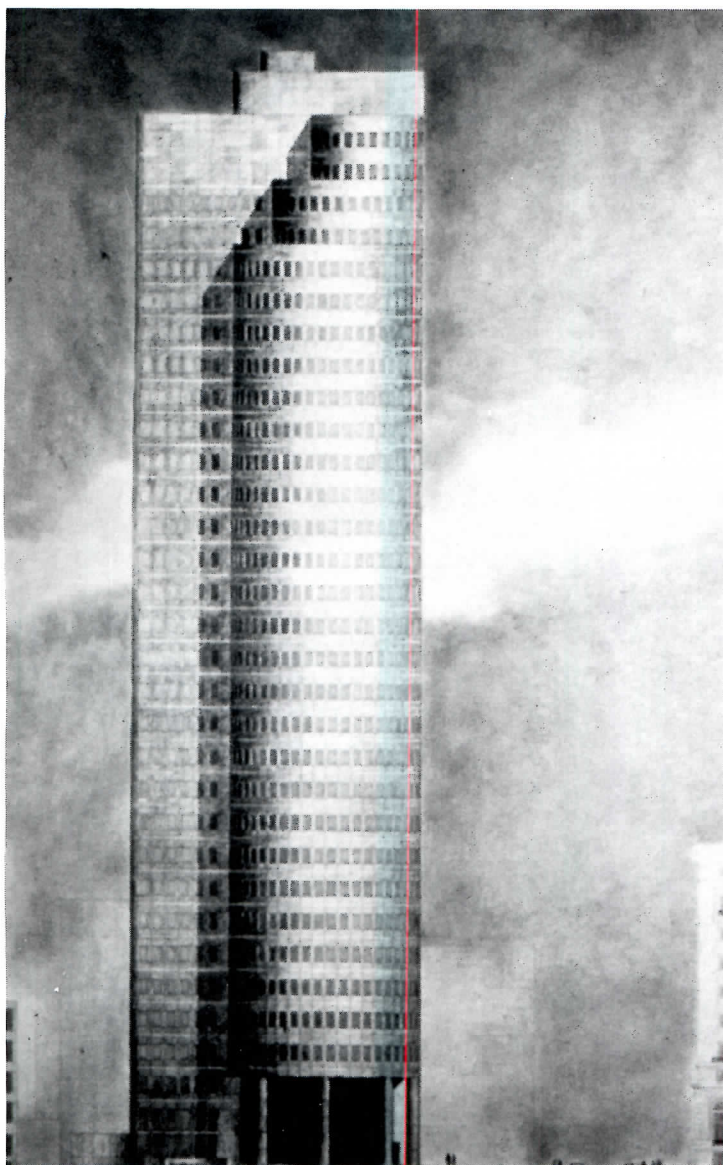

1 Taking its cue from a similar event held by the national American Institute of Architects, the Memphis Chapter/AIA recently sponsored an architectural drawing competition for individual practitioners and firms in Tennessee, Arkansas, and Mississippi. The purpose of the competition and subsequent exhibitions of 36 selected entries held at the Dixon Gallery in Memphis and at Mississippi State University was to underscore the ways that

architects convey their ideas via a variety of graphic media—and, not incidentally, to make the public more aware of the profession as it is practiced in the mid-South. The theme of the program, "Communicating Architecture," seemed especially appropriate in light of the AIA's current attention to the increasing dialogue that is developing between architects and the public—a concern that will be the focus of this year's national convention in Phoenix. Observed the Memphis jury, "We were particularly pleased by the way many of the participants

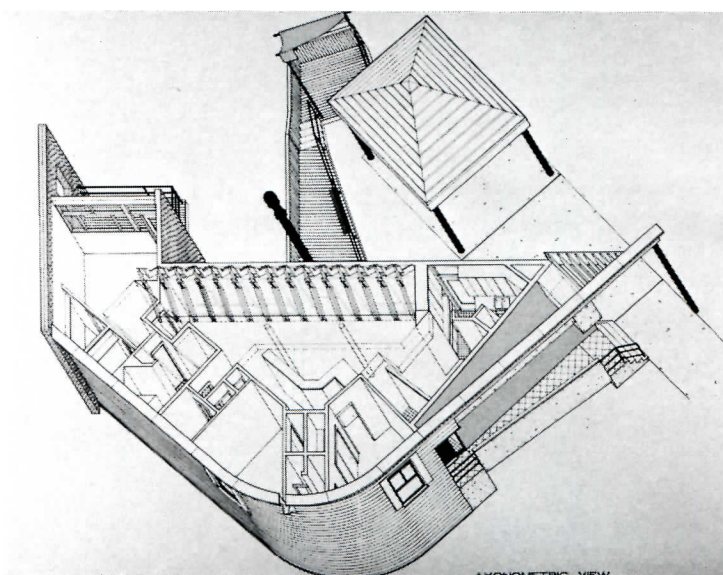

2

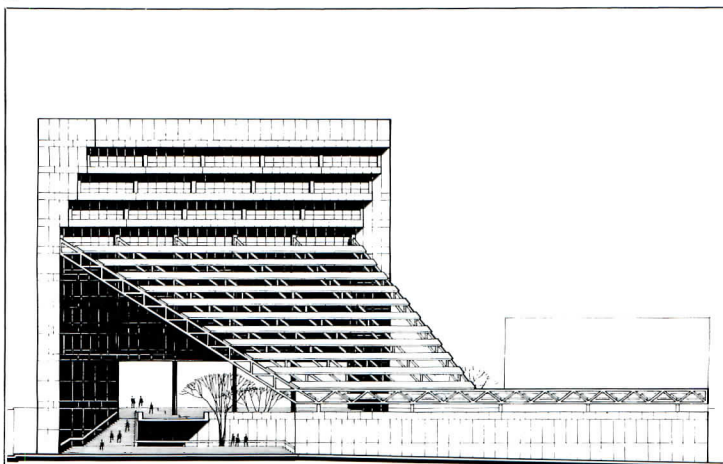

HENLEY STREET ELEVATION

3

exhibited a combination of excellent drafting technique with the power to communicate through their drawings." The eight projects illustrated here were chosen from 149 entries as honor award winners by jurors Alice Bingham, owner of a private art gallery in Memphis; Phillip Morris, dean of the Memphis Academy of Arts; and Herbert L. Smith, Jr., AIA, senior editor of ARCHITECTURAL RECORD.

1. Mike Milo, Jr. and Seab A. Tuck III, Gresham, Smith & Partners; Nashville City Center.
2. Byron B. Carson, Jr., House designed for the artist's brother.
3. James M. Evans and Tom Sutton, Gassner, Nathan & Partners; United States Pavilion, Knoxville World's Fair.
4. Jack R. Tucker, Jr., Lennox School Condominiums.
5. Phil Hamilton, The Brewer Firm; Beale Street Baptist Church.
6. William Henry Asti, Hooks Farm House.
7. Sam Mockbee, Mississippi Pavilion, New Orleans World's Fair.
8. L. Coleman Coker, Corinth Coliseum.

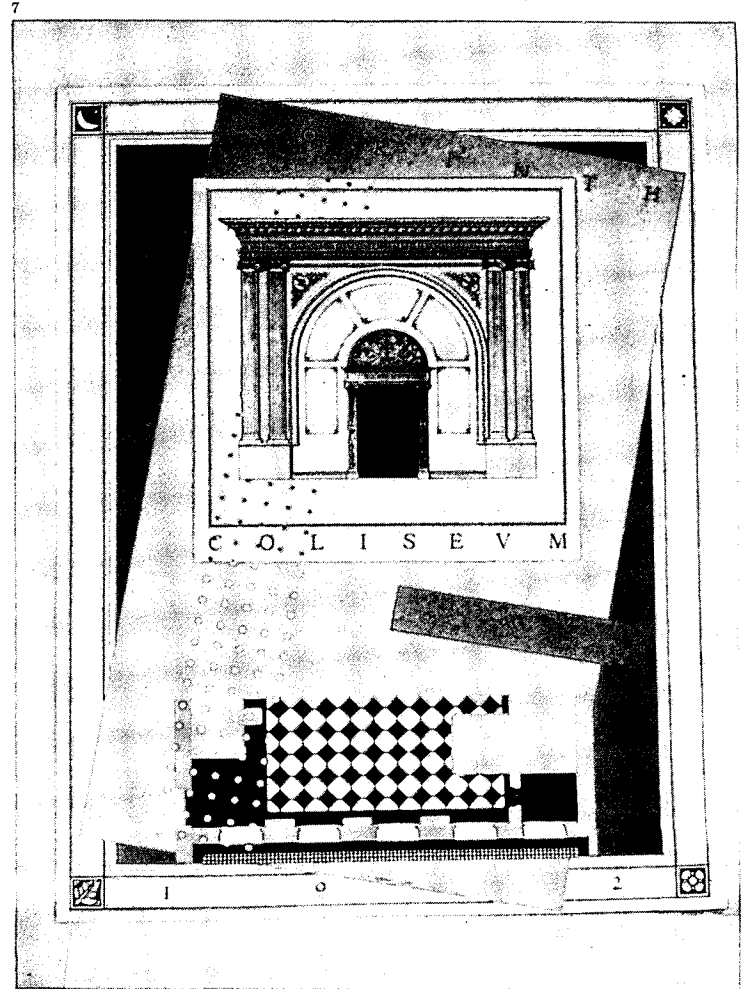
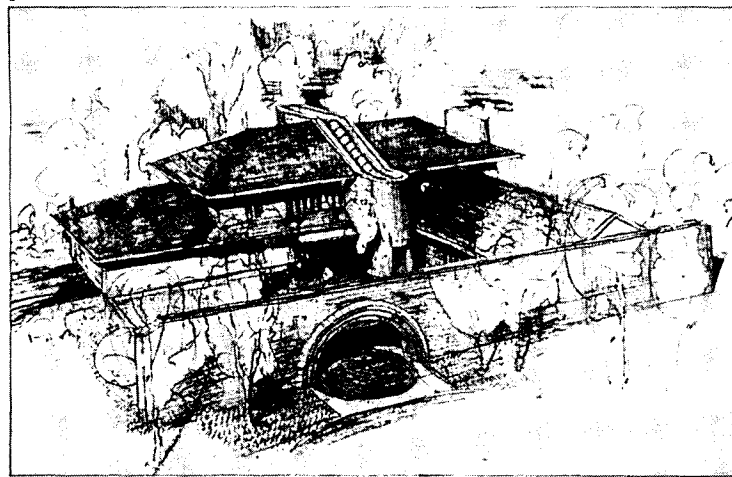
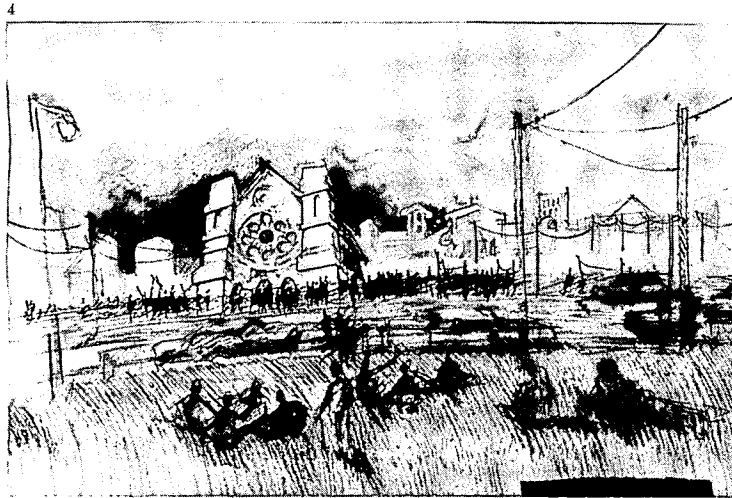

WHY DERBIGUM MAY BE YOUR SINGLE BEST CHOICE IN SINGLE-PLY ROOFS.

Most single-ply roofs have built a reputation on how easily they go down. The Derbigum™ roof system, though, long ago built its reputation on how well it stands up.

THE STRENGTHS OF BUR IN A SINGLE-PLY

Derbigum™ is a unique commercial roofing system that combines the strengths of traditional, asphalt, built-up roofing with the ease and low-cost installation of a single-ply.

This patented system is a bitumen modified with polypropylene, to slow the aging process and increase

roof life. And, like proven, built-up roofs, it's made with reinforcing mats for greater strength. All in a single-ply.

In addition, Derbigum's built-in adhesive layer ensures easy, torch-on application, high-strength bonding and a smooth, finished surface.

Derbigum will excel on virtually any kind of roof—dome, barrel, peaked and flat decks. In new as well as re-roof applications.

16 YEARS PROVEN PERFORMANCE

With all this going for it, it's small wonder that Derbigum is one of the world's best-proven, single-ply roofs. With over 1.6 billion square feet installed since 1967. On roofs all over

the world. In virtually every kind of climate.

Since it was first introduced in the

United States, there have been no known product failures.

40 YEARS OF ROOFING EXPERIENCE

Owens-Corning knows that Derbigum roof systems are called upon to endure torturing extremes. Driving winds, ice, snow and roof temperature variations of over 100 degrees in a single day can be expected on a commercial roof.

That's why we have invested over 40 years and hundreds of millions of dollars in providing the highest quality, state-of-the-art roofing asphalts, membranes and insulations.

So that when you specify Derbigum, you've singled out a single-ply roof you can rely on.

For more information, contact your Owens-Corning sales representative. Or write B.T.A. Meeks, Owens-Corning Fiberglas® Corp., Fiberglas Tower, Toledo, Ohio 43659.

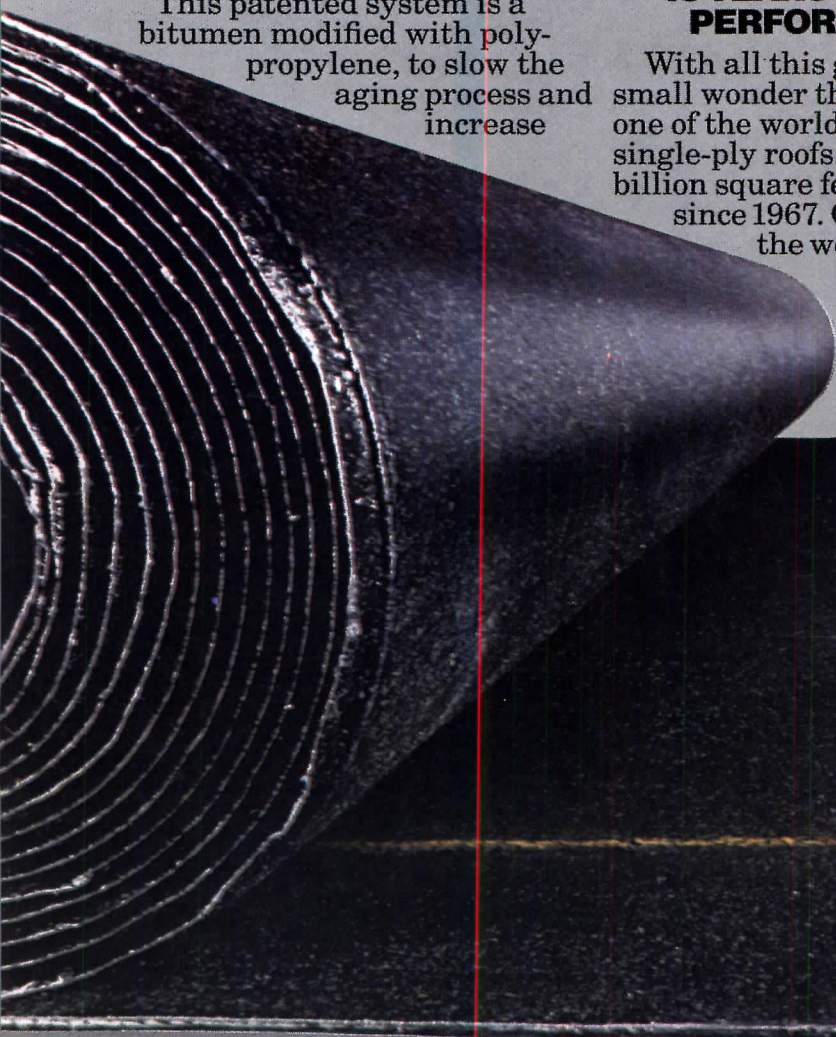

THE TOP ROOF FOR ANY BOTTOM LINE

OWENS/CORNING
FIBERGLAS
TRADEMARK®

© O.-C.F. Corp., 1983

Circle 61 on inquiry card

Ornamentalism: The New Decorativeness in Architecture & Design, by Robert Jensen and Patricia Conway. New York: Clarkson N. Potter, \$40.00.

Reviewed by Helen Searing

"Ornamentalism is characterized by a fascination with the surface of things as opposed to their essence...sensory stimulation as opposed to intellectual discipline." The words chosen by Robert Jensen and Patricia Conway to describe what they identify as a distinct contemporary movement may be applied with equal force to their own treatment of "the new decorativeness in architecture and design." For the authors tend to see architecture in graphic rather than spatial terms, and their extremely sumptuous (some 290 color and 215 black-and-white plates) volume lacks a rigorous intellectual structure.

Nevertheless, the book offers material of interest and value if one approaches it as a compendium of recent works that display patterned and/or polychromatic surfaces, rather than as a sustained investigation of a discernible style with a coherent set of formal and theoretical criteria. There are sections on architecture and interiors, the decorative crafts, furnishings and lighting, and patterning, decoration and usable art. Each section is introduced by an essay with thoughtful, if summary, observations, and the quality of the numerous illustrations is unusually fine. The problem is that the buildings and objects presented as examples of Ornamentalism are so heterogeneous as to vitiate the authors' claim to have isolated a coherent direction in today's art and architecture.

Thus centrally planned neo-Palladian villas (Moore Grover Harper's Country House in Williamstown, Massachusetts) share space with decorated sheds (Venturi, Rauch and Scott Brown's Best Products and I.S.I. buildings), and tasteful, classicizing interiors (Michael Graves's Sunar show rooms) vie for attention with intentionally gaudy ones (Americana Hotel ballroom and restaurant in Fort Worth by Roger C. Ferri & Associates). Elegant furnishings reminiscent of the Empire period (Machado and Silveti) are grouped with antic faunamorphic pieces (Judy Kensely McKie and Tigerdale Studios). In pursuit of Ornamentalism one encounters the picturesque irregularities and

neo-Victorian polychromy of Ralph Erskine's Byker Redevelopment in England as well as the symmetrical layout and applied Doricism of Taller de Arquitectura's Les Arcades du Lac in France, the spare clapboard surfaces of Graham Gund's Shapleigh House on the Massachusetts coast, as well as the eclectic extravagances of Robert A.M. Stern's pool house in Llewellyn Park, New Jersey. Naturalistic and historically referential *trompe l'oeil* frescoes that give the illusion of receding space are considered identical in spirit and meaning to those that are abstract and frankly two-dimensional.

One can sympathize with the authors' desire to discern a unifying thread underlying the bewilderingly pluralistic manifestations of the last two

decades. They acknowledge that they are seeking an alternative concept to that of postmodernism, which they mistakenly assert implies that "the whole of the Modern Movement is now being abandoned." In fact, the term signifies a reaction against only certain aspects of orthodox modernism while other features endemic to 20th-century modes of production and cultural sensibilities are maintained. Jensen and Conway proceed in a manner diametrically opposed to that of Charles Jencks, who insists on such a scrupulous taxonomy that he has been taken to task for mere labeling. In his *Architecture Today* (New York: Charles Abrams, 1982), which is far more comprehensive than *Ornamentalism* while including many of the same buildings,

Jencks makes a necessary distinction between Late and Post Modern, and addresses far more exhaustively the socioeconomic, technological, and philosophical issues necessary to an understanding of the current architectural scene.

Still, in the 20-page general essay that introduces their subject, the authors have provided helpful insights. They have demonstrated the various practical and symbolic functions that decoration can serve, and have given sensible explanations for the ornamental appetite that has inspired so much recent design activity. They point to the role played by the preservation and restoration movement, and explode the erroneous notion that buildings that incorporate decorative details in the 1980s must be poorly executed or



"Come now, Mr. Claypool—surely you're not going to be carried away by first impressions!"

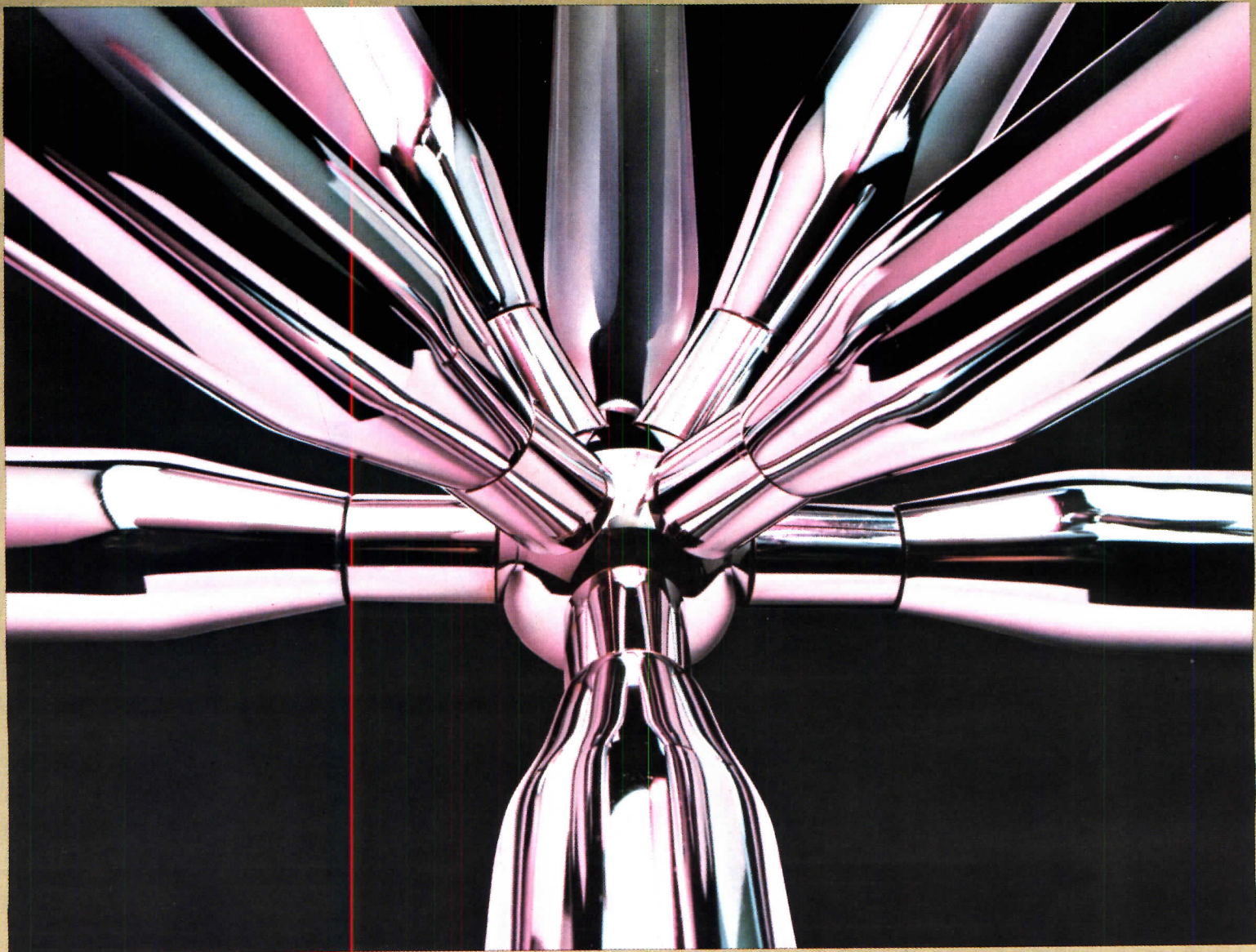

FIRE YOUR IMAGINATION

■ Light, spatial networks spanning an atrium, plaza, or cathedral. Geometric arrays wrapping a building exterior like a taut membrane, providing incredibly strong—yet surprisingly light—support systems for skylights, window lights, deck, sun panels.

■ Inryco Space Frames provide you with an abundant selection of shapes and patterns, colors and forms, to fire your imagination with magnificently intricate design expressions. And our computer design analysis and on-site erection can help make those visions a reality.

■ Send for more information in Catalog 28-2. Write INRYCO, Inc., Suite 4033 P.O. Box 393, Milwaukee, WI 53201. (ITT) 4993931 INRYCO A WMIL.

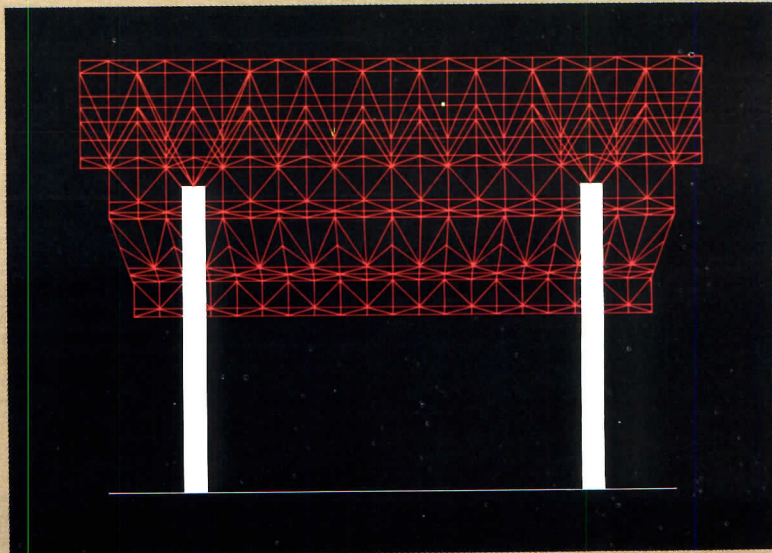

Inryco

an Inland Steel company

INRYCO SPACE FRAMES

Circle 62 on inquiry card

hopelessly uneconomic. On the one hand, there is still available an army of willing and gifted craftsmen (and they append a directory of some of these) who have kept alive traditional skills; on the other, there are ingenious new methods of reproducing what was once laboriously handcrafted. Jensen and Conway also prove that the intrinsic cost of much high-tech construction can exceed that of work that comes under the rubric of Ornamentalism. They are right on target when they observe that the seamless wall, for example, requires such perfection of manufacture that it is either prohibitively expensive or unsatisfactory because of faulty workmanship.

There are unexpected lacunae in the survey of previous attitudes toward decoration. There are no references to the Rococo, nor to A.W.N. Pugin and his influential pronouncement that "all ornament should consist of enrichment of the essential construction of the building" (1841). The Art Nouveau is mentioned only in passing, as a foil to Ornamentalism. This is all the more astonishing because the numerous examples of contemporary ironwork that the authors have reproduced are strikingly similar to metalwork created during the *fin de siècle*. The authors properly note that the goal of the Art Nouveau designer was the integration of ornament, function, and structure, but their insistence that, in contrast, present-day practitioners use ornament exclusively "to contradict and override the forms to which it is applied" seems exaggerated, at least based on the evidence in these very pages. Similarly, although they point to a preference for "borrowing as opposed to originality," they serve up many instances of highly original motifs beside examples of the artful manipulation of conventional ones. Thus confusion once again ensues because of a failure to adhere to a consistent set of attributes.

While there is no pretense that this work is scholarly or definitive, its usefulness would have been enhanced by some recognition of the growing body of literature on the topic. Within the last ten years there has been an expanding preoccupation with the place and nature of ornament in contemporary architecture. Among publications, one thinks of the book by Julian Barnard, *The Decorative Tradition* (London: The Architectural

Press, 1973), and the brilliantly provocative *VIA III: Ornament* (Journal of the Graduate School of Fine Art, University of Pennsylvania, 1977). Among events, one counts the exhibition in 1978 at the Cooper-Hewitt Museum, curated by Richard Oliver, and the symposia organized by the American Institute of Architects and the Architectural Association in London, both held in 1981 and reported in the professional press.

While many of the buildings illustrated will be familiar to devotees of ARCHITECTURAL RECORD, the authors have scouted fresh projects in the San Francisco Bay Area by the firms of Hanns Kainz & Associates, and Richard Fernau + Laura Hartman, and in New York by Peter Wilson Associates. But the selections tend to be restricted geographically. In the architecture and interiors section, there are only seven examples from outside the United States, and these are solely European: three Viennese works by Hans Hollein, a Lanvin boutique in Zurich by R. Haussmann and Trix Haussmann-Hogt, the redecoration of the United States ambassador's residence in Paris by Poetic License, plus the two housing complexes already cited.

Undeniably, the unique contribution made by *Ornamentalism* is the presentation of work in media that architectural critics commonly neglect. However, for many readers such inclusiveness will obscure as much as illuminate the lively and controversial topic of the new decorativeness in architecture and design.

Helen Searing is Alice Pratt Brown Professor of Art at Smith College.



Architectural trompe l'oeil by Richard Haas in the foyer of a Manhattan loft. From *Ornamentalism: The New Decorativeness in Architecture & Design*.

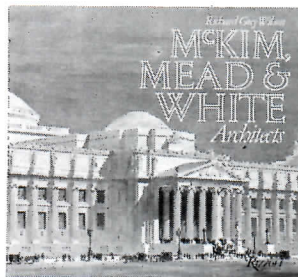
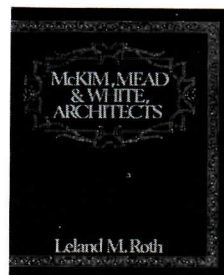

McKim, Mead & White, Architects, by Leland Roth. New York: Harper & Row, \$40.00.

McKim, Mead & White, Architects, by Richard Guy Wilson. New York: Rizzoli, \$35.00.

Reviewed by Robin Lynn

Between 1870 and 1920 the firm of McKim, Mead & White received nearly one thousand commissions and became the largest architectural practice in the world. The firm designed clubhouses, town houses, summer cottages, museums, hotels, universities, gates, pedestals, and even a powerhouse and transmission tower. Much of their work was in the Northeast and, in particular, New York City, where they left a legacy of well-crafted buildings whose form, detail, and ornamentation reveal the architects' reverence for classical sources.

Yet by the end of Charles McKim's life in 1909, the firm's work was literally overshadowed by the new tall buildings that McKim considered anti-urban. The firm's work later fell into further disfavor with the ascendancy of the International-style skyscraper. Now, not surprisingly in the postmodernist era, the pendulum of opinion has shifted. The recent wave of architectural historicism has heralded a revived interest in classical forms, and two new books by Leland Roth and Richard Guy Wilson document the enduring qualities of the former New York firm.

The books have identical titles, but they serve different audiences. Roth, a professor of architecture at the University of

Oregon, used his dissertation as the foundation for a monograph, and he has written a scholarly, readable history of the firm. His lengthy book is a chronological description of McKim, Mead & White's accomplishments, from individual contributions of the 1870s until Mead's retirement in 1919. Wilson, a professor of architecture at the University of Virginia, has composed a large-scale pictorial record of 31 McKim, Mead & White buildings, some well-known like the Pierpont Morgan Library, others comparative strangers. His informative introductory essay and short commentary on each building provide a capsule summary of the firm's work.

Roth obviously knows his subject well. He describes the principals' backgrounds—McKim, the child of an abolitionist father and Quaker mother; Mead, the son of New England parents; and White, the talented offspring of an Anglophile critic—and he chronicles their studies, travel, and work in such fine detail that (and this is one of the strengths of the book) one looks out on the American 19th-century landscape through their eyes. To read Roth's book is to live in a pre-income-tax era when wealthy individuals commissioned the firm to build such summer cottages as "Rosecliff," a turn-of-the-century, French-inspired glazed terra-cotta home in Newport, or to redefine entire town centers as in Naugatuck, Connecticut, where the firm built a collection of public buildings between 1891 and 1905. Reading Roth is to live in the confident, early 20th-century time when the firm created new college campuses for Columbia and New York University and redesigned the Mall in Washington, D.C. as part of the McMillan plan.

Roth is best when he describes the background of each commission. He explains how the firm was selected and the roles of the partners and assistants. White, the ultimate club member, obtained the majority of the firm's commissions during its later years. Mead's office nickname was "Dummy." McKim instructed President Theodore Roosevelt not to refer to the firm's work on the White House solely as "McKim's restoration." One consults Roth's numerous footnotes to discover the sources of his knowledge.

Furthermore, Roth teaches us the design precedent for each project. The Baths of Caracalla, for instance, served as the prototype for the general waiting



IF YOU DON'T HAVE ROOM FOR A GARDEN IN YOUR YARD, PLANT ONE IN YOUR HOME.

The new Marvin Sun Bay Window lets you add a greenhouse almost anywhere. Above the kitchen sink. In the den. Even above the tub in your bathroom.

The glass top and sides capture sunlight year 'round. So your houseplants will flourish.

**THIS WINDOW CAN EVEN
MAKE A ROOM GROW.**

The Sun Bay can make a small room seem brighter and more airy. Or make a large room seem even larger.

The sloping glass top really collects sunlight. And the trapezoid-shaped sides open for ventilation.

A SHINING EXAMPLE OF
MARVIN CRAFTSMANSHIP.

The sash, frame and seat board are carefully constructed



of fine-grained Ponderosa pine. This wood was chosen for its excellent insulating properties and the way it accepts a stain-and-varnish, or paint, finish.

All exterior wood is deep-treated to permanently protect against rot and decay. And a polycron exterior finish is available. (This finish has been proven to last at least as long as aluminum or vinyl cladding.)

For energy efficiency, the Sun Bay is carefully weather-stripped. You can also choose from insulating glass, removable double glazing, or tripane insulating glass.

And we can deliver your Sun Bay fast, usually within two weeks of the time we receive your order.

For more information and a free booklet of bay and bow ideas, write Marvin Windows, Warroad, MN 56763. Or call 1-800-346-5128 toll-free. In Minnesota, call 1-800-552-1167.

**MARVIN
WINDOWS** 
**ARE MADE
TO ORDER.**

room of Pennsylvania Station. We rarely learn, however, whether he considers the finished building to be a success. His descriptions are impartial, but when we do find criticism, such as his assessment of Naugatuck, it is tempered and balanced: "While the individual buildings are not of the caliber of the firm's most notable buildings, their ensemble merits special attention. . . ." We long to hear more of Roth's voice. He knows McKim, Mead & White's work so well that we are eager for his comments.

Roth, moreover, spends comparatively little time exploring interiors. Too often he takes us to the door of the building, but leaves us outside while he discusses the building's style, relation to the street, or historic precedent. A few more plans or interior photographs might have remedied this situation.

Richard Guy Wilson's book is an abbreviated study of the firm's work. The 31 projects represent what Wilson defines as buildings of the early, consolidation, and high-classical periods. The Isaac Bell House in Newport, for example, reveals the firm's early concern with designing summer cottages in a modernized colonial style. The now-demolished Rowland Gibson Hazard House in Peacedale, Rhode Island, an American adaptation of an English country house that represents the consolidation period, shows how far the firm had come from the rambling wooden dwellings of the early 1880s. The Boston Public Library and University Club in New York of the high classical period show McKim, Mead & White's dominant interest in urban architecture, with forms and features that are increasingly derived from Italian Renaissance sources.

Wilson's essays are eminently readable, and he often throws in gossipy detail to personalize the structures. Mary Sherwood Hopkins, whose palatial house Stanford White designed in Great Barrington, Massachusetts, married Edward Searles, the designer who replaced White. He was 21 years her junior, and when she died four years after their marriage, he inherited most of her fortune. Wilson also walks us through the spaces until we feel we are inside them.

Visually, the book is often at its best when Wilson incorporates plans and drawings. The sumptuous proportions of McKim, Mead & White's 1,560-square-foot music room in the Breese House in Southampton, Long Island is apparent from its plan. The preliminary design and accepted design drawing of the Morgan Library reveal McKim's mind at work in modeling the facade.

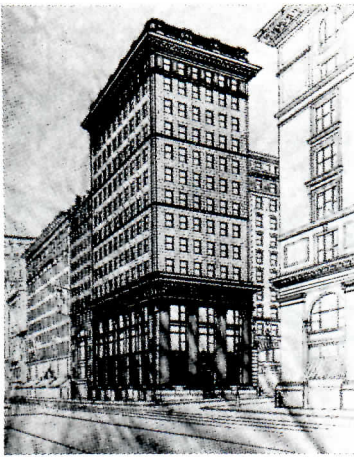

McKim, Mead & White, Knickerbocker Trust, New York City. Perspective of initial scheme, 1901.

Although Wilson has carefully selected buildings that illustrate the range and development of the firm's work, there are not enough of them. Considering McKim, Mead & White's prodigious output, we need to see more commissions to understand better his divisions. If Wilson had more judiciously selected the photographs (and if the book's designers had been less enamored of the white space that dominates many pages), he could have given us more.

Admittedly, much of the photography is superb: the view of the Low Library rotunda at Columbia set up as a reading room with circular wooden benches reveals how ill-suited it was for use as a library. The exterior view of the Brooklyn

Museum before its monumental stairway was rudely torn from it during the 1930s shows the heroic proportions of the steps and facade. But too often Wilson, a poor photographer, substitutes his own pictures. Many of his details are in shadow, and frontal views of some buildings occasionally appear tilted.

No matter. Both books constitute a new appreciation of McKim, Mead & White. They focus attention on a venerable firm whose work, long out of fashion, has been waiting to be rediscovered.

Robin Lynn is an architectural historian and free-lance writer from New York City.

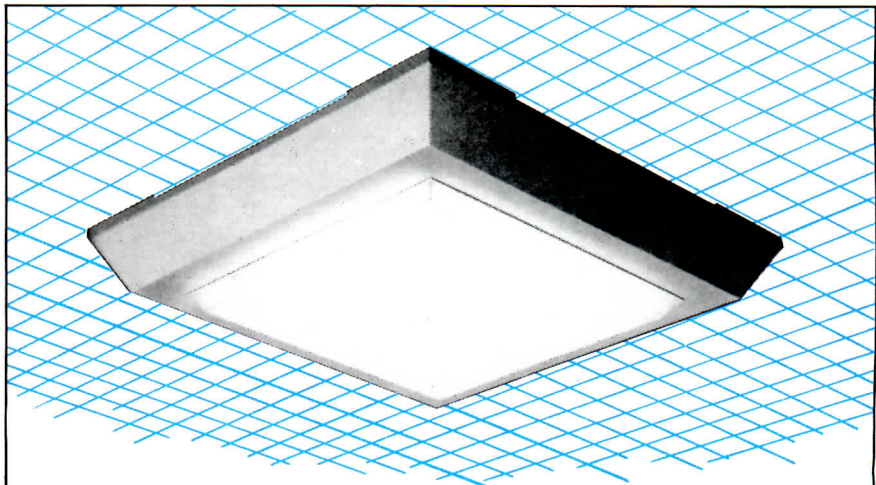

Thomas' new Low Profile Fluorescent.

The most affordable and efficient fixture ever!

This fixture's two-lamp version produces light equivalent to most 100W recessed fixtures; it's almost maintenance-free because the lamps have a 10,000 hour life up to 14 times greater than incandescents; and its housing is made of virtually indestructible Noryl™.

Tamper-proof versions are available with Lexan® lens. Retrofit kits are available for mounting over existing recessed fixtures.

Write now and discover the many styles available in this ultra-durable Low Profile Fluorescent with the highest efficiency of its kind. (Size: 9 5/8" square, 1 1/8" deep)



THOMAS
INDUSTRIES INC.

Mail to: Thomas Industries, Dept. TM
207 E. Broadway, P.O. Box 35120
Louisville, Kentucky 40232

- Please send me literature on the new Low Profile Fluorescent.
 I am enclosing \$20 for a sample two-lamp fixture.

Name _____

Address _____

City _____

State _____

Zip _____

AREC

What new directions in color will interiors be following? Karastan offers 50 subtle hints.

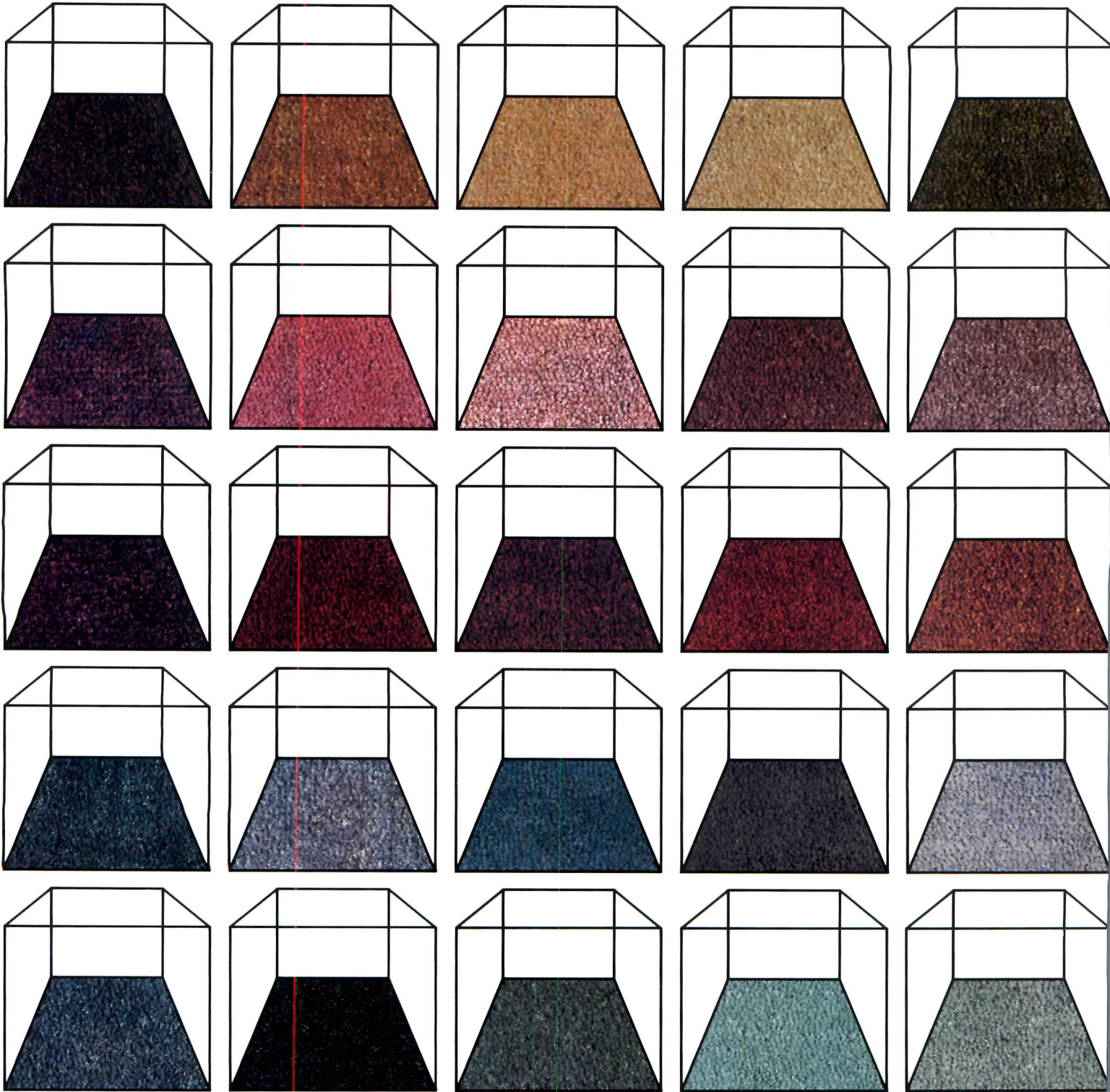

Post-smokestack industry

Even as we talk about obsolete steel mills and the emergence of the service economy, a new kind of industry has arisen—clean, well lit, usually small-scale (at least initially) and, most important, meant for humans. The sort of physical and spiritual degradation in factories so vividly described by Dickens and the muckrakers is, if not entirely gone, much harder to find than it was in the 19th century. Without patting our century on the back more than it merits and without forgetting 150 years of effort by social reformers and labor organizers, the disappearance of the gloom and grime that accompanied the Industrial Revolution's heyday has much to do with the nature of new products and the new nature of workers.

The first of the four buildings discussed in this study is a familiar type—the industrial lab. But where the traditional industrial lab concerned itself with measuring product quality, Westvaco Corporation, its eye still strictly on business, has undertaken a program of genetic research to improve the quality of trees for pulp and paper, its basic product. New England Biolabs, notwithstanding their name and appearance, are a production facility, the product being enzymes and other arcana devised for sale to DNA researchers. In both cases, the work force consists largely of scientists with Ph.D.s, self-confident self-starters who deserve, and get, the kind of surroundings in which they can work best.

Even in more conventional industrial plants, however, brain replaces brawn in the labor force. This is perhaps most observable in the multiform computer industry, which both evokes and requires an orderly, bright environment. (In fairness, it should probably be pointed out that the louder and smellier aspects of production, such as forming metal and plastic housing for machines, takes place off the premises.) Data I/O, for instance, acquires microchips elsewhere, then assembles boards for inclusion in still other manufacturers' machines. The assembly process is demanding and needs dust-free space, but the work does not call for brute strength. IBM, whose very initials symbolize for many the notion of high tech, has long favored good design out of both corporate self-respect and respect for its employees. In its new North Carolina plant, it repeats the courtesy.

But then, respect for work and workers characterizes each of these post-smokestack factories. *Grace Anderson*



Westvaco Forest Science Laboratory
Summerville, South Carolina
Lucas Stubbs Pascullis Powell & Penney Ltd., Architects



Research to improve the breed

Gordon H. Schenck, Jr., photos except as noted



Westvaco's forest research laboratory has a residential bearing, both in scale and materials, for the scientists, technicians and clerks who work inside the rural facility. The weathered lapped cedar siding, a familiar building material in the region, changes to redwood inside the attached greenhouses in favor of the material's resistance to humidity. An entrance ramp for

the handicapped (above top) runs alongside a stepped entry, while the back doors (above bottom) give pedestrian access through the trees to detached greenhouses, garage and chemical storage. The south-facing roof over the central "headhouse" (preceding pages), which now carries a small solar collector for domestic hot water, was designed to accept a larger collector in future.

As a producer of pulp and paper and other wood products, Westvaco Corporation decided in the late '70s to pursue with determination a Green Revolution for trees of the kind that has so changed agriculture. To that end, they expanded their research program with a new laboratory in South Carolina. Here the aim is not simply to improve forest management and timber production but actually to alter the breed so as to grow better trees faster. The genetic research calls not only for raw materials—soil and chemicals as well as plants—but for computers and other highly sophisticated scientific equipment.

The greenhouses that form such strong compositional elements on the front facade (see preceding pages) fill an assortment of functional and symbolic roles. They are, first of all, working greenhouses, even though larger plants need plantations and a far larger greenhouse on fields nearby. But architect Thompson Penney, resenting somewhat the banishment of these basic facilities to an inferior position "out back," saw them as powerful integrative elements, both inside and out, where their presence could remind occupants, visitors and passers-by of the building's essential purpose.

From one of the two circulation spines that connect the ends of the building, the greenhouses also provide views both of themselves and of the outdoors. Equally important for the refreshment of users moving about, a series of glazed exterior courtyards offers the same courtesy along both spines.

The architect, energy-conscious as most people are these days, made considerable use of passive solar energy, using the south-facing greenhouses as sources of warmth in winter and, with their evaporative cooling systems, as sources of coolness in summer. Moreover, he devised three sets of monitors and light scoops to make the most of daylight. The majority of the building's scientist occupants have their own offices on the north side, where their windows admit diffuse light for evenly lit work surfaces. Long monitors on the two wings illuminate the north corridor and the spaces adjoining it. Additionally, tall light scoops along the ridge of the "headhouse" illuminate core laboratories, while others serve the library. The hvac system, in addition to other conservative measures, uses heat exchangers to recycle heat from the greenhouses and from autoclaves on the south side of the building.

The 27,700-square-foot building cost an estimated \$81 per square foot.

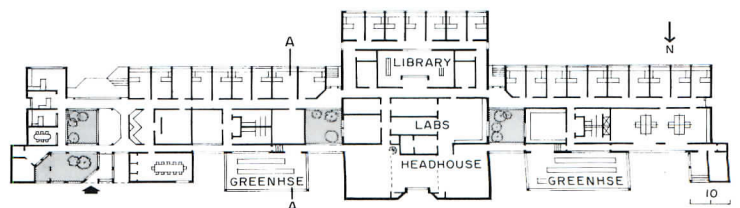

Varied sunscoops bounce light taken in through invisible north-facing clerestories from white canted walls into work space behind the headhouse (directly below) and into the library (below right). In the library, gypsum board jackets the timber trusses. Though structure is chiefly timber, the headhouse, which must receive trucks, is concrete and steel.

Westvaco Forest Science Laboratory
 Summerville, South Carolina
Owner:
 Westvaco Corporation
Architects:
 Lucas Stubbs Pascullis Powell & Penney Ltd.—Thompson E.
 Penney, AIA, principal-in-charge and designer

Engineers:
 Johnson & King (structural); Rosser White Hobbs Davidson McClellan & Kelley (mechanical/electrical); G. Robert George (civil)
Consultant:
 Frank Torrey (laboratory)
Construction manager:
 SCM

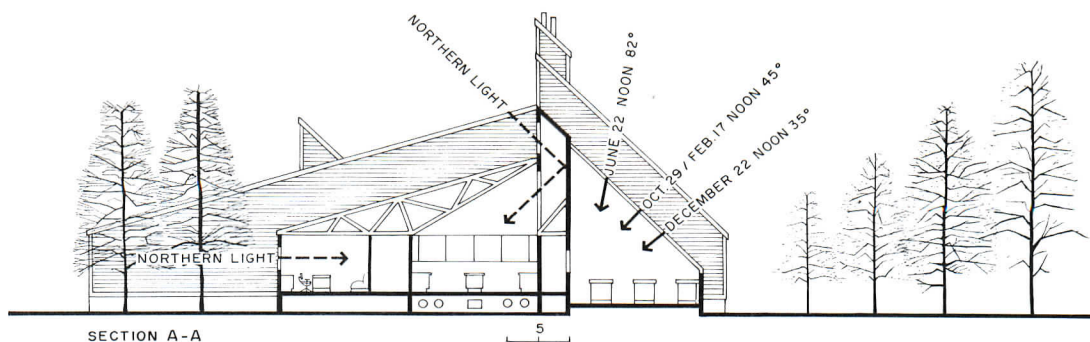



Interfacing hardware and software

Data I/O Headquarters Facility
Redmond, Washington
The NBBJ Group, Architects

Dick Busher photos

As all of us have noticed or been forced to concede, the computer explosion keeps on exploding. The need for buildings to facilitate the computer industry's activities—engineering, production of both hardware and software, distribution—has had considerable architectural impact, not uniformly impressive, around Boston's Route 128, in California's Silicon Valley and, lately and increasingly, around Seattle. Moreover, changes and improvements in both product and production techniques occur with such rapidity that buildings virtually obsolesce even before they have been occupied.

Data I/O, a company whose products have been described as "interfacing hard and soft ware," needed space not only for assembling and shipping microchip boards to other manufacturers; they also needed quieter space for programming, engineering and design as well as conventional offices for administration. Their architects, the NBBJ Group, also recognized that the company needed flexibility even beyond the usual sought by growing companies. On the topmost of the three floors, which contains a large area obstructed only by steel columns, production machinery has already been moved around and added to. The middle floor, similarly open, now accommodates engineering offices and production management (see section overleaf), but it is potentially sacrificial space, ready for conversion to manufacturing as need be. The lowest floor houses executive and marketing quarters in addition to providing general reception space.

The architects, taking expansion for granted, designed a second manufacturing building for the 17.5-acre site (see site plan below). A detached cedar screen with steel beams on the north side of the building was intended to carry bridges from existing spaces to the new facilities. When that happens, this space will become a connecting atrium. In the meantime, the screen and tiered planting along the stairway compose an entrance at once luxurious and cordial for visitors and workers alike.

Because all floors have egress at grade, construction could be, and is, nonrated, allowing the exposure of structural-steel columns. Nonetheless, the building is fully sprinklered in addition to other fire-safety measures. In modestly decorative fashion, fire extinguishers and other equipment nestle ready to hand between black-painted flanges.

Plans for future expansion also include a third building for conferences and employee recreation.

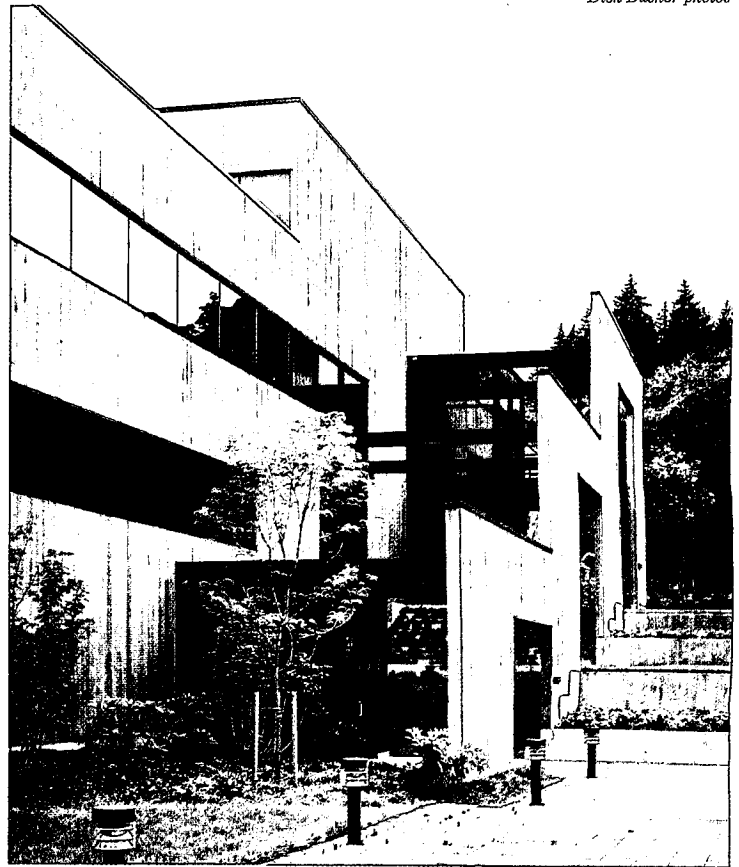

The three stories of Data I/O's manufacturing and office building step back in deference to the sloping site. On the side of the building, the main entry is at the lowest level (opposite and at top), from which stairs and planting rise to another entry at the middle floor. The 97,500-square-foot building cost \$44 per square foot.

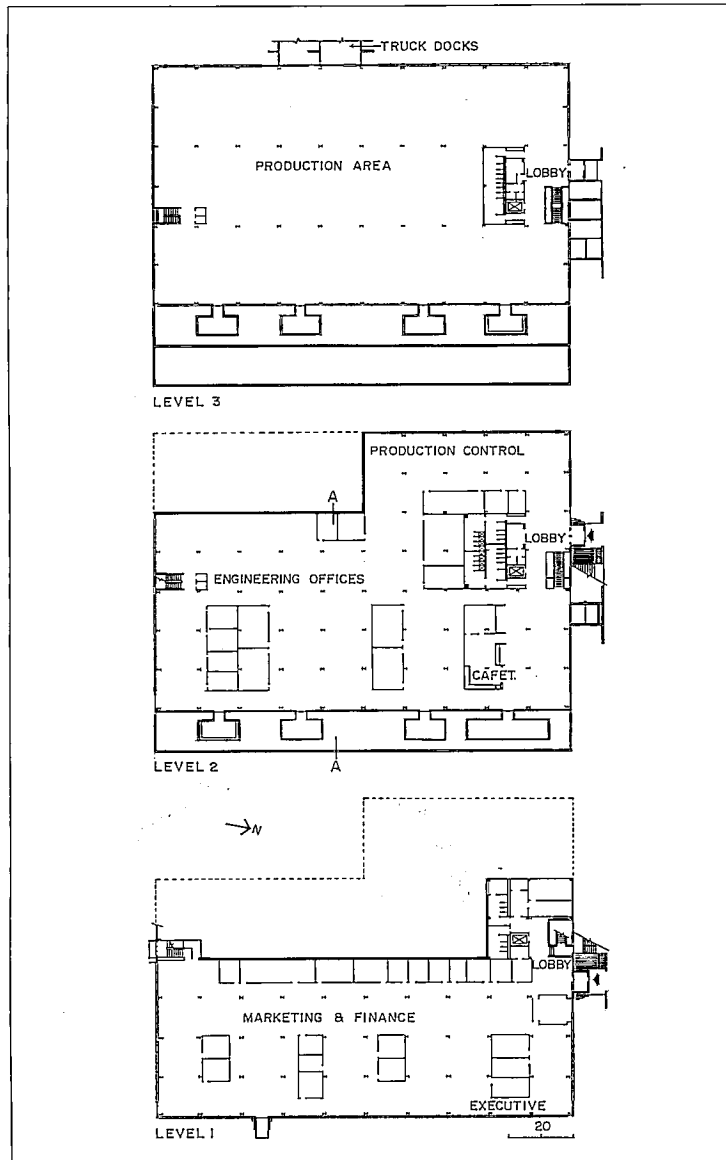

By placing the manufacturing space on the top of Data I/O's headquarters facility, the architects could include shipping docks at grade and out of sight at the back of the building, and could also raise a clerestoried penthouse above production space. Executive quarters and other conventional administrative offices are located on the ground floor. The middle floor provides a quiet precinct for

engineers at one end, a cafeteria at one corner, and offices for manufacturing control in another corner easily reached from the working space upstairs. Since the building was designed for a great degree of flexibility, this floor could be adapted for production. Planted terraces at the front of the building are accessible from the top floors.

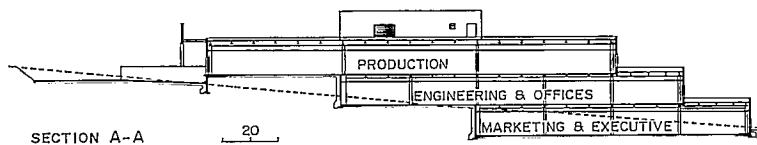

Manufacturing space (below at top) is quite as clean and nearly as tidy as the photograph indicates. An open stairway connecting all three levels (bottom left) has railings of black-painted structural steel, a clear reference to the exposed columns as well as a reminder that, for all its neatness, this is a working industrial building. Offices (bottom right) were designed by NBBJ's interiors department.

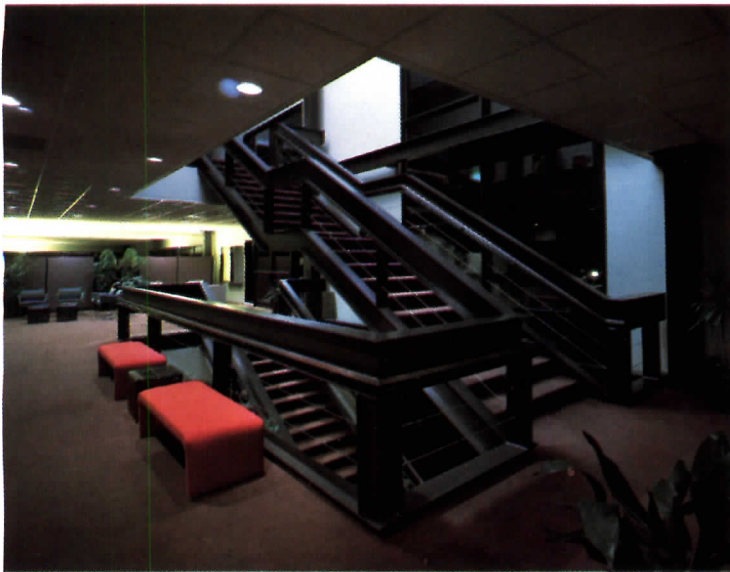

*Data I/O Headquarters Facility
Redmond, Washington*

Owner:
Data I/O Corporation

Architects:
The NBBJ Group—William Bain, Jr., FAIA, partner-in-charge; Donald Breiner, AIA, project architect; Peter Damento, design assistant; Ross Pouley, technical assistant

Engineers:
Andersen Bjornstad Kane Jacobs (structural); Benjamin S. Notkin Associates (mechanical); Alexander H. Hargis (electrical); Bush Roed & Hitchings (civil)

Consultants:
Jongejan/Gerrard/McNeal (landscape); Rittenhouse Zeman & Associates (geotechnical); Michael R. Yantis (acoustical)

General contractor:
Morrison-Knudsen Company, Inc.

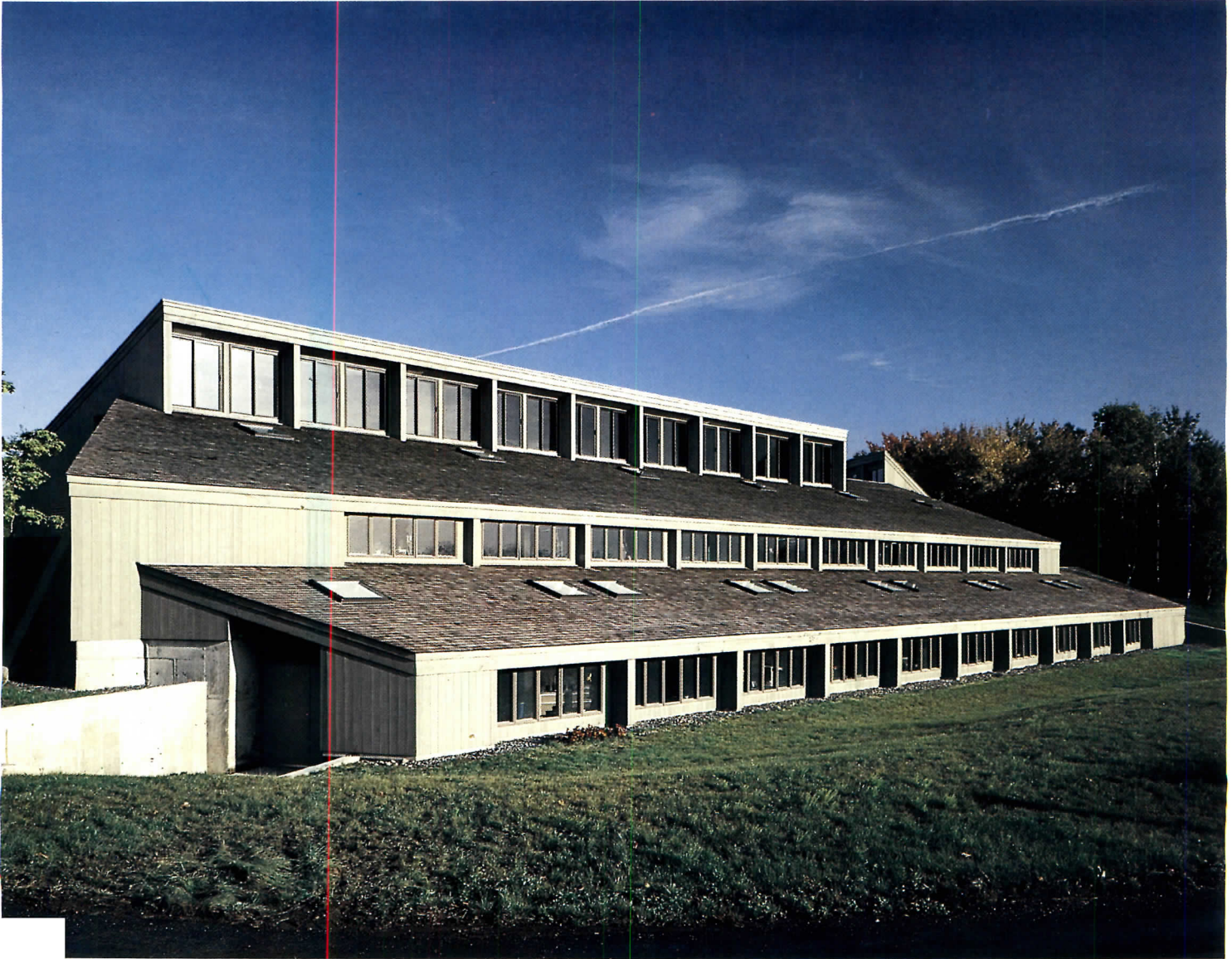

The tiered roofs of this DNA factory in Massachusetts attest the company's rapid growth. Phase I, 10,600 square feet completed in September 1979, included the clerestory and the middle floor shown above, and Phase II, 12,510 square feet completed in November 1982, included the lower extension and an angled wing at the southeast. A lounge at the end of the wing (opposite at top)

Accommodates a variety of activities: lunch, Ping-Pong, weekly lectures by visiting scientists. Four-person labs at grade on the lower floor (opposite center) are separated from the corridor by doors for projects that might require security. The only function of the greenhouse (opposite) is to give pleasure in a notably no-nonsense environment.

A factory for the double helix

Despite its casual, almost domestic, character, the wood building across page is a factory. It isolates and produces for sale restriction enzymes, cloning vehicles and the like for use in recombinant DNA research. (The fascinating if recondite company catalog offers, among other things, a DNA Synthesis Kit, which "provides you with a simple, inexpensive way to prepare oligodeoxyribonucleotides of determined sequence without previous experience in DNA synthesis." Price: \$700, but you'll have to supply your own spectrophotometer.)

The building's relaxed air reflects not only the owner's own attitudes but also the lifestyle of the work force—young men and women, most with advanced degrees in biology or chemistry, who combine an unaffected democracy with industriousness.

The organization of work affected quite basically the form of the building. Four-person research teams share diagonal pods on the first and second floors, each of the pods provided with lab counters, storage, refrigerators and running water and supplemented with fixed equipment in rooms along the back wall. Low partitions separate each pod from the next. Such openness encourages easy exchange of information. By stringing the pods one by one in a long line, architect Douglas Trees could provide the end of each with a window to the outdoors, welcome relief to scientists engaged in unremittingly minute tasks.

Even though research and production functions in the factory are small-scale and almost entirely nontoxic, they do require extraordinary amounts of air, water and power for both the standard laboratories and special equipment rooms. A deep chase enclosing ducts and pipes for steam, acid waste, gas, distilled water and special exhausts snakes both vertically and horizontally to service both lab floors (see toned area in section on page 109). Though Trees confesses that he has no great faith in the payback value of solar collectors, in this case he deemed them more than worthwhile for domestic hot water: the processes carried out here require great numbers of flasks, test tubes and other glassware, which in turn require a vast amount of washing and sterilizing.

Shipping raised an unexpected architectural problem. Though the products are typically shipped in small thin silica gels in little plastic envelopes, they must be sent in wet ice contained in large foamed plastic boxes. To store the boxes, which are light but irksomely bulky, a new room was added at grade behind the third-floor packing room.





New England Biolabs, Inc.
Beverly, Massachusetts

Owner:
Dr. Donald Comb

Architects:
Douglas F. Trees Associates—
Douglas F. Trees, principal-in-
charge; Benjamin C. Nutter, project
architect

Engineers:
Souza & True (structural)

General contractor:
Lindentree Corporation—Douglas
F. Trees, president

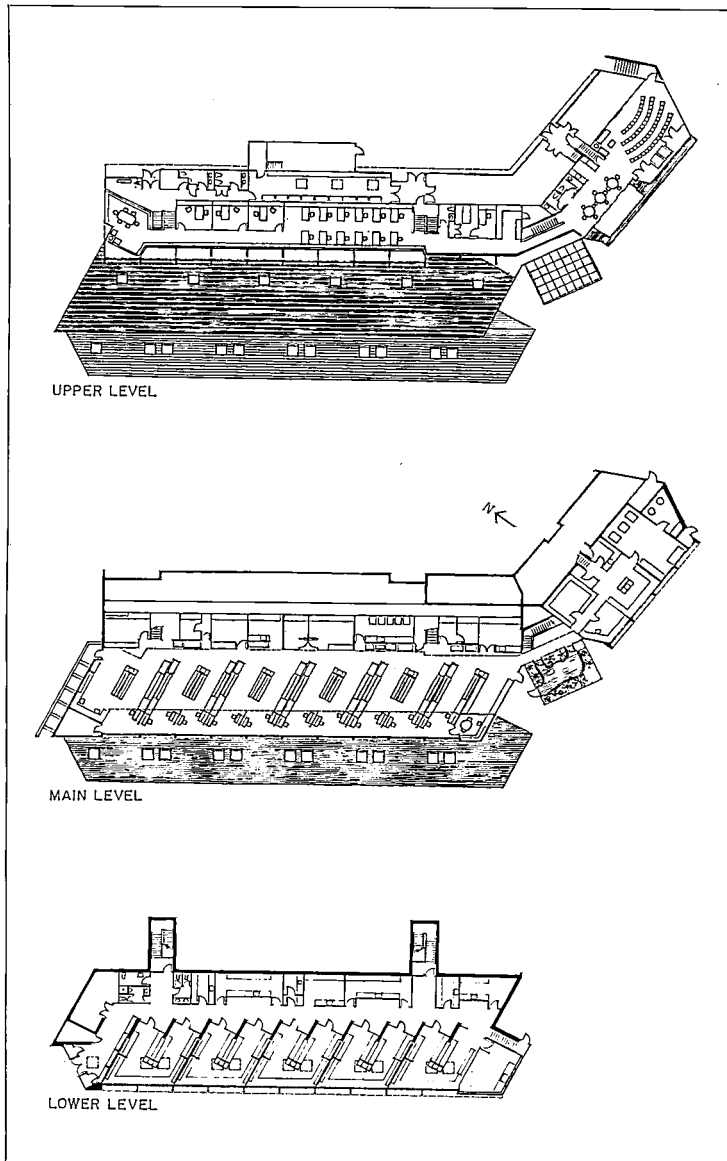

The long balcony on the office floor (opposite), lit by the high clerestory at the top of the building, typifies the company's open informality, in which people upstairs can easily communicate viva voce with those in the labs below—although in fact the youthful work force, while friendly, tends to stick quietly to its knitting. A large chase for mechanical and electrical conduits

(toned area on section below) verges on interstitial space, permitting physical access to the complex of ducts and pipes. This work was engineered and constructed by the design-build firm Lindentree Corporation, of which architect Trees is president (see also RECORD, July 1982, page 19 et seq.). Costs were \$37.30 a square foot for Phase I, \$98.50 for Phase II.

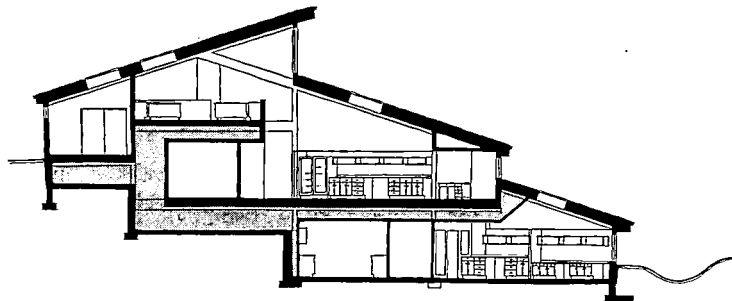

CRTs and other business machines

Rick Alexander

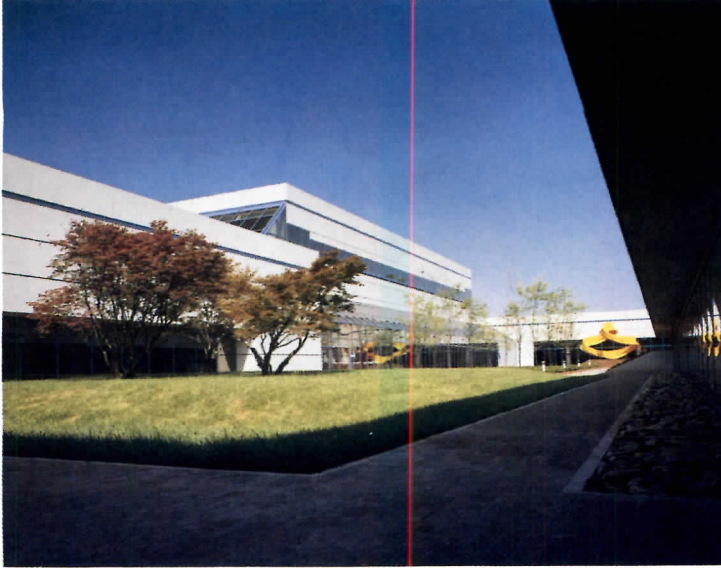

Gordon Schenck, Jr., photos except as noted

At first impression, IBM's new manufacturing facility in North Carolina might seem to correspond more closely to the stereotypical factory than the other buildings shown in this study. It is big (1.5 million square feet), populous (about 3,000 workers) and extremely busy (laboratories and offices and assembly lines and a lot of truck traffic). Nonetheless, it is also immediately evident that this clean and orderly plant fits most comfortably into the post-smokestack category of industry. No cavernous gloom, lurid fires or oil smears depress the spirit here.

After the buildings' size, the first thing to strike a visitor is the sleek taut wall that wraps the buildings. The metal panels—sometimes steel, sometimes aluminum, depending on the contracts bid during different phases—have a baked-enamel fluoropolymer finish. The panels became the architects' chief tool in fashioning a design vocabulary. The pale gray was selected to remind the viewer of the beech trees growing on the large rural site, while the blue bands and mullions show a color familiar on IBM's boxes. The designers also worked out the geometrically precise panels to recall IBM's well-known pursuit of meticulous design for its own products.

The vocabulary allows different uses of the panels on different building types within the complex. Laboratory and administration pods, for instance, have stripes of tinted glass windows, while the single-story manufacturing buildings have only a low row of windows under overhangs. The tallest building element, which is the 75-foot-high structure for the automatic storage and retrieval system (ASRS), has *two* blue stripes at the roof. The ASRS, with its seven stories of steel shelving, provides all of the building's structural support.

Two skylit spines, both wide enough to become actual as well as symbolic internal streets, dominate interior circulation. At the front of the complex, the Pedestrian Mall runs between office pods and manufacturing buildings. Because it contains such employee services as medical department, library and credit union, it quite naturally acts as a villagelike meeting place. At the back of the complex, the Materials Spine carries both pedestrian and small vehicular traffic.

The spines also have important consequences for energy conservation. Occupying space between enclosed buildings, they eliminate, by the architects' reckoning, 120,000 square feet of exterior wall. Moreover, the skylights and the relatively relaxed hvac standards also reduce energy requirements.

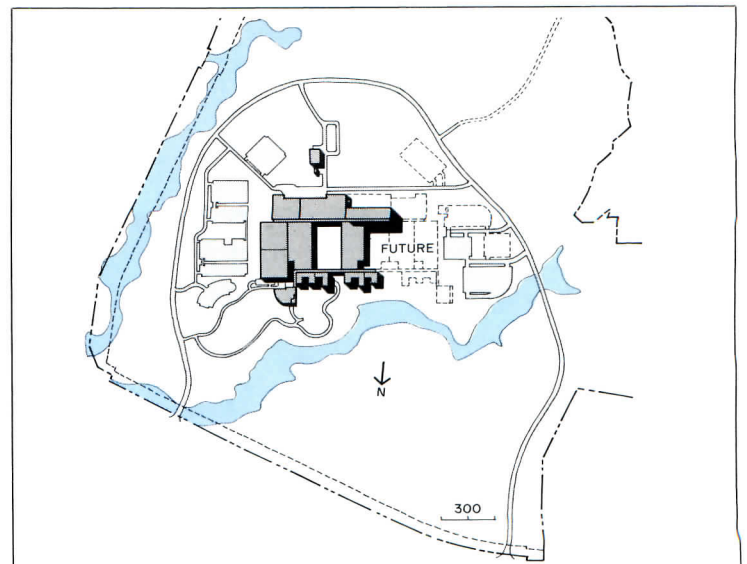

Rick Alexander



The IBM industrial complex at Charlotte includes a number of different buildings involving at least three main building types, visible in the photograph at top opposite: single-story manufacturing buildings at right and left, one of the six multistory office/laboratory pods at left rear, and the cafeteria at the rear of the courtyard. Visitors see first the quarter-round of the cafeteria

building (bottom photo opposite) and next Charles O. Perry's monumental yellow steel sculpture Hovering at the main entry (above), which opens at the end of a glass-enclosed corridor (see also plan on page 112). The precisely tooled metal wall panels and the blue stripes recall IBM's distinguished record of product design.



*IBM Manufacturing & Development Facilities
Charlotte, North Carolina*
Owner:
International Business Machines Corporation
Architects:
Thompson, Ventulett & Stainback, Inc.—David Cameron, Ray Hoover, project managers; Jeffrey Folinus, Robert Meaders, Harry Vann, project architects
Engineers:
Ross H. Bryan, Inc. (structural); Brady & Anglin Engineers (mechanical/electrical); Ralph Whitehead & Assoc. (civil); Stanley Seroka Associates, Inc. (controls)
Consultants:
Roy Ashley & Associates (landscape); TVS & Associates (interiors); Cini Grissom (food service)
Construction manager:
Blount International

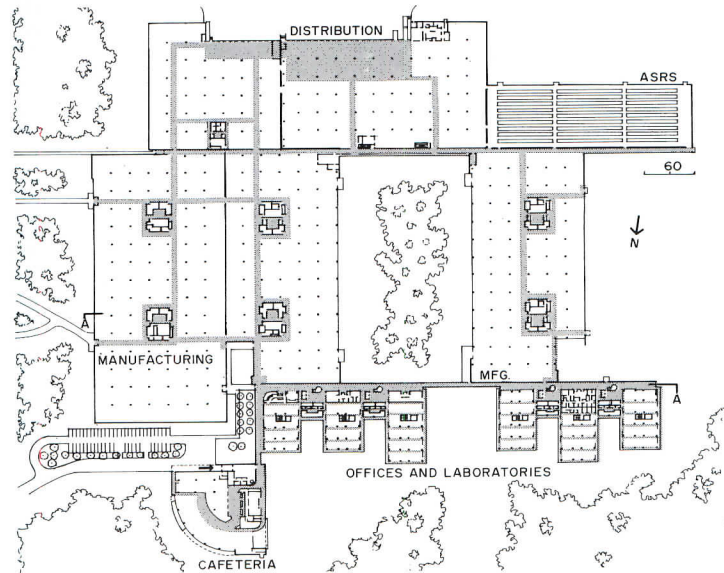

The Pedestrian Mall (opposite), one of two major circulation spines, connects all six office/laboratory pods on one side and manufacturing spaces on the other. While the mall effects considerable energy saving by eliminating exterior walls on both sides, its most important role is to humanize scale and to provide social space. Its focal areas at either end of a bridge joining the two sets of office pods

(see plan above and section below) are color-keyed—one red, one yellow—for orientation. At the back of the complex, the Materials Spine between production and distribution buildings repeats the form and some of the functions of the Pedestrian Mall. A terrace outside the cafeteria (top) offers a quiet view of offices and the wooded countryside.

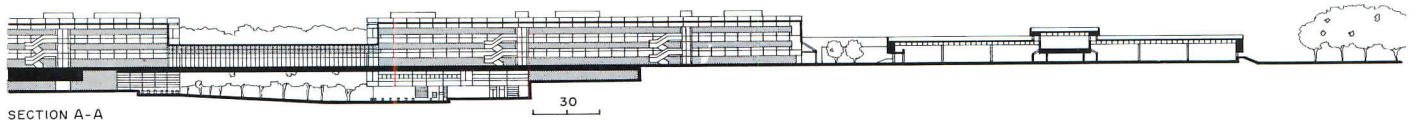



But is it avant-garde?

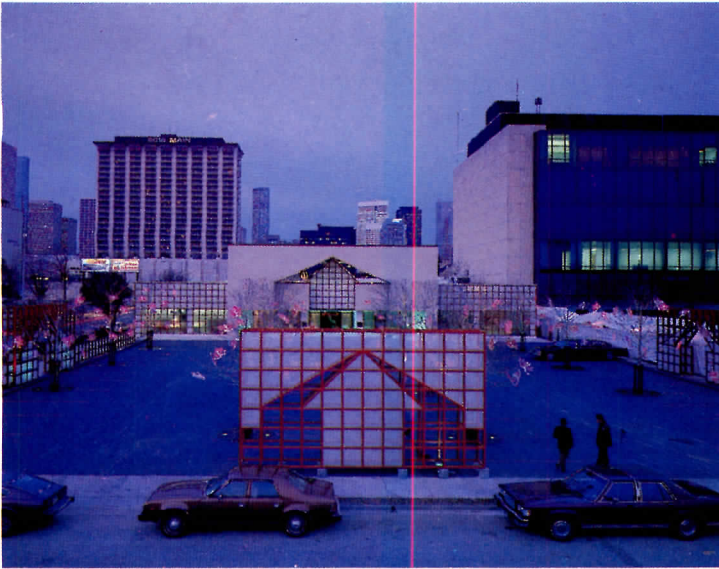

Timothy Hursley photos (except as noted)

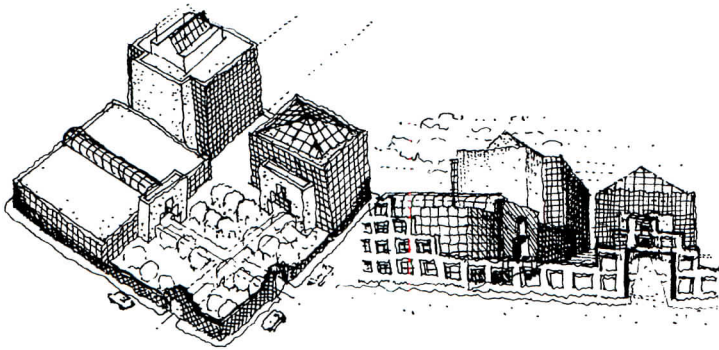

KNOLL
HOUSTON, TEXAS
1982
S. J.

When Knoll International was evicted from its Houston show room in 1981, company co-chairmen Stephen Swid and Marshall Cogan went shopping for real estate. Feeling "secure enough to be on the fringe," they acquired a square city block—bordered by a funeral parlor, a bridal salon, a bath house, and a parking lot—on the very edge of downtown. The task of master planning what was to become the Knoll compound fell to Chicago architect Stanley Tigerman, who submitted a three-phase proposal within seven days of his first site visit (above). With the Phase I show room now complete (as of January), only the flagging Houston economy is standing in the way of the Phase II renovation of a seven-story office building (which Knoll leases out) and the Phase III construction of a 12-story (at last count) "alternative" design center (which Knoll hopes to lease out).

When Knoll International announced the selection of Stanley Tigerman as the architect for its new Houston show room, the design community greeted the news with raised eyebrows and a uniform "You're kidding!" The incredulity was understandable. After all, Knoll has a reputation as a bastion of modern design, and Tigerman...well Tigerman strayed long ago from his original modernist path, abandoning the rigorous discipline of fellow Chicagoan Mies van der Rohe for an idiosyncratic brand of postmodernism best labeled "autobiographical." Compounding this basic disparity in esthetic directions is Knoll's recent decision to woo the lucrative (and conservative) open office systems market. In short, Stanley Tigerman and Knoll International make strange bedfellows indeed.

Except of course to Knoll co-chairman Stephen Swid, who regards the contract furniture company he and partner Marshall Cogan purchased in 1977 as "avant-garde," not as—repeat *not* as—"International Style modern." Swid argues that the choice of Tigerman was "logical," and for a precedent he points to the company's flagship show room in Manhattan, designed by the perennially avant-garde, and decidedly *un*International-Style-modern Robert Venturi (RECORD, March 1980). Swid adds, not incidentally, that the "controversial" selection of Venturi "got the community to look at Knoll again." (To perhaps re-evaluate the company's slightly dusty design reputation?) It would be fair to assume that Swid now hopes that the "controversial" selection of Tigerman will get that same community to look at Knoll yet again, and to finally see it his way—avant-garde, not... (Which is, after all, the way Hans and Florence Knoll envisioned the company they founded in 1938. Remember, Mies was in the vanguard of his day.)

Though Knoll's reputation obviously will be confirmed or denied on the basis of the furniture it manufactures rather than the show rooms it builds, commissioning high-profile architects to design high-style environs for said furniture certainly doesn't hurt—the company's reputation *or* visibility. Assisting in the visibility department is Knoll's newly acquired preference for "stand-alone" show rooms. Case in point: Houston, where space in the city's design center was bypassed in favor of autonomous quarters along a semi-seedy strip on the outskirts of downtown.

"If you want the truth, this is the easiest job I ever did...like rolling out of bed," confesses Tigerman, who purports to have completed the mini-urban-renewal Knoll master plan in a record week (left). And though the alleged ease and breakneck speed can no doubt be attributed to the simplicity of the approach, at least the approach to the exterior, it is a simplicity not inappropriate to the task. For the Phase I show room—a modest renovation of a pre-existing, flat-roofed box—Tigerman merely wrapped the bland but structurally sound building with a riveting red grid—stepping it inward to form the entrance and extending it outward to corral (this is Texas) the parking lot. To heighten the low-lying structure's profile along the Main Street strip, Tigerman erected a billboard-scale "gateway" above the main entrance (right): the gateway frames a bold gridded arrow, guaranteed to capture the attention of even the most preoccupied passer-by.

According to Tigerman, the Knoll show room effectively ushers in a new phase in his career: "My work today is much more sophisticated, but much less spontaneous." And though the project does bespeak an uncharacteristic reserve, it should not be inferred that Tigerman has lost his spontaneous touch. On the contrary. For the show room opening, Tigerman adorned the oak trees in the parking lot with a heaven's worth of fluttering angels; the male and female angels were—as more than one visitor gleefully noted—anatomically correct. *Charles Gandee*

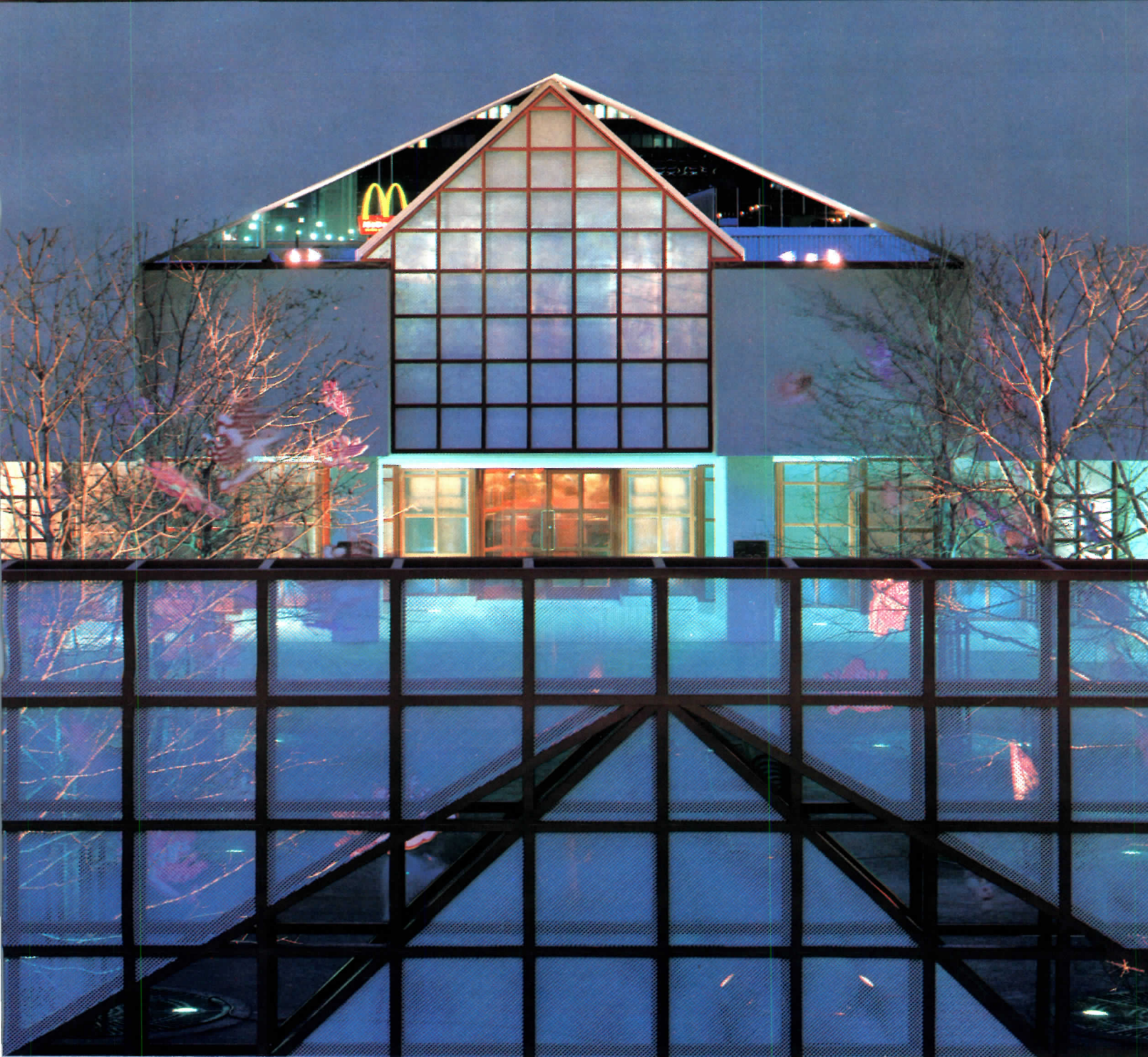

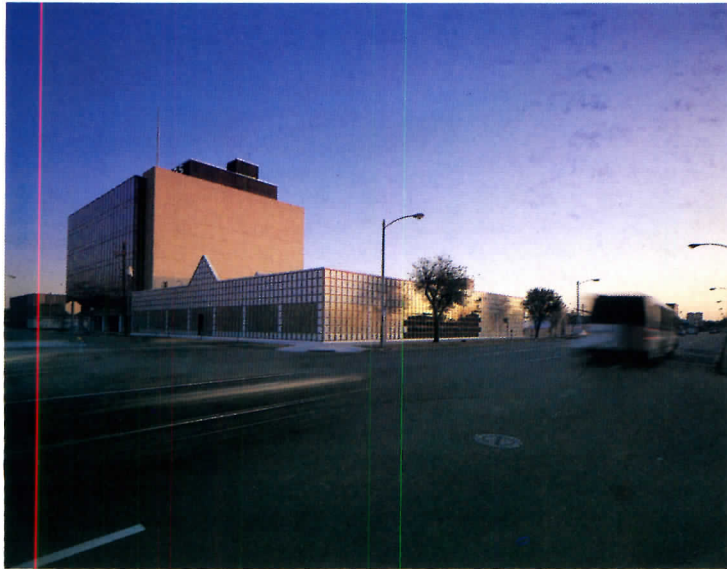
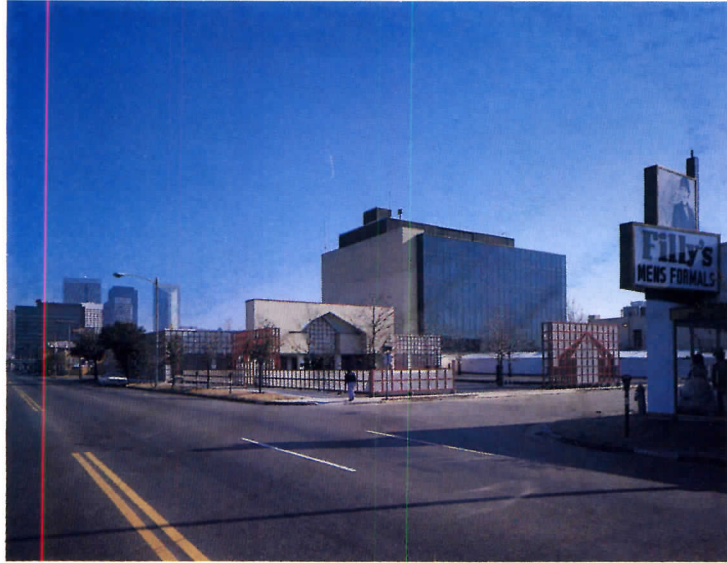

The flashy red aluminum-and-glass grid that wraps the Knoll show room was inspired, according to Stanley Tigerman, by the millions of the solar bronze curtain wall of the 1957 Victor Newhouse-designed office building that adjoins it (above). "We tried to be contextual," solemnly supplies the architect. (We would have had less trouble believing Tigerman if he had told us that the grid was intended as an homage to conceptual artists Christo and Sol Lewitt.) Though Tigerman's transformation of a former eyesore into a sprightly contract furniture show room may be a modest-scale job, particularly by Texas standards, it is nonetheless much appreciated by Houstonians. Because along this particular section of Main Street, the \$2-million renovation is the first sign of development to be seen in lo

these many years. And though Knoll hopes that its efforts will serve as a "spur" for future development, the current troubled state of the Houston economy will undoubtedly postpone the desired effect. In the meantime, however, Knoll is a conspicuous and welcome addition along the scraggly strip. The company will be even more conspicuous, and perhaps even more "contextual," when the three small gateways that "organize," according to Tigerman, the compound's fourth quadrant, i.e., the parking lot, have been capped with the 6-foot-high red letters spelling, what else?, K-N-O-L-L. (At present, the company identity is practically hidden in the two brass plates flanking the main entrance, opposite page.)







A bit of historical research netted Tigerman the rather curious news that the 1919 building he was to transform into a furniture show room had originally been a furniture show room. And though the over-all dimensions of the heavy-timber structure were more-than-slightly ungainly (124 by 125 feet), and though the floor took an awkward and inexplicable 2-foot drop in the middle, the 65-year-old building was surprisingly adaptable to contemporary furniture display. After making a few basic alterations to the shell, (some post-1919 modifications were removed, some non-bearing exterior walls taken out), Tigerman made his big interior move: "The building is so fat that we wanted to cleave it, and, in so doing, introduce light into the center." The resultant central axis not only bisects the 15,500-square-foot show room (thereby rendering it less warehouse-like), but provides the primary circulation artery as well. The spine is designated "public"—as opposed to the suggested "private" of the furniture display area (overleaf)—by means of an acoustically hard terrazzo floor, and steeply pitched translucent skylight that floods the spine with natural light. For an appropriately grand terminus to his grand axis, Tigerman turned to Greek mythology. He found the myth of Arachne, who challenged the goddess Athena to a weaving contest. (An enraged Athena, envious of the perfection of Arachne's tapestry, transformed her into a spider.) Tigerman's gilded statue of Arachne does double duty: she not only offers a glittering focal point for the primary circulation axis, but assists Knoll's textile division in its marketing effort by allowing herself to be draped in the "fabric of the month." The massive trusses spanning the central spine were pre-existing, and though Tigerman "fatted them up" with gypsum board, their basic configuration was unaltered. Tigerman likes to think of the show room as borrowing its plan from a basilica: he refers to the entrance as the "narthex" (photo left); to the circulation spine as the "nave"; and to Arachne's ebonized wood case as, naturally, the "altar."

Before you reach Arachne standing guard over the textile display (below), you must first pass by the two furniture display areas flanking the central circulation spine: "A person walking down the aisle becomes a performer," according to Tigerman; "the furniture, a mute audience." To appreciate the theatrical scenario, you must experience the circulation spine as a runway (stage).



Harr, Hedrich-Blessing



Harr, Hedrich-Blessing

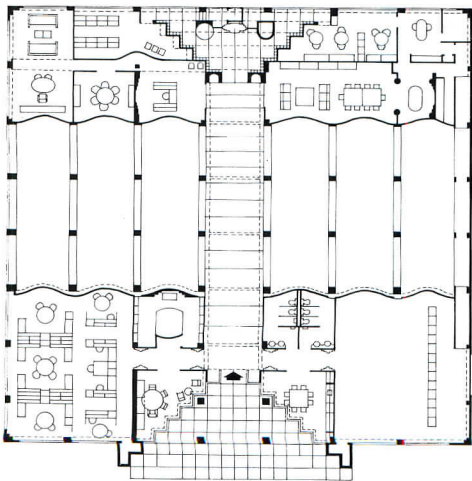

Although the neat symmetry was assisted by some fake (non-structural) columns, the two furniture display areas flanking the central circulation spine are each three bays deep and three bays wide (plan above). Their north and south walls are conspicuously curvilinear to sustain Tigerman's fantasy: "I ripped the building apart, thus revealing the show room that had been there all along."





Except for the furniture display segment of the Main Street elevation (which has black mirrored glass), and the entrance doors (which have clear glass), the aluminum grid that wraps the Knoll Building is infilled with slightly-opaque glass. The particular translucent quality of this particular "pattern glass," according to Tigerman, assists in what is for the architect an important public perception: "One can see through in such a way that the pre-existing building is clearly related to the new facade—it is a dialogue between the old building and its remodeling. . . the traces of the original building are made apparent." (Clear glass was rejected early on, because, according to Tigerman: "No matter that Knoll's furniture is very elegant, if it were a transparent building, and you could see inside, it would all look like tsachskes gathering dust on your mother's mantelpiece.") From the interior, however, the aforementioned "dialogue" does not exist: so thorough is Tigerman's renovation that one would be hard pressed to find traces of the 1919 building. What one finds instead is, particularly in the staff work areas, a soft natural glow (opposite page). For the non-perimeter areas, however, a more dramatic, artificial lighting plan is put into effect—as in the audiovisual-cum-conference room (top right). Even in such secondary spaces as the corridor leading to the divisional vice president's office (below right), Tigerman was intent on adding a few extra flourishes of detail. For the extra dollars which enabled Tigerman to do so, the Chicago architect would like to thank Knoll's Stephen Swid, whom he refers to as a "mensch."



The Knoll Building
Houston

Owner:
Houston State Associates

Architects:
Tigerman Fugman McCurry—
Stanley Tigerman, design; Robert
Fugman, partner-in-charge;
Margaret I. McCurry, interiors; Lee
Stout (creative director, Knoll
Interior Design), show room design

Associated architects:
Ray B. Bailey Architects, Inc.—Ray
D. Leiker, associate-in-charge

Engineers:
Ray Beebe, Inc. (structural);
Wallace & Migdal, Inc.
(mechanical/electrical)

Consultant:
Incorporated Consultants Limited,
Carroll B. Cline (lighting)

General contractor:
Robert E. McKee, Inc.



Harr, Hedrich-Blessing



Harr, Hedrich-Blessing

Delineation as design





Houses in search of a type

"Line drawings can lie," says architect Michael Fieldman. So despite their mastery of line, Bobrow/Fieldman bring into play for projects best understood by exploring surfaces as surfaces (rather than as lines delineating surfaces) the idiosyncratic and freewheeling painting technique—oil on ozalid, paper towel "brushes," pencil shading—exemplified here and on the preceding and following

pages by studies of faculty housing for The Rockefeller University. The success of the images as art is self-evident. Less evident, save to a keen eye, is their value as representations that, as Fieldman says also of the line drawings, "allow the architect to come to terms with the project well in advance of detail design." One such keen eye is that of architectural historian and critic

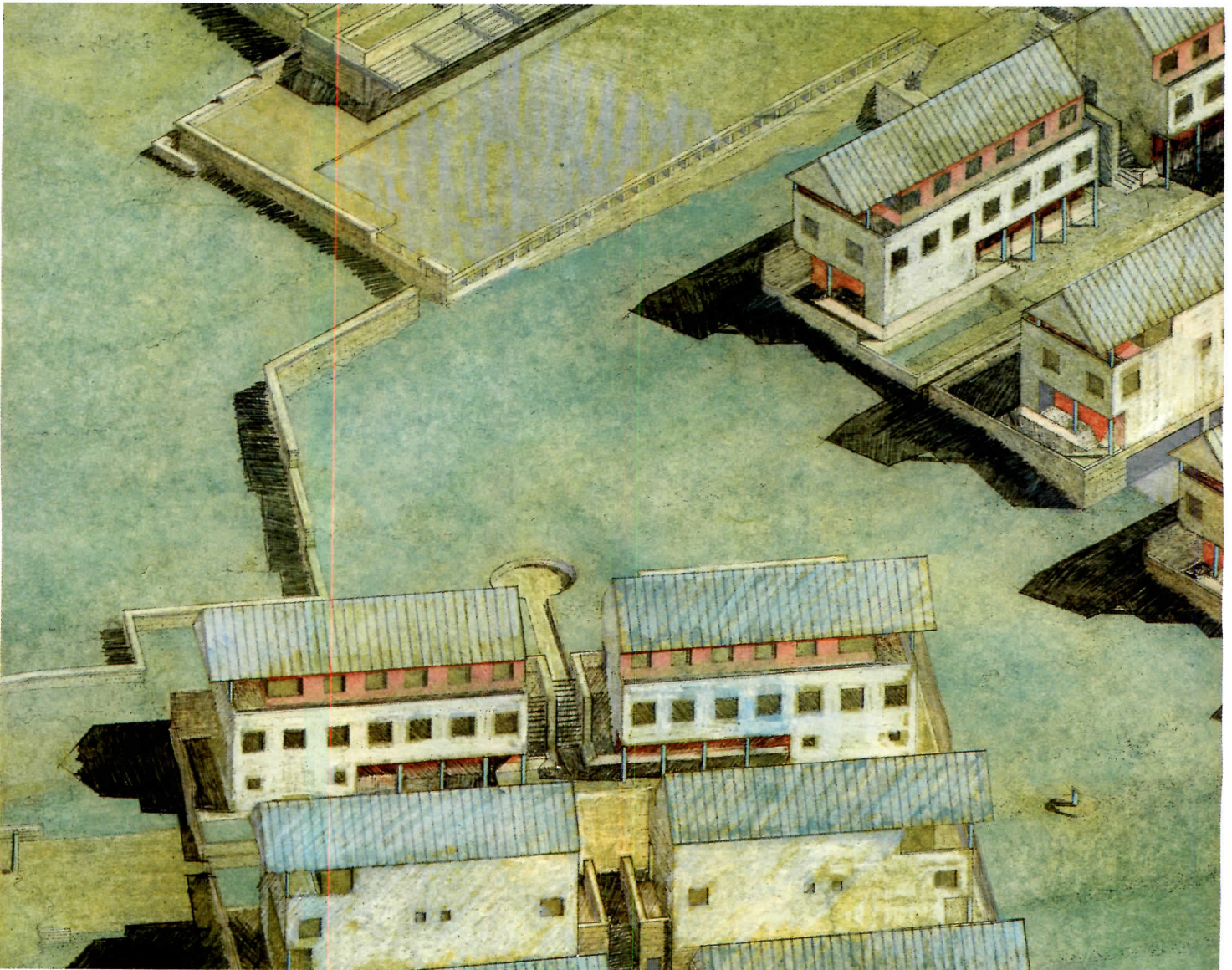

Architect Michael Fieldman offers as apologia for his profession, and confessed passion, Alberti's comment in *Ten Books on Architecture* that a building "...should be easy of access, beautifully adorned, and rather delicate and polite." He might well offer a like apologia for its rendered image.

The New York-based principal in the Montreal-Ottawa-New York firm of Bobrow/Fieldman, Fieldman is the primary author of the drawings and paintings shown in this portfolio. Clearly, the work is of gallery quality—and indeed is often exhibited. Just as clearly, the images are on a lofty plane of complexity and abstraction. Why, the question comes, does a relatively small firm lavish itself on fine renderings opaque to all but the most sophisticated clients? "We do it," replies Fieldman, "for ourselves."

The motivation is rooted in Bobrow/Fieldman's approach to the built form, which includes an early assault on program issues so as to quickly set up project content and constraints as a stable platform for launching an uninterrupted design effort. In this, delineation plays an *integral part*, but as Fieldman stresses, "nobody just draws something." Drawing, rather, is seen as

freezing moments in the creative act so that the project can at stages from the embryonic to late development be brought to a meaningful level of completion. Moreover, the process of delineation is a conscious progression from verbal discussion of the graphic approach to its formulation in freehand sketches and finally to its formalization in precise renderings. In the entry to the picture plane and the establishment there of foreground, midground, and background, the way is opened for penetration and layering, revealing conditions that may lead either to refinement or to change.

While recognizing that the ultimate level of refinement rests in the contract documents, Bobrow/Fieldman believe that it can be closely approached through formal representation (which not incidentally also smooths the flow of information from designer to draftsman). Meanwhile, arresting and exploring ideas—surface and sequence, dimension and depth, continuity and separation—through the act of drawing or painting fixes those values and reflections that emerge in the patient and painstaking search for the evolving design. "In the end," says Fieldman, "architecture must be definable." *Margaret Gaskie*

Kenneth Frampton, who on viewing the works quickly perceived the conflicts underlying their surface resolution. His "catalog notes" follow.

"The brief was simple—faculty houses to be discreetly inserted into a country estate—but the site was difficult, dominated by a dour pseudo-Edwardian mansion that instantly declared itself the last resting place of a dynasty's

memorabilia. How should one build on a site so impregnated with illustrious mortality? Clearly not on the high flat ground, since this would compete with the mass of the mansion. Equally clearly not on the rising approach, since this would violate the leisured seclusion of the entry. The sole alternative was to build on the steep landfall to the rear of the house—which severely restricted the site area available."

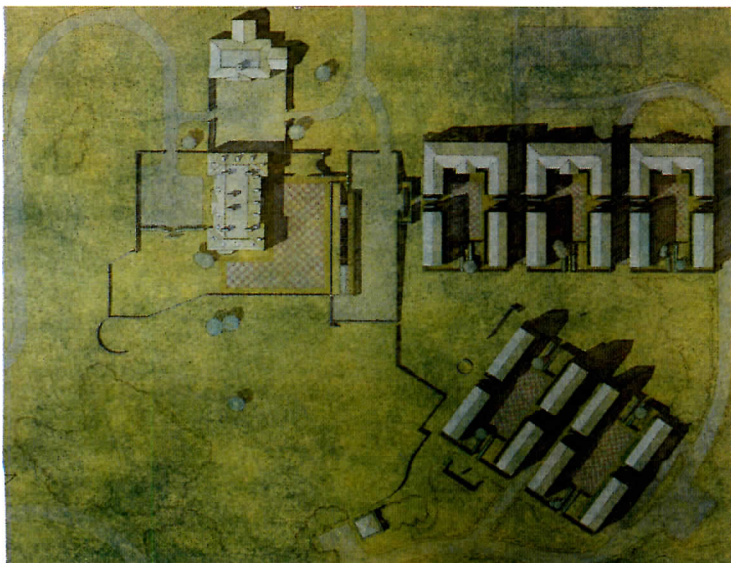
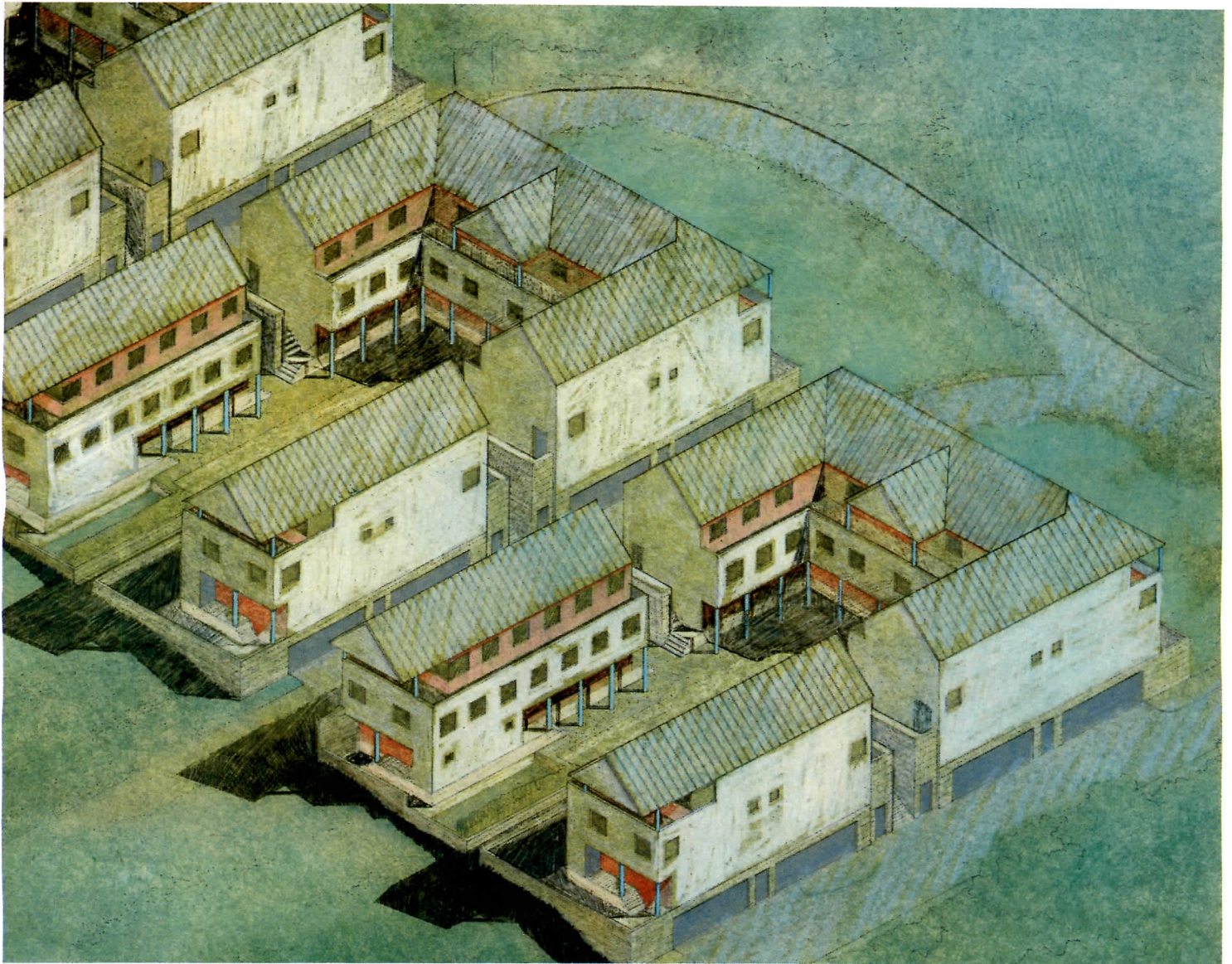

"A comparable difficulty was style. Neo-Palladianism was unsuitable for its implication of a false affinity between the faculty houses and the family seat, as was an imagined picturesque vernacular for the risk of upstaging the mansion. On the other hand the aura of suburbia was mandatory as being the consensus aspiration of the academic community. Hence the poetic ambiguity of the

synthesized type adopted, which is at once collegiate and suburban, the former appearing in the quadrangular courts about which the stepping sequences of housing are organized, the latter in the profile of over-sailing pitched roofs which evoke an air of country-club domesticity. Open at their ends, the courts are focused about rising cross axes, stepped walkways that lead the eye to the hilltop mansion.

At this juncture the hybrid nature of the complex is apparent, for while the 'collegiate' quads dominate the plan, in section a paradigm of the Mediterranean hill town prevails. The opposing forms have in this study been deftly combined but not fully reconciled."

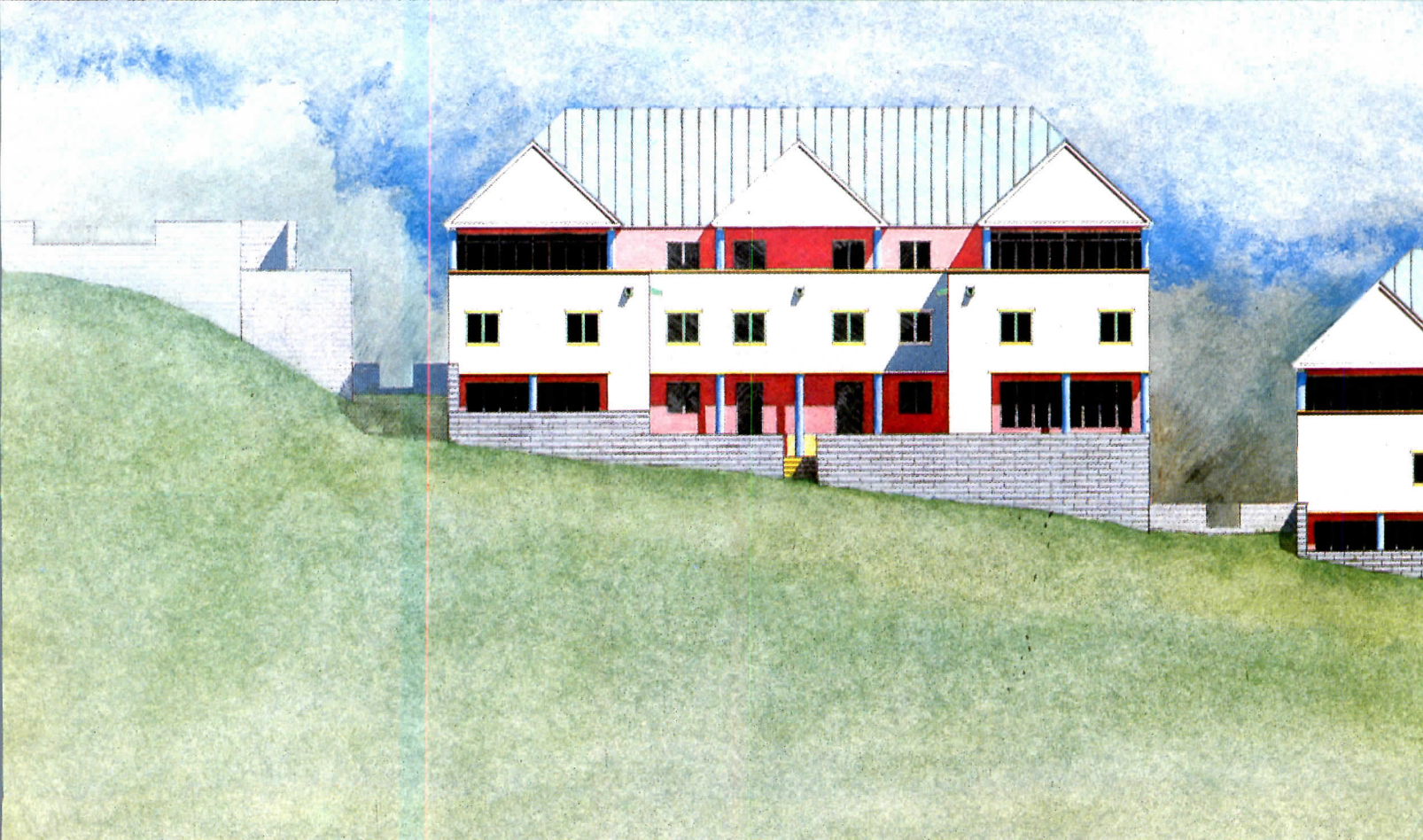

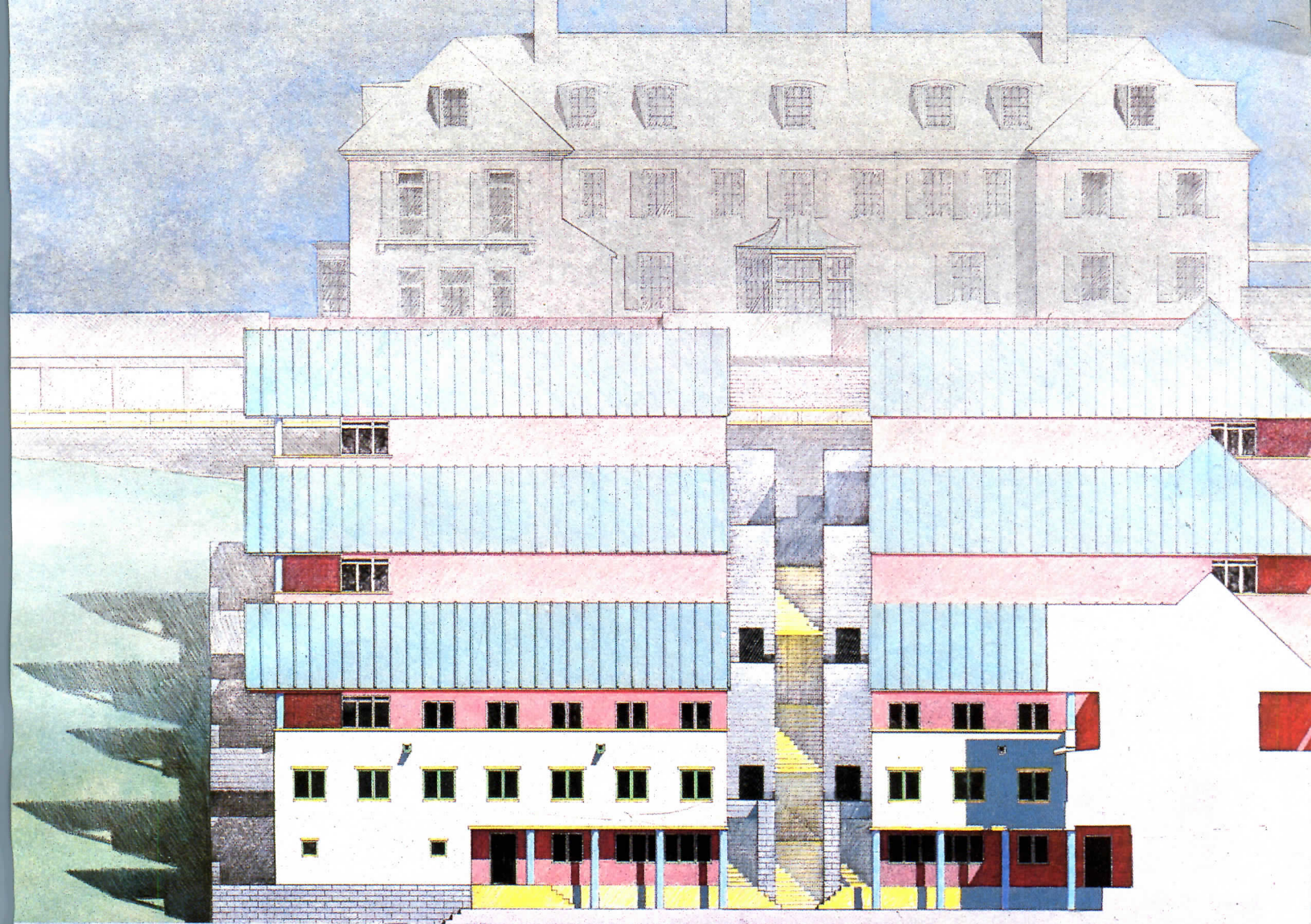

An agora for a city campus

Bobrow/Fieldman's competition entry for the expansion of the law school at Fordham University's Lincoln Center campus clusters the principal program components around an "agora" that by historical association implies a place conducive to intellectual discourse. The atrium/court allows two readings: as the pivot point for all student activities and as a commanding presence in itself, a

space open and compelling yet near-monastic in its sense of isolation and repose. Against the monumentality of this volume, the axial symmetry has been formalized (and wryly ecclesiasticized) so that entry is on the axis of the "nave," and "aisles" (circulation) about "transepts" (lounge and cafeteria). The whole is lit by an overhead skylight ("triforium") and "rose" window.

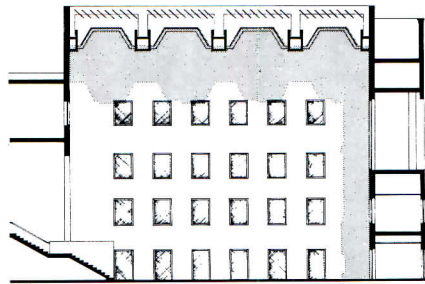
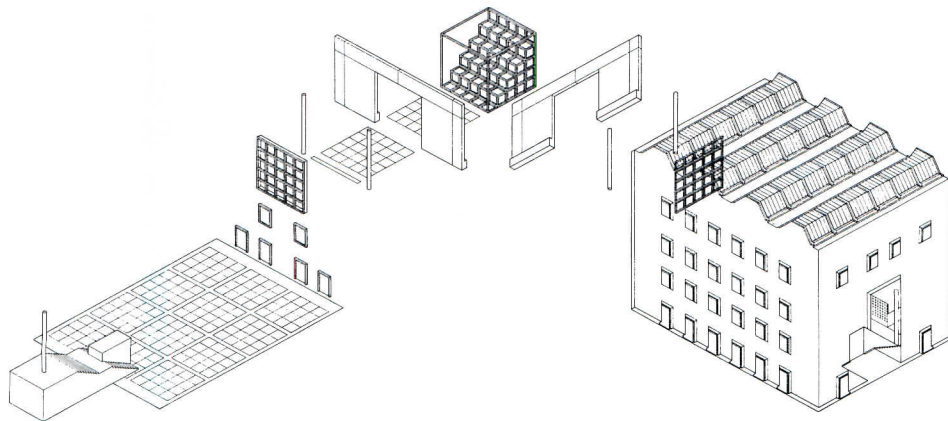
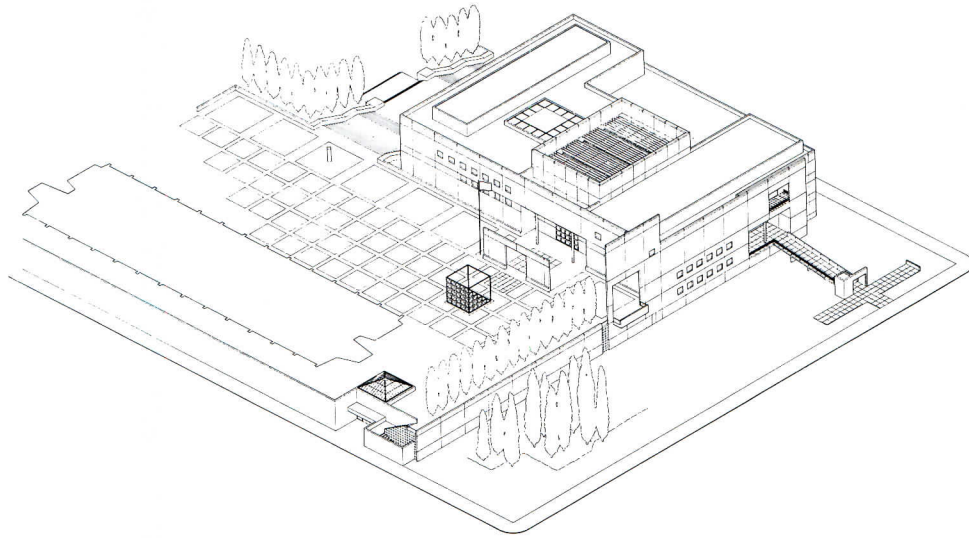

A post-industrial "factory"

Developed as "a series of accrued emblems and implications," the replacement facility providing new offices, show rooms, and a service and distribution center for 3M Canada's eastern Canadian operations headquartered in Dorval, Quebec, reinterprets for this "post-industrial" enterprise the idioms of early Modern industrial architecture, complete to the imagery of the "factory gate" and

"court." In its dialectical relationship with history, however, the design is also thought of in terms of its contemporary situation and thus embodies the ideas of change and inventiveness. "The question here," says architect Michael Fieldman, "is the conditions under which architecture can enjoy authenticity without losing its nerve."

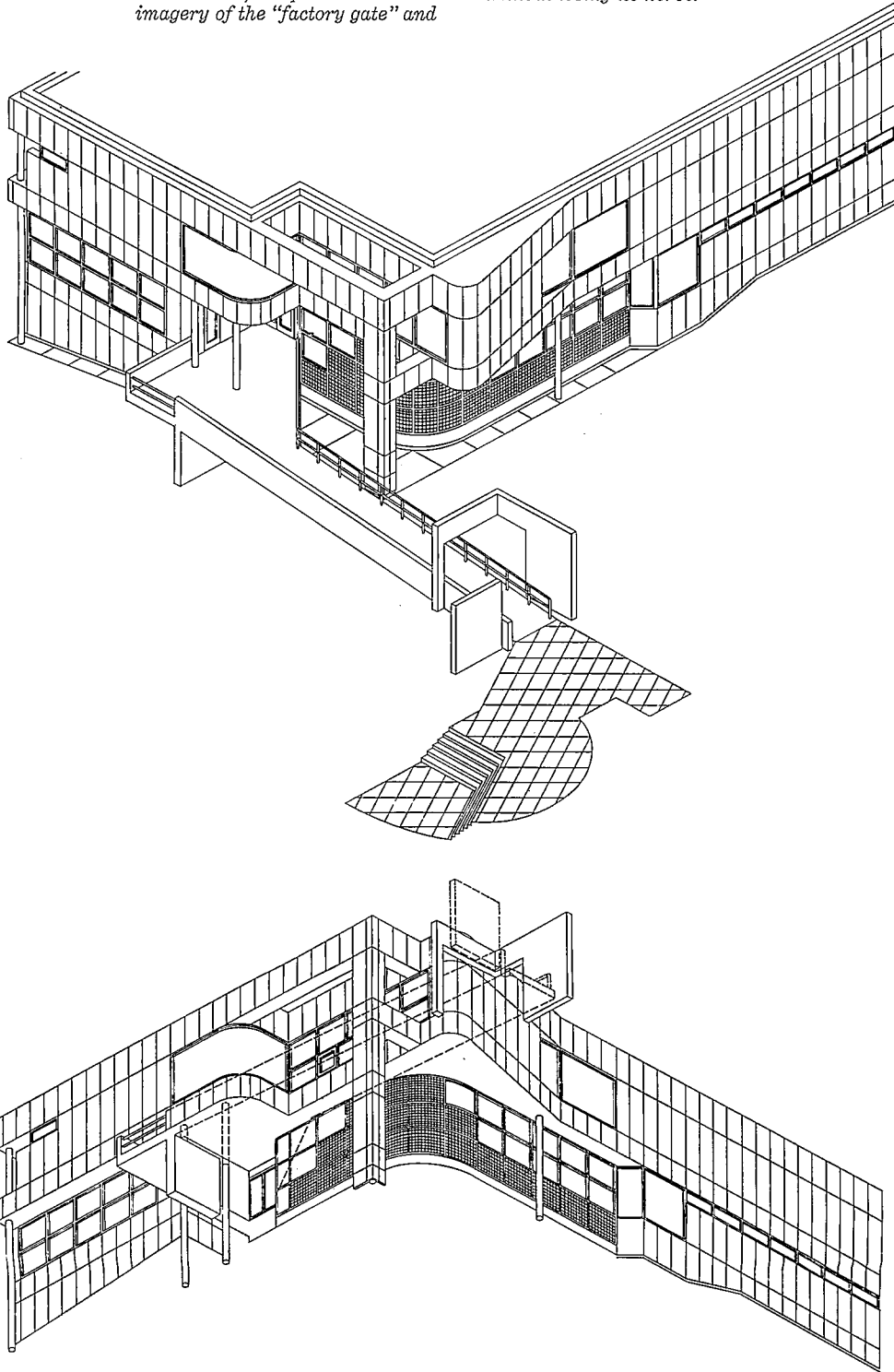

Time as vantage

The new sales, administration, and production facilities for Degremont Infilco, a manufacturer of water treatment and filtration systems, are sited in a Montreal industrial park adjacent to a high-speed highway. Accordingly, the impulse for the design sprang not only from the program and plan definitions of primary and secondary functions and their interaction, but also from consideration of the object seen in

time as well as space—the quick glance of the passing motorist devolving to the more leisured view of the approaching visitor or employee. The small administration unit with its freestanding portico and entry court itself suggests a portico to the larger court fronting the manufacturing structure, which in turn is entered from its own corner court.

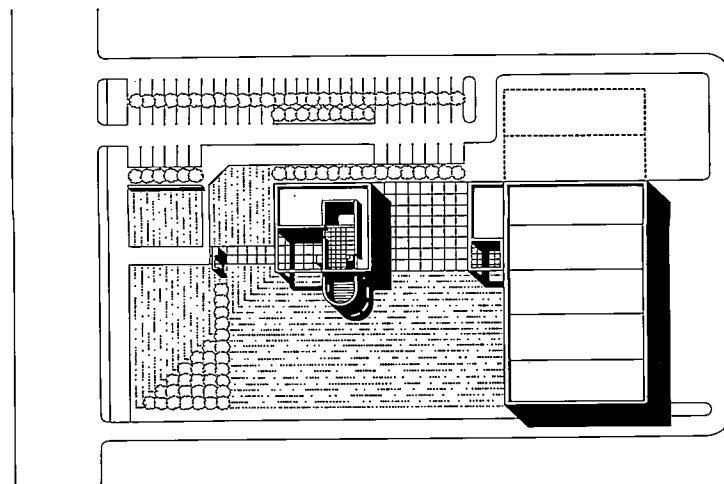
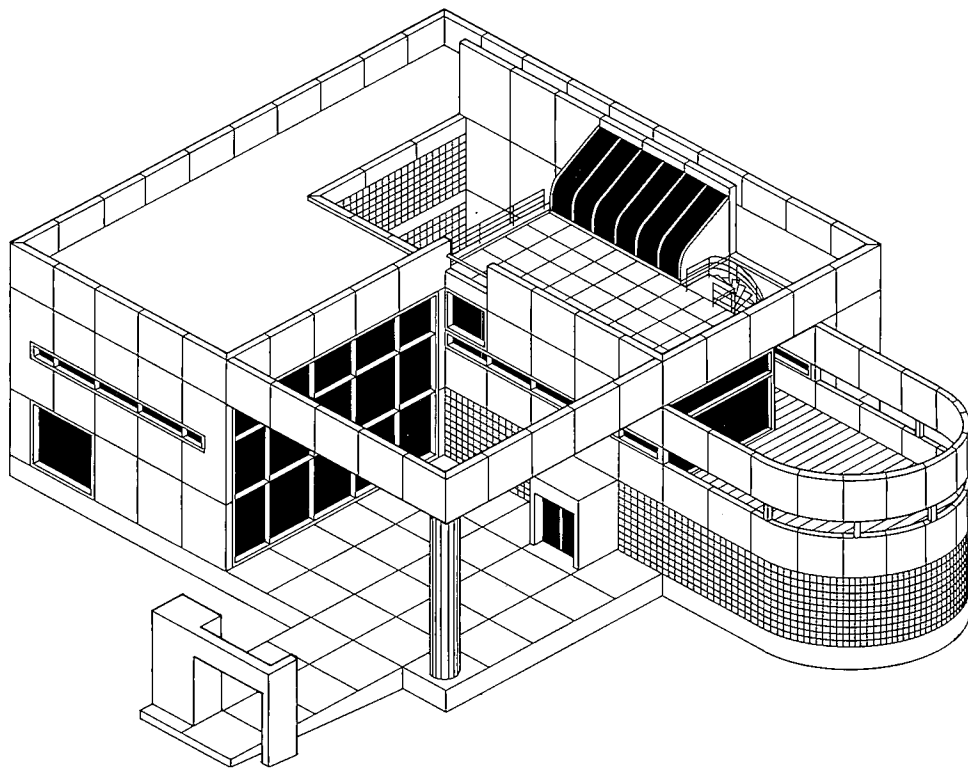

Double identity

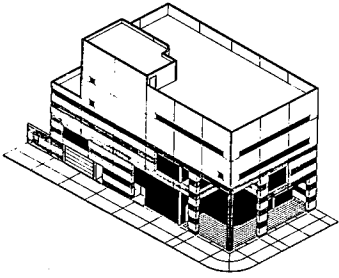

Located at the intersection of a busy commercial thoroughfare and a minor residential street in Westmount, Quebec, the offices and show rooms for a carpet company and a furniture company read as a single architectural entity but retain the firms' separate identities. The straightforward plan is animated by the evolution of the section as a sequence of interlocking layers accentuating the

relationship between the upper- and lower-level shops. The development of the building form as "plinth" and "superstructure" reflects its dual function and responds to both the traditional domestic architecture on the side street (stone base, brick superstructure) and a facing office block (travertine base, black steel-and-glass superstructure).

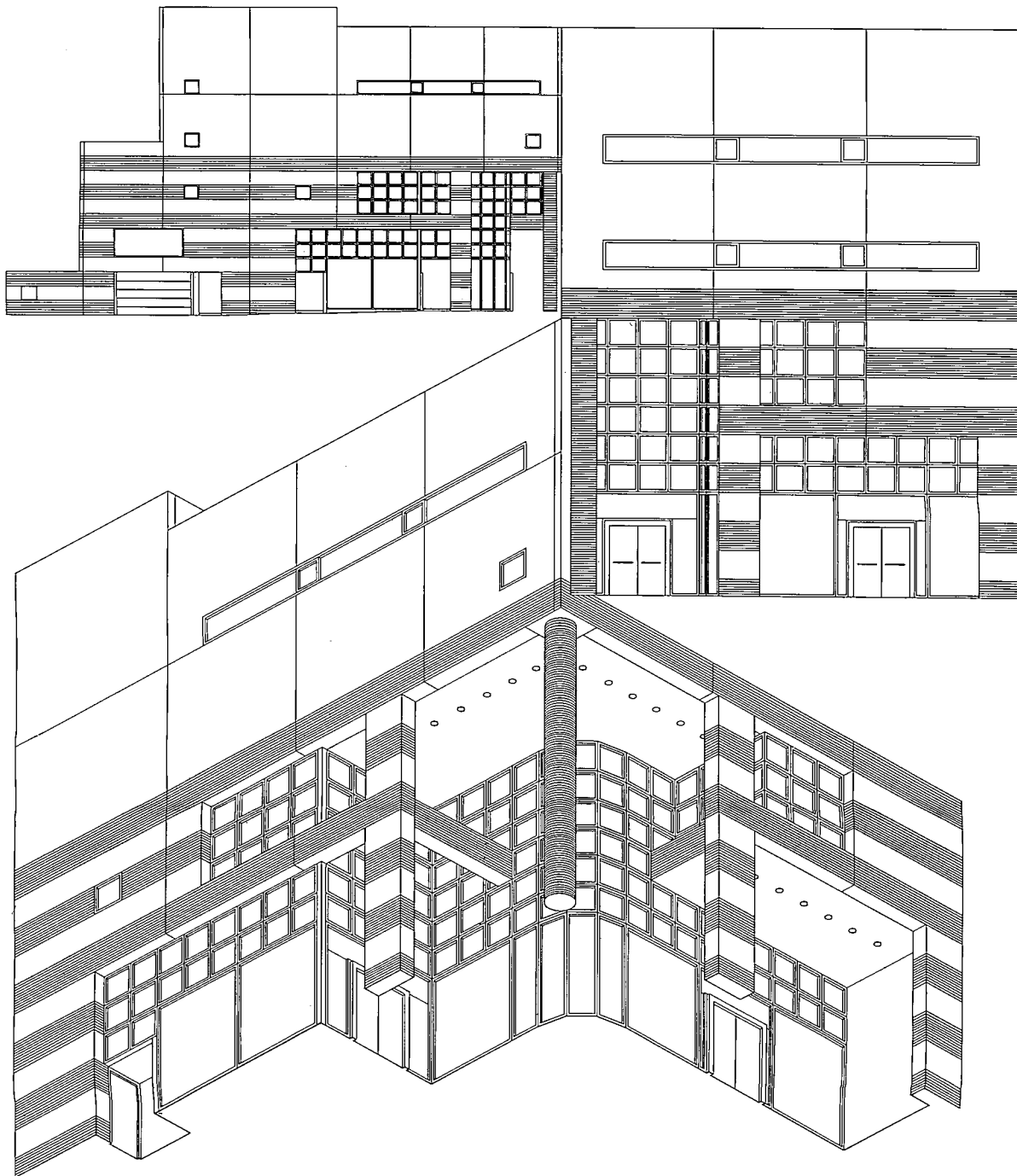

City hall; civic gateway

To create a grand civic presence in a mixed-use area dominated by a major roadway and an elephantine shopping center was the competition brief for a new city hall in Mississauga, Ontario. In response to a program that called for a bridging civic square between the city hall and a proposed cultural center directly off the highway, as well as an open visual corridor from road to hall, Bobrow/

Fieldman's design creates a building legible at two scales: as a cut-out "billboard" from passing cars and as a peristyle to the civic square at pedestrian level. At both scales the metaphor is that of a giant portal opening to the city and disclosing the main elements of the hall: internal atrium, cylindrical council chamber, prismatic conservatory, and administrative office slab. Rendered as the

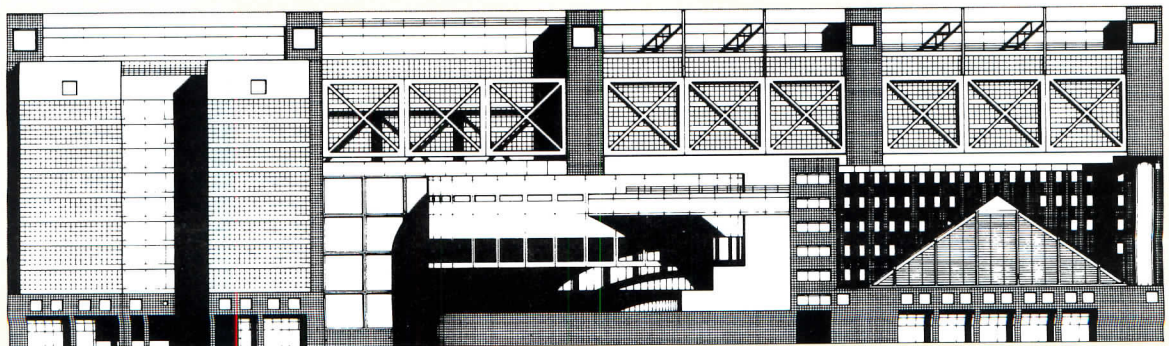
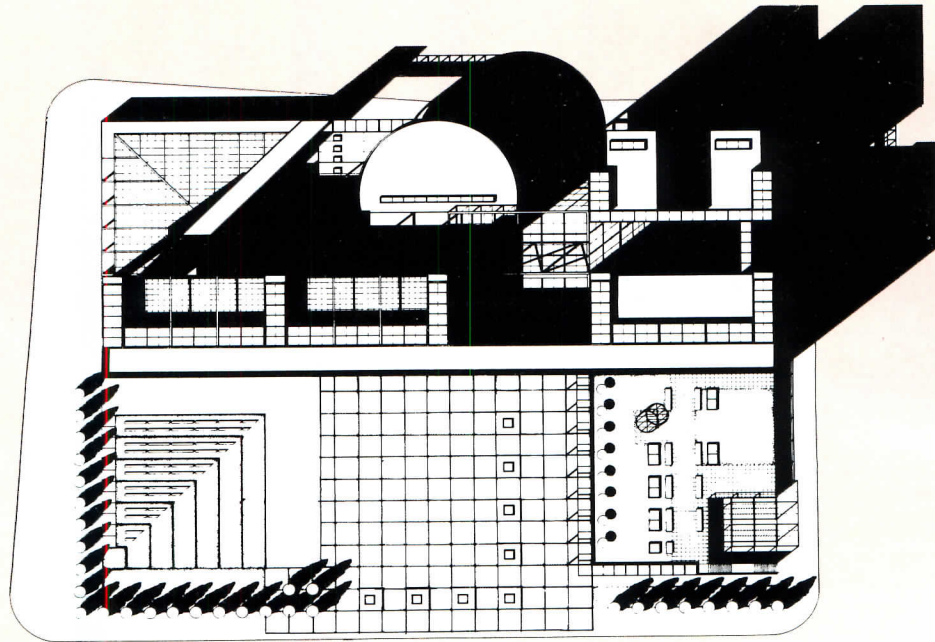

symbolic and formal limit of the city, the office slab is layered structurally across its depth and flanked by arcades that imply a classical forecourt but are inflected to express the asymmetrical order of the building composition. The glazed eastern arcade provides covered passage from underground parking to the square seven-story atrium, while the opposite arcade, which is pulled forward from the

raised slab as if hinged, is treated as a loggia that angles visitors from the western side of the civic square to the nearby shopping gallery. The unbuilt areas on either side of the civic square are rendered as strictly ordered garden terraces, one extensively planted and the other arranged as an amphitheater.

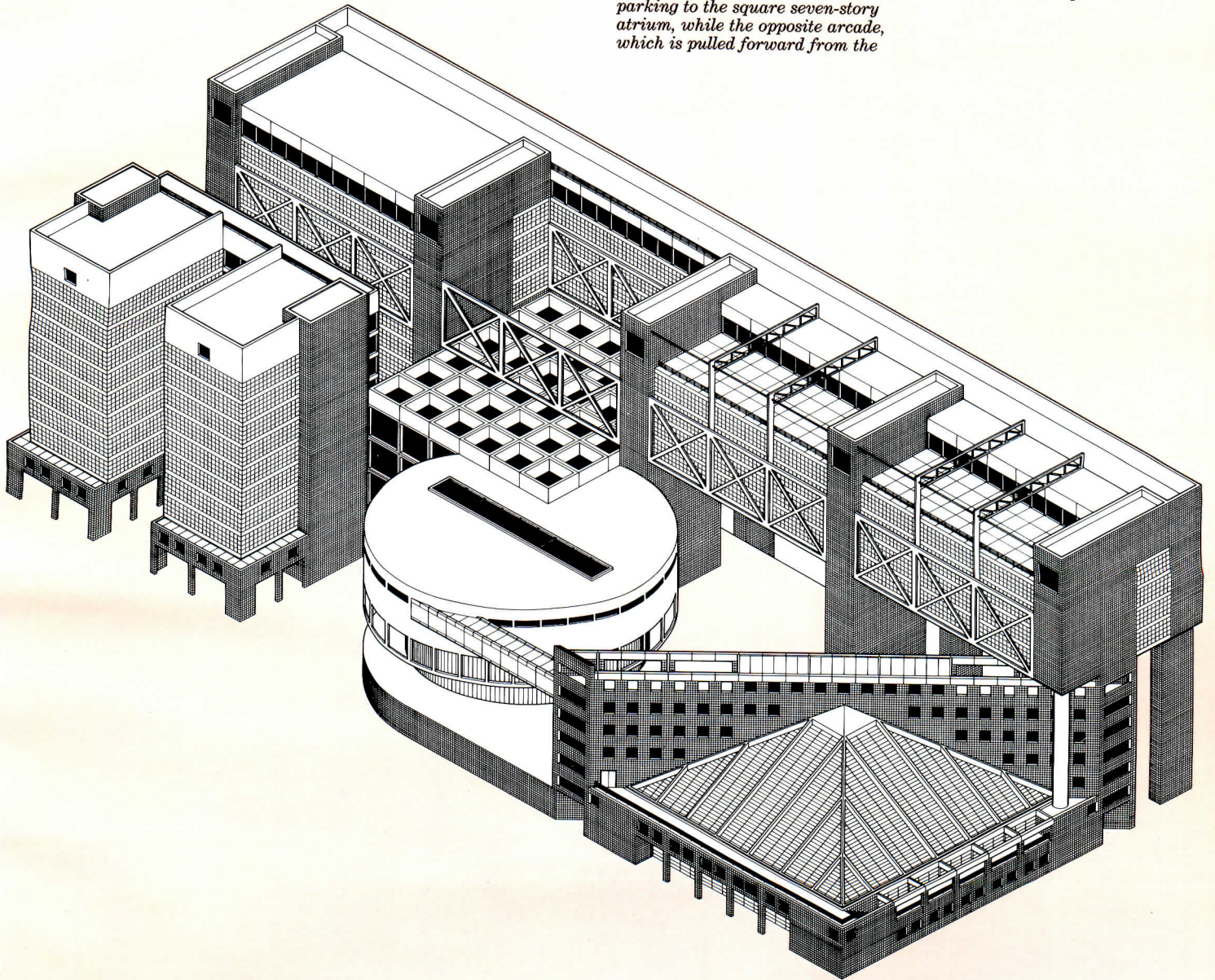

Structure as sequence

In the renovation of the upper two levels of a three-story row house in the Montreal suburbs to serve as a pied-à-terre for a family of four, a major focus was to extend the living areas while retaining the existing structural placement. Although the disposition of spaces is traditional, a strong sense of place has been established through the thematic treatment of spatial organization and architectural

elements—a progression through wall opening, screen, arch, and column used to mark a series of spaces that alternate rhythmically between movement and stasis. The sense of motion is heightened by the relationship between the exterior access stair and a rear entry at garden level, which combine to emphasize a continuous sequence from public street to private garden.

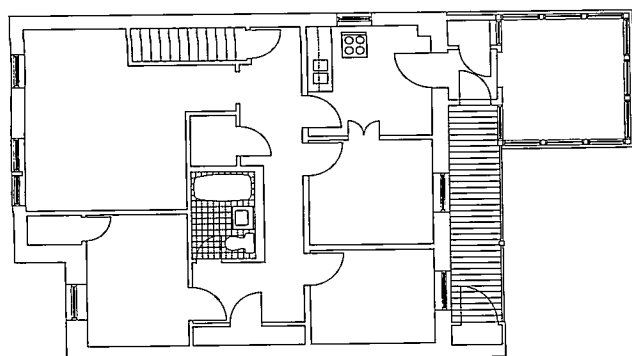
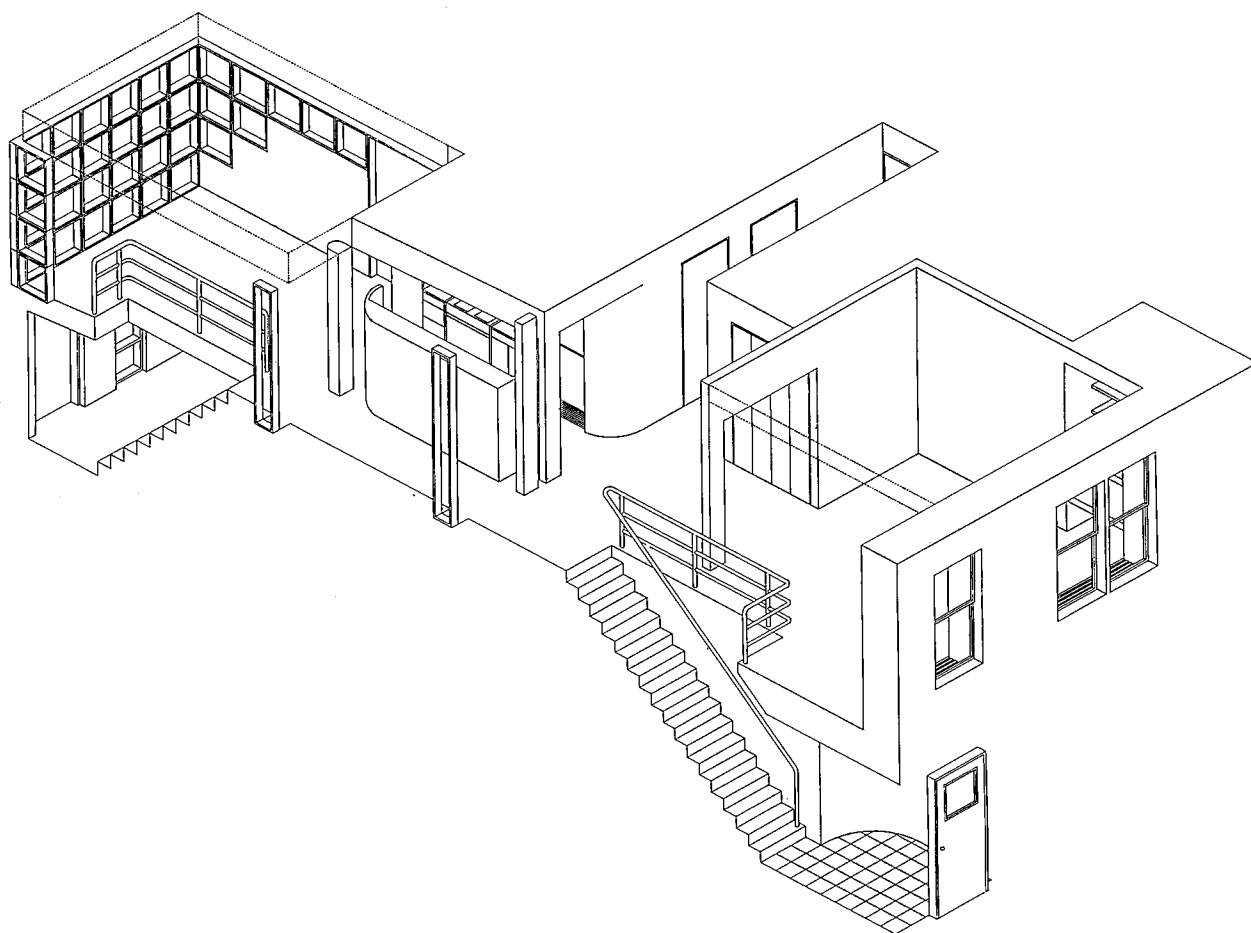

Before renovation

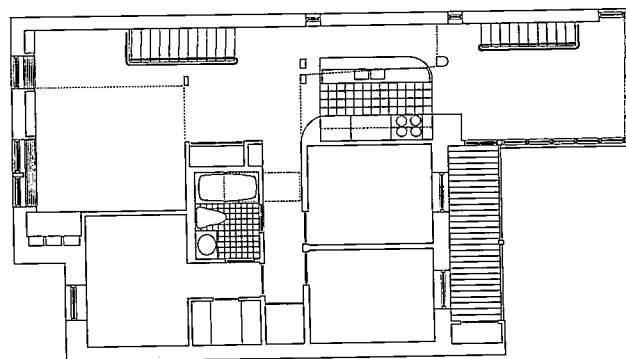

After renovation

Tradition updated

Emplacement 20.11 Marie-Victorin, a housing project proposed for the City of Montreal under a program to promote the development of moderate-cost housing within the city, disposes 166 dwelling units on a meager 7.4-acre site. The two-story cottage, duplex, and triplex house forms, and the attendant land-use patterns, are drawn from existing local typologies—notably the propensity for placing

rectangular houses sidewise on shallow lots, in contrast to the usual urban row house scheme, so as to present a more imposing facade to the street. Here, however, the familiar types were transformed to emphasize public spaces through variations in plan and lot preparation and through the development of a double-crescent row house unit.

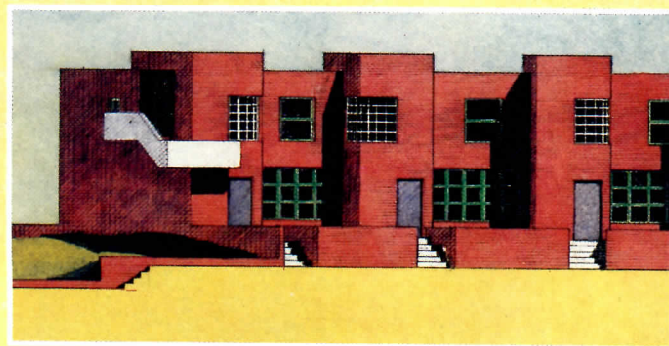
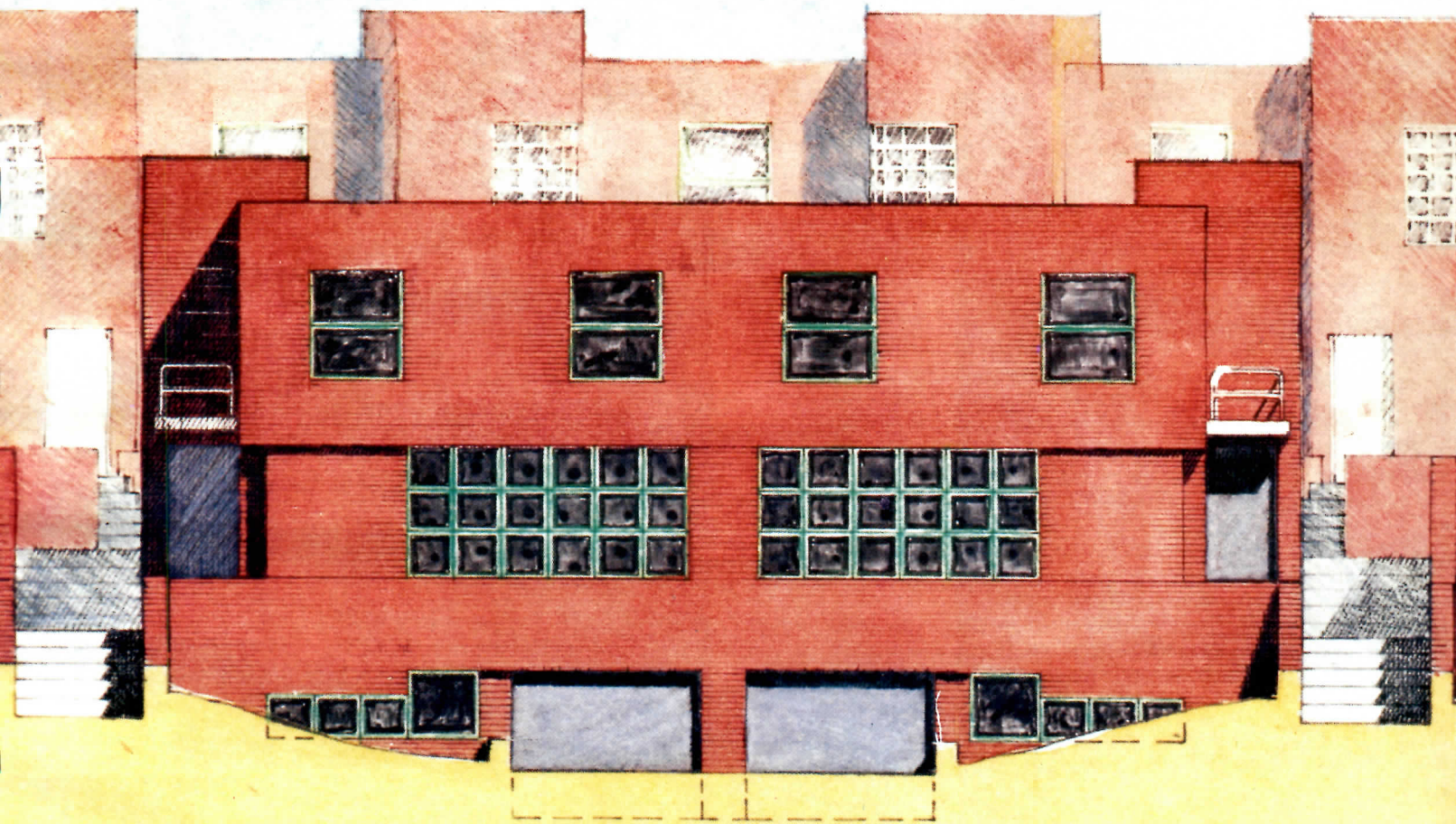

A neighborhood of offices

The design of community buildings holds a strong allure to many architecture firms. Such commissions are envisioned as opportunities to play the role of advocate for a general public whose activities are rarely graced by lively and harmonious environments. Despite the best of intentions, too often during the final stages of design the double-edged sword of a conservative bureaucratic client and a stringent budget whittle high-minded architectural intentions down to a finished building with a regrettably "stripped" character. The Chatham County Social Services Building in North Carolina represents the efforts of one architect, Norma Burns, who was able to realize an inspired design within the standard battery of constraints presented by a low-budget public project. Her success is largely attributable to the variety she was able to create within the inherent simplicity of a humble building technology, and to a remarkably sympathetic involvement with future users in the fashioning of a lively and humane facility.

Though sparsely populated, Chatham County, geographically, is one of the largest in the state. The county's Department of Social Services exists to administer a number of programs, including food stamps and Medicare as well as public assistance in areas such as nutrition and day care. Its 33-member staff formerly operated out of makeshift offices on the outskirts of the small town of Pittsboro. In 1980 the county supervisors decided to build a new facility for the department and engaged Raleigh architect Norma Burns, of Burnstudio, for design.

In planning the building, representatives of the Social Services staff expressed a desire that the offices be homey. In response, the architect designed, within the envelope, a "neighborhood" of offices complete with pathways that intersect in small squares under light monitors. Each office has its own doorway and double-hung window addressing the path. Inside the offices, which have built-in furniture, is natural lighting backed up with incandescent lamps. Office-as-house humanizes the working environment for the staff. It also contributes toward a friendly atmosphere designed to greet county citizens who come to the building for assistance—and how appropriate, as most assistance is related to the home.

Having assessed the spatial requirements and budget, the architect chose to design a light-steel-frame building. The structural members and infill are conventional and rely by and large on manufacturers' stock items. Walls incorporate columns with square tube sections placed eight feet on center. Each column supports a bar joist that spans between the walls and the roof ridge. Both walls and roof are fully insulated and sheathed with low-maintenance materials. This otherwise generic envelope is animated with six roof monitors; glazed panels that toplight the interior have been placed adjacent to them. In addition to a south-facing clerestory window, each monitor has a fan and louver that work in conjunction with motorized dampers at the ends of the building as an energy-efficient cooling system for common spaces.

The building's over-all energy efficiency has been recognized with a 1983 Owens-Corning award in the government-built category. Locally, the project was given one of four Triangle Development Awards and a North Carolina AIA award. Conservation techniques, over-all economy, scale-giving elements based on domestic imagery, the rhythm of parts in the exterior and generous use of natural light have made this governmental building a delight to all. *Darl Rastorfer*

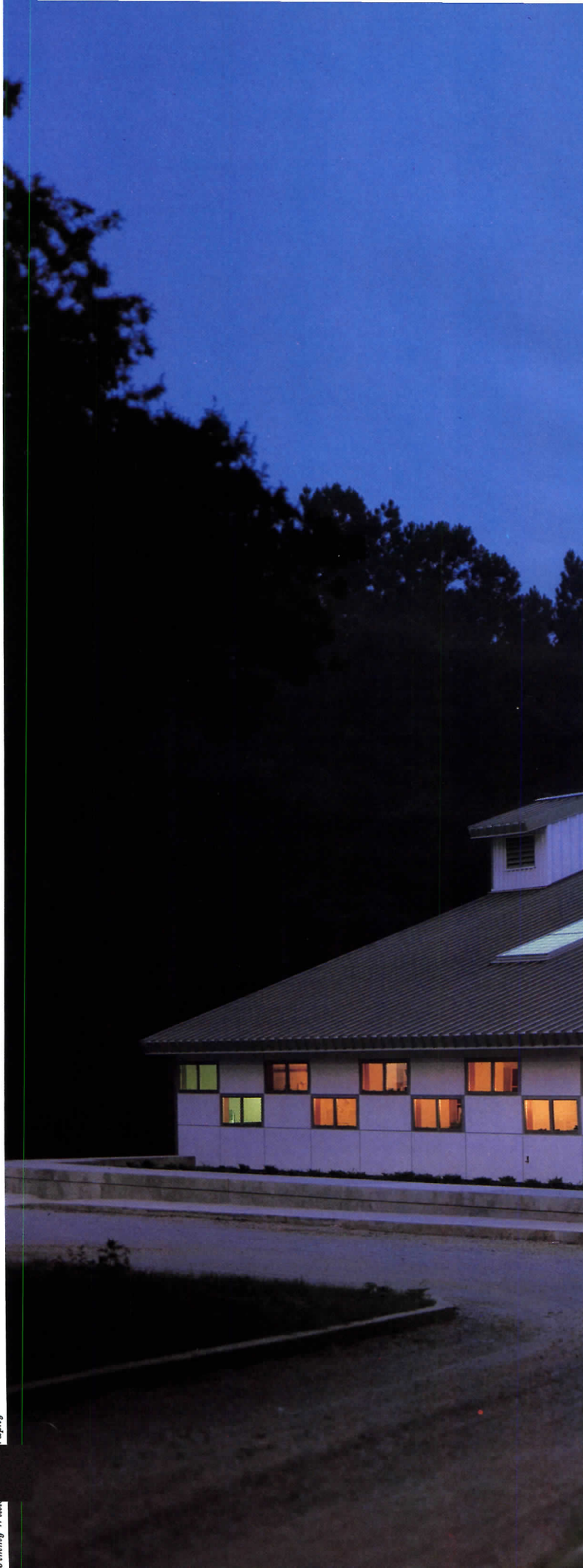



Chatham County Social Services Building
Pittsboro, North Carolina
Burnstudio Architects



Approximately 40 county residents, often mothers and their children, come to the Social Services Building each day for assistance. The architect has made every effort to ensure that their visit is pleasant. The sunny waiting area is landscaped with trees and furnished for both adults and youngsters (above and below). The corridors they pass to reach their case worker's office are animated

by the carefully painted steel structure, and reduced to a domestic scale by office clusters modeled after one-story row houses (opposite and overleaf). The walls are composed of steel studs insulated with fiberglass batts and sheathed on the exterior with cementitious asbestos panels and on the interior with gypsum board, or fenestrated with double-glazed aluminum-frame awning windows. The roof, which is infilled with metal purlins and rigid insulation, has gypsum board on the interior and standing seam aluminum roofing on the exterior.

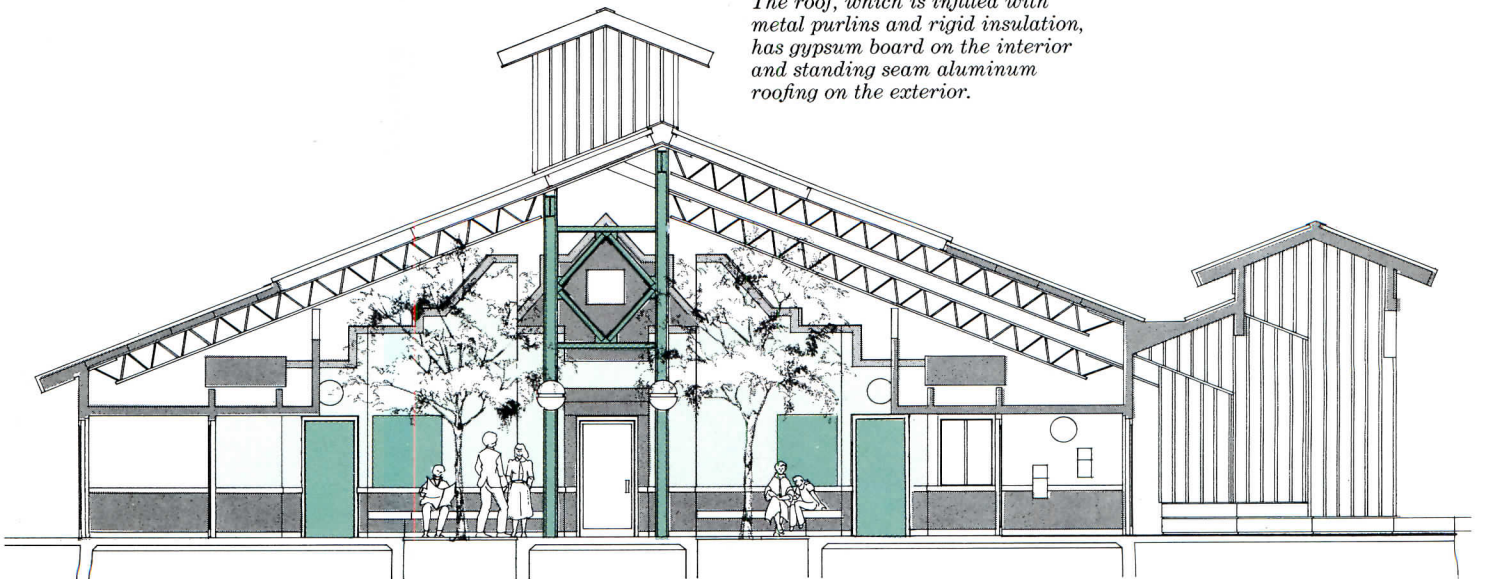



132

133

EXIT



118

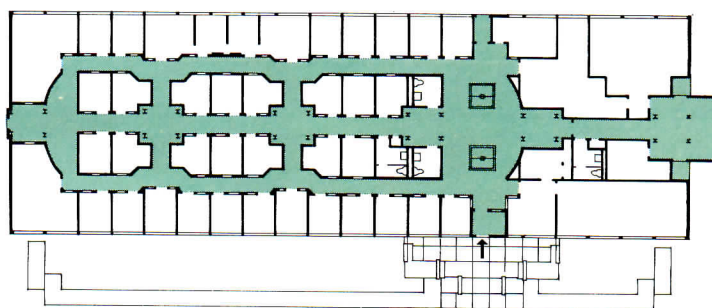
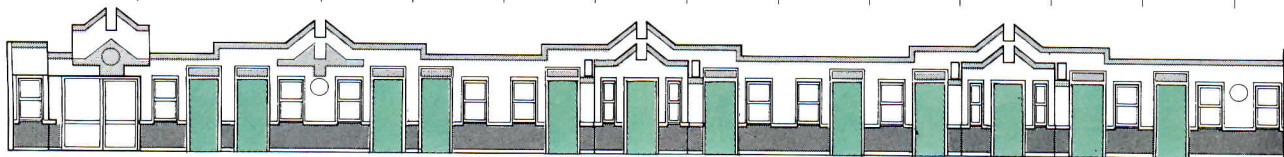
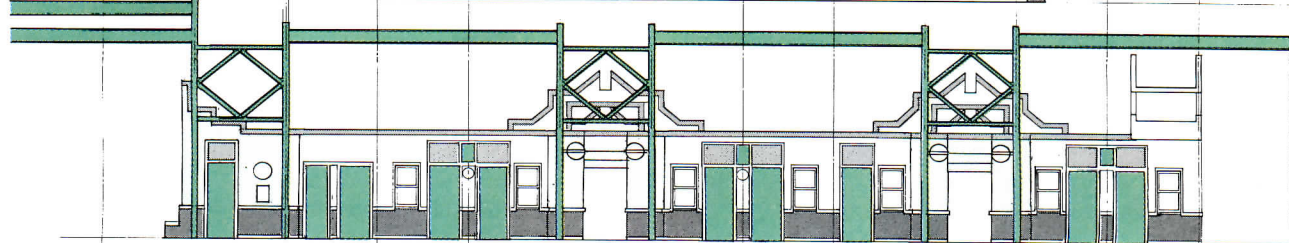
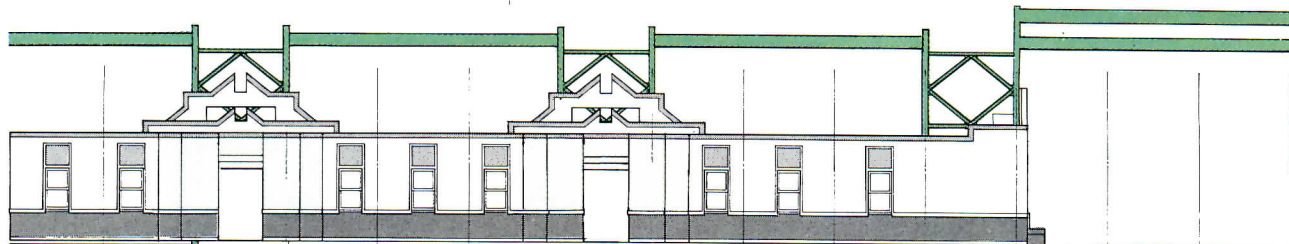
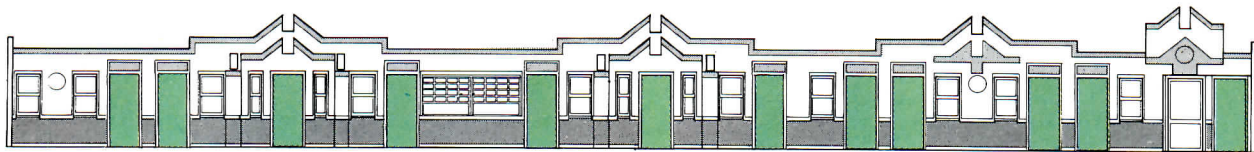

The spaces are heated and cooled according to a "thermal enclosure" concept. That is, the space within the over-all envelope is largely tempered with passive techniques, while a heat-pump mechanical system is directed toward the office enclosures within the envelope. To date, this design has yielded savings of approximately 27 per cent in heating and 21 per cent in cooling costs over a conventional system.

*Chatham County Department of Social Services
Pittsboro, North Carolina*

Architects:

Burnstudio Architects, P.A. — Norma DeCamp Burns, design principal and partner-in-charge, interior design; Robert P. Paschal Burns, Paul N. Paliyenko, Brenda Domanic Eitelman, project team

Associated architects:

Leland Associates, Construction Administration

Engineers:

Dennis W. Carter of G.W. Francis Associates (mechanical/electrical); David C. Fischetti Structural Engineers (structural)

General contractor:

Van Thomas

Flat wire: new alternative for wiring office space

Before flat wire (also called flat conductor cable or just flat cable), there were two ways to manage wire in offices. One was to distribute it in the ceiling and create branch circuits at workstation level in walls, partitions or power poles, or to use poke-throughs to the floor above. The other was to house it within the floor slab.

Speculative developers traditionally favored ceiling systems. Wires had to be there anyway for lighting; there was plenty of capacity; the system was inexpensive. And, until open-plan offices sharply reduced the amount of full-height walls—the important link in ceiling distribution—outlets could be placed pretty much where required.

In most owner-occupied buildings, floors were the preferred place to house wires. Duct and cellular floor systems, in particular, with their neat gridlike approach, could allow an outlet to be placed within about 2 ft of any point needed. Not only did these systems maintain the open plan's clean esthetics by overcoming the need for power poles, but as the raceways were already in place, modifications could be made at low cost. Of course, the built-in redundancy of the grid system, and the duct work itself, tended to make first costs high, and capacity was more limited than that of ceiling systems. Nevertheless, for many, this was (and is) the more elegant solution.

Now there is a third alternative—flat wire—shaped to fit between a slab and a carpet. Flat wire was approved only in 1980, but already it has become a popular system for many branch wiring applications because of its special capabilities:

- Flat wire can interface with virtually all distribution systems and deliver services, unobtrusively, to any point on a slab. (This is important because, as Don Chambers, a project manager with Caudill Rowlett Scott, notes, “the best place for an outlet in the open-plan office is 9 in. away from the worst place.”)
- Flat wire permits outlets to be moved, or others added later, with little disruption to occupants and at a cost that manufacturers claim is competitive with that of other systems. Flat wire requires no special form work during construction or core drilling later on.
- Since the cable is not a permanent part of the building, flat wire offers the potential for savings from investment tax credits or accelerated depreciation. Nor is it necessary to advance the capital required to install outlets or duct work long before a space is rented or occupied. Furthermore, flat wire can be used to

add new “reach” to existing wire management systems, or for retrofitting buildings that require additional capacity.

Because a length of flat wire is more expensive than the equivalent length of round wire, designers favor using conventional techniques, such as wire-in-conduit “home runs,” for distribution from panel boxes. The flat wire branch circuits and telephone and data cable runs are kept as short and direct as possible, reducing initial costs and simplifying later changes.

As with most new technologies, architects and engineers have been reluctant to try flat wire in hopes that others will discover any pitfalls. These can include costs that are higher than anticipated, incompatibility with some computer systems, less capacity than hoped for, the need to use carpet tiles, and the “telegraphing” (or show-through) of the wire through the carpet.

Despite its drawbacks, architects and engineers are, increasingly, specifying flat wire for both new and repeat applications. Installations in the United States number over 5,000. One of the largest, Sun Refining and Marketing Company, at Philadelphia's 10 Penn Center, encompasses more than 400,000 sq ft, while jobs of 100,000 sq ft or more are not uncommon. And manufacturers are refining their designs and developing new parts, both for added flexibility and to keep their systems compatible with rapidly evolving telecommunications technology. (One manufacturer's system, for example, has grown from 140 parts to over 1,000 in just four years.)

What happens, as many ask, if someone drops a heavy, sharp object on the cable and it penetrates to one of the conductors? What if the coffee pot is spilled onto the live cables or a sprinkler pops? In either case, a surge of current would flow back to the panel box through the cable or its grounded top shield and trip a circuit breaker.

A flat wire system is composed of several main components: *Transition boxes* mate conventional building wiring with the flat cables. *Tap and splice assemblies* permit the cables to branch off main runs or be added to existing ones. *Outlets* (which different manufacturers call “service fittings,” “pedestals” or “monuments”) permit the services delivered in a flat wire to be accessed and utilized wherever desired. These building blocks, a layout to determine their placement, and the carpet tiles to cover them, comprise a complete system. As an aid to a better understanding of such systems, each part is examined more closely on the next seven pages. *James B. Gardner*

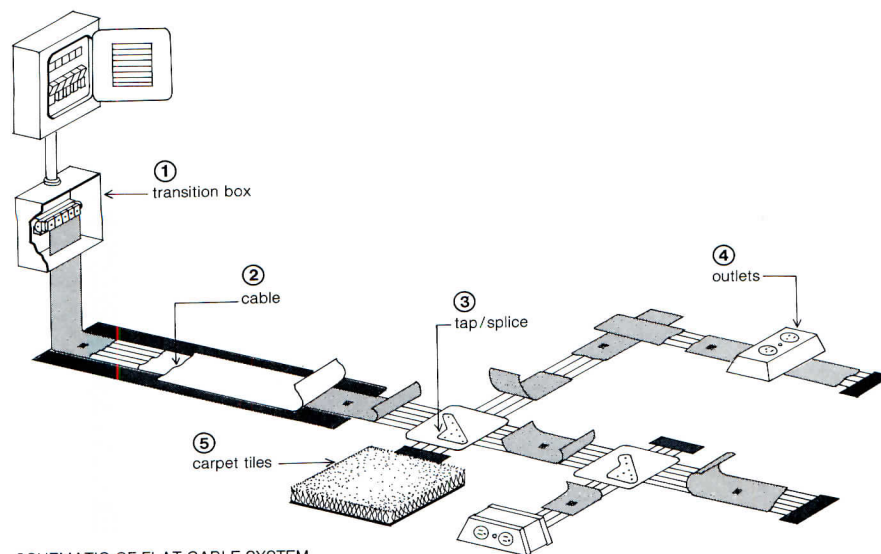

1. Transition boxes convert round wire to flat wire and can be fitted almost anywhere

"Transition boxes" are metal enclosures of different shapes in which conventional building wiring is connected to flat wire to begin a flat wire run.

Typically, transition boxes are placed in column enclosures (photo 1) and perimeter walls and fed by conventional means, such as metal-conduit "homeruns" located in suspended ceilings. Other designs include boxes that mount in poke-through fittings (photo 2), surface-mounted raceways (photo 3) and floor ducts (photo 4). These devices illustrate how flat wire can be combined with conventional systems to create useful hybrids, often adding flexibility and "reach" to the conventional system.

An even newer transition box (figure 5) mounts virtually anywhere in a floor slab to distribute power, telephone and data services from one place: metal conduit carries conventional wiring in, flat wire comes out—very near workstations to be served. This flush fitting can help keep runs short, first costs low, and, more important, permits circuits to be easily added or reconfigured.

The perimeter raceway transition box (photo 3) permitted a San Francisco architectural firm, MBT Associates, to avoid full-height partitions and power poles when it converted an old factory to its new headquarters. Thick masonry walls and concrete slabs made the surface-mounted perimeter raceways the logical choice for distribution wiring. Flat wire was used to deliver services the rest of the way to outlets and to lighting kiosks located throughout the space. If the need for additional outlets is anticipated, extra transition boxes and distribution circuits can be installed and activated as necessary.

The only "moving" part in a transition box is a terminal block (the transition box in photo 1 shows two terminal blocks), which permits the round and flat power wires to be joined quickly and securely. For telephone and data cables, a plug-together connector, or bayonet, is the equivalent of a terminal block. Codes require that transition boxes contain a minimum volume depending on the number of circuits housed. When different services are distributed from a single box, partitions keep them separate. Additional safety features of transition boxes are strain-relief devices for the cables and provisions for secure grounding.

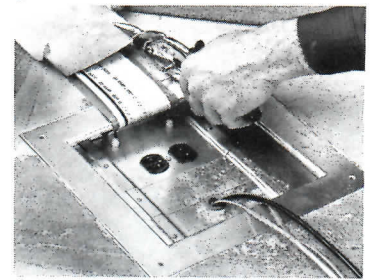
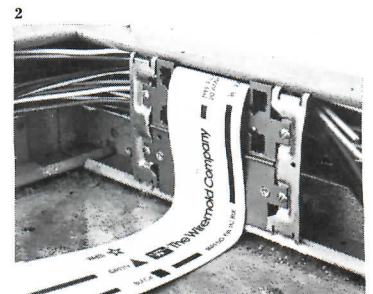
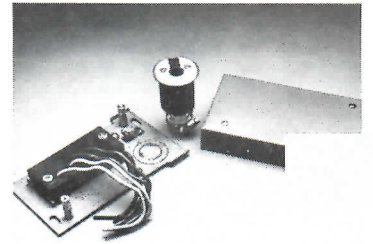
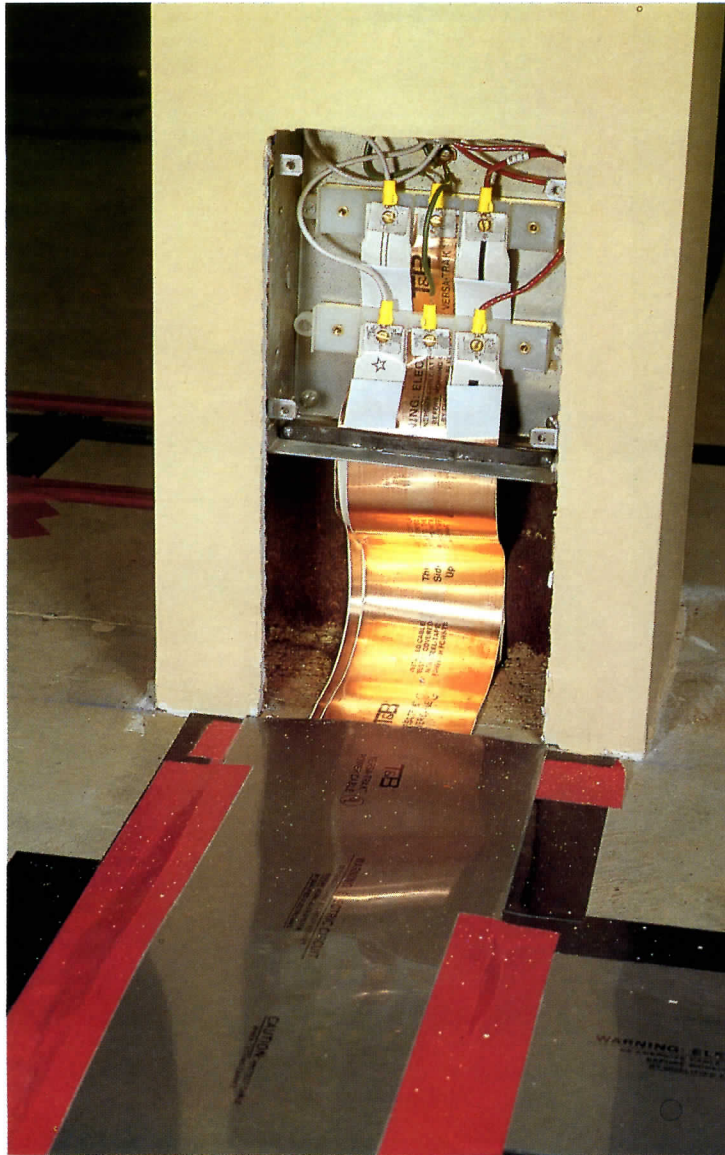
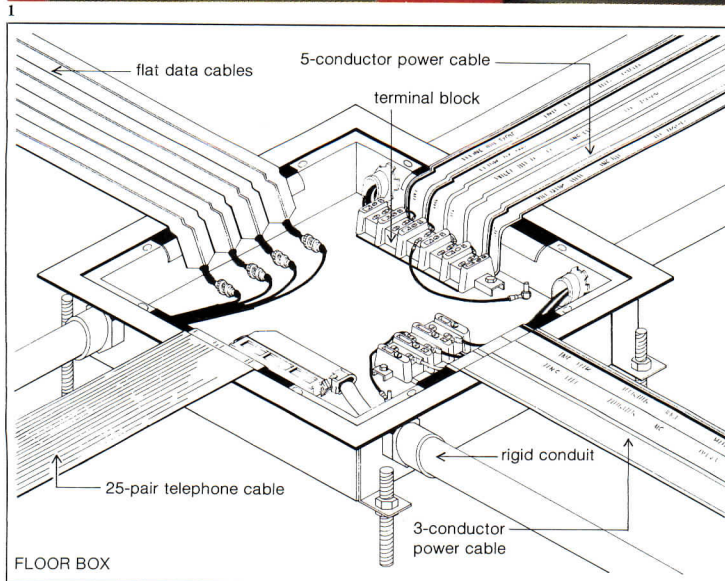

Photo 1: double-stack transition box for power, Thomas & Betts Corp.; photo 2: fire-rated poke-through fitting and floor-mounted transition box, The Wiremold Company; photo 3: surface-mounted raceway transition box, Wiremold; photo 4: access box for Multi-A-Cell underfloor duct, Midland-Ross Corp.; photo 5: flush-mount floor service box, AMP Special Industries.



5

2. Cables vary in thickness from 35 to 90 mils; a nickel is about 70 mils

As an electric circuit requires three wires—hot, neutral and ground—a basic flat cable is three parallel strips of copper insulated in a jacket of polyvinyl chloride or polyester (figure 6). By adding a fourth or fifth conductor, a single cable run can be made to contain up to three circuits. At an average thickness of about .035-in., flat wire has the same cross-sectional area as conventional 12-gauge round wire. (The National Electric Code specifies the use of 12-gauge flat wire for 20-amp circuits, and a heavier 10-gauge wire for 30-amp circuits—as with round wire.)

Flat wire is installed over a bottom shield of polyvinyl chloride or polyester and covered with a grounded steel or copper top shield. These components are shown in photo 6, as is the method for making a right-angle turn of the cable. By thickening the polyester jacket that encases the conductors, one manufacturer has eliminated the bottom shield, reducing parts and installation time. This cable is shown being folded for a turn in photo 8 (before the top shield is applied). Another manufacturer's variation on the basic design increases shock protection by ensuring ground continuity. It is a copper shield factory-welded to the cable's ground conductor every 27 in. (photo 7).

For telephone conversations to be transmitted over wire, not only must there be a flow of current, as for electricity, but the signal must be isolated to prevent "crosstalk," or the melding of signals together. Before flat wire, crosstalk was usually controlled by twisting the individual wires in a cable into pairs. For flat wire, though, twisted pairs of wires would be overly bulky, so manufacturers have developed alternate techniques, including special spacings of the wires, insulations and shielding, to achieve similar results. Typically, flat telephone cables consist of 2-, 3-, 4- or 25-pairs of 26-gauge wire encased in protective jackets of polyvinyl chloride (figure 9 and photo 10). Cables generally come in standard lengths and are factory-preterminated with modular plugs for hookup to RJ-11 jacks supplied with most telephones. For flexibility, some cables can be terminated in the field.

Other developments permit voice conversations and some forms of computer data to be transmitted simultaneously on a single cable. This combining of signals, or "multiplexing," can reduce, considerably, the amount of cable required in a system.

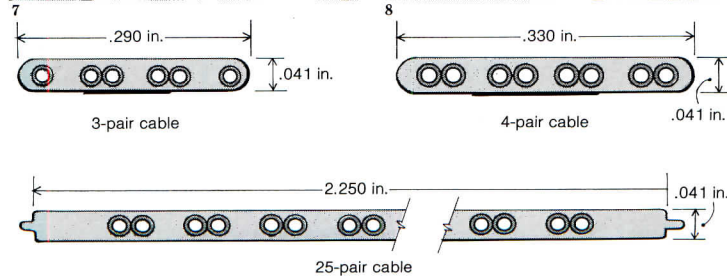
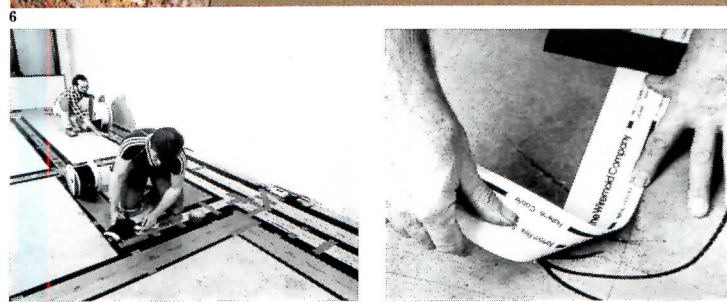
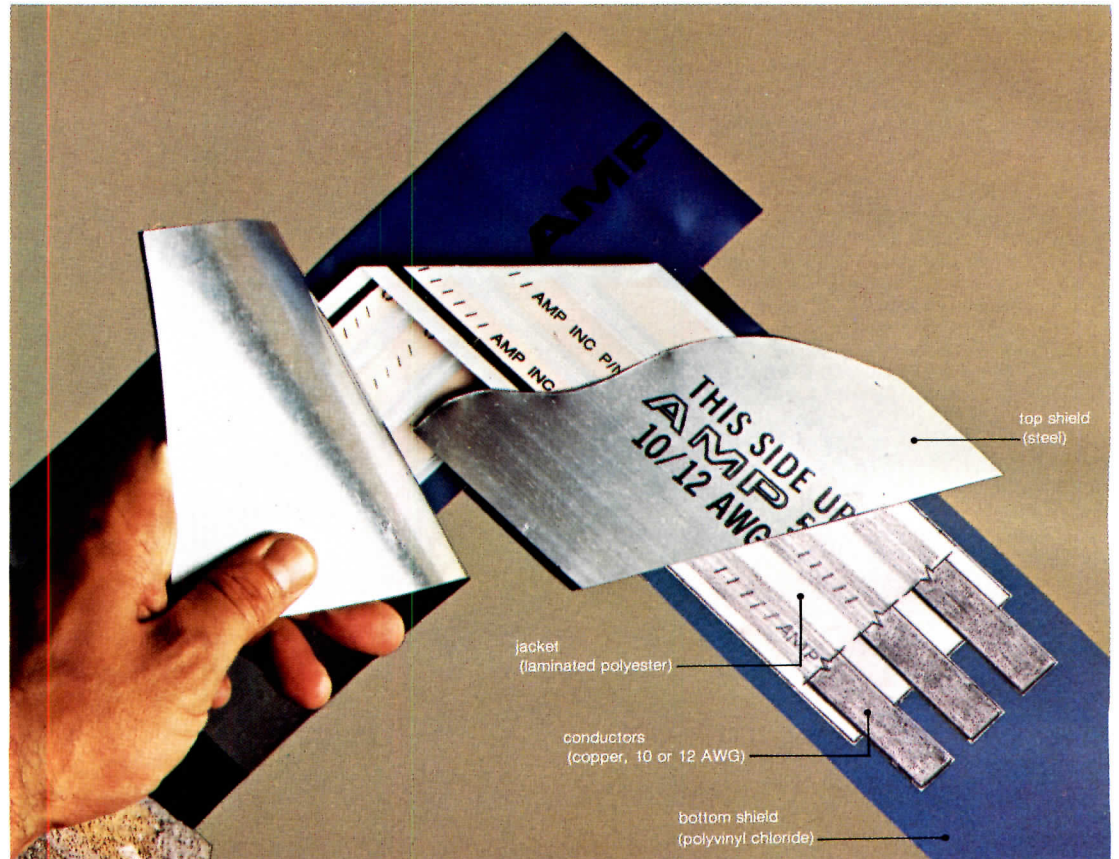

TELECOMMUNICATIONS CABLE

Photo 6: three-conductor power cable and shields, AMP; photo 7: power cables with copper ground shield, Thomas & Betts; photo 8: three-conductor power cable with integrated bottom shield, Wiremold; figure 9: telecommunications cables in three-, four-, and twenty-five-pairs, Brand Rex Co.; photo 10: twenty-five-pair telecommunications cable with CHAMP connector, AMP.

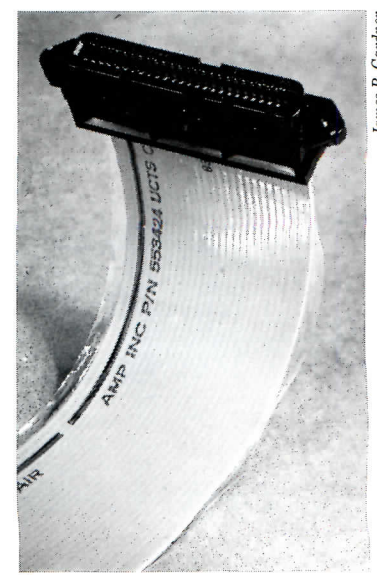

James B. Gauthier

Computer cable designs reflect the need to shield data during transmission

Data, to be transmitted from one terminal to another, is modulated at extremely high frequencies, and this can cause the signals on various wires to interfere with each other or with other equipment in the vicinity. To prevent "EMI," which is a measure of this disturbance, and for other important reasons as well, computer manufacturers have normally required heavily shielded coaxial cables. The need to develop flat wire equivalents that satisfy computer manufacturers and comply with a new FCC regulation that sets stringent and specific limits on EMI has spawned some ingenious solutions.

One is a miniaturized coaxial cable encased in a protective polyvinyl chloride jacket (photo 11 and drawing 12 at right—note how a turn is made). The jacket is tapered, or "feathered," to be less prone to telegraphing through the carpet tiles as they wear. By altering the distance slightly between the center conductor and the drain wire, manufacturers can change its impedance to make it compatible with different computer systems. Compatibility also requires that a cable be terminated with the correct connector for the type of computer equipment used. Photo 13 shows a number of coaxial cables in varying impedances and with different connector types—each for a specific computer system.

A second type of computer cable designed to meet the requirements of computer manufacturers and the FCC is called a pseudo-coaxial cable. It consists of two drain wires carefully positioned on either side of a central conductor (see the top cable in drawing 14). The relationship of the drain wires to the central conductor, again, determines impedance. A recent version of the design (bottom of drawing 14) enables the cable to more easily pass the FCC test by utilizing an aluminum polyester shield that encases the two drain wires and center conductor.

Generally, pseudo-coaxial cables can be made thinner than true coaxial designs. Yet, there are many important issues to consider when determining the ideal cable for a particular computer installation, and this must include consultation with the computer vendor. Which of the two basic designs is best often varies depending on which expert you're speaking with. Both types of cables, however, are being continually refined utilizing experience gained from actual installations.

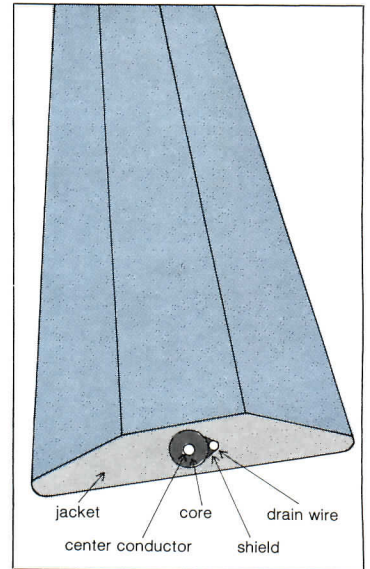
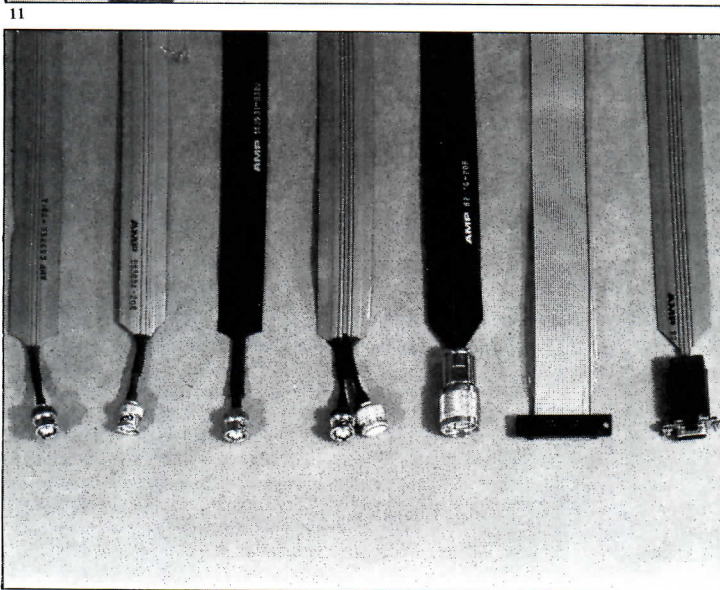
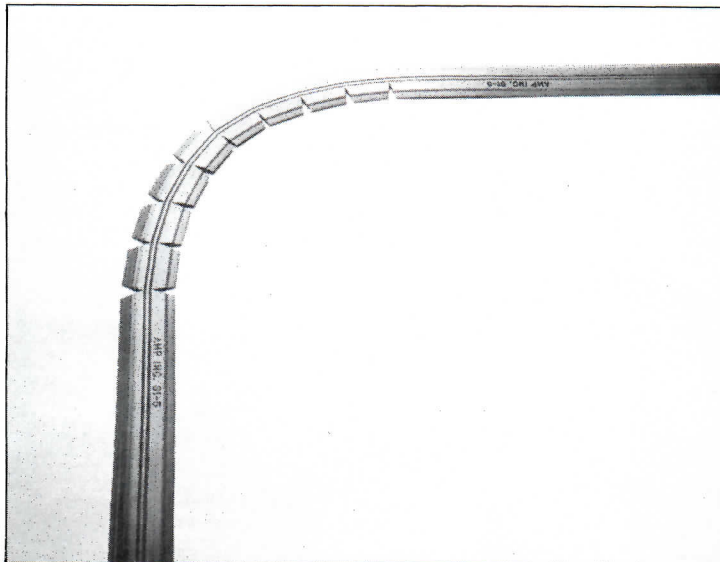
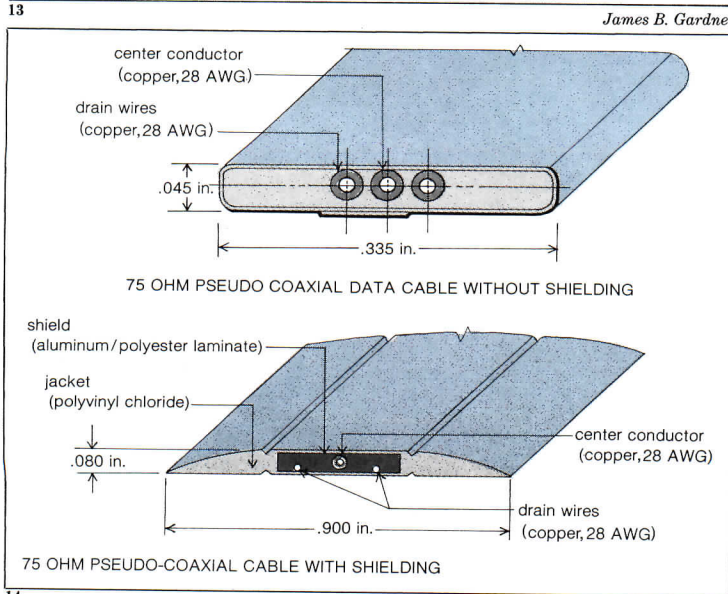

Photo 11: coaxial data cable notched to permit radial turn, AMP; figure 12: 75 Ohm coaxial data cable, Thomas & Betts; photo 13: left to right: 93 Ohm RG 62 AU-equal for IBM 3270 and Telex, 75 Ohm RG 59-equal for IBM 3670, 50 Ohm RG 58U-equal for NBI, dual 75 Ohm used with Wang, twin-axial 100 Ohm cable for IBM 34/38, RS 232 for Zentee and Hewlett Packard, Atex interface, AMP; figure 14: single-pair pseudo-coaxial cable (top) and cable modified with an aluminum/polyester composite shielding (bottom) to comply with FCC test procedure MP4-1983, which measures EMI, Burndy Corp.



James B. Gardner

3. Taps and splices allow junction-box-like connections to occur in a flat space

Taps and splices illustrate the ingenious techniques developed by flat wire product engineers for performing—unobtrusively under a carpet—what normally takes place in a three-dimensional junction box. These devices allow cables to split off a main run so that branch circuits can be created on the floor, just as they are in ceilings, partitions, ducts, or cellular raceways in more conventional wiring systems.

To make a “tap,” cables are crossed at right angles (photo 15). Then, special connectors are fastened through the appropriate intersecting conductors (see the close-up in photo 16). Color coding of the cables helps installers keep circuits straight. Templates (the clear plastic piece in photo 16) make aligning the cables easier, further assuring correctly wired circuits. When a tap is completed, it is encased in a dielectric “patch” that fully shields and insulates the otherwise exposed connectors. (An example of such a patch is the two square black pieces of mastic material in the lower right of photo 15.)

By tapping a three-conductor cable (which carries one circuit) into a five-conductor cable (which carries three circuits), up to 30 outlets (10 for each circuit) can be created—and these outlets can be placed anywhere.

While taps permit circuits to branch out and grow like trees, splices are used to connect two cables that each have the same number of conductors, to extend flat cable runs. They are often used when changes are made to the original layout. Caution and common sense must be exercised to prevent runs from becoming too long, however, for this can raise costs and overload circuits.

With power, one circuit feeds many outlets, and taps are common. Telephone and computer signals, on the other hand, travel discreetly, usually in separate wires, and there is little need to have wires tap into one another. Instead, the challenge is to manage many separate wires and permit them to be routed anywhere necessary while taking as few paths as possible.

The wiring for a telephone system (photo 17) illustrates this: a 25-pair cable, which could be routed, for instance, from a telephone closet or a call director, connects to an adaptor that yields six individual four-pair runs. These may be connected directly to individual phone sets, or, through further subdivisions, routed to additional sets as well.

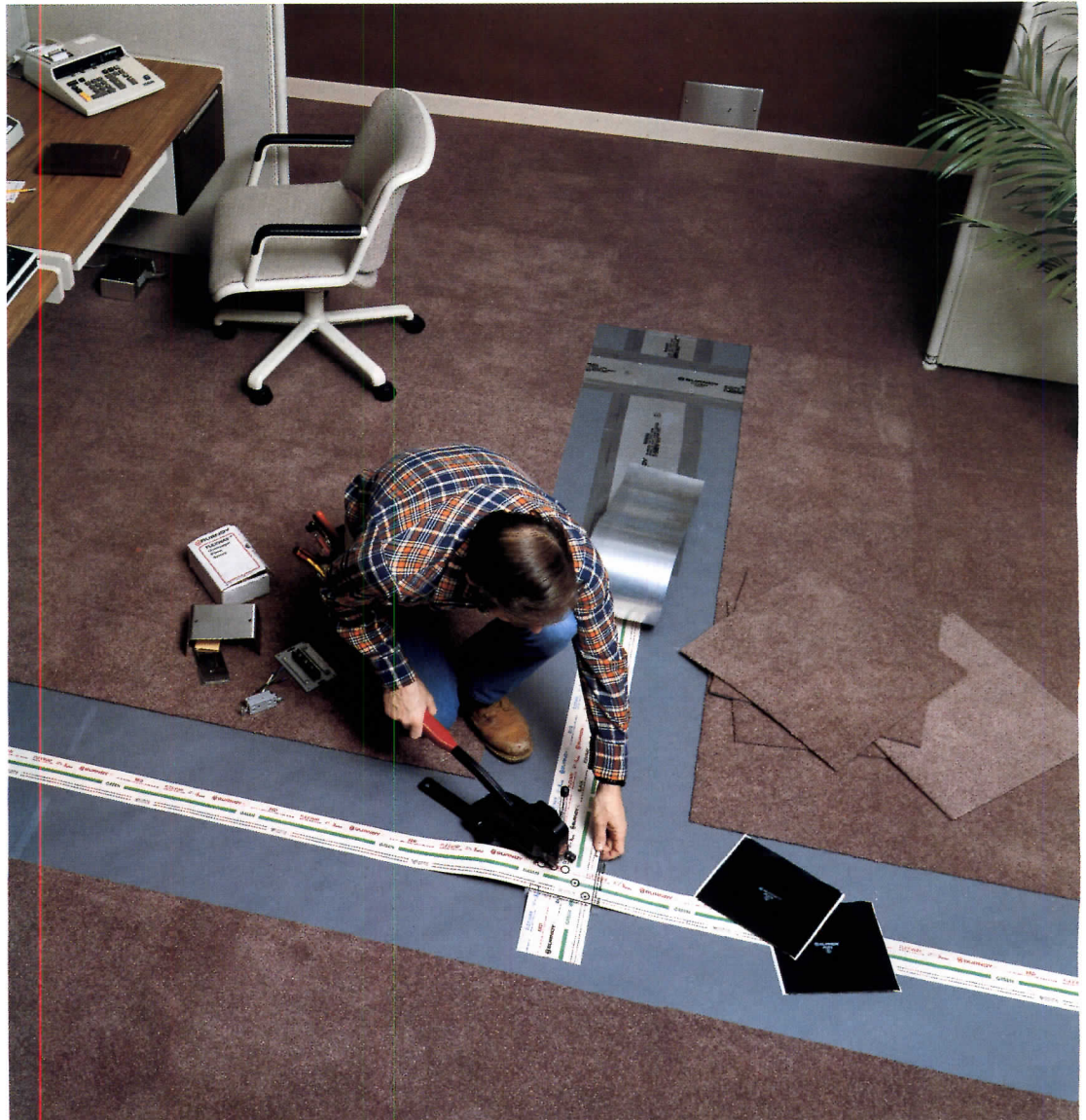

15

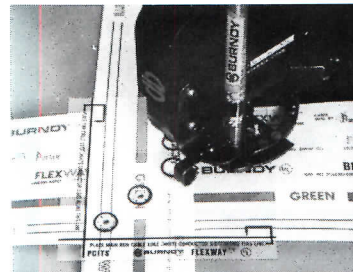

16

Photo 15: “tap” of three-conductor cable into five-conductor cable utilizing one-tool, one-connector system, Burndy; photo 16: close-up of same, Burndy; photo 17: system using modular plugs for linking a variety of telecommunications equipment, Brand-Rex.

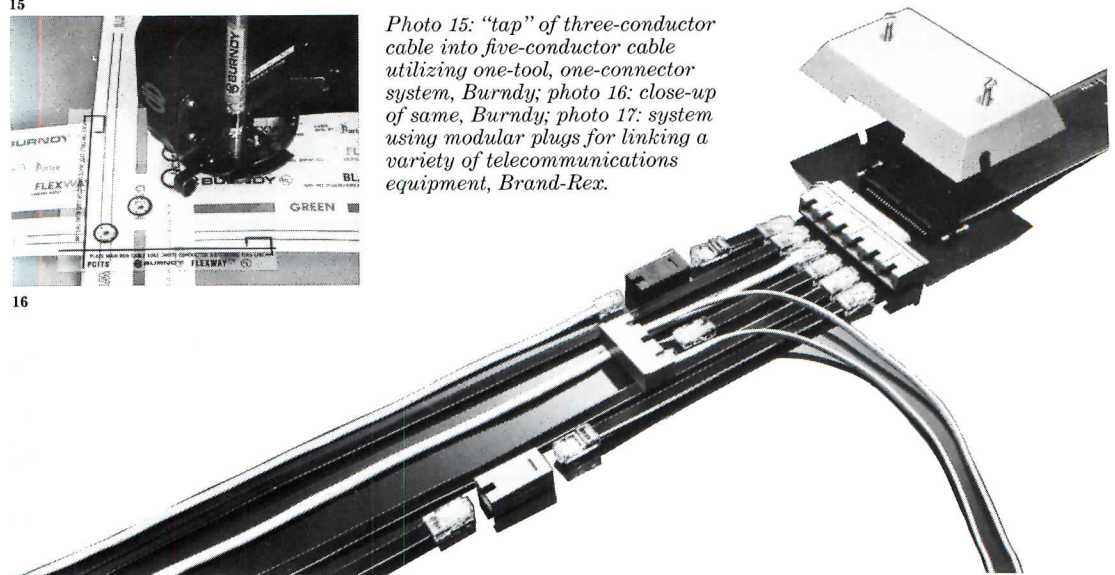

17

4. Outlets can be placed almost anywhere and moved easily, or others added

Outlets for power-carrying flat cable must incorporate a method for connecting the flat conductors to conventional receptacles. And because the goal of flat cable is to provide services as unobtrusively as possible, product engineers have been challenged to develop outlets that are inconspicuous, yet strong enough to withstand being kicked or bumped. Telephone and computer cables, again, use simple modular plugs for connections, and in many cases the flat cables are connected directly to the phone set or computer terminal.

There are two basic methods of connecting a power receptacle to a flat cable. In the first, a transition connector (photo 18) pierces the flat cable's insulating jacket and contacts the conductors with special connectors. Round wire leads, (see photo) fitted to the connectors in a factory, are then attached to the receptacle just as in conventional wiring.

The second method eliminates round wires entirely by having a receptacle itself pierce the insulation of the flat cable and make direct contact with the conductors (photo 19).

In both designs, cables do not have to be terminated, but can "feed through" the outlet, reducing installation time and allowing outlets to be moved and the cable reused. The latter design permits the copper ground shield to feed through the receptacle and be reused as well. In an even newer version of this design, two direct-contact, duplex receptacles are housed side-by-side in a single pedestal housing, thus providing four outlets at once. The pedestal measures 1½-in. high.

Power, telephone and data services don't have to be distributed from a single outlet. This is demonstrated by a lone outlet for a data cable (photo 20) and a pair of outlets (photo 21)—one for power, the other for telephone and data. Nevertheless, manufacturers have worked hard to develop outlets that incorporate all three services in one fitting. Progress is illustrated (photo 22) with a design that permits up to two fittings to be added to the basic outlet (photo 23) for additional capacity. Some outlets, for telephone and data signals, can be mounted directly on desks or partitions. Flat cable's usefulness doesn't have to end at an outlet; it can be connected directly to electrified furniture panels, lighting kiosks and other open-office components as well.

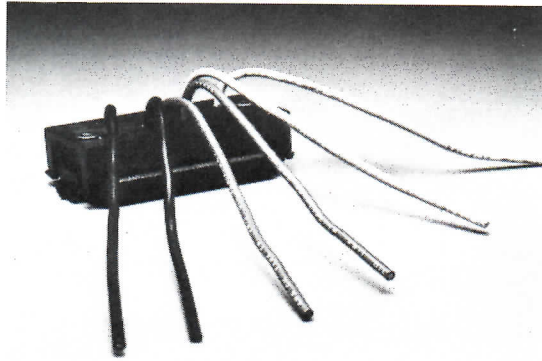

18

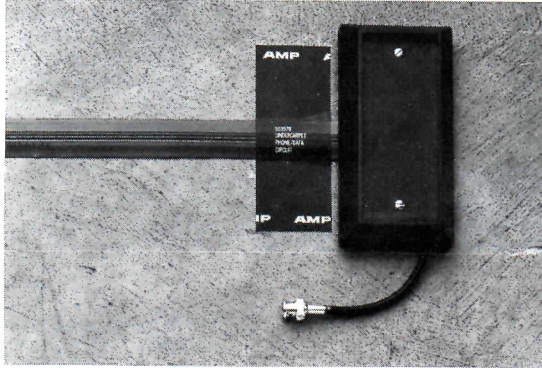

20



22

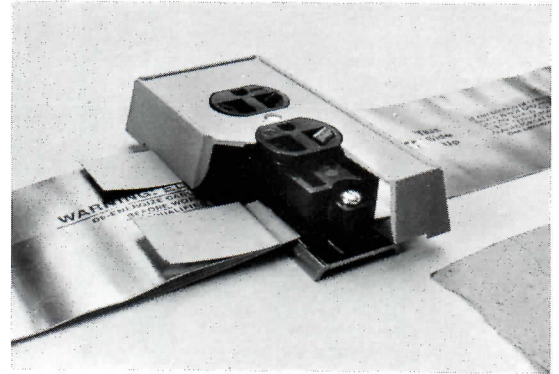

19

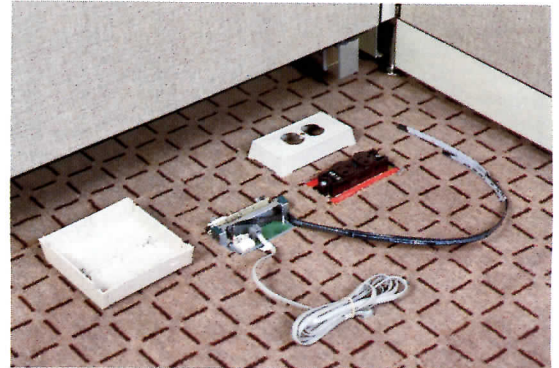

21

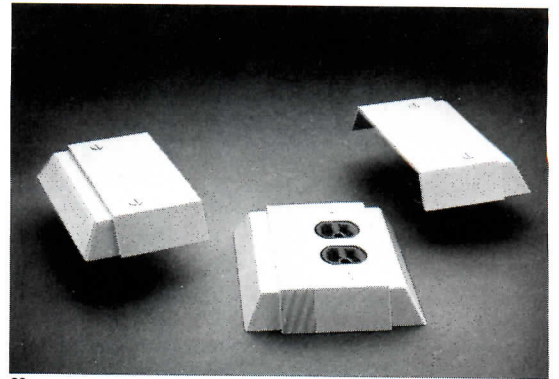

23

Photo 18: transition connector for three-conductor cable, Wiremold; photo 19: direct-contact duplex receptacle for three-conductor cable, Thomas & Betts; photo 20: single data outlet, AMP; photo 21: side-by-side computer and telephone, and power outlets, Thomas & Betts; photos 22 and 23: modular service fittings for distributing power, telephone and data from a single unit, Burndy.

5. Carpet tiles are mandated by codes, yet desirable for their flexibility and looks

Article 328-10 of the 1984 National Electric Code requires that flat wire systems be covered with carpet tiles for inspectability. Yet, as Ray Anderson, chairman of the board of Interface Flooring Systems, points out, "covering a flat cable system with broadloom or other rolled goods would be a little like epoxying modular workstation panels together."

Carpet tiles have advantages, aside from flexibility, that can often justify their premium cost and make them desirable whether flat wire is used or not. Among them, tiles can be rotated and cleaned for more even wear, easily replaced if damaged, installed to create interesting patterns and delineations of space, and, by inserting specially printed tiles, used for signing and directions.

Today's carpet tiles are much improved over those of a few years ago, and the ones most used in flat-wire installations employ a technique developed in Germany for fusing yarns to a reinforced thermoplastic backing called fusion bonding. This permits yarns—even four-ply yarns that produce thick, rich textures—to be packed more densely and evenly in both the machine and cross-machine direction (see top of figure 25). The result is a longer wearing carpet tile with a more monolithic appearance.

The heavy-duty construction of the backing (figure 25) keeps the tile from stretching, shrinking, curling or doming—drawbacks of some conventional tufted designs. Also, this stiff backing bridges smoothly over the cable to reduce telegraphing. A lighter backing will, more likely, conform to the cable and eventually show through. Interface Flooring Systems touts the backing's advantages further, claiming that its dimensional stability permits tiles to stay in place without glue. A second manufacturer, Milliken & Company, suggests fastening tiles with a releasable adhesive placed on 2-ft centers.

The debate over gluing or not gluing stems from two contentions. One is that adhesives may chemically attack the cable's protective jacket, or attract grit, which, if held in contact with the cable, could abrade the jacket and eventually wear through. The other is that adhesives, even releasable types, might set up and permanently bond tiles to the floor, destroying the flexibility that is one of carpet tile's most appealing advantages.



Hedrich-Blessing

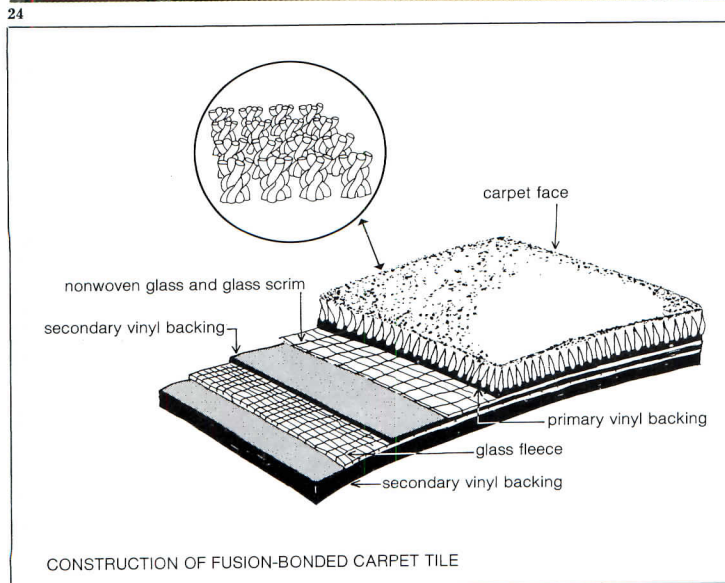

Photo 24: model P5300 Series fusion-bonded carpet tiles over flat telephone cable, installed at AMP Inc., Schaumburg, Illinois, Interface Flooring Systems; figure 25: construction of fusion-bonded carpet tile, Interface; photo 26: fusion-bonded carpet tiles, Milliken & Company.



26

Layouts require thought and care, to reflect flat cable's strengths and weaknesses

Since flat wire is new, few architects or engineers have had much experience designing an installation or writing a specification that will avoid pitfalls. But, says Chris Rotman, product manager of AMP, one of the leading flat wire manufacturers, laying out flat wire requires no more aptitude or skill than conventional lighting or conduit layouts.

To aid the uninitiated, most manufacturers offer training and self-help programs. Some, such as AMP, furnish completed layouts produced on a computer-aided drafting system from information the architect or engineer supplies (see drawing 28 at right). Yet whether the system is laid out by computer or by a person, experience suggests it is important to:

1. Keep runs short. Large, clear-span spaces tend to force long runs of flat cable from the perimeter in order to service outlets placed in the center, which means that flat cable becomes a distribution system—something it was not intended to be—rather than a delivery system. Long cable runs result in high initial costs and cable densities, difficulties with carpet tiles that won't lie flat, and, with many computer cables, signal attenuation or loss. In addition, later changes to layouts become disruptive, time-consuming, and costly.

The solution is to install additional transition boxes in interior columns—even dummy columns if necessary—or to use floor-mounted transition boxes placed in the middle of the area to be serviced. These can, if necessary, also be installed in existing floor slabs.

2. Floors that aren't clean, flat, free from cracks, rough finishes or burrs, can hamper initial installation, slow future changes or cause failures that are hard to trace.

3. Insofar as carpet tiles are concerned (see facing page), one tile manufacturer, Interface, recommends keeping folds and taps, the bulkiest part of a flat cable system, to a minimum and planning them so that they do not occur where the edges of two carpet tiles butt.

If possible, flat cable runs should not be placed in main corridors, but, rather, along less traveled paths or at least off to the side of main corridors.

In the long run, the quality of any flat cable system will depend on the care and thought that go into the original layout design, and the care with which it is executed.

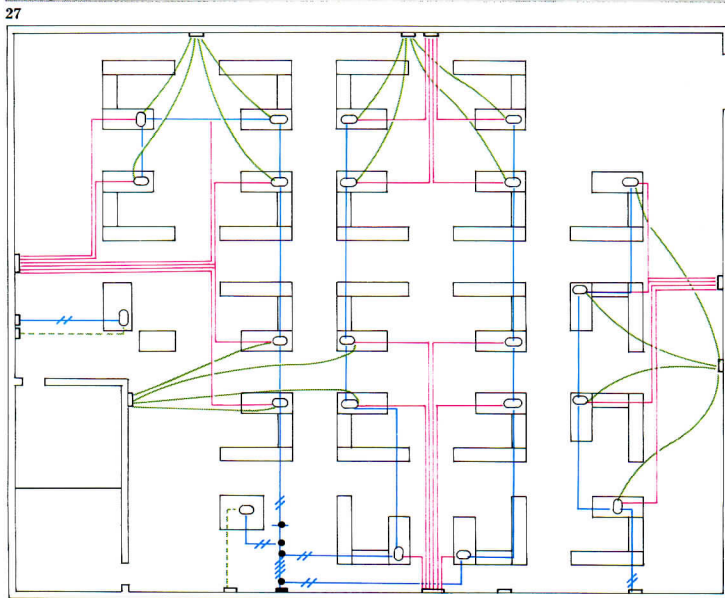
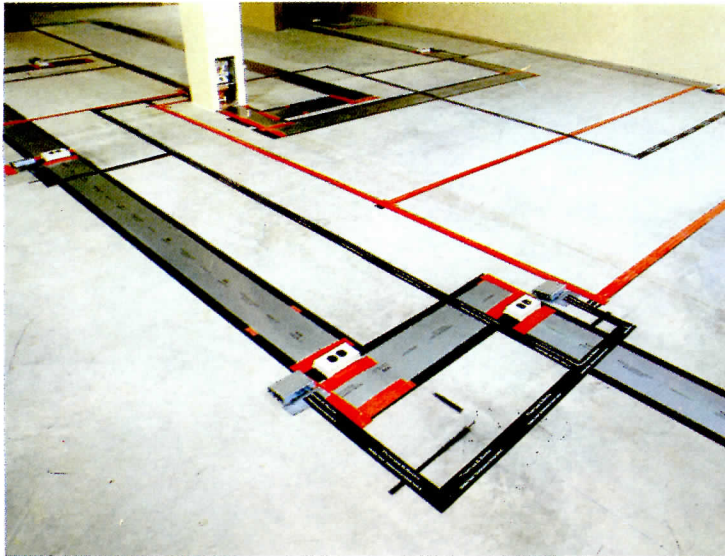

- transition box (5-conductor)
- transition box (3-conductor)
- combination outlet (power, telephone and data)
- coaxial data cable
- - - RS232 cable
- tap
- splice
- 5-conductor cable
- 3-conductor cable
- telephone cable

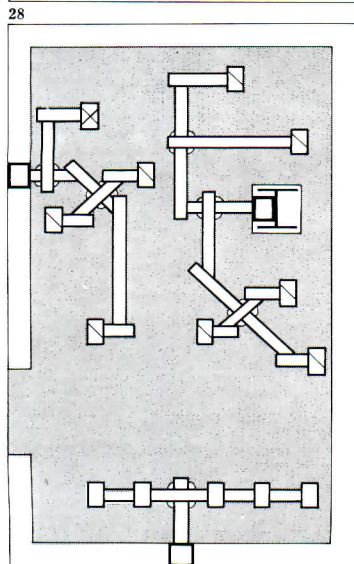

Photo 27: typical flat wire installation for power, telephone and data, Thomas & Betts; figure 28: computer-generated layout for power, telephone and data produced on a system comprising a Prime CPU, a Hewlett Packard 7580A pen plotter and modified Medusa software, AMP; figure 29: layout illustrating the principle of through-receptacle wiring and variable-angle cable bends, Thomas & Betts.

New products

For more information, circle
item numbers on Reader Service
Card, pages 223-224

Contract contemporary

Facets is a collection of executive office furniture that was recently introduced at the Condes market in Dallas to commemorate Helikon's 25th anniversary. Conceived by vice president of design Bob Becker as "a play of multiple materials within a simple form," the new line consists of angle-cornered desks, credenzas, breakfronts, and bookcases available with a variety of wood panels, trim, and metal reveals. Sample options include dark or natural mahogany with fiddleback borders and wenge wood inlay, black mahogany with fiddleback borders, medium walnut with anigrewood borders and wenge inlay, and polished brass, bronze, or stainless steel trim. Helikon Furniture Co., Taftville, Conn.
Circle 300 on reader service card



American classic

The Andover Chair is a new seating unit that represents a product development program by Stendig based on collaborations with well-known American architects. Designed by Davis Allen of Skidmore, Owings & Merrill in a sleek transitional mode reminiscent of the 18th-century Windsor Chair, the unit is conceived for either contract or residential interiors and measures 22-in. wide by 22½-in. deep by 36-in. high. The solid beech chair is available in natural, palisander, red or black glossy, and black matte finishes, and may be ordered in a wide range of fabrics and leathers from Stendig's textile collection. Stendig International, Inc., New York City.
Circle 301 on reader service card

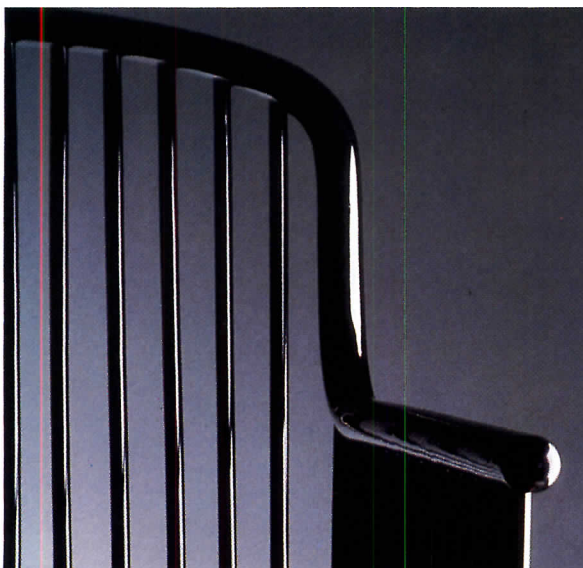

Executive transitional

Avatar is a new collection of desks, credenzas, tables, breakfronts, and bookcases that feature radius corners and ⅛-in.-wide reveals of chrome, brass, or black lacquer. All components are available in mahogany or walnut in a variety of finishes with matching or contrasting tops of crotch mahogany, English brown oak, or leather. The line includes both low- and medium-profile executive and secretarial desks that are offered with a range of wire management systems, pedestal configurations, and returns. Hardwood House, Rochester, N.Y.
Circle 302 on reader service card
More products on page 155



CAD for the small architect—
at less than \$10,000
 CADPLAN is a new design software package that sells for \$1,200. Designed to run on an IBM Personal Computer or PC-compatible computer (which sells for about \$5,000), it requires a graphic input device (mouse or digitizer) and output device (a number of alternatives are available from several hardware manufacturers)—all of which puts a computer-aided design system on an architect's desk for less than \$10,000. CADPLAN, as the system is called, was written by Personal CAD Systems Inc., a major software supplier. It is suited for producing most of the two-dimensional drawings that a small office would generate, including elevations, floor plans, furniture or equipment layouts, and the like. While CADPLAN is an entry-level system, it has many of the editing commands of systems operating with larger computer systems, including zoom, copy, move, rotate, delete and undo—which simplify manipulation of the drawing and enable the designer to pan around a drawing for an over-all view and zoom in and out of a particular area for checking details. CADPLAN lets users put components (such as floor plan,

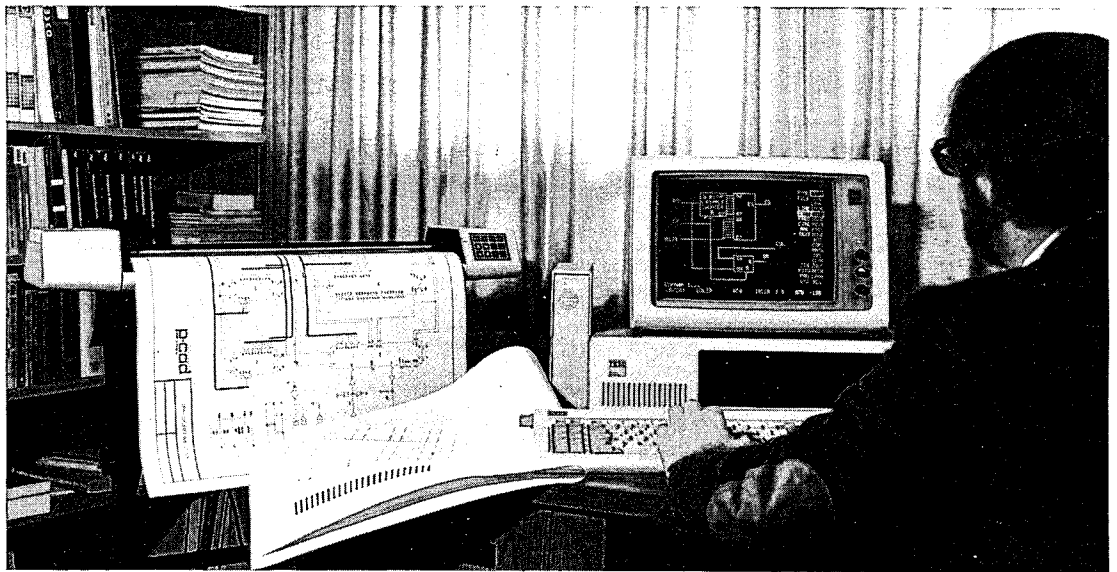

column plan, electrical distribution layout, duct layout, and lighting plan) on as many as 65 different layers, as though transparent overlays were used. Further, a symbol library of frequently used items, such as windows or desks, can be created and the symbols reused as needed. With a plotter or printer linked to the computer, a scaled drawing (or any portion of the

drawing) can be generated up to size E. CADPLAN has a database management system (an optional \$350 extra) that keeps count of design elements—for example, it is possible to ask the system to total the number of chairs or doorknobs—and enables the architect (after inputting current vendor information on costs) to produce an itemized bill of materials and costs. An

automatic dimensioning option is \$250.
 For novices, a software package called CADMATE is offered to teach how to use CADPLAN. There is no manual, since all instructions are on a diskette. Price: \$125. Personal CAD Systems Inc. Los Gatos, Calif.
Circle 303 on reader service card



Mirror laminate
Reflex is a new shatterproof surfacing material made by laminating a thermoplastic core between two sheets of aluminum. The surface is electroplated with a layer of nickel and chromium, and is appropriate for applications where a glass mirror might be unsafe. Nevamar Corp., Odenton, Md.
Circle 304 on reader service card

Door hardware
Flexigrip is a line of door and furniture hardware manufactured in Great Britain and recently introduced to the American market. The collection consists of lever door handles, push/pull door handles, fixed pull handles, forearm pulls, swivel pulls, and door and furniture knobs. The unusual feature of the hardware is its semi-matte black polyurethane foam skin molded over an aluminum core—a combination of materials that was developed in the automobile industry for armrests and head restraints. Although design consultant Bob Cantor conceived the soft-to-the-touch products primarily for installation in hospitals, nursing homes, and other facilities used by the handicapped, the hardware is also appropriate for a variety of commercial, institutional, and industrial applications. The handles and knobs are available with satin-finish anodized aluminum accessories. The Ironmonger, Inc., Chicago.
Circle 305 on reader service card
More products on page 175



A FUTURA ROOF

The performance roofing system that's proven long lasting, tough, light weight, ultra energy efficient and very economical.

The Futura performance roof is totally sprayed in place and consists of Futura's super tough elastomeric urethane membrane coatings and energy efficient urethane foam insulation. This, combined

with Futura's added "System of Service," is your assurance of the best in design, modern light materials and craftsmanship. The unique "System of Service" encompasses a five part program consisting

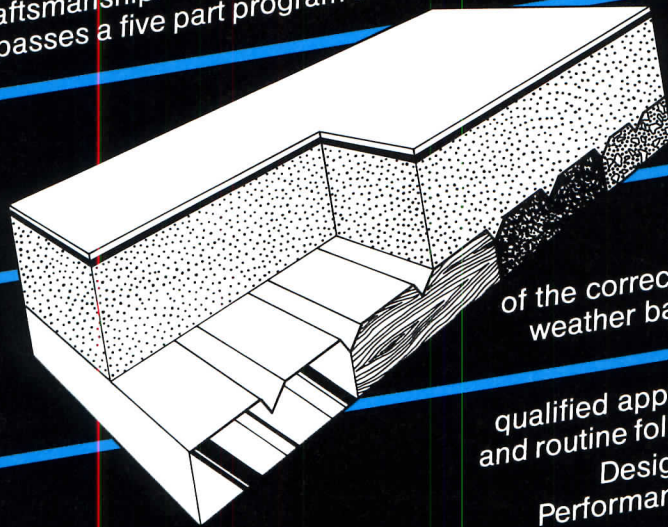
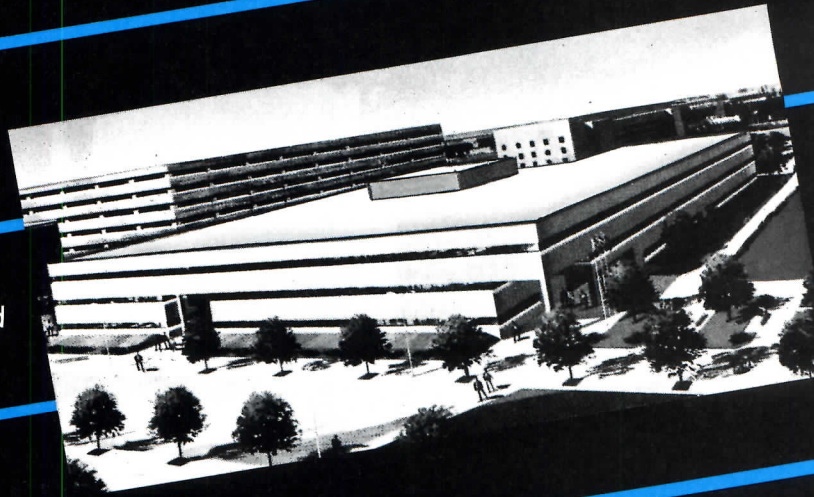

of the correct specifications, a Futura elastomeric weather barrier membrane system, a monitored

qualified applicator program, installation inspection and routine follow-ups, and a performance guarantee. Design with assurance—design with a Futura Performance Roof. Keep the COOL and WARM in,

and the WATER and WEATHER out! Write or telephone us for information and literature on this system, or Futura's architectural elastomeric waterproofing membrane and coating systems

FUTURA COATINGS, INC.
9200 Latty Avenue • Hazelwood, MO 63042
Phone (314) 521-4100 • TWX 910-760-1622



Circle 70 on inquiry card

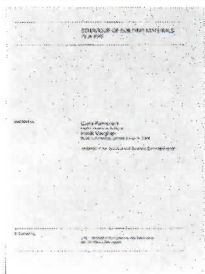

Fire test results

A 34-page booklet describes the results of flame tests on wood, fabrics, plastics, paper and ceramic tile. Results cover combustibility, development and length of flames, and toxicity of each material. Diagrams are used to illustrate results. The Italian Tile Center, New York City.
Circle 400 on reader service card



Laboratory refrigerators

Blood bank and liquid chromatography refrigerators, blood plasma storage freezers, and morgue equipment are among the products covered in a 12-page brochure. Models are shown in photos, and size and capacity charts are included. Jewett Refrigerator Co., Inc., Buffalo, N.Y.
Circle 406 on reader service card

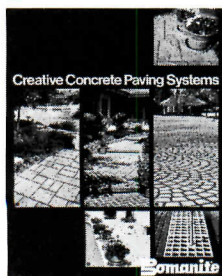

Concrete paving systems

Photos show installations of four different paving systems in a 4-page color brochure. Colored and imprinted concrete paving and flooring systems as well as a concrete pool deck, which serves as a solar collector, and a waffled concrete slab are all described. Bomanite Corp., Palo Alto, Calif.
Circle 401 on reader service card

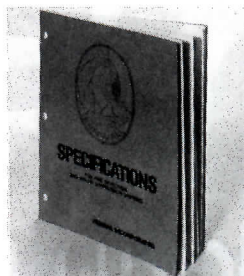

Fire protection

An 18-page specification guide for fire detection and extinguishing systems covers eight storage and distribution options for any size area as well as multiple areas. Several control units also are included. All components meet UL and/or FM requirements. Fenwal, Inc., Ashland, Mass.
Circle 407 on reader service card

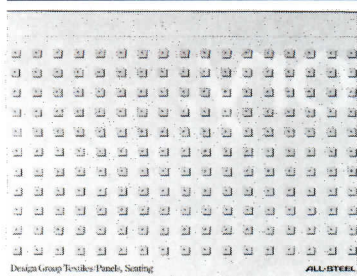

Fabrics

Sixty colorful fabric swatches, ranging from silk blends and billiard cloth for panels to tweeds and herringbones for seating, are featured in a foldout brochure. They are available in widths up to 66 in. for panel fabrics and up to 54 in. for seating fabrics. All-Steel, Inc., Aurora, Ill.
Circle 402 on reader service card

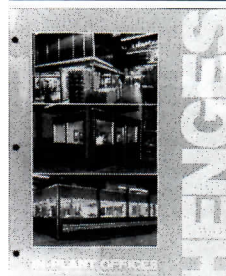

Prefabricated offices

A 12-page color brochure covers prefabricated in-plant offices in sizes from 8- by 8-ft to 20- by 20-ft. Photos and drawings illustrate such features as tempered glass windows, prehung doors and concealed raceways. Specifications are included. Henges Manufacturing, Inc., Maryland Heights, Mo.
Circle 408 on reader service card

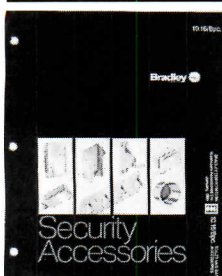

Security washroom accessories

Stainless steel accessories for detention facility washrooms are featured in a 4-page brochure. They include mirrors, toilet tissue holders, soap dishes, clothes hooks, and utility shelves. Tamper-proof mounting hardware is also covered. Bradley Corp., Mt. Laurel, N.J.
Circle 403 on reader service card



Furniture

Furniture for computers, other office machines and libraries is featured in a 32-page color brochure. Also covered is an adjustable wall/ceiling mount for a TV. Each product is accompanied by specifications. Bretford Manufacturing, Inc., Schiller Park, Ill.
Circle 409 on reader service card

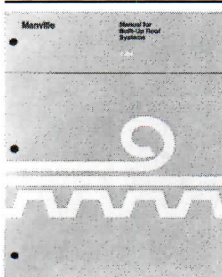

Built-up roofing

A 56-page guide is available to help architects, engineers, and roofing contractors select built-up roofs. The guide offers a wide range of specifications for roofing systems that address climatic demands as well as substrate, slope and service life requirements. Manville Service Center, Denver.
Circle 404 on reader service card

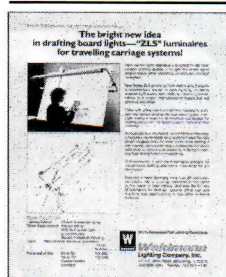

Drafting lamps

A product data sheet features a luminaire designed to light a drafting board evenly and another lamp designed to light work surfaces without creating a glare on CAD terminal screens. Drawings with dimensions and specifications are included. Waldmann Lighting Co., Inc., Wheeling, Ill.
Circle 410 on reader service card

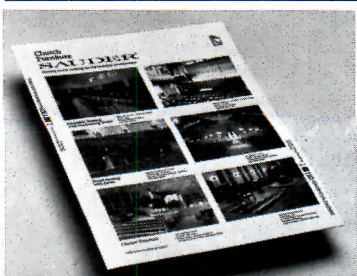

Church furniture

An 8-page color booklet on church furniture shows five chair systems with dimensions and construction specifications. A section on pews includes all-wood to fully upholstered styles. Photos show a variety of pew ends as well as chancel furniture. Sauder Manufacturing Co., Archbold, Ohio.
Circle 405 on reader service card



Door hardware

Door pulls, bars, bumpers and corner guards are shown in an 8-page color brochure. All come in aluminum, brass, stainless steel or bronze. Available vinyl acrylics and laminates for kickplates are illustrated. Hiawatha, Inc., Minneapolis.
Circle 411 on reader service card
More literature on page 159



T.M.

Sloan presents the no-hands lavatory.

Take the operation of the lavatory *out* of people's hands, and it becomes a cleaner, more cost-efficient fixture.

That's the big idea from Sloan—the no-hands lavatory, with no handles to turn on, no handles to forget to turn off. The Sloan Optima™ electronic sensor is in charge.

When the user approaches the lavatory, he breaks an invisible beam of light generated by the Optima sensor. This opens a solenoid valve and water flows from the faucet automatically. When the user steps away, the water shuts off.

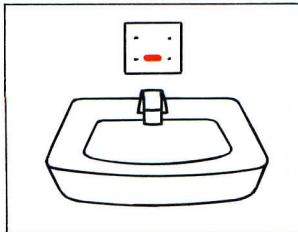

With no-hands lavatories, bacterial contamination is reduced. There's less clean-

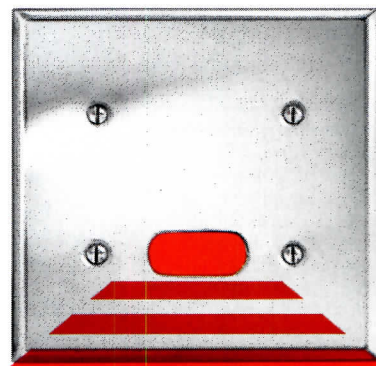

ing, with no handles to get dirty and less chance of sink-top mess. There's less water waste, because water flows only when needed and the user can't forget to turn the water off. Using less water, of course, also means saving on energy used to pump and heat

that water. There's also less maintenance—reliability is built in. And there's far less chance of misuse or abuse.

No-hands operation easily adapts to the rest of the restroom—toilets *and* urinals. And even to soap dispensers, hand dryers, and more. With Optima systems everywhere, you get optimum savings and optimum sanitation.

Ask your Sloan representative about Optima systems today. Or write us.



SLOAN VALVE COMPANY
10500 Seymour Avenue, Franklin Park, IL 60131

Circle 71 on inquiry card



Ceramic tiles

Several different styles of ceramic tiles are shown in detail and installation photos in a 32-page color brochure. Dimensions are listed for tiles and trim shapes. Setting and grouting products are also described and specifications are included. Summitville Tiles, Inc., Summitville, Ohio.

Circle 412 on reader service card

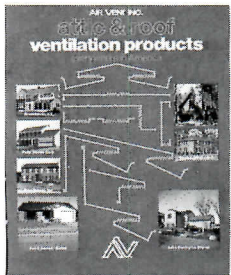

Ventilation

Diagrams illustrate vents for a variety of applications, including eaves, ridges and soffits, in a 12-page brochure. Dimensions are given for each vent type. An insulation baffle is also shown and described. Specifications are included. Air Vent, Inc., Peoria Heights, Ill.

Circle 413 on reader service card



Flooring accessories

Vinyl and rubber cove bases, stair treads, matting, carpet stair nosings and molded corner bumper guards are covered in a 12-page color brochure. Available colors and patterns are shown in photos and diagrams. Dimensions are listed. Johnson Rubber Co., Middlefield, Ohio.

Circle 414 on reader service card

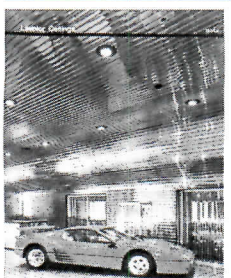

Ceilings

Linear ceilings for interior and exterior use are shown in dimensioned diagrams and photos of typical installations in a 16-page color brochure. Sizes, finishes, technical data and specifications for 14 different systems are included. Levolor Lorentzen, Inc., Lyndhurst, N.J.

Circle 415 on reader service card

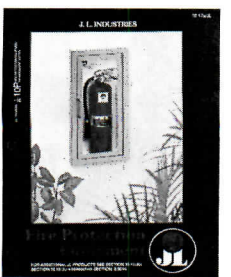

Fire protection

A 12-page brochure features fire extinguishers, extinguisher cabinets and accessories. Specifications include cabinet dimensions and extinguisher sizes, types, capacities and ratings. Accessories include brackets and signage. J.L. Industries, Inc., Minneapolis.

Circle 416 on reader service card

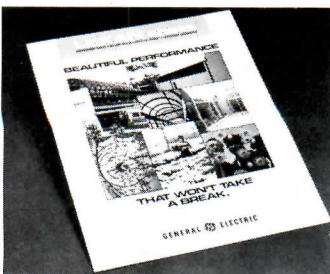

Glazing

An 18-page color catalog on Lexan glazing materials includes double-walled profiled sheet, Solar Grade sheet, Margard abrasion-resistant sheet and Lexgard bullet-resistant laminates. Technical data and dimensions are included. General Electric Co., Pittsfield, Mass.

Circle 417 on reader service card

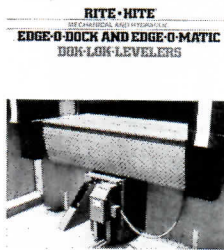

Dock levelers

Two dock levelers, the Edge-O-Dock and Edge-O-Matic, are covered in a 4-page color brochure. Photos and diagrams show the features of each as well as a mechanism that prevents vehicles from leaving loading docks unexpectedly.

Specifications are included. Rite-Hite Corp., Milwaukee.

Circle 418 on reader service card

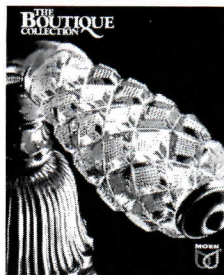

Bathroom faucets

Faucets and matching tub/shower ensembles as well as towel bars, rings and soap dishes are featured in a 12-page color brochure. Two-handle, wide-spread and wing-handle faucets in polished satin or antique brass finishes are highlighted. Moen Div., Standayne, Inc., Elyria, Ohio.

Circle 419 on reader service card

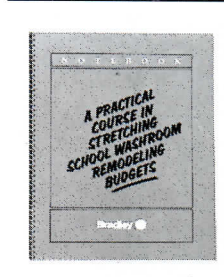

Washroom equipment

A 12-page brochure features washroom products designed to be vandal-proof and barrier-free. Products illustrated and described include a washfountain, mirrors, towel dispensers, timed shower valves and a range of barrier-free designs. Bradley Corp., Menomonee Falls, Wis.

Circle 420 on reader service card

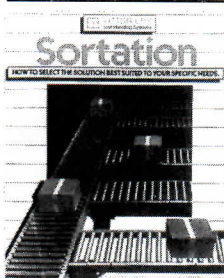

Conveyor systems

Manual, medium-speed and high-speed automatic conveyor systems are illustrated and described in a 6-page brochure. Photos show a variety of pre-engineered conveyor configurations incorporating different angle and diverter combinations. Litton UHS, Florence, Ky.

Circle 421 on reader service card



Roofing insulation board

The physical properties of expandable polystyrene resin (EPR) and its applications as roofing insulation are described and shown in a 4-page color brochure. Flat, tapered and laminated EPR boards and edge details are described. Georgia-Pacific, Atlanta.

Circle 422 on reader service card

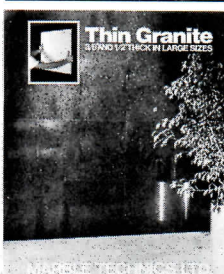

Granite panels

Granite panels of various dimensions and thicknesses of 3/8- and 1/2-in. are described and illustrated in an 8-page color brochure. Information on the fabrication and installation of panels is included. Marble Technics, Ltd., New York City.

Circle 423 on reader service card
More literature on page 181



principal showrooms: new york, chicago, dallas, los angeles, miami, washington, D.C.

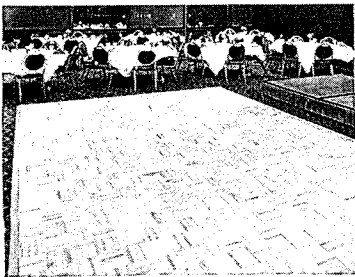

Portable dance floor

A teak or oak parquet portable dance floor consists of 3-ft-square sections coupled with a metal-to-metal tongue-and-groove design. A metal strip surrounds each square and floor edges are protected with aluminum trim, beveled to prevent tripping. Sico, Inc., Minneapolis.
Circle 306 on reader service card

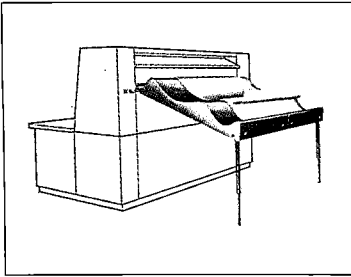

Print stacker

The *Super Stacker* is a rear delivery system for whiteprint machines. It is designed to stack different sizes of prints together and to require a minimum of handling after a set is run. The stacker is claimed to be easy to install on a number of diazo printers. Ozalid Corp., Binghamton, N.Y.
Circle 309 on reader service card

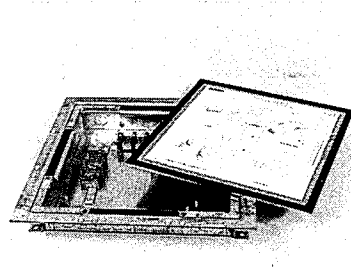

Floor service box

A floor service box for distributing this manufacturer's undercarpet cabling system is installed prior to pouring concrete. The flush-mounted box handles power, telephone and data cables. It can be located anywhere in the floor. AMP, Inc., Southeastern, Pa.
Circle 310 on reader service card

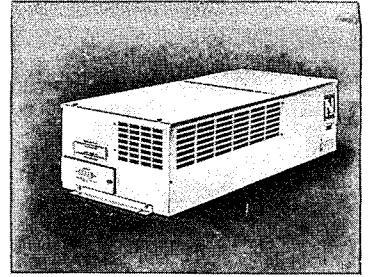

Heat exchanger

The UL-listed *Model AE-200* air-to-air heat exchanger is designed to alleviate indoor air pollution. It has a CFM rating sufficient to ventilate an area of up to 2200 sq ft. The unit is also said to offer up to 75 per cent heat recuperation. NuTone Housing Group, Scovill, Inc., Cincinnati.
Circle 311 on reader service card
More products on page 177

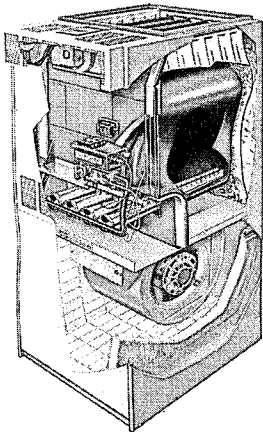

Furnace

The *Conservator III* furnace is claimed to burn at an efficiency of 80 per cent without condensate problems. It is available in three input capacities—50,000, 75,000 and 100,000 Btuh—for natural gas or LPG use. Each model accommodates add-on evaporator coils, electronic air cleaners, and power humidifiers. Lennox Industries, Inc., Dallas.
Circle 307 on reader service card

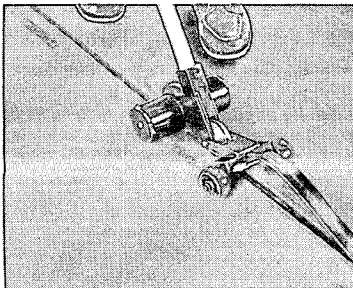

Roof membrane anchoring

FasTrac is an anchoring system that does not penetrate its EPDM single-ply rubber membrane. A galvanized metal retainer track is screwed directly to the roof substrate. EPDM sheets are then laid over this track and a polymer insert strip is channeled into it to tuck and lock the sheets to the substrate. Firestone Industrial Products, Indianapolis.
Circle 308 on reader service card

A Modular Paging System You can Depend on!

Count on Dukane to produce a modular paging system designed to meet the rigid specifications of the telephone industry. Dukane's new Select-A-Page Voice Paging System contains all the amplification, control and termination facilities required to connect your telephone system to paging speakers. Featuring plug-in circuit cards which snap into pre-wired slots, the system has the flexibility to grow as your customer's needs grow.

The Select-A-Page extends the

communication capability of your telephone system, providing the most complete communications package available. Paging, background music distribution, monitoring and public address are all included in one unit.

For an increase in revenues, feature a product with quality assurance, the Select-A-Page Voice Paging System—from Dukane.

Attach your business card to this ad and send for free information.

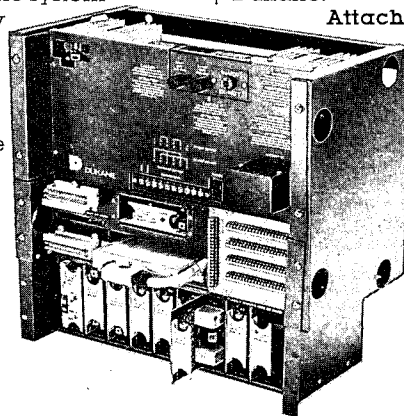

DUKANE CORPORATION/COMMUNICATIONS SYSTEM DIVISION
 2900 DUKANE DRIVE, ST. CHARLES, ILLINOIS 60174, 312-584-2300

Circle 74 on inquiry card

Wiremold.® Period.

Some people continue to specify "Wiremold or equal". Which is too bad, when they know there often is no alternative equal to the Wiremold design. And when they remember how Wiremold products always performed so dependably for them on prior jobs.

Other people - when naming raceways, overhead systems, power poles and undercarpet wiring - simply spec "as manufactured by The Wiremold Company", period. They're the ones who take no chances about getting the best. Period.

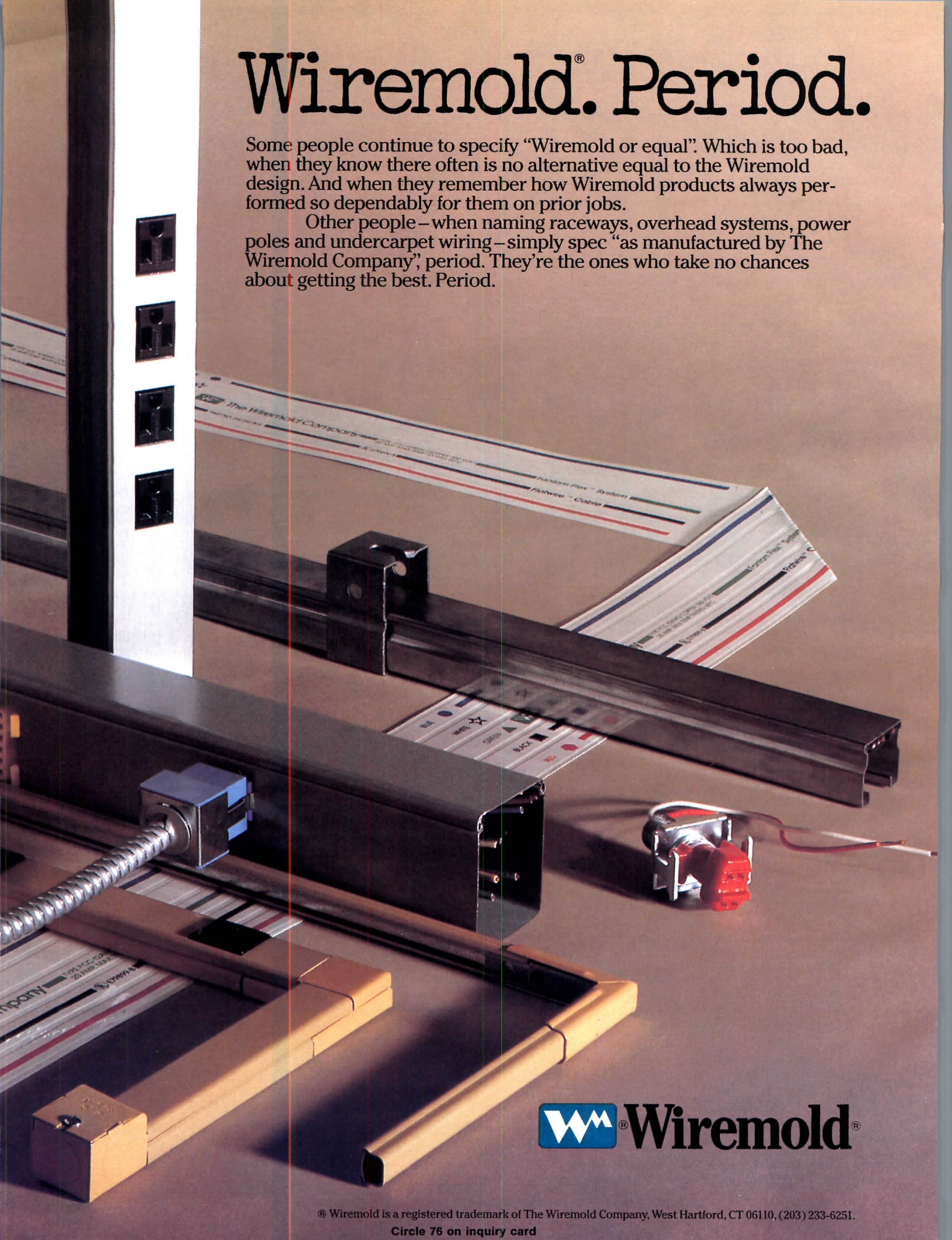

 **Wiremold**®

© Wiremold is a registered trademark of The Wiremold Company, West Hartford, CT 06110, (203) 233-6251.

Circle 76 on inquiry card



Office chair

The anti-static *Compu-Chair* features upholstery with conductive filaments and a frame with a built-in conductive circuit. Metal casters or glides are claimed to dissipate static electricity. The chair comes with or without arms. Its seat height, back height and angle are adjustable. United Technical Products, Inc., Westwood, Mass.
Circle 312 on reader service card

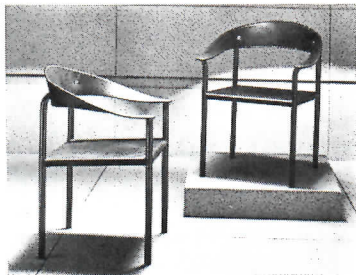

Chair

The *Mobius* chair measures 23 in. wide by 18 in. deep by 32 in. high. It features a metal frame finished in either baked enamel (in a choice of four colors) or chrome. The sling seat and back come in leather in any one of the four enamel colors or natural. Cy Mann Designs, Ltd., New York City.
Circle 315 on reader service card

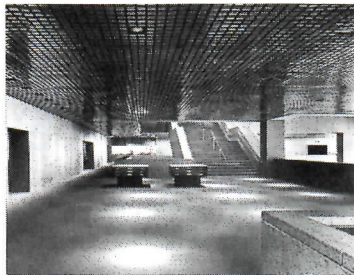

Linear metal ceiling

The *Gothic* aluminum or steel acoustical ceiling system consists of 3-in. metal squares with painted, 1-in.-deep reveals. The ceiling is laid over 2-in.-thick, 1.5 pcf fiberglass in a self-extinguishing polyethylene bag and carries an NRC rating of .90. Erdle Perforating Co., Inc., Rochester, N.Y.
Circle 316 on reader service card

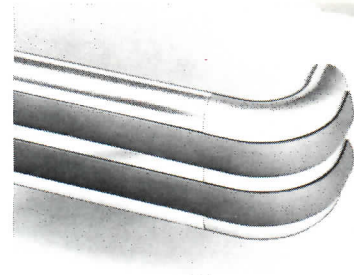

Handrails

The *531-BS* handrail and wallguard system features rail sections made of anodized aluminum in satin-finished silver, gold or bronze and PVC buffer strips in umber/maroon. Tepromark International, Woodmere, N.Y.
Circle 317 on reader service card
More products on page 179



Skylight

The *Horizonvault* skylight consists of an extruded aluminum sill, caps, and extruded neoprene gaskets. It may be single-, double-, or triple-glazed and may feature manually or electrically operated sections. The skylight is designed to reduce fabrication and installation time. O'Keefe's Inc., San Francisco.
Circle 313 on reader service card

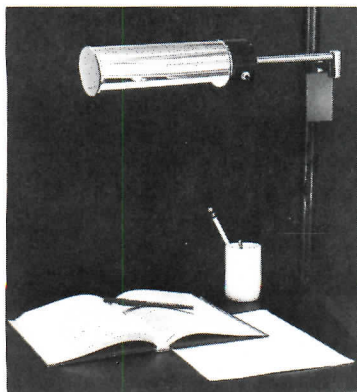

Fluorescent task lamp

Designed for open office systems, a fluorescent task lamp on a swinging arm mounts directly onto the upright channel of a wall panel. The lamp features an arm extension of 25½ in. and a reflector that rotates 90 deg with an on/off switch on the ballast housing. The lamp comes in solid brass with a polished chrome finish. Nessen Lamps, Inc., Bronx, N.Y.
Circle 314 on reader service card

Sentinall by kenall
 Lighting unequalled in style, efficiency and durability.

The Sentinall series by Kenall has been designed for the eighties and beyond. With its stylish, compact design, Sentinall can be used in any indoor or outdoor application where aesthetics and durability are important. Sentinall is available with several different trim effects and refractor combinations.

The Sentinall series combines contemporary looks and features. Included are a one piece injection-molded polycarbonate lens for unbreakability, a choice of several efficient low-wattage fluorescent lamps that provide energy savings, gasketing and an anodized aluminum backplate for weatherproof protection. A single tamperproof POSIGRIP® screw or a standard slot screw is provided.

The Sentinall is here, providing all of the features you expect from a Kenall lighting fixture!

©1983 Kenall Manufacturing Company Patents Pending
 4140 W. Victoria Street • Chicago, IL 60646 (312) 463-8500 • Telex: 721481

Circle 77 on inquiry card

Marblstal[®]

"The Permanent Solution"



Marblstal, the answer to all of your partition needs. Shower stalls, toilet stalls, urinal, and dressing room partitions, all become beautifully permanent with Marblstal.

The shower stall pictured here is Georgia Marble[®] Mezzotint. It's dramatic in character with the famous crystalline matrix that gives Georgia Marble its waterproof surface and time defying durability.

Easy to maintain, beautiful, and permanent. . . Marblstal.



 **georgia marble**
company
structural division
Nelson, Georgia 30151 (404) 735-2591
a jim walter company

Circle 78 on inquiry card



Light pen

A light pen for the *Apple II+* and *IIE* interacts directly with the monitor while a built-in pushbutton controls drawing operations. The pen is connected to a module, which is interfaced through the computer's game port. Included with the system are *Quick-Draw*, a graphics software package, and *Amper-Pen*, a software package that incorporates light pen operation into *Applesoft BASIC* programs. Magellan Computer, Inc., Indianapolis.
 Circle 318 on reader service card

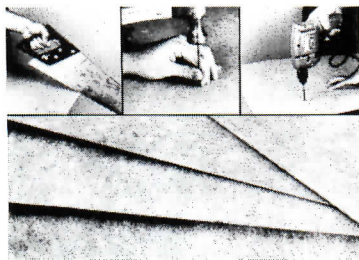

Building board

Asbestos-free *Ultra-Board* is composed of cement bonded with cellulose and other organic fibers. It is available in thicknesses of 3/16 in., 1/4 in., 3/8 in. and 1/2 in. Typical applications include wall and ceiling lining, insulation panels, partitions, and soffits. BRIT-AM Venture Marketing, Inc., Middlesex, N.J.
 Circle 321 on reader service card

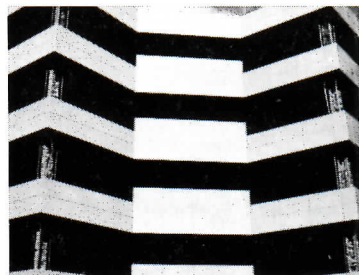

Coating system

Visulure is a 3-coat fluorocarbon finishing system for exterior components of aluminum and galvanized steel. It produces a metallic appearance without using a metal pigment and therefore does not require a protective fourth coat. The system is available in eight colors. SCM Corp., Cleveland.
 Circle 322 on reader service card



Plaster

A veneer plaster system is developed by applying *Imperial* basecoat plaster over gypsum base board. A 1/16-in. finish coat of gauging plaster is blended with lime and troweled over the base coat for an abuse-resistant surface at a cost comparable to drywall. United States Gypsum Co., Chicago.
 Circle 323 on reader service card

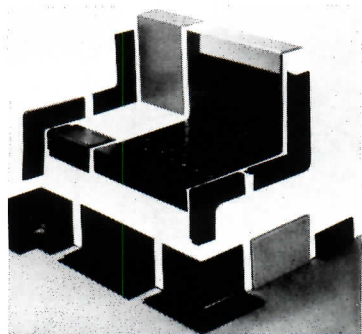

Flooring trim

Rubber flooring trim and stair coverings are color coordinated to complement other flooring products from this manufacturer. Coverings include *Noramant Steptread*, available as a one-piece nosing-tread-riser or as a nosing-tread combination. All products come in a variety of dimensions. Accessories such as straight bases and coved bases are supplied in five meter sections. Nora Flooring, Madison, Ind.
 Circle 319 on reader service card

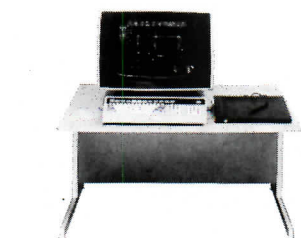

CAD/CAM

The *CADMAX-M* entry-level 2-dimensional CAD/CAM system displays commands on a screen menu for easy selection by an operator. The system is based on a single mini-computer. It features separate display, keyboard and tablet assemblies, a 10-megabyte disk and a floppy disk for archival storage. Vector Automation, Inc., Baltimore.
 Circle 320 on reader service card



KALCURVE™

A MAJOR DEVELOPMENT OF KALWALL®

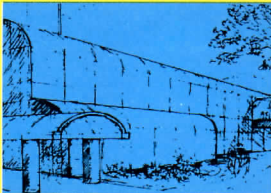

Robert Wagenseil Jones & Associates, Architect

"For the purity of a true curvilinear surface!"

Unlimited diameters; manufactured to your design. Design/detailing/engineering assistance is available. To arrange a personal product presentation, call.

Kalwall®
CORPORATION

P.O. Box 237, Manchester, New Hampshire 03105
PHONE 800-258-9777

©1984 KALWALL CORPORATION

PATENTS PENDING

Circle 79 on inquiry card

"18 years' service and still counting. That's the performance record of single-ply roofing of Hypalon.®"

—John Breitenstein, DuPont

"Single-ply roofing membranes of DuPont HYPALON synthetic rubber have been weathering everything under the sun for the past 18 years," says John Breitenstein, Programs Manager. "That's because HYPALON is a high-performance rubber with durability benefits that meet the most demanding roof requirements."

A single-ply membrane of HYPALON is installed quickly and easily. Since it is thermoplastic when put down, seams are as strong and reliable as the membrane. The mem-

brane gradually cures in place to produce an integral, tough, strong elastomeric roofing surface.

Roofing membranes of HYPALON also offer:

- Reflective white color for energy efficiency.
- Resistance to flame propagation.
- Excellent resistance to oils, chemicals and pollutants.
- Excellent resistance to ozone and UV rays.

- Serviceability over a temperature range from -40°C (-40°F) to 93°C (200°F).
- Colorability for a range of aesthetic designs.

Specify HYPALON—made only by DuPont*—for durable, low-maintenance roofing membranes. Call toll free, 800-441-7111, ext. 44, for further information. Or for free literature, write: DuPont Company, Room X-40097, Wilmington, DE 19898.

*DuPont manufactures HYPALON, not single-ply roofing membranes or systems.



Circle 80 on inquiry card





Fountains

Installation photographs highlight an 8-page color brochure by this manufacturer of architectural fountain systems. Information on design services, water and lighting control capabilities, and available prepackaged equipment is included. Imperial Bronzelite, San Marcos, Texas.
Circle 424 on reader service card

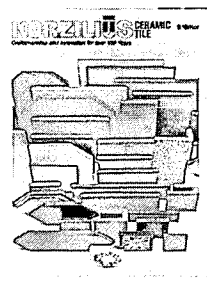

Ceramic tile

A line of German glazed and unglazed tiles, including a new skid-resistant model, is featured in an 8-page color booklet. Photographs and specifications are included, along with a chart reporting results of tile tests by an independent laboratory. Korzilius, Inc., Anaheim, Calif.
Circle 427 on reader service card

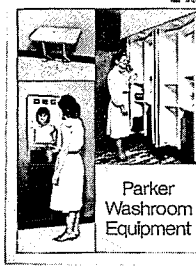

Washroom equipment

A 60-page catalog features stainless steel mirrors, grab bars, soap dispensers, medicine cabinets, and bathroom accessories. New products described and pictured include the *Omni-Lav* convenience module and the *Handi-Wash* handwashing center. Charles Parker Co., Meriden, Conn.
Circle 428 on reader service card



Signs

A large selection of signage for interior and exterior applications is covered in a 36-page color catalog. Included are product photographs, dimensions, and charts outlining available colors and materials. Best Sign Systems, Kansas City, Mo.
Circle 429 on reader service card

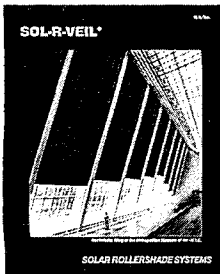

Shading systems

A 4-page color brochure outlines a series of architectural shading systems designed for either interior or exterior installation. The shades are made of a fabric woven from vinyl-coated fiberglass yarn and are available in automated or handcrank models. Sol-R-Veil, Inc., New York City.
Circle 425 on reader service card

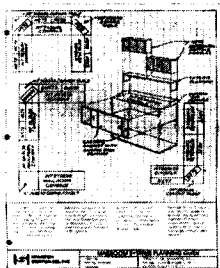

Mailroom equipment

A 10-page planning guide features drawings and dimensions of a line of freestanding mailroom components, including cabinets, sorting modules, processing stations, wrapping tables, and zip code presort units. A layout grid to facilitate system design is included. Hamilton Sorter Co., Fairfield, Ohio.
Circle 426 on reader service card

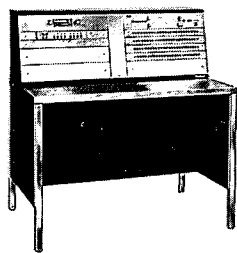

Rauland "Director" Systems set the standards for school communications management, emergency alert, flexible program distribution — with simplest operation.



"Philips" "hands-free" Intercom and Conference Systems are distributed by Rauland in the U.S. and Canada.

- instant 2-way talk
- clear natural speech
- emergency alert
- program distribution
- proved reliability

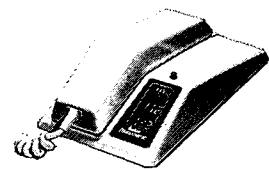

"Telecenter" systems are widely used in schools, correctional and other institutions, dorms, retirement homes. Direct 2-way communications; emergency alert; digital readout.

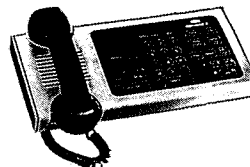

"Responder" Systems for hospitals are microprocessor-controlled to provide the most effective patient-nurse communications ever achieved. Fully responsive to staff needs; simplest possible operation.

AT YOUR COMMAND: Our nationwide network of Authorized Rauland Communications Specialists with system design expertise and full installation and service facilities is available to you for consultation without obligation. For the name of your nearest Rauland Communications Specialist, write or call today or use the reader service card.



RAULAND-BORG CORPORATION

3535 W. Addison St., Chicago, Ill. 60618 • 1-312-267-1300

In Canada: Rauland-Borg Corporation (Canada) Inc. • 6535 Millcreek Dr., Unit 5, Mississauga, Ont., Can. L5N 2M2

Circle 81 on inquiry card



AMP undercarpet Your firm foundation

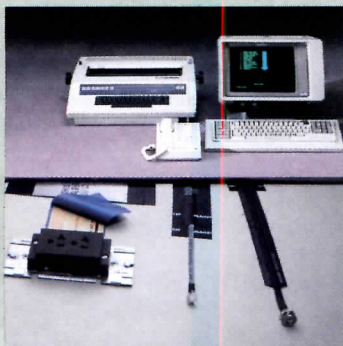

Only AMP makes undercarpet cable for every use you'll design into an office.

Flexible offices are a hot architectural concept. And they mean a whole new set of rules for designing power, phone and data systems that can adapt and change with your clients.

Undercarpet cabling is the ideal way to provide that flexibility. The question is, whose should you specify? The answer is, ours. And there are several good reasons why. First, as the only manufacturer of undercarpet power, phone and data cabling and connectors, we've already dealt successfully with the problems of designing integrated systems that include all three.

Second, thanks to our ingenious direct connecting power receptacle, we simplify both installation and renovation. The direct connecting receptacle addresses every need you

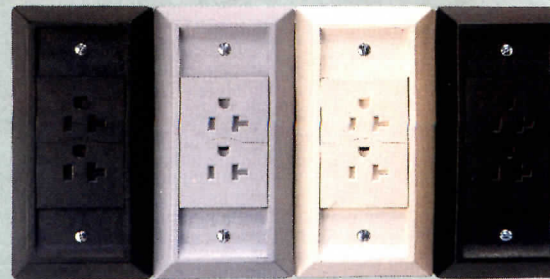

Only AMP makes receptacles in colors to help blend with modern office environments.

BOOKS

**ARCHITECTS!
A NEW BOOK
FOR YOU**



MELTON ARCHITECT'S SERVICES is a book of more than 200 pages that shows you the way to determine the minimum cost of Architect's Basic Service for more than 75 different types of buildings. It is 5 1/2" x 8 1/2" in size and has a beautiful leatherette back with wire roll binding and heavy weight pages for long life.

Send me _____ copies of MELTON ARCHITECT'S SERVICES at \$25.00 per copy. Enclosed is my check or money order for \$_____. I understand you will pay postage and handling. CANADIAN PRICE: \$30.00 per copy. (NOTE: GA residents add 4% sales tax.)

Send to T. L. MELTON CO., P.O. BOX 2644, ATLANTA, GA 30301

NAME: _____

ADDRESS: _____

CITY: _____ STATE: _____ ZIP: _____

**COMPUTER
SOFTWARE
KNOW-HOW**
If you've got it,
advertise it!

Do you have software packages or services to sell? Or computer consultant skills to offer?

For as low as \$122.60 per inch, you can advertise their availability in Architectural Record's Computer Software Section.

Your message there will reach 75,000 owners, architects and engineers in the magazine they read to keep up-to-date on what's happening in their field.

**Architectural Record
Computer Software
Section**

Post Office Box 900
New York, NY 10020



**Telephone Sales:
212/512-2556**

**COMPUTER
SOFTWARE**

DODGE

**Computer-Aided
Estimating Systems**

The Dodge Systems offer three levels of estimating corresponding to the three basic phases in design development—Conceptual, Preliminary Design and Detailed.

SYSTEM 90 for Conceptual Estimating

SYSTEM 73 for Preliminary Estimating

SYSTEM 1 for Detailed Pre-Bid Estimating

Increase your business...

Increase your profit!

call Toll-Free 800-257-5295

Cost Information Systems
McGraw-Hill Information
Systems Company
P.O. Box 28
Princeton, N.J. 08540



Design & Testing Software

Over 25 programs. More than 30 popular formats. Telecom capability. Free catalog.

Mix Design Methods, Inc.
P.O. Box 113, Pennndel, PA. U.S.A. 19047
215-757-3350 Since 1970

BUSINESS OPPORTUNITIES

Wanted For Acquisition — 3 to 8 person Architectural Firm with solid track record in South or North Carolina. Write to: Bates Architects, P.O. Box A-147, Kiawah Island, SC 29455.

Inventions, ideas, new products wanted! Industry presentation/national exposition. 1-800-528-6050. Arizona, 1-800-352-0458.

SPECIAL SERVICES

Architect Engineer Vacations — Charter a 41 ft. cruiser to Keys or Bahamas. Ideal for couples or family any time of year with or without captain. Architect owned and operated by Professionals Yacht Charters Limited, 1-305-626-5814 or 1-305-626-5577.

MATERIALS WANTED

Wanted: Photographs or perspective rendering houses that can be made available for plan sales. 500,000 circulation offers good royalty to architect. Write Country Living Magazine, Box 622, Princeton, New Jersey 08540, 609/ 924-9655.

**Manufacturer
sources**

For your convenience in locating building materials and other products shown in this month's feature articles, RECORD has asked the architects to identify the products specified.

Pages 98-101
Westvaco Forest Research Laboratory by Lucas Stubbs Pascullis Powell & Penney Ltd.

Pages 98-100—Asphalt shingles: Johns-Manville. Sheet metal (terne-coated stainless): Follansbee Corp. Skylights: Plasteco, Inc. Stains: Olympic Stains. **Page 101**—(left) Carpeting: Stratton. Workstation: GF Business Equipment. Chair: Herman Miller Inc. (right)—Carpeting: J&J Industries. Paints: Glidden. Shelving: Library Bureau. Tables: Intrex. Chairs: Claude Bunyard.

Pages 102-105
Data I/O Headquarters Facility by The NBBJ Group
Pages 102-103—Doors, entrances with insulated glass: Kawneer. Steel doors: Fenestra. Aluminum windows: Eastside Glass. Glass: Viracon. Tempered glass: Millgard Industries. Stains: Olympic Stains. **Page 105**—Carpeting: Interface. Ceilings: OCF. Demountable partitions: U.S. Gypsum (Ultrawall). Workstations, seating: Steelcase. Guest chairs: ICF.

Pages 110-113
Manufacturing and Development Facility by Thompson, Ventulett & Stainback, Inc.
Pages 110-111—Curtain walls (metal wall panel systems): H. H. Robertson, Consolidated Aluminum. Elastomeric roofing: Dynamit Nobel, Braas. Doors and windows (aluminum and tempered glass): Kawneer. Glass: Hordis Brothers. **Page 112**—Chairs: Knoll International. **Page 113**—Flooring: Gail Ceramics. Porcelain wall panels: Ferro. Partitions: U. S. Gypsum.

Pages 114-123
The Knoll Building by Tigerman Fugman McCurry
Pages 114-117—Aluminum and glass curtain walls, entrances: Amarlite. Cement coating: KRT. Sheet roofing: Sika. Skylights: Kalwall Corp. Metal doors: Hallmark Industries. Wood doors: Prassel Manufacturing Co. Glass: PPG. Pattern glass: Mississippi Glass Co. **Page 118**—Suspension ceiling: Armstrong (Travertone). Terrazzo flooring: National Tile & Terrazzo. Paints: Benjamin Moore & Co. Lighting: Edison Price (track), Koch Lowy. All furnishings, carpeting: Knoll International. **Page 120**—(top, left) Cabinet and custom woodwork: Accurate Woodcrafting. Granite table top: White Marble Co. Plastic laminate surfacing (black): Nevamar.

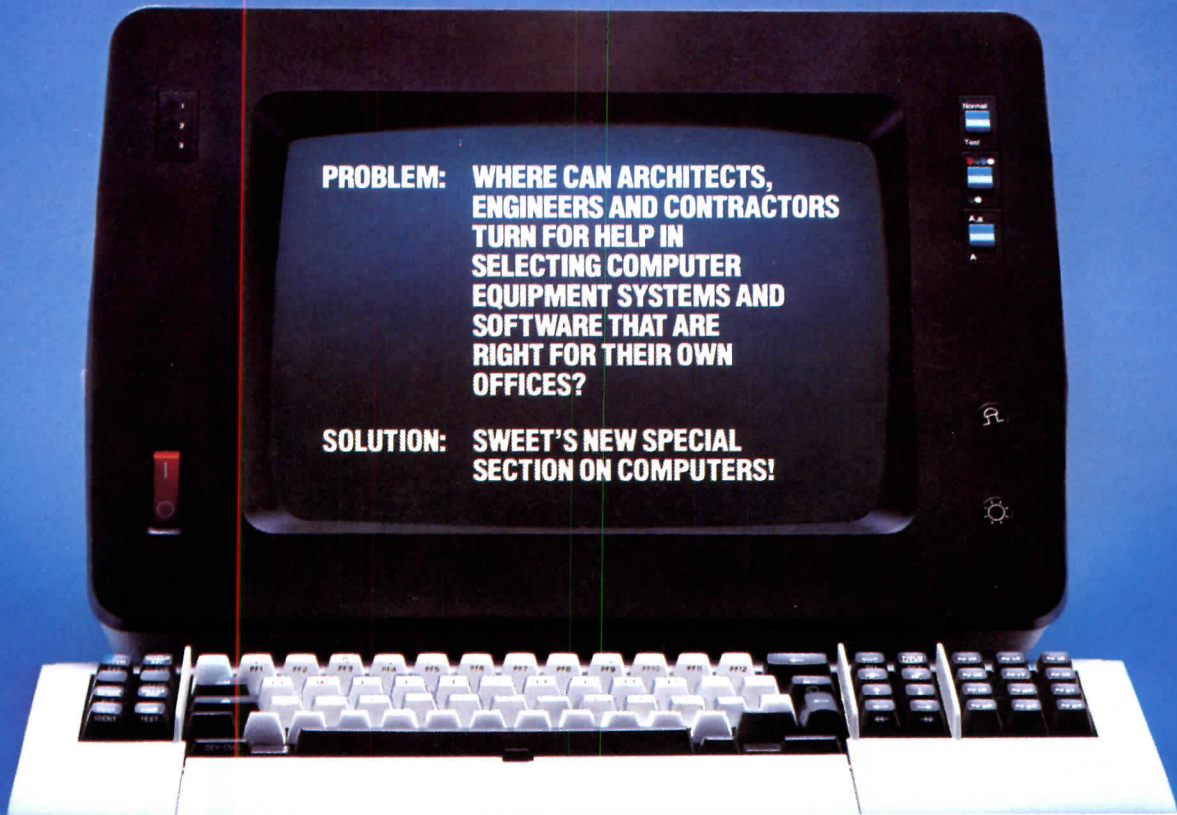

PROBLEM: WHERE CAN ARCHITECTS, ENGINEERS AND CONTRACTORS TURN FOR HELP IN SELECTING COMPUTER EQUIPMENT SYSTEMS AND SOFTWARE THAT ARE RIGHT FOR THEIR OWN OFFICES?

SOLUTION: SWEET'S NEW SPECIAL SECTION ON COMPUTERS!

Sweet's new Section 1.9, "Computers in Design/Construction" — developed in conjunction with Datapro Research Corporation, and appearing in all 1984 Sweet's Editions — contains comprehensive information on:

everything necessary to choose the *right* equipment and software. Datapro Research Corporation is the most widely accepted and respected source of up-to-date information on data processing products and services, and their special expertise has been combined with Sweet's unmatched knowledge of the construction industry to provide 56 pages of

indispensable editorial information on all aspects of computer products selection and applications. In addition, this special Sweet's section contains detailed catalog information (on computer systems, CAD and software) from a variety of manufacturers.

The editorial content of Sweet's new Computer Section:

"Three Approaches to Using Computers." (In-house computers vs. computer service bureaus vs. remote computing services.)

"How to Select a Timesharing or Remote Computing Services Vendor." (The benefits that can be gained—and the pitfalls to watch out for.)

"Word Processing Systems." (Standalone equipment, multi-terminal word processors and wp/dp systems—from A to Z.)

"Personal Computers." (Their continuing evolution, their various office applications, and how-to-buy guidelines.)

"How to Evaluate a Personal Computer for Word Processing Applications." (The computer, the keyboard, the video display, the storage medium, the software, the documentation, and service and support.)

"All About CAD." (What computer-aided design systems consist of, and what they can do.)

"How to Buy Software Packages." (More than 25,000 packages are now available. This report explains how to go about selecting and buying the right ones.)

The manufacturers with 1984 catalogs in Sweet's new Computer Section*:

Bausch & Lomb¹... Carrier Air Conditioning Co²... Cost Information Systems Division, McGraw-Hill Information Systems Company³... Holguin and Associates, Inc³... IBM⁴... Summagraphics Corp⁵.

Products and services detailed in these manufacturers' catalogs make Sweet's new computer section even more valuable to construction industry professionals!

*Catalogs appear in following Sweet's editions:

- 1—General Building & Renovation, Engineering & Retrofit;
- 2—General Building & Renovation, Industrial Construction & Renovation, Mechanical Engineering & Retrofit;

3—All editions;

4—All editions except Contract Interiors;

5—General Building & Renovation, Mechanical Engineering & Retrofit.



Sweet's Division

McGraw-Hill Information Systems Company
1221 Avenue of the Americas
New York, N.Y. 10020
(212) 512-6034



The Ultimate Security Force



In locks, it's Assa. Over 2,000,000 installed in 170,000 systems. From condos in Hawaii to the newest highrise in Seattle to Pratt & Whitney's R&D center in Quebec. Specifiers rely on Assa for a number of reasons, including maximum security lockcases that resist bending/breaking forces; that simplify door preparation Assa's Twin cylinder, recognized and proven to be the industry's highest level security control system; unparalleled in withstanding picking, drilling never-sag lever

handles that give the handicapped the freedom to lock and unlock doors easily, quickly innovative electric lock systems that economically and effectively meet all electrical and fire code specs; that eliminate wiring through door and hinge. There are more unique and proven high-security benefits in our comprehensive brochure. Write for it. Assa, Inc., Arboretum Business Center, 2600 Warrenville Road, Downers Grove, Illinois 60515. Telephone: (312) 968-3774.



Circle 117 on inquiry card

REAL WOOD SIDING FROM GEORGIA-PACIFIC. BECAUSE NOTHING WORKS LIKE WOOD.



SANDY & BABCOCK, SAN FRANCISCO, CA, ARCHITECTS. EASTSIDE INVESTMENT CO., RENO NEVADA, DEVELOPER.

Wood siding is working wonders in today's commercial buildings. Because, in addition to its built-in good looks and versatility, wood siding on frame construction can deliver higher insulative values—and lower material and labor costs—than many masonry or metal siding systems.

We're Georgia-Pacific. And we're the name you can build on for an entire product line of Real Wood lumber and plywood siding. In redwood, cedar, pine, fir and cypress. Or, for even greater cost savings, build on the Georgia-Pacific Hardboard Siding selection.

What's more, we know how to

put wood siding products together with nationwide distribution. And that means you can work with the versatile warmth of wood anywhere in the country. In practically any commercial design. In dramatic style.

So call 800/243-8160 toll-free for Georgia-Pacific distribution information in your area.* And start working wonders with the name you can build on.

*Except Alaska and Hawaii. In Connecticut, call 800/842-0225.

YOU CAN BUILD ON OUR NAME.™

Plywood, Insulation, Gypsum Board, Hardboard, Siding, Paneling, Oriented Strand

Georgia-Pacific



You can Build On Our Name is a trademark of Georgia-Pacific Corporation.
© 1984, Georgia-Pacific Corporation. See us in Sweet's Catalog, 9.12/Ge; 9.6/Ge; 7.6/Ge; 7.7/Geo