

ARCHITECTURAL

TECHNOLOGY

SUMMER 1985

THE AMERICAN INSTITUTE OF ARCHITECTS

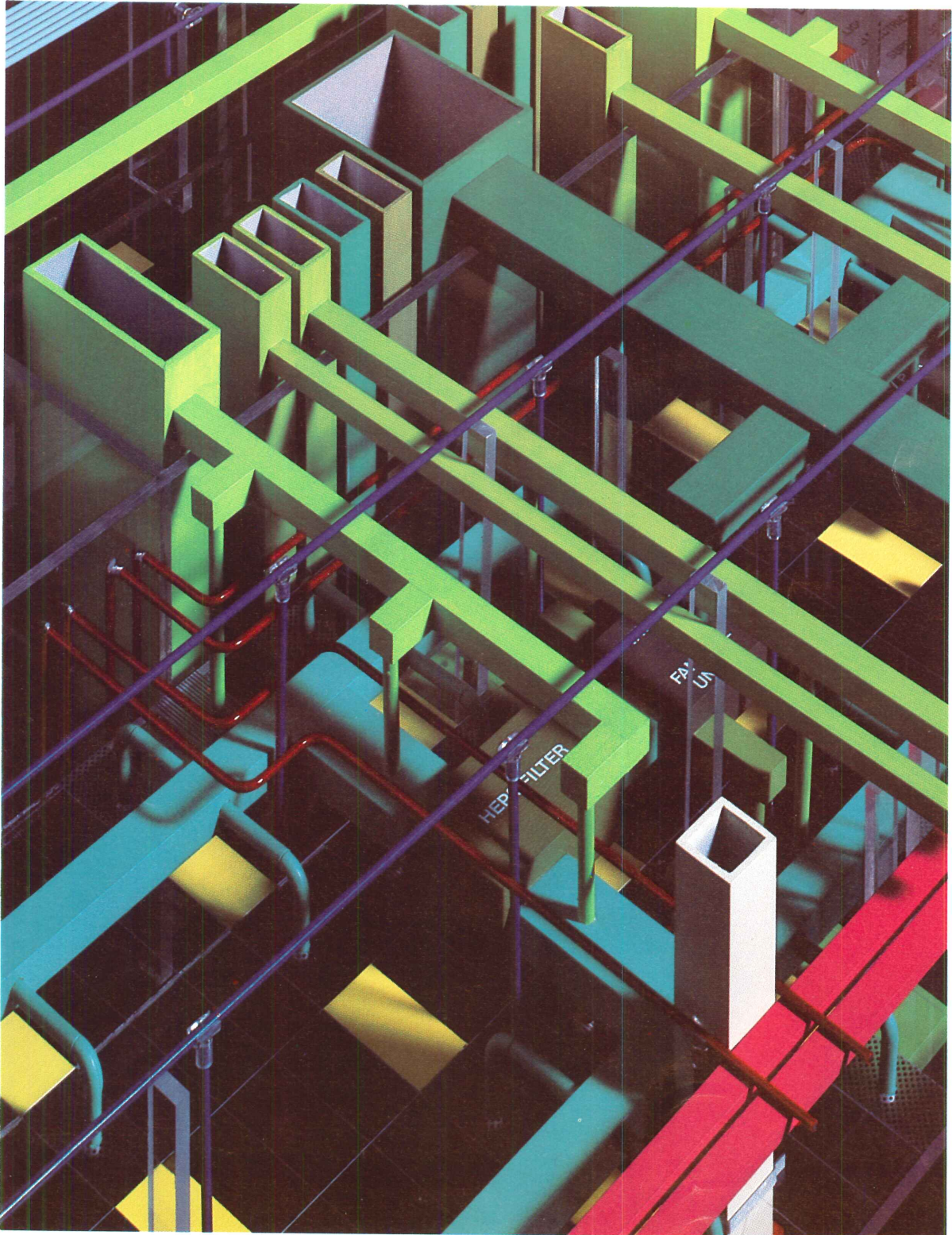

LABORATORIES AND OTHER
HIGH-TECH TYPES

EARLIER OCCUPANCY

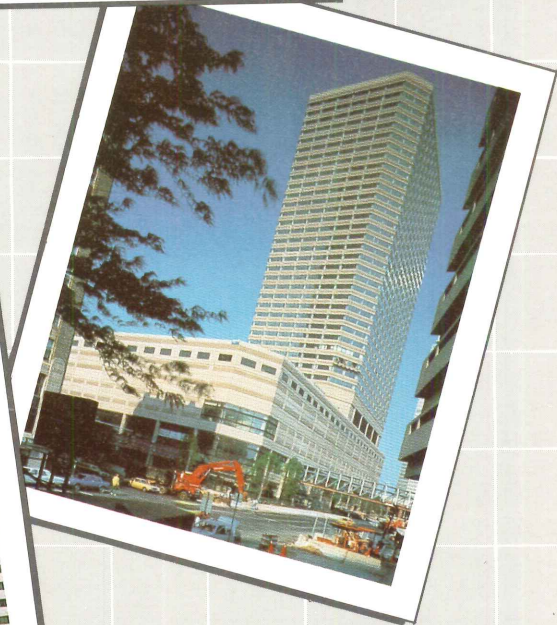
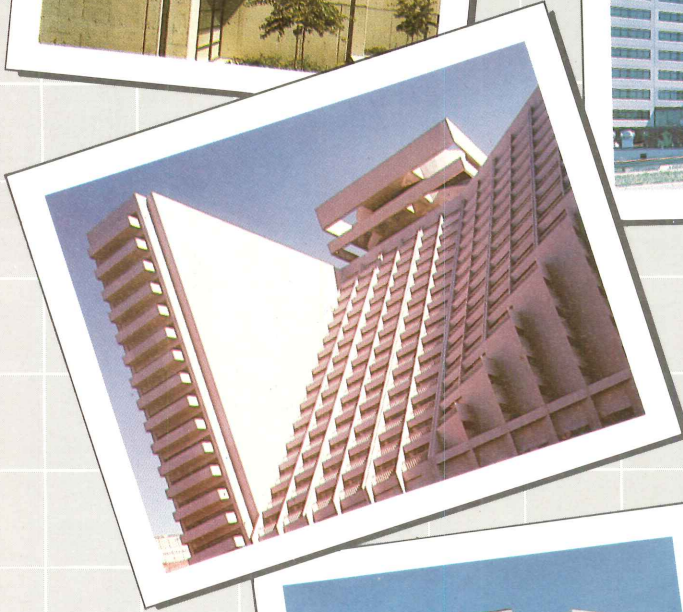
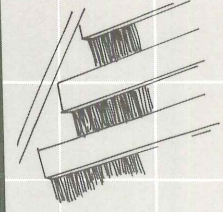
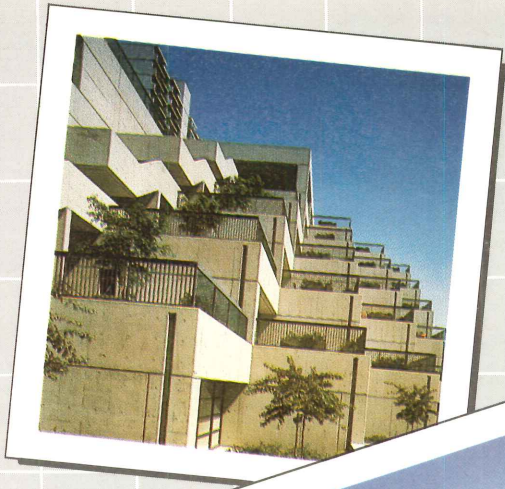

Ray-
Check with
bank - shorter
construction time
should mean
lower interim
financing
J.N.

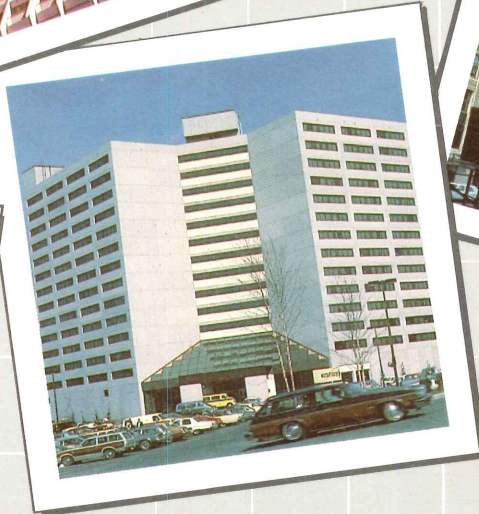

LOWER INSURANCE RATES
FIRE RATING #6

Draw Your Own Conclusion

Functional multi-dwelling precast/prestressed concrete buildings...as creative as the imaginations of their architects.

Manufactured, fire-resistant, structural and architectural components and hollow core slabs mean savings of construction time, money, fire insurance rates and maintenance. Seismic design connections add unpar-

alleled protection. Dramatic design is achievable with many colors and textures.

Explore what precast/prestressed concrete can offer the next multi-unit structure you design. Consult your local producer-member of the Prestressed Concrete Institute for information. Then draw your own conclusions.

prestressed concrete institute

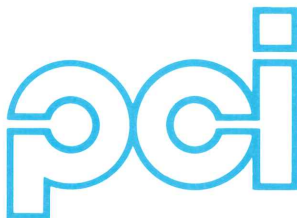

201 N. WELLS ST. CHICAGO, IL 60606

Circle 1 on information card



ARCHITECTURAL TECHNOLOGY

SUMMER 1985 THE AMERICAN INSTITUTE OF ARCHITECTS

The American Institute of Architects: Officers

R. Bruce Patty, FAIA, *President*
John A. Busby Jr., FAIA, *First Vice President*
Donald J. Hackl, FAIA, *Vice President*
Robert E. Gramann, AIA, *Vice President*
Ted P. Pappas, FAIA, *Vice President*
Philip Wade Dinsmore, AIA, *Secretary*
Henry W. Schirmer, FAIA, *Treasurer*
Louis L. Marines, *Executive Vice President*

Directors (Year indicates expiration of term)

Paul R. Neel, FAIA (86), *California*
Robert A. Odermatt, FAIA (86), *California*
William E. Patnaude, FAIA (85), *California*
Frederic P. Lyman, AIA (87), *California*
John R. Birge, AIA (85), *Central States*
H. Kennard Bussard, FAIA (87), *Central States*
Henry G. Meier, FAIA (85), *East Central States*
Howard Byron Bochiardy, FAIA (85),
Florida/Caribbean
Glenn Allen Buff, FAIA (87), *Florida/Caribbean*
William W. Herrin Jr., AIA (86), *Gulf States*
Norman L. Koonce, AIA (87), *Gulf States*
T. Graham Bradley, FAIA (87), *Illinois*
Almon J. Durkee, FAIA (86), *Michigan*
Leon Bridges, AIA (86), *Middle Atlantic*
Robert Calhoun Smith, FAIA (87), *Middle Atlantic*
Kenneth John Filarski, AIA (85), *New England*
G.W. Terry Rankine, FAIA (86), *New England*
Kenneth D. Wheeler, FAIA (86), *New Jersey*
Laszlo Papp, FAIA (85), *New York*
John M. Laping, AIA (87), *New York*
David E. Lawson, FAIA (85), *North Central*
Ray Crowder, AIA (86), *Northwest*
Christopher J. Smith, AIA (87), *Northwest*
A. Notley Alford, FAIA (85), *Ohio*
Sylvester Damianos, FAIA (87), *Pennsylvania*
Elizabeth B. Lee, AIA (85), *South Atlantic*
Raymond F. Stainback Jr., FAIA (86), *South Atlantic*
Benjamin E. Brewer Jr., FAIA (85), *Texas*
M. Allen McCree, AIA (86), *Texas*
Velpeau E. Hawes Jr., FAIA (87), *Texas*
William C. Muchow, FAIA (85), *Western Mountain*
David A. Daileda, AIA (87), *Western Mountain*
Scott Norberg, *ex officio, President, ASC/AIA*
George A. Allen, CAE, *Chairman, CACE*
Susan Stamberg, *Public Director*

Headquarters

The American Institute of Architects

Louis L. Marines, *Executive Vice President/Chief Executive Officer*
James A. Scheeler, FAIA, *Program Group Executive*
Fred R. DeLuca, *Chief Financial Officer*
James V. Siena, *General Counsel/Group Executive Government Affairs*
Francis X. Brown, Hon. AIA, *Administrator, Conventions/Conferences/Special Events*
Stephanie Byrnes, *Administrator, Librarian*
James E. Ellison, AIA, *Administrator, Membership Services*
James R. Franklin, AIA, *Administrator, Practice*
Susan Allen Hecht, *Administrator, Institute Affairs*
John E. Lynn, *Administrator, Government Affairs*
Robert T. Packard, AIA, *Administrator, Editorial*

AIA Service Corporation

James P. Cramer, *President/Chief Executive Officer*
Steven A. Etkin, *Corporate Vice President*
Donald Canty, Hon. AIA, *Editor in Chief, Architecture*
Fred R. DeLuca, *Assistant Treasurer*
Deborah A. Diffendal, *Senior Manager, Management Information Services*
Sandy G. Dresser, *Senior Manager, Human Resources*
David S. Godfrey, *General Manager, AIA Press*
Susan Allen Hecht, *Assistant Secretary*
William D. Hooper Jr., AIA, *Senior Manager, Professional Systems*
Ronald J. Panciera, Hon. AIA, *Senior Manager, Controller*
Ann Parenteau, *Senior Manager, Marketing Group*
Mitchell B. Rouda, *Editor, Architectural Technology*
John H. Schruben, FAIA, *Senior Executive Manager, Business Development*

AIA Foundation

Mary C. Means, *President*
Gordon J. Alt, *Vice President*
Susan Stein, *Administrator, Arts and Education*

Editor:

MITCHELL B. ROUDA

Managing Editor:

JAMES B. GARDNER

Assistant Editor:

AMY E. LIGHT

Editorial Assistant:

ASHLEY E. WISNER

Contributing Editors:

DOUGLAS E. GORDON
FORREST WILSON
OLIVER R. WITTE

Senior Editorial Advisor:

ROBERT T. PACKARD, AIA

Editorial Advisors:

JAMES E. ELLISON, AIA
JAMES R. FRANKLIN, AIA
JAMES A. SCHEELER, FAIA

Art Director:

LESLIE ABNEY FORD

Technical Illustrator:

TIMOTHY B. McDONALD

Creative Advisor:

THOMAS L. MURPHY

Associate Publisher:

DAVID S. GODFREY

Assistant to the Publisher:

MARY FITCH

Circulation:

BRENDA OWENS

Publishing Director:

JOHN D. PAYNE

Publisher, Magazine Group:

JAMES P. CRAMER

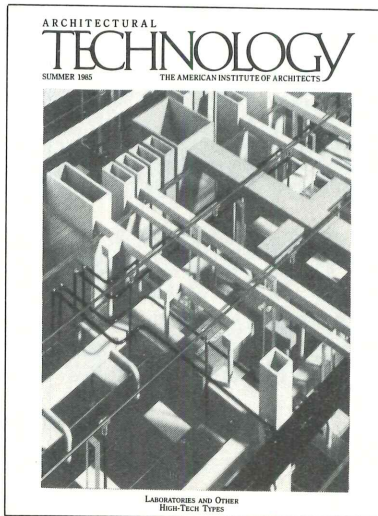

The model on the cover, built by architects Haines Lundberg Waehler to study the engineering systems for a microelectronics manufacturing facility, shows why service distribution networks are often the starting point for the design of laboratories and other high-tech building types. More about laboratory design—and innovative methods for channeling services—in a 3-part study beginning on page 19.

Instructions to contributors:

Articles with graphics are invited on any subject relating to architectural technology, practice, management and design. Preliminary calls or letters of inquiry are recommended. Address them to Editor, or call (202) 626-7590. Include an outline and a plan for graphics, primarily drawings. All rights to published materials are retained by the AIA. Corrections and comments from readers are encouraged.

ARCHITECTURAL TECHNOLOGY, publication number ISSN0740-6142, is a magazine of The American Institute of Architects. It is published by the AIA Service Corporation at 1735 New York Ave., N.W., Washington, D.C. 20006, phone (202) 626-7300. Copyright © 1985 by The American Institute of Architects. Opinions expressed are not necessarily those of the AIA. Vol. 3, No. 3. Single copies \$8. Twelve month subscriptions (4 issues) \$20. Contact Circulation Manager (202) 626-7327. National Sales Office: Washington, D.C., (202) 626-7470.

AEPEX

INTRODUCING...

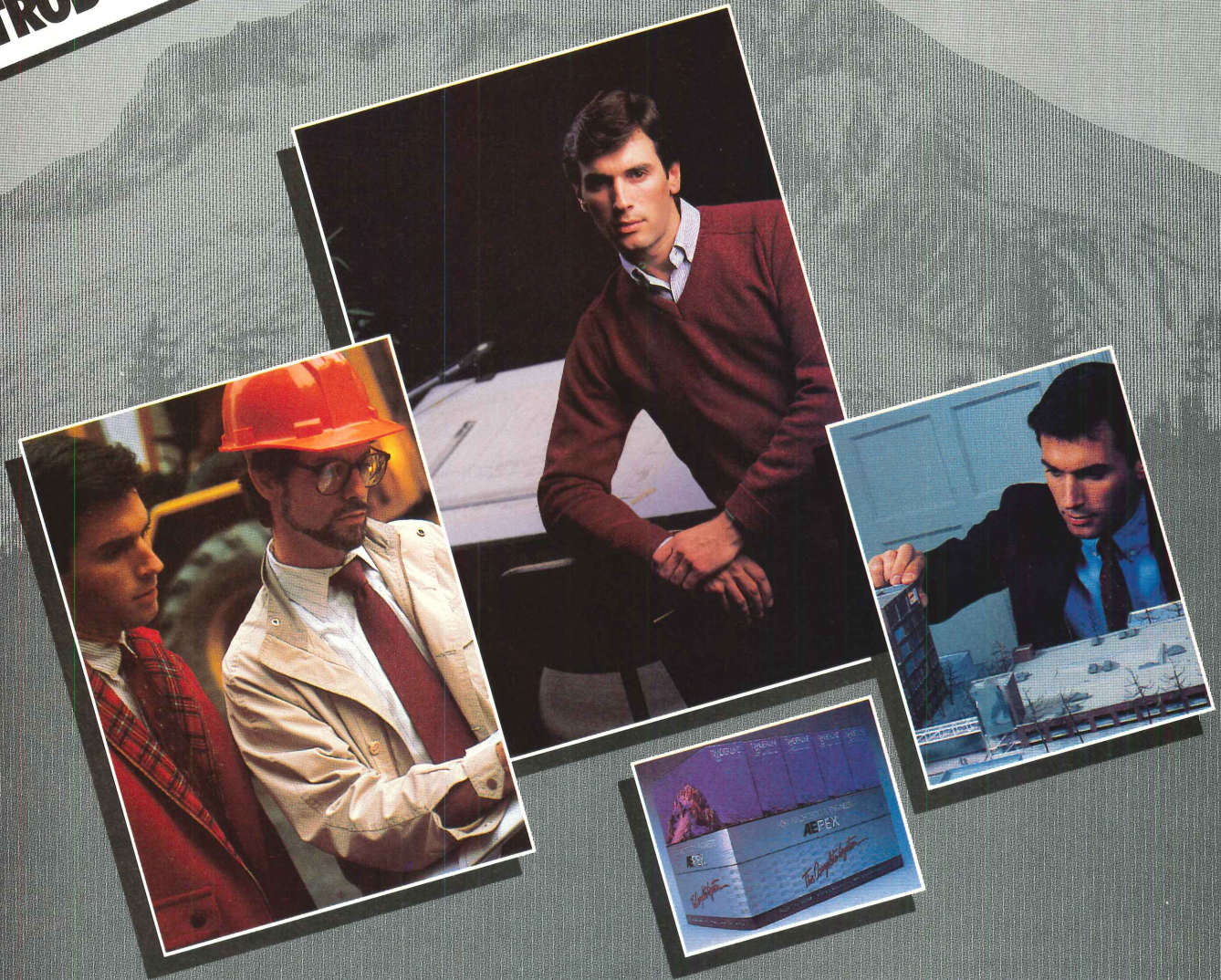

THE SMALL SYSTEM THAT CAN MAKE A BIG DIFFERENCE IN YOUR FIRM.

AEPEX is an easy-to-use project management and accounting software package designed for architects and engineers.

AEPEX allows you to spend more of your time doing what you want to do . . . designing. It can help you improve cash flow, increase profits, enhance production and reduce the time spent on job tracking.

AEPEX saves you time while increasing your effectiveness. Time sheets are transformed into payroll checks, project reports and client billings.

UNCONDITIONAL 90-DAY MONEY BACK GUARANTEE:

You'll love AEPEX completely, or we'll take it back. It's the small system that can make a big difference in your firm. Contact us today.

See us at Booth #104 at the A/E Systems '85 Show.



Love it or Leave it!™

**TIMBERLINE[®]
SYSTEMS** 

7180 SW Fir Loop
Portland, OR 97223
(503) 644-8155

Circle 4 on information card

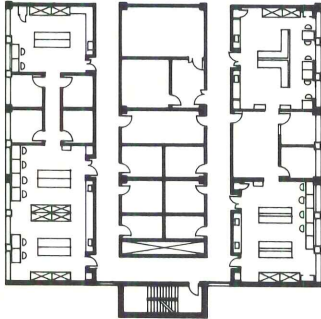
19



34

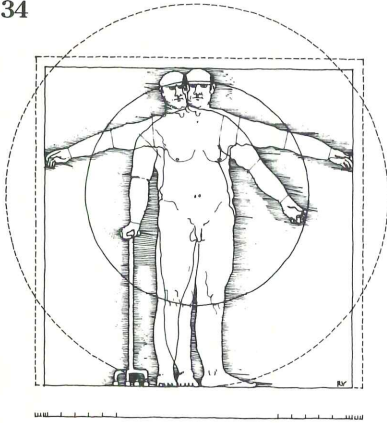

42

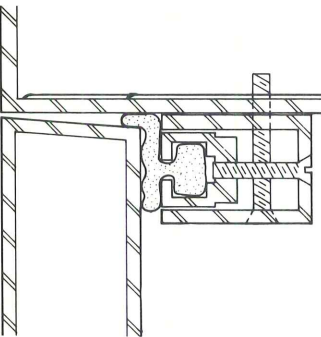

88

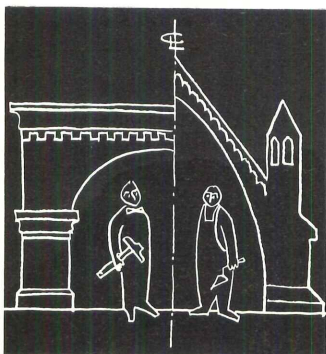

P R A C T I C E

19 LABORATORIES AND OTHER HIGH-TECH TYPES

- Testing Ground
BY MITCHELL B. ROUDA
- From Program to Design
BY STANLEY STARK, AIA
- The Flexible Invention Factory
BY STEVEN A. PARSHALL, AIA, AND ROBERT KNIGHT

34 DESIGN FOR AGING

BY KEVIN W. GREEN

42 RADIO-FREQUENCY SHIELDING

BY BEA SENNEWALD

P R O F E S S I O N

48 TEN INDICATORS OF GOOD FINANCIAL HEALTH

BY G. NEIL HARPER

50 CAD BUYER'S CHECKLIST

BY MICHAEL SCHLEY, AIA

56 COMPUTER-COST ACCOUNTING

BY BRIAN M. JACK, AIA

58 RX FOR THE COMMON CODE

BY M. STEPHANIE STUBBS

7 EDITORIAL

9 FEEDBACK

11 COMMENTARY

13 REPORTS

85 PRODUCTS

87 AD INDEX

88 LOW TECH

USG® STEEL FRAMING

**Big job expertise
is yours for the asking!**

Building systems capability makes the major difference. United States Gypsum Company works with you to optimize systems performance—computer-sizes framing components from a total job perspective—delivers utmost economy in quantities, sizes and weights of USG®

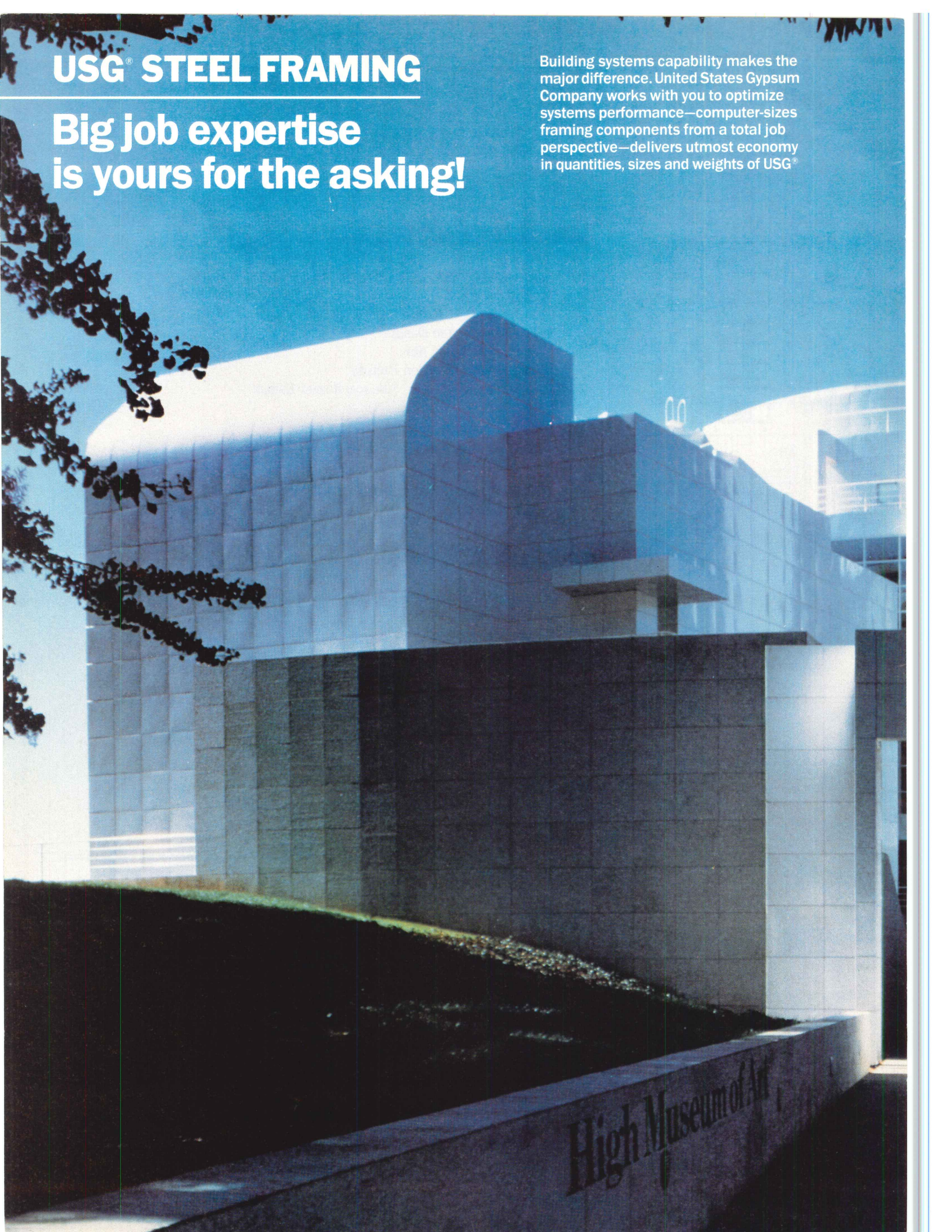

Steel Framing. As a result we can provide a decided edge over competition. In complete, readily available detail recommendations. In improved fastener technology. And in compatibility with a wide variety of exterior materials. You know the basic benefits of lightweight

steel framing systems. Now look into USG® Steel Framing advantages. You'll find nobody supplies more building systems support to help you complete projects sooner. Phone today. Or write to us for specifics at 101 S. Wacker Dr., Chicago, IL 60606-4385. Dept. AT885.

CALL US NOW:

Atlanta (404) 393-0770

Dallas (214) 357-6271

Chicago Area (312) 456-1086

Los Angeles Area (213) 320-4062

New York Area (201) 263-4635

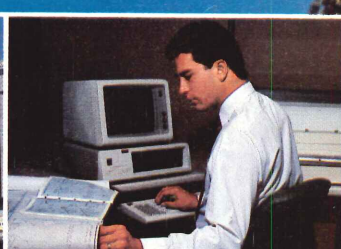

UNITED STATES GYPSUM COMPANY

© 1985 U.S. Gypsum Co.

USG® is a registered trademark of USG Corporation

BUILDING AMERICA

Circle 5 on information card

COPPER ARMORED SISALKRAFT®

EMI/RFI SHIELDING



NSA Operations Building 2A, Fort Mead, Maryland

COPPER ARMORED SISALKRAFT® is an ideal EMI/RFI shielding material for large surface areas where a high degree of attenuation across a broad frequency range is needed. It has been used for shielding in hospitals, EDP facilities, government/military installations, radio/television broadcast stations, scientific laboratories, and anechoic chambers.

The lightweight, flexible roll form of **COPPER ARMORED SISALKRAFT®** offers an ease of handling and installation that makes it the most cost-effective, high performance shielding material available.

FORTIFIBER CORPORATION has developed a complete EMI/RFI shielding system consisting of **COPPER ARMORED SISALKRAFT®,** SOLDER-SEAL COPPER SEAMING TAPE, and a wallboard adhesive.

FORTIFIBER CORPORATION has combined with SISALKRAFT to provide the finest in building papers and barrier materials for use in commercial, industrial and residential construction.

For specification information and samples, write to **FORTIFIBER CORPORATION** P.O. Box 959, Attleboro, MA 02703, or call toll free 800-343-3972. Within MA call 617-222-3500.



Circle 6 on information card

LIKE ANY YOUNGSTER, ARCHITECTURAL TECHNOLOGY is growing, and changing fast. This year, we increased our publication frequency, clarified editorial policy and helped launch two important AIA programs—on compensation and liability. We've also added two new editors, an art director and a new sales team.

To the AIA's Board of Directors, Institute staff, the editorial team and many readers, ARCHITECTURAL TECHNOLOGY has always been as much a mission as a magazine. Many of us have long sensed a need for more discussion of technical and managerial aspects of practice.

Those of us who recently joined the staff came here to be a part of that mission. We have been rewarded by hundreds of readers who have expressed their support.

Another reward has been the stimulation that comes from the freedom to explore architecture in new ways. Many of you have

shared your ideas about the changing role of the architect; these discussions help us to focus the magazine.

An exciting by-product of all this talk has been the increased participation of many organizations and individuals concerned with broadening the profession and advancing building technology. The committees of the AIA, of course, stand out in this regard. So too do the National Bureau of Standards' Center for Building Technology, The National Institute of Building Sciences and the National Research Council's Building Research Board—all groups that have rarely had the ear of a widely-read architectural publication.

Design remains a fundamental concern of any architect. But it is increasingly clear that technical and managerial issues also shape our buildings. With this in mind, we hope you are also excited about the steady maturation of ARCHITECTURAL TECHNOLOGY.
Mitchell B. Rouda

P.S. This issue, we introduce a new section called Commentary. It's a place for architects and others to share perceptions on professional trends; two appear in this issue. We encourage readers to submit 1,000-word essays for this section.

Watch for more changes next issue including a collection of short technical tips. Our updated "Affordable CAD Shoot-Out" will appear in the first issue of 1986.



© David R. Phillips Collection

REALIZING

CAD FROM MCDONNELL DOUGLAS GIVES ARCHITECTS THE TOOLS TO CREATE DESIGNS THAT BECOME REALITIES

Today the architect needs a CAD system that saves time and keeps pace with his imagination. Our Building Design and Drafting System (BDS/GDS) uses a unique design feature called *object intelligence*. This gives you the capability of infinite layering.

Design an object once, associate costs and specifications, and then store it. After that, you can repeat that object on any drawing, at any scale or orientation. You can then report on it at any time, whether

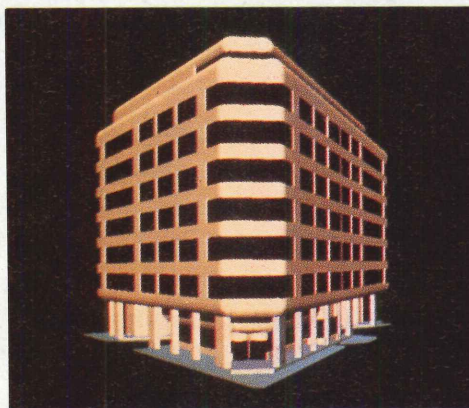

at the drawing level or for the entire project.

That's just one of the many features of BDS/GDS for increasing your productivity. It makes CAD an integral part of your design/production team. Talk to the McDonnell Douglas professionals. They understand the CAD needs of architects. If you're ready for the tools that will put you on the frontier of architecture, call someone who speaks your language. Call McDonnell Douglas from the U.S. and Canada at 1-800-325-1551.

**MCDONNELL DOUGLAS
ARCHITECTURAL, ENGINEERING AND CONSTRUCTION
INFORMATION SYSTEMS COMPANY**

ON THE INFORMATION FRONTIER

Circle 7 on information card

RUDIMENTS OF ROOFING

The lead article in your Spring 1985 issue should have been more carefully selected. It repeats several myths that have been voiced ad nauseam inside and outside the roofing industry.

I question each of the following assertions made in the article:

- Greater insulation quantities "subjected built-up roof membranes to greater temperature extremes, which resulted in cracking."
- Asbestos sheets were "long a dependable performer," and roofing problems have increased since they were forced off the market.
- "In warm weather, radiant heat softens and 'heals' minor cracks and splits that develop." (Self healing is a mythological property of roofing bitumens—it is only found in the laboratory under special test conditions and in some manufacturer's literature.)
- "The physical properties of BUR felts are determined by the density of the felt and the amount of bitumen used to coat them." (Tensile strength, fiber type, and dimensional stability are all more important.)

I suggest you have your technical articles reviewed by specialists prior to publication.

—*Carl G. Cash*
Simpson Gumpertz & Heger Inc.
Consulting Engineers
Arlington, Mass.

All technical articles in ARCHITECTURAL TECHNOLOGY are reviewed by specialists. We commit to an even more rigorous review process in the future. I called Mr. Cash and asked him if he would review future articles on roofing; he agreed. Are there other readers who will contribute their expertise in other fields to this professional review process?—ed.

ROOFING

We were delighted to see the subject of roofing featured in your Spring 1985 issue. The articles and technical information are sure to be of great interest to your readers since

roof problems continue to plague the building industry.

Your readers may wish to know of another valuable resource for information in this field. The Roofing Industry Educational Institute (RIEI) is a non-profit, independent, objective organization. Its purpose is to educate those concerned with improving the performance of roofing systems.

We would be glad to add any interested readers to our mailing list and send them literature and seminar schedules. They can write to The Roofing Industry Educational Institute, 6851 South Holly Circle, Suite 100, Englewood, Co. 80112, or call (303) 770-0613.

—*R.L. Fricklas, Director*
The Roofing Industry Educational
Institute
Englewood, Co.

COMPENSATION CRISIS

I have just finished reading the series of articles on "The Compensation Crisis" (ARCHITECTURAL TECHNOLOGY, Winter 1985), and I wanted to tell you how vital and informative I found it to be.

As a marketing director preparing management planning for a midsize architecture firm, I was startled by the limited information available on the architecture market, particularly in Texas. Although aware of the Birnberg studies, I was pleased to see the information you acquired from the other respected management consulting groups. I found the articles insightful and provocative, and have made them required reading among our principals.

I think it is progress when the industry begins to focus on the business aspects as well as the creative.

—*Sue W. Froehlich, Marketing*
Director
White, Dolce & Barr
Austin, Tex.

CREDITS AND CORRECTIONS

Russell M. Sanders, of Hoffmann Archi-

itects, Hamden, Conn., drew the expansion-joint detail on which the Spring 1985 cover was based.

Our article on Financial Management Software, (ARCHITECTURAL TECHNOLOGY, Spring 1985), erroneously implied that Harper and Shuman's "CFMS" package lacked an accounts receivable module. We regret the error. Also, Harper and Shuman's correct address is 68 Moulton Street, Cambridge, Mass. 02138.

The American Terra Cotta Institute, mentioned in "Guide to Diagnostic Tests" (ARCHITECTURAL TECHNOLOGY, Winter 1985), was disbanded in the 1960s. A Terra Cotta Manufacturers Association is being established. For now, persons interested in terra cotta should contact the Friends of Terra Cotta, P.O. Box 421393, San Francisco, Calif. 94142, (415) 556-7741.

ARCHITECTURAL TECHNOLOGY *welcomes your feedback. We reserve the right to edit letters.*



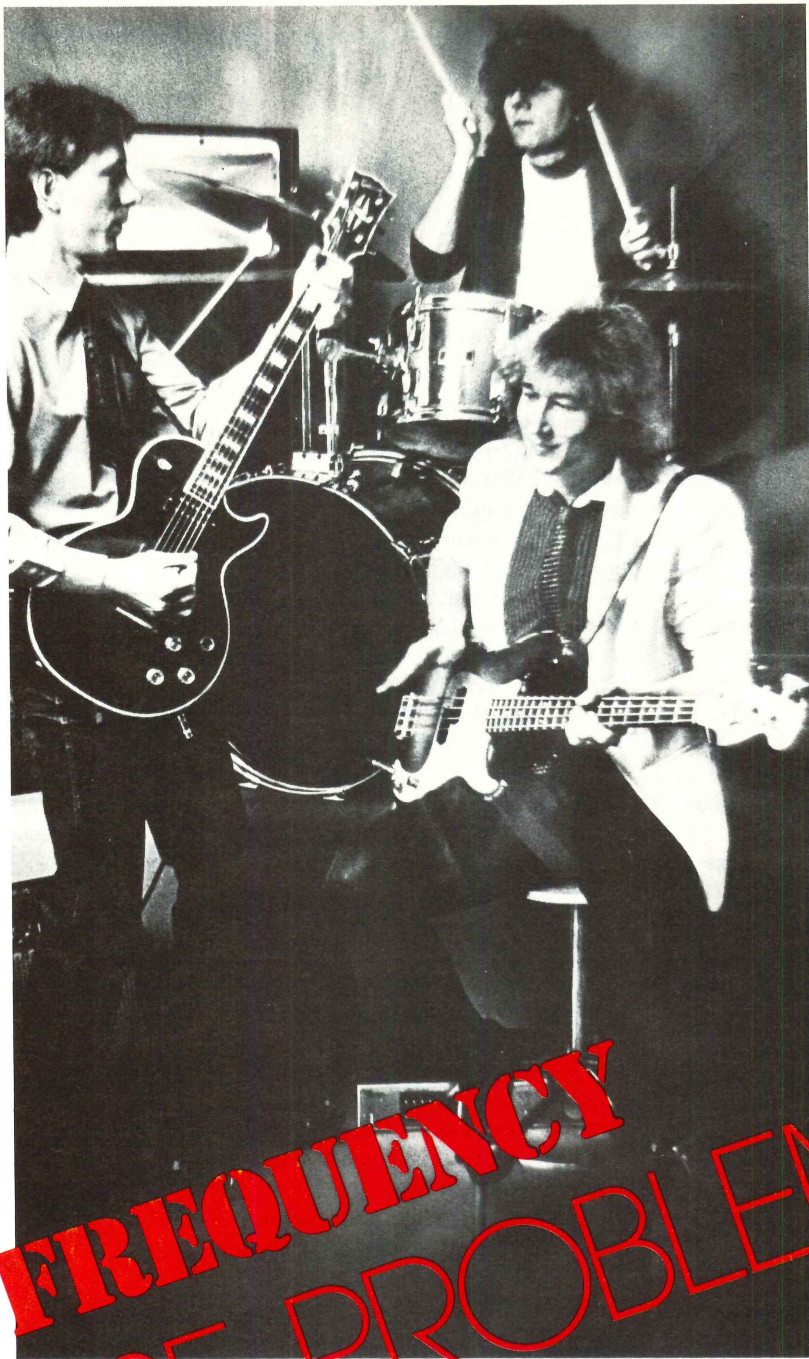

LOW FREQUENCY NOISE PROBLEM?

New high performance drywall partition system effectively isolates sound – even low frequency!

Now, you have the exclusive sound control solution to everything from speech to blower motors, machinery, music – especially low frequency noise pollution. It's our new high performance H-Spline Wall System – for party, chase and furring walls. Much lighter in weight than masonry walls (only 13 lbs. per sq. ft.), this superior wall system delivers sound ratings of 60 STC/57 MTC*SM and a 3-hr. fire rating (UL Design U441). To get system folder SA-926, including data on tests conducted at Riverbank Acoustical Laboratories, give our Architectural & Construction Services Dept. a call at 312-321-3739. Or send your business card to us at 101 S. Wacker Dr., Chicago, IL 60606-4385, Dept. AT885

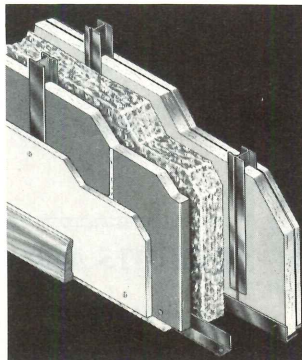

*MTCSM is a single number rating, resulting from a methodology developed and copyrighted by U.S. Gypsum, as an index of partition performance in low-frequency sound isolation such as music, motors and some other types of mechanical equipment.

Or call on us now at:

- **Eastern Construction Products Division**
555 White Plains Road, Tarrytown, NY 10591;
(914) 332-0800
- **Southern Construction Products Division**
P.O. Box 16511, Atlanta, GA 30321
53 Perimeter Center—East, Atlanta, GA 30346;
(404) 393-0770
- **Central Construction Products Division**
101 South Wacker Drive, Chicago, IL 60606;
(312) 321-4128
- **Western Construction Products Division**
P.O. Box 2452, Los Angeles, CA 90051
620 North Brand Boulevard, Glendale, CA 91203;
(213) 956-1882

UNITED STATES GYPSUM COMPANY
BUILDING AMERICA

WHY ARCHITECTS EARN SO LITTLE

BY MICHAEL R. HOUGH

Over the years, in my role as a management and marketing consultant to architects, I've often been asked why architects are not paid as well as other professionals such as lawyers. My answer is that architecture is being practiced as an *art*, not as a *professional service* to clients.

Good design and good management are, in fact, not mutually exclusive. Artistic expression can be a desirable quality to bring to a project. But today's client (I heard the Harvard professor David Maister say) is interested primarily in an architect who will absorb the hassles related to *managing* the design and building process.

I would add that there is no reason why competent architects who provide these services should not be well paid for them. Yet many architects ignore clients' greatest needs. Bill Marriott and several other clients said as much at a conference in Dallas, sponsored by the AIA, called "Power, Image and Compensation." "A necessary evil," was the way one client described the architects he works with.

The press and lecture circuits abound with comments that attempt to explain architects' meager remuneration:

- "Many laymen see architects as capricious egotists—unfathomable and deaf to the real needs and real circumstances," says Rai Odamoto, FAIA, former San Francisco Planning Director.
- "I believe the problem (of inadequate compensation for architects) traces clearly back to architectural education, which teaches students a mistrust of money and elevates the artistic endeavor," Elaine Cohen, an architect practicing in New York City says.
- "Many corporate officers notice a tendency for architects to perform (and design) to meet self-imposed standards that are more costly and time consuming than necessary to meet the client's requirements," writes Martin McElroy,

Michael R. Hough publishes several management-related newsletters, including PSMJ, A/E Marketing Journal and A/E Systems Report. Also, he co-sponsors numerous conferences and seminars.

"Here, simply, is why architects are among the lowest compensated professionals: Because so many clients do not perceive the value of hiring an architect, except perhaps to obtain a building permit, architects must literally beg for work. Further, architects are considered by many clients as no more than an expensive drafting service—and consequently get little respect."

head of New York City management consultants Sixty-Eight/52 Associates, in a recent issue of *Architectural Record*.

At last fall's Professional Services Management Association (PSMA) annual meeting, three high-design-oriented New York architects discussed their styles. Statements such as "architecture is an art," "you should not practice architecture if you want to make money" and "the design process cannot be controlled" were common.

There will, of course, always be clients who desire high-visibility architecture above all else. But this is a very narrow niche in the market. Most clients seek a professional *service* that manages the entire process of creating a building. High-visibility design can be a part of this service, but not an end unto itself.

Here, simply, is why architects are among the lowest compensated professionals: Because so many clients do not perceive the value of hiring an architect, except perhaps to obtain a building permit, architects must literally beg for work. Further, architects are considered by many clients as no more than

an expensive drafting service—and consequently get little respect.

Clients will, however, pay excellent fees for an architect who "really can contribute and help solve my problems." (The quote is from a client, Richard Everett, in a recent roundtable discussion.)

Architects must sell the concept that good design has a specific value to clients: For example, the building will rent for \$10 more per square foot; the innovative HVAC system will save \$500,000 per year in energy costs; the zoning commission will approve the plans six months earlier.

Becoming part of the solution instead of the problem will take effort. These are some of the changes I see are necessary:

- Change attitudes about management—of the project as well as of the firm.
- Study what services clients really want and then specialize in providing them (to cite just one example, energy-efficient design).
- Document how you can actually solve these problems and then sell this solution to clients. (For example, "Our buildings cost 13.2 percent less to heat and cool than the average.")
- Adopt a personal attitude that the architect does, in fact, provide a valuable service and act accordingly: Charge an appropriate fee, push for the proper design solution and stand up to the client as an equal member of the building team.

In addition, at the 1985 meeting of the AIA Planning Committee, chaired by the first vice president, John Busby of Atlanta, I suggested that The American Institute of Architects create an image campaign to show that architects solve real-world problems for clients. Included would be a public relations effort as well as paid advertising.

Finally, all design-award competitions might state, carefully and clearly, how a winning design served the specific needs of the client.

It is not too late to reverse the economic malaise of the architectural profession. But to do so, architects must acknowledge the importance of good management, as well as good design, and then demand to be paid equitably for their success. □

CODES—SO WHAT, WHO CARES?

BY JOEL "TICK" VICARS AND M. STEPHANIE STUBBS

To many architects, the building regulatory process is too complicated, confusing and technical. Seen only as a necessary evil in our complex society, architects tend to be unsure of how to use codes and standards and they shy away from involvement in the regulatory process.

Inability to deal with codes and standards in a positive way is part of the architectural profession's general acquiescence of responsibility to other specialists as technological changes move architects away from the historical role of master builder. As a direct result, the regulatory process has fallen further and further into the hands of fire marshals, product manufacturers and materials suppliers, all of whom play vital roles yet lack the overall perspective that is the architect's charge.

The results can be disastrous, points out Ralph Rowland, FAIA, (former chairman of the AIA Building Performance & Regulations Committee). "Of all participants in code development, only the architects have the training and experience to understand the total effect of code-change proposals," Rowland says. "The most important message for architects is that if we do not participate in the development of building regulations and standards, we must certainly be resigned to have design regulated by others who may be less competent."

The confusion with building codes and standards arises, to a great extent, because of the ways in which these regulations are developed. Very few architects have input into the system; therefore, few understand them. True, the thought of 3,900 different building codes and the thousands of standards in use across the country can be daunting, yet most regulatory development follows a basic process that offers the architect numerous chances to be involved.

There are only three model building codes from which almost all state and local codes are adopted. Each group develops, maintains or sponsors a building code, a mechanical code and a plumbing code as well as other

"As protectors legally responsible for public safety, architects must take an active role in the development of regulations governing architectural design."

documents which are helpful to jurisdictions responsible for establishing minimum levels of building safety.

Each model code organization conducts at least two public hearings a year. At the first hearing, a committee made up primarily of building officials hears testimony on published code-change proposals. Anyone may submit a proposal, and anyone may testify at a public hearing. The code-changes committee then recommends approval, approval with revision, disapproval or further study.

Recommendations are printed and made public. Anyone may submit a formal challenge to any recommendation. These challenges are also published, but a change at this stage is harder to effect.

Committee recommendations and opposing challenges are considered by all voting members at the annual business meeting. Although architects do not yet have voting rights, attending the first hearing is often the most important step. Recommendations made by the *first* code-changes committee are seldom overturned at the final meeting. Recommendations that go unchallenged are often automatically approved.

The building codes often elect to adopt the standards set by national organizations, both public and private. Standards are acceptable practices to those knowledgeable in a particular expertise and do not constitute law *unless* adopted as a reference by a code. Many standards-writing groups such as the American Society for Testing Materials (ASTM) use the consensus process, where committees of volunteer experts address subjects in question. The best

known of the consensus process groups is the National Fire Protection Association (NFPA), publishers of what is commonly known as the "Fire Code."

NFPA's Fire Code is actually a large set of standards for the fire-safe operation of various facilities or pieces of equipment, such as the Life Safety Code (NFPA 101). NFPA also sponsors the widely referenced National Electric Code. Most codes reference the NFPA standards in some manner. Standards groups like NFPA need architects as technical contributors to the consensus process. The easy-to-read, more graphically oriented format of the 1985 NFPA 101 Code owes mainly to increased participation by architects.

The model code groups have also joined together to form the Council of American Building Officials (CABO), in order to make their documents more consistent. CABO's Board for the Coordination of Model Codes needs the technical expertise of architects as testifiers. The National Institute of Building Sciences (NIBS) (which provides a forum for discussion of the regulatory requirements of Federal agencies) offers another opportunity for architects to participate.

Complaining about the regulatory process isn't good enough. Get involved! As protectors legally responsible for public safety, architects must take an active role in the development of regulations governing architectural design.

Here are steps every architect can take:

- Participate in the Model Codes change process. Submit code change proposals! Testify! Challenge!
- Volunteer to serve as a technical expert for a standards-making organization. Set the standards!
- Be aware of and participate in national forums for code consistency and uniformity. Speak out!
- Join the AIA's Building Performance and Regulations Committee. The BP & R Committee monitors the activities of the model codes and standards-making bodies, recommends codes-related policies to AIA's Board of Directors and serves as a clearinghouse for information. □

"Tick" Vicars is AIA's Director of Building Performance and Regulations; Stephanie Stubbs is a member of the BP&R Committee.

ASBESTOS LIABILITY CRISIS CONTINUES

The situation regarding asbestos-related liability insurance has deteriorated. Ronald V. Gobbell, AIA, a leader in the field and author of "Asbestos Abatement" (ARCHITECTURAL TECHNOLOGY, Spring 1985), has now lost his insurance.

"This has been a devastating, frustrating experience," Gobbell says. "A lot of people believe it can't happen to them—that you have to do something wrong to lose your insurance. But we don't have a bad record. We've *never* been sued or had a claim made against us in our seven years of practice, (four of which have included asbestos work)."

Gobbell's loss of insurance reflects both the unwillingness of insurers to take on high risks, such as asbestos claims coverage, and the overall crisis in the insurance industry that is forcing some carriers to drop professional liability coverage altogether.

Building owners face a real dilemma. They are often under intense pressure to eliminate asbestos hazards, but they're having an increasingly difficult time finding qualified people to help. Asbestos abatement specifiers and contractors face a quandary: To do asbestos work they must be insured, yet if they go ahead, they will lose their insurance.

The AIA is grappling with these asbestos-related problems on a number of levels. It held a symposium in July, joined in an industry-wide task group and established a "Professional Liability Network" to collect information from the membership on insurance rates and claims, court decisions and local legislation.

At the July symposium, sponsored by the AIA's Committee on Architecture for Education, a broad spectrum of views was expressed.

It was said that asbestos is an incomparably useful and abundant resource that, with better understanding, could continue to serve in a variety of commercial uses; that breathing the ambient asbestos fibers in a

typical asbestos-insulated building is less hazardous than breathing the tobacco smoke of a fellow office worker; that asbestos is so dangerous, its use must be totally phased out; and that the insurance industry is well aware that abatement contractors of the '80s can't be compared with shipyard workers of the '40s, but will be anyway because actuaries do not have any other point of reference.

Many speakers also said there was a growing need for a certification program for abatement contractors and an industry-generated set of specifications for asbestos management, enclosure, encapsulation and removal.

Steve Biegel, AIA, of the National Institute of Building Sciences (NIBS), described the blue ribbon task force formed by NIBS and the Association of Wall and Ceiling Industries (AWCI) to overcome some of the major obstacles facing asbestos abatement professionals. The task force, which the AIA has joined, will concentrate on developing a certification program, establishing guidelines for abatement and solving the insurance problem.

The AWCI is forming a claims-made group insurance program through its offshore insurance company. However, the ultimate solution to the lack of insurance, according to the task force is to educate carriers.

Toward that goal, the AIA has formed a Professional Liability Network to collect and disseminate information from members around the country on how liability is affecting them and others in their area. Network staff want to know if insurance rates are rising, what major claims have been made throughout the areas (not just in asbestos abatement, but in all areas of design service), any major court decisions affecting architects and any legislation enacted or proposed involving professional liability. The information will help guide AIA staff in efforts at legislative and insurance-industry reform.

For more information on the Professional Liability Network, call Ava Abramowitz at (202) 626-7380. For more information on the task force, call Steve Biegel at (202) 347-5710. For more information on the symposium, call Mike Cohn at (202) 626-7366.

—D.E.G.

FINDING VALUE IN SAN FRANCISCO

"Value Architecture" was the convention theme. But was the annual gathering of the clan a true value investment? The answer at times seemed to hinge on one's stamina.

The convention's planners eschewed a specialized, boutique approach for a super-market concept—that is, the shelves were stocked to overflowing with public lectures, point/counterpoint theme programs, business sessions, eye-catching exhibits (a record number of booths), professional development seminars (a record there, too) and a number of site-specific, San Francisco case studies.

For the Institute's efforts, the reward was record attendance—some 10,000 plus.

But some were bewildered by the variety; there were too many sideshows under the Moscone big top. No one could accuse this convention of not trying to be all things to all architects.

If there was a serious disappointment, it was from Bauhaus-to-Our-House T. Wolfe's cheap shots and awful slides—or was it the fact that Wolfe's lucubrations drew an audience of over 3,500, while the far more challenging and informative San Francisco case studies attracted only a handful?

The best of the theme sessions was the point/counterpoint between Washington, D.C. architect Hugh Newell Jacobsen, FAIA, and Charles B. Thomsen, FAIA, president of 3D/International, Houston.

More than a matter of scale (Jacobsen small firm; Thomsen, large), both speakers staked out the heart and soul of the profession as it exists in 1985. Jacobsen occupied the ground of the architect as artist supreme for whom the client is a necessary evil. Thomsen's geography found him in the camp of the client whose needs always come first.

Of course, each man stated his position in the extreme. But by doing so, both performed a service for their audience by identifying the polarities—architect's vision and the client's needs—between which architecture happens. Any convention that can pull off that kind of act so succinctly and with so much panache more than satisfies the criteria of a value investment.

Unless otherwise noted, ARCHITECTURAL TECHNOLOGY's reports were compiled and written by assistant editor Amy Light.

STRUCTODEK

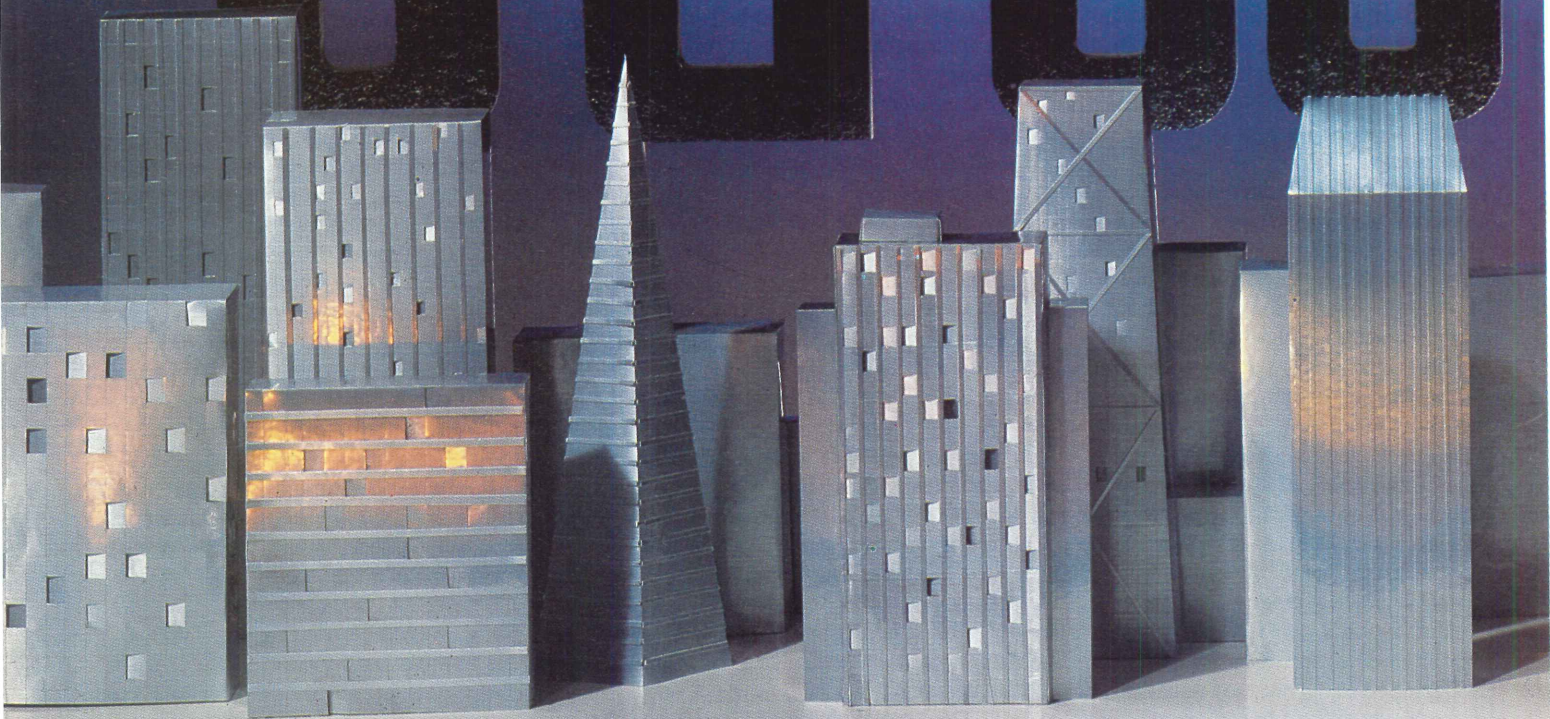

Now! A substrate that exceeds today's tough demands for single ply systems

STRUCTODEK™ wood fiber substrate is fast-becoming today's professional choice in underlayments for new or re-roof applications. It is scientifically designed to actually exceed the stringent standards established for single ply systems. Whether mechanically anchored, adhered, or used in a ballasted system, the substrate you use should equal the highly advanced technical requirements set for single ply membranes. That's why we urge you to compare this superior underlayment with alternative products on all five counts pictured here.

Tough, rigid STRUCTODEK substrate is asphalt coated to provide an excellent moisture retarder. Special water resistant additive helps reduce wicking. And it's also available in an asphalt-free formulation for PVC membrane systems. Get specifics on this UL Classified roofing substrate with service to match. *Call Chicago at 1-800-621-9624...the Philadelphia area at 1-800-257-7885...or Los Angeles at 213-380-3461. Or write to us at 101 S. Wacker Dr., Chicago, IL 60606-4385, Dept. AT885*

© 1985 USG Industries, Inc.

Contractor: Leonard Smith,
SHEETMETAL & ROOFING, INC.
Salem, VA

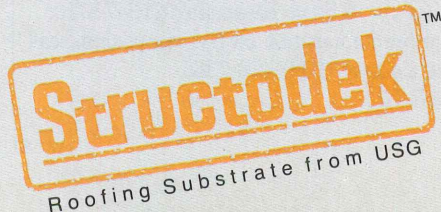

WOOD FIBER DIVISION
USG Industries, Inc.

Circle 9 on information card

toodek

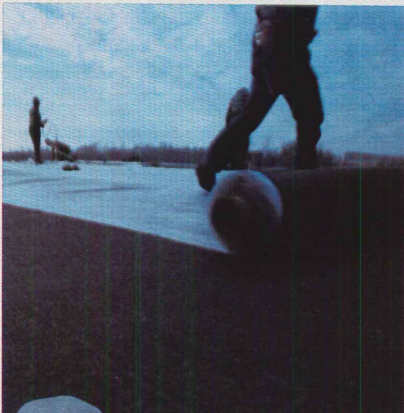

High compressive strength permits normal foot traffic during installation.



Precision cut square edges expedite professional quality installations.



Superior surface characteristics offer improved base for fully or partially-adhered surfaces.



Provides excellent base—even over uneven surfaces.



Greater tensile/transverse properties add extra mechanical attachment strength.

ENERGY PERFORMANCE STANDARDS EXPLORED

The age-old debate over energy performance standards has entered a new phase.

The American Society of Heating, Refrigerating and Air-Conditioning Engineers Inc., (ASHRAE), the Illuminating Engineering Society of North America (IES) and the AIA are forming a research team to establish whole-building energy-consumption targets for new commercial building designs. The U.S. Department of Energy is funding the project.

By concentrating on "whole building" targets, the joint team hopes to establish performance, rather than prescriptive, guidelines. The aim is to offer flexibility in the use of various systems, materials and designs rather than prescribing specific component performance requirements. Because they are "voluntary," the targets are intended to inform building designers and owners of energy-use levels that are feasible and practical, not to dictate allowable levels of energy use.

DOE has asked the team to consider a wide range of building types, sizes and functions, and to explore standard design concepts as well as more innovative ones.

Because of the difficulties in setting fair targets that reflect all building types, the project team encourages comment. Call Earle Kennett, AIA, (202) 626-7500; William Seaton, ASHRAE, (202) 636-8400; or John Kaufman, IES, (212) 705-7916.

The research group will send regular updates on the project upon your written request.

FINANCIAL SURVEY UPDATE

The latest edition of Birnberg and Associates' "Financial Performance Survey for Design Firms" shows an upswing in the financial health of design firms for the first time since the survey began in 1978. Earlier surveys were liberally quoted in "The Compensation Crisis" (ARCHITECTURAL TECHNOLOGY, Winter 1985). The financial improvements stem from higher profits and liquidity and lower overhead rates, says Howard Birnberg, who publishes the survey.

The 1985 update was based on informa-

tion from 136 of the 254 firms that participated in the 1984 study.

Copies of the updated report are available for \$28 prepaid. The 1984 survey is offered for \$38. Both reports are available for \$50. Write or call Howard Birnberg, 1905 North Halsted Street, Chicago, Ill. 60614, (312) 664-2300.

JUSTICE SYMPOSIUM

As an experiment in committee educational sessions, the AIA Committee on Architecture for Justice invited product manufacturers to attend a half-day symposium on security components in Washington, D.C.

The July 2 symposium consisted of three concurrent sessions: perimeter security and electronic devices; door, hardware and locking devices; and glazing and windows.

The topic that generated the most interest was the need for uniform testing and fire-rating systems for security components. For example, attendees noted that, without standard testing criteria for protective glazing, many sheriffs insist on having their beefiest deputies go at a proposed security glass with a hammer.

In pursuit of standardized testing methods for security components, the committee has been working with ASTM on a draft specification for testing detention security doors and security glazing. These specifications are now facing ASTM-wide review.

For more information, call Mike Cohn, (202) 626-7366. — D.E.G.

IN THE SPIRIT OF GIVING

Many architects contribute their time and talent to charitable institutions. The federal government encourages such behavior by sharing the cost via tax deductions.

The major problem for contributing architects is that the value of *services* (the architect's time and talent) is expressly *not deductible*. Nevertheless, this limitation may not be as bad as it first appears.

Out-of-pocket, unreimbursed expenses for items like paper and supplies, transportation, living expenses while traveling, meals, phone calls and reproduction of documents, which architects incur in contributing services to qualified institutions generally *are deductible*. It also seems reasonable to infer that payroll expenses for an architect's

employees' time spent in providing services are deductible by the contributing architect employer. In that case, the only element of an architect's normal compensation that would not be deductible is the value of the architect's own services and profit. (This restriction may not apply if the "architect" is a corporation and not an individual.)

Taking a different approach, some architects and their accountants have suggested that drawings and specifications are "property" whose fair market value is approximately equivalent to the architect's normal compensation for preparing those documents. This categorization potentially increases an architect's tax deduction from the amount of payroll costs and out-of-pocket expenses incurred to the amount of compensation foregone.

The AIA's Owner-Architect agreements (for example, B141) make the point that drawings and specifications are "instruments of service" and are the architect's property. However, as mere "property" distinct from the "services" of the architect, the drawings and specifications may have value equal only to that of the underlying materials.

A variation on the "property" theme might be for the architect to contribute a license to the recipient institution to use the drawings and specifications. Licenses are commonly considered to be property. This approach may make it easier to justify a fair market value for the contribution essentially equivalent to the architect's normal compensation.

Regardless of the tax consequences of contributing services and/or drawings and specifications to charitable institutions, there are other factors to consider. Generally, architects are legally liable for their services whether or not they receive any compensation. Institutions that have accepted donations of services from architects (however categorized for tax purposes) have just as much right as any other paying client to sue them if there are problems.

The right to reuse drawings and specifications should also be considered. An architect would not want to see the drawings and specifications used inappropriately on future projects. Retaining the right to consent to future reuse and to be involved in making necessary adaptations to the documents is important. Licensing, as mentioned earlier,

can be an effective way to do this.

If architects are thoughtful about their giving, they may be able to take substantial tax deductions for charitable contributions. Of course, individualized legal and tax advice should be sought before acting on any of the information in this article. And we must all watch for tax reforms the new year may bring.

—Charles R. Heuer, Esq., AIA

STUDY ON FOAM INSULATION PUBLISHED

The applications, properties and performance of urea-formaldehyde foam insulation is the focus of a study available from the U.S. Department of Energy. In it, NBS researchers review and summarize more than 100 reports from organizations around the world.

The study discusses the release of formaldehyde, shrinkage, corrosion of metal, effects of moisture and resistance to fungus. Standards for urea-formaldehyde foam insulations developed in North America and Europe are also reviewed, as are measures being developed (primarily in Canada) to reduce or eliminate formaldehyde levels in foam-insulated houses.

NBS performed the last such review in 1977. The new publication, *Urea-Formaldehyde Foam Insulations: A Review of Their Properties and Performance* (TN 1210), is available from the superintendent of documents for \$2.75 prepaid. Write to the U.S. Government Printing Office, Washington, D.C. 20402. Order by stock no. 003-003-02641-7.

BUILDING DIAGNOSTICS BOOK AVAILABLE

A 30-page report that describes the concept of building diagnostics and its evolutionary development is available from The Committee on Building Diagnostics of the National Research Council's Building Research Board.

The committee prepared the report as part of the technical program of the Federal Construction Council, whose purpose is promoting cooperation among federal construction agencies and other elements of the building community. The FCC focuses on technical issues of mutual concern to these organizations.

IT BEATS BANKING!

Worker's compensation insurance can be boring, **unless** you know what you may be missing — perhaps Europe! The rates and benefits for this type of coverage are usually highly regulated, and are often the same throughout a state — so you normally pay the same for the coverage within most states no matter where it's purchased. However, if you're not in a dividend-paying plan, **you don't get back what's left over!**

While dividends can't be guaranteed, the Design Professionals Safety Association Group Workers' Compensation Plan*, underwritten by the Hartford Insurance Group, has returned a remarkable 32.6% during its first two years! 32.6% can add up to be a lot for some firms — enough to pay for airline tickets to Europe. **If you're not getting yours, someone else may be.**

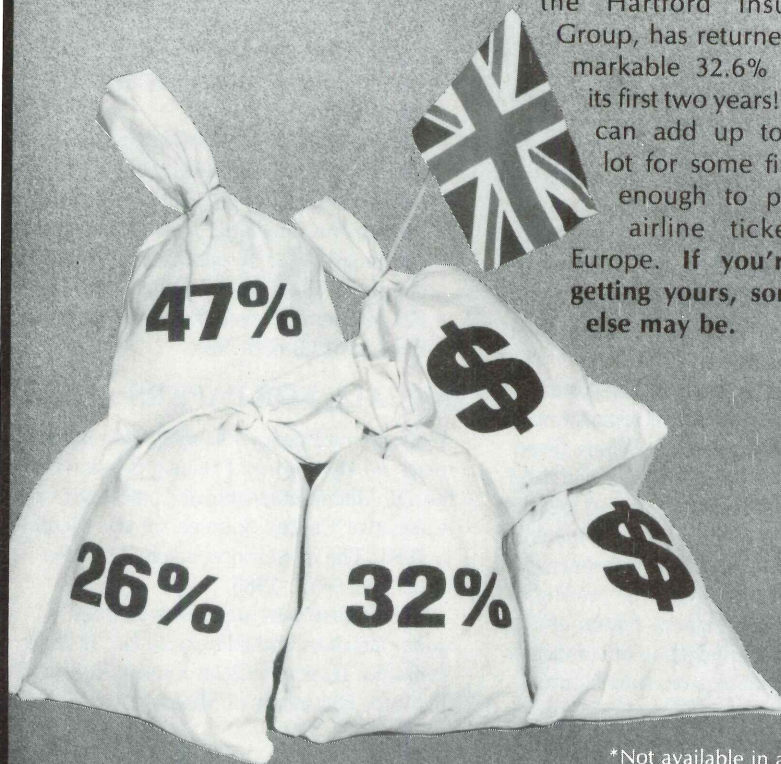

*Not available in all states.

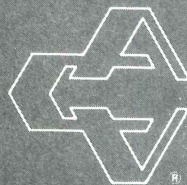

For "information", please contact:

Association Administrators & Consultants, Inc.
The Design Professionals Insurance Service Organization
19000 MacArthur Boulevard, Suite 500
Irvine, California 92715

1-800-854-0491 Toll Free
(714) 833-0673 Collect in California

Circle 10 on information card

Much of the material in *Building Diagnostics—A Conceptual Framework* emerged from a workshop the committee conducted in March 1983.

To order this report or obtain further information, write to the director of the Building Research Board, National Research Council, 2101 Constitution Ave., N.W., Washington, D.C. 20418.

MASTERGUIDE: SUPPLIER FOR THE SMALL FIRM

"When I'm searching for a local supplier, I don't always want to deal with national suppliers or national vendors. I want to deal with people close to my project, and for that I'll go to *MasterGuide*. It's the best-kept secret in the Institute," says architect Frank Deichmeister, AIA, of Alexandria, Va., principal of a small design firm.

The *MasterGuide* directory, organized into the Construction Specifications Institute (CSI) 16-Division MasterFormat, allows an architect to find information not readily available heretofore.

Each edition contains listings of regional and national suppliers. The directory features seven main sections, indexed and clearly marked by black tabs. These seven sections are as follows:

- **Classified**—consists of 17 categories, and serves as a compilation of regional manufacturers and distributors. Within these categories are product and service headings. Supplier's names are listed together with addresses and telephone numbers. Each heading has a CSI MasterFormat five-digit code identifying the product or service heading. A unique feature of this section is the identification of companies as either distributors or manufacturers.
- **Keyword Index**—provides information when the heading number or the overall division of a particular product is not known. The section cross-references common building terms to headings in the Classified section or to numerical headings.
- **Heading Index**—lists the 860-plus product service headings from the Classified section in numerical order as they appear within the 17 CSI divisions. The Keyword Index refers the user to an overall section number, but this section identifies the

exact heading under which a particular product is listed.

- **National Suppliers Section and Brand Name Index**—lists companies that sell their products nationally. The Brand Name Index is helpful when the name of a product is known, but the type of product or the company name is not. The index refers back to specific headings and page numbers in the Classified listings.
- **Resource Guide**—lists related professional associations, key documents, AIA publications and other resources of interest.
- **Color Advertising Section**—contains display ads arranged in accordance with the 17 CSI categories.
- **Professional Services**—is located at the beginning of the Classified Section. This section enables architects to quickly locate special services (for example, consultants, software programs and CAD/CAM Systems).

Comments on *MasterGuide: The Official Specifying and Buying Directory of the American Institute of Architects* and suggestions for improving next year's edition are encouraged. To purchase a copy of the directory, dial (800) 874-7717, ext. 68. For additional information, call Marianne Bohr at (202) 626-7585.

CALL FOR PAPERS

Abstracts on Energy Planning and related topics for the Energy Planning Session at the 7th Miami International Conference on Alternative Energy Sources are due October 1, 1985. The conference is scheduled for December 9–11, 1985.

Submit abstracts together with your name, affiliation and address to Dr. T. Nejat Veziroglu, Director, Clean Energy Research Institute, University of Miami, Coral Gables, Fla. 33124.

SLIDE PROGRAM ON LIGHT AND COLOR

A 22-minute slide/audio program, called *Color Under Energy Efficient Lighting* discusses three variables that affect the way colors are perceived and describes NBS research on how energy-efficient lighting systems influence color perception.

The program also suggests design considerations for developing energy-efficient light-

ing systems in commercial, institutional and industrial buildings.

Order the program (for \$57) from the National Audiovisual Center, Attn: Order Section, 8700 Edgeworth Drive, Capitol Heights, Md. 20743. The telephone number is (301) 763-1896. The package includes 116 35 mm color slides, an audiocassette and a complete script.

BIFMA STANDARDS ESTABLISHED

The Business and Institutional Furniture Manufacturers Association (BIFMA) is developing a prime source of product-related safety standards for the office.

The standards evaluate safety, durability and structural adequacy of furnishings used in working environments and are intended to protect consumer-workers who have little or no chance to select the furnishings used in their offices.

BIFMA members represent 85 percent of the nation's contract office furnishings manufacturers. The new standards will define specific techniques for testing furniture, the laboratory equipment used for the tests, the conditions for the tests and recommended minimum acceptance-levels for evaluation.

For information on the procedure used for developing these standards, write to BIFMA, 2335 Burton St., S.E., Grand Rapids, Mich. 49506.

REFERENCE DICTIONARY AVAILABLE

The Means Illustrated Construction Dictionary offers cost-related information on construction terms, materials, products, systems and methods.

The illustrated 150-page hardbound book contains key terms and abbreviations found in architectural plans and specifications and provides information on new materials and installation techniques.

Product choices are listed along with an explanation of cost differences.

The dictionary, which was prepared by the editors of Means construction publications, is available in local bookstores, through Scribner's or directly from the publisher. For additional information, write R.S. Means Company, Inc., 123 Construction Plaza, Kingston, Mass. 02364.

Laboratories

(and other high-tech types)

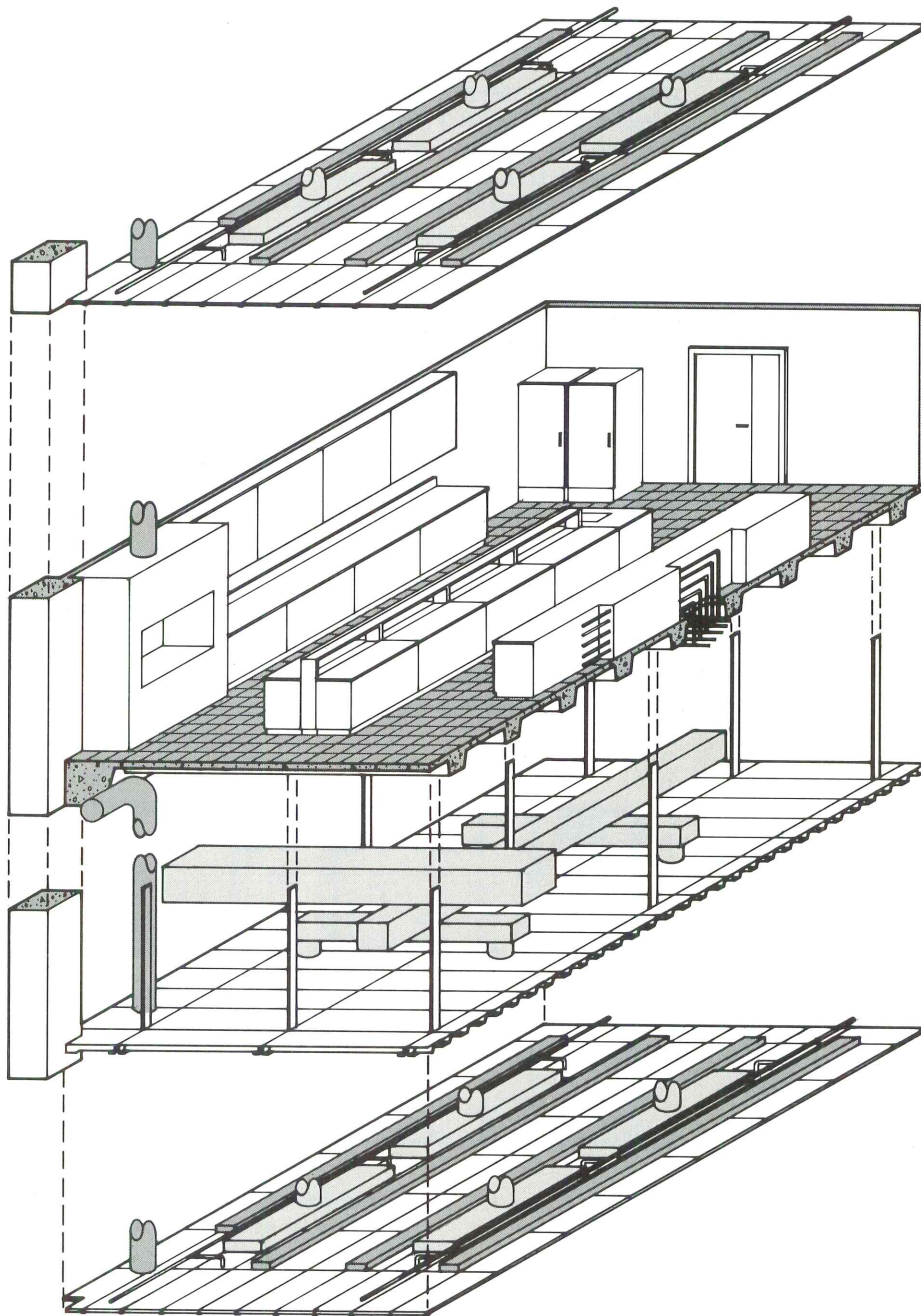

Laboratories merit study not only because they represent a fast-growing market for architectural services, but because designing them forces architects and engineers to confront tough issues—ones faced by designers of all building types:

- How can buildings—inherently static—keep up with an increasingly fast-changing society?
- What happens to architecture when technological requirements must be considered first and foremost?
- What, in the end, is a building anyway—a network of spaces or a network of services and capabilities?

An analysis of design-objectives for today's laboratories and their relationship to more fundamental, architectonic questions begins on page 20. Calculations and details, from the desk of a firm specializing in laboratory design, follow on page 24. Finally, a presentation of a research study jointly funded by an A/E firm and a furniture manufacturer asks the deepest question of all: What are the limits of the relationship between a building and its occupancy? That story starts on page 30.

—M.R.

TESTING GROUND

BY MITCHELL B. ROUDA

INDUSTRIAL RESEARCH LABORATORIES ARE EXPENSIVE, DEMANDING and fickle buildings. The activities they house and the spaces they require change often and unpredictably. These buildings demand intense mechanical and electrical support—requirements that are at times unprecedented and may, themselves, change. And to meet the needs of creative yet sometimes dangerous experimentation, laboratories call for an environment that is both rigidly defined and adaptable.

Altogether, labs challenge architects to balance a wide range of conflicting and immutable design objectives. Perhaps because of this, they serve as a testing ground for many architectural advances—in such areas as energy conservation, utility distribution, environmental control, interpersonal communication and design standards. Laboratories compel architects to explore building flexibility, in terms of both space and systems. And as the productive life of a building grows shorter, labs force architects to wonder just how long a building should last.

GETTING STARTED

One of the most difficult parts of the laboratory design process is knowing where to start. Spaces and adjacencies need defining, of course. But in laboratories there are many disparate adjacency requirements. Materials move in one direction; samples, test data and personnel move in others. Waste materials travel independently. Flows of information between people and between equipment are an added complexity.

Compromising any of these flows may threaten the usefulness, safety or efficiency of the building. Nevertheless, because each flow depends on activities that are, by the very definition of experimentation, unknown, few can be established with confidence during the design phase. The search for a laboratory concept hinges, therefore, on the creation of a universal environment that can be adapted later to suit any eventuality.

Often, the most reasonable starting point for developing a building concept is the service delivery system—a most unlikely place for architectural explorations to begin. Indeed, laboratory designers refer to the few prototypical models upon which most research facilities are based in terms of these service distribution networks.

LABORATORY PROTOTYPES

The first laboratories—where Eastman, Edison and Bell made history

This article is based on a body of knowledge collected by several leaders in the field of laboratory design. The contributions of Fernand Dahan, AIA; Jerrold Koenigsburg; Martin D. Raab, FAIA, and Stanley Stark, AIA, are particularly appreciated.

—were merely large rooms in loft-type buildings. Furniture and measuring devices, not arrangements of space, defined the laboratory. Even as industry's investment in research grew and activities became more organized, little need was perceived for a unique building type.

In the '40s and '50s, when hundreds of industrial companies launched vast in-house research programs, patterns began to emerge. One of the most important of these was modular construction. It presented the first somewhat effective tool for making buildings flexible. The series of small workrooms that resulted from modular design also gave each scientist a "kingdom," and that helped attract talent to industry from academia.

Laboratory modules became the building block for research facilities of all kinds. Designers focused less on ways to organize space and more on perfecting this fully-equipped, self-contained cell. The theory was that if a module contained all necessary mechanical, electrical and structural systems, then "design" would entail only calculating the number of modules required and stringing them together with administrative and amenity spaces.

The laboratory module represented the smallest unit of working space that could economically contain a complete set of laboratory facilities and services. Its dimensions defined intervals for subdividing floors. The width of a typical module ranged from 6 to 12 feet. Lengths varied from 16 to 30 feet. Movable partitions, of metal or gypboard, could define single-module rooms or wider, multimodule areas.

Servicing these "first-generation" laboratories was equally standardized. Modules were strung along a double-loaded corridor. Repetitive service shafts lined this circulation path, one to a module, supplying services to all rooms in the building regardless of where partitions were placed (see Figure 1).

FIGURE 1

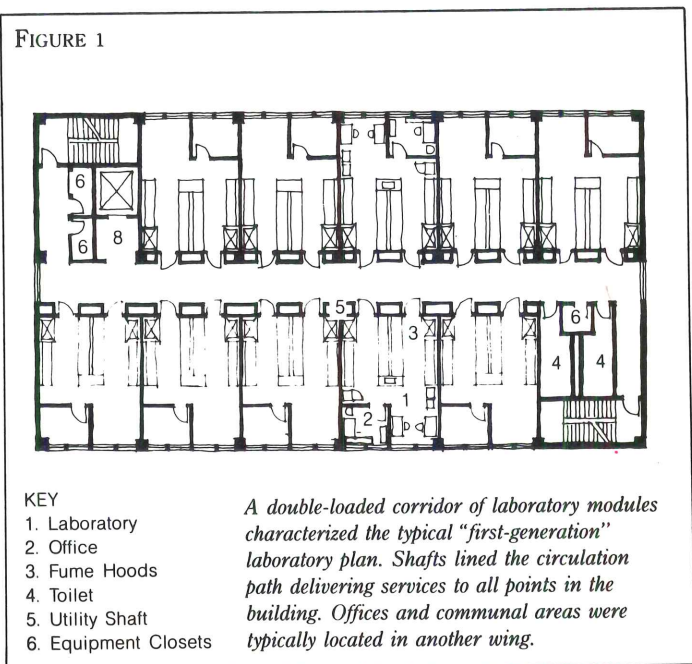

A SECOND GENERATION

In the 1960s, several changes in research methods caused designers to rethink many principles of the lab module concept. Emphasis on test reproducibility made documenting results and charting the experimental process as important as the discovery. This led, in turn, to a need for more desk space and more rigid ways of organizing lab areas. A series of regulations promulgated by the Food and Drug Administration and the Environmental Protection Agency in the late 1970s, known collectively as the GLPs (good laboratory practices) amplified the need, in many industries, for a "one-room-after-the-other" experimental path. Coupled with this was increased use of electronic testing equipment. Walk into virtually any unrenovated 1950s laboratory and these research changes are apparent: expensive bench space cluttered with papers, logs, reference materials and machinery.

Fortunately, these changes paralleled a surge in capital R&D spending by industry, a surge that has yet to peak. This "second generation" building boom afforded architects and laboratory planners an opportunity to reconsider laboratory design.

TWO LABS BY KAHN

Though not the first laboratories to exhibit second-generation char-

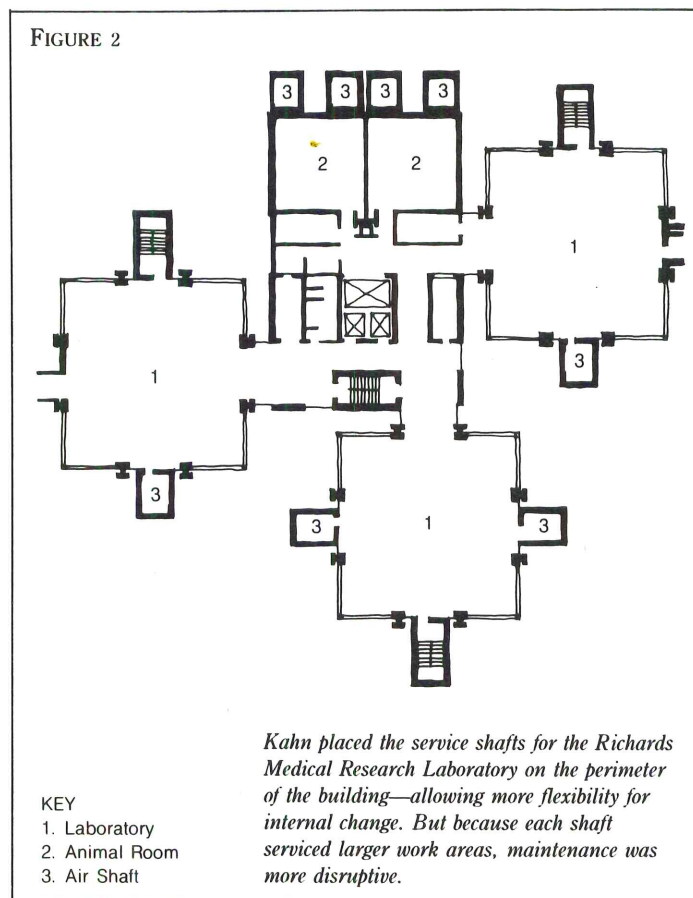

acteristics, two laboratories designed by Louis Kahn are among the most famous. They also show that architects known for design can also pioneer significant technological advances.

Kahn's Richards Medical Research Laboratory, opened at the University of Pennsylvania's Philadelphia campus in 1961, still distributed services vertically, but consolidated them into larger shafts (Figure 2). Instead of serving single laboratory modules, each shaft supplied a group of laboratories clustered around the service towers. Essentially, this increased the size of the planning module.

Of even greater importance, Kahn pulled these shafts away from the core of the building. His motivation was largely visual, but its by-product was easier rearrangement of internal spaces.

In his design for the Jonas E. Salk Institute, built in La Jolla, California, four years after the Richards lab, Kahn turned the service network, which he called "servant space," horizontally, sandwiching it between floors. Piped services, air supplies and exhausts were run in these full-height interstitial floors (Figures 3a, 3b and 3c).

Using a truss system that spanned long spaces without intermittent supports, the Salk Institute's design permitted a whole new level of flexibility. Spaces could be made both longer and wider and service systems could be completely rearranged without disrupting laboratory work areas.

The service floor eliminated the need for placing shafts in every laboratory module, a redundancy necessary in earlier labs to cover unforeseen partitioning. With the interstitial scheme, only services needed at initial occupancy were supplied. Additional services could be added later, as required.

TODAY'S PATTERNS

Distributing lab services *horizontally* instead of vertically (whether in a full-height interstitial space or a thicker floor/ceiling sandwich) was a turning point. This idea, and variations of it, have become guiding principles for many systems now being constructed.

Some modern laboratories follow more traditional service patterns, either because of cost constraints or because less flexibility is necessary. Nevertheless, horizontal distribution above or below the laboratory work area, even if only to channel services from a central shaft into the module, continues to gain popularity.

To reduce the higher first-cost of interstitial floors, some laboratory planners have developed hybrid solutions. Others build off another model—itsself a form of horizontal distribution system—called the "service corridor" scheme (Figure 4).

The economic significance of analyzing these models can be great. Mechanical costs can make up nearly half the construction cost of a facility, which prices out at \$200 to \$300 per square foot.

Operating expenses in a laboratory are equally high, particularly energy costs. Consumption is typically six or seven times that for a conventional office building. This is because labs are constantly "broomed" clean with a steady flow of air from other areas such as corridors. The air moves to the laboratory room and out through fume hoods. Air changes are frequent, and to prevent contamination, recirculation may be forbidden. In addition, to avoid backflows, air velocities across the face of the fume hoods must be maintained at high levels.

Shaping the indeterminate lab

Some new systems have been developed to reduce energy costs. "Auxiliary air" systems maintain the high velocity of air across the hood's face by delivering the make-up air right to the hood. This reduces the total volume of air that must be conditioned. Variable-air-volume controls increase the flow of air through the laboratory only when hoods are switched on.

OTHER CHANGES

Regardless of service systems and distribution patterns, other aspects of laboratory planning are being questioned. One is room size and shape—particularly in industries that do not require sealed

partitions for isolation. In many food laboratories and medical testing centers, large open rooms, with work spaces defined by furniture alone, have become more common.

Advantages are that large rooms encourage more communication between scientists, promoting teamwork. Like open office plans, open labs permit easy reconfiguration of work stations. Furniture systems, often constructed with electrical and piping raceways included, can be moved easily and serviced quickly. Placing as much service as possible in the domain of furniture can also simplify maintenance. To laboratory directors, who know that many sophisticated laboratories require a level of maintenance practically impossible to procure, this is significant.

Even air handling can sometimes be provided in movable, snap-together components. This concept is demonstrated by the Brady System (developed for electronics "clean rooms," where air-circulation requirements are most intense). As authors Steven Parshall, AIA, and Robert Knight point out in their article beginning on page 30, the speed with which such a system can be installed—not to mention the increase in flexibility and capital-cost recoverability—can alone justify this approach.

Perhaps the greatest proof of the trend towards flexibility *within* the laboratory module is the increasing availability of flexible labora-

FIGURE 3A

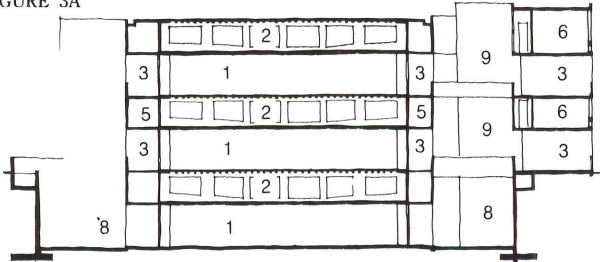

FIGURE 3B

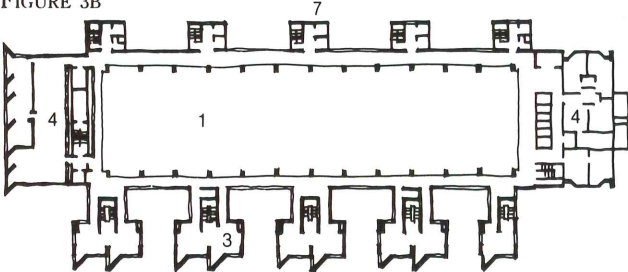
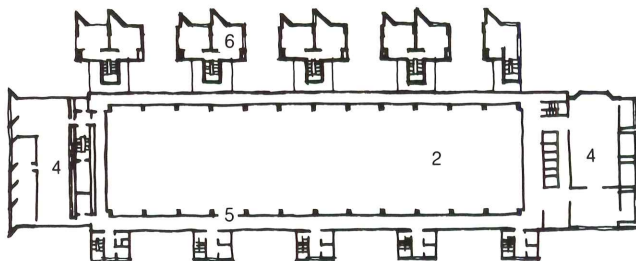

FIGURE 3C



KEY

- 1. Laboratories
- 2. Mechanical Floor
Interstitial Space
- 3. Open Loggia
- 4. Offices
- 5. Corridor
- 6. Studies
- 7. Stairs Utility Rooms
- 8. Open Court
- 9. Bridge

At the Salk Institute, Kahn employed an interstitial scheme to distribute mechanical services and accommodate structure (section, Figure 3a). Research/office floors (plan, Figure 3b) alternated with mechanical equipment floors (plan, Figure 3c).

FIGURE 4

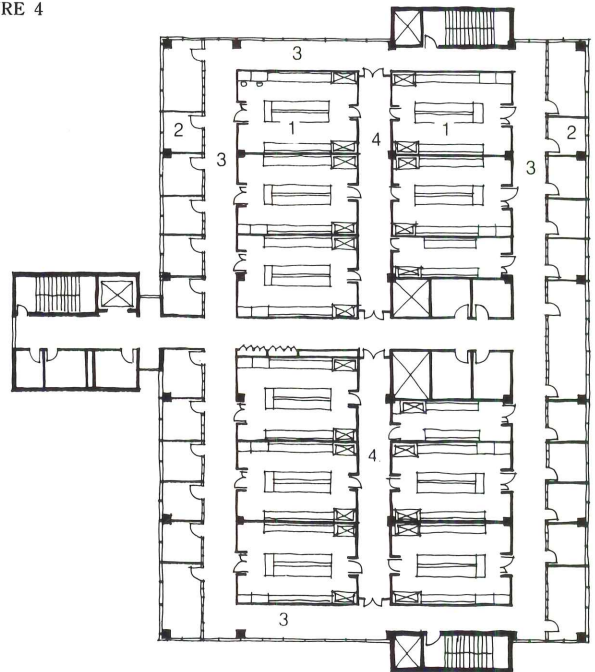

KEY

- 1. Laboratories
- 2. Offices
- 3. General Circulation
Corridor
- 4. Utility Corridor

"Service corridors" have been popular since the 1960s as a form of horizontal supply usually cut through the center of the building. "Clean" traffic (research staff) enters rooms from perimeter circulation corridors; mechanical equipment, service distribution and maintenance zones occupy the center.

tory furniture components, most including service support networks. Virtually every major manufacturer of laboratory casework now offers a line of flexible components.

Oddly, the net result of many of these changes is a contemporary lab design model not unlike the labs constructed more than a half century ago. Large rooms with shaft-free floor areas, often called "open fields," recall the earliest loft spaces used by scientists. And using furniture and equipment rather than structural or mechanical systems to define a laboratory also recalls the older models (Figure 5).

MORE BIG QUESTIONS

Though today's laboratory designers still focus much of their exploration on building systems that respond to heavy service demands and flexibility, two additional challenges have emerged in recent years to complicate laboratory design further. These new areas of concern raise still more questions that point to lessons for other building types.

The first of these challenges concerns an area always considered part of the architect's purview—the habitability of the environment.

Laboratories can present a hostile face; the rigors of the environment are matched by rigorous management control that often can make a lab a confining place to work in. Because of the processes and materials researchers work with, laboratories can indeed be hazardous places, or at least they might be if strict working procedures were not followed and if the building were made of softer materials or surfaces. Yet at the same time, it is in laboratories that we expect our society's greatest minds to perform their greatest work, and it becomes an architect's responsibility to contribute to these talented worker's motivation.

Clients want their laboratories to represent their company's vision of the future and at the same time portray a non-threatening image to neighbors.

The second challenge is a tougher one, if only because it lies outside the architect's traditional role. It involves the relationship between building projects and larger corporate objectives.

The design of laboratories presents a company with some tough questions about its future, and the answers are not always available. Architects recount innumerable stories of projects put on hold after more than a year of programming and design. It seems the process of designing a laboratory raises more soul-searching than is usual for other building projects, and tough strategic decisions must often be made before proceeding.

There are always ways an architect can help in a company's strategic planning process, and one such method is described in a paper mentioned in the reading list on page 33. But regardless of whether or not architects dive into this "preprogramming" phase, all would do well to be wary of research projects undertaken for companies that lack a clear vision of their own futures. Those companies will have to face up to that lack of knowledge sooner or later but not on the architect's time.

LESSONS LEARNED

How an architect is to grapple with a task as difficult as designing

industrial research facilities remains debatable. Some architects begin with space assumptions, others start with air-handling requirements. All will tell you the first point of departure is a long-term research management plan, but most report that, despite its importance, a plan is rarely available.

What seems most critical is that, no matter the starting point, somewhere along the course of the design process, thousands of issues must be explored from countless angles. Solutions that work well to the engineer may not meet the scrutiny of the industrial hygienist. Patterns that work well for laboratory administrators may fail to meet regulatory requirements. Solving all of these balances may throw energy consumption so far out of whack that the whole process will have to be started again.

If there is a lesson in all this, it involves the way experts in many fields can contribute to a programming process and then together develop a workable solution. No other building type offers such a strong case for an integrated design process, an argument not lost on the many architecture *and* engineering firms that are steadily increasing their share of the lab-design market.

That a building's design may be rooted so heavily in the dictates of the engineer, the government, the corporate boardroom, the medical profession, the market and still other (sometimes unknown) forces is one of those big ideas few can afford to ignore. □

FIGURE 5

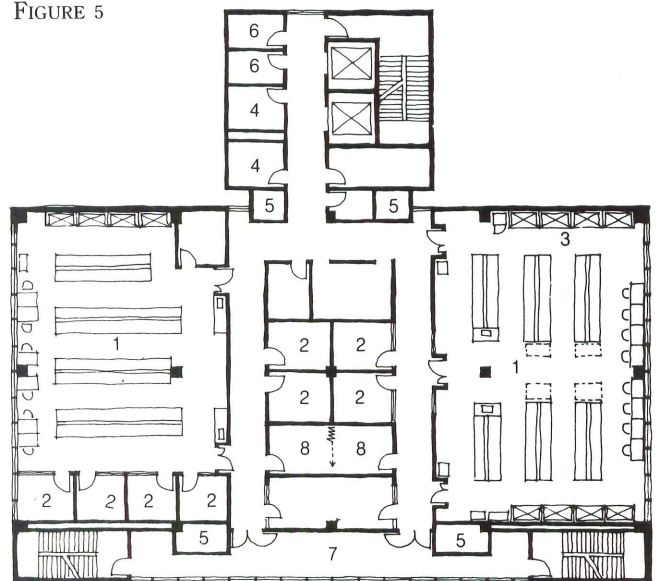

KEY

- 1. Laboratory
- 2. Office
- 3. Fume Hoods
- 4. Toilet
- 5. Utility Shaft
- 6. Equipment Closets
- 7. Staff Corridor and Break Areas
- 8. Conference

A typical "second-generation" laboratory, using horizontal service distribution, allows complete reconfiguration of room sizes and shapes in all directions. Even circulation corridors need not remain fixed, and plans can vary greatly from floor to floor.

FROM PROGRAM TO DESIGN

BY STANLEY STARK, AIA

LABORATORIES ARE EXTREMELY COMPLEX BUILDINGS THAT MUST respond to many constituencies—scientists, research administrators, managers, safety officers, engineers, the neighboring public and others. Often, agendas conflict.

At the same time, laboratories must adapt to unpredictable research directions and the physical requirements they may impose. A consensus on these directions is seldom reached. Accommodating change, whether technological or organizational, is therefore always a fundamental design requirement.

Lab design is where “push comes to shove” has real meaning. Goal setting drives programming. Programming drives design. Design synthesizes all of the requirements—space, service distribution and flexibility—and emerges with a lab unit and the patterns it generates. The issues of proximity, work flow, circulation and flexibility generate their own patterns which push back.

Nevertheless, the process must start with the fundamental character of any R&D facility: supporting a research process while protecting the researcher and the environment.

The sketches on the following pages illustrate some of the factors that must be considered to get from program to concept (building size and space standards, office/lab relationships, utility distribution patterns and flexibility types) and from concept to design (lab layout, service delivery, safety, furniture and fume hoods).

Although not illustrated directly, the most poignant argument for responsible design concerns the need to reconcile habitability with the standardized, rigid R&D environment compelled by safety regulations and process control. The mandate to make R&D facilities amenable to the users and supportive of staff communications (vital to big team science) is overwhelming. How—for example—can corridors, daylight and support spaces be marshalled to create an attractive and productive workplace?

If it is the human assets that produce results, it is the supportive environment that sustains the effort and the interchange. □

AGENDAS AND ASSUMPTIONS

Programming for a laboratory begins with a rigorous exploration of long-term research agendas. Then, a series of operational assumptions must be made. Three of the most critical are highlighted here: space standards, office/laboratory relationships and flexibility. Each may, in different cases, be a starting point for developing schematics.

This algorithm converts the figures shown below (based on laboratory work space to total building projections): first, the net area per person is multiplied by the projected number of staff. This figure, together with the space required for scientific support functions (related to the specific research programs) and administrative support functions (related to the other structures and activities on the site) yields the net building area. Multiplying this by a “gross factor” of 1.6–1.8 yields a “gross building area” assumption.

NET AREA (IN SQ. FT.) PER PERSON (Predictable research functions)

Research Activity	Technicians (Labs Only)	Technicians & Scientists (Lab + Office)	Total Lab Area Including Direct Scientific Support
Basic Discovery	190	180	370
Chemistry and Analytic	200	175	345
Pharma. Formulation & Development			
□ Labs only	175	150	340
□ Including Piloting	—	—	550–650
Chemical	220	180	—
Electronics and Telecom.	—	—	200

Stanley Stark, AIA, is an associate with Haines Lundberg Waehler, a New York City-based architecture, engineering and planning firm that specializes in the design of research facilities.

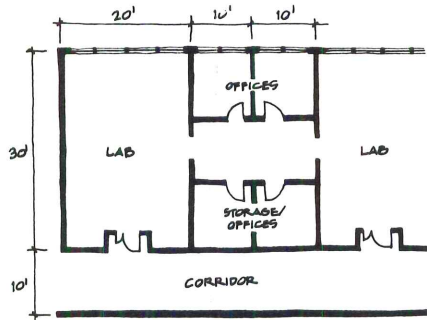

Most laboratories employ variations of these three lab/office relationships. The scheme at left offers the advantages of daylight, close proximity to lab space and storage. But these offices may disrupt future changes, can be costly (with lab-type space used for less significant functions) and do not permit independent access to offices.

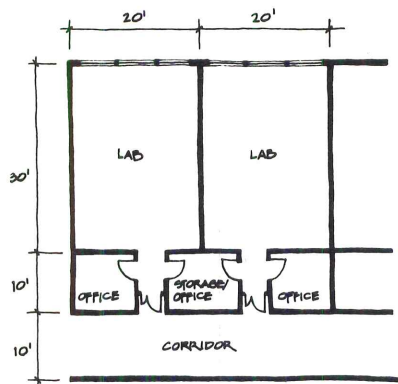

This arrangement still permits direct accessibility from lab to office, and—by permanently dedicating a strip between corridor and lab rooms—won't affect building expansion or reconfiguration. The offices have semi-independent access but lack windows (although the partition between office and lab could be glazed).

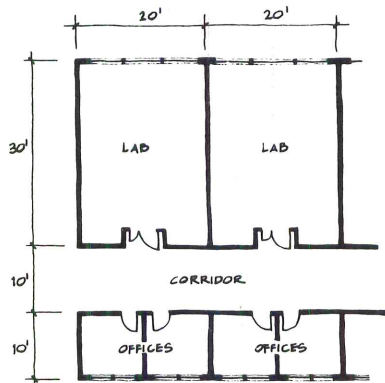

Locating offices across a corridor from the laboratory allows both spaces to have access to daylight, but tends to elongate the building and decreases flexibility. This arrangement provides independent access to the office, but sacrifices the direct relationship to lab space.

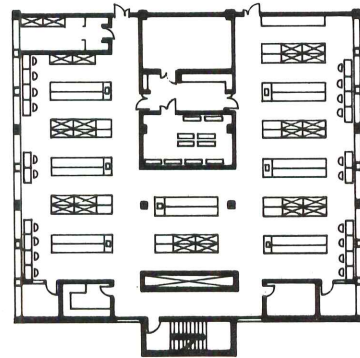

ENTIRE WING AS LAB UNIT

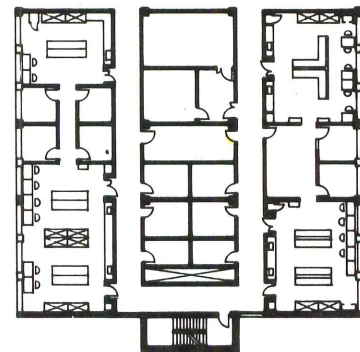

TYPICAL LABS & SUPPORT

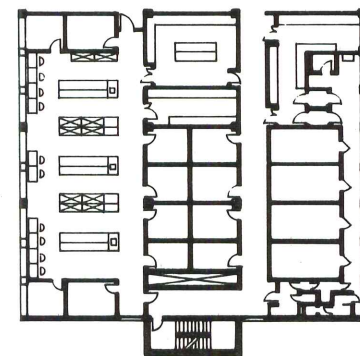

SEQUESTERED SUITE

CONTAINMENT SUITE

Lab designers think of flexibility in four ways: expandability (building growth), convertibility (building reconfiguration), versatility (change within the room) and interchangeability

(furniture system modification). The lab wing in the drawings above permits different occupancies, illustrating three of the four types of flexibility.

THE LABORATORY UNIT

Although R&D activities typically require many diverse spaces, the typical laboratory unit represents a basic, repetitive space common to most research buildings. It greatly affects the development of building structure and servicing modules. Typically, laboratory unit layouts develop as a function of:

- Staffing
- Process functions
- Office/laboratory relationships
- Circulation patterns
- Attitude to daylight access
- Typical laboratory furniture and equipment

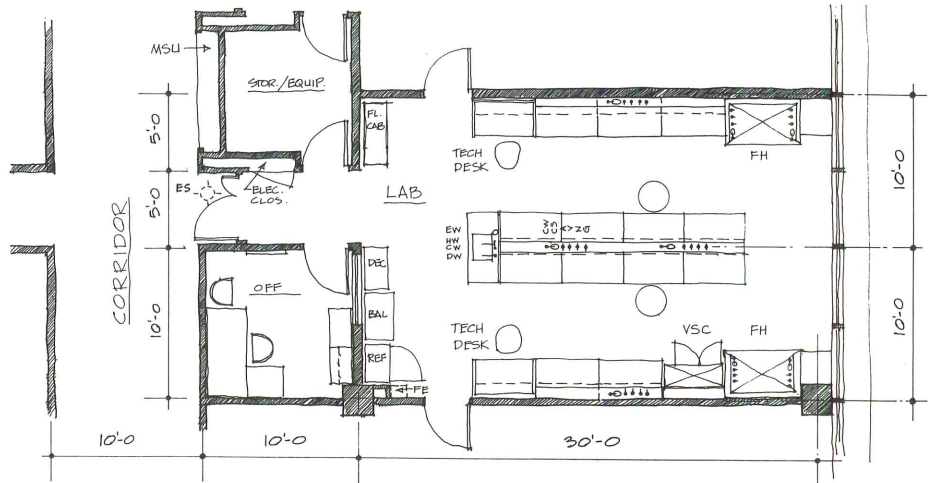

The laboratory layout shown on this and subsequent pages represents only one of many possible layouts. It illustrates the relationship between overlapping systems of use, furniture, service, structure and safety.

The length is governed by the size of the fume hoods, 16 feet of benching, a technician's desk and cross-circulation.

The width represents an effective center-to-center dimension for laboratory bench service strips.

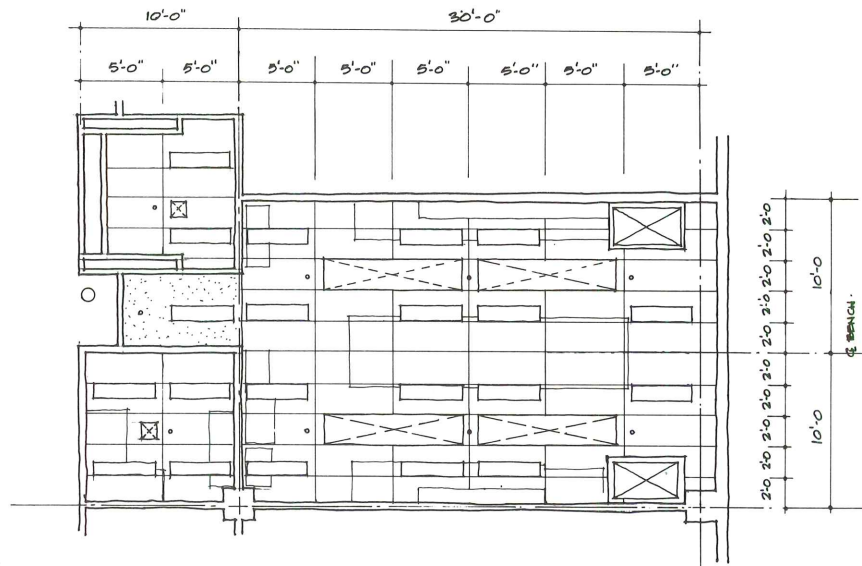

The reflected ceiling plan illustrates how the laboratory ceiling relates to the laboratory layout plan.

This plan illustrates how the dimensional grids are broken

down to deliver services to each laboratory in an integrated pattern. It also shows the relationships between furniture, lighting, sprinklers and supply and exhaust registers for HVAC.

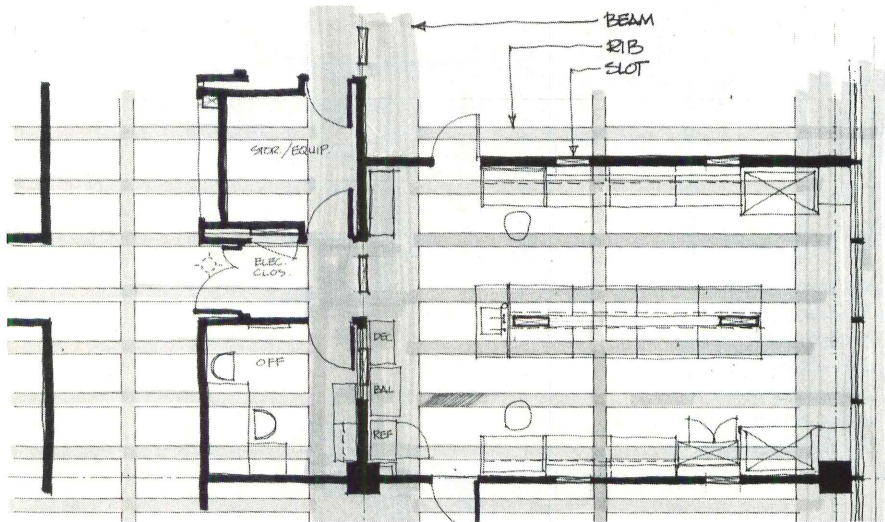

The relationship between the floor framing structure and lab furniture establishes the position for floor slots used to deliver piped services. Benches and service strips

run parallel to structural ribs to gain maximum clear area for floor openings. Service strips are centered between structural ribs to limit interference with the structure.

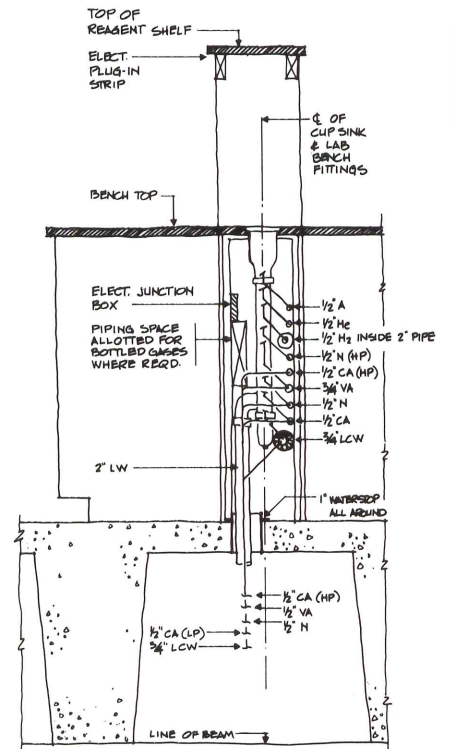

Services in a laboratory unit are delivered to the bench via pipes housed in service strips. Pipes may come down from the ceiling or up through the floor.

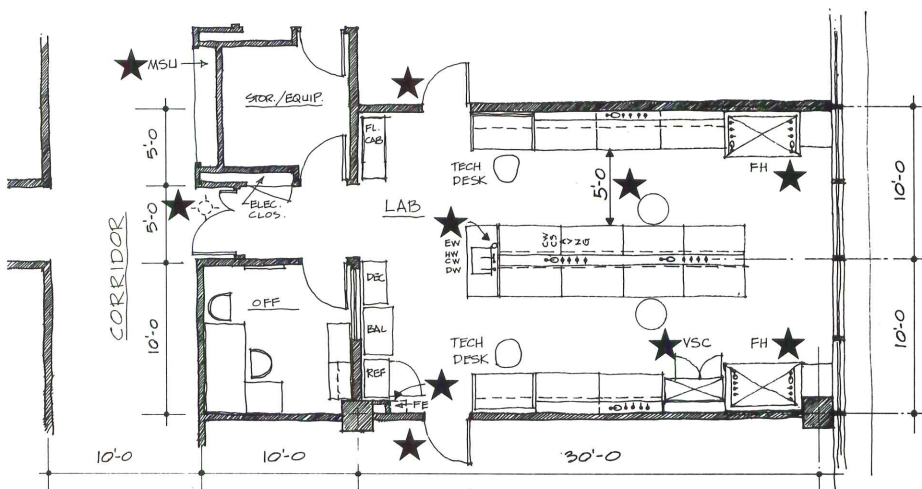

Safety considerations within the lab unit are indicated by stars: 1) the placement of fume hoods (FH) away from egress and circulation patterns; 2) maintaining a 5-foot aisle width, which eases passage without inviting in-aisle storage; 3) vented sol-

vent storage cabinets (VSC) for storage of flammables; 4) two means of egress; 5) an eyewash (EW); 6) fire extinguisher (FE); 7) emergency shower and 8) modular safety unit (MSU) containing fire hose, crash kit, safety cabinet, etc.

FUME HOODS

Fume hoods are ventilated work cabinets where researchers experiment with substances that could prove toxic. A laminar flow of air washes across the face of the hood to an exhaust vent inside protecting researchers from fumes. But the amount of air required (see chart) and the frequent requirement that none be recirculated poses a number of design challenges.

If the air required to maintain velocities across the hood (make-up air) is supplied through the building's HVAC system, it all must be conditioned, increasing energy costs. Auxiliary air (unconditioned air supplied near hoods) can be effective, but can create drafts that disturb the researcher and cause turbulence that can compromise one-way air flow. Turbulence must also be considered in the placement and use of all fume hoods.

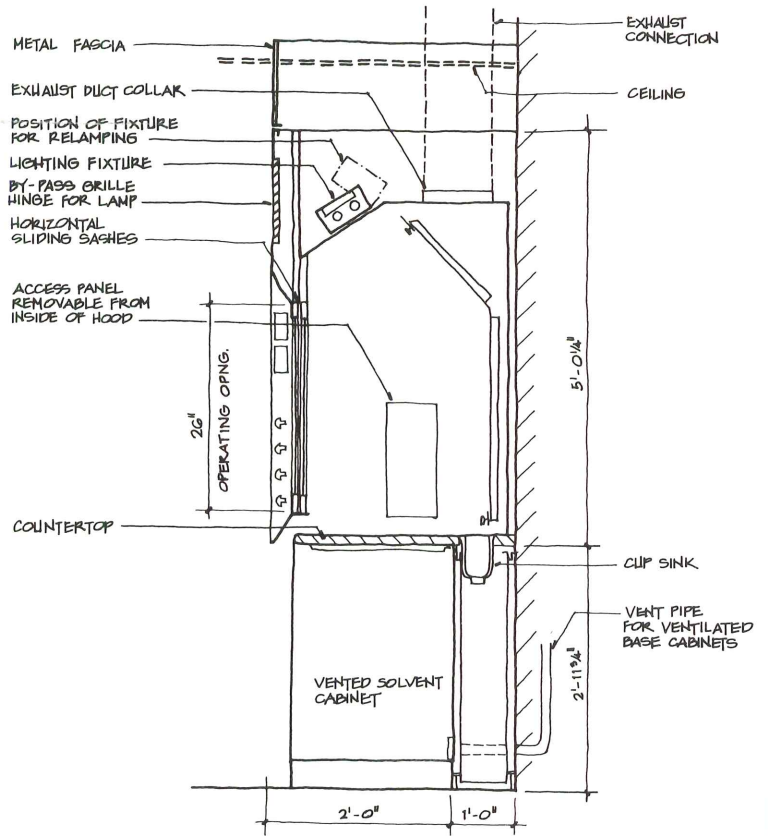

Limiting the face opening of the hood is one way to maintain high face velocity without greatly increasing the amount of air that must be supplied to the lab room.

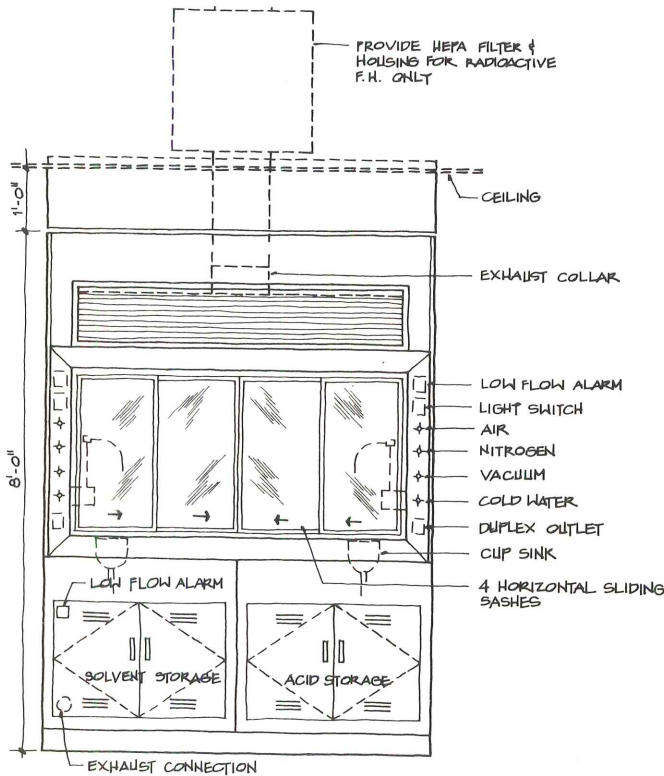

FUME HOOD GUIDELINES & STANDARDS

NFPA-45	Face Velocity Must be Sufficient to Prevent Escape of Contaminants
NFPA-56	100 FPM average
Scientific Apparatus Manufacturers Association	100 FPM average
ASHRAE Handbook	100 FPM average

THE FLEXIBLE INVENTION FACTORY

BY STEVEN A. PARSHALL, AIA, AND ROBERT KNIGHT

IN MENLO PARK, NEW JERSEY, DURING THE EARLY PART OF THIS century, Thomas Edison built what many consider the first industrial research laboratory. Edison called it an "invention factory." He made little distinction between inventing and producing. Moreover, there was little difference in the buildings that housed the activities.

Today, we are seeing many high-tech companies returning to Edison's example. Some, like INTEL, house technology development and manufacturing together in architecturally similar buildings. Others house marketing and manufacturing groups in the research complex, like the 3M Company, which introduces one new product each year for every five products it makes. As the automation of manufacturing increases, this trend will accelerate. High-technology industries will be driven even more by invention than by science. Thus, it is not unrealistic to envisage research, "in real time," merging with production. In other words, applied research will occur wherever the industrial team happens to be—creating what we call the "virtual" lab.

In the high-tech arena, continuous and unimpeded change rules. Commercial success depends on the speed of transition from new technology to new product. The time lag between discovery and commercial application is shortening in response to the forces of global competition. Moreover, market windows are becoming narrower and less certain. This is forcing building delivery to happen fast, and requiring building designs that permit ongoing correction and modification.

It is easy to say what should be done: Build labs that can flex. To avoid becoming truckloads of rubble leaving a site, a laboratory must be truly flexible—capable of change like a living organism—able to convert existing components to new forms with only minimal discard. To achieve this, a radical conceptual change is necessary—one that permits a shift from investment in fixed structures to investment in portable component systems. This limits "construction" to a lower-cost "permissive shell."

When the outer building becomes independent of an inner build-

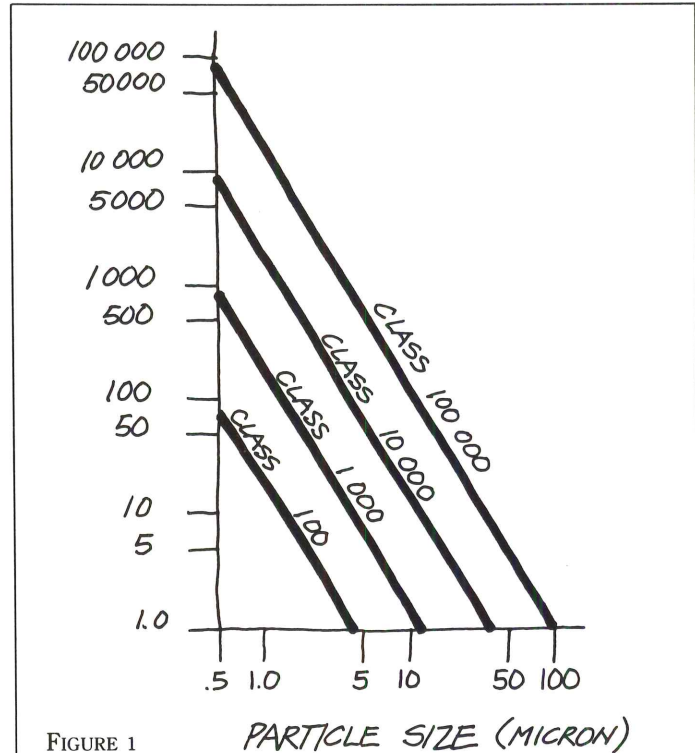

FIGURE 1

Particle count and particulate size for filtered air peaks around 0.5 microns (1 micron 1×10^{-6} meter). Since particle detection by available instruments becomes more difficult with decreasing size, 0.5 was adopted as the lower limit of the air particle count for purposes of classification. In a class-100 clean room, air will contain fewer than 100 particles larger than 0.5 microns per cubic foot. Federal Standard 209b defines class -100, -1,000, -10,000 and -100,000 rooms by a logarithmic chart relating particles, sizes and counts.

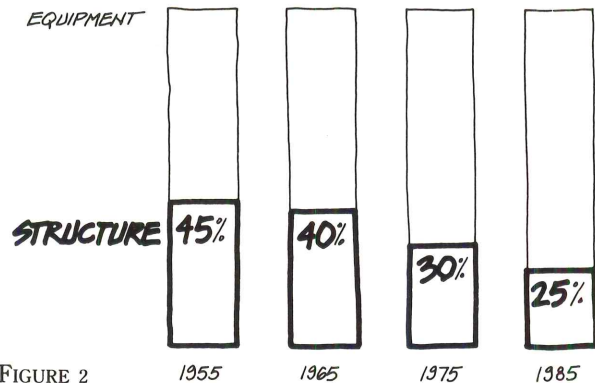

FIGURE 2

Industry has steadily shifted investment from capital-intensive building structures to recoverable furniture and equipment in order to make facilities more responsive to shorter product cycles and take advantage of depreciation and investment tax credits.

Steven A. Parshall, AIA, is vice president and director of research for CRS Sirrinc, Inc., an architectural and engineering firm. Robert Knight is currently a private consultant specializing in the design of semiconductor fabrication facilities.

This paper was presented at the AIA's Research and Design Conference held at Los Angeles in March.

ing, we reach a new level of flexibility. We create not one building, but two envelopes joined in one purpose. Together and alone, these envelopes perform their specialized tasks better, at less cost, than a single building could. Even more important, this construction is quicker and more standardized.

CRS Sirrinc and Herman Miller collaborated in an effort to identify and describe the application of the "building within a building" concept to a high-tech industry. The study centered on the Brady Interior Architecture System developed by Robert Knight and others for IBM in San Jose, California. William Kistler, from IBM, along with Thomas Wolterink, from Herman Miller, worked with William Caudill, FAIA, Paul Kennon, FAIA, and Kevin Kelly, AIA, all from CRS Sirrinc, as the principal investigators.

CLEAN ROOMS

The development and application of the Brady System was centered in facilities for the microdevice industry, where the need for strict environmental control, rapid construction and equally rapid change are especially intense. Today's microdevice labs house space dedicated to the manufacture of disk-file read-write heads, disks, integrated circuits, microsensors and other devices in which microstructure is critical. Success depends primarily on the strict control of airborne particulates, and temperature and humidity. The degree of control achieved is represented by a clean room classification based on the number of particles measured in a cubic foot of room air during use (Figure 1).

The current industry standard for designing microdevice clean rooms is a custom-built, permanent installation employing conventional materials and traditional construction methods. A common design is a three-level structure with a full basement below and an interstitial space (or penthouse) above. Fixed utilities, centralized mechanical systems, hard walls, and permanent ceilings, however, resist simple, quick modification. Moving equipment or expanding the spaces becomes disruptive and costly.

The total cost of a conventional microdevice building, including offices and support space, ranges from \$190 to \$250 per gross square foot. The cost of the clean-lab area alone can run as high as \$450 to \$900 per net square foot, depending on clean room classification (see box on costs, page 33).

Design/construct time is another major problem. It takes from 12 to 30 months to design and build most new facilities. Because of the 3- to 18-month market life of many high tech products, some research and development projects that have commercial potential never leave the laboratory. This places an additional burden on accommodations for subsequent research programs.

Another consequence of the long delivery time for new facilities is that a laboratory designed two (or more) years before beneficial occupancy may be outmoded before it is completed.

LOOKING FOR A SHELL

Evidence is that in the microdevice industry, and some others as well, there is a need to design indeterminate outer buildings that are decoupled from the specific, time-dependent activities that they contain. The two-year design and construction time of *buildings*

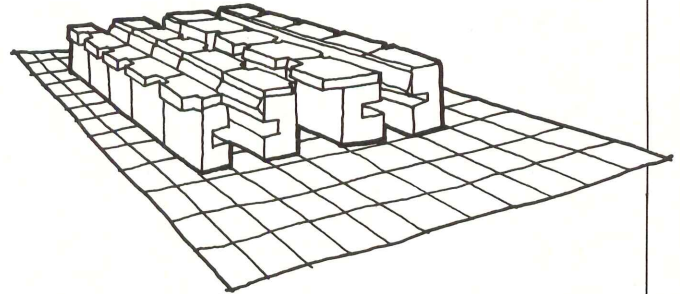

FIGURE 3

Independent of the structure overhead, workstations are created with demountable walls and ceilings.

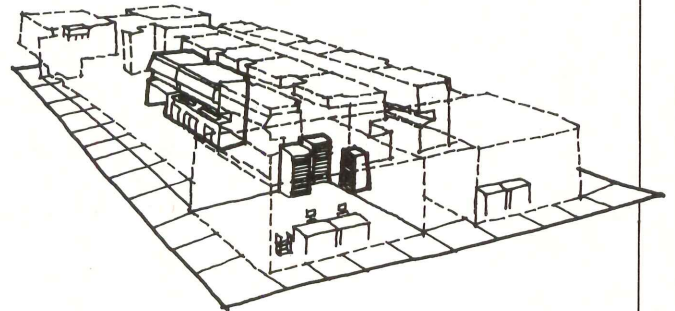

FIGURE 4

Controlled Environment Process Stations (CEPS) hoods form the building blocks for this class-1,000-to-100 clean room. Each hood accommodates a 3-foot-deep x 6-foot-wide opening for inserting individual work stations.

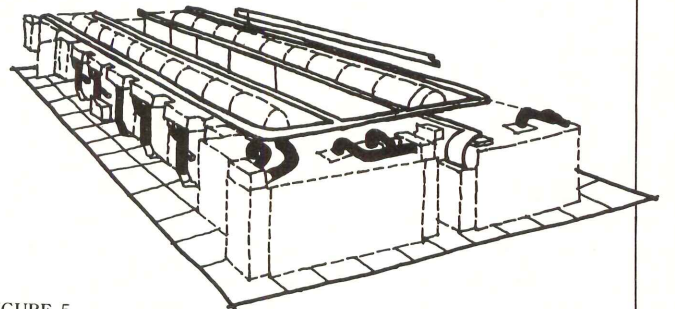

FIGURE 5

A unistrut system permits plumbing, electrical lines and duct work to be installed later, using flexible connections that lead from the back of the CEPS hoods.

A generic shell houses prefabricated components

becomes aimed not at mirroring occupancy, but at developing a *generic* shell. Then, move-in needs could be accommodated quickly using components as sophisticated as traditional HVAC systems but as movable as furniture.

This theory parallels bigger economic trends. Over the last 25 years, industry has steadily shifted investment away from buildings toward equipment (Figure 2). In response, we are now seeing the development of new modular interior systems and distributed building systems based on factory-prefabricated components.

BRADY INTERIOR ARCHITECTURE

The Brady interior architecture is an example of an inner-building system—an alternative to the built-in-place clean room. Its name is derived from the Civil War photographer, Matthew Brady, who carried his complete wet processing lab in a wagon—the ultimate in flexible, indeterminate architecture.

Brady represents a kit of parts assembled freestanding on a slab floor. Placed on a chemical-resistant floor covering, the installation avoids penetrations into the floor. In place of gravity drains, for example, Brady uses a vacuum collection system that carries waste chemicals overhead (Figure 3).

The work-station hood contains a small custom-designed air handler with high-efficiency particulate air (HEPA) filters and point-of-use temperature control. Humidity controls can be added, where necessary, without disruption once the clean area is in operation. Flex duct carries exhaust gases between the hood and the host-building exhaust system. Recirculated air is picked up at floor level

and carried through flex duct to the air handler located on the top of the work-station hood.

The hood is also the primary structural unit of the interior architecture, supporting the ceiling, pipeways and electrical distribution. Herman Miller Action Lab components, augmented with many custom-built items, provide wall and ceiling enclosure, work surfaces, vertical storage and transport containers. Standard flexible office wall panels are used as bearing walls by the addition of aluminum extrusions that rest along the top edge and attach at the panel connectors to distribute load as well as provide structural integrity. Brady is a totally modular, demountable assembly. Typical wall sections, when bolted together, can form rooms of any practical size or shape (Figure 4).

The back of the work-station hoods support service connections for instrument air, gases, process and waste vacuum, bulk chemicals and deionized water. Hoods are maintained from the rear by workers who enter a utility core (see section immediately below). This arrangement keeps workers out of the space, eliminating both the possibility of contamination and disruption to laboratory workers.

Flexible piping is used almost exclusively for chemical handling. Overhead vacuum waste collection is made possible by modular vacuum units located within 50 feet of any chemical work station and capable of serving more than 20 such stations. The microprocessor-controlled vacuum waste collection unit is small, less than 20 inches on a side, portable and capable of discharging more than 15 gallons per minute. Flex distribution and collection lines are carried overhead in ladder trays. These are visible and accessible for both safety

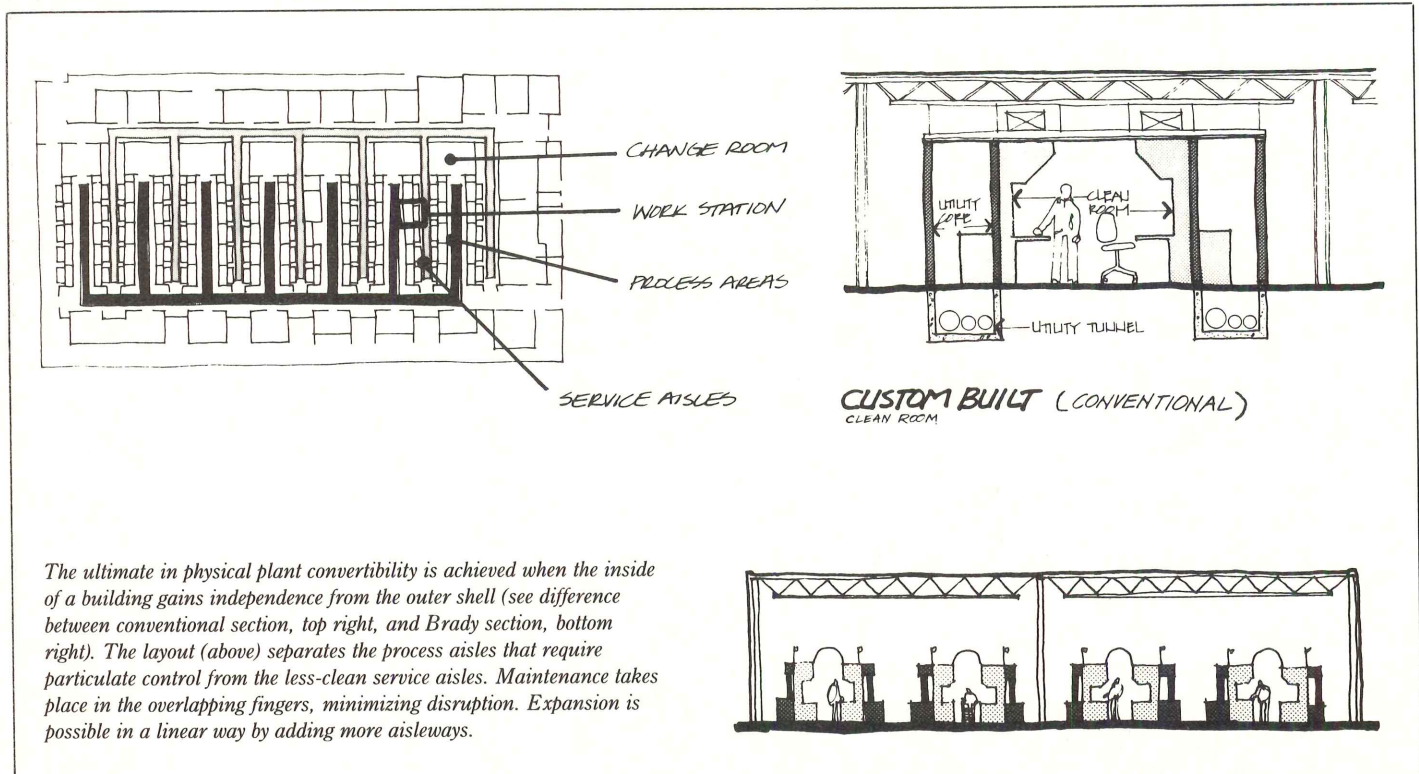

The ultimate in physical plant convertibility is achieved when the inside of a building gains independence from the outer shell (see difference between conventional section, top right, and Brady section, bottom right). The layout (above) separates the process aisles that require particulate control from the less-clean service aisles. Maintenance takes place in the overlapping fingers, minimizing disruption. Expansion is possible in a linear way by adding more aisleways.

and alteration. All lines flow through a chemical-distribution terminal. The terminal, which contains monitors and controls, serves as the utility interface with the outer building (Figure 5).

Particle counts taken under operating conditions indicate performance better than class 1,000 in aisleways and class 100 in clean-room work space. Temperature and humidity are maintained at 72 degrees, plus or minus 2 degrees, and 35 percent, plus or minus 2 percent, respectively. Levels can be set to correspond to specific

process requirements. Cleaner air is merely a matter of installing more modular filters and air handlers.

During a pilot project, a 4,000-square-foot section was installed in a shell building. It took less than 40 working days to make the lab ready for equipment installation. An even greater benefit was that approximately 80 percent of the labor and equipment investment was recoverable for future retrofit.

COMPARISON OF COSTS—"CONVENTIONAL" VERSUS "BUILDING WITHIN A BUILDING"

This comparison assumes the conventional design is a three level structure that has centralized air handling. In contrast, the building within a building design is a slab-on-grade structure that has distributed air handling.



BUILDING WITHIN A BUILDING

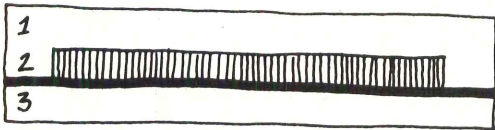

CONVENTIONAL

Area Comparison	Conventional	Building Within A Building
Clean Room Area (NSF)	16,000	16,000
Service Area (NSF)	2,500	5,000
Total Lab Area (NSF)	18,500	21,000
Building Efficiency	÷ .30*	÷ .45*
Gross Building Area (GSF)	61,700	46,700
Cost Comparison		
Architectural	\$65.00	\$25.00
Mechanical	110.00	70.00
Electrical	20.00	20.00
Plumbing/Piping	55.00	55.00
Building Shell	\$250/GSF	\$170/GSF
Inner Building	\$15,425,000	\$7,939,000
	included	\$220/NSF
	-0-	\$4,620,000
Total Building Cost	\$15,425,000	\$12,559,000

*empirically derived average

BENEFITS

The Brady concept offers several benefits during the construction and life cycle of a facility:

- Decoupling the inner building from the host structure allows design changes without significant cost or schedule disruption.
- Off-site fabrication and assembly eliminates the normal competition for the limited space at the work site, and enables a compressed construction schedule.
- Seventy to 80 percent of the inner building costs are in reusable components whose life exceeds that of many built-in-place applications.
- Standardized components facilitate computer-aided design applications.
- Interior enclosure system is capitalized as equipment (not as a structure), which allows faster depreciation and other tax advantages.
- Energy cost is 20-25 percent less with modular, distributed mechanical systems rather than with centralized air-handling equipment (largely because of lower horsepower required to operate fans, and more-efficient air recirculation, which reduces the cooling requirements). □

References and Further Reading

Carnes, Larry E., "HVAC of Clean Facilities for Electronic Research Laboratories," *ASHRAE Transactions*, 1981.

Dahan, Fernand W., Three articles on "Planning and Designing Chemical and Bio Chemical Laboratories:" "The Planning and Programming Function," "New Versus Renovated Spaces, Owner Versus Leased Space" and "Factors, Requirements and Considerations for Laboratory Design." For copies at cost write to author at 5410 Amberwood Lane, Rockville, Md. 20853.

Foster, Richard N. and Schwartzwalder, Steven B., "A Perspective on the Competitiveness of U.S. Companies in Advanced Manufacturing Technologies," Center for International Business, July 1984.

Keenberg, Ronald, Yamashita, James and Blakey, Donald, "Industrialized Buildings: Our Theories and Techniques," *Architectural Technology*, Fall 1984.

Landefeld, J. Steven and Seskin, Eugene P., "Plant and Equipment Expenditures, First and Second Quarters and Second Half of 1984," *Survey of Current Business*, March 1984.

McKelvey, John P., "Science and Technology: The Driven and The Driver," *Technology Review*, January 1985.

Nelson, George, "Tribute to the Permissive Shell," *AIA Journal*, July 1981.

Design for Aging

BY KEVIN W. GREEN

MORE THAN FOUR MILLION BIRTHS WERE RECORDED IN THE United States every year between 1947 and 1964—a perpetual bump in the American population curve. The generation that caused a school-building explosion in the '50s, made the Beatles rich in the '60s, entered *yuppie* into the dictionary in the '70s and precipitated a baby boomlet of its own in the '80s shows no signs of slackening in either size or influence.

This may explain why, of the nearly 200 seminars, workshops, consultation sessions and other learning opportunities at the 1985

Kevin Green edited Design for Aging: An Architect's Guide, upon which this article is based. Mr. Green is the former editor of Research and Design and the Journal of Architectural Research.

Design for Aging: An Architect's Guide will be published this fall by the AIA Press. It was assembled by the AIA Task Force on Aging.

AIA Convention, one of the most popular was a workshop aimed at tutoring architects in the design of facilities for aging. Called "Design for Aging," the program drew more than 300 professionals, surprising even the workshop's sponsors.

Baby boomers are getting older. By the year 2030, Americans over 65 will have increased from 11 percent of 1980's population to 18.3 percent of a significantly larger U.S. population. The baby boom will have become an aging boom, and the need for facilities designed to house and care for elderly Americans will have increased apace.

But one needn't wait until 2030 for the aging-facility market to change; it's changing now. Improved health care has seen to it that more Americans are living longer, and the impact of that actuarial fact is already noticeable. In 1980, the year we elected the oldest President in U.S. history, the percentage of American heads of household aged 65 or older actually surpassed the number of those aged 30 or younger.

The demographics are clear: America's already substantial population of elderly is growing more substantial both in simple numbers and as a percentage of the nation's overall population. And it will continue to grow well into the next century (Figure 1). The market for design services keyed to meeting the needs of aging Americans is also growing, and may even be the fastest-growing user-specific market in the design and construction industry today.

THE DYNAMISM OF AGING

The U.S. Consumer Product Safety Commission recently estimated that the United States today spends \$2 billion a year on therapeutic and rehabilitative health care resulting from falls and burns suffered by the aging in their own homes. One of the conclusions prompted by that report was that architects should design all homes—even those intended for purchase by persons in their 30s—with an eye to the physical, mental and social changes those homebuyers will experience in their later years.

According to the AIA Task Force on Aging, architects undertaking the design of any facility, especially one for older users, must realize that aging is not just a narrow phase of life but a process that begins at birth and continues, inevitably and at its own pace, until death.

Dynamism is clearly aging's most definitive characteristic, which is why the AIA task force titled its new guide for architects *Design for Aging*, rather than *Design for the Aging*. Newborn infants are strikingly similar. As they grow older, and the human experience unfolds, idiosyncrasies develop. Teenagers are almost predictably alike; young adults, less so. Extrapolated to its furthest extreme of age, one discovers a tremendously diverse population of individuals span-

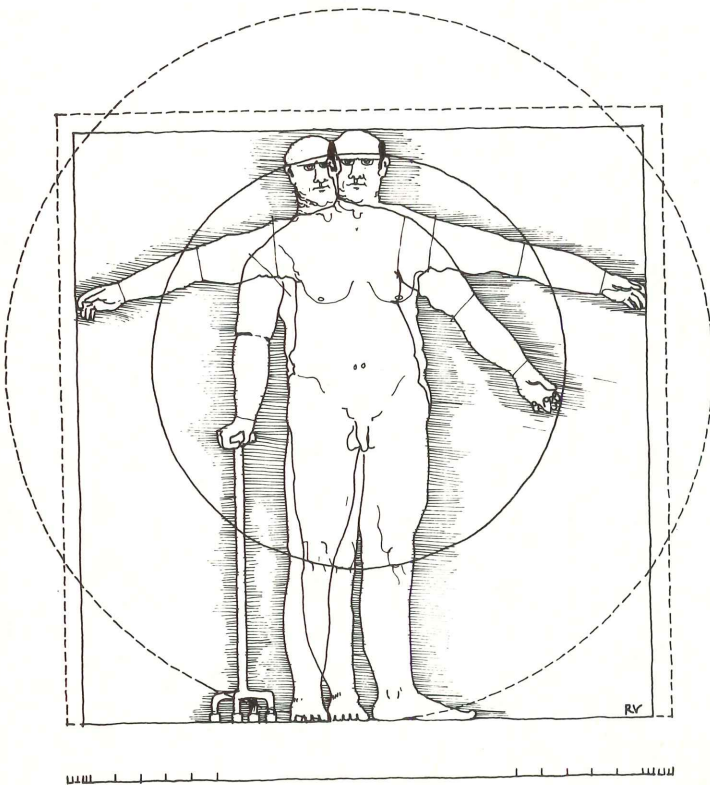

illustrations by Darrell Rippeteau Associates, Rick Vitullo

ning an age spectrum of 40 or 50 years, living and working in a wide range of environments and exhibiting an even wider range of functional capabilities.

Still, we talk of "the aging." Who are they? Statisticians tend to use age 65 as the line of demarcation separating middle age from aging status. But that line is remarkably hazy. Many Americans in their late 60s and older are as vital and healthy as people 20 years younger, and often more so.

Stereotypes, of course, portray little of this complexity. Aging's image in America today remains one of heightened infirmity and dependence. But the research on aging Americans puts that image in question.

Eighty percent of Americans aged 65 and over live independently in their own houses and apartments. Only 20 percent will live in a nursing home at *any* time in their lives, and their average age at entry is a venerable 82 (Figure 2).

Facilities for aging must be designed to be flexible enough to serve all the members of America's aging population. Design for aging requires a commitment to flexibility because this population's users occupy all points on the spectrum of capabilities and because individual users can move from the capable end of that spectrum to the incapable end and back again in a remarkably short time. People change, as the saying goes, but buildings don't, at least not inexpensively. Hence the argument for a residential architecture that will serve its aging users as well as it serves its initial, youthful purchasers.

IMPAIRMENTS OF THE AGED

Underlying this concentration on process and flexibility is the realization that "worst-case" scenarios do indeed exist, and that they must be accommodated. In the health and social service industries, they represent one end of a "continuum of care" that might begin with meals-on-wheels for a relatively independent person in a private home, and end with the kind of intensive care provided in nursing homes, hospitals and hospices. This continuum is phrased differently in the argot of sociology, which describes people rather than services. One specialist applies the term "go-go's" to elderly people—perhaps recently retired—who are active, capable and eager to exploit the new freedom that retirement has given them. People in the next phase are called "go-slows," reflecting diminished capability or activity (or a diminished eagerness to put either to the test). People approaching the worst case are known as "no-go's."

Each of these languages is important to architects engaged in design for aging. The language of the health and social service industries is the language of clients who need facilities in which to provide the continuum of care. Terms like "go-go's" and "no-go's," on the other hand, have to do with users. A key step toward attaining architectural fluency in both of these languages is to understand the physical, psychological and social changes that mark the aging process—the changes that place a user at a particular point on the continuum of care, and that characterize the journey from "go-go" to "no-go."

The physical changes that accompany aging generally affect mobility, strength, stamina and the sensitivity of the senses—primarily vision, hearing, tactile and thermal sensitivity. The degree of

dysfunction experienced by a user in any one of these areas (and most elderly people experience dysfunction in only one or two areas) can vary widely, but even minor dysfunction can prompt a downward spiral into a disproportionate sense of disorientation and vulnerability. Design may be limited in its potential to overcome sensory or physical impairment, but it can do a great deal to quell that sense of disorientation and vulnerability by providing the appropriate physical supports and behavioral cues in the environment.

Mobility is gradually hindered by a variety of factors, most of them products of a lifetime of wear and tear on the body. Gravity itself slowly overcomes our ability to stand erect. The stooped posture that characterizes some older persons can make such simple activities as walking, sitting, standing and turning difficult. Reductions in ambulatory speed are a frequent result, abetted by slowed reaction times. Hearing and visual impairment can also contribute to impaired mobility, simply because they decrease the amount of incoming information one needs to navigate quickly and confidently.

The automobile may be more essential to mobility than the foot in America, and because many elderly Americans continue to drive very late in life, site design can be as challenging as interior space configuration in a facility for aging. Just as interior environments should minimize the likelihood of tripping and falling, building sites and roadways should allow for slowed reaction times and limitations of sight.

Hindered mobility leads to reductions in strength and stamina. Joints normally become more rigid with advancing age. Muscle

FIGURE 1

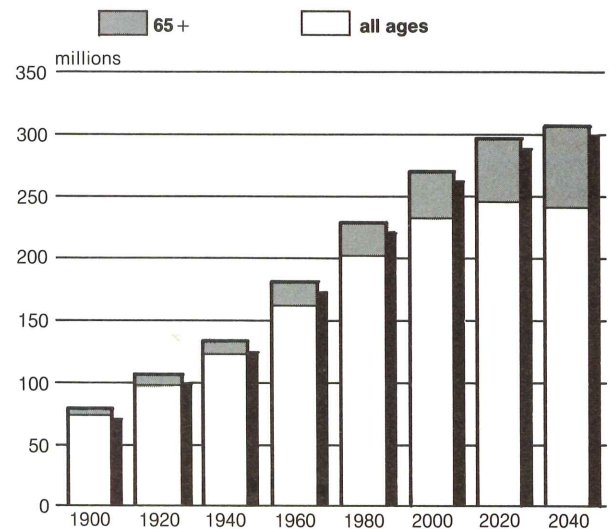

ELDERLY POPULATION AS % OF TOTAL U.S. POPULATION

By the year 1990, there will be four million more Americans than in 1980. The population of the United States will have tripled since 1900. Moreover there will be eight times more Americans over 65.

Go-go's, go-slow's and no-go's

strength and coordination decrease. Elevated cabinets and shelves may become awkward and out of reach, and round knobs difficult to grasp and manipulate. This is why many facilities for aging feature lever-handles and added support for mid-height storage on interior walls. And because once-simple movements may now require more exertion, strength and stamina, distances in both interior and exterior layouts become important considerations.

Handicapped accessibility may be one of the more familiar embodiments of the principle that facilities for the healthy also be designed to accommodate the infirm. But handicapped accessibility is not the same as design for the infirm elderly. One-in-12 is a standard grade for a handicap access ramp, but is too steep for someone racked with arthritis and enfeebled with extreme advances in age. The ideal grade for elderly access is considered to be one-in-20. Reduced joint flexibility and muscle strength affects every aspect of day-to-day life, from the ability to reach shelves in the home or turn the head to check the rear view mirror in a car, to simply twisting the body to carry on a conversation with a friend on a straight bench.

Vision begins to decline as early as age 40, and long-term impairments can include loss of visual field and sharpness, decreased light sensitivity and increased sensitivity to glare. Older people may require up to twice as much light as younger people to see as well. Colors of similar intensity—particularly pastels, very dark shades and blue-green combinations—are more difficult to differentiate, especially under uniform lighting conditions or when viewed against surfaces that are reflective or textured similarly. Designers can

address these problems by increasing light levels and sign sizes and using highly contrasting colors.

Glare, often caused when unshielded artificial light or direct sunlight beams into a reflective interior space, deserves special attention. The distraction can affect balance, orientation, attention span and short-term memory.

Hearing declines even earlier than visual acuity, and most often in the higher frequency ranges (where bells, sirens and voiced sibilants are commonly heard). In design, control of sound becomes an important issue because older people frequently have trouble discerning one sound or one voice against a background of competing sounds or voices. And designers should always consider redundant-cueing alarm systems—systems that issue alarms in both audible (at the right frequency) and visible modes—when planning for fire- and life-safety.

In terms of other sensory impairments, touch is a controlling factor. Our sense of touch naturally declines with advanced age because skin becomes drier and less elastic. Thus, subtle changes in environmental texture can go unnoticed by older users. Smell declines with touch, although sensitivity generally remains high enough to make odor control an important concern, particularly in environments where incontinence is likely to occur.

Most important among the tactile issues accompanying aging are common declines in immediate sensitivity to pain and temperature. The latter poses a dual threat, because an elderly user may be both dangerously unaware of significant changes in ambient temperature and substantially less able than a younger person to tolerate such changes. Many older people suffer a narrowed "comfort zone" (they require more warmth in winter and are less tolerant of drafts), a much-increased susceptibility to hypothermia (lowered body temperature) and frostbite in their extremities, and a reduced ability to recover from these conditions.

Equally important to tactile moderation is avoiding tactile sterility. In most institutional design today, texture is an unused resource, which is frustrating for residents. Often, when texture is used—in the form of planters, rock gardens and fountains—it is placed out of reach, which is more frustrating than none at all. Likewise, variation in odor is too often omitted from institutional design. The designer can add texture to an otherwise drab living experience through gardens. Just digging in the dirt is an excellent means of working off frustrations—both because it provides texture for all of the senses, and because it provides a means for constructively expressing aggression and anger.

The psychological changes that accompany aging are as important as the physical changes, and often directly related. At issue is the user's sense of confidence, orientation and security in the environment.

Viewpoints differ, but research has suggested that not intelligence, per se, but the *speed* with which we process, store, summon and express information, may decline with advancing age. It doesn't take much imagination to realize that such changes in perception, cognition and expression can have a depressing and perhaps debilitating effect, even—or especially—when a person's intelligence is still vitally intact.

FIGURE 2

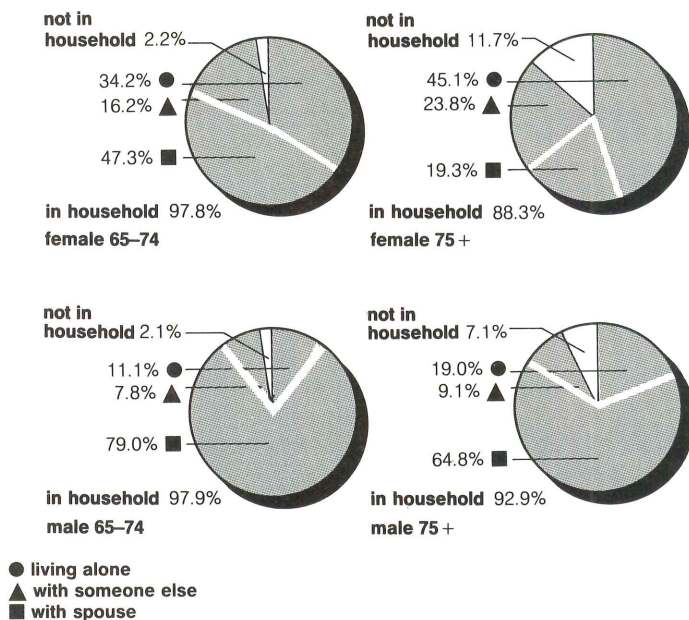

LIVING ARRANGEMENTS OF THE ELDERLY 1981

Eighty percent of Americans 65 and over live in their own houses, townhouses and apartments. More than 65 percent of Americans aged 65 and over live in family settings, with spouse, children or relatives.

DESIGN FOR CHANGING

Our ability to adapt to a new environment is related to our capacity for exploring that environment and processing all the new information it provides. Many older people experience increasing difficulty with cognitive mapping in unfamiliar settings. Interestingly, an older user may be more at home in a cluttered spatial environment—one filled with objects that provide visual stimulation, tactile involvement and memories of past experiences and attachments to other people—than any open and orderly spatial configuration.

Extreme cases of cognitive impairment used to be filed under the general heading of “senility.” Today we know enough to classify many of these cases in the range of organic dysfunctions that includes organic brain syndrome and Alzheimer’s disease, and to understand that a user so impaired can feel at odds with even the most familiar elements and cues in an environment and have severe problems dealing with large, busy, noisy, complex and unfamiliar places. From the designer’s standpoint, it is important to realize that the vast majority of elderly people have little experience with such extreme dysfunction. For the moment, designers need address these problems only when designing highly specialized spaces not commonly programmed in facilities for aging. In the future, though, these spaces will figure more highly in design for aging as more is learned about the problems of organic impairment and the dysfunctions that cause them.

Along with the physical and psychological transformations of aging come social adjustments. Retirement from the workplace, new limitations on mobility in the larger world and separation from or losses of close friends and family members all place enormous emotional burdens on older people, and there is certainly nothing a designer can do to lift those burdens. But a designer can be attuned to the fact that most older people continue to be vital, alert, sensitive people whose capacities for social and emotional relationships remain unchanged throughout their lives. Just as younger people do, they seek opportunities for independence, control, choice, privacy and intimacy—and designers can provide those opportunities.

Such needs, admittedly, can be difficult to meet as the elderly require increasing levels of care in increasingly institutional environments. Architects can help by refusing to let the clinical, technical demands of design for aging overwhelm their concern for the personal and social needs of the people they design for.

Understanding the physical, psychological and social trials of aging is a good first step toward making that concern an educated one. There are, however, two additional rules worth remembering.

First, engage in the most extensive dialogue possible with the people who actually use facilities for aging—elderly and staff alike—and work hard to understand and appreciate the experiences of those users.

Second, remember that aging is a universal process, and that the desire to live an independent, satisfying life burns as intensely in us when we’re old as it does when we’re young. Since all of us will participate in the aging process, we owe it to ourselves as well as to our users to create environments that help sustain that independence and satisfaction for as long as possible. □

KEY FACILITY TYPES

FACILITIES DESIGNED FOR OLDER PERSONS CAN USUALLY BE characterized by the physical settings they provide for the personal, social and health care services that make up the “continuum of care.” Along the parallel continuum of facility types for aging, the permutations are virtually limitless—a tribute to the imagination of American architects and their clients.

The AIA Task Force on Aging, in *Design for Aging: An Architect’s Guide*, selected five “landmark” facility types that, taken together, raise most of the programming requirements and design issues likely to confront an architect designing any type of facility for older persons.

ELDERLY HOUSING

Elderly housing is a broad category that includes building types ranging from resident-owned single-family homes to multi-unit housing projects and high- and low-rise congregate housing (and includes such ancillary services as meal preparation, housekeeping and organized social activities).

The principal form-generators in elderly housing units are similar to those in residential design: entry, living/dining space, kitchen, bathroom, bedrooms, storage and patio or balcony. All should be handicapped-accessible or adaptable. Basic design considerations include the size and number of dwelling units, the kinds of common spaces (lounges, dining and assembly areas) and service facilities (for management, maintenance, housekeeping and security), parking requirements and site characteristics (particularly location with respect to off-site services (Figures 3 and 4).

Livability is often equated with density. Experience suggests that every elderly housing development offer a range of dwelling-unit types and sizes to accommodate different life styles and housing needs. On economic terms, 100-150 units is generally considered a minimum to justify the ancillary services and facilities offered in elderly housing developments. Because larger developments tend to isolate their users from the surrounding community, 200-350 units is a conventional limit.

SENIOR CENTERS

Senior centers are non-residential and usually serve as community centers for the elderly. A senior center might be the focal point of a specially-developed continuing-care retirement community (CCRC), or it might serve the independent elderly residents of a neighborhood, town or city (in which case, because such centers often reuse existing churches, schools or other recycled buildings, the architect’s challenge may well be redesign and retrofitting rather than design for new construction).

Spaces commonly programmed for senior centers include entries, lobbies, lounges, common dining areas, commercial-scale kitchens,

Facilities offer a continuum of care

snack bars, tv-viewing areas, rooms for music rehearsal, activity and assembly areas, individual-service spaces (for counseling or clinical services), management offices and exterior recreation areas.

The programming mix of a senior center usually hinges on the users it will serve—who may number anywhere between 25-500 persons. CCRC senior centers generally are larger facilities designed to serve 350-500 persons, including both CCRC residents and non-residents participating in outreach programs the CCRC sponsors. Whether a senior center is located in a CCRC or a neighborhood, common design requirements include handicapped- and wheelchair-accessibility, linkage to public transportation, proximity to the user group, a strongly visual image that announces the center's presence, and an entry that ensures easy, protected access for pedestrians and vehicles.

RESIDENTIAL-CARE FACILITIES

Residential-care facilities were originally created in this country as domiciles for veterans after the Civil War. They provide care for people who can no longer live independently, but who don't need the medical care nursing homes provide.

The key component of a residential-care facility is the resident's room. This is typically a private or semi-private room that contains a bathroom but no kitchen, in a building that offers a residential (instead of institutional) atmosphere. Rooms are commonly grouped on a wing or a floor of a facility in multiples of 30 or 40.

Each building within a residential-care complex contains a lounge,

activity area, outdoor patio or balcony, kitchenette/snack bar and staff work area (including a central bathing area). Buildings connect to main-resident facilities (such as a common dining area, formal lounge, library, beauty salon, gift shop, craft rooms and assembly area) and to staff facilities (offices, central laundry, commercial-scale kitchen, maintenance and security).

Residential-care facilities with less than 100 living units total are generally deemed uneconomical unless developed as part of a CCRC. A facility with more than 200 units may prove to be too large, isolating the facility from its neighborhood or altering the neighborhood's development pattern.

Development of residential-care facilities has been spurred by high costs of health care, which has constrained the number of beds available in nursing homes. In response to this new market, many CCRCs are developing residential-care facilities as cost-effective components among other facilities they offer the elderly.

NURSING HOMES

While residential-care facilities are usually licensed by state departments of social services, nursing homes typically are licensed by state departments of health and hygiene to provide long-term medical and nursing care (and housing, housekeeping, meal service and custodial care) within a complete living environment.

The 1980 census reported some 20,000 nursing homes in the United States. Seventy-two percent of the 1.4 million residents of these homes were 85 or over. Residents of nursing homes, who generally require 24-hour care and assistance with most personal activities, tend to fall into three groups: the terminally ill who have been discharged from a hospital, older persons recovering from surgery or injury and medically stable but functionally impaired older persons. At least half of all residents of nursing homes at any given time are long-stay residents, generally from the third group above. The remainder, on average, stay three months or less. Half recover and go home or to another kind of facility. Half die.

The principal form-generator in a nursing home is the nursing unit—an administrative unit containing as many as 60 beds (depending on state regulations) in private and semi-private rooms. Resident facilities in a typical unit might include a lounge or dayroom, a common dining space and a central bathing area. Spaces occupied primarily by staff generally include a nursing station, a medication room, a floor kitchen or "nourishment station," rooms for examination and treatment, a conference/consultation room, housekeeping areas, residential service space, storage for wheelchairs and other equipment, and office space.

Unless otherwise stipulated by regulatory agencies, nursing home development is usually recommended in multiples of 40- to 60-bed units. Guidelines call for a high proportion (up to 80 percent) of private rooms, with no more than two beds to a room and a 180-bed maximum. This reflects concern for neighbors in the community, particularly those who live close by.

CONTINUING CARE RETIREMENT COMMUNITIES

CCRCs translate the full continuum-of-care concept into environmental terms, providing facilities for independent living, residential care,

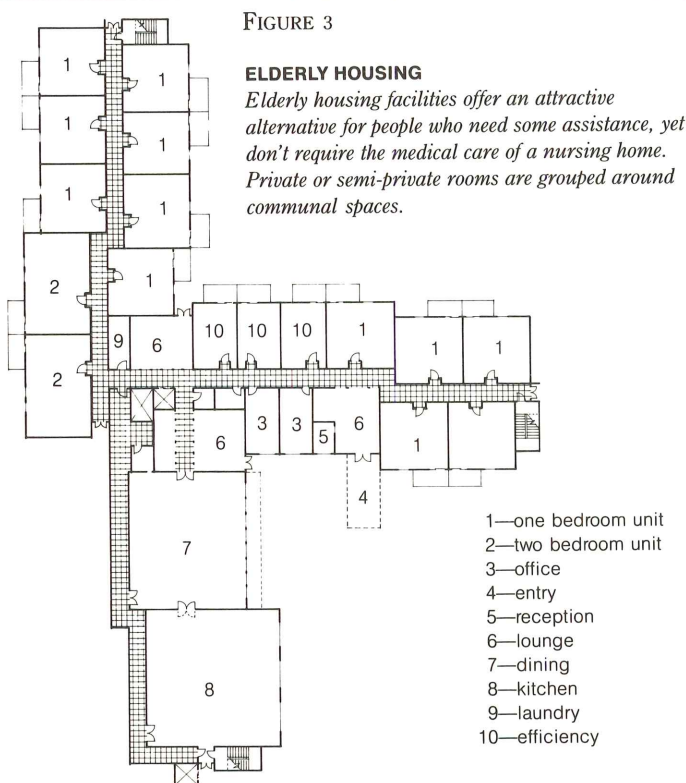

community socialization and nursing-home care in a single development. Typically, it's a CCRC's wide range of care services and residential settings that make it attractive. A resident can make the transition from independent living to increasing levels of assistance without the threat of abrupt changes in surroundings. Come what may, CCRC residents have clearly defined health care and housing alternatives in one place, and can elect to use a range of services—say from help with shopping to meals on wheels to communal dining—as their needs change.

Most CCRC residents move in when they're still active and independent, with plans to stay for the rest of their lives—a period that may cover 30 or 40 years. One in three retirement communities in the United States is a CCRC, and most house 350–500 residents—a population range proven economically viable.

Development of a CCRC is a complex, multifaceted endeavor, involving the planning, programming, design, financing, marketing and operation of all of the previously mentioned facility types combined. The chief design problem is to develop each component in response to its own internal requirements and, at the same time, create relationships among components that optimize their functions. For example, in a CCRC that provides nursing-home or health-care services in a separate building, the siting and visual screening of that building can be particularly important. Residents like to know a nursing home is available in the event they need it, and it should be readily accessible to those who do, but rarely do healthy residents want to be reminded of the possibility of future infirmity. □

FIGURE 4

LIVING SPACE

The elderly require as much or more living-space floor area than younger people need for performing the same activities. They may also require special furnishings because of physical limitations.

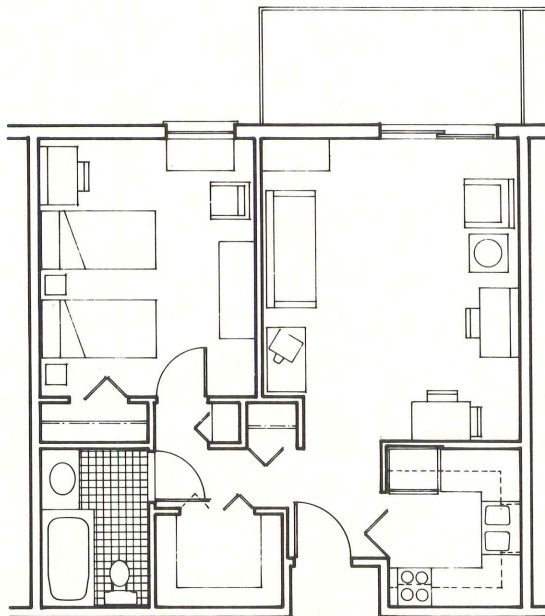

DESIGN FOR AGING GLOSSARY

THE AIA TASK FORCE ON AGING'S NEW HANDBOOK ON FACILITIES for the elderly, *Design for Aging: An Architect's Guide*, includes a glossary that details many of the design and programming issues these facilities raise. Entries range from *accessory apartments* and *adaptability* to *wayfinding* and *windows*. An index and a programming and design checklist created for each of the five key facility types in the guide permit quick reference.

Below are some samples:

ALCOVES

Alcoves in activity areas, corridors, lobby/reception areas and lounges provide semi-private spaces in which people can meet and converse. By helping to divide larger spaces into niches that may better facilitate small-group activities, alcoves can be especially important in nursing homes and other facilities that provide reduced semi-private space.

Wide or multiple alcoves along a corridor can impede independent mobility for some by breaking up the continuity of handrails. Free-standing handrails provided along the perimeter of a corridor alcove wherever a major break in the handrails would otherwise occur will maintain that continuity.

ASSEMBLY AREAS

Assembly rooms are public areas that tie in well to lobby or lounge areas. Aisles that are a minimum of 3 feet, 6 inches wide permit movement of wheelchairs and walkers where seating is fixed. In such a case, open space within the assembly area will accommodate wheelchair-bound persons (see ANSI A117.1 or applicable barrier-free design standard). A minimum of 40 inches for back-to-back row spacing and firm, upholstered seating that is 14 to 16 inches high in the front and 22 to 30 inches wide, with armrests seven to eight inches above the seat and extending beyond the seat front will allow comfortable access and seating (see Figure 5).

A good, distortion-free public address system is important. Listening systems for the hearing-impaired that use FM, infrared, induction or other equally-effective interior transmission systems with individual headsets are available on the market. Projection rooms also help. They eliminate background noise from projectors, which can be bothersome to older persons.

In senior centers, and particularly in larger facilities, space devoted solely to meetings makes sense when frequent meetings are anticipated. Small gatherings with low daily attendance can often

The challenge is helping without patronizing

take place in rooms that serve other functions such as lounges, dining areas or multi-purpose rooms.

ENTRIES

A building's main lobby or front porch can be an important community space, particularly in a facility where the comings and goings of residents and visitors can be watched. Some residents, however, prefer to come and go without constant surveillance. For these residents, consider a secondary entrance that does not include space for "watchers."

Building Entries

Easy-to-follow signs and other visual cues in the entry and lobby will increase convenience for both residents and visitors. Accessibility to vehicle pick-up points and, if possible, a public transit stop, will also help. Use of vestibules as well as outdoor canopies or building projections will protect people waiting inside from drafts and people waiting outside from rain and snow.

The building entry is also a key element in any security system, offering a location for concierge stations and/or security office, including closed-circuit systems for surveillance of entrances and parking lots.

Dwelling-Unit Entries

Providing an alcove in the corridor outside the dwelling unit creates a point of transition between public and private areas and provides space for a small table or shelf on which the resident can place packages while opening the door. Likewise, a vestibule, with a coat

closet and enough space to greet visitors and take hats and coats, provides another point of transition between public and private space.

Lighting in the entry area that adequately illuminates the door key-hole will accommodate the likelihood of failing eyesight. If all the dwelling unit entries along a corridor look alike, consider using non-uniform hallway furnishings as place markers, or allowing residents to decorate their doors. A security peephole in the entry door 56 inches above the floor will adequately serve a person of average height.

Service Entries

Facilities designed for older persons usually include service entries that are separate from main entries, so that service circulation will not interfere with the circulation of primary building users. Service and delivery activities can be of great interest to older people, providing another lively connection to the broader world. When planning entries and circulation, consider allowing some delivery and service circulation through the front door. When a separate service entry is necessary, consider an activity center or lounge overlooking this (traditionally screened) area.

OFFICE AND ADMINISTRATIVE SPACE

In a variety of facilities used by older persons, staff need spaces where they can work effectively, hold private conversations and leave unfinished business unattended and secure. In larger community and senior centers, where elderly users need occasional access to office space, office areas can be separated from main activity areas. In small facilities, unobtrusive office spaces can be centrally located adjacent to the lounge, lobby/reception or multi-purpose spaces.

In multi-unit residential facilities, staff in the central management office are generally responsible for visitor reception, control of resident and visitor access, coordination of services and general administration. Communication systems should be provided here for contact with visitors and for emergency contact with elevator phones and dwellings.

Nursing home office functions require all of these administrative facilities, plus accounting space and office spaces for medical staff, nursing staff, dieticians, social services workers and the manager of ancillary medical and support services—plus medical residents, interns and/or students, where appropriate. When a nursing home is a component of a continuing care retirement community, state and local codes often require that office and administrative spaces be separated from management areas serving the non-health components of the community.

An administrative area with an open, welcoming quality will give residents a sense of security without being overbearing. An office with direct access to the building's main entrance/exit, lobby and main-floor room, and with a view of critical areas of the site will further enhance the residents' sense of security.

PRIVACY

People of all ages need opportunities to be alone and to be left alone. Unfortunately, observation and supervision are important parts of

FIGURE 5

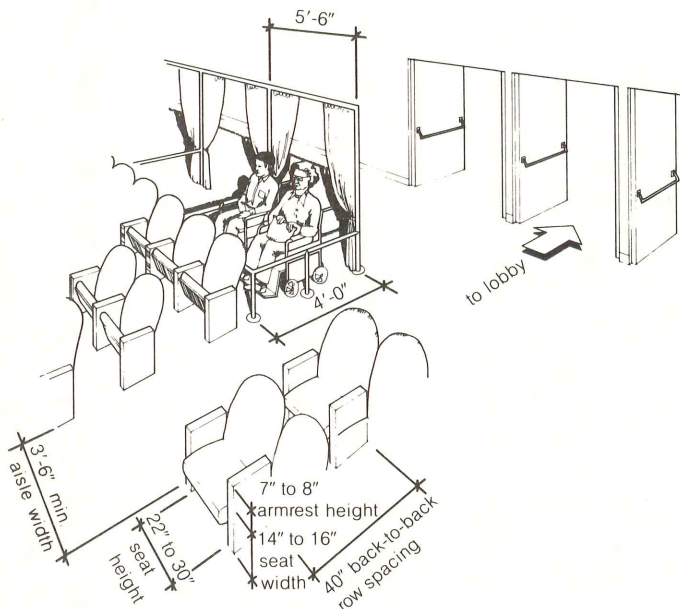

ASSEMBLY AREAS

Assembly areas must take into account the special needs of wheelchair-bound persons and those using walkers or canes. When the seating in an assembly room is fixed, aisles should be a minimum of 3 ft. 6 in. wide.

higher-level care for older people who face the risk of life-threatening disease or accident. When an older person requires assistance in the most private of activities—bathing, toileting and dressing—the opportunity for them to enjoy private moments is almost entirely lost.

Design for privacy involves more than visual screening. Resident embarrassment during such private activities as toileting frequently stems from the lack of acoustic privacy and odor control—amenities that are afforded by spaces with doors on them (such as private rooms, baths, toilets, etc.).

In nursing homes, the privacy offered by a normal space hierarchy is also disrupted by the absence of lockable doors, vestibules, private hallways and, sometimes, private bedrooms.

Physical opportunities for privacy in facilities designed for older people can be enhanced by limiting views into private spaces and by restoring a normal space hierarchy through the use of “front porches,” vestibules and other kinds of space that make up the sequence from “public” to “private.”

REDUNDANT CUEING

Redundant cueing helps communicate with older persons who have sensory or cognitive impairments by sending the same message in more than one sensory mode, in more than one way in the same sensory mode or more than once at different times or places. For example, alarms might emit visual as well as audible signals in case of fire. Many visual alarms incorporate white strobe lights in addition to red flashing lights to better draw attention to the warning.

The redundant cueing concept also applies to helping older persons find their way through a building. For example, changing the texture of the floor covering at corridor intersections, or changing the color and lighting schemes between defined areas will create an identifiable cue to location above and beyond the information conveyed by architectural signage.

WAYFINDING

Age-related changes in sensory and cognitive abilities, as well as the loss of short-term memory, contribute to the difficulty some older people have in knowing where they are, where they want to go and how to get there. A physical environment that presents complex routes lined with repetitive architectural elements, fixtures and finishes adds to this distortion.

Views to the outside provide an excellent means of psychological orientation relative to interior circulation by providing cues to location, time of day and weather conditions. Outside views should be *along* the corridors instead of at the ends, where they can create glare and confusion. Windows to the outside can be tied in with small seating areas in alcoves.

A straightforward building plan utilizing right angles minimizes many of the orientation problems that result from circular-plan buildings and from encounters with multiple obtuse angles (see Figure 6). Disorientation can also be reduced with readable maps and signs, redundant cueing, landmarks, “neighborhood” decorating schemes, porches that can be personalized, doorways, and varied illumination levels, floor surfaces, sounds and smells. □

References and Further Reading

- Aranyi, L., and Goldman, L.L., *Design of Long-Term Care Facilities*, Van Nostrand Reinhold, New York, 1980.
- Hoglund, J. David, *Housing for the Elderly: Privacy and Independence*, Van Nostrand Reinhold, New York, 1985.
- Koncelik, Joseph A., *Aging and the Product Environment*, Dowden Hutchinson & Ross, Stroudsburg, Pa., 1982.
- , “Human Factors and Environmental Design for Aging,” *Environmental Context of Aging*, Garland Publishing, New York, 1979.
- Lawton, Mortimer Powell, *Environment and Aging*, Brooks/Cole Publishing, Monterey, Calif., 1980.
- National Council on Aging, *Fact Book on Aging*, Harris, Charles, Research Coordinator, The National Council on Aging, Inc., Washington, D.C., 1978.
- Pastalan, L.A., and Corson, D.H., eds., *Spatial Behavior of Older People*, University of Michigan Press, Ann Arbor, Mich., 1970.
- Sanoff, Henry and others, *Senior Center Design Workbook*, Division of Aging, North Carolina Department of Human Resources, N.P., School of Design, North Carolina State University, Raleigh, N.C., 1979.
- Zeisel, John and others, *Midrise Elevator Housing for Older People; Behavioral Criteria for Design*, D.C. Office of Policy Development and Research, U.S. Department of Housing and Urban Development, Washington, D.C., 1981.

FIGURE 6

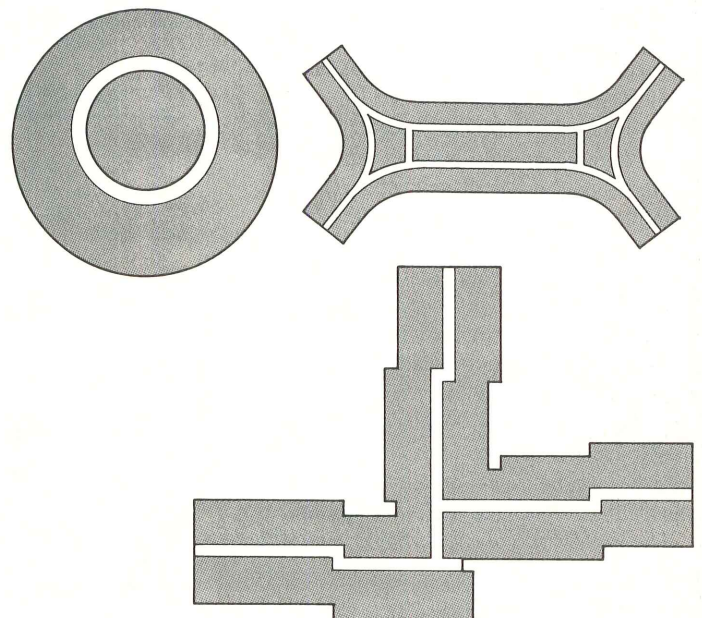

WAYFINDING

The overall “footprint” of a facility can either help or hinder older people in finding their way. Rectilinear organizations with nodes, as well as views to the outdoors, help; circular plans can disorient.

Radio-Frequency Shielding

BY BEA SENNEWALD

Shielding buildings or parts of buildings against radio-frequency waves—whether the waves are generated by equipment in the building, spies across the street or a telecommunications dish overseas—is becoming a basic requirement for many projects. Why is shielding necessary? How does it work? What are some basic designs? Read on.

IN THE WINTER OF 1976, THE U.S. Embassy in Moscow was in the spotlight of national news. The Soviets, it was reported, had for 10 years been beaming microwaves at the Americans from a building across the street. The signals were purported to activate listening devices the Soviets had planted and also jam listening equipment belonging to the Americans. When, amid the furor caused by these disclosures in the press, the State Department ordered aluminum screens installed over the windows, the Moscow embassy became the first well-known building to shield against radio-frequency waves.

Although radio-frequency shielding is still a little-known aspect of building design, it can be found today in many building types. Data-processing areas of banks and insurance companies, electronics manufacturing facilities, hospitals, police stations, universities, computer-design laboratories and telecommunications facilities routinely employ radio-frequency shielding.

The annual sales volume of the RF-shielding industry is \$100 million, estimates Jim Graham, manager of business development for Keene Rayproof, a manufacturer of shielding materials and enclosures.

The significance of RF shielding in building

Bea Sennewald is a project manager with Henningson, Durham & Richardson in Alexandria, Va., an A/E firm that specializes in high tech projects. Ms. Sennewald received her M. Arch. from the University of Oregon.

design is linked directly to the continuing exponential growth in the number of radio-frequency transmitting devices. According to FCC statistics, there are now roughly 10,000 radio stations; 250,000 microwave relay towers; 100 million television sets, and 20 million CB radios operating in the United States. All of these, along with radar, communications satellites, computer terminals, microwave ovens and garage door openers, emit enough electromagnetic radiation to merit describing atmospheric conditions in many urban areas as "electronic smog."

APPLICATIONS OF RF SHIELDING

One of the uses of RF shielding is preventing electronic devices from interfering with one

another. In a hospital, for example, a diathermy machine may cause false readings in an electroencephalograph if the two machines are operated too close to one another.

At the physics department at Yale University, where researchers used a particle detector to visualize the interaction of subatomic particles in high-energy fields, the 50,000-volt pulse of electromagnetic energy produced every second disabled ordinary lab instruments. "Our oscilloscopes would just die and computers would stop," Dr. Richard Majka, research physicist, said. To remedy the problem, Yale constructed a prefabricated RF-shielded enclosure two years ago. Said Majka, "It's been very effective—unlike

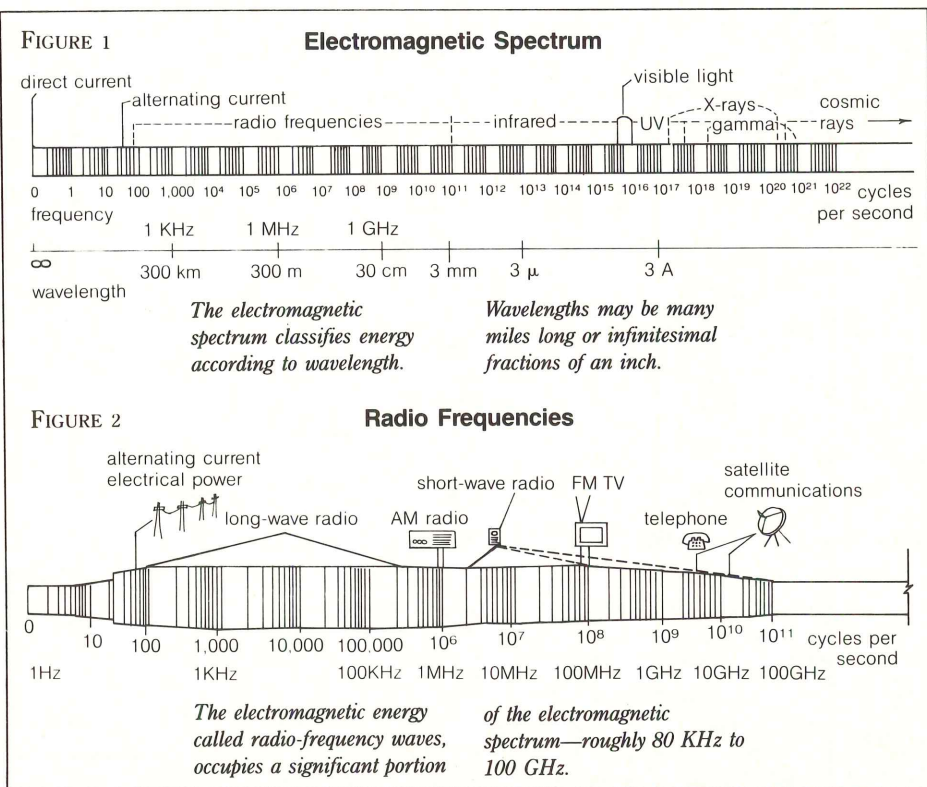

the homemade screens we constructed for shielding in earlier days.”

Concern about the security of information stored electronically has prompted private industry and government to use RF shielding in more and more buildings. One of the problems data-processing managers have long faced is the ease with which computer data can be stolen or manipulated from a distance. Much publicity has been given to “hackers,” the computer whizzes who access corporate computer systems over the telephone lines, yet there are more insidious ways data can be stolen—without leaving a trace. A computer keyboard produces a distinct radio signal for each character struck by an operator. Someone in a van can detect and analyze this signal a quarter-mile away, given sufficiently sensitive reception equipment. To protect against this kind of eavesdropping, many government buildings, from the FBI to the White House, employ shielding.

A third application of RF shielding is protecting people and other living things from radiation—most notably radiation produced by high-powered transmitters employed in large arrays of earth stations for satellite communications. RF radiation heats and will cook living tissue—the principle of microwave ovens—if the power levels are high enough. At low levels, microwave radiation has been associated with eye cataracts, blood disorders, cancer and chromosomal damage. An exact threshold of danger for human exposure is not known, and considerable controversy exists over just how dangerous this form of radiation is.

According to Paul Brodeur, *New Yorker* staff writer and author of the book *The Zapping of America*, new epidemiological information confirms earlier fears about the health risks inherent in low-level electromagnetic radiation. To further his point, Brodeur quoted a recent study conducted in Poland that found a tripling of the cancer rate among military radar workers when they were compared with a group of general soldiers. A second study he cited, completed by Hans-Arne Hansson of the University of Gothenborg, Sweden, demonstrated chemical changes in the brain and abnormal protein patterns in spinal fluid of radar workers.

When the Port Authority of New York and

When a wave hits a shield . . .

When electrons move from one energy level to another, especially at regular intervals, they generate electromagnetic waves that can propagate in space, in wires or in hollow conduits called waveguides. A wave's length (the distance between successive “crests” or “valleys”) and its frequency (the number of “crests” in a second) are chief determinants of wave type. Radio-frequency waves, light and X-rays are all examples of electromagnetic waves. Each has two main parts called fields: an electric field (E in drawing below) and a magnetic field (H in drawing).

If the source of an electromagnetic wave generates a large current flow relative to its voltage, it is called a magnetic source, and the wave it produces is called a magnetic field. When the current flow from a source is small relative to its voltage, the source is considered an electric source, and produces a wave known as an electric field. The further a wave travels from its source, the more the electric and magnetic fields become balanced. When they reach parity, the wave is called a “plane wave,” and it has the same impedance (377 ohms) as space.

When electromagnetic waves encounter a grounded shield, part of the signal is reflected. Some energy enters the shield and is conducted through free electrons to a ground. Another part travels through the shield, strikes its opposite surface and is reflected back and forth between the surfaces. The remainder of the energy propagates beyond the shield. The amount of attenuation is the sum of the reflection loss (r1), absorption loss (L1) and re-reflection factor (r3). If the absorption loss within the shield is small, a good part of the wave hitting the second surface will bounce back to the first surface (r2) and again back to the second surface, where it will leave the shield and enter the space. In that case, the re-reflection will contribute to the total power that propagates through the shield. The amount of attenuation of a signal is expressed as a ratio of the signal's field strength on either side of the shield. The equation, $\text{Attenuation} = 20 \log t_1/t_2$ (dB), expresses this mathematically.

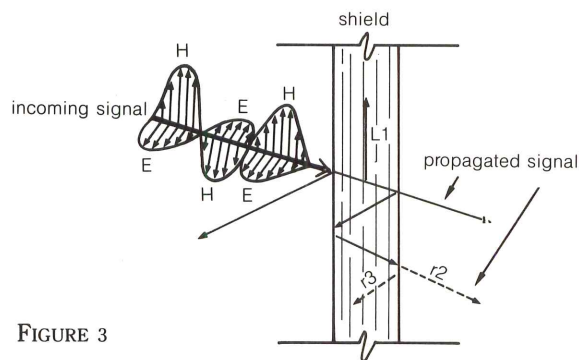

FIGURE 3

When an electromagnetic wave hits a shield, part of the energy deflects off the shield's front surface, some of it travels within the shield to a ground and some of it passes through the shield and out its other side.

New Jersey planned its Teleport, a site that includes about two dozen transmitting and receiving satellite antennas, shielding, in the form of large earth berms, was incorporated into the design for a dual purpose: to protect the antenna arrays from radio interference and to protect neighboring Staten Island residents from RF radiation. An electromagnetic shielding study, prepared as part of the

environmental impact statement, included detailed calculations demonstrating the shielding effectiveness of the earth berms.

EARLY SHIELDING

Prior to World War II, there was little need for RF shielding. Engineers and inventors experimenting with new applications for “wireless telegraphy,” as it was still called in

Modern shielding evolved from "Faraday cages"

the 1920s, constructed their own homemade enclosures called "Faraday cages"—after the English physicist Michael Faraday. With the spectacular development of radar by the British and Americans during the war, there came a need for an "RF-quiet" environment in which to test antennas and other equipment. By 1951, two reports were published on RF-shielded enclosures, one by Stanford Research Institute, the other by the Naval Research Laboratory.

At about the same time, the first prefabricated shielded enclosures became available. These enclosures, which have been refined considerably since, are now available for many different types of radiation conditions. Alongside shielded enclosures, a parts industry has developed that supplies conductive gaskets, caulking compounds, air vents and shielded glass, mostly for use in equipment shielding. Manufacturers of these products are a valuable resource for the architect of an RF-shielded building.

SHIELDING CRITERIA

In any project requiring RF shielding, the purpose of the shielding, the frequency range and the degree of attenuation required are the primary criteria to establish. The purpose could be freedom from radio interference, signal security, public health or protection from electromagnetic pulse. The frequency range covered will usually lie between 14 kilohertz (KHz) and 40 gigahertz (GHz). The bandwidth may be narrow or broad. An example would be a requirement of 120 decibels of attenuation in the range between 15 KHz and 1 MHz. (An attenuation of 120 decibels means that the power of the signal current is reduced by a factor of 1 million. The equation used to derive this number is shown in the box on page 43.)

If the project calls for a room-sized shielded enclosure, a prefabricated system designed specifically for the required attenuation may offer several advantages over a custom design. These include guaranteed performance, predictable cost and relatively simple integration of the unit into the design. Prefabricated panelized systems are available for shielding magnetic fields, plane waves and electric fields, the three primary types of RF waves, at varying levels of per-

Radios that go silent in tunnels demonstrate an effect called waveguide-below-cutoff.

FIGURE 4

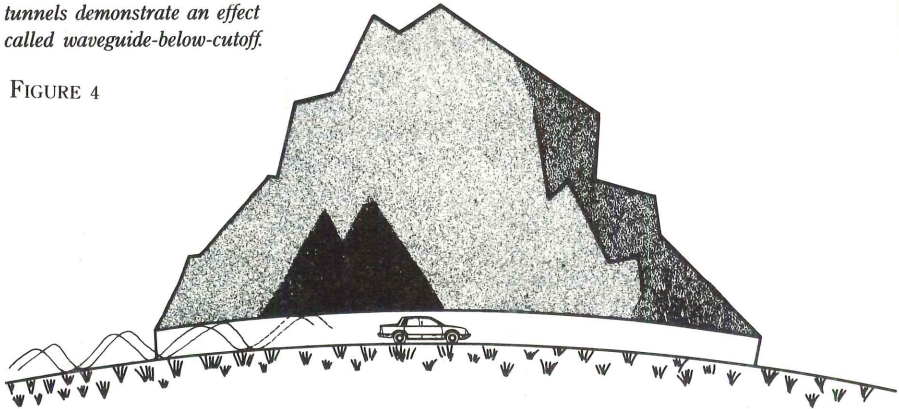

Designers use the principle of waveguide-below-cutoff to shield openings in buildings—entrances, corridors and air ducts, for example.

FIGURE 5

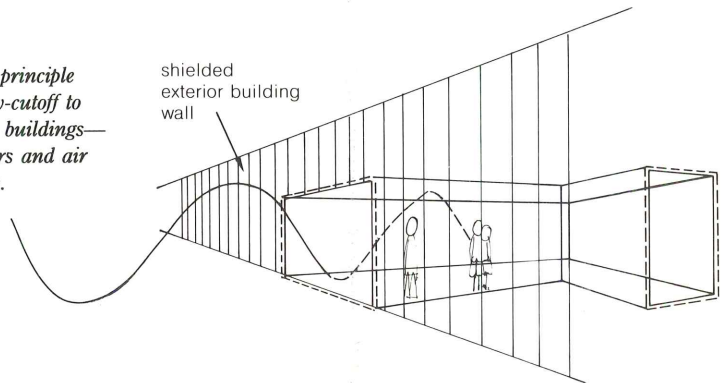

This diagrammatic section shows the basic treatment of openings in a building to shield against radio-frequency waves.

FIGURE 6

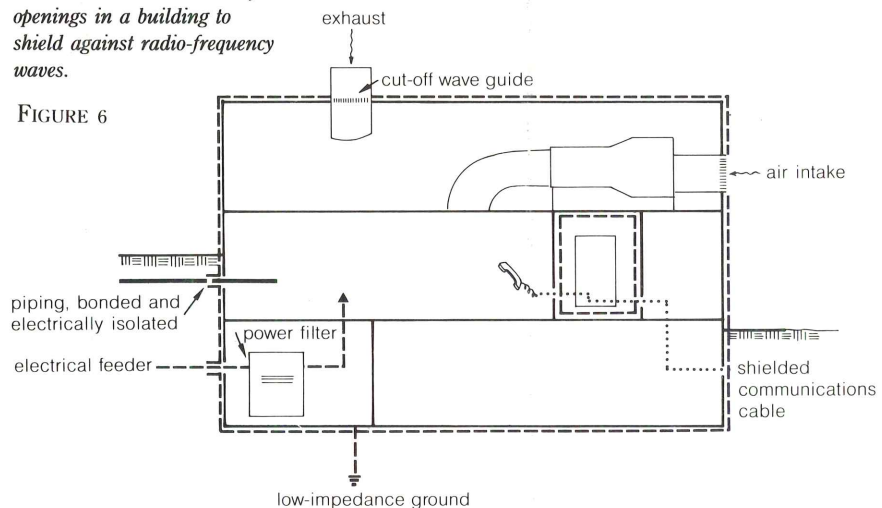

formance. These panel systems also come with options such as vibration control and added X-ray protection.

On larger projects, where shielding is required for a whole floor or an entire building, prefabricated panels are impractical. A better approach is to incorporate the shielding into the building design as part of the floor, wall and roof construction.

A number of consultants specialize in helping architects integrate RF shielding into a building design. Often, these consultants are product representatives or former employees of companies in the RF-shielding industry and know a lot about shielding but little about building materials or construction methods. In these situations, a rich collaboration between architect and consultant is required for a successful design.

THE IDEAL SHIELD

In theory, the ideal shielded building is a closed, seamless metal box. Radio waves contacting the shield are either reflected or absorbed by the metal and carried to a ground. Only a very small amount of radiation propagates through the shield. The material selected for the shield, and the material's thickness depend on the type of radiation and its frequency range. Steel or other ferrous (magnetizable) metals are required to shield against magnetic fields.

At low frequencies, the shield works primarily by absorbing radio waves. A thicker shield attenuates a signal better than a thin one. In high-frequency electric fields, attenuation works primarily by reflection, which makes conductive, nonferrous materials well suited. In some instances, reinforced concrete can function as part of a shield, particularly where attenuation requirements are less stringent.

When a radio-frequency shield is constructed of metals, seams between adjoining sheets must be electrically continuous or the shield will "leak." Welding, brazing and gasketing are the primary means of assuring uninterrupted metal-to-metal contact. To function properly, the shielding envelope must have a low-impedance, single-point ground. Its perimeter must be smooth and seamless with no projections that could act as antennae. The basics of an RF-shield building are shown in Figure 6.

The ideal shielding envelope has a low-impedance single-point ground. Shields are tied into this system using the standard detail shown here.

FIGURE 7

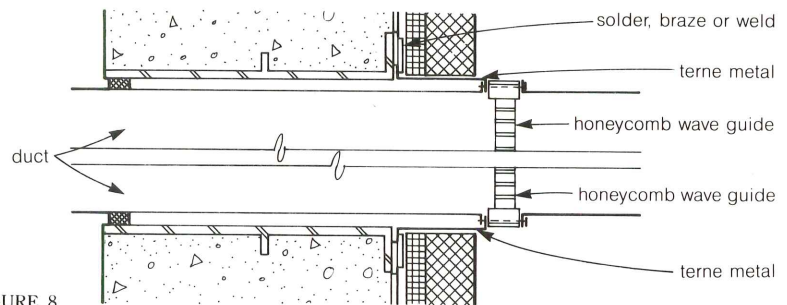
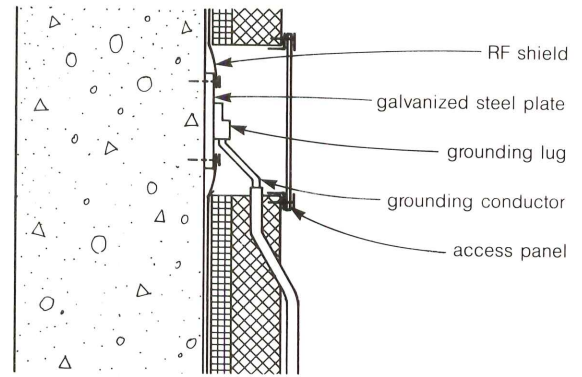

FIGURE 8

Shielding a typical duct penetration requires a waveguide and a secure

electrical connection between the duct and shield through which it passes.

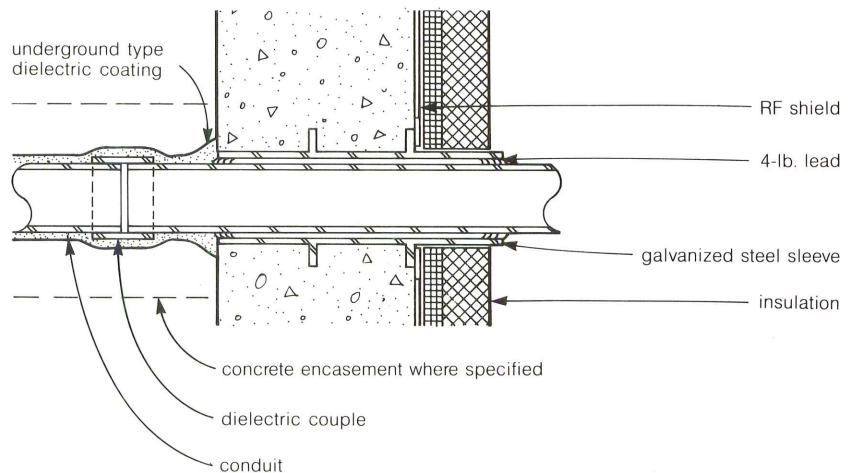

FIGURE 9

To keep a pipe from acting as an antenna, it must be electrically bonded to the shield by soldering, brazing or

welding. Also, if the pipe is metallic, a dielectric couple is necessary to interrupt electrical continuity.

Architects can keep shielding costs manageable

Unlike a closed box, a building has doors, windows, air intakes, exhausts and pipes penetrating the exterior walls. Without treatment, these openings in the shield will make the building "leak."

To overcome this problem, architects and engineers employ the principle of *waveguide-below-cutoff*. The effect is illustrated by the way radio reception dies in a tunnel (Figure 4). The wavelength of a typical FM radio signal at, say, 100 MHz is about 10 feet. If the cross section of the tunnel is 15 feet and the tunnel is 50 feet long, only that part of the radio signal that moves in perfect alignment with the long axis of the tunnel will pass through. If the tunnel cross section is any smaller than one-half of the wavelength, the signal will break up. The waveguide-below-cutoff effect will work only if the tunnel's length is at least three times that of its width.

The effect of waveguide-below-cutoff can be created at any building opening. At air intakes, for instance, a metal honeycomb designed to produce this effect will let air pass through while each cell attenuates the RF signal. A pipe penetration through an exterior building wall can be designed on the same basis: a steel sleeve, three times as long as its diameter, becomes a waveguide-below-cutoff (Figure 9). If the pipe conducts electricity, a di-electric coupling used right outside the shield will prevent the pipe from acting as an antenna and promoting signal transfer. At building entrances, a corridor can be designed as a waveguide by applying shielding to its walls, floor and ceiling. The waveguide entrance eliminates the necessity of shielded doors in high-traffic areas.

Where a shielded corridor is impractical, an RF door is the only alternative. Commercially available doors, although expensive, are used in most high-grade shielded installations. If the attenuation requirements are not stringent (less than about 60 dB), an ordinary hollow metal door could be adapted to RF-use by applying special stops and gaskets (see Figure 11 and Figure 12). The problem with all RF-shielded doors is that the gaskets or interlocking metal fingers used to seal the crack between door and frame will wear and require periodic replacement. The RF-shielded waveguide corridor, on the other hand, is maintenance free.

Windows have been more problematic. Fine-mesh metal screens (22 wires to the inch) installed either in a separate layer behind the vision glass or laminated within the glass, provide only low levels of attenuation. Further, the technique is ineffective with low-frequency magnetic fields. A new commercial product promising attenuation of up to 60 dB is a double-insulating glass window that incorporates thin layers of metal film between the two panes. A sample window attenuates an electromagnetic signal 40 dB between 10 MHz and 1 GHz, claims Southwall Technologies, the manufacturer. Light-transmittance of this sample window, which utilizes dark green tinted glass that transmits 67 percent of the light striking it, is 25 percent. See page 86 in the Products section for more information about this product.

USING CONVENTIONAL MATERIALS

For now, there is a shortage of products designed specifically to shield electromagnetic radiation. Those currently on the market are often prohibitively expensive. Until more affordable products become available, ingenuity in adapting common building materials to RF use will be the primary way to keep shielding costs for large buildings manageable. Sheet metal, metal siding, insulated metal sandwich panels and steel gratings can

all become good and economical shielding materials.

If, for example, the shielding requirement is for higher-frequency plane waves and electric fields, 26-gauge sheet metal will adequately protect a building's concrete roof and floor slabs. Laps need to be welded or soldered together for electrical continuity. Because welding is not practical on thin metal and because solder will not adhere well to stainless or galvanized steel, plain steel or stainless steel that is terne-coated is a better material for this application, despite its extra cost. Sheet metal can act not only as a shield, but also as a vapor barrier if it is placed at the appropriate location in the floor or roof assembly.

Walls incorporating metal panels can provide economical shielding in some circumstances. Because of all the bare metal-to-metal contact necessary for electrical continuity, the shields themselves need protection from weather. The metal liner panels of both insulated and uninsulated systems have better potential than the exterior metal faces. The joints of these panels usually have a tongue-in-groove snap-in configuration that permits compressible RF gaskets to be used in lieu of welding or soldering (see Figure 10). Copper foil laminated to a kraft paper backing is another material that has been used successfully for RF shielding

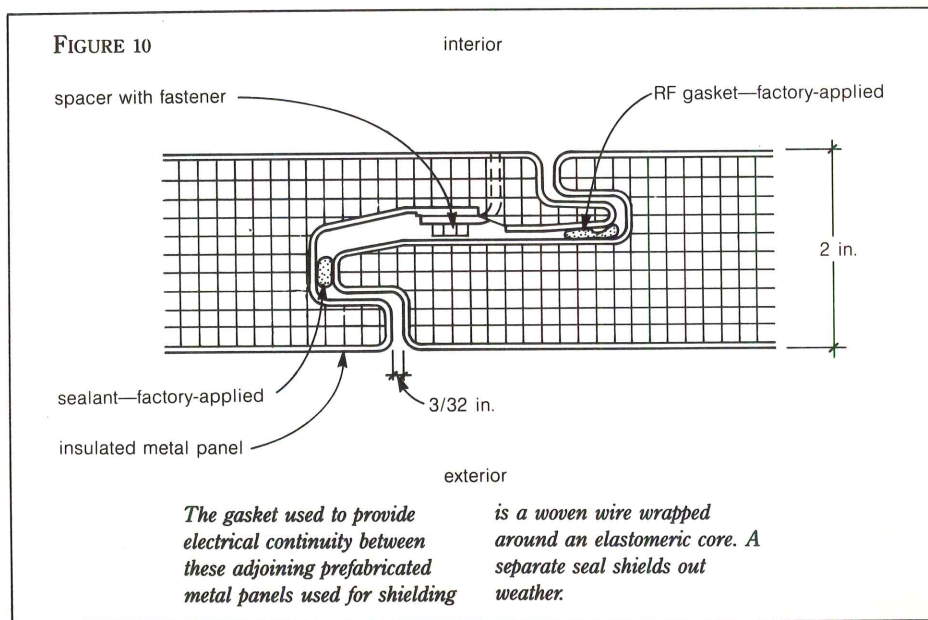

in exterior wall construction and curtain walls. It can be applied, like wallpaper, to building sheathing.

Of course, manufacturers constantly develop new materials. A new copper soldering strip is available from Fortifiber. An RF-shielded door stop is now being tested by Chomerics. Coral has invented a fabric with shielding properties. To get in on this market, manufacturers of conventional building materials are constructing test panels to evaluate their shielding efficacy. On a recent project, for example, H.H. Robertson, Inryco and Construction Specialties all participated in a test program for metal panel systems.

DESIGN FINE POINTS

Whether materials employed for shielding mechanisms are fabricated in factories or on construction sites, designing an RF-shielded building and getting it built can be considerably more difficult than for a conventional building. Water from wind-driven rain or snow, condensation, and the potential for galvanic reaction between dissimilar metals, inevitable in most designs, will pose tricky detailing problems. To protect the materials from water and from wear and tear, it is desirable to place the metals away from exterior and interior wear-surfaces. At the same time, because many RF-shielding techniques and materials are new, a design that provides simple access to the shields for testing or repairs may represent a considerable savings to the owner over the life of the building.

Given the many often conflicting requirements encountered in an RF-shielded building, it is important to realize that there is no such thing as perfection. This truth becomes particularly apparent during the construction stage. Although quality control is fairly easy to achieve for rooms shielded with prefabricated panels, problems in large-scale shielded buildings often surface during construction. These difficulties stem in large measure from contractors' and workmen's unfamiliarity with RF shielding. A roofer, for instance, knows from years of experience whether the flashing joint he has just constructed will be watertight. But when he uses the same metal for shielding, he may not know whether the joint will be RF-tight.

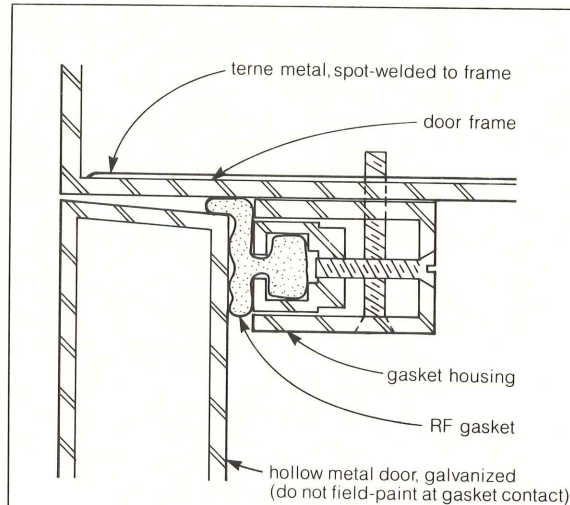

To adapt these aluminum headjamb extrusions that comprise a door frame normally used for lightproofing or soundproofing, the neoprene gasket supplied with the frame is replaced with a radio-frequency gasket—a woven wire wrapped around an elastomeric core.

FIGURE 11

FIGURE 12

To assure electrical continuity between a door and its threshold, and at the same time reduce wear of the gasket, designers will often specify a drop-seal mechanism for doors used for radio-frequency shielding.

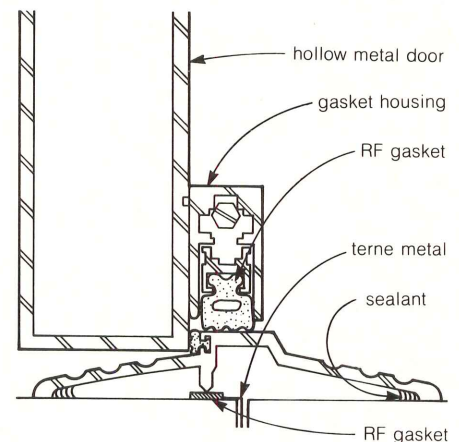

One way to overcome this problem is to construct a small, expendable test-building using the same shielding materials and joint details as the main project. The test-building enables work crews to practice. A small testing rig can be used to evaluate the continuity of each joint as it is being constructed, and gradually, the workers acquire a feel for how to avoid leaks. Once standards of workmanship are established, construction on the main building is more likely to proceed smoothly and successfully.

Quality control is most effective if shields are tested as they are being constructed. To test a shield under construction, a low-amperage current is applied to the shield. Gaps are detected by an instrument called a seam sniffer. Flaws in the shield are repaired before the shielding envelope is covered by subsequent construction. Once the whole shielding envelope is completed, a signal is set up inside the building and detailed measurements can be made of the overall system performance. □

Ten Indicators Of Good Financial Health

BY G. NEIL HARPER

2 x 11 = 22

HOW CAN YOU ASSESS THE FINANCIAL CONDITION OF YOUR FIRM? Are there performance measures you can use for comparison with other firms? What actions might you take to improve the relationship between fees and productivity?

These are the questions confronting the managers of today's design offices as they struggle to win commissions, negotiate better fees, control costs and increase compensation and profitability.

Each year, Harper and Shuman surveys the firms that use its Computer-based Financial Management Software (CFMS*). Based on the financial details provided by some of the respondents, we have concluded that ten indicators summarize a firm's financial health and serve as a guide in monitoring operational efficiency.

1 PERSONNEL RATIO

Providing architectural and engineering services begins with people, so we begin by inspecting key personnel ratios. The ratio of technical (including principals) to nontechnical people is an important indicator of productive staffing. Four to one is average. Similarly, the ratio of total personnel to number of principals (median of 11 to 1) indicates whether a firm's decision-making power is centralized or decentralized (see Figure 1).

2 CHARGEABLE TIME RATIOS

The proportion of time that employees charge to productive work is perhaps the single most important indicator of the health of the firm, short of ultimate bottom-line profitability. Many firms look at two ratios: one that considers all hours for all staff (63 percent charge-

able time was average in 1984—see Figure 2) and another that considers only technical staff (77 percent average in 1984).

3 AVERAGE PAYRATES

Having the right mix of personnel (Indicator 1) and applying their time productively (Indicator 2) will be effective only if pay rates are in line with competition. Average rates in 1984 ranged from \$5.44/hour for messengers to \$17.78 for project managers, with principals recording an average rate of \$29.71 for job costing purposes (see Figure 3).

4 DIRECT PERSONNEL EXPENSE FACTOR (DPE)

DPE is a measure of the mandatory and customary benefits provided to employees; it is also the most commonly used base for billing employee labor to clients. DPE comprises paid time off and out-of-pocket benefits. For each dollar of direct time worked, firms paid an average of .13 for paid time off (26 days/year on average), plus another .18 for out-of-pocket benefits such as payroll taxes, unemployment and medical insurance. The total cost of .31 results in an average DPE rate of 1.31. Fringe benefits must be liberal enough to attract and keep good employees, but not so large as to make the firm noncompetitive in billing its clients.

5 OVERHEAD RATE

The overhead rate is the ratio of all indirect costs (including DPE costs) to the direct labor costs charged to projects. This ratio has

FIGURE 1

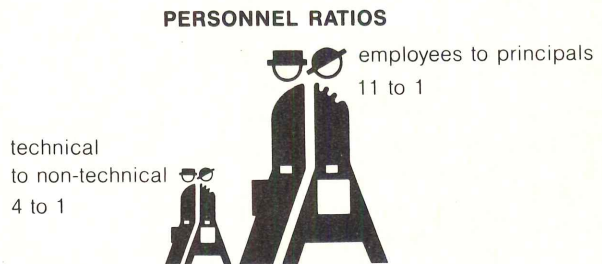
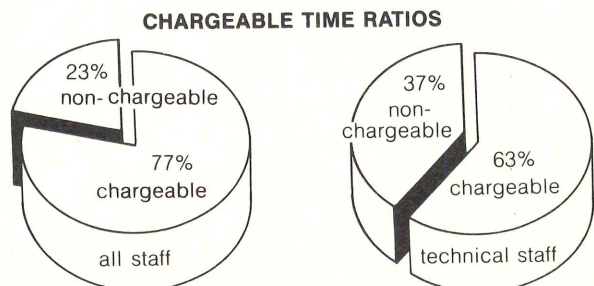

FIGURE 2



*CFMS is a registered trademark, jointly owned by Harper and Shuman, Inc., and The American Institute of Architects Service Corp.

G. Neil Harper is president of Harper and Shuman, Inc., a Cambridge-based financial-management firm specializing in the A/E market.

been climbing steadily over the past decade, primarily because of more-accurate time recording; increased marketing, employee benefits and administrative costs, and reduced direct labor resulting from automation. The current average overhead rate of 170 percent (see Figure 4) seems destined to go higher if the trend toward automation and reduced technical time continues.

6 EFFECTIVE MULTIPLIER

This ratio measures both the contract negotiation skills of the principals and the effectiveness of the organization in billing time to the client. The effective multiplier is computed as the ratio of revenues generated (exclusive of reimbursables, consultants and other miscellaneous direct nonlabor costs) to the cost of direct labor (not DPE labor). The 1984 average of 2.92 says that for every dollar of direct payroll cost on a job, the firm billed \$2.92 to cover payroll, overhead and profit.

7 BILLINGS PER EMPLOYEE

Billings per employee is an indicator of the revenue-generating capacity of the organization on a per-employee basis. Firms with specialty services and strong negotiating skills can perform significantly better than those that must compete purely on the basis of price. There are two common ways to compute this critical indicator. The first is on the basis of gross fees per employee; the 1984 average was \$61,000. The second is based on net fee (gross fees less consultant and reimbursable billings) per technical employee, and is probably more significant. The 1984 average was \$57,000. Firms with the highest average often are those with a well-organized, job-

costing system—one that permits accurate tracking of services, especially services not normally offered.

8 AVERAGE AGE OF RECEIVABLES

The average age of a firm's receivables indicates its effectiveness in collecting from clients. The average age is computed by dividing the average amount of outstanding accounts receivable during the month by the average billings per day. The average in 1984 was 75 days.

9 OFFICE COSTS AND PROFIT

This indicator is "the bottom line." In a way, it sums up all the rest. In 1984, firms reported, as a percentage of total revenue, 47 percent for direct costs, 45 percent for overhead, 6 percent for reimbursables and 2 percent for profit (see Figure 5).

10 CAPITAL INVESTMENT PER EMPLOYEE

After the bottom line, what comes next? Our observations lead us to conclude that capital investment per employee may be a leading indicator of success for the service professions. It is likely to be a measure of productivity gains in the future. This indicator is obtained by dividing total assets on the balance sheet (omitting any real estate holdings) by the number of full-time-equivalent employees. The average of \$24,000 in 1984 shows that it takes \$24,000 of assets (cash, receivables, furniture and equipment) to support each employee. Firms appear to be allocating increasing proportions of their resources to this component. □

FIGURE 3
AVERAGE HOURLY PAY RATES

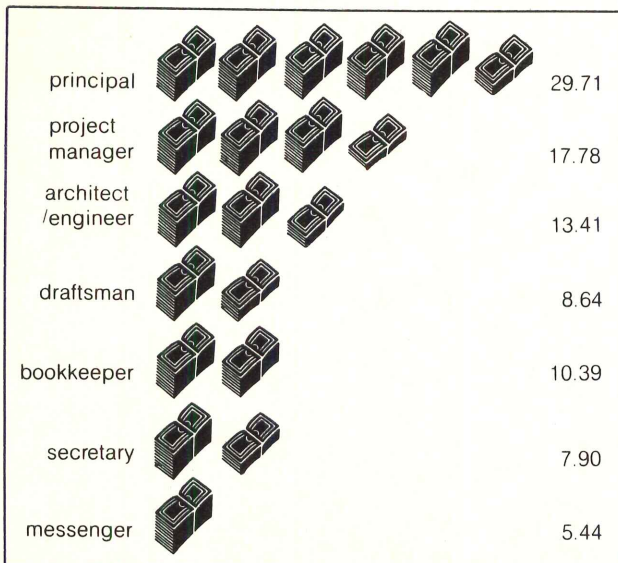

FIGURE 4
OVERHEAD RATES

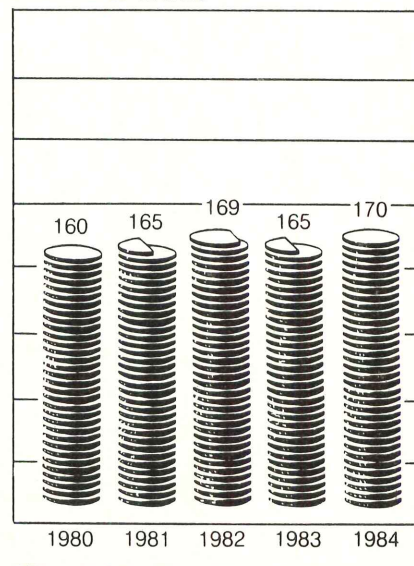
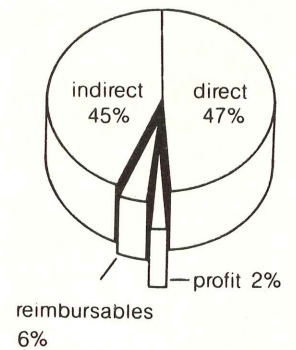

FIGURE 5
OFFICE COSTS AND PROFITS



CAD Buyer's Checklist

BY MICHAEL SCHLEY, AIA

Selecting a computer-aided design system is difficult. Computers confront architects with a bewildering array of capabilities and prices. The performance checklist here can be a big help in evaluating CAD systems. By grading different systems using the same criteria, it is easier to separate fact from impression. Also, it's a useful way to reveal deficiencies that a typical demonstration might hide.

FINDING THE RIGHT CAD SYSTEM IS basically a process of elimination. To begin, select several CAD systems for detailed evaluation. Then, armed with this checklist, study how each performs, weighting factors according to your own needs and work habits.

Schedule an appointment with each vendor and provide a copy of the checklist several weeks in advance. During the evaluation session, ask that each checklist item be demonstrated on the vendor's system.

Although the checklist can be scored quantitatively, there is also value in the qualitative information you will uncover. During the evaluation session, explore any unique features or approaches the program offers. Note any "next release" promises, but until a feature can be demonstrated, be skeptical.

A useful approach to examining the checklist results is to ignore all the "yes's" and concentrate on the "no's" of each system. No CAD system is perfect. Many deficiencies are not serious, particularly if the task can be accomplished in other ways.

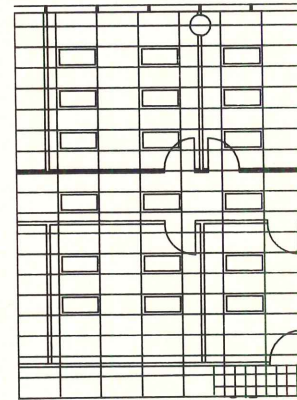

BASIC DRAWING FUNCTIONS

- Can the system display different line styles such as dashed and dot-dashed?
- Can a user define line styles using symbols and text? (For example, alternating the letter "g" with line segments to represent a gas line.)
- Can the system display variations in line thickness? (You should be able to draw

heavy lines and light lines to adequately represent drawing intent. Some systems can plot different line weights on the final drawing, but can't display them on the screen. This makes it difficult to confirm that you're drawing what you think you are.)

- Can different colors be displayed on the same layer?

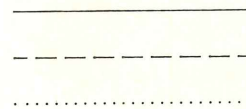

TEXT FUNCTIONS

- Can different sizes of text be displayed on the same drawing?
- Can text be changed to create compressed or expanded characters?
- Is there a way to edit text after it has been placed? (With many PC CAD systems, if you make a mistake in a note, you must delete and retype it.)
- Can the system display more than one font (typeface) on the same drawing?
- Can users create their own text fonts?
- Can text be made to appear "bold"?

- Can the system center text?
- Can the system right-justify text?
- Can text be placed at an angle?
- Is there a command to "fit" a string of text within a given width of space?
- If a portion of a drawing is copied to form a mirror image, will the text still read from left to right?
- Is there a way to insert a text file created by a word-processing program into a drawing? (This feature is useful for placing general notes on a drawing.)

④ Wall Section
3/4" = 1'-0"

↙ Sales Counter by
Fixture Contractor

Sheet:

A-12



Michael Schley, AIA, is president of Facility Systems Group, Houston, a consulting firm that assists architects with computer applications. He also serves on the national AIA Computers in Architecture Committee.

BASIC GEOMETRY

- Can the user define a circle by three points on the circumference?
- By a centerpoint and radius?
- Can arcs be defined by three points along the circumference?
- By a centerpoint, starting point and endpoint?

- Can the user create an ellipse and an elliptical arc?
- Can the system create a fillet (an arc tangent to two lines) between two intersecting lines?
- Does the system permit the user to draw complex curves?

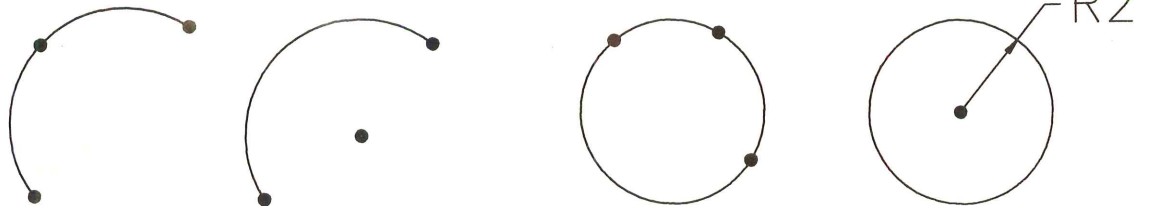
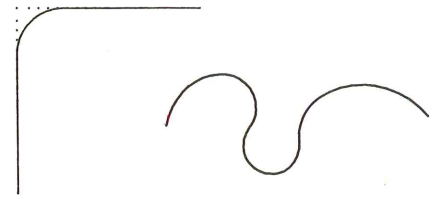

PRECISION INPUT

- Can drawing-entities (lines, circles, arcs and other drawing elements) be created by describing them in words typed on the keyboard?
- Can drawing-entities be placed with absolute X-Y coordinates? (Absolute coordinates are expressed as X [horizontal] and Y [vertical] distances from a common origin point.)
- Can drawing-entities be placed with coordinates relative to another location?

- (Relative coordinates are expressed as X and Y distances from a location on the drawing. For example, placing a line 4 feet to the right and 2 feet up from the corner of a room.)
- Can lengths be entered in feet and inches, or must they be entered in decimal feet or database units?
 - Can fractions be entered in the conventional form (1/8)?
 - Can lines be placed by polar coordinates (distance and direction)?

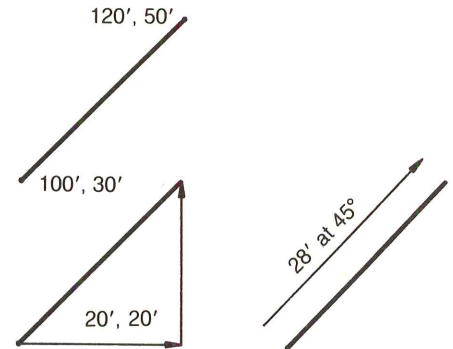

EDITING GRIDS

Most CAD systems provide editing grids to aid drawing lines at precise locations. When the user designates a location on the screen, the system will "snap" the cursor over to the nearest grid point.

- Is there a snap grid on the system?
- Can the grid be displayed?
- Can the grid display be turned off with the snap grid still active?
- Can the user define a rectangular grid?

- Can the user reset the origin of the grid? (This function is useful if you want to start the grid increments at a different location for part of a drawing.)
- Can the system simultaneously display both a major grid and a subgrid? (For example, a major grid at 1 foot by 1 foot and a minor grid at 1 inch by 1 inch.)
- Can the system display a rotated grid?
- Can the system display an isometric grid?

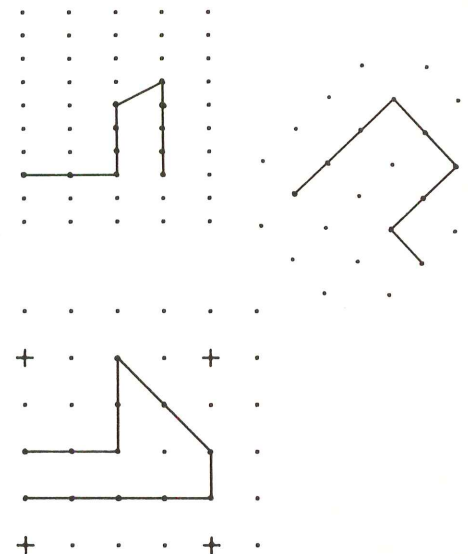

KEYPOINT SNAPS

The keypoint snap feature lets the user locate the cursor near the endpoint of a line or the center of a circle, then automatically "snap" the cursor precisely to the nearby keypoint. This feature is essential for drawing accurate geometry.

- Can the system snap to the endpoint of a line?
- Can the system snap to the intersection of two lines? (This feature is useful for placing a column at the intersection of two column grid lines.)

- Does the system highlight or indicate the object found by a snap? (In a crowded drawing it's difficult to tell which line the cursor is snapping to.)
- Can the system snap to the midpoint of a line or perpendicular to another line?

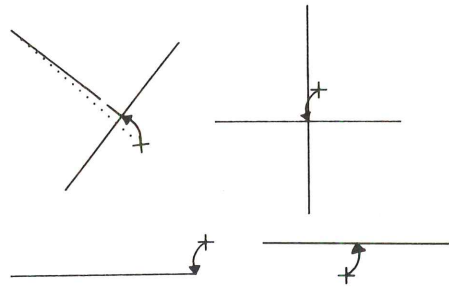

ORTHOGONAL LOCK

The orthogonal lock feature lets you draw perfect vertical or horizontal lines by entering two points that are "close" to orthogonal.

- Does the system provide an orthogonal lock feature?
- Can the user set the orthogonal lock to an angle?

EDITING FEATURES

Most CAD systems provide a method of moving, copying or deleting a group of elements all at once. Usually this is done by defining a boundary (sometimes called an "edit fence") around the elements you want to move or copy.

- Can a group of entities be moved, copied or deleted in one command by using an edit fence?
- Can the edit fence be defined as items completely within the edit fence, items partially within the fence and items partially within the fence but defining only the portion of the lines within the edit fence?
- Can you move an entity from one layer to another?

- Can you copy an entity about an axis to create a mirror-image copy? (This feature reduces the time it takes to draw symmetrical geometry. Draw half of it once, then flip it. An advanced feature allows you to copy about an axis on an angle.)
- Can you "undo" or restore elements that are accidentally deleted?
- Can an entity be rotated?
- Can an entity be scaled up or down in size?
- Can part of a line be deleted?
- Can the ends of two intersecting lines be trimmed to make an "el" intersection?
- Can one line be extended to intersect with another line to form a "tee"?

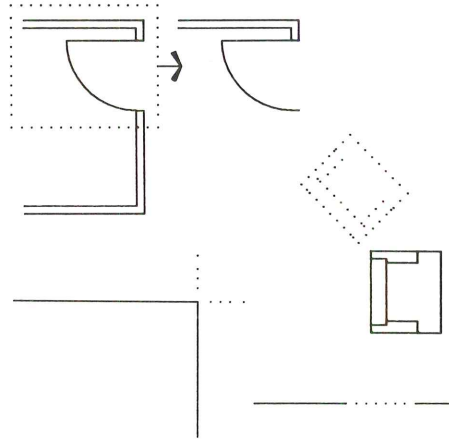

DISPLAY CONTROL

- Can the user zoom closer to and farther from the drawing?
- Can the user pan across the drawing?
- Can the user zoom into a "windowed" area?
- After you have zoomed into a portion of a drawing, can you save the view settings? (This lets you quickly return to that portion of the drawing at a later time.)
- Can text be displayed on one line for faster redisplay time?
- Can the screen be split to display several views (or windows) at once?
- Are changes in one view automatically reflected in the other views?
- How fast can the system redisplay a drawing? (Test this function by having a different view redisplayed.)

- Can redisplay time be reduced by turning layers "off" or partitioning the drawing in some manner?
- How fast can the system pan across a drawing?
- Are different line styles properly displayed on the screen?
- Can the system "drag" elements being moved or copied across the screen?
- Can other drawings be displayed on the screen as "reference" drawings? (A reference drawing feature is analogous to placing a second drawing under the tracing paper of the drawing you're working on. You can look at the reference drawing, but you can't change it.)
- Can you snap to keypoints in the reference drawing?

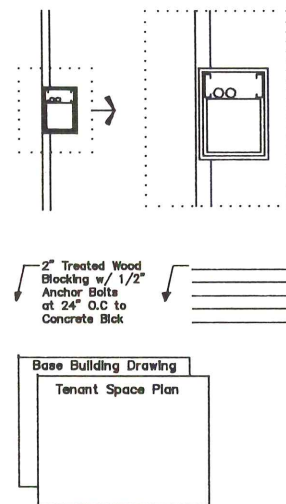

BENCHMARK TEST

How fast can the system redisplay a drawing containing 500 horizontal lines, 500 vertical lines, 500 lines at 45 degrees, 200 3-foot-radius arcs, 200 1-foot-diameter circles and 100 strings of text displaying the alpha-

bet? (This is a benchmark test that can be quickly developed on any CAD system. Draw a drawing with these elements, zoom in, then clock the time it takes to zoom out, redisplaying the entire drawing.)

CROSSHATCHING

- Can the system automatically crosshatch a portion of the drawing?
- Are standard crosshatch patterns provided?
- Can a user define his own crosshatch patterns?
- Can areas with angled boundaries be crosshatched?
- Can areas with curved boundaries be crosshatched?
- Can crosshatch patterns include any

- pattern or are they restricted to straight lines?
- Can void areas be excluded from the crosshatching? (For example, in crosshatching a brick pattern on an elevation drawing, you would exclude door and window openings.)
- Can the user define the starting point of the crosshatching? (This function is essential if you want to create ceiling grids with the crosshatching feature.)

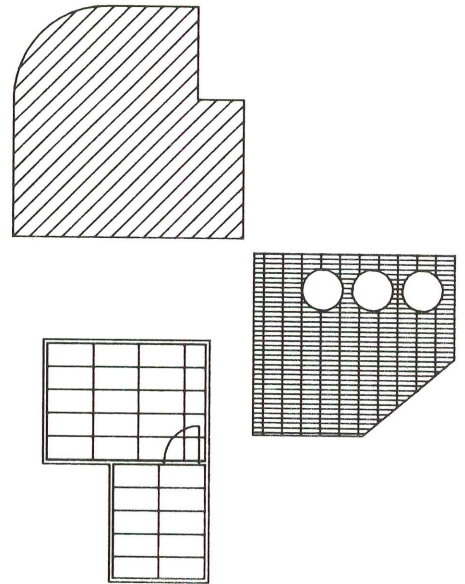

SYMBOLS

Symbols enable a user to store and recall frequently-used repetitive geometry such as furniture or plumbing fixtures.

- Is a symbol library available for the system?
- Can symbols (for example, electrical or mechanical equipment) placed in a drawing be enlarged or reduced so that their size will remain constant in drawings plotted at

- different scales?
- Can the symbol be exploded into basic elements to allow editing? (This lets you modify standard symbols. On some systems this operation is called "dropping status.")
- Are "nested" symbols allowed? (For example, you might combine several furniture symbols into a single workstation symbol.)

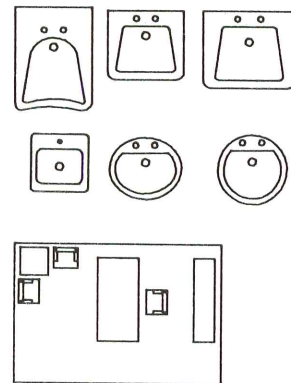

DIMENSIONING

- Can the system automatically dimension a drawing? (This process usually includes determining the distance between two specified points, drawing the extension lines, drawing the dimension line and placing the dimension text.)
- Can dimensions be displayed in feet, inches and fractions?

- Can the system dimension diagonal lines?
- Is there a choice between arrowheads, tick marks or dots?
- Is associative dimensioning supported? (Associative dimensioning automatically revises the dimension string if the drawing geometry is changed.)

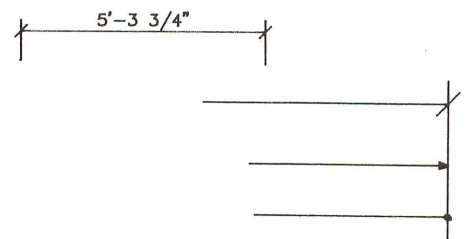

LAYERS

Layers are the CAD equivalent of systems-drafting overlays. Typically, similar information is assigned to the same layer. For example, a column grid might be assigned one layer, partitions a second and doors a third. CAD systems allow you to view your drawings "selectively." You can turn the layers you're interested in "on" and turn "off" the

irrelevant layers.

- How many layers does the CAD system support? (You need at least 64 layers for adequate flexibility.)
- Can layers be designated by names rather than numbers?
- Can more than one color be assigned to layers?

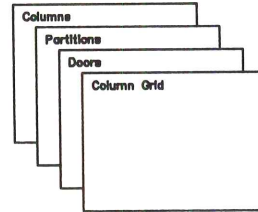

EASE OF USE

A good CAD system should be easy to learn, easy to use and easy to remember. This "feature" is particularly important if you want to train a number of people on CAD.

- Does the system provide on-screen menus? (Many CAD systems display the commands on the display screen. This eliminates the need to remember commands and increases productivity by keeping attention focused on the screen. In order to offer a complete selection of command choices without using the entire computer screen, some systems present commands in a hierarchical fashion. For example, you might first select the "editing" submenu, then the "lines" sub-submenu.)
- Does the system provide command menus on a graphics digitizing tablet? (Tablet menus are similar to on-screen menus except that they are located on a paper menu taped down to a graphics digitizing tablet. Like on-screen menus, tablet menus

eliminate the need to learn a special command language. However, they don't permit hierarchical menu choices. Further, paper menus tend to get lost or misplaced.)

- Does the system prompt the user for information? (A good system will tell you what it wants to know. For example, a "copy" command should first ask you what you want to copy, then ask you where you want the information copied.)
- Does the system provide on-line help?
- Is there a self-teaching program available for the CAD system? (Some systems offer an on-line tutorial that uses the computer as a teaching tool.)
- What formal training is available on the system? (Ask about the availability of organized training. Find out if it's available in your office, in your city or only at the vendor's training center. Also, ask about costs.)
- Are the commands clear and intuitively obvious?

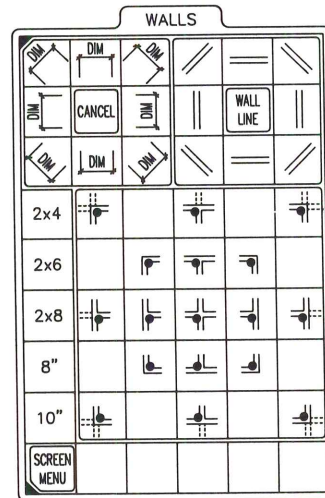

illustration courtesy Autodesk Inc.

SPECIAL FEATURES

As this checklist quickly shows, CAD systems have dozens of features. Some are more helpful than others.

- Can the system draw parallel lines of specified width to represent walls?
- Is there a command to break a wall and insert a door or window at a specified location?
- Is there a command to clean up over-

lapping lines of walls at "tee" or "el" intersections?

- Can you place a note and draw the leader line with an arrow in a single operation?
- Can the system generate room finish and door schedules?
- Is there a program to automatically generate stair drawings?

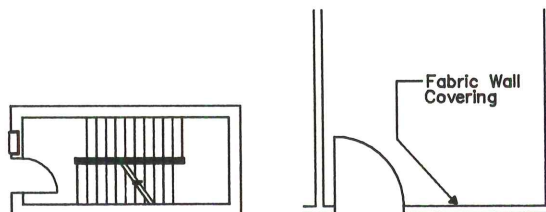
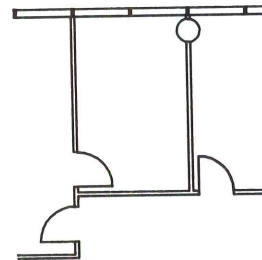

Room	No.	Fir	Base
Office	140	CPT	RES
Receptn	142	CPT	RES
Office	144	CPT	RES
Corridor	146	CPT	RES
Office	148	CPT	RES
Coffee	150	VCT	RES
Office	152	CPT	RES
Office	154	CPT	RES
Storage	156	VCT	RES

ATTRIBUTES

Attributes are items of nongraphic information such as text or numbers that are linked to parts of the drawing.

- Does the system support attributes?
- Can the user define his own attributes?
- Can the user generate a furniture or equipment schedule?
- Can the system create a bill-of-materials report?

Can attributes be displayed and edited as text on the drawing? (By displaying the attribute as text on a scratch layer, you're more likely to catch errors.)

Can the user change an attribute without creating a new symbol? (This feature is critical if you want to assign specific inventory numbers to furniture or equipment on the drawing.)

Swivel Arms
700
CH3
HM

Arms Leather
950
CH5
HM

Mfr.	Item		Qty
HM	CH1	Guest Chair	122
HM	CH2	Sec. Chair	68
SC	CH3	Exec. Chair	72
SC	TA2	Conf. Tbl	6

AREA CALCULATION

- Can the system calculate areas?
- Can curved areas be calculated?
- Can area boundaries be associated with attributes such as department names?

Can the system generate an area calculation report that includes both department names and appropriate square-foot areas?

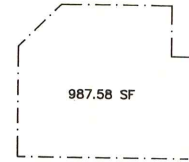

THREE-D

- Does the system support three-dimensional graphic information?
- Can you work directly in 3-D views, or are the 3-D views "derived" from two-dimensional drawings? (Systems that derive 3-D geometry are sometimes called "2½-D" systems.)
- Can an isometric view be displayed?
- Can the system display a user-defined orthographic view?
- Can this view be dynamically rotated (turning the drawing on the screen to the desired setting)?
- Can the screen be split into windows that display several different views such as plan, front elevation and isometric view at once?
- Can the user set a maximum and minimum display depth to limit the portion of the drawing displayed on the screen?
- When the user is drawing in three dimensions, is it easy to determine the active depth (the dimension coming "out" or "into" the screen)?

- Is there a command to project lines into rectangles and rectangles into boxes?
- Can a floor plan be "extruded" to create a three-dimensional drawing?
- Can the system automatically generate perspectives?
- Is there full flexibility in defining the perspective view?
- Can the system remove hidden lines from the perspective?
- Can hidden lines be displayed as dashed lines?
- Can the system apply shading and shadowing to the perspective drawing?
- Are functions for solids-modeling provided? (Solids-modeling deals with volumes rather than lines. For example, solids-modeling software can determine the plane between two intersecting solids. Although solids-modeling is useful in many fields, the extensive graphic detail needed to depict most buildings and the high cost of hardware and software have limited its practical use for architects up until now.)

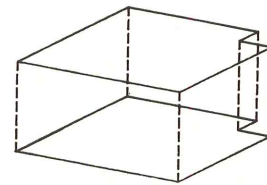
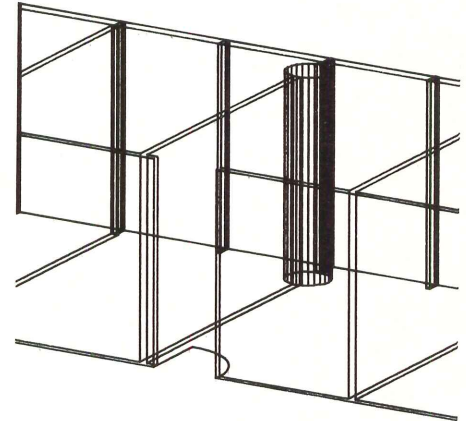

ADVANCED FEATURES

- Can the user create his own on-screen or tablet command menus?
- Does the system support macro commands? (Macro commands tie together several simpler commands into one.)
- Can macro commands be programmed to pause for keyboard or digitizer input?
- Can the user define a series of views to

create a "slide show" presentation?

Can the system convert a graphics file into an ASCII text file? (This function allows access to the drawing by other programs and is the first step in conversion from one CAD system to another.)

Are programs available for converting CAD drawings to other CAD systems?

Computer-Cost Accounting

BY BRIAN JACK, AIA

ONCE YOU HAVE A COMPUTER, HOW DO you know if it's cost-effective? When and how do you decide to expand or reduce your equipment base, operating schedules or personnel?

Making the initial decision to acquire a computer system is only the beginning in what should be a continuing evaluation of computer-system performance.

To track its investment in computer equipment, Skidmore, Owings & Merrill (SOM) established a management system that organizes computer operations into an independent cost center. This approach has proved extremely useful in monitoring the effectiveness of the firm's in-house computer resources.

ORGANIZING A COST CENTER

Setting up a computer-cost center requires establishing "accounts" in which labor and expenses are recorded for purchasing, operating and maintaining computer equipment. Examples of accounts and types of expenses within accounts are shown in Figure 1.

Accounts and the categories within them will likely vary from firm to firm, depending on the size and scope of the computer operation. An architect considering investing in computers will want to anticipate, to the greatest degree possible, what all the accounts and categories might be. The exercise provides valuable insight into the significant ongoing costs of operating a computer.

Costs mount quickly in the accounts, and would appear a huge overhead burden if they weren't balanced in some way with revenues. The balance is created by establishing an account in which computer time charged

to projects is credited. Figure 2 shows how an annual pro forma for evaluating a computer operation's costs against revenues might look.

SETTING RATES

The linchpin in this financial model is the *rate* at which computer time is charged to projects. The objective is to set a rate that produces revenues equal to costs—after depreciation is figured. The pro forma in Figure 2 does just that, striking a zero balance between computer billings to projects and direct computer costs. This approach permits individual projects to remain the basis for evaluating gross profit performance for the entire firm. The computer-cost center does not, therefore, earn a profit.

The rates set, and the manner in which they are tracked, will depend largely on the operating characteristics of the computer. The operating system on large computers will record connect time, CPU time, disk storage and numerous other parameters. In selecting a measure for system performance, however, the rule should be to keep it simple. SOM currently charges for computer usage based on connect time for graphics work and CPU time for engineering analysis work.

Several factors may be considered in determining computer rates. These include 1) anticipated volume and types of computer usage, 2) billing rates of outside service bureaus and 3) a rate structure designed to enhance or encourage system usage (e.g., offering lower rates for running batch jobs during off hours). In any case, the basis for computer charges should be clear and concise. This approach promotes understanding and affords simplicity in budgeting for computer usage.

EVALUATING PERFORMANCE

Rates established with thought and care

enable managers to evaluate the cost center routinely. SOM includes a summary report of its computer-cost center in its monthly

FIGURE 1

EXAMPLES OF OVERHEAD ACCOUNTS
IN A COMPUTER COST CENTER

ADMINISTRATION

- opening and closing accounts
- scheduling computer time and computer resources
- time spent meeting with vendors and suppliers

SUPPLIES

- non-job-chargeable supplies
- non-depreciable hardware (not capitalized)

TRAINING

- initial training of staff
- ongoing training

SYSTEM SUPPORT

- daily and weekly backup
- maintaining central tape library
- monitoring system performance

SOFTWARE DEVELOPMENT

- in-house applications programs
- purchase/license software

HARDWARE MAINTENANCE

- regular maintenance

DEPRECIATION

- depreciation of hardware on a straightline basis, over five years (20 percent of purchase price each year)

If the equipment was not purchased, this category would, alternatively, be designated, "lease expenses."

Brian Jack, AIA, an associate partner with Skidmore, Owings & Merrill, Chicago, received his M. Arch. and MBA from the University of Illinois. Mr. Jack manages SOM's in-house computer operations.

FIGURE 2

PRO FORMA FOR COMPUTER COST-CENTER PERFORMANCE

COMPUTER TIME BILLED	250,000
DIRECT COSTS:	
<i>computer administration</i>	15,000
<i>computer supplies</i>	20,000
<i>technical training</i>	15,000
<i>system support</i>	30,000
<i>software development</i>	20,000
<i>hardware maintenance</i>	+ 50,000
	150,000
DEPRECIATION	100,000
TOTALS	- 250,000 + 250,000

operating report for the firm.

In an evaluation, consistently positive cost-center performance might justify expanding computer facilities and/or reducing rates. Negative performance would suggest underutilization of the system.

Reducing computer hardware and overhead-account expenditures and/or increasing rates charged for computer time could each improve the picture. Increasing rates, however, requires caution. It may make manual

design and production techniques appear suddenly more appealing to a project manager—discouraging use of an otherwise productive tool.

SOM charges computer time to projects irrespective of arrangements to bill or not bill computer time to a client. The attitude is that a well-defined computer program for a project will contribute to performance regardless of the type of contract arranged.

USAGE AND GROSS-PROFIT PERFORMANCE

Architects have traditionally evaluated their performance on projects by examining ratios between the gross profit and their own technical labor costs—their largest expense in completing a project. With the growing application of computer resources to a project, misleading interpretations of gross-profit performance can occur when conventional assumptions are made.

Take as an example two fixed-fee projects, identical in all respects, except that one project utilizes computers significantly and the other does not (see Figure 3). The gross profit is the same for both projects but the performance criteria, typically expressed as a ratio of technical labor costs, suggests that the project utilizing computers was significantly more efficient. In Project B, technical labor costs were displaced by computer expenses, thus reducing the technical labor base used in calculating project performance. This scenario produces the misimpression of superior performance.

Incorporating technical computer charges with labor costs to serve as the basis for project performance factors or, alternatively, using a simple ratio of gross profit/net fee would more correctly express project performance.

HOW LONG A CAPITAL EXPENSE?

Just how long before computers become what pocket calculators are now is a matter for some debate. Granted, there is probably no need to monitor "calculator time." And as price/performance ratios continue to improve, computer equipment may indeed become regarded as a general overhead item. But the "horsepower" necessary to create the sophisticated graphic images that architects and engineers work with will continue to require major capital outlays in technical computer equipment for the foreseeable future.

Time-shared "mini" systems currently run \$60,000 to \$80,000 per workstation. Newer, "distributed" systems may run \$30,000 to \$40,000 for comparable performance. Even for PC-based systems at the low end, the \$10,000 to \$15,000 required is still a major capital outlay. Furthermore, many trends point toward additional sophisticated electronic tools becoming integrated with the computer systems we use in our practices today.

All this equipment—these tools—will require care and warrant a control system capable of insuring their effective application and use. □

FIGURE 3

PROJECT A

CONVENTIONAL PROJECT

	Dollars	Labor ratios
GROSS FEE	100,000	
Consultants	- 5,000	
NET FEE	95,000	3.16 (net fee/labor)
Labor	- 30,000	1.00 (labor)
Expenses	- 2,000	.06 (employees/labor)
GROSS PROFIT	63,000	2.10 (gross profit/labor)

PROJECT B

SIGNIFICANT COMPUTER INVOLVEMENT

	Dollars	Labor ratios
GROSS FEE	100,000	
Consultants	- 5,000	
NET FEE	95,000	4.75 (net fee/labor)
Labor	- 20,000	1.00 (labor)
Computer usage	- 10,000	.50 (comp/labor)
Expenses	- 2,000	.10 (ex./labor)
GROSS PROFIT	63,000	3.15 (gross profit/labor)

Evaluation of project performance for conventional vs. computer-assisted projects. Conventional labor ratios won't work.

RX FOR THE COMMON CODE

BY M. STEPHANIE STUBBS

REHABILITATION OF EXISTING STRUCTURES IS AN IDEAL OUTLET for the architect's talents and interests. Yet many reconstruction projects never progress beyond the drawing board before slamming into a brick wall of regulatory and economic restraint. Now, thanks to an innovative building code change, older buildings will soon have a better chance for new life as adaptive reuse and rehabilitation projects.

Making many older structures usable and habitable often requires extensive remodeling or total rehabilitation. Frequently, changing use is the only recourse for keeping a building economically viable. In most building codes, however, structures changing use must meet standards of the current code for new construction. Bringing an existing structure "up to current code" can make such a project economically unfeasible and, sometimes, physically impossible.

Article 25 for the "Repair, Alteration and Change of Use of Existing Buildings," adopted in the 1985 Building Officials and Code Administrators Inc. (BOCA) model building code, offers an alternative method of code compliance for renovated buildings. Its methodology is performance based, and thus gives architects freedom to

meet equivalent life-safety requirements in several ways. Article 25 introduces an "overall building performance" scoring system that distills the essence of life-safety intent, so that rehabilitated buildings can be upgraded to a safe level without having to conform to all current new construction requirements. The tool is all the more remarkable because of its clarity and ease of use.

Despite the simplicity of the product, development of Article 25 was a monumental effort, spearheaded by David S. Collins, AIA; Wayne M. Meyer, AIA, and the Ohio Consultative Council of the National Institute of Building Sciences (OCC/NIBS). They decided on an equivalent performance method after considering various approaches found in existing city and state building codes.

Building codes may be classified as either performance or prescriptive in nature. A performance code presents the objective to be accomplished, and allows the designer leeway in selecting appropriate methods and materials. A prescriptive code describes in detail the material, dimensions, methods of assembly, etc. required to meet code. Although performance codes are typically more difficult to interpret and enforce, architects generally prefer them because of the freedom they permit. In fact, current AIA policy supports the concept that codes and standards be "designed to serve performance rather than prescriptive criteria whenever practicable."

HOW ARTICLE 25 WORKS

The text of Article 25 is divided into two major areas: *administration* and *evaluation*. The administration section defines and separates the responsibilities of the owner/developer, the designer and the building official (see Figure 2).

The evaluation section is the heart of Article 25. It spells out 16 issues of life safety (see Figure 1), their methods of evaluation, performance criteria and point values. The numerical scores for these 16 issues are added to derive overall performance ratings in three major categories: fire safety, means of egress and general safety. The building under study must earn a minimum score in each of these three categories or it fails to comply with the building code.

M. Stephanie Stubbs, an architect researcher and writer, is a member of the AIA's Building Performance and Regulations Committee.

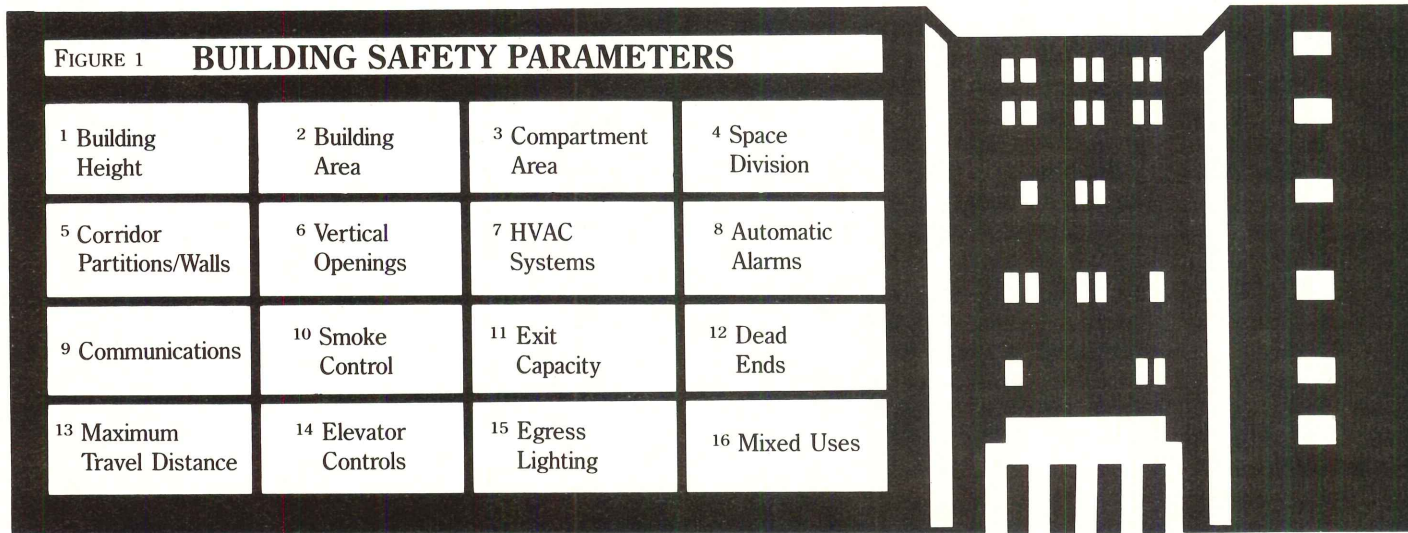

ing one of the 16 categories is probably the clearest way to see the way the new code works. Take "elevator controls" as an example:

Generally, the goal of elevator controls in a fire situation is to return elevators to the main floor to prevent them from being used in an egress. At the same time, special controls allow the fire department to continue to use the elevators without interference from building occupants. Article 25, a building under evaluation falls into one of four categories depending on whether it has: a) no elevator and is three stories or less, b) fire department control or is less than three stories and no elevator, c) automatic control of elevators or d) fire department control and automatic recall or is a one-story building. Each category is assigned numerical values, as shown in Table 3. For example, a proposed rehabilitation of an office building (category type B) with an automatic recall elevator would be placed in category "c" and receive three points for its elevator-controls

Building would be evaluated in the 15 remaining categories in a similar manner. The authors of Article 25 stress that it is the total score that counts. Buildings get "extra" points for certain safety features such as smokeproof enclosures or additional exits. Likewise, points are subtracted for less safe conditions, such as no emergency egress paths.

IMPLEMENTING THE CODE

Performance-based evaluation is not new. It has already been used in the form of the National Fire Protection Association's Life Safety Code. Finding the right combinations for its use in the model development process proved to be an arduous task. The model buildings themselves were rejected as "models" because they did not address problems of changing occupancy types or extensions. OCC/NIBS, therefore, turned to those states and cities with codes specifically devoted to rehabilitation, such as New York, Massachusetts and Chicago.

The Article 25 evaluation process began with the base figures extracted from the New York City Code for existing highrise offices (Local Law 5). Numerical values were assigned to levels of performance to permit comparisons with minimum baseline values. The base numbers were adjusted for other use-groups, risk factors, and differences in code language to make them compatible with the model codes. In fact, Article 25 directly parallels the BOCA code.

"With Article 25 as a part of the BOCA Code," Collins says, "rehab will no longer be a game of economic roulette or 20 questions, but will become a straightforward process for decision-making." Extensive multidisciplinary input and testing were used to fine-tune the numbers and the compliance process.

"Article 25 can't be attributed to the efforts of any one person or group," Meyer adds. "Architects, engineers, contractors, building officials and fire officials all contributed to the life-safety assessment method. And we all recognized the value of these older structures in our urban areas."

By taking an active role in the code formulation process, Collins, Meyer and OCC/NIBS have broken the "so what, who cares" barrier toward building codes so often attributed to architects. The implications of their efforts have already begun to take effect.

Although the other two model codes have not yet adopted the concept of Article 25, the State of Ohio building code has, and other states will soon follow suit. The adoption of Article 25 by BOCA is an important step in acknowledging the importance of rehabilitation.

The new article is an integral part of the 1985 supplement to the BOCA/National Building Code. The original draft article also contained a reference section, which was not adopted as part of the BOCA code, listing documents useful in determining compliance alternatives, such as the U.S. Department of Housing and Urban Development Guidelines for Rehabilitation. Collins and Meyer, both members of AIA's Building Performance and Regulations Committee, developed a concise, informative report explaining the history, rationale and derivation of the formulas in Article 25. Copies of the report are available from the AIA practice department. □

ADMINISTRATIVE RESPONSIBILITIES	
OWNER	<ul style="list-style-type: none"> • Evaluate Building
OPERATOR	<ul style="list-style-type: none"> • Structural Analysis
INSPECTOR	<ul style="list-style-type: none"> • Report on Those Conditions
ENGINEER	<ul style="list-style-type: none"> • Describing Current Conditions This may involve an as-built set of documents depicting all conditions contributing to occupants' safety
FINAL AUTHORITY	<ul style="list-style-type: none"> • Determine Safety The final authority for determining that there are no conditions which are being made less safe and that no serious hazards remain in the structure

FIGURE 3 ELEVATOR CONTROL VALUES

	Use Groups	Categories			
		A	B	C	D
theaters	A-1	0	3	6	9
assembly, no stage	A-2	0	3	6	9
assembly, amusement	A-3	-7	0	3	6
churches	A-4	-7	0	3	6
educational	E	-7	0	3	6
business	B	-7	0	③	6
factory and industry	F	-7	0	3	6
mercantile	M	-7	0	3	6
residential	R	-7	0	3	6
storage	S-1	-10	-7	0	3
utility and miscellaneous	S-2	-10	-7	0	3

Article 25 in action—a case study

In one of the first applications of Article 25, a 13-story textile manufacturing plant in Cincinnati was evaluated. Built in 1906, the building had housed light manufacturing, offices and retail space. The owners, Fourth and Elm Developers, wished to renovate it exclusively for office use. Architects Glaser and Myers Inc. worked with code consultant Wayne Meyer of Arcodect, Inc. to determine the new design's code compliance.

The floor plan and summary sheet indicate the proposed fire safety features. The life safety parameter chart shows how the building fared in its life safety test. Stars indicate those matrix relationships not considered significant. For example, maximum travel distance to an exit (category 13) does not contribute to the spread of fire, so fire safety is not rated for that category.

The score for the textile building exceeded the minimum safety score for office occupancy; therefore, the proposal complied with Article 25. The renovation process is now underway.

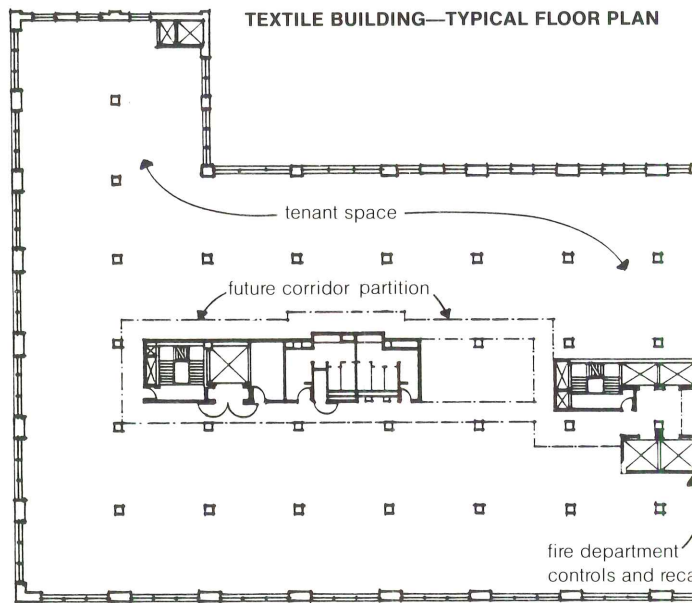

TABLE 2505 SUMMARY SHEET

Existing use: _____	B, M, F, S-1
Proposed use: _____	B
Year building was built: _____	1906
Number of stories: _____	13
Height: _____	168'
Type of construction: _____	1B
Area per floor: _____	18,720
Percentage of open perimeter: _____	75%
Percentage of height reduction: _____	0%
Completely sprinkled: _____	Yes
Corridor wall rating: _____	NOT REQUIRED
Compartmentation: _____	No
Required door closers: _____	No
Fire resistance rating/vertical opening enclosures: _____	TWO HOUR
Type of HVAC system: _____	HEAT PUMP
Serving number of floors: _____	5 MAXIMUM
Automatic alarms: _____	Yes
Type and location: _____	ION, CORRID./ELEV. LOBBY
Communication systems: _____	Yes
Type: _____	CENTRAL CONTROL STATION
Smoke control: _____	Yes
Type: _____	STAIR PRESSURIZATION
Adequate exit routes: _____	Yes
Dead ends: _____	No
Maximum travel distance: _____	90'
Elevator controls: _____	Yes
Emergency lighting: _____	Yes
Mixed use: _____	No

LIFE SAFETY PARAMETER CHART	Fire Safety	Means of Egress	Ge Sa
building height	10	10	
building area	14	14	
compartment area	-6	-6	
space division	0	0	
corridor partitions/walls	-5	-5	
vertical openings	2	2	
HVAC systems	2	2	
automatic alarms	8	8	
communications	10	10	
smoke control	****	4	
exit capacity	****	0	
dead ends	****	5	
maximum travel distance	****	10	
elevator controls	6	6	
egress lighting	****	2	
mixed uses	0	****	
Building Score—Total	41	62	
Mandatory Safety Scores (B)	28	40	

DP/architecture '85

COMPUTER ADVERTISING SUPPLEMENT



Firms Agree on Computer's Value
Vendors See Acceptance Grow
User Groups Smooth Transition
On-Site Computer Is Marketing Sizzle

Picture this on a \$2,500 CAD program.

When Ultracam Incorporated set out to design the Ultracam™ K35, they knew that their design tool needed to be as professional as the camera they were designing. That's why they chose AutoCAD™, the most widely used computer-aided design and drafting tool in the world today.

Mainframe CAD Capability at 5% of the Price

If you have an IBM PC, PC/XT, PC/AT, NEC, DEC, TI, Tandy, Wang, or one of over 30 desktop computers AutoCAD supports, you already own the most expensive part of a CAD system. Add AutoCAD for only \$2500 more, and you can have the power of CAD on your desktop at a price you can afford. With a pointing device and a plotter (the choice is yours, we support over 50 popular peripherals,) you can assemble a complete CAD workstation for less than \$10,000.

Once you've installed AutoCAD on your computer, you'll have a tool at your fingertips which removes the drudgery from designing.

Quick to Learn, Easy to Use

The beauty of AutoCAD is that you need no prior knowledge of computers. Even if you've never seen a CAD system, you'll pick it up in a matter of days, and feel comfortable within a week.

Simple pop-up menus point you in the right direction. You can also easily create your



own menus. On-line HELP keeps you on track.

Sailboats, Landscapes, and Custom Homes

Since AutoCAD is general-purpose and user-customizable, it doesn't matter what type of drafting your work requires.

Ultracam K35 is a trademark of Ultracam Incorporated. AutoCAD, CAD/camera and AE/CADD are trademarks of Autodesk Inc.

Camera designs provided courtesy of Ultracam Incorporated

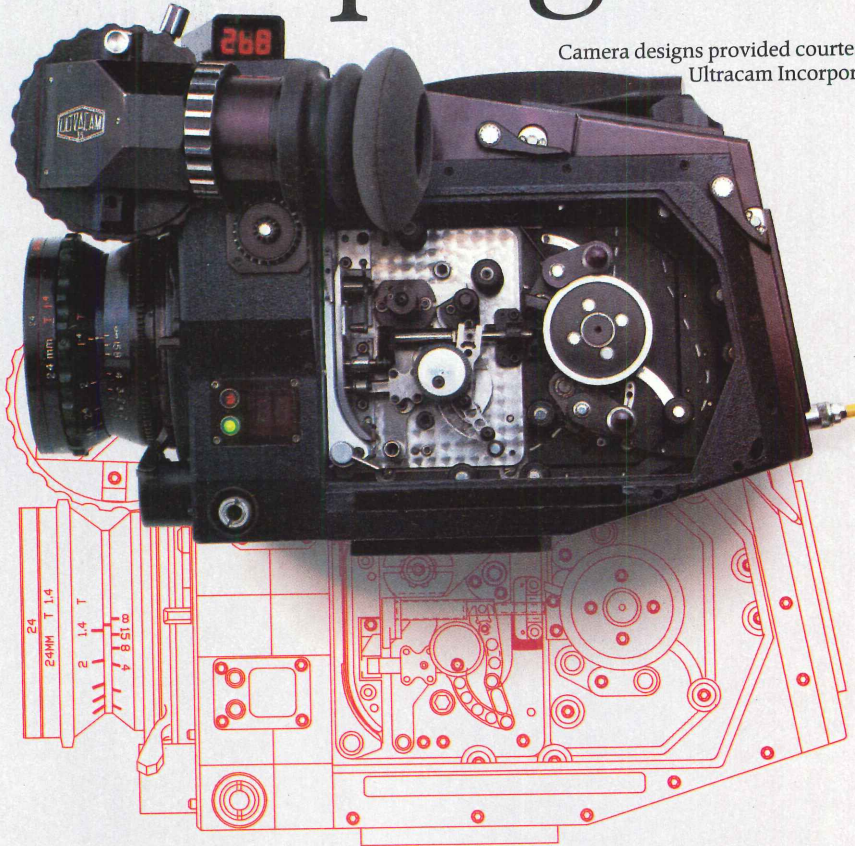

Tens of thousands of AutoCAD users are creating drawings and developing designs in every discipline with ease and accuracy never experienced before.

The Heart of Your CAE System

Drawings are only part of the story. Pre-defined standard symbols, translators to allow AutoCAD to exchange drawings with mainframe CAD systems, data base analysis programs for bill of material lists, job costing and drawing distribution by telephone are only some of the capabilities available with AutoCAD. These capabilities make AutoCAD the central component in your desktop computer-aided engineering (CAE) system.

Whether you're in a two-person shop or a two-billion dollar company, you'll find that AutoCAD pays for itself in just a few months.

In the future, AutoCAD will run on newer, more powerful computers as they become available—so that you can be sure your investment in creating drawings and training staff won't be wasted.

Powerful New Capabilities

Call or write us today for the name of the dealer nearest you and a demonstration of the latest in AutoCAD capabilities, including polylines, curves, and 3D visualization with hidden line removal. Also ask about other cost-effective Autodesk products: AE/CADD™ CAD/camera™

AutoCAD, world leader in design and drafting software, will save you time and money.



AUTOCAD™

AUTODESK, INC.

2320 MARINSHIP WAY
SAUSALITO, CA 94965

(415) 331-0356

or (800) 443-0100 EXT. 406
TELEX 275946 ACAD UD

Circle 28 on information card

Large, Small Firms Agree: Computer Architecture Helps Firms Compete, Improve Profits

Whether it is a small, PC-based drafting system in a four-man architectural firm, or a sprawling mainframe in a 400-person office, the computer is becoming the dominant architectural tool. Computer users are reporting dramatic benefits that include better designs; faster, more accurate drawings; more persuasive client presentations; speedier reports, and smoother work flow.

VAX computers, which support 20 graphics terminals.

"Initially we were attracted to CADD because we hoped it would reduce our design and drafting costs," McLean says. "But we found that the computer gave us an even more important benefit. It improved the quality of our work. Our drawings are more accurate, and they're easier and faster to do, which gives us freedom to explore design alternatives."

Time and cost savings have been substantial. McLean estimates CADD allows architects at the firm to complete twice as many projects—and twice as many billings—as architects using manual techniques.

The firm also uses computers to create spread sheets, plan work load and time flow for projects, develop charts and graphs and for word processing.

Another West coast firm that has embraced the computer revolution is Kaplan/McLaughlin/Diaz, San Francisco. The 200-person firm uses a combination of large CADD systems and PCs to handle all phases of project management and facilities planning.

Kaplan/McLaughlin/Diaz uses IBM ATs to run Primavera Project Planner software. "Project management—especially large project scheduling—is a process that has never lent itself to quantification," says Phil Bernstein, the architect who coordinates computerized project management for the firm.

The firm has been using the software for project sequencing for hospitals, creating schedules to manage the design and construction process. "This is a big experiment for us," Bernstein says. "But we've been able to offer this as an additional service to our clients, and the service is making money."

Lester B. Knight & Associates, Inc., Chicago, recently demonstrated that computers can help architects score points with planners, potential project investors and the public as well. When a group of private developers asked the 400-person firm to design a domed

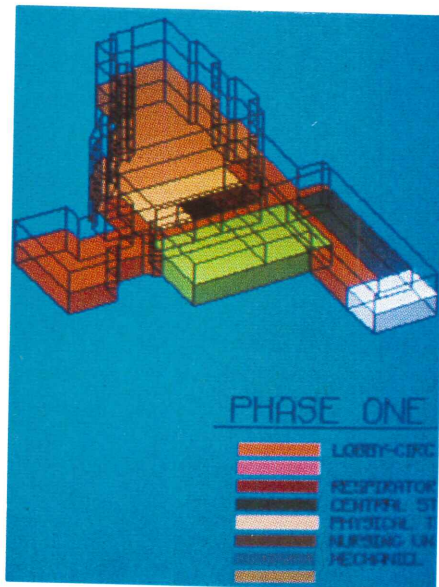

What is more, computerized architectural firms say they are getting new types of jobs that did not even exist before the advent of the technology.

One early innovator in CADD systems was Albert C. Martin and Associates, Irvine, CA. "We got into computer graphics about nine years ago, when the only programs available were very primitive," says Eugene McLean, the firm's design director. The firm has made its own software improvements, most of which have been incorporated in Arcad's Architectural Interactive Design System (AIDS).

Currently, Martin's 22-person Irvine office runs its CADD software on a six-terminal Digital VAX mini-computer. The firm's Los Angeles office uses two

Architecture '85

COMPUTER ADVERTISING SUPPLEMENT

Executive Editor
James A. Horstman

Managing Editor
Richard J. Bordeaux

Art/Production Director
Henning P. Jacobshagen

Editor
Dawson

Graphic Artist
Raymond L. Schmidt

Photography
Michael R. Horstman

Architecture '85 is published by Technologies
1350 E. Touhy Ave., Suite 110-W, Des
0018. Copyright © 1985. All rights reserved.
in whole or in part prohibited without
permission of the publisher.

ing model courtesy of Holabird & Root.

er-generated graphics in the DP/
'85 supplement were directed by
es Media Corp. and executed by the staff of
n.



© David R. Phillips Co

REALIZING

CAD FROM MCDONNELL DOUGLAS GIVES ARCHITECTS THE TOOLS
TO CREATE DESIGNS THAT BECOME REALITIES

Today the architect needs a CAD system that saves time and keeps pace with his imagination. Our Building Design and Drafting System (BDS/GDS) uses a unique design feature called *object intelligence*. This gives you the capability of infinite layering.

Design an object once, associate costs and specifications, and then store it. After that, you can repeat that object on any drawing, at any scale or orientation. You can then report on it at any time, whether

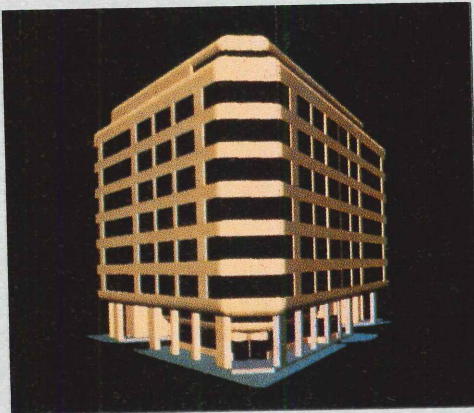

at the drawing level or for the project.

That's just one of the many features of BDS/GDS for increasing productivity. It makes CAD an integral part of your design/production team. Talk to the McDonnell Douglas professionals. They understand the CAD needs of architects. If you're ready for the tools that will put you on the frontier of architecture, talk to someone who speaks your language. Call McDonnell Douglas from the U.S. and Canada at 325-1551.

**MCDONNELL DOUGLAS
ARCHITECTURAL, ENGINEERING AND CONSTRUCTION
INFORMATION SYSTEMS COMPANY**

ON THE INFORMATION FRONTIER

Circle 29 on information card

ge, Small Firms Agree

...m complex for the city, architects
Sigma III CADD system to
p a complete set of images
ng the facility as it would appear
arious points in the city.
m those images, we made about
les, which we worked into an
ate slide presentation," explains

...al computer or mainframe, ...mputer is becoming the ...ant architectural tool

...hter, director of architectural
"We were able to take very
ary designs and were able to
ally demonstrate the total
of the facility on the area."
...night firm has screened the
efore city planners, community
potential financial backers and
ams that may ultimately use the
"People's reaction has been
nt, in terms of understanding the
s of the proposal," Richter says.
ore people can see the reality
gn, the better. Using CADD in
really puts designs in a better
e for the lay public."

...yman, managerial associate for
ays computerized architecture
ng new types of jobs. "From a
ng point of view, we have been
ropose projects we've never
e to handle before. Several of
cts we've seen have consisted
of creating a data base or
ng a design program," Lyman

...some large firms are using
ers with spectacular results,
rms are computerizing too,
ally rewarding benefits.
ngel, Jr.'s four-person firm in
, purchased an IBM AT and
software late last year. "We
e work than we could handle.
to go after some of the larger
I didn't want to increase my
" Engel says.

...terization provided the
The system is great for the
petitious drafting we do on
se projects. I think that now
to be able to land some of

the larger jobs, as I demonstrate the accuracy of the drawings we can produce, and the ease with which those drawings can be modified."

What advice do these architects have for colleagues who are considering computerizing their own operations? They offer three guidelines:

- **Decide what you want the computer to do before you shop for a system.** "You have to have an

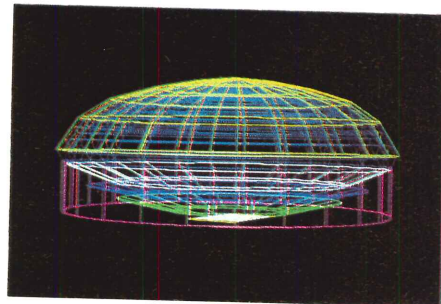

Photo courtesy Lester B. Knight & Associates.

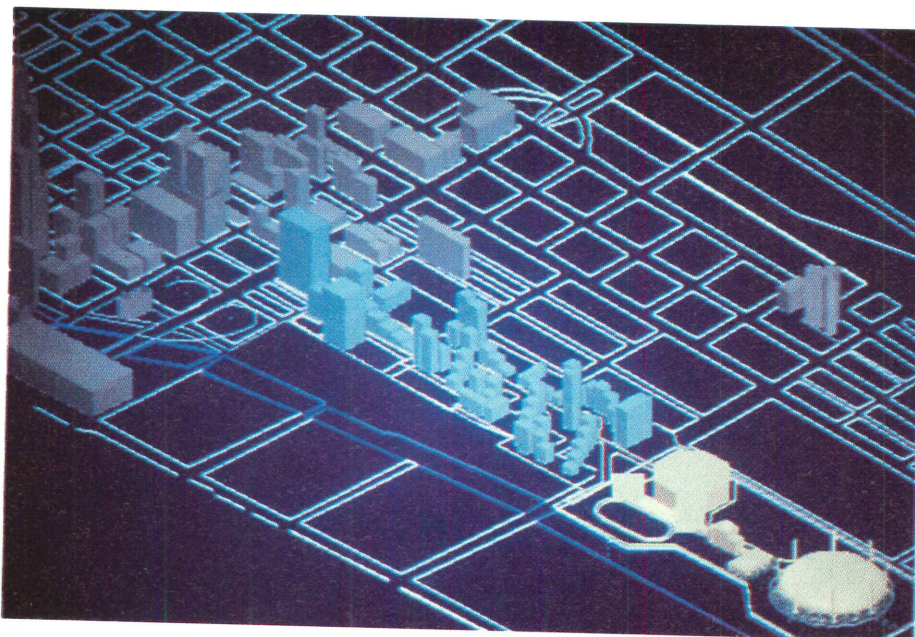

Photo courtesy Lester B. Knight & Associates.

understanding of your own production process and where you want the computers to fit in," Bernstein says. "It's a mistake to go out and buy the sexiest equipment and then open the boxes and say 'Now what?'"

Firms are getting new types of jobs that did not even exist before the advent of computers

- **Research your options thoroughly before you buy.** "I went to some architectural computer shows, and the selection was just mind-boggling," Engel says. "But I think that research was important, because it made me realize that there is not just one or two available systems, there are 70 or 80."

- **Select a system that's neither too small for your needs nor too large for your budget.** "We were over-cautious when we purchased our hardware," McLean says. "We didn't foresee how much the demand for the system would grow."

Engel agrees: "Don't buy a toy, only to find out it can't do what you want it to do."

On the other hand, over-investment can be a mistake too, architects say. "Don't mortgage your firm to get into CADD," Lyman says. "If you're a smaller firm, start with a PC-based system and add capability as you can handle it." □

INTRODUCING CADVANCE™

YOU'LL PICK IT FOR ITS LOOKS. BUT RESPECT IT FOR ITS INTELLIGENCE.

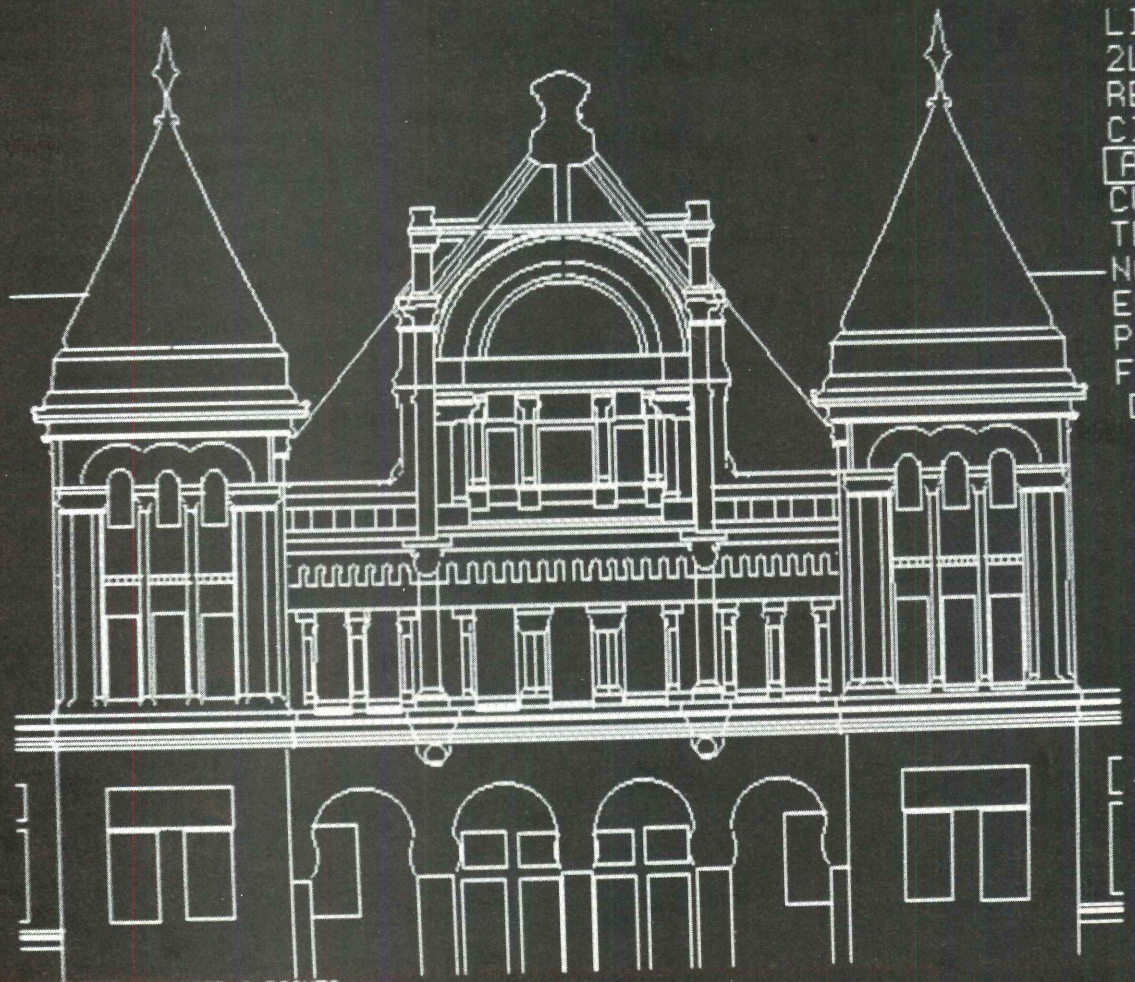

LIN
2LI
REC
CIR
AR
CUR
TEX
NOD
ELI
PGO
FLU
DI

RADIUS DIAMETER 3-POINTS

SOLID Wght: 8

20:FRONT

— ABS

The first intelligent CAD software for the PC is here.

And designing will never be the same again.

Imagine drawing an object—a stairway, for example—from data such as maximum and minimum stair rise, width, and overlap. Then creating a staircase between top landing and bottom points that you define.

Now you can. With CADVANCE Intelligent Macros. Much more than a replay of keystrokes, they allow the program to think, or interpret, from a knowledge base that you define.

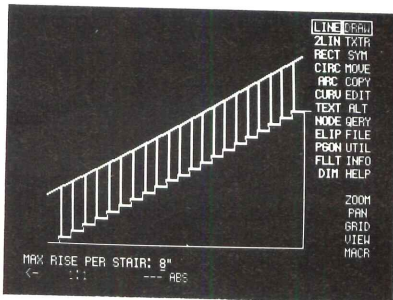

And you can modify your macros and see the effects of the change instantly. Change a stair width, and the result appears on the screen. You can even 'nest' macros and run them within other macros. Creating complex designs in seconds, with just a few keystrokes.

But CADVANCE innovations don't end there.

While drawing a line, CADVANCE can zoom, pan, change grids, run macros, change active layer and line style, without leaving the draw command.

You can even nest symbols within symbols—a sample office, made up of tables and chairs, for example—can be drawn with a single command.

Other advanced editing features include group moves on several layers of data, defining windows of data to manipulate—such as stretching an entire wall section of a building—in real time. Even tedious chores such as cleaning up corner sections are quickly and easily handled with CADVANCE.

Circle 30 on information card

CADVANCE draws, and extracts databases, 4, 5, even 6 times faster than any other PC-based CAD product. And zooms 20 times faster. It even lets you replace symbols and text with 'boundary boxes' that show the size of the symbol or text string without drawing the entire object, for faster redraw and editing.

CADVANCE is compatible with dBase II™ and Lotus 1-2-3™. Even IGES 2.0. So you can interchange your CAD designs with other business applications. Including 3-D wireframe and solids modeling packages.

ALL THE CAD YOU'LL EVER NEED

CADVANCE is CalComp's newest addition to its continuum of top quality computer-aided design software for architects, facilities planners, engineers and designers. Including CADPLAN, the industry-acclaimed professional drafting package that CalComp obtained in its recent acquisition of Personal CAD Systems' AEC Division.

CADVANCE gives you the features of a large-scale CAD System on a personal computer. And you can transport your designs—without modification—to CalComp's powerful System 25 when you're ready for more processing power.

Call or write: CalComp, Personal Systems, 200 Hacienda Blvd., Campbell, CA 95008. (408) 866-6272.

And don't settle for just a good-looking CAD system. Get one with some intelligence.

Ask about our 100% trade-up allowance from CADPLAN to CADVANCE.

Lotus 1-2-3 is a trademark of Lotus Development Corp. dBase II is a trademark of Ashton-Tate.

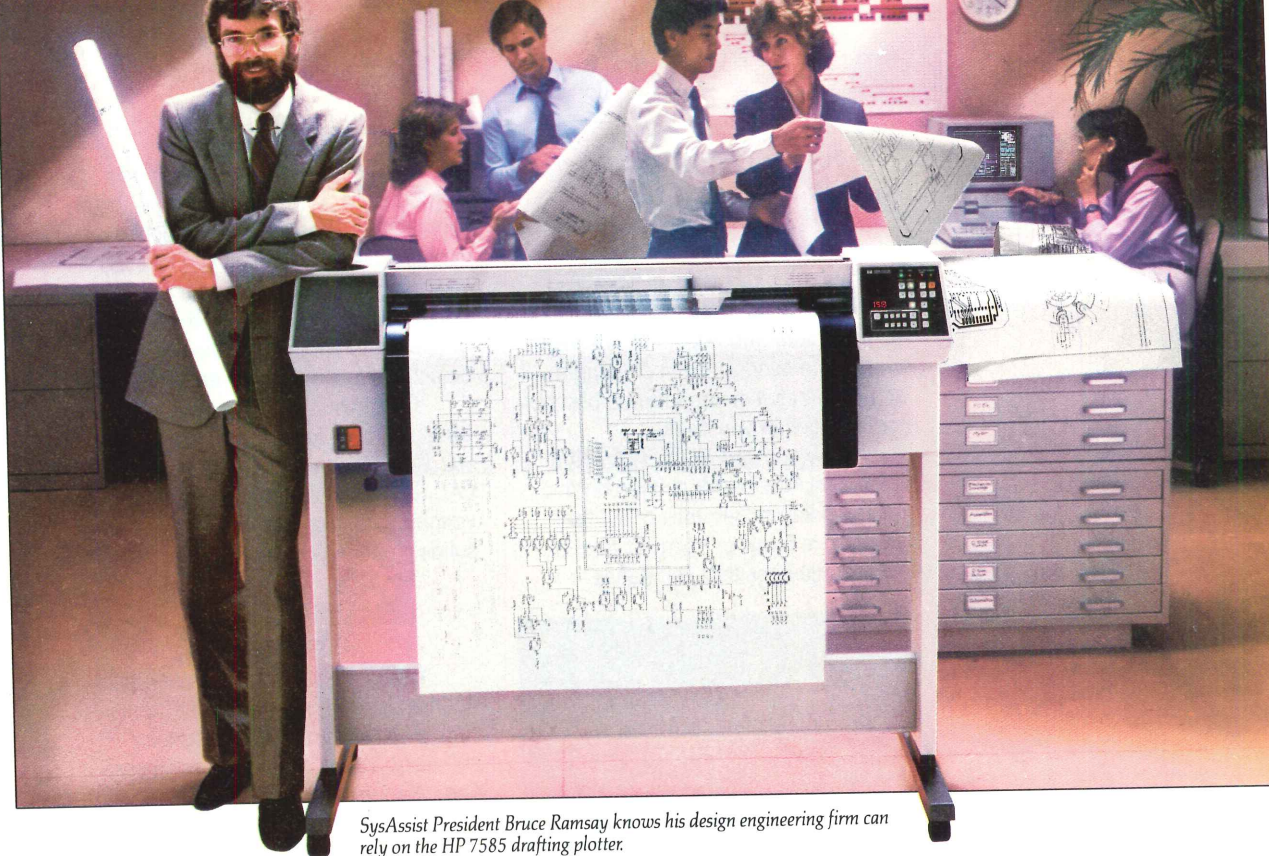

SysAssist President Bruce Ramsay knows his design engineering firm can rely on the HP 7585 drafting plotter.

“When running 3 shifts a day, 6 days a week, we can’t afford to have our drafting plotter fail. That’s why we bought Hewlett-Packard.”

With HP you can count on design time...not down-time.

Meet engineer and designer Bruce Ramsay. Entrepreneur on the fast-track. Very fast. “Sometimes my firm accepts and turns design projects around within 2 days. We need the most reliable products available. For us that means HP!”

Perhaps the most integral part of Bruce’s CAD/CAM system is his drafting plotter. His Hewlett-Packard drafting plotter. “I can count on HP. In the last year and a half, we’ve run our HP 7585 up to 18 hours a day, 6 days a week. It has never let us down.”

HP plotters meet—or exceed—rigorous testing standards.

Hewlett-Packard makes one of the world’s most reliable drafting plotter families. And that’s not an idle boast. HP drafting plotters undergo the most rigorous testing and analysis in the industry. First we test cold and heat, operating the plotters in 0° C up to 55° C temperatures. Then we make our plotters sweat: they spend 24 hours

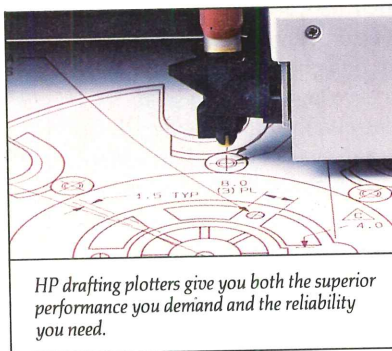

HP drafting plotters give you both the superior performance you demand and the reliability you need.

in 65° C temperatures with a 90% humidity factor. Finally, before any member of our HP 7580 drafting plotter family is shipped, it runs a minimum of 16 hours. We call this “burn-in.” You’ll call it, quite simply, dependable plotting.

And now HP delivers dependable plotting at a reduced price.

Hewlett-Packard offers you a broad range of drafting plotter sizes and models to choose from. Each gives you superior performance that you can count on...and at a cost much lower than you’d expect.

Prices for the HP 7580 drafting plotter family now start at just \$9900*.

Discover how HP built-in reliability means trouble-free plotting for you.

Call us now at (619) 487-4100, ext. 4947 and discover an important reason for Bruce Ramsay’s success—his reliable HP plotter. We’ll send you sample plots, plus detailed information about HP’s entire line of drafting plotters. Call today. Because to make the most of your design time, you need the plotter that won’t let you down. You need Hewlett-Packard.

Call (619) 487-4100, ext. 4947, or write: Hewlett-Packard, Attn: Marketing Communications, 16399 West Bernardo Drive, San Diego, CA 92127-1899.

*U.S. List price

Leadership in Design Graphics.
For Leaders in Design.

 **HEWLETT
PACKARD**

Circle 31 on information card 11015

As Architectural Computer Market Heats Up, Vendors See Acceptance Growing

or not, architecture is becoming a computerized profession. Due to increased competition for work, a growing number of once-traditional architectural firms are now turning to computers for everything from word processing and work-flow management to advanced CADD and project management.

It is the consensus of vendors in the architectural computer market. They are responding to increased demand and innovations in hardware and

computerization of architecture has had a profound impact on the industry, these vendors say. Computers are not only allowing architects to produce better designs, drawings and more attractive presentations. Computers are changing the very concept of architecture itself. "There's definitely more activity in the architectural computer market," says Martin Stein, director of product development for CalComp. "Large firms are experimenting with configurations of PCs and larger workstations. Smaller firms are buying advanced systems than before. Really small firms are buying PC workstations like they're going out of style." says Murphy, vice president of marketing and sales, T&W Systems, says that the architectural market is experiencing a flurry of activity.

You lose a job to an architect with CADD, the point is driven home by McKenzie

Innovators have brought out competing, low-cost CADD systems, says Murphy. "Now there's a lot of activity as architects discover that these systems aren't what you expected."

Competition leads the list of reasons to computerize. "The architectural industry is increasingly computerized," says Scott Drushella, vice president of product marketing for T&W Systems, Inc. "Architects have to constantly

monitor cash flow and project performance. In addition, they need to increase their marketing capability." Computerizing operations is the only way to keep up with these demands, Drushella says.

Client pressure forces more architects to use computers in design and drafting as well. "There are still some architects who will never, ever use a computer," says Peter Clifton, product manager for

Autodesk, Inc., makers of PC-based AutoCad software. "With the price of PCs, plotters and other peripherals coming down, a small firm can buy all the tools it needs to do CADD for \$12,000."

An important reason that CADD is becoming more affordable is the advent of extremely powerful PC-based CADD systems. Murphy says that new

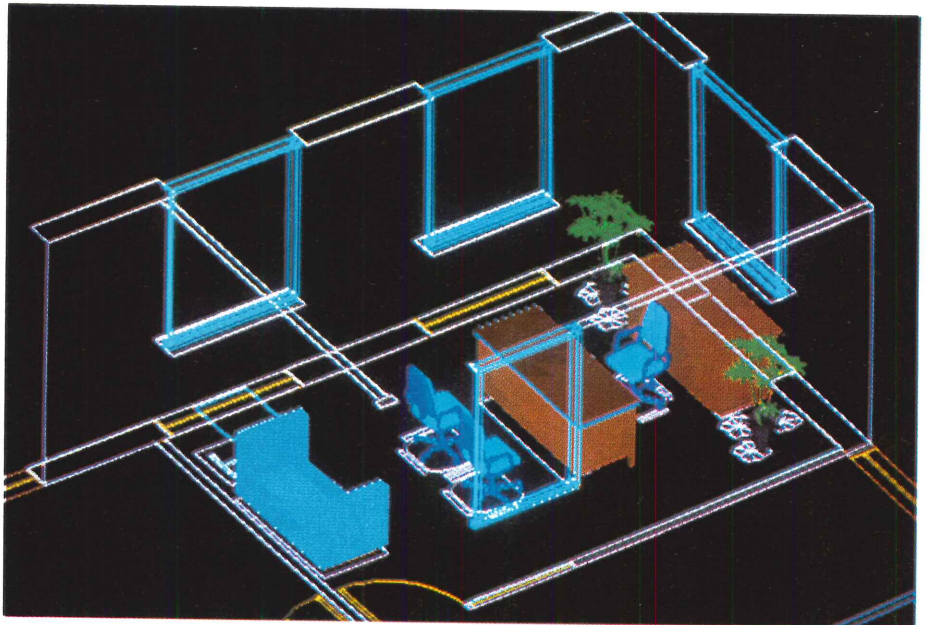

Wiley Professional Software. "But more architects are realizing that they must look into new products in the computer field, and their clients are demanding this of them as well."

Ronald A. McKenzie, product marketing manager for Bruning's architectural division, adds, "When you lose a job to an architect with CADD, the point is driven home."

The fact that many government jobs now require that drawings be submitted on CADD systems further adds to the pressure to computerize, McKenzie says.

Falling prices for hardware and software are also luring some firms into computerization—especially smaller firms. "The two traditional barriers preventing small firms from using CADD were price and the difficulty of using the software," says Mike Ford,

PC CADD systems can handle two-dimensional drafting almost as well as larger systems can.

"The major cost factor for an architect is producing drawings," says Clifton. "With a PC-based CADD system, a small firm can get four or five times the productivity possible with manual techniques, without spending a lot of money on higher-level systems."

One testimony to the importance of PC-based CADD systems is CalComp's acquisition of the PC architectural software division of Personal CAD Systems.

But David Skok, president of Skok Systems, Inc., thinks the comparisons between PC-based CADD systems and more powerful systems is misleading. "Many architects are still confusing \$2,000 PC-based drafting programs

Market Heats Up

with design management systems," says Skok, whose firm produces turnkey work stations.

"The financial benefits of computers go beyond simply reducing drafting hours," Skok continues. "The right system can provide both a design tool and a management tool and actually expand the scope of an architect's value to his client."

CalComp is seeking to bridge the gap between PCs and larger systems with its new Cadvance software for the IBM AT and XT. "With Cadvance, a designer can do simple work on a PC, then transfer that information to the System 25 data base," Stein says. "CalComp is seeking to provide a continuum of work stations, so that people can choose the right power for the right task."

Perhaps the most important aspect of the growing use of computers in architecture is the way technology is

Lower prices open doors for smaller firms to afford computers

changing the very concept of the profession. "Architecture is becoming an information business, and architects should be selling themselves as an information service," Skok says.

Otto Buchholz, product manager, architecture and building engineering, Computervision Corp., agrees, adding, "With automation, constant communication of design information from the initial stages becomes possible, allowing for more client input into the final design solution. Integration of client and architect ideas promotes a unified design *team* approach.

"By evolving a 3-D model from initial schematic massing to a detailed description, the system records all design decisions and keeps track of all data used to make those decisions. The client thus has an historical record of the project, encapsulating design process decisions for reference and subsequent design projects," Buchholz adds.

"The advent of better, lower-cost communications technology will allow for faster sharing of architectural information with all disciplines involved—mechanical, structural, architectural," notes Buchholz. "The result is more in-depth investigation of alternatives and, ultimately, a better product."

"Instead of simply producing drawings, architects ought to be building a data base for each project,

rich, and the firms that still resist technology will be information-

Despite such predictions, Murphy maintains that many firms still aren't making full use of the systems they own. "There's a pain threshold that people have to go through with CADD, and most firms aren't crossing it," Murphy says. "Instead of fully integrating the computer in their practice, they're still playing with

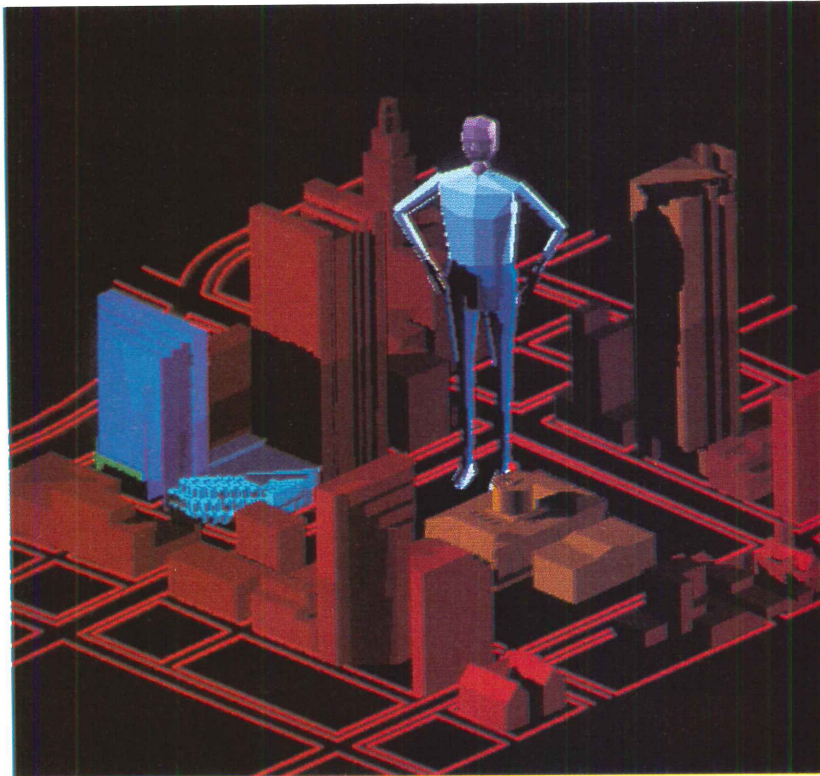

Photo courtesy Bohm

starting from the initial design—including schedules and bills of materials—through the recording of the project as built and continuing through the life of the building, taking into account additions and modifications," Skok says. He believes that building and maintaining this data base ought to be an essential part of the services an architect offers.

McKenzie, himself an architect, makes the same point more bluntly: "In the future, we're going to see information-rich architects and information-poor architects. The firms that use computers will be information-

Most of the vendors interviewed agree that customers in the architectural computer market are showing more understanding and less fear of the technology. "The customer is really becoming very, very sophisticated," says David Lutz, president of sales, Graphic Horizons. He credits the growing number of college seminars on CADD with contributing to the new computer savvy among architects. □



The TI Professional Computer takes CAD where no PC CAD has gone before.

With the TI Professional Computer and AutoCAD™ 2 software from Autodesk, we team up to bring you the best of both worlds in CAD and personal computing. You'll put true CAD on your desktop in an affordable price. And you'll have a superior PC system for all your computing needs—available in a package of hardware, software and exclusive services and support options *no other offers.*

You get top-quality mainframe capabilities that let you explore the outer limits of your imagination. Like multilayering and precise dimensioning. Isometric design. Zoom with one-to-one precision. The ability to create your own symbol libraries. And to edit, copy, rotate or delete any part of a drawing.

You also get the perfect match of CAD and machine. TI gives you superb high-resolution graphics, a palette of up to 8 simultaneous colors, fast processing speed, and more. Including top performance

from the best-selling software for other applications. And you can choose from a wide range of options to put together a system that precisely fits your needs.

Draw your own conclusions. For the TI-authorized reseller nearest you, call 1-800-527-3500, extension TBA.

In Canada call 416-884-9181. Or, for more information, write Texas Instruments Incorporated, Dept. DCC 053A0, P.O. Box 809063, Dallas, TX 75380-9063. We'll show you out-of-this-world CAD you can afford.

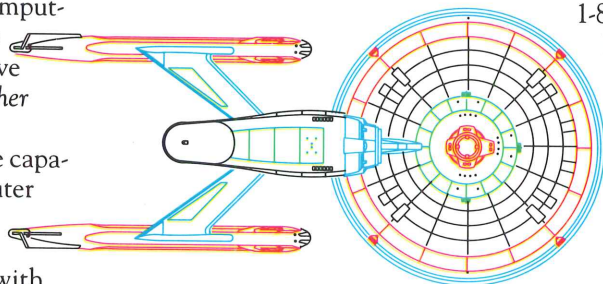

Create drawings of any size to any scale.

AutoCAD is a trademark of Autodesk, Inc. "Star Trek" elements used with permission of Paramount Pictures Corp., the copyright owner.

TEXAS INSTRUMENTS

Creating useful products and services for you.

Now your firm can afford the best

The dual-screen Interact™ is designed for continuous production work in the architectural office, and features extensive display and dynamics capabilities.

The Professional Interpro 32 operates not only as a graphics terminal networked to a VAX or Micro II—but also as a standalone workstation running software developed for the IBM PC family and for the UNIX operating system.

For a system to meet the needs of any architectural firm—large or small—look to Intergraph for a solution.

With Intergraph, you can configure a system that best suits your firm now, and that can grow as your need for automation increases. Begin with our new entry-level Micro II™ processor and up to four workstations, then meet any future requirements by adding additional processors and workstations, linking your entire system with our Ethernet network.

The low-cost Intergraph Micro II, offering roughly the same power as a VAX-11/750, measures only 24"x11"x 29", and serves as a standalone system in an office environment.

The System supporting the Solution

(because there's more to architecture than just drafting)

graph, we design our systems
you through *all* phases of a
not just drawing production.
ractive graphics solutions work
y different fields as you do,
ng the complete range of
d engineering disciplines.

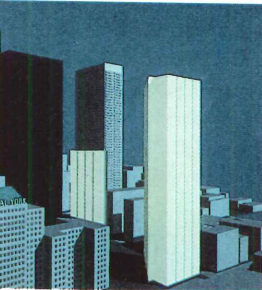

Marketing and Programming

First job is marketing, and
helps with design
solutions that let your prospects
view projects before construction.

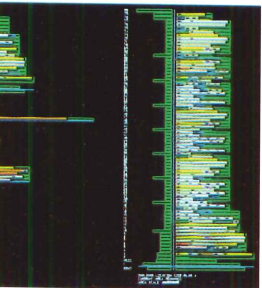

Facility planning, Intergraph
offers an extensive array of tools,
including the ability to generate multi-
stacking diagrams.

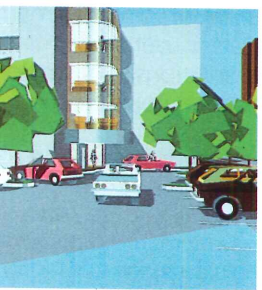

Interior Design

In schematic design, we combine
modeling with adjacency analysis so
that you can preview the proposed

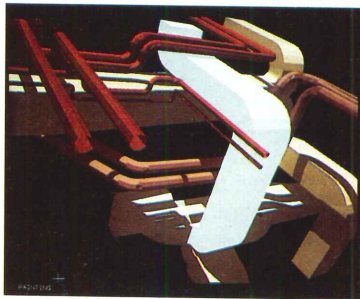

Design Development and Engineering

Intergraph offers complete software
for mechanical, electrical and plumbing
engineers. From schematic layout to
analysis to documentation, our system
automates each phase of the
engineering process.

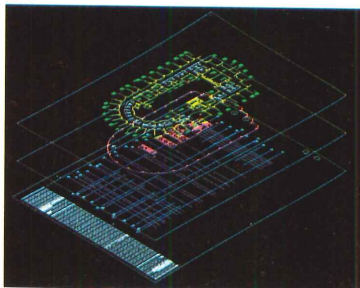

Courtesy Gensler and Associates

With an Intergraph system, teams of
engineers and designers have common,
simultaneous access to a project
database, so that the latest version of all
work is available to all.

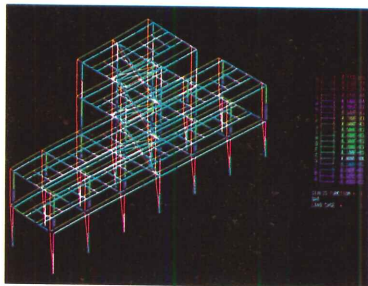

Intergraph enables engineers to
solve structural analysis problems
without having to buy time on a
mainframe computer. The new
Intergraph RandMicas™ product is
interactive software for 2-D and 3-D
frame and finite element analysis and
design.

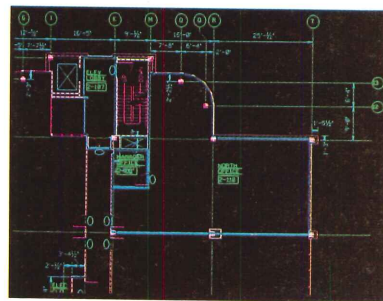

Construction Documents

Our drawing production software—
including sections, details, elevations,
site plans and engineering drawings—is
the most mature in the CAD industry.

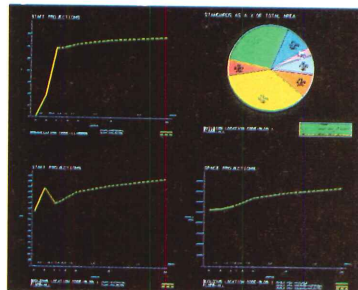

Facilities Management

Occupancy information becomes part
of the design process with the
Intergraph system's ability to combine
database management information with
graphics.



For marketing a franchise, the
Intergraph system helps prepare
detailed facility plans for potential
clients.

*For more information, or to
schedule a demonstration, contact:*

INTERGRAPH

Department AR95
One Madison Industrial Park
Huntsville, Alabama 35807
205/772-2000

Users. You can't live with them, and you can't live without them.

But you can overcome many of the problems in establishing and continuing computer usage by creating and properly convening an in-house user group. A user group is responsible for providing direction and support to the computer usage efforts of a firm. The benefits are many: Better definition of computer needs...Increases motivation levels...Reduces number and magnitude of potential political problems...A more balanced approach to the range of potential applications...A broad base of support—encouraged by the feeling of control and participation...Feedback to the computer staff.

Eliminates Common Problems

Creating a user group will not be the total solution, but the group will help avoid some common problems in computer operations.

- The employees directly responsible for computer operations will not be making an isolated purchase with no user support.
- The computer system purchased or developed will not be a specialized tool with limited application within the firm.
- The users will not be unhappy with the system and the computer staff's inability to find a solution.

5 Members Is Ideal

When you set out to form an in-house user group, remember that five members is ideal. You do not want a big group because it is too difficult to foster the essential active discussion in large groups. If necessary, each member of the user group may represent the needs and concerns of other large groups of users in the organization.

Usually, you will choose one person from each discipline in the firm. It is best to have someone who does the work and understands the details so they can take a broader view of solutions to problems as they arise.

Establish a Format

Establishing a format for user

group meetings is important. Each meeting should incorporate a general discussion. Together the group should draft a statement of problems requiring action. An action plan can be created within the meeting, if time permits. Depending on the severity of the problems and time required to map out a solution, the committee may assign the task of developing an action plan to a group member.

A much longer period of time will be required for the group to complete the Implementation Phase. Typically lasting four to six months, the Implementation Phase may require meetings every two weeks with added meetings held when major milestones occur. The implementation will require a detailed orientation of staff to the use and capabilities of the computer.

Finally, but on an open-ended

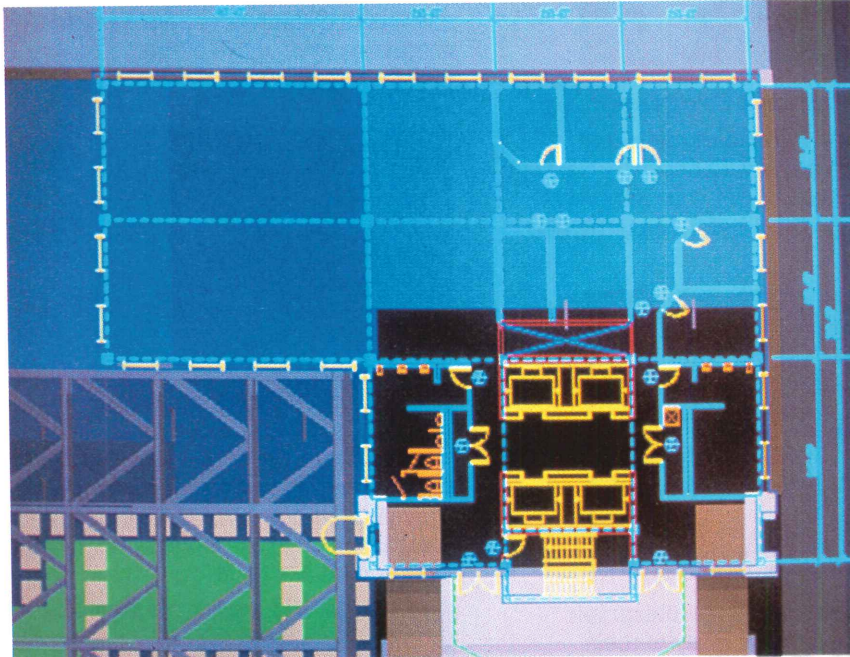

Plan 4 Phases

A user group can plan to move through four phases.

The first step or phase the group will enter is the Master Planning Phase. This is the time when a strategic plan will be drawn. As a voting body, the user group will decide which of the options the firm's computer expert outlines will actually be written into the firm's master plan. During this phase, the group will meet once a week for four to six weeks to complete a plan and a schedule for implementation.

The Specification Phase is the second step. This stage may take four to six weeks for each application, and the group will be meeting as needed every two weeks to generate the main content for the specifications.

basis, the user group will enter the Operations Phase. This is the main phase, during which group members will form lists of user problems and alternative solutions to be implemented by the next user group meeting.

Charles "Ched" E. Reeder is a founding principal in The Computer-Aided Design Group, Marina del Rey, CA, with a background in computer-aided design, space planning, interiors and facility management. In addition to consulting work that includes establishing in-house user groups, he regularly teaches at the Southern California Institute of Architecture and lectures to professional organizations.

© 1985 The Computer-Aided Design Group

DISCOVER THE POSSIBILITIES



LOOK INTO TODAY

Sigma Design has created a new generation of Computer Aided Design tools for today's design/build industry . . . thoughtfully developed systems with a full range of capabilities to analyze needs, explore alternatives and increase productivity. With elegant 3D modeling . . . sophisticated structural, civil and HVAC engineering . . . efficient production drafting . . . integrated post occupancy management . . . the CAD system for the building design professional. Come see the Sigma III and discover the possibilities.

SIGMA DESIGN

*7306 South Alton Way
Englewood, Colorado 80112
303/773-0666*

Circle 33 on information card

INVOICING MADE FAST, SIMPLE & ACCURATE

HARPER AND SHUMAN INTRODUCES "THE BILLING SYSTEM"

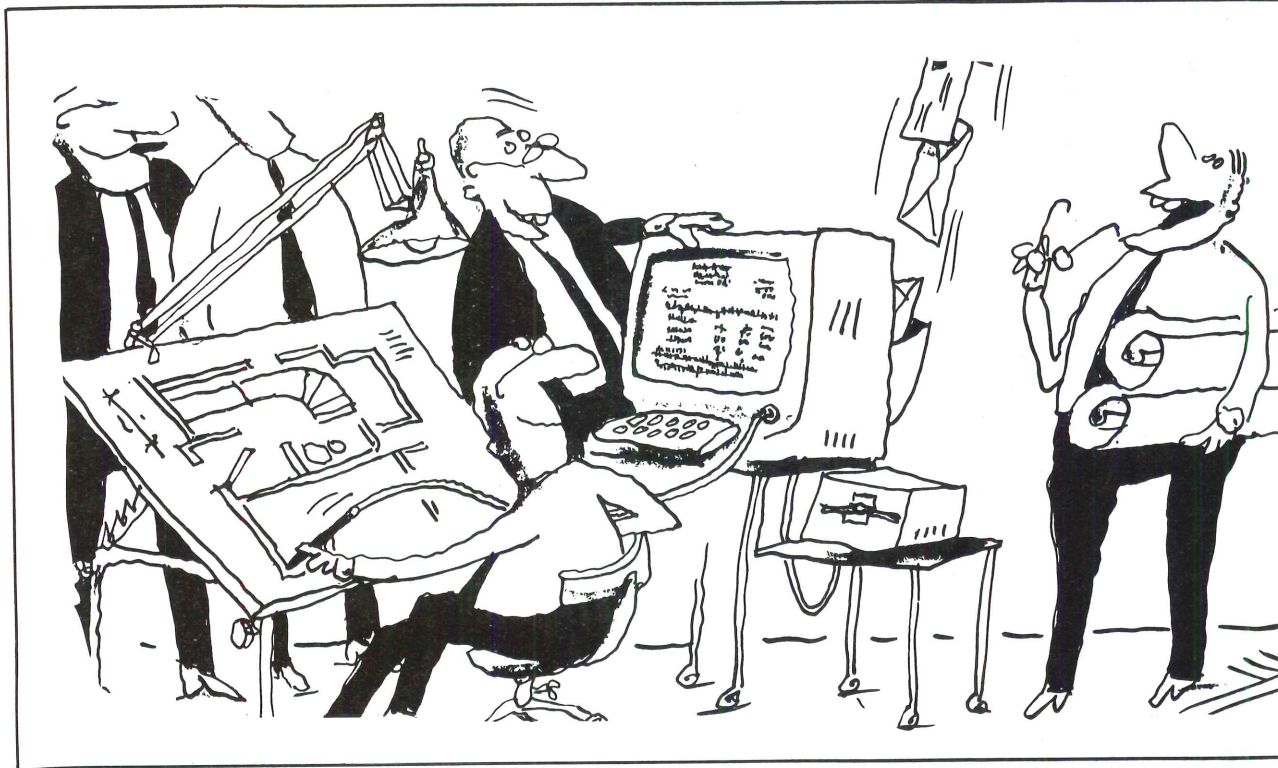

Billing procedures in many design firms can be a comedy of errors. The format is not right. The multipliers are wrong. Too much detail, or not enough. The billing rates are out of date. And the bills are late. We think billing is serious business. And we are introducing our MICRO/CFMS Billing System to prove just that. In fact, our clients have three words for it: Fast, simple and accurate.

FAST You can select projects for billing individually, or in groups, at any time. Print out a draft invoice, check it with project managers, and run off the final invoice on your company's letterhead or invoice form. On the Hard Disk version, you can even use a built-in full-screen editor to add text and customize invoices for each client. You can see the invoice on the screen, or route it to a printer. On-line changes

can be made easily due to quick access to the billing-terms file.

SIMPLE *The Billing System* software comes with easy-to-use menus. Help messages are clearly explained and presented on line. Integration with the rest of MICRO/CFMS makes project labor and expense retrieval just keystrokes away. And, as with the rest of MICRO/CFMS, *The Billing System*

HARPER AND SHUMAN, INC

68 Moulton Street
Cambridge, MA 02138
617/492-4410

625 Third Street
San Francisco, CA 94107
415/543-5886

comes with documentation and phone-in support.

ACCURATE You bill projects by labor category or employee category using multipliers or labor rates. Easy-to-use options and tables to standard multipliers can make the one-of-a-kind invoice a snap. And it's comprehensive—invoice formats can be made to comply with the standard and the less-frequently-used coding methods. *The Billing System* is especially effective in accurate generation of labor-based and expense-based bills.

The Billing System operates with MICRO/CFMS Project Control Accounting Systems and can be purchased with or easily added to existing MICRO/CFMS systems. It's the state of the art—no other billing system is quite like it.

Circle 34 on information card

On-Site Computer Systems: Time, Cost Savings Win Contracts for Architectural Firm

noting the time and cost savings—and the responsiveness—of computer-aided design and drafting is that at least one firm maintain an increasingly competitive edge. But Boston-based Stewart Group is taking the process to the next level. On some projects, the firm works entirely in the computer.

In a recent proposal in association with MacLachlan Cornelis & Filoni to develop a master plan for the 400-bed Allegheny Hospital, Pittsburgh, Stewart Group offered to ship a complete Graph/Net stand-alone workstation to the hospital site at the beginning stages of the project. The project team will use the workstation to provide total design services for the hospital. The client will keep the workstation in the computer, along with the design files and complete lists and drawings stored on the system's 240-terabyte hard disk.

Innovative marketing and the donation of the computer helped Stewart win the contract, says Clifford Art, president. "There is no question that the computer option made the big difference," he says. "Our proposal was the client's choice."

In presenting his proposal, Stewart outlined several key benefits: "For a complex institution, a hospital needs the optimal use of space. The computer simplifies the planning process by testing assumptions about the layout and arrangement of individual rooms as well as the effect various designs will have on people and equipment. It helps avoid design errors before the project reaches construction."

The on-site computer allows client participation in the design process. The designer and client together at the workstation can lay out a specific space, place pieces of equipment illustrated in our computerized listings, and adjust the layout to respond to design techniques, dynamically simulating the movement of people, equipment and materials in the space. The user can 'walk through' the space from a perspective-generating

programs of the computer system," Stewart explains.

In addition, Stewart says, the computer's ability to generate diagrams of ideal physical relationships enables the architect and client to determine the best relationships between functions, spaces and buildings.

- Of equal importance to the client is the computer's ability to create three-dimensional simulations. Clients see



the future environment without the time and money to construct models.

In the case of a hospital operating room, the architect can show a surgeon precisely how the work area will look. "The doctor can say, 'Let's do a bone-marrow transplant,' and the doctor and architect can quickly modify the drawing on the computer, which can show how the operating room will function with all the necessary staff and equipment in place," Stewart says. The design team can do 10 such simulations in four hours.

With simulations, an architect can convince professionals that space will be adequate. The computer thus enhances the architect's credibility and makes facility users active participants.

In presenting his proposal, Stewart argued that the use of CADD would help the architects address the changing needs of the aging medical facility, which was preparing to offer

more out-patient services and needed segregated circulation paths for the different types of patients.

- By donating a complete stand-alone graphic workstation, the firm gives the client a means to record future changes to the building, such as the installation or rerouting of valves, pipes and ducts. By giving a room-by-room listing of equipment and furnishings, along with detailed listings of dimensions and service needs, the firm provides its client with tools with which to plan future space and cost requirements.

- Underlying specific advantages of CADD is the main thrust of Stewart's marketing argument: An architectural firm that uses computer technology effectively can probably offer its client the services of a better-qualified, more-talented designer because the computer allows the design decision maker to work directly on the design.

"To use the best talents available in the direct production of design and construction documents is logical and far more constructive than to use an experienced designer as an administrator of others less talented than himself. Only interactive computer graphics allows this to happen," Stewart says.

"Because of its marvelous ability to compress time, the on-site computer puts a lot of pressure on the architect to be on his toes when he visits the building site. He has to come through when he's there because he no longer has the leisure to come, leave, sketch, correct and come again."

Such efficiencies save money as well as time. Using on-site CADD in the initial design stages can save the firm as many as 60 man/days, Stewart estimates. That adds up to cost savings of about \$48,000 in that stage alone.

Stewart is confident in the advantages of on-site CADD systems. He is including the concept in two current proposals, both for projects located beyond the firm's commuting distance. He believes staff and travel cost savings, as well as depreciation tax credits, will amortize the cost long before construction on the project is completed. □

Rapidograph

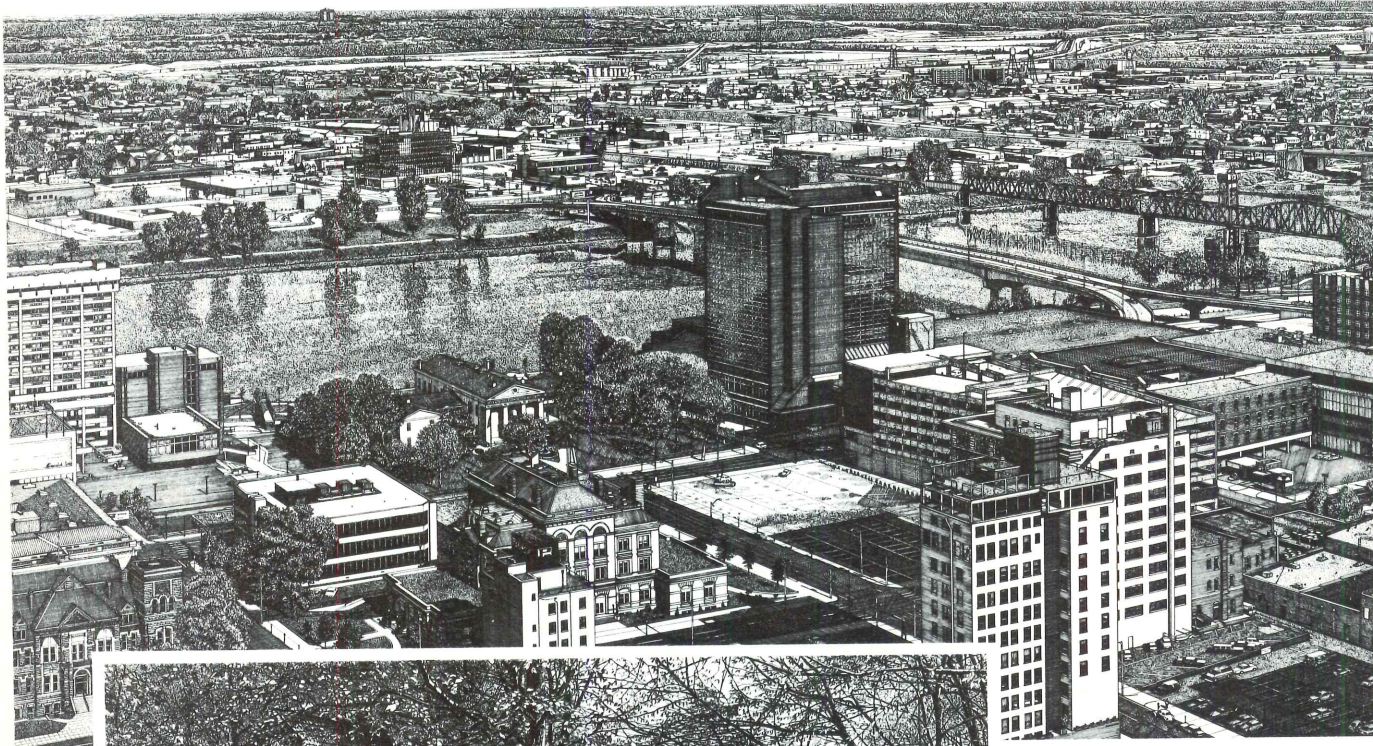

... precision-c

These drawings by Richard DeSpain are copyrighted by the artist and may not be reproduced for any reason without written permission from

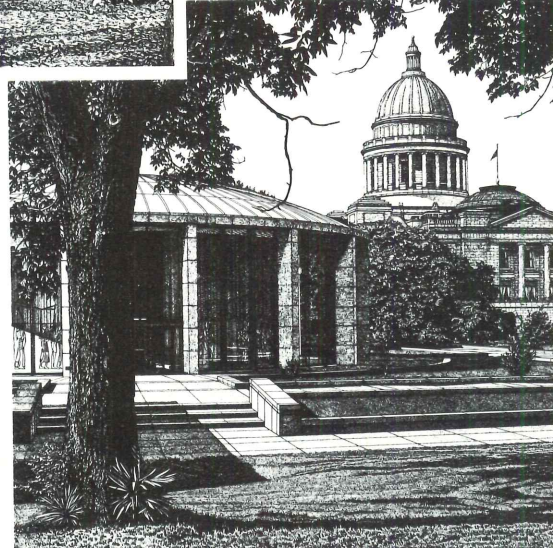

renderings



Architectural detailing by Richard DeSpain

better way to present a proposal building design than to show it in fine detail in its intended environment. The Rapidograph® technical pen helps you create such renderings, turning good ideas into the best visuals. Whatever the project — a mid-rise, a restoration, conversion of an old house into a nursing home or computer center — the precision of Rapidograph® rendering puts it into its best light.

Rapidograph® ink drawings can be constructed, or developed with fine detail to enlarge portions of the drawing for close study, as the tower and window, above, are lifted out for drawing of the old house.

The Rapidograph® pen (available in 13 line widths) is a Rapidograph® pen to glide smoothly over drawing surfaces with the feel of a pencil. Just the weight of the pen and the hold to keep the pen sufficient to provide a consistent line. The designer, drafter or artist only to guide the pen with an easy-fatiguing hold. The patented Double-Seal™ cap keeps ink

throughout the balanced ink-flow system ready for instant startup, contributing to optimum drawing time. Refillable ink cartridge also helps keep productivity high.

You might now be using Rapidograph® pens for precision for clean, crisp floor plans and elevations; so let exciting Rapidograph® renderings present your design proposals in their best possible light. Look for the *Koh-I-Noor Rapidograph®* on the pen to be sure of the dependability and ease of performance that make the Rapidograph® pen the most widely used technical pen in the United States and Canada.

“Get-acquainted” packaging (Product No. 3165-BX) offers a special saving with pen/ink combination. Ask your dealer, or send the coupon for details about Rapidograph® pens, pen sets and the largest selection of drawing inks available from one source:

Koh-I-Noor Rapidograph, Inc.,
Bloomsbury, NJ 08804
(201) 479-4124

In Canada: 1815 Meyerside Dr.,
Mississauga, Ont. L5T 1G3
(416) 671-0696

KOH-I-NOOR RAPIDOGRAPH®

Please send me complimentary Koh-I-Noor Catalog A, describing Koh-I-Noor Rapidograph technical pens, point sizes, Koh-I-Noor and Pelikan inks and other materials.

I would like the names of Koh-I-Noor dealers in my area.

NAME _____
(please print or type)

COMPANY _____

ADDRESS _____

CITY _____ STATE _____ ZIP _____

Koh-I-Noor Rapidograph, Inc.,
100 North St., Bloomsbury, NJ 08804
In Canada: 1815 Meyerside Dr.,
Mississauga, Ont. L5T 1G3

ASK FOR AMERICA'S FINEST DRAFTING FURNITURE BY NAME...THE NATURALISTS BY **MAYLINE**



MAYLINE COMPANY INC., 619 COMMERCE STREET, SHEBOYGAN, WI

Circle 36 on informa

Product Reviews

Hardware for Smaller Firms

na Design has released the Sigma IIIa system, a new hardware configuration for small- and medium-sized CADD users. Sigma IIIa incorporates many of the features of the powerful Sigma III, including a standalone Motorola M68010 processor and the UNIX operating system. Software features include enhanced 2-D and 3-D graphics, relational database management, file management and architectural presentation menus. The introductory hardware and software package is priced at \$58,700.



Data/Net Software for IBM PC

Electronic Horizons, Inc., has adapted its Graph/Net-compatible programs for the IBM PC. Data/Net is a multi-purpose data management system that allows users to produce accurate reports detailing a building's square footage and estimated construction and outfitting costs. Opti/Draw assists in the development of alternative bubble and block diagrams and evaluation of alternatives against selection criteria. The adaptation of these programs allows users to run them on IBM PC.

Company Announces New Computer Software

Smith, Obata & Kassabaum, Inc., has announced the formation of the Computer Service Corp., (HOK/CS) The corporation is marketing a new line of software that was designed for use by HOK architects, programmers, engineers and designers. The new company will sell DEC's VAX series of minicomputers and super microcomputers,

as well as peripherals from other sources, as turnkey systems. HOK/CSC currently markets professional design systems, which match 3-D graphics capability to a relational database. Facility management systems are also being marketed.

New Workstation from Auto-trol

Auto-trol Technology has introduced the Advanced Graphics Workstation/70 (AGW/70), a system with three times the processing power of the original AGW without a significant increase in cost. The system makes use of a 32-bit Apollo bipolar bit-slice processor. The modular system can be placed on existing desks or tables, allowing operators to customize their work environment. In addition, Auto-trol has enhanced its Series 5000 Advanced Graphics Software for architects and engineers. New item selection and manipulation features allow users to manipulate whole objects instead of lines.

New Software for Data General

Data General Corp. has announced the availability of independently produced A/E software packages for its DS/4200 32-bit standalone graphic workstation. Easinet, developed by Sys Comp Corp., is a 3-D design program containing a relational database for integrated design, analysis and drafting. Also available for the DS/4200 will be the Sys Comp application library, including more than 70 engineering programs that allow users to compare alternate design and construction strategies quickly through interactive menus, supplier says.

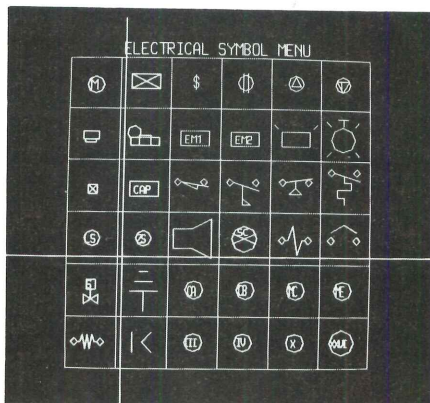

Multi-User Financial Management

Business Information Systems, Inc. has announced the new multi-user version of ACE, an integrated financial management system for architects, consultants and engineers. ACE functions include project management, timesheet, billing, budgeting, accounts receivable/payable, consultants payable and general ledger. The software is available for use on most mini- and microcomputer models.

Timberline Expands Aepex

Timberline Systems has added a custom report writer module to its Aepex software package for A/E firms. Package allows automated project management, billing and reports. Other package modules: architect/engineer, general ledger, payroll and accounts payable. The five-module package is priced at \$5,790. The A/E module is available singly at \$2,800. Aepex runs on IBM PC/XT and AT, Texas Instruments PC, DEC Rainbow and AT&T PC 6300 computers.

Arcad System Uses Microcomputer

Arcad, distributor of the Architectural Interactive Design System (AIDS), has announced that it has expanded its CADD system to utilize the Digital Equipment Corp. 32-bit MicroVAX I and the VAX 32-bit mini-computers. A complete turnkey system, including a MicroVAX I micro-computer, a graphics display terminal, a pen plotter and the Arcad/AIDS software, can be purchased for \$47,000.

HP Lowers Plotter Prices

Hewlett-Packard Co. has lowered the prices, effective immediately, of its HP7580 family of drafting plotters by an average of 25 percent. HP 7580B will be reduced from \$13,900 to \$9,900; HP 7585B from \$16,900 to \$12,900, and HP 7586B from \$21,900 to \$16,900. The price reductions were motivated by the downward trend in prices of CADD systems and fast growth of CAE (computer-aided engineering) workstations and personal computers in today's market, the vendor says.

Converts Paper Drawings to CADD

CAD/Camera™, a product that allows instant digitizing of existing paper drawings into AutoCad drafting system has been introduced by Autodesk, Inc. The software automatically identifies, extracts, connects and rectifies lines from an original image, vendor says. CAD/Camera runs on an IBM PC with a Datacopy scanner or on the Wang PIC system. The software is priced at \$3,000. The complete CAD/Camera system, including computer, scanner and software, costs less than \$25,000, according to vendor. Circle 106.

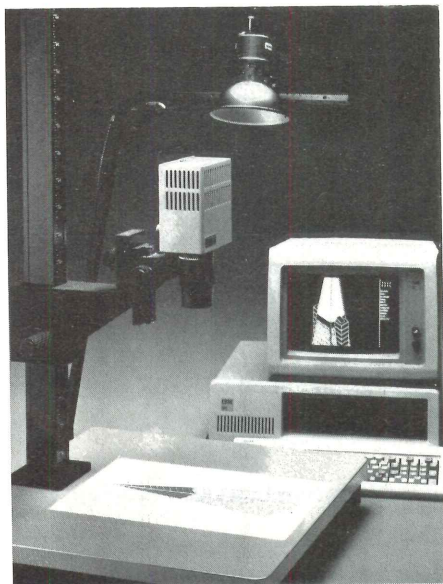

Combines CADD, Office Management

Computervision Corp. has introduced Personal Architect, a PC-based system that performs both CADD and architectural office management. The software package uses artificial intelligence techniques to define a building in actual volume and construction technology. It allows users to automate design development, documentation, construction specification, project management, cost accounting and record-keeping functions. The system includes an IBM PC/AT with 512K of RAM, and five software packages: Architectural Design and Drafting, Advanced Architectural Drafting, Schematic/Urban Design, Architectural Drafting and CV/CFMS. Circle 110.

Project Management Software for PCs

Harper & Shuman, Inc.'s new Micro/CFMS is a fully integrated project control/financial management software package designed for smaller A/E firms. Micro/CFMS includes such applications as payroll, project budgeting, time utilization, accounts payable/receivable, general ledger, automated billing and workload forecasting. Software operates on IBM and Wang PCs, as well as the DEC Rainbow series. Circle 112.

Facilities Management for Prime

Prime Computer, Inc., has announced its Facilities Management + (FM+) software line, which consists of three products. FM+ Planning contains a space projection module. It also has a vertical stacking module. FM+ Tracking contains an equipment management module for inventory maintenance, as well as a project budget module. FM+ Leasing helps users identify optimum spaces for potential lessees. Software runs exclusively on Prime 32-bit computers. Circle 104.

Five Computer Aids for Architect

McDonnell Douglas has announced Architectural Pak, five user aids that supplement the company's CADD system. Included in the \$4,000 package are Architectural Road Map, which helps the user develop drawing files, window commands and parameters; Architectural Methodology; Specification Interface; Facilities Library of standard furniture and fixtures, and four application menus. All symbols in the application menus have imbedded CSI codes and work in conjunction with Specification Interface. Circle 102.

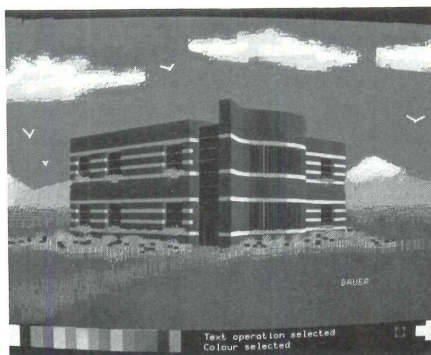

CADD Advanced from New PCs

VersaCad Advanced is a general purpose CADD program introduced by T&W Systems for more powerful personal computers. More than 100 commands, along with symbol libraries, geometric calculations, bill of materials and database extraction capabilities, are available with the software. VersaCad Advanced is available for IBM PC/AT and XT, Tai 1200 and 2000, AT&T 6300, Texas Instruments Professional and Hewlett Packard Series 200. Circle 116.



Two Additions for Arplan

Skok Systems Inc. has added an Applications Customizer and an Applications Library to Arplan, its drafting and design package for the Artech CADD system. Application Customizer allows users with no programming experience to create their own special drafting applications and vendor claims. Applications Library includes a set of three pre-written groups of ready-to-use drafting applications: architecture, site/structure and ceilings/notes. Circle 115.

CalComp Introduces Cadvance

CalComp's recently acquired personal systems unit has introduced Cadvance, a PC-based software package that vendor says offers capabilities previously available only on high-end CADD systems. Cadvance employs programmable macros. The software contains many nested commands, allowing the user to zoom and pan the image, or change group and active layers, without leaving the draw command. The software runs on the IBM PC/AT or XT. Circle 109.

Over 600 Professionals Can't Be Wrong!

Over 4 years Concept Group has been providing Computer Solutions to Architects and Engineers Worldwide.

Concept Group, Inc. provides the software and hardware to allow companies like yours to keep pace with the rapidly changing world of Automated Architecture. Whether you need to automate your Design Department with a CAD system, automate your Specification Department, computerize your Financial Accounting and Project Cost Controls, or automate Surveying and Civil Engineering activities, we can design the system to fit your needs.

Solutions

From simple two dimensional floor planning to sophisticated three dimensional modeling, Concept Group has the solution for you. We offer the most powerful and popular micro-CAD systems. Such as AUTOCAD 2 from Autodesk, CADPLAN and CADVANCE from Calcomp, DATACAD 2 from Microecture - the three leaders in two dimensional design. Or Design Board Professional from MegaCADD for three dimensional design. We can provide not only the CAD software, but entire CAD systems. From desktop computers to full-size Plotters, Concept Group provides everything you need to automate your designs.

Specification Solutions

Concept Group is also the world's largest supplier of automated versions of AIA's Masterspec specification system. Whether you have an IBM, an Apple II, or even a Macintosh, we provide you with the tools you need to produce professional Project Specifications on your computer.

Financial Management Solutions

Now ready to computerize your Financial Accounting and Project Cost Controls, Concept Group has the tools for you. Four programs, the Architects Business Manager, Business Manager, P.A.M.S., and Microecture Accounting can be custom designed for your Architectural or Engineering Firm.

Surveying and Earthwork Solutions

For advance surveying/civil engineering software - the heavy duty coordinate geometry/CAD system is available that allows the smaller firm to compete in an area that has been available only to larger firms. Now on your IBM PC XT or AT you can grid a site, input actual stake elevations and watch the system automatically finish a cut and fill at each point. You can also calculate topsoil depth for topsoil cut and fill, raise/lower grade for better earth balance, and many other unique, powerful features. Available only through Concept Group.

Concept Group, Inc.

Computer Concepts for Architects, Engineers & Related Design Professionals

North Mesa - Suite 301 El Paso, Texas 79912-5936

448-4414 In Texas: (915) 544-4444

Circle 37 on information card

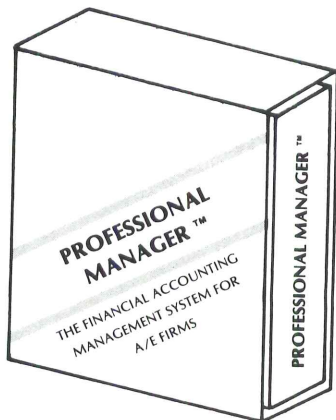

PROFESSIONAL MANAGER™

FULLY INTEGRATED
FINANCIAL ACCOUNTING MANAGEMENT
SYSTEM FOR ARCHITECTS & ENGINEERS
PROFESSIONAL MANAGER™ IS ONE OF THE
MOST ADVANCED FOURTH GENERATION
SYSTEMS DEVELOPED FOR USE ON THE MICRO
AND SUPER-MICRO COMPUTERS WITH THE
FOLLOWING KEY FEATURES:

- Ease of Use
- Flexible Billing
- Query Language
- Report Writer
- Competitive Pricing

PROFESSIONAL MANAGER™

CONSISTS OF:

- Job Cost with Billing
- Accounts Payable
- Accounts Receivable
- Payroll
- General Ledger
- Project Management

AVAILABLE AS SINGLE USER UNDER MS-DOS
AND MULTI-USER UNDER XENIX/UNIX

FOR INFORMATION CONTACT

CANADA:

PROSOL CONSULTING LTD.
29 CENTENNIAL ROAD, UNIT 1
ORANGEVILLE, ONTARIO L9W 1R1
TELEPHONE: 519-941-5070

USA:

AUTOMATE COMPUTER SOFTWARE
7475 CALLAGHAN ROAD, SUITE 201
SAN ANTONIO, TEXAS 78229
TELEPHONE: 512-377-0461

A/E SYSTEM '85 - BOOTH 568

HOK DRAW

is a powerful three-dimensional CADD system.

HOK DRAW

is tied to a sophisticated relational database.

HOK DRAW

is proven on over one hundred projects.

HOK DRAW

is aggressively priced.

HOK DRAW

is backed up by professional documentation, training programs, and telephone support.

HOK DRAW

is part of the fully integrated series of professional design and facility management systems from HOK/CSC.

For more information,
call or write us at:

HOK/CSC
100 North Broadway
St. Louis, Missouri 314-421-2000

© 1985 HOK Computer Service Corporation

Circle 39 on information card

LABORATORY PRODUCTS

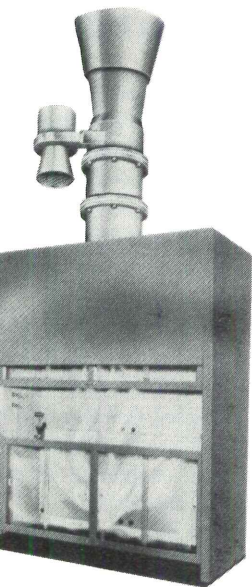

HOOD

six-stage air baffle built into this fume hood ensures an even flow of air through the more than 500 baffles positioned around the hood's face. Because the air is filtered directly into the exhaust stream, unconditioned room air can be used. The hood exhausts only a small quantity of conditioned room air. Advantages of the design, the manufacturer claims, are optimized air flow across the face of the fume hood, reduced air velocity and reduced heating and cooling costs.

Labconco Corporation, Kansas City, Mo.

Circle 15 on information card

Information compiled and written by Editor Amy Light.

LABORATORY CASEWORK BROCHURE

A free brochure from Duralab highlights the advantages of lead-coated steel in the manufacture of laboratory casework. It also describes and illustrates construction features that result in safe, flexible and durable casework.

Duralab Equipment Corporation, Brooklyn, N.Y.

Circle 13 on information card

LABMARC MODULAR FURNITURE

The Labmarc system consists of a series of self-contained modular units designed to be durable, yet flexible enough to allow for periodic layout changes.

The basic module is made up of units 4 feet long x 6 feet high. Plumbing and wiring are contained along the bottom half of the module and concealed by removable panels.

Any combination of component units may be attached to these spines, including adjustable-height tables, workbenches, cabinets, drawers and sinks.

In addition to the standard bench units, the system can include fume hoods, cut-up and staining modules, safety stations and equipment storage and drying cabinets.

Shelves and work surfaces are available in laminate, resin epoxy, polypropylene, stainless steel, wood and artificial-stone finishes.

Labmarc, Cambridge, Mass.

Circle 14 on information card

NEW WASHER

The FlaskScrubber, a laboratory washer specifically designed for narrow-neck glassware, cleans and dries flasks, test tubes, beakers and graduated cylinders.

The washer consists of 36 spindles that securely hold flasks during operation. The spindles come with adjustable clips to fit any flask.

The washer is constructed of corrosion-resistant stainless steel, and is available in mobile, freestanding and under-the-counter models.

Labconco, Kansas City, Mo.

Circle 15 on information card

TWO LABORATORY CHAIRS

Adjusto offers two chairs designed for the laboratory.

Model 20B61, a standard model, is available in chrome-plated metal parts. It comes with casters as standard, and may be purchased in vinyl, nylon or custom vinyls.

Chair model 30C64-VUV is designed for use in controlled atmospheres. It contains a unique system that filters out particulates of 0.2 microns or larger, complying with Federal Standard 209B. This model comes with glides as standard (although casters are available), and must be upholstered in custom vinyls. It is also available in a static dissipative version that counteracts static electricity.

Adjusto, Bowling Green, Ohio.

Circle 16 on information card

AGING PRODUCTS

PLUG-IN INTERCOM

This intercom, the IM-110, plugs into any AC outlet, making it easy for bedridden persons to communicate with people in other areas of a house or institution.

The system measures 7 1/4 inches x 4 7/8 inches x 2 inches. Each unit has an adjustable on/off volume control.

Units are portable; up to eight stations can be added.

A free brochure is available.

Nutone, Cincinnati.

Circle 17 on information card

VAS SYSTEM

A visual alert system (VAS) uses a sound-activated strobe light housed in a small portable box to alert the deaf or hard-of-hearing to a smoke alarm, door knock or telephone ring.

The portable box, made of impact-resistant plastic, is designed to fit on a bedside table or credenza. A series of red lights on top of the electronic box indicates which alert function is in progress.

Customized Engineering Services Incorporated, Laurel, Md.

Circle 18 on information card

NO-HANDS BATHROOM

The "no-hands" bathroom consists of solenoid-operated flushing systems, faucets, a shower head, soap dispenser and a hand dryer, which are activated by sensors that send and receive a beam of invisible light reflected by a person. Flushing systems supply a metered quantity of water.

Sloan Valve Company, Franklin Park, Ill.
Circle 19 on information card

RF SHIELDING PRODUCTS

SHIELDING WINDOW BROCHURE

A 40-page brochure from Technit outlines methods for designing and selecting EMI-shielding windows.

The brochure explores EMI-shielding performance, optical performance, optically clear window substrates, contrast enhancement, assembly techniques and different methods of mounting windows.

Technit, Cranford, N.J.

Circle 20 on information card

EMI WINDOW

A near-transparent, standard-appearing window shields electromagnetic interference (EMI).

The shielding mechanism of the double-insulating glass window is a conductive, transparent metal film, which has been sputter-deposited onto an optical-grade polyester. The thin film is suspended in the airspace between two panes of glass and grounded to the metal window frame, which is then grounded to the building infrastructure.

Southwall Technologies, Palo Alto, Calif.

Circle 21 on information card

SISALKRAFT SHIELDING SYSTEM

Copper Armored Sisalkraft Shielding is available in 5-foot × 120-foot rolls and is suitable for shielding single rooms or entire buildings. The material doesn't require heavy building structures or high welding

costs normally associated with steel-plate shielding systems.

Copper foil offers high conductivity and an inherent resistance to corrosion, which make it an effective shielding material for large surface areas where a high degree of attenuation across a broad frequency range is needed.

Fortifiber Corporation, Attleboro, Mass.

Circle 22 on information card

SOUNDPROOF FACILITIES

Modular, soundproof steel rooms meet U.S. Government specifications for strong-room environments where classified or sensitive documents are handled.

The rooms can be custom-engineered to suit individual specifications and can be demounted, rearranged and reinstalled in new locations or existing buildings as room linings or freestanding structures. The facilities can be erected outdoors on concrete

foundations or on slabs.

Industrial Acoustics Company, Bronx, N.Y.
Circle 23 on information card

SILICON ELASTOMER

Consil-C, a silicon elastomer, offers shielding for a wide range of radio-frequency applications at and beyond 10GHz.

The elastomer is filled with silver-plated copper particles designed to achieve maximum electrical conductivity as well as moisture sealing and vibration dampening at seams and enclosure joints.

This combination of shielding and sealing properties makes Consil-C elastomer especially suitable in applications involving molded and extruded designs, military aerospace systems, high-frequency microwave systems and as gaskets for waveguides and RF connectors.

Technit, Cranford, N.J.

Circle 24 on information card

ATTENTION PRODUCT SPECIFIERS...

ARCHITECTURAL TECHNOLOGY provides you with an invaluable opportunity to obtain information about the latest products available. Simply fill out one of the READER SERVICE CARDS located in the back of this issue, circling the numbers of those products you'd like to know more about. Stamp it and mail it in. That's all there is to it! In no time at all you will receive the information you've requested.

And best of all
it's free!

ARCHITECTURAL TECHNOLOGY is published by The American Institute of Architects Service Corporation.

AN
TE
CTS
E
TION

The American Institute
of Architects
1735 New York Avenue, N.W.
Washington, DC 20006
(202) 626-7300

g Director
Payne
5-7471

Production Manager
Mary Fitch
(202) 626-7451

t to the
g Director
. Wilkins
5-7471

OFFICES

Dallas
crest, Suite 123
X 75230
-8953
Midgley

Pacific Northwest
151 Yesler Way, Suite 317
Seattle, WA 98104
(206) 621-1031
James A. Anderson

ia
o, Suite B
CA 94952
-6042
Anderson

Pennsylvania
3 Neshaminy Interplex, #301
Trevose, PA 19047
(215) 639-3731
Linda C. Cherry

ackson Blvd., #1604
L 60604
4116
Anderson
les

St. Louis
1466 Summerhaven
St. Louis, MO 63146
(314) 569-3210
Richard D. Grater

ew England/
k
Avenue, Suite 1042
NY 10017
3415
Matranga

Ohio
46 Main Street
Sparta, NJ 07871
(201) 729-4937
Thomas R. Crow

ADVERTISERS

	Page No.	Circle No.
Association Administrators & Consultants	17	10
AutoCAD <i>Autodesk</i>	S-2	28
Automate Computer Software	S-23	38
CalComp <i>Jansen Assoc.</i>	S-6-7	30
Challenger Software	Cover 3	2
Concept Group	S-23	37
Fortifiber Corporation	6	6
Harper & Schuman	S-16	34
Hewlett-Packard <i>Ogilvy & Mather Direct</i>	S-8	31
HOK/CSC	S-24	39
Intergraph Corp.	S-12-13	
Koh-I-Noor Rapidograph, Inc. <i>KR Advertising</i>	S-18-19	
McDonnell Douglas AEC Information Systems <i>J. Walter Thompson</i>	8	7
McDonnell Douglas AEC Information Systems <i>J. Walter Thompson</i>	S-4	29
Mayline Co., Inc. <i>Jacobsen Adv.</i>	S-20	36
Prestressed Concrete Institute <i>The Delos Co., Ltd.</i>	Cover 2	1
Sigma Design	S-15	33
Texas Instruments <i>Bozell & Jacobs, Inc.</i>	S-11	
Timberline Systems, Inc.	2	4
United States Gypsum <i>Marstrat</i>	Cover 4	3
United States Gypsum <i>Marstrat</i>	4-5	5
United States Gypsum <i>Marstrat</i>	10	8
United States Gypsum <i>Marstrat</i>	14-15	9

A MIXED MARRIAGE

BY JOHN F. HARTRAY JR., FAIA

The human species appears to be programmed for individual thought and collective action. This genetic irony is exhibited during rowing regattas in which burly, backward looking crews are directed by noisy lightweights. The construction industry sometimes seems to be organized in much the same way. The mutual dependence of architects and builders is rich in dramatic possibilities.

Architects who have survived in practice long enough to develop a realistic sense of modesty are well aware that the nastiest trick a builder can play on them is to construct a project in exact accordance with the drawings and specifications. They therefore try to write construction contracts that encourage suppliers and fabricators to contribute their knowledge and experience to the common undertaking. They also treat the opinions of craftsmen with great respect.

Builders, in turn, are usually happy to defer to architects on those formal issues that fall outside the rational realm of construction technique. "Don't ask me," they say, "I'm not the architect."

This division probably existed on the Acropolis between slave stonecutters and their supervisors, even though there is evidence that the supervisors were also slaves. Spiro Kostoff, in his recently published history of the profession, quotes Plato as giving the price of an architect at about 20 times that of a laborer. Presumably the architects were purchased with the classical equivalent of an NCARB money-back guarantee.

When an architect's design conflicts with the practical and esthetic imperatives of the craft tradition, the builders will usually work for a change. Construction etiquette for improving details begins with a request that the architect explain how the designs are to be built. Good manners demand that we be given enough time to discuss the design intent, but not enough to demonstrate technical ignorance. The builder then suggests an improvement in a way that allows us to claim the

John F. Hartray Jr., FAIA, is a partner at Nagle Hartray Associates, Chicago. Hartray also teaches at the Illinois Institute of Technology.

idea as our own. "Oh, in other words you mean. . . ." "Why yes, that's what I was getting at."

This ritual is not restricted to construction. It is the method by which boatswains' mates prevent ships' captains from sailing through breakwaters and nurses make sure that heroic surgical operations are performed on the right patients.

The modern separation between formal intent and the traditional lore of construction probably began when Brunelleschi dismissed the master mason and installed himself as architect of the cathedral of Florence in order to assure his fellow citizens that their church would express the ideals of an Italian republic rather than those of the French or Austro-Hungarian monarchy.

The elimination of the politically offensive North European buttresses led far beyond the limits of the 15th-century building tradition to the experimental design of lightweight vaults, the load testing of structural models and the use of tension members to resist thrust at the base of the dome.

The modern era, whose beginnings coincided with a rebirth of interests in classical antiquity, had much more to do with this unprecedented development of the scientific method than with the formal prototypes unearthed from ancient Rome. Humanism involved a belief in the untapped possibilities of the intellect rather than a cultivated taste for acanthus leaves.

Still, modern history has demonstrated that absolute faith in the human intellect is unjustified. Instinct and the traditions in which it is embodied remain an important

resource—especially in the practice of architecture, which seeks to respond to human aspirations.

John James's book *Chartres, The Master Who Built a Legend* provides an interesting insight into what the lore of construction is able to produce before our upstart profession began its effort to rationalize and control the process.

Based on their individual approaches to layout problems and the profiles of construction details, Mr. James has identified nine builders who, in less than 50 years, built the cathedral in a series of horizontal layers. Each of their crews accepted the earlier strata as it found them, but proceeded on the basis of its own widely diverse system of measurement, proportion and geometry. Because there was no medieval consensus on statics, the master masons even reshaped and realigned partially completed buttresses to resist loads based on their individual senses of structural behavior.

Mr. James's description of this process provides an explanation for the mysterious vibrancy that Chartres presents to visitors. It hints at why the form of certain buttresses and the vaults of the apse seem inevitable to the eye but are inaccessible to memory. The cathedral's layers of structural intelligence and inherited technique create a far richer harmony than could be expected or designed by a single mind. In a vital city, the building can be added to and enjoyed but never fully comprehended.

Occasionally, instinct breaks through the bounds of industry etiquette. O'Neal told me of the construction of a small

where the creative energies released by a case of tequila resulted in the construction of a series of blind arches in what he had designed as a plain bond wall. He said that this was his idea at first, but that by the time the masons sobered up to a point where they could comprehend the geometry of their act, he had grown fond of the revision. It was highly decorative and would have been very expensive if it had been change order.

I suspect that we all know of details that might be improved by the wisdom of West Texas cadenza. □

—Jack Hartray

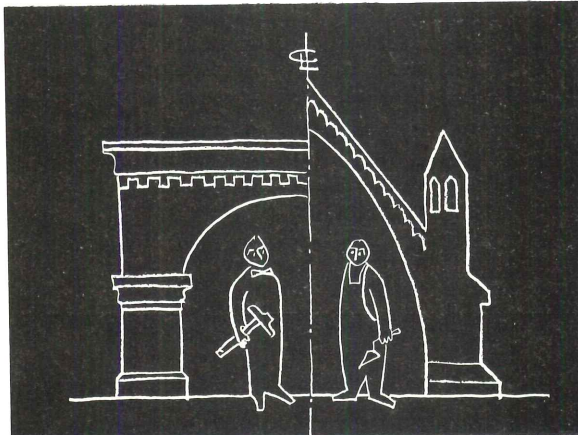

Mac3D

...a power tool for your mind.

Mac3D™ is a powerful, three-dimensional graphics software package now available for the Apple® Macintosh™ personal computer.

For productivity and production tools help you to maintain competitive edges everyday. Accountants have spreadsheet programs, writers have word processors, now architects have Mac3D. Mac3D is a power tool for your mind at an affordable price and, for the first time, at a personal level.

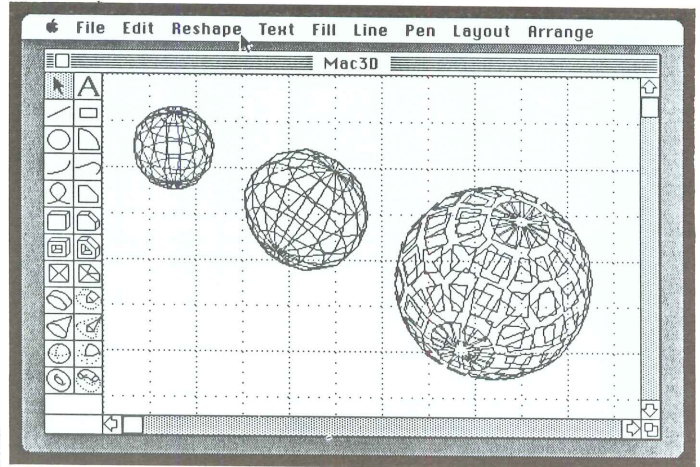
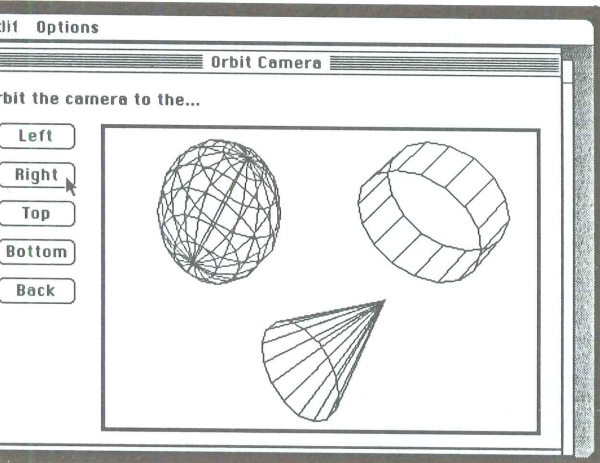

• **Power Tool.** With Mac3D you can produce high quality design work in minutes. You can draw to scale with standard or user defined rulers, draw Bezier curves and wireframe meshes, and even specify dimensions up to four decimal places in accuracy.

• **Productivity Tool.** Improve your productivity two ways: (1) produce meaningful work directly--spend less time creating and editing preliminary drawings and exploring alternatives; and (2) gain a more thorough understanding of your design--examine it from any point of view and play "what if" in real time on your personal computer.

Production Tool. If you produce large models you appreciate the tremendous utility of Mac3D. Two useful features of Mac3D include: (1) the ability to manipulate large numbers of objects in real time--limited only by disk space; and (2) the ability to view and print complex models with hidden lines and surfaces removed.

Mac3D™...a new dimension in software.

For more information see your local computer dealer or contact:

CHALLENGER SOFTWARE

18350 Kedzie Avenue
Homewood, IL 60430
Phone (312) 957-3475

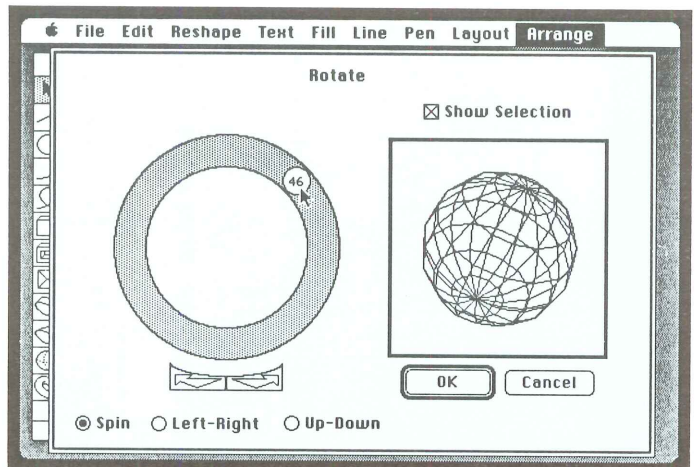

Mac3D™ works in the Macintosh Office and requires a 512K Macintosh and an external disk drive.

Apple is a trademark of Apple Computer, Inc.

Macintosh is a trademark licensed to Apple Computer, Inc.

Challenger Software, the Challenger Software logo, Mac3D and the Mac3D logo are trademarks of Challenger Software Corporation. © 1985 Challenger Software Corporation. All rights reserved.

Suggested retail price for Mac3D™ is \$195.00.

Circle 2 on information card



New two-tone look brings good taste to workaday ceilings.

Auratone[®] Surf Acoustical tiles and panels

Most low-priced ceilings are made to be ignored. Now comes Surf, value with some style to it... a white-over-grey textured look that pleases the eye as it reduces noise. Works well in a small room as well as a supermarket. Available in 12"x12" tiles and 2'x2', 2'x4' and shadowline, all 5/8" thick. Call our representative. Or write to USG Acoustical Products, 101 S. Wacker Dr., Chicago, IL 60606-4385, Dept. AT885



Good: Surf Panels enhance standard grids system.

Better: Surf Panels in slender USG[®] Profile Grids.

USG makes the most elegant ceilings affordable.

© 1985 USG Acoustical Products Company
USG[®] is a registered trademark of USG Corporation

USG Acoustical Products Company

Circle 3 on information card