

ARCHITECTURAL RECORD

A MCGRAW-HILL PUBLICATION • SEVEN DOLLARS • JUNE 1990



**THE MAINE MARITIME MUSEUM
BY WINTON SCOTT ARCHITECTS**

**MODERNISM IN THE DANISH MANNER:
RECENT WORK OF HENNING LARSEN**

**CRITICISM: NEW ARCHITECTURE
IN DOWNTOWN LOS ANGELES**



SUFFIELD™ FLOORS. VARIATIONS IN VINYL.

Multicolored accent chips provide coordinated design options.
Palette of 12 colors. Chemically bonded seams. Easy to clean.
For more information, call 1 800 233-3823 and ask for Vinyl Floors.

CONTENTS

FEATURES



Page 58

58 CORE CONCERNS

Don Canty evaluates new architecture in downtown Los Angeles and concludes that tall buildings, even when designed by celebrated architects, do not guarantee metropolitan greatness.

66 ON AXIS WITH THE PAST

Spillis Candela & Partners' Volusia County Administration Center serves a growing area of central Florida as an efficient government complex and a symbol of civic pride.



Page 66

72 HARBORING TRADITION

For the new Maine Maritime Museum, architect Winton Scott was inspired by the powerful industrial vernacular of a local 19th-century foundry.

76 MODERNISM IN THE DANISH MANNER

British architectural historian Chris Abel reviews recent work in Europe and the Mideast by Danish architect Henning Larsen.

BUILDING TYPES STUDY 680

87 HOSPITALS: TARGETING TREATMENT

An essay by architects Michael Bobrow, Julia Thomas, and Anthony Roesch of Bobrow/Thomas Associates reports on the gathering crisis in health care and the move by hospitals to develop more sharply focused physical responses to a changing spectrum of social and economic forces.

90 Building a Caring Community: Freeport Hospital Health Care Village, Kitchener, Ontario; NORR Partnership Ltd., Architects

94 Acute Care Stacked on Public Uses: Marin General Hospital Addition, Greenbrae, California; Kaplan McLaughlin Diaz, Architects

98 Making Special Care Special: Lake Pavilion/Family Birth Center, Baptist Hospital of Miami, Miami, Florida; The Ritchie Organization, Architects



Page 72

SYSTEMS / COMPONENTS

105 Selecting Glass for Tall Buildings: Improved products and more restrictive criteria call for a systematic approach. By Joseph E. Minor

108 A Thin-Stone Veneer Primer: A list of points to check when specifying popular stone claddings. By Ian R. Chin, John P. Stecich, and Bernard Erlin



Page 76

Of The Interior.



© 1990, The Glidden Company

match any color, weight and embossing you have in mind.



One source. One supplier. One group of people giving you The Professional Edge™ Glidden.

And you'll always have the inside track on decorating interiors and exteriors too.

For more information, contact The Glidden Company, Department GM, 925 Euclid Avenue, Cleveland, Ohio 44115.



The Professional Edge

Circle 4 on inquiry card

DEPARTMENTS

11 PRACTICE AND DESIGN NEWS

28 DESIGN AWARDS/COMPETITIONS

California Council/AIA 1990 Design Awards Program.

30 COMPUTER PRACTICE

The Future Is Now. Harvard GSD's inventive computer-system setup.
By Steven S. Ross

35 MARKETING

How Architects Market Themselves. By Nicholas Polites

37 CONSTRUCTION COSTS

The Price of Building Declines. A four-quarters' slide in the rate of construction-cost hikes continues deflationary trend.

40 CONSTRUCTION FINANCE

Interest Rates' Stubborn Stance. Despite predictions, rates stay up and their drag on construction persists. By Phillip Kidd

43 PROFILE

George White, Architect of the Capitol. By Donald Canty

47 OBSERVATIONS

Spain Fetes Modernism: Recent work by the new generation of Spanish architects. By David Cohn

51 BOOKS

56 EDITORIAL

It's Time . . .

115 NEW PRODUCTS

Architectural Cast Stone

123 COMPUTER TECHNOLOGY

Software reviews for architects. A 2.5-D Package Tailored for Architects.
By Steven S. Ross

144 OUTTAKES

Watching Their Garden Follies Grow

4 Letters

127 Calendar

138 Manufacturers' Sources

131 Product Literature

136 Classified Advertising

142 Advertising Index

147 Reader Service Card

COVER

The Maine Maritime Museum, Bath, Maine,
Winton Scott Architects; Photographer: ©Brian Vanden Brink



Page 87

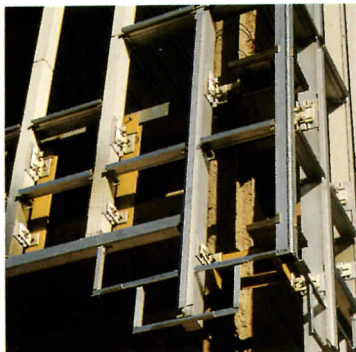

Page 105

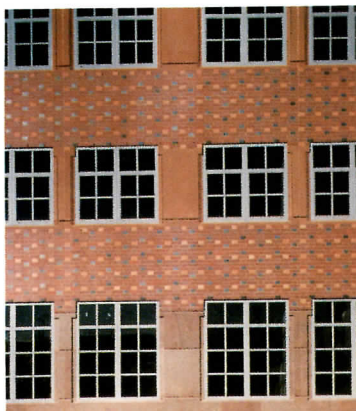

Page 115

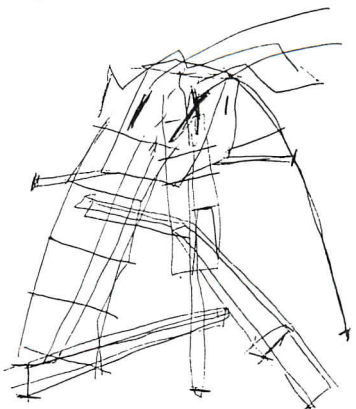

Page 144



*Bill Pittman, President
Xerox Engineering Systems*

“Our Customers Helped Design It— That’s Why So Many Who Tested It Ended Up Buying The 2520”

“The 2520 gave us close-to-stat quality copies.”

Ron Hurkley, Jervis B. Webb Company.

“You can feed it third generation reproductions and the copies come out looking like originals.”

Bruce Boore, T. Rogvoy Associates, Inc.

“The 2520 gives us straight feeds every time.”

Otto Auch, George W. Auch Company.

“Our people learn on the 2520 in no time.”

Maryanne Barsotti, Partlan-Labadie Sheet Metal Company.

“Our customers used their experience with the 2510 to come up with ideas that led to this new copier. They all agree, it’s a feature-rich bargain, with size-for-size copying, collated set copying, or partial copying on bond, film, or vellum. It has automatic document handler, lead edge adjust, auto cut-to-size, delayed time out, heated media box, document organizer, scale adjust, job recall—the works. It’s affordable for almost any size firm. And I think you’ll agree, it’s a lot of copier for the money.”

Call Or Write For A Free Videotape Demo Of The 2520—

See why it’s the future of large document reproduction, and hear why Bill Pittman believes Xerox will be the world force in the transfer of architectural, engineering, and construction information in the 90’s. Call toll free 1-800-THE-2520 for a free VHS or Beta copy. Or write to the address below.



Engineering & Graphic Products
Xerox Corporation, Xerox Square-06, Rochester, NY 14644

Xerox®, 2510® and 2520® are trademarks of Xerox Corporation.
©1990, Xerox Corporation.

Circle 5 on inquiry card

EDITOR

Stephen A. Kliment, FAIA

MANAGING EDITOR

Carolyn De Witt Koenig

EXECUTIVE EDITOR

Paul M. Sachner

EDITOR AT LARGE

Donald J. Canty, Hon. AIA

SENIOR EDITORS

Grace M. Anderson

Margaret F. Gaskie

Charles K. Hoyt, AIA

Karen D. Stein

James S. Russell, AIA

ASSOCIATE EDITORS

Joan F. Blatterman

Clifford A. Pearson

EDITORIAL OFFICE MANAGER

Anne S. Ting

DESIGN DIRECTOR

Alberto Bucchianeri

SENIOR ASSOCIATE DESIGN DIRECTOR

Anna Egger-Schlesinger

DESIGNER

Lillian R. Engel

EDITORIAL PRODUCTION MANAGER

Annette K. Netburn

TECHNICAL ILLUSTRATOR

Muriel Cuttrel

CONTRIBUTING EDITORS

David Ballast, AIA;

Peter Piven, FAIA;

Kristine Fallon, AIA

EDITORIAL CONSULTANTS

George A. Christie, Jr., Economics

Steven S. Ross, Computers

Phillip Kidd, Finance

Peter Hoffmann, Washington

CORRESPONDENTS

Aaron Betsky; Gerald Moorhead, AIA;

Beth Dunlop

CIRCULATION DIRECTOR

Richard H. Di Vecchio

DIRECTOR OF BUSINESS AND PRODUCTION

Joseph R. Wunk

ADVERTISING PRODUCTION MANAGER

Laura Marchisio

DIRECTOR OF MARKETING

Camille H. Padula

ASSISTANT TO PUBLISHER

Elizabeth Hayman

PUBLISHER

Roscoe C. Smith III

Inquiries and submissions of work for publication may be sent to the editors listed below who are responsible for the subject areas named:

Paul M. Sachner, houses

Karen D. Stein, interior design

Grace M. Anderson, design news and competitions

Clifford A. Pearson, observations and book reviews

Charles K. Hoyt, practice

James S. Russell, technology

Joan F. Blatterman, new products and product literature

Watch the first step!

On the cover of your April 1990 issue, showing the Bonauro studio, I was relieved to see a soft bed beneath the turn in the oh so dangerous stairs. It will soften the fall that is sure to occur. The stairs appear too steep, too narrow, and without proper winders, or landings, or hand- and guard-rails. Architecture is more than art, and even artists need protection from built-in safety hazards.

JAN P. GASTERLAND
BUILDING CODE OFFICER
St. Paul, Minnesota

RECORD received many letters enumerating the same design faults. The architects point out, however, that the stairs lead to a storage loft and thus comply with the local building code because the space is uninhabitable.—Editor

Set thy house in order

I was singularly unimpressed by the majority of the houses you chose to feature in Mid-April's Record Houses of 1990. It is a shame, for every year I look forward to this issue.

I can't agree with the premise of your introduction on page 33. It's my belief that you should publish what you consider to be the best houses of the year, whether they are all in one city or spread over five continents.

DAVID HALE, ARCHITECT
San Francisco

My thoughts about the selection of the "Hamptons Style" residence as one of the best [RECORD, Mid-April 1990, pages 34-41] are rather one-sided. After looking at so many equally fine submissions, your tired jury selected the strangest, most discordant example. In my opinion, the Slesin/Steinberg house is ugly. How could you allow the owners to say, in print, that the house is "unpretentious"? It must be because they are from the Times and an avant-garde New York City showroom. I might as well be reading P/A.

JOSEPH C. WIENER
FOLGERS ARCHITECTS & FACILITY DESIGN
Miami

I was recently very much angered by the cover photo of a house on the April 1990 issue of *Architecture* magazine. The house was ugly and appeared poorly constructed. Its very presence on the cover implied that this was the very best that American architecture currently has to offer.

Then I received your Mid-April 1990 ARCHITECTURAL RECORD, with an even more stupid house on the cover. Are you more concerned with cute, kitsch, shock, weird, et al., than you are with beauty, endurance, serenity, quality?

Several years ago, when I was president of the Indiana Society of Architects, we discussed the importance of getting architectural magazines into the hands of the public—schools, libraries, corporate board rooms, etc. You make this thought frightening.

BILL BROWN, ARCHITECT
Colorado Springs, Colorado

Corrections

In the Profile on David Neuman [RECORD, April 1990, pages 49-53], the architect of record for the dining facility at the University of California/Irvine was William Wein Cohen, with Rebecca L. Binder as design consultant.

The Pierson Lakes residential development [RECORD, April 1990, page 27] is in Sterlington, New York, in Rockland County.

Chermayeff and Geismar Associates will design the art for the Tempozaan Marketplace in Osaka [RECORD, April 1990, page 25].

Architects of the Yokohama Convention Center [RECORD, April 1990, page 29] were Nikken Sekkei.

Credits for the Canadian Museum of Civilization [RECORD, February 1990, pages 88-93] should have included: Gabriel/Design; Howard Brandston (lighting); Valcoustics Canada (acoustics); Theatre Projects (theater); Imax, Inc. (Imax/Omnimax); Peter Mill (building science); Bernard & Associates (food services); Facilities Programming (laboratory); Delean (traffic).

ARCHITECTURAL RECORD (Combined with AMERICAN ARCHITECT, and WESTERN ARCHITECT AND ENGINEER) (ISSN0003-858X/90) June 1990, Vol. 178, No. 7. Title © reg. in U. S. Patent Office, copyright©1990 by McGraw-Hill, Inc. All rights reserved. Indexed in Reader's Guide to Periodical Literature, Art Index, Applied Science and Technology Index, Engineering Index, The Architectural Index and the Architectural Periodicals Index.

Every possible effort will be made to return material submitted for possible publication (if accompanied by stamped, addressed envelope), but the editors and the corporation will not be responsible for loss or damage.

Executive, Editorial, Circulation and Advertising Offices: 1221 Avenue of the Americas, New York, NY 10020.

Officers of McGraw-Hill, Inc.: Chairman, President and Chief Executive Officer: Joseph L. Dionne. Executive Vice President, General Counsel and Secretary: Robert N. Landes. Executive Vice President: Walter D. Serwatka. Senior Vice President, Treasury Operations: Frank D. Penglase. Senior Vice President, Editorial: Ralph R. Schulz.

Associated Services: Sweet's Catalog Files (General Building, Engineering, Industrial Construction and Renovation, Light Residential Construction, Interiors), Dodge Reports and Bulletins, Dodge/SCAN Microfilm Systems, Dodge Construction Statistics, Dodge regional construction newspapers (Chicago, Denver, Los Angeles, San Francisco).

Subscription rates for personnel of Architectural, Engineering, Interior Design, Design and other directly related firms and students thereof, are as follows: U. S. Possessions and Canada \$42.50; Europe: \$150.00 (including Air); Japan: \$160.00 (including Air); all other Foreign: \$125.00.

Single copy price for Domestic and Canadian: \$7.00; For Foreign: \$10.00. For Subscriber Services (U.S. only): 1-800-525-5003; (Canada & Foreign): 609/426-7070.

Publisher reserves right to accept or reject any subscription.

Change of Address: Forward changes of address or service letters to Fulfillment Manager, ARCHITECTURAL RECORD, P. O. 566, Hightstown, NJ 08520. Provide both old and new address; include zip code; if possible attach issue address label.

Guarantee: Publisher agrees to refund that part of subscription price applying to unfilled part of subscription if service is unsatisfactory.

Copyright and Reprinting: Title © reg. in U. S. Patent Office. Copyright©1990 by McGraw-Hill, Inc. All rights reserved. Where necessary, permission is granted by the copyright owner for libraries and others registered with the Copyright Clearance Center (CCC) to photocopy any article herein for personal or internal reference use only for the base fee of \$1.50 per copy of the article plus ten cents per page. Payment should be sent directly to the CCC, 27 Congress Street, Salem, MA 01970. Include code with request: ISSN0003-858X/90 (\$1.50 + .10).

Written permission must be secured for any other copying. Write Reprint Manager for such permission at address below, or to obtain quotations on bulk orders.

Subscription List Usage: Advertisers may use our list to mail information to readers. To be excluded from such mailings, subscribers should send a request to ARCHITECTURAL RECORD, Mailing List Mgr., P. O. Box 555, Hightstown, NJ 08520.

Publication Office: 1221 Avenue of the Americas, New York, NY 10020. ARCHITECTURAL RECORD (ISSN0003-858X/90) published monthly, except semi-monthly in April and September by McGraw-Hill, Inc. Second-class postage paid at New York, NY and additional mailing offices. Postage paid at Windsor, Ontario, Canada. Registration Number 9617.

Postmaster: Please send address changes to: ARCHITECTURAL RECORD, Attn: Fulfillment Manager, P. O. Box 566, Hightstown, NJ 08520. THIS ISSUE is published in national and separate editions. Additional pages or separate editions numbered or allowed for as follows: Central Section 16Ca through 16Cb. Western Section 16Wa through 16Wb. Sunbelt Section 16Sa through 16Sf.





ARMSTRONG CONTRACT INTERIORS

SHOWROOMS
NEW YORK
CHICAGO
LOS ANGELES

 **Armstrong**

Circle 2 on inquiry card

PRACTICE

One Victory for Licensed Practice

Confronting inroads on practice plaguing architects all over the country, New Jersey is putting teeth into its existing licensing laws and has passed new legislation, effective last month, drawing the line on engineers' ability to design whole buildings. Its experience should be instructive to other states grappling with similar problems.

One aspect of New Jersey's existing legal system deserves attention. While the prosecution of unlicensed practice in most states has fallen not to the registration boards, but to the attorneys general who are busy with more visible crimes, New Jersey's board is within the Department of Consumer Affairs and can enforce its own laws.

At the urging of the state society of architects, it has just sent cease-and-desist orders to more than 20 building contractors who falsely advertised architectural services. And it is



NJSA president Litwack: Legislation truly in the public interest.

investigating the fraudulent use of other architects' seals by design-builder companies. "We're clamping down on illegal practice," says registration board director Barbara Hall.

Other items on the state society's agenda for board action are contractors who trace architects' drawings and then present them as their own, and

homeowners who falsely claim they have prepared their own house plans, which, under the state law, would exempt them from needing a professional.

Equally important is New Jersey's resolution of the age-old dispute between engineers and architects over who may design buildings. While the national AIA and many state boards have been reluctant to deal with the problem [RECORD, June 1989, pages 41-43], New Jersey's architect and engineer boards and societies have worked together over the past five years to hammer out an agreement that, of 10 categories of buildings, engineers may design four, architects all 10. The resulting legislation will be enforced by building officials when they issue permits for construction.

Also in the legislation is permission for architects to incorporate at the discretion of the board. This reduces to 17 the number of states that do not permit incorporation [RECORD, September 1989, page 39].

C. K. H.

Loss Prevention is Source of New Work

Increased interest in protecting life and property against natural disasters, otherwise known as loss prevention, could lead to more work for architects and engineers in retrofitting existing buildings for higher standards of, to name two, fire safety and structural adequacy—as well as resulting in higher safety standards for new building products. Loss prevention was the subject of one recent workshop sponsored by the South Carolina Society of Architects.

"Two natural disasters and one major explosion of a petrochemical plant in 1989 focused corporate America's need for disaster planning," says John A. Love, the president of Factory Mutual Insurance's engineering and research division, which counsels businesses on

how to plan. "These events make obvious the need to think the unthinkable."

And, as Love will tell you, the enormous losses insurance companies suffered during the year may well make disaster planning mandatory for businesses that want to go on being insured.

He sees the trend stretching through the decade due not only to Hurricane Hugo and last October's San Francisco quake, but also to such business trends as mergers and acquisitions. These leave managers controlling facilities previously subject to a wide variety of construction and personal-safety standards. And, says Love, the fall of Common Market barriers in 1992 will be an impetus toward global standards for building products to facilitate trade. These standards, if the

concerns left over from 1989 have any impact, will include close consideration of flammability and structural ratings.

C. K. H.



Factory Mutual's John Love: "Think the unthinkable."

Action, Not Talk, Gets Houses Built in Nicaragua

A largely American group, Architects and Planners in Support of Nicaragua (APSNICA), has spent the last five years helping build housing and other community-development projects in Nicaragua. It plans to stay under the new government, despite its vocal Sandinista bent. "We're positive we're staying," affirmed Stephen Kerpen, the group's director shortly after the February 25 elections, which threw out the Sandinistas.

Using brigades of volunteers from the U.S. and other countries, APSNICA built some 90 houses in its first three years. By U.S. standards, they were small and modest, consisting of several rooms and a covered patio, concrete-slab floors, wood framing with concrete-block infill half way up, wood siding above that, and corrugated zinc-coated roofing exposed inside. There was no electricity and several shared a communal water supply. Nonetheless, they were a major improvement over the usual shacks with dirt floors.

Knowing the client

APSNICA started with a design created by a Nicaraguan architect, made changes, and tried to ask the intended residents for their opinions. That was far from easy, however. "The 'clients' weren't about to say anything," comments Jeff Bishop, a builder who has worked with the group from the start. "They were afraid if they said anything, you'd take the houses away and build them for someone else."

One way the architects discovered what the Nicaraguans preferred was to see the modifications they made after they had moved into the first units. One of the most common was to replace inside kitchens by building



WHAT HAPPENS WHEN A NEW DESIGN IDEA GOES COMMERCIAL?

At last there's an answer to that age-old design problem...how to bring leading-edge design ideas to the masses without compromising aesthetics.

Marlite.

The people who bring the newest solid colors, contemporary woodgrains and sophisticated designs to life on virtually any commercial surface. Wall, door or ceiling. All designed with one eye on high aesthetics and the other eye on durability and time-saving installation.

Marlite...the place where you can order complete product packages from five Regional Operations Centers across America. And coordinate their delivery to jobsites nationwide...with utter dependability.

Marlite...where cutting-edge design ideas learn to live in high-traffic commercial environments without being sliced to ribbons.

Can we bring your best ideas to life? Just try us.

Write or call today for more information on Marlite Planks, Tambours, Displawall™, Doors & Frames, Sanitary wall and ceiling products, Symmetrix™ FRP Panels, Firetest™ Planks, Restroom Partitions, Linear Wood Ceilings and more. 202 Harger St., Dover, Ohio 44622. (216) 343-6621.

 **Marlite**
WHERE IDEAS COME TO LIFE

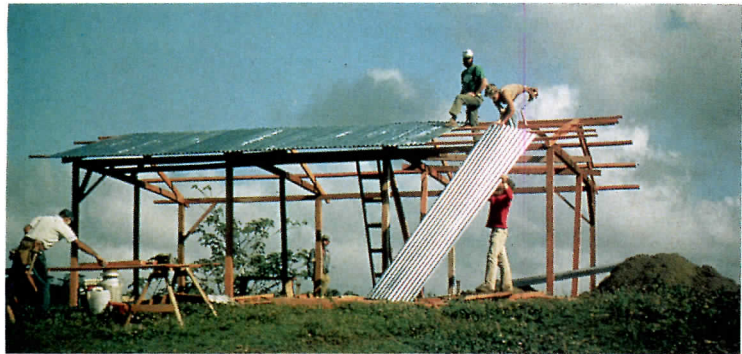

BILL BLACK

Architects get hands-on experience in basic construction.

outside wood lean-tos. "They said," reports Bishop, "we don't want to get the zinc roof dirty with smoke, or the cement floor dirty with grease. It's too good for that."

In response, the APSNICA architects adjusted their designs and installed stoves with chimneys to carry away the smoke. Also in the room intended to serve as a kitchen they put in a stone "molinero," for grinding corn, as well as a sink, drain, and concrete floor. "We made that room so much of a kitchen it wouldn't be used for anything

else," says Bishop.

The group looked for ways to save construction costs. They replaced the concrete block with local stone that did not have to be transported so far. About one-third of the houses' \$600-to-\$800 cost was in the imported zinc roofing. To take its place, APSNICA set up shops to manufacture tiles made of cement and sisal fibers.

Activism meets capitalism

Eventually, the group added economic development to its agenda. Instead of just cutting

trees and milling the wood for its own projects, it set up carpentry shops where Nicaraguans would learn the trade from American volunteers.

"It's nice to build a house," observes Achem Franksman, a West German volunteer who directs APSNICA's construction projects in Natiguas, "but it's better to invest the money in a motor saw. With the profits from cutting wood, we can build many more houses each year."



Finished house, late model.

The group has moved beyond just building houses. In Matiguas, APSNICA built the town's first large warehouse used to store fertilizer and other supplies. The architects have planned a 20-room hotel for the

Atlantic coast. The purpose: to house volunteers working in the area and to accommodate tourists. To share the knowledge they have accumulated, the group has published a 168-page manual in comic-book format to show step-by-step procedures for building low-cost housing.

Kerpen first went to Nicaragua in 1984 with 20 other architects and planners. During that trip, a government official asked the group if it could help finance new housing. Kerpen returned to the U.S. and raised \$45,000. In talking with other architects and builders, however, they decided they could be more effective designing and building rather than funding alone. Thus the group was formed.

Where will it be active now? In the districts that supported the old government.

BILL BLACK

Mr. Black is a Washington, D. C., journalist who spent two weeks in Nicaragua at the time of the February elections.

Handicapped Object to HUD's New Guidelines

Two coalitions of groups, one representing the handicapped and another representing contractors, are at odds over pending accessibility guidelines for new multifamily housing, [RECORD, October 1989, page 35], catching HUD in the middle.

One group, the National Coordination Council on Spinal Cord Injury, has teamed up with the National Association of Home Builders in condemning the new guidelines, currently under review at the Office of Management and Budget, as "impractical, inflexible, and too costly."

Another coalition, the Consortium for Citizens with Disabilities, says HUD is right on target when it projects that the new requirements would add no more than some 1 percent to the cost of multifamily housing.

New regulations

At a late-April briefing, representatives of the NCCSCI and NAHB pointed out that the new regulations will specify that almost all new housing units in

structures receiving building permits after January 13, 1990 will have to meet the requirements—even though they have yet to be issued. (Previously most codes required builders to

provide only one unit on the first floor of each multifamily building to be completely accessible to persons with disabilities.)

The likely result of the added costs would be, in effect, another

barrier to accessibility, said R. Jack Powell, president of NCCSCI and executive director of the Paralyzed Veterans of America. HUD, he charged, had disregarded design options developed jointly by NAHB and NCCSCI, and endorsed by the National Multi Housing Council and the AIA.

Powell added that, when the bill was first debated two years ago, Congressional leaders estimated its added cost at less than \$500 per unit. "Now we estimate the cost of meeting HUD's proposed guidelines will range from \$1,300 to \$3,700 per unit in walk-up buildings and from \$3,200 to \$4,250 for mid- to high-rise units." A coalition analysis of the current proposals recalls the 1988 debate in the Senate:

Tom Harkin: "The cost of certain of these requirements is zero and minimal for others."

Paul Simon: "We are talking about very small amounts to make housing acceptable."

Edward Kennedy: "We are talking about the widening of doors. The cost is \$4 to \$27 for studs in the bathroom."

The coalition conclusion: "It is apparent from the floor debate that Congress recognized that

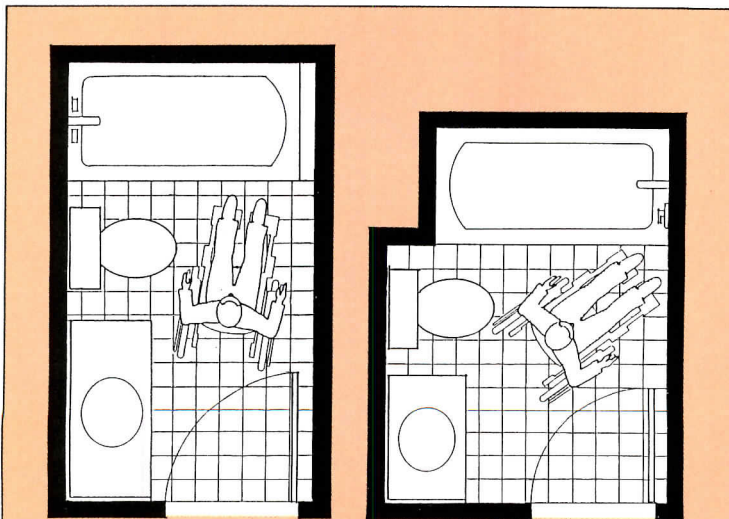

Standards for bathrooms are typical of what opponents of the new HUD guidelines dislike. While minimal builder bathrooms have contained 37.5 square feet, the HUD bathroom (left) would increase that to 51 square feet. But the opponents' version (right) would only require 43 square feet and allow more wheelchair maneuverability.

The HUD Guidelines So Far

Applies to:

- Ground-floor units in non-elevator multifamily buildings with four or more units.
- All units in multifamily buildings with elevators.

Specific requirements:

Handicapped access to:

- All public and common areas.
- All units and rooms inside them.
- All light switches, electrical outlets, thermostats.

Usability for persons in wheelchairs of:

- All doors.
- Grab bars around toilet, tub, shower stall. (Initially, reinforcement in walls for installation as appropriate.)
- A shower seat. (Installation as above.)
- All kitchens and bathrooms.

affordable housing is in short supply for low- and middle-income persons and therefore did not intend to require costly changes."

NAHB's executive vice president Kent W. Colton said the industry's confusion about the guidelines "has already severely disrupted the already-battered multifamily construction market." He observed that, after the rush to meet the January deadline, requests for multifamily-building permits sank to its lowest two-month rate since the deep recession of the early '70s. He estimated the aggregate cost of meeting the proposed HUD design standards for some 310,000 of the 350,000 multifamily starts projected for 1990 at about \$858 million.

Thomas D. Davies, Jr., an architect with the Paralyzed Veterans of America, spent a year on the NAHB/NCCSCI task force developing its alternatives to HUD's proposals. He said that, in addition to doubling the average cost of requirements over the alternatives, HUD's de-

signs have serious basic flaws. He cited bathrooms as a conspicuous example. HUD will require that every bathroom in every unit be made larger than current standards but not necessarily fully accessible. His task-force design requires one fully accessible bathroom. See diagrams (page 13) for comparison.

Those in favor

Representatives of the Consortium for Citizens with Disabilities have blamed the delay in issuing the guidelines and a follow-up public-comment process on intense lobbying pressures by the housing industry. They also have asserted that a new HUD cost analysis requested by OMB is consistent with that of two years ago—that the average added cost per unit would be less than \$250.

A HUD spokesman disputes NAHB's assertion that the builders' January rush for permits and the subsequent decline was due to the uncertainty over guidelines. "It had to do with the unusually warm weather then."

How to move

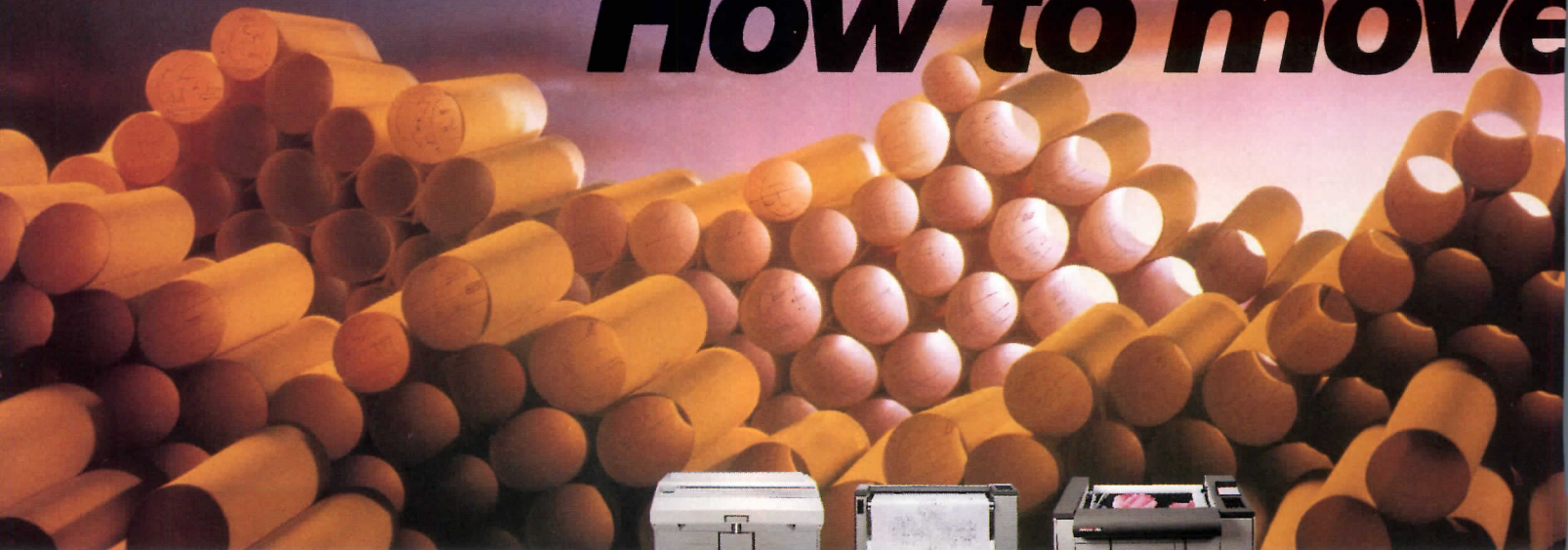

Let Versatec do it for you. At speeds up to 15 times that of pen plotters, our laser and electrostatic plotters quickly make molehills out of mountains.

While giving you all the features you can't get from pens.

Our 8836 II™ plotter is the first and only wide format laser plotter to use plain paper and film. Which means you



8836 II Wide Format Laser Plotter #200



CADmate Electrostatic Monochrome Plotter #201

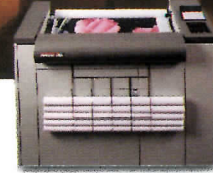

8936 Electrostatic Color Plotter #202

can get both working drafts and finished drawings. All at a laser-sharp 400 ppi.

For high performance on budget, try CADmate.™ CADmate

offers electrostatic monochrome performance at a pen plotter price and connects easily to your 286 or 386 PC CAD system.

And our 8900 series electrostatic color plotter makes



Panel at April briefing: R. Jack Powell, PVA and NCCSCI; Kent Colton, NAHB; Al Eisenberg, AIA.

Gordon Mansfield, HUD's assistant secretary for Fair Housing and Equal Opportunity—a wheelchair user himself—believes at least part of the disagreement is due to a different reading or different assumptions of what's required. "It's a question of interpretation," he says. One HUD expert adds that part of the problem may be the language of the law. NAHB/NCCSCI designs specify a bathroom, for instance, that is "fully accessible." The law, on the other hand, merely says bathrooms and kitchens will be "usable by handicapped persons," and HUD has to com-

ply with what it sees as Congressional intent. "If they want to rewrite the law they should go to Congress, not us." No one is saying so outright, certainly not for attribution, but there are suggestions that the CCD coalition that backs HUD does not really represent the physical problems faced by wheelchair users and similarly afflicted persons face. The CCD counts among its members the National Easter Seal Society, United Cerebral Palsy Association, Inc., the Association for Retarded Citizens of the United States, the Epilepsy Foundation, the National Association of Private Residential Resources, the National Council on Independent Living, the American Foundation for the Blind, the National Association of the Deaf, the Disabilities Rights Education and Defense Fund, the American Civil Liberties Union, and the Leadership Conference on Civil Rights. "The issue is basically access to buildings," said Albert Eisen-

berg, the AIA senior director of government affairs. "If you are hearing-impaired, then turning a wheelchair in a bathroom is not particularly relevant. The parts of the guidelines of concern affect people with mobility problems." **PETER HOFFMANN**

Fallon, Ballast Piven Named to Editorial Board

RECORD has named David K. Ballast, AIA, Kristine K. Fallon, AIA, and Peter Piven, FAIA, to its Board of Editorial Contributors. Ballast, a Denver-based architect and consultant, is a former staff member of C. F. Murphy Associates (now Murphy & Jahn) and former director of project management for the Denver office of Gensler & Associates. He is author of such books as *The Architect's Handbook* and *A Guide to Quality Control for Design Professionals*.

Fallon is president of Computer Technology Management, Inc., an A. Epstein company, and a former manager of the Chicago Computer Group at Skidmore, Owings & Merrill. She is an authority on the practical applications of CADD and other computer systems to day-to-day practice. Piven is president and principal consultant of The Coxe Group, one of the oldest and most respected management- and marketing-consulting companies in the design profession. He is a former principal of Geddes Brecher Qualls Cunningham in Philadelphia, and an authority on the financial management of architectural and design firms. RECORD also announces appointment of Aaron Betsky as its correspondent in California, Gerald Moorhead, AIA, in Texas, and Beth Dunlop in Florida, covering the Southeast. □

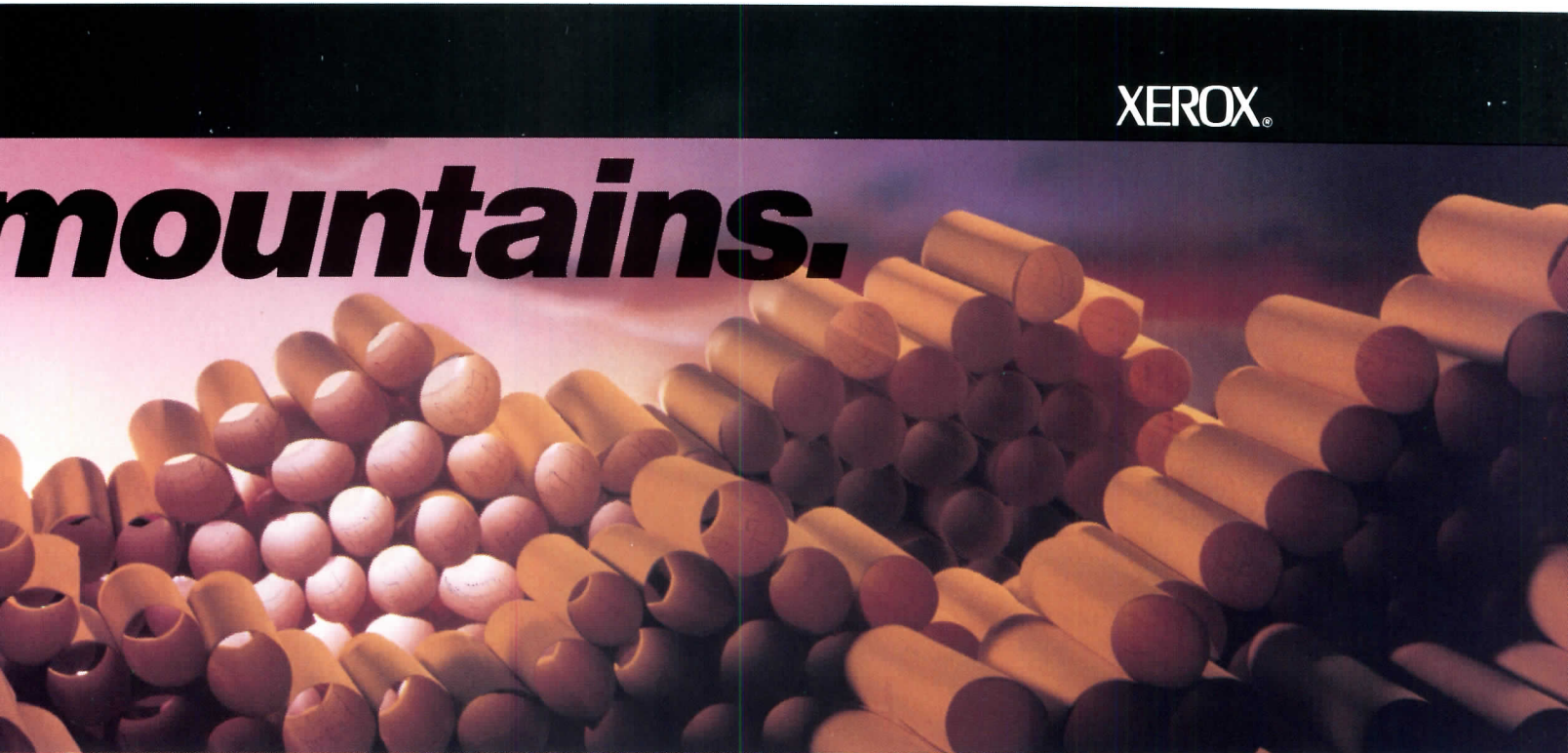

ant color affordable. Its embedded controller gives you color fill and shading capabilities you want and the trostatic speed you need. Of course, Versatec plotters are at home on any range. y can be configured with RS-232C, Centronics parallel ersatec's interface for connecting to most mainframes, s, workstations and PCs. Our plotters accept HP-GL or '907 pen plotter data so you can use the most popular

CAD software packages, such as AutoCAD® For more information on Versatec's high performance plotters, circle the reader service numbers below the products. Or call (800) 538-6477. In California, (800) 341-6060. And see how fast your business can move.

VERSATEC 2710 Walsh Ave., Santa Clara, CA 95051 Versatec, 8636 II, and CADmate are trademarks of Versatec, Inc. Xerox is a trademark of Xerox Corporation. AutoCAD is a registered trademark of Autodesk, Inc. © 1990 Versatec, Inc.

From TRACTION TREAD saddles and nosings, to sound, smoke and air sealing systems, there is nothing better than ZERO.

With TRACTION TREAD, ZERO reaches a new threshold in saddles and nosings. Their innovative design features specially formulated rubber inserts fitted into precisely profiled grooves in heavy-gauge aluminum or bronze. Unlike abrasive coatings, with TRACTION TREAD, the metal and rubber will wear evenly to provide continuous traction. Plus, without grooves, water and dirt can't accumulate. Maintenance is minimized, safety is maximized. TRACTION TREAD can be easily cut, shaped and drilled on-site.

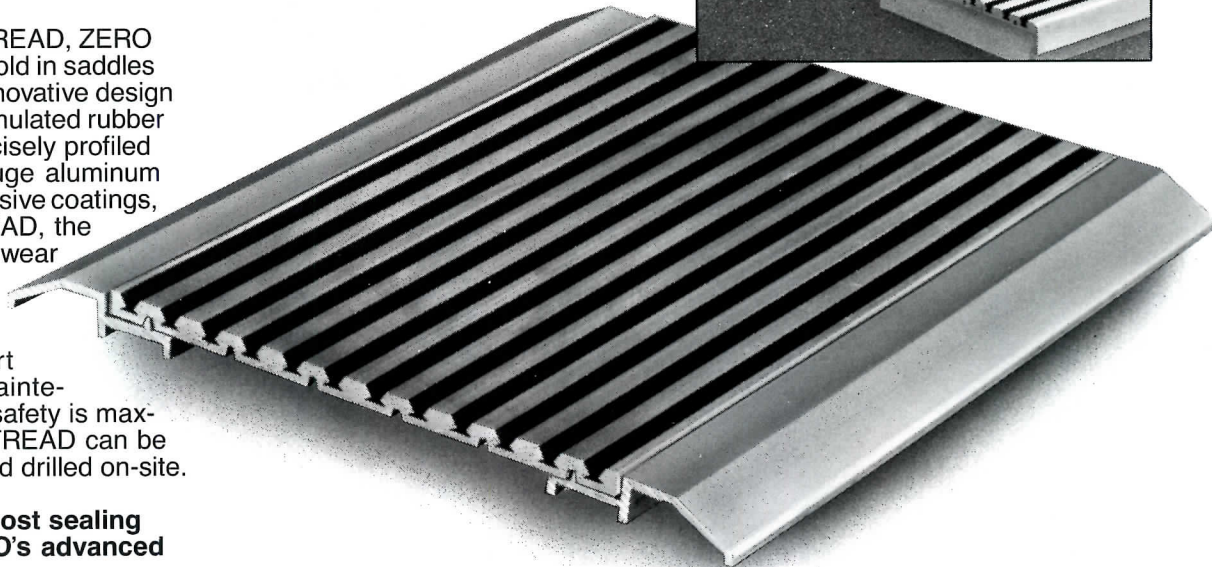

Slam the door on most sealing problems with ZERO's advanced technology.

Smoke, fire, noise, light, temperature and air-loss problems need never challenge you again. All the information you need for complete head and jamb protection, automatic door-bottom assemblies, and handicap access systems, is included in our 28-page catalog. You'll find scaled, detailed drawings to make specifying fast and accurate. Virtually everything in our product line can be customized to specifications. Design ZERO products into your plans.

Write or call for product information, engineering assistance and our catalog.

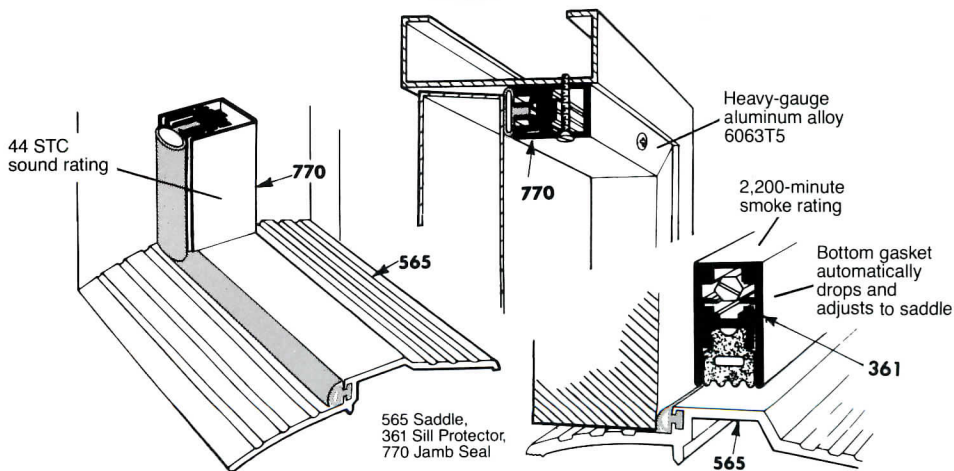

ZERO INTERNATIONAL, INC.
415 Concord Avenue, Bronx, NY 10455-4898
1-800-635-5335
In NYC, call 212-585-3230
FAX 212-292-2243
TELEX 239777 ZERO UR



WHEN NOTHING ELSE
IS GOOD ENOUGH
FOR LONG ENOUGH.

DESIGN

Metro-North Plans Major Renovation of Grand Central

After 77 years of punishing use and ad lib alterations, New York's Grand Central Terminal will receive a massive, \$400-million overhaul. The 1913 building, a designated national landmark, was designed by Reed & Stem and Warren & Wetmore; members of the consortium designing the 1990 restorations and renovations are architects Beyer Blinder Belle of New York City and Harry Weese & Associates of Chicago, and engineers STV/Seelye Stevenson Value & Knecht of New York City, commissioned by Metro-North, the commuter line that operates the terminal. Construction will take up to 10 years.

The most radical changes will take place at the eastern end of the main concourse (right), where until quite recently the Kodak Colorama, a large backlit photomural, obscured the magnificent round-headed win-

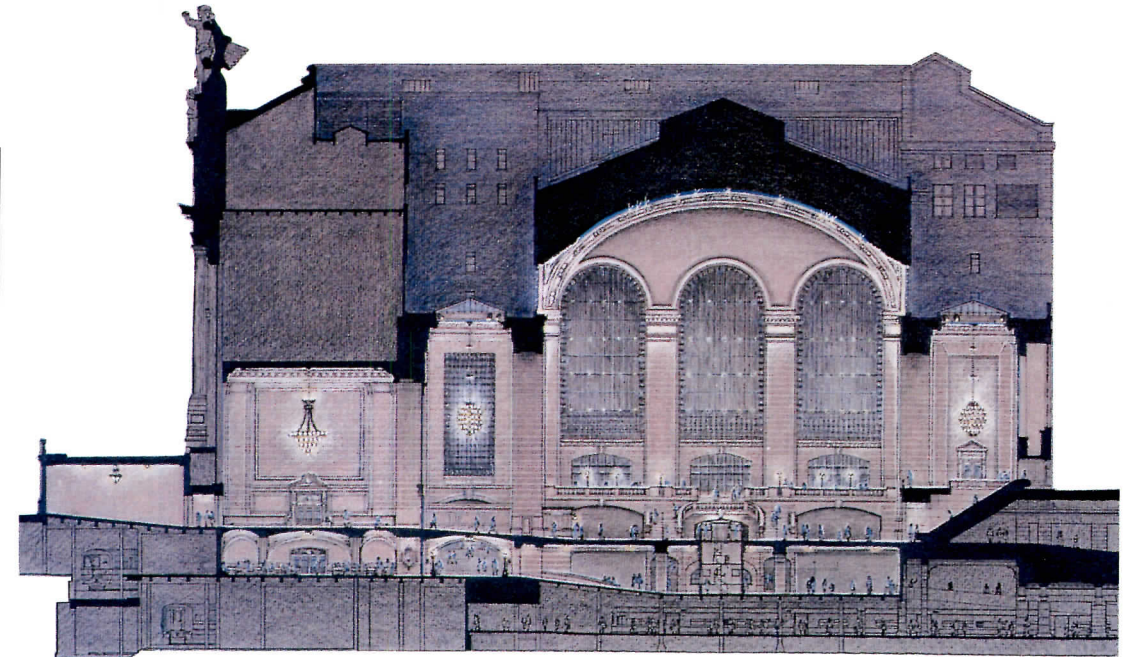

At Grand Central, windows will be restored and monumental stairs replicated.

dows. The 1913 design called for identical windows and curving grand stairways at each end, but the eastern stairs were never built. Basing their design on Warren & Wetmore's original, Beyer Blinder Belle plan a stairway giving access to the mezzanine, which overlooks the main concourse. Restaurants and bars will occupy three sides of the balcony.

For the half-million people who use the terminal daily, changes of circulation patterns should prove almost as dramatic as the new stairway. An enlarged passage from Lexington Avenue on the east will provide an escalator to the lower level. The architects also hope to open exit routes to the north along Park Avenue, where many tall office buildings have sprung up

since the terminal opened.

Many renovations will be invisible. Finishes and materials must be repaired, especially the esteemed Guastavino tile throughout the building, and mechanical equipment is in dire need of modernization. Though few deny the need for repairs to the infrastructure, some observers have criticized the grandiosity of the project. □

Low-rise offices have design ambitions

To make a design statement, there's no need to start from scratch. In Southern California, Eric Owen Moss has designed two low-rise office buildings that integrate, replace, or sequentially demolish existing small buildings.

Samitaur 3 (1), located in an industrial section of southwestern Los Angeles, will utilize an overhead office wing joining two long buildings used for light manufacturing. The new offices will cover a roadway for trucks. The street entrance is marked by a large conical element that provides an open deck and stairs, as well as identification. The single floor of offices increases in height to a story and a half, a volume that will contain the board room. Because fire codes required that the new

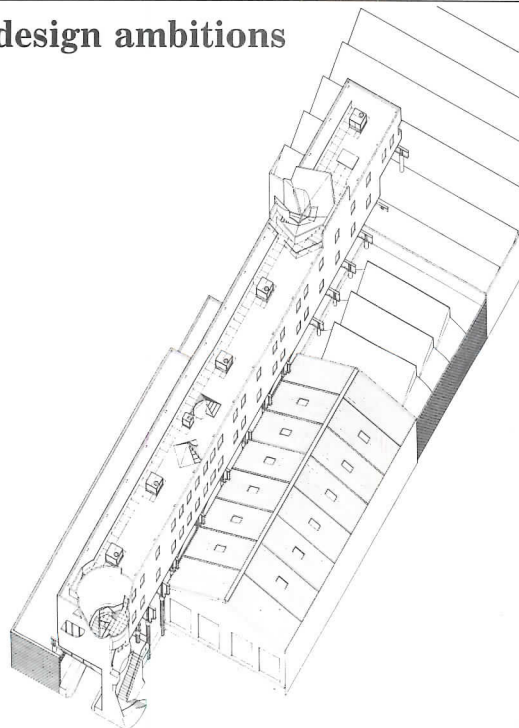

1



2

floor clear the old roofs, daylight is admitted beneath the floor to illuminate the covered roadway. The architects hope that the entire complex will eventually be used for offices and that the covered road will become a promenade.

The Gary Group (2), a complex of four small buildings for a public-relations firm in Culver City, will replace four old buildings with four new buildings, in order as new ones are needed and old ones demolished. Moss calls this a "very free" design, the new buildings serving basically as spare parts. For the building along the street front, the back-tilted facade acts as a billboard. A flying staircase connects the top floor with the roof but is essentially a viewing platform. □

We don't go to pieces in a crisis.

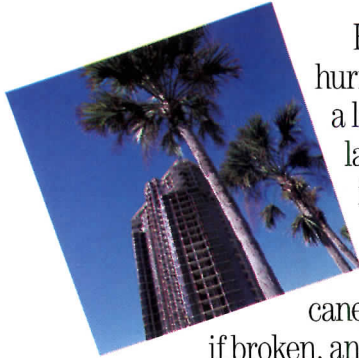

Everybody knows how destructive hurricanes can be. That's why Risher Hall, a leading glass consultant, specified laminated glass with Saflex® interlayer for the LeParc Condo Project in Naples, Florida.

He knows it can withstand hurricane-force winds. It tends to remain intact if broken, and therefore can continue to offer protection against wind-blown debris. It meets the toughest building codes. And it provides



© Monsanto Company, 1990. ® Registered trademark of Monsanto.

added safety, security and sound control, plus protection against solar heat gain and damaging UV radiation.

For more information on how well laminated glass stands up in a crisis, send for our free *Guide To The Structural Performance Of Laminated Architectural Glass* and software package. Just complete and mail in the coupon below, call 1-800-24-TOUGH, or write Monsanto, Dept. 204, 800 N. Lindbergh Blvd., St. Louis, MO 63167.

Please send me your free *Guide To The Structural Performance of Laminated Architectural Glass* and software program.

Name _____
Title _____
Company _____
Address _____
City _____ State _____ Zip _____
Telephone (_____) _____ AR-6-90



Tough glass for tough problems

Briefs

New architectural school: the architect Herman Hertzberger will serve as chairman of the Berlage Institute in Amsterdam, a new postgraduate school of architecture with an international team of architect/lecturers; it will have its first academic session this fall. For information: The Berlage Institute, P. O. Box 7042, 1007 JA Amsterdam, The Netherlands.

McGraw-Hill as landmark: the U. S. Department of the Interior has designated McGraw-Hill's former headquarters a national landmark. The green brick and porcelain-enamel tower, built in Manhattan in 1931, was designed by Raymond Hood.

Rome Prizes were won this year by two architects, both practicing in Princeton, New Jersey: Jason H. Ramos, with the Hillier Group, and Christian Zapatka, with Michael Graves Architect. The fellowships offer a year of living and working at the American Academy in Rome. Other fellows include architectural photographer Steven Brooke of Miami, and landscape architect Peter Lindsay Schaudt, with the North Carolina firm Clark Tribble Harris and Li, Architects.

Graphics honors: in its annual awards program, the Society of Publication Designers cited the overall design of ARCHITECTURAL RECORD's Mid-September 1989 issue, Record Interiors 1989, as a merit award winner; the magazine's February 1989 cover received the same honor.

More awards: Harry G. Robinson, III, Dean of the Howard University School of Architecture and Planning in Washington, D. C., will receive the AIA's Whitney M. Young, Jr., Citation. He was particularly commended for establishing Howard as a center for dialogue and research on black American architects.

Architectural commissions: Antoine Predock, Albuquerque, as design architect, and Conroy-Hedrick Associates, Phoenix, as executive architects, have been commissioned for the first phase of the Museum of Science and Technology in Phoenix; RTKL Associates of Baltimore will design a federal prison near Cumberland, Maryland.

Major Addition Will Expand the University of Miami's Library

Though opened less than 30 years ago, the University of Miami's Otto G. Richter Library in Coral Gables some time ago fell short of the school's needs. An expansion planned by Koetter, Kim & Associates of Boston will add a three-story colonnaded stucco wing and will expand the existing 200,000-square-foot library by another 100,000 square feet. The top two floors of the new building will become a double-height main reading room.

The design will also renovate the present mid-rise library, which will acquire a corner tower to house new vertical circulation.

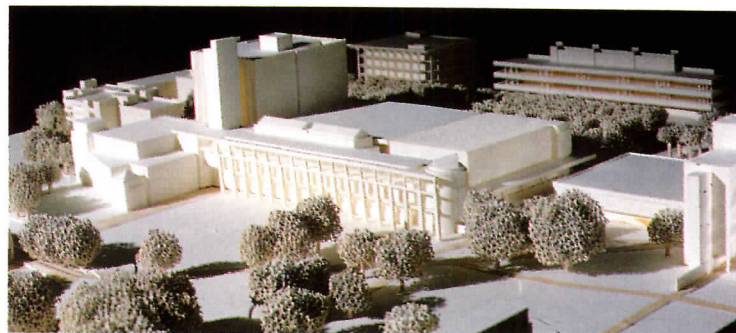

A library wing defines a quad at the University of Miami.

Functioning as a prominent element within the campus plan, the building will also serve to define a new central green. Designer Fred Koetter hopes that

the large round tower at one end of the colonnade will entice pedestrians around the corner of the library to reach the formal tree plantations behind. □

Jerusalem City Hall Square Designed for People

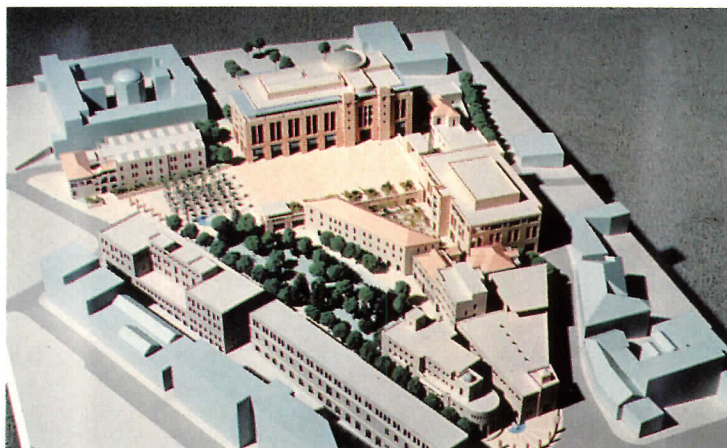

City Hall Square will open to both sides of Jerusalem.

Though the city of Jerusalem can hardly be thought of as a typical municipality, it needs the same governmental services

and facilities as any other town. To this end, it is currently constructing a new city hall with a major public square.

The new complex, planned and designed by Toronto architects A. J. Diamond, Donald Schmitt and Company, will have four new buildings, including the city hall, and 11 restored historic buildings. The triangular site straddles the border between East and West Jerusalem, and the five-story city hall will occupy its highest point at the northeast corner. The top floor will command views of the Old City to the southeast.

The square, with access to both parts of the city, will be deliberately nonmonumental. Instead, narrow paths, casual seating, fountains, shade — and views — will encourage public use. Associates are Volker Volker Epstein Architects, Bugod Figueiredo Krendel Architects, and Meltzer Igra Architects, all of Jerusalem. □

Tokyo Club Mixes Sports and Society

The Keihin Tennis and Sports Club will combine not only the social and physical aspects of games but also the disciplined formality of traditional athletics like swimming and running, along with the jazzy freedom of modern exercises like aerobics.

Designed by Albert C. Martin & Associates for suburban Tokyo, the complex encompasses two new buildings and existing covered tennis courts. The three-story Sports Club (right) will have an undulating wall of

multicolored, multitextured glass, which when lit from inside will disclose athletes at work. Underwater swimmers in a dive tank at the building's corner will also be visible.

The Tennis Club (not shown) will be located at the far end of the site behind the covered courts, and will be smaller than, though similar in appearance to, the Sports Club. □

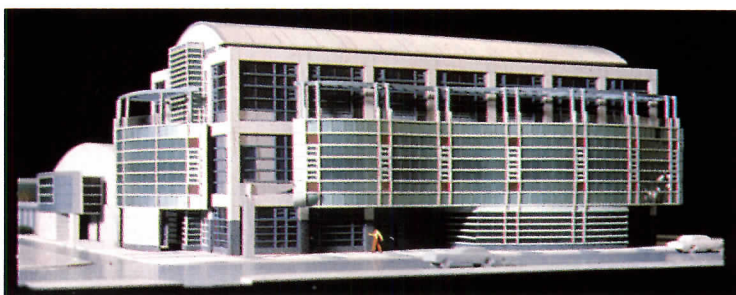

A serpentine wall will reveal athletes inside.



NOW ACHIEVEMENT™ VINYL TILE LETS YOU GET JUST WHAT YOU'RE AFTER.

It's always been hard to get your hands on a vinyl tile that offers color, variety and a true range of exciting possibilities in terms of high design.

But now it's all within your grasp. When you design with Achievement, from Flexco. Featuring 10 distinctive hues and a sophisticated, classic pattern, Achievement's flecked textured surface looks great while it hides scratches, nicks and stains in any high traffic area. You can also get Flexco's

Achievement in 10 solid colors, for bands, borders and spot accent colors to compliment any color scheme.

In fact, with its beauty, versatility, low maintenance and pure vinyl durability, you might just say Achievement is the cat's meow.

For samples and information see your nearest Flexco distributor, or contact FLEXCO Company, P. O. Box 81368, Atlanta, GA 30366. (800) 933-3151.



F L E X C O

WORKING FLOORS FOR THE WORKING ENVIRONMENT

Circle 14 on inquiry card

Boston Hospital Means to Fit Easily Into the South End

Boston City Hospital has been a landmark in the South End since it was founded after the great city fire of 1872 — a fixture both as teaching hospital and as a primary-care facility for nearby residents. But though the outworn pavilions had to be superseded by inpatient replacement facilities (right), treatment could not be interrupted. The phased program called for the temporary removal of patients, the demolition of three buildings, and, starting next month, construction of a new building designed by Hoskins Scott Taylor and Partners/CANNON in an architectural joint venture.

To forestall any sense of intimidation, the eight-story build-



Boston City's inpatient wing will join its outpatient center.

ing aims for an unassuming scale. The stone and brick facade is fashioned after the old hospital's remaining pavilions

and the district's Victorian row-houses. A glass solarium covers a bridge to the existing Ambulatory Care Center. □

Competition Calendar

•“The American Express Historic Preservation Awards Program for the Caribbean: 1990-1992” will present annual awards for the next three years to both completed and contemplated preservation projects in the Caribbean. The competition is sponsored by the American Express Philanthropic Program in cooperation with the Caribbean Tourism Organization.

One project in development will receive as much as \$10,000 seed money, while completed projects will receive a silver medal or other trophy. The deadline for entries is July 1. For information: Russell V. Keune, Vice President for Programs, US/ICOMOS, Decatur House, 1600 H Street., N. W., Washington, D. C. 20006 (202/842-1866).

•The New World Center Foundation, an arm of Miami's Downtown Development Authority, and the Miami Chapter of the American Institute of Architects will cosponsor a competition for the design of “the architectural enhancement and illumination of the new Brickell Avenue Bridge.” Each of five finalists will receive \$5,000, and it is intended that the winning entrant be retained to execute the project. Registration is due by August 20, and submissions by November 2. The jurors will be William Lam, Rodolfo Machado, and Elizabeth Plater-Zyberk. For information: Clyde Judson, Downtown Development Authority, 1818 One Biscayne Tower, Miami, Florida 33131. □

An Ongoing Relationship of Architects and Scientists

A biological research campus at Cold Spring Harbor, New York, is expanding to include a new laboratory for neuroscience. The 50,000-square-foot project continues a 17-year collaboration be-

tween Centerbrook Architects, of Essex, Connecticut, and lab director James Watson.

The red and brown brick laboratory nestles in a hillside with views of the harbor. Mechanical systems occupy the top floor. Centerbrook also designed a separate 60-room lodge for international visitors who come to the lab and take courses there.

SUSAN R. BLEZNICK

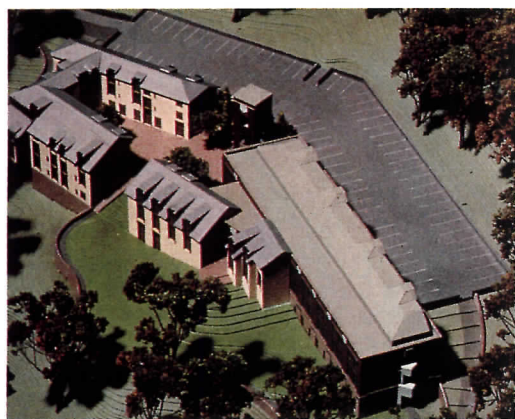

The lodge (far left) faces labs.

Building Briefs

1. **HomeWorld**, designed for suburban Toronto by the Zeidler Roberts Partnership, may be a new mixed-use building type: Eberhard Zeidler describes the sandstone, copper, and fabric building as “a shopping mall, a home store, a factory outlet, a designer's walk, an entertainment center, a learning place . . .”

2. **The Golda Meir Center** in Tel Aviv will offer a 1,650-seat house for the Israel Opera, a 1,000-seat concert hall, and two theaters, as well as offices and apartments. Tel Aviv architect Yacov Rechter used the buildings to enclose a central plaza as an outdoor foyer, “like piazzas in Italian cities.”

3. **Borodinskaya Center**, a Moscow office building, combines

perestroika and glasnost. An American team — Boston architects SBA/Steffian Bradley Associates and developers Millpond International — will work

with the Moscow High-Rise Housing Authority to convert a three-story apartment house into a five-story office building for Western businesses.

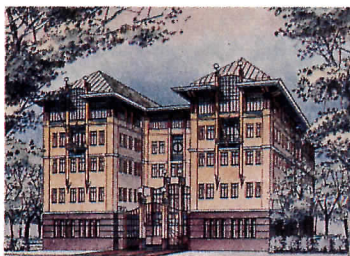
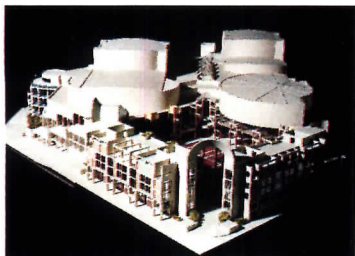

Stop \$75 million from going up in smoke.

Money seems to be no object when it comes to making a high rise impressive. Yet, too often, budgets seem to run dry when it comes to fire containment systems that improve occupant safety.

Cut corners by specifying low-melt-point foam or glass fiber insulations, and risk the spread of fire and deadly gases when they break down. Install sprinklers to improve fire safety, but smoke and fire still might not be effectively contained, causing fatalities away from the source.

A tested, reliable method for containing fire and smoke to the floor of origin is the THERMAFIBER™ Fire/Smoke Stop System. By sealing off all perimeter openings with foil-faced THERMAFIBER® curtain wall insulation, safing insulation and SMOKE SEAL™ compound, and filling poke-through openings as well, fire and smoke can be effectively contained.* The added protection costs little more than assemblies using insulations that are not fire resistant.

Experts agree that the first line of defense against fire and smoke is containment.

It's also the most sensible way to keep a lot more than property from going up in smoke.

*Test results and system information are published in our brochure "THERMAFIBER Life Safety Insulation Systems." For a copy, write USG Interiors, Inc., Thermafiber Division, 101 South Wacker Drive, Chicago, IL 60606-4385, Dept. AR690

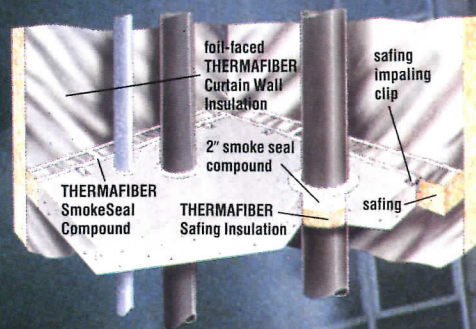

USG

Copyright 1989, USG Interiors, Inc.

USG Interiors, Inc.
Thermafiber Division

Circle 15 on inquiry card

Two Office Towers Will Rise in Boston



© STEVE ROSENTHAL

125 High Street in Boston will have twin towers.

Two office towers joined by a 10-story skylit atrium will rise above Boston's downtown skyline over the next two years. The 21- and 30-story towers are components of 125 High Street, designed by Jung/Brannen Associates, Boston.

In addition to three existing 19th-century brick warehouses that will be renovated, 125 High Street will have an elaborately

ornamented marble and glass atrium devoted to public use.

Offices for New England Telephone will occupy part of the towers, and the rest will be speculative office space, according to project director Norman Adams. Shops and restaurants will be located on the ground level, along with a city fire station and an ambulance facility.

SUSAN R. BLEZNICK

Downtown Center Mixes Old And New

Palmer Center, a mixed-use redevelopment that focuses on a landscaped courtyard in down-



New offices overlook the Palmer Center courtyard.

town Colorado Springs, is a joint venture of the Klipp Partnership, Denver, and Kohn Pederson Fox, of New York City. The project incorporates an existing 14-story building and a new 16-story office tower, a hotel, a conference center, and retail space, master planned by both firms.

"We're trying to provide a focal point for downtown Colorado Springs," explained Greg Cromer, an associate of the Klipp Partnership. Toward that end, the plan calls for a mix of the new and the old. A new, almost two-acre courtyard will become the entry for the Antlers, a venerable hotel that has long served as a symbolic gateway from the city to Pikes Peak. All the buildings connect via a new continuous, enclosed arcade that wraps around three sides of the landscaped courtyard.

S. R. B.

Layered Lights Top Baltimore Tower

Boasting a 40-foot-high grand entrance lobby and views of Baltimore's harbor, 300 East Pratt will rise 33 stories. The site is the last undeveloped parcel remaining on the northern edge of Baltimore's Inner Harbor.

Kevin Roche John Dinkeloo and Associates designed 300 East Pratt, which is capped by a five-story-high prismatic beacon that glows from within at night.

The building will be clad in gray granite and glass, and all floors above the eighth story will have 12 corner offices. The tower will occupy an approximately 1.25-acre site, half of which will be a landscaped plaza.

Though the ground floor will house a small amount of retail space, the remainder of the building will be occupied by offices. An anchor tenant has not been determined yet, according to Tom Brodie, of Lazard Realty, Inc., a New York-based real-estate development and investment firm that formed a joint venture with Nationale Nederlanden, N.V., to build the tower. Construction will cost an estimated \$150 million.

S. R. B.

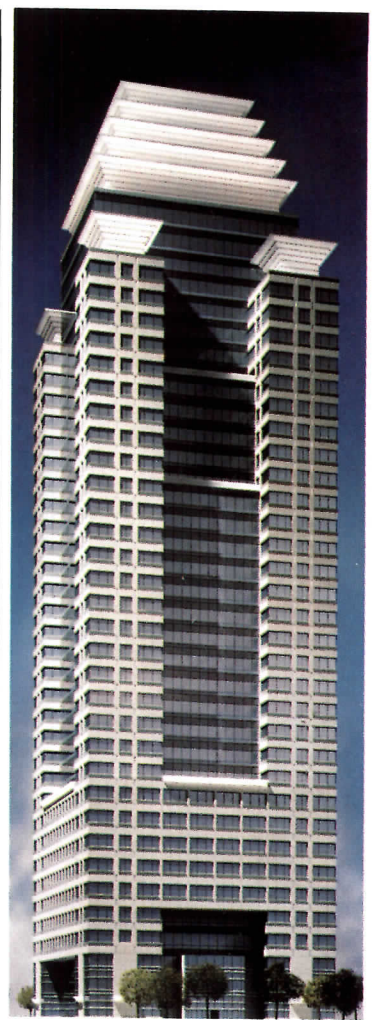

Baltimore's 300 E. Pratt Street overlooks the harbor.

Tricks of The Trade: Hidden Research Equipment

Although it sounds like something out of the movie *ET*, the Department of Terrestrial Magnetism is part of the down-to-earth Carnegie Institution of Washington. With a work force consisting primarily of astronomers, seismologists, geologists, and chemists, the department and a geophysical laboratory will be consolidated in a new facility in Washington, D. C. The new building will be located next to a brick laboratory with a tile roof built in 1912.

Peirce Pierce & Kramer, of

Cambridge, Massachusetts, designed the three-story building, which sits on a steeply sloping site in a residential neighborhood. The designers took special care to disguise required laboratory equipment, explained architect Robert Kramer, and a metal sloped roof encloses the mechanical floor, which contains, among other things, cooling towers and 50-foot-long air-handling units. Concealing those units helped avoid disrupting the residential character of the neighborhood.

S. R. B.



Geotechnical labs in Washington have a residential scale.

1990 DESIGN AWARDS, CALIFORNIA COUNCIL, AIA



1



2

STEVE SIMMONS



3

RANDALL J. CORCORAN



4

FARSHID ASSASSI



5

JOHN GOLDMAN



6

MARK DARLEY



7

STEVEN EVANS



8

RYAN ROULETTE

The 25-Year Award, given each year by the California Council of the American Institute of Architects (CCAIA) for a 25-year-old building of "enduring significance," goes this year to the (1) **Marin County Civic Center, San Rafael**, Frank Lloyd Wright's last commissioned design. The Firm Award, which is given to a practice that has produced distinguished architecture over 10 or more years, went to LPA (formerly Leason Pomeroy Associates) of Orange County, Los Angeles, San Diego, and Sacramento. Others receiving awards:

2. **Thornhill House, Davis**; LPA, Architects (Honor Award). The jury said that this large house in an almond orchard "gives you a sense of place and progression and the ability to linger within any space."

3. **Edgemar Development, Santa Monica**; Frank O. Gehry & Associates, Inc., Architects (Honor Award). In this Santa Monica combination of museum and commerce, "Gehry has summed up the very nature of Southern California."

4. **Leon Max Los Angeles Showroom, Los Angeles**; Morphosis Architects (Honor

Award). While calling the designers of this apparel showroom "the rock stars of architecture," the jury found their precise drawings "a tribute to the clarity of [their] thinking."

5. **Biedeman Place Townhouses, San Francisco**; Daniel Solomon & John Goldman, Architects (Honor Award). These small rowhouses "capture the exuberance of old Victorians with minimal means."

6. **Berggruen House, Napa County**; Fernau & Hartman, Architects (Honor Award). The jury thought that this collection of new wood and tin vernacular

structures "sets a high standard for 'critical regionalism.'"

7. **Chiat/Day/Mojo, Toronto**; Frank O. Gehry & Associates, Inc., Architects (Honor Award). The jury thought this advertising office "one of Frank Gehry's best" designs.

8. **The Mills Building/MTS Headquarters, San Diego**; Delawie/Bretton/Wilkes Associates, Architects (Honor Award). The landmark building at the hub of the city's light-rail lines "gets all its strength from good proportions."

9. **Hollis Street Project, Emeryville**; Banta Collins, Archi-

Since one in five American architects now practices in California, CCAIA's judgments on the quality of regional architecture have unusual import.

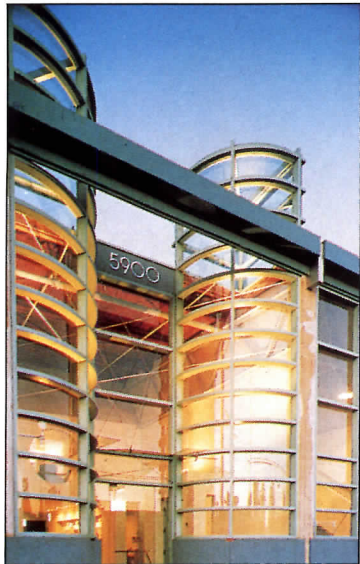

9 ANDREW MCKINNEY



10

TOM RIDER



11

STEPHEN FRIDGE



12

©TOM BONNER



13

H. S. BARAM



14

BRUCE STERNBERG



17

RICHARD BARNES



15



16

BRUCE STERNBERG

tect (Merit Award). The conversion of warehouse to offices has "a lot of verve."

10. Petaluma Community Center, Petaluma; Roland/Miller/Associates (Merit Award). The building combines recreation and community services, and is "clearly an anchor in the town."

11. Lincoln Plaza, Sacramento; Dreyfus & Blackford Architects (Merit Award). The jury said, "The luxuriant plantings seem to make [the offices] less building than landscape."

12. Seaview Terraces, Malibu; Goldman/Firth/Architects (Merit Award). Considering the

complex of three small office buildings, the jury liked "the simple, almost industrial forms . . . cascading down the hillside."

13. Cannery Row Garage, Monterey; Hall Goodhue Haisley and Barker, Architects (Merit Award). The jury found the "profiles, corrugated metal, and color reminiscent of the Wild West."

14. Coalinga Community Swim Complex, Coalinga; Edwin S. Darden Associates, Inc. Architects (Merit Award). The two pools are covered with canvas and metal forms "in a playful manner."

15. Winward Circle Redevelopment, Venice; Steven Ehrlich AIA Architects (Merit Award). "A charming ensemble," the mixed-use buildings are sited at a juncture of Venice's canals.

16. Imogen Apartments, Los Angeles; Bruce Sternberg and Associates, Architect (Merit/People in Architecture Award). The jury liked the breakdown of scale in the low-income family housing complex.

17. Mendelsohn House, San Francisco; Robert Herman Associates, Inc. (Merit/People in Architecture Award). The jury appreciated that the downtown

housing did not "put [the elderly] in a remote part of the city."

Design Awards jurors were Sarah Harkness, The Architects Collaborative, Boston; Margaret McCurry, Tigerman McCurry, Chicago; and James Stewart Polshek, New York City. Council Honors jurors were photographer Morley Baer; architect Henrick Bull; CCAIA Student Director Robert Habian; CCAIA Associate Director North George Landistoy; Dean Marvin Maleaha, Cal Poly Pomona; CCAIA President Larry Segrue; and Norma Sklarek of The Jerde Partnership.

THE FUTURE IS NOW

Harvard GSD's inventive computer-system setup.

Computing is far more than CAD at Harvard's Graduate School of Design. Architecture students there are required to take a one-semester course that acquaints them with rendering-like drawing techniques, collection and use of data, and a bit of Pascal and Hypercard programming, as well as computer-assisted drafting. Harvard's approach, and what it means for architects, planners, and landscape architects, was discussed in a day-long symposium for professionals and software and hardware vendors this spring. Although the meeting was keynoted by Scott McNealy, president of Sun Microsystems, no vendor got much of an edge. In fact, Harvard has managed to hook an eclectic collection of equipment to its Sun NSF UNIX network. There's a preponderance of Macintoshes, plenty of Sun 386i machines, some IBM RTs, and even some old IBM XTs. Most of the computers use software loaded into them "locally" at the machine itself and rely on the network only for retrieving and storing data, and for creating output. The result is that students can use the system

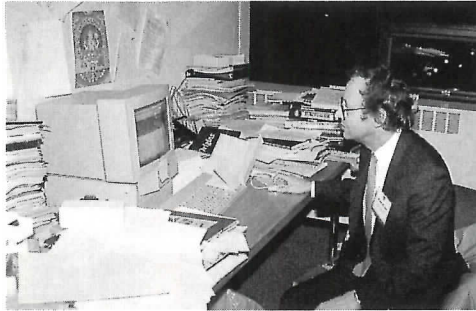

Professor William J. Mitchell retrieves a file in his office.

for almost anything, all at the same time.

Much of the computing power of GSD's 75-machine network is, in fact, devoted to image storage and manipulation, rather than the production of working drawings. "Students can model an idea and present it in a way that a client and public bodies can understand it," said William Mitchell of GSD. Students can, for instance, use the computer to create a rendered drawing of a building, and then place the drawing into an actual photograph of the site, complete

with surrounding structures.

Until now, the computer has been used mainly to make existing tasks more efficient, said Douglas Stoker, president of AESi. Stoker, who helped develop computer systems at Skidmore, Owings & Merrill, said this involves making the computer do what a camera, or model, or drawing does. For example, the computer can now be used to render a drawing of light and shadow, given lighting sources the architect specifies. Harvard students have used computers to produce almost photographic-like renderings from CAD drawings. Why not simply tell the computer where you want the light, and let it make suggestions? At present computing speeds, the number of calculations needed would tie up the computer too long. Faster computers are available, but at too high a price. He also said SOM had, block by block, built up a large database of most buildings in Chicago, their profiles and where they cast shadows, because the firm does so many projects there. The data—computerized files of the buildings as they exist

Commercial spec-grade Decora

Decora is now available in a full line of Commercial Spec-Grade wiring devices designed to enhance any interior and deliver top performance in demanding commercial applications.

Best of all, when you specify Decora Commercial Spec-Grade, you get all the devices you need for virtually any remodeling or new construction project; you get all specification-grade switches (identified **DCS**), illuminated or pilot light in 15 and 20 amp ratings. Commercial Spec-Grade receptacles (identified **DCR**), which meet the latest Federal Spec; isolated grounding, GFCI's, surge suppressors, Commercial Spec-Grade dimmers and more.

Easy to install and built to last, Decora delivers the quality accent, performance, and reliability that add value to your projects.



now—can be sold in their own right, to aid in planning.

Stoker admits the data are not perfect (new buildings go up, old buildings come down), but that they do not have to be. "We use the computer to communicate rather than to document" the context in which the new structures would sit.

The technology can change the role of architects in other ways, too, he said. "Architects describe things that are not there. Documentation is a consequence of design, not an objective. If you use a computer system to design ducts, you can send the data to a metal-cutting computer, legal issues aside."

Is what Harvard wants to do worth doing? Harvard faculty members admitted some of the tasks are not yet economically worthwhile for the typical practice. But they defended their approach as helping students to better visualize their designs, especially in the context of specific sites. That is, computing helps produce better architects. That's a worthy goal, even if they may not step into a professional environment that emphasizes computers.

And, of course, tasks that are too expensive or too cumbersome for widespread handling on the computer today will become commonplace as computing power continues to get cheaper and easier to use. McNealy said the least powerful computer

GSD's 75-machine network is devoted to image storage and manipulation rather than working drawings.

Sun sells is rated at 12 million instructions per second (MIPS). The fastest new 80386- and 80486-based computers run at about 5 MIPS. Three or four years from now, computers of about the same \$15,000 price per seat will handle 100 MIPS.

The new equipment will be needed if large projects are to be totally computerized. "There are 300 megabytes of information in a typical building," said Stoker. "Little software programs do not deal with that amount of information. Computers can take us to places we've never been."

Stephen Ervin, assistant professor of landscape architecture at GSD, and Carl Steinitz, professor of landscape architec-

ture and planning, described studies of the Massachusetts Turnpike, for example, that could lead to a safer highway as well as one that is more pleasant to drive. One design study, for a structure in the median that would distract drivers from looking at the ugly roadside, uses computer-generated motion pictures to visualize how the structure would look the way drivers will see it as they move at about 60 miles per hour rather than standing still.

John Dyer, of Dyer/Brown, Boston, said it was becoming easier to find designers who are comfortable with CAD. But he still "has frustration with computer people," he said. "We still build models. I'm a very tactile person."

John Sviokla of the Harvard Business School said architects are facing the same challenge the computer has brought to other professions, such as law, medicine, and even stock brokers. "The computer is not like other, older tools," he said. "The computer embodies some design ability. It is not like the telephone or the parallel rule." Organizations and architectural practices will evolve to accommodate computing, he said.

Stoker put it another way. If you are going to get hit by a freight train, he said, make sure it is heading in the direction you want to go. The direction? About 1,000 MIPS at the turn of the century. □

the most in performance and style.

Experience the beauty and brawn of Decora. Send us your business card and get a free 20 amp Commercial Spec-Grade illuminated switch and a complete literature package.

Leviton Manufacturing Co., Inc., 59-25 Little Neck Parkway, Little Neck, NY 11362-2591, (718) 229-4040, ext. 6486. In Canada, Leviton Manufacturing of Canada, Ltd., 165 Hymus Blvd., Point-Claire, Quebec, H9R 1G2 or call (514) 954-1840.

LEVITON

Turn on the
power of
Leviton
The industry's choice for all construction.

Circle 16 on inquiry card



Drowning In Doubtful Information? Stay Afloat With Sweet's.

It's rough finding product information when you're drowning in catalogs and floundering in "junk mail." And the information you do come up with may well be incomplete or out of date.

Sweet's organizes and triple indexes hundreds of catalogs filled with detailed product information. *SweetSearch*®, a computerized index of manufacturers' catalogs, makes product searches easier than ever.

BuyLine® finds local representatives for you.

*THAT'S WHY OVER NINE OUT OF 10
ARCHITECTS NOW REACH FOR SWEET'S.*

For more information on how Sweet's can help you: Call 1-800-421-9330 or circle and return the reader service card today.

Sweet's General Building & Renovation Catalog File
Information to Build On



SWEET'S
McGraw-Hill Information Services Company
1221 Avenue of the Americas
New York, NY 10020

Fax 1-212-512-4302

Circle 49 on inquiry card



IDEAS IN FLIGHT

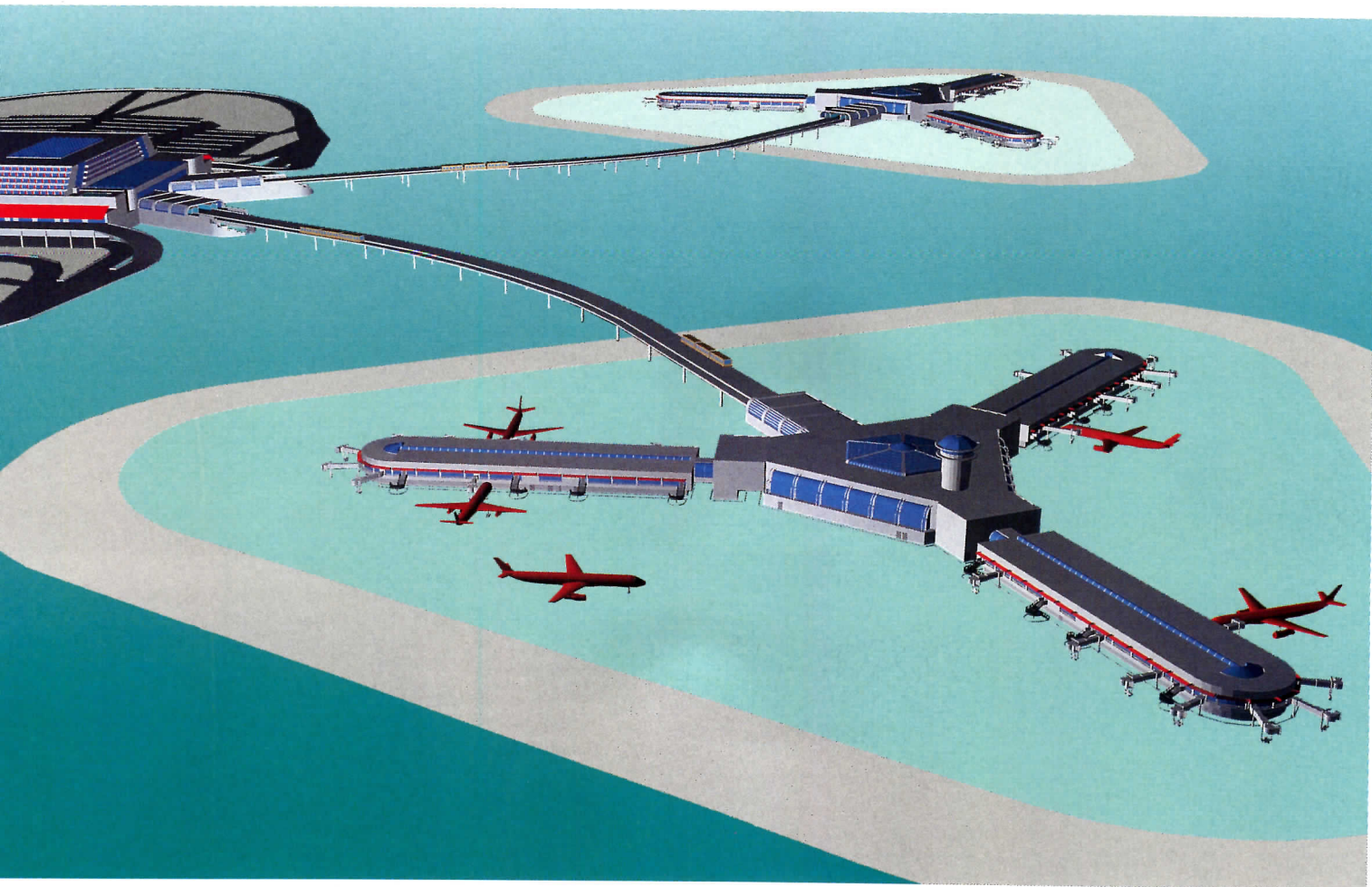

Expanding The Orlando International Airport

You would imagine that an airport-sized project could be tackled only by a large architectural firm with rooms full of engineers and designers. They'd probably use expensive mainframe-based CAD systems, as well. And more likely than not, the job would run over budget and past the deadline. That's the way it usually goes on projects like this.

But not on the expansion of the Orlando International Airport. The project was headed up by a relatively small firm, KBJ Architects Inc. of Jacksonville, FL, who directed a team of independent consultants, and finished the job on time and without cost over-runs.

One reason that KBJ was so successful was that they produced most of their design and engineering drawings on a personal computer-based CAD system. After extensive research, KBJ selected AutoCAD, from Autodesk, Inc. They based their choice on AutoCAD's

affordability, ease of learning (they had little previous computer experience), its flexibility to be customized to the many tasks in the project, and its widespread use, which allowed them to easily exchange data and drawings between all their consultants.

A FAST GROWING AIRPORT

Designated as a major hub by the FAA, the Orlando International Airport averages over 800 commercial flights a day to more than 100 cities. Today it is the fastest-growing metropolitan airport in the U.S., with a capacity far beyond that imagined by the original planners when it was first converted from an Air Force Base to a commercial facility in the late 1950s.

Since then, Central Florida has undergone tremendous surges in growth. The NASA Space Center was developed at Cape Canaveral, sparking the space boom of the

Roland adds an important point to its most advanced plotter line.



With the industry's most versatile pencil capability, Roland's new DPX-3500/2500 plotters make drawing revisions effortless.



When revisions put you under pressure, having pencil drawings you can erase and quickly change means you'll meet your deadlines.

That's why Roland's DPX plotter series is optimized for pencil. The unique flatbed design lets you use nearly any standard media type, weight or thickness, without worrying about tearing from pencil pressure. Unlike roller plotters, you can draw right to the edge of the paper – especially important for title blocks – and see your entire drawing as it plots.

The DPX-3500/2500 incorporates the latest Roland technology... intelligent enough to set itself up with any computer, while automatically sorting pens and pencils for maximum drawing efficiency. The one-megabyte memory buffer accepts your entire drawing at once, so you can get on with your work... or replot as many times as you wish.

We'll be happy to show you even more capabilities. For the name of your nearest Roland dealer, call (714)975-0560 today. Or write for a catalog of the complete Roland line– the broadest collection of computer output peripherals in the world.

Circle 18 on inquiry card
1961 McGaw Avenue, Irvine, CA 92714
Telephone: (714)975-0560
Fax: (714)975-0569

Roland
DIGITAL GROUP
Technology so advanced, it's simple.

See Roland's plotter line
Demonstrated at A/E/C Systems,
Booth # 1912.

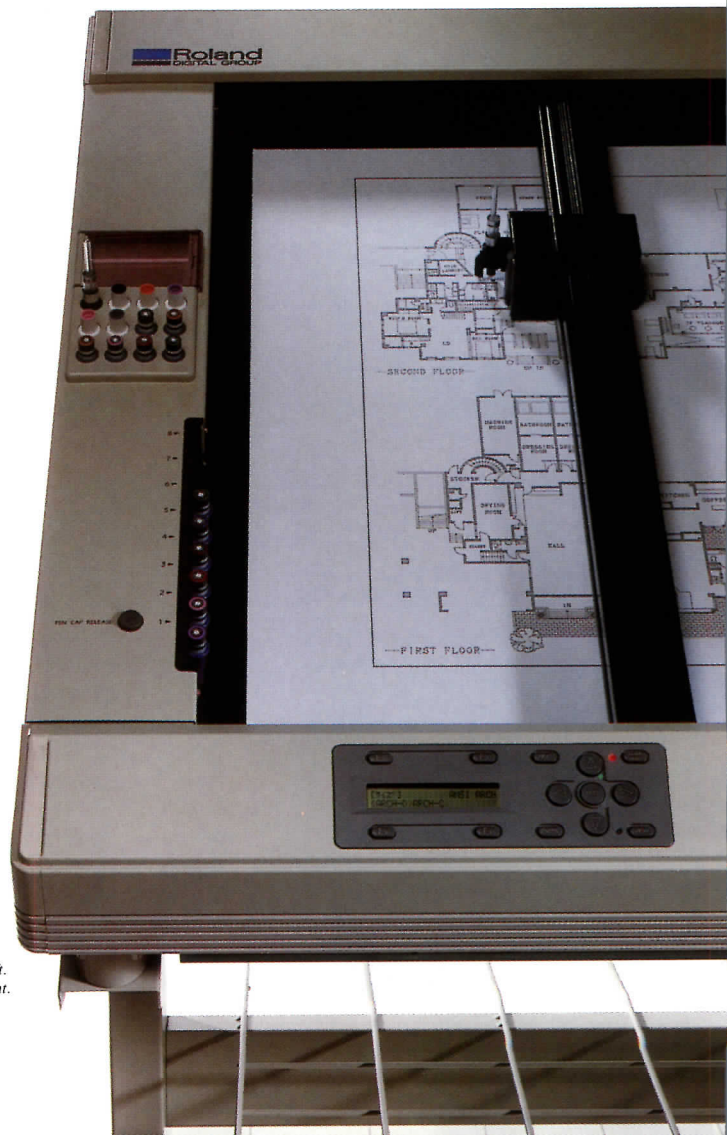

C size DPX-2500 shown top left.
D size DPX-3500 shown at right.

early 1960s. Walt Disney World opened in 1971, a host of other theme parks followed. The millions of tourists annually attracted generated considerable numbers of related hotel and shopping facilities, and provided thousands of new jobs that fueled population growth.

As a result, air traffic through Orlando rapidly increased. The Greater Orlando Aviation Authority (GOAA) hired Greiner, Inc. (an engineering firm specializing in air and ground transportation) to engineer a completely new airport. The number of passengers rose from 1.3 million in the early 1970s when the project started, to over 6 million in the early 1980s, when the new complex was completed. As Construction Manager, Greiner contracted KBJ to handle architectural design.

The new facility was designed as a destination airport. That is, unlike many other major hubs that handle high volumes of passengers flying in, transferring planes, and flying back out again, Orlando is the final destination of most people flying there. Thus, airport planners wanted to minimize walking and maximize conveniences to accommodate this unusual passenger profile.

In the resulting design, ticketing, check-in, baggage claim, rental-car pickup, restaurants, and shops are in a three-level main "landside" terminal. Gates for passenger boarding and deplaning are located in two remote "airside" terminals with concourse wings fanning out at

90 degree angles where the aircraft pull up. Airside and landside terminals are connected by an Automated Ground Transit system (an AGT, commonly known as a people mover) with trains running on an elevated track to shuttle passengers back and forth.

According to the master plan at the time, the airport would handle air traffic demands through the year 2000, at which point it would undergo a major expansion. But, with Orlando growing faster than even the most conservative projections, the increasing passenger traffic prompted GOAA to initiate the expansion ten years ahead of schedule, so that the airport could accommodate the more than 35 million passengers forecast annually through the year 2006.

Because of their involvement in the earlier airport construction, KBJ was awarded the architectural design and engineering contract for the expansion. This expansion project was a major undertaking. Kim Goos, KBJ vice president and leader of their CAD efforts says, "This time around, we had three times as much work to do in one-third the time."

To meet this anticipated demand, GOAA specified a 130% expansion of the airport facilities, involving over one million square feet of floor space. Plans called for: a new 24-gate airside terminal with concourse wings arrayed at 120 degree angles to accommodate larger widebody aircraft, expansion of the existing

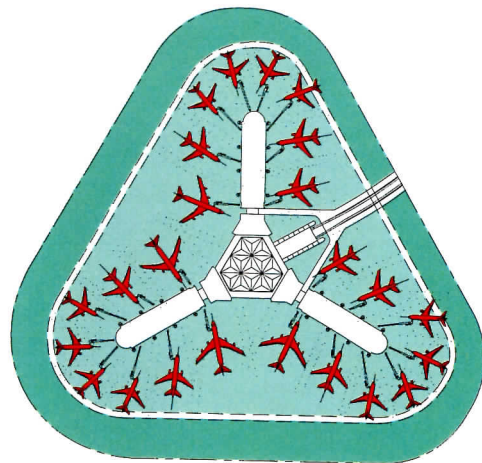

The new airside building features wings arrayed at 120-degree angles to handle a large variety of aircraft. AutoCAD was used to draw the different planes and to check how they would fit the building and surrounding aprons.

As the world's top vacation destination, the Orlando area's rapid growth began over twenty years ago and is still going strong. The first phase of the new Orlando International Airport, highlighted in gray and red, was completed in the early 1980s. With air traffic exceeding all expectations, the Greater Orlando Aviation Authority (GOAA) decided to expand the airport ten years earlier than planned. KBJ Architects, Inc. (Jacksonville, FL) handled the entire project with AutoCAD, the popular design and drafting software package from Autodesk, Inc. The yellow and blue areas show the two new parking decks, the additions to the central "landside" terminal that include a 420-room hotel and seven-story parking deck, and the "people-mover" transit system that shuttles passengers to their gates at the "airside" buildings. Because KBJ shared their AutoCAD drawings with all of their engineering consultants, the first portions of the expansion will open in the summer of 1990, just 39 months after the first design drawings were prepared.

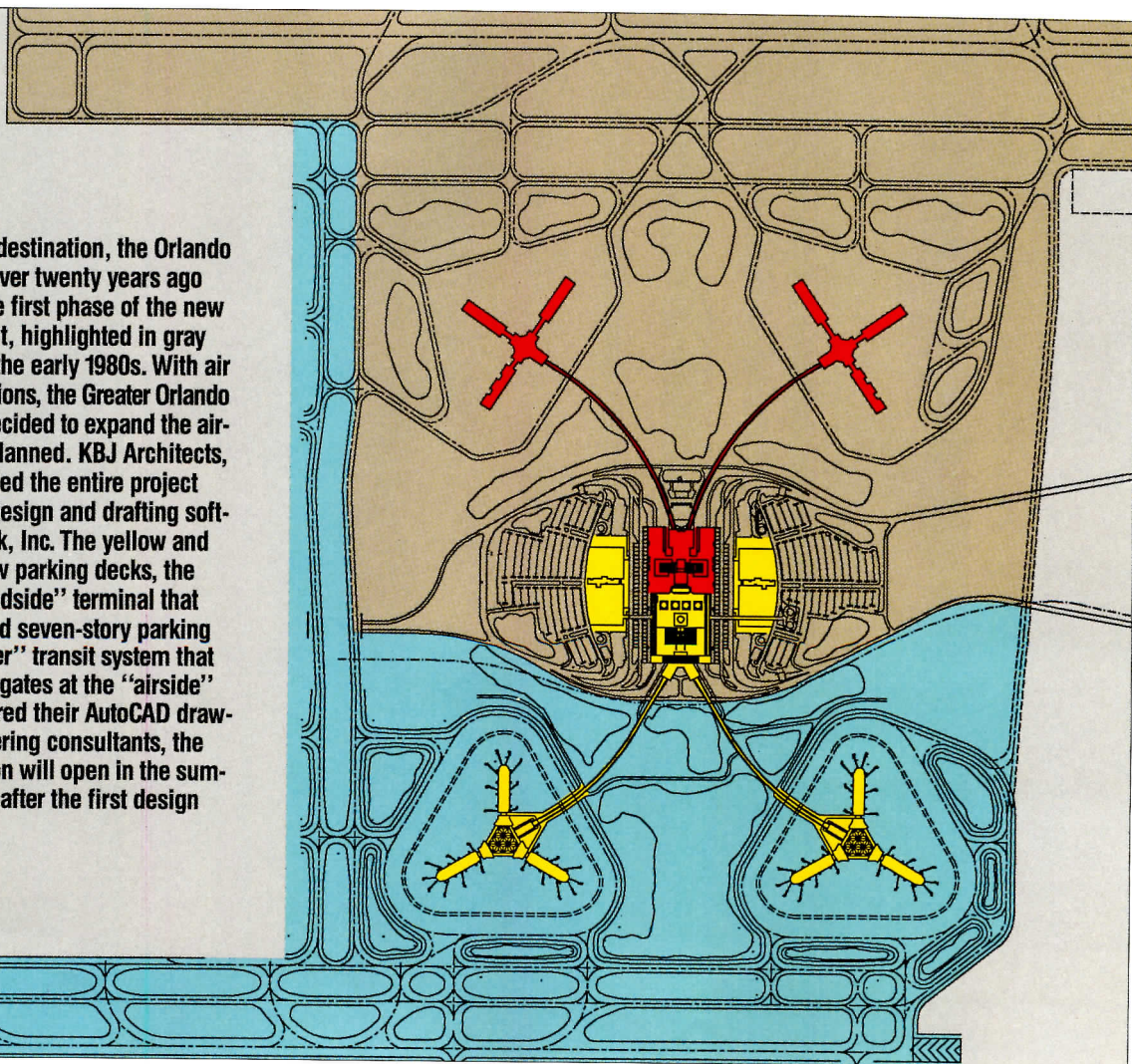

Tomorrow's At Hand...

SweetSearch® Puts Product Data At Your Fingertips



SweetSearch...

The revolutionary new way to help you find the products you need. And it's free!

- Provides electronic access to the more than 23,000 products in Sweet's
- Improves your productivity
- Eliminates wasted time & missed opportunities
- Free to use on as many projects as you want

Call the
Electronic
Sweet's
HelpLine:
1-800-848-9000

Free Demonstration Diskette Available

See how SweetSearch
works on your system!

The Future Is Now.



Sweet's Group/McGraw-Hill, Inc.
1221 Avenue of the Americas
New York, NY 10020
Circle 17 on inquiry card

half of the landside terminal facility and a mirrored replication of this design in a new half, a new 420-room luxury hotel complex attached to the new side of the landside terminal, one 7-story parking garage placed on top of the landside terminal, and an AGT system to the new airside terminal.

The project was to be completed in two parts: the landside terminal facilities and one airside terminal were scheduled to be in service by mid-1990, with the rest to be finished in late 1991. This gave designers only 30 months from the start of the project's conceptual design until an operable passenger facility could be opened. Not much time for such a complex project.

COORDINATING MANY DISCIPLINES

KBJ Architects was responsible for overall architectural design of the airport as well as coordination of the many subcontractors, consultants, and other third parties involved in the project. Mechanical engineering (HVAC, electrical, fire protection) was handled by Newcomb & Boyd of Atlanta, GA. Structural engineering by Kun-Young Chiu & Associates of Valdosta, GA, and O'Kon & Company of Atlanta, and civil engineering by HNTB (Howard, Needles, Tammen & Bergendoff. KBJ also had to deal extensively with rental-car companies as well as Delta Airlines and Hyatt Hotels, which were doing their own facilities design for the airside terminal and hotel. General consulting, i.e.: airspace and operations engineering, runways,

and facilities planning was performed by Greiner, Inc.

Typically, large architectural firms have many of these disciplines working under the same roof. As a relatively small firm, KBJ's strategy was to custom-tailor a project team made up of the best independent specialists around. Their challenge would be to communicate design geometry and specifications to all these parties so all their work meshed together, all in the face of the constant change that is typical in a project of this scope.

KBJ was able to meet this challenge with AutoCAD, which CAD manager Kim Goos describes as an indispensable tool in the project. GOAA specified that a CAD system must be used to produce all plan drawings on the project. KBJ went with AutoCAD on personal computer systems because the mainframe-based systems typically used by larger firms were too expensive, making it impossible to give a workstation to everyone who needed one.

SELECTING A CAD SYSTEM

After evaluating a range of packages, KBJ selected AutoCAD for several reasons. The menu structure made the program easy for them to learn, even though they had little previous computer experience. AutoCAD's embedded programming language allowed KBJ to adapt the program to meet specific needs. There were numerous third-party programs

The airport's first phase, completed in the early 1980s, is a showcase of art and Floridian architecture. Most artistic works, ranging from sculpture to murals, were commissioned especially for the airport. The Florida look is achieved with dramatic combinations of color, textures, foliage, sunlight and open space.

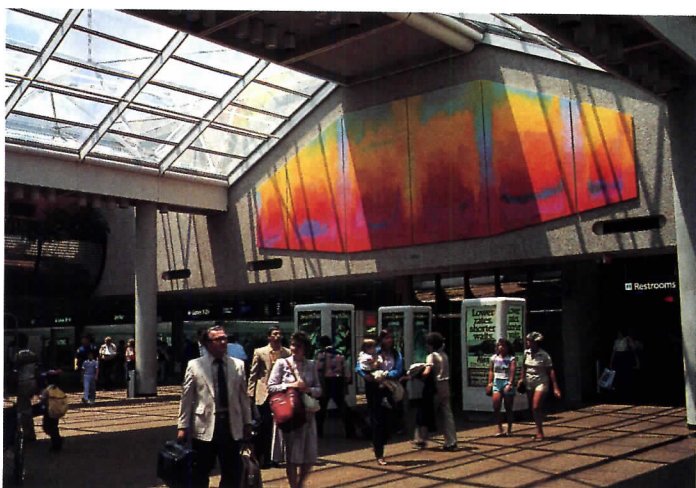

available to enhance the basic package. And it was most likely that their consultants used AutoCAD, since it is used by more engineers than all its competitors combined.

Explains Goos, "AutoCAD gave everyone a way to communicate project data back and forth. With all their associated intelligence, exchanging AutoCAD drawings between disciplines dramatically increased efficiency and accuracy throughout the entire project."

AUTOCAD AIDS THE EXPANSION

KBJ's approach to the Orlando airport expansion was typical of that on any large architectural project. First, a program document is

generated to assimilate the project's diverse requirements. Next, a schematic design gets basic architectural concepts down on paper. In the third phase, design development, cross-section drawings show the basic layout of major features on various levels of the building. These define the architectural "look and feel" of the buildings to the owner and consultants, and allow for creative feedback from everyone involved. Finally, engineers prepare the contract documents, highly detailed production drawings that define precisely how the project will be built.

The program document consists mostly of text and tables and was prepared manually,

in the latest version without any conversions or compatibility problems.

HOW CAD TOOLS HELPED

Several AutoCAD functions were found to be helpful at various stages of the project:

Layering: The technique most extensively used to coordinate the activities of many other engineers and consultants. Information in a master drawing file is strategically categorized into various "overlays" which can be selectively turned on and off according to what's needed at the time.

In most cases, the complete drawing file was supplied to subcontractors, who would then mask every layer except the ones that contained details pertinent to their work. In this way, each user makes a template for their own detailed drawings, without getting slowed by extraneous details. All drawings then originated from a common file, so everyone worked to the same overall building dimensions, speeding the response to changes made during the course of the project.

Mechanical engineers Newcomb & Boyd used an innovative third-party product to take further advantage of AutoCAD's layering capabilities. Using the "template" function of an Nth Engine graphics display card, N&B engineers layered their AutoCAD drawing and created compact "overlay template" files which they then used to produce their trade work drawings. The Nth engine board is designed to use these files in conjunction with AutoCAD drawing files to reduce overall file size and increase drawing speed.

N&B made templates of many cross-section drawings and floor plans with wall layouts. Using these as templates, N&B engineers then produced their own AutoCAD drawings adding details of the mechanical and electrical systems running to and through the walls. N&B also used these functions to generate reflected ceiling plans showing mechanical and electrical connections to lighting and diffuse locations specified on the master drawing.

"Normally, there would have been a set of sepia run off our drawings," explained Goos, discussing the days before CAD. "We would have needed two complete sets of drawing because it would be very hard for us to turn our dimensions on paper. Someone would have laid another piece of paper over the drawing traced a template for the consultant to use. The layering system on the AutoCAD system is a lot faster, easier, and more accurate."

KBJ also sent the same layered master drawing file to their structural engineering consultants, Kun-Young Chiu & Associates and O'Kon & Co. To prepare their designs, both firms used overall building features as well as the size and location of major structural elements such as load-bearing walls, column stairways, and elevator towers.

Structural engineers then go to work, using these drawings as a template for developing their own AutoCAD drawings showing the design of structural steel framework and poured concrete, from the ground up. In the

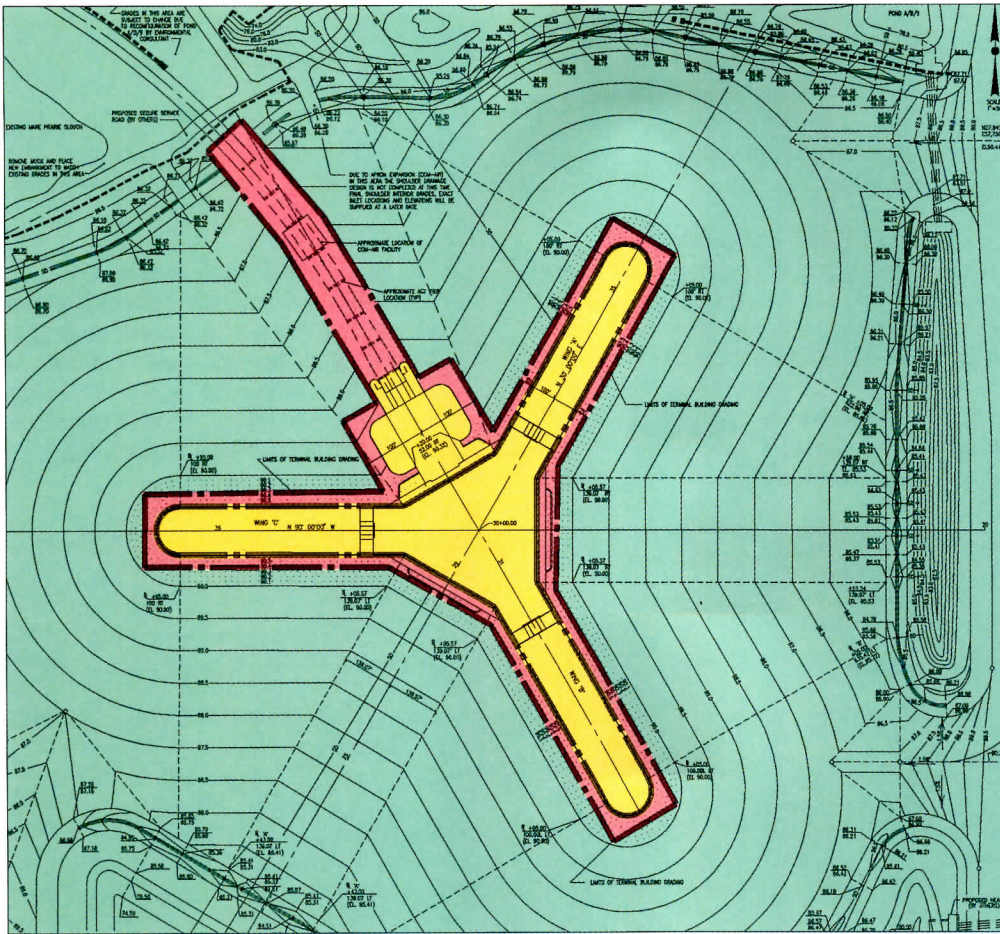

The siting of the airside terminal and many portions of the civil engineering were done with AutoCAD. KBJ worked with HNTB, Inc. (Miami, FL), using AutoCAD to provide surveyor's coordinates that were useful in meshing the land work with the architecture.

AutoCAD was initially used to prepare conceptual drawings in the schematic design phases of the project. The greatest time and cost savings came by using AutoCAD in the most drawing-intensive parts of the process: design development and contract documents.

Explains KBJ's Goos, "This is where the computer became involved to its greatest extent. We saved a tremendous amount of time going from design development to construction documents. Normally, without the computer, that's almost a complete start-over."

KBJ started the project with a 2-dimensional version of AutoCAD. As the project progressed, they began exploring 3-D using the updated AutoCAD Release 9. AutoCAD Release 10 is now in use, and its full 3D design tools are being applied much more heavily in subsequent projects. Most important, the drawings created with earlier releases of AutoCAD can be used

ay, structural engineers design the foundation and skeleton of the building that supports all components of the building such as the roof systems, wall systems, interior partitions, mechanical/electrical systems, as well as live loads such as people and other moving systems which will be applied to the building.

The airport's landside terminal structure is a reinforced concrete two-way rigid frame. The floor system is made of precast joists composited with cast-in-place reinforced concrete decking. Structural steel elements were used at various locations for long spans, with heavily reinforced transfer trusses embedded in the reinforced concrete as well as in the exterior canopies and skylight areas.

Needless to say, conveying proper architectural design data to the structural engineering groups for such a complex structure was one of the critical steps of the project. And coordination between KBJ, Kun-Young Chiu, and O'Kon was particularly important because structural design was carried out almost in parallel with architectural design.

Kun-Young Chiu's W. Brick Rosenbaum tells how the structural engineers proceeded. "Because the project was on a fast track, we were always working ahead of the architect. But we got the overall data we needed from the AutoCAD files. As a result, we were able to start driving piles for the foundation eight months before the final architectural design of the building was completed."

Working in this fashion was complicated by design changes. The structural design of inside levels 4 through 11 (the hotel and parking garage) was revised whenever the lower levels were modified to meet different ceiling height requirements and walkway clearances in the passenger areas. Coordinating these details in a timely fashion was hectic. "On a project like this, timing and coordination of everything," says Goos, "There were just too many details to work out without a computer."

Blocking: Another AutoCAD productivity feature designers found useful in the airport project was blocking. Blocks, which are groups of drawing entities (lines, arcs, etc.) grouped into a compound object, are useful for creating, placing and updating repetitive features. Once a block is drawn and named, it can be placed anywhere in a drawing with a single operation. Then, if a change is made to a block, simple routines can be written to update it wherever it occurs. Blocks can be as simple as symbols for doors and windows, or as complex as a hotel room arrangement or a gate area layout.

In combination with layering, blocking was extremely useful in helping KBJ contend with the mountains of contract drawings needing to be updated to reflect changes.

"The tremendous scope of this project made the management of change quite difficult," explained Goos. "It's the ripple effect. Over 5000 drawings were generated for this airport. So even trivial things snowballed when you looked at how many sheets of drawings they affected. AutoCAD helped us keep up with it all."

3D Features: The ability to work in three

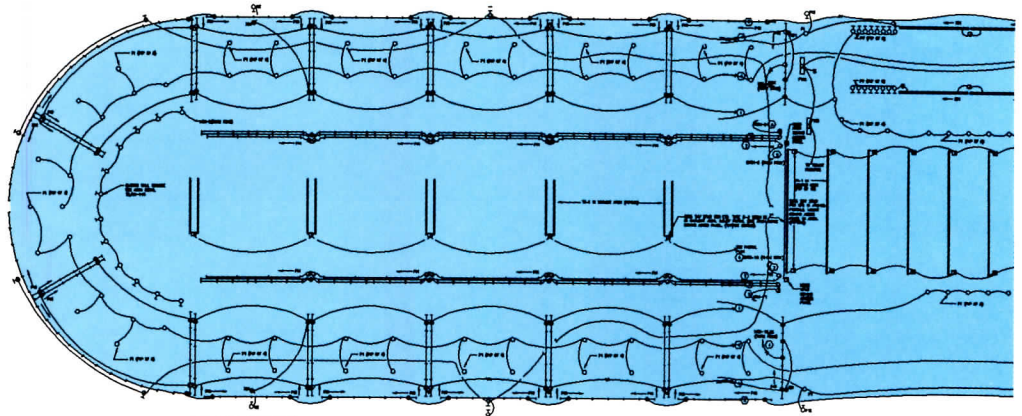

ELECTRICAL

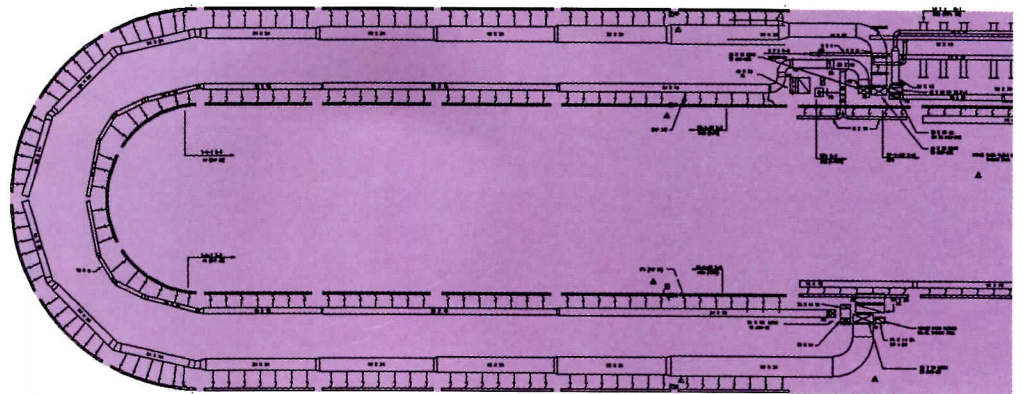

MECHANICAL

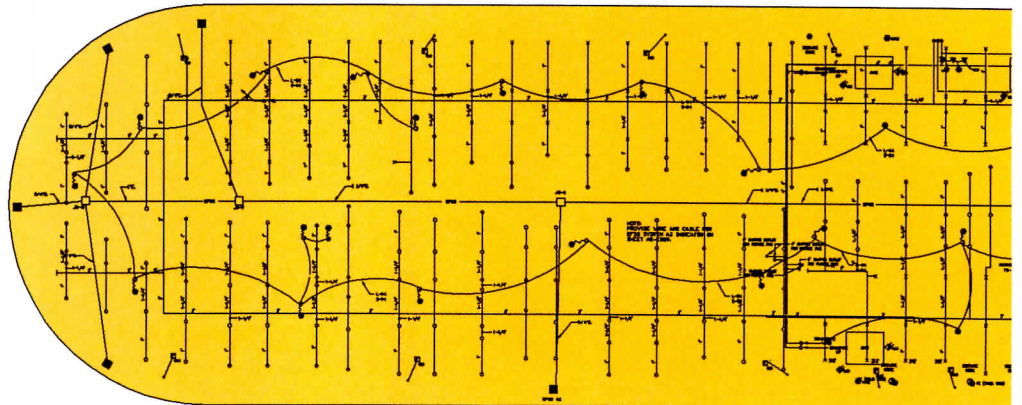

FIRE PROTECTION & SECURITY

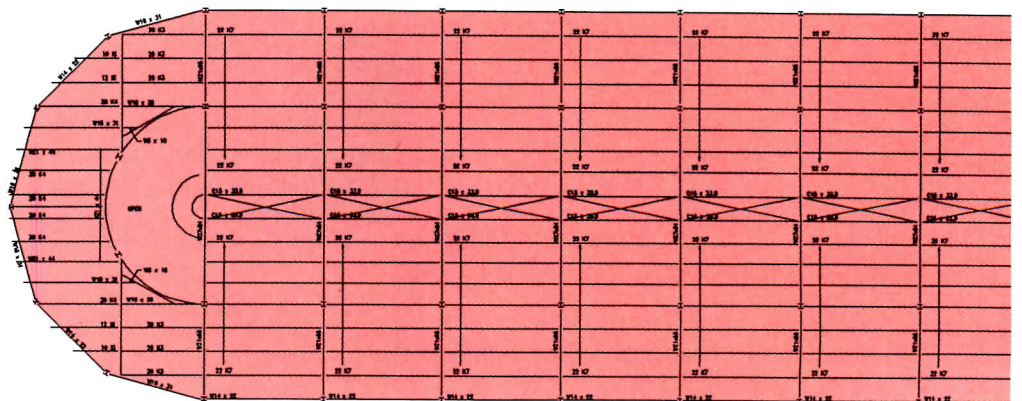

STRUCTURAL

KBJ shared their architectural floorplans with consulting engineers Newcomb & Boyd and O'Kon & Co. (both of Atlanta, GA), who used them in AutoCAD as templates for preparing their electrical, mechanical, fire protection, security system and structural

designs. Symbol libraries marketed by third-party developer ASG (Sausalito, CA) were used in conjunction with the template functions of the Nth Engine (Austin, TX) graphics display hardware to speed the work.



ELEVATION: NORTHWEST TUNNEL GRAPHICS - OCEAN SIDE
SCALE: 1/2" = 1'-0"

Linda C. Mack 1987



ELEVATION: NORTHWEST TUNNEL GRAPHICS - DUNE SIDE
SCALE: 1/2" = 1'-0"

Linda C. Mack 1987



Lake Edge Park
City Views

Downtown from I-4

Linda C. Mack 1987

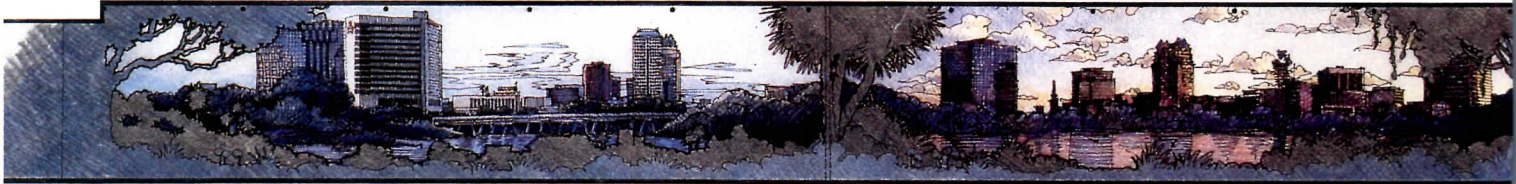

Downtown at Dawn

Downtown Skyline at Dusk

Linda C. Mack 1987

ELEVATION: CITY OF ORLANDO THEME - Lake Views
SCALE: 1/4" = 1'-0"

dimensions with later versions of AutoCAD was found to be useful in the expansion project. On this project, KBJ started with a 2D release of the package, and began exploring 3D design using Release 9.

Release 10 is now in use with full 3D and will be applied much more heavily in the subsequent projects. Engineers found that 3D allowed for greater visualization and design efficiency. Goos explains the time savings of 3D AutoCAD. "3D is a nice way of looking at things to make sure you go down the right path. Studying spatial relationships on the computer is far faster than doing it on paper, and we can get a more in-depth understanding of what we're looking at. Once you've made the model, a single perspective view that might take days on paper takes only seconds on the computer."

Accurate Positioning & Alignment: Drawings generated with AutoCAD for the expansion were laid out using a coordinate system tied to local airport grid coordinates for precise location of new airport structures relative to existing ones. This helped keep everything properly aligned and made it possible to compute accurate surveyor grid coordinates for in-the-field alignment.

AutoCAD was a key player in determining optimal building shapes, placement of passenger gates, widths of taxiway aprons, and

siting of structures so as not to obstruct the view of air traffic controllers. Using grid coordinates from AutoCAD, KBJ worked with the civil engineers and with Westinghouse (the supplier of the AGT system) to locate both ends of the AGT track that connected the airside and landside terminals. Additionally AutoCAD provided highly accurate siting input for locating the future mag-lev bullet train planned to serve the Orlando, Miami and Tampa airports.

KBJ also used AutoCAD's coordinate system to align individual drawing files for making composite plots encompassing large areas of the airport. Since all drawings were inserted using a common insertion point, KBJ developed a routine that automatically aligned individual drawing and plotted out the resulting composite. This generally took overnight to complete the plot, which was used to produce excellent overall views of the airport design.

This also helped spot errors and omissions, such as changes made in one drawing but not in adjacent ones, a common error that is often difficult to detect.

Customization: Although they had little computer experience and were essentially non-programmers, the KBJ designers were nevertheless able to produce highly productive utility programs geared for their application.

Using AutoLISP, the programming language

To enhance the Florida feeling, KBJ delineator Linda Mack designed these murals for placement in passenger walkway tunnels. Ms. Mack has been commissioned by GOA to produce the murals. She plans to use AutoCAD to create the tree silhouettes that separate the various city views, and then pass the drawing files to a laser-cutting system to make the finished pieces.

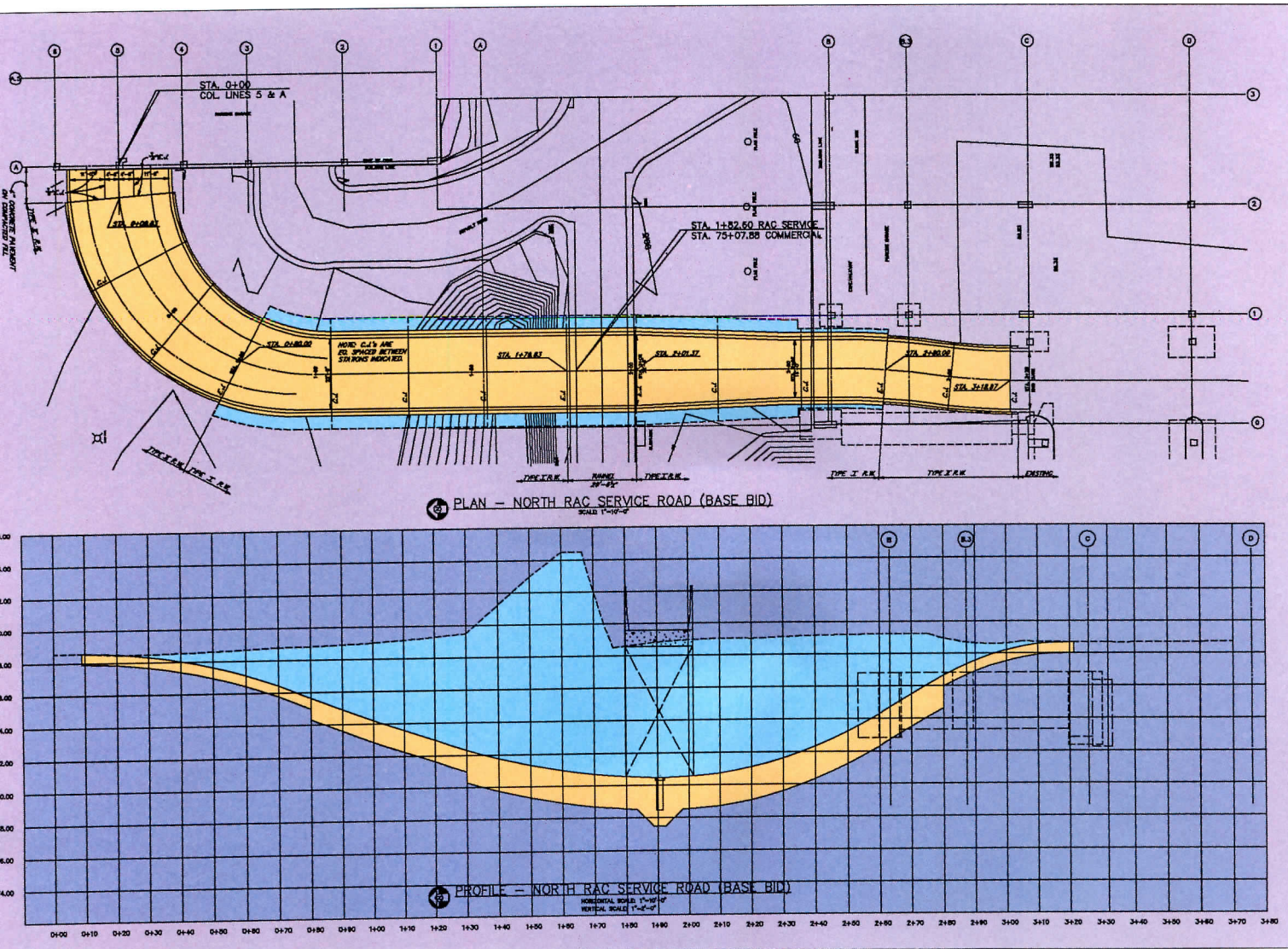

embedded within AutoCAD, they could write programs that automatically updated their drawing files whenever a change to the contents of one shared block occurred. This feature was used extensively in the hotel's design, where you might have 200 room drawings that share common blocks.

AutoCAD can also be customized by interfacing it with the numerous application-specific programs and utilities marketed by third-party developers. To place the thousands of details throughout their design, KBJ used an architectural symbol package marketed by ASG of Sausalito, California. Kun-Young Chiu used AutoCAD in conjunction with the AutoCOGO coordinate geometry application program from A/E Microsystems to develop a tunnel to move rental cars through the facility. "We had to design the roadway, snake it through the building, go under an existing road, and come up into the parking garage," explains Kun-Young Chiu's Brick Rosenbaum. "We used AutoCOGO for calculating the highly complex vertical and horizontal curves, providing data that AutoCAD used to draw the profiles."

'What-If' Studies: AutoCAD was instrumental in exploring design alternatives, saving time and money by eliminating lengthy manual calculations, hand drawing and physical models. In the early stages of the project,

AutoCAD was instrumental in exploring alternatives in siting the new airside terminals, placement of passenger gates, and design of the taxiways.

The precise end locations of the AGT track connecting airside and landside terminals had to be defined for supplier Westinghouse. Gates had to be placed to accept a wide range of aircraft, and taxiway aprons had to be configured to give planes the required area to taxi in and back away from the gates.

To determine these positions, KBJ got together with civil engineers at HNTB and laid out the entire arrangement with AutoCAD, placing overall terminal geometry, gates, different airplane shapes, and apron boundaries on different CAD layers. Once all this was modeled, the engineers then were quickly able to move around the various elements on the screen to experiment with different arrangements until they found the best. "That's when we first discovered that the machine was very fast in simulating different conditions," says Goos.

KBJ worked with Greiner engineers to develop "shadow" diagrams to check the design's compliance with FAA regulations that air traffic controller's view of aircraft anywhere on a runway must never be obstructed. That had major implications for the design and

To define the complex curves required to place a rental car return tunnel under the existing landside building, structural engineering consultants at Kun-Young Chiu (Valdosta, GA) used AutoCAD in conjunction with AutoCOGO, a third-party coordinate geometry package from A/E Microsystems (West Chester, OH). The tunnel's curve profiles were generated by AutoCAD using coordinates from the building's survey.



It's about time.

Specifying a roofing system used to take days. But now it takes just minutes.

Tam-CADD® from Tamko generates CSI-formatted specifications, drawings, construction details, even multiple roofs with electronic speed and total accuracy.

All you need to operate Tam-CADD is an IBM PC or compatible computer with MS-DOS as the operating system, a minimum 640K RAM, a 30 megabyte hard drive, AutoCAD Release 10 or higher and word processing software capable of importing ASCII files.

If you're an architect, Tam-CADD will help you create a better specification in less time and with fewer associated costs. If you're a contractor, Tam-CADD can give your bids more credibility.

Call 1-800-641-4691 today for a copy of our free brochure. Tam-CADD. Isn't it about time?



TAM CADD
ROOFING DETAIL & SPECIFICATION SYSTEM

Tam-CADD is a product of TAMKO Asphalt Products, Inc.
© 1990 TAMKO Asphalt Products, Inc.
System developed by Architectural Synthesis Inc., Nashville, TN.

Circle 23 on inquiry card

position of the buildings. The task was complicated by the fact that the control tower is over a mile from the airside building and thus at a very oblique angle to it.

Greiner performed these checks with AutoCAD, using the program to calculate the trigonometric variables that defined the shape of the "shadows" given the position of the tower and the shapes of the buildings and the airplanes. This procedure simulating the various positions allowed engineers to see when buildings obstructed views much quicker and more accurately than manual methods.

ENGINEERING AIRPORT OPERATIONS

In addition to the architectural and structural aspects of the airport buildings, AutoCAD was used to develop plans for managing airport operations. These applications are good examples of how Greiner worked closely with third-party software developers in writing custom packages geared specifically for airport operations.

Greiner used AutoCAD to address FAA Part 77 regulations regarding the definition of protected airspace surrounding the airport. Their approach was to use AutoCAD in conjunction with E.S. COGO from third-party developer E.S. CADD of Tampa, Florida. Coordinate geometry was developed with input from the FAA, which was used to drive AutoCAD's creation of 3D surfaces. E.S. CADD wrote special algorithms to compute the intersections of the air surfaces to complete the

model. And AutoLISP was used to program custom interactive menus.

The 3-D application was developed by Greiner for use by GOAA in determining conflicts with the airport's protected airspace. The airspace model shows limitations on the approach ends of the runways as well as around the airport, and it can be used to check whether proposed buildings, towers, and other structures interfere with aircraft flight paths. Now non-CAD users (such as county commission staffers) can graphically see whether proposed construction will interfere with protected airspace.

Previously, these maps were tediously drawn manually, in 2-D as part of the master plan showing critical airspace surfaces around the airport. Greiner's Robert Ori explains, "We normally do this by hand, calculating where each critical surface is in relation to the runways and connecting areas in a contour map. This is tedious work, and it's possible for errors to creep into the process when you do it manually. And the 2-D was hard to visualize."

In another application, Greiner is developing an AutoCAD-based facilities management system for managing airport property operations such as waste disposal, storm water drainage, and space leasing.

The planning system uses AutoCAD as a graphics engine driven by GeoSequel, a GIS (geographic information system) from third-party developer Generation Five Technology, Denver, CO, and Oracle SQL, a relational

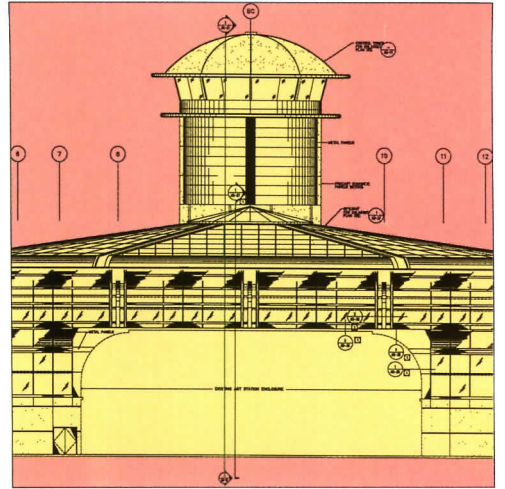

The new airside terminal building will be occupied by a single airline tenant, who wished to incorporate a control tower into the design. The elevation was drawn in AutoCAD.

THE AUTO-ARCHITECT



Powerful Software to Realize your Design . . . Efficiently!

The *Auto-Architect* is the most complete software program available for architecture and facility design. Operating inside AutoCAD®, it is available for personal computers and SUN™, DEC™, and Apple Macintosh™ workstations. The *Auto-Architect* links to our Facilities Management, HVAC, Plumbing, and Electrical programs to give you maximum design and planning capability. Call us today for more information.

DCA Engineering Software, Inc.

Unifying the AEC World with a Single Source for Solutions

7 LIBERTY HILL ROAD • HENNIKER, NEW HAMPSHIRE • 03242 • USA • 603/428-3199 FAX 603/428-7901
AutoCAD, SUN, Apple Macintosh and DEC are either trademarks or registered trademarks of their respective corporations.

DataCAD is dedicated to **architects**. In fact, it was written by **architects** for design professionals just like you.

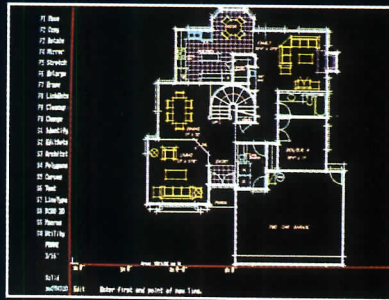
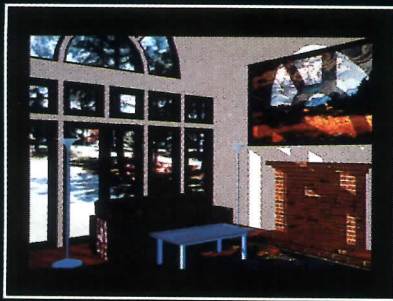

Unlike "all-purpose" CAD programs, **DataCAD** works the way **architects** work—the way you think, design and present.

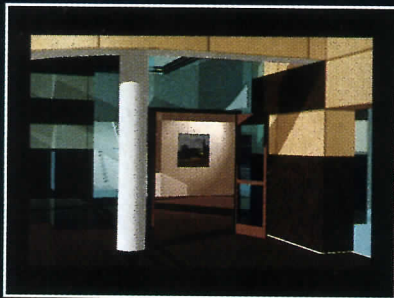

Adding this power to your own creativity lets you investigate more design options. Increase your productivity.

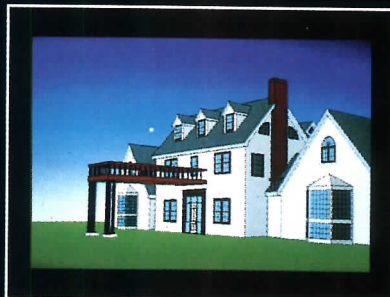
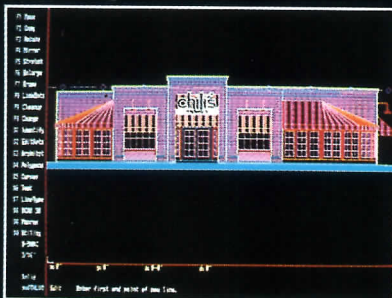

And turn projects around faster, easier and with fewer errors. **DataCAD**. Designed by **architects**, for **architects**.

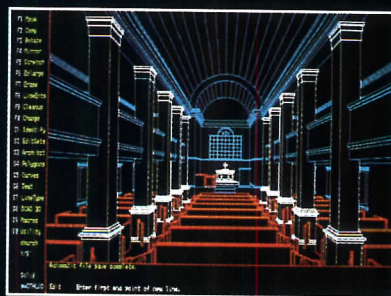

DataCAD. 2D design and drafting. Parametric macros. Interactive 3D database. 3D viewing. Hidden line removal and Rendering. DXF file transfer. Hundreds of architectural symbols. 3D modeling using 3D primitives. Viewmaster for dynamic fly-thrus. Call for additional information about DataCAD, or for the name of the dealer nearest you.

DataCAD[®]
1-800-654-3413

CADKEY, INC. • 440 Oakland Street • Manchester, CT 06040 • DataCAD is a registered trademark of CADKEY, INC.
Credits: The Gleason Partnership, Brenenberg Brown Group, Vincent Associates + Architects, Bassian Lagoni Architects, New World Graphics, Ormonde Presentations

Circle 25 on inquiry card

A E C Systems show
Booth 1840

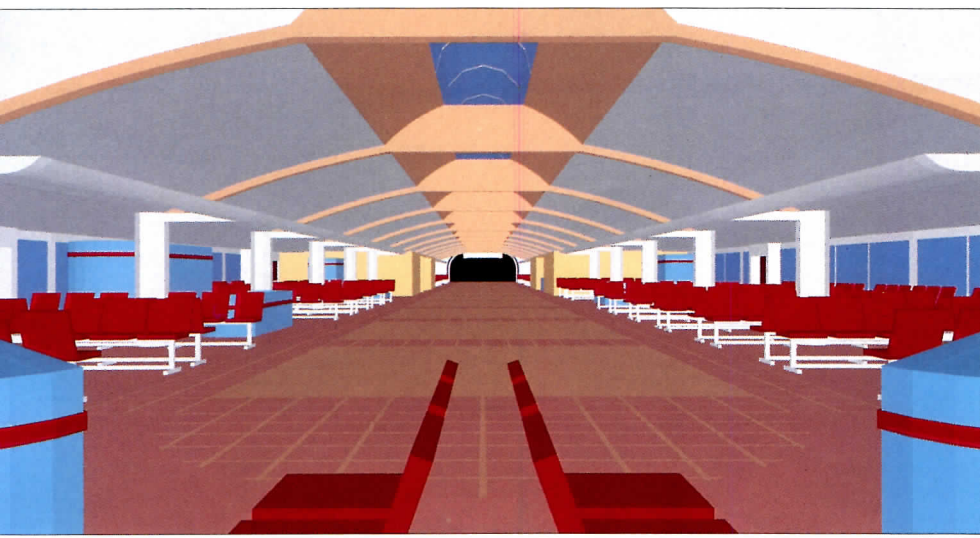

AutoCAD's 3-D models are complemented by AutoShade's rendering capabilities. This rendering places the viewer at the end of one of the airside terminal's wings and looks toward the center of the building.

database manager from Oracle Corporation, Belmont, California. This combination is used to graphically display and manage a huge database of spatial information associated with the airport property.

For example, the airport properties office can use the system to query and display all leased property for a prospective tenant. Or the search can be narrowed to find spaces over 100,000 contiguous square feet, for example. From this, you can generate a lease drawing showing the exact location and size of the space. Potential uses for this application package go far beyond basic facilities management, however. Other uses are site selection studies, land acquisition, and noise analyses. For instance, the program can show areas of high noise levels and print out a list of names and addresses of affected homeowners which the airport might want to contact.

MAKING THE DEADLINE

The use of AutoCAD in saving significant time and cost of drawing preparation allowed KBJ to complete the architectural project within the tight 30-month timeframe. In fact, it is highly unlikely that the deadline could have been met if there were CAD compatibility problems. Walter Taylor, head designer on the project and KBJ's Chairman and CEO, believes that AutoCAD was critical to the project's success. For KBJ, AutoCAD provided the capability for a relatively small architectural firm to compete with much larger firms. "There are extremely large architectural firms which have all in-house specialists in mechanical design, structures, civil, and so forth," says Goos. "But KBJ custom tailors the best team for each project.

AutoCAD makes that strategy extremely workable. Its database was kind of a language design. We could communicate with all our consultants faster, with greater detail and more accurately than we could on paper. A drawing is just graphite on paper. But a line on a computer has a lot of intelligence behind it."

Because it is the dominant CAD package in the AEC industry, AutoCAD was readily available and understandable to everyone in the project. It was readily customized for special

GEOCAD[®]

- IS FOR ARCHITECTS
- IS IN A CLASS BY ITSELF
- WORKS WITH AutoCAD

If you have avoided CAD because it is too intimidating...

If you don't like to type...

If you don't want to spend a lot of time and resources on training...

If you want your drawings to retain a "personal touch"...

If 80%-90% of the billable time in your office is spent on drawing production...

If you have a CAD system which is underutilized and has become the most expensive paper weight in your office ...

...It is time to take a serious look at GEOCAD, the easiest to master, the most "Architectural" Application to AutoCAD.

GEOCAD is complemented by GEOVUE, which uses plans and elevations to create one and two-point perspectives inside AutoCAD, and GEOEST, which extracts estimates from AutoCAD drawings without using attributes.

Available for MS-DOS and Macintosh computers.

For more information call or write to:
GEOCAD Inc.
 P.O.Box 186, Laurel Road
 Pound Ridge, NY 10576
 Tel. 914 764-4072

GEOCAD was developed by:
 Rudolph Horowitz Associates,
 Architects

**AEC SYSTEMS '90
 BOOTH 2929**

Circle 26 on inquiry card



AutoCAD[®]

GEOCAD is registered in the U.S. Patent and Trademark Office by GEOCAD Inc. GEOVUE and GEOEST are trademarks of GEOCAD Inc. AutoCAD is registered in the U.S. Patent and Trademark Office by Autodesk Inc. MS-DOS is a trademark of Microsoft Inc. Macintosh is a trademark of Apple Computer Inc.

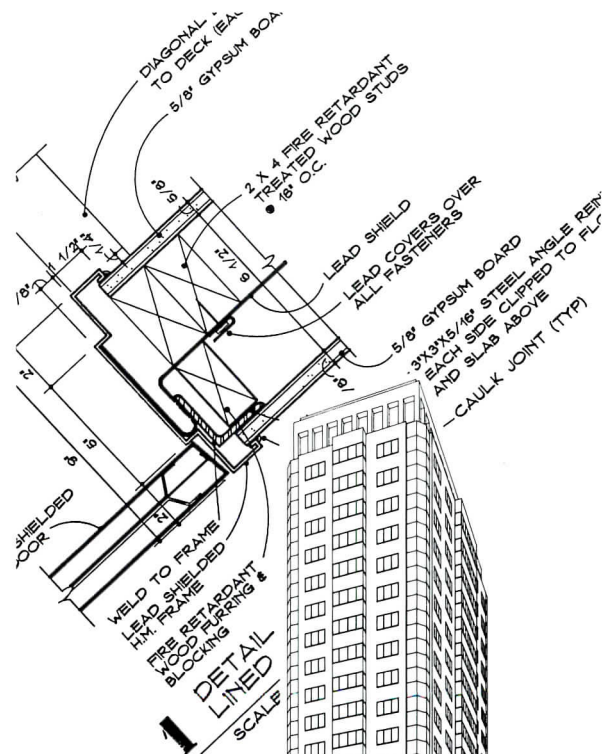

GEOCAD drawing and GEOVUE perspective by RHA Architects.

The hotel planned for the landside building surrounds a multi-story atrium capped by a 210-foot-span skylight structure. This delineation explores a concept for the atrium's landscaping, paving pattern and seating arrangement.

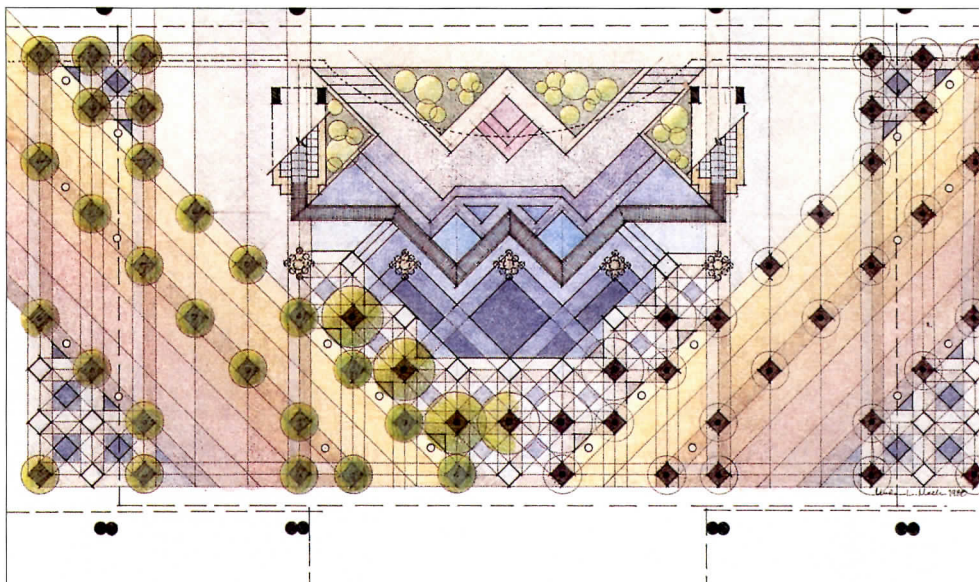

tasks and is supported by a wide range of third-party programs. Moreover, it was affordable to the individual companies. As one manager put it, "None of us could spend 6 figures on a mainframe-based system and we didn't need to."

Indeed, some of the firms involved in the project saw the merits of AutoCAD over larger systems. Greiner previously used a mainframe-based CAD program, for example, but after their experience on this project are convinced that AutoCAD will be their standard for the future.

Observers coming into the project at its conclusion were very much impressed that KBJ was able to come up to speed so fast and do so much in this, their first use of AutoCAD. Previously, they only had limited experience with another package. But they learned a lot in a short time. Says Goos, "I look forward to another project where I can start from scratch knowing what I know now."

It may not take long to put that experience to use. According to the master plan, the current expansion should allow the airport to handle

passenger demand for the next twenty years. But airport authorities acknowledge that accelerated growth patterns in Central Florida might require another expansion in as little as 5 to 10 years. So KBJ is already starting to use AutoCAD to look into factors that will make the next project even more complicated than today's: the heaviest traffic flow the area has ever seen, and its impact on the environment, which both GOAA and the Orlando community place the highest priority on protecting.



Plumbing Product Symbols

Now American Standard lets you take full advantage of the power of AutoCAD with their Symbols Libraries, the only software packages to offer a comprehensive selection of plumbing product symbols in 2-D or 3-D. Each Symbols Library makes time-consuming hand drawing a thing of the past with symbols that automatically provide accurate dimensions and proportions.

Circle 29 on inquiry card

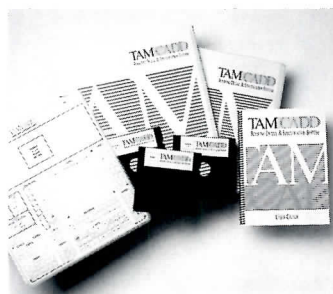

Roofing Detail/Specifications

TAMCO Asphalt Products, Inc. introduces a comprehensive package of both written specifications (in SCI format) and complete construction detail drawings. Tam-CADD operates with an IBM PC or compatible computer with MS-DOS, with minimum 640K RAM and a 30 MB hard drive; with AutoCAD Release 10 or higher and word processing software capable of importing ASCII files.

Circle 30 on inquiry card



Font Library

X-Fonts from Autograf Utilities, is a library of high quality AutoCAD fonts that operate on IBM platforms, using AutoCAD Release 9 or 10 or AutoSketch 2.0, and Macintosh IIx platforms using AutoCAD Release 10. All X-Fonts are full 98 character sets and feature true ARC-segmented characters, automatic kerning and razor-sharp accuracy.

Circle 31 on inquiry card



Drawing Management Products

SoftSource, developer of BLOW and DRAWING Librarian, take great pride in introducing their new AutoCAD drawing management products at A/E/C System '90: Drawing Librarian JUNIOR and PROFESSIONAL. SoftSource products offer unmatched drawing display, translation, and management capabilities to CAD design, engineering, facility and project managers. Phone 206/676-0999.

Circle 32 on inquiry card

HOW ARCHITECTS MARKET THEMSELVES

Cecil Baker & Associates and Ben Thompson & Associates principals make sure they choose the marketing approach that works for them.

Whatever labels are ultimately used to describe the architecture of the '80s, the business side of it will surely be seen as the Age of Marketing. Probably more has been said or written on the subject in the past decade than in all previous years combined.

To find out just how architects are marketing their services these days, RECORD called on a few who we know are enjoying more than average success. Below is the first of a two-part sampling of reports from the field.

Cecil Baker & Associates

Looking at sales as if it were a design problem

Philadelphia architect Cecil Baker takes a soft approach to marketing, but uses a moderately structured and innovative approach all the same. Baker looks at marketing as a design problem.

The challenge he sees is to integrate marketing into the firm's design philosophy. The philosophy is to get interesting and varied assignments that the designers can throw themselves into without unnecessarily arbitrary restraints from the client.

Finding a solution has been a career-long quest for Baker, who started out as an architect/developer. In this, he was only partially successful, failing to win commissions from other developers, who saw his firm as competition. He felt forced to choose between being an architect and being a developer. "Two separate images, two separate roads to take," is how he puts it.

When he formed Cecil Baker & Associates in 1982 he hired a full-time marketing person to develop leads and make cold calls. But the aggressive approach seemed to go against the grain. For one thing, Baker didn't want to specialize, which made the marketing person's job more difficult. For another, how could you say "no" to clients brought in by a hard sell if

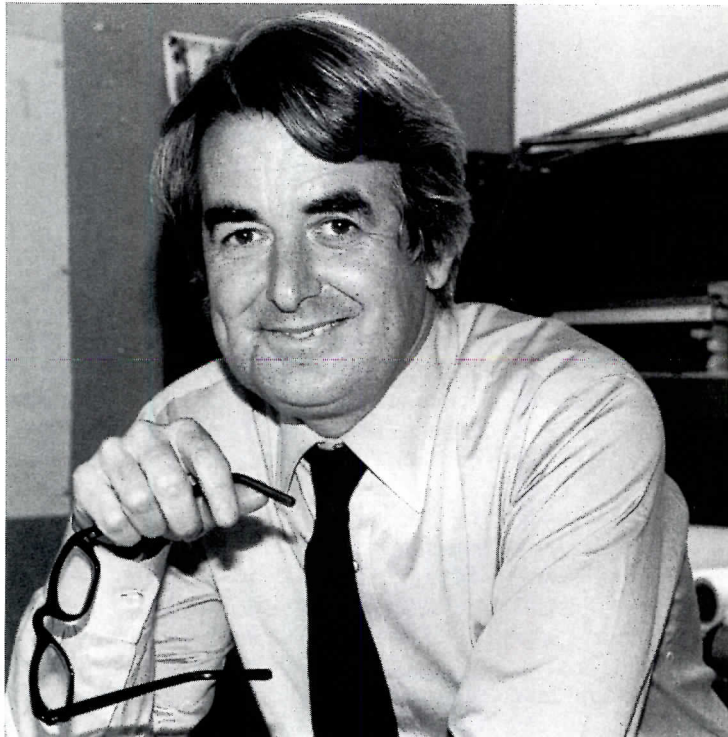

Baker, an architect-developer turned architect. "Two separate images. Two separate roads to take."

"It's following the human chain rather than finding out there's a job there."

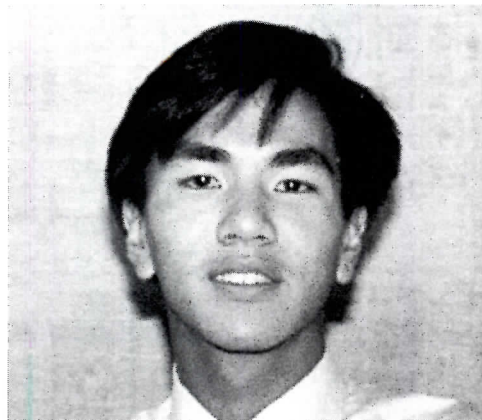

Cheu holds a degree in two fields.

they asked you, for example, to throw in a few Victorian flourishes on their building?

So Baker rethought his marketing approach with his longtime consultant Carol McConochie and his young marketing and management director Lloyd Cheu, whose unusual background includes a joint degree in architecture and marketing.

Commenting on how the program took shape, Baker says, "We keep finding that all our work is referral," which can mean simply getting a lead. Then he slips into metaphor: "It's following the human chain rather than finding out that there's a job there and coming in and taking people up for helicopter rides."

To cultivate and extend the human chain, CBA devised a multitiered program. The centerpiece is a one-page newsletter, measuring approximately 8 inches by 14 inches, which differs from other firms' newsletters

in that the lead story focuses on a client's design problem instead of a design.

The newsletter doesn't necessarily mention CBA's role in solving the problem. This draws clients into the newsletter and helps them identify with the firm. It's followed by "Cecil's Column," giving Baker a platform to talk about other client issues or describe services offered by the firm. The newsletter is sent quarterly to about 700 people, and all of them are contacted once a year to make sure they want to stay on the list.

For short announcements to specialized clients, another communications piece is used. Reprints are sent to those groups which have a direct interest in a specific subject, usually with a handwritten note from Baker. "When you have a handwritten note you usually stop before throwing it out—even if just for five seconds," says Cheu.

Other program elements are even more innovative. "One of the greatest sales tools we've found is walking people

through the office, to show them what we're doing," says Cheu. Another is a monthly office lunch to get post-occupancy reports from clients.

Baker preps them by saying, "We know you're happy with the architecture, you've told us so. We really want to know what went wrong." This gives the architects useful information and lets clients know that CBA is interested in their buildings.

The firm is now experimenting with a new element, a series of large, portable boards each displaying a photo of a project and a few items of printed information relating to problems and solutions. Baker may use them if he decides to make selected cold calls again, this time to prospects receptive to quality design.

The idea came to him after a meeting he

"One of the greatest sales tools we have is walking clients through our office to show them what we're doing."

requested with a developer to talk about marketing. Baker asked him what kinds of materials he liked to see from architects. Not books, brochures, not slide shows, was

the answer, but something larger that relates directly to his concerns.

Behind the scenes

The most important part of the program is one that's not visible to clients. It's an annual retreat held outside the office and attended by the entire 15-person staff. The past year's effort is evaluated, changes for the coming year are proposed and discussed, and Lloyd Cheu takes the information back to the office and rewrites next year's marketing plan. The retreat does more for internal communications than anything else the firm does and that makes it valuable.

Other firms have very different approaches. Witness how Benjamin Thompson & Associates gets clients.

Benjamin Thompson & Associates

When a firm as innovative and successful as Benjamin Thompson & Associates turns to marketing, you expect it to take a different tack, and it does. "The phone rings all day long," says Jane Thompson, a partner and also the wife of Benjamin Thompson. "We're asked endlessly to submit material for what are essentially limited competitions. People come and interview us. Basically, the clients have not been solicited. We're solicited."

The visibility and success of urban-scale projects such as Faneuil Hall Marketplace in Boston and South Street Seaport in New York, as well as the adaptive reuse program for Union Station in Washington and the design of the acclaimed Orduay Music Theater in St. Paul, exert a tremendous pull on developers everywhere, and on other clients too.

She continues: "There are a hundred developers out there. About 98 would prove inappropriate to us. Their mode of operation, their quality objective, their way of dealing with people, what they would want from us, their ability to be decent clients, interactive clients, knowledgeable clients, would probably not meet our standards. We're looking for people who think along our lines. A really important criterion is that they know what they're doing and have good ideas."

Despite having enough quality work to keep an office of 100 busy, BTA still sees a need for more active marketing. One

reason is that, while concentrating on major planning and development projects in farflung places like London, Dublin, Cardiff, and Brisbane—not to mention California—the firm, based in Cambridge, Mass., has for some time been neglecting its own back yard of Boston.

In part this was due to what it perceived as an unfavorable building climate. But one day it realized that a lot of building was going on in Boston, and it took steps to reassert itself. It mounted a large exhibit at Faneuil Hall for its 20th anniversary and made calls to friends and agencies. A commission to design the Downtown Cultural Center resulted.

Now the firm is planning to contact a few developers. "But it will be a one-to-one target," says Thompson. "We will not do anything in a blanket, cold-calling way. We'll figure out a way to get to know someone we want to know." Half-laughingly, she adds, "The trouble is, every time we start for the phone another job comes in and we don't have time to market."

BTA would also like to use marketing to get contemporary experience in areas in which it's currently weak. "We haven't done any recent condominium projects that are built," says Thompson.

"We wouldn't want to go after that market as a market, but it's very often a component of a bigger project we're doing." The same goes for hotels. Most of its work in that area dates to the '70s.

BTA also sees a need for marketing to help it attract and retain high-caliber staff capable of doing diversified work. "We have a lot of very young people in this firm, and we're trying to attract the best and the brightest," says Benjamin Wood, another BTA partner. "To keep them you have to have very good work. If you start stamping out one product or another, they leave. You'd better have terrific work."

And so, in the end, what does it all mean? Simply that a marketing program has to be tailored to individual firms' objectives and goals. In other words, do what works for you.

Mr. Polites is a free-lance journalist in New York City who specializes in writing about art and architecture.

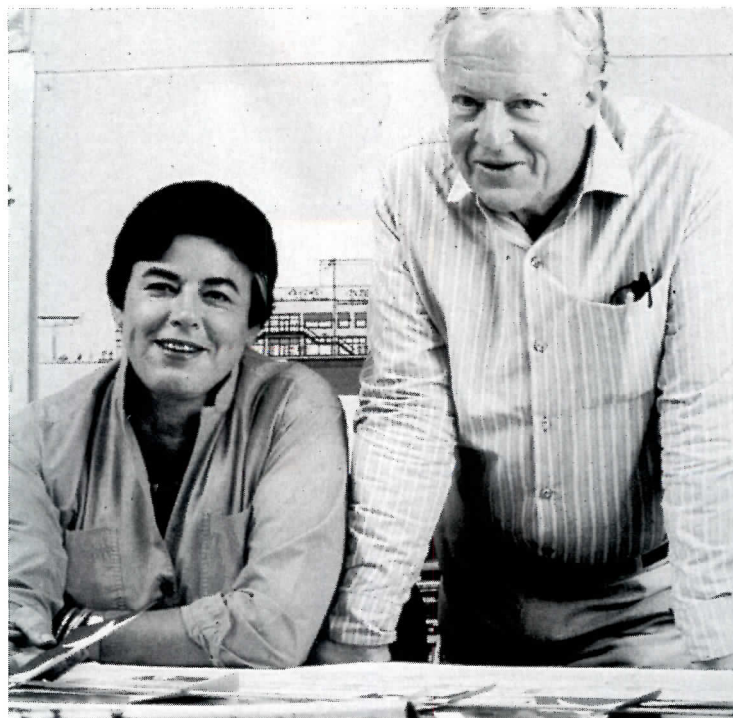

Jane Thompson (with partner and husband, Ben):
"We're looking for people who think along our lines."

THE PRICE OF BUILDING DECLINES

A four-quarters' slide in the rate of construction-cost hikes winds up in deflation.

The national average of construction costs fell by almost 0.1 percent in the closing quarter of last year. This was in spite of an unexpectedly strong showing for construction volume in December [RECORD, March 1989, page 17], which could well have created enough demand on materials and labor to send costs the other way. It was also in spite of some high labor settlements, now blamed in part as the root of inflation in the general economy.

It was, however, consistent with the direction of costs over the past four quarters. After an alarming jump of 0.8 percent in the third quarter of 1988, cost increases had been progressively subsiding, leading to speculation that deflation might be ahead. [RECORD, February 1990, page 60]. A drop in costs had not occurred since 1977.

As usual in recent years, the law of supply and demand worked only partially. On a regional basis, cost declines were most noticeable in the Northeast. Dodge vice

SUMMARY OF BUILDING CONSTRUCTION COSTS

	Number of metro areas	10/89 to 1/90	1/89 to 1/90	1977* to 1/90
Eastern U. S.				
Metro NY-NJ.....	18	0.61	3.32	2001.33
New England States	33	-0.04	0.97	1847.69
Northeastern and				
North Central States.....	120	-0.20	1.45	1755.97
Southeastern States	106	-0.10	1.42	1822.16
Average Eastern U. S.	277	-0.09	1.50	1808.17
Western U. S.				
Mississippi River and				
West Central States.....	122	-0.10	0.55	1706.87
Pacific Coast and Rocky				
Mountain States.....	106	-0.10	0.44	1816.06
Average Western U. S.	228	-0.10	0.50	1757.64
United States Average	505	-0.09	1.05	1785.35

*Using only cities with base year of 1977

where the decline was least noticeable, and the metropolitan New York-New Jersey district, the only one in which costs rose—by over 0.5 percent. The other districts were remarkably uniform in their 0.1 percent decline of costs despite very different rates of new building.

A look at the costs of materials shows that it is the manufacturers who are taking a beating in this counter trend to the economy. Almost all materials were down.

The declines did reflect, in part, the relative strength of housing. Some bigger losers were materials often used in other buildings: structural steel and copper off 0.6 percent and 0.9 percent respectively. But so were materials often used in houses: plywood and asphalt shingles off 0.6 percent and 0.4 percent respectively.

CHARLES K. HOYT

president and chief economist George Christie termed the construction volume there "recession" in 1989. But he also applied the term to the New England states,

Data supplied by Dodge Cost Systems, Marshall + Swift

Metropolitan area	HISTORICAL BUILDING COSTS INDEXES										Average of all Nonresidential Building Types, 21 Cities				1977 average for each city = 1000.0			
	1979	1980	1981	1982	1983	1984	1985	1986	1987	1988	1989							
											1st	2nd	3rd	4th				
Atlanta	1925.6	2098.6	2078.0	2360.6	2456.7	2448.7	2518.3	2561.9	2580.9	2697.3	2729.1	2736.6	2744.0	2740.4				
Baltimore	1304.5	1446.5	1544.9	1639.5	1689.7	1703.7	1743.8	1765.2	1780.2	1849.1	1891.4	1889.5	1891.5	1886.8				
Birmingham	1329.9	1407.2	1469.9	1468.1	1535.7	1594.7	1565.7	1587.4	1542.6	1612.5	1629.0	1636.6	1647.3	1643.0				
Boston	1236.0	1283.7	1432.5	1502.0	1569.9	1646.0	1721.0	1773.6	1883.0	1921.6	1944.1	1944.8	1925.8	1917.2				
Chicago	1199.7	1323.6	1344.7	1425.8	1439.5	1476.7	1528.0	1599.9	1591.4	1636.5	1654.3	1672.1	1677.6	1672.8				
Cincinnati	1323.9	1385.2	1350.4	1362.6	1430.8	1484.5	1486.6	1499.4	1510.9	1526.8	1544.6	1554.4	1557.4	1560.7				
Cleveland	1287.5	1388.2	1459.5	1511.4	1475.9	1464.0	1474.1	1525.7	1541.8	1550.7	1536.1	1557.5	1559.7	1556.3				
Dallas	1431.9	1481.9	1750.6	1834.3	1925.9	1958.0	1963.3	1973.9	1947.2	1927.2	1930.0	1910.7	1895.7	1877.3				
Denver	1495.6	1487.4	1632.2	1679.1	1800.1	1824.3	1821.8	1795.8	1732.7	1725.3	1725.1	1745.4	1736.6	1725.9				
Detroit	1275.3	1447.4	1580.3	1638.0	1672.1	1697.9	1692.6	1696.6	1689.3	1734.4	1740.9	1744.3	1754.7	1751.2				
Kansas City	1125.8	1233.2	1323.4	1381.8	1407.5	1447.1	1472.5	1484.7	1493.7	1505.6	1511.7	1518.8	1520.4	1518.8				
Los Angeles	1255.3	1387.5	1474.3	1503.3	1523.9	1555.1	1571.0	1609.7	1675.1	1789.5	1784.8	1798.2	1817.0	1813.7				
Miami	1330.1	1380.6	1369.1	1392.1	1467.6	1522.2	1540.6	1566.2	1589.2	1625.2	1654.5	1638.0	1643.0	1641.3				
Minneapolis	1286.9	1327.7	1442.6	1576.8	1624.6	1640.4	1661.0	1674.0	1677.0	1690.6	1700.5	1698.2	1696.4	1712.5				
New Orleans	1291.9	1505.7	1572.7	1616.9	1650.5	1691.4	1762.5	1760.2	1699.8	1707.3	1706.9	1690.6	1698.4	1685.0				
New York	1247.1	1319.4	1419.2	1491.8	1672.5	1747.2	1806.7	1899.9	1980.9	2065.3	2091.3	2137.6	2144.9	2157.2				
Philadelphia	1487.5	1539.5	1660.7	1769.4	1819.5	1922.1	1967.9	1992.7	2023.5	2171.4	2216.4	2220.4	2247.0	2244.3				
Pittsburgh	1227.0	1341.7	1493.2	1479.5	1497.2	1576.1	1611.0	1665.8	1647.3	1700.3	1708.1	1721.3	1719.7	1721.3				
St. Louis	1275.9	1320.0	1397.3	1451.2	1524.9	1625.5	1641.8	1647.4	1653.5	1705.7	1727.7	1740.6	1748.2	1761.1				
San Francisco	1473.4	1644.8	1776.4	1810.1	1856.8	1935.3	1961.8	1995.5	1992.0	2090.9	2079.2	2091.4	2105.5	2114.3				
Seattle	1373.4	1616.8	1814.9	1962.7	1979.0	1948.9	1937.9	1925.3	1874.7	1968.0	1962.7	1968.4	1988.0	1987.0				

Costs in a given city for a certain period may be compared with costs in another period by dividing one index into the other; if the index for a city for one period (200.) divided by the index for a second period (150.0) equals 133%, the costs in the one period are 33% higher than the costs in the other. Also, second period costs are 75% of those in the first period (150.0 divided by 200.0 = 75%) or they are 25% lower in the second period.

**Knoll introduces
chairs. How many
buy one? An afford
for everyone in th
for whom? The Pri
affordable for com
500. I knew it wasn
affordable if you're
are they going to r
Introducing Bulldo**

new line of office
million do I need to
ble line of seating
office. Affordable
ess Aga Khan? **It's**
nies in the Fortune
cheap. **And equally**
t. How many times
eat "affordable?"
Affordable.

Knoll

Circle 36 on inquiry card

INTEREST RATES' STUBBORN STANCE

Despite predictions, rates stay up and their drag on construction persists. Here is why.

Uncertainty clouds the economic outlook. The economy continued to advance in the spring, despite higher inflation, tighter monetary policy, and rising interest rates. But, if rates climb much more, can the expansion last much longer?

The first-quarter rebound in real growth above 2 percent had been anticipated. It reflected such temporary factors as the end of the Boeing strike, which bolstered exports; very warm January and February weather, which increased housing starts and other construction; appealing auto incentives, which initially encouraged their sales; and the early introduction of spring fashions, which aided retail sales.

The surge in activity was also expected to raise prices only moderately. Instead, the GNP deflator jumped from 3.2 percent in the fourth quarter of 1989 to 5.7 percent in the first quarter of 1990. That is a rate not seen since the recession of 1981/82, when inflation was subsiding from double-digit levels.

Before the first-quarter spurt in prices, the Federal Reserve had been orchestrating monetary policy to supply just enough reserves to sustain a moderate economic advance without encouraging inflation. During the first quarter, it changed its stance on evidence that inflation was rising unacceptably, while the economy still grew.

Throughout the late winter, the Federal Reserve restrained monetary policy. In turn, interest rates rose. By the first of May, interest rates had moved up by 50 to 100 basis points (one-one hundredths of a percent) from the beginning of the year.

Higher interest rates are intended to retard demand throughout the economy, thereby reducing inflationary pressures. As demand weakens, the Federal Reserve will face tough decisions about monetary policy in the next few months.

The temporary forces, which supported economic growth in the first quarter, are dissipating. Unfortunately, nothing is com-

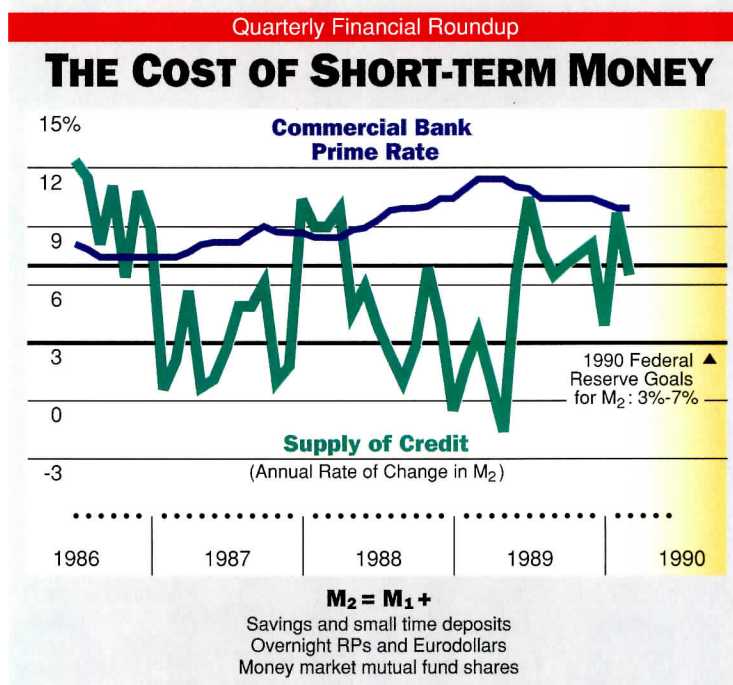

Sources: Supply of Credit—Board of Governors of the Federal Reserve System, Prime Rate—Federal Reserve

ing on stream to replace them in keeping the economy expanding.

Manufacturing slowly recovers from its downturn. Construction is suffering from the higher interest rates. Exports are likely to lag soon as the rising dollar makes American products more costly abroad. Moreover, many service industries, such as retail trade, finance, and real estate, are slumping.

Meanwhile, inflation is proving even more intractable than first thought. A tight labor market has driven labor costs up faster than productivity has increased in the past year, eroding profit margins.

In this situation, goods producers and service providers would raise prices to protect profits. However, intense foreign competition has forced manufacturers to limit their price hikes. Instead, industrial concerns since the middle of 1989 have trimmed employment and worked even harder to boost productivity. Consequently, industrial production is moving into position for a strong rebound once interest rates fall and demand revives.

In contrast, many service industries without the threat of international competition have been less stringent about con-

trolling labor costs and raising productivity in recent years. Now, as demand for services shrinks and costs continue rising, more companies are laying off employees and making efforts to increase productivity.

In the summer, unemployment rates will move upward. Labor costs will stop climbing. However, core inflation, primarily due to personnel expenses, will remain in the 5.5- to 6-percent range. That level is well above the 4.5 percent of 1989's fourth quarter.

With unemployment rising, real economic growth will lose its first-half zip and slip to under 1 percent in the third quarter. As the late-spring and early-summer statistical reports reveal a weaker economy, the Federal Reserve will ease monetary policy. Inflation concerns will preclude opening wide the

monetary spigot. Nevertheless, a less-restrictive monetary policy will reverse the climb in interest rates.

Short-term interest rates (under 1 year) will tumble 100 basis points this summer to the 7- to 7.5-percent range in late August. Longer-term rates (10 years or more) will react much more slowly. Still, interest rates on fixed-rate home loans will be below 10 percent by the end of the third-quarter of 1990.

Until mortgage rates break, single-family housing starts will continue to drift downward. Even when rates do fall, activity will only gradually recover. As a result, third-quarter starts and sales will not do better than those in the second quarter, but at least the overall trend in housing will be upward.

Nonresidential and multifamily construction will continue to slump until a much more vigorous upswing in real economic activity occurs. Industrial building will bottom out in anticipation of improving manufacturing production. Retail building will slip for awhile longer, awaiting a sustained housing recovery. Meanwhile, office building and multifamily housing will need even more time to work off their vacant space.

CHART BY ELIOT BERGMAN

GEORGE WHITE, ARCHITECT OF THE CAPITOL

George White oversees several hundred projects at a time. But in his 19 years in office he has completed only one new building.

He runs the largest single architectural office in the nation, with 2,400 employees. He has an average of 200 projects going at any one time. Yet in 19 years on the job he has been involved in the design of only one building. Unusual combinations seem to surround George White, who has practiced architecture, engineering, and law, holds an MBA from Harvard University, and is now an apolitical official in the most political setting imaginable. In his present status as Architect of the Capitol he has brought the monument to perhaps the greatest splendor in its history, making it a significant museum of American art and, in operational terms, technically up to date.

The functions of White's office are likewise varied. According to his official job description, "The Architect of the Capitol is charged with the direction and supervision, as well as with the structural and mechanical care, of all improvements, alterations and repairs to the following buildings and grounds:" the U. S. Capitol, the House of Representatives and Senate office buildings, the Library of Congress, and the U. S. Supreme Court. In addition, White oversees the U. S. Botanical Garden, and House and Senate restaurants, and is civil defense coordinator for the Capitol buildings.

"It is not just an architectural office with a few additional duties tacked on," explains White. "In reality this office is a conglomerate. We are in the transportation business, responsible for 250 elevators and escalators, six subway cars, and a fleet of shuttle buses. We're also in the energy business, with a full-scale power plant and 3 1/2 miles of tunnels supplying Union Station and the Capitol complex. And we are in the property-management business. We're responsible for 12 million square feet of space, with \$360 million in gross annual rents."

"This role makes use of all the formal training that I've ever had," White confesses. He received his master's degree in electrical engineering from MIT just be-

fore World War II and then worked for General Electric designing radar transmitters. After the war, he pursued his MBA with no particular future course in mind. While at Harvard, White decided to accept a standing offer from his father to join the family design and construction company in Cleveland. He began engineering work for the firm, but soon his interests turned to architecture.

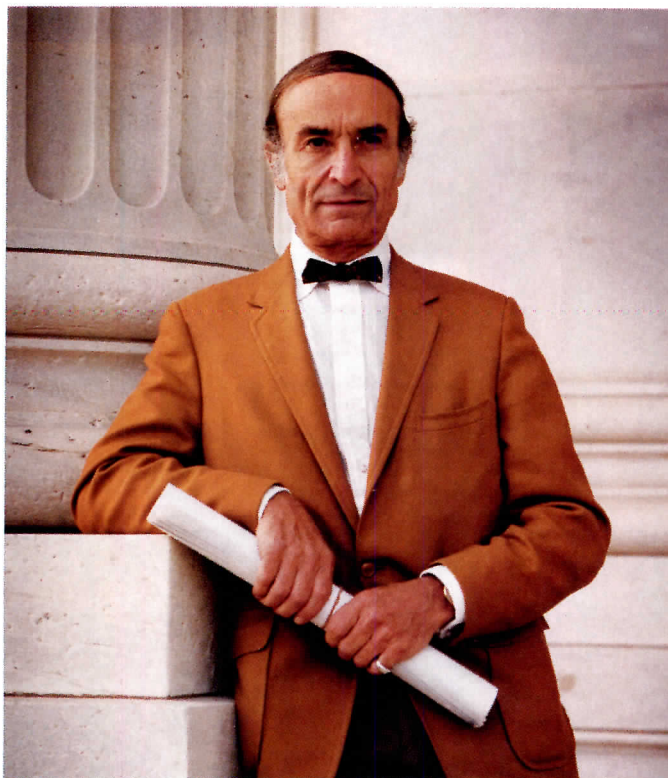

George White was appointed Architect of the Capitol in 1971 by President Richard Nixon.

"I took some courses, studied a bit on my own, and passed the state licensing exam," he says. He became active in the American Institute of Architects during the 1960s, eventually serving as a member of the national board of directors and vice president. A failed effort to become AIA president eventually led to his appointment as the first licensed-architect Architect of the Capitol in nearly a century.

White's predecessor, George Stewart, had died in 1970. At that time, Daniel Patrick Moynihan, domestic counselor to President Nixon and a long-time architecture

buff, called AIA's new executive vice president, William L. Slayton, to ask for unofficial suggestions of architects who were good managers and, not surprisingly considering the administration, Republicans. White was recommended.

White was at first reluctant when the appointment was offered. He had a Midwesterner's distrust of federal bureaucracy and a fondness for practicing architecture. He has since come to feel that he did not leave architecture when he went to Washington but simply entered into a more satisfying realm of it. He believes that his office should be held by an architect, albeit one with a bent toward management. "Architects see things whole, and a great many esthetic decisions are made in this office," he claims.

Extending the Capitol

Yet when asked what he feels to be his major achievements in the office, White does not at first single out new buildings. He has served in a time of rising concern for preservation of historic structures, so his proudest achievements are in that area. Stewart had persuaded Congress to extend the east front of the Capitol, which enraged preservationists. He then turned to the west front for expansion, and they were again up in arms.

A west front extension would obscure the last visible segment of the original Capitol. As an AIA officer, White had fervently opposed it. But as Architect of the Capitol, he came to realize that the extension not only would provide needed new space but also would make a more suitable base for the dome, which was not part of the original design. Congress, however, disagreed and White faced restoration rather than replacement of the original sandstone west front. He performed the task admirably, and today the building gleams as it presides over the Mall.

The interior has taken on a new grandeur as well under White, who regards himself as part curator. "This building is a

PHOTOS COURTESY ARCHITECT OF THE CAPITOL

museum as well as a workplace," he says. When White took office, museum directors were reluctant to lend works to the Capitol for fear they would not be cared for properly. Now they do so freely.

White has applied high standards to the restoration work inside the Capitol. Two legacies of his reign are the original Senate and Supreme Court chambers, restored for the nation's bicentennial—not for governmental use but for the edification of visitors.

At the same time that White has shown reverence for the Capitol's past, he has taken the lead in outfitting it to meet the increasingly complex technological demands of the present. Electronic voting was introduced in the House, and regular television coverage of both House and Senate proceedings was instituted. Computers were put to use, not just on climate control and security systems but also to bring information more readily to members of both houses. "If they have the facts immediately at hand they can spend more time weighing issues," White maintains. These physical changes, he maintains, can "change the very ways that governance is conducted."

An achievement of which White is particularly proud is the 1981 master plan for the Capitol and its grounds, which was drafted with the aid of a blue-ribbon advisory panel. The plan is notable for its three-dimensional character and its attention to open spaces and circulation as well as buildings. The plan proposed elimination of parking on the Capitol's east plaza and construction of an underground garage. It also called for construction of a major new building just east of Union Station and a pedestrian promenade from the station to the Capitol.

Other major buildings would be placed around open spaces in the southern sector of the capitol grounds to "re-establish the characteristic profile of the hill," which had eroded. "Environmental limits" were established during White's term, and the historic Capitol Hill residential area was to be protected from encroachment.

The plan was not formally adopted by Congress, but White says its basic tenets are "in force and referenced in many pieces of legislation." The building next to Union Station is under construction and will house federal judiciary administrative offices.

New construction during White's tenure
What about the new buildings of the White years? There have been only two so

As the Architect of Capitol, George White is now an apolitical official in the most political setting imaginable.

far. The first was the Madison Building of the Library of Congress, designed before White's time and delayed in construction so long that it was bound to be a dinosaur upon completion. White changed the mode of construction but made a deliberate decision not to second-guess the design. This may have been professionally proper, but it allowed a bland bulky structure to be built.

The first building under White's direct

ing that principal-in-charge Warnecke move to Washington and stay until the working-drawing stage. The other was that the building be a joint venture of sorts, with White a full participant in design. The building (top) initially received more attention for its cost than its design. White blames the sizeable overrun on the fact that it was built during a period of 20-percent inflation. Nevertheless, many senators were reluctant to move in, fearing constituent reaction. The building was not only expensive but looked it, with high ceilings in the offices, a soaring central atrium, and luxurious materials. White, while acknowledging he cannot be objective, feels that the building succeeded "in the basics, such as its proportions and rhythms."

Although senators are now eager to occupy its offices, the Hart Senate Office Building projects a bland presence on the street and a somewhat chilly environment inside. White acknowledges that if it were designed today, there might be more ornament and perhaps some references to the Classicism of Capitol Hill.

Such allusions to Classicism abound in the design of the Judiciary Office Building (model photo bottom), designed by Edward Larrabee Barnes in a designer-developer competition. White's influence is apparent mainly in a set of strong design guidelines, in particular that the new building be in harmony with adjacent Union Station. It promises to achieve that and a strong presence of its own as well.

White, who is 69, will serve up to six more years under provisions of legislation that he supported. Now, for the first time, legislation calls for a limited term on service in his office and gives the Senate authority over appointment of his successor. In the remaining years of his tenure, he hopes to put through a reorganization plan that establishes deputies for each of the major activities of the office.

In the end, White's most significant achievement may perhaps be the condition in which he leaves the office. It is vastly more competent and effective than ever before. And in raising the stature of his office, he has raised the stature of the profession as a whole. "It shows," White concludes, "that architects can cope with a variety of demands."

DONALD J. CANTY



Hart Senate Office Building, by John Carl Warnecke and Associates (top); model of Judiciary Office Building by Edward Larrabee Barnes (above).

design influence was the Hart Senate Office Building. White presented the Senate office building commission with a list of potential architects whom he felt "could design in a contemporary way but were schooled in the classics."

The commission selected San Francisco-based John Carl Warnecke and Associates. White imposed some stipulations, includ-

SPAIN FETES MODERNISM

Even before the 1992 festivities begin in Barcelona and Seville, a new generation of Spanish architects shows it still believes in Modernism.

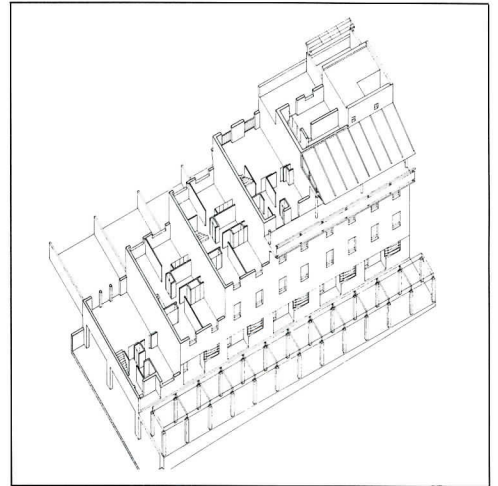

HISAO SUZUKI, COURTESY OF EL CROQUIS EDITORIAL, EXCEPT AS NOTED

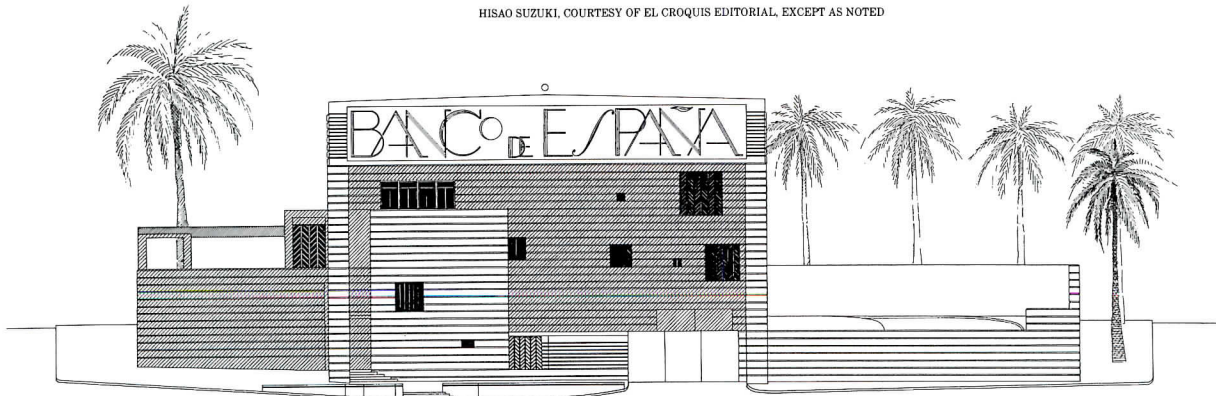

Vazquez Consuegra's housing in Seville (top photo and axonometric) stacks two levels of townhouses. Moneo's Banco de España (above) is an elegant fortress for a drive-in age.

In Spain the vitality of Modern architecture has never seriously been in doubt. Modernism still represents change and progress — the public face of the country's dynamic young democracy, symbol of its rapid advance from the isolation of the Franco era into the European mainstream.

Since the ruling Socialist Party came to power in 1982, an unprecedented number of public and private projects have been commissioned, encouraged in part by the upcoming celebrations of 1992 — the Barcelona Olympics and the Seville World's Fair — and by the prospect of Common Market unification in the same year.

This work has brought forward a new generation of architects. Like the governing Socialists, they find themselves participating in a development process they once watched critically from the sidelines. Their Modernism is tempered by realism and

critical distance as they seek to balance the positive and negative impact of Spain's rapid growth.

Guillermo Vazquez Consuegra's Ramon y Cajal housing in Seville, for example, mixes Modern functionalism and Postmodern contextualism in what Spanish critic Antón Capitel has called a style of eclectic rationalism. Set in an anonymous district of working-class apartments, the building (top left and right) uses a sophisticated program of two stacked levels of duplex rowhouses, the lower-level units with individual entrances and gardens and the upper level with roof terraces and entrances off a long open-air gallery.

The design's repetitive units are enhanced by rhetorical gestures such as the use of public spaces to unify the composition. An upper gallery, for example, acts as a cornice, while a vertical slot in the cen-

ter of the building exposes the central stair. Significantly, the single elevator is hidden within the building: human rather than mechanical movement is given prominence. Vazquez Consuegra dedicates his building to the pedestrian.

If Vazquez Consuegra's housing looks back to the pedestrian spaces of the traditional city, the work of Rafael Moneo, outgoing chairman of architecture at Harvard's Graduate School of Design, examines architecture's ambiguous role in the modern city. His design for the Banco de España in Jaen (above) makes use of the contrast between the role of the building as a public symbol and the bank's requirements for high security. The bank houses a state money vault accessed primarily by armored trucks, guards, and bank officials. Even the plans for the vaults have been censored by the government.

The design combines a sunny open canopy with a fortress under its eaves, superbly built of rusticated red stone blocks and surrounded by walls. The randomly sized windows, some no larger than peepholes, are covered with stainless-steel grilles like the barred windows of ancient monasteries. An oversized coat of arms over the diminutive entry door reinforces the reference to medieval architecture.

Learning from Venturi

The truck entrance's monumental canopy (with the name of the bank carved in handsome letters across its marble lintel) is the building's grand public gesture. The design recalls the expressive, symbol-laden Neoclassicism of Gunnar Asplund's Woodland Crematorium, while at the same time referring to the simple sheds with elaborate signs that Robert Venturi wrote about in *Learning From Las Vegas*. Moneo's building reads as a dressed-up drive-in for armored trucks.

More overtly Postmodern architecture generally remains on the periphery of Spanish design, although there are a few notable exceptions. For example, Pep Bonet's Rius i Taulet Pavilion, an addition to Barcelona's convention center (top photo and section), revives the grand large-span public interiors of the 19th century.

The building consists of four large skylit vaults sheathed in precast concrete walls with a corner entrance and central pillar that establish a rotating circulation pattern. As Moneo did with the Banco de España, Bonet faced the problem of a large interior volume virtually closed to the outside. He resolved the situation by breaking the interior walls with three tiers of shallow balconies that recall those around traditional Spanish plazas. Bonet's balconies, though, are reserved for mechanical services and are otherwise unoccupied. As a result, they merely hint at, rather than replicate, elements associated with the absent city.

Helio Piñón and Albert Viaplana take a more extreme position in their cultural center in the former convent of Santa Monica on Barcelona's Ramblas, the fam-

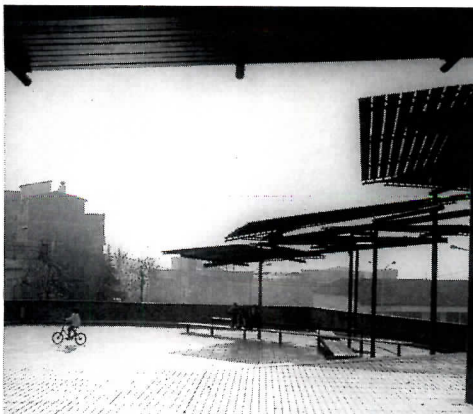
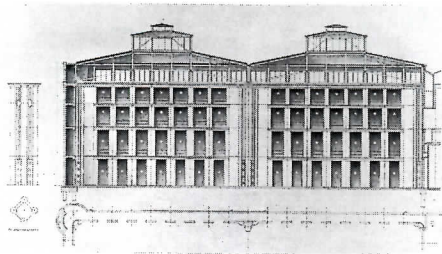
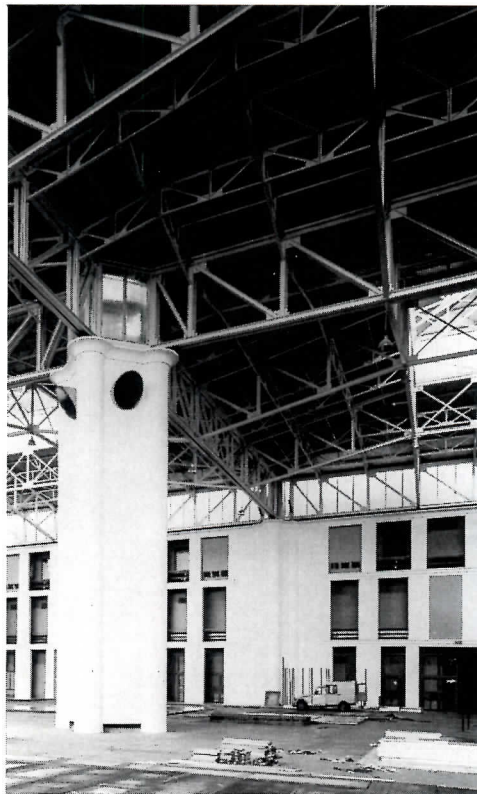

FERRAN PREIXA



ous pedestrian artery. The building (bottom plan and photo), like all of their designs, is influenced by the somber minimalism of the Spanish Modern master Alejandro de la Sota. Their previous designs reduce buildings to structural grids, cut in section by stairs and ramps that, in their zigguratlike ascent, project movement through static space. At Santa Monica, the static space is provided by the existing convent, while a new entry ramp that pauses in a sloping mid-level plaza establishes a dynamic path for visitors to follow.

The other major element of the design is a collection of subtle symbols. To the right of the ramp, for example, a single round opening in the new wall now covering the old parish church reads almost as a modern rose window. And like the grin of the Cheshire cat from Lewis Carroll's *Alice in Wonderland*, it reminds us of what is absent—namely, a church gable and a bell tower (which conveniently is suggested by the silhouette of a modern office tower behind the site).

Enric Miralles and Carme Pinos belong to a second, even younger generation that has come of age in the optimism and growth of the post-Franco era. Miralles worked for several years in the studio of Viaplana and Piñón, but has charted his own course since then. While Viaplana and Piñón tend to distill architecture to its very essence in their minimal drawings, Miralles and Pinos use their delicate touch with pencil and paper to conjure up freshly imagined worlds. Their small project for sunshades in the Plaza Mayor of Parets del Valles has the lightness and directness of a thumbnail sketch (middle photo). The discipline learned from Viaplana and Piñón provided a solid foundation for the younger architects' improvisation with sunshades, bringing a deceptive simplicity to the complex composition of tilted squares and zig-zagging beams.

Miralles and Pinos are now working on several larger projects, which together with the engineering feats of Santiago Calatrava point to a second vital phase of Spain's architectural development.

DAVID COHN

David Cohn is a freelance writer who lives in New York and Madrid.

Pep Bonet's addition to Barcelona's convention center (top photo and section) is more overtly Postmodern than most Spanish designs, while sunshades by Miralles and Pinos (second from bottom) exhibit a delicately Modern approach. Piñón and Viaplana converted a convent in Barcelona into a cultural center (left photo and plan).

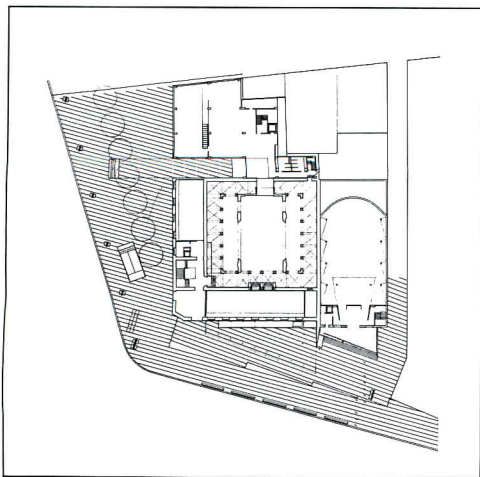

DEATH AND LIFE OF GREAT CITIES

Reviewed by Scott Gutterman

Downtown, Inc., by Bernard J. Frieden and Lynne B. Sagalyn. Cambridge: The MIT Press, 1989, 382 pages, \$19.95.

This fascinating book traces the course of commercial growth in American cities from mid-century to the present, focusing on recent schemes that have invigorated beleaguered downtowns. Authors Frieden and Sagalyn, both professors at MIT, detail how a group of cities changed from burgeoning, self-sufficient metropolises to emptied-out shells receiving governmental assistance (which often hurt more than it helped), and then back again to lively and responsive civic centers.

The initial postwar flight from cities to suburbs is presented here as swift and devastating. Solutions to the dual problems of urban flight and commercial decay were sought early; unfortunately, however, most of these were elitist and monolithic in nature. By the mid 1950s, architects, business leaders, and public officials were busy trying to make sense of city life in "the automobile age." Clutter was identified as a major problem, and so-called urban renewal began in earnest around 1957. The horrors of that movement and of the federally funded highway projects are recounted here—tales of intimidation and rampant racism on the part of developers, and of displacement and depression among residents, most of them members of minority groups.

Although the bulldozers did manage to make plenty of room for cars, they also left behind rubble-strewn lots, which seldom gave rise to the expected commercial development. Throughout the late '60s and early '70s, all but the most resilient downtown stores languished, while suburban shopping malls flourished.

Boston's Faneuil Hall, opened in 1976, was the first development to buck the trend, and the authors point out that the venture was a risky endeavor, carried out with improvised panache and plenty of luck by developer James Rouse. The project used history as a calling card, removing it from the hands of antiquarian societies and returning it to the general public in the form of a vibrant central marketplace. Faneuil Hall was a hit that spawned many imitators; some of these, such as Pike Place Market in Seattle, improved upon the original, embracing vernacular architecture and local wares to create a stronger link between the market and the city.



ROBERT S. BRANTLEY

A staircase in the Garden District offers a display of opulence.

The authors stress the ways in which private developers' profit motive forced these projects to be more flexible and responsive to the public. But they are not blind to the markets' drawbacks and limitations. Most architecture critics and many city residents find them cloying—urban Disneylands with no character of their own. But for the short run, at least, they've brought people back downtown, and they may indeed represent, as critic Robert Campbell suggests, "a stage we have to go through as we begin cautiously, self-consciously to re-enact the urban culture we abandoned."

Scott Gutterman is a New York-based freelance writer.

Southern Comfort: The Garden District of New Orleans, 1800-1900, by S. Frederick Starr. Cambridge: The MIT Press, 1990, 308 pages, \$35.

The idea of focusing on a single area over a 100-year period might seem limiting, were the area under review not the host to so many fascinating stories. New Orleans is a world unto itself, and the Garden District is that world's Eden.

Author S. Frederick Starr (with solid help from photographer Robert S. Brantley) takes the reader deep inside this civic paradise. He disputes the myth that inherited wealth was the cornerstone of the community, arguing that self-made men and entrepreneurs were largely responsible for building these monuments to their own success. His recounting of the sagas of entrepreneurs such as James Robb and Henry Lonsdale, who helped found and expand the Garden District, add immeasurably to a deepened feeling for its special character.

The Civil War spared the district, and successful reconstructionists only added to its glory. Despite the many competing styles of architecture put on display (Italianate, Greek Revival, and Queen Anne among them), the area as a whole maintained an almost magical unity of style. But by the turn of the century, New Orleans' wealthy families stopped congregating in the area, and neglect began to set in. Thankfully, enough of the houses have been preserved intact to ensure the visual and esthetic unity of this elegant domain.

SCOTT GUTTERMAN

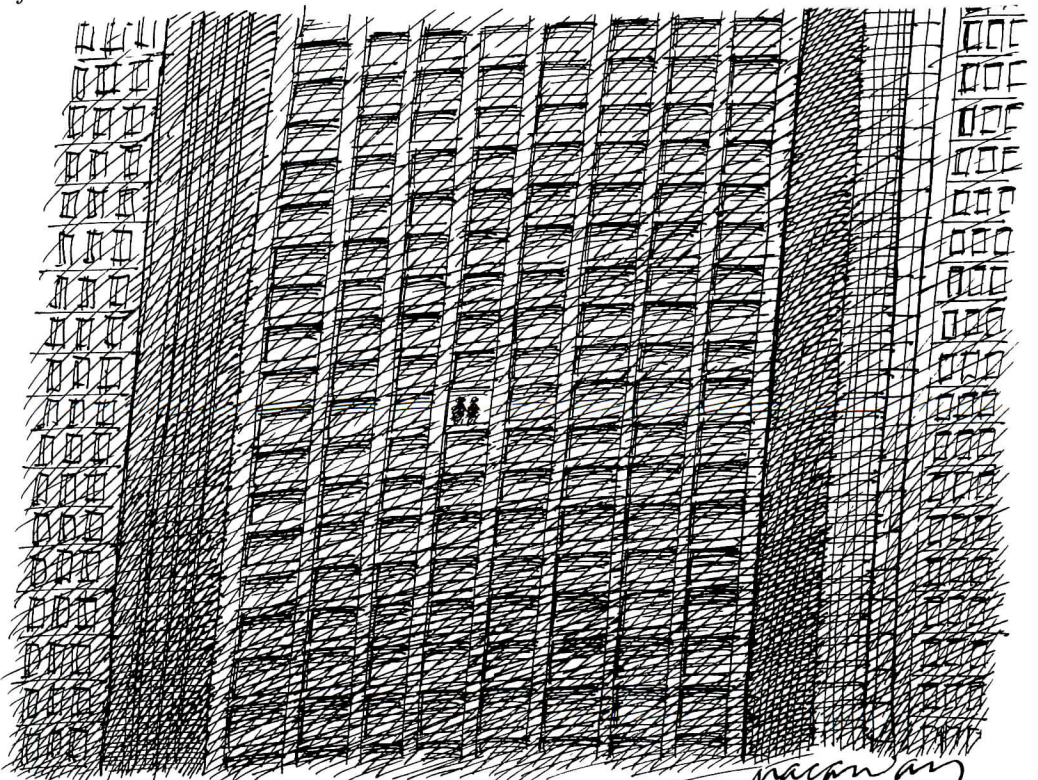

Look, Joe! Up there. Isn't that sky?

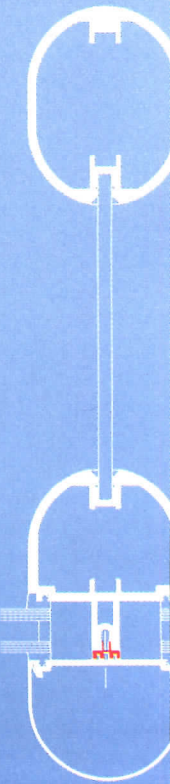
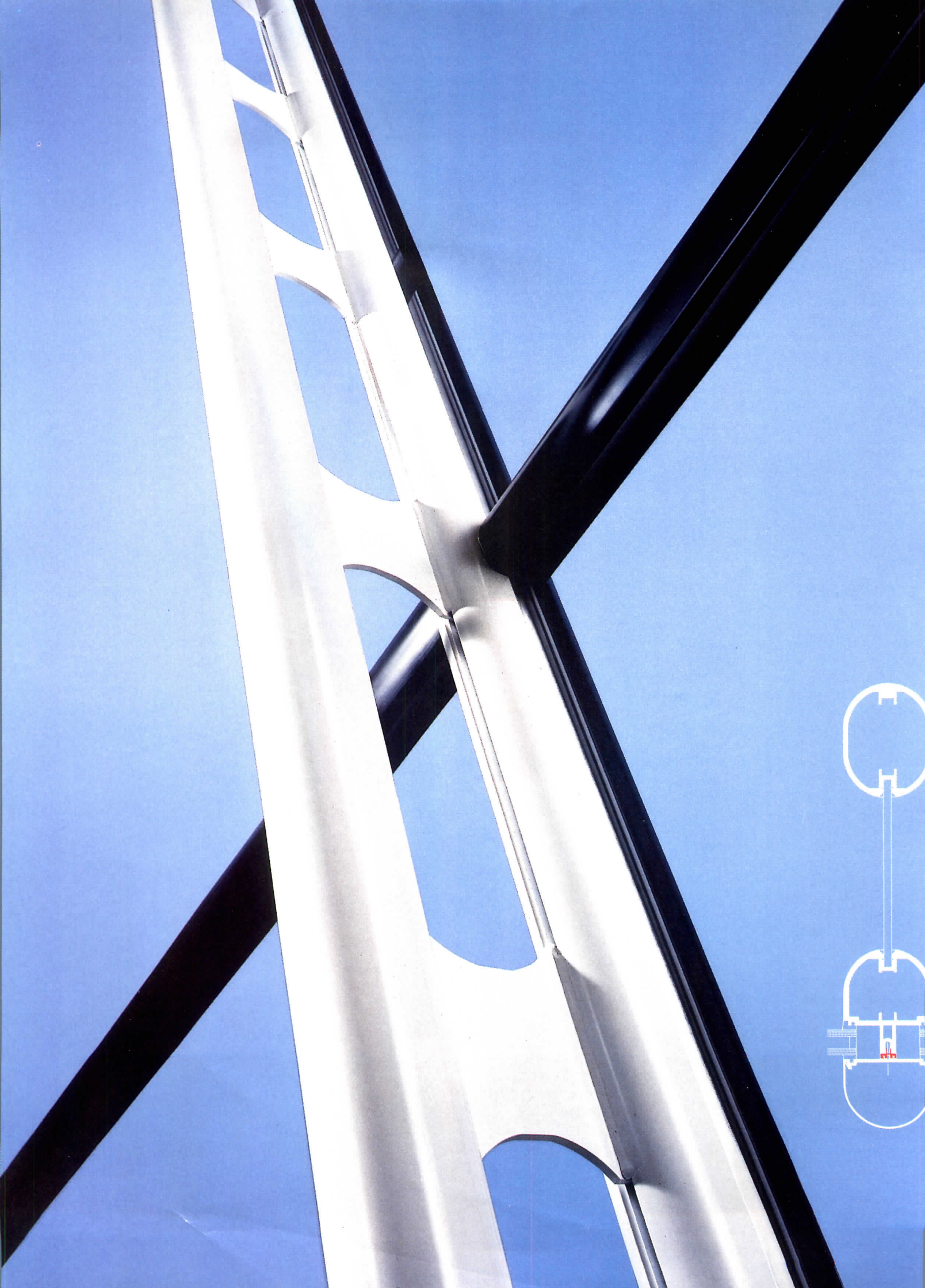

We don't know of any other company in the business that can make that claim.

And that makes you wonder.

If these other window



COVERED BY A WARRANTY. A TARP.

companies don't have that much confidence in the stuff that they build, why should you?

For a free copy of our Windowscaping[®] Idea Book, and the location of The Pella Window Store[®] nearest you, call 1-800-524-3700.



Circle 44 on inquiry card

It's Time...

1. to take a new look at the star system of architectural credits and to honor the *teams* that make building projects possible.
2. to recognize that the 1990s will see a leaner firm that depends heavily on CADD, and on "outsourced" temp expertise for drafting, project management, and design.
3. to face the fact that the medium-sized (20- to 40-person) firm will become increasingly unstable due to the economics of practice, with the future belonging to large firms and to small specialized "niche" or boutique firms.
4. to grasp the opportunity of global practice in hitherto blocked regions such as Western Europe, especially with the 1992 ending of trade barriers in the European community.
5. to come out against the rage of treating architecture as fashion, with a new ism invented every Monday morning; and to begin to question celebrating those arbitrary, self-indulgent designs that break every rule of scale, proportion, structural integrity, and human comfort handed down to us in three millenia of architect-designed building. Face it: some of our emperors are simply naked.
6. to question the pseudoprofundity of so much writing about architecture that merely serves to conceal an absence of thought via circumlocutory cycles of verbal sonorosity.
7. to guard against efforts by government to make up for profligate spending through an ever-expanding tax base, which is now beginning to knock at the gates of designers and other professions providing essential services to the public.
8. to execute, rather than pay lip service to, increased quality assurance and quality control as standard operating procedures in all firms, small or large. It's the best way to cut the mountainous errors and omissions premiums draining the profits of design firms.
9. to cease backing out of responsibility for construction-contract administration and, by training and selecting skilled site people, build back the reputation of the architect as key player on the building team.
10. to recognize that the U. S. and global housing problem is one of the three great survival issues in the world today—the others being hunger and the environment—and that it is time to cut back on megaconferences of housing experts eating pheasant in aspic at glam-

orous watering holes, and to realize instead that the solutions lie in finances, infrastructure, and administration as much as in design and construction technique. We need less talk and more action (see story on Nicaragua, page 11).

11. to take a hard new look at our schools of architecture. Recognize that it is their job to turn out people for careers rather than men and women who will merely hit the ground running their first day on the job, but note that much of the recondite philosophy dished out by resident gurus does the students a disservice, and that greater attention to the basics of design, technology and practice, and the ability to write a simple declarative sentence, come first.

12. to look forward to a whole new set of markets for the architect's services, as grandchildren of the World War II baby-boomers hit the school systems and as medicine and a decent diet and exercise create a whole new client at the aged end of the spectrum.

13. to begin to look more closely at the real meaning of CADD for architects and their clients. Some 50 percent of firms are now said to use CADD, but this statistic never tells the whole story. It ignores the productivity factor, which is shaped by unproductive staff being trained to use the system; by quality control, linkages with engineering consultants, value to the client—the soft side, in other words, of this great god.

14. to come to terms with the fact that the value of CADD as a marketing tool will fade away as every firm gets to have it.

15. to look increasingly to the building-product manufacturer for solid technical information, on the grounds that the architect simply lacks the money and skills to do viable building research on any sort of scale. More and more of this information will come in automated form as product manufacturers seek to incorporate into the architect's CADD software tested details, symbols, specifying data, and even routines for creating custom products.

16. to rebuild the architect's sense of worth, to take a tougher stand in fee negotiations, to realize that profit is not a dirty word, and to point the client to the risks incurred in eroding the architect's authority.

It is not too late, but it is time. Stay tuned to a new RECORD.

STEPHEN A. KLIMENT



©WARREN AERIAL PHOTOGRAPHY

New stars on L. A.'s skyline include Pei Cobb Freed's First Interstate World Center (tall setback building, center background), Cesar Pelli & Associates' 777 Tower (building under construction, right foreground), and Kohn Pedersen Fox's Coast Savings Tower (patterned building to right of the Harbor Freeway).

As recently as 1985, the *Guide to Architecture in Los Angeles and Southern California* began its section on downtown Los Angeles with the assurance that "Yes, [Virginia,] there is a downtown Los Angeles." Locals like to say that generations have grown up without ever seeing the city's downtown, except from a car speeding down the freeway. Now it is indisputable that Los Angeles has a bonafide downtown core—the result of a concentrated public/private renewal effort that began in 1976.

Construction in L. A.'s central business district, all but dormant in the two decades following World War II, accelerated during the 1970s and '80s and is climaxing today with a set of tall buildings by some of the nation's most celebrated architects. (In the recent photo above, towers erected during the '70s are

flat-topped Modernist boxes; the newer buildings, built over the past 10 years, tend toward rounded forms and setback tops.)

A brief history of downtown

Downtown L. A. began near El Pueblo de Los Angeles, the city's historic heart. Broadway evolved as the city's main commercial artery, and development moved south along this spine before turning west on Seventh Street, forming an L-shaped business district around the mansion-studded promontory of Bunker Hill. During the 1960's urban-renewal bulldozers leveled not just the mansions but the hill itself. This seemingly rash act had one unanticipated benefit: it acted as a safety valve that took development pressure off the *old downtown*, so that Broadway today survives as a thriving

Core Concerns

Nearly 15 years ago, Los Angeles introduced a downtown urban-renewal plan that combined a mix of public and private investment. Although the plan has attracted some of the country's most celebrated architects, the city, reports Don Canty, is still struggling to find its center.

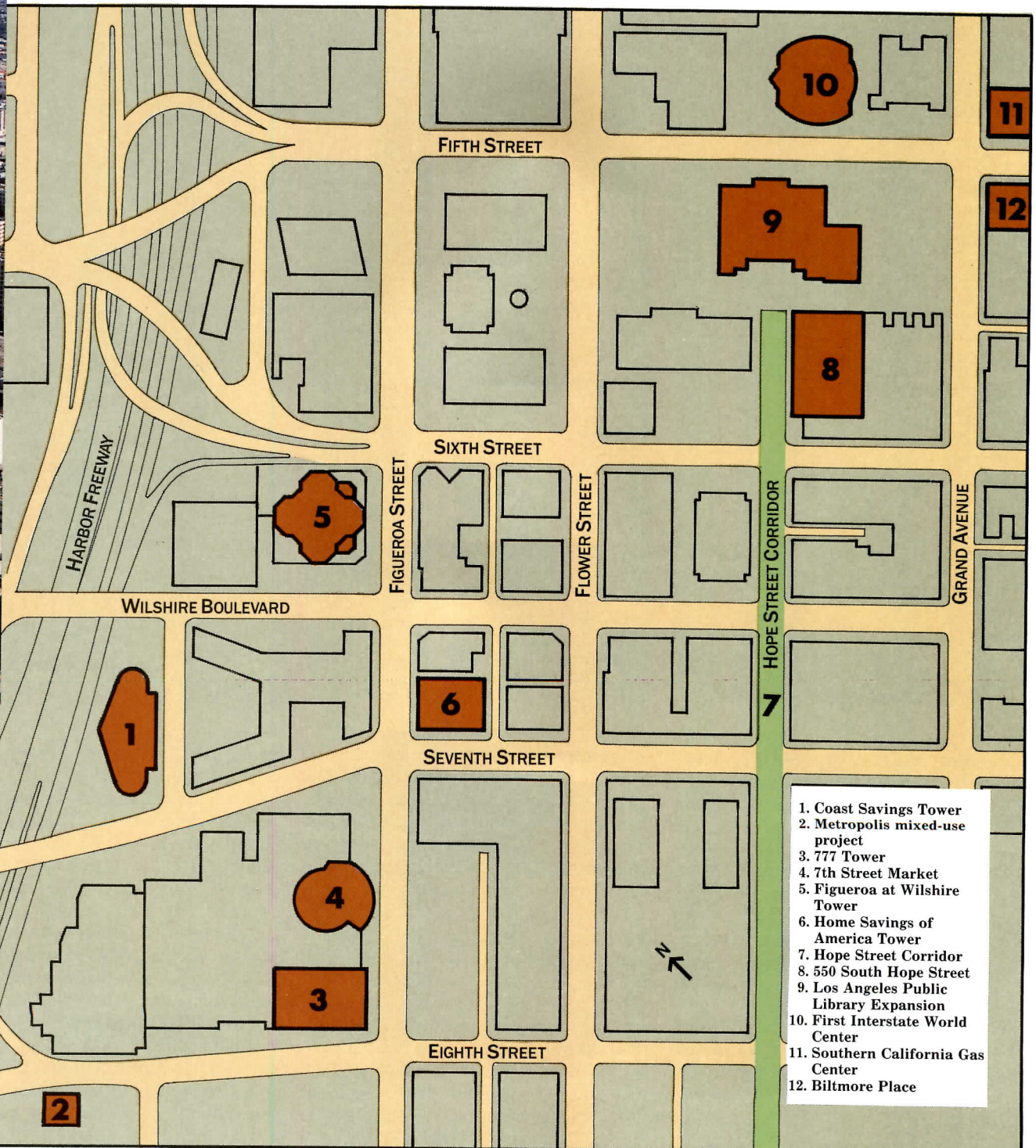

Below: Arthur Erickson's One California Plaza (right in photo) initiated the Bunker Hill renewal program. Across the street is the Wells Fargo Tower by the San Francisco office of Skidmore, Owings & Merrill.

JOHN PASTIER PHOTOS, EXCEPT AS NOTED



Above: First Interstate World Center rises above Bertram Goodhue's 1922 Los Angeles Public Library. The tower was built as part of a complex real-estate transaction involving the library's restoration and expansion.

center for the city's Hispanic population.

In recent years the Harbor Freeway has pulled downtown development west. As Los Angeles has gradually replaced San Francisco as the West Coast's financial hub, Figueroa Street, just east of the freeway, has become its "Wall Street." The current wave of major downtown redevelopment has focused on a corridor along Figueroa, together with a second node of activity centered on the corner of Fifth Street and Grand Avenue (see map page 59).

Downtown L. A. today: inventory of the new Questions that one must address in assessing L. A.'s new architecture are: how urbane an environment has downtown redevelopment thus far yielded, where will the next wave occur, and what form it will take? For the time

being, the new crop of downtown buildings can best be called competent in design, with only occasional flashes of distinction. Centerpiece of the skyline is the 73-story First Interstate World Center, by Pei Cobb Freed & Partners (above left). This building, the tallest structure west of Chicago, is the result of a complex set of air and development rights tradeoffs involving Bertram Goodhue's central library across the street, the architectural jewel of downtown Los Angeles now undergoing renovation and expansion with proceeds from the transaction.

First Interstate is a subtly patterned granite-clad cylinder with various protrusions and setbacks as it proceeds upward to a crown that is an oversized version of the principal tenant's logo. While a noteworthy punctuation mark from afar, First Interstate lacks great impact

Below: The Landau Partnership's 24-story Biltmore Place is appended to the remodeled Biltmore Hotel. The project shifted the hotel's entrance from problem-plagued Pershing Square (in foreground) to Grand Avenue.

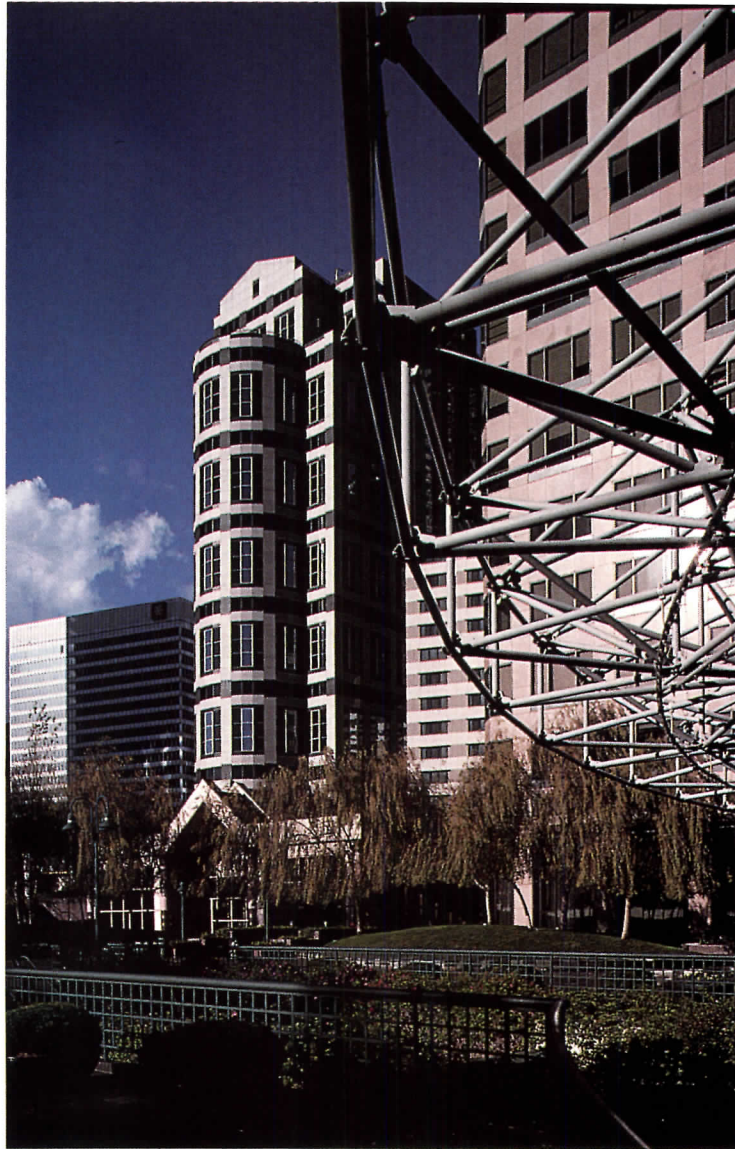

at street level, partly because of a slender profile imposed by the building's small site.

An important participant in the library-tower transaction, developer Rob Maguire, was a key player in the celebrated 1980 "Battle of Bunker Hill," the architect/developer competition for the last 11 acres in the Bunker Hill redevelopment area. Maguire entered the competition with an all-star architectural team and quickly became the public and professional favorite. The land, however, went to B. H. A. Associates, with Arthur Erickson as architect.

Now in place on the site are Arata Isozaki's Museum of Contemporary Art and the initial Erickson tower. Isozaki's building is a widely heralded gem; Erickson's, to put it mildly, is a disappointment. Called One California Plaza, Erickson's tower is a curvilinear reflective

glass shaft rising incongruously from a rectangular granite base (right opposite).

Also underway is the 22-story residential Museum Tower, for which Barton Myers Associates was design consultant. Myers also will do a hotel and a 35-story residential tower on the northern portion of the site, and early renderings promise more distinctive design than contained in the office towers. Nearby, Frank Gehry's Walt Disney Concert Hall will mediate between Bunker Hill and the huge concentration of government buildings just to the north.

Downtown L. A. does have its architectural sports. One is a gabled tower appended to the Biltmore Hotel (above left), designed by the Landau Partnership, which has the effect of re-orienting the historic hotel to the commercial core and away from Pershing Square, once

Above: Kohn Pedersen Fox's Coast Savings Tower rises behind Skidmore, Owings & Merrill's Citicorp Plaza. A metal trellis (right foreground) roofs the Jerde Partnership's Seventh Street Market.

Below: Albert C. Martin & Associates' Home Savings of America Tower, a neo-Deco gesture to an earlier downtown building boom, contrasts with the Modernist structures around it.

Below: Together with Citicorp Plaza, Cesar Pelli & Associates' 777 Tower is part of the CBD's movement south, a trend expected to accelerate sharply during the next two decades.



©GREG MURPHEY

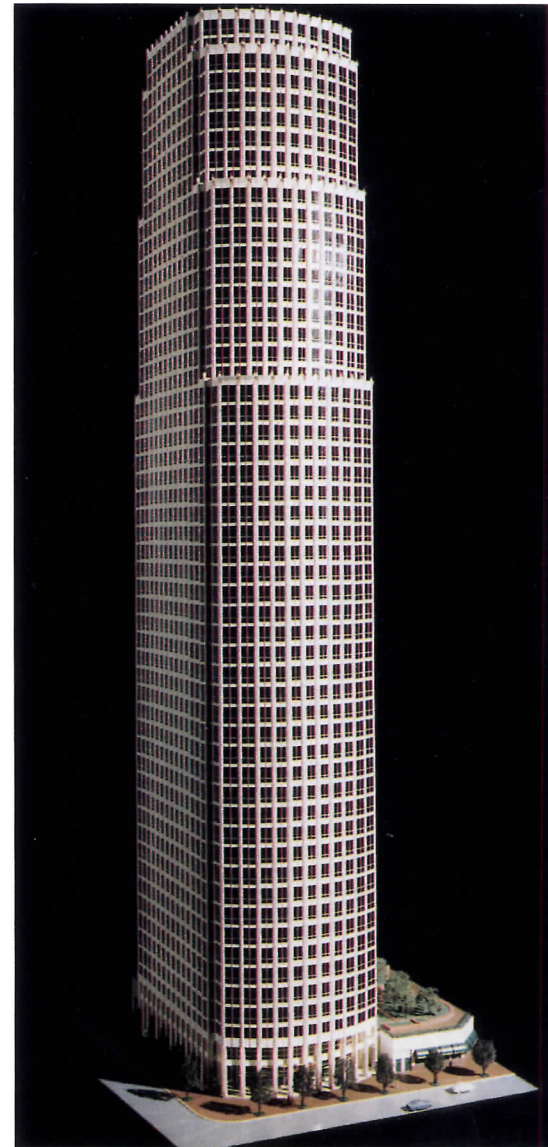

The Seventh Street Market is an urban grotto.

one of downtown's major amenities but now a tattered haven for the homeless.

The biggest little building downtown is the Coast Savings Tower by Kohn Pedersen Fox (right page 61). Though just 22 stories tall, KPF's building has an aggressively overscaled granite-patterned facade, along with a large and somewhat mordant plaza bearing little temples and other classical devices. A much more beguiling eccentricity is the Home Savings of America Tower by Albert C. Martin & Associates with Thomas R. Vreeland as project designer (above left and *RECORD*, February, 1990, pages 94-97). This unabashedly Deco Revival building is a suave reminder of the numerous early 20th-century structures that have escaped the downtown-renewal bulldozer.

Martin also has two other towers underway.

One, a 52-story office tower atop a retail atrium and plaza, is nearing completion at the crucial intersection of Wilshire and Figueroa (right page 64). The second is 865 South Figueroa, which will include a sculpture by Elyn Zimmerman that resembles a boulder-strewn stream extending from the plaza to the lobby.

Next door to 865 South Figueroa, the curving facade of Cesar Pelli's 53-story 777 Tower is clad in an elegant off-white curtainwall. Pelli's tower (above right) is part of Citicorp Plaza, which contains two of downtown L.A.'s most notable public spaces: an open greensward that comes as a complete surprise in this paved precinct, and a sunken marketplace (small photo left), designed by the Jerde Partnership as a kind of atrium in reverse with steel trellises and gazebos.

Halprin's open-space corridor: New hope for L. A. pedestrians

Landscape architect Lawrence Halprin has designed a continuous spine of open space connecting Bunker Hill on the north and Grand Hope Park on the south. The project begins at Wells Fargo Center with a handsome atrium between the twin towers. Pedestrians then descend 50 feet via a set of stairs running alongside First Interstate World Center (top right). These stairs are flanked by escalators, with a

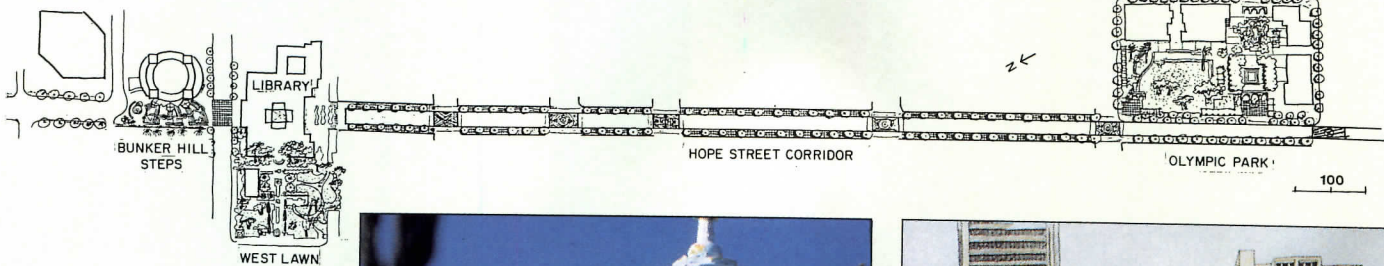
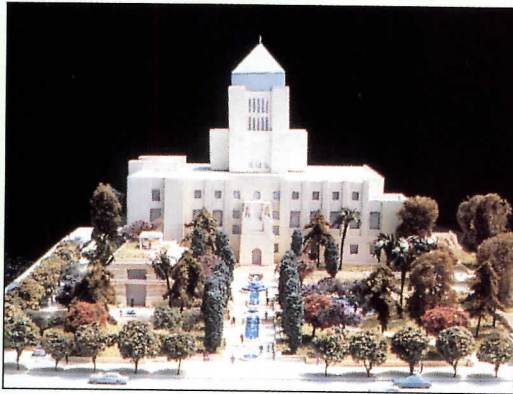

sculpture-bearing water course down the center and sidewalk cafés along the way. A midblock crossing leads to the new west lawn of the central library (top left), with parking below. (The library's lawn for years was used as grade-level parking.) South of the library Hope Street has been transformed into a tree-shaded promenade with widened sidewalks that extend to Grand Hope Park—formerly Olympic Park—which eventually will be adorned with a fountain, a symbolic clock tower, and an arcade containing shops and restaurants (bottom left). **D. J. C.**

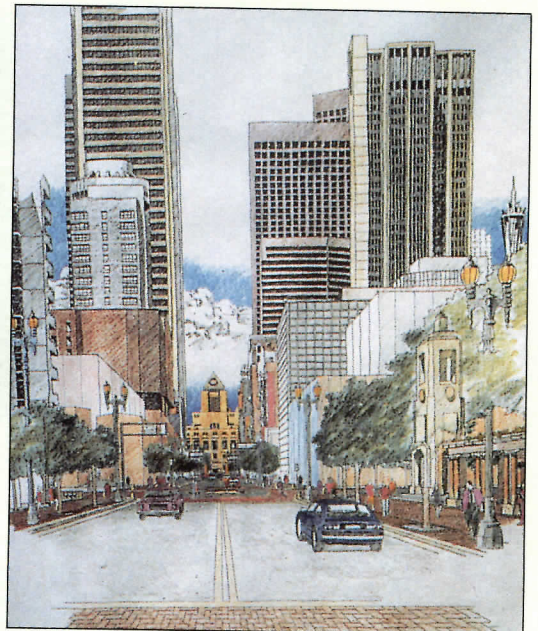
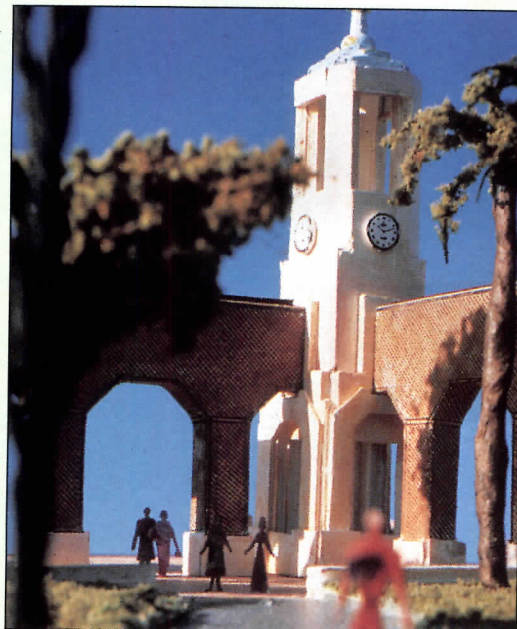

The search for a center continues

These are the individual components of L. A.'s new downtown. What does it all add up to so far? A symposium of critics held in the city last September offered some answers.

The symposium generated "substantial negative commentary" about downtown, reported Aleks Istanbullu in *L. A. Architect*. The critics took the architects of the city's new buildings to task "for not addressing the needs of pedestrians, for failing to create viable new public spaces, and for creating clichéd towers with cheap wallpaper . . . It is unsettling that the national talent and vast resources poured into these projects has produced anything less than one of the most convincing urban settings in Los Angeles." He noted that one of the critics called Bunker Hill "an unbelievable disas-

ter of useless and empty plazas"—without rebuttal by architects and city officials present.

One of the latter most directly involved with downtown is John Kaliski, chief architect of the Community Redevelopment Agency (CRA). Kaliski believes that the renewal of downtown has succeeded, though only on its own terms. "The idea was to stimulate private development, and that has been done," he says. Just blocks from the new downtown towers, however, are neglected pockets of degradation. There are also vital and vibrant ethnic neighborhoods that need to be nourished and protected. "It's time for a reassessment of downtown development priorities," Kaliski believes.

CRA has played a significant role in the past generation of downtown renewal. Kaliski's office draws up detailed design guidelines for

Below: A model of SOM's Southern California Gas Center, currently rising at the corner of Fifth Street and Grand Avenue. Bottom: Model view of a new spec office tower at 550 South Hope Street, designed by Kohn Pedersen

Fox. Top and bottom right: Model views of Albert C. Martin's 760-foot tower at the corner of Figueroa and Wilshire. The building's street-level atrium features exposed structural members and delicate glazing.



©BOB HARR, HEDRICH-BLESSING



©JOE AKER



MARK LOHMAN

each major project, dealing with such matters as open space and scale. CRA also has invested in development and public improvements. When California voters adopted Proposition 13, putting a lid on local taxation, it exempted redevelopment agencies, and CRA became a prime source of new municipal revenue. The agency itself, however, is now in transition. In January Mayor Tom Bradley reshuffled its board and staff and placed new priorities on social services. In terms of development "CRA's activist days are over," says Kaliski.

The future: housing will predominate

Downtown office construction also may have about run its course, although there are some significant towers still to be completed. KPF has a 28-story office building on South Hope

Street that bespeaks the firm's recent return to Modernism (bottom left), while SOM's L. A. office has underway the 52-story Southern California Gas Center (top left), located off Pershing Square. With an arching glass crest emerging from a faceted granite tower, it may be most promising of the new mega-buildings. Work on the public library itself, moreover, is proceeding according to a design by Hardy Holzman Pfeiffer (bottom right opposite) that will double the size of the original building.

The direction of future downtown development is likely to be to the south, and its nature mainly residential. South Park, between downtown and the University of Southern California campus, is site of the city's convention center, now being vastly enlarged according to a design by Pei Freed Cobb. Nearby will be Mi-

Below: Michael Graves's mixed-use Metropolis will be built in five stages on a 6.3-acre site between Eighth and Ninth streets, adjacent to the Harbor Freeway. The elevation shown will face downtown.

MARK LOHMAN



Michael Graves's mammoth Metropolis (top), a 2.5-million-square-foot multiuse development in the architect's signature historicist mode.

Finally, there is the Central City West plan being developed across the Harbor Freeway. Its development as an extension of the core would require new ramps from the freeway and extension of downtown's new rail lines. The concept raises the question of why Los Angeles, after spending a generation on development of a concentrated core, would now want to diffuse it. The city's imposing skyline aside, downtown still contains only about 15 percent of greater L. A.'s total office space. With such competitive business centers as Santa Monica, Westwood, and Century City continuing to thrive, Los Angeles remains a city in search of a center. **DONALD J. CANTY**

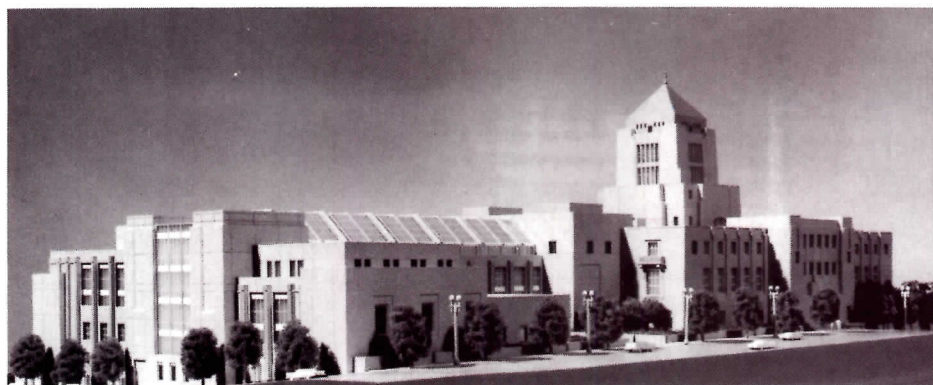

Hardy Holzman Pfeiffer's addition to the Los Angeles Public Library.



On Axis with the Past



©DAN FORER PHOTOS

A new administration center by Spillis Candela & Partners serves a growing county in central Florida as an efficient government complex and a symbol of civic pride.

Having grown helter-skelter during the 1980s, the Volusia County government today has a handsome home with enough room for its entire family of agencies. Much of the credit goes to Spillis Candela & Partners, the Miami-based firm that not only designed the building but also helped with the site selection and negotiations between county and town officials.

Located just north of Orlando, Volusia County shared in the same boom that swept through much of Florida during the last decade. From 1980 to 1987, Volusia's population grew 27.9 percent and county agencies spread out among various offices in both DeLand and Daytona Beach. While other counties in Florida converted former department-store space into offices for public agencies, Volusia decided to bring its disparate services together in a new administration center. The facility would also include more appropriate quarters for the County Council than the former supermarket being used at the time.

The first decision Spillis Candela helped the county make was to build in DeLand, a town with a fine array of three-story

brick and stucco buildings along its main street, Woodland Boulevard. Once committed to staying downtown, the county proposed a site it owned diagonally opposite the Neoclassical County Courthouse, on a street perpendicular to Woodland. The small (one-acre) lot, however, would have required a seven- or eight-story administration building, much taller than anything else in the area. Standing on the front steps of the courthouse, Julio Grabiell, the principal in charge of the project, knew a much better site would include a strip of city-owned land directly across the street and on axis with the venerable old building. To make his vision a reality, Grabiell worked with the county to acquire the property from the city and include an existing city park in the design of the new building.

With the larger site, Grabiell was able to reduce the administration building to four stories and bend it around a brick plaza linked to the courthouse (site plan page 68). By breaking down the massing of the concrete-frame structure and using two colors of precast cladding (dusty rose for the rotunda and beige

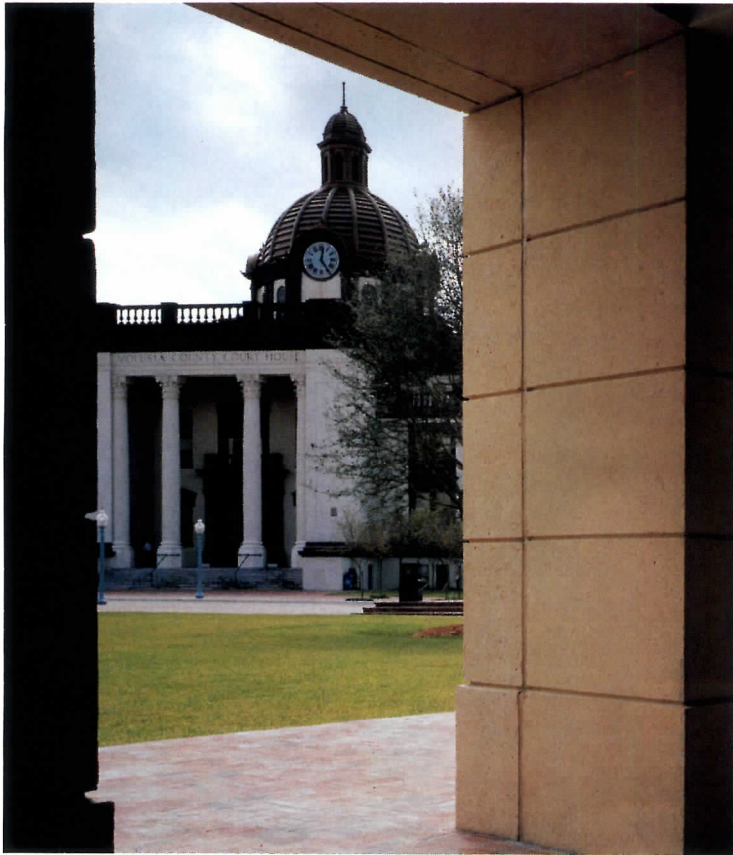

To reinforce the relationship between the county courthouse (top left) and the administration center, Spillis Candela cut a passageway through the new building and laid out a long pool on axis with the old one (bottom left).

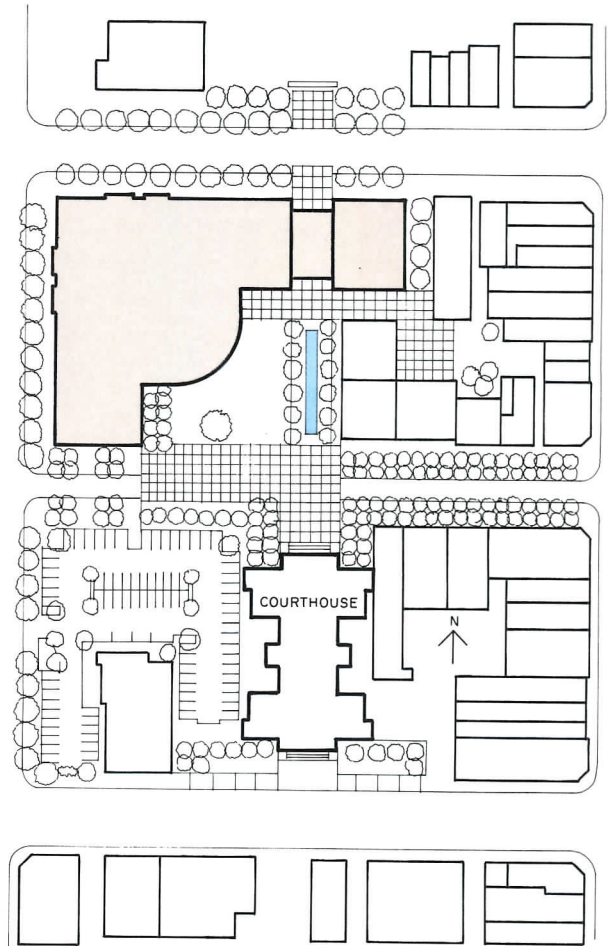

for the rest of the building), Grabiell scaled the complex to fit in with its smaller neighbors. While some county officials suggested closing off the street between the two buildings and turning it into a pedestrian mall, Grabiell disagreed and won. "We need to keep the streets alive," he explains.

Linking past and present

Spillis Candela's 162,000-square-foot building houses county agencies in two wings set at a right angle, with a skylit rotunda acting as a hinge at the corner. Curving around the rotunda on the front of the building is the council chamber. To emphasize the relationship between the administration center and the courthouse, Grabiell cut an arched passageway through the new building directly on axis with the old one. The new building takes other cues from the courthouse as well, picking up the cornice line and matching the height of its rotunda with the drum of the dome across the street.

Entering the building is awkward, due to budget cuts that

eliminated the twin arcades designed to draw people through the foyers and into the rotunda. Without the arcades extending beyond the building's facade, the entrances are hidden behind the council-chamber block.

To add ceremonial character to the project, Grabiell placed the council chamber one flight above the ground, creating a *piano nobile*. A wedge of stairs leads visitors from the ground floor of the rotunda to an anteroom behind the council chambers. To enter the chamber itself, visitors must then walk down one of two corridors, each offering a view toward the old courthouse. While this sequence is a bit complex, Grabiell wanted to establish a strong sense of procession and arrival. "A county council chamber isn't a drive-in kind of function."

Following the example of private companies, Spillis Candela built flexibility into offices by using systems furniture for three-quarters of the space. Agencies with the most public contact are on the lower floors, while those with less walk-in traffic are on higher ones. Working with a tight budget (\$12.5

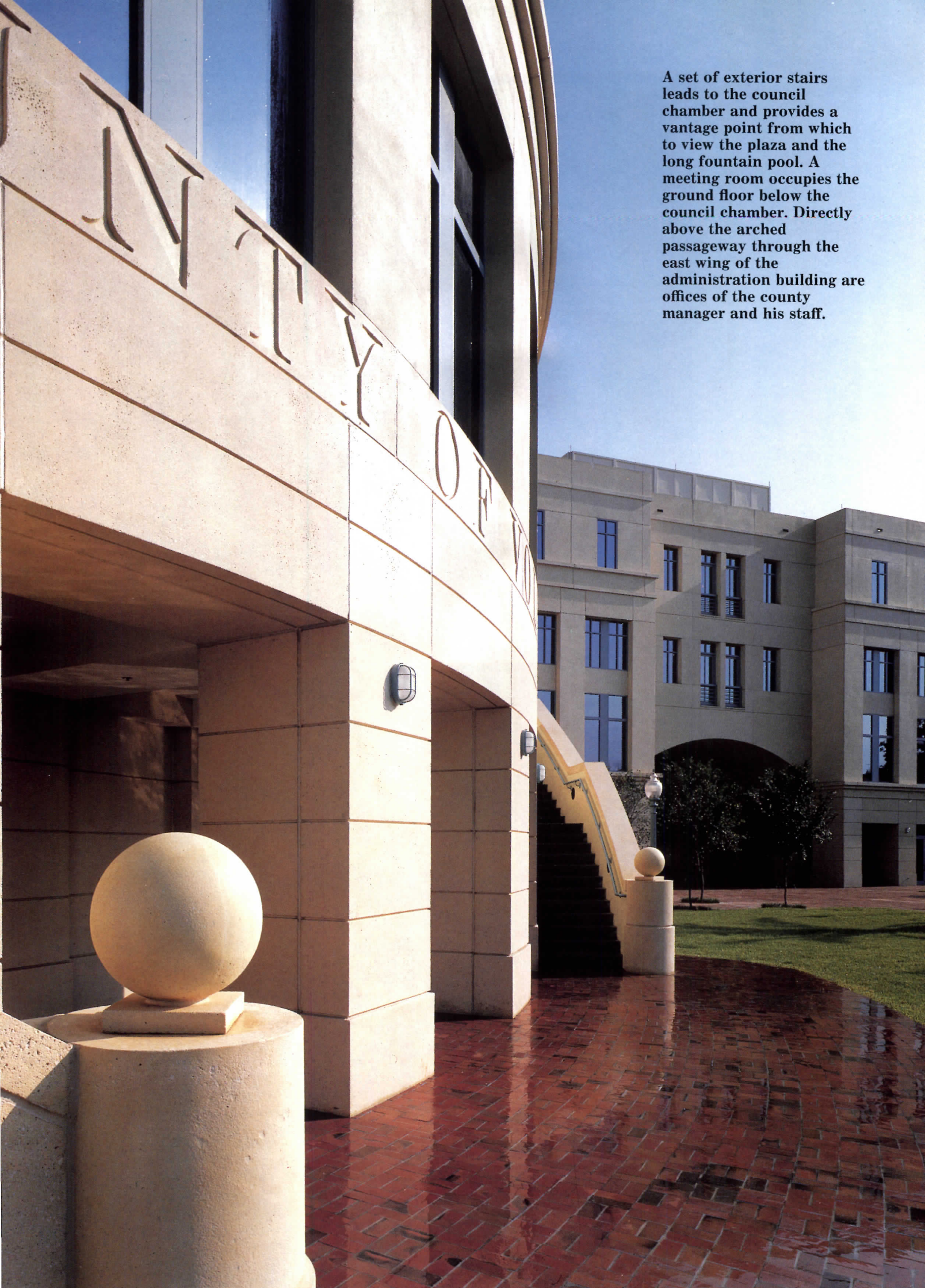

A set of exterior stairs leads to the council chamber and provides a vantage point from which to view the plaza and the long fountain pool. A meeting room occupies the ground floor below the council chamber. Directly above the arched passageway through the east wing of the administration building are offices of the county manager and his staff.

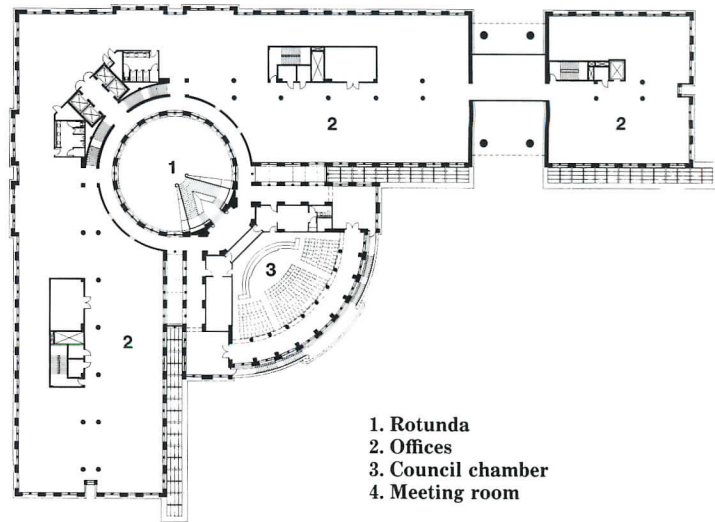

SECOND FLOOR

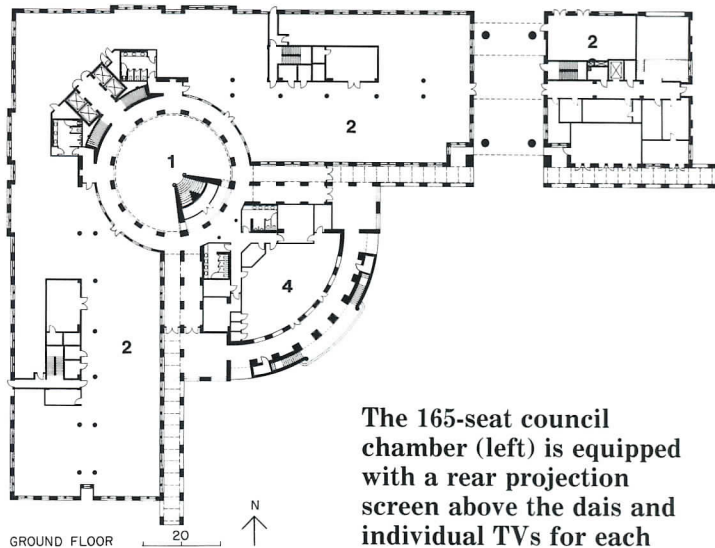

GROUND FLOOR

- 1. Rotunda
- 2. Offices
- 3. Council chamber
- 4. Meeting room

The 165-seat council chamber (left) is equipped with a rear projection screen above the dais and individual TVs for each council member. Though not air-conditioned, the 85-foot-tall rotunda (opposite) stays cool because it is surrounded by air-conditioned offices and is topped with a translucent plastic skylight that reduces heat intake.

million for the building and \$17 million for the entire project), Spillis Candela delivered a complex that serves as a dignified symbol of progressive government. **CLIFFORD A. PEARSON**

*Volusia County Administration Center
DeLand, Florida*

OWNER: County of Volusia

ARCHITECT: Spillis Candela & Partners—Julio Grabiell, principal-in-charge; Charles Hugh Crain, project manager; Ozzie Leal, Carolina Macias, project designers; Armando Garcia, job captain; Dean Newberry, principal-in-charge of interiors; Miriam Collada, Maite Echevarria, interior designers; James Starzinski, site representative

ENGINEERS: Spillis Candela & Partners

CONSULTANTS: Miami Audio/Visual (audio/visual); Dr. Augusto Condom (acoustics)

LANDSCAPE ARCHITECT: Glatting Lopez Kercher Anglin

GENERAL CONTRACTOR: Gilbane Building Company



Harboring Tradition



The Maine Maritime Museum was founded in 1964 by a group of amateur historians to focus on the state's nautical history in general and shipbuilding in particular. The modesty of this initial endeavor was reflected in its location: a downtown storefront in the historic shipbuilding city of Bath. Later that year the descendants of a prominent local family donated the Federal-style Sewall House to the museum, and the collection was moved to that structure. Over the years the museum acquired more buildings, including a shipyard, a sail loft, and an 1843 Congregational church. By 1982, the institution was scattered over four sites, an inefficient setup that discouraged visitors.

The museum's eclectic physical plant posed other problems. The small-scaled rooms of the Sewall House, punctuated with doors, windows, and fireplaces, frustrated exhibit designers and precluded the display of large objects. None of the buildings was climate-controlled or fire-protected, an obvious hazard for a growing collection of paintings, logbooks, photographs, ship models, and other maritime industrial artifacts.

Guided by director John Carter, the museum planned a modest expansion: 5,000 square feet, divided between exhibit and storage space. ("We were thinking along the lines of a prefabricated structure," admits Carter.) By the time the trustees were ready to hire an architect, however, the proposed building had grown to over 30,000 square feet, and included an administrative wing, conservation lab, library, and shop. The board decided to consolidate the institution on one site—the historically important Percy and Small Shipyard on the west bank of the Kennebec River—thus creating a coherent campus.

In Winton Scott, the museum found an architect who had worked with Louis Kahn on the Kimball Museum and with Kevin Roche on the Oakland Museum before opening his Portland office in 1975. For this project, Scott found inspiration in photos of Bath's 1890 Hyde Windlass Foundry (demolished in the 1970s). From the start Scott felt strongly that a maritime museum ought to make ample use of natural light; the museum agreed, provided the light could be carefully modulated.

For a new maritime museum on the coast of Maine, architect Winton Scott was inspired by the powerful industrial vernacular of a local 19th-century foundry.

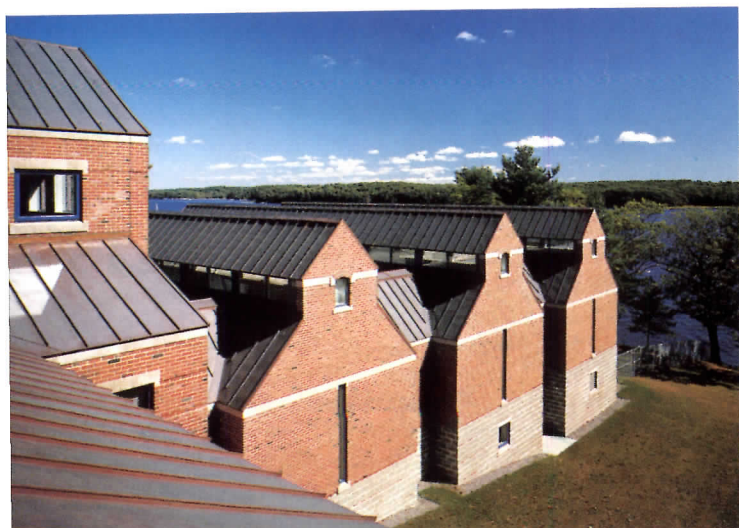

By aligning the museum's three principal exhibition galleries (above and left) along a north-south axis, Winton Scott ensured a palette of natural light entering the museum through east- and west-facing clerestory windows.

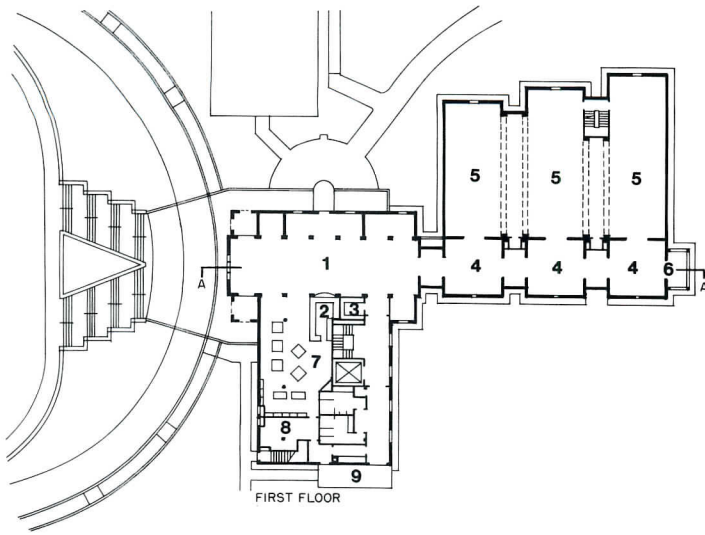

1. Exhibit hall
2. Information
3. Coat room
4. Exhibit
5. Gallery
6. Overlook
7. Store
8. Storage room
9. Loading dock
10. Reading room
11. Archivist
12. Stacks
13. Upper exhibit hall
14. Upper gallery

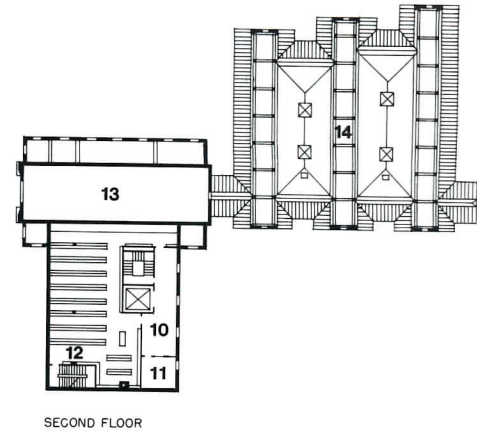

The museum's main axis ends in a view of the Kennebec.



Three exhibition galleries feature clerestory daylighting.

Scott derived the new museum's long, linear plan and its stepped, clerestoried, gable-roofed section from the old factory. In the galleries the repetition of this form produces evenly lit, flexible space. While the gable-roofed clerestories define three zones, the plan allows the exhibit designer to treat the space as a single volume. The building's massing, the sum of the basic form, reduces its apparent size—an important consideration since the museum shares its 17-acre site with several small wood structures.

Scott handled circulation through the exhibits with sensitivity. At the north end of each gallery, a window allows visitors to enjoy re-orienting views of outdoor exhibits and, in the distance, the Bath Iron Works, a large modern shipyard that produces guided-missile frigates. (This play between old and new delights both architect and museum staff.) At the west end of the building's 170-foot-long organizational spine is a bay window. From this spot, visitors can look out at the Kennebec, where in the summer they see moored the Sherman Zwicker, a

142-foot, two-masted Grand Banks schooner and the largest single object in the museum's collection.

Perhaps the truest test of a museum is how far it enhances its collection. "For me," says curator Robert Webb, "the building elevates the artifacts. In a way it's as if I'm seeing the collection for the first time."

NANCY LEVINSON

*The Maine Maritime Museum
Bath, Maine*

OWNER: Trustees of the Maine Maritime Museum
ARCHITECT: Winton Scott Architects—Winton Scott, Mark Wilcox, Cynthia Loebenstein, John Turk, Chris Wriggins, Wiebke Theodore, project team
ENGINEERS: Swift Engineering (structural); Bennett Engineering (mechanical); Thomas Engineering (electrical)
CONSULTANTS: James Stockman (lighting); Arthur Cannon (specifications); Anthony Muench (landscape design)
GENERAL CONTRACTOR: H. E. Callahan Construction Co.

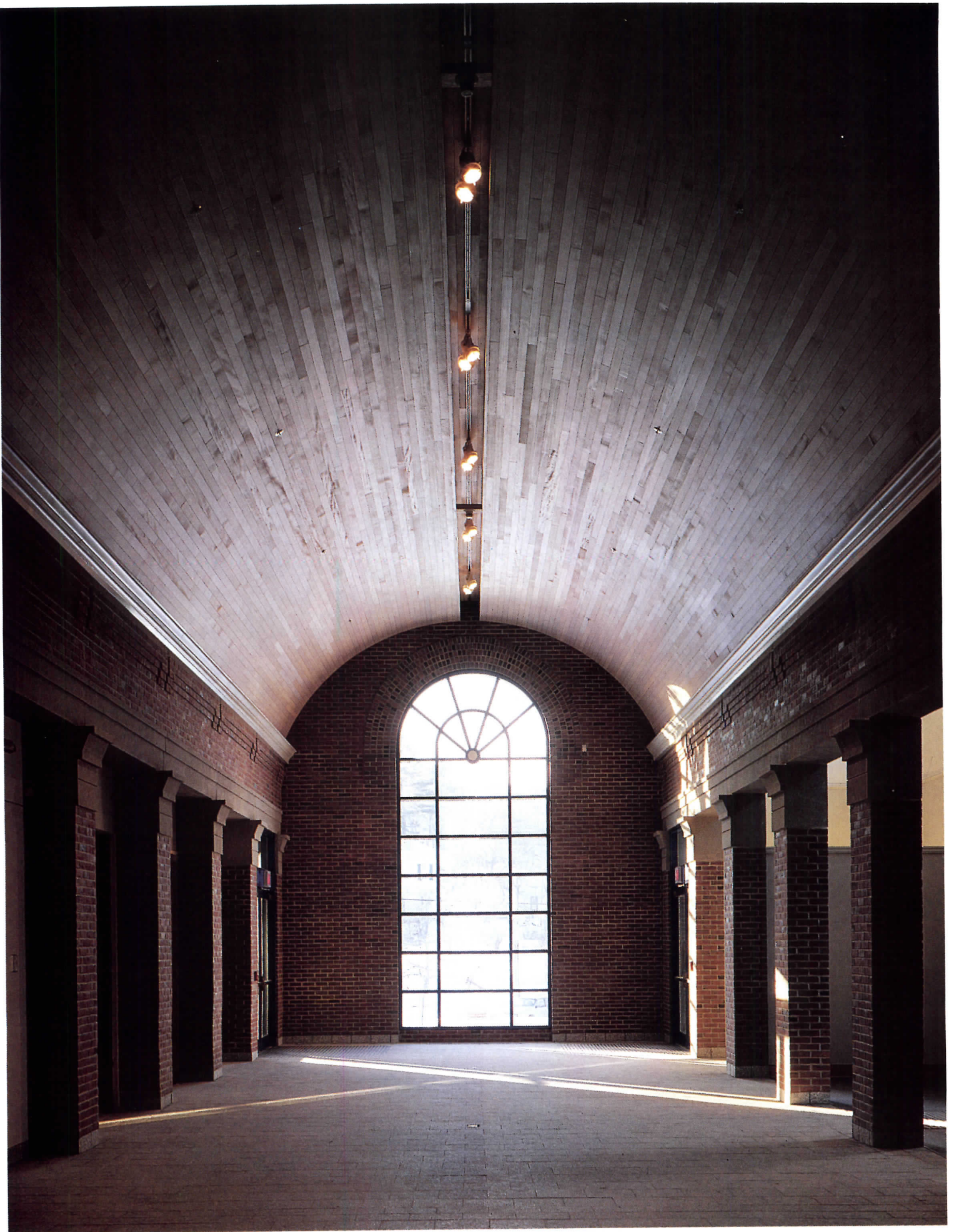

The entrance hall is crowned by a barrel-vaulted roof of quarter-sawn Douglas fir finished in a light gray wash.

Modernism in the Danish Manner

British architect and critic Chris Abel assesses the built work of Henning Larsen, the 67-year-old Danish architect whose recent projects in the Middle East and Great Britain reinterpret Scandinavian and American postwar Modernism.

HØJE TAASTRUP COUNTY GRAMMAR SCHOOL
NEAR COPENHAGEN 1978-1982

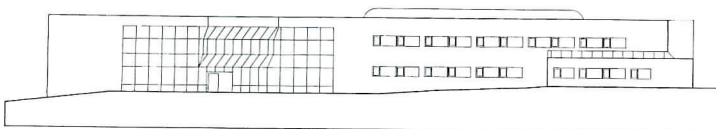
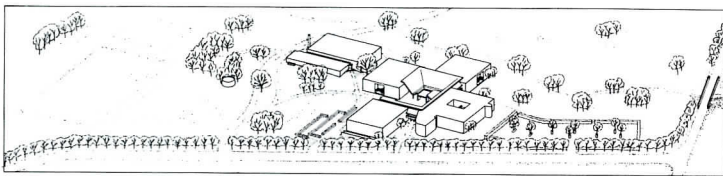

MAIN LIBRARY, GENTOFTE, DENMARK
1979-1984

Henning Larsen is best perhaps known for his building for the Ministry of Foreign Affairs in Riyadh, Saudi Arabia, for which he won an Aga Khan Award last year [RECORD, April 1990, pages 57-61]. Recent major competition victories in the United Kingdom for the Compton Verney Opera and Churchill College, Cambridge, ensure his continued ascendancy. Yet Larsen's path from industrialized building enthusiast through neo-Classicism back to Modernism's roots is of as much interest as any specific design. Together, the Larsen oeuvre constitutes almost a record in itself of postwar experiments in Modern architecture. It also stands as a peculiarly native testament to those developments, for no matter what sources he assimilates, what emerges is nearly always stamped with the distinctive mark of Danish austerity.

Early practice

In his early practice during the 1950s, Larsen designed a number of courtyard-based projects built of brick and timber frame which typified Danish Modern architecture of the period. Historically, Danish architecture is an amalgam of imported and local forms, and Danish Modernism is no exception. Influenced by the work of Frank Lloyd Wright as well as Japanese traditions, Larsen's low-level, high-density building clusters revealed a gentler, less dogmatic Modernism than architects were then accustomed to see coming out of Europe.

International recognition first came to Larsen with his university designs of the 1960s, which established him as a leader of the emerging "structuralist" school. Inspired partly by linguistic theories of "deep structures" underlying human language forms, Larsen's plans were based on a reinterpretation of the principles generating historic patterns of human settlement. In spatial terms, they effectively reversed orthodox Modernist patterns, in which isolated buildings are treated as objects in free space, replacing them with a compact and relatively permanent circulation and services structure infilled with indeterminate building forms. While the typical grid layout of internal covered "streets" and articulation of public and private spaces suggests the historic city in miniature, the open-ended nature of circulation pattern, building infill, and construction system is expressly designed to respond to 20th-century rates of growth and change.

These ideas culminated in Larsen's extension to the Berlin Free University and the glass-covered arcades and prefabricated building technology of the Trondheim University complex in Norway.

The Høje Taastrup County Grammar School of 1979 (top left) signaled a radical change from the flexible building technology and spatial patterns of previous projects. Forgoing indeterminism in favor of a fixed hierarchy, Larsen split the school into four classroom blocks grouped around a central court, which is also the main point of entry and assembly. By focusing his plan in this fashion and exploiting the sculptural potential of in situ reinforced concrete, Larsen also found his own answer to the

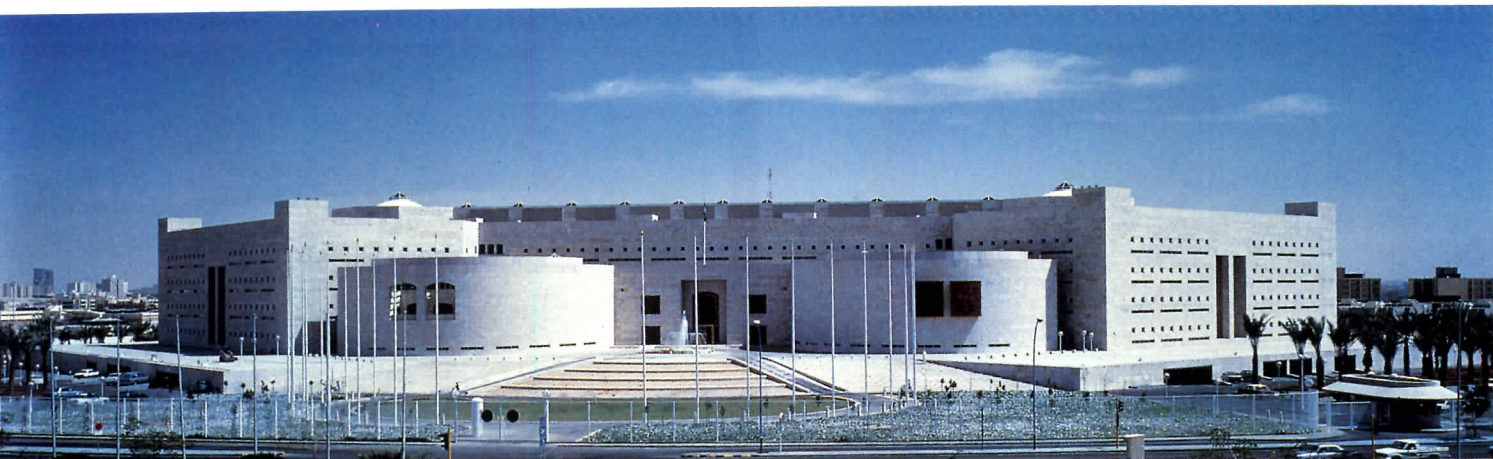

SAUDI MINISTRY OF
FOREIGN AFFAIRS
RIYADH, SAUDI ARABIA
1984

Larsen conceived the symmetrical plan of the Saudi Ministry of Foreign Affairs as a hollow square subdivided into four hollow quadrants of offices. One

quadrant was eliminated to fit the building into a triangular site. In its place is the entrance and two rounded wings containing a library and banquet hall.

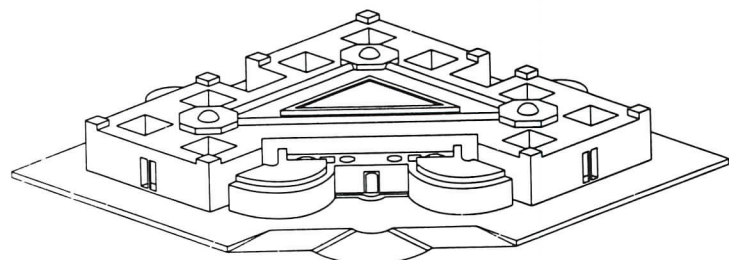

BUILDING AXONOMETRIC

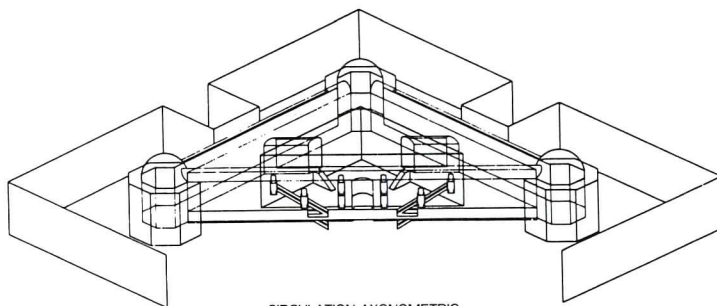

CIRCULATION AXONOMETRIC



perennial question of how to add character to a building type composed of repetitive spaces by putting it into the communal and circulation areas, where a concentration of open floors and overlooking galleries connected by grand stairways creates the desired formal and spatial effects. These areas are further differentiated internally and externally from the flat-roofed remainder by a pitched roof dropping down from the two-story classroom blocks to a child-scaled single story around the courtyard. Despite an austere white-painted outside reminiscent of earlier and purer Modernist exteriors, Larsen abandons his Danish reserve with a blue-and-white-striped PVC finish to the sloping roof, complete with rolled ends, that might be likened to a festive awning or deckchair.

Though finished later, the scheme for the Main Library in Gentofte belongs to the same creative phase as the Høje Taasttrup School (bottom, page 76). Once again, a sober all-white exterior conceals a vibrant interior, this time centered on a two-story, top-lit library and adjacent exhibition space. Ancillary spaces are accessed on the upper floor from a continuous gallery. The natural light emanating from circular pools overhead recalls Alvar Aalto's libraries and anticipates increasingly bold experiments with toplighting in Larsen's later work.

Working in the Middle East

The year 1979 also saw Larsen winning the limited competition for the Saudi Ministry of Foreign Affairs (MOFA). The building (page 77) is generally recognized as a masterful reinterpretation of pan-Islamic architectural themes, yet even here what appears at first sight to have nothing much to do with Danish architecture has in fact a great deal to do with it. Like the Saudis, the Danes live in a harsh climate, with little in the flat landscape to stand between them and stormy weather coming down from the North Sea. As a result, even major buildings, such as Copenhagen Town Hall are turned inward on covered atria and have few exterior frills. Similar attributes characterize much of Larsen's earlier work, just as they mark the dwellings and fortresses of central Arabia, suggesting that the architect's affinity for the buildings of that region has at least as much to do with his own background as with diligent study of the foreign culture.

There are other, more direct indications of Larsen's background in the design. With its central semipublic atrium and circulation system of top-lit "souks" modeled after the vaulted market streets of the Middle East, the MOFA not only suggests another variant on the city-in-miniature theme, but was also the first of Larsen's designs to show distinct neoclassical tendencies. Surprisingly, though the building resembles a desert fortress from the outside, the plan form and podium setting were inspired by the quadrangular Taj Mahal. However, Scandinavian architecture has a strong tradition of stripped-down neoclassicism, and Danish precedents, though less explicit, are also apparent, especially the spartan and introverted Copenhagen Police Headquarters of 1924 with its great circular court and long, flanking galleries. There are no Doric columns or pediments in the MOFA, just as there is no precise imitation of Islamic forms or motifs (the carved plasterwork was the client's idea), but the internal impression from the atrium and parallel streets of a monumental, white-washed Roman ruin competes effectively with Islamic metaphors.

Yet another, mannerist tendency emerges in the floating roof—a nod toward Le Corbusier's Chapel at Ronchamp—over the central atrium as well as in the atrium space itself, the peculiar geometry of which results in its own optical distortions. Even more striking is the matching pair of stairways leading up to the library and banqueting hall from their lower level entrance halls (bottom photos, page 77). Each stairway comprises twin flights wrapping around the pierced walls of an octagonal light well, so that they appear to be both inside one building and climbing up outside another. Openings in the walls separating the entrance halls from surrounding corridors complete the sur-

ROYAL DANISH EMBASSY RIYADH, SAUDI ARABIA 1982-1986

The embassy comprises four two-story pavilions, each with its own adjacent walled space, symmetrically clustered around a courtyard. The two larger, square pavilions house the chancellery and ambassador's residence; the two smaller rectangular pavilions are living quarters for embassy personnel.

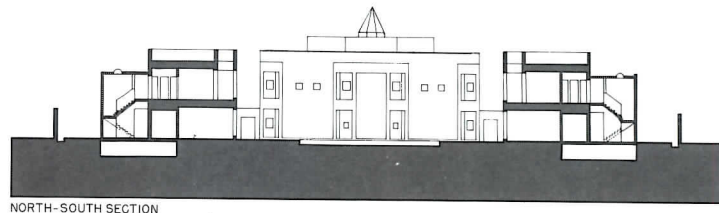

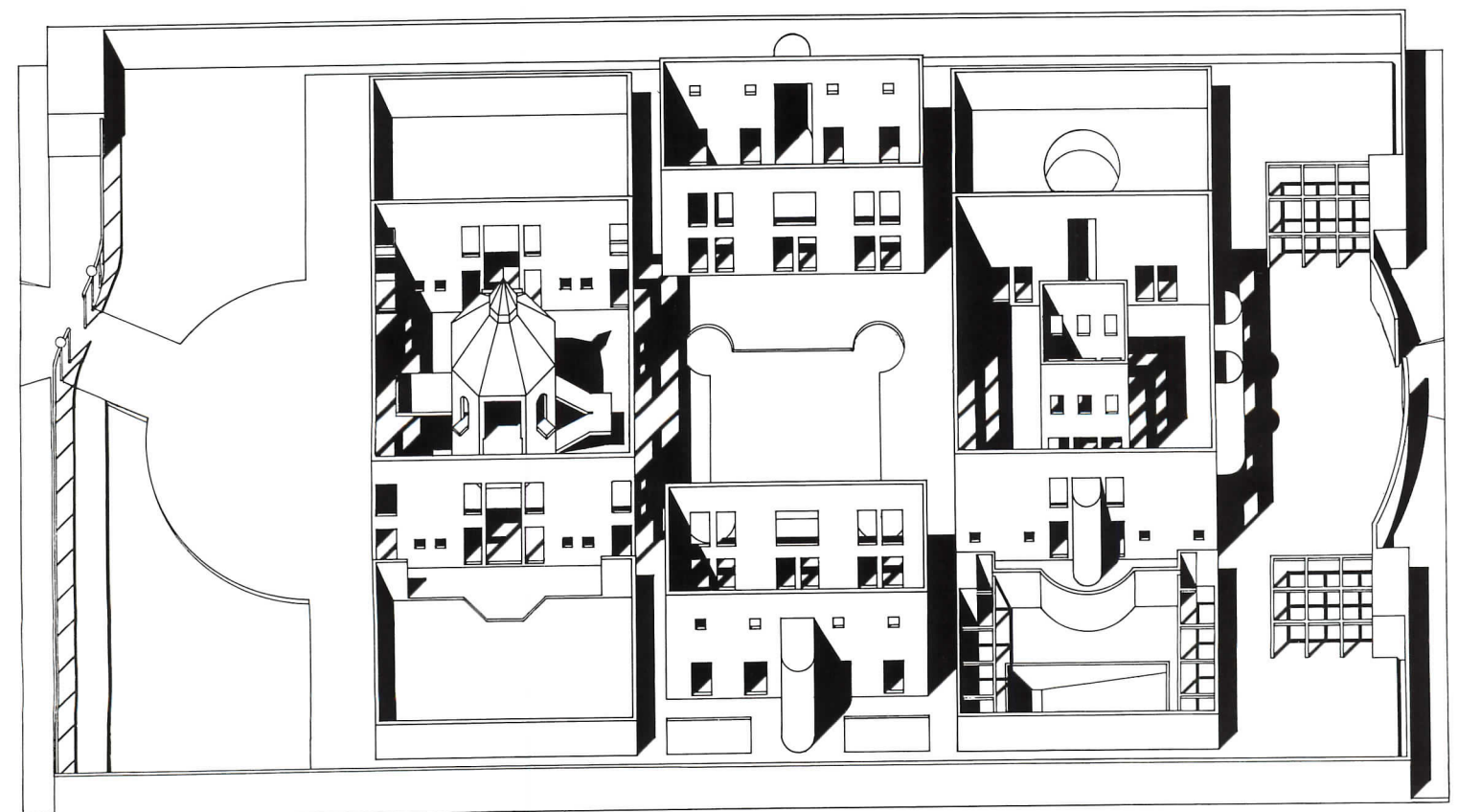

real illusion, creating a series of transparent planes where “solid” and “void” or “inside” and “outside” lose their meaning. Together with the dramatically lit atrium and “souks,” these small immensely powerful spaces provide a memorable experience.

Built soon afterward in the same city, the Royal Danish Embassy, like the MOFA, achieves a neoclassical dignity while suggesting local dwelling types (pages 78-79). Further similarities with the MOFA are apparent in the building’s details: the view down into the open courtyard at the center of the ambassador’s residence, for example, provides a scaled-down but almost identical scene to that in the three open courts of the MOFA. Luxurious interior finishes and refined detailing contradict the stark exteriors and imbue the two main pavilions with a jewel-box preciousness.

Projects under construction

Larsen’s latest major project, and the first of his large-scale urban schemes to be realized, is for a mixed development in the Copenhagen suburb of Frederiksberg (right and opposite). The centerpiece of the Beaux Arts composition and the first component to be occupied is the Copenhagen College of Business Administration. The three-story building is 660 feet long and aside from the regular indentations, the only exterior relief is provided by a semicircular bulge in the middle of the south side, which houses the cafeteria, auditorium, and library stacked one above the other.

Viewed on its own, the building presents a bland and seemingly endless exterior more like the sort frequently encountered in oversized new developments surrounding Paris than anything built by the normally moderate Danes. The logic of the design only becomes apparent when seen in the context of the total site development. The linear building intentionally provides both an acoustic and visual buffer between the railway line running along the southern edge of the site, the low-cost high-rise housing on the other side, and the up-market speculative housing on the rest of the site. When the two linked U-shaped housing blocks are finished, what appears now as an endless facade will take on its proper urban aspect as the street frontage to one side of the college complex. The other side of the street will open out into two landscaped public spaces enclosed by the curved terraces. The remaining housing units along the east, north, and west peripheries are smaller in scale in keeping with the surrounding suburban residential pattern and consist of a loose chain of five-story blocks, broken on the north side by an existing building and a smaller U-shaped block of apartments.

The extreme contrasts between exterior and interior that typify so much of Larsen’s work both at home and abroad also characterize the business college. The main circulation as well as the primary visual excitement is provided by a three-story galleria running between the center courts of each wing, which also lie in the same secondary site axes as the two large “U” blocks. If left in a straight line, the view down such a long space, even though it stops well short of the building’s full length, would have been unacceptable. Instead, Larsen offset the galleria a small but telling four degrees—preventing any full-length view—and he punctuated the change at angle and terminal points with top-lit octagonal spaces.

What could have resulted in tedium has therefore been transformed into a brilliant set-piece interior. The theatrical ambiance is reinforced by Larsen’s handling of the pierced screen walls that separate the galleria space from the corridors on either side and also define the octagonal spaces. The same surreal effects already seen around the octagonal stairways at the MOFA are here multiplied by several layers of pierced screens, between which the building’s occupants move like figures in a dream world. It was entirely fitting that Larsen and the owners chose to celebrate the opening of the new building by staging a specially commissioned theatrical event in the galleria.



**COPENHAGEN COLLEGE OF BUSINESS ADMINISTRATION
FREDERIKSBERG, DENMARK
1982-1988**

The three-story College of Business Administration is 660 feet long. The entrance, cafeteria, and main auditorium are located in a semicircular apse, which repeats the horseshoe shape of two housing blocks Larsen proposes for a facing site. The long lean volume of the business college is punctuated at both ends by two octagonal towers, which accommodate informal lounges topped by skylights. Classrooms and meeting rooms are arranged symmetrically on either side of the central corridor.

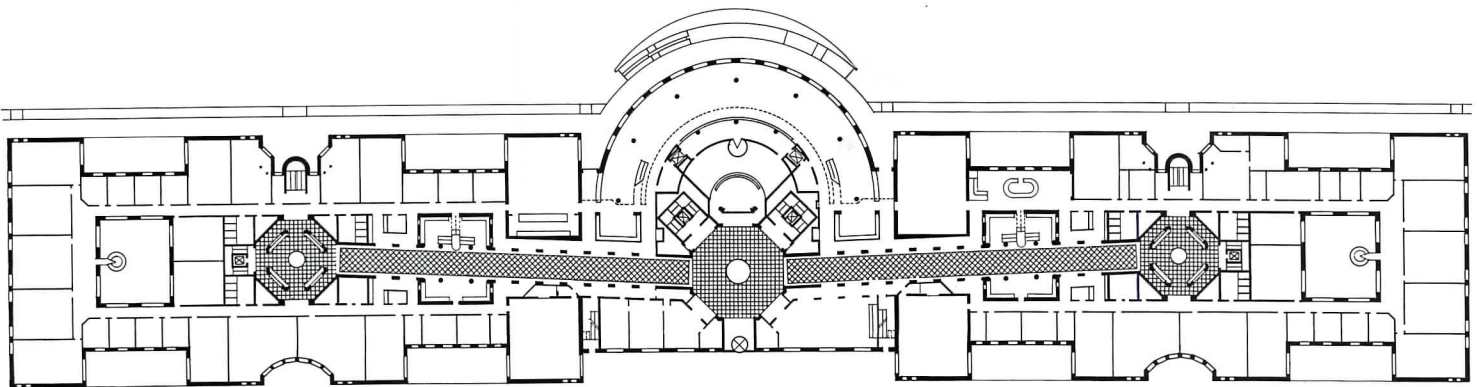
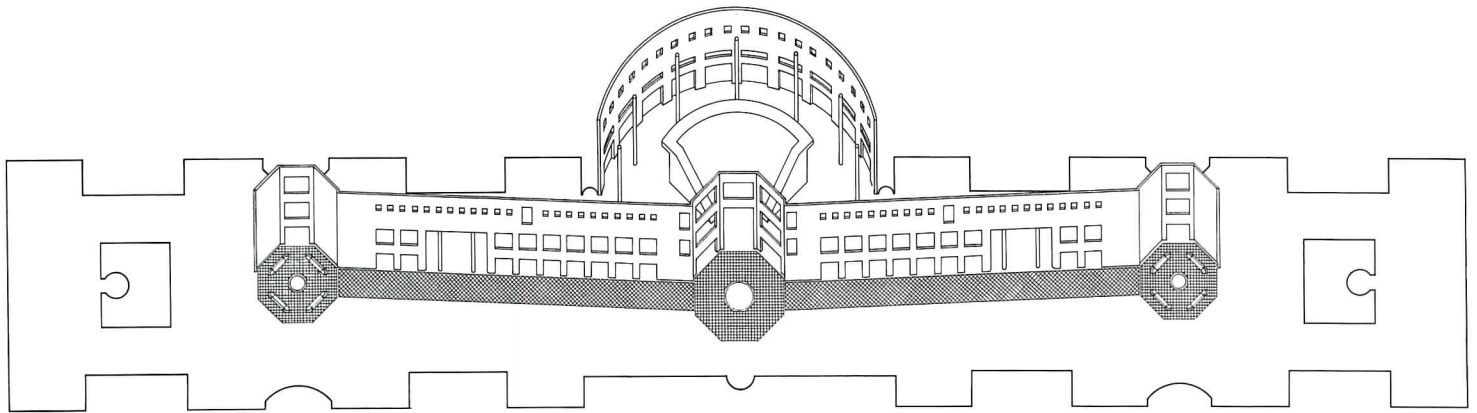
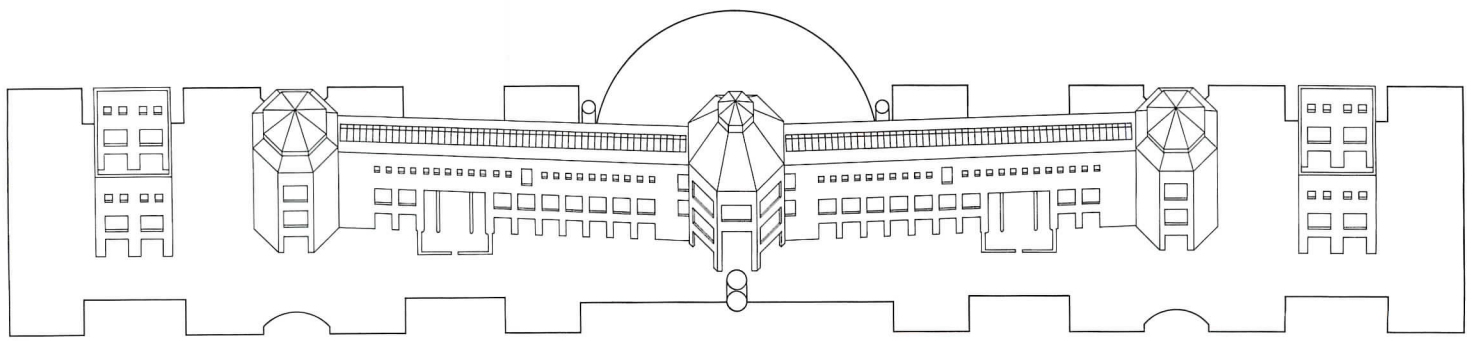

The projected Opera at Compton Verney estate in Warwickshire promises to be Larsen's most important design since the MOFA and features both old and new themes (top right and opposite). The main elements of the site plan are classical in spirit and provide an appropriate foil to the English romanticism of Capability Brown's landscape, with its rolling lawns, serpentine lake, and carefully spaced clumps of trees. The opera house sits on the southern edge of the lake with the semicircular auditorium projecting out into the water. A pierced screen wall separates the three-story circulation zone giving access to the auditorium from the surrounding glazed foyer space, while still affording views down into the foyer and through the stepped glass wall to the lake beyond.

For the first time in Larsen's work, interior and exterior achieve an equally powerful and harmonious expression in the transparent foyer and "Colosseum wall" of the auditorium. The usual monolithic character of Larsen's buildings is also modified here by a clutch of various neoclassical appendages. A colonnaded circulation axis cuts east-west across the junction between the auditorium and the main rectangular block housing the rear stages, production spaces, and other supporting functions. At one end of the axis a circular colonnade provides a drop-off point for patrons arriving by car, while a circular cafeteria terminates the other end. Entry into the opera house is either directly into the main block along this axis or else more dramatically across the water via another colonnade lying at a tangent to the curved glass wall of the foyer. Patrons taking the latter route have views across the lake toward the 18th-century bridge and mansion house beyond.

At Compton Verney, the exterior pavilions and colonnades provide accents to the great mass of the opera house. In the new postgraduate residential wing for Churchill College, similar elements dominate the composition (bottom right and opposite). The basically linear scheme is violently disrupted by a colonnaded route starting in an entrance pavilion by the access road and then slashing through the building at a 45-degree angle, coming to a halt on the north side in an octagonal structure containing the main common rooms. From here, students will enjoy 360-degree views over the college grounds and beyond. A second deep incision is made toward the sharper end of the building, creating a further covered vantage point and gathering place. Two additional structures at the rear house a small auditorium and more student rooms respectively and are linked by another colonnade running parallel to the main building and cutting across the 45-degree entrance route.

For all the shared colonnades and octagons, the dynamic composition at Churchill College is a far cry from the classical repose of the Compton Verney opera. The fragmentation of elements, competing axes, and interpenetrations are closer to the restless compositions of early constructivists than to any preceding Larsen designs. Yet as always with Larsen's architecture, the formal scheme, balanced or otherwise, is not what counts most. Instinctively, the down-to-earth Dane in Larsen has always appreciated that formal ideas invariably look most impressive on paper. What matters more to the occupants is the living experience of moving through and using a building on a day-to-day basis. In this respect, Churchill College promises to deliver no less satisfaction than his previous projects. As such, Larsen's work stands as an effective reminder to Postmodernists with surface preoccupations that architecture doesn't stop at the front door. It is through these enduring spatial qualities, as well as his special Danish talent for assimilating many and diverse influences, that Larsen has been able to breathe new life into Modern architecture. □

Chris Abel, a graduate of London's Architectural Association, is currently a senior lecturer in architecture at the Duncan of Jordanstone College of Art, University of Dundee, Scotland.



**OPERA AT COMPTON VERNEY
WARWICKSHIRE, ENGLAND**

The main stage of the proposed Compton Verney opera house is on the ground floor of the cubic volume, with auditorium seating contained in the semicircular apse. Offices, rehearsal space, backstage rooms, and a restaurant are located above the stage. A covered pergola connects the public entrance with parking.

**CHURCHILL COLLEGE
CAMBRIDGE UNIVERSITY
CAMBRIDGE, ENGLAND**

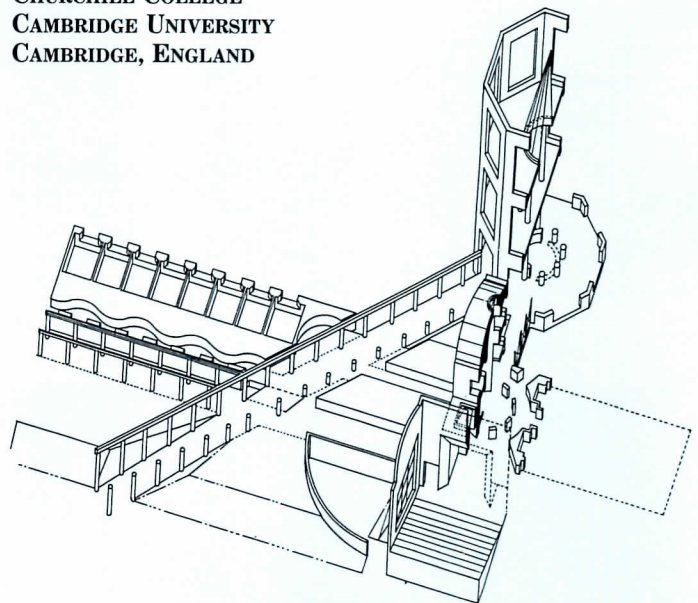

A three-story slab contains 77 student suites and faces playing fields. An octagonal tower houses the dining room and connects to the cylindrical stair tower and the entrance hall, which cuts through the building at a 45-degree angle.

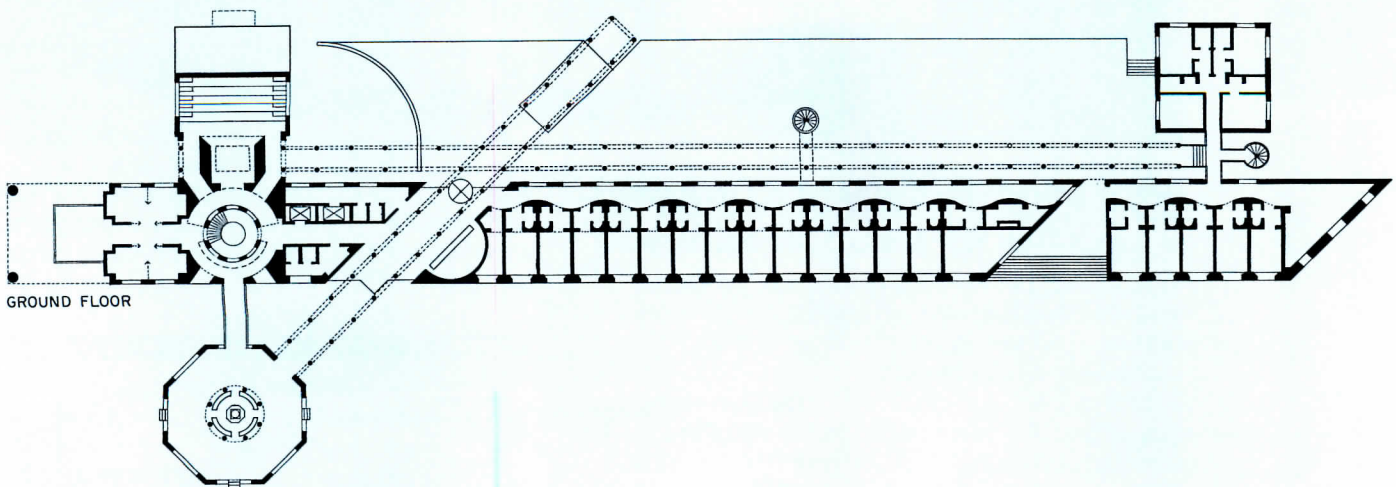
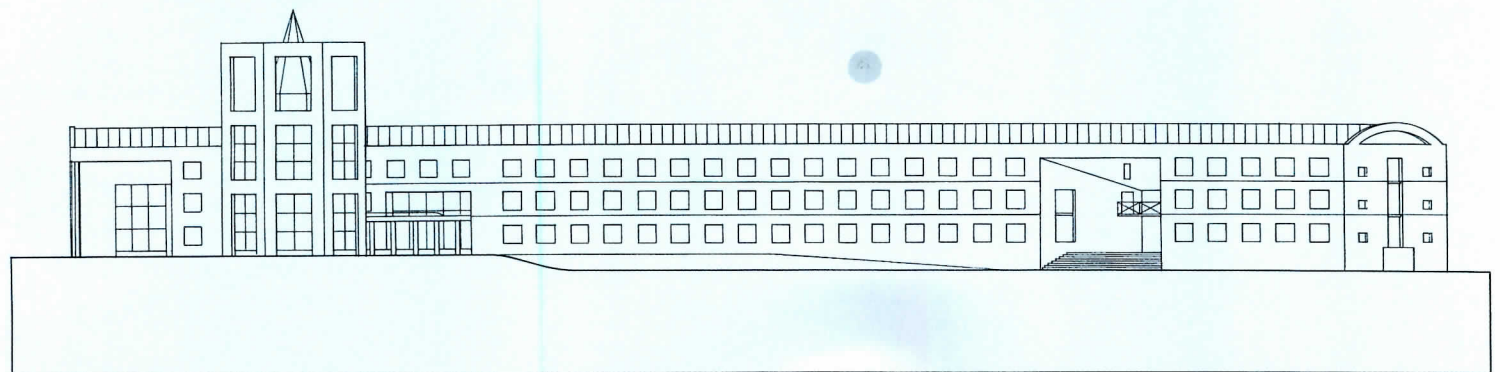
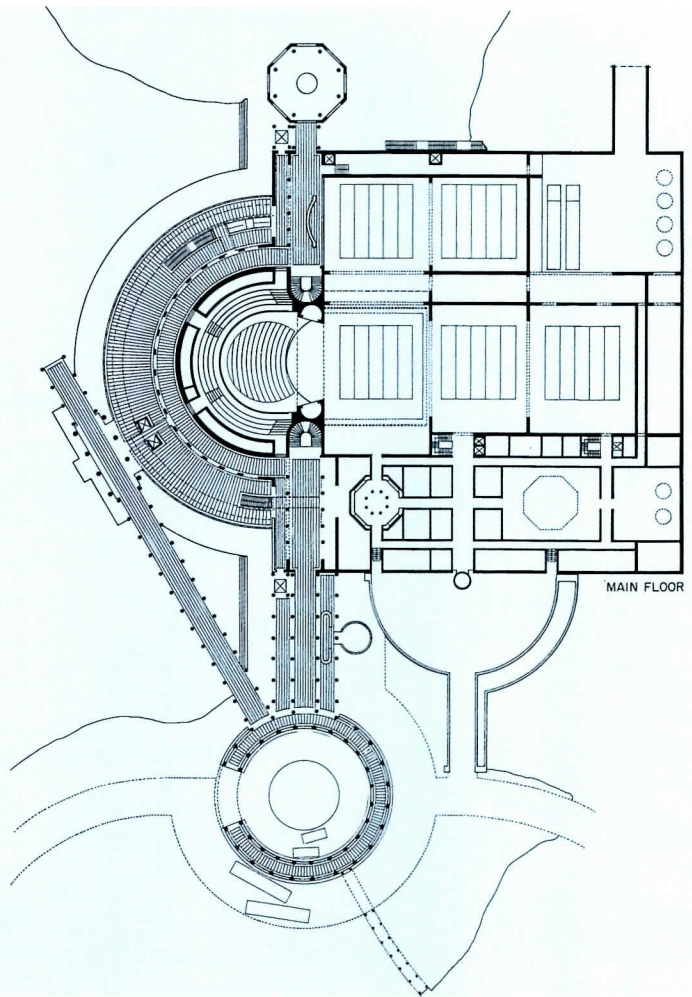
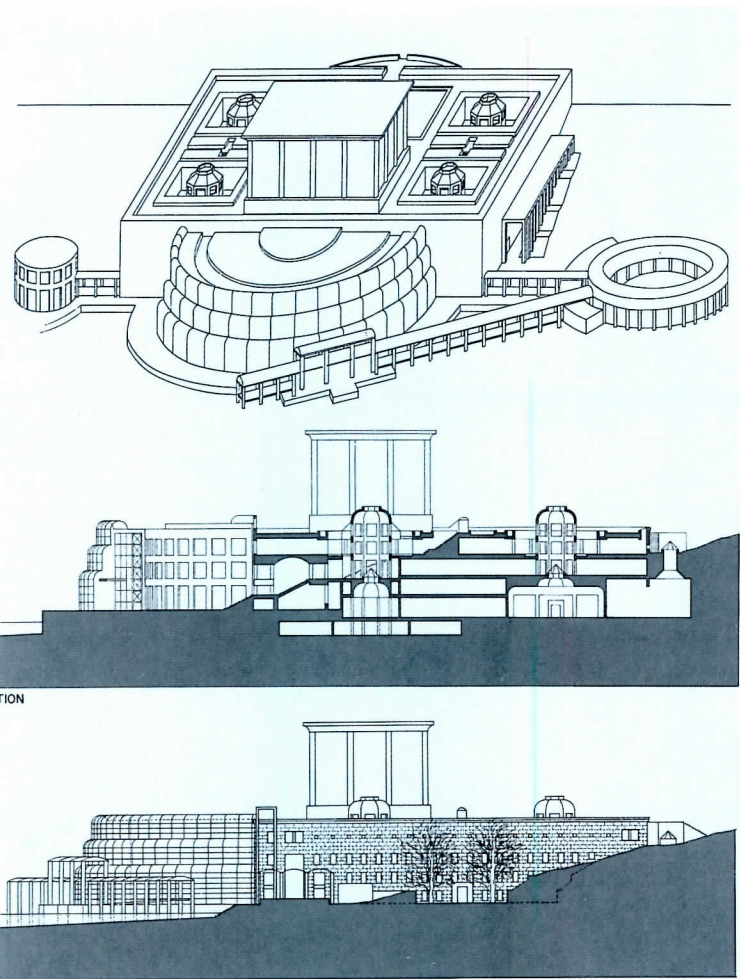

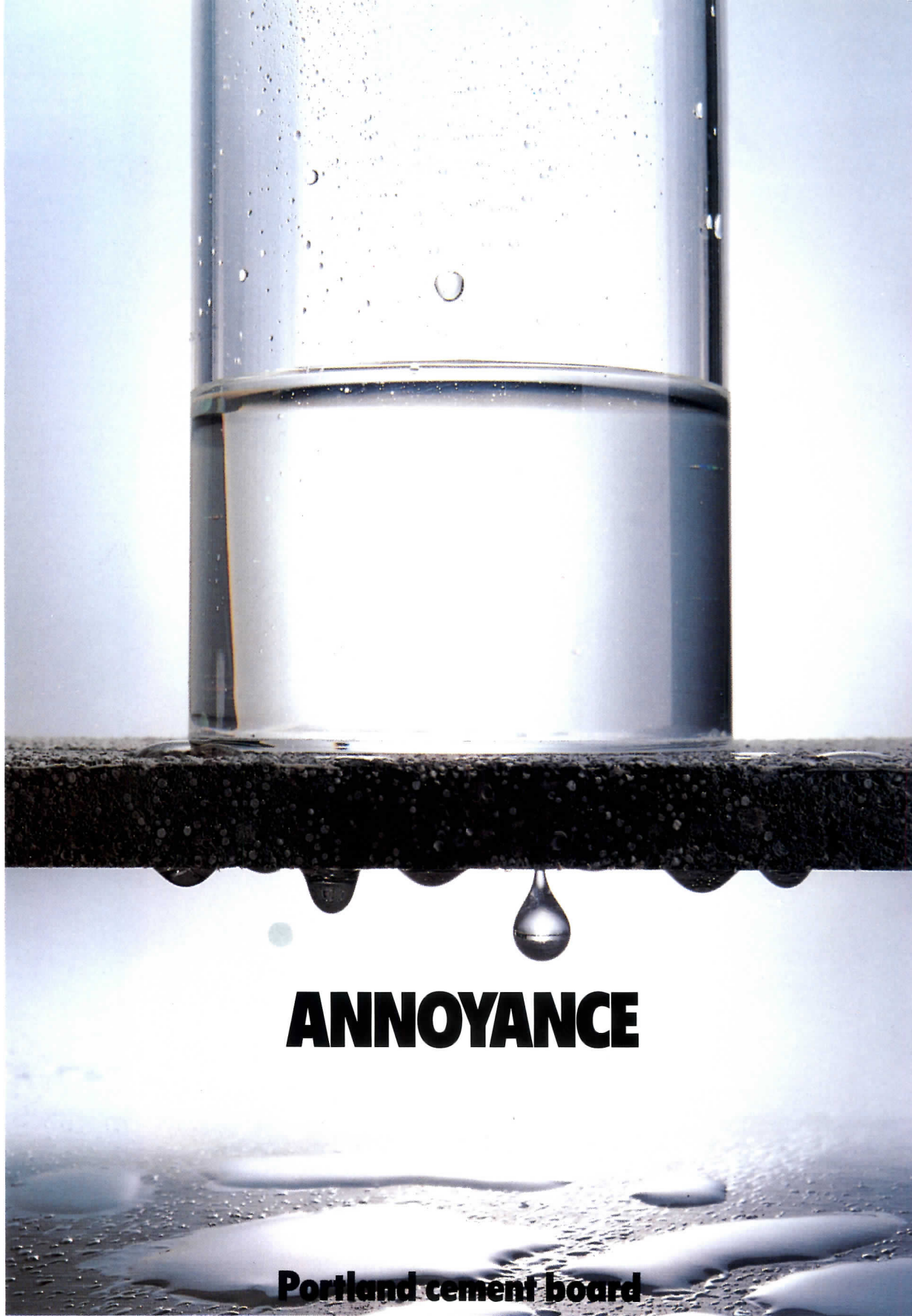

ANNOYANCE

Portland cement board

PERFORMANCE

When you specify Georgia-Pacific products, you're depending on G-P quality and performance. And you know you'll get it with Dens-Shield® tile backer.

Unlike Portland cement board, Dens-Shield has a specially formulated water-resistant coating. Combine it with the proprietary silicone-treated core, penetrated front and back by inorganic fiberglass mats, and the result is a product

with high resistance to wicking, rot and other water-related problems. And *without* the extra vapor barrier required with Portland cement board. Dens-Shield is lighter and easier to

Properties	Dens-Shield*	Portland cement board
Weight, lbs/m sq. ft.	2060	3300
Surface water Ab. (Cobb test) ¹ grm.	.5	12.8
Vapor transmission, perms ²	1.2	8.9
Wicking, inches ³ after 30 minutes	.00	1.48
after 24 hours	.00	3.06

¹ASTM C473 ²ASTM E96, dry cup method ³CTI-T83

*Tests conducted at Georgia-Pacific Gypsum Laboratory, per ASTM guidelines.

Targeting Treatment

As the gathering crisis in health care—its quality, its distribution, and above all its cost—nears the top of the national agenda, hospitals are developing more sharply focused physical responses to a changing spectrum of social and economic forces.

Looking to the coming millenium, Michael Bobrow, Julia Thomas, and Anthony Roesch of Bobrow/Thomas Associates—an architectural firm long at the forefront of planning and design for health-care facilities—foresee new conceptual and physical models to respond to new pressures buffeting the field. Their prognosis follows.—M. F. G.

Planning facilities for the health-care field is no longer the linear process it was in the past, when you could simply study demographic patterns or rely on statewide health-care planning guidelines. Standard planning formulas fly out the window under the impact of such issues as reductions in patient beds, corresponding increases in the volume of outpatient services, the introduction of massive, space-eating diagnostic equipment, and other factors beyond the compass of traditional models for hospital design. In addition, financial and revenue considerations play a more dominant role in health-care design than ever before.

Among the concerns that will top the list of planning issues for most medical centers in the next decade are:

- 1. Reducing or better controlling debt;
- 2. Retaining or increasing market share;
- 3. Better managing operational expenses;
- 4. Increasing one's diagnostic capability;
- 5. Improving the patient's environment;
- 6. Reusing existing institutional facilities;
- 7. Acquiring land and developing new, more efficient facilities;
- 8. Improving physician relationships and referral patterns.

Tomorrow's successful institutions will be those that position themselves with an effective plan for building capital while using their facilities to tomorrow's marketplace. As a result, several longstanding conceptual models for physical facilities are evolving into new models that better respond to changes in the health-care climate and in delivery approaches.

An overview of the health-care climate

For the first time in history, business leaders and the medical establishment agree on the need for some form of a national health-insurance program—a policy that, if enacted, will rekindle strict health-care planning regulations. To a great extent the need for such a program has stemmed from the large numbers of uninsured patients whose care is “bankrupting” the existing system. Some states are already beginning to experiment with limiting such expensive and “esoteric” procedures as organ transplants in order to distribute available funds to a broader population for primary and preventive-care

measures, particularly in the area of maternal and child care.

In addition, the choices to be made by and on behalf of patients with and without insurance have already led to a health-care system partitioned into at least two tiers. The upper tier is characterized by a clear division between those carrying “full-choice” health insurance and those under “managed care” plans, while the lower tier is divided between patients who are eligible for government programs and the increasingly large group who are wholly uninsured. Within each of these tiers, hospitals are fiercely competing for survival.

Competition among
hospitals is generating
new facilities that offer
new services This is
where the major
expansion is occurring
in health care.

States and counties, in particular, are struggling to find the financial resources to meet the extraordinary demand for care within the lower tier—an onslaught triggered by the proliferation of uninsured patients. At the same time, non-government hospitals are trying to limit care of these patients as much as possible because of the huge impact their treatment has on the institutions' bottom lines. Without a national health policy, there is no reimbursement for treating the uninsured, and hospitals are forced to fully absorb the costs, often by shifting them to patients covered by insurance. Many institutions have responded by abandoning the two services in which the needs of the uninsured are concentrated—trauma and emergency care and maternal/child care. The result has been a

massive overloading of state and county facilities, which consequently are demanding additional space.

A surprising aspect of the crisis is that most people who are not insured are, in fact, employed. They are either employed by small businesses that, for cost or other reasons, are unable to provide health insurance for their employees, or they are insured only to the limit covered by Medicare. To be fully effective, state and national health programs must include coverage for employees of small businesses as well as people who are self-employed or employed part-time.

Among hospitals serving the upper tier of patients, competition is spurring investment in new facilities that offer new services: this is where the major expansion is occurring in health-care construction. Two significant but opposing forces affect the types and number of facilities built. The first is a push toward cost containment and managed care—a road that is leading to rationed care. The second, which works at cross purposes to cost-containment measures, is the rapid development of capital-intensive, high-technology treatment methods, particularly in imaging and other diagnostic tools, and in genet-

ic engineering. Financing the equipment required by such new technologies—which carries price tags in the millions of dollars—can drastically affect the feasibility of a capital project as well as the amount of square footage that can be built.

New directions in health-care delivery

The evolving health-care delivery models make ever sharper distinctions between the functions of critical care, ambulatory care, specialty care, and chronic care. As services offered by the health-care campus are differentiated according to the acuteness of patients' illnesses, facilities will respond through corresponding variations in patient environments, levels of care, and sources of financial reimbursement.

Today's medical practices are changing due to the advent of fast-paced delivery systems with tight schedules and constricted time allotments. Inpatients are moved rapidly from one level of nursing care to another, and often go from surgery through intensive care to discharge in less than 24 hours. Experimental programs such as administering postsurgical recovery care in hotel-like settings outside the hospital itself are multiplying. Even cardiac catheterization is making great gains as an outpatient procedure.

This dramatic shift from the traditional method of delivering care, under which patients were managed as inpatients from admission to recovery, to outpatient treatment management is bringing the most profound changes in the practice of medicine. In the past 15 years, the relative allocation of space for hospital facilities has reversed, resulting in a 2:1 ratio of outpatient and diagnostic services over inpatient services. In some communities, 70 percent of all surgery is being done on an outpatient basis.

In the case of nonsurgical procedures as well, a majority of patients are now treated either in outpatient clinics that are discrete components of a hospital or in doctors' offices. The trend will accelerate as more physicians expect to practice in groups or as employees of health-maintenance organizations (HMOs) and preferred-provider organizations (PPOs), and therefore locate their offices on or near health-care campuses.

•As marketing considerations and cost-containment efforts have influenced the growth and direction of ambulatory centers, so will improvements in information systems and computer technology, which are also leading to new methods of delivering and coordinating health care. Interactive systems, in particular, will increase the productivity of outpatient services by means of improved communications, scheduling, and admitting procedures.

Patients may be admitted to the hospital from their doctor's office, for example; physicians can be brought closer to specific hospitals; and advanced digital imaging will allow the computer transmission of images and diagnoses. By boosting efficiency, such technologies can cut operating costs, while as the systems become more affordable, the costs of the equipment itself will be of less concern.

In addition to exploiting more sophisticated communication and information systems, facilities designed to fit the new conceptual models will function more flexibly and economically, with fewer full-time employees. Finding and applying the best facilities models for particular health-care institutions will, of course, require a close look at prevailing trends in medical practice, technology, and reimbursement methods, in the light of their relationship to the specific institution and its competitive environment. Generally, however, the emerging models that reflect major trends in project development consist of

variations in how individual hospitals approach the allocation and integration of their inpatient and outpatient services.

"Acute care" emerges as "critical care"

Today, only the sickest patients are treated within a hospital. As a result, the term "acute care" as presently defined is fast becoming synonymous with what is now seen as critical care, for which the model is a triad of surgery, emergency and trauma services, and intensive care, with diagnostic imaging services playing an interactive role.

Although smooth coordination among departments is essential to patient care, bottlenecks in patient processing and flow often arise from a lack of space to support new treatment technologies and techniques—especially treatment rooms, operating rooms, and critical/intensive-care beds. A shortage of recovery beds, for example, coupled with a shortage of nurses, can block the use of critical-care services, as can the physician's too-common practice of keeping patients closely monitored by nurses for long periods during their hospital stay. A related trend is the proliferation of telemetry units, or electronically

monitored beds, where patients are also being held for long periods: some never move to standard surgical beds. By filling the supply of available beds, such practices limit the number and type of beds ready to serve incoming critical-care patients, thus creating chaotic backups in emergency rooms. In each case, the result is higher cost of care.

The most direct response—providing more intensive-care facilities—is costly in terms of both space and nursing staff. A better response to the increasing demand might be to create a full spectrum of critical-care recovery services, which would allow physicians to decide under which service, and for how long, to keep each patient. Another approach might be to electronically monitor all patient beds but vary the level of nursing care from

one unit to another, distributing patients among them according to their diagnosis and ability to pay.

•*Subacute care*, or chronic care, has to date comprised skilled nursing, rehabilitation, and psychiatric treatment. Now, however, the removal from hospitals of all but the most acutely ill patients, caused by a combination of skimpy reimbursement and an aging population, is leading to major growth in subacute-care facilities. While newly admitted patients, and those needing intensive-care or critical-care services, will continue to be treated within the hospital, those needing longer stays will frequently be transferred into related subacute facilities for treatment that is less demanding of staff and therefore less costly. These facilities are often prime candidates for reusing old acute-care nursing units, which can be converted for skilled nursing, rehabilitation, assisted living, or retirement housing. Although chronic care will be a big part of the health-care market, experimentation and experience will be needed to balance health policy, reimbursement methods, and facilities.

Ambulatory care—the "23-hour hospital"

In the shift from inpatient to outpatient treatment, several models have emerged for ambulatory-care facilities: medical office buildings, freestanding imaging and surgery centers and specialty clinics, which may be owned by physicians, third parties, hospitals, or a combination of these. Increasingly, however, the factors behind the development of such facilities—notably the drive for cost containment and the increasing use of less invasive treatment procedures—are also encouraging their incorporation by hospitals themselves. In the future, am

As health-care services
are differentiated
according to the
severity of the patient's
illness, facilities will
respond with varying
patient environments.

ambulatory centers will play a major role in health-care campuses, and physicians will be trained in group practices within ambulatory-care settings as the "23-hour hospital" becomes the dominant treatment mode. Even now, sophisticated procedures that previously called for four to six days in the hospital are being administered on an outpatient basis, entailing patient stays of less than 24 hours. Surgery, radiology, endoscopy, ophthalmology, oncology, orthopedics, labor and delivery, and cardiology have all become part of ambulatory services.

Treatment in an ambulatory setting, however, does not do away with the patient's need for a supportive environment. Surgical patients kept for 23 hours or less still require a recovery/holding room (though it need not be licensed) with amenities beyond those of a conventional recovery space. In a number of institutions, these outpatient holding rooms are as spacious and well-fitted as a private single-bed hospital room. (Often such spaces can be created by upgrading outdated inpatient units.)

• *Specialty care.* In response to ever greater medical subspecialization and hence higher costs, specialty institutions are springing up under the flag of "centers of excellence," which centralize programs in cardiac medicine, oncology, maternal care and pediatrics, rehabilitation, drug dependency, and many more medical specialties.

By focusing expensive facilities and staff, these centers attempt to attract a sufficient patient volume from their regions to be viable businesses—or sometimes try simply to establish a marketing edge over competing services. Some of these facilities take the form of a "mini-hospital" with its own campus; others are integrated with an existing institution. In either case the close focus on related functions allows for a more efficient operation and easier patient management, and aids marketing and fund-raising. The disadvantage is the added investment in plant and equipment required for independent diagnostic and treatment facilities such as imaging, laboratory, and surgery.

Integrating the new models—the unbundled campus

The differentiation by mode of treatment and the accompanying distinctions by type of facilities are leading hospitals to assume a new form: the unbundled health-care campus with discrete but related treatment clusters. With unbundling, facilities can be designed to respond to their specific use, rather than being subject to the "worst case" codes and regulations that govern the traditional tertiary-care hospital.

At the same time, such a campus assembles the primary models for treatment delivery—critical care, ambulatory care, chronic care—along with support services. As noted, the critical-care unit will be designed to handle the most sophisticated and demanding methods of treating the critically ill. The ambulatory-care unit will offer an array of specialty services, dominated by noninvasive procedures, in a humane environment. The chronic-care facility will provide less intensive nursing care and may include space for subacute care within facilities for psychiatric treatment, rehabilitation, skilled nursing, and other long-term patient services.

Diagnostics/imaging. A critical factor in planning health-care campuses is the role of radiology, with its new diagnostic and imaging techniques. Certainly, the radiology department will continue to be modified to accommodate the development of new technologies and procedures, many of which point to a wider distribution of the department's services. Although a case has been made for centralizing radiographic and digital

imaging in order to use staff efficiently, a single department will become more difficult to manage as the service expands, slowing the processing of patients.

Prominent among the emerging influences on radiology and related imaging services are computerized viewing, which allows the reproduction of clear on-screen images for diagnosis, and the ability to store film on laser disks. As these come into common use, the need for centralizing such facilities as viewing rooms and film storage vanishes. As a result, future radiology services will be better integrated, more widely distributed, and less space-consuming, enabling the service to come to the patient rather than the patient to the service.

The trend to decentralization, accelerated by the growing specialization of health-care delivery, has had a particular effect on the relationship between radiology and such other departments as cardiology, obstetrics, oncology, and surgery. In the future, diagnostic imaging could be seen as a service component available for distribution to other departments, each with its own resources for magnetic resonance imaging (MRI), CT scans, ultrasound technology, or even PET scans.

• *Exploiting existing facilities.* In the present economy, healthy hospitals face the dilemma—and the opportunity—posed by the bankruptcy and closure of their underutilized fellows, which will tax the surviving institutions' ability to grow and adapt to heavier workloads. Obvious opportunities for adaptive growth lie in the reuse potential of closed facilities as well as in land development around still-viable hospitals. Thus major institutions are reviewing and revising their master plans in response to changing conditions, and looking at additional land acquisition over the long term.

In the short term, as investment capital becomes scarcer, hospitals will also take better advantage of available resources, including existing facilities that may be downgraded from inpatient care to less demanding uses. Now seen as albatrosses weighing on future plans, older buildings may with creative planning contribute to both the health-care campus and the surrounding community. In some cases, such facilities may be reused for certain ambulatory and acute-care functions; more often, they will be adapted for office buildings, senior housing, public buildings, research space, administrative facilities, or support centers.

• *The competitive climate.* Especially among young professionals and older people, the setting in which care is offered is an important factor in their selection of providers under managed-care plans as well as free-election insurance programs. Similarly, an attractive setting for physicians may induce them to relocate to facilities on the health-care campus. (With appropriate planning, physicians may also be offered a share in ownership.)

The challenge facing health-care providers, then, is to market their leading tertiary-care programs while providing convenient, accessible, and user-friendly ambulatory services for the managed-care and private-patient markets. Just as corporations are using signature architecture to assert their identity in a highly competitive environment, design will play an important role in marketing hospital facilities not only to patients but to staff and physicians as well. Hospitals will continue to evolve toward a creative mix of a noninstitutional image for their hospitality components and a high-tech image for the systems aspects. The competitive edge will stem from a balanced use of resources, quality of planning and design, and the introduction of architecture to function-dominated buildings. □

The future health-care campus will integrate and support a range of medical delivery systems based on distinctions among types of treatment.



BUILDING A CARING COMMUNITY

A medical “village” responds to the special needs of patients who are confined for long periods of time.

Freeport Hospital Health Care Village
Kitchener, Ontario
NORR Partnership Ltd., Architect

While other hospitals work to further trim patient stays already cut to less than a week, chronic-care facilities such as the 350-bed Freeport Hospital expect to house their patients for an average of six months, and in some cases for many years. Variety, stimulation, personal relationships—the ingredients of a normal life—become paramount in treatments that emphasize support and rehabilitation. To provide them, the NORR Partnership capitalized on the hospital’s ambitious 313,000-square-foot expansion program by translating its diverse requirements into discrete elements suggesting a small tightly knit village.

The heart of the village is a “town square” anchored by a new “government” building containing administrative offices on the west end, opposite it, an auditorium that serves as the community’s town hall. Closing the sides, two four-story nursing units, designed to read as a cluster of individual buildings, employ a “living-over-the-store” arrangement of special treatment facilities and activity rooms (library, game

room, café, laundry) on the ground floor and patients’ rooms above.

Street-level spaces are prefaced and linked around the central open space by the “veranda,” a glass-walled arcade that offers a ready reference point as well as outdoor access. By gently controlling circulation beyond the inner ring of public areas, it also allows ambulatory patients—including disoriented Alzheimer’s victims—to move freely and securely about the complex. A small “gateway” pavilion between the new complex and a renovated existing wing affords visitors direct entry to the court from the main parking lot.

In addition to lending diversity to the village streetscape, pulling office functions into a separate building freed them from the physical and mechanical strictures of the nursing modules. The most formal of the hospital components, the administration building combines a two-story hollow square, which disposes clinics, medical staff offices, and the cafeteria around a pyramid-roofed atrium, with a slim four-story slab of open office floors. The two



WILLIAM SANTILLO PHOTOS



Within a limited range of structure and materials, strong massing and varied fenestration produce a lively streetscape of four-story patient wings that reflect their division into smaller "houses" around a semicircular lounge. Ground-floor public spaces front on a glass-enclosed veranda around a courtyard bracketed by a large two-part office block (left) and a low gabled auditorium (far right in photo opposite).



1. Courtyard
2. Auditorium
3. Existing patient wing
4. South patient wing
5. North patient wing
6. Administration

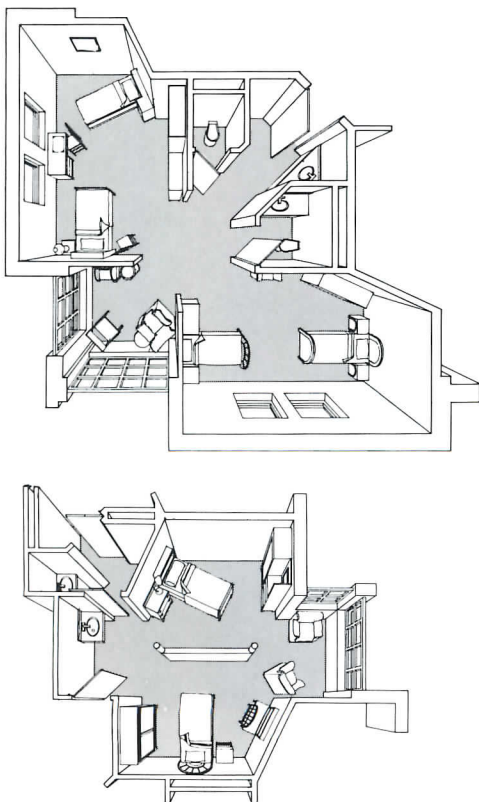

are joined by a freestanding elevator/stair shaft—the village clock tower.

By contrast, the auditorium is a low, permeable shed that serves as meeting hall, theater, movie house, and church. Movable walls allow the stage to be opened to either the interior or the courtyard, which on summer evenings becomes a drive-in theater for wheelchairs.

By dispersing its components, both recreational and therapeutic, while tying them together via the veranda and courtyard, the architects have transformed an ordinary space program into a lively and diverse environment. But its livability finally depends on the patients' residences, whose thoughtful arrangement also allows for a variety of relationships. The elevator/stair lobby on each floor gives onto a public kitchen, dining, and lounge area, surrounded by a pinwheel of three 15-bed "houses," which can be operated in several combinations from a single nursing station placed for unobtrusive supervision. The zoning of public and private realms continues through semipublic house living rooms

to the patients' bedrooms, which share small attached sunrooms. Within the bedrooms, furnishings may be arranged as residents please, providing another measure of privacy and autonomy. **M. F. G.**

*Freeport Hospital Health Care Village
Kitchener, Ontario*

OWNER: The Freeport Hospital
ARCHITECT: NORR Partnership Ltd./
NORR Health Care Design Group—
Skip Schwartz, partner-in-charge; Skip
Schwartz, Flo Berman, Patsy Poulin,
Tom Patton, Steve Bagworth, Donna
Johnston, Dwight Lander, Norris
Carter, Brian Browne, Sandy Smith,
Greg Ballentine, John Hale, design
team

ENGINEER: Walter Fedy McCorgar
Hachborn (structural/mechanical/
electrical)

CONSULTANT: Colourwell—Annabel
Weinstein (color/floor patterns)

LANDSCAPE ARCHITECTS: Andres Kalm,
Frances Barnes

GENERAL CONTRACTOR: Ellis-Don Ltd.

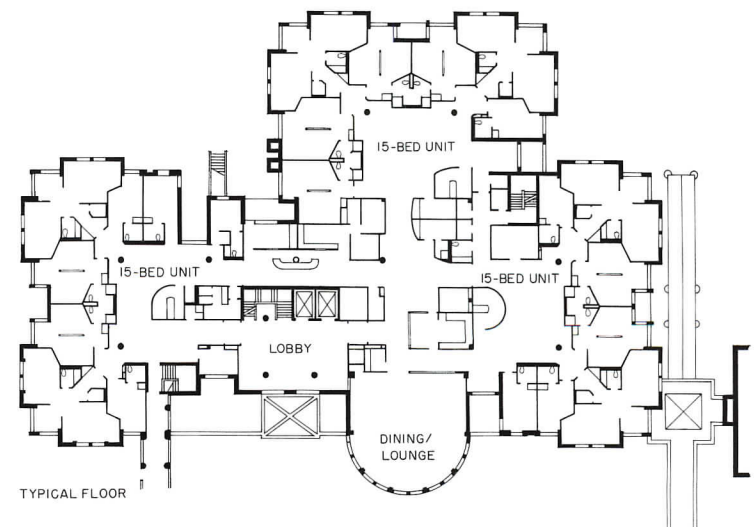
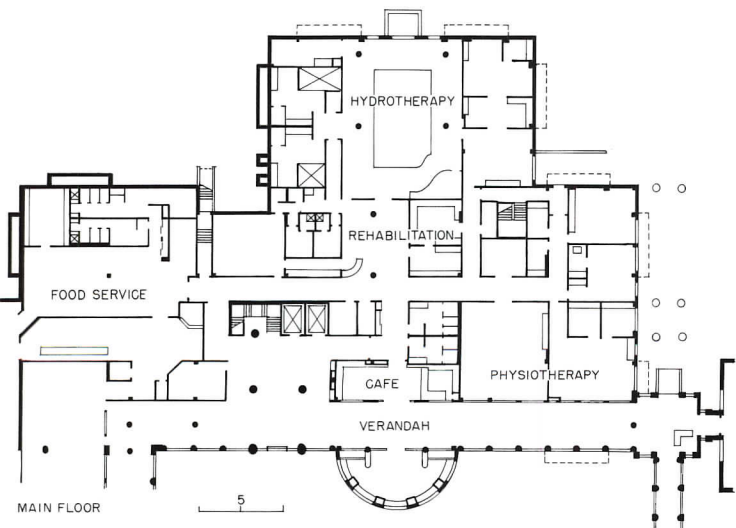

The veranda that links such interior public spaces as the café (top left) and conservatory lounge (above left) to one another and to the courtyard typifies an openness carried through to the office-building atrium

(above right) and a two-sided auditorium stage that allows al fresco viewing. In the patient wings, an inner zone of social spaces merges with an outer zone of treatment and service facilities. Patient floors

offer a similar sequence from public lobby and dining lounge to 15-bed units with their own living rooms. Shared bedrooms (below opposite) accommodate various furniture arrangements.

ACUTE CARE STACKED ON PUBLIC USES

An addition to serve severely ill patients also triggered an upgrade of amenities for the hospital as a whole.

Marin General Hospital Addition
Greenbrae, California
Kaplan McLaughlin Diaz, Architects

The recent addition to the Marin General Hospital is an example of what architect Herb McLaughlin calls a “sandwich”—a sometimes unlikely combination of facilities that is among the more frequent types of health-care commission. Broadly speaking, such additions answer the demands posed on the one hand by marketing considerations and on the other by advances in medical-treatment techniques.

Marin General, like many hospitals built in the 1950s, was faced with updating or replacing its existing facilities in order to keep up with population growth and advancing technology, and modernizing to hold its own against competing hospitals in nearby San Francisco. The new 100,000-square-foot addition, the first phase and anchorpiece of a long-range on-site replacement plan also developed by Kaplan McLaughlin Diaz, provides state-of-the-art care for critically ill patients and at the same time improves shared facilities that serve the institution as a whole.

At ground level, which on the sloping site is one story below the main floor of the existing hospital, a zigzag canopy of square open pavilions reaches from the auto drop-off to a relocated main entrance, around which similar closed pavilions pile up in Mondrian-patterned glazed cubes against a tall, boldly modeled tower containing public and service elevators. Inside, a skylit two-story sitting area introduces a lobby defined by the admitting office, the gift shop, and the elevator bank.

Much of the main floor, however, is given over to food service in an expansion prompted not only by patient dietary needs but by the substantial increase in employees per bed that has accompanied growth in the hospital’s outpatient and diagnostic services, together with the larger nursing staff needed for critical care. In addition to food preparation and serving areas, the first floor houses a small physicians’ din-



TOM RIDER PHOTOS, EXCEPT AS NOTED

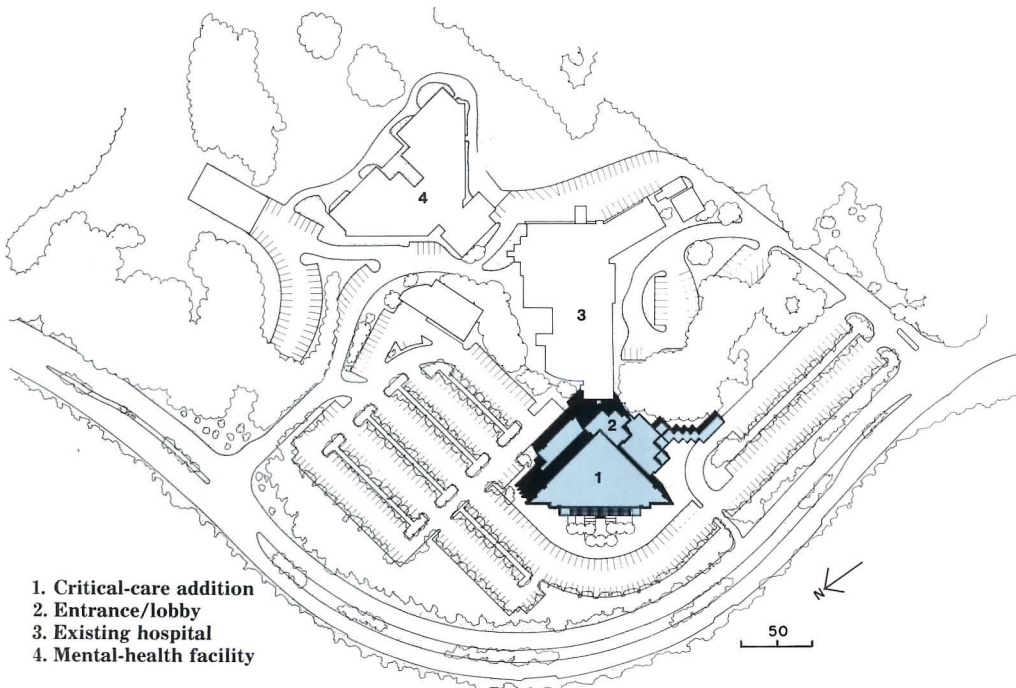

- 1. Critical-care addition
- 2. Entrance/lobby
- 3. Existing hospital
- 4. Mental-health facility



DONNA KEMPNER



ing room, a large staff dining room open to a trellis-shaded outdoor terrace, and adjoining convertible conference space.

The second layer of the sandwich is dedicated to a surgical suite, replacing an original that resisted upgrading to current standards for layout and circulation systems. In addition to general and special operating rooms designed to house sophisticated new procedures, the floor contains an inpatient recovery room and the hospital's central sterile processing facility. For visitors it provides a small balconied waiting room overlooking the lobby.

Above the two-story base, the addition becomes a triangular three-story nursing tower that stacks floors for intensive care and cardiac care, each accompanied by suites for transitional care, with a top-floor surgical and orthopedic pavilion. Chosen as an efficient configuration for the nursing units, the triangle also offers a relatively high ratio of exterior wall—and so daylight and views—to interior space, and will readily receive future additions. Although the 80-bed addition joins the existing hospital only through a short corridor at the elevator core, ramping to match connecting floors was kept to a minimum by using a flat-plate concrete slab with a steel moment frame at the perimeter. For future flexibility, the slab is punctured by a regular grid of eight-inch-diameter cores, while retaining a two-inch fire seal.

Keyed to the landscape, the building's base is faced with strongly scored deep gray-green stucco that pales to a warmer and lighter tone on the upper levels. The nursing floors' strongly horizontal glazing is accented by extruded aluminum reveals and white window frames and shielded with latticed sunscreens.

M. F. G.

*Marin General Hospital Addition
Greenbrae, California*

OWNER: Marin County

ARCHITECT: Kaplan McLaughlin Diaz—
James Diaz, partner-in-charge

ENGINEERS: PMB Systems Engineering
(structural); Colman, Selmi & Wright
(civil); Guttman & MacRitchie
(mechanical); Cammisa & Wipf
(electrical)

CONSULTANTS: Cattanea & Stroud
(health care); Health Facility Systems
(equipment); Marshall Associates (food
service); Harding Lawson Associates
(geotechnical); TJKM (transportation);
Lee Saylor, Inc. (cost); Wesselberg
Keese & Associates (elevator)

LANDSCAPE ARCHITECT: Royston,
Hanamoto, Alley & Abey

GENERAL CONTRACTOR: Lathrop
Construction



DONNA KEMPNER PHOTOS THIS PAGE

- 1. Entry
- 2. Lobby
- 3. Public elevator lobby
- 4. Service elevator lobby
- 5. Admitting
- 6. Gift shop
- 7. Food preparation
- 8. Servery
- 9. Physicians' dining room
- 10. Main dining room
- 11. Conference
- 12. Volunteers' workroom
- 13. Waiting rooms
- 14. Transitional-care unit
- 15. Intensive-care unit
- 16. Nurse station
- 17. Staff lounge

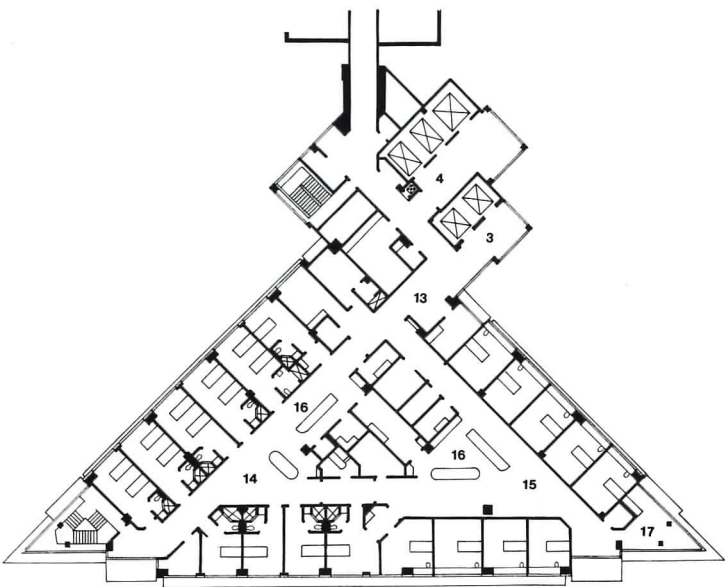

SECOND FLOOR (3 AND 4 SIMILAR)



ROUND FLOOR



At the two-story base, Marin General's footprint spills beyond the triangular nursing tower, taking in a new main entrance and lobby encased in concrete-framed cubes (top opposite) with glazing patterns that repeat on the elevator tower. Arriving visitors move from a small glass vestibule to a two-story

waiting area (top right) flooded with light from a skylight and ceiling-high windows. The ceiling drops again at the circulation lobby, which contains the information desk (right) and gift shop, and adjoins the admitting office. The expanded food services include a terraced dining room (bottom opposite).

MAKING SPECIAL CARE SPECIAL

Despite an umbilical link to the parent hospital, a new birth center realizes an identity of its own.

**Lake Pavilion/Family Birth Center
Baptist Hospital of Miami**
Miami, Florida
The Ritchie Organization, Architects

As The Ritchie Organization's principal-in-charge Patrick Davis recalls it, the program for the new birth center at the Baptist Hospital of Miami could hardly have been more straightforward: "They wanted 'the nicest place around for having babies.'" Nor was the ambition an unrealistic one for a hospital whose founder made hospitality the cornerstone of the institutional culture: "guest relations" is still a required course for its entire staff.

Miami Baptist was more fortunate than many hospitals in being endowed with a campus large enough (63 acres) to absorb necessary expansion—and a governing body quick to commission a master plan when growth began to accelerate. Over the past 10 years, while the institution doubled in size, The Ritchie Organization has presided over the design of several buildings focused on special services, including oncology, emergency care, and pediatrics. When obstetrics moved to the top of the agenda in the hospital's ongoing development program, it too was envisioned as a discrete entity but one that also demanded a link with other women's services—which were housed on the second floor of the existing main building.

Although other locations were considered, the combined criteria of identity and linkage were best met by a highly visible site at the hospital's front door, where the pavilion establishes a new entrance facade overlooking a pair of lakes. To connect with the older facility, the 50,000-square-foot birth center was raised to second-floor level, allowing a physical rehabilitation center to be slipped beneath. A flat-plate structure eased the insertion of up-to-date mechanical and electrical services within the skimpy 11-foot, 4-inch floor-to-floor height needed to align with the adjoining building. Like other additions, the center's



JOHN GILLIAN PHOTOS

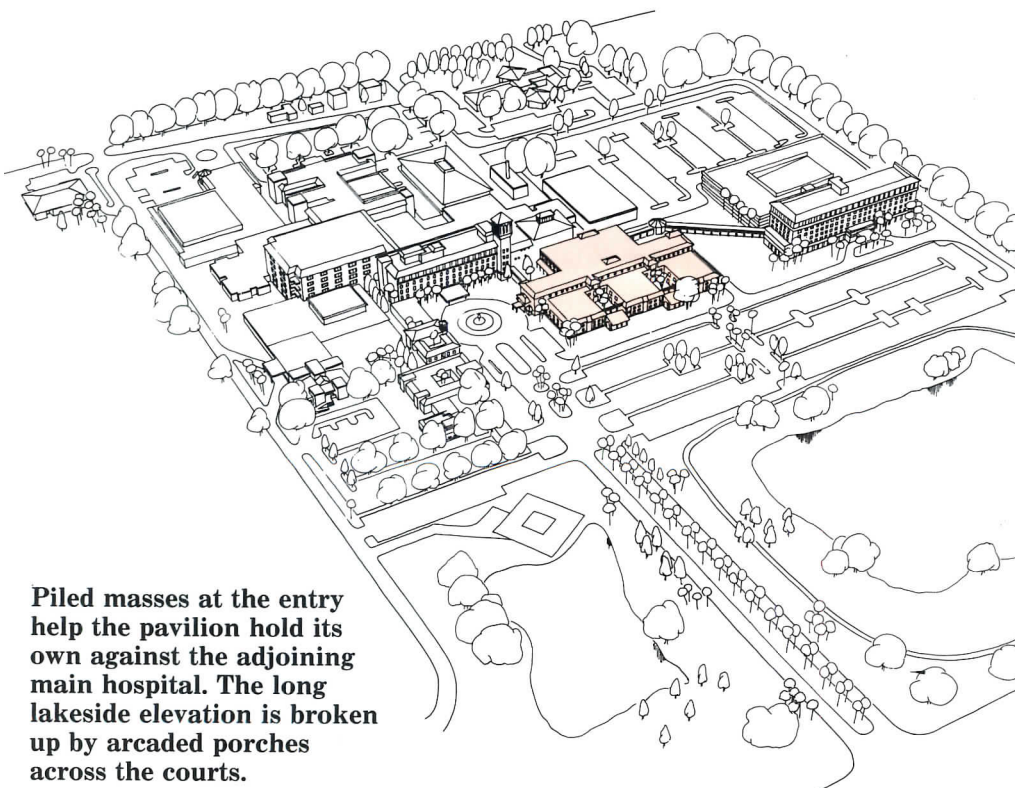

Piled masses at the entry help the pavilion hold its own against the adjoining main hospital. The long lakeside elevation is broken up by arcaded porches across the courts.





State-of-the-art labor/delivery/recovery rooms (above) are softened by touches of wood and a concealed headwall. In the post-partum nursing unit, 16-bed clusters are grouped around the nurses' stations and nearby sitting areas (right). Carefully furnished rooms (below) look out on lakes or courtyards (opposite).



exterior conforms to the Italianate theme and lively color—coral-pink stucco with yellow trim—of the original hospital.

The interior layout, however, was determined mainly by the workings of the birth center. In fact, to Davis's initial dismay, the client "insisted on building the bubble diagram," perceiving in it the clarity and simplicity that carried through to the final plan, which is organized in three distinct sectors: a support area adjoining the main hospital building, a maternity suite with eight labor/delivery/recovery rooms and three high-risk delivery rooms, and a 48-bed nursing unit composed of three 16-room clusters interspersed by courtyards. Nurseries, including a neonatal intensive care unit, form a long spine between the delivery and nursing areas.

By dispersing activity, the intimate clusters contribute to a relaxed, nonclinical setting further enhanced by rooms that boast such custom furnishings as armchairs containing television and music equipment and a small refrigerator, oversize sleeper chairs that allow fathers to comfortably join mothers and babies overnight, and—of course—rocking chairs. **M. F. G.**

*Lake Pavilion/Family Birth Center
Baptist Hospital of Miami
Miami, Florida*

OWNER: Baptist Hospital of Miami
ARCHITECT: The Ritchie Organization—Patrick B. Davis, Jr., principal-in-charge; Charles E. Penuel, project architect; James R. Kolb, designer
ENGINEERS: Walter P. Moore & Associates, Inc. (structural); Bradley, Whitworth Associates (mechanical/electrical/plumbing)

CONSULTANTS: Earl Myer & Associates (planning); Seiger Associates (interior design); Guynes Design (custom furnishings)

GENERAL CONTRACTOR: Witters Construction Company

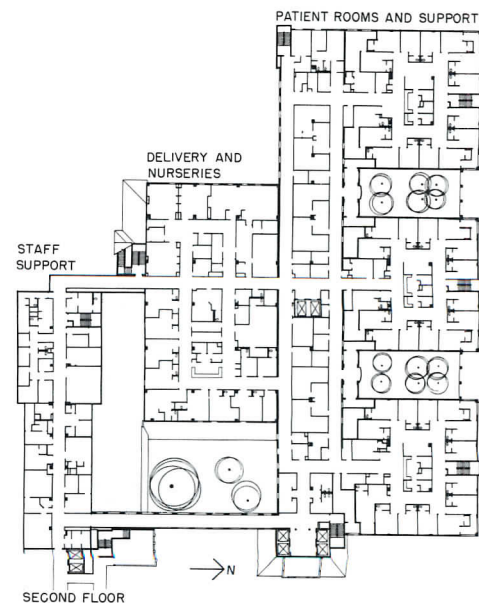



OUR TIMELY DELIVERY TO WOMEN'S AND



SELECTING GLASS FOR TALL BUILDINGS

Improved products and more restrictive criteria call for a systematic approach.

It's time to simplify selection of glass for buildings.

Once this was a straightforward process involving a limited choice of products. But, a decade ago, the rise in concern for energy conservation brought on a wave of innovation and produced myriad new products. Lately, a more sophisticated understanding of wind effects, particularly on tall buildings, has come about. And some incidents of window-glass failure in high-rise buildings received national exposure, and focused attention on the safety (and potential liability) of accepted curtainwall design techniques. Now, when choosing glass, it's important to understand both the nature of products that are on the market and the way various design criteria interact.

Coping with conservation

To reduce solar-heat gain and winter heat losses, glass may be tinted or covered with a reflective coating. Sometimes both treatments are used to achieve a combination of esthetic quality and energy performance. Laminated glass, which consists of two plies of glass adhered by an interlayer of polyvinyl butyral, offers the option of tinting the interlayer instead of the glass. Since these types of glass absorb energy, temperatures on sun-exposed areas can be much higher than on shaded portions, inducing glass-expansion stresses that may be excessive for conventional annealed float glass. Heat-treated glass types (heat-strengthened and fully tempered) are pre-stressed—the surfaces and edges placed into compression—thus helping to resist differential thermal effects.

The most effective solution to energy control, insulating glass (IG), found wide acceptance in the late 1970s. (An IG unit consists of two lights of glass, separated by a perimeter metal spacer, and sealed.) Though its thermal efficiencies derive from the use of a sealed air space, IG units may be improved further by use of tinted or reflective glass in one light or both lights and/or suspension of a tinted film between the lights. An IG unit is structur-

ally efficient because the force of applied wind pressure is shared through the spacer. Although the two lights in most IG units resist these forces equally, this is not always the case. The designer should seek assistance in analyzing the unit's structural properties.

New products offering greater conservation opportunities are rapidly moving into the market. Already appearing are

high T (for transmissivity) glass coatings, and low E (for emissivity) coatings that admit and retain heat within the building. These clear coatings pass light from the high-frequency end of the spectrum (ultraviolet and visible), but absorb and reject infrared energy from the low end. New interlayers for laminated glass provide greater color selection and more energy-management options. IG units filled with inert gases (such as argon), as opposed to air, are gaining acceptance as are new organic seals, new spacer configurations, and new corner designs that improve IG-unit performance.

New ways to measure the pressure effects of wind

The ability of the boundary-layer wind tunnel to precisely define pressures on high-rise building surfaces has changed the way tall buildings are designed. The required thickness of glass for a given opening area has customarily been obtained from a single chart prepared more than 25 years ago. Most building codes still incorporate this chart in only slightly modified form. Wind-tunnel models have shown that turbulence in the approaching—boundary layer—wind and the turbulence surrounding sharp corners and irregular surfaces can magnify wind pressures so that a single building can experience an enormous range of wind forces (page 106).

Current building codes may not take into account these varying pressures. Although thicker lights of annealed glass may be selected to meet high wind-pressure criteria, heat-strengthened or fully tempered glass may be a better choice, since these glasses are stronger than annealed glass (of the same thickness) by factors of two and four, respectively.

What happens when glass breaks?

In the 1970s, widely publicized failures of cladding on a few high-rise buildings—including the John Hancock Building in Boston—focused attention on what happens to glass after it breaks. Is it held within the frame, or does it fall to the street as dan-

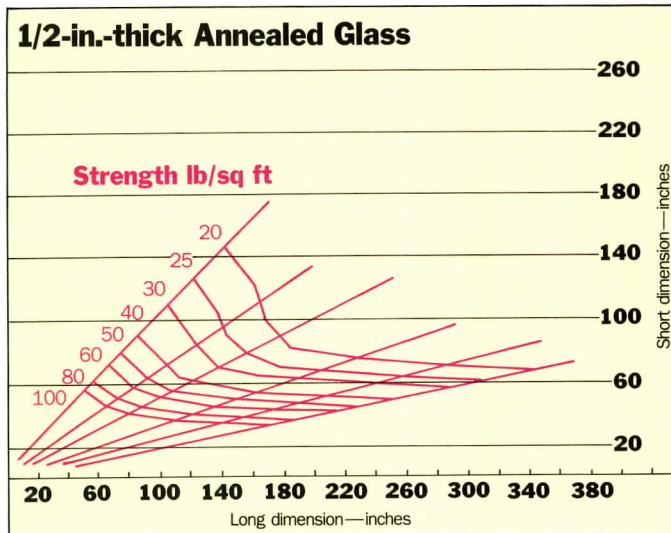

Top: New glass-strength chart.
Bottom: Hurricane Alicia damage.

JOSEPH E. MINOR

Wind-tunnel testing shows enormous variations across the face of a tall building, in this case one of the analyses for 900 North Michigan Avenue, Chicago (Kohn Pedersen Fox, architect).

gerous shards? Buildings in downtown Houston suffered substantial damage during the passage of Hurricane Alicia in August 1983 (page 105), much of it caused not by the strength of the wind itself but by wind-borne debris, particularly gravel carried from roofs. Analysts are asking whether fallout-resistant glass should be a requirement in high-rise buildings.

Though annealed and heat-strengthened glass pieces tend to stay in the window opening when broken by impacts, shards will not long remain in place during severe windstorms. Hence, in locations subject to high winds and where falling glass may injure passers-by, the selected product should be strong enough to resist missile damage or, once broken, be retained within the opening even after subsequent wind gusts. Fully tempered glass is the most resistant to impacts, but when this type of glass is penetrated, it shatters, leaving little of the glass within the opening. The particles are very small, however, and not as sharp as the shards of broken annealed or heat-strengthened glass.

Laminated glass and film-coated glass resist fallout after breakage. A film coating (commonly polyester), will do a better job of retaining a broken glass light within a frame than an uncoated light. However, such a light has essentially no stiffness, and while the film may hold the broken light together, a gust of wind could cause it to fall from the opening as a unit.

A light of laminated glass can be retained more readily. Since the film is placed between the two plies of glass and adheres them, one ply can withstand substantial wind pressures if the other ply is broken (opposite). Manufacturers' literature indicates the initial impact resistance of laminated glass, but there is no standard that quantifies the missile forces and post-breakage wind speeds to be resisted by broken lights with either film coatings or interlayers.

A glass selection procedure

Choosing glass products for exterior cladding in high-rise buildings or other demanding locations calls for trial and error because of the interactive nature of energy conservation, strength, and safety requirements. The flow chart (opposite)

gives a diagrammatic picture of the process described below. If, for example, acoustical criteria are critical, though, the designer may have to go through the process in a different order.

Conservation criteria for the glazing should be the starting point in design. Monolithic glass is the least heat-flow resistant, although it may be tinted and/or coated to improve its thermal efficiency. The performance of these treatments must be balanced against esthetic criteria. Tints or coatings affect the optical quality of the glass, the shading coefficient of the glazing system, the relative heat-gain characteristics of the glass, the light transmittance of the glass, and its U-value. The designer must keep in mind that glass that has been tinted or coated is susceptible to breakage from thermally induced stresses. If the glass edge is marred or chipped, tensile stresses across these flaws can induce glass fracture. Glass manufacturers provide guidance for assessing compliance with these criteria.

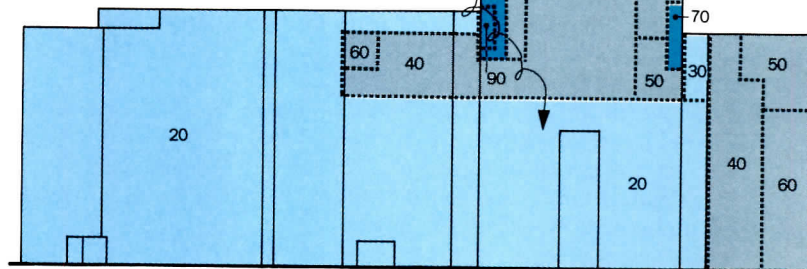
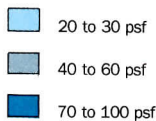

SOUTH ELEVATION

COURTESY ROWAN WILLIAMS DAVIES & IRWIN, INC.

The most heat-flow resistive product is an IG unit with one or more tinted and/or coated lights. Laminated glass also has good heat-flow resisting properties relative to monolithic glass because the interlayer that joins the two lights of glass may be tinted. Further improvements may be obtained by using gas-filled IG units.

Structural characteristics

A glass product selected for energy control and resistance to thermal stresses must then be evaluated with respect to its ability to resist wind pressure. Two procedures for determining design wind pressures for cladding are currently in use.

The wind-load provisions in ANSI A58.1 are prescriptive standards based on boundary-layer wind-tunnel data. Most high-rise building designers, however, have wind-tunnel studies performed on a scale model of their actual design to see if the building geometry and its surroundings produce unexpected pressures.

Once design wind pressures are known and the glass product has been configured (i.e., glass type selected and IG unit type—if used—established), the product can be designed from a structural perspective.

Until we have a more thorough understanding of in-situ behavior, several manufacturers now ask designers to determine

GLASS SELECTION CHART

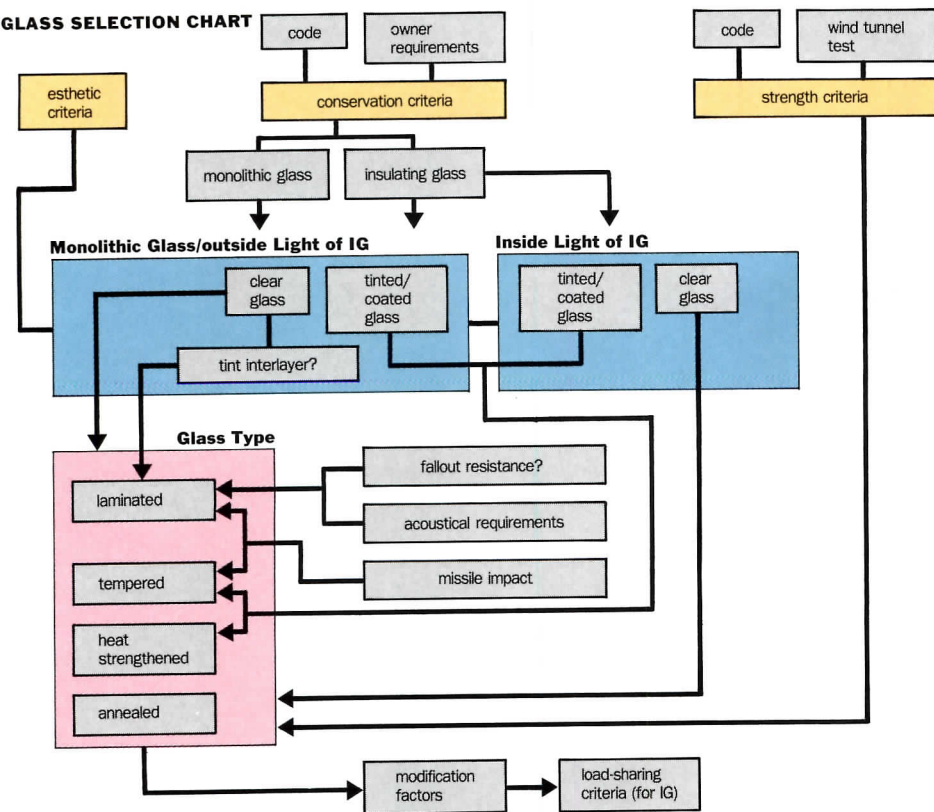

Certain design decisions point the designer toward specific types of glass (left). At each step the architect should consider whether earlier choices continue to be appropriate. Middle left: Modification factors.

For the selected glass type, a trial thickness is defined, its load-carrying capacity is obtained from the corresponding chart, modification factors—if needed—are figured in, and this strength is compared with the design pressure. If necessary, the process is repeated with a different thickness. The architect may at this point want to see whether the glass type is suitable (the chart may be showing a hard-to-obtain thickness or size).

More changes in store

The determination of design wind pressures for high-rise buildings is becoming even more detailed. In a new method of analysis, likely to be adopted in building codes, the occurrence probabilities of wind direction, wind speed, and pressure are mapped on the face of the building. A number representing the combination of these phenomena is then used as the design wind pressure.

Glass product choices continue to grow, offering designers ever more freedom, but at the cost of greater design complexity. Manufacturers are bringing new spacer and sealant configurations to market which reduce heat flow at the edge of lights; glass that can be curved and bent around corners is gaining in acceptance. [See also page 116.] Though the choices may be bewildering, we can take comfort that glass does more than ever to make our buildings work.

Additional information:

ANSI A58.1, "Minimum Design Loads for Buildings and Other Structures," (1982). American National Standards Institute, 1430 Broadway, New York, N. Y. 10018 (212/354-3300).

A. Kareem (Editor), "Proceedings, ASCE Specialty Conference on Hurricane Alicia: One Year Later," (1985). American Society of Civil Engineers, 345 East 47th Street, New York, N. Y. 10017, (212/705-7496). □

Joseph E. Minor is a professional engineer with research experience in the field of architectural glass and glazing. He is chairman of the Department of Civil Engineering at the University of Missouri-Rolla.

Laminated Glass Strength¹

Design Load ²	Modification Factors ³					
	Strength Factor			Load Duration Factor		
	Annealed	Heat Strengthened	Fully Tempered	Annealed	Heat Strengthened	Fully Tempered
Wind Load (Vertical and sloped glazing)	1.0 ⁴	2.0 ⁴	4.0 ⁴	1.0	1.0	1.0
Snow Load (sustained load up to 14 days)						
Glass temperature ≤ 32°F	1.0	2.0	4.0	0.6	0.8	0.95
Glass temperature > 32°F ⁵	0.75	1.5	3.0	0.6	0.8	0.95

¹Two plies of glass of equal thickness supported four sides

²From applicable building code

³Apply to strengths from annealed glass strength charts, (thickness of laminated glass is total thickness)

⁴If glass temperature is > 120°F when design load occurs, use AN 0.75, HS 1.5, FT 3.0

⁵e.g., inner, laminated glass lite in insulating glass unit over heated airspace

SOURCE: MONSANTO COMPANY



JOSEPH E. MINOR

If a flying object damages only an outer light, a laminated-glass pane will usually remain within its frame.

the required thickness using new charts recently promulgated as part of ASTM E 1300 (1989). Instead of one basic chart for annealed glass, some manufacturers now recommend use of more detailed charts for each common glass thickness and type (example, page 105). Further, where strengths for annealed glass from the single chart were modified by numerical factors to account for heat treatment, IG-unit load sharing, and laminated-glass behavior (above), some manufacturers now offer separate sets of charts for these glass products.

To close on a glass thickness that matches structural criteria is an iterative process.

A THIN-STONE VENEER PRIMER

Easily overlooked factors can lead to problems in the design of these popular claddings. This is a list of points to check.

With the use of rational, engineered design principles for masonry, established in the 1960s, and the introduction of sophisticated stone-cutting technology, the thickness of stone for curtainwalls has gradually decreased to a point where panels of exceedingly thin material are now commonly used on high-rise buildings. While thinness per se overcame the problems of stone's cost and weight, it produced problems that had rarely occurred in the empirical and rational design of thicker stone wall facings.

The use of thin-stone veneers (defined as less than 2 inches thick) on high-rise buildings is relatively new, so aspects of their in-service behavior are still not completely understood. Investigations of problems in these facings show that distress can occur through ignorance of the essential physical properties of the stone; the use of improper loads and improper safety factors in the design; a design approach that does not address stress concentrations at attachment holes and kerfs; and insufficient care in the design of joints, connections, and the flashing system.

Slimming down stone's profile

Prior to the advent of steel-frame construction, exterior walls of buildings carried structural building loads, and consisted mostly of solid brick or stone masonry, and solid brick masonry with bonded exterior ashlar of stone or terracotta. Although the advent of the steel skeleton frame at the beginning of the 20th century replaced load-bearing exterior walls in high-rise structures with non-load bearing curtainwalls, masonry materials were still desired because of their esthetic effect, weathering durability, and low maintenance costs.

Historically, load-bearing and non-load-bearing exterior masonry walls were designed as solid walls based upon empirical design principles. According to an early

BY IAN R. CHIN, JOHN P. STECICH,
BERNARD ERLIN

Ian R. Chin is a principal and John P. Stecich is consultant at Wiss, Janney, Elstner Associates, in Chicago. Bernard Erlin is president of the Erlin Company in Chicago.

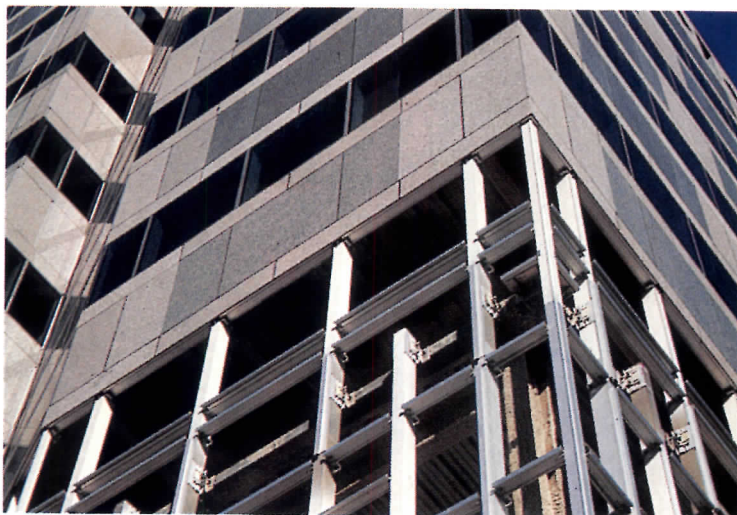

Erection of thin-stone panels at Commerce Square, Philadelphia. Pei Cobb Freed & Partners, Architect.

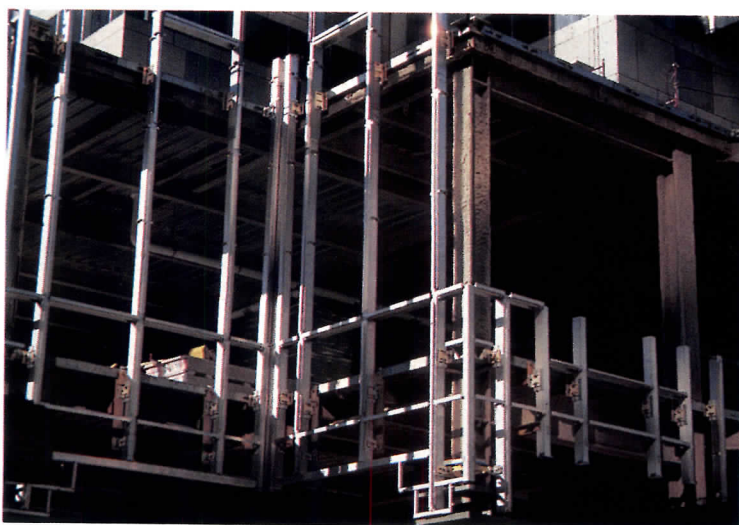

JAMES S. RUSSELL PHOTOS THIS PAGE

building code, for example, a 100-foot-tall solid-brick exterior bearing wall with bonded exterior ashlar of stone or terracotta was required to be constructed with a total wall thickness that varied from 20 inches at the top to 28 inches at the bottom. When empirical principles were applied to a similarly clad non-load-bearing exterior ma-

sonry curtain wall on a 100-foot tall skeleton frame structure, a wall thickness of only 12 inches was required for the entire height.

According to this early building code, the minimum thickness of stone ashlar anchored to exterior load-bearing and to exterior non-load-bearing walls was required to be 4 inches. With greater use of engineering analysis, a better picture of the actual loads borne by materials has become available, with the result that walls have become ever more efficient in the mass of material required. Serviceability tolerances are now so tight, however, that in-depth acquaintance with the characteristics of individual types of building stone is essential.

Stone's essential properties

The kinds of stone most commonly used as veneers on buildings are granite, limestone, marble, sandstone, slate, and travertine. (Travertine is a form of limestone precipitated from cave or spring waters. Some varieties that take a polish are marketed as travertine marble under the classification of "commercial marble.")

The minimum physical property requirements of these building stones and the test methods used to verify a sample's physical properties are presented in Table 1 (page 110). Many of these properties were developed with dimension stone in mind. The design of thin-stone veneers is more demanding, however, and the consequences of thinness must be addressed when evaluating the additional physical properties presented in Table 2 (page 110). Because stone is a product of nature, its physical properties may vary widely, even among blocks removed from the same quarry, so the values presented in the tables should be used only for preliminary design. Prior to completion of design, tests should be performed to verify that the

properties of the stone conform with the minimum requirements of applicable ASTM standards.

Choice of finish affects strength

Some of the architectural surface finishes listed in Table 2 affect the strength and durability of the stones. The scorching process used to obtain a thermal finish on veneers of granite reduces the effective thickness by about 1/8 inch with a corresponding reduction in theoretical bending strength of about 20 percent and an increase in theoretical elastic deflection (under wind loads) of about 37 percent.

Actual performance may be worse: laboratory tests by the authors on similar specimens revealed that the thermal finish reduced the bending strength of the specimens by as much as 30 percent. Actual bending strength of thermally finished stone specimens is further diminished over time by the effects of cyclical freezing and thawing. A polished finish, on the other hand, helps protect the surface of the veneer from deterioration by atmospheric weathering agents through better sealing of the stone pores.

The following are qualities of stone that have not been problematic when used as laid-up ashlar veneers but which must be considered on thin-stone facades because one or more may be critical to long-term strength or durability.

Permanent volume change

Most stones used for veneers are considered to be relatively volume-stable, meaning that they return to their original dimensions after thermal expansion or contraction. However, certain uniform-textured, fine-grained, relatively pure marbles retain a small but permanent volume increase after each heating cycle. This is referred to as hysteresis, and is not foreign to other building materials such as concrete.

For thicker marble veneers, hysteresis is normally inconsequential because the permanent residual expansion occurs in the surface region exposed to higher temperatures, and the hysteresis effects are restrained or accommodated by the unaffected portion of the veneer. For thin marble veneers, though, dilation of the surface region can overcome the restraint of the backside portion and cause bowing. The bowing is actually a dishing of the marble veneer because of the greater expansion across the diagonal axis of the stone.

The compressive force at the backside of the veneer causes creep which helps retain the dish shape. The dilation in the front portion of stone veneers also causes an increase in the stone's porosity, which renders it more vulnerable to attack by atmospheric acids and cyclic freezing. Some kinds of thin marble veneer can also be "granulated" by relatively light impacts

such as pelting from wind and rain. [Hysteresis and the consequent loss of stone material is said to have occurred in the Carrara marble facade of the Amoco headquarters in Chicago. The thin-stone panels of the 20-year-old building are being replaced by granite, which is expected to cost \$70 million. See also RECORD, March 1990, page 127—Ed.]

If stone subject to these kinds of effects is to be used in thin veneers, tests should be performed to establish the minimum thickness required. A test developed by

rendered frost-sensitive by thermal cycling that changes the pore structure. Additionally, some stones possess an original porosity-permeability relationship that renders them vulnerable to damage by cyclic freezing. Degradation may begin if the stone becomes saturated: the water freezes, thereby expanding cracks or causing surface spalling.

Thermal treatment of granite surfaces may cause degradation by cyclic freezing. Though this treatment produces a desirable architectural finish, it also causes mi-



JAMES S. RUSSELL

The designer must take into account stone's natural variations, such as jointing systems visible in this granite quarry near Loimaa, Finland.

the authors has been used to evaluate bowing of marbles. This test involves cyclic heating and wetting under controlled temperatures simulating wall-gradient conditions.

Freeze-thaw weathering

As described above, a stone that initially has good freeze-thaw weathering can be

crofracturing, particularly of quartz and feldspars. These micro-cracks permit absorption of water to a depth of about 1/4 in., which may freeze within the stone.

An accelerated-aging procedure has recently been developed to simulate the effects of cyclic freezing, thermal cycles, and exposure to acid in the environment. It is currently being considered by ASTM

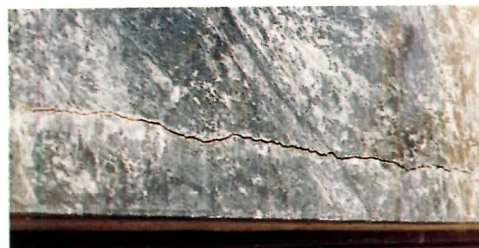

Stone damaged by differential movements: at a connection (top left), above a window (bottom left), and pavement over a structural slab (above).

committee C18 for implementation into an ASTM standard test procedure. In addition, this test, or a variation of it, is frequently appearing in current project specifications.

Environmental conditions can do more than physically damage the surface of stone. They can affect its flexural strength as well. Flexural strength tests should be conducted on the selected stone in just-fabricated condition and after accelerated-aging tests to verify whether, and how much, strength has been reduced. To assure usable results, the designer should be involved in determining which tests are required and verify that specimens are taken randomly from representative stone slabs.

Chemical weathering

Limestones, dolomites, and marbles are vulnerable to severe attack by sulfurous and sulfuric acids (components of acid rain), and to a lesser extent by carbonic acid and ammonium salts. These substances react chemically, the sulfur-based acids forming gypsum and the carbonic acid and ammonium chemicals causing dissolution of the lime component. The result is loss of stone material. In the past, masonry sealers have been recommended, but it is difficult to assure that the correct amount is applied, and sealers must be periodically renewed. The designer might more prudently evaluate susceptibility of stone through the accelerated-aging procedure, and avoid those types likely to be degraded by airborne contaminants.

Chloride ions, such as those derived from de-icing salts, do not chemically react with components of stone, but can still cause damage. Sources of chloride distress are forces of crystal growth when calcium chloride salts precipitate from solutions within the stone body, and osmotic forces created by cyclic wetting.

Characteristics of stone that influence these types of chemical distress are porosity-permeability relationships, and macro- and micro-fractures. An example of distress is spalling at the base of stone panels flanking sidewalks to which chloride de-icing salts have been applied. ASTM C672 ("Scaling Resistance of Concrete Surfaces Exposed to De-icing Chemicals") may be used to evaluate the resistance of stone surfaces to such chemical damage.

Stone texture

The performance of stone is significantly affected by factors that range from the stresses in the earth's crust to the micro-texture of individual particles. Features such as rift planes (where stones tend to split), jointing and crack systems (photo page 109), and preferred orientation of minerals that have good cleavage in a direction parallel to the axis of orientation may result in significant variations in strength, weathering performance, and behavior of anchors.

To properly evaluate natural variations, statistical methods should be applied to an adequate number of test samples. A useful guide is ASTM E122, "Recommended Practice for Choice of Sample Size to Estimate the Average Quality of a Lot or Process." For types of stone that have wide variations in strength, the architect should use design values based on a reasonable lower bound rather than a mean value. Testing should be done on stone with the

same finish and thickness as that to be used on the building.

For some building stones, there is an orientation that will provide a higher flexural strength. Unless the designer can ensure that the selected stone will be fabricated to take advantage of the strongest grain orientation, the strength in the weakest direction should be used as the basis for design.

Permeability

From a historical standpoint, the perme-

Physical Properties of Commonly Used Building Stones						
Physical Property	Granite ASTM C615	Limestone ASTM C568	Marble ASTM C503	Sandstone ASTM C616	Slate ASTM C629	ASTM Test Method
Compressive strength, min., psi	19,000	1,800(a) 4,000(b) 8,000(c)	7,500	2,000(d) 10,000(e) 20,000(f)	not listed	C170
Modulus of rupture, min., psi	1,500	400(a) 500(b) 1,000(c)	1,000	300(d) 1,000(e) 2,000(f)	9,000(g) 7,200(h)	C99 C120(i)
Absorption by weight, max., percent	0.40	12.0(a) 7.5(b) 3.0(c)	0.75	20(d) 3(e) 1(f)	0.25	C97 C121(i)
Density, min., pcf	160	110(a) 135(b) 160(c)	162(j) 175(k) 168(l) 144(m)	140(d) 150(e) 160(f)	not listed	C97
Abrasion resistance min., hardness (n)	not yet established	10	10	8	8	C241(10)

a. low-density, 110 pcf to 135 pcf
 b. medium-density, greater than 135 pcf and not greater than 160 pcf
 c. high-density, greater than 160 pcf
 d. sandstone (o)
 e. quartzitic sandstone (o)
 f. quartzite (o)
 g. across grain
 h. along grain
 i. for slate only
 j. calcite marble (p)
 k. dolomite marble (p)
 l. serpentine marble (p)
 m. travertine marble (p)
 n. pertains only to stones subjected to foot traffic
 o. refer to ASTM C119 and ASTM C616 for classification definition
 p. refer to ASTM C119 for classification definition

Physical Properties of Commonly Used Stones on Building Facades					
Physical Property	Granite	Limestone	Marble	Sandstone	Slate
Coefficient of thermal expansion in. per in. per °F	0.0000063 to 0.0000090	0.0000024 to 0.0000030	0.00000369 to 0.00001230	0.0000050 to 0.0000120	0.0000094 to 0.0000120
Modulus of elasticity, psi	5,700,000 to 8,200,000	3,300,000 min. to 5,400,000 max.	1,970,000 to 14,850,000	1,900,000 to 7,700,000	9,800,000 to 18,000,000
Ultimate shear strength, psi	2,000 to 4,800	900 min. to 1,800 max.	1,638 to 4,812	300 to 3,000	2,000 to 3,600
Ultimate tensile strength, psi	600 to 1,000 psi	300 min. to 715 max.	150 to 2,300	280 to 500	3,000 to 4,300
Available finishes	polished honed rubbed shot ground thermal sand blasted cut sawn	smooth plucked machine tooled chat sawed shot sawed split face rock face custom (26)	polished honed sand blasted abrasive (28)	split face rustic face pitched face chat sawed sand sawed (33)	natural cleft sand rubbed honed (33)
Standard thickness for veneers, in.	none (a)	none (b)	¾, 1¼, 1½, 2	none (c)	1, 1¼, 1½

a. Suggested minimum thickness for exterior veneer: bush hammered or pointed finish, 4 in., all other finishes, 2 in., thickness less than 2 in. depends on panel size, final face finish, anchoring detail, structural design load requirements
 b. Thickness depends on structural and architectural requirements and panel size. Conventional support systems should be limited to veneers that are 3 in. or greater in thickness.
 c. Thickness depends on structural and architectural requirements and panel size

Characteristics of stone such as compressive strength and absorption are commonly evaluated (Table 1, top), but such properties as modulus

of elasticity, coefficient of thermal expansion, and surface finish are critical in the design of thin-stone facades (Table 2, bottom).

ability of stone veneers on buildings has not caused any significant strength or serviceability problems and so has not been a factor considered in the design. The results of water permeability tests (shown in Table 3, below) and the authors' observations of in-service behavior of thin-stone veneers indicates that water may penetrate these facades in greater amounts and at faster rates than empirical experience with thick stone suggests, and that damp areas may appear on the exterior of

the structure is warranted when severe wind loading is anticipated.

Handling stresses

Large handling loads, which may be critical, occur when stone is transported flat and when lifted from a horizontal position. Other handling stresses can occur from accidental impact and from forcing the stone into tight locations. Although such stresses are sometimes difficult to define, their effects must still be addressed in the de-

sign. Some standards include minimum thickness requirements for stone veneers that take into consideration certain handling-load conditions, particularly jarring and vibration from vehicular transport.

Stresses at attachment

Clip angles set into kerfs are common methods of attachment, supporting both vertical and horizontal loads when they are located at the bottom of the stone panel. They may also be used to support only horizontal loads when they are located at the top or sides of the stone veneer (details left). The clip angle may be continuous or intermittent depending on conditions. Other methods of supporting thin-stone veneers utilize pins that are either loose or are cemented into holes drilled into the sides of the veneer.

Dry-sawing and dry-drilling of kerfs and anchor holes may cause stresses due to differential thermal conditions. If, for example, the stone contains materials such as feldspars, these stresses can cause microfractures in the immediate region of the drilled hole that can propagate for significant distances along cleavage planes. If the crystal size of the feldspar is sufficiently large, and the stone sufficiently thin, then these fractures can sharply lower bending strengths.

The authors encountered an example of this phenomenon when 3/4-in.-thick medium-grained granite veneer cracked between pin holes aligned horizontally on opposite sides of a panel. The cracks were almost microscopic in size but extended across the panel face and through the full thickness of the stone.

Blind anchorage techniques

Blind anchorage techniques were originally developed to attach stone panels to interior partition walls. Anchors, fastened to the stone, bridge the air space and are set into grout pockets in the concrete or masonry back-up. For a time this technique was regularly used to attach stone veneers to building exteriors, but it has proven to be a highly risky procedure since verifying the bond of the anchor to the backup is difficult. Current specifications insist on a "positive mechanical" anchorage not exclusively dependent on bond.

Safety factors

Laboratory tests show that the strength of some building stones can either increase or decrease when the stones are saturated. The strength of some types of stone decreases after exposure to a number of heating/cooling and freeze/thaw cycles. Because of these factors, and the expected variation in the physical properties of building stones, safety factors that are larger than those used for other common building materials are recommended by

Continued on page 113

Permeability Of Commercial Building Stones (cu in. per sq ft per hr for 1/2 in. thickness)			
Kind of stone	Pressure, psi		
	1.2	50	100
Granite	0.6-0.8	0.11	0.28
Limestone	0.36-2.24	4.2-44.80	0.9-109
Marble	0.06-0.35	1.3-16.8	0.9-28.0
Sandstone	4.2-174.0	51.2	221
Slate	0.006-0.008	0.08-0.11	0.11



Ignoring stresses at clip angles, especially from movement of adjacent panels, can lead to spalling (above).

the stone veneers. These damp areas result when the rate of evaporation of water from the stone surface is lower than the rate at which the water moves from within the stone.

Kerfs, which can retain water, should be detailed to prevent water from pooling. Any voids that do occur should be filled with a compatible elastomeric sealant.

Recognizing critical design loads

Stone veneers should be designed for conditions that include gravity, wind, seismic, and handling loads. Approved methods for calculating wind and seismic loads are covered under various codes and standards. One of these standards, ANSI A58.1 ("Minimum Design Loads for Buildings and Other Structures"), recognizes the difference between wind loading on the overall structure and on individual components, and that winds exert both positive and suction pressures. In addition, it requires higher wind loads at corners and edges of buildings. Wind-tunnel testing of

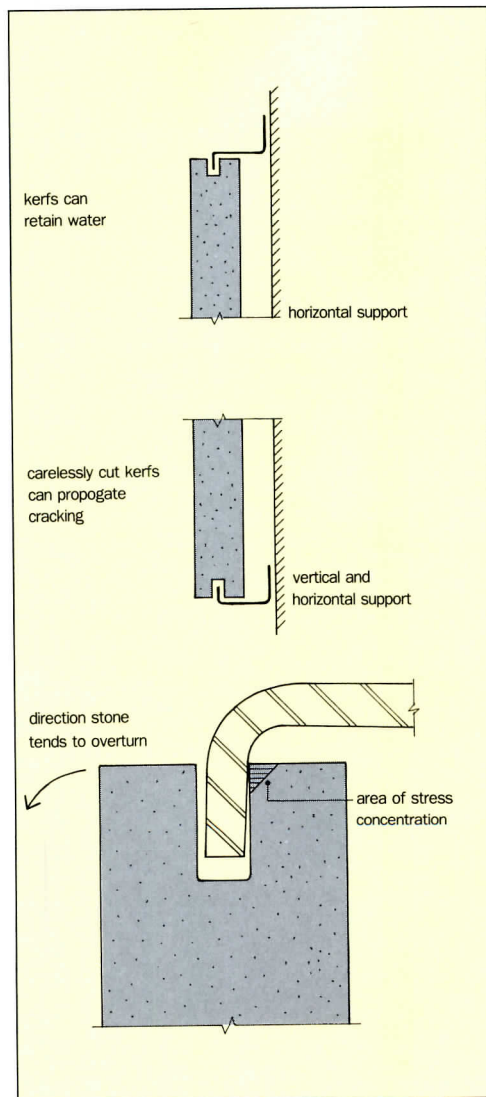

The absorption of a given type of stone (Table 3, top) and the design of kerfs (above) both affect whether the facade will trap water.

Until now,

architectural design

on the computer was just

a CAD and mouse

game!

Discover the power

of a dedicated CAD

workstation on the

Macintosh II.

Call now for an

Evaluation Kit

or more info.

Graphisoft

400 Oyster Point Blvd.,

Suite 517A

S. San Francisco,

CA 94080

1-800-344-3468

(415) 266-8720

Circle 19 on inquiry card

A R C H I C A D[®]

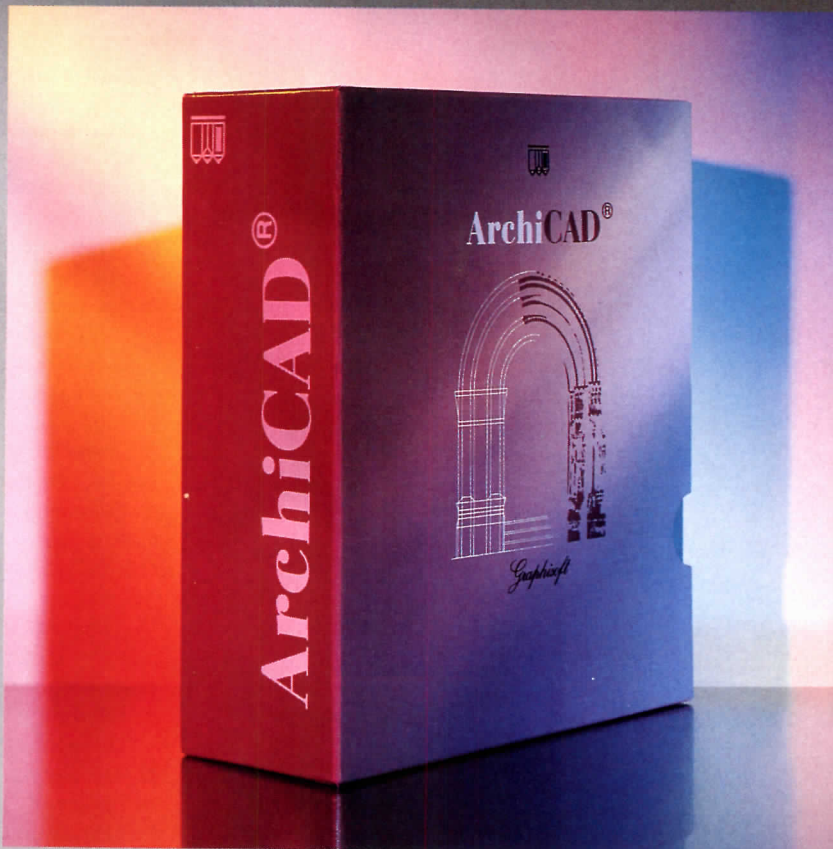

SIMPLICITY THROUGH SOPHISTICATION

UNIFIED APPROACH

WORKING DRAWING

UNLIMITED 3D VIEW

QUANTITY TAKE-OFF

Visit us at A/E/C Systems, Booth #2951

Architectural design courtesy of Elizabeth Vespremi Planning & Architecture. ArchiCAD is a registered trademark of Graphisoft, Macintosh is a registered trademark of Apple Computer, Inc.

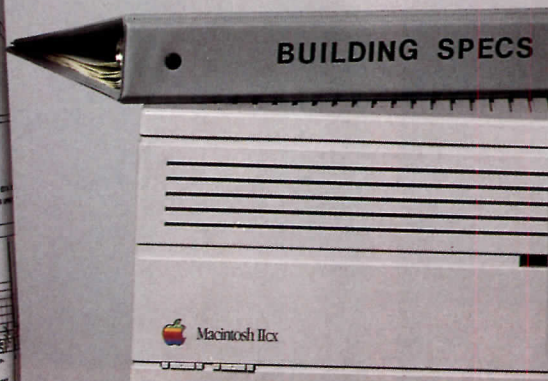
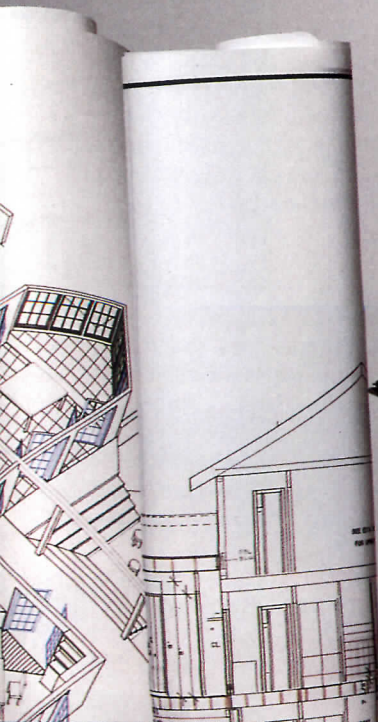

THIN-STONE PRIMER*Continued from page 111*

trade associations and stone suppliers for use in the design of stone facades. (Recommended design safety factors for sandstone and slate are not presently available. In the authors' opinion, they should not be significantly different from granite, limestone, and marble.)

The standard tests recommended by the American Architectural Manufacturers Association (AAMA) for metal curtain-walls are normally performed on full-scale mockups. These should not be construed as a certification of the structural adequacy of the veneer and its attachment system, because the load factor is much lower than the safety factors required for stone veneers. The stone veneer component should be tested separately (utilizing ASTM E72 "Standard Methods of Conducting Strength Test of Panels for Building Construction") to establish an appropriate test load factor based upon safety factors recommended under stone industry standards.

Designing for movement

To forestall stresses and associated distress in stone veneers, it is important to consider the movement likely to occur in the building's supporting framework. Expansion joints must be located in the horizontal gap between stone panels and beneath supporting steel clip angles. If stone veneers lack horizontal expansion joints, stress concentrations due to vertical expansion of the stone veneer, spandrel beam deflections, building sidesway, and differential vertical movements between the stone veneer and the structure of the building can cause cracking and spalling of the veneer. Rigid spacers and leveling devices that have been improperly left in place between stone panels or beneath supporting clip angles may also cause the panels to crack and spall.

It is also essential that properly sized vertical expansion joints be located at appropriate intervals in long, horizontal stone panels to accommodate thermally induced horizontal movements of the stone veneer, its supports, and movement caused by deflection of the building frame.

Cantilevered beams and floor and roof slabs may have sizable elastic deflections, causing stone panels resting on them to move undesirably. This is especially true if such cantilevers are made of concrete that will be subjected to long-term creep deflections. Tall panels may be forced to act as deep beams when they are supported by relatively shallow building-frame spandrel beams. Veneers supported on cantilever outriggers may also induce thermal twist in spandrel beams.

Control of water

A certain amount of water will penetrate

through the veneer under wind-driven rain conditions and condensation could develop on the back side of the veneer. A second "line of defense" should be provided in the form of flashings and weepholes to collect and divert the water to the exterior.

These recommendations are useful in the preliminary selection of thin stone for buildings. To accurately specify and detail the stone, the designer should obtain reliable data from laboratory tests performed on specimens of the selected stone finished as intended for the specific building. What is lacking today, however, is a widely accepted test that establishes water permeability criteria for building stones. With demand for thin stones continuing, the au-

thors strongly recommended that the stone industry develop such a standard test procedure.

Further information:

Indiana Limestone Handbook, Indiana Limestone Institute of America, Inc., Stone City Bank Building, Suite 400, Bedford, Indiana 47421 (812/275-4426).

The Architect's Handbook of Marble, Granite, and Stone, by Enrico Corbella and Lucio Calenzani. New York: Van Nostrand Reinhold, 1990.

Marble Design Manual, Marble Institute of America, 33505 State Street, Farmington, Mich., 48024 (313/476-5558). □

Now, The Beauty & Security of PC GlassBlock® Products in Handsome Aluminum Frames

IBP glass block grid system™

WINDOWS • WALLS • SKYLIGHTS FLOORS



The New American Home '90,
Atlanta, GA
Architect: Claude Miquelle AIA,
Miquelle & Associates
DECORA® Pattern

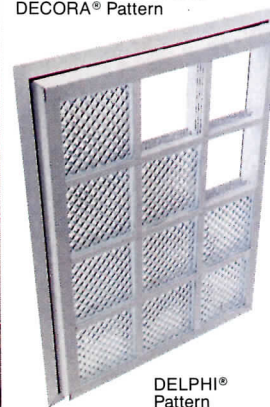

The handsome, tailored image created by the IBP Glass Block Grid System™ gives windows, skylights, walls and floors of PC GlassBlock® products a totally new look. All the advantages of glass block... controlled light and sound transmission... privacy... security... insulation value, in classic metallic or painted frames.

The IBP System™ is available in white and bronze, bright gold or bright silver aluminum alloy frames that complement interior decors. Colored sealants provide a totally coordinated look to the exterior.

These lightweight, sturdy, frames install like any other aluminum window. Then 8" square PC GlassBlock® units are inserted and sealant applied around the exterior edges of the glass block. Totally mortar-free assembly and installation are done quickly.

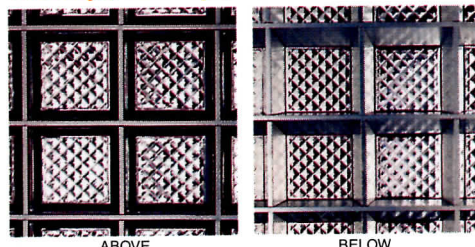
Walkways, Stairways, Between-Floor Panels

Horizontal panels employing IBP's mortarless, brushed aluminum, modular frame system and PC GlassBlock® paver units are equally attractive from above or below. Walkways, up to 72" wide, in any length, meet code requirements for supporting specific loads.

For information call the PC GlassBlock® Products Hotline, Monday through Friday from 8 a.m. to 4:30 p.m. Eastern Time.

800-992-5769

Or contact Pittsburgh Corning Corporation, Marketing Department IBP-90, 800 Presque Isle Drive, Pittsburgh, PA 15239; Tel: (412) 327-6100; or visit the PC GlassBlock® Design Center in the Atlanta Decorative Arts Center. In Canada, write to 55 Renfrew Drive, Unit 205, Markham, Ontario L3R 8H3, Tel: (416) 222-8084.

PITTSBURGH
PC
CORNING

Manufactured by
IBP
INNOVATIVE BUILDING PRODUCTS, INC.
1305 Avenue H
Grand Prairie,
TX 75050

PC GlassBlock®, DECORA® and DELPHI® are registered trademarks of Pittsburgh Corning Corporation

* IBP Glass Block Grid System is a trademark of the manufacturer, Innovative Building Products, Inc. (U.S. and foreign patents pending)

© 1990 Pittsburgh Corning Corporation

CSI SHOW
BOOTH 671-
673-675

Circle 50 on inquiry card

EFCO MAKES A GRAND ENTRANCE.



We wouldn't make an entrance any other way. EFCO Entrances are available in narrow, medium, and wide stile configurations. Each is compatible with EFCO Storefront Systems 401 and 402, and each is available with a wide range of standard and custom hardware. Need a grand entrance? Call EFCO toll free. **1-800-221-4169**. In Missouri, call 1-417-235-3193. EFCO Corporation, P. O. Box 609, Monett, Missouri 65708-0609.

©1990 EFCO Corporation



ARCHITECTURAL CAST STONE

Spectrophotometer and CAD software facilitates the color-match performance of cast stone.

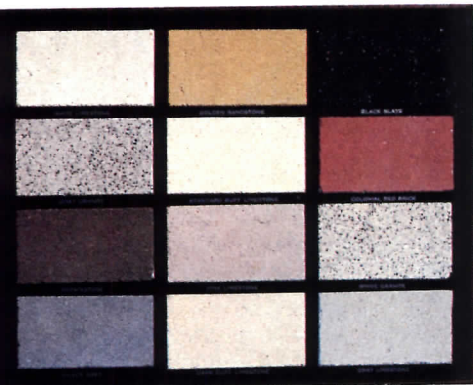

1. A sample chart illustrates the wide range of colorations possible in cast stone. 2. Upper-floor coping and window trim duplicates ground-level limestone on Heritage on the Garden in Boston, designed by The Architects Collaborative. 3. Pink limestone cast stone details the Theological Seminary, Princeton, N. J.; Ewing Cole Cherry Parsky, Architect. 4. Clinical Research Building at the University of Pennsylvania, by Venturi Rauch and Scott Brown, has window surrounds that mimic German brownstone. 5. Cast stone replicates white terra-cotta and Lowell granite on the Reading Terminal Head House, Philadelphia; John Milner, Historic Preservation Consultant.



Cast stone is an economical means of simulating natural cut stone for use in repetitive architectural elements such as cornices, sills, and window surrounds. It can be integrally reinforced, with cast-in-place anchors, and can incorporate fine details and profiles that would require costly hand-cutting in natural stone. By selecting the correct balance of Portland cements, mineral oxide pigments, and stone aggregates, the architect can match the weathered stone colorations of older buildings or achieve a desired contrast on new construction.

But color can be in the eye of the beholder, and at least one manufacturer—W. N. Russell and Co.—sought a more exact and repeatable method of matching cast stone materials to an approved sample. Russell developed this capacity using technology common for years in the paint industry. A spectrophotometer measures the exact balance of lightness, chroma, and hue that constitutes the color of the sample, considering three different lighting conditions simultaneously: daylight, fluorescent, and tungsten halogen. Then, using a data base and software specific to cast-stone components created by Applied Color Systems of Princeton, N. J., a PC with VGA monitor calculates the exact amounts of each ingredient required to make the color match and displays the result. The system can monitor plant production to determine whether finished prod-

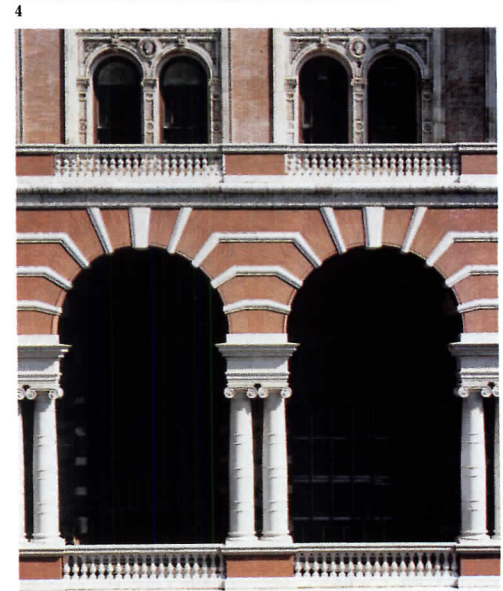

ucts or raw materials should pass or fail an inspection, and can revise the mix to compensate for any color deviation in an individual component.

However, in the manufacture of evenly textured, uniformly colored cast stone there is no substitute for the skill and care that the artisan gives to the material, both in the creation of the molds and the application of the surfacing concretes. **J. F. B. W. N. Russell and Co.**, Westmont, N.J. *Circle 300*

More products on page 116



UNLOCKING THE GRID

Totally flush glazing system uses hidden fasteners to secure insulating glass units.

The Duratec structural spacer system, a unique insulating glass unit with a recessed aluminum channel around all four sides of the glass light, is said to provide a fail-safe mechanical method of flush-glazing buildings of any height. A new curtain-wall design, introduced by the H. H. Robertson Company at the National Glass Show in April, incorporates Duratec glass units into all-glass, glass-and-stone, and glass-and-panel configurations.

Developed by Geoffrey V. Francis, PE, Vision Engineering and Design, Inc., of Toronto, Duratec offers mechanical, safety, esthetic, and installation advantages over both standard two-sided systems with exterior metal stops and four-sided structural silicone glazing. The unit consists of a channel-shaped extruded-aluminum spacer recessed within the two lights of glass, held by a factory-made joint consisting of a desiccating butyl tape and a two-part silicone sealant. The silicone seal has a large contact area and nearly parallel adhesive surfaces, and is backed up by the tape, eliminating three-sided adhesion. Glass units are clipped or hooked in place using standard glazing methods, with the interior light mechanically attached to the curtainwall frame, and the exterior light held by the sealant joint.

The seal is capable of significant movement, resisting rupture when subjected to

forces of edge rotation under large negative wind loads. Full-size units (4- by 5- and 5- by 8-ft) were tested in chambers that replicated real-world conditions of severe wind loading at heights, and confirmed the ability of structural pressure equalization to hold the outer light in place even if the sealant bond was completely cut through. (Failure of the seal places less than 10 percent of the load on the outboard light.)

Major safety features include: mechanical attachment of the interior light; a factory-made structural seal with proven compatibility, strength, and long-term performance; and the ability of pressure equalization to hold the outer light in place if the sealant should fail. On site, any

break in the integrity of the hermetic seal will quickly fog up the IG unit, providing a simple yet reliable visual test for failure. Damaged lights are easily replaced without glass cutting and adhesive residue clean-up.

Working with the basic design of the Horizon curtainwall, H. H. Robertson developed alternative framing systems incorporating Duratec glazing units. The isometric drawings below illustrate three completely flush assemblies using various cladding materials. Geoffrey Francis sees Duratec as giving architects the ability to build up a mosaic of metal, glass, and stone in a totally free fashion, unconstrained by the grid patterns of exterior metal stops.

J. F. B.

H. H. Robertson Co., Pittsburgh. Circle 301

More products on page 117



Curtainwall using Duratec glass; Sherman/Carter/Barnhart, Architects.

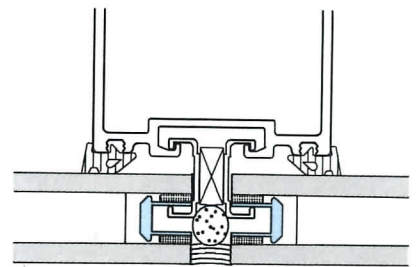

Plan view of Duratec unit, showing Structural Spacer.

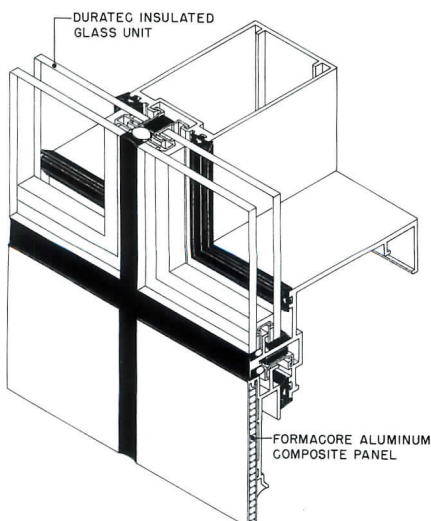

Horizon with metal core panel.

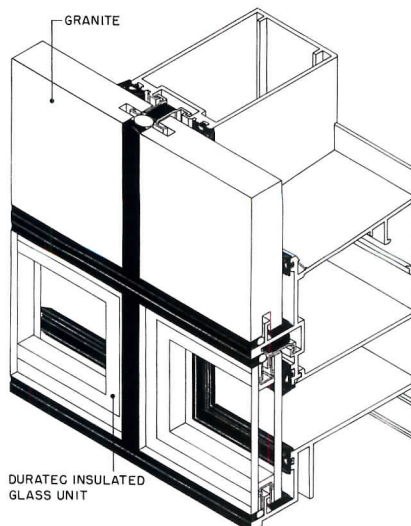

Horizon system with stone.

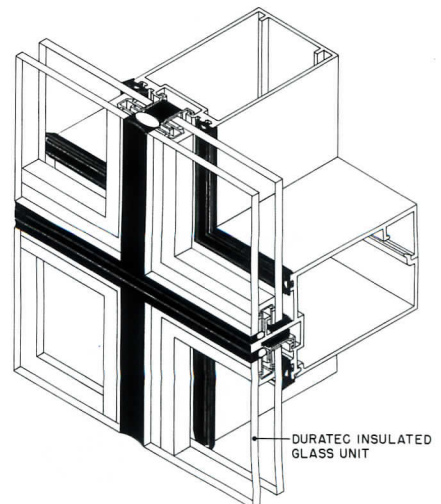

Vision/vision Horizon curtainwall.

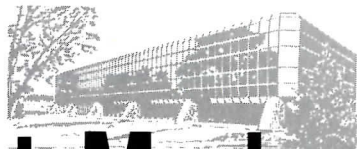

At Medart, quality is getting *personal.*

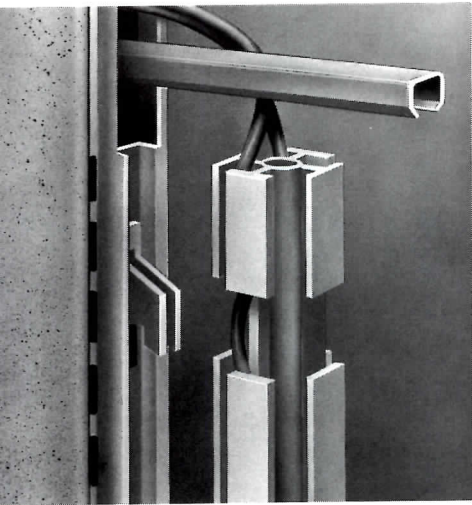

Interconnecting panel raceway

A new capability offered with Equation office-system panels, a compartmentalized raceway is said to provide doubled capacity and increased flexibility in electrical and communications cable management. The connecting element illustrated routes cabling from the panel-top trough to the lower raceway. Westinghouse Furniture Systems, Grand Rapids, Mich. *Circle 303*



Environmentally aware finish

Nienkämper, a Toronto-based contract furniture manufacturer, has introduced Lucent, a new finish process that imitates the rich hues of mahogany and other endangered tropical hardwoods. The finish, applied on composition-wood cases with veneer tops, is available on Management Plus seating, tables, and desks, pictured above, designed by Thomas Lamb. Nienkämper, Inc., Toronto. *Circle 304*

More products on page 122

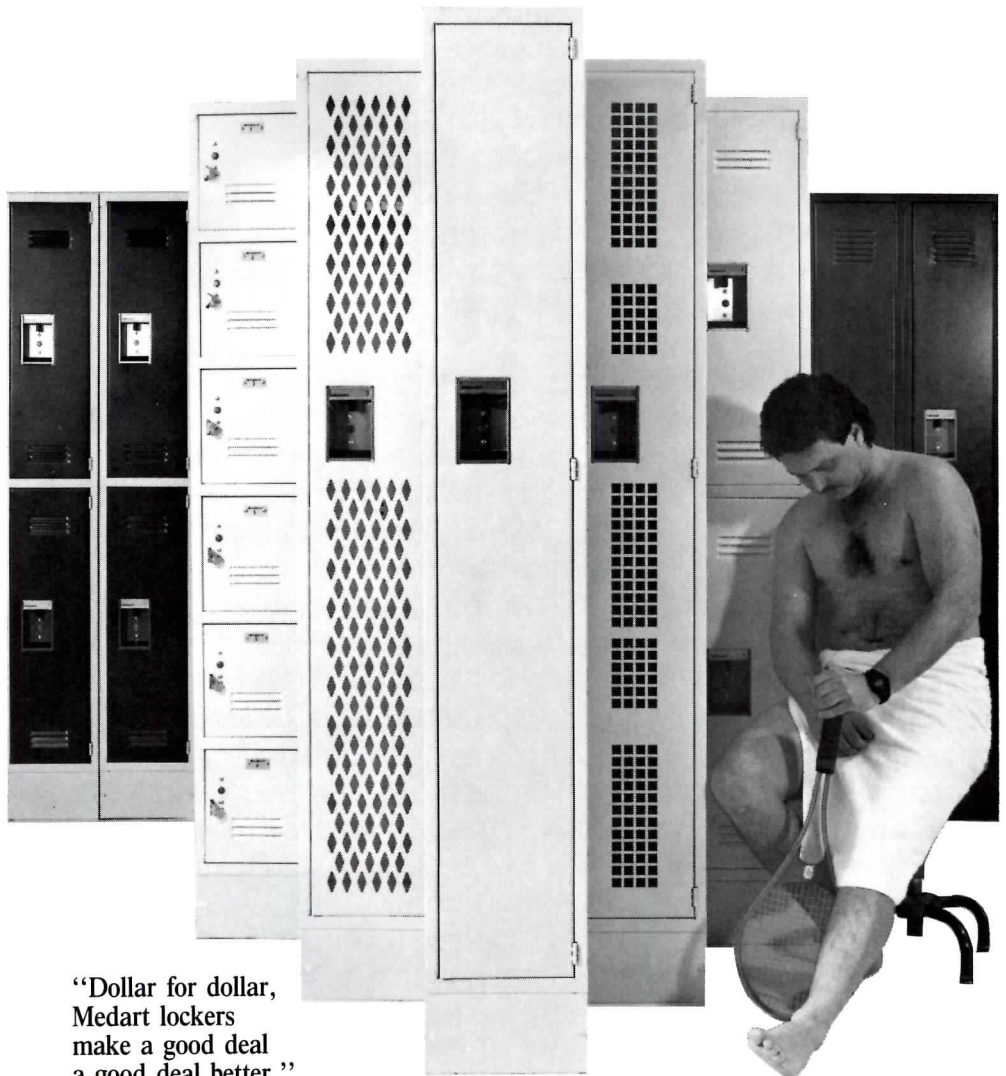

“Dollar for dollar,
Medart lockers
make a good deal
a good deal better.”

Increased security for students, employees, and athletes is Medart's personal goal. Our new locker line provides recessed handles and louvers to eliminate easily damaged protrusions and increase our “tamper-proof” goals. We've eliminated noise pollution with our “quiet locker.” We've beefed up our heavy-duty steel construction with more welds, new textured finishes and colors plus new rattle-free lockrod assemblies. We've done it to the largest selection of lockers made in America. Discover Medart for the 1990s — customized designs for standard prices. **For more information, call toll-free today: 1 (800) 647-7155.**



Medart

Medart, Inc. • P.O. Box 658 • Greenwood, Mississippi 38930 • (601) 453-2506

Circle 52 on inquiry card

The proof's still

ANNOUNCING our latest innovation, the 5632 series. When Grant designed this slide with 100 pound load capacity, silky-smooth precision ball bearing and the hole pattern that accommodates pan head and Euro screws both, it achieved a major breakthrough in slide technology for the furniture industry. With additional features like full extension, trigger disconnect and hold in detent, the 5632 is not only capable of replacing existing slides, it's also perfect for applications some competitors don't even make slides for. It's the best slide in the business. And we back it with the lifetime warranty that's exclusive to Grant.

When it comes to slides, Grant makes the best. Maybe because we've been doing it the longest. Over the years, our reputation for quality grew slide by slide. We've accomplished a lot and as we complete our first century, we continue to excel.

Much of the slide technology you've always taken for granted was invented by Grant. We were making ball bearing slides long before most of our competitors were even a gleam in their founders' eyes. While some manufacturers don't even adhere to BIFMA standards, Grant consistently meets or exceeds them, sometimes by double, triple, or more.

95 years of expertise has resulted in state of the art engineering. Our methods form the metal in the most precise fashion. To achieve this precision takes care, control, testing and strict attention to tolerances. Tolerances 3 to 4 times more precise than the norm. Each new series is subjected to rigorous testing. Then, it's continuously monitored on line using highly sophisticated computer technology we developed to analyze the performance of the slide from start to finish. No one demands more from a Grant slide than Grant.

Grant slides are made by professionals for professionals. The value they add to everything they're part of can't be measured in dollars alone. After you listen to us, listen to a Grant slide. What you don't hear speaks volumes.

GRANT LIFETIME PRECISION SLIDES

**After 95 years the proof's
still in the pulling.**

Circle 53 on inquiry card



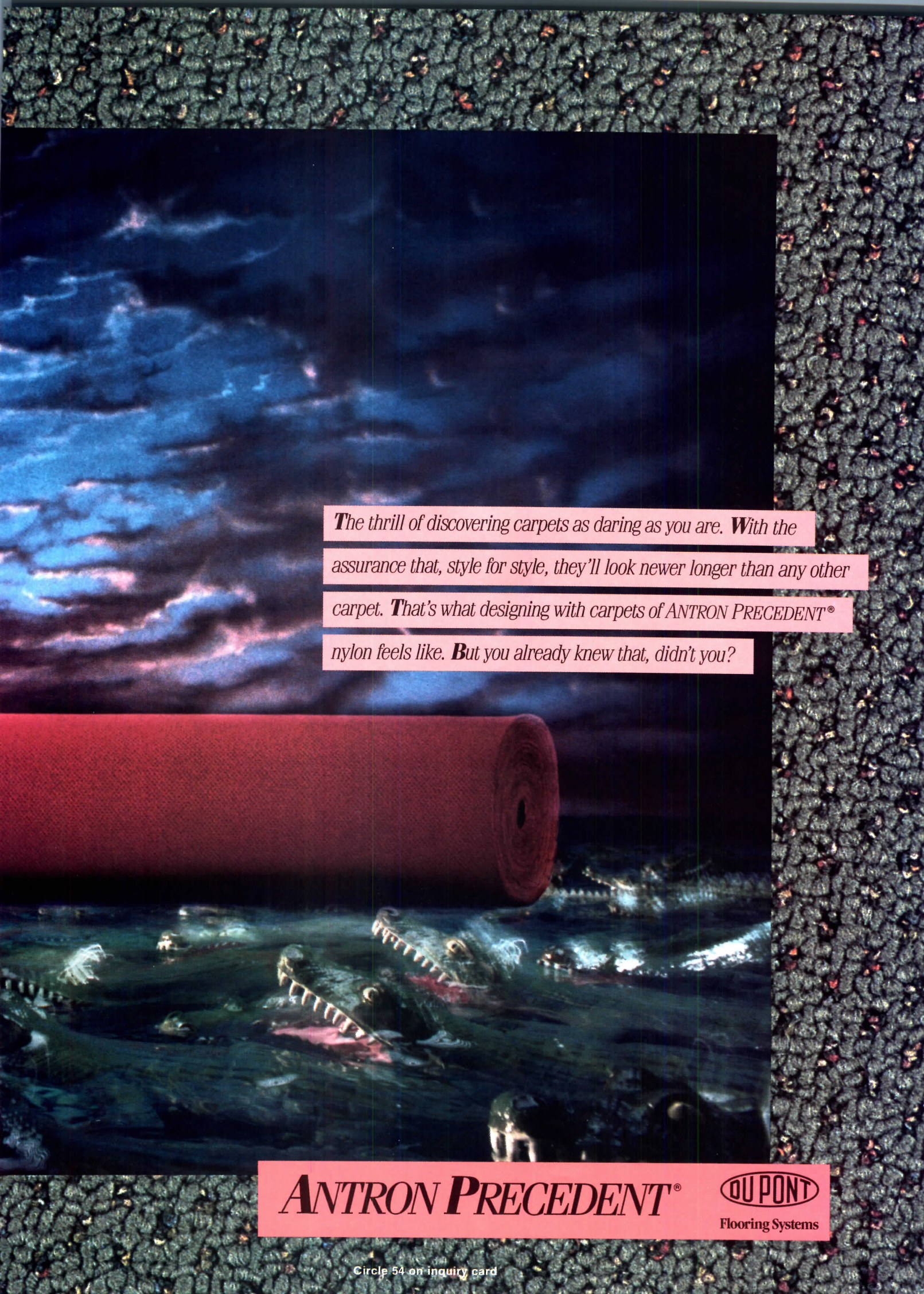

*The thrill of discovering carpets as daring as you are. **With** the assurance that, style for style, they'll look newer longer than any other carpet. **That's** what designing with carpets of ANTRON PRECEDENT[®] nylon feels like. **But** you already knew that, didn't you?*

ANTRON PRECEDENT[®]

DU PONT
Flooring Systems

Circle 54 on inquiry card

Products continued from page 117

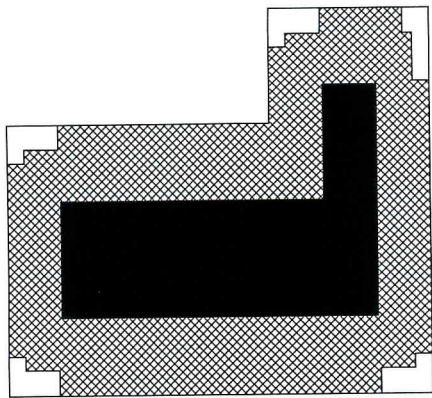

Wind-load design for membrane roofing
Trocal, a vinyl single-ply roofing system, provides a Wind-Engineered Computer Service for architects and specifiers. Using such site-specific data as building height, roof dimensions, and ground roughness condition by ANSI classification, the program determines the number and placement of mechanical fasteners and the most efficient membrane sheet width and layout. Hard-copy drawings display wind pressure layout coefficient zones, as well as corner, perimeter, and roof-field layout patterns, even for multiple roof elevations with different deck materials. Huls America, Inc. Piscataway, N. J. *Circle 305*

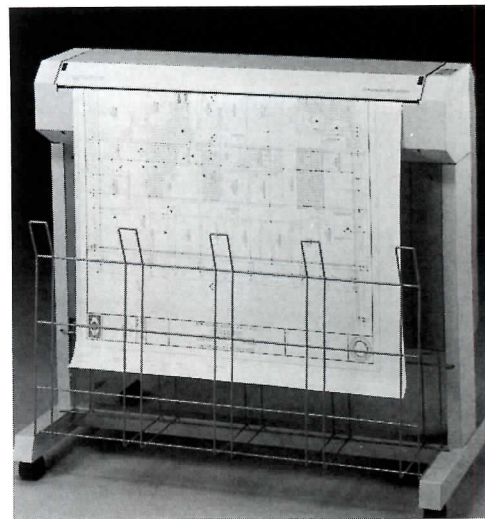

Direct-imaging plotter

The new DrawingMaster Model 52235, described as a low-priced, high-performance plotter, produces one- or two-color ANSI E/ISO AO-size drawings on thermosensitive paper or film. Suitable for very complex drawing or large-volume plot requirements, the unit offers a choice of speed and resolution options, and works with a variety of roll-feed media designed for different hard-copy needs. The DrawingMaster comes preset for use with PC/compatible computers running AutoCAD, and will be offered at a list price of \$19,995. Call Comp, Anaheim, Calif. *Circle 306*



Beautiful Choices

Saying we build columns isn't saying enough.

The responsibility placed on those producing columns today continues to mount, since even this long and valued tradition must also offer creative flexibility as well as functional durability.

It has become expected that our columns and capitals will always meet design standards according to the Orders of Architecture, and the variety

of styles available provides the designer with creative flexibility - all backed by more than ninety years of expertise and our unprecedented warranties.

Call us today or write for more information about our continually expanding product line and to learn why specifying Hartmann-Sanders columns results in so many Beautiful Choices.



HARTMANN SANDERS CO.

4340 Bankers Circle • Atlanta, Georgia 30360 • (404) 449-1561 • (800) 241-4303

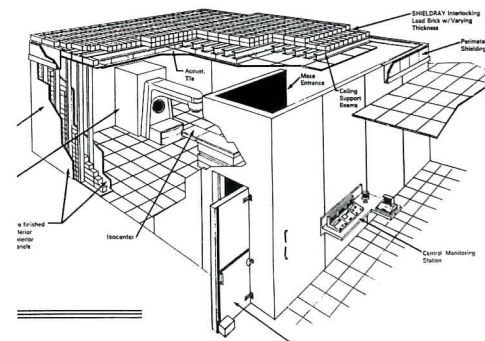

Radiation-shielding construction

The Shieldray System of interlocking lead bricks and special wall-frame units was developed as a space-saving substitute for much thicker solid-concrete walls used for shielding linear accelerator treatment rooms in hospitals. The compact installation saves up to 44 percent of the floor area, meets all applicable codes, and weighs much less than comparable concrete walls. Shieldray components are said to be easy to expand and relocate. Atomic Industries, Inc., Telford, Pa. *Circle 307*

Products continued on page 13

A 2.5-D PACKAGE TAILORED FOR ARCHITECTS

Author Ross calls Drawbase's drawing tools "flexible and easy to use" and the underlying database capabilities "superb."

Drawbase 5000

This 2.5-D (2-D drafting, 3-D modeling) package is tailor-made for architects. The drawing tools are excellent. But the integrated database capabilities are particularly useful for practices that service the space-planning and renovation needs of clients. A version using the Phar Lap DOS extender for computers equipped with the 80386 or 80386SX CPU chip is scheduled for release at this month's AEC/Systems show in Atlanta.

REVIEW

There is a lot to recommend Drawbase, especially for those who need the database capabilities. Data in the database—the total area of walls or floors, for example—changes automatically as the drawing is changed. Space accounting is essentially automatic, tracking the area and volume as well as the linear dimensions of objects you draw. Determining the space of an enclosed area on a plan is simple. A typical command sequence would be:

- select active layer

- space
- display options window (then move the cursor to space fill).
- select spaces fill & color
- create space

This brings up a form window. You add a new form and call it "spaces." You can take a form from another drawing and modify it to use in the new drawing. In fact, Drawbase expects you to do just that.

Once you have the form, you insert attributes (perimeter, area, and so forth). Drawbase calculates the values. Then go to form options and switch to "record" mode to fill in type of office, the room number, function, and so forth.

CAD Overlay, included with the package, can be used to scan an old drawing into the system as a raster image. Once inside, the raster image can be updated with normal CAD (vector) drafting, to show sections that, for instance, are being renovated.

The 3-D module is quite versatile as well. It allows viewing in one-, two-, or three-point perspective, orthographic, or isometric projection. Hidden-line removal is built in. Macros can be constructed to allow walk-through or fly-around tours of the model.

Although you cannot draw in any plane, you can copy or move existing objects in the z-axis. And you can extrude planes to draw a plane in 3-D (with a finite thickness) at any oblique angle.

The Drawbase command structure also bucks the modern trend of menu trees. In-

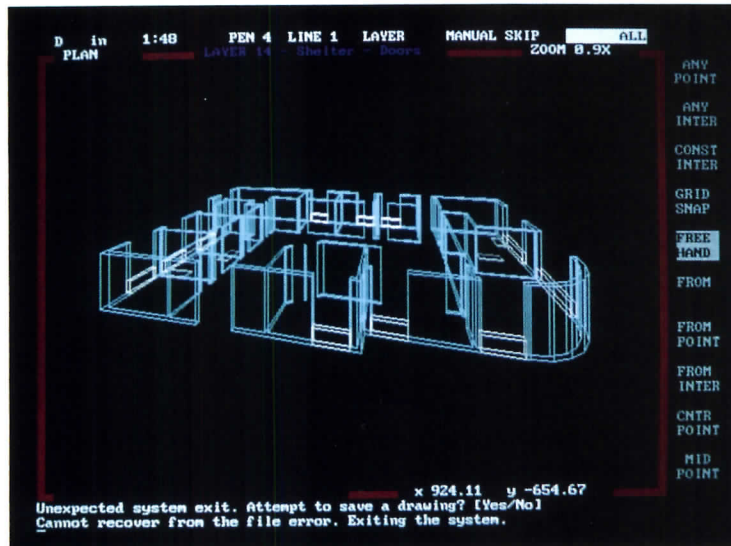

Even after deliberately trying to crash the system by filling all disk space, we were able to save the drawing.



It is easy to change drawing attributes, either from the drawing window or from a window listing specs.

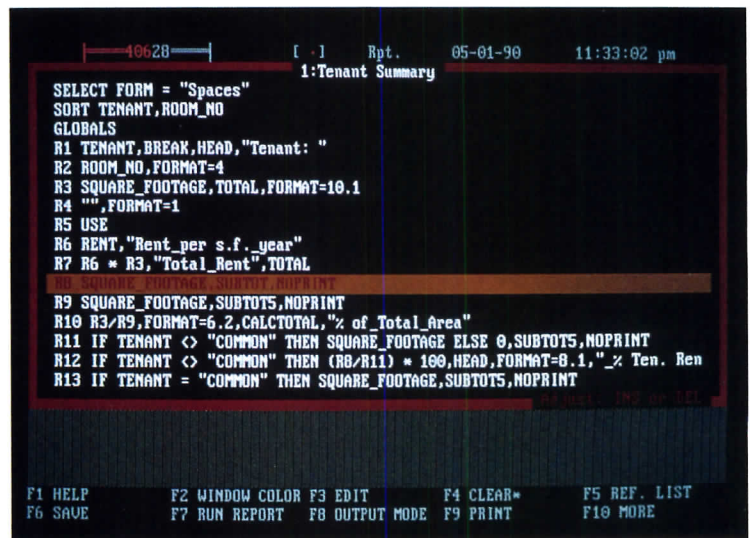

Hitting F2 from the drawing window opens up a list of reports, such as space usage or tenant lists.

NUTS-AND-BOLTS SUMMARY

Equipment required: An IBM AT or compatible (80286 CPU chip); a computer equipped with 80386 chip is strongly recommended. Fixed disk, coprocessor chip (80287, 80387, or pin-compatible substitute), 640K (3 MB for the Phar Lap version), 12-by-12 or 11-by-17 graphics tablet. Drawbase works with a variety of tablets, monitors, graphics accelerator cards, and plotters.

Vendor: CADworks Inc., 222 Third Street, Cambridge, MA 02142. (617) 868-6003. \$4,995. The price includes CAD Overlay by Image Systems Technology. Drawbase 4000 (2-D drafting plus database), \$3,995. Drawbase 3000 (2-D drafting, 3-D modeling, no database), \$2,995. Drawbase 2000 (2-D drafting only), \$1,995. Drawbase 386, add 10 percent. Shade program for versions 5000, 3000, and 386, \$495. Updates, \$200. Note: CADworks is the successor to Skok.

Manuals: There's a detailed reference manual and a tutorial manual that can be used alone or along with automated on-disk lessons.

Ease-of-use: Good. The database interface is intuitive, on-line help is available, and the 2-D drafting tools are fine. To get 3-D models, you extrude 2-D plans and then modify the resulting solids. Drawbase is more flexible than some other similar software; the vertical plane can be cut with oblique planes at any angle, and in any number.

It is possible to use Drawbase without a tablet, by using a mouse to move the cursor and the command line to enter commands. But the command structure is wordy, so the tablet is really a necessity. We reviewed Drawbase with a Numonics 12x18 GridMaster emulating a Summagraphics M-series tablet.

Program speed is good for such a large package, even without graphics accelerator cards. Even on an old AT-class (80286) speed was acceptable. But a fixed disk with fast access speed—or a RAM disk in expanded memory—is best. Using an IBM PS/2 Model 80 with third party SCSI fixed disk, Drawbase will bring up a data window instantly.

Error-trapping: Good. Drawbase creates a backup of your drawing at the beginning of the session, and it warns you when disk space is running short. Files can be quite large—100K or more. The database can be fooled, creating duplicate entries. But the interface is intuitive enough to keep you out of trouble.

Any command that would cause a file to be destroyed or that would cause you to exit the system without saving a file must be confirmed at least once.

stead, all commands are available from all points in the program. About 200 are accessible from the tablet overlay. Using Drawbase without the tablet is a chore. Commands are wordy ("quit active drawing," instead of "quit" or "exit," for example. If you misspell a command, the error message will probably be abstruse and not particularly helpful. Thus, being able to click on a specific tablet point is a big improvement.

Tablet menus are available in 12-by-12 and 11-by-17 sizes. The larger size is laid out better.

For 2-D drafting, Drawbase has plenty of nice touches that make drawing easy. Double lines (for walls and pipes) clean up automatically at end-points. You can draw a single line and double it, either inside or outside the original line, or using the original line as a centerline. Again, using the command line is awkward. The command sequence would be:

- walls
- a thickness and style (6,0,0 would give you 6" wall thickness with the lines capped at both ends).
- hold vertical (to line up with existing intersections).
- close

Along with standard grids, you can lay out "construction geometry" guidelines—circles and offsets—to make drawing easier.

The tutorial software allows you to run all the commands as an automatic macro, so you can see ahead of time where the lesson is leading. It takes about a week to go through the entire tutorial.

Drawbase can import DXF files from AutoCAD and other CAD packages. It can export DXF or HPGL files to desktop publishing, and accept or export ASCII text files from most word-processing programs. Database files can be exported to Lotus 1-2-3, Symphony, and other spreadsheets. Most outside database software,

The database interface is intuitive, on-line help is available, and the 2-D drafting tools are fine.

such as dBase III and Rbase, can accept data in CSV (comma separated variable) format, which Drawbase 5000 can also export.

Memory management has been a bit touchy because Drawbase is so big. Nevertheless, Novell and Lantastic have been used to network Drawbase. And the new 386 version removes any practical constraints except those that are imposed by DOS.

Drawbase, like most modern CAD software, makes enormous demands on fixed-disk space. The program files for Drawbase 5000, Shade, and CAD Overlay take about 7 megabytes. It takes another 1.5 mb to load the tutorial, but double that to hold the drawing files you create by running the tutorial.

Circle 424

Attributes	Type	Len	Frac
15. Cost	Money	14.2	
16. Date	Date	10	
17. Description	Alpha	35	
18. Purpose	Alpha	20	
19. Floor_no	Integer	6	
20. Building	Alpha	10	
21. Project	Alpha	10	
22. Room_no	Integer	6	
23. Door_no	Integer	6	
24. Extended_Cost	Float	10.2	
25. Volume	Float	10.2	
26. Serial#	Alpha	10	
27. Floor_F	Alpha	15	
28. Ceiling_F	Alpha	15	
29. Ceiling_C	Alpha	15	
30. Wall_F	Alpha	15	
31. Wall_C	Alpha	15	
32. Base_F	Alpha	15	
33. Base_C	Alpha	15	
34. Trim_F	Alpha	15	

Standard attributes can be edited for bills of materials or other reports.



TCS

creative response in beauty and durability

Surrounded by cropland on the outskirts of a farming community, this private residence is, as stated by the architect, "a response to the historical and physical characteristics of its site. Its sloped roof areas are covered with silver gray TCS (terne-coated stainless steel), suggesting the color and form of traditional rural architecture."

In addition, TCS satisfied the owner's stated need for, "a maintenance-free roofing material that will last several lifetimes."

Architects everywhere are finding that TCS is singularly adaptive to all types of structures, superbly functional as a design component—important advantages which provide maximum creative latitude at relatively modest cost.

We will be happy to send you more detailed information about TCS.

Call us toll-free, 800-624-6906.

Lee Residence, Northeast Arkansas
Architect: Polk, Stanley, Gray, Architects, Ltd.
Little Rock, Arkansas
Roofers: Gerald Rooks Contractor
McCrary, Arkansas
Photographer: Hursley & Lark

TCS is available in Europe and in the Pacific Rim.
For more information, see our catalog in Sweets

FOLLANSBEE
FOLLANSBEE STEEL • FOLLANSBEE, WV 26037
FAX 304-527-1269

Circle 56 on inquiry card

Numonics Grid Master

This digitizing tablet—the company calls it a digitizing mat—is only 1/32" thick. It comes in two sizes, 12 by 12 and 12 by 18, and is packaged with either side-button pen or four-button puck, and software to emulate Summagraphics SummaSketch or Bit Pad tablets.

REVIEW

The new generation of CAD programs offers so many commands that control is often difficult. Intergraph MicroStation and CADworks Drawbase are two notable examples. The temptation of many is to expand the tablet surface from the PC quasi-standard 12 by 12 to the workstation quasi-standard 12 by 18 or 11 by 17. If space is a problem, consider the GridMaster. It is thin—only 1/32" thin—so it hugs your tabletop. Other objects can overlap it a bit, and still leave it functional. Thus, it takes up three or four inches less in either dimension than its competitors.

It also features low power consumption, so it can be powered from the serial port in most systems.

The thin form of the tablet makes it flexible as well. In fact, it can be rolled up and stored in a drawer. That feature could make it useful for moving around with a

portable computer in the field. But in such circumstances, which usually do not involve production drawing, a mouse would probably be even easier.

Out of the box, the GridMaster emulates the SummaSketch MM1218 tablet, with 500 points per inch resolution. The GridMaster is capable of 1000 ppi, however. Using the setup software you can specify various baud rates and data configurations. The software can configure the tablet for any serial port DOS can recognize—COM3 and COM4 as well as 1 and 2. Any configuration can be saved to nonvolatile memory. That is, the configuration is stored in the tablet itself, and remains in place even when the computer is turned off.

Numonics includes drivers for Microsoft Windows, and to emulate the Microsoft Mouse. With the mouse driver, the tablet can be used with Microsoft-Mouse compatible software, in digitizer mode. The tablet has to be in Numonics mode, not Summagraphics, for that, however.

Circle 425

Another software review follows

Mr. Ross is a prominent computer consultant and contributor to RECORD. His latest book, Data Exchange in MS/PC-DOS, was published by McGraw-Hill.

NUTS-AND-BOLTS SUMMARY

Equipment required: IBM PC, XT, AT, PS/2 or compatible with standard serial port (9- or 25-pin). Some computers with nonstandard ports require an extra power supply. Can also be used with Macintosh in mouse mode, with separate adaptor kit.

Vendor: Numonics, 101 Commerce Dr., Montgomeryville, PA 18936. 215-362-2766. GridMaster 12 by 12, \$449, \$469 with 4-button puck. Gridmaster 12 by 18, \$649, \$669 with 4-button puck. Macintosh adaptor and software, \$30. Auxiliary power supply, \$65. **Manual:** Clear and concise.

Ease-of-use: Good. Setup can be done on-screen, or with a simple setup menu overlay for the tablet itself.

Error-trapping: Good. Pen-tilt correction is built in. Information on the most common formats (Numonics' own, Summagraphics M-series, Summagraphics Bit Pad, and Microsoft Mouse compatible) is actually built right into the pad's electronics. Accidentally unplugging the stylus or the serial cable does not freeze the computer. □

WHEN YOU WERE TAUGHT MULTI-STORY CONSTRUCTION SOME IMPORTANT MATERIAL MAY HAVE BEEN LEFT OUT.

Western Wood.

Chances are, just the mention of wood makes you think house. That's the way most designers have been taught to think.

But the fact is, virtually any multi-story building up to four stories



Wood frame structures are cost-effective in high density areas and difficult terrain.

can be framed in versatile Western Wood. It always could be. (The nation's major building codes have allowed it for years.)

And not just in the West. Award-winning wood frame buildings are going up all over the country. In projects like malls, commercial and multi-family complexes, even hotels.

Through July 23

"Screens and Boxes," showing furniture as functional art; at the Gallery of Functional Art, Santa Monica, Calif.

Through September

"Money Matters: A Critical Look at Bank Architecture," a photographic survey from the Museum of Fine Arts, Houston, and the Parnassus Foundation; at the National Building Museum, Washington, D. C.

June 11 through July 28

"Compasso d'Oro: Current Italian Industrial Design," sponsored by the Italian Trade Commission, Chicago, and the Chicago Athenaeum, and "Gary Lee: Chicago Designer of the Year"; both at the Chicago Athenaeum: The Center for Architecture, Art, and Urban Studies, 333 Wacker Dr., Chicago.

June 19-21

The International Lighting Exposition, held in conjunction with the Canadian IES Regional Conference, sponsored by the Illuminating Engineering Society of North America — Toronto Section; at the Metro Toronto

Conference Center, Toronto. For information: Kerrwil, Trade Show Div., 395 Matheson Blvd. E., Mississauga, Ont. L4Z 2H2 (416/890-1846).

June 21 through November 4

"Architectural Drawings of the Russian Avant-Garde, 1917-1935," comprising loans from the Shchusev/Architecture Museum in Moscow, showing work by Leonidov, the Vesnin brothers, Melnikov, and Ginsburg; at the Museum of Modern Art, New York City.

June 27 through July 20

"New Chicago Architecture," showing 60 recent corporate, commercial, and institutional projects, sponsored by the Chicago Athenaeum, the Office of the Mayor, City of Chicago, and the Mid-America Committee; at Union Station, Washington, D. C.

June 29 through July 1

34th Annual Convention and Exhibit of the Construction Specifications Institute; at McCormick Place East, Chicago. For information: Sandy Humphries, Convention Services Dept., CSI, 601

Madison St., Alexandria, Va. 22314-1791 (703/684-0300).

July 11 through August 2

"Figures of Speech: Projects by Douglas Darden and David Mayernik," showing theoretical architectural projects in Italy and Egypt; at the Graham Foundation for Advanced Studies, Chicago.

July 16-18

The Fourth Annual Engineering Workstations Conference (EWC), concentrating on seminars about electronic CAD/CAE and on special events for the Institute of Electrical and Electronics Engineers, sponsored by the National Institute for Management Research, the Institute for the Advancement of Engineering, and the Los Angeles Council of Engineers and Scientists; at the Hynes Convention Center, Boston. For information: Laura Thomas, EWC, P. O. Box 3275, Santa Monica, Calif. 90403 (213/430-0300).

July 18-20

Second Annual Quality Management Conference, "Quality Management — Making It Happen,"

sponsored by the Design & Construction Quality Institute and 17 other associations; in Atlanta. For information: Rita Bahl, DCQI, 1015 15th St., N.W., Washington, D. C. 20005 (202/347-7474).

July 23 through December 31

"Chicago Skyscrapers: Selections from the Permanent Collection," showing more than 50 architectural drawings, including Daniel Burnham's turn-of-the-century skyscraper plans and Helmut Jahn's drawings of the Northwest Terminal Tower; at the Art Institute of Chicago.

August 6-18

Computer Graphics Institute, a series of courses (Three-Dimensional Computer-Aided Design, Image Synthesis and Image Processing, Developing and Managing Electronic Design Networks, and CAD in Practice) offered by the Harvard University Graduate School of Design, in Cambridge, Mass. For information: Professional Development, Harvard University GSD, 48 Quincy St., Cambridge, Mass. 02138 (617/495-9340).



That's because Western Wood species offer design flexibility that concrete and steel can't match. Not to mention lower costs, faster construction — in all kinds of weather — and better aesthetic qualities.



Award of Excellence for multi-story wood design by Shen/Glass Architects, Berkeley, CA.

So before you design your next multi-story building, contact the WWPA for a little homework on Western Wood. It's material you should know.

Mark the reader service card and we'll send you a packet on woodframe construction — design specs, code provisions, case studies — you name it. Or see us at the PCBC, Booth #2228 and the CSI, Booth #476. **Circle 57 on inquiry card**

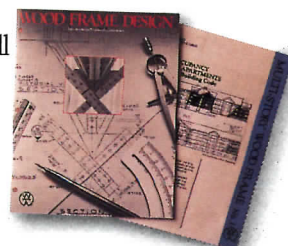

WESTERN WOOD PRODUCTS ASSOCIATION

Dept. AR/6-90, Yeon Building, 522 S.W. 5th Ave., Portland, OR 97204-2122



**Search through piles of product literature for your
lighting specifications and what do you get?**



Power Outage.

**Don't waste your time and energy.
Turn to Sweet's Catalog File, your source for detailed
lighting product information.**

Manufacturers in Sweet's 1990 Catalog File

Fiberstars*
Hubbell, Inc., Lighting Division
Illumination Technologies*
Lighting Systems, Inc.*
Lithonia Lighting
Lucifer Lighting Company*
Raak Lighting, Inc.
Rejuvenation Lamp and Fixture Company, Inc.
Roberts Step-Lite Systems
Task Lighting Corporation*

A.L.P. Lighting & Ceiling Products, Inc.*
American Louver Company
Scientific Lighting Products Division, Koller
Enterprises, Inc.
Bodine Company*
Emergi-Lite, Inc.*
Gilbert Emergency Lighting, Don Gilbert
Industries, Inc.
York Lite Electronics
Holophane Co., Inc.
Siemens AG
Antique Street Lamps, Inc.
Beacon Products, Inc.

Idaho Wood Industries, Inc.
Liteform Designs
Neri Domenico SpA
Niland: Thomas M. Niland Company
Pinecrest, Inc.
Sentry Electric Corporation
Sparkle Plenty Inc.
Spring City Electrical Manufacturing Company
Sternberg Lanterns, Inc.
Valley Iron & Steel Company
Western Lighting Standards

* Manufacturer Premiering in Sweet's 1990 Catalog



Sweet's Group
McGraw-Hill, Inc.
1221 Avenue of the Americas
New York, New York 10020

For further information,
telephone:
1-800-421-9330

Circle 58 on inquiry card



For more information, circle item numbers on Reader Service Cards

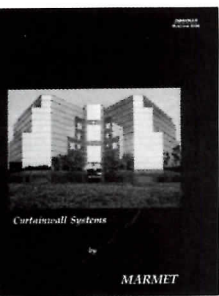

Curtainwall glazing
Architectural brochure provides detail drawings, installation photography, and performance data on several standard and custom curtainwall systems, including the outside-glazed Pressure Wall and a unitized four-sided silicone system. Marmet Corp., Wausau, Wis. *Circle 400*

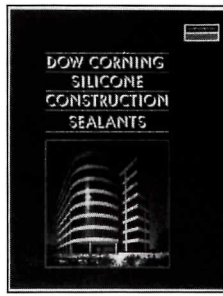

Structural glazing
A 10-page brochure describes the types and benefits of silicone sealants used in structural glazing applications involving adhesion to glass, ceramic, metal, stone, and composite claddings. Fundamentals of design are covered. Dow Corning Corp., Midland, Mich. *Circle 406*

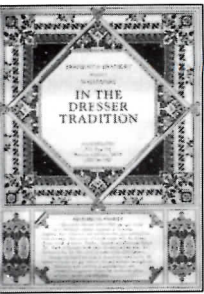

Art wallpapers
Elaborate handprinted patterns in the Victorian tradition of Morris and Dresser are offered in a range of decorative elements for ceilings and walls. A color catalog shows room settings and explains a custom planning service. Bradbury & Bradbury, Benicia, Calif. *Circle 401*

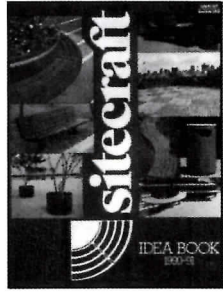

Site furniture
A 16-page "idea book" illustrates standard product and custom installations of redwood site furnishings, including planters, free-form and linear benches, trash receptacles, and decking components. Sitecraft, Long Island City, N. Y. *Circle 407*



Ceramic tile
A 48-page full-line catalog covers glazed wall and floor tile, quarry and paver tile, and porcelain mosaics. Tile projects are shown in color; shapes and trim pieces for each pattern are illustrated. Mannington Ceramic Tile by Mid-State, Lexington, N. C. *Circle 402*

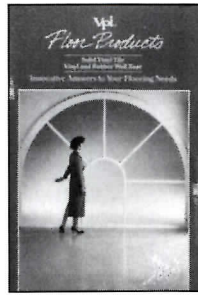

Vinyl flooring
Made of solid vinyl for heavy-traffic applications, tile flooring line now offers a new granite-look design in seven colorways and updated colors in Vinylast styles. A 16-page catalog illustrates all patterns, colors, and accessories. Vinyl Plastics, Inc., Sheboygan, Wis. *Circle 408*



Glass products
Architectural glass laminates of all types are discussed in a 20-page technical catalog. Glass can be chemically strengthened to create lighter-weight and more secure laminated configurations. Globe Amerada Glass Co., Elk Grove Village, Ill. *Circle 403*

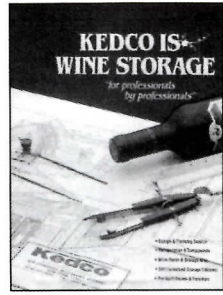

Wine-storage cabinets
Temperature-controlled cabinets and wine racks in sizes from undercounter to restaurant are illustrated in a color catalog. Units may be free-standing or built-in; finish options include oak and redwood. Kedco Wine Storage Systems, Syosset, N. Y. *Circle 409*



Surveillance technology
A source for high-tech CCTV security systems offers a videotape version of its in-house training seminars for specifiers and installers, as well as a manual that discusses the basics of closed-circuit video applications. Vicon Industries, Inc., Melville, N. Y. *Circle 404*

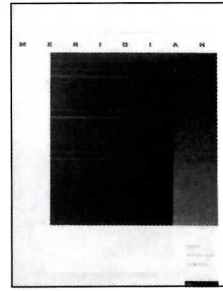

Office filing systems
A 24-page File and Storage brochure features application photos and CAD drawings of stackable, lateral, and vertical files, storage/multimedia cabinets, and pedestal units. All pull-hardware and finish options are shown. Meridian, Inc., Spring Lake, Mich. *Circle 410*



French-made paints
A color chart contains sample chips of Ripolin architectural paints, a deep-pigmented, high-coverage system said to be extremely long-wearing. Now sold in the U. S., Ripolin is said to meet all VOC requirements. Fine Paints of France, Blooming Grove, N. Y. *Circle 405*



Pocket-door hardware
A booklet describes the Stor-A-Door, with dual-function hinges that permit doors to swing open, then slide back into the closet along the side walls for full-view access. J & J Peterson, Inc., Darien, Conn. *Circle 411*

More literature on page 132

For more information, circle item numbers on Reader Service Cards

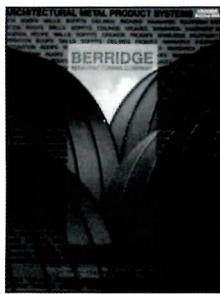

Metal roofing

A 36-page architectural catalog covers a full line of roofing and fascia products, including standing seam and curved panels, tiles, and a distinctive Victorian shingle. Finishes include Kynar coatings and metallic colors such as aged copper. Berridge Mfg. Co., Houston. *Circle 412*

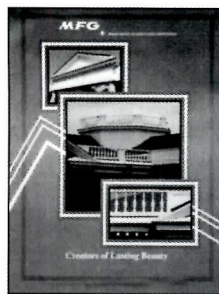

Architectural composites

The decorative potential and physical properties of fiber glass-reinforced plastic elements, from dentil moldings to signature tops for skyscrapers are highlighted in a technical brochure. Molded Fiber Glass, Union City, Union City, Pa. *Circle 418*



Insulating concrete

Roof systems using fire-resistant Zonolite are explained in a 12-page catalog. A composite of lightweight concrete and expanded polystyrene board, the insulation can slope built-up, modified asphalt, and single-ply roofs. W. R. Grace & Co., Cambridge, Mass. *Circle 413*

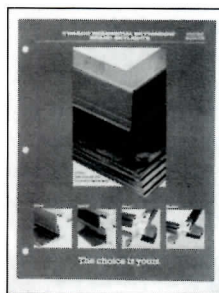

Residential daylighting

A 16-page catalog on skylights and roof windows introduces the Excel-10 step-flashed unit skylight, which can be used with most roofs, including clay tile and wood shake. Glazing options include low-E, Heat Mirror, and acrylic domes. Wasco Products Inc., Sanford, Maine. *Circle 419*



Monumental skylights

On-site photography of large dome, barrel, ridge, and sloped installations highlight a 20-page skylight catalog. Unusual configurations include a telescoping swimming-pool enclosure and an arched, segmented vault roofing an atrium. Naturalite/EPI, Garland, Tex. *Circle 414*

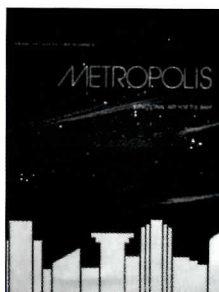

Decorative faucets

Contemporary bath fittings, including waterfall and S-shaped styles, are featured in a fold-out brochure. Faucets, tub spouts, and accessories such as towel bars come in 14 metal or enamel finishes. Metropolis, Los Angeles. *Circle 420*



Horizontal doors and fire vents

Color catalog includes product and installation photos, complete dimensional information, and code approvals for a full line of vents, ceiling and sidewalk doors, scuttles, and other special-access configurations. The Bilco Co., New Haven, Conn. *Circle 415*



Ground-water control

Geocomposite prefabricated drainage systems, designed to meet specific site and loading requirements, are said to offer superior collection efficiencies and faster, more economical installation. Contech Construction Products, Inc., Springboro, Ohio. *Circle 421*

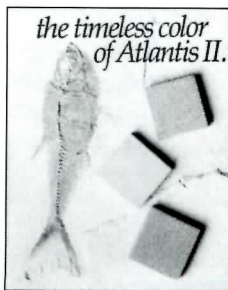

Porcelain tile

A selection guide for Atlantis II tiles illustrates all 24 colors, offered in polished, smooth, or textured surfaces and a wide range of sizes and shapes. Buchta USA, Roswell, Ga. *Circle 416*

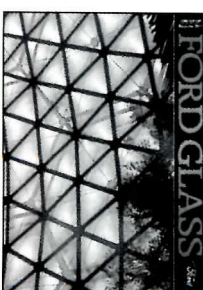

High-performance glazing

A technical catalog illustrates recent projects using Sunglas architectural glass, including reflective, heat-absorbing, and low-E types. Thermal, shading, and installation data are included. Ford Glass, Detroit. *Circle 422*



Tile flooring system

Arredosterling single-fired ceramics form a modular commercial floor, with 23 colors of tile in compatible sizes, accents, and trim shapes. A 40-page catalog demonstrates the system. ICR Appiani, Fort Lee, N. J. *Circle 417*

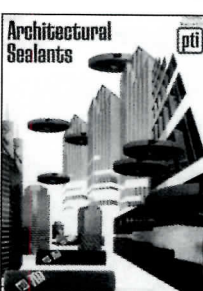

Construction sealants

A product comparison chart profiles glazing and weatherproofing materials, including butyl tapes, acrylic and polyurethane sealants, and fire seals. Protective Treatments, Inc., Dayton, Ohio. *Circle 423*

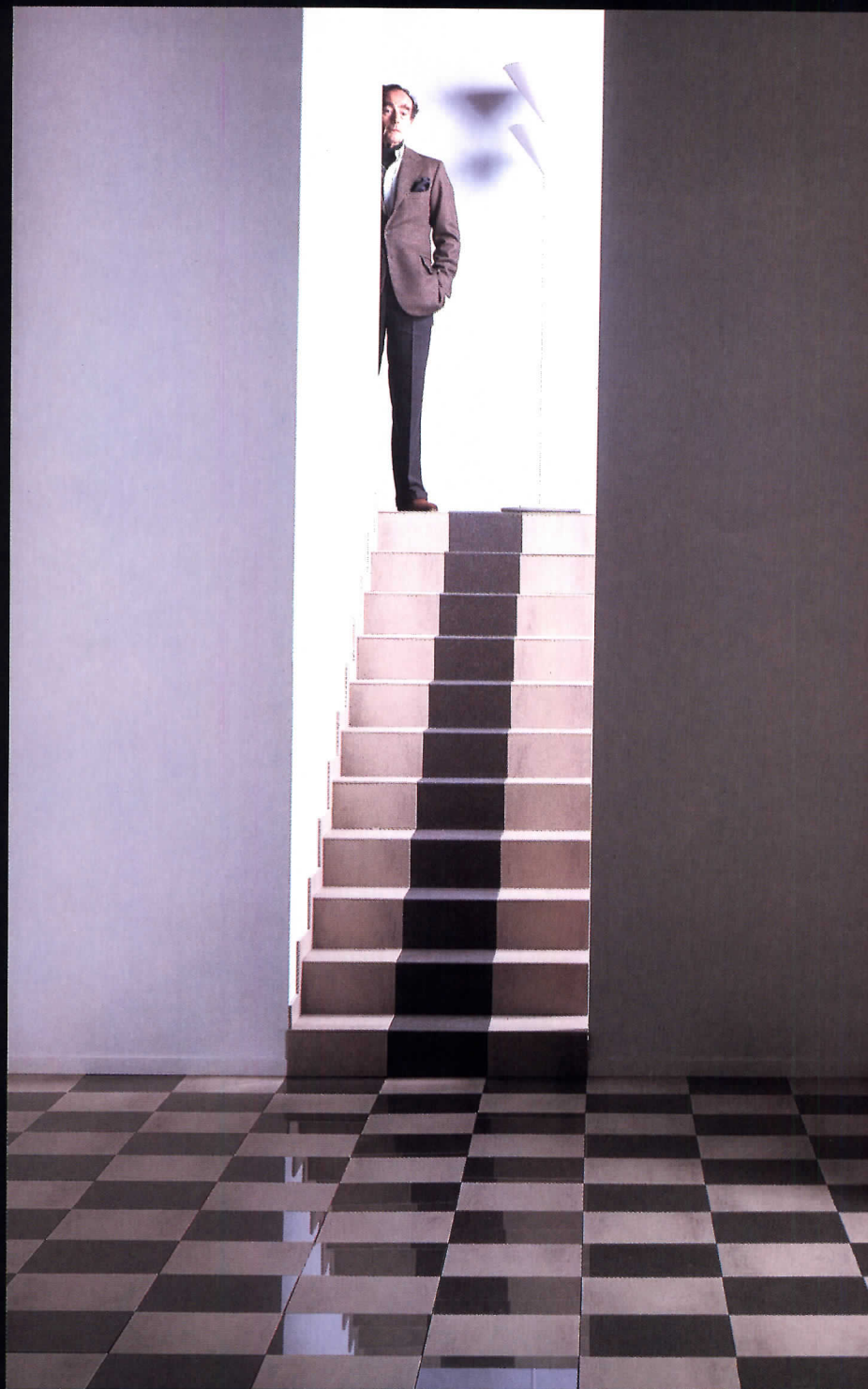

"Hall with small staircase". Top: Antracite 39 and Iridescent Grey F 37, 30x30 cm.

Top according to Vico Magistretti.

Top the fine porcelain tile produced by Cooperativa Ceramica d'Imola offers another great interpretation.

Vico Magistretti has made of it an absolute protagonist here, able to express that rigorous style and that essential cleanliness which made his projects unique and unmistakable all over the world.



Top – thanks to its richness in tones and gradation and to all its different surfaces – proves to be not only a ceramic tile with exceptional characteristics but also a new way of conceiving ceramic (and its utilization): from home and office interiors to exterior environments, public facilities, industrial buildings – without restriction and compromise.

COOPERATIVA CERAMICA D'IMOLA
116 years of research and experience.

Via Vittorio Veneto, 13 - 40026 Imola (Italy) Tel. (0542) 601511-31500 - Fax (0542) 31749 - Telex 510362 Imola I

U.S. Sales Offices: MFG Inc. - Miami, FL - Phone (305) 573-4506 WVS-Miami, FL-Phone (305) 858-4744 - JOHN PENTO - West Long Branch, NJ - Phone (201) 229-1277 - GIMINI GIANCARLO - Los Angeles, CA - Phone (213) 858-1481

Circle 94 on inquiry card

Imagine the design possibilities.

Interior solution:
SILENT™ 95 Walls
AURATONE® Ceilings
DONN® Grid

Whatever you can imagine, you can design. We'll provide the full complement of sound-absorbing possibilities. From the tremendous variety of patterns, colors and textures in our ceiling panels and grids, to the lush abundance of fabric choices from our wall collection. All color-coordinated. All from USG Interiors, the people who can make design a product of *your* imagination. Contact: USG Interiors, Inc., 101 S. Wacker Drive, Chicago, IL 60606-4385, Dept. AR69

Interiors from every angle.™

USG Interiors, Inc.

Circle 95 on inquiry card

USG

© 1988 USG Interiors, Inc.
Trademarks owned by USG Interiors, Inc.: AURATONE, DONN, SILENT.