

ARCHITECTURAL RECORD

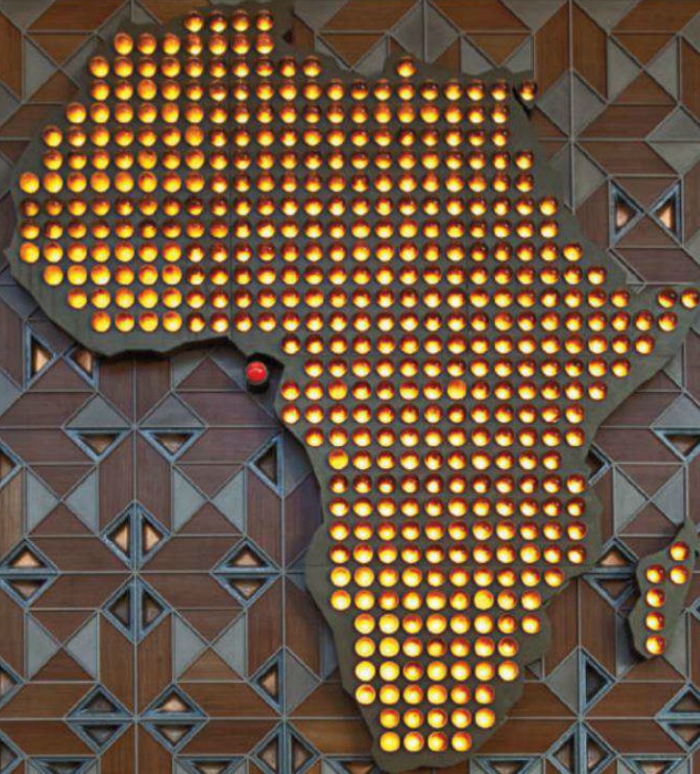

INTO AFRICA

**Economic Growth + Rapid Urbanization
Create Opportunities for Architecture**

McGraw Hill
CONSTRUCTION

08
2012

\$9.95 A PUBLICATION OF THE MCGRAW-HILL COMPANIES
www.architecturalrecord.com

CEILING&WALL SYSTEMS

Between us, ideas become reality™

Loma Linda University
Medical Center, Murrieta, CA
WoodWorks® Radial Custom Ceiling System
in Reconstituted Wenge Quartered
Inner Design Studio, Brentwood, TN;
Davis Stokes Collaborative, P.C.,
Brentwood, TN



above all, biobased

WoodWorks® Ceiling Systems are the first wood ceiling panels with biobased certification. Standard WoodWorks products – including Canopies, Channeled, Concealed, Linear, Tegular, Vector®, and Walls – contain 100% biobased content that's certified by the USDA BioPreferred® program. And many WoodWorks options are available with FSC®-certified wood. Stop by our website to explore the sustainable choices of WoodWorks Ceiling Systems and put biobased above all.

armstrong.com/woodworks 1 877 ARMSTRONG

Armstrong®



DESIGN LEADERS ENVISION THE NEXT DECADE

ARCHITECTURAL RECORD'S INNOVATION CONFERENCE
CELEBRATES ITS 10TH ANNIVERSARY

This year's conference will highlight the profession's top innovators, most influential projects, and achievements in super-tall, super-efficient and super-smart buildings.



REGISTER NOW & SAVE

RECORDINNOVATION.COM
800.371.3238

Featured speakers include:

David **Adjaye** | Adjaye Associates

Jeanne **Gang** | Studio Gang Architects

Stephen **Selkowitz** | Lawrence Berkeley
National Laboratory

Product Gallery Exhibitors
GRAPHISOFT. **Turner**

**ARCHITECTURAL
RECORD**

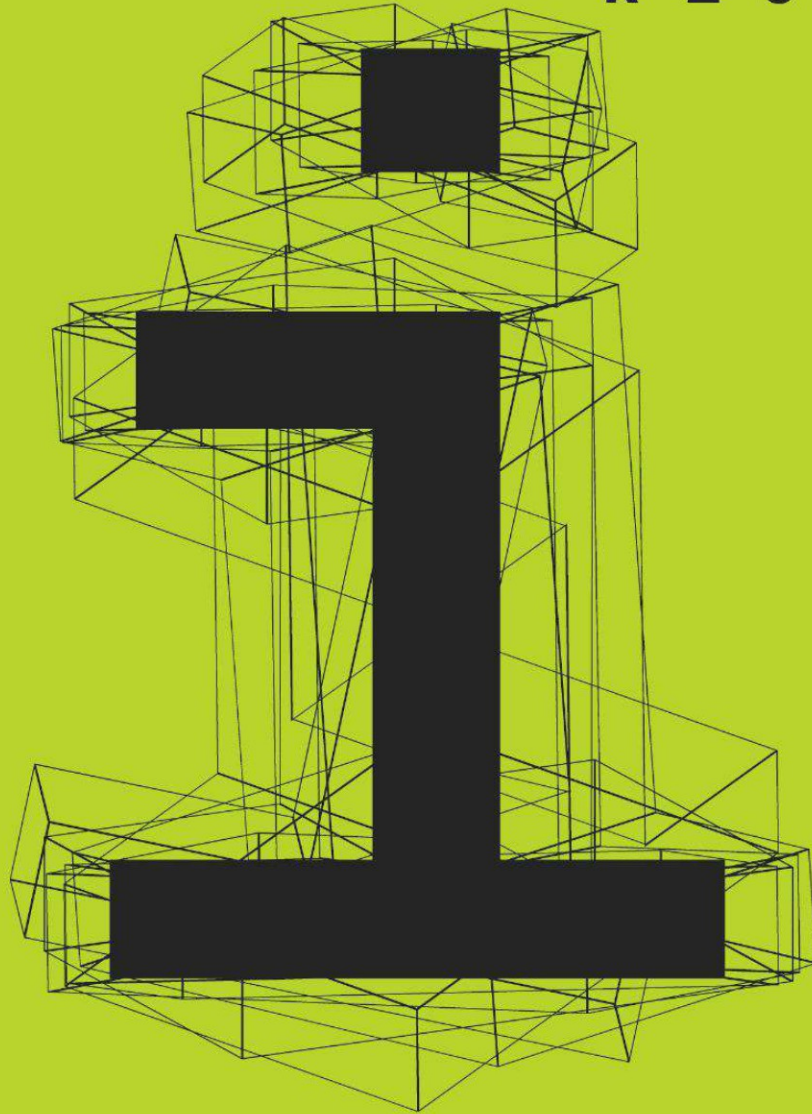

INNOVATIONCONFERENCE2012

NEW YORK CITY | OCTOBER 4 | RECORDINNOVATION.COM

INSPIRED BY PASSION. DESIGNED FOR PERFORMANCE.

WELCOME TO
THE WORLD
OF SPANISH
CERAMIC TILE.

Be inspired by texture, be surprised by dimension. Rethink the possibilities. For innovative design and boundless inspiration visit the single source for over 200 Spanish ceramic tile manufacturers.



FIND
INSPIRATION!

Tile of Spain - Trade Commission of Spain
305.446.4387 miami@mcx.es



tile of spain®

TileofSpainUSA.com

CIRCLE 15

ARCHITECTURAL RECORD

EDITOR IN CHIEF	Cathleen McGuigan, cathleen_mcguigan@mcgraw-hill.com
MANAGING EDITOR	Beth Broome, elizabeth_broome@mcgraw-hill.com
SENIOR GROUP ART DIRECTOR	Francesca Messina, francesca_messina@mcgraw-hill.com
DEPUTY EDITORS	Clifford A. Pearson, pearsonc@mcgraw-hill.com Suzanne Stephens, suzanne_stephens@mcgraw-hill.com
SENIOR EDITOR	Joann Gonchar, AIA, LEED AP, joann_gonchar@mcgraw-hill.com
PRODUCTS EDITOR	Rita C. Orrell, LEED GREEN ASSOCIATE, rita_catinella@mcgraw-hill.com
NEWS EDITOR	Jenna M. McKnight, jenna_mcknight@mcgraw-hill.com
SPECIAL SECTIONS EDITOR	Linda C. Lentz, linda_lentz@mcgraw-hill.com
ASSISTANT EDITORS	Laura Raskin, laura_raskin@mcgraw-hill.com Asad Syrkett, asad_syrkett@mcgraw-hill.com
EDITORIAL ASSISTANT	Laura Mirviss
MANAGER, CONTENT OPERATIONS	Juan Ramos, juan_ramos@mcgraw-hill.com
EDITORIAL PRODUCTION	Rosa Pineda, rosa_pineda@mcgraw-hill.com
ART DIRECTOR	Helene Silverman, helene_silverman@mcgraw-hill.com
ASSOCIATE ART DIRECTOR	Gordon Whiteside, gordon_whiteside@mcgraw-hill.com
CONTRIBUTING ILLUSTRATORS, PRESENTATION DRAWINGS	I-Ni Chen Peter Coe
EDITORIAL SUPPORT	Monique Francis, monique_francis@mcgraw-hill.com
CONTRIBUTING EDITORS	Sarah Amelar, Fred A. Bernstein, Robert Campbell, FAIA, Andrea Oppenheimer Dean, C.J. Hughes, Blair Kamin, Jayne Merkel, Robert Murray, B.J. Novitski, David Sokol, Michael Sorkin, Ingrid Spencer
SPECIAL INTERNATIONAL CORRESPONDENT	Naomi R. Pollock, AIA
INTERNATIONAL CORRESPONDENTS	David Cohn, Tracy Metz
WEB EDITOR	William Hanley, william_hanley@mcgraw-hill.com

ARCHITECTURAL RECORD: (ISSN 0003-858X) August 2012. Vol. 200, No. 08. Published monthly by The McGraw-Hill Companies, 1221 Avenue of the Americas, New York, NY 10020. **FOUNDER:** James H. McGraw (1860-1948). Periodicals postage paid at New York, NY, and additional mailing offices. Canada Post International Publications Mail Product Sales Agreement No. 40012501. E-mail: arhcustserv@cdsfulfillment.com. Registered for GST as The McGraw-Hill Companies. GST No. R123075673. **POSTMASTER:** Please send address changes to ARCHITECTURAL RECORD, Fulfillment Manager, P.O. Box 5732, Harlan, IA 51593. **SUBSCRIPTION:** Rates are as follows: U.S. and Possessions \$70.30; Canada and Mexico \$79 (payment in U.S. currency, GST included); outside North America \$199 (air freight delivery). Single copy price \$9.95; for foreign \$11. Subscriber Services: 877/876-8093 (U.S. only); 515/237-3681 (outside the U.S.); fax: 712/755-7423. **SUBMISSIONS:** Every effort will be made to return material submitted for possible publication (if accompanied by stamped, self-addressed envelope), but the editors and the corporation will not be responsible for loss or damage. **SUBSCRIPTION LIST USAGE:** Advertisers may use our list to mail information to readers. To be excluded from such mailings, send a request to ARCHITECTURAL RECORD, Mailing List Manager, P.O. Box 555, Hightstown, NJ 08520. **OFFICERS OF THE MCGRAW-HILL COMPANIES, INC:** Harold W. McGraw III, Chairman, *President and Chief Executive Officer*; Kenneth M. Vittor, *Executive Vice President and General Counsel*; Jack F. Callahan, *Executive Vice President and Chief Financial Officer*; Elizabeth O'Melia, *Senior Vice President, Treasury Operations*. **COPYRIGHT AND REPRINTING:** Title ® reg. in U.S. Patent Office. Copyright © 2012 by The McGraw-Hill Companies. All rights reserved. Where necessary, permission is granted by the copyright owner for libraries and others registered with the Copyright Clearance Center (CCC), 222 Rosewood Drive, Danvers, MA 01923. To photocopy any article herein for personal or internal reference use only for the base fee of \$1.80 per copy of the article plus ten cents per page, send payment to CCC, ISSN 0003-858X. Copying for other than personal use or internal reference is prohibited without prior written permission. Write or fax requests (no telephone requests) to Copyright Permission Desk, ARCHITECTURAL RECORD, Two Penn Plaza, New York, NY 10121-2298; fax 212/904-4256. For reprints call 800/360-5549 x129 or e-mail architecturalrecord@theygsgroup.com. Information has been obtained by The McGraw-Hill Companies from sources believed to be reliable. However, because of the possibility of human or mechanical error by our sources, The McGraw-Hill Companies and *Architectural Record* do not guarantee the accuracy, adequacy, or completeness of any information and are not responsible for any errors or omissions therein or for the results to be obtained from the use of such information or for any damages resulting there from.

EDITORIAL OFFICES: 212/904-6229. Editorial fax: 212/904-4256. E-mail: monique_francis@mcgraw-hill.com. Two Penn Plaza, New York, NY 10121-2298. **WEBSITE:** ArchitecturalRecord.com.



The McGraw-Hill Companies



PRINTED IN USA

Reynobond®
Architecture



Creating a symbol of hope and healing required imagination, precision – and Reynobond®.

The Seidman Cancer Center's defining feature, its dramatically sloping face, wouldn't have been possible without Reynobond® Natural Brushed Aluminum. These unique 62"-wide natural metal panels provided the flexibility and visual impact the architects needed to make their vision a reality. And Reynobond will help this project meet another important goal: LEED® certification. Functional, flexible, sustainable – Alcoa Architectural Products expands your possibilities from inspiration to implementation.



Alcoa Architectural Products • 50 Industrial Boulevard • Eastman, GA 31023-4129 • Tel. 800 841 7774 • reynobond.com
©2012 Alcoa Architectural Products. Reynobond® is a registered trademark of Alcoa Inc.

TUCKER

InterlockingRock® PANELS AND TILES

Tucker ©2011 ModularArts, Inc.



AVAILABLE IN BOTH
LARGE-SCALE PANELS
& SMALL-SCALE TILES



modulararts®

ARCHITECTURAL RECORD

VICE PRESIDENT, PUBLISHER Laura Viscusi, laura_viscusi@mcgraw-hill.com

SENIOR DIRECTOR, MEDIA OPERATIONS Brenda Griffin, brenda_griffin@mcgraw-hill.com

DIRECTOR, CREATIVE SERVICES William Taylor, william_taylor@mcgraw-hill.com

PRODUCTION MANAGER Marilyn DeMilta, marilyn_demilta@mcgraw-hill.com

SENIOR DIRECTOR, MHC MEDIA PRODUCT DEVELOPMENT Michael McNerney, michael_mcnerny@mcgraw-hill.com

MANAGER, CONTINUING EDUCATION Marissa Wyss, marissa_wyss@mcgraw-hill.com

VICE PRESIDENT, BUSINESS SERVICES Maurice Persiani, maurice_persiani@mcgraw-hill.com

DIRECTOR, CIRCULATION Brian McGann, brian_mcgann@mcgraw-hill.com

SENIOR MARKETING MANAGER Mary Beth Whited, marybeth_whited@mcgraw-hill.com

FINANCE DIRECTOR Ike Chong, ike_chong@mcgraw-hill.com

FINANCE MANAGER Tom Maley, tom_maley@mcgraw-hill.com

ASSISTANT TO MEDIA DEPARTMENT Pina Del Genio, pina_delgenio@mcgraw-hill.com

ADVERTISING SALES

NEW ENGLAND, NY, AND PA: Joseph Sosnowski
(610) 278-7829 Fax: (610) 278-0936, joseph_sosnowski@mcgraw-hill.com

SOUTHEAST/MID-ATLANTIC: Susan Shepherd
(859) 987-9913 Fax: (404) 252-4056, susan_shepherd@mcgraw-hill.com

MIDWEST (IA, IL, MN, MO, WI): Martin McClellan
(312) 233-7402 Fax: (312) 233-7430, martin_mcclellan@mcgraw-hill.com

MIDWEST (IN, MI, OH, EASTERN CANADA): Lisa Zurick
(513) 345-8210 Fax: (513) 345-8250, lisa_zurick@mcgraw-hill.com

NORTHWEST: Bill Madden
(503) 557-9000 Fax: (503) 557-9002, bill_madden@mcgraw-hill.com

PACIFIC/TEXAS: Sherylen Yoak
(760) 568-0465 Fax: (720) 559-9818, sherylen_yoak@mcgraw-hill.com

AL, AR, KS, LA, MS, NE, ND, SD, TN: Risa Serin
(212) 904-6041 Fax: (212) 904-4652, risa_serin@mcgraw-hill.com

TECHNOLOGY: Roy Kops
(415) 357-8191 Fax: (415) 357-8005, roy_kops@mcgraw-hill.com

SPOTLIGHT SALES: Risa Serin
(212) 904-6041 Fax: (212) 904-4652, risa_serin@mcgraw-hill.com

WORKFORCE/ RECRUITMENT: Diane Soister
(212) 904-2021 Fax: (212) 904-2074, diane_soister@mcgraw-hill.com

INTERNATIONAL

GERMANY: Uwe Riemeyer
(49) 202-27169-0 Fax: (49) 202-27169-20, riemeyer@intermediapartners.de

ITALY: Ferruccio Silvera
(39) 022-846716 Fax: (39) 022-893849, ferruccio@silvera.it

JAPAN: Katsuhiko Ishii
(03) 5691-3335 Fax: (03) 5691-3336, amkatsu@dream.com

KOREA: Young-Seoh Chin
(822) 481-3411/3 Fax: (822) 481-3414

MCGRAW-HILL CONSTRUCTION

PRESIDENT Keith Fox

SENIOR VICE PRESIDENT OF SALES, MHC Robert D. Stuoano

VICE PRESIDENT, OPERATIONS Linda Brennan, linda_brennan@mcgraw-hill.com

VICE PRESIDENT, MHC PRODUCT DEVELOPMENT Kathryn E. Cassino, kate_cassino@mcgraw-hill.com

VICE PRESIDENT, TECHNOLOGY Isaac Sacolick, isaac_sacolick@mcgraw-hill.com

VICE PRESIDENT, STRATEGIC MARKETING Patricia France, patricia_france@mcgraw-hill.com

SENIOR DIRECTOR, FINANCE John Murphy, john_murphy@mcgraw-hill.com

WEBSITE: ArchitecturalRecord.com **SUBSCRIBER SERVICE:** 877/876-8093 (U.S. only); 515/237-3681 (outside the U.S.). Subscriber fax: 712/755-7423. E-mail: arhcustserv@cdsfulfillment.com. If the Post Office alerts us that your magazine is undeliverable, we have no further obligation unless we receive a corrected address within one year. **INQUIRIES AND SUBMISSIONS:** Letters, Beth Broome; Practice, Suzanne Stephens; Books, Clifford A. Pearson; Products, Rita Catinella Orrell; Lighting and Interiors, Linda C. Lentz; Residential, Laura Raskin; Architectural Technology, Joann Gonchar; Web Editorial, William Hanley. **REPRINT:** architecturalrecord@theygsgroup.com. **BACK ISSUES:** Call 877/876-8093, or go to archrecord.com/backissues/



The McGraw-Hill Companies



PRINTED IN USA

modulararts.com | 206.788.4210
now with 44 InterlockingRock® designs
made in the USA

CIRCLE 17

LEADING THE WAY TO ENHANCED PROTECTION.

Go ahead. Explore the far reaches of your imagination. VT will always be there to guide you to the perfect solution for architectural wood door design and performance—whether your project calls for antimicrobial protection, superior acoustics, or added durability. Because when inspiration hits, VT is there.



VTDoors.com 1-800-827-1615 (ext. 512)



The mark of
responsible forestry



©2012 VT Industries, Inc. All rights reserved.



Caged in by limitations of aluminum frames? Unlock your creativity with the SteelBuilt Curtainwall Infinity™ System from Technical Glass Products. Build taller free spans with larger pieces of glass. Deliver unobstructed views with smaller frame profiles and thinner profile depths. Design with back mullions that can be almost any type of structural member, from stainless steel to glulam beams. In other words, open up to a new vision of freedom.

Project: Corporate Office and Manufacturing Facility | **Location:** Seattle, WA | **Architect:** Callison | **Product:** SteelBuilt Curtainwall Infinity™ System

© 2012 Technical Glass Products. SteelBuilt Curtainwall Infinity and Where Strength Meets Design are trademarks of Technical Glass Products. Technical Glass Products, One Source. Many Solutions., and TGP America are registered trademarks of Technical Glass Products.

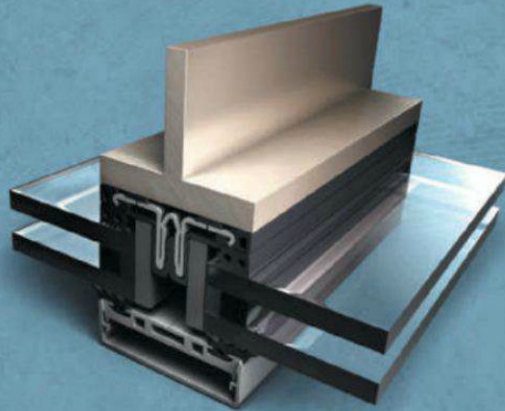

**THE CORNER OFFICE
SHOULDN'T FEEL LIKE
CELL BLOCK C**

STEELBUILT CURTAINWALL INFINITY™ SYSTEM

STEELBUILT

Where Strength Meets Design™

tgpamerica.com | 800.426.0279

TGP  **ARCHITECTURAL**
one source. many solutions.®



MORE SHADES OF VERSATILITY. **VERSOLEIL™**

Kawneer's next generation sunshade platform – first introduced in a Single Blade System – is now more versatile with the addition of new Versoleil™ Outrigger SunShades.

Pre-engineered for multiple Kawneer systems, the common component design offers versatility in both form and function. Versoleil™ SunShades offer a broad range of products to suit almost any project under the sun and the design flexibility to incorporate sunshades easily into any building envelope to help create your vision. All this, plus highly configurable blade options for maximum shading and energy saving potential. Kawneer's Versoleil™ SunShades – versatility eclipsing all others.



**VERSOLEIL™
SINGLE BLADE**



**VERSOLEIL™
OUTRIGGER**

Architectural Aluminum Systems
Entrances + Framing
Curtain Walls
Windows

kawneer.com
kawneergreen.com

**KAWNEER**
AN ALCOA COMPANY

© 2012 Kawneer Company, Inc.

ARCHITECTURAL RECORD

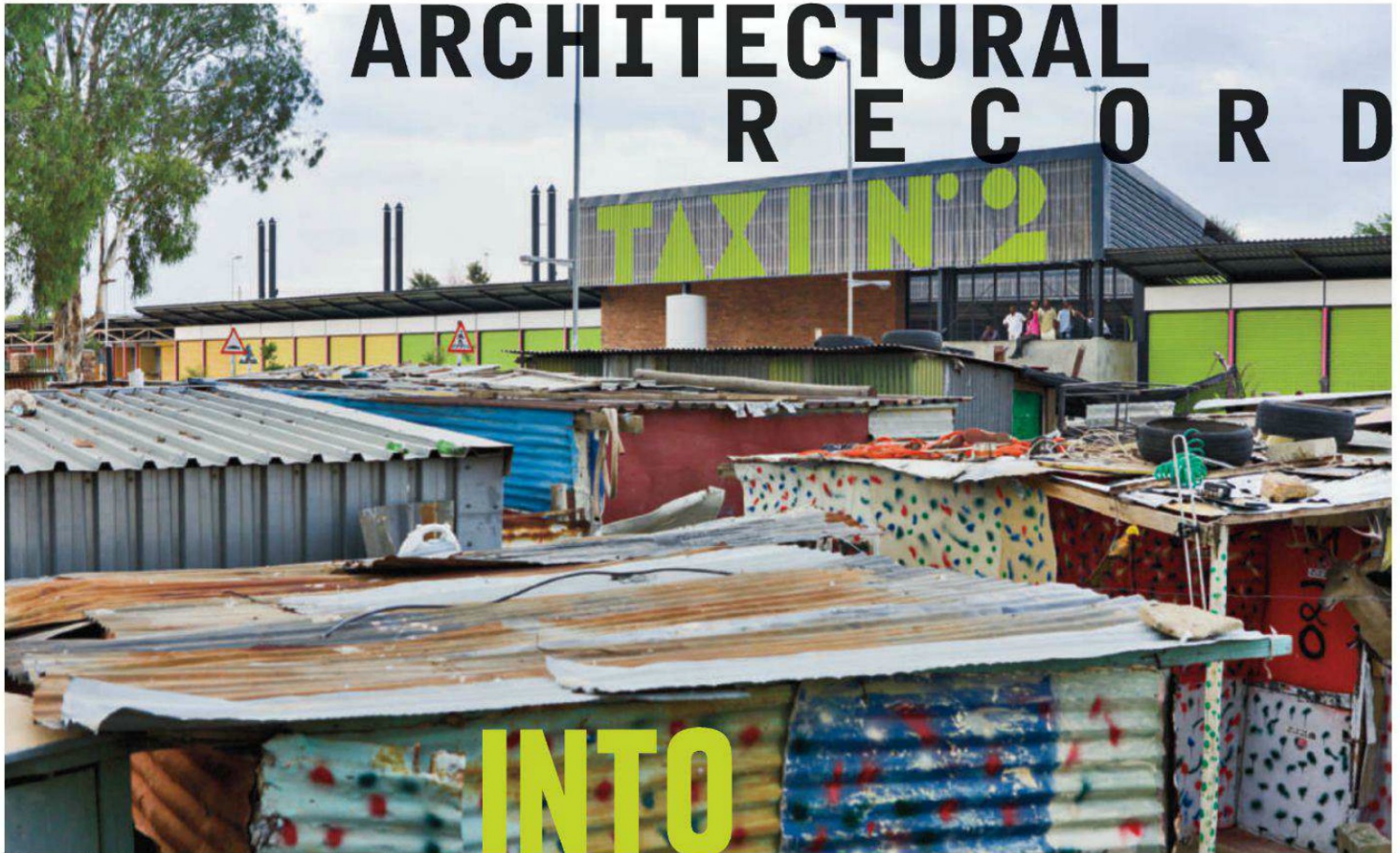

08 2012 INTO AFRICA

NEWS

- 21 AN UNCLEAR PROGNOSIS FOR HEALTH-CARE ARCHITECTURE *By Staff Editors*
- 22 ROBERT HULL RETURNS TO AFGHANISTAN *By David Hill*
- 24 NEWSMAKER: SANTIAGO CALATRAVA *By Fred A. Bernstein*
- 28 ROCK STAR TAKES CENTER STAGE AT LACMA *By Marissa Gluck*

DEPARTMENTS

- 14 EDITOR'S LETTER: AFRICA TODAY AND TOMORROW
- 34 ARCHITECTURAL ANALYTICS
- 37 PRACTICE: THE PAIN IN SPAIN *By David Cohn*
- 39 HOUSE OF THE MONTH: DENTON CORKER MARSHALL'S VIEW HILL HOUSE *By Laura Raskin*
- 41 REVIEW: DAVID ADJAYE'S NEW BOOK *By Adebayo T. Teriba*
- 47 PRODUCT BRIEFS: NEOCON *By Rita Catinella Orrell*
- 51 PRODUCT FOCUS: GREEN MATERIALS *By Rita Catinella Orrell*
- 148 DATES & EVENTS
- 152 READER SERVICE
- 160 SNAPSHOT: SERPENTINE GALLERY PAVILION *By Laura Mirviss*

PROJECTS

- 57 INTRODUCTION
 - 58 CONTINENTAL SHIFT *By Howard W. French*
 - 61 FORWARD THINKING *By Asad Syrkett*
 - 65 INTERVIEW: DAVID ADJAYE *By Clifford A. Pearson*
 - 66 SIPOPO CONGRESS CENTER, EQUATORIAL GUINEA TABANLIOĞLU ARCHITECTS *By William Hanley*
 - 72 TAXI RANK NO. 2, SOUTH AFRICA 26'10 SOUTH ARCHITECTS *By Hannah le Roux*
 - 76 UNIVERSIDADE AGOSTINHO NETO, ANGOLA PERKINS+WILL *By Fred A. Bernstein*
 - 82 RED LOCATION CULTURAL PRECINCT, SOUTH AFRICA NOERO WOLFF ARCHITECTS *By Karen Eicker*
- ### BUILDING TYPES STUDY 925 HEALTH CARE
- 97 MASSACHUSETTS GENERAL HOSPITAL, THE LUNDER BUILDING, BOSTON NBBJ *By Suzanne Stephens*
 - 101 PAUL S. RUSSELL, MD MUSEUM OF MEDICAL HISTORY AND INNOVATION, BOSTON LEERS WEINZAPFEL ASSOCIATES ARCHITECTS *By Suzanne Stephens*
 - 102 UCLA OUTPATIENT SURGERY AND MEDICAL BUILDING, CALIFORNIA MICHAEL W. FOLONIS ARCHITECTS *By Laura Raskin*
 - 108 BROOKLYN INFUSION CENTER, NEW YORK ZGF ARCHITECTS *By Asad Syrkett*

ARCHITECTURAL TECHNOLOGY

- 114 NATURE NURTURES
TWO HOSPITALS IN VERY DIFFERENT SETTINGS RELY ON SIMILAR STRATEGIES TO CREATE ENVIRONMENTS FOR HEALING. *By Joann Gonchar, AIA*

LIGHTING

- 123 NATIONAL SEPTEMBER 11 MEMORIAL, NEW YORK CITY MICHAEL ARAD / FISHER MARANTZ STONE *By Linda C. Lentz*
- 124 FUTAKOTAMAGAWA RISE GALLERIA, TOKYO LIGHTDESIGN *By Naomi R. Pollock, AIA*
- 127 BROKEN LIGHT, ROTTERDAM DAGLICHT & VORM *By Tracy Metz*
- 131 LIGHTING BEIRUT ARCHITECTURE, LEBANON LIGHT CIBLES *By Jessica Dheere*
- 135 LIGHTING PRODUCTS *By Linda C. Lentz & Rita Catinella Orrell*

THIS PAGE: TAXI RANK NO. 2, DIEPSLOOT, SOUTH AFRICA, BY 26'10 SOUTH ARCHITECTS. PHOTO BY IWAN BAAN.

ON THE COVER: SIPOPO CONGRESS CENTER, EQUATORIAL GUINEA, BY TABANLIOĞLU ARCHITECTS. PHOTO BY EMRE DÖRTER.

Expanded coverage of Projects and Building Types Studies, as well as web-only features, can be found at architecturalrecord.com.

☐ This symbol denotes that enhanced content is available in our iPad edition.

Maputo Modern

Visit architecturalrecord.com to view photographs taken by Iwan Baan for a book he is doing with Alan G. Brake and Liz McEnaney on the rich architectural heritage of the Mozambican capital.

LEARN & EARN



Earn all your continuing education credits free online or at Architectural Record's Continuing Education App!*

IN THIS ISSUE

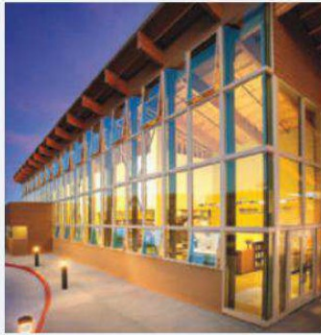

Fenestration Innovations for Leaner, Greener Times

Credit: 1 HSW/SD

Sponsored by Guardian Industries Corp., SAFTIFIRST, Pella Commercial, and EFCO, a Pella Company

Page 141

NEW ONLINE AT ARCHRECORD.COM



Translucent Cellular Polycarbonate Delivers Design Versatility

Credit: 1 HSW

Sponsored by EXTECH/Exterior Technologies, Inc.

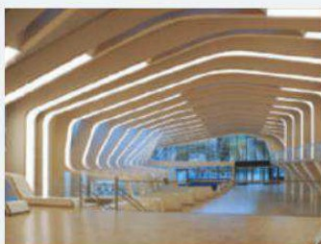

Good Design is Good Business

Credit: 1 AIA/CES

Sponsored by Graphisoft®



Light and Truth: Greener Interiors with Glass Partitions

Credit: 1 HSW/SD

Sponsored by THE SLIDING DOOR COMPANY®

ARCHITECTURAL RECORD

ONE MILLIONTH CEU TEST TAKER SWEEPSTAKES

We're giving away over \$10,000 in prizes as we celebrate our one millionth Continuing Education test to be taken this fall. Celebrate with us! ENTER OUR ONE MILLIONTH TEST TAKER SWEEPSTAKES. Take any test at archrecord.com between August 1 and October 31, 2012 for your chance to win. COMPLETE RULES AT ARCHRECORD.COM

Take your chance at winning these celebratory prizes at archrecord.com

\$5,000 cash

Talak LED table by Artemide

Knoll Womb Chair

\$100 AMEX Gift Card

Courtesy of Ron Rubin/Art Dept.

ALSO ONLINE AT ARCHRECORD.COM

Cool Energy House: Redesigning a Contemporary Home for Deep Energy Savings
Sponsored by BASF Neopor, DuPont Surfaces, Fischer SIPS, Formica, GE, Johns Manville, Metal Roofing Alliance, Panasonic, Simonton Windows, Structural Insulated Panel Association (SIPA)

Earn Free Health Safety Welfare (HSW) and Sustainable Design (SD) credits with Architectural Record

*All Architectural Record articles and presentations count toward the annual AIA continuing education requirement. All exams are available at no charge and are instantly processed.

LIBRARY.

Introducing the Architectural Record CEU App. The only app that allows you to fulfill credits and track your progress without Internet access.

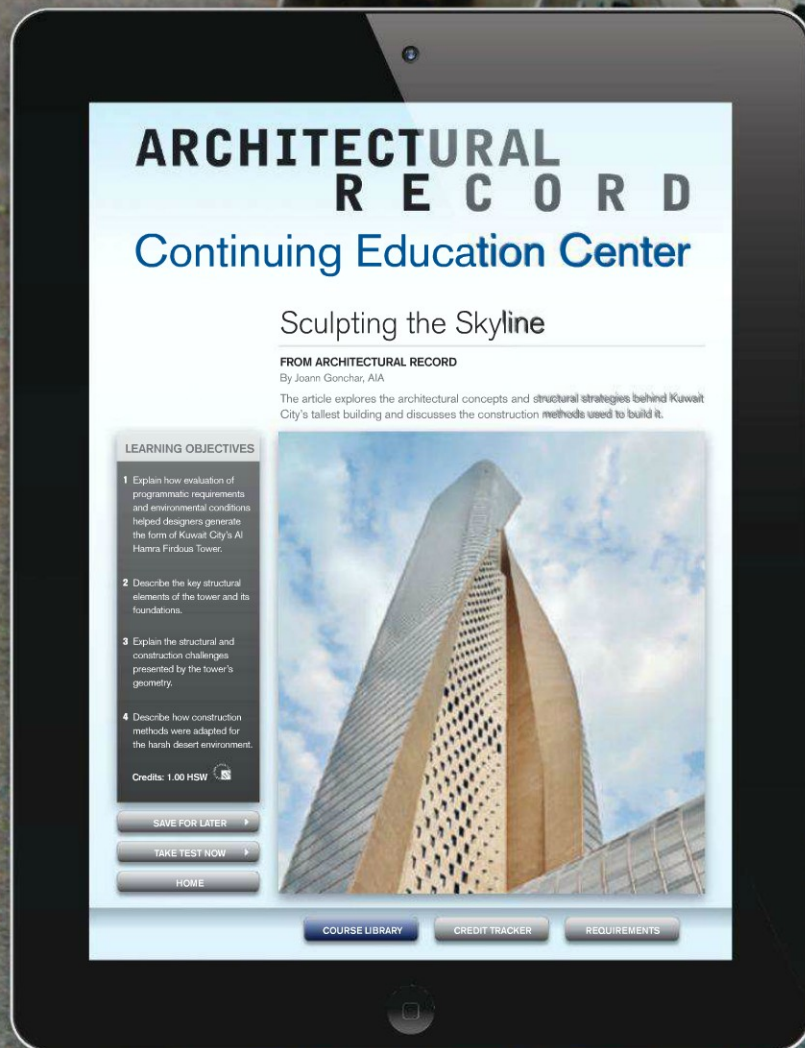

Download free at iTunes. Sponsored by  Armstrong

QUALITY & BALANCE SYSTEMS

Africa Today and Tomorrow

Western architects are beginning to design all over the swiftly urbanizing continent.

WE ALL KNOW that American architects are finding work in China, Korea, and Qatar—but Angola, Botswana, and Burundi? Africa is booming: The continent is home to seven of the 10 fastest-growing economies in the world, according to the International Monetary Fund. It is also urbanizing at astonishing speed, with rapidly rising education rates and a burgeoning middle class. Yes, in parts of Africa there are tragic clashes of violence, desperate refugees, and entrenched poverty—and growing development may only widen the socioeconomic chasms. But news reports rarely paint the complex portrait of a continent of rich resources, increasing political stability in many countries, vast and varied topographies and cultures, and a relatively youthful population of more than a billion, where one of every two people has a cell phone.

This economic growth has enormous potential for construction and architecture. As we highlighted in our recent issue on Building for Social Change (ARCHITECTURAL RECORD, March 2012), Western and African architects have long been actively, if quietly, engaged in humanitarian projects on the continent, and we are featuring some similarly significant work this month. But in addition, in the last year or so, we began to hear of more and more Western architects doing ambitious work for other kinds of clients—governments, institutions, developers—such as Perkins+Will's Chicago office, which recently completed a university campus in Angola (page 76). In a conversation we had a few months back with David Adjaye, the Tanzanian-born, British-educated architect who has offices in London, New York, and Berlin, we learned more about Africa's future growth and the role that architects could play in the sensible and sensitive development of its cities (see our interview with Adjaye on page 65).

The Aga Khan Development Network (AKDN), which has done so much to promote good architecture in the developing world through the architectural prizes it awards every three years, is now commissioning projects as well, such as plans for a new university in Tanzania, designed by the award-winning New York firm Weiss/Manfredi and the Mexican architects Legorreta + Legorreta. (The AKDN is also establishing links with some of the best young African architects through the newly formed ArchiAfrika Educational Network.) Many institutions and some private developers are also actively seeking the best proposals for projects such as eco-resorts, technology centers, housing, parks, and new town plans.

In postcolonial Africa, nascent governments spurred the design of new cities and buildings—indeed, some of the continent's most grandiose projects of recent decades helped promote the greater glory of autocratic leaders. The founding president of independent Côte d'Ivoire, Félix Houphouët-Boigny, ruler for 33 years until his death in 1993, built the largest church in the world, based on Saint Peter's in Rome, only bigger. In this issue, we feature the Sipopo Congress Center in Equatorial Guinea (page 66)—a stunning project architecturally, which serves as a meeting place for the heads of Africa's 54 nations—



though we need to note that its home country has a long rap sheet of human-rights abuses. Equatorial Guinea's strongman president Teodoro Obiang Nguema Mbasogo commissioned the Istanbul firm Tabanlıoğlu Architects to design the complex, after he saw its shimmering Tripoli Convention Center, completed three years ago, in Libya (we can't help but wonder if Muammar Gaddafi provided the reference). The architects say they focused more on the mission of these projects—to promote the African Union—than on the clients.

We were struck by the way the Congress Center addresses its context—how the architects artfully employed an elegant metal screen system against the brutal equatorial sun. That's the defining principle of the best design in Africa today. In 1900, 90 percent of the continent was under the yoke of European colonization, and many cities adopted European styles, from Beaux-Arts to Modernism. But what characterizes the architecture in the pages ahead is that a contemporary design sensibility is clearly inspired by local conditions: the climate, and often the materials and vernacular construction techniques.

It may seem a little myopic to look at the countries of Africa—with their disparate politics, problems, and potential—and think about architecture. But we agree with Adjaye's argument about the "architecture of governance" and how good design helps express a government's relationship with its citizens. Architecture at its best could support and enrich the cultures and aspirations of the people of this sweeping, vibrant continent. ■

Cathleen McGuigan

Cathleen McGuigan, Editor in Chief



Search: Construction Specialties



WE LISTENED

**Acrovyn® 4000—
no PVC, ever**

**No chemicals
of concern**

**Contemporary
new texture**

**Most realistic
simulated
woods and
metals**

We invented modern wall protection in 1968 and have led the industry ever since. You can't do that without being a good listener. That's why C/S Acrovyn was also the first to introduce real wood and metal with our Renaissance and Platform series wall protection, durable yet realistic simulated wood and metal patterns, and now the industry's only complete line of PVC-free wall protection. Stay tuned to find out what's next. Don't settle for imitators, choose Acrovyn. For more information, visit www.c-sgroup.com or call 888-621-3344 or find Construction Specialties on ,  or  twitter.com/acrovyn.



 **Acrovyn®** *Protection for tomorrow's environment*



What's in a name?

A promise.

"My family has been in the lumber business for four generations and we've been committed to sustainable forest management since 1940. I've been a lumber grader, a forester, a management trainee and a project specialist. As a land-based company, we're committed to the places where we operate. By nurturing the forests and communities that provide our natural and human resources, we intend to serve our customers for generations to come."

Terry Collins, Forester, Collins Almanor Forest

SPECIFY CollinsWood®

Collins Softwood Lumber

Dimension, common and industrial, slicing flitches

Collins Hardwood Lumber

Millwork and dimension, veneer logs

Collins Pacific Albus®

Plantation hardwood lumber

Collins Pine FreeForm®

No added formaldehyde resins, CARB 2, available moisture resistant, FSC-Certified

Collins Pine Particleboard®

No added formaldehyde resins, CARB 2, available moisture resistant

TruWood® Siding & Trim

Engineered wood



Truman Collins, Founder, Collins Almanor Forest, 1940s



Information and Sales:
800.329.1219 CollinsWood.com
Mike Shuey Ext 2222 mshuey@collinsco.com

Collins

The first name in FSC-certified forest products.



58th

Jesse H. Neal
National Business Journalism Awards

Record Achievements

BIG WINS THIS YEAR FOR
ARCHITECTURAL RECORD

The 58th Annual Jesse H. Neal Awards

2012 GRAND NEAL

Judged on service to the industry, editorial craftsmanship, journalistic enterprise and innovation.

Architectural Record also won Best Use of Social Media; Best Integrated Package; and Best Single Issue of a Magazine (Sept. 2011).

2012 BtoB Magazine

MEDIA POWER 50

Selected on the basis of ad revenue, audience, and something even more valuable: influence, as evaluated by the nation's top media buyers, advertisers and industry analysts.

2012 BtoB Magazine

GREAT MEDIA WEBSITE

The industry barometer of best practices in driving web traffic and connecting with professional audiences. Judges analyzed key metrics and measured the amount of user-generated content.

2012 MIN Sales Executive of the Year Awards

TEAM LEADER OF THE YEAR

Architectural Record Publisher Laura Viscusi was recognized for more than just her team's success, but for her innovation in helping customers achieve their own marketing goals.

**ARCHITECTURAL
RECORD**

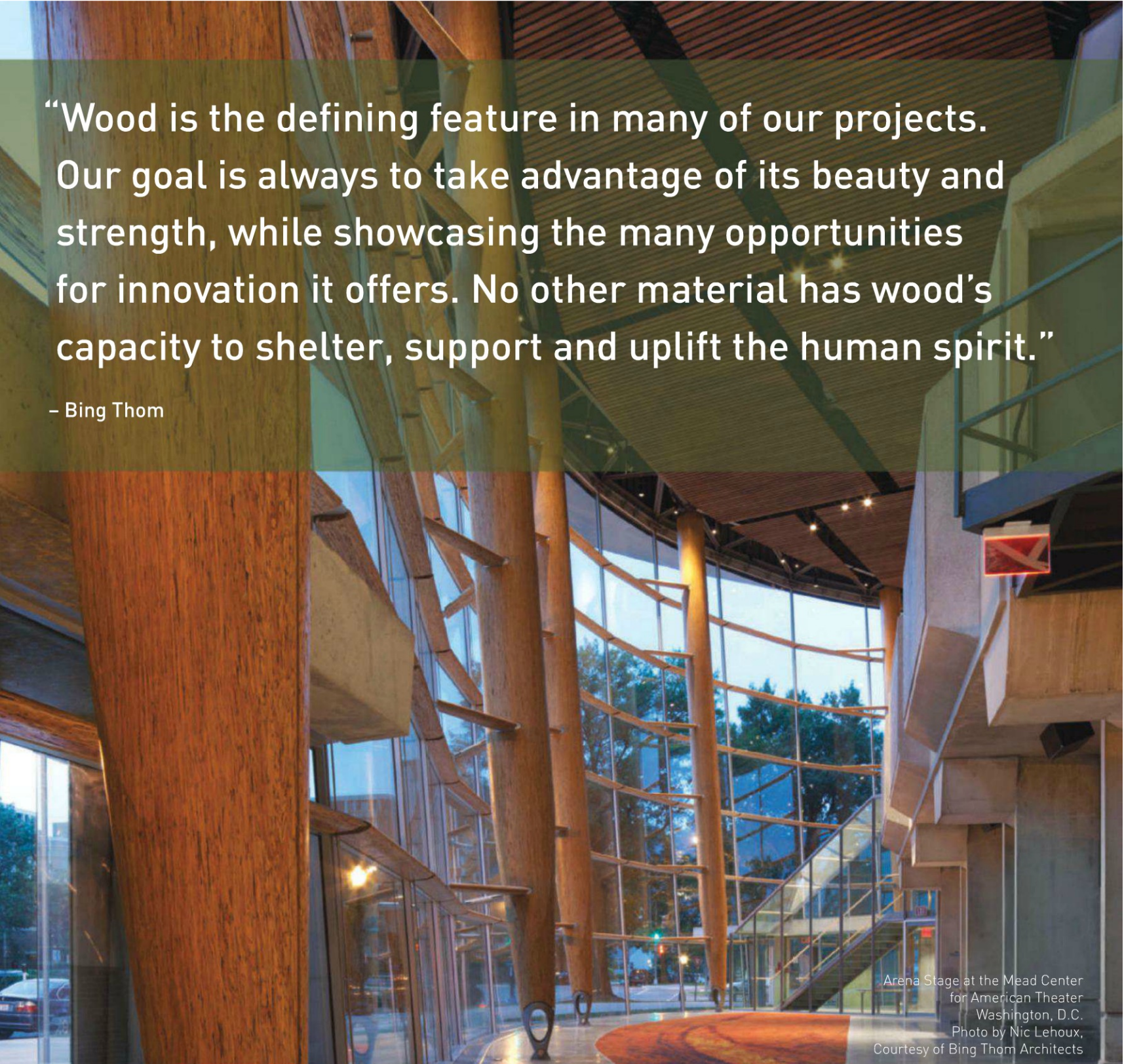

“Wood is the defining feature in many of our projects. Our goal is always to take advantage of its beauty and strength, while showcasing the many opportunities for innovation it offers. No other material has wood’s capacity to shelter, support and uplift the human spirit.”

– Bing Thom

Arena Stage at the Mead Center
for American Theater
Washington, D.C.
Photo by Nic Lehoux,
Courtesy of Bing Thom Architects

With growing pressure to reduce the carbon footprint of the built environment, building designers are increasingly being called upon to balance functionality and cost objectives with reduced environmental impact. Wood can help to achieve that balance.

Wood costs less—economically and environmentally—while delivering more in terms of its beauty, versatility and performance. It meets code requirements in a wide range of low- and mid-rise building types. Innovative new technologies and building systems have enabled longer wood spans, taller walls and higher buildings, and continue to expand the possibilities for wood use in construction.

Wood is more than a building material; it’s a renewable and responsible choice.

CIRCLE 23

reTHINK
WOOD

ARCHITECTURAL RECORD

ONE MILLIONTH CEU TEST TAKER SWEEPSTAKES

We're giving away over \$10,000 in prizes! This year, we mark our 15th anniversary as an official AIA continuing education provider. This fall, our one millionth continuing education test will be taken. To join in the celebration, ENTER OUR ONE MILLIONTH TEST TAKER SWEEPSTAKES. Take any test at archrecord.com between August 1 and October 31, 2012 for your chance to win.

Take your chance at winning these celebratory prizes at archrecord.com. ENTER THE ONE MILLIONTH TEST TAKER SWEEPSTAKES.



\$5,000 cash

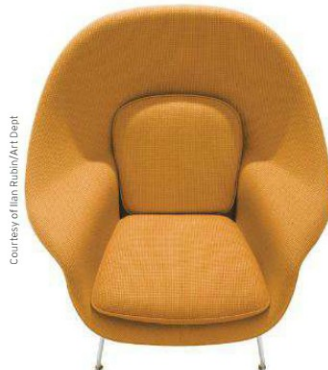

Knoll Womb Chair



\$100 AMEX Gift Card



Talak LED table by Artemide

CHECK OUT COURSES FROM OUR SPONSORS:

Platinum Sponsor:

reTHINK
WOOD

Sponsors:



Take any test at our Continuing Education Center at archrecord.com between August and October 2012. First prize: The person who takes the 1,000,000th test will win the Grand Prize of \$5,000 cash. Second prize: The person who takes the 1,000,001st test will win a Knoll womb chair. Third prize: The person who takes the 1,000,002nd test will win a Talak LED table by Artemide. Ten additional winners, drawn at random, will receive a \$100 AMEX gift card. No purchase necessary. All tests are free. **COMPLETE RULES AT ARCHRECORD.COM.**



Earn AIA continuing education hours (CEHs) including AIA Health Safety Welfare (HSW) and Sustainable Design (SD) credits with Architectural Record. Select courses are also approved by the Green Building Certification Institute for GBCI CE Hours for LEED Credential Maintenance.

All tests are available at no charge and are instantly processed.

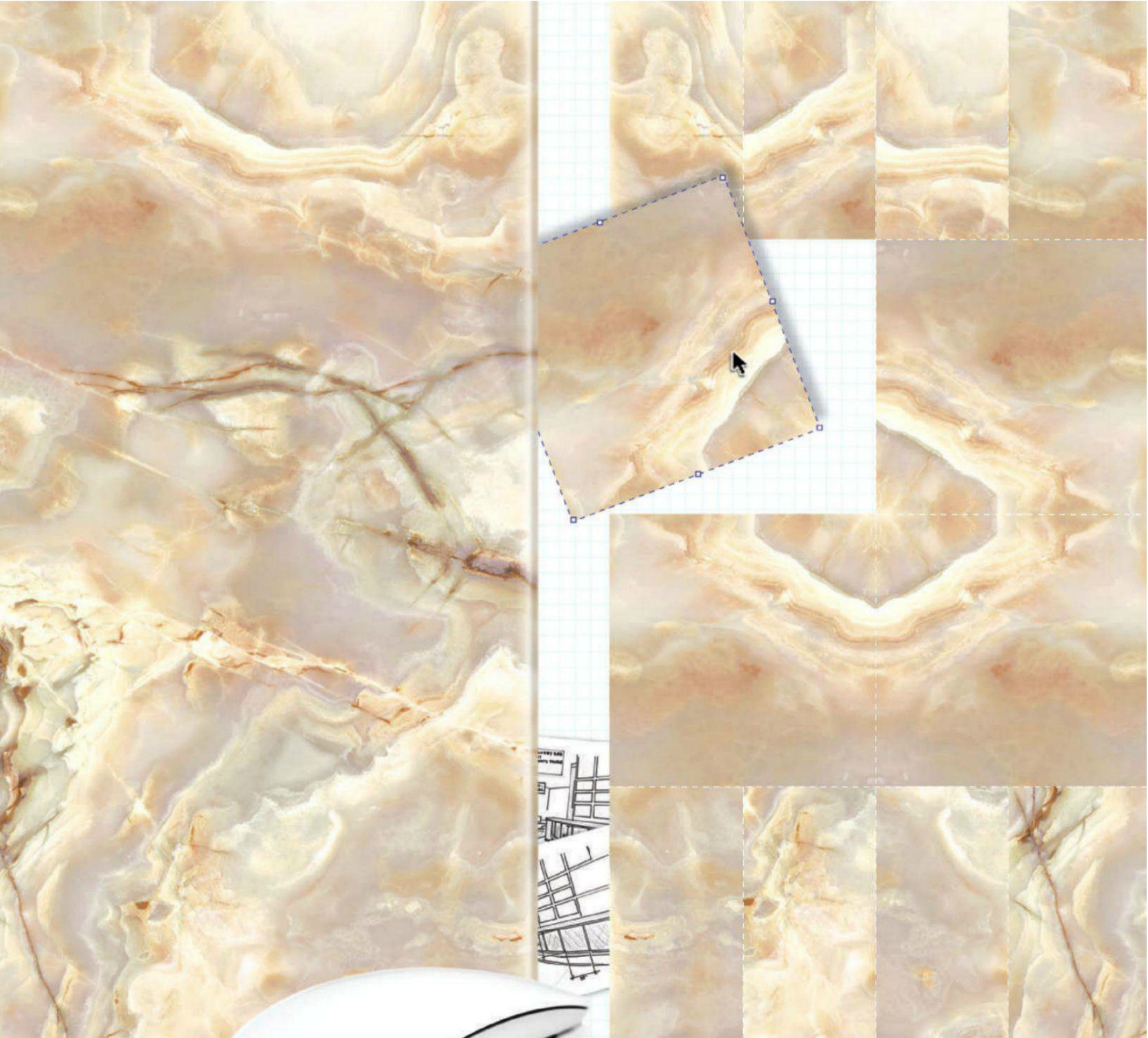

virtual quarry.

Take your ViviStone glass designs from drawing-board vision to spec-ready reality – with our online Virtual Quarry, it's easy. This interactive tool lets you select your ViviStone slabs, configure your designs, share ideas, and request a quote, all from a single application. Give it a try. Unleash your creativity. And transform your projects with ViviStone and the Virtual Quarry.

www.virtualquarry.com

FORMS+SURFACES®

DAILY UPDATES
archrecord.com/news
twitter.com/archrecord

perspective **news**

An Unclear Prognosis for Health-Care Architecture

BY STAFF EDITORS



NBBJ recently completed an expansion of Massachusetts General Hospital in Boston. Read more on page 97.

IN LATE June, the Supreme Court issued its landmark ruling on the Affordable Care Act, essentially upholding the law. Architects and industry experts say the decision could jump-start projects and lead to shifts in facility design, although the upcoming presidential election and the struggling economy will also play a critical role in the future of health-care architecture.

Jennifer Coskren, a senior economist with McGraw-Hill Construction, believes the law will give a shot in the arm to a flagging building sector. After peaking at \$30 billion in 2008, health-care construction starts nationwide dipped to \$24.4 billion in 2010 and \$23.0 billion in 2011. Through May of this year, total starts (in square-footage terms) were down 24 percent. "Now that the uncertainty is gone, thanks to the Supreme Court upholding the constitutionality of the law," says Coskren, "we feel that the industry will be able to move ahead more confidently with capital-expenditure plans."

Mary-Jean Eastman, founding principal of

Perkins Eastman, says her clients are "taking a big collective sigh of relief." She adds: "They have some sense of where things are going and are able to plan for the future." Eastman believes the decision will spur design work, although architects likely will be focusing on primary-care facilities and optimizing efficiencies in existing hospitals.

"It will definitely affect the way we design the environments. It will be about quality, not quantity, which is probably a good thing," says the New York City-based architect. "In the Northeast, we don't need more beds. It's an issue of having the right beds."

Jean Mah, Perkins+Will's health-care global market leader, says the court's decision "is good news for health-care clients and owners," as it eliminates much uncertainty. She suspects clients will proceed "with some proposed projects, especially in areas of underserved and unserved populations," but many will remain cautious because of the fall election. *(continued)*

"We do a very dangerous job as architects. If you make a mistake, it lasts a long time."

—Renzo Piano, in a Building Design story about the Shard's inauguration in London

Americans in Venice

The 13th Venice Architecture Biennale, a massive grab bag of design exhibitions, opens August 29 and runs through November 25. As in past years, there will be an "official" exhibition, this time curated by the British architect David Chipperfield, and 55 separate national displays (with Peru, Angola, Kosovo, and Kuwait joining 51 returning countries).

The U.S. display, funded by private contributions and a \$100,000 contribution from the State Department, will feature 124 projects that in most cases lack clients and have budgets of only a few hundred dollars. Grouped under the title "Spontaneous Interventions," they include guerrilla bike lanes, spray-painted at night; a pavilion in San Francisco where visitors are offered soup while waiting for soil samples from their yards to be tested; and a mobile produce market meant to serve urban "food deserts."

Given economic conditions in the United States, "a show about high-end architecture for a very small group of people would not be the right approach," says Cathy Lang Ho, the official curator for the U.S. pavilion (she worked with the Institute for Urban Design and a group of advisers). "These projects are about asserting democracy; it's what is happening in architecture and design right now." *Fred A. Bernstein*



The Venice Architecture Biennale opens this month. The exhibitions will be on view at the Arsenale complex (above) and the Giardini della Biennale, a public garden.

(Health Care continued)

Indeed, most architects say the court's decision is just the beginning. "This ruling needs time to gain momentum," says Martin Valins, a Philadelphia-based principal at Stantec. "I don't see it having an immediate impact on architects' projects." Those presently working on hospitals should pay special attention to creating flexible emergency rooms, perhaps by incorporating primary-care functions, he says: "If everyone has a primary-care doctor, the ER will begin to fade."

Cannon Design, whose health-care clients are mostly large hospital systems, is already designing "hyperadaptable" spaces. For instance, it has created ambulatory areas that can later be converted into patient rooms, says Michael Puksza, who chairs Cannon's health-care steering committee. "We're designing buildings that can do anything in their lifetime," he says. He adds that many of his firm's clients need more space but are hesitant to build facilities because they can't forecast their revenue. The court's ruling offers some clarity, but it's just one step. "The decision helps us understand the direction we are going as a country," he says, "but it will take a year or more to really understand what it means for our hospital clients."

Jim Hannon, director of SmithGroupJJR's health-care practice, expects that in the long term, architects will be working on a "broader bandwidth" of buildings. "I don't see a huge boom for hospitals as a building type, although there certainly will be places in the country where new acute-care facilities are built," he says. "The real gain is in other health-care venues, places you go before and after the hospital: primary-care facilities, outpatient facilities, postacute facilities, rehabilitation facilities, continuing care."

These facility changes fall in line with current shifts in the health-care industry, Hannon says. "I'm a strong believer that most or all of the major drivers that were encouraged by the Affordable Care Act were already happening, particularly the move toward greater integration of health-care services and systems of accountability," he explains.

His sentiments are echoed by Charles Griffen, senior principal at WHR Architects and board member of the AIA's Academy of Architecture for Health. He says most successful health-care systems are already changing the way they do business: They're creating accountable-care organizations, investing in IT infrastructure, engaging more primary-care doctors in group-practice acquisitions, and improving overall efficiency. The court's ruling will enable clients to "continue thinking about facility improvements that reinforce the direction" of the new health-care law. Much hinges, however, on the outcome of the forthcoming election, says Griffen.

Richard Dallam, a partner at NBBJ, wishes the Affordable Care Act better addressed a core issue: healthy behavior. "To me, the big absence—and opportunity—in the debate is understanding how design at every scale can actually help encourage, support, and enable health. And not just physical health, but also social health, mental and emotional health, environmental health, and economic health," he says. "It's hard to be healthy in a toxic environment. It's hard to be healthy when economically you do not have access to healthy food. If people understood that more, they would better appreciate how design can help their organization and business thrive, to focus on health and well-being rather than this endless debate about intervention." ■

Afghan Health Clinic Marks Return to Roots for Hull

BY DAVID HILL

SEATTLE ARCHITECT Robert Hull remembers Afghanistan in the late 1960s and early 1970s as a poor but peaceful country, with people who were kind and tolerant of foreigners—a far cry from the war-torn nation of today.

Hull, then fresh out of Washington State University with a bachelor's degree in architecture, served as a Peace Corps volunteer with five other architects in Herat, about 500 miles west of Kabul. They designed sustainable schools based on traditional Afghan structures, with arches, domes, and vaults.

Hull returned to the United States in 1972 and eventually founded the Miller Hull Partnership with another former Peace Corps volunteer, David Miller. Afghanistan became a distant memory as Miller Hull grew into one of the Pacific Northwest's top design firms.

Now, 40 years—and many buildings—later, Hull has designed a medical clinic outside Herat. He was asked to work on the project by a California businessman, Sadiq Tawfiq, who grew up in Herat but left Afghanistan in the 1970s to get a master's degree in education at the University of California, Irvine. When the Russians invaded Afghanistan in 1979, Tawfiq remained in California and opened an Afghan import shop in Laguna Beach. Since 2002, he has funded several schools and orphanages in Herat through a nonprofit he started, the Afghan Amity Society. "All over Afghanistan," Tawfiq says, "we need clinics and hospitals. Many haven't been updated in the last 30 or 40 years."



ROBERT HULL



Hull's design for the 20,000-square-foot clinic is based on a traditional caravanserai, a kind of walled roadside inn for weary travelers. The idea, he says, is "to create security, protect from the harsh desert, and provide a place of comfort for those in need of medical care." The structure will employ traditional Persian "wind catchers," or ventilated towers (which are sometimes used in combination with underground water reservoirs), and passive solar panels to augment a hot-water-boiler system. Brick vaults and thick walls made of mud "are still the architectural vocabulary," Hull says.

Tawfiq is currently raising funds for the project, with construction set to begin in 2013. The clinic will rise on land donated by Herat University, which plans to build a teaching hospital next door. Hull is working pro bono; he plans to travel to Herat for the first time since 1972 as the project moves forward. "I've come full circle," he says. "I'm going back to my architectural roots." ■

The
Clear
Solution

JUST GOT CLEARER

SuperLite II-XL™ with

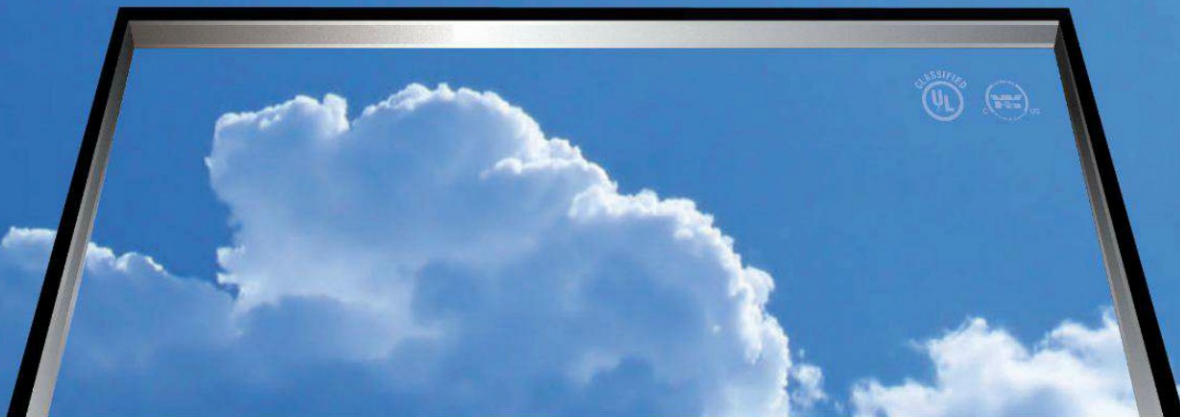

mySAFTI App



WWW.SAFTI.COM
888.653.3333

 **SAFTIFIRST**



Proudly made in USA

CIRCLE 24



"SpecLink has the content and quality that our firm needs."

Ross Deckman and Associates

- Reduce spec production time.
- Speed up editing tasks.
- Update specs automatically and painlessly without disruption.
- Improve spec coordination.
- Reduce errors & omissions.
- Transition seamlessly from schematic design to design development specs to full construction specs, using the same database.
- Access built-in automation for simplifying LEED certification.
- Connect to BIM through BSD LinkMan-E



Building Systems Design, Inc.
 888-BSD-SOFT (273-7638)
 www.speclink.com/ar



[NEWSMAKER]

Santiago Calatrava

BY FRED A. BERNSTEIN

IS IT THE best of times or the worst of times for Santiago Calatrava? One of the few architects whose names are recognized around the world, he lives like a pasha (with no fewer than three townhouses on Park Avenue in Manhattan, and lavish homes in Spain and Switzerland), while shuttling to building sites in Europe, Asia, and both North and South America. His bridges draw tourists to cities as diverse as Venice, Jerusalem, Calgary, and Dallas. And he is currently the subject of a show at the State Hermitage Museum in St. Petersburg, Russia (*Santiago Calatrava: The Quest for Movement*, June 27 to September 30, 2012).

But he has also been the target of intense criticism, much of it involving the staggering costs of his buildings. In New York, the price of his transit hub at Ground Zero has risen to \$3.8 billion. In Valencia, Spain, his hometown, he has been described as "bleeding the government dry," with architectural fees approaching 100 million euros for his City of Arts and Sciences. And there have been questions about the practicality of some of his designs. Calatrava was happy to tackle these subjects by phone from Zurich, just days before his exhibition opening in Russia.



Will the show at the Hermitage be like the one at the Metropolitan Museum of Art in 2005?

It's much bigger. The Metropolitan wanted to make a very dense show. This one will be about 20,000 square feet. There will be 60 or 70 architectural models, and also sculptures and watercolors that will let people understand my approach to projects.

Some critics of your show at the Metropolitan thought you were trying to present yourself as an artist like Brancusi, whose work was shown near yours, rather than as an architect.

I never saw it like that. It has never been my intention to, let's say, do a sculpture to imitate the great art of Brancusi, just as Brancusi never wanted to imitate Rodin. I do those pieces as a vehicle to research architecture, like Le Corbusier—*la recherche patiente*, the patient research. It's a very intimate work. (continued)

The face of education.

*-Project: William Allen High School, Allentown, PA
-Product: Trenwyth, Astra Glaze*

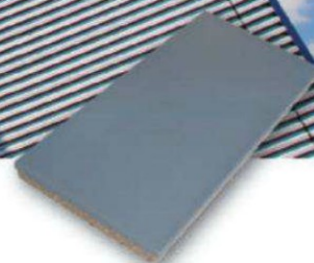

Astra Glaze®
Additional colors, sizes &
shapes at Trenwyth.com



The face of masonry.

The face of masonry. No matter where you are, chances are we're somewhere close by. In fact, you've probably seen us many times before in the places you shop, work, play, learn and live. We manufacture the brands and products used in the interiors and exteriors of civil, commercial and residential construction projects across the nation. We're Oldcastle Architectural. We are the face of masonry.



For more information about our SmartBIM models and continuing education units, visit oldcastleapg.com/ceubim.html

CIRCLE 27

Brands **TRENWYTH®** | ENDURAMAX™ | ARTISAN MASONRY STONE VENEERS™ | QUIK-BRIK® | AMERIMIX®

For more information on our broad range of products or for free literature call 1-855-346-2766 or visit oldcastleapg.com

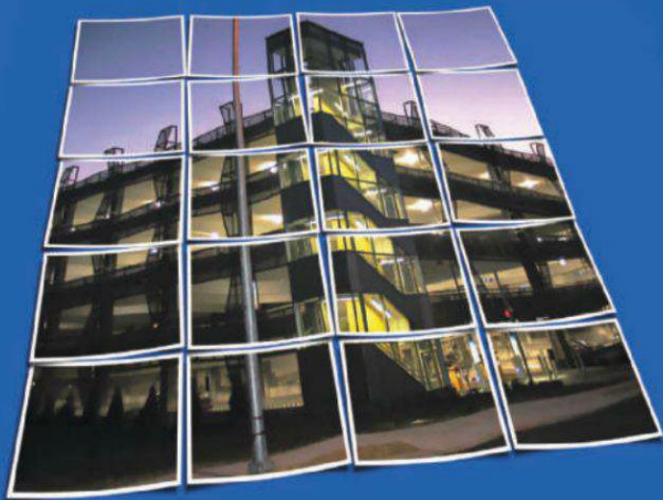

Preserve Your Project Before It's Even Built.

Galvanizing is Thinking Big Picture.

Hot-dip galvanizing with AZZ Galvanizing Services is the best way to ensure that your project will stand the test of time, saving money in costly maintenance repairs later. And since using eco-friendly zinc is less expensive than other corrosion barriers, the cost savings begin before the construction does — and will extend the life of the structure. Save money now and in the big picture.



We Protect More Than Steel.



azzgalvanizing.com

CIRCLE 28

(Calatrava continued)

Have you ever sold your art?

I have been tempted, very much in the beginning, to work with an art dealer, but then I renounced that because my production is so limited.

It's been reported that your house in Valencia may someday become a Calatrava museum.

I don't have the ambition to do a museum, although we have been taking care to archive all these things. Tina [his wife, Robertina Calatrava] has been creating a kind of catalogue raisonné of my work.

How do you divide your time between art and architecture?

It is impossible for me to have an architecture office and, far away, a studio for sculpture. I have to put these things together. I spend at least three or four hours a day on the art, and the rest of the time overseeing and designing for the office.

You've been taking some criticism lately. Several of your buildings have been denounced as impractical.

But I built a train station in Liege, which took more than 12 years, and now I am building a second station for the same client. The same thing happened in Dublin. I was commissioned to do a second, much larger, and more complex bridge. And in Dallas I did a bridge, and we're doing a second bridge there. The important thing is that the client thinks it's worth it to work with me.

And the price of the New York City transit hub?

In a democracy, people think money should be spent in different ways. I am completely convinced that what we're doing at Ground Zero is an important work. It is in the tradition of the great buildings, like Grand Central Terminal.

What about the criticisms in Valencia? The left-wing Esquerra Unida party says you've charged the Valencia government 100 million euros.

Thank you very much for this question. I have been working there for 20 years. My firm has received fees of 90 million euros, which is very modest if you consider that I have been doing the architecture, landscape architecture, and all the engineering—structural, mechanical, plumbing. Also, I've had a huge team of people there doing site control and site administration. I am responsible for everything, from the first sketch to the finished buildings.

What do you think has caused the criticism?

It is a political maneuver by the communists. They are not attacking the Alhambra in Granada. They are not attacking the cathedral in Santiago de Compostela. They are not attacking the Prado in Madrid. Still, 1.1 billion euros [the project's total cost] is a lot of money in this economy.

Spain has received 100 billion euros [as an initial bailout] from the European community. People are saying it will need 1 trillion euros altogether. Compared to that, the 1.1 billion euros for my buildings is nothing. It is wrong to say I have made too much money there. It is not true.

You're very passionate about this.

I like very much this word "passion," because it comes from the Latin *passio*, which means "suffering." I have been working very hard. This is the truth, Fred.

And you think the Valencia project will stand the test of time?

It's not something volatile, like making a bailout for the banks. It is something that has been built and will remain for generations as a testimony that Spain has found its place in the world as a free and democratic country. ■

OUR GLASS
ISN'T DESIGNED
FOR OFFICES.
IT'S DESIGNED
FOR PEOPLE.

Only SageGlass allows you to electronically tint your windows to dynamically control sunlight, glare and temperature.

It's cooler. It's more energy efficient. And it opens up a new world of possibilities for people-centric spaces.



SAGE

CIRCLE 29

SAGE Headquarters, Faribault, MN

ARCHITECT: I&S Group

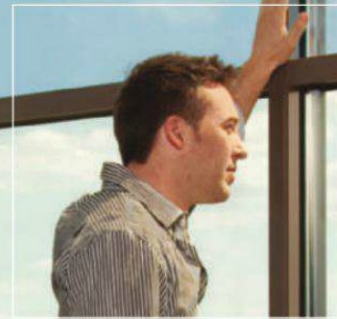

©2012 SAGE Electrochromics, Inc.

To see this brilliant technology in action, visit www.sageglass.com or call 1-877-724-3325



Levitated Mass, a permanent installation by artist Michael Heizer, was unveiled in June in Los Angeles.

Rock Star Takes the Stage at LACMA

FOUR DECADES after its conception, artist Michael Heizer's *Levitated Mass*—a giant boulder looming over a sunken concrete walkway—has finally been realized. The 340-ton rock made a much-chronicled trip through four counties over 11 days in March on its way to the Los Angeles County Museum of Art (LACMA) from a quarry 60 miles east of the city. In late June, a crowd of more than 1,000 people gathered at the museum to watch the sculpture's unveiling. LACMA raised \$10 million in private donations to finance the project, and construction of the trench began over a year ago. Public safety was a primary concern. The design and engineering team inserted nine 18-inch steel rods into the boulder to ensure it won't overturn during an earthquake; additionally, they installed steel wedges on both sides of the rock to prevent it from sliding sideways. Two concrete triangles stabilize the walls underground. Says structural engineer Greg Otto, a principal at Buro Happold: "We had to creatively address the fundamental engineering realities and code requirements to achieve Michael's vision." *Marissa Gluck*

Gehry Technologies Unveils GTeam Collaboration Tool

Gehry Technologies plans to release an interactive, cloud-based collaboration platform called GTeam. The product will feature storage and computing functions and will automatically translate 3-D files from AutoCAD and Revit, among other programs, to a common format.

Project by Rogers Marvel to Rise on Brooklyn Waterfront

Rogers Marvel Architects, with developers Toll Brothers and Starwood Capital, has secured the commission to design a 550,000-square-foot condominium and hotel building overlooking Brooklyn Bridge Park (by Michael Van Valkenburgh) and the East River.

Grimshaw and Gruen Prevail in Union Station Competition

Beating five other finalists, Grimshaw Architects and Gruen Associates have scored the \$4.15 million contract to design the master plan for Los Angeles's Union Station and the 40 acres surrounding it. The plan is due to be completed by the summer of 2014.

Serie Tapped for Judicial Campus in Singapore

London-based Serie Architects has won a competition to design a new Singapore court complex in collaboration with the local firm Multiply Architects. The \$350 million project calls for the renovation of a 1970s building and the construction of two new towers. ARCHITECTURAL RECORD named Serie's founders, Christopher Lee and Kapil Gupta, Design Vanguard winners in 2005.

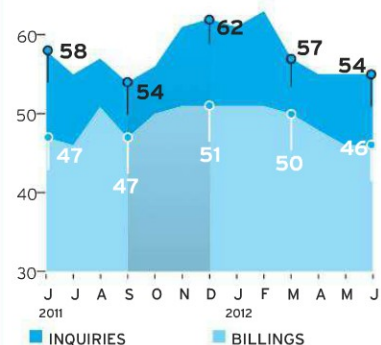

ABI Remains Below 50

The Architectural Billings Index hit 45.9 in June, nearly identical to May's 45.8 (a number below 50 indicates decreased activity). "While not all firms are experiencing negative conditions, a large share is still coping with a sluggish and erratic marketplace," said AIA chief economist Kermit Baker. The inquiries score was 54.4.



Back then, you didn't need to worry about insulating exterior wall systems. Today, you still don't.



With the all-new Owens Corning's™ CommercialComplete™ Wall Systems, we offer a simple solution for your exterior wall systems that gives your project outstanding energy efficiency coupled with complete air and water barrier performance, as well as fire, structural and acoustical performance qualities. It's one complete solution from the company that invented insulation, so you can spend your time taking care of other things. Learn more at www.OCbuildingspec.com.



INNOVATIONS FOR LIVING™

THE PINK PANTHER™ & ©1964-2012 Metro-Goldwyn-Mayer Studio, Inc. All Rights Reserved. The color PINK is a registered trademark of Owens Corning. ©2012 Owens Corning. All Rights Reserved. Owens Corning Foam Insulation, LLC

862

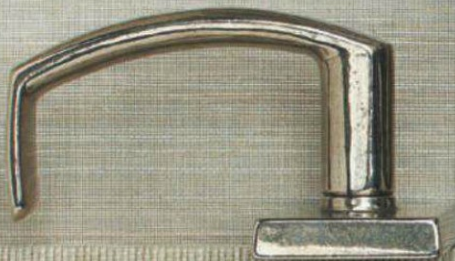

Rocky Mountain[®]
HARDWARE

HOSPITALITY

CIRCLE 32

HANDCRAFTED BRONZE HARDWARE

888.552.9497

rockymountainhardware.com

MADE FROM 90% POST CONSUMER RECYCLED MATERIALS. MADE IN THE USA.

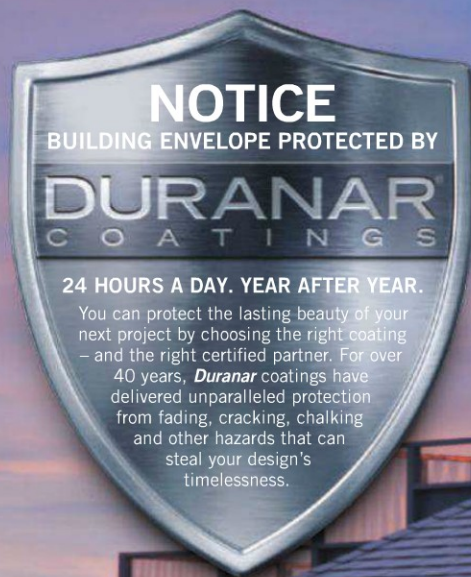

**18 Certified partners.
One goal: yours.**

PPG CMPP™
CERTIFIED METAL PANEL PROGRAM
www.ppgcmpp.com

Roof Panel Manufacturers

Architectural Metal Systems
Englert, Inc.

Wall Panel Manufacturers

Alcoa Architectural Products

Pre-engineered Building Members

American Buildings Company
CBC Steel Buildings
Gulf States Manufacturers
Kirby Building Systems
Nucor Building Systems

PPG CAP
CERTIFIED APPLICATOR™ PROGRAM
www.ppgcap.com

Extrusion Applicators

Architectural Window
Astro Shapes
Kawneer Company, Inc.
Keymark Corporation
Linetec
Spectrum Metal Finishing, Inc.
Tecnoglass S.A.
TRACO, a Division of Kawneer
Windsor Metal Finishing, Inc.
YKK AP America, Inc.

Bandon Dunes Golf Resort, Bandon, OR

To serve and protect, choose Duranar® coatings – and a certified partner.

When you work with members of the PPG Certified Applicator Program® or Certified Metal Panel Program®, you get the best people, practices and products. Which give you consistent, durable color. And a whole lot more. To learn more, call 1-888-PPG-IDEA. Or visit ppgduranar.com.



All trademarks are marks of PPG Industries Ohio, Inc.

CIRCLE 40



PPG Industries, Inc., 151 Colfax Street, Springdale, PA 15144 1-888-PPG-IDEA www.ppgideascpes.com

Hole Metal Designs

The
Hole
Story

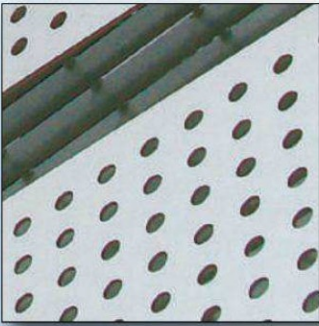

These sunshade panels were fabricated from **McNICHOLS**® aluminum Perforated Metal with 1/2" diameter holes on straight rows.

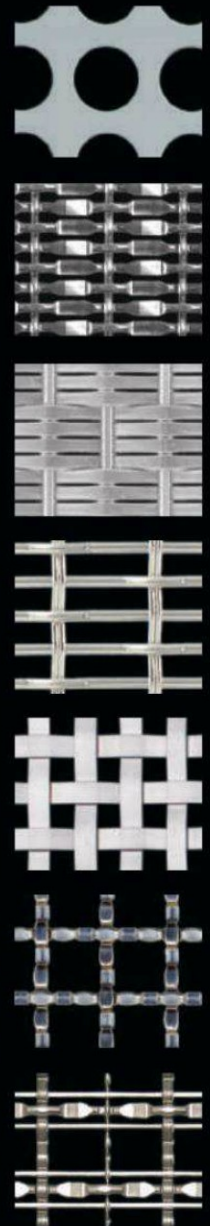

The Barnes Jewish Hospital has an intriguing banded wrap of **McNICHOLS**® Perforated Metal panels. The panels provide shade from the sun for patients.

Architects and contractors look to **McNICHOLS**® **Designer Metals** for sustainable, functional and aesthetic solutions for their projects.

McNICHOLS offers endless design opportunities and striking aesthetics with their Designer Metal series of products. Selections include perforated metal, wire mesh, and gratings in a myriad of materials and styles.

Our highly trained Architectural Design Consultants are ready to assist with your next design project.

We look forward to serving you!



© Jad Ryherd Photography

McNICHOLS® Designer Metals

mcnichols.com/arec • 866.754.5144

CIRCLE 34

Radiant Infrared Heating Technology

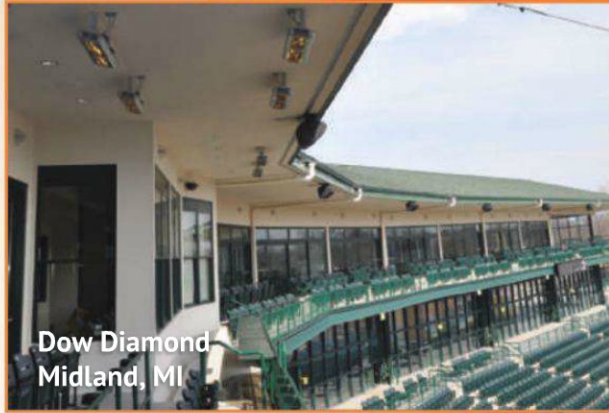

Dow Diamond
Midland, MI



Outdoor Patio
Baltimore, MD



Bonita Bay CC,
Bonita Springs, FL



New York Palace Hotel Courtyard
New York, NY

Solaira Commercial Electric Infrared Heaters are engineered for architecturally sensitive indoor/outdoor heating on patios, decks and waiting areas. Solaira technology converts 91% of the energy consumed into directional, comfort heating. Solaira Heaters achieve full output within 1 second and can also be controlled with digital variable controls, thermostatic, timer and occupancy sensors to minimize consumption.

- Virtually unaffected by wind
- Waterproof engineering
- Color options available to suit

Solaira^o

The Architect and Engineers Choice

In association with members of:



CIRCLE 33

www.SolairaHeaters.com
866-321-8373



DODGE MOMENTUM INDEX SLIPS

Mirroring the recent softening of the U.S. economy, the Dodge Momentum Index retreated 2.3% in June, falling to 92.2 (base year of 2000 = 100). The decrease follows a 0.7% pullback in May, to a revised 94.4. Although the commercial segment climbed 5.9% in June, the performance of the index was weighed down by a 10.2% decline in the institutional sector, which reflects a drop in the number of planning projects for educational buildings.

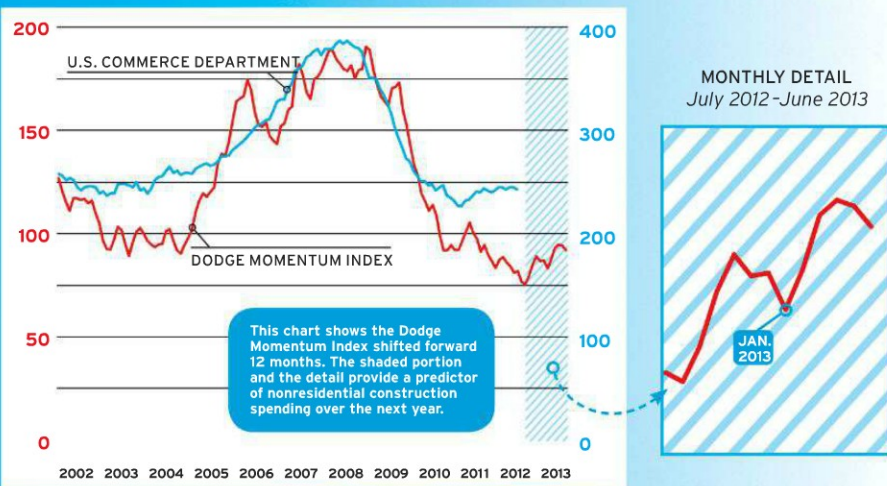

The Dodge Momentum Index is a 12-month leading indicator of construction spending. The information is derived from first-issued planning reports in the largest database of construction projects in the U.S., McGraw-Hill Construction's Dodge Reports. The data have been shown to lead the U.S. Commerce Department's nonresidential spending by a full year.

HEALTH-CARE CONSTRUCTION

With the uncertainty surrounding health-care reform largely resolved and a population that continues to age, construction of medical facilities should be a growth sector in the coming years.

Health-Care Starts by Region

Including U.S. total and 2012 forecast figures, by billions of dollars

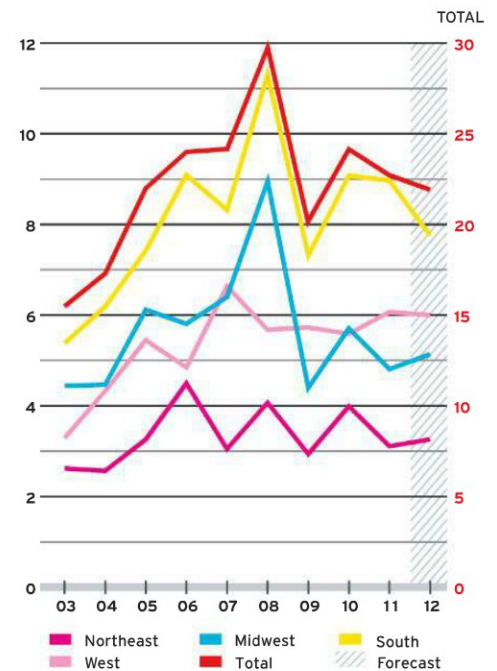

Top Metro-Area Markets

Total health-care starts, 1/2011-5/2012

		\$ millions
1	Denver	1,894
2	San Francisco	1,208
3	San Diego	1,144
4	New York	1,057
5	Los Angeles	922

Top 2012 Health-Care Projects *Ranked by construction-starts value through May*

Values indicate the construction cost of the health-care portion of projects and exclude ancillary facilities, such as parking garages.

<p>\$583M</p> <p>PROJECT: Exempla Saint Joseph Hospital</p> <p>ARCHITECTS: ZGF Architects Davis Partnership H+L Architecture</p> <p>LOCATION: Denver</p>	<p>\$420M</p> <p>PROJECT: University of California San Diego Jacobs Medical Center</p> <p>ARCHITECT: Cannon Design</p> <p>LOCATION: La Jolla, CA</p>	<p>\$335M</p> <p>PROJECT: Saint John's Mercy Medical Center</p> <p>ARCHITECTS: HKS Architects Archimages</p> <p>LOCATION: Joplin, MO</p>	<p>\$300M</p> <p>PROJECT: Children's Hospital of Philadelphia Ambulatory Care Center</p> <p>ARCHITECTS: Pelli Clarke Pelli FKP Architects Ballinger</p> <p>LOCATION: Philadelphia</p>	<p>\$234M</p> <p>PROJECT: Jennie Sealy Hospital</p> <p>ARCHITECT: HDR</p> <p>LOCATION: Galveston, TX</p>
--	--	--	---	--

THE DODGE INDEX FOR HEALTH-CARE CONSTRUCTION

5/2011-5/2012

This index is based on seasonally adjusted data for U.S. health-care starts. The average dollar value of projects in 2003 serves as the index baseline.

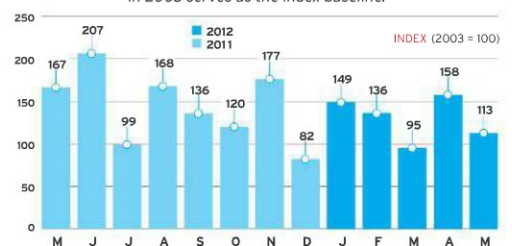

WINDOWS • CURTAIN WALL • ENTRANCES • STOREFRONT



The best thermal performance. Now with even greater possibilities.

EXACTLY.

EFCO's *XTherm*® line of high performance thermal products set a new standard for commercial window efficiency. And all the advantages of this innovative technology are available for curtain wall as well. Offering best-in-class U-factors, the *XTherm* line opens up a whole new world of design possibilities. View the thermal performance video at efcoexactly.com/xtherm. Only from **EFCO. Exactly.**



To learn more, call 1-800-221-4169 or visit efcocorp.com.
© 2012 EFCO Corporation



THE REFLECTIVE SERIES

CHANGING THE WAY YOU THINK ABOUT CONCRETE MASONRY



AN AMERICAN OWNED COMPANY SINCE 1868



800-234-8970

www.edillon.com

E. Dillon & Company is a leading manufacturer of Architectural Concrete Masonry including our "Top-Of-The-Line" **REFLECTIVE SERIES**.

- Unsurpassed Reflective Quality
- 24 Standard Colors
- Wide Variety Of Shapes And Sizes
- Sample Board Available Upon Request

The Pain in Spain

The economy is having a devastating effect on architectural talent.

BY DAVID COHN

CAN SPAIN'S architects survive the nation's deepening economic downturn, now in its fourth year? Over the last several decades the country had gained international renown for the quality and innovation of its architecture, designed by both local and international figures. The exhibition *On-Site: New Architecture in Spain* at New York's Museum of Modern Art in 2006 attested to its accomplishments.

But the collapse of the speculative building bubble, with housing starts dropping from 920,000 in 2006 to 60,000 last year, triggered an implosion of public works, bringing the entire construction sector—and architectural commissions with it—to a standstill.

Various sources estimate that more than 45 percent of Spain's architecture studios have closed since the start of the crisis, and many others remain open in name only. Surviving firms have shed staff and cut expenses. The 11 partners of Associated Architects, Engineers & Urban Planners (AUIA), specialists in social housing and urban planning for over 40 years, have dismissed their entire staff of 40, rehiring them on temporary contracts as needed. Revenues are only 10 to 15 percent of those during the boom, says partner Manuel Paredes. But his former staff receives unemployment benefits, he notes, unlike those in some firms that skirt the law.

Rafael de La-Hoz, who heads his own firm in Madrid, says he has cut staff 50 percent over the past four years, and his billings have fallen 30 percent. Most discharged architects, says La-Hoz, are collecting unemployment, going after master's degrees, or teaching. Some have returned to their countries of origin, while others, he notes, have found work abroad, mainly in London and Germany.

Small firms, which dominate the profession, face a more dramatic situation, particularly those architects who got their start in open competitions for public works during the boom years. Clara Eslava and Miguel Tejada, married and in their forties, got their first break in the 2004 competition to redesign Calle Serrano, Madrid's Madison Avenue, which they finished last year. Now Eslava says she feels part of "a lost generation." Like many colleagues, she is working on a Ph.D. thesis and seeking teaching posts.

Iciar de las Casas, in her early forties, is



Sparked by the crumbling economy, peaceful protests began taking place in Spain, such as one on May 19, 2011, at the Plaza de la Encarnación in Seville. The Metropol Parasol designed by J. Mayer H. Architects framed the occasion.

also working on a Ph.D., as well as developing a product in conjunction with a manufacturer and a university. "I spend many sleepless nights planning new ventures," de las Casas confesses. She has eliminated staff and moved her studio into her home.

Meanwhile her brother and partner, Sergio de las Casas, has applied for a visa to move his family to Perth, Australia. He joins a diaspora of talent estimated at 4,000 of Spain's 60,000 licensed architects, according to an informal poll conducted by the Sindicato de Arquitectos de España. Of those surveyed, 65 percent said that they would "be willing to consider" moving abroad. Young architects lead the exodus to other European countries, where their licenses are recognized, or farther afield to, say, South America, Qatar, or China. Sometimes they can double their salaries. José Antonio Granero, president of the Colegio de Arquitectos de Madrid (COAM), the city's professional association, comments that Spanish professionals are highly valued abroad for their "technical and humanistic training."

Many architects lacked work and high pay even in good times, owing to an oversupply. Spain produces 3,000 architectural graduates a year, and has one licensed architect per 800 inhabitants, compared with one per 1,500 in the rest of Europe. Granero maintains that an architecture degree prepares students for many different fields (e.g., graphic design, energy conservation), although the Sindicato survey found only 14 percent of the architects who responded worked in other specialties.

To change the situation for the better, Granero

proposes redirecting private development from new construction to renovation. COAM is working on legislative proposals to ease this change. "Spain has 6 million housing units more than 50 years old," he points out. "Renovating them can attract foreign investment."

Individual architects are coming up with other alternatives. The Madrid firm Ecosistema Urbano recently won a competition to revitalize a Barcelona shopping center with falling revenues. Instead of the face-lift proposed by the owners, partners Belinda Tato and José Luis Vallejo suggested dedicating empty storefronts to community activities, converting the mall into an urban center.

Working in Vallejo and Tato's studio are several activists in Madrid's 15-M movement, named after the peaceful protests of May 2011 that the Spanish claim inspired Occupy Wall Street. Social activism has spread to older architects in Madrid's comfortable northern suburbs. Landscape architect Beatriz Lombao, her associate Marta Torres, and Lombao's husband, the architect Javier Maroto, converted a neglected estate into an organic vegetable garden, with chickens and geese, a crafts fair, and a shaded hangout for food and drink. This back-to-the-earth movement, familiar to certain Americans, was previously unheard of here. "It's not an intellectual project," Maroto says, "but activism based on people relating to one another, and sharing a different way of living." ■

Based in Madrid, David Cohn is an international correspondent for RECORD.

BEGA

New Compact Floodlights

LED, Halogen, and H.I.D. light sources

Very narrow, narrow, or wide beam distributions

BEGA sets the standard



BEGA-US

www.bega-us.com

(805) 684-0533

No. 149



perspective house of the month

DENTON CORKER MARSHALL'S SCULPTURAL VIEW HILL HOUSE IN YARRA VALLEY, AUSTRALIA, OVERLOOKS 78 ACRES OF VINEYARDS. BY LAURA RASKIN

IN 1996, architect John Denton purchased 150 acres of land—78 of them under vine—in the middle of the Yarra Valley, about an hour's drive from Melbourne; think of it as Napa Valley's Australian cousin. Denton, who founded the architecture firm Denton Corker Marshall in 1972, now produces chardonnay and pinot noir, among other grape varieties. He also designed a 3,500-square-foot steel-frame second home, completed in 2011, on top of the property's one big hill.

GROWING SEASON
 "Being in the country, sustainability is important," says the architect. The house has a highly insulated building envelope and uses graywater to flush toilets, recycled blackwater for irrigation, and filtered and treated rainwater for the tap. The house sits on a hill of granite from the Devonian period.



Surrounded by the mountains of the Great Dividing Range, Denton's sculptural, telescopic house combines two simple rectilinear volumes, one balancing perpendicularly atop the other and cantilevering 29 feet to the south and 19 to the north. The lower bar is clad in Cor-Ten steel, while the upper is wrapped in black powder-coated aluminum. Both are lined on the interior with green-stained oriented strand board made from pine-milling leftovers. Perforated steel panels conceal the long window in the ground-floor living/dining area—these 13-by-12-foot panels lift up in three sections to become a pergola. The panels were a tricky construction feat because their electric motors had to be concealed within the ceiling. The doors had to operate in high winds, but managed to have minimal framing, says Denton.

Inside the house, the bars are divided

into simple boxlike rooms according to "service blocks." The living and dining area on the ground floor and the main office on the second floor look out over the vineyard to the north. The bedrooms contained in each end of the lower bar and the southern end of the upper bar amplify views of the valley and the surrounding mountains.

Denton says that View Hill House is a continuation of his exploration of architecture as land art, citing, among other examples, the firm's Marshall House, a series of walls buried in the dunes in Victoria, Australia. ■

- 1 ENTRY
- 2 KITCHEN
- 3 BEDROOM
- 4 BATHROOM
- 5 OFFICE
- 6 LAUNDRY
- 7 LIVING
- 8 DINING

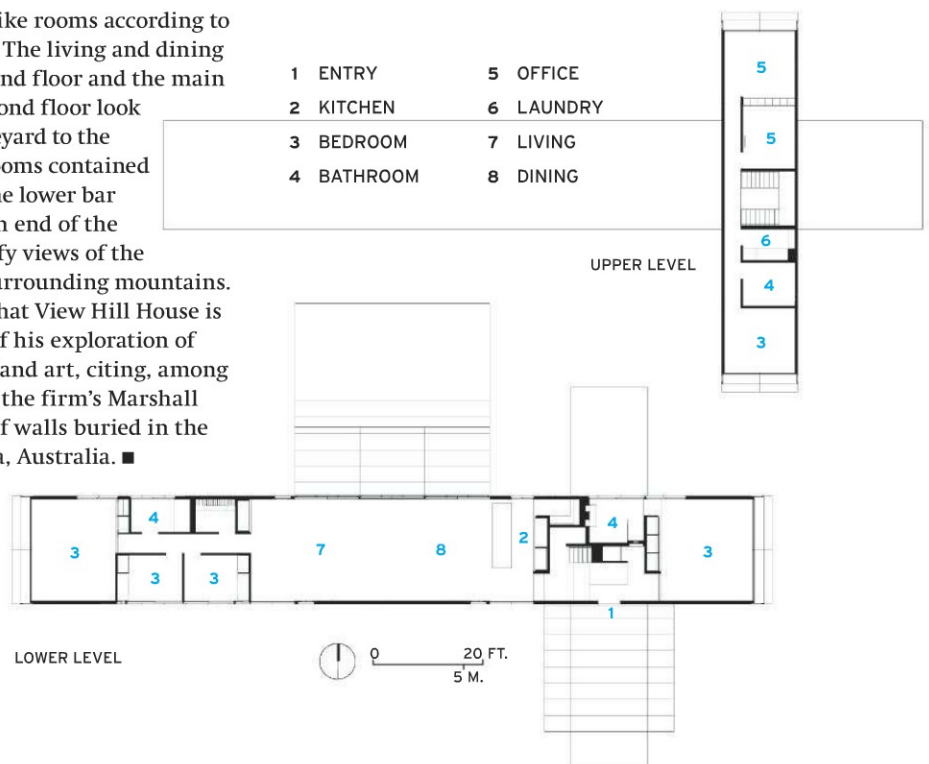

PHOTOGRAPHY: © TIM GRIFFITH

THE Advantage



POST FRAME AN ENGINEERED WOOD BUILDING SYSTEM

The Post-Frame Advantage provides free resources to building owners, code officials, architects, and structural engineers who would like to learn about post frame for commercial construction.

For a low-rise engineered wood building system that combines value and efficiency, consider the Post-Frame Advantage:

DESIGN FLEXIBILITY—Post frame allows for open floor plans and a wide array of appealing architectural features.

ENERGY EFFICIENCY—Overall building energy savings are achieved through wood's natural thermal resistance and post frame's wide-column spacing, which means fewer insulation interruptions.

DURABILITY AND STRENGTH—A uniquely engineered post-frame system produces a long-lasting structure with outstanding resistance to wind and seismic forces.

COST-EFFECTIVENESS—Dollar for dollar, post frame provides more building space than other types of construction.

For more information on using post frame for your building projects or to locate a post-frame contractor, please visit our website.



THE POST-FRAME FIRE WALL: NEW, TESTED, AND ECONOMICAL

The National Frame Building Association has successfully achieved a 3-hour fire rating for a post-frame wall system that can now be incorporated into a post-frame building without having to go to more expensive nonwood framing systems. An hourly rated wall—rated as high as 3 hours—is often required to separate building areas or occupancy types to meet the *International Building Code* requirement for life safety.

Full-scale testing of a 3-hour post-frame fire wall by Underwriters Laboratories in 2011 showed for the first time that a wood-constructed assembly is a viable alternative to a traditional block wall system.

Scan this QR code to learn more or visit www.postframeadvantage.com/codes.



www.postframeadvantage.com

POST-FRAME
ADVANTAGE

A Native Son Returns to Africa

African Metropolitan Architecture,

by David Adjaye. New York: Rizzoli, 2011, 568 pages, boxed set, \$100.

Reviewed by Adedoyin T. Teriba

THIS HANDSOME book is a culmination of a series of exhibitions held in Massachusetts; London; Bern, Switzerland; Lisbon; and Tokyo that showcased architect David Adjaye's photographic survey of Africa's urban environment. Six of the seven paperback volumes in this boxed set, edited by Peter Allison, consist of pictures of the diverse architectural forms that exist on the continent. The author, who was born in Tanzania but practices in London, should be commended for attempting to document Africa so thoroughly. The book serves as a visual archive for architects, urban planners, and architectural historians interested in the continent's built environment.

The decision to assemble the pictures on the page in multiple rows, like courses of masonry blocks, adds to the architectonic quality of the book. The photographs vary in size and dimension, preventing a visual monotony that would have resulted from displaying pictures of similar dimensions on every page. Also, the decision to leave the photographs unlabeled allows the buildings and streetscapes to speak for themselves. However, this omission makes it hard for readers to learn more about the architects or clients of the buildings.

The seventh volume contains

essays by various authors who discuss topics such as the history of the metropolis in Africa, cultural production, security, and intertribal conflicts. Contributors include Kwame Anthony Appiah, who teaches philosophy at Princeton; cultural historian and filmmaker Nana Oforiatta Ayim; curator and critic Okwui Enwezor; architect Naigzy Gebremedhin; and Suzanne Preston Blier, who teaches fine arts and African studies at Harvard. These essays, which are published without illustrations, explain how the built environment continually shapes the topics being addressed—and vice versa.

Perhaps a subsequent edition of the book could incorporate visual documentation along with the essays. This would be especially helpful with Blier's piece, "The African Urban Past: Historical Perspectives on the Metropolis,"

which examines precolonial African cities. Placing the visual archive alongside the text would help trace the evolution of the city in Africa.

Each of the six illustrated volumes looks at a different African ecosystem, providing a simple way of organizing a large and diverse continent. The volumes are: the Maghreb (northwest Africa), Desert, the Sahel (the semi-arid fringe south of the Sahara), Forest, Savanna and Grassland, and Mountain and Highveld. One advantage of this arrangement is that descriptions of the architecture and monuments of different cities are placed side by side in one volume, allowing the reader to compare built works in cities with similar climatic conditions. A short history of each city precedes its visual documentation, serving as an introductory guide to the place. Pictures of kiosks

are placed alongside municipal, residential, and commercial buildings, furthering Adjaye's argument that the designs of small-scale structures can inspire local architectural solutions in larger building types.

I would like to see photographs of some of the buildings' interiors in a subsequent edition, which would help elucidate the design decisions that are not apparent from just the exteriors.

Nevertheless, Adjaye and the contributing essayists should be commended for creating a cultural and visual history of Africa's urban environment that is unprecedented; it fills a void in the field of architectural history as a whole. ■

Adedoyin T. Teriba is a graduate student in architecture at Princeton University who grew up in Lagos, Nigeria.

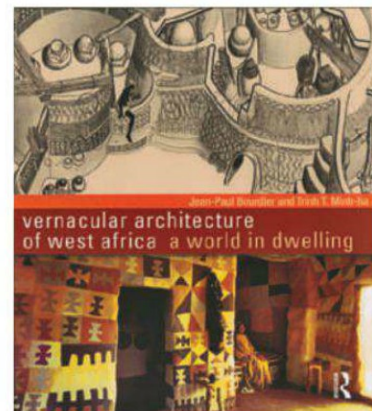
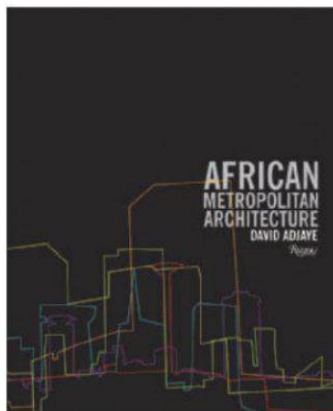

[BRIEFLY NOTED]

Vernacular Architecture of West Africa: A World in Dwelling, by Jean-Paul Bourdier and Trinh T. Minh-ha. London and New York: Routledge, 2011, 192 pages, \$75.

JEAN-PAUL BOURDIER, a professor of architecture at the University of California, Berkeley, has published several books on vernacular architecture, particularly in Africa. His latest, coauthored by Trinh T. Minh-ha, also a professor at UC Berkeley and a filmmaker, looks at dwellings designed by hundreds

of ethnic groups in Africa, with the premise of helping to resolve the tension between Western architects who wish to step away from modernization and non-Western practitioners who need to square traditional building practices with the benefits of technology. Using cinematic photographs and engaging drawings, the authors devote nine chapters to African architecture's direct relationship to spirituality; each house is both a living thing and a metaphor. The next 12 chapters dissect the structures and plans for different types of dwellings,

such as those on the northwest bank of Lake Nokue in southern Benin. These houses on stilts have straw roofs and permeable walls and floors to combat for the area's humidity. Bourdier and Minh-ha state that "given the great diversity of rural dwellings in Africa, as well as of beliefs and practices, nothing seems more difficult than speaking of 'African architecture' or treating it as an undifferentiated whole." The authors wisely limit their study to dwellings in West Africa south of the Sahara in order to say more about less.

Laura Raskin

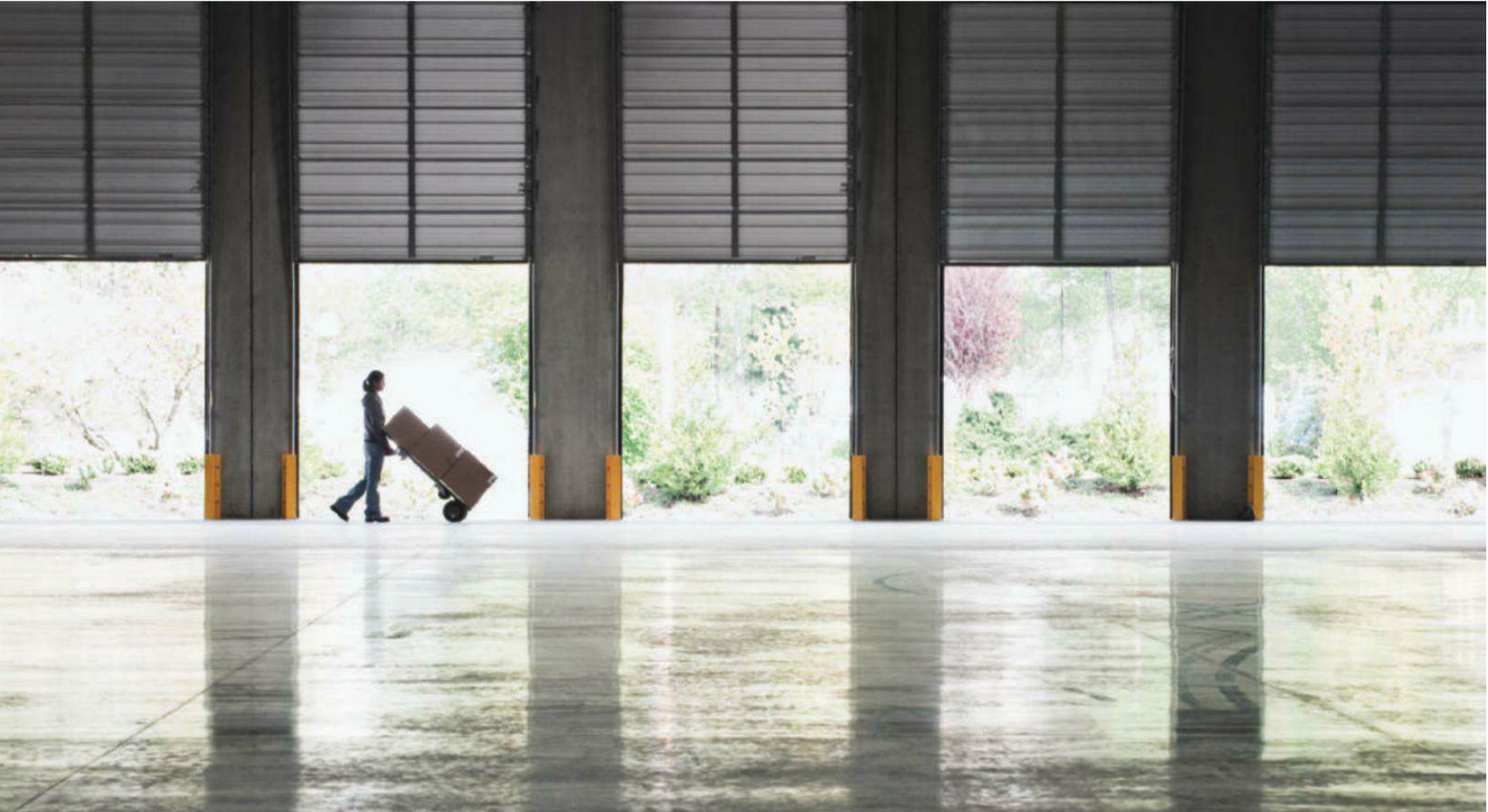

The safest installation meets the smartest innovations.

Next-generation LiftMaster® door operators lead the way with groundbreaking innovations that protect your clients.

Our new line of door operators protects your clients' employees and property with continuously monitored entrapment protection and state-of-the-art safety features, making it easier than ever to incorporate warning lights, bells, and timers.

Plus, they meet tough new UL325-2010 standards, which is critical in complying with state and local building codes. It's all what you'd expect from the #1 brand of professionally installed door operators. There's no smarter way to protect what matters most...your reputation.

Specify safe. Specify smart. Specify LiftMaster.
To learn more, visit liftmaster.com or call 800-323-2276.

Residential Garage Door Openers • Commercial Door Operators • Access Control
Residential and Commercial Gate Operators • Telephone Entry Systems
liftmaster.com

LiftMaster®
Commercial Door Operators

ALTITUDE™

This is the Next Revolution in LED Outdoor Lighting.
This is Kim Lighting.



KIM LIGHTING

www.kimlighting.com/products/altitude



CIRCLE 48



Amisco®

INSPIRATIONAL

Amisco's inspirational designs innovatively combine texture, color and pattern to create a vibrant product ideal for expressing any design vision.

Leading the way in LVT flooring for over 40 years.



Made in the USA.

Amisco Stria Crater

www.amisco.com

CIRCLE 09



CertainTeed Ceilings

decoustics® Ecophon® Gyptone® PERFORMA™

© 2012 CertainTeed Corporation

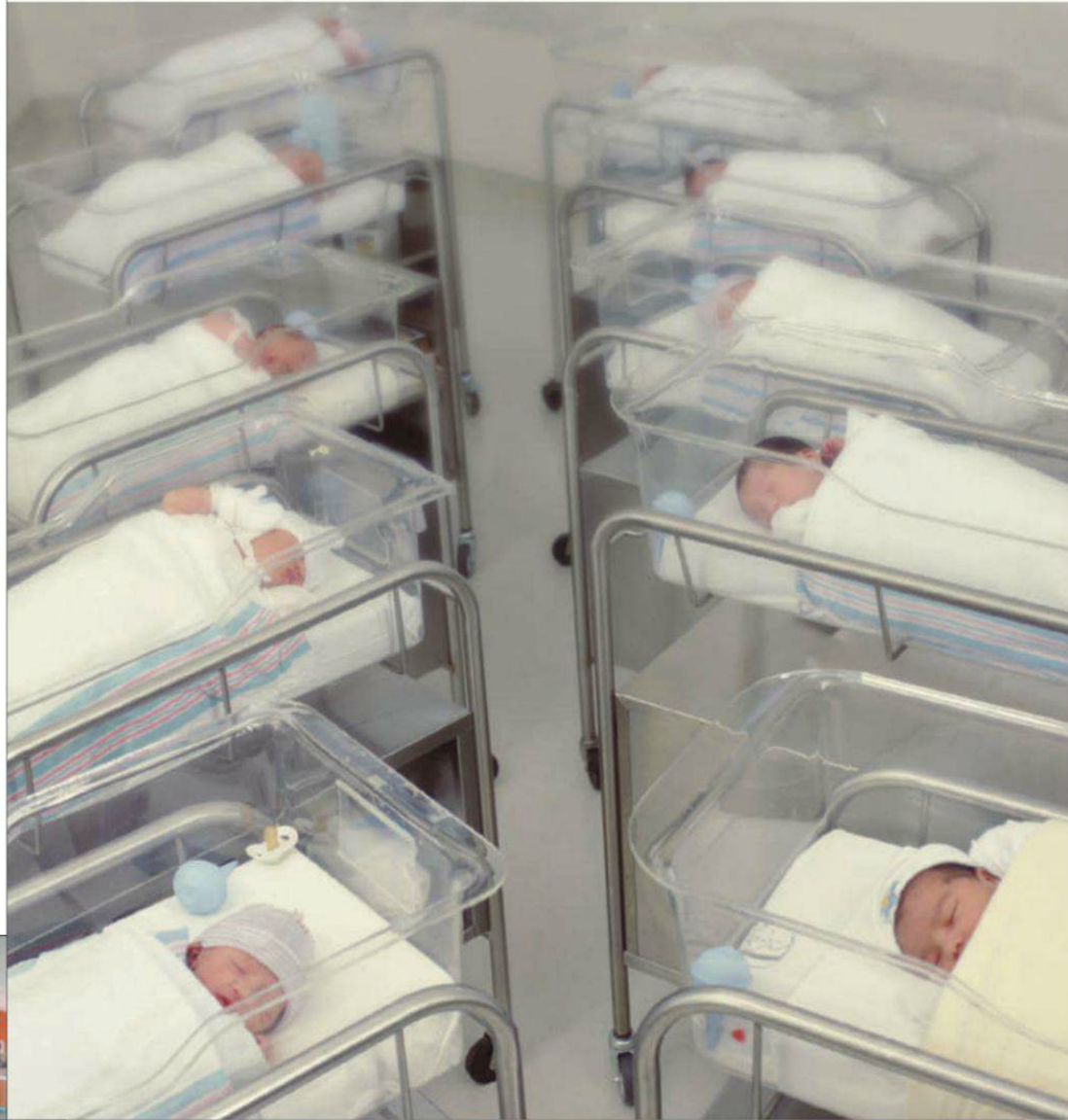

REST

Sleep well, and grow strong—there's a big world outside these hospital walls. I'll ensure you have the quiet and rest you need to be ready. As a CertainTeed ceiling, I offer completely customizable solutions for proper **Environmental Acoustics™**, allowing patients and practitioners—from young to old—to rest, heal and work better. With me, you can Be Certain™ you'll thrive in a sounder healing environment.

Explore how Environmental Acoustics can enhance any patient's experience.
www.CertainTeed.com/Ceilings

800-233-8990 • certainteed.com • <http://blog.certainteed.com>

ROOFING • SIDING • TRIM • DECKING • RAILING • FENCE • FOUNDATIONS
GYPSUM • CEILINGS • INSULATION • PIPE

CertainTeed
SAINT-GOBAIN

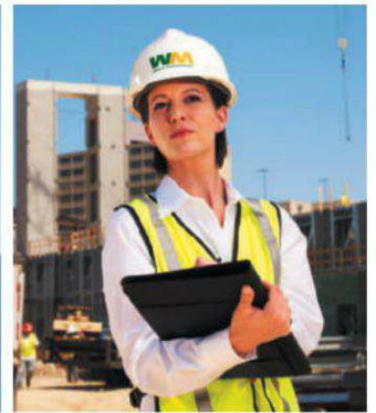

When hardison/downey asked us to help them reach 75% diversion, we delivered 90%.

Building the American Campus Communities' Lobo Village at The University of New Mexico was no small task. And the biggest number in the \$42.1 million project may have been the planned diversion rate. Working with our exclusive Diversion and Recycling Tracking Tool (DART™), we were able to track green efforts every step of the way and deliver an amazing result.



Go to wm.com/hd to download our McGraw-Hill SmartMarket Report and white paper.

Download the case study at wm.com/hd, or call 866 319 1923 to learn more.



THINK GREEN.®

Shopping the Mart

June marked the 44th edition of NeoCon, North America's largest design expo and conference for commercial interiors. Nearly 41,000 interior designers, architects, and trade professionals walked through more than 1 million square feet of exhibition space in Chicago's Merchandise Mart to check out the latest products and resources for corporate, hospitality, health-care, retail, government, institutional, and residential interiors. Here we present a few highlights, including a new concept for using video in the office and a conference table with a split personality.

By Rita Catinella Orrell



Video Concept Spaces

While more workers than ever are using video in their professional and personal lives, the physical spaces for videoconferencing haven't kept up. In response, Steelcase has unveiled concept spaces and technology that will optimize video interactions at work by addressing common issues such as light and sound quality and privacy. Ideal for one-to-one interaction, the units (which resemble photo booths) can also accommodate two people for impromptu meetings or calls. The booths offer controlled lighting, an acoustically enhanced background, and a height-adjustable display screen (not shown) that contains the monitor, microphone, speakers, processor, and camera, all in one. steelcase.com CIRCLE 204

Color Wash Carpet

Color Wash is a tufted, loop/tip-sheared modular carpet-tile collection that provides a richly sensory experience in two designs: Matter, a soft organic pattern, and Medium (shown), a linear expression of nuanced color change. Designed by Milliken's global creative director Cresta Bledsoe in collaboration with print research scientist Scott Parry, the collection is available in Milliken's certified Wear-On Nylon Type 6,6 in 40 standard colors, ranging from bright, clear vibrant shades to neutrals. Milliken claims its proprietary digital print technology offers substantially higher resolution than any competing method. All products are PVC-free, CRI Green Label Plus-approved, and include 25% recycled content. millikencarpet.com CIRCLE 205

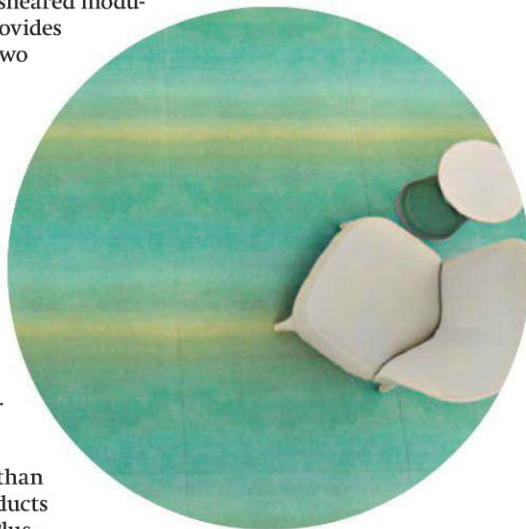

Passport Conference Line

Nucraft took home Best of Competition for the Passport conference line of adjustable tables and activity walls that create more flexible meeting spaces. The conference table has a first-of-its-kind sliding top that allows users to position the table near a presentation surface or monitor. The sliding top also allows two tables in adjacent rooms (divided by a movable partition) to be transformed into one large table. An extra bonus: Power and data access move with the table, while it remains fully connected. nucraft.com CIRCLE 206



Equo LED Desk Lamp

The award-winning Equo desk lamp features a discreet counterweight design—with one finger, users can raise or lower the floating arm's position while the tilting head stays at whatever angle it is set at. Users can slide a finger along the touch strip on the stem of the lamp to dim it gradually, or touch anywhere along it to jump directly to any brightness (or turn it off). The luminaire head can be rotated up to 180° and is detachable for easy replacement. Compatible with an optional occupancy sensor, Equo is illuminated by 28 LEDs in a color temperature ranging from 3,500K to 4,500K. koncept.com CIRCLE 207



Hosu Lounge

As the boundaries between work and home continue to dissolve, Coalesse—one of the three core brands of Steelcase Inc.—has found a niche specializing in designs that cross over from private to public spaces. The Hosu seating collection, by the prolific Spanish architect/designer Patricia Urquiola, addresses the idea of “relaxed work” with a design that can be converted from a low lounge chair to a chaise longue. Hosu features the exclusive textured Hexa fabric, also designed by Urquiola, which is offered in six colors. The lounge is available in two sizes, a 36”-wide one-seater in fixed and convertible versions and a fixed 64”-wide two-seater. Standard features include rear and side storage pockets, cord access points, and a lumbar pillow. coalesse.com CIRCLE 208

Lens Table Series by Barbara Barry

HBF teamed up once again with designer Barbara Barry to create a new collection of seating and occasional tables—her largest number of pieces for the company in a decade—that includes four seating groups and five table series. The Lens table (shown) features strapwork legs of brushed stainless steel holding two shelves on their tangent. Top and shelf options, including maple veneer, Ligno-Grain (a high-quality reconstituted wood veneer), clear glass, or solid surfacing, give designers more flexibility. hbf.com CIRCLE 209



Jot Drapery by Suzanne Tick

Designed by textile guru Suzanne Tick for KnollTextiles, Jot drapery fabric was inspired by digital binary code and DNA strands. An orderly matrix of small-scale dots is created by a process incorporating burnout and printing technologies. The pixelated drapery, which comes in four colorways, combines three light neutral ground dots and two accent colors. Made of 100% polyester, Jot is Greenguard-certified and can be used for windows or as a room divider. knolltextiles.com CIRCLE 210



The Maharam Collection by Joel Berman Glass Studios

Using a flexible precision digital printing process, Joel Berman Glass Studios is able to accurately transfer these designs and colors onto large panels of glass that can be used for building facades, backsplashes, wall dividers, and other applications. The initial collection features four designs by the Maharam Design Studio—Disperse, Contrary, Fathom, and Anagram (shown)—that represent Maharam’s clean, graphic approach to modern pattern design. Using ceramic inks, the collection can be printed and scaled to suit site-specific applications, in tempered, laminated, drilled, and polished glass options. jbermanglass.com CIRCLE 211

Beyond Architectural Walls

Entering into larger-scale designs, Allsteel introduced a movable, frameless glass-wall system featuring a unique built-in scissor-lift mechanism, which functions like a pneumatic jack, to level the glass within the floor channel and allow faster installations. Created in partnership with inventor Eberhard von Huene, the system features ½”-thick soundproof glass strong enough to accommodate an optional privacy panel system that hangs directly on the glass (shown). The unitized and nonprogressive wall panels allow the room to be reoriented by moving the door without moving all the walls. allsteeloffice.com CIRCLE 212



REIMAGINE METAL



INNOVATIVE DESIGN. PERSONALIZED CARE.

Creating and controlling a healthy environment is critical for hospitals. So is creating a design that is welcoming for patients and reflective of the critical work going on inside. When you choose metal for your building envelope enclosure, a single panel meets every need. CENTRIA's Formawall Dimension Series® and Smart-R Wall System offer unlimited design possibilities. And our innovative ATMP technology ensures the best thermal performance and moisture protection on the market today. Learn more about what goes on in front, and behind, the wall at

CENTRIA.com/reimaginemetal | 800.250.9298



Scan the QR Code with your smart phone to view the Cooper University Hospital project gallery and learn more about the CENTRIA products selected.



REIMAGINING THE BUILDING ENVELOPE

sophisticated affordability

Advantages of the Dri-Design Wall Panel System:

- No sealants, gaskets or butyl tape in the panel joints, means no dirty streaks or a legacy of maintenance for the building owner.
- Panels are not laminated nor a composite—they will never delaminate.
- Dri-Design is a friend of the environment. The fact is, the production of an aluminum composite panel requires significantly more fossil fuel than we use in making a Dri-Design panel. Dri-Design panels are made with recycled content and are 100% recyclable. At Dri-Design we make panels the world can live with.
- Fully tested to exceed ASTM standards and the latest AAMA 508-07 for pressure equalized rain-screens. Miami-Dade approved.
- Available in any anodized or Kynar color on aluminum, plus VMZINC, stainless steel, copper and titanium.
- Interlocking panel design makes installation quick and easy.
- Dri-Design is economical. Our highly automated manufacturing process makes panels in seconds.

PROJECT: Eastside Human Services, Denver, CO

ARCHITECT : RNL, Denver, CO

MATERIAL: Painted aluminum – Ultra pure white and Amber Wave



Call 616.355.2970
www.dri-design.com

products **green materials**

THE LATEST MATERIALS AND PROCESSES, FROM CARBON-NEGATIVE WINDOW FILM TO WATER-FREE TEXTILE DYEING, THAT HELP SAVE RESOURCES, REDUCE EMISSIONS, AND RECYCLE WASTE. RITA CATINELLA ORRELL

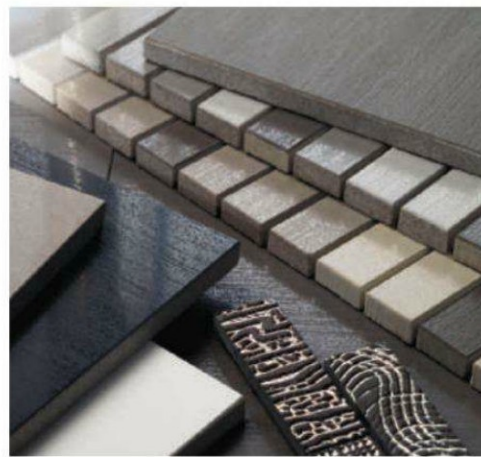

Columbia Radius Bending Plywood

Columbia Forest Products cfpwood.com
Suited for curved columns, arches, and cabinetry, Columbia Radius Bending Plywood flexes easily at a minimum radius of 12 inches, and can achieve even smaller radii when additional force is applied. Milled from regionally sourced, sustainably harvested wood, it features soy-based, PureBond formaldehyde-free technology developed in conjunction with scientists at Oregon State University. **CIRCLE 209**

Window Film Line's Second EPD

Solar Gard solargard.com/energy/home
Solar Gard completed the company's second Environmental Product Declaration (EPD), bringing its total number of carbon-negative architectural window films to 46. The new EPD states that the window films are a more cost-effective and carbon-effective solution than other improvements such as replacement windows. Stainless Steel 20 window film was specified for this office building in Barcelona. **CIRCLE 210**

DyeCoo Waterless Dyeing Process

DyeCoo Textile Systems dyecoo.com
The global materials consultancy Material ConneXion selected Netherlands-based DyeCoo Textile Systems B.V. as winner of its third annual Medium Award for Material of the Year. The award recognizes materials and processes, selected from the organization's materials library for the past year, that demonstrate outstanding technical innovation and contribution to design, society, and the economy. Instead of water, DyeCoo's commercial dyeing machine technology uses "supercritical" CO₂ (the fluid state of carbon dioxide) to infuse fabric with color—a major achievement, since the textile industry is considered one of the largest consumers of water. In addition, approximately 95% of the used CO₂ will be recycled by the company. The process—which currently can be applied to polyester fabric—reduces energy, dyeing time, and air emissions, and can improve the quality of the dyed fabric, resulting in fewer re-dyes.

Shades by Crossville

Crossville Inc. crossvilleinc.com
The design of a new porcelain tile line stemmed from a renovation by Cannon Design of the restrooms in Mies van der Rohe's John C. Kluczynski Federal Building in Chicago, where all of the old tile and fixtures were recycled into new tile for the building. Offering a minimum of 20% recycled content, the line features subtle linear details in gray and white hues for residential or commercial projects. **CIRCLE 211**

Cradle to Cradle—Certified Bioplastic

InPro inprocorp.com
Made from plants, not oil, InPro's NatureWorks Ingeo biopolymer is the first of its kind to become Cradle to Cradle (C2C) Silver certified. InPro, a manufacturer of impact-resistant wall and corner-protection products, combines Ingeo with Eastman Chemical's PETG plastic, which is also C2C Silver certified. Combining Ingeo, PETG, and recycled content, the company has arrived at a more durable formula than was possible with plain PETG. **CIRCLE 212**



Commercial Pavers from America's #1 Brand of Hardscapes



Permeable Pavement Solutions



High Vehicular Traffic

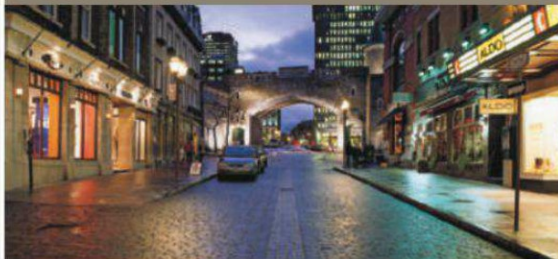

Retaining Walls



National Coverage

Since 1995, Belgard® Hardscapes by Oldcastle® has set the standard for innovative paving and landscape solutions with premium interlocking concrete pavers and segmental retaining walls. Feel confident in your next project with our nationally available premium products and services for all your site solutions, including storm water management and low impact development.

For more information visit: www.belgardcommercial.com or call **877-235-4273** **CIRCLE 46**

WATCH WHAT WE CAN DO

GKD Mediamesh® transformed one of New York's most forgettable buildings into a model of modern technology.



Port Authority Bus Terminal
42nd St and 8th Ave, New York City



We can't just show you a picture.
GKD Mediamesh® is best seen in action.
Watch what we can do.

GKDMEDIAMESH

800 453 8616 www.gkdmetalfabrics.com



**INTRODUCING THE INFINITE ROLL
OF DUPONT™ TYVEK®.**

**DuPont™ Tyvek® Fluid Applied WB— 30 years
of industry-leading performance engineered for
everything from high-rises to hospitals.**

The superior performance of DuPont™ Tyvek® CommercialWrap® is now available by the gallon. Tyvek® Fluid Applied WB goes on quickly and easily, making it the ideal solution for buildings from five to fifty stories. And it works on a range of materials from concrete to gypsum board. So when you're looking for a weather barrier you know you can trust, there's just one place to turn—DuPont. Learn more at www.fluidapplied.tyvek.com



CIRCLE 39



Gordon's Acoustical Metal Ceilings Combine Acoustics with Aesthetics

Project: The Children's Hospital at Oklahoma University Medical Center
Oklahoma City, OK

Architect: Miles Associates

Applications: Aluma Vault Ceilings, Contura Perimeter Trims, Light Covers,
Final Forms Drywall Trims, Fin Mate Vertical Baffles, Exterior Canopies

Contributes to LEED®1 Certification

1 LEED is a registered trademark of the USGBC.



CIRCLE 49

GORDON
INCORPORATED



gordon-inc.com
800.747.8954

TOTO®



From left to right: Pint Urinal with EcoPower® Flush Valve, Gooseneck Wall-Mount EcoPower Faucet, Clean Dry™ Concealed Hand Dryer, and Wall-Mount High-Efficiency Toilet with EcoPower Flush Valve

PEOPLE-FIRST INNOVATION™

With more “firsts” than anyone else, TOTO leads the world in innovating eco-friendly products that simply perform better. That means peace of mind, knowing that your TOTO fixtures will perform at the highest level, day in and day out, year after year, and look beautiful doing it.

TOTOUSA.COM | 800.350.8686

©2012 TOTO U.S.A., Inc.



CONTINENTAL SHIFT

With the economies of many African countries growing rapidly, the continent's cities are beginning to reflect the enormous potential for creating a new urban realm.

BY HOWARD W. FRENCH

FROM THE AIR, Juba, South Sudan, the capital of Africa's newest country, looks like nothing so much as a giant village, sprawling brown, flat, and ragged from the banks of the White Nile. At first glance this might seem a most unlikely frontier for architects seeking new markets, but the closer one looks, the more this city begins to resemble a vast construction project waiting to happen.

I had been warned to carry a lot of cash with me here, because there were no international banks, much less functioning ATMs, from which to access funds. But wandering by foot "downtown" my first evening in the city, on a dusty side street I stumbled upon the gleaming local headquarters of Stanbic Bank, a subsidiary of South Africa's Standard Bank and a major presence around the continent. When I inquired, the watchmen standing guard out front informed me that the large blue glass-and-metal structure had been inaugurated by the new nation's president that very week.

This country may embody underdevelopment like few other places, but because it is swimming in oil wealth, lots of other banks will undoubtedly follow Stanbic's example in the near future—and that is just for starters.

For the time being, South Sudan's year-old government works out of a jumble of white buildings—half overgrown villas, half hastily built concrete blocks—at one end of the city's main avenue, across the road from a national stadium that comprises little more than a pair of opposing bleachers and a forlorn dirt field. Someday, perhaps soon, these will be replaced by an administrative district that will give a fresh definition to this fast-growing city of 300,000 people. Who will design

and build it remains an open question.

In large part because of its newness, South Sudan is an extreme example of a phenomenon taking place all over sub-Saharan Africa. Here, a combination of some of the world's most vigorous economic growth—at least a dozen African economies have grown by 6 percent or more a year for six straight years—and the planet's fastest urbanization rates are creating new cities and reshaping existing ones on a scale exceeded only by China. This phenomenon, which is likely to last at least until mid-century, is underpinned in equal parts by strong international demand for the continent's immense mineral and hydrocarbon riches and by the rapid rise of new middle classes in one country after another.

But South Sudan is an extreme example in another sense, too. Whether the country will be able to harness its resources for the huge building boom that is so clearly needed will depend on whether it can reach a *modus vivendi* with Sudan, the country to the north from which it recently seceded—and, just as crucially, whether its leaders can keep corruption within reasonable limits.

High political risk—involving poor governance, weak rule of law, and corruption—is a problem in many African countries. Yet international players are increasingly attracted to the continent's markets, including in the construction industry, because the demographic and economic fundamentals are so strong. By 2050, one in four working-age people in the world will be African, and 60 percent of the continent's population will live in cities, compared with about 40 percent now, according to the United Nations. Because Africa's overall popula-

tion rate is zooming, there will be three times as many urban dwellers as there are today. Like people everywhere, a great many of them will demand to shop in modern malls, to stay in international-style hotels, and to live and work in modern buildings.

In the last two years, traveling widely around the continent while researching a book about China's booming relations with Africa, I have seen glimpses of this emerging urban realm in city after city. New expressways deliver motorists to the hearts of fast-growing capitals like Windhoek, Namibia; Dakar, Senegal; and Bamako, Mali. Construction cranes crowd the skyline in cities as far-flung as Dar es Salaam, Tanzania; Lusaka, Zambia; Accra, Ghana; and Maputo, Mozambique.

The last of these countries, and places like Guinea, Liberia, and Sierra Leone, are now embarking on huge, resource-fueled booms that stand to transform decrepit and overcrowded capitals. Thanks to massive coal exports and vast discoveries of natural gas, Mozambique has enjoyed an annual average growth rate of 7.2 percent for a decade. The resulting optimism has spurred the first big building push in Maputo, the elegant but hitherto sleepy seaside capital, since independence from Portugal in 1975.

In Nigeria's commercial capital, Lagos—which could become the world's third-largest city by mid-century, with a population approaching 40 million—an ambitious light-rail system is under construction, along with an entirely new district that will be half financial center and half high-end oceanfront residential neighborhood. The land for this bold project is being reclaimed from the sea.

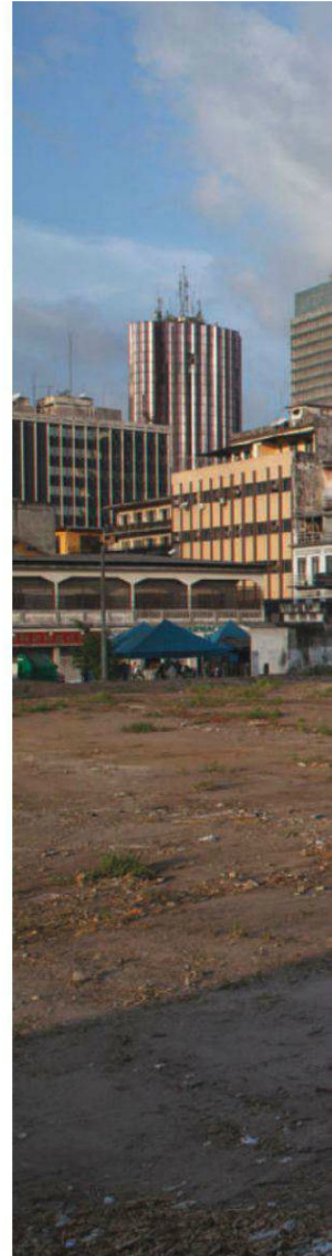

ABIDJAN, CÔTE D'IVOIRE

By mid-century, 60 percent of Africa's booming and relatively young population will live in cities like this modern metropolis, which, with more than 5 million people, is now the second largest on the continent.



Meanwhile, south along the Atlantic coast, Angola has seen some of the fastest economic growth in the world, averaging over 17 percent per year between 2004 and 2008, with 9 percent growth expected next year. Large swaths of the capital, Luanda, are being completely rebuilt, with modern new quarters rising to replace blighted squatter settlements. At the same time, the city's colonial Portuguese seafloor, which compares for scenic value with Havana's more famous Malecón, is being lavishly restored and refurbished.

However ambitious, ongoing building spurts like these represent only a small foretaste of the construction and property boom that is likely in store for much of sub-Saharan Africa.

To get a sense of what is to come, it helps to consider the not-so-distant

past. Tanzania, Côte d'Ivoire, and especially Nigeria all stand out as exemplars of a kind of boldness of urban development that few outsiders associate with Africa. In each of these countries, new capitals were decreed and built, each more ambitious than the last—beginning with Dodoma, Tanzania, in the 1970s and followed by Yamoussoukro, Côte d'Ivoire, in the 1980s and Abuja, Nigeria, in the early 1990s.

Yamoussoukro's international claim to fame ever since has been the largest church in the world, the Basilica of Our Lady of Peace, built by the country's late founding father, Félix Houphouët-Boigny, and finished in 1989 at a reported cost of \$300 million. The city contains other monumental structures, such as a presidential palace made famous in the writings of V.S. Naipaul,

a large five-star hotel complex, and, most recently, a National Assembly building. But Yamoussoukro has never drawn large-scale migration from other parts of the country, and its avenues, some as broad as Paris's Champs-Élysées, remain eerily free of traffic.

By contrast, Abuja, the capital that Nigeria began to build in 1991, has quickly become one of the biggest cities in Africa's most populous country. When I first visited there, in 1994, the neighborhoods meant to house newly arrived civil servants emerged from an uninspiring grid and still had a rough and unfinished feel to them. Back then, the streets were also largely deserted. The city's two big international hotels were the main focus of life and housed senior officials—and sometimes even their domestic staffs, who cooked their

meals in the rooms—for long-term stays.

Although the official census puts Abuja's population at just over a million, Nigerian demographers say that the true number today approaches 5 million, and the city has quickly established itself as one of the biggest and busiest construction markets on the continent, with office buildings, modern housing complexes, and shopping centers rising everywhere.

Unless they do more to join the

ministries, hospitals, national theaters, and new central-business-district complexes.

Perhaps the best measure of China's ambition can be found in oil-rich Angola, where the China International Trust and Investment Corporation (CITIC) is completing work on an entire satellite city at Kilamba, 18 miles from Luanda. This new urban development, comprising 750 eight-story apartment buildings, a dozen schools, and more

designs that convey an off-the-shelf feel. Their building costs are low, but it is the lack of originality and the rapid execution that have fed a widespread perception among Africans of cheap quality and even poor durability.

Though China is aggressively pursuing development, certain competing players are undaunted, seeing huge, untapped possibilities. Here South Africa is the best example, with its architecture and building firms



JUBA, SOUTH SUDAN

A road near the dusty capital, a few months before South Sudan became the world's newest nation last year. Chinese investors have a jump-start here, as they do in much of Africa.

ongoing building fray, students of African urbanism may look back someday at Yamoussoukro and Abuja as the high-water mark for Western architecture and city design in Africa. With the end of the Cold War, the West's engagement with the continent faded sharply, leaving a void that China has moved energetically to fill since the turn of the century.

Nowadays, there are few major African cities without significant Chinese building projects underway, and the Chinese construction firms plying these markets have moved well beyond their initial penchant for large stadiums to sleek airports, government

than 100 retail spaces, was built at a cost of \$3.5 billion in a mere three years.

With their own economy now slowing, Chinese builders are looking to Africa to pick up the slack, pushing plans for similar satellite cities in numerous markets including Nigeria, Kenya, and Mozambique. Although China has drawn controversy and criticism for employing large numbers of its own workers in the construction of projects like these, its biggest advantage probably lies in the low financing costs its companies can offer because of support from China's state-owned banks.

In most of their big projects in Africa, Chinese companies have used

ranging ever farther in new markets, notably Nigeria.

The opportunities for international architecture and construction firms are potentially enormous. If, as more and more experts are beginning to predict, Africa can sustain its recent strong economic growth, what has long been discounted as the world's poorest continent will instead become the scene for globalization's next big act. ■

Howard W. French, an associate professor at the Columbia University Graduate School of Journalism, is the author of A Continent for the Taking: The Tragedy and Hope of Africa.



FORWARD THINKING

Western-trained architects are designing housing, schools, and buildings for social services in Africa's expanding cities and its rural areas. Here's a look at a number of projects currently on the boards. **BY ASAD SYRKETT**

ARCHITECTS HAVE long traveled to far-flung corners of the world in search of inspiration, information, and work. But few places remain as unfamiliar to most architects as Africa—a continent with an area equal to the United States plus Europe and half of Asia. According to the World Bank, Africa's rural populations are moving into urban centers at such a rate that 60 percent of the people will live in cities by the middle of the century. Urban areas are booming, along with opportunity to build.

But many Western architects fail to see the potential. "People have very strong notions of Africa based on specific, singular images like famine and war," says Bjarne Mastenbroek, whose Amsterdam-based firm, SeARCH, completed the Dutch embassy in Ethiopia in 2005 (RECORD, December 2006). Increasingly, however, American architects are ignoring these misconceptions, working with not-for-profit foundations and government agencies to get commissions.

The most successful designs are those that don't just import stale Western ideas but respond to the local topography and culture. That's how New York-based design-build practice SHoP Architects landed the job to design the graphic, 320,000-square-foot Botswana Innovation Hub, a new center for technological and scientific research. Botswana's dry, hot climate and local basket-weaving tradition inspired aspects of SHoP's design, explains founding principal William Sharples.



SHoP ARCHITECTS

GABORONE, BOTSWANA The Botswana Innovation Hub (BIH), top and above, will be a 320,000-square-foot center for research in technology and science. SHoP snagged the \$100 million commission through a competition sponsored by Botswana's government, with its plan for a sustainable series of interconnected offices and laboratories; the BIH is designed to be the country's first LEED-certified structure. Government officials, who are still raising construction funds, hope the building will spur growth in the country's tech sector, decreasing the nation's economic dependence on diamond mining by providing a place for local and foreign entrepreneurs to incubate ideas and interact.



KÉRÉ ARCHITECTURE

LAONGO, BURKINA FASO The late German film and theater director Christoph Schlingensiefel convinced Berlin-based architect and Burkina Faso native Diébédo Francis Kéré to build the Opera House for Africa, a music-education complex, in the landlocked country known as a center of African film and music. The first phase, which opened in October 2011, is a school for up to 500 local children. The 30-acre master plan includes several clay-and-cement pavilions that will house a theater, guesthouses, and a health center.



FREDERIC SCHWARTZ ARCHITECTS

DIAMNIADIO, SENEGAL Former Senegalese president Abdoulaye Wade commissioned New York-based architect Fred Schwartz to design One Family, One Home, an 800-acre town plan with 3,600 units of affordable housing north of the capital city, Dakar. The new town will also provide parks, shopping, schools, and other services for a working-class population. Ground was broken for phase one in October 2011, and construction is under way.

EHRlich ARCHITECTS

ABUJA, NIGERIA In the 1960s, California architect Steven Ehrlich was a Peace Corps volunteer in Africa, working for Morocco's Department of Urban Planning. After his service, Ehrlich traveled around the continent, living in Mali for a time and finally arriving in Zaria, Nigeria, to teach architecture at Ahmadu Bello University. In the mid-1970s he completed his first work on the continent, for the university, a clay-and-mud

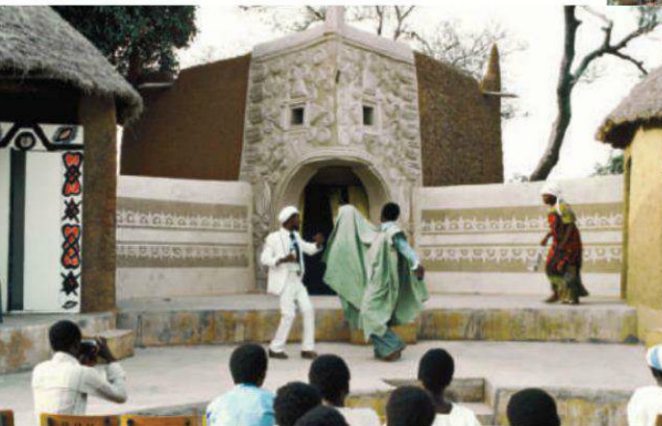

amphitheater that features bas-relief carvings in a traditional pattern (left). In 2009 Ehrlich won a competition to build the New Abuja Gate City, a 98-acre complex and symbolic entryway into the new Nigerian capital, Abuja. Commissioned by the government and designed to resemble a traditional bow harp, the gateway is meant to symbolize national unity. Its packed program includes a reception hall, children's zoo, gymnasium, and marketplace. It's not clear when construction will begin on the project.



SHARON DAVIS DESIGN

KAYONZA, RWANDA The nonprofit Women for Women International (WFW) commissioned New York architect Sharon Davis, who had worked with WFW in Kosovo, to design the Women's Opportunity Center. The 5-acre "mini-village," with classrooms, dormitories, and communal spaces, is meant for women survivors of the war in Rwanda. Canopies of corrugated metal sit atop circular bases of handmade brick, fired and produced by local women. WFW hopes to open the center on March 8, 2013, International Women's Day.



DeBARTOLO ARCHITECTS

SHEBRABER, ETHIOPIA Phoenix-based architect Jack DeBartolo partnered with the nonprofit Engineer Ministries International to design the Shebraber School, a K-12 facility in this rural town near the Ethiopian capital, Addis Ababa. DeBartolo developed both a master plan and construction documents with a group of Arizona State University students of architecture and design. Now under construction, the library, community spaces, and school building are slated for completion in late 2013.

This project and a host of others—including a master plan for affordable housing in Senegal by New York-based Frederic Schwartz Architects and an opera “village” in Burkina Faso by native architect Diébédo Francis Kéré, who practices in Berlin—reflect the ambition of clients across the continent. One prolific client, the Aga Khan Development Network, which has raised the profile of Muslim architecture in Africa with a triennial award, has begun commissioning its own projects, including a university in development in Tanzania, with a master plan by Beyer Blinder Belle of New York and design by Weiss/Manfredi, also of New York, and Mexican firm Legorreta + Legorreta. Smaller but no less significant pro bono work for social initiatives—like Phoenix architect Jack DeBartolo’s Shebraber School in Ethiopia or New York-based Sharon Davis’s Women’s Opportunity Center in Rwanda—points to an ethos of forward-thinking, inventive architecture on a variety of scales.

Such adventurous approaches don’t mean there aren’t serious challenges for architects who build in Africa. Simply transporting materials to a site can be a major stumbling block. Just ask Louise Braverman, who had rebar and other industrial goods unavailable in the small central African nation of Burundi shipped to the site of a new health complex from “as far afield as Dubai and Israel,” she reports. That’s one reason why local design and building traditions often figure prominently in the work of Western architects in Africa. Increasingly, this is a way to meet the challenges posed by difficult climates and poor transportation infrastructure. In the years to come, the best of contemporary architecture on the continent is likely to be this hybrid of Western design and local construction methods, rather than an imposition of Western styles in the vein of the colonial era. The goal is “to break the gaps between the Western world and Africa,” says Mastenbroek of SeARCH. “We can create a dialogue through architecture.” ■

LOUISE BRAVERMAN ARCHITECT

KIGUTU, BURUNDI Louise Braverman’s plan for this 40-acre medical campus in Burundi, contracted by the nonprofit organization Village Health Works, includes a 29,000-square-foot women’s health center, staff residences, and several other facilities. Though operating rooms require HVAC, the New York-based architect designed most of the buildings on site to be naturally ventilated, and the complex will produce its own electricity with photovoltaics and other energy sources. Phase one of construction—the staff residences—is scheduled for completion this fall.



ADJAYE ASSOCIATES

ELMINA, GHANA London- and New York-based architect David Adjaye is currently developing a number of projects in Africa, including at least two in Ghana. Elmina College, a private international boarding school (left) on 116 acres, is modeled on a Maghreb military fortification, elevated and centered on a quad within its forested site.

PRINCES TOWN, GHANA Adjaye’s design for a 52,000-square-foot five-star resort, commissioned by British-Ghanaian developer Soroma Capital, sits along Ghana’s southern coast (below). It, too, draws on the country’s history, incorporating a former German fort, built in 1683, that is now a World Heritage site.



[INTERVIEW]

DAVID ADJAYE REVISITS AFRICA

The architect spent 11 years traversing the continent, working on a book and reconnecting with his past.

Since starting his own firm in London in 2000, the award-winning David Adjaye has designed artists' studios, retail spaces, and public buildings such as the Nobel Peace Center in Oslo and the National Museum of African American History and Culture, currently under construction in Washington, D.C. Born in Tanzania to Ghanaian parents (his father was a diplomat), he grew up in various parts of Africa before studying architecture in London. Deputy Editor Clifford A. Pearson sat down with him at his New York City office to discuss the economic, demographic, and architectural changes sweeping through many parts of Africa.

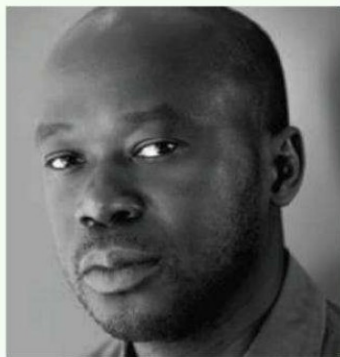

ARCHITECTURAL RECORD: Your book *African Metropolitan Architecture* was published this past year. What made you decide to start such a project?

David Adjaye: It began as an autobiographical effort, a way to return to my childhood. For the first 13, 14 years of my life, my family moved around—east Africa, north, and west. My memories had become thinner, and I just wanted to reconnect with these places.

How did you go about doing the research?

I started in 1999 and slowly visited all 53 capital cities. [With the establishment of South Sudan in July 2011, there are now 54 countries in Africa.] I would hire a car and driver and spend a few days, a week, two weeks exploring a place. I would spend day and night with the driver, so invariably we would become great friends. We would drive until we exhausted the city. When I felt like I couldn't take any more photographs, I would stop. I used just a digital camera to keep the process discreet. Africans don't really like being photographed, contrary to all those images you see of children running around everywhere.

How did the project turn into a book?

I showed some of the photographs to friends in the U.K., Europe, and the U.S., and realized that they had no idea of what Africa was like; they had no imagery of the built environment there. I found that astonishing. There are nearly 1.5 billion people living in Africa, but

nobody in the West seemed to know anything about the urban context there. Then I did a show at Harvard and got an amazing response. People were really excited. They hadn't seen images of Africa taken from an architect's perspective.

What did you learn that was most significant about Africa?

Working on the book taught me that you can't understand Africa until you realize that it has six extraordinary geographic zones—each one very precise and extreme. In the northwest you have the Maghreb, then to the east you have the desert, and to the south the

Sahel, which is between the desert and the forest. Other parts of the continent are forest lands or savanna or the mountains. Foreigners look at Africa with its dozens of countries and find it bewildering. But if you think of it as six climatic zones, then you can start to understand it. An American architect can look at Mali and Chad and relate to them as an Arizona-type region, or see Ghana and Mozambique as a bit like California. Each place, of course, has its own particularities, but culture grows from climate. And linguistically, there are really just two zones—the Anglophone world and the Francophone world—with Arabic in the north and Portuguese in Angola and Mozambique.

What about the political situation?

Since the end of colonialism 50 years ago, places that had been groups of kingdoms have been trying to establish national identities. These are young countries, not nations. Many of them are still struggling to identify who they are, while accelerating into the 21st century. There's also an awareness that Africa is having its Brasília moment, with about 25 countries building their capital cities, their infrastructures, their identities. And they're all wrestling with figuring out what the right model should be.

There seems to be a struggle between the concept of the nation-state and what came before in Africa.

I was talking at a conference in Nigeria recently, which was attended by lots of mayors of African cities. I was hammering home this idea that you've got to stop thinking about the

nation, which is perfect for politics and governance but doesn't help when it comes to culture. For culture, you have to go back to the regional and the geographic. What are your regional ties? When you do this, you realize that actually the river-delta people have similar cultures whether they're in the east, west, or south. They're unique peoples, but they have the same kind of climatic conditions and the same kind of identities. Yes, Namibia is different from Ethiopia, but they share a mountain culture. And when you're there, you feel that. I think we sometimes overplay the specifics of history to the detriment of understanding the bigger picture of nature. People may speak 10 different languages, but if they work the land the same way and grow the same crops, they're going to have the same kind of culture. The specifics may be different, but the essential DNA is the same.

How does this translate into architecture?

I was speaking with Gregg Pasquarelli [one of the partners at the New York firm SHoP] after they won a huge project in Gaborone, Botswana, for an innovation center [page 61]. They won because they showed a specific response to the geology and geography of that place. And that's what Africa at this moment is interested in. How do you respond to this extreme climate and make an architecture that becomes African?

Having spent the first part of your career working on projects in the U.K., Europe, and the U.S., you are finally getting the chance to build in Africa. Where are you working there?

At the moment, we're doing projects in Accra [Ghana], Lagos [Nigeria], and Libreville [Gabon]. We're doing a complete range of work there, from educational to cultural to housing. The educational projects include both K-12 schools and a new university. Private-sector universities are opening in Africa now, which is changing the educational landscape. In Lagos we're doing retail work and housing. We may be getting projects in Cape Town and Nairobi. Kenya is booming. Uganda is booming. With the discovery of gas and oil recently, the east African corridor is going to experience a massive shift. Suddenly these countries are able to raise billions of dollars in bonds. The Chinese are involved in a lot of the work, but it's still up for grabs because there is so much of it.

What are the critical building needs there?

A lot of it is infrastructure. But when I say infrastructure, I mean it in the broadest sense—including not just roads, but the architecture of governance. Many of these countries want to build new administrative centers that reflect the modern world. Architecture needs to be used in a way that helps them establish a relationship with their citizens. ■



Sipopo Congress Center | Equatorial Guinea |
Tabanlıoğlu Architects

DIPLOMATIC MANEUVER

A Turkish firm combines natural forms and rich materials in a meeting hall for the African Union.

BY WILLIAM HANLEY

GRAND ENTRANCE A double-height space finished in wood, glass, marble, and metal greets visitors attending meetings at the Sipopo center.

FIRMS WORKING everywhere from China to Saudi Arabia have to navigate the often grandiose ambitions of authoritarian regimes. With the Sipopo Congress Center, Murat Tabanlıoğlu says his Istanbul-based firm used the challenge to design “a showcase” for Equatorial Guinea as an opportunity to promote peace and development across Africa. A glass box wrapped in a geometric painted aluminum screen, the project was built in 2011 to house meetings of the Assembly of the African Union, an annual gathering of heads of state from the organization’s 54 member countries. Equatorial Guinea’s long-ruling leader, Teodoro Obiang Nguema Mbasogo, had been struck two years earlier by the luminous hall that Tabanlıoğlu Architects designed for Tripoli, Libya, when it hosted the Assembly, and he asked the firm to create a similarly impressive structure for the Union’s meetings in his country. (The Tripoli building survived the revolution that toppled Muammar Gaddafi, though work stopped on a nearby conference center there by Zaha Hadid.)

Tabanlıoğlu agreed his firm would take the commission, focusing, he says, less on working for another autocratic government than on promoting the African Union. “We were aiming to create a scene for negotiations and peace among many countries,” he says. “Nature and harmony were the elemental inspirations for the building.”

A two-story steel structure, the 148,000-square-foot congress center positions three gathering spaces and a restaurant around a central meeting hall. Raised on a plinth, it is connected by a narrow, glass-enclosed bridge to a separate, existing convention center (built by the China State Construction Engineering Corporation a few years earlier). The congress center’s most distinguishing feature is the shimmering metal screen that veils its double-glazed facade in a curtain of geometric filigree. To be ready in time for the African Union meetings

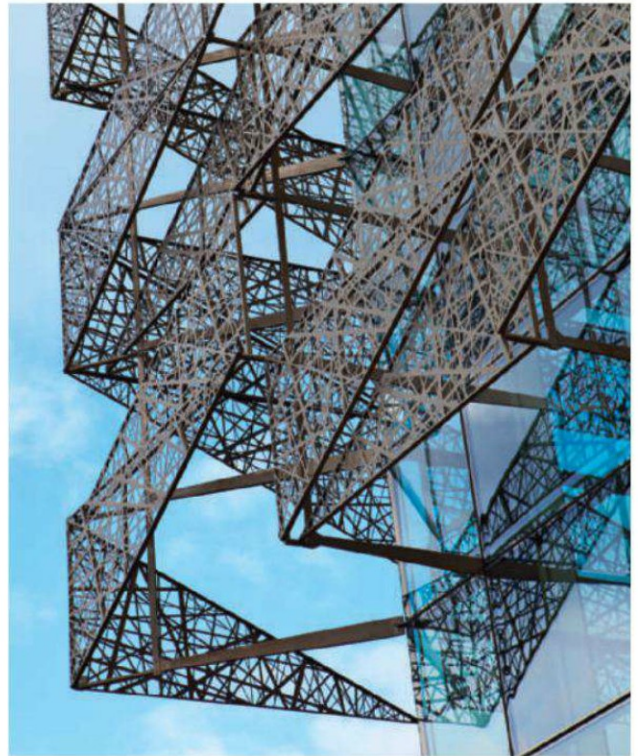

ORNAMENTAL NATURE The designers based many of the Sipopo center’s details on Bioko island’s tropical flora. Murat Tabanlıoğlu arrived at the pattern on the project’s exterior metal screen (above) by first sketching the canopies of trees in the surrounding forest and abstracting the forms into an irregular geometric lattice (top).

Members of the Assembly of the African Union arrive at the Sipopo center via a bridge (opposite, top) that connects the project to an existing convention hall. The firm modeled the alternating mirror and wood panels of the wall coverings in the restaurant (opposite, bottom) on the skin of local pineapples.



in June 2011, the entire building was designed and built in six months by Tabanlıoğlu and the large Turkish construction firm Summa. Obiang was pleased with the result. “The building was like an Olympic stadium,” says Tabanlıoğlu. “It was important for him to show it off to the other African leaders.” The building is currently used for a rotating program of conferences.

Located in the coastal curve of West Africa, Equatorial Guinea consists of three primary islands and a mainland swatch wedged between Cameroon and Gabon. The capital, Malabo, sits on the northern tip of Bioko, the largest of the islands. Obiang took power in a 1979 coup and has presided over an economic boom since the discovery of large oil reserves—estimated at 1.1 billion barrels—in the mid-1990s. The Sipopo center is part of an oceanside development on the capital city’s northeastern edge that also includes a cluster of hotels and recently built infrastructure, all primarily financed by oil revenue. (Travel to Equatorial Guinea by foreigners can be difficult, and RECORD was unable to send a reporter to view the project in person.)

The building’s glazed envelope provides views to the ocean on one side and a forest on the other. Tabanlıoğlu made preliminary sketches for the metal screen’s angular bands based on the canopies of surrounding ceiba trees. “When you go there, you see buildings made by local people without architects, you see colonial buildings that came from the French and the Spanish, and you see new hotels and office buildings that look like they came from Europe and landed on the island,” he says. “It was important for us to distinguish our building by making it part of the surrounding nature.”

Working with an Istanbul fabricator, the firm made several mock-ups of the screen before settling on a series of triangular units that could be shipped to the project site and bolted to the facade. The screen’s hatching is densest on the upper portions and at the angles where the equatorial sun shines most directly into the glass. The pattern becomes more open as it moves down the facade to

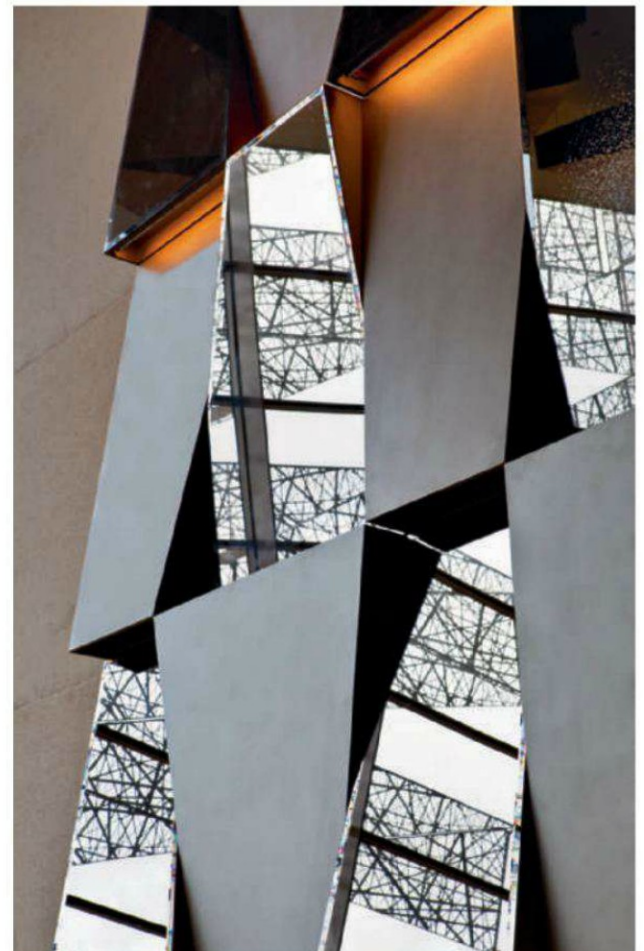

- 1 MEETING HALL
- 2 RESTAURANT
- 3 LOUNGE
- 4 LOBBY
- 5 BRIDGE

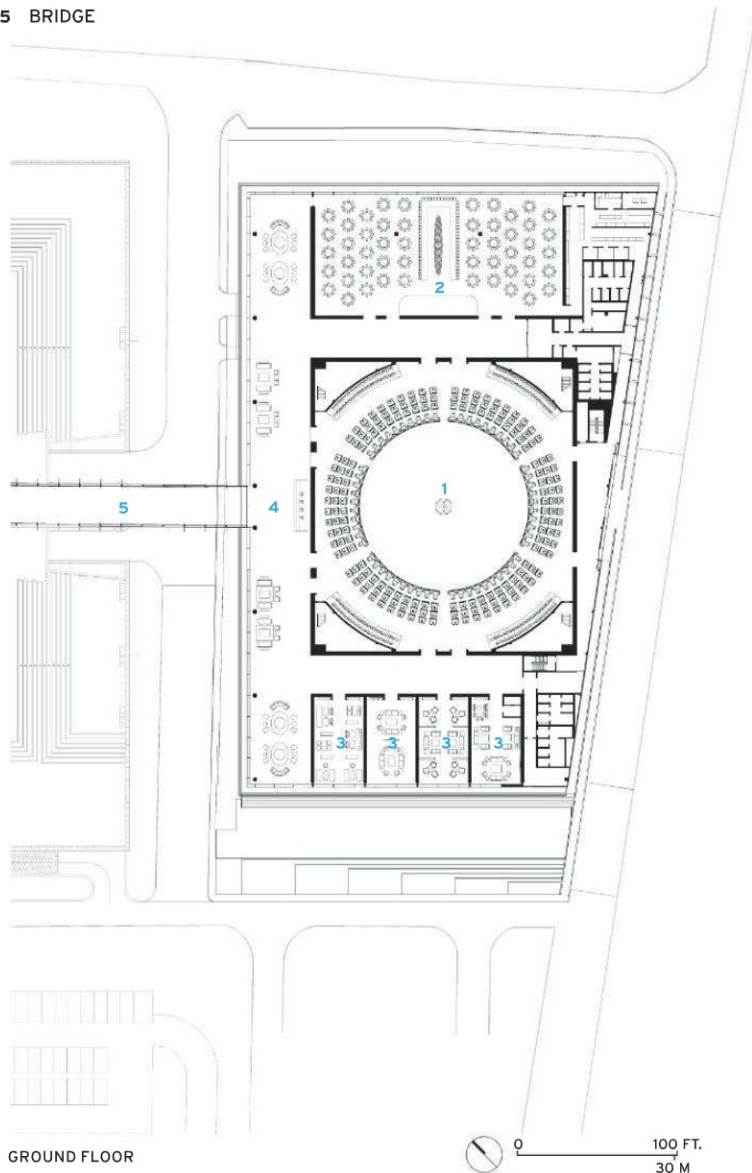

GROUND FLOOR

credits

ARCHITECT: Tabanlıoğlu Architects – Murat Tabanlıoğlu, Melkan Gürsel, Salih Yilgörür, Ali Çalıoğlu, Sertaç Tümer, Utkan Yonter, Emre Çetinel, Elvin Erkut, Tuğçe Güleç

ENGINEERS: Emir Engineering (structural); DT Engineering (m/e/p)

CONSULTANTS: Ateksis (sound and media); Abdurrahman Kılıç (fire); ZKLD Studio (lighting)

CLIENT: GE-Projectos (Oficina Nacional de Planificación y Seguimiento de Proyectos de Guinea Ecuatorial)

GENERAL CONTRACTOR: Onur-Summa

SIZE: 148,000 square feet (gross)

COST: withheld

COMPLETION DATE: June 2011

SOURCES

GLASS AND ALUMINUM FACADE: Arte

METAL MESH SCREEN: Arte

WOOD FINISHES AND FURNITURE: Nurus

STEEL STRUCTURE: Modül Çelik/UMD

allow unobstructed views to the landscape.

Inside, the glass-enclosed bridge from the existing convention center brings visitors into a double-height space, where a reception desk stands below an illuminated map of Africa—backlit by LEDs, its glass domes perforate a metal silhouette of the continent with a red lens indicating Malabo's location. The map hangs against a textured chevron pattern of metal and teaklike afrormosia panels that runs the length of the wall. Similar finishes designed by the firm continue in the other double-height spaces that ring the central meeting room, including a restaurant with ocean views on the north side and lounges for visiting dignitaries on the south.

At the core of the building, a box inside a box encloses the 420-seat meeting room. Rings of desks emanate from the open center of the space. Suspended from the ceiling, an array of video monitors can be raised and lowered around a tiered chandelier. Tabanlıoğlu designed it and other lighting fixtures with rainlike droplets of crystal. "Normally these conference centers are very chic places," says Tabanlıoğlu. "We tried to find a way to incorporate natural forms with that expectation." He and his team buried audiovisual equipment and the restaurant's back of house, as well as cooling and other mechanicals, in the building's basement and plinth.

The contractor, Summa, had to import all of the building materials—except concrete—from abroad, which forced Tabanlıoğlu to keep the constraints of shipping containers and cargo planes in mind and to do it all on the tight, six-month timeline. But the resources of Equatorial Guinea's leader kept pushing the project forward. "There were no constraints on the budget," he says. "We don't normally work that way." ■

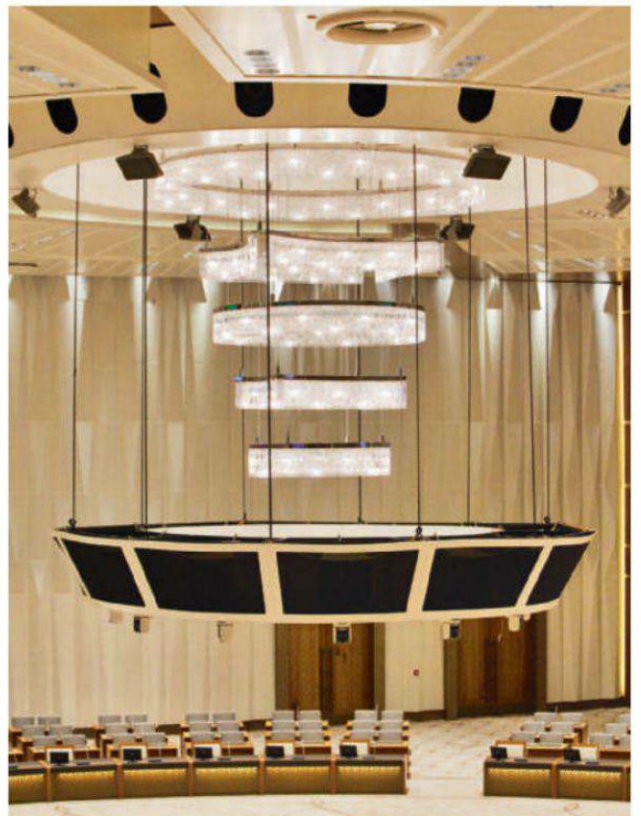



DRAMATIC DETAILS
 Tabanlıoğlu Architects custom-designed most of the Sipopo center's interior finishes, including the raindrop-inspired lighting fixtures (opposite) found throughout the project. The designers used a palette of wood and metal for the interior-wall surfaces in the public spaces (above). They lined sections of the central meeting hall (right) with perforated acoustical panels.



Taxi Rank No. 2 | Diepsloot, South Africa | 26'10 South Architects

ROADSIDE ATTRACTION

A revamped station serves more than just minibus taxis. It engages the entrepreneurial spirit and social vitality of a settlement outside of Johannesburg.

BY HANNAH LE ROUX

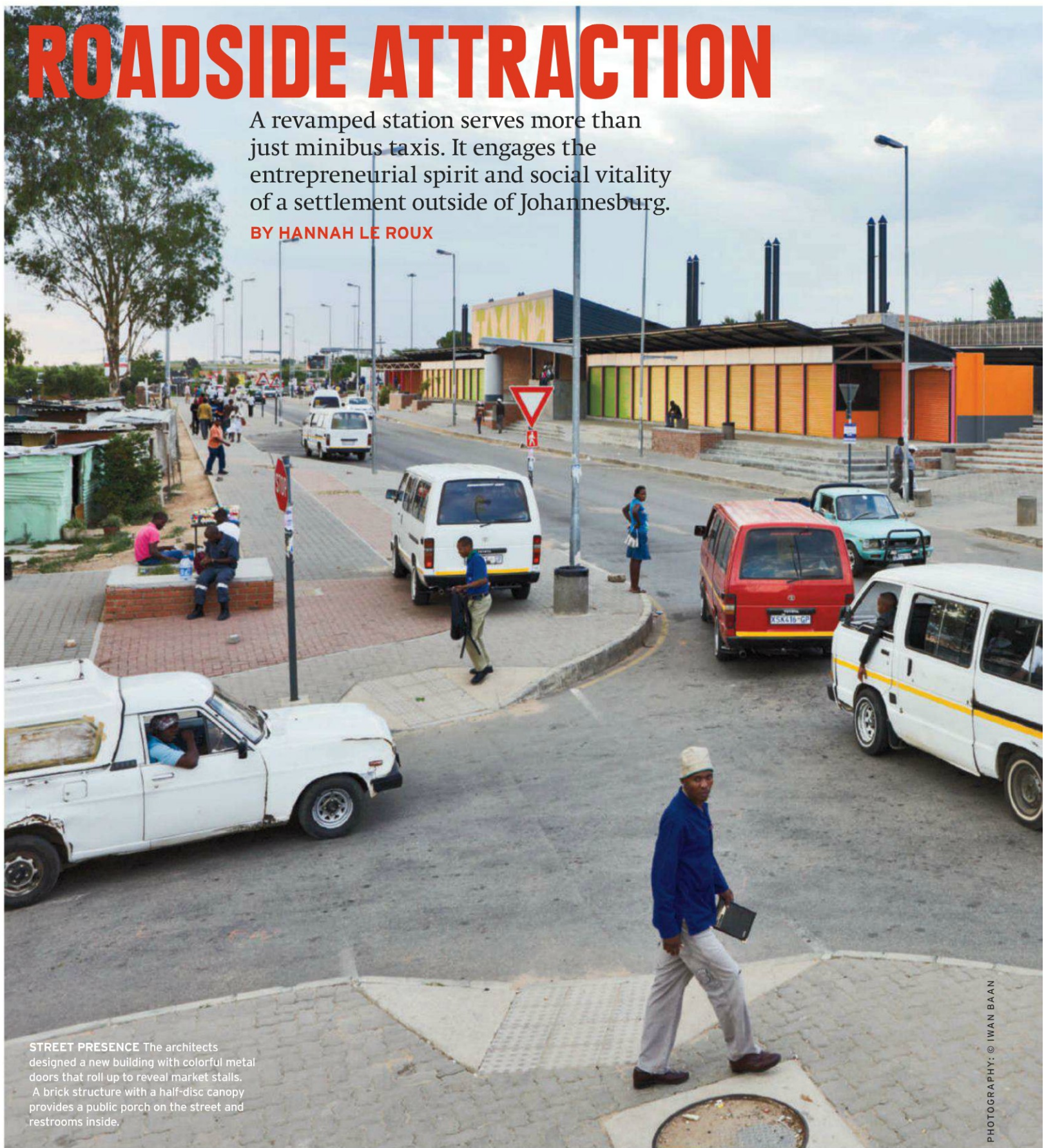

STREET PRESENCE The architects designed a new building with colorful metal doors that roll up to reveal market stalls. A brick structure with a half-disc canopy provides a public porch on the street and restrooms inside.



FROM THE CENTER of Johannesburg, it takes a minibus taxi about an hour to get to Diepsloot, a poor, densely populated settlement beyond the fringes of the city's wealthy suburbs. Trips in the privately managed minibuses—often the only affordable transportation—usually begin and end inauspiciously on a dusty field or at a dark shed surrounded by hundreds of other vehicles. But now travelers to Diepsloot arrive at a very different kind of place: a refurbished taxi station (or rank) that combines bold graphics and an engagement with the small-scale entrepreneurs who bring vitality to South Africa's urban streets.

In the less than 20 years since its establishment, first as an informal settlement and then as a dumping site for evicted squatters, Diepsloot has grown in an ad hoc way with camplike construction and self-built housing. It now has a population of roughly 200,000 people, including immigrants from other African countries, rural job seekers, and low-paid employees who work in Johannesburg's rich northern suburbs, says Anton Harber in his 2011 book *Diepsloot: A Place at the Side of the Road*. Despite its newness and its distance from the city center, the settlement has developed an intricate urban fabric, largely through residents' often-ingenious appropriation of the spaces between its simple buildings.

Thorsten Deckler and Anne Graupner of the Johannesburg firm 26°10 South Architects have been preoccupied with these interstitial spaces since the Johannesburg Development Agency (JDA) appointed them in 2008 to survey one of Diepsloot's main roads, ahead of an upgrade that would relocate the numerous small enterprises encroaching on the street. But as the architects documented the fabric of these shops and social spaces, they realized the effectiveness of self-built, microscaled places in humanizing Diepsloot's urban environment. So they developed an alternative plan to improve the housing stock through small catalytic projects—an effort that unfortunately did not move forward.

Deckler and Graupner have since applied their insights to another JDA project, the renovation and expansion of Taxi Rank No. 2, Diepsloot's main minibus station, asserting the role of microenterprises in the organization of the urban realm. Their design makes significant changes to the existing rank, a utilitarian shed that was set back from the street. The architects lengthened the structure and brought more daylight inside by adding pitched roofs with clerestory glazing above some of the original barrel vaults. They also enlarged a small block of offices and encircled it with a curving brick wall that softens its profile. Other improvements include an expanded toilet block, a service bay for the vehicles, and a new area for garbage bins.

From the street, the most visible portion of the project is a new 400-foot-long structure that functions as a colorful gateway to the taxi queues and flexible space for small shops and services. Constructed on a tight budget with prefabricated steelwork and local labor, this long, narrow building mediates between the taxi area and the street several steps below. Stalls set behind steel roller doors are allocated to traders who sell food, household items, cellular airtime, and clothing, and whose activities create a safer environment for people arriving at the rank in the early morning and at night. An overhanging roof lets shops spill out onto the pavement during the day, while cross-ventilation keeps the covered spaces cool and chimneys remove smoke from stalls

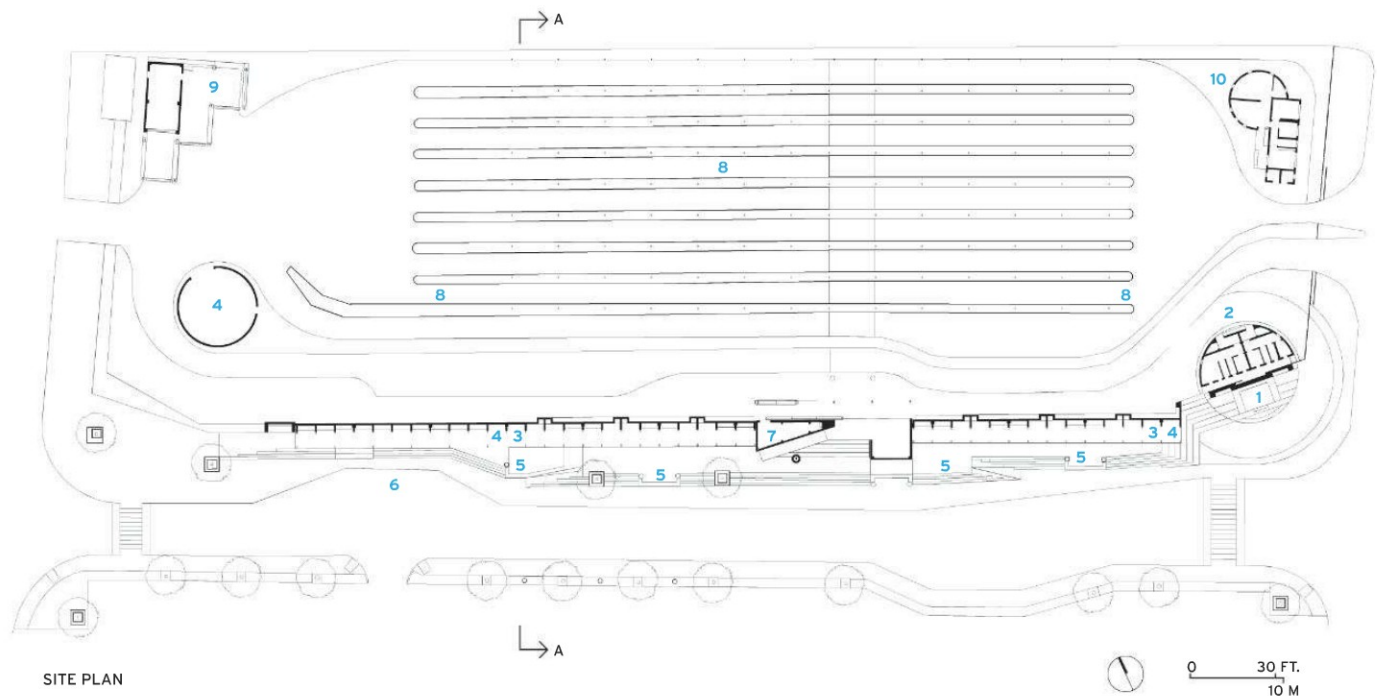

SITE PLAN

- | | | |
|----------------|---------------------------------------|----------------------------|
| 1 PUBLIC PORCH | 5 TRADING STALLS | 8 TAXI AISLES |
| 2 RESTROOMS | 6 BUS STOP | 9 TAXI REPAIRS AND WASHING |
| 3 WASH-UP | 7 UNINTERRUPTED POWER SUPPLY (FUTURE) | 10 ADMINISTRATION |
| 4 TRASH BINS | | |

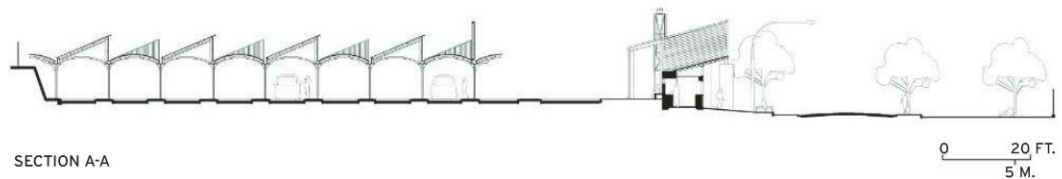

SECTION A-A

where food is cooked. The architects envisage using the stoa-like building's roof for harvesting rainwater and its chimneys as supports for billboards that might provide an extra source of revenue.

Rodgers Makhubele, the local councillor, watched the project throughout its three-year gestation (from December 2008 to December 2011) and is excited about its potential as a model for local development. He understands that the new stalls facing the street will bring immediate value and vitality to the precinct, while other opportunities for the project as a whole develop over time. Makhubele would like to negotiate with the taxi companies and the rank's management to establish a community radio station there and add public art, banking facilities, and temporary stalls and eateries on the north side of the retail building. What he pictures is urbanity itself, happening through an architecture that has secured a space within which it can take place. ■

Hannah le Roux is an architect, writer, and curator based at the University of the Witwatersrand in Johannesburg.

credits

ARCHITECT: 26'10 South Architects & Urban Designers – Thorsten Deckler, Anne Graupner, principals; Nkululeko Bhengu, Stephen Reid, Carl Jacobsz, Guy Trangoš, Lara Wilson, Nzinga Biegueng Mboup, Alexandra Howell, Thulani Rachia, Mtembekhi Ngema, design team
ENGINEERS: Hlanganani Consulting Engineers & Project Managers (structural and civil); Selanya Consulting Engineers (electrical)
CONSULTANTS: Triviron (project management); Envirolution Consulting (environmental and community liaison); PCQS Parsh Chiba (quantity surveyor)
GENERAL CONTRACTORS: Dryden

Construction; Moseme Construction (administration and washroom buildings)

CLIENT: Johannesburg Development Agency

COST: \$1.44 million

COMPLETION DATE: December 2011

SOURCES

MASONRY: Corobrik

CONCRETE PAVERS: Infraset

METAL ROOF: Chromadek

METAL WINDOWS: Durowin

CEILINGS: Rhino Board



SOCIAL HUB The new retail building engages the local community with places to sit and shop (top). The architects added pitched roofs and clerestory glazing above some of the shed's original barrel vaults to bring more daylight to the taxi aisles (this photo).

Universidade Agostinho Neto | Luanda, Angola | Perkins+Will

UNDER AFRICAN SKIES



The first phase of an ambitious national university creates a community of buildings and outdoor spaces adapted to a hot, dry climate.

BY FRED A. BERNSTEIN

WHEN PERKINS+WILL'S Ralph Johnson first visited the site of the new campus of Universidade Agostinho Neto, near Luanda, Angola, in 2001, the five-mile drive from the city center involved military checkpoints, refugees living in squalid camps along the road, and warnings to steer clear of land mines. Back then, the country was still in the throes of a decades-long civil war.

But Angola was beginning to use oil revenue to improve its social infrastructure. At the time, Angolans seeking higher education tended to go abroad. Officials of Indiana University, which had a number of Angolan students, had begun to advise that country's government on ways of improving its own university system. In 1999, they suggested hiring Perkins+Will—a firm known for designing crisply modern academic buildings and for its painstaking attention to sustainability—to build a new campus for Agostinho Neto, the nation's largest public university. (Agostinho Neto was Angola's first president following the country's independence from Portugal in 1975. The university formerly had campuses around the



country; the ones not in Luanda have now become autonomous universities.)

G. William Doerge, Perkins+Will’s international-practice director, served as the point man for the project, traveling to Angola dozens of times during the last 12 years. Now the university is starting to move into its new campus, the first phase of which comprises 350,000 square feet for the faculties of math, physics, chemistry, and computing, and can accommodate 3,000 students.

Perkins+Will has always practiced what the firm’s president, Phil Harrison, describes as “human-centered Modernism.” On trips to Angola, Johnson and Doerge confirmed that their Corbusian aesthetic was appropriate to that country. In fact, Luanda is filled with mid-century buildings (from the last years of Portuguese rule). The trouble, says Johnson, a principal in the firm’s Chicago office, is that the Modernist buildings have been poorly maintained. That observation served as a warning: Make sure the new university buildings are easy to care for, or, as he put it, “have very few moving parts.”

CLIMATE CONTROL

The architects used a number of strategies to accommodate the semi-arid climate and sparsely vegetated landscape, including shading buildings and courtyards with louvered canopies (opposite) and designing raised roofs that work as airfoils to pull hot air up and out. They oriented

buildings 19 degrees off the north-south axis to increase shadows and catch prevailing breezes. As a result, classroom buildings (above and top) use only natural ventilation to cool interior spaces.



The land set aside for the university presented a blank slate, but the architects were determined to create a sense of place even before the campus reaches its ultimate form as an institution accommodating 40,000 students. They did so with an elliptical ring road that helps define an academic village and a pinwheel master plan that arranges buildings around a series of courtyards and orthogonal paths. The first phase concentrates buildings at the center of the plan, with additional faculties to grow along its outstretched arms of streets. Student and staff housing will be added around the academic village.

Phase one includes four classroom buildings and a central library—the latter an R-shaped structure, most of it raised four stories above the ground to allow cooling breezes to reach classroom blocks on its leeward side. (Right now, the library building includes student-union and administrative facilities, which will eventually get their own structures as the library expands.) The library is the only building that is air-conditioned; other structures depend for cooling on the ingenuity of the architects (and consulting engineers Battle McCarthy, based in London) in limiting solar gain and stimulating airflow.

To reduce energy consumption, the architects arranged the academic buildings in what Johnson calls “a simple, linear bar scheme,” with short east-west facades and long north-south facades (adjusted 19 degrees to increase shadows and give prevailing winds—which don’t follow compass directions—the maximum cooling effect). A variety of devices, including painted aluminum sunscreens, allow daylight into the buildings while minimizing solar gain. (Because Luanda is near the equator, sun can shine from north or south, depending on the time of year.) Corridors also buffer classrooms from too much direct sunlight, since a hot corridor is less of an impediment to education than a hot classroom.

But the buildings’ most distinctive features may be their roofs, angled to serve as airfoils. When the wind blows, the zigzag surfaces of galvanized and painted steel reduce the air pressure above the buildings. The decrease in pressure

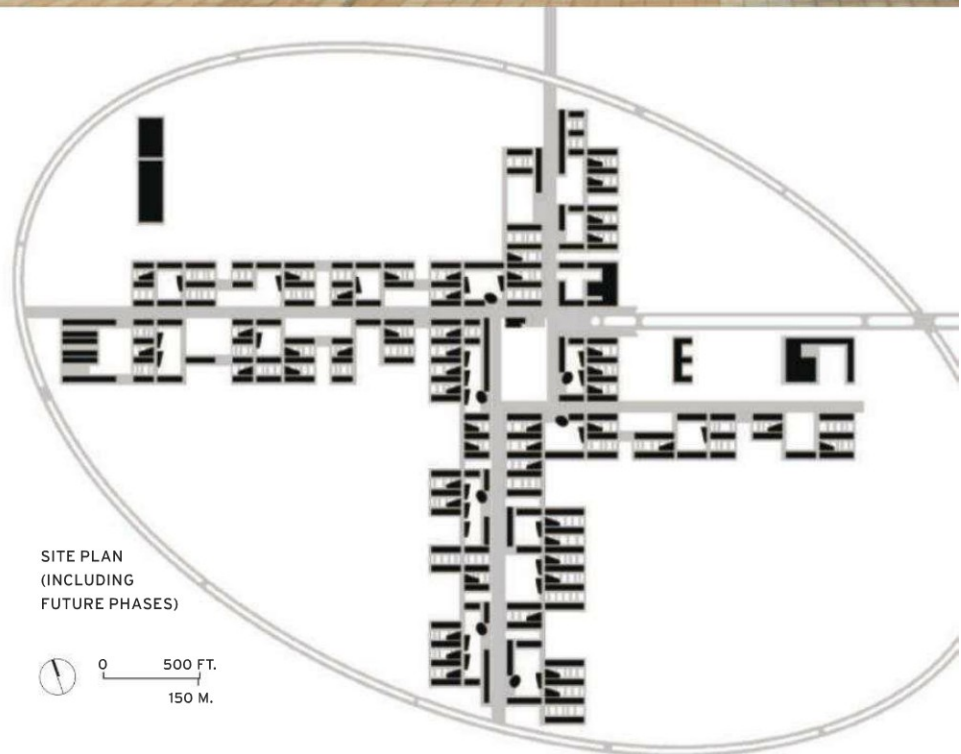

SITE PLAN
(INCLUDING
FUTURE PHASES)

0 500 FT.
150 M.

credits

ARCHITECT: Perkins+Will – Ralph Johnson, design principal; G. William Doerge, project director; David Gutierrez, Thomas Demettrion, Cengiz Yetken, Mark Hartmann, Kenneth Soch, Marius Ronnett, Nathalie Belanger, Bryce de Reynier, Todd Snapp, Angel Ortiz, Flavia de Almeida, Lori Day, Todd Accardi, John Ruthven, Jeffrey Hayner, Michael Weiner, Michael McPhail, design and technical team
ENGINEERS: Dar Al-Handasah/Shair and Partners (structural/civil/mechanical/electrical)
CONSULTANTS: Battle McCarthy (sustainability)

CLIENT: Angolan Ministry of Urban Affairs and Public Works on behalf of the Ministry of Education

SIZE: 350,000 gross square feet (Phase 1)

COST: \$175 million (Phase 1)

COMPLETION DATE: 2011 (Phase 1)

SOURCES

CURTAIN-WALL GLASS: Saint-Gobain

LIBRARY CURTAIN WALL: Technal/Hydro

LIBRARY STEEL ROOF: Seveme; Macalloy

CERAMIC FLOOR TILES: Margres



CAMPUS CORE
 The main library and its sunken plaza serve as the hub of the university (left). Various faculties have their own buildings and courtyards organized in a pinwheel around the academic core. The first phase accommodates four faculties and 3,000 students, but the campus will eventually grow to 6.45 million square feet and 40,000 students (site plan, opposite).

- 1 LIBRARY
- 2 CHEMISTRY
- 3 MATHEMATICS
- 4 PHYSICS
- 5 COMPUTER SCIENCES

PINK = INSTRUCTIONAL SPACES

GREEN = OFFICES

BLUE = ASSEMBLY SPACES

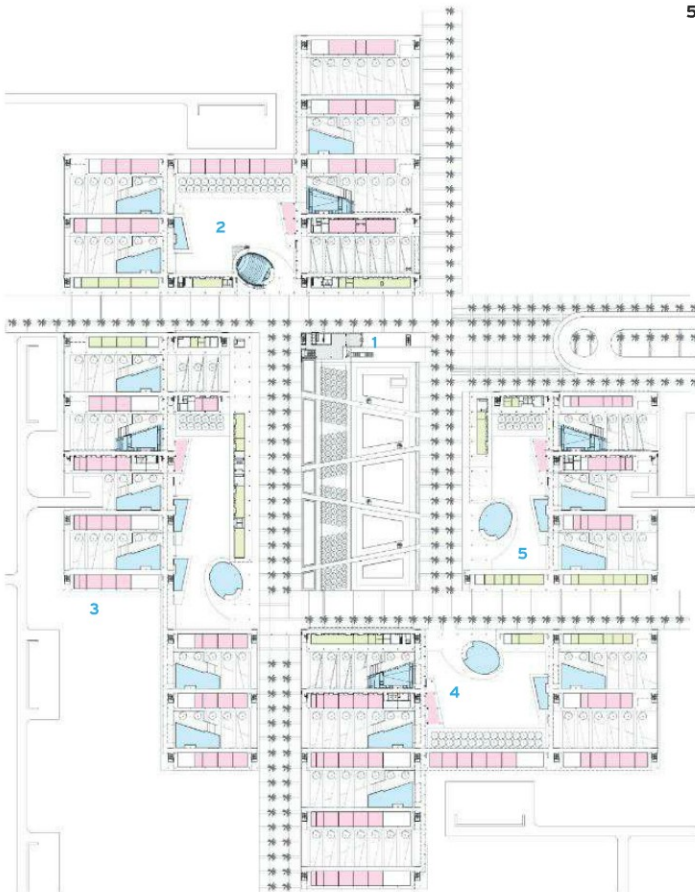

GROUND FLOOR—CORE CAMPUS

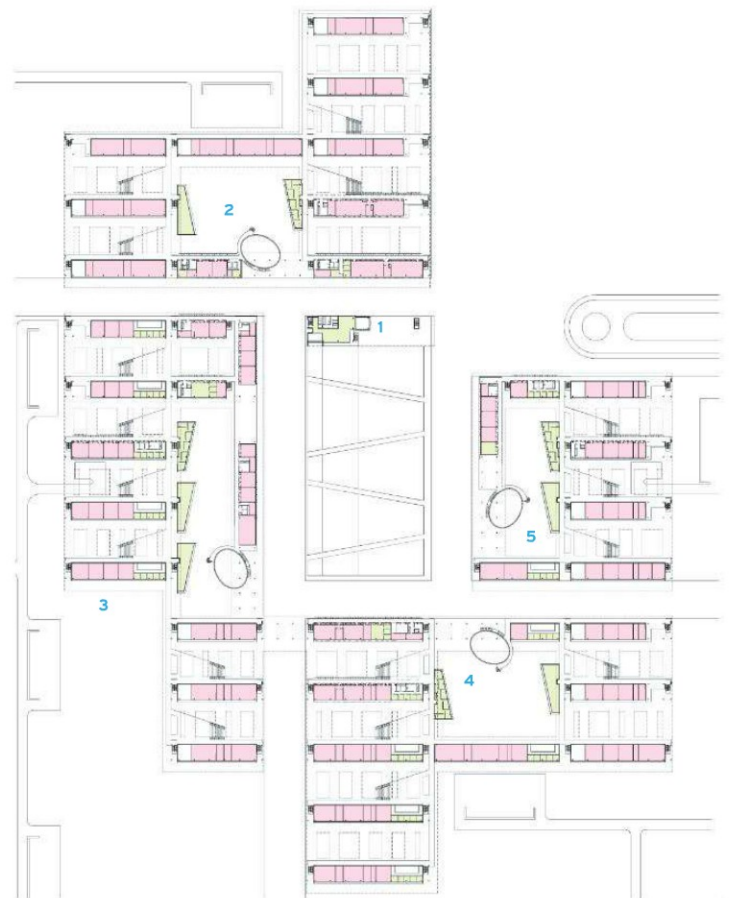

SECOND FLOOR—CORE CAMPUS



MODERN QUADS

Like many traditional universities, Agostinho Neto organizes its buildings around quadrangles. But the architects at Perkins+Will and consulting engineers at Battle McCarthy designed the quads so they form shaded courtyards and increase airflow. The firms used different landscaping strategies for each courtyard to give them unique identities and help students navigate around what will be a very large campus. Administrative offices occupy the middle

levels of the library tower, while the main reading rooms sit at the top to provide views of the campus (above). Additional reading rooms occupy the plaza level around the sunken courtyard (left). The library, the only air-conditioned building on campus, is entered through a four-story-high lobby (opposite).



pulls hot air up and out of the classrooms through operable louvers. The louvers, says Johnson, allow air to get through while keeping dust out. Such methods to keep air moving have been known for centuries, as Doerge points out, but in recent years computer modeling has given architects the ability to fine-tune them for maximum efficiency.

Construction was carried out by a succession of companies, including contractors from South Africa, Portugal, and, ultimately, China, which has been aggressively pursuing business in Angola and throughout sub-Saharan Africa. The poured-concrete frames, formed mostly by the Portuguese contractor, are “as good as I’ve seen anywhere,” says Johnson. (The writer was not able to travel to Angola for this article.)

The firm learned a lot about doing architecture—and business—in Africa. “As with many foreign projects, it sometimes took a while to get paid; we had to be patient,” says Johnson, who notes the firm is now doing 15 percent of its work overseas, including a hospital and a health center in Kenya. The 12-year effort on Universidade Agostinho

The buildings’ most distinctive features may be their roofs, angled to serve as airfoils that reduce pressure and pull hot air out of the classrooms.

Neto was an investment. Its second phase—775,000 square feet—should go out to bid later this year. If the campus is built out as planned—a total of 6.45 million square feet—it will be a kind of “annuity” for the firm, says Doerge. Looking back on the project, Johnson says, “Not only is it important socially, but it’s a real prototype for sustainable design in developing countries.” ■

Contributing editor Fred A. Bernstein studied architecture at Princeton and law at NYU and writes about both subjects.

Red Location Cultural Precinct | Port Elizabeth, South Africa | Noero Wolff Architects

WHERE DEFIANCE BEGAN

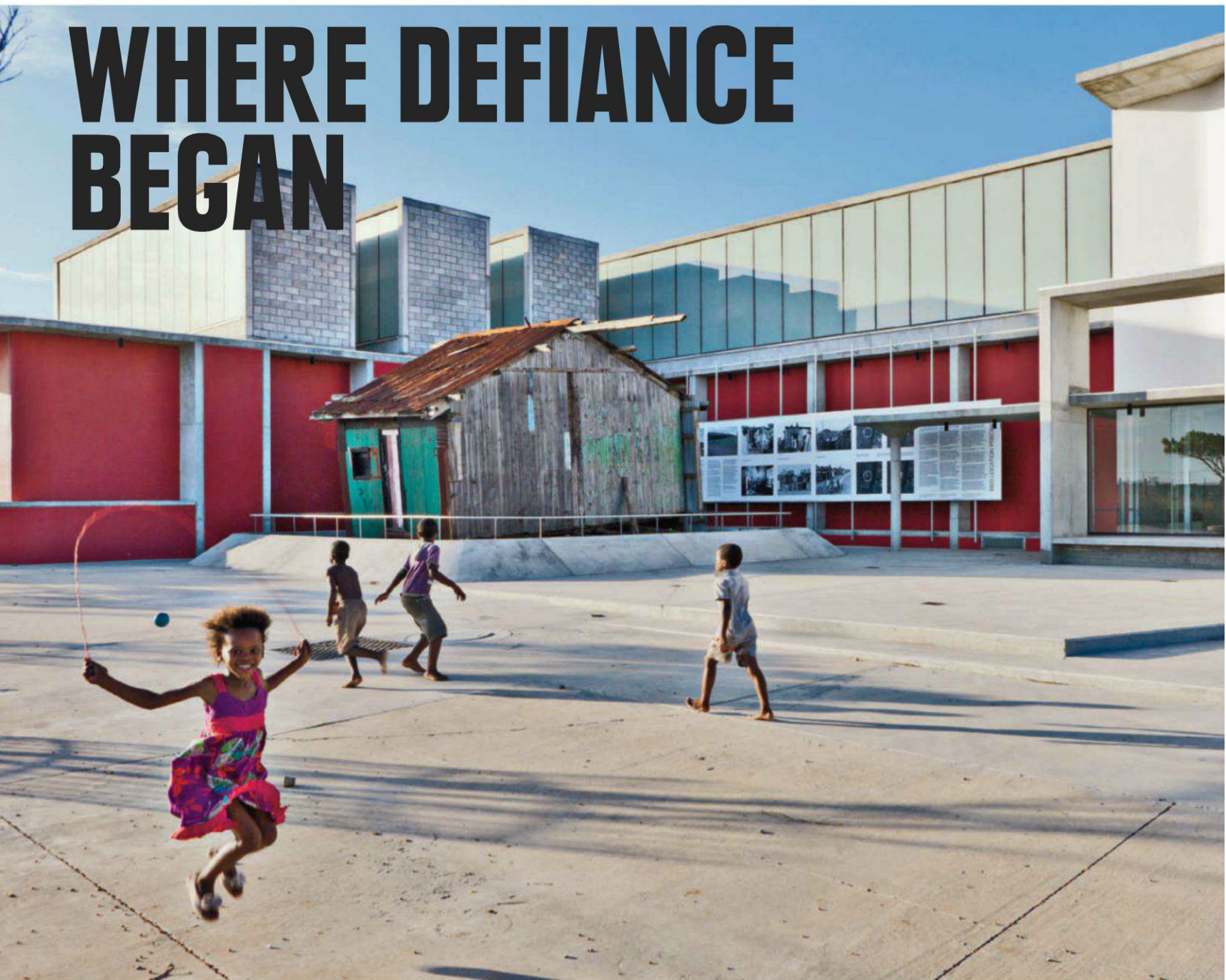

A cultural complex honors the legacy of the fight against apartheid, while bringing it alive for a new generation of South Africans.

BY KAREN EICKER

RED LOCATION is the oldest surviving relocation site in Port Elizabeth, where thousands of native Africans were forced to settle by the colonial government in the early 1900s. It is one of South Africa's original centers of antiapartheid activism, as well as a cradle of culture in the Eastern Cape; one of its townships, New Brighton, is the home of the Serpent Players (made famous by playwrights Athol Fugard, John Kani, and Winston Ntshona), as well as artists such as George Pemba, and many jazz musicians.

The Red Location Cultural Precinct, in New Brighton, honors the turbulent history of the area, while providing the surrounding community with opportunities for education, employment, and artistic expression. The first phase of the project, the Museum of Struggle, opened in November 2006 with exhibits on the contemporary history of South Africa, particularly the resistance against



SITE SPECIFIC The entry court of the new art gallery (above) wraps around a shack from 1902, connecting its mission to the area's past and its roots as a home to people of humble means. Noero Wolff Architects planned the complex so buildings engage the streets and activate the public realm (right).

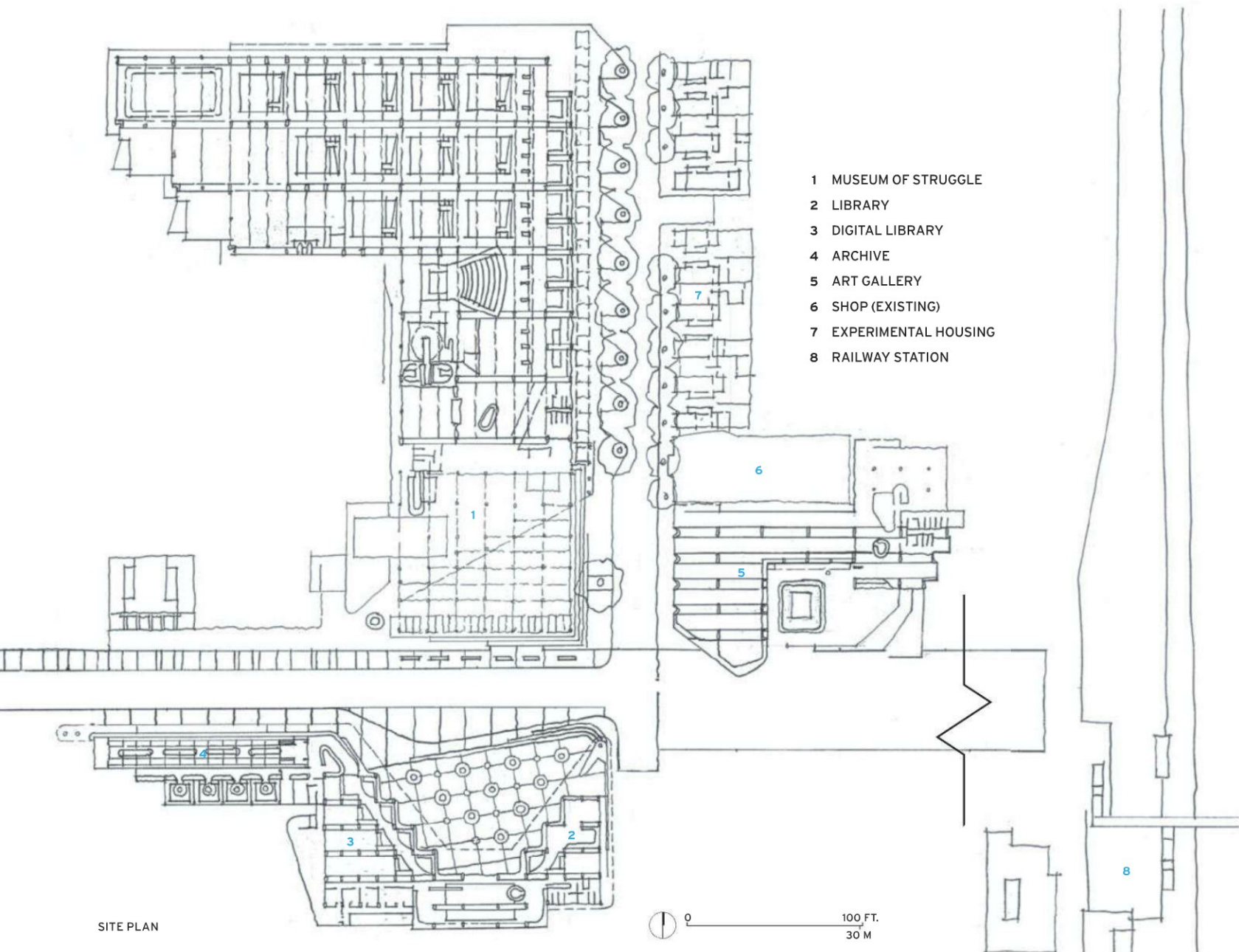

SITE PLAN

credits

ARCHITECT: Noero Wolff Architects – Jo Noero, partner in charge and principal designer; Robert McGiven, John Blair, Kylie Richards, Korine Stegmann, Stanley Ngarinda, project team

ENGINEERS: Goba in association with de Villiers & Hulme (structural and civil); Clinkscapes Maughan-Brown (mechanical); Bham Tayob Khan Matunda (quantity surveyors)

CLIENT: Nelson Mandela Bay Municipality

GENERAL CONTRACTOR: SBT

Konstruksie Oos Kaap

SIZE: 16,000 square feet (library/archive); 12,000 square feet (art gallery)

COST: \$4 million

COMPLETION DATE: July 2011

SOURCES

CONCRETE BLOCK: Terraforce

CEMENT: Holcim

GALVANIZED ROOFING: Mittal Steel

STEEL WINDOWS: Dura Industries

LIGHT TOUCH
Glazing on the upper portion of the art gallery's multiple bays (opposite, top) brings daylight into barrel-vaulted galleries (opposite, bottom). The gallery presents shows of work by emerging artists, as well as providing arts education for people in the area.

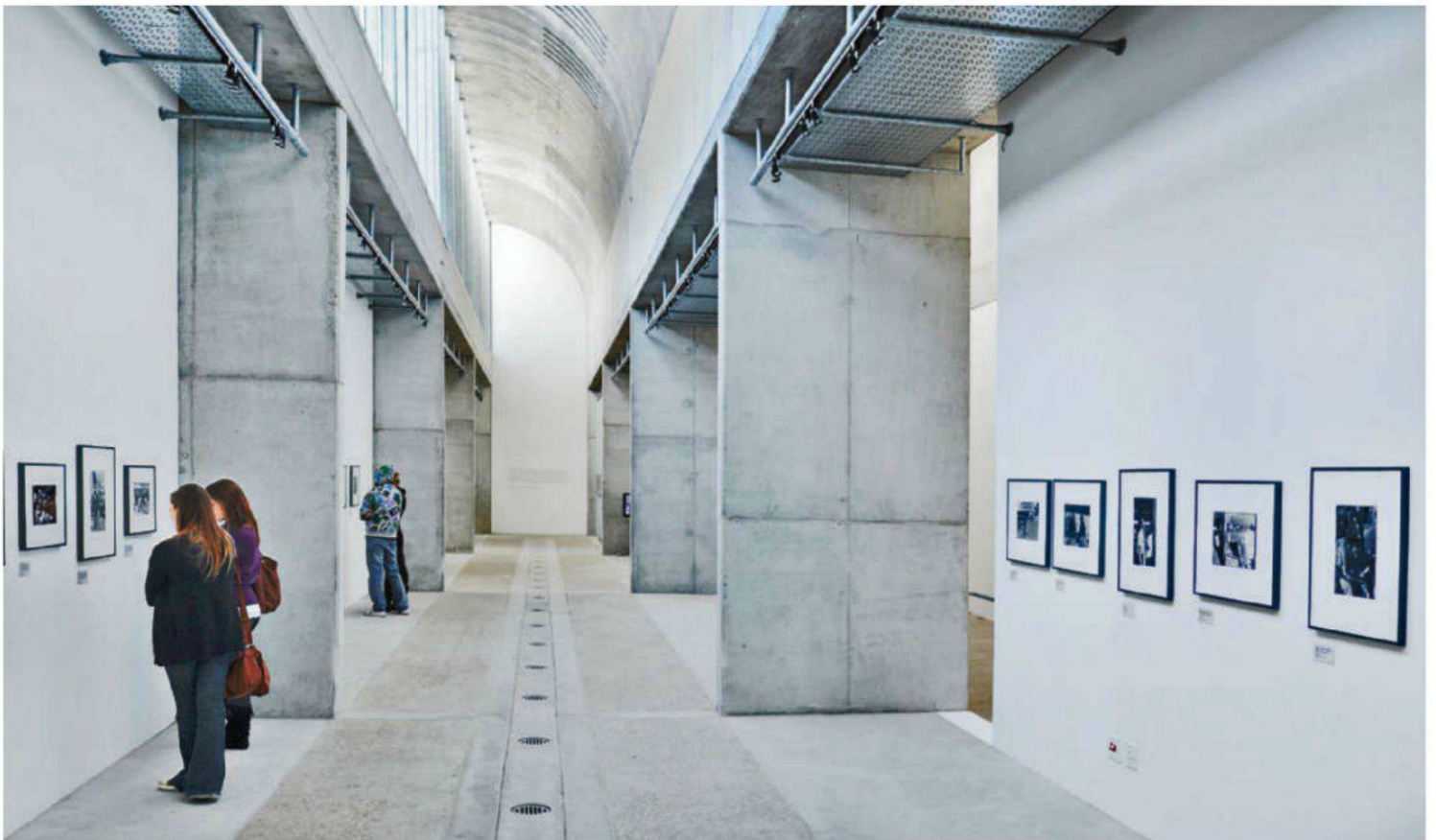

PHOTOGRAPHY: © ROB DUKE (TOP); JON RIORDON (BOTTOM)

apartheid (RECORD, March 2006, page 98). Noero Wolff Architects, the Cape Town-based practice, designed the entire complex after winning a national competition in 1998.

In July 2011, construction of the second and third buildings in the precinct—an art gallery and a library/archive—was completed, though the facilities have yet to be occupied. The final phase will comprise a performing-arts center and a school for the performing arts, to be designed by Jo Noero, who recently separated from his partner Heinrich Wolff. Construction is scheduled to start on these buildings in two years. Eventually, the complex will also accommodate 210 houses for people working in the cultural precinct, and various commercial and public open spaces.

Rory Riordan, chief executive of Dojon Financial Services and one of the project's tireless supporters, explains that the Red Location precinct began as an idea in 1992 when a group of politically interested people, including himself, were traveling outside the country studying local governmental issues. One of the group members was a township activist from New Brighton, Ernest Malgas, who had been imprisoned for his political activities and tortured numerous times. "During the trip, shortly before he died, Ernest called us together," says Riordan. "He entrusted us with the joint responsibility of somehow commemorating how the people of Red Location have always had to live, and how they suffered in their fight against apartheid."

After the dismantling of apartheid in 1994, several members of the group were elected to be councillors in the city government and began to plan a cultural center on a piece of open land next to the historic New Brighton Railway Station, where in 1952 activist Raymond Mhlaba initiated the Defiance Campaign by walking through the "whites only" entrance.

Noero recalls, "In a progressive move, the city agreed to leave the site as a single subdivision for the duration of the development." This allowed the architects "to push the buildings as close as possible to the streets" and activate the public realm with visitors and local residents moving through the site. Noero is designing the performing-arts center and school so that some of their elements—including a performance space and a set-design area—can spill outdoors. The intention is to let people take charge of the street, especially as the project grows and commercial and social activities intensify over time.

Reinforcing the precinct's connection to its social context, a mix of formally and informally constructed houses—ranging from shacks to subsidized units—surround the site. Noero responded to the scale of these residential areas by articulating his buildings with porticoes and colonnades that reach out to their neighbors while serving as thresholds to the larger civic spaces inside.

He also acknowledged the area's industrial heritage and its powerful trade-union movement in his buildings' saw-tooth roofs, which echo those of nearby factories and the railway station. The roofs and their clerestory glazing provide good ambient lighting as well as natural ventilation. "The language and form are explicit yet simultaneously ambiguous, using pragmatic measures like volume and the quality of light to express the various purposes of the spaces," says Noero.

The new 16,000-square-foot library and archive sits directly across the street from the museum, responding to the older



building's large entry pergola with its own forecourt and thin concrete canopy. The different programs—digital library on one side of the central foyer and computer school, reading rooms, and archive on the other—are expressed as separate forms within the building's two embracing wings. Different floor finishes—concrete, timber, carpeting, and cork—reinforce the separate identity of each function. The saw-tooth roof brings in a diffuse south light (the equivalent of north light in the Northern Hemisphere) that softly reflects off the

PAPER PALACE
Much of the library is dedicated to the digital world, but a double-height reading room in the archive will be filled with printed books.



interiors' warm timber surfaces. A double-height reading room that will house printed works relating to South Africa, the Eastern Cape, and the Nelson Mandela Bay Municipality (which includes Port Elizabeth) acts as a visual and spatial exclamation mark for the building.

The 12,000-square-foot art gallery welcomes visitors with a forecourt displaying a small, corrugated-iron shack dating from 1902. Inside the gallery, concrete vaults scoop south light into the exhibition spaces, their exposed concrete surfaces providing a cool, bright ambience for the art. A floor-to-ceiling window at one end of the sophisticated exhibition space, though, looks onto the ramshackle houses, offering a stark reminder of the building's context. The gallery will provide arts education for local residents as well as exhibition opportunities for emerging artists in the area.

"The fact that this project has moved forward very slowly has been of huge benefit," says Noero. "To create quality architecture, particularly social architecture within complex communities, you need time to properly understand the processes and relationships."

This careful consideration has produced a family of three closely related, yet distinctly individual buildings that gently capture the tough history and tenacious dreams of a community caught, always, in the throes of change. ■

Karen Eicker is a Johannesburg-based architect, writer, and curator, and director of the nonprofit Architects' Collective.



PUBLIC REALM A thin concrete canopy curves around the forecourt of the library (top), looking across the street at the portico and steps of the Museum of Struggle, which was completed in 2006. The archive building (this photo) offers space for book storage and an impressive reading room.

SOMETIMES YOU CHOOSE
FLOORING BASED ON LOOKS.
OTHER TIMES FOR VALUE OR
DURABILITY OR, IN THIS CASE,
ALL THREE.

EarthWerks™ is the perfect flooring choice based on good looks alone. It offers architectural beauty that clients appreciate. More importantly, it is easy to install, maintain and repair and stands up to spills, messes and a ton of traffic.

EarthWerks™ commercial grade vinyl tile and plank flooring are also Earth friendly and recyclable. So, before you take the next step, consider EarthWerks™ – be demanding and get everything in one beautiful product.



For information regarding our extensive line of sustainable vinyl flooring, please call 800-275-7943, or visit us online at www.earthwerks.com

earthwerks
FLOORING INSPIRED BY NATURE

Sustainable Architecture

Designing with natural wood for
half a century.
Respecting Forest Sustainability.

Our Commitment:

PEFC Certification: Adherence to Sustainable Forest Management

ISO 14001: Environmental Management Certification

ISO 14006: ECODesign Certification: Positive Environmental Footprint

LEED Qualifier

Natural **Wood** Rainscreen Façade

Offerings:

- Exterior Wall Cladding
- Interior Wall and Ceiling Coverings
- High-Performance Flooring
- Acoustical Panels
- Natural Wood Veneers



Prodema[®] (Prod**EX** :: Prod**IN**)
Made to last wooden Products exteriors by Prodema[®] interiors by Prodema[®]



Prodema North America

FORMAS • 5582 N.E. 4th Court, 7B • Miami, FL 33137 • office: 305-756-2062/2000 • toll: 866-776-3362 • www.formasinc.com

Prodema Head Office and Plant

B^o. San Miguel, s/n • 20250 Legorreta - Gipuzkoa (SPAIN) • T.: (+34) 943 80 70 00 • F.: (+34) 943 80 71 30 • E.: prodema@prodema.com

Request a catalogue at: www.prodema.com/request/usa

Many more examples at: www.prodema.com

QUESTIONS ANSWERED. PROBLEM SOLVED.



If you could take some of the legwork and a lot of the frustration out of your job, why wouldn't you? You're just an email or call away from trusted information on code compliance and UL certified products from an impeccable source. Simply go straight to our website for a list of code experts in the U.S. and in Canada.

CHECK BEFORE YOU SPEC AT
UL.COM/CODERESOURCE

Join the Discussion > Discover our new group at LinkedIn.com—search “UL Codes”



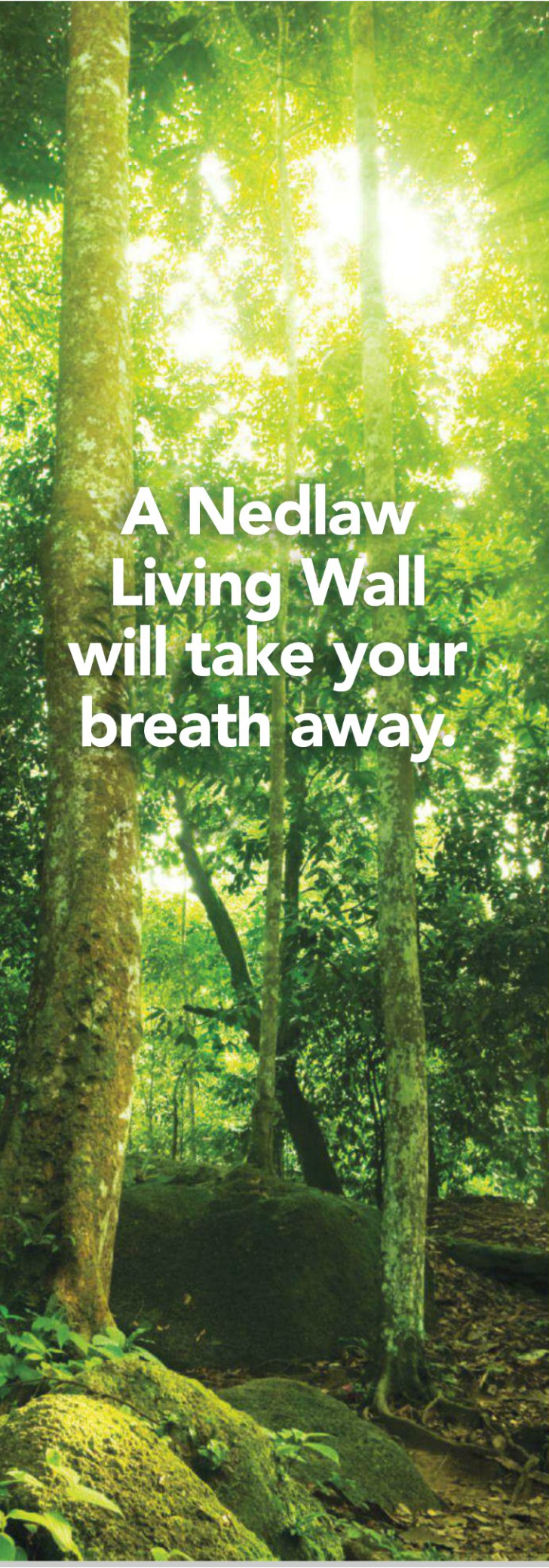

**A Nedlaw
Living Wall
will take your
breath away.**

**But it will return it
fresh and purified,
Naturally.**

Nature is phenomenal. It calms. It energizes. It breathes life. And, as in the case of Nedlaw Living Walls, it truly inspires. We've spent years studying how nature cleans outdoor air. So proficient; so perfect. Then we did something almost as amazing. We brought those biological processes indoors. Beautiful and smart. Fully integrated into a building's own air-handling system, a Nedlaw Living Wall isn't just a bunch of pretty plants. While a typical plant grouping can't remove anything, our internationally patented biofilter technology not only captures airborne pollutants, it breaks them down. Off-gases. Odours. Chemicals.

They aren't just filtered; they're quantifiably eliminated. So, we can all breathe a little easier.

It's time we changed the indoor landscape. It's time to talk to Nedlaw Living Walls.

NEDLAW
LIVING WALLS ™
Clean air, naturally.™

www.nedlawlivingwalls.ca

CIRCLE 60

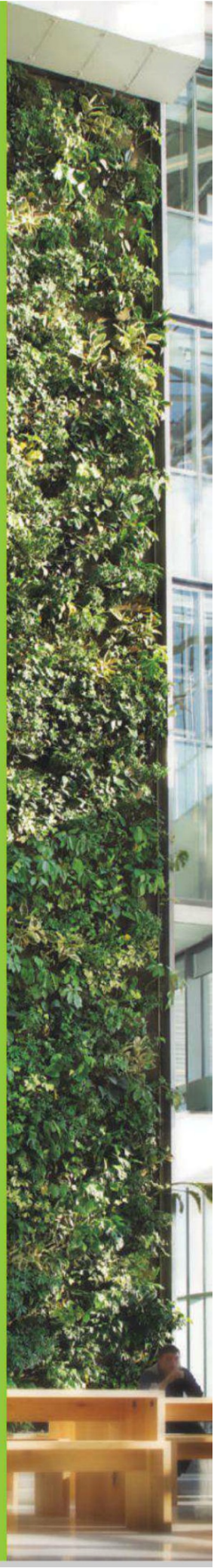



PROOF THAT PRODUCTS ARE AS GREEN AS THEY CLAIM

UL Environment empowers purchasers to identify environmentally-preferable products with ease and confidence. We provide lifecycle-based, multi-attribute product certifications, environmental product declarations, claim validations, and indoor air quality certifications to help manufacturers create better products in a more environmentally-responsible way. Trust UL Environment to help you find and specify greener products. Visit www.ul.com/environment.



Environment

Actual size.

Actual performance.

INNOVA3™ Insulated Metal Wall Panel has raised the bar.

Metl-Span's new INNOVA3 is the industry's most thermally efficient architectural panel today – and it sets the standard for the future. This 3" continuous insulation panel delivers a tighter building envelope while meeting the most rigorous sustainability and energy requirements. With a beautiful, sophisticated appearance, the INNOVA3 is ideal for high-profile applications and it provides endless design options for any façade. And, when it comes to performance, durability and ease of installation, the INNOVA3 is second to none.

PIONEERING INSULATED METAL PANEL TECHNOLOGY

metlspan.com/innova3

877.585.9969





We Live.



We Play.



We Pray.

BELDEN

THE BELDEN BRICK COMPANY

We surround ourselves with buildings that last generations and hold strong memories. Brick has long been known as a solid choice for its durability and integrity. For 127 years Belden Brick has been supplying quality brick products to buildings that we trust to last a lifetime.

*How can **we** help you build your next project of a lifetime?*

www.beldenbrick.com
info@beldenbrick.com / (330) 456-0031

An ISO 9001:2008 Registered Quality Management System
An ISO 14001:2004 Environmental Management System

CIRCLE 58

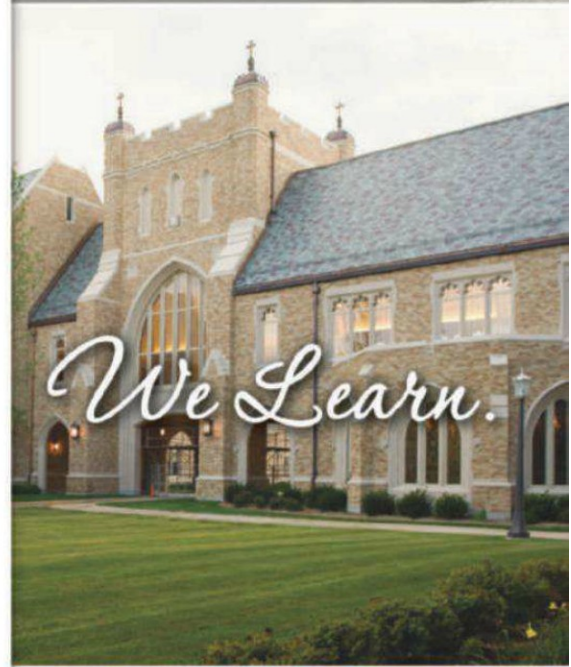

We Learn.



We Work.





Beautiful, versatile, sustainable western red cedar

Western Red Cedar has unique, natural performance characteristics and exceptional beauty that bring warmth, character and longevity to homes and commercial buildings around the world. It is this bundle of properties that has made "Cedar" the choice of discerning architects, builders and homeowners alike.

Western Red Cedar is renowned for its naturally occurring resistance to moisture, decay and insect damage. Its natural durability, dimensional stability and exceptional beauty make it ideal for a wide variety of exterior and interior uses. Western Red Cedar offers enormous versatility in styles and applications. Equally important, it has a low environmental impact relative to other building materials. Western Red Cedar is harvested legally and sustainably from independently certified forests in British Columbia.

Enhance the beauty of your next project, build with Western Red Cedar. For more information and suppliers near you, please visit our website.

www.wrcla.org

1.866.778.9096



KING ABDULLAH UNIVERSITY OF SCIENCE AND TECHNOLOGY - JEDDA, SAUDI

ARABIA . CLUB UNION - PANAMA CITY, PANAMA . DEPARTMENT OF PUBLIC

WORKS - JOHANNESBURG, SOUTH AFRICA . THE QUEEN'S UNIVERSITY MCCLAY

LIBRARY - BELFAST, IRELAND . ESTO LUIS POMA - SAN SALVADOR, EL

SALVADOR . CHEVROLET CENTERS - LUANDA, ANGOLA

. LITTLE SWITZERLAND . GOLF

CLUBHOUSE . HERITAGE

BUILDING - VANUATU . SAINT JAMES

ISLAND . CHINA

PATENTED .

ANTHONY

AMERICA

Beautiful wood ceilings and walls...
all over the world!

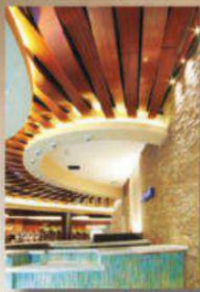
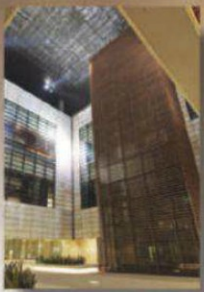

Forest Stewardship Council (FSC) products available upon request.

© 1996 Forest Stewardship Council A.C.

Manufacturing the finest suspended wood ceilings, acoustical wood wall systems, suspended uPVC ceiling and canopy systems

CIRCLE 55

904-584-1400



RULON INTERNATIONAL
www.rulonco.com

1-800-227-8566

BUILDING TYPES STUDY 925 **HEALTH CARE**

- 97 MASSACHUSETTS GENERAL HOSPITAL, THE LUNDER BUILDING
- 101 PAUL S. RUSSELL, MD MUSEUM OF MEDICAL HISTORY AND INNOVATION
- 102 UCLA OUTPATIENT SURGERY AND MEDICAL BUILDING
- 108 BROOKLYN INFUSION CENTER

Tight Site

Boston

NBBJ introduces light and views into a new building at Massachusetts General Hospital.

By Suzanne Stephens

IN RECENT years the design of hospitals that emulate hotels has generated a warming trend in this often forbiddingly cold, institutional building type. Evidence-based design, stemming from scientific studies that show patients get better faster in settings with daylight, views, plants, and physical and acoustical privacy, gave impetus to this revolution (RECORD, August 2009, page 73). It usually helps if the hospital occupies a significant slice of nature, with vistas of trees, other vegetation, and water. But some hospitals, such as Massachusetts General Hospital (MGH) in Boston, have created a noninstitutional environment on an existing, dense campus downtown.



NBBJ's New York office based its design for MGH's Lunder Building on those aforementioned principles to produce a 14-story structure wedged into an agglomeration of buildings that all but hides the pillared portico of Charles Bulfinch's original neoclassical hospital of 1818. The new 150-bed, 535,000-square-foot facility, with 28 procedure and operating rooms, needed to provide services in cancer, neurology, neurosurgery, radiation oncology, and emergency care. "While evidence-based design figured into the planning," says NBBJ partner Joan Saba, "the whole idea was to enhance operational efficiency as well as healing."

On the tight 42,000-square-foot site, the architects inserted a glass and steel-framed squarish polygonal volume on the west side of the arrivals court to MGH's main entrance. To mitigate its hulking presence, NBBJ fragmented the massing and angled exterior planes, in addition to detailing the glass facade, to express the building's separate functions on the exterior. While clear glass sheathes the first two floors (devoted to reception, emergency admissions, and circulation), vertical fritted glass fins on the third and fourth floors (dedicated to procedural services) allow daylight to enter the interior while affording occupants a sense of privacy. Above, on the fifth level, a solid wall of insulated metal panels, covered in wire mesh, masks a double-height mechanical space. For the patient-room portion, from the sixth to 10th floors, the architects emphasized the horizontal lines of glass curtain walls, which are broken by receding and slanted planes that follow

LIGHT WELL An 80-foot-high skylit atrium (previous page) extends from the sixth level to the top of the Lunder Building to give patient rooms a sense of light and view. Silk plants were installed for ease of maintenance and concerns about infection.

The new building (above) occupies the center of a dense complex of the hospital campus. At the main entrance to the hospital (right), the Lunder extends along the west side of the drop-off, its large, hulking presence mitigated by changes in massing and curtain-wall detailing. The top five floors of the patient-room tower feature single rooms (opposite, top), along with private spaces where family members and friends can congregate. Below ground are two floors devoted to radiation oncology. Here NBBJ designed a 23-foot-high reception room with soft cylindrical lighting to make up for lack of daylight and views out (opposite, bottom).



the carved-out portions of the floor plate.

The building inflects horizontally to MGH's Yawkey Center for Outpatient Care to the south and to the vertical glass tower of the Ellison Building to the north as part of the architects' intention to seamlessly connect Lunder visually and physically to other hospital structures around it.

Connection is a major subtext: Visitors enter the new facility from the White Building, the hospital's main entrance to the north. As you come into Lunder, you find that a large stair, parallel to the glass facade, takes you to the second level, where a corridor snakes along the glass front of the building to connect Yawkey on one end with White and Ellison on the other. By placing the main circulation on the second floor, the architects linked Lunder physically to adjoining buildings, while staying within existing floor-to-ceiling heights.

In the five-story bed tower, two wedge-shaped openings cut out of the overall volume accommodate an 80-foot-high skylit atrium, as well as an open-air garden court, where bamboo trees shoot upward past the patient levels. (For more details on planting for health care at Lunder, see page 114.) All rooms are single-occupancy in order to prevent the spread of infection, afford privacy and acoustical isolation for recuperation, plus accommodate the patient's family members and visitors. To give the inpatient rooms views of the outdoors yet enable nurses and doctors to reach patients quickly, NBBJ placed the rooms around the edges of the broken perimeter, and located support staff in two blocks in the center. A diagonal corridor cuts through from one corner—where the elevators stop at the atrium—to the exterior garden well opposite.

By breaking the nursing pods apart and connecting the floor with a diagonal circulation spine, NBBJ also mitigated excessive noise generated by movement and conversation in hospital halls and stations. Acoustical ceiling and wall panels and rubber floors also help alleviate unwanted sounds. And since rooms project into the corridors at an angle, their serrated configuration helps cut down on acoustic reverberation. This feature, along with ample cove lighting from reveals along the ceiling soffits, also softens the ambience visually.

Owing to typical 9-foot ceiling heights, ample windows, and views of the city, the patient rooms seem light and airy. Translucent sliding glass doors promote visual and physical access, and for extra safety, caregiver stations inside the rooms overlook patient beds and private bathrooms.

Certain treatment areas in Lunder, however, do lack daylight—specifically the radiation-oncology center in the below-grade third and fourth levels of the concrete substructure. To alleviate the sense of being so far underground, the architects designed two waiting rooms as 23-foot-high volumes; one, for reception, is illuminated by rodlike lighting fixtures suspended above the seating. Soft colors and bamboo wall panels add a residential feeling to the space.

In addition, the client and NBBJ undertook sustainable measures to meet LEED Gold certification standards. These include selecting recycled or locally obtained materials plus renewable bamboo finishes, conserving water by installing low-flow plumbing fixtures, and feeding plants with nonpotable water, rainwater, and air-cooling condensate. The architects used energy-efficient insulated glass with low-E





SIXTH FLOOR



GROUND FLOOR

- | | | |
|-------------------------|---------------------|----------------------|
| 1 MAIN CAMPUS LOBBY | 5 AMBULANCE PARKING | 11 RECEPTION |
| 2 EMERGENCY RECEPTION | 6 WHITE BUILDING | 12 SUPPORT |
| 3 LUNDER BUILDING LOBBY | 7 ELLISON BUILDING | 13 IMAGING |
| 4 NURSE STATION/SUPPORT | 8 YAWKEY CENTER | 14 ICU PATIENT ROOMS |
| | 9 ELEVATOR LOBBY | 15 EXTERIOR GARDEN |
| | 10 ATRIUM | 16 STAFF LOUNGE |



HEALTHY WAY Parallel to the front glazed facade, a stair leads to the second-level sitting areas and connections to other buildings.

coating throughout. For patient floors they chose glazing with a high visible-light transmittance and a high shading coefficient. In addition, NBBJ selected low-iron insulated glazing for the atrium, adding fritted glass to cut glare and heat and reduce visibility in private consultation areas.

All told, the Lunder Building seems to solve a lot of problems with ease. Although the hospital is not yet monitoring the effects of these design strategies on recovery time, the overall planning would suggest a promising bill of health, architecturally speaking. The scheme, at the least, offers health-care specialists an important laboratory in which to conduct and refine their research as befitting the 200-year-old institution. ■

credits

ARCHITECT: NBBJ – Joan Saba, Tim Johnson, partners in charge; Rodney Crumrine, project manager; Jay Siebenmorgen, design lead; Jorge Gomez, delivery lead; Christine Vandover, interior-design lead; Sarah Markovitz, medical-planning lead

ASSOCIATE ARCHITECTS: Chan Krieger Sieniewicz (now NBBJ)

ENGINEERS: McNamara/Salvia (structural); Thompson Consultants (m/e/p; fp and low voltage)

CLIENT: Massachusetts General Hospital

SIZE: 535,000 square feet (gross)

COST: \$500 million (construction and equipment)

COMPLETION DATE: May 2011

SOURCES

METAL PANELS: Benchmark Architectural Systems; Metecno-Aluma Shield

TERRA-COTTA RAINSCREEN: Shildan (Longoton)

CURTAIN WALL: Hankins & Johann; Sota Glazing; W&W Glass

GLASS: Viracon, Pilkington, Oldcastle BuildingEnvelope, Bendheim, Skyline

ACOUSTIC CEILING: Armstrong

A Medical-History Museum for a 200-Year-Old Hospital

Leers Weinzapfel Associates designs an exhibition pavilion for Mass General.

THE FIRST challenge in designing the Paul S. Russell, MD Museum of Medical History and Innovation for Boston's Massachusetts General Hospital began with the location. The small, narrow 5,750-square-foot site extended 130 feet along Cambridge Street at the entrance to the hospital's downtown campus. Since the new museum would act as a gateway to the complex, Leers Weinzapfel Associates Architects followed the elongated street line of the property for its low-rise building. From the 18-foot-6-inch-wide entrance on the east, the museum widens to 31 feet at the western end. The wedge-shaped 12,270-square-foot space abuts the historic, 19th-century brick Resident Physician's House, containing museum offices.

Exhibitions devoted to the hospital's accomplishments occupy the ground level, with a mezzanine for lectures and receptions above. A roof garden, topped by a steel pergola, offers panoramic views of the nearby brick and copper-trimmed historic architecture of Beacon Hill. The architects clad much of the \$7.9 million, steel-framed structure in a shimmering copper (with both flat-lock and standing seams) that will patinate in time to match to the mottled green trim of cornices and oriel windows nearby. As principal Jane Weinzapfel explains, the firm chose raw copper since "prepatinated copper is lifeless and lacks sheen." S.S.

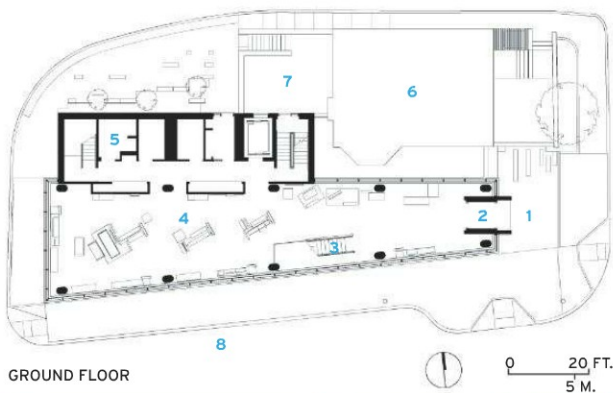

- 1 FRONT COURT
- 2 VESTIBULE
- 3 STAIR TO MEZZANINE
- 4 EXHIBITION SPACE
- 5 SERVICE CORE
- 6 RESIDENT PHYSICIAN'S HOUSE
- 7 TERRACE
- 8 CAMBRIDGE STREET

COPPER GLOW Raw copper in 16-inch-wide, 10-foot-long panels emphasizes the horizontality of the facade (above). On the rear core (bottom left), copper panels run vertically. A stair (bottom right) leads to the lecture and reception area.

credits

ARCHITECT: Leers Weinzapfel Associates Architects – Jane F. Weinzapfel, principal in charge; Winifred A. Stopps, project manager; Alan Christ, project architect; Tom Chung, design architect

ENGINEERS: Lim Consultants (structural); BVH Integrated Services (m/e/p; fp; IT)

CONSULTANTS: Brown Sardina (landscape)

EXHIBIT DESIGN: Museum Design Associates



Light Touch

Santa Monica, California

The Corbusian pavilions of the UCLA Outpatient Surgery and Medical Building, by Michael W. Folonis Architects, bring daylight to the patient experience.

By **Laura Raskin**

MICHAEL FOLONIS reacted with baffled delight when he was chosen to design the 50,000-square-foot, three-story UCLA Outpatient Surgery and Medical Building in Santa Monica. He had no background in health care. But his client, Randall Miller, an owner-developer who was constructing the building with the intention of leasing it to UCLA, simply told him that a good architect should be able to design anything.

Educated at SCI-Arc and UCLA, Santa Monica-based Folonis worked for Frank Gehry and Ray Kappe before starting his own firm in 1983. His residential, mixed-use, and preservation work of the last three decades expresses his loyalty to the legacy of California Modernists—buildings that use daylight as a material and strive to connect the interior with the outdoors. Perhaps because his portfolio does not include other medical buildings, the architect was able to bring an unencumbered approach and elegance to the UCLA center. “I needed to think about what this building means to people,” says Folonis. “What it means to me is: This is a very scary place. How can I change this experience?”

Two smooth, poured-in-place concrete pavilions frame the three floors and rest on a base of board-formed concrete. A central glass-walled atrium topped with a fritted glass roof separates the two volumes. (A rooftop photovoltaic array supplies 15 percent of the facility’s energy. The building is slated for LEED Gold certification.)

To make the lobby as transparent as possible, the architect decided on a point-fixed curtain wall: Suspended sheets of glass are joined with spider fittings, which in turn connect to shiplike steel masts. This system delicately holds the glass in place and eliminates the need for heavy mullions. Three perforated metal sunshades on the exterior shield the western facade from the sun. In addition, the atrium acts as a chimney, funneling warm air up and out when the entry doors are open and a fan is on.

“Wayfinding in most of these places is unbelievably difficult” and an unnecessary stress for visitors, says Folonis. A central, cantilevered steel stair with bamboo treads in the lobby organizes the space, connecting the second- and third-floor bridges that link to services, such as the clinics that span both pavilions on the third floor. Because concrete can be rough and cold, the architect clad many of the interior walls in the public spaces with bamboo panels, to “soften the edge.”

Since the service aspects of the program—such as oncology, prep, and recovery—take up more room than the





WELCOMING CENTER
The architect divided the center's massing between two concrete pavilions; the southern volume cantilevers 25 feet over a first-floor waiting room. A central glass lobby glows at night.

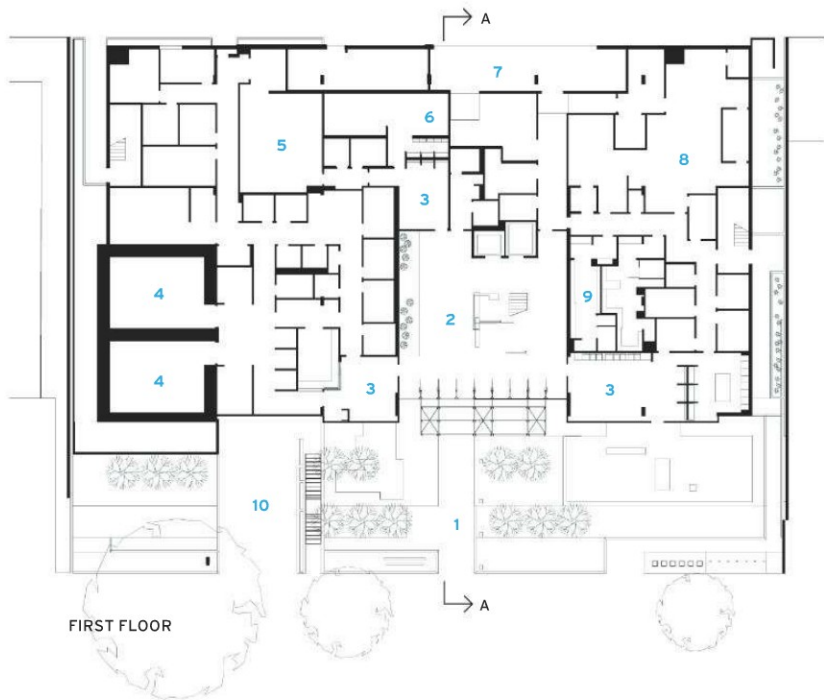

SECOND FLOOR

FIRST FLOOR



PARKING FLOOR

- 1 MAIN ENTRY
- 2 LOBBY
- 3 WAITING ROOM
- 4 LINEAR ACCELERATOR
- 5 LAB
- 6 PHARMACY
- 7 LOADING DOCK
- 8 STERILE PROCESSING
- 9 STAFF LOCKERS
- 10 DRIVEWAY
- 11 PREP AND RECOVERY
- 12 OPERATING ROOMS
- 13 STERILE CORRIDOR
- 14 SERVICE CORRIDOR
- 15 OFFICES
- 16 DOCTORS' LOUNGE
- 17 STAFF LOUNGE
- 18 VEHICLE-DOCKING BAYS
- 19 VEHICLE-TRANSFER STATION
- 20 EXAM ROOM
- 21 AUTOMATED PARKING

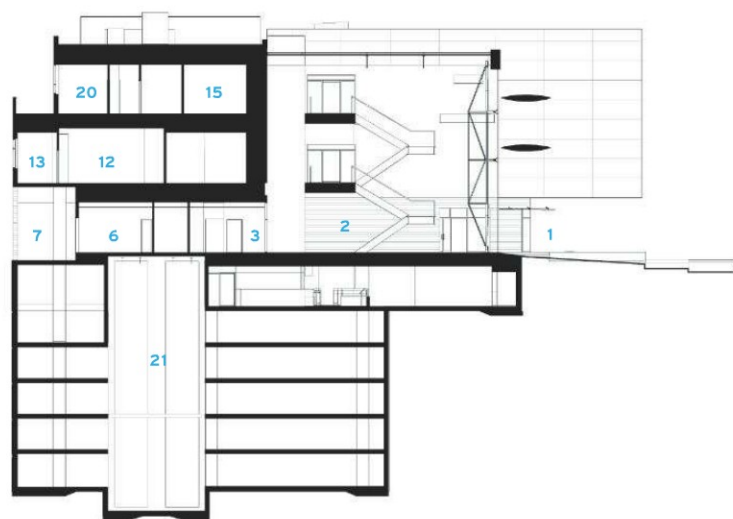

SECTION A-A

credits

ARCHITECT: Michael W. Folonis Architects – Michael Folonis, principal; Rudy Gonzalez, project architect; James Kersten, Tommy Johnson, design architects

CONSULTANTS: Pamela Burton & Company (landscape); Kaplan Gehring McCarroll Architectural Lighting; Arup (acoustical/LEED); Planning Decision Resources/George Pressler

ENGINEERS: Vision Mechanical (mechanical); Levine/Seegel Associates (e/p); Nautilus Group (structural)

CLIENT: Sixteenth Street Medical Center

GENERAL CONTRACTOR: Nautilus Group

SIZE: 50,000 square feet

COST: \$28 million

COMPLETION DATE: February 2012

SOURCES

METAL PANELS: Azurelite

CURTAIN WALL: AVIC Sanxin, Novum, Oldcastle BuildingEnvelope

FLOORING: Lonseal, Johnsonite, Capri Cork



SUN BREAK The center stands alone on the site, allowing each elevation to receive direct sunlight. Staff lounges and offices along the southern facade have views from windows framed by red metal boxes.

support spaces, the architect housed them in the larger, north pavilion. It was important to Folonis to push prep and recovery rooms to the glazed northern and western perimeters, rather than the dark cores where they are typically relegated. Even the sterile corridor behind the operating rooms gets daylight from clerestory windows along the eastern facade. On the ground floor, the linear accelerator, the device that uses X-rays to destroy cancer cells, is enclosed in the building's concrete base to prevent radiation leaks.

The smaller, south pavilion contains staff lounges, amenities, and offices. The architect also set this smaller volume apart by cantilevering the second and third floors 25 feet over the first, shading the main waiting room where patients' friends and family members may spend hours. From here they can wander out to a garden designed by Paula Burton.

With no room to grow in UCLA's inpatient hospital across the street, designed by Robert A.M. Stern (with its

Italianate flair, it could be seen as the architectural opposite of Folonis's almost Corbusian center), the university needed to shift outpatient services but keep them close, says Richard Azar, director of real estate and design and construction for UCLA's health system. When owner-developer Miller purchased the site in late 2007, it came with the stipulation that he had to build a medical center and give first dibs to UCLA (which had previously owned two of the four combined parcels). It proved to be perfect timing for the university.

UCLA knew it wanted an ambulatory-surgery clinic with eight operating rooms, a radiation-oncology clinic, a blood lab, general clinics, and parking; it worked with Miller, Folonis, and the late health-care planner George Pressler to refine the program room by room.

Over a six-month period, building users, including operating-room nurses, prep/recovery nurses, and sterile-processing technicians, voiced their needs for the center in a series of focus

“I needed to think about what this building means to people,” says the architect. “To me, this is a very scary place. How can I change this experience?”



LIGHT PATH A steel stair in the lobby leads to second- and third-floor bridges that direct visitors to the north or south pavilion (top left). Prep and recovery rooms on the second floor benefit from northwestern sun that filters through horizontal louvers (bottom left). The architect carries the material palette—bamboo panels and concrete—throughout the public spaces, including the third-floor clinic waiting room (top right). The ground-floor waiting room has views through the central lobby (bottom right).

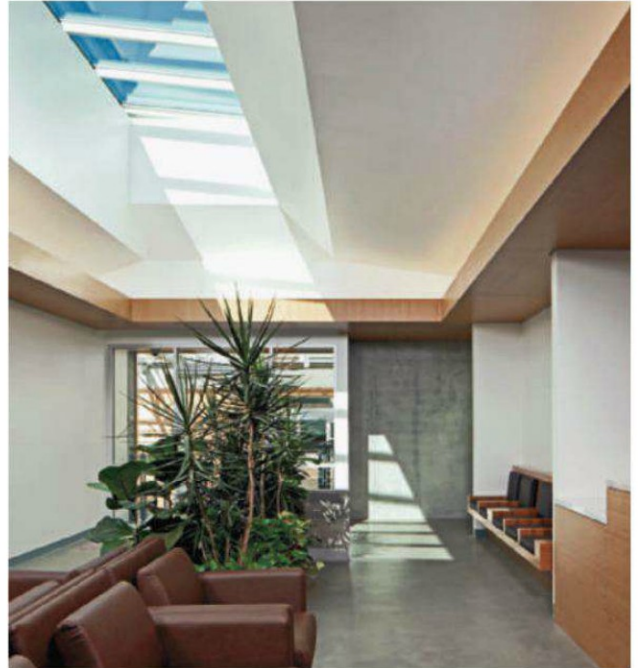

groups. “We weren’t building to the typical University of California spec, where everything is 300 percent oversized and gold-plated. We designed a delivery system to avoid that,” says Miller. He also conceived an innovative automated parking system below the center (see sidebar, right).

Collaborating with UCLA, Pressler, and the user groups helped Folonis to focus on his thesis: that there was no reason a medical building couldn’t achieve a connection to the outdoors and be filled with daylight. The result is an advanced outpatient center that respects its patients and staff: a great model for the future, since signs point to all but the most acute care taking place outside of large, unwieldy hospitals in years to come.

“It’s one of these things that as a young architect, which I’m not, you try to tell potential clients: that you can design lots of different building types,” says Folonis, who is still moved by the opportunity he was given. “It’s really about having somebody who will believe in you.” ■

Park and Go

Speedy automated parking below the UCLA Outpatient Surgery and Medical Building reduces stress and energy use.

“IT’S **NOT** uncommon in Los Angeles to see parking structures that are bigger than buildings,” says Randall Miller, the owner-developer of the UCLA Outpatient Surgery and Medical Building. To avoid that ratio and relieve patients and their caregivers of the stress of parking and searching for their cars, Miller paired a software company with a manufacturer to create a 380-space system to his specifications: Visitors wait only two or three minutes for their cars to be retrieved and rotated so that they face out of the garage, ready to drive away.

“I wanted a people-friendly system,” says Miller. “The public area needed to be wide open. I didn’t want anything coming at you from the floor, or grates where you get your high heels stuck.”

At the center, drivers park in one of six drop-off bays, as directed by LED signs, then swipe their UCLA identification card or a credit card at a kiosk. The automated system takes over, directing one of two cranes to align its lift platform with the bay where

the car is parked. A roll-up garage door opens, allowing a load-handling device, called the satellite, to slide underneath the car. The satellite lifts the car about an inch off the ground by cradling the tires and carries it onto the crane’s lift platform. The crane takes the car to its storage location by moving vertically and horizontally. Valets, watch out! L.R.

NO HANDS The waiting area in the garage extends architect Michael Folonis’s material theme, with bamboo panels on the ceiling and concrete benches (top). The automated system (bottom) reduces parking volume by 50 percent compared with conventional garages, and saves at least 10,000 miles annually because drivers aren’t circling multilevel garages as they look for parking spaces, according to owner-developer Randall Miller.

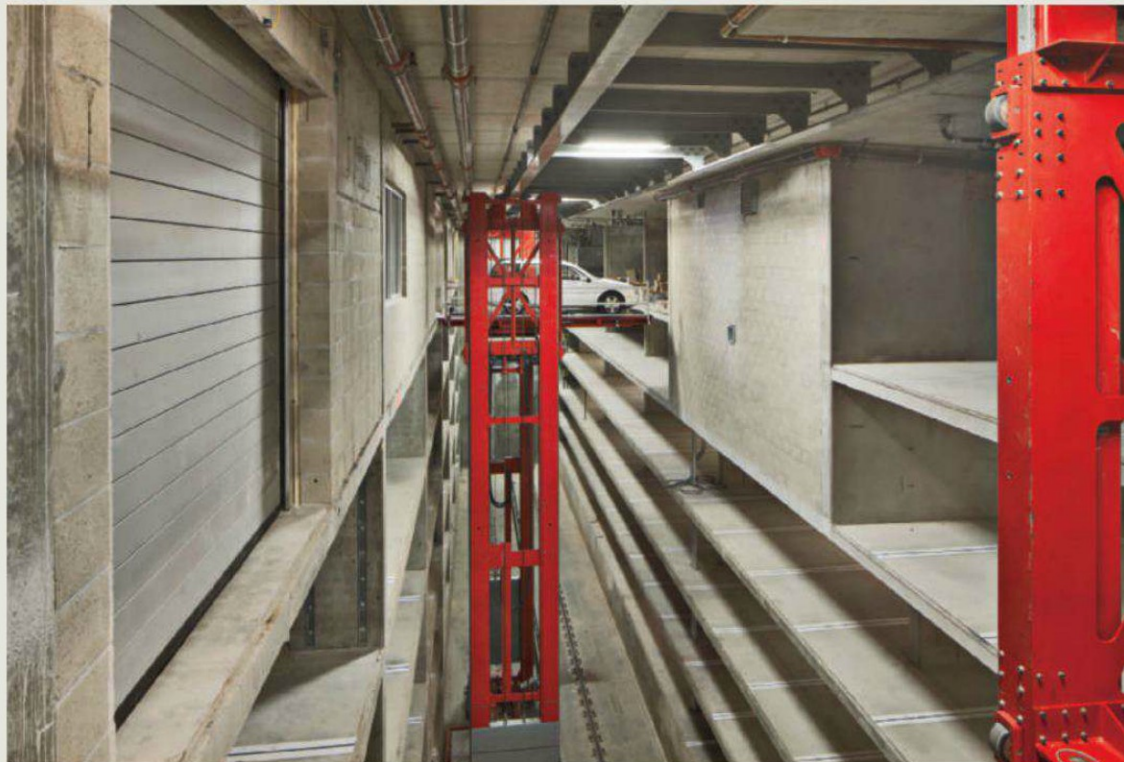

Healing Close to Home

Brooklyn, New York

A treatment center by ZGF Architects brings patient-focused cancer care to New York's most populous borough.

By Asad Syrkett

ALONG BROOKLYN'S Atlantic Avenue, buses and cyclists whiz by to the sounds of car horns, laughing children, and the occasional jazz quartet. Blink and you may miss the storefront Brooklyn Infusion Center, the newest treatment facility of Memorial Sloan-Kettering Cancer Center (MSK). Designed by Portland, Oregon-based Zimmer Gunsul Frasca (ZGF) Architects, the 7,745-square-foot clinic, tucked into a ground-level retail space in a new high-end condominium, is a change of scale for the 128-year-old cancer-research and medical-services institute—MSK's flagship hospital on Manhattan's Upper East Side occupies an entire city block. "This is a very nontraditional environment for us," says Wendy Perchick, chief of strategic planning and innovation at MSK. "I'm still shocked," she adds with a laugh.

Perchick's humor belies the year of workshops, simulations, and careful planning that went into creating MSK's Brooklyn outpost: Though the prevalence of neighborhood-based cancer care has increased in the last decade, this was uncharted territory for the health-care institution. So, to bring care closer to the 15 percent of its patients living in the

borough, MSK worked with ZGF, its oncologists and nurses, and the Boston office of design consultancy IDEO. The team aimed to greatly decrease or even eliminate wait times in the treatment process. Typically, patients wait up to an hour and a half to have their blood drawn and analyzed, and to speak with a physician, before a nurse administers chemotherapy. At the infusion center, nurses make assessments over the phone and pharmacists prepare drugs overnight, so that patients need only arrive and check in on their treatment day, saving time and money for both patients and the hospital.

Getting rid of wait times meant that MSK could take a new approach to the center's layout and programming. For example, the reception area, which in a typical clinic would serve as a waiting room, became a storefront gallery that features the work of Brooklyn-based artists and blends in with Atlantic Avenue's eclectic mix of boutiques, restaurants, bookstores, and antiques shops. The gallery creates a connection to the community by engaging with passersby, as well as benefiting patients, Perchick explains: "Patients said they

PUBLIC FACE The Brooklyn Infusion Center doesn't look out of place in its Main Street-style surroundings (above). Inside, a gallery space (opposite, top) often hosts community health classes, in addition to changing exhibitions featuring local artists' work. Patients can pause here, or head for the check-in kiosk (opposite, bottom). A wall of rectangular cutouts in the foyer is LED-backlit, and the colors change every few seconds.





FLOOR PLAN

0 10 FT.
3 M.

lose track of time over the course of treatment, so we wanted to provide something that would be visually interesting, dynamic, and changing.”

Three large, storefront windows along the street admit daylight into the gallery and the clinical areas beyond. Because ZGF downsized the reception area, the team was free to create 12 sizable treatment “pods”—averaging 115 square feet—and to include amenities that increase patients’ sense of calm, like the four central, plant-filled alcoves that run the length of the Infusion Center. “We looked at this like a public space,” says Jan Carl Willemse, a partner at ZGF who cites New York’s pocket parks and Brooklyn’s stoops as inspiration. Patients pass through the sun- and LED-lit common areas into the treatment pods, via sliding glass doors that are embossed with a subtle frit of swaying grass. This detail enables nurses to see in and gives patients views out while retaining a sense of privacy. “We wanted to give patients a bit of horizon, so that they didn’t have a sense of being closed in,” says Perchick. As treatment sessions can last up to 10 hours, pods are equipped with lounge chairs that feature a

high-tech touch-screen console, which allows patients to video-chat with family members and friends, watch the latest episode of their favorite television show, or order food from neighborhood restaurants. The light level in the pods can also be manipulated from the consoles. “So often, people are infantilized by the system that takes care of them,” says Perchick. “So you give back control wherever you can.”

Creating a health-care facility in what was intended for ground-level retail meant conquering obstacles both large and small: Pipes leaked from apartments above, and mechanical systems had to be fitted for use with special health-care equipment. “We also had to work around a lot of structural columns,” Willemse explains. “And because this is a residential building, none of the columns were on a grid.” So ZGF enclosed these structural supports in white synthetic surfacing, creating banquettes for each of the four communal alcoves. “And there are everyday challenges,” adds Jeanine Gordon, a lead nurse at the center. “We still have to deal with noisy neighbors.” Despite these annoyances and the busy city street, not much disturbs the center’s

- 1 ENTRANCE
- 2 GALLERY
- 3 RECEPTION
- 4 TREATMENT ROOM
- 5 COMMUNAL AREA
- 6 FLEX ROOM
- 7 STAFF OFFICE

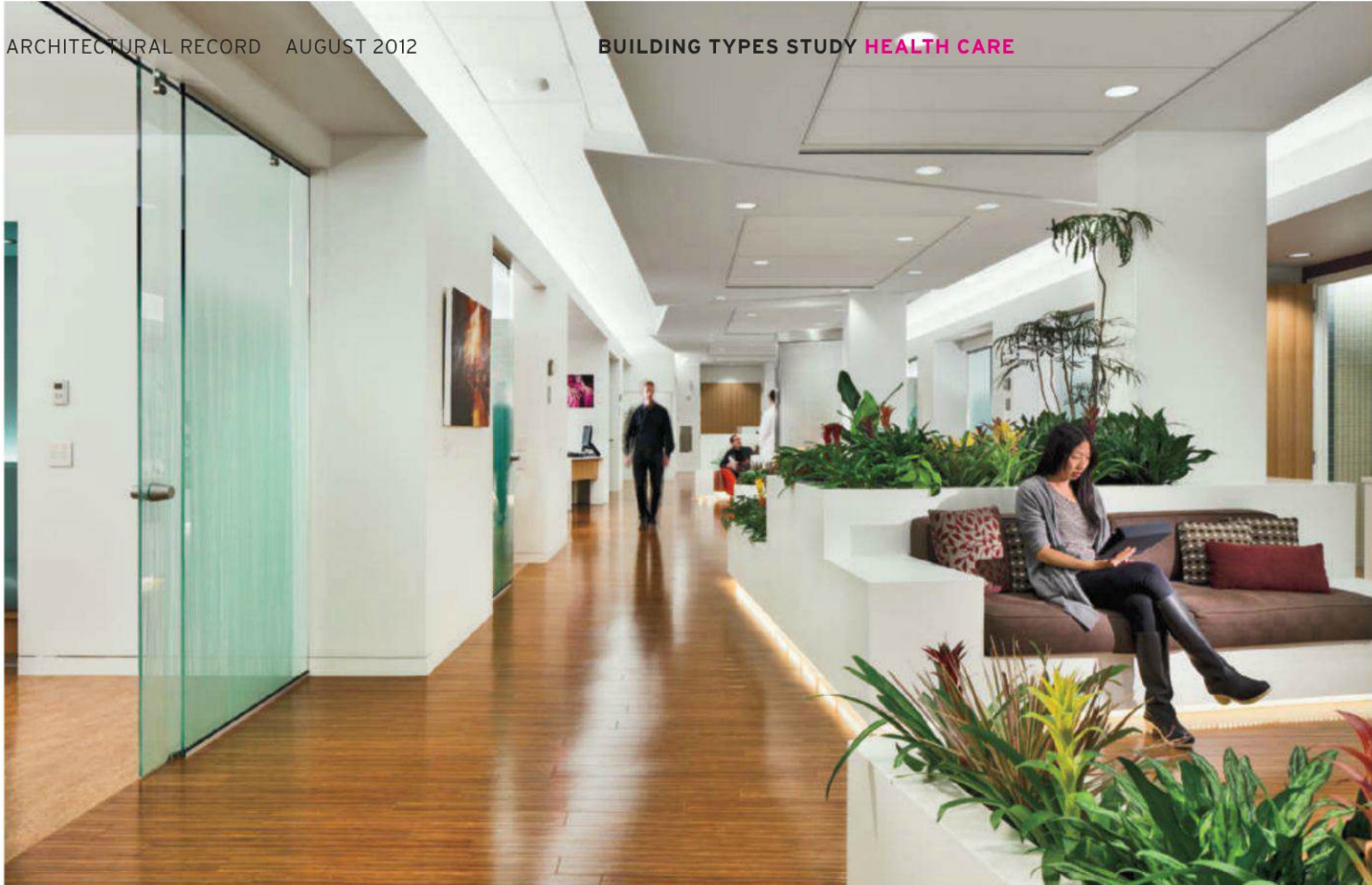

quiet, restorative atmosphere.

The warm, patient-oriented space also encourages the kind of spontaneous activity uncommon in health-care facilities. "I received a picture one day of a woman receiving chemotherapy in one of these bays," says Perchick. "And next to her was her teenage daughter, playing the cello for her. She had drawn up the nurse's chair and brought it close to her mom. There's nowhere else I know where a patient's family member would say, 'I can do that here.'" ■

HEALING SPACE Gardenlike niches (above) animate the treatment center's public space. Each is lit from below with white LEDs. Patients can bring their IV poles out to communal spaces, or retreat into the privacy of their comfortable treatment pods (left).

credits

ARCHITECT: ZGF Architects – Jan Carl Willemsse, partner in charge; Sharon van der Meulen, principal interior designer; Matthew Fleck, senior designer; Michael O'Meara, project architect; Bethany Clouse, interior designer

ENGINEERS: Silman Associates (structural); AKF Group (m/e/p)

CLIENT: Memorial Sloan-Kettering Cancer Center

GENERAL CONTRACTOR: JGN Construction Corporation

SIZE: 7,745 square feet

COST: withheld

COMPLETION DATE: October 2010

SOURCES

DOORS: Pioneer (metal doors); Mohawk (wood doors)

FINISHES: Armstrong (acoustical ceilings, suspension grid); Formica (plastic laminate); DuPont (solid surfacing); 3form (special surfacing)

FLOORING: Forbo, Marmoleum (pod flooring); Armstrong

FURNISHINGS: Knoll, Designtex, Maharam, Arc|Com, Brentano, Pollack (central-garden cushions and pillows)

LIGHTING: Amerlux (track spot); Day-Brite (recessed/office)



Sanitaryware, bathroom furniture, bathtubs, shower trays, wellness products and accessories: Duravit has everything you need to make life in the bathroom a little more beautiful. **Austin** Morrison (512) 928 1110, **Boston** Splash (800) 686 6662, **Chicago** Studio 41 (312) 222 4900, **Dallas** Elegant Additions (214) 745 0088, **Denver** Bella Vie (720) 382 1090, **Long Island** Blackman (631) 283 1500, **Los Angeles** Snyder Diamond (310) 450 1000, **New York** Davis & Warshow (212) 688 5990, **Miami** Decorator's Plumbing (305) 576 0022, **Perrysburg** Waterhouse Bath Studio (419) 874 3519, **Phoenix** Central Arizona Supply (602) 943 3488, **San Francisco** The Bath & Beyond (415) 552 5001, **San Juan** Luis Freire (787) 622 0505, **Seattle** Keller Supply Kitchen & Bath Showcase (206) 285 3300, **South Norwalk** Klaff's (203) 866 1603, www.duravit.us

2012 CALL FOR ENTRIES Record Products

The editors of ARCHITECTURAL RECORD are currently accepting submissions for the **2012 Record Products** competition. Manufacturers and designers are welcome to submit new building products for the December issue, which will present the best and most innovative offerings available to architects, specifiers, and designers in 2013.

There is no fee. For more details and to enter online, visit <https://www.wizehive.com/apps/recordproducts2012>. E-mail questions to rita_catinella@mcgraw-hill.com. (Please use *Record Products* as the subject of the e-mail.) **Submissions are due September 7, 2012.**

Flexibility. Convenience. LEVITY™!

Levity™ – The New Standard in Task Lighting

Simply lift cap and it automatically turns ▶ on its LED lights and raises to 6". Then pull up to 20" or anywhere in between. Two telescoping arms move in any direction, wherever you need light. Levity™ offers 360° of controlled, directed, focused task lighting. Push down closed when done, lights go out and Levity™ hides away. Includes two 15A/125VAC outlets. ETL listed and tested to meet UL153.

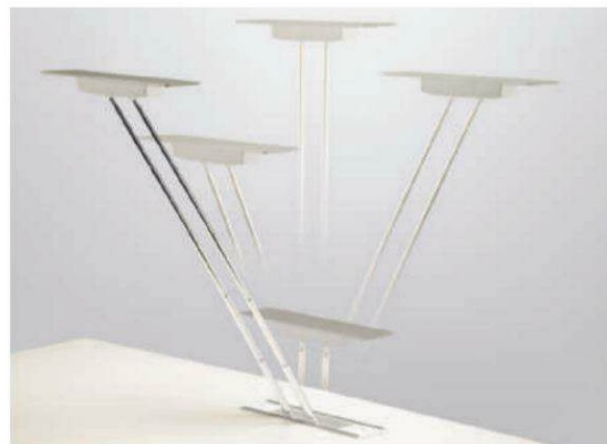

Moves from right to left, front to back and anywhere in between.

"FINE ARCHITECTURAL HARDWARE FOR YOUR FINE FURNITURE"®

MOCKETT
DOUG MOCKETT & COMPANY, INC.

BEDR™ ROOFS

Stone Wool Insulation by Roxul® Demonstrates Superior Moisture Management Capabilities, and Remains Dimensionally Stable Over Time - Even with Extreme Fluctuations in Temperature

High Performance Roofing Insulation

- ✓ Energy Saving Long-Term R-Value
- ✓ Dimensionally Stable
- ✓ Fire Resistant
- ✓ Moisture, Mold and Mildew Resistant
- ✓ Sound Absorbent
- ✓ Environmentally Sustainable



800.265.6878
www.roxul.com

ROXUL
The Better Insulation™



Nature Nurtures

Two hospitals in very different settings rely on similar strategies to create environments for healing.

By Joann Gonchar, AIA

THE WORD “BIOPHILIA” is increasingly bruited about in debates on the design of health-care facilities. Although the term sounds like an incurable physical ailment, it actually means “love of life or living systems.” First used by social psychologist Erich Fromm in the mid-1960s, the word was popularized by biologist Edward O. Wilson in his 1984 book of the same name, referring to humans’ innate attraction to nature. Biophilic architecture accordingly

embraces nature or natural elements to improve occupants’ physical and mental health, increase productivity, and enhance overall well-being.

Not surprisingly, the study of these therapeutic effects has its own history. The same year that Wilson’s book came out, Roger Ulrich published the first rigorous study of the relationship between health outcomes and physical surroundings. Ulrich, co-founding director of the Center for Health Systems

& Design at Texas A&M University, reviewed records for two groups of patients recovering from gallbladder surgery in a suburban-Philadelphia hospital. One set recovered in rooms that overlooked a small stand of deciduous trees, while the other set occupied rooms that looked out onto a brick wall. Ulrich found that the patients with views had shorter postoperative hospital stays, took fewer and less potent analgesics, and were less likely to develop complications.

Since that groundbreaking study, at least 50 others have been published that demonstrate a link between biophilic features—such as daylighting

SURGICAL REMOVAL
A number of the patient rooms in Massachusetts General Hospital’s Lunder Building look out onto a bamboo garden (above). The garden occupies one of two notchlike voids in the building’s 10-story glass-clad volume (opposite). The other void is a skylit atrium containing hanging vines. Lunder has a green roof that is not accessible but is visible from adjacent towers.

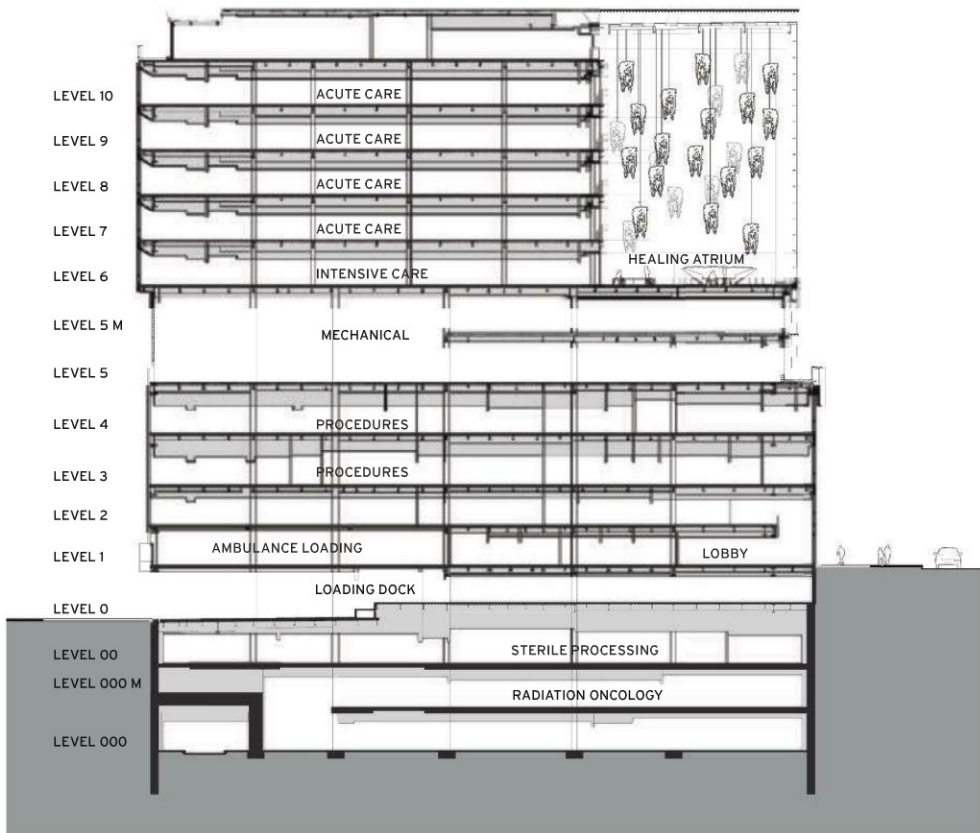

LUNDER EAST-WEST SECTION

0 30FT.
9M

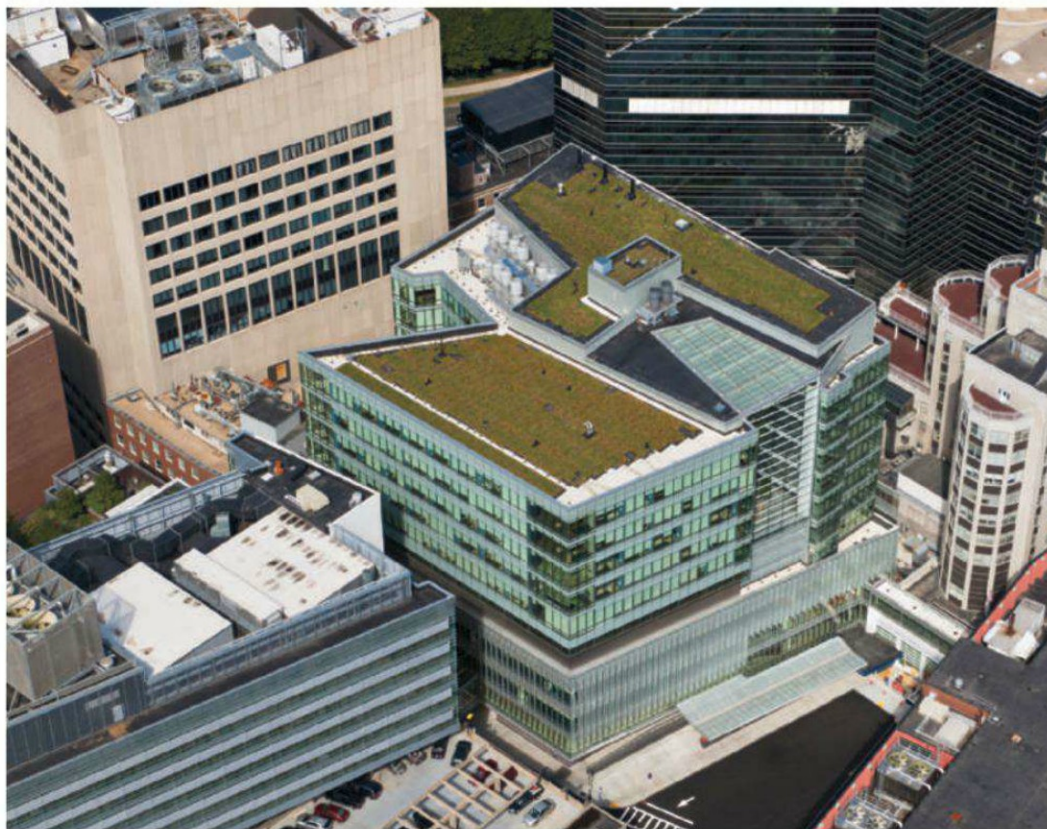

and views of nature—and faster recovery rates, decreased dependency on medication, and reduced stress for both family members and staff, according to Terrapin Bright Green, an environmental-consulting and strategic-planning firm. Terrapin recently published its own study, *The Economics of Biophilia*. The white paper assigns financial value to productivity and human health benefits garnered by incorporating nature into a variety of building types, including schools, offices, retail spaces, and hospitals. For example, by correlating current data on the average per diem expense of inpatient care with the results of Ulrich's 1984 study, the paper concludes that deployment of biophilic strategies in health-care facilities nationwide could reduce the average cost of a post-surgery hospital stay by about \$2,000 and save Americans more than \$93 million each year. The objective was not to pinpoint exact industry savings, says Terrapin partner Bill Browning; "instead, we wanted to provide a sense of their order of magnitude."

The overarching goal of this analysis is to promote widespread adoption of biophilia in buildings of all types. And there is an indication that health-care providers and the architects who work with them are more receptive than ever to biophilic strategies. Robin Guenther, a Perkins+Will principal, credits this new traction to developments like the increased importance of sustainability and the emergence of evidence-based design (a multidisciplinary process that relies on credible research as the basis for design decisions). Hospitals are no longer seen simply as "repositories of machinery," she says.

Examples of biophilic design tactics include the incorporation of water features, healing gardens, daylight, and views out to nature, as well as the use of natural materials or biomorphic architectural forms. Often such features are discrete elements in a building, but sometimes they serve as a fundamental organizing principle. Such was the case at two health-care facilities in very different settings on opposite coasts: Massachusetts General Hospital's 535,000-square-foot Lunder Building, completed last year on the institution's densely developed campus in Boston, and the 736,000-square-foot Palomar Medical Center West, set to open later this month in northern San

Diego County. The glass-clad Lunder has two wedges sliced from opposite sides of its 10-story cubelike volume: One void houses an outdoor bamboo garden, and the other is an 80-foot-tall atrium containing hanging vines. The more suburban Palomar's signature feature is a 1.5-acre, subtly undulating green roof. It covers a two-story diagnosis-and-treatment wing that is an extension of the base of an 11-story patient tower. The roof is visible from many of the facility's 360 rooms.

The decision to include these biophilic elements is tightly coordinated with the institutions' broader mission of delivering safe and efficient medical care, maintaining patient comfort, and ensuring staff satisfaction. For example, the steel-framed Lunder is configured so that its five acute-care floors, typically with 32 private rooms each, stack on top of a four-story base containing the lobby, emergency room, and procedural rooms. An intermediary mechanical zone effectively "liberates" the structure of the upper-portion building from that of its base, allowing an unconventional layout for the patient-room floors, explains Jay Siebenmorgen, design lead for NBBJ, Lunder's architect. The plan features two interlocking C-shaped groups of rooms—all with views of the city, the atrium, or the bamboo garden—and a diagonal circulation spine that connects the two green voids (page 97). The arrangement yields the maximum number of beds within Lunder's tight footprint, yet allows daylight to penetrate into the core of the building, and serves to break the typical central nursing station into two pods, minimizing staff travel distances between rooms and support areas.

At Palomar, similarly practical considerations prompted the decision to locate the equipment-intensive diagnostic and treatment functions in a dedicated wing: Designers wanted to accommodate expected advances in medical technology and control retrofitting costs. The wing's structure—with its rolling roof supported by a series of trusses more than 100 feet long, without intermediary columns—is intended to facilitate the replacement of outmoded equipment and permit changes to room layouts, explains Frances Moore, an associate principal at CO Architects, the project's designers. The space



directly below the waveform roof provides a zone for the wing's copious mechanical infrastructure.

To bring daylight into the interior of the diagnosis-and-treatment wing's vast volume, CO has provided "skywells." These planted courtyards, defined by ground-to-roof glazing, provide a link between the outdoor environment and surgery-prep areas, operating rooms, and recovery spaces. As part of its participation in the Pebble Project—a research initiative administered by the Center for Health Design—Palomar plans to document the effect of the skywells on staff productivity and medical errors.

On top of the two-story wing, the green carpet of native herbs and grasses, chosen by landscape-architecture firm Spurlock Poirier for their ability to thrive in the roof's hills and valleys, provides environmental benefits such as creating habitat for birds, helping control storm-water runoff, and mitigating heat-island effect.

Unlike the rolling roof, which was designed to be viewed but not occupied, gardens included in the patients' tower at Palomar were conceived as planted terraces where family members and other visitors can sit surrounded by ferns, shrubs, and flowers, and take in the view of surrounding hills and

mountains. The design team staggered the floor plates to create double-height spaces tall enough for trees, and provided planting beds with sufficient soil depth for the trees' root systems. The sensory stimulation—the sound of rustling leaves, the textures and aromas of the different plants, and changes in light levels—should prove therapeutic, says landscape architect Andrew Spurlock.

In contrast, the goal for the bamboo garden at Mass General's Lunder, which can be seen from adjacent patient rooms and circulation areas but is not accessible, was to create a composition that would provide visual interest in all seasons, explains Herb Sweeney, a senior associate at Michael Van Valkenburgh Associates (MVVA), the project's landscape architect. Designers chose a type of evergreen bamboo that will eventually grow as tall as 40 feet, flowers such as daffodils and hellebores, and a species of dogwood with red branches that are especially noticeable when it is leafless in the winter.

For Lunder's skylit atrium, MVVA selected a robust vine species with 20-foot-long tendrils to emphasize the space's verticality and developed an integrated irrigation system. But before the facility's opening, the owner replaced the live vines with silk

ROLLING ROOF An undulating 1.5-acre living roof at Palomar Medical Center West covers a two-story wing for diagnosis and treatment. The green carpet of more than a dozen native plant species is supported by a series of long-span trusses. This structural strategy should allow the hospital to replace outmoded equipment and change room layouts.

TERRAZZO Points the Way to Health

University of Minnesota Amplatz Children's Hospital • Minneapolis, MN



Jennifer Mango
IIDA, ASID
Interior Designer
Tsoi/Kobus & Associates

"Terrazzo offers sustainable opportunities for durable design and unlimited color choices. The flexibility of design allowed us to create a memorable welcome experience by orienting visitors, and helping to set the hospital's 'Passport to Discovery' theme into motion. The glittering effect of the mirror chip aggregate also engages children and encourages exploration."

<http://www.tka-architects.com> Photo by Ben Stoner

<http://www.uofmchildrenshospital.org>

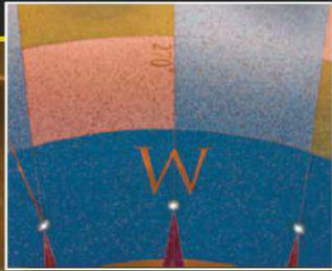

NTMA[®]

The National Terrazzo & Mosaic Association, Inc.

www.ntma.com

800.323.9736



facsimiles, citing maintenance and infection-control concerns.

Both hospitals have exterior envelopes detailed so that the occupants can derive maximum benefit from the buildings' natural (or natural-looking) features. For instance, the patient-room levels at Lunder are clad in full-height insulated glazing units. These units' lower lites include a frit that provides a perceptual edge, while allowing light to bounce off the floor. At the top edge of the room the ceiling tapers, with the glazing extending above the typical 9-foot room height. This detail ensures the maximum view of the exterior environment, even for bed-bound patients, explains Siebenmorgen.

Straightforward but thoughtful details, like the Lunder patient-room soffits, belie the complexity of the buildings' programs, mechanical and structural infrastructure, and architecture. Both project teams credit their successful coordination of these overlapping systems to their use of building information modeling (BIM), which was not yet widespread in 2005 when design work at Lunder and Palomar kicked off. The teams depended on BIM for tasks such as exploring program alternatives, better understanding site constraints, virtually simulating construction, and coordinating trades. They also used it to help design challenging geometric conditions, like the staggered garden terraces in Palomar's patient tower, dictated by the projects' biophilic goals. ■



Continuing Education

To earn one AIA/CES continuing-education hour (CEH), including one hour of health, safety, and welfare (HSW) credit, read the extended "Nature Nurtures" article and complete the test at ce.construction.com. Upon passing, you will receive a certificate of completion and your credit will automatically be reported to the AIA. Find additional information regarding credit-reporting and continuing-education requirements at ce.construction.com, under "requirements."

Learning Objectives

- 1 Define the term "biophilia."
- 2 Discuss the potential therapeutic effects of incorporating biophilic elements in health-care facilities.
- 3 Outline the history of scientific research relating to biophilia.
- 4 Describe the biophilic elements incorporated into two current examples of health-care facilities and discuss how these elements are integrated with the buildings' structural, mechanical, and envelope systems.

AIA/CES Course #K1208A

SOOTHING SURROUNDINGS Palomar's patient tower includes garden terraces planted with ferns, flowers, and shrubs (above). To create double-story spaces tall enough for trees in these gardens, the design team has staggered the tower's floor plates. The hospital's operating rooms (below), housed in a two-story wing for diagnosis and treatment, have windows that provide medical staff with views into courtyards.



FOR CEU CREDIT, READ THE EXTENDED "NATURE NURTURES" STORY ONLINE AND TAKE THE QUIZ AT CE.CONSTRUCTION.COM OR USE OUR FREE ARCHITECTURAL RECORD CONTINUING-EDUCATION APP, AVAILABLE IN THE ITUNES STORE.

GREEN BUILDING. BLUE INSULATION.

ENERGY SAVING THERMAL PERFORMANCE
EXCEPTIONAL SOUND ABSORPTION
80% POST-CONSUMER RECYCLED CONTENT
NO CHEMICAL IRRITANTS
PERFORATED FOR EASY INSTALLATION



UltraTouch[™]
Denim Insulation

BONDEDLOGIC.COM

**Financial
Incentives
for
Energy
Efficiency**

FREE Energy Benchmarking

All over the state, facility managers, business owners and local government officials are wisely taking advantage of FREE Energy Benchmarking from *New Jersey's Clean Energy Program*[™]. The report costs nothing, but what you learn is priceless. We'll analyze how energy is used in your building and prepare a guide that can save you money down the road. Organizations that benchmark end up reducing their energy use by an average of 20%, and with this profile, you'll be able to identify the most cost-effective upgrades in your building and the sources for financing and additional incentives.

FINANCIAL INCENTIVES AVAILABLE

New Jersey's Clean Energy Program[™] provides a comprehensive package of initiatives that make energy efficiency a reality for business owners, local government officials and residents. Save up front with sizeable financial incentives and down the line with dramatically reduced utility bills.

To learn more about benchmarking for buildings in the public and private sectors, visit NJCleanEnergy.com/BENCHMARKING or call 866-NJSMART to speak with a program representative.

NJ SmartStart Buildings[®] is a registered trademark. Use of the trademark without permission of the NJ Board of Public Utilities is prohibited.



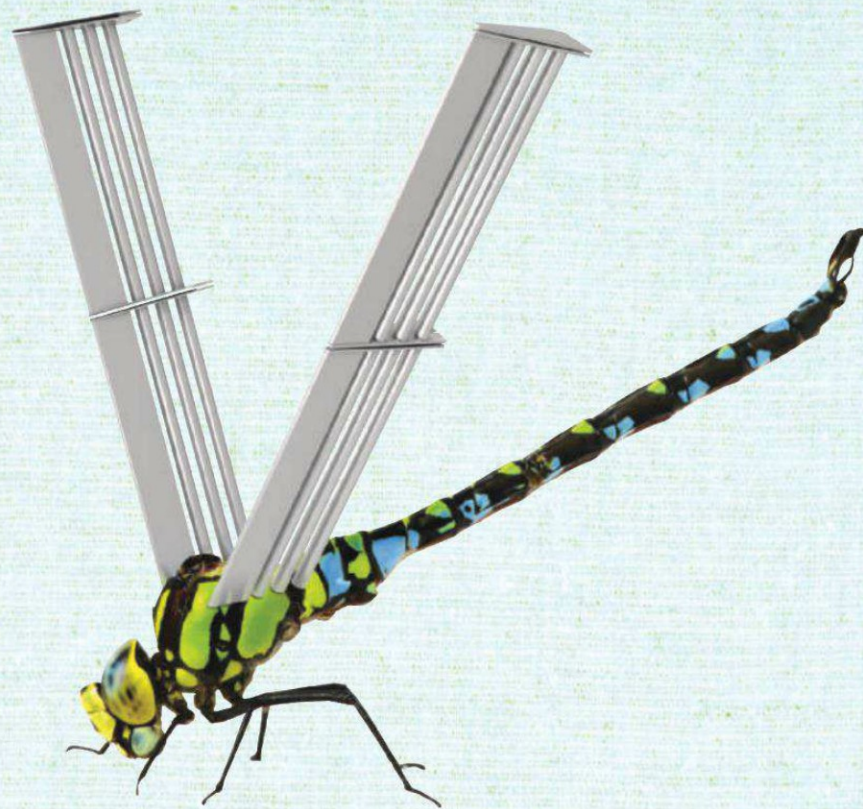

BEAUTIFUL, NATURE INSPIRED DESIGN.

FROM SUN CONTROLS TO CURTAIN WALLS, YKK AP's enerGfacade® SYSTEMS DEFINE BUILDING ENVELOPES

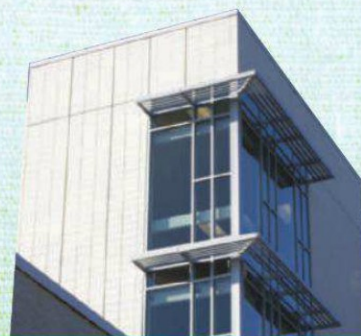

ENTRANCES STOREFRONTS CURTAIN WALLS SUN CONTROLS WINDOWS BALCONY DOORS

800-955-9551 - ykkap.com/inspire

YKK
ap®
Quality
inspires®

©2012 YKK AP America Inc. YKK AP® is a registered trademark of YKK Corporation.

Louis Poulsen, Gl. Strand, Copenhagen, Denmark. Photo: Jesper Ray

F+P

WALL LED



Design: Foster+Partners. F+P WALL LED emits a symmetrical downlight. The opal cone ensures an even and diffuse light, free from obtrusive glare. The light emitted through the cone helps reducing the contrasts. The polished edges of the cylinder glow and hence clarify the shape of the fixture.



**louis
poulsen**

www.louispoulsen.com

The Power of Light

- 123 National September 11 Memorial
- 124 Futakotamagawa Rise Galleria
- 127 Broken Light
- 131 Lighting Beirut Architecture
- 135 Lighting Products

Potent reflections of troubled times, the four projects featured in this section—all winners of this year's International Association of Lighting Designers (IALD) Award of Excellence—demonstrate how an effective lighting scheme can fulfill the functional demands of a program with subtlety and artistic flair, and at the same time evoke the spirit and determination of individuals, communities, and nations striving to overcome adversity.

National September 11 Memorial New York City Michael Arad / Fisher Marantz Stone

By Linda C. Lentz

FOR SEVERAL years on the anniversary of 9/11, a pair of temporary light beams were projected heavenward as luminous reminders of the attacks on the Twin Towers. In contrast, Michael Arad's permanent memorial, completed for the tragedy's 10th observation, looks inward (RECORD, September 2011, page 68). Speaking to loss and the healing process, the architect created a serene parklike plaza and carved a void into the hollow of each tower's footprint, surrounding the black holes with gently illuminated pools of cascading water. To achieve the introspective effect Arad desired, lighting designer Paul Marantz and his team tucked light columns, rigged with T8 lamps behind prismatic reflectors, under a canopy of trees in the plaza, and persuaded city officials to lower light levels there from the mandated 5 to .5 footcandles. Then they lined the base of the pools' 30-foot-high waterfalls with over 1,500 feet of submersible, 3,500-Kelvin (K) LED luminaires, driven at 24 volts. Framed by a bronze parapet containing the stencil-cut names of the victims—lit indirectly from below by 3,000K linear LED fixtures and custom reflectors for a warm, even glow—the monuments are so discreet within the peaceful setting that they are barely visible from adjacent walkways and streets. ■

credits

ARCHITECT: Handel Architects – Michael Arad, Gary Handel, partners

LIGHTING DESIGNER: Fisher Marantz Stone – Paul Marantz, Zack Zanolli, Carla Ross-Allen, Barry Citrin

CONSULTANTS: Dan Euser Waterarchitecture (water feature); PWP Landscape Architecture (landscape)

CLIENT: National September 11 Memorial & Museum

CONSTRUCTION MANAGER: Port Authority of New York and New Jersey

COMPLETION DATE: September 2011

SOURCES

LIGHTING: Winona (waterfall, parapet); Selux (plaza)

**Futakotamagawa
Rise Galleria**
Tokyo
Lightdesign

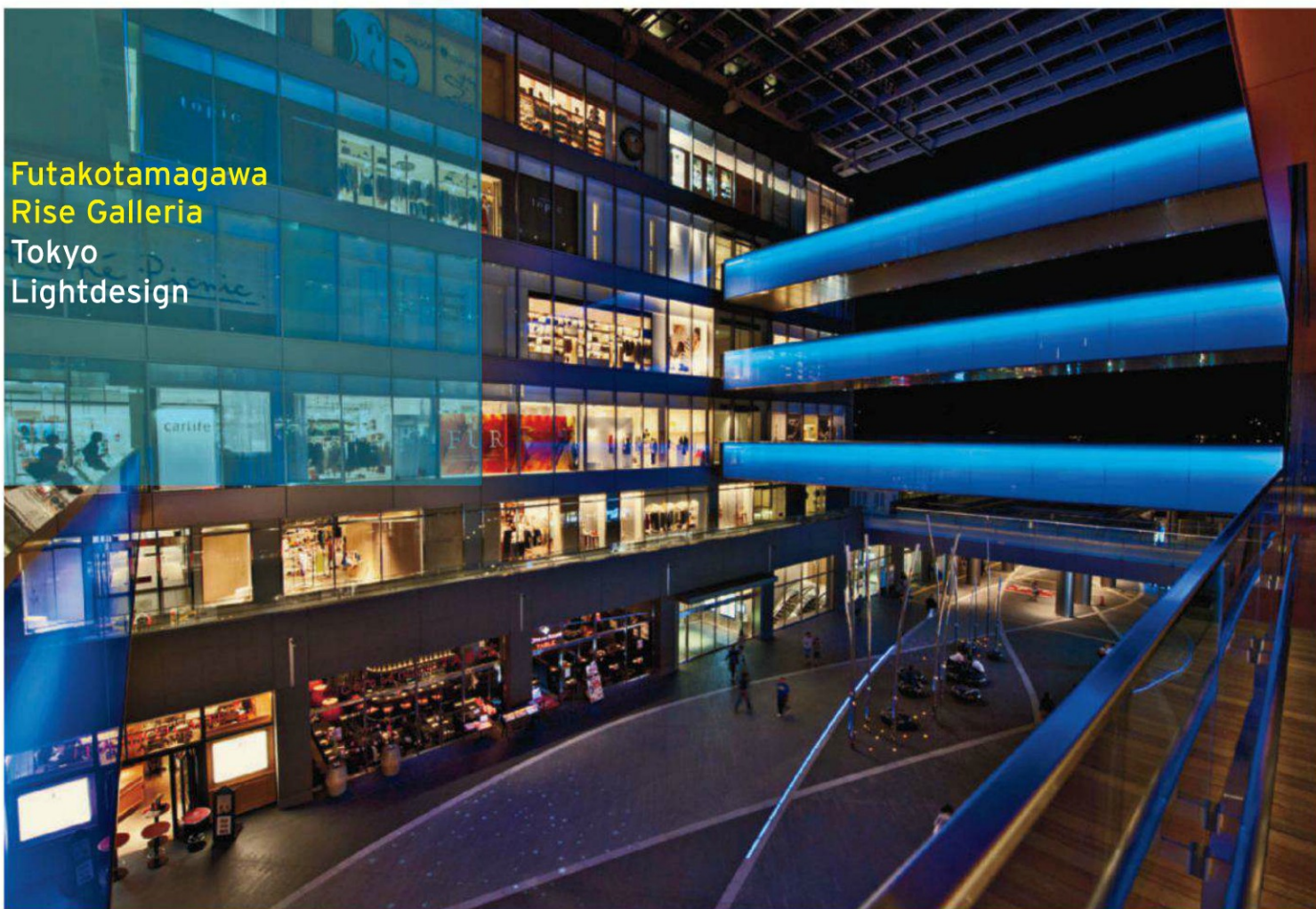

By Naomi R. Pollock, AIA

LOCATED AT the edge of Tokyo, the Futakotamagawa Rise Galleria had the misfortune of being completed just six days after the Great Hanshin Earthquake jolted Japan on March 11, 2011. Though the earthquake and the subsequent tsunami did not physically impact the city, they triggered a nuclear crisis that caused drastic energy-conservation measures nationwide. Lighting designer Hiroyasu Shoji of the Tokyo-based Lightdesign had to revamp the complex's outdoor illumination before it ever had the chance to shine.

The Galleria comprises a pair of buildings containing shops and offices spanned by a covered court. A joint venture of the Research Institute of Architecture, Tokyu Architects & Engineers, and Nihon Sekkei, the project aims to transform a quiet, low-scale transportation node adjacent to Futakotamagawa Station into a thriving commercial center. Shoji's scheme begins at the station's busy ticket gates, where LED downlights installed in a low ceiling provide the light level of 600 lux (lumens per square meter), or 56 footcandles (lumens per square foot), needed for safety and function. The atmosphere changes as the station flows into the Galleria's soaring 131-foot-high glass-topped central space, where the light softens to a more welcoming 500 lux (46 footcandles).

One hundred 150-watt metal-halide lamps, affixed in neat rows to the roof's steel grid frame, provide general lighting, while LED fixtures mounted vertically on the sides of the buildings illuminate the facade, and cold-cathode fixtures line the handrails on the bridges spanning the concourse. At ground level, ribbons of LEDs embedded in the pavement and reedlike stainless steel poles topped with acrylic-cylinder-encased LEDs abet wayfinding and ambience.

Concerned with saving energy even before the disaster, Shoji envisioned three computer-controlled "light scenes" that change over the course of the night to reflect the flow of pedestrian traffic. Fortunately, Shoji was able to adapt this staged lighting system after the earthquake by shortening operating times and shutting off some fixtures altogether, such as the roof's downlights. As a result, the Galleria's illumination level dropped from 500 to 10 lux (.9 footcandles). "Before March 11 Japanese people liked well-lit spaces," explains Shoji. Afterward they willingly accepted less light, in keeping with Japan's somber mood and energy crunch. Though today many of the Galleria lights have been switched back on to the original light levels, the memory of the disaster has yet to dim. ■

Tokyo-based Naomi R. Pollock is an architect and special international correspondent for RECORD.

STAGED EFFECT Reflecting the slowing flow of shoppers as the sky darkens, light levels drop and the colored hues of the bridge, pole, and ribbonlike LED fixtures turn from warm orange after sunset (opposite), to red-purple in the evening, and to deep blue (above) at 11 p.m. when the downlighting shuts off completely and pedestrian traffic tapers off for the night.

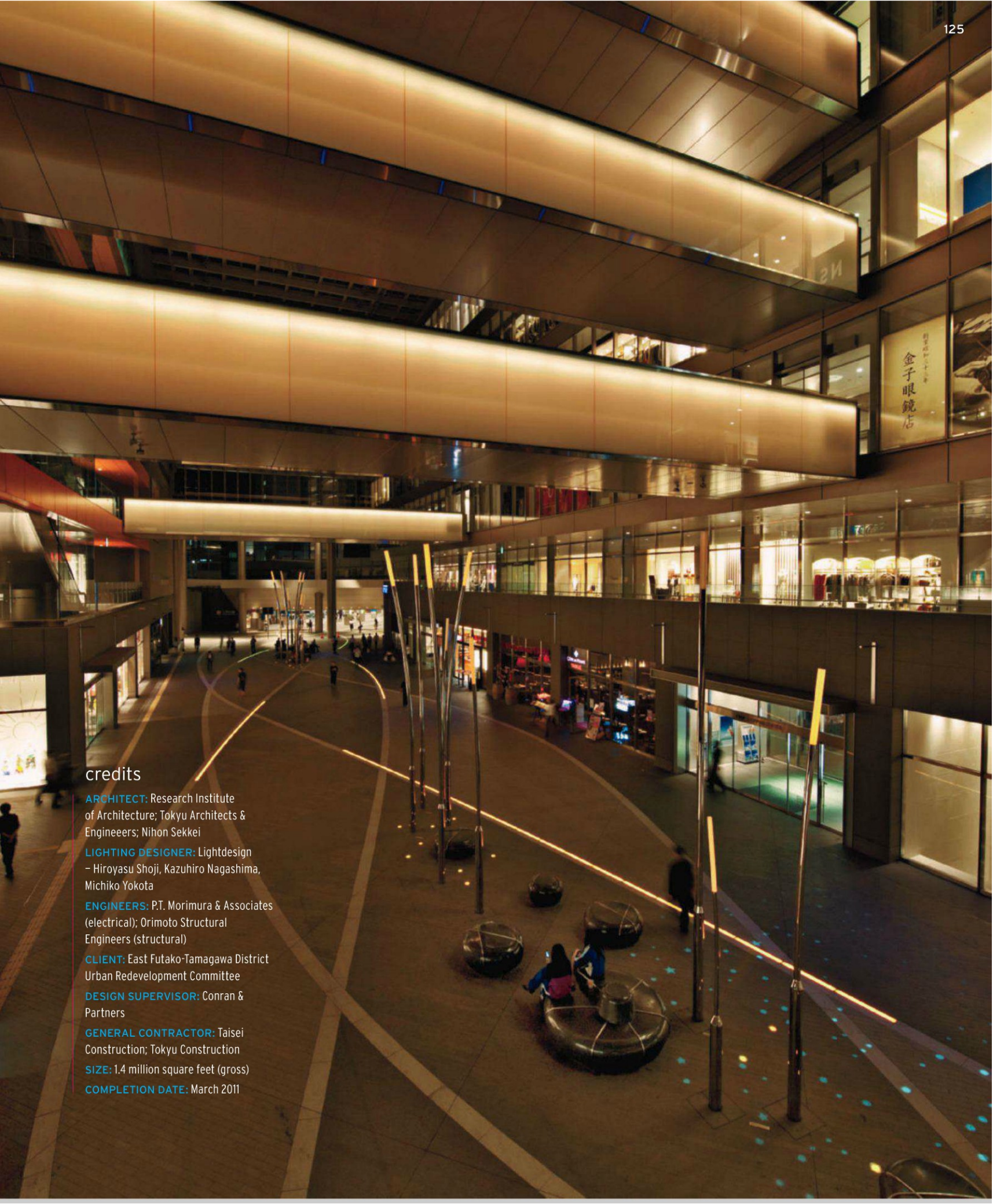

credits

ARCHITECT: Research Institute of Architecture; Tokyu Architects & Engineers; Nihon Sekkei

LIGHTING DESIGNER: Lightdesign – Hiroyasu Shoji, Kazuhiro Nagashima, Michiko Yokota

ENGINEERS: P.T. Morimura & Associates (electrical); Orimoto Structural Engineers (structural)

CLIENT: East Futako-Tamagawa District Urban Redevelopment Committee

DESIGN SUPERVISOR: Conran & Partners

GENERAL CONTRACTOR: Taisei Construction; Tokyu Construction

SIZE: 1.4 million square feet (gross)

COMPLETION DATE: March 2011

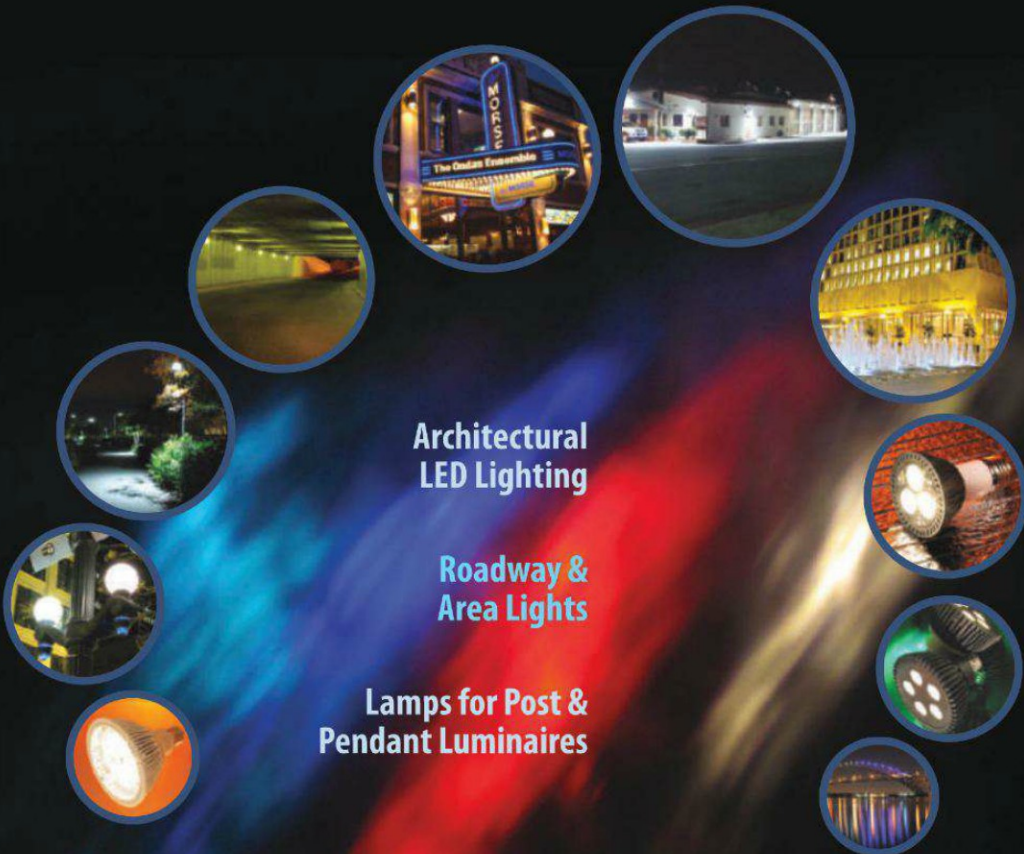

Architectural
LED Lighting

Roadway &
Area Lights

Lamps for Post &
Pendant Luminaires

LEDtronics.com

Creating the Future of Light Since 1983.

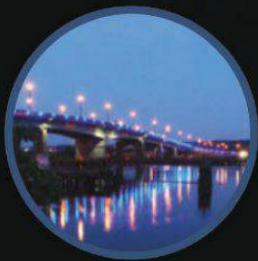

LED Tube Lights

LED Strip/String
/Path Lighting

Miniature &
Intermediate
Based LED Bulbs





Broken Light Rotterdam, The Netherlands Daglicht & Vorm

By Tracy Metz

THE ATJEHSTRAAT was just an ordinary street in Katendrecht, a hardscrabble neighborhood in Rotterdam's old harbor area, where immigrants and young people have taken the place of sailors and prostitutes. Now it is a special street, thanks to the Broken Light project of artist and lighting designer Rudolf Teunissen and his firm Daglicht & Vorm (Daylight & Form). The project covers sidewalks in a wavy, underwater-like pattern of soft light, while adorning the facades of rental apartments in strips of light that look like pilasters. The overall effect is to create an atmosphere of peace and tranquillity.

Broken Light originated in 2006 as part of a cleanup and refurbishment of Katendrecht, for which the municipality commissioned a group of artists to create public art. They, in turn, put out a call for lighting designs that would evoke the erstwhile gaiety in the neighborhood's former bars and brothels. Teunissen worked in conjunction with Max industrial designers to develop a scheme that would enhance Atjehstraat's public spaces, with its generic no-frills public housing from the 1970s. His intent: to combine streetlighting and illumina-

tion in a way that brings the horizontal and vertical planes together into one unified space. According to Teunissen, "This project is about using light to reconquer public space."

To do this he removed the existing streetlighting and installed 18 new poles with custom-designed projection fixtures, nine on each side of the street between trees that are 49 feet apart. Half of the poles also contain upgraded standard lights for traffic illumination. Each projection unit is mounted at a height of 20 feet and contains a 50-watt metal-halide high-pressure gas-discharge lamp with high color-rendering properties. These lamps also transform 80 percent of their energy into light rather than heat. A series of mirrors inside the fixtures distributes the light, which is then projected through one vertical and one horizontal projector as wavy patterns on the sidewalk and stripes on the building facades.

In terms of energy use, the blocklong stretch—492 feet long and 66 feet wide, 48,438 square feet all told—consumes 1.5 kilowatts per hour. That is actually 50 percent more than typical streetlights in Rotterdam, but it covers a greater

GLOWING REHAB
Winner of an International Association of Lighting Designers (IALD) Award of Excellence and its top Radiance Award, the Broken Light project has transformed this previously rough block into a safe and serene cathedral-like setting with a unique streetlight system that both illuminates the road for traffic and casts dappled patterns of light across the sidewalk and buildings.



PHOTOGRAPHY: © DAGLICHT & VORM (BELOW)

surface area. Additionally, most streetlights are oriented toward cars rather than pedestrians, who are blinded by them. “Here the construction of the fixture prevents glare for all the various users,” says Teunissen.

The poles are firmly anchored in the ground so that they won’t shake or sag; otherwise the stripes of light might be projected onto the windows rather than the walls. At first, the building occupants worried that they would be staring directly into the lights. So Teunissen rented an apartment and set up two test light poles to demonstrate the effect. “Now they are all proud of their street,” he says.

In public spaces, light is most often used to create a safe environment or for commercial purposes. While Broken Light deals with the visual quality of darkness often associated with danger, it establishes contrasts and engages the aesthetic and sensual value of light. “Most urban illumination is used for buildings that already stand out,” says Teunissen. Instead, Broken Light has rejuvenated an ordinary street and given it not only a new identity but also a source of pride. ■

Netherlands-based author and journalist Tracy Metz is an international correspondent for RECORD.

SHADOW PLAY Custom fixtures at the tops of the poles (right) face away from the street and house a series of mirrors and projectors that distribute a playful array of vertical and horizontal light patterns across the sidewalk and between the windows of the residential buildings—without any glare (above).

credits

LIGHTING DESIGNER: Daglicht & Vorm – Rudolf Teunissen, Marinus Van Der Voorden

CONSULTANTS: Max Designers (industrial design); Modernista (streetlight calculation); Alanod (reflector efficiency)

CLIENT: City of Rotterdam (DSPS/De Player; Center Arts; Pact op Zuid Rotterdam)

SIZE: 48,438 square feet

COMPLETION DATE: November 2010



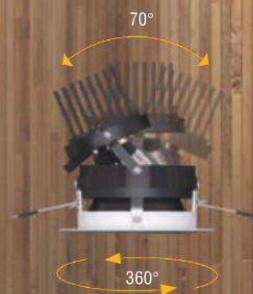

L144

Adjustable 14W LED Downlight

The NEW L144 features $\varnothing 4\text{-}7/8\text{'}$ recessed trim, 70° vertical tilt, and 360° rotation. Light output comparable to a 50W MR16 recessed luminaire.



*Scan for The Mill,
an Interactive Lighting Design Project*

[M] MPLIGHTING®

www.mplighting.com

1 877 708 1184

Small Package. Big Performance.



**GET A FREE SAMPLE IN YOUR HAND & SEE FOR YOURSELF
VISIT RABLED.COM**

5W LED Flood Precision Engineered to Deliver Stunning Output

The new RAB LFLED5 is proof that great things really do come in small packages. Designed with a special microprismatic lens, it produces a smooth, even light distribution that replaces 35W halogen fixtures without the excessive heat that can damage plants. Its industry-leading thermal management technology keeps both the LED and driver cool to ensure optimum performance. Plus, with its optional spot reflector (NEMA Type 2H x 2V) you get highly versatile landscape lighting in a palm-sized package.

RAB[®]
L I G H T I N G

CIRCLE 69

Lighting Beirut Architecture

Lebanon

Light Cibles



GRAND ILLUSION Light from rooftop-mounted projectors accents and aligns with the details of an early-20th-century facade along downtown Beirut's Allenby Street, creating contrast and drama usually reserved for theater and film sets.

By Jessica Dheere

AS IN ANY great film, Beirut's illuminated downtown reveals no unintended harsh shadows, no light sources or fixtures. Its Ottoman-style and French-mandate buildings and their Arabesque, Art Nouveau, and Art Deco details subtly emerge with strokes and washes of what might be moonlight. It's all an illusion, except the illusion hasn't been created for the ephemeral moment of the shot.

Lighting Beirut Architecture, an ambitious project designed by the French lighting-design firm Light Cibles, was a first step in an ongoing transformation of the city's downtown nightscape. The initiative, directed by Solidère, the real-estate developer responsible for the Beirut Central District and its post-civil-war reconstruction since 1994, was conceived in 2004. It was put on hold after the assassination of former Lebanese prime minister Rafik Hariri in February 2005, then revived in 2009, in part to spotlight Rafael Moneo's Beirut Souks, a new shopping complex there.

Essentially, Light Cibles principal Emmanuel Clair and his team developed a scheme whereby the facades of 28 architectural landmarks, religious buildings, and the Souks would be illuminated every night by 147 custom-designed, high-definition projectors. Mounted on adjacent rooftops, these are protected by housing designed to meet an IP65 rating in order to withstand the area's harsh weather conditions. To highlight the arches, pilasters, cornices, balconies, corbels, and other elements without creating unwanted shadows, the lighting designers inserted 5½-inch-round glass discs called gobos (short for "go-between") between the projectors' metal-halide lamps and lenses. Each disc is printed with the image of a building, or part of a building, made up of tiny black dots whose varying density lets different amounts of light through in different places. The result is a kind of light in grayscale that brings the details into high relief. "The concept," says Clair, "is to give the illusion that it is traditional lighting, begging the question, where does the light come from?"

Rooftop projectors provide several benefits. They will not damage the stone facades of the buildings, and will eliminate the need for bulky housing at ground level. In addition, as their beams shoot downward, they preserve the dark sky. The remote fixtures were not without challenges, however. The landlords of the buildings where they would be mounted hesitated to provide access to their properties and power supplies. Meanwhile, the owners of the facades to be highlighted had to be enticed to turn off existing lighting. "It was difficult to explain what the advantages would be for them," says Bachir Moujaes, an urban designer with Solidère.

Logistically, each facade required several projectors, often positioned on different buildings, at a variety of distances from the planes they are illuminating, and casting light from oblique angles. This required the use of five precise beam spreads (15, 20, 30, 40, and 50 degrees) and, because each gobo covered only a fraction of a facade, necessitated painstaking alignment. There was a "certain



level of tolerance that we didn't take into account," says Moujaes. "A shift of even 1 millimeter at the light source could result in being off by several centimeters on a facade."

It took six months to get things right—adjusting the tilt and pan of the projectors, and the concrete and steel fittings. The launch on June 18, 2011, was attended by excited crowds and received rave reviews. Even the building owners seemed impressed, says Moujaes. Still a work in progress, Lighting Beirut Architecture was turned off this June for maintenance. Fluctuating voltage—due to poor management of the country's electrical infrastructure and widespread shortages that require building owners to alternate between government-provided power and generators—damaged some projectors. But a survey of the problem is under way, and with luck the evocative lights of downtown Beirut will be back on soon. ■

Jessica Dheere is a freelance writer for RECORD based in both Beirut and Washington, D.C.

credits

LIGHTING DESIGNER: Light Cibles – Louis Clair, Emmanuel Clair, Marta Coda, project directors; Elena Dallai, project manager; Alejandra Gomez, Victor Garcia, Martina Bordini, Havisha Ratore, design team

CONSULTANTS: Nadia Nordera (graphic design); Gérard Harlay

(image projection); Mamari Frères (fixture installation)

CLIENT: Solidère

SIZE: 269,100 square feet

COMPLETION DATE: June 2011

SOURCES

PROJECTOR: Lampo

GOBOS: Goboland

MODERN ART The herringbone-patterned elevations of Rafael Moneo's Beirut Souks provide a textured canvas for a contemporary color interpretation of the lighting adjacent to a garden (above). Beirut's 1934 neo-Mamluk-style town hall was the longest facade to be illuminated. Eight projectors were needed, some mounted at a distance of between 75 and 110 yards (right).





LED Lighting With Style

Serrano[®] LED infuses the latest solid state technology into a high performance, architecturally elegant design. With efficacies up to 95 lumens per watt and a batwing distribution, Serrano[®] LED blends quality, uniformity, and energy savings.

Visit us at LIGHTFAIR International 2012 booth #1921 (Hubbell Building Automation) and at AIA booth #2421.

MTR SQUARE

MONUMENTAL

The sleek, contemporary design is a compliment to today's modern exteriors. MTR square offers patented refractor rings to reduce glare, enhance visual comfort and direct light to the task plane. The "square" addition to the MTR family allows additional freedom into various landscape environments.

Project: The National September 11 Memorial, New York, NY — Architect: Michael Arad Project — Landscape Architect: Peter Walker (PWP Landscape Architecture) — Lighting Designer: Fisher Marantz Stone



To learn more, visit us at selux.us

CIRCLE 70

selux

Coming of Age

LEDs are finally ready for prime time, and if the new products displayed at this year's Lightfair and AIA trade shows are any indication, there's an LED solution for every program—indoors and out, retrofit, renovation, or ground-up construction. Improved output, optics, color, and dimming are among the options available in a wide range of fixtures. Plus, a consortium called Zhaga aims to enable interchangeable LEDs by different manufacturers, simplifying installation and maintenance.

By **Linda C. Lentz & Rita Catinella Orrell**

Lumenbeam Family

Lumenpulse has expanded its Lumenbeam offering of high-performance LED projectors to include a new size. The 14-watt luminaire (shown below, far left) is a compact, low-wattage, high-performance projector for lighting exterior applications such as landscapes, trees, columns, pathways, monuments, and architectural details. The line-voltage luminaire (120 to 277 volts) offers a choice of optics for floor or accent lighting in white or RGB arrays.

lumenpulse.com CIRCLE 214



MBW2 Vertical Wall Wash

At this year's Lightfair, Intense Lighting introduced more than 30 LED products and announced a new LED 10-year warranty. As part of the new line, the company has expanded the MB-LED track series for accent and wall-wash lighting. Ideal for use in retail and other commercial environments, the luminaires offer lumen outputs ranging from 650 to more than 3,000. Delivering over 2,500 lumens at 54 watts, the MBW2 (shown) is a high-output LED wall-wash fixture utilizing two LED arrays that provide a powerful, uniform, vertical illumination. The fixture consumes 25% less energy than a similar ceramic metal halide and offers up to 50,000 hours of operation.

intenseighting.com CIRCLE 216



Lumination Luminaires

Measuring 12" x 48" x 1.4", the Lumination suspended luminaire (shown) delivers remarkable light output in a slim design that combines direct and indirect lighting in one highly efficient translucent LED fixture. A clear, narrow band surrounds the edge of the fixture, making the light source appear to float in midair. The 57-watt luminaire has a lumen output of 4,000 and a CRI of 80, and comes in 3,000 Kelvin (K), 3,500K, and 4,000K color temperatures. Also joining the Lumination line are ultrathin recessed troffers that fit seamlessly in most common T-bar ceiling grids and provide energy cost savings of up to 26%, depending on the lamp type.

gelightingsolutions.com CIRCLE 213



Y Series Downlight

Lucifer's LEDX Y Series downlight is intended for high-ceiling applications in hospitality, residential, corporate, or other high-end spaces that require greater light levels. Engineered for ceilings up to 30' tall, the downlights use LEDs delivering 1,300 (17W), 2,000 (35W), and 3,000 (53W) lumens. The ability to deliver 3,000 lumens puts the fixtures among only a handful in the world capable of offering so much light with an LED. The fixture can also be installed "zero-sightline," meaning that the trim is flush with the ceiling.

luciferlighting.com CIRCLE 215

Adelie LED Post-Top Luminaire

At 10' high, Adelie is a nonglare, energy-conserving indirect LED post-top luminaire for pedestrian-scale outdoor spaces including malls, parks, and corporate campuses. The indirect post-top reflector is finished in white powder-coat and protected by Teflon. The housing is cast aluminum; a finned LED housing adds a functional design element by ensuring effective thermal management. Thirty-two LED sources are available in 3,800K or 5,300K color temperatures, with a CRI of 70. The LED driver is located remotely in the pole base with 120- or 277-volt input. (Power consumption is only 51 watts.)

hessamerica.com CIRCLE 217



Element

Tech Lighting's new adjustable 4" LED recessed downlight accepts multiple LED sources, making it ideal for adjustable accent and general-illumination applications. Current options include proprietary lamping using a Citizen LED for maximum light output and efficacy, tight beam control, and field-changeable optics, or integrated lamping using a Molex Helieon module (pictured) with an integrated driver that makes lamp replacement as simple as a twist and lock.

techlighting.com CIRCLE 218

**L223 Spotlight**

MP Lighting's new L223 luminaire is an 18-watt high-output indoor track light for walls, pictures, or signage. The dimmable fixture, which features an anodized aluminum housing, uses seven 2.5-watt LEDs. The L223SR version (shown here with a black metal shroud) is designed for use on a 12V or 24V MP single-rail system. The spotlight features an Active Cooling System (ACS) that detects temperature changes and controls the speed of a cooling fan.

mplighting.com CIRCLE 219

**Trac 12 Modules**

Ideal for linear lighting applications including cove, undercabinet, undershelf, task, and casework display lighting, the highly efficient Juno Trac 12 TL214 Miniature LED Modules use approximately 1/8 of the energy of a typical 5- or 10-watt xenon lamp, while reducing energy use by 85%. Designed with a wraparound diffuse lens, the modules provide a wide, uniform light distribution with performance of up to 398 lumens per foot and efficacy of up to 57 lumens per watt.

junolightinggroup.com CIRCLE 220

**Soraa MR16 Lamp**

In 2007, Soraa's founders invested in an LED technology platform completely different from industry practice at the time. Soraa predicted that gallium-nitride substrates for LEDs (or GaN-on-GaN LEDs) would produce more light and be more cost-effective than any other technology. Soraa currently uses GaN-on-GaN crystals for its LED lighting products, including its new MR16 lamp. According to the manufacturer, the lamp offers better light quality than halogen, needs no fan for cooling, has the highest compatibility with dimmers and transformers, and fits all current MR16 fixtures for retrofits.

Soraa MR16s are available in 2,700K and 3,000K color temperatures, 10°, 25°, and 36° beam spreads, and GU-5.3 and GU-10 base types.

soraa.com CIRCLE 221

Linealuce Compact LED

The Linealuce Compact fixture, designed by Paris-based architect Jean-Michel Wilmotte, is an outdoor wall-mounted and wall-recessed luminaire. UL-listed for wet locations, the luminaire has an innovative optic capable of producing a uniform wall-wash effect in heights of up to 59 feet. The distribution of the LEDs inside the luminaire allows designers to create continuous rows of fixtures without shadows between modules. An innovative wiring system eliminates the need to open the modules during installation.

iguzzini-na.com CIRCLE 223

**Fraqtir S170 Outdoor LED**

The classic elliptical profile was the inspiration for the extruded aluminum heat sink/housing designed for the fraqtir light engine. The new S170 outdoor LED is smaller than comparable outdoor units and features an improved optic that produces an extremely tight beam. Using only 18 watts, it delivers more light than a 100-watt tungsten halogen or 20-watt ceramic metal halide. The removable light engine is powered by advanced Luxeon A emitters. Mounting options include surface, cantilever (shown), and side- and top-mount slipfitter. The fixture offers a light output of 751 lumens, a CRI of 86, and a bright-white color temperature of 3,108.

thelightingquotient.com CIRCLE 222



INTRODUCING

FINO

Stunningly THIN



No downlights need apply

Indirect • 5/8" deep • 5w/ft

Experience precision as never before, with Fino, our new, stunningly thin indirect LED lighting solution. Designed to promote a crisp, comfortable work environment, Fino runs seamlessly across the walls without interfering with wall studs, leaving your ceilings pristine clean.

Add our 10 year limited warranty, and Fino is the LED fixture you've been waiting for.

The Fino LED was introduced at Lightfair 2012. For more information contact info@amerlux.com. Or, call Amerlux at **973-882-5010** to learn more.

So thin. So precise. So Fino.

10 year limited
warranty
AMERLUX LED

amerlux

2012

New from

DELRAY
LIGHTING
INCORPORATED

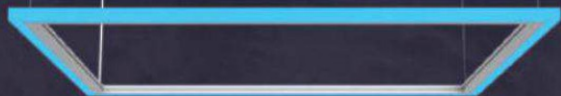

MEDIA² – 2, 3, 4 ft. squares & rectangles, LED, side



MEDIA² – 2, 3, 4 ft. LED squares & rectangles, LED, down

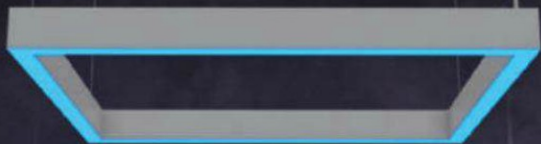

COMPLETA² – 2, 3, 4 ft. squares & rectangles, LED

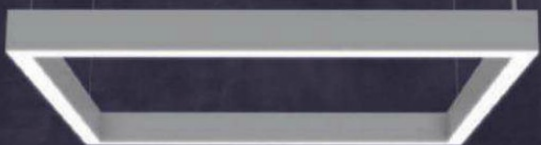

COMPLETA² – 2, 3, 4 ft. squares & rectangles, T5 fluorescent

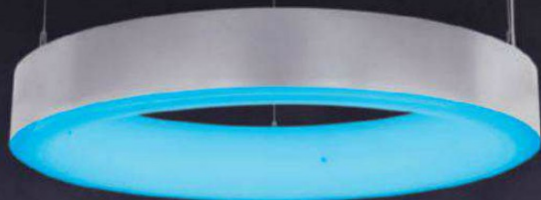

CYLINDRO II – 3, 4, 5 ft. LED pendant



CYLINDRO III – 3, 4, 5 ft. LED pendant

www.delraylighting.com

CIRCLE 74



Loomis

CHARLES LOOMIS, INC.
P: 800.755.0471/425.823.4560
www.charlesloomis.com

Palisade S15 Sconce

"Lighting the world with bright ideas"

CIRCLE 75

HUNZA™ PURE
OUTDOOR
LIGHTING



PURE SUSTAINABILITY

This Euro Twin Wall Spot is one of many Hunza luminaires that offer the latest LED options to provide the ultimate in energy efficiency, safety and longevity. At Hunza we take pride in making the finest outdoor lights in the world, engineered in New Zealand from the best materials to provide a lifetime of pure enjoyment.

www.hunzausa.com

Ph: +1 888 578 6005 Toll Free
sales@hunzalightingusa.com



PURE NEW ZEALAND LIGHT™

CIRCLE 76

One Power Source



For Hundreds
of Lighting Options!

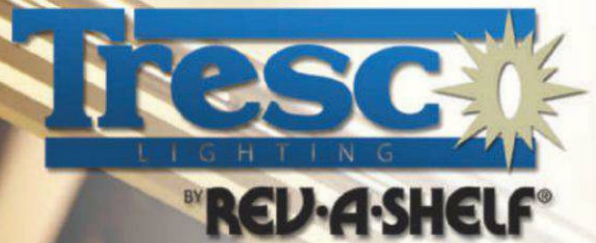

Residential Lighting
Commercial Lighting
Display Lighting

trescolighting.com
800.227.1171

CIRCLE 77

When a hole in your ceiling or wall... *is a good thing!*



"Hole In The Ceiling"
HITC Series Fixtures

"Hole In The Wall"
HITW Series Fixtures



Our "HITC" & "HITW" fixtures are plaster/glass-fiber castings. When installed, they blend into the surface and appear to be a custom built drywall "light niche." They efficiently illuminate your space without calling attention to themselves.

Call us now for more info:
626 579-0943

Visit our website today:
www.elplighting.com

CIRCLE 78

How Guardian SunGuard helps improve patient care and recovery. With light.

Well-daylighted hospitals with outdoor views enhance patient care and recovery. That's why HKS specified Guardian SunGuard glass for



the C.S. Mott Children's Hospital, in Ann Arbor, Michigan. The combination of Neutral 40 and SuperNeutral 68 in an insulated glass unit delivers plenty of visible light and a low, 0.25 solar heat gain coefficient, all with lower reflectivity than previously possible, so patients

can easily see outside. HKS's selection of SunGuard products also improved the building's energy efficiency and created a comfortable setting for children and families. The building is LEED Certified Silver. For complete performance data, project photos and other ways to Build With Light, visit SunGuardGlass.com. Or call 1-866-GuardSG (482-7374).

**GUARDIAN
SUNGUARD®**
ADVANCED ARCHITECTURAL GLASS

BUILD WITH LIGHT®

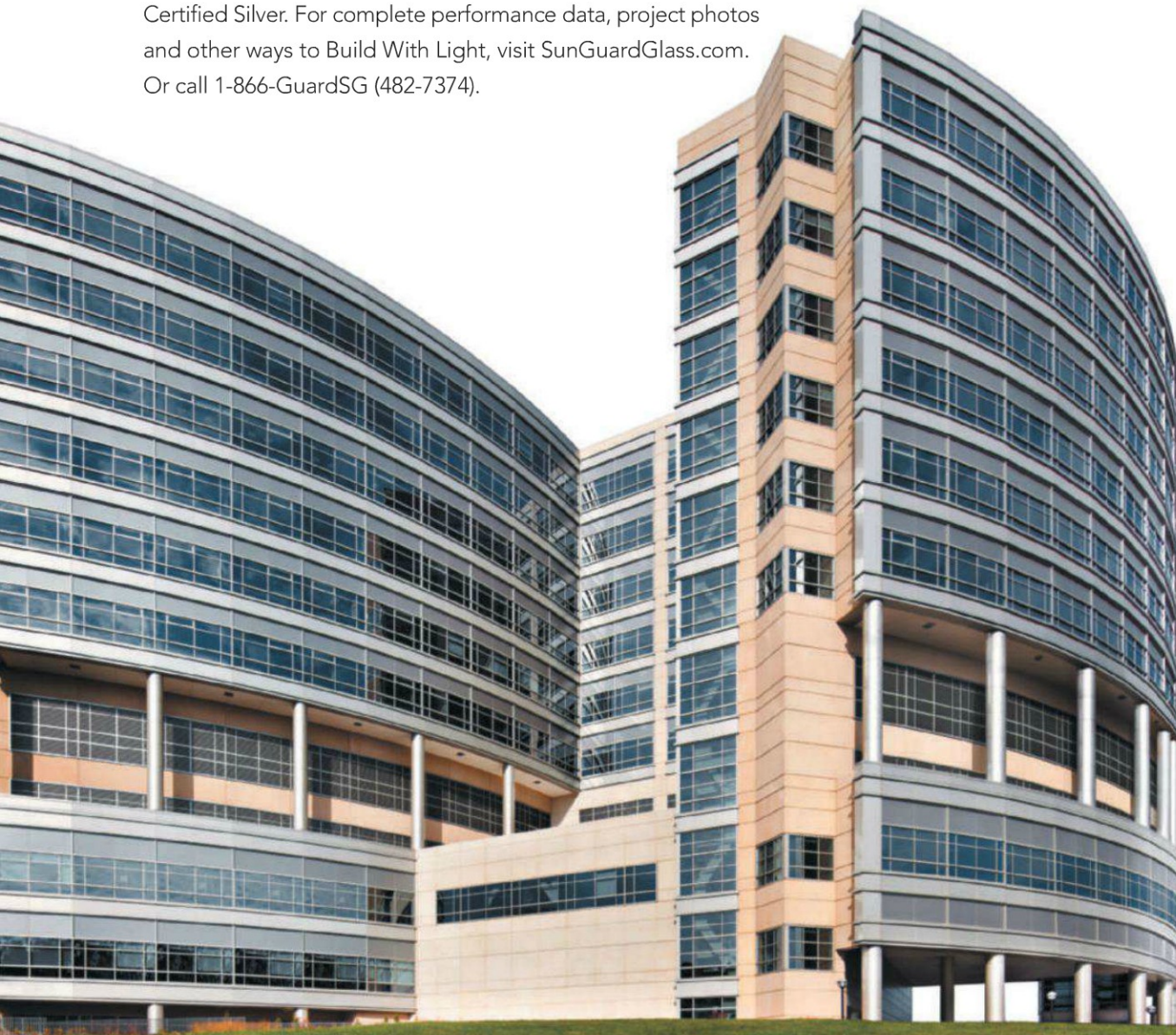

UNIVERSITY OF MICHIGAN
C.S. MOTT CHILDREN'S HOSPITAL
ANN ARBOR, MI
ARCHITECT: HKS
GUARDIAN
SELECT FABRICATOR:
Trulite Glass & Aluminum Solutions
GUARDIAN GLAZIER
CONNECTION MEMBER:
CGI
SUNGUARD GLASS:
Neutral 40 on clear and
SuperNeutral 68 on clear



© 2012 Guardian Industries Corp.
SunGuard® and Build With Light®
are registered trademarks of
Guardian Industries Corp.

Please order glass samples for
accurate color evaluation.

CIRCLE 80

Fenestration Innovations for Leaner, Greener Times

Novel technologies and design innovations allow the fenestration industry to meet codes and build greener.

Sponsored by Guardian Industries Corp., SAFTIFIRST, Pella Commercial, and EFCO, a Pella Company | By C.C. Sullivan

Photo by Costea Photography, courtesy of Pella Commercial

Energy codes and green building standards are not the only trends affecting how architects design building enclosures. Far and away, however, they are the most likely to spark permanent change. The new International Energy Conservation Code (IECC), like its predecessors, sets prescriptive and performance paths for achieving better enclosure performance. In addition to the growing stock of LEED-branded properties, the spanking new International Green Construction Code (IGCC or IgCC) has been coordinated with the International Code Council (ICC) family of model regulations. As with the IGCC, recent local or statewide rules such as California's CalGreen add new impetus for architects to adopt best practices for exterior insulation, air barriers and high-performance fenestration.

"The emergence of green building codes and standards is an important next step to provide communities with the opportunity to build sustainable and safe buildings," summarized ICC's chief executive Richard P. Weiland in March, as communities in Western states began to voluntarily adopt the IGCC.

The energy codes and the new green rules offer fresh, clear guidance to municipal inspectors on

CONTINUING EDUCATION



EARN ONE AIA/CES HSW/SD
CONTINUING EDUCATION HOUR (CEH)

Learning Objectives

After reading this article, you should be able to:

1. List key energy codes and green building standards that impact fenestration selection, and their underlying metrics.
2. Explain how various fenestration technologies have been adapted or developed to meet the goals of energy efficiency, green building and fire-safe construction.
3. Discuss how fenestration systems and glazing materials may be specified to meet prescriptive and performance-based energy codes or green building standards.
4. Describe one or more case studies showing how fenestration systems can meet energy efficiency or green building goals.

To receive AIA/CES credit, you are required to read the entire article and pass the test. Go to ce.architecturalrecord.com for complete text and to take the test for free.

AIA/CES COURSE #K1208C

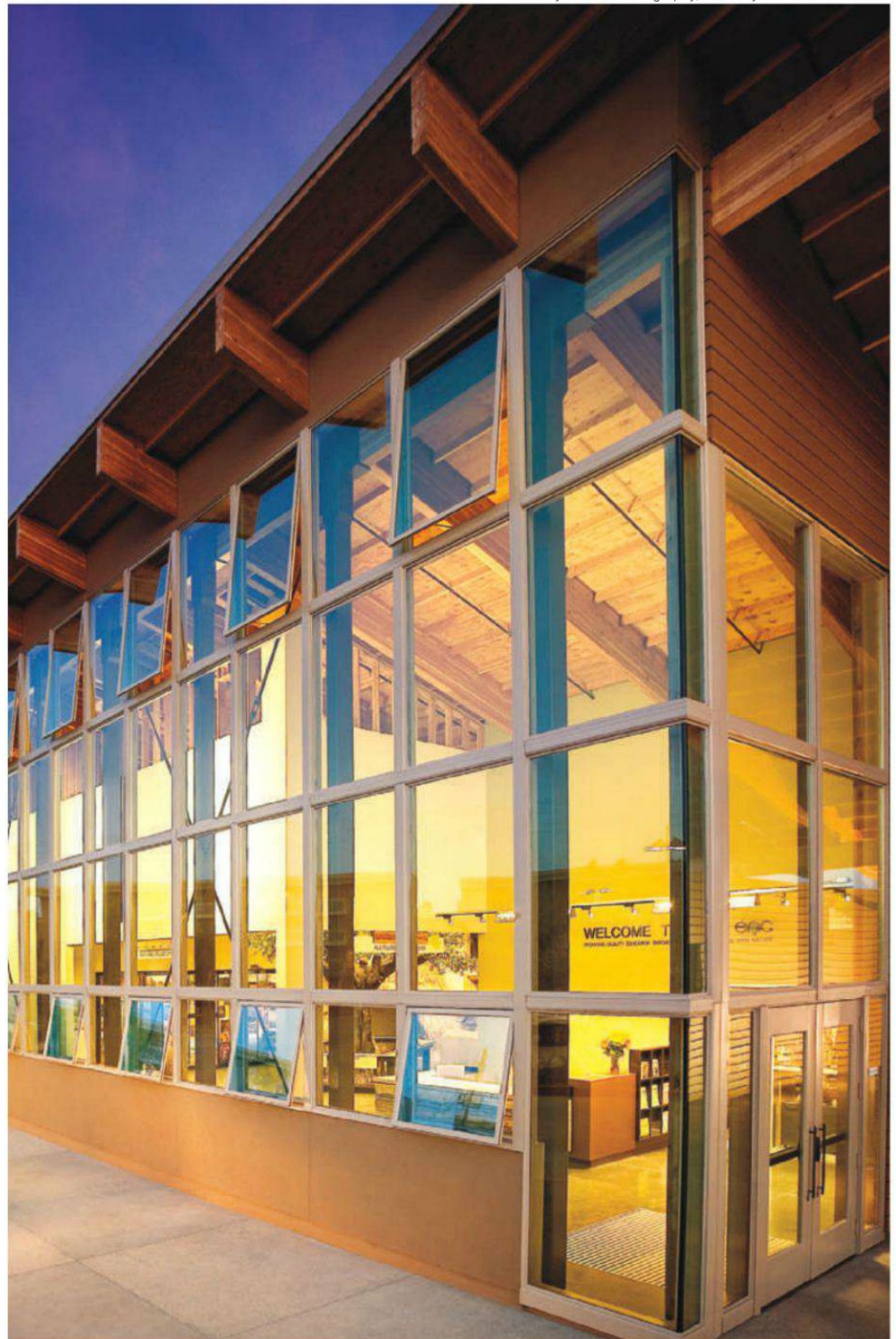

A high-performance aluminum-clad wood window wall at the Environmental Nature Center in Newport Beach, Calif., captures natural ventilation and daylight while limiting heat gain with advanced, low-E insulating glass.

Photo courtesy of SAFTIFIRST



For this Dept. of Veterans Affairs Medical Center in Orlando, Fla., currently under construction, fire-rated glazing has been specified to improve safety and increase daylighting within.

a variety of performance indicators. Among the most useful is the baseline performance criteria handed down for windows, storefronts and doorways—places where air leakage, thermal gain and glare from daylight can hamper the goals of sustainable, energy-efficient construction. Add to that the new recognition of fire-safety performance for glass and windows in the 2012 International Building Code (IBC) chapter 7 tables—comparing fire-protective and fire-resistive applications—and local codes will eventually offer better minimum performance than ever before alongside new pathways to high-performance fenestration.

Better minimum performance is not the best performance—nor is it the most efficient or greenest possible. Yet there are more ambitious standards that, like the U.S. Green Building Council's LEED program, set design standards as baselines for green construction. Jurisdictions can adopt the rules in the IGCC, CalGreen or ASHRAE Standard 189.1—another green building baseline—for a more aggressive local policy.

The result of all this on fenestration options has been twofold: Improving specification and field applications on the one hand, and encouraging innovations by product developers on the other.

“The IECC and IGCC are really driving how framing assemblies and glazing materials are made,” says Terry Zeimetz, AIA, CSI, CCPR, commercial marketing manager with Pella Commercial. “A new generation of fenestration systems is available with more internal chambers, triple glazing, multiple types of low-emissivity coatings, integral shading and other novel, energy-saving features.” (See 2012 IECC Prescriptive Fenestration Requirements chart online.)

“The codes are what really matter, and they don't distinguish between project types,” concurs Chris Dolan, director of commercial glass marketing with Guardian Industries. “Government buildings, institutional facilities and LEED-rated projects all have increasingly stringent energy requirements, so they are all seeking high-performance fenestration with the best-performing glass available.”

More critically, says Dolan and other fenestration experts, the codes and green standards rely on climate zone data to determine energy-efficiency requirements. They may also vary by jurisdiction, according to the Efficient Windows Collaborative (EWC), Minneapolis. “In the 2006 IECC and later, this variation is based on eight climate zones, with each county assigned to one climate zone,” according to the EWC. “However, older versions of the IECC specify 19 different climate zones.” Maximum U-factors and solar heat-gain coefficients (SHGCs) are given in the model energy codes and green-building standards. Skylights are treated separately, and have their own maximum values.

The development of novel fenestration systems, products and materials is the focus of this course. In order to put these innovations in proper context, a general understanding of the energy codes and green building standards—and their underlying building science—is critical.

FENESTRATION PERFORMANCE FACTORS

Underlying the codes and standards is a well-established foundation of building science related to glazing and fenestration design. A number of those help design teams calculate

energy performance, while others relate to safety and fire performance. Among the most important to consider are:

Air leakage

The energy codes and green standards offer guidance to protect buildings from excessive air leakage, often given as maximum levels of air movement in cubic feet per minute (cfm). Poorly designed window-wall interfaces and leaky curtain wall assemblies, for example, transfer heat via air movement in an uncontrolled manner.

U-factor

“Air infiltration is important but distinct from U-factor, which describes the heat transfer rate or insulating ability of an entire fenestration assembly, glazing panel or a window frame,” says Erik S. Sutton, Assoc. AIA, manager of product marketing with EFCO, a Pella Company. “When the temperature inside is different from outside the building, heat will be lost or gained directly through a window. U-factor is the overall rate of heat movement.” (See Fenestration U-factors chart online.)

Solar heat-gain coefficient

Direct sunlight on fenestration also adds heat to the building interior through solar radiation, even on the coldest winter day. Glass and window assemblies can control this heat gain to a predictable extent, says Guardian Industries' Dolan, defined as solar heat-gain coefficient, or SHGC.

Photo courtesy of Guardian Industries



High-performance low-E glass was specified for Ashton Judiciary Square, Washington, D.C.

Image courtesy of Guardian Industries

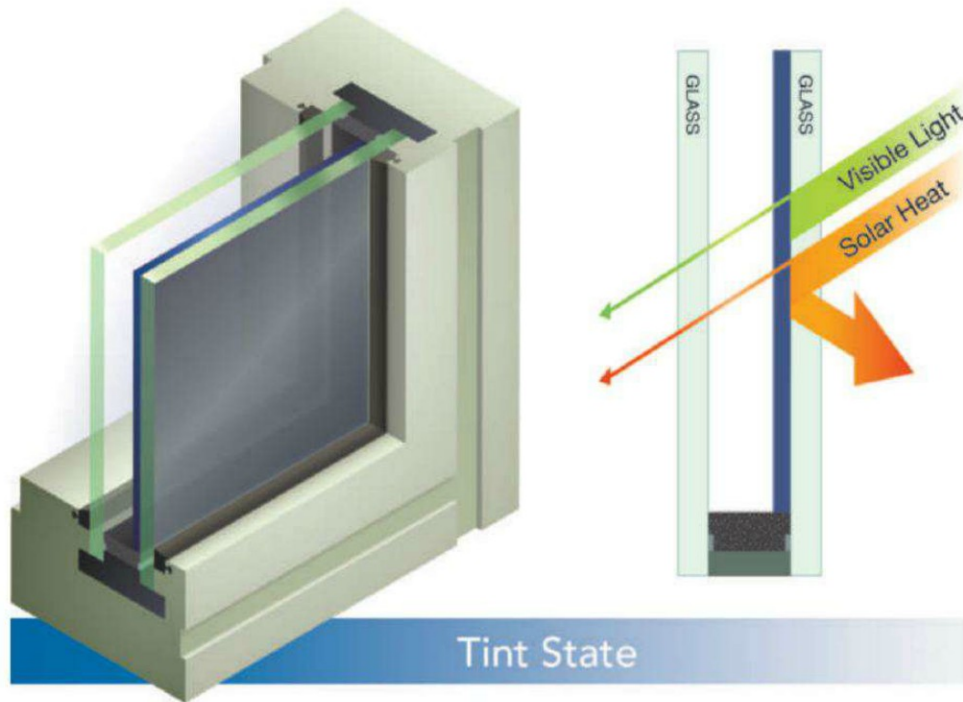

Electrochromic glazing provides a range of operating conditions, including lower VLT (transmittance) and lower SHGC in its tinted, or activated, state.

Visible light transmittance

To calculate how much daylight will be available inside a building to offset electrical lighting needs or to address potential glare, the measure visible light transmittance (VLT) provides a basis for comparison.

Fire-protective and fire-resistive glass ratings

While not associated directly with energy consumption, fire ratings for glass provide a means for comparing the ability of fenestration to protect building occupants and property against fire.

To allow for daylight opportunities and maximize lines of sight, for example, fire-protective and fire-resistive glass can be applied in areas where traditionally only opaque, fire-rated construction materials have been used. “We are seeing fire-rated glass used in stairwells, occupancy separations, exit corridors and property line applications,” says Diana San Diego, director of marketing for SAFTIFIRST, a U.S. manufacturer of specialized glass for fire-rated applications. “Now, designers can use fire-rated glass to bring natural light into a space, allow it to penetrate further into the building, and even lessen electrical lighting loads by sharing artificial lighting between spaces separated by glass, while still meeting all the fire-rated requirements of the application.”

These performance indicators help describe the control of fire, light, heat and air movement in the building envelope and interior separations.

The ability of fenestration systems and materials to control environmental factors is an important criterion for successful building designs.

A RAFT OF GLASS INNOVATIONS

Better ratings and test values are an important trend but they are not the only reason that fenestration products are improving. “In five to 10 years, buildings are going to be very different than they are today because of the energy requirements we face,” says Barry B. Corden, senior director of product applications for Guardian Industries. “So all kinds of technological transformations will really change the game, including building-integrated photovoltaics, or BIPV, as well as electrochromic glazing.”

Several of the newer technologies add renewable and self-sustaining energy production to building designs, says Corden, an outgrowth of the net-zero-energy building movement. Net-zero-energy designs, which dramatically reduce the carbon footprint of the structure, use methods to maximize efficiency while also using onsite electrical generation or water reuse, or both, according to the National Renewable Energy Laboratory (NREL), Golden, Colo. In the new green building codes, the use of *renewable energy* is encouraged and rewarded.

In the past, solar cells blocked daylight transmission—which reduced solar gain but also increased the use of electrical lighting, all things equal. Next-generation photovoltaic glass materials have been designed for greater transparency, increasing direct and indirect

daylighting—which trims electrical lighting needs—and enhancing visibility through the envelope while also more efficiently generating electricity. Where solar cells were previously limited to only rooftop arrays, now the PV glass panels can be integrated into curtain wall, windows, spandrel panels, skylights and roof windows, says Corden. The maximum panel size today is about 5 feet by 5 feet.

While BIPV is a game-changing technology, other incremental advances are just as significant, notes Pella’s Zeimetz. Next-generation vinyl windows, for example, are potentially very high-performing fenestration systems today in spite of their longtime association as a cost-conscious alternative spec.

The main reason? Advances in *thermal control*, say fenestration experts. Thanks in part to the use of triple-pane glazing, vinyl windows have been shown in recent studies to be up to 83% more energy efficient than past models (calculated based on U-factors for a next-generation vinyl window with advanced low-E triple-pane insulating glass with argon compared to a single-pane vinyl window in winter conditions). “State-of-the-art product designs have up to 18 insulating air chambers within the vinyl window frames—that’s three times more than typical vinyl windows,” says Pella’s Zeimetz. The result is a total window unit U-factor of as low as 0.15, which compares to the 2012 IECC maximum U-factors for vertical fenestration of 0.29 and 0.37, respectively, for fixed and operable units, in the most stringent climate zones.

Photo courtesy of K. Easley, courtesy of Pella Commercial



Next-generation vinyl windows provide advances in thermal control such as triple-pane glazing and more insulating air chambers.

Photo courtesy of Guardian Industries



The University of Michigan C.S. Mott Children's Hospital and Von Voigtlander Women's Hospital was designed by the firm HKS to use low-E glazing with low reflectivity and a neutral appearance.

In addition, new vinyl and aluminum windows can be specified with optional foam insulation to further improve the energy performance. To improve control of solar gain and daylight glare, new window designs can include shades or blinds between the glass panes. This feature generally reduces solar heat gain while also protecting the solar control layer from degradation, wear and tear, and mishandling by occupants. Most importantly, it brings the solar protection layer closer to the building exterior, which improves thermal control and occupant comfort.

In fact, the position and location of the active fenestration layers, such as the low-emissivity (low-E) glass coating, can significantly improve enclosure performance, says Guardian's Dolan. "A new low-E glass coating designed for interior glass surfaces is designed to reflect heat back into the building, which further reduces the U-factor," he explains. "So for a typical double-glazed unit, an architect can achieve a center-of-glass U-factor of 0.20, which is an R-factor equivalent of R-5."

The secret to the innovation is a highly resilient interior-surface low-E coating that is not composed of a silver-based compound. The durable, scratch-resistant surface will not corrode like typical low-E coatings, so it can face the building interior surface rather than the insulating glass unit (IGU), which has been typical.

Another type of glazing innovation, electrochromic glass, also helps to control SHGC, VLT and U-factor. "Electrochromic glazing

technology can be switched on demand from clear to variable-tint states, giving occupants and owners unprecedented control over the amount of light and heat that enters a building," says Guardian's Corden. "This switchable tinting capability delivers environmental benefits, improved occupant comfort and potential operating cost reductions." The product also allows architects to eliminate blinds, shades and other window treatments that may reduce outdoor views, he adds.

Photo courtesy of SAFTIFIRST



The Sapphire Towers in San Diego have glazed openings with a minimum 45-minute fire rating.

ASSEMBLIES ADVANCE

In addition to better glass formulations, a number of improvements motivated by stringent codes and industry technical advances have been applied to storefront and curtain wall. Some unitized curtain wall systems now offer novel, integral vent windows, for example, to allow for more fresh air circulation to improve IEQ. A novel unitized aluminum curtain wall, for example, takes advantage of a proprietary, high-strength fiberglass composite technology developed originally to resist *thermal expansion and contraction*.

Used as struts in the unitized curtain wall, the five-layer composite helps achieve excellent U-factors, says EFCO's Sutton. It can also be employed for the pressure plate, providing thermal conductance values approximately 300 times better than those for aluminum plates. The composite has also been shown to improve thermal conductance and overall frame and glass U-factor gains of about 27 percent versus standard aluminum pressure plates. The material swap can also reduce installation steps, because it eliminates the need for a thermal isolator between the back member and pressure plate.

Introducing greater levels of fresh, outdoor air into occupied interior zones is known to improve occupant health and productivity. To improve *indoor environmental quality* (IEQ) through the fenestration choice and design, architects may select a high-performance architectural-grade vent, also known as an AW-rated vent, that is integral to the curtain wall system.

Another novel fenestration product is an aluminum-clad wood window wall with a wood or steel structure for structural attachments. The system design provides structural, technical and water-management capabilities while offering a wood interior and an aluminum exterior. In some cases, the aluminum-clad wood products are tied to the building structure using steel tubes or similar metal connections.

Beyond structural integrity of the fenestration systems, predictable performance under heat, flame and smoke during fire emergencies is important for code officials in order to allow the use of glass for fire-rated fenestration, exterior walls and interior partitions. That need—in addition to the desire to maximize exterior views and daylighting within the building for further improvements to IEQ—has led to the increased use of fire-protective and fire-resistive glass.

Continues at ce.architecturalrecord.com

Chris Sullivan is principal of C.C. Sullivan, a communications consulting and marketing agency focused on architecture, construction and building products. www.ccsullivan.com

TECHNICAL CAPABILITIES.

CREATIVE POSSIBILITIES.

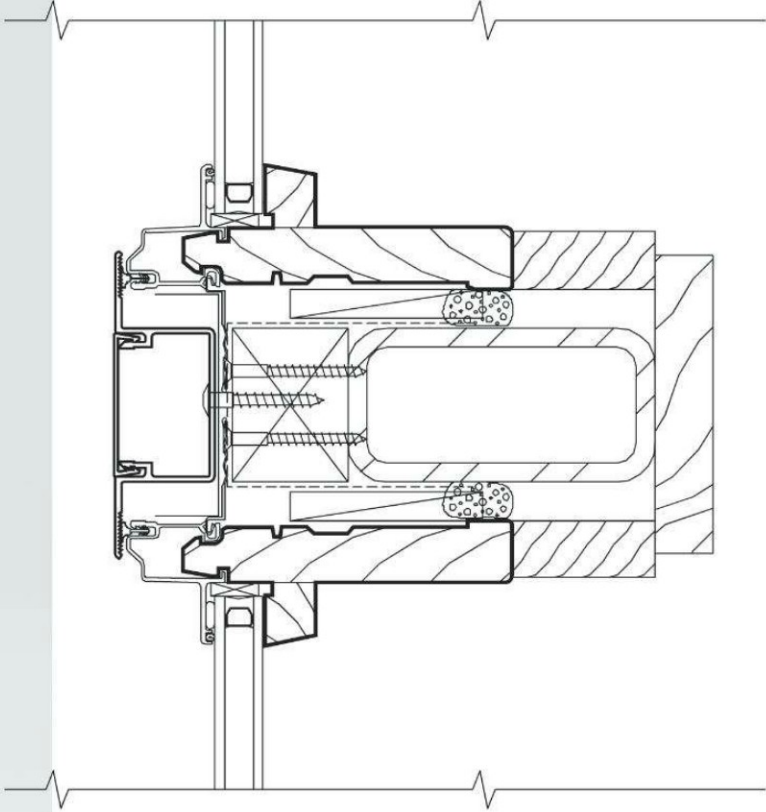

VERTICAL MULLION

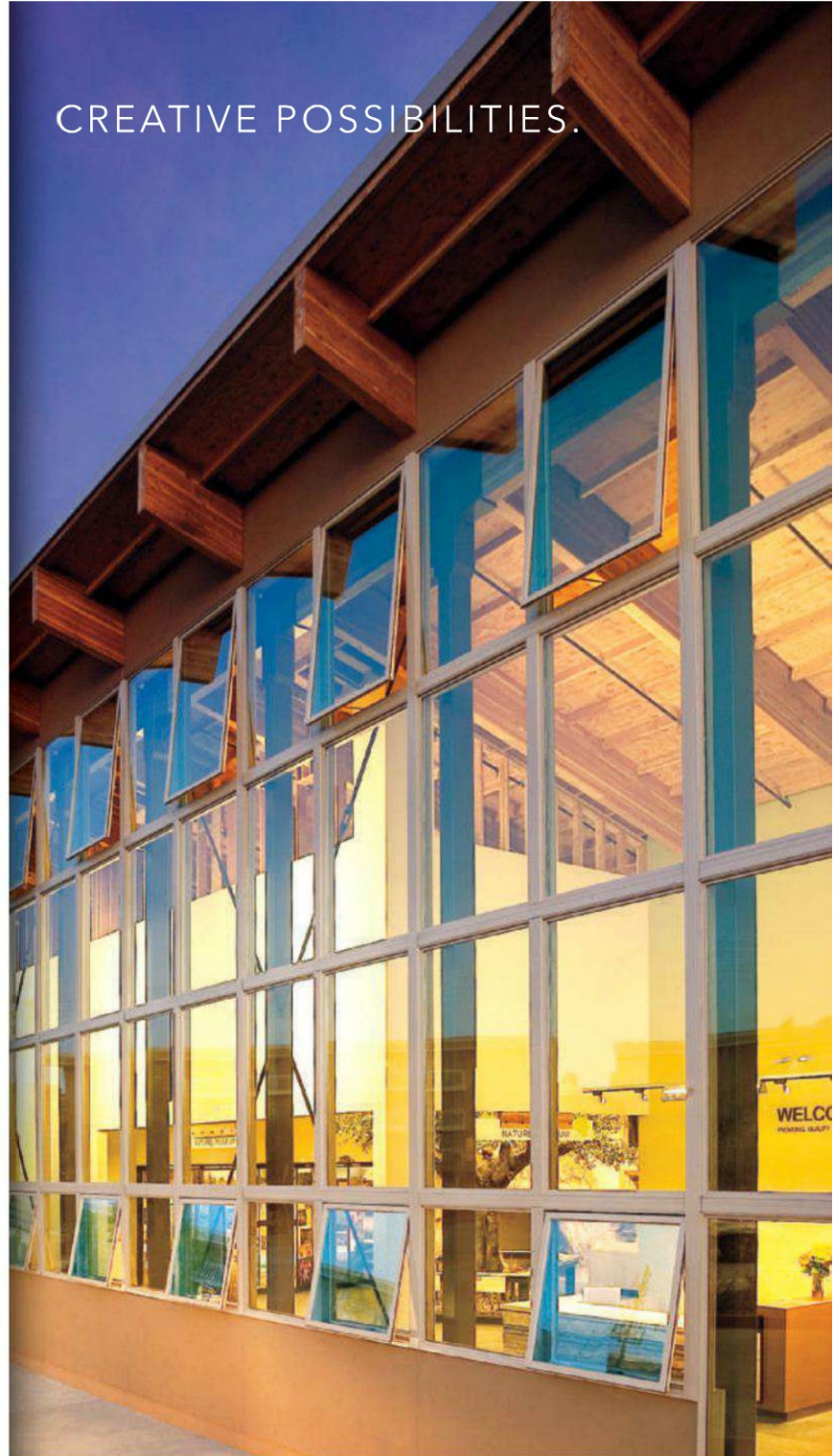

See both sides of this story at pellacommercial.com/enc.

ENVIRONMENTAL NATURE CENTER
NEWPORT BEACH, CA
ARCHITECT: LPA, INC.

A complex custom mullion design to meet rigorous structural, thermal and moisture control specifications. Windows with natural wood interiors to enhance an environmentally conscious design aesthetic. The Pella Commercial team can help you put the art in smart thinking.



COMMERCIAL

PRODUCT REVIEW

Fenestration Innovations for Leaner, Greener Times

Guardian Industries



Advanced Technology Glazing Products

Guardian's new advanced technology glazing products—SunGuard PVGU (a building-integrated photovoltaic product, pictured here) and SunGuard EC (electrochromic)—can increase a building's energy efficiency, generate electricity through the façade and help projects achieve new energy codes. These products provide solutions that can help architects create LEED-certified, net-zero buildings.

www.sunguardglass.com

Circle 92

SAFTIFIRST Fire Rated Glazing Solutions



Clear Fire-Rated Solution

SAFTIFIRST offers SuperLite, advanced fire-rated glass with superior clarity and performance for every application. From fire-rated doors and windows to custom-engineered wall assemblies, you can count on them to deliver high-quality products with fast lead times and competitive pricing made here in the USA.

www.safti.com

Circle 93

EFCO, A Pella Company



Unitized Curtain Wall

The 8750XD Unitized Curtain Wall is the newest member of EFCO's XTherm® family of products. Thanks to their strut design, with patented Duracast® fiberglass composite, they can offer a best-in-class U-factor. With their optional 875X Wall Vent, EFCO is sure to meet your design needs.

www.efcocorp.com

Circle 94

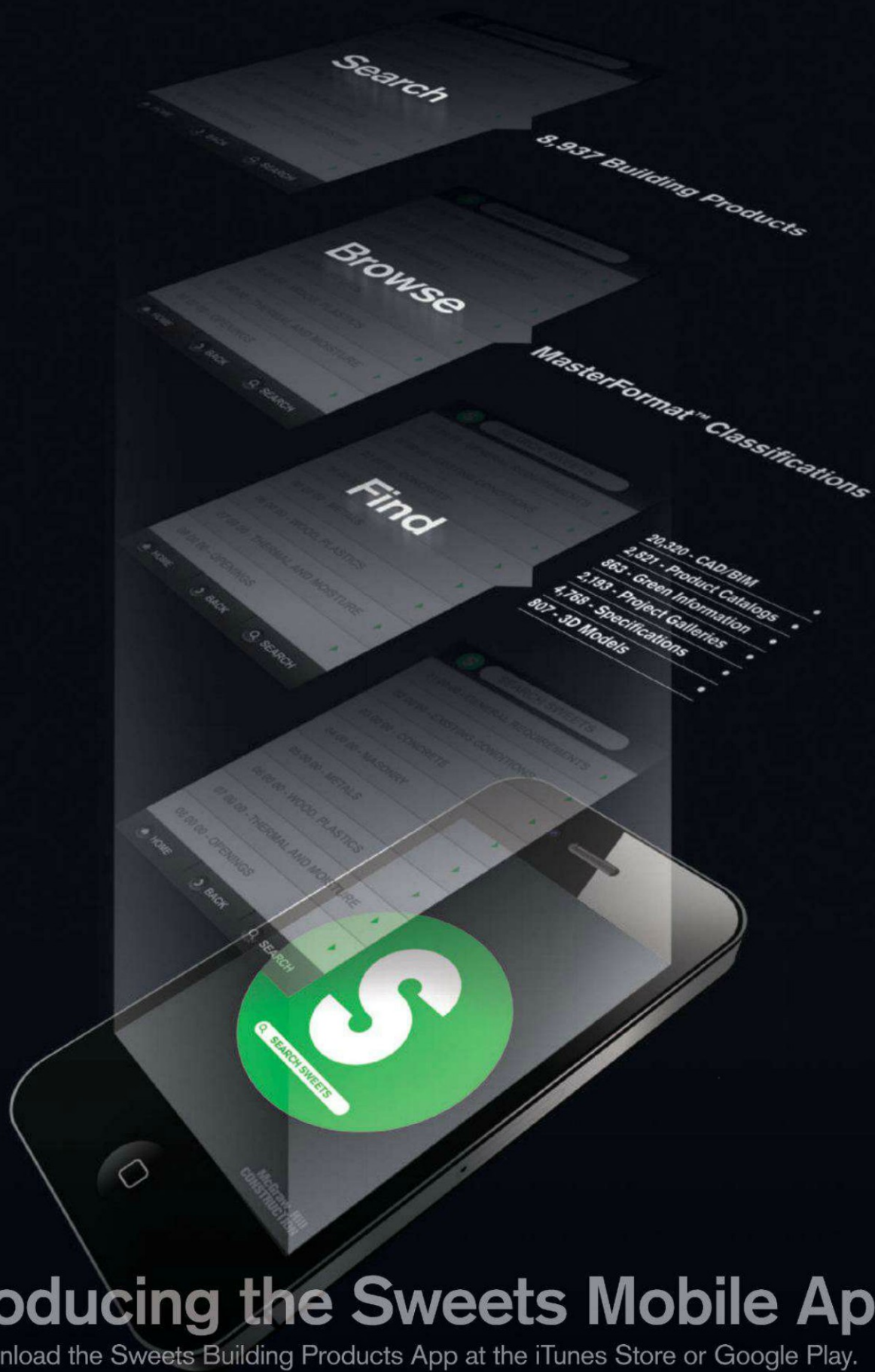

Introducing the Sweets Mobile App

Download the Sweets Building Products App at the iTunes Store or Google Play.

New and Upcoming Exhibitions

Carlo Scarpa. Venini 1932–1947

Venice

August 29, 2012

The opening of this exhibition celebrating architect Carlo Scarpa marks the inauguration of a new permanent space at the Giorgio Cini Foundation, designed by Selldorf Architects. The new galleries will feature the work of international artists, both contemporary and historical, who use glass. The aim is to illustrate the numerous uses of the medium and put glass back at the

center of the international art scene. For more information, visit cini.it.

Field Conditions

San Francisco

September 1, 2012–January 6, 2013

This exhibition at the San Francisco Museum of Modern Art will bend and blur the boundaries between conceptual art and theoretical architecture, using the notion of the “field” to frame an investigation into the construction, representation, and experience of space. Nearly 30 works in various media by both contemporary artists and practicing architects will be on view, including pieces by Tauba Auerbach, Daniel Libeskind,

Rafael Lozano-Hemmer, Sol LeWitt, and Lebbeus Woods. For more information, visit sfmoma.org.

The Drawing Center Reopening

New York City

September 13, 2012

The Drawing Center will reopen after a yearlong hiatus in a newly expanded facility at 35 Wooster Street, with significant alterations to the building's architecture and facade. The grand reopening will feature a daylong series of community activities on September 15, including guided tours of the exhibitions, artist-commissioned projects, and family workshops. For more information, visit drawingcenter.org.

Ongoing Exhibitions

Inventing the Modern World

Kansas City, Missouri

Through August 19, 2012

This exhibition traces the technological, design, and artistic innovations catalyzed by World's Fairs. It features furniture, ceramics, jewelry, textiles, and glass. In keeping with World's Fairs as incubators for technological and stylistic advancements, the Nelson-Atkins Museum of Art has launched a design contest for a temporary pavilion to be constructed on the museum grounds during the exhibition. Visit nelson-atkins.org.

Unfinished Business: 25 Years of Discourse in Los Angeles

Los Angeles

Through August 26, 2012

This retrospective at the WUHO Gallery unpacks the Los Angeles Forum for Architecture and Urban Design's archive, revisiting a history of commentary and debate. In looking backward, the exhibition finds architectural questions, urban-design conversation starters, and critical loose ends that are just as relevant now as they've been for the past quarter century. For more information, visit laforum.org.

Waterline

Chicago

Through August 31, 2012

A dozen Harvard graduate design students studying with Skidmore, Owings & Merrill (SOM) urban-design partner Philip J. Enquist spent a semester investigating opportunities for a stretch of the Chicago River's South Branch, from Wolf Point to Pilsen. This exhibition at the Bridgehouse Museum presents their proposals. The group of students, representing concentrations in architecture, landscape architecture, urban design, and urban planning, developed proposals to use underutilized



MANUFACTURED BY
C.R. LAURENCE

CRL ARCHITECTURAL ENTRANCE SYSTEMS

- 'All-Glass' Entrance and Storefront Systems
- Commercial Patch Hardware
- Panic Handle Systems
- Sliding and Stacking Doors
- A Full Line of Complementary Accessory Items

**NEW!
COMING SOON!**

**CRL14D
ARCHITECTURAL
DOOR AND
ENTRANCE
CATALOG**

Showcasing the largest selection of door systems in one catalog!

CRL
USALUMINUM

C.R. LAURENCE COMPANY
crlaurence.com | usalum.com | crl-arch.com
mail: crl@crlaurence.com | usalum@crlaurence.com

WORLDWIDE MANUFACTURER AND SUPPLIER
Glazing, Architectural, Railing, Construction, Industrial, and Automotive Supplies
Entrances, Storefronts, Curtain Walls, Window Walls, Window Systems, and Sun Control

JAB351-7/12

riverfront land to create a new microeconomy, reenvisioning postindustrial properties as a riparian habitat that could leverage public and private investment into a new kind of development. Visit bridgehousemuseum.org.

Judith Turner: The Flatness of Ambiguity
Ann Arbor, Michigan

Through September 2, 2012

Judith Turner is a noted American photographer whose subject is mostly architecture. Her training as a designer allows her to visually understand an architect's intention and to reveal it in compositions that she constructs and edits through her camerawork. This exhibition will present approximately 40 photographs spanning Turner's three-decade career. At the University of Michigan Museum of Art. Visit umma.umich.edu.

George Nelson: Architect, Writer, Designer, Teacher

Bloomfield Hills, Michigan

Through October 14, 2012

George Nelson is considered one of the most influential figures in American design from the second half of the 20th century. As design director at the furniture manufacturer Herman Miller for more than 20 years, Nelson had his sights firmly focused on Cranbrook, which was also playing a defining role in the development of Modernism. This shared Michigan history comes into sharp focus in this exhibition at the Cranbrook Art Museum. Visit cranbrook.edu.

Designed to Win

London

Through November 18, 2012

This exhibition at the Design Museum explores the ways in which design and sports combine, pushing the limits of human endeavor to achieve victories of increasing wonder. From the design of F1 cars to running shoes, bikes, and carbon-fiber javelins, the quest for enhanced function is endless. Visit designmuseum.org.

Lectures, Conferences, and Symposia

5th International Urban Design Conference
Melbourne, Australia

September 10–12, 2012

If the act of planning is to legitimize "what should be done," opportunistic design thinking seeks action for "what can be done." The theme of this year's International Urban Design Conference, Opportunistic Urban Design, invites attendees to consider innovative urban-design solutions that respond to a

specific context. For more information, visit urbandesignaustralia.com.au.

Suburban Design: Future of Post-War Neighbourhoods
Helsinki

September 12–14, 2012

This seminar for urban planners and architects focuses on the functional development of suburbs. Visits to new and old Finnish suburbs, from Tapiola to Kartanonkoski, are part of the program. Speakers include Joan Busquets, Kristien Ring, Marja Straver-Nevalainen, and Kari Jormakka. Visit safa.fi/suburbandedesign.

Cersai

Bologna, Italy

September 25–29, 2012

With more than 1,000 exhibitors from nearly 140 countries, this ceramic-tile and bathroom-furnishings show at the Bologna Exhibition Centre is one of the most important trade fairs in the world. Visit cersaie.it.

AIA Europe International Conference & Chapter Meeting

Hamburg, Germany

October 18–21, 2012

Attendees of this annual conference will study

INTRODUCING

BASYS™



Any Application. Any Environment.™

Backed by a century of experience and proven Sloan technologies, Basys delivers a revolutionary approach to sensor faucets that meets the demands of the commercial plumbing industry. Fueled by two years of field research and in-depth interviews with architects, engineers and plumbers, Basys has the strength and versatility to meet the needs of any application or environment.

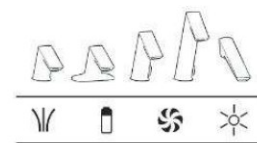

Build a Basys online:
sloanvalve.com/basys

CIRCLE 82



SLOAN®



is to



as



is to



INTRODUCING DESIGNS

www.DESIGNSFRP.com

The newest FRP wall panels from Crane Composites combine the traditional benefits of fiberglass reinforced plastic with innovative and attractive patterns. DESIGNS FRP wall panels have style, perform like FRP and are available with pattern matched moldings for seamless and moisture resistant installations.



1.800.435.0080



CIRCLE 12

dates&events

the HafenCity development taking shape at Hamburg's old harbor. As a redevelopment of former industrial land, it expands the city-center area by 40 percent. Attendees will be exposed to one of the largest concentrations of recent construction in Europe, including the centerpiece Elbphilharmonie and buildings by Herzog & de Meuron, Richard Meier & Partners, Behnisch Architekten, and others. Visit aiaeurope.org/hamburg.

Competitions

Annual Mockett Design Competition

Submission Deadline: September 4, 2012

For the past 27 years, Doug Mockett & Company has hosted an annual competition to discover the most innovative and creative furniture parts, accessories, and hardware. First-place winners are awarded \$1,000, an engraved achievement trophy, and a royalty based on sales. For more information, visit mockett.com.

Silestone Design Contest

Submission Deadline: September 30, 2012

Silestone, a leader in natural quartz surfacing, recognizes designers on the forefront of creative kitchen design. From bold backsplashes to innovative islands, Silestone is seeking designers who celebrate the influence of color and push the envelope of design possibilities in the foremost room of the home. The first-place winner will receive a six-day trip to Spain and \$2,500. Visit silestoneusa.com/contest.

Architecture at Zero 2012

Submission Deadline: October 1, 2012

Architecture at Zero 2012 is a net-zero-energy design competition open to students and professionals worldwide. The challenge is to create a net-zero-energy student-housing or administrative-office building design for the University of California, Merced. As part of the challenge, entrants will also be asked to create a diagrammatic district energy plan for the Bellevue Gateway development. For more information, visit architectureatzero.com.

eVolo 2013 Skyscraper Competition

Late Registration Deadline: January 15, 2013

eVolo magazine invites architects, students, engineers, designers, and artists to redefine skyscraper design through the implementation of novel technologies, materials, programs, aesthetics, and spatial organizations. There are no restrictions in regards to site, program, or size. What is a skyscraper in the 21st century? Visit evolo.us.

E-mail information two months in advance to recordevents@mcgraw-hill.com. For more listings,

TGP. IT'S PERSONAL.

Seeking long-term relationship with secure, polished single with a clear view of the world. Not into labels (except the fire-rated kind). Must be beautiful on the inside and out. Can you take the pressure? Don't reply if you are looking for the dull or wired type. Email me sales@fireglass.com

FireLite® Family of Products

Build a LTR with TGP and get unmatched service and support, plus the very best products like FireLite. This fire-rated glazing's unique ultraHD™ Technology delivers a clearly superior product. Take a closer look at how the clarity and sharpness compares to the competition at fireglass.com/hd.

- Fire ratings up to 3 hours
- High impact safety ratings
- UL listed and labeled



FireLite®

Family of Products

TGP  FIRE RATED
one source. many solutions.®

fireglass.com

CIRCLE 83

Improve
your outlook.



McGraw-Hill Construction

Outlook

EXECUTIVE CONFERENCE

Robert Murray Presents 2013

Washington, DC

October 23-24, 2012

Featured Speakers:

Alex Castellanos & Karl E. Case

Register ▶ Outlook2013DC.com
or call 800-371-3238

Sponsors:

Diamond

SIEMENS

Platinum



**United
Rentals**

Gold

CMiC
CONSTRUCTION SOFTWARE & SERVICES

Silver

Hill International

**McGraw Hill
CONSTRUCTION**

Get Free Information

from our advertisers! Fill out this Reader Service Card and send back today
or go to ArchRecord.com > Products tab > Reader Service

Advertisers Index

Reader Service #	Advertiser	Page	Reader Service #	Advertiser	Page	Reader Service #	Advertiser	Page
16	Alcoa Architectural Products <i>reynobond.com or reynolux.com</i>	5	45	Dri-Design <i>dri-design.com</i>	50	63	National Terrazzo and Mosaic Assn., Inc. <i>ntma.com</i>	117
	ALPOLIC / Mitsubishi Plastics Composites America, Inc. <i>alpolic-northamerica.com/naturalmetals-series</i>	16a-b	39	DuPont Tyvek <i>fluidapplied.tyvek.com</i>	54	60	Nedlaw Living Walls <i>NedlawLivingWalls.ca</i>	91
73	amerlux <i>amerlux.com</i>	137	59	Duravit <i>duravit.us</i>	111	27	Oldcastle® Architectural <i>oldcastleapp.com</i>	25
9	Amtico Company <i>amtico.com</i>	44	36	E. Dillon & Company <i>edillon.com</i>	36	25	Owens Corning <i>owenscorning.com</i>	29
	Architectural Record Continuing Education App <i>itunes.com</i>	13	51	Earthwerks® <i>earthwerks.com</i>	88	79	Pella Corporation <i>pella.com</i>	145
	Architectural Record Editorial Excellence <i>archrecord.com</i>	17	35	EFCO Corporation <i>efcocorp.com</i>	35	40	PPG IdeaScapes <i>PPGIdeaScapes.com</i>	31
	Architectural Record Innovation Conference 2012 <i>recordinnovation.com</i>	2-3	78	Engineered Lighting Products <i>elighting.com</i>	139	53	Prodema <i>www.prodema.com</i>	89
	Architectural Record One Millionth CEU Test Taker Sweepstakes <i>archrecord.com</i>	19, cv3	84	Excel Dryer, Inc. <i>exceldryer.com</i>	155	69	RAB Lighting <i>RABLED.com</i>	130
14	Armstrong World Industries <i>armstrong.com</i>	cv2-1	21	Forms+Surfaces <i>forms-surfaces.com</i>	20	23	ReThink Wood <i>rethinkwood.com</i>	18
28	AZZ Galvanizing Services <i>azzgalvanizing.com</i>	26	47	GKD <i>gkdmetailfabrics.com</i>	53	77	Rev-A-Shelf, LLC <i>rev-a-shelf.com</i>	139
42	BEGA <i>bega-us.com</i>	38	49	Gordon Incorporated <i>gordon-inc.com</i>	55	32	Rocky Mountain Hardware <i>rockymountainhardware.com</i>	30
58	Belden Brick <i>beldenbrick.com</i>	94	57	GREENGUARD Environmental Inst. <i>greenguard.org/ar</i>	92	62	ROXUL <i>roxul.com</i>	113
46	Belgard <i>belgard.biz</i>	52	80	Guardian Industries <i>sunguardglass.com</i>	140	55	Rulon Company <i>rulonco.com</i>	96
85	Bison Deck Supports <i>BisonIP.com</i>	155	88	Headwaters Resources <i>flyash.com</i>	156	87	S-5 Solutions <i>S-5-ColorGard.com/ar</i>	156
64	Bonded Logic <i>bondedlogic.com</i>	119	90	Huntco Supply LLC <i>huntco.com</i>	157	24	SAFTI / FIRST Fire Rated Glazing Solutions <i>safiti.com</i>	23
26	Building Systems Design, Inc. <i>speclink.com</i>	24	76	Hunza Lighting <i>hunzausa.com</i>	138	29	SageGlass® <i>sageglass.com</i>	27
81	C.R. Laurence Co., Inc. <i>cl Laurence.com</i>	148	33	Inforesight Consumer Products, Inc. <i>solairaheaters.com</i>	33	70	Selux <i>selux.com/usa</i>	134
86	Cascade Coil Drapery <i>cascapecoil.com</i>	156	20	Kawneer <i>kawneer.com</i>	10	82	Skyscraper Museum, The <i>skyscraper.org</i>	154
44	CENTRIA <i>CENTRIA.com</i>	49	48	Kim Lighting <i>kimlighting.com</i>	43		Sloan Valve Company <i>sloanvalve.com</i>	149
37	CertainTeed Ceilings <i>certainteed.com</i>	45	72	LEDtronics <i>ledtronics.com</i>	126		Sweets Mobile App <i>itunes.com</i>	147
41	Chamberlain Group, Inc. <i>liftmaster.com</i>	42	67	Louis Poulsen <i>louis poulsen.com</i>	122	19	Technical Glass Products <i>tgpamerica.com</i>	8-9
75	Charles Loomis <i>charlesloomis.com</i>	138	91	Lutron Electronics Co., Inc. <i>lutron.com</i>	cv4	83	Technical Glass Products <i>fireglass.com</i>	150
22	Collins <i>CollinsWood.com</i>	16		McGraw-Hill Construction Outlook Executive Conference <i>outlook2013dc.com</i>	151	15	Tile of Spain <i>tileofspainusa.com</i>	4
71	Columbia Lighting <i>columbialighting.com/products/iser</i>	133	34	McNichols Co. <i>mcnichols.com</i>	32	50	TOTO USA <i>totousa.com</i>	56
30	Construction Specialties, Inc. <i>c-sgroup.com</i>	15	54	Mett-Span I, Ltd. <i>mettspan.com/innova3</i>	93	65	TRC Solutions <i>NJCleanEnergy.com/ssb</i>	120
12	Crane Composites <i>cranecomposites.com</i>	150	17	modularArts® <i>modulararts.com</i>	6	52	Underwriters Laboratories, Inc. <i>ul.com/coderesource</i>	90
74	Delray Lighting Incorporated <i>delraylighting.com</i>	138	68	MP Lighting <i>mplighting.com</i>	129	18	VT Industries, Inc. <i>vtindustries.com</i>	7
	Dodge SpecShare® <i>construction.com/specshare</i>	158-159	89	Musson Rubber Company <i>mussonrubber.com</i>	157	43	Waste Management <i>wm.com</i>	46
61	Doug Mockett & Company Inc. <i>mockett.com</i>	112	8	National Frame Building Assn. <i>postframeadvantage.com</i>	40	56	Western Red Cedar Lumber Association <i>wrcla.org</i>	95
						66	YKK AP America Inc. <i>ykkap.com/inspire</i>	121

Publisher is not responsible for errors and omissions in advertiser index.

To access PDFs of all full-page or larger ads appearing in this issue, go to ArchRecord.com > Products tab > Product Ads

Get more info at www.sweets.com

PRODUCT SPOTLIGHTS

Advertisement

DOORS, WINDOWS

DOOR CLOSER WITH HIDDEN BENEFITS

\$\$\$

Samuel Heath

▲ Perko Power™ concealed door closers deliver benefits in aesthetics, performance, and safety for hotel, healthcare, education, and other applications.

Product Application:

- Aria Resort, Las Vegas, NV
- Hilton Hotel
- Godolphin and Latymer School

Performance Data:

- UL10B/10C/228
- ANSI/BHMA A156.4

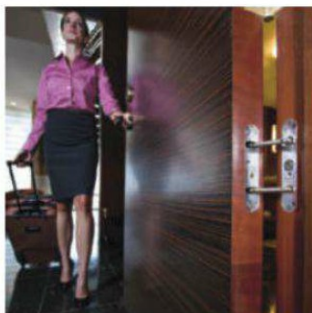

www.perkopower.com
212.599.5177

Circle 150

DOORS, WINDOWS

GLASS FIREWALLS

\$\$

Technical Glass Products

▲ Pilkington Pyrostop® is a UL listed and labeled fire-rated and impact safety-rated glazing material that blocks radiant heat transfer.

Product Application:

- Volkswagen Manufacturing Plant, Chattanooga, TN
- NYFD Engine Co. 239 Firehouse, New York, NY
- The Morgan Library & Museum, New York, NY

Performance Data:

- Barrier to radiant and conductive heat transfer
- Fire ratings up to 2 hours

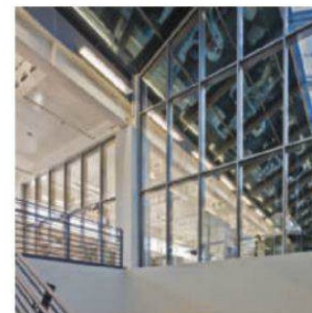

www.fireglass.com
800.426.0279 | Contact: sales@fireglass.com

Circle 151

ELECTRICAL, LIGHTING

ADJUSTABLE LED DOWNLIGHT

\$\$ | G | NEW

MP Lighting

▲ The L144 is a 14W adjustable LED downlight featuring ø4-7/8-in. recessed trim, 70° vertical tilt, and 360° rotation.

Product Application:

- Commercial or residential
- Non-insulated ceilings
- Insulated ceilings

Performance Data:

- Light output comparable to 50W MR16 recessed luminaire

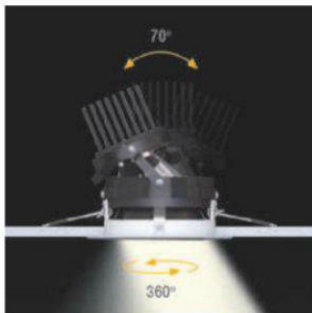

www.mplighting.com
877.708.1184 | Contact: Bruce Anyon

Circle 152

INTERIOR FINISHES, FURNISHINGS

ULTIMATE DESIGN FLEXIBILITY

\$\$\$ | NEW

Decoustics Limited, A CertainTeed Ceilings Company

▲ Ceilencio® Ceiling Systems are as functional as they are beautiful, with completely customizable designs and 100% downward accessibility.

Product Application:

- Professional private office
- Atrium or concourse
- Conference room

Performance Data:

- Every ceiling custom designed and manufactured
- Integrates with numerous materials and finishes



www.Decoustics.com
800.387.3809 | Contact: Customer Service

Circle 153

MATERIALS

ARCHITECTURAL NATURAL STONE

\$\$\$ | G

Vermont Structural Slate Company

▲ Quarrier and fabricator offering select slates, quartzites, sandstones, limestones, marbles, granites and basalts.

Product Application:

- Agnes Varis Campus Center, Tufts University, MA
- Unfading Mottled Green & Purple slate wall panels and Heathermoor slate sculptures
- Finegold Alexander + Associates Inc.



www.vermontstructuralstone.com
800.343.1900 | Contact: Craig Markcrow

Circle 154

MECHANICAL SYSTEMS, HVAC, PLUMBING

LINEAR DRAIN SYSTEMS

WR

Infinity Drain

▲ Infinity Drain's Site Sizeable linear drain systems give an architectural aesthetic and limitless possibilities for your outdoor project.

Product Application:

- Pool surrounds; patios, balconies, decks, terraces; driveways, storm drainage

Performance Data:

- Combine length of top grate and channel to achieve any length; suited for both residential and hospitality applications



www.InfinityDrain.com
516.767.6786 | Contact: Info@InfinityDrain.com

Circle 155

ROOFING, SIDING, THERMAL & MOISTURE PROTECTION

ARCHITECTURAL CONCRETE CLADDING

WR | G

Easi-Set Worldwide

▲ Slenderwall is a 30 lb./sf award-winning architectural precast concrete and steel-stud exterior panel system that can contribute up to 28 LEED points.

Product Application:

- Westin Luxury Hotel, Virginia Beach, VA
- Torre Ave Tower, Monterrey, Mexico
- Hilton Gardens, Montreal, Quebec, Canada

Performance Data:

- Optional: factory-installed windows and up to R-42 foam insulation; 66% thinner than traditional precast concrete, with no moisture or air infiltration—guaranteed

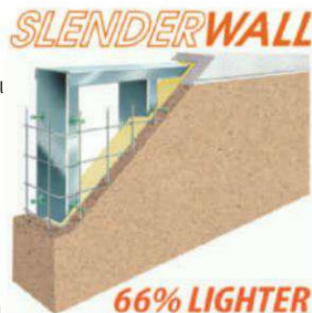

www.slenderwall.com
800.547.4045 | Contact: Rick Groves

Circle 156

ROOFING, SIDING, THERMAL & MOISTURE PROTECTION

INNOVATIVE METAL WALL SYSTEMS

WR

ATAS International, Inc.

▲ ATAS offers a variety of horizontal and vertical wall panels; mix and match profiles for visual impact with interesting patterns and designs.

Product Application:

- Profiles: ribbed, corrugated, smooth, structural panels with exposed or concealed fasteners; complementing Elite Trim for crisp sight lines; mix and match profiles with multiple color choices

Performance Data:

- Perfornated panels; multiple gauges and various colors



www.atas.com
800.468.1441 | Contact: info@atas.com

Circle 157

PRODUCT SPOTLIGHTS

Advertisement

SPECIALTY PRODUCTS

INDOOR AIR QUALITY GYPSUM BOARD PRODUCT LINE EXPANDED

WR | G | NEW

CertainTeed Gypsum

▲ AirRenew® Extreme Abuse and Extreme Impact remove volatile organic compounds (VOCs) circulating indoors, contributing to a healthy indoor air quality.

Product Application:

- Ames Montessori School, Marrero, LA
- Bryant Elementary Job, Bryant, AR
- UNCG Quad Renovations, Greensboro, NC

Performance Data:

- Superior resistance to hard impacts, penetrations; high performance against surface abrasion, indentation; exceptional durability, increased sustainability

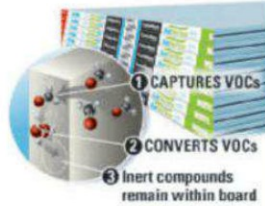

www.cpdaylighting.com
800.759.6985 | **Contact:** Talia Vinograd

Greenbuild Booth #154

Circle 158

SPECIALTY PRODUCTS

MEGAPIXEL VIDEO WALL

WR | G

Christie

▲ Christie® MicroTiles® are video "building blocks" offering design flexibility, superior color palette, and maximum image quality in indoor, high-ambient-light environments.

Product Application:

- NASCAR Hall of Fame, Charlotte, NC
- Emory University, Atlanta, GA
- London Stock Exchange, London, UK

Performance Data:

- Scalable to any size, shape, orientation
- 24/7 performance, no consumables, low TCO



www.microtiles.com
519.749.3176 | **Contact:** Virginia Bartosek

Circle 159

CLASSIFIEDS

POSITIONS VACANT

PROJECT DESIGNER

Project Designer (NY, NY & locs throughout US): Create 3-dimensional conceptual models, sketches & renderings of commercial & residential properties & vehicles using latest computer-aided dsgn technology. Master's deg in Architecture, Civil Engg, Dsgn or rldt fld. 6 mths exp in job offd, or 6 mths exp creating 3D models of commercial & residential spaces, incl offices & restaurants, using computer-aided dsgn technology. Exp must incl dsgng interiors of aircraft & luxury vessels (employer will consider exp gained professionally or during internship). Must be proficient in Maya 3D, Rhino 3D, Maxwell, Autocad & Adobe Suite. Frequent int'l travel reqd. Send resume to Recruiting, MacAndrews & Forbes Group, LLC, 35 E. 62nd St., NY, NY 10065 or Recruiting@mafgrp.com.

WWW.SMPSCAREERCENTER.ORG

Find marketing/BD professionals with A/E/C experience. Call 800-292-7677, ext. 231

ARCHITECTURAL RECORD

To view Architectural Record online visit:
www.architecturalrecord.com

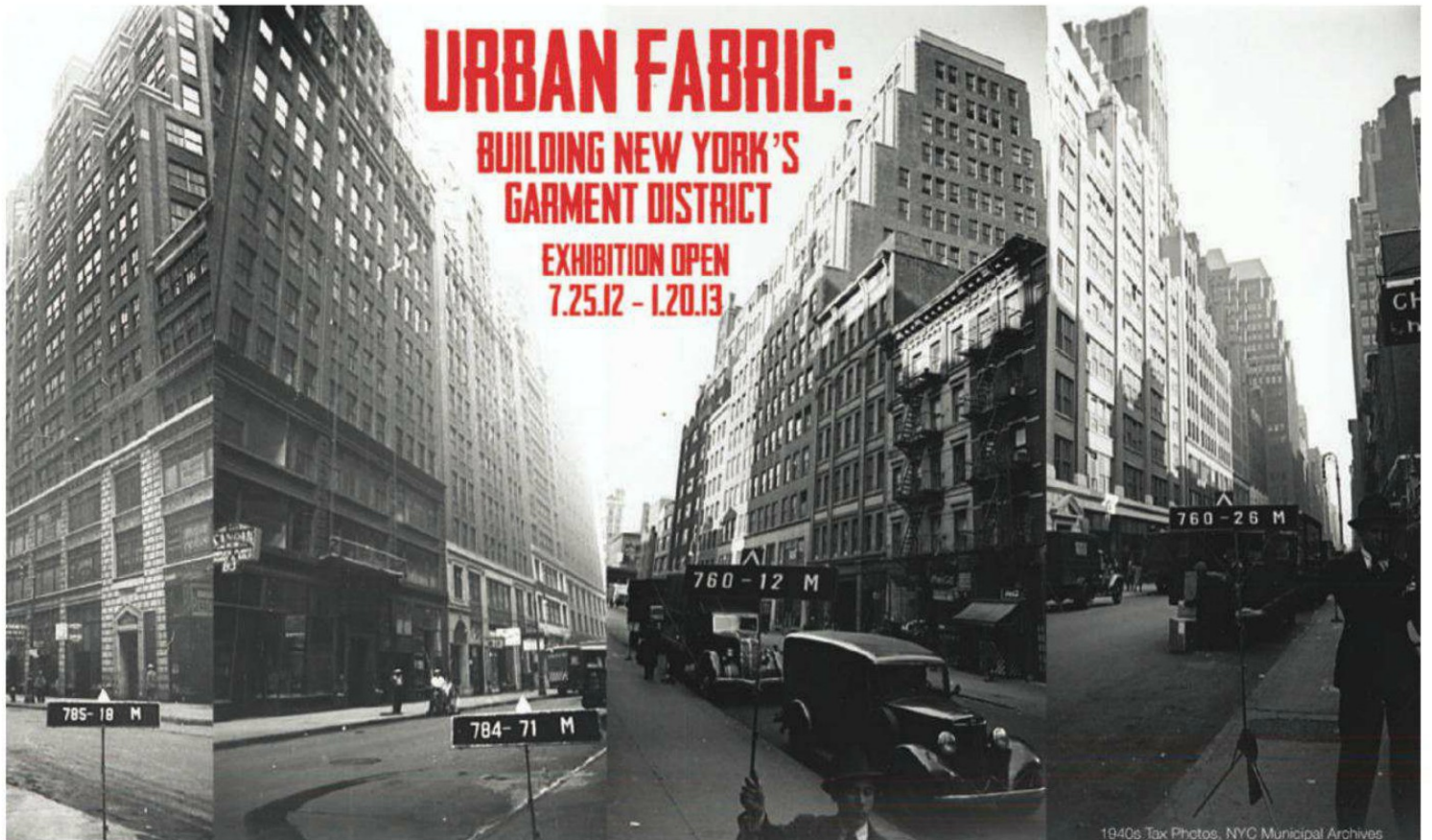

1940s Tax Photos, NYC Municipal Archives

THE SKYSCRAPER MUSEUM | 39 Battery Place, NY, NY 10280 | www.skyscraper.org

GREEN RESTROOMS SAVE MONEY AND THE ENVIRONMENT



NEXT GENERATION GREEN RESTROOM DESIGN

The USGBC, SLOAN and Excel Dryer join forces to offer a new CEU Course, Next Generation Green Restroom Design (NGGRD). NGGRD shows architects and designers how to specify the most cost effective, hygienic and green restrooms with today's newest technologies.

REDUCE

WATER UP TO 50% • COSTS BY 90% • CARBON FOOTPRINT OVER 70%

REQUEST INFORMATION AND PRICING

OR TAKE THE COURSE AT www.aecdaily.com
(SEARCH "EXCEL DRYER" OR "SLOAN")



800-255-9235
www.exceldryer.com

SLOAN

800-982-5839
www.sloanvalve.com

CIRCLE 84



Innovative Products

CREATING ROOFTOP ENVIRONMENTS

Bison Wood Tiles

Custom Sizes Available
Standard in Ipê & FSC®
Certified (FSC-C013454)

Bison Deck Supports

Supports paving materials
for level decks on rooftops

Bison Cubes

Standard & Custom Sizes
Many Colors Available
Aluminum and Ipê



CIRCLE 85

www.BisonIP.com | 800-333-4234



The mark of responsible forestry



CASCADE COIL DRAPERY



Frank Russell
Columbia Bank Center
Tacoma, Washington

Manufacturers of woven wire fabrics for partitions, window treatments, GuardianCoil blast mitigation screening, and other ornamental metal applications.

www.cascadecoil.com | 800-999-2645

CIRCLE 86

HOW TO

combat
global warming,
reduce the
production of
greenhouse gases,
and **build a**
stronger infrastructure.

SPECIFY FLY ASH

(a recovered resource)

**as a replacement for cement
in concrete.**

When you specify fly ash as replacement for cement in concrete, you help reduce CO₂ emissions from cement production, conserve landfill space, and decrease water usage. You also enhance workability and chemical attack resistance, increase strength and produce more durable concrete.

Contact Headwaters Resources for free technical literature and information on how fly ash use benefits the environment and produces better concrete.



www.flyash.com | 1-888-236-6236

CIRCLE 88

1.2 Million Roofs



1,200,000 metal roofs around the world utilize S-5![®] attachment solutions to mount ancillary items. Perhaps this is because S-5! clamps install faster and easier than any other attachment solution available on the market today. Or perhaps it's because our patented round-point, zero-penetration setscrews maintain the roof's integrity and preserve the panel manufacturer's warranty. We suspect it's because with holding strength measured in tons and dependability measured in decades, roofing professionals can't afford NOT to use S-5!

1.2 million metal roofs and counting.
Always choose the best solution. Always choose S-5!

To learn more about S-5![®] Systems, go to:
www.S-5.com/million or call 1-888-825-3432

CIRCLE 87

S-5![®]
The Right Way!

Snow Retention | Wind Performance | Fall Protection | Utility Attachment

RAISED DESIGN RUBBER STAIR TREADS



- Raised surface patterns of disc, diamond or square
- Molded of thick, flame resistant solid rubber, plain or marbled
- High traffic stairs become safer and durable
- Available in a variety of colors
- Matching floor tile and coved risers available

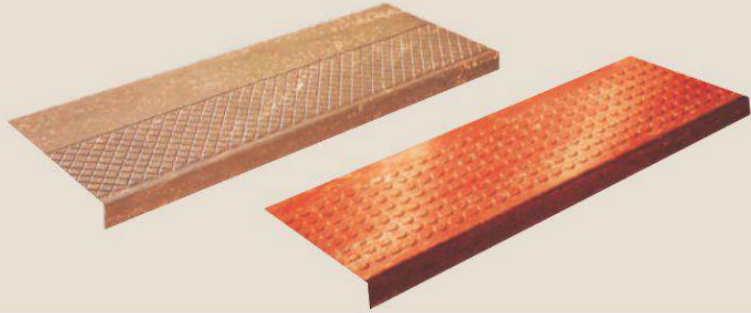

**MUSSON
RUBBER CO.**

P.O. Box 7038 • Akron, Ohio 44306
800-321-2381 • Fax 330-773-3254
info@mussonrubber.com • www.mussonrubber.com

CIRCLE 89

TRADITION AND INNOVATION SINCE 1980



The leading manufacturer
and distributor of
bike racks and lockers,
benches and
trash receptacles.
See our online catalog
www.huntco.com

or call

800.547.8909

Huntco

SITE FURNISHINGS, LLC

CIRCLE 90



Are you **Spec Smart?**

SpecShare[®]  is a powerful new strategic

tool for building product manufacturers 

to quickly assess their competitive position

and  target the right architectural firms

more effectively than ever before.

Introducing Dodge **SpecShare[®]** | Take charge. Sell more.

Visit construction.com/specshare or call 888-810-2829 to request a free demo.

SPEC HABITS BY BRAND AND GEOGRAPHY

Select Product Group:

Paint

Spec	Architect	Arch	Arch. Eng	Spec. Eng	Eng	Gen. Bldg.	Blvd. Eng	Platng	Const.	Landscap	Consult.	Demol. & Ap.	Inter. Des.	All Firms
Count	1,000	950	880	800	650	520	390	420	250	240	200	130	15	14,810

FIRMS BY PRODUCT / BRAND



FIRMS BY LOCATION



FIRMS LISTING

Rank	Co. Name	City	State	Pre-Bid	Building	Peak Est.	Spec. For Spec. Firm	Paint	Design/Plan	Spec. Services	Other
1	MCPartners	Dublin	OH	85	15	472	1,000	14,810	25,000		
2	Behr Paint	Memphis	MS	81	13	321	1,000	83,710	100,000		
3	H2Z Architects	Dayton	OH	40	8	430	1,000	20,000	100,000		
4	Herman	Berkeley	CA	40	11	150	1,000	20,000	100,000		
5	Remond	Dallas	TX	21	4	160	1,000	20,000	100,000		

PROJECT SERPENTINE GALLERY PAVILION
 LOCATION LONDON
 DESIGNERS HERZOG & DE MEURON AND AI WEIWEI



COLLECTIVE MEMORY was the driving force behind the latest incarnation of the annual, temporary Serpentine Gallery Pavilion, by Swiss architects Jacques Herzog and Pierre de Meuron and Chinese artist-activist Ai Weiwei. To build a kind of manufactured archaeological site based on the previous 11 pavilions, the team created a drawing that fused the foundations of those structures into a single digital rendering, and then carved this form out of the ground. The three, who collaborated on the Bird's Nest Stadium for the 2008 Beijing Olympics, worked around Ai's house arrest by communicating via Skype. The subterranean 4,300-square-foot floor, consisting of overlaid geometric forms, is blanketed in compressed cork that fits together like pieces of a 3-D jigsaw puzzle. A massive dishlike steel roof supported by 12 steel columns wrapped in cork is a nod to the temporary canopies that cover fragile archaeological sites. It holds a shallow pool that reflects the neo-Georgian gallery across the lawn. Visitors can walk all over the pavilion's lower-level surfaces and can rearrange the movable stools and benches to create a makeshift stage, platform, or jungle gym, or simply sit quietly to take a breather from the bustle of the Olympics nearby. *Laura Mirviss*

ARCHITECTURAL RECORD

ONE MILLIONTH CEU TEST TAKER SWEEPSTAKES

We're giving away over \$10,000 in prizes as we celebrate our one millionth Continuing Education test to be taken this fall. Celebrate with us! ENTER OUR ONE MILLIONTH TEST TAKER SWEEPSTAKES. Take any test at archrecord.com between August 1 and October 31, 2012 for your chance to win.

Take your chance at winning these celebratory prizes at archrecord.com. ENTER THE ONE MILLIONTH TEST TAKER SWEEPSTAKES

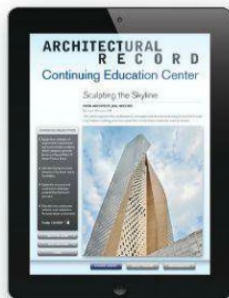

Try our new app. It allows you to take tests and track your progress without internet access.

Download for free at the App store today.

\$5,000 cash

Talak LED table by Artemide



Knoll Womb Chair

\$100 AMEX Gift Card

Courtesy of Ilan Rubin/Art Dept

CHECK OUT COURSES FROM OUR SPONSORS:

Platinum Sponsor:

reTHINK
WOOD

Sponsors:



To Enter: Register and take a test at <http://ce.construction.com/> between 9 am EST on Wednesday August 1 through 5 pm EST on Wednesday October 31 (the "Contest Period"). There is no fee to take a test. If either the 1,000,000th, 1,000,001st or 1,000,002nd test has not been taken by 5 pm EST on October 31, 2012, then the winner for that prize will be selected in a random drawing from all remaining eligible entries. You can take more than one course test during the Contest Period. The Sponsor is not responsible for late, misdirected or illegible entries or for technical or Internet access failure.

WINNERS AND PRIZES: First prize: The person who registers and takes the 1,000,000th test will win the Grand Prize of \$5,000 cash. Second prize: The person who registers and takes the 1,000,001st test will win a Knoll womb chair (valued at \$4,801). Third prize: The person who registers and takes the 1,000,002nd test will win a Talak LED table by Artemide (valued at \$935). If either the 1,000,000th, 1,000,001st or 1,000,002nd test has not been taken by 5 pm EST on October 31, 2012, then the winner for that prize will be selected in a random drawing from all remaining eligible entries. The Sponsor will pay for shipping within the U.S. by UPS. Ten additional runners up will be selected at random from all remaining eligible entries and each will win a \$100 AMEX gift card. Total retail prize value of all prizes: \$11,736. The random drawings will take place at the conclusion of the Contest Period and will be announced by November 19, 2012. **COMPLETE RULES AT ARCHRECORD.COM.**



Earn AIA continuing education hours (CEHs) including AIA Health Safety Welfare (HSW) and Sustainable Design (SD) credits with Architectural Record. Select courses are also approved by the Green Building Certification Institute for GBCI CE Hours for LEED Credential Maintenance.

All tests are available at no charge and are instantly processed.

The world's highest performance buildings use **Lutron® complete solutions**



Only Lutron offers complete solutions for light control, shading, and energy management to provide optimal performance and savings.

- A single manufacturer ensures clear accountability and simplifies the design process
- Digitally addressable shades, ballasts, and LED drivers allow for easy reconfiguration of the space without rewiring
- A broad range of wireless devices (sensors, keypads, and load controllers) allows for seamless future expansion

Specify Lutron on your next project – visit www.lutron.com/commercial



SAP America, Inc., Newtown Square, PA

This facility, designed to LEED Platinum standards, utilizes a Lutron Quantum® Total Light Management™ System.

Architect: FXFOWLE



©2012 Lutron Electronics Co., Inc. | P/N 368-2727 REV B

CIRCLE 91

