

COLLEGE BUILDINGS | BUILDING TYPES STUDY NUMBER 199

**ARCHITECTURAL  
RECORD**

JUNE 1953

when buying unit heaters

**be sure you  
get this**

**...not this!**

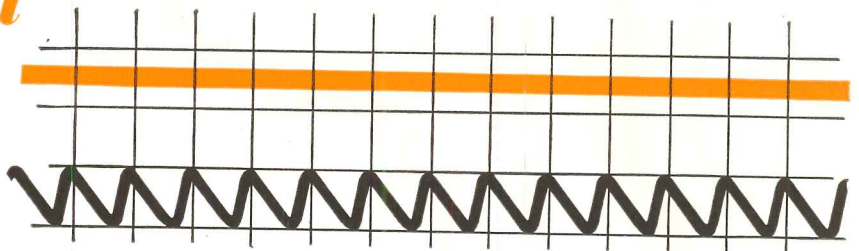
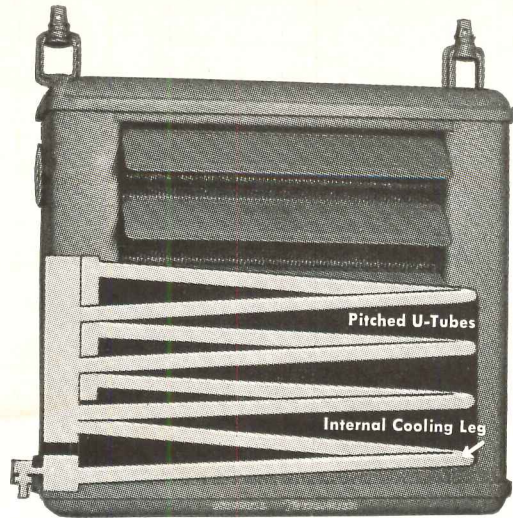

With **THERMOLIER...**  
the Grinnell Unit Heater . . . you get  
**CONTINUOUS RATED CAPACITY**

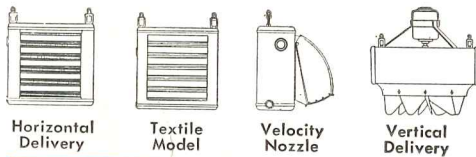

**THERMOLIER FEATURES**

**INTERNAL COOLING LEG** A Grinnell feature which permits the use of a plain thermostatic trap for draining condensate.

**PITCHED U-TUBES** Built-in pitch of U-tubes provides complete drainage of condensate and elimination of destructive water hammer.

**CONTINUOUS RATED CAPACITY** The combination of Thermolier's internal cooling leg and the built-in pitch of tubes assures continuous rated capacity.

**BUILT-IN EXPANSION PROVISIONS** Every tube is an expansion bend of the U type to allow for independent expansion and contraction of each tube.

**TUBE-TO-HEADER CONSTRUCTION** Safety and durability assured by unique tube-to-header construction.

**EASE OF ERECTION** Exclusive with Thermolier are the adjustable swivel couplings which provide an easy, cost-saving method of hanging the unit.

**SIMPLE PIPE CONNECTIONS** The supply and return piping connections are on the same side to assure compactness, neatness and economy in installation.

**MOTORS** Thermolier motors are built specifically for unit heater duty. They give maximum operating efficiency with minimum power cost.

The practical advantages of unit heating, of course, are well known. But in order to get *maximum* economy and efficiency, certain engineering and structural features *must be* present in the unit heater of your choice.

Take provisions for draining off condensate. Failure to provide freedom from collected condensate in the heating element can interfere with heat output and adversely affect capacity.

A Thermolier Unit Heater successfully handles this drainage problem with its pitched U-tubes and internal cooling leg, through which all the condensate passes. In fact, condensate cooling is so efficient with Grinnell Thermoliers that a thermostatic trap — the simplest and least expensive of all traps — can be used with every model. Condensate temperature is lowered to the point where the trap is always draining — giving Thermolier Unit Heaters their *continuous rated capacity*.

Check Thermolier's advantages at left. For more details, call your local Grinnell distributor — or send for catalog.

**GRINNELL**  
**THERMOLIER UNIT HEATERS**



Grinnell Company, Inc., Providence, Rhode Island

Coast-to-Coast Network of Branch Warehouses and Distributors

Manufacturer of: pipe fittings • welding fittings • forged steel flanges • steel nipples • engineered pipe hangers and supports  
Thermolier unit heaters • Grinnell-Saunders diaphragm valves • prefabricated piping • Grinnell automatic fire protection systems

ARCHITECTURAL RECORD (Vol. 113, No. 6, June, 1953) is published monthly by F. W. Dodge Corp., 10 Ferry Street, Concord, N. H., with editorial and executive offices at 119 W. 40th St., New York 18, N. Y. \$4.50 per year; Foreign, \$6.50.

Entered as second-class matter at the Post Office, Concord, N. H., March 16, 1946, under the Act of March 3, 1879.

# ARCHITECTURAL RECORD



Copyright 1953 by F. W. DODGE CORPORATION, with all rights reserved • Publishing Director, Magazine Division, H. Judd Payne • Business Manager, Robert F. Marshall • EDITORS: Executive Editor, Joseph B. Mason; Managing Editor, Emerson Goble; Senior Associate Editor, Frank G. Lopez, A.I.A.; Associate Editors:

James S. Hornbeck, A.I.A., Robert E. Fischer (Engineering), Florence A. van Wyck, Herbert L. Smith, Jr., A.I.A., Jeanne M. Davern (News), Elisabeth Kendall Thompson (Western); Contributing Editors: Ernest Mickel (Washington), John Caulfield Smith, M.R.A.I.C. (Canada); Assistant Editors: Jeanne G. Whitbeck (Reader Service), Enid Belding (Books), Carl Scarenco (News); Editorial Assistant, Patricia O'Donovan • DESIGN: Consultant, M. Peter Piening; Director, Alfred Petersen; Assistants: Donald Ervin, Joseph D'Amato; Drafting, Sigman-Ward • CONSULTANTS: Industry Relations Consultant, Thomas S. Holden; Statistical Consultant, Clyde Shute; Field Consultant, Clifford Dunnells, Jr.; Public Relations Consultant, Samuel C. Pace.

Architectural Record (combined with American Architect and Architectural) is published monthly by F. W. Dodge Corporation, 10 Ferry Street, Concord, N. H., with editorial and executive offices at 119 West 40th Street, New York 18, N. Y. Western editorial office, 2877 Shasta Road, Berkeley 8, Calif.

Chairman of the board, James McV. Breed; vice chairman of the board, Paul Abbott; president, Thomas S. Holden; vice president and treasurer, Howard Barringer; secretary, Sanford D. Stockton, Jr.; vice presidents: Irving W. Hadsell, Chauncey L. Williams, H. Judd Payne, T. Oliver Morgan; assistant secretaries: George W. Morgan, Jr., William C. Breed, Jr.; assistant vice presidents: Clyde Shute, Clifford G. Dunnells, Jr., Howard M. Thompson, Marc Wayne, Robert F. Marshall; assistant treasurers: Walter F. DeSaix, Edwin H. Freed, Irving B. Satin; regional vice presidents: Carl S. Bennett, Ralph M. Hairston, Julius T. Little, Richard H. Roy.

Subscription rates: United States and possessions, Canada, Cuba, Mexico, Central and South America, and Spain, \$4.50 a year, \$7.50 for two years, \$9 for three years; elsewhere, \$6.50 a year, \$11.50 for two years, \$15 for three years. Single copy \$2. Circulation manager, Marshall T. Ginn.

Member of Audit Bureau of Circulations and Associated Business Publications. Architectural Record is indexed in Readers' Guide to Periodical Literature, Art Index, Industrial Arts Index and Engineering Index.

Every effort will be made to return material submitted for possible publication (if accompanied by stamped, addressed envelope), but the editors and the corporation will not be responsible for loss or damage.

Other Dodge services: Dodge Reports and Dodge Statistical Research Service, Sweet's Files, Home Owners' Catalogs, Chicago Construction News, Daily Pacific Builder, Denver Daily Journal, Real Estate Record & Builders' Guide.

<b>THE RECORD REPORTS</b> .....	9
Perspectives .....	9
News from Canada. By John Caulfield Smith .....	24
News from Washington. By Ernest Mickel .....	38
Construction Cost Indexes .....	42
Periodical Report .....	316
Current Trends in Construction .....	352
<b>REQUIRED READING</b> .....	46
<b>BUILDING TYPES STUDY NO. 199: COLLEGE BUILDINGS</b> .....	121
INTRODUCTION .....	121
UNIVERSITY OF MINNESOTA CAMPUS, DULUTH, MINN. ...	123
Winston A. Close, Advisory Architect	
CLEMSON A. & M. COLLEGE BARRACKS, CLEMSON, S. C. ...	128
William G. Lyles, Bissett, Carlisle & Wolf, Architects and Engineers	
ARIZONA STATE COLLEGE WOMEN'S DORMITORY, TEMPE, ARIZ. ....	133
Guirey & Jones, Architects	
KISKIMINETAS SPRINGS SCHOOL DORMITORY, SALTSBURG, PA. ....	138
Hunter, Caldwell & Campbell, Architects	
NORTHWESTERN UNIVERSITY HILLEL CENTER, EVANSTON, ILL. ....	140
Harrison & Abramovitz, Architects	
UNIVERSITY OF ILLINOIS, BENJAMIN M. FRANKEL MEMORIAL BUILDING, CHAMPAIGN, ILL. ....	143
Harrison & Abramovitz, Architects	
WOMAN'S COLLEGE, UNIVERSITY OF N. C., PHYSICAL EDUCATION BUILDING, GREENSBORO, N. C. ....	144
Edward Loewenstein, Architect	
BAYLOR UNIVERSITY LAW SCHOOL, WACO, TEX. ....	148
Stanley W. Bliss, Architect; Herman A. Kelling, Associate	
<b>ARCHITECTURAL INTERIORS</b> .....	150
Upper-floor Office Invites Public View: Offices for the Marquette Cement Company, Jackson, Miss. James T. Canizaro, Architect-Engineer	
<b>SMALL PRIMARY SCHOOL ADDITION USES RIGID FRAMES OF WOOD</b> .....	154
Elementary School Addition, Boulder Creek, Calif. John Lyon Reid, Architect	
<b>TWIN LABORATORY AND MANUFACTURING BUILDINGS FOR ORTHO PHARMACEUTICALS</b> .....	158
Ortho Pharmaceutical Corporation, Raritan, N. J. Shreve, Lamb & Harmon Associates, Architects	
<b>RAISED BASEMENT EXPANDS HILLSIDE HOUSE</b> .....	162
Residence of William Wallace Landsberg, Architect, Port Washington, L. I., N. Y.	
<b>SAFETY FOR CHILDREN — PRIVACY FOR ADULTS</b> .....	166
Residence for Mr. and Mrs. Samuel Sale, Pasadena, Calif. Whitney R. Smith, Architect	
<b>GOLF HOUSE FOR LAKE PLACID CLUB</b> .....	170
Lake Placid, N. Y. Ronald Allwork, Architect; Eleanor Allwork, Interiors	
<b>ARCHITECTURAL ENGINEERING</b> .....	171
<b>THE ROLE OF CONCRETE ADMIXTURES:</b>	
A Panel Discussion .....	171
<b>CRACKING OF CONCRETE BLOCK WALLS:</b>	
Research Study by HHFA .....	176
<b>A STEEL WALL THAT BREATHES</b> .....	177
Modernized Office Building for the Heppenstall Co., Pittsburgh, Pa. Hoffman & Compton, Architects	
<b>PRODUCTS FOR BETTER BUILDING</b> .....	179
<b>LITERATURE FOR THE OFFICE</b> .....	180
<b>TIME SAVER STANDARDS</b> .....	183
Structural Forms — 19, 20, 21: Thin Shells of Reinforced Concrete. By Seymour Howard, Architect, Instructor at Pratt Institute	
<b>CASE OF THE MISPLACED SCUPPER</b> .....	268
By Richard M. Bennett, F.A.I.A.	
<b>SEMI-ANNUAL INDEX</b> .....	355
<b>INDEX TO ADVERTISING</b> .....	360

Site plan: Duluth Campus, University of Minnesota. Winston A. Close, Advisory Architect

# Another interesting REMOTAIRE installation!

**Individual-room  
remote type units in resort hotel  
provide  
year 'round air conditioning**

*Summer cooling...  
winter heating*

● The Concord Hotel, Kiamesha Lake, New York, found the answer to efficient, economical year 'round air conditioning through the installation of the Remotaire Well Water System—one of a number of different Remotaire systems available for multi-room buildings.

The Remotaire Well Water System may be used in localities where well water is known to be available in adequate supply, proper temperature, and of good quality. The cold well water is used in lieu of a water chilling plant. Consisting of Remotaire Room Units in each room connected by a piping system to the central plant equipment (as shown in

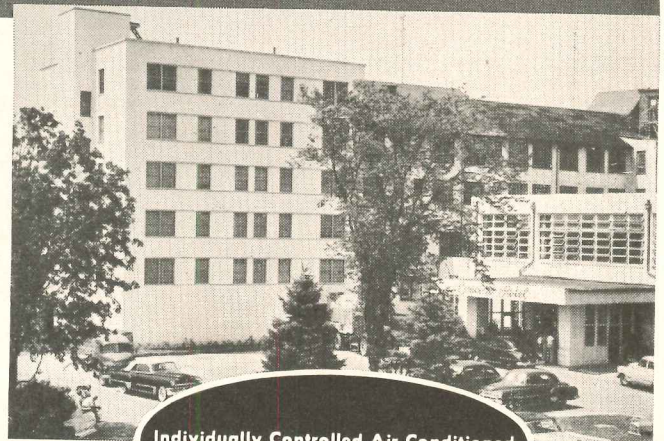

Individually Controlled Air Conditioned Rooms at Concord Hotel

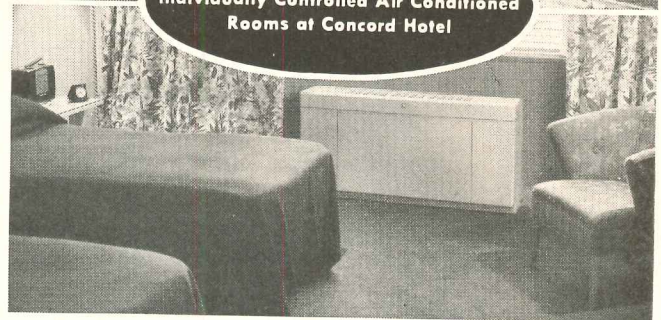

the diagram), this system costs less to install and less to operate. Individual control of each Remotaire unit allows the occupant to choose the room temperature that suits him best without affecting adjoining rooms.

This resort hotel installation is another example of the versatility of the Remotaire for hotels, motels, hospitals, apartments, and other multi-room buildings.

## Top Quality Construction... Easy To Install

The Remotaire is sturdily built of heavy-gauge steel—plus a reinforced air grille—with a bond-erized, baked-on semi-gloss enamel finish. All air passages are acoustically insulated for thermal efficiency and quietness. Coil is designed for right or left hand connections. Spacious end compartments permit easy access to coil connections and controls. Adaptable to a variety of ventilation systems, the Remotaire is ideal for modernization as well as new construction and is available in three models—200, 400 and 600 cfm.

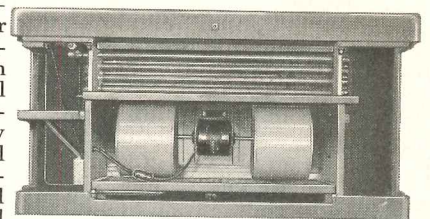

Write for Remotaire Brochure, Form 298.

American Radiator & Standard Sanitary Corporation  
P. O. Box 1226, Pittsburgh 30, Pa.

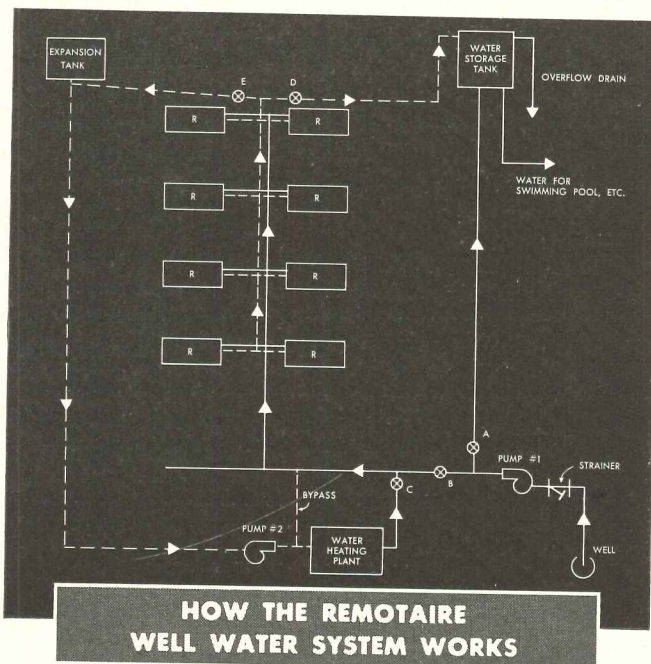

**HOW THE REMOTAIRE  
WELL WATER SYSTEM WORKS**

The Remotaire Well Water System consists of Remotaire Room Units in each room connected by a simple piping system to the central plant equipment—a well with pump, water heater, water circulating pump, expansion tank, storage tank and water filter or strainer as shown above.

**FOR COOLING**—Valves A and C are closed. B is open. Pump No. 1 pumps water from well to Remotaire units on each floor from which it travels thru valve D to storage tank on roof. This water is usable for swimming pool or other purposes.

**FOR HEATING**—Heating circuit includes Water Heater, Valve C, Valve E, Expansion Tank, Pump No. 2 and bypass. For operation, close Valves B and D, start Pump No. 2 and boiler, and the hot water circulates through the system.

When cooling is not required, well water may be used for other purposes, and can be pumped direct through Valve A to Water Storage Tank by Pump No. 1.

**AMERICAN-Standard**  
HEATING-COOLING



*Serving home and industry*

AMERICAN-STANDARD • AMERICAN BLOWER • CHURCH SEATS & WALL TILE  
DETROIT CONTROLS • KEWANEE BOILERS • ROSS EXCHANGERS

# THE RECORD REPORTS

## P E R S P E C T I V E S

FOR SOME YEARS now it has been clear that architecture has been reaching for something new. Having joined, perhaps belatedly, the march of science, architecture has arrived at the universal problem of how to use technology without worshipping it: the discovery that the machine should be servant, not master, to man. How architecture might better serve "the whole man" has been the subject of a series of articles published over the past two years in ARCHITECTURAL RECORD. While the authors took many different approaches, the following quotations add up to a rather remarkable statement of architecture's new goals.

The Bauhaus did much to break down the eclectic surge. . . . Europe and even America were so overwhelmed with history there was great need of coming clean to structure without a study of history. . . . However, the slavish copying of *new* masters is just as overwhelming, just as suffocating, as that of the *old* masters. — *William Wurster*, ARCHITECTURAL RECORD, Jan. 1951

Today we are more honest, more practical and quite functional, but it has been at the expense of grace and gentility. We have taken away many of the established forms, so cherished by our ancestors, and have replaced them with stark utilitarian ones, which give little nourishment to the senses. We have taken away from the man in the street all the stereotyped little ornaments, cornices, cartouches, and green fake shutters, but we have not been capable of giving him back the equivalent in emotional value. — *Pietro Belluschi*, ARCHITECTURAL RECORD, Feb. 1951

In my view, if our contemporary architecture turns out in the long run to have been one of the great cultural achievements of man, posterity will then regard engineering architecture as the primitive stage and functional architecture as the transitional stage. For one more ingredient needs to be added. . . . The ingredient as yet only partially supplied is humanism. — *John Burchard*, ARCHITECTURAL RECORD, July 1951

The International Style was not presented, in the 1932 book which first gave currency to the phrase, as a closed system; nor was it intended to be the whole of modern

architecture, past, present, and future. Perhaps it has become convenient now to use the phrase chiefly to condemn the literal and unimaginative application of the design clichés of 25 years ago; if that is really the case, the term had better be forgotten. The "traditional architecture" which still bulked so large in 1932 is all but dead by now. The living architecture of the twentieth century may well be called merely "modern." — *Henry-Russell Hitchcock*, ARCHITECTURAL RECORD, Aug. 1951

By now, many architects have become aware of a self-imposed poverty: in absorbing the lessons of the machine and in learning to master new forms of construction, they have, they begin to see, neglected the valid claims of the human personality. In properly rejecting antiquated symbols, they have also rejected human needs, interests, sentiments, values, that must be given full play in every complete structure. This does not mean, as some critics have hastily asserted, that function is doomed; it means rather that the time has come to integrate objective functions with subjective functions: to balance off mechanical facilities with biological needs, social commitments and personal values. — *Lewis Mumford*, ARCHITECTURAL RECORD, Nov. 1951

Contemporary interest in the core is part of a general humanizing process; of a return to the human scale and the assertion of the rights of the individual over the tyranny of mechanical tools. . . . The lack of imagination usually shown today . . . in our attempts to devise new city centers — new city cores — is invariably excused on the ground that we no longer have a way of life that it is possible to express. What Michelangelo has mirrored in his Area Capitolina is the baffling irrationality of historic events and the enigmatic omission of any direct relation between effect and cause. Once more we realize that a great artist is able to create the artistic form for a phase of future social development long before that phase has begun to take shape. This is our task today! — *Siegfried Gideon*, ARCHITECTURAL RECORD, Apr. 1952

"Less is more" unless less, already little, becomes less than nothing at all and "much ado about nothing." — *Frank*

*Lloyd Wright*, ARCHITECTURAL RECORD, May 1952

Three-dimensional architecture, as every art, is the result of the individual's expression of his beliefs and convictions; if you will, it is his statement of a philosophy. . . . Thus, the work of a creative individual is his handwriting, expressing in some ambition and vanity; in others, the warmth and delight of understanding; in some, harshness and boldness; in others, firmness and grace; in so many, the mediocre; in so few, something that adds more to the integrity and dignity of men. — *Henry Hill*, ARCHITECTURAL RECORD, June 1952

For ours is not an age of maturity, of accepted style. It is a time for relating things, of experiment, of youthful enthusiasm, of much promise. . . . Our buildings inevitably tell our story, haltingly or beautifully. As a chorus they make an incoherent babel that reflects how little our whole society is in accord, but here and there is an architectural statement whose calmness and serenity bespeak a well-adjusted designer who has used the full range of sound and made a building not talk, but sing with full chords. And when he does transcend a thin tinkling tune, it is because his heart was set on a song for many people, not a solo for himself. — *Richard Bennett*, ARCHITECTURAL RECORD, July 1952

If, in fact, we are witnessing a new departure, then it would be churlish to conclude without paying a tribute to the stern, if sometimes inhibiting, discipline which the Modern Movement imposed. If one thinks as I do that it always remained inextricably confused between ends and means, it nevertheless fulfilled an essential task. As with abstract painting it was not, as some might think, a blind alley but a necessary diversion, and those who passed through are likely to have traveled considerably further than those who stuck to the main road. — *Osbert Lancaster*, ARCHITECTURAL RECORD, Sept. 1952

The genius in architecture is he who, commanding the means of expression, feels beauty and meaning in the general life of mankind more clearly and intensely than do other men. — *Joseph Hudnall*, ARCHITECTURAL RECORD, Mar. 1953

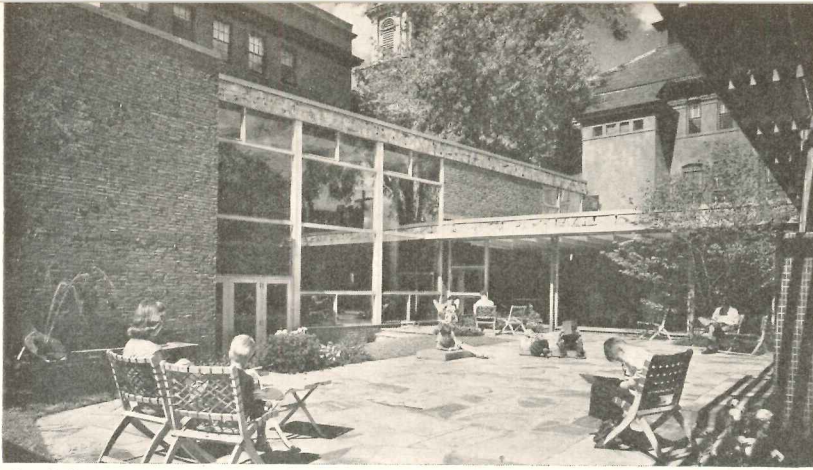

c Ezra Stoller

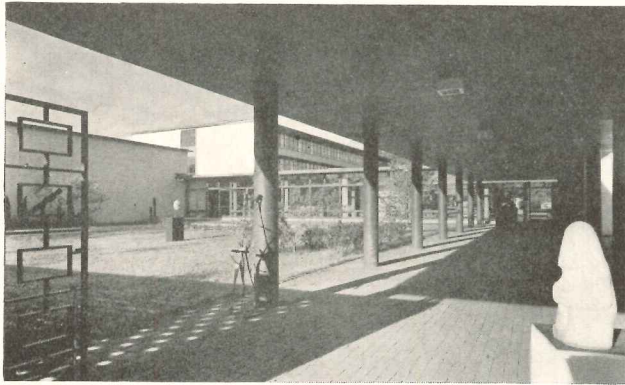

Lionel Freedman

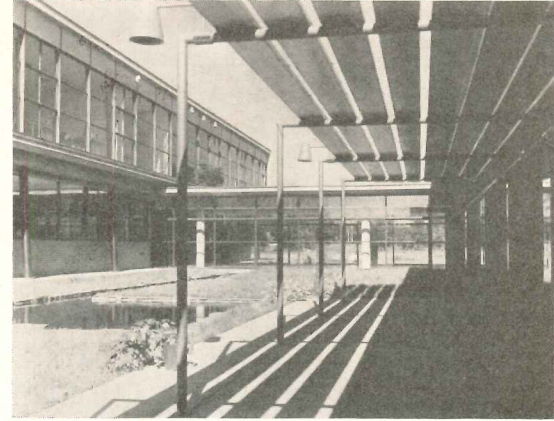

Architecture. Gold Medal: Carl Koch & Associates, for Youth Library (left), Fitchburg, Mass. Silver Medal: Raymond & Rado, for Readers' Digest Building (below), Tokyo. Honorable Mention: Edward D. Stone & Associates, for Art Center (below left), Fayetteville, Ark.

## ARCHITECTURAL LEAGUE HONORS NINE IN 56TH ANNUAL

THE ARCHITECTURAL LEAGUE OF NEW YORK, founded in 1881 to encourage collaboration between architecture and the allied arts and communication between their practitioners, this year held its 56th annual Gold Medal Exhibition.

The 1953 program included architecture, landscape architecture, mural decoration, sculpture, design and crafts in native industrial arts and — for the first time as a separate category — engineering. Considering that it is intended

to be a national exhibition, open without even an entry fee to all architects and artists in the United States, whether or not they are League members, it was not a very big exhibition — there were only 11 entries in architecture, for example, four in engineering and none in landscape architecture.

Entries in each of the categories are judged by juries of League members drawn from that category. One Gold Medal may be given each year in each

field; but when none of the submissions appears to the jury to be of sufficient merit, the Gold Medal in that field may be withheld. In addition, Silver Medals and Honorable Mentions may be given at the discretion of the jury.

This year's awards, all of which are shown on these pages, included three Gold Medals, three Silver Medals and three Honorable Mentions. No Gold Medal was given in sculpture or in design and crafts in native industrial arts.

Lewis P. Watson

Engineering. Gold Medal: Severud-Elstad-Krueger, for North Carolina State Fair Pavilion, Raleigh. Architects: the late Matthew Nowicki and his associate, William Dietrich

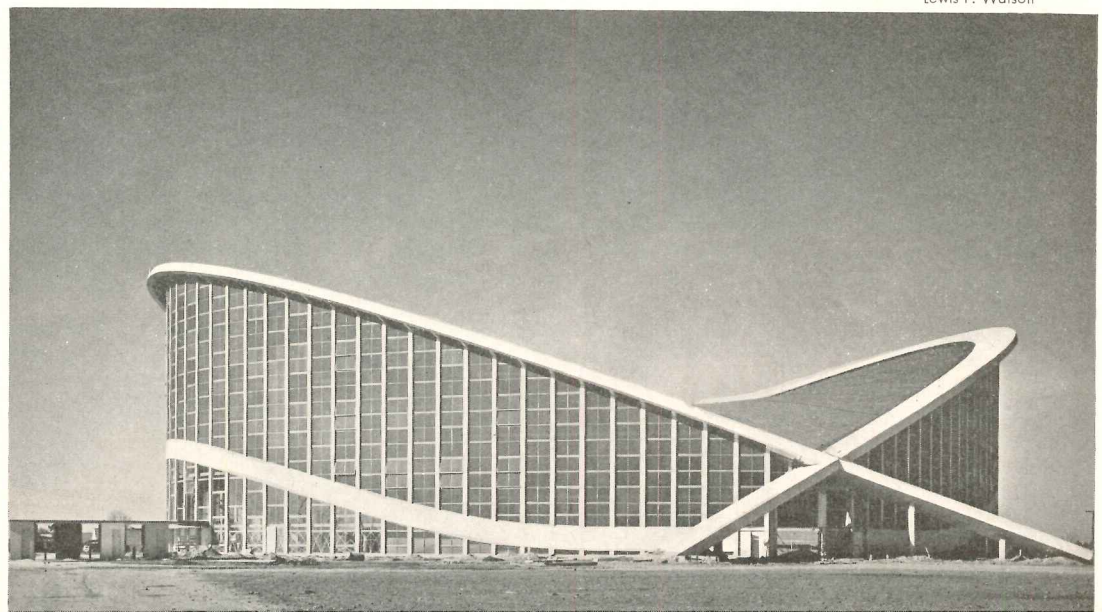

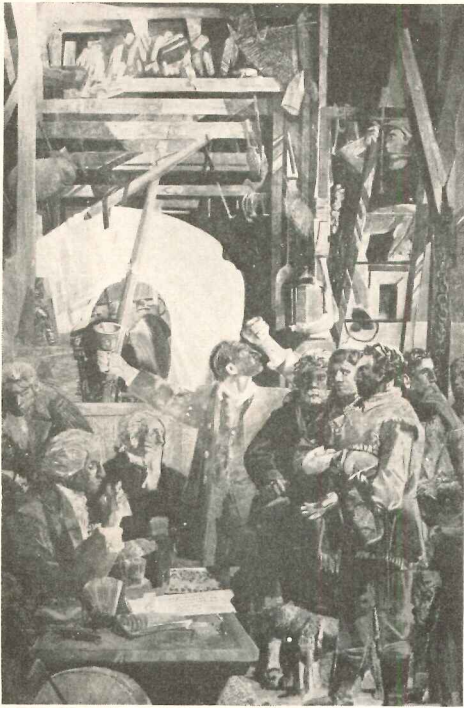

Mural Decoration. Gold Medal: George Harding, for murals for Montgomery County, Pa., County Courthouse (one section above) and "creative output throughout the years"

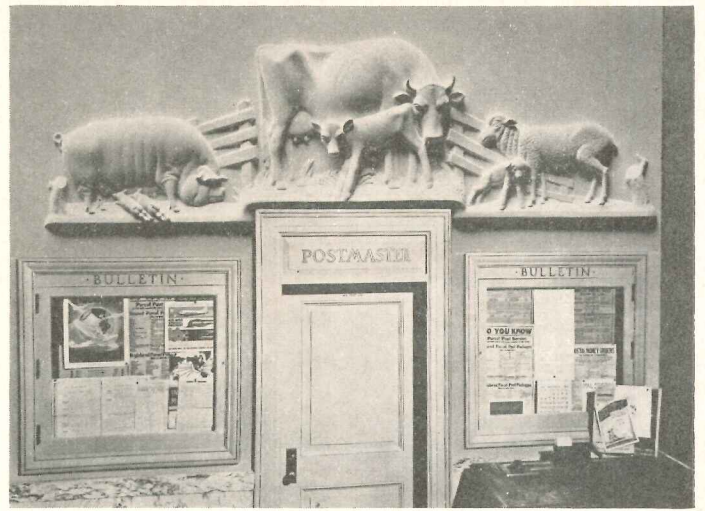

Sculpture. Silver Medal: Moissaye Marans, for his study (above) for Boyertown, Pa., Post Office. Honorable Mention: Thomas Lo Medico, for his group *The Apprentice* (left)

## GOLD MEDAL EXHIBITION

Louis Skidmore, F.A.I.A., of Skidmore, Owings & Merrill, Architects & Engineers, was chairman of the 1953 exhibition. Chairmen of the committees on selection and juries of award were: *mural decoration* — Joep Nicolas; *architecture* — Louis Skidmore; *design and craftsmanship in native industrial arts* — Viggo F. E. Rambusch; *landscape architecture* — Alfred Geiffert III; *sculpture* — Leo Friedlander; *engineering* — Henry F. Richardson.

*Design and Crafts in Native Industrial Arts.* Silver Medal: Doris Hall, for enamel panel (below) produced at Betteinger Corporation. Honorable Mention: J. Arthur Harriton, Harriton Carved Glass, for glass panel (right) for liner United States

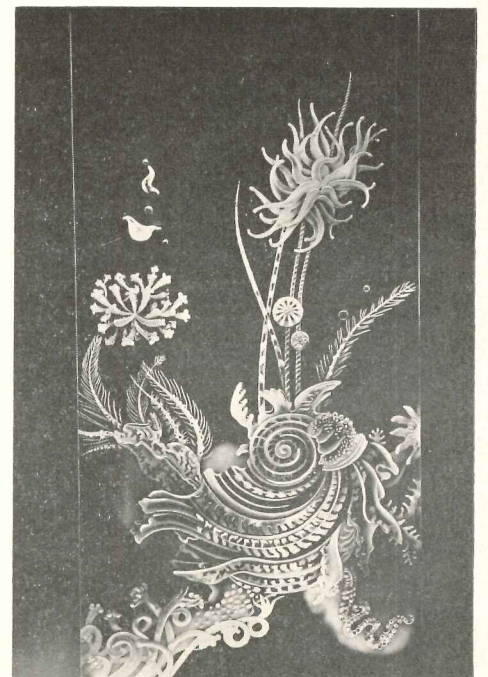

## THE RECORD REPORTS

# O P I N I O N

Editor, ARCHITECTURAL RECORD:

Herewith is an article which I am sending to the principal architectural magazines of the world . . . I think you should use it as you see fit . . . should be published by you apropos the Hitchcock piece.

Frank Lloyd Wright

Excerpts from

“THE ‘INTERNATIONAL STYLE’”

By Frank Lloyd Wright

[Dated February 1953]

THE INTERNATIONAL STYLE IS NEITHER INTERNATIONAL NOR A STYLE. . . .

All ISMS are merely derivative.

An ISM is only a *notion*.

At most the notion becomes a fashion and a Fashion is — always — some passing show of imitation: probably an imitation of a bad imitation by a bad imitator. In any international “style,” therefore, we would have more invasion than invention. Though unfortunately serviceable to the commerce of Education as it now runs in this latest propaganda “Post-war Architecture” sold by the Museum of Modern Art, New York, N. Y., I see a cliché for the rising tide of mediocrity. . . .

By way of this pestiferous procession of professionalism there is real harm in internationalism. It poses a *style*. There is no sense at all in a *style* for what should now constitute the free architecture of a Democracy. Not much harm in this tricky little trickle from a museum except that so many people of purely bureaucratic stature who labor under the distinction of being nobody at all are somehow in position to put wrong ideas into the heads of babes and sucklings who don't know Vasari from Vesuvius.

The cognoscenti — European especially — are not affected. They well know that any “International Style” is the degeneration of a good IDEA.

Regarded by whatever creative architecture is left in the world, this substitution of façade for substance is annoying, because it is unenlightened betrayal: recession to the realm of

“make believe” in the land of never-never. . . .

Old man BOX merely *looks* different when glassified, that's all. But the more the box is glassed the more it is evident as the box. No new ideas whatever are involved. The old sham front has had its face lifted. What radical change may be seen lies wholly in appearance.

Organic (or intrinsic) architecture abolishes the old post and lintel box, resents and rejects “the slab.” Organic-architecture is a *new idea of what constitutes a building*. That idea introduces wholly new values into the building. An entirely new ethic (as esthetic) comes to life when the building is so conceived as *intrinsic*. Wherever it is built you see a new countenance. Organic modern architecture is first of all interior, *of the thing not on it*. Not a dead style therefore, but STYLE that bears ever fresh form. A true dissidence and its origin is American.

Back there, in the sinister shadow cast upon modern Organic-architecture at the new Museum of Modern Art, about twenty years ago, this renaming and retiming of old wine in new bottles began. A style might have looked to the museums (then the morgues of Art) like expedient reformation. But this confluence of equivocal minds and circumstances looks like a foolish attempt to do much the same service to American Organic-architecture now that the Chicago World's Fair of '93 did to the modern

Tommy Weber

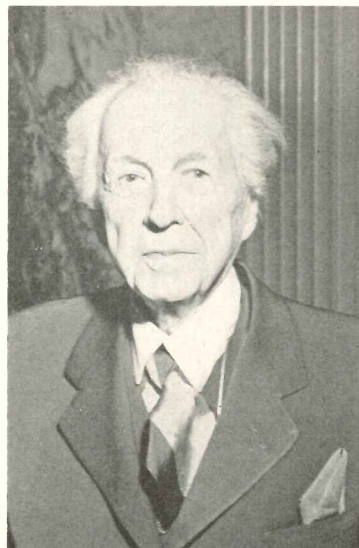

movement then led by Louis Sullivan. . . .

. . . To hitherto convenient “classicism” now, by way of classicism, do we revert? Whatever best serves our commercially mechanized society or vice versa will do, so far as the profession is concerned. But the people?

This servile recourse to the Machine by a style, this rise of mediocrity now flooding into high places, is our American heartache in architecture. We who love our country believe in the original meaning and intent of our forefathers' “Declaration” and the wisdom of the Constitution they devised. We do not like much of what we see or any of what we read in “Post-war Architecture.”

The world in which we now share is not smaller than it used to be because of airships, atom bombs and electrification. The world is larger because more comprehensive and therefore less comprehended by us. There is more confusion of mind now than ever existed before. Far less sympathetic understanding.

As human beings, our view both personal and national, comprises so much we never dreamed of before and do not understand now. What merely existed for us before mechanization set in and this cliché appeared the ideal expedient, is an unsolved problem now.

That does not mean “*one world*” but *many*. Too many maybe (as we are going) because *we are not yet ready with our own!*

If ever international cooperation is to come true the need for solidarity of Individual-independence grows immensely in importance because of easy intercommunication. The strength of our native spirit more necessary to Freedom. . . .

It is the strength of the philosophy of a free intrinsic or organic-architecture that it loves, (and cherishes) these infinitely individual human traditions of the great TRADITION. Because of our increased techniques such architecture could easily afford all nations new means of realization on their own soil along lines of character and development already peculiar to themselves in their own country. Whatever is modern in Architecture should, in this new view of reality which inspired architecture may reveal, intensify the individualities of all nations, not strip them of the charm of innate distinctions. As a nation we have little such or none. If, instead of our own inspired

(Continued on page 332)



FOCUS ON SEATTLE: 85TH A.I.A. CONVENTION JUNE 15-19

SEATTLE becomes the architecture capital of the United States this month, as an estimated 2000 delegates, members and guests of the American Institute of Architects converge on the Olympic Hotel in that city for the Institute's 85th annual convention June 15-19.

The first A.I.A. convention ever to be held in the Pacific Northwest will emphasize that area's contributions to American architecture in the convention theme "New Country — New Architecture" and in a combination of tours and seminars designed to explore the relation of the region's vast lumber resources to the art and science of building.

The program, arranged under the over-all direction of Northwest Regional Director Irving Smith of Portland, Ore., as general chairman and Waldo Christenson of Seattle, chairman of the Steering Committee of the Washington State Chapter, host chapter for the convention, will feature, in addition to three seminars on wood tied in with the convention theme, seminars on "Oriental Influences on American Art and Architecture," "Liturgical Arts," and "Condensation in Buildings." There will be special meetings on the home building industry and on civil defense.

**Major Speakers Named**

Pietro Belluschi, F.A.I.A., who left his Portland, Ore., practice three years ago to become dean of the school of architecture and planning at Massachusetts Institute of Technology, and William M. Allen, president of the Boeing Airplane Company of Seattle, will be the "keynote" speakers. Mr. Allen will open the business sessions on June 16, speaking on "New Country"; "A New Architecture" will be Dean Belluschi's topic at the closing session on June 19. Speaker at the annual banquet on June 18 will be George H. T. Kimble, geographer, meteorologist and since 1950 director of the American Geographical Society, who will relate architecture to the broader study of environment.

**Officers to be Elected**

New officers will be elected to succeed the present slate, headed by President Glenn L. Stanton of Portland, Ore., which has completed the usual two one-

year terms. Kenneth L. Wischmeyer of St. Louis, the present first vice president, and Clair W. Ditchy of Detroit, the present secretary, are both candidates for president. Four regional directorships also fall vacant this June.

**Honors Listed**

Awards and honors to be conferred at the 85th convention include the 1953 A.I.A. Gold Medal, to William Adams Delano, F.A.I.A., of Delano and Aldrich, New York architectural firm; the Fine Arts Medal, to Sculptor Donal Hord of San Diego; the Craftsmanship Medal, to Emil Frei, stained glass artisan, of St. Louis; and the Edward C. Kemper Award (for service to the Institute) to Gerrit J. de Gelleke, F.A.I.A., of Milwaukee. Honorary memberships will be awarded to Gurdon M. Butler of Tucson, Ariz., dean emeritus of the University of Arizona's College of Engineering, and Frank Creedon, director of installations for the Department of Defense. Thirty A.I.A. members will be advanced to Fellowship in the Institute (ARCHITECTURAL RECORD, May 1953, page 12).

Exhibits will include entries in the A.I.A.'s Fifth Annual Program of National Honor Awards; the Producers' Council display of building materials and equipment of 53 manufacturers chosen for "design quality and interest to architects"; examples of the work of the Fine Arts and Craftsmanship Medal winners; and examples of the architectural work of the new Fellows.

Among the scheduled pre-convention meetings are sessions of the National Council of Architectural Registration Boards, the Association of Collegiate Schools of Architecture, the Producers' Council and the Board of Directors of the A.I.A. A major convention feature will be an all-day "logging tour" on June 15 to the Olympic Peninsula across Puget Sound from Seattle as guests of the Simpson Logging Company.

Under the auspices of the United States Travel Agency, Inc., "convention special" trains are being run to provide scenic trips to and from Seattle with Chicago as a starting point. Post-convention tours to Hawaii (by air) and Alaska (by steamship) are also being offered.

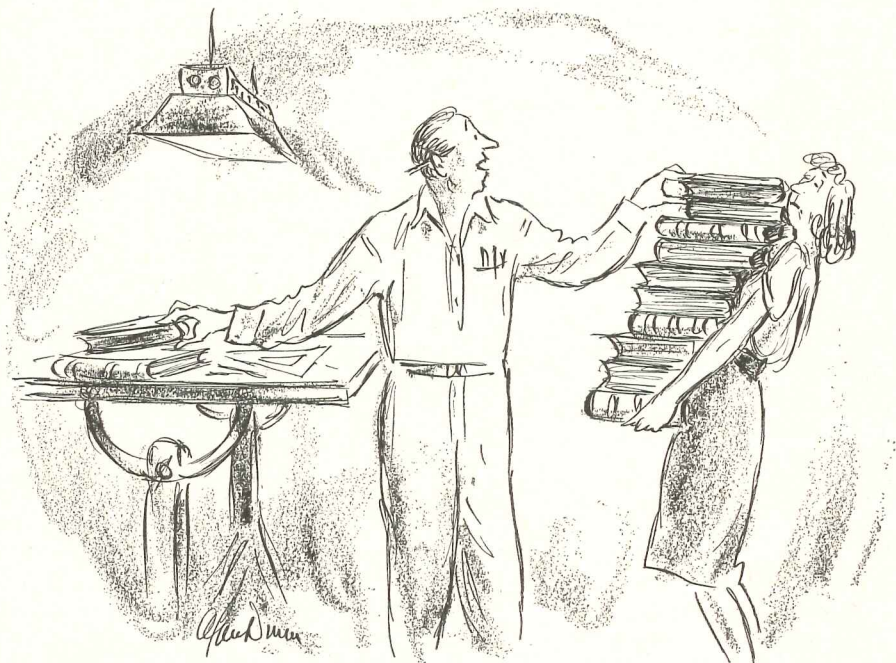

—Drawn for the RECORD by Alan Dunn

"Don't worry, Miss Roberts—I figured out that you had a psi of 268.25 pounds—"

## THE RECORD REPORTS

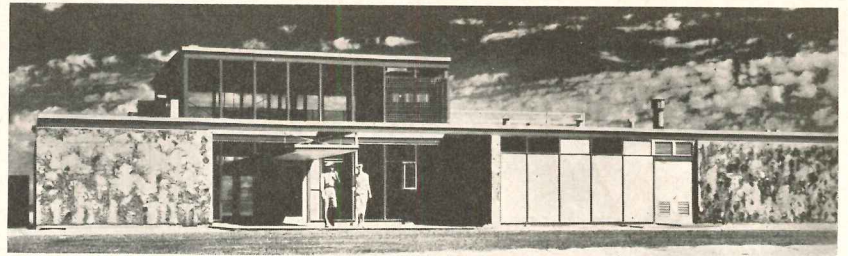
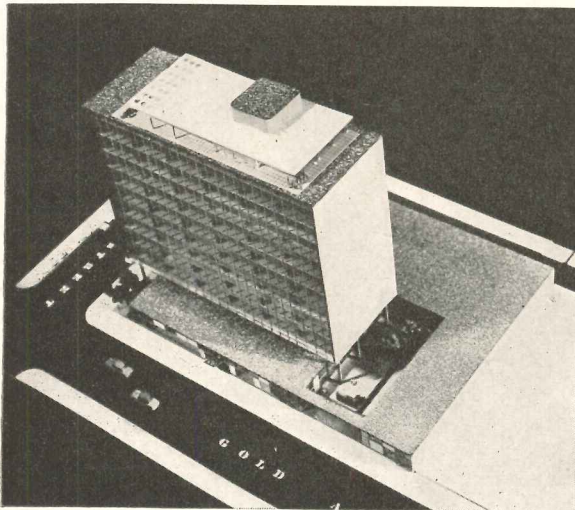

Three entries from the Albuquerque firm of Flatow & Moore were among 12 award winners in A.I.A. Western Mountain District exhibit. Left: Simms Building, Albuquerque, first award in commercial category; above: Airport Terminal Building, Farmington, N. Mex., second in commercial group; below: Intermediate School, Los Alamos, first award in school category

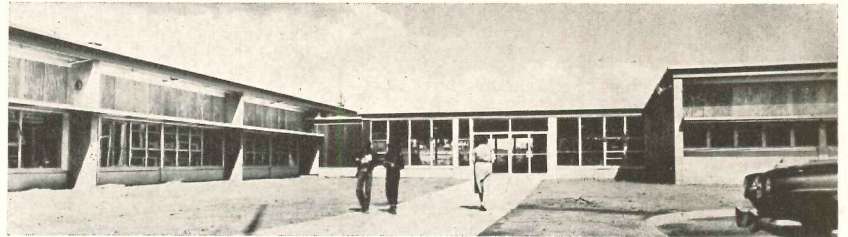

## WESTERN ARCHITECTS MEET—12 BUILDINGS CITED

SOME VERY DOWN-TO-EARTH SUBJECTS were the meat of a very popular program at the second annual regional convention of the Western Mountain District of the American Institute of Architects. The three-day session was held in April at Colorado Springs.

Public relations for architects and the A.I.A. Standardized Accounting System were the subjects of the two main seminars, both of which produced some very intensive question-and-answer sessions. Speakers were Walter M. Megronigle, manager of the public relations division of Ketchum, Inc., Pittsburgh firm which is directing the national A.I.A.

public relations program, and David C. Baer of Houston, chairman of the A.I.A. Committee on Office Practice and Accounting.

Eduardo Contini, director of engineering for Victor Gruen Associates, Los Angeles, and Roger Allen of Grand Rapids were other speakers. W. Gordon Jamieson, regional director, presided at two business sessions.

Aside from the program, major interest centered in the regional exhibit and the awards announced at the meeting. Max Flatow, whose firm, Flatow & Moore, won three of the 12 awards, was named "Architect of the Year."

The award-winning buildings, by categories, and their architects:

**Commercial**—First, Simms Building, Albuquerque, Flatow & Moore; second, Airport Terminal, Farmington, N. Mex., Flatow & Moore; third, Boulder, Colo., City Hall, James Hunter.

**Residential**—First, Mrs. R. H. Winsor house, Tucson, Arthur T. Brown; second, King house, Boulder, James Hunter; third, house, Albuquerque, Ferguson & Stevens.

**Schools**—First, Intermediate School, Los Alamos, Flatow & Moore; second, Pueblo, Colo., School, Edward L. Bunts; third, Church school, Walter de Mordaunt, Pueblo, Colo.

**Institutional other than schools**—First, St. Timothy's Evangelical Lutheran Church, Ferguson, Stevens & Associates; second, Colorado A.&M. dormitory (project), James Hunter; third, Aurora Library (project), Victor Hornbein.

St. Timothy's Evangelical Lutheran Church (right) won for Ferguson, Stevens & Associates of Albuquerque the first award among institutional buildings other than schools

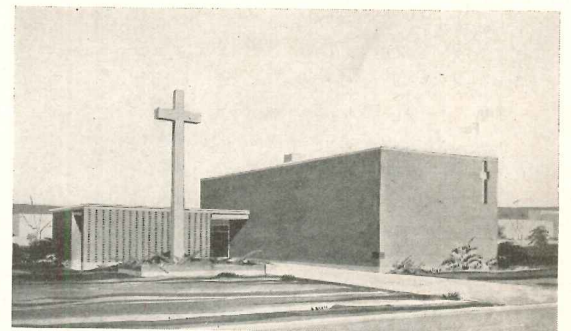
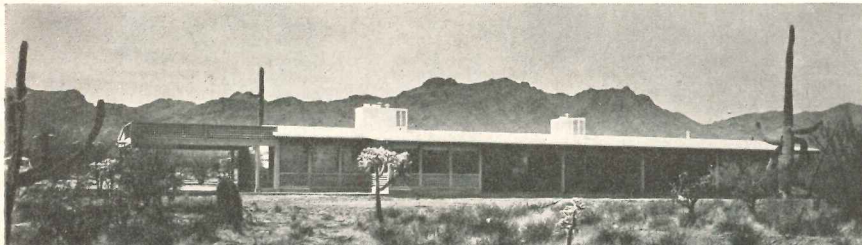

First in the fourth category—residential—was this house for Mrs. R. H. Winsor; Arthur T. Brown, Tucson, architect

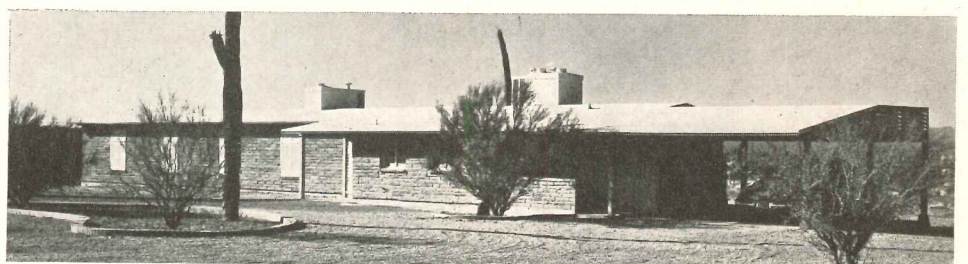

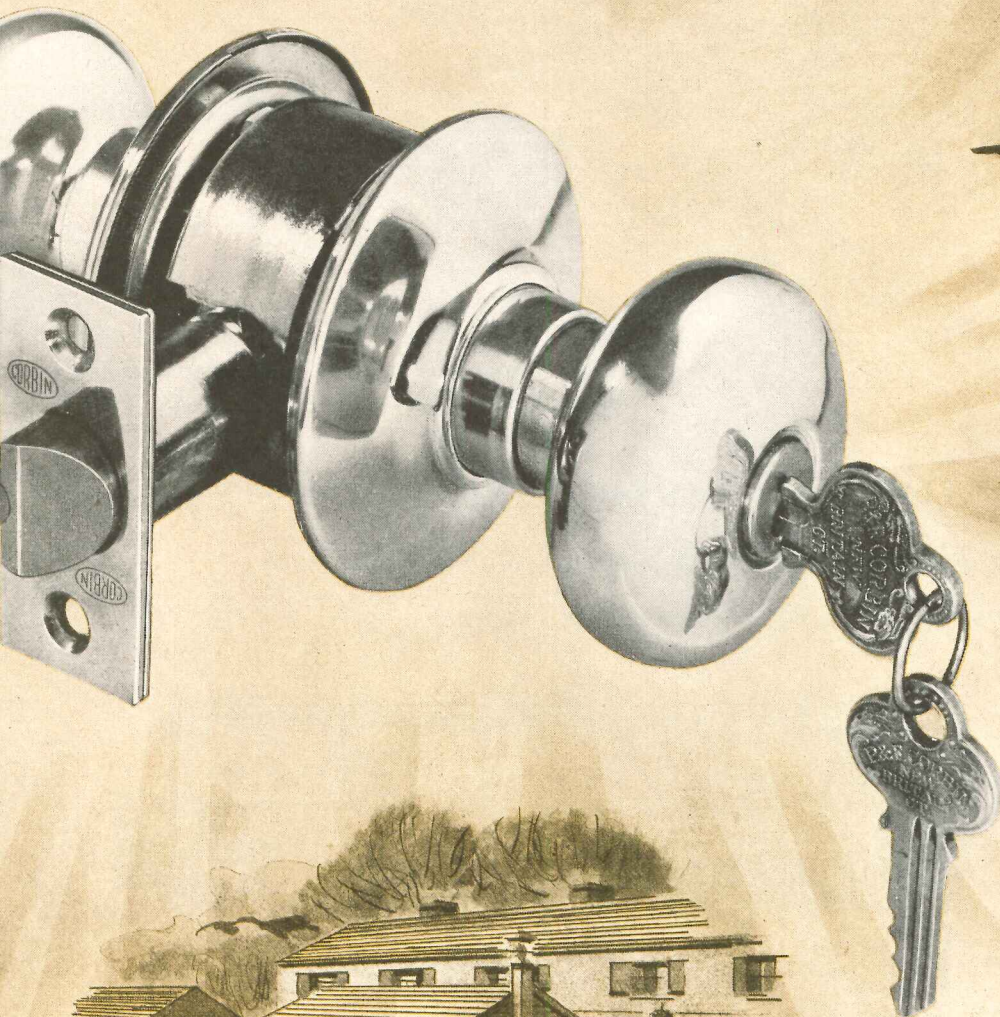
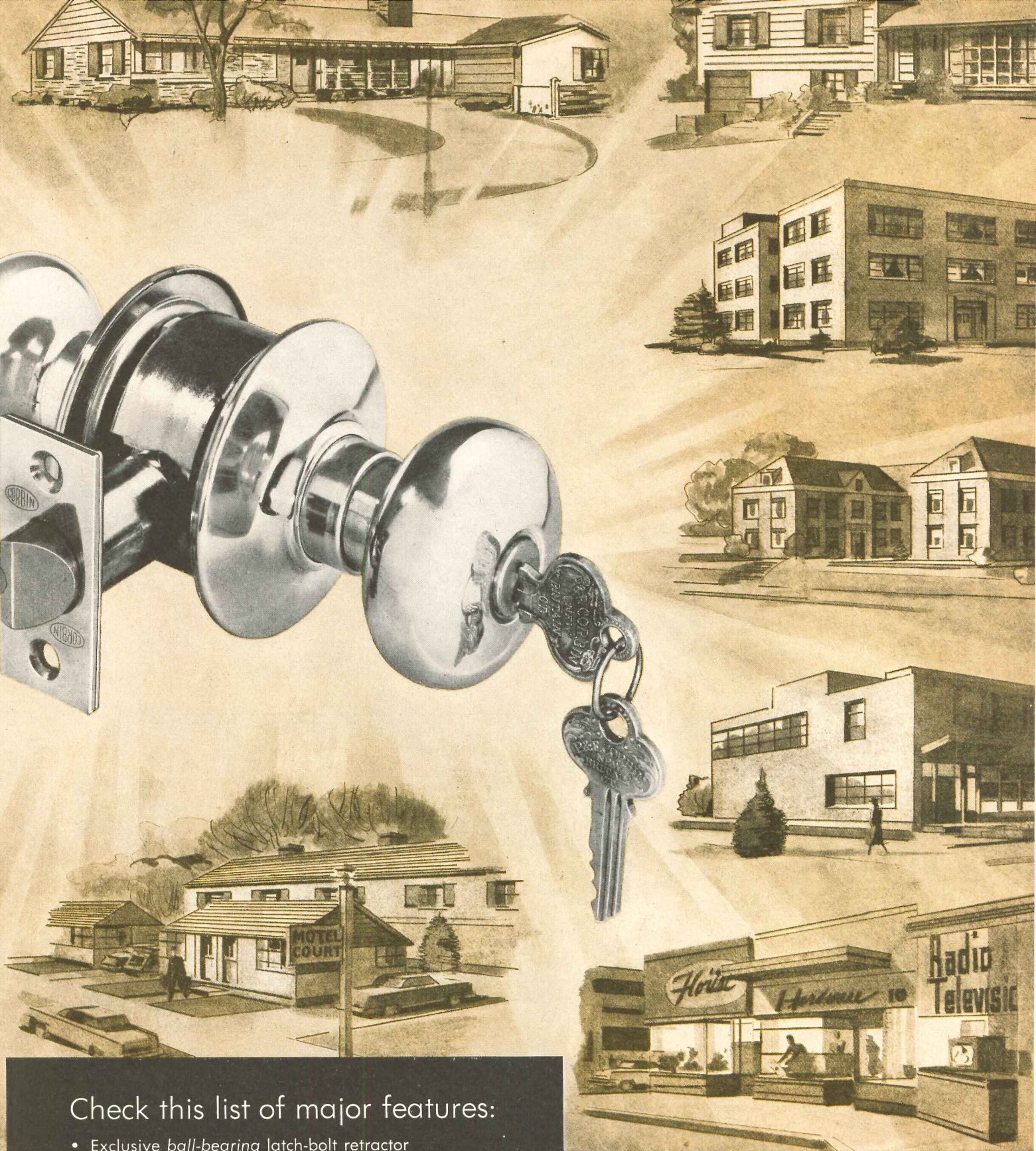

## Check this list of major features:

- Exclusive *ball-bearing* latch-bolt retractor
- Exclusive outside knob feature that permits fast change of hand of door; or removal of cylinder — without sacrifice of security
- Time-tested P. & F. Corbin 5-pin tumbler security
- Master-keying
- Factory assembled
- All trim wrought or cast brass, bronze or aluminum
- All internal parts zinc-plated, di-chromated steel
- Double compression springs
- Screwless knobs and roses
- Meets or exceeds Federal specifications
- Thirteen popular functions



**P. & F. CORBIN Division**  
 The American Hardware Corporation  
 New Britain, Connecticut, U.S.A.

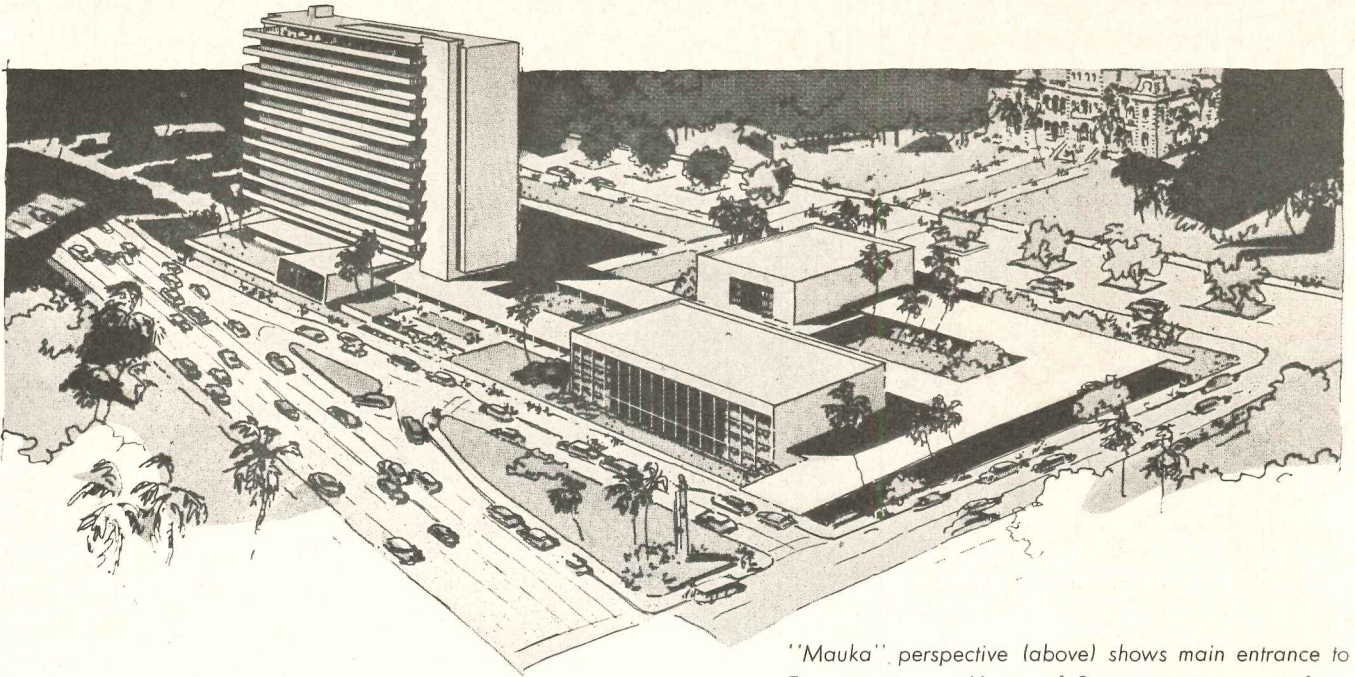

"Mauka" perspective (above) shows main entrance to Executive tower; House of Representatives is in foreground, Senate behind it. Below: drawings show plan of typical office floor and section of Executive unit

## HAWAII PLANS EXECUTIVE AND LEGISLATIVE BUILDING

*Architecture for Statehood: Proposals for Expanded Capitol Grounds*

*Would Also Preserve Historic Iolani Palace and Iolani Barracks*

THE TERRITORY OF HAWAII may become the 49th state before this session of Congress adjourns; and if that long-heralded event occurs, it will find the Territory's planners ready with proposals for an expanded Capitol Grounds and a new Executive and Legislative Building to replace historic Iolani Palace as the Capitol.

The preliminary plans for the building, as prepared by Merrill, Simms & Roehrig-Ossipoff-Heen, Associated Architects, provide for four main elements — the Senate, the House of Representatives, auxiliary offices for the two chambers, and an Executive Office tower. The multistoried form for the executive unit was adopted to preserve a maximum of open area for Capitol grounds. The Senate, the House and their special offices would surround a private garden court for the legislators. The four units would be connected by broad lanais.

All construction is to be earthquake-resistant and fireproof, finishes of native stone and hardwoods.

The 350,000-sq-ft site, originally selected for the project on the Master Plan and Honolulu Civic Center Plan adopted in 1945, would include and preserve in the new Capitol Grounds historic Iolani Palace, the Archives, Iolani Barracks and the Library of Hawaii.

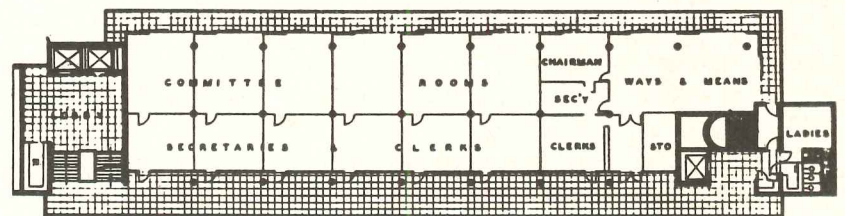

8<sup>TH</sup> FLOOR

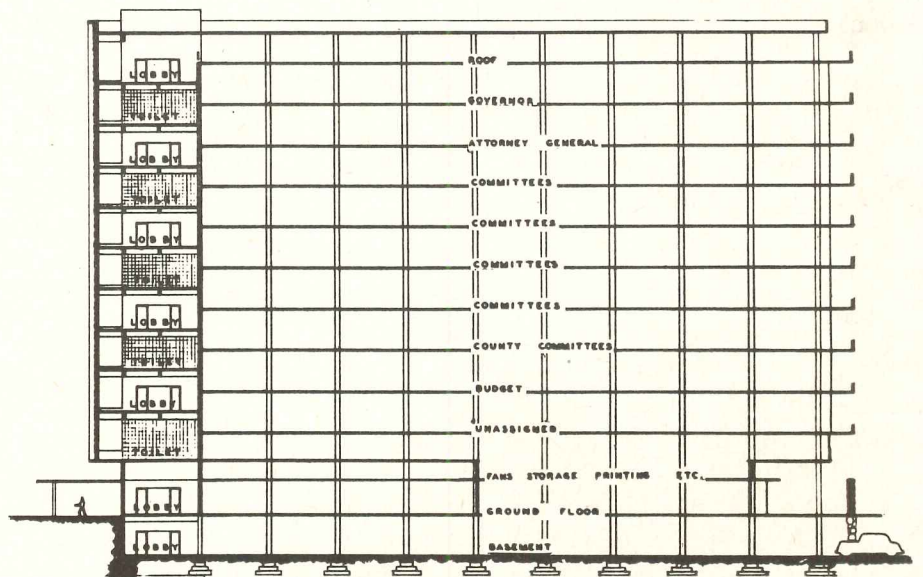

# Automatic Temperature Control

## Now Include

### POWERS - PACKLESS - VALVES

For Controlling Convectors, Unit Ventilators, Unit Air Conditioners and Radiators.

Now, at **NO Extra Cost** — users of Powers pneumatic control systems will get the additional benefits of still lower operating and maintenance costs — insured by Powers packless valves.

**Duo-seal Construction Gives Them Superior Performance.** Bronze packless bellows is the Primary Seal which eliminates packing maintenance — packing friction — steam and water leakage or loss of vacuum. Secondary Seal permits servicing of valve top without draining the water system or shutting off the steam supply.

#### Typical Specifications for POWERS-Packless-Pneumatic Control Valves

Control valves for convectors, radiators and unit ventilators shall be packless type with bronze packless bellows to eliminate steam and water leakage or loss of vacuum. This packless bellows shall be located so that it is not subject to corrosive action of the steam or water. A spring-loaded secondary seal shall be provided to permit convenient inspection or servicing of valve top without draining the water system or shutting down the steam supply.

Valve sizes shall be determined by control manufacturer



for capacities specified. Type of valve body and valve top to be used shall be as required to best satisfy the application.

Valves shall be equipped with phosphor bronze bellows or Neoprene diaphragms of sufficient size to close off against specified line pressures. Diaphragms shall be replaceable. Valves shall be equipped with characterized throttling plugs to insure a measured flow of steam or water in direct relationship to the demand of the controlling thermostat.

#### THE POWERS REGULATOR CO.

Skokie, Ill. • Offices in Over 50 Cities in the U. S. A., Canada and Mexico  
See Your Phone Book

OVER 60 YEARS OF AUTOMATIC TEMPERATURE CONTROL



**Banish PACKING Maintenance**

#### No Loss of Vacuum

... leakage of air reduces efficiency of heating system and increases corrosion in return lines



**No Steam or Water Leakage**

(b18)

Only a Few of **POWERS** Complete Line of Modern Control Valves for Regulating Heating and Air Conditioning Systems

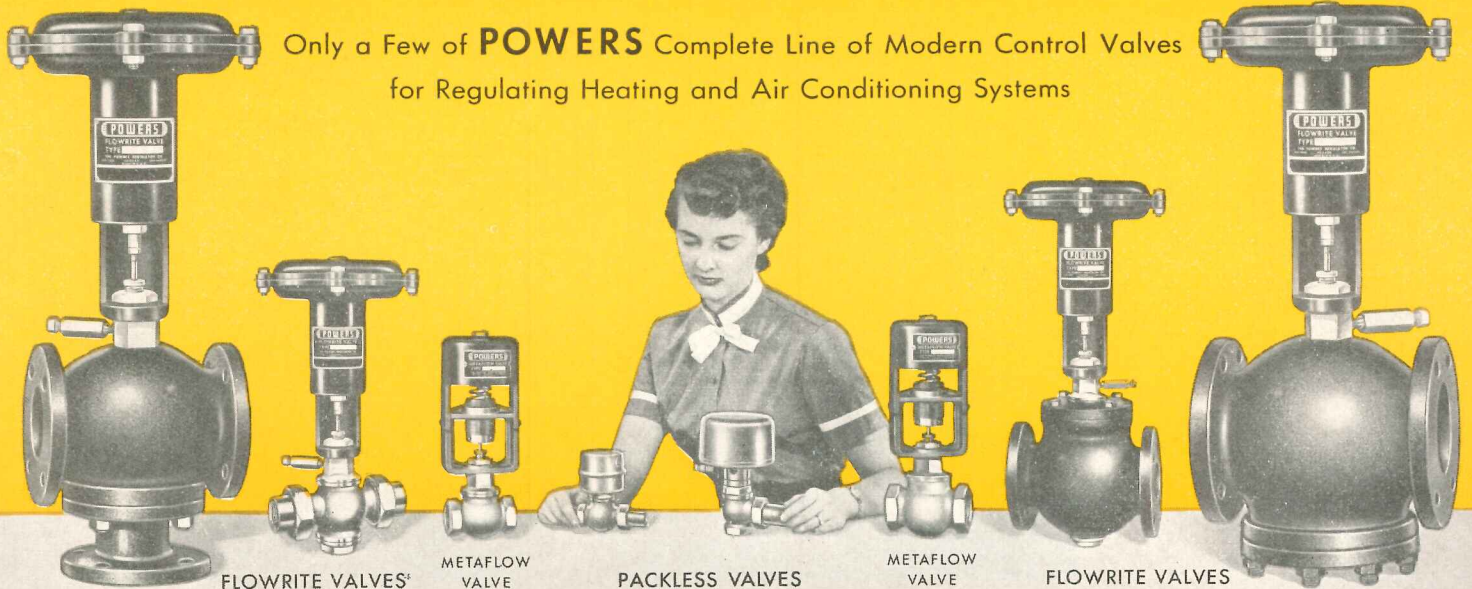

FLOWRITE VALVES\*

METAFLOW VALVE

PACKLESS VALVES

METAFLOW VALVE

FLOWRITE VALVES

**R.A.I.C. 46TH ANNUAL ASSEMBLY HELD IN TORONTO**



*R. S. Morris, president of the R.A.I.C. addresses convention's annual dinner*

THE 46TH ANNUAL ASSEMBLY of the Royal Architectural Institute of Canada, held in Toronto, April 23-25, concluded on a note of optimism and confidence in the construction outlook. The executive, headed by President R. S. Morris of Toronto, remains in office for another year.

In his annual report, President Morris reminded the convention that "there have been more architects doing more work and with a larger average income than ever before. Our membership has increased more than eight per cent in the past year." Graduates from five schools of architecture comprise the bulk of the new membership, and concerning these, Mr. Morris said, "I am one who be-

lieves that ability, mental capacity and the general attitude and character of the graduate are more important to the profession than what he knows, or what has been described as his 'muzzle velocity' on graduation."

Referring to standard professional documents and standardization of professional practice, Mr. Morris reported that the R.A.I.C. committee on legal documents "is doing splendid work in the revision of our owner-contractor cost-plus standard agreement."

Among features of this year's assembly was a seminar on new structural systems, conducted by C. D. Carruthers of the Toronto firm of Wallace, Car-

*(Continued on page 26)*



*At the annual dinner: Above, left to right: Mr. and Mrs. A. S. Mathers, Toronto, Sir Hugh Casson, London, England, guest speaker at the convention, and Mr. and Mrs. Robert Pilot, Montreal*

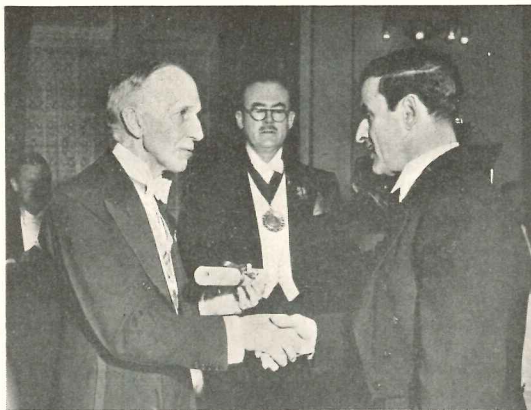

*The Governor-General, the Rt. Hon. Vincent Massey, presents the Allied Arts Medal to sculptor Armand Filion*

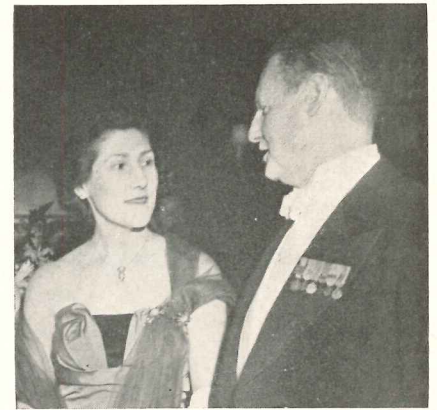

*Edmund Purvis, executive director of the American Institute of Architects, chats with Mrs. H. Gordon Hughes*

*Near right: Mr. and Mrs. Peter Thornton of Vancouver, at left, discuss things with Mr. and Mrs. H. Ross Wiggs of Montreal. Far right: H. Gordon Hughes of Ottawa, Mrs. Edmund Purves, and John H. Wade of Victoria compare notes*



# Pella® MULTI-PURPOSE WINDOWS



## CREATE CUSTOM-LIKE EFFECTS ECONOMICALLY

In residential and commercial jobs everywhere, Pella Wood Multi-Purpose units are providing "walls of windows" at moderate cost. Stationary and ventilating units can be combined in dozens of ways, projecting in or out, according to application. Pella Multi-Purpose Windows come completely assembled and fitted, with sash hardware attached to save on installation costs. Removable screens included with all ventilating units. Dual glazing panel optional. Fixed or ventilating frame sizes: widths — 32" and 44"; heights — 16", 20" and 24". Stationary sizes: 44" x 48" and 44" x 64".



FOR DETAILED INFORMATION  
WRITE: Dept. E-26, Rolscreen  
Company, Pella, Iowa.

see our catalog in  
ARCHITECTURAL  
FILE  
or write for copy

Pella Wood Multi-Purpose Windows shown here adapted to the famous "Trade Secrets House" which was designed by a panel of leading architects, builders and designers.

AWNING  
WINDOWS

"HOPPER VENTS"

CASEMENTS

PICTURE  
WINDOWS



PLAN WITH *Pella* PRODUCTS MADE BY ROLSCREEN COMPANY, PELLA, IOWA

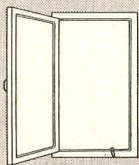

*Pella*  
WOOD CASEMENTS



*Pella*  
ROLSREENS



*Pella*  
LITE-PROOF SHADES



*Pella*  
WOOD FOLDING DOORS



*Pella*  
VENETIAN BLINDS

## THE RECORD REPORTS

### CANADA

(Continued from page 24)

ruthers & Associates, consulting structural engineers. Another seminar, on air conditioning, was conducted by Charles S. Leopold, consulting engineer from Philadelphia.

At the annual dinner which climaxed the assembly, nearly 400 guests saw the



Directors of four of Canada's five schools of architecture meet at the opening session of the R.A.I.C.'s 46th annual assembly. Left to right: Pierre Morency, Ecole des Beaux Arts, Montreal; H. H. Madill, University of Toronto; John Bland, McGill University, Montreal; John A. Russell, University of Manitoba, Winnipeg



FIREMEN EVERY 10 FEET

**READILY INSTALLED...no interruptions**

GLOBE Automatic Sprinkler Systems are installed by GLOBE engineers and craftsmen while your own operations go on without interruption. Insurance savings often pay for a GLOBE system in 4 to 8 years. Ask our nearest office for details.

**GLOBE AUTOMATIC SPRINKLER CO.**  
NEW YORK . . . CHICAGO . . . PHILADELPHIA  
*Offices in nearly all principal cities*

THEY PAY FOR THEMSELVES

Rt. Hon. Vincent Massey, Governor-General of Canada, accept an Address of Loyalty from Institute president Morris for transmission to Her Majesty the Queen, herself a Patron of the Institute. The Address was beautifully inscribed and illuminated by A. Scott Carter, Toronto architect and one of Canada's leading heraldic authorities.

The Governor-General presented the Allied Arts Medal to Armand Filion, Montreal sculptor, and the R.A.I.C. Scholarship Medal to his son, Hart Massey, Ottawa architect. He also presented College of Fellows certificates to the following new Fellows of the Institute: W. G. Blakey, Edmonton; F. Bruce Brown, Toronto; Frank G. Gardiner, Vancouver; H. Gordon Hughes, Ottawa; Lucien Mainguy, Sillery, Que.; Henri Mercier, Montreal; Robert E. Moore, Winnipeg; Hugh P. Sheppard, Windsor, and H. Ross Wiggs, Montreal.

Robert F. Legget, director of building research, National Research Council, Ottawa, was elected an Honorary Fellow in recognition of his work on the National Building Code.

President Morris was invested with a chain of office, presented by the Royal Institute of British Architects. John Roxborough Smith, immediate past president of the R.A.I.C., served as the investor.

Special guest at the dinner was Sir Hugh Casson, British architect in charge of the Coronation decorations for the city of London, who urged architects to use great occasions as a lever to effect

(Continued on page 30)



# SEASONMASTERS

*...everything you've wanted in  
Central Station Air Conditioners!*

You've never seen a central station air conditioner that does so much, so well, under such a wide variety of conditions as McQuay's *new* Seasonmaster.

Fourteen models, in both horizontal and vertical types, many combinations of cooling and heating coils, a wide variety of accessories give you a unit adaptable to all year 'round demands . . . cooling and dehumidification, heating and humidification, positive ventilation, and air filtering.

Seasonmasters are furnished with  $\frac{1}{2}$ " rigid insulation and are available with various air discharge arrangements. All parts are readily accessible for ease of installation and service.

McQuay construction of these versatile units is your assurance of quality and dependability. All coils are made with the exclusive McQuay Ripple-Fin construction for unmatched heat transfer efficiency. Seamless copper tubes are expanded into wide, smooth collars of aluminum fins. Headers are heavy wall, seamless copper tubes. In common with all McQuay products, the Seasonmaster was perfected after long and careful study, to give you maximum performance and trouble-free service.

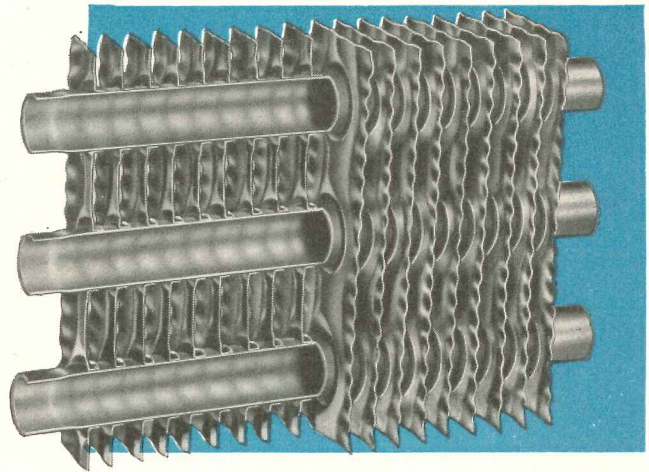

**NOW...THE MOST UNIVERSAL  
LINE IN THE INDUSTRY!**

Seasonmaster's wide range of Cfm and Btu capacities . . . its many practical combinations of coils and accessories add up to the most universal line of air conditioners in the industry. For air conditioning that will solve the problem to the complete satisfaction of both you and your customers, specify McQuay.

**McQuay** INC.



HEATING  
AIR CONDITIONING  
REFRIGERATION

## THE RECORD REPORTS

### CANADA

(Continued from page 26)

the brightening of their cities' appearance. He told his listeners that some sort of festivity was the "only thing that would restore civic consciousness." This was brought home to him in his role as designer of the Coronation route,

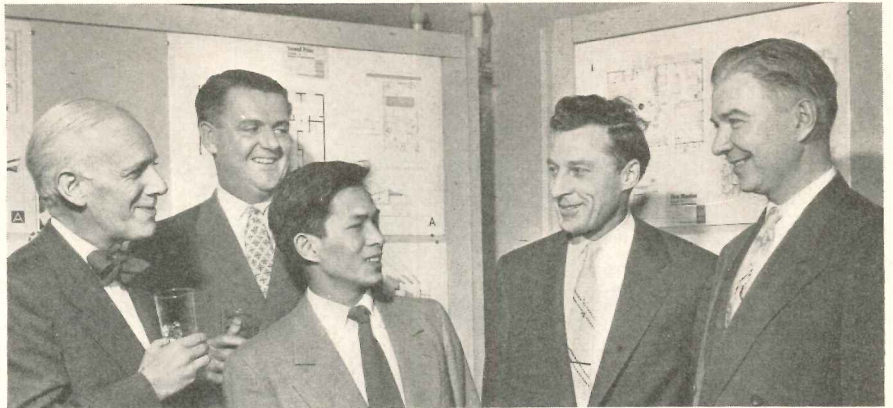

Group at exhibit of architectural competition sponsored by the Douglas Fir Plywood Association. Left to right: Professor Eric Arthur, University of Toronto; G. H. Tullidge, president of the Plywood Manufacturers Association; John Ma, second prize winner; Stan Barclay, first prize winner in eastern region; Professor John Russell, University of Manitoba

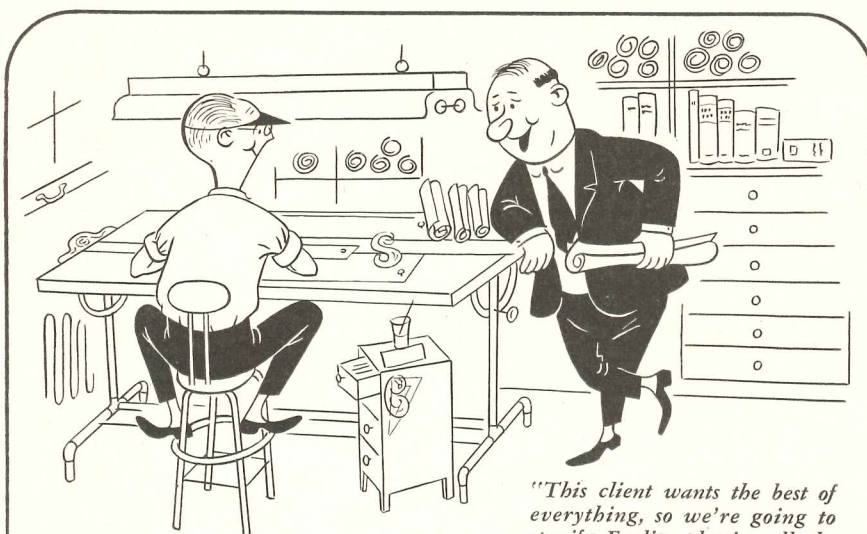

"This client wants the best of everything, so we're going to specify Farlite plastics all the way through!"

# FARLITE

EXTRACTS FROM A STUDY BY MONY  
Guaranteed by  
Good Housekeeping  
NOT AS ADVERTISED THEREIN

## ... the very best in PLASTIC LAMINATES

Whatever the job — residential, commercial, or industrial — you (and your clients) will be better satisfied if you specify FARLITE when you plan new construction or remodel present facilities. It's the very *best* in plastic laminates for partitions and paneling . . . for counter, table, desk, bar, and soda fountain tops . . . for decorative interior treatments . . . for a host of other uses. Its glass-smooth, non-porous surface is sanitary, easy to clean, permanently beautiful . . . resists heat and burning cigarettes . . . is not affected by alcohol, grease, fruit acids, mild cleaning solutions . . . will not chip or fade.

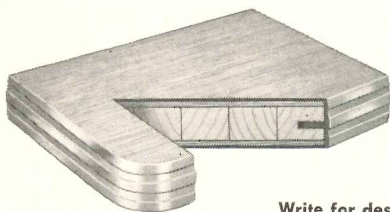

### SUPERIOR CONSTRUCTION . . . FULL RANGE OF COLORS AND DESIGNS

Farlite's superior 5-ply construction means extra smoothness and warp resistance. Over 50 new standard colors and patterns give you full decorative range . . . edges can be supplied with metal trim or natural wood finish. Also available in standard sheet stock or can be made up to your specifications.

Write for descriptive folder and name of nearest distributor.

PLASTICS DIVISION  
FARLEY & LOETSCHER MFG. CO., DUBUQUE, IOWA



Board of Assessors for plywood competition look over the entries. Left to right: John A. Russell, University of Manitoba architecture director; Gordon S. Adamson, Toronto architect; Peter M. Thornton, professional advisor; John B. Armstrong, Manager, Plywood Manufacturer's Association; Pietro Belluschi, M.I.T. architecture dean

he said, when he found that people in London never noticed the lamp posts until he put things on them.

"As children, we notice everything," he said, "but as we grow older our eyes seem to gum up. By the time we become adults it's as though we had blinkers on. The artist is more alert visually than his fellows. He has a role to play in overcoming the boring, vulgar trivialities of our cities. The architect is the person best suited to get society and the artist back on speaking terms."

(Continued on page 32)



Paul Thiry, Architect

MODERN DOOR CONTROL BY *LCN* • CLOSER CONCEALED IN HEAD FRAME

OFFICE OF PAUL THIRY, ARCHITECT, SEATTLE, WASHINGTON

LCN CATALOG 12-A ON REQUEST OR SEE SWEET'S • LCN CLOSERS, INC., PRINCETON, ILLINOIS

**VA, FHA INTEREST RATES  
ON HOME LOANS GO UP**

THE HOME BUILDING INDUSTRY finally won its long battle for a raise in VA and FHA loan interest rates. VA Administrator Gray capitulated early in May and the interest charges on VA-guaranteed housing loans (those mortgages made by private lenders) advanced from  
(Continued on page 286)

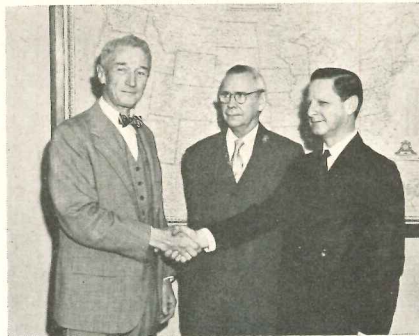

Guy T. O. Hollyday, the new Commissioner of the Federal Housing Administration, with his predecessor, Walter L. Greene, now Assistant Commissioner, and Albert M. Cole, HHFA Administrator

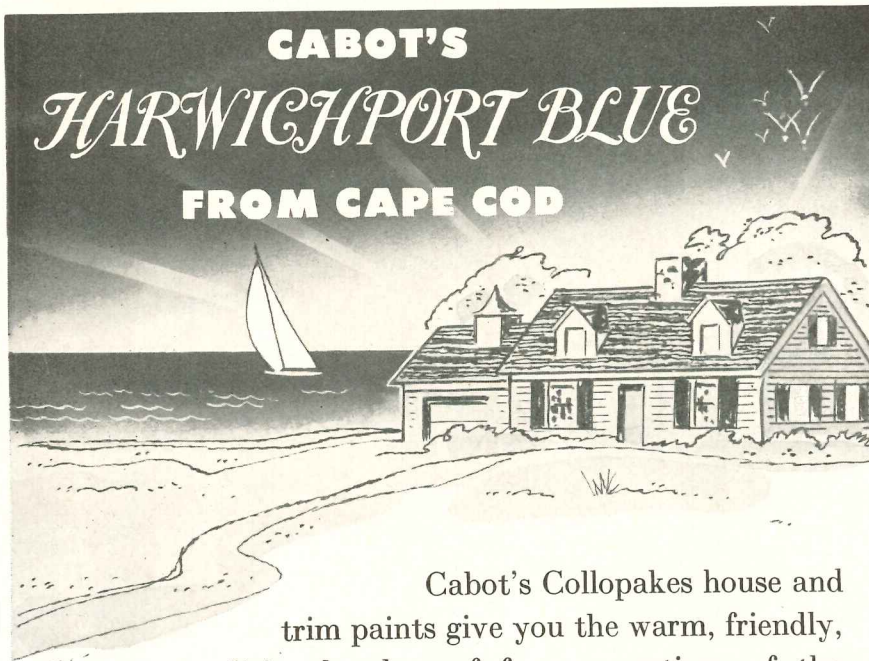

Cabot's Collopakes house and trim paints give you the warm, friendly, traditional colors of famous sections of the country . . . add charm and distinction. Choose *Cape Cod Harwichport Blue, Haddam Barn Red, Vineyard Ivory or Hickory Yellow* from Colonial New England; *Old Virginia White*; or *Moravian Gray* from Bucks County, Pa.

Cabot's Gloss Collopakes flow on smoothly, leave no brush marks . . . won't collect dirt . . . keep that newly-painted look for years.

*Write today* for Cabot's Gloss Collopakes Color Card showing many unique colors available from no other source.

**SAMUEL CABOT INC.**  
629 Oliver Bldg., Boston 9, Mass.

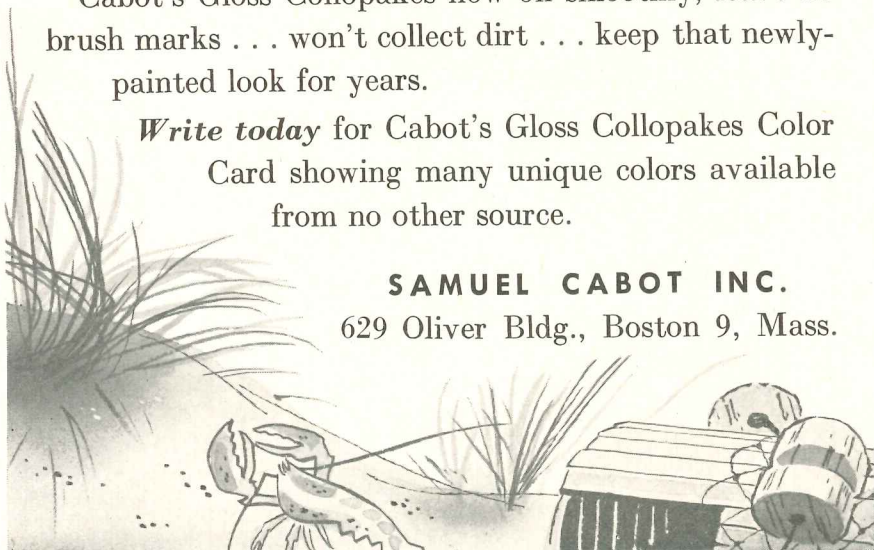

**Trends in Brief**

*Credit gets more expensive.* Commercial interest rates around the country were reported up generally from a quarter to a half per cent following the initial series of Government moves for tighter money. On April 13, in the Administration's first major financing operation, the Treasury launched a billion-dollar 30-year bond issue at 3¼ per cent, the highest yield offered by the Treasury in 20 years (2.95 had been tops). . . . On May 2, Federal Housing Administration loan rates were upped from 4¼ to 4½ per cent. . . . On May 5 VA-guaranteed home loan rates went up from 4 per cent to 4½ per cent.

*Steel prices inch upward.* Major steel companies led a parade of price boosts on steel items, mostly on "extras" — charges added to the base price to cover costs of such special processing as that for gage, size and metal composition. Increases in base prices were not expected before conclusion of steel wage talks; and on the theory that a wage raise of 10 cents an hour may be negotiated, a steel price increase of \$4 a ton was thought likely in some quarters, with some items, including structurals, getting a bigger boost.

*Economy, economy, economy.* New construction programs were proving to be one of the easiest items to cut as the Administration continued its efforts to pare budget requests to a minimum — the Department of Commerce, for example, eliminated all funds for aid to new airport construction from its asking for the Civil Aeronautics Administration. An even more economy-minded Congress slashed away at appropriations requests. The first appropriations bill passed by the House at this session — the so-called Independent Offices Appropriations Bill — cut \$721 million or 62 per cent from the Truman budget figure. It gave the Housing and Home Finance Agency \$44.5 million less than the 1953 appropriation and allowed no funds at all for new public housing nor for housing research. The Senate, where Senator Taft was supporting the 35,000-unit level asked by the Administration, was expected to restore some funds for public housing — its usual role in the annual charette.

# by Von Duprin Exit Devices



**"FOR THE SAFE  
WAY OUT!"**

 **Von Duprin**

*Fire and Panic  
Exit Devices*

CONSTRUCTION COST INDEXES

Labor and Materials

United States average 1926-1929 = 100

Presented by Clyde Shute, manager, Statistical and Research Division, F. W. Dodge Corp., from data compiled by E. H. Boeckh & Assocs., Inc.

NEW YORK

ATLANTA

Period	Residential		Apts., Hotels Office Bldgs. Brick and Concr.	Commercial and Factory Bldgs. Brick and Concr.		Brick and Steel	Residential		Apts., Hotels Office Bldgs. Brick and Concr.	Commercial and Factory Bldgs. Brick and Steel	
	Brick	Frame		Brick	Steel		Brick	Frame		Brick	Steel
1930	127.0	126.7	124.1	128.0	123.6		82.1	80.9	84.0	86.1	83.6
1935	93.8	91.3	104.7	108.5	105.5		72.3	67.9	95.1	87.1	85.1
1939	123.5	122.4	130.7	133.4	130.1		86.3	83.1	96.9	97.4	94.7
1940	126.3	125.1	132.2	135.1	131.4		91.0	89.0	136.8	98.5	97.5
1946	181.8	182.4	177.2	179.0	174.8		148.1	149.2	158.1	136.4	135.1
1947	219.3	222.0	207.6	207.5	203.8		180.4	184.0	178.8	157.1	158.0
1948	250.1	251.6	239.4	242.2	235.6		199.2	202.5	180.6	178.8	178.8
1949	243.7	240.8	242.8	246.4	240.0		189.3	189.9	185.4	180.8	177.5
1950	256.2	254.5	249.5	251.5	248.0		194.3	196.2	204.2	183.7	185.0
1951	273.2	271.3	263.7	265.2	262.2		212.8	214.6	88.6	202.8	205.0
1952	278.2	274.8	271.9	274.9	271.8		218.8	221.0	212.8	210.1	214.3
Jan. 1953	278.4	275.0	274.0	277.6	273.8		220.4	222.7	215.9	214.3	217.9
Feb. 1953	278.2	274.8	273.7	277.4	273.6		220.2	222.5	215.6	214.1	217.7
Mar. 1953	278.9	275.4	274.9	279.0	274.2		221.7	223.3	217.9	218.4	220.0
Mar. 1953	125.8	125.0	110.3	109.1	110.8		156.9	168.7	129.1	124.2	132.3
	% increase over 1939			% increase over 1939			% increase over 1939			% increase over 1939	

ST. LOUIS

SAN FRANCISCO

1930	108.9	108.3	112.4	115.3	111.3	90.8	86.8	100.4	104.9	100.4	
1935	95.1	90.1	104.1	108.3	105.4	89.5	84.5	96.4	103.7	99.7	
1939	110.2	107.0	118.7	119.8	119.0	105.6	99.3	117.4	121.9	116.5	
1940	112.6	110.1	119.3	120.3	119.4	106.4	101.2	116.3	120.1	115.5	
1946	167.1	167.4	159.1	161.1	158.1	159.7	157.5	157.9	159.3	160.0	
1947	202.4	203.8	183.9	184.2	184.0	193.1	191.6	183.7	186.8	186.9	
1948	227.9	231.2	207.7	210.0	208.1	218.9	216.6	208.3	214.7	211.1	
1949	221.4	220.7	212.8	215.7	213.6	213.0	207.1	214.0	219.8	216.1	
1950	232.8	230.7	221.9	225.3	222.8	227.0	223.1	222.4	224.5	222.6	
1951	252.0	248.3	238.5	240.9	239.0	245.2	240.4	239.6	243.1	243.1	
1952	259.1	253.2	249.7	255.0	249.6	250.2	245.0	245.6	248.7	249.6	
Jan. 1953	260.2	253.2	253.4	260.7	253.8	252.1	246.5	250.1	254.1	254.6	
Feb. 1953	260.3	253.3	253.7	261.4	253.9	251.9	246.3	249.8	253.9	254.4	
Mar. 1953	261.1	254.0	255.2	263.5	254.6	252.3	246.7	250.4	253.9	254.4	
Mar. 1953	136.9	137.4	116.3	119.9	113.9	138.9	148.4	113.3	108.3	118.4	
	% increase over 1939			% increase over 1939			% increase over 1939			% increase over 1939	

The index numbers shown are for combined material and labor costs. The indexes for each separate type of construction relate to the United States average for 1926-29 for that particular type — considered 100.

Cost comparisons, as percentage differences for any particular type of construction, are possible between localities, or periods of time within the same city, by dividing the difference between the two index numbers by one of them; i.e.:

index for city A = 110  
 index for city B = 95  
 (both indexes must be for the same type of construction).  
 Then: costs in A are approximately 16 per cent higher than in B.

$\frac{110-95}{95} = 0.158$   
 Conversely: costs in B are approximately 14 per cent lower than in A.  
 $\frac{110-95}{110} = 0.136$

Cost comparisons cannot be made between different types of construction because the index numbers for each type relate to a different U. S. average for 1926-29.

Material prices and wage rates used in the current indexes make no allowance for payments in excess of published list prices, thus indexes reflect minimum costs and not necessarily actual costs.

These index numbers will appear regularly on this page.

## go down fast, cut labor costs in half

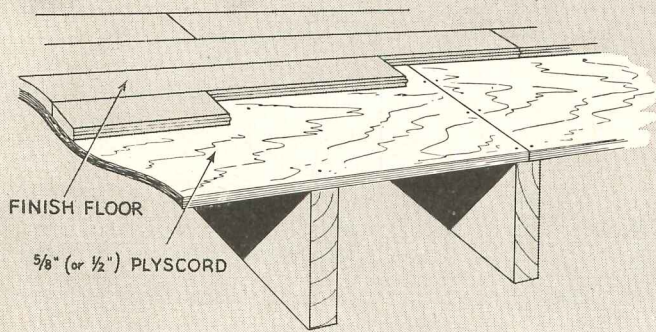

APPLICATION: Apply with face grain across joists. Usual installation is over joists 16" o.c., but spacing up to 24" o.c. satisfactory with 25/32" strip flooring. Use 8d com. nails for 5/8" plywood, 6d for 1/2"; nail 6" o.c. at panel edges, 10" o.c. on other bearings.

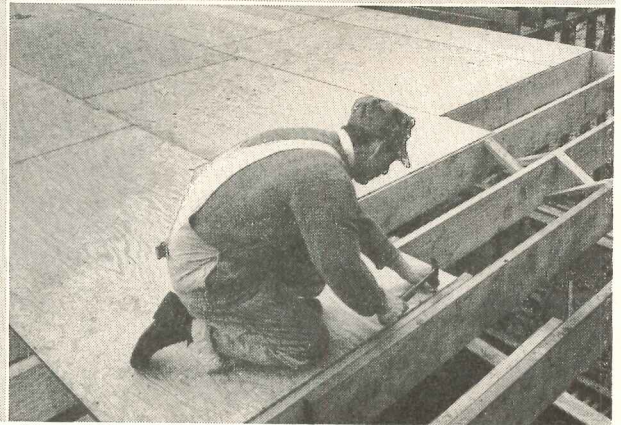

## faster floor construction

### makes floor coverings look better, last longer

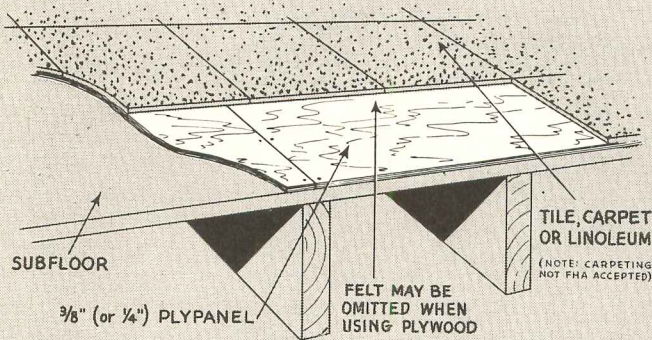

APPLICATION: Preferable to place panels with face grain running across joists, breaking joints over joists. Nail approximately 6" o.c. on panel edges, 8-10" o.c. elsewhere. Ringed nails hold better.



### subfloor-underlay gives really big savings

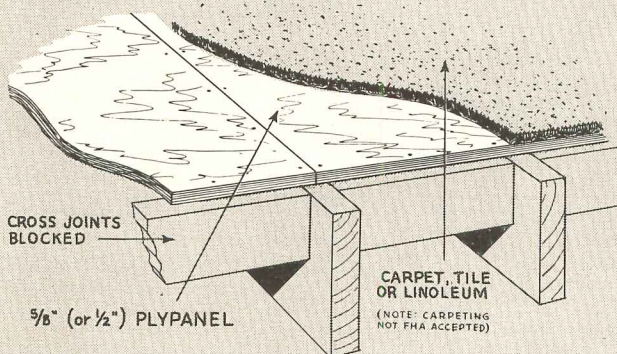

APPLICATION: Apply panels and nail as for subflooring above. Note blocking along panel edges at right angles to joists.



# REQUIRED READING

## PRACTICAL HOUSES FOR CONTEMPORARY LIVING

*Practical Houses for Contemporary Living.* By Jean and Don Graf. F. W. Dodge Corporation. (119 West 40th St., New York, N. Y.) 1953. 8¾ by 11¼ in. 192 pp., illus. \$6.95.

### REVIEWED BY

HENRY OTIS CHAPMAN, A.I.A.

THIS unusual book, dealing with one of the most interesting phases of architecture, handles the problems of contemporary living in a broad, unprejudiced manner. The unquestioned ability of the authors, and their unique position in the architectural profession in which each is well qualified through his or her own experience, affords them background and authority essential to such a book.

Don, a member of the American Institute of Architects, who has practiced in North, South, and West, and has created Don Graf's Data Sheets which are used as standards in so many architectural offices, with his wife, Jean, student, writer and critic, make up the team of Graf and Graf.

They traveled more than 12,000 miles while studying the subject of this effort, visited hundreds of houses, met the owners and the architects, and without taint of prejudice recorded in workable manner the material thus procured.

They are not designers, nor do they compete with the architects whose designs they have selected. Some real purpose motivated the selection of each

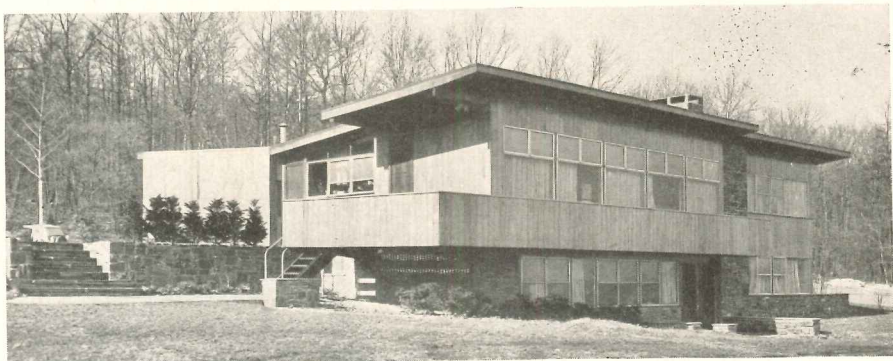

Mike Pearlman

Residence of Dr. and Mrs. I. S. Ravdin, Bucks County, Pa. George Daub, A.I.A., architect. From "Practical Houses for Contemporary Living"

house without regard for the designer. Prominent names are mingled with the lesser known, but each in his own right has solved an interesting problem. The authors, with real authority, submit their message to the public with humor and good judgment.

This is a working book worthy of study. There is splendid balance of geographical location, economic range, and personal tastes and desires. The simplicity of the format, with story geared to the consumer yet completely architectural in background and material, makes for interesting and pleasurable reading. The photographs are by better than average photographers, while the plans, consistent and simply rendered, drawn to one scale for easy comparison, are neatly keyed to the supporting photographs.

The authors reveal a democratic approach to taste. They impose no dictates except of site, budget and locale. They realize and emphasize that the fundamental problems and influences of family life must guide the architect, and that the practical houses for contemporary

living are those designed to satisfy the personal demands of the owner adapted to site and regional climatic conditions.

To be truly workable, the authors have selected practical details and listed them under appropriate subject headings so that those seeking some special feature may find it readily available. This is more than a reporting book. It analyzes, weighs and reveals how personality is required to produce a home — not a house.

Through careful consideration and judgment, the authors have presented an unusual group of houses from every part of the country, examples representative of the region well adapted to site conditions and designed for diversified family circumstances. It is well to point out that climate is important and stressed as a guiding influence in many designs.

The authors seem to realize and prove that a successful structure is the result of a wise compromise and a happy balance of plan. They have treated their subject well and have produced a book worthy of their name.

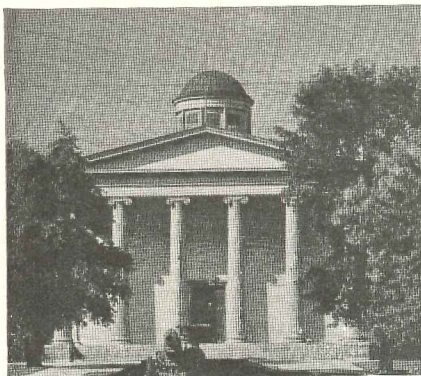

Facade, Old Capitol, Frankfort, Ky.  
From "Architecture In Old Kentucky"

## ARCHITECTURE IN OLD KENTUCKY

*Architecture in Old Kentucky.* By Rexford Newcomb. University of Illinois Press (Urbana, Ill.). 1953. 8½ by 11 in. 185 pp., 70 plates.

### REVIEWED BY CARL SCLARENCO

FOR a long time this reviewer (who happens to hail from Kentucky) has been hoping for the kind of book on the state's architecture which has now been made available with Professor Newcomb's comprehensive general study.

Generously illustrated and written with care and sympathy, this is a volume which should be welcome to everyone who enjoys reading about or looking at the graceful and vigorous buildings of America's past, in this case those of a region rich in tasteful and craftsmanlike structures. However, aside from the author's own and more specialized earlier book of photographs and measured drawings ("Old Kentucky Architecture," William Helburn, Inc., New York, 1940)

(Continued on page 48)



for time-saving,  
money-saving

# POWER DISTRIBUTION

## SQUARE D FEED-IN DUCT

is the most efficient way to transmit large amounts of power. It provides the lowest known voltage drop—only 1.8 volts per 1000 amperes per 100 feet.

Exclusive design requires no ventilation—permits a totally enclosed, compact, dust-excluding enclosure. Rigid construction provides high resistance to heavy electrical stresses.

## SQUARE D PLUG-IN DUCT

provides flexible power distribution for branch circuits. Machinery can be rearranged quickly at minimum cost. Plug-in units can be attached at frequent intervals along the length of the duct, providing power where it's needed, when it's needed.



## BUSWAY FEATURES PROVE DESIGN LEADERSHIP

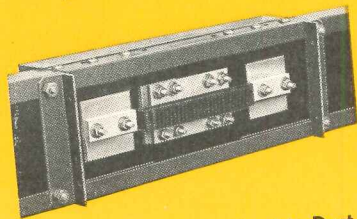

**NEW JOINT DESIGN.** Feed-in Duct joint design saves installation time and reduces maintenance cost. Duct ends are identical—unnecessary to select mating ends before positioning or hanging duct sections. Outward-facing, pre-installed bolts permit rapid assembly and easy maintenance.



**ROUND BUS BARS** for Plug-in Duct provide greater mechanical strength and resistance to short-circuit stresses. Circuit breaker or fusible type plug-in units are easily installed at 2-foot intervals along both sides of the duct. Plug-in stabs grip the round bus bars with exceptionally high pressure.



**FLEXIBLE CONNECTORS** of laminated copper join bus bars between sections—permit proper alignment, insure tight joints and provide for expansion and contraction at Plug-in duct joints. All bolt heads face outward for greater accessibility.

ASK YOUR ELECTRICAL DISTRIBUTOR FOR SQUARE D PRODUCTS

# SQUARE D COMPANY

1903 • 50 YEARS OF DESIGN LEADERSHIP • 1953

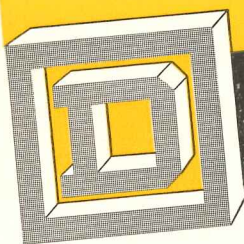

One of a series of papers prepared by leading authorities on air conditioning. The opinions and methods presented are those of the author and are not necessarily endorsed by the Du Pont Company. Reprints of this article, and others in the series, may be had free upon request.

# AIR CONDITIONING FOR THE PRINTING INDUSTRY

by JAMES MONGITORE



**JAMES MONGITORE** is in complete charge of the design of air conditioning, refrigeration and mechanical systems for the firm of Mongitore & Moesel, Consulting Engineers, N. Y., successors to the office of Sullivan A. S. Paterno. Mr. Mongi-

tore has designed air conditioning systems for several prominent newspaper plants, business offices and research laboratories.

Today, it is generally agreed that the efficiency of the modern printing plant can be increased through installation of a properly designed air conditioning system. Printing is an extremely complicated process. Paper, ink, photographic materials, plates, equipment . . . all are affected by atmospheric conditions which must be controlled. Printing is done by one of three basic methods: letterpress, lithography or offset, and intaglio (rotogravure). Since production methods differ in various plants, they present individual air conditioning problems. However, basic requirements remain similar, and these will be treated here.

## HUMIDITY CONTROL

Although extremes of temperature should be avoided in the plant, temperature control is of secondary importance. The chief function of the air conditioning system is the rigid control of humidity. This is important because both materials and equipment used in the printing industry are extremely sensitive to an excess of high or low humidity conditions. For these reasons, the following must be taken into account:

## PAPER

As paper is a hygroscopic material, humidity changes cause it to shrink or swell. When improperly stored, paper will curl, wave or buckle. Low humidity results in accumulation of static electricity. These conditions may result in loss of production time, lowered quality, or even the suspension of work on very humid days.

Lithography requires particular care in the seasoning

and storage of paper. Relative humidity 5 to 8 per cent above that of the pressroom must be maintained. Water used in the lithographic process is absorbed by the paper during printing, causing changes in dimensions of the paper and consequent misregister of impressions. To counteract this, the moisture content of the paper must be raised so that it will lose an amount of moisture equal to that added by the presses during the printing operation.

Variations in pressroom humidity must also be checked, since they can cause serious trouble. A moisture content change of only  $\frac{1}{2}$  of 1 per cent, resulting from humidity variation of about 5 per cent in surrounding air, can cause distortion of .03 in. on a 60-inch sheet. In many types of work, this will cause serious misregister.

Paper for other processes may be stored at the same relative humidity as the pressroom, but with low limit of 40-45 per cent to prevent static electricity, and high limit of 60 per cent to prevent buckling, curling, or waving. Relative humidity of 50 per cent at temperature of 70° to 80°F. is recommended.

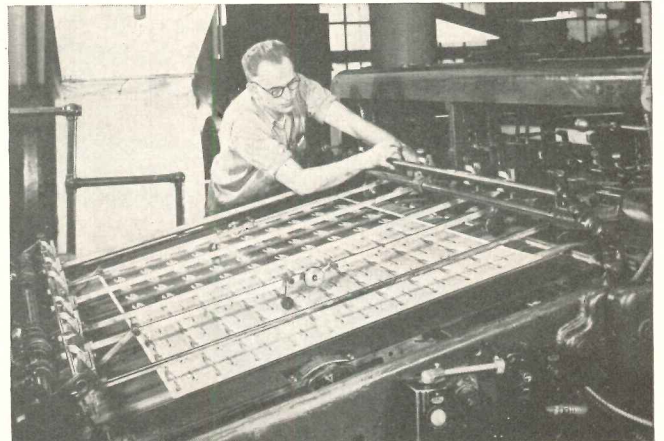

Air conditioned printing plant of Edward Stern & Co., Philadelphia. Note ventilation hood leading to ducts above press.

## INK

The printer's primary humidity problems with ink are rate of flow, proper distribution, rate of drying . . . the latter perhaps being the most critical. High humidities cause slow drying, disruption of schedules, increased operating costs. In winter, static electricity from low humidities can prevent trapping air between sheets of paper, which slows drying of the ink. Proper and accurate control of humidity is essential for satisfactory drying.

## EQUIPMENT AND PRODUCTION

The biggest air conditioning problem in printing is elimi-

nation of static electricity. When it accumulates in paper, it may interfere with the operation of automatic pile feeders, which deliver sheets into the presses, causing slowdowns and costly stoppages.

Rubber rollers on presses are affected by both high and low humidities and present a constant problem. In summer, high temperatures and humidities soften the rollers; while in winter, low temperatures and humidities dry them out so they cannot distribute ink properly.

The mechanical and electrical equipment used for the presses emits heat, which must be carried off to prevent overheating. Plants with camera and plate-making departments for offset work must control humidity to minimize problems of handling and storing photographic materials. Coatings used to sensitize plates are also affected by changing moisture conditions.

In composing rooms, linotype machines are fitted with gas or electrically heated lead-melting pots and excess heat must be carried off to make working conditions suitable. Finally, in respect to personnel, air conditioning plays the same valuable role that it does in other industries. Comfort provided for employees results in improved morale, increased efficiency, decreased absenteeism, maintenance of production schedules and work of better quality.

## OPTIMUM HUMIDITY CONDITIONS

Temperature and humidity requirements for air conditioning the equipment vary in different locations within a printing plant. The table following offers recommendations for some of these areas.

PROCESS	TEMP. F.	RELATIVE HUMIDITY %
Pressroom:		
Multicolor offset lithography	75-80	46-48
Other sheet-fed printing	75-80	45-50
Newspaper and other web printing	75-80	50-55
Stockroom:		
Multicolor offset lithography	73-80	(a)
Other paper storage	70-80	(b)
Binding, cutting, drying, Folding, gluing	70-80	45-50
Roll Storage	73-80	50
(a) 5 to 8 per cent above pressroom		
(b) Same as pressroom		

The above areas, with exception of the roll-storage space, are found in both large and small printing plants. Large plants often maintain additional departments covering almost the entire range of preparation and production processes. Optimum humidity conditions for some of these follow: Photographic, Art, Plate Preparation and Photo Composing Departments: 75°F., 50 per cent relative humidity. Ink Manufacturing, Paper Preparation, Varnishing Departments: 80°F., 50 per cent relative humidity. Rotogravure plants require different conditions from lithographic plants and operate better at 72°F. with 40 per cent relative humidity.

## DESIGN DATA FOR PRINTING PLANTS

Since the separate sections of printing plants require specific temperature and humidity conditions for best operation, it will be seen that large-scale plants with many departments will require zoned air conditioning systems. From the standpoint of production, areas of the plant which need air conditioning are the pressroom and paper-storage room. They should have a common system. Air from the pressroom and storage rooms should not be recirculated through administrative offices or other departments.

Smaller printing plants, which do not require elaborate central systems, can still increase the efficiency of their facilities by using factory-built "package" air conditioning units. Initial air conditioning for most plants can be in the pressroom alone. Economy is important in such installations.

Summer conditions of 80°F. with 50 per cent relative humidity, and winter conditions of 72°F. and 45 per cent relative humidity are acceptable design conditions.

\* \* \*

The printing industry is another in which air conditioning and the control of humidity are factors of considerable importance. In highlighting requisites, Mr. Mongitore shows how these relate to various operations and frequently affect production and quality of finished work.

Although the needs of printing plants necessarily differ and must be determined by size of the shop, number of presses, paper storage and other details, *basic requirements remain similar*. For that reason, whenever a client discusses the subject, and specific installations and types of equipment are being considered, you can serve his interests well by calling attention to the importance of selecting air conditioning machines operated with Du Pont "Freon" refrigerants. There are many excellent makes and models available.

"Freon" refrigerants, of course, are ideal because they are safe . . . nonflammable, nonexplosive, virtually non-toxic. Strict adherence to laboratory-controlled methods of manufacture insures uniform quality and further promotes economical, trouble-free performance of the system over long periods of time. In addition, "Freon" refrigerants meet all building-code requirements. E. I. du Pont de Nemours & Co. (Inc.), "Kinetic" Chemicals Division, Wilmington 98, Delaware.

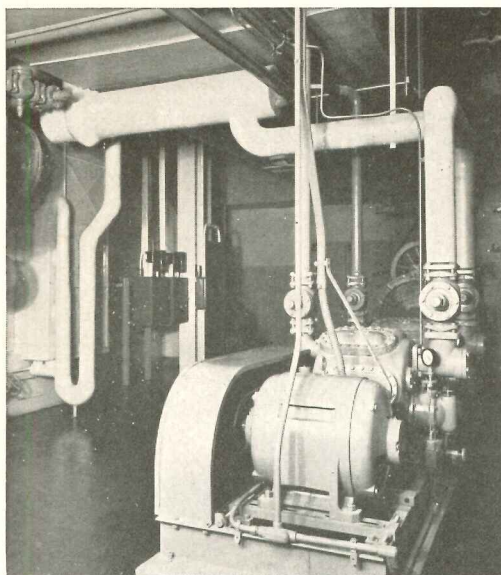

Two 80-ton model VMC Vilter compressors operated with "Freon-12" refrigerant installed in midwestern print shop.



BETTER THINGS FOR BETTER LIVING . . . THROUGH CHEMISTRY

### "FREON" SAFE REFRIGERANTS



"Freon" is Du Pont's registered trade-mark for its fluorinated hydrocarbon refrigerants

LOOK WHAT

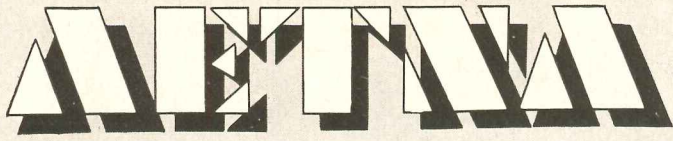

DID IN HOUSTON!

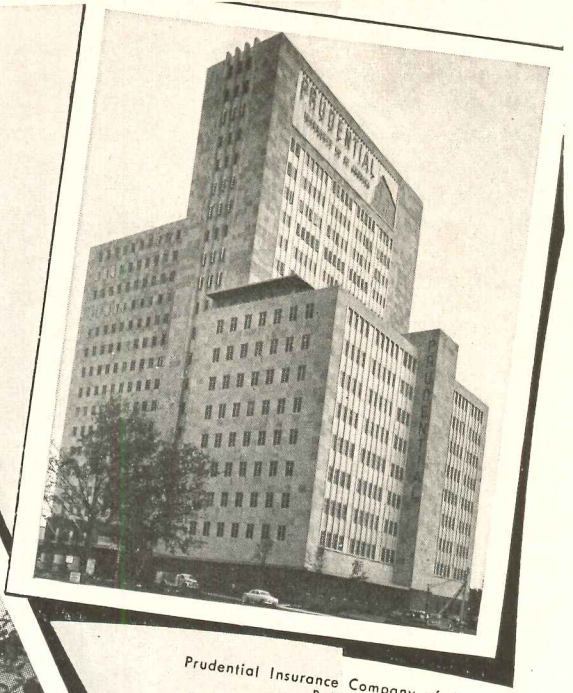

Prudential Insurance Company of America  
Building—Houston, Texas  
Kenneth Franzheim, Architect  
W. S. Bellows Construction Corporation,  
General Contractors

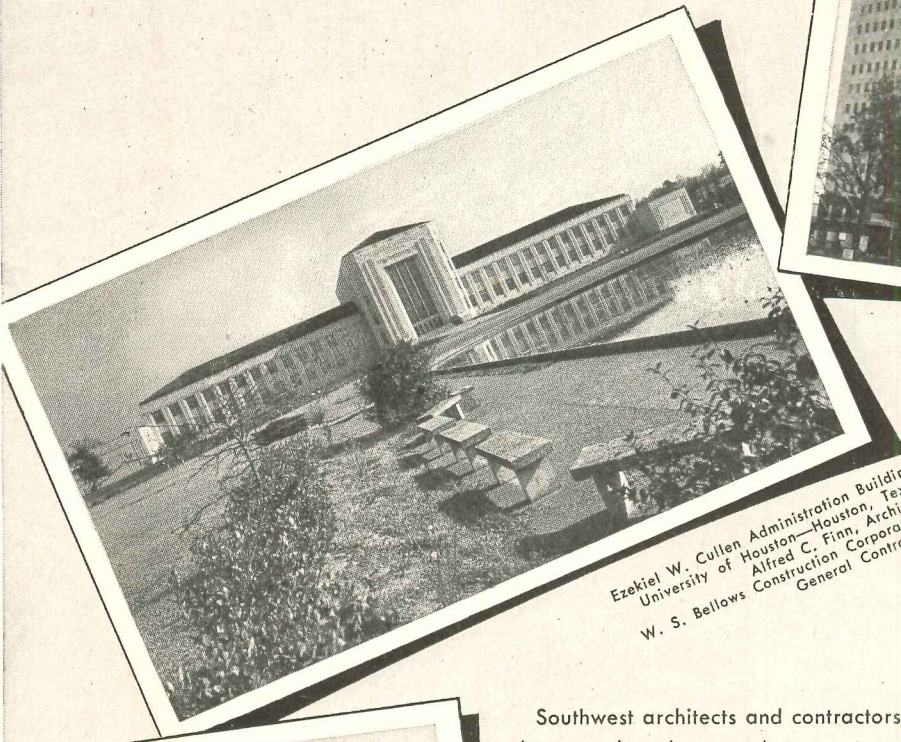

Ezekiel W. Cullen Administration Building  
University of Houston—Houston, Texas  
Alfred C. Finn, Architect  
W. S. Bellows Construction Corporation,  
General Contractors

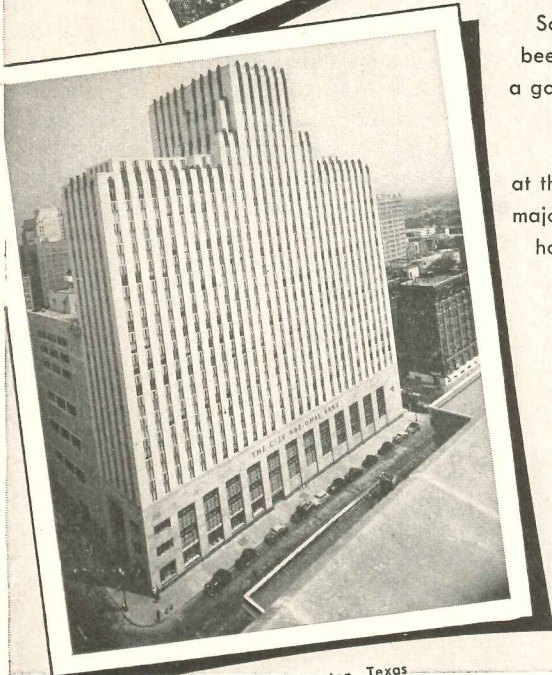

City National Bank Building—Houston, Texas  
Alfred C. Finn, Architect  
W. S. Bellows Construction Corporation,  
General Contractors

Southwest architects and contractors have been numbered among Aetna's more than 50 years in the building-products field.

Houston is particularly well represented at the moment with three recently-completed major building projects equipped with Aetna hollow metal doors, door frames and trim.

The Southwest likes us for the same good reasons that others do—because the name Aetna implies:

- Thorough and painstaking engineering •  
and technical co-operation and follow-through.
- Precision, quality mass production •  
with assured scheduled deliveries.
- Confidence—an outgrowth of Aetna •  
pioneering and leadership in the hollow metal field.



**AETNA STEEL PRODUCTS CORPORATION**

730 FIFTH AVENUE, NEW YORK 19, NEW YORK

MANUFACTURERS OF STANDARDIZED STEEL DOORS AND FRAMES FOR HOUSING UNITS.

FABRICATORS OF QUALITY HOLLOW METAL PRODUCTS FOR SCHOOLS, HOSPITALS, OFFICE BUILDINGS, ETC.



pick the stainless  
that fits best

When selecting stainless steel be sure you pick the correct type for your particular application. For some grades resist corrosion better . . . others have superior heat resistant properties. Some are easier to machine . . . still others can be more readily formed or welded.

In every case there is a grade of Crucible REZISTAL Stainless Steel that is best suited to the job. And to help our customers select the type that will provide the best service for the lowest cost, we make available all the design, metallurgical, fabricating and application data we have accumulated in our years of stainless steel experience with many different industries.

Our staff of field representatives brings you the benefit of our vast technical resources. And the quality of REZISTAL Stainless Steel sheets, strip, plates, bars, wire, forgings, castings and tubing produced in our modern integrated mills is unsurpassed in the industry. When you have an application for stainless, call Crucible.

**CRUCIBLE**

first name in special purpose steels

53 years of *Fine* steelmaking

**STAINLESS STEEL**

CRUCIBLE STEEL COMPANY OF AMERICA, GENERAL SALES OFFICES, OLIVER BUILDING, PITTSBURGH, PA.

STAINLESS • REX HIGH SPEED • TOOL • ALLOY • MACHINERY • SPECIAL PURPOSE STEELS

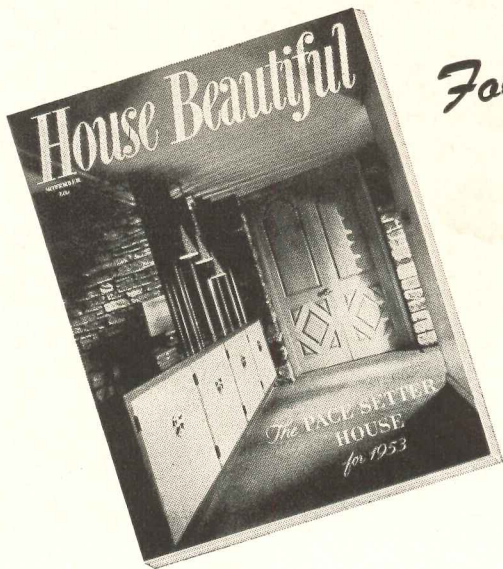

*For cooling and ventilating*

## House Beautiful's 1953

## Pace Setter House

## Uses Hunter Attic Fans

■ One of the many features of this beautiful new home in Bronxville, N. Y. is the use of Hunter Attic Fans for perfect ventilation and cool comfort in hot summer weather. This modern home-cooling system is low in cost and adaptable to any home. You have a choice of 5 sizes (from 4,700 to 16,000 CFM) to fit the home size and the climate. Easily installed fan unit is complete with automatic ceiling shutter and all accessories—no extras to build or buy.

For complete data, write for free copy of "How to Cool for Comfort."



### HUNTER FAN AND VENTILATING COMPANY

396 S. Front St., Memphis 2, Tenn.  
*Exclusive Fan Makers Since 1886*

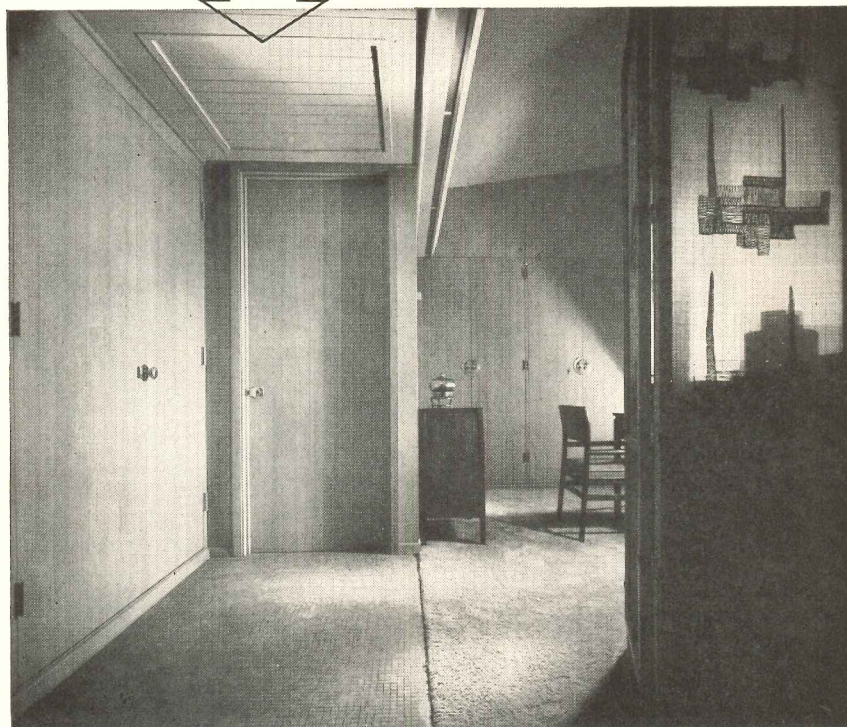

*Henry L. Eggers—Architect. Westchester Construction Co., Inc.—House Contractor.*

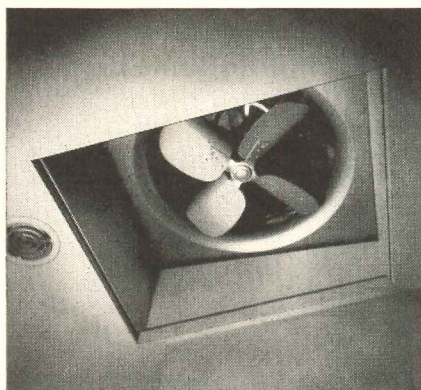

**Compact Package Fan** rests on attic floor of Pace Setter House. This unit is ideal for homes with low roofs as it requires less than 18" clearance.

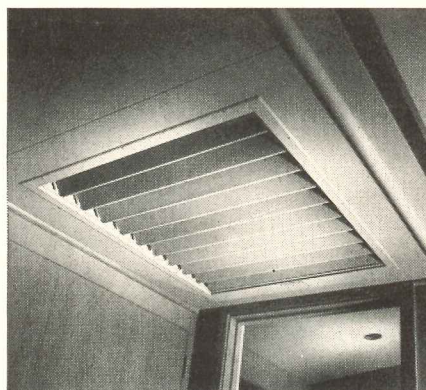

**Automatic Shutter** harmonizes with modern interior of Pace Setter House. Easily installed by screw-fastening metal trim to edges of ceiling opening.

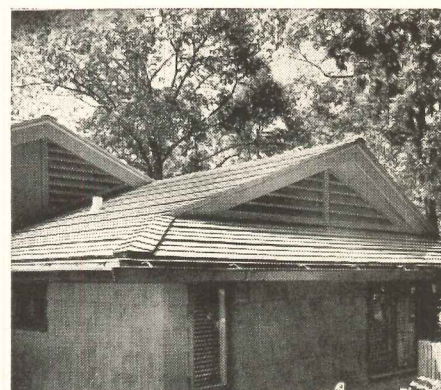

**Hot air is exhausted** through these louvers. Cool fresh outside air is pulled in through open windows. Result: temperature in house drops 10 to 20°.

WHEN ARCHITECTURAL RECORD published a study of college building design in June, 1950, we thought our colleges faced an acute problem. All the figures and opinions indicated the need was pressing. The intervening years have hardly improved the situation.

Why? For one thing, the amount of building and rebuilding undertaken recently has been enough only to offset the worst cases of overcrowding and obsolescence; and it has often had the effect of intensifying dissatisfaction with other structures or expedients, those we once thought might be put up with a while longer. Now, compared with new buildings which even seem to anticipate demands, the restrictions imposed by unsuitable architectural antiques — few of them “genuine” antiquities! — tend to become unbearable.

For another, college enrollments continue to jump. Prof. R. Clyde

## COLLEGE BUILDINGS

ARCHITECTURAL RECORD

BUILDING TYPES

®

STUDY | NUMBER 199

White, director of institutional research at Western Reserve University, writing in the January 1953 issue of the journal of the American Council on Education, expects enrollments to double by 1965 and continue high until 1970. Using 1950 as a base, he predicts increases of 12 per cent by 1955, 49 per cent by 1959, 87 per cent by 1961, 137 per cent by 1964. He cites a definable trend toward increased college entrance among secondary school graduates, greater proportions of women students and students from low-income families, and greater pressure from employers for college-graduate employees. “We have about eight years,” he concludes, “in which to plan to determine admission requirements and to supply faculty, buildings and equipment for the roaring 60’s.”

Where is the money coming from? On March 5 Dean Rusk, president of the Rockefeller Foundation, told the National Conference on Higher Education meeting in Chicago that higher education could use \$300,000,000 to \$400,000,000 more annually than it now receives — not all of it for building construction, of course; and that private endowments or foundations cannot meet this additional need; that it is three times their combined income. In the past some Federal funds have been available under the Housing Act of 1950. In one month, September 1952, for instance,

# COLLEGE BUILDINGS:

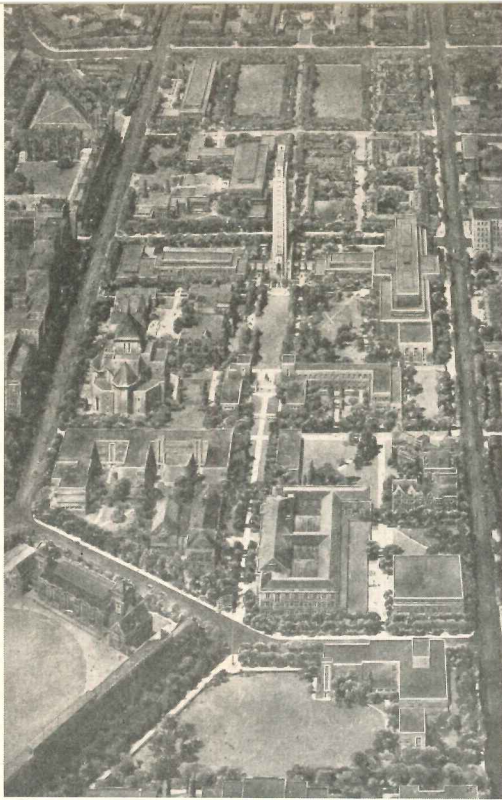

Proposed campus development and . . .

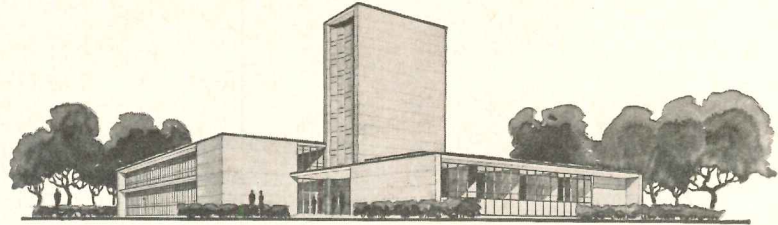

High voltage lab, Rice Institute; Pierce & Pierce, Archts.

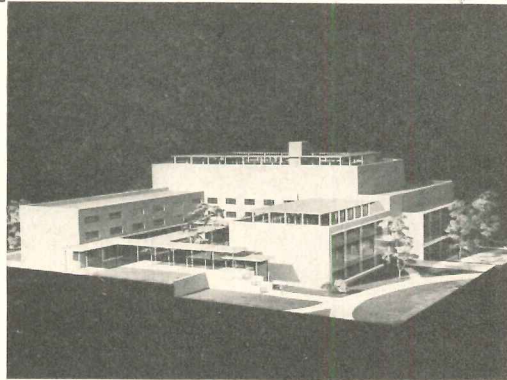

. . . design for new library, University of Pennsylvania; Harbeson, Hough, Livingston & Larson, Archts.

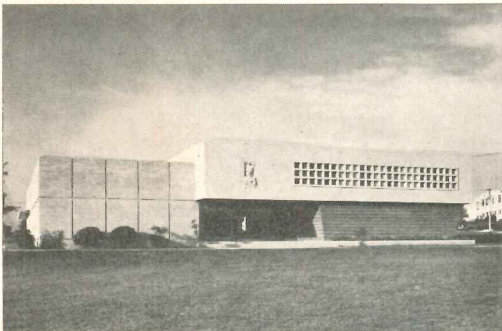

Museum, Bob Jones University, South Carolina; W. E. Freeman Assoc., Archts.

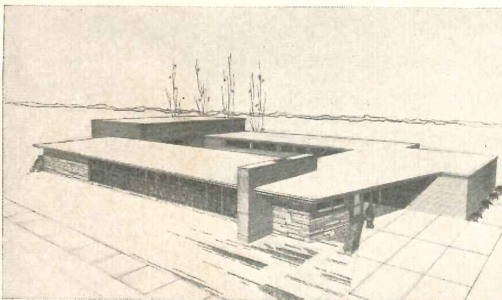

Baptist Student Center, West Texas State; Norton & Mayfield, Archts.

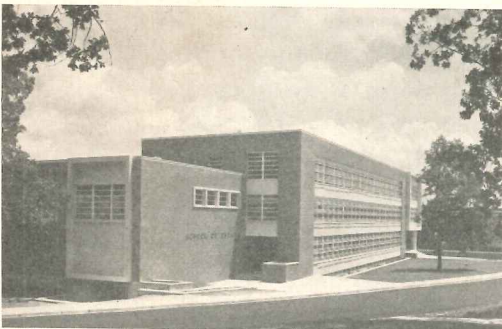

Chemistry Building, Clemson; Hopkins, Baker & Gill, Archts.

approved applications under the Act's Title IV totalled \$32,675,000, all for college building construction. But changes in housing policy are under way; what is happening to the small revolving fund set up by the 1950 act? Can government money continue available without strings attached?

It behooves us, then, to be doubly sure to design the needed buildings with true economy, regarding not only initial construction expense but also the long-term economies of maintenance, replacement and obsolescence, and above all with their avowed purpose, education, firmly in mind. Under such criteria the contemporary architect performs best. The situation is made to order for him. One large university, which had always built in the Georgian style despite continual pressure from its architects, has just commissioned a "modern" library. Another's conservative planning committee condemns "the sacrifice of plan for elevation" extant on its own campus, recommending "contemporary" design. Not only are students demanding buildings in tune with our times, as we intimated in June 1950; scarce dollars and huge enrollments force us in that direction.



# NEW UNIVERSITY OF MINNESOTA CAMPUS AT DULUTH

*Winston A. Close, Advisory Architect,*

*U. of M. Chairman, Campus Plan Committee*

THE UNIVERSITY of Minnesota is currently developing a new campus for a branch of the University in Duluth. The branch is a co-ordinate college of the University, with a present enrollment of 1200 students and an anticipated peak enrollment of 3500 in 1970, drawn chiefly from Duluth, surrounding communities and

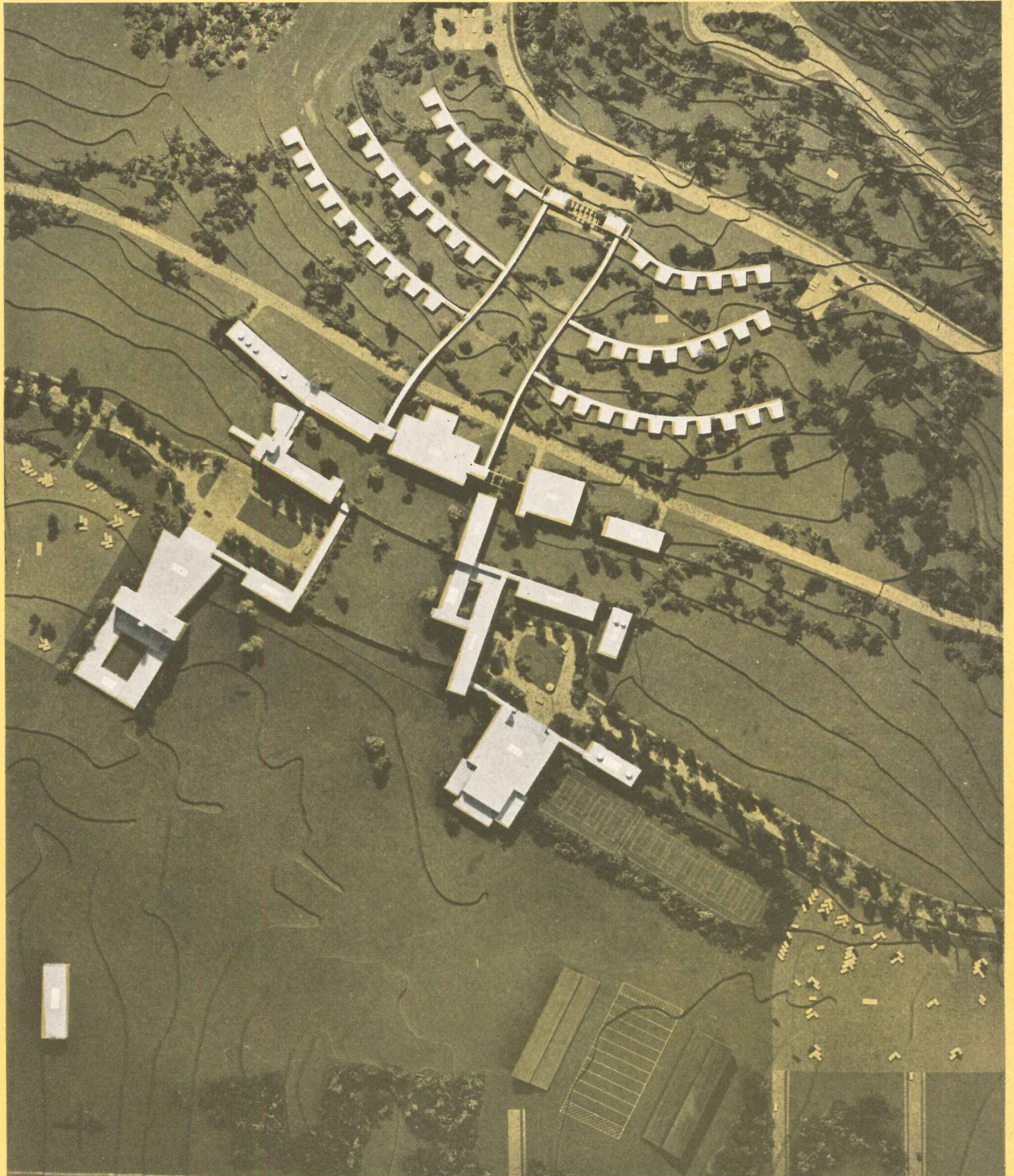

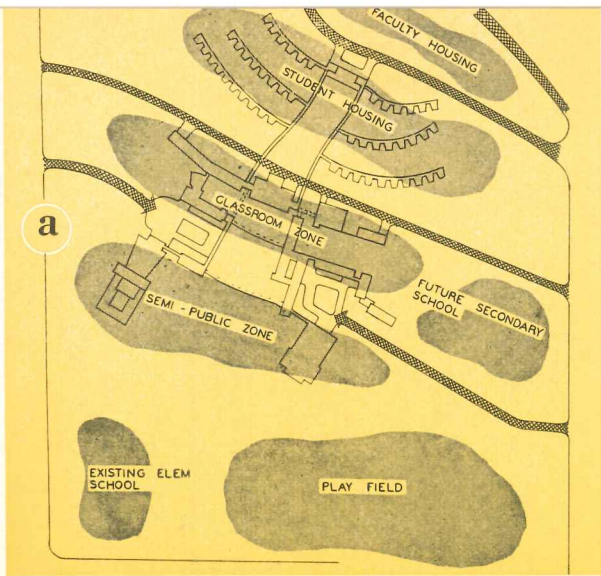

**a**, general allocation of space; building zones parallel contours for ease of cross-campus circulation; no roads except service drive which underpasses enclosed corridors. **b**, condition in 1952; Science and Math building in use, Physical Education building under construction. **c**, first phase of development; Boiler Plant containing

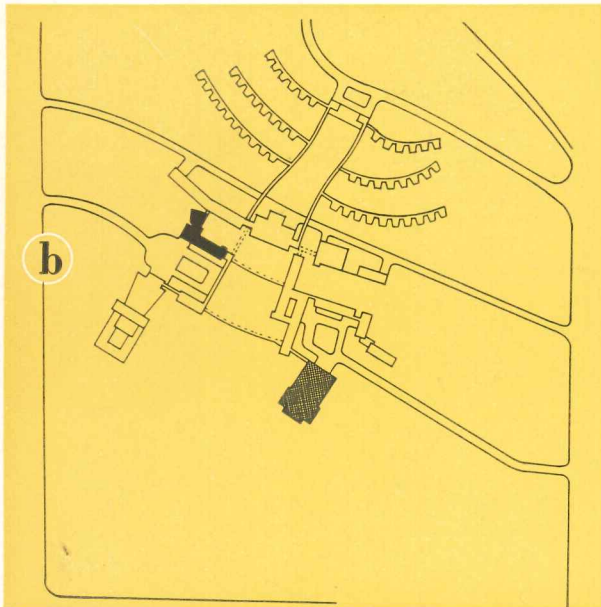

maintenance shops, Classroom Building (eventually to become Administration) and Library (to become classrooms). **d**, second phase; some student housing, general purpose classrooms and studio space added; entire group interconnected

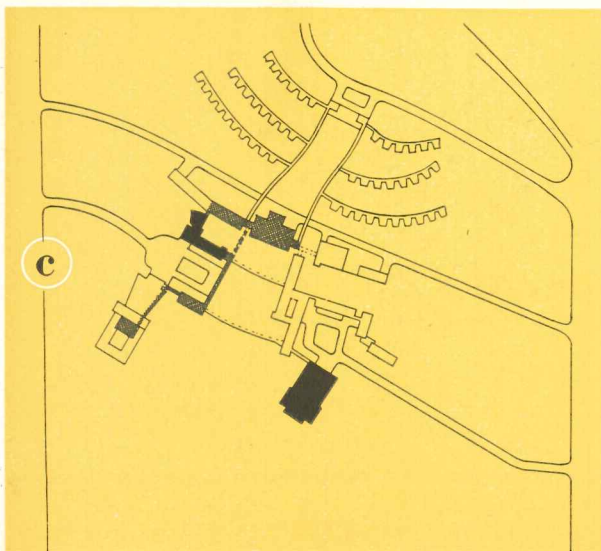

some more distant points. The 160-acre site, in a fine residential area of the city, overlooks Lake Superior. The natural approach is from the lower side of the sloping campus. After several studies, a free yet compact plan closely related to the topography, and with buildings interconnected to offset the severe winter climate, was determined upon.

Semi-public buildings are on the approach side, the lowest range of buildings accessible to streets and parking spaces. Next above are the main instructional buildings, served by the only vehicular road on the campus, a service drive which underpasses corridors leading downhill from the students' quarters. Farther up the hillside are the ranges of single-story student housing units

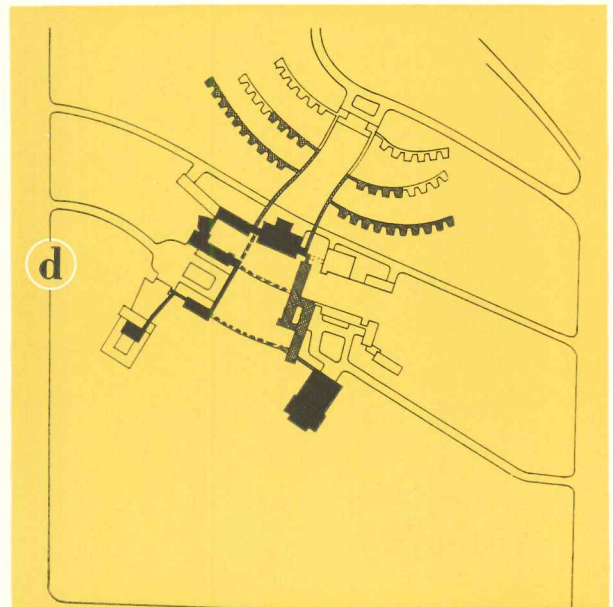

which look out to the lake over all the buildings below. These cottages, each accommodating eight students, are connected by corridors to each other, to the reception lounge on their uphill side, and to the student center in the instructional zone. Circulation between buildings across the slope is accomplished by enlarging the utilities tunnels, which would be required in any event, to become passageways. Due to the slope these tunnels will have natural light through one exposed wall.

The Department of Admissions and Records at the Minneapolis Campus contributed in an important way to the program formulation by careful study of probable enrollments and inter-

**COLLEGE BUILDINGS: MINNESOTA—DULUTH CAMPUS**

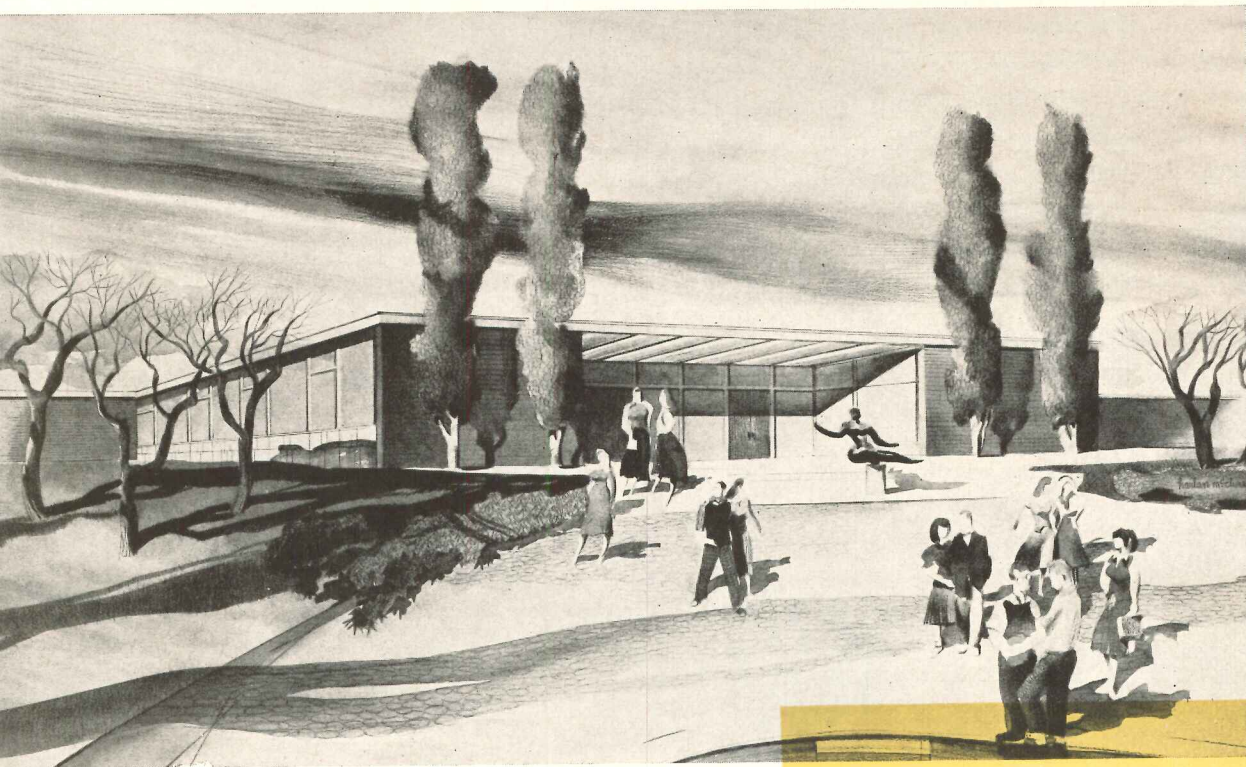

*Students are to be housed eight to a cottage (below) with connecting ramped, enclosed corridors leading to academic buildings. Above: reception lounge in cottage group*

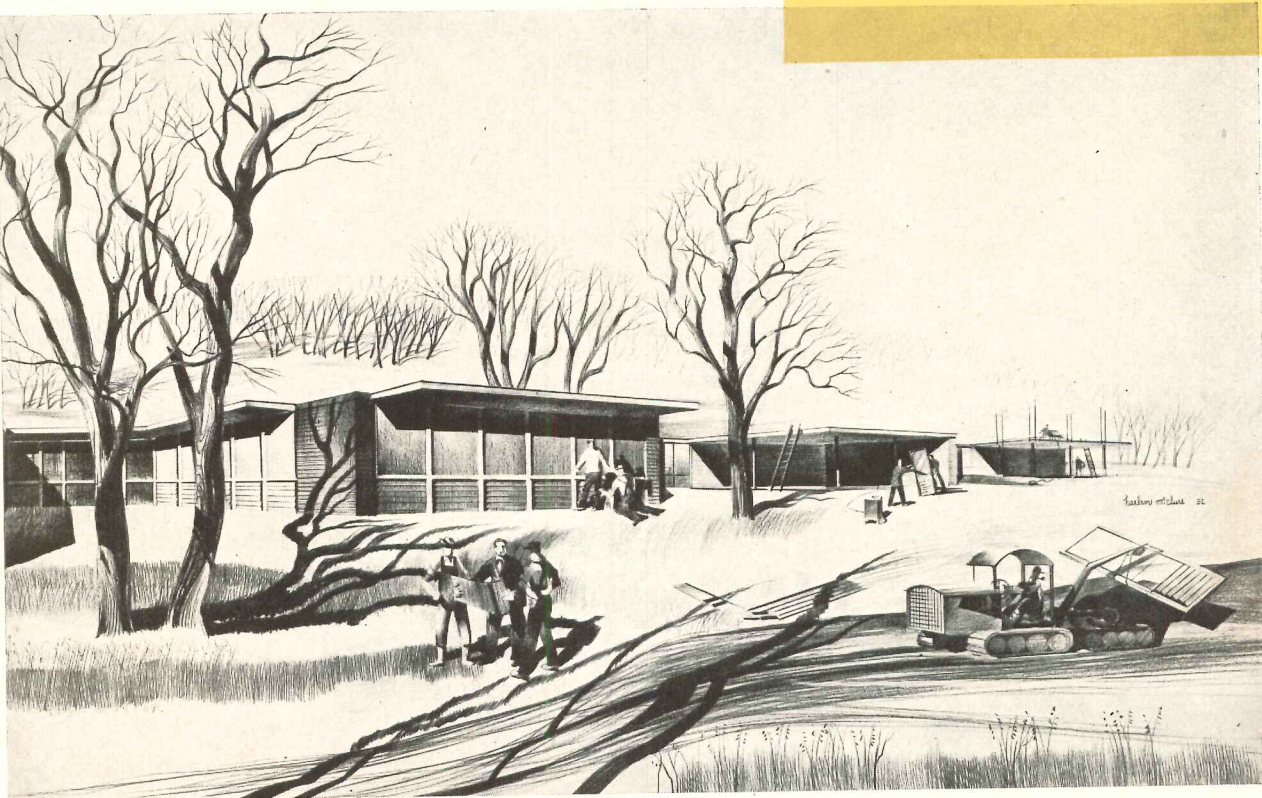

Sketches by Harlan McClure

departmental student contacts for various phases of the plan development. Since a competent, experienced faculty is in being at Duluth, and since the courses of study are clearly prescribed, a rare opportunity existed to establish with reasonable certainty the requirements twenty years hence.

Preliminary schematic studies have been made for most of the buildings. These studies are continuing to a stage of fairly complete preliminary plans which can be reviewed and developed quickly as funds become available for construction of the various units.

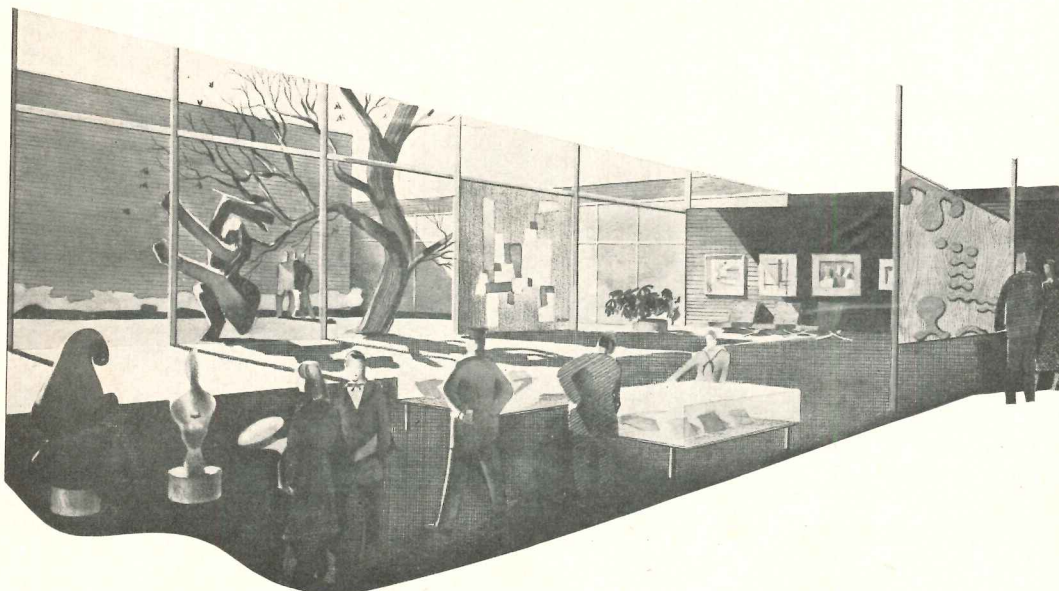
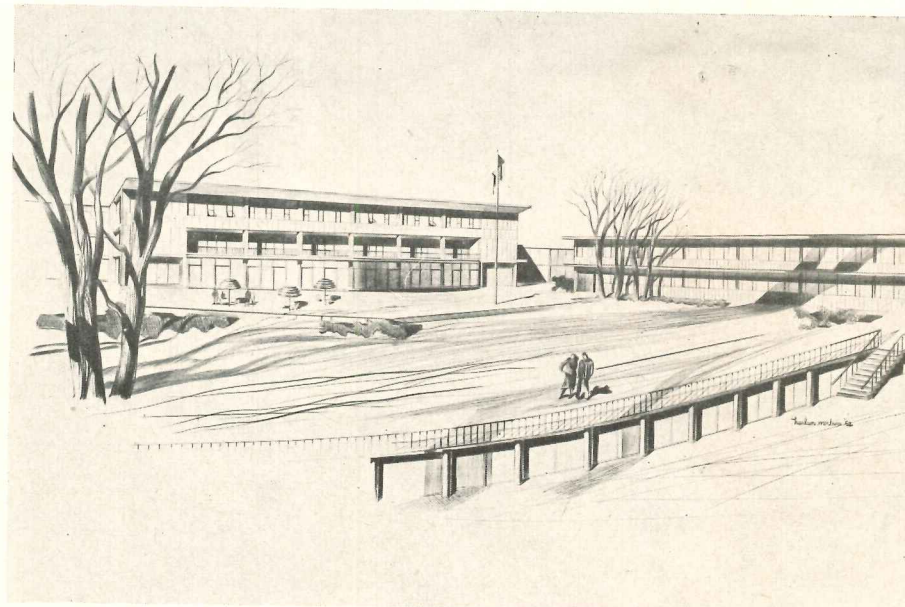
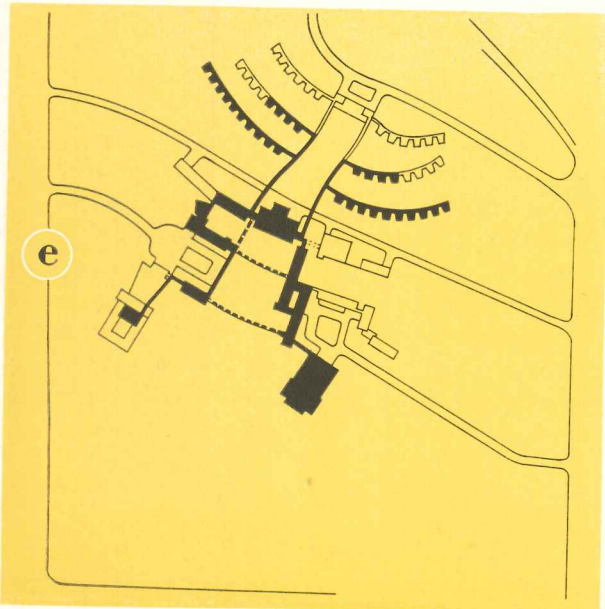

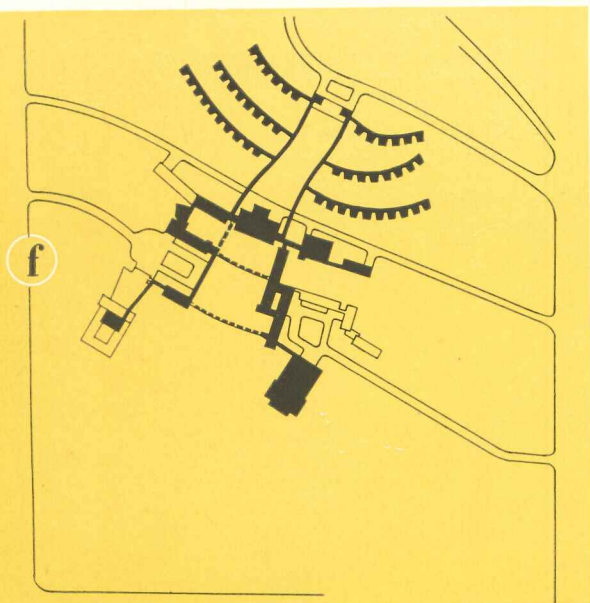
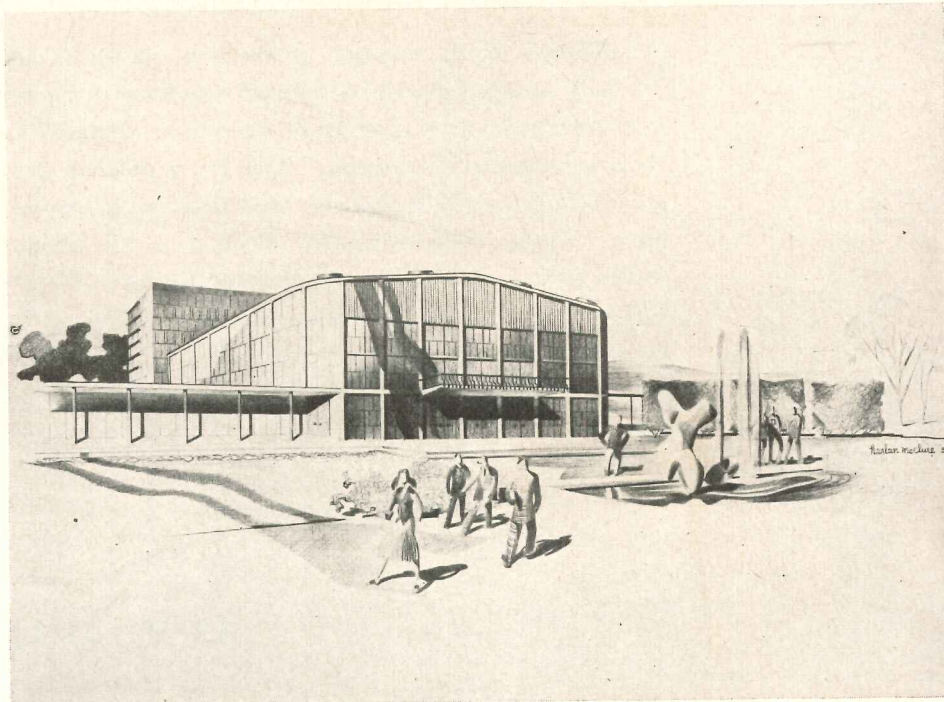

*e*, third phase of development: as enrollment expands more student housing is needed. Additional classroom requirements necessitate removal of library and health service from areas used as classrooms; by now, space needs for these functions can be accurately determined and suitable buildings provided. *f*, final stages, about 1970; several special buildings, including Science Laboratory, another classroom building, Home Economics Building, Military Science Building, Auditorium for predicted peak enrollment of 3500, expanded heating, physical plant shops and storage facilities. Further expansion by developing more quadrangles can be easily accomplished. Sketches on facing page: Student Center, Museum gallery and sculpture court. Above and below: Auditorium

Sketches by Harlan McClure

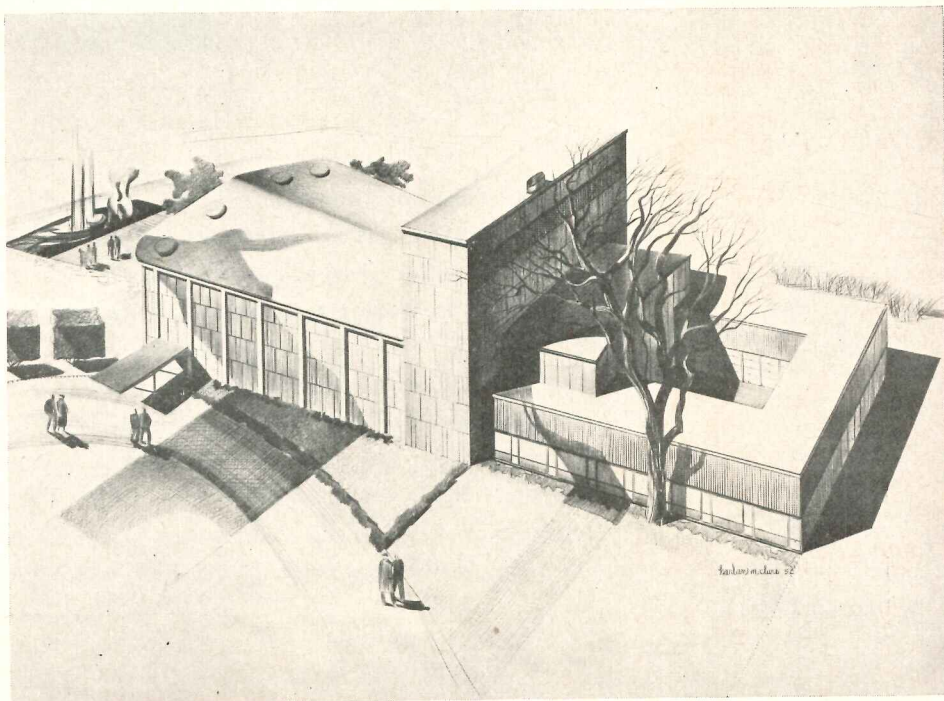

CLEMSON A. & M. COLLEGE, at Clemson, South Carolina, has for years been struggling with outmoded dormitory buildings, an inadequate mess hall and a rash of more or less unpremeditated structures, some of them supposedly "temporary." This is no problem peculiar to Clemson; other colleges, north and south, have been grappling with it too. Piece by piece, Clemson is providing new facilities on its rolling, wooded campus. A few years ago (see ARCHITECTURAL RECORD, August, 1951) Clemson House, a combination hotel-apartment house, and Clemson Homes, faculty housing, were built. They were designed by the architects now commissioned to develop a dormitory "barracks" quadrangle for students. A new mess hall, shown in white at the left of the site plan, is to be included.

## COLLEGE BUILDINGS: NEW DORMITORY "BARRACKS"

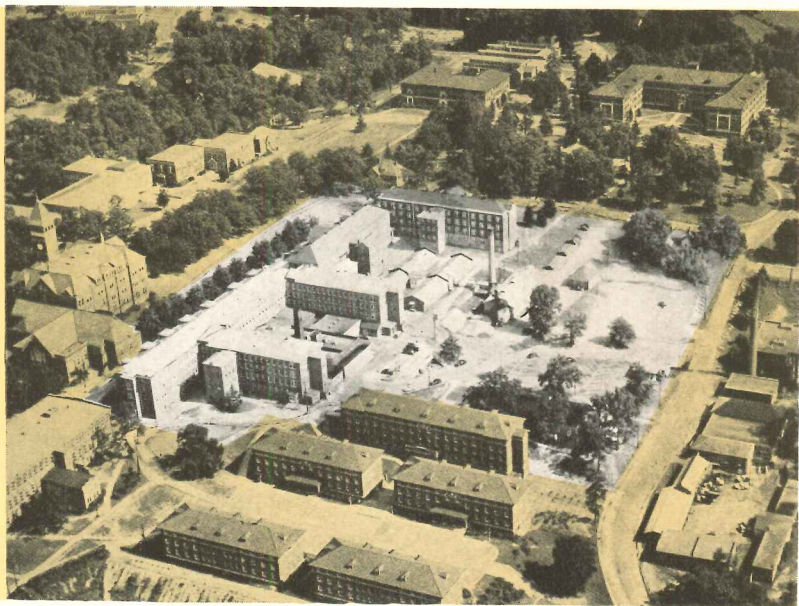
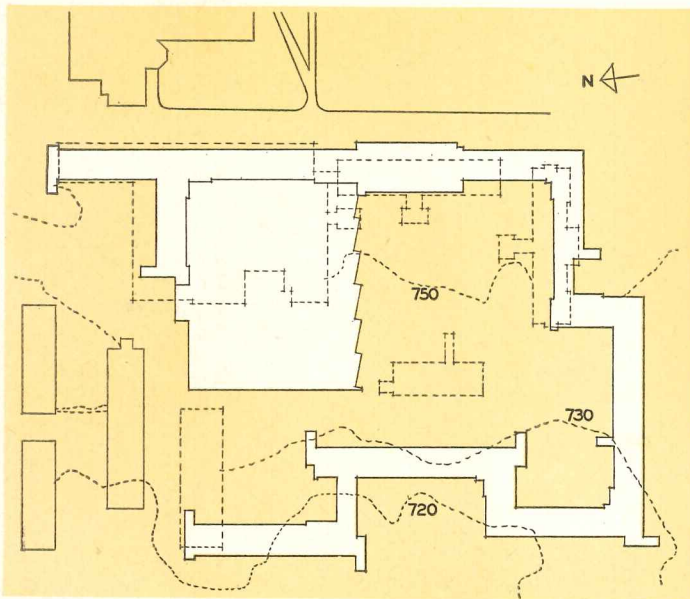

The thinner dormitory buildings are also shown in white; dotted black lines indicate the principal old buildings to be removed in addition to several lesser doomed structures, all shown in the air view of the existing area.

Because it is a military college, Clemson students march in formation into the Mess Hall. The weather sometimes interferes seriously with this custom. The new barracks, though they are treated as a series of building units, are to be internally connected so students can get to meals under cover. There is even to be a bridge which will take advantage of changes in grade to span from an upper dormitory level to the Mess Hall.

The site slopes sharply down to the east. This characteristic is put to work by making the buildings step up the slope, making further distinctions

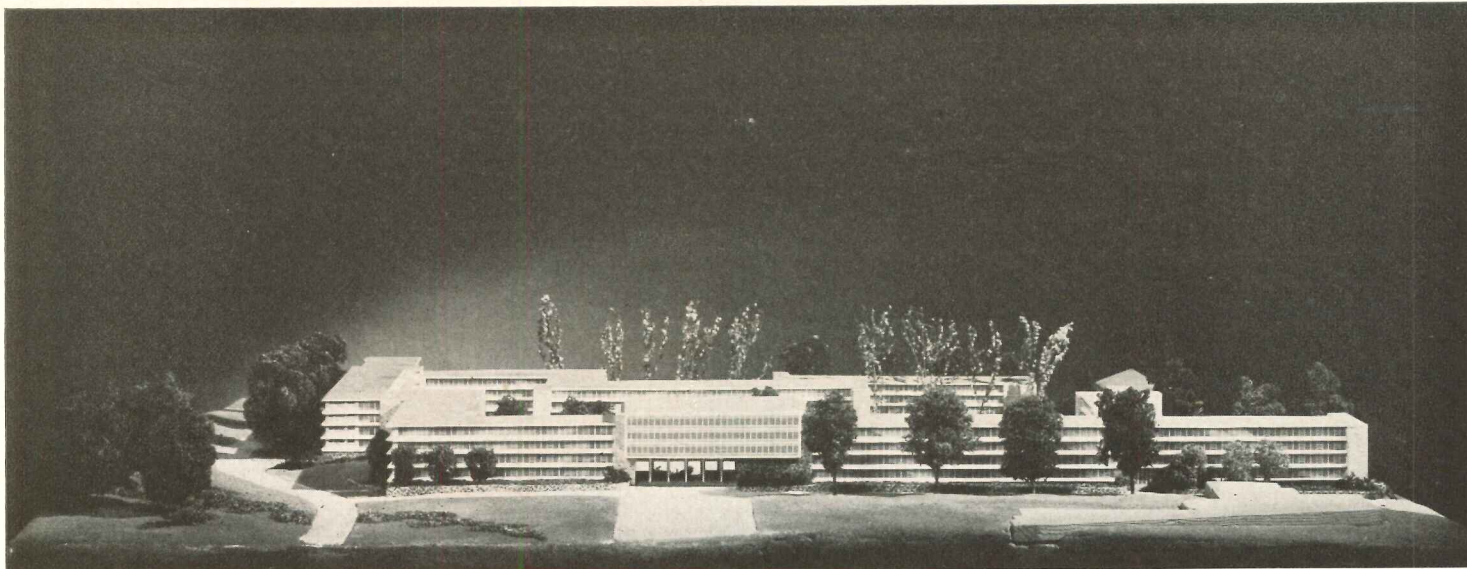

## GROUP TO REPLACE OUTMODED BUILDINGS AT CLEMSON

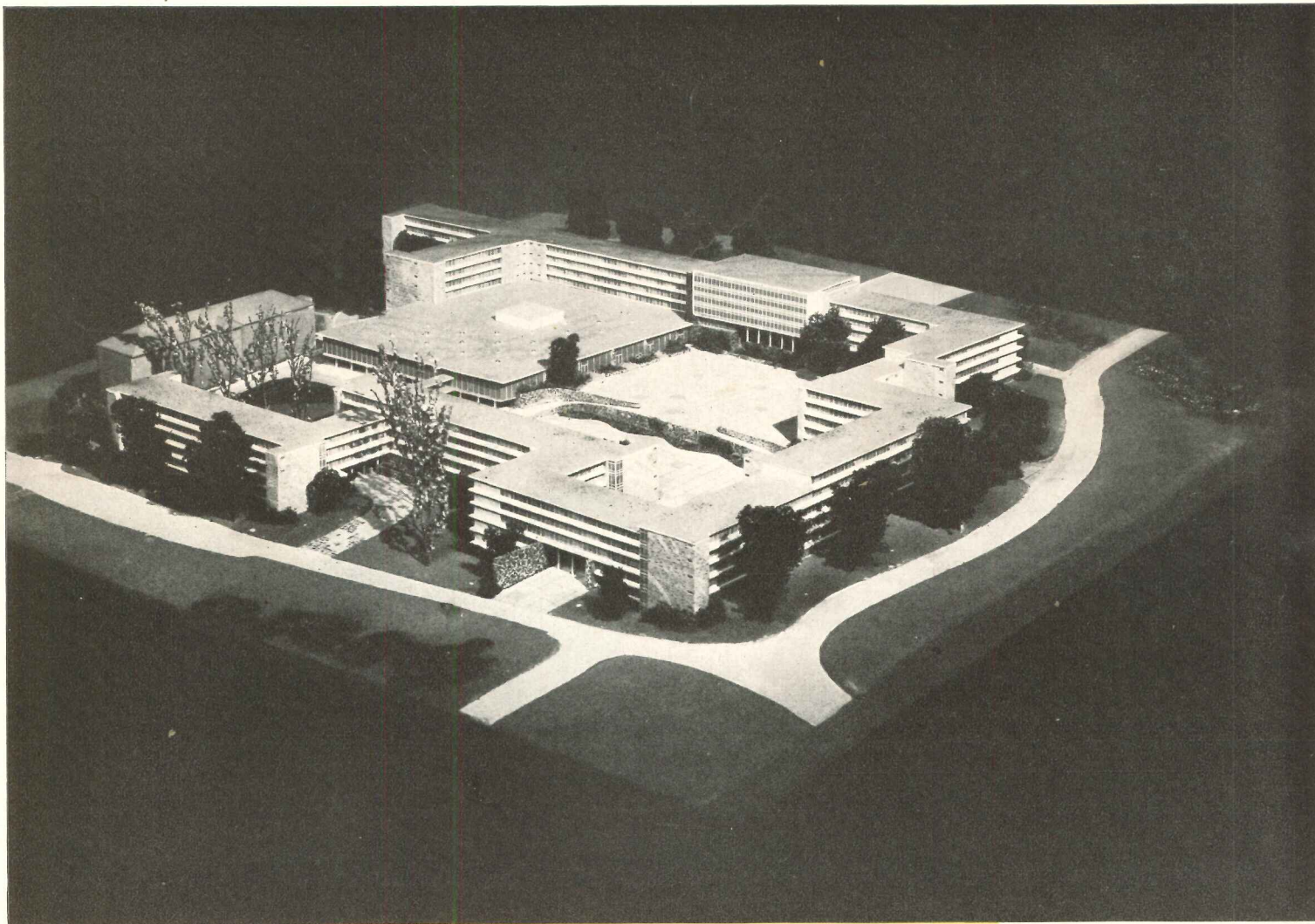

Alt-Lee

*William G. Lyles, Bissett,  
Carlisle & Wolff, Architects and Engineers*

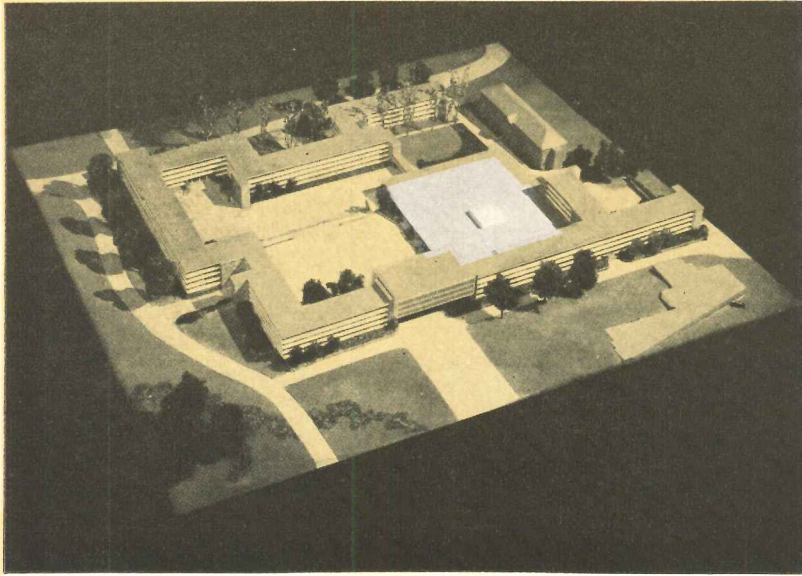

Alt-Lee

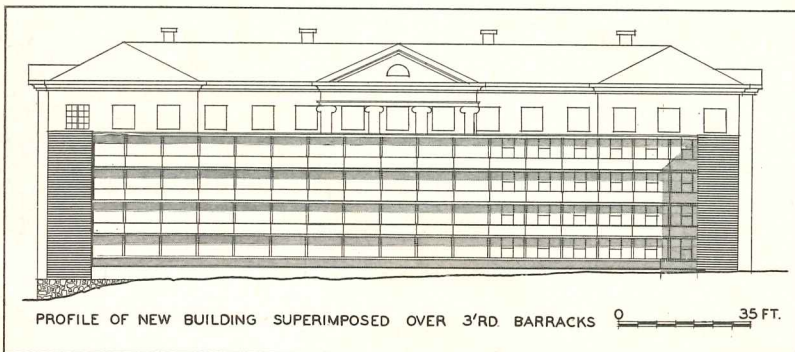
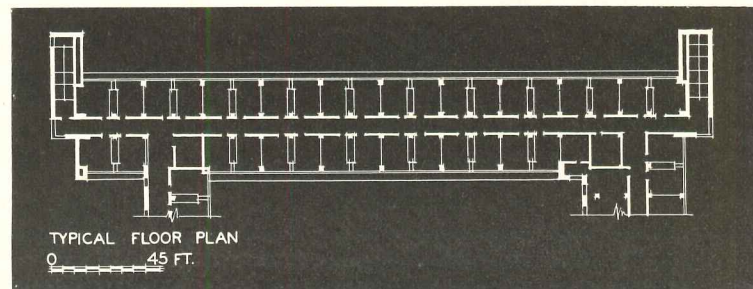
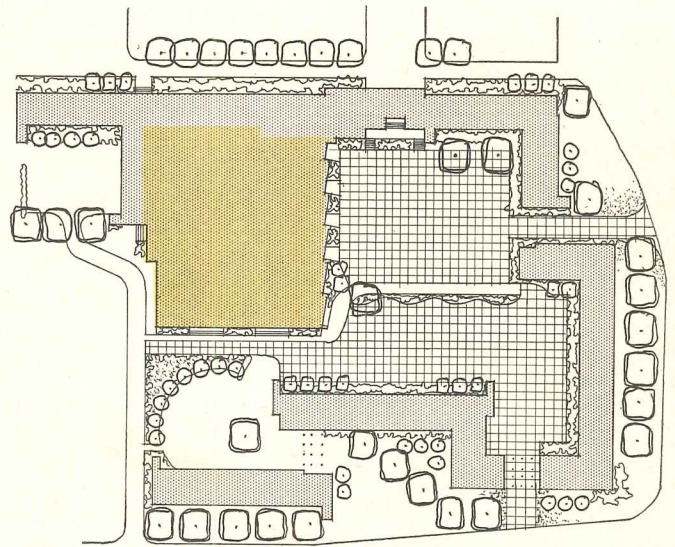
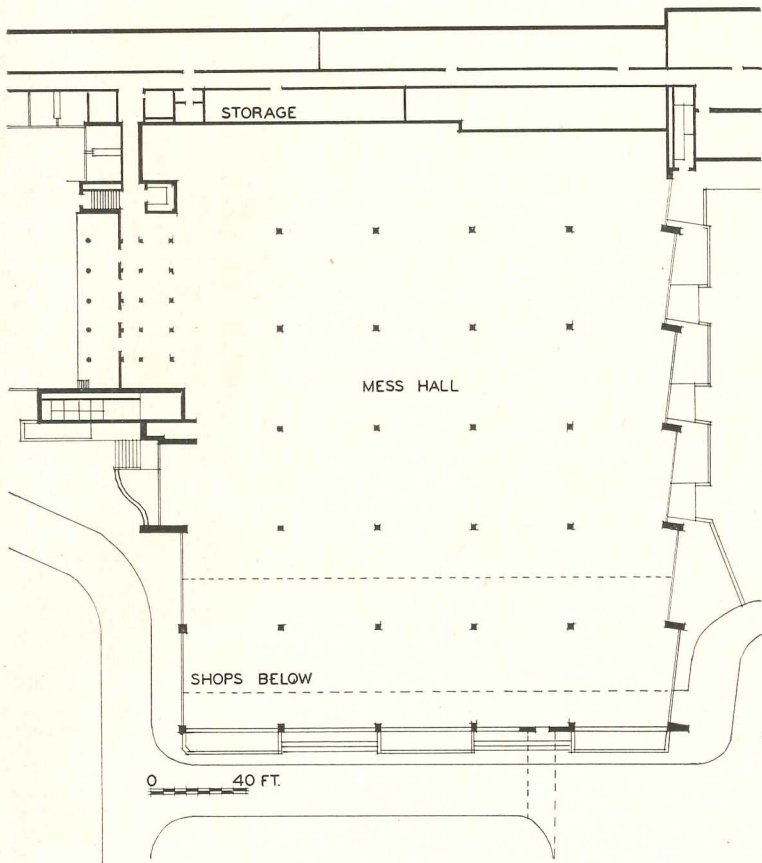



between units. In the main, the buildings will parallel the contours to avoid excessive grading and structural problems.

The large court thus to be enclosed is also designed to utilize existing grades as much as possible. It is to be divided into two levels, separated by masonry walls, ramps and planting, one for the formations of upper classmen, one for lower classmen. At intervals the buildings are to be pierced at ground level by wide entrance loggias.

The decision to raze some buildings, however unsightly, inefficient and expensive to maintain, was not made lightly. The values pro and con were exhaustively studied and numerous comparisons, of which the drawing of a new building superimposed on one of the old is just one of many examples, were made and debated. Efficient planning of dormitory rooms, shown on the following page, makes the smaller volume possible.

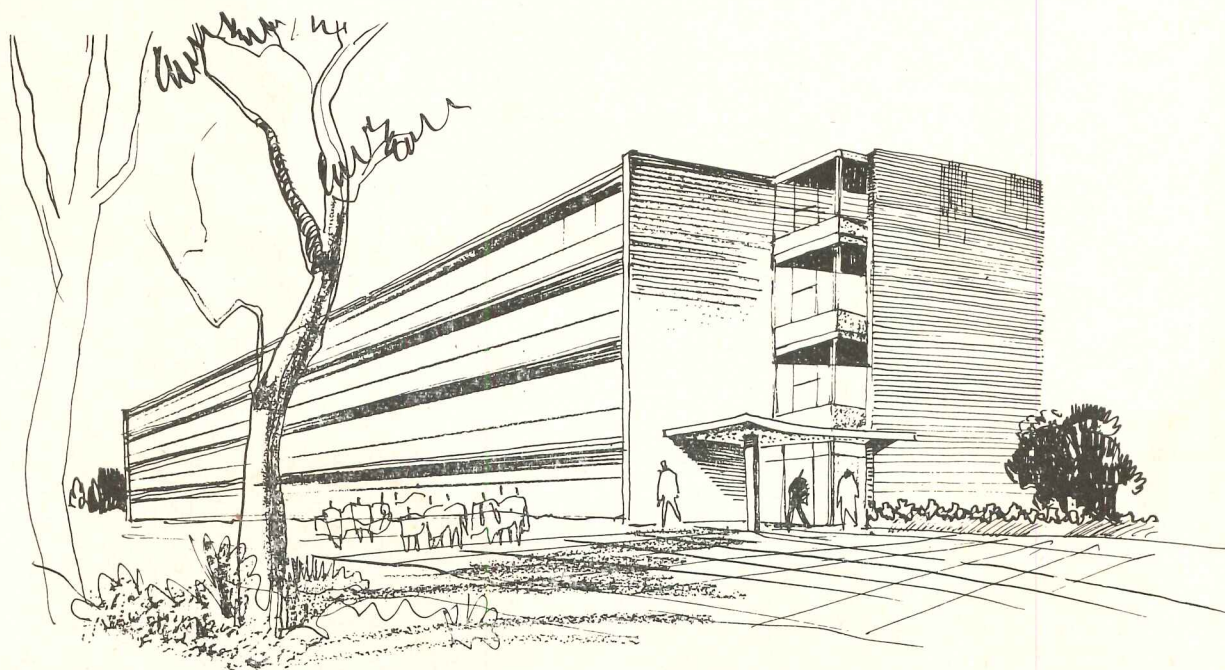
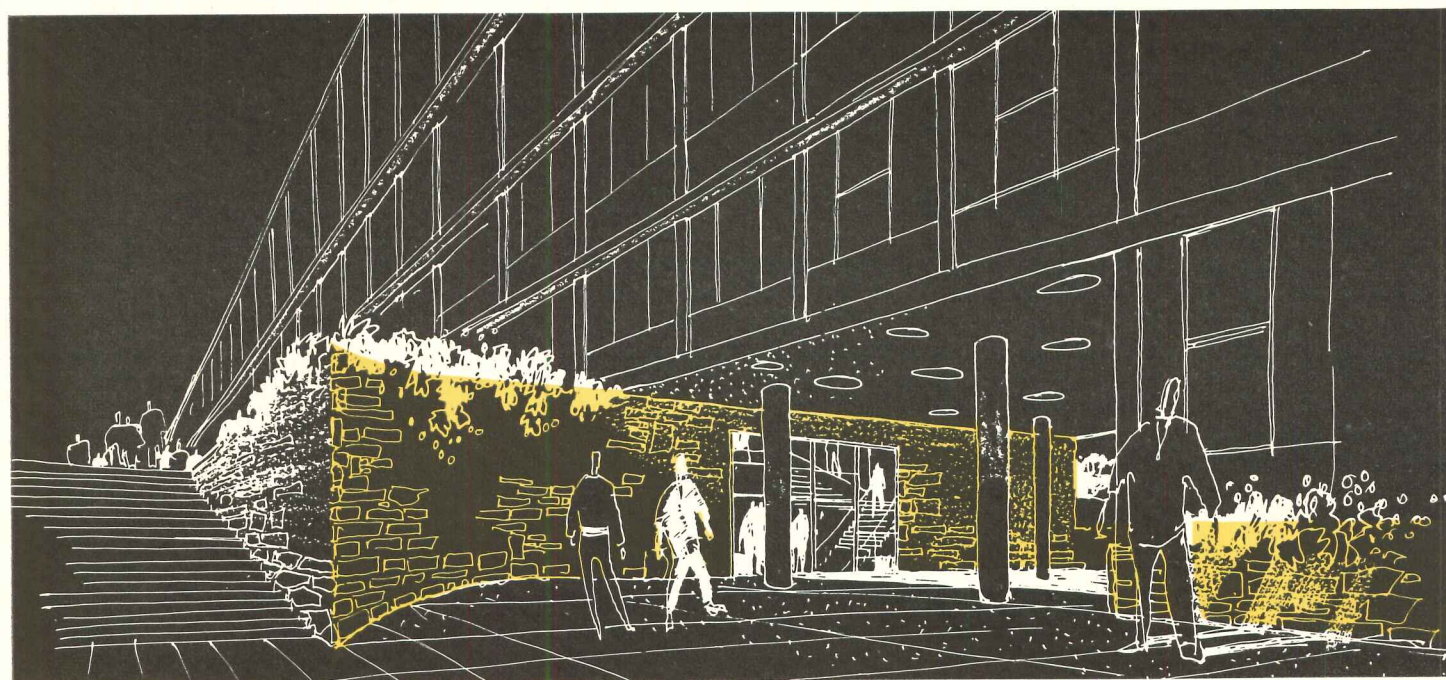

CLEMSON BARRACKS

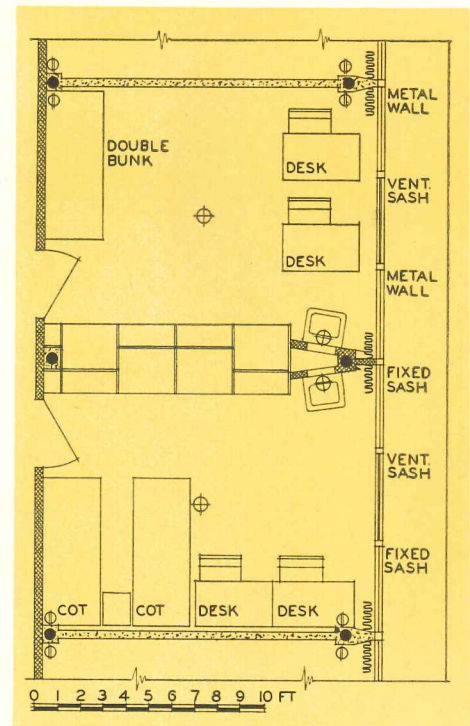
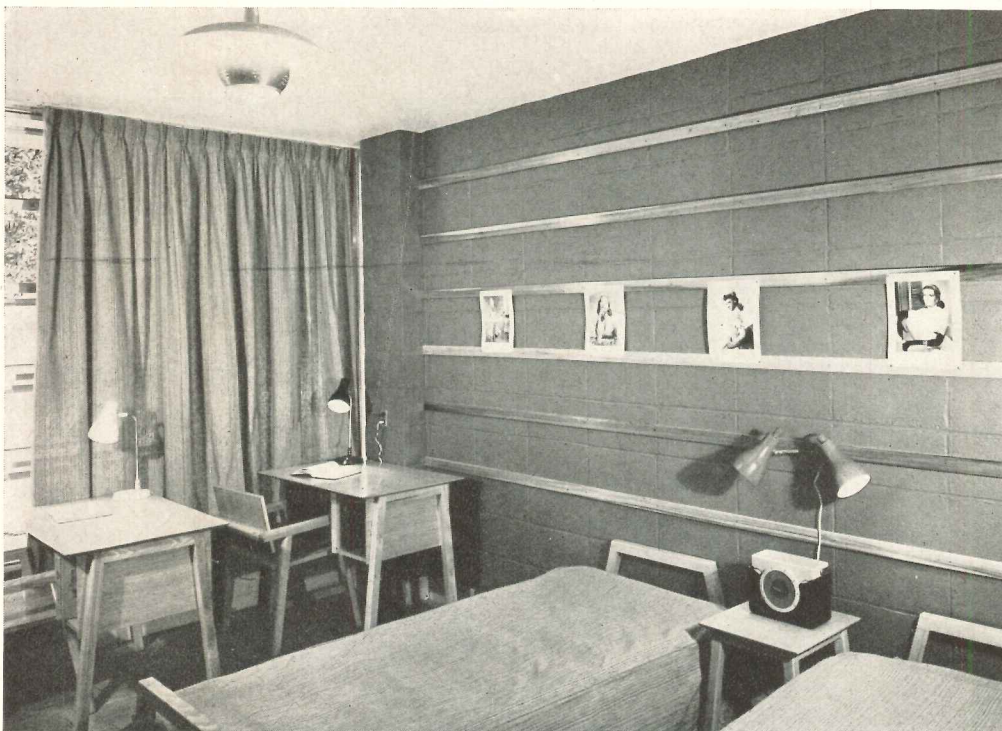
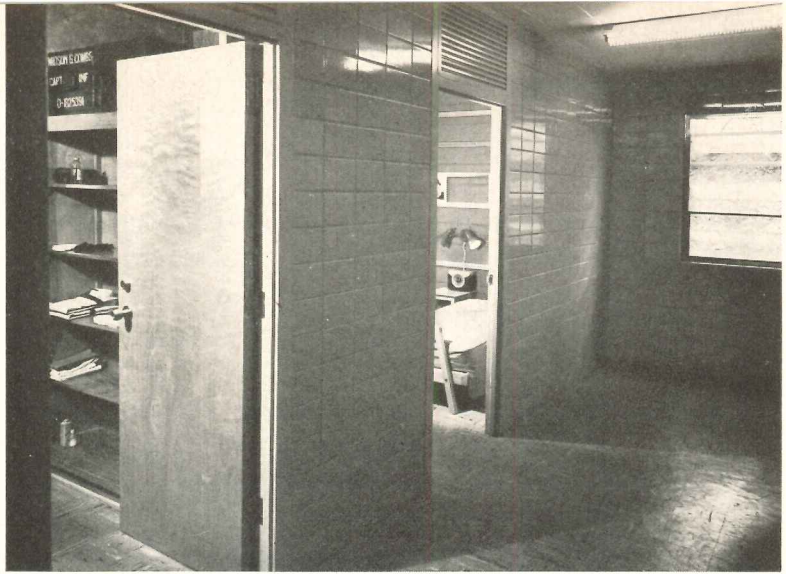

*To study and demonstrate the typical dormitory room a full-scale mock-up was built and completely equipped. In plan, rooms are paired with a storage wall (containing wardrobes, dressers, shelving and lavatory) between. Other walls are painted concrete block. Special radiant panels are installed under windows*



# COLLEGE BUILDINGS: WOMEN'S DORMITORY QUADRANGLE

ARIZONA STATE COLLEGE, TEMPE, ARIZ. | *Guirey & Jones, Architects* | *J. E. Hastain, Structural Engineer* | *M. M. Lowry, Mechanical, Electrical Engineer* | *Mary Louise McLeod, Color Consultant*

**S**IMPLE NEARLY TO AUSTERITY yet serene and most pleasant, Gammage Annex, the new women's dormitory at Arizona State, surrounds three sides of a quadrangle whose present attractiveness is due to increase as grass and trees become better established. The existing building forms the fourth side of the quadrangle, which the three wings of the Annex do not quite enclose.

*(Continued on next page)*



Stuart Weiner



Stuart Weiner

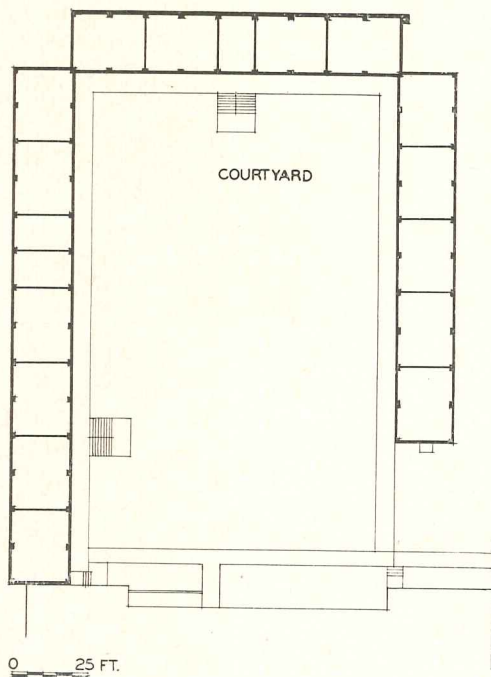

All three wings turn their backs, punctuated only by high rows of windows, on the rest of the campus. Into the privacy of the court, however, all the rooms open hospitably across wide balconies that serve as both sunshades and corridors. There is no waste in this design, and on the other hand it is by no means a concession to poverty. Though the building is liberally enhanced with color, which undoubtedly increases its femininity, the satisfaction it affords depends primarily on the logical disposition — and even exposure — of its elements.

The design module, a four-person dormitory unit (see following pages), is expressed in the plan at left, where the sound-resistant partitions of pumice block are indicated. Upper floors in both two- and three-story wings are similar.

Construction was equally simple and economical. The frame is steel, in bays that are completely repetitive. Floor slabs and roof deck, which cantilever to form the balconies, are concrete. The roof is built-up, with a heat-reflecting surface. Outer walls, except on quadrangle sides, are iron spot face brick. Partitions between units, and spandrels on the court sides, are painted pumice block; other interior partitions are painted plywood. Glazed structural tile is used in baths. Ceilings are vermiculite plaster; floors, asphalt tile. Sash are wood, in station-wagon guides. Insulation is mineral wool. Heating is provided by the college plant; air washers were built specially.



*The three wings open generously to the interior quadrangle. The concrete floor and roof slabs overhang to serve as balconies, sunshades and corridors; there are no internal corridors. The unity and privacy of the quadrangle are enhanced by the narrow strip-windows which the dormitory presents to the outer world*

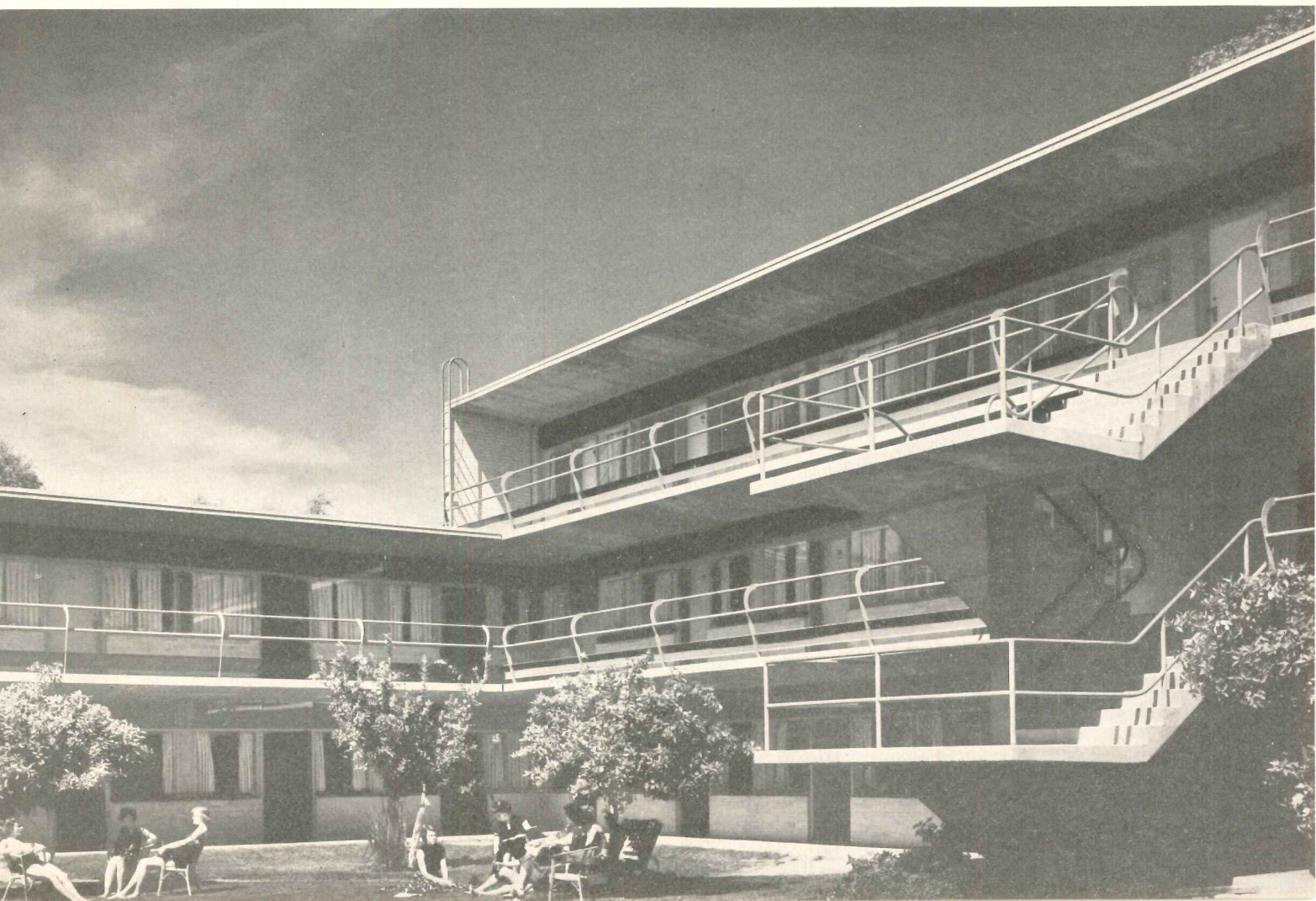

The dormitory unit, extremely simple and economical of space, with pleasantly colorful painted block and plywood wall surfaces, is the building's module. It consists of two double bedrooms and two studies paired about a utility wall. Against this wall in each bedroom is a recess containing two built-in dressers with a lavatory set into the counter-top. A single bath-

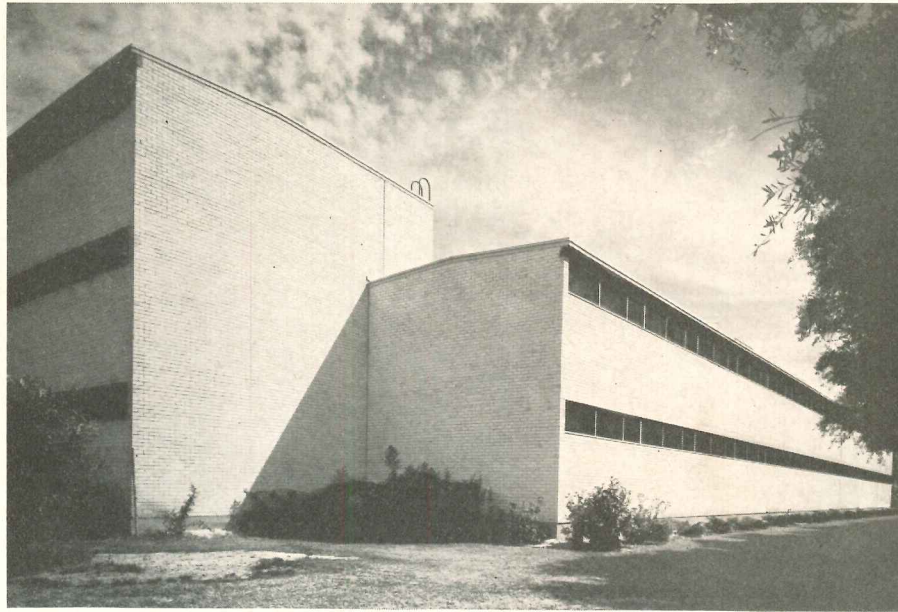

**COLLEGE BUILDINGS: ARIZONA STATE**

room, containing shower and water closet, is accessible from both bedrooms. Beds are springs and mattresses on a lumber base. Only portable furniture: two chairs per desk

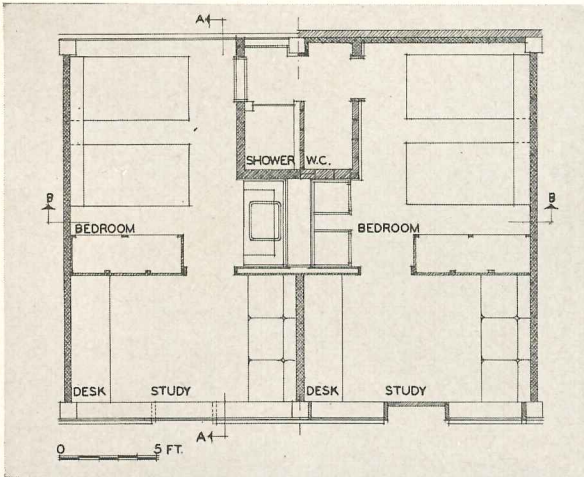
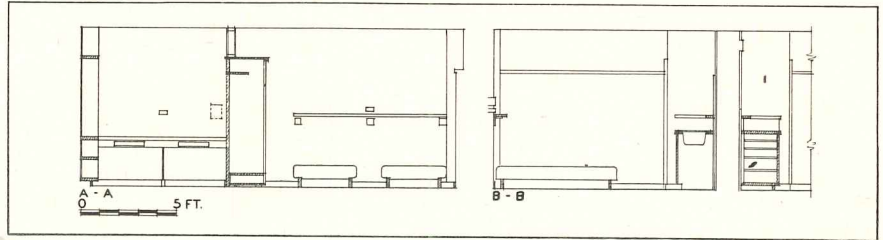

Study has double built-in desk





*Bedroom; utility wall at left*

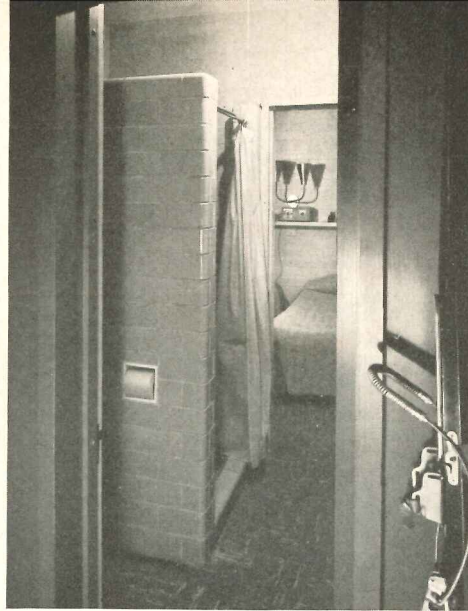

*Looking through bath*

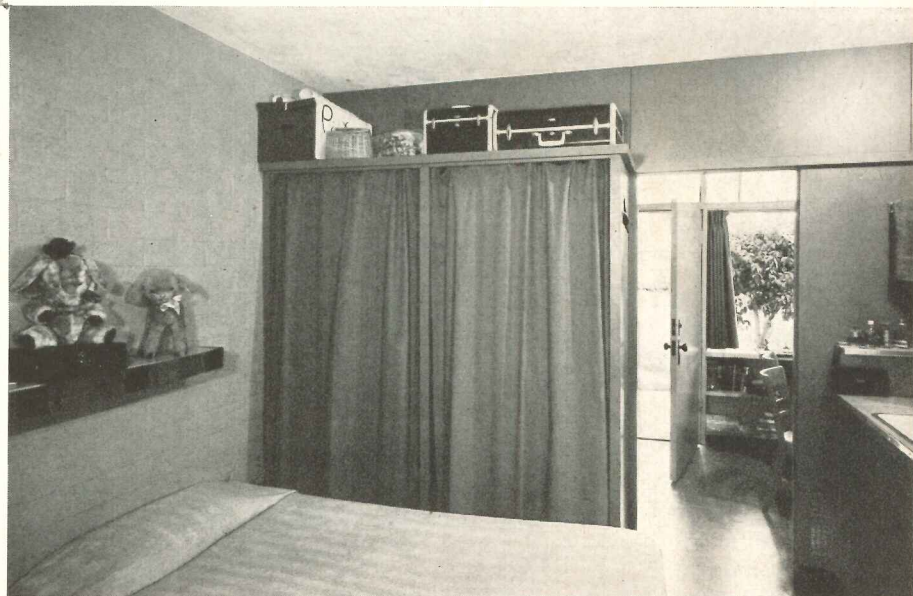

*Above, wardrobe forms wall between bedroom and study, below*

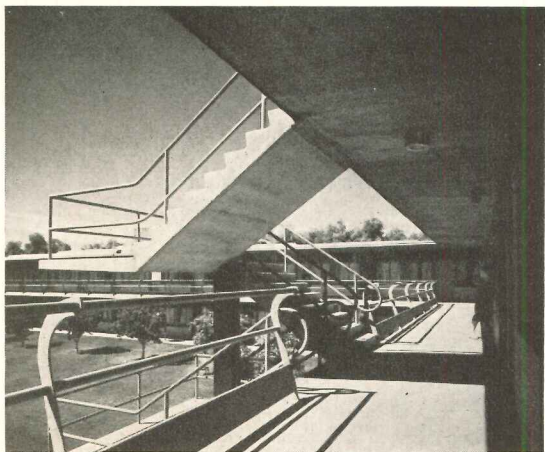

*Stuart Weiner*



# DORMITORY, KISKIMINETAS SPRINGS SCHOOL

SALTSBURG, PA.

*Hunter, Caldwell & Campbell, Architects*

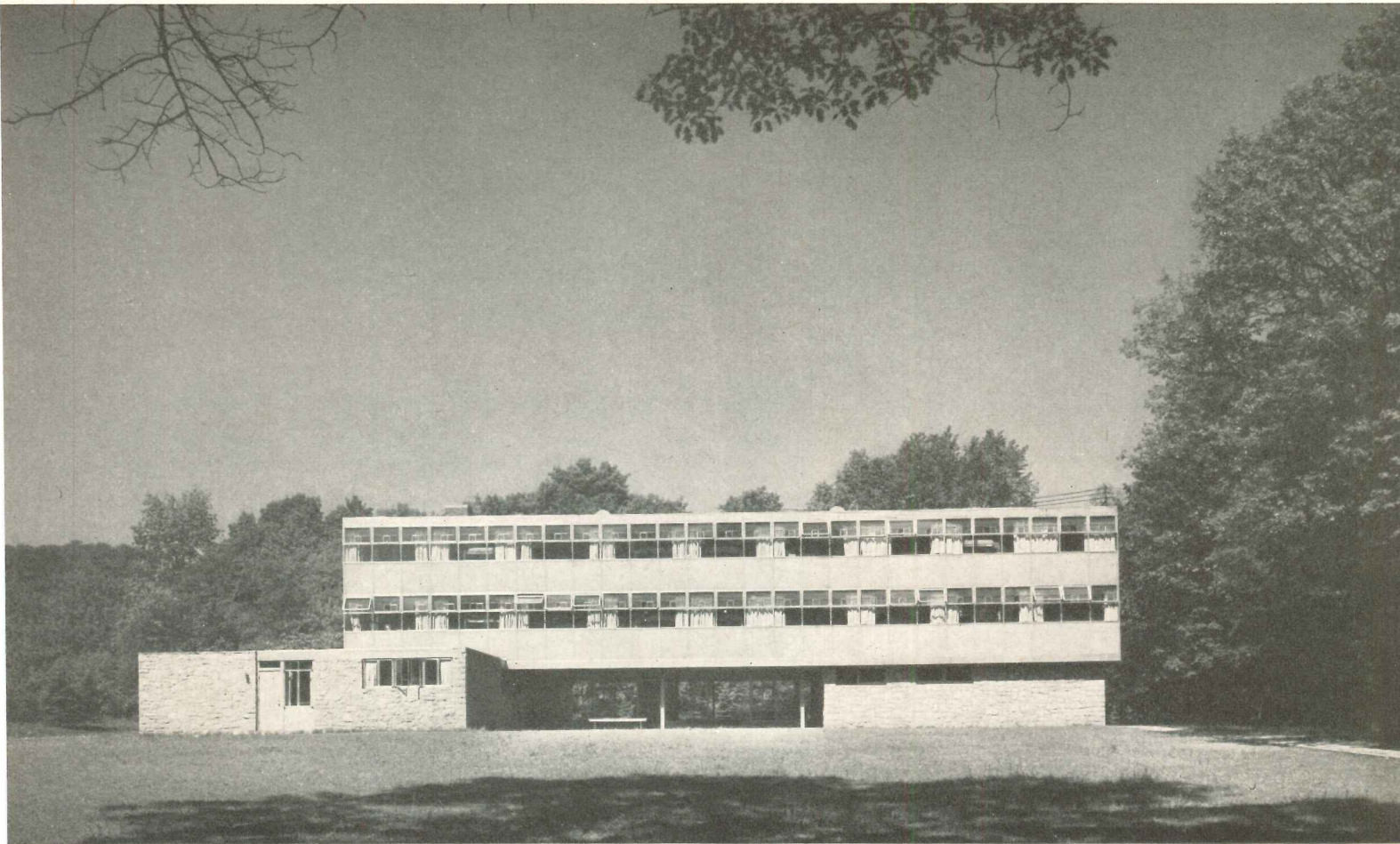

AT FORWARD-LOOKING KISKI preparatory school, the new dormitory is as interesting as the plan of study. On this wooded campus the boys concentrate on a single subject for nine weeks, cover four subjects each year, with results gratifying to both teachers and pupils.

Equally successful is this dormitory, the realization of such design studies as the model shown in the photograph at right, which was first published in ARCHITECTURAL RECORD, June 1950. The overall building program for the future includes five more such dormitories, a field house, chapel, and dining commons. The present unit has a glass-walled lounge on the ground floor which yields a vista through the building. Also on the ground floor are faculty apartments and activities rooms.

Second and third floors contain two-room apartments for 64 boys, four to a suite, 32 to a floor. The above-ground location achieves privacy and affords pleasant views. Finishes are practical and economical: acoustic tile ceilings, painted block walls, asphalt tile floors. Beds are double-decker; dresser, wardrobe, bookcases are built-in.

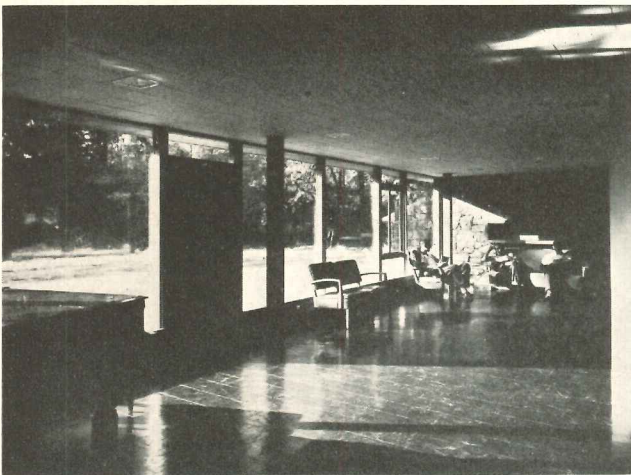



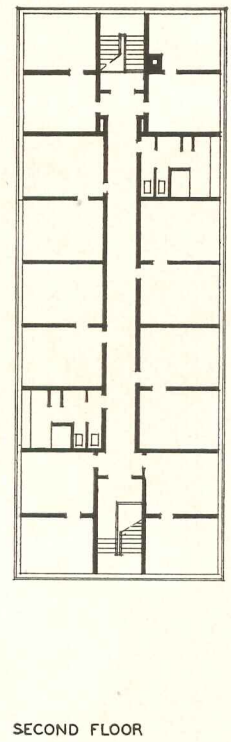
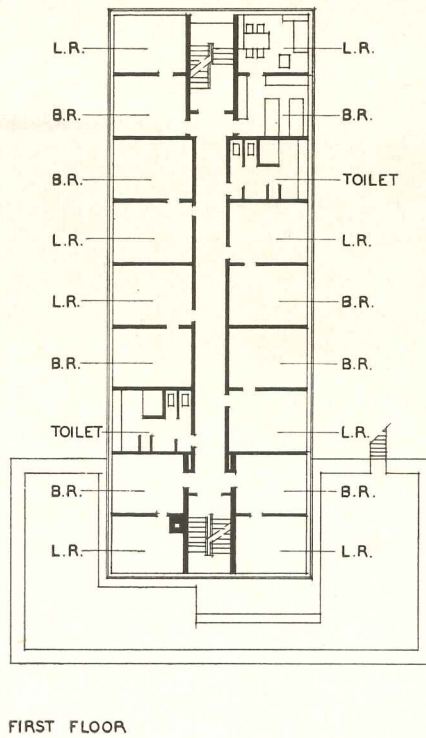
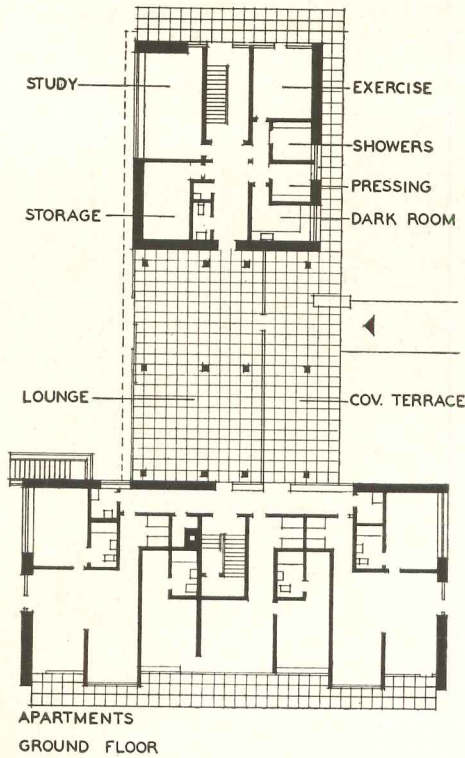

*Exterior skin of upper stories is blue-green glass in aluminum frames, with projected sash for ventilation. Frame is light steel; floors are radiant heated concrete slabs. Photos at right: faculty apartments, easily accessible, control students' comings and goings*

Robert Lautman

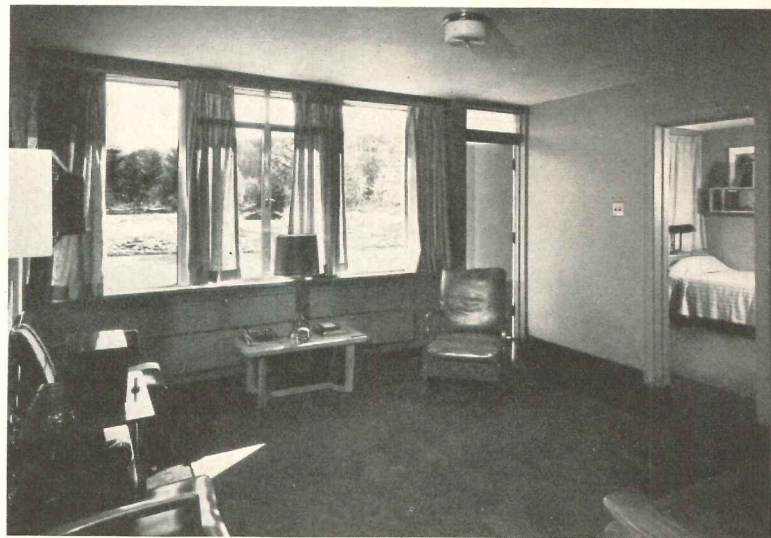
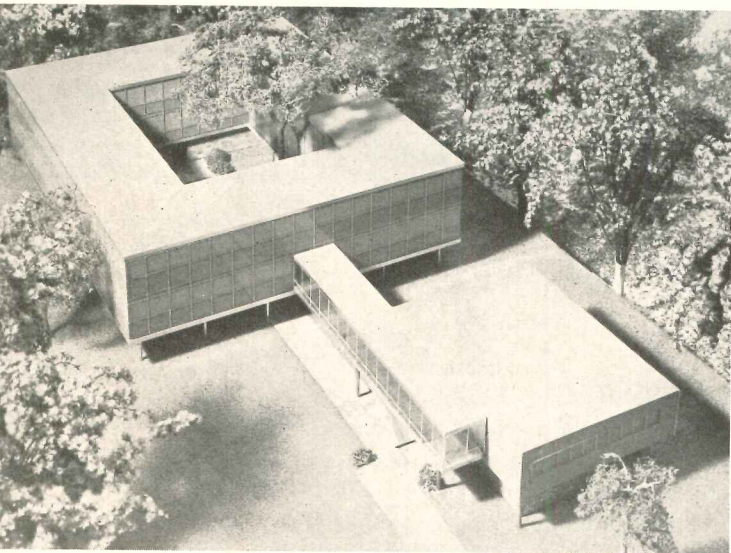

## COLLEGE BUILDINGS: TWO CAMPUS RELIGIOUS

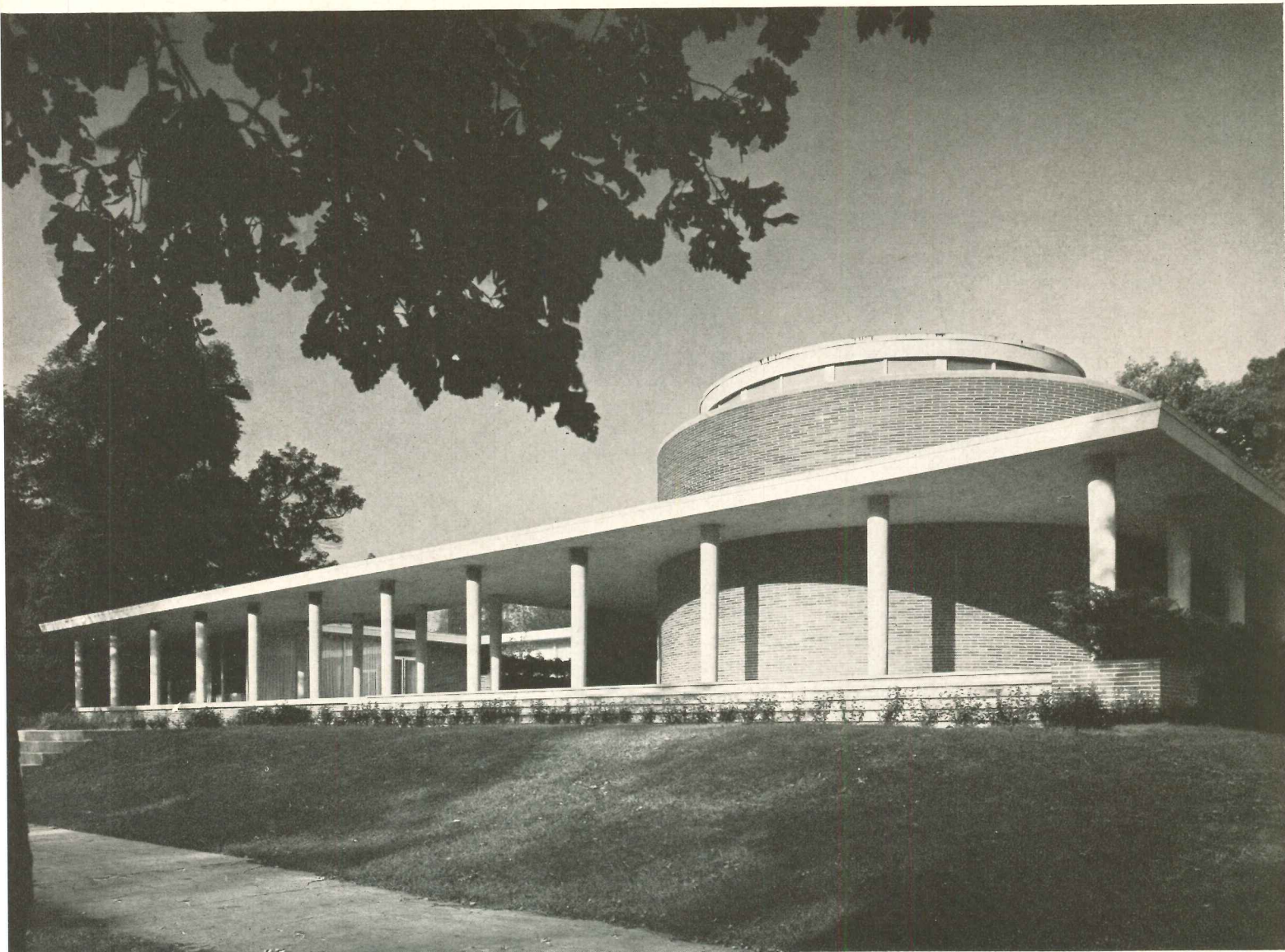

Hedrich-Blessing

### EVANSTON CONGREGATION HILLEL

**D**ESIGNED IN 1947 and first published in *ARCHITECTURAL RECORD* in June 1948, this building provides a center for religious, cultural and interfaith activities of the Jewish community at Evanston, Illinois, and for Jewish students at Northwestern University. It is duplicated in purposes and essential parts by the Benjamin M. Frankel Memorial at Champaign, shown on succeeding pages. Both were designed and built nearly simultaneously, antedating considerably the very similar cylindrical chapel designed (but not yet built) for the M.I.T. campus by Eero Saarinen.

The Evanston site has many trees. To take advantage of a view of Lake Michigan to the east, the entire structure is built on a platform raised three feet above the surrounding grade. Its several units are developed as contemporary expressions of historic elements of the Jewish temple, and incorporate also the facilities needed by a modern community center.

# AND SOCIAL CENTERS

*Harrison & Abramovitz,  
Architects*

*Edwards & Hjorth,  
Structural Engineers*

*Jaros, Baum & Bolles,  
Mechanical Engineers*

*Smith & Silverman,  
Electrical Engineers*

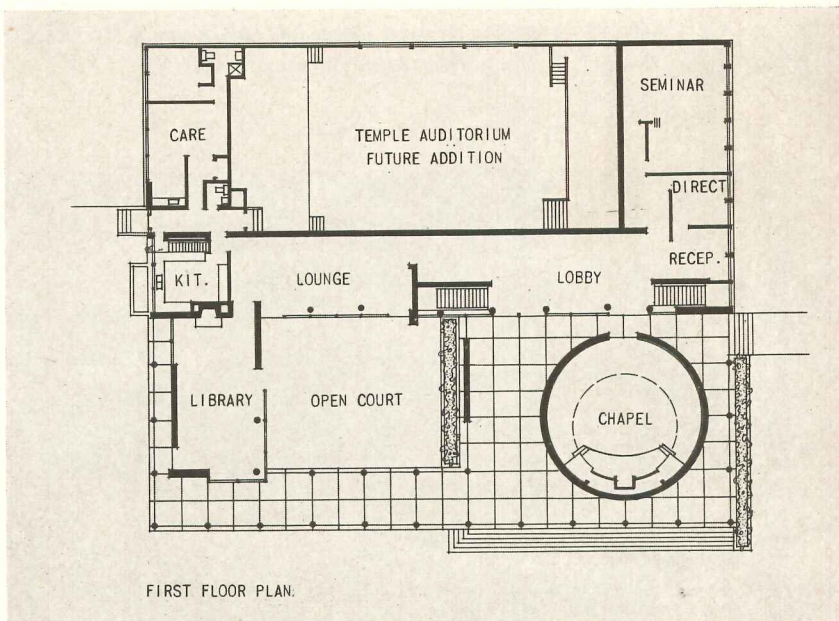
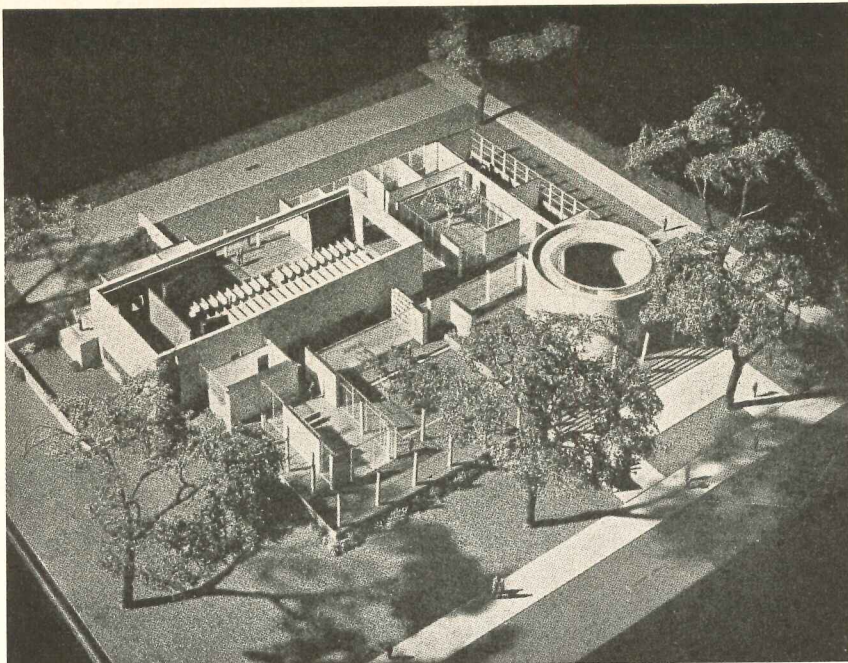

FIRST FLOOR PLAN.

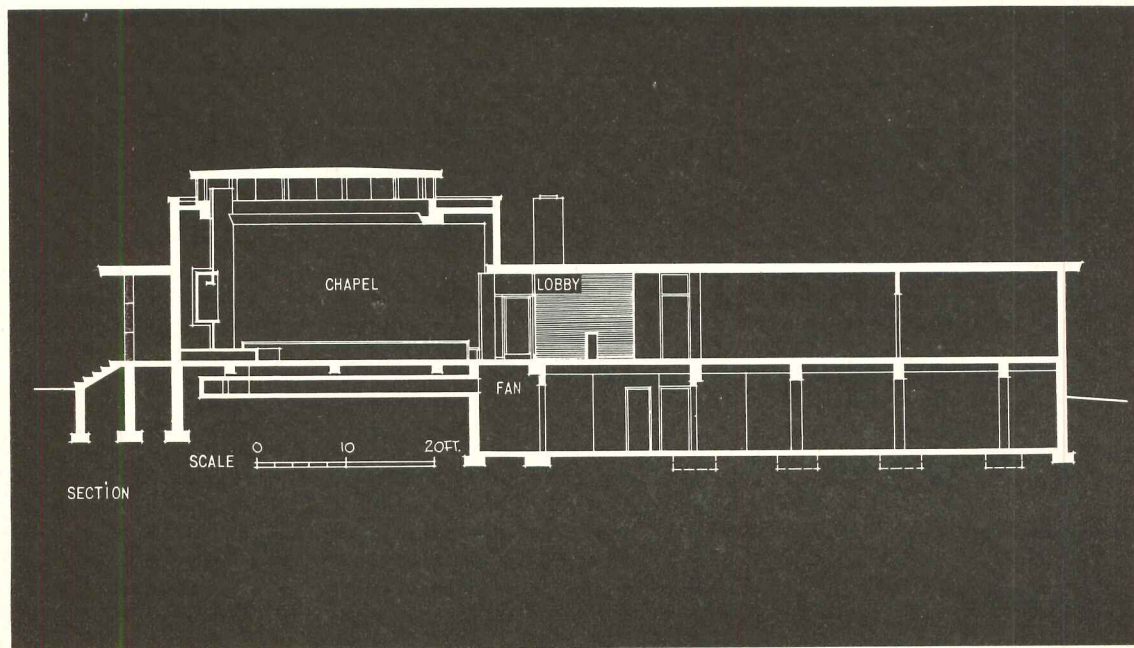
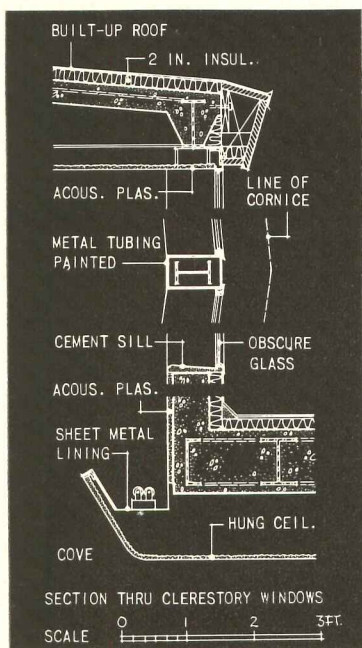



**COLLEGE BUILDINGS:**

**NORTHWESTERN UNIVERSITY**

*Above, the lounge opens a glass wall to the historic courtyard, helping to integrate social and religious significances. Center of page, columned loggia forms covered approach to library while recalling the portico of an ancient temple*

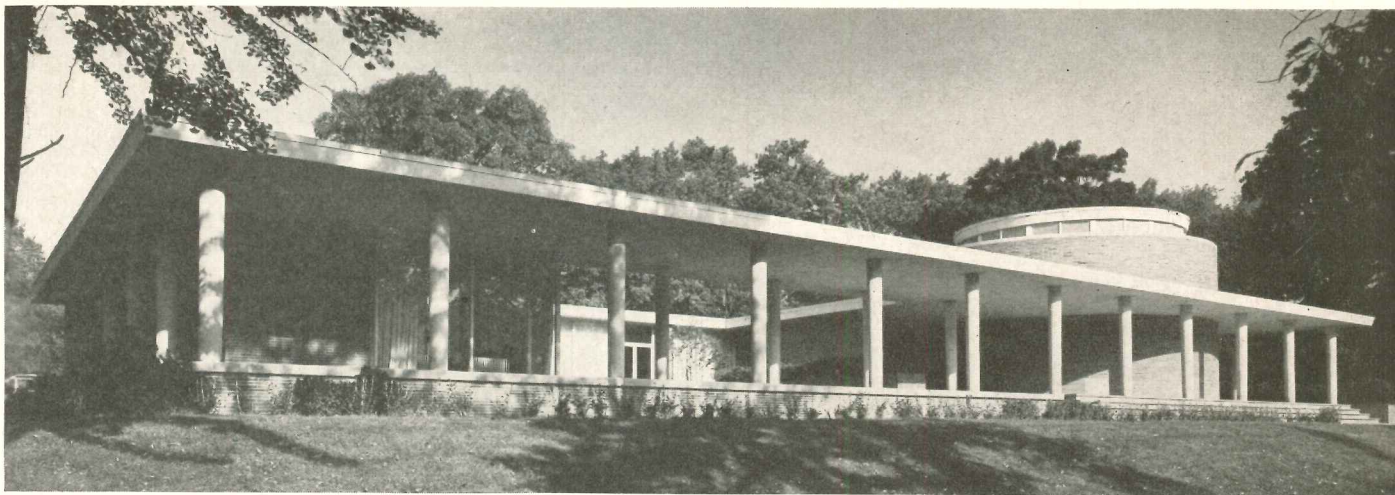

*Below, looking from loggia into the sequestered "Courtyard of the Lord." Materials are simple brick and concrete; framing, steel*

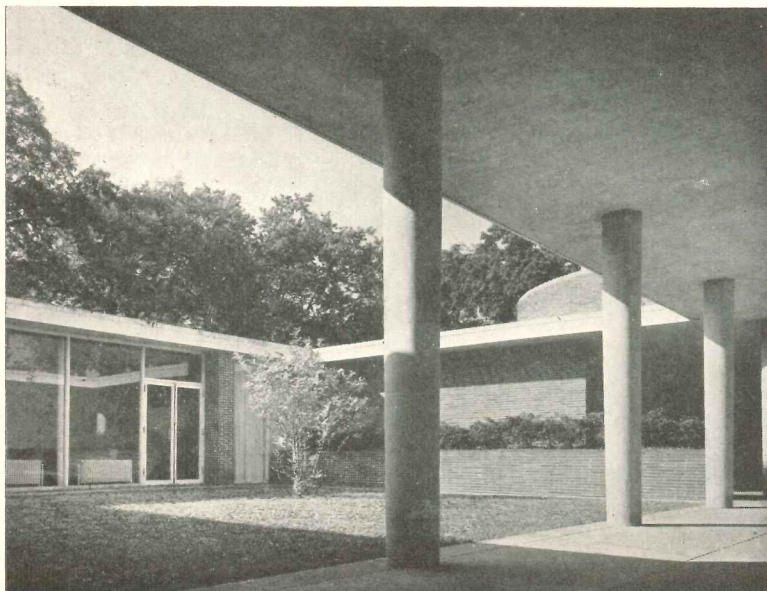

Hedrich-Blessing

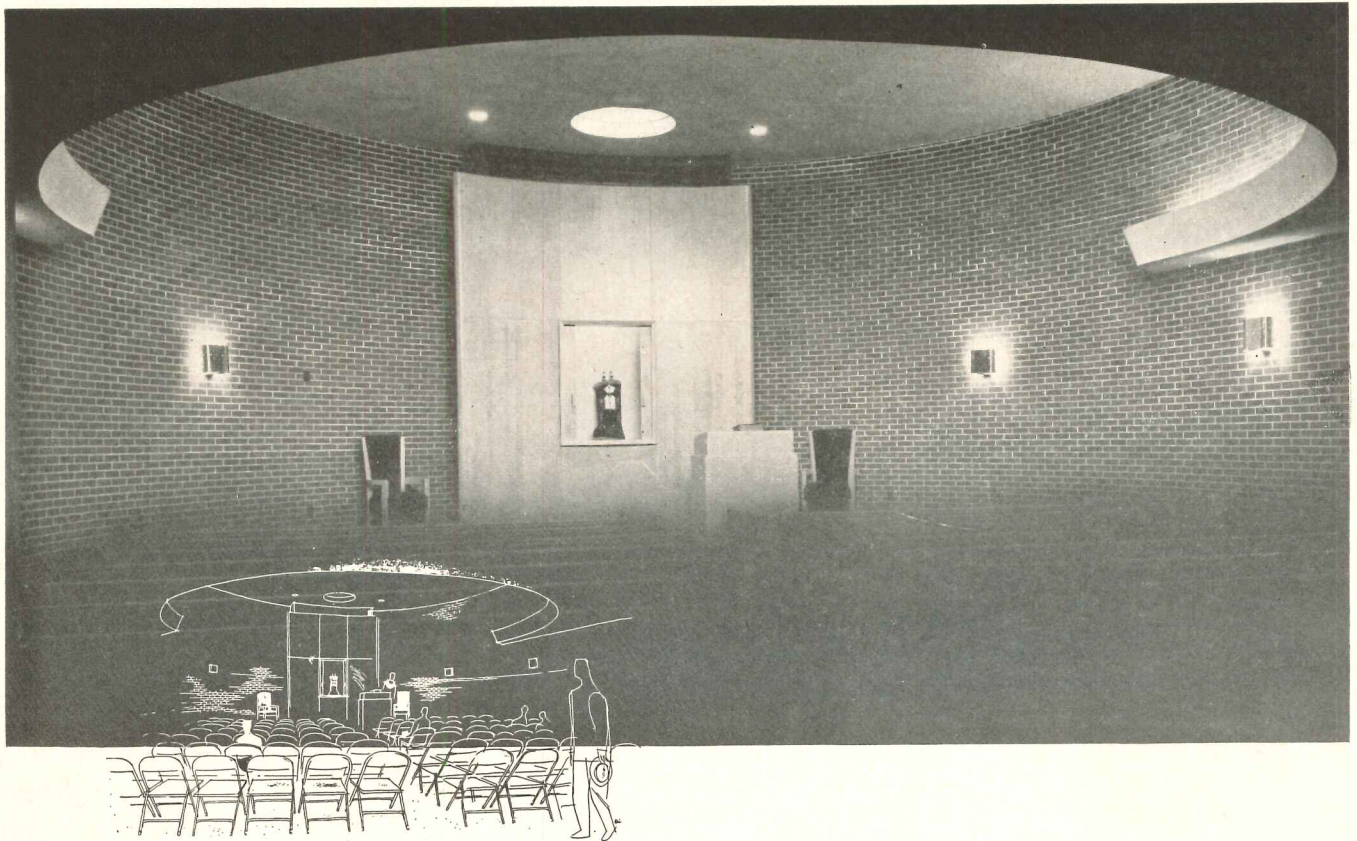

## BENJAMIN M. FRANKEL MEMORIAL BUILDING

*Harrison & Abramovitz, Architects*

*Tuck & Eipel, Structural Engineers*

*Jaros, Baum & Bolles, Mechanical Engineers*

*Smith & Silverman, Electrical Engineers*

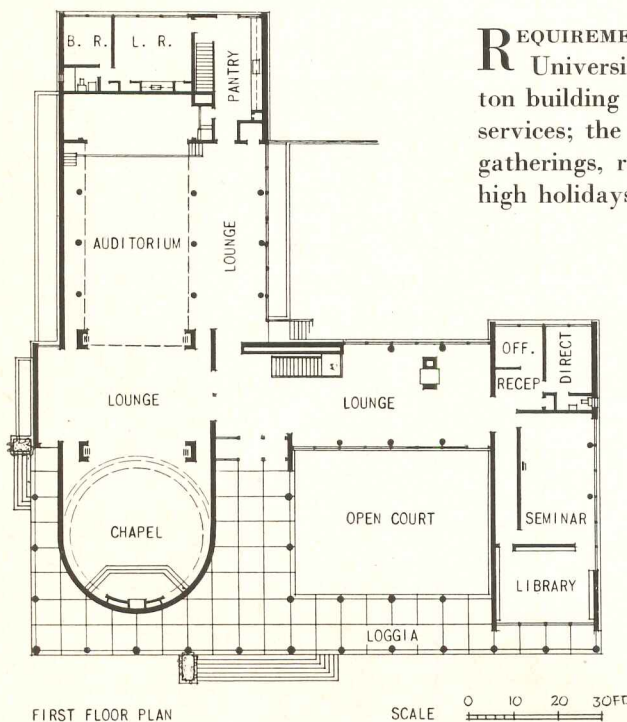

**R**EQUIREMENTS for this Hillel center at Champaign, Illinois, serving the University of Illinois, were virtually identical with those at the Evanston building shown on preceding pages. The chapel seats 100 for religious services; the auditorium accommodates 300 for lectures, dramatics, social gatherings, recreation, and also for the larger attendance at services on high holidays. Seminar rooms, library and social rooms are used by both

*Construction of the Hillel center at Champaign, like that at Evanston, is steel frame, brick and concrete. Interior surfaces are plaster and brick, painted; floors are asphalt tile. Each building has its own heating plant*

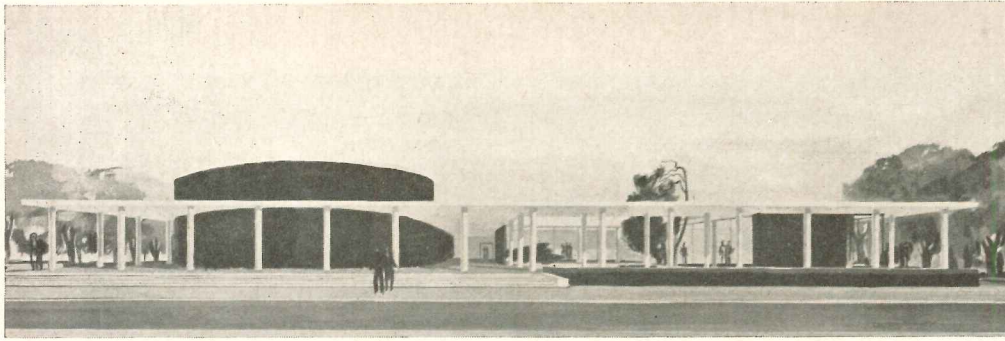

## UNIVERSITY OF ILLINOIS

students and the community. From the kitchen suppers and teas are served; there are caretaker's and administrative suites. Partly surrounded by these areas and partly enclosed by a loggia is the Courtyard of the Lord, an unroofed grassy garden of traditional origin, used in connection with religious festivals.

The chapels of both centers are circular and the other elements are similarly disposed. The round form, in the comfort and privacy it gives to worshippers, recalls the variously shaped holy places of Jewish temples in Asia Minor. There are differences between the two centers, of course; not only those dictated by site and orientation, but also one chapel is a free-standing cylinder, the other is only partly so. As photographs, drawings and details show, natural light is diffused across the ceiling of the Evanston chapel while the Champaign chapel is artificially lit. At Evanston the one lounge has only one wall glazed and the auditorium area is not yet completed; at Champaign the two lounges are each open on both sides and the auditorium is finished.

Hedrich-Blessing

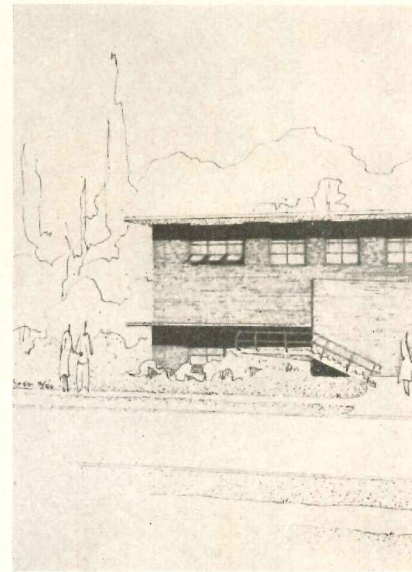

## COLLEGE

*WOMAN'S COLLEGE*  
*UNIVERSITY OF N. C.*

*Edward Loewenstein, Architect*  
*Watson & Hart, Engineers*

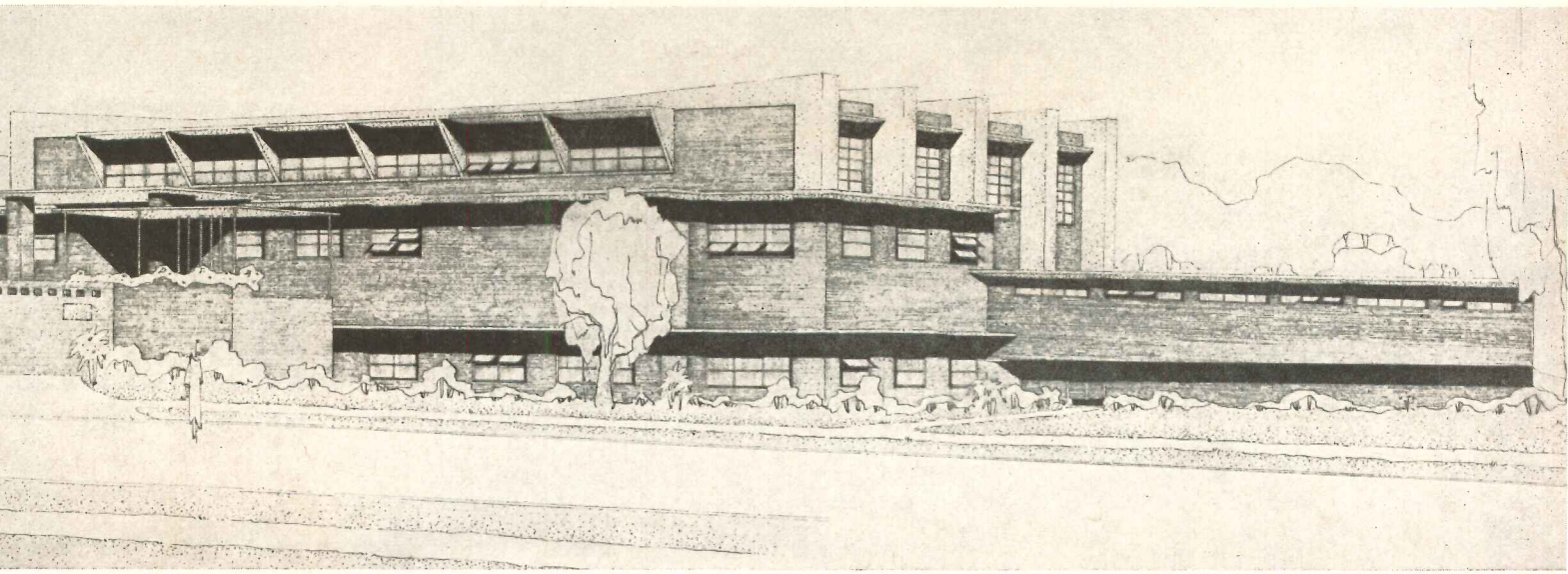

## BUILDINGS: NEW PHYSICAL EDUCATION BUILDING

ACTUALLY AN ADDITION to an existing building to which it is joined by an enclosed passage, this structure was designed within strict limits set by the State Legislature. Total volume, 798,085 cu ft, was within the 800,000 permitted. Cost was \$11.06 per sq ft, \$0.91 per cu ft. The design program was determined in consultation with the Head of the Department, Miss Ethel Martus, and her staff. The teaching program includes dancing, bowling, games, etc. The college, though it has no intercollegiate athletic program, engages in meets with neighboring women's colleges. The building is also used for social functions.

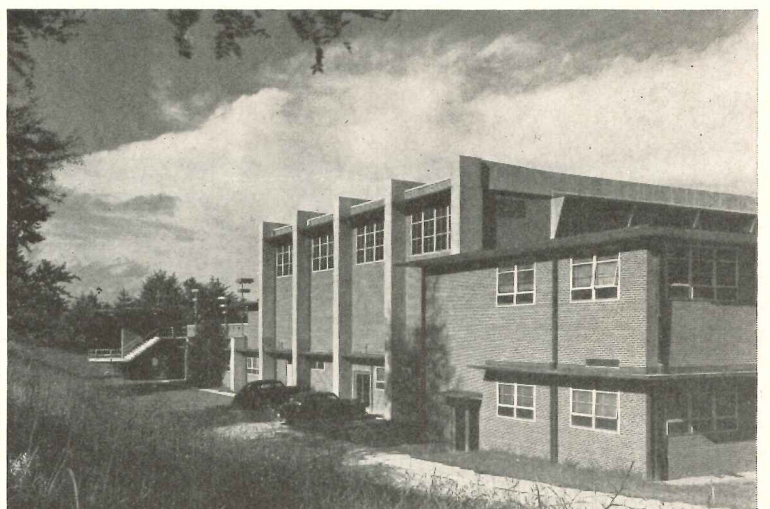
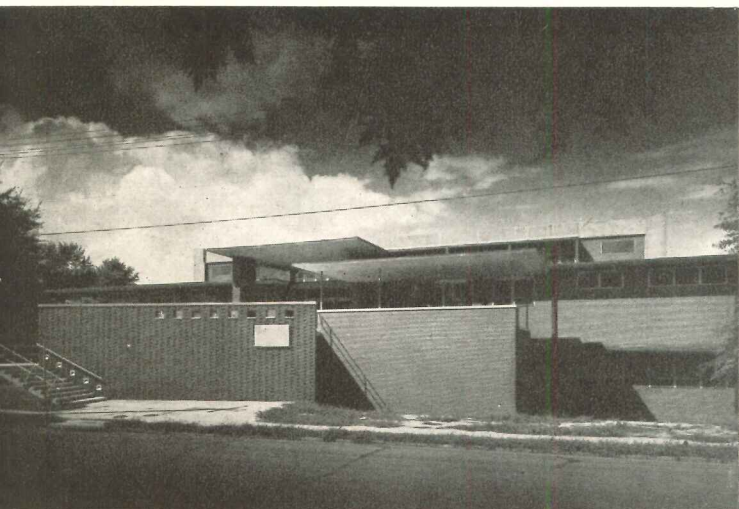

Joseph W. Molitor

*Front entrance (left) is reached via a concrete "bridge." Rigid steel frames spanning gymnasium (right) are exposed to reduce total cubage, covered with Gunitite, blown on*

PRACTICE GOLF RANGE

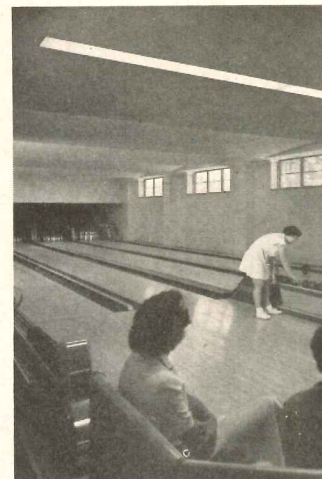
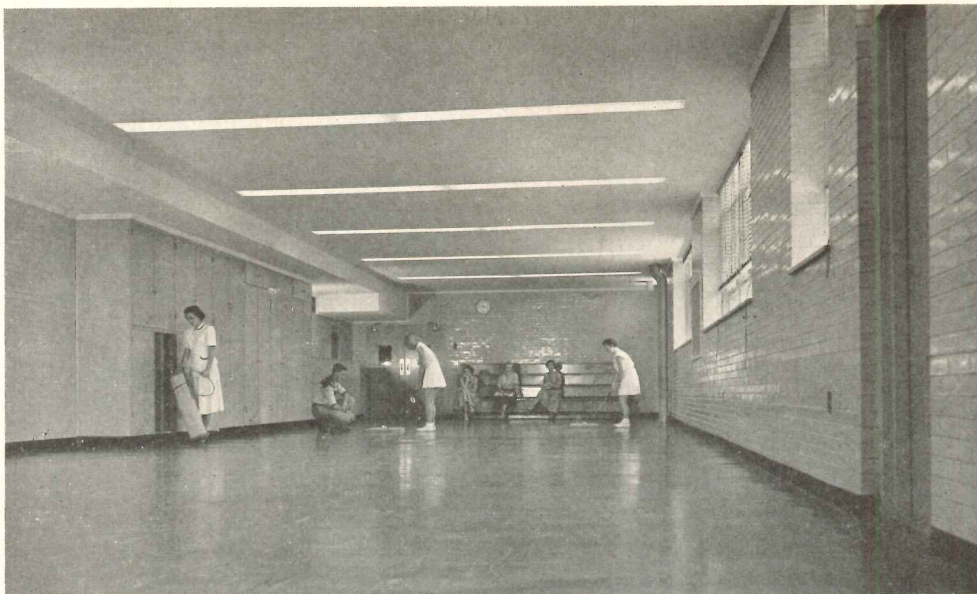

BOWLING ALLEYS

BASKETS, LOCKERS

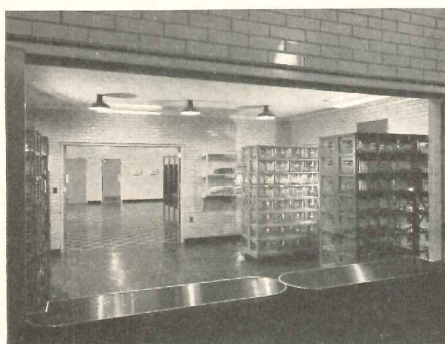

Finish materials were selected for low maintenance. Most interior partitions are glazed brick, with common brick in equipment and service rooms. Toilet partitions and shower stalls are ceiling mounted, fixtures wall mounted

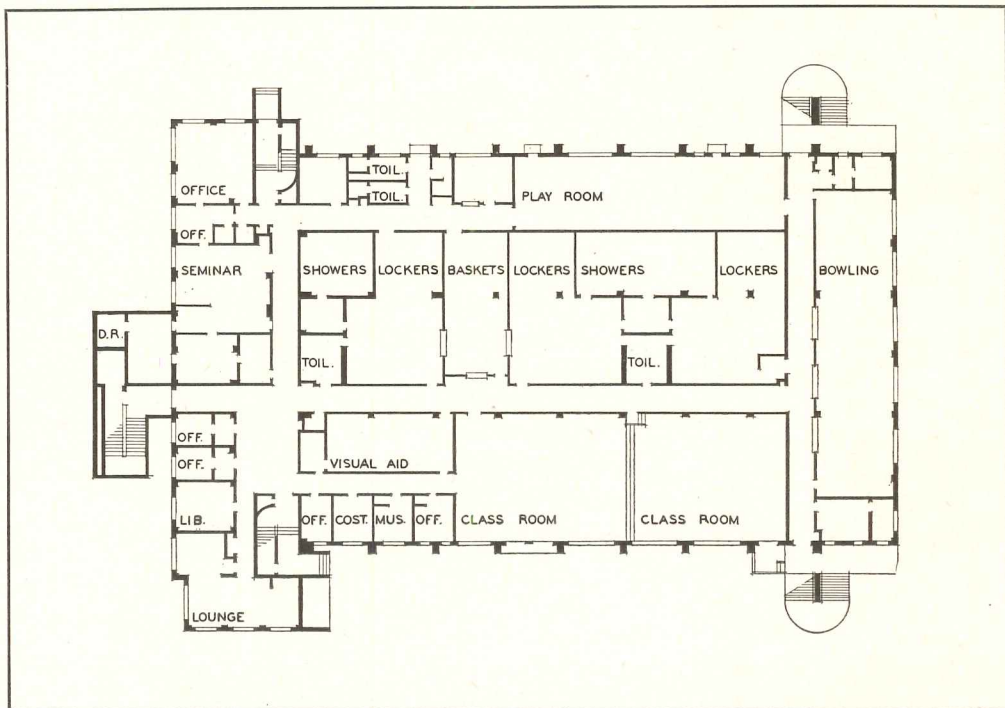

SEMINAR

VISUAL AIDS

DANCE STUDIOS

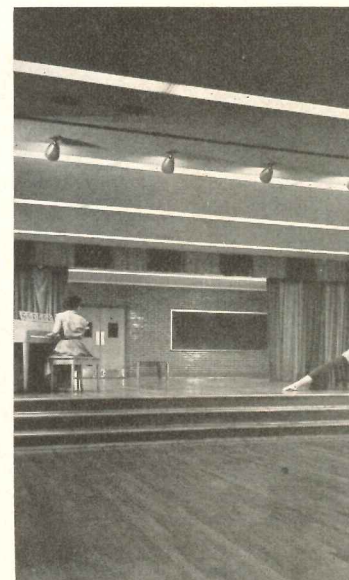
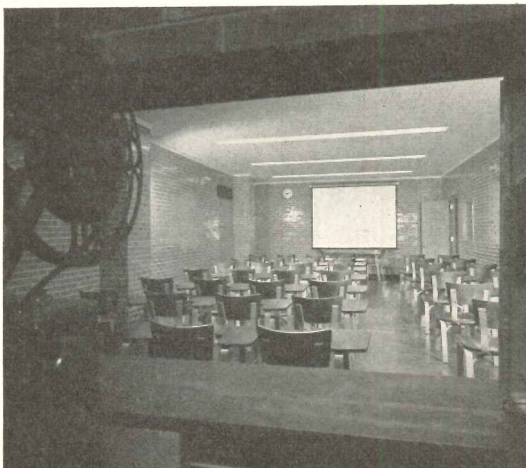
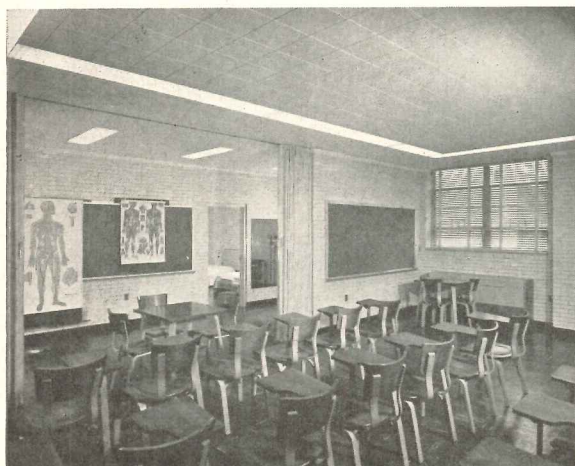





**CORRECTIVE GYMNASIUM**

*Lounges (lower floor) have small kitchens adjacent. Terrace (photo below), used for roller skating, dances, games, has terrazzo floor over a sand cushion, with a membrane-water-proofed concrete slab beneath*

**LOUNGE**

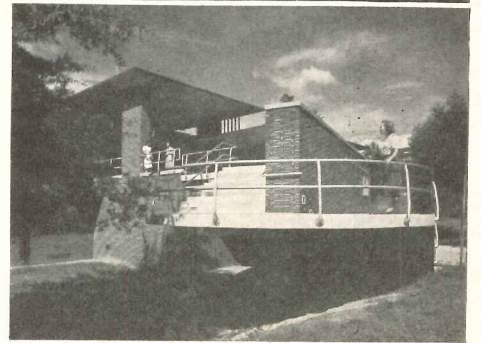

**ROOF TERRACE**

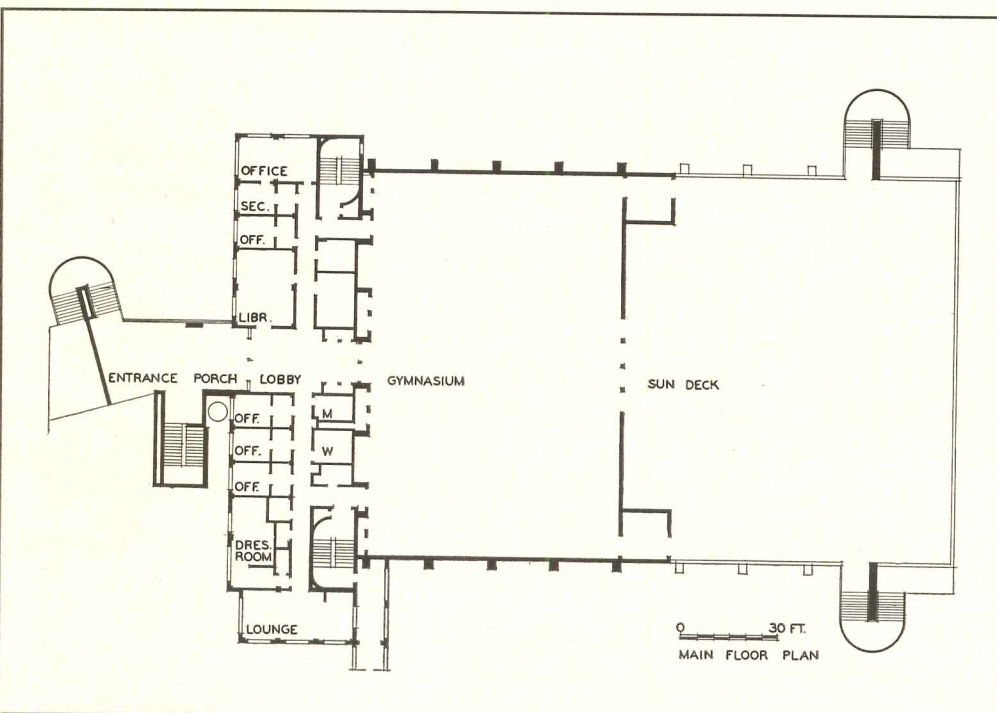

*Gymnasium (main floor) has sound-deadened maple floor, metal pan acoustic ceiling, recessed incandescent lights with tempered glass lenses. Sound system has speakers concealed in ceiling; pan perforations are speaker outlets*



Joseph W. Molitor

**ENTRANCE LOBBY**



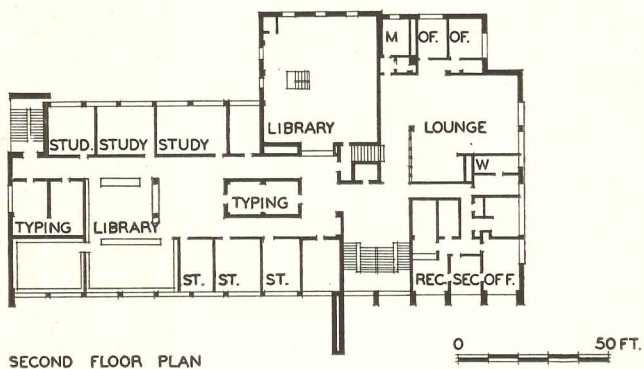
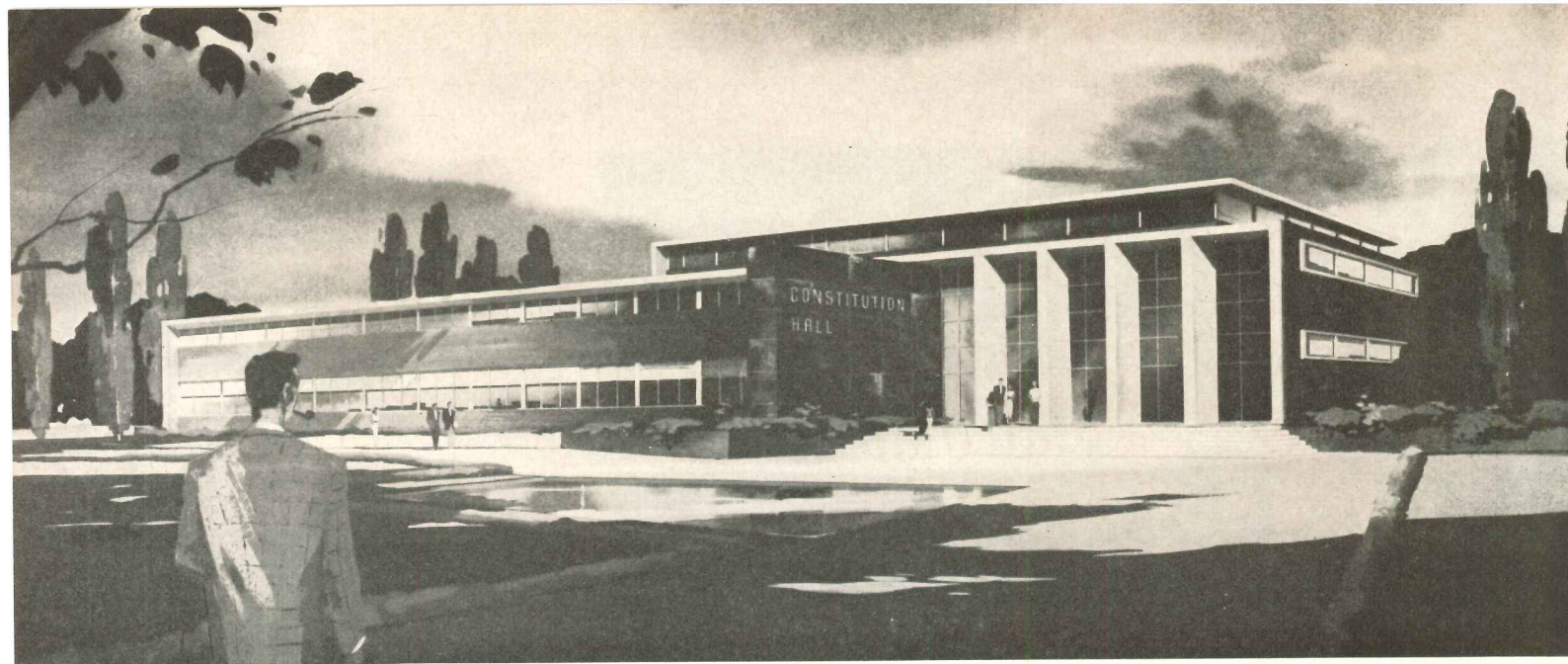

SECOND FLOOR PLAN

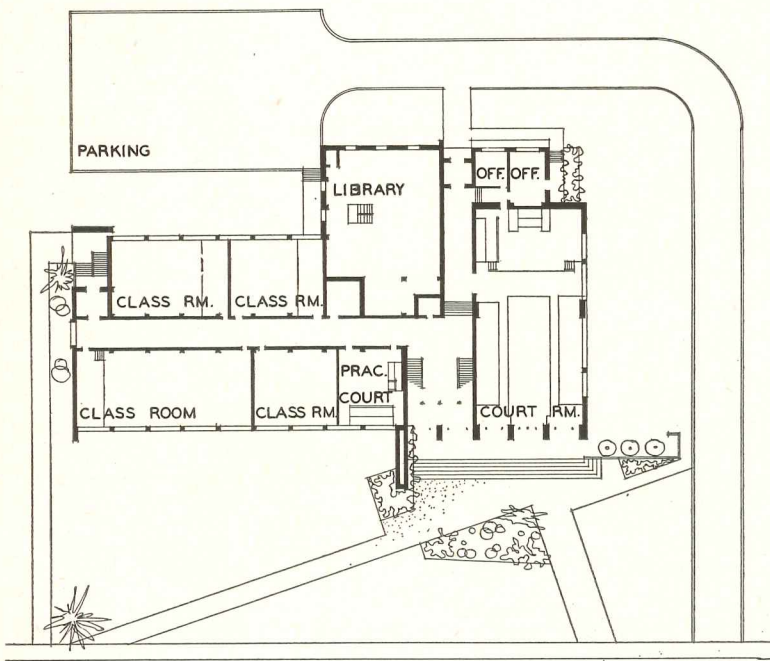

FIRST FLOOR PLAN

## COLLEGE BUILDINGS:

**B**AYLOR, one of the oldest educational institutions in the Southwest, was chartered to the Baptist Church by the Republic of Texas in 1845. As a private, denominational school, it is not expected to reach the size of the average tax-supported college. Its total present enrollment is approximately 5000, of whom about 200 are students in the Law School. The new Law Building is just getting under construction.

No fixed architectural concepts are evident on the Baylor campus; each building is more or less accurately dated by its appearance; many of the buildings were erected in 1870. Recently the values of superficial style and exterior appearance have been — as they continue to be — hotly debated on the campus. This lack of a mold to conform to proved helpful in designing the Law Building, whose exterior is a clear expression of its interior parts.

The familiarly tight budget also affected design by dictating simplicity and virtually prohibiting the monumental use of space. Excluding land, the total cost is expected to fall within \$600,000. In holding to the budget, determining essential requirements, preparing the program and reaching such decisions as settling on a red brick and stone exterior (the colors of adjacent buildings), the architects acknowledge invaluable help from the chairman of the building com-

mittee, Dean A. V. McCall, and other committee members.

The design program was in many respects like that of any professional college or university department, but no clear statement of principles of organization, or of desirable types and sizes of spaces, could be found. Examining the usual source materials provided little inspiration. Visits to other law schools were disappointing. Only after painstaking analysis of the school's actual operation did the pattern of activity, involving research, discussion, recitation, lectures and practice, plus school administration and student activities, become apparent. These were translated into space requirements: library and bookstack area accessible to all the other parts; student lounge, which meets re-

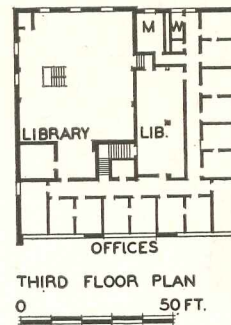

## NEW LAW SCHOOL, BAYLOR UNIVERSITY, WACO, TEX.

*Stanley W. Bliss, Architect*

*Herman A. Kelling, Associate*

quirements of the American Bar Association as a place for free discussion of legal principles and problems; classrooms; a small practice court room; a large (270-seat) court room used also for lectures to the entire student body, as an assembly room, and for some public functions; administrative offices, faculty offices, and offices for student affairs. A legal aid section, initially considered, was later dropped after much discussion.

At many times the entire student body will be in the building at once, in classrooms, practice court or assembly room. Hence these divisions were placed on the first floor, directly accessible from outdoors. The noise incident to changing classes, etc., is thus confined to one area. Most of the second floor is library area, of which much consists of small study rooms to permit concentration and also permit small groups to discuss and study legal subjects without causing disturbance. Two soundproof rooms provide table space for typing close to reference sources. In book-stack areas are carrels for students, faculty and visiting researchers.

Air conditioning was considered essential for the climate. Due to varying loads and seasonal use of parts of the building, the system is zoned. The same water is chilled in summer and heated in winter by a central unit in the basement, then distributed to air treatment units in the various sections of the building.

---

“IT HAS BEEN DISCOVERED,” says an eminent trustee of an eastern college, “that only in the United States . . . have college buildings been designed in any but contemporary style.” In realistic programming and in esthetic conception our college buildings are catching up to both the needs and desires of college students.

---



## UPPER-FLOOR

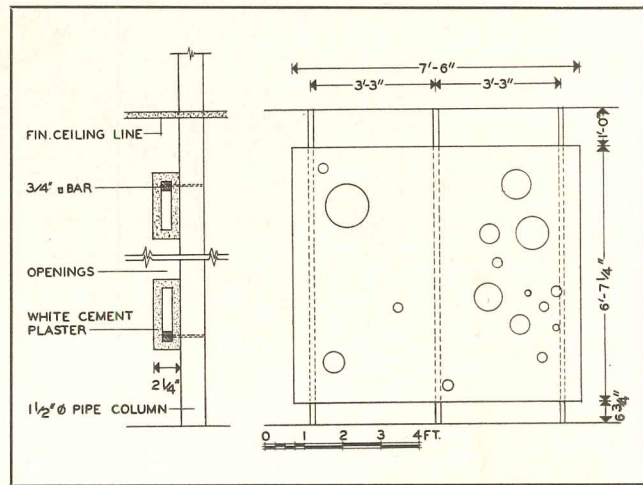

*Offices for the Marquette Cement Company*

*Jackson, Mississippi*

Joseph W. Molitor

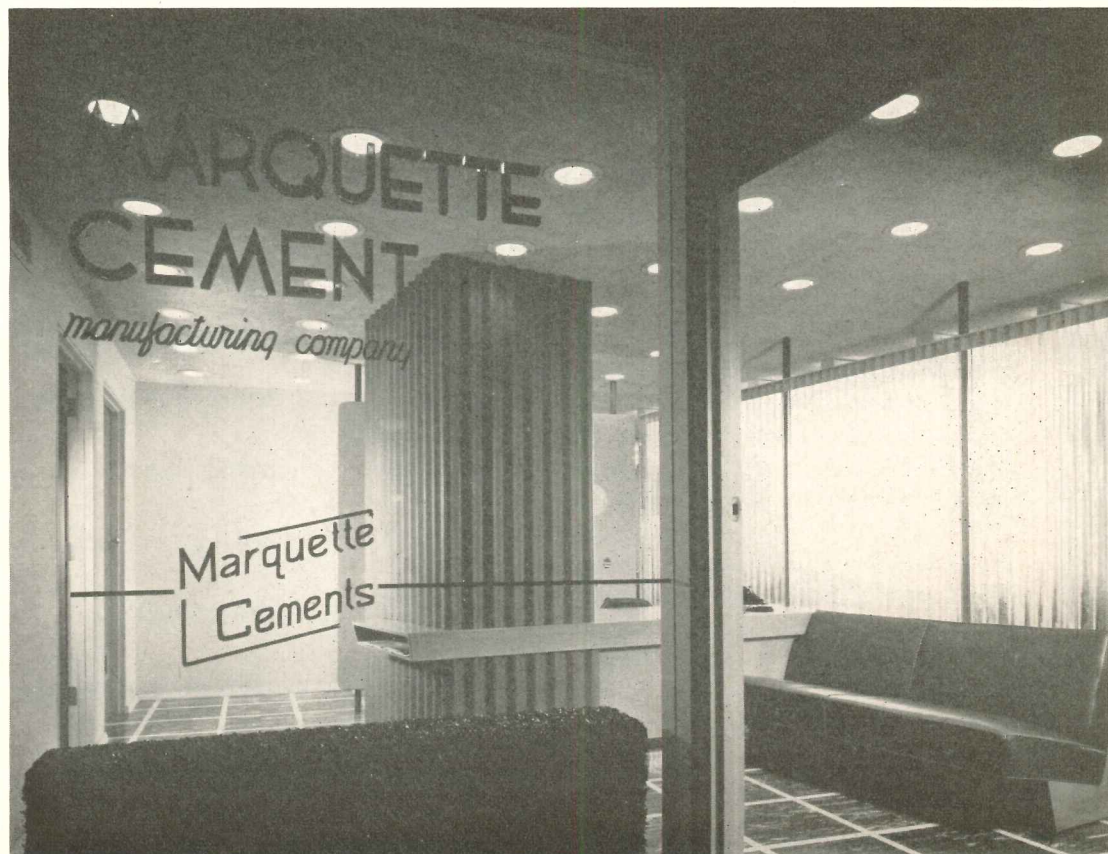

# OFFICE INVITES PUBLIC VIEW

The conversion of approximately 1420 sq ft of typical office building space into the kind of offices the Marquette Company wanted for its Jackson headquarters won the architect a well-earned Award of Merit at last October's convention of the Gulf States Region, A.I.A. The problem was complicated by Marquette's major requirement: the office must attract public attention and be visible in part from the elevator lobby even though the space leased was on an upper floor and at the far end of the public corridor. The area provided, furthermore, was barely adequate to accommodate the required reception room, general office, and three private offices — one of the latter large enough to double as a conference room and to be equipped with a bar for use in client entertaining. *And* — there was a large concrete column, load-bearing and non-removable, in almost the exact center of the rented area.

Since the reception room was the only part of the office which logically could be exposed to public view, its position at the end of the corridor was inevitable. An entrance wall of clear glass extending the full width of the

*James T. Canizaro, Architect — Engineer*

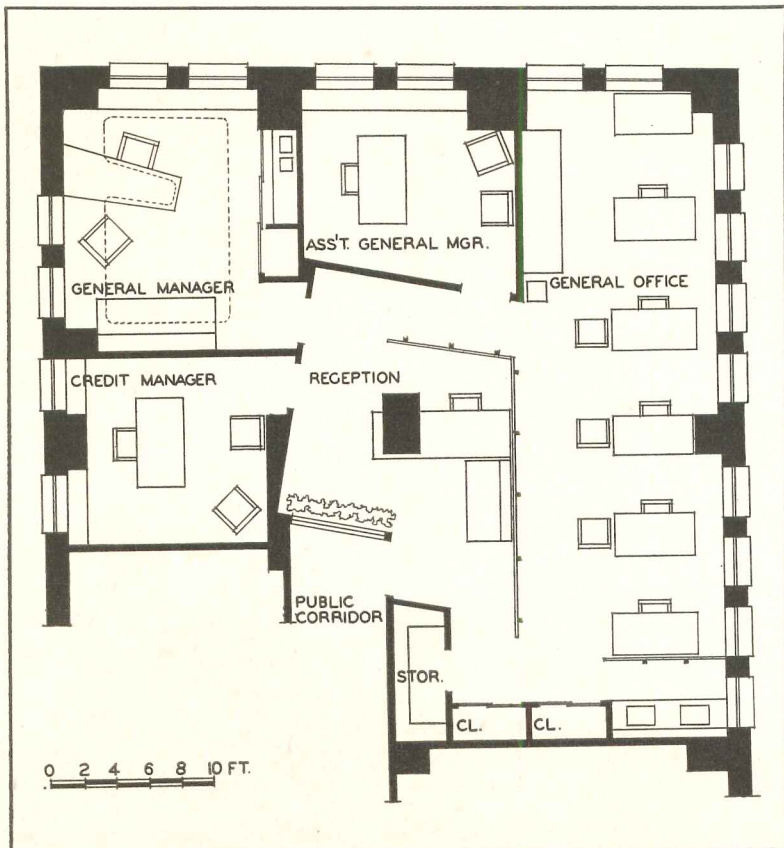
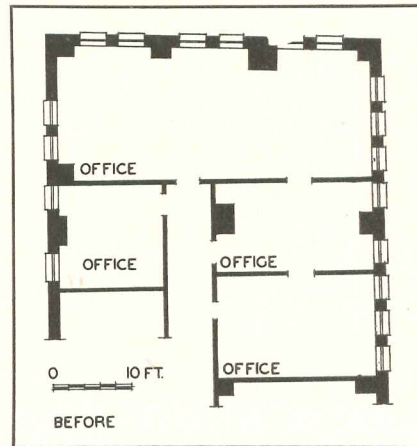

Floors in reception room and general office are covered in green and white rubber tile; walls are light green, ceilings bright yellow. Corrugated cement-asbestos board covering column in reception room is dark green, columns of general office partition are rust-colored, as is reception room couch. Decorative panel of cement plaster (detail opposite) behind desk advertises company's product, increases privacy of executive offices. Desk and couch in reception room were designed by architect, most other furniture selected by him

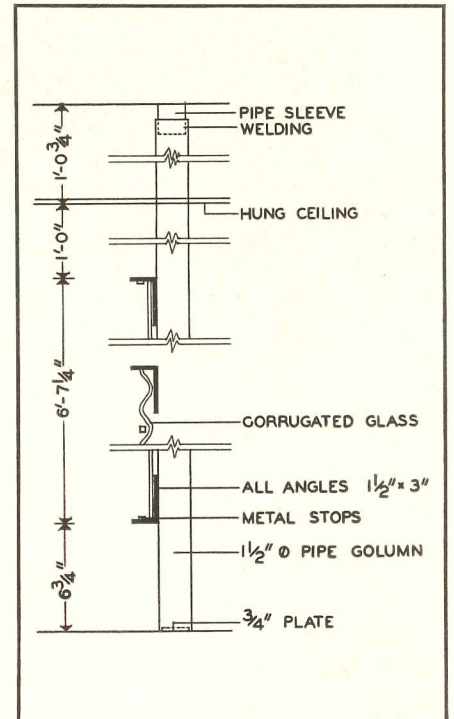

Behind corrugated glass partition at end of general office is a cabinet containing two lavatories and individual storage space for each employee's toilet articles; clothes closets are adjacent

corridor allows roughly half of this area to be seen from the elevator lobby. The receptionist, however, is no goldfish-in-a-bowl; she is protected by the awkwardly placed structural column, now covered with corrugated cement-asbestos board and incorporated into the design of the reception desk. A decorative panel of cement plaster behind the desk advertises the company's product and at the same time increases the privacy of the offices at the rear of the reception area.

Since not one inch of floor space could be wasted, the partitions separating the private offices and the reception room were angled to give each office as much room as possible. The partition between the general office and the reception room is of corrugated glass, with a foot of open space at top and bottom, providing the central area with natural light and ventilation.

# ARCHITECTURAL INTERIORS

Design | Details | Materials | Equipment

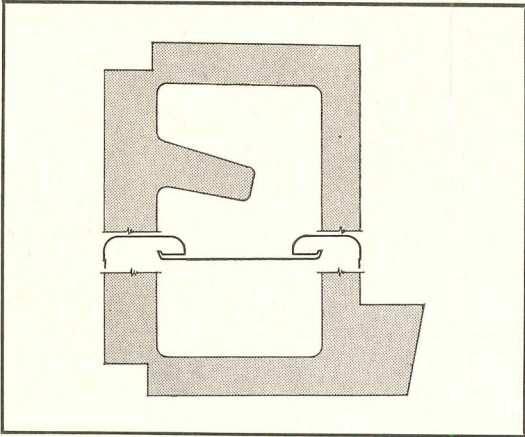

Walls of general manager's office (right and below) are light oak plywood; suspended acoustical plaster ceiling contains light cove, is painted a dark blue-green. Oak desk was designed by architect. Carpet is beige, chairs are upholstered in red. Office has built-in bar complete with refrigerator, sink, work counter, storage cabinets

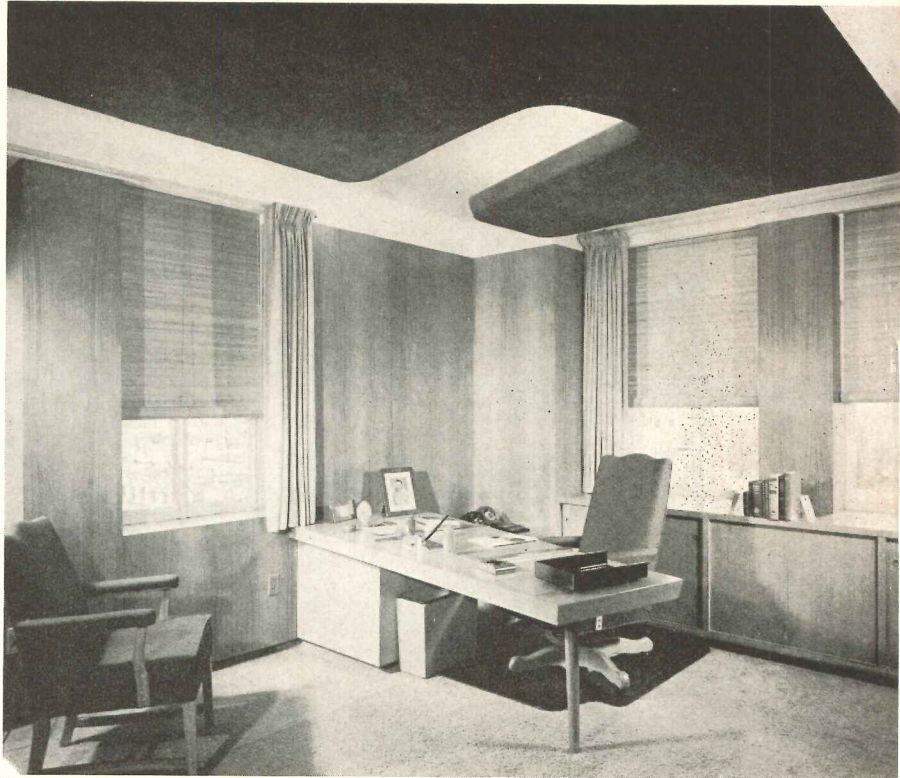

Assistant manager's office (below) and credit manager's office have green and white rubber tile floors, light yellow walls, rust-colored acoustical plaster ceilings. Desks and chairs, selected by architect, are walnut, as are cabinets below windows

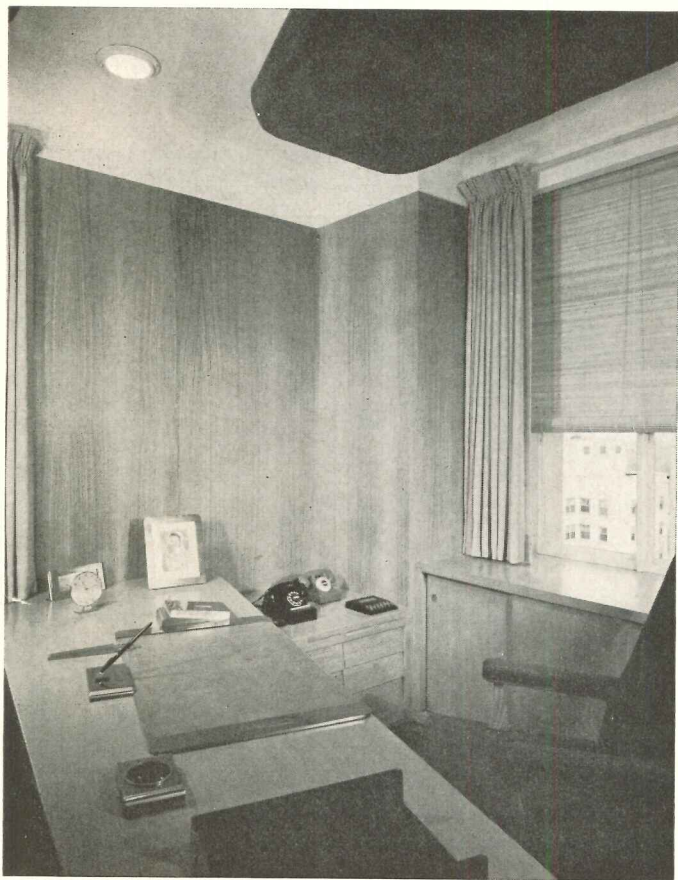

Joseph W. Molitor

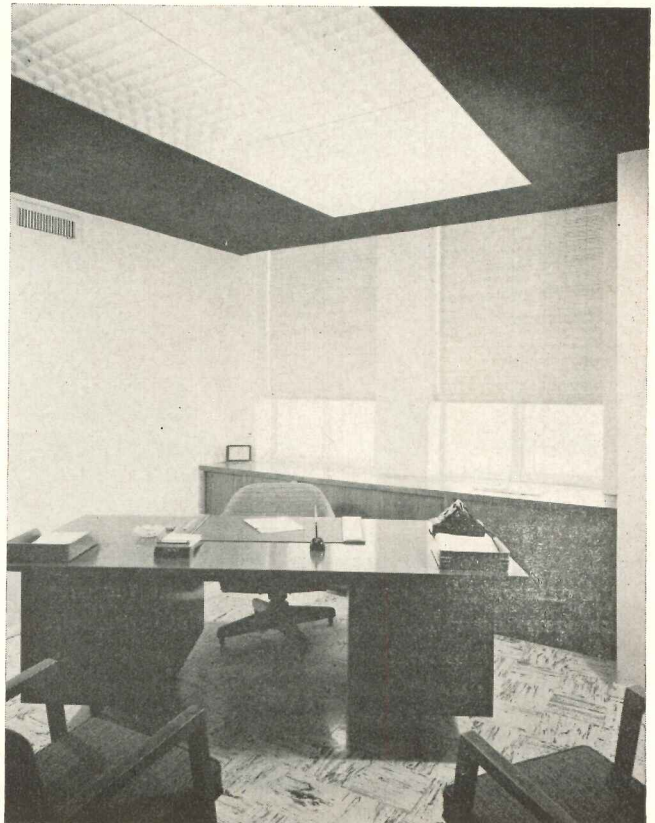

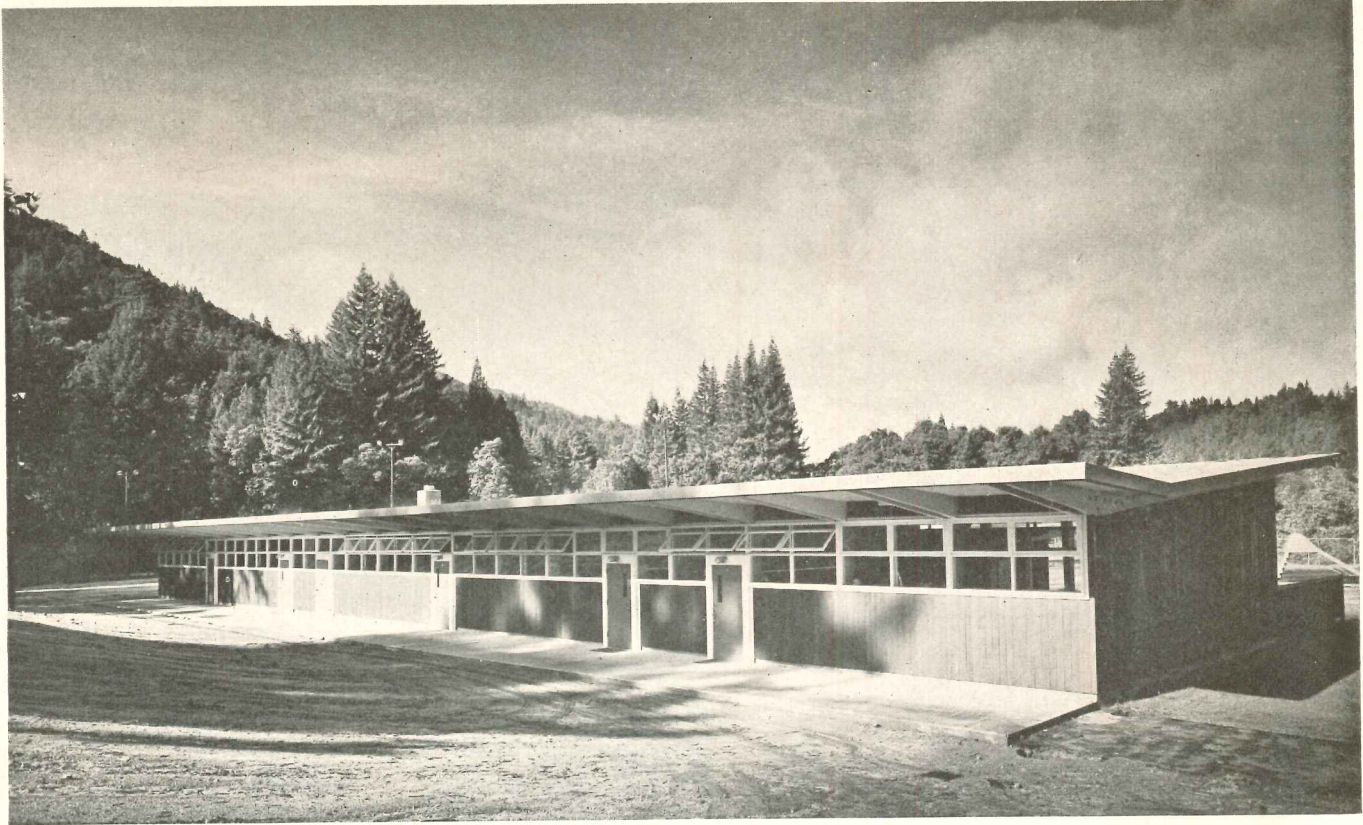

Morley Baer

## SMALL PRIMARY SCHOOL ADDITION

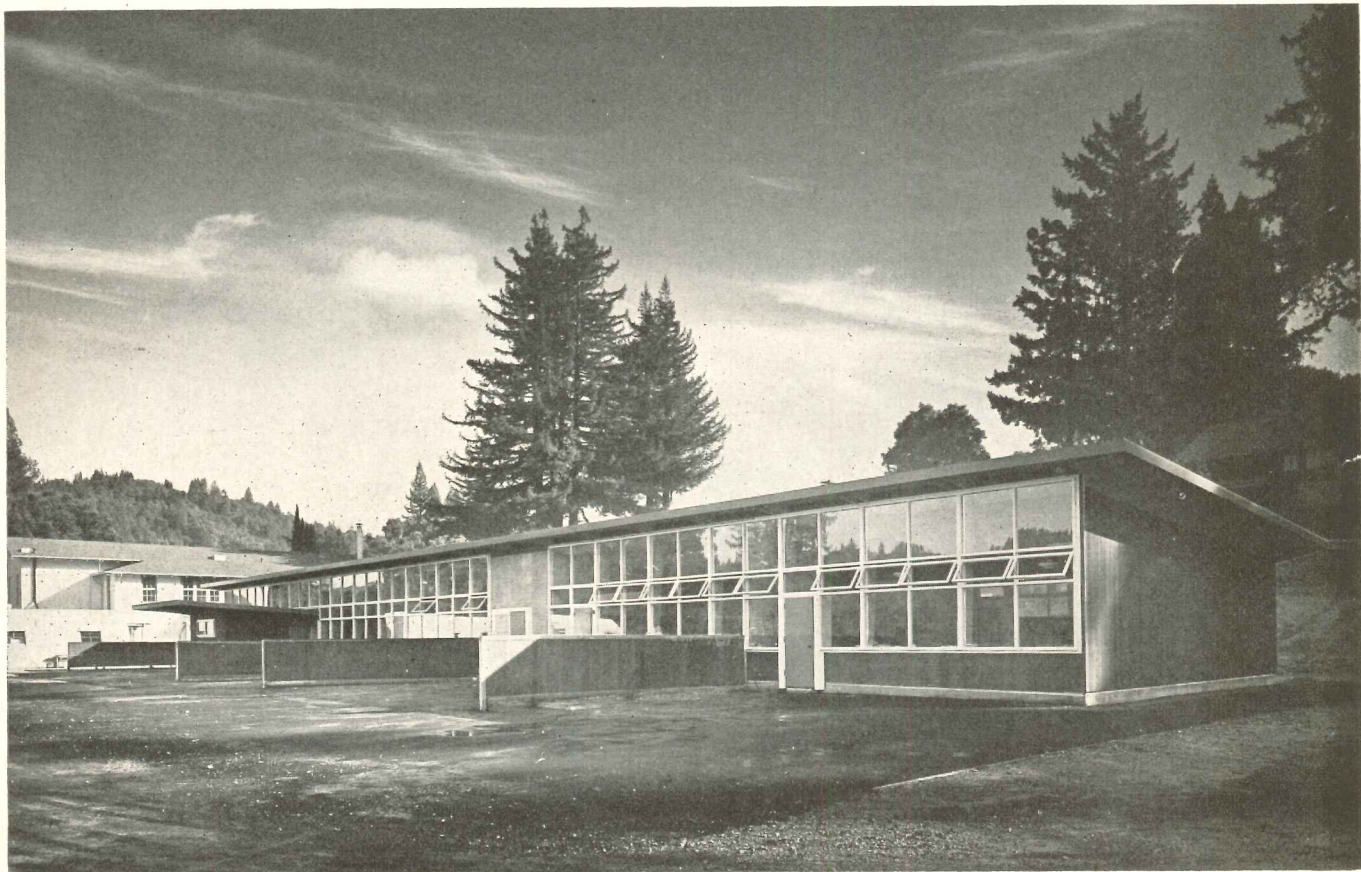



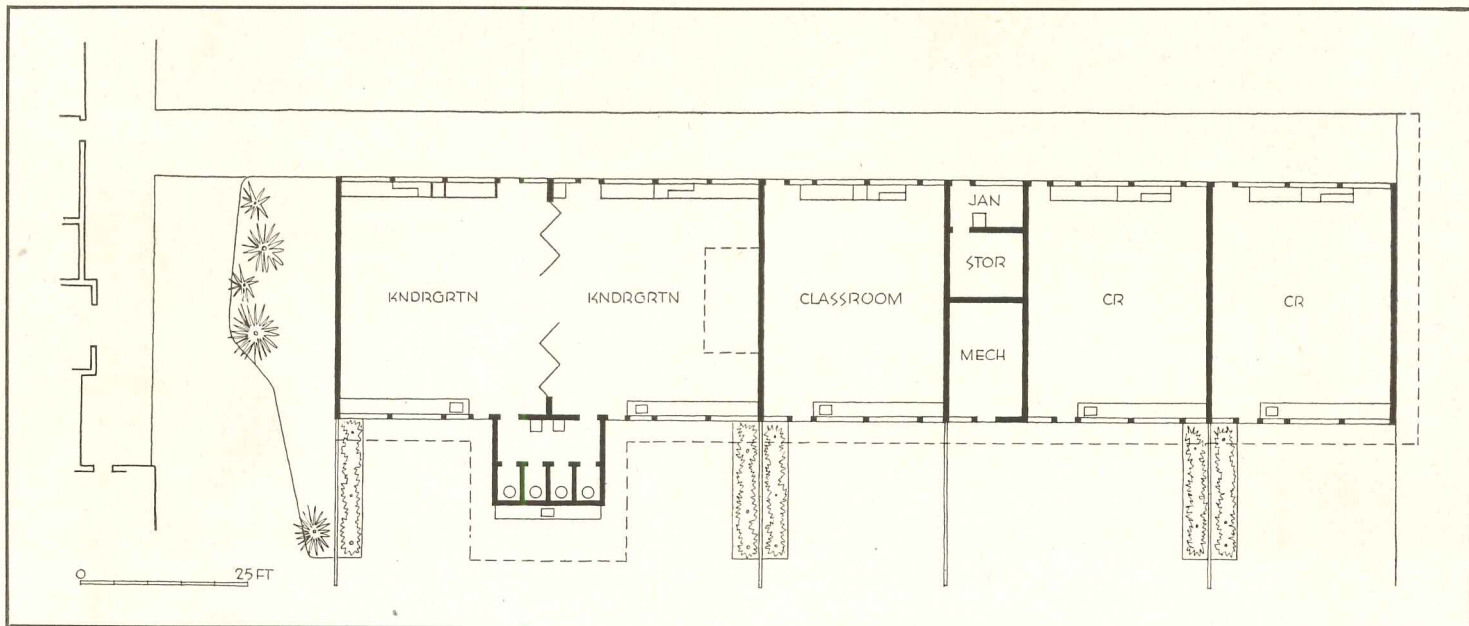
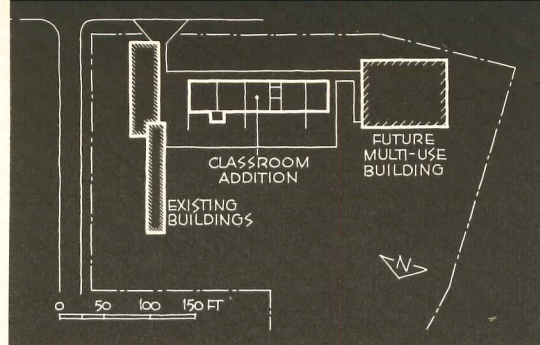

## USES RIGID FRAMES OF WOOD

WHILE this little school building might be analyzed for several different contributions, it seems chiefly notable for a structural system forced upon it by the late steel shortage. The architects set out to emphasize flexibility, for the early program called for this little addition to house only one kindergarten, one primary classroom, administration and multi-purpose room, the latter two spaces to be ready for conversion into classrooms. They wanted to avoid the use of bearing partitions that would be fixed, so steel construction seemed logical. But steel was in doubtful supply. The answer was a system of rigid frames constructed of wood with timber connectors (see details next page). These frames are spaced 8 ft on centers, and straight 2-in. T&G sheathing is applied directly to the frames without joists, forming the roof deck. Diagonal rods carrying the seismic load were installed later in the construction schedule. The frames were erected in a day and a half, after having been cut and assembled on the site. Work crews could then go to work all over the structure.

Actually the school enrollment increased so fast that the full classroom development was made almost before the first contract could be completed, so that right from the start the building developed as in the above plan.

*Elementary School Addition,  
Boulder Creek, California*

*John Lyon Reid, Architect*

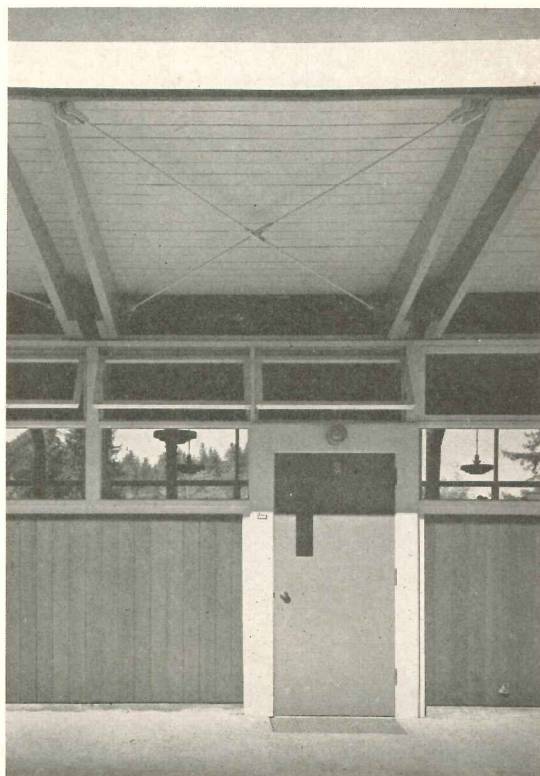

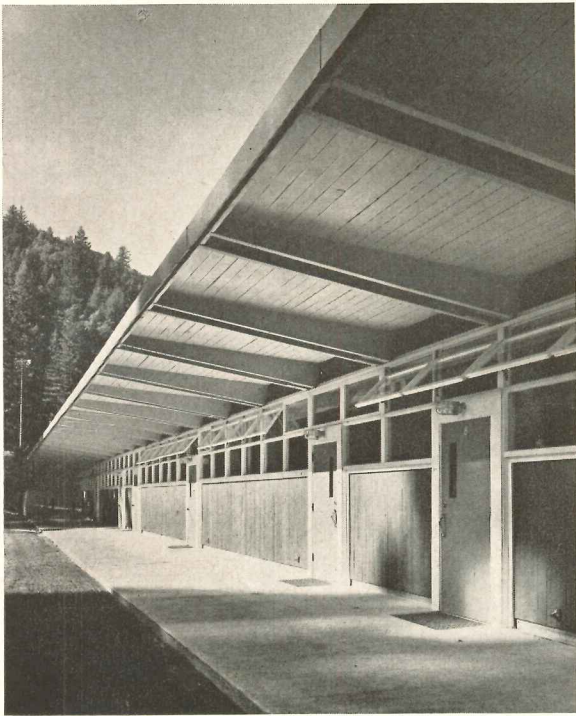

Morley Boer

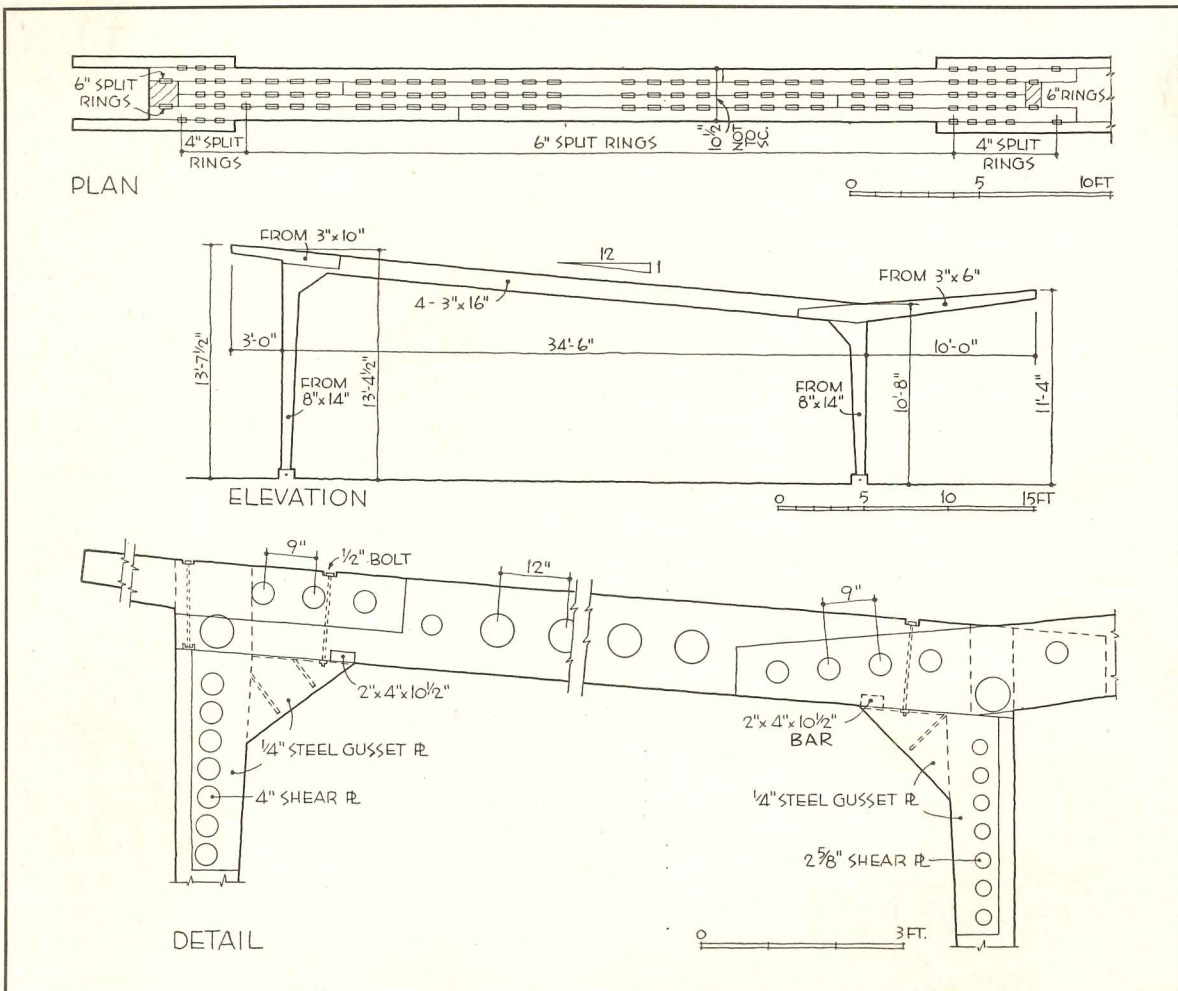
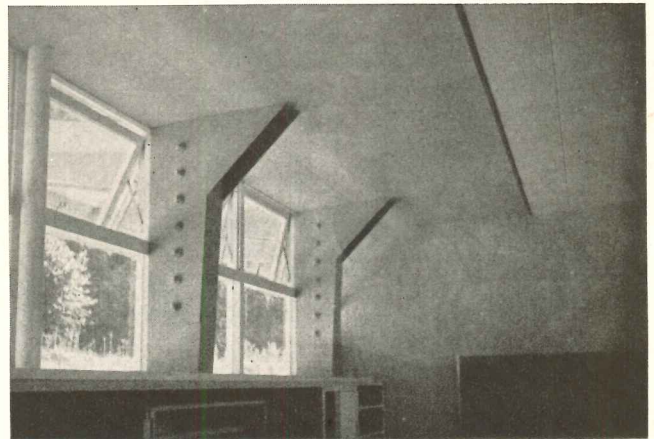
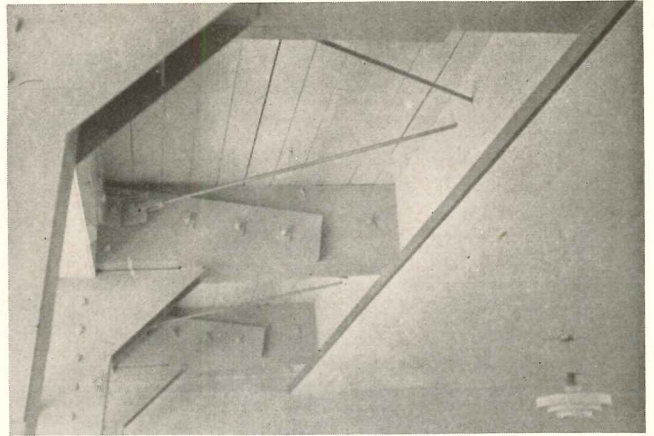

The architects rather felt that the exposed framing, with steel rods for seismic loads, should be left exposed near the window walls, as in the upper view on the opposite page. School officials felt that beyond the acoustic ceiling there was an unfinished look, and voted an additional \$1200 to enclose the framing with plywood, as in lower view opposite

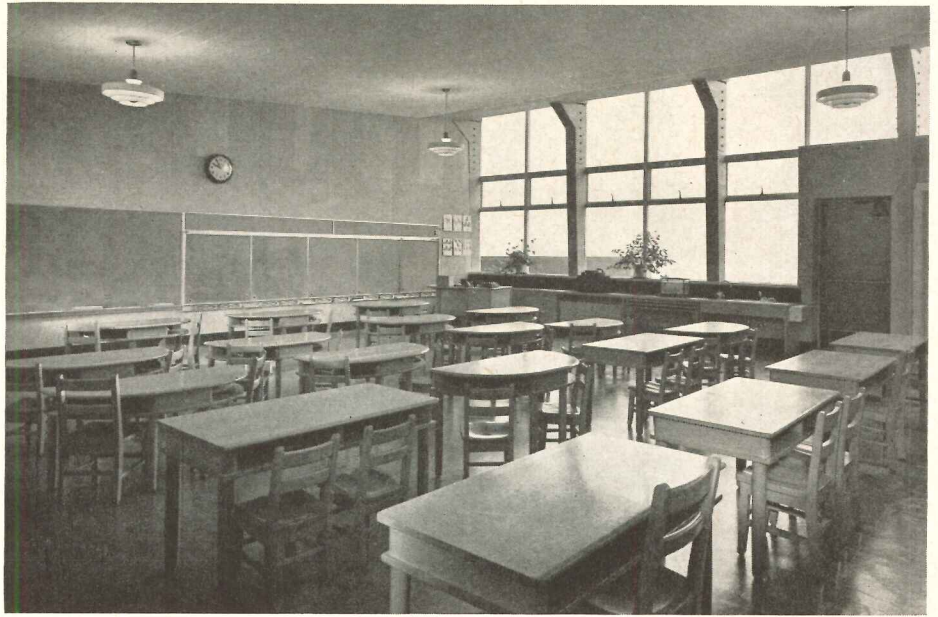

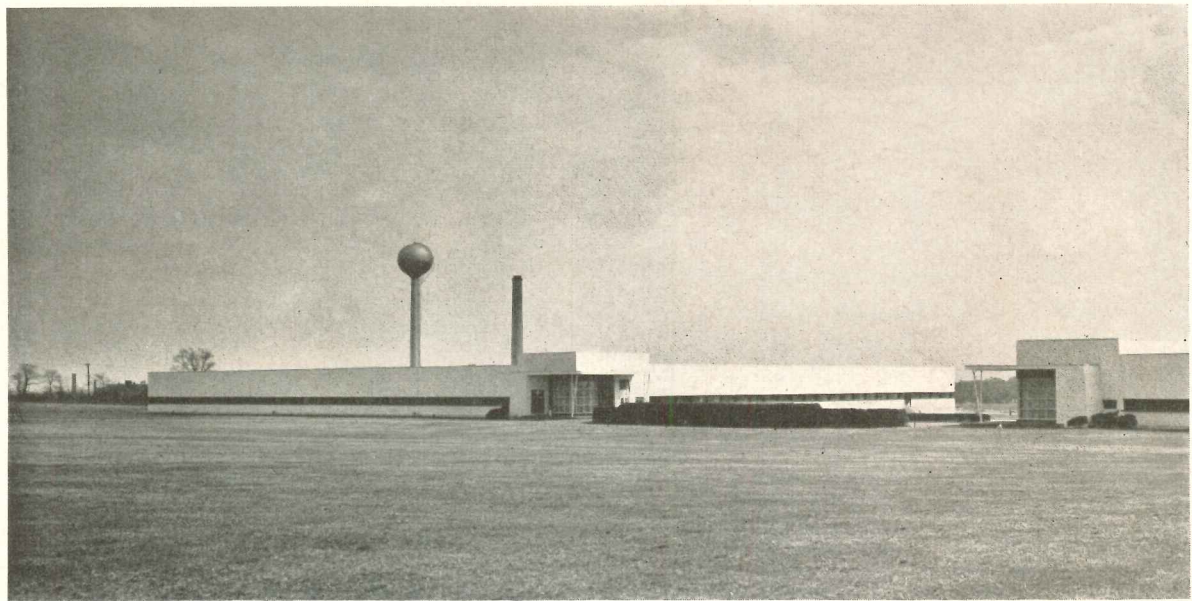

Ben Schnoll

## TWIN LABORATORY AND MANUFACTURING BUILDINGS

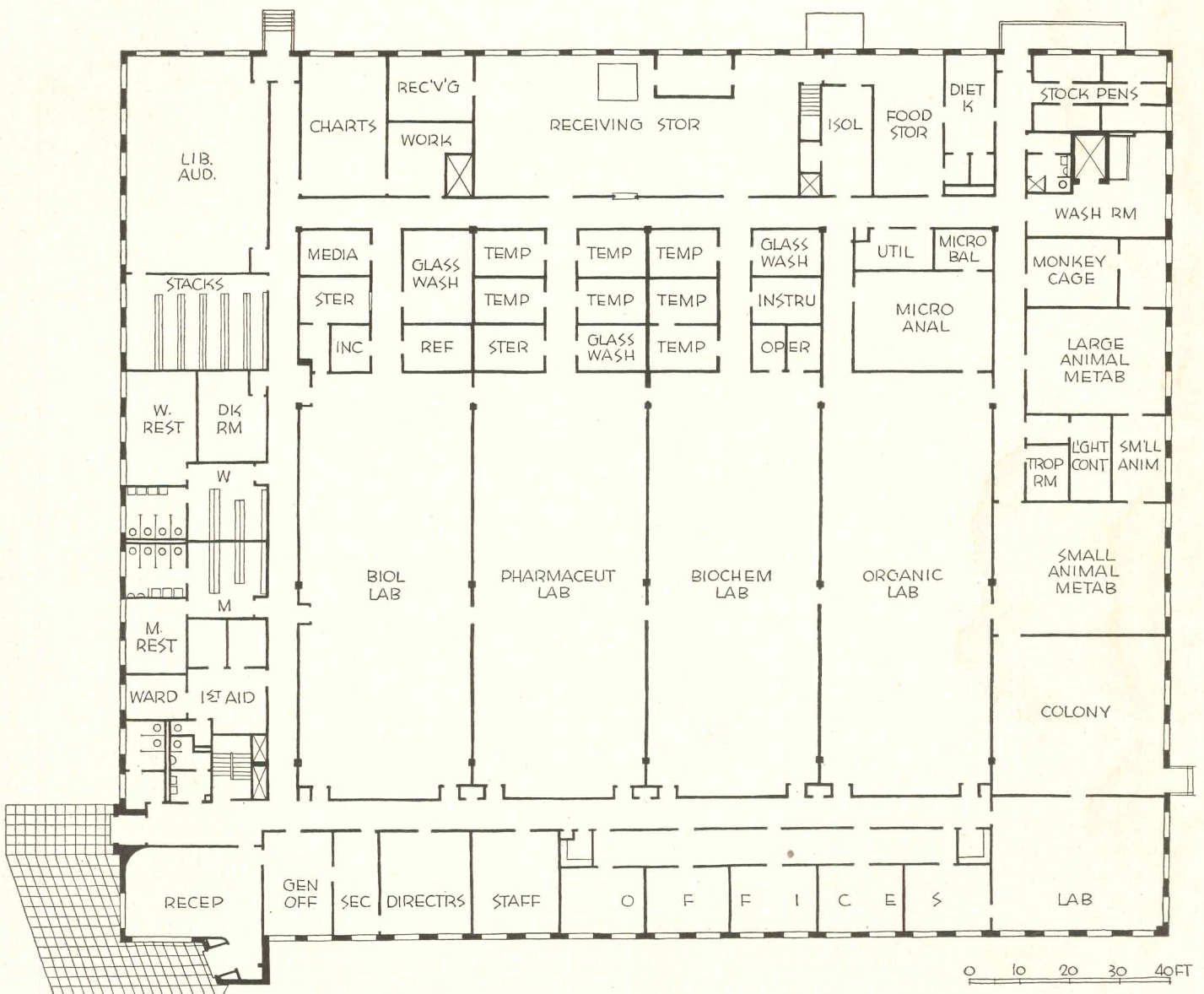

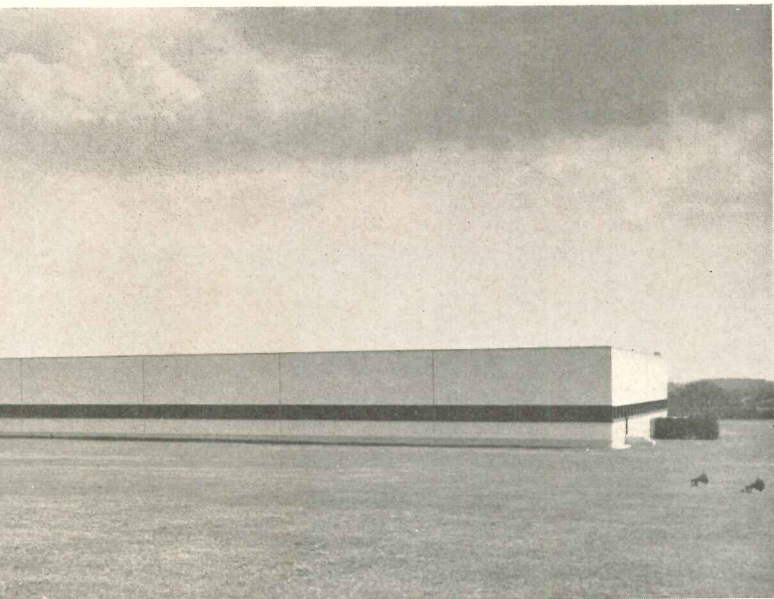

**Concept of an industrial plant:  
remote location; lawns and land-  
scaping; functional facilities for  
both research and manufacturing**

## FOR ORTHO PHARMACEUTICALS

*Ortho Pharmaceutical Corporation, Raritan, N. J.*

*Shreve, Lamb & Harmon Associates, Architects*

*Eadie, Freund & Campbell, Mechanical Engineers*

*Peter A. Strobel, Structural Engineer*

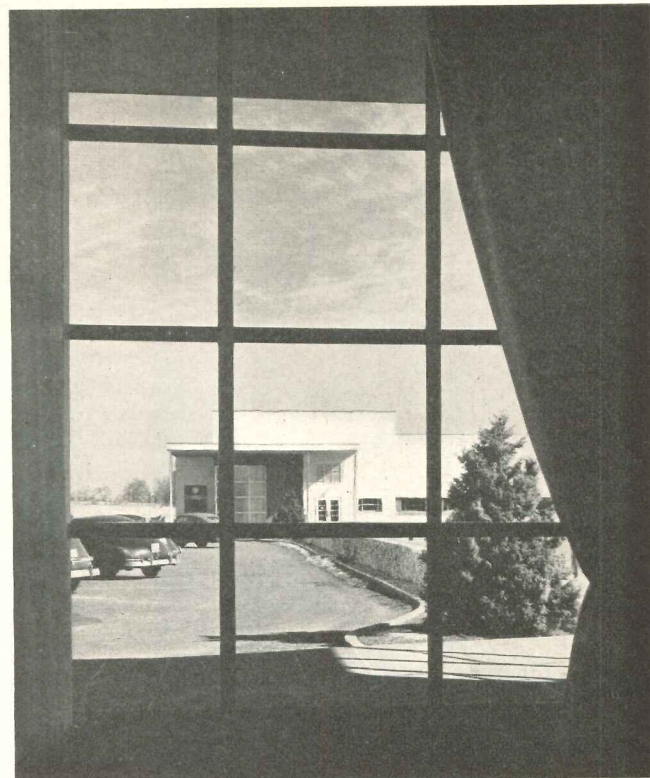

Molitor

**W**HILE the two buildings shown in the photograph might be quickly described as "clean," these twins actually tell an interesting story of modern industrial thinking. One point is the remoteness of the plant from the usual industrial congestion, made possible by the small bulk of the medical products and the development of good truck transportation. As far as the worker is concerned, remoteness is an asset; easy driving and plenty of parking are preferable to any forms of transportation associated with the city. There is also the morale factor of being able to work in pleasant country surroundings, with open lawns to brighten his outlook and dignify his work. These amenities are protected by the extent of the site, which itself is made feasible by the low land cost. The plant has a substantial frontage on a railroad, permitting future installation of a spur.

The two buildings are apparent twins, though one is a manufacturing plant and the other a laboratory, the scientific aspects of this business being comparable, space wise, to the processes of manufacturing. The buildings are connected by a tunnel for service lines,

the paved top of which was intended to serve as the floor of a future connecting passage. Separate reception rooms and offices are provided in each building. The research building has a supported first floor throughout, part of the area below being used for mechanical equipment and storage, part for a crawl space 6 ft high for service lines. The manufacturing and administration building is constructed with its floor slabs on fill, except for a small basement for mechanical equipment.

Exterior walls of both buildings are of cinder concrete block with 1 in. of cement stucco on outside surfaces. At column centerlines, 35 ft on center, walls have control joints with sheet metal bellows covered on the exterior face with snap-on stainless steel strips. Window spacing and size were largely determined by the client; windows are not depended upon for illumination. All bulkheads, fans, and so forth on the roof were kept low as possible, to make them invisible from the road approach to the building, as an important consideration in this company's thinking is the very practical institutional values in architecturally "clean" appearance.

Walk between buildings is paved top of service tunnel, can be roofed over for enclosed passage if desired. Each building has reception room and row of offices along north side. Parking space is between buildings, and is screened from the road by shrubbery. Extensive lawns are considered a "must"

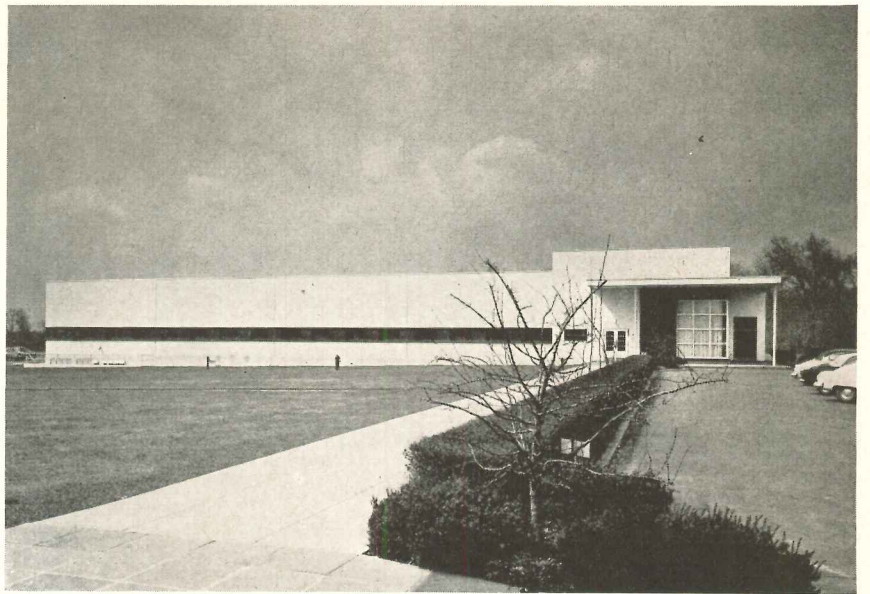

Long masonry walls gave some concern over movement, especially with high parapet walls. Back of parapets have an enlarged cant to equalize temperatures in attic space and behind parapets to minimize cracking at joints. Built-up roof is designed to carry a 2-in. covering of water for insulations

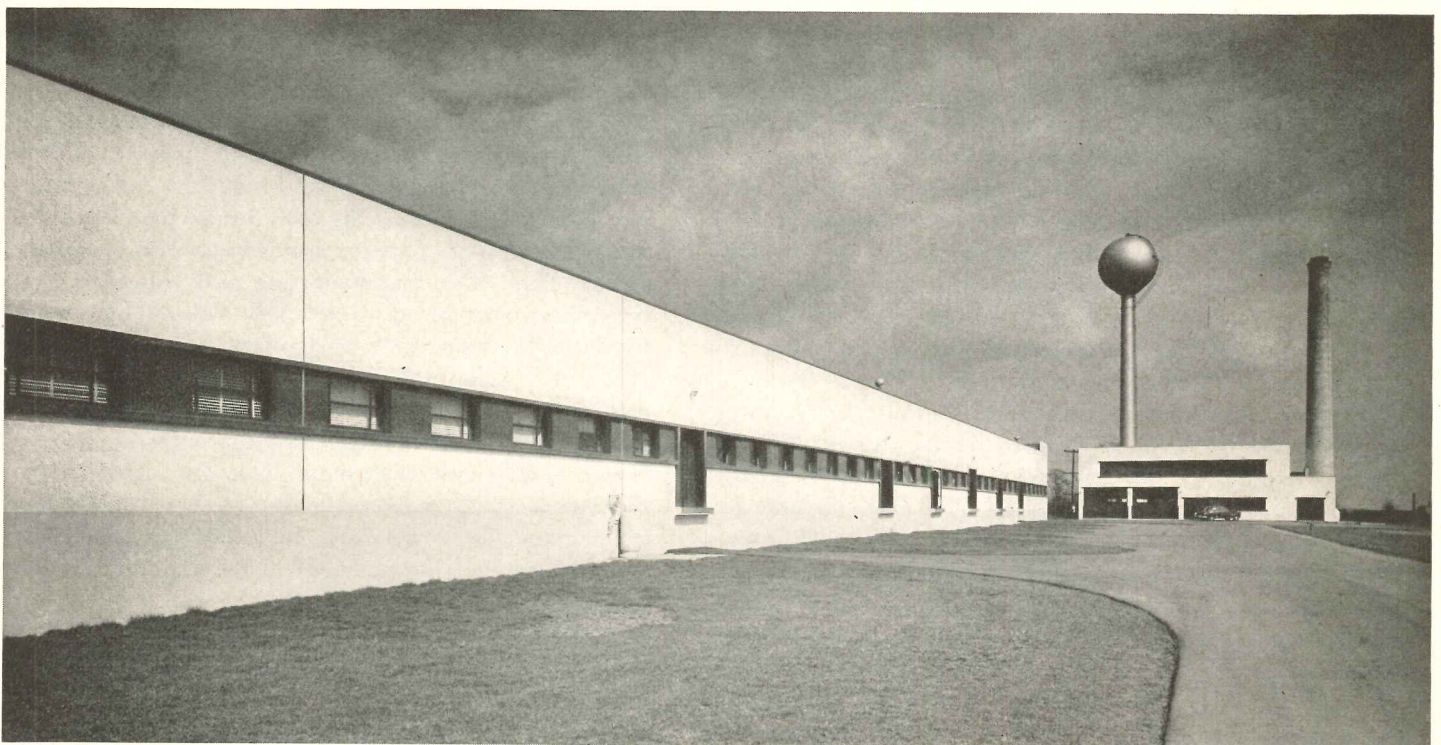



Molitor

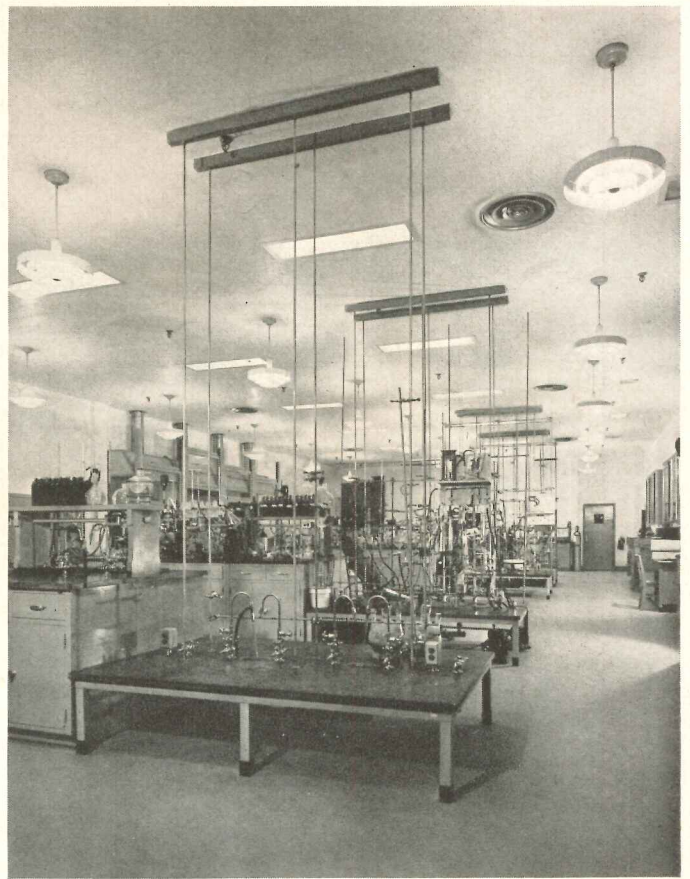

Laboratories are all inside rooms, and are quite large. The owner prefers large open laboratories to small cubicles, to encourage close cooperation of research workers. Service piping runs in trunk lines in crawl space, with connections on a module of 11 ft 8 in. corresponding to table spacing



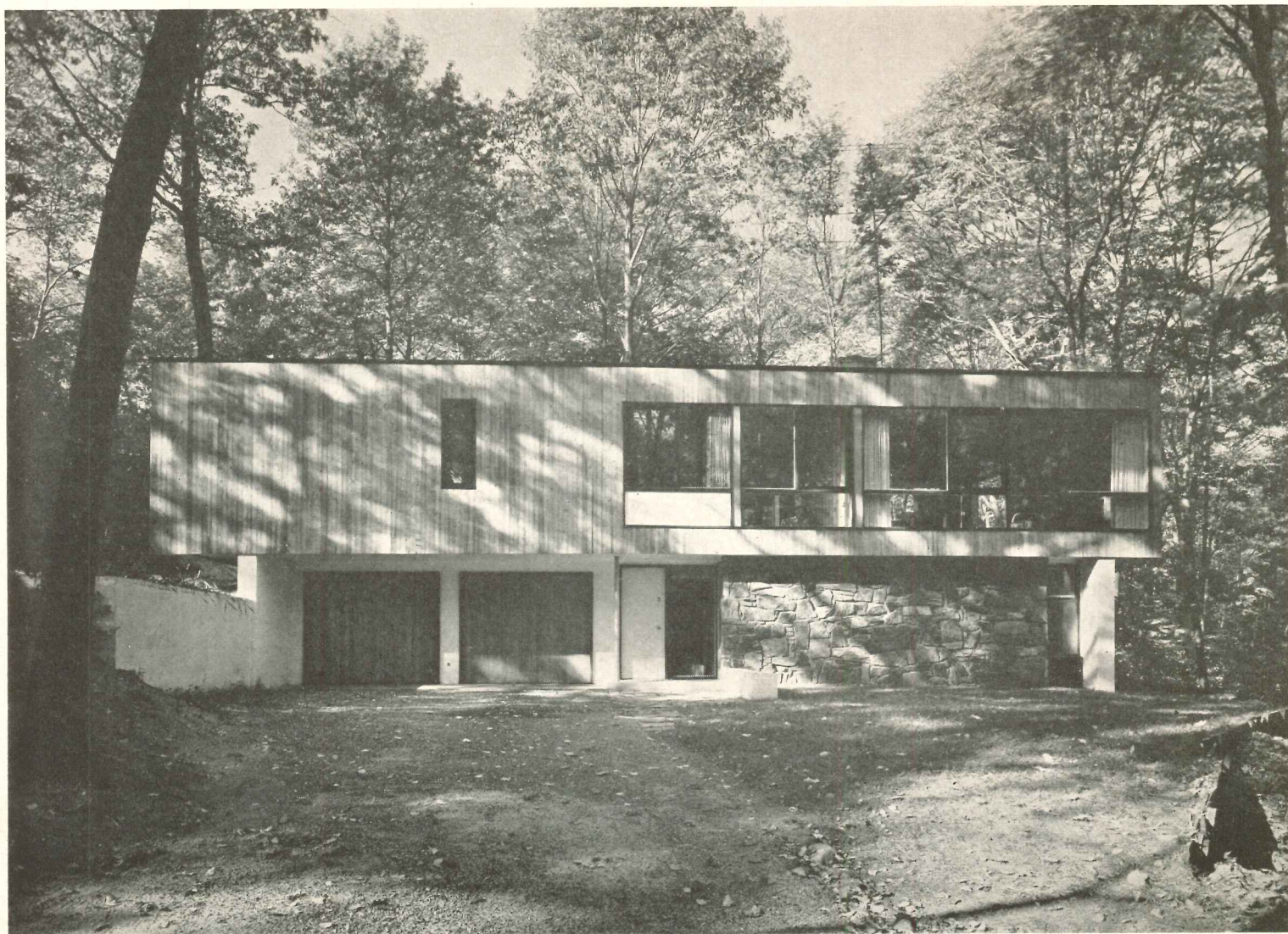

## RAISED BASEMENT EXPANDS HILLSIDE HOUSE

*Residence of William Wallace Landsberg, Architect  
Port Washington, Long Island, New York*

FOR HIS OWN HOUSE on Long Island, William Landsberg has added several new twists to ways of gaining more real and illusionary space from a compact plan, and at relatively low cost. The hillside site was used to considerable advantage. The "basement" area was only partially set into the slope, reducing excavation costs, and providing extra usable space at ground level. This area contains a studio which can be converted into a spare bedroom and bath, storage space, a large reception hall, and an economical and convenient arrangement for the garage. The basement has, in effect, only three

foundation walls, of concrete block; the fourth consists of openings and a stone veneer panel. The wood frame structure of the upper floor is cantilevered out from the ground floor, and gives protection to the openings. Fairly standard techniques were used to increase the apparent size of the living space: large, carefully placed glass areas, open planning and direct access to a terrace and ground level at the rear. Costs were reduced, however, by using exposed studs as a screen partition, gang-ing utilities, and dividing glass areas into smaller simply-framed units.



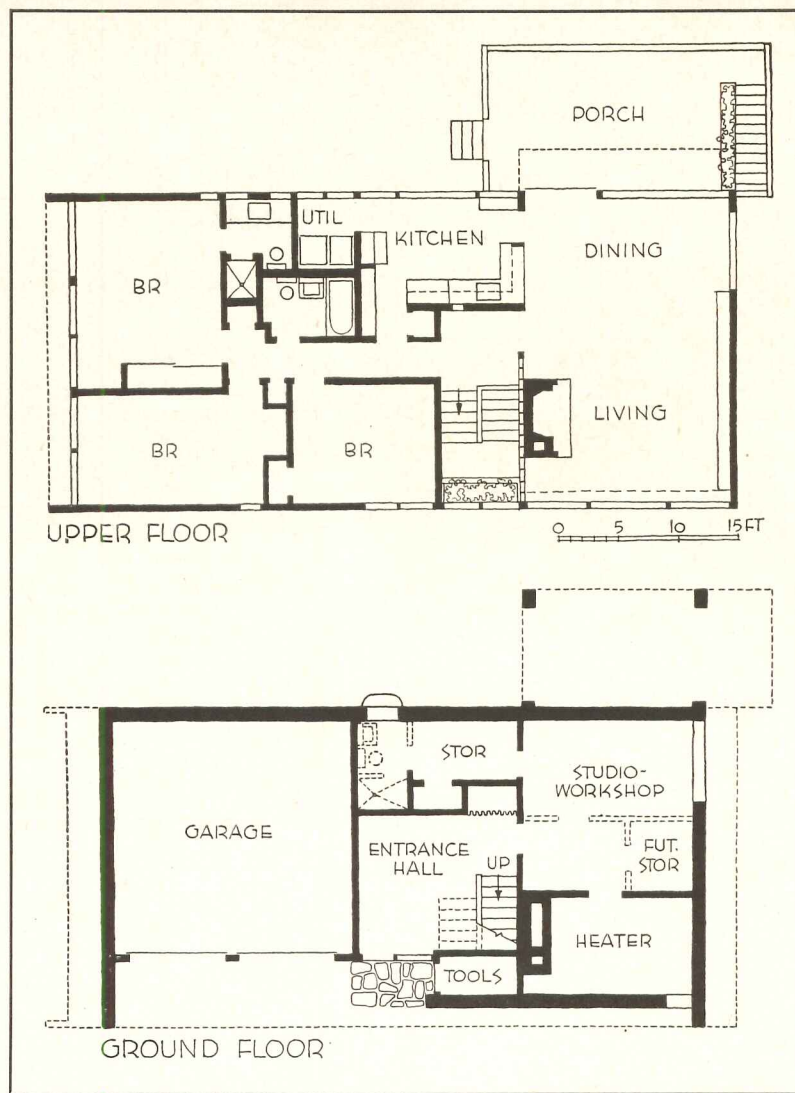

*Very good circulation and convenience for a servantless household are provided for in the plan. The kitchen is placed for easy access to both indoor areas and the porch; overlooks play yard at back*

Joseph W. Molitor

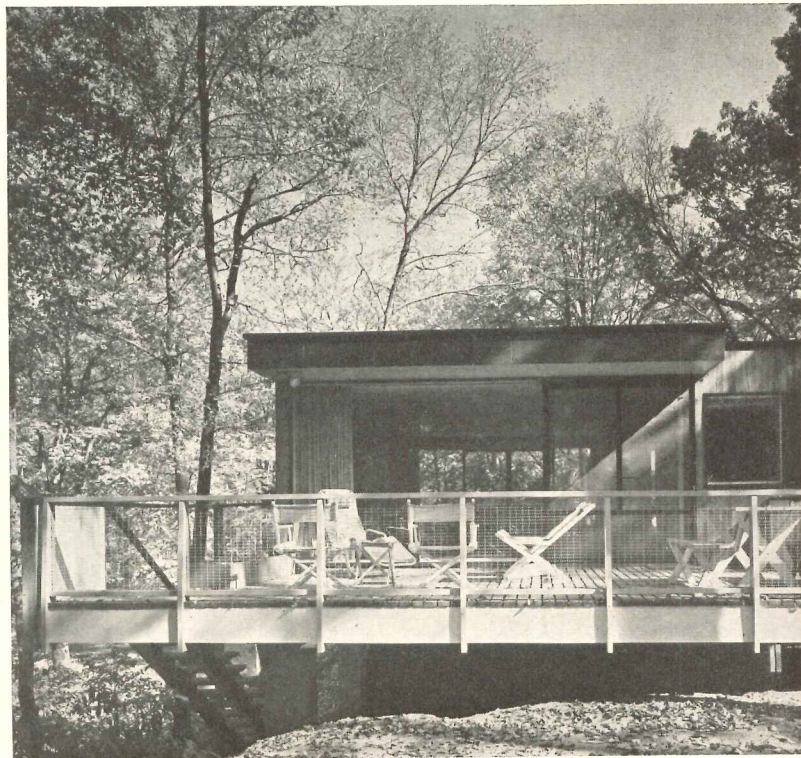

LANDSBERG HOUSE

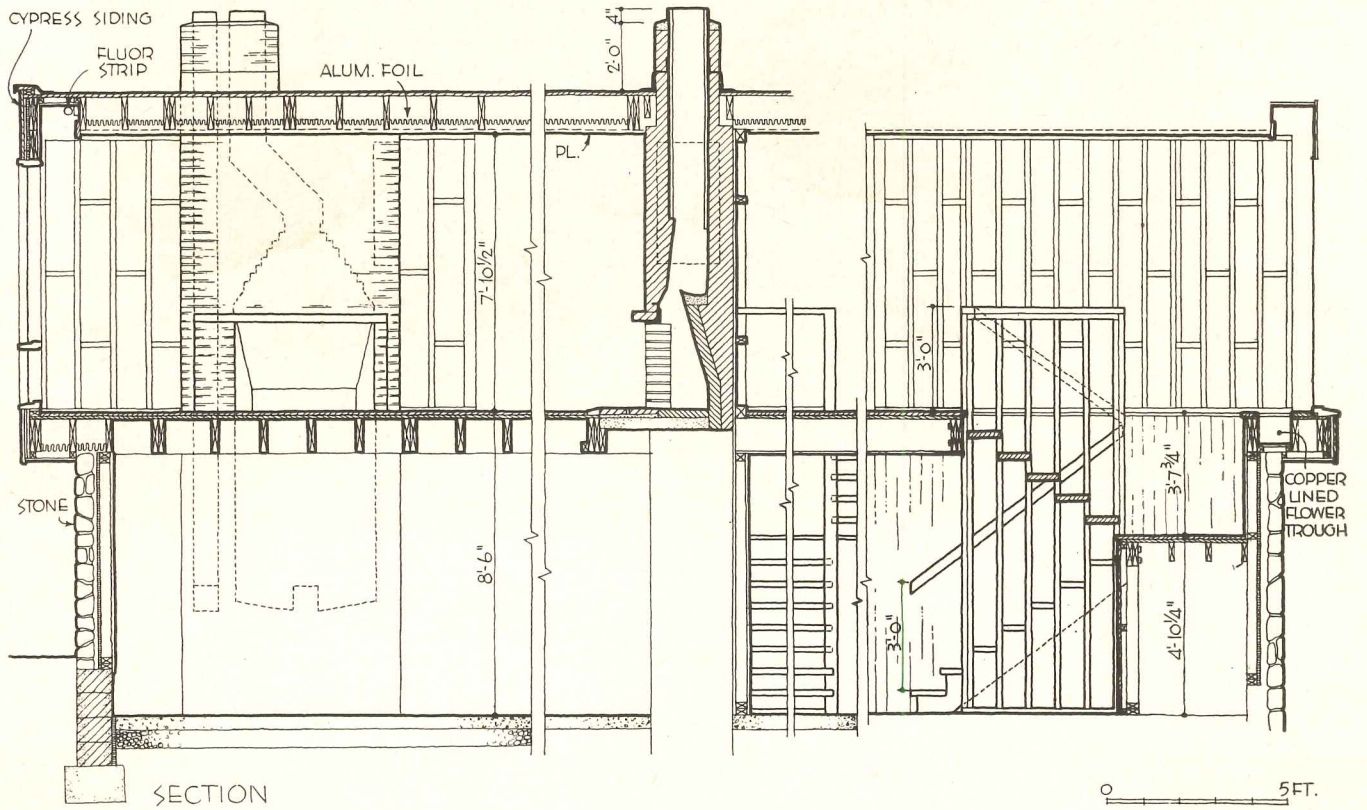

The entrance stair hall (right) gives an unexpected sense of space as the intermediate landing is reached. Sections above show details of stairs, fireplace and the exposed stud partition



The quantity of large trees reduced the problem of orientation (south and east elevations shown above). The exterior has cypress siding, asbestos cement board below bedroom windows, copper coping. Most rooms have cross ventilation



Joseph W. Molitor

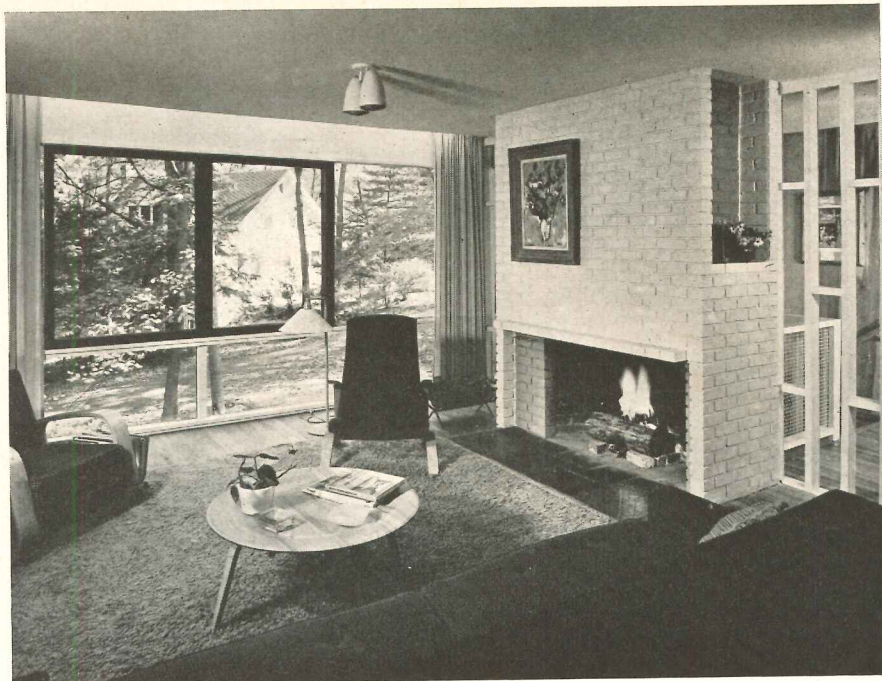

*Raised living room gives some privacy from entrance drive, excellent views. The house has radiant heat in ceilings of upper level, floors of lower level; basement floor is 4-in. concrete slab on 6 in. of gravel*

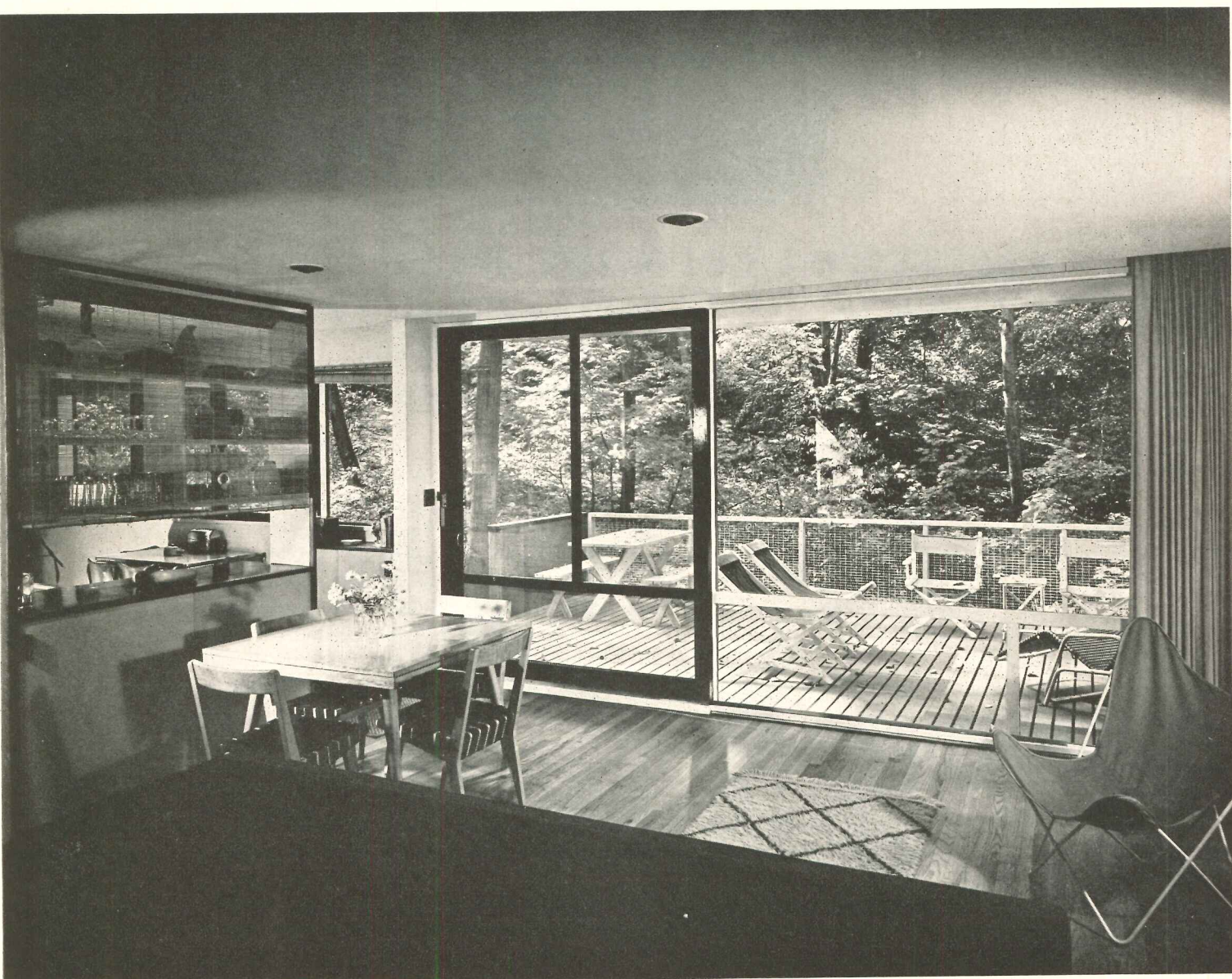

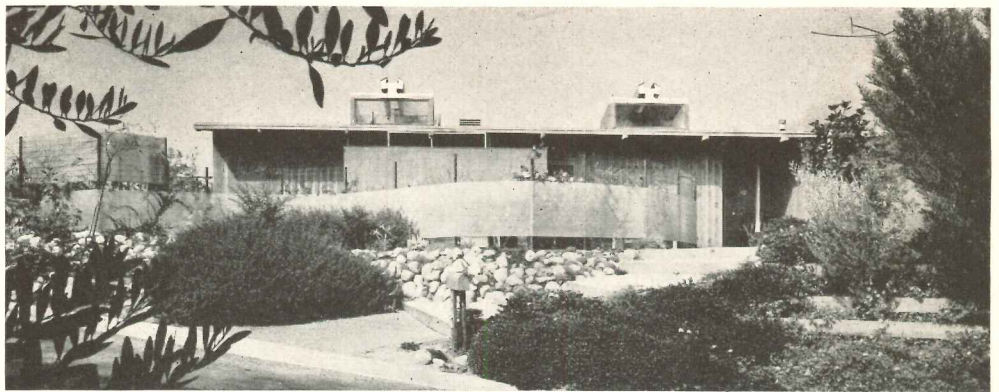
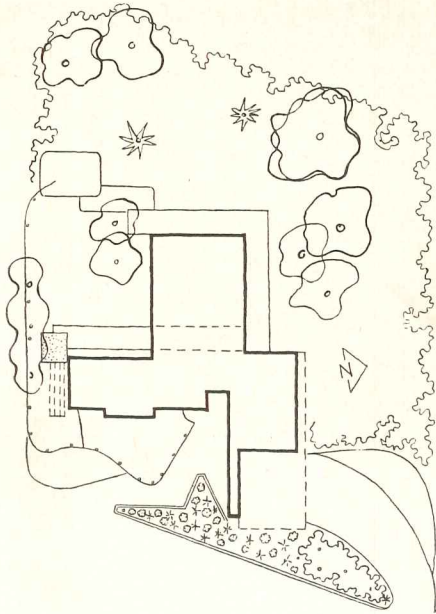

## SAFETY FOR CHILDREN—PRIVACY FOR ADULTS

*Residence for Mr. and Mrs. Samuel Sale*

*Pasadena, California*

*Whitney R. Smith, Architect*

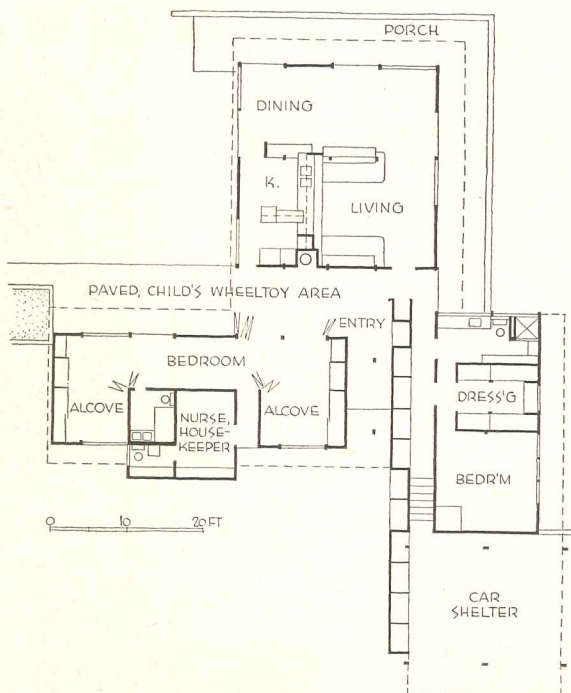

SAFETY for the young children and privacy for the parents highlight this small California house. Since neither the safety nor the privacy, nor even the combination of the two, is unusual, the chief interest here is in the skillful use of a rather small and restricted site. Had the house not been placed across the lot as it was, neither the children nor the adults would have had such complete privacy in their outdoor recreation areas; the proximity of the house to the road, however, required special treatment of the main entrance areas.

As the plans at left show, the house was divided into three separate wings: one for the children, one for the dining-living area, and one for the master bedroom suite. The children's wing is accessible only from the main entrance hall and the sheltered play terrace. The rest of the house can be reached either by a path from the street to the front door or by the more private route between carport and master bedroom wing.

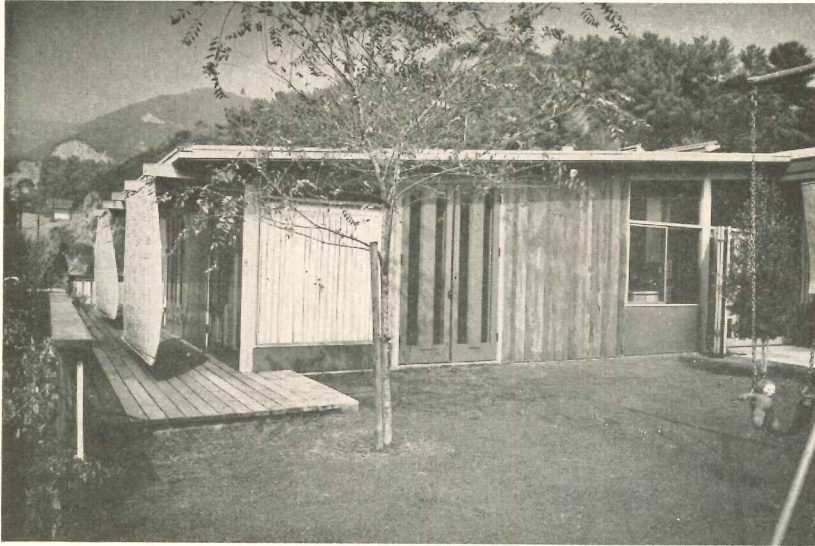

House was placed across site to close off children's wing from driveway and street, and to give adult wing direct access to carport. Photos opposite: top, bedroom wing and carport; center, house from street. Left: porch around living-dining area is at ground level only at rear of house. Below: adult wings are connected with rear terrace by hall leading past cork-covered accordion doors of children's quarters

Julius Shulman



**SAFETY FOR CHILDREN  
PRIVACY FOR ADULTS**

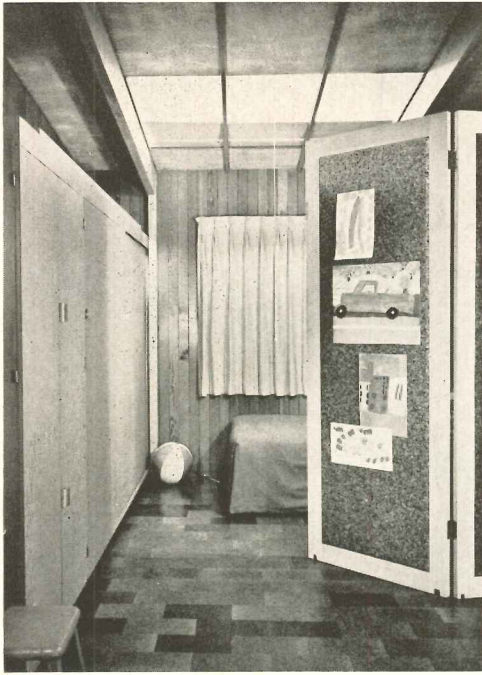

*Sleeping alcoves in children's wing are diplomatically alike in size and arrangement. Each has one whole wall of closets and cabinets—enough storage space to see any child through collecting stage. Skylights have adjustable light control*

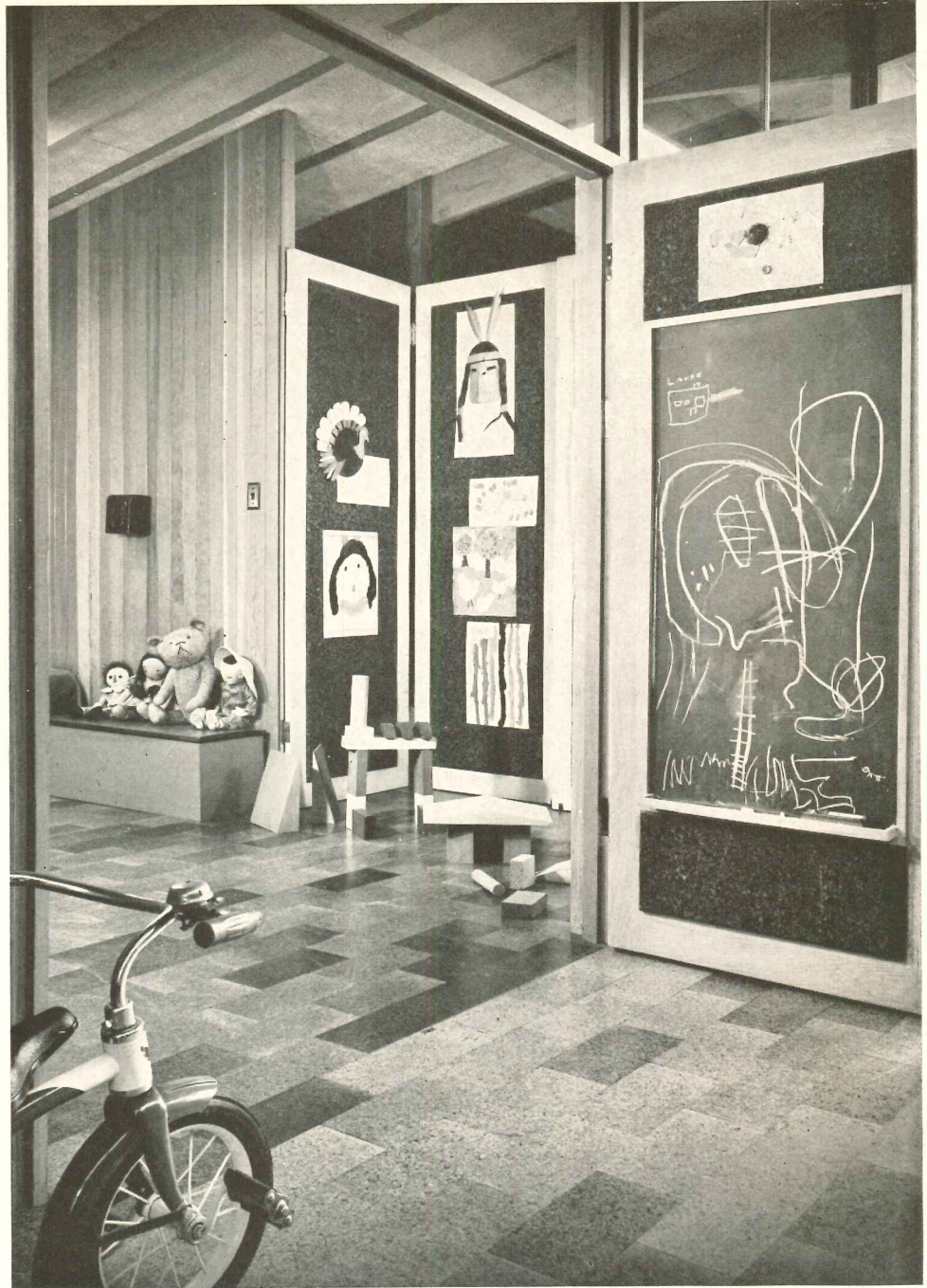

Julius Shulman

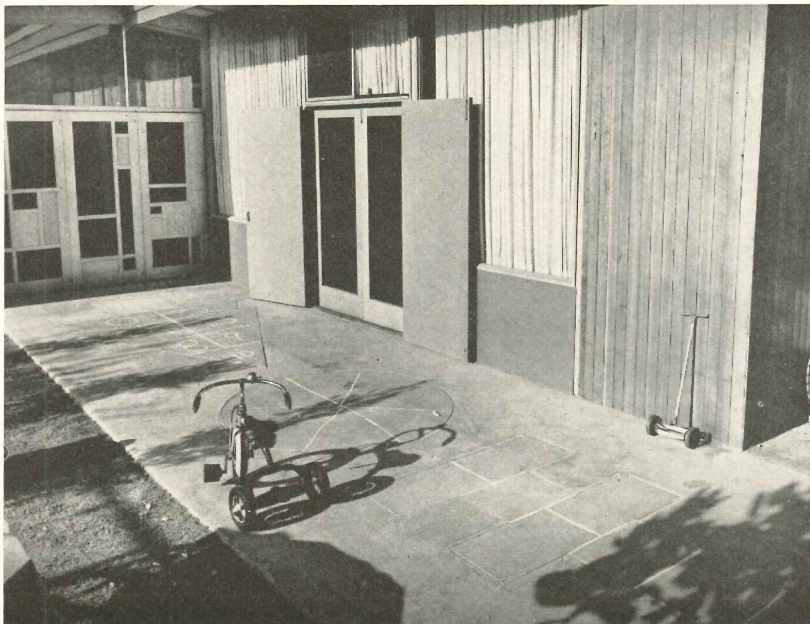

*Doors separating sleeping alcoves from central play area and rest of house are accordion-type, covered with cork, and equipped with ball-bearing rollers to facilitate operation and prevent damage to cork floors; check blocks on connecting jambs keep doors from opening on straight line, eliminating need for auxiliary support. Outdoor play terrace (left) is direct extension of playroom; hop scotch and shuffle board "courts" were built into terrace slab*

Entire living-dining section of house is rimmed by elevated porch protected by roof overhang. Dining area (below) is connected with kitchen by pass-through which may be opened or closed as desired. Record player and record storage unit (bottom of page) was made focal point of living room instead of more usual fireplace; built-in couches slide out, can be made up as beds. Upholstery is plastic. Light fixtures throughout house are plastic arcs held by ceiling battens

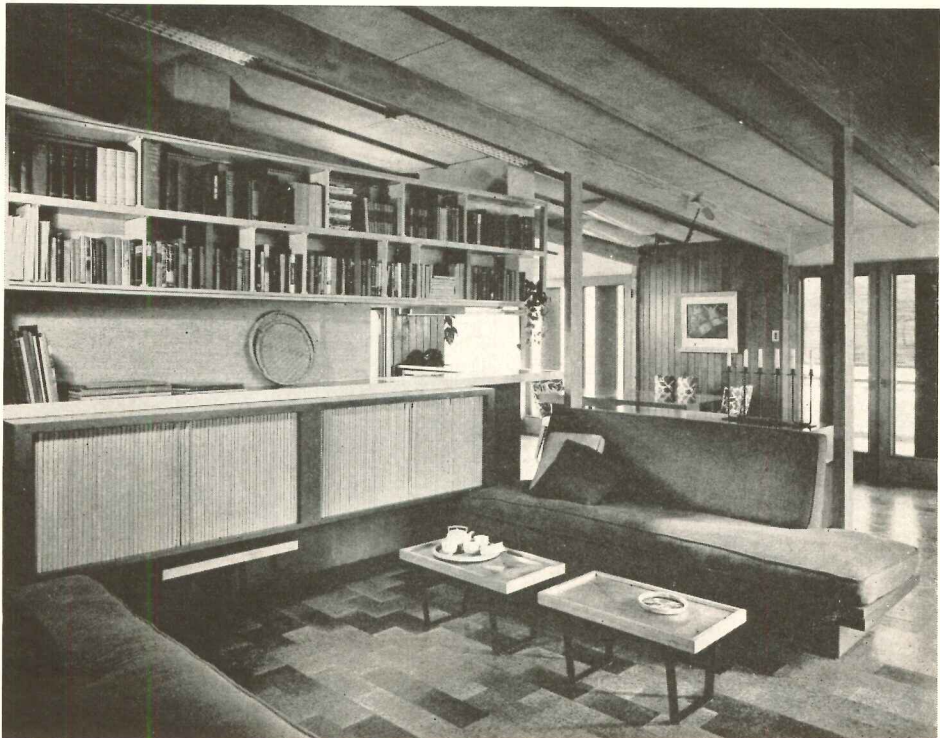
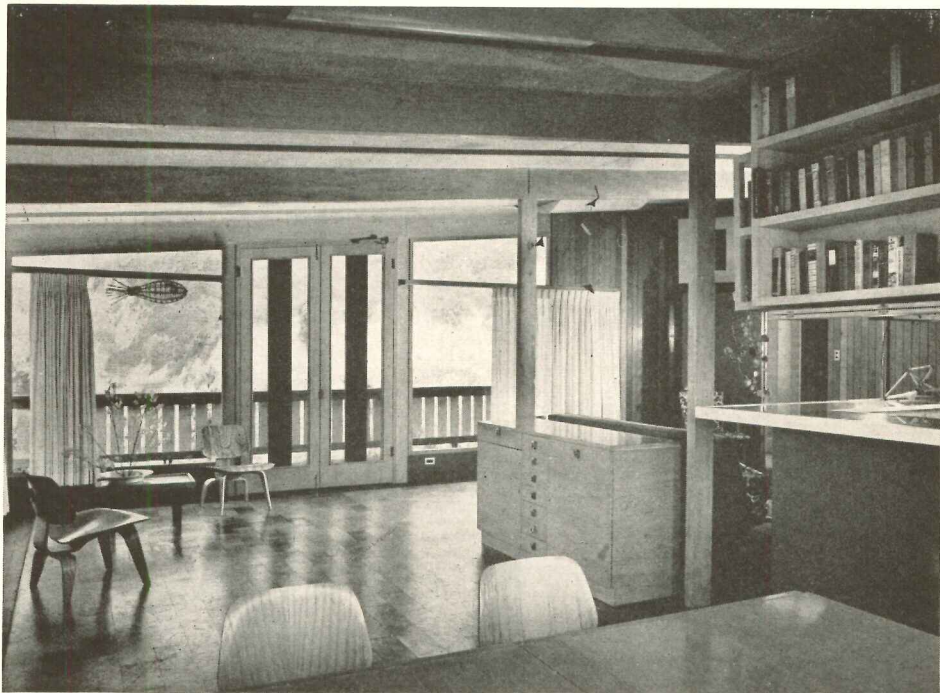
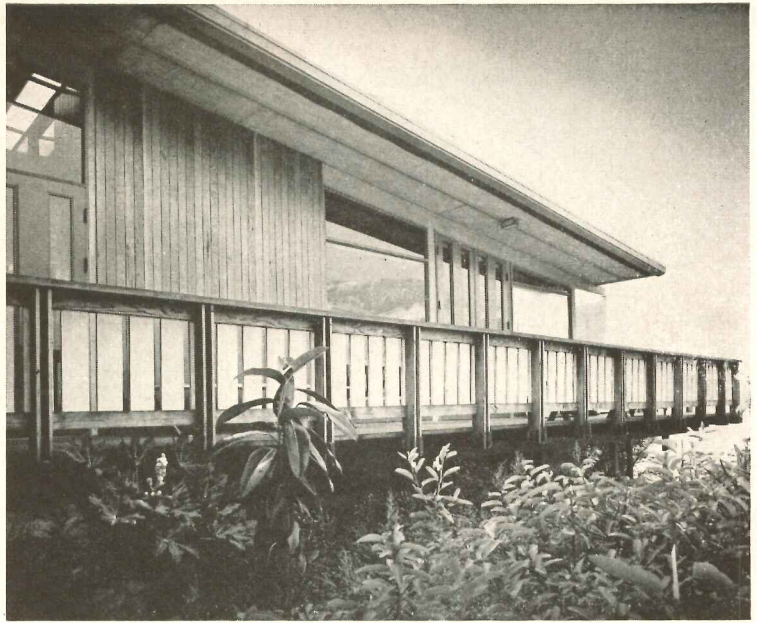

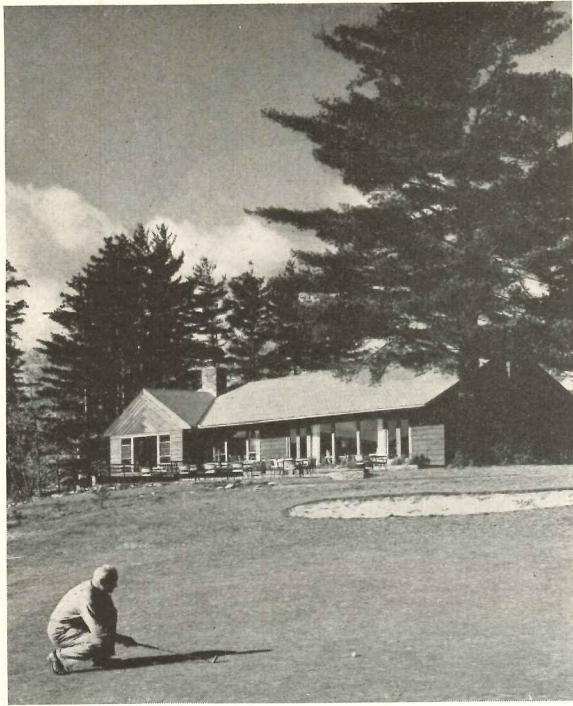

## GOLF HOUSE FOR LAKE PLACID CLUB

A TWO-LEVEL SITE, Adirondack view and dual use (as golf house and party lounge) directed the plan of this first addition to the famous club's plant in 30 years. Golfers have direct access from motor entrance to teeing off area via lower level lobby. Upper level lounges open on the large flagstone terrace which is connected by footpath to the main clubhouse. Effective separation of men's and women's locker areas is achieved; the lower lobby displays of golf supplies are well handled. Local pine boards, creosoted, and local scrap slate contribute to the rustic character. (More illustrations on page 282.)

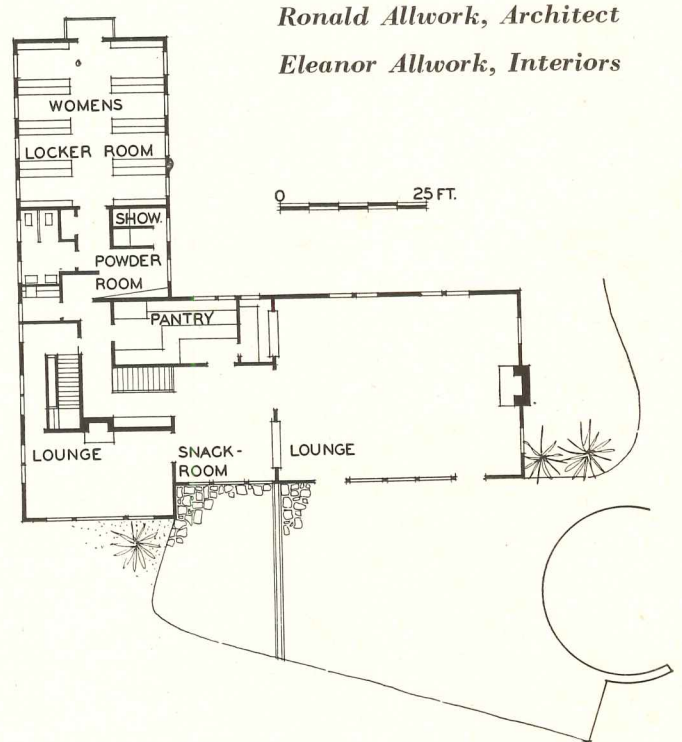
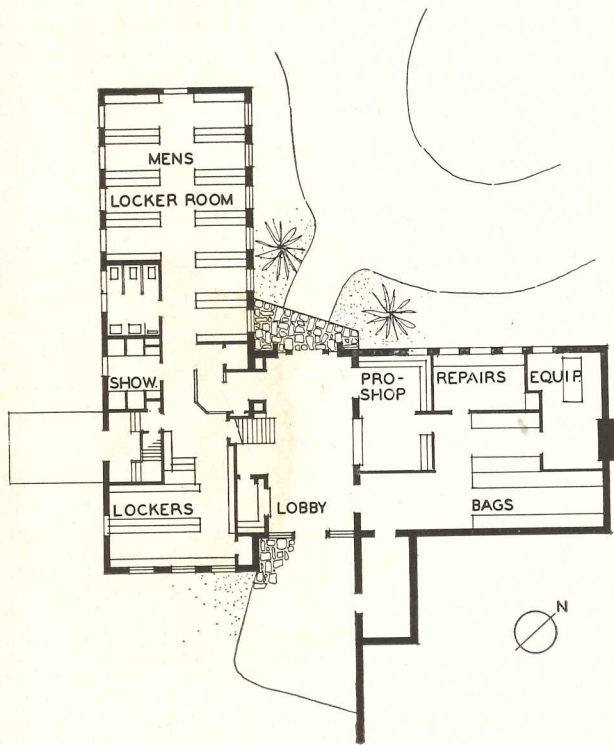

Ronald Allwork, Architect

Eleanor Allwork, Interiors

Golf supply displays are built in; glass end-walls light lower level lobby (below)

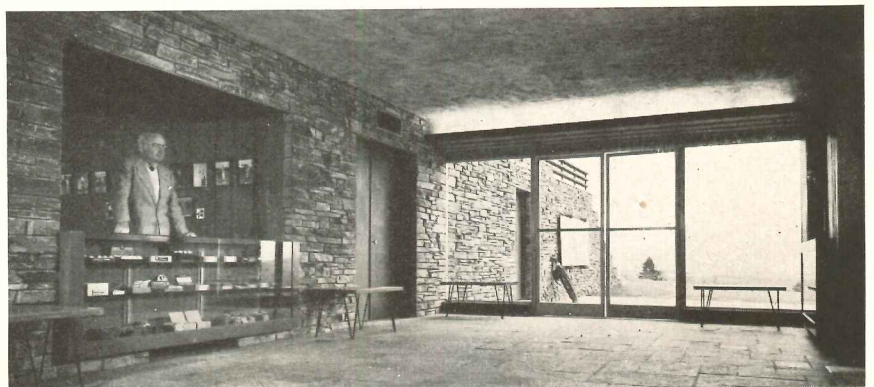
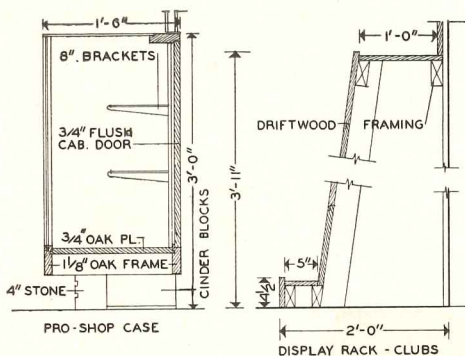



## THE ROLE OF CONCRETE ADMIXTURES:

### A Panel Discussion

Concrete admixtures are by no means new, but like lightweight aggregates they are winning new attention due to the tremendous increase in the use of concrete structures. The value of admixtures was given much discussion and brought into clearer focus recently at a meeting of the Concrete Industry Board of New York City, a new organization initiated by Roger H. Corbetta, well-known president of the Corbetta Construction Co.

The meeting was in the form of a panel discussion, printed here in its entirety, which included among its participants: Edwin M. Forbes, of Brown, Lawford & Forbes, Architects; Francis L. Brown, of Brown and Blauvelt, Consulting Engineers; Ernst Gruenwald, chief engineer of the In-cor Division, Lone Star Cement Corp.; Robert L. Mauchel of Master Builders Co.; and Emil Schmid, of the Sika Chemical Corp. Roger Corbetta was chairman and leads off the discussion.

**Corbetta:** The subject of admixtures is of great interest because of the mystery in it. *The purpose of an admixture is to alter the normal properties of concrete*, and a lot of intriguing, tempting claims are made by admixture manufacturers. The cement manufacturers, on the other hand, say, "If admixtures were any good, we'd put them in ourselves."

As it is now, most architects and engineers — not to mention the rest of us — are simply in a quandary, and it is to our benefit to get ourselves out of it as soon as we can. This discussion will be of great value if it tends at all to minimize the confusion which exists in the minds of a great many people in the concrete industry, relative to the merits of the various admixtures available.

**Brown:** It must be assumed that the reader is acquainted with the basic



Architect and Engineer on the panel were; from left to right, Edwin M. Forbes of Brown, Lawford & Forbes, Architects; Francis L. Brown of Brown and Blauvelt, Consulting Engineers. At right is Jacob Feld, Consulting Engineer

factors of good concrete strengths ranging from 2500 psi to as high as 8000 psi. The effects of various aggregates and combinations of aggregates are also assumed to be well known, as well as the use of different types of cement.

First, let me ask Mr. Schmid for a few words on the nature of cement and how it can be affected by admixtures.

**Schmid:** The final product of cement manufacture contains four principal components, namely, tricalcium silicate, dicalcium silicate, tricalcium aluminate, and tetracalcium alumina ferrite. These have different rates of reaction. The tricalcium silicate and tricalcium aluminate react very quickly and contribute to the early strength development, while the dicalcium silicate is sluggish and does not complete its reaction until several months have passed.

The setting time of the cements is controlled by the regulated addition of gypsum during grinding of the cement clinker. Specifications set time limits for initial and final set. These are related to the time required for placing concrete under normal job conditions.

*By the use of certain admixtures the normal setting rate can be either retarded or hastened as job conditions may require.*

Another property of cement that can be affected by admixtures is physical in nature. When water is added to cement, the surface of the cement will absorb water and form a gel. It is this gel layer which imparts the characteristic fattiness to concrete or mortar. Should an admixture be added to modify gel formation, radically different properties of the mix are possible. *In concrete more water usually is added than required for hydration. By admixtures this excess water can be reduced while maintaining workability of the concrete mix.*

**Brown:** As reported by the American Concrete Institute Committee 212, admixtures are defined as: accelerators, air-entraining agents, gas-forming agents, natural cementing materials, pozzolanic materials, retarders, water-repelling agents, water-reducing agents, and workability agents.

*The desired effects of admixtures upon concrete mixes can be enumerated as (1) improvement of workability, (2) acceleration of the rate of strength development at early stages, (3) retardation of initial stiffening or increasing the time of set, (4) retardation or reduction of heat evolution, (5) increase in bond to steel reinforcement, (6) modification of the type or speed of bleeding, (7) increase in durability or in resistance to special conditions of exposure to deteriorating elements, (8) decrease in capillary flow of water, (9) decrease in permeability to liquids, (10) improvement of penetration and pumpability as in gunites or grout mixtures and reduction in segregation, and (11) prevention of settlement or creation of slight expansion.*

## THE ROLE OF CONCRETE ADMIXTURES

Mr. Forbes, the architect member of our committee, has shown the committee some of the problems facing him and his interest in them, so perhaps he can discuss these applications from his standpoint.

**Forbes:** I believe that my study of admixtures on this committee has convinced me of one thing. *Basically the concrete technology must be sound. Admixtures are not a cure-all.*

**Brown:** Has the fact that an admixture may have more than one effect complicated your thinking on the problem?

**Forbes:** Yes it has. Fundamentally, however, it has emphasized that *the need of the admixture must be known; otherwise, specification of result is not possible in this field. The architect must know what he wishes to accomplish and then specify an admixture suitable to accomplish the results.*

**Brown:** Mr. Schmid, I believe you told me one case concerning retarding agents in which lack of knowledge in the field caused a little problem.

**Schmid:** Yes, in this case the contractor had requested permission to use a retarder to help him pump concrete in place. One pour worked so well that he increased the quantity the next day by four times.

**Brown:** What happened?

**Schmid:** The concrete had not set when the men reported for work the next day and almost 24 hours elapsed until the set began. Incidentally, this was just a retardation and the ultimate quality of the concrete was very high.

**Brown:** What type of a retarder was used?

**Schmid:** This was a retarder that reduced the gel formation and made excess water available for easier placing. This, of course, made the mix flow well in the pump.

**Forbes:** If the specifications had been established for the quantity first recommended, no trouble would have been experienced. This is a warning that admixtures and proportioning should be used in accordance with the manufacturer's recommendation.

**Brown:** Mr. Gruenwald, *is calcium chloride an anti-freeze admixture?* In cold weather do we add  $\text{CaCl}_2$  to prevent freezing?

**Gruenwald:** No. In fact, the concentrations of calcium chloride in water used in cold weather concreting does not lower the freezing point of the solution more than 1 or 2 degrees. *Calcium chloride simply acts as an accelerator. It shortens this time of initial and final set;*

*therefore, the danger of freezing may be reduced.*

As a matter of fact, if enough calcium chloride were used to lower the freezing point appreciably, a flash set would occur and the concrete could not be moved into place.

**Brown:** The various trade name products containing calcium chloride must be accepted then for their true value. Freezing is not overcome but acceleration of set may reduce the chances of freezing. It is important that sufficient outside heat be available.

**Gruenwald:** That is right.

**Forbes:** I think all architects would do well to keep this important fact in mind. Cold weather concreting is a serious problem.

**Mauchel:** In concrete used in highway construction, air entrainment has been demonstrated, beyond any question, that *air-entrained concrete is much more resistant to deterioration from alternate freezing and thawing action, and the use of de-icing materials in northern latitudes, and other salts, sea water, etc.*

*Purposeful air entrainment of concrete introduces other desirable properties. Air bubbles of themselves are workability agents, and are a part of the mortar; because of this the harshest component of the mortar, i.e. sand, can usually be reduced, yet workability of the concrete is increased. In turn, air entrainment reduces bleeding and segregation which is particularly desirable or necessary when concrete is plant-mixed and transported in open dump trucks. Also it is contended, but not proven to the fullest extent, that air entrainment adds to the water-tightness of concrete.*

Therefore, it would seem that greater application of air entrainment to architectural concrete can be made.

**Forbes:** That is probably true, but *don't concretes with entrained air have lower ultimate strengths, and perhaps other detrimental properties?*

**Mauchel:** *Yes, there is some sacrifice of strength* — generally conceded to be approximately 5 per cent reduction for each 1 per cent of air entrained. However, this reduction in strength does not usually commence until after 3 or 4 per cent air has been entrained, but this loss of strength can obviously be overcome by the use of more cement, or by an admixture which further reduces the water-cement ratio and unit water content, below that produced by the air-entraining agent.

The only other detrimental property, to the best of my knowledge, is in the case of excessive air content which

## TYPES OF ADMIXTURES DISCUSSED BY THE PANEL

Accelerators

Air-entraining agents

Gas-forming agents

Natural cementing materials

Pozzolan materials

Retarders

Water-repelling agents

Workability agents

Water-reducing agents

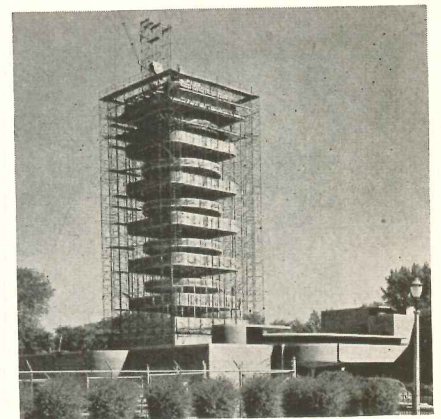

Above: an air-entraining and water-reducing agent was incorporated in the concrete for the Johnson's Wax building. Across page: in the Parkmerced apartments (top) the high-strength architectural concrete had a workability agent in it. A workability agent was also used in the Gateway Center apartments, Pittsburgh, (bottom) as well as a retarder

## PURPOSE

Primarily to decrease time of initial set of portland cement, lessening the possibility of freezing during cold weather operations

To improve resistance of concrete to weathering, and to freezing and thawing. Reduces scaling resulting from use of calcium chloride for ice removal

To produce lightweight mortar or concrete, using natural aggregates with portland cement

To react chemically with portland cement, decreasing deleterious effect of free lime; also to improve plasticity of portland cement mortar or concrete

To increase workability and decrease possibility of disintegration due to high alkali action

To retard the initial and final set of portland cement, primarily to attain sufficient time for finishing operations during hot weather

To decrease the permeability of portland cement mortar or concrete

To increase the plasticity of portland cement mortar or concrete, and to decrease the water-cement ratio for a given consistency

Same as for workability agents

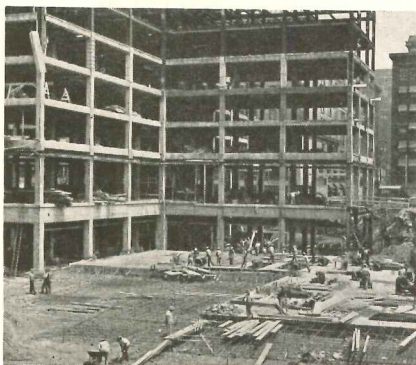

retards the setting of the concrete.

**Forbes:** Mr. Brown, can you cover briefly the position of pozzolanic materials in the admixture field?

**Brown:** Committee 212 of the ACI tells in general that pozzolanic materials may be substituted for 10 to 35 per cent of the cement in large structures, especially dams. The materials improve workability, reduce bleeding and segregation, and reduce heat and hydration. Strengths are lower for the early stages but eventually strengths may be equal or greater.

**Forbes:** Can fly ash be included in the general terminology "pozzolanic materials?"

**Brown:** Yes, *I would like to add a few words about fly ash.* We are presently engaged by a large power company on a test program for the use of fly ash in a group of seven hydroelectric projects. The ideas on specifications for fly ash are being formulated. It is possible to use as high as 40 per cent of fly ash as an admixture, substituting it for cement. The serious drawback is that strength develops slowly. For a 20 per cent substitution the strength curve does not intercept the curve for a normal cement mix until about the fiftieth or sixtieth day. However, the heat of hydration is lower, and ultimate strength may be higher.

**Forbes:** You are covering the problem of fly ash in mass concrete. *What about the use of fly ash in structural concrete?*

**Brown:** *Because of the low initial strength of fly ash admixture concrete a person would have to be very careful before selecting it for structural concrete.*

**Forbes:** If fly ash were substituted for 20 per cent of the cement, what would be the problem of cold weather concreting for structural concrete?

**Brown:** In that case, too much calcium chloride as an accelerator might have to be used. Inasmuch as calcium chloride is an accelerator and fly ash is a retarder, the two cancel each other. For fly ash admixture, artificial heat must be supplied for a longer period until the danger of freezing has been eliminated.

**Forbes:** Will air-entrainment agents work with fly ash admixture concrete?

**Brown:** Yes. But again there may be an opposition of properties. General results indicate a considerable increase of air-entraining agents to maintain normal 3-5 per cent air contents. I would like to mention another property of pozzolanic materials, including fly ash. When the pozzolanic material is substituted for a part of the fine aggregate and the cement content is kept normal, erosion by salt

water or by other chemical attack results.

**Forbes:** This is particularly true when the concrete does not have a good gradation of fine aggregate isn't it?

**Brown:** Yes, that is true. If the fine aggregate is too high in fines, the addition of more pozzolanic materials may require higher water-cement ratios and cause high absorption and drying shrinkage. Mr. Forbes, from the discussion what do you make of the use of fly ash as an admixture?

**Forbes:** For mass concrete it has many desirable characteristics. For sea wall and open exposed areas, the substitution of suitable fly ash for part of the fine aggregate offers much. When we consider it for normal structures, then slow setting and slow development of strength would offset many of the economical gains from its other features. I think we must also emphasize the fact that accelerators like calcium chloride cannot be used to advantage in cold weather.

**Brown:** This is another case of multiple effects which must be balanced.

Now, Mr. Gruenwald, I could give you a tough one and ask you about natural cement, but I won't. However, [it should be mentioned] that New York State for many years has used natural cement in its structures and pavement. Air entrainment advantages were gained in the use of natural cements, but the "why" of this represents a long story of our competitive democracy in action. Need we say only that increased durability with special reference to resistance of pavements to freezing and thawing resulted.

**Gruenwald:** The Portland cement industry, among others, has studied the effects of air entrainment since 1935. *The cement manufacturers use various additions to produce air-entraining cements and, of course, air-entraining admixtures can also be added at the mixer.* The amount of additions is very small. Incidentally, one of the oldest air-entraining materials is alumina powder and you may be familiar with its use in lightweight concrete where, however, the amount of air entrained was greatly in excess of what we are using today.

**Forbes:** *I recently had a problem of a fish pond. How could I introduce admixtures to affect the concrete for this purpose?*

**Mauchel:** There are many so-called waterproofing admixtures. However, the Fair Trade Practices Commission has ruled that no one may legally use the word "waterproofing" in connection

## THE ROLE OF CONCRETE ADMIXTURES

with admixtures for concrete, certainly not in literature or advertising. It might be well to differentiate between types of so-called waterproofing and water-repellent admixtures.

There are those in the general classification which use calcium chloride as a base — the properties of which are well known.

There are those which have as a base soaps or fatty acids. These products reduce capillary attraction, but do not resist water under a high head.

There are other admixtures which make concrete more water-tight by physical measures such as by reduction of the water-cement ratio and unit-water content. Cement-dispersing agents are among such. The Bureau of Reclamation, in its concrete manual under the heading of "water-tightness," states that the required properties, in part, are "lower water-cement ratio with lower water content."

► *No economically feasible admixture can completely and entirely eliminate the normal absorptive qualities of concrete. They can aid only in making concrete more water-tight.* Obviously, therefore, there is no substitute for a properly designed concrete, using properly graded aggregates.

► *Broadly speaking, there are four main causes for leakage through concrete:*

1. Excessive water use in the manufacture of concrete, which creates capillary tubes or pores caused by the excess water leaving the concrete while it is setting and through which, subsequently, water and other liquid can pass.

2. Honeycombing — sometimes due to an engineer's attempting to have concrete of insufficient workability placed too dry; also concrete placed with improper compaction. (By this is not meant overvibration.)

3. Sand streaks due to poor concrete design; or porous sections due to segregation.

4. Weak planes between lifts and layers of concrete caused by excessive bleeding; thus laitance formation, and, of course, cracks in the concrete caused by excessive shrinkage and settlement.

**Brown:** Water-tight concrete can therefore be made by using good concrete first and by insuring that the properties do not change due to segregation. Isn't that true?

**Mauchel:** Yes.

► **Brown:** Let us talk about retarders for a moment. *Under what circumstances would a retarder be desirable?*

**Schmid:** *One case is hot-weather concreting.* We have mentioned accelerators

on cold-weather concreting. The corollary is true. Retarders in hot weather are very desirable to reduce the setting time to a point that the concrete may be moved from mixer to final location. By insuring a proper interval for placing, pumping is possible; or placing by other means need not be accelerated. *Retarders are very desirable when mixers break down or additional time for floor finishing is needed.*

**Forbes:** I remember one application that comes to mind now. By adding a retarding agent to the top surface of concrete, the body of the mix may set normally. Then the cement paste may be washed from the surface leaving an exposed aggregate for its architectural effect.

**Gruenwald:** That is very special application, and it has been used for architectural effects.

**Mauchel:** May I summarize that part of the discussion which was assigned to me by Mr. Brown? At the risk of reiteration, may I say that you gentlemen who have to do with specifying concrete mixes, or their use, should first of all make up your minds what the needed property or properties of concrete are for each particular project. Having determined this, you should then seek out the admixture which by research, test and performance has demonstrated that it introduces the properties which you require.

The subject of admixtures, as you well know, is highly controversial. There are many admixtures which have been offered for use and sale which have dubious, if any, real value. I am referring more to the past than present.

However, make no mistake — admixtures are here to stay. They are being used to a tremendously greater degree and extent today than they were in past years, and in the future their use will be even greater, regardless of differences of opinion which might presently exist.

As an illustration, no concrete is placed under the jurisdiction of the Bureau of Reclamation except air-entrained concrete — whether it is produced by means of air-entraining cement or by an air-entraining admixture. This is also true of the New York and surrounding state highway departments. Ten or fifteen years ago, this would have seemed ridiculous. Today, it is accepted practice.

Similarly, the use of certain other admixtures has increased immensely in the last several years and continues to do so.



Above: the problem in a California reservoir was to gain watertight concrete under difficult placing conditions. A retarder and a workability agent were the admixtures. Below: concrete for this 4,750,000 gal. water tank had a cement-dispersing, water-reducing agent in it

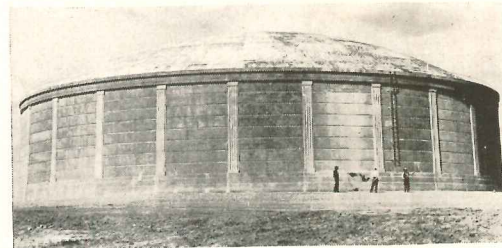

Below: for uniform concrete and floors with high surface hardness and crack resistance, a retarder and water-reducing agent was used in constructing this bus terminal and parking garage at Bridgeport, Conn.



Below: an integral floor hardener was the admixture in the concrete floor of the American Optical Co. building in Vermont

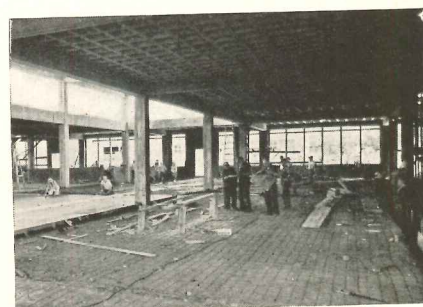

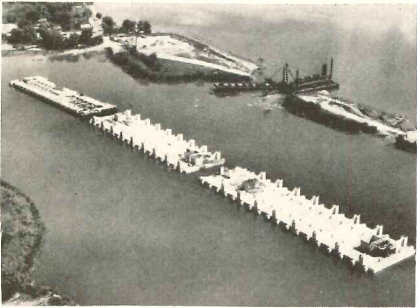
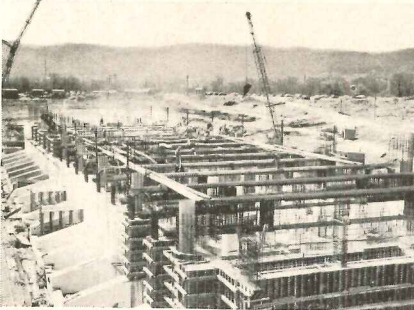
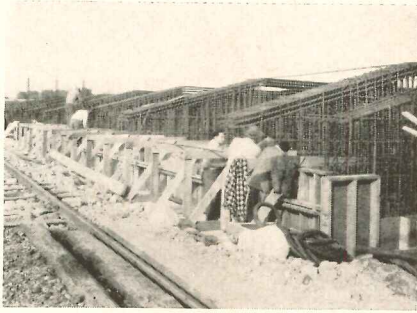

Above: the admixtures in the concrete for New York City's Pier 57 provided for water-reduction, workability, retarding

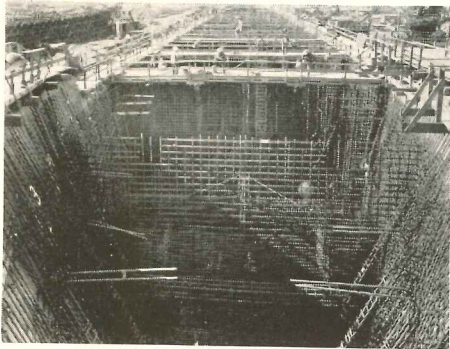

Above: a water-reducing and workability agent was used to aid in the embedment of steel, give high strength and water tightness for this concrete ship of the U. S. Maritime Commission

It is no exaggeration to say, that out of between 150,000,000 and 200,000,000 yards of concrete placed in the U. S. annually, 25 per cent contains an admixture. Consequently, the subject of admixtures merits close attention and study.

The public and private university and government laboratories have a wealth of information on sundry products, and the counsel and advice of these agencies can well be sought by anyone lacking specific knowledge.

Obviously the reputable admixture manufacturers must and do have today competent technicians capable of discussing concrete in all of its phases, in whom the engineer and architect and contractor can place their confidence.

In other words, the admixture industry has come of age!

**Brown:** Concrete is one of the most useful of building materials. It can and does perform many varied functions.

Unlike other commonly used building materials, concrete does not come to the job as a completely manufactured item ready for installation. It must be properly designed and properly applied in order to successfully perform its design function. In my opinion the greatest difficulty arises in the fact that the users of concrete are not aware of its complexity and believe that it can be used indiscriminately and still do its proper work.

*The greatest part of our troubles would be eliminated if every user of concrete were perfectly clear as to what the desired results were and then made sure that the concrete was proper for these results. This is particularly true when the admixture is considered.* I think that we have demonstrated here today that admixtures can be both beneficial and detrimental. I think that it is further evident that the ill-advised use of admixtures can be really serious. I would summarize the position as follows:

1. Know your requirements.
2. Know or find out the proper mix and the proper ingredients to achieve these ends.

**Brown:** Now Mr. Gruenwald.

**Gruenwald:** The best admixture for concrete is Portland cement. In my life-long experience with concrete, I find that it has given and continues to give excellent performance without admixtures. There may be isolated instances where some particular condition of concreting operations calls for the use of admixtures to produce special acceleration or retardation.

Experience over the last 15 years has conclusively proved the advantages of air-entrained concrete. They improve workability of concrete and also increase its resistance to weathering actions.

However, before using any admixture the user should satisfy himself by tests as to what effect any admixture will have with the particular concrete being used. Otherwise the expected results may not be obtained.

**Brown:** Now, may we hear from Mr. Schmid.

**Schmid:** Admixtures have to be used intelligently to secure the desired results most economically. We must use them alone or in combinations to suit the job at hand. In winter we may need an accelerator. The quantity will have to be varied with the temperature and job conditions.

In exposed slab work we should specify an air-entraining agent, and its quantity will have to be varied depending on the aggregate, the temperature and other job conditions to give the optimum percentage of air needed for frost resistance. For structural work we may need a retarder and again the quantity should be varied with temperature and job conditions.

During cold weather some work may require the use of air-entrainers and accelerators. For other purposes a retarder plus air-entraining may have to be employed.

If in any of the above work we need properties as secured with a pozzolanic material, such product should be employed in addition to other admixtures.

It can be seen that there cannot be one material in one package that can do all these things under all conditions. There can be no cure-all. Admixtures should be used in varying quantities alone or in combination to give the specific qualities we desire for the type of structure. Specifying admixtures to achieve this is not an impossible task. When specifying end results and classes of admixtures to be employed under each specific condition, proportions can be varied by the engineer during the progress of the job, depending upon the temperature and job conditions.

**Brown:** Gentlemen, you have heard the various ideas of the Committee. We have not given you any recipes — we don't think that we can. That would take just too long, but we have told you the fundamentals of them, their multiple effects, and that admixtures can be good and can be bad, depending on how you use them.

# CRACKING OF CONCRETE BLOCK WALLS:

Research Study by HHFA

The first of a series of investigations indicates shrinkage of concrete block to be a factor. Additional study is contemplated on (1) performance of block in walls, (2) effect of mortars, (3) effect of door and window openings, (4) value of reinforcing, (5) control joints, and (6) possible use of admixtures to reduce shrinkage

CONCRETE BLOCKS have many advantages, but these have been offset partially by the tendency of walls comprised of blocks to develop cracks which are unsightly and often permit leakage through the wall.

Observations of concrete masonry structures damaged by cracking indicate that there are causes other than unequal settlement of foundations or stresses set up by the movement of floor or roof slabs bearing on the walls. It is believed that an important contributing factor is the volume change in the blocks due to drying shrinkage.

The Housing and Home Finance Agency has recently reported\* the results of a research study on this subject conducted at the University of Toledo (Ohio). In addition to determining the relation of shrinkage to the moisture content of concrete blocks, it was found that specimens could be made with relatively inexpensive laboratory equipment which could duplicate commercial concrete blocks, making it possible for university and other laboratories to test materials native to their particular area.

The study involved some 200 or more combinations of the following variables:

- Six types of aggregates (sand and gravel, pumice, cinders, expanded shale, expanded slag and sintered shale).
- Four methods of curing (a fifth was included for expanded shale).
- Two strengths of mix.
- Two cycles of wetting and drying.
- Two methods of production (commercial and laboratory).

In order to eliminate variables of temperature and humidity, the cured masonry units were placed in water until saturated. Then they were allowed to dry under controlled temperature and humidity conditions.

## Some Interim Conclusions

The results of the investigation lends

\*"Relation of Shrinkage to Moisture Content in Masonry Units," Housing Research Paper 25, Housing and Home Finance Agency, March 1953. For sale by Supt. of Documents, Washington 25, D. C., 25 cents.

support to the following interim conclusions:

- Shrinkage varies considerably, depending on the type of aggregate used and also on the method of curing. In general, shrinkage is inversely proportional to the weight of the unit, with some minor exceptions.
- High-pressure steam curing of full-strength units reduced shrinkages by approximately one-half compared with other curing methods (with pumice it was approximately one-third).
- High-pressure steam curing of full-strength cinder, expanded shale, expanded slag and sintered shale aggregate units resulted in shrinkage values which were as low or lower than for sand-gravel

units cured by any other method except high-pressure curing.

4. The specimens, except those cured at high pressures, showed a residual shrinkage when they were again saturated after the first drying, the amount depending on both the aggregate and the method of curing. The resaturated units shrunk approximately the same amount during the second cycle as they did in the first, except for those cured at high pressure, which had little or no residual shrinkage.

5. Results on leaner mixes (giving approximately half strength) showed some marked decrease in shrinkages for units cured at atmospheric pressures (73

(Continued on page 190)

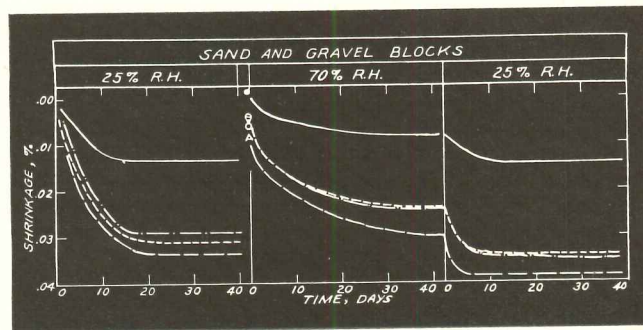

During tests, saturated concrete blocks were dried to constant length at 73 F and 25 per cent relative humidity. At the end of 40 days the blocks were resaturated and dried at 70 per cent rh. The relative humidity was then reduced to 25 per cent

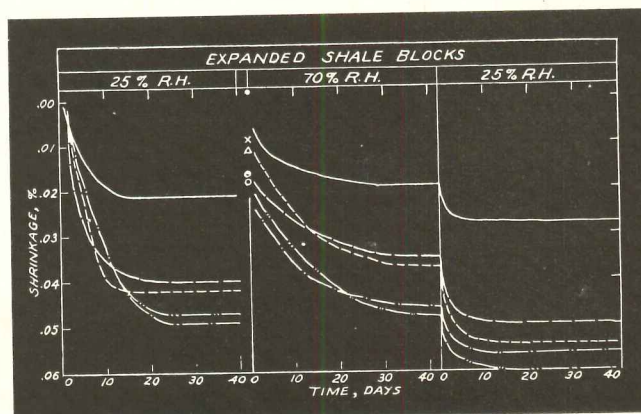

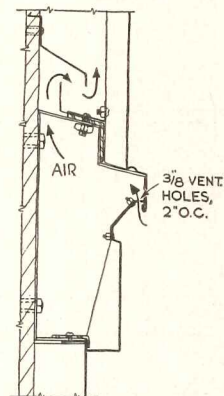
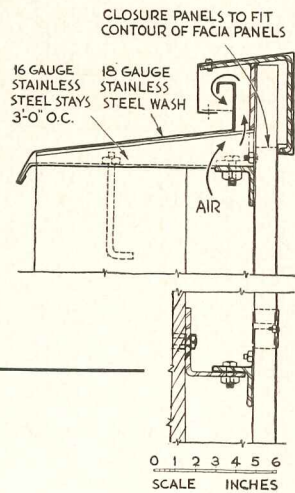
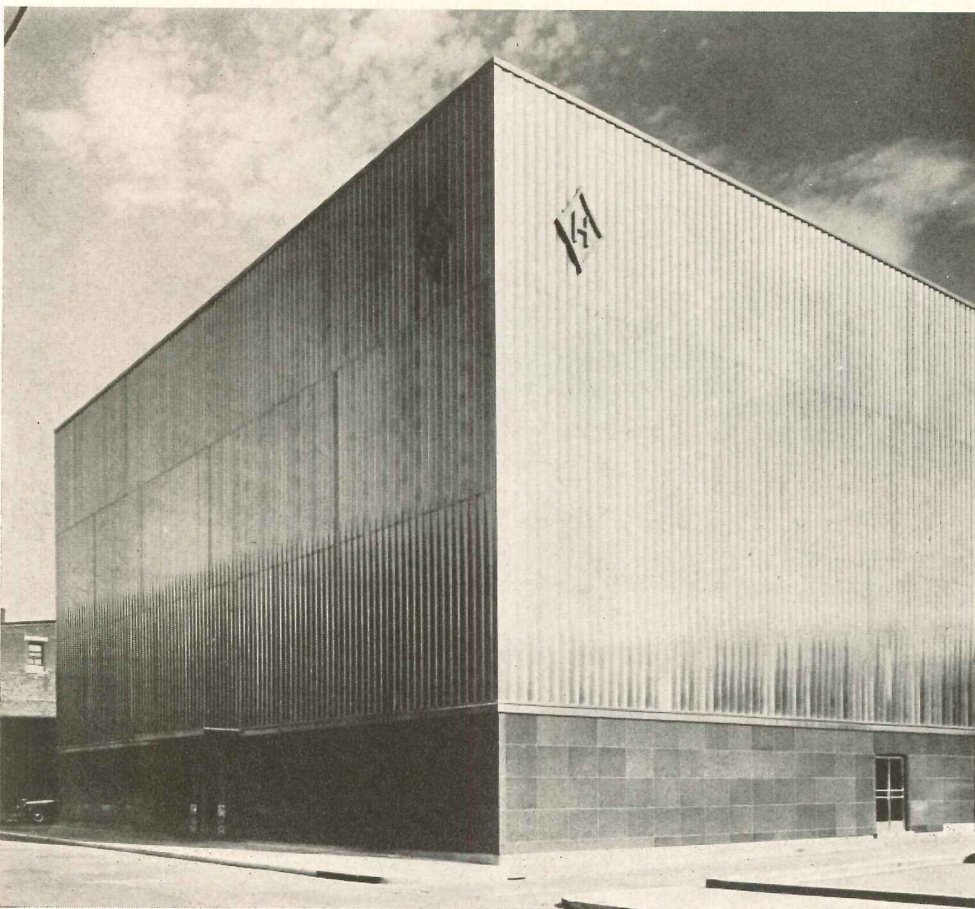

Unsightly grill work is eliminated by designing the stainless steel skin so that fresh air is drawn in at street level underneath the molding and exhaust air is discharged at the roof. Steel panels unify the original four-story structure and a three-story annex to which a fourth story was added. In addition a courtyard in between was filled in

## A STEEL WALL THAT BREATHES

*Modernized office building for the Heppenstall Co., Pittsburgh, Pa.*

*Hoffman & Compton, Architects*

OF UNUSUAL INTEREST in this modernized office building is the way the stainless steel fascia, parapet, parapet cover and roof were designed to make the building's air conditioning system more efficient.

No intakes for the air conditioning system are visible on the exterior walls. Instead, fresh air is drawn in through

the openings at street level between the terra-cotta tile and the stainless steel molding (see sketches). Exhaust air is discharged at the roof. In this way there is a continual circulation of air between the stainless skin and the masonry wall to which it is attached. Unsightly grill work is eliminated, and the space between the skin and wall is thoroughly

ventilated to prevent the formation of condensation.

The Heppenstall Co., a steel forgings manufacturer, originally occupied a four-story masonry structure built in 1918. Then a three-story annex was added in 1923. The problem was how to get more office space by joining the two old buildings in such a way that the new struc-

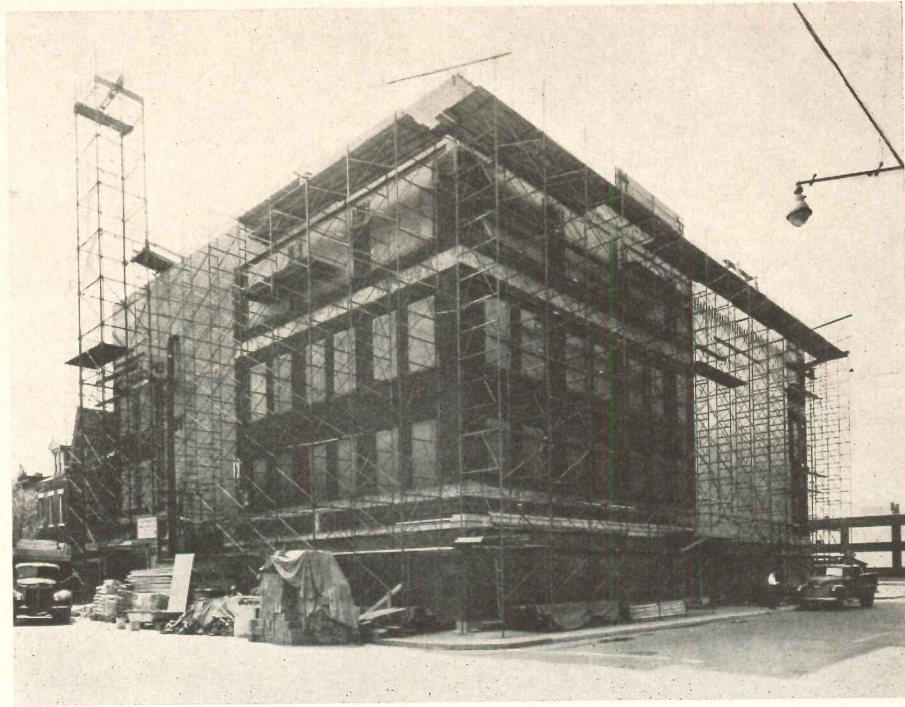

*Windows of the old building were completely sealed before the stainless steel panels were attached. Terra-cotta tile serves as the base trim. Fresh air enters the wall just above the tile*

## STEEL WALL THAT BREATHES

*(Continued from page 176)*

ture would have a trim, unified appearance without looking like a patched up job.

The problem was solved by adding a fourth floor to the annex, building a new

central unit to replace the courtyard, sealing all the windows and sheathing old and new portions with fluted stainless steel panels and a base trim of granite-like terra-cotta tile. The unified

structure has 30 per cent more space.

Since the windows are completely sealed off, dirt and noise are kept out, and at the same time the air conditioning load is cut down.

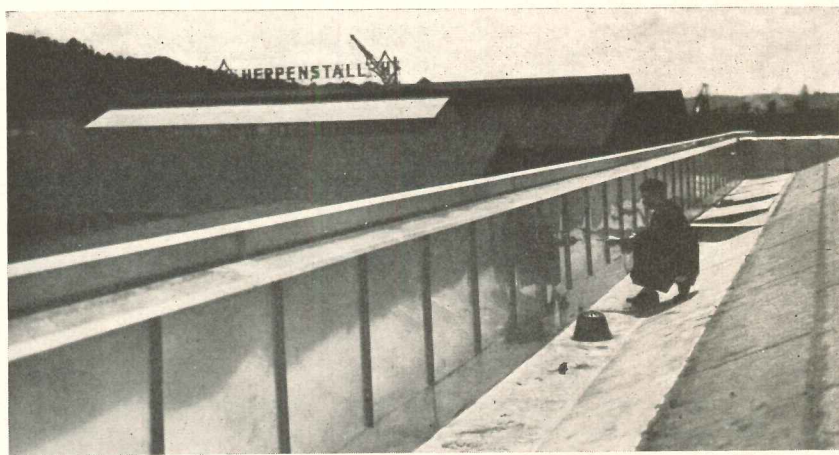
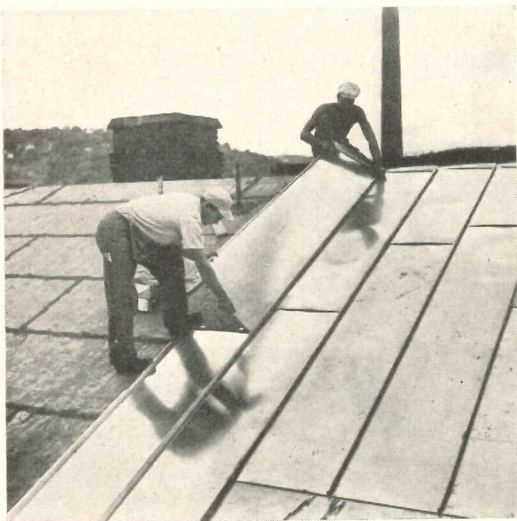

*Above: the parapet cover is conventional except that it forms an outlet for exhaust air. Both parapet cover and parapet are of stainless steel. Left: stainless roof panels were placed over felt*



# PRODUCTS for Better Building

## FLEXIBLE CLASSROOM FURNITURE IS DESIGN-WISE AND COMFORTABLE

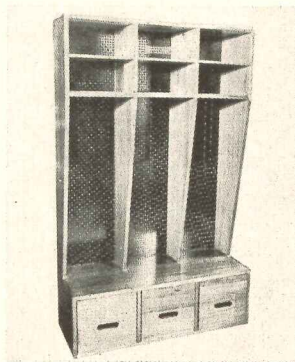
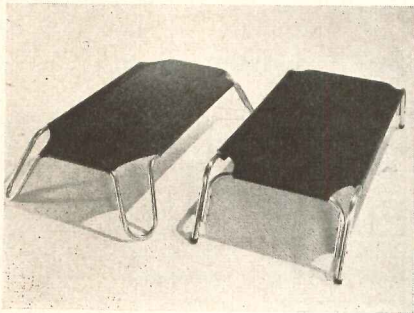
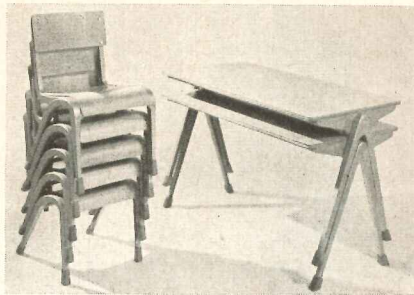

A new degree of flexibility in classroom planning has been introduced with the marketing of some ingenious classroom furniture by two firms.

- Stackability is the basic theme of *School Interiors Furniture*, which includes cast aluminum and tubular steel stacking chairs, molded plywood and cast aluminum stacking tables, desk units, clothing lockers and stacking cots. Light in weight and exceptionally sturdy, the units may be easily re-arranged for the conversion of study areas into play or conference areas. All wood laminates are bonded with urea-resin adhesives, and molded under hydraulic pressure with electronic heat, for maximum strength and resistance to moisture and extremes of climate. Designed for comfort and posture, the furniture is aimed at promoting the health and well-being of growing children. Colors and finishes are chosen to reflect light without creating glare. School Interiors Co., 5 University Pl., New York 3, N. Y.

- New engineering and design principles have been applied to the *Brunswick Line* of school furniture with the use of tubular aluminum frames.

(Continued on page 192)

▲ School Interiors table-desks have rigid aluminum frame and hardwood writing surface. Standard and heavy duty cots with tubular aluminum frames come with blue or white covers. Birch laminates and cast aluminum form chairs; tables are molded plywood. Clothing locker is wood and perforated Masonite

► The Brunswick classroom chair is easily converted into a tablet-arm or lounge chair by the addition of detachable units. Lift-lid combination has spacious book storage. Teacher's desk is movable conference style. Individual open-front desk has maximum flexibility

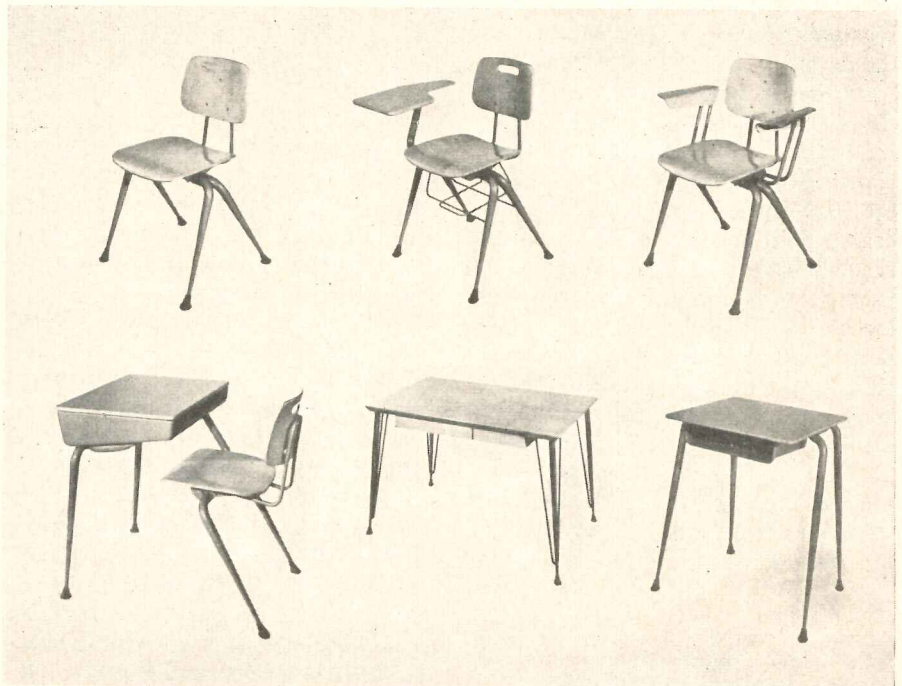

LITERATURE for the Office

**GARAGE DOOR DESIGN**

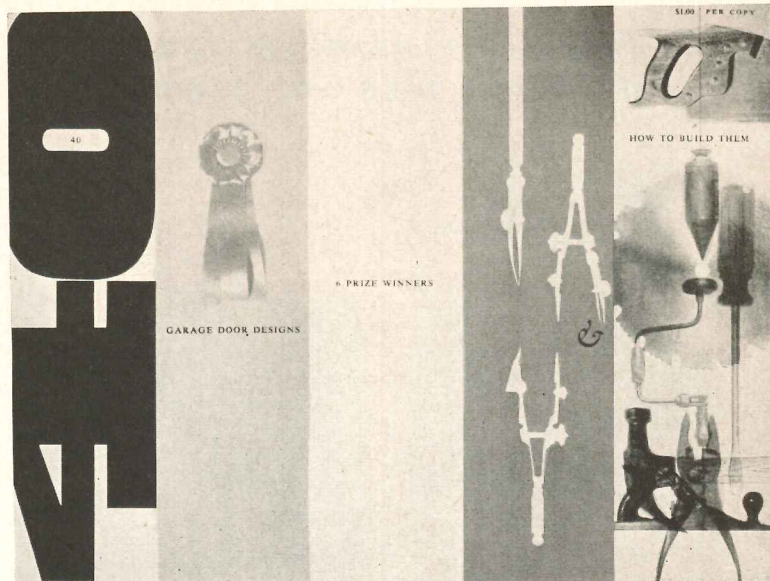
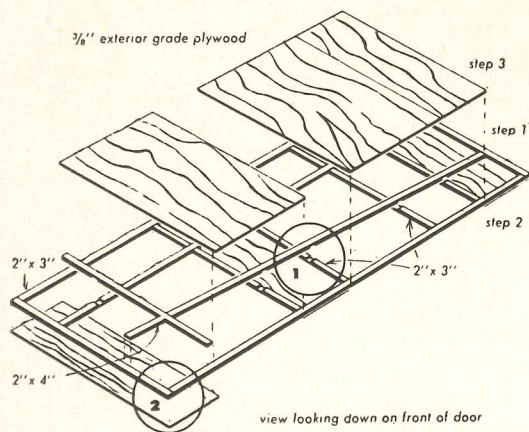

Above, left: construction detail of first prize design shown in booklet, right. Below: other suggested designs

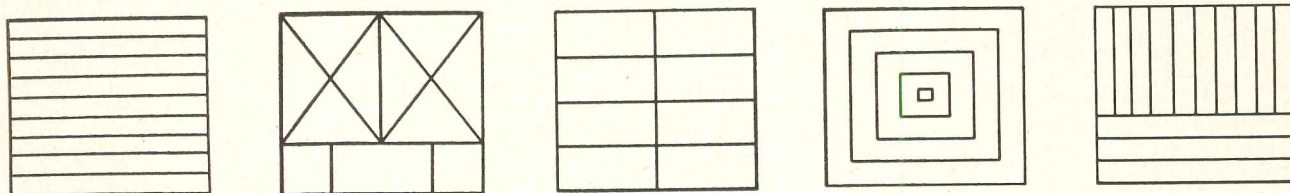

40 Garage Door Designs — 6 Prize Winners & How to Build Them. Handsome little booklet, based largely on results of a garage door design competition sponsored by the Travert Company and the magazine *Arts & Architecture*, presents the six prize-winning designs in the contest, together with 14 other competition entries. These are illustrated with renderings and details and are accompanied by materials lists and construction procedure outlines. Small sketches of 20 other design possibilities using three basic framing schemes are included. John Kewell, A.I.A., winner of an honorable mention in the competition, contributes a short discussion of good garage door design as an introduction to the booklet. Also included is an illustrated outline of procedure for hanging a garage door with the manufacturer's hardware. Booklet is available free to architects, designers and

architectural school libraries when requested on letterhead. Available to all others for \$1. Travert Co., Paramount, Calif.

**Paint Samples**

*Decorator's and Architect's Color Manual.* Looseleaf book contains complete specifications for using paints. Second through fifth sections contain color cards on Liquid Velvet, Satin Finish, Lustre-Tone paints; give a formula mixing guide, a color scheme guide, and present an index to the large color sheets which follow. The large color sheets, 114 in number, are divided in half, so that contrasting colors may be matched alongside one half. Included in the 114 color samples are both standard and simple mixture colors, and the selection of hues is particularly good. The final section of the book has color cards on other Pre-Shrunk finishes, including quick-drying enamel, rubberized paint, concrete floor enamel, exterior paint and wood finishes. The O'Brien Corp., South Bend 21, Ind.

**Sound Products**

*RCA Sound Products.* Attractive brochure contains information on micro-phones, amplifiers, speakers, baffles, driver units and horns, intercommunication equipment, television antenaplex systems and unit-built cabinets and racks. Photographs of the various models of each unit are shown, with an accompanying textual description. 18 pp., illus. Engineering Products Dept., Radio Corporation of America, Camden, N. J.

**Built-In Electric Ranges**

*Presteline Built-In Electric Ranges.* Exclusive features of this large built-in oven are clearly described in this handy brochure. Photographs point out the convenience and freedom of design possible with eye-level oven and various available models of the range are shown. Installation information is included, complete with dimensions of the different models. 4 pp., illus. Presteline, 612 N. Michigan Ave., Chicago, Ill.

(Continued on page 246)

\* For other product information see *Sweet's Architectural File, 1953.*

put  
an end  
to ...

# Draft dodging

**WITH ANEMOSTAT**



Drafts and "draft dodging" are no longer a problem when air conditioning systems are equipped with Anemostat draftless air diffusers. Anemostat air diffusers are designed to eliminate the cause of drafts. But that's not all. Anemostat air diffusers equalize temperature, humidity and assure draftless air distribution, *the big three* for healthful air conditioning comfort. That's why leading architects, engineers and contractors who demand the best in air conditioning equipment specify Anemostat . . . why more Anemostat air diffusers are in use than any other make.

Put an end to the "draft dodging" problem by specifying Anemostats, the draftless aspirating air diffusers.

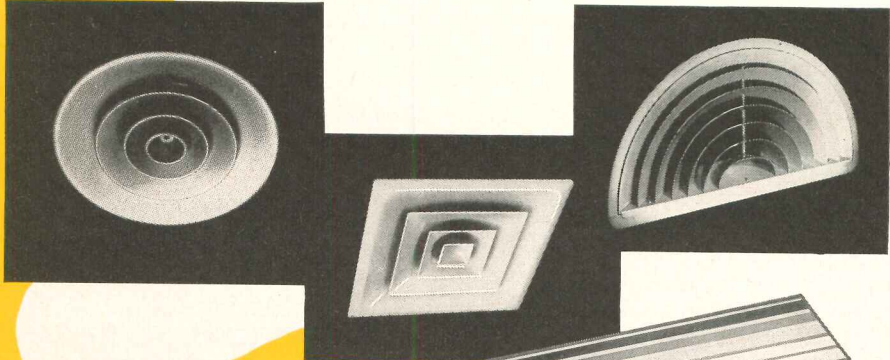

*"No Air Conditioning System  
Is Better Than Its Air Distribution"*



**ANEMOSTAT®**

**DRAFTLESS Aspirating AIR DIFFUSERS**

**ANEMOSTAT CORPORATION OF AMERICA**

10 EAST 39th STREET, NEW YORK 16, N. Y.

REPRESENTATIVES IN PRINCIPAL CITIES

Milcor self-supporting window stools with removable facia panels installed in Boston University School of Theology by Dillaby Fireproofing Co., Cambridge, Mass.

Architect: Cram and Ferguson, Boston, Mass.

General Contractor: Turner Construction Co., Boston, Mass.

Metal Trim Sub-contractor: Dillaby Fireproofing Co., Cambridge, Mass.

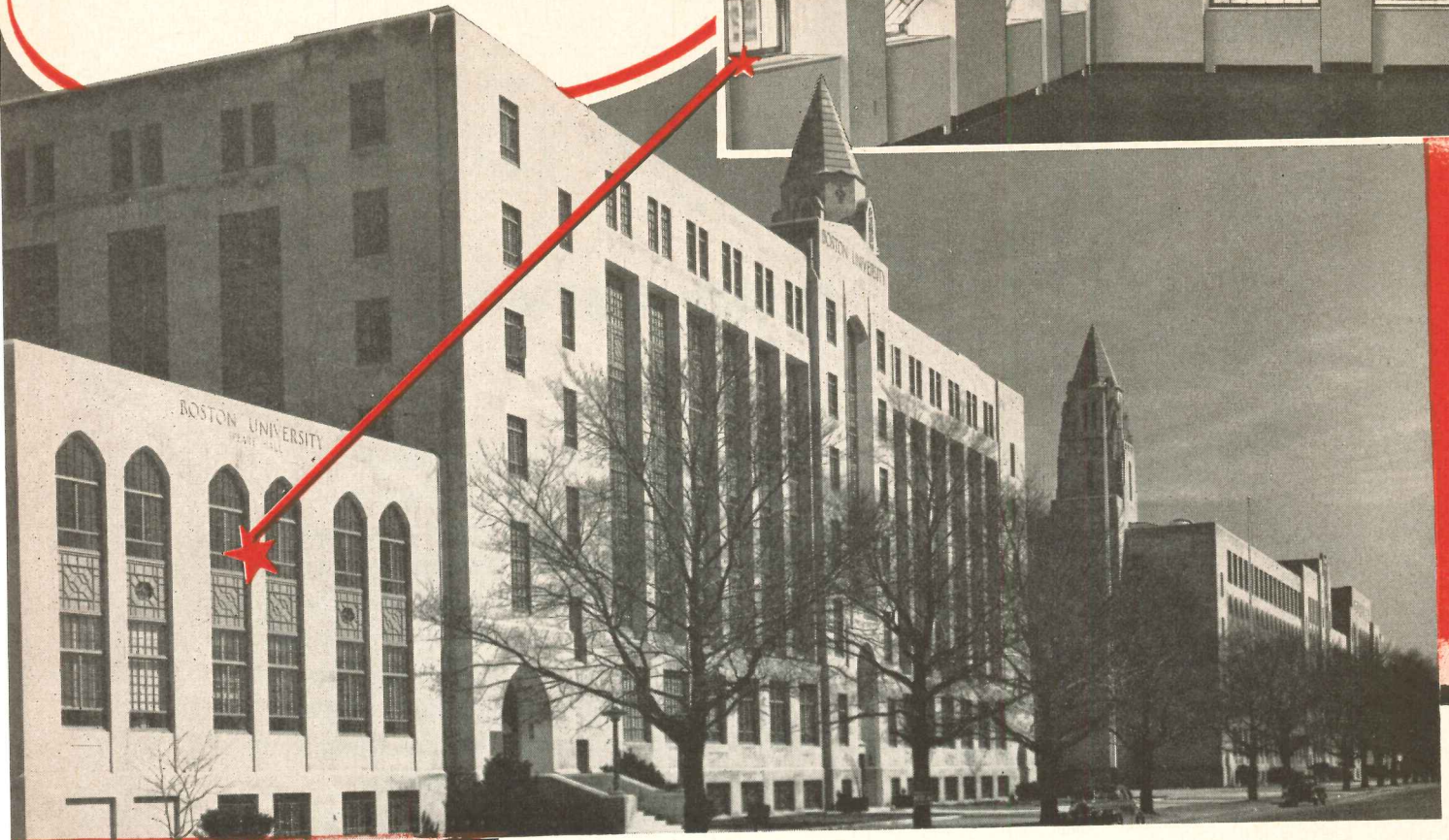
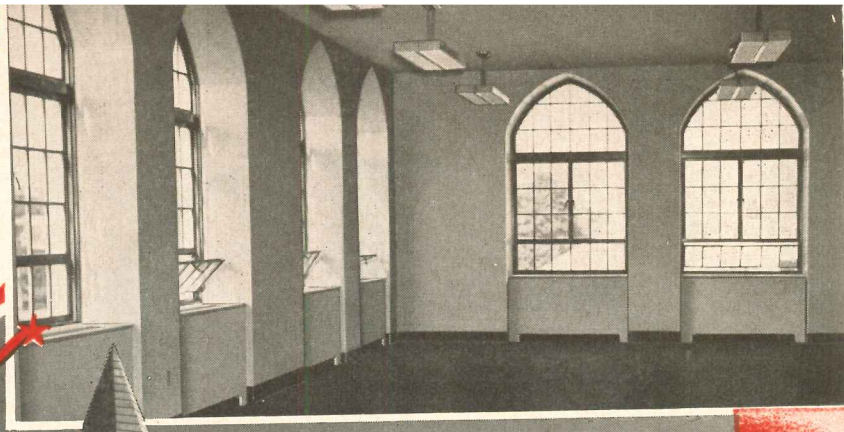

## **MILCOR\*** Steel Window Stools

*...practical, permanent, and firesafe*

Milcor Steel Window Stools are *practical* — because they are economical to install, easy to clean and maintain . . . *permanent* because they are wear-resistant — can't warp, rot, shrink, or crack . . . and *firesafe* because they are made of steel!

The complete Milcor Window Stool line gives you an attractive selection, too—in a full range of styles, types and sizes to suit your specific interior design.

These handsome window stools may be used separately or together with Milcor Metal Window Trim, corner fittings, and other accessories. Look for full details in Sweet's, or write for a copy of the latest Milcor Manual.

\*Reg. U. S. Pat. Off.

F-375

# INLAND STEEL PRODUCTS COMPANY

4035 WEST BURNHAM STREET

MILWAUKEE 1, WISCONSIN

BALTIMORE 5, MD. — 5300 Pulaski Highway • BUFFALO 11, N. Y. — 64 Rapin St. • CHICAGO 9, ILL. — 4301 S. Western Avenue Blvd. • CINCINNATI 25, OHIO — 3240 Spring Grove Ave. • CLEVELAND 14, OHIO — 1541 E. 38th St. • DETROIT 2, MICH. — 690 Amsterdam Ave. • KANSAS CITY 8, MO. — S. W. Boulevard and State Line • LOS ANGELES 58, CALIF. — 4807 E. 49th St. • NEW YORK 22, N. Y. — 230 Park Ave. • ST. LOUIS 10, MO. — 4215 Clayton Ave.

STRUCTURAL FORMS-19: Thin Shells of Reinforced Concrete

By Seymour Howard, Architect, Instructor at Pratt Institute

A-1 CENTER(S) OF CURVATURE BELOW SHELL (Continued)

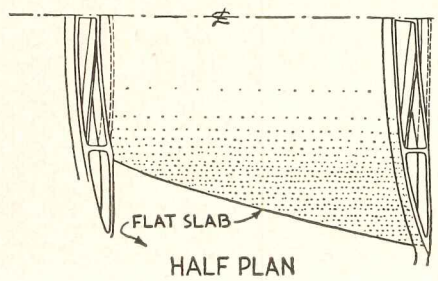
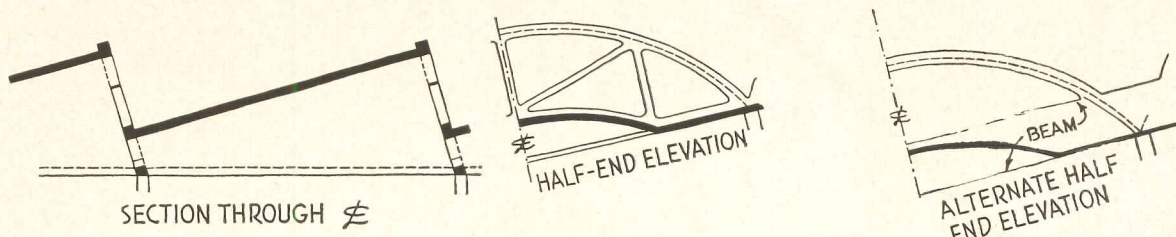

Tilted Cylindrical Shell

NOTE that: Shell has same radius of curvature throughout its length; intersection of shell and flat slab traces part of an ellipse in plan.

Awkward flat areas between shells can only be eliminated by using another type of surface for the shell, such as cone (see below) or a conoid (see later sheet on B-3, shells curved in two directions); or by using another type of surface for the area between shells (such as an inverted shell).

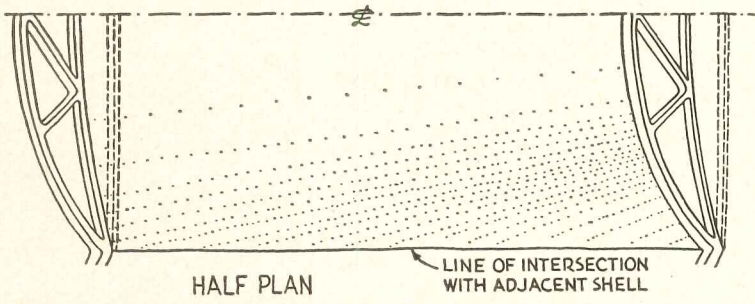
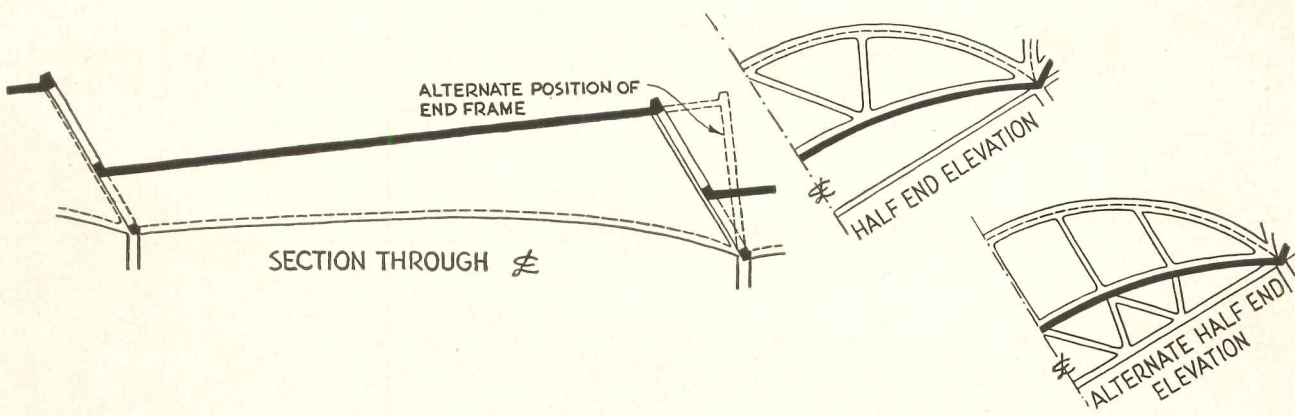

Tilted Conical Shell

NOTE that: Shell has radius of curvature which varies uniformly throughout its length; intersection of adjacent shells traces part of a hyperbola in side elevation.

If cone is not tilted and if shorter radius is not used at outside curve of end elevation, large flat slab portions would have to be used between shells, similar to those formed between tilted cylinders (see above and also later sheet on A-2 Center of curvature above shell).

If end frame is placed in alternate position (see section), at right angles to side of cone instead of at right angles to center line of cone, the end elevation of frame would show ellipses instead of circles.

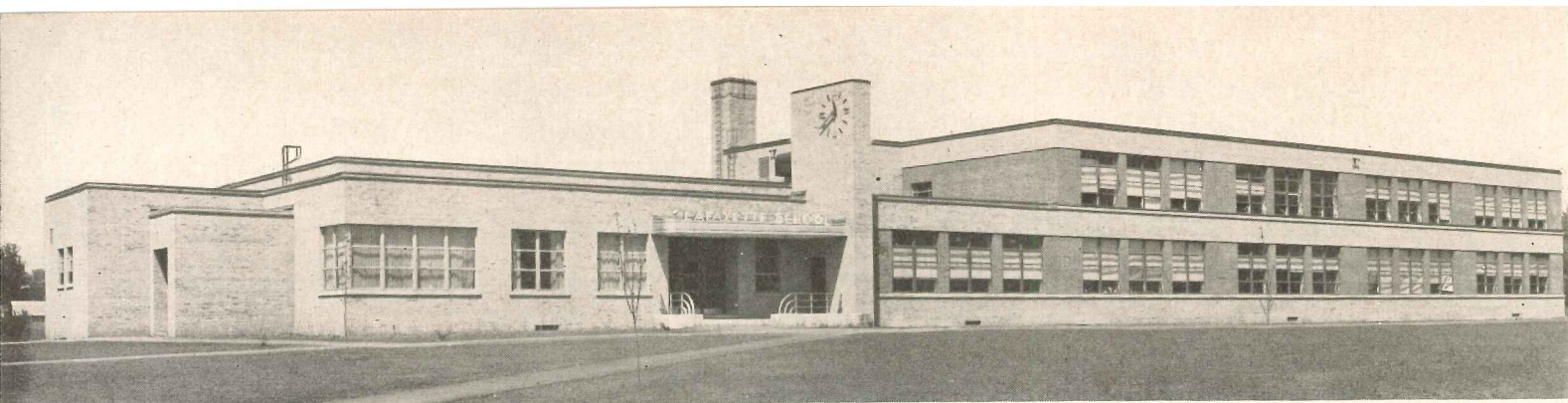

Lafayette Elementary School, Waterloo, N. Y. Completed 1951 at a cost of \$550,000. Architect and Engineer: Carl C. Ade. Heating Contractor: A. Burgart, Inc.

# COLD MEETS ITS WATERLOO

## In Waterloo, New York

### New York Community Modernizes its School System With New Schools and Tru-Perimeter Heating

When Waterloo, N. Y., decided its educational shoe was pinching they called on Carl C. Ade, prominent Rochester architect and engineer, to help remedy the situation.

Result — the handsome new Lafayette Elementary School illustrated here and the even larger Skoi-Yase (Indian for 'bubbling water') Elementary School now under construction. With these new schools, and its existing buildings, Waterloo has solved its educational space problems for many years to come.

For efficient, modern heating, both these new schools use Webster Walvector, as do many of the schools designed by Carl C. Ade's office.

Here is Tru-Perimeter Heating. The cold perimeter walls of the buildings are heated gently and evenly. There are no cold spots, no hot spots, no drafts. With Webster Walvector, the heating element and piping are concealed in attractive metal enclosures.

Webster Walvector in perimeter heating simplifies piping, uses fewer risers. Heating up is quick, effectively controlled. Buildings can be heated just before occupancy and the heat reduced immediately after the need is gone.

Whether you are contemplating new construction or modernization, look into the advantages of Webster Walvector. For complete information call the Webster Representative or write us

Address Dept. AR-6

**WARREN WEBSTER & COMPANY**  
Camden 5, N. J., Representatives in Principal U. S. Cities  
*In Canada, Darling Brothers, Limited, Montreal*

*Webster*  
**WALVECTOR**  
REG. U. S. PAT. OFF.  
**For Steam or Hot Water Heating**

### Recent New York State Schools by Carl C. Ade that use Webster Walvector

- Elementary School, Fulton;
- Britton Road School, Greece;
- Irondequoit Jr.-Sr. High School District #3, Irondequoit;
- Pittsford Jr.-Sr. High School, Pittsford;
- Griffith Institute, Springville;
- Bryant School, Hornell;
- Lafayette School, Waterloo;
- Skoi-Yase School and Bus Garage, Waterloo;
- Webster Central School, Webster;
- West Webster Elementary School, West Webster

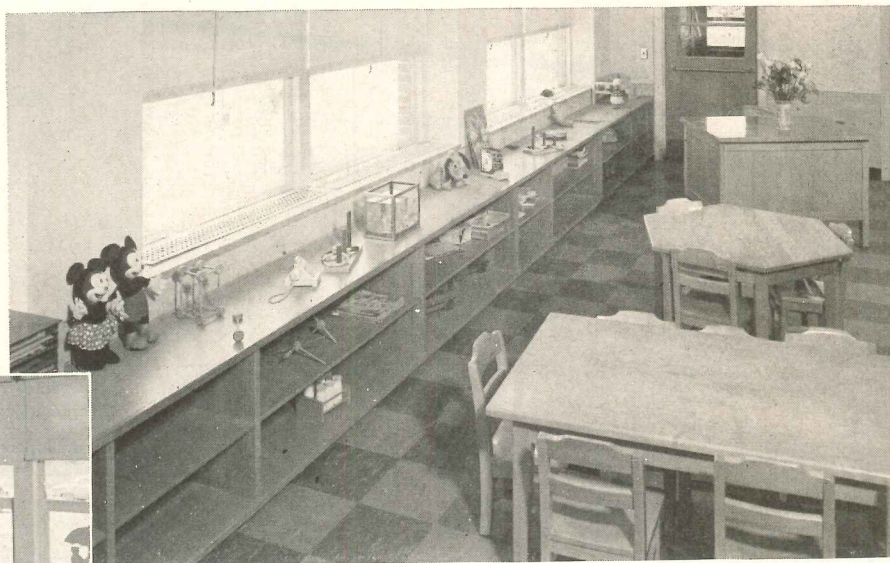

Above: Kindergarten of the Lafayette School. Here concealed Webster System Radiators deliver heat through top outlet grilles shown in window sills. Air enters below toy shelving.

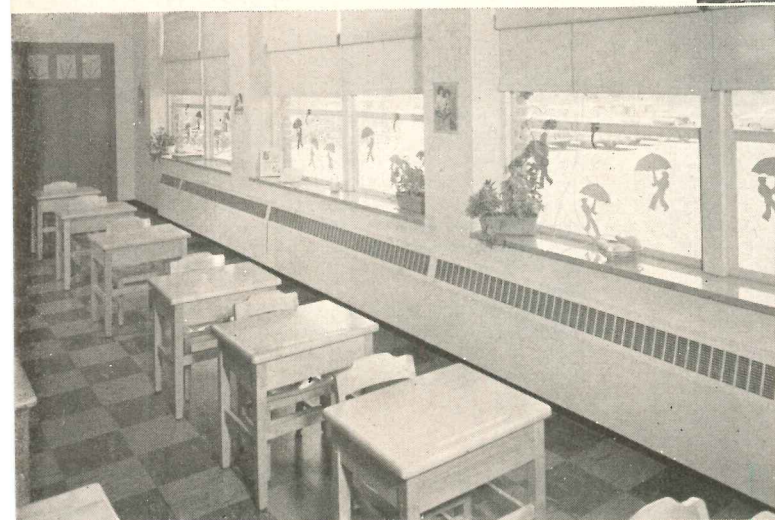

Left: Webster Walvector under windows in Lafayette School classroom. Air enters below Walvector enclosure, is gently warmed by heating element and passes out through the attractive grilles. Wall-to-wall warmth, no cold spots.

STRUCTURAL FORMS-20: Thin Shells of Reinforced Concrete

By Seymour Howard, Architect, Instructor at Pratt Institute

A-1 CENTER(S) OF CURVATURE BELOW SHELL (Continued)

For short barrel shells the arch and its abutments become the primary consideration. Some typical sections:

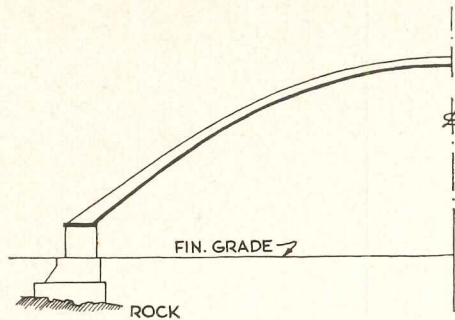

PEDESTAL AND VERTICAL BUTTRESS ON ROCK  
ON POOR SOIL, USE TIE BARS

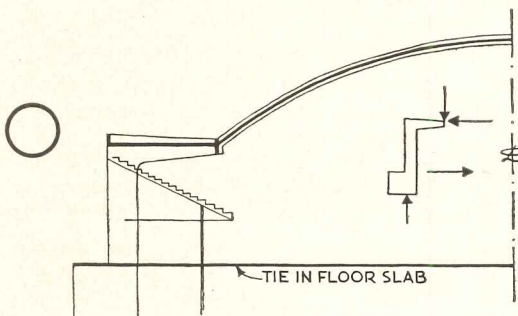
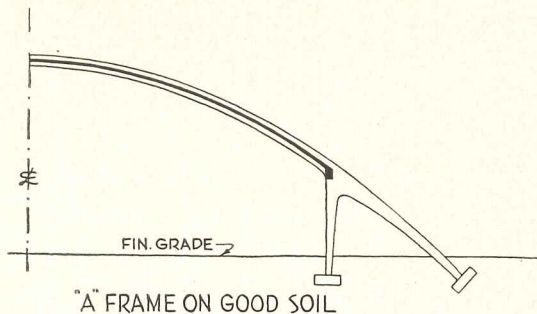

BUTTRESS WITH HORIZONTAL CANTILEVER

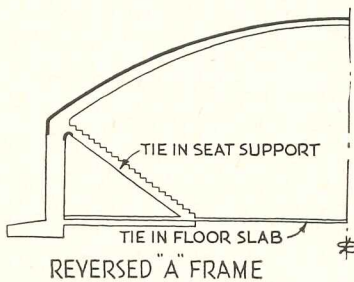

REVERSED "A" FRAME

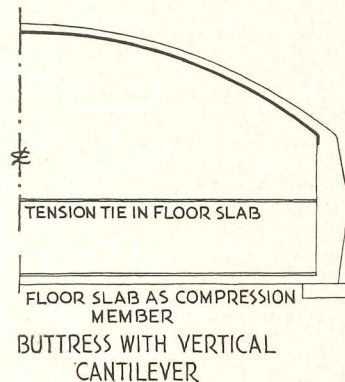

Horizontal component of arch thrust forms couple with tie, which is balanced by couple formed by vertical component of arch thrust and vertical reaction of foundation.

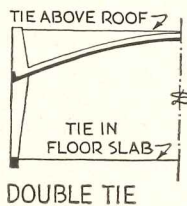
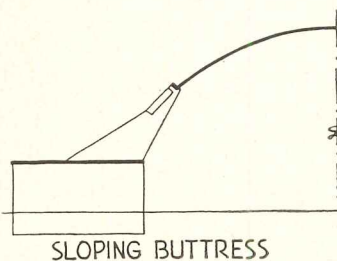

DOUBLE TIE

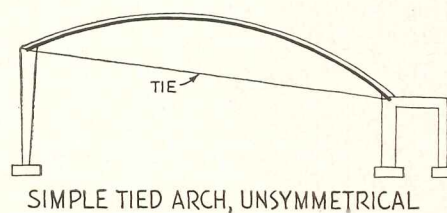

SIMPLE TIED ARCH, UNSYMMETRICAL

Transverse joints can be provided as shown in these three side elevations:

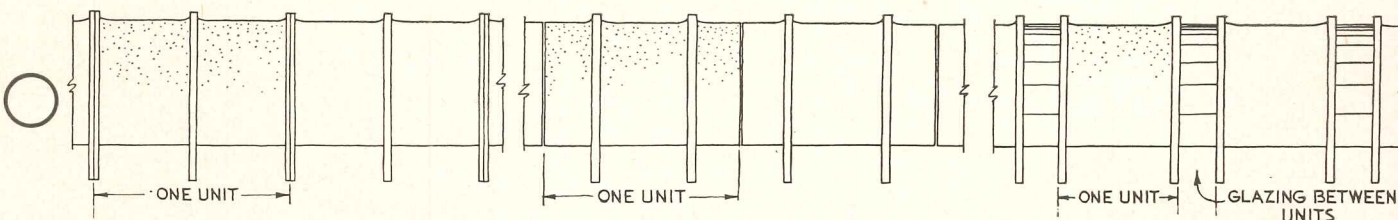

Joints are necessary for expansion, for construction convenience (limit of formwork) or to permit introduction of another element such as glazing.

# WHY THE FITZGIBBONS BOILER "D" TYPE IS

# 7 ways better for big buildings

**1** Steel Construction — heavy "flange" quality steel plate is electrically welded to provide strength and durability. Workability of steel permits boiler design for quick, economical transfer of heat.

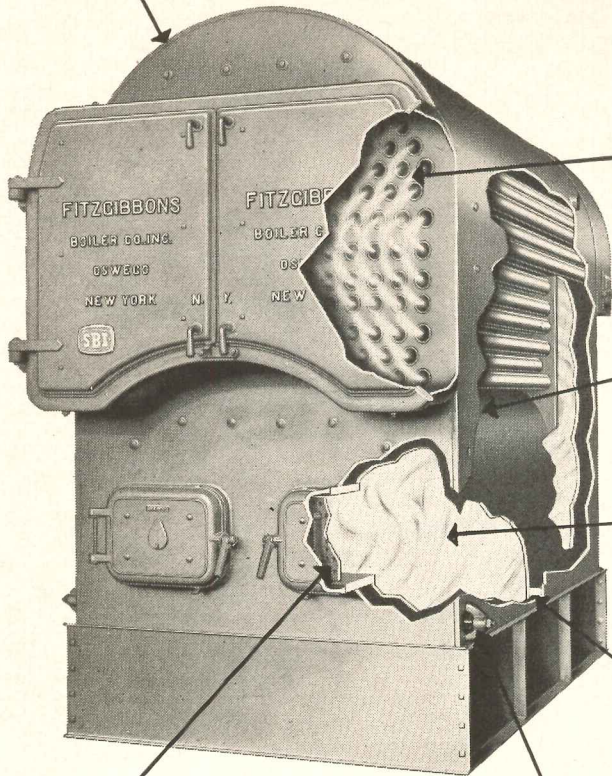

**2** Easy Cleaning For All Surfaces — tubes are reached through large doors at front of boiler. Firedoors give ample access to firebox heating surfaces.

**3** Rapid Water Circulation — concentration of heat at high point of crown sheet and unimpeded waterways induces faster circulation, brings more water in contact with more heating surface in a given time.

**4** Complete Combustion — firebox of adequate height and volume provides maximum efficient burning of fuel. Ideal for oil, gas, or coal (stoker or hand-fired).

**5** Welded Mud-Ring Design — a heavy steel bar is welded between side-walls of shell and firebox to give added strength to water-leg section and longer life to the boiler.

**7** Rugged Door Frame — water-cooled fire door frame of extra-heavy steel is welded between shell and firebox water wall. An asbestos gasket-sealed, soot-tight fire door completes the assembly.

**6** Waterside Inspection — hand holes, 3" x 4½" large, permit complete inspection and cleaning of crown sheet and water-leg. From 6 to 14 hand holes depending on size of boiler.

All these features add up to economy, long life, and low maintenance cost. Fitzgibbons boilers meet or exceed ASME code requirements in all construction details; are certified by a Hartford Inspector. Sixteen sizes from 876,000 Btu to 10,200,000 Btu. For complete details, write to the Fitzgibbons Boiler Company, Inc., 101 Park Avenue, New York 17, N. Y. Ask for catalog AR-6.

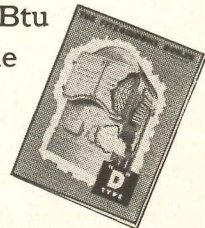

# THE FITZGIBBONS BOILER®



**STRUCTURAL FORMS-21: Thin Shells of Reinforced Concrete**

By Seymour Howard, Architect, Instructor at Pratt Institute

**A-2 CENTER(S) OF CURVATURE ABOVE THE SHELL**

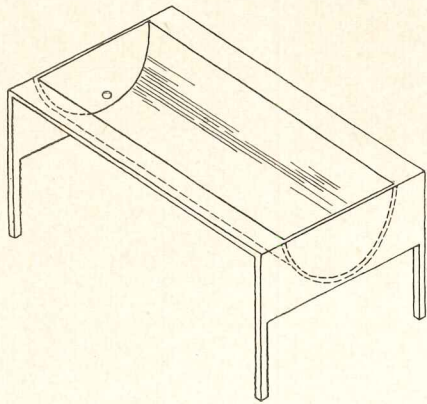

Inverted, concave shells are basically shapes best realized in tensile materials, such as wire or fiber rope, canvas, steel. The danger of buckling of the free edges of the shell requires stiffening or frequent bracing. Concave shells are therefore used chiefly as a supplement to convex shells, which have their centers of curvature below.

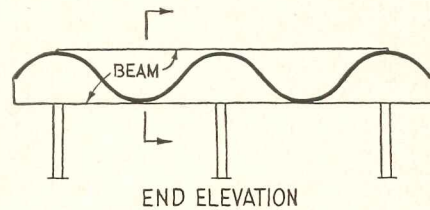
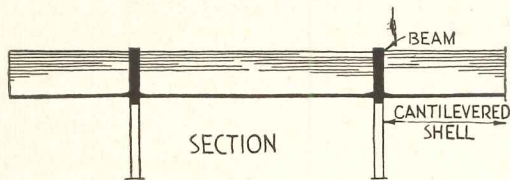

**Typical Flat Corrugated Shell**

Between the supports the concave part of the shell will carry the main tensile reinforcement. In the cantilevered ends the concave part will provide the main compressive strength. The shape of the corrugations has little statical importance; segments of circles are shown, but others may be used including the sine curve.

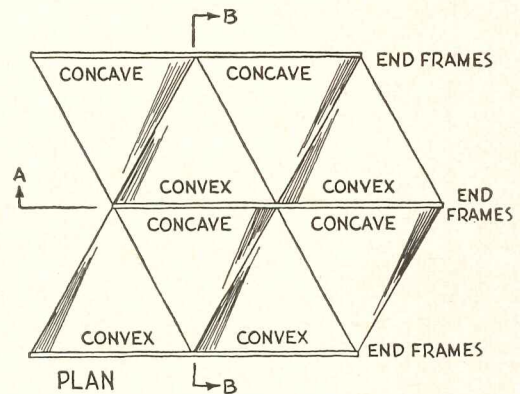
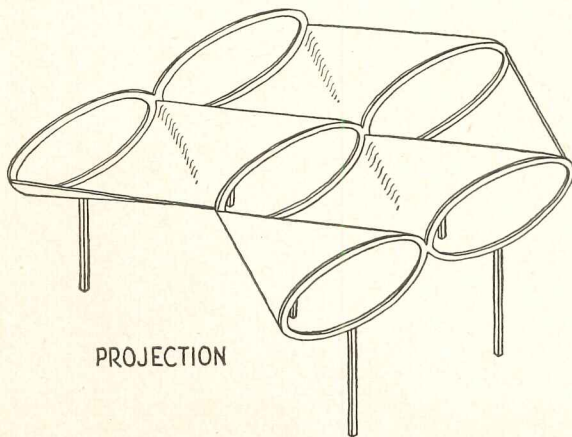
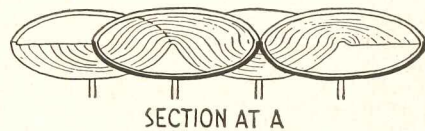
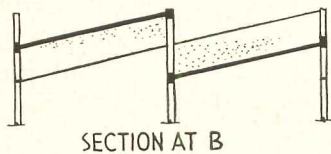

**Inverted Shells Used to Fill Spaces Between Conical Shells**

(Bracing members not shown in end frames, for clarity.) (This is a scheme of Architect Horacio Carminos and Engineer Antonio B. Aracibia of Argentina.)

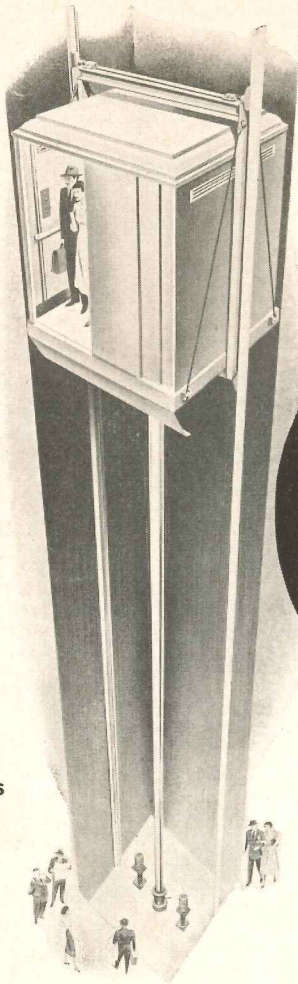

The trend is to

# Rotary OILDRAULIC<sup>®</sup> Elevators

for modern buildings

Smooth, safe,  
economical  
Oildraulic power  
supports and moves  
the elevator car

## CHICAGO

Walgreen General Offices

Architect: A. Epstein and Sons, Inc.

General Contractor: Sumner S. Sollitt  
Construction Co.

Rotary Oildraulic Elevator (Freight)  
installed by Gallaher & Speck, Inc.



Decorate  
with a door?

sure...look →

Step up to a door like this and you can't help but admire it. It's more than an entrance—it's a pleasant introduction. It reflects good taste on the part of the architect, the decorator and the owner.

This is a Blue Ridge *Securit*\* Interior Glass Door. It is a single piece of translucent glass which matches the fixed panel of Muralex *Patterned Glass* alongside it.

Beautiful—and equally practical.  
Here's why:

The  $\frac{3}{8}$ "-thick glass is tempered so it can stand hard usage.

The translucent glass lets light through to brighten rooms. Yet the pattern provides privacy.

The *Securit* Door is easy to hang. No cutting, planing or painting. Everything comes to the job with the door—beautiful hardware and ball-bearing hinges. When specified, the door can be shipped with a Sargent closer or prepared for use with an LCN concealed closer.

The cost? It compares favorably with high-quality doors of other materials—and you make important savings in installation time and costs.

No longer need doors be just something to let people in and out. Make them highlights of beauty in your decorating plan—with Blue Ridge *Securit* Interior Glass Doors. Your L-O-F Glass Distributor or Dealer can tell you more about it. He's listed in the yellow pages of phone books in many principal cities. Or mail the coupon for further information.

\*®

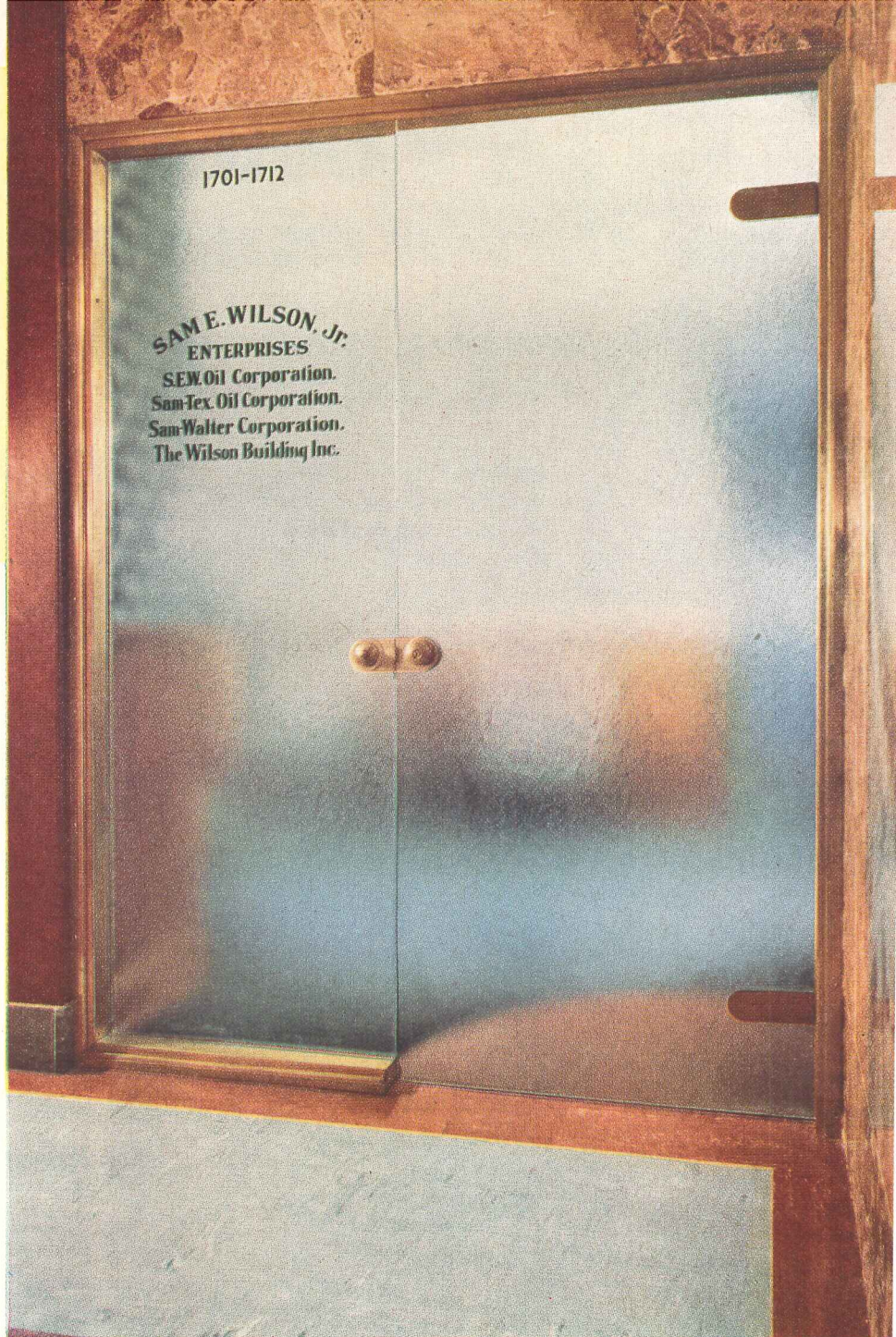

Architect: Walter W. Ahlschlager, Dallas, Texas

#### BRIEF DATA

**Glass**— $\frac{3}{8}$ " thick. Muralex pattern on both surfaces.

**Tempered**—3 to 5 times stronger than untempered glass of same thickness.

**Reversible**—can be used right or left hand.

**Standard Sizes**— $2'6'' \times 6'8''$       $3'0'' \times 6'8''$   
 $2'8'' \times 6'8''$       $3'0'' \times 7'0''$

—also 4 sizes for openings of these dimensions with proper allowance for clearances.



securit®



INTERIOR GLASS DOORS

Libbey-Owens-Ford Glass Company  
Patterned & Wire Glass Sales  
B-2463 Nicholas Building, Toledo 3, Ohio

Please send me your folder, *Blue Ridge Securit Interior Glass Doors*.

NAME \_\_\_\_\_ (PLEASE PRINT)

ADDRESS \_\_\_\_\_

CITY \_\_\_\_\_ STATE \_\_\_\_\_

# "WE SAVE \$9,000 A YEAR—AND HEAT MORE SPACE—BY BURNING COAL THE MODERN WAY!"



**NEW COAL INSTALLATION SAVES US 31.9%—  
43¢—ON EVERY THOUSAND POUNDS OF STEAM!"**

says Mr. Robert W. Paul,  
Heating Engineer,  
the University of Akron,  
Akron, Ohio.

## **NO SMOKE CONDITION... NO DUST NUISANCE—**

*this plant is located in a residential neighborhood and operates well within the bounds of extremely tight smoke and dust regulations—thanks to burning and handling coal with up-to-date equipment!*

This view shows Akron's two new stoker-fired boilers. The old equipment delivered a thousand pounds of steam at a cost of \$1.35. Now Akron gets a thousand pounds of steam for only 92 cents, *cutting cost by nearly 1/3!* For about \$26,000 a year, this new plant does the work that would have cost \$35,000 with the old one.

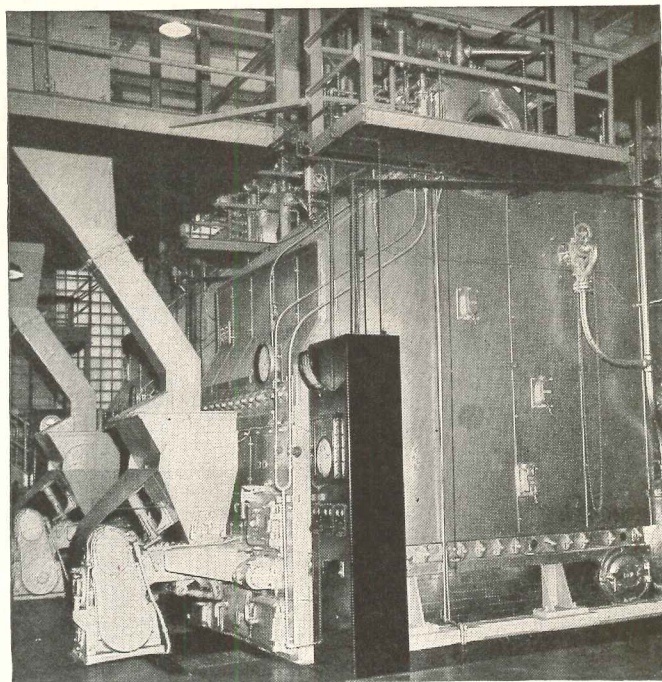

**If you operate a steam plant, you can't afford to ignore these facts!**

- COAL** in most places is today's lowest-cost fuel.
- COAL** resources in America are adequate for all needs—for hundreds of years to come.
- COAL** production in the U.S.A. is highly mechanized and by far the most efficient in the world.
- COAL** prices will therefore remain the most stable of all fuels.
- COAL** is the safest fuel to store and use.
- COAL** is the fuel that industry counts on more and more—for with modern combustion and handling equipment, the inherent advantages of well-prepared coal net even bigger savings.

**BITUMINOUS COAL INSTITUTE**

A Department of National Coal Association, Washington, D. C.

**Planning to modernize?** Building a new plant? In either case an up-to-date coal installation can save you lots of money!

Labor costs are cut to a minimum with modern coal- and ash-handling systems . . . modern combustion equipment gives more steam per dollar—10 to 40% more power from every ton of coal!

A consulting engineer can show you how these savings really mount up—and mount up fast—when you burn *bituminous* coal in a modern plant designed to meet your *specific* needs.

And coal's your best bet for the future, too. Of all fuels, coal alone has virtually unlimited reserves. And America's coal is mined by the most productive and efficient coal industry in the world. That's why coal offers greater price stability and more dependable supply than any other fuel!

FOR HIGH EFFICIENCY  FOR LOW COST

# **YOU CAN COUNT ON COAL!**

# CRANE'S COMPARTMENT BATHROOM

A prize-winning room plan from  
Crane's national architectural competition

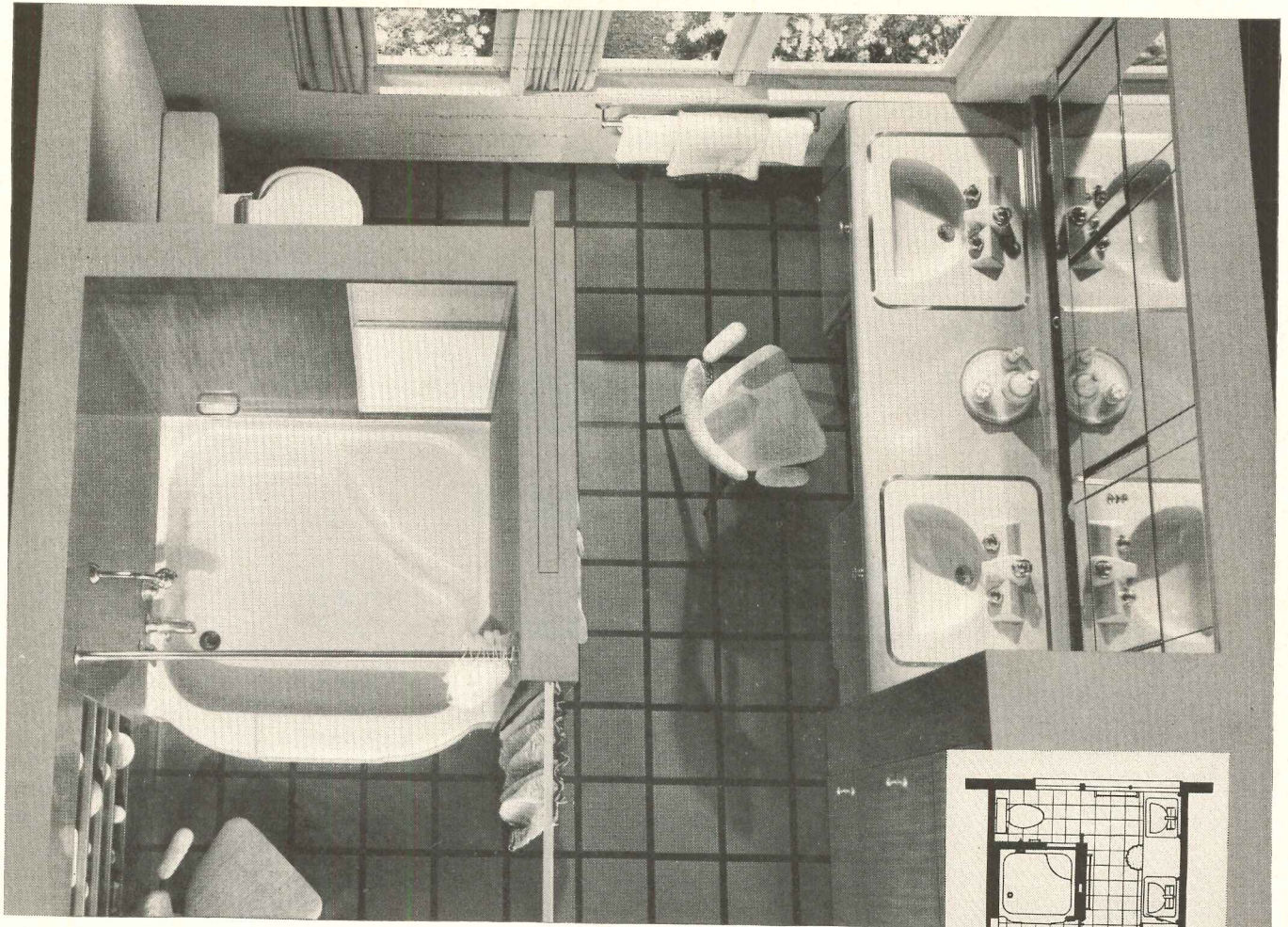

**1ST  
PRIZE  
BATHROOM**

*First prize winner, bathrooms for homes costing up to \$25,000, in Crane's national architectural competition—designed by J. A. Curtis, graduate student, Massachusetts Institute of Technology.*

Here's one of the many new ideas that came out of Crane's national architectural competition.

*We call it Crane's Compartment Bathroom.*

By careful planning, the designer has provided the efficiency and privacy of two bathrooms at little more than the cost or space of one . . . a room that as many as four members of the family can use at the same time.

*See how privacy is obtained.* A sliding door shuts off the Crane Drexel water closet. A draw-curtain does the same for the Crane Neuvogue tub in the bath and dressing area.

And instead of the usual single lavatory, there are twin Crane Marcia lavatories installed in a trim counter-top with cabinets.

The Compartment Bath is typical of the many new practical room ideas available from Crane. Each room is described in an "Idea Folder" which also includes suggestions for decorating and furnishing. Together with the Crane Sketchbook of Ideas, these folders help your clients visualize and approve new room arrangements. Ask your Crane Branch or Crane Wholesaler.

# CRANE CO.

GENERAL OFFICES: 836 SOUTH MICHIGAN AVE., CHICAGO 5  
VALVES • FITTINGS • PIPE  
PLUMBING AND HEATING

LITERATURE

(Continued from page 262)

*Vinyl Plastic Sheeting Material*

*Facts About Kalistron.* Leaflet tells the complete story of this material—what it is; how it is made; in what dimensions, colors and patterns it is available; how it is applied, etc. Photographs of actual applications on both furniture and walls are given, along with a chart of physical characteristics. A separate specification form is also included. 7 pp., illus. Kalistron, Inc., div. of U. S. Plywood Corp., 55 W. 44th St., New York 18, N. Y.

*Swimming Pool Construction*

*Swimming Pool Construction Portfolio.* This portfolio is an unusually complete compilation of technical information available to the architect or builder of swimming pools, containing catalogs on equipment and price lists as well as engineered typical plans for form-poured, gunite and concrete block pools. A coordinating booklet, "How to build a swimming pool" (Bulletin B-1), deals with most general problems connected with this type of design, and treats those individual facets that would come up naturally in the course of the job. In addition, the manufacturer will furnish photographs of swimming pools on request from architects or builders. 8 pp., 8 pp., 8 pp., 5 plans, illus. Landon, Incorporated, 5920 Sepulveda Blvd., Van Nuys, Calif.\*

LITERATURE REQUESTED

The following individuals and firms request manufacturers' literature:

Robert J. Bratton, Jr., Construction Estimator, Bryant & Detwiler Co., 1166 Woodland, Inkster, Mich.

Thomas A. Kapczynski, Architectural Designer, 32 Kendall Blvd., Oaklyn 6, N. J.

Norman Klehamer, Student, 1608 Alder St., Eugene, Ore.

Allan F. May, Architect, Hesson & May, Architects, 148 Olmos Dr., W., San Antonio, Tex.

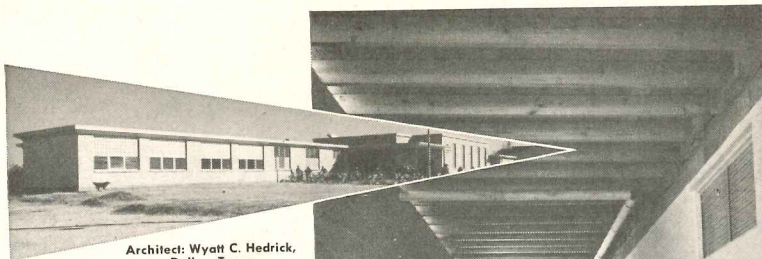

Architect: Wyatt C. Hedrick, Dallas, Texas

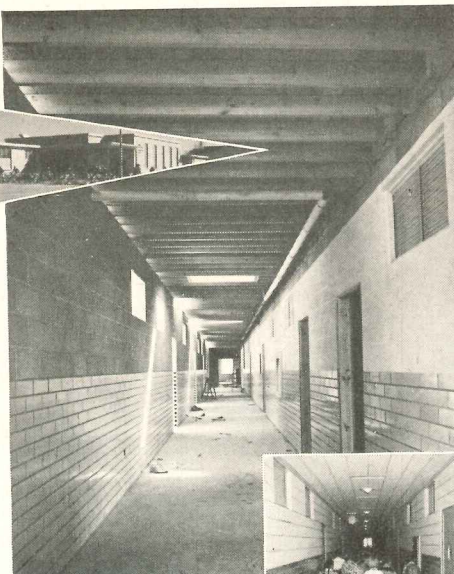

Four Longview school buildings used approximately 400,000 fbm of Minalith-treated lumber for roof decks, ceiling joists, wood framing around openings.



WE'VE BEEN EXPELLED!  
THIS SCHOOLHOUSE LUMBER'S  
BEEN MINALITH FLAME  
PROOFED . . .

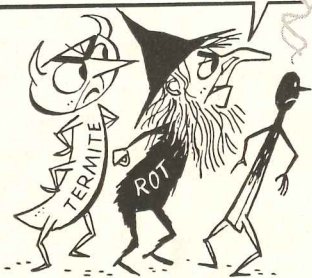

**How Longview, Texas, PROTECTS  
Its School Children  
and Its Tax Dollar Investment**

When the citizens of Longview, Texas decided their community needed four new school buildings, they demanded absolute structural safety plus practical economy of design and construction. They also wanted long serviceability with minimum maintenance.

Wyatt C. Hedrick, well-known Dallas architect suggested a popular and economical method of construction—brick veneer supported by fire-retardant chemical-impregnated lumber.

Hedrick specified that lumber be pressure impregnated with Minalith.\* Listed by Underwriters' Laboratories, Minalith also meets Federal Specifications for Fire Retardants. Wood treated with Minalith will not support combustion—it will char slowly where flame touches it, but will not ignite. During a fire, Minalith-treated lumber

maintains its load bearing strength without sudden collapse. As a plus-value, Minalith protects wood from decay organisms and insect attack. And Minalith has no undesirable effects on lumber, keeps it clean for handling and completely paintable.

With Minalith-treated lumber readily available, local labor was able to proceed at once. Longview was pleased to note that use of local labor and local materials kept construction tax dollars at home.

Minalith-treated lumber is a product of American Lumber and Treating Company, who also produce Wolmanized\* preservative-treated lumber. There are Wolman preservative treatment plants in all parts of the country. For further information write:

**American Lumber & Treating Company**

General Offices: 1601 McCormick Building, Chicago 4, Illinois

Offices: Little Rock, Arkansas • Portland, Oregon • Boston • Los Angeles  
San Francisco • Baltimore • New York • Jacksonville, Florida • Seattle

Producers of the Original



**MINALITH**  
FLAME PROOFED  
LUMBER

a companion product to  
**Wolmanized**  
PRESSURE TREATED  
Lumber

\* Reg. U. S. Pat. Off.





Newest branch of Lord & Taylor at West Hartford, Conn. Designed by Raymond Loewy Associates, New York City. Extrud-A-Line Entrances and Alumiline Store Front Construction were used. Architect: Irving W. Rutherford of Hartford.

## ALUMILINE

EXTRUDED ALUMILATED ALUMINUM PRODUCTS

Specified by Leading Architects for:

HOSPITALS • SCHOOLS • RELIGIOUS BUILDINGS • BANKS  
STORE FRONTS • OFFICE BUILDINGS • INDUSTRIAL PLANTS  
HOUSING PROJECTS • SHOPPING CENTERS

- Extruded Aluminum Store Front Construction
- Extruded Aluminum Factory Assembled Entrance Frames
- Narrow and Wide Stile Extruded Aluminum Doors
- Custom Built Extruded Aluminum Windows

Send for new 1953 Catalogs "Alumiline" Store Front Construction and "Extrud-A-Line" Entrances

**THE ALUMILINE CORPORATION**

1540 COVERT STREET BROOKLYN 27, N. Y.



## ..... 3 UNIT HEATERS with a Purpose

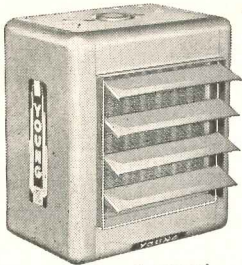

Horizontal Type "SH"

• Horizontal discharge and adjustable louvers provide a variety of heat direction angles for eliminating "cold spots." Available in 14 sizes for steam or hot water systems.

• Particularly adept at delivering heat from high levels. Unique "ventilating" method prevents motor baking. Made in 7 sizes with 3 types of diffusers for regulating heat patterns.

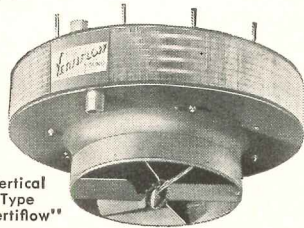

Vertical Type "Vertiflow"

• Adds attractive cabinet styling to unit heater performance. Quiet operating. Available in 3 sizes in each of 3 cabinet styles to meet all requirements.

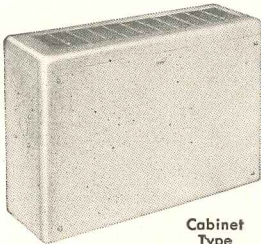

Cabinet Type

For full details on one or more of these Unit Heater types write for free catalogs.

**YOUNG RADIATOR CO.**

Dept. 613-F, Racine, Wisconsin  
Plants at Racine, Wis., & Mattoon, Ill.

Sales and Engineering Offices in All Principal Cities

# TRUST YOUR future reputation to LAWLER CONTROLS!

CERTIFICATE  
of  
Good Will

**BAM Water Controller**

For group showers . . . hospitals . . . industrial purposes . . . single outlets . . . multi-outlets.

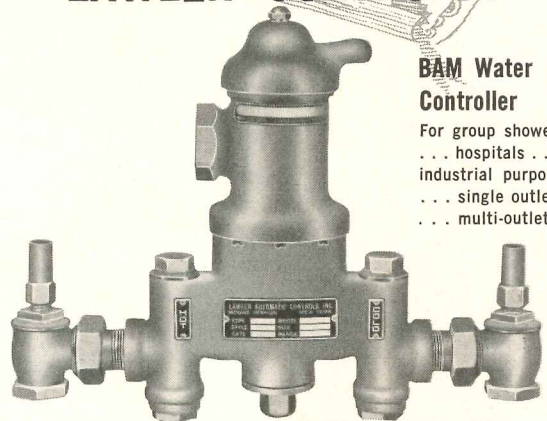

Lawler's "Performance-Tested" design combines pioneering experience with engineering leadership. The use of specially chosen metals assures YOUR customers years of positive, accurate temperature control with lowest maintenance cost . . . the best insurance YOUR REPUTATION can have!

Compare!

#### COMPARATIVE CHECK LIST

LAWLER BAM WATER CONTROLLER	Product "A"	Product "B"
Most Complete Line	✓	
Hydraulic Thermostat	✓	✓
Polished Chrome	✓	
Non-Ferrous Construction	✓	✓
Loose Key Angle Stops	✓	

List the facts . . .  
Check them off . . .  
Lawler comes out first every time!  
YOUR REPUTATION is protected!

The Lawler Line  
Thermostatic Controls

"Performance-Tested" for Longer Life

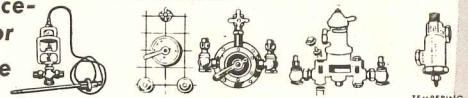

STEAM TEMPERATURE REGULATORS SHOWER MIXING VALVES WATER CONTROLLERS TEMPERING VALVES

**LAWLER AUTOMATIC CONTROLS, INC.**  
453 North MacQuesten Parkway Mount Vernon, New York

## THE RECORD REPORTS

(Continued from page 316)

which he outlines the curriculum. Separate articles on basic design, architectural design and town planning curricula follow, each illustrated with examples of student work. Articles on a field trip to New York and the university's architectural society are also included. To round out the issue, a fifth year thesis by a student at the school, David Powrie, is appended. Mr. Powrie's essay is a gen-

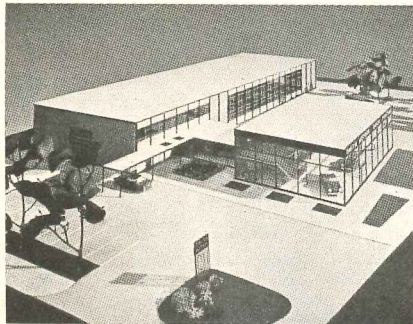

Toronto student Allan Young's third year project for a General Motors sales and service outlet

eral speculative investigation of the state of architecture today, and as one student's student's-eye view of things, it contains some interesting observations, including the following whole-hearted blast at the longsuffering architectural press:

"The popularization of the modern idiom today is being abetted largely through the efforts of the architectural and building magazines, and it may be assumed that, as in other cases of mass media, they wield a mighty pen. But of course the turn-about that is characteristic of mass media, the fact that they expound only what they feel will sell, leads one to suspect that they are no indication whatever of what serious men in architecture are thinking. It only takes a glance at many of these periodicals to realize that they regard architecture in much the same way that *Vogue* regards clothing. It is, perhaps, inevitable that architecture will become a thing of fashion when such widespread propagation seizes every idea and spews it across the world for the entertainment of great masses of people who can never know the meaning of architecture. The North American ideal of something new every day is implicit in these publications and the spectacle of them vying for the publication of new buildings and outdoing each other in lavish praise of the buildings' merits is amusing and saddening at once."

### Domus

March, 1953

Gio Ponti, the well-known Italian architect who manages to take time from his practice to edit *Domus*, also found time last Fall to attend the Eighth Pan-American Conference of Architects. Among the sights he saw in the western hemisphere was the Pedregal Gardens project in Mexico City. In the magazine's March issue, he delivers a report on his impressions of the project, partly as follows:

"The Pedregal Gardens are a splendid example of a perfectly successful enterprise. Architect Barragan has had not only the rare insight to discover this forgotten bad land (outside) Mexico City, but he had the faith and the courage to invest in this project his economic and professional future. It is a kind of lyric 'land reclamation' project. Nobody would believe him when he started the project by buying most of this cheap land, but his vision and his

(Continued on page 320)



### 1. Your RCA Sound Distributor

For expert, "no obligation," planning assistance, you'll find your RCA Sound Distributor is the man to know.

He can offer you advice on the latest in equipment, the newest in sound techniques. His experience covers a wide range of applications including schools, plants, hospitals, hotels, institutions, and stores.

Call on him for the answer to any question involving sound.

### 2. New RCA Sound Products Catalog

Here, in easy-to-find form is the full line of RCA Sound Products.

In 17 pages, you'll find helpful data on RCA sound equipment from microphones to large sound system centers. Get this booklet for your files. It's a handy reference for any sound job you may tackle.

**MAIL COUPON** for your copy of the RCA Sound Products catalog now.

Sound Products, Dept. 13R, Building 15-1  
Radio Corporation of America, Camden, N. J.

- Please have an RCA Distributor Sound Specialist call on me.  
 Send me the new free RCA Sound Products catalog.

Name \_\_\_\_\_ Title \_\_\_\_\_

Company \_\_\_\_\_

Address \_\_\_\_\_

City \_\_\_\_\_ Zone \_\_\_\_\_ State \_\_\_\_\_

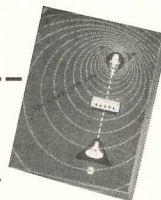

**RADIO CORPORATION of AMERICA**  
SOUND PRODUCTS CAMDEN, N. J.





**ONLY ADLAKE ALUMINUM  
WINDOWS GIVE  
ALL THESE "PLUS"  
FEATURES:**



- Woven-pile Weather Stripping and Exclusive Patented Serrated Guides
- Minimum Air Infiltration
- Finger-tip Control
- No Painting or Maintenance
- No Warp, Rot, Rattle, Stick or Swell

**THE  
Adams & Westlake  
COMPANY  
ELKHART, INDIANA**  
Established 1857 • New York • Chicago

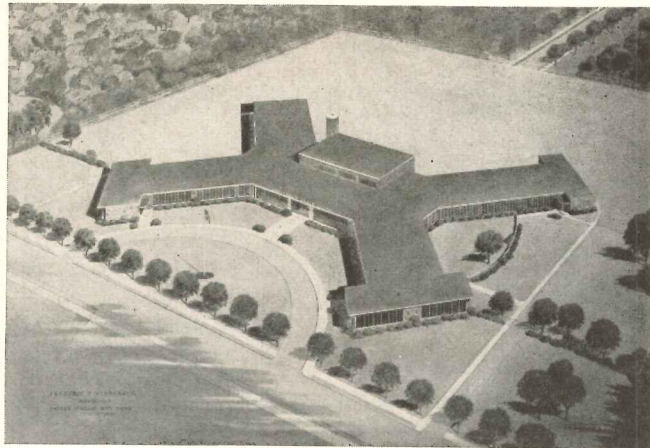

The Northside School at Levittown, New York, heated by radiant heat. Frederic P. Wiedersum, Architect; Courter & Co., Heating Contractors; Piping by Carl Pipe Bending Corporation.

## RADIANT HEAT PIPING "A PACKAGED JOB" IN NORTHSIDE SCHOOL

*Architect saves money, gets better heating by having all pipe fabricated in one shop*

Packaged jobs like this saved time and money for Frederic P. Wiedersum of New York City and Valley Stream, Long Island, in the Northside School and a number of other important Long Island schools. In every case the pipe was fabricated and furnished by Carl Pipe Bending Corporation, specialists in bending and welding pipe for modern radiant heating systems.

Architects all over the country are taking advantage of the special techniques developed by Carl Pipe Bending Corporation. They know that on-the-job fabrication costs more and is less reliable. Standardize your radiant heat installations on a quality plane . . . have coils fabricated with as few radii as possible by taking advantage of the Carl Pipe Bending packaged system and save substantial sums.

A file-size booklet, giving concise, basic information to enable you to design economical, uniform-bend, trouble-free radiant heat installations, has been prepared by Carl Pipe Bending Corporation. It is yours for the asking. Use coupon below.



**CARL PIPE BENDING CORPORATION**  
43-50 Tenth Street, Long Island City, N. Y.

Please send me booklet on radiant heat pipe layout.

Name.....Title.....  
Firm.....  
Address.....  
City.....Zone.....State.....

**EXPECT  
THE BEST FROM  
NEO-RAY**

**IT'S NEW!**

**NEO-RAY ROTO-STRIP**

Pat. Pend.

WINDOW LIGHTING • RUG DISPLAYS • FARMS, POULTRY, ETC.  
PROVEN & SPECIFIED FOR SCHOOLS • FOOTLIGHTS, CHALKBOARDS ETC

Here's an entirely new development in display lighting—a complete shallow unit with swivel sockets inbuilt in strip. Finger-Tip adjustment—swivels 90° in all directions through complete circle.

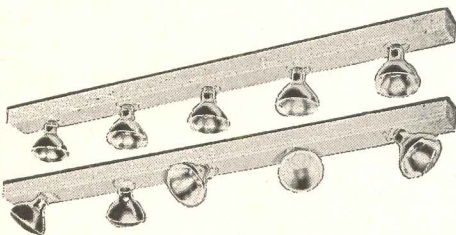

IT'S TRIED & TRUE!

**NEO-RAY ML LOUVRED CEILINGS**

Send for  
New Catalogs

**NEO-RAY  
PRODUCTS, Inc.**  
315 East 22nd St.  
New York 10, N. Y.

See our catalog  
in Sweet's Archi-  
tectural File for  
1953

sec. 30a  
NE

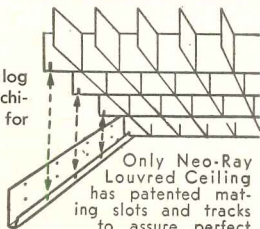

Only Neo-Ray Louvred Ceiling has patented matting slots and tracks to assure perfect alignment always—eliminates cork-screw effect.

# CURRENT TRENDS IN CONSTRUCTION

Charts by Dodge Statistical Research Service

THE RECORD REPORTS

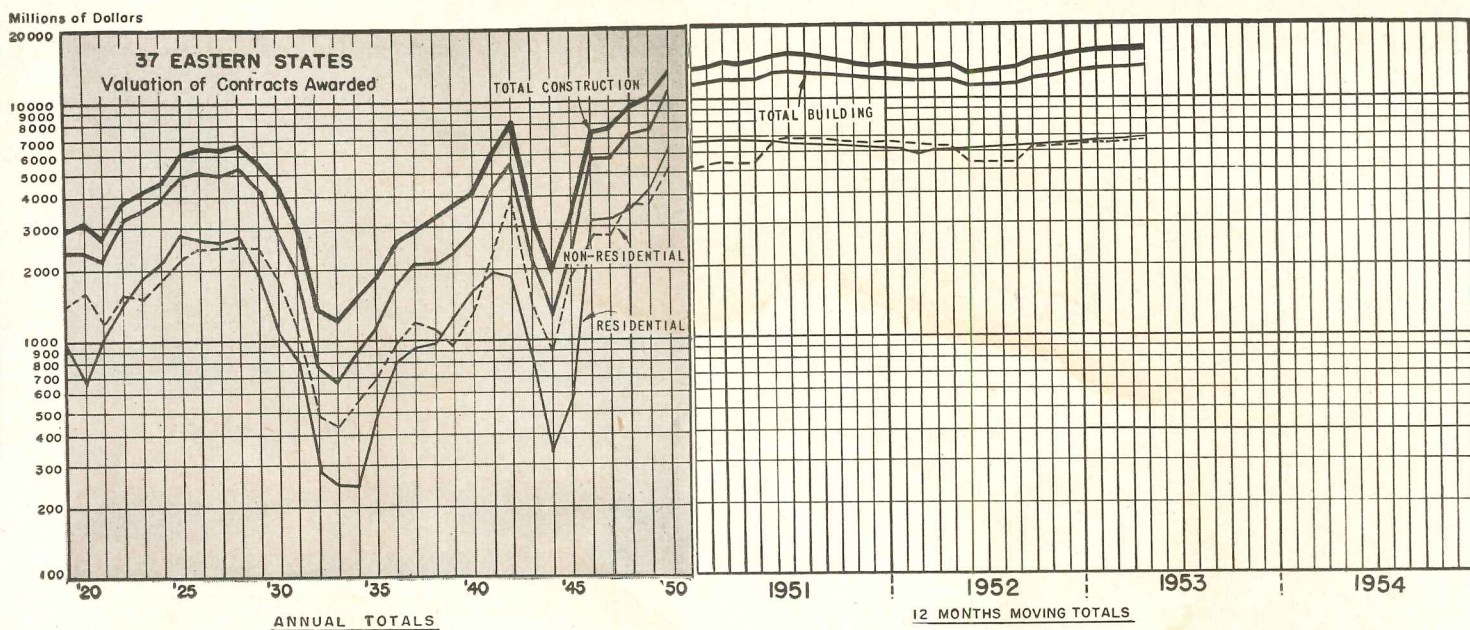

## TREND CONTINUES HIGH

Construction activity in the United States continues at a record high level and is running well ahead of 1952. Contract awards in April as reported by F. W. Dodge Corporation were up 9 per cent over '52; this brought the total for the first four months of this year to 10 per cent above '52, with gains registered in all major construction groups.

The sharpest increase was in nonresidential work which was running 13 per cent ahead (in contract dollar value) of '52. This reflected, however, the inclusion of portions of large Atomic Energy Commission projects which materially raised the industrial building category.

Dollar value of residential building contracts for the first four months held at 7 per cent ahead of last year although there was a slight dip in April. Earlier estimates of a million-home year seemed likely to be fulfilled.

The four-month total of Dodge Reports of contracts awarded in the 37 eastern states was \$5,186,238,000, up 10 per cent. The nonresidential four-month total was \$1,910,740,000, up 13 per cent; residential, \$2,157,691,000, up 7 per cent; heavy engineering, \$1,117,807,000, up 10 per cent.

Educational building contracts were also setting new highs. Regional comparisons are shown in the table below.

**EDUCATIONAL & SCIENCE BUILDINGS—REGIONAL COMPARISON**  
Contract Awards—Thousands of Dollars (37 Eastern States)  
First four months 1953—1952

Region	1953	1952	Region	1953	1952
37 East. states	479,238	455,353	Cincinnati	19,404	9121
New England	36,074	28,918	So. Michigan	20,693	24,120
Metropolitan			Chicago	47,240	53,953
N. Y.	44,906	78,033	St. Louis	18,255	18,968
Upstate N. Y.	33,547	20,701	New Orleans	8757	15,070
Middle Atlantic	64,422	60,837	Minneapolis	16,753	18,431
Southeastern	60,884	38,231	Kansas City	27,930	25,206
Pittsburgh	19,854	11,860	Texas	31,075	23,414
Cleveland	29,444	28,490			

## NONRESIDENTIAL BUILDING (37 EASTERN STATES)

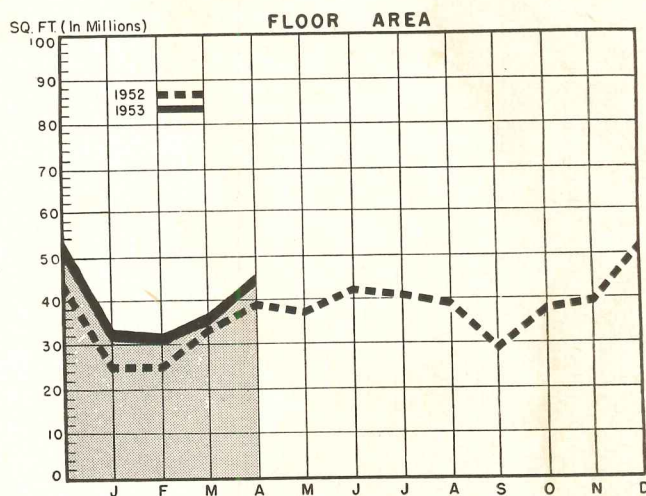

## RESIDENTIAL BUILDING (37 EASTERN STATES)

