

engineering for architecture



# ARCHITECTURAL RECORD

MID-AUGUST 1974  A MCGRAW-HILL PUBLICATION THREE DOLLARS PER COPY

# CONDITION WITH



Plexiglas acrylic plastic is a combustible thermoplastic. Observe fire precautions appropriate for comparable forms of wood. For building uses, check code approvals. Impact resistance a factor of thickness. Avoid exposure to heat or aromatic solvents. Clean with soap and water. Avoid abrasives.

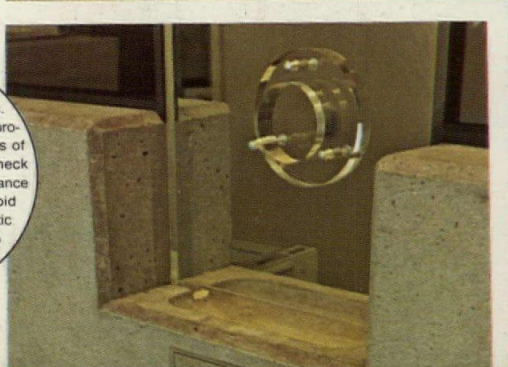

today,  
more than ever...  
it makes such  
beautiful  
sense.

# PLEXIGLAS®

Flat or formed. Clear or color.  
Strong. Light weight. Beautiful.  
Plexiglas brand acrylic plastic.  
Making sense, solving problems  
... any way you look at it.  
In banks where it provides  
transparency, security and  
crystal-clear beauty. In school  
skylights and windows where  
it resists breakage, controls  
glare and conserves energy.  
In homes where its formability  
makes small worlds larger.

Find out more about Plexiglas  
by writing for our brochures and  
engineering data. For on-the-  
spot answers to specific  
questions write or call our  
Architectural Coordinator (215)  
592-6799. See our catalog in  
Sweet's—8.26/Roh

*Building codes limit areas of plastic  
glazing. Approvals for large-area Plexiglas  
enclosures must be applied for on a special  
permit basis. Fire safety design  
considerations must take into account  
the combustibility of Plexiglas.*

Martin Luther King Elementary School  
Pittsburgh, Pa. (above)  
Architects: Liff, Justh and Chetlin  
Pittsburgh

Suffolk Franklin Savings Bank  
Boston, Mass. (left)  
Architects: Bastille-Neiley  
Boston

Beach Cottage, Harvey Cedars, N.J. (right)  
Architects: Murphy Levy Wurman  
Philadelphia, Pa.



the trademark

PLEXIGLAS

the company

ROHM  
& HAAS  
PHILADELPHIA, PA. 19105

For more data, circle 1 on inquiry card



## Win fire insurance, building code and employee acceptance, specify Osmose Flame Proof<sup>®</sup> fire retardant wood

In addition to allowing the architect to use the economy and flexibility of wood, Flame Proof makes a major contribution to life safety, lower insurance rates and property protection. Flame Proof pressure treated plywood and lumber is UL FR-S classified...a recognized building material. Whether structural or decorative, it is widely specified from floor joists underfoot to trusses and roof decks overhead. Consider it for churches, schools, offices, hospitals, shopping centers, motels, nursing homes, restaurants, anywhere the protection of

fire retardant material is required. For additional information, including personal assistance with fire insurance and building code acceptances, plus name of nearest Osmose treating plant write:



**OSMOSE**

980 ELLICOTT ST., BUFFALO, N. Y. 14209  
SOUTHERN OFFICE, 1016 EVEREE INN RD., GRIFFIN, GA. 30223

*Member Society of American Wood Preservers, Inc.*

*For more data, circle 2 on inquiry card*

**EDITOR**

WALTER F. WAGNER, JR., AIA

**MANAGING EDITOR**

HERBERT L. SMITH, JR., AIA

**SENIOR EDITORS**

ROBERT E. FISCHER  
WILLIAM B. FOXHALL  
MILDRED F. SCHMERTZ, AIA  
ELISABETH KENDALL THOMPSON, FAIA

**WASHINGTON EDITOR**

ERNEST MICKEL, Hon. AIA

**ASSOCIATE EDITORS**

GERALD ALLEN  
BARCLAY F. GORDON  
CHARLES E. HAMLIN  
CHARLES K. HOYT, AIA

**EDITORIAL ASSISTANT**

JANET NAIRN

**PRODUCTION EDITOR**

ANNETTE K. NETBURN

**DESIGN**

ALEX H. STILLANO, Director  
ALBERTO BUCCHIANERI, Associate  
ANNA-MARIA EGGER, Assistant  
MURIEL CUTTRELL, Illustration  
J. DYCK FLEDDERUS, Illustration  
JAN WHITE, Consultant

**EDITORIAL CONSULTANTS**

EDWARD LARRABEE BARNES, FAIA  
JONATHAN BARNETT, AIA, Urban design  
GEORGE A. CHRISTIE, JR., Economics  
PAUL RUDOLPH, FAIA  
Foreign architecture:  
*L'Architecture d'Aujourd'hui*, Paris

**McGRAW-HILL WORLD NEWS**

RALPH R. SCHULZ, Director  
10 domestic and 8  
international news bureaus:  
Bonn, Brussels, Buenos Aires,  
London, Milan, Moscow, Paris, Tokyo.

**SALES MANAGER**

LOUIS F. KUTSCHER

**CIRCULATION MANAGER**

HUGH S. DONLAN

**PUBLISHER**

BLAKE HUGHES

Of particular assistance to the editor in the preparation of this issue were:

Robert E. Fischer, editor-in-charge  
William B. Foxhall, senior editor  
Elisabeth Kendall Thompson, senior editor  
Barclay F. Gordon, associate editor  
F. J. Walsh, consulting engineer  
Grace Anderson  
Joan Blatterman  
Carol Deegan  
Jan White, art direction  
Muriel Cuttrell, illustration

# ENGINEERING FOR ARCHITECTURE

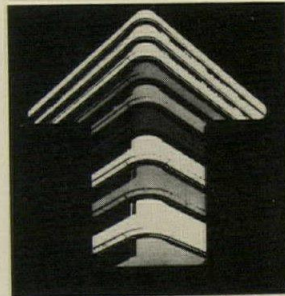

Cover design: Steven Feinberg

## THE RECORD REPORTS

- 9 Editorial  
The right people with the right expertise at the right time
- 35 News in brief
- 37 News reports
- 39 Required reading
- 40 Office notes

## ARCHITECTURAL BUSINESS

- 61 Urging producers to join the building process at day one
- 153 Product Reports
- 155 Office Literature
- 209 Reader Service Inquiry Card

## BUILDING TYPES STUDY 465

- 77 Engineering for Architecture  
An argument for a new look at the basics: the expertise and technical resources we have in such abundance.
- 80 Case examples of effective architect engineer collaboration  
A collection of the best examples of inventive and innovative engineering—selected from hundreds submitted.
- 114 Round Table on Codes and Standards for Fire Safety  
A report on the problems and prospects for setting better rules for life safety in buildings.
- 122 Architecture for engineering  
A case history of the effective work of 20 architects working within a major engineering firm doing work that seldom gets much design attention.
- 128 The education of engineers  
An interview with structural engineer Abba Tor which discusses the very different education of engineers and architects—with some thoughts on the problems raised by that difference.
- 130 Systems revisited  
An analysis—from the perspective of 10 years of experience—of the real and imagined benefits of systems building vs. conventional approaches.
- 138 Changing dialogue: architects, engineers, and manufacturers  
The results of thoughtful answers from professionals to RECORD survey probing the problem areas of the marketplace.
- 144 Energy management as a way of life  
A report on the work of engineer Frank Bridgers, who has worked for energy conservation and management for 20 years. Plus a look at government response.

ARCHITECTURAL RECORD (Combined with AMERICAN ARCHITECT, ARCHITECTURE and WESTERN ARCHITECT AND ENGINEER) Mid-August, Vol. 156, No. 3, Title® reg. in U.S. Patent Office copyright© 1974 by McGraw-Hill, Inc. All rights reserved. Copyright not claimed on front cover and editorial four-color separations. Indexed in Reader's Guide to Periodical Literature, Art Index, Applied Science and Technology Index, Engineering Index, and The Architectural Index. Published monthly except May, August, and October when semi-monthly, by McGraw-Hill, Inc. Quotations on reprints of articles available. Every possible effort will be made to return material submitted for possible publication (if accompanied by stamped, addressed envelope), but the editors and the corporation will not be responsible for loss or damage. EXECUTIVE, EDITORIAL, CIRCULATION AND ADVERTISING OFFICES: 1221 Avenue of the Americas, New York, N.Y. 10020. Other Editorial Offices: 425 Battery Street, San Francisco, Cal. 94111; 1249 National Press Building, Washington, D.C. 20004. PUBLICATION OFFICE: 1221 Avenue of the Americas, New York, New York 10020. Second class postage paid at New York, New York 10001 and at additional mailing offices. OFFICERS OF McGRAW-HILL PUBLICATIONS COMPANY: John R.

Emery, president; J. Elton Tuohig, executive vice president-administration; David J. McGrath, group publisher-vice president; senior vice presidents: Ralph Blackburn, circulation; John B. Hoglund, controller; David G. Jensen, manufacturing; Gordon L. Jones, marketing; Jerome D. Luntz, planning & development; Walter A. Stanbury, editorial. CORPORATION OFFICERS: Shelton Fisher, chairman of the board and chief executive officer; Harold W. McGraw, Jr., president and chief operating officer; Wallace F. Traendly, group president, McGraw-Hill Publications Co.; Robert N. Landes, senior vice president and secretary; Ralph J. Webb, treasurer. SUBSCRIPTIONS: Subscriptions solicited only from architects and engineers. Position, firm connection, and type of firm must be indicated on subscription orders. CHANGE OF ADDRESS or subscription service letters should be forwarded to Fulfillment Manager, ARCHITECTURAL RECORD, P.O. Box 430, Hightstown, N.J. 08520. Provide old and new addresses, zip code or postal zone number. If possible, attach issue address label. Annual subscription prices: U.S., U.S. possessions and Canada: \$10.00 for architects, engineers and other individuals in the fields served, all others \$22.00. Other countries: \$25.00 to architects,

engineers; others \$35.00. Single copies \$3.00. GUARANTEE: Publisher agrees to refund that part of subscription price applying to unutilized part of subscription if service is unsatisfactory. ASSOCIATED SERVICES / McGraw-Hill Information Systems Co.: Sweet's Catalog Files (Architectural, Light Construction, Interior Design, Industrial Construction, Plant Engineering, Canadian Construction), Dodge Building Cost Services, Dodge Reports and Bulletins, Dodge/SCAN Microfilm Systems, Dodge Management Control Service, Dodge Construction Statistics, Dodge regional construction newspapers (Chicago, Denver, Los Angeles, San Francisco). THIS ISSUE is published in national and separate editions. Additional pages of separate edition numbered or allowed for as follows: Western Section 32-1 through 32-4. POSTMASTER: Please send form 3579 to Fulfillment Manager, ARCHITECTURAL RECORD, P.O. Box 430, Hightstown, N.J. 08520.



# energy management:

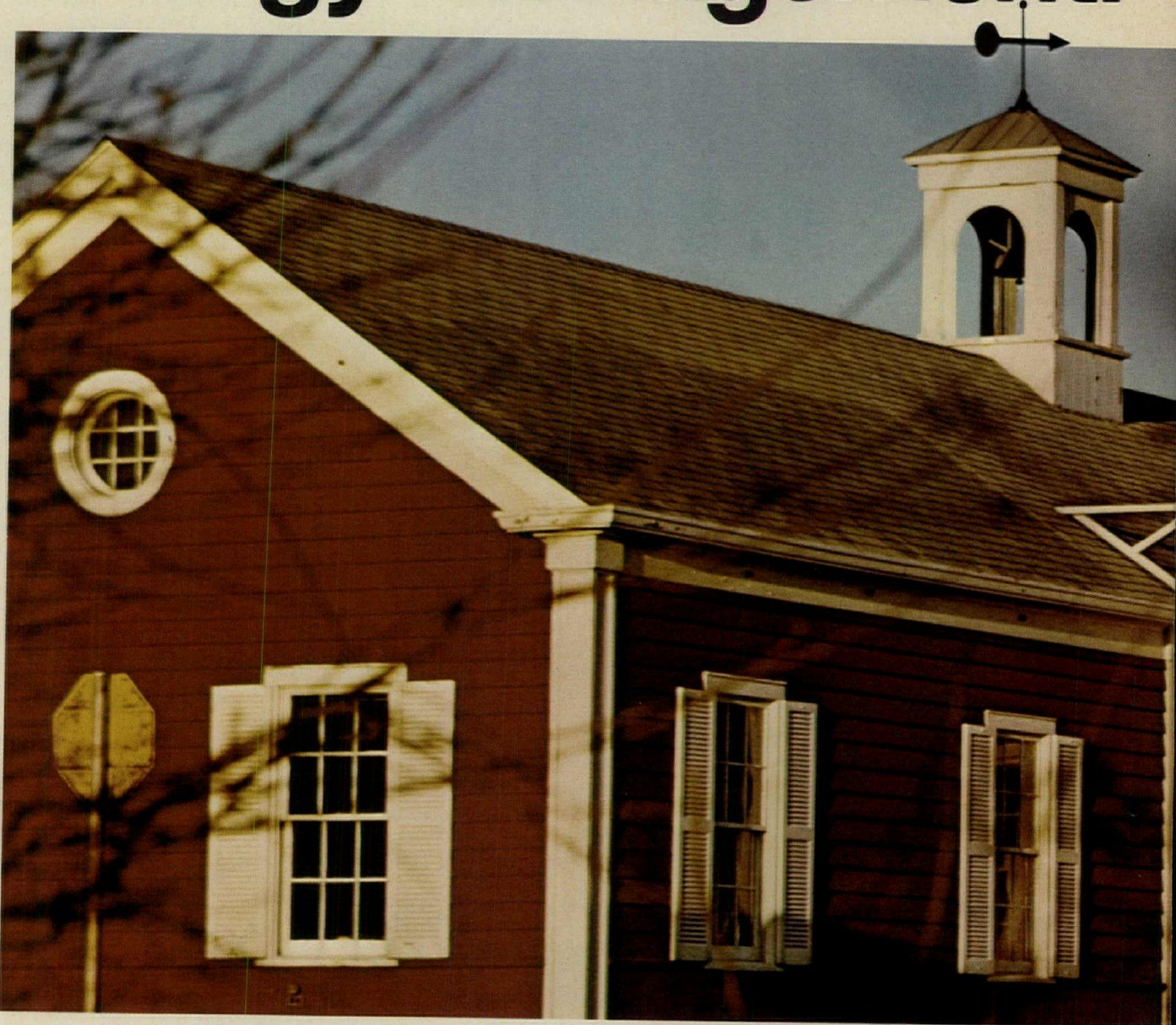

## this is how it can work for you.

This is the Bell & Gossett training center at our Morton Grove, Illinois headquarters. We call it the Little Red Schoolhouse. And if the name is a little old fashioned, what's taught inside is as timely as today's headlines.

We teach energy management. Which covers the design, installation and operation of hydronic systems to assure the most efficient and economical use of energy. And money.

It's a practical, professional approach to system design. And it works. The principles we teach here, used by B&G representatives, produce savings in thousands of kilowatt-hours and thousands of dollars. In job after job. With equipment like heat exchangers, evaporators and pumps.

here's where we teach it.

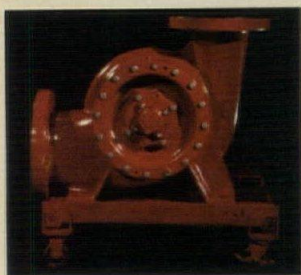

**Cutting the energy bill by cutting pumps down to size.**

All too often heating/cooling system design includes oversized pumps as a "safety factor." This conservative approach is understandable since the specifier may not get

the brand of pumps he wants. But it does waste energy. Your B&G Red Schoolhouse graduate knows this. And he'll work with you after the system is turned on to proportionally balance it and eliminate pumping horsepower wastage—no small item today.

With the B&G back pullout pump design, he can remove impellers easily and quickly for trimming.

This fine-tune feature assures better balance in final system performance—and in operating budgets.

Your B&G representative knows how to make energy management work. He can help you save energy and money. Call him or write Bell & Gossett, a unit of International Telephone and Telegraph Corporation, 8200 N. Austin Avenue, Morton Grove, Illinois 60053. In Canada, ITT Fluid Handling Division, 55 Royal Road, Guelph, Ontario.

**the problem-solving ideas come from the fluid handlers.**

**BELL & GOSSETT** **ITT**

For more data, circle 3 on inquiry card

# From U.S.G.

THERMAFIBER Safing Insulation inserts between floor slab and curtain wall to block spread of smoke and flame rising from floor to floor. THERMAFIBER Curtain Wall Insulation provides thermal and fire-resistant protection to spandrel panels, column covers, window and track fillers.

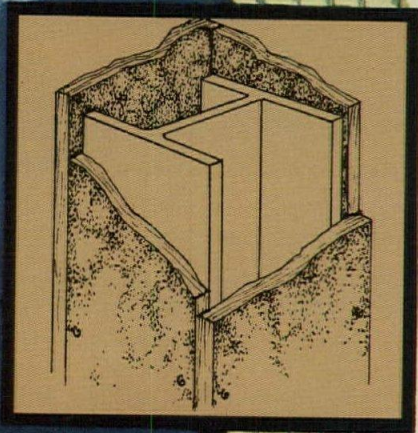
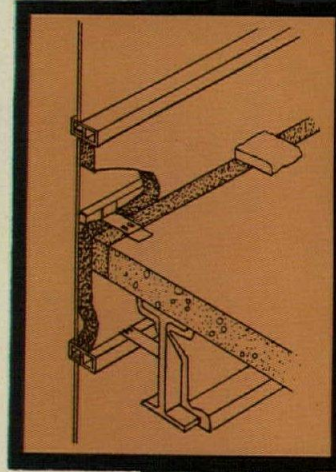

THERMAFIBER Mineral Fireproofing protects steel columns.

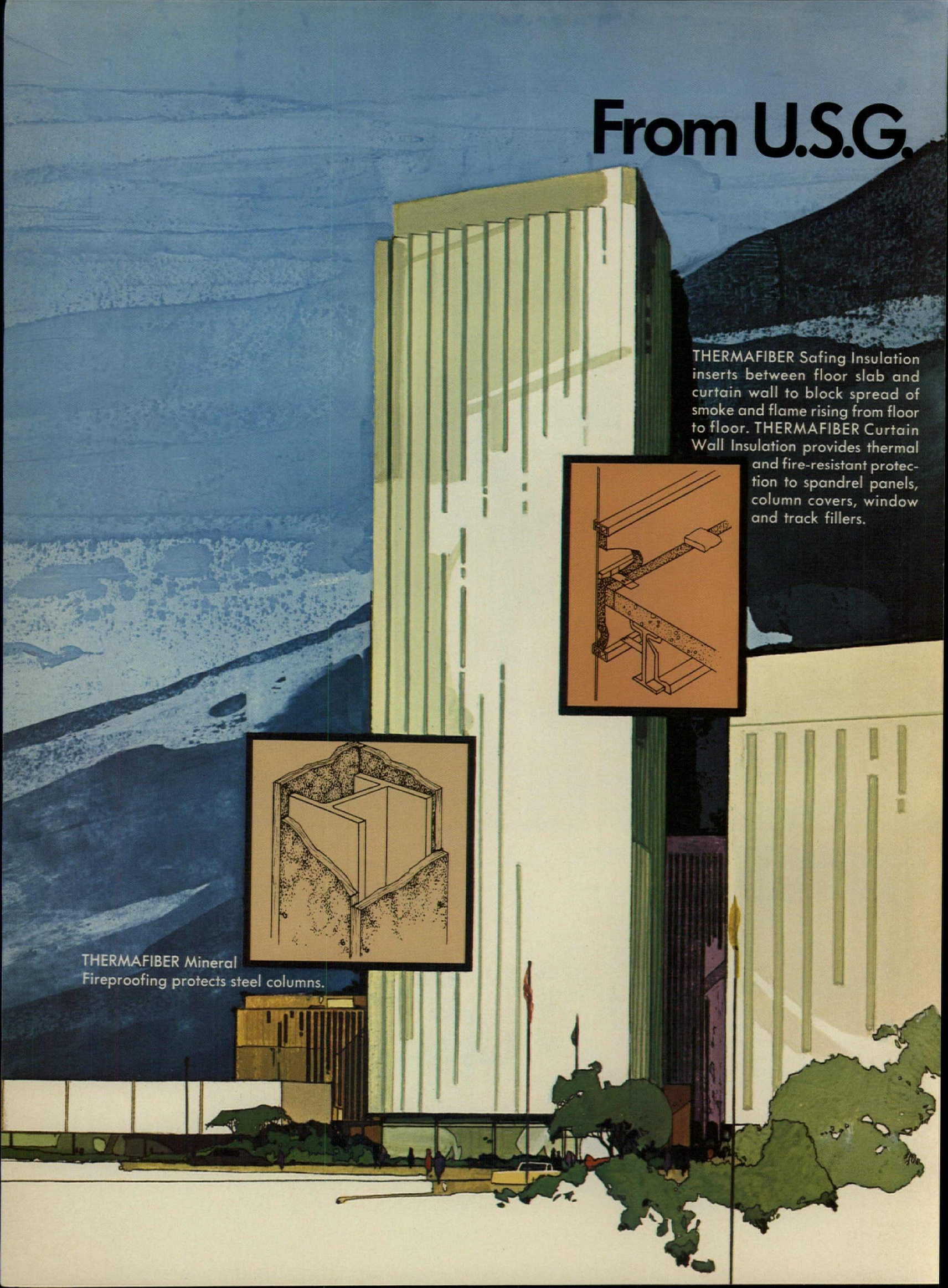



# More systems to resist fire.

## THERMAFIBER® Insulation proves to be a fire barrier the new high-rises need.

Today's new high-rise construction methods create open spaces between floors and spandrels where fire and smoke can penetrate and spread to floors above unless properly sealed. Needed is a low-cost, resilient material dense enough to stop smoke, and fire resistant enough to hold up under intense flame.

In the U.S.G. laboratory, tests proved the material that best meets these criteria is THERMAFIBER Mineral Wool. Our new high-density THERMAFIBER Safing Insulation, for instance, tested out for over three hours at 2,000°F. It is noncombustible and produced no smoke when exposed to fire. As a result, today's high-rises, protected by a "security blanket" of THERMAFIBER, are as safe as U.S.G. innovation can make them.

**A.** SHEETROCK® FIRECODE® "C" Gypsum Panels, with a special core, provide partition fire ratings as high as two hours. Basic fire protection for furnace areas and garages.

**B.** A typical U.S.G. wood-frame exterior wall system consists of SHEETROCK Gypsum Panels, THERMAFIBER Insulating Blankets and USG® Gypsum Sheathing. A truly effective fire shield at an affordable price.

**C.** CONCORDE Shingles look like expensive hand-split wood shakes but are actually made of noncombustible minerals. Unlike wood, they won't burn or rot. And they're termite-proof, warp-resistant and completely weatherproof.

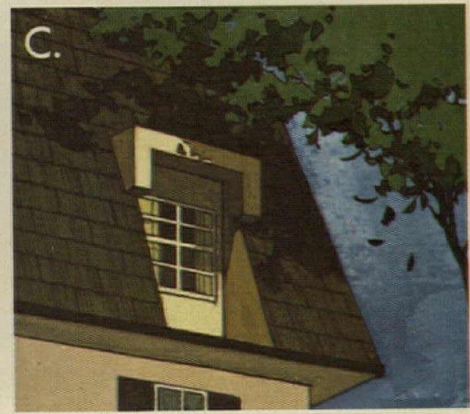
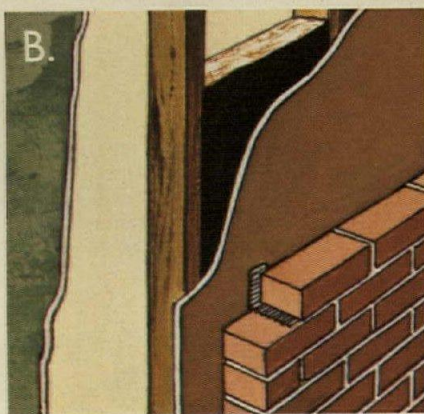
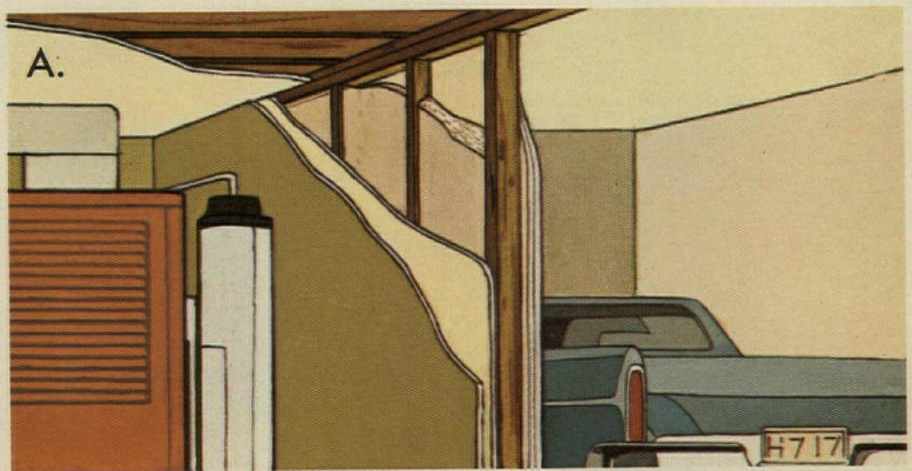

For details on any of these systems, write to Dept. AR-84, 101 S. Wacker Drive, Chicago, Ill. 60606.

# Lennox announces a major breakthrough in energy utilization.

## Introducing the Lennox DMS4 multizone rooftop system, with exclusive Outside Air Discriminator.<sup>TM</sup>

Here is one of the most versatile problem-solving machines in space heating and cooling...its efficiency and energy-conserving superiority challenge all other HVAC systems available today.

**Feature 1: Exclusive Outside Air Discriminator<sup>TM</sup> automatically determines heating/cooling modes.** Which is more efficient: Cooling with outside air and heating with primary energy...or, cooling with mechanical refrigeration and reclaiming condenser heat for heating? The DMS4 makes the decision for you automatically. It trades Btu's available within the multizone system for maximum economy... and it reacts promptly when the efficiency of cooling with outdoor air is greater than the energy savings of condenser heat reclaim.

**Feature 2: The DMS4 conserves energy.** The DMS4 continually monitors the ratio of heating input to cooling requirement, in order to operate at the lowest energy level.

Discharge sensors are placed in zone heads for quick zone response. And the DMS4 solid-state electronic control system is designed for maximum dependability.

**Feature 3: The DMS4 saves money.** This exceptional energy-conserving sensitivity is achieved without adding significantly to the unit cost, and results in lower operating costs.

**Application Versatility.** Lennox DMS4 offers gas, electric, hot water, or steam heat. Seven models range from 16 to 45 tons cooling capacity.

Lennox DMS4 Multizone vs. Other Units.  
RELATIVE POWER INPUT @ 45° OUTSIDE TEMP.  
(4 zones, 2,000 cfm each. Typical supply air temperature requirements.)

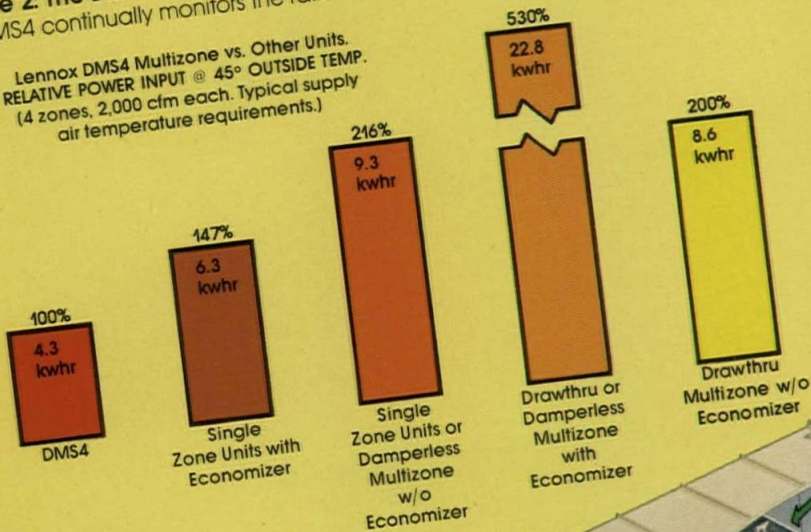

The DMS4 will show similar performance efficiencies at other typical outdoor air temperatures.

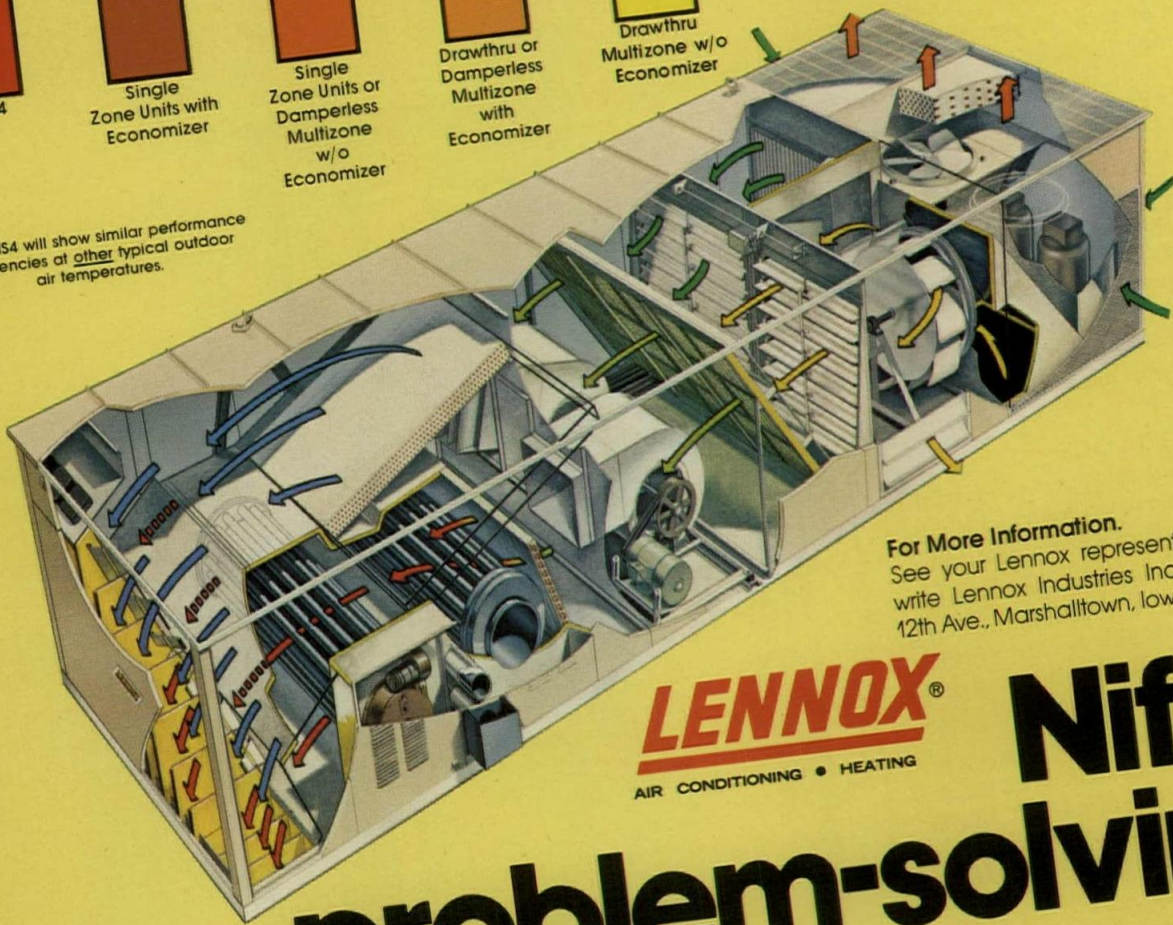

For More Information.  
See your Lennox representative, or write Lennox Industries Inc., 475 S. 12th Ave., Marshalltown, Iowa 50158.

**LENNOX**<sup>®</sup>  
AIR CONDITIONING • HEATING

# Nifty problem-solving ideas from Lennox.

For more data, circle 5 on inquiry card

## The right people with the right expertise at the right time

This is—despite the proliferation of engineering drawings and details on the editorial pages—an issue about people.

What people? First, engineers—that large body of conceptual engineers who are so critical to the design process that we call architecture. Many of these engineers are consulting engineers, but these engineers are also in architectural firms, or are the principal technical advisors to producers and manufacturers, and to Federal, state and local governments.

What other people? Architects, who in the course of developing their designs, can profit so effectively from the right engineer with the right expertise consulted at the right time.

In short, as faithful readers will have already surmised, this is an issue about you—the architects and engineers whose work we publish every month.

But there's a difference. In emphasis.

In most issues of RECORD, you'd have to say the emphasis is on architecture—and especially on architectural design. That is as it should be because the bulk of our readers are architects. But perhaps some of you don't know that we number among our subscribers over 12,000 engineers—engineers who subscribe not just for the Architectural Engineering section each month, but because the various engineering disciplines are so intimately related to architecture that engineers must "know what's happening" in architecture.

But in this "spotlight" issue the emphasis is on engineering—the kind of engineering that marks the best work of the best men. The kind of work that (again because architecture is so intimately related to the engineering disciplines) architects must be reminded is available whenever they need it.

### Why did we produce this mid-month issue? Because we wanted to talk fundamentals

The editors wanted to do this issue because of an increasing concern we've felt—a concern that in an attempt to "do something" about the costs and complexity of building we are searching in the wrong places—with dubious proprietary technology, with "buzz-ideas" like Tinker-Toy systems and new kinds of consultants that borrow your watch to tell you what time it is.

We wanted to do this issue because we think the place to search for solutions to the costs and complexity of building is with people. Which people? Architects and engineers. So while this issue will update RECORD's readers, whether they are architects

or engineers, on the most important developments in all of the major disciplines of "Engineering for Architecture," in addition . . .

### . . . There's a moral: or maybe several morals

As it says on the introductory page (page 77) this issue is also intended to:

- demonstrate the enormous technical resources that we have available and that are making fresh impacts on architecture.
- explain the unique (and uniquely interrelated) nature of technical expertise that exists in our industry.
- identify and explain the significance of "systems building"—separating the dubious "revolutionary ideas" from the thoughtful evolution that architects and engineers have been developing for many years.

And finally, to . . . .

- give recognition to engineers in building for their essential and too-often unrecognized inventiveness and resourcefulness in working with architects to achieve economical and rational (as well as beautiful) buildings.

So . . . .

This issue is about people. It's *about* engineers. It's *for* architects and engineers. The right people, with the right expertise, at the right time.

If any engineer wants to put this one on his coffeetable (after he's read and used it, of course) we'd be pleased.

—Walter F. Wagner, Jr.

### A postscript: If I may be permitted to talk about some people around here . . .

It's considered a little amateurish in publishing circles to praise an editorial staff—I mean it's their job to do something special each month. But the heck with it:

Senior editor Robert E. Fischer was the editor-in-charge of this issue—and when you've read it I think you'll agree he did some job. Bob developed it, and organized it, and wrote enormous quantities of it. Of course he got, as they say, a little help from his friends on the staff, and from engineer friends across the country. And a lot of help from Grace Anderson and Joan Blatterman, who used to work with Bob on the staff and came back to work on this one; his secretary Carol Deegan; and from Frank Walsh, consulting engineer and close friend.

Any criticisms of this issue come to me. The goodies go to Bob.

—W.W.

**3 BINKLEY Xpediter clips and 3 fasteners**

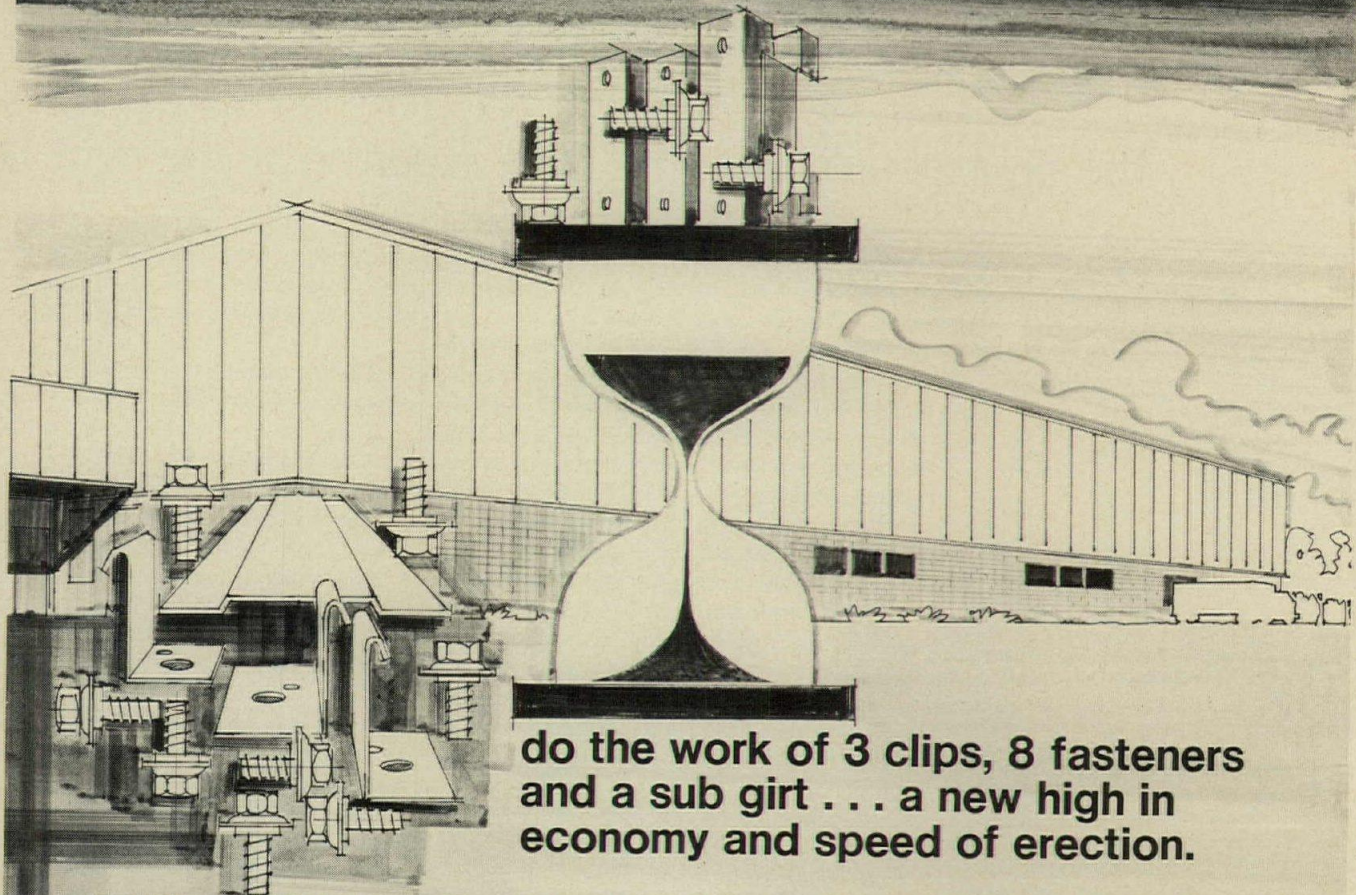

**do the work of 3 clips, 8 fasteners and a sub girt . . . a new high in economy and speed of erection.**

## **BINKLEY Quick-Wall System**

Fully insulated, high-strength metal walls—ONLY 2-1/2" THIN—go up in a fraction of the time required for erection of conventional metal walls.

Binkley's new Xpediter Clip at each fastening point holds both liner and face panel. This Quick-Wall System completely eliminates sub girts and takes advantage of the greater U Value of 1" thick light-density insulation.

Fewer Materials. Fewer Pounds. Fewer Fasteners. Fewer Headaches . . . Greater Speed. Greater Ease. Greater Economy.

Full range of coatings and weathering steel available.

*Call or write today for full details*

**THE BINKLEY COMPANY**  
**BUILDING PRODUCTS DIVISION**  
 331 THORNTON AVENUE • ST. LOUIS, MISSOURI 63119  
 PHONE: 314-968-4750

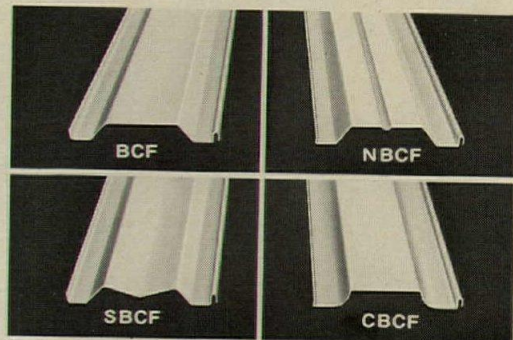

You can choose from various panel designs in Binkley's BCF series.

To utilize the Quick-Wall System for Pan-L-Rib and Bink-Rib Panels, contact your Binkley sales representative.

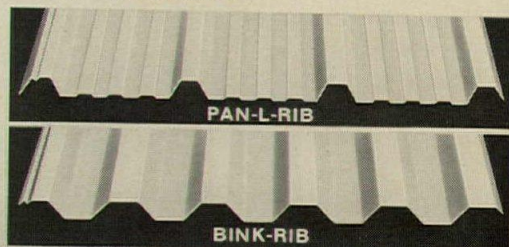

*For more data, circle 6 on inquiry card*

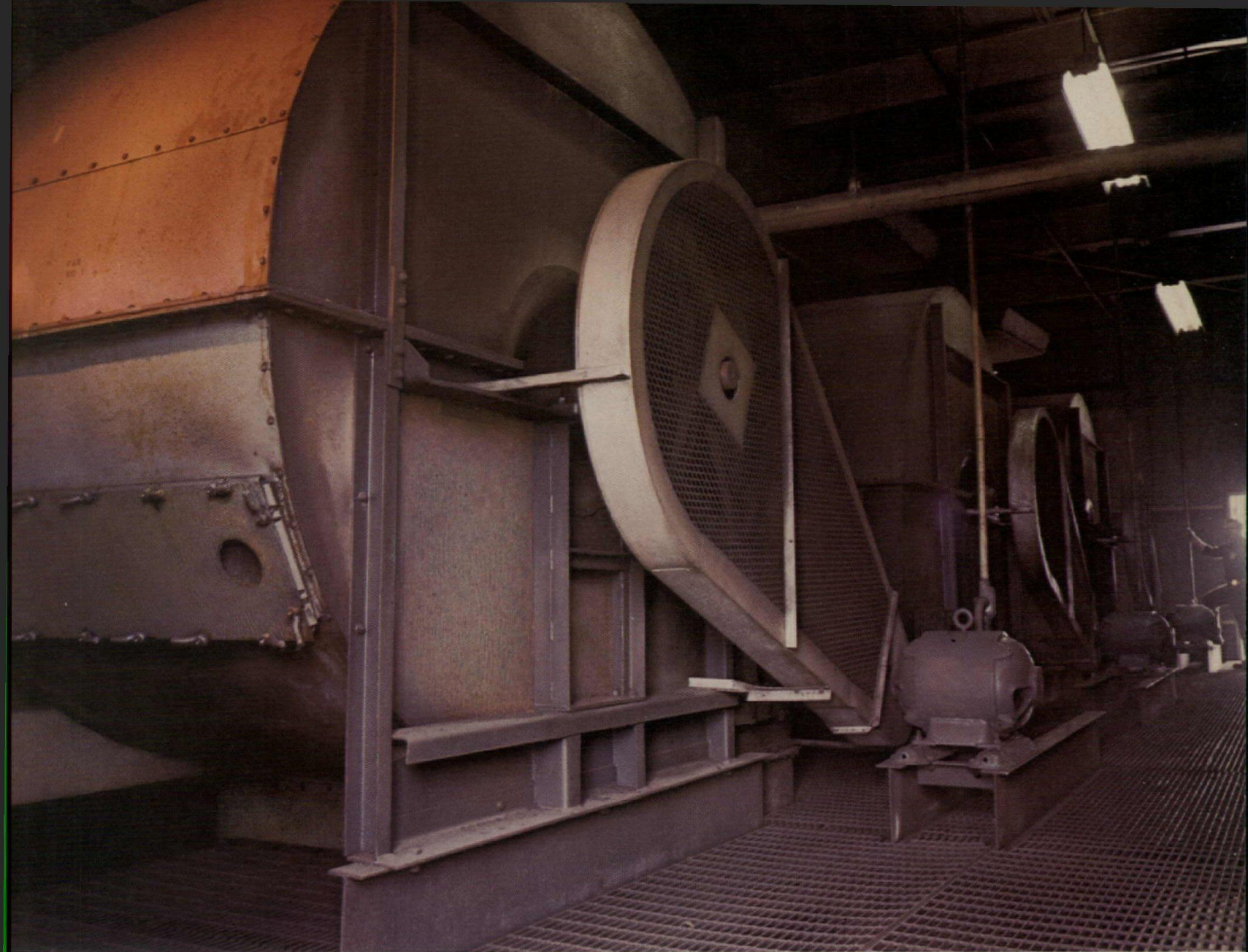

## IBM System/7 installed at Saco-Lowell to conserve electricity.

A System/7 continually monitors the inflow of electricity and controls air-handling equipment so that working conditions throughout Saco-Lowell's Greenville, S.C. plant remain comfortable with minimum power consumption.

"In this era of energy shortages, the System/7 helps us conserve energy for productive use elsewhere," says T.N. Papeacos, vice president, operations. "It is also saving us money at a net savings rate even greater than the \$25,000 a year we originally estimated. We were pleased to find IBM offers a small computer system and an IBM-developed program that make an application like this justifiable."

Saco-Lowell Corp., a subsidiary of Platt International Ltd. and a world leader in textile machinery, cools and cleans the air in its 11-acre building by circulating it

through curtains of water. Sets of pumps and blowers, one of which is shown above, are selectively turned off and on by the computer for brief periods during each hour on an adjustable pre-determined schedule. Working conditions, however, always remain comfortable throughout the building.

Concurrently, in a sensor-based function, the System/7 constantly monitors actual power usage so that power cut-backs can be adjusted accordingly and costly demand peaks avoided.

Full information on the System/7 is available through your IBM representative or local office. Or write IBM Data Processing Division, Dept. 83F-AR, 1133 Westchester Ave., White Plains, N.Y. 10604.

**IBM**

For more data, circle 7 on inquiry card





# Be a real stinker when you specify fence.

Chain link fence is *not* all alike. A "bargain" fence looks like any other kind. But it gets expensive fast.

That's why it makes sense to know the problems your clients can run into...and make sure your specifications avoid them.

Take fence fabric itself. It's formed from steel wire, and generally it's the first thing to cause maintenance problems in fence. The "weak link."

However, aluminum-coated fabric\* will greatly extend the life of the fence. It combines the strength of steel with the corrosion resistance of aluminum...and lasts 3 to 5 times longer than its galvanized equivalent.

But you won't get aluminum-coated fabric...or important details like box-beam terminal posts, or H posts...unless you spell them out in your specs. Fortunately, we've made it as easy to specify a good fence as a bad one.

We'll send you a complete set of specifications that can be used as is—if you send us the coupon. They're nonrestrictive. They don't even mention our name. But it's no coincidence that CYCLONE Fence meets them in every way. It lasts longer. Looks better. Takes less maintenance than any other chain link fence.

And CYCLONE Fence is local and convenient, with sales and supply points in 32 areas around the country.  
CYCLONE Fence. Engineered and erected by U.S. Steel Supply.

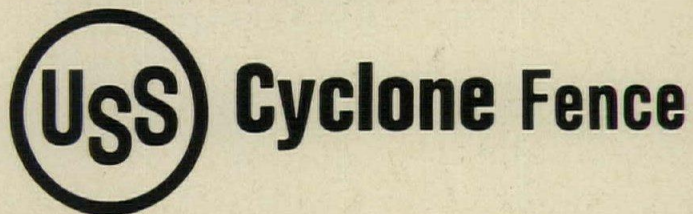

CYCLONE Fence, USS Supply Division  
Box 86 (USS C263)  
Pittsburgh, Pa. 15230.

Teach me how to be a stinker. Send me a set of your specifications for chain link fence.

\_\_\_\_\_  
Name

\_\_\_\_\_  
Title

\_\_\_\_\_  
Firm

\_\_\_\_\_  
Address

\_\_\_\_\_  
City

\_\_\_\_\_  
State

\_\_\_\_\_  
Zip

\*Not available on the West Coast.

USS and CYCLONE are registered trademarks.

# CHESTER POOL SYSTEMS BEGIN HERE

the same place your pool problems end

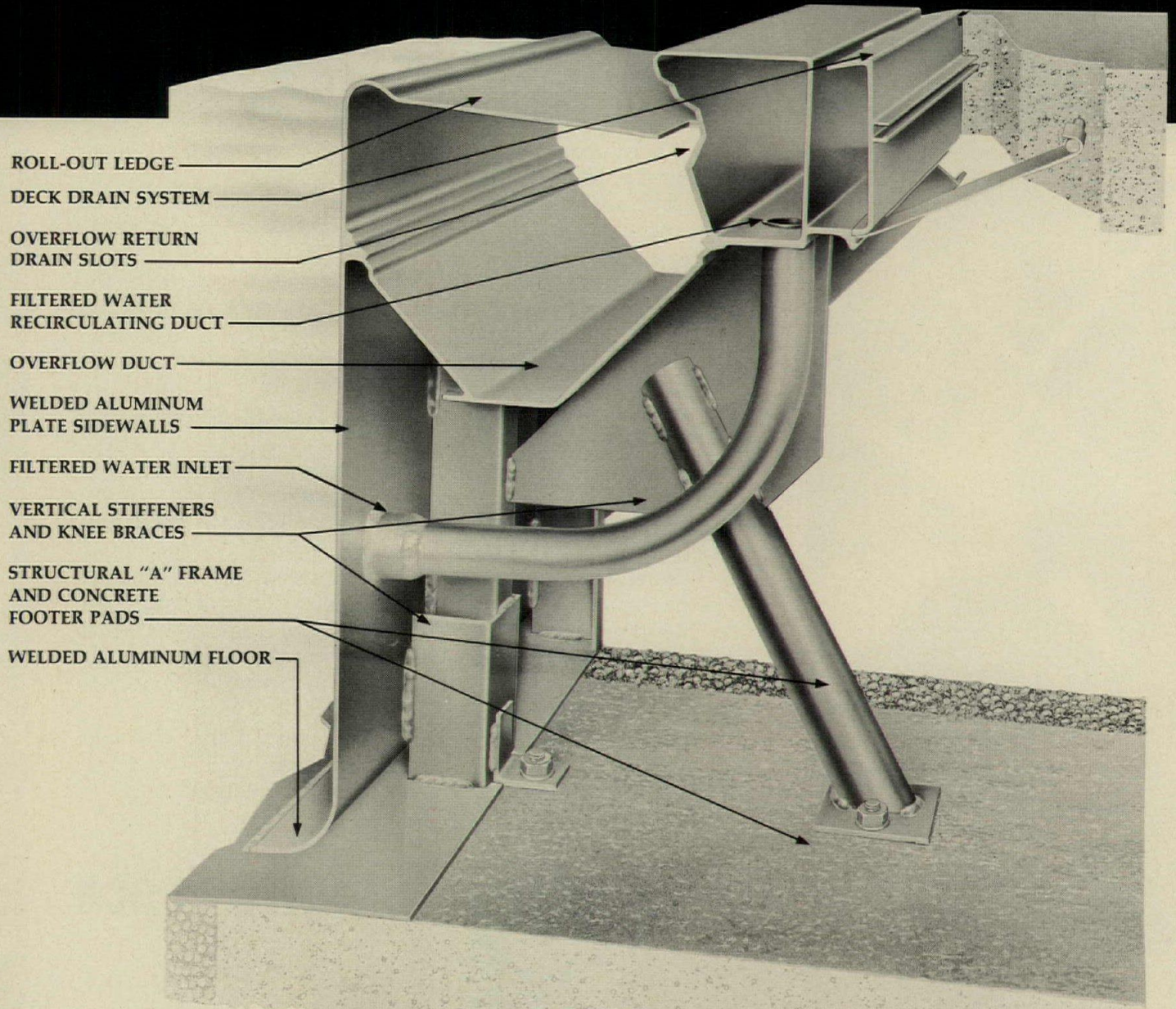

ROLL-OUT LEDGE

DECK DRAIN SYSTEM

OVERFLOW RETURN  
DRAIN SLOTS

FILTERED WATER  
RECIRCULATING DUCT

OVERFLOW DUCT

WELDED ALUMINUM  
PLATE SIDEWALLS

FILTERED WATER INLET

VERTICAL STIFFENERS  
AND KNEE BRACES

STRUCTURAL "A" FRAME  
AND CONCRETE  
FOOTER PADS

WELDED ALUMINUM FLOOR



The Chester pool wall. Self-supporting. Structurally stable. Incorporating an extrusion forming all circulation and overflow ducts. The beginning of a totally engineered pool system, low in maintenance, free of repair. The Chester system — pool, filtration tank, piping between. All aluminum. Chester . . . the single source, single responsibility pool package . . . designed, fabricated, and constructed by the builders with over 20 years of proven performance . . . backed by a comprehensive 5 year warranty. See Sweets architectural file 13.22 Ch. Case histories are available for study which may parallel your present situation.



## CHESTER

POOL SYSTEMS

1300 Lafayette Avenue  
Middletown, Ohio 45042.



A woman with blonde hair, wearing a light-colored dress with a dark, repeating pattern, stands in an elevator. The elevator walls are composed of large, rectangular panels that are backlit, creating a soft, diffused glow. She is holding a dark shoulder bag and looking towards the camera.

# TOUGH, LUCENT, IMAGINATIVE UVEX.

Take the elevator you see here.

Notice the soft appealing backlight diffused through sculpted panels.

That's Uvex® plastic sheet at work.

The panels were designed by Rudolph de Harak of N.Y.C. and vacuum formed from Uvex sheet by County Neon Sign Corporation, Plainview, New York.

Why Uvex sheet? Simply this. A unique combination of optical excellence, toughness and deep-draw advantages.

Which helps explain why Uvex sheet is good for more than signs.

So why not use it for fascia panels? Indoor displays. And still more.

Remember too, that Uvex is available in both sheets and rolls. And it's backed by Eastman's capabilities in color.

Write for Publication No. PS-29, our colorful new 20-page booklet on ideas for using Uvex sheet. Eastman Chemical Products, Inc., Plastics Products Division, Kingsport, Tennessee 37662.

*For more data, circle 10 on inquiry card*



Eastman makes only UVEX sheet and not the finished product and therefore makes no warranties with respect to finished products.

**Fast enclosure.  
Design freedom.  
Versatility.  
Economy.**

**They're all built-in  
benefits of J-M's  
new wall system.**

J-M has done it again, with an all-in-one wall system that's attractive, goes together fast, goes up fast, saves money.

This new concept combines punched light gauge structural steel studs with gypsum interior panels, J-M fiber glass insulation and J-M architectural exterior panels.

Prefabrication of large panels can save on-the-job time and speed closure, while lowering construction costs.

And the system is particularly suited to exterior treatments combining the appearance and beauty of natural stone in a man-made panel product with the accent of reveal joints.

For details on the system that might change your ideas about walls, write Johns-Manville, Box 5108, Denver, Colorado 80217.



Exterior walls of the new Huntsville, Alabama, Civic Center are J-M Stonehenge architectural panels secured directly to the steel studs. Here insulation is sprayed on the back of the panels. A combination of hidden and reveal joints was chosen by the architect.

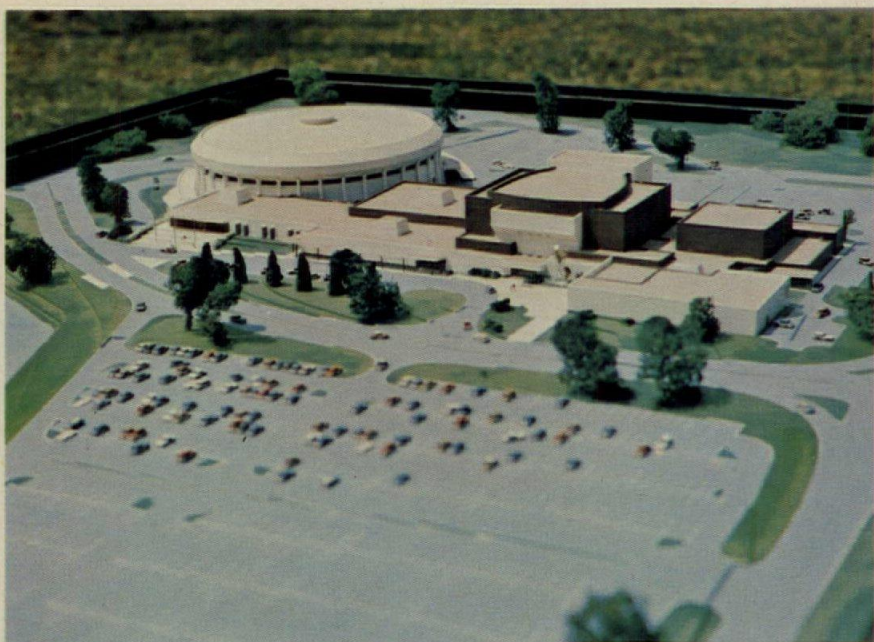

Architects model of the new Von Braun Civic Center, Huntsville, Alabama.  
Architects: Northington, Smith, Kranert & Tomblin & Associates.  
Jones, Mann and Associates. Dickson and Davis.  
Fabricator: Bonitz Insulation Co., Birmingham.



**Johns-Manville**

For more data, circle 11 on inquiry card

# Now. One source standby power systems from Kohler.

A whole new breed of matched standby power systems from Kohler. A new look, but more than that, a new system, with one source availability and total system responsibility, backed up by Kohler's worldwide service network. Now nobody offers you more than Kohler. Nobody.

**Kohler generator sets.** The heart of the system... Kohler's rugged, reliable generator sets deliver full rated output. Dependably. And with more models available, from 500 watts to 500 KW (gasoline, diesel and natural gas powered—50 or 60 cycles) there's no doubt about matching the most demanding application. With power to spare.

**Kohler transfer panels.** Total standby capability... automatically. Designed and engineered for maximum compatibility with normal line circuit protection, Kohler transfer panels insure matched-component integration for reliable standby protection. Kohler transfer panels are available in 30, 70 and 100 ampere models with high interrupt contactor switchgear and in thirteen circuit breaker models ranging from 30 to 2000 amperes. All available with a wide range of accessories. And each Kohler panel meets the stringent standards of UL 1008 and CSA for Automatic Transfer Switches.

The switch is on to Kohler "gold" standby systems. For more information call your Kohler Distributor (he's in the Yellow Pages), or write KOHLER CO., KOHLER, WISCONSIN 53044.

*For more data, circle 12 on inquiry card*

## depend on Kohler "gold" standby power systems

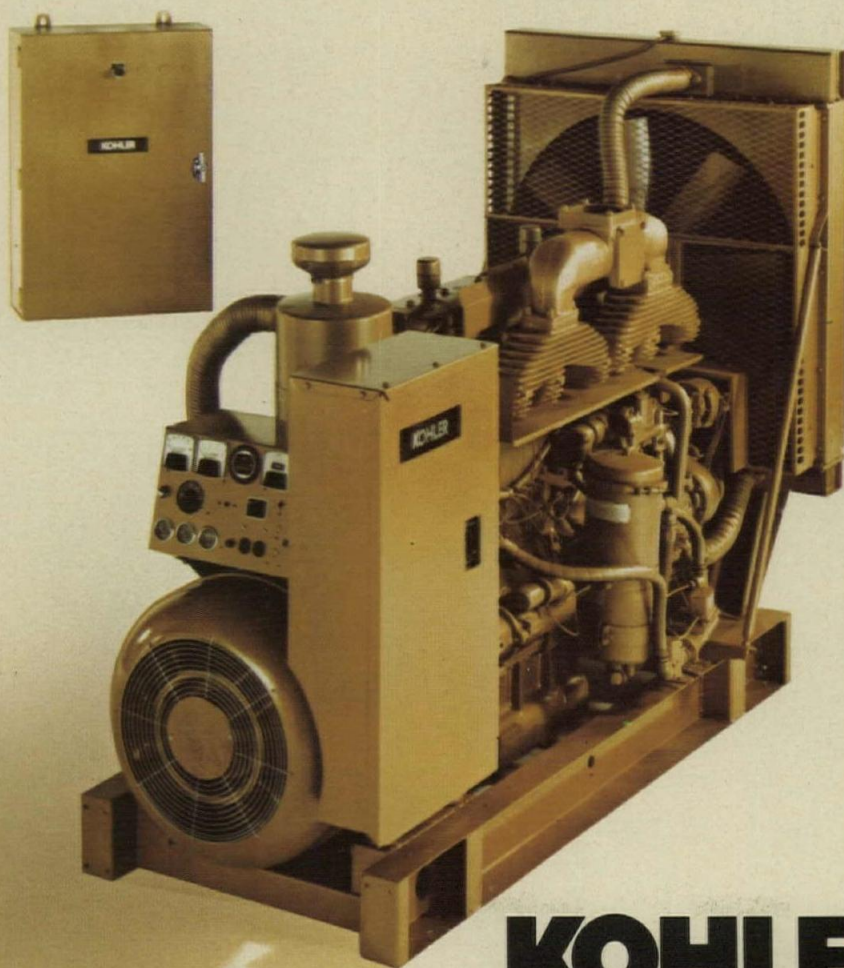

# KOHLER

# Introducing EnerCon.

## AAF's heating/cooling system that can

**It doesn't exhaust heat like other systems.**

Instead, the EnerCon system takes heat exhausted by units on the cooling cycle and redistributes it to units that are heating. A simple, water loop makes it possible. The water loop—interconnecting each unit in the system—captures the heat and circulates it throughout the system. Or, stores it until it is needed.

**Why pay to heat air you've just cooled?**

Much of the time, the average office building calls for both cooling and heating at the same time. For instance, heat gain from lights, equipment and people is greater in core areas than perimeter areas. So, core areas usually

must be cooled even while perimeter areas are being heated. And during moderate weather conditions, the shifting of the sun from one side of a building to the other can make the difference as to whether you heat or cool the perimeter. Only the most elaborate, high energy consuming central systems can keep up with this fluctuating need.

EnerCon does it easily. Your client gets cooling or heating where he wants it, quickly.

*Units can be totally concealed in the ceilings.*

*This keeps installed cost at approximately \$2.25 to \$3.50 per sq. ft. for new construction or modernization*

*Cooling tower and chiller operated on a cold day. Heat wasted to atmosphere.*

*EnerCon doesn't waste heat like other systems.*

*Approx. energy cost per sq. ft. per year*

*EnerCon - 19¢  
Fan Coils - 18¢  
Central VAV - 26¢  
Dual Duct - 30¢*

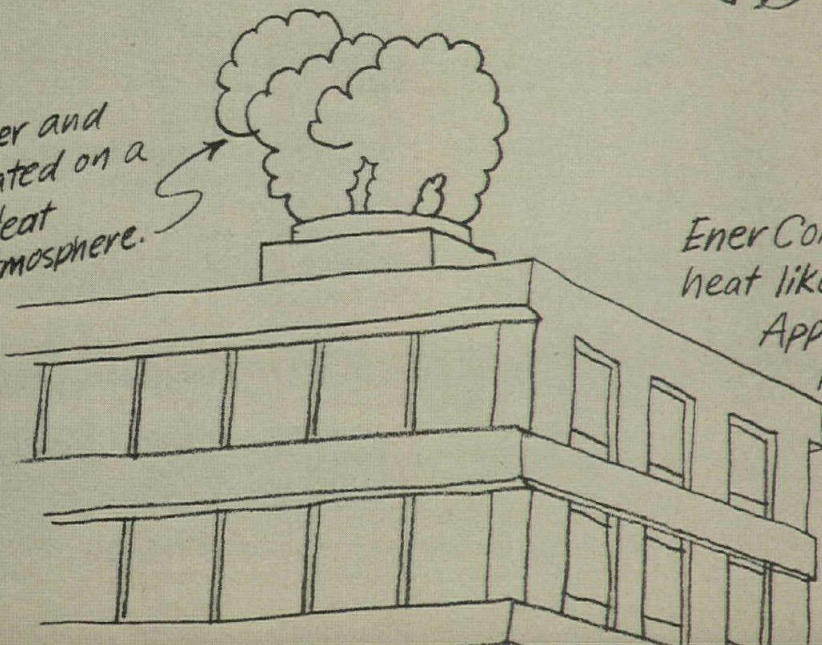
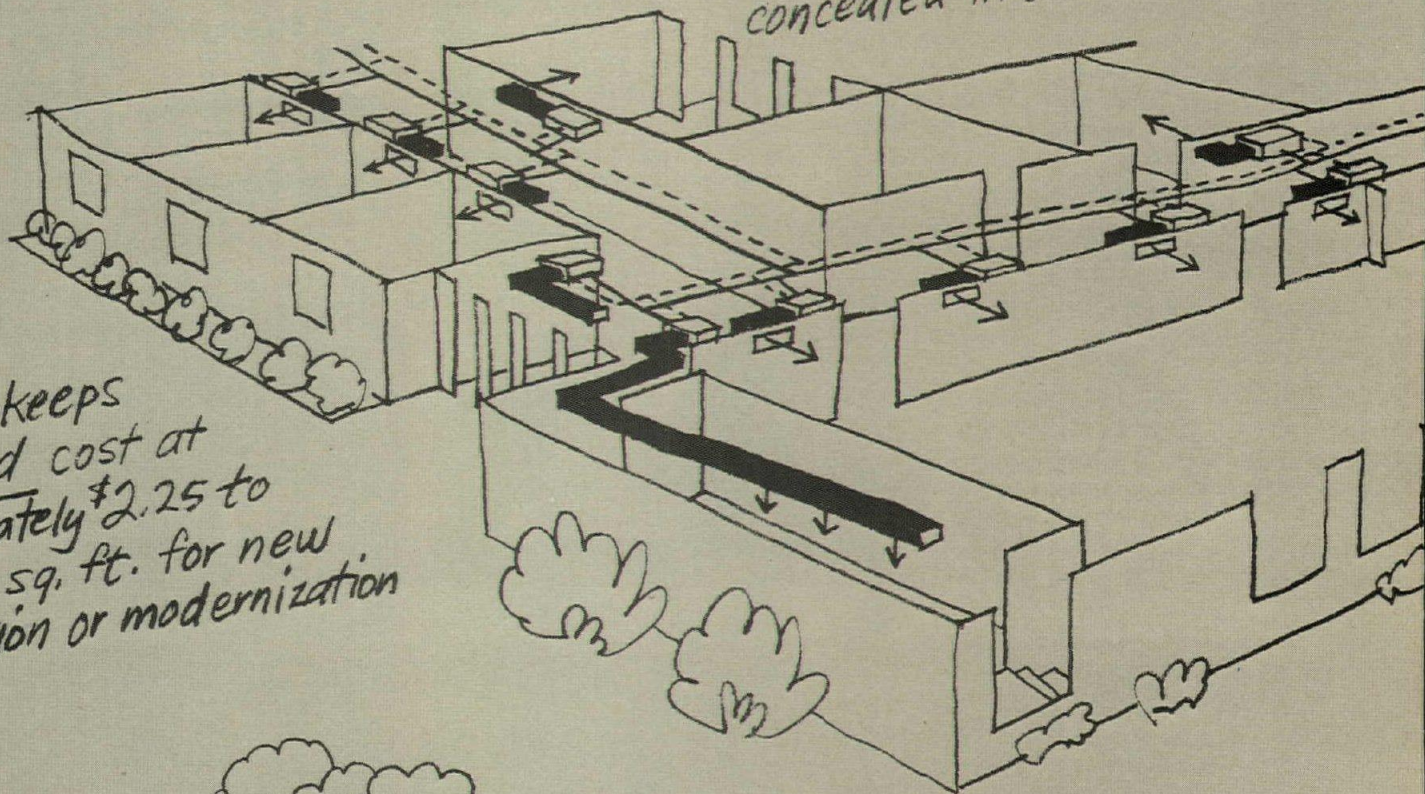

# save your client up to 25% on energy costs.

## In fact, much heating comes free of charge.

Just about all the heat needed to warm 200 square feet is produced by units in other areas of the building that are cooling only 100 square feet. This re-distributed "free" heat could, in many cases, be all the heat that is needed.

## EnerCon uses simpler hardware, too.

No expensive ductwork, no rooftop equipment, no chiller or high pressure boiler. Most of EnerCon's apparatus is right there in the unit. Add on the uninsulated water loop, a small in-line auxiliary water heater and an evaporative cooler and you've got the entire system. Easy to install, easy to maintain.

## Complete installation flexibility.

EnerCon comes in a variety of sizes with more than 4 tons of cooling

capacity. Smaller units can be wall mounted in each room for individual climate control, or you can conceal larger units in ceilings and cool or heat several areas with one piece of equipment.

## Cuts costs all around.

Energy costs. Installation costs. Owning and operating costs. They're all cut to the minimum with EnerCon, the heating/cooling system designed for your clients' needs today.

EnerCon. The new system from American Air Filter that can cut your clients' energy costs up to 25%. For complete details, write: AAF, Self-Contained Air Conditioning, Dept. 220, Box 1100, Louisville, Ky. 40201. In Canada: 400 Stinson Blvd., Montreal 9, P.Q.

Better Air is our Business.

**AAF** American Air Filter  
**SELF-CONTAINED AIR CONDITIONING**

For more data, circle 13 on inquiry card

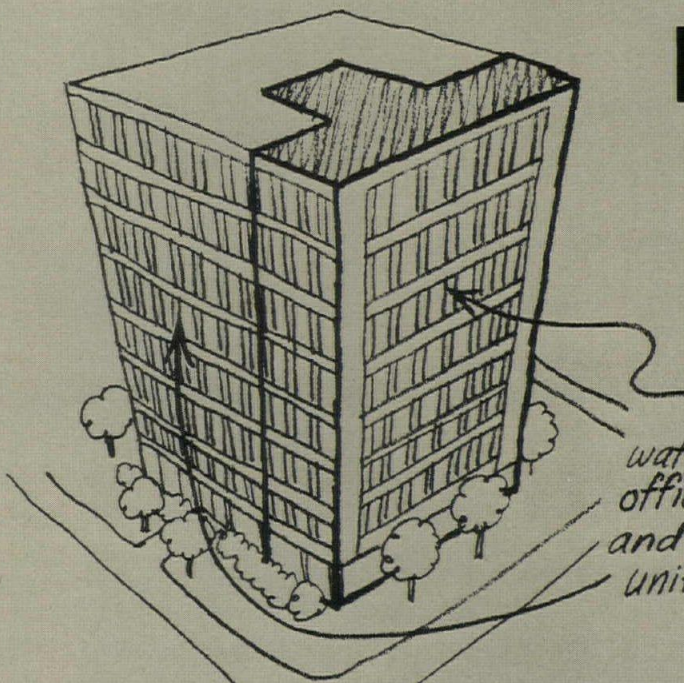

*Heat absorbed in water loop while these offices are cooling is stored and distributed to units calling for heat.*

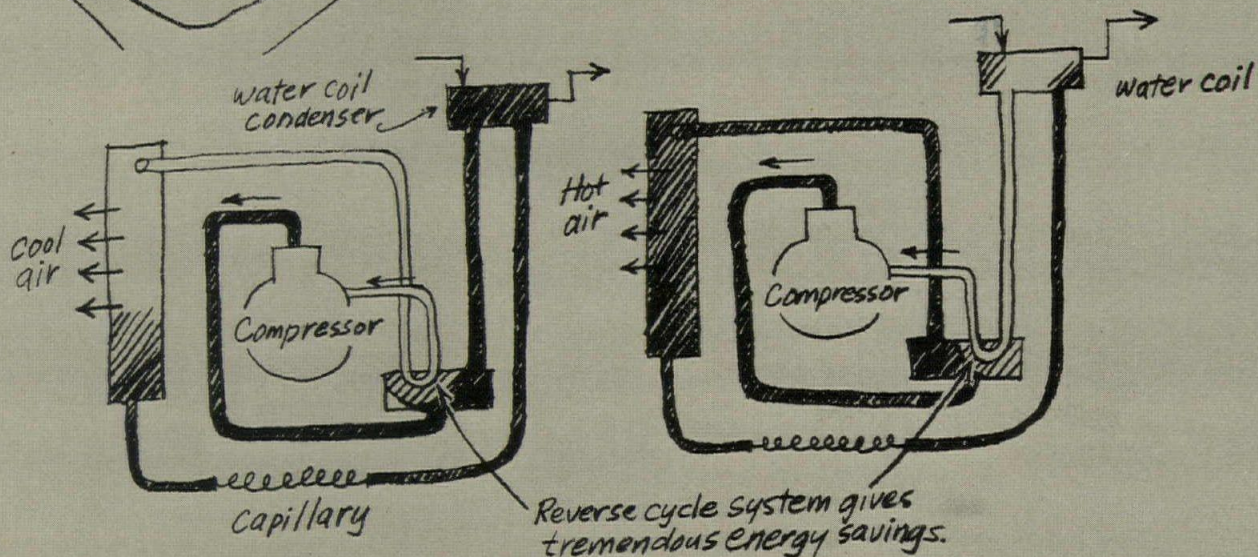

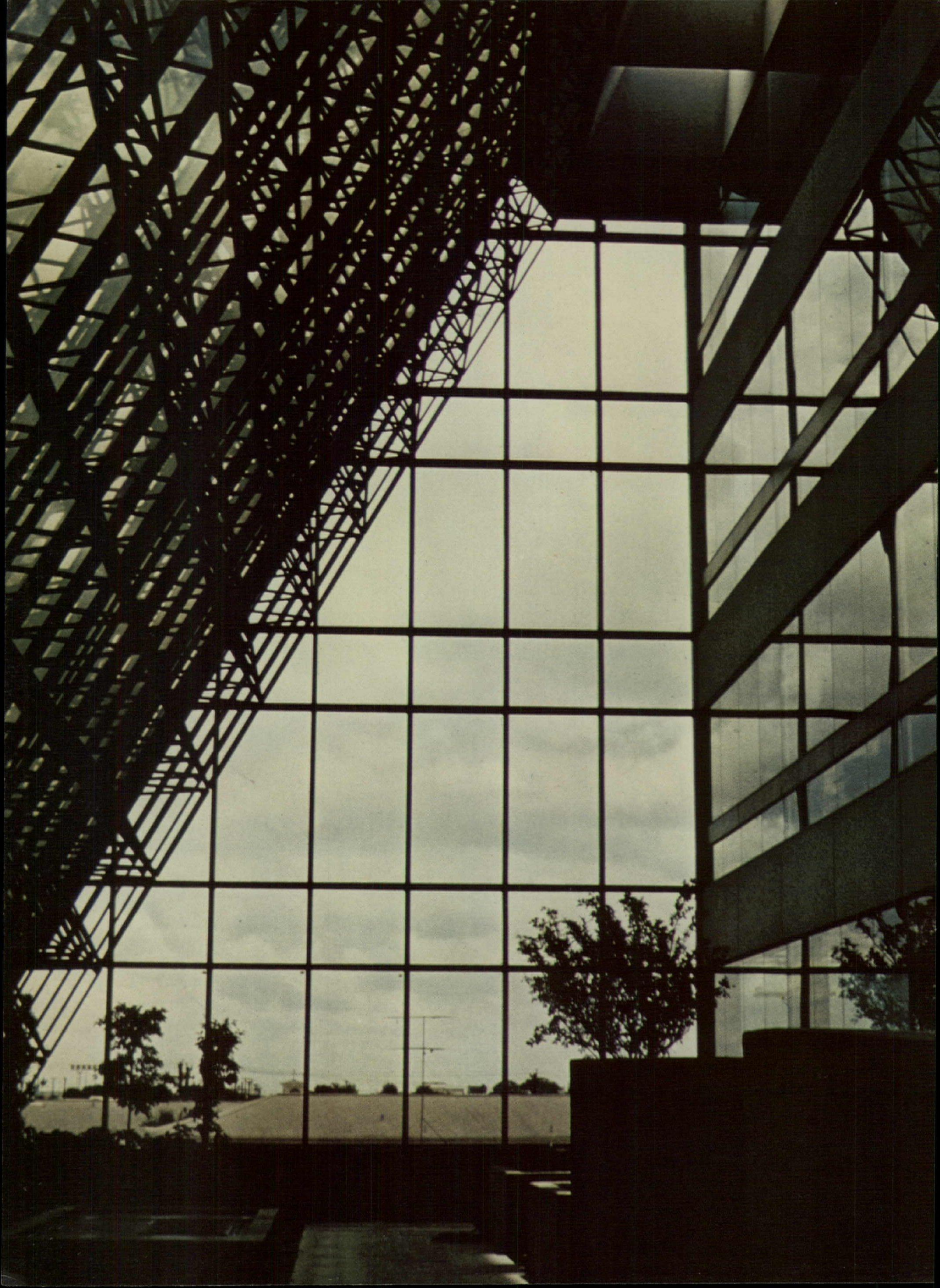

# moduspan:®

## The architectural cover-up that asks to be seen

The MODUSPAN Space-Frame system allows architects to break out of the ordinary into a wide range of exciting roof, wall and specialty designs. One reason is the system's unique structural behavior which encourages random column supports and unusually large overhangs. Another is MODUSPAN's modular configuration and simple nut and bolt construction which virtually eliminates job-site assembly problems. Even the standard finish is special. MODUSPAN components are now electro-coated for maximum resistance to corrosion and impact damage.

But there's more to MODUSPAN than function. There's style. Grace. And a kind of bold presence that makes it a completely distinctive architectural medium. That's why MODUSPAN is a natural in open design formats.

And now there are six baked enamel colors to choose from—half-a-dozen new ways to achieve visual impact with the MODUSPAN system.

Discover the exciting design possibilities offered by MODUSPAN Space-Frame systems. Contact your local Unistrut Service Center. Or circle the reader service card for more information.



WORLD HEADQUARTERS WAYNE, MICHIGAN 48184  
TELEPHONE 721-4040—AREA CODE 313—TELEX 23-5457

*Inclined Wall  
Century Properties Building  
San Antonio, Texas  
Architect: Neuhaus & Taylor  
Houston, Texas*

*1. Entrance Canopy  
Mt. Bell Telephone & Telegraph Company  
Phoenix, Arizona  
Architect: Alfred Newman Beadle & Associates  
Phoenix, Arizona*

*2. Eastgate Square Shopping Mall  
Hamilton, Ontario  
Architect: Petroff and Jeruzalski  
Toronto, Ontario*

*3. Canopy Structure for Office Complex  
University of California  
Sacramento, California  
Architect: Ian MacKinlay & Associates  
Orinda, California*

*4.&5. Franklin Park Mall  
Toledo, Ohio  
Architect: Daverman Associates  
Grand Rapids, Michigan*

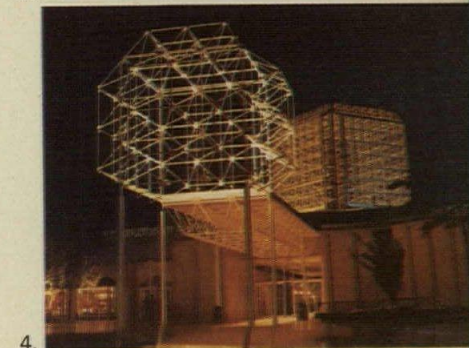
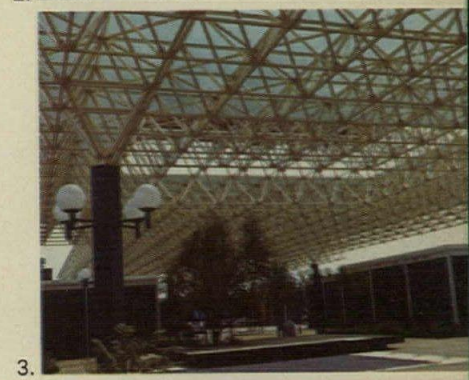

**GTB SYLVANIA**

For more data, circle 14 on inquiry card



# **SIMPLY BEAUTIFUL**

GUTH LIGHTING'S "Project E. C." environmental ceiling system is an achievement in simplicity. It's simple to integrate, simple to install, simple to maintain. And simply good-looking.

Your local GUTH Representative is equipped to conduct a ten-minute demonstration on the Project E. C. system. Just give us your phone number and we'll have him call for an appointment. Or send in the reader service card for the literature. It's as simple as that.



P. O. Box 7079, St. Louis, Missouri 63177 (314) 533-3200

**GUTH LIGHTING** **SB**  
SOLA BASIC

SOLA BASIC DIVISIONS: ANCHOR ELECTRIC • BISHOP ELECTRIC • DIELECTRIC COMMUNICATIONS • DOWZER ELECTRIC • GUTH LIGHTING  
HEVI-DUTY ELECTRIC • LINDBERG • NELSON ELECTRIC • SIERRA ELECTRIC • SOLA ELECTRIC • TEMPRESS  
TOMIC ELECTRIC • WARREN G-V COMMUNICATIONS

*For more data, circle 15 on inquiry card*





# Polysulfide sealants stick to your job year after year

Years ahead of competing materials, LP<sup>®</sup> polysulfide polymer base sealants continue to ensure waterproof and airtight construction joints in structures all over the world. For more than 25 years, polysulfide base sealants have been at work in buildings—keeping a tight bond, and preventing moisture and air penetration while expanding and contracting year after year with seasonal temperature changes.

You can't beat this experience record, but you can *buy* it in any of the more than 200 sealants made by 14 manufacturers covered by Thiokol's Seal of Security Program. This program subjects polysulfide base sealants to rigid performance tests conforming to the Thiokol Building Trade Performance Specification. Those that pass are certified as Tested and Approved and carry the Thiokol Seal of Security Emblem.

Specifying and properly applying one of the Tested and Approved one- or two-part polysulfide base sealants will pay dividends for years in providing a trouble-free airtight bond in joints in any kind of construction project, whether it is a high-rise prestige office building, a one-story merchandise warehouse, or a flagstone walkway. The tallest building in the world is built to last with polysulfide base sealants.

Look for the Thiokol Seal of Security—it means years of problem-free performance in construction sealant products properly applied. For highest proven reliability, it's LP polysulfide base sealants every time. Further information—and an answer to your sealant questions—can be obtained from Thiokol/Chemical Division, P.O. Box 1296, Trenton, N.J. 08607, telephone 609-396-4001.

# Thiokol

*Specialty Polymers • Off-Road Tracked Vehicles • Synthetic Fibers & Fabrics • Sprayers • Propulsion • Educational Services  
Disc Brake Pads • Ski Lifts • Pyrotechnic Devices • Closures • Rubber and Rubber Chemicals • Medical Electronics Equipment*

For more data, circle 16 on inquiry card



# Symons continues at the future of and at some practical ways to

Today, you are challenged as never before to use concrete with imagination.

In the esthetics and innovations that characterize your buildings.

In making productive use of less and less land at increasing costs.

In improving the surroundings of the community. In solving transportation problems. Congested cities. Water shortages.

While the challenge to achieve new levels of efficiency is clear, the solution is clouded by soaring costs. So you'll need a

practical approach to concrete forming.

A businesslike approach that will keep your customers happy by bringing in their jobs—on time and on budget.

A hard-nosed approach that will keep your accountant happy by improving your net profit.

Like the Symons Systems Approach. It's more than forms. And materials. And accessories.

It's analyzing the problem. Selecting the right system for you. Developing a bill of materials. Suggesting economical pouring

## When we promise a solution,

# to take a hard look concrete forming.

## improve both of your bottom lines



schedules. Training your people to be efficient. Working with you on the job from start to finish . . . to help you meet both bottom lines—customer satisfaction and net profit.

It's ideas. Dedication. Thoroughly trained account men. And a full-size R&D staff to help solve the unusual problems.

The right system can help you cut job-built forming costs substantially. That's the Symons Systems Approach.

Call us. To help you meet the challenges of the future. 312/775-5060.

### you get a solution.



# SYMONS

118 E. Touhy Ave., Dept. 7497 Des Plaines, Illinois 60018

For more data, circle 17 on inquiry card

# HOW STEEL FABRICATORS, INC. TAUGHT EVERYONE A LESSON AT THE HARRISBURG MIDDLE SCHOOL.

The lesson was how to cut three to six months off the design and construction time for completing a school.

The teaching materials were Vulcraft's steel joists and joist girders as utilized in Steel Fabricators' "Fab-Lok" structural subsystem, which made "fast track" construction scheduling possible for this job.

By using Vulcraft steel joists and joist girders instead of concrete, the structural work on the building could be started before the final design was completed. Because Vulcraft's joist girder system utilizes a standard five-foot panel point spacing.

Knowing this allowed designers to standardize lighting/ceiling components as well as heating, ventilating and air conditioning components. And layouts for wiring, ducts and pipes. Also, because Vulcraft's steel joists use an open web construction pattern, installation of all wiring, ducts and pipes goes easier and faster. They actually can

pass right through the joists and joist girders.

The light weight of Vulcraft's joists and joist girders offers other advantages, too. Erection is easier and faster. Supporting columns can be spaced further apart to provide for larger bay areas. And foundation size can be decreased.

The "fast track" technique worked in Harrisburg, Pennsylvania. Plus ten other schools throughout the country where Vulcraft steel joists and joist girders have been used by Steel Fabricators, Inc.

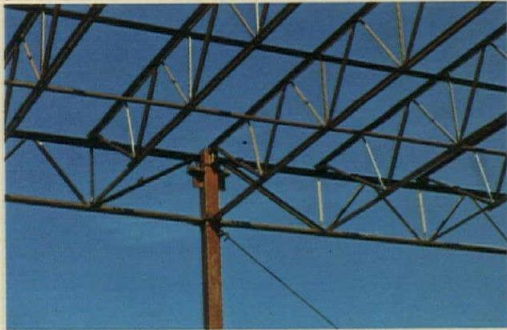

*Vulcraft's steel joists and joist girders allow a standard five-foot module between connecting points.*

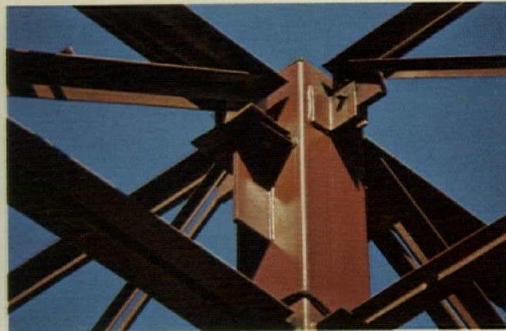

*The standardization of column connection also speeds up construction. And requires fewer connecting bolts.*

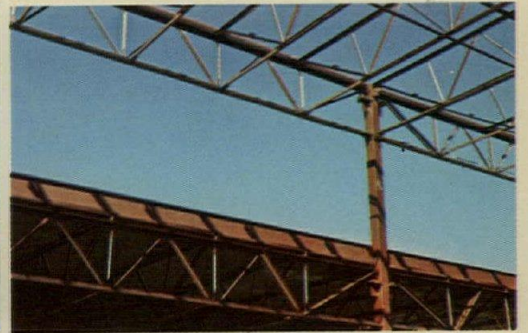

*The light weight and simplicity of Vulcraft's steel joists and joist girders make erection fast and easy.*



*The open web feature of steel joists and joist girders allows ducts, pipes and wiring to pass directly through the steel members.*



*The high strength of steel joists and joist girders provides increased clear span area, allowing larger bays.*

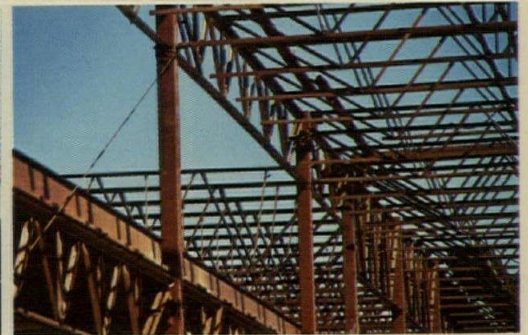

*The ease and versatility of designing with steel joists and joist girders solve otherwise complex design problems.*

And it can work for you. Just contact your local Vulcraft representative for your Joist Girder Specification Guide. Or write Vulcraft, P.O. Box 17656, Charlotte, North Carolina 28211 to learn how to speed up your work. Or call (704) 366-7000.

We have the know-how. And we have five plants located throughout the country to make sure your deliveries are there on time.

After all, when school time rolls around, nobody wants to be late.

## VULCRAFT

*Architect: William Lynch Murray & Associates, Harrisburg, Pennsylvania. Erector: Walsh Steel Services, Pittston, Pennsylvania. General Contractor: Ritter Brothers Construction, Harrisburg, Pennsylvania. Steel Fabricator: Steel Fabricators, Inc., Fort Lauderdale, Florida. Consulting Engineer: Quentin Bowers, P. E., Harrisburg, Pennsylvania.*

For more data, circle 18 on inquiry card

# Andersen™ Perma-Shield® Windows.

## THE BEAUTIFUL WAY TO SAVE TIME, SAVE MONEY,

Rapidly increasing fuel and maintenance costs can make a sizable dent in any building operation budget.

But Andersen™ Perma-Shield® Windows help keep operating costs in line.

They save fuel. Beneath their protective vinyl sheath is a wood core, one of nature's best insulators.

And Andersen Windows are two times more weathertight than industry standards. To help prevent biting outside winds from becoming chilling inside drafts.

Add double-pane insulating glass, and Perma-Shield Windows cut conducted heat loss through glass area by 35% (compared to single-glazed units).

1-2. Weathertightness and low maintenance are two reasons why the Anne Arundel County Government Center, Annapolis, MD, has Perma-Shield Casement Windows.  
3-4. Perma-Shield Casement Windows with varying glass/Mirawall insulated panel combinations help provide flexibility and tenant privacy in the Newburg Professional Bldg., Louisville, KY.



# SAVE FUEL.

They cut maintenance costs, too. Perma-Shield vinyl won't rust, pit or corrode like metal. Perma-Shield windows won't warp, stick or bind, either. Thanks to the perfect combination of rigid vinyl and stable wood.

So, no matter what you're building, specify

Andersen Perma-Shield Windows.  
For more information, see your local Andersen Dealer or Distributor. He's in the Yellow Pages under "Windows, Wood." Or write us direct.

**Andersen Windowalls®**  
ANDERSEN CORPORATION BAYPORT, MINNESOTA 55003



For more data, circle 19 on inquiry card

St. Louis, MO.

Copyright © Andersen Corp., Bayport, Minn. 1974.

5. Perma-Shield Narroline® double hung windows complement the Williamsburg Colonial design of the Town & Country Medical Center, St. Louis, MO.  
6-7. Perma-Shield fixed windows created an appealing curtain wall for the Montana State Employment Office, Great Falls.



**ELJER**<sup>®</sup>

hospital/institutional  
plumbing fixtures and fittings



## New...from Eljer—62 pages of modern hospital/institutional plumbingware

You won't notice much change from the hospital fixtures of yesterday unless you look at this Eljer catalog. The Eljer line is different, modern. Smooth, flowing contours provide generally unbroken surfaces, remarkably free of difficult-to-clean nooks and crannies. From every standpoint—appearance, functional design and highest quality, the Eljer line of hospital and commercial fixtures is in keeping with any modern building, from a corner gas station to a large medical center.

Don't specify another commercial job until you have the full Eljer story. Eljer's new 62-page Hospital/Institutional catalog contains all you need to know about hundreds of modern, freshly-

styled and easily-installed specialized fixtures and fittings.

Sitz baths and scrub-up sinks . . . specimen toilets and instrument trays . . . and much more, including wrist-, knee-, and pedal-control valves. Like the rest of the complete Eljer commercial line, they are available through independent plumbing supply wholesalers.

So, before you specify your next commercial job, ask your Eljer wholesaler for information on the complete Eljer line, or write today for the new Hospital/Institutional catalog:

**ELJER PLUMBINGWARE**, Wallace-Murray Corp.  
Dept. AR, 3 Gateway Center, Pittsburgh, Pa. 15222

**ELJER**

**WallaceMurray**

For more data, circle 20 on inquiry card



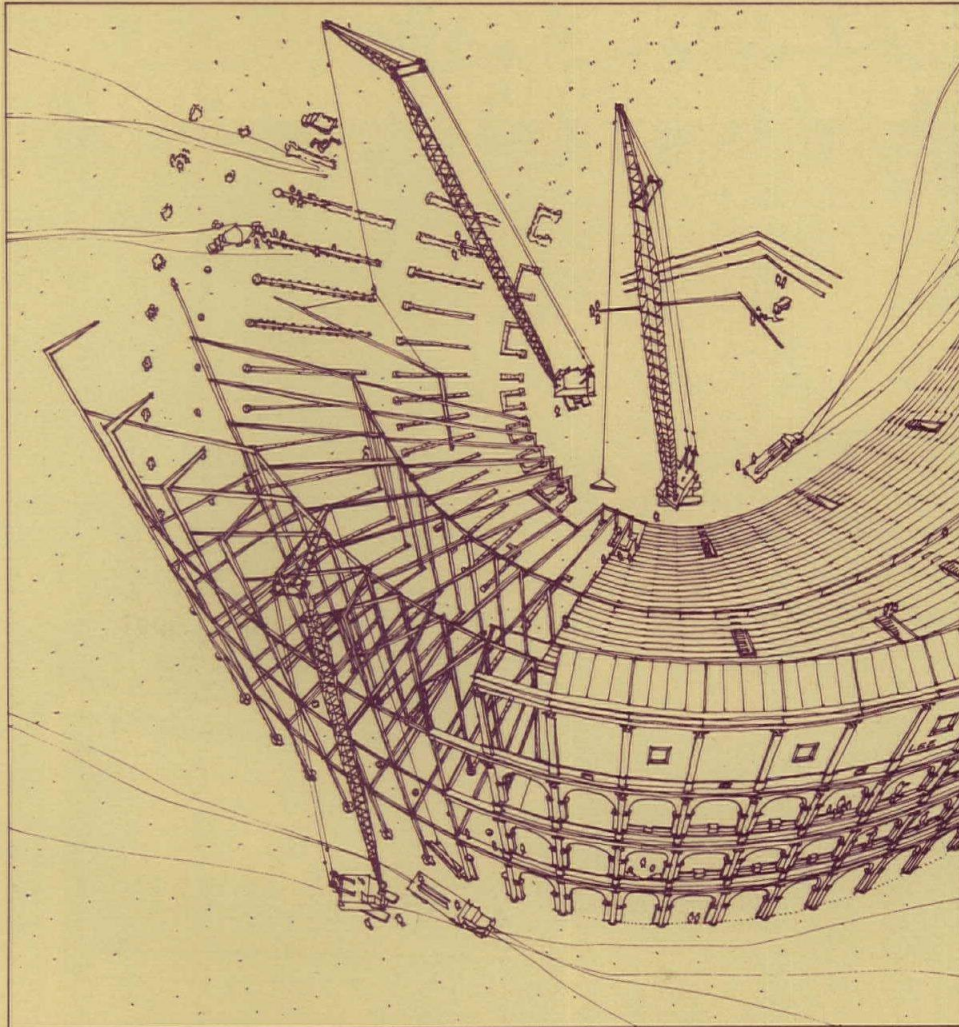

**The Colosseum.** Perhaps we're being presumptuous in suggesting Star's pre-engineered steel components for the Flavian amphitheatre. But the point is this: the flexibility and versatility of the Star System is limited only by imagination. The system offers a truly wide range of computer-designed components that go together quickly, correctly and economically. And Star components are compatible with other materials. Is it any wonder we say Star has a place in the minds of modern architects?

If Star had been around in 70 A.D., it wouldn't have taken us twelve years to build the Colosseum. That might have helped the Roman Gladiators. They were an expansion team and attendance was down. By the time the Colosseum was completed, the team was gone. They'd been replaced by an animal act.

**Star**   
**Buildings**

There's a place for us.

For more information about Star Building Systems, write: Star Manufacturing Company, Dept. AR84, Box 94910, Oklahoma City, Oklahoma 73109.

# ECO, today's answer to tomorrow's security problems.

Unobtrusive. Economical. Reliable. Simple to install. Hager's Electronic Control of Openings (ECO) offers a unique, new concept in building security and traffic control. ECO's patented electronic contact and switch hinge now makes it possible to lock, unlock and monitor openings electrically from one central security station. Only slight modification to standard A.N.S.I. door and frame preparation is required. Installation is simple. Electrical contractors can easily incorporate ECO into the building's wiring system. For more information, call your architectural hardware consultant or mail this coupon today.

**eco**  
electronic  
control of  
openings

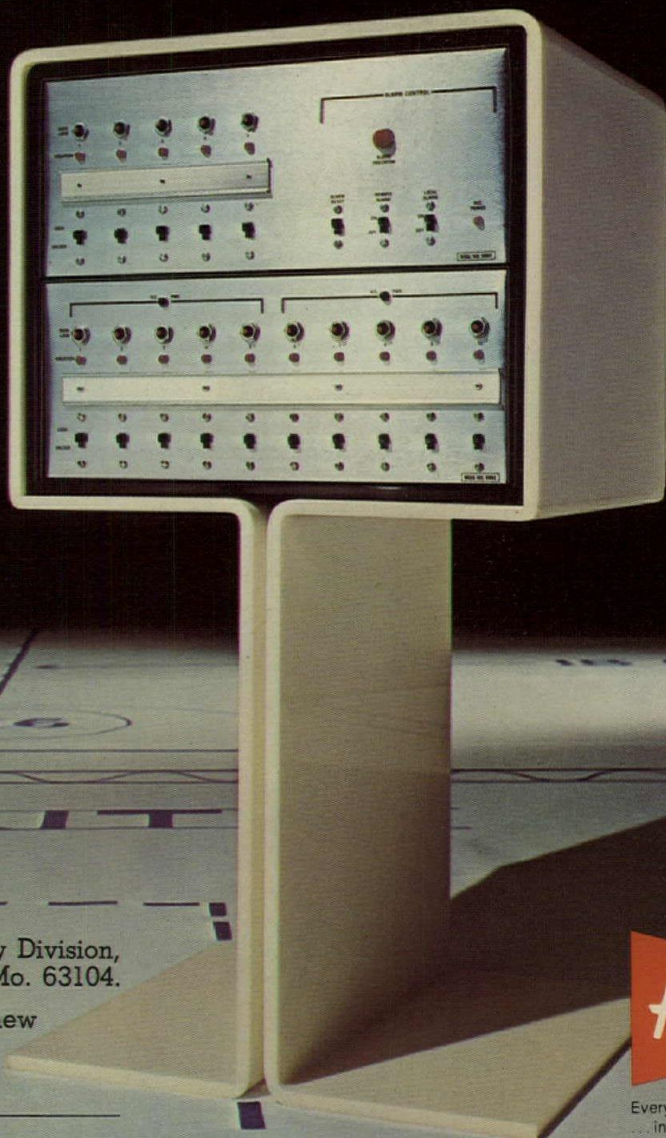

Mail to: Clarence King, FCSI, President—ECO Security Division,  
Hager Hinge Company, 139 Victor Street, St. Louis, Mo. 63104.

Please send me more complete information on Hager's new  
ECO security system.

Name \_\_\_\_\_

Company \_\_\_\_\_ Phone \_\_\_\_\_

Address \_\_\_\_\_

City \_\_\_\_\_ State \_\_\_\_\_ Zip \_\_\_\_\_



Everything hinges on Hager  
...including security.

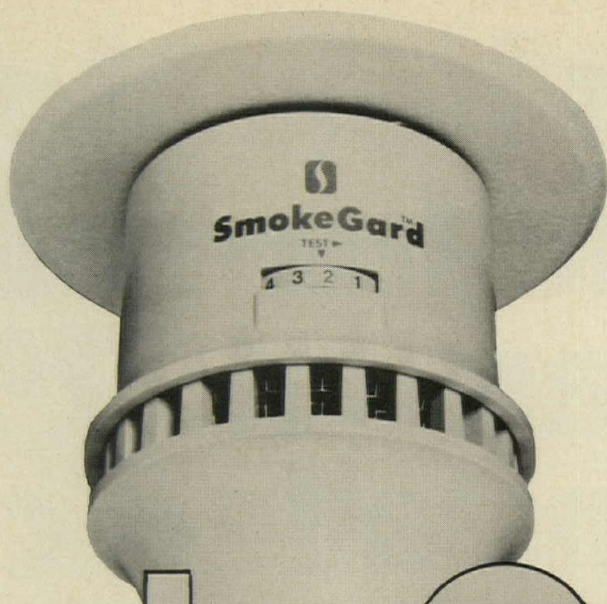

# SmokeGard 770

## New—Low Cost—A.C. Powered Ionization Smoke Detector

*Meets Latest Building Code Requirements... Local—State—Federal*

**SMOKEGARD 770**—We've done it again—produced a new, ionization, smoke detector with the contractor in mind. Specifically designed for new construction projects where early warning smoke detection is required.

This rugged detector features the reliability and long life of the ionization principle of smoke detection. Easy to install. Attach the adaptor plate to a standard electrical outlet box, connect two pre-stripped power wires and twist into place.

Now you can meet building code requirements for both single and multi-family housing with a **COMPETITIVE PRICED** ionization detector. The new Model 770 offers the same outstanding performance as our time proven battery powered Smokegard Model 700.



Contact your Building Supply or Electrical Supply Wholesaler for further information on the A.C. Model 770 or the battery operated Model 700.

For additional information on these or other early warning detectors, write to Statitrol—the leading U.S. manufacturer of ionization detectors to meet residential, commercial and industrial requirements.



### STATITROL

140 SO. UNION BLVD.  
LAKEWOOD, COLORADO

**BETTER FIRE DEFENSE PRODUCTS...WORLDWIDE**

*For more data, circle 26 on inquiry card*

# Here's how McQuay Hi-Line fan-coil units can cut 17% off installed costs.

It's really very simple: we practically install your McQuay Seasonmaker® Hi-Line fan-coil units for you.

**Factory pre-fabricated.**

We ship these units already installed with all risers for chilled water, hot water and drains, and with all internal control systems. Which saves you money on both field-supplied labor and materials. (In one documented case, the saving was 17% — and that was a conservative estimate!)

**Even greater savings** are possible when you consider that one Hi-Line fan-coil unit can do the job that used to require 2, 3 or even more conventional units.

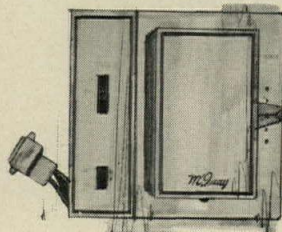

**Plug-in thermostat is standard to add to your savings.** The Hi-Line fan-coil unit includes a plug-in

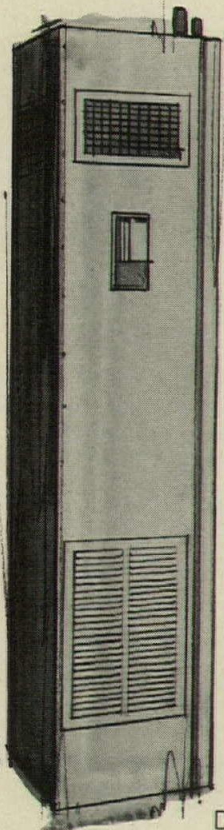

thermostat as standard equipment. It just plugs in after the unit is concealed in place, with no complicated (or expensive) wiring or troublesome delays.

**Easy on the ears.** We think a good fan-coil air conditioner should be seen and not heard. So we made sure that what's on the inside of the unit runs quietly.

For more facts on the economies and features of the Hi-Line Seasonmaker® Fan-Coil Units, just ask your McQuay Representative for Catalog #770.

Or write: McQuay Division, McQuay-Perfex Inc., Box 1551, 13600 Industrial Park Blvd., Minneapolis, Minn. 55440.

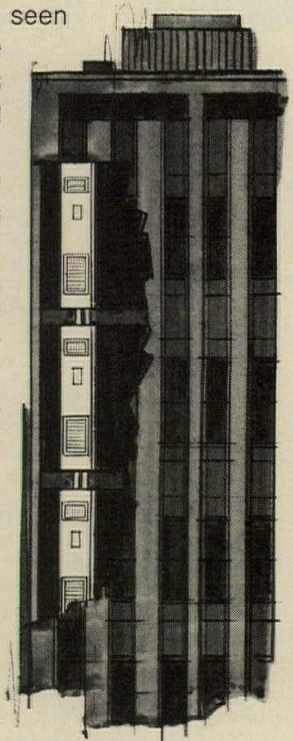

Look to the leader . . .



*McQuay*®

For more data, circle 27 on inquiry card

**A decision in the Justice Department-NSPE trial is not expected before the end of the year.** With the district court trial of the National Society of Professional Engineers on charges of violating the Sherman Act completed, it is expected that Judge John Lewis Smith, Jr. will not be able to come to a quick decision. Justice charges NSPE with wording its Code of Ethics to oppose competitive bidding for engineering services. See page 37.

**The House voted 374 to 21 appropriations of \$4.47 billion for public works for water and power developments** and the Atomic Energy Commission for outlays in the year begun on July 1. About \$1.7 billion is specified for the AEC, and over \$2.3 billion for projects of the Army Corps of Engineers, Bureau of Reclamation, and power agencies of the Interior Department.

**The "how, what and who of government architect-engineer contracting" has been published in a new document** available from the American Consulting Engineers Council, at \$2 per copy. Included is a check list for anyone interested in securing Federal consulting engineering contracts, with 13 suggestions for dealing with various agencies. Copies may be ordered from the ACEC, 1155 15th Street, N.W., Washington, D.C. 20005.

**State water control agencies will have \$1.5 million to study waste water treatment facilities costs,** according to the Environmental Protection Agency which is making the money available this year. Results will be submitted to Congress in the fall for use in determining future allocations of Federal funds to aid in building these facilities.

**NFPA Standard No. 13 on installation of sprinkler systems is recalled.** The new edition of the standard released the week of July 8 is identified by the numbers 15M-7-7R-FP-HO in the lower left portion of the cover. Users should be aware that copies of Standard No. 13, 1974 bearing this reference number should be returned to NFPA for replacement because of "errors in content and in printing." Contact the National Fire Protection Association, 470 Atlantic Avenue, Boston, Massachusetts.

**Improved effectiveness in dealing with proliferating building codes and regulations is being sought** by the National Architect-Engineer Liaison Commission which met at NSPE headquarters June 27. The Commission, composed of two members each from ACEC, AIA, and NSPE noted the need for the design professions to coordinate efforts in light of the emergence of many governmental and private organizations concerned with codes. Establishment of a Design Professions Codes, Standards and Regulations Center is the goal of NAELC.

**David Rickelton, Charlotte, North Carolina, was installed in June as ASHRAE president,** at the organization's annual meeting in Montreal. Mr. Rickelton is vice president of Aeronca, Inc., Environmental Control Group in Charlotte. Other officers newly installed are: William J. Collins, president-elect; William P. Chapman and Bruno P. Morabito, vice presidents; and Morris Backer, treasurer.

**Federal Energy Administrator John C. Sawhill will support curtailment of urban expressways** and other urban new road construction. In a speech to a Philadelphia business group, Mr. Sawhill said urban centers face a new potential for revitalizing their cores, and the greatest possibilities for change lie in transportation. He called the opening up of the highway trust fund to urban public transit capital outlays a "major step toward reducing the near-monopoly that highway construction held on transportation funding."

**November 30, 1974 is the deadline for entries in the CRSI design awards program,** sponsored by the Concrete Reinforcing Steel Institute. There are no specific categories of eligible structures, and no entry blank is required. To obtain rules for the competition, write: George F. Leyh, Concrete Reinforcing Steel Institute, 180 North LaSalle Street, Chicago, Ill. 60601.

**The International Federation of Consulting Engineers will meet in Cape Town, September 29 to October 4.** This 1974 general assembly will be hosted by the South African Association of Consulting Engineers. For more information, contact the American Consulting Engineers Council, Washington, D.C. (See address above.)

**Canada has approved metric conversion and will study the feasibility of converting by July 1, 1977,** after which all design, construction and manufacturing will be in metric. Canadian plans were outlined by the Canadian Metric Commission and construction industry who briefed the Building and Construction Coordinating Committee of the American National Metric Council.

**The Environmental Protection Agency has published final water planning regulations as state guides** to development of water pollution control planning processes. They show what each state must submit annually to EPA as a requirement under the governing Federal law of 1972. The regulations, titled "Policies and Procedures for State Continuing Planning Processes," and "Preparation of Water Quality Management Basin Plans," were developed with the aid of eight states, including California.

# UNPARALLELED PROTECTION

Solutions for every fire/life safety door control problem. From the pioneer and leader of the field, a comprehensive range of code-orientated smoke detection and door control products... fully tested under actual fire conditions... backed by the industry's best-known staff of fire protection professionals.

Write today for complete information.

## **RIXSON-FIREMARK, INC.**

9100 W. Belmont Ave., Franklin Park, IL 60131  
In Canada: Rixson-Firemark (Can.) Ltd.

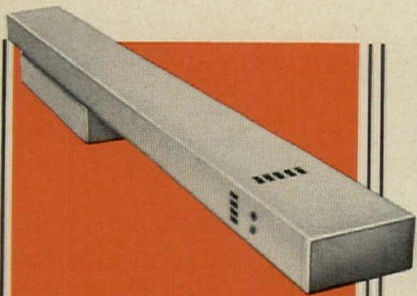

**Smok-Chek IV:**  
Ultimate combination detector and hydraulic door control protection.



**Smok-Chek III:**  
The original combination unit.



**FM-1001M:**  
Advanced photoelectric type smoke detector.



**FM-1601:** Low profile ionization detector.

... and the long Firemark line of electromagnetic door holder-releases.



For more data, circle 28 on inquiry card

## Decision pending in Justice-NSPE trial

After five days of court proceedings, trial ended June 11 in the case involving charges by the Justice Department that the National Society of Professional Engineers—through its ethical prohibition against competitive bidding—violates the Sherman Antitrust Act.

In U.S. District Court in Washington, D.C., the Justice Department charged NSPE with a conspiracy consisting of "an agreement to suppress and eliminate price competition in the sale of engineering services by NSPE members and other engineers." The Justice Department case represents a two-pronged attack on competitive bidding and professional fee schedules, including those setting legal fees for lawyers.

NSPE argued that the Sherman Antitrust Act exempts "learned professions" since they do not create products affecting interstate commerce but instead involve products of the designer's mind.

Briefs have been filed with a decision six months away.

In the meantime, AIA—in this "atmosphere of growing and conflicting court activity" has again advised its components to recall any fee schedules still in use. Failure to do so, according to the AIA, could result in costly legal proceedings if "components sponsor pricing information that could, or might appear to, result in near-uniformity of price quotations."

## NFPA votes code change on cable

The National Fire Protection Association has voted an important change in the National Electrical Code which will bar non-metallic sheathed (Romex) cable from installations in buildings above three stories in height. The change becomes effective when published.

The wording reads: "type NM and NMC Cable shall be permitted to be used in one- and two-family dwellings or multi-family dwellings and other structures not exceeding three floors above grade."

The action, taken at the NFPA meeting in Miami recently was a modification of earlier proposals which would have eliminated the non-metallic sheathed cable from all buildings, it was said. When the National Association of Home Builders learned of the plans, it conducted a protest campaign in the form of letters to the chairman of the correlating committee of the National Electrical

Code and forced return of its proposed change in Sect. 336-3.

The NAHB protest was triggered by the prospect of higher home construction costs if the non-rigid cable had been barred, forcing the use of metal-sheathed wire throughout residential work. It is argued that use of the Romex style wiring reduces costs considerably.

It has been feared, too, that a major change in the code reflecting a total ban on non-metallic-sheathed cable would trigger a rash of appearances of affected parties—contractors and union representatives—before local code enforcing groups seeking waivers and exceptions.

A letter from the Home Builders Association of Greater Tulsa, Okla., to the correlating committee claimed that use of Romex in that area in 35,000 units over the past 15 years had saved from one-third to one-half the cost of installing rigid conduit. Labor costs increase with the latter because of time required to pull wires through the conduit runs.

## Atlanta transit answers architects

Metropolitan Atlanta Rapid Transit Authority (MARTA) general manager Alan Kiepper addressed the Atlanta Chapter of AIA in July on architects' complaints about MARTA's dealing with them. Their basic complaints have been (1) not enough work is going to local architects; (2) architects are being forced into joint ventures with engineers; (3) architects are not involved in the early stages of design; (4) negotiations for contracts are too slow; (5) flaws in scheduling at MARTA interfere with firms' scheduling of MARTA work, and once firms accept MARTA work they are hindered from accepting other commitments; and (6) affirmative action requirements are hard to meet.

Kiepper denied some of the charges and admitted that some of the others have validity. Among the allegations denied were the first three. Eighteen architectural firms, 13 of which are Atlanta based, are in the 16 design teams selected thus far. He asserted that the major portion of MARTA work is engineering and the Authority is committed to all local professionals, not just engineers, and will not force any joint ventures. MARTA also is going all the way to involve architects as early as possible, even going to "single man" contracts with individuals when contract negotiations bog down.

On the other hand, Kiepper said there's no question that contract negotiations are slow. He blamed UMTA's inexperience for the slowdown and said that MARTA is paying a penalty for this lack of expertise. There's also "some validity" to complaints about scheduling, he said, but the Authority is trying to improve, and architects must also realize the magnitude and complexity of MARTA. And, finally, he said, there is a shortage of minority professionals to fulfill affirmative action commitments, but that such fulfillment is basic to MARTA. In fact, he said results in this area may be as durable and beneficial to Atlanta as the transit program itself.

## Two per cent energy growth sought for U.S.

Energy conservation measures are no mystery and large amounts of fuel can be saved through tighter construction, more insulation and use of heat pumps, according to Dr. S. David Freeman, director of the Energy Policy Project of the Ford Foundation.

He testified before the House Interior subcommittee on the environment headed by Representative Morris K. Udall (D-Ariz.), who has introduced a bill establishing a formal Federal policy toward energy consumption. The measure proposes to set a goal of limiting the nation's annual increase in energy consumption to two per cent by 1980.

Dr. Freeman, who served as energy adviser under both Presidents Kennedy and Johnson said large savings can be achieved by reforming transportation policies so that freight and people are moved more efficiently, and by recycling energy-intensive materials. "We are satisfied that two per cent growth can provide the nation with all the energy we need if conservation programs that are feasible and economical are put into effect," he said.

Freeman was critical of what he called conflicting Federal policies, referring to "the spectacle of Federal agencies moving in opposite energy policy directions." He said Interior had launched a program based on a high—four per cent—demand assumption while the Environmental Protection Agency and the Council on Environmental Quality urge a two per cent annual energy growth target. And he claimed the Federal Energy Agency has yet to declare the growth assumption for Project Independence.

"The energy industry and

consuming public have every right to be confused," he told the Udall subcommittee, claiming the nation cannot afford the time required to change these policies and practices one at a time. He called for establishment of a basic conservation policy at once.

## Speakers announced for transit meeting

Speakers have been announced for the Sixth International Conference on Urban Transportation, to be held in Pittsburgh, September 8-10, 1974.

Those who have agreed to address the Conference include: Sir Richard Way, chairman of London Transport; Joseph L. Alioto, mayor of San Francisco; Taek Shik Yang, mayor of Seoul, South Korea; Dr. William J. Ronan, chairman of the Metropolitan Transportation Authority, New York City; and Jaime Lerner, mayor of Curitiba, Brazil.

Also addressing the Conference will be Eleanor Holmes Norton, director of the New York Commission on Human Rights; Edgar Kaiser, chairman of the board of Kaiser Industries; Maurice Alpert of the International City Corporation; John Galbreath, president of John W. Galbreath & Company; Richard G. Mitchell, Administrator of the Community Redevelopment Agency of Los Angeles; and Lawrence L. Gellerstedt, Jr., president of Beers Construction Company.

Special planning is underway to attract additional urban leaders from Europe and the Far East, in addition to those representing the North and South American continents.

A dinner, followed by a 90-minute entertainment special, has been set for Monday night September 9, and a high-ranking U.S. Government official has been invited to address the Tuesday evening closing dinner and awards ceremony.

Conference registration forms are now available for both the meetings and local Pittsburgh hotel accommodations by writing the Sixth International Conference on Urban Transportation, Post Office Box 2149, Pittsburgh, Pennsylvania 15230, or by calling (412) 261-3562.

The Conference has been a biannual event in Pittsburgh since 1966, and conferees have included government, civic, business, labor and academic leaders prominent in transportation and urban development. The upcoming Pittsburgh Conference expects over 1500 attendees.

## GSA breaks ground for energy project

Federal, state and local officials broke ground in Manchester, N.H. on June 7 for an \$8.5 million Federal office building designed to consume at least 40 per cent less energy than a comparable conventional structure.

Arthur F. Sampson, GSA Administrator, said "this building will serve as a prototype for the construction industry in saving energy. As GSA's first energy conservation demonstration project, this will be a living, working laboratory designed to minimize energy consumption and recover heat that ordinarily would be lost in building operations."

When completed in 1975, the Manchester building will incorporate more energy-savings features than any other Federal building. It will include a 10,000-square-foot solar energy collector that will furnish nearly 30 per cent of the building's power.

The 175,000 square-foot building will architecturally complement adjacent buildings, blending quality esthetics with sound, innovative engineering according to GSA. Its exterior shell will be of pre-cast resin-based pebble and insulated metal panels that will reduce the heat transfer between inside and outside environments.

The building's windows will be faced with fins that will admit warm solar rays in the winter and exclude them in the summer. The double-glazed windows will be carefully located to avoid any sense of confinement while giving the facade a highly-sculptured and distinctive appearance.

It is expected that about 500 Federal employees now scattered throughout Manchester will be consolidated in the new building, designed by Dubin-Mindell-Bloome Associates.

Government agencies will be assigned office space on the basis of accessibility. Those agencies which serve elderly or handicapped citizens such as the Social Security and Veterans Administration will be located on the ground floor.

Sampson said the building will be constructed under a purchase contract procedure which allows the government to purchase it over a 30-year period. During this period, the property will remain on local real estate rolls.

This building is one of two major GSA experiments—or demonstration projects. The other is in Saginaw, Mich.

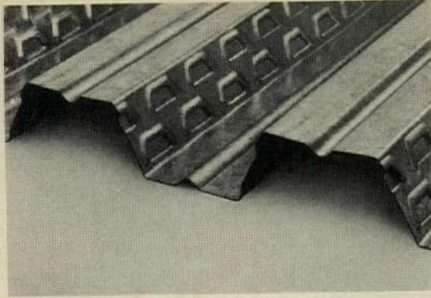

*The unique double embossing technique used on new COMDEK sheets is the key to the strong composite action that makes construction move fast.*

Efficient construction savings is what Granco's new COMDEK is all about. You save time because COMDEK's wide 36" coverage means fewer welds, less labor. You save again because no positive reinforcing steel is added. And you save concrete because the deep, double embossed rib indentations provide super positive composite action. Thus your pouring form becomes an integrated structural unit as concrete sets.

And, for greater economies, COMDEK is available in both 2" and 3" depths. Lengths to 45'.

Like to get down to specifics? Send for the new Granco COMDEK Catalog. Complete specs, fire ratings, and load tables. Write Granco, P. O. Box 40526, Houston, Texas 77040.

*For more data, circle 29 on inquiry card*

**Granco®**  
Building products that perform

 Granco Steel Products Co.  
Subsidiary of  
National Steel Corporation

# New COMDEK™ by Granco may simply be the simplest, most efficient composite deck system available today.

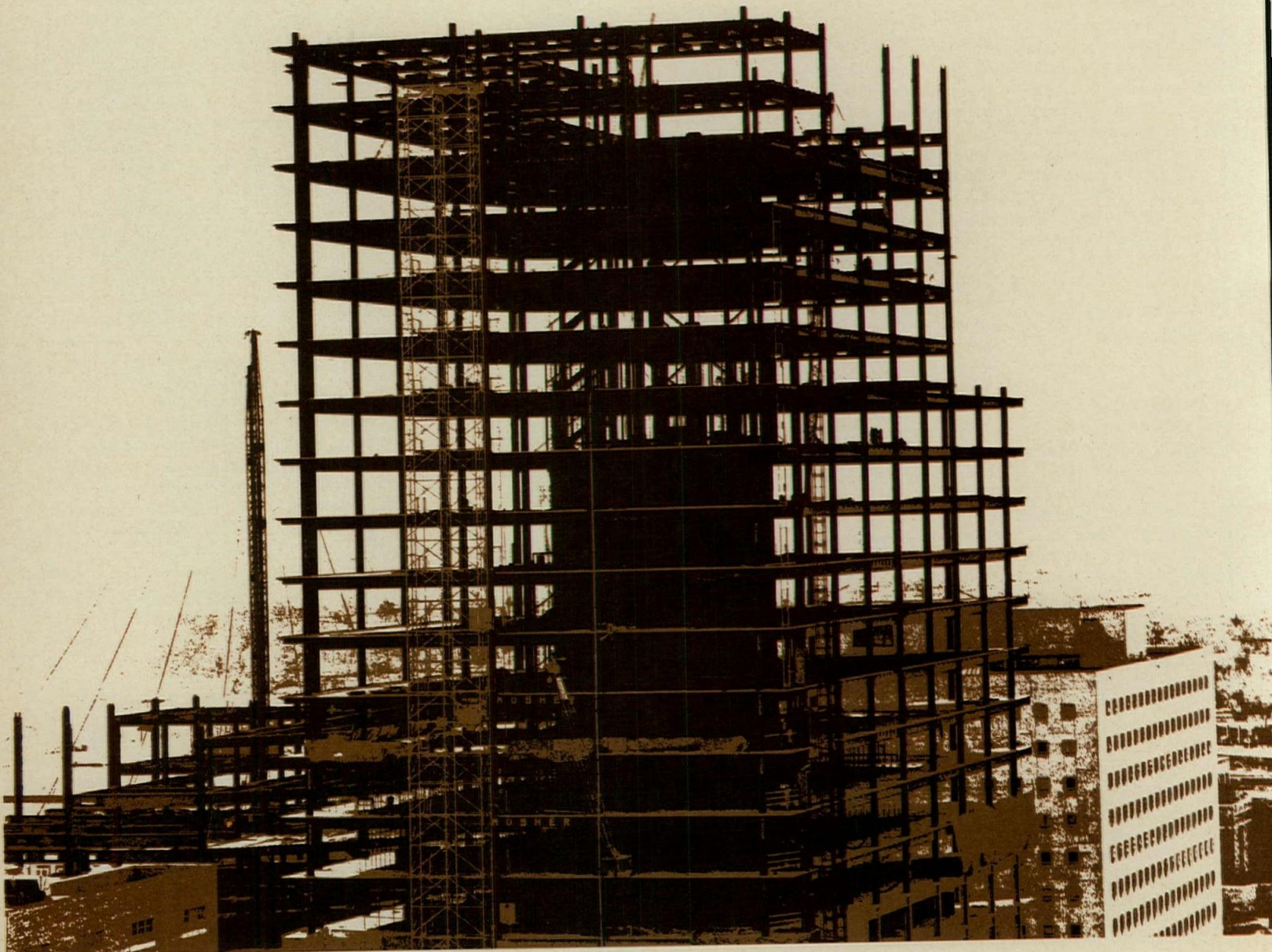



## REQUIRED READING

### Recently received books on architectural engineering and related fields

**ANALYTICAL AND COMPUTER METHODS IN FOUNDATION ENGINEERING**, by Joseph E. Bowles; McGraw-Hill Book Co., New York, 1974, 519 pages, \$17.50.

This book uses computer-oriented computational tools to solve all types of soil-structure interaction problems, and it covers in a single volume the design and analysis of foundation engineering structures. Equal emphasis is placed on standard U.S. and metric units, both of which are included in examples in every chapter. The finite element method is extensively utilized, and current modes are cited throughout.

Computer programs in FORTRAN IV language are part of each major topic, with a description of the program, variable identification and program limitations given in each case. By discussing both theory and methodology, the author has aimed this book at the professional practitioner as well as the student.

**ENERGY PRINCIPLES IN STRUCTURAL MECHANICS**, by Theodore R. Taichert; McGraw-Hill Book Co., New York, 1974, 380 pages, illus., \$18.50.

The development and use of energy method is the major emphasis of this book. Beginning with a discussion of classical elasticity, the applicability and limitations of linear structural mechanics are established. The principles of virtual work, complementary virtual work, and various energy theorems that are derived from these are then used to study the static and dynamic behaviors of elastic structures. Thermal and mechanical loadings on structures are examined. An introduction to structural stability is also included.

**BASIC STEEL DESIGN**, by Bruce G. Johnston and Fung-jen Lin; Prentice-Hall, Englewood Cliffs, New Jersey, 1974, 246 pages, illus., \$15.95.

An outstanding contributor to the modern field of steel structural design and a specialist in computer programming have collaborated to produce this book; their treatment is broad-ranging, from basic properties of steel through the structural behavior of components, to more advanced and specific topics. Throughout, relevant American Institute of Steel Construction building specifications are stressed.

**MATERIALS AND METHODS FOR CONTEMPORARY CONSTRUCTION**, by Caleb Hornbostel and William J. Hornung; Prentice-Hall, Englewood Cliffs, New Jersey, 1974, 292 pages, illus., \$16.00 c.l.

This book for students is organized around a series of "study units" and begins with an over-all discussion of the building process and of its fundamental preliminaries—earth formations, soil tests, utilities, site preparation and excavations. The studies then proceed to the subjects of footings and foundations and site building drainage. This is followed by coverage of the techniques and materials of placing and pouring concrete. Subsequent sections discuss masonry and stone, wood, metals, glass, plastics, paints, flooring, plastering, insu-

lation, roofing, siding, doors and windows.

**CONCRETE CONSTRUCTION HANDBOOK**, by Joseph J. Waddell; McGraw-Hill Book Co., New York, Second Edition, 1974, 918 pages, illus., \$32.50.

The specifics of mixing, pouring and curing of specification-quality concrete are clearly outlined in this practical guide for field inspectors, construction superintendents, field engineers, and contractors. In addition to serving as a quality control manual, this handbook also includes sections on form work, shoring, aggregates and additives.

**TIMBER CONSTRUCTION MANUAL: A Manual for Architects, Engineers, Contractors, Laminators and Fabricators Concerned with Engineered Timber Buildings and Other Structures**, by the American Institute of Timber Construction; New York, John Wiley and Sons, Second Edition, 1974, 799 pages, illus., \$15.00.

First published in 1966 the AITC Timber Construction Manual has served as a standard for designers, specifiers and builders in need of technical data on engineered timber construction. The Second Edition contains new information on design stresses, new lumber and timber sizes and new design procedures for wood structural elements and fastenings.

**CHEMICAL MATERIALS FOR CONSTRUCTION: Handbook of Chemicals for Concrete, Flooring, Caulks and Sealants, Epoxies, Latex Emulsions, Adhesives, Roofing, Waterproofing, Technical Coatings and Heavy Construction Specialties**, by Philip Maslow; Structures Publishing Co., Farmington, Michigan, 1974, 570 pages, \$32.50.

An encyclopedic introduction to the general subject of chemicals in the construction industry; a specialty reference and textbook.

**MODERN AIR CONDITIONING PRACTICE**, by Norman C. Harris and David F. Conde; McGraw-Hill Book Co., New York, Second Edition, 1974, 483 pages, illus., \$14.95.

This book is a basic text for the education of engineers and engineering and industrial technicians.

**ELEMENTS OF PHOTOGRAMMETRY (With Air Photo Interpretation and Remote Sensing)**, by Paul R. Wolf; McGraw-Hill Book Co., New York, 1974, 562 pages, illus., \$18.50.

This book is primarily for use as a textbook for an introductory course in photogrammetry at the college level. It provides a description of the field of photogrammetry, including such topics usually found in photogrammetry textbooks such as cameras, photographic geometry, stereoscopy, parallax, radial-line triangulation, and stereoscopic plotting instruments.

**ROOM ACOUSTICS**, by Heinrich Kuttruff; John Wiley and Sons, New York, 1973, 298 pages, illus., \$29.75.

The science of room acoustics has been enriched during recent years by many new ideas about the physical understanding of sound. This book presents some of these advances in a general framework and attempts to provide a comprehensive picture of modern room acoustics.

# Weld-Crete®

(Think No. 1 . . .  
It's available)



## to bond new concrete to old concrete PERMANENTLY

**1** **FIRST** patented, job-proved liquid bonding agent.\*

**SAVES** time. No roughing, undercutting, or scarifying concrete surfaces.

**EASY** to apply with brush, roller or spray.

**READY** when dry to touch. Apply new concrete right away or days later.

**STRONGER** than the original concrete. **BONDS** 3 ways — mechanical, adhesive, chemical — to any clean, structurally sound surface, including metal & glass.

**SAFE** even in confined areas. Non-toxic, non-volatile, non-flammable. Helps meet OSHA.

**COSTS** far less than epoxies **PERFORMS** in any climate. Bond unaffected by temperature extremes.

**EXCEEDS** all official U.S. and Canadian regulatory specs.

**1** **Look to the Leader . . . Look to**

**LARSEN**  
PRODUCTS CORP.

Best in Bonding by 22 years



5420  
Randolph  
Road,  
Rockville,  
Md.  
20852

Phone 301-  
770-5200  
Cataloged  
3.1 & 9.6  
in  
SWEET'S

\*Use protected by U.S. Pat. 2,760,885.

MORE DETAILS? GET OUR NEW CATALOG.

# High Rise/Life Safety Code Requirements

If you will be designing a multi-story building which must comply with the ICBO, BOCA or Southern Building Codes, Wasco Products can help you. Having worked very closely with the professionals in developing the smoke control provisions, Wasco is now able to provide the hardware that can meet them. For instance, we have completed or are now installing exterior wall smoke vents with remote release devices, similar to the drawing below, in eight multi-story buildings.

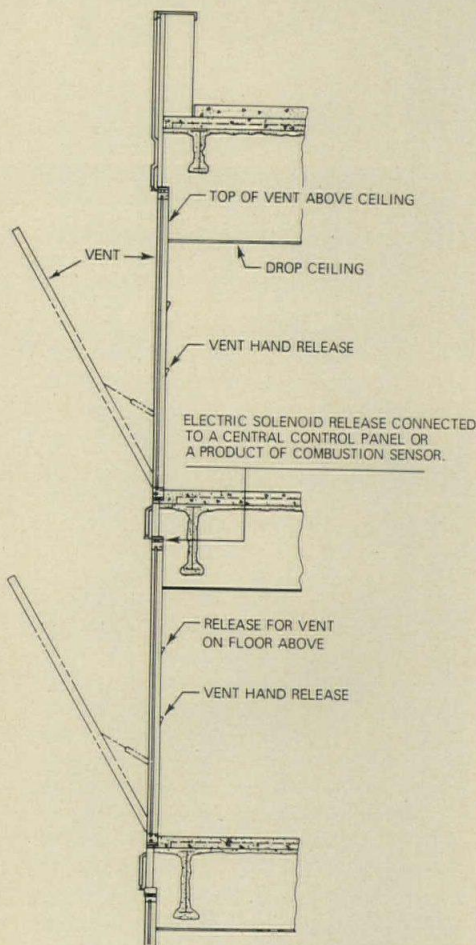

**WASCO EXTERIOR WALL  
SMOKE CONTROL VENT**

These vents not only meet code requirements but allow the architect a wide range of choice of both exterior and interior panels or glazing. Because Wasco has been so close to this life safety effort, we can also offer extensive design assistance. For copies of the various code sections pertaining to life safety or for specific help on individual jobs, write Richard L. Swan, Wasco Products, Inc., Box 351, Sanford, Maine 04073, or call 207-324-8060.

For more data, circle 31 on inquiry card

## OFFICE NOTES

### New firms, firm changes

Edward N. Rothe, AIA, and Allan R. Johnson, AIA, has recently announced the formation of **Rothe-Johnson, Architects-Planners**, at 140 Main Street, Metuchen, New Jersey.

The new partnership of **Hilfinger Asbury Cufaude and Abels, Architects** was recently announced with offices at Meara Building, Fourth Floor, Bloomington, Illinois.

The firm of **Martin Price, Architect**, has moved to new offices located at 18 East 53rd Street, New York City.

Herbert W. Riemer, AIA, will continue in practice under the firm name of **Herbert W. Riemer and Associates** with offices at 1 Mayfair Road, Eastchester, New York and 103 Park Avenue, New York City.

**Warren and Van Praag, Inc.**, consulting engineers and architects, have recently opened offices at 330 Brady Street, Davenport, Iowa.

Architects Robert P. Darlington and Richard J. O'Neil, have announced formation of a corporation to practice architecture and construction management. The firm, **INTERACT, Inc.** will be located at 403 Massachusetts Avenue and 3 Bulette Road, Acton, Massachusetts.

**West Associates** will be located in new offices at Suite 208, 7100 Hayvenhurst Avenue, Van Nuys, California.

**Welton Becket and Associates** has moved its Chicago regional office to Two Hundred West Monroe Building, Chicago, Illinois.

Nelson W. Aldrich, FAIA, and Samuel C. M. Wang, AIA, formerly of the firm of Campbell, Aldrich and Nulty have announced the formation of a new firm name of **Nelson W. Aldrich & Associates-Architects**, 100 Boylston Street, Boston, Massachusetts.

Lawrence F. Nulty, Glenn R. Merithew, William E. Palk, Jr., Jan K. Sterling and David E. Hasselhofer formerly of Campbell, Aldrich & Nulty have formed a new partnership under the firm name of **Nulty, Merithew, Palk and Sterling Partnership** with offices at 177 Custom House Plaza, Boston, Massachusetts.

**Walker-Grad Inc.** are now in new offices at 304 East 45 Street, New York City.

The firm of O'Leary & Terasawa, AIA, Architects has changed its name to **O'Leary, Terasawa and Takahashi, Architects**. The firm has moved to new offices at 319 South Robertson Blvd., Beverly Hills, California.

### New partners, new appointments

The architectural firm of Renshaw and Taylor, North Little Rock, Arkansas, has announced the appointment of **Michael R. Hahn** as associate in charge of project design.

**Peter P. Bolles** has been elected as president of John S. Bolles Associates, San Francisco. **John Bolles**, FAIA, will become chairman of the board.

Robert Royston, Asa Hanamoto, Eldon Beck and Kazuo Abey have announced that **Louis G. Alley**, AIA, and **Patricia A. Carlisle**, ASLA, as principals in the firm of Royston, Hanamoto, Beck & Abey, landscape architects.

**Peter H. Semrad**, AIA, has joined the firm of Ficker Architects in Newport Beach, California, as an associate. *more office notes on page 48*

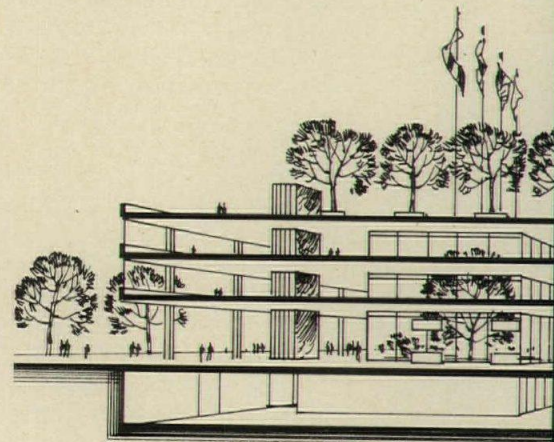

# call the



# For total design

## Bell System when preplanning.

Efficient buildings provide facilities to install today's sophisticated communications systems. Since these facilities should be integrated with your design, we want you to know about our Building Industry Consulting Service.

A Bell System consultant can advise you on local building codes which affect communications, and suggest a system that offers maximum efficiency and makes optimum use of space. And there's no extra charge for this service.

Calling us early can eliminate the need for expensive alteration, or exposed cables and wires.

Our insert in Sweet's Catalogue has basic information. For questions on current or future projects call a Building Industry Consultant at your Bell Company or send in our coupon. At AT&T and your Bell Company, we want to help you produce an efficient end product.

### We hear you.



For more data, circle 4 on inquiry card

Building Industry Consulting Service K  
American Telephone and Telegraph Company  
Room 2238D, 195 Broadway  
New York, New York 10007

I am interested in the Building Industry Consulting Service.

- Please send me additional information.  
 Please have a representative contact me.

Name \_\_\_\_\_

Title \_\_\_\_\_ Tel. \_\_\_\_\_

Company \_\_\_\_\_

Street \_\_\_\_\_

City \_\_\_\_\_ State \_\_\_\_\_ Zip \_\_\_\_\_

# Quality by Design

## Means Satisfaction Down the Eaton Cooler Line

### Simulated-Recessed Coolers



Designed to look recessed for beauty. Hangs like a picture to provide all installation economies of a wall-hung unit. Mounts compactly to wall and extends only 9½". 6 and 13 gallon capacities.

**EAT•N** Controls Products

### Semi-Recessed Coolers



Satin-finished, stainless steel basin and full height back splash. Smoothly contoured cabinets available in sandalwood finish, vinyl clad, or stainless steel. Spacious servicing area. 8 and 15 gallon capacities.

**EAT•N** Controls Products

### Wheel-Chair Level Coolers



Meets federal law 90-480 stating buildings constructed, leased or financed by the federal government must provide facilities for use by the physically handicapped. Choice of dual action bubbler or glass-filler faucet. 6-gallon capacity.

**EAT•N** Controls Products

### Compact Floor Model Coolers



Low in cost, high in quality. Uses only one square foot of floor space. Constant stream control chrome-plated bubbler. Removable front panel allows easy access for servicing components. 4 thru 11 gallon capacities.

**EAT•N** Controls Products

Individual cooler spec sheets or full line catalog available from your Eaton Cooler representative, listed in Sweets, MPC and Yellow Pages. Or, write Eaton Corporation, Dispenser Division, 3727 Mt. Prospect Road, Franklin Park, Illinois 60131.

Follow the Pyr-A-Larm<sup>®</sup>

# "COMPAS"

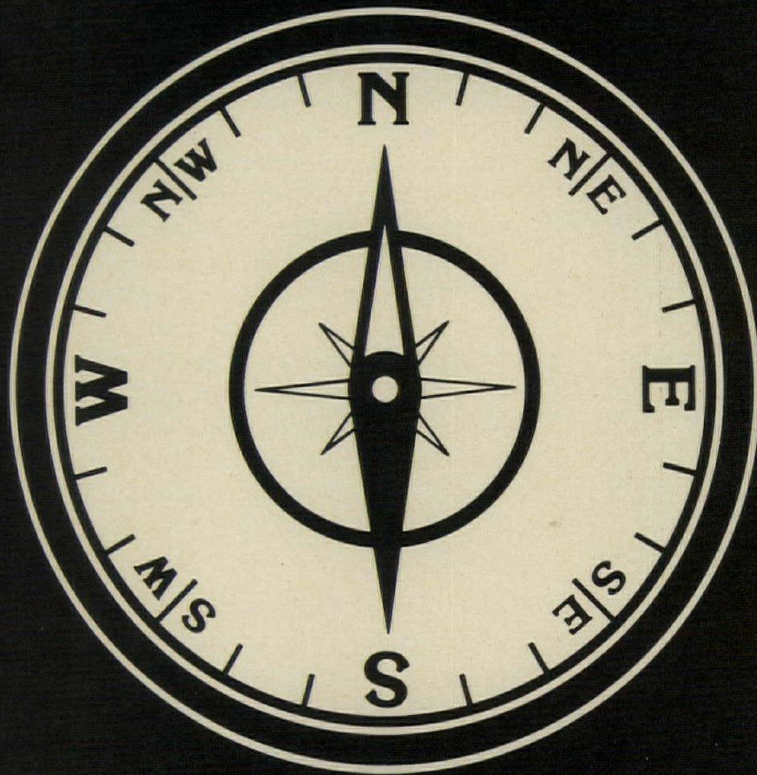

...your guide to fast  
computerized early warning  
fire detection design.



# Computerized Pyr-A-Larm Analysis System.

Studies, recommends, and documents the appropriate Early Warning Fire Detection Systems in accordance with the latest Fire Detection engineering practices for your specific hazard.

remote alarm lamps or audible signals are normally used in the room, you'll get that information too. In addition, you'll get suggested guidelines for other good fire detection practices (detector locations, remote alarm lamps, possible explosion-proof

requirements, ventilation problems, etc.). Plus system summaries that to date have not been provided, such as, recap by areas, and by zones. Consider all the exclusive benefits of COMPAS. Every analysis incorporates the cumulative knowledge and experience of over a quarter century of early warning fire detection throughout the world. The information comes back to you in minutes, rather than days or weeks. And the data you receive is expressed in a variety of ways, ready for immediate use. This Computerized Analysis System virtually eliminates the risk of incorrectly designing your next fire detection system.

---PRICING INFORMATION---

1. ALL DETECTORS INCLUDE BASE AND INDICATING LAMP.
2. ALL PRICES SUBJECT TO REGULAR TERMS.
3. CONTROL EQUIPMENT IS NOT INCLUDED.
4. PRICING IS FOR HIGH VOLTAGE ONLY.

PYROTRONICS IONIZATION DET.	4 @ 93.00 EA	372.00
PYROTRONICS RATE OF RISE	2 @ 33.50 EA	67.00
INFRARED FLAME DETECTORS	4 @ 150.00	600.00
BAC-6S POLARIZED ALARM BELL	1 @ 22.50 EA	22.50
MFS-2 MANUAL STATIONS (SURFACE MOUNTING BOX NOT INCLUDED)	3 @ 19.00 EA	57.00
REMOTE ALARM LAMPS	3 @ 6.50 EA	19.50
<b>TOTAL PRICE</b>		<b>1138.00</b>

TIME OF ANALYSIS 14:13:00

Precise Cost of System. Provides exact price of each and every detector!

We invite you to investigate this remarkable breakthrough in the design, specification and pricing of early warning fire detection system. To learn more about COMPAS, or to see a demonstration, call William A. Columbus, Pyrotronics, 8 Ridgedale Avenue, Cedar Knolls, New Jersey 07927 (201) 267-1300.

ROOM NUMBER 4 ZONE NUMBER 2 ROOM TYPE 170

ROOM LENGTH 36.0 TIME PER AIR CHANGE 5.0  
 ROOM WIDTH 39.0 AIR FLOW IN CFM 2574.0  
 ROOM HEIGHT 11.0 SQUARE FOOTAGE 1404.0  
 NFPA 101-73(10-1235) REQUIRES SOME ROOMS GT 1000 FT2 TO HAVE TWO EXITS  
 STANDBY POWER ROOMS  
 IONIZATION DETECTORS COMBINED WITH INFRARED DETECTORS ARE RECOMMENDED FOR THIS AREA  
 HIGH VENTILATION RATES CAN BE PRESENT IN THESE AREAS; CARE SHOULD BE TAKEN IN THE LOCATING OF THE UNITS.  
 A MANUAL PULL STATION IS RECOMMENDED HERE.

NO. OF DETECTORS 2 MAXIMUM SPACING 750.0  
 ACTUAL SPACING 702.0 SQUARE FEET/DETECTOR  
 MANUAL PULLS 1 REMOTE ALARM LAMPS 0  
 THE INFRARED DETECTOR REQUIRES A 10 SECOND DELAY

NO. OF DETECTORS 4 MAXIMUM SPACING 0000.0  
 ACTUAL SPACING 591.0 SQUARE FEET/DETECTOR  
 MANUAL PULLS 1 REMOTE ALARM LAMPS 0

ROOM NUMBER 5 ZONE NUMBER 2 ROOM TYPE 150

ROOM LENGTH 36.0 TIME PER AIR CHANGE 8.0  
 ROOM WIDTH 37.0 AIR FLOW IN CFM 1332.0  
 ROOM HEIGHT 8.0 SQUARE FOOTAGE 1332.0  
 NFPA 101-73(10-1235) REQUIRES SOME ROOMS GT 1000 FT2 TO HAVE TWO EXITS  
 PATIENT ROOMS  
 RECOMMENDED FOR THIS AREA OUTSIDE THIS ROOM.

Room Print Out From Computer. Includes all input data.

---SYSTEM RECAP BY AREAS---

ZONE NUMBER	ROOM NUMBER	SQ FT/DETECT.	TYPE OF DETECTORS	#-OF BELL	#-OF MAN	#-OF RALS
1	1	360	ION R-R THERM INF	0	0	1
1	2	126	0 0 2	0	1	0
2	3	361	1 0 0	0	0	0
2	4	351	2 0 0	4	0	1
2	5	666	2 0 0	0	0	2

---SYSTEM RECAP BY ZONES---

ZONE	NUMBER OF	TOTAL SQUARE	TYPE OF DETECTORS IN EACH ZONE	ADDITIONAL EQPT IN EACH ZONE
1	2	486	ION R-R THERM INF	1
2	3	1348	ION R-R THERM INF	5

Area Recap/Zone Recap. Returns all data including square footage, detectors, additional equipment and zones.



# "COMPAS"

by **Pyr-A-Larm**

A Division of Baker Industries, Inc.



For more data, circle 33 on inquiry card

**"Because you're in the construction business in a big way..."**



When you're talking commercial/industrial air conditioning, you're talking GE's language.

Single package central air conditioning systems? GE offers application flexibility. Our systems can be ducted, or equipped with optional/grille/filter frame. They can be installed through the wall, on the roof or on a slab at ground level. Factory charged refrigerant simplifies installation, improves reliability.

Combination Gas-Electric Units? General Electric offers a complete line of year-round comfort systems for commercial applications. These units combine in one cabinet gas furnace economy and electric air conditioning



comfort and convenience. These units, with cooling capacities up to 20 tons, may be used in multiples where greater heating and cooling requirements exist, with the added benefit of zonal temperature control.

Split cooling systems? GE has a large selection of condensing units available in capacities from 12,500 BTUH through 240,000 BTUH. GE also has cooling coils with capacities from 12,000 BTUH through 120,000 BTUH in "A" configuration to couple with virtually any warm air furnace. ("Flat" coils are available in capacities from 24,000 to 60,000 BTUH).

Count on GE for a wide selection of indoor and outdoor air handling sections to accommo-



# we're in the central air conditioning business in a big way."

Joseph H. Gauss, Vice President and General Manager, Air Conditioning Products Division.

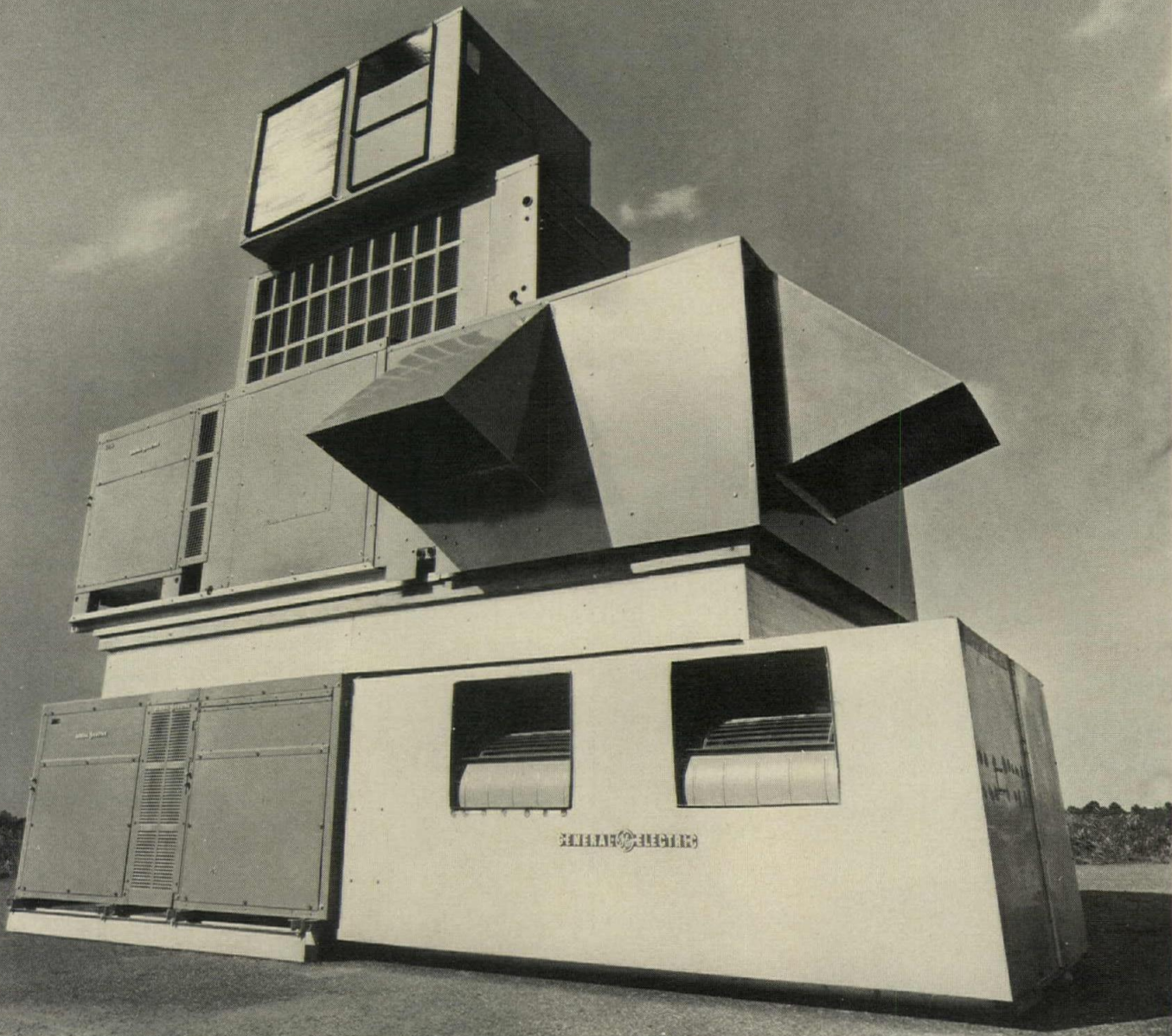

date a variety of supplementary electric heaters in capacities from 12,000 to 480,000 BTUH. Also available: steam and hot water coils, return plenums and air distributors.

Then there is the GE Weathertron® heat pump—an all-weather heat pump that provides year 'round comfort and convenience for commercial and industrial buildings. Used in multiple units, GE heat pumps cool and heat tremendous areas with the added advantage of zone-by-zone temperature control. Split systems are available from 18,000 to 240,000 BTUH and packaged equipment from 29,000 to 120,000 BTUH. The 7½ and 10 ton Weathertron units are compatible with roof top accessories.

So, as you see, we're in the central air conditioning business in a big way. And we intend to be in it in a bigger way all the time.

If you're contemplating an air conditioning installation, get in touch with a General Electric central air conditioning dealer. He's in the Yellow Pages under Air Conditioning Equipment and Systems.

**"We're going to be in this business for a long time!"**



Joseph H. Gauss

**GENERAL  ELECTRIC**

For more data, circle 34 on inquiry card

# Fascia: the facts, ColorKlad

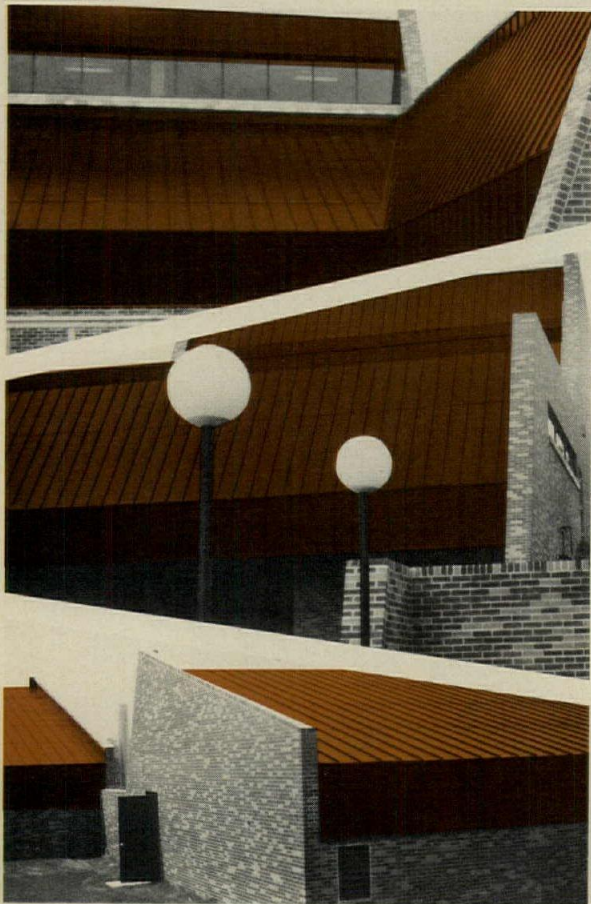

- **COLORKLAD** — Roll-coated galvanized sheet coated with PPG's Duranar with Kynar. Ideal for FASCIA, GRAVEL STOPS, STANDING, BATTEN AND FLAT SEAMED ROOFS.
- **SIX BEAUTIFUL COLORS.**
- **WARRANTED FOR 20 YEARS AGAINST FADE AND CHALK.** (Written warranty upon request)
- **COSTS LESS THAN HALF OF COPPER, LESS THAN SHOP OR FIELD-PAINTED GALVANIZED.**
- **ECONOMICALLY SPECIFY ONE SHEET OR A THOUSAND.**



**Vincent**  
BRASS & ALUMINUM CO.  
BUILDING PRODUCTS DIVISION  
724 - 24th Avenue S.E.  
Minneapolis, Minn. 55414  
A/C 612 378-1131

Write for our new full color brochure showing many actual Colorklad installations.

Mail coupon to: Vincent Brass & Aluminum Co.  
Building Products Division  
724 - 24th Ave. S.E., Minneapolis, Mn. 55414

**Please check:**

Send new brochure plus sample.

Have your local architectural representative contact me.

Name \_\_\_\_\_

Company \_\_\_\_\_

Address (Street) \_\_\_\_\_

City \_\_\_\_\_ State \_\_\_\_\_ Zip \_\_\_\_\_

For more data, circle 35 on inquiry card

Three architectural firms have merged to form a new professional service corporation. The firms, Architectonics, Al Feinstein/Architect, and Herald R. Holding and Associates, have named their company **Architects & Planners International, Inc.** located at 612 South Tejon, Colorado Springs, Colorado.

**Robert S. Misere, Architect** has announced the opening of his office at 8200 Traphagen, Massillon, Ohio.

Raymond Ziegler, FAIA, announced the formation of **The Raymond Ziegler Partnership Architects**, 525 South Virgil Avenue, Los Angeles, California.

**R. Landon Doggett** is now engaged in the practice of architecture with an office at 324 Twelfth Street, Suite 201, Huntington, West Virginia.

Hamby, Kennerly, Slomanson & Smith Architects has changed the name of the firm to **Kennerly, Slomanson and Smith Architects**, 540 Madison Avenue, New York.

**Gilbert Arnold Sanchez** has relocated his office to 1571 Lincoln Avenue, San Jose, California.

Anthony C. Belluschi AIA, and Emmanuel P. Daskalakis AIA, formed the office of **Belluschi/Daskalakis Inc., Architects**, located at 286 Summer Street, Boston, Massachusetts.

**William Blurock & Partners** have relocated their office to South Coast Shipyard and Design Center, 2300 Newport Boulevard, Newport Beach, California.

**Steven H. Rosenfeld, AIA**, formerly the American Institute of Architects' director of Professional Practice Programs, has joined **Ronald S. Senseman, FAIA**, as an associate along with **William P. Trulio, Jr.**

**Sumer O. Berk** has been named the third associate of Danielian Moon Sampieri & Ilg, Newport Beach.

Herbert D. Rader and William Mileto have announced the addition of **George Batori** to the partnership of Rader Mileto Associates, Rome, Italy.

**James E. Kinville, AIA**, has joined Ellis/Naeyaert Associates, Inc., as head of their Construction Services Department.

James P. Chapman Architect and Associates has announced that **John B. Beasley, Jr.** has become an associate of the firm.

**Robert D. Peterson, AIA**, has been promoted to vice president of William L. Pereira Associates and managing director of the San Francisco Project Center of the firm.

**E. C. Kobs** has joined Caudill Rowlett Scott as senior vice president and operations manager of the firm's Business Development Division.

**S. John Klettner** has joined the firm of Walk Jones + Francis Mah, Inc., as a staff executive.

**John A. Mascari** has been named chief civil engineer and planner at Longardner & Associates, Inc.

**John T. Coyne** and **Donald W. Denzer** have been named vice presidents at Ellerbe in Bloomington, Minnesota.

Searle Wilbee Rowland, are pleased to announce the appointment of **Richard H. Baggley, Irving S. Cooper** and **J. Hugh Westren** as associates in the firm.



## Beautiful, isn't it?

The United States of America creates 70% of the solid waste produced in the world.

Which is a lot of garbage. And garbage creates a lot of problems. Disposal problems. Collection problems. Sanitation problems. Esthetic problems.

ECI Air-Flyte® pneumatic waste collection systems have solved these problems for many companies and communities. As the originators of the pneumatic waste disposal idea, we

have the capability to engineer an efficient, flexible and safe waste disposal system for almost any installation.

The benefits of an Air-Flyte pneumatic system, both in operation and cost, are many. Its flexibility (trash can be moved up, down, around corners) offers tremendous advantages in the

design of new buildings, be they residences (high rise apartments, multi-structure developments), industrial plants, hospitals—you name it. And centralized collection and compaction eliminate the accumulation and "display" of trash—inside or outside the building.

Ask your ECI representative for the whole story on Air-Flyte pneumatic trash collection systems. It's beautiful.

*For more data, circle 36 on inquiry card*

"AIR-FLYTE" is a registered trademark

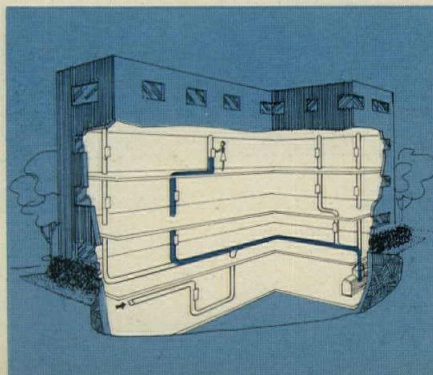

**ECI Air-Flyte Corp.**

Subsidiary of Eastern Cyclone Industries, Inc.  
 15 Daniel Road • Fairfield, N. J. 07006  
 Regional Sales Offices:  
 BOSTON • CHICAGO • LOS ANGELES • ATLANTA  
 AFFILIATIONS IN EUROPE, AFRICA, AUSTRALIA AND ASIA

# Push our button for

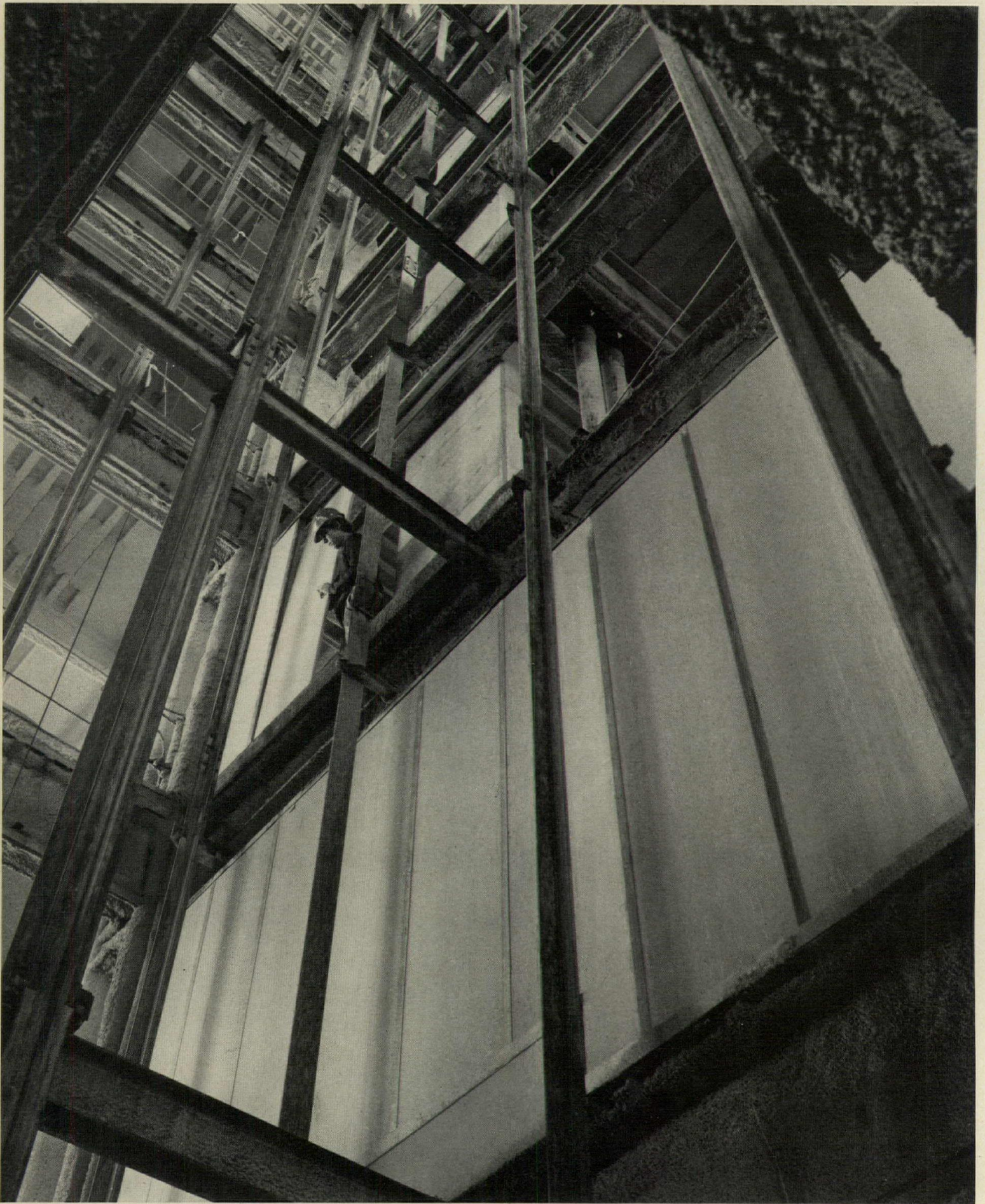

# elevator shaft enclosures.

## KW 620

Up go speed and safety.

Down come cost and weight.

At last there's a system of enclosing high-rise elevator shafts that's in the same league with the high-speed elevators that ride inside. And it's building code approved and proven in use in major highrises all across the U.S.

Kaiser KW-620 elevator shaft enclosures go up so fast they make laborious, block-by-block masonry construction seem like the dark ages. You can now enclose all shafts about as fast as the steel frame goes up.

So you really save—in time, labor and materials costs. KW-620 knocks off plenty of over-all dead weight, too. Which translates into structural steel savings.

And by closing open shafts immediately, you eliminate one of your biggest safety hazards before it becomes one.

The KW-620 System is so simple commercial installation crews become experts in minutes. There are *only three components*—J-runner, stud, and gypsumboard! Our ingenious new C-T stud is the key to simplified installation. It comes in 24 and 20 gauge galvanized steel—in 2½", 4" and 6" depths to provide partitions up to 31'-6" in height depending upon load and deflection requirements.

With floor and ceiling J-runner tracks in place, it's just a matter of sliding Kaiser 1" Type X Shaftwall Board into the C-T studs. The board is automatically locked in place by installation of successive studs. Then, two thicknesses of 5/8" Type X wallboard are screwed to the corridor side of the studs—one horizontally, the other vertically.

That's it. With a crew as few as two, that's all it takes today to build 2-hour fire-resistive, non-loadbearing, partition enclosures for elevators, plumbing and air shafts. And the whole system is installed from the corridor side—with no work performed inside the elevator shaft.

If you have new high-rise construction in your future plans or on your drawing board, push our button. We'd like the chance to show you how the Kaiser KW-620 System can open doors to new ideas in speed, safety, reduced cost and weight—floor after floor. Refer to our catalog in Sweet's Architectural File.

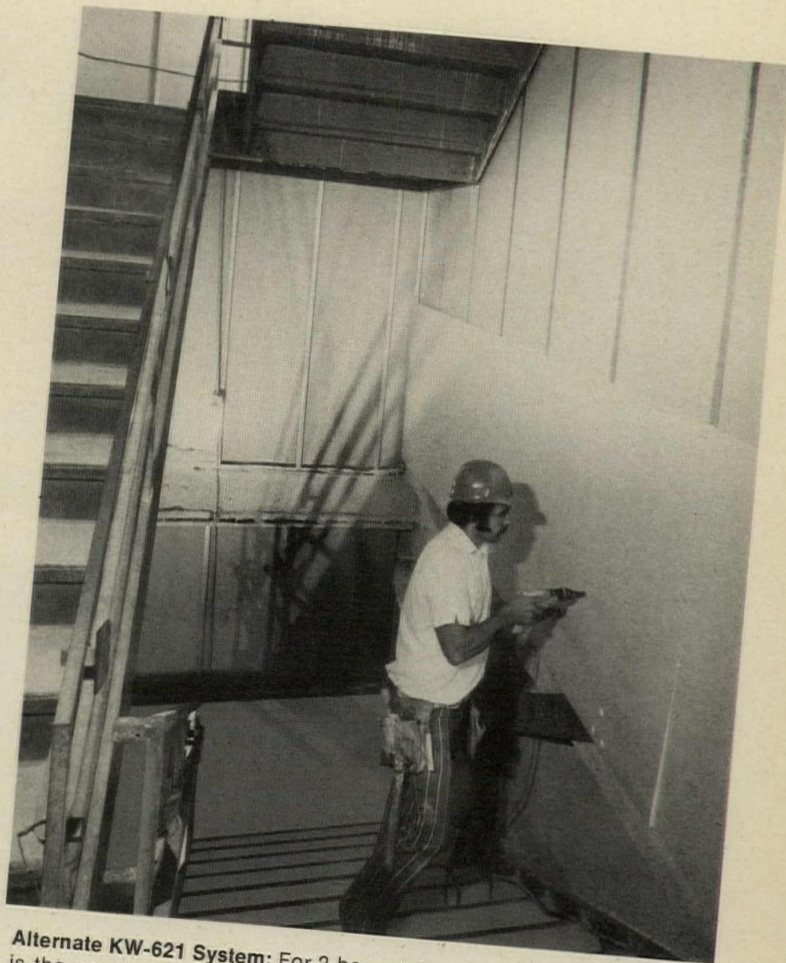

**Alternate KW-621 System:** For 2-hour stairwell enclosures, application is the same except that the second layer of 5/8" board is screwed to the studs from the stairwell side of the wall.

## KAISER GYPSUM



Push our button for more information on elevator shaft enclosures.

Kaiser Gypsum  
Kaiser Center  
Dept. 1114 KB  
Oakland, Calif. 94604

- Send me more technical literature on the KW-620 Shaft Enclosure System.
- Arrange a showing for my staff of your new demonstration film.

Name \_\_\_\_\_

Address \_\_\_\_\_

City/State/Zip \_\_\_\_\_

For more data, circle 37 on inquiry card

# J-M puts it



## **A J-M asbestos roof saves energy.**

A built-up roof can take a lot of asphalt. Or it can take a lot less. That's the one big advantage of using J-M asbestos roofing felts. It makes possible a smooth surface roof—one that doesn't need a poured asphalt-gravel protective surface. Use asbestos roofing felts and you save a lot of asphalt. Save asphalt and you're also doing your part to conserve petroleum, a vital energy source.

## **A J-M roof ... a systems approach to quality.**

A quality built-up roof is no better than its component parts. And no better than the techniques used to put them together. That's why it's so important when you specify a roof, to consider every aspect of the system, if you expect true value and lasting protection when the job is done. And that's why a J-M built-up roof makes sense. You benefit from the experience of over 100 years in the roofing business—on J-M quality in a complete line of roofing products built to work together—and on the skills of the J-M team of roofing specialists.

## **A J-M roof means single-source materials responsibility.**

Because J-M makes everything that goes into a built-up roof, you can have Johns-Manville quality all the way—from the deck up. From vapor barrier to top dressing, you're assured of components made to go with each other. And when those materials are applied in accordance with J-M specifications, the result is "from-the-deck-up" dependability. Plus, another important benefit: Clear-cut responsibility for the performance of the materials used in the finished assembly. And that can be a real advantage in case follow-up is needed after the roof is completed.

# all together.



## J-M Ventsulation<sup>®</sup> Felt vents entrapped moisture before it can cause roof failure.

Moisture trapped within the built-up roofing assembly can create serious problems. Unless it's permitted to escape.

An easy solution is J-M Ventsulation Felt used in place of the base felt in most roof specifications.

Ventsulation Felt, with its *exclusive* waffle pattern, is designed so that trapped air containing moisture passes harmlessly in all directions through the channels and out into the atmosphere. It provides a built-up roof that breathes. Reduces the possibility of premature failure caused by entrapped moisture-laden air.

Ventsulation can be used on most any type of deck: on nailable or non-nailable surfaces, over lightweight fills, with insulation. It's particularly effective on re-roofing jobs since most old roofs contain a certain amount of moisture.

There's no reason to lose a good roof to entrapped moisture. For details and specifications on J-M Ventsulation Felt, or for assistance of any kind with a built-up roofing problem, contact your J-M District Office. Or contact Dick Ducey at Johns-Manville, Box 5108, Denver, Colorado 80217. (303/770-1000, Ext. 3740.)

Because it lets the roof breathe, Ventsulation Felt solves the problem of premature roof failure caused by entrapped moisture.

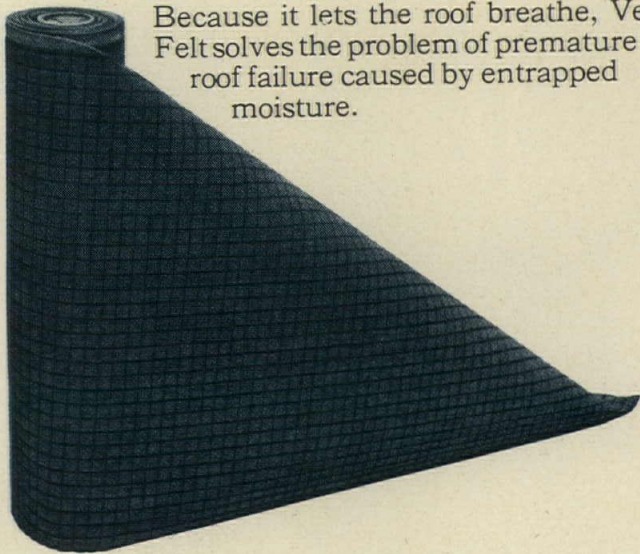

The  
single-source  
built-up roofing system.



**Johns-Manville**

For more data, circle 38 on inquiry card

# It's time to get rid of old-fashioned heating ideas



## Here's the NEW approach to complete freedom of design

The clean, clear interior . . . for greatest comfort and economy

The AIRTEX Radiant-Perimeter System consists of installing a narrow band of radiant ceiling around the perimeter of a building. This band of radiant ceiling provides more comfortable heating without taking up any usable space. It is normally less expensive initially than perimeter fin tube installations. The piping and control is similar to what would be used with perimeter fin tube, except that all pipes are in the ceiling cavity and accessible, rather than hidden in the wall or floor, where necessary penetration would be difficult and expensive. Floor areas are clear right up to the outside wall for unrestricted placement of furniture or equipment. Regular housekeeping is minimal and less expensive. Draperies are not interfered with by mechanical enclosures. The resultant installation provides a clean, clear, totally usable interior with a most desirable appearance.

*Write today for our full color brochure which answers questions and gives you facts too important to ignore.*

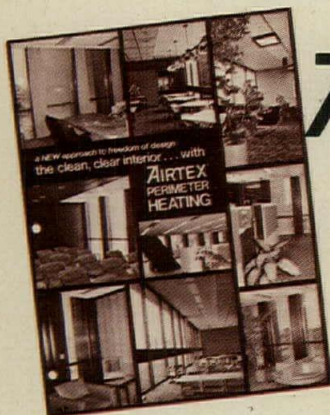

**AIRTEX** Corp.

**RADIANT  
PERIMETER  
HEATING**

2900 N. Western Ave.  
Chicago, Illinois 60618  
Phone 312/463-2500



*For more data, circle 39 on inquiry card*





# STEEL JOISTS USED IN NEW FLORIDA CONDOMINIUM

The opportunity of getting seven buildings completed and ready for occupancy in fast time was a principal reason open web steel joists were selected for these Longboat Harbour Condominiums in Sarasota, Florida.

Planned and constructed by I. Z. Mann & Associates, Inc., they are located in an attractive setting in the beautiful Longboat Key area. Overall economy, plus the speed of erection for floor and roof support made steel joists the structural answer to this building need. The lighter total dead load also permitted savings in foundation construction costs in the sandy soil.

Learn more about the benefits of open web steel joists. Send coupon today.



ARCHITECT:  
J. J. Claret,  
Sarasota, Florida  
STRUCTURAL  
ENGINEERING:  
Musselman Steel  
Company,  
Tampa, Florida



**STEEL JOIST INSTITUTE**  
2001 Jefferson Davis Highway  
Arlington, Va. 22202

Mail to:  
**STEEL JOIST INSTITUTE**  
7th Floor, 2001 Jefferson Davis Hwy.  
Arlington, Va. 22202

Please send me your new copy of Specifications and Load Tables for Open Web Steel Joists.

Name \_\_\_\_\_

Title \_\_\_\_\_

Firm \_\_\_\_\_

Address \_\_\_\_\_

City \_\_\_\_\_ State \_\_\_\_\_ Zip \_\_\_\_\_

For more data, circle 40 on inquiry card

# WANTED

---

## stouthearted air handling system designers

Give a Buffalo Sales Engineer 20 minutes and he will show you why Buffalo's Model "J" Air Handling System approach is indeed the way to go. Especially so if you want the advantages of a quality built-up system with the economies of factory fabrication.

Problem is, you will have to be firm about a Model "J" specification.

In today's highly competitive market, one of the many imitators may try to tempt you with a lower price. Of course you'll be getting less. After all, this old adage still holds true, "you get what you pay for."

If the most comprehensive selection of air handling components ever offered in a factory fabricated unit is what you need to do the job correctly — if reliability with longevity and lowest operating and maintenance costs are foremost in your thinking — you will certainly want to insist on Model "J".

Here are three examples of the excellent systems you can create with Model "J". And it's only the beginning. Look them over, then contact the Buffalo Sales Engineer in your area. He's listed in the Yellow Pages. Or write direct for Buffalo Bulletin AC-101. Air Handling Division, Buffalo Forge Company, Buffalo, N.Y. 14240. In Canada: The Canadian Blower & Forge Co. Ltd. In Mexico: Buffalo Forge S.A. de C.V. • Air Handling Equipment • Finned Coils • Machine Tools • Centrifugal Pumps



**BuffaloForgeCompany**

*For more data, circle 41 on inquiry card*

# 3 ways to go with model

A TYPICAL HOSPITAL SYSTEM to more than meet stringent hospital standards for air filtration and conditioning. (1) Backwardly-curved BLD fan section (2) Draw-thru stainless steel sprayed coil (3) Chilled water coil (4) Preheat coil, freezstat section, reheat coil in plenum with access door (5) Non-freeze steam coils (6) Medium efficiency pre-filters (7) Diffuser/access section to service after-filters (8) High efficiency after-filters (9) Discharge section with access door and duct connection (10) Insulation (11) Epoxy finish.

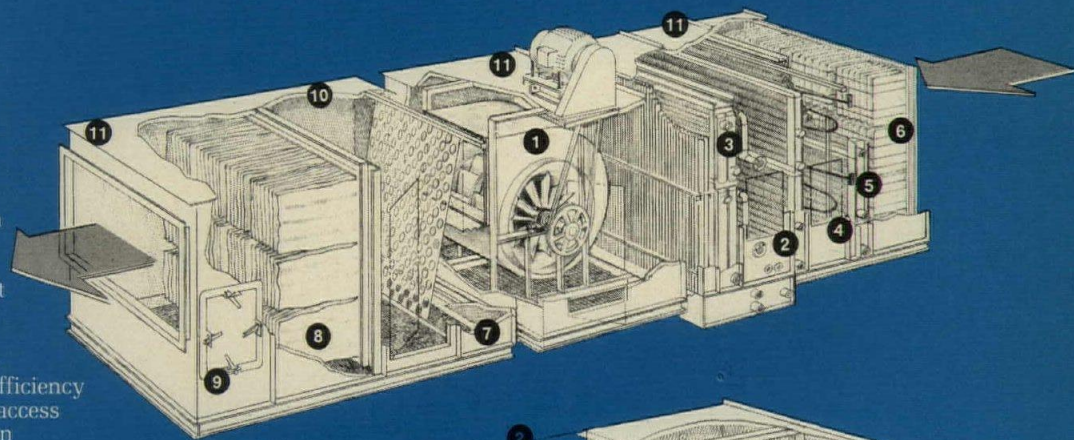

A TYPICAL VARIABLE VOLUME SYSTEM that provides the greatest potential for optimum performance under all load conditions. (1) High pressure fan section containing BLD fan with variable inlet vanes, motor, fixed drive, inertia base (2) Damper, filters by others (3) Blow-thru, single zone coil section (4) Discharge section with bell-mouthed outlet (5) Drain pan with Thermal 90 insulation (6) Low pressure return fan section with BLD fan having variable inlet vanes (7) Walking grate (8) Insulation (6 lbs/ft<sup>3</sup> density) with weld pins.

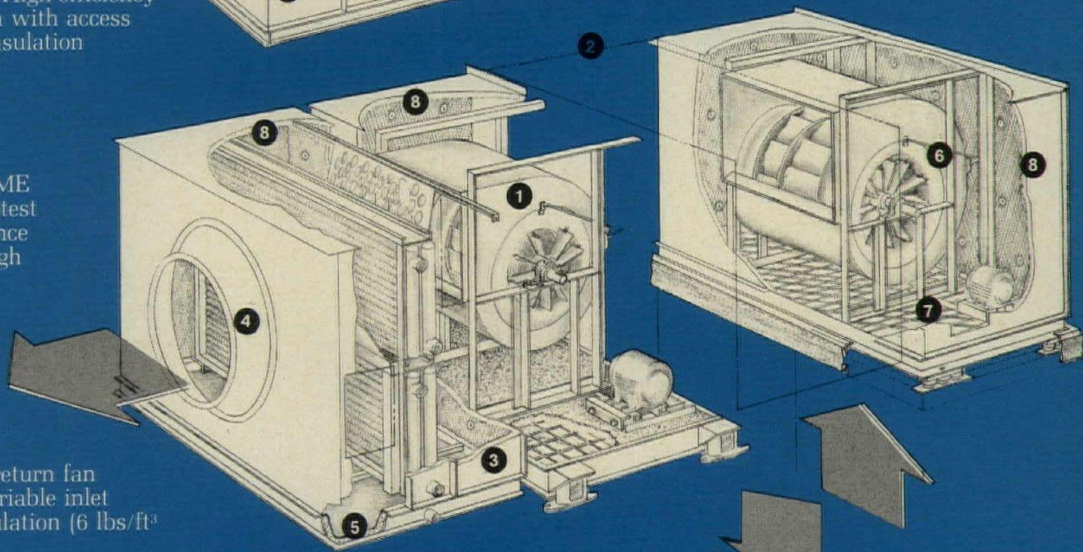

A TYPICAL DUAL-DUCT SYSTEM to provide a high degree of control for a quality air conditioning system. (1) Fan section, with BLD fan, motor, fixed drive, split pillow-block bearings (2) Built-in concrete inertia base with spring isolators (3) Flexible connection and sound attenuator (4) Dual-duct coil section (5) Hot water heat recovery and steam reheat coil (6) Multi-zone damper and service door (7) Large face area chilled water coil (8) Drain pan (9) Steam grid humidifier (10) Filter section for pre-filters and medium efficiency filter cells (11) Coil section with access space (12) Chilled water coil for summer dehumidifying and winter preheat (13) Return air bypass damper (14) Neoprene coated fiberglass 2" thick, on interior (15) Zipcor exterior finish.

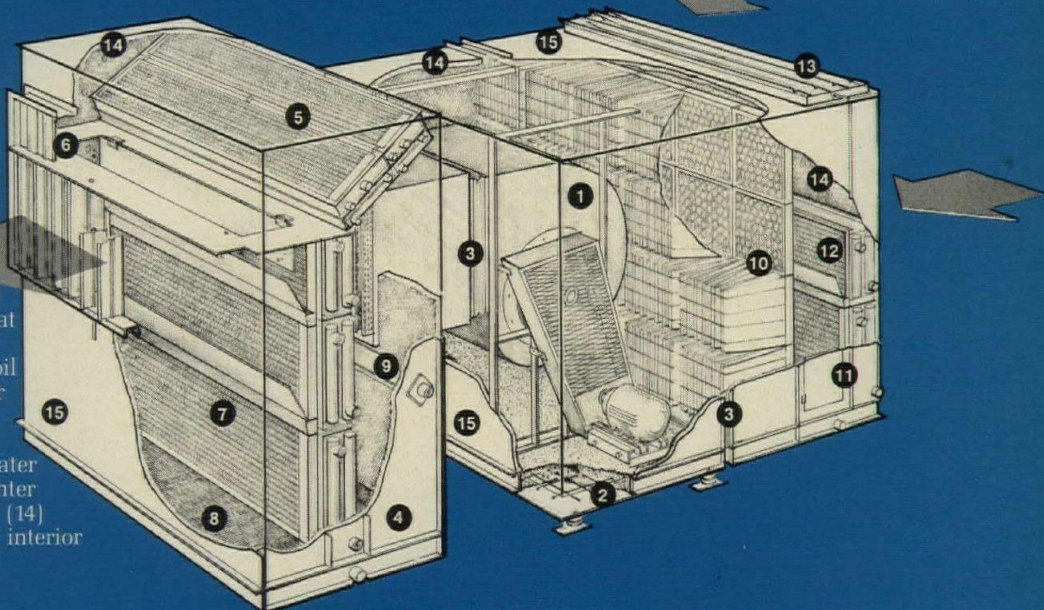

# Drawing on vellum?

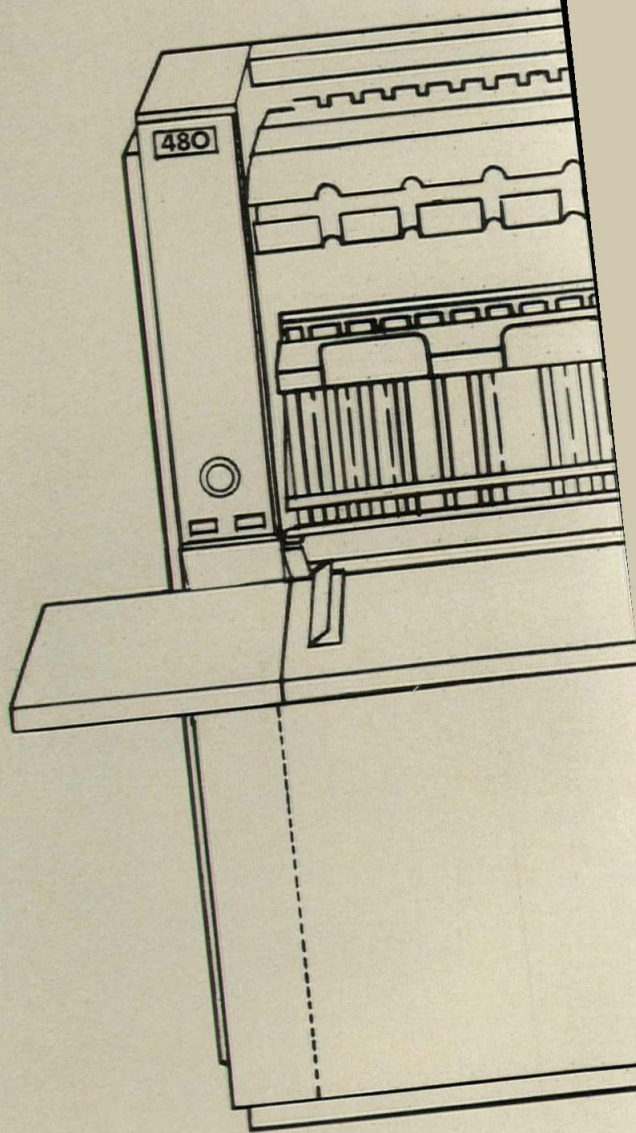

## Draw on GAF!

Introducing GAF DRAFTRACE® and POLYTRACE®...drafting materials from America's oldest manufacturer of film, photographic papers and chemicals.

GAF DRAFTRACE-Papers—They're permanent so you eliminate re-dos of older drawings. They're non-yellowing which saves lots of drafting time (and money). High fracture resistance adds life to mis-handled drawings. DRAFTRACE accepts pen and pencil...so you use only one product. The special

# Drawing on film?

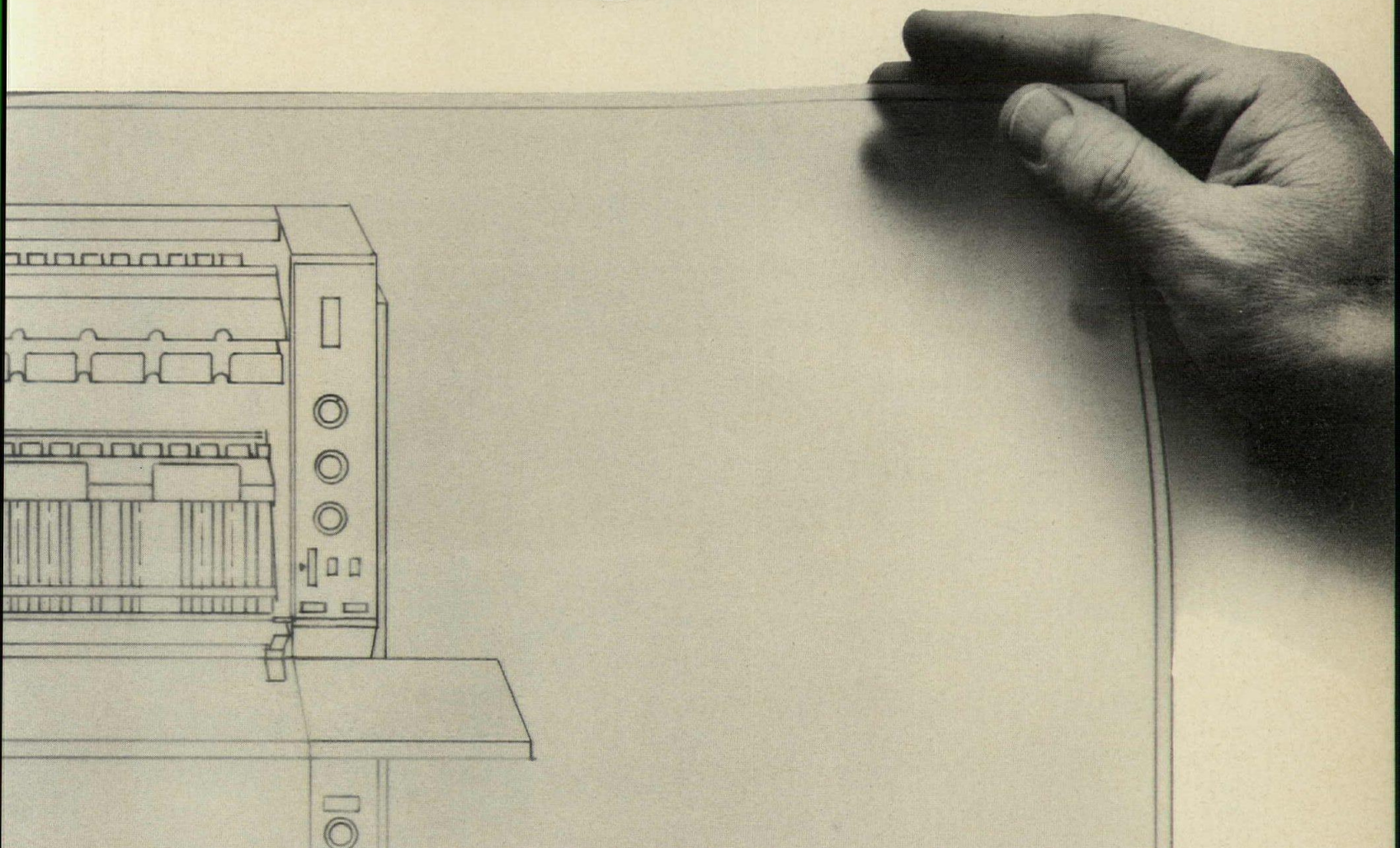

473-0700

**GAF Corporation**

Office System Division 140 West 51st Street New York, New York 10020	Gentlemen: Please send me more information on <input type="checkbox"/> GAF Drafrace <input type="checkbox"/> GAF Diazoprinters <input type="checkbox"/> GAF Polytrace <input type="checkbox"/> Have a salesman call for an appointment.	
NAME	TITLE	
COMPANY		
ADDRESS		
CITY	STATE	ZIP
PHONE		

Line drawing of the new GAF 480 Automatic Diazoprinter

optical brightness tint allows DRAFTRACE to deliver excellent contrast for high quality micro-filming. DRAFTRACE's erasability lets you pick up graphite particles, leaves no ghosts when reproduced.

GAF POLYTRACE-Films—Specially designed to take and hold pencil and ink. Erases easily without ghosting. High translucency assures excellent reprints at higher copying speeds. POLYTRACE is virtually impossible to tear, damage

or fracture. Delivers longer lasting drawings. Reduces re-dos of old ones. Its dimensionally stable base makes undimensioned drawings and templates a breeze. And its high whiteness assures quality reproduction on diazo and other systems.

Looking for materials that will help you deliver a quality end product? Get acquainted with GAF DRAFTRACE and GAF POLYTRACE. And don't forget our complete line of diazoprinters.

  
**Rediscover  
 Diazo**<sup>®</sup>

© COPYRIGHT GAF CORPORATION

For more data, circle 42 on inquiry card

As Charles Luce, Chairman of the Board, Consolidated Edison recently stated:

can help bring this about.  
"Building Construction must be critically reviewed for long term energy efficiency—one of the most important places to start is with properly insulated walls and roofs."

Most major building projects



... and  
we agree

# ENERGY CONSERVATION in new buildings begins with a Smith Wall System

## COMPARE ENERGY SAVINGS WITH SMITH WALLS vs CON- CRETE BLOCK CONSTRUCTION

How much energy and actual dollars can you save by using insulated metal panel walls instead of conventional concrete block? Naturally, it depends on many variables. However . . . to give you a valid comparison, we designed a typical building and had a professional heating consultant calculate the possible energy (and dollar) savings you could have. We found that over the life-span of the building . . . regardless of the type of heating energy used . . . savings would be considerable.

### COMPARE SMITH WALL- U-FACTORS . . .

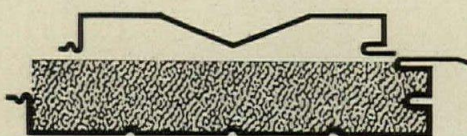

Varispan Panel System with 3" Glass Fiber Insulation. U-Value=0.111 btu



Standard Foamwall Panel System with 2" Urethane Insulation. U-Value=0.070 btu

Based on the design criteria, here is what we found:

12" CONCRETE BLOCK WALL VS SMITH VARISPAN PANEL SYSTEM WITH 3" GLASS FIBER INSULATION

**49.8% LESS ENERGY AND DOLLARS**  
using VARISPAN\*

\*IMPORTANT: Even greater energy and dollar savings can be obtained by using SMITH FOAMWALL

Energy must be conserved! So it makes sense to consider this particularly important factor early in the design stages of new building construction. The savings go on . . . and on . . . and on . . . during the life-cycle of the building. Write for further information and the report "THINK OF 'U' and \$."

### DESIGN CRITERIA FOR THEORETICAL BUILDING ON WHICH COMPARISONS WERE BASED . . .

Size: 96' x 125' x 36' building.

Location: Pittsburgh, Pa.

Floor: Slab on Grade.

Glass: Single Pane.

Roof: Built-up on steel deck, 1" Insulation.

Walls: 12" Concrete Block vs. 3" SMITH VARISPAN PANEL.

Results calculated by an Independent Consulting Mechanical Engineering Firm using recent ASHRAE procedures. Cost figures based on standard rates per KWH, per gal. of oil, or per cu. ft. of gas.

Write for documented report titled . . . "THINK OF 'U' AND \$."



## ELWIN G. SMITH DIVISION

100 WALLS STREET, PITTSBURGH, PENNSYLVANIA 15202 | (412) 761-7474

EGS-110

For more data, circle 43 on inquiry card

## Urging producers to join the building process at day one

*Architects and engineers are coping with new urgencies of management and cost control in which communication with owners, producers and a host of special consultants is a preamble to effective design. Joseph H. Newman, senior vice president of Tishman Research Corporation and first vice president of Tishman Realty and Construction Company, Inc., has been an articulate spokesman in this complex market place.*

*The following article is based on a speech Newman delivered to a group of building products manufacturers at the last Building Products Executive Conference in Washington. He reminds the producers themselves that performance—an operative word nowadays—is increasingly contingent on the adept design of systems to which a variety of producers may contribute parts. He urges broadening the base of communication to preserve the inherent skills and roles of architects and engineers.*

In these times of inflation, material shortages, high interest rates, and of the environmental and civil rights and consumer movements, how many people are aware that there is an owner's revolt going on? How many are aware that owners are tired of having their buildings not function as intended and not completed on time and within the budget? How many realize that owners are fed up with buildings that are not efficient to maintain and become obsolete too soon? In the final analysis it is the public and private owner who, in a climate of uncertainty, finds himself taking the risks, paying for unanticipated extra costs, and who is often considered the bad guy because his buildings use too much energy or water, or because they do not meet present standards of safety.

### Experienced owners are getting into the act

The owner is a relatively new member of the building team. Previously, he entrusted his interests to his architect/engineer or his general contractor, or to both. In many cases these groups were caught in the complex web of not having the total array of talent or tools to do the total job. Today the public and private owner wants to get into the act himself:

- Today he either strengthens his own in-house staff (if he has an active continuing building program), or he hires a qualified construction manager to act as his agent rather than his adversary, or he sets new rules and procurement regulations—or he does a combination of these things.
- The public and private sectors have joined

hands to form an owner/user group. Charter members include the Public Buildings Service, AT&T, Sears, the Corps of Engineers, the City of Boston, the Veterans Administration and others. This group plans to work aggressively for needed improvements in the quality of buildings, reduction in design and construction time and reduction in construction and life cycle maintenance costs. It hopes to obtain improved performance for buildings by combining the purchasing power and influence of the public and private sectors. It plans to stimulate use of the subsystems concept, identify potential markets for subsystems, and standardize owner/user requirements wherever possible. The group will also probably try to influence codes and regulatory reform.

- Owners are becoming more politically active and organized. As an example, note the relatively new National Realty Committee, Inc.
- Local governments through their research arm, Public Technology, Inc., will be conducting a problem-solving experiment in 26 cities with populations of from 50,000 to 500,000. Technology agents will be placed in residence for several years in these cities to study needs and opportunities including those involving buildings and maintenance. These agents will be given central technological support from Washington.
- The National Science Foundation plans a series of experiments testing alternative Government policies to make technology transfer and utilization more effective in solving critical problems.
- The Department of Justice's Law Enforcement Administration Agency has launched a \$4-million effort to solicit proposals for improved security for buildings through architectural, technical and social solutions.
- There have been several meetings, initiated by pressure from the states, to establish a national energy conservation standard. Also, in the energy area, owners are designing an experiment to determine the effects of reducing air rate changes and the amount of outside air used for cooling and heating buildings, with a view to modifying existing code requirements that may have become antiquated.
- The use of performance specifications and the search for alternative designs continue to grow.
- GSA has awarded a contract based on the sum of first costs and operating costs over a period of nine years.
- The U.S. Consumer Product Safety Commission is publishing a list of injuries associated

with product categories, and is planning controls or corrective actions to reduce the incidence of injuries in buildings. Of concern to our industry are stairs, ramps, landings, fuels, architectural glass, bathtubs and shower structures. Hazard indexes are here to stay.

- During the last eight years many innovations, like the systems approach, fast track, dry (as opposed to wet) construction, better comfort, acoustical and lighting standards, modular construction and longer-lasting or better-performing products have been inspired by private and public owners.

### Getting producers into the act

Each of these developments has the common feature of discarding old and conventional ways of doing business for new ones. For building product manufacturers they should suggest opportunities, because the new concerns and problems of the owner will obviously influence the way producers do business in the field.

The confidence of the owner group will have to be earned, and no one can forget that owners still want the best at the lowest price. What's different now is that owners are willing to be educated, and they are willing to take into consideration many new factors that they have previously overlooked or ignored—so that "best at the lowest price" now means something different.

### Owners want producers to take a new role

Before they gain the owner's confidence, producers must understand some of the problems that undermine it and devise solutions to them. One of the most serious problems is that producers who do not provide installation services cannot get subcontractors to reflect the intended benefits of their products or systems, especially when they are new, or when they offer advantages during construction. The typical owner is not yet sophisticated enough to use marketplace forces to persuade a subcontractor to reflect an inherent savings of a new idea. This places a major burden upon the building product producer who finds it difficult to accept that his destiny is largely in the hands of installers.

Because markets are diverse, small or heterogeneous, and buildings are different in many ways, the approach of producing a limited spectrum of standard products and having others install them has made sense over the years. But now, with many of the changes I cited, and with growing owner unrest, it would

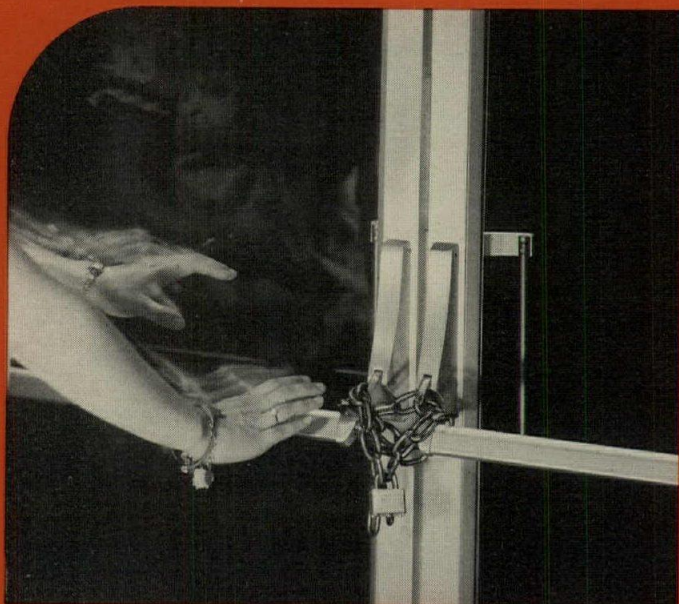

# Are you endangering lives to protect property?

## PANIC-GUARD™ entrances offer the first secure answer to meeting life safety codes

Up till now, there's been no good solution to the security problem created by pairs of panic doors.

Armed with an ordinary coat hanger, an intruder can reach through the gap between doors. Hook the crash bar. And get in and out. With no signs of forced entry for insurance claims.

Chaining the doors together or defeating the crash bars with blocks or poles helps stop intruders.

But it also blocks emergency escape. And clearly violates life safety codes.

Kawneer's PANIC GUARD™ entrances offer optimum security without violating life safety codes. This new system features a unique bar that extends the full length of the doors.

When closed, the bar locks into place, completely closing the gap between the doors.

The crash bars still allow quick exit in emergencies, fully complying with life safety codes.

PANIC GUARD entrances eliminate the need for a removable mullion. A "clear opening" is always available when needed. And the unique full-length astragal bar makes break-ins very difficult. So difficult that clear signs of forced entry are usually evident if anyone does succeed in getting through.

For full information, see your Kawneer representative or contact Kawneer Architectural Products Information, 1105 N. Front Street, Dept. C, Niles, Michigan 49120.

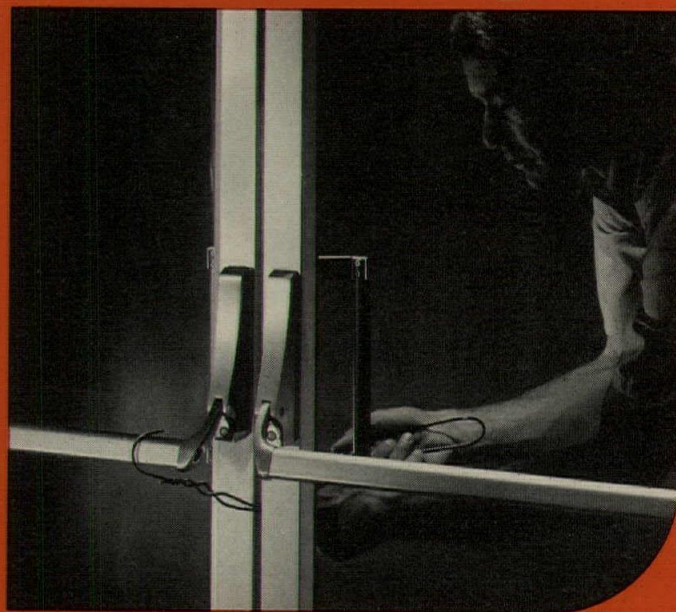

PANIC GUARD. The only practical solution to making pairs of doors safe and secure. At the same time.

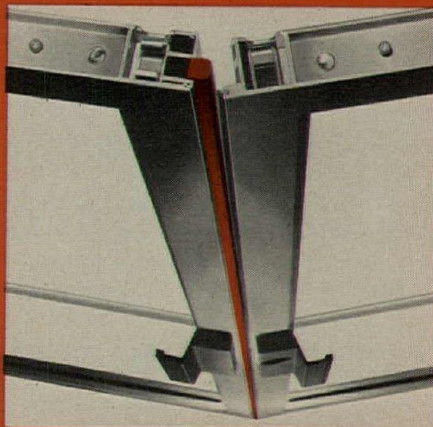

**KAWNEER**  
ARCHITECTURAL PRODUCTS

For more data, circle 44 on inquiry card



be prudent to re-examine the traditional relationship between building product suppliers and installers. I am not implying that manufacturers should go into the contracting business, although for some that may make sense. I see the suppliers' responsibility as orchestrating a total delivery process, which means they must motivate the installers to reflect their wishes.

Another problem undermining confidence is the one of subcontractors' reflecting benefits that may not be there. This problem is most prevalent among producers who manufacture, furnish and install an entire subsystem, under single responsibility, but it could be a growing problem in any situation where producer and installer collaborate closely.

What would you do, if you were a subcontractor, when a valued customer tells you that your price is, say, 10 per cent too high and, if you lowered it, the job was yours? Would you talk yourself into taking a bad deal by rationalizing that you can save this or that if certain things were to go your way, when in fact they are not likely to? Or would you do your homework and come back with a value engineering approach telling the owner that you would give him the savings if he would allow a reasonable design change or some other acceptable accommodation?

My observation is that unfortunately, the former is more likely than the latter.

I believe an owner who really understands the pitfalls of doing business with someone who is taking a job that will likely cause him difficulties will not buy trouble. In the end, the buyer usually pays for a bad deal. On the other hand, a seller who gambles on taking a deal without any real technical basis, will pay for it in the short and long of it.

The best deal is usually effected when both parties are equally expert, disciplined, and sensitive to the construction process.

To court the owner requires facing up to these two kinds of problems and trying to do something about them along the lines I suggested.

#### **Owners want to see the alternates**

Another way to court the owner is to develop the ability to consider and submit alternatives where possible in a relatively tight time frame. Most decisionmakers do not have the time, dollars, or capability of evaluating alternatives or doing value engineering. Therefore, many good products and systems get lost by the way-side. An example of an approach being used to court owners is one practiced by many steel companies who go to the decisionmaker even after a complete concrete design has been prepared and offer to prepare a steel frame design at no cost to him, in sufficient detail to have it priced, to line up subs who will bid responsively and to let his engineer use his drawings and calculations as his own. This approach has been successful. However, it requires a great deal of technical expertise and a special set-up to provide such a service. One good way to undermine confidence is not to be able to show the owner the available options and their value in such a way that will lead to a quick decision.

Another way to court the owner is to be willing to put your money where your mouth

is. Instead of bragging about your product being more durable, easier to replace, providing better performance or resulting in the least operating or maintenance costs, take the responsibility for what is now popularly referred to as life cycle costs, or improve your guarantees. Obviously, before you can do this, you must offer a combination of all the physical components that interact and bear upon the performance of a portion of a building or project, or you must team together with producers with related products and make a combined offering. In so doing, the issue of split responsibility for materials and installation will come to the fore again, and you will have to face up to it. Eventually, this issue will be academic because enough owners will demand a guaranteed life cycle performance and enough producers will go along.

#### **Owners want real performance data**

Many kinds of problems that many building product producers are facing today have been brought about because of their inability to articulate in a positive way how buildings function, or because they remained mute when owners single-handedly took up the cudgel after a rash of recent major fires and other catastrophes. Producers can't win owner confidence if they buckle under stress when accused of contributing to potential danger, rather than showing that in fact the culprit is elsewhere.

Do you really know how total products or systems actually behave? When someone seeks your assistance in testing a composite construction, do you still complain, "I only have a small per cent of the total system, so why should I promote or pay for the test"—or do you go out and raise the money as some of the more aggressive owners have been doing?

What do you do when the naive dogooders point out that materials are the culprits in fire safety and everything that burns should be removed from inside buildings? Fire is not a materials problem. A safe building is one whose structure will not collapse and one which will allow occupants to go from an area of danger to one of safety. Tall buildings stand witness to the ability of the industry to achieve this. While well over 100,000 people perished in fires in the U.S. in the last decade, well under 100 died in tall buildings in the same period. The promulgators of hazard indexes would never have agreed that fires in tall buildings were a serious problem in light of their other statistics.

There are no criteria to tell me if a combination such as detectors, compartmentation, smoke shafts, and communication systems are better or worse than sprinklers or some other combination. Owners are demanding such criteria and the question is whether the producers will be in the forefront in establishing them and designing products and systems compatible therewith, or wait around until their products and systems are designed out.

One of the great opportunities for producers that I am certain will please owners is bringing curtain wall to the middle market, that is, for use on those buildings such as apartment houses and low-rise office buildings that are still constructed with concrete block, wet ma-

sonry, or other materials *in situ*. Until recently, this was not in the cards because of the low price of wet construction. This is changing. With the advent of brick panels, extruded cement asbestos components, improved aluminum products and finishes, the opportunities have increased dramatically.

However, this opportunity poses all the problems I have mentioned and then some. Because an exterior wall, as a system, can be made up of an infinite number of variations, there is the problem of coordination and design understanding. Nothing frustrates an owner more than when his architect tells him that his designer does not know how to bring the pieces together to work properly, or that they are incompatible or that he is afraid. Further, nothing frustrates an owner more than his inability to find an installer who can take the furnished and installed responsibility.

To alleviate this frustration, it may be necessary for producers to offer one another's products or components after developing compatibility, with one producer taking the responsibility for the entire system. There is no marketing or sub-contracting arrangement or business approach that should be rejected if it will get the order profitably and develop the market in an orderly fashion.

How else can you court the owner and help yourself? Persuade the less sophisticated owner to retain a team consisting of design and construction professionals who may have never worked together previously, but who are capable of cooperating with the mutual owner/building product producer interest in mind. In some cases, you may have to try and persuade the owner to give you equal involvement on the team, from the start, in return for a promise to work on achieving solutions to certain needs without necessarily using your own products—unless, of course, they provide the best solution.

The more you participate in the construction process, the more you can influence and initiate changes in the total building system that will make your products more attractive. This means knowing 101 alternatives to do the same thing; how to extend competition from the narrow base of a small subsystem to the broader base of a large subsystem and still to a broader base of a total project—or the converse of this. It means understanding industry problems that affect your business. It means being more selective about where and with whom you concentrate your development and marketing efforts. It means recognizing that the gestation period of typical new products and systems is about seven years, and that this is a costly process that may include underwriting early applications.

When producers do these kinds of things, they will be harnessing the new forces and making them work for their own advantage. The end result will be better and more economic buildings and communities.

*This kind of communication between the owner-designer-constructor universe and the manufacturers of building products gains further perspective in the "Dialogue," beginning page 138, where manufacturers express their views and J. Karl Justin responds.*

# Now, the way to buy a PD-80 is to rent it.

We claim the odorless, instant-on, 110-volt PD<sup>®</sup>-80 is the best thing going for quality and convenience in engineering copying. Four years in the marketplace and lots of happy customers bear us out. But you don't have to take anyone's word for it. The good news: a unique *Rent with Option to Buy* plan for the PD-80. Yes, we understand capital is tight. You want to be sure before you commit. So rent your PD-80 for \$30 a month, and make your

buying decision after you realize you can't afford to be without one.

For the first three months, every cent you pay in rent is applied toward the purchase price of a PD-80. From four to six months, 75% of your rent applies. A declining scale sets in after that. Don't confuse our plan with anyone else's. Ours gives you a no-questions, no-penalty, 30 day cancellation.

The *Rent with Option to Buy* plan is our way of showing you out front that in cost, convenience and quality, the odorless PD-80 can't be beat. Send for complete information. Or call your nearby Bruning sales office and get the whole story in a hurry. Bruning, 1834 Walden Office Square, Schaumburg, Ill. 60172.

**We help engineers communicate.**

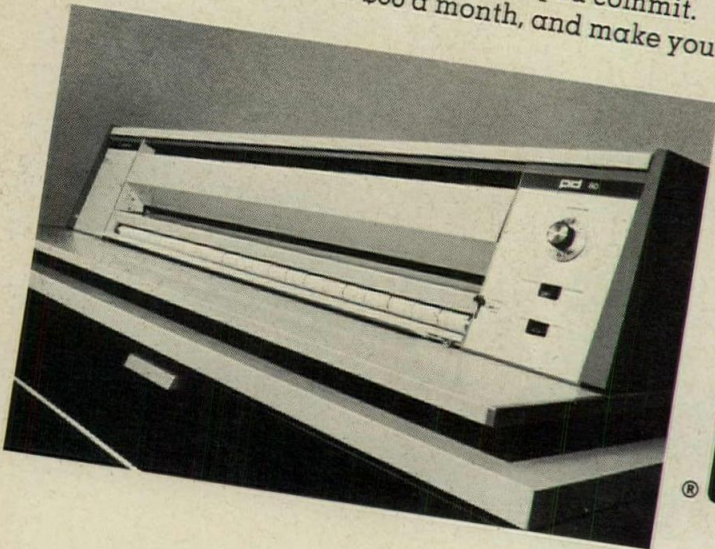

**BRUNING**

DIVISION OF  
ADDRESSOGRAPH MULTIGRAPH

DO YOU BUY OR RENT  
YOUR BUSINESS  
EQUIPMENT?

I CERTAINLY DO.



# Couple Wade with No-Hub and you've got a couple of winners.

Roof drain installation is fast and easy when the roof drain is Wade hubless and the pipe is Tyler  $\Phi$  NO-HUB<sup>®</sup>.

Fast because Wade hubless roof drains — like all Wade hubless products — eliminate threaded connections, lead pots, ladles and caulking irons.

Easy, because all you need is a Tyler No-Hub coupling

and torque wrench. And one man does the job.

Put a couple of winners on your next DWV job — Wade hubless roof drains and Tyler No-Hub.

For information on the complete line of Wade hubless products write Box 2027, Tyler, Texas 75701. Or see your local plumbing wholesaler.



**Tyler  
Pipe**

Subsidiary of  
Tyler Corporation

*For more data, circle 47 on inquiry card*

Member Plumbing and Drainage Institute

© 1974 Tyler Pipe

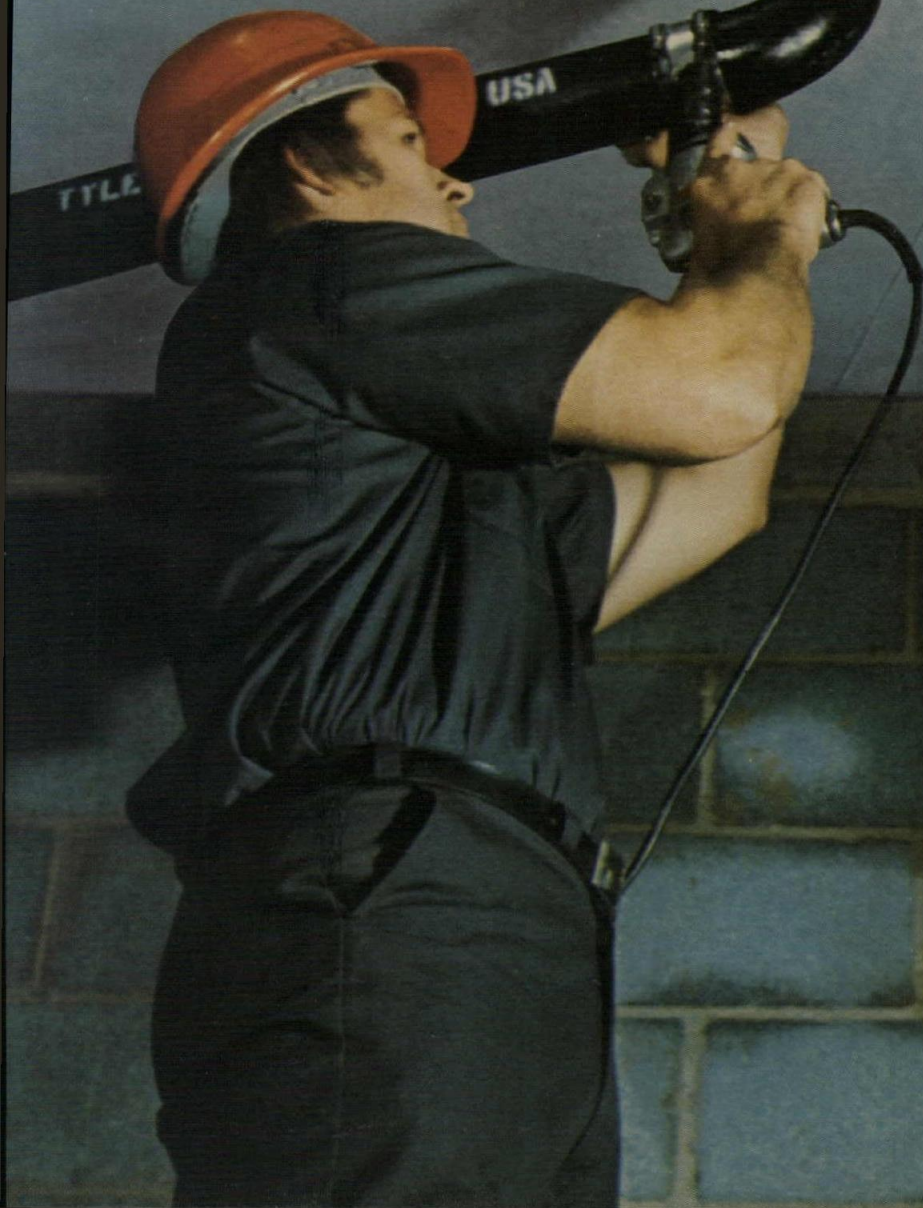



**Polarpane<sup>®</sup>**  
**Reflective Insulating Units**

*. . . To keep your cool and your  
warmth and look beautiful doing it.*

Beautiful gold or silver outboard lites combined with clear, bronze or gray inboard. Gold rejects over 90% of infra-red solar energy at 20% visible light transmission. Total indoor heat gain as low as 37 BTU/hr/sq. ft. .31 U value.

# Power Windows



We make glass with muscle. To put power in your windows. Power to curb the power of the sun. And the cold. And noise. Power to slice a big hunk out of HVAC costs, and energy costs, every day, from now on.

Check to see how well our power windows work. See our catalog in Sweets: 8.26/CE. For further facts, answers and planning assistance, ask your local C-E Glass representative. Or write us: C-E Glass, 825 Hylton Road, Pennsauken, N.J. 08110. (609) 662-0400.

## Polarpane® Insulating Glass Units

*... So you don't have to watch all your heat go out the window.*

Available in a wide selection of pattern, clear or tinted glass; annealed and tempered. Hermetically sealed in moisture-free construction. 5 and 20 year warranties.



## Polarpane® Sun Control Units

*... Ideal answer to a glaring problem. Adjustable for privacy.*

Rotating venetian blind between sealed lites for full control of sunlight and glare as well as outside view. Blinds stay dust and maintenance-free. Excellent temperature and sound insulating characteristics.



## Polarpane® Sound Control Units

*... So you can hear yourself think without tractor-trailers, jets, assorted motor bikes and missing mufflers.*

Basic unit shuts out as much noise as a 6-inch concrete block wall. Higher STC ratings available. .48 U value. Choice of such prestige customers as the Marriott Corporation for their luxurious facilities at Chicago O'Hare, Dulles, Miami, Kansas City and St. Louis International Airports.

**CE GLASS**

COMBUSTION ENGINEERING, INC.

For more data, circle 48 on inquiry card

# IF YOU'RE PLANNING A BUILDING, AMERICA'S ENERGY CRISIS JUST HAVE BECOME YOUR BIGGEST



Here's an actual case study of  
a proposed building:

**ORIGINAL DESIGN:**

- 20 story building
- 300,000 sq. ft.
- 1st year cash flow - \$125,675
- Gas and electric energy
- Absorption water chiller
- Double duct air conditioning system
- 50% Glass
- Insulated clear glass
- 4 watts/sq. ft. lighting intensity
- East/West primary exposures
- 3" Insulation
- 18 CFM/person ventilation

A TRACE analysis showed the effect the  
following alternatives have on cash flow\*

\*Cash flow values apply only to this study.

TRACE said: "Change the type of energy  
used for heating."

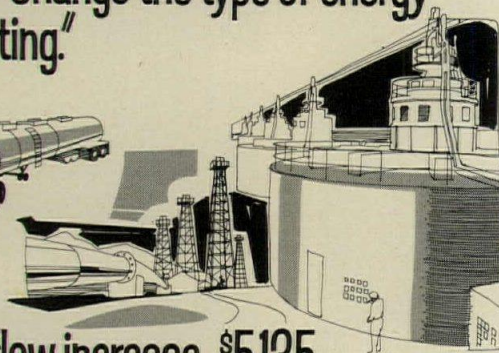
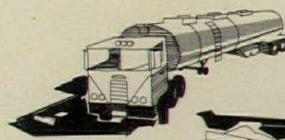

The result:  
A 4.1% cash flow increase...\$5,135

TRACE said: "Change from clear glass to  
reflective glass."

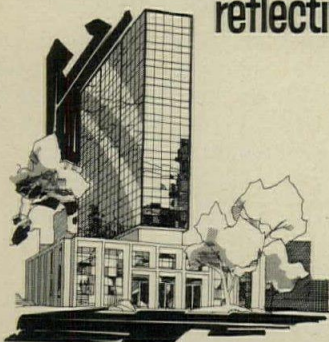

The result:  
A 12.1% cash flow  
increase...\$15,221

TRACE said: "Change the amount of glass  
from 50% to 20% and reduce  
energy cost."

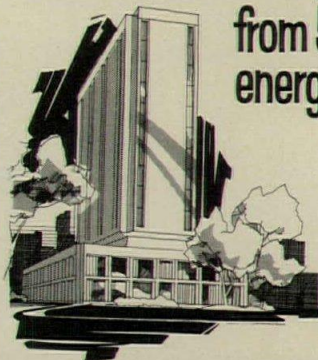

The result:  
A 13.5% cash flow  
increase...\$16,932

TRACE said: "Increase insulation  
by 3" and reduce energy cost."



The result: A 2.7% cash flow  
increase...\$3,395

TRACE said: "Decrease intake of outside air  
from 18 cfm/person to code...  
7.5 cfm/person"

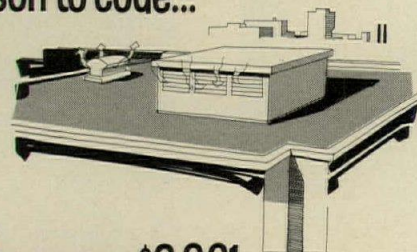

The result:  
A 1.6% cash flow increase...\$2,061

# MAY PROBLEM...

1

But there's a new computerized analysis program from Trane that can help you. It's called **TRACE** ...*Trane Air Conditioning Economics*.

Before you design your next building TRACE can evaluate thousands of design variables that can effect energy consumption and building cash flow.

2

**TRACE** said: "In this case change from an absorption water chiller to a centrifugal water chiller."

5

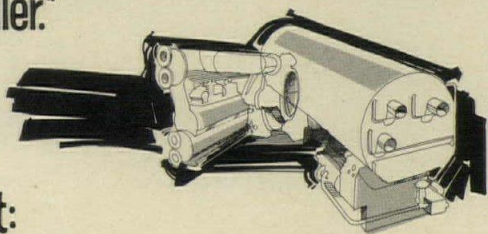

**The result:**  
A 1.9% cash flow increase...\$2,343

**TRACE** said: "Change from a double duct to a variable air volume system."

6

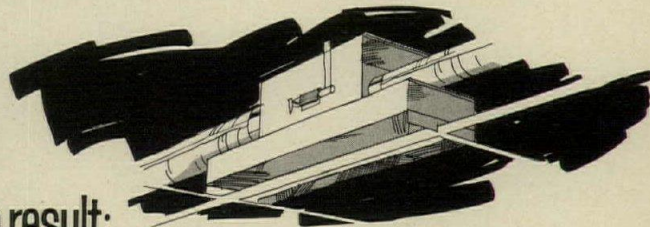

**The result:**  
A 9.1% cash flow increase...\$11,449

**TRACE** said: "Consider decreasing the lighting intensity 1 watt/sq. ft."

9

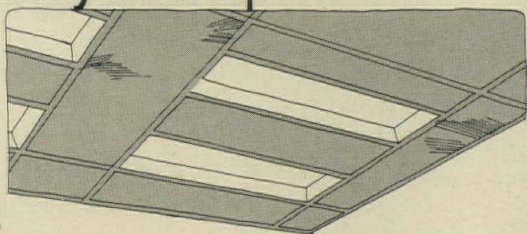

**The result:**  
A 7.2% cash flow increase...\$9,089

**TRACE** said: "Rotate the building by 90° to change solar exposure."

10



**The result:**  
A 3.8% cash flow increase...\$4,805

In this case study...

13

The total net increase in cash flow was \$45,874 or an increase of 36.4%.

An annual utility cost savings of \$63,354...  
Based on current rates.

Let TRACE help you increase the profits on your next building. Call your professional engineer, your nearby Commercial Air Conditioning Division District Office, or send us the coupon for more information.

The Trane Company, La Crosse, Wisc. 54601

**TRANE**  
AIR CONDITIONING

Name \_\_\_\_\_

Company \_\_\_\_\_

Address \_\_\_\_\_

City \_\_\_\_\_ State \_\_\_\_\_ Zip \_\_\_\_\_

In Canada, contact Trane Co. of Canada, Limited, 401 Horner Ave., Toronto, Ont.

For more data, circle 49 on inquiry card

# Steel-framed modular system most economical for 14 bulk mail centers

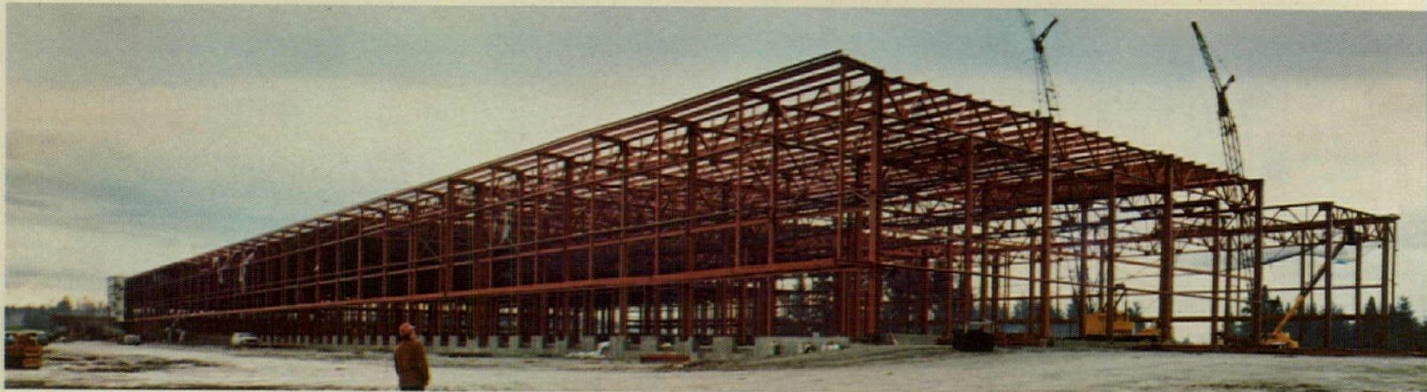

When you design 14 buildings essentially all alike, the potential for design cost savings per unit is substantial. That's what Giffels Associates, Detroit did when they drew up the plans for 14 steel-framed bulk mail handling centers for the U.S. Postal Service. The centers, which are strategically located in or near major metropolitan centers, are expected to be operational by 1975.

Departing from normal design procedures, the structures were planned and engineered from the inside out. A detailed computer program determined the mechanization required for each facility. From the program results, the designers determined each facility's present mechanization needs, as well as projected workloads up to 1985.

## **Seattle center requires high-strength steel**

The 307,000 sq ft Seattle bulk mail center is typical of the group, al-

though the 14 centers range in size from 300,000 to 400,000 sq ft depending on mail loads. Dimensions of the building envelope were established by the mechanization within.

Several materials were considered for the structural framing, but steel was found to be the most economical overall. It also provided maximum design flexibility, and eased installation of the various hanging and attachment devices required for the complex equipment.

The building columns on all 14 projects were standardized to facilitate the modular design, as well as to permit uniform detailing of the mechanization equipment and support steel. The columns used in the Seattle project were designed for the extreme of all loading conditions that would be encountered at all 14 sites. These conditions included seismic, hurricane, and snow loads. The only deviation was that the building columns in seismic areas specified ASTM

A572 Grade 50 (Bethlehem V50) high-strength steel, whereas other areas used ASTM A36 steel columns.

Even though the heights and spans on all 14 projects were the same, the remainder of the steel frame was designed for the actual snow, wind, seismic, and equipment loads prevailing at each site.

Every bay module was designed to support from the trusses or columns a minimum uniform load of 30 psf of equipment loads, observation galleries, and walkways. The maximum equipment loads that were supported from roof trusses equaled as much as 60 kips at midspan. The building frame was also designed for the seismic forces.

The steel superstructure of the Seattle center was completely designed using data obtained from ground response analysis made for the site based on geologic, seismologic, and soil investigation.



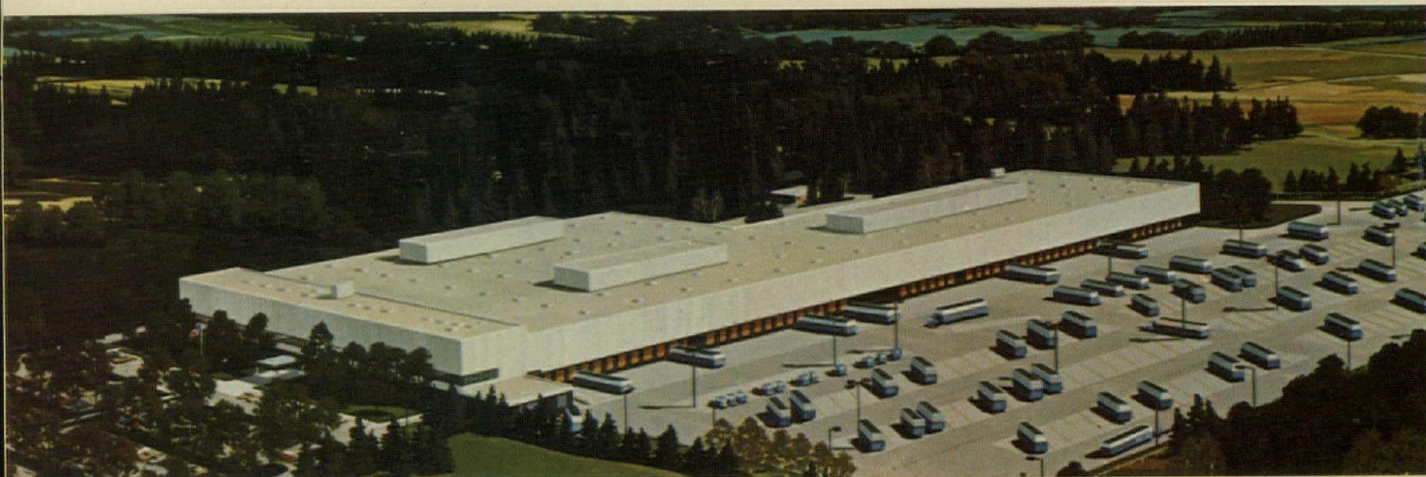

The 307,000 sq ft Seattle center contains 300 canvas and rubber belt conveyors, which have a combined length totaling 26,000 ft.

### Modular design simplifies expansion

The 48-ft-sq bay modules simplified sizing the machinery to the building and will ease future expansion.

Eighteen lines of A36 steel trusses span the building 24 ft on center. All major electrical feeder lines are run along the base of the seven-ft-deep trusses. The use of 1½-in. composite deck helped speed construction and reduce floor section depth.

Lower levels and docking areas are clad in precast concrete panels. The rest of the structure is enclosed with metal sandwich panels. Several 8-ft x 12-ft panels are removable at the third level to permit access to the mechanical systems.

Giffels Associates, Detroit, are the architects and engineers for the project. Bethlehem furnished, fabricated, and erected about 4,200 tons of structural shapes for the Seattle center. Nelse Mortensen & Co., Inc., Seattle, is the general contractor.

We would be happy to furnish you with information on the applications of high-strength steel for building construction. Just get in touch with the Bethlehem sales engineer through the Bethlehem sales office nearest you. Bethlehem Steel Corporation, Bethlehem, PA 18016.

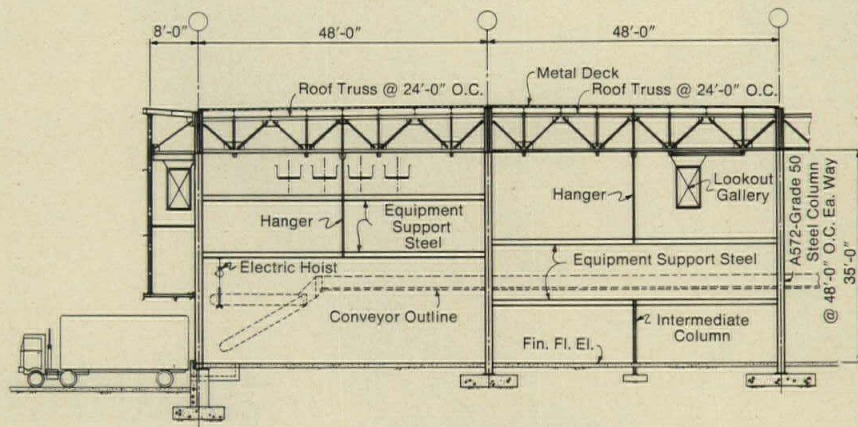
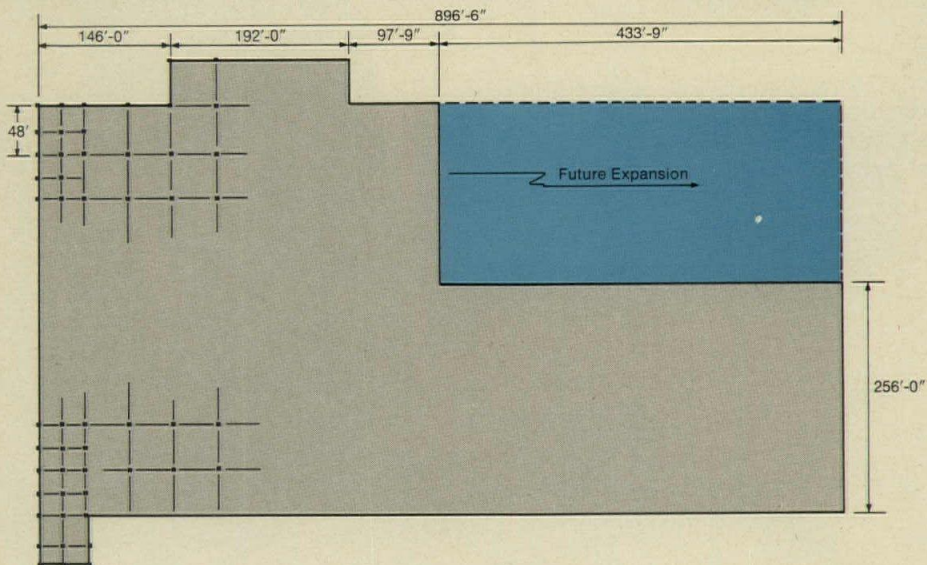

TYPICAL PARTIAL BUILDING CROSS-SECTION

ASTM A36 steel columns, 24 ft on center, are suspended from the bottom chord of the trusses to carry the third floor conveyor loads. High-strength steel perimeter and interior columns support the balance of the loads.

# Bethlehem

...emergency latches on top are actuated automatically to close the doors tightly – and shut off all power. Exit can be made only by...

2.

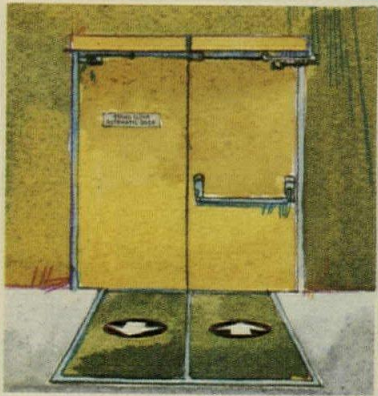
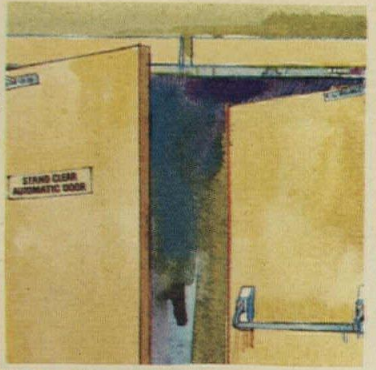

1. Normally, these double egress doors open automatically as one approaches from either side. But at first sign of smoke or fire...

3. ...the fire exit hardware cross bar. A reset button returns the doors to automatic operation once the emergency is over.

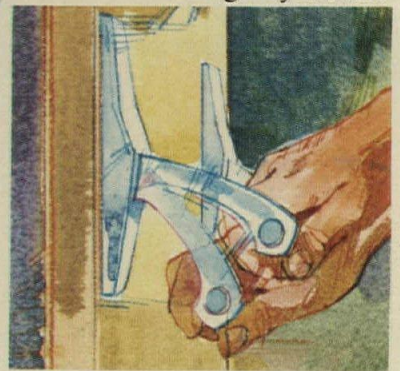

## Stanley's new automatic doors lock out fire. Automatically!

Life Safety Codes insist that hospital and nursing home corridors be protected by a pair of swinging fire doors. Stanley's Magic-Door® fire package goes one step further – with automatic swinging. And automatic latching! It's the sort of forward thinking you'd expect from the leader. We're the Magic-Door people – the Door Operating Equipment Division of The Stanley Works, Farmington, Connecticut 06032.

**STANLEY**  
helps you do things right

For more data, circle 50 on inquiry card

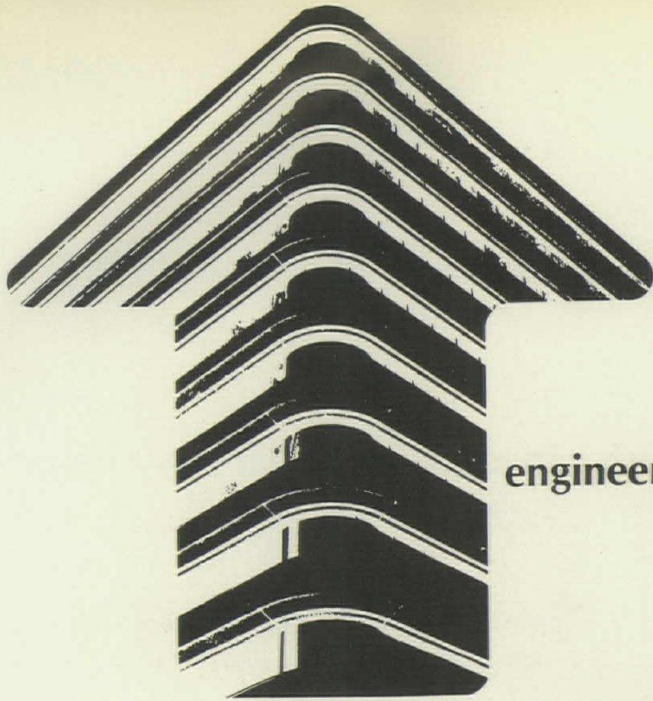

## engineering for architecture

“Change” is the magic word these days. We all live in a world of new ideas, new materials, new techniques, new disciplines, new design trends. And there’s a lot of that “new” in this issue. But. . . .

In its more important sense, this issue is about something as old and as basic as building. For what is most important in building is not any of the new techniques of building or management. What is most important is the people involved and their inter-relationships as each contributes his experience and expertise. What is most important is knowing the right way to use the right people with the right expertise at the right time. And understanding how to use imaginatively the enormous technical resources that are already at hand.

So this issue is designed not just to show the most important developments in the major disciplines of “engineering for architecture;” but to portray the technical resources that are having an impact on design; to explain the unique nature of technical expertise in the building field; and most importantly to give recognition to engineers in building for their inventiveness and resourcefulness in work with architects to achieve economical and rational (as well as beautiful) buildings.

## The most important technological developments of the year ---the critical and

In an editorial some time ago—an early criticism of Operation Breakthrough of sad memory—we argued that “while we can work for a revolution, and hope for a revolution—we cannot wait for a revolution, or count on a revolution.”

And as we have researched this issue—writing to hundreds of architects and engineers and manufacturers, and talking to hundreds more—we have become more convinced of that than ever.

We have sometimes been criticized around this editorial department for “negative attitudes”—for predicting, for example that Operation Breakthrough would not work, or for predicting that systems building was not the revolution that so many thought it was going to be. But we weren’t being negative. We were arguing, as we do in this issue, that there has to be balanced thinking about our real needs versus our imagined needs; that government action needs to be channeled into productive channels, not popular political channels. We were arguing that we need to examine what is right as well as what is wrong with the building industry—in terms of the real constraints: political, economic, social, and regulatory; and we need to make that study with the knowledge that serious change takes place only when people and organizations have a meaningful economic incentive.

So on the pages that follow you will not find evidence of an architectural engineering revolution—but you will find overwhelming evidence of the sophisticated and highly advanced technical expertise available for building. You’ll find overwhelming evidence that with good collaboration between architects, consulting engineers, and the best technical expertise of the producers and manufacturers, there are few problems in any of the engineering disciplines that cannot be solved rationally and economically, while at the same time leaving open sufficient design options—indeed, enhancing them. This evidence begins in section 1 on the next pages.

### **1** Case examples of architect-engineer collaboration

In this largest (34-page) section of the issue are 30 case studies covering important engineering developments in all of the disciplines—structural, hvac and electrical, lighting, acoustics. We had thought at first to “package” these by discipline, but found, not surprisingly when you think about it, that that was impossible because of the inevitable integration of structure and services and architectural scheme. Many of the examples, chosen from hundreds submitted by architects and consulting engineers when this issue was announced, emphasize cost-reduction. Items: Long-span structures using off-the-shelf steel members, a concrete structural system using only two pre-cast components with three cast-in-place connectors, “flying forms” for four-floors-a-day construction, and an ingenious system of using structural members as mechanical chases and return air plenums. More than a few of the cases point up how effectively standard building products—from beams to bricks and lighting fixtures to sound insulation—can be used in new and inventive and sophisticated ways to solve design and cost problems. Beginning on the next pages.

### **2** Round table on codes and standards for fire safety

Among the most important technological developments of the year must be listed the new concern about fire safety—and most especially life safety—in new and existing buildings. Even though the loss of life in tall buildings is statistically small—about five to six deaths a year, compared with 4000 from fire in automobile accidents, 6500 from residential fires, and 1500 in low-rise commercial and industrial buildings—the potential for catastrophe in tall buildings has acted as a catalyst for broad and drastic public concern. There has, in fact, been what many professionals regard as considerable (and technically dubious) over-reaction; and this Round Table was held in an attempt to re-establish the basics. The Round Table—including some of the country’s most knowledgeable architects, engineers, and code and standards experts—examined the role of codes and standards in fire protection, discussed how their technical content can be improved, analyzed and criticized the make-up of the codes- and standards-promulgating bodies, and proposed a number of possible courses of action to make codes and stand-

## continuing evolution

ards more helpful and meaningful to designers. While the Round Table includes GSA's "revolutionary" and provocative new "systems approach" to life safety in fire, again the emphasis is on the evolutionary improvement of our basic life-protection rules: the codes and standards to which everything must be built. Page 114.

### **3** Case history: architects in an engineering firm

Much of this issue is devoted to demonstrating how effective the engineer's input is to the architect. The reverse is, of course, equally true. Most engineers can profit from the architect's penchant to ask searching questions about *why* processes, operations, and subsystems are handled the way they are. And this case history—of the work of Camp, Dresser & McKee, civil engineers of Boston—makes that point. The firm, with a heavy involvement in water purification plants and sewage disposal plants—building types which normally do not receive much architectural attention—has a staff of 20 architects. These architects have a responsibility not just to "design the buildings" associated with these engineering projects; but also to become intimately involved in the conceptual process from the start. Presentations of several projects of the firm—under this unusual architect-engineer collaboration—are, in our view, an impressive proof of the pudding. On page 122.

### **4** The engineer's education

As any architect or engineer knows, the architect-engineer collaboration is often complicated by the very different approaches and educational backgrounds of the two professions. This interview with structural engineer Abba Tor explores those basic background differences. Are engineers guilty of attacking broad and complex problems on a piece-by-piece basis—forgetting the broad synthesis which marks the problem-solving approach of the sophisticated architect? Is the very different nature of engineering and architectural education responsible for a communications barrier that adversely affects the problem of building design? On page 128.

### **5** Systems revisited

After a too-publicized and inadequately analyzed beginning, sufficient experience in systems building has now accumulated—and that fact must be counted as one of "the most important technological developments of the year." Here, the results of systems building are judged against comparable alternatives—and the credits and debits analyzed. An attempt to clear up the confusion and muddy thinking surrounding the concept of systems building. On page 130.

### **6** The changing dialogue: architect, engineer, manufacturer

The relationships among these three major professional inputs to building design are now under careful study—with many changes being discussed as a result of increased packaging and standardization of some building subsystems, the new construction-manager input, the new emphasis on life-cycle costing, and owner frustration over costs and building time. This article includes a thoughtful study by architect Karl Justin on "Perils at the Interface" of performance specifications, and includes comments from a broad range of technical experts in industry, submitted in response to a questionnaire from RECORD. On page 138.

### **7** Energy management is a way of life

The questions and problems of managing our energy resources continues, of course, on every architect and engineer's list of "most important technological problems." This article explores the work of engineer Frank Bridgers, who has been concerned about energy conservation—and very effectively using his broad skills in this area—for some 20 years. Illustrations of his work form a casebook of effective engineer input to architectural problems that bears study by other professionals just beginning to cope. Plus an up-to-the-minute analysis of governmental criteria on energy "budgets." On page 144.

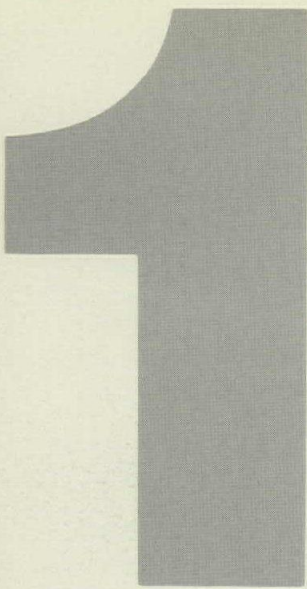

The next 33 pages contain a collection of roughly 30 examples of **effective architect-engineer collaboration**. Few of these buildings are spectacular—a couple of tall office towers, a few long spans, some more than ordinarily handsome solutions—but by and large the lessons these projects teach are more modest. Perhaps the most important lesson is that the sooner architects and engineers exchange ideas, the more rational the over-all design, and the fewer the compromises to be made toward the end. Moreover, many of these examples demonstrate that inventive designers, not bound by preconceptions, can use standard materials to achieve original solutions.

**Estribou House**, Big Sur, California. Architect: Thomas R. Aidala. Engineers: Hirsch & Gray (structural). Contractor: Big Sur Construction Co. Supplier: Shradler (iron works). —81

**Hennepin County Civic Center**, Minneapolis. Architects: John Carl Warnecke and Associates; Peterson, Clark and Associates, Inc. (associate architects). Engineers: Ketchum, Konkel, Barrett, Nickel, Austin (structural); Jacus and Amble, Inc. (structural associates); Bentley Engineers (mechanical/electrical); Michaud, Cooley, Hallberg, Erickson and Associates (mechanical/electrical associates). Contractor: Knutson Construction Co. —82

**The Omni**, Atlanta. Architects: Thompson, Ventulett & Stainback, Inc. Engineers: Prybylowski & Gravino, Inc. (structural); Morris Harrison & Associates (electrical); C. P. Boner & Associates (acoustical). Contractor: Ira H. Hardin Co. —83

**Yale Center For British Art and British Studies**, New Haven, Connecticut. Architect: Louis I. Kahn. Engineers: Pfisterer, Tor & Associates (structural); van Zelm, Heywood & Shadford (mechanical). Supplier: Air Floor Company of California, Inc. —84

**Rutgers University Athletic Center**, New Brunswick, New Jersey. Architects: The Eggers Partnership and J. Robert Hillier. Engineers: Lev Zetlin Associates, Inc. (structural); John C. Morris Associates (mechanical/electrical).

**Lehigh University Field House**, Bethlehem, Pennsylvania. Architects: Warner Burns, Toan Lunde. Engineers: Lev Zetlin Associates, Inc. (structural); Kallen & Lemelson (mechanical/electrical). —86

**Highway Administration Building**, State of Washington, Olympia. Architects: The Richardson Associates; project architect: John L. Rogers; design director: Philip L. Jacobson. Engineers: Victor O. Gray & Company (structural); The Richardson Associates (mechanical); Beverly A. Travis & Associates (electrical). Contractor: Donald M. Drake Co. —88

**Birmingham-Jefferson Civic Center Coliseum**, Birmingham, Alabama. Architects: Geddes, Brecher, Qualls & Cunningham. Engineers: Weidinger Associates (structural); Leonard Weger Associates, Inc. (mechanical/electrical); Donald F. Nardy & Associates (electrical consultant).

**Philip Morris Cigarette Manufacturing Plant**, Richmond, Virginia. Architects: Skidmore, Owings & Merrill; Engineers: Weidinger Associates (structural); Syska & Hennessy (mechanical/electrical). Contractor: Daniel Construction. —89

**Denver Convention Center**, Denver. Architects: Muchow, Ream and Larson (joint venture); Karl Berg, George Hoover, Edward Tower, development team. Engineers: Ketchum, Konkel, Ryan & Hastings (structural); McFall & Konkel (mechanical); Swanson-Rink & Associates (electrical). Contractors: Burkhardt Steel Co. (space trusses); F. R. Orr Construction Co. (general). —89

**KKBNA Office Building**, Lakewood, Colorado. Architects: Muchow Associates. Engineers: Ketchum, Konkel, Barrett, Nickel, Austin, Inc. (structural). Contractor: Dom Brothers Construction Co. —90

**Park Centre**, Cleveland. Architects and engineers: Dalton Dalton Little Newport (Robert N. Yoder, principal-in-charge;

Norman K. Perittola, architect-in-charge; Lyle R. Amiet, structural engineering director). —90

**Federal Reserve Plaza**, Boston. Architects: Hugh Stubbins and Associates, Inc. Engineers: LeMessurier Associates/SCI (structural); Jaros, Baum and Bolles (mechanical/electrical). Consultants: Boundary Layer Wind Tunnel Laboratories (model testing); Eugene O. Tofflemire (curtain-wall); SI Handling Systems (materials handling). Contractor: Perini Corp. —91

**The George Brown College**, Casa Loma Campus, Toronto. Architects: Fairfield/DuBois, Alan R. Moody. Engineers: M. S. Yolles Associates Ltd. (structural); G. Granek and Associates Ltd. (mechanical); Jack Chisvin & Associates Lt. (electrical). —92

**Juanita Senior High School**, Juanita, Washington. Architects: Kirk, Wallace, McKinley, A.I.A., and Associates. Engineers: Skilling, Helle, Christiansen, Robertson (structural); Benjamin S. Notkin and Associates, Inc. (mechanical); Sparling and Associates, Inc. (electrical). Contractor: Linton Construction Company. —94

**Lambert Houses**, Bronx, New York. Architects: Davis, Brody & Associates. Engineers: Goldreich, Page & Thropp (structural); Wald and Zigas (mechanical). Contractor: HRH Construction Co. —94

**John A. Brashear High School**, Pittsburgh. Architects: Curry Martin Highberger and Klaus. Engineers: R. M. Gensert Associates (structural); R. Bruce Miller and Associates (mechanical); Horneick Engineering (electrical). Contractor: Jendoco Construction Company. —95

**Washington Metro**, Washington, D.C. Architects for stations: Harry Weese & Associates. Engineers: DeLeuw, Cather & Co. (general engineering consultants); Bolt, Beranek and Newman (acoustical).

**Granville Square**, Vancouver, B.C. Architect: Francis Donaldson. Engineers: Read Jones Christofferson, Ltd. (structural); Bolt, Beranek and Newman (acoustics and vibration).

**Ginn & Co.**, Boston. Architects: Anderson Beckwith & Haible. Engineers: LeMessurier Associates (structural); Hankins & Anderson (mechanical/electrical); Bolt, Beranek and Newman (acoustical). —96

**Library for the State University Agricultural and Technical College**, Morrisville, New York. Architects: Morris Ketchum, Jr. and Associates (Ian C. Brown, associate-in-charge); A.E. Bye & Associates. Engineers: Ames & Selnick (structural); Wald & Zigas (mechanical). Consultant: Henry J. Wald (lighting). —98

**Headquarters Building for the Aid Association for Lutherans**, Appleton, Wisconsin. Architects: John Carl Warnecke & Associates (E. Eugene Kohn, partner; William E. Pedersen, project designer; Walter A. Rutes, project director; Michael Koenen, planning director). Engineers: Paul Weidinger Associates (structural); Joseph A. Loring & Associates, Inc. (mechanical/electrical and site/civil). Consultants: Jason Cortell (ecological); George Nelson & Co., Inc. (interior design); Joseph A. DiBernardo & Associates (lighting). Contractor: Oscar J. Boldt Construction Co. —101

**Philadelphia National Bank** (International Department) Philadelphia. Interior designers: Interspace, Incorporated. Lighting de-

signers: Sylvan R. Shemitz and Associates, Inc. —102

**Ravenwood Elementary School**, Kansas City, Missouri. Architect: Kivett & Myers. Engineers: Pfuhl & Stevson (structural); Smith & Boucher (mechanical). Contractor: Bob Eldridge Construction Co. —103

**Chantilly High School**, Fairfax County, Virginia. Architects: Beery, Rio & Associates; Jansons Roberts Taylor (coordinating architects). Engineers: Kluckhuhn & McDavid (mechanical); Goodwin H. Taylor (engineer for design-build HVAC system). —104

**Government Employees Insurance Company**, Northeastern Regional Office Building, Woodbury, New York. Architects: Vincent G. Kling & Partners. Engineers: Kling-Lindquist, Inc. (mechanical/electrical). General Contractors: Turner Construction Company (general); KSI Incorporated (mechanical).

**Volvo of America Corp.**, Rockleigh Industrial Park, New Jersey. Architects: Goldstone, Dearborn & Hinz. Engineers: Beck, Simon & Mantel (structural); James Montgitoro (mechanical/electrical). Contractor: B. D. Malcolm Company, Inc. —104

**One Old Country Road Office Building**, Carle Place, New York. Architect: Theodore E. Bindrin, A.I.A. Engineers: S. M. Li-moggio (mechanical). —106

**United California Bank Building**, Los Angeles. Architects: Charles Luckman Associates. Engineers: Levine & McAnn, Div. of Syska & Hennessy, Inc. (mechanical). —107

**The Exchange**, Farmington, Connecticut.

## A far-out design for a mountain-top house reflects engineers' involvement from the beginning of the design process

The form of the Estribou house at California's Big Sur reflects what both the architect and the engineers describe as nearly total collaboration. Early discussion of engineering possibilities allowed the architect to stretch his design conception as far as technology would take it. "Any other structural system would be unimaginable," says the architect, "since it would result in a different architecture." Less sweepingly, the engineers remark, "The house demonstrates that technology is now

available to achieve this precision of form on a very difficult and remote site."

The framing, of prefabricated welded steel bents, is sheathed with plywood and plastic foam panels, over which is stretched the aluminum skin. The preformed panels run the length of the house, and were shipped to the site in 4-by-55-ft units; they are fastened to laminated wood nailers laid along the frames. The skin is held in place with sheet metal screws. The end walls, one side wall, and

a strip of roof are entirely glazed.

Although wind bracing is not ordinarily a major consideration in domestic structures, both the form of this house and its exposed site made deflection a serious concern. The bents themselves provide transverse lateral resistance, while the plywood sheathing acts as a shear wall on one side. Where the house is glazed, longitudinal lateral forces are taken by three sets of diagonal rods, bolted into chrome-plated steel rings where they intersect.

Architect: Thomas R. Aidala. Engineers: Hirsch & Gray (structural).

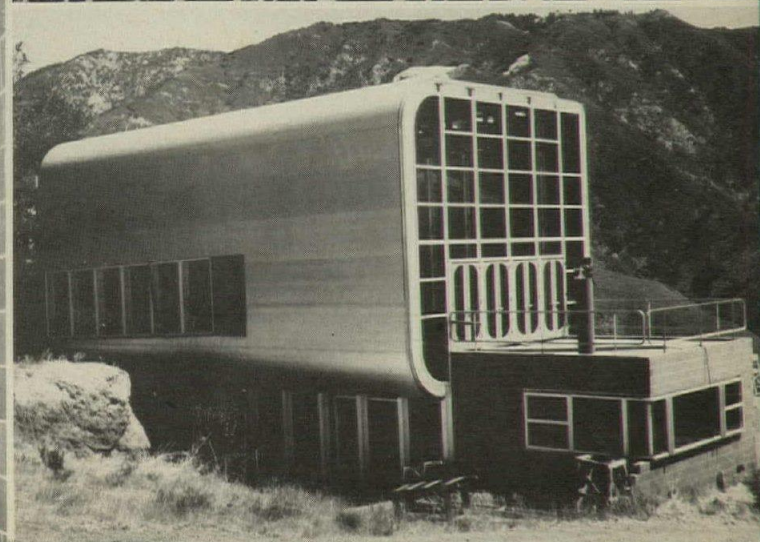
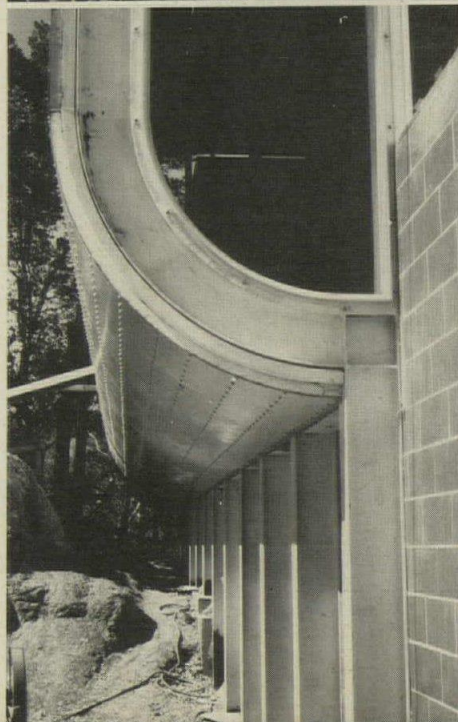
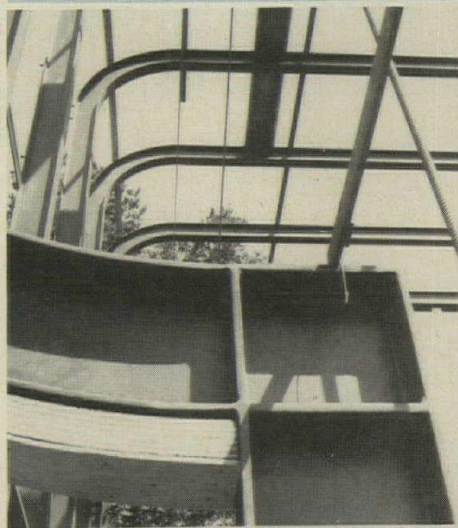
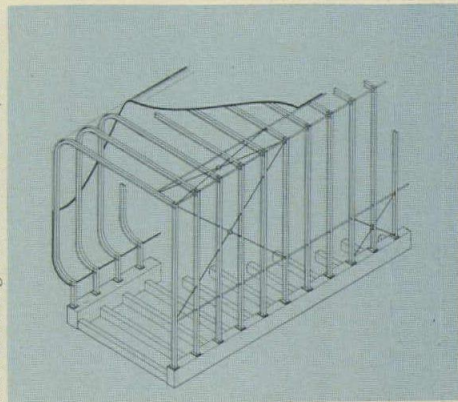

Ephraim Hirsch photos

Architects: Callister, Payne and Bischoff. Engineers: James S. Minges & Associates (mechanical). —108

**Yonge & Balliol Building**, Toronto. Architects: Crang and Boake. Engineers: Cooper Consultants Ltd. (structural); Tamblin, Mitchell and Partners Ltd. (mechanical); Mulvey Engineering Ltd. (electrical).

**Guardian Royal Exchange Tower**, Toronto. Architects: Searle Wilbee Rowland. Engineers: G. Granek and Associates, Ltd. (mechanical); Jack Chisvin & Associates Ltd. (electrical). Contractor: Poole Construction. —108

**Moore Products Company**, Spring House, Pennsylvania. Designers and builders: William F. Lotz, Inc. Engineers: Robert G. Werden & Associates Inc. (mechanical); William G. Flurer (electrical). —110

**Graduate Physics-Mathematics Laboratory**, Stony Brook, New York. Architects: Gruzen & Partners; M. Paul Friedberg & Associates (landscape). Engineers: Paul Weidlinger Associates (structural); Cosentini Associates (mechanical/electrical). Consultants: Earl L. Walls & Associates (laboratory); Bolt, Beranek & Newman, Inc. (acoustical). —110

**Newark College of Engineering**, Newark, New Jersey. Architects: Philips-Kaufman & Associates, (formerly Epple & Seaman). Engineers: Herbert Fox & Associates (mechanical). —112

**The Lodge at Snowbird**, Alta, Utah. Architects: Brixen & Christopher. Engineers: Joseph F. Patrick (structural); Bridgers & Paxton (mechanical). Contractor: Cannon Construction Co. —113

## At the ends of a 24-story atrium, wind bracing assumes an ornamental function as well as a purely structural one

The Hennepin County Government Center is in effect two 24-story towers, one housing courts and the other offices. The atrium between the towers proved a convenient place to put wind bracing, and furnished a rare opportunity for this structural necessity to have a substantial esthetic impact.

At each end of the atrium, an I-shaped space truss that extends the height of the building acts like a vertically cantilevered beam. The "web" of this beam is the prominent grid of diagonal mem-

bers at the ends of the atrium; the "flanges" are sheathed outside the building and exposed inside. Additional bracing, also revealed, is provided at the center of the atrium wall. Composite floor slabs transmit lateral load to the core, while horizontal collector beams focus loads at specified points on the atrium frame.

Esthetics apart, the structural engineers figure that the cost of using the atrium wall for bracing members was 4 per cent less than the alternative rigid frame.

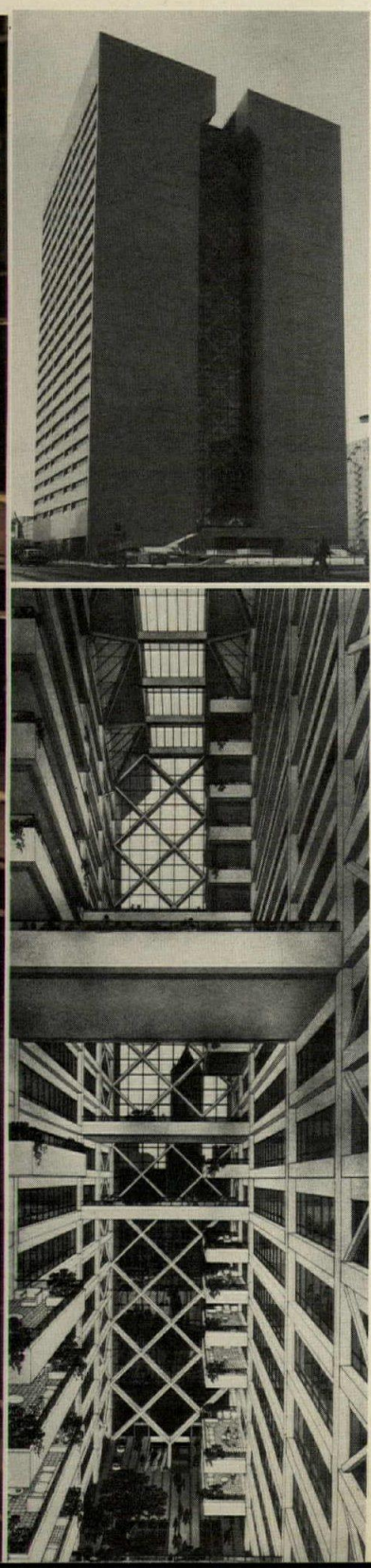
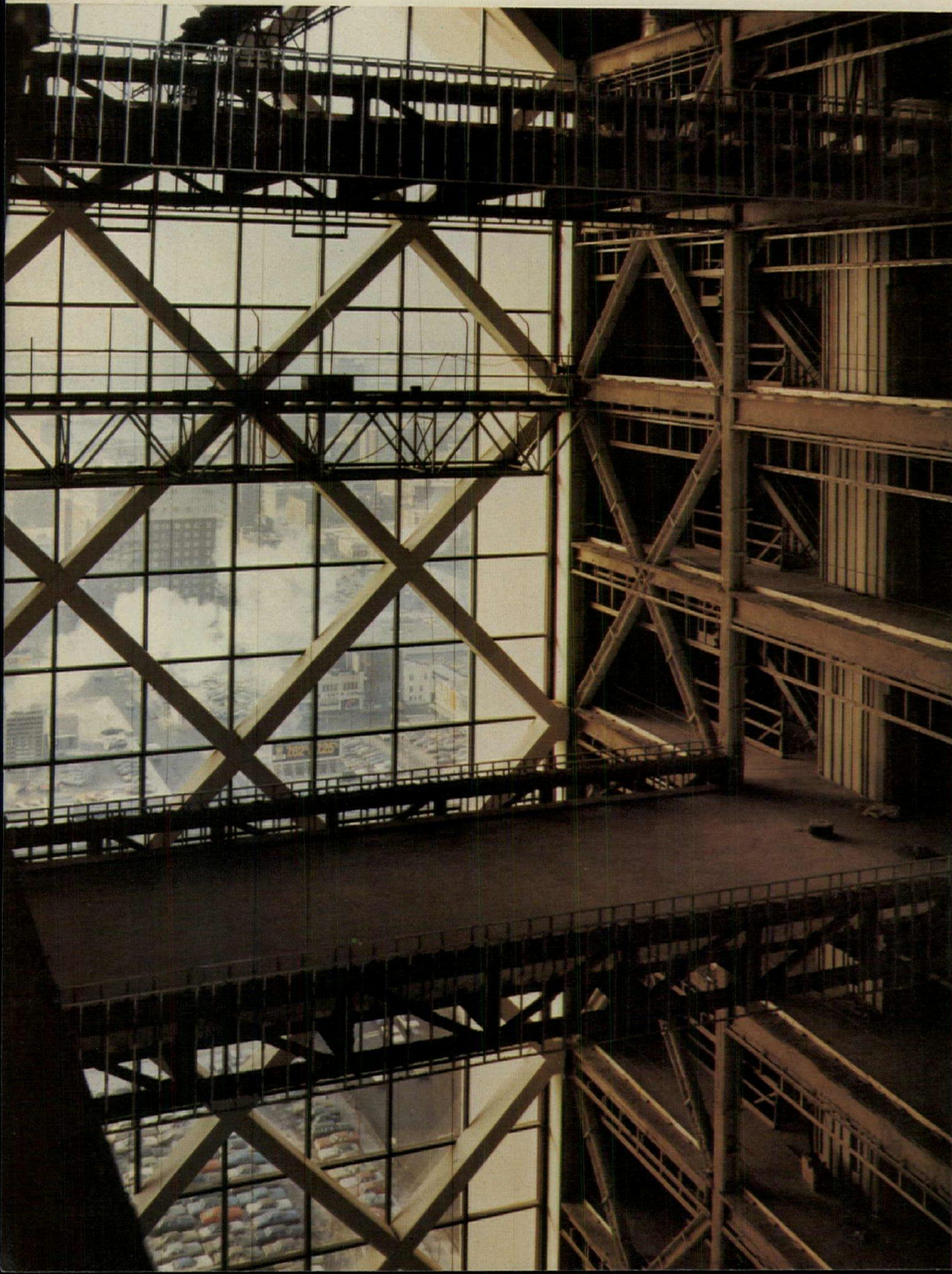

Architects: John Carl Warnecke and Associates. Engineers: Ketchum, Konkel, Barrett, Nickel, Austin (Structural).



## For the roof of Atlanta's civic coliseum, a space truss of steel-sheathed pods is an elegant way to attract attention

Sports entrepreneurs, not surprisingly, want exciting buildings to attract attention and fans, a rule that obtains even when the entrepreneurs, as here, are city and county governments. Atlanta's Omni (the Atlanta/Fulton County Coliseum) was designed as a showcase for the city's professional hockey and basketball teams and for conventions, ice shows and musical programs.

The arresting patented roof system, christened by structural engineers Prybylowski & Gravino

an Ortho-Quad Truss, is more easily understood as a modified space truss. The top of each pyramid forming the space truss was sliced off, and the diagonal shear members replaced with heavy plates of weathering steel to form the distinctive pods that crown the roof. The pods alternate with flat roof sections in a checkerboard pattern, their corners touching so that the bottom edges form the space truss's lower chord. The upper chord is formed by diagonal rods that connect the pyramid's

corners and transfer shear forces.

The roof system is supported by 100-ft-high wall trusses that cantilever at each end. This configuration is largely a response to architectural considerations: the seating bowl, which accommodates about 16,000 spectators, is set on the diagonal, and the architects wanted large, column-free lobbies beneath the seating tiers at the corners of the building. These trusses also satisfy some structural requirements, however. Deflection of the cantilevers applies a

counterforce at the ends of the 350-ft spans, and the central tower resists wind loading. (Feature strips of weathering steel were applied to the face of the building to evidence the lines of the truss behind.)

The pods were assembled partly in the shop and partly on the site. The relatively high fabrication costs were offset, however, by the light weight of the structure—16 lbs per sq ft against an estimated 23 lbs per sq ft for a more conventional two-way truss.

Architects: Thompson, Ventulett, & Stainback, Inc. Engineers: Prybylowski & Gravino, Inc. (structural).

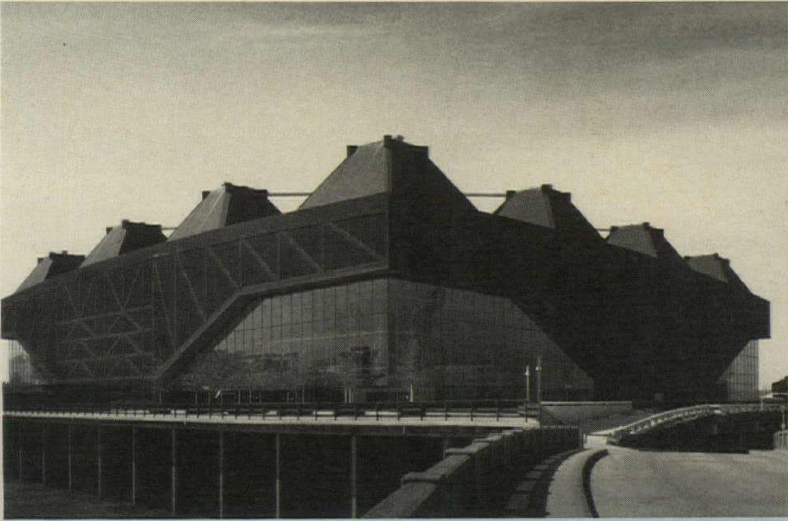

William A. Barnes



E. Alan McGee

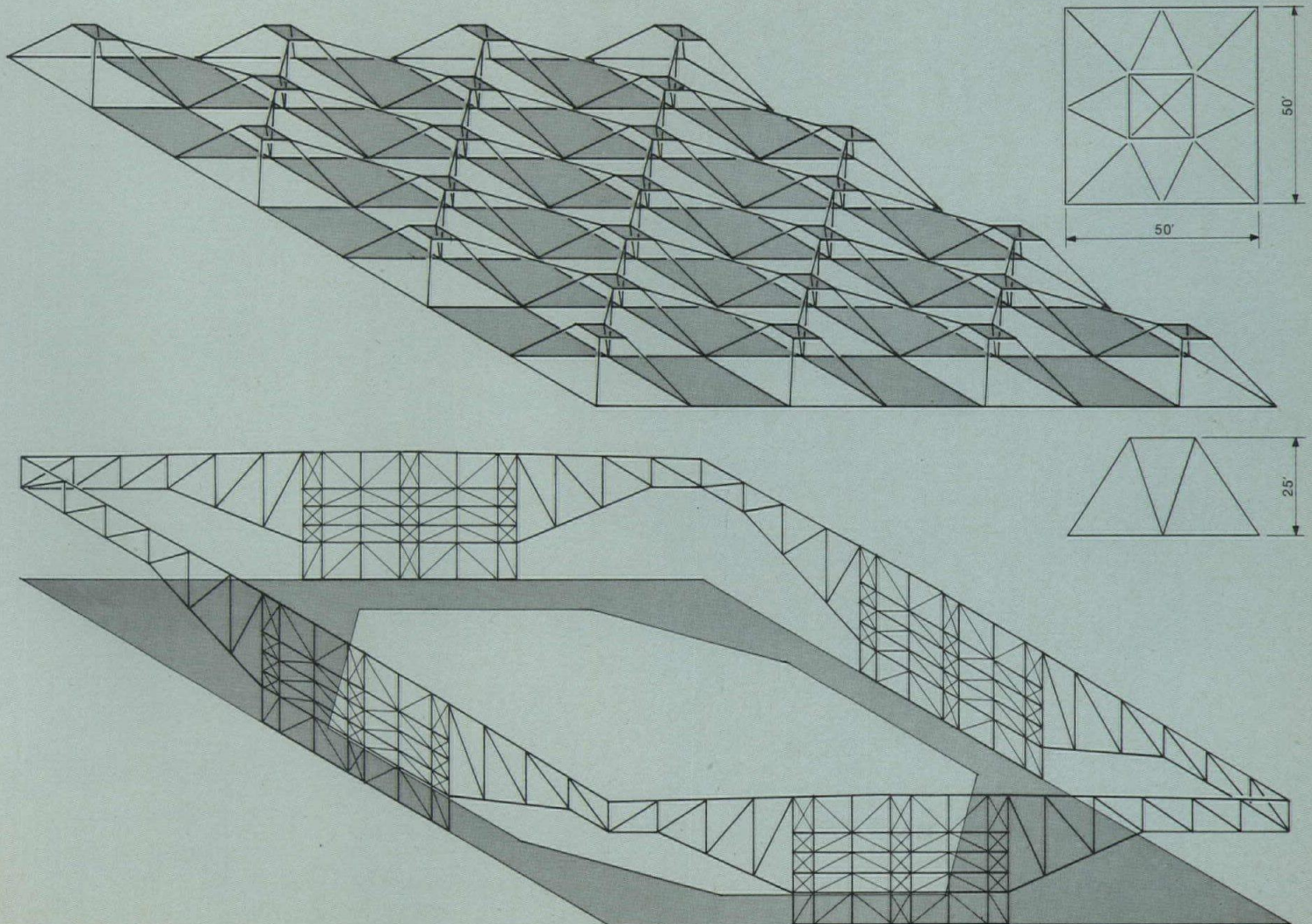

## In the philosophy of Louis Kahn, engineering and architecture were inseparable parts of total form

The late Louis Kahn was a strong-minded artist who never tired in his efforts to tame wiring, ductwork, and other unappealing necessities of modern building. He strove to impose on these services the same ordered form and visual clarity that many architects seek only in structure and plan. Needless to say, Kahn's engineering consultants often faced unaccustomed and demanding problems.

At the Yale Center for British Art and British Studies, Kahn, as always, rejected the easy camou-

flage of the hung ceiling. Because exposed ductwork housing was to be hung beneath the floor, an unusually thin slab was needed to allow necessary headroom. And because exposed return-air ducts would inevitably conflict with fenestration, it was decided that the slab itself would have to provide return-air delivery.

A patented system hitherto employed only on-grade was used to form the 14-in. flat slab. This is in fact a double slab. The lower slab incorporates horizontal rein-

forcing and conduits as well as vertical reinforcing dowels. The two-part form for the second slab consists of "cans" placed around these dowels, and pressed sheet metal domes. When the top slab is poured, the cans and vertical dowels, set on a 12-in. grid, form concrete stubs, tying lower and upper slabs. The domes create a layer of interconnected voids, and the entire slab can thus act as a horizontal plenum, through which return air moves from perimeter inlets to one or another of two me-

chanical shafts ("servant spaces") that serve as vertical plenums. (Kahn called these shafts, which also carry supply ducts, "Franklin stoves.")

The entire surface of the roof is covered with skylights, which are supported by 12-in. columns and precast girders shaped like truncated Vs. The angle of the Vs, which form large coffers in the fourth-floor ceiling, was designed to give the maximum spread of daylight over exhibition areas. Their dimensions, on the other

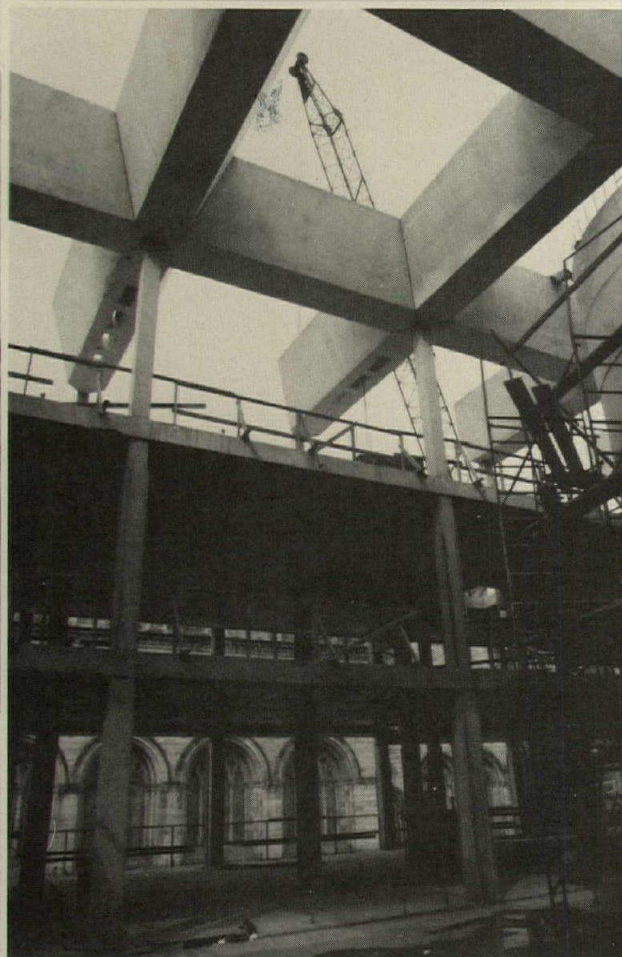
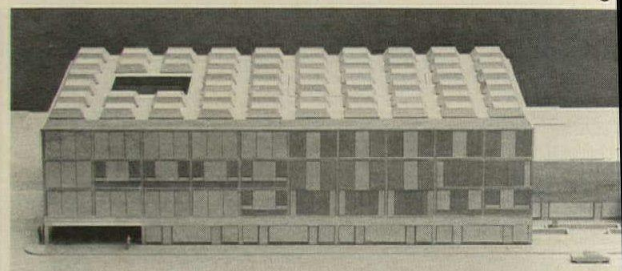

George Pohl (bottom top)

hand, were at least partially dictated by mechanical requirements; air-supply ducts nest inside the girders, which are pierced at the bottom to admit diffusers. Return air is taken in over the lip of the girders.

On the second and third floors (the first floor is largely commercial space), supply ducts are run overhead. Distribution requires only eight unbranched ducts of equal circumference for each floor. These ducts are partitioned horizontally across their di-

ameters, with outlets on the bottom halves. The bottoms are then stopped by corner bulkheads, and air from the top half continues to move through unpartitioned ducts. The ductwork will be cased in pewter-colored stainless steel, as will the vertical shafts.

The electrical system centers entirely in a single panel located near the elevator shaft—an arrangement that necessitated uncommon coordination of conduits and the 12-in. reinforcing grid within the lower slab.

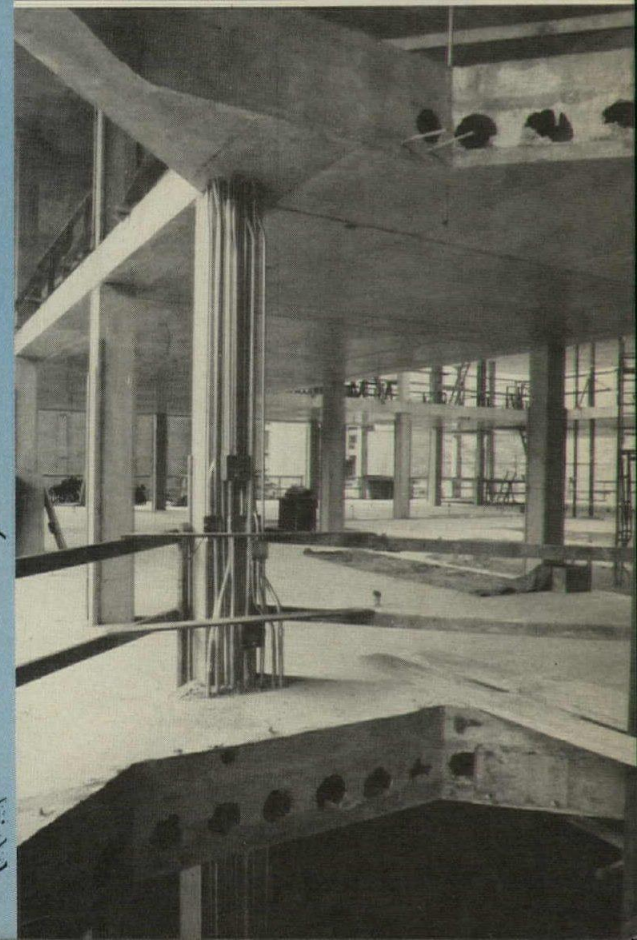
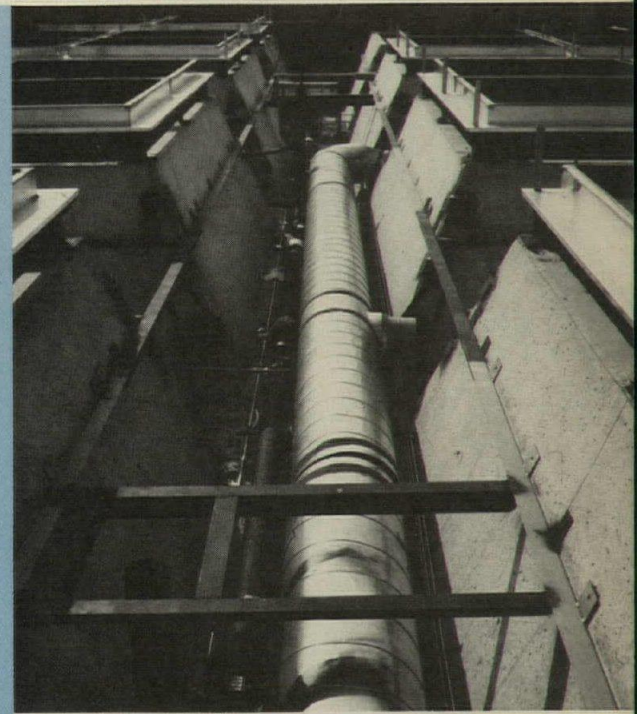
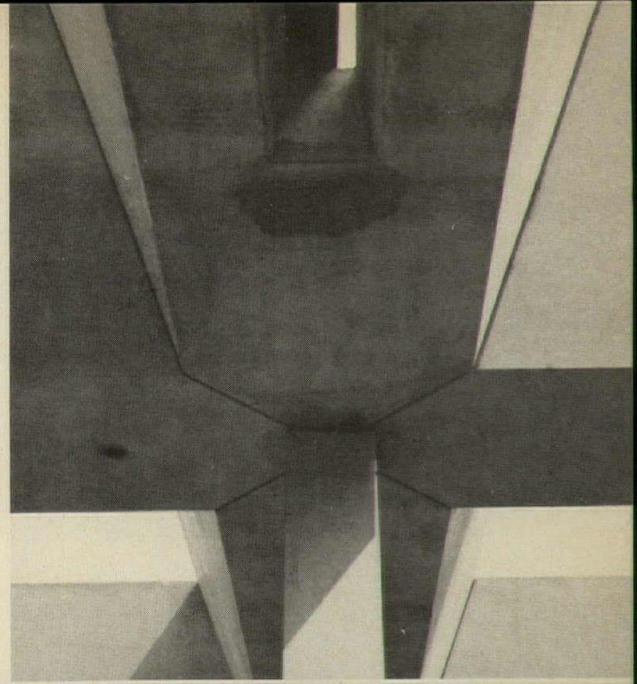
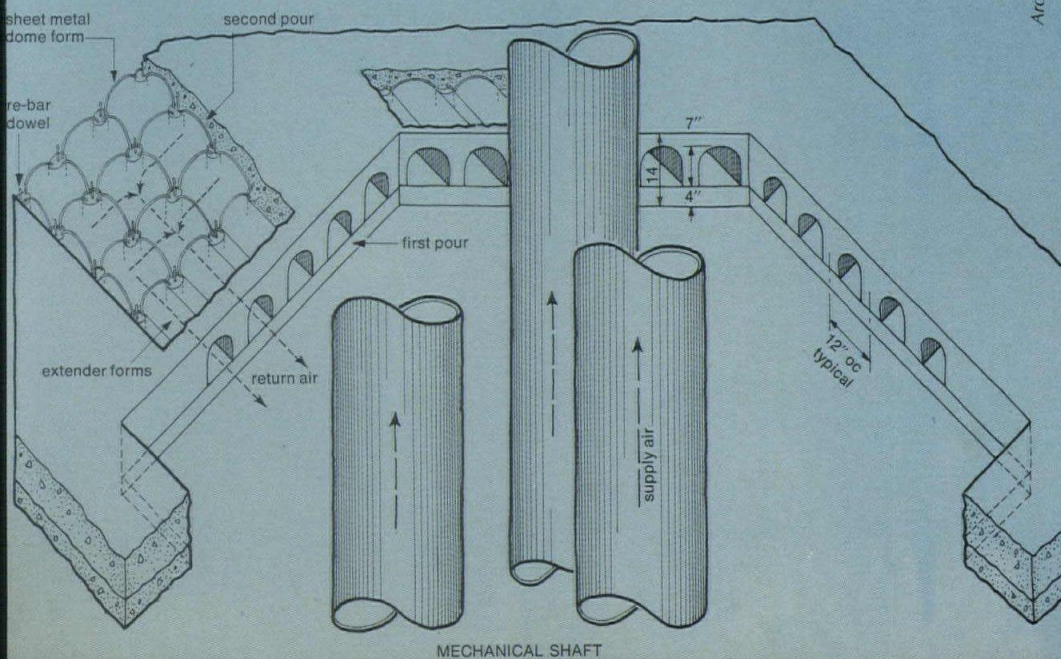
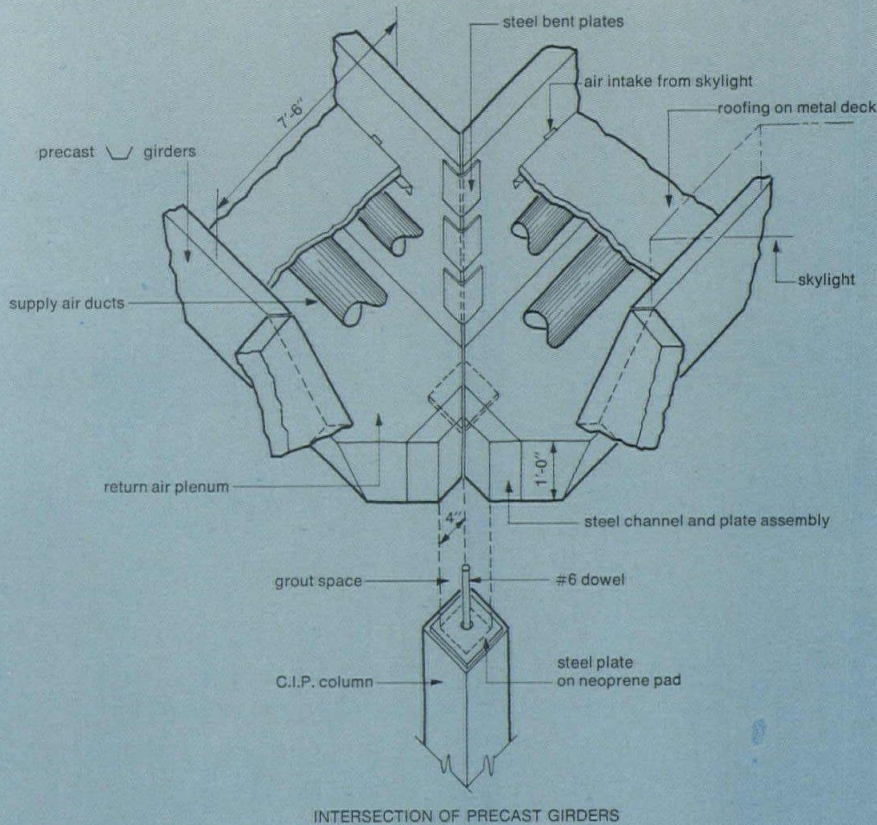

Architect: Louis I. Kahn. Engineers: Pfisterer, Tor & Associates (structural); van Zelm, Heywood & Shadford (mechanical).

## Structural engineers exploit spatial geometries for economy and architectural fitness

Apart from spanning the kind of unobstructed area required by these athletic facilities, Lev Zetlin Associates had two additional engineering goals for their design. Because steel is, after all, sold by the ton, the first of these goals was to minimize the weight of these structures. The other goal was to minimize special fabrication: all members in both these buildings are standard sections specified in lengths that can be shipped without special arrangement.

A The chief function of the Rutgers

University Athletic Center will be to house varsity basketball games and spectators, although the building will also accommodate intramural sports. The building's cruciform plan, by eliminating seating at the corners, requires a clear span only over the playing area rather than over the entire building. The unobstructed area here is 120 by 180 ft.

After rejecting a space frame as requiring an unacceptable number of field connections, and after rejecting conventional trusses be-

cause of the amount of field fabrication needed and because of architectural limitations, the engineers devised a modified space truss. A grid of 40-by-60-ft bays is supported and stabilized by a "tension cradle" hung beneath it. The cradle consists of a tension ring, constructed of four pairs of 14-in. high-strength-steel flanged members, and four corner pyramids constructed of lengths of 12-in. steel pipe.

The structure requires only 20 connections—16 for the grid

and four for the tension ring. The assembled truss will be 22 ft deep. As a counterforce to the tendency of the center spans to sag, the pipes at the outside corners are tensioned by jacking, applying a downward force at the corners and an upward force at the centers in an action like that of a longbow being drawn. The tension ring also provides space for lighting fixtures between its lower flanges and support for a rigger's catwalk above.

A roof over the permanent seating on the long sides of the

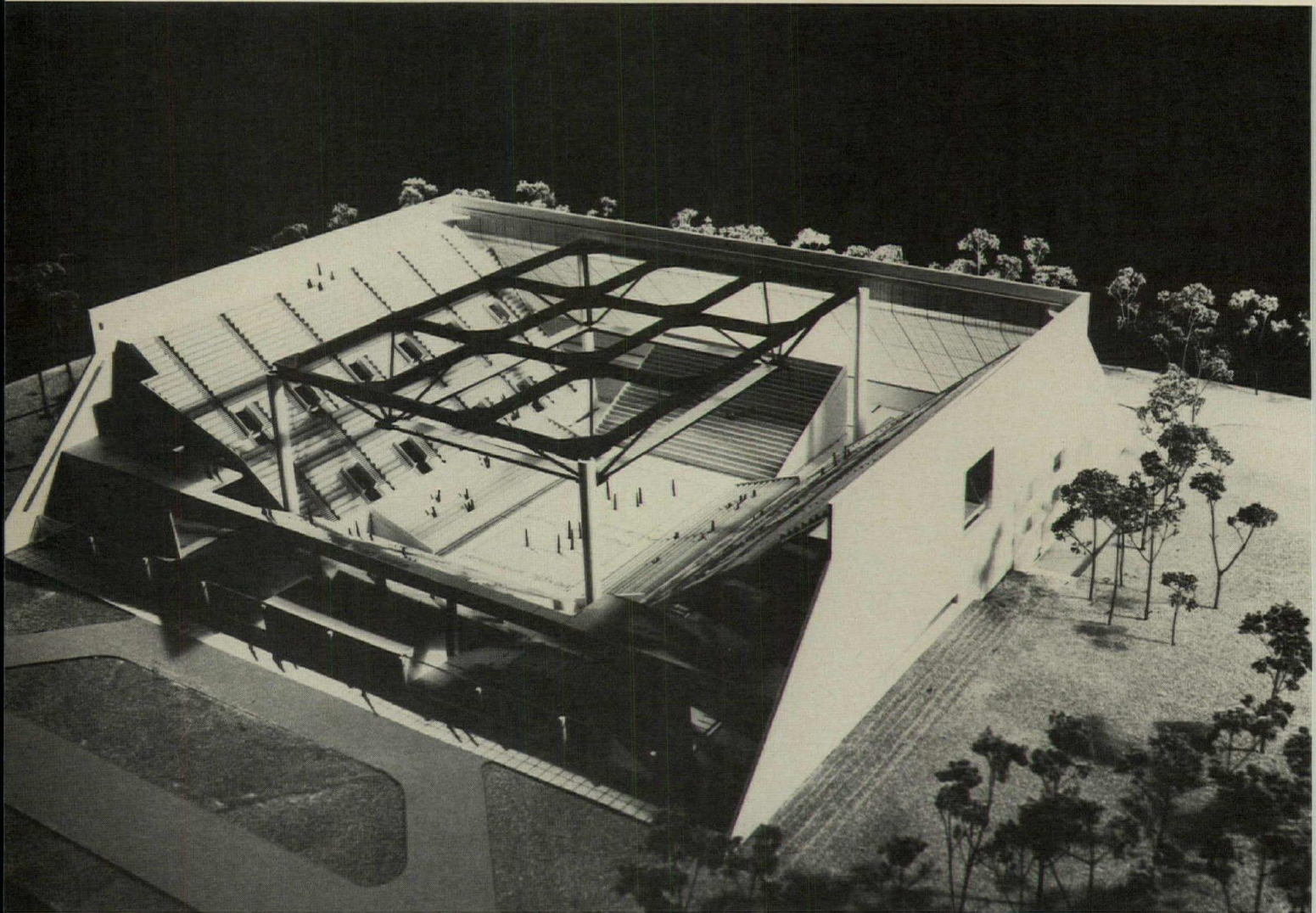

Architects: The Eggers Partnership and J. Robert Hillier. Engineers: Lev Zetlin Associates (structural).

Architects: Warner Burns Toan Lunde. Engineers: Lev Zetlin Associates (structural).

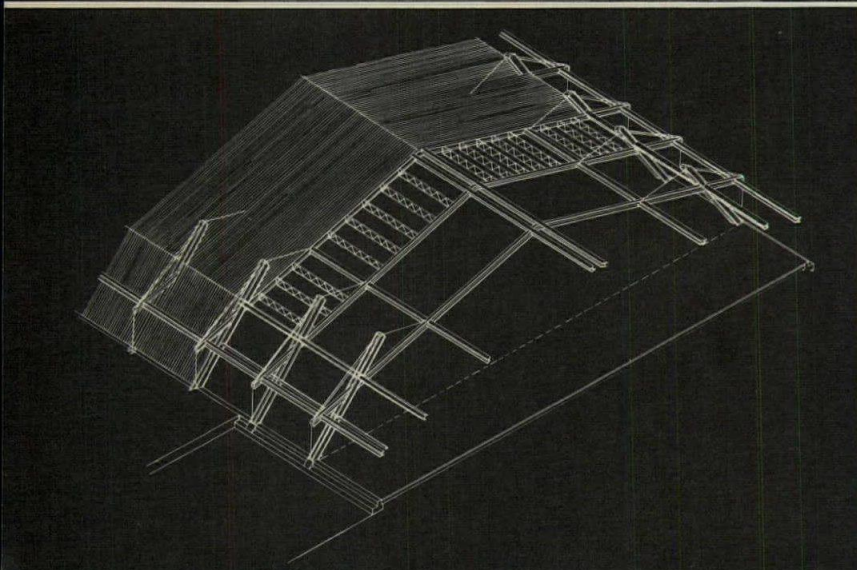

B

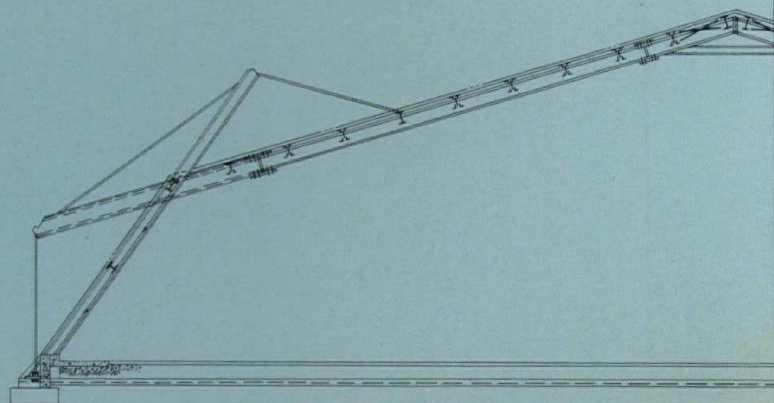

grid will be supported by bar joists run out from the truss. A 60-ft truss supports the seating to provide a clear span on the lower level for intramural basketball as well as for wrestling, fencing and dance. On the short sides, a sloping plane of translucent plastic will double as wall and roof.

**B** In a proposed structure designed by Zetlin Associates for a field house for Lehigh University, a relatively lightweight structure spans 180 ft with 2-ft-deep steel girders. The span is supported from above

by a number of skyhooks—high-strength hanger rods fastened about midway along the stayed girder and strung, via the top of the angled column and the end of the girder, to the footings. The girder, which extends past the building line to form an outrigger, is seated on a plate between the two column channels which also extend up past the decking.

A continuous brace connecting all girders outside the building stiffens the structure at the perimeter. To counteract the strain of

uplift forces on the hangers and to prevent their slackening, extra tension is imposed by jacking the rods from the end of the outriggers. The rods are doubled between column and outrigger not for strength but to allow the intersecting rods to bypass each other at the connections. Bracing beams that connect the girders where the hangers join them are designed only to facilitate assembly, though they will remain as roof support.

Detail drawings at bottom of the page show how the hanger

rods relate to the structure at the angled column and outrigger.

Uncertain soil conditions—the ground here is pocked with sinkholes—favored the use of an asphalt floor, which is more resilient and at the same time less expensive than a concrete slab. Therefore, because the structure could not be simply tied with extra reinforcing in the slab, tie rods connecting column bases are buried 3 ft below the floor. Continuous concrete footings also guard against uneven settling.

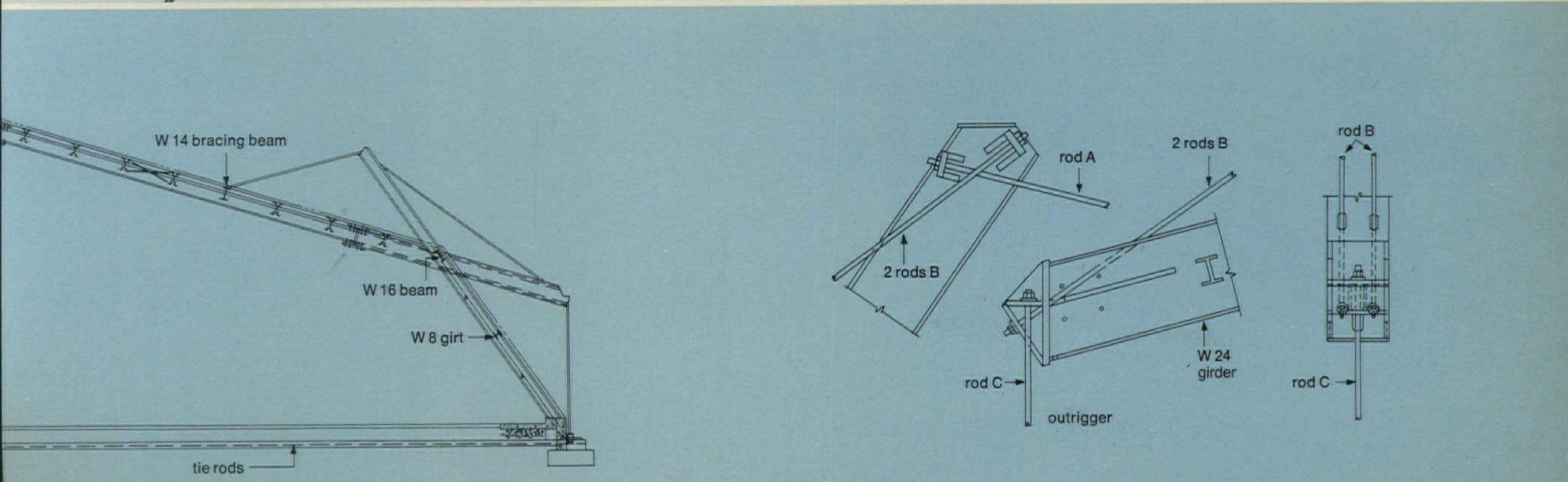
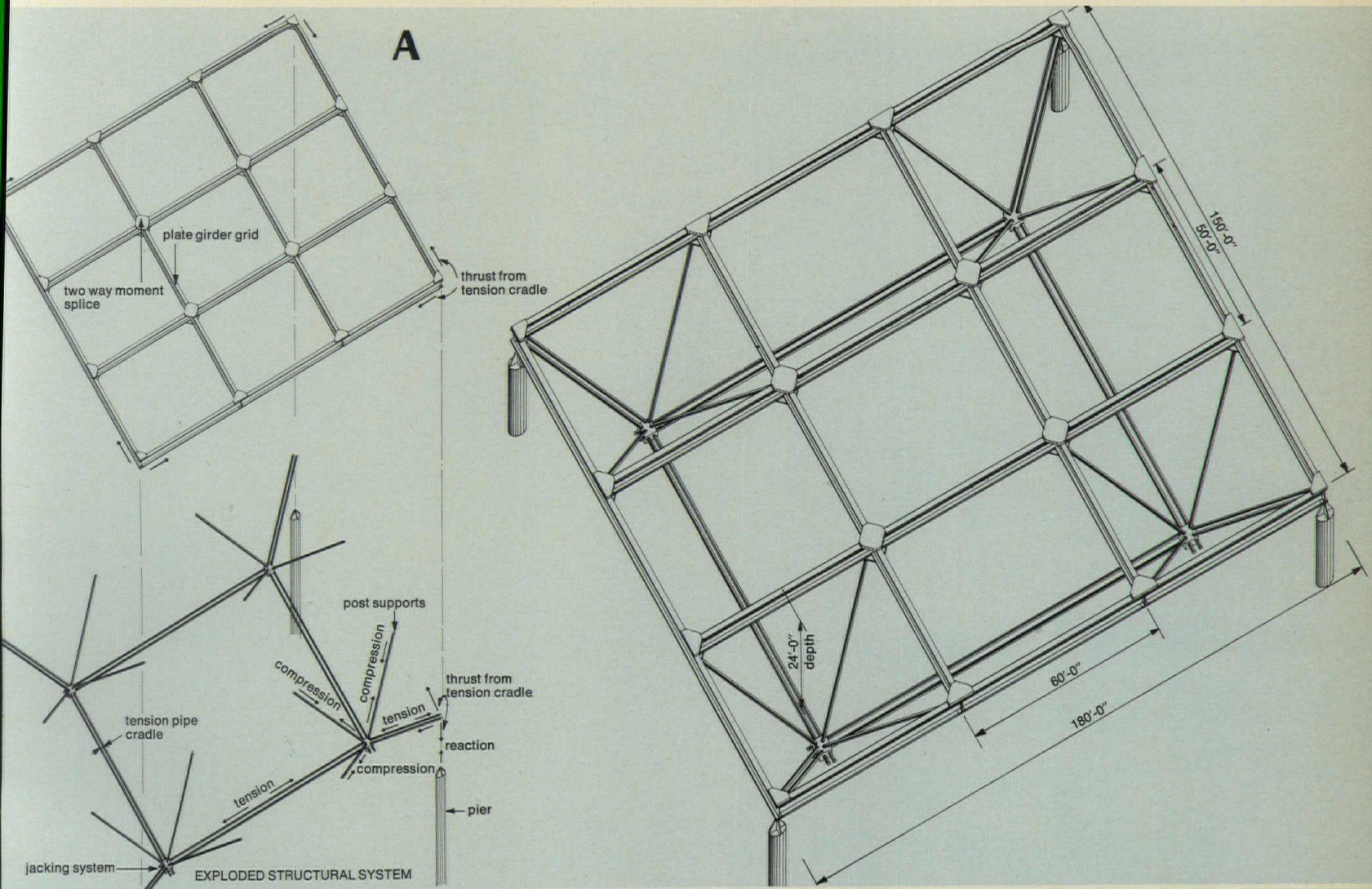

## Two-component precast structural system, one part a load-bearing wall panel, is assembled with cast-in-place connectors

Designed for the Washington State Highways Administration Building, this simple-seeming structural system essentially comprises only two precast components: a three-story, load-bearing wall panel and a 55-ft. span floor slab—more properly, a floor channel. Both of these elements are 10 ft wide.

However careful their fabrication, precast concrete elements inevitably display some variations of dimension, especially when large structural members are in-

involved. This property prohibits the precise tolerances assumed by too many designers of precast structural systems, whose assemblies often encounter unexpected complications. The system here, on the other hand, exploits the plasticity of concrete to form adaptable cast-in-place connectors, which automatically plug minor dimensional discrepancies.

The two precast components, assembled on a cast-in-place foundation, are joined by three connectors. A concrete column

core poured between the panels both holds the panels in place and furnishes additional vertical support. The floor channel tees are seated on corbels precast as an integral part of the wall panel. The system's only welded connection is at the beam-seat.

The floor channels are joined by a cast-in-place "filler" on top of the column core that extends about 6 ft in from the outside edge of the channel. A cast-in-place topping slab is tied into this filler, which is in turn tied into the col-

umn core. At the outside edge of the slab, reinforcing rods tie together the wall panel and the topping slab. Lateral stability is provided vertically by the wall panels and horizontally by the floor channels.

On one side of the building, the foundation walls are exposed inside a sunken court. Although the slope at the bases of these columns was basically an esthetic consideration, the added thickness thus provided does serve to reduce structural stress.

Tom Upper photographs

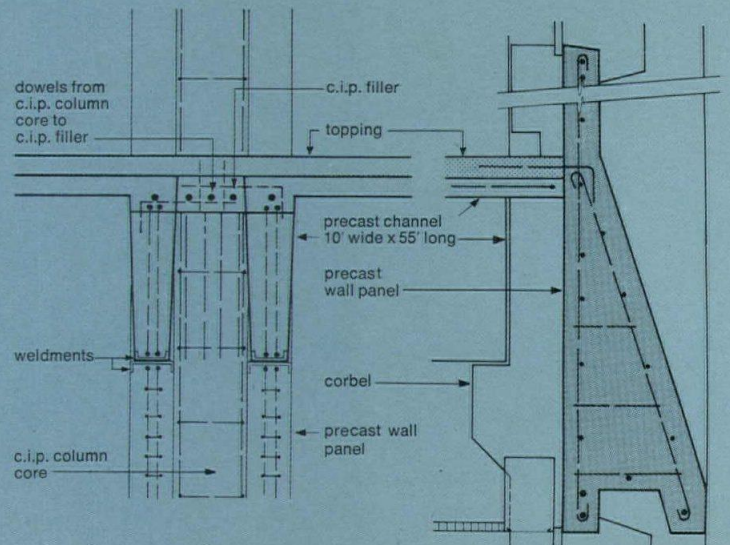
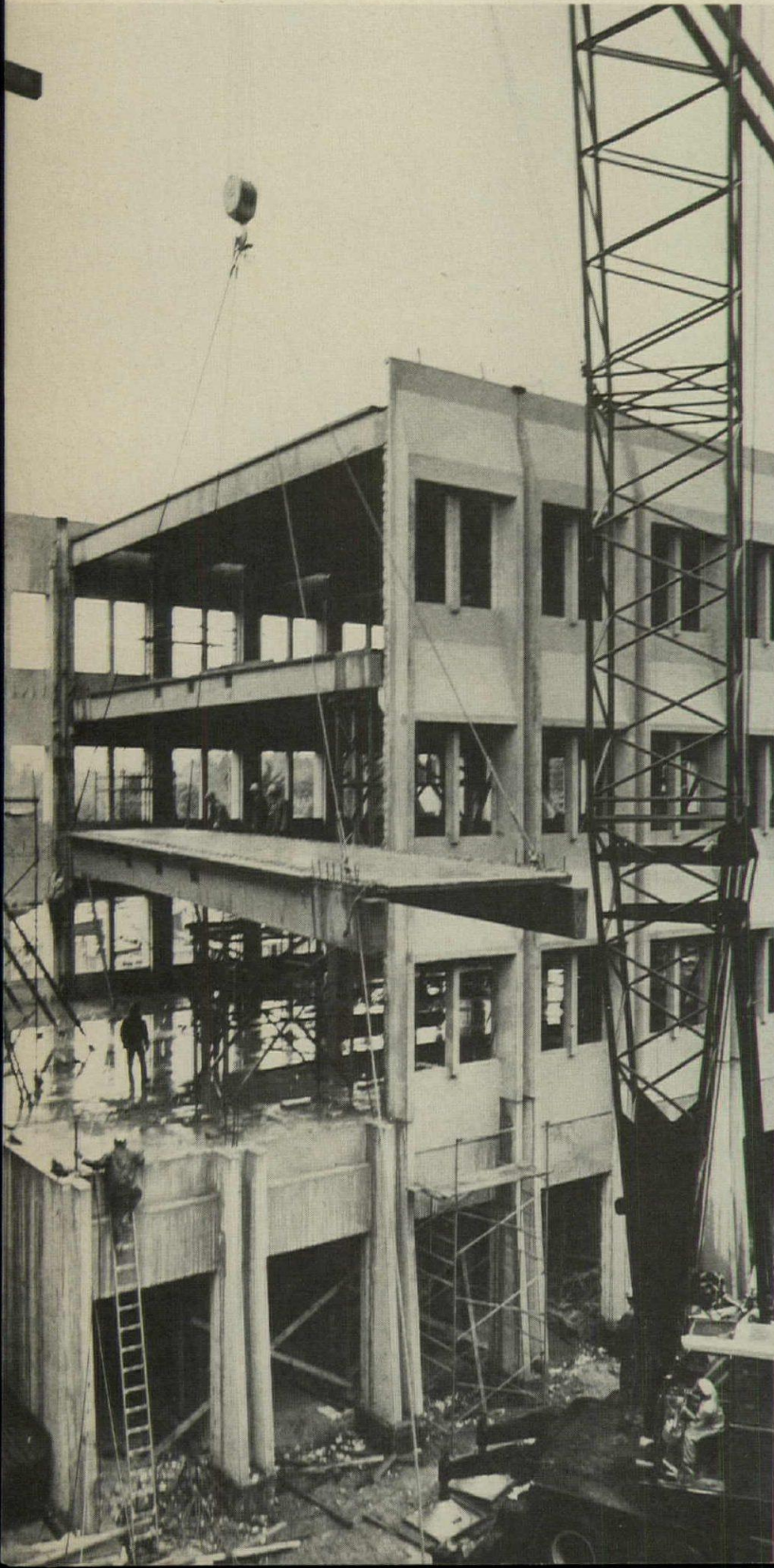

VERTICAL SECTION THRU FLOOR PANEL EDGES      VERTICAL SECTION AT SPANDREL

1 2 FT

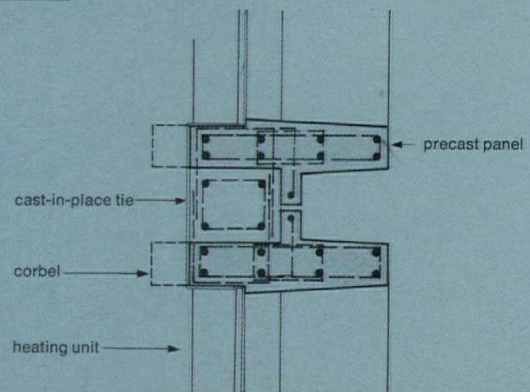

HORIZONTAL SECTION AT PANEL INTERSECTION

Architects and mechanical engineers: The Richardson Associates. Engineers: Victor O. Gray & Company (structural).

## Deep trusses split across the middle to achieve portable dimensions and the economies of shop fabrication

Though shop fabrication of steel trusses is both less expensive and more precise than field assembly, trusses for long spans require depths that preclude shipment. For the Birmingham-Jefferson Civic Center Coliseum in Alabama (at top), for instance, Weidlinger Associates determined that the most economical truss to span the 280-ft main space would be 28 ft deep. Taking a lesson from the Bailey bridges of World War II—portable panel trusses assembled to afford a great variety of

spans—the structural engineers conceived the idea of splitting the truss horizontally, reducing it to transportable size and minimizing field connections.

To facilitate transportation and assembly, a horizontal member is provided along the midline of the diamond truss. This member is without structural significance and will be removed at Birmingham. In Richmond, Virginia, however, at the Philip Morris plant (center and bottom), it will remain in place as ceiling support.

## A system of structural forming pans satisfied unusual esthetic needs as well as practicalities of cost and time

At the Denver Convention Center (RECORD, December 1970), the slab for the center's 60,000-sq-ft main floor served as a platform for assembly of the giant space-frame roof, so speed of erection was a must. Additionally, the architects wanted the basement ceiling to reflect the angular geometry of the space frame upstairs.

Engineers KKBNA responded by inventing the "Diadeck" system of triangular precast forming pans. Four of these right triangles compose each 30-ft bay, their angled

sides defining the contours of the haunched beams on the underside of the slab. Spaces between the pans act as forms for the beams. The reinforcing grid and post-tensioned orthogonal beams, along with the concrete pans, form a monolithic structure.

Because the Diadeck makes economical use of steel and concrete, and because it cut construction time by about six weeks, the patented system was competitive with conventional methods despite development costs.

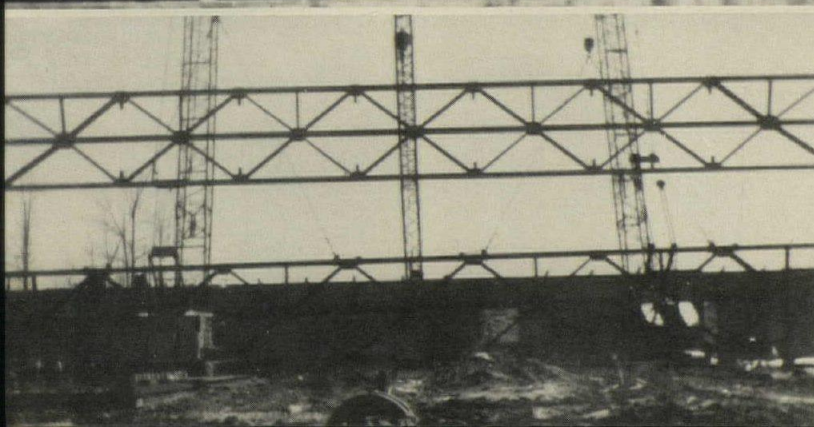
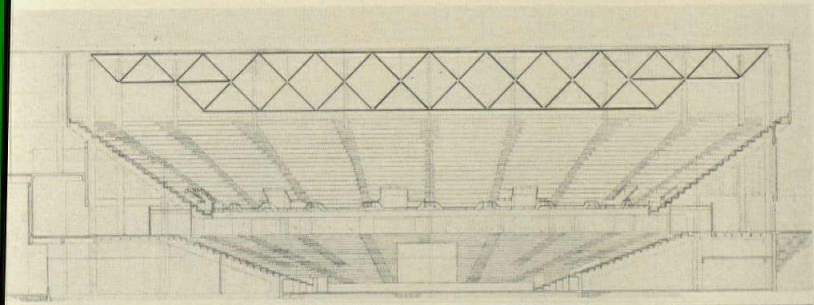

Architects: Geddes, Brecher, Qualls & Cunningham (Birmingham); Skidmore, Owings & Merrill (Richmond). Engineers: Weidlinger Associates (structural); Architects: Muchow, Ream and Larson (joint venture). Engineers: Ketchum, Konkel, Barrett, Nickel, Austin (structural).

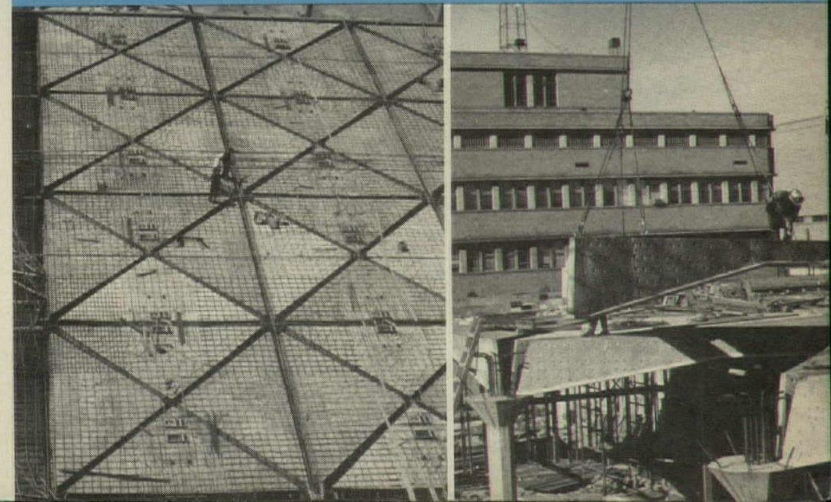
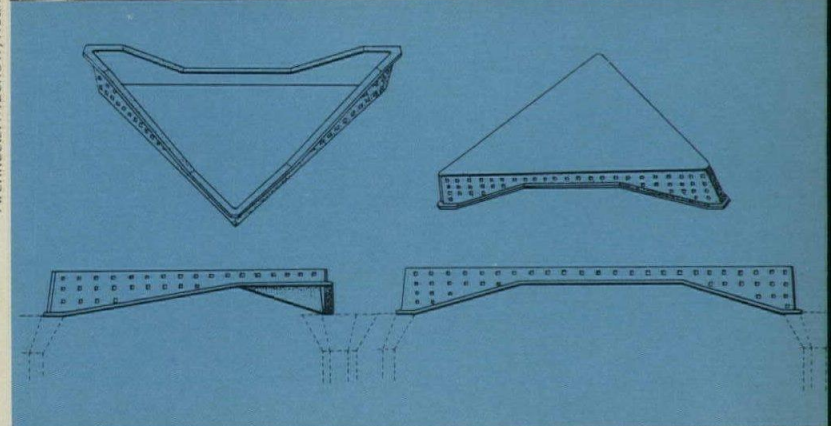

## A structural system precast on the site gives an engineer's new offices a touch of luxury at a bargain price

When engineers and architects build for themselves, they want adventurous, sophisticated design, but since they seldom have the capital resources of the great corporations, they want their adventure to be as cheap as possible.

Combining their own engineering experience with their architect's skill, KKBNA, Inc., managed to get a good deal of luxurious space for only \$16 a sq ft when they built their new offices in Denver. The center of the building is a 70-ft-high atrium, over-

hung by ledges and greenery and crossed by bridges at the second and third floors. Office space, accommodated in impressive 96-ft bays, overlooks either the outdoors or the skylighted atrium.

The engineer-owners attribute the building's low cost to the use of site precast concrete. Slabs were stacked near their final location to minimize crane set-ups.

Cables draped from cornice to base on all sides of the building will support climbing vines and add a final dash of glamour.

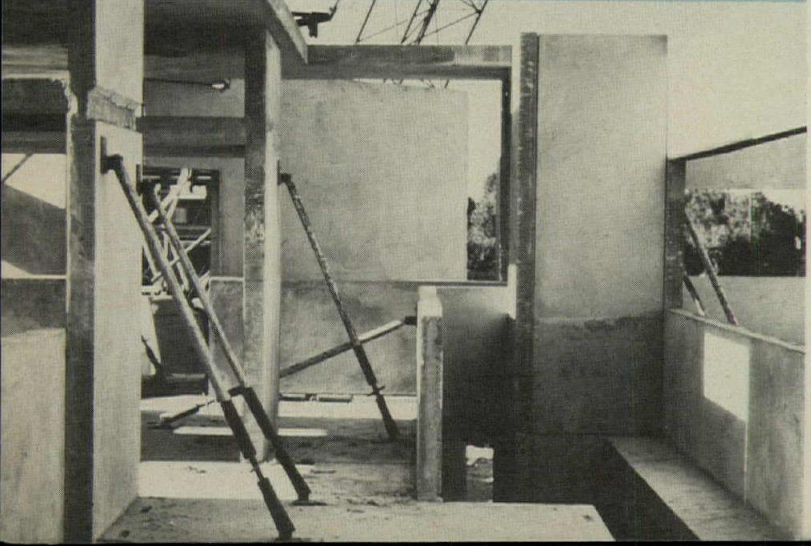
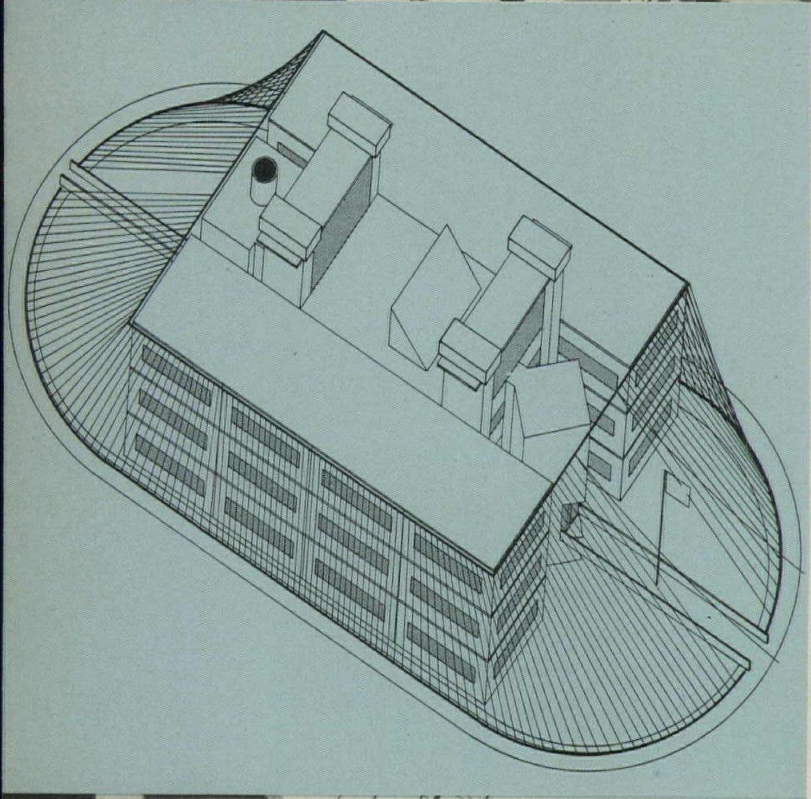
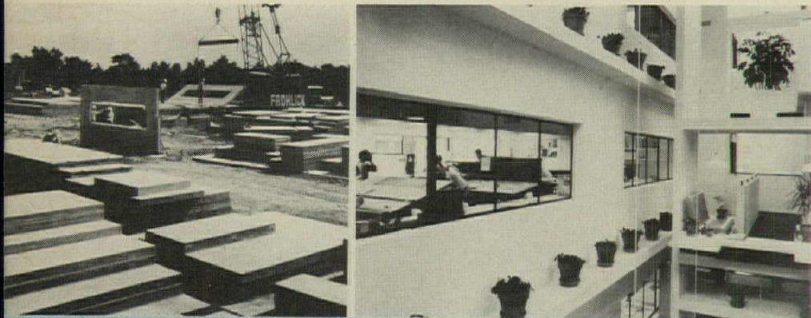

## Flying forms speed the construction of shear-wall apartment buildings—a floor every four days

Use of flying forms for in-situ concrete construction of repetitive-element buildings, such as apartment buildings, has been responsible for amazing speeds of completion. Experienced contractors have found this innovation to be of considerable promise, providing that the building design allows an uninterrupted recycling of the forms. One such case is Park Centre in downtown Cleveland, by Dalton Dalton Little Newport, that has twin 23-story apartment towers totaling 1000 units.

The towers were constructed at the rate of one block-long floor every four days, using self-braced steel forms for the walls, and truss-supported table forms for the floors. The structural system at Park Centre was based upon the use of shear walls and post-tensioned flat-slab floors.

The builder, who also was co-developer of the project, had constructed 4100 living units this way prior to the Park Centre project, and in the year of this project, 7200.

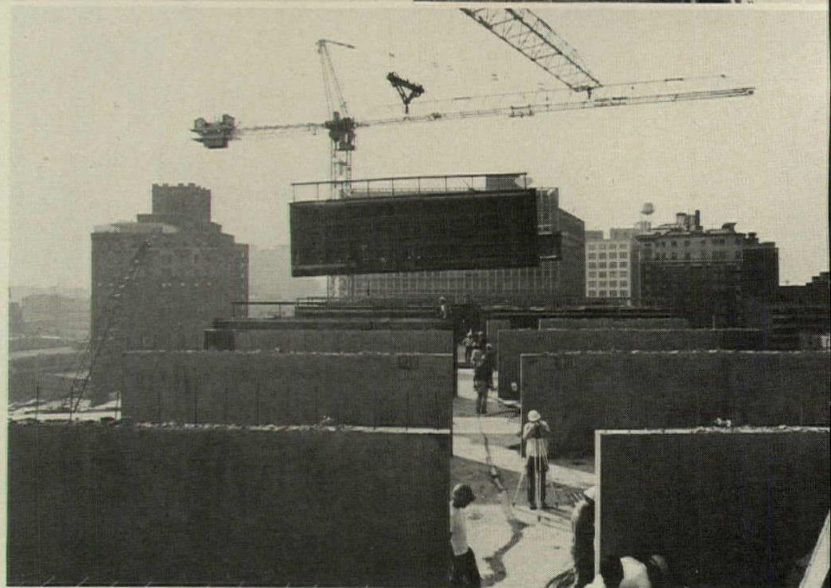
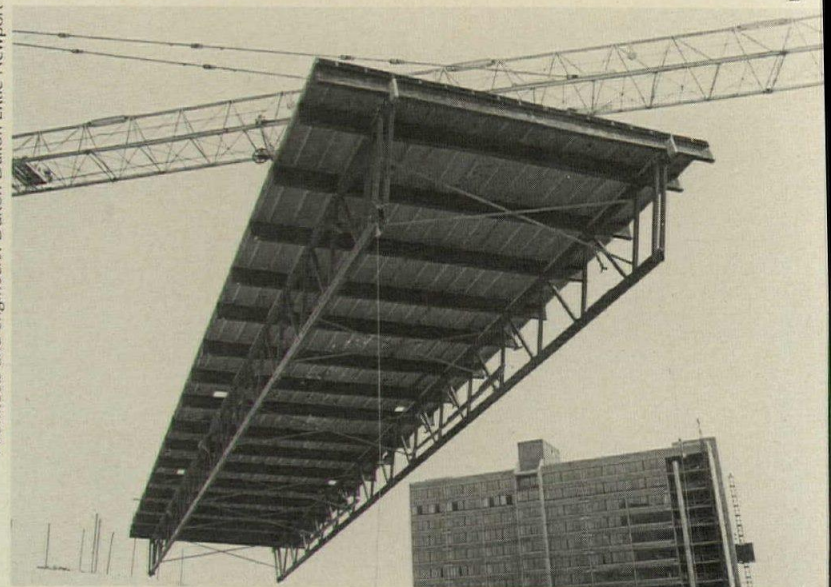

Architects: Muchow Associates. Engineers: Keitchum, Konkell, Barrett, Nickel, Auslin, Inc. (structural). Architects and engineers: Dalton Dalton Little Newport



## In a display of structural sleight-of-hand, a mighty 36-ft-deep transfer truss supports 30 floors above nothing

With some clients, architects have an opportunity to develop striking and unexpected designs, as Hugh Stubbins did for the Federal Reserve Bank of Boston. This project calls for two buildings—a 600-ft office tower with an open base, and a low “secure building” for banking operations.

Striking and unexpected designs usually pose striking and unexpected engineering problems. In this case, the first question was how to support 30 stories above a 143-ft void. To span the void, Le-

Messurier Associates designed an immense 36-ft-deep transfer truss, which at the fifth floor picks up the load from the columns and takes it out to flanking core walls. Below the void, lower floors hang from a lesser 12-ft truss.

To reduce bending moments at the columns, the outside 16 ft of each floor are cantilevered. This solution raised a fresh problem: the effect of eccentric live loads on cantilever ends and the resultant stress on mullionless glazing. The solution was to connect the

cantilever ends vertically with steel hangers to restrict excessive movement, raising still another problem: how to prevent the hangers' buckling under compression. The lower end is therefore bolted through a horizontal slot, allowing it to slide back and forth.

Two types of models were subjected to extensive wind-tunnel testing: an aeroelastic model, shown here once fully assembled and again with its interior wiring exposed, and a rigid model, shown in close-up and in the top-

ographic model, which was rotated on a turntable to simulate changes in wind direction and turbulence. The aeroelastic model was used chiefly to observe deflection and acceleration, the rigid model to measure forces on the skin and to determine velocities at the plaza level. Among other things, this last test revealed that the sunshades, which project about 5 ft at a 45-degree angle, break up the flow of air down the face of the building to assure pedestrian comfort on the ground.

Architects: Hugh Stubbins and Associates, Inc. Engineers: LeMessurier Associates/SCI (structural); Consultants: Boundary Layer Wind Tunnel Laboratories.

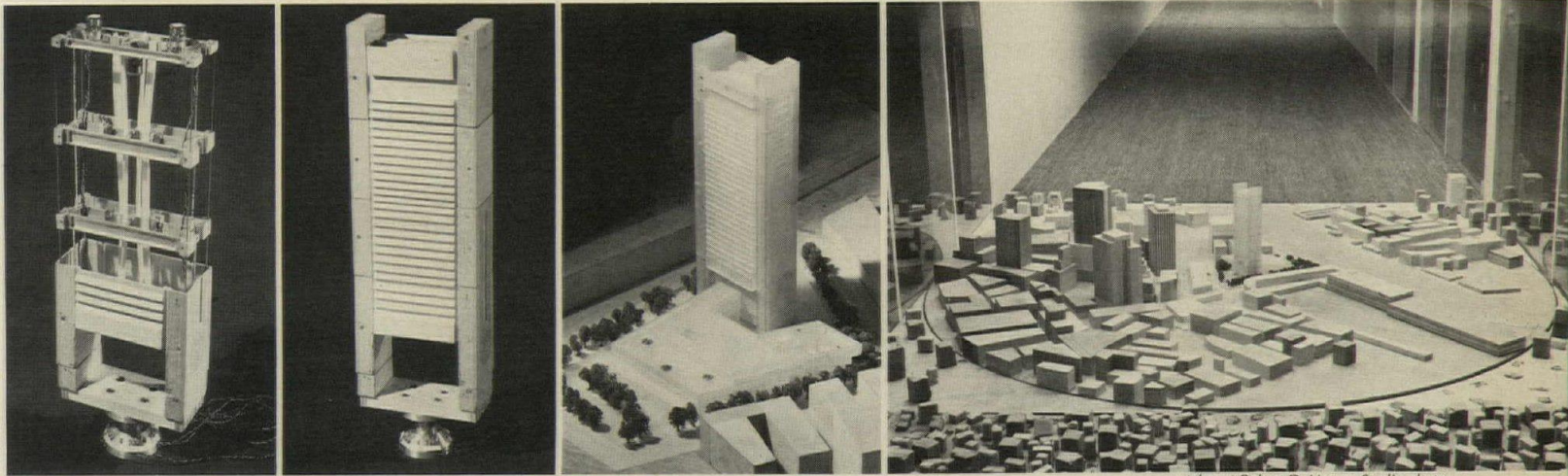

(below) Ron Nelson photos

(above) Robert D. Harvey Studio photos

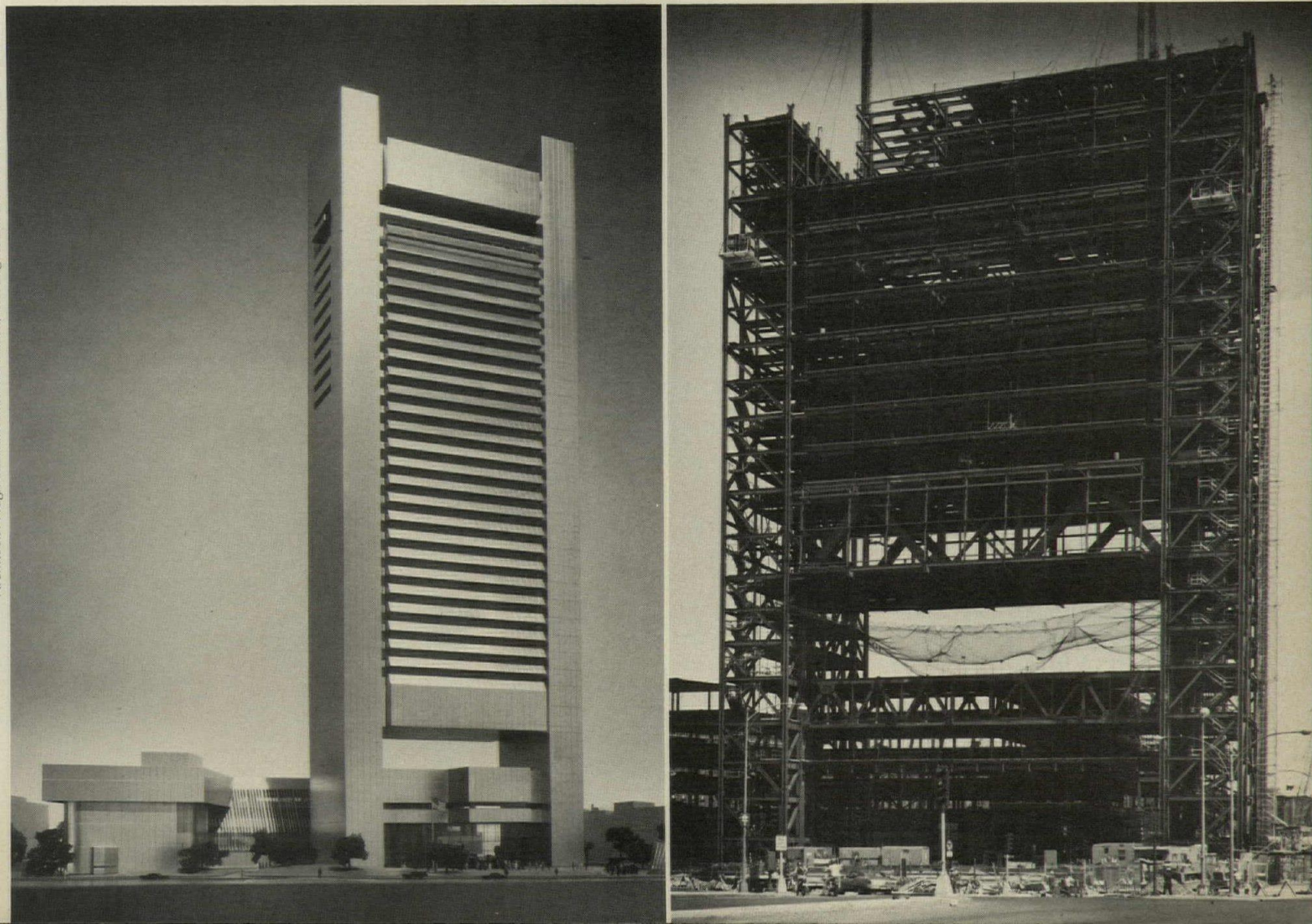

## Precast system for a vocational school, designed to satisfy a tight budget, permits unusual integration of services

The precast structural system designed for Toronto's George Brown College solved many of the project's budgetary and esthetic problems simultaneously. The budget was stringent—\$20 a sq ft for larger-than-average teaching spaces—but at the same time the building trades school had to have an appearance of quality.

The essential advantage of the precast system was economy: it was speedily constructed, allowed an orderly shipment of components onto an extremely

constricted site, and was available at reasonable cost from local industry. Only five precast elements were needed for the simple framing system—a five-story column with haunches at each floor level, an interior girder, a spandrel girder, a spandrel beam, and the floor slab.

"Irregular framing is death to economical precasting," argues structural engineer, M.S. Yolles. This consideration determined the unusual exterior form of the buildings, where the most commanding

feature is the massive metal housing for mechanical risers, placed on the outside to preserve the economical uniformity of the precast elements. This housing, hunched over the penthouses, is stepped back as it approaches the ground to express the diminishing volume of the air-supply ducts.

The double-tee floor slab admits an integrated mechanical system and provides sufficient space between floor and girder to run pipes and ducts. The building, laid out on a strict 36-ft grid with-

out corridors, provides unusual flexibility for the placement of the mechanical elements. Major air-supply ducts and piping are run along the girders; their branches, as well as lighting fixtures, are tucked between the tees. Because the precast concrete surface was pleasing and the mechanical services tidy, there was no need to install a suspended ceiling, eliminating still another expense, and incidentally offering students an elegant demonstration of the combined building arts.

Robert Perron photos

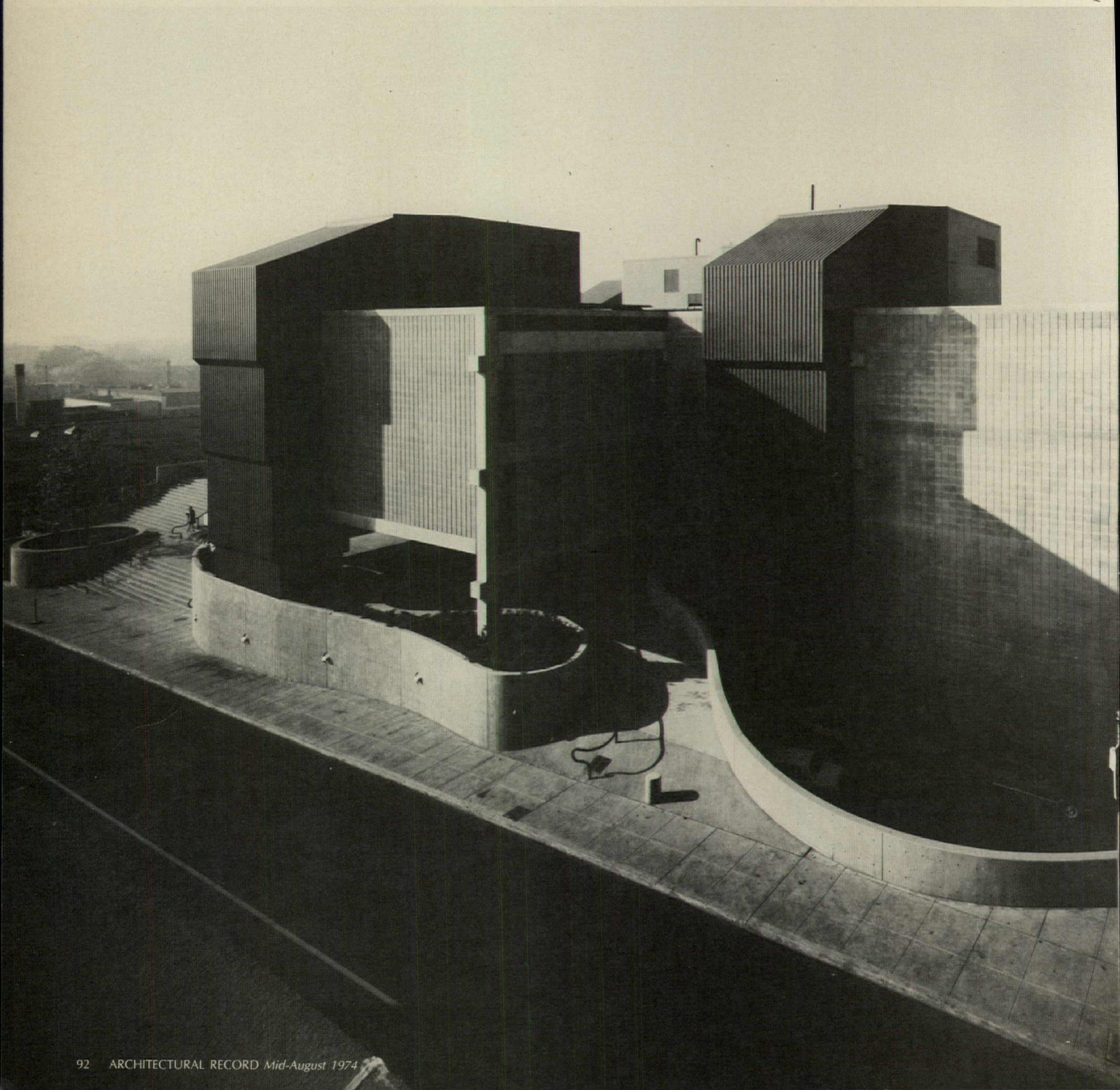

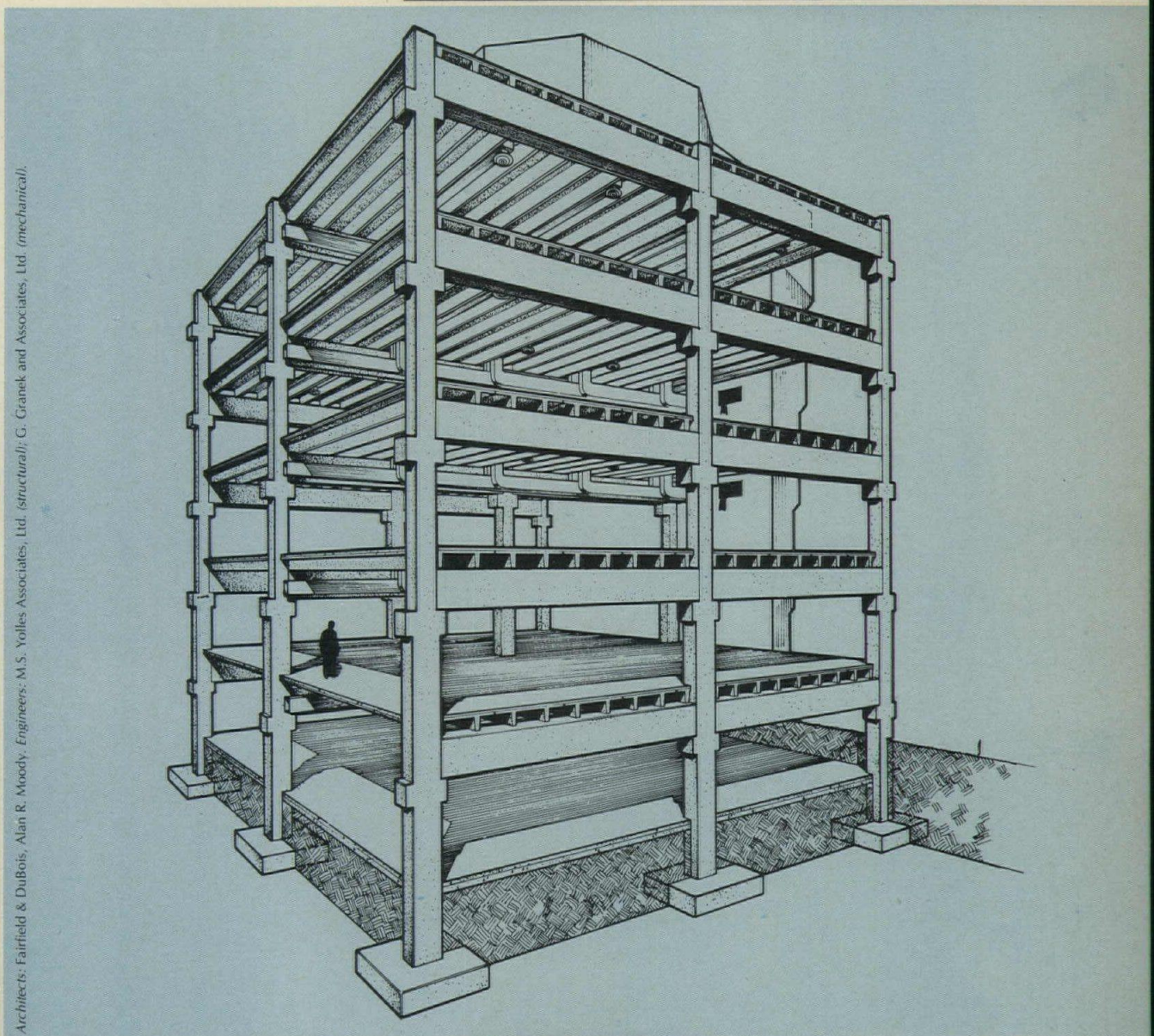
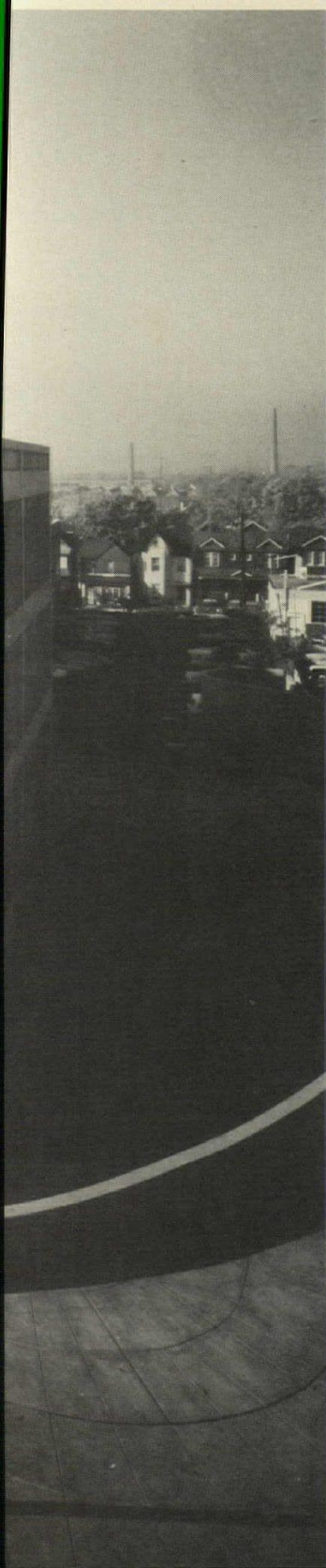
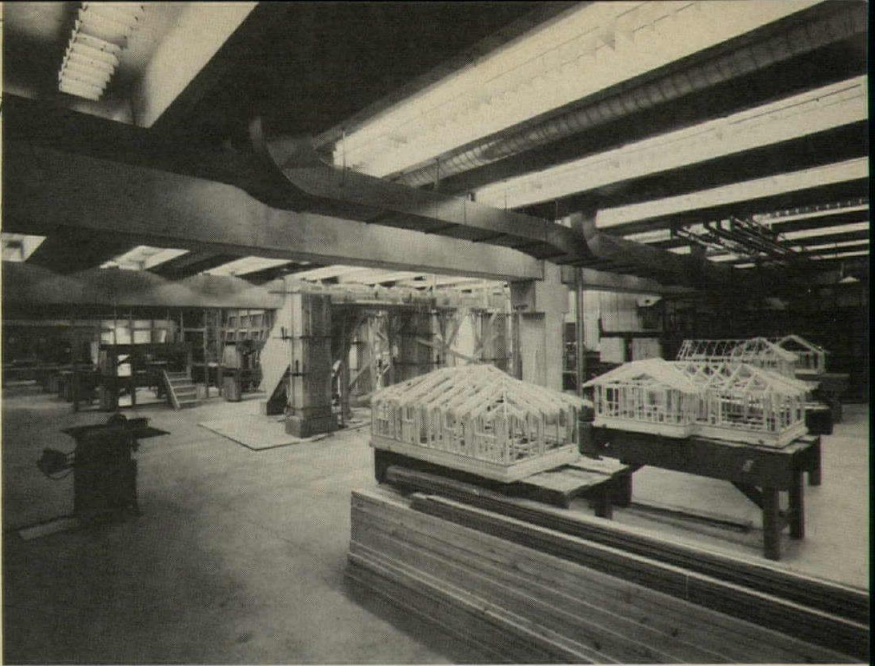
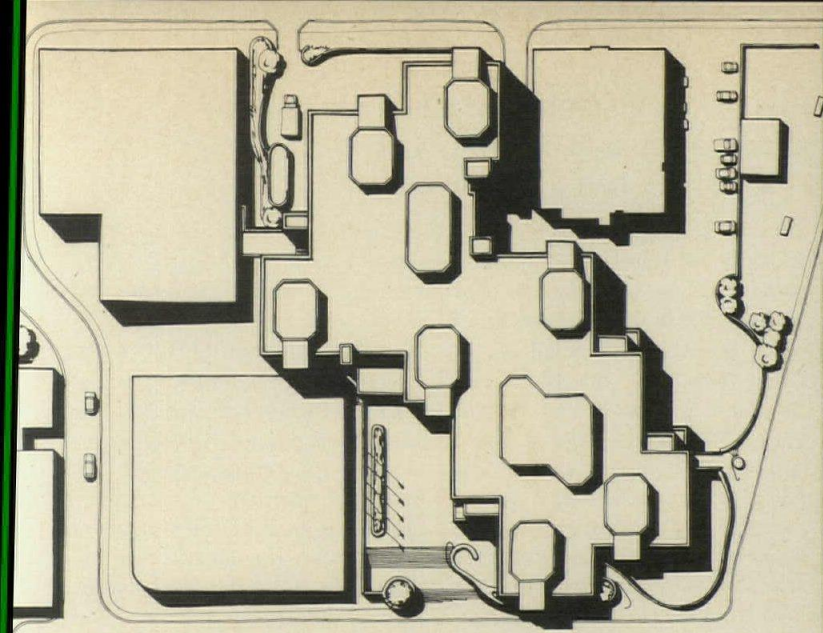

Architects: Fairfield & DuBois, Alan R. Moody, Engineers: M.S. Yolles Associates, Ltd. (structural); G. Granek and Associates, Ltd. (mechanical).

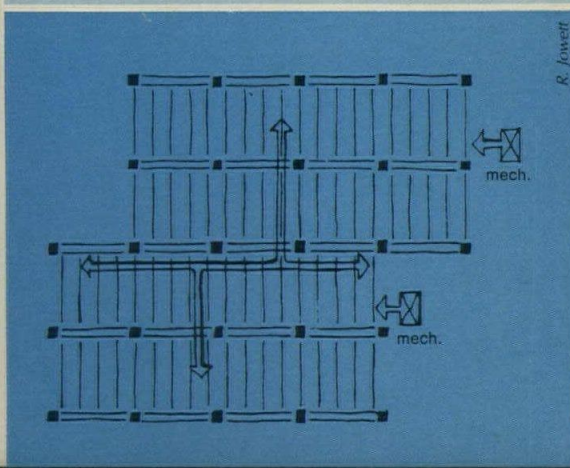

R. Jowett



## In an open-plan high school hollow columns house mechanical services to allow unimpeded flexibility

An unusual plan for an open classroom high school demanded unusual integration of structure and services to achieve a large, versatile, and unobstructed area at Juanita Senior High School in Kirkland, Washington. The key to this integration is a hollow structural column, a dozen of which constitute the only immovable elements within the central area's 63,690 sq ft.

Set on 55-ft centers, the columns support exposed laminated wood beams and a truss-joist roof,

and provide lateral resistance to wind and seismic loads. The T-shaped caps also support continuous skylights that cross the area. (The appearance of these columns, though not their exact form, is repeated elsewhere.)

The hollow columns serve as return-air plenums and as chases for conduits, water supply, and roof drains. The open sides of the U-shaped columns receive return-air grilles and, in some cases, drinking fountains and electric clocks.

Hugh N. Stratford (top); Ron Partridge (below)

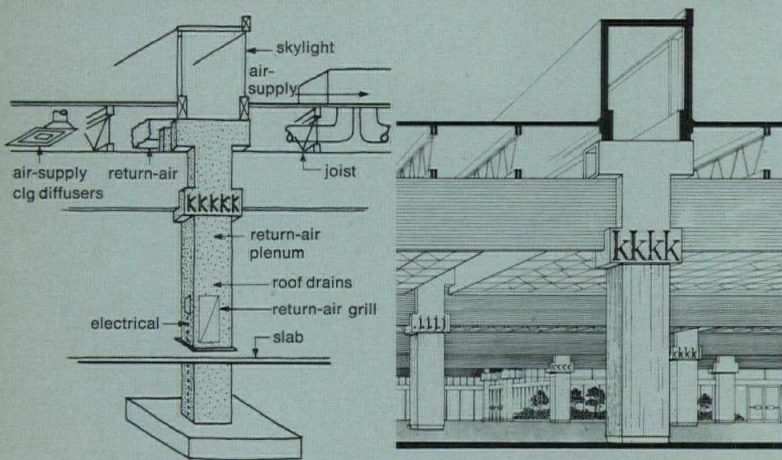
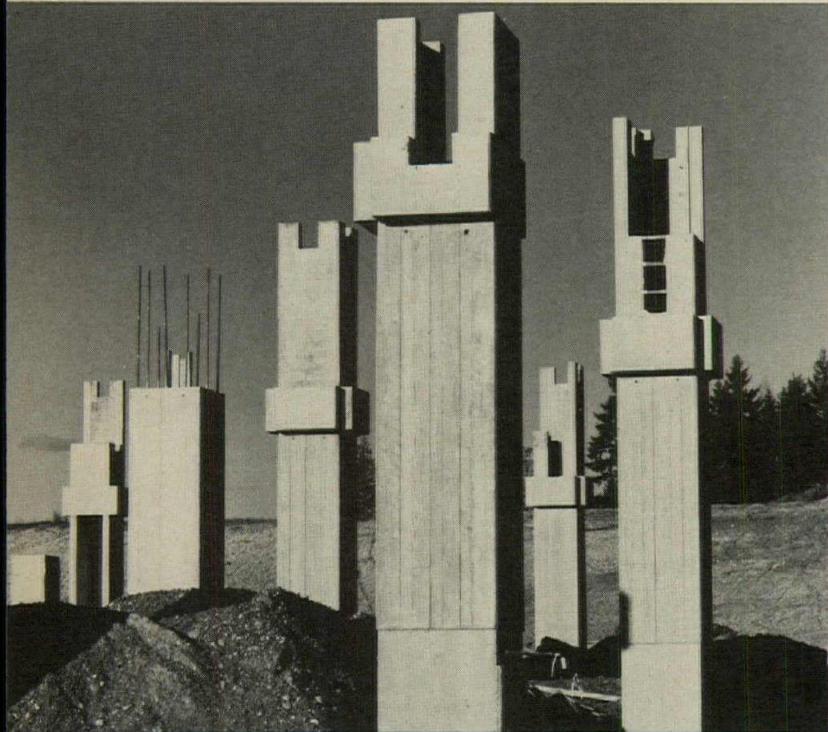

Architects: Kirk, Wallace, McKinley, A.I.A., and Assocs. Engineers: Skilling, Helle, Christiansen, Robertson (structural); Benjamin S. Notkin and Assocs. (mechanical); Sparling and Assocs. (electrical).

## Masonry engineering for a housing project produced an 8-in. bearing wall—and saved half a million dollars

Brick masonry, one would think, is about as standard a building method as any, offering little possibility of surprise or improvement. For the Lambert Houses in New York City, however, the structural engineers, Goldreich, Page & Thropp, devised an 8-in., single-wythe bearing wall that cut costs by about \$500,000.

Most of this saving resulted from a change in the masonry specification that increased the height of the brick by 2 3/8 in., thus reducing the number of courses

needed. This change, plus a channeled handle set into the brick, measurably increased the masons' productivity.

The unusually thin wall, which in some buildings goes as high as seven stories, underwent extensive laboratory testing to determine its bearing strength. The empirical standards for conventional load-bearing brick masonry would have demanded that the base of the seven-story wall be 16-in. thick—that is, exactly twice the thickness of the finished wall.



Robert Gray

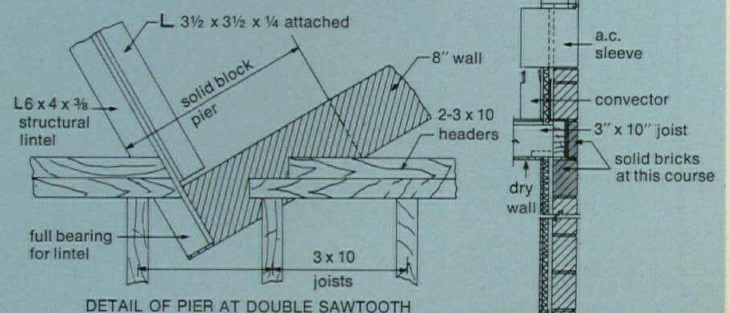
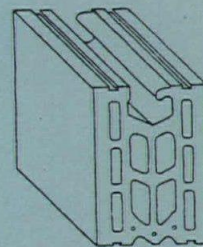

Architects: Davis, Brody & Associates. Engineers: Goldreich, Page & Thropp (structural). Merritt Brick Incorporated, suppliers.

# An integrated building system is achieved with usual materials and unusual forethought

The sought-for advantages of building "systems"—coherence, economy, elimination of waste effort and last-minute changes—are obtainable even without elaborate research and development. Using conventional materials and construction methods, the architects and engineers for Pittsburgh's Brahear High School, by the application of cooperative forethought, were able to evolve an integrated "system" for a typically complex modern high school.

In some of its academic

areas, the school needed maximal, if not total, flexibility. The steel structural system devised for this open, variable classroom space, located in four-story wings at each end of the building, took its basic planning module from 5-ft movable partitions. The system employs members of four different lengths to allow considerable variation in dimension; large spaces may have 40-, 50-, or 55-ft spans, while lesser spans are available for corridors and ancillary spaces like mechanical rooms.

The plan of the classroom wings reflects the pattern of mechanical distribution, which duplicates the pattern of horizontal circulation. From centrally-located mechanical rooms, main ducts follow the corridors, the shallow framing of which supports the ductwork; the ducts then branch into classroom ceilings through open-web joists.

The different space needs of the school's three physical education facilities would seem to preclude a consistent structural sys-

tem—the swimming pool was to have a clear span of 60 ft, the girls' gym 75 ft, and boys' gym 105 ft. These conflicting requirements were reduced to a system, however, by the use of a 60-ft precast Vierendeel truss as the basic module, and by providing ingenious add-on elements to extend the span as needed. The extensions are held in place by tendons run through the bottom chord, threaded through conduits in the extensions, and then taken down the columns for post-tensioning.

Architects: Curry Martin Highberger and Klaus, Engineers: R.M. Gensert Associates (structural); R. Bruce Miller and Associates (mechanical); Hornieck Engineering (electrical).

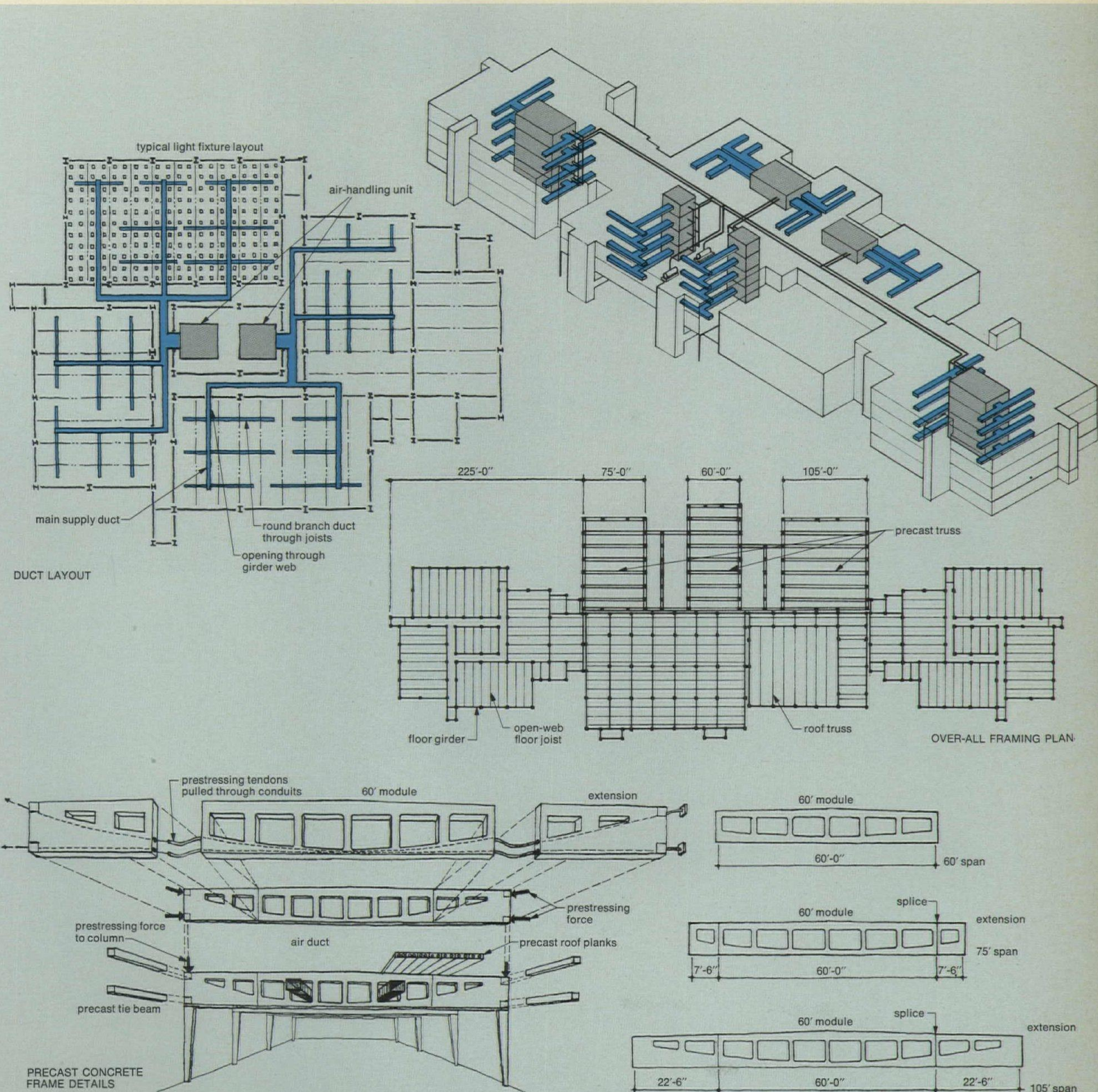

## Noisy trains and noisy typewriters pose different acoustical problems—so get different acoustical treatment

Confronting three different noise problems—different even though two of them involved trains—consultants Bolt, Beranek and Newman made use of three different acoustical defenses: absorption, isolation, and masking.

**A** In the Washington Metro, now under construction in the District of Columbia, the essential problem was to deal with the unholy racket of trains heard at close quarters underground—the Washington Metropolitan Area Transit Authority wanted “the quietest

system in the world.” Another acoustical irritant suffered in subways is the unintelligibility of public address announcements, caused by excessive reverberation time.

Primary acoustical treatment is provided by panels unobtrusively installed at the top of each coffer in the vaulted ceiling. These panels are constructed of perforated aluminum pans that contain 2-in. sound-absorbing fiber-glass batts; plastic bags enclose the batts as protection against dirt

and moisture. Similar panels will be installed beneath the platforms. Analysis of the installation showed a 10-decibel reduction of station noise and a reduction from 5 to 2 seconds in reverberation time, adequate to render public address speech intelligible.

**B** To utilize air space above Canadian Pacific’s freight yards in Vancouver, British Columbia, Project 200 will raise a plaza, a parking garage, and a 32-story office tower above a complex of busy railroad tracks. In addition to

airborne noise, this arrangement also raises the problem of rumbly conducted by the structure itself. To prevent this conduction, the structural framing is discontinuous, the tower columns sunk in neoprene-lined pockets; these isolation joints are introduced just above track level. Since the superstructure is not tied to the foundation, the pockets, indented 1 ft in the concrete slab, counteract horizontal and uplift forces.

The lining consists of a checkerboard of neoprene pads

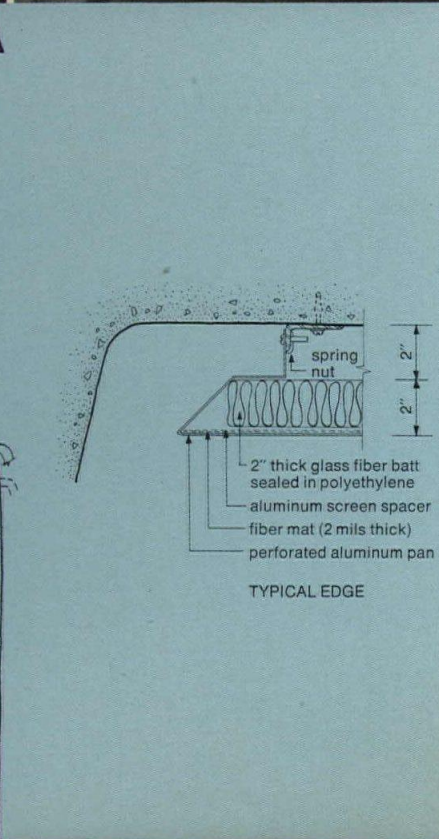
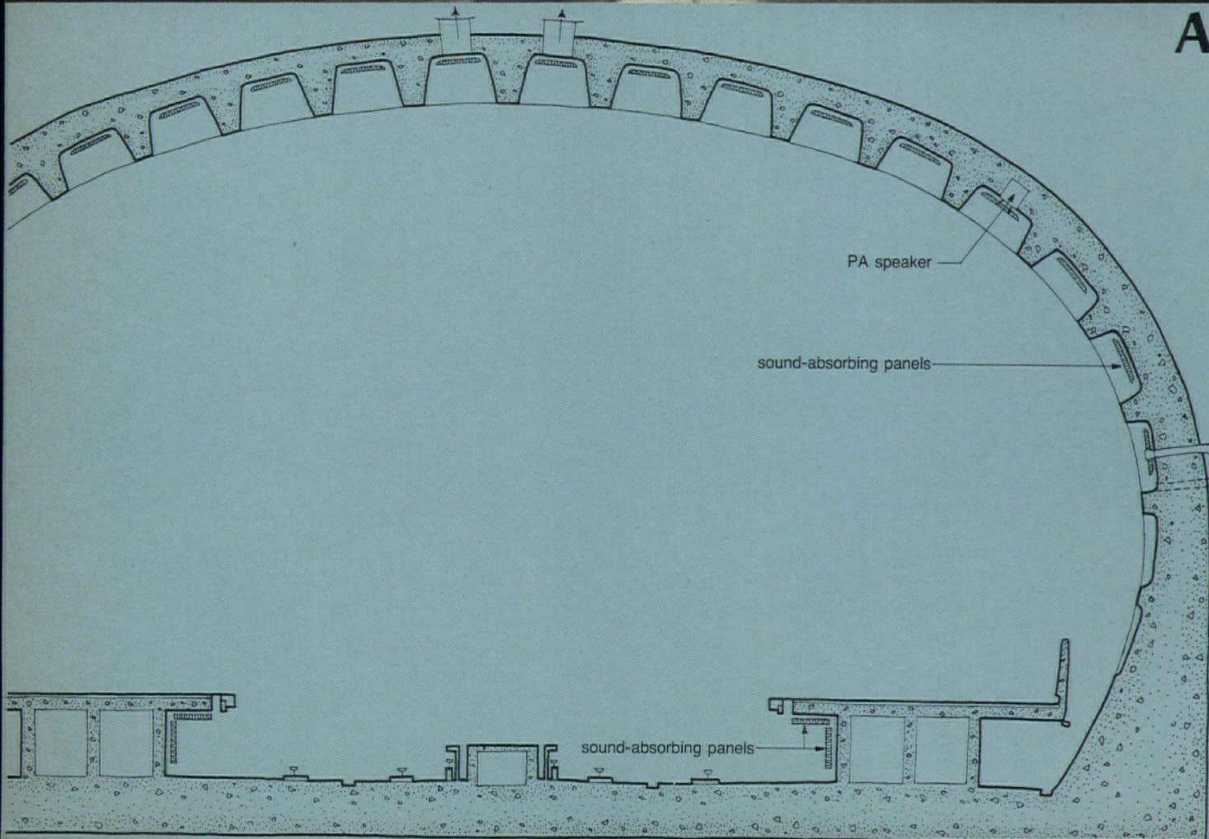
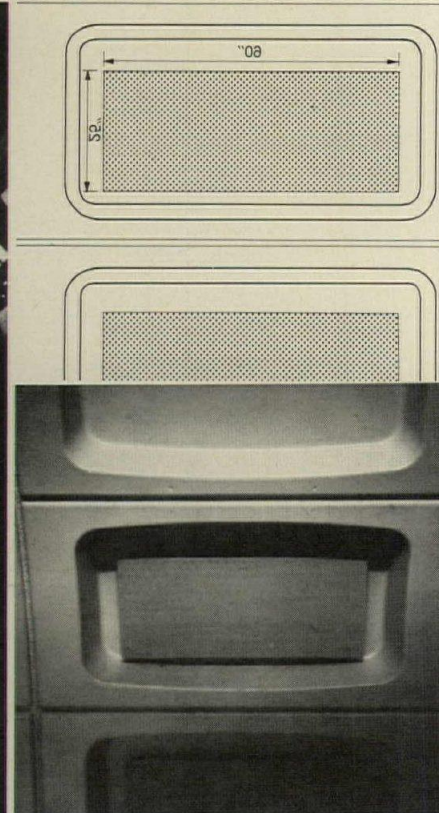
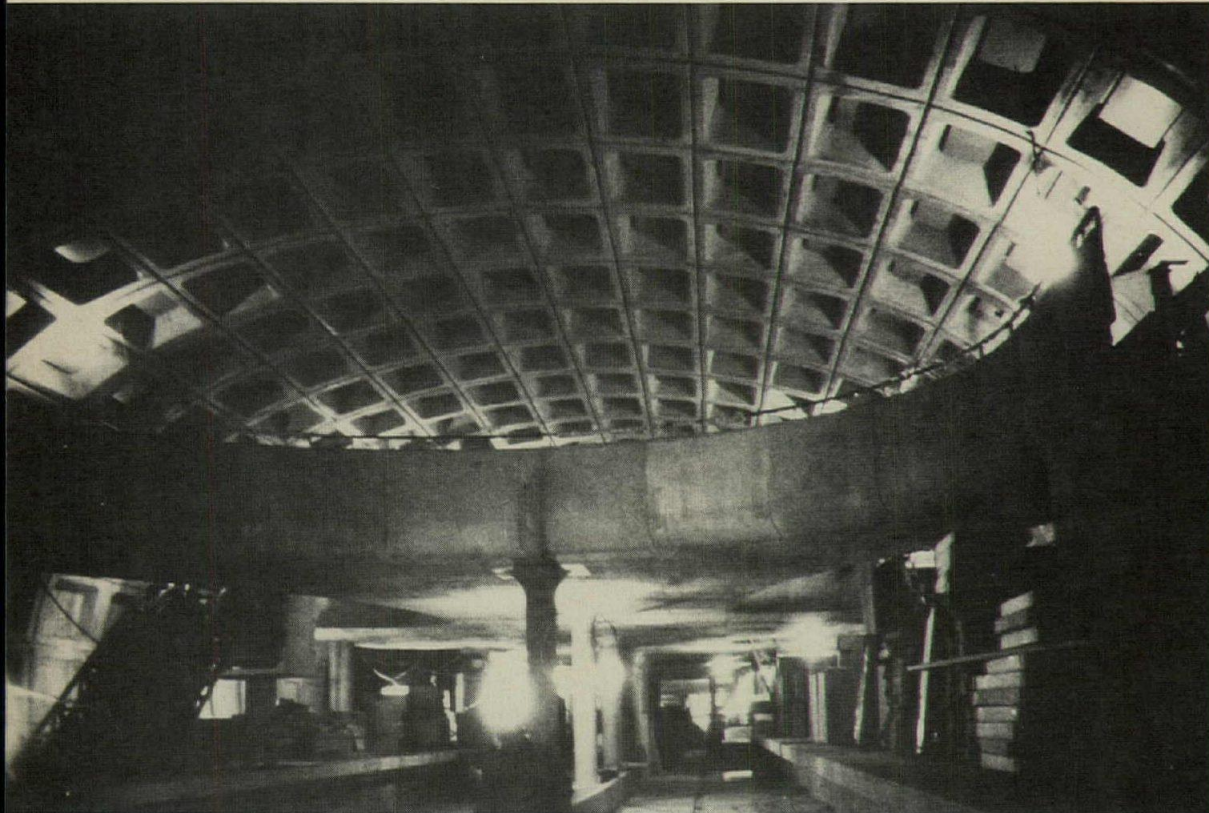

laid at the base and along the sides of the pockets: these pads are separated by synthetic foam strips whose elasticity forces the neoprene back into its original shape when compression is relieved. (The side pads work structurally as well as acoustically, accommodating wind and seismic loads.) After neoprene is installed, the pocket is lined with a ¼-in. steel pan and edges are caulked.

Because of the complexity of both structural and acoustical requirements, dimensions and ma-

terials were submitted to extensive analysis, and each of the bearings is in effect custom-designed.

**C** The problem in most offices is not one of sheer volume of noise but rather of distracting sounds and unavoidably overheard conversation. This problem is fairly routinely solved in open-plan offices by sound-absorbent surfaces and often by the transmission of over-all innocuous sound to mask office noises.

In the open-plan offices of Ginn & Company, a Lexington,

Massachusetts, publishing house, the situation was complicated by an architectural decision to eliminate a hung ceiling. The customary acoustical tile ceiling was replaced by sound-absorbing baffles. In an ordinary office acoustical system, masking sound is adequately distributed by speakers within the ceiling plenum. Here, however, the speakers, hung above the baffles, had to be specially designed to distribute sound evenly. In addition, speakers for the two-channel electronic

noise generator alternate in a calculatedly irregular pattern to offset disagreeable auditory overlap.

Sawtooth fenestration along the building's two long walls serves the ends of both illumination and acoustics. Windows are set perpendicular to the exterior line of the building, and the walls, surfaced with cement-fiber plank, slope back at about 30 deg. Sound reflected off the angled glass is thus absorbed by the soft walls rather than bounced back into the office area.

Interfilm Canada Ltd. photos

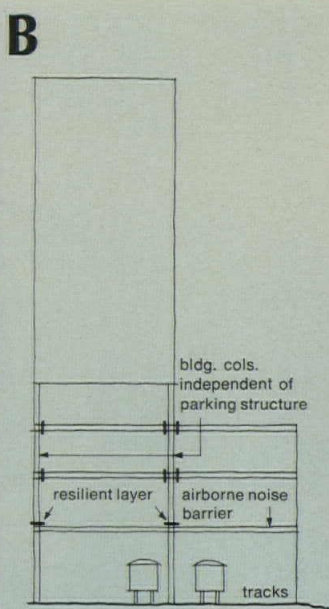

Architect: Francis Donaldson. Engineers: Read Jones Christofferson, Ltd. (structural); Bolt, Beranek and Newman (acoustics and vibration).

Architects: Anderson Beckwith & Haible. Engineers: Bolt, Beranek and Newman (acoustical).

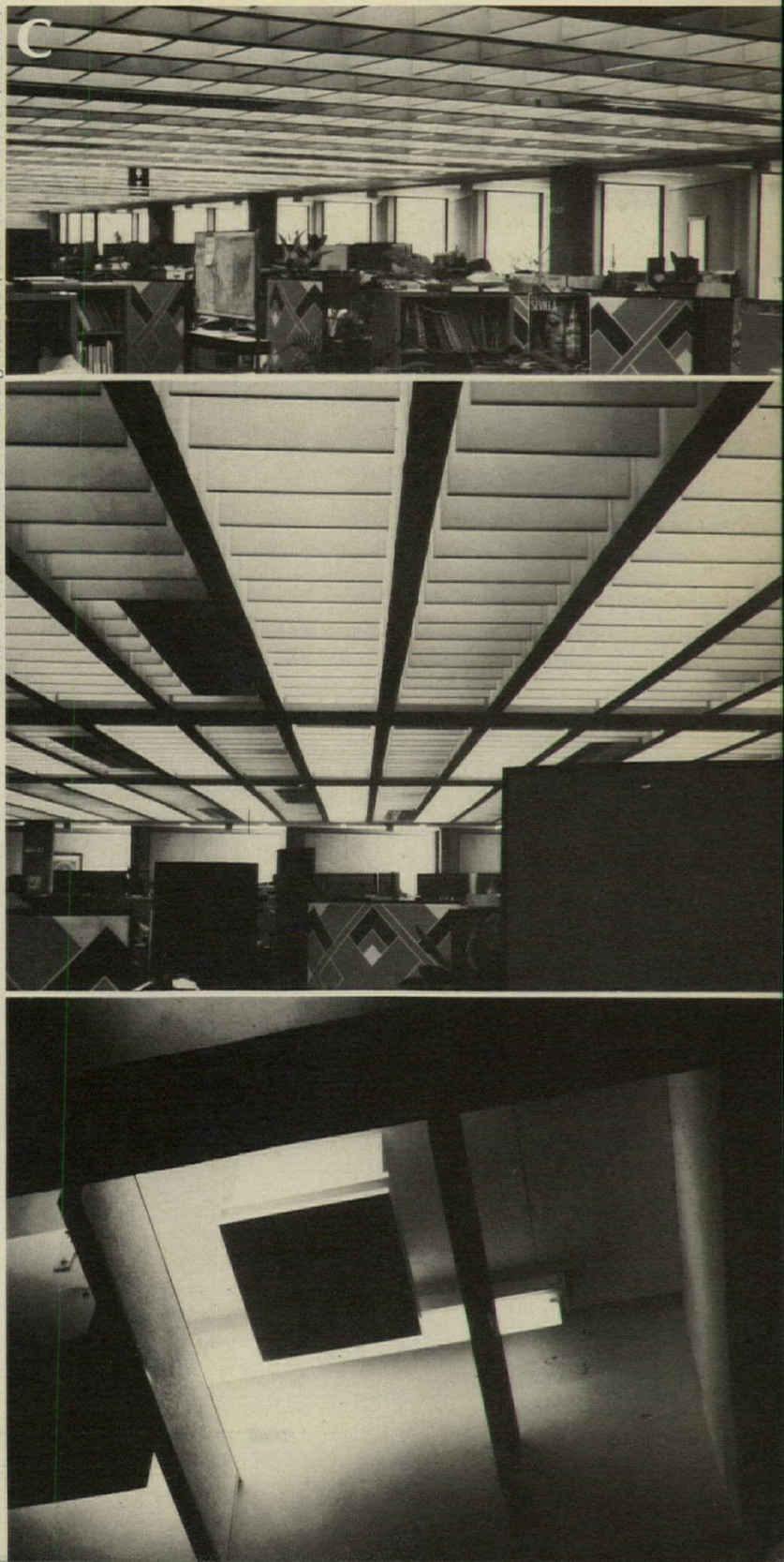

## An ability to see beyond the conventional generates a new use for wall washers: general illumination for working space

In their project for unpartitioned library space at New York State University's Agricultural & Technical College in Morrisville, architects Morris Ketchum, Jr. & Associates resisted the use of a flat ceiling with flush lighting fixtures in order to avoid the nervous pattern this arrangement so often produces. They provided instead a stronger rhythm established by large columns supporting deep oblong coffers. They then asked electrical engineer Henry Wald and his lighting associate James

Kaloudis to devise a structurally integrated system that would provide soft but adequate general illumination and that would also define architectural spaces.

About the only place to position lighting fixtures without mutilating the ceiling's appearance was around the upper edges of the coffers. Conventional strip lighting, however, would not only waste a good deal of the available illumination against the sides of the coffers, which would obstruct its distribution into adjacent areas;

it would fail the essential task of providing sufficient light for readers and librarians working in the center of the areas beneath each coffer. Paradoxically, what was needed to obtain evenly spread over-all light was a strongly directional beam to bring light to the center from all four sides of the coffer.

The strip fixtures that provide this beam are standard wall-washer lenses ingeniously tilted 20 deg. Rather than directing the beam away from the wall at about

15 deg, as it does when normally installed, the angled lens projects its main beam at about 35 deg, sufficient to place light where it is needed. As a lighting bonus, 35 deg is also a favorable angle with respect to reflected glare.

Despite the lens's relatively restricted area of distribution—its spread is only 20-25 deg—a small amount of backlight remains to wash the sides of the coffer. Besides emphasizing the ceiling form, this wash also contributes importantly to visual comfort in

Alexandre Georges (photo bottom)

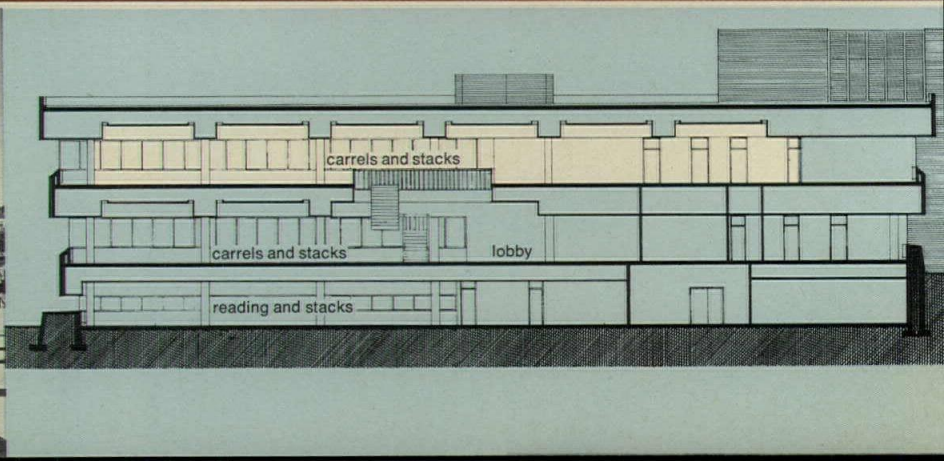
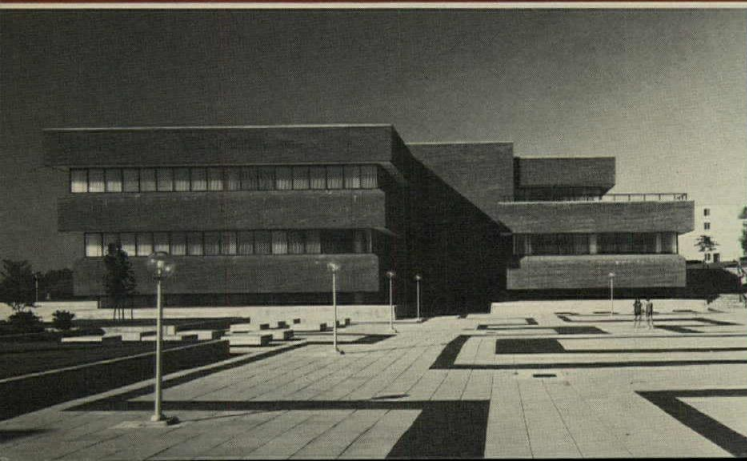
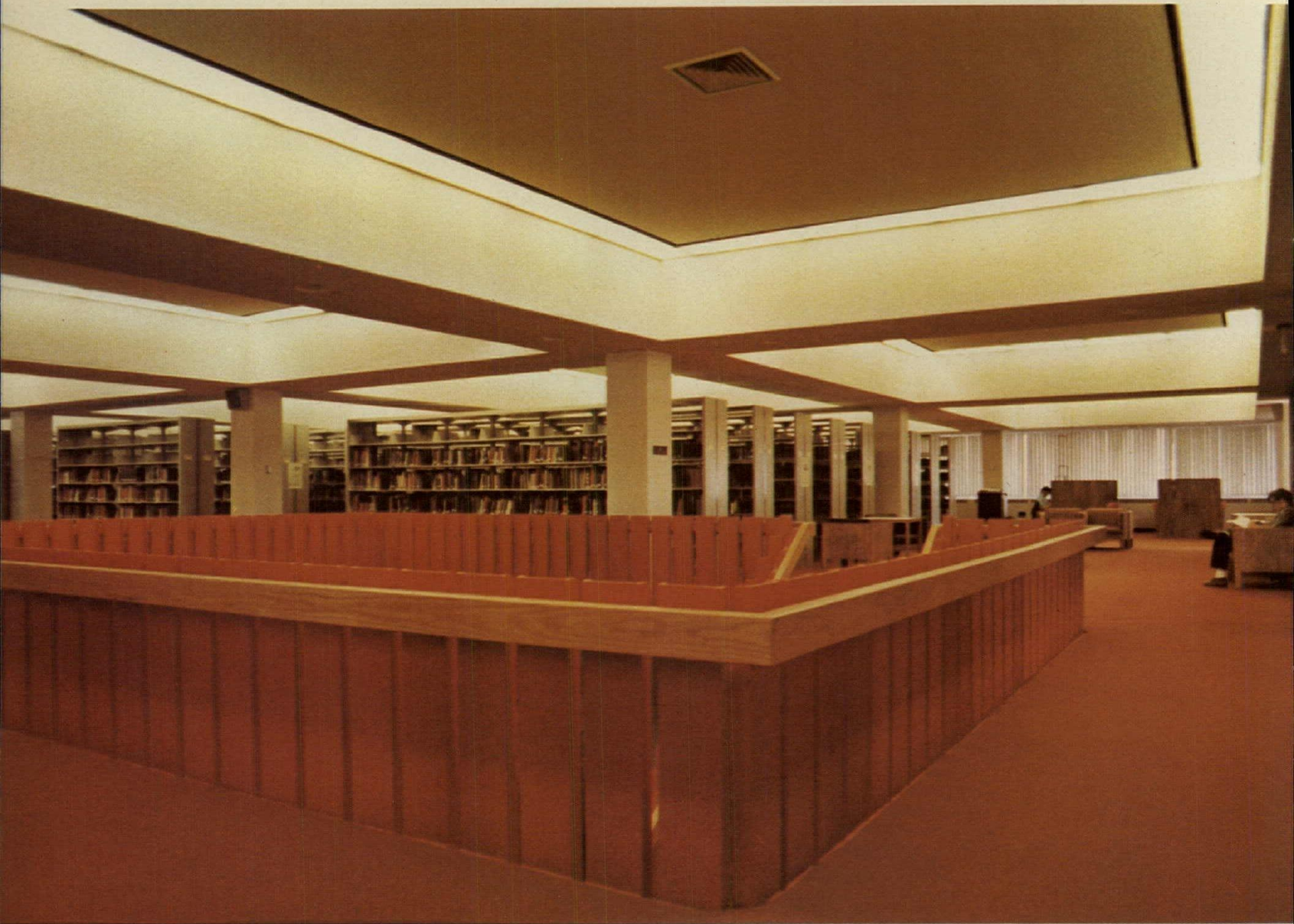



the space. One of the designers' early concerns was that the lens, which was obviously never intended to be looked at directly, would be unacceptably brilliant when tilted and highly visible. The engineers ran subjective tests, viewing the angled lens alone and beside a light-colored vertical surface—in place, the lighted sides of the coffers—is to offer the eye an expanse of brightness that diminishes awareness of the still brighter strip of the lens.

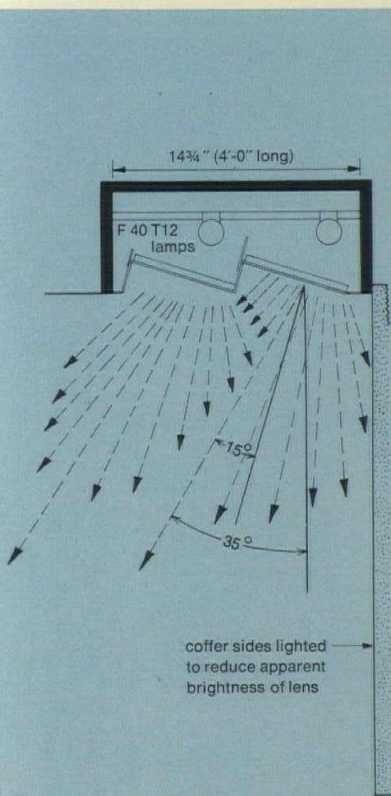

Architects: Morris Ketchum, Jr. & Associates, Engineers: Wald & Zigas (mechanical/electrical); Ames & Selnick (structural).

## In the rapidly changing field of electrical power distribution, electrical engineers have to keep on their toes to make systems safe, economical, flexible

By Joseph F. McPartland, editor  
*Electrical Construction and Maintenance*

Distribution of electrical power in commercial and institutional buildings involves a sophisticated and sometimes complex combination of electrical technology, commercial and economic considerations, and diligent attention to safety for persons and property. In system design, the electrical engineer must observe the general principles that will help ensure the system meets the owner's utilization needs. And, equally, he must observe technical details of layout, design and installation to meet modern codes and standards to provide safe, effective operation of all segments of the overall electrical system. But electrical systems cannot be designed by code alone, because the designer must consider factors not fully covered by code such as voltage drop, power factor, detailed analysis of watts-per-square-foot loads, demand factors, and provision of substantial spare capacity.

Important aspects of modern electrical design that concern the engineer are:

**Codes and standards**—More than ever before, codes are being vigorously enforced with substantial penalties for violations. And, of course, OSHA mandates that all new electrical systems in places of employment, or any alterations, additions, modifications or extensions to existing electrical systems, comply with the National Electrical Code.

A corollary to the intensified enforcement and expansion of electrical codes in the interest of safety to personnel and property is an almost universal insistence by inspection authorities that "certified" equipment be used.

**Reliability**—Because of the vital role electricity plays in modern buildings, reliability and continuity of electrical circuits is a major concern. Thus, a separate source of emergency supply for critical loads is fast becoming a must.

**Energy conservation**—With rising electric utility rates, and general concern for optimizing energy usage, efficiency of electrical systems has to be considered much more carefully by the electrical designer. Not only must he try to incorporate higher efficiency equipment and components (such as high-efficiency lighting ballasts) into his designs, but he may need to provide means for load-shedding during high demand periods. In larger buildings, load-shedding is often integrated into the centralized building control system. Power-factor correction can be significant, but it requires careful design considerations, including those applying to the whole protection system.

Premium prices for efficient equipment are often readily justified by substantial energy savings.

**Maintenance**—Selection of equipment and materials must always be made considering maintenance for the operating life of the equipment. Depending upon the type and size of a building, availability of maintenance personnel, and the type of business or activity, premium for low-maintenance products or techniques may or may not be justified.

**Load growth**—Every electrical distribution sys-

tem must include some spare capacity for load growth, including conductors, substations, transformers, and protective devices. And invariably, unanticipated loads will show up.

### Electrical technology changes rapidly, and designers must consider their implications

Because electrical design is dynamic, the electrical designer must learn the new techniques and follow the promising trends. But electrical design also involves clear understanding of old, accepted techniques and the reasons why those techniques have survived. Some important specifics of today's systems are:

**Equipment standardization**—Maximum standardization of equipment type and ratings can effect significant savings because standard equipment costs less than special equipment, and replacement parts are easy to get.

**Overcurrent protection**—Because of the continual increase in building electrical loads, larger and larger service entrances are being fed from utility supply systems that have greatly increased levels of available short-circuit currents. The potential destructiveness (fire, "explosions") must be held in check by overcurrent protection.

**Ground-fault protection**—Faults are aberrant conditions in which current can take wrong paths and create hazardous conditions such as fire or potentially fatal shock; a fault between a conductor and "ground" is commonly called a short circuit. Arcing ground faults occur more frequently nowadays because of the use of higher-voltage distribution in buildings. Particularly at 480/277-v three-phase distribution, an arc can develop between one phase and ground, possibly drawing insufficient current to trip a current-protective device, but creating a sufficient arc to start a fire.

Ground faults at lower voltages may not develop an arc, but can energize a presumed grounded surface, such as an appliance. Enough current can flow to be fatal to a person without a conventional protective device being tripped.

Both of the above conditions have led to the development of ground-fault interrupters that sense small "leakage" currents.

The NE Code requires ground-fault protection on grounded-wye, 480/277-volt electrical services where the disconnect is rated at 1000 amperes or more. Also GFP is required for outdoor residential circuits, at construction sites, and under some conditions for swimming pools.

The system designer can provide fast, effective isolation for potential faults through coordinated selective protection. This means that a faulted section can be isolated from the system without interrupting service to other sections of the system.

The implications of this approach are that protective devices for feeders and branch circuits must operate quickly enough to prevent serious damage, but in a manner such that only the faulted circuit is interrupted and not others functioning properly (interruption of normal circuits is known as "nuisance tripping").

## Engineers can use new design tools, in this energy-conscious era, to get quality lighting with fewer watts

The new measure of effective levels for visual tasks, accepted by the Illuminating Engineering Society, is equivalent sphere illumination. (ESI). This concept provides 1) a rational basis for establishing the illumination levels required for many types of work, and 2) a means to compare lighting design alternatives on the basis of task visibility. Furthermore, if the lighting designer is working within an energy budget, the ESI concept is a powerful tool to get maximum lighting efficiency from the kilowatt-hours used.

There are, however, several complications in designing for ESI footcandles. In the first place, the ESI values provided by a typical lighting installation vary widely according to the location of the visual task. ESI values, and hence visibility, improve as reflected glare is reduced, and ESI values, it follows, are affected by luminaire light distribution, luminaire placement, luminaire ceiling geometries, room reflectances, and by horizontally polarized light.

Ordinary ("raw") footcandle values, which are not a real measure of visibility, can be predicted easily, even by hand computation. Not so with ESI footcandles. Because of the mathematical complexities, the only practical way of prediction is by computer. The architectural and engineering firm of Smith, Hinchman and Grylls has developed a computer program called "Lumen II" that calculates both ESI and VCP (visual comfort probability) i.e., the percentage of people likely to find a given lighting design comfortable for specific points in a space in relation to a particular lighting system. This computer program is being used for a number of SH&G buildings now in design.

At the IES National Conference last month in New Orleans, David DiLaura, a research assistant at SH&G, presented the algorithms used for the firm's ESI program, representing all of the mathematical input. With this information, a computer programmer could, though at some expense, develop the same program for anyone willing to pay for it.

For most lighting designs, SH&G investigates the ESI and VCP values for the four viewing directions—north, east, south and west—at approximately 400 points in a space. A contour plot is available for designers if they wish to see mapping of equi-ESI and equi-VCP values. The program also gives the statistical mean values for all the points, as well as the deviation from the means, so that comparisons can be made for different luminaires and different luminaire layouts.

In some recent SH&G-designed buildings, including the GSA's "energy-saving" Saginaw Federal Office Building, Stephen S. Squillace, SH&G corporate director of electrical engineering, and David DiLaura found that, with judicious placement of luminaires, approximately 65 ESI footcandles could be obtained with approximately 2 watts per square foot, rather than the usual 4 watts psf.

In the American Motors Tower in Detroit, which will be occupied both by the owner and by tenants, a number of different configurations were assumed to anticipate all reasonable office sizes and uses. Where office space is to be tenant-occupied, SH&G have found renting agents wary of the new low-watts-per-square-foot approach. Because clients are prone to accept the premise that "more is better," they must be shown, Squillace says, that they are in fact getting better light at lower wattages. Put more colloquially, Squillace says, "you don't have to hit a fly with a baseball bat to kill it. A fly swatter does the job just as well and a lot more effectively."

The projected savings from lower wattages are substantial. In the American Motors Tower by SH&G, the engineers estimate that by going from 4 to 2 watts per square foot the air-conditioning tonnage could be reduced from 1600 tons to 1350 tons because of the lower heat load of the lighting system. In addition to the direct savings of 2 watts psf of the lighting system, the engineers say there would be another ¼ watt psf savings in operating the cooling system.

## A ceiling of remarkable theatricality evolved through exhaustive research into designing for interior daylight

A striking ceiling of great visual richness evolved from efforts to answer a single functional question: how to provide natural lighting and a sense of the outdoors for workers inside the horizontal vastness of the insurance offices of the Aid Association for Lutherans in Appleton, Wisconsin. The search, more or less gradually, involved many other functions—structure, services, acoustics, not to mention artificial lighting—to culminate in a completely integrated ceiling whose remarkable

shape is animated from morning through late afternoon by subtle changes in the direction and color of daylight.

The major elements in the daylighting system include continuous double-glazed skylights projected above the girders, and curving valances that also run the length of the building. The huge girders—they are 5-ft-deep and span 88 ft between the core walls—are sheathed in gypsum board and as reflective surfaces become a basic component of the

Architects: John Carl Warnecke & Associates. Engineers: Weidlinger Associates (structural); Joseph R. Loring & Associates (mechanical/electrical).

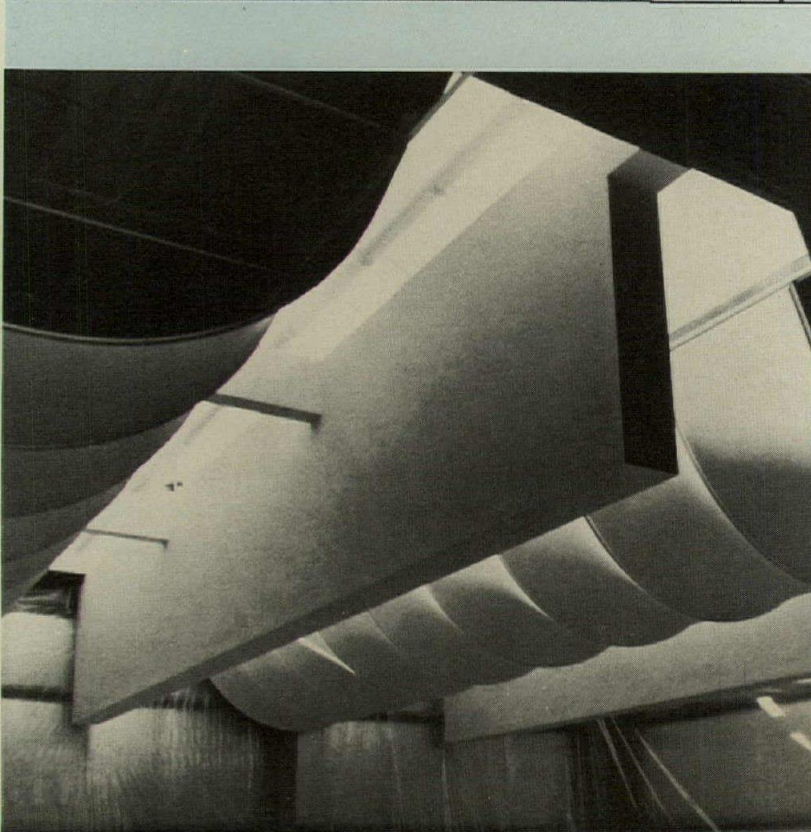
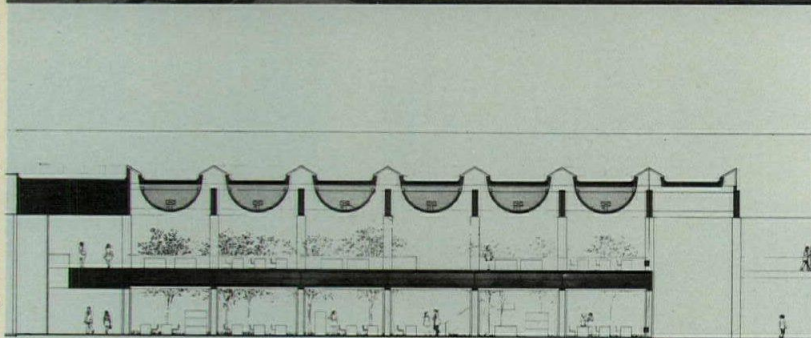
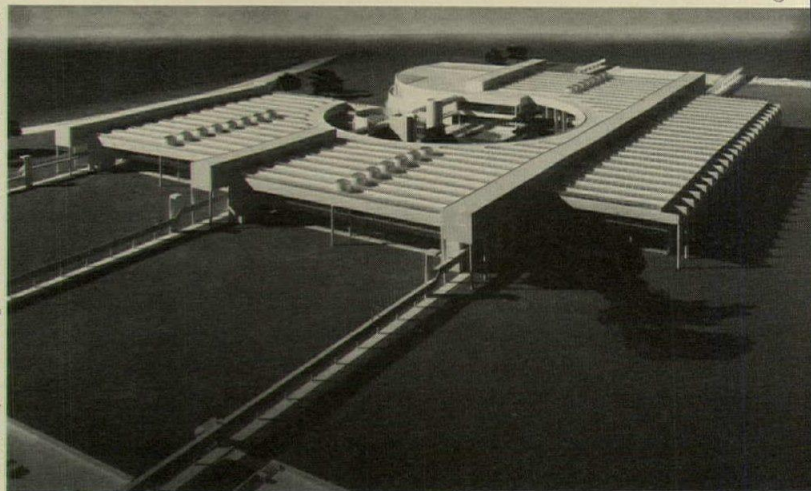

©Louis Checkman

lighting system. Purlins double as light baffles.

The key to the ceiling system, however, is the fabric valance. Interspersed between girders, its taut curving surfaces offer maximum vertical reflecting area to diffuse daylight evenly over the interior work area. The complex curvature, chosen after considerable deliberation not only for its effectiveness but for the visual interest of its modeled surfaces, results from the construction of the valance—off-white fiberglass fabric

stretched over steel hoops and held with *Velcro* fasteners. The reflecting surface of the valance is extended upward by continuous sloping strips of gypsum board that terminate at the skylight.

Supplementary lighting for nighttime and overcast days is supplied by fluorescent lamps housed in cylindrical fixtures mounted on top of the girders. The location is intended to mimic as nearly as possible the effect of daylight.

Acoustically, the ceiling per-

forms as a noise trap, capturing sound in the recesses, then reflecting it off the girders toward the valance, where it penetrates the outer fabric and is finally absorbed by a 1-in. fiberglass mat suspended from the hoop connectors. (See section below).

In addition to its lighting function, the valance encloses all major services except electrical and telephone lines, which are run through the floor. Supply ducts are tapped every 8 ft along a continuous grille just above the

valance. The same grille takes in return air, and all the space within the acoustical mat serves as a return-air plenum. The valance also houses an assortment of such items as roof drains, sprinklers, and the public address system.

Pre-design studies recorded monthly and hourly light readings, yielding detailed information about the intensity and direction of daylight as these vary with season and weather. Further studies were conducted at a mock-up of the ceiling built near the site.

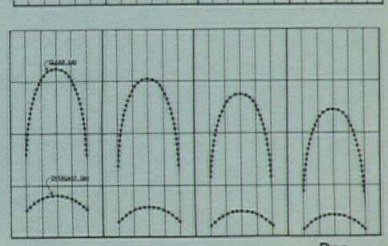
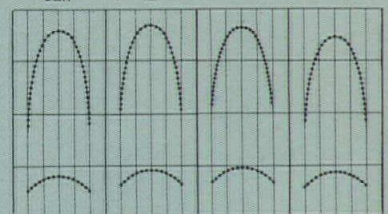
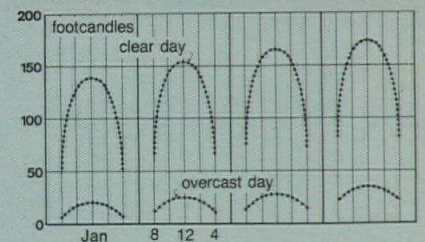
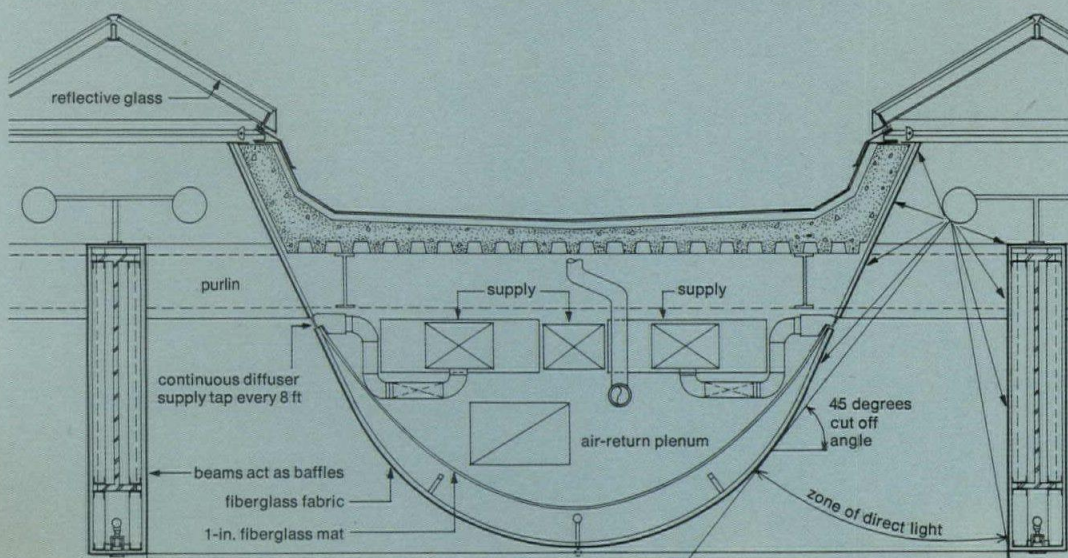
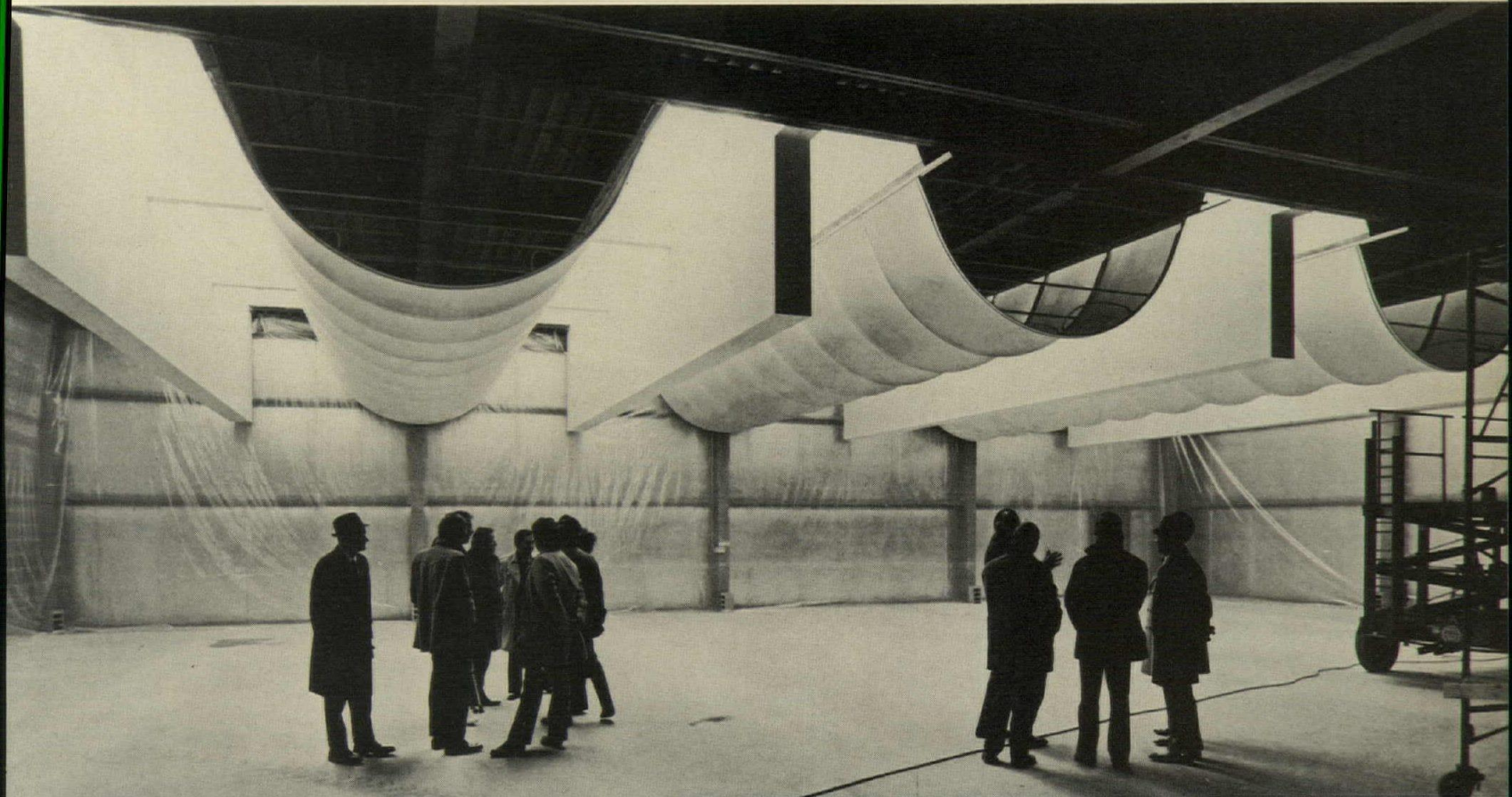

## Office work units with built-in lighting combine up-to-date planning flexibility with a new form of the old desk light

Given their choice, many office workers would like the idea of having localized desk light rather than only general illumination. Such light gives a sense of focus on specific tasks, and in open-plan offices it fosters a welcome sense of privacy. Planning flexibility is a commercial convenience in most large office buildings, however, and sometimes a management necessity even in small ones. This flexibility has usually been achieved with uniform lighting from modularly

spaced luminaires in the ceiling. In Philadelphia National Bank's remodeled International Department, lighting consultant Sylvan R. Shemitz met the combined demands of worker comfort, planning mobility and ease of maintenance by fitting movable office units with built-in fixtures that supply localized light for desks and uplight for general illumination. Light is thus greatest where it is most needed—on the task. The uplight, reflected off the high ceiling, seems to fill the air

with ambient light. (When ceilings are high, uplight spreads out diffusely; more care is required with low ceilings, however, to avoid "hot spots.")

A standard line of office furniture was modified to accept three lighting units: a two-lamp unit for executive desks, with a lens above for downlight and a louver above for shielding uplight; a two-lamp unit for cabinet tops that provides only uplight; and a one-lamp unit, providing both downlight and uplight, that is supported by either

standards or wall brackets to light auxiliary work surfaces like typewriter tables.

Because furniture tops are below the eye level of passers-by, the units are shielded by parabolic wedge louvers that conceal the fluorescent lamps. The fixture lenses, recessed in the soffits of desk units, are invisible to users.

An additional advantage of the system in a time of growing concern about energy consumption is its low wattage average—2.13 watts per sq ft.

Harris/Davis

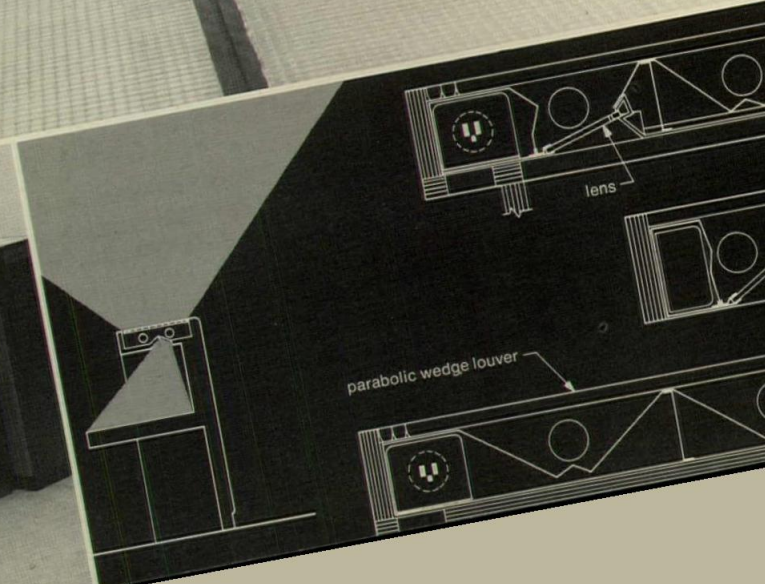

Lighting consultants: Sylvan R. Shemitz and Associates, Inc.

## A high-efficiency, air-source heat pump suits a school's design and saves on energy usage

A number of architectural design aspects of Ravenwood Elementary School, in Kansas City, Missouri, precluded engineer Robert E. Smith from using a conventional fossil-fueled boiler combined with direct-expansion or central chilled-water cooling. The school is corridorless, open-plan—limiting ceiling space for ducts—and has a raised roof over a large multi-purpose room. An on-grade boiler plant would have interfered with a future addition, and the roof was not suitable.

Smith's answer—which yielded economy, and met architectural objectives as well, was a special-type, heavy-duty, 80-ton, air-source heat pump with matched multizone air handler, mounted in a roof-top penthouse.

The owner wanted maximum weather-protection for the mechanical equipment, and both the owner and architect favored minimum visual obtrusiveness.

Because the available space for penthouse was small, the engineer considered at first mechani-

cal cooling and electric resistance heating, but rejected it in favor of the lower energy costs he would get from the heat pump. While some unitary heat pumps had been used in the area, engineer Smith's attention was drawn to one manufacturer's activity with a heavy-duty, air-source heat pump that had a very flexible refrigeration concept and heavy-duty air handlers. Further, it could provide reliable operation down to low outdoor air temperatures without defrost problems, and

have a superior coefficient of performance (efficiency).

The engineer says that a number of years of satisfactory operating experience, and proven higher heating efficiency, convince him that this type of equipment should be more available today. (The manufacturer discontinued the line because of low sales before the energy crunch.) He also believes that greater manufacturer back-up, plus involvement in refrigerant piping design and system start-up is important.

Paul S. Kivett (photo top) Fred Preisler (photo below)

Architects: Kivett & Meyers. Engineers: Smith & Boucher, Inc. (mechanical).

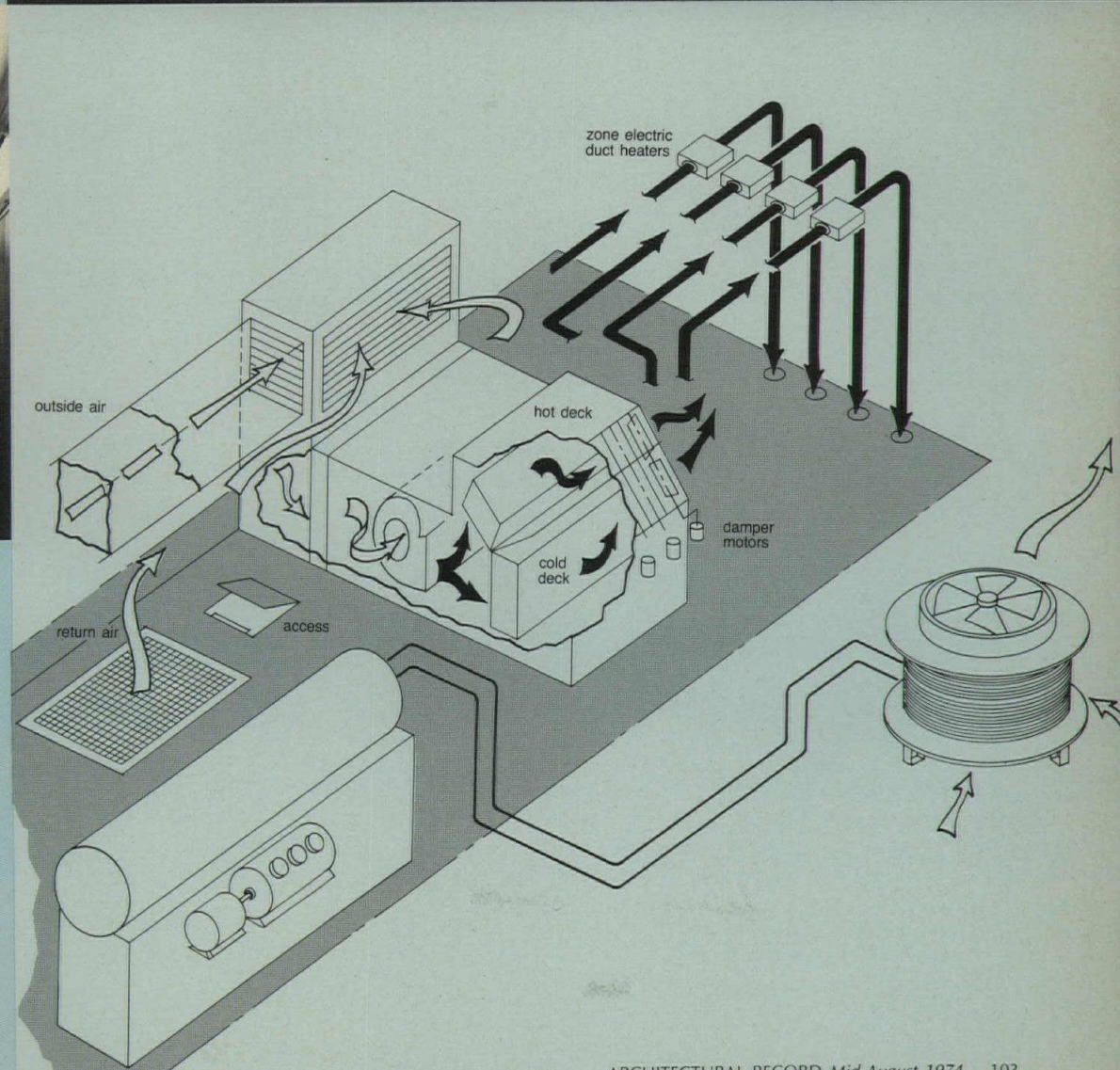
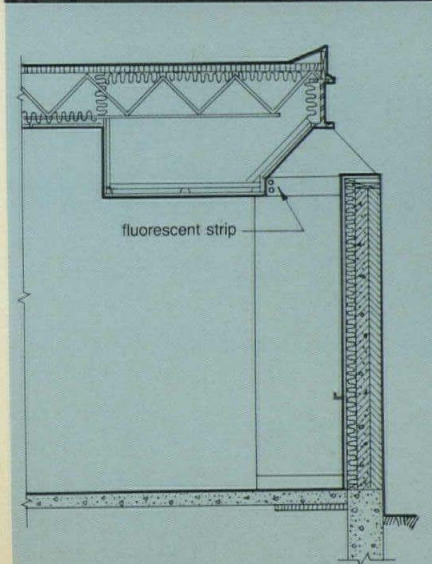
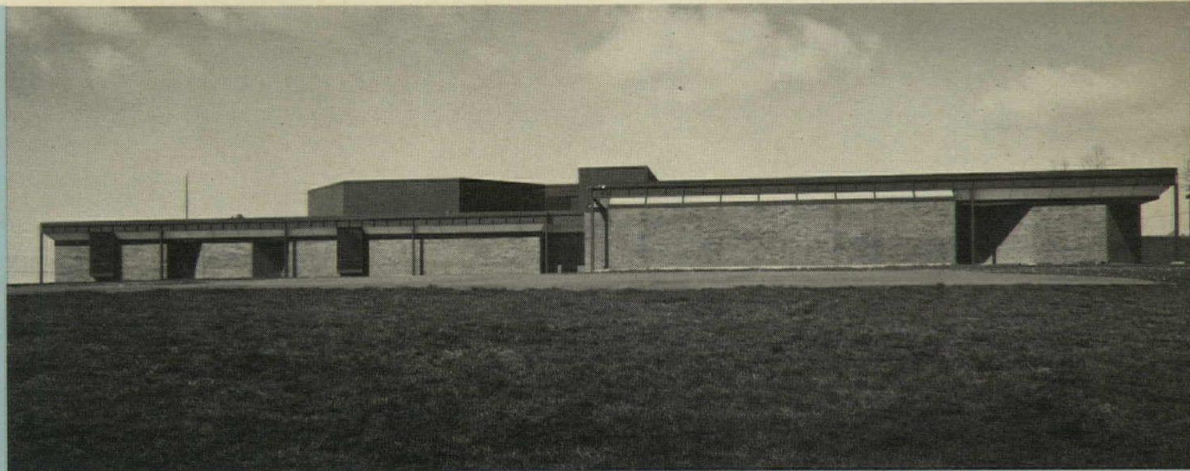
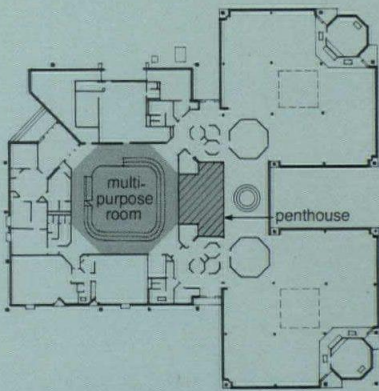

## A central plant won out for its life-cycle costs, but standardized air handlers saved initial costs

Roof-top air-conditioning equipment has become highly popular for school buildings because of the potential flexibility for future change and because of the lower initial cost compared with central systems for low buildings.

Chantilly, Virginia High School was originally designed and built conventionally. When original bids came in too high, the school was rebid on the basis of performance specifications. Though the performance specifications allowed either roof-top or

central systems, they were basically oriented toward roof-top. But on the basis of the owner's life-cycle cost criteria for a 20-year period, a system was chosen that used a central chilled-water and boiler plant, and packaged roof-top and interior air handlers with variable-air-volume air distribution. Almost all of the air handlers are roof-top, except for a few special purpose areas. Approximately 210 variable-air-volume terminal units were used for zoning purposes.

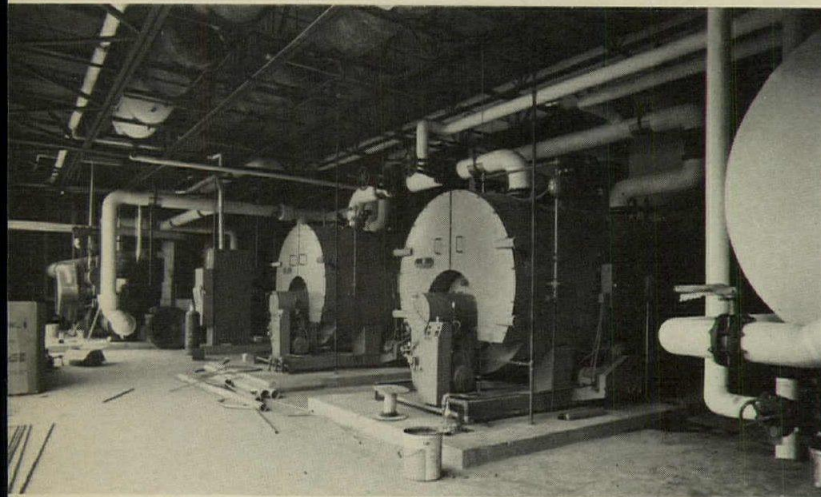

Architects: Berry, Rito & Associates. Engineers: Kluckhuhn & McDavid (mechanical).



Architects: Vincent G. Kling & Partners. Engineers: Kling-Lindquist (mechanical/electrical).

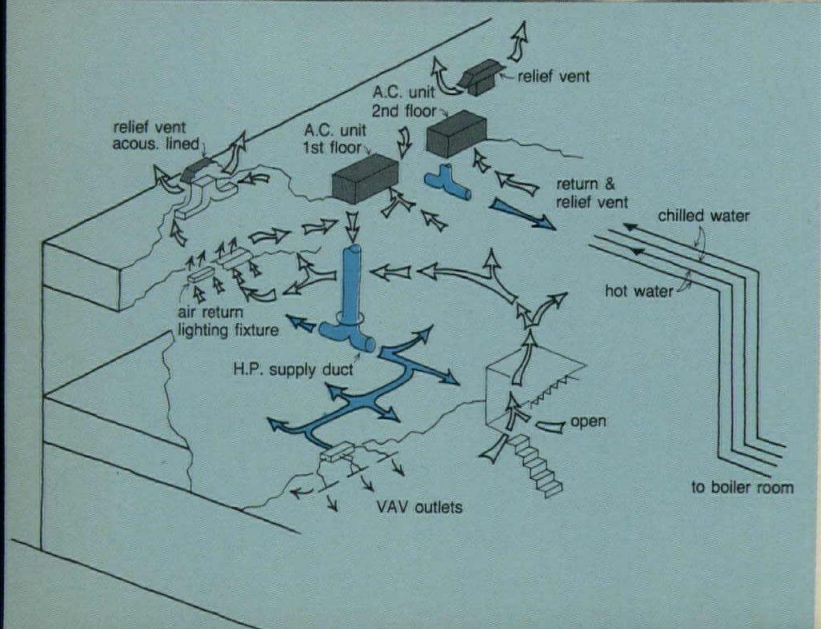

Architects: Goldstone, Dearborn & Hinz. Engineer: James Mongitore Associates (mechanical).

## Small single-package heat pumps work quietly and efficiently by exchanging heat from a water loop

Providing thermal comfort conditions in modern buildings often has turned out to be, thermodynamically, redistributing heat. Thus, we have seen the frequent application of what have been termed "internal source heat pumps" with large central systems—recouping heat from lights, people, and sometimes the sun, and rerouting it to spaces that need heat. Comparably, on the unitary side there is the water-to-air unitary heat pump, in sizes of  $\frac{3}{4}$  to 5 tons, that is tied into a

water loop for either abstracting or rejecting heat. Interior units generally need to produce cooling, except for morning warm-up in winter. When cooling, they reject their heat into the loop which is taken out in winter by the perimeter units that are calling for heat. In summer, when all units are cooling, the heat is rejected to the atmosphere via a closed-circuit evaporative cooler. If more heat is needed in winter than is rejected by interior units it usually is supplied by an electric boiler, or from

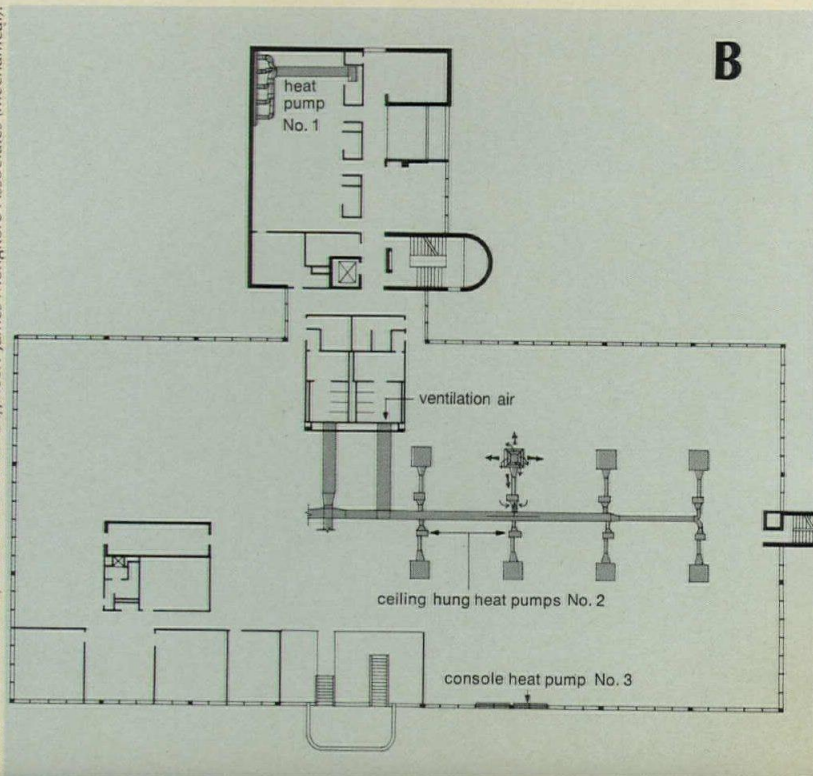
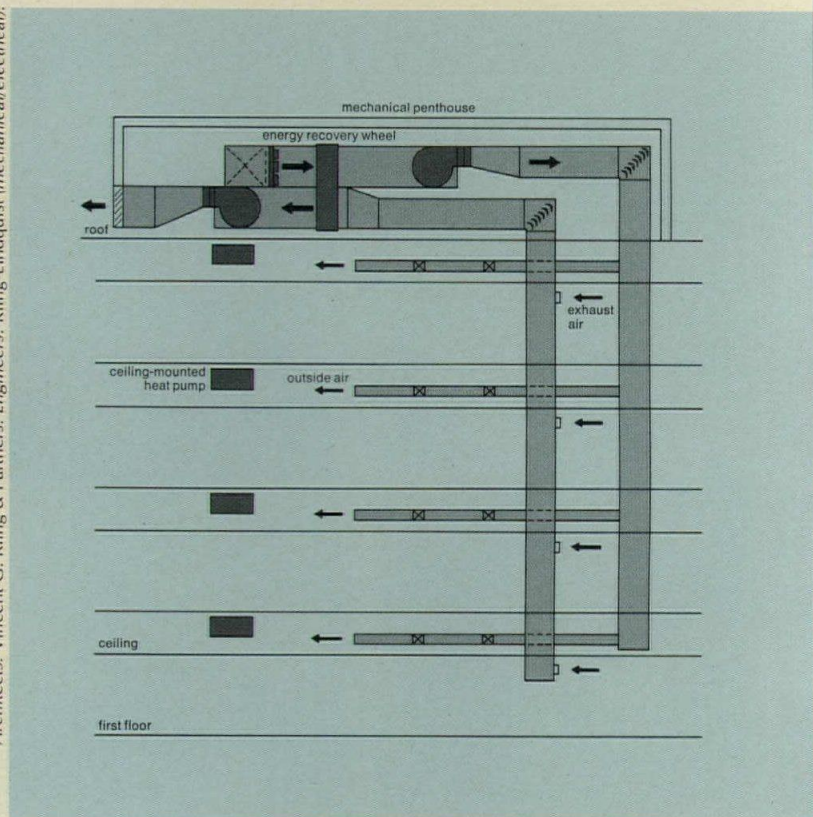

a storage tank having electric immersion heaters.

The two installations shown here are suburban office buildings whose clients wanted quality architectural design as well as quality hvac at reasonable cost.

**A** The Geico office building was conceived as an all-electric building because of the shortage of gas for heating in the Long Island area, and because of the wish to avoid the cost and environmental complications of an oil-fired boiler plant. The heat pumps are all ceiling-mounted, except for the cafeteria and telephone room.

ing-mounted, except for the cafeteria and telephone room.

The basic open floor plan had to be considered in mechanical system selection. The use of ceiling-hung units allowed maximum utilization of floor space, and also gives the owner maximum flexibility when rearranging offices.

Each heat pump is controlled by a space thermostat, and each has automatic change-over controls to ensure prompt reaction to space conditions.

The ceiling space also is used

as a return-air plenum, minimizing the amount of ductwork required. Return air is through heat-recovery light troffers, directly picking up heat from the lamps—reducing heating load to the space, and lowering operating temperature of the lamps which adds to their life.

A simple heat-recovery wheel system for ventilation air conditions is used so as to reduce heating and cooling loads. Condenser water storage minimizes electric-load peak of the system.

**B** The Volvo building has long-span, column-free, open-plan spaces, whose deep girders made it possible for the engineer to consider above-ceiling heat pumps in the 5-ton size, which are light-weight and vibration-free. At the perimeter, on the other hand, console units are provided, using architect-designed custom enclosures. Minimum ventilation is provided through a separate outside air system ducted to the ceiling heat pumps. Floor-standing units are in the smaller wing.



Lawrence S. Williams, Inc. photos

Bill Rothschild photos

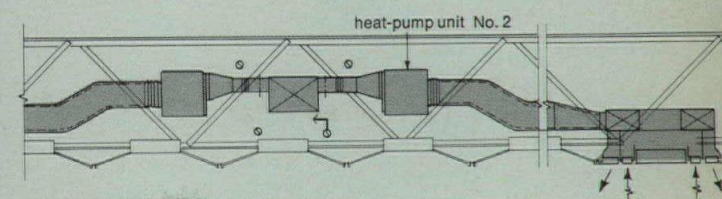
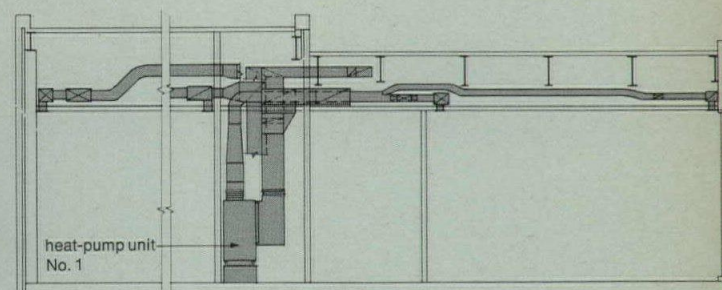
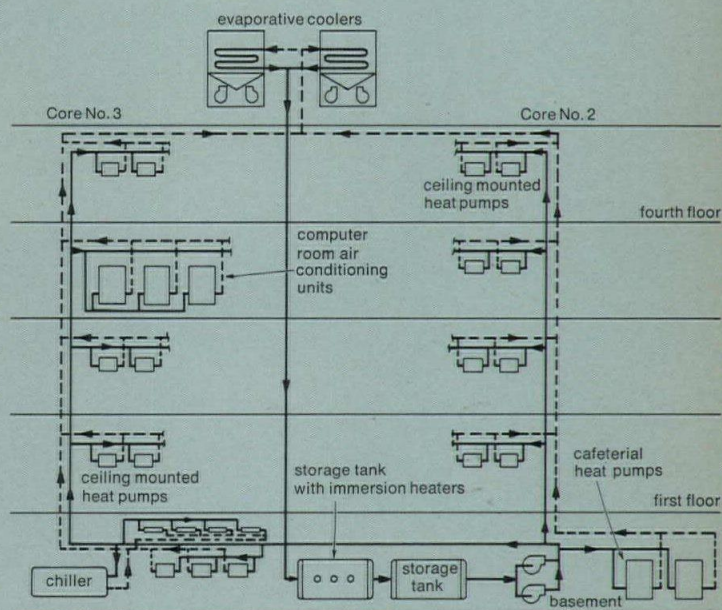
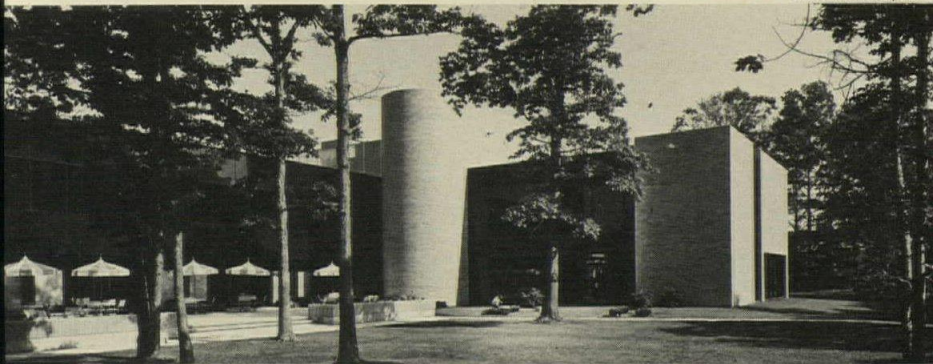

## Contrary to popular opinion, packaged air conditioners can find a place in multi-story buildings.

Packaged unitary air conditioners conventionally have been installed on roof tops, and generally they have not been used for buildings more than three-stories-high. The acknowledged advantages of this equipment, such as factory-matched components, savings in field labor, and low first cost, can be extended, however, to taller buildings by using equipment that is designed specifically for inside-equipment-room locations.

The self-contained air conditioners use air-cooled refrigeration

equipment, and generally gas-fired or electric heaters. For areas with varying load conditions multizone air-handling sections are provided. When only cooling is required with fairly stable loads, single-zone units can be used.

The extent to which this approach can be applied to medium—and perhaps even high-rise—buildings depends upon what provisions can be made in the building (shafts and openings) for rejection of heat from the air-cooled condensers, for the intake

and discharge of ventilation air, and for equipment-room space.

In this Long Island building, area available for shafts permitted four floors to be handled by rooftop units; the engineer's cost evaluations proved the feasibility of the approach. The ground floor and a lower-level floor were served by interior units.

The manufacturer took responsibility for the refrigerant piping systems between interior evaporator-blower-heater units and condensing units. The refrigeration contractor had to be approved by both the consulting engineer and the manufacturer. Start-up, follow-up service and maintenance were required from the same contractor.

The engineer points out that, for economical energy usage, separate multizone units are required for the exterior zones. In other words, a multizone unit should not handle both interior and exterior zones because of the divergent load requirements which can cause very inefficient operation.

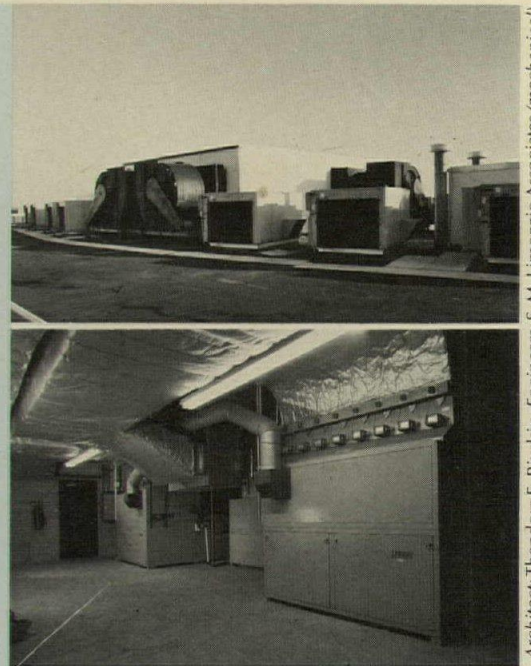
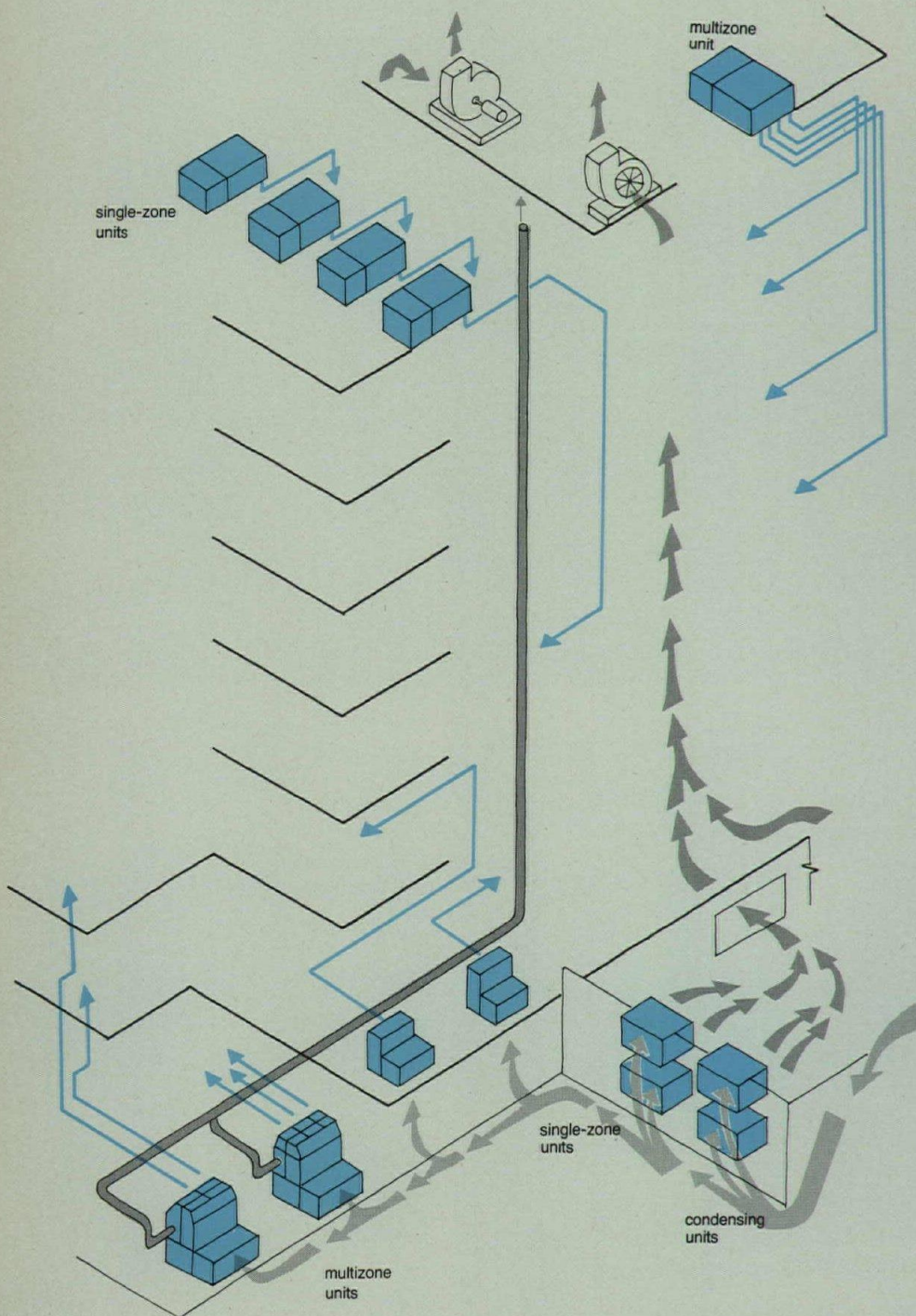

Architect: Theodore E. Bindrin. Engineers: S. M. Limoggio Associates (mechanical).

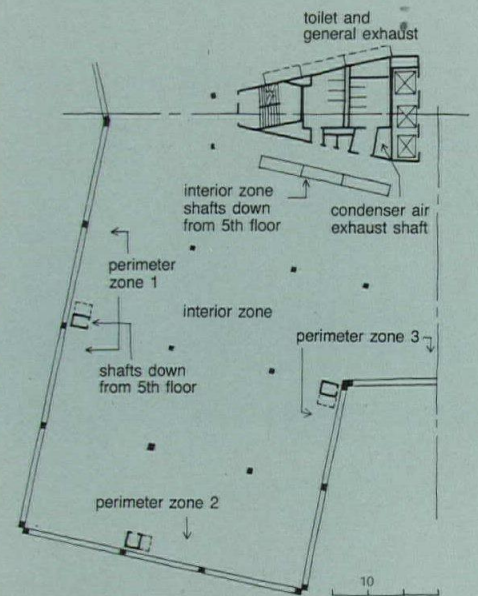

TYPICAL QUADRANT ZONING AND DUCT SHAFT LOCATIONS—FLOORS 2-5



## Los Angeles engineers "invent" an all-air system for a skyscraper that saves shaft and fan-room space

All-air systems of the double-duct type have been popular in Los Angeles because the mild climate has been in their favor, and because fewer trades are involved in their installation.

But in a tall structure such as the 62-story United California Bank Building, shaft space of a double-duct system could eat up a lot of valuable rental area.

To minimize this problem as well as to cut down fan room height at the 22nd- and 42nd-floor levels (there are fan rooms at

levels 4, 5, 22, 42, 61 and 62), the engineers designed a unique variable-air-volume system that only requires single-duct risers, cutting down on shaft space required. In addition, fan room height can be lower because only one set of coils is required rather than both hot- and cold-deck coils.

Each floor has two duct loops, one cold and the other warm. The cold loop supplies single-duct variable-air-volume (VAV) terminals in the interior space, and both loops serve variable-tempera-

ture, constant-volume double-duct boxes serving the perimeter offices.

Altogether there are five air-handling systems. Three of them are cooling only—feeding the inner loop. System No. 4, however, serves either as a cold-air supply, or, in cold weather, as the main hot-air supply. This change-over concept necessitated the use of continuous hot- and cold-loop ducts, with switchover provisions for System No. 4. Because some heating is required in interme-

diate-season, sunny weather, when System No. 4 is still needed for cooling duty, System No. 5 (a small, recirculation-only system) is provided for heating-only duty.

Return-air lighting fixtures are used that draw air through the lamp chambers. The fan systems conserve heat energy during the cooler weather: Fan System No. 4 is set for minimum ventilation to get maximum benefit from the warm return air, while the three cooling-only systems operate with increased outdoor air.

Architects: Charles Luckman Associates, Engineers: Levine & McAnn Div. of Syska & Hennessy, Inc. (mechanical)

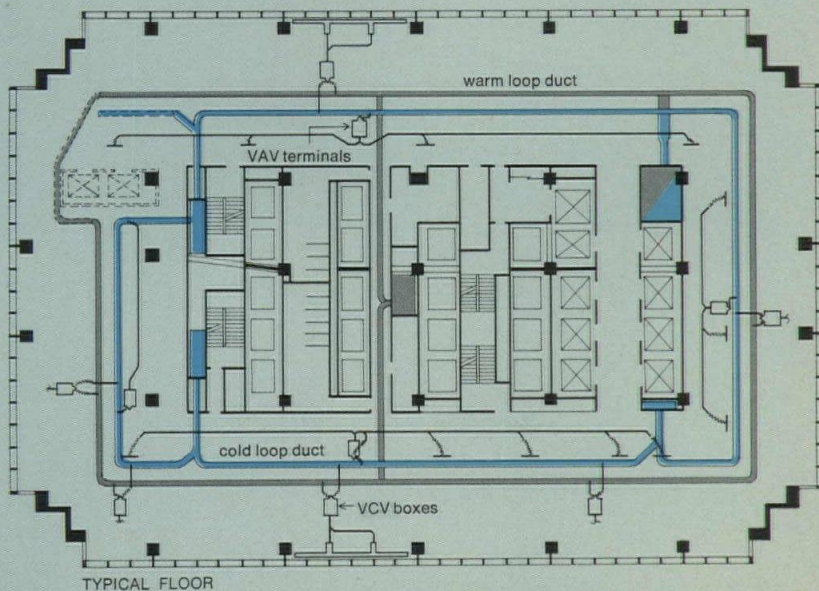
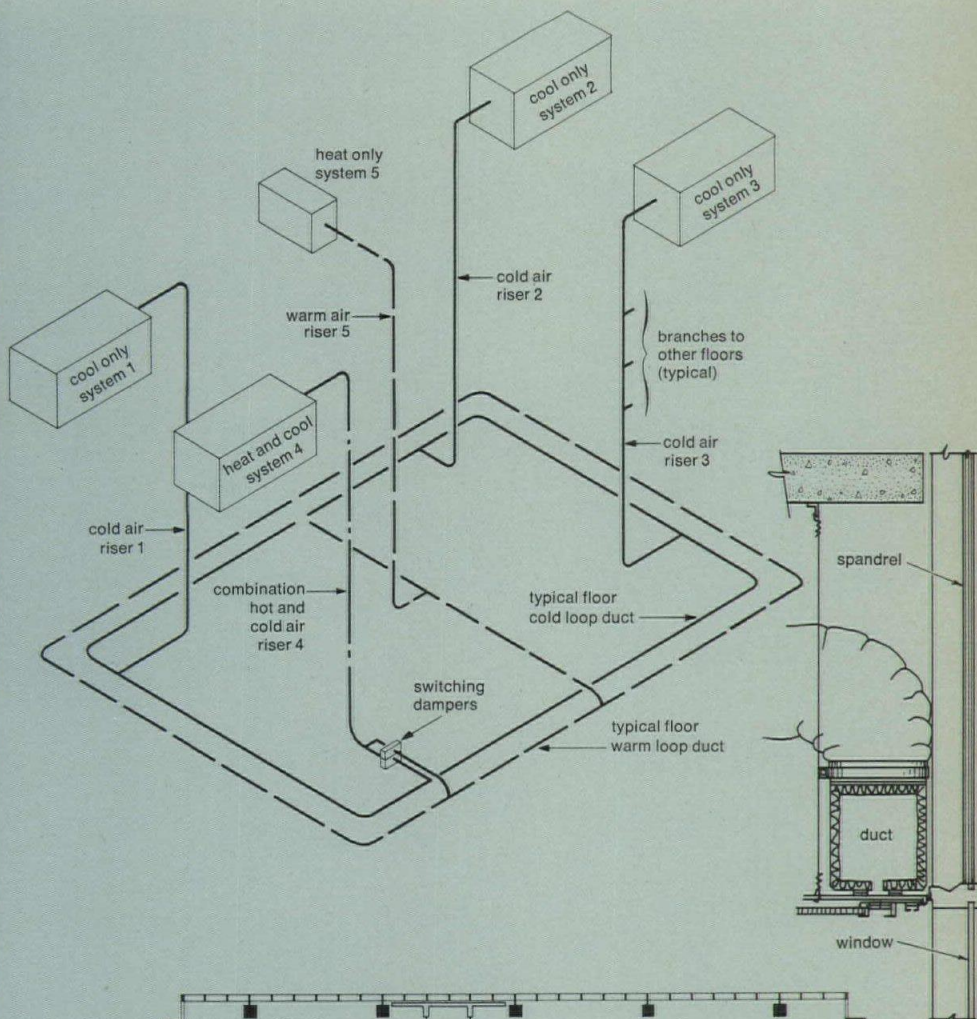
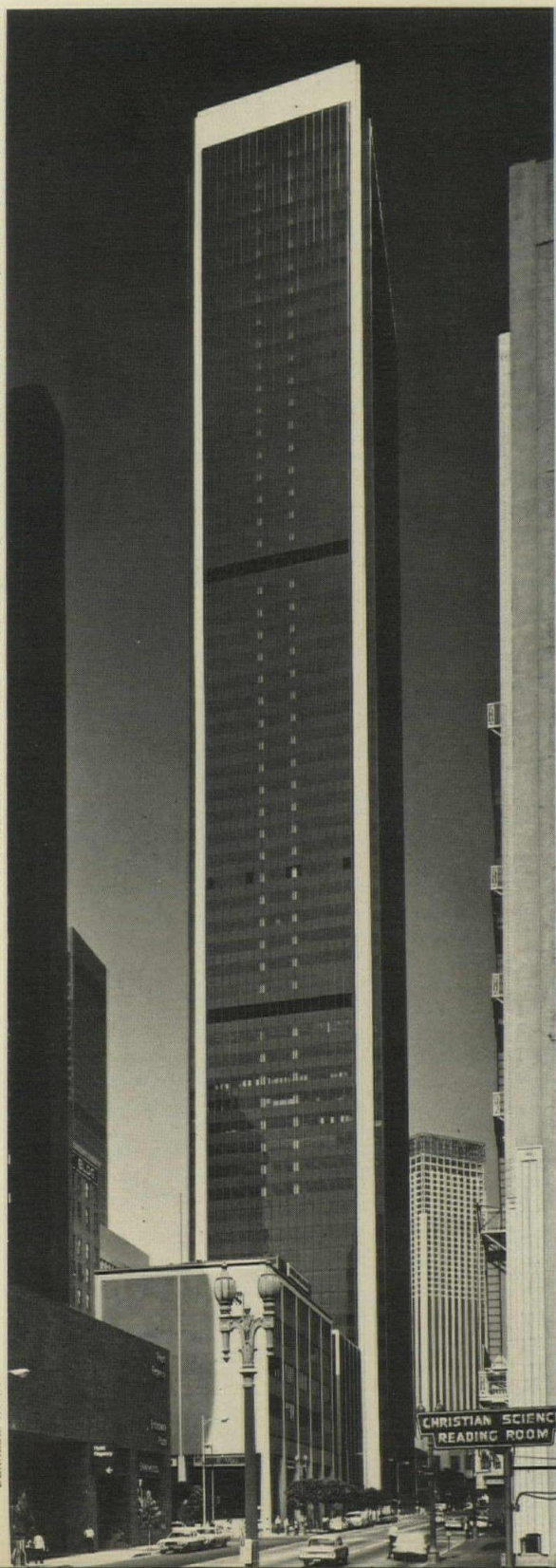

Balfanzar Korab

## Water-loop heat pumps in an office building are piggybacked by a larger well-water-source heat pump

The unitary water-loop (water-to-air) heat-pump system can redistribute heat as required—removing it from some spaces; adding it to others. Or, at times, the system requires that heat be dumped to the outside, or that heat be added to the pipe-loop circuit.

The Exchange in Farmington, Connecticut, has over 300 water-loop heat pumps in a sprawling office-building complex.

The heat pumps operate at high efficiency because the water loop is maintained at 85 F by a

230-hp package screw-compressor heat pump that abstracts "free" heat from 55 F well water. Because of this small lift, the screw compressor (noted for its stability of operation over a range of conditions) has a high coefficient of performance.

The well water system is also used in summer to provide the major portion of the loop cooling capacity, for the unitary heat-pump condensers. A closed-circuit evaporative cooler is available for additional capacity.

## Individual packaged air handlers for each floor of high-rises save money and make buildings safer

It is not heresy, but rather a series of practical considerations that are involved in some forward-looking engineers' use of individual air-handling systems on every floor of some recent high-rise office buildings, instead of centralized fan rooms girdling a building every 15-20 floors.

One of the most cogent reasons for this approach is life safety: smoke and lethal gases cannot be spread by the fan system to other floors. But, beyond this, the initial cost and operating

economics are very favorable.

Engineers say the air handling apparatus and ventilation shafts can fit in the same space or less than was formerly required for the air shafting alone.

Another advantage on the operating side is that people working overtime can be provided with heating or air conditioning at a reasonable cost because fans can be operated individually.

A Robert T. Tamblyn, Toronto consulting engineer, has developed a "compartment" concept

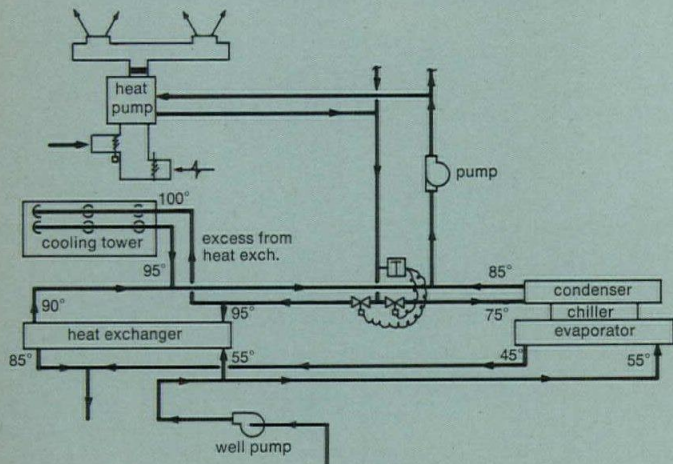
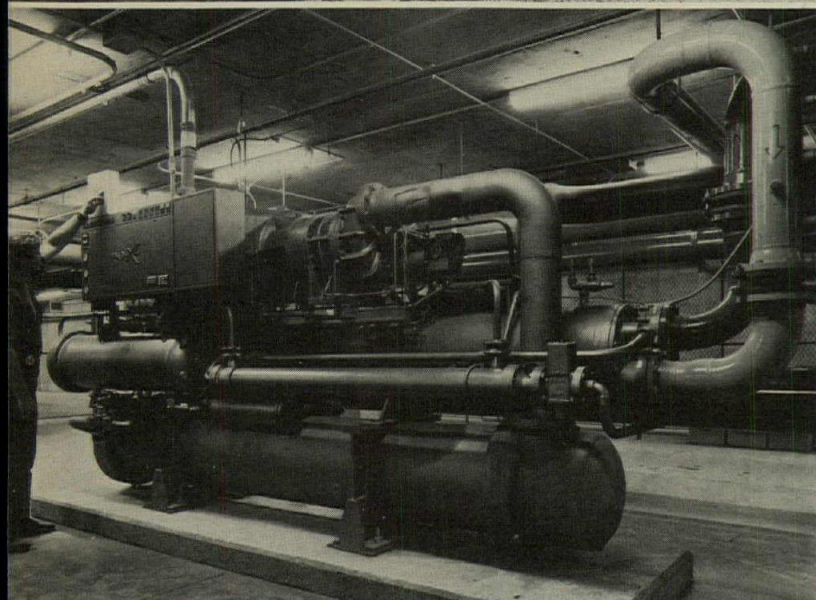
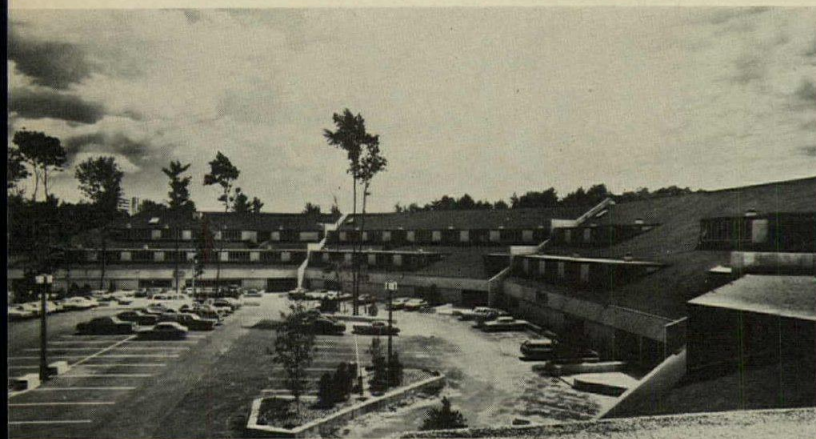

Architects: Callister & Payne, and Bischoff. Engineers: James S. Mingos & Associates (mechanical)

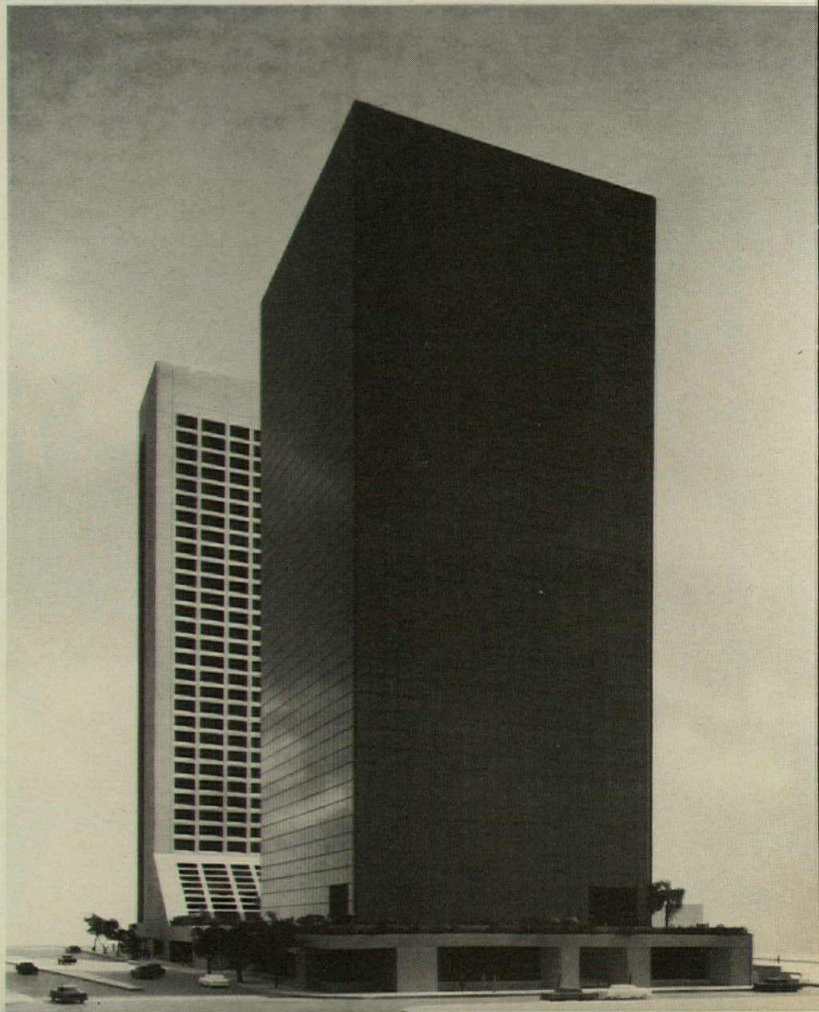
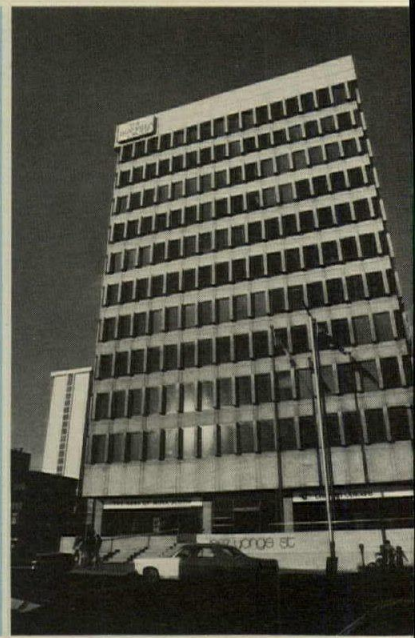
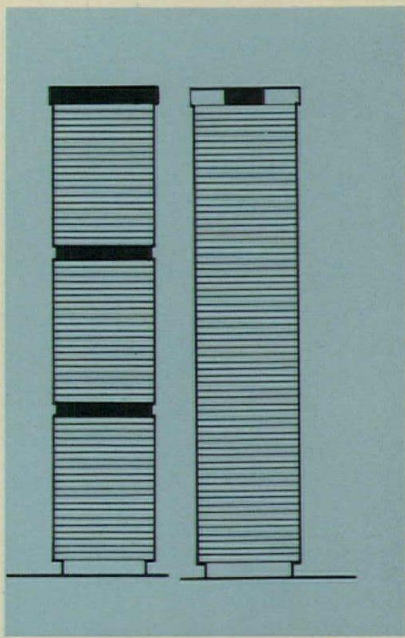

in which one fan serves an entire floor, both exterior and interior. The system is single duct with variable-air-volume terminals to provide temperature compensation for various zones and exposures. Tamblyn saves money by using all overhead air supply; so, to take care of building skin heat loss in winter, he calls for shallow (only 3 to 6 in.) fin-tube radiation at the perimeter of the building.

The system calls for variable-air-volume fan systems stacked in vertical alignment so that they can

be served from one shaft for the preconditioned ventilation air.

Special attention was paid to the design of the "compartment" fan units to get top performance in a minimum of space. They were developed over a two-year period, in consultation with several manufacturers, for precise acoustical, dynamic and thermal performance. Further, high standards were adhered to in the selection of materials and components.

A recent change to the Canadian National Building Code

makes it mandatory for all new high-rise buildings to have a masonry smoke shaft, unless the building is fully sprinklered.

There are other approaches such as providing axial-type ventilation fans that can be reversed in the event of fire, with an elevator shaft being dampered and opened to relieve the smoke and gasses.

**B** A different approach to the compartment concept has been developed by another Toronto firm, G. Granek and Associates,

for the 20-story Guardian Royal Exchange Tower. It uses fan units on each floor for the interior zone, but has a conventional perimeter induction-unit system for the exterior zone. This induction-unit system supplies the makeup ventilation air for the whole floor. The building also has a separate masonry-enclosed smoke shaft for emergency automatic operation. The interior-zone system only recirculates and cools the air; return is via the hung-ceiling plenum.

Architects: Crang and Boake  
Engineers: Tamblyn, Mitchell and Partners, Ltd. (mechanical)

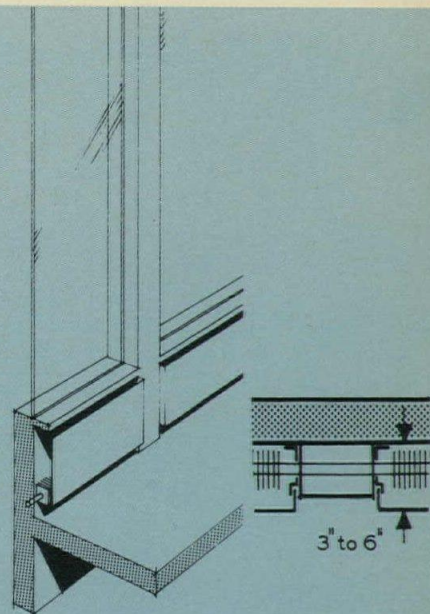
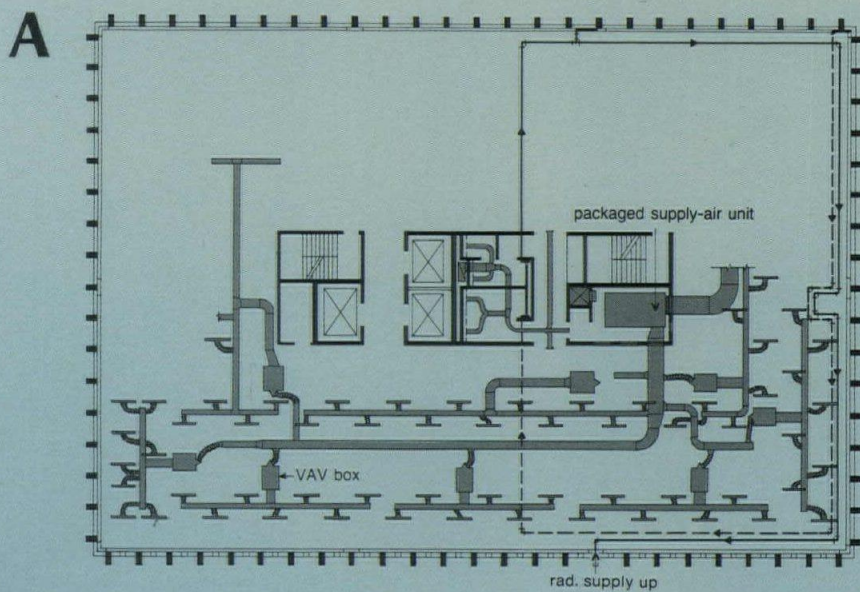

Architects: Searle Wilbee Rowland  
Engineers: G. Granek and Associates, Ltd. (mechanical)

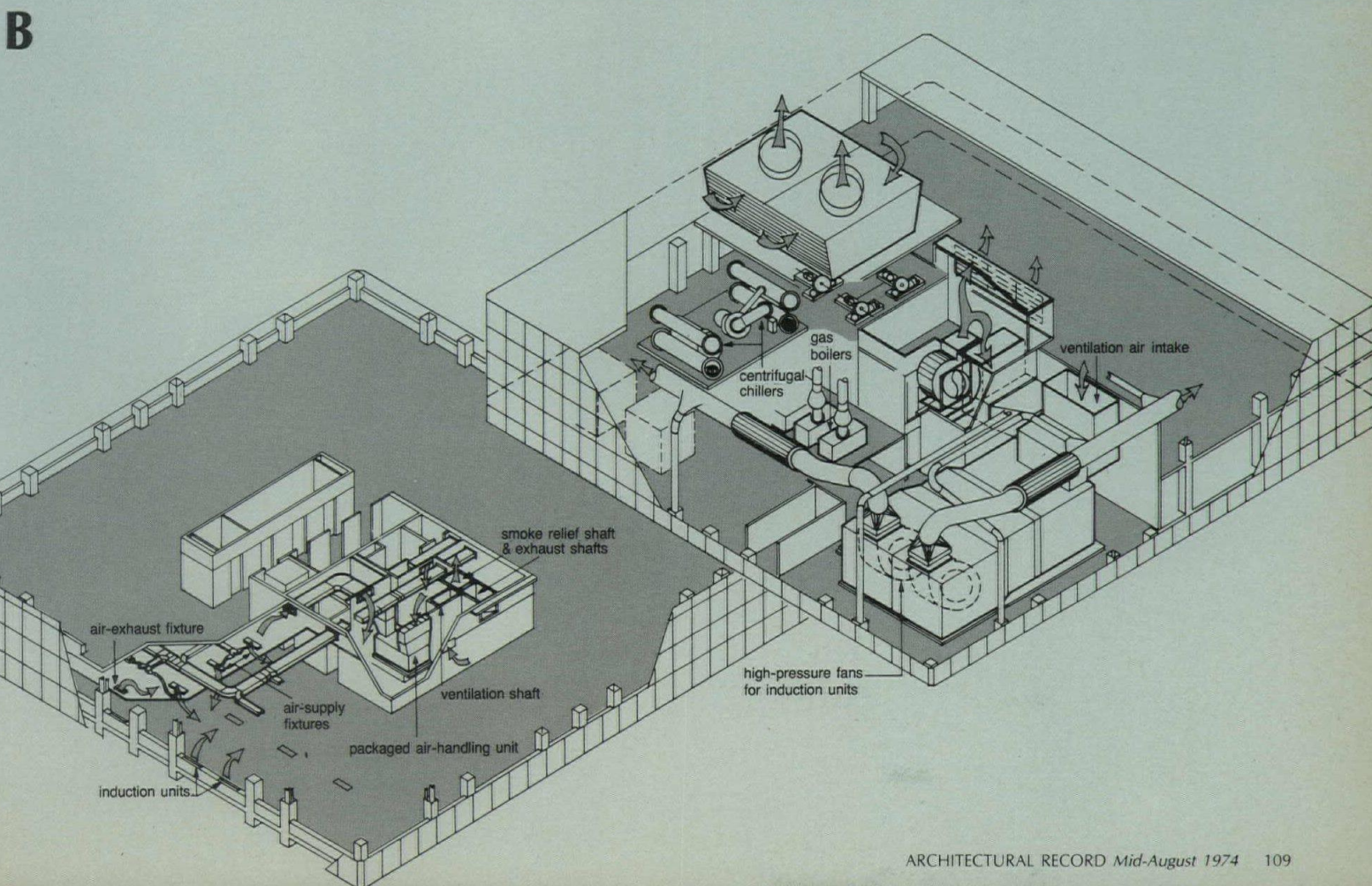

## A custom air-source heat pump works down to zero-degree outdoor temperature for an industrial plant

The efficiency of air-source heat pumps drops when the outdoor temperature decreases. But there are ways of getting around the difficulty, and consulting engineer Robert E. Werden has done a number in this genre, with custom refrigeration designs.

A recent one is a specially engineered "cascade" air-source heat pump for the Moore Products industrial plant near Philadelphia. With the "cascade" hook-up used here, the condenser of the "low" stage (using a reciprocating com-

pressor) is cooled by the chilled water of the "high" stage (centrifugal chiller). This way, it can abstract heat down to zero.

The centrifugal chiller has a double bundle—one for the cooling tower circuit when it has heat to get rid of, and the other for the space heating circuit.

The custom cooling tower works conventionally in warm weather, but in the heating season, its fan is used to draw outdoor air across the heat pump's outdoor coils.

## Exposed, perforated duct provides draft-free, low-noise-level air distribution for a laboratory

Two of the main air-distribution requirements for physics laboratories at the Stony Brook, New York, campus of the State University were freedom from drafts that might affect sensitive experiments, and quietness. As usual, the budget was tight, so much so that a hung ceiling together with a duct/diffuser installation, coordinated with lighting and other services, turned out too expensive.

To the consulting engineer, simplifying the air distribution system to the utmost seemed to be

the most logical approach. Both architect and engineer were sympathetic to the idea of omitting the hung ceiling and letting standard-size duct runouts serve as both duct and diffusers. The architect felt that, with proper treatment, a valid and strong design statement related to space usage could evolve.

A promising possibility, the engineer thought, was the use of inexpensive, perforated, spiral-wound ducts of thin metal. Trouble was that not enough perform-

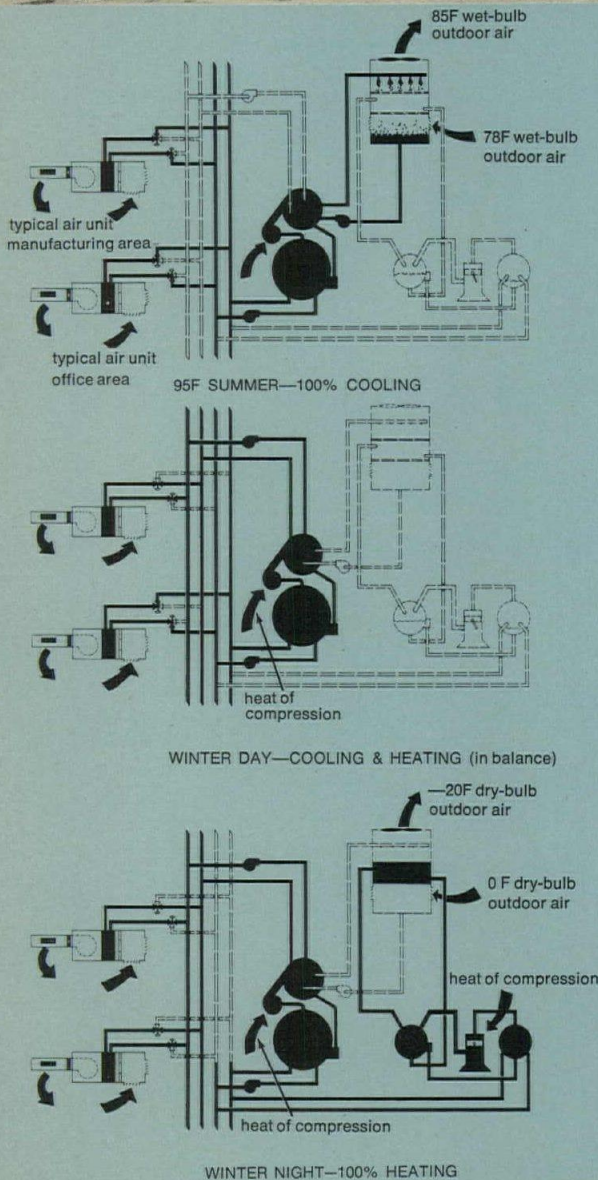
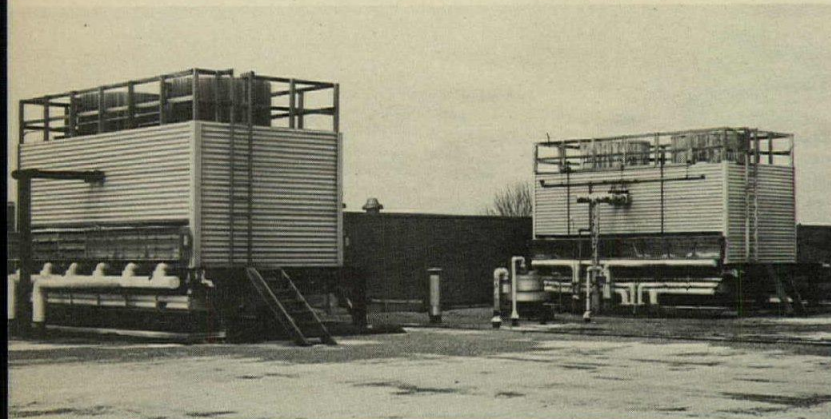

Designers and builders: William F. Lotz, Inc. Consulting engineers: Robert G. Werden & Associates (hvac and heat pump)

Architects: Gruzen & Partners, Engineers: Cosentini Associates (mechanical/electrical).

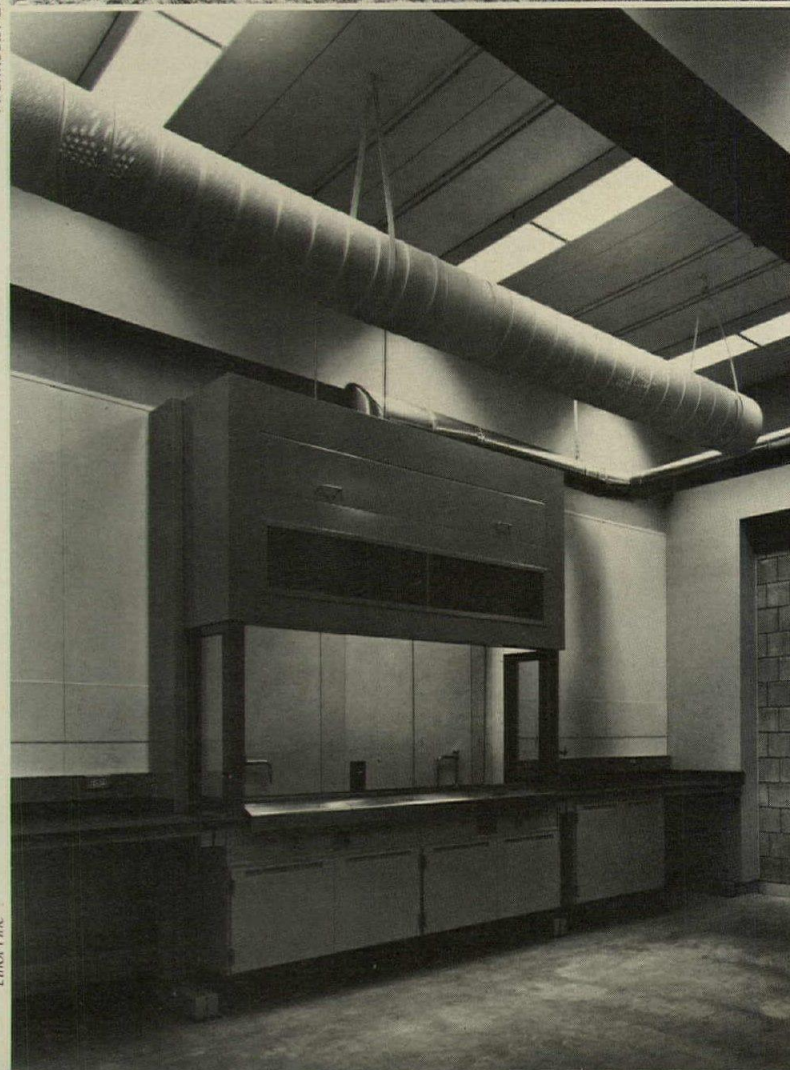
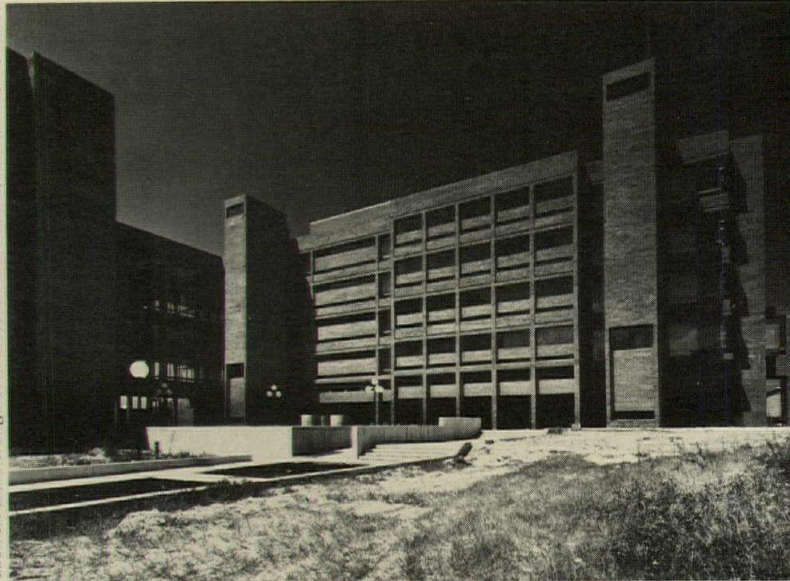

Elliot Fine

ance data on air distribution and acoustic properties of this approach were available. It was decided, therefore, to run prototype mock-up tests at Kodaras Acoustical Laboratories.

A 27-ft length of duct was tested for noise levels, and for ability to satisfactorily diffuse the air in a draft-free manner.

Adjustments were made, based upon these tests, to customize air flow within the ducts so that air distribution would meet specification criteria. The ducts

were equipped with orifice-plate baffles from 6½ to 7½ ft apart to control air flow (see drawing bottom of page).

The modular air-distribution approach, along with modular service corridors, allows the space to be partitioned into a typical physics lab (20 by 40 ft), or into smaller offices, or even opened up to a maximum size space of 40 by 100 ft. The utilities are accessible to all labs through the common service corridors that run along the short walls.

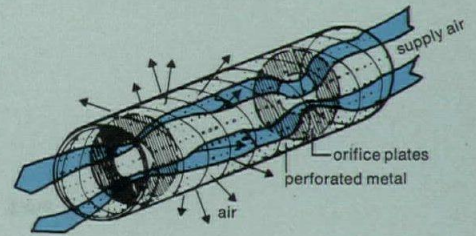
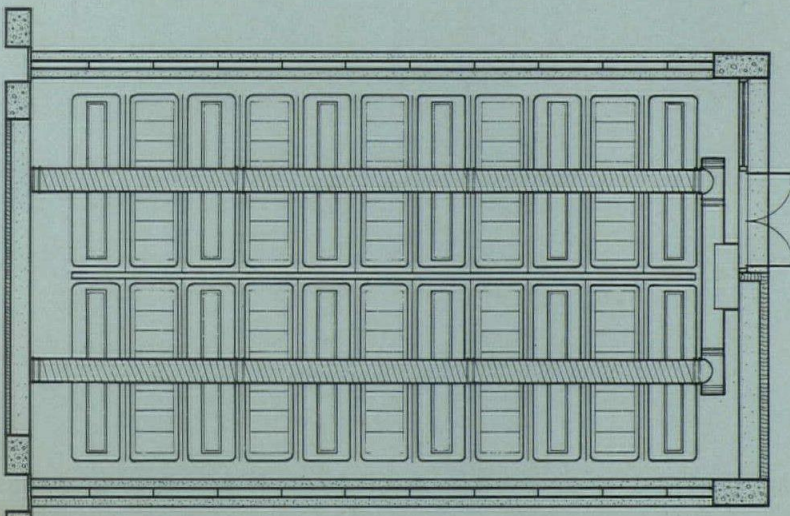
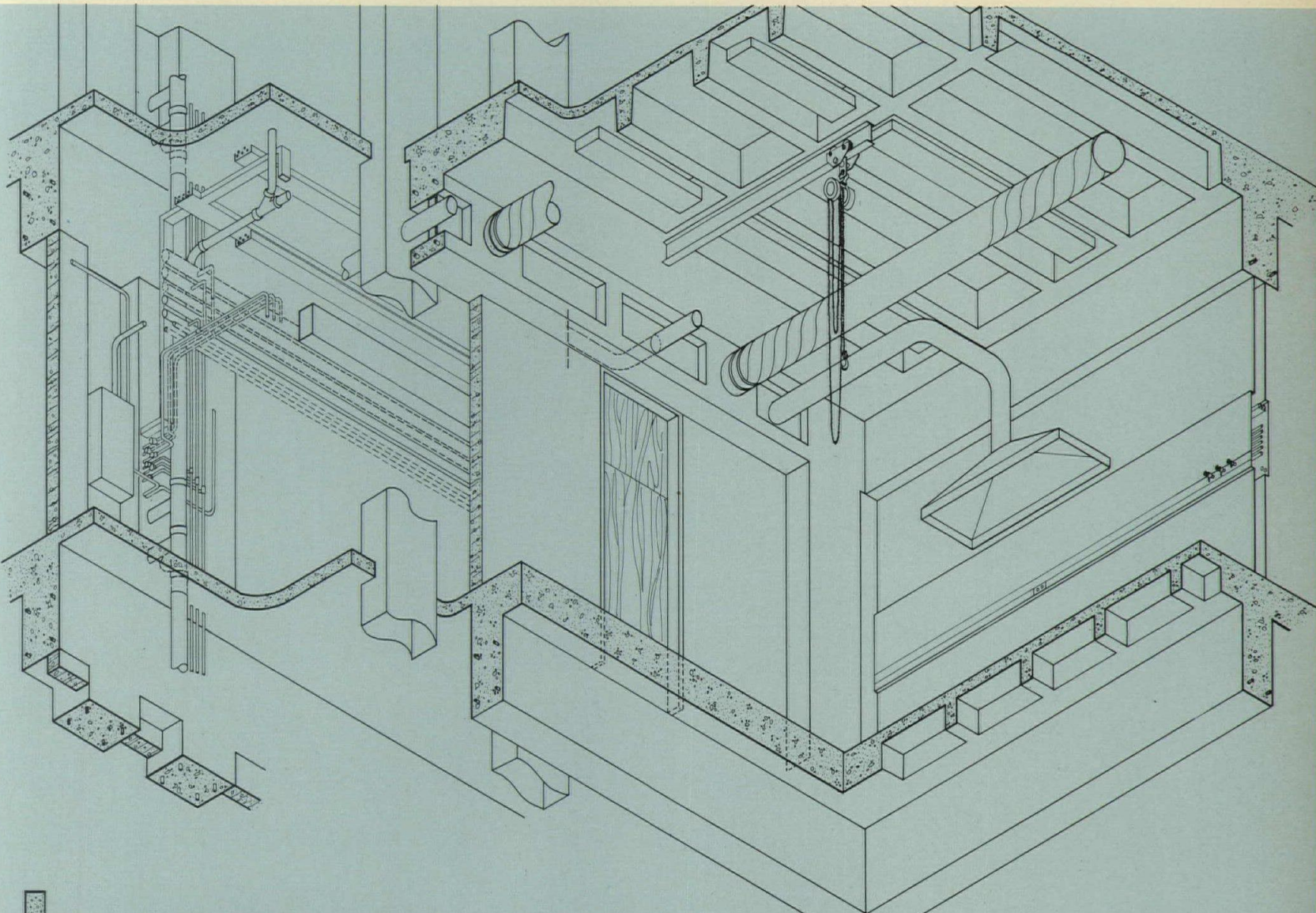

## A lab's supply-air system is designed so that exhaust hoods can be turned off—saving energy

In a novel energy-saving approach, exhaust hoods of a new chemistry/chemical engineering building at Newark College of Engineering can either be on or off without disturbing the main supply-air system—which means that only a minimum of outside air is needed for hoods.

The approach evolved partly from the client's requirement of constant-face-velocity hoods (fixed exhaust). Ventilation air is supplied directly to each hood from the variable-air-volume sup-

ply system through self-regulating, constant-volume devices. The regulators are operative when the individual hood exhaust fans are turned on. The above approach made it unnecessary to have complex static-pressure sensing and regulation within the air-supply system to balance air within each laboratory.

The extensive and complex ventilation and hood-exhaust requirements led to a joint architect-engineer decision to provide exterior shafts for running hood ex-

haust to the roof, and similar shafts to deliver uncontaminated outside air to the central air-handling-system penthouse on the roof. Toxic fumes are removed by high-velocity fans mounted atop the exhaust flues.

The high-velocity air systems reduced cubage, and allowed easier physical installation and coordination of services. Further, the unique combination of high-velocity air supply and exhaust hood system allowed considerable flexibility in space layout.

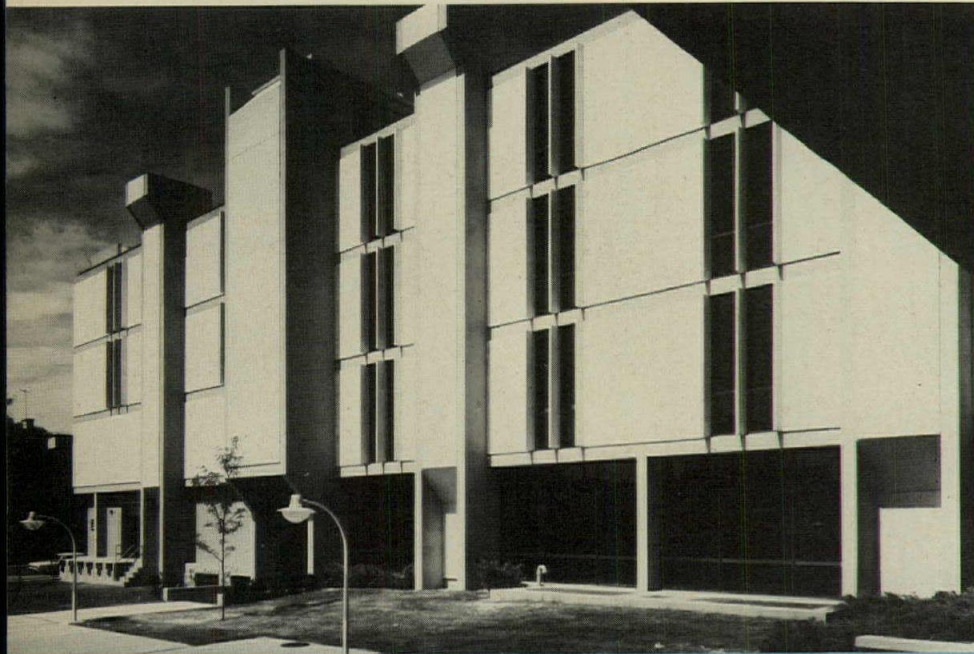

Otto Baitz

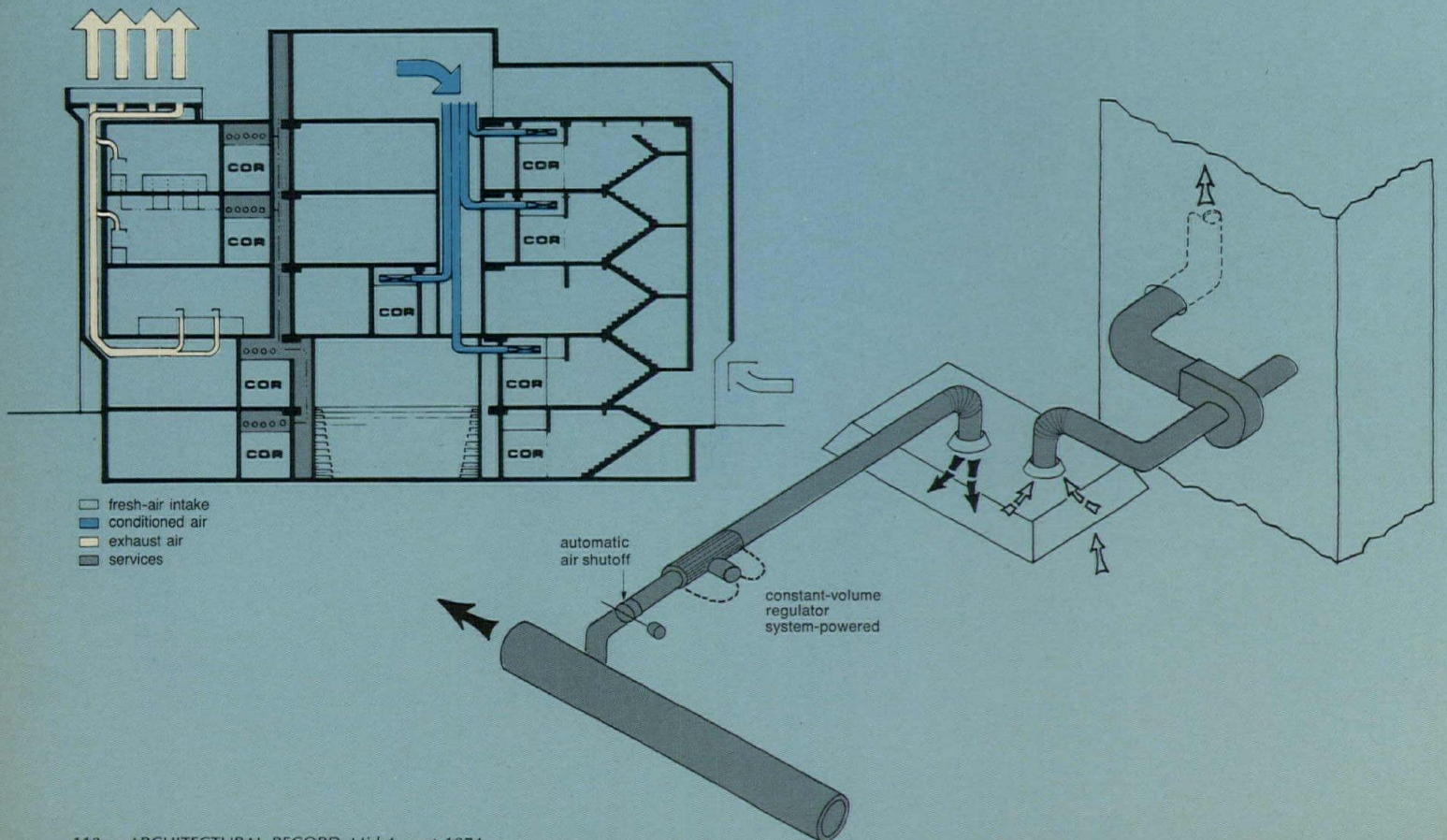
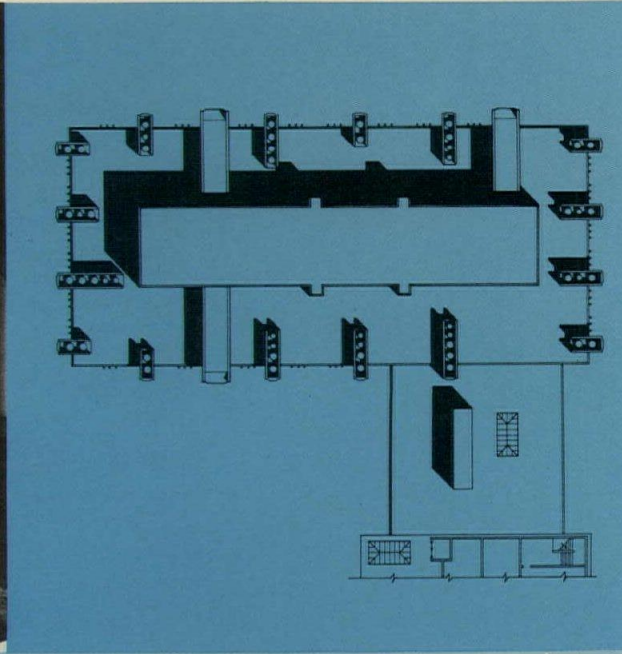

Architects: Phillips-Kaufman & Associates, (formerly Epple & Seaman). Engineers: Herbert Fox & Associates (mechanical).

# In an energy-poor area with sub-zero weather, a heat-recovery system reclaims expensive warmth from exhaust air

One of the major assignments given the mechanical engineers for the Lodge at Snowbird, a ski resort near Alta, Utah, was to provide an efficient heating system in an area where the temperature sometimes drops to 25 below, where no low-cost natural gas was available, and where the aerial tram and ski lifts had first claim on the limited electrical power. Ventilation difficulties were compounded by the fact that half of the units in the lodge are furnished with wood-burning fireplaces,

threatening a reversal of air flow. The system centers about a propane-fired boiler, augmented by electric resistance heating around the perimeter to offset heat loss through the large expanses of glass. Fresh air is tempered with heat from both the boiler and a heat-recovery wheel that extracts heat from exhaust air before it is released. The tempered air rises through a seven-story shaft, entering corridors through transfer grilles and supplying enough air pressure to prevent backflow from

the fireplaces. The heat recovery system, apart from conserving relatively expensive heat, provides a design bonus by clearing exhaust fans off the roof, which is highly visible from both the ski slopes and a nearby road. The roof is turfed, and mechanical equipment for the building includes a rooftop lawn sprinkling system. The boiler is fitted with two heat exchangers, one for the domestic hot water system and the other for a snow-melting system.

Architects: Brixen & Christopher; Engineers: Bridgers & Paxton (mechanical); Joseph F. Patrick (structural); Patrick King

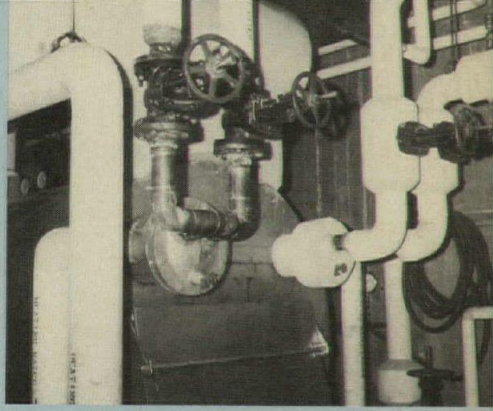
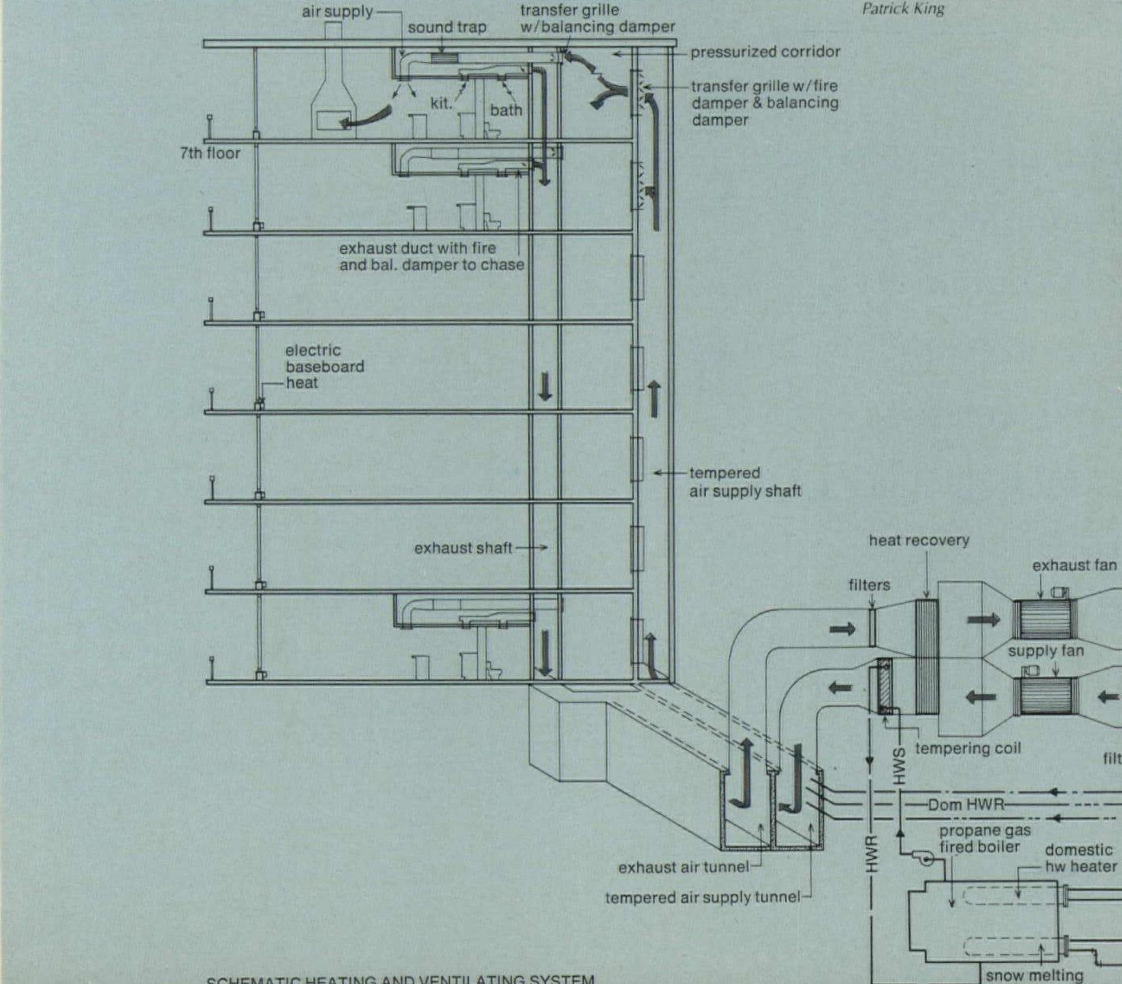
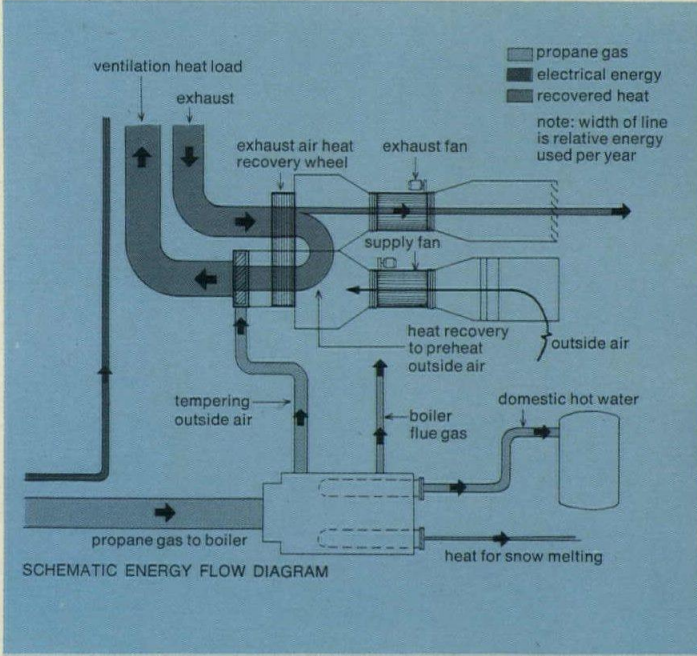

# 2

In response to growing awareness and concern, Record held a **Round Table on Codes and Standards for Fire Safety**. To participate as panelists, we invited some of the country's best-informed professionals—architects, engineers, fire consultants, officials of codes and standards enforcing and formulating bodies, government officials and private clients. To audit the meeting, we invited manufacturers affected by the new concerns about property and life safety.

This article is based on the 236-page transcript of the day-long meeting. It offers no pat solutions, but raises questions which must be solved if we are to protect lives at affordable costs—and react with thoughtful engineering rather than thoughtless emotion.



## These were the participants at the Round Table

### **Irwin A. Benjamin**

Associate director for fire technology  
Programmatic Center for Fire Research  
Institute of Applied Technology  
National Bureau of Standards

### **Jack Bono**

Assistant chief engineer,  
fire protection  
Underwriters Laboratories, Inc.

### **Carrol Burtner**

Chief, Fire Safety  
and Mobilization Planning Branch,  
General Services Administration

### **John G. (Gus) Degenkolb**

Fire protection consultant

### **Arthur W. Diemer**

President  
CC&F Property Management Company, Inc.  
(Cabot, Cabot & Forbes)

### **James R. Dowling**

Director, Code & Regulations Center  
The American Institute of Architects

### **Melvin Epstein, P.E.**

Meyer, Strong & Jones, P.C.  
Consulting mechanical and electrical engineers

### **D. Bert Haring, P.E.**

Vice president, Hatzel & Buehler  
electrical contractors

### **Jasper S. Hawkins**

Hawkins & Lindsey, Architects; and  
chairman, Codes Committee  
The American Institute of Architects

### **Paul Heilstedt, P.E.**

Technical director  
Building Officials and Code Administrators  
International, Inc.

### **John Jablonsky**

Assistant vice president  
American Insurance Association

### **Rolf H. Jensen, P.E.**

Rolf Jensen & Associates, Inc.  
Fire protection engineers and consultants

### **John C. Knight, AIA**

Vice president  
Charles Luckman Associates, Architects

### **Richard E. Masters, P.E.**

Jaros, Baum & Bolles  
Consulting mechanical and electrical engineers

### **Irving E. Minkin, P.E.**

Executive engineer  
Department of Buildings,  
Housing & Development Administration  
The City of New York

### **Robert G. Sandvik**

Director of research, development and education  
Sheet Metal & Air Conditioning  
Contractors National Association

### **Richard Stevens**

Director of engineering services  
National Fire Protection Association

### **Robert T. Tamblin, P. Eng.**

Engineering Interface Limited

### **Jeremiah T. Walsh**

Commissioner, Department of Buildings  
Housing and Development Administration  
The City of New York

### **Calvin H. Yuill**

Department of Structural Research  
Southwest Research Institute  
Technical adviser to the RECORD:  
F. J. Walsh, consulting engineer.

Co-moderators:

Robert E. Fischer and W. F. Wagner, Jr.

Auditors are listed on page 121.



There is a serious question whether or not the codes and standards under which we build are, on the one hand, adequate in terms of life safety in the event of fire, and on the other hand needlessly costly and/or redundant in terms of building cost.

There are few in the building industry who are not deeply concerned about the increasing pressure from the government, from the public, and from some professional sources to increase life safety, especially in tall buildings—to “do something!” Though the vast majority of deaths from fire occur in residences and au-

tomobiles, the catalyst for the new pressure is concern over the catastrophic possibilities inherent in high-rise fires—a type of fire which has so far resulted in a statistically small loss of life in this country, but a type of fire which lends itself to dramatic journalistic coverage.

Because the pace of change is quickening with respect to building design and materials, there is more demand for quicker consideration and evaluation of proposed changes in the fire codes and standards. And the rational consideration of changes gets right to basics (and the subject of the Round Table):

1. How the technical content of codes and standard is developed,
2. How the content is disseminated,
3. How they are interpreted and enforced,
4. Whether the best qualified people are involved in writing the codes and standards,
5. Whether the codes and standards are well enough understood by the people who must use and enforce them, and
6. Whether a whole new technology—a drastic “systems approach” to life safety is possible and/or desirable to augment the evolutionary system of gradual code change.

## **The first question the Round Table asked itself was “What is acceptable risk? We cannot assure 100 per cent life safety, so what should the goal be?”**

A thoughtful discussion of “acceptable risk” developed from Moderator Wagner’s question on public reaction to the life-safety/fire-safety problem: Whether the public reaction is not close to panic, and whether the government reaction has not been a too-much/too-fast proliferation of codes and laws.

Answered Irwin Benjamin of NBS: “I think public over-reaction has been good—it has brought to light a problem. I think government over-reaction can best be described as a willy-nilly, helter-skelter profusion of code changes and additions which really cannot be called a fire protection system. I think professional over-reaction has been disappointing—what we have seen in the last year or two is everyone trying to load a building with so many gadgets that it may sink from multiple

redundancy—a paradise for hardware manufacturers and installers . . . We’ve designed in all kinds of hardware without really standing back and saying: ‘What do we need for fire safety?’” In other words, said Benjamin: “No one has really defined the level of risk that we are willing to accept in a building and then develop a design to meet that risk level.”

Said Gus Degenkolb: “I’ve been working on the model codes since 1955, and until ten years ago the codes showed little concern for life safety. I would attend a meeting as the lone representative of a fire service, and I was on the other side of the fence. Only since 1960 or 1962 have the building codes started to concern life safety.

“There is a slowness in switching gears.”  
Dick Stevens of NFPA also spoke on the

need for an agreed-upon level of risk: “We have to decide on the level of life safety we want. A fine role for the Federal government, and especially the Congress, would be to determine what society will accept as a reasonable degree of life safety.”

Is it impossible to reach such a consensus? No one at the Round Table knew how. But, as the present level is clearly not acceptable and 100 per cent is clearly not possible, perhaps we can reach empirically toward a new standard of “acceptable risk” as we are now under the pressure for higher auto safety.

Countless points made at the Round Table showed that we are not doing the best that we could in regard to codes and standards—and thus the question is how do we do this job better in order to improve life safety.

## **Codes and standards are now, of course, the basic tool in protecting against fire. What’s wrong with them as is? What changes are needed? Are we forgetting the basics?**

Rolf Jensen, a fire protection consulting engineer, opened the discussion on code formulation and “over-reaction” by saying that “The history of codes and standards has traditionally been a history of reacting to disaster—a disaster that suddenly produces discomfort level in the eyes of professionals who are supposed to represent the public interest.

“I think that what is happening today in codes and standards is that many professionals are trying to get out of this over-reaction to disaster or possible disaster and get back to basics—re-evaluate where we are and attempt to go forward intelligently.”

Said Irving Minkin of the New York City Building Department: “I don’t think there is an over-reaction—I think for the first time there is general public involvement. The building laws and everything related to them make very dull reading to most of the public. But a tragedy occurring in one of ten thousand cases makes the public aware of the fact that construction has some rules and guidelines—and that sometimes they are inadequate.”

**There is clearly a proliferation of new standards related to fire. Too many? Too fast?**  
Said Dick Stevens of NFPA: “We no sooner get

one standard enacted than they come out with a new edition! We spent six weeks last summer on an intensive study of the problems of making consensus standards—and new editions was a major one. Under our new system our committees have to submit to our standards council a schedule of what it proposes to do every year, and this will be reviewed by the council so we will not have committees putting out new editions every year.”

Said Rolf Jensen: “This year, we have about 600 pages of changes to the BOCA building code, over 500 in the Uniform Building Code, 4800 pages of changes in the National Fire Protection Association’s standards. This rate of change is, in my judgment, running promiscuously out of control.” The reason for all the changes? “Over-reaction” in Jensen’s judgment. He sees a lot of forces for change preceding the relatively new public demand to do something:

“Before the early or mid-60s, the pressure for fire protection requirements in codes and standards were primarily economic—the insurance company gave the owner an incentive, in the form of lower premiums, to install fire protection. And the emphasis was on property protection.

“Then the firemen became concerned about their safety. Soon behind came the code enforcement officials saying ‘It’s not enough just to meet the insurance requirements. We’ve got to start thinking about life safety as well.

“And these new forces have been the reason for all this wrestling for change . . .

“It’s hard to keep up with changes and the pressures for more change even if you are on the committee.”

### **. . . but some felt there was nothing wrong with change—that change was essential**

Said Gus Degenkolb, fire protection consultant: “I don’t see anything wrong with 500 code changes—or a thousand. There’s been criticism of lack of input and lack of interest on the part of professionals and code enforcement people—and now that there is a growing awareness of life safety we shouldn’t gripe about too many changes.

“More importantly, building officials are much more professional than they were a few years ago. There are more architects and engineers coming up—and they see errors or reasons for change because they look at it from a professional viewpoint. They know what’s important and what is inconsequential. But we



The panelists . . .

need discussion on any serious proposed change—I think this is part of the participation we want from design people, the fire people, the codemaking side, the manufacturers.”

And Robert Sandvik, director of research, development and education of the Sheet Metal & Air Conditioning Contractors National Association, made a key point: “One reason we need a lot of code changes is that the nature of building has changed. Many of the basic codes developed when we were working under a ‘departmentalization theory’ of piling so many fire boxes on top of each other. And they were great when the Empire State Building was built—but today we have thin skins, and we have air conditioning. The problems are entirely different than they were, and I think we have to speed up code changes to keep up with building changes.”

#### Another reason for all the code changes is “the infant state of the art”

Said architect John Knight: “Part of the problem is that definition of terms, and recognition of what the problem is, is still in its infancy. While there has been a tremendous amount of good work done in the past few years, there are still many problems that are being looked at for the first time. . . . There have been many theories advanced over the last two years which we haven’t had time or funding to test for validity. For example, many people have run all kinds of computer print-outs as to what will happen in a particular situation. But the more experienced people have to ask: What happens if the skin leaks? Or what about this? Or that? We see a lot of solutions offered which we feel are impractical if not impossible. Experience is critical.”

#### Are the codes too rigid—do they block innovation? The codes were stoutly defended

In response to the criticism that, in order to meet the requirements of the codes, buildings are becoming stereotyped, consulting engineer Rolf Jensen argued that: “The degree of stereotyping is related principally to the designers’ failure to design to meet the intent of the code. All of the model codes, and most local codes, carry provisions for equivalency. They allow a designer who is willing to prove his case to come up with a fire safety system that is equal to the level required by the code.

“If you don’t believe that, look at the buildings we have built recently with atriums, with multiple functions, with arcades. We are building them, and building them safely.”

Added consultant Gus Degenkolb: “Al-

most all of the model-code organizations have a research committee, and you can take your problem to them and get a resolution. So there is a provision for alternates—and that is the advantage of belonging to a model-code group when an individual building official cannot make a determination himself.”

#### One major problem: lack of research coordination

Said owner Arthur Diemer: “It seems to me that we have to have some agency with the prime responsibility for coordinating and collecting research. There is plenty of input from many different groups—but we need some agency to coordinate it all, and then disseminate it to the industry, the various professional societies, the manufacturers, and the building owners—a report that will indicate where they are headed and ask for comment back.”

Irwin Benjamin agreed: “There is no one today who is actually sitting down and taking the information we have and processing it into code changes for submission to the different model codes.”

#### Is the rationale of codes and standards well enough understood?

Asked Moderator Wagner: Does the industry—architects and engineers and the manufacturers—understand the philosophy behind the various codes—or are they simply read as cookbooks?

Answered Paul Heilstedt, technical director of Building Officials and Code Administrators International: “We try to maintain records of every decision that the BOCA membership makes—and any BOCA member can contact us to find the rationale behind the decision. Sometimes a professional might have to obtain, in writing, this rationale in order to support his decision on how he interpreted the code. This is available to any member and the response is the same.”

Added Jerry Hawkins, architect and chairman of the AIA’s Codes Committee: “As long ago as 1968 AIA recommended to ICBO (International Conference of Building Officials) that they publish a separate volume of basic data, and the reason behind every approved code change—to do essentially what BOCA does. And I do believe this is soon going to take place . . .

“We also recommended that they pull out about five basic engineering-design chapters and get the code back down to being a handbook of life-safety considerations. And I think that is going to take place . . .”

Irving Minkin, executive engineer of the Department of Buildings of New York City’s Housing and Development Administration, scolded a bit: “The problem of interpretation is difficult, no doubt about that. Our New York City code, for example, is a complex one and a lengthy one. But our major problem is the refusal of a not-insignificant number of architects and engineers to believe that the code applies to them. . . . A great many architects, especially those involved in existing buildings, have as their prime concern getting an approval consistent with what their client wants—and the fact that the code requires that they enclose a stairway or strengthen the floor to accommodate a use change from office to warehouse doesn’t faze them one bit! Before we need a fine-grained analysis of a sophisticated law, we have to close a credibility gap; before we get down to philosophy, we have to get a lot of practitioners to read the damn thing and believe it.”

#### Sometimes you can work with “city hall”—and sometimes you need consultants

Architect John Knight spoke effectively of the importance of working closely with local code enforcement people: “There are some cities—and some building departments—who work very hard to see that the architect has every bit of information they have—to the degree that they will assign a man to your project whom you can call on, who will attend your meetings with the client and consultants.

“We go to them at the very outset of the project, and as the design program is being put together. This is especially important with unusual design ideas—such as an atrium-type hotel. This is the only way you can do it—there has to be involvement on both sides.”

Mr. Knight went on to talk about consultants: “The codes have become so complicated that—even with the code enforcement people working with us, in order to develop some ideas or designs—we call in consultants. Because we don’t have time to read all the codes, we just have to have some additional input.”

#### Everyone favored preliminary planning reviews—when you can get them

The question was asked whether day-to-day working relationships with enforcing officials was unique, or commonplace.

Said Paul Heilstedt of BOCA: “We encourage discussions between the professionals and the building department. In cases where the subject involves a unique design, or the appropriate building department doesn’t have the



time, BOCA provides a preliminary plan review service. The results of our discussions are provided to the official for his information and also for his use.

"This interchange is important."

Jerry Hawkins of AIA added: "Preliminary plan review is an ideal solution to the problem."

But Gene Rowland, a Round Table auditor representing the National Bureau of Standards, and a one-time code enforcement official in Wisconsin, sounded this warning: "When

we opened the door for preliminary programs, we found that we had no problems with the qualified architect. The problem is with the unqualified architect who hadn't done his homework and wanted us to do it for him. The good architects took the beating because the program was terminated—we were spending time educating firms that were not qualified."

**One example was held up to show how local participation can work**

"For the electrical code in New York," said en-

gineer and electrical contractor Bert Haring, "we have a process of constant review with the proper city department. Every week for the past 15 years, a panel representing professional engineers, real-estate members, utility people, and electrical contractors meet with the city. Thus—in discussing national versus local codes, I feel the local New York code is closer to the grass roots problem. We coordinate with model codes, but we must have the opportunity to solve local problems locally that are peculiar to a city such as New York."

**There was much criticism of the lack of architect-engineer interest in fire safety—and many panelists thought the problem begins back in school**

Mr. Minkin started the discussion: "While it is possible to improve considerably the fire safety of buildings, the report of the National Commission on Fire Prevention and Control observes that there is unenthusiastic attention on the part of architects and engineers . . . One of the reasons cited was the lack of training during professional education or practice leading to an awareness of the principles of fire.

"My own experience with the [New York City] building department is that there is a very strong need to begin right back in college. Too many people do not seem to understand the fact that the open stairway is a hazard, that you need an alternate route when the possibility of being trapped exceeds an arbitrary value, that many of the things that look nice could be the cause of death. They draw an arbitrary line and say 'I am responsible for this, but not that' . . ."

Architect John Knight responded: "In many cases what Mr. Minkin says is quite

true—and perhaps schools do not stress enough the practical side of architecture or engineering. Consequently it is the job of the graduate, the new architect, the new engineer, to obtain this knowledge through practical experience. This is good in some ways—but it takes a great deal of effort to become knowledgeable . . ."

"The AIA," responded Jim Dowling, "developed a fire safety task force last year . . . and we are working in the accredited schools of architecture, and the NCARB. Our survey indicated that only three of 78 schools of architecture offer courses in fire protection, so there is a lot to be done."

Engineer Rolf Jensen, agreeing that there was not nearly enough training in the engineering schools, discussed a major change in the curriculum at IIT: "Beginning in the sophomore year, our students will get a course in the philosophy of risk management. They will then

go through a series of what I call 'tool courses'—how to design a sprinkler system, or fire exits; how to evaluate fire loading and structural fire protection. And they will end up with a course on systems analysis—on how to put the tools together in a meaningful way and quantify it. If we are right in this change, when these people leave school and begin to have an impact on the industry, they are going to make some big changes."

Engineer and electrical contractor Bert Haring summed up the education need near the close of the Round Table: "The key point is in this education process—and the key question is how we as practitioners get educated. A great deal can be done to make clear what we are doing constructively by the trade publications. This Round Table is part of that process—to take a particular issue in which we are not fully knowledgeable and discuss it with all parties concerned."

**A major question was: Are the right people involved in making codes? Are the people with the best understanding and expertise the people doing the job?**

And this question raised some strong differences of opinion:

Said architect Jerry Hawkins of the AIA Codes Committee: "I think that is one of the basic problems we have—too often the composition of national committees that develop standards or codes seems to be based on personal friendship, on who is willing to volunteer to serve, or who can afford to come to the meetings at his own expense.

"We need a better system. The AIA has

one approach: We have developed a man-bank of well qualified people, and when we get requests for architects to serve as members of various national committees, we try to find the most appropriate person with the right background. . . . We try to fund the expenses of these people as often as we can."

Paul Heilstedt of BOCA said: "We like to feel that we have the best technical input the industry can gather for our codes—and I would like to echo what Mr. Hawkins said about AIA

involvement. Fire protection engineers are getting more involved. But the void we see is input from the professional engineers. We need more help from them."

Dick Stevens of the NFPA said: "Our board of directors has ruled we must balance our committees in accordance with the recommendations of ANSI which say that not more than one-third of your committee structure can represent any one interest. Under our procedure, if anyone requests membership, he has to



submit a description of his qualifications to serve, he has to indicate whom he will represent, and he has to indicate his ability to attend meetings and participate actively. All of our committee members are subject to annual reappointment, and if a man has not participated, he will not be reappointed. "We also have a new standards-making system: Once a committee document or amendment has cleared the committee with a two-thirds vote, it has to be published by the NFPA, and sent out for a 60-day review. We will send anyone who requests it the committee report, and then anyone can propose amendments—stating the problem providing supporting data, and giving the actual wording they would like to see. You can't just write and say 'We don't like it.'

"Then the committee must deal with that input, and explain their action on that input.

"We think this system is another means to get a great deal more input than we have had in the past."

But consulting engineer Gus Degenkolb had this criticism: "The people who serve on the model code committees are generally representatives of materials producers or manufacturers, and of course the building firms themselves . . . The structural and mechanical engineers are notable by their absence on fire and life safety committees, though they are out in force on matters of general design. It was

only about five years ago that the AIA started to have representatives, but they are prone to sit and listen and not say an awful lot unless it is an item in which they might individually be interested."

Said Dick Stevens: "We must keep committees within manageable working limits—somewhere in the order of 25 to 30. If a committee gets bigger, it cannot operate."

Calvin Yuill, staff engineer of the Southwest Research Institute, made another point on the problems of getting the best men for the job of code-making: "It is interesting to note the differences in the set-up between model code organizations and organizations like NFPA and ASTM. Most of the model-code groups have code-review or research committees made up of their own membership, all qualified building officials. They do not have to work on the consensus principle as we do in ASTM, where [as noted earlier] we have to have balanced committees.

"This balancing causes problems in that we usually have a waiting list of industry members who want to get on the committees—and for whom such committee work would be part of their paid job. But we cannot take them on because we cannot balance them—building officials have to go to the city council for their budget; and similarly it is difficult to get fire-department representation."

Consulting engineer Rolf Jensen added: "Architects and engineers in private practice who are participating in committee meetings have to dig into their own pocket to pay expenses, and give away time they otherwise could sell. I think you limit the input of design professionals because there is no way they can be compensated."

Said Robert Tamblyn, consulting engineer from Toronto: "I don't believe it's necessary to pay people—I don't think that is the problem. The problem is to make it important to belong or to participate . . . I think one has to start with the appointment of a peer group—have the best possible people to select other people. Then the appointment becomes important. It should terminate regularly at the end of each year, and reappointment should be made only when a considerable contribution has been made."

So while there were criticisms and frustrations about committee membership on codes-making bodies, the Round Table seemed to agree that the "involvement" question was improving, and Rolf Jensen made a final point: "In working on standards committees, it has been my experience that when someone with obvious and respected knowledge in a particular area expresses a position, the others tend to give extra weight to his position. As it should be. . . ."

## So if codes are not perfect, they're the best we have. And if not all the right people are involved, many are. Some thought the problem was in code application

Said John Jablonsky of the American Insurance Association: "I think we have very good people on these committees, and by and large, we have excellent codes and standards. Where the system fails is in the application of these codes.

"You get a standard written by a national body of qualified people, it gets down to the local level, and at once there are 'skatety-eight' people clamoring to downgrade it.

"And looking at the fires that occur in the United States today: Very few of the fires and very, very few of the life losses due to fire, are caused by a lack of technological updating of our codes. The losses are caused by blatant lack of enforcement of codes.

"We've known for many years that if you have a fire-rated floor-ceiling assembly and you knock a three-foot hole in it, the fire is

going to go from one floor to another. We also know that if you leave a door off an enclosed stairway you are going to have a problem."

### To some, incentives and economic reality were the biggest problem

Said engineer Richard Masters: "We have to put some emphasis on the economic realities of life. Unfortunately, the main thrust of all improvements in fire safety has put the onus on the owner.

"There is a public good that comes out of improving the fire safety of buildings, but the owner is penalized. For example, if one were to design and build a structure that was idiot-proof in respect to life safety, its assessed valuation would probably go up. On the other hand, the shoddiest of builders who are willing to live with the minimum the code requires

will probably benefit in the form of reduced taxation.

"Should we not look at it in reverse and give bonuses to those who are willing to invest additional money in the interests of fire safety?"

And Mr. Masters argued that "I am not impressed with the role that the insurance companies are playing. I have yet to see a scale-down of rates for additional safety and protection provisions."

Answered John Jablonsky: "The problem is that the rate is already so low that there is no incentive to lower the rate. It has been suggested by some that what we should do is to triple the rate on all office buildings that are not sprinklered. Then it would be possible to lower the rate on sprinklered buildings.

"I think too much has been said in the



... and some of the auditors

past about rates on the property end. I think the insurance companies should be approached on the life question—not life insurance, but liability insurance that the owner must carry.”

#### **Another possible incentive to improve fire safety is the cost of fire protection**

Dick Stevens of NFPA points out: “The economic burden of fire service in this nation is becoming burdensome. One recommendation to the politicians might be that if a building owner puts in private protection, he ought to get a tax credit because he is taking some burden off the fire service.”

Added engineer Gus Degenkolb: “This is a serious problem in smaller towns and cities. They may have never had a building taller than five or six stories, and now some 10- or 20-story buildings start up. All of a sudden, you’ve got ‘a high-rise problem,’ and you may have to have five more men on duty to fight fires in those buildings. For five men on duty, you have to hire 23. If the salary is \$12,000 a year, and most of the major fire departments are getting considerably more, you are talking about \$275,000 a year in salaries alone. The fringe benefits will add another \$135,000. And that is \$410,000 you put on the taxpayers. In many cities, if you have three buildings over a certain height, you must add another ladder company or the entire populace may find it is downgraded for insurance purposes.”

Mr. Jablonsky added: “A theory that is gaining momentum among city manager

groups is that the city should provide any resident with the basic fire-alarm response—that is, two engines and one ladder truck. If your fire potential is above that, it is up to the owner to provide the additional protection.”

#### **Another incentive—coming on strong—is a legal incentive: liability**

Said Jack Bono, assistant chief engineer, fire protection, of Underwriters Laboratories: “First, we are seeing more and more Federal laws—some of them primarily environmental—that affect the design and construction of buildings.

“And the second impact I see is on product liability. We seem to be accepting—more and more—a concept that if something goes wrong, someone should pay. And this means that whenever something goes wrong from a fire safety standpoint, then there ought to be someone around to compensate the victims—and that includes architects, engineers, consulting firms, product manufacturers and testing laboratories.”

Mr. Jablonsky added some dimension to the product-liability question: “We have hired in our engineering service [of the American Insurance Association] two people to work full time on product liability. With the advent of the Consumer Product Safety Commission, the public is more aware of the responsibility of the manufacturer to produce a product that is safe. And this enters into the code field through the landmark decision on

the Yonkers Jewish Center fire—where the Center, the architect, and the manufacturer of a product involved all were fined.

“People used to check the code and say: ‘It doesn’t state I can’t put that product in, so I’m going to.’ They are going to be checking much more carefully because of this new liability. Up till now, they could argue the code was at fault. But now if a manufacturer sells a product, and it is installed in a building and proves to be hazardous, the manufacturer will be liable.

“I think this is going to cut out a lot of our problems in fire safety . . .”

#### **Building “contents” came in for a lot of criticism from the Round Table**

Said Jim Dowling of the AIA Codes and Regulations Center: “We feel that the built-in fuels that are part of the building are far outweighed by what is moved into the building—material that the architect may have no control over. We would also suspect that structural fire resistance has been overstressed in relation to items moved into a building.”

Engineer Dick Masters agreed: “Most of the effort has been directed toward the building itself—and conspicuously absent has been any concern about the furnishings and other materials that go in a building. Just as it is important for architects and engineers to worry about fireprotecting the beams and stair enclosures, let building owners and tenants start to worry about what they put into the building.”

## **One way to go back to basics is the systems approach the GSA is now exploring.**

### **The Round Table saw some hope—and more than a few problems—in this alternate**

Carrol Burtner, chief of the Fire Safety and Mobilization Planning Branch of the General Services Administration described the GSA’s new systems approach and its philosophy:

“We need, as many have said today, a way to look at our risks and find out what they are. We want to build buildings that will be safe for the occupants and the public. We are concerned about the use of taxpayers’ money.

“As we have attempted to increase our knowledge base, we have been led to the systems approach. We now feel that we can look at the total building—and reduce some of the current code requirements by looking at the total safety picture. . . . There is an opportunity through broadening the concept of the codes and their applications to reach designs that will

be safe and less costly. . . . Is a building 100 percent safe because it meets a code? What does 100 per cent safe mean—absolutely safe under any conditions, with no one injured? This gets back to the general concept of risk: What is the likelihood that we will have a fire? If we do, what is the likelihood that it will extend beyond the work station? Beyond the room? Involve the whole structure?

“What we are trying to do is come up with a rational method of evaluating the probability of risk based on an analysis of the risk and capability of the building sub-systems—not just the structure, and the sprinklers, and the air-handling system, but all the components of the building. This requires a great deal of knowledge; and we are trying to get it.

“On fuel loading of a building’s contents, for example, we are going to physically survey 10,000 rooms in various parts of the country. We will evaluate the fuel load on the basis of the furniture and other material in each room—by type of room—and use this data to help us decide if we have to have a two-hour building or a three-hour building. This will help us look at the total risk.”

In response to a question about how GSA decides on trade-offs, Mr. Burtner made clear that “They aren’t really trade-offs. Trade-off implies a bartering—and this is not bartering. It is an analysis of risk and a decision that this will be the better way to go to meet the risk.”

And Irwin Benjamin of the National Bureau of Standards saw great benefit in the



GSA system: "Forget the idea of trade-off. We are not really swapping three detectors for two hours' fire resistance or three sprinkler heads. The purpose is to come up with a system.

"The systems approach has the possibility of giving optimum economic fire protection: the possibility of providing in a rational manner all of the protection that the codes provide. The systems approach has the potential of putting fire-safety engineering—which is now in the Middle Ages—up as a science like structural engineering. I'm not sure we yet have all the necessary knowledge, or level of competence, but we're moving in the right direction."

#### **What about research? Are we developing the expertise for systems analysis?**

Irwin Benjamin of NBS argued: "All our codes are technologically obsolete to the extent that they never reflect the newest state of the art. There are many areas in the codes as they exist which do not reflect knowledge that would result in modification of the codes. Beyond that, you must realize that, over the last two years, the amount of effort going into fire research has exploded—there is new and useful data coming out, but no mechanism to get it into the code quickly.

"If you look at the mechanism of input to the codes, you find that most changes—78 per cent in a recent study we made—are suggested by industry. Generally, these changes were pertinent to their particular material or interests, and not necessarily based on the latest research.

"We need someone, some agency, who has the responsibility of taking all the information we have—whatever its source—processing it into code changes, and submitting it to the model codes."

#### **The biggest value of systems? You have to identify all the elements**

"The biggest value of the systems approach," said Rolf Jensen, "is that it forces you to identify the inter-relationship of all of the elements of the fire-safety system. With the code approach, the tendency has been to consider each element in isolation.

"What systems does for you, as I see it, is to force you back to basics and say: 'I've got a building with a certain function. Some things in it will burn, it has a certain number of people. What are the conditions? How many burnables? What degree of relative isolation can I tolerate? What are the special design requirements?'"

Then you start balancing problems and solutions to come up with a final answer. It has to be done systematically."

John Jablonsky answered: "Systems can give us better responsibility than we have now. With codes, it is easy to run back and say that 'the code didn't say we had to, so I am free and clear.' Under systems, somebody has to take the responsibility of saying: 'I stake my reputation on this building being a good building.'"

#### **But more than a few saw real problems with the systems approach**

Gus Degenkolb said: "I am not opposed to the systems approach, but I am concerned about the buildings we have to build this year and next year. I think the systems approach is so far down the road that I am not going to be around to use it. In my opinion, the building code is a systems approach. It goes into the use of the building, the type of construction, exits, interior finish requirements, and so on.

"The decision tree that has been developed by GSA is applicable to one building

type—the office building. If we take it over into the field of public-assembly buildings or hospitals or warehouses, that whole decision tree has to be re-evaluated. We would end up with a decision tree for each occupancy—which would mean a big thick book just for a little bit of the building code.

And Rolf Jensen asked too if the code-approach didn't relate closely to the systems approach: "If you design a proper fire-protection system, you are going, in substance, to meet the codes. You may have problems with some of the minutiae, but if you design a good system you will meet the code. The codes are not stupid! Most of what is in the codes is pretty solid stuff—and we shouldn't lose sight of that."

Asked Mr. Hawkins: "You have to make some judgment decisions [about degree of risk]. Are those decisions part of your program?" Answered Burtner: "You recognize there are ranges of probabilities." Answered NBS's Benjamin: "The numbers [degree of risk] do not come from the tree. The numbers are something you decide on and the tree is what you use to meet those numbers."

#### **A key warning on the systems approach: Don't forget those existing buildings**

Said Mr. Minkin: "Whether or not you realize it, you are thinking new building construction. Be careful! Don't start eradicating this ready-made decision process called a building code. You might come up with a very rational and perhaps correct approach for new buildings, and forget we have 200 million people living in hundreds of thousands of existing buildings.

"Do you think you can take something compatible with new construction and apply it to existing building? That's a real problem!"

### **Asked for priorities, the Round Table suggested many, supporting the philosophy that ran throughout: There is no simple answer. Complex problems demand complex approaches**

Asked by Moderator Wagner: "What do you think the priorities are? What do we most have to get done?"

While agreeing that more basic research is needed in residential fire safety, Paul Heilstedt of BOCA thought that "Top priority should be education, not only of design-team professionals but building officials and the public." Gus Degenkolb again emphasized professional education: "Architects who appear at meetings like this, or at code meetings, are the

ones who have studied the codes and are involved in fire safety; but they are a very small minority.

"We need more effort on enforcing the codes we have now," said Robert Sandvik of SMACNA. "I think we have to get right down to the grass roots.

"We've heard comments that most of the fire losses are the result of blatant fire code violations, and this gets down to the grass roots—the building inspector, the code enforcement

official—and their expertise, or lack of it.

"A few of our local chapters have had considerable success in helping these people, who are very much concerned. If the industry put a little more effort into better enforcement of the codes we have now, we would see an immediate effect."

Architect Jerry Hawkins: "I think the top priority should be a complete re-analysis of the building-law process—of which fire safety is only a part. If the process is not streamlined



into a delivery system that gets research into the codes as quickly as possible, we are not going to solve the fire-safety problem. If we re-evaluate the system, identify the participants and their proper roles, I think we will be better able to solve our fire-safety problems."

City building commissioner Walsh's priority: "Government at all levels, but particularly at the Federal level, ought to start showing how willing and able they are to participate in meaningful efforts to reach the common goal. Government has to understand that it is a participant, and exactly where and how it participates."

Said Calvin Yuill of Southwest Research Institute: "Can we establish priorities? Many things discussed today are extremely important, and enforcement of our present code ranks very high on the list. But the definition of hazard is a gap in our whole fire-protection code that we have not managed. . . . We need to know the level of safety we can accept."

Said owner Arthur Diemer, "First, we owners would like to see the use of practical codes that we had a part in developing or commenting on, and good judgment used in weighing the economic benefits. Two: codes should not give unfair advantage to some owners versus others. Three: owners have no way of recouping extra capital investment to meet new codes—and existing leases normally do not permit increasing rent for this additional capital expenditure. Therefore, some consideration of tax relief might be considered. Four: A progressive and quality developer would probably lean toward providing additional safety features in his building within reasonable cost, and then maximize these benefits in his marketing program."

**An afterword by the moderators:**

Complex problems, call for complex answers. This Round Table, far-ranging enough, confined itself to the code and standards aspects of fire safety—and got into systems because they are inextricably bound up with codes and standards.

But in this complex area, new approaches are emerging all the time. In its infancy is the idea that we can look at fire safety as an over-all systems analysis problem—amenable to innovative concepts, innovative designs, innovative approaches.

RECORD will follow any and all research in this area and report it on a continuing basis. Perhaps, soon, whole new concepts for protecting lives will make the subject of another Round Table. We hope so.

—R.F. and W.W.

**These building-industry producers and manufacturers audited the Round Table:**

- |   |  |
|---|--|
| Lou Almgren<br>The Ansul Company                              | Thomas R. Lasier<br>LCN Closers Incorporated                             |
| Paul Anderson<br>Copper Development Association               | Jerry Lowry<br>Pyrotronics Incorporated                                  |
| Robert Borgess<br>PPG Industries                              | John Lyons<br>The Bilco Company  |
| Rodney Burgin<br>National Gypsum Company                      | Joseph McDermott<br>The B.F. Goodrich Chemical Co.                       |
| Walter Calahan<br>Detex Corporation                           | William D. McKay<br>Johnson Service Company                              |
| Clarence Clarkson<br>ASG Industries, Incorporated             | James Orefice<br>Mobay Chemical Company                                  |
| Robert Coyle<br>Eaton Corporation                             | Richard Pardee<br>A-T-O Incorporated                                     |
| George Cross<br>Amspec Incorporated                           | F.J. Rarig<br>Rohm & Haas Company  |
| William M. Daniels<br>L.E. Carpenter & Company                | Paul J. Roach<br>Pyrotector Incorporated                                 |
| Curtis Early<br>Monsanto Company                              | John Ed Ryan<br>National Forest Products Association                     |
| William Elliott<br>Gamewell, A Gulf+Western Systems Company   | E.V. Salvo<br>U.S. Gypsum Company  |
| Neal English<br>International Masonry Institute               | Morton Sherman<br>The Celotex Corporation                                |
| Arthur Goldman<br>Arthur Sworn Goldman & Associates           | Larry Siegel<br>U.S. Steel Corporation                                   |
| Ernest Hartog<br>American District Telegraph Company          | Jerry L. Smith<br>Libby-Owen-Ford Company                                |
| John Hauserman<br>The E.F. Hauserman Company                  | James Spence<br>American Iron & Steel Institute                          |
| James E. Hazeltine<br>Armstrong Cork Company                  | E.A. Stroupe<br>ITT Grinnell Corporation                                 |
| Harold Hornberger<br>Marlite Division<br>Masonite Corporation | Richard Swan<br>Wasco Products Incorporated                              |
| Ernest D. Hunter<br>U.S. Steel Corporation                    | Dr. Ross Valentine<br>Homasote Company                                   |
| Rodney James<br>Otis Elevator Company                         | John Viniello<br>National Automatic Sprinkler & Fire Control Association |
| Carl Jewell<br>Honeywell Incorporated                         | John F. Vyverberg<br>Owens-Corning-Fiberglas Corporation                 |
| Joseph Johnson<br>Pyrotronics Incorporated                    | James Webel<br>Owens-Corning-Fiberglas Corporation                       |
| J.E. Kindregan<br>Johns-Manville Corporation                  | Howard Yunker<br>Dover Corporation                                       |
|   | Vladimir Zazworsky<br>Bethlehem Steel Corporation                        |

# 3

Reversing the theme of this issue for a few pages, the following article describes a case of **architecture for engineering**, which architects are enlisted in the service of engineering design. The design of plants for water purification and sewage treatment (euphemistically, wastewater treatment) is, for obvious reasons, beyond the technical scope of the architect. Nonetheless, these projects from Camp Dresser & McKee, a large firm of sanitation engineers, show that staff architects working within the dictates of process engineering have made essential contributions to the better design of these plants—and their contributions were by no means limited to esthetic embellishment.

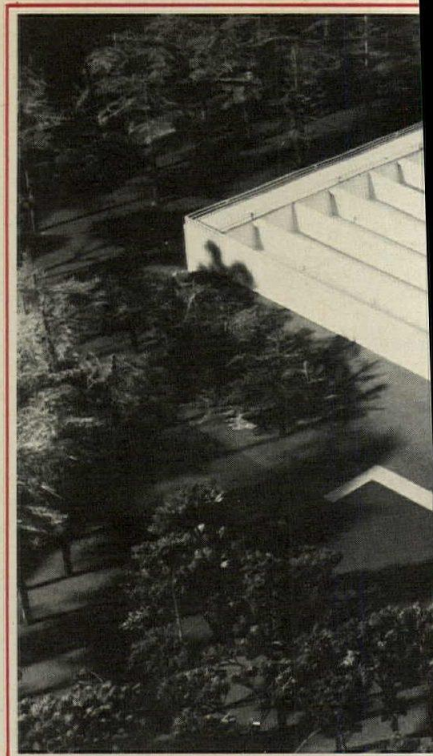

Architects rarely engage in the design of such highly specialized utilities as waterworks and sewage plants, which are the province of highly specialized process engineers. Since its establishment in 1947, however, Camp Dresser & McKee, a large Boston-based firm of environmental engineers whose work involves principally the design of wastewater treatment plants and water purification plants, has employed architects. Undoubtedly this decision was originally taken as an expedient for the design of incidental buildings and perhaps for the prettification of these utilitarian structures. What has developed is a liaison between architect and engineers

## SPOKANE, WASHINGTON

Along the Spokane River, on a long sliver of a site, drawing at right and continued on next page), CDM is making a major addition to an existing wastewater treatment facility. What the designers are faced with is more than just complex engineering on a difficult site. It is also finding a suitable and expressive idiom for enclosing a frankly industrial process—a process that traditionally has been regarded as a bad neighbor, treated as an eyesore, and more often than not tucked away out of sight. For this project, CDM was associated with Bovay Engineers, Inc., of Spokane.



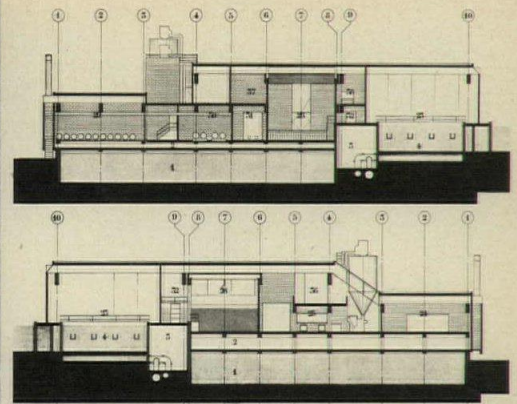
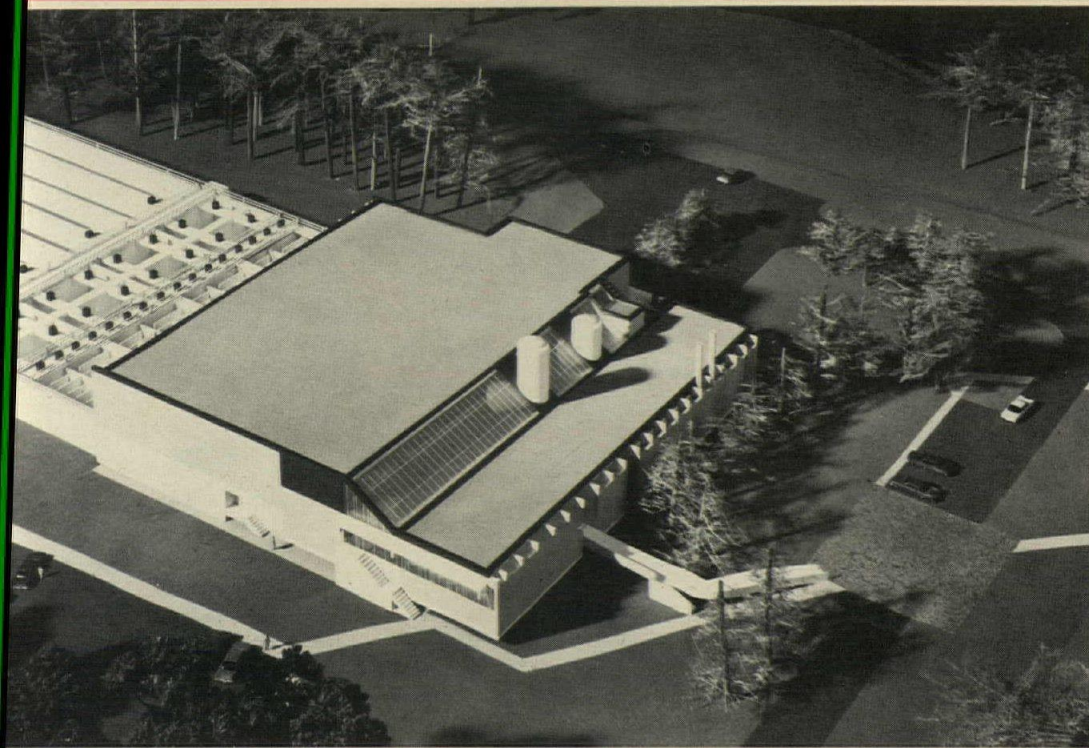

### NEW BEDFORD, MASS.

This water treatment plant exemplifies the compact, rational results that can be achieved when architects and engineers work in close cooperation. The building's front band is for staff, the high roofed section for equipment (each must be scaled and dimensioned differently), and a troughed section over the filters at the rear. Staff spaces occur over the clear well where purified water is stored.

© Steve Rosenthal

resulting in tighter, more coherent plans for sanitation plants. To the engineers' expertise in process, the architects have added their unique three-dimensional approach to such spatial considerations as site planning and circulation, as well as their inbred sensitivity to the practical needs of people.

This liaison has elevated the familiar collection of smelly tanks and scruffy sheds that typically have characterized wastewater treatment plants to a well-designed, environmentally positive engineering work set in a landscaped site, with only one or at most a limited number of architecturally coordinated buildings.

This article is drawn from the observations and comments, both oral and written, of Gary Dunbar and Patrick Houlihan, two members of CDM's 20-man architectural staff. This article is illustrated by a group of projects now under design or construction that speak eloquently in behalf of the firm's interdisciplinary approach. They demonstrate with unusual clarity the benefits that can accrue when architects and engineers unite their special talents and learn from each other.—Ed.

One of the architect's most important contributions to Camp Dresser & McKee's design approach has been in the familiar ar-

chitectural exercise of site planning. A typical wastewater treatment plant used to be basically a physical translation of a flow diagram, with pipes starting at the influent and ending at the effluent to the river and with such buildings dotted along the flow line as need suggested. This sort of planning, apart from generally ending in visual disorder, was also inefficient in terms of three principal modes of circulation: process, trucking access and egress, and personnel.

#### A fresh view of functional needs led to more compact site plans

When the architect was given an opportunity to become involved, his contribution was to organize

all enclosed functions into a single building complex, with all the consequent simplification of road access, personnel control, all-weather operation, and heating and ventilation efficiency. Further, what had been distributed about the site as the Screenings Building, the Grit Building, the Blower Building, the Flotation Thickener Building, the Gravity Thickener Building, the Vacuum Filter Building, the Maintenance Building, the Operations Building and the Garage, became one unitized structure, organized to promote access to piping and zoned as required for gas isolation. The requirements of the treatment process dictate relative location,

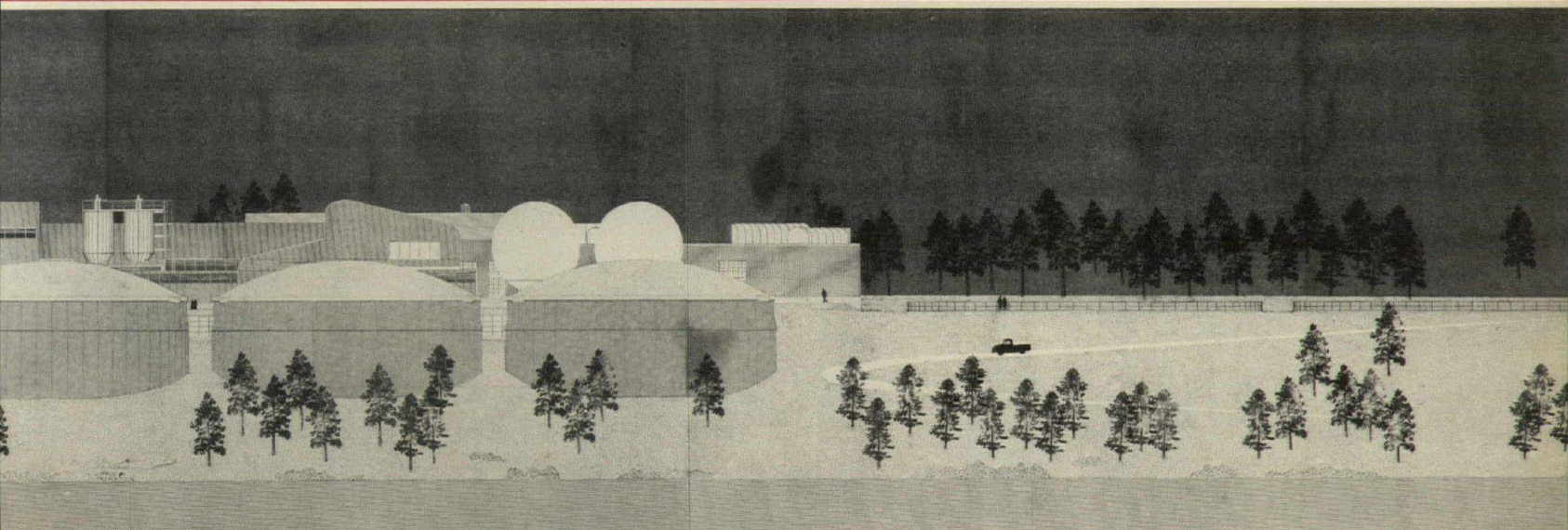

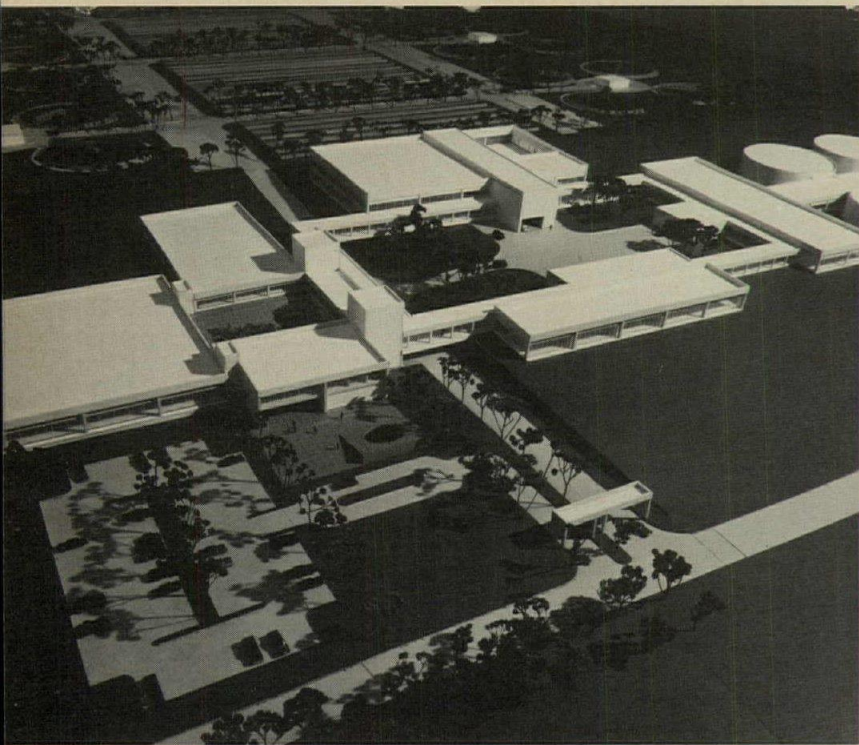

George Zimberg

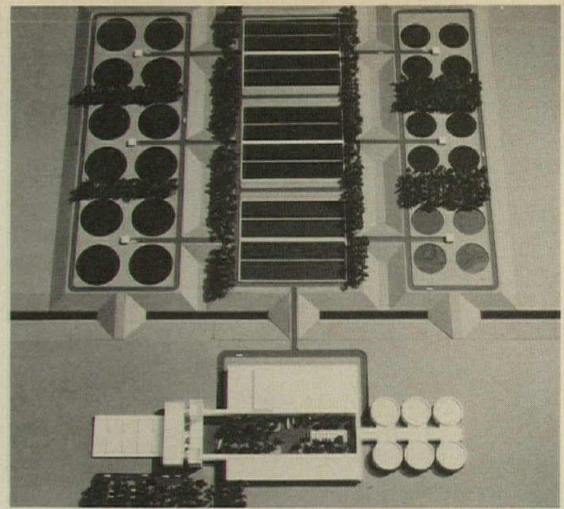

### SALT CREEK, CHICAGO

The client for this wastewater treatment project at first wanted a vast roof to cover the aeration basins. CDM and architects Johnson-Hotvedt developed instead a system of berms designed to shield the basins from view. They also plan an ecology garden. A long service spine will link all the project's components to simplify maintenance.

but the architectural compacting of operations meant a more coherent site layout and less site used.

Where the engineer's idea of circulation is generally confined to a flow line, the architect's, by both training and experience, always includes people. One result of this architectural input has been to increase the CDM design team's awareness that personnel access to equipment for repair and maintenance is important—in the case of some breakdowns, speed of access may even be critical, since the materials involved often include raw sewage and toxic chemicals. One of the functional advantages of tightening up the site plan is to shorten lines of com-

munication and improve maintenance control.

#### Not all design problems are engineering problems

There are some nonengineering ancillary functions associated with these installations that fall naturally into the architect's lap. These plants, for instance, receive an astonishing number of visitors—school children on field trips and environmental interest groups as well as "visiting firemen." Provision for guided tours, it turns out, is, if not strictly necessary, certainly appreciated by plant personnel. Experience shows, further, that well designed plants draw still more visitors.

Site development has also become a major consideration in the design of these facilities, largely, of course, in response to community beautification groups and increased public concern about the natural environment. Since many of these plants are necessarily on riverbanks, there is often a community demand for public access to the water. At the outset, most sites designated for sewage treatment are pretty grubby; CDM has designed plants for sites at abandoned gravel pits, on old garbage dumps, and surrounded by oil-storage tanks. The finished plants are handsomely landscaped and sometimes include community

parks and recreational facilities like fishing piers.

#### The problems of process design are new to architects

The architect's task in the design of engineering works associated with pollution control can really be understood only by understanding the problems of design. These problems are complicated by such matters as:

- fluctuating design data, data that change as the many engineering specialists involved add their requirements;
- the peculiarities of the scale of the problem and the technology of its solution; also, location and site characteristics, which affect the

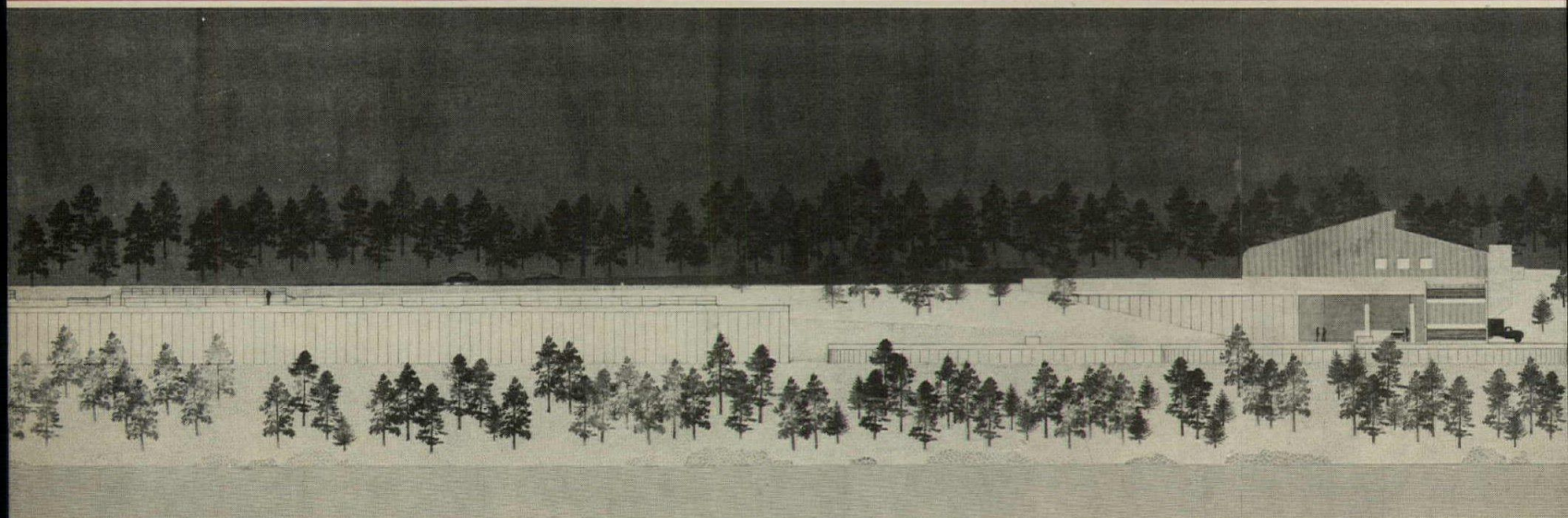

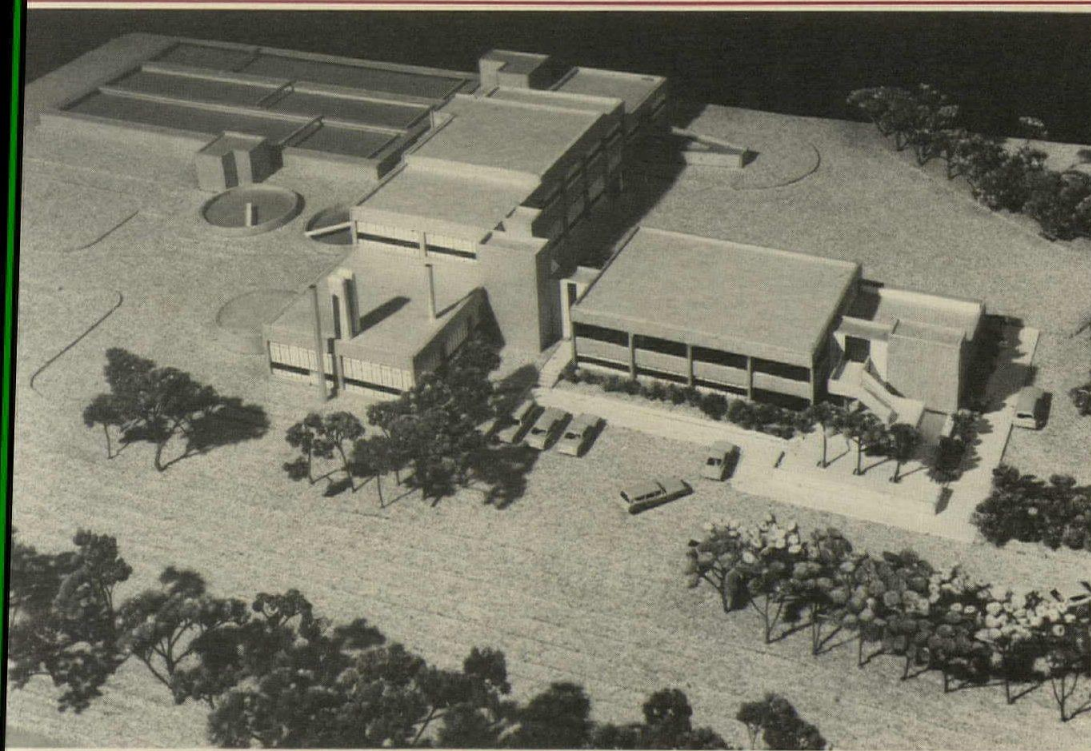

© Gorchey and Gorchey

## Haverhill, Massachusetts

CDM architects describe this wastewater treatment plant as "perhaps the most tightly ordered and rational plan of this kind that we've done to date." It is a compact group of buildings expressed as an almost continuous mass. But the massing, though simple in appearance, encloses a highly engineered process, as the sections below effectively suggest.

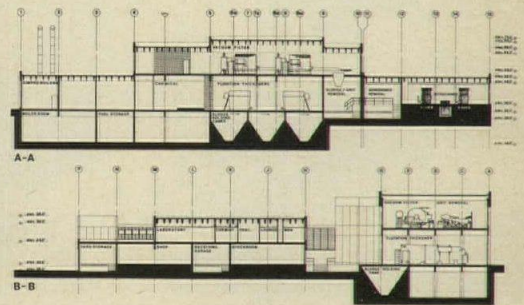

problem as in any normal building project;

—technological information, the substance of the physical engineering, and an area in which the architect is not trained;

—multiprofessional design participation: up to 12 professional specialists cooperate in the design of most plants, including civil engineers, HVAC engineers, plumbing engineers, instrumentation engineers, hydraulic engineers, electrical engineers, sanitary engineers, structural engineers, architects, landscape architects, soils engineers and chemists.

Among these various team members, the architect has a unique view of the project as a

whole. And he has the most visible effect on the end product of the design process. This visible effect, however, is only part of his total contribution. In addition, the architect is also concerned with the function of the facility, with its cost, with construction methods, and with the long-term operation and maintenance of the physical plant as a public utility.

These concerns give the architect a specialized and highly technical role in the project. For the conventional architect to have an impact in this role, he must acquire skills, broaden his engineering acumen, modify some of his traditional attitudes, and channel his energy and talent to maxi-

mize his effect as a team member rather than leader.

### The earliest design phases are chemical and technological

From the inception of a project, the job is under the over-all direction of a process engineer. His work is to carry out the sanitary engineering design for the project and to coordinate the design efforts of all other "functional groups."

His work starts with the collection of data related to the pollution problem in the town or region under consideration. To test the water and to determine ways of treating it to remove pollutants, pilot plants are often established

and operated for six months or more. On the basis of this data, further analysis establishes the basic technology to be employed. Then consideration is given to the physical form of machines and tanks needed to cope with these processes. Tank sizes are estimated and numbers and type of machines suggested.

### The architect's involvement begins with site analysis

The architect receives this information and begins analyzing it in terms of the site. Site analysis is executed with the knowledge of the functions the site is to accommodate. In this way, various arrangements of basins and build-

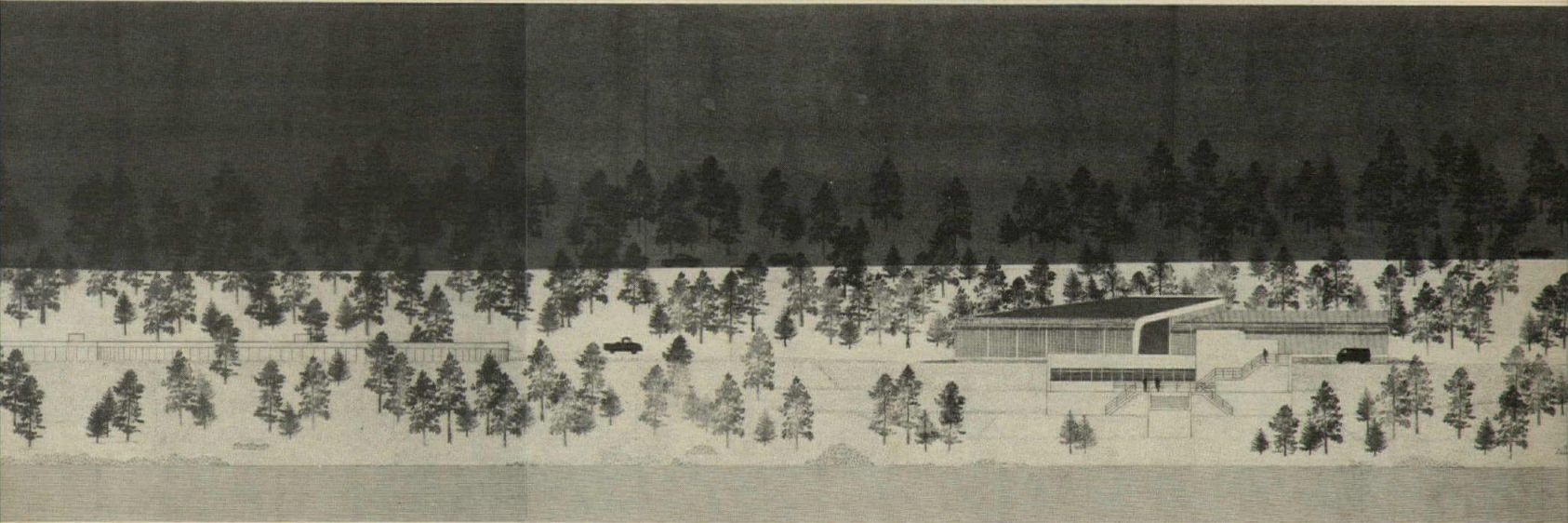

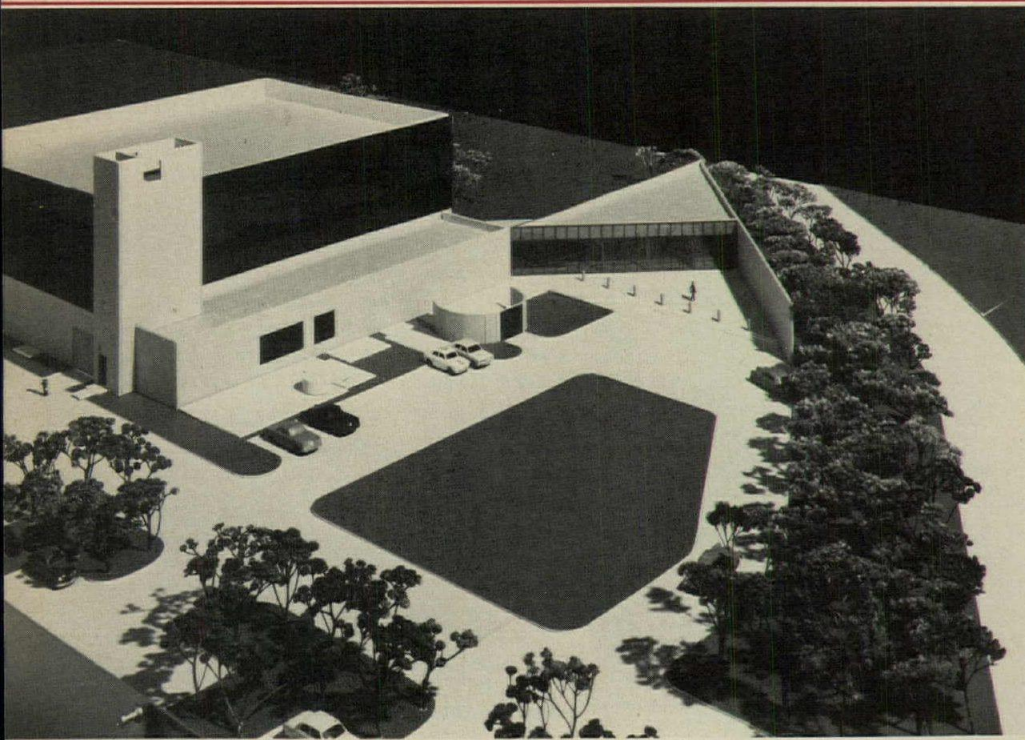

© Gorchev and Gorchev

### TALLMAN'S ISLAND, NEW YORK

In Queens, New York, CDM is now renovating and extending this 1931 wastewater treatment plant. Earth from the new aeration basins is being used to create a park. The waterfront is being opened up for public use so Queens residents will receive not only a park but a new fishing pier as well. The architects for this project were Johnson-Hotvedt Associates.

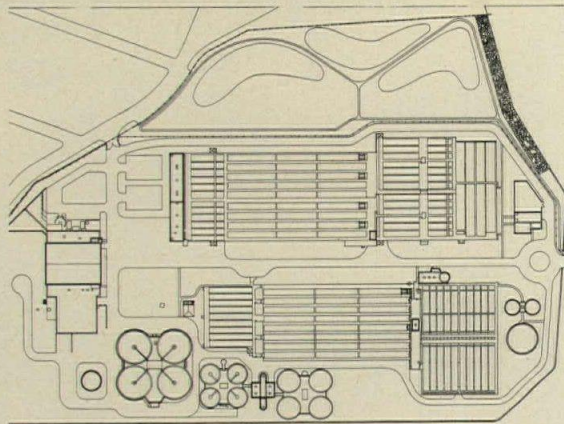

ings can be evaluated in terms of the three circulation needs mentioned earlier. In addition, the ecological aspects of the site are considered and problems of overlook, visibility, wind and odor control are weighed.

During this phase, the architects try out various combinations and arrangements of building forms, reflecting various tank layouts, site configurations, accessibility for truck delivery and disposal, and public access. To an appropriate extent, the community represented by the client, as well as interested individuals and groups, is examined to determine attitudes, expectations and requirements relevant to the site.

The project engineer follows this analysis by testing the engineering of each suggested site layout. One of these, along with the building layout it implies, is accepted and then tested to a larger scale. If it holds together, outline schematics are prepared.

Progressive development of the preliminary phases involves all functional groups in the design of all parts of the plant. Pumps are accurately sized, pipes and their runs are determined and drawn. HVAC is consulted to establish spatial allowances. Instrumentation is asked to predesign all control panels throughout the plant. Structural is asked to examine ways of building the structures.

The architect coordinates all of this information in his plans for the buildings, and, through his influence on and control of certain features of the site plan, extends the same coordination to outside structures, tunnels, pump galleries and land formation. The architect's final preliminary designs embody all the agreements reached by the functional groups on the design of everything to be built in the plant.

#### Bewildered at first, the architect learns to interpret the discipline

While the architect is a key member of the team, he finds himself in the unusual position professionally of being subordinate to

the designing engineer in charge. He must interpret the requirements of an engineering discipline in which he has never been trained and the facts of which he must accept as given by the project engineer.

When dealing with the design criteria of an engineering problem of the sort encountered in wastewater treatment plants, the novice architect is invariably at a loss. What can he do, except possibly put a roof over it—whatever it is—and throw some walls around it?

To the architect, the engineer's solution at first seems inviolable. Surely something so scientifically calculated and estab-

© Gorchev and Gorchev

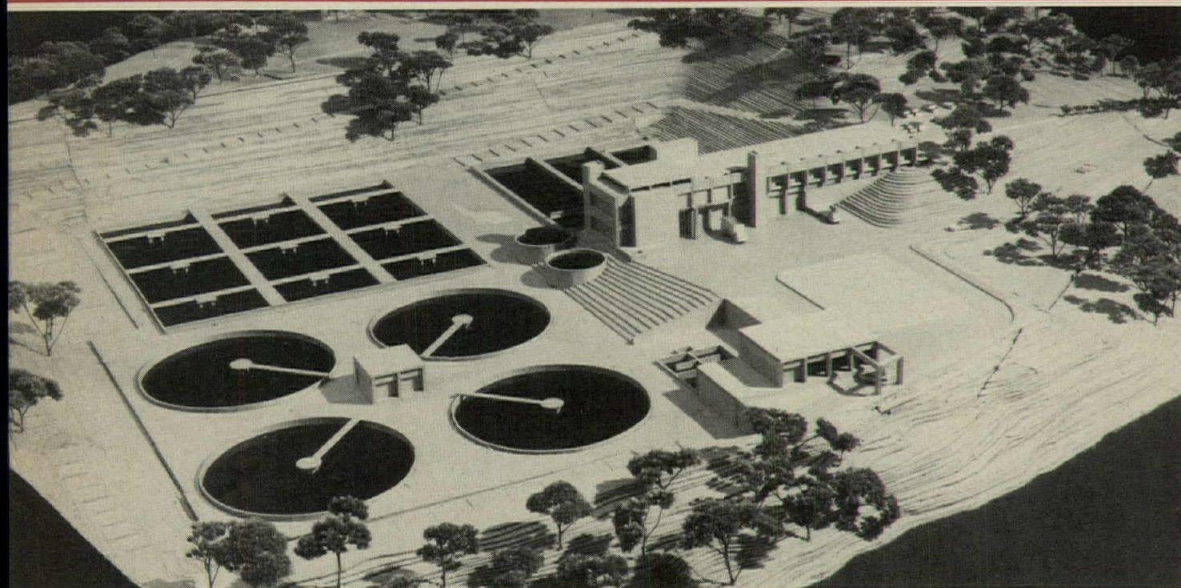

### WATERVILLE, MAINE

On a peninsula in the Kennebec River, CDM placed this wastewater treatment plant (photo left) in an abandoned gravel quarry. It is a concrete structure with staff spaces above, equipment spaces below. The steep sides of the quarry were regraded and planted with trees to improve the site and eliminate further erosion.

### FITCHBURG, MASSACHUSETTS

Two new plants for this community: one for waste water, the other for industrial wastes. West Fitchburg will be built in weathering steel. At East Fitchburg (near photo) the incinerator will be walled in vertical louvers matched to the cladding.

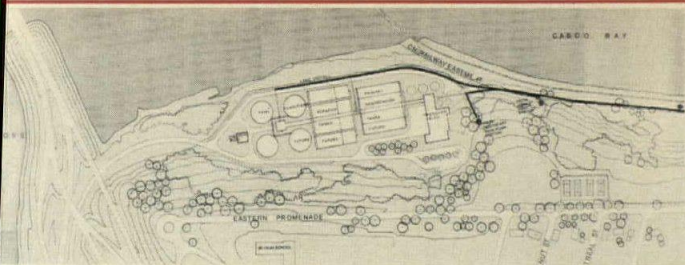

## PORTLAND, MAINE

A tight, functional grouping expressed as what it is—a container for an industrial process. The elevation and location of the tanks were determined by sight lines from a nearby bridge that provides major access to the city from the north. The coherence of the building forms and the clarity of the site planning are exemplary.

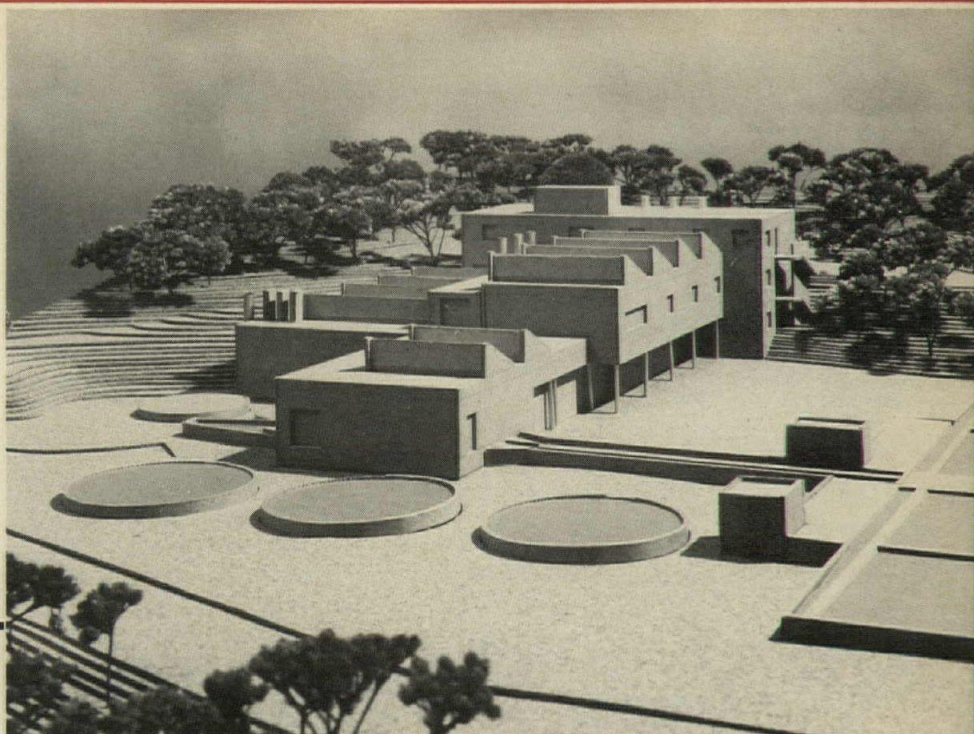
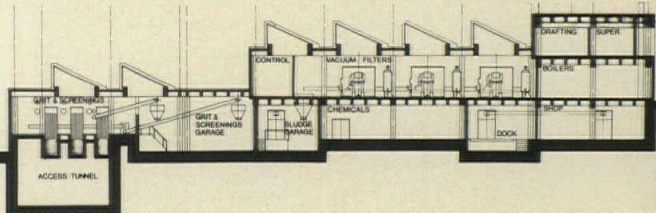

© Gorchev and Gorchev

lished must be "correct." If the ungainly conjunction of pumps, pipes and concrete channels before his eyes seems not to conform to the dictum, "truth is beauty, beauty, truth," the architect presumes humbly that he has missed the point, that he cannot see the truth, that he fails to understand the engineering principles behind the design and that it is probably therefore sound engineering. He may, of course, be absolutely right. But one soon learns that even the best process engineers have not been trained to ask the questions about space and circulation that are second nature to the architect, and that the "design" may indeed be bad engi-

neering as well as bad architecture.

### The engineer, too, must readjust some of his preconceptions

Even in this day of high-tech imagery, the engineer is curiously diffident about the physical appearance of the apparatus surrounding his process. The "plumber" is never happier than when his pipes are concealed in ducts. The engineer's conception of an orderly arrangement is too often a neat four-square box with no "unsightly" protuberances. The architect, on the other hand, is trained to perceive and to express a different sort of order, a spatial and visual order that

emerges from the practical and the necessary and encompasses economy of means as well as style.

In an engineering office, the architect is often presented with a fixed scheme that may in fact be only a partial solution to the planning problem. Though the scheme satisfies all the requirements of the process, it may still fail to satisfy some of the requirements of people working in the plant, such as convenient access to equipment for repair and maintenance. The architect must of course recognize that the dictates of the process govern plant design; his part is to derive a more complete order from the combined de-

mands of process, personnel and the community.

There is a great deal in the engineering layout of wastewater treatment plants that is subject to definite physical laws, but not as much as one might think. Teamwork presently seems the only way to minimize the inadequacies of each profession and to utilize the strengths of all.

At CDM, the close teamwork of engineer and architect has gradually altered preconceptions or prejudices regarding professional self-image. Traditional definitions break down and realign, based on the knowledge and talent of individuals as they meet the needs of the project.

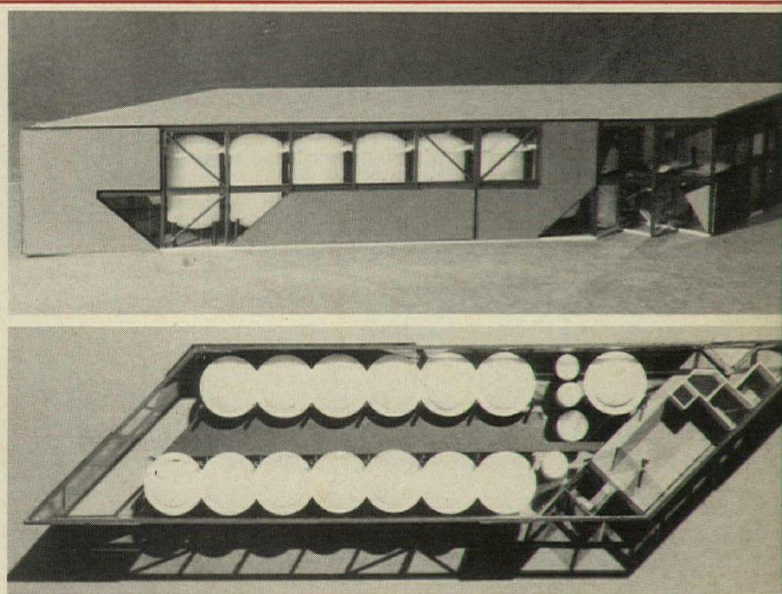
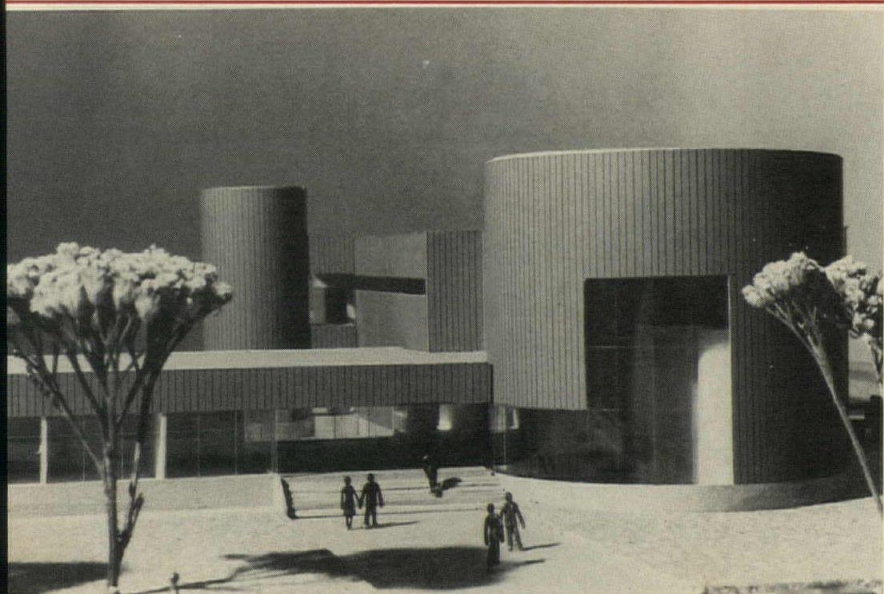

# 4

Though they are both engaged in pursuit of the same end—better building—architects and engineers have been heard to complain of troubles with interprofessional communication, a difficulty sometimes ascribed to **the engineer's education** with respect to the design process. In an informal interview, Abba Tor, a consulting structural engineer who practices in New York, draws on his memories and experiences as a student, as a teacher, and as a practicing engineer in both Israel and the United States to throw some light on how engineers get that way, and offers some thoughts on educating engineers to take the broader view of building design.

If you think in terms of semantics, you find an interesting discrepancy in the way Americans and Europeans regard engineers. In Europe, in Germany as well as France, the designation is *ingenieur*, from the word *ingenuity*. The English *engineer*, from the word *engine*, is just the guy who runs the engine. Every once in a while, the ASCE or another professional engineering organization will have heated discussions about "professionalism" and the engineer's lack of status. European engineers don't have this hangup because they don't doubt they are the equal of the other professions.

But it's not the name, it's what's behind it. And what's behind it is the system of education.

I have found basically three types of engineers. One is the engineer who really wants to be the architect—an intuitive engineer, who doesn't carry a heavy burden of theory. He always tries to simplify the problem in the early stages.

The other extreme is the Ph.D. who can never handle a project. He's very good as an auxiliary man when a specific tough problem arises—flutter in a suspended cable structure, for instance. He'll handle that kind of problem beautifully.

But there's also another kind of engineer, sort of midway between those two, who is very detail-oriented. He has a knack of zeroing in on the critical detail of a building, rather than on the over-all issues, and then working his way from the critical detail into the over-all solution.

All these approaches are valid. The architect, as well as the engineer, may work from the general to the particular, or he may extrapolate the general solution from the crucial detail. The inadequate engineer is the one who will not give his client more than purely technical service, the one who solves these problems in a way unrelated to the rest of the building.

As far as the education of the engineer affects his approach, I would say that there is a difference between young engineers—and between young architects—based very much on the kind of school they went to. I think engineers who went to institutes of technology, such as MIT and most European schools, which have both schools of engineering and schools of architecture, are exposed during their schooling to other disciplines, and may work with members of the other fields in a team approach.

Most engineering schools are not structured this way, and the engineers they produce have the ability to analyze given problems—to analyze stresses or size up members—but not necessarily the ability to initiate solutions to a broad problem. Even as a graduate student at Columbia, as I recall, problems were defined *a priori*; we were not exposed to projects where we had to define the problem rather than simply to come up with a solution. In Israel, on the other hand, where I was an undergraduate, we did share a course with architectural students. We would be given a problem—a stadium, say, for so many people on such-

and-such a site—and then the group would start from scratch.

### **Where the architect learns by doing, engineers get little problems to solve**

The architect, on the other hand, learns the design sequence by being thrown into the water to swim. So—maybe he's going to swallow some water, and he's going to thrash about, and he'll come up gasping, and sometimes he won't make it. But he's taught to jump right in. He's put on a drafting board with a blank piece of paper, he takes a big pencil, and he starts drawing. From this educational process, the architect acquires his sense of confidence.

I think the engineer should be educated this way. I think only this kind of education will turn him into a professional.

The engineering student in this country has been taught a lot of disparate courses—structural design, plates and shells, elastic stability, computer applications, what have you—but he has not been subjected to the problems of project design, which require synthesizing data rather than dealing with elements.

Even in Israel, where they have broader exposure, engineering students tend to be a little buttoned-up. When, as a teacher, I assigned a project, one of the first questions was always, "Is there any literature on that?" The students would immediately run to the library and start looking at examples, instead of starting with basic premises, doing a lot of doodling, and coming up with a fresh solution. They were just afraid.

Schools of engineering, as far as I know, have no exercise parallel to the architectural student's design presentation, when he must defend his design, both in general and in detail. Even within given data, there are always structural choices. But the engineering student is given specifics—today we study frames, tomorrow arches. He is not asked to think critically about the relative merits, in a given situation, of, let us say, a rigid frame versus a simple supported structure.

I think the schools have tried to broaden engineering education, but not in the sense of broadening students' appreciation of problem definition. They still have the little problem-solving courses, and at the other end they offer social studies and economics. They train their students to become, on the one hand, directors of major government bureaus, and, on the other, to become competent designers of pipelines. But they don't expose them to anything in the middle. They don't prepare them to become project engineers, to lay out a project, to come up with three or four solutions to a large problem which they can present to the public, to the economists, to the user. These things the engineer will have to do under any circumstances, whether the technology changes or not.

This kind of training should go under the head of engineering planning rather than engineering design. Just as we have

planners in architecture who think in a larger scope than single buildings, so we should have engineering planners.

### **The young engineer joins an office for his professional training**

The schools of engineering rely too much on offices to train the engineer to become a professional. This is wrong, I think, because if you read the statistics of the composition of the consulting engineering profession, you see that the great majority of practitioners are in small offices, offices of ten people or less. Now these firms cannot offer the young engineer much scope; they must use him right away on immediate problems. If he is a "natural," this may be a good thing, because he will not have to spend a lot of time repeating the same specific calculation over and over again. But no one will have time to give him the background, the methodology, behind the solving of engineering problems.

In large firms, the situation may be even more discouraging. Graduate engineers may stay on as subprofessionals almost forever. I remember interviewing one engineer with three years' experience in a large firm, experience which might have been valuable. As it turned out, all he did over those three years was check certain beams against stresses. That's 36 times one month's experience. I think if he had been given a broader education, he just wouldn't have stood for it.

But because the economics of engineering practice involve production as well as personal service, the average office cannot afford to take their young engineers off the boards to attend project meetings. Usually the project engineer and maybe one assistant go to a meeting, get the architect's thinking, come back to the office, and tell the young man, "Do this." This process may in itself retard the engineer's development, since he is removed from the process that determines the solutions.

In other professions, this is not the case. With lawyers and physicians, there is an interaction between practice and teaching. But there are not too many engineers who both practice and teach.

I think that if the engineer were exposed at school to the broader view of problem solving he would be sufficiently motivated to ask his supervisor for explanations, instead of just sitting and waiting until somebody tells him the end result.

Perhaps, even, the whole system of engineering education should be restructured to produce two levels of engineers—a paraprofessional level that could do computations and the nitty-gritty work, and a professional level trained to develop into project leaders and conceptual thinkers.

### **The schools should foster mutual respect between architects and engineers**

There's another problem I think the educational system might correct if it addressed itself to it—the animosity that exists between some architects and engineering

consultants. When one engineer talks to another about an architect, he has an almost instinctive impulse to insert the word *crazy*—that crazy architect. At the same time, architects will characterize the engineer as "dull" and "unimaginative." The engineer has the feeling that the architect is arbitrary, and that he has a tendency to pull rank. And the architect loses patience because he thinks the engineer tries to steer him to a pedestrian solution.

Many engineers are very uncomfortable when they are not given enough data. Some of them get impatient when they don't get architectural input, when the architect doesn't tell them ahead of time, "That's where I want my column." Personally, I dislike very much getting an architectural plan with the structure already marked in; it freezes me into a given solution that I find difficult to work out of. I find, in many instances, that the only way to discuss structural solutions with an architect is to put to him the proposition: Assuming that it *can* be done, *should* it be done? Anything and everything can be done, but whether it should be done is something else again. I will put it to the architect and let him answer the question.

I've talked mostly about the difficulty engineers have understanding the architect's broader viewpoint, but architects have problems in understanding too. Sometimes even the same problems. As a teacher of architectural students in advanced structures, I found that, like engineering students, they could design a beam down to the reinforcement. But if I gave them as a different kind of problem—to choose a structural system, say—they were at a loss. In their earlier education, architects get so-called tools they don't really need; they'll never design beams down to the reinforcement. They need instead to acquire a "feel" for structure, of, say, depth of member to breadth of span, that you don't use an 18-inch beam for a 50-foot span. With this feel, I think, they can be more at ease, perhaps less suspicious, when they work with the engineer.

Furthermore, in most schools of architecture, the structural courses are taught by engineers who may be working in an engineering office, but on a low level—as a designer, maybe, but not as a project engineer. Then from time to time, the school will bring in a glamorous engineer as a guest lecturer—he'll be very impressive, but I consider this intelligent entertainment rather than food for thought.

If engineers and architects, in their formative years, took some courses together, they would, I think, develop a certain measure of mutual respect. And if the engineer were exposed to some case-solving, rather than problem-solving, courses, he would realize that the architect, when discussing his (the engineer's) structural system, must think not only of structural esthetics, but he must also consider such matters as the integration of mechanical and electrical services, or lighting.

# 5

Ten years have elapsed since the first systems building project emerged in the United States—sufficient time for **systems revisited** to give a basis for: understanding why systems building happened; evaluating results compared with conventional approaches; asking ourselves where systems building stands now; and for projecting some thoughts concerning future effective action. In short, in an era when resources—materials, technology, expertise—need to be used as efficiently as possible, the time is now for examining the premises and the promises, the myths and the realities, the accomplishments and the failures.

by Robert E. Fischer,  
senior editor, and  
F. J. Walsh,  
consulting engineer

Nowadays, the word "systems" in the building field, with all its permutations and convolutions, means so many things to different people, that it is difficult to interpret and evaluate what has been going on.

As used in the vernacular, "systems building" may connote one or more of the following: pre-fabrication, packaged subsystems, interfacing by manufacturers, performance specifications, volume purchasing, consideration of the building "delivery" process (manufacturer, subcontractor, builder), studies of users' needs.

If we sharpen our focus, however, it is safe to say that lately interest in multiple-building systems projects in the school field has waned, and that industrialized (factory-built) housing is in trouble. The reasons, we have learned, are simple enough: these approaches have not been flexible enough either to meet the competition of the marketplace as it fluctuates, or to suit the requirements and idiosyncracies of the public. On the purchasing side, the market is likely to be even more volatile and cantankerous with temporary dislocations in materials supplies. On the users' side, the public did not see a lot of difference between systems schools and others built conventionally at the same time, (or other buildings in the private sector) except that there may have been more standardization and more modularity.

There are residual effects, however from the experimental school systems projects, some of which are good, such as the greater acceptance of off-the-shelf products and subsystems and modularity, and some of which could be good or bad, such as performance specifications, depending upon how carefully they are written and administered.

Why have many of the promises gone unfulfilled? Much can be learned from the premises, and from where the stimulus came from in the first place. We will see that some of the problems stem from not considering the context of "system" schools and industrialized housing abroad, and from too literal adoption of aerospace operations research concepts.



**First system building abroad; then a mix of approaches here**

The British "system" schools are essentially modular structural frameworks, interfaced with exterior skin and fenestration. They are simple buildings mechanically and electrically.

The approach developed out of need. Following World War II, there was a tremendous demand for both housing and schools in England's new towns. But housing had first priority, and the construction labor force was diverted there. So there was no skilled labor to build the schools. At the same time, wartime industries such as aircraft were looking for work. The county councils, staffed with large numbers of design professionals, conceived the idea of cooperating with manufacturers to come up with prototype systems eliminating as much handcraft as possible, so that assembly would be fast and simple in the field. And then, upon selecting a manufacturer, to commit themselves to a number of years' construction volume. This provided an inducement for manufacturers, and a continuity for refinement—the same manufacturer, and the same central staff honing the design.

On the continent, industrialized housing systems grew by leaps and bounds after the war. Again, housing and construction labor were scarce, so factory-produced precast concrete seemed an answer. Most of the producers were large contractors; systems were largely alike, except for connection details. But these entrepreneurs had several things in their favor. First of all, governments committed themselves to large quantities of housing over extended periods—"aggregating markets." Secondly, the economically-fixed 100- 200-mile travel radius involved, in concentrated Europe, a viable market.

But the trouble is if a factory is set up to produce panels for housing, that is all it can do. The result was that recently, with soaring inflation, and finally, the staggering increase in the price of Arab oil, the housing market evaporated. In a recent talk, an official of Bison, Ltd., a huge London precast firm, said that the only way for a precaster to stay in busi-

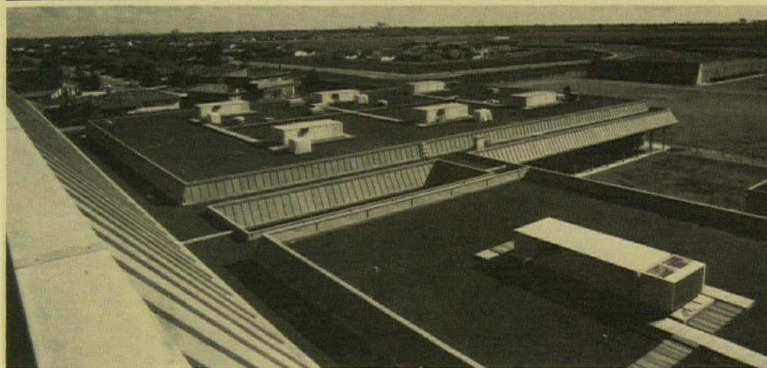
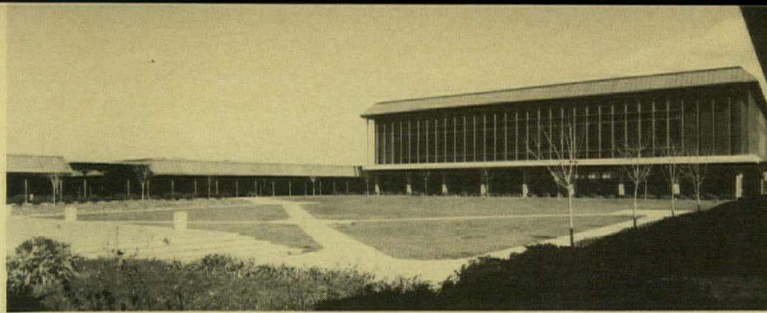

The most recognizable characteristic of the SCSD program was the packaged subsystem—bid in a mass-purchasing arrangement for 13 California schools. Perhaps the greatest departure in school construction of a standardized approach that followed in the wake of this program was the use of rooftop packaged air-conditioners. Before then they had primarily been used for low-cost office buildings, stores and industrial plants. The principal novelty of the multi-zone units was their lowered profile for sake of appearance (Sacramento). Architects: Stafford & Peckinpaugh.

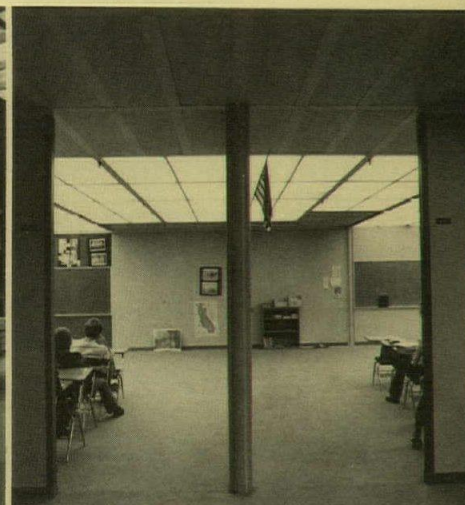

**Exteriors of the SCSD schools varied considerably because they were out-of-system.** The envelope only had to be physically compatible with the structure, and have a specified overall U-factor. In milder climate, extensive use was made of covered walkways. A southern California school (at right) used louvered shading. While the lighting-ceiling subsystem had a "mechanical" look about it and occasionally became a little boring, imaginative architects conceived interesting patterns (Fullerton). Architects: William Blurock & Partners.

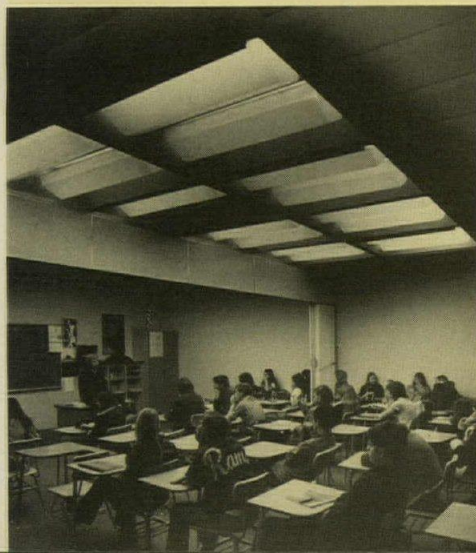
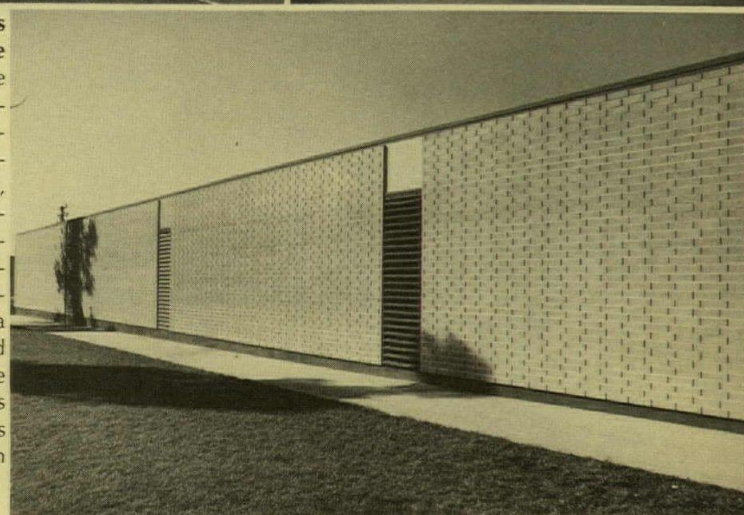

**The lighting-ceiling subsystem had its good and bad points from a functional standpoint.** The quality of the diffusers and fixtures was poor: warping and yellowing of diffusers, loosening of sockets, etc., giving maintenance personnel one of their biggest headaches. On the other hand, the ceiling proved to be an excellent fire barrier (example, right). Arsonists set a fire in the space on a holiday resulting in very hot temperatures. Damage was confined to the interior—only slight charring of fiberglass ducts could be seen.



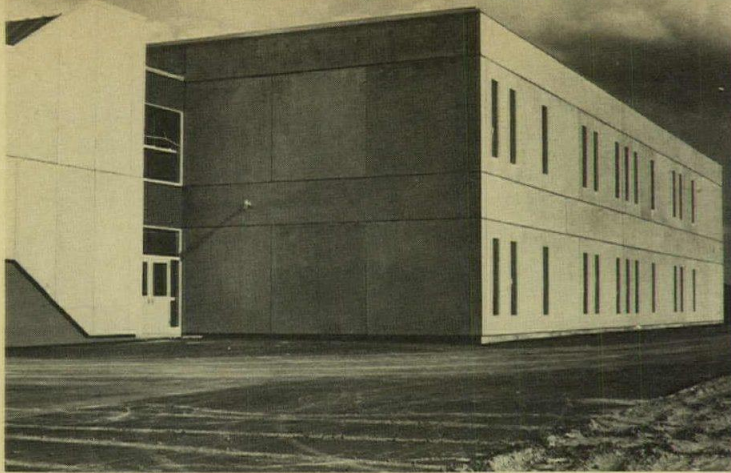

Toronto's SEF school program was patterned after SCSD, but included more subsystems, more detailed evaluations, and required manufacturers to use architects and engineers for interfacing studies. One of the subsystems in the program was exterior walls—a major constraint on design. Because of the colder climate, penthouses were required to cover all of the hvac multizone-unit equipment except for condensing section.

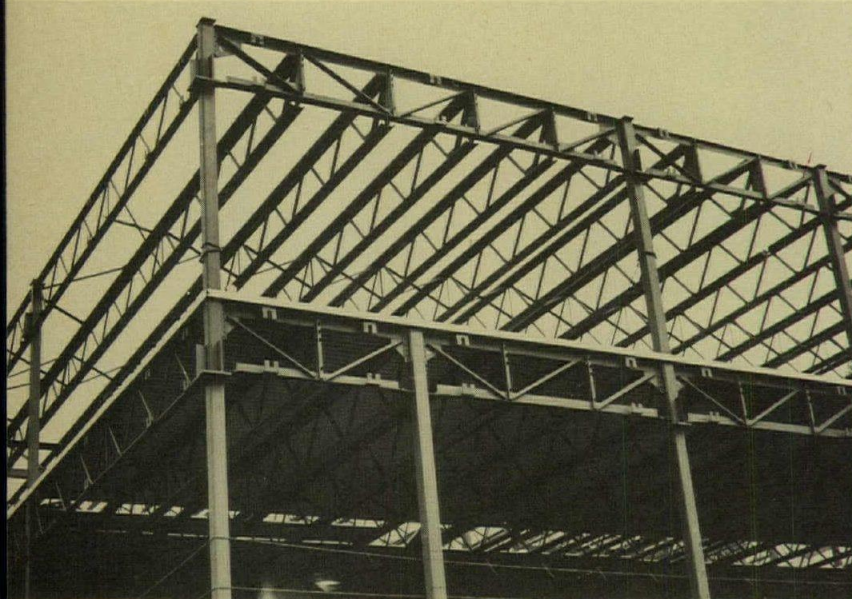
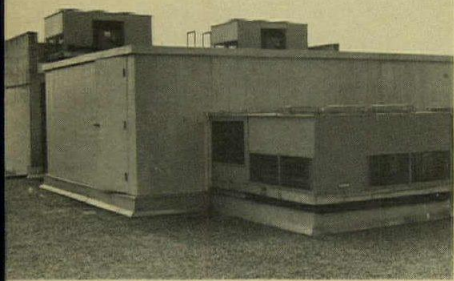

In a recent, abbreviated third phase, SEF had to forego some subsystems to cope with costs. Exteriors were split block instead of precast panels; electrical distribution and communications were conventional. Lighting was of similar good quality. Areas were cut down. Interiors were made cheerful by the choice of colors and tasteful designs in paint.

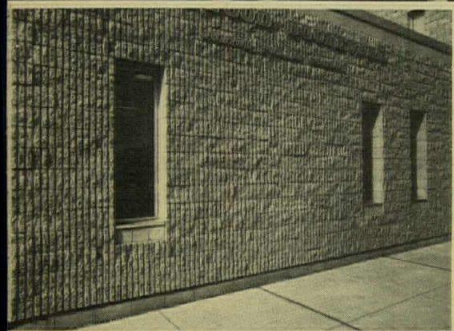

ness under these circumstances was to be able to supply components for almost any type of building—wall and floor panels for office buildings, long prestressed floor members for parking garages, etc. Manufacturing flexibility has to be the byword.

**A "crisis" situation led to the emergence of "systems" here**

Ezra Ehrenkrantz studied the British schools in 1954 as a Fulbright fellow, and upon his return, tried to generate interest in the approach. But it wasn't until 1961, when it looked like the "stock plan" approach was heading toward official approval in New York State, that the Educational Facilities Laboratories of the Ford Foundation felt that their prestige and financial backing should be put behind the "systems" idea, patterned after the British approach, but modified to suit American circumstances.

But there were other "crises" as well contributing toward a new milieu in the school building field, and these turned up in educational philosophies, the demand for classroom space, and financing. On the one hand, the burgeoning school population needed buildings. On the other hand, the post-sputnik reaction (chagrin) gave a boost to new educational theories that already were manifesting themselves in new school designs such as open planning and flexible space.

The expanding need for schools began to outstrip the funds available from existing real estate tax bases, and this, of course, led to public dissatisfaction with the results of conventional design and construction methods, and the demand for cost-cutting and reorientation.

It is difficult, if not impossible, for individual architects and their engineers to institute broad, radical change in design and construction in the public sector—assuming this is wanted, and needed. And the reason is that many school "buying groups" tend to be fairly rigid bureaucracies that don't have the competitive pressures of the private sector to urge them on to productive change. It is safe to say, for example, that many school dis-

tricts would not have accepted, prior to the school systems projects, the kinds of constructions that were fairly common in the private-sector commercial and industrial buildings—long-span light-weight steel framing, pre-engineered walls, roof-top air-conditioners, stock lighting-ceiling systems, etc.

This situation can be circumvented, however, if a prestigious review panel that has clout is brought in from the outside: their recommendations will be accepted. Radical change can look good, but carry a lot of danger because of the lack of experience. Because the public is not knowledgeable about construction, it is easy for politicians—both elected, and those with school administrations—to exaggerate the potential of new, radical approaches. But the trouble is that after these projects are completed, there is no careful evaluation by independent, knowledgeable groups. The intrinsically good features of experimental projects—such as standardization, modularity, greater use of prepackaging of subsystems—live on, even though they are not radical departures in themselves, except perhaps in the public sector. But, unfortunately, because these projects are not put in perspective, the created mystique is easily perpetuated, in a society that has been nurtured on innovative technology.

**Systems approach means looking at the past, to change the future**

We know that systems approach in its purest sense derived from sophisticated, all-out aerospace projects of a comprehensive nature. These were directed to precisely measurable results. Cost was of little consequence.

All-out approaches in private-sector building are almost unheard of because no one can afford them. Furthermore, they are unnecessary because the evolutionary changes appear to suffice, even though there are breakthroughs in other technological or management areas.

There are many systems approaches possible in the building field to appraise the many changes and shifting functions taking place. These changes need

to be recognized and identified: some relate to management problems and functions such as purchasing and project management; others relate to areas of technology and setting guideline criteria for architect/engineer design.

Systems approaches to building relate more to management practices than to physical building systems—the end result. They involve the organization and management of people, and purchasing of materials, services, etc.

Ongoing and monitored systems approaches produce evolutionary results, with gradual and non-disruptive change.

### In the public sector, the rules get changed to produce change

Owners, indirectly or directly, decide how buildings will be designed, bought and built. Only a few private owner-builders or developers—or public owners—can set the “rules.” The private owner evolves rules to maximize profit. The public owner can change anything he wants to as long as he will get enough bidding response.

To effect change in the public sector, an agency may be face-lifted to give it new rules to operate by, or change can be effected by bypassing an existing bureaucracy and setting up a new one—usually an independent, semi-public authority that can raise its own financing. Since it is outside of civil service it is expected to be more amenable to change. Federal agencies also play a part in effecting change by their control of partial capital funding, or guarantee of low-interest loans.

### Systems building permutations and spin-offs can be identified

All systems approaches to physical buildings involve modularity, standardization, and, to varying extents, physical interfacing of subsystems. The categories include:

1. Proprietary industrialized building systems;
2. Non-industrialized modular building systems, with various degrees of on- or off-site prefabrication to suit local conditions;
3. System building (England) involving limited interfacing, volume purchasing, monitoring of re-

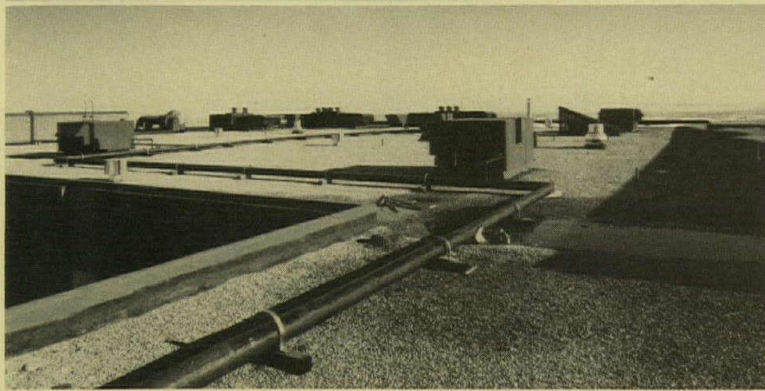

**Design-build projects have picked up some elements used in systems building approaches.** Performance specifications that leave system options open to bidders are characteristic of many of these. When low bid is the selection basis, the specifications have to be carefully written for the owner to get the quality of materials and equipment that he deems necessary. This design-build high school in Denver, for which William Blurock & Partners were architects, uses rooftop, single-zone air-conditioners serving large, open areas. Interiors, though spare in some places, are pleasantly human in spaces such as the resource center.

**In conventionally designed and bid schools where first cost is not overriding,** the architect (William Blurock again in this case) may use materials and designs that are a little more elegant to enrich the interiors, and the engineer may elect to use a central heating and cooling system supplying air-handling units. In this school they are spotted around the perimeter in offset equipment rooms.

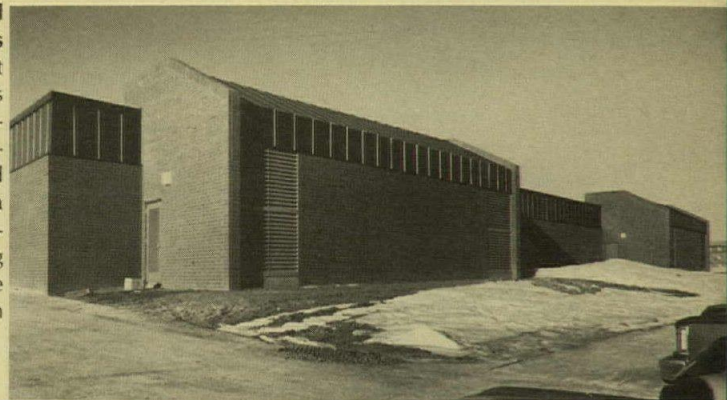

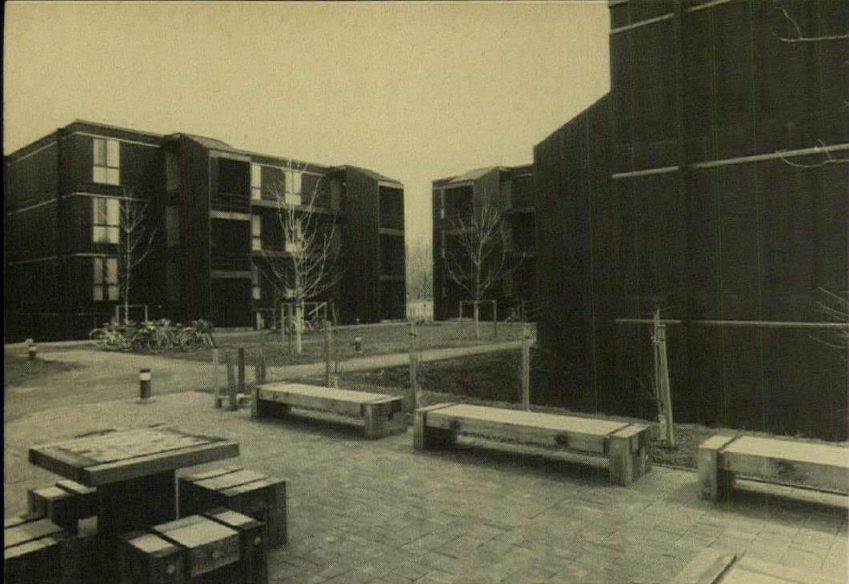

**State University of New York recently tried out the design-build approach** for student housing at Brockport based on a fixed price and performance specifications. The specifications went into detail on humanistic characteristics. The winner was chosen on the basis of point scoring involving students, administration and state officials. Architects: Caudill Rowlett Scott.



**Precast concrete systems for high-rise housing have been imported from Europe**, hopefully to make inroads into the still vast need for habitation. Some systems are in financial difficulty because of logistical problems, because of their plant amortization costs and because of a variety of management problems. Quality of product often has been excellent. This building for UDC is in Rochester's Southeast Loop. Architects: Hoberman & Wasserman.



sults, and modification of details based upon monitoring;

4. Systems building (U.S.). See definition at end of text. There are a number of variations that include:

a) systems building projects (multibuilding) that involve performance specifications, research and prototype development, volume purchasing of components and subsystems (with guideline application rules for administrators and A/E's);

b) systems building prototype spin-off (multibuilding) employing volume purchasing and guideline application rules in the form of specifications and other contractual documents;

c) modular-building project (single- or multibuilding) using conventional purchasing of previously developed prototype subsystems and components;

d) modular building projects with a mix of prototype spin-off subsystems and new performance-specified components and subsystems; sometimes incorporating some form of design-build approach.

Question is how much in each of these categories developed out of systems approaches, and how much in the desire to stimulate innovation.

#### **The shaking up of the status quo—what has it achieved?**

On the positive side, the above approaches have led to a general questioning of design and construction standards previously used, and have given impetus toward less wasteful, more economical, more modular buildings, with a greater degree of standardization.

Architects and engineers, while still confused to some extent over professional and contractual implications, have put standardization and modularity to effective use.

Manufacturers of subsystems and components that do not require a long lead time for product research and development time have been able to benefit from large volume-purchasing contracts. Manufacturers of highly-engineered products, however, may find the new "rules" difficult and expensive to cope with.

#### **What could the public sector do that the private sector cannot?**

For one thing, public-financed bodies ought to be able to put together information that the private sector cannot afford to do adequately on an organized basis such as: The collection and dissemination of an adequate data base for life-cycle costing—which does not exist at the present time. Such data might include information on ranges of equipment and product life, operating costs, maintenance costs, etc.

The public sector also could help establish systems approaches for better utilization of the expertise that exists in the private sector.

And the public sector could collect and disseminate data on various practices in the construction industry that relate to management operations.

The public sector can learn from the private sector, and only the professions can provide the equivalent of the private-sector's marketplace in public-sector work.

Of course, the largest amount of building is in the private sector, which is primarily profit-motivated. Changes are made to meet competition and/or regulatory requirements. But because profit is the name of the game there is little sharing of competitive information in a meaningful way. Building practices for various building types are affected to a greater or lesser extent by tax laws: depreciation, capital gains and other tax shelters.

If, however, too great an emphasis is placed upon first cost and quick write-off, quality and performance have to suffer. In any event, industry has to provide the lowest-common-denominator result that buyers, wittingly or unwittingly, demand. Consumerism trends, though, do indicate that the private market doesn't have all the answers to what buyers want and need.

#### **Public vs private sector: how the rules differ**

The "crisis" approach tends to short-circuit complete and objective discussion of: 1) proof of need for drastic corrective action, 2) the long-term goals sought, 3) the

availability and cost of suitable remedies, 4) alternative possibilities, 5) beneficial or harmful side-effects.

In the public sector, evaluation of approaches and results tend to be limited because there is political mileage to be made out of the "crisis" approach. The politician furnishes and controls all of the information on the results. Unlike the private sector, there is no competition against which the effectiveness of any approach can be measured.

At the initiation of a program, it is only the political representation that has to be sold on a program. And careful evaluation of procedures and alternatives in the beginning are avoided because they might impede the program. What is really wanted is a salable and newsworthy result, preferably visual and dramatic, but *on time*, so that it can be of political benefit.

At the same time, the philosophy of many foundations is to stimulate change and innovation—shaking up the status quo.

The question, then, is: who are the experts? How are they and how should they be selected? Is the imprimatur of a public agency or a foundation an adequate substitute for peer-group selection and evaluation of credentials?

The private sector is restrained by the marketplace, and the public generally is not hurt by a few wrong decisions. But because citizen participation in the public sector is not as effective as it might be, all concerned professionals and other key elements in the building industry have a public responsibility to monitor what the public sector is doing. Unfortunately, no effective mechanism presently exists for utilizing such talent on an unbiased basis.

Unfortunately, too often what is recognized as progress is skillfully-argued opinion. This can easily happen because of the wide gap in the levels of understanding between those with technical expertise, and the decision-makers.

In industry-at-large, a systems approach, to be valid, must deal with carefully-defined problems, agreed upon by knowledgeable people to exist, and to be worth expending time upon to investi-

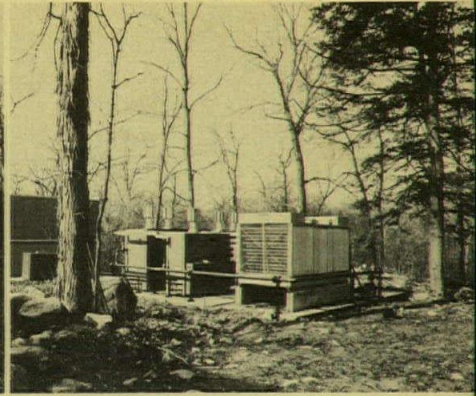
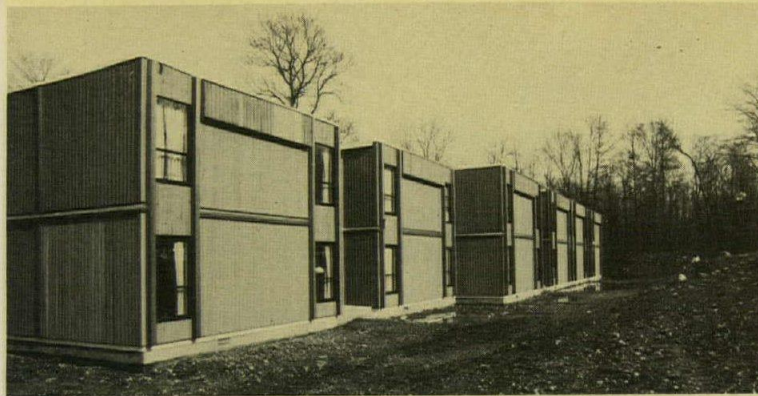

**New Jersey established a design-build program for a number of college campuses,** based on low bid. Specifications were partly prescriptive and partly performance, but many quality decisions were left to the bidder's discretion. Only a few city campuses required high-rises. Most of the buildings turned out to be stick-built because local builders could come in with low prices. Modules got in trouble when the original supplier filed for bankruptcy. Outdoor central heater-chiller packages were used with these.

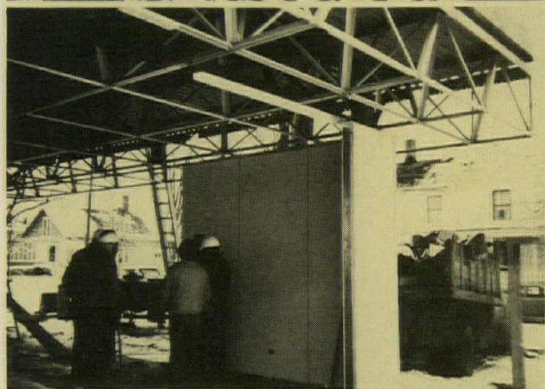
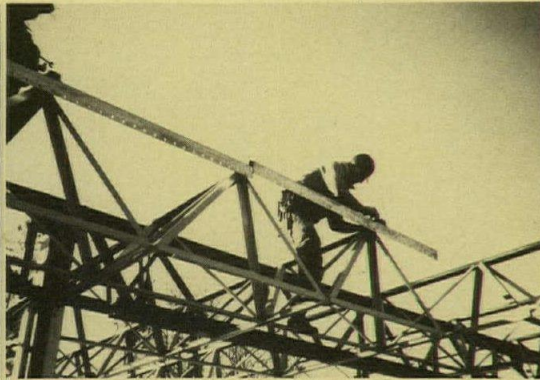
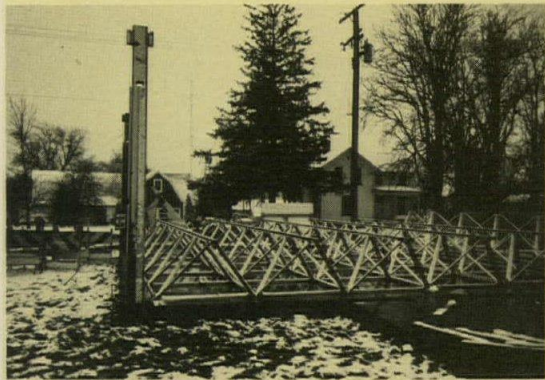

**In a procurement program for small, localized post offices to be of a standardized nature,** specifications allow either manufacturers to bid complete componentized buildings for a large number of sites, or for local builders to bid and construct conventionally in a stick-built manner. The bidding package, containing complete sets of standardized and detailed construction drawings, was developed by the A/E firm of Dalton Dalton Little Newport. The buildings are designed for modular expansion as needed.



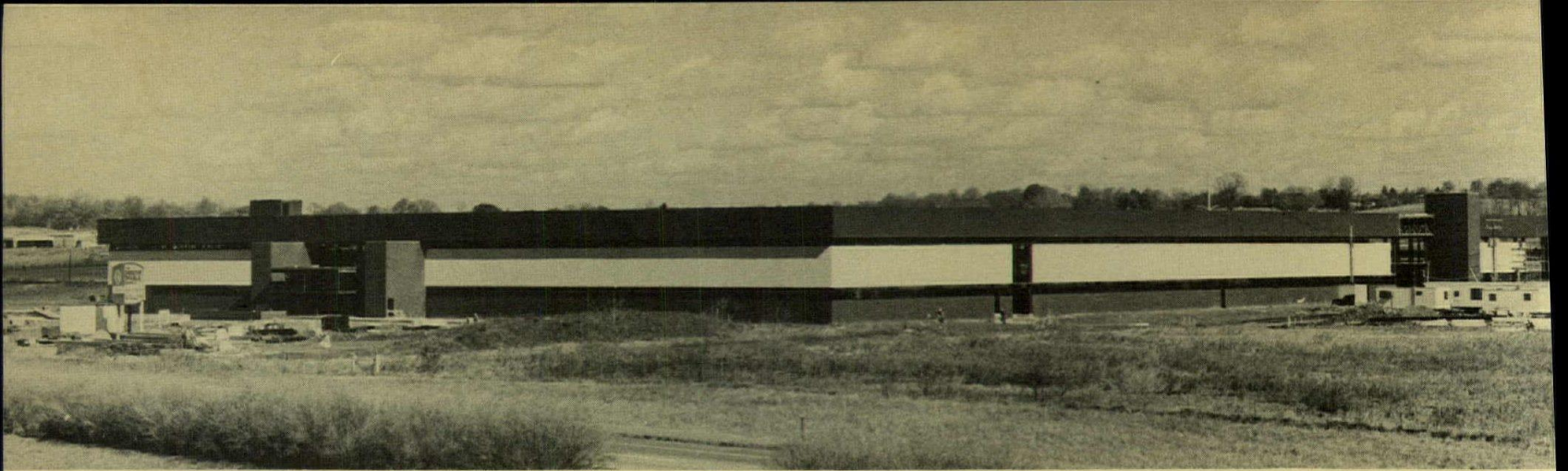

**The need for flexibility of operations in this factory called for a systems approach to structure.** Engineer Richard Gensert designed the framing system so that crane runway beams, mezzanines or catwalks could be put wherever they might be needed in this modularly-laid-out plant for the Hoover Com-

pany. The elements are standard and simple, but the system had to be designed for all possible combinations of dead, live and dynamic loads. Change is anticipated for this one-off project, avoiding makeshift solutions later. Architects were: Lawrence Dykes Goodenberger and Bower.

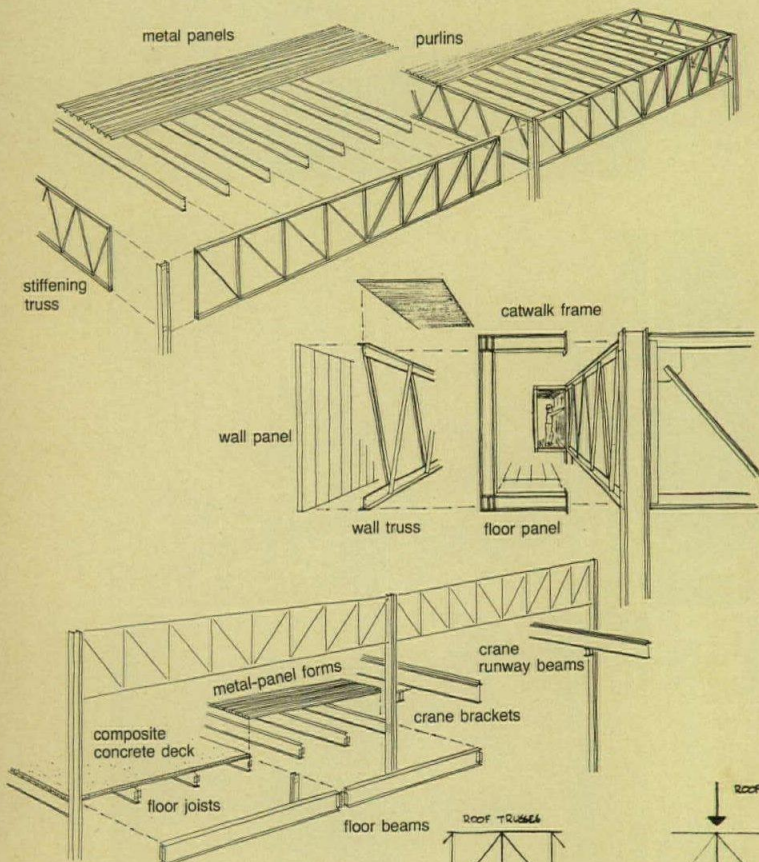

Shown here diagrammatically are some combinations of loads the engineer had to consider.

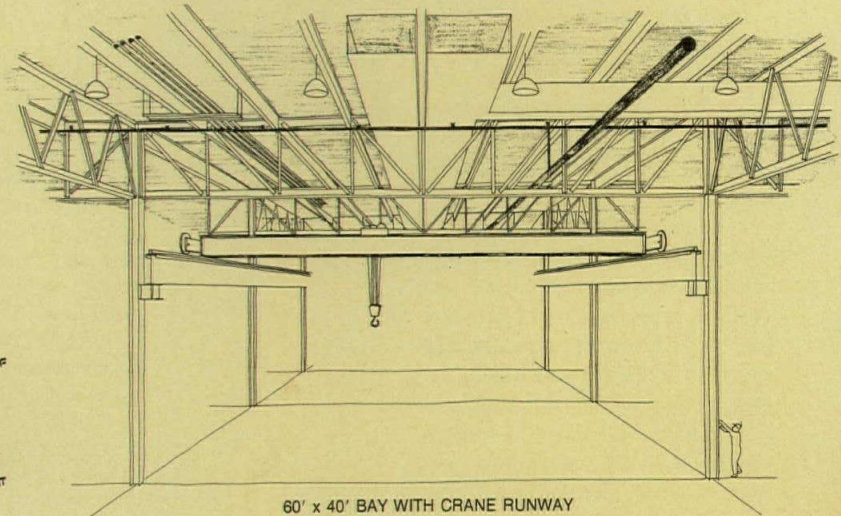
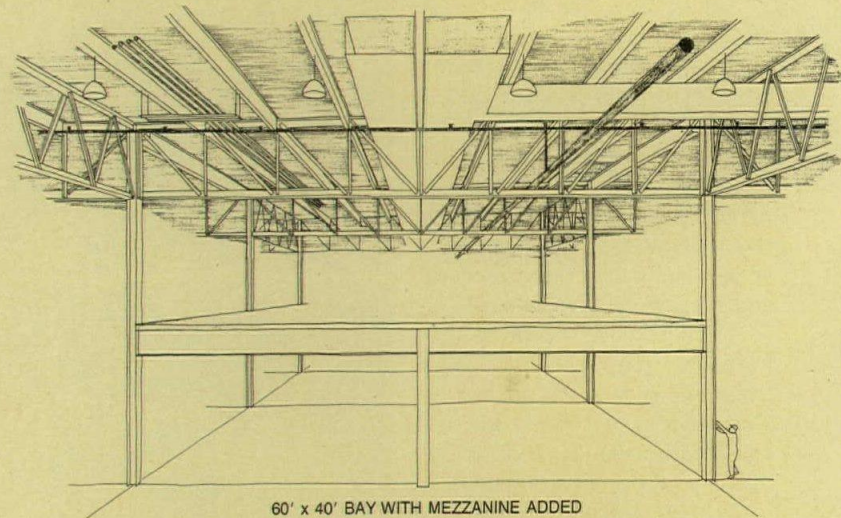
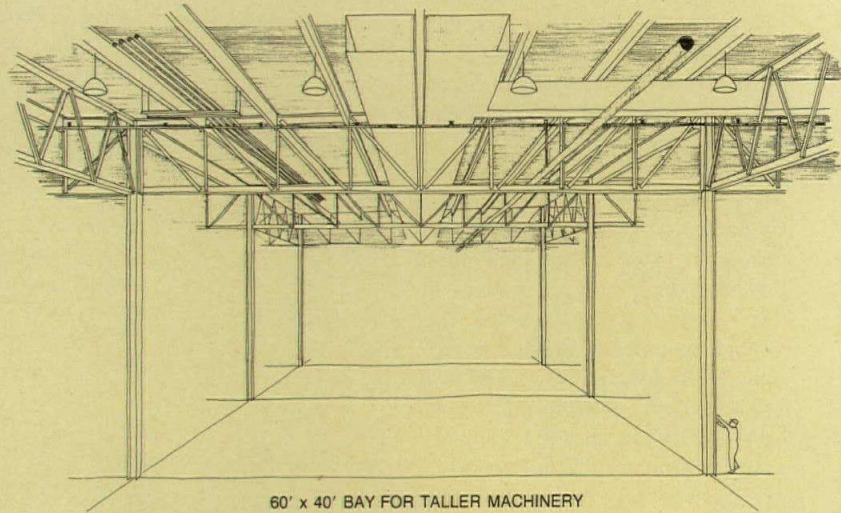
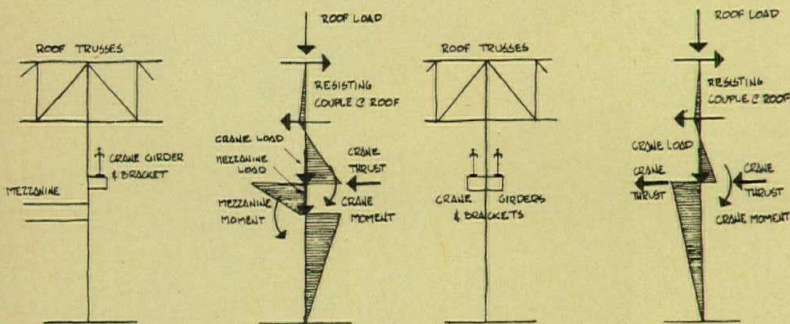



Roof trusses are shown at a column. The smaller diagonals are in the stiffening truss.

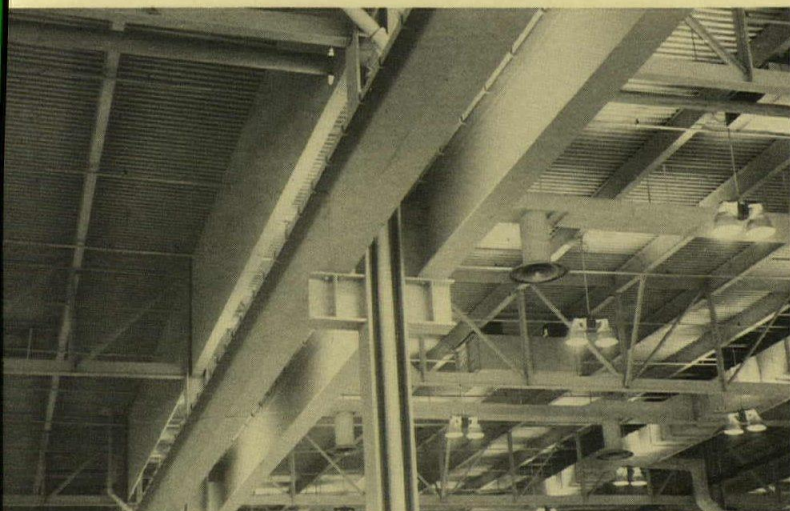

The crane runway beams are shown in the photo above. Below is a view of a mezzanine.



gate fully to determine practical solutions. The interrelationships between the various elements of the industry must be known in detail, and the "rules of the game" for effective competition must be fully understood.

#### **"Systems Building," defined on the basis of U.S. practice**

Systems building is an approach to designing and constructing buildings on a modular basis in which the building systems and subsystems are designated on a functional basis rather than on a trade basis, with physical coordination being required, and multifunctional capabilities, preferred. The specification of components, equipment and subsystems is on a performance basis rather than a prescriptive basis—except for those "hardware" items developed and used on earlier major prototype systems building projects. This is a wholly unique approach evolved from the methodology of the SCS D project.

There is involvement, to the maximum extent possible, of component and equipment manufacturers, directly or indirectly, who take responsibility for physical interfacing and total subsystem performance.

Strong manufacturer involvement and commitment must be present, reinforced by detailed and strong performance specifications, or it is not a valid systems building approach. A project that merely uses "systems hardware," without the other controlling features is neither systems building, nor conventional building.

#### **Premises of systems building**

1. The building industry was not using the best in technology available from industry at large;
2. User needs were not being determined adequately;
3. Maximum use of modular and flexible design is a must;
4. Standardization, prefabrication volume purchasing, and use of performance specifications could improve cost, quality and time factors. The way to do this is to change the "rules" and involve manufacturer and contractor directly in the process on a competitive basis—pushing ahead the application of new technologies.

#### **Selling points of systems building**

1. For the school administrator—greater flexibility and adaptability to varied usage, as well as greater consideration of user needs;
2. For the architect—a "kit of parts" with guidelines (performance specifications) from which custom designs can be done.

#### **Some questions raised . . . and some objections**

1. How far should modularity go? Might it be extended beyond users' needs?
2. How much space flexibility makes sense?
3. Can long spans lead to problems such as vibration; limberness affect roofing?
4. Does locking in on a prototype system produce a rigid standard?
5. Do life-cycle costing criteria lose their validity when long-term maintenance contracts are not bought?

Frequently there is a lack of understanding by A/E's of the true relationship on a systems project among owner, contractor, and A/E as to who is legally responsible for what.

The systems approach to building will be too limited unless there is ongoing review and monitoring. This cannot be done completely in-house. New (fresh, independent) thinking from the architects, engineers and contractors who do a lot of private-sector work should be encouraged.

#### **Performance specifications**

The adequacy and effectiveness of performance specifications follow no consistent pattern except for the controlled situation in which it is known how all the participants will perform—based upon screening and unwritten understanding rather than clear-cut definition and spelling out of responsibilities. It is too easy for the owner to read into hazily-worded, all-inclusive specifications, the maximum value for his money.

Such approaches tend to degenerate A/E expertise because expertise is gained only when specifications are set up for a complete design and complete follow-through by the design A/E. When this primary activity is curtailed, design A/E's learning will be reduced in proportion.

# 6

A host of new influences, disciplines and buzz words complicate today's **dialogue between manufacturers and building designers.**

The questionnaire reported here was sent to manufacturers in an effort to probe the problem areas of the market place as well as to tap the resources of thoughtful minds confronting changes on many fronts. The summaries and quotations of essay response to this questionnaire are significant in themselves and are further rounded by the interpolated article by J. Karl Justin beginning page 141. The purpose is to clarify the lines of communication and to support the proposition that architects, engineers, owners, consultants, contractors and the technical experts of manufacturers comprise one world in a building universe.

## THE QUESTIONS

---

### A. For which of the following reasons have your major product lines been changed?

1. New or changed market demands following trends in:
  - a) building or system design concepts,
  - b) building financing,
  - c) government funding,
  - d) owner tax considerations,
  - e) construction time costs.
2. Advanced product or system design concepts.
3. Reliability and longevity considerations.
4. Energy cost/shortage considerations.
5. Major redesign to simplify products or otherwise cut costs to meet competition.
6. Increasingly automated production and closer inventory control.
7. Increasing attention to modularity, standardization, interfacing with other products and subsystems.
8. Increasing building automation (centralized control of HVAC, lighting, fire safety, and security).
9. Reconsideration of higher-first-cost, technologically more complex equipment and systems and products.

---

### B. What changes have taken place in your technical assistance to architects and engineers?

1. In application engineering, technical assistance, or field back-up services?
2. In system application comparisons
  - a) based primarily upon feedback from actual installations?
  - b) hypothetical?
3. In semi-promotional comparisons related to new products, systems, or services?
4. Would better communication with architects and engineers help you make further assistance in these areas more economically justifiable?
5. In what areas have you increased your technical assistance to take care of greater product sophistication caused by greater complexity of design details, installation, or other new parameters?
6. In what areas have you increased your technical assistance to help avoid in-service failures or problems due to changed labor conditions?



**C. What do you see as the effects of systems building and cost-control techniques, i.e., construction management, cost-benefit/value engineering?**

1. What is right and what is wrong with present-day industry standards? Should design architects and engineers seek to upgrade them, and if so, how?
2. Should large-volume purchasers be encouraged to use industry performance and certification standards, but adding or deleting items to get a higher level of quality?
3. How specific should A/E specifications be? For your product lines, what sort of mix of industry standards, manufacturers' suggested specification elements, etc., should be included to secure equitable bidding?
4. How can better field installation quality be obtained? And how specified?
5. What should architects and engineers be doing to get the proper level of quality in components of complex subsystems and packaged equipment?
6. What interest do you see today (government and private) in the systems building approach?
  - a) To what extent have these provided adequate (or not) guidelines to bidding?
  - b) To what extent do prescreening and preselection of bidders play a part in securing an optimum level of quality?
7. Should there be more specific guidelines for owners and design professionals to use in establishing the required expertise and mode of operating of the various construction consultants, cost consultants, etc.?
8. Do you find that volume purchasers tend to cut down on "safety factors" included in original architect/engineer plans and specifications?
9. Shouldn't owners be educated to ask for detailed proof, validating cost-saving choices presented to them by construction/cost consultants?
10. To what extent have cost cutting changes mentioned in (8) above been the result of detailed engineering follow-up, rather than by reliance solely on the judgment of the construction consultant?

The dialogue between building product manufacturers and the rest of the building design and construction universe is not so much a dialogue as it is a multi-directional broadcast. The simple message from the producer to the marketplace is no longer sufficient. Not only is the building process itself generating new relationships among owners, designers and constructors, but the design process itself is entering a period of readjustment.

Architects and engineers, still the essential key to the process, are responding to the effects of much more complex input to their design problems. This complexity derives from two main sources. First, the building itself is viewed as a performing aggregate of systems rather than an adroit assembly of parts. Second, the pressures for designing and building within adamant frames of time and budget have generated a new and more disciplined milieu for the design operation.

One consequence, more intense attention by designers to systems and their performance, has the corollary consequence of directing the attention of manufacturers toward the compatibility of their products with the performance goals of systems designers. This, then, is the focus of the dialogue between manufacturers and designers.

**THE ANSWERS**

The questionnaire at the left was directed to a list of some 400 manufacturers of building products and systems. It may be testimony to the urgency that producers are feeling toward communication that many responded to this questionnaire in great detail. Others responded more briefly. It is apparent from the questions themselves that no statistical tabulation of results could be expected. Moreover, the temptation to respond by promotional forensic is apparent at key points. The intent of the questionnaire to stimulate essay response and to probe the quandaries as well as the resources of manufacturers has been well rewarded.

There are several changes in the building process that can be identified. Some are the consequences of others. The following is a list of much-talked-about changes without serious attempt to probe the fundamental reasons for their occurrence.

- Owners are participating more directly in the building process.
- Inflation has increased the urgency of time.
- Financing methods have set more absolute limits on budget.
- Technical advances have complicated the whole building process.
- Construction management, value analysis, life-cycle costing, environmental impact, energy conservation and many other new labels for older disciplines have lengthened the roster of consultants and have obscured the clear lines of marketing communication between producers and users of building products.

This same multiplication has placed an added premium on such efforts as this questionnaire to clarify and unify the whole process.

This summarization of replies to the questionnaire attempts to maintain clarity by two

devices. One is a response to the wishes of many of those who replied to remain anonymous. Hence, the simple device of massive quotation is avoided as much as possible. The second is to organize the responses on two lines of order: the order of the questions and the order of general categories of respondees.

**Product line changes reflect long-term values**

As might be expected, most manufacturers change their product lines to meet competitive positions in the market place. They do not seek to deceive us into believing that this is inevitably an improvement of the products *per se*. The marketplace today makes two classes of demand upon the ingenuity of manufacturers. First, is the immediate pressure of competitive first cost. Second, is the apparently increasing insistence by specifiers and owners that the quality and performance of products be assessed against a broader scale of value and longevity.

So, the response of manufacturers to this section of the questionnaire acknowledged briefly the residual effects of entrenched emphasis on first cost and turned their attention, with frequently enlightened purpose and perspective, to considerations of long-term value and the changing patterns of influence by owners, energy, systems, value analysis and environmental considerations.

Among product change influences is the increasing attention to the fit of products to the capability of designers to make subsystems physically compatible one with another.

A manufacturer of insulating materials pointed out that the greater usage of standard, compatible subsystems had influenced their approaches to market in two ways: first, through the manufacturers of systems themselves as a direct outlet; and second, to the multiplication of their own line to include subsystems using their own basic materials, such as ceiling systems, duct systems and others. This was by no means an isolated instance. Manufacturers of many kinds of basic materials, metals, glass, insulation and others, followed a similar pattern of response to the increasing trend of designers to think in terms of integrated systems.

In almost all the responses, the presence of energy cost and shortage was a factor in the company's attempts to reduce its own production energy by changing manufacturing techniques or adapting a line for energy conservation in its end uses.

Subsystem manufacturers (hvac, lighting, ceiling, etc.) had in common a major concern for modularity in the systems they produce, clarity in performance specifications, and improved methods of handling the bidding process on an equitable basis. More detail on these matters is presented in later sections, but the perspective of this whole consideration ties back to earlier remarks about the increasing influence of the owner in the process, and the needs for industry response to conditions that often, especially among public owners, are more entrenched than logical. The reliance of the process on ability to pre-qualify bidders,

for example, is often the key point at which the process fails in the public sector.

Questions A—5, 6 and 7, dealing with manufacturers' own problems, brought forth interesting, but not unexpected response. One materials manufacturer, for example, said that "increasing attention to modularity in building construction prompted us to broaden certain product lines by increasing the number of sizes available. We added several large sizes to acoustical ceiling boards and, on large projects, produced on a made-to-order basis. Further, we have introduced products for the express purpose of interface with other subsystems."

Re-design of products for cost reduction is, as one reply stated, a way of life. Modularity and more complete factory assembly are virtually universal objectives, while material substitutions, simplification of installation, and automated production are as important as might be expected.

That centralized building control is becoming much more common is illustrated by the following manufacturer comments on question A-8: "Clearly building automation systems represent the fastest growing segment of the hvac control industry. This should continue to be the major growth area for the next 10 years. We hope that first cost will more closely be tied in with operating costs to justify higher-first-cost systems."

Another noted that, "This, of course, is the 'big gun' in the environmental control industry today. There is no doubt that it is here to stay in view of energy costs, complexity and size of today's buildings, and the new life/safety codes. More sophisticated systems have been introduced, such as computer-controlled systems; demand-limiting and load-shedding systems."

#### **First cost is taking a recalculated back seat**

Question A—9 regarding the reconsideration of higher first cost and technical complexity brought forth a virtually unanimous agreement that increasing attention to value analysis and life cycle costing will inevitably improve the quality of both systems and materials. As one manufacturer of hvac systems put it: "increasing labor costs for field construction have increased use of factory assembled modular equipment. Greater quality can be provided without sacrificing economy because of reduced field labor and also because of opportunities to introduce energy-saving designs, such as heat pumps, on a long-term basis."

Lighting manufacturers, for example, reported that higher initial cost for more complex equipment works out as a life-cycle saving in the case of heat extraction troffers. This is not a new concept but its use is being adapted to many types of recessed luminaires.

The role of insulation in conserving energy elicited the expected response that greater thicknesses are warranted on a life cycle basis and, further, this fact had prompted development of a composite roof insulation in a single layer, thus reducing the installation cost of a higher-first-cost material.

#### **Changes in technical assistance provide greater depth and breadth**

In category B of questions regarding changes in technical assistance to architects and engineers, there were two sub-categories: the first three questions asking about areas in which changes might have taken place; the second three probing more directly into the climate and rationale of change.

One terse response in kind was the blanket word: "Increased!"

More serious attempts reported a general increase in computer-aided assistance via field consultation in systems comparisons, capacity and strength selection, spec preparation, application techniques, value analysis and in some cases actual planning and layout.

Materials producers have expanded their programs in technical service representatives to redefine material properties in terms of performance and compliance with standards of government agencies and codes.

Lighting manufacturers have found increasing need not only for specialized consulting staff who can move away from footcandle levels into sounder physiological and performance terms, but also they have increased research and development activities along these new lines. Their concern with combined systems and out-of-system connections has stimulated a broader base of communication with architects and engineers. Computerized selection services, value analyses and libraries of highly technical literature on lighting and energy are made available.

Some firms find it increasingly expedient to move personnel from engineering into marketing to communicate more adeptly with architects and engineers making basic selection decisions. "The easier the lines of communication between architects, engineers and manufacturers' technical representatives," says one producer, "the less costly this function is to perform."

Not surprisingly, with regard to ensuring product performance re: field installation, one manufacturer said: "Most problems that develop in the application of our material can be traced back to improper installation. The best way to avoid these problems is to limit bidding to experienced fabricators who will supervise and guarantee the installation."

One manufacturer has changed his mode of technical assistance, as applications of his material have become more standardized: "We have recently changed our approach in the manner in which we offer technical assistance to architects and engineers. Previously, we felt it necessary to have a group of building product specialists scattered throughout the country. During development stages of buildings we were obliged to custom-design most applications. We could not economically continue to do this. We now depend more on our advertising and technical bulletins to guide the architect in choosing a more standardized design available from independent manufacturers in those design application areas."

Another said that, "We continue to provide complete technical assistance to architect and engineer and have attempted to increase

the scope of these extensive programs. We are offering an even greater variety of technical assistance seminars to customers. Regrettably, many architects and engineers do not take advantage of the technical assistance available to them."

#### **The effects of systems building and cost-control techniques**

The questions in category C deal with industry standards and the modes by which architects' and engineers' specifications can not only comply with updated standards but also ensure some level of installation quality as well as quality in subsystem components. The influence of large-volume purchasers is observed as both positive, in enlisting skills of manufacturers in producing larger systems, and negative, in the temptation of purchasers to bargain about component costs to the detriment of over-all performance.

One component manufacturer agreed that architects and engineers should seek to upgrade industry standards while thinking in terms of true performance values on a basis of owning and operating costs. Initial costs, this manufacturer (filters) avers, thus become a minor consideration. Other component manufacturers (controls) lamented a lack of current standards and pointed to nonuniformity and cumbersome application of attempts now at work to establish standards.

"Many industry standards are outmoded," said one manufacturer. Another averred that, "Present-day industry standards are too diverse, and thus too difficult for the designer to use or even understand." This same manufacturer said that he was adding laboratory and test facilities with the goal of development of improved standards.

Materials producers were concerned that, for their lines, first cost seems to be the prevailing standard without much hope of being replaced by standards based on quality.

One producer of insulation materials pointed out that industry standards come from many sources including professional societies, ASTM and ANSI. Many materials specifications, however, are written to include so many types, grades, or classes of materials that it is difficult for designers to select that which will best meet job performance conditions.

This manufacturer further supports the opinion that "architects, engineers, owners and building materials manufacturers should seek to upgrade the present industry standards in the direction of life-cycle costing." To do this, of course, will require all these participants to seek new and more detailed information regarding the life expectancy, operating costs and maintenance requirements, as well as the cost implications of interfacing these products or systems with other building systems. The effects of these considerations upon the research and development objectives of manufacturers are dramatic, this company believes.

Lighting manufacturers, in general, caution designers to make sophisticated analysis of standards that prevail. To present the most value to his client, one producer said, the de-

signer should recognize that current recommendations for illumination levels are 1) for specific tasks; 2) for lighting on the tasks, which suggests that non-uniform lighting is appropriate; 3) that the recommended values are based on requirements for healthy, normal, young vision, representing a minority of the U.S. population. Older people with valuable years of service are penalized with seeing conditions that will not allow them to perform at a reasonable fraction of their capability. Closer attention to lighting design and specification standards, this producer states, will represent value added for the owner.

Another lighting manufacturer cautions, however, that there is a danger that cost-benefit and value-engineering evaluations will use over-simplified and possibly misleading criteria for "benefit" or "value." The level of illumination used as the only measure would ignore total impact of the lighting system on the people using it and might indicate a benefit where none exists. Reflections, glare, and other factors should be considered in standards for evaluating lighting systems, and the industry-recommended levels of illumination themselves should be reviewed.

#### **Impact of large volume purchasers should upgrade quality and cut costs**

The general reaction of producers is that large-volume purchasers should be encouraged to use industry performance and certification standards and to contribute to upgrading all those standards in the light of long-term value. Manufacturers are more than willing to get together with large users in developing genuine improvement and/or cost benefits in materials and systems. And, of course, such benefits should be passed on as information to architects and engineers for application wherever appropriate.

One systems manufacturer (hvac) suggests that large-volume purchasers should lead the way in high-level, high-quality, subsystems standards. Cooperation among such purchasers would tend to offer the possibility of even higher quality and higher value equipment made possible by their combined purchasing power.

It is a general feeling that as long as the established standards are not compromised, the product changes brought about by volume purchasing should be public information.

One point made by several producers is that architects and engineers should keep better abreast of changing standards, whatever they may be, so that they do not continue to issue obsolete requirements. The plea of most respondents was for coherence and definite criteria (whether prescription or performance) to permit legitimate suppliers to respond intelligently and specifically. One component manufacturer said: "as far as we are concerned, there is no need to name a product, but there is a need to specify the values an architect or engineer desires that will achieve the desired end results. In general, component suppliers favor performance specifications based as often as possible upon widely used industry standards. One materials supplier

## PERIL AT THE INTERFACE

**J. Karl Justin, AIA** is partner in the New York firm of O'Brien and Justin, architects. An MIT graduate, Justin is both a registered architect and a licensed engineer. His earliest experience included contracting and the development and merchandising of building products.

The current heightened interest in performance specifications really should be looked at against the backdrop of a much broader context. It seems increasingly clear that we are living on an interface in the development of our species. Technologically, transitions might be regarded as going from the implicit to the explicit. Inherent in such a time is the fact that activities appropriate to life on either side of the interface are going on at the same time.

In this light, a performance specification appears as one facet of the explicit identification of goals in the architectural design process. To what extent goals identified in the design process (or which of them) belong in a specification as part of construction contract documents, however, depends on considerations in addition to their benefits to efficacious design.

One problem in the use of these techniques has to be that we are inserting the methodology from the advanced articulate side of the interface into the more intuitive environment that still hangs on from the past.

A major value to spelling out desired end results, if properly handled—i.e. good performance specifications—can be the improved communication of what the plans and specs are really trying to achieve. Contract documents are initially a one-way communication, made two-way by the architect's on-site visits, meetings with the contractor, clarifications, and field orders—not to say change orders. It would make some of those careful drawings and schedules more informative if there were some indication of what the designer was after in the first place. It might help the contractor to offer substitutions that are mutually (*mirabile dictu*) beneficial. In this sense, a performance spec can avoid arbitrary, archaic, or even unintentional restrictions. The bidder can better understand the architect's need and the architect can more clearly understand the bidder's offer.

Following this line of thought through on a broader level, a performance specification can make the contract documents more dynamic in allowing the contractor to suggest intelligent trade-offs between labor and materials of various trades and manufacturers.

All this suggests a strong component of increasing competition in a non-destructive direction: lowering costs without losing results. Until we can remove some of the artificial barriers between the building trades, this is certainly one way for the architect to optimize his time by helping the contractor to negotiate that labyrinth with him. Whether the contractor will do so as creatively as the architect is another matter.

What of the architect's role? An explicit consciousness of goals makes us more, rather than less, responsible for and capable of the execution of the details in organic resonance with the whole. Architecture is where art meets the earth; where the abstraction meets the concrete. It is where, in reality, the concept stands or falls.

One cannot feature a specification requiring that "the facility shall have commodity, firmness and delight, or equal." The performance specification can be a cop-out as well as a useful tool. Engineering focuses on function. Architecture adds style and grace; accentuates; expresses; integrates. In other words, if "God is in the details," should they be left to be done "by others"?

Legally, we may not have much choice. One benefit often sought through the use of performance specifications is to pin down the contractor to specific end results; making it impossible for him to hide behind the supplying only of specified parts and pieces without producing an adjusted functioning whole. The police aspects of the specifications are more vital, of course, in public competitive bidding.

### You simply cannot have it both ways

It is essentially considered improper to specify *both* methods and results. For example, in a New York case in 1899, still considered a standing precedent, *strict* compliance with plans and specifications was stated to be the requirement for the contractor's successful completion of the work.

In this situation, waterproofing was called for, detailed and fully described. The spec in summary required the waterproofing to be guaranteed for five years. There was leakage and a suit was brought against the contractor. Under the rule of reasonable construction, the court decided that since the contractor was, of course, not required to guarantee the sufficiency of the plans and specs, and since he was not only required to do a particular thing, but to do it in a particular way and constrained to use specific materials per the design, he could not be held responsible for the leakage.

In the writing of a performance specification, therefore, the contractor must be given considerable leeway to choose his methods and materials to get the required result. Since we are traveling in relatively uncharted waters, prudence would dictate that we give him a wide berth; but at what other costs?

The details of this depend a great deal on what level we are dealing with. On one level we might write a specification for the performance of an entire project, at a *given* cost, the bids for which will themselves include plans and specifications describing how each contrac-

---

**"Soon, the exuberant but inexperienced, who sought to release the contractor's ingenuity from the bonds of detailed specs, learned that the low bidder . . . could meet the spec by doubling the owner's power bill . . ."**

---

tor proposes to satisfy the spelled out criteria; with selection to be made based on the sum of ratings given in functional, maintenance, and other areas. At least in this case, provision can be made for evaluating the esthetic qualities of the solution. On other hand, bid submissions cannot include full working drawings, or bidding costs would be prohibitive.

The key practical question on any performance specification, though, is how do you make sure you get what is wanted; how do you guard against poor substitutions?

There are booby traps in any case, and what sets them off is not what you don't know, but what you don't suspect. One can acquire missing knowledge if one is conscious of the specific lack. This is a particular problem because, by the nature of the competitive bidding process, for protection you have to specify what you *don't* want as well as what you *do* want. Otherwise the bidder may take gross advantage of the loop-hole.

One often mentioned method for improving assurance of the contractor's performance is "pre-screening." This is most generally done as a matter of course in private work. Where a specific list of bidders can be invited, the low bidder does not necessarily have to be chosen; and many factors can be taken into account without extensive legal justification. On public work, however, meaningful criteria chosen for pre-screening usually wither under fire.

Efforts to establish requirements for financial stability, percentage of work done by own forces, prior experience in similar size or types of projects, and other criteria, sometimes can be made to stand up; particularly if there are enough other projects to be bid by the unqualified. Criteria such as a successful track record on past projects with respect to adherence to schedule, workmanship, and change orders, are harder to apply. When contractors really want to bid the work, the chances are that these and most other pre-screening criteria can be circumvented or eroded under pressure.

In cases where such circumvention is allowed though, it might be observed that more harm than good has been done. The more desirable bidders who are inclined to observe the requirements may wind up at a competitive disadvantage. The same can be said of perform-

ance specifications that are relaxed by the architect or owner after the bids are in, consciously or not. This is where an often unconsciously hoped for benefit of performance specs back-fires, as follows.

As a result of common public competitive bidding practices that essentially make the low price the sole determinant of the successful bidder, the architect has been cut off from the know-how of many specialists among contractors and sub-contractors. These days their specific knowledge is needed earlier in the design process. Thus if he is to participate, the prime or specialty contractor or supplier has to make a greater and greater input earlier and earlier; i.e. make a bigger investment longer before he gets the order, and with less chance of getting it at that.

It is as a stratagem to correct these difficulties that the performance spec is sometimes used in the hope of writing a sufficiently tight set of requirements which will assure that capable (sometimes uniquely so) suppliers and contractors get the job. But competing subs, or general contractors trying to buy out the job most favorably are very perceptive about such efforts—and often very resourceful about thwarting them:

Some more or less subtle innuendo wielded on the superiors of the public officials responsible for the project; pointing out to one and all the covert intention of the spec, claiming that based on the precedent of "free competition," it was assumed in preparing the bid that a cheaper approach could be used; marking time by entering one submission after another of items that don't meet the spec; threatening through a lawyer to get a writ of mandamus that would oblige the architect to approve substitution for his "excessively and arbitrarily restrictive" requirements (or incurring costs of defense); and, after lost months, claiming that the desired specification cannot be met within the required scheduled completion time of the project.

### Can you really bid life-cycle costs?

In the final analysis all this raises the still more abstract speculation as to whether even in theory you can ever get a satisfactory job through a performance spec—particularly under competitive public bidding conditions. There are a number of ways to do the job right. There are an infinite number of ways to do it wrong. Given an unscrupulous or conveniently over-optimistic bidder this fact presents an enormous opportunity for harm. What in fact do you do when the contractor who bid on given performance requirements fails to meet them, or more likely meets them by transgressing in some other area not specifically forbidden by the specification. Stop the job? Turn the loaded moving trucks around and refuse to take beneficial occupancy? Maybe you won't find the faults for a year. In any case, your attorney will counsel compromise.

Just one example of this is some of the early performance spec type bidding that specified space temperatures, humidity and ventilation to be provided. Soon, the exuberant but inexperienced, who sought to release the contractor's ingenuity from the bonds of detailed specifications, learned that the low bidder could reduce the initial cost of HVAC systems while still meeting the spec by doubling the owner's power bill and furnishing short-life components.

Thus was "Life-Cycle Costing" revealed to them.

Today perhaps the mechanical-electrical loophole has been plugged, but similar traps await him who rushes imprudently on. Extensive life-cycle costing, by the way, is a necessary concomitant to successful use of performance specifications. Lamentably, though, the data bank is only now being developed that will permit preparation of properly safeguarded performance specifications for the bulk of architectural items in most buildings. There is a great deal of information that still needs to be gathered on maintenance, replacement frequency, comfort, quiet, and efficiency.

In other words, we are still just at an interface. Applying new rationalized techniques in an as yet substantially intuitive industrial, legal and social structure, must be done realistically, very prudently and without the expectation that magic will result.

sums up a general view: "loose enough to permit completion but tight enough to prohibit abortion to minimum product level.

Many manufacturers tended to favor the performance specification, but urged the design professionals to study the implications and pitfalls and to strive for uniformity in the ways in which performance specifications are written for best comprehension.

Better field installation is a direct result of the specifier making sure that his document is not violated in the field. Inspection and continuing job surveillance are recommended. The suggestion was advanced that, for special systems, independent consultants often can be enlisted on the side of installation quality. Those producers who provide an installation service, of course, propose this as available assurance to the designers.

The quality of components can be assured, according to component manufacturers, when the designers of systems are accurate in their performance specifications and remain in close touch with both the component and the systems manufacturer through test and demonstration programs. Here, again, attention should be paid to quality and longevity.

Systems manufacturers propose a three-step program of specifications that can help sustain quality: First, a well-structured performance specification from the architect and engineer; second, a program of comparative measurement; third, a formalized and fair evaluation procedure.

Materials suppliers urged factory visits by designers to keep abreast of quality and availability of materials.

The interest in the systems approach to buildings using guideline plans and performance specifications appears to be increasing some respondents thought, but mainly in the government sector. One component manufacturer observes, however, the problem is that guidelines and performance specifications do not always keep abreast of product evolution. This imposes a penalty on advanced products which are out of step with the formalized guidelines and/or performance specifications programs, especially as they are frozen into government documents.

As might be expected, systems building brought varied responses. One manufacturer close to government programs had this to say: "Both government and private sector participants have grown weary of the glamour of systems buildings because of massive failures and embarrassments over the past five years. Guideline plans and performance specifications, as used by agencies like HUD, NBS

and the military, simply cause bureaucratic delays because judgments and decisions are required, and most officials aren't willing to make them. The role of government should be to clear obstacles, define objectives, and then step aside. If government subsidization of funding is required, it should be provided at arm's length so that the inherent government defensiveness does not delay or overkill the project. Systems in the future will have to establish themselves on their merit and substance, and evolve and succeed without help from outside sources.

"In general, the evolution and refinement of systems building and job control techniques appears inevitable. The road to success will not be a smooth one, and many participants will fall by the wayside. The total building 'establishment' will be affected as the evolution gains momentum. Those professionals with the proper combination of flexibility, ability, experience, insight, perspective, leadership, discipline, team-play, integrity, patience, respect for profits, and stamina will prosper from the adventure."

Another manufacturer thought that, "The systems building approach using performance specifications has received good government support, but mild support from the private sector. The dichotomy of most systems approaches is the strong pull for ultimate first cost reduction versus the need for lowest total owning and operating cost, and highest quality over the life of the system."

One lighting producer observes that the systems approach has received limited support in the private sector. This, he believes, is a result of different priorities in value analysis, where first cost may have greater influence in the private sector. Systems, he observes, are difficult to bid competitively because they are sold as a package which may be unique to a key supplier. He observes: "without being too cynical, pre-screening tends to reduce the final result to the lowest common *good* denominator rather than the lowest common denominator."

The same lighting manufacturer stressed the need for more consultant design time for better-quality lighting solutions: "Providing quality illumination does not necessarily mean a more expensive lighting system, but does necessitate closer attention to lighting design and specification... There have been various design outlines suggested for factors to consider in the lighting design process. Perhaps the most severe problem in implementing these is the matter of time available for design. To fully account for the many factors that could allow

better lighting quality and lower life-cycle costs, greater amounts of time must be spent which are not normally accounted for in the standard design fee. Perhaps it is time to ask the client to spend more for better design and maximize his consultant's professional services."

Subsystem manufacturers were understandably optimistic about future growth of the systems approach, but they observe that pre-screening of bidders is difficult to implement under the conditions of today's market. Two proposed criteria for bidders are financial stability and research resources of the systems suppliers.

Criteria guidelines for owners and professionals to use in evaluating expertise of construction consultants were difficult to identify, but almost unanimously desired. Manufacturers themselves have been called upon to perform the consultant service, even when a professional consultant is on the job. They are not reluctant to do this, but are aware of the perils of combining both the sales and the consultant roles. Their plea, in general, is that they be called upon for specifics of their own lines but excused from a role of general trade advisors in the product selection process.

One manufacturer thought that, "Too often, consultants are self-made. Educational and professional standards should be set, appropriate tests developed, followed by comprehensive licensing procedures."

Evaluation of cost consultants, like that of most consultants, eventually resides in the performance of the individual, and there are few structured modes of pre-qualifying consultants other than through their records.

### Do volume purchasers cut quality? Not when the specs are good

Component suppliers are not as concerned about this as are the subsystems manufacturers which are more vulnerable to the pressures of volume purchasers. But most suppliers contend that there is no danger of undue degradation of quality where the performance specification is appropriately drawn and stoutly defended by design professions.

There was, of course, unanimous agreement that owners should be educated in their ability to evaluate choices presented to them by construction/cost consultants. The observation is made, however, that while owners must involve themselves more directly in the building process, the reliance upon professional integrity of designers and consultants is also an essential ingredient of the process.

## The manufacturers who replied

ADT Security Systems

Air Balance, Inc.

Alco Controls Division—Emerson Electric Co.

ALCOA Construction Systems, Inc.

Aluminum Company of America

Arrow United Industries

Barber-Colman Company

Bethlehem Steel Corporation

Buffalo Forge Company

Cambridge Filter Corporation

Carrier Corporation

J.W. Carroll & Sons

Circle F Industries

Day-Brite Lighting Division

Emerson Electric Co.

General Electric

Commercial Air Conditioning Department

Lamp Marketing Department

Component Sales Department

GTE Sylvania Lighting Products Group

Guth Lighting

Holophane

Inland Ryerson Construction Products Co.

ITT Reznor—Environmental Products Division

Johns-Manville

Johnson Service Company

Lennox Industries, Inc.

Lightolier

Liskey Aluminum, Inc.

Lear Siegler, Inc.—Mammoth Division

Master Builders

McQuay Division—McQuay-Perflex, Inc.

Owens-Corning Fiberglas Corporation

PPG Industries, Inc.

Prescolite

Robertshaw Controls Company

H.H. Robertson Company

Rohm and Haas Company

Square D Company

Sterner Lighting, Inc.

Thiokol/Chemical Division

The Trane Company

Westinghouse Electric Corporation

Interior Lighting Division

Construction Sales Development

Zurn Industries, Inc.

Swartwout Division

# 7

Though there have been energy scares before, we know this one is for real, and that now **energy management is a way of life.**

Frank Bridgers, past-president of ASHRAE, has been energy-conscious since he started his practice over 20 years ago.

His own office building was designed for solar heating, and he is consultant for the largest solar-heating system proposed so far. He also has sought ways to make beneficial use of the sun that normally gets into buildings. His work exemplifies what competent, conscientious engineers can do by imaginatively using technical resources already at hand. This article is a profile of his work and attitudes. It also examines the implications of government response to the energy crisis.

Energy saving in buildings can be accomplished in design via brute-force techniques or finesse. The brute-force route is simple: use less lighting, less glass; reduce optimum temperature levels, etc. For the mechanical and electrical engineer, and the lighting designer, the finesse route means bringing to bear a greater depth and breadth of knowledge, putting in more time for investigation of alternatives for design (which the client should pay for), and embarking upon projects with some courage and conviction—and with the attitude that husbanding energy resources is the engineer's responsibility along with the architect's and the owner's.

Frank Bridgers of Bridgers & Paxton, consulting mechanical engineers of Albuquerque, has always had a deep interest and belief in energy-conserving systems—and his interest predates the start of his firm in 1951. Some of his interest undoubtedly stems from his gradu-

---

Albuquerque, New Mexico, site of the Bridgers & Paxton office building, has a maximum of solar radiation in the winter—so it was an ideal situation to try out the concept. The building shape reflects an optimized angle for the collectors. The system includes storage and a heat pump for cooling as well as heating.

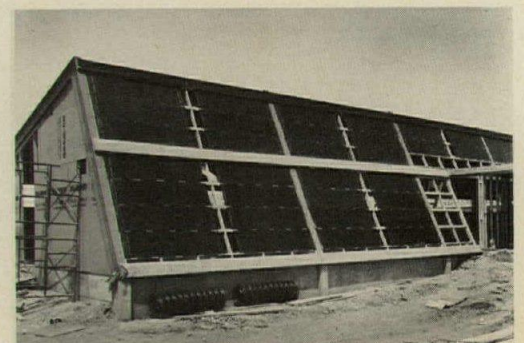
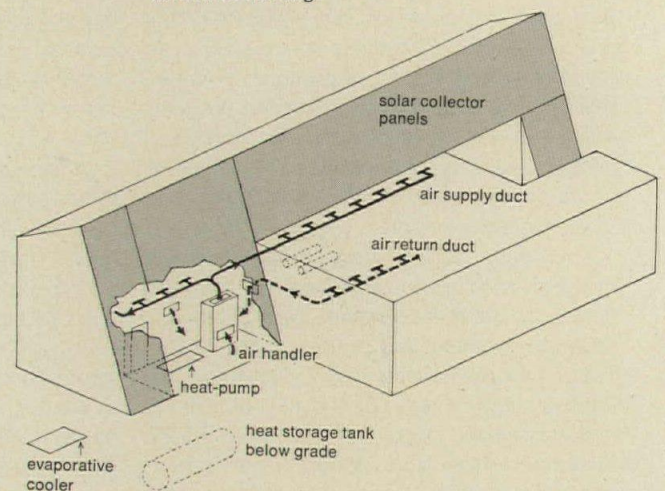

ate engineering work with F.W. Hutchinson at Purdue University, who pioneered early mathematical analysis for radiant heating panel design; and also from his early experience in the consulting engineering firm of the late Charles S. Leopold of Philadelphia—who designed some of the earliest commercial installations of radiant-panel heating and radiant-panel cooling, and also the earliest test installations of water-cooled lighting fixtures.

### Bridgers' concern with heating efficiency predates the energy crisis by 20 years

A reflection of Bridger's interest in energy conservation is the firm's own office building, designed in 1954—20 years ago!—to use solar collectors for space heating. One whole side of the building was covered with solar collectors, and sloped for optimum solar energy recovery. A packaged water chiller, used for air-conditioning in summer, is used as a heat pump dur-

ing the heating season, combined as a system with the solar collectors and an underground storage tank. If heat from the sun is inadequate on cloudy or very cold days, heat is drawn from the stored water.

The building is being instrumented by Dr. Stanley Gilman of The Pennsylvania State University through a National Science Foundation grant, and data will be developed by Bridgers and Gilman to provide application guidance for other engineers.

Bridgers also was one of the first engineers in the country to design a heat-pump system for a high-rise office building—with the main objective being to pick up heat from one side of the building that required cooling and transferring it to another calling for heating.

Furthermore, the system included radiant heating-cooling panels in the perimeter ceiling and under the windows to reduce air-conditioning supply-air requirements—which was

aided further by the novel sill air-return arrangement that helped minimize heat-transmission effect through the glass into the occupied space.

Since then, Bridgers has done a number of internal-source heat-pump designs, including the use of large unitary (packaged) water-cooled air conditioners in a school that pulled heat from the interior in cold weather and utilized it on the perimeter where heat is needed. Bridgers has shown that larger-size, heavy-duty package air conditioners up to 60 tons in refrigeration capacity may offer an attractive alternative to central chilled-water-plant systems. He has also done a number of buildings with large central-plant, internal-source heat pumps—giving special attention to some of the idiosyncracies of refrigeration-plant design that can cause operational difficulties—particularly with respect to the method of heat rejection from the chiller's condenser.

## 1954

In the Simms Building in Albuquerque, Bridgers designed an air-return system that captures some of the sun's heat and delivers it to a heat-pump system that redistributes the heat in winter to the cold side. Radiant heating-cooling panels, tied in with a solar compensator control, reduce air-conditioning air-supply requirements. The panels provide perimeter heat on the north side in winter, and on the south side when there is no sun. Well water is available as a standby if there is not enough solar energy or internal heat.

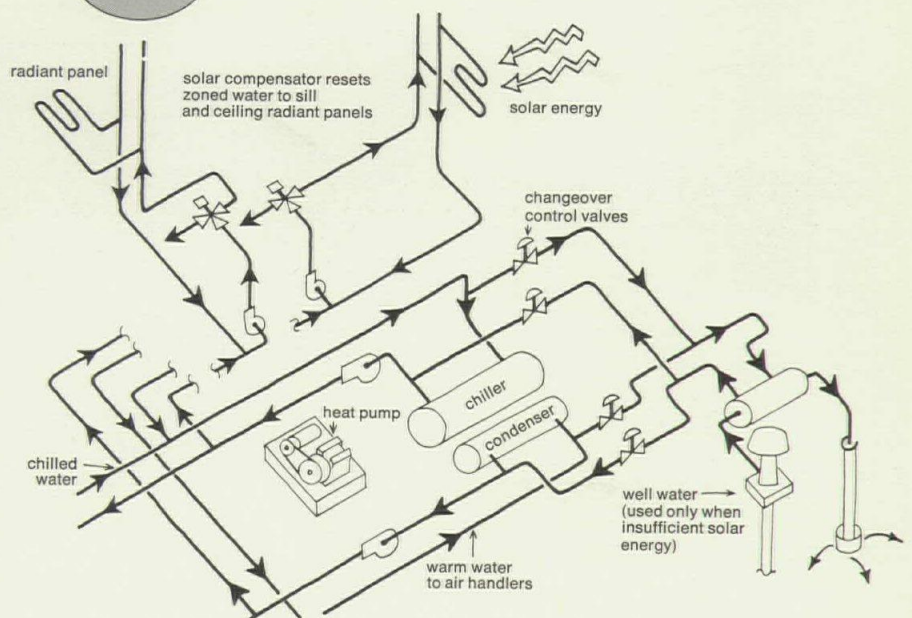
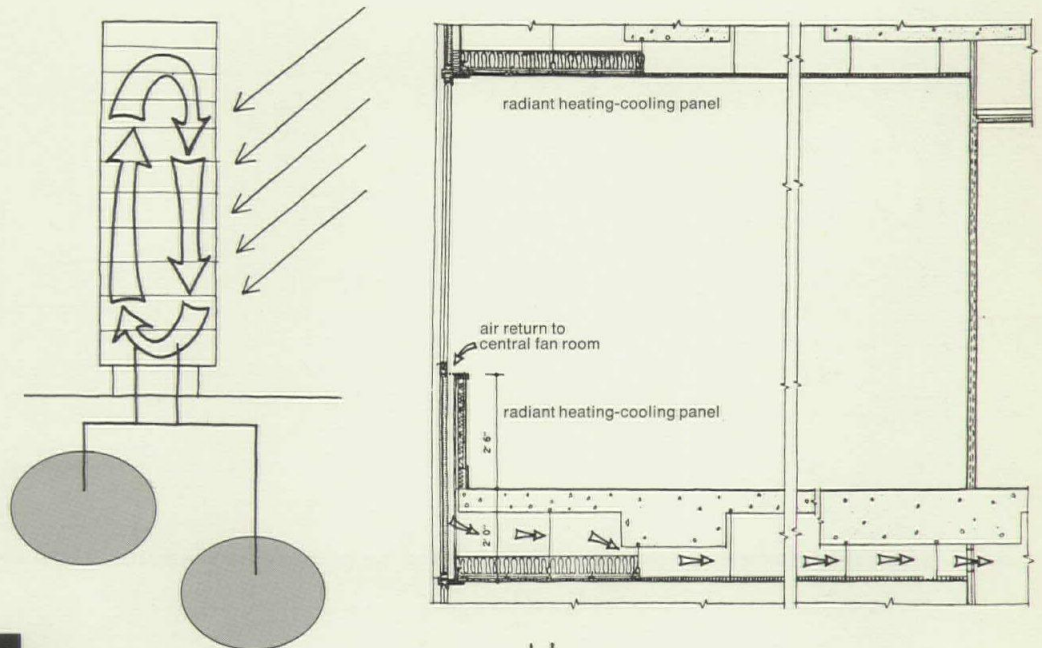

**Benefits from solar energy are possible in both ordinary and special buildings**

Frank Bridgers looks at the beneficial utilization of solar energy from two different standpoints: 1) use of solar collectors to pick up heat directly or indirectly from the sun's rays; and 2) controlling the sun's heat that manages to penetrate the building's glass. He is now involved in the design of the largest solar-collecting system for space heating application yet to be used—Denver Community College. One of the practical problems he is working on is how to prevent the freezing of the collectors at night. One solution is to provide an anti-freeze loop for the collector circuit only, with a heat exchanger to transfer heat to the solar storage tank. Although this solution reduces the efficiency of heat transfer to some extent, the operation and maintenance problem of venting air from a large amount of collection piping everyday in winter would be a less practical

solution. Bridgers points out that the technology of solar collection has changed little in 20 years; but, on the other hand, engineering data for design, the collectors themselves, and economic feasibility are changing.

Beneficial utilization of transmitted solar energy has been an integral part of the mechanical-system design of several office buildings Bridgers has been involved with. What has to be stressed in the future, he says, is a proper concern with building orientation, combined with carefully chosen (or designed) interior and exterior shading or sun control to make it possible not just to limit or reject solar radiation in summer, but also to "capture" it in wintertime.

The more dedicated engineers, such as Frank Bridgers, continually strive to improve upon their past designs, to broaden their background expertise, and to investigate new approaches involving a wider range of design so-

lutions. Furthermore, they put together highly-qualified engineering "teams" that get in-depth direction from a highly-qualified principal of the firm. Characteristically, the principals and chief associates of such firms have high educational qualifications—formal or otherwise—combined with broad practical design, installation, and field-testing expertise on a wide range of systems and equipment.

Bridgers has considered active technical and administrative participation in the American Society of Heating, Refrigeration and Air Conditioning Engineers—the consulting engineers' primary technical society—to be an important responsibility. Furthermore, his educational-engineering background has made him particularly aware of the value of basic fundamental data developed by ASHRAE. Designing a system that is *practical* is always uppermost in Frank Bridgers' approach, and some of the specific elements of that approach follow.

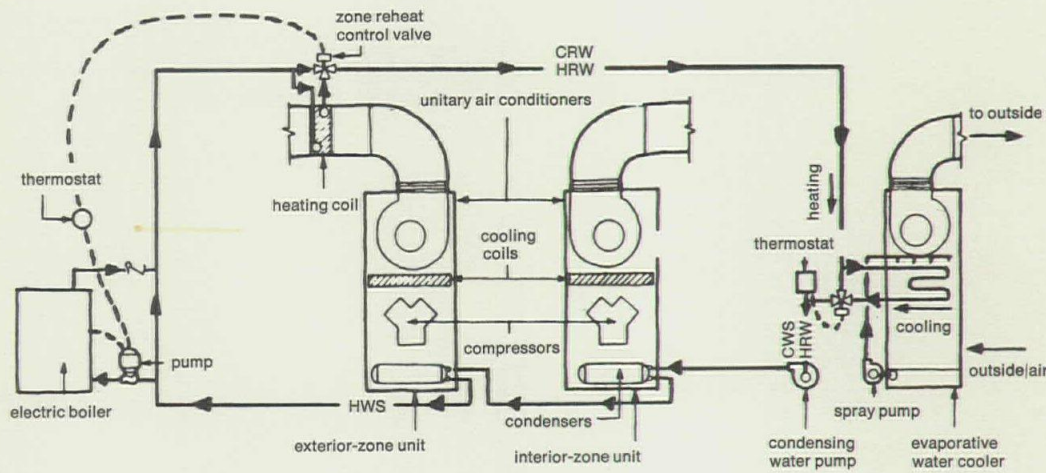

**1968**

Bridgers conceived the idea of using packaged unitary air conditioners for both heating and cooling in low-rise buildings with large interior areas. The interior units in cooling pick up heat and transfer it to exterior units. A boiler makes up any deficit in heat, and an evaporative water cooler rejects excess heat. The approach is best for buildings with adequate space for low-pressure ductwork.

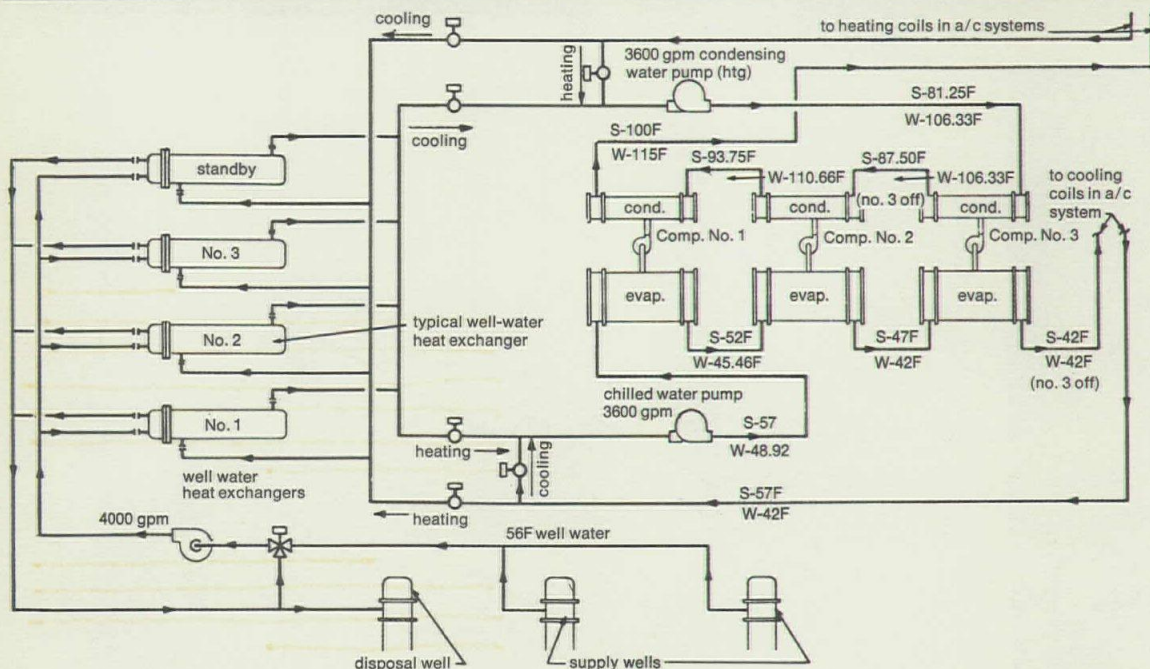

**1972**

This large (2500-ton) heat-pump system for the huge, high-rise LDS office tower in Salt Lake City uses well water as a source. At times internal heat will balance external load of the building. When more heat is required it can get it from the well water. If, on the other hand, there is excess heat, it is rejected to the well water. Use of separate heat exchangers avoids potential corrosion problems from well water.



**All agree we need to manage energy better in buildings. But the question is, how? Prescriptive criteria limit alternatives. Many favor the energy budget. But what should the numbers be?**

Though good energy management has been a concern of a number of individuals and groups for several years (and for some much longer), it wasn't until the oil embargo that the flurry to do something fast really began. There is almost universal agreement that the country needs to face up to the harsh realities of limited energy resources—if we are to remain economically, even socially, viable, we have to change our habits. But when the pressure is on, who gets squeezed, and how hard? Since everyone is affected, shouldn't everyone share?

During the oil embargo there were real problems of energy allocation. But presented with this crisis, the Federal government also felt impelled to accelerate its efforts to develop energy design criteria for buildings; and the Federal Energy Office, as an immediate step, asked for a reduction in lighting footcandle levels—to the numbers that now fall from many tongues—50/30/10.

In a crisis, obviously some arbitrary steps have to be taken. But why the rush to get out energy design criteria for new buildings, when: 1) they represent such a small fraction of total buildings; and 2) when any regulatory approach based upon criteria, or standards, that could be considered fair, sensible and sound—if this can be done at all—would require considerable input from a wide variety of knowledgeable groups and individuals; and 3) when many questions would require considerable investigation, and even research, to develop valid answers?

Perhaps, in the long run, the cost of energy, itself, will be a major impetus for the husbanding of energy—though the poor get hurt more than the rich. But even the rich will be responsive when it's money out of their pockets. And also we can't discount the social pressure of being good citizens.

As we know, the three governmental groups promulgating energy design criteria and recommendations are the National Bureau of Standards, The General Services Administration, and the Federal Energy Administration.

NBS staff developed a series of "Design and Evaluation Criteria for Energy Conservation in New Buildings (NBSIR 74-452)" at the request of the National Conference of States on Building Codes and Standards to "provide the technical basis for a performance-type document." Though termed this, the standards were almost wholly prescriptive. Because the document was prepared by NBS staff it lacked experienced input regarding the design and construction requirements of actual buildings. Furthermore, the industry representatives on the technical advisory panel apparently had only token input. The result was that the document did not face up to the economic realities of the industry.

When the hvac criteria were presented to ASHRAE at its annual meeting in January, all hell broke loose. Some systems such as terminal-reheat and double-duct were ruled out. Consulting engineers were hemmed in, and manufacturers were cut off from selling some components and systems. The consultants also foresaw a tremendous increase for their design time and for re-evaluation of approaches without much likelihood of additional compensation.

To still the uproar, ASHRAE's board of directors agreed to appoint a committee to redraft the hvac criteria, and in July, they were published as Proposed ASHRAE Standard 90P (idea is for this to eventually become a consensus standard through ANSI). The result is a shortened and considerably circumscribed group of prescriptive specifications, referenced standards and evaluative procedures.

The new criteria put little bite on anyone—insulation requirements are hardly stringent, and energy efficiency ratios for unitary equipment appear more than generous. But limit on instantaneous load through glass implies for sunny orientations that the glass either have effective shading or that it be reflective. In any event the approach is still energy conservation by prescription and by fiat.

AIA, though cooperating in the effort stated that, "the present state of the art is such that no reliable standards can be set and that the adoption of the standards approach in formal legislation even to the practices which are recommended in this present draft document may retard the nation's realization of its greatest potential in conserving energy in buildings." Further AIA said . . . "we do not know exactly how and under what conditions certain actions might be effective . . . the variations of building situations tend to make 'standards approach' ineffective . . . we lack adequate knowledge of the psychological and physiological relationships of some energy-conserving tactics."

GSA/PBS in their "Energy Conservation Design Guidelines for Office Buildings" have presented a fleshed-out laundry list of energy-saving tactics (including all the common sense ones, plus some sophisticated ones of unproved or marginal economics), and the proposed "achievable" energy budget of 55,000 Btu/gross square foot/year. Most engineers consider this value to be unreasonably low—requiring

pretty close adherence to all of the guidelines to achieve such numbers. But, no matter, the energy-budget concept has attracted more and more adherents because it gives both designers and owners choices.

The Federal Energy Agency, beyond initially proposing a mandate of 50/30/10 footcandle levels (task/immediate surround/circulation), has recently authorized a \$75,000 research grant to Ross & Baruzzini, Inc., St. Louis consulting engineers for extensive illumination research.

Ross & Baruzzini also submitted a "Lighting Systems Study" to GSA/PBS, and among their conclusions were that the general background level should be approximately 30 footcandles and that the level of illumination at each workplace should be a nominal 50 footcandles, maintained, increasing to 70 or 100 footcandles, if required by task requirement." The basis for this recommendation is not made clear. Another was that "suitable lighting for office space can be provided in the typical case for a power input not in excess of 2.3 watts (2.5 va) per sq ft net rentable floor area."

It is fair to say that most design professionals would prefer to have an energy budget of watts/square foot that gives the designer and the owner latitude in system choices, rather than prescriptive footcandle levels. As John Flynn, professor of architectural engineering at Penn State puts it, "The proposal of 50/30/10 is not unlike the levels recommended by IES in the early 1950's . . . and the response then was silver-bowl (incandescent) in classroom and incandescent corridor lighting. If someone were to ask me 'What is the most economical way to meet the proposed levels?' I would think that incandescent would offer some attractive initial cost savings. Recognize that I'm not really advocating that we go back to inefficient incandescent systems, because I want to conserve energy too."

Though the energy budget is appealing and rational, the question is where do the numbers come from? Lighting designers don't pall at the thought of 2-3 watts per square foot for general office lighting. But if the designer/owner want to use more (say, because they prefer incandescent lighting), but are willing to save elsewhere, why not? What are reasonable numbers, though, for over-all energy consumption? Typically, office buildings today use 100,000—120,000—180,000 Btu/sq ft/yr. All-electric air-conditioned schools with minimum ventilation and well insulated skins have records of 68,000 btu/sq ft/yr. for 40 hr/week and partial summer use.

Obviously energy budgets would have to be specified in ranges within given building types. But aside from tax penalties, and/or tax incentives, the energy budget approach appears to be the best sugar to help the medicine go down.

### Innovation can be made practical by using standard equipment packages

Bridgers' guideline to design for practical innovation include:

1) Use standard production-line equipment packages, combined with manufacturers' standard options—as proven by field experience. The component selection and arrangement and the piping design in a refrigeration system are critical. Use of other than standard "matched-performance-package" configurations can be troublesome and costly, and can limit bidding. This caution, to some extent, applies to centrifugal chiller heat pump systems employing double-bundle condensers because of the complexities in evaluations for stability of operation at the lower heating-load conditions they encounter;

2) Don't ask for custom features with which the manufacturer has not had experience. Rather, analyze the detailed perform-

ance of standard heating-cooling packages to see how they might be used in new and unique systems to improve over-all efficiencies;

3) When applying standard packages in new systems, think through the over-all system including: a) pipe and duct system dynamics, b) heat-exchange options and limiting factors, c) selection of control-system elements and their over-all coordination—perhaps the most essential element to ensure that the hvac system will perform as designed;

4) With unique systems, make sure the contractor is guided in terms of start-up, balancing, testing, and adjustment of the system. This means the consulting engineer must have experienced and knowledgeable engineers in these areas;

5) Optimize duct and piping system design and fan selection to achieve an optimum balance between first cost and operating cost of the heating and air conditioning system.

## 1974

When built, Denver Community College will have the largest solar heating system in the country. The architects, ABR Partnership of Denver, favored the approach because it is pollution-free, would not be affected by the shortage or cost of natural gas, and because the climate of Denver is ideal for a solar system. There will be 50,000 square feet of collector surface tilted at 60 degrees from the horizontal. Solar-heated water will be stored in 400,000-gallon-capacity tanks underground. If the sun heats it to over 100 F it is used directly, if not, a heat pump system adds supplementary heat to raise it to 100 F.

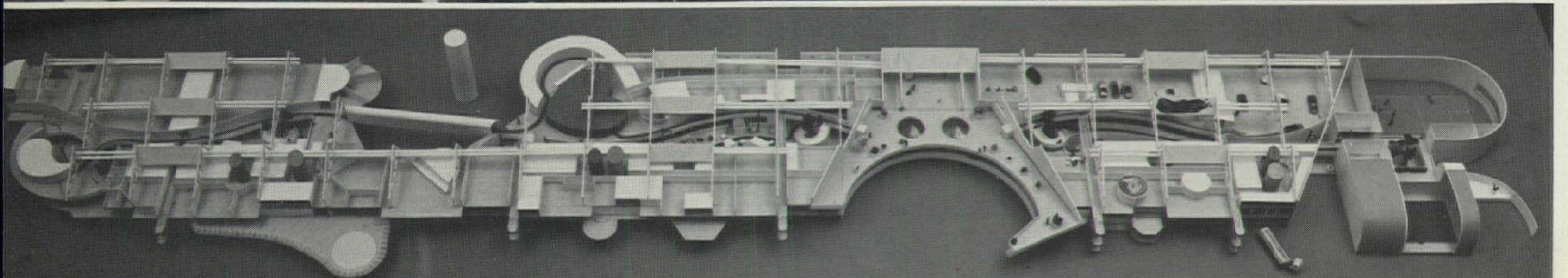
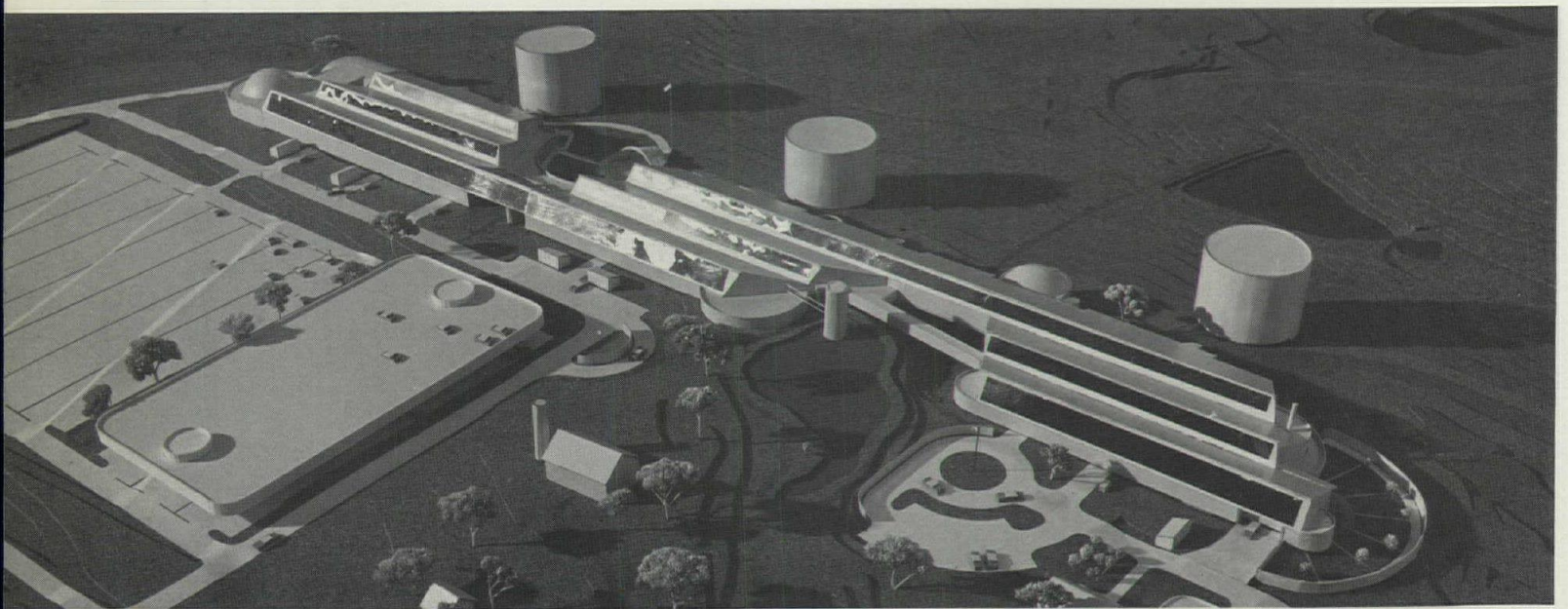
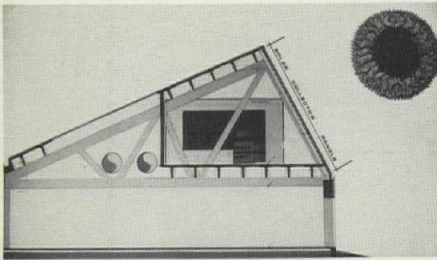

For more information, circle numbers on Readers Service Inquiry Card, pages 209-210.

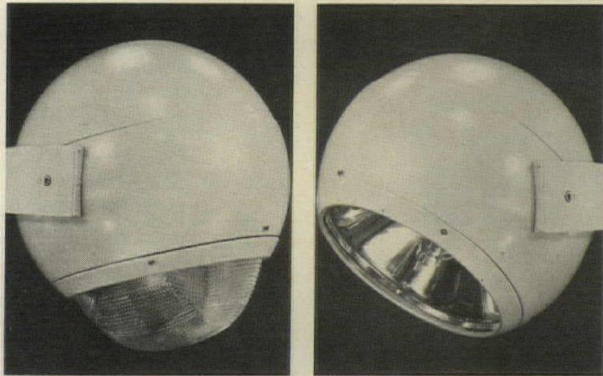

### HID fixtures introduced for outdoor applications

Two series—one for street and area lighting (left), and one for floodlighting (right)—can accommodate 400- or 1000-watt *Metalarc* and mercury lamps, or 400-watt high-pressure sodium light sources. Both series are pre-wired and come with integral ballasts, trunnion mounting

and double locking devices to hold the fixtures securely in place. Units measure 25½ in. in diameter. The floodlight's beam spread is from 26 to 128 degrees with a high beam efficiency of 65.5 per cent ■ GTE Sylvania Inc., Stamford, Conn.

Circle 300 on inquiry card

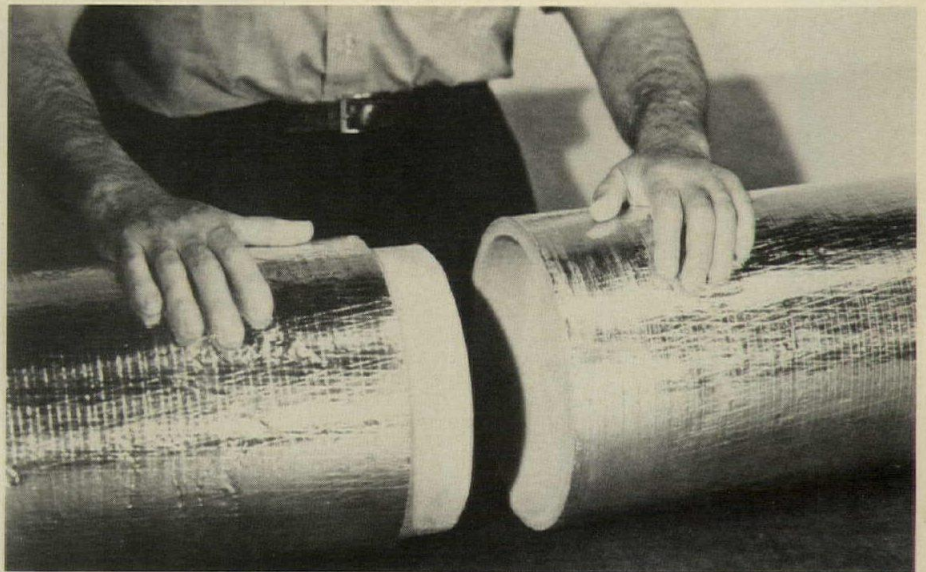

### Round fiberglass duct features scrim-reinforced foil jacket that resists tearing

This preformed fiberglass heating and cooling duct for high-pressure and low-pressure systems is designed to provide thermal insulation, vapor barrier and acoustical absorption in one product. The cylindrically

molded duct is covered with a scrim-reinforced foil jacket which resists tearing, but cuts easily in fabrication work. An integral high density "slip joint" provides a snug connection between duct sections. Condensa-

tion problems are said to be eliminated, along with air rush noises and expansion-contraction noises associated with metal duct. ■ Johns-Manville, Denver, Colo.

Circle 302 on inquiry card

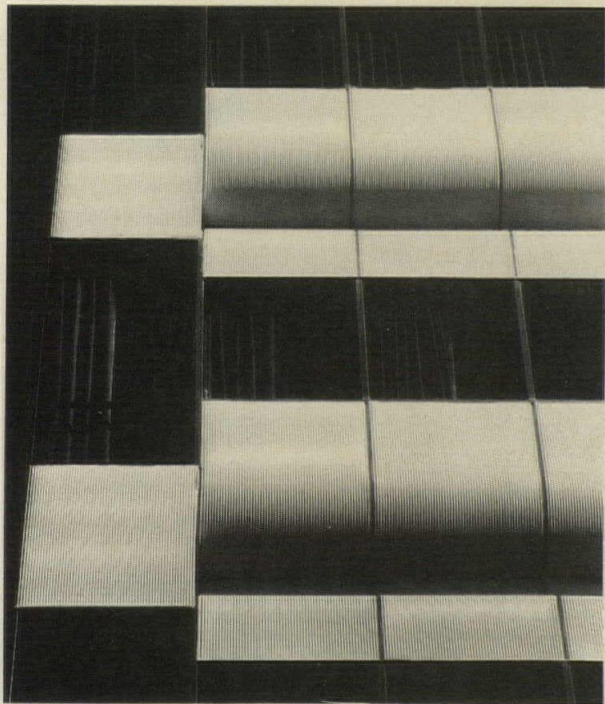

### Embossed metal panels for sculptured facades

Three-dimensional facades, curtain wall panels, fascias, louver walls, ceilings and many other uses are suggested for these lightweight, incombustible metal panels. For interior and exterior applications, the panels can be executed in nu-

merous designs and textures, and finished in bronze, copper, stainless steel, weathering steel, aluminum, and in color films bonded to steel or aluminum. ■ Forms & Surfaces, Santa Barbara, Calif.

Circle 301 on inquiry card

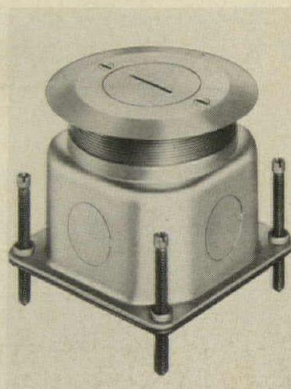

### Self-leveling floor box available

The tiltable top is said to flush mount to floor or carpeting even if the level varies up to 10 degrees from horizontal. Covers are available for many device requirements; the box comes with three knockout patterns. ■ Bell Electric Co., Chicago.

Circle 303 on inquiry card

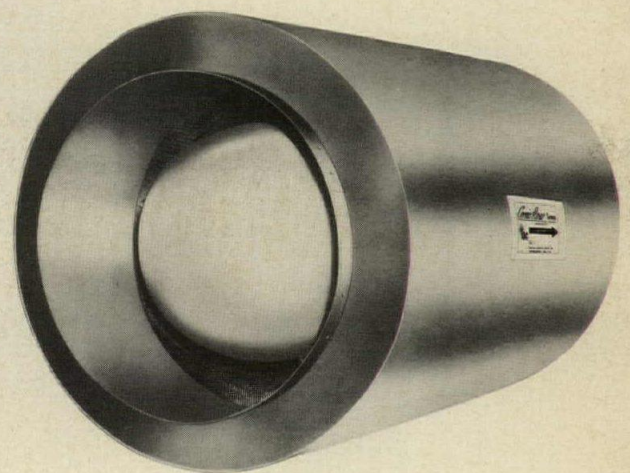

### Duct silencers feature reverse and forward ratings

Duct silencers featuring reverse- and forward-flow aerodynamic ratings are offered in two configurations—rectangular and tubular (shown). The rectangular model, in lengths of 3, 5 and 7 ft, range in cross section from 12 by 6 in. to 36 by 36

in. The tubular model is available in 18 cross sections. According to the company, duct silencers rated as these meet ASTM E-477. ■ Industrial Acoustics Co., Inc., Bronx, N.Y.

Circle 304 on inquiry card  
more products on page 159



XEROX® is a trademark of XEROX CORPORATION.

# One thing they don't teach you in drafting class is how to use a drawer.

1. Open the drawer.
2. Take out whatever standard details you need.
3. Use the Xerox duplicator to copy them onto adhesive-backed Mylar.
4. Place the imaged Mylar onto the new working drawings.
5. Put the standard details back in the drawer until the next time you need them.
6. Close the drawer.

For a firsthand lesson, have our Architecture/Construction/Engineering specialists show you all the ways a Xerox duplicator can help you turn repetitive time into creative time.

And then instead of going back to the drawing board, maybe you'll start going back to the drawer.

## XEROX

For more data, circle 51 on inquiry card

MYLAR® is a trademark of DuPONT CORPORATION.

For more information, circle item numbers on Readers Service Inquiry Card, pages 209-210.

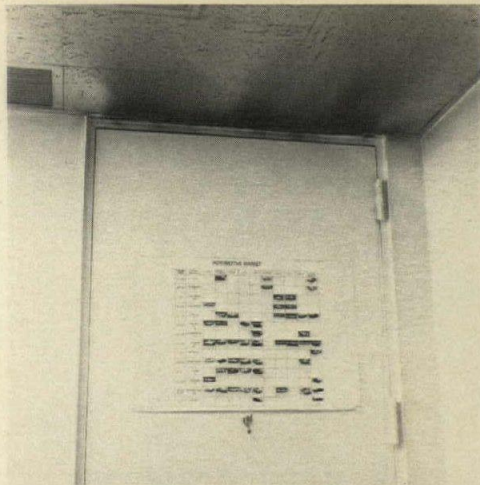

Many questions about wood fire doors may be answered in a recent publication, "All about U.S. Plywood fire doors," a 12-page color brochure detailing the company's *Weldwood* fire door line. The brochure cites wood's low heat transmission and dimensional stability as extra measures of protection. Performance of the product is demonstrated through charts and photos, such as those shown here, in which a one-hour B-label wood door remained operable throughout and after a fire on the outer side of an office in New York City's Pan Am building. A work chart remained intact (top), illustrating low-heat transmission characteristics of the *Weldwood* fire door, according to the company. The surface exposed to the fire only charred (bottom), with the noncombustible *Weldrok* mineral core preventing heat transmission, and the possible spreading of the fire. Besides details, specifications, comparative data and the company's guarantee, the brochure also lists typical fire door requirements of the four major building codes. It includes the NFPA Pamphlet 80 Standard, the FHA Minimum Property Standards and UL ratings for fire doors. A wide range of finishes—veneers and laminates—are also discussed in the brochure. ■ U. S. Plywood, New York City.

Circle 400 on inquiry card

**INTER-FLOOR NOISE** / A fast and economical approach to solving between-floor noise problems in low-rise apartments, townhouses and condominiums is discussed in a four-page brochure on a wood-joint system which controls transmission of airborne and impact sound, according to the company. Installation methods, sound transmission data and a complete, illustrated description of the system are included. ■ Kaiser Gypsum Co., Inc., Oakland, Cal.

Circle 401 on inquiry card

**RECREATIONAL FACILITIES** / A 12-page brochure presents metal building design ideas for indoor tennis, ice skating, roller skating, curling, municipal recreation, golf pro shops, swimming pools, gymnasiums, bowling, even boat sales and storage. ■ Armco Building Systems, Middletown, Ohio.

Circle 402 on inquiry card

**PONDING WATER REMOVAL** / The year-around removal of ponding water from roofs is the subject of a new four-page brochure. To assist the roof maintenance manager/specifier, the brochure also includes sketches of typical installations, complete specifications, and a handy reference table for computing the approximate weight load of ponded water on roofs. ■ Tremco, Cleveland, Ohio.

Circle 403 on inquiry card

**HEALTH CARE CATALOG** / To help in the planning stages the company has recently introduced a "Healthcare Facility Equipment" catalog. The catalog is said to combine the experience of professional planners and the convenience of "one stop shopping" and is designed to equip a well-balanced nursing home. Primary importance is placed on outfitting a patient's room. A complete, yet compact nurses' station that includes a kitchen unit, chart rack, instrument sterilizer and a number of instruments is available. ■ Sears Contract Sales, Chicago, Ill.

Circle 404 on inquiry card

**DRINKING FOUNTAINS** / A comprehensive 24-page condensed catalog is illustrated with photos, diagrams and charts. In addition to covering the full product line, the catalog also features a color chart and a brief description of the "Modular Service Wall System." ■ Halsey Taylor Div., King Seeley Thermos Co., Warren, Ohio.

Circle 405 on inquiry card

**FIRE PUMPS** / New fire pump and flow metering systems with complete illustrations and information on split case, horizontal and vertical turbine fire pumping systems are described in two full-color bulletins. Details concerning various applications, standard equipment, accessories and available options are described. All company fire pumps are UL listed and FM approved. ■ Aurora Pump, N. Aurora, Ill.

Circle 406 on inquiry card

**GRAPHICS SYSTEM** / A new, 123-page reference manual describes a software system used to automatically generate charts, networks, and diagrams displaying cost, schedule and resource information for project management; cost and manpower resources graphs; and task charts in addition to time-phased network diagrams. Fully illustrated, the manual shows how the system can be adapted to virtually any computer and plotter to draw networks and graphs in a matter of minutes—cutting manual drafting time by as much as 97 per cent with comparable cost savings, according to the company. ■ Systonetics, Inc., Anaheim, Cal.

Circle 407 on inquiry card

**HIGH MAST LIGHTING** / The catalog includes pole specifications, mechanical lowering device specifications and design drawings. Included are photographs illustrating features of the company's lowering device, exclusive chain drive system, and antifall device with ring head assemblies. ■ Skyline Structures, Flint, Mich.

Circle 408 on inquiry card

# Light Safe, Dust Free Space Saving Consolidated Revolving Darkroom Doors

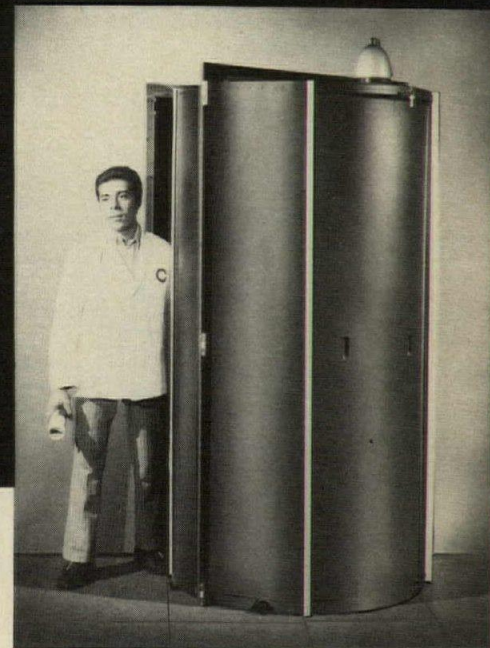

Ideal for Clean Rooms,  
X-ray, Data Centers and  
all Photographic Darkrooms

Consolidated's all metal revolving darkroom doors are the recognized standard, safe door for the industry. Manufactured in five sizes and three types for every darkroom layout. A single door can accommodate two, three or four rooms. They are easy to install, saves space and eliminate drafts, dust and are 100% light safe.

	dia. overall
2-way slim slimline	28 1/2" x 79"
2-way slim line	34 1/2" x 79"
2-way standard	40 1/2" x 79"
3-way slim line	40 1/2" x 79"
3-way standard	48 1/4" x 79"
4-way standard	48 1/4" x 79"
4-way jumbo	60 1/2" x 79"

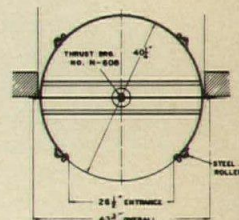

Available in wood grain finish, standard black, or to match your paint.

Stick-on scale 1/8" and 1/4" to foot available to help you layout the most efficient darkroom.



Write, wire or phone for information

**CONSOLIDATED INTERNATIONAL CORP.**

4501 S. Western Blvd., Chicago, Ill. 60609  
Phone (312) 376-5600  
Cable: Copeeco • Telex No. 25-3205

For more data, circle 52 on inquiry card

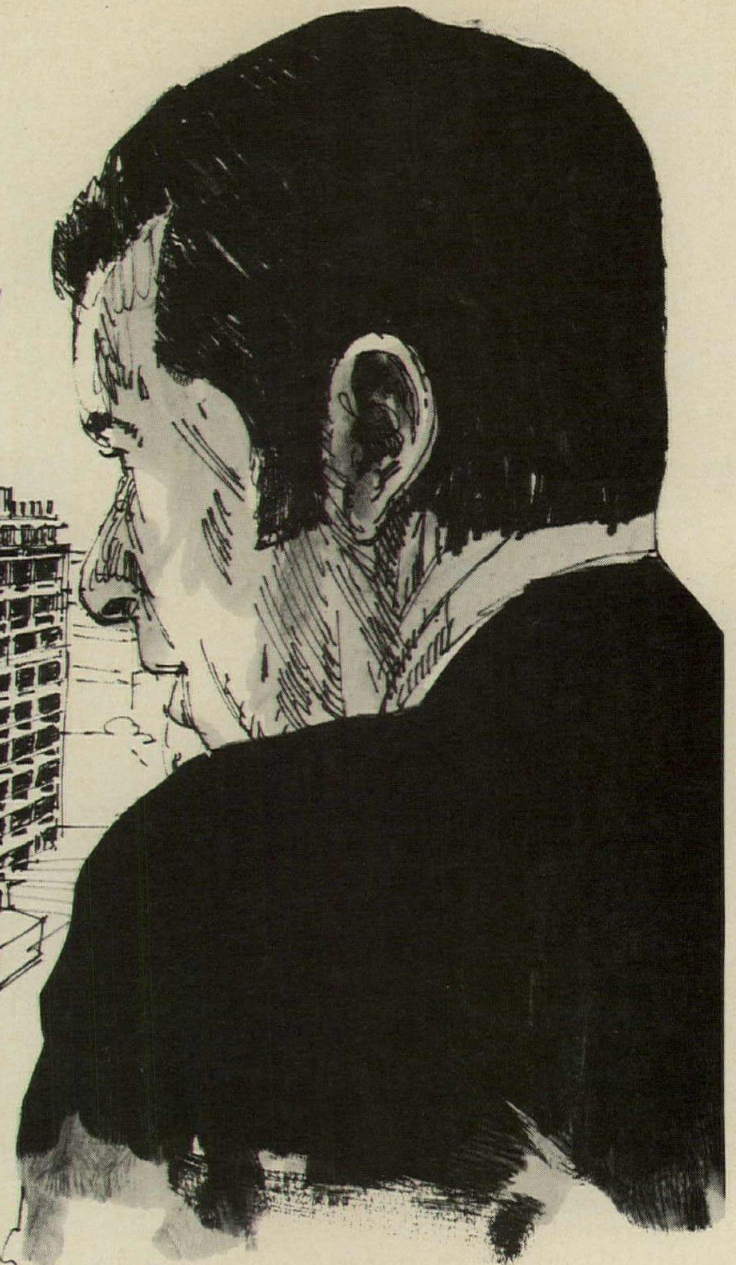
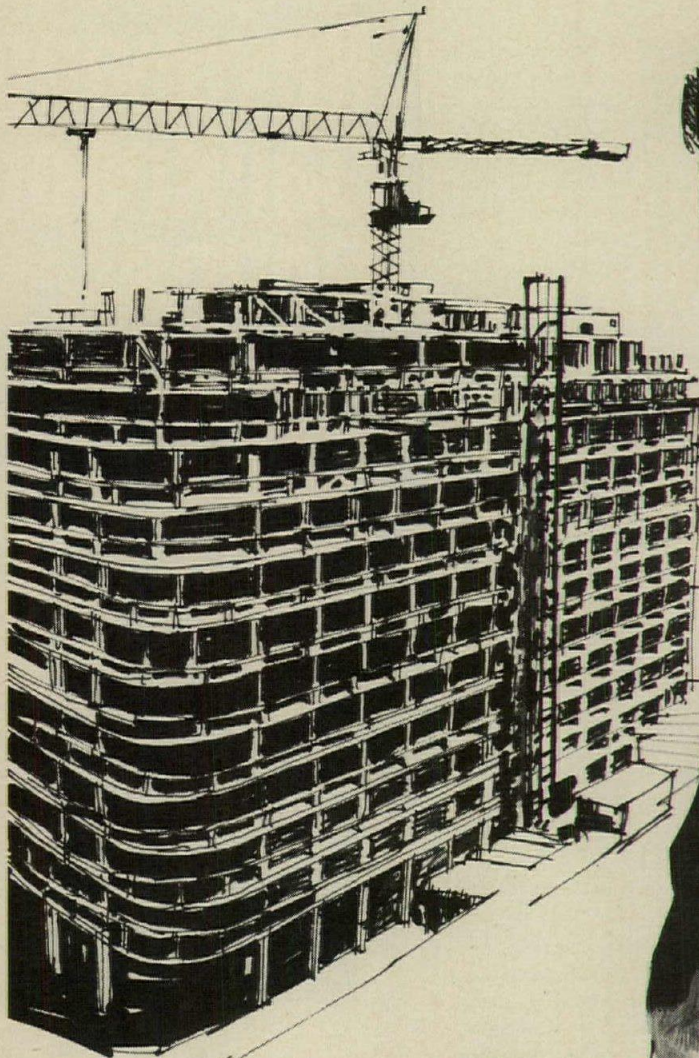

## How do you select an electrical contractor?

### NECA study reveals opinions of design professionals.

NECA, the National Electrical Contractors Association, recently completed a study among key decision makers on the building team to determine what characteristics they look for in selecting or recommending electrical contractors for new construction and modernization projects.

Most participants agreed: Competence is the single most important characteristic looked for in professional electrical contractors. Closely related qualifications include integrity, reliability, efficiency, quality of work, financial

position, caliber of work force and equipment, and ability to coordinate with other construction craft groups. All these qualities are found in professional electrical contractors. Advantages?

Work well done, when and where it is needed. Economically, accurately, efficiently. Handled by

a flexible, well managed work force of electrical craftsmen. Competent in everything electrical—from power line construction and power distribution wiring to interior and exterior lighting, communications, security alarms, motors and controls, space conditioning, etc., etc., etc.



National Electrical  
Contractors Association, Inc.  
Washington, D.C. 20014

**If electricity makes it possible,  
electrical contractors make it practical.**

# Now! Two great products bring you one great metal roof deck system.

- 2-hour fire rating
- Lowest U-value
- Slope to drains!

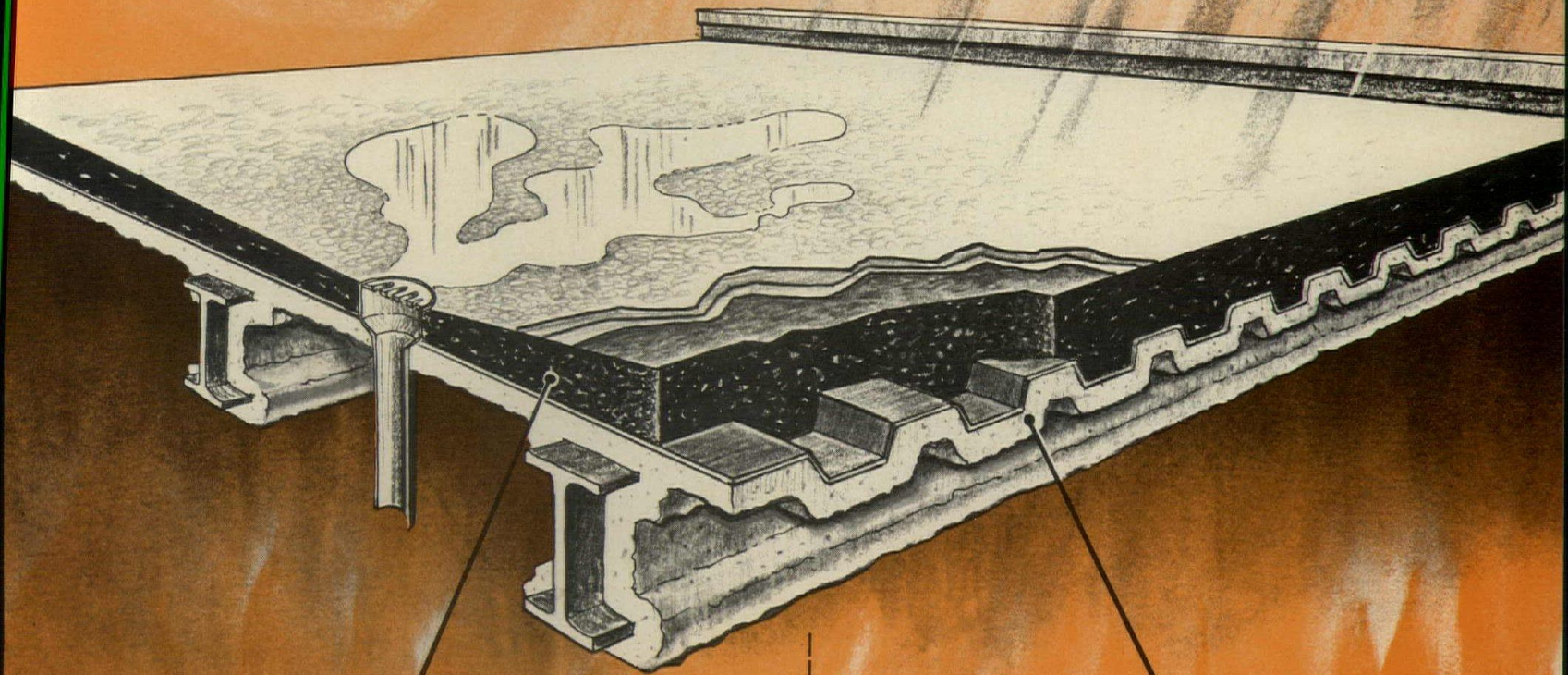

  **All-weather Crete**<sup>®</sup>  
ROOF DECK INSULATION

 **DECK-SHIELD C/F**  
**CAFCOTE V**  
SPRAY FIRE PROOFING

**ENERGY SAVER!** The excellent insulating properties of All-weather Crete insulation provide this system with a completely dry, seamless installation having a better k factor than any other poured roof deck insulation (.40 k factor). It is applied hot to the metal-deck, sloped to drains, and compacted to any desired thickness from 1½" to 5". Energy saving capabilities of this fine system offer life/cost economies that are unsurpassed by similar systems. Get the facts. For complete literature and specifications contact Silbrico Corporation, 6300 River Road, Hodgkins, Illinois 60525, (312) 735-3322.

**FIRE PROTECTOR** - Protecting and insulating the lower half of the system is CAFCO direct-to-steel spray fireproofing. CAFCO products are factory blends of non-crystalline refractory materials containing no asbestos. They have excellent fire resistive qualities, are usually applied in one coat, and harden quickly. CAFCO dependability has been proven in many of the world's finest buildings. Complete specifications for 1, 1½ and 2 hour systems can be found in the UL Fire Resistance Index (Design Nos. P-802, P-804, P-705 and P-706), or contact United States Mineral Products Company, Stanhope, New Jersey 07874, (201) 347-1200.

 **SILBRICO**  
CORPORATION

 **UNITED STATES MINERAL**  
**USM**  
PRODUCTS COMPANY

For more data, circle 53 on inquiry card

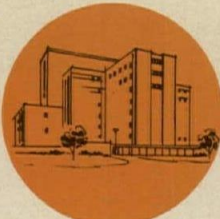

Institutional

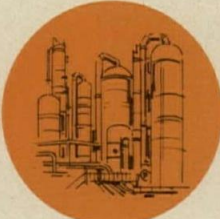

Chemical Plants

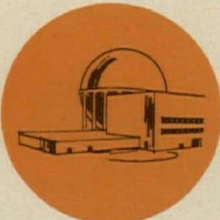

Nuclear Reactors

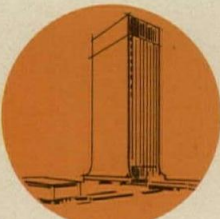

Office Buildings

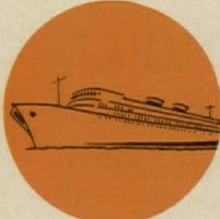

Ship Installations



Industrial Plants

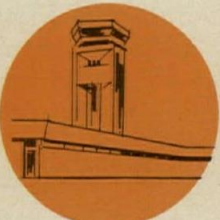

Airports

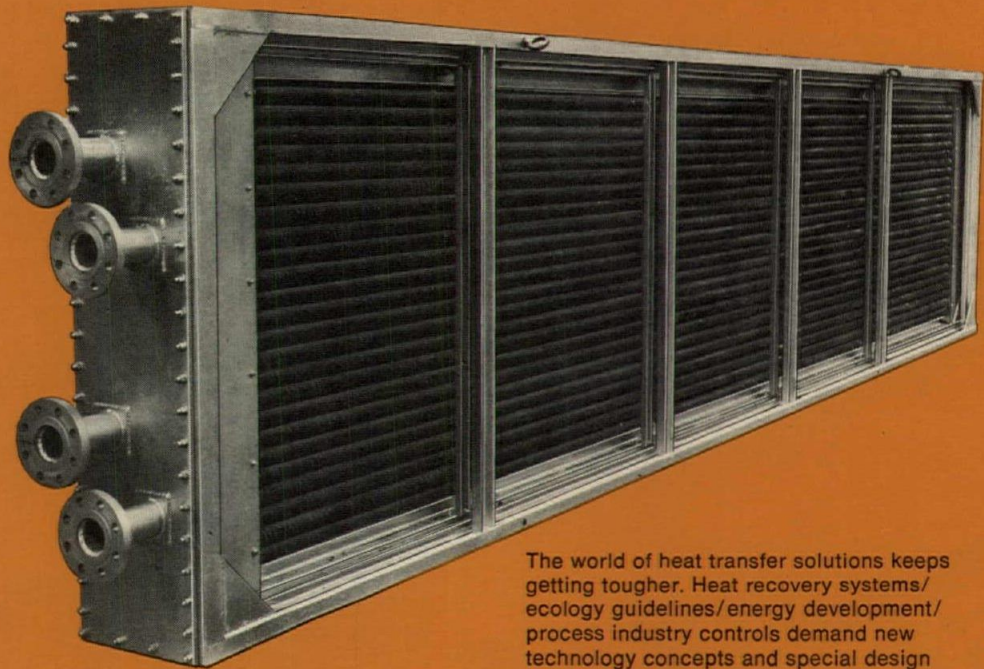

The world of heat transfer solutions keeps getting tougher. Heat recovery systems/ ecology guidelines/energy development/ process industry controls demand new technology concepts and special design coil versatility.

## Find a tough heat transfer coil problem ...and you'll find Aerofin

### Ask for data on standard coils

#### HOT WATER COILS — HEATING AIR

Type CH - Bulletin CH-72

Type C - Bulletin CCW-71

Type MP - Hot Water Booster—  
Bulletin MP-72

#### STEAM COILS — HEATING AIR

Type B - Flexitube Steam—  
Bulletin B-58

Type CH - Steam-Bulletin CH-72

Type MP - Steam-Bulletin MP-72

Universal Steam Coil  
High Pressure Steam Coil

#### Non-freeze Steam Coil

Type A - (1" tubes) Bulletin A-61

Type B - (3/8" tubes) Bulletin B-58

#### REFRIGERANT COILS

##### COOLING AIR

Type DP - Direct Expansion —  
Bulletin DP-66

##### WATER COILS

##### COOLING/DEHUMIDIFYING

Type C - Bulletin CCW-71

##### Removable Header

Type R - Bulletin CCW-71

Type RC - Bulletin CCW-71

We've learned a few things about heat (whether it's going in or out) during our 50 plus years. Aerofin coils are pretty much considered the industry *standard* for standard coils. But our leadership really surfaces with those tough, offbeat applications.

You won't faze us specifying unusual sizes, like the boiler preheat coil above—variable flow circuits with compatible pressure drops—all-season sprayed coil dehumidification—systems combating freeze-up hazards—complicated recovery of solvents—cleanable/drainable tube requirements. We're also knowledgeable about fin/tubing options of copper, cupro-nickel, carbon steel, stainless steel and special alloys. And with it all many of these special coils are quickly assembled from pre-engineered and stocked components.

Considering today's pressure for cost optimization, doesn't it make sense to work with the total fan-coil system house—Aerofin. You also get first-team application engineering help from offices in Atlanta, Boston, Chicago, Cleveland, Dallas, Los Angeles, New York, Philadelphia, San Francisco, Toronto, Montreal.

# AEROFIN CORPORATION

LYNCHBURG, VIRGINIA 24505

Aerofin is sold only by nationally advertised fan manufacturers. Ask for list.

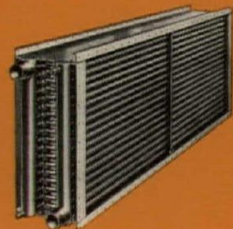



# Forming Architectural Concrete Textures

Standard/Custombuilt Form Lining Systems



16 Standard Corrugations

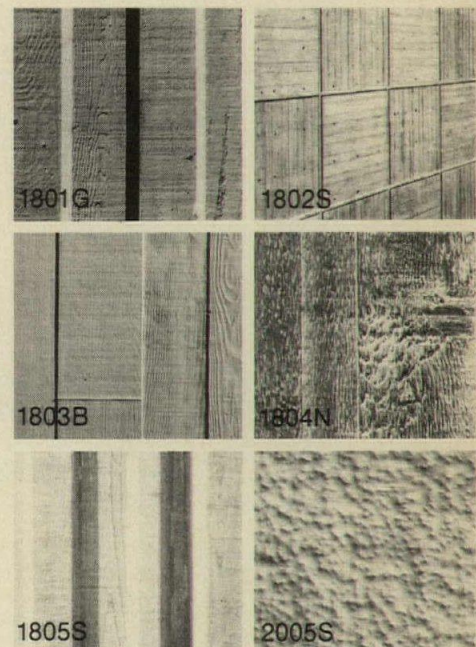

**Total Systems Concept for Concrete Forming**

Standard And Special Domes/Joist Pans/Forms: Beam, Long, Column, Wall, Balcony/Integrated Flying Form Systems/Architectural Formwork/Special Form Hardware

## INTERFORM

**Main Office:** 18744 S. Reyes Avenue Compton, California 90221 Dept. AR 8 L Telephone (213) 537-4063

**Regional Offices:** Los Gatos, California New York, New York Cincinnati, Ohio Denver, Colorado

For more data, circle 55 on inquiry card

### METAL BI-FOLD DOORS

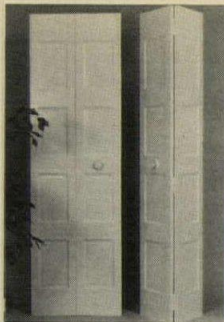

Designed to fit any size opening—from 18 in. to full room width, and up to 8 ft high—the prefinished metal door units operate in aluminum tracks at top and bottom. They allow for field variables and can be adjusted from the room side of doors. The door units come in five styles, in Winter White, a baked-on enamel color that

needs no further finish at installation. Also available is an embossed leather-grain textured finish. ■ U.S. Plywood, New York City.

Circle 305 on inquiry card

### ELECTRONIC LOCK

An electronic combination lock, which can be used to activate all types of electric door strikes and door operators features a ten-key pushbutton panel, mounted near the door outside the protected area. The system has the capability to activate either a holdup or error alarm. Also available is weatherproof equipment, as well as an automatic battery standby. ■ Continental Instruments Corp., Hicksville, N.Y.

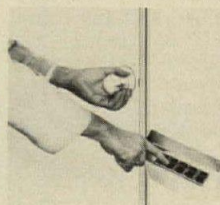

Circle 306 on inquiry card

### ALL-WEATHER ADHESIVE



*Glu-on*, a multi-purpose construction adhesive used on floor joists, tongue and groove panels for subfloors, paneling, siding and sheathing, expands and contracts after application, to maintain a flexible bond to wood and metal joists and subfloors. *Glu-on* bonds to most building materials: plywood, brick, wood, steel, aluminium, concrete and dry-wall. ■ Whilhold Glues, Inc., Santa Fe Springs, Cal.

Circle 307 on inquiry card

### ECONOMICAL LEVEL LOOP

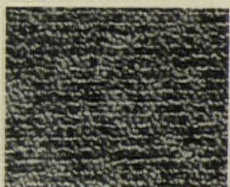

*Presidio* (shown) is made with a blend of continuous filament nylon and polypropylene to produce a carpet that has a very low static propensity and low soiling characteristics. It is a 1/8 gauge construction which creates a pile height that ensures excellent acoustical absorption. It comes in seven tweed colors, and is recommended for both residential and light commercial use, according to the company. ■ Burke Carpet Mills, San Jose, Cal.

Circle 308 on inquiry card

### INDUSTRIAL DOOR OPERATOR

The new low-cost *Air-Guide* air-powered door operator offers a double safety system which immediately reverses the door at any time it encounters an obstruction. Both opening and closing speeds can be easily adjusted by turning a slotted valve. The product handles heavy duty industrial doors up to 1500 lbs. using standard air pressure and low voltage (24-volts AC) controls. ■ Betmar Products Corp., Mequon, Wis.

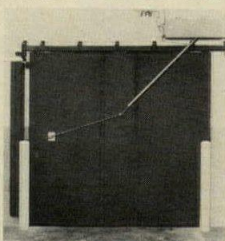

Circle 309 on inquiry card

more products on page 169

**You Can Forget Winter... If You Remember Easy-Heat!**

### SERIES D HEATING MATS

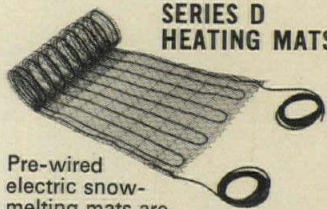

Pre-wired electric snow-melting mats are designed for concrete slabs — uniform heating at the lowest material cost. Installation is fast. Great for designing around special shapes.

### SERIES DS STEP HEATING MATS

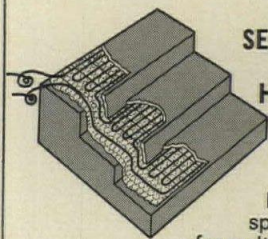

Designed specifically for melting snow and ice from steps.

These mats provide easy and flexible installation. Standard sizes fit two and three-step applications.

### M.I. PIPE TRACING HEAT CABLE

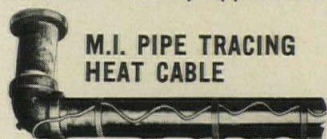

Factory assembled, single or double-conductor models, assure trouble-free installation . . . no cutting . . . no splicing . . . no moisture problems. Resistant to thermal shock. Unusually strong, yet easily bent by hand.

Plan now to forget *next* winter. Remember, Easy-Heat offers a line of quality products to fight the worst of winter and the damage brought on by low temperatures.

easy heat — wirecraft  
Division MSP Industries Corporation  
Dept. 570, Lakeville, Ind. 46536

**easy-heat**®

For more data, circle 54 on inquiry card

# DUWE DULITE®

the ideal way of integrating  
"ROOF DECKS" and structure for  
an economical and rational building

Not only are DUWE DULITE ROOF DECKS an economical engineering approach for tasteful architectural expression, but much more too. For example, DULITE ROOF DECKS —

- Have a two-hour fire retardent value as stated by the Insurance Rating Bureau. This means building owners are assured a higher safety factor and lower insurance premiums.
- Are Underwriters' Laboratories approved.
- Have a high insulating quality that is equal to 2" rigid board insulation.
- Permit energy savings through reduced heating costs.
- Help owners meet OSHA requirements for sound control because of their acoustical effectiveness (NRC = .75).
- Allow for "nailability" where desired to cover them with various types of roofing materials on sloped or flat roofs.
- Have a light, gray natural finish that can easily be spray-painted.
- Are produced with a "textured surface" for added decorative attractiveness.

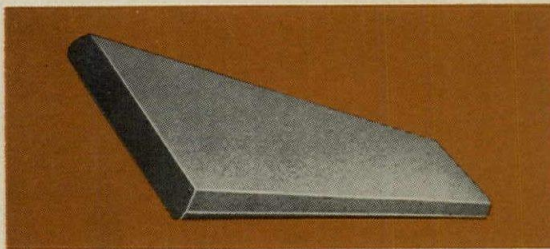

- Weigh no more than 10 pounds per square foot.
- Are made with DuCrete aggregate, the lightest and strongest aggregate available.
- Consist of roof slabs in three thicknesses — 3", 3-1/2", and 4" and a variety of lengths up to 8'4". Standard lengths are 4 and 5 foot.



CONTACT —

## DUWE

PRECAST CONCRETE  
PRODUCTS, INC.  
P.O. BOX 2068  
OSHKOSH, WI 54901  
(414) 231-3980

For more data, circle 56 on inquiry card

**You need more than just more insulation.  
You need more information.**

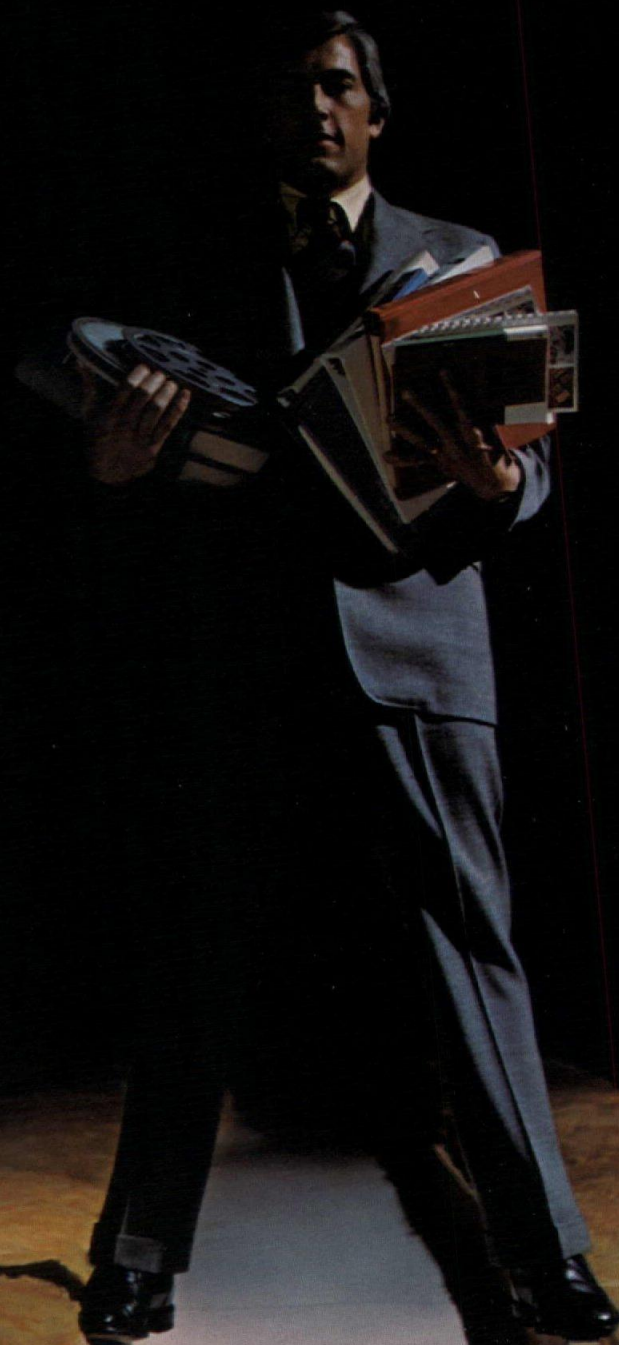

**Johns-Manville gives you both...**

# More insulation.

## Half of America's attics are uninsulated.

The era of plentiful natural gas, oil and electricity has passed. And it's left America a sad legacy. Today, half our homes have no insulation.

According to The Johns-Manville Insulation Center, the average uninsulated attic wastes 30,000,000 BTU's a year.

We're working hard to get Johns-Manville insulation into all these attics. And making a new product—Re Insul—for homeowners who want to add to the insulation they've already got.



## This roof isn't just going to keep the rain out.

It's going to save the owners of the building \$130,000 by 1980. All because of Johns-Manville roof insulation.

It insulates so well it not only cuts fuel consumption year after year—it also allows the HVAC engineer to specify smaller capacity heating and air conditioning equipment.

One of the key energy-saving ingredients in J-M roof systems is Fesco Board® rigid roof insulation. For exceptional performance, call on Fesco-Foam® which combines Fesco Board with polyurethane foam.

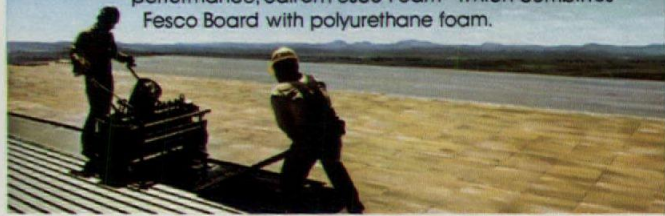

## If it weren't for a very special kind of insulation, the temperature would be 150°

The heat loss from underinsulated steam pipes can be enormous.

But when they're enclosed in Johns-Manville Thermo-12™ pipe insulation, they lose very little heat en route to wherever they're going.

J-M also makes a wide variety of efficient fiber glass pipe insulations.

If you have pipes that are losing heat (or coldness), better get in touch with The Johns-Manville Insulation Center.

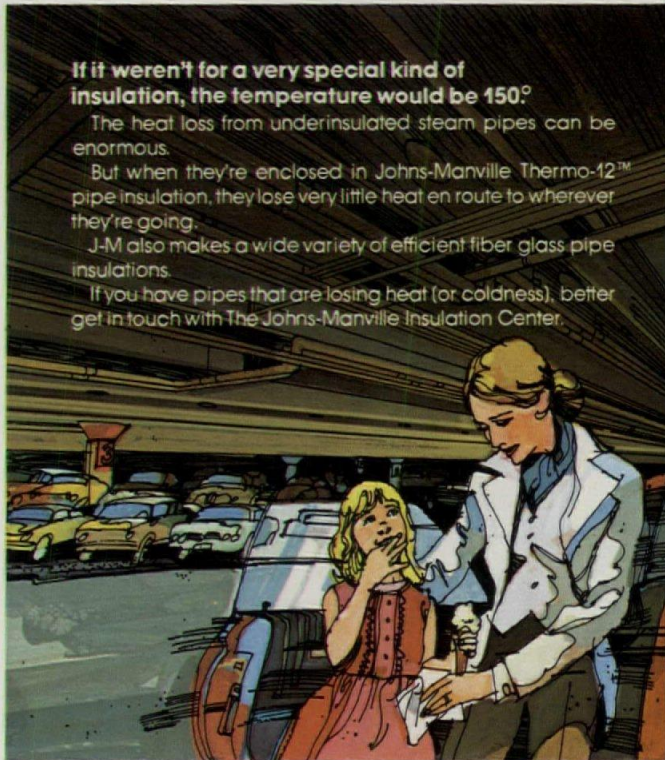

## Refrigerators should refrigerate food. Period.

When refrigerators refrigerate the rooms they're in, they're wasting energy. Lots of it.

The same goes for freezers.

Johns-Manville makes quite a number of specialized insulations for home appliances.

If the appliance you manufacture needs to be better insulated, The Johns-Manville Insulation Center can help you determine exactly which type would be best.



## The metal building is a thermos bottle.

Metal is not famous for its insulating qualities.

No problem. J-M fiber glass insulation for metal buildings is.

J-M makes a number of insula-

tions for metal building manufacturers as well as for on-site installation.

The right combination of these can make a metal building perform like a thermos bottle. What's inside will maintain a constant

temperature regardless of what's outside—often with smaller capacity heating and cooling equipment.

If you're in metal buildings—or in a metal building—better get in touch with The Johns-Manville In-

ulation Center.

According to The Center's computer, the owner of a typical 20,000 sq. ft. metal building that's properly insulated can expect to save around \$15,000 worth of fuel—and billions of BTU's—by 1985.





**Underground pipe that doesn't lose its cool. (Or hot.)**

When Temp-Tite® thermal pipes go underground to take chilled or heated water or steam from one place to another, very few BTU's are lost in the transmission.

To calculate precisely how much heat is lost or gained once required a great deal of figuring.

To save hours of computation, Johns-Manville engineers (with a little help from The J-M Insulation Center's computer) have just compiled a 72-page book of underground thermal data tables. It's available from The Insulation Center.



**It's always lovely weather for ducts. And for saving fuel.**

According to The Johns-Manville Insulation Center, the energy-saving potential of the millions of miles of heating and air conditioning ducts throughout America is tremendous.

Helping to realize this potential:

Johns-Manville's Micro-Aire® ducts, duct wrap and duct liner.

They're made with insulating fiber glass, so they work hard at reducing fuel waste all year around.

**This is not your average brick.**

It's a J-M insulating firebrick. It withstands temperatures to 3200° F.

It's not your average insulating firebrick, for that matter. It has an extremely low thermal conductivity to enable kilns, blast furnace stoves, forges and heating furnaces to operate with above-average efficiency.

J-M produces eight temperature grades of insulating firebrick for high temperature equipment in the steel, non-ferrous metals, petroleum, electronics, ceramics and glass industries.

The Johns-Manville Insulation Center can tell you which is right for your specific application.



# More information.

303/770-1000, Ext. 3111.

That's the number of The Johns-Manville Insulation Center.

It's the place to call when you've got a thermal insulation question that needs an immediate answer.

The J-M Insulation Center is staffed with residential, industrial, and commercial insulation experts who'll give you quick, accurate information regarding any insulation problem you may have.

After all, the need for fuel conservation hasn't just caused an unprecedented demand for thermal insulation. It's also brought about a tremendous demand for information about insulation.

Whatever you want — a fact, a figure, an answer, a speaker, a film, data, design criteria, application know-how or product information — The Insulation Center can supply it.

If there's a way we can help you, give us a call.

## The Johns-Manville Insulation Center.

Drawer 17-L, Denver, Colorado 80217  
Action Line: 303/770-1000 Ext. 3111

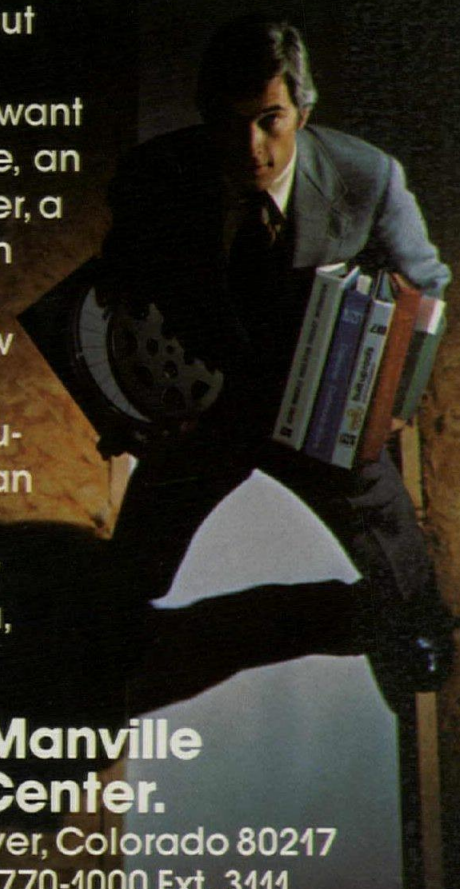

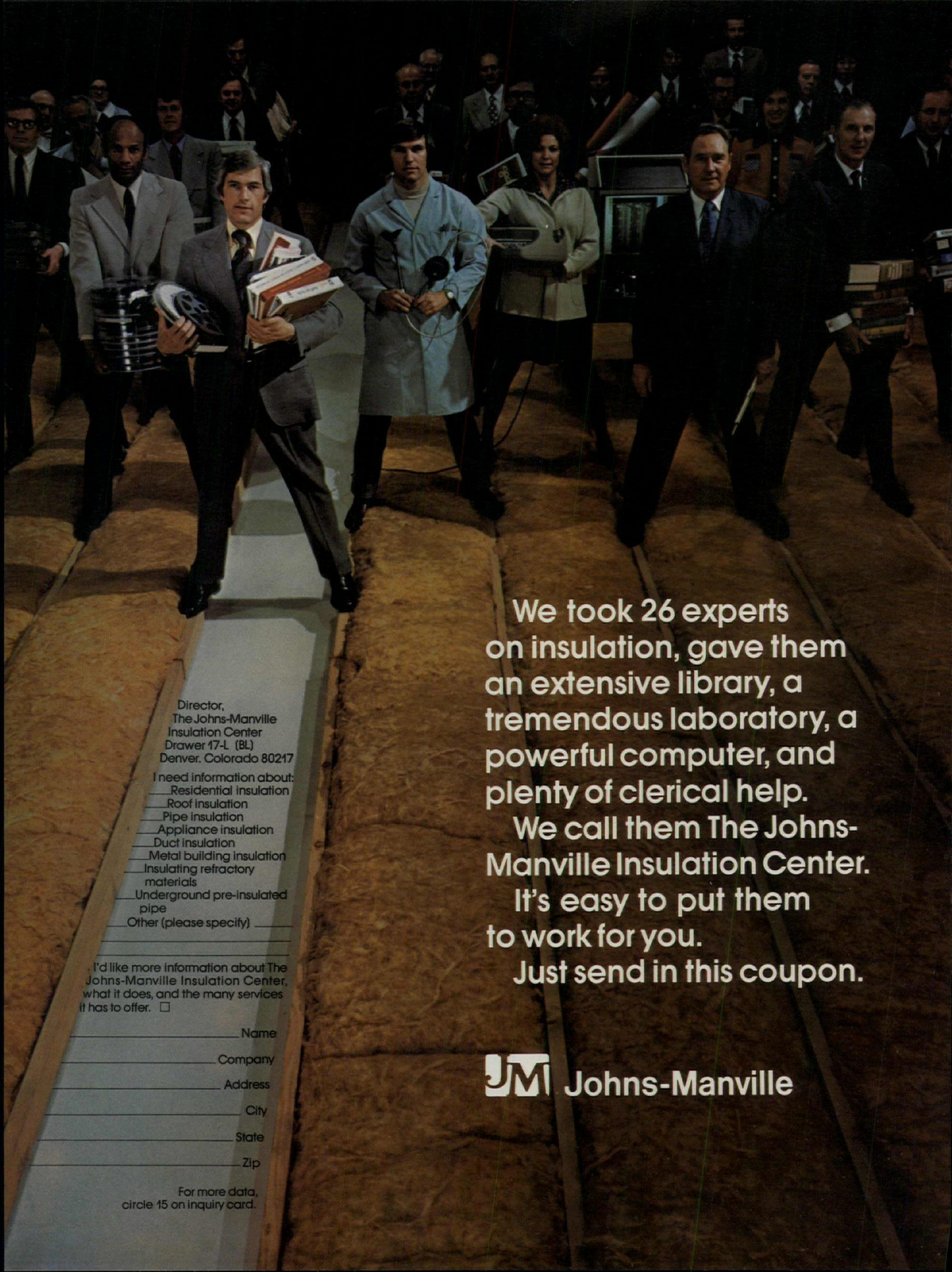

We took 26 experts on insulation, gave them an extensive library, a tremendous laboratory, a powerful computer, and plenty of clerical help.

We call them The Johns-Manville Insulation Center. It's easy to put them to work for you.

Just send in this coupon.

Director,  
The Johns-Manville  
Insulation Center  
Drawer 17-L (BL)  
Denver, Colorado 80217

I need information about:

- Residential insulation
- Roof insulation
- Pipe insulation
- Appliance insulation
- Duct insulation
- Metal building insulation
- Insulating refractory materials
- Underground pre-insulated pipe
- Other (please specify) \_\_\_\_\_

I'd like more information about The Johns-Manville Insulation Center, what it does, and the many services it has to offer.

\_\_\_\_\_  
Name

\_\_\_\_\_  
Company

\_\_\_\_\_  
Address

\_\_\_\_\_  
City

\_\_\_\_\_  
State

\_\_\_\_\_  
Zip

For more data,  
circle 15 on inquiry card.

**JM** Johns-Manville

**FLAME-RETARDANT CUBICAL CURTAINS** / Deco-



rative colorful, flame retardant cubical curtains designed to stand up to hospital use have the look and feel of cotton, but are woven from man-made fibers; they are 75 per cent *Leavil* and 25 per cent polyester. Woven in a yarn-dyed stripe, the new cubical curtains are available in three colors. The same fabrics, either plain or foambacked, are offered for draperies, wall coverings, upholstery or other uses. ■ Toltec Fabrics, Inc., New York City

Circle 310 on inquiry card

**SECURITY LIGHTING** / *Nite-Hawk* has been specifically designed to utilize

new, energy-saving 100-, and 150-watt High-Pressure Sodium lamps. The new luminaire is recommended for dusk-to-dawn lighting of security perimeters, alleys, loading docks and residential streets, and is offered in both High-Pressure Sodium and Mercury versions as a complete, ready-to-install package. ■ McGraw-Edison Co., Racine, Wis.



Circle 311 on inquiry card

**POLYURETHANE COATING** / A new one-coat protective coating that combines polyurethane with aluminum can be used as a primer and a primer/finish coat to protect transmission towers, storage tanks, piping and structural steel against corrosion or atmospheric weathering. The manufacturer also points out that *Awlgrip* is especially recommended where proper surface preparation of rusted metal is difficult. ■ Prufcoat Div., Cleveland, Ohio



Circle 312 on inquiry card

**HARDBOARD SIDING** / A new hardboard siding which duplicates in high fidelity detail the dimension and textured appearance of natural cedar shakes is produced in self-aligning 1 by 4 ft panels. Lap-grooved panel ends are designed to overlap to provide a continuous weather-tight seal. There are no knots, no grain to crack and the surface is highly resistant to denting. *Forestex Roughsawn* is available factory-primed and in a selection of mill-furnished colors. ■ Forest Fiber Products, Forest Grove, Ore.



Circle 313 on inquiry card

**ADD-ON INSULATION** / *Reinsul* is a fiberglass insulation for attic ceilings where existing insulation is inadequate. It has no aluminum foil or kraft paper backing (none is needed) and is designed to be laid over existing insulation. It is simply rolled out and lightly tamped into place between the attic floor joists. ■ Johns-Manville, Denver, Colo.



Circle 314 on inquiry card

**ARCHITECTURAL SHEETMETAL** / A highly corrosion-resistant architectural sheetmetal, *Ti-Guard 430* is composed of Type 430 stainless steel clad on both sides with DHP copper. The stainless core is 80 per cent of the total thickness, and the copper cladding is 10 per cent on either side. Joined simultaneously via a proprietary process, the three layers are metallurgically bonded at the atomic level. Combining the surface look of copper with the internal strength of stainless steel, *Ti-Guard 430* is recommended for roofing, fascia, flashing, rain drainage, and structural applications such as wall panels, door, entryway and curtain wall framing. ■ Texas Instruments Inc., Attleboro, Mass.

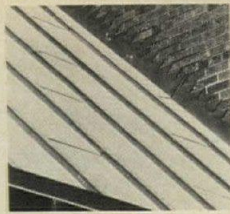

Circle 315 on inquiry card

**TRASH RECEPTACLE** / A dual-purpose ash and trash floor receptacle which virtually eliminates fire hazards is constructed of flame-retardant, self-extinguishing *Cycovin*, K.A. The rectangular receptacle has a patented tip-action top ash receiver with stainless steel blades. The aluminum inner ash receiver is seamless, leak-proof and has a weighted enamel metal frame which holds a disposable trash bag. ■ McDonald Products Corp., Buffalo, N.Y.



Circle 316 on inquiry card  
more products on page 171

# If Leif had been lucky...



...he would have contacted Gates for the latest info about waterproofing with UWM-28

Of course, Gates hasn't been around that long and they've never built a ship. But Gates has been around long enough (since 1939) to know all about the best in liquid-applied Urethane Rubber waterproofing membrane systems as well as elastomeric roofing, flashing, and walk deck systems. Had Leif and the Vikings, expert seamen though they were, been lucky enough to have Gates technical know-how about waterproofing . . . had their ships, sturdy as they were, been built with the same quality control that Gates put in their products and systems . . . then, history might have been different. Who knows where Leif could have sailed? Today, the architects, contractors and specifiers that sail with Gates get the job done right the first time, because Gates runs a "tight ship." Before you launch your next project, send for your free literature now.

Send me the free literature as checked:

- UWM-28 Liquid Waterproofing Membrane System
- N-3S Sheet Waterproofing Membrane System
- CONTOURFLASH Flashing System
- GACOFLEX® Liquid Roofing System
- GACOFLEX® Sheet Roofing System
- GACODECK® Waterproofing Walkdeck System

Name \_\_\_\_\_

Company \_\_\_\_\_

Address \_\_\_\_\_

**Gates Engineering Company, Inc.**

100 S. West St., Wilmington, DE 19899/P.O. Box 1711/(302)-656-9951

For more data, circle 60 on inquiry card



**“General Electric HID lighting systems are easy to install, easy to maintain and there’s no ballast audibility problem.”**

**Richard R. Jencen** — Richard R. Jencen Associates, architects and interior designers for the Marianne, Stuarts and Petrie chains



Architects, consultants, electrical contractors and building owners demand a lot of an indoor lighting system. And they're finding that General Electric's energy-efficient HID lighting systems meet their most exacting requirements.

Richard Jencen was concerned about ballast noise. He says, "We've encountered audibility problems with some HID systems, but the General Electric Panelglow® system solved all of our problems. It's easy to install, easy to maintain and there's no ballast audibility problem."

If you'd like to know more about GE's HID solutions for commercial lighting applications, contact your local GE representative or write:  
GE Lighting Systems Business Department, Section 460-99 A, Hendersonville, N. C. 28739

**GE lighting makes the difference**

**GENERAL  ELECTRIC**

For more data, circle 61 on inquiry card



**COMBINATION SAFETY SHOWER / Model 9201** is a freestanding drench shower made with 1 1/4 in. spray painted galvanized pipe. A heavy cast flange provides rigid floor support. The shower features a 1-in. ball valve that is activated by a pull rod. The valve remains open until manually closed. Unit is also outfitted with a stainless steel eye/face wash, activated by a 1/2-in. self-closing valve attached to both hand and foot controls. ■ Western Drinking Fountains, Glen Riddle, Pa.

Circle 317 on inquiry card

**PORTABLE HUMIDITY CONDITIONING /** These portable units are recommended where there are temporary dehumidification requirements or where future requirements dictate relocation due to changes in the production line. The skid-mounted systems are available in unit sizes of 1100 CFM, 2500 CFM, 5000 CFM, or 7500 CFM and are capable of moisture removal rates from 80 to 420 lbs/hr. Optional features include steam or electric regeneration. ■ Kathabar Systems, Brunswick, N.J.

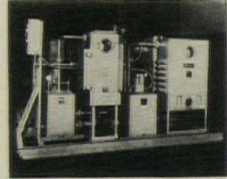

Circle 318 on inquiry card

**COMPACT WHITEPRINTER /** A new compact console whiteprinter with high volume capability offers synchronized printing/developing speeds up to 30 ft per minute. It requires no venting, and can be used with either ammonia or Diazol deodorized whiteprint developing solution. Rugged, all-aluminum construction provides long-life, lightweight, according to the company. The console base has storage space for roll-stock and cut-sheets up to 24- by 26-in., plus a paper cutter. ■ Blu-Ray Inc., Essex, Conn.



Circle 319 on inquiry card

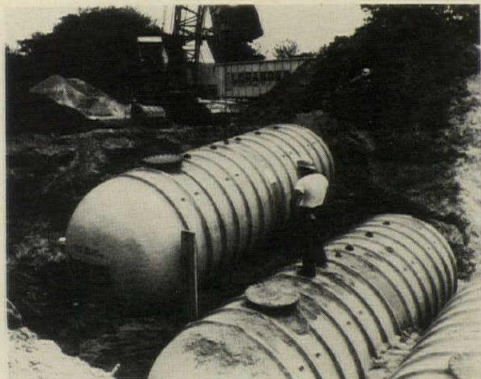

**FIBERGLASS TANKS /** *Fiberglas* UL-labeled underground tanks will not corrode, and can be used to store gasoline, fuel oil, aviation gas, diesel fuel and other petroleum products. *Fiberglas* is impervious to the effect of external corrosion. Properly installed, *Fiberglas* tanks are said to be strong enough to withstand constant traffic from the heaviest over-the-road vehicle (H-20 axle loads—32,000 lbs). Tanks are made from polyester resins reinforced with *Fiberglas*. ■ Owens-Corning Fiberglas, Toledo, Ohio

Circle 320 on inquiry card

**SHOWER/BATH FITTINGS /** Part of a new line of plumbing brass for residential and multi-unit dwellings *Flow-Free* showers feature direct sweat, reversible i.p.c. or c.c. union couplings to facilitate installation. Available are three-handle transfer valve shower/bath fittings, two-handle fittings with transfer control unit on the spout, two-handle fittings for shower only, and two-handle fittings for bath filler installations. Shower unit valve mountings are all brass unitized construction with Type 18-8 series stainless steel seat washer screws for extended service life. ■ Speakman Co., Wilmington, Del.

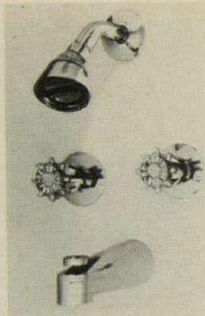

Circle 321 on inquiry card

**NOISE-BARRIER GASKET /** A noise-barrier gasket for edges around doors, windows, wall panels, housings, and other industrial and commercial applications is made of tough, "springback" extruded polypropylene with a three-finger design that functions as three airlocks. As a result, the noise reduction capability of *Cousti-Gasket* is equivalent to that of five beads of permanent commercial caulk, according to the company. Gaskets are available in a natural off-white polypropylene color in standard 12-ft lengths. Other lengths are also available on special order. It is easily installed with an adhesive or flush rivets. ■ Ferro Corp., Norwalk, Conn.

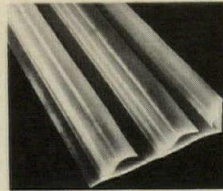

Circle 322 on inquiry card

more products on page 173

# the ENERGY CRISIS is news — KALWALL® isn't!

## but KALWALL is certainly timely!

### Kalwall is a complete, translucent, insulating wall — or roof — system!

Kalwall lets you save heating and air conditioning energy — and use the sun's energy to even greater advantage to save on artificial lighting, and even pick up solar heat in the cold months! (We call this our Kalwall Solar Control System.)

You can design your buildings with a choice of key ENERGY SAVING factors:

- It can have a variety of "U" Factors ranging between .06 and .40!
- It can have a light transmission value ranging between 3% and 75%!
- It can have Shading Coefficients from .50 to less than .10!

And Kalwall can be engineered for every building situation, every location, and every exposure!

PLUS — Kalwall buildings win design awards every year!

Write or phone Mr. Bruce Keller, Vice President, for complete information.

**KALWALL CORPORATION**  
1111 Candia Road  
Manchester, N. H. 03103  
Phone 603-627-3861

Patented

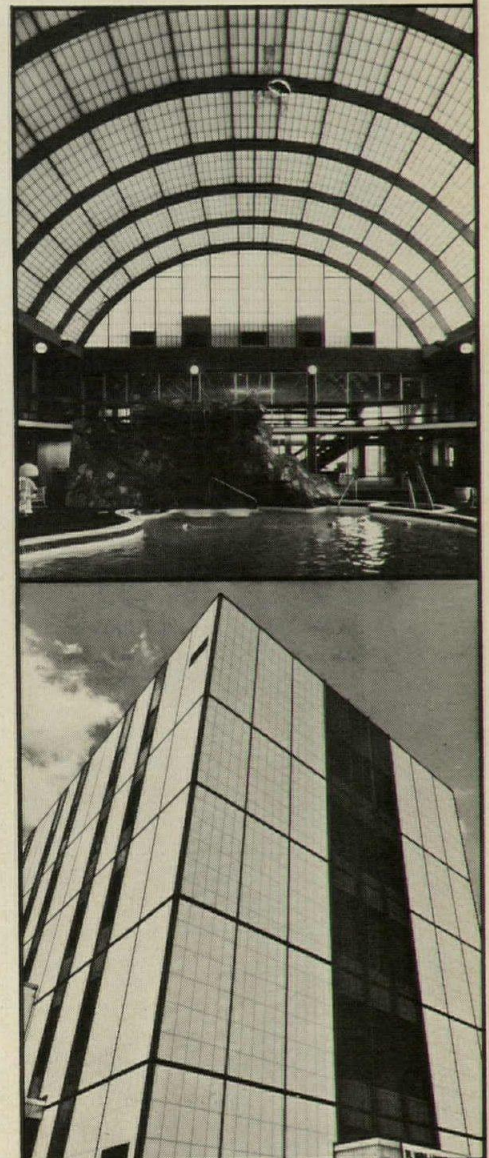

For more data, circle 62 on inquiry card

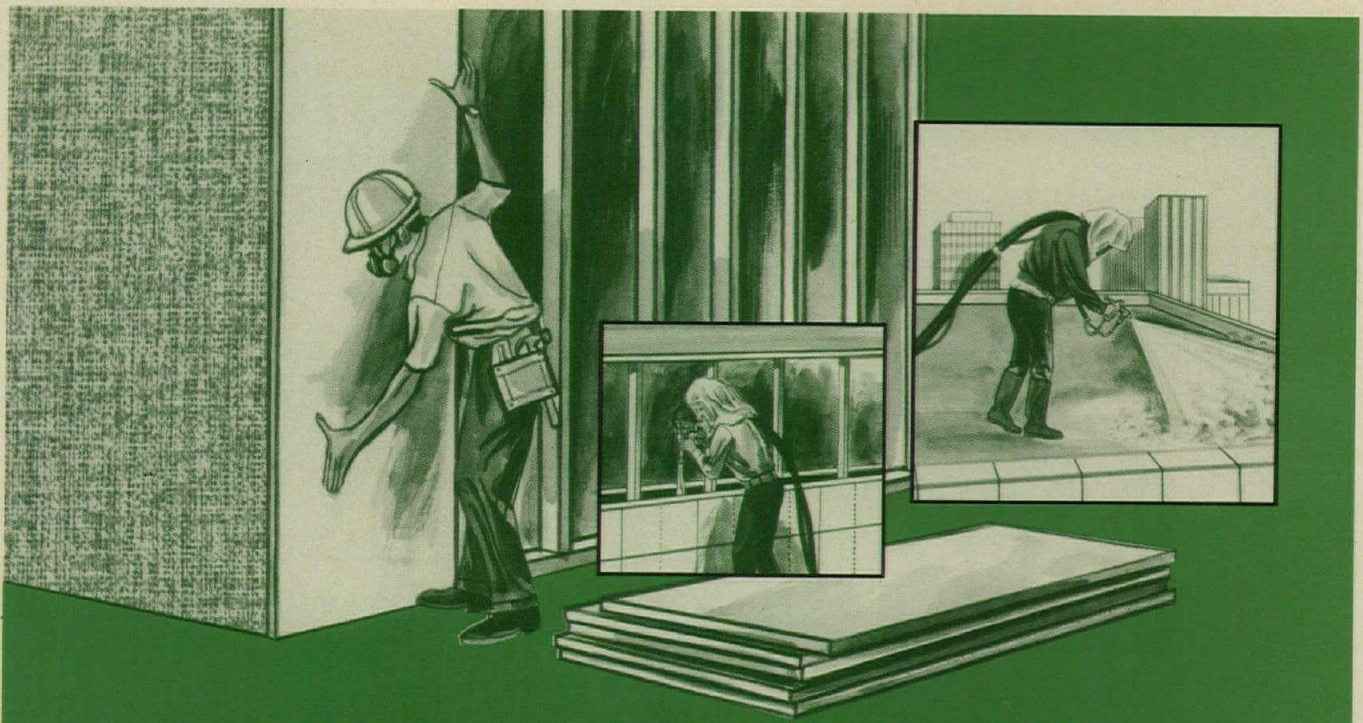

## Presenting a Trio of Trymers

**TRYMER 9545**

**TRYMER 421**

**TRYMER 442**

Maintains the insulation advantages and improves the properties of urethane.

**Upjohn**

**CPR**

## Unequaled Insulation for Roofs and Other Construction

These three isocyanurate insulating materials offer improvements on urethane—the best insulation now on the market. Their thermal insulating efficiency is almost twice that of any other non-urethane commercial insulation. Their high strength/weight ratio, combined with the need to use less than half the thickness for equal insulating values, means savings in weight, space, and costs.

**TRYMER™ 9545** is available in buns or pre-cut board stock. It is the ideal insulation for roofs, buildings, pipes, commercial refrigeration, aerospace, railroad/truck/marine transportation, and as a core material for sandwich panels.

**TRYMER™ 421** is the improved cellular plastic foam insu-

lation material that can be sprayed-in-place right on the job. It bonds immediately to itself or adheres to almost any material. It makes insulation...even difficult configurations...an integral part of the structure. Spray it directly on walls, roofs, pipes, and tanks, followed by appropriate coverings.

**TRYMER™ 442** is a pour-in-place system designed especially for use as a core material in insulated sandwich panels. Foam produced from TRYMER 442 has been tested and approved by Factory Mutual Engineering Corporation as a Class I material in building panels.

Write for more information or ask a CPR Technical Sales Representative to call. (Please specify your application)

### **CPR DIVISION, THE UPJOHN COMPANY**

555 Alaska Ave., Torrance, California 90503 • (213) 320-3550

**CAUTION:** Polyisocyanurates and polyurethanes may present a fire hazard in certain applications if exposed to fire and/or excessive heat, e.g. welding and cutting torches, in the presence of oxygen or air.

For more data, circle 63 on inquiry card

**AIR HANDLING FIXTURES / UNIVAIRE** is a 2- by 4-ft lay-in grid unit for two, three, or four 40-watt lamps and comes with a recessed aluminum floating door with mitered corners. Available with a variety of enclosures, the product is shipped as a static unit, easily converted to a heat transfer unit, air supply unit, air return unit, or a combination of any or all of these. ■ Day-Brite Lighting, St. Louis, Mo.

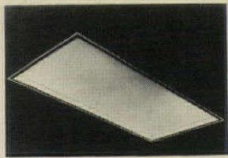

Circle 323 on inquiry card

**HID SURFACE SQUARE LUMINAIRE** / The new 2- by 2-ft HID surface square luminaire designed for installation where lighting must be suspended below the ceiling joins the company's recessed square featuring the floating door design. The surface or pendant mounted fixture accommodates mercury vapor lamps of 250 or 400 watts or 400 watt metal halide lamps. The fixture is UL listed for damp locations and has the IBEW/AFL label. ■ Art Metal Lighting, Vermilion, Ohio

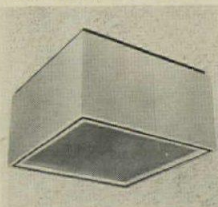

Circle 324 on inquiry card

**INSULATED WINDOW / The Colony** is a traditionally styled double-hung wood window featuring factory sealed insulating glass with a thermo-barrier. The factory-finished exterior is primed and finished in white and the removable sash simplifies cleaning. The screen installs from inside. The Colony is made of pre-treated Ponderosa pine with quality stain grade interior and brick moulding. These units are available on special quotation for manufactured housing, production builders, apartments and condominiums. ■ The Malta Co., Malta, Ohio



Circle 325 on inquiry card

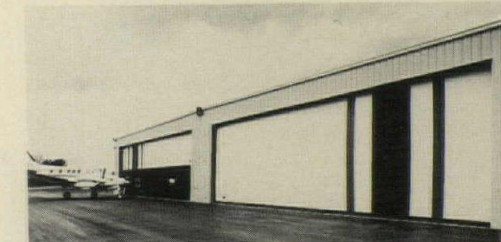

**CLOSURE FOR LARGE OPENINGS** / Similar to a gigantic, power-driven window shade, this roll-up plastic closure door provides a method for closing large industrial and hangar openings or dividing internal areas such as gymnasiums and auditoriums. The closure is constructed of nylon, dacron and other special materials coated with a weatherproof vinyl surface which requires no painting or upkeep. Tested to withstand 140 mph winds, the translucent panels permit the entry of natural light but seal out rain, snow or birds. Roll-up closures have a wide range of applications and have been installed in openings as large as 200-ft-wide by 30-ft-high. They are installed and serviced nationally. ■ Overhead Door Corp., Dallas, Tex.

Circle 326 on inquiry card

More products on page 176

## REINFORCED concrete facts

# HIGH-STRENGTH REINFORCED CONCRETE

**9000 psi-plus concrete is here. It means bold, new designs and big savings in building costs.**

The technology and the materials are here today for practical use of reinforced concrete with compressive strengths of 9000 psi and beyond. So architects and engineers now have a new design tool. And builders and owners have a new way to trim building costs.

A prime example of high-strength concrete in action: A new 23-story office building in Chicago's Loop. On the lower floors, 9000 psi concrete was used for interior columns and 6000 psi concrete for exterior columns. The resulting slender columns permitted more usable floor space. Column interaction with flat plate floors and spandrel beams eliminated the need for shear walls.

The savings were many. Material costs were less. The forms were less congested, thus concrete placement went faster. And no air entrainment was needed to improve durability—another saving in time and money.

By using moderately high-strength concrete of 6000 psi for the facade (exterior columns and spandrels), the designers eliminated cladding costs. The durable exposed surface of the concrete itself served as an attractive exterior finish, eliminating painting costs.

Conventional 4000 psi concrete was used for the flat-plate floor slab except where 9000 psi concrete was puddled in the floor around the high-strength column. Thus, three strengths of concrete were used in lower floor construction.

And when all of the economies of the high-strength concrete frame were added up and compared with structural steel, the result was an impressive \$1.00 per square foot savings.

*Developer:* Fleetwood Realty, Chicago  
*Structural Engineer:* The Engineers Collaborative, Ltd., Chicago  
*Architect:* Welton Becket and Associates, Chicago  
*General Contractor:* Crane Construction Co., Chicago  
*Steel Supplier:* United States Steel Supply, Division U.S. Steel Corp., Chicago

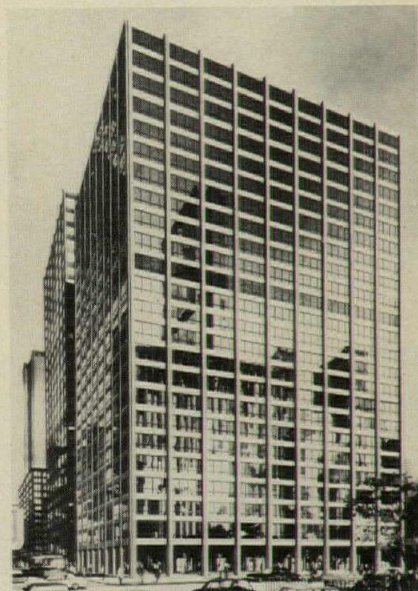

Note slender, exposed high-strength concrete columns.



Detail shows contrast between 9000 psi column concrete (in the slab immediately adjacent to the column) and 4000 psi flat-plate floor concrete.



**CONCRETE  
REINFORCING STEEL  
INSTITUTE**  
180 North LaSalle Street  
Chicago, Illinois 60601  
Room 2108

For more data, circle 64 on inquiry card

# What New NEC



## **IMC PRODUCTION BEGINS ON NEW HIGH SPEED MILL**

*Inspecting the first production run of the new gold colored IMC are Theodore H. Krengel, president and founder of Allied Tube, and C. W. Beile, director of new product development and marketing. Allied's new high speed mill, one of the world's largest, is located in the recently expanded Harvey plant and will be providing a considerable amount of Allied's initial IMC production.*

The 1975 National Electrical Code was officially adopted at the NFPA Convention and includes our proposal, Article 345, Intermediate Metal Conduit. Soon this new lightweight rigid steel conduit will be replacing rigid metal conduit (NEC Article 346) in many installations.

Allied is proud to be a part of NEC history through the development of IMC and the initiation of Article 345. When we began IMC development almost five years ago, steel and conduit shortages were practically unheard of. At that time our idea was to make a better product by a better process. Convinced of this, we centered our expansion program around this product and ordered the new high speed mill, the tooling and the steel to be ready when the time came. Today that planning is a reality.

Our better process is forming high grade, cold rolled steel on an electric weld line, further strengthening the steel. The result is a stronger and smoother product that requires about 40% less steel than heavy wall rigid conduit.

Research and comparative tests were conducted on IMC and other metal conduit systems. Results prove that IMC not only performs as well as Rigid Steel Conduit in many cases, but surpasses Rigid Aluminum and E.M.T. in most cases.

Because IMC is specifically engineered for electrical purposes, utilizing steel to its utmost capabilities, we believe IMC is a giant step toward bringing you more and better conduit.

IMC production began this month. Full production is expected by late September when our expansion program will be completed.

I would like to close by expressing my deep appreciation for the support and interest we received from many people in the industry.

Sincerely,

A handwritten signature in cursive script that reads "Theodore H. Krengel".

Theodore H. Krengel  
President  
Allied Tube & Conduit Corporation

# Article 345 Means to You!

**A strong, lightweight conduit that will replace heavy wall rigid conduit in many applications.**

Not a substitution, but a replacement for the outdated design of rigid conduit. We're putting an end to the myth that more steel means more protection. Better production techniques and higher grades of steel make IMC the product for today's electrical needs.

**More conduit for you in spite of the shortage problems.**

We had the solution before we had the problem! IMC did not evolve from the steel shortage. We've been planning and testing IMC for more than five years. Because it can be produced with 40% less steel than rigid conduit, IMC will ultimately help ease the severe conduit shortage.

**Easier handling and installation.**

Wires glide right through IMC's larger and sleeker interior, requiring less wire pulling effort particularly in multiple bends. And because it's lightweight, handling and assembling are much easier and quicker — one man can easily handle a 10-foot length in most trade sizes.

**Completely interchangeable with standard rigid conduit fittings.**

You won't need any special equipment or instructions to specify or install IMC. Standard bending, cutting, and threading equipment and hanging devices can be used. Threaded IMC is available in 1/2" through 4" sizes, hot-dip galvanized and chromated for complete protection. You can easily identify Allied IMC by its distinctive gold colored finish.

IMC can be used in the same manner as rigid metal conduit (NEC Article 346) in apartments, stores and offices, industrial plants and factories, schools and dormitories. IMC should not be used in hazardous locations.

3/4" Trade Sizes

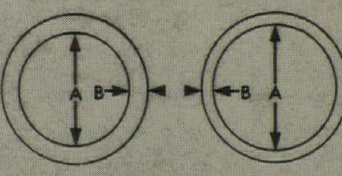

	Rigid Steel	IMC
O.D.	1.050"	1.029"
A	0.824"	0.887"
B	0.113"	0.071"

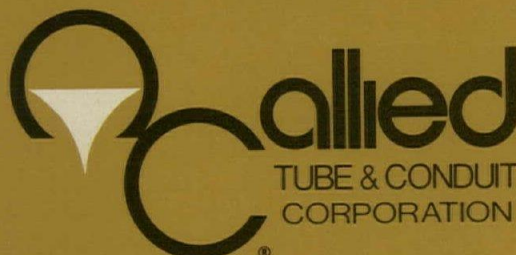

16100 SOUTH LATHROP HARVEY, ILLINOIS 60426 (312) 339-1610

**COMPARISON OF WEIGHTS**  
(Minimum Lbs. per C Ft.)

Trade Size	Rigid Steel W/Coupling	IMC With Coupling
1/2"	79.0	53
3/4"	105.0	72
1"	153.0	106
1 1/4"	201.0	144
1 1/2"	249.0	177
2"	332.0	236
2 1/2"	527.0	382
3"	682.6	469
3 1/2"	831.0	547
4"	972.3	610

Call or write us for our IMC Technical Data Brochure, Form 634.  
For specific installation requirements, check the new 1975 National Electrical Code Book.

**LAUNDRY SYSTEM** / A new "hands off" laundry

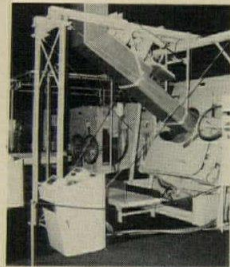

washing system operated entirely by automatic programmers features tilting, open pocket combination washer-extractors; automated loading and unloading devices, and a central liquid supply injection system. High speed loading and unloading is said to greatly minimize turnaround time between loads. ■ Pellerin Milnor Corp., Kenner, La.

*Circle 327 on inquiry card*

**HID DOWNLIGHTS** / High Intensity Discharge

downlights with wattages from 100 to 250—for architectural applications in commercial and institutional buildings indoors or outdoors—these recessed, and semi-recessed units are cast aluminum, satin anodized for permanence and meet OSHA requirements. Units are available with louver guard, intensifier, open baffle, prismatic refractor or white glass diffuser and may be provided with tamper-proof glass for security installations. ■ McPhilben Lighting, Melville, N.Y.

*Circle 328 on inquiry card*

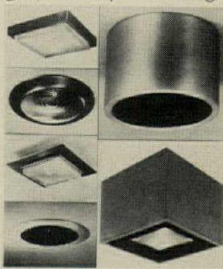

**WOOD PATIO DOORS** / The new doors are offered

in five sizes, ranging from 5 to 12 ft wide. Features of the doors include reversible panels that may be interchanged; double weatherstripping of rigid vinyl and woven pile; a thermal barrier in the aluminum sill to reduce heat loss, condensation and frost; one-inch tempered insulating glass; water repellent preservative; and white extruded aluminum on screen frames, with non-rust fiberglass mesh and nylon rollers. ■ Rodman Industries, Inc., Rock Island, Ill.

*Circle 329 on inquiry card*

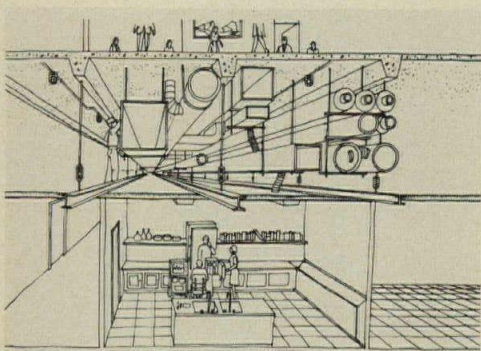

**SERVICE CEILING** / A lightweight, noncombustible ceiling mezzanine provides unlimited walk-around maintenance access and complete partition flexibility. Service ceilings can be either Pyrofill gypsum concrete poured over formboards and supported on truss tee sub-purlins, or 24 in. wide laminated gypsum plank on truss tee or bulb tee sub-purlins. The ceilings may be suspended from the floor structure above or supported separately. They create an interstitial space at each floor for locating, relocating and easy servicing of all utilities and mechanical equipment. ■ United States Gypsum Co., Chicago, Ill.

*Circle 330 on inquiry card*  
*more products on page 179*

# Check here for the Reynolds Distributor nearest you

**Atlanta, Georgia**

Reynolds Aluminum Supply Company  
1441 Ellsworth Drive  
(404) 355-0310

**Baltimore, Maryland**

Reynolds Aluminum Supply Company  
4030 Benson Avenue  
(301) 247-1600

**Baton Rouge, Louisiana**

Anco Insulation Company  
5575 Adams Street  
(504) 355-7731

**Birmingham, Alabama**

Reynolds Aluminum Supply Company  
4500 5th Avenue  
(205) 591-2341

Anco Insulation Company  
15 Office Park Circle  
(205) 879-8501

**Charlotte, N.C.**

Reynolds Aluminum Supply Company  
6424 Pineville Road  
(704) 525-3281

**Cincinnati, Ohio**

Reynolds Aluminum Supply Company  
Blue Ash Industrial Park  
10823 Joslyn Road  
(513) 984-0770

**Dallas, Texas**

Southwestern Material & Supply  
11310 Newkirk  
(214) 241-4676

Reynolds Aluminum Supply Company  
1211 Regal Row  
(214) 631-1860

**Gretna, Louisiana**

Waco Insulation Company  
430 First Street  
(504) 368-7055

**Houston, Texas**

J. T. Ryerson  
1211 Kress Street  
(713) 675-6111

**Jacksonville, Florida**

Reynolds Aluminum Supply Company  
590 Beautyrest Road  
(904) 388-0792

**N. Kansas City, Missouri**

Reynolds Aluminum Supply Company  
1925 Bedford Road  
(816) 842-2200

**Knoxville, Tennessee**

Ingall's Iron Works  
Steel Supply Division  
P.O. Box 5331  
(615) 687-1251

**Los Angeles, California**

Reynolds Aluminum Supply Company  
6446 E. Washington Blvd.  
(213) 726-7111

**Louisville, Kentucky**

J. F. Wagner & Sons  
P.O. Box 10185  
(502) 636-3755  
Reynolds Aluminum Supply Company  
1500 Fern Valley Road  
(502) 366-0314

**Memphis, Tennessee**

Reynolds Aluminum Supply Company  
703 North Royal Avenue  
(901) 525-4714

**Metairie, Louisiana**

Halmar, Inc.  
3332 North Woodlawn  
(504) 887-0151

**Miami, Florida**

Reynolds Aluminum Supply Company  
3690 Northwest 52nd Street  
(305) 635-0647

**Mulberry, Florida**

Corbesco, Inc.  
Highway 60 West  
(813) 425-1169

**Nashville, Tennessee**

Reynolds Aluminum Supply Company  
1440 Poplar Lane  
(615) 242-3405

**Orlando, Florida**

Reynolds Aluminum Supply Company  
2920 Eunice Avenue  
(305) 293-6430

**Paducah, Kentucky**

ASK Supply Company  
P.O. Box 806  
(502) 422-4312

**Philadelphia, Pennsylvania**

Merchant & Evans Company  
2035 Washington Avenue  
(215) KI 5-0820

**Phoenix, Arizona**

Reynolds Aluminum Supply Company  
3327 North 29th Street  
(602) 258-7121

**Pittsburgh, Pennsylvania**

Pennsylvania Industrial Supplies Co.  
1234 Ridge Avenue  
(412) 322-5010

**Raleigh, N.C.**

Reynolds Aluminum Supply Company  
1431 Courtland Drive  
(919) 834-6221

**Richmond, Virginia**

Reynolds Aluminum Supply Company  
2605 Cofer Road  
(804) 233-9693

**San Francisco, California**

Reynolds Aluminum Supply Company  
3201 Third Street  
(415) 648-0170

**Seattle, Washington**

Reynolds Aluminum Supply Company  
7416 South 228 Street  
Kent, Washington 98031  
(206) 854-0260

**Shreveport, Louisiana**

Herren Metals, Inc.  
1122 Hawn Avenue  
(318) 221-0531

**St. Louis, Missouri**

Reynolds Aluminum Supply Company  
136 Progress Parkway  
(314) 878-4747

**St. Petersburg, Florida**

Reynolds Aluminum Supply Company  
4241 - 31st Street, North  
(813) 527-1123

**Tulsa, Oklahoma**

Reynolds Aluminum Supply Company  
29th Street, North & Florence  
(918) 939-3305

**Wilmington, Delaware**

Metal Sales and Service Company  
500 East Front Street  
(302) 658-8651

Or write: Director, General Construction Market



**Reynolds Metals Company**  
325 West Touhy Avenue  
Park Ridge, Illinois 60068  
(312) 696-1400

## Another REYNOLDS ALUMINUM landmark

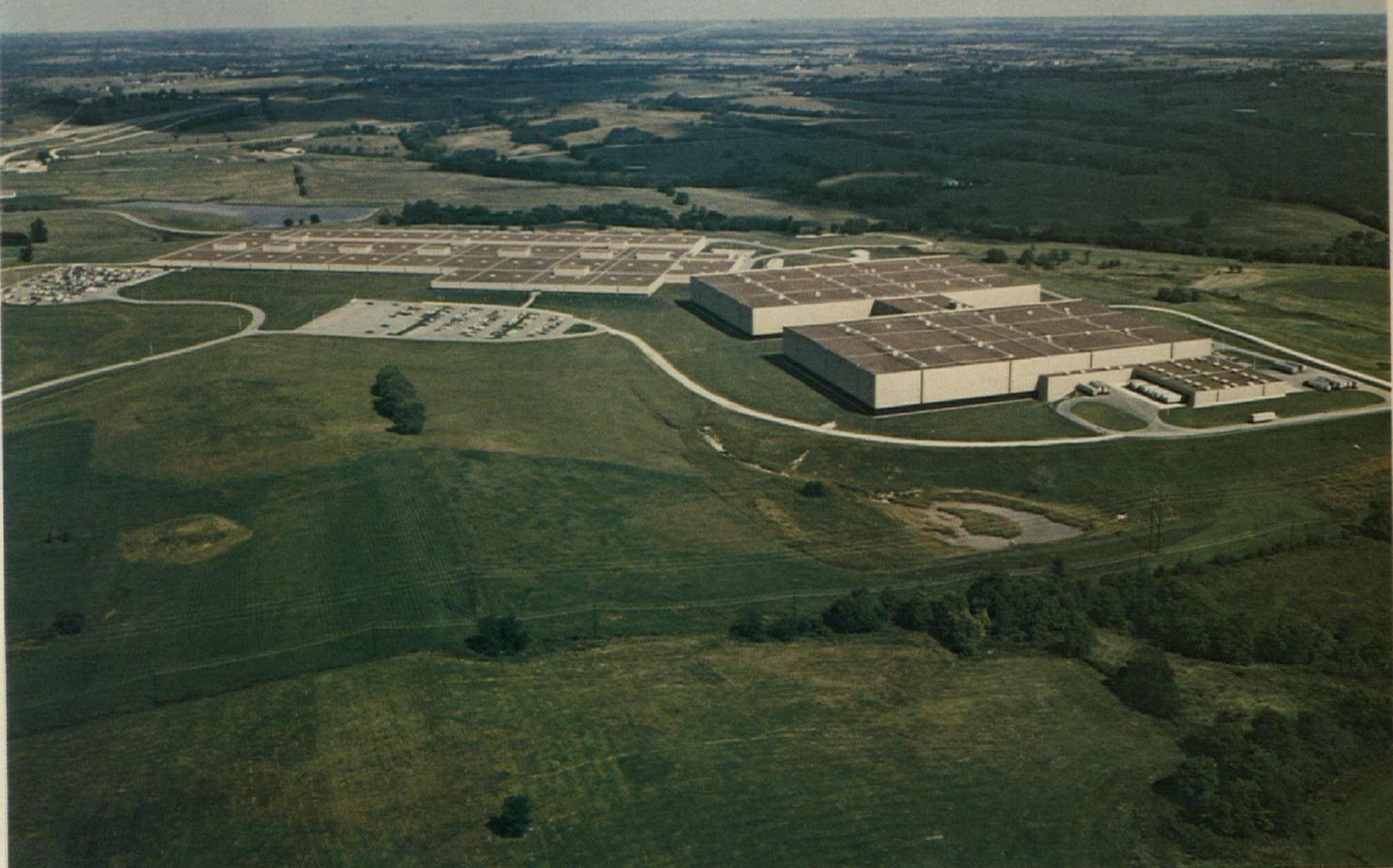

Owner: Hallmark Distribution Center, Liberty, Missouri  
Architects: Marshall & Brown, Kansas City, Missouri  
General Contractor: Eldridge, Construction Co., Kansas City, Missouri  
Panel Subcontractor: A. Zahner Sheet Metal Company, Kansas City, Missouri

# Today, nearly 6 thousand squares of Reynolds Aluminum Commercial Siding enclose the Hallmark Distribution Center

First, came one of the nation's most sophisticated computer controlled materials handling systems with fully automated stacker cranes, 25 miles of conveyors and a 2400 foot sortation loop that deposits orders, ready for shipping, at any one of 600 regional accumulation stations. Then came the shell to enclose it.

And that meant nearly 600 thousand sq. ft. of Bold Beam and PlaneWall siding from Reynolds.

"That siding sure went up easily," commented panel subcontractor president Leo Zahner. Aluminum meant his crews could easily handle big 28' x 4' panels.

Look to Reynolds today for tomorrow's buildings. And Reynolds Colorweld® 200 fluopolymer finish can help make your next job a landmark.

### SPECIFY REYNOLDS WITH CONFIDENCE

Write for complete information. You'll find a wide variety of panel profile shapes and colors in the complete line of Reynolds Commercial Building Products. Write Reynolds Metals Company, Architectural and Building Products Division; 325 W. Touhy Avenue, Park Ridge, Ill. 60068



For more data, circle 66 on inquiry card

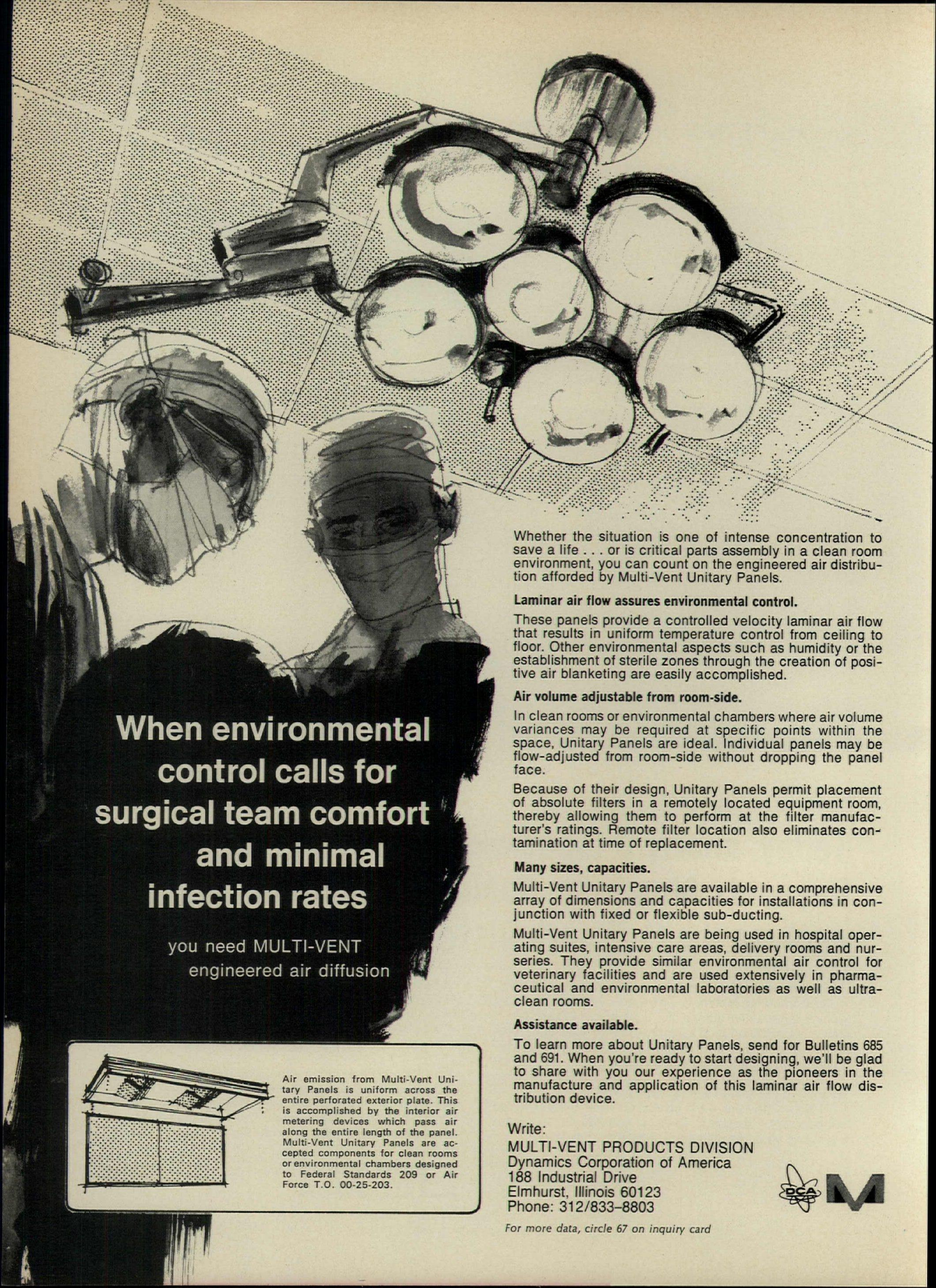

**When environmental control calls for surgical team comfort and minimal infection rates**

you need MULTI-VENT  
engineered air diffusion

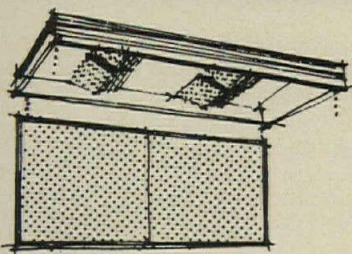

Air emission from Multi-Vent Unitary Panels is uniform across the entire perforated exterior plate. This is accomplished by the interior air metering devices which pass air along the entire length of the panel. Multi-Vent Unitary Panels are accepted components for clean rooms or environmental chambers designed to Federal Standards 209 or Air Force T.O. 00-25-203.

Whether the situation is one of intense concentration to save a life . . . or is critical parts assembly in a clean room environment, you can count on the engineered air distribution afforded by Multi-Vent Unitary Panels.

**Laminar air flow assures environmental control.**

These panels provide a controlled velocity laminar air flow that results in uniform temperature control from ceiling to floor. Other environmental aspects such as humidity or the establishment of sterile zones through the creation of positive air blanketing are easily accomplished.

**Air volume adjustable from room-side.**

In clean rooms or environmental chambers where air volume variances may be required at specific points within the space, Unitary Panels are ideal. Individual panels may be flow-adjusted from room-side without dropping the panel face.

Because of their design, Unitary Panels permit placement of absolute filters in a remotely located equipment room, thereby allowing them to perform at the filter manufacturer's ratings. Remote filter location also eliminates contamination at time of replacement.

**Many sizes, capacities.**

Multi-Vent Unitary Panels are available in a comprehensive array of dimensions and capacities for installations in conjunction with fixed or flexible sub-ducting.

Multi-Vent Unitary Panels are being used in hospital operating suites, intensive care areas, delivery rooms and nurseries. They provide similar environmental air control for veterinary facilities and are used extensively in pharmaceutical and environmental laboratories as well as ultra-clean rooms.

**Assistance available.**

To learn more about Unitary Panels, send for Bulletins 685 and 691. When you're ready to start designing, we'll be glad to share with you our experience as the pioneers in the manufacture and application of this laminar air flow distribution device.

Write:  
MULTI-VENT PRODUCTS DIVISION  
Dynamics Corporation of America  
188 Industrial Drive  
Elmhurst, Illinois 60123  
Phone: 312/833-8803



For more data, circle 67 on inquiry card



**PIPE CASING INSULATORS** / A durable plastic coating that is heat fused to the metal insulator band over a thermosetting, baked-on primer protects the insulators against corrosion and damage. A 90-mil thick PVC inner liner protects the pipe coating and provides back-up insulation between the pipe and casing. The new, long-life, plastic coated casing insulators are available in any size and configuration, including insulators for multiple pipelines in a single casing, insulators with "high rise" runners for large diameter casings and other specialized applications. ■ PSI Industries, Burbank, Cal.



Circle 331 on inquiry card

**SECURITY MONITORING** / An integrated security system for medium to large public and private facilities, the system can monitor up to 600 points of security, fire and other potential hazards. All monitoring information is directed to an in-house guard-installation for processing. A single guard can monitor remote sensors, control remote devices, read status changes and talk to remote personnel. Every type of electrical or electronic sensing and control device, including existing equipment, can be integrated into the system, which can also be employed to start and stop equipment, and to test and reset sensors and alarms. ■ Gamewell/Alarmtronics, Marlborough, Mass.



Circle 332 on inquiry card

**LIGHT DIMMING** / Dimming features include smooth, continuous dimming with no "pop-on," square law circuitry which allows light level to change proportionately to amount the knob is turned; and voltage compensation which prevents flickering when line voltage varies. The solid state dimmers are available in 600-, 1000-, 1500-, and 2000-watt models, all UL-listed. Soft beige is standard with black, brown, white and woodgrain colors available on request. All models fit a standard single gang wall box. ■ Lutron Electronics, Coopersburg, Pa.

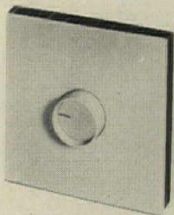

Circle 333 on inquiry card

**SPECIMEN PASS-THROUGH** / The newly designed B-505 Specimen Cabinet mounts through walls 3 to 6 in. thick. A unique locking mechanism prevents both doors from being opened at the same time. The unit is constructed of type 304 stainless steel, with exposed surfaces and satin finish. The cabinet is welded construction. Drawn, seamless flanges add a neat appearance to the exteriors. ■ Bobrick Architectural Service Dept., New York City

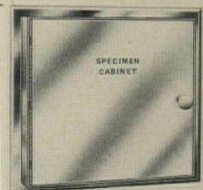

Circle 334 on inquiry card

More products on page 184

# Vicrtex

adds the fourth dimension of

# Quiet

to your interior designs!

Set off individual spaces physically and acoustically with

**NEW**

# Vicracoustic

## Wall Systems

faced with Vicrtex Vinyl Wallcoverings!

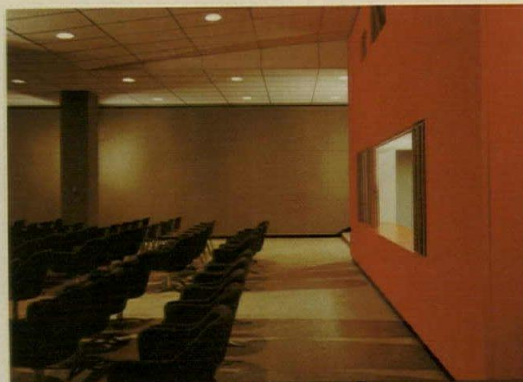

**VICRACOUSTIC** Wall Panels control sound—beautifully! They blend the sound absorbency of a glass fiber core with the decorative finish of any of the 85 Vicrtex® Vinyl Wallcoverings patterns. Create quiet, protect against the clamor of typewriters, ringing phones, voices, any noise. Ideal for all

- Perimeter Walls
- Interior Walls
- Free-Standing Landscape Panels

**Versatile? VICRACOUSTIC** wall panels can be finished in a variety of ways, on one or both sides—buted, framed, or set out as separate panels. Five basic types, in standard and custom sizes.

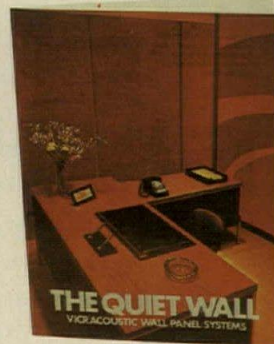

Full-color catalog gives all the data, plus acoustical-test findings. Write or phone for your copy—do it Today!

**L.E. CARPENTER**  
AND COMPANY



A DAYCO  
COMPANY

964 Third Avenue, New York, N.Y. 10022  
(212) 355-3080 For more data, circle 68 on inquiry card

**DISTRIBUTED BY: VICRTEX SALES DIVISION,**  
New York, Atlanta, Chicago, Dallas, Los Angeles, San Francisco, Boston, Minneapolis,  
Toronto/HOWELLS, INC., Salt Lake City/PAUL RASMUSSEN, INC., Honolulu.

# Ceco helps save the construction industry one of the most important materials of all.

## Time.

We work with your industry in a variety of ways. From concrete forming services to steel joists to steel doors to pre-engineered buildings—and more. A wide range of products and services that have one common denominator—saving time at the job site.

Here are just a few of the things we do and make:

**Concrete forming services.** Our experienced crews supply, erect and remove steel and fiberglass forms for poured-in-place concrete floor construction. Ceco uses methods of forming monolithic concrete floors, roofs and columns to produce rigid structures with speed and safety.

**Reinforcing bars.** Our three mills produce rebars, which we fabricate to your specifications. We've kept pace with metallurgical changes in the production of high strength steels which enable designers to use fewer bars in concrete work. Result: less time and labor.

**Joists and truss beams.** We've helped develop new designs, engineering and fabrication methods which result in stronger and lighter steel joists. Steel is placed only where needed for strength. Lighter weights mean easier, faster erection.

**Steel doors, frames and hardware.** Many and various standard types, sizes and styles of doors are available from 17

warehouses. We manufacture doors and frames fully drilled, tapped and ready for installation in minutes. Hardware is specially prepared for quick attachment to the doors and frames.

**From our Mitchell Engineering division**—Innovative pre-engineered metal buildings in a variety of designs and colors for commercial, industrial and community uses.

**From our Windsor Door division**—Ready-to-install overhead doors engineered for every type of structure—from airport hangars to home garages. Contemporary designs in steel, fiberglass, aluminum and wood.

Get to know us better. Write for literature that tells the full scope of our operations in the construction industry.

### Quick facts about Ceco

- One of the 500 largest industrial corporations
- Annual sales total approximately \$250 million
- Supplies the commercial, manufacturing, institutional and multi-unit residential building markets
- 28 manufacturing and fabricating plants, 34 warehouses and equipment storage centers, 3 steel mills, and 48 corporate, divisional and sales offices.

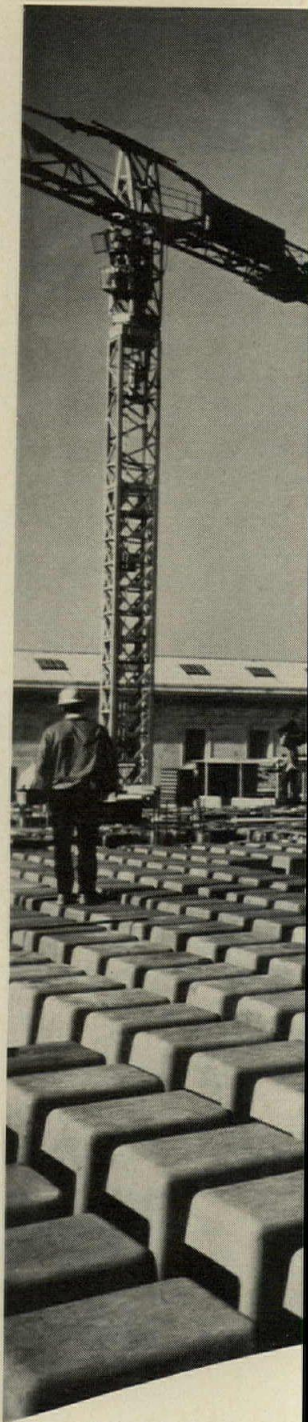



James Madison Memorial Building  
Library of Congress, Washington, D. C.  
George Hyman Construction Co., *Contractor*  
Roscoe DeWitt, A. J. Tatum,  
Alfred Easton Poor, Albert Homer Swanke,  
Jesse M. Shelton, A. P. Almond, *Associate Architects*  
Severud, Perrone, Sturm, Conlin,  
Bandel, *Consulting Engineers Superstructure*

Concrete forming services ■ reinforcing bars ■ steel joists  
■ pre-engineered buildings ■ hollow-metal steel doors  
■ overhead doors ■ metal roofing and siding ■ metal lathing  
products ■ farm buildings ■ concrete pipe

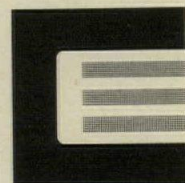

**CECO**

The Ceco Corporation • General Offices  
5601 West 26th Street • Chicago, Illinois 60650

*For more data, circle 69 on inquiry card*

look at  
 if you're looking  
 for the most  
 modern, mature, and  
 sophisticated material  
 distribution system in the world...  
**MOSLER**  
 It's got a lot going for you.

**Mosler**

An American-Standard Company

for more information contact:

MOSLER/AIRMATIC SYSTEMS DIVISION,

415 PATERSON HAMBURG TURNPIKE, WAYNE, NEW JERSEY 07470 TELEPHONE: (201) 278-6300



# Some current examples of

# LOAD BEARING CONCRETE MASONRY HIGH RISE STRUCTURES

Featuring fast low cost construction and early return on investment



**Connecticut**

Trade Union Plaza/  
77 Unit/9 Building Low Income Housing Project/  
New Haven, Connecticut

**Structural Cost: \$3.42 P.S.F.**

(including "In-Block" bearing walls, roof and floor slabs, footings, foundation and beams).



**Florida**

The Royale Riviera/7-story apartments/  
Vero Beach, Florida

**Structural Cost: \$1.73 P.S.F.**

(not including foundation cost).



**Minnesota**

Clamor Manor/4-story apartment

**Structural Cost: \$3.00 P.S.F.**

(Includes appliances, carpet, loan costs and overhead)



**Ohio**

Kent Way, Kent, Ohio/7-story apartment

**Structural Cost: \$5.45 P.S.F.**

(Includes: concrete, masonry, steel, general requirements, profit)

Need more evidence? Just send this coupon for a free brochure and information on our computer feasibility study for load-bearing high-rise structures.



Vice President, Marketing Services  
National Concrete Masonry Association  
P.O. Box 9185, Rosslyn Station, Arlington, Virginia 22209

Please send, without obligation, further information on load-bearing concrete masonry.

NAME

COMPANY

CITY

STATE

ZIP

## ELECTRONIC THERMOMETER SYSTEM /

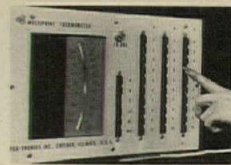

A low cost, easy-to-read multi-temperature electronic thermometer system designed to monitor up to 30 points to ensure meeting OSHA requirements for working and living areas is available from stock with ten and 30 point push button configurations, each with a choice of three different temperature ranges. Six basic models in all have a system accuracy of plus or minus 1 per cent. The system is recommended for factories, hospitals, laboratories, warehouses, hotels, motels, apartment and office buildings, etc. ■ Pak-Tronics, Inc., Chicago, Ill

Circle 335 on inquiry card

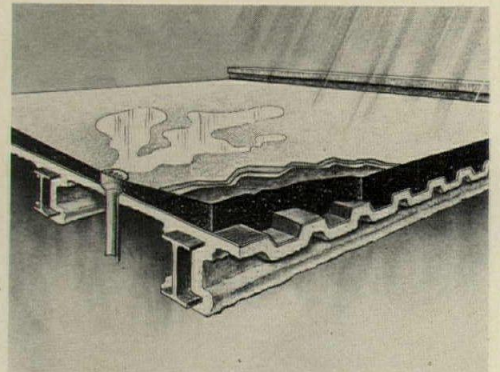

## TWO-HOUR FIRE-RATED DECK /

Two products by two manufacturers have combined to provide a metal roof deck system said to be unique in fire protection, energy-saving thermal insulation and water drainage. The insulating properties of All-weather Crete insulation provide this system with a completely dry, seamless installation having a better k factor than any other poured roof deck insulation (.40 k factor) according to the maker. Fire protecting and insulating the lower half of the system is direct-to-steel spray fireproofing. ■ United States Mineral Products Co., Stanhope, N.J. or Silbrico Corp., Hodgkins, Ill.

Circle 336 on inquiry card

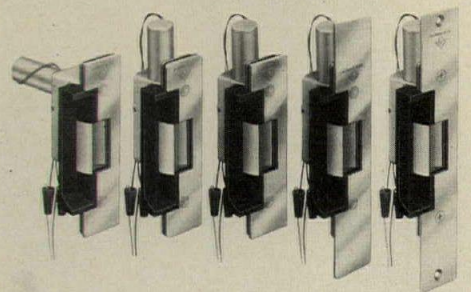

## ELECTRIC STRIKE /

Carrying the label of Underwriters Laboratories' new category for "burglary-resistance," a complete line of electric release strikes is available for alternating current in 16- or 24-volt models and for direct current at six, 12, 16, or 24 volts. The strikes shown (left to right) are for wood, aluminum, hollow steel and replacement (to cover older, larger cutouts) in aluminum or wood. Although their over-center cam/roller mechanism offers the greatest available resistance against tampering or brute force attacks, they are so compact that the hollow steel version will fit the standard ANSI cutout for non-electric strikes and the aluminum version will fit the 1 3/4 in. stile of the inactive leaf in a pair of doors. ■ Adams Rite Mfg. Co., City of Industry, Cal.

Circle 337 on inquiry card

# We "Wrote the Book" on Dock Design.



## Our 350 Dock Specialists put it into practice

Everything you move in or out of your plant, warehouse, or terminal moves across the loading dock. Today's competition, rising labor costs, and safety considerations place critical demands on your dock operation.

To help you achieve a safe, efficient dock, Kelley Company offers the services of one of 350 trained dock specialists. He will work with you, your personnel, architect and contractor. And he will assume complete responsibility for the dock layout, equipment recommendation, its installation and operation.

It's the kind of total responsibility you expect from the people who "wrote-the-book" on Dock Design, and who manufacture and install more permanent dockboards than anyone else in the world.

So if you're building, remodeling, or simply concerned about your present dock operation, ask for this free, no obligation consultation service. Just contact the "responsible" dockboard people.



Kelley Company, Inc.  
6768 North Teutonia Ave.  
Milwaukee, Wisconsin 53209  
Phone: (414) 352-1000 Telex: 26-661

For more data, circle 72 on inquiry card

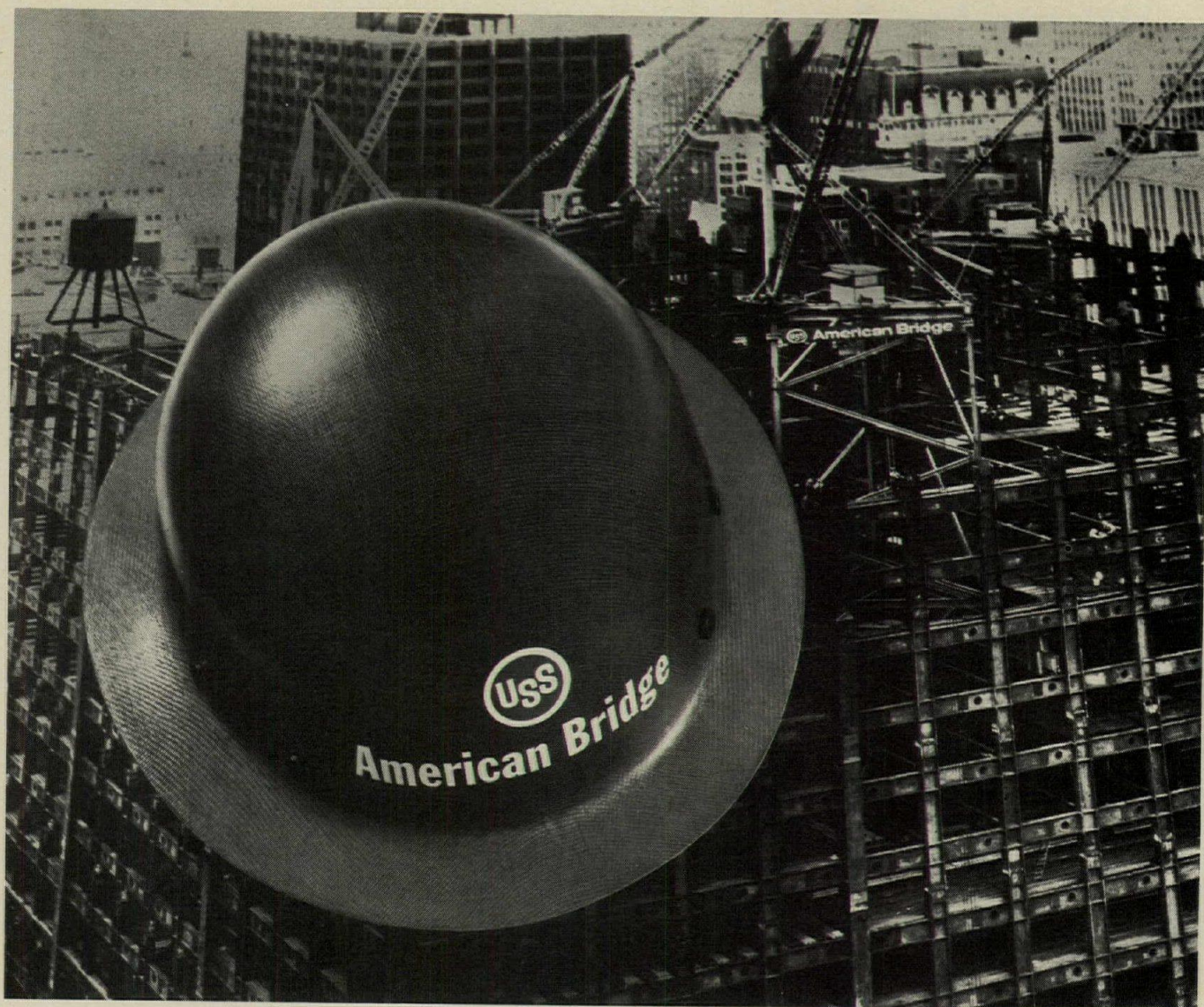

## When you buy a part of us, you buy every part of us!

When you come to American Bridge, you get all our experience. And no organization in the world can top that!

For over 70 years we've been fabricating and erecting structural steel. We fabricated the steel for 4 of the world's 5 tallest buildings, and erected 3 of them. And that's just one part of us!

No one can duplicate our engineering and management teams. No company can claim so many sophisticated engineering centers, and plants, ideally located throughout the country. Nowhere else can you find such extensive research, metallurgical and engineering services. And nobody can top the variety of buildings and special jobs we've worked on: chances are we've handled jobs like yours many times before.

All our vast resources are part of the package when you come to American Bridge. Buy a part of us and you'll find every part of us is ready to work for you—to save you time, trouble and money.

Talk to us now, before your job reaches the bidding stage. Call us, or write: American Bridge, Division of United States Steel, 600 Grant Street, Pittsburgh, Pa. 15230.  
**No job is too anything for American Bridge.**



TRADEMARK

### American Bridge

Division of United States Steel



# IS THIS THE FUTURE OF GLASS BUILDINGS?

The energy crisis has triggered a ground swell of opinion against glass.

In the search for a scapegoat the recurring theme has become: get rid of glass.

Glass, we're told, wastes energy.

Glass buildings have been labeled "energy sieves."

Glass vision area has come to be thought of as a necessary evil (if, indeed, all that necessary).

Rash solutions are a dime a dozen.

And virtually all these solutions are just arbitrary prescriptions against the amount of glass used.

The fact of the matter is that compared to marble, steel, aluminum or wood, only wood insulates better than glass. Even so, since insulated backing can equalize them all, the argument against glass in nonvision areas becomes moot.



But of the five, only glass is transparent. So for vision areas there's not much choice.

Another fact is that in a typical 10- to 20-story building a mere 15% of the energy consumed goes to compensate for heat gained or lost through the walls and ceiling.

And that's using basic 1/4" single-glazed clear glass.

A building's energy efficiency should be judged by performance, not prejudged by outdated misconceptions.

And you can get efficient performance without resorting to high-rise log cabins or towering dungeons. You can get it from glass. PPG Glass.

The Empire State Cabin.

# PPG WANTS YOU TO



## Glass is glass is nonsense.

Virtually all of the criticism of glass is aimed at the simplest, most basic kind — clear, single-glazed, 1/4" thick.

But glass is more than that. Much more.

Glass is a product of modern technology. And at PPG it has evolved and grown until, today, glass is a whole host of architectural materials that are as scientifically sophisticated and esthetically advanced as any other building product available.

In short, there is a glass to meet virtually every building demand. Including those made by the energy crisis.

## Mirror, mirror.

Today there is reflective glass. And there is insulating glass.

And there is PPG Solarban® Twindow® reflective insulating glass.

It is as far superior to single-glazed clear glass as a 747 is to a single-engine prop.

A comparison (see diagram) shows that there is indeed no comparison. Solarban 575 Twindow reflective insulating glass is practically four times more efficient in reducing solar heat gain.

Esthetically, its reflectivity produces an optical effect no other building material can approach. A building of Solarban Twindow reflective glass becomes virtually one with its surroundings. No matter how monumental the structure, it's never a ponderous, heavy-handed intrusion onto the scene.

Solarban Twindow reflective insulating glass combines high performance and enviable esthetics to help produce buildings that can, in effect and efficiency, please everybody.

## It's not brand new.

PPG Solarban Twindow reflective insulating glass fits in so perfectly with the demands created by the energy crisis that you might think it was designed specifically to meet them.

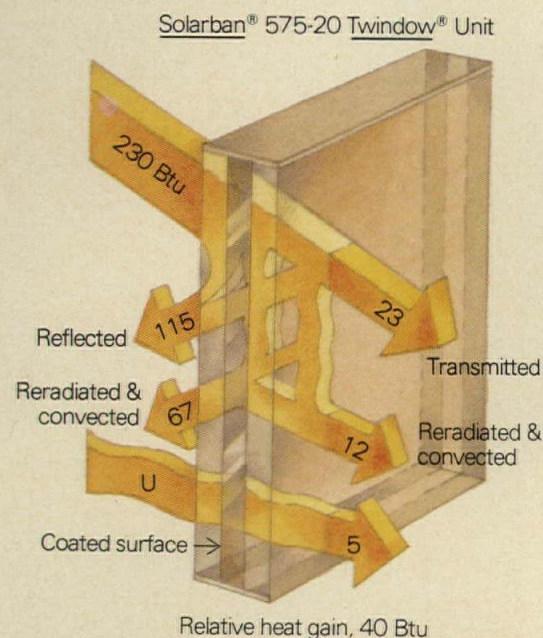
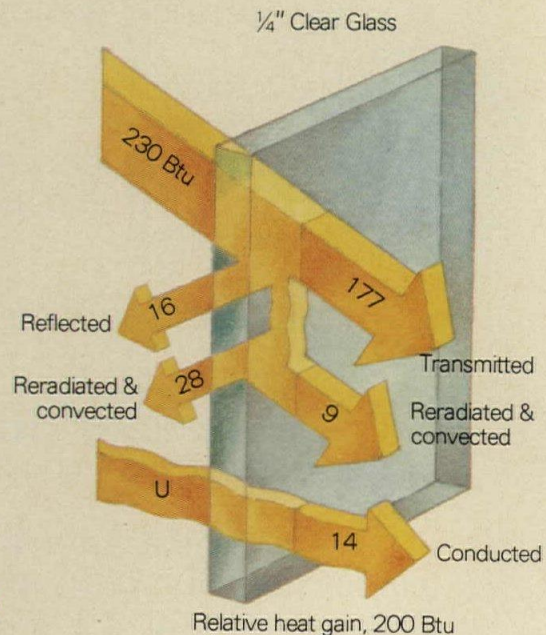

# KNOW THE FACTS.

But it wasn't. Solarban Twindow insulating glass was already being used when energy was still a cheap commodity. So it's not some novel curiosity to be viewed with a skeptical eye. In more than seven years of use in some of the most prestigious buildings in the country, Solarban Twindow reflective insulating glass has proved itself a highly effective energy saver.

## The Equivalent Energy Benefit.

Some people are saying that, to save energy, glass should comprise no more than 20% of the wall area.

In addition to the obvious esthetic and psychological shortcomings of this suggestion, it's once again a case of talking about the wrong kind of glass.

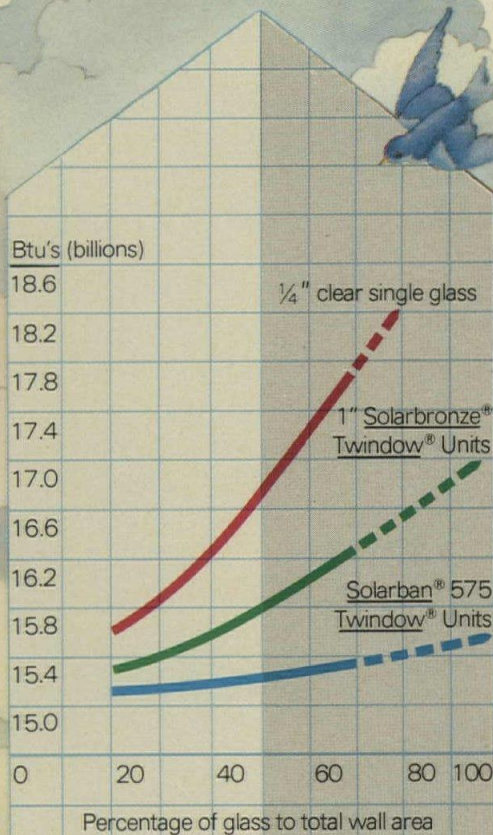

Billions of Btu's required annually for heating and cooling as a function of the percentage of glass to total wall area.

To prove our point we conducted computerized research. Using a hypothetical office building 15 stories high, we plotted (see graph) the annual energy consumption of this building as a function of different quantities of different kinds of glass.

As you can see, you can achieve greater energy efficiency using 70% Solarban 575 Twindow reflective insulating glass than you can with 20% single-glazed clear glass.

In fact, the difference in energy consumption between a wall 70% Solarban 575 Twindow insulating glass and an opaque wall\* is virtually negligible.

So the answer to more efficient buildings is not a head-long rush to less glass, but a calculated move to high-performance glass.

\*Nonvision wall areas in this study are presumed to be heavyweight construction (U=0.09).

# PPG HIGH-PERFORMANCE GLASS IS NOT A GAMBLE.

## Smart money is still on glass.

The big developers—the ones with the most to lose from inefficient buildings—haven't been scared off by all the clamor against glass.

They know that a building that doesn't rent, no matter how efficient, is the biggest waste of all.

Like us at PPG, they believe that glass buildings can meet any reasonable, sensible standards of efficiency (measured, perhaps, in Btu's/sq. ft.).

## Computer analysis.

Before we try to sell you even one square foot of our high-performance glass, we'll have your building specifications and our glass recommendations evaluated by PPG Computer Analysis.

The analysis can evaluate a wide variety of alternative glass products, giving you specific energy requirements for each option, and long-range costs. It takes the guesswork out of selecting glass.

So if you're planning a building, get in touch with PPG. High-performance glass can give your building efficiency as well as excitement.

Write: ENERGY, PPG Industries, Inc., One Gateway Center, Pittsburgh, Pa. 15222.



*For more data, circle 73 on inquiry card*

The First International Building  
Owner: The First National Bank  
in Dallas  
Architects: Harwood K. Smith  
& Partners, Dallas; and  
Hellmuth, Obata &  
Kassabaum, Dallas and  
St. Louis



## Write tougher specs for standby power.

Get test requirements down in black and white.

And give your customers added assurance that they really can depend on the standby power systems you specify.

For openers, make sure that the prototype for any system you specify has been rigorously tested.

You might start by insisting on torsional analysis of the whole mass elastic system as a check on wear points and stress areas.

Ask for fatigue tests on components. Cooling tests on the radiator fan and the engine. Endurance tests that closely simulate actual load conditions. Short-term and long-term stability tests. Life tests.



Balance tests. Vibration tests. Sound tests. Drop tests.

And don't forget tests on such things as transient response, high-temperature performance, or dips and rises in voltage and frequency.

This is the kind of basic design testing Onan does. The kind we think everybody should do if they make something as critical as standby power systems.

For more information, call an Onan Distributor. Or write: Onan Division, Onan Corporation, 1400 73rd Ave. N.E., Minneapolis, Minn. 55432.

**Onan** Power on demand for the **Critical** things in life.

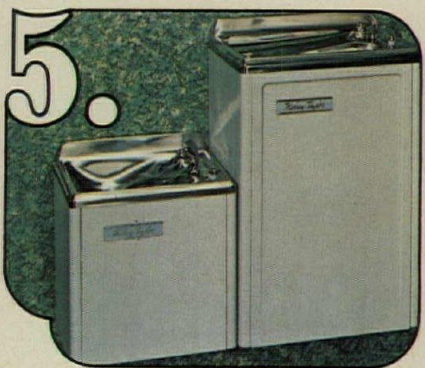
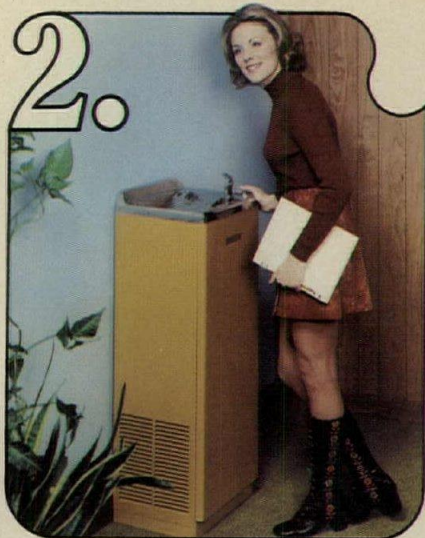
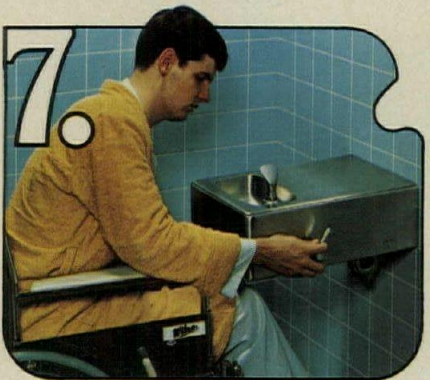
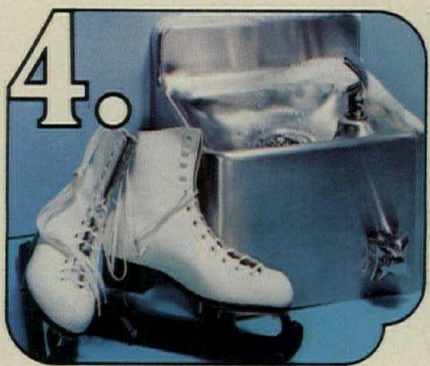
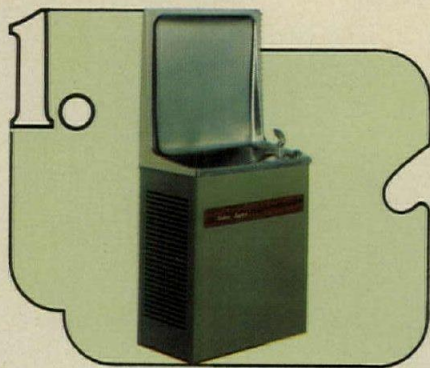

## Liquid assets.

Every Halsey Taylor water cooler is an asset to the people who own it and use it. It consistently lives up to its billing as the world's number one water cooler because we've established a standard of quality unmatched by anyone. And we never let it slip. We test every Halsey Taylor product—thoroughly—as it comes off the line. No spot checking. Every feature of every cooler must be perfect.

One more thing. Halsey Taylor offers the widest selection of water coolers you'll find anywhere. Coolers for just about any application, any decor.

For details on the following, write to Halsey Taylor Division, 1554 Thomas Road, Warren, Ohio 44481.

**1. New simulated semi-recessed cooler—HBW Series.** Designed for today's thin-wall construction. Requires no cutout yet looks like a semi-recessed cooler. Capacity: 8 and 13 g. p. h. of 50° water.

**2. WT Series.** For wall-tight installation. Standard gray or any of 8 Polychrome colors at no extra cost. Capacity: 8 to 20 g. p. h. of 50° water.

**3. Fully recessed RC Series.** One-piece, contour formed fountain receptor. No welds, no crevices to catch dirt. Grille vanes individually formed and fitted, not stamped out. Available in PATINA bronze-tone or satin finish stainless steel. Capacity: 8 and 12 g. p. h. of 50° water.

**4. All-climate wall fountain No. 5905-AC.** For all outdoor installations. Frost-proof supply valve and drain assembly. Vandal resistant. Other all-climate models available in fiberglass and porcelain enameled cast iron.

**5. Wall-mounted cooler with accessory fountain—WM-BL Series.** Special for small fry. Polychrome colors or vinyl-laminated steel at no extra charge. Capacity: 14 and 16 g. p. h. of 50° water.

**6. SW Series.** Just 20½" top to bottom. Can be wall-mounted at adult or child height. Famous anti-squirt, two-stream bubbler. Polychrome colors at standard cost.

**7. Model 6800 WC fountain.** Designed for wheel chair patients. Extends 19" from wall. Meets state and federal regulations for the handicapped. Lever-type control. Capacity: remote cooling units available from 5 to 19 g. p. h. of 50° water.

**8. Outdoor fountain No. 6837.** Weather resistant. Automatic stream control and positive shut-off service valve. Vandal-resistant exposed fittings. Cabinet also available in gray enamel.



**Halsey Taylor**  
KING-SEELEY **IST** THERMOS CO. ®

For more data, circle 75 on inquiry card

# MO-SAI UNITS ENGINEERED TO WITHSTAND 16,000 POUND STRESSES



Seattle's new Federal Building is located in earthquake zone 3. For this reason, Mo-Sai architectural concrete units and anchors were required to withstand forces two times the units' weight (8,000 lbs.) in any direction. Threaded inserts, six to an average unit, were welded to the steel reinforcing of each panel and cast integrally with the Mo-Sai. Steel angles were bolted to the back of the panel, and then bolted to the building's concrete floors and steel frame. (See detail.)

Connections also are designed to accommodate twice the estimated  $\frac{3}{8}$ -inch story drift on the 37-story building.

Originally designed in brick, the intricate exterior contours were faithfully reproduced in Mo-Sai at a savings of over \$800,000. A light texture of exposed beige aggregates in a white concrete matrix was used on the Mo-Sai units to give the building a warm-white appearance. The Mo-Sai finish should require little or no upkeep to maintain its new luster throughout the years.

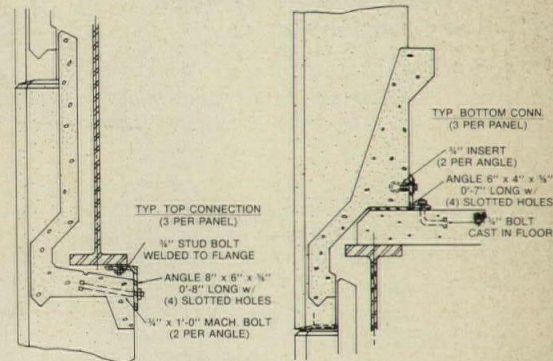

## Mo-Sai

PRECAST, PRESTRESSED CONCRETE  
WITH EXPOSED AGGREGATE

### MO-SAI INSTITUTE, INC.

Information Office  
110 Social Hall Ave.  
Salt Lake City, Utah 84111  
Members, Producers Council

**BEER PRECAST CONCRETE LIMITED**  
110 Manville Road  
Scarborough, Ontario, Canada

**CAMBRIDGE CEMENT STONE CO.**  
P.O. Box 41  
156 Lincoln Street  
Allston, Massachusetts 02134

**ECONOMY CAST STONE CO.**  
P.O. Box 3-P  
100 E. Franklin Street  
Richmond, Virginia 23207

**GOODSTONE MANUFACTURING CO., INC.**  
470 Hollenbeck Street  
Rochester, New York 14621

**HARTER CONCRETE PRODUCTS, INC.**  
1628 West Main Street  
Oklahoma City, Oklahoma 73106

**JACKSON STONE CO., INC.**  
P.O. Box 4355  
Fondren Station  
Jackson, Mississippi 39216

**OLYMPIAN STONE CO., INC.**  
P.O. Box 685  
192nd N.E. and Union Hill Rd.  
Redmond, Washington 98052

**SOUTHERN CAST STONE CO., INC.**  
P.O. Box 1669  
Sutherland Ave. and Concord Street  
Knoxville, Tennessee 37901

**SEKIGAHARA STONE CO., LTD.**  
2-11-1 Takara-Cho, Chuo-Ku  
Tokyo, Japan

**WILSON CONCRETE CO.**  
P.O. Box 56  
Red Oak, Iowa 51566

P.O. Box 7208  
South Omaha Station  
Highway 75 Avery Road  
Omaha, Nebraska 68107

Federal Building / Seattle, Washington

Architects: John Graham and Company and Fred Bassetti and Company  
Structural Engineers: Skilling, Helle, Christiansen & Robertson  
General Contractor: Hoffmann Construction Company

For more data, circle 76 on inquiry card

# What You Should Know about Plexiglas<sup>®</sup> and Fire for safer Building Design

Plexiglas brand acrylic must be used with an appreciation for the fact that it is a combustible material.

**In general the same fire precautions that are observed in connection with the handling and use of any ordinary combustible material should be observed when handling, storing or using Plexiglas sheet or lenses extruded or molded of Plexiglas molding compounds.**

Knowledge of a material's characteristics is the best assurance that the material will be properly and safely used.

That's why all Rohm and Haas Company advertising and promotional materials carry this informational disc:

Plexiglas acrylic plastic is a combustible thermoplastic. Observe fire precautions appropriate for comparable forms of wood. For building uses, check code approvals. Impact resistance a factor of thickness. Avoid exposure to heat or aromatic solvents. Clean with soap and water. Avoid abrasives.

Building codes and Underwriters' Laboratories standards define good practice in the use of Plexiglas acrylic plastic for light transmission and control on a design and engineering basis that takes into account the combustibility and fire characteristics of the material.

The fire hazard of uses of Plexiglas can be kept at an acceptable level by complying with building codes and applicable Underwriters' Laboratories standards, and observing established principles of fire safety. The fire response characteristics of Plexiglas are listed to the right with corresponding recommended practices.

## Fire Response Characteristic

## Recommended Practice

The ignition temperature of Plexiglas is higher than that of most woods but it will ignite readily; and when involved in fire, will burn vigorously and generate heat rapidly.

Install Plexiglas away from sources of intense heat or flame. Enclose edges of Plexiglas components. Observe building code stipulations and restrictions. Do not use more Plexiglas than required to perform the function required of it. Employ fire protection systems, e.g., sprinklers, fire detectors, automatic vents as hazard analysis indicates.

Plexiglas softens when heated above 260°F which is approximately 300° below its ignition temperature.

Do not use Plexiglas as a supporting element or in any location where resistance to fire penetration is required.

Plexiglas, if held in position when burning, will drip burning droplets.

In overhead lighting, mount Plexiglas in free channel mountings to assure fallout prior to ignition. Extinguish burning Plexiglas with water or fire extinguishers.

When installed as a wall or ceiling finish or when laminated to a substrate, Plexiglas provides a surface over which flame may spread rapidly and release heat and gases contributing to flash-over.

Do not install Plexiglas as applied wall or ceiling finish or as a substrate surfacing material for large interior surface areas in building applications unless the areas are protected by an automatic sprinkler system.

Large area installations of Plexiglas such as transparent enclosures are not provided for in building code regulations because they do not conform to area limitations and therefore require special permits based on analysis of all relevant fire-safety considerations.

Relevant considerations are use of the structure (occupancy); location (exposure); height and area; nature of interior arrangements (decorations, finishes and furnishings); availability and construction of fire exits; need for special fire protection systems such as sprinklers, automatic heat and smoke vents, early warning devices and deluge systems or water curtains.

Impact resistance of Plexiglas, particularly Plexiglas 70, may create entry and venting problems for firemen.

When possible, install Plexiglas 70 in operable windows. Fire departments and building occupants should be informed of the location of fixed Plexiglas 70 glazing in order to provide for alternative evacuation and venting facilities.

Burning Plexiglas does not produce either excessive quantities of smoke or gases more toxic than those produced by burning wood or paper. The concentration of carbon monoxide and/or carbon dioxide released by burning Plexiglas is a factor of the quantity of Plexiglas involved and the conditions of burning.

The use of Plexiglas is not restricted because of the character of its products of decomposition but because of its combustibility and burning characteristics.

Copies of the approvals of Plexiglas acrylic plastic under various codes will be made available on request. In addition, reports on the status of Plexiglas under Federal Government regulations will be provided promptly. Assistance will also be provided by Rohm and Haas code consultants and engineers in obtaining approvals for installation of Plexiglas which constitutes justifiable exceptions to existing restrictions. A considerable amount of information is available to support such applications. Approvals of general interest include: ICBO Research Recommendation No. 1084; BOCA Report No. 72-33 and SBCC Report No. 7246; New York City Board of Standards and Appeals Calendars 444-60-SM, 255-69-SM, 657-63-SM; New York City Department of Water Supply, Gas & Electricity approval for use in signs and lighting fixtures; New York City MEA 107-69-M; California Fire Marshal File No. A2560-007.

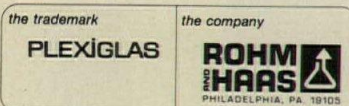

For more data, circle 77 on inquiry card





Plaza Madera at Corte Madera, California. Matt Copenhaver Associates.

## Simpson Custom Ruf-Sawn Redwood Plywood. For offices as beautiful as all outdoors.

Architects today are depending more and more on materials that blend harmoniously in natural environments. And almost nothing looks more natural than Simpson's Custom Grade Ruf-Sawn Redwood Plywood.

No other commercially available wood surpasses redwood for beauty in any setting. Left natural, it weathers to a soft driftwood gray. And redwood is exceptionally resistant to surface checking, making it outstanding for durability and maintenance in any climate.

Simpson Custom Ruf-Sawn, with its rough-sawn

surface and pleasing contrasts of heartwood and sapwood, enhances redwood's natural charm. And because it's plywood, you get all the advantages of plywood, too. High strength-to-weight ratio. Easy handling. Excellent workability. Plus economy when compared with solid lumber.

Simpson Custom Ruf-Sawn Redwood Plywood. A beautiful way to get back to nature.

For details on patterns and sizes, contact Simpson Timber Company, 900 Fourth Avenue, Seattle, Washington 98164. Phone 206-292-5000.

# Simpson

*For more data, circle 78 on inquiry card*



# Rx: INTERSTITIAL SPACE DESIGN—

Thirty-five hospitals and clinics are using a revolutionary new structural framing system. It's called Interstitial Space Design and it can be most effective in reducing maintenance and operating costs.

Interstitial Space Design achieves an absolute minimum of routine servicing interference with normal hospital functions. It is also a highly flexible system, allowing for functional changes. This is why it is admirably suited to hospitals,

clinics and other medical facilities.

As the model shows, the new system is essentially a series of structural "sandwiches" of mechanical floors between the patient floors. Within these intermediate spaces (service levels), equipment and all mechanical, electrical and communication lines are housed and serviced. Distribution and collection systems are also accommodated between floors.



# THINK OF IT AS "SANDWICHES" OF STEEL.

The Interstitial "sandwich" levels can, of course, vary in height—depending on the specific functional needs of the floors they service. They can be constructed to a height in which men can work efficiently. Catwalks can provide access to equipment rooms and platforms located within the Interstitial service spaces.

Find out more about this developing concept. Contact a USS Construction Marketing Representative through your nearest USS sales office or write: United States Steel, 600 Grant Street, Pittsburgh, Pa. 15230.

United States Steel



TRADEMARK

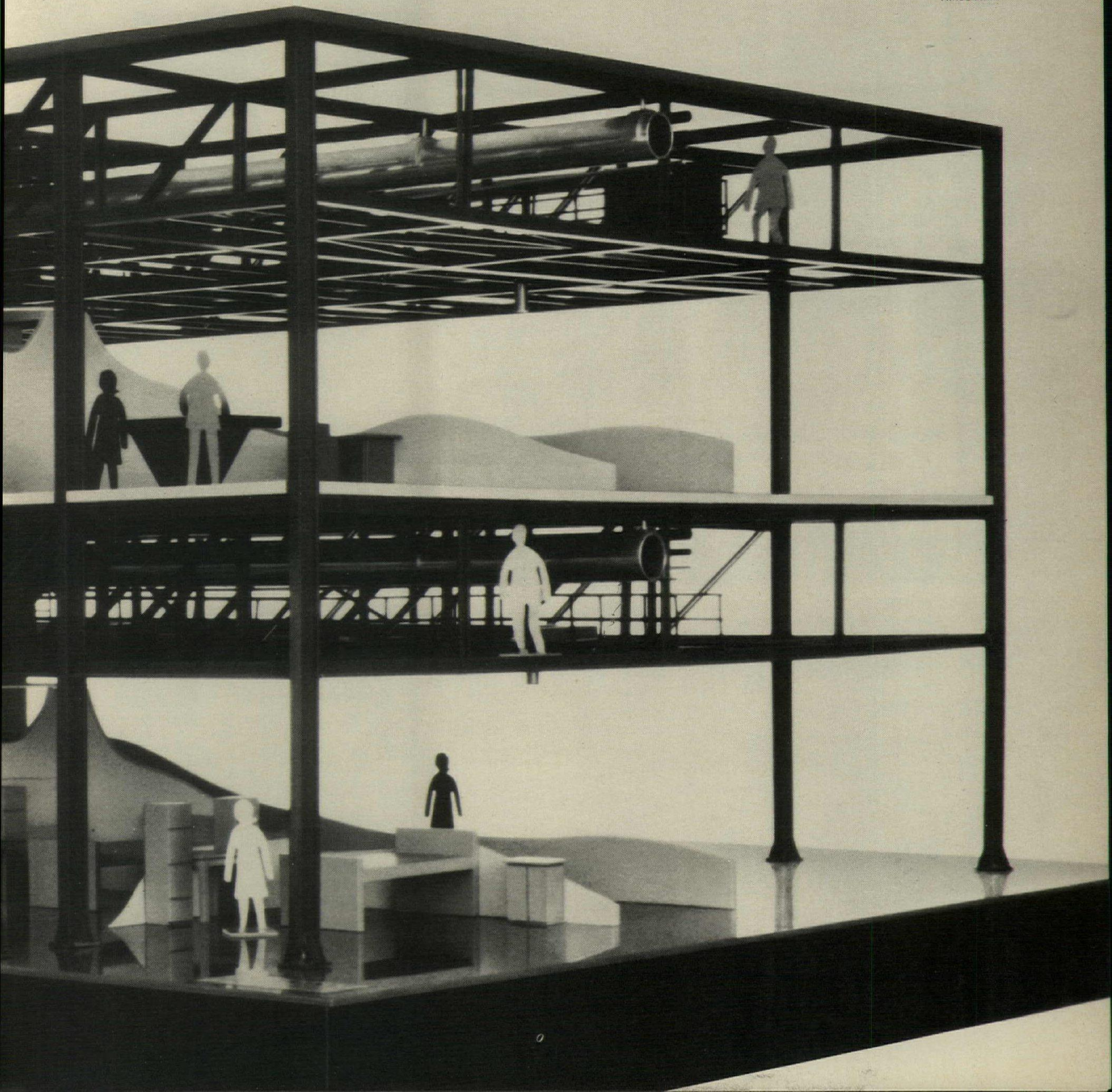



# The Classic Coverage.

## Architects and Engineers Insurance for today, tomorrow, and yesterday— by Northbrook.

Compare our coverage—point for point—with any other Errors-and-Omissions professional liability, and you'll see why we call ours "The Classic Coverage." Architects and Engineers now can have complete confidence of customized professional liability coverage.

As underwriting managers for Northbrook Insurance Company\*, we have the unique expertise and limits, to \$10 million, to tailor a liability policy precisely to your needs. And only your needs. Thus saving you big premium dollars.

And it will be a policy in which you can have complete confidence. For example, not all such policies cover prior acts *with present limits* of coverage. This feature alone can save you thousands of dollars should a claim be made against you. Our coverage also includes such special features as payment of defense costs in addition to limits, worldwide coverage, and more.

In short, we have analyzed and anticipated the *total E&O* insurance needs of today's architect and engineer—whether large corporation or independent professional. And backed by the vast resources of Northbrook, we can provide the very finest, customized professional liability protection for Architects and Engineers today.

The Classic Coverage. Ask your insurance agent about it.



**Shand, Morahan & Company, Inc.**

636 Church Street Evanston, Illinois 60201  
312/866-9010 Cable Shanmor Telex 72-4328

**Where form always follows function.**

*For more data, circle 79 on inquiry card*

# TECHNICAL KNOCKOUT.

Sears Tower:  
After you're amazed  
at its height,  
be impressed with its  
stainless steel.

You talk about Sears Tower in superlatives: height (world's tallest building at 110 stories, 1,454 feet); concept ("multiple tube" approach); location (Chicago); and stainless steel (Republic's ENDURO®.)

Building team member Flour City Architectural Metals of Minneapolis fabricated and installed the stainless architectural metal products throughout the building. Glass framing has a mill prebuffed finish. Wall and door panels, embossed in subtle texture design, are supplied in 2-BN finish polished to highlight the texture. Outside railings and flagpoles are also durable stainless steel.

It's easy to see that Republic stainless adds its own special kind of superlatives to the structure — beauty, cleanability, and durability.

Republic stainless steel can be equally superlative in your architecture. Learn how you can become a member of our exclusive "TKO" Club and receive the information you need today to benefit from tomorrow's uses for stainless steel. Write Republic Steel Corporation, Dept. 1441. Cleveland OH 44101.

**Republicsteel**  
The new steel company



Member Steel Service Center Institute

For more data, circle 80 on inquiry card

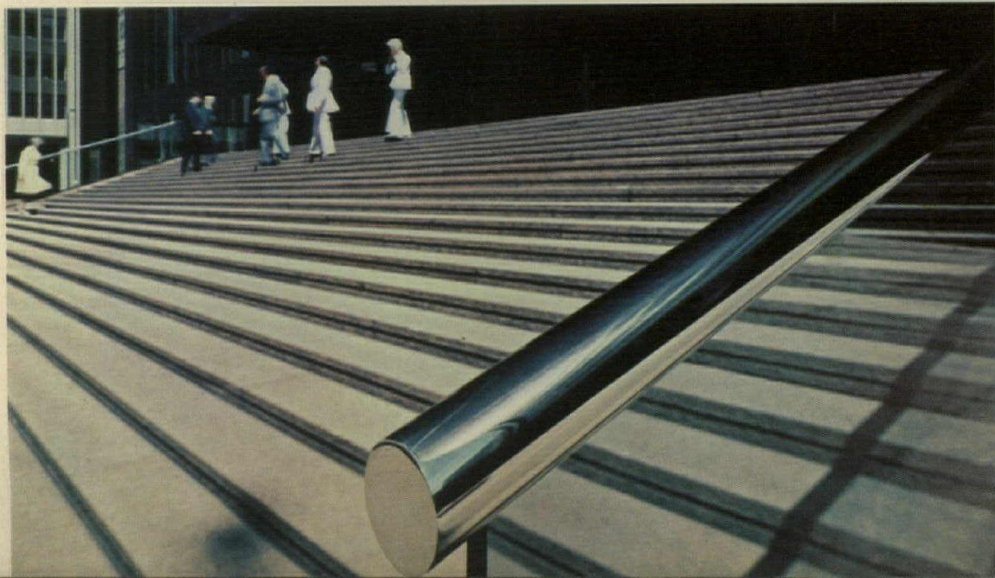

# If our salesmen could carry samples, You'd always specify BILCO.

When all you have to go by are the pictures on the catalog pages, one brand of horizontal doors looks pretty much like another. But if our sales representatives could carry samples you would immediately recognize the advantages of Bilco Doors.

You would see for yourself how easily they open and close, their superiority in design and workmanship. You would readily see that Bilco Doors are built to deliver long, trouble-free service, assuring your clients of sound value and complete satisfaction.



**ROOF SCUTTLES**  
Standard sizes for personnel access; special sizes in single and double leaf types for equipment access.



**FLOOR and PIT DOORS**  
Four standard types in a variety of sizes for every interior and exterior requirement. Special sizes on order.

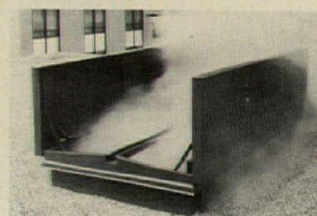

**FIRE VENTS**  
The finest in fire protection equipment. Eight standard sizes with UL and FM labels. Special sizes to order.



The BILCO Company, Dept. AR-84, New Haven, Connecticut 06505



For more data, circle 81 on inquiry card

## NO CHARGE TO YOU! **FIRE** PROTECTION REPORT

Plus Details Of The Many Benefits Of NFPA Membership

"FOR ARCHITECTS AND BUILDERS — 1973 REVISIONS TO THE LIFE SAFETY CODE" a concise, informative 6-page summary of the 17-chapter Life Safety Code of vital importance to the modern fire-conscious architect and builder. A valuable guide to the latest revisions affecting every individual entering a building you constructed.

### How YOU Will Benefit By Joining The National Fire Protection Association

As a NFPA member, you have access to more than 800 fire protection publications, including the new 1974 National Electrical Code; a subscription to *Fire Journal* and *Fire News*; personal NFPA assistance . . . plus many more benefits of special value to you and your architectural career!



Mail This Coupon For Your REPORT And Membership Brochure-Application . . . TODAY!



**NATIONAL FIRE PROTECTION ASSOCIATION**  
A Nonprofit Organization . . . "Moving Mankind Toward Safety From Fire"

**NFPA** 470 Atlantic Avenue, Boston, Massachusetts 02210

Name \_\_\_\_\_

Title \_\_\_\_\_

Organization \_\_\_\_\_

Address \_\_\_\_\_

City \_\_\_\_\_ State \_\_\_\_\_ Zip \_\_\_\_\_

(FJ74-2)AR8

For more data, circle 82 on inquiry card

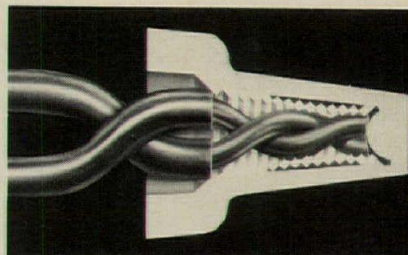

**IDEAL**

## Ideal Wing-Nut Connectors screw on easy; grip tight!

Ideal Wing-Nuts come in four color-coded sizes to let you select the most economical connector to fit any branch circuit wiring job. Send for FREE SAMPLES and the Ideal Connector Guide. It describes the industry's biggest line of solderless wire connectors.

**IDEAL INDUSTRIES, INC., 1328-HBecker Place, Sycamore, Ill. 60178.** In Canada: IDI ELECTRIC (Canada) LTD., Ontario.



**YELLOW**

**RED**

**GRAY**

**BLUE**

For more data, circle 83 on inquiry card

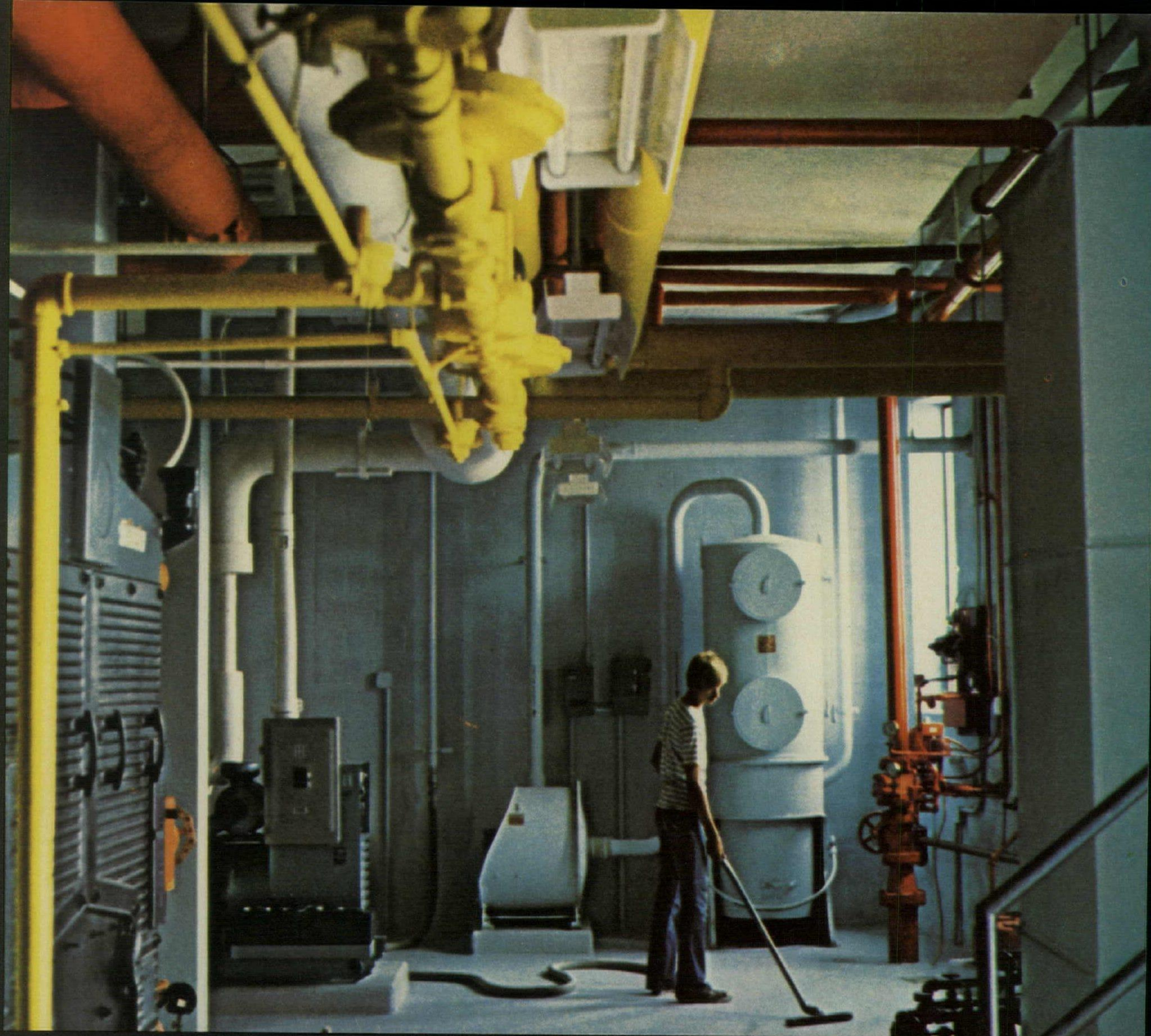

**By shrinking the maintenance budget, a Spencer central vacuum system pays for itself in a surprisingly short time.**

**And you never had it so clean.**

We spell it out for you in Bulletin 280.  
Send for it.

The Spencer Turbine Company, Hartford, Connecticut 06106

*For more data, circle 90 on inquiry card*

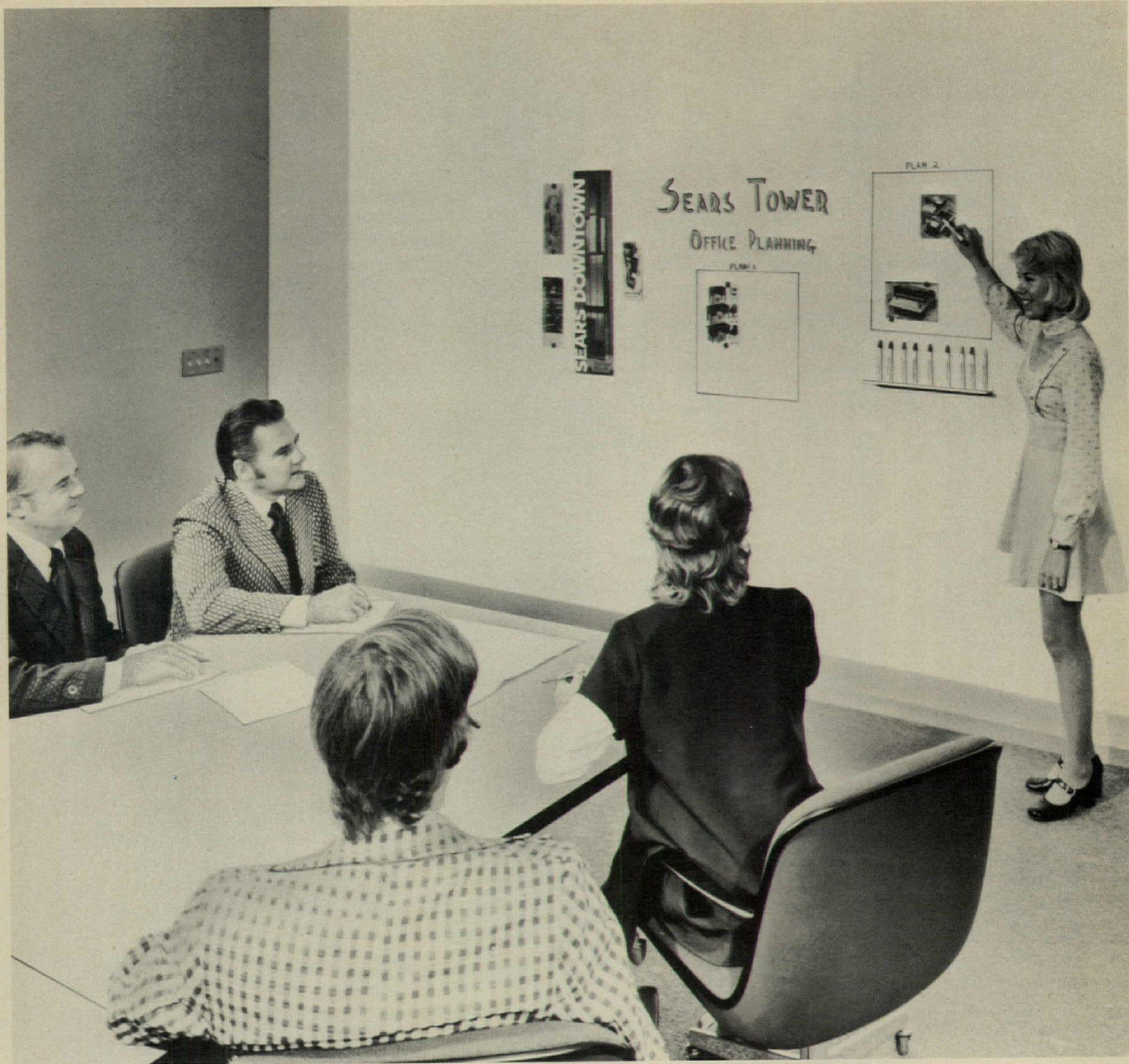

## Specify Eberhard Faber - Boards and turn blank walls into communications walls.

More and more leading architects are specifying our Eberhard Faber-Board® panels for some of the biggest jobs going up today. Like the new Sears Tower and Standard Oil building in Chicago. And the World Trade Center in New York. They're versatile. Eberhard Faber-Boards are appli-

cable for new or present construction or renovations. They're the visual aid panels that really aid communications. Because they're three communications areas in one. The surface lets you write with Eberhard Faber-Board color markers because it's white. Lets you project without distortion because

it's lenticular. And lets you post or schedule without hang-ups because it has magnetic capability. For a kit with sample material, information on types, sizes and all specifications on the visual aid panels of the future, write today.

**EF EBERHARD FABER®**  
CRESTWOOD, WILKES-BARRE, PA. 18703  
 Products for Graphic Communications.





Model 1070



Model 1400

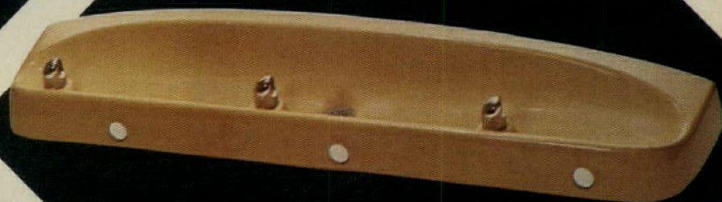

Model 1405



Model 1205

Haws polymarble fountains meet very demanding requirements at a cost comparable to ordinary fountains. They are durable, attractive, highly resistant to impact and abrasion, and available in six colors at no extra cost. The color runs throughout the material, so it won't chalk or fade. Flush-mounted, patented, push-button valves and new heavy-duty bubblers provide excellent vandal resistance.

■ Today, many polymarble models are excelling in practical application. For more information and product test results, contact Haws Drinking Faucet Co., 1441 Fourth Street, Berkeley, CA 94710.

*Haws offers the world's best drink*

*For more data, circle 86 on inquiry card*

THE BEAUTY OF  
**polymarble**  
**Haws**

# Alcoa EZ Wall. A vertically textured facing that adds zest to wall surfaces.

The basic unit is a 12-in. striated aluminum extrusion. But there's no stereotype, no standard effect of these ribbed planks. Do you want a random effect? Alcoa® EZ Wall achieves it for you on fascia, interior wall decor, spandrels, column covers, or as curtainwall facing. If you seek a highly disciplined pattern, EZ Wall can achieve that, too, depending on the modular mix of components and colors chosen by the designer.

The point is, it's individual. Re-

strained or free. A modular surface that goes with you. Complements surrounding architecture. Enhances the vertical dimension of the building. Available in Alumilite\* finish, Duranodic\* bronze tones, or the brighter palette of Super Alualure® colors. And, surprisingly low in installed cost.

For detailed information, send for our EZ Wall brochure. Write to Aluminum Company of America, 1219 Alcoa Building, Pittsburgh, PA 15219.

\*Trade Name

*For more data, circle 87 on inquiry card*



Change for the better with  
Alcoa Aluminum

 **ALCOA**

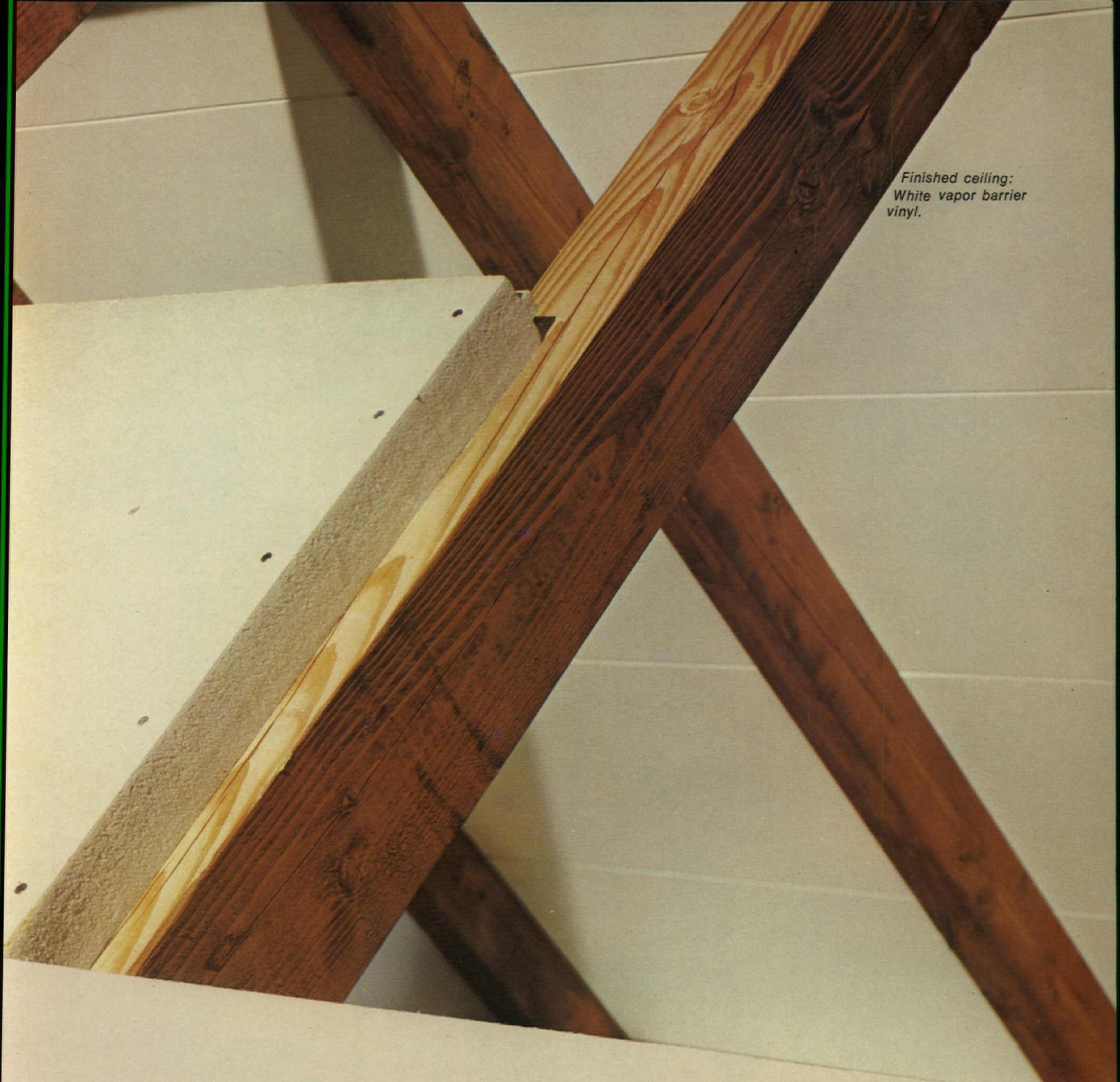

Finished ceiling:  
White vapor barrier  
vinyl.

## Inside and outside, Homasote is a different form of wood decking that makes sense!

Homasote Easy Ply® Roof Decking provides a tough structural base for finish roofing, weather resistant thermal insulation and vapor barrier finished ceiling – all in a one-step application.

Made from multiple plies of Homasote Structural Building Board, Easy Ply® Roof Decking is available in thicknesses for rafter spans up to 60" o.c. The "k" value is up to 114% better than the "k" value of wood *and* our vapor barrier is bonded to the ceiling faceside where it belongs – to resist moisture penetration into the deck itself.

A choice of factory-applied film laminates, gives both exceptional vapor barrier protection and a beautiful, decorative, *finished* ceiling. The 2'x8' (nominal) panels are finished with T & G on the long edge and are easy to handle, cut and shape.

When it comes to value in Building Products, builders have recognized Homasote for over 65 years as a *different form of wood that makes sense!*

For product information and literature, contact your local Building Supplies Dealer or write: The Homasote Company, Box 240, West Trenton, N. J. 08628

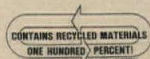
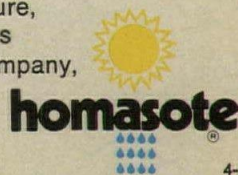

More than 65 years of technology for building and ecology.

For more data, circle 88 on inquiry card

# ADVERTISING INDEX

Prefiled catalogs of the manufacturers listed below are available in the 1974 Sweet's Catalog File as follows.

- A Architectural File (green)
- I Industrial Construction File (blue)
- L Light Construction File (yellow)
- D Interior Design File (black)

**A**

Aerofin Corp.	158
AirTex Corp.	54
Allied Tube & Conduit Corp.	174-175
A-I-L Aluminum Co. of America	204
A American Air Filter Co.	18-19
A-I American Telephone & Telegraph Co.	40-41
A-L Andersen Corp.	28-29
Armor Elevator Co. Inc.	3rd cover

**B**

Bell & Gossett, ITT	4-5
A-I Bell Telephone System	40-41
Bethlehem Steel Corp.	74-75
A-I-L Bilco Co.	200
A-I Binkley Co., The	10
Bruning Division, Addressograph	
Multigraph Corporation	64
Buffalo Forge Co.	56-57

**C**

A Carpenter & Co., Inc., L.E.	179
A-I Ceco Corp.	180-181
A Chester Products Inc.	14
A Combustion Engineering—C-E	
Glass Division	70-71
A Composit Shower Pan	207
Concrete Reinforcing Steel Institute	173
A Consolidated International Corp.	155
A-I CPR Division of the Upjohn Co.	172

**D**

DeSoto, Inc.	208
A-I De Vac Inc.	168
A Duwe Precast Concrete Products Inc.	160

**E**

Eastman Chemical Products, Inc.	15
Easy Heat-Wirekraft Div.—MSP	
Industries	159
A-I Eaton Corporation, Dispenser	
Division	42
A Eberhard Faber, Inc.	202
A-I E.C.I. Air Flyte Corp.—Sub. of	
Eastern Cyclone	49
Edo Western Corp.	32-1
Eljer Plumbingware Div., Wallace-	
Murray Corp.	30

**G**

GAF Corp.—Diazo Equipment	58-59
A Gates Engineering Co. Inc.	169
General Electric Co. Lighting	
Systems Business Dept.	170
A-I-L General Electric Co.—Zonline	46-47
A Granco Steel Products Co.	38
GTE—Sylvania, I/C Lighting	65 to 68
Guth Lighting—Div. Sola Basic	
Industries	22

**H**

Hager Hinge Company	32
A Haws Drinking Faucet Company	203
Homasote	205

**I**

Ideal Industries Inc.	200
A Interform	159
International Business Machines	
Corp., Data Processing Div.	11
ITT-Bell & Gossett	4-5

**J**

A-I-L-D Johns-Manville Corp.—Architectural	
Division	16, 52-53
A-I-L-D Johns-Manville Corp.—Insulation	
Center	161 to 164

**K**

A-I-L Kaiser Gypsum Co.	50-51
A Kalwall Corp.	171
Kawneer Co.	62
A-I Kelley Co., Inc.	185
A Kohler Co.—Electric Plant—	
Standby	17
A-I Koppers Company	149 to 152

**L**

A Larsen Products Corp.	39
A-I-L Lennox Industries, Inc.	8

**M**

A-I McQuay Group, McQuay—Perflex, Inc.	34
MoSai Institute Inc.	193
Mosler/Airmatic Systems Division	182-183
Multi-Vent Products Div. of	
Dynamics Corp. of America	178

**N**

National Concrete Masonry Assn.	184
National Electrical Contractors	
Association	156
National Fire Protection Assn.	200
Nucor Corp. Vulcraft Division	26-27

**O**

A-I Onan Division, Onan Corporation	191
A Osmose Wood Preserving Co.	2

**P**

A-L PPG Industries, Inc., Commercial	
Glass	187 to 190
Prestressed Concrete Institute	165
A-L Pyrotronics Inc.	43 to 45

**R**

A-I Republic Steel Corp.	199
A-I-L Reynolds Metals Co.	176-177
A Rixson-Firemark, Inc.	36
A-L Rohm & Haas Co.	2nd cover, 194

**S**

Shand Morahan & Co. Inc.	198
A-I Silbrico Corp.	157
A-I Simpson Timber Co.	195
Sloan Valve Company	4th cover
A Smith, Elwin G. Div. Cyclops Corp.	60
Soule Steel Co.	32-4
Southern California Gas Company	32-2-32-3
A-I Spencer Turbine Co.	201
A-I The Stanley Works	76
A-I Star Mig. Co.	31
L Staitrol Corp.	33
Steel Joist Institute	55
A-I Symons Corp.	24-25

**T**

A-I Taylor Co., The Halsey W.	192
A-I Thiokol Chemical Corp.	23
A-I Trane Co.	72-73
Tyler Pipe	69

**U**

A-I Unistrut Corporation	20-21
A-I-L-D United States Gypsum	6-7
A-I United States Mineral Products Co.	157
U.S. Steel Corp.—American	
Bridge Div.	186
A-I U.S. Steel Corp.—Cyclone Fence	
Div.	12-13
A-I U.S. Steel Corp.	196-197

**V**

Vincent Brass & Aluminum Co.	48
Vulcraft Division of Nucor Corp.	26-27

**W**

A Wasco Products, Inc.	40
Wide-Lite Corporation	166-167

**X**

Xerox Corp.	154
-------------	-----

## ARCHITECTURAL RECORD

McGraw-Hill, Inc., 1221 Avenue of the Americas, New York  
New York 10020  
Advertising Sales Mgr.: Louis F. Kutscher (212) 997-2838  
Eastern Sales Mgr.: Robert G. Kliesch (215) 568-6161  
Western Sales Mgr.: James A. Anderson (312) 751-3770  
Advertising Services Mgr.: Joseph R. Wunk (212) 997-2793  
Marketing Services Mgr.: Elizabeth Hayman (212) 997-2858  
Research Mgr.: Camille Padula (212) 997-2814  
Classified Advertising: (212) 997-2557

### District Offices:

**Atlanta** 30309  
Edward G. Graves, 100 Colony Square, (404) 892-2868

**Boston** 02116  
Robert L. Tagen, 607 Boylston St., (617) 262-1160

**Chicago** 60611  
James A. Anderson, Robert T. Franden, Edward R. Novak,  
645 N. Michigan Ave. (312) 751-3770

**Cleveland** 44113  
Willis W. Ingersoll, 55 Public Square, (216) 781-7000

**Denver** 80202  
Harry B. Doyle, 1700 Broadway (303) 266-3863

**Detroit** 48202  
John W. Maisel, 1400 Fisher Bldg., (313) 873-7410

**Los Angeles** 90010  
Richard R. Butera, 3200 Wilshire Blvd.-South Tower (213) 487-1160

**New York** 10020  
Blair McClenachan, 1221 Avenue of the Americas (212) 997-3584

**Philadelphia** 19102  
Robert G. Kliesch, George T. Broskey, Three Parkway  
(215) 568-6161

**Pittsburgh** 15222  
Edward C. Weil, III, 4 Gateway Center, (412) 391-1314

**St. Louis** 63011  
Richard Grater, Manchester Rd., (314) 227-1600

**San Francisco** 94111  
Richard R. Butera, 425 Battery Street (415) 362-4600

**Overseas Offices:**

**Brussels**  
Galerie Porte de Namur, 22-26, Chaussée de Wavre  
1050 Brussels, Belgium

**Frankfurt/Main**  
Elsa-Brandstroen Str. 2, Frankfurt/Main, Germany

**London**  
34 Dover Street, London W.1, England

**Milan**  
Via Baracchini No. 1, Milan, Italy

**Paris**  
17, rue Georges Bizet, 75 Paris 16e, France

**Tokyo**  
2-5, 3-chome, Kasumigaseki, Chiyoda-ku, Tokyo, Japan

# MOMENT OF DECISION

*The architect has a variety of materials from which to choose... he must consider the cost... the suitability for the purpose intended... the practicality of installation...*

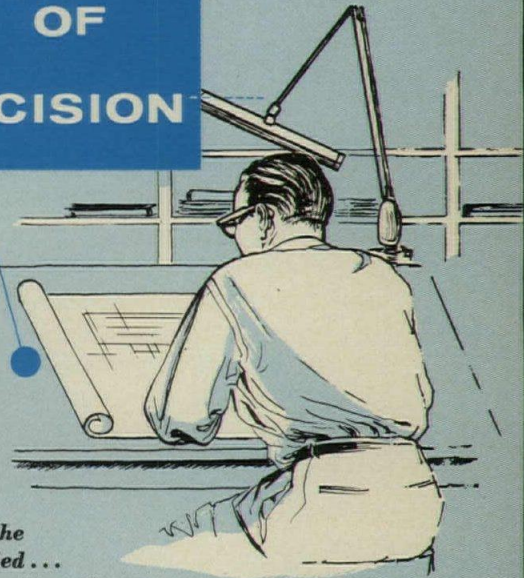

When he comes to subfloor  
**WATERPROOFING... he finds that**

# Compotite<sup>®</sup>

**is one-fourth to one-half the cost** of sheet lead, copper, or comparable weight butyl, neoprene or vinyl...

**is designed specifically** for direct installation on either wood or concrete without adhesives or asphaltic protection...

**easily fits any space** from showers in single widths to large areas by lapping...

**may be scheduled without interference** to other construction and thus satisfies his client by truly unstoping the bottleneck of the subfloor waterproofing phase of building!

**Compotite is available through wholesale plumbing suppliers in cut pans and in 100 foot rolls... in widths of 48"-54"-60"-72".**

Meets requirements of Model Plumbing Codes, FHA/VA, and Military Guide Specifications for Family Housing and for Plumbing, General Purpose.

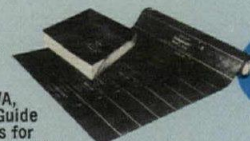

**Compotite**  
Shower Pan

P.O. Box 26188  
Los Angeles, Calif. 90026

For more data, circle 89 on inquiry card

# There's only one Fluoropon.<sup>®</sup> Don't settle for less!

Fluoropon is *the* leading full-strength fluorocarbon\* finish that has the super durable properties you need for long lasting beauty on your modern designs and constructions.

Let design innovation take over. Fluoropon offers outstanding adhesion and is flexible enough to withstand the toughest forming processes, the contours and configurations of today's modern designs.

You can count on full-strength Fluoropon's color consistency . . . batch-to-batch, year-to-year.

\*Fluoropon meets Pennwalt license requiring 70% Kynar 500<sup>®</sup> resin.

Future additions will match existing buildings even years from now; damaged panels can be replaced without showing.

Fluoropon keeps its rich sheen for years. It is unexcelled in gloss retention.

And, Fluoropon is *the* full-strength one that resists the unsightly effects of sunlight, humidity, and common solvents years longer than conventional finishes.

Its non-static surface also resists the potentially damaging effects of adhering dirt and general air pollution. Rain washes it clean. The savings in repainting and maintenance expense alone can

make it virtually pay for itself over the years.

Fluoropon offers all this, plus a range of colors including true bright whites, blues, golds, greens and garnets, as well as amber-bronze tones.

Don't settle for less. Write or call for more information on "the only Fluoropon." Fluoropon!



## DeSoto, Inc.

Chemical Coatings Division  
1700 South Mt. Prospect Road  
Des Plaines, Illinois 60018  
(312) 296-6611



Sears, Roebuck and Co. Floorcovering Distribution Center Alsip, Illinois

For more data, circle 84 on inquiry card