

# ARCHITECTURAL RECORD

The Legacy Continues

Samuel  
MOCKBEE  
GOLD MEDALIST

nting **AIA HONORS & AWARDS**

also in this issue

**25 Year Award: A Conversation With I.M. Pei**

plus **OFFICE INTERIORS**

*Introducing*

## THE STERLING DOUBLE HUNG



When Kolbe & Kolbe's Research & Development team set out to design the *Sterling Double Hung*, they consulted with architects, builders and industry experts from across the country to find the ideal concept behind the "perfect window." Up until now, window manufacturers have only come *close*. Kolbe & Kolbe's *Sterling Double Hung* is packed with everything you've wanted in a window, including less obtrusive hardware and truly concealed jamb liners. And, whether your project calls for the low maintenance of extruded aluminum cladding or the historic look of an all wood window with true divided lites, Kolbe & Kolbe can provide exactly what you've been looking for in a window.



Kolbe & Kolbe  
Windows & Doors

*See the Difference Quality Makes*

[www.kolbe-kolbe.com](http://www.kolbe-kolbe.com)

1-800-955-8177

# Letters

## Working globally

My profession whose environmental works range from the pyramids to the Uffizi Gallery to the Hong Kong Shanghai Bank to the Cincinnati Center for Contemporary Art to the Disney Performing Arts Center ... and to a country, ours, the United States of America, that is inclusive to all, of course, have a focal issue on Chinese Architecture [RECORD, March 2004], and of course Zaha Hadid recognized for architectural achievement.

When I am putting together that next wall or listening to the needs of the client, it is to know from the micro to the macro level our profession in America does extend itself beyond its walls.

I find inspiration in a profession where every day, I see, think, or hear something architecturally related that moves or inspires me.

*Margaret A. Harper  
Pittsburgh, Pa.*

## Extended Architecture

I read with great interest Robert Campbell's critique "Okay, architects, lighten up—but don't lose your ideals in the process" [Critique, May 2004, p. 67], in particular the point that architectural development has been characterized by mutually exclusive shifting foci. This is certainly true.

What we need is an architectural concept that encompasses the totality that comprises the architectural problem and that unifies two poles—on one the architect's personal capacity for insight, investigation, and imagination, and on the other the cultural reality of the site comprising its unique historical, humanistic, and ecological characteristics. This concept defines an "Extended Architecture"—architecture that takes its initial formal cues from the unique or particular historical, humanistic, and ecological characteristics of the project area as a whole. That applies both to the neighboring context in the case of a new building and to the existing building as the context for an interior/exterior renovation and/or rehabilitation. While taking its cue from the cultural reality of the site, Extended Architecture goes beyond simple contextualism and deductive derivation of form from consideration of the constraints of local context resulting, at best, in derivative architecture of good fit and perceptual continuity. Extended Architecture, on the other hand, juxtaposes the architect's personal (this is where the "playfulness" can come in!) reinterpretive flexibility of underlying principles as deductive idea

adding a universal or abstract dimension to architecture that supercedes the immediate environment—it is a poetic dimension that evokes meanings that are both related to the unique context from which they originate and are universal in that they touch on meanings and memories that are shared by other places. Extended Architecture is thereby a "lens" dialectically related to its context—an architecture that is both poetic and narrative—that is historically sensitive, ecologically sound, and reflects the special and unique character of the place and the people that it serves.

*—Val Zarro, AIA  
Pittsburgh, Pa.*

## Bringing down the house

I was both impressed and disturbed by the "feast of houses" offered in the April 2004 Record Houses issue.

On the one hand, I was impressed by the delicious collection of mouth-watering images. The stunning panoramas of ocean, desert, and sylvan landscapes were very appealing—dare I say "sexy." Upon closer examination, however, I wonder if this plate was served up empty. Do the seductive images obscure a troubling and continuing trend in the architectural press: promoting image over substance? I also wondered if the photogenic sites made these projects that much more publishable, and if creating beautiful architecture in a "high-end enclave ... along a precipitously steep sandy cliff cradling a secluded beach" isn't a bit facile.

I was disturbed by this focus on "high-end enclaves" in exotic locations. Of the nine offerings in the 2004 Record Houses, only one was displayed in an urban context, and only one integrated energy-efficiency into its design. The program was typically a "vacation" house (i.e., not a primary residence), typically in a semiremote locale, on several acres of land. The houses average over 3,000 square feet, accommodate an average of seven occupants, for an average of nearly 500 square feet per person. In lieu of the excesses of the 2004 Record Houses, it is ironic that one of the houses is praised "in its unadorned simplicity ... in counterpoint to ... multi-gabled McMansions." I suspect that in the final analysis, few McMansions use as many resources to construct or maintain as do many of the 2004 Record Houses. My suspicion is that the bourgeois, late-20th-century architectural ideal of the private house in the country needs to be reevaluated. It goes without saying that I am left with an unpleas-

KUSSER AICHA Graniteworks USA

Design with  
Natural Stone

Making the  
Impossible  
Reality!

- Original KUGEL Floating Ball
- Floating Objects
- Monumental Works of Art
- Granite Fountains, Waterwalls
- Natural Stone Elements
- Prestressed Granite
- Custom Design
- Complete Engineering Support



800-919-0080  
www.kusserUSA.com  
kusserUSA@kusser.com

Magdeburg, Germany  
Axis: Nero Assoluto granite, polished  
Disc: Balmoral granite, honed  
Scale 1:1.000.000  
Artist: Timm Ulrichs, Münster, Germany

Polar Axis of the Earth

## Letters

ant taste in my mouth.

How can we serve a more palatable dish that is both tasty and visually appealing? Is it possible for architects to create innovative design solutions that are both socially responsible and environmentally sustainable? Now is the time for our profession to reevaluate our responsibility to educate ourselves, and our clients, and to promote truly integrated, sustainable architecture. By this I mean more than paying lip service to "green" architecture, and LEED certified architecture. As a profession, we should critique whether each and every project we do is sustainable. As shepherds of the built environment, we need to develop sustainable practice through legislation, activism, and our actions. I challenge ARCHITECTURAL RECORD to lead the way by publishing more works that are truly innovative, socially responsible, and environmentally sustainable. Then we will truly

feast on a banquet of architectural delights.

—Kent Hikida, AIA  
Via e-mail

### Chicago on my mind

Just wanted to let you know how much I enjoyed reading last month's [May 2004] issue. I appreciate the way in which the articles were arranged to enliven the debate the issues raised; at least it appeared to be purposeful.

I cannot help but comment on the Soldier Field [Projects, page 114] and IIT [Projects, page 122] articles. First, I think that Mr. Giovannini does an excellent job of positing the issue, that is, Classical vs. Modern ideals vis-à-vis public space. The fact that the debate in this case is over a major sporting venue makes it even meatier. The contrast of Mr. Tigerman's opinion just adds flavor. I have to admit that my first take on

his "collage" was that it was a commentary on professional sports. Although I think that his views, strangely enough, sound like those of a past era, it does reflect the opinion of the average citizen shackled with the visual and financial weight of these massive projects. His comments regarding irony in this context brought to mind some of the sexualized floor plans by Robert A.M. Stern that I was introduced to in college.

Also, as it relates to the IIT projects, I could not help but think about the criticism of "American arrogance" that we are constantly barraged with from Europeans. Placing Rem Koolhaas next to Murphy/Jahn was terrific. Here we have the intellectually cool European shamelessly wagging his artistic arrogance around on American soil. Is it me, or does it appear that this project is a cross between a night club and a 1970s-era bowling alley?

—Chris McCray  
Associate Architect  
Fitzpatrick.Butler Architects  
Tyler, Tex.

### Cities making their mark

I really enjoy it when RECORD focus on a particular U.S. city in a single issue, such as May's Chicago issue or last year's November issue about Los Angeles. *This seems like a new tactic for the magazine, and I'm hoping that when you've covered all the biggies, you'll move to some of the smaller U.S. cities that are making their marks with good solid design and innovative solutions to housing, transportation, and sprawl.* Hopefully once you've covered San Francisco, New York, Dallas, and others, you'll move on to Portland, Seattle, and my favorite, San Diego.

—Rayne Adley  
San Diego

### Fans across the water

I have been reading ARCHITECTURAL RECORD for more than five years. Since I have an architecture background with a bachelor's degree in architecture, I need sources for new designs and research.

With its solid information on current design of the world's arch

## SatinTechTure™

an Arrangement Etched in Glass

Beauty and flexibility mean as much to the architect as the jazz musician.

SatinTechTure, Bendheim's exclusive new line of architectural glass, provides extraordinary elegance and design flexibility.

SatinTechTure etched glass styles can enhance a variety of architectural designs for commercial, retail, and residential applications. Whether the approach is traditional or contemporary, pragmatic or elegant. The crisp refined designs offered within the SatinTechTure line encompass both architectural and organic types.

Maintenance-Friendly.

Bendheim's exclusive etching process produces a permanent surface which prevents the absorption of grime, resists staining, and makes the glass easy to clean.

Now in stock for immediate delivery, SatinTechTure is available in tempered and laminated forms.

**BENDHEIM** since 1927  
www.bendheim.com  
See us at Booth #619

Bendheim East    Bendheim West  
800-835-5304    888-900-3064

New York Showroom  
212-226-6370

Cool. Clean. Refined.  
An arrangement etched in glass.

SatinTechTure  
from BENDHEIM

Fabrique

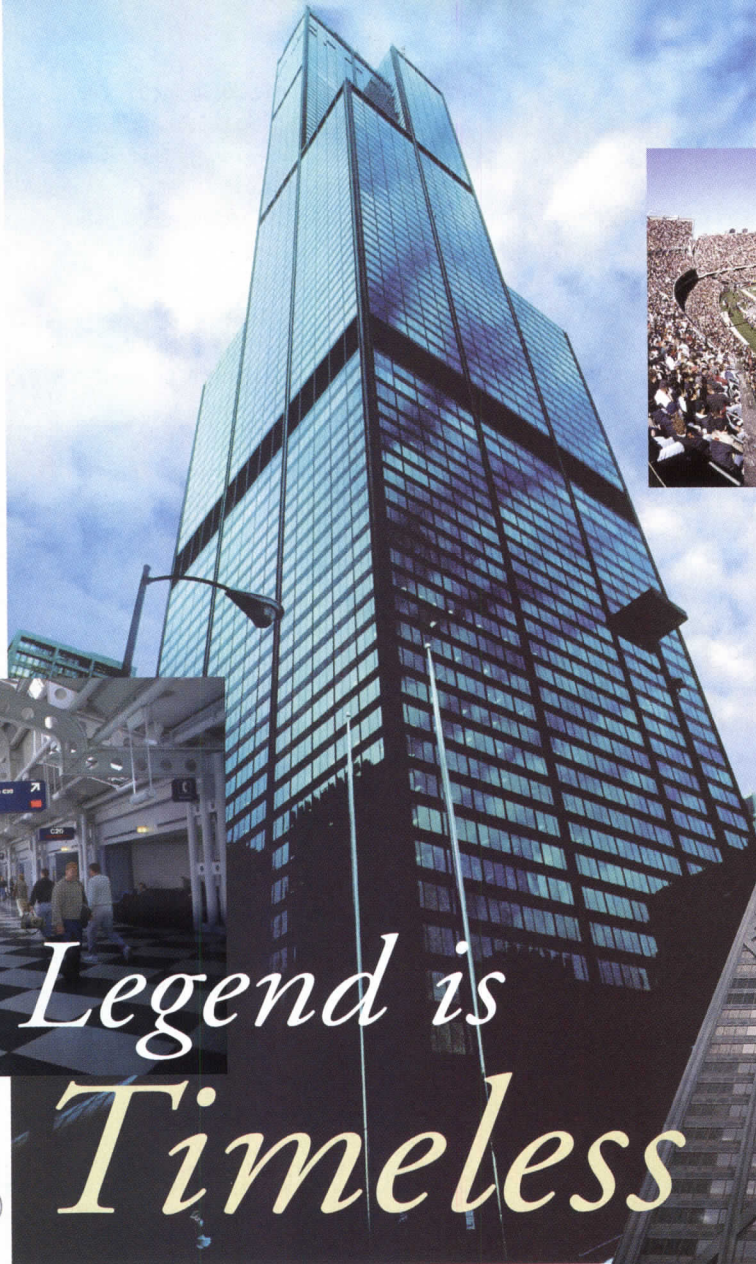

*Soldier Field*

*Sears Tower*

*John Hancock Center*

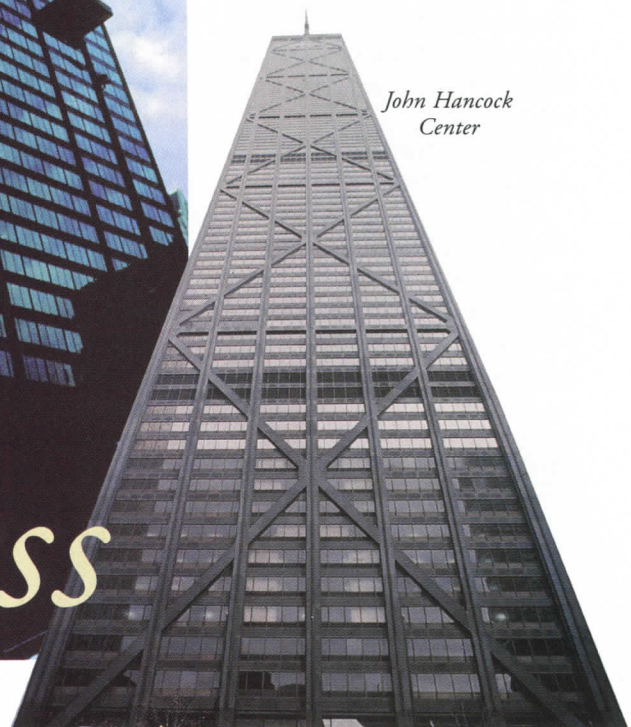

*O'Hare International Airport*

# *A Legend is Timeless*

A city is surrounded by legends. Since 1906, Sloan Valve Company has manufactured and sold more Flushometers to the world markets than all other brands combined.

From our manual Royal® Flushometers and Polaris® faucets ... to our electronic Optima® Flushometers and faucets ... from our new products such as Waterfree Urinals and XLerator® hand dryers to SloanStone® sinks ... Sloan is a legend.

**Welcome to the 2004 AIA National Convention and Design Exposition!**

For more information on the complete line of Sloan plumbing systems, visit [www.sloanvalve.com](http://www.sloanvalve.com) or call **800-9-VALVE-9 (800-982-5839)**.

**In China:**  
Sloan Valve Water Technologies (Suzhou) Co. Ltd.  
Suzhou New District, China  
[www.sloan.com.cn](http://www.sloan.com.cn)



# **SLOAN®**

**CIRCLE 20 ON READER SERVICE CARD  
OR GO TO [WWW.LEADNET.COM/PUBS/MHAR.HTML](http://WWW.LEADNET.COM/PUBS/MHAR.HTML)**

# Letters

ecture, RECORD helps me explore the latest designs of famous architects such as Steven Holl, Tadao Ando, Zaha Hadid, and others.

I accidentally discovered back issues of the magazine at the library, which I have also found fascinating.

I will become a faculty member of Thammasat University's school of architecture in Thailand, the most prestigious and innovative school of architecture in Thailand. The magazine is very valuable to me, but with shipping, the subscription cost is very high. I wonder if there is a way for me to get the magazine without paying such high costs?

—Non Arkaraprasertkul  
Bangkok, Thailand

ARCHITECTURAL RECORD is available in a new digital format, which you may find easier to get in Thailand than waiting for the print version, and paying shipping costs. The new digital

version is exactly the same as the print edition, with every page reproduced in the digital format. Visit <http://archrecord.construction.com/digital/> to try the service, and let us know what you think.—The Editors

## Corrections

The cover photograph of Soldier Field in the May 2004 issue should have been credited to Doug Fogelson (photo shown at right). Also, the Soldier Field and North Burnham Park Redevelopment project was completed as a joint venture between Lohan Caprile Goettsch Architects, with primary responsibility for the master plan and North Burnham Park project, and Wood & Zapata, with primary responsibility for the architectural design of Soldier Field. Joe Dolinar was the project manager for Lohan Caprile Goettsch on the assignment. A May News item about new designs for Los Angeles animal

shelters [page 36] omitted Rossetti Architects, of Southfield, Michigan. The firm worked on the South Central Los Angeles Animal Shelter. The curator of *Unbuilt Chicago* [Exhibitions, May 2004, page 77] is actually Martha Thorne, associate curator of architecture at the Art Institute of Chicago. Dan Wheeler is the installation designer of the exhibition. To clarify, in the May News section [page 42], the winning team for the new urban park in Milan is Inside Outside (landscape/interior designer—Amsterdam, Netherlands); Mirko Zardini (architect/urban theorist—Milan, Italy); Michael Maltzan Architecture (architect—Los Angeles); Irma Boom (graphic designer—the Netherlands); Piet Oudolf (botanist—Hummelo, the Netherlands); Ro D'or (technical engineer—the Netherlands). In the April Correspondent's File [page 79], the correct credit for the National Ballet School is: Kuwabara Payne McKenna Blumberg Architects,

Goldsmith Borgal and Company, architects in joint venture. Also in April, I like to clarify that in the April News article on San Francisco high-rises [page 44], the comments of John Parman, AIA, cochair of *Line*, the online journal of AIA San Francisco, w



his own and do not reflect the opinion of AIA San Francisco, its board of directors, or *Line*.

Write to [rivy@mcgraw-hill.com](mailto:rivy@mcgraw-hill.com)

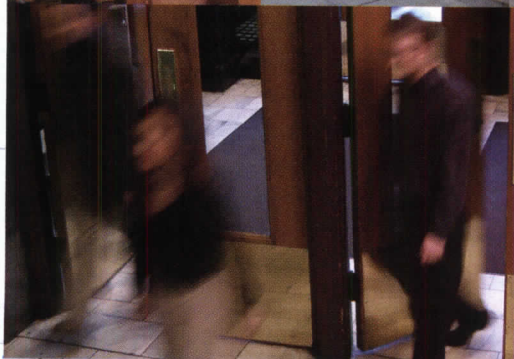

## The ideal way to specify quality door hardware, hinges and all.

Visit [www.hagerco.com](http://www.hagerco.com) to see our full selection of hardware. Register in the My Hager area to develop your own catalog and job record to log and store your door specifications.

Find exactly what you need including hinges, trim, thresholds, weatherstripping and sliding door hardware – all in one place. Every Hager product features solid construction for longer wear and lasting dependability.

For over 150 years, Hager has been dedicated to creating reliable door hardware. And now we've made it easier for you to specify hardware according to your project plan. To learn more about My Hager, log on our Web site or call us at 1-800-255-3590.

CIRCLE 21 ON READER SERVICE CARD  
OR GO TO [WWW.LEADNET.COM/PUBS/MHAR.HTML](http://WWW.LEADNET.COM/PUBS/MHAR.HTML)



[www.hagerco.com](http://www.hagerco.com)



Hinges



Roton



Thresholds



Trim



Weatherstripping



Sliding Door  
Hardware

## REBUILDING LOWER MANHATTAN

### Silverstein's court loss could put Trade Center plans in jeopardy

Because of his defeat in a May court case over insurance policies for the destroyed Twin Towers, real estate developer Larry Silverstein is facing a multibillion dollar shortfall in the funds that he needs to rebuild the World Trade Center. A federal jury in Manhattan ruled on May 3 that the majority of Silverstein's insurers owed one payout, not two, for the attacks. Instead of a hoped-for \$7 billion, Silverstein is now looking at compensation of between \$3.5 billion and \$4.5 billion, which is likely not enough to pay for all of the five buildings called for in Daniel Libeskind's master plan.

Silverstein maintains that his legal setback in court will not significantly affect development of the site. "What he [Silverstein] will do is every other real estate developer in the city does and has done in the past 50 years: traditional building," says Dara McQuillan, a Silverstein spokesperson. "He will build Freedom Tower and the other buildings as collateral for loans and the next ones."

But with a 12.9 percent vacancy rate for class A office space in Lower

Manhattan in April, there is widespread disagreement about Silverstein's ability to raise the estimated \$7 billion that it will cost to build the five office towers. Some speculate that the Libeskind plan



Silverstein leaving court in February.

might have to be modified to include slimmer residential towers, and that Silverstein could even lose control of a part of the World Trade Center site. "I think that [Governor Pataki] is going to be able to ease him out," says Peter Slatin, a Manhattan real

estate analyst. "There is no such thing as a master plan without money," adds Mitchell Moss, director of the Taub Urban Research Center at New York University.

Some argue that scaling back the overall master plan and incorporating more uses, including residential, on the site would help ease Manhattan's housing crunch and address the concerns of those who wanted Ground Zero to have a more 24-hour-a-day atmosphere. "If the demand isn't there for office space, I'd expect that they'd consider a broad mix of uses," says Jeremy Soffin, director of public affairs at the Regional Plan Association.

Some New York City real estate analysts, however, say that Lower Manhattan should easily be able to absorb the 10 million square feet of office space envisioned in the Libeskind master plan even though it may take more than a decade to build all of it. "I don't think even if there was \$7 billion available, that [Silverstein] would be building it now," says Michael Slattery, senior vice presi-

dent for research at the Real Estate Board of New York. "I think that everybody always understood that the pace of development was going to be tied to market demand. Would it have been easier if Larry Silverstein had \$7 billion than \$3.5 billion? Without a doubt, but it still wouldn't have resulted in buildings being built with no tenants."

While there has recently been a relatively large amount of empty office space in Lower Manhattan, the recent uptick in the economy looks promising for Silverstein. The increase in new office space occupied in Lower Manhattan for the first four months of 2004, 701,000 square feet, is on track to equal the increase of 2.9 million square feet for 2000, when the city's economy was booming, according to Robert Sammons, director of research at Colliers ABR, a real estate services firm. "With the economy showing signs of recovery, I think that we will need to be prepared to get these buildings up and running, because in the last boom the reason that we lost a lot of people and businesses to New Jersey is that we couldn't put buildings up fast enough." Alex Ulam

## WTC Briefs

**Freedom Tower ahead of schedule, and becomes a partner** On May 5, New York Governor George Pataki announced that the 1,776-foot World Trade Center Freedom Tower would break ground on July 4, two months ahead of schedule. He added that the dismantling of the Deutsche Bank tower, adjacent to the Trade Center site, would begin in the fall and be com-

pleted by 2005.

Meanwhile, in late April, World Trade Center Memorial designer Michael Arad joined New York-based Gary Edward Handel + Associates as a partner. "I felt that this was a group of people that I could work with very well," says Arad, who adds that the company's skills and resources will help him best "serve the memorial." Firm principle Gary Edward Handel firmly maintains that the new partnership will not

change Arad's vision for the memorial. "We have no desire but to help Michael with his vision," says Handel. Handel meanwhile brushed aside suggestions that Arad was too untested to be a firm partner. "I think if you spent time with Michael, he's remarkably talented and mature and has an incredibly clear vision of what he wants to accomplish. We have faith in his ability to perform not just on this project, but on ongoing work with the firm." Sam Lubell

A photograph of two soccer players in action on a green field. The player on the left is wearing a white and dark brown jersey and dark shorts, while the player on the right is wearing a blue jersey and dark shorts. They are both reaching for a soccer ball on the ground. The background shows a blurred crowd of spectators in a stadium.

Autodesk Revit. Because something designed for the job is better than something that isn't.

**Only Autodesk Revit delivers true building information modeling.**

No more coordination errors. True parametric modeling. 40% less production time. And that's before you get to the really cool part. Autodesk® Revit® is the only design software purpose-built for building information modeling. So it can help you gain, and keep, new clients—even in the most competitive business environment. Plus, it incorporates the compact, fast, secure DWF™ file format for viewing and publishing complex design data. And when you add the power of Autodesk Buzzsaw®, you bring new levels of collaboration and productivity to every phase of every project. Test drive the Autodesk AutoCAD® Revit® Series at [www.autodesk.com/revitdemo](http://www.autodesk.com/revitdemo)

**autodesk®**



REBUILDING LOWER MANHATTAN

Libeskind's World Trade Center guidelines raise doubts

Perhaps the biggest uncertainty at Ground Zero is whether the new World Trade Center will take shape, as other questions loom large. They revolve around Daniel Libeskind's World Trade Center Commercial Design Guidelines, which were issued in February in a "confidential" form and were recently reviewed by RECORD.

The guidelines are 267 pages long and their purpose, as stated, is to "describe the scale, character, and standards of development that support the master plan." They are separated into 10 thematic chapters focusing on areas of development, including "overall site development guidelines" and "public open space guidelines."

But a few members of New York New Visions (NYNV), a group helping establish design principles for Lower Manhattan, have argued that the guidelines are too vague and weakly worded to support Libeskind's plans for the Trade Center. Comments from Bruce Fowle, FAIA, of Fox & Fowle Architects in New York, and a member of the NYNV executive board, "There are lots of 'shoulds' but very few 'shalls,' so there is no real obligation to do anything. The most definitive thing was the sloped tops on the towers to follow Libeskind's radial scheme." Sam Gruzen, FAIA, also with NYNV and with Samton Architects in New York, adds that there's confusion in the guidelines whether anyone has the power to make anything happen. "They also maintains that there is little provision for oversight in the plans: 'They have yet to establish an administrative process, who is going to shepherd this, and who is going to make the decisions of where variances are going to be granted,'" he says.

The guidelines are indeed filled with "shoulds" and "mights," although they also feature many "shalls" and "musts," as well as concerns about, for instance, sidewalk widths

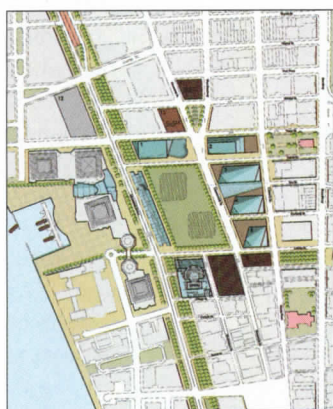
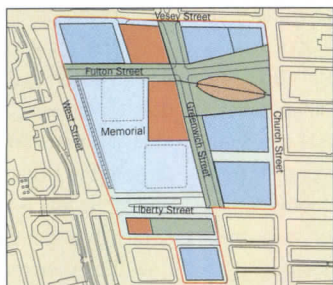

Master plan diagrams look similar: Daniel Libeskind's (left), Cooper Robertson's (below left), and Beyer Blinder Belle's (below) all feature comparable layouts. All faced similar site restrictions.



and the designs of building bases. Libeskind replies, "In the design guidelines, the major elements of the master plan are defined, maintained, and strengthened. Some have called them too loose, while others have called them too rigid. The intention is to strike a fair medium." Other building officials stress that the guidelines are still being developed and are not ready for scrutiny.

Meanwhile, Fowle also charges that Libeskind's designs for the site are starting to look similar to those originally proposed by Beyer Blinder Belle and Cooper Robertson back in summer 2002. Those plans were widely derided for a lack of imagination. All three plans, he points out, include an "assemblage of individualistic towers with a radial spiraling effect." The only difference, he says, is the Freedom Tower. Libeskind again begs to differ: "That's like saying a man and a chicken are the same because 98 percent is the same," he says. "It's that small difference that makes it radically different—the architecture, spirit, culture, space, design, and its meaning. The earlier plan was basically just an abstraction. There are so many subtle differences. How you articulate streets. How you make streets more important than the buildings themselves, and so on." S.L. and A.U.

So realistic, you can almost smell the new paint.

Get new Autodesk VIZ 2005.

Autodesk® VIZ 2005 is the 3D design and image creation software that presents your designs exactly as they would appear in real life. It offers a flexible and accurate way to visualize your designs at every stage of your project.

Now for a limited time, buy Autodesk VIZ 2005 with subscription for only \$1,240—that's a \$1,000 savings! For details, visit [www.autodesk.com/save1000](http://www.autodesk.com/save1000)

autodesk®

©2004 Autodesk, Inc. All rights reserved. Autodesk is a registered trademark of Autodesk, Inc., in the USA and/or other countries. All other brand names, product names, or trademarks belong to their respective holders.

The Think® chair conforms to your body. It also conforms to the highest environmental standards.

Yet it's so positively nonconformist.

When engineers, environmentalists

and top designer Glen Oliver Löw

put their heads together, the Think®

chair was born. Both graceful and

intuitive, it uses dynamic seat and

back flexors to support and follow

the movement of the user. The

Think chair's effect on the planet

has been equally well thought out.

Not only is it 99% recyclable; a

global Life Cycle Assessment was

conducted to determine its life-

long impact. To learn more about

Think, the chair with a brain and

a conscience, call 800.333.9939

or visit [www.steelcase.com](http://www.steelcase.com).

Steelcase®

## Record News

### REBUILDING LOWER MANHATTAN

#### 9/11 memorials, not just in Manhattan

As the highly scrutinized designs for the World Trade Center and Pentagon memorials continue to progress, several smaller, more specific 9/11 memorials of interest have also been developing. In at least one case, even construction has begun.

On Staten Island, contractors working for New York City's Economic Development Corporation broke ground for Staten Island's memorial, which its architect, Masayuki Sono, calls "Postcards." Sono has been working to refine the design with another architect, Lapshan Fong, since he won the open competition in June 2003.

"When I started working on the competition," Sono said, "I thought the most important thing was to connect the victims back to us."

That led Sono to develop his design, which is an abstract representation of two curling postcards. Individual Staten Islanders who died on September 11 will each have individual profiles on

"commemorative stamps."

North of New York City, Frederic Schwartz won a competition to design a memorial for Westchester County. Schwartz's design incorporates 109 steel rods, one for each Westchester victim, that swoop up from the ground to form a single spire.

Schwartz is also a finalist in a competition to design a memorial for a pier on the Hoboken New Jersey, waterfront. His entry, designed in collaboration with landscape architect Brian Toews, would put a framed ramp on the pier.

"The frame doubles as a lens through which to observe [the World Trade Center site] and reflect," Schwartz said at a public presentation at Hoboken City Hall in late April.

The FLOW group, comprising architect Jean Gang, artist Janet Echelman, and others, proposed an artificial island in the Hudson River, with a kinetic sculpture on top of 75-foot fiberglass columns.

Architect Ralph Lerner and landscape architect Kate Orff propose a series of 53 lights (one for each Hoboken victim) on top of 60-foot copper poles, along the south side of the pier. A path along the edge of the pier would lead to what Lerner described as an "ear of personal contemplation that focuses the sound of the river and orients viewers back to the World Trade Center site." The fourth Hoboken finalist team of Krzysztof Wodiczko and Julian Bonder showed a commemorative path along the pier. Wodiczko cited his Polish ancestry as part of the background of his and Bonder's design. "In Poland, Wodiczko said, "we say that somewhere between the memorials, there is Polar

Two sculptors are also adding memorials to the New York area. Anish Kapoor, the Turner Prize-winning artist, has designed a monolithic sculpture to anchor the British Memorial Garden, which will honor the 67 Britons who died in the World Trade Center. The garden will be in Hanover Square in Lower Manhattan, which has been designed by landscape architects Julian and Isabel Bannerman. In Brooklyn, Robert Ressler has designed an abstracted speaking trumpet that will serve as a beacon on the 69th Street in the Bay Ridge Section. Kevin Lerner



Memorial projects include Frederic Schwartz's plans in Hoboken (above) and Westchester (right), Masayuki Sono's in Staten Island (bottom right), and Robert Ressler's in Brooklyn (bottom left).

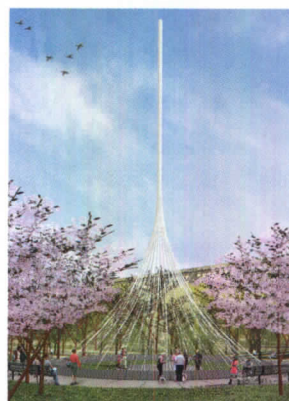

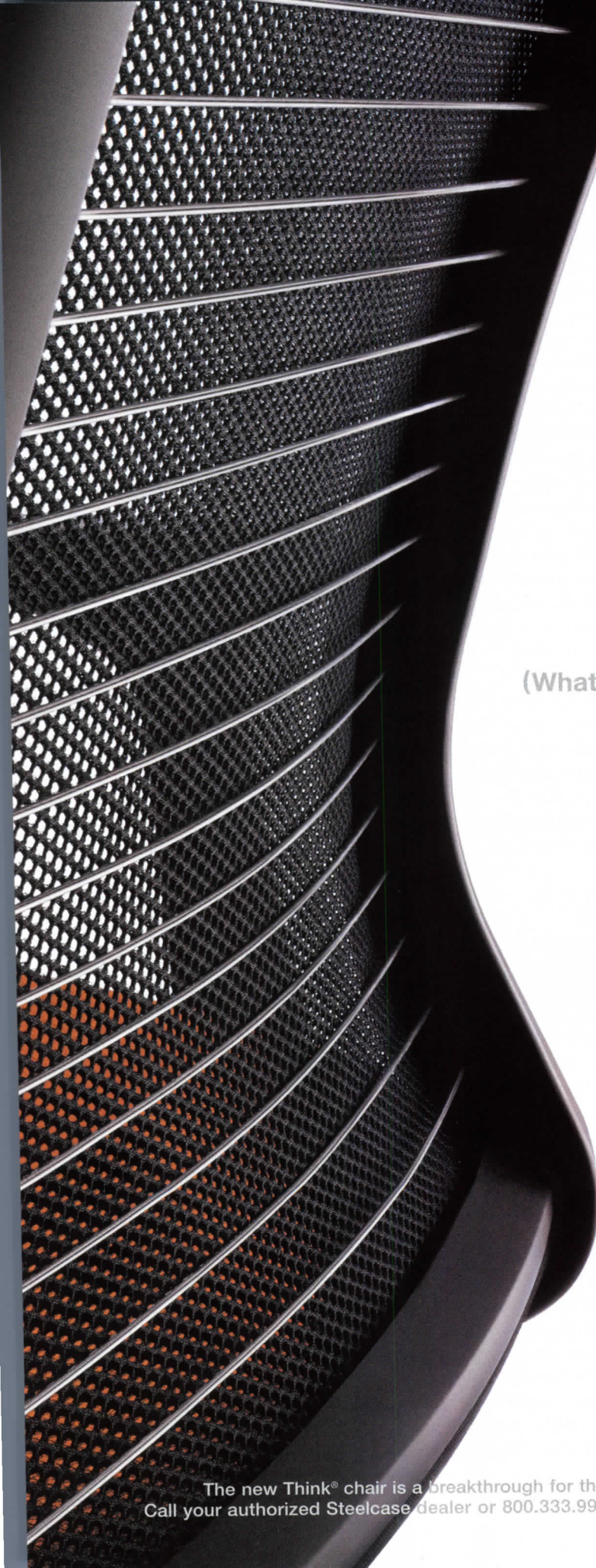

Introducing the chair with a  
brain and a conscience.  
(What an inspiration for the corporate world.)



The new Think® chair is a breakthrough for the planet and the person.  
Call your authorized Steelcase dealer or 800.333.9939. [www.steelcase.com](http://www.steelcase.com)

**Steelcase®**

# MÓZ

Decorative Metals  
+  
Custom Fabrication

Column Covers  
Aquaknox Restarant  
Las Vegas, NV.

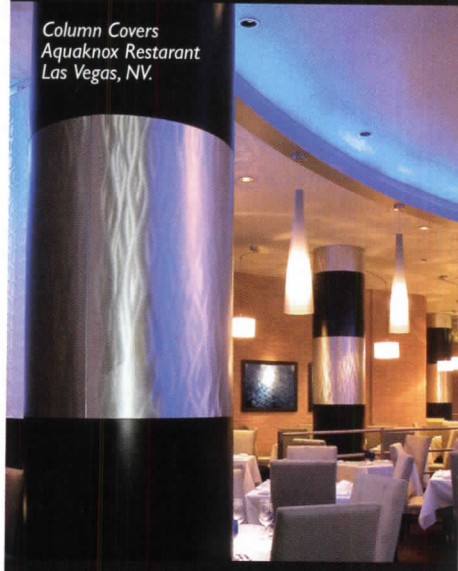

Custom Column Covers  
Golden Moon Casino  
Choctaw, MS.



**WE ENGINEER, BUILD  
& INSTALL**

column covers   canopies  
wall panels   signage  
ceiling panels   furniture  
room dividers   art

510.632.0853

[www.mozdesigns.com](http://www.mozdesigns.com)

## Record News

### MIT's Stata Center opens, raising issues about cost control

Last month, MIT officially opened Frank Gehry's much-anticipated Stata Center for Computer, Information, and Intelligence Sciences, the key-stone of the school's ambitious billion-dollar campus expansion.

The sprawling deconstructivist complex, which includes asymmetrical forms, interconnected interior spaces, and alternating titanium and brick surfaces, was at one point projected to cost \$200 million. The final cost was \$300 million. While Steven Holl's award-winning 2002 Simmons Hall dormitory, once estimated at \$60 million, came in at \$95 million. Both serve as case studies of institutional investment in serious architecture, with its potential for cost overruns and expensive program changes.

MIT's experience is hardly unique. Rem Koolhaas's Illinois Institute of Technology campus center ran into similar problems. Works by the likes of Gehry and Holl come at a premium and increase the risk of overruns, employing costly materials and often introducing techniques unfamiliar to most contractors, notes MIT executive vice president John Curry.

The projects also ran into a perfect storm of national and regional economic conditions, according to MIT officials, Gehry, and Holl's project architect Tim Bade. Having been planned during the go-go 1990s, MIT put several major projects up for bid just as the dot-com bubble burst and Boston's Central Artery Tunnel project tied up much of the area's construction capacity. The "Big Dig" drove up costs 25 percent in the Boston area, according to Gilbane Construction Company's 2000 review of MIT's construction plan, Curry says. Current trends in materials and fuel prices point to higher project costs, according to analysts, who blame the high cost of steel on a global shortage and U.S. import tariffs.

The Stata Center evolved from an early-1990s scheme for a 150,000-square-foot, roughly \$160 million building in keeping with MIT's Neoclassical main complex. A 1997 revision called for a 324,000-square-foot structure, at about \$200 million.

The tight market and MIT's addition of below-ground parking, a pedestrian thoroughfare and day-care and fitness centers dramatically increased costs. As of May, the official total for the 730,000-square-foot complex was \$283.3 million, of which about \$31 million went to design, according to project manager Nancy Joyce, who notes that much of the project's contingency went to cover construction costs.



The new Stata Center features folded titanium planes and an interior "student street."

Nonetheless, the Stata Center project was "in the norm for this type of lab building in the U.S.," says William Mitchell, head of the Media Arts and Sciences Program and architectural adviser to MIT president Charles Vest. The Stata project, "We've

engineered, cut things, bit bullets," Gehry adds.

Legal delays, MIT's rush to occupy Simmons Hall by fall 2002 and its addition during construction of kitchen and dining facilities, contributed to that project's runaway costs, according to participants. As of early May, MIT was reviewing the Simmons project for "errors and omissions," which are covered under the school's insurance policy, according to Curry.

In riding the late '90s investment wave and persevering through the downturn and project overruns, MIT's strategy has been one of "principled opportunism," says Mitchell. "It's an investment for a hundred years at the very least. You can't let short-term economic exigencies deter you." *Ted Smalley Bowen*

PROMISED TO SEE MORE  
OF HER SOCCER GAMES

KISSED TIME CONSUMING  
SERVICE CALLS GOODBYE

SWITCHED TO JELD-WEN  
WINDOWS AND DOORS

PROMISE KEPT



Int. Router  
Carved



Custom Wood  
Radius Casement



Clad-Wood Patio Doors



IWP® Cherry 383 N

happen just on the loading dock. It happens at her soccer matches and your family barbecues and all the moments in between. JELD-WEN helps give  
e of mind to enjoy these moments by crafting reliable windows and doors that are built to last. We're also committed to providing on-time, complete  
d hassle-free service. Find out more about the windows and doors you can rely on. Visit [www.jeld-wen.com/JW4](http://www.jeld-wen.com/JW4) or call 1-800-877-9482, ext. JW4.  
promises, so you can keep yours.

**RELIABILITY** *for real life*™

**JELD-WEN**  
WINDOWS & DOORS

, inc. JELD-WEN, IWP and Reliability for real life are trademarks or registered trademarks of JELD-WEN, inc., Oregon, USA.

CIRCLE 33 ON READER SERVICE CARD  
OR GO TO [WWW.LEADNET.COM/PUBS/MHAR.HTML](http://WWW.LEADNET.COM/PUBS/MHAR.HTML)

## Total Flooring Solutions



From decorative epoxy terrazzos and quartz broadcast systems to Micro-Topping architectural concrete overlays, turn to Dex-O-Tex systems for your **single-source solution**. We offer the latest polymer flooring technology to provide the right product for even the most challenging applications. Dex-O-Tex functional flooring products include decorative floors, repair products and underlayments, plus a wide range of coatings and sealers to ensure maximum performance. Call us at 866-354-9100 or visit our website at [www.dexotex.com](http://www.dexotex.com).



**Dex-O-Tex Division of Crossfield Products Corp.**

*Providing beautiful, seamless functional flooring solutions for over 65 years.*

CIRCLE 34 ON READER SERVICE CARD  
OR GO TO [WWW.LEADNET.COM/PUBS/MHAR.HTML](http://WWW.LEADNET.COM/PUBS/MHAR.HTML)

## Record News

### New plans making London a skyscraper capital

In 1991, London had only two skyscrapers, by global standards: the 800-foot Canary Wharf Tower, designed by Cesar Pelli, and the 600-foot National Westminster Bank Tower. The city has strict rules on building height, and permission to build skyscrapers is granted on a case-by-case basis—meaning the ones that get through are notable landmarks, like Norman Foster's Swiss Re tower (page 218). Swiss Re's transformation of London's skyline unleashes the prospect of a new picture-postcard image of London as skyscraper development is set to catapult it into a new era.

Renzo Piano's London Bridge Tower, for instance, dubbed "The Shard of Glass," is as slim and sharp as Swiss Re is tubby and textured. At 1,016 feet, it will be Europe's tallest building. Its steeply sloping facades of white glass will make the tower seem partly to disappear into the sky. The building's design sparked controversy and claims that it would spoil the skyline; others have praised it for the elegant, tapering shape that prompted its nickname. The tower will house offices, a hotel, restaurants, apartments, retail, and three viewing areas.

The tower's approval last fall represents a triumph for Mayor Ken Livingstone's support of tall buildings. One year ago, Livingstone announced plans to add up to 15 new skyscrapers in the city by 2013, and immediately came under fire from government inspectors; he has defused their criticism by saying they're necessary to ensure London's economic health. "The Corporation of London needs to ensure that demand for office space can be met within the Square Mile [where much of the city's financial industry is located]," says Judith Mayhew, who heads up policy and resources for the Corporation of London, the municipal governing body of the city. "In this context, tall office buildings are becoming increasingly necessary as a result of the efficient use that they make of the limited land available."

Numerous other projects point to the emergence of skyscrapers as a reality in the U.K.—the result of client demand for floor space as well as the iconic glory of their street presence. Recent tall

buildings include Richard Rogers's 122 Leadenhall Street, whose slender, tapering form is strikingly similar to Piano's "Shard." The 48-floor glass tower's transparency reveals its structural steel frame, with color and light adding depth and animation to the north-facing facade. It rises to a

height of 736.5 feet in the eastern cluster of tall buildings in London, which also includes the Heron Tower in Bishopsgate, designed by Kohn Pedersen Fox and approved in 2002. The 727-foot, 37-story tower arranges workplaces around a series of 11 triple-height atria. When completed in 2005, it will be one of the tallest buildings in the city. Mayor Livingstone reportedly joked "go back and make it bigger" when KPF initially presented a 590-foot tower.

Another skyscraper, the Minerva Building by Grimshaw Architects, also won recent planning permission. At 712 feet and 50 stories, it will provide more than 1 million square feet of office space. Its design is described by the architect as four open books standing on another. Its facade, which enables natural ventilation, is projected

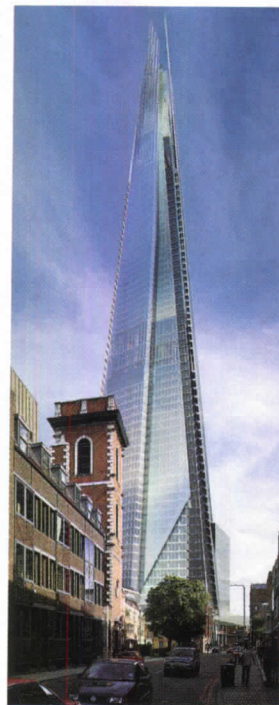

**Piano's London Bridge Tower.**

cut energy use by two thirds and eliminate the need for air-conditioning most of the year.

Even the architects of the London Eye have proposed a skyscraper design. Marks Barfield's 72-story Skyhouse would house shops, health clubs, nurseries, restaurants, and gardens. Yet most of the city's proposed skyscrapers are designed for purely commercial rather than residential or mixed-use needs.

Convincing evidence of the need for new skyscrapers in London will come as they fill up with tenants, theoretically. Meanwhile, the rigor of the mayor's policies and the Corporation of London's advocacy of good design will act in concert to ensure, with luck, that only exceptional projects are realized. "Our skyline has seen exciting and rapid change," says Peter Rees, chief planner for the Corporation. "The public can find that hard to accept, because it has been poorly served by architecture in the postwar period. Size isn't everything. I want to see buildings with flavor."

*Lucy Bullivant*

the only  
*characteristic*  
of wood we  
couldn't *imitate*.



**AURORA™ COLLECTION** | Every IWP Aurora custom composite door is designed to emulate real wood doors (minus the fresh forest). These doors look and feel like wood, yet they offer low-maintenance performance that genuine wood just can't match. In fact, IWP doors are engineered to withstand harsh weather and extreme temperatures for years. These benefits, as well as a host of options, are sure to enhance any home. To learn more about reliable JELD-WEN® doors, visit [www.jeld-wen.com/auradoors2](http://www.jeld-wen.com/auradoors2). IWP Aurora A1202 in Knotty Alder Woodgrain with a Bordeaux Speakeasy Grille; Inset, IWP Aurora A252 in Mahogany Woodgrain.

**RELIABILITY** *for real life*™

**JELD-WEN**  
WINDOWS & DOORS

JELD-WEN, inc. JELD-WEN, Aurora, IWP and Reliability for real life are trademarks or registered trademarks of JELD-WEN, inc., Oregon, USA. "CAR-FRESHNER", and "ROYAL PINE" are registered trademarks of Julius Sämann Ltd., and are used with permission.

CIRCLE 35 ON READER SERVICE CARD  
OR GO TO [WWW.LEADNET.COM/PUBS/MHAR.HTML](http://WWW.LEADNET.COM/PUBS/MHAR.HTML)

The best wheelchair lift  
in the industry



Inside...



and Out

- Fiberglass shell won't rust
- Available in 28 standard colors
- In stock and ready to ship
- Industry's longest warranty

Give us a call to see how your business can benefit from selling Inclinator's Spectraliff®.

**INCLINATOR**  
COMPANY OF AMERICA

www.inclinator.com • 800-343-9007

Dept. 66

## Record News



Boston's new redevelopment zone (left) includes needed green space (in green, below).



### New plans forming above and around Boston's "Big Dig"

Only a few hulking remnants of the I-93 platform clutter Boston's Surface Artery as the "Big Dig" wraps up, giving this swath of downtown the air of a movie lot at the end of a production. The next feature, something of a revival, is generating major buzz.

While much has been made of the above-ground projects capping the Big Dig, little has been done to clarify how they will work as a whole and mesh with the surrounding city. With this in mind, Boston officials have weighed in with a district-level scheme for the property along the fringes of the roughly 30-acre arc of reclaimed land, the new Rose Kennedy Greenway.

Urban planner Ken Greenberg of Toronto-based Greenberg Consultants presented the program at a public meeting recently, which also marked the kickoff of a 7-to-10-year public/private capital program to fund planning, improvements, and maintenance for areas adjacent to the artery. Construction of the Greenway's parks, cultural institutions, commercial, residential, and mixed-use projects is due to begin next year. The city has earmarked \$1 million in its 2005 budget for the effort.

The district boasts access to the South

Bay/Fort Point Channel, Boston Harbor, the new Harbor Island National Park, and the Charles River.

"Boston is becoming a waterfront city again, but in a profoundly different way" than in its maritime and industrial past, says Greenberg.

The evolving plan calls for improving pedestrian access (the transitions into the Greenway and throughout the waterfront area), widening sidewalks, planting trees, improving signage, and adding mixed-use and affordable housing to its waterfront. The integration scheme also promotes nighttime uses and year-round activities throughout the district and envisions connecting the area's multiuse trails to the waterfront district.

The Massachusetts Turnpike Authority is overseeing the \$1

billion federal-state Central Artery/Tunnel Project and is heading up the development of the state-owned surface artery. Nearby property owners and business tenants, whose real estate value and quality of life stand to benefit, will be tapped for contributions toward improvements and upkeep, and the city will seek philanthropic support for events and activities to be staged in the Greenway, and projects like the proposed fountain, according to Maloney.

The city and the Massachusetts Pike Authority have agreed on the broad outlines of plans for parks along the Greenway, particularly Chinatown and the North End, and are hammering out differences over the central wharf district parks, according to Maloney. The parks are expected to be finished in 2007 at the earliest.

Complicating matters, ownership and maintenance of the Greenway parks is under dispute. Governor Mitt Romney fights the Massachusetts Turnpike Authority for long-term control.

"The city [wants] to have a governance structure that can be responsive to the mayor," says Mark Maloney, director of the Boston Redevelopment Authority, the city's planning development arm. *Ted Smalley Bowen*





we build our *craftsman doors*  
from *memories.*

**MORGAN COLLECTION** | At JELD-WEN, we remember a time when everything was crafted from natural elements. When, quality was evident everywhere you looked, from hand-built toys to classic Arts & Crafts architecture. Take customers back to this time with JELD-WEN® craftsman wood doors from the Morgan Collection. We created these doors to satisfy today's design demands beautifully and reliably, with a wide range of wood species, glass and coming options. To learn more about JELD-WEN Premium Wood Doors and all our reliable windows and doors, visit [www.jeld-wen.com/craftsman](http://www.jeld-wen.com/craftsman).  
1837 Premium Wood Door in Pine.

**RELIABILITY** *for real life™*

**JELD-WEN®**  
WINDOWS & DOORS

# Lightology

North America's premier contemporary lighting source



CHICAGO SUMMER NIGHTS:  
WORK HARD, PLAY HARD.

## AIA 2004 Convention and Design Expo

Booth 3263 – Showing new products  
in the Lightology Collection



• June 10, 6:30 pm:  
**CEU training** FOOD & DRINK  
PROVIDED  
**Cutting Edge  
Lighting Techniques  
for Interior Architecture**

**Paul Gregory**, Focus Lighting, Inc. - NYC  
Location: **Lightology** (shuttle provided from Expo)



• June 10, 6:30 pm-Til?:  
**"Welcome Architects"  
rooftop party**  
**Food, drink, music, prizes**

Location: **Lightology** (shuttle provided from Expo)



• June 11, 4:30 pm:  
**CEU training** FOOD & DRINK  
PROVIDED  
**21st Century  
Daylighting**

**James R. Benya** PE, FIES, IALD, LC  
Location: **Lightology** (shuttle provided from Expo)

Register, RSVP or for more info:  
[Lightology.com/AIA2004](http://Lightology.com/AIA2004)

See Us at NeoCon Booth 2-1115  
CEU & Party Info:  
[Lightology.com/NEOCON04](http://Lightology.com/NEOCON04)

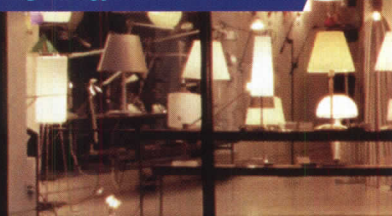

215 W. Chicago Avenue  
Chicago, IL 60610  
866.5LIGHTS • [www.lightology.com](http://www.lightology.com)

## Record News

### National World War II Memorial opens in Washington

With little fanfare, the National World War II Memorial opened to the public in Washington, D.C., on April 29. Designed by a team led by Los Angeles-based architect Leo A. Daly, FAIA, and Rhode Island-based architect Friedrich St. Florian, AIA, the memorial honors the 16 million people



The rainbow pool, backset with granite pillars.

who served during the Second World War, and the more than 400,000 who died.

Located between the Washington Monument and the Lincoln Memorial, the design is dominated by the Memorial Plaza, a round granite space lined with bronze plaques, and the Rainbow Pool, a curvi-

linear pond adorned with fountains on either end. Two 43-foot arches, signifying hostilities in the East and the West, mark entries on the north and south ends of the plaza, while 56 granite pillars, representing each state and territory, surround the pool, connected by bronze oak and wheat wreaths.

The space is meant, describes St. Florian, to provide contemplative quiet, with simple stone arches looming above the tranquil (yet celebratory) fountain. "I didn't want to have any ornaments. I wanted just the details of the stones to speak for themselves," he says. Classical architecture, meanwhile, evokes the aura of stability and reason felt throughout most of the Capital, he adds. Critics, meanwhile, have complained that the memorial blocks the vista between the Washington Monument and the Lincoln Memorial, and that the design is too austere and unrefined.

The memorial was conceived in 1993, and construction began in September 2001. More than \$195 million in cash and pledges have been received for the project, with \$16 million from the federal government. At press time, an official dedication was scheduled to take place on Saturday, May 29—the Memorial Day weekend. S.L.

### Paris unveils new ideas for Les Halles

The City of Paris recently unveiled four projects in competition for a complete redesign of the area known as Les Halles. For centuries, Les Halles had been the city's central market. By 1969, the neighborhood was choked by traffic, and the market was moved near Orly airport. In its place, the Forum des Halles, a half-buried commercial center, was built as the entrance to an important transportation hub. Then, in the 1980s, Paul Chemetov designed an extension to the underground complex, while a 10-acre park was created above. The result is a warren of disconnected spaces that together form the city's largest mall.

The city's main objectives for Les Halles are to create fluid and rapid access between underground levels and the city, to add value to the surrounding historic structures, and to improve security and the quality of the architectural landscape. Work must be phased to allow the 200 Forum businesses to stay open or be relocated.

The four finalists are AJN/Jean Nouvel, MVRDV/Winy Maas, OMA/Rem Koolhaas, and



Seura/Mangin employ modern lighting and colors.

Seura/David Mangin. Nouvel's project covers the most area, adding buildings along both sides of the park and out into the neighborhood. Koolhaas created transparent "control towers" that evolved from the underground layers like volcanic eruptions, while his "canyon" opens the view to the train concourses below. All four projects used the idea of a dynamic vertical opening leading down to the trains. Maas has then added a layer above ground with alternating areas of garden and transparency. Mangin's plan creates a central axis leading to the old commodities exchange building converted into a new cultural and restaurant.

Projects are on display within the Forum des Halles, and Parisians have been encouraged to vote for their favorite. A winner will be chosen in late 2006, and first phase construction is to be complete by 2007. Claire Downey



Wood Windows  
with Exclusive  
20-year Warranty

wood *windows* and *patio doors* that last  
as LONG as the WOODS THEMSELVES.

AuraLast™ wood, the beauty of JELD-WEN® wood windows and patio doors simply lasts longer. AuraLast wood is solid pine which has virtually 100 percent penetration of the active preservative ingredients. So it's protected from wood decay, absorption and termite infestation all the way to the core. Our windows and patio doors with AuraLast wood are also backed by a superior 20-year warranty. To learn more, please call 1-866-447-7580 or visit [www.jeld-wen.com/auralast\\_ar](http://www.jeld-wen.com/auralast_ar).

RELIABILITY *for real life*™

**JELD-WEN**  
WINDOWS & DOORS

get  
 v  
 I need  
 cabinetry  
 specs to  
 create great  
 designs.  
 at  
 kraftmaidspec.com



Only KraftMaidSpec.com lets you download AutoCAD drawings of every single cabinet and gives detailed information on door styles, finishes, storage solutions and our quality construction. Visit KraftMaidSpec.com and see why so many architects rely on it as their design resource.

Made just for you.

**KraftMaid**  
 Cabinetry

www.kraftmaidspec.com

CIRCLE 40 ON READER SERVICE CARD  
 OR GO TO WWW.LEADNET.COM/PUBS/MHAR.HTML

## Record News

### Adjaye to design Denver Contemporary



The Denver Museum of Contemporary Art recently announced its choice of David Adjaye of Adjaye/Associates, London, to design its permanent building.

The 15,000- to 20,000-square-foot structure will provide the museum—which currently has no permanent home—with spaces for galleries, education, lectures, and movies, as well as an outdoor sculpture center.

Adjaye was chosen among an impressive field that included TEN Arquitectos of Mexico, Snohetta of Norway, Rick Joy Architects of Arizona, Predock\_Frane of California, and Gluckman Mayner Architects of New York. The selection process included extensive interviews from not only museum officials but from the public, in the form of open discussions.

"We asked for an architect who would build a building that supports rather than defines the



Adjaye (left) has already designed high-profile contemporary work like the Idea Store (above).

mission," notes curator and director Sydney Payton. "David had a direct relationship to the mission, and he had a clear understanding of contemporary art."

Adjaye/Associates, formed in 2000, has designed buildings for the Nobel Peace Center Oslo, Norway, the Idea Store libraries in London (scheduled to be opened by the end of the year) and two libraries in Tower Hamlets, England.

Founded in 1996, the Contemporary is now located in a temporary space in Denver's Sak

Square. Daniel Libeskind's upcoming Denver Museum of Art is located less than a mile away, and the two buildings will be the city some of the most dynamic architecture in the country. "We hope it brings attention to Denver. It's part of an ongoing architectural dialogue with what's happening here," says Payton. The building is scheduled to open in late 2006. S.L.



Libeskind's Denver Museum will be just minutes away.

### Piano's Los Angeles County Museum of Art Design approved

Renzo Piano's design (rendering, below) for an estimated \$100 million upgrade of the Los Angeles County Museum of Art (LACMA) recently received board approval. Unlike the previous scheme, presented by Rem Koolhaas in 2001 and later abandoned due to cost, Piano blends old buildings with new ones while still creating a cohesive architectural experience.

Plans call for a new three-story, 80,000-square-foot Broad Contemporary Art Museum, plus 20,000-square-foot, glass-enclosed entry pavilion along the axis of Ogden Drive. Additionally, there will be an 800-foot-long pedestrian concourse that cuts through the entire site, linking the new structures to the LACMA West, the former May Company building at Fairfax Avenue and Wilshire Boulevard, and the existing complex to the east. In order to create more visual unity, the buildings will all be wrapped in light-weight fabric screens.

Museum officials hope to break ground on the improvements by December 2005, and finish by summer 2007. Tony Illia

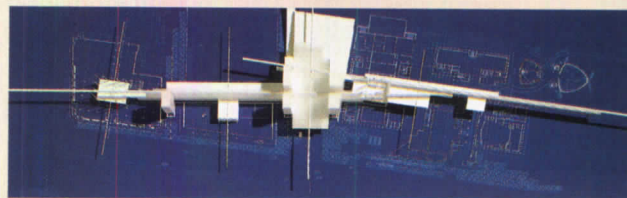



Life.

PRUDENTIAL LTG.

From light comes life.

From Prudential Ltg. comes life that no other lighting company can offer. Designs that are as beautiful as they are innovative. Products built with genuine American reliability and price points that work with today's price conscious budgets. Light creates life. Create with Prudential Ltg.



[www.prulite.com/ARlife](http://www.prulite.com/ARlife)

CIRCLE 41 ON READER SERVICE CARD OR GO TO [WWW.LEADNET.COM/PUBS/MHAR.HTML](http://WWW.LEADNET.COM/PUBS/MHAR.HTML)



the ultimate cable system

## Arakawa

Arakawa Hanging Systems supplies quick-release cable grippers for hanging art, signage or shelves, stair balustrades, or suspending light fixtures.

With the Arakawa Gripper system, your displays are secure and locked in place but quickly adjustable to modify displays at will. The mechanical grip fastens to the cable, eliminating set screws and damaged cable.

Visit us today.

[www.arakawagrip.com](http://www.arakawagrip.com)

no set screws

### Arakawa Hanging Systems

1020 SE Harrison Street Portland, OR 97214  
phone: 503.236.0440 fax: 503.236.0427  
toll free: 888.ARAKAWA

## Record News

### New Entrance Completed for Brooklyn Museum of Art

The Brooklyn Museum of Art finally reopened its front doors in April, thanks to New York-based Polshek Partnership's front entrance and public plaza.

The \$63 million project uses an elaborate roof of stepped, shingled glass to create a 15,000-square-foot entrance pavilion, projecting a modern face in front of the McKim, Mead and White Beaux Arts masterpiece. The glass steps recall the building's original, tall entrance stairway, while the space, notes Polshek principle James Polshek, will be used for gatherings and fundraising events. But its main function, he adds, will be as "a meeting space for the community," like similar areas at the British Museum in London and the Louvre in Paris. "It's part of an emerging redefinition of the modern museum," says Polshek.

The redesign also reshapes 82,000 square feet of public space, with new trees, plantings, and pavings organized in a formal semicircular configuration. Already a highlight of the space for visitors



The new entrance, made mostly of glass and steel.

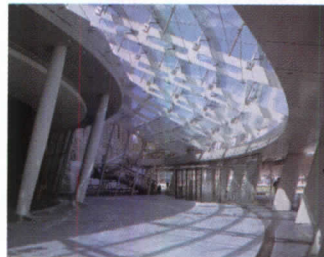

is a new fountain, designed by Los Angeles firm WET Design (which designed the Bellagio fountains in Las Vegas), which uses "dancing" water jets to create a kinetic show.

Other improvements include upgraded public amenities, a new floor surface and air-conditioning for the lobby, and a restoration of the Eastern Parkway facade of the building. The project's first phase took place from 1998 to 2000, while the most recent phase began in 2000. S.L.



### Ford Calumet winner announced

Studio Gang Architects, led by Jeanne Gang, AIA, and Mark Schendel, AIA, were announced winners in April of a two-stage international competition for the \$6.8 million Ford Calumet Environmental Center in Chicago.

The proposed building's setting on the city's far-southeast side is an undeveloped wetland surrounded by heavy industrial uses that have ravaged the area's natural landscape for the past century. Sponsored by the Chicago Department of Environment, the Illinois Department of Natural Resources, and Chicago's Environmental Fund, the building will utilize LEED standards for sustainable building.

The 26,800-square-foot, single-story structure (rendering, above) will be built to a seed-shaped plan with a glass wall along its

south facade. Shaded by a porch constructed of steel rebar and other discarded man-made materials found near the site, the building is intended to sit lightly on the land. Salvaged bundles of steel columns will be driven into the marshy site to support the structure. Slag will be used as a surface material in the exterior garden and as aggregate for terrazzo in the interior floors.

"We're weaving discarded materials into something more refined, like a basket," explains Gang. The firm's design was chosen from an original field of 108 architects representing seven countries.

Questions were raised after the announcement, when it was revealed that Studio Gang's predecessor firm, Studio Gang/O'Donnell, had prepared the initial program statement for the project but David Reynolds, first deputy commissioner of the Department of Environment, points out that the draft was three years old, had changed in scope, and was for a different site. The jury's recommendation is currently being reviewed by the City's Public Building Commission. The building is scheduled to open in 2006. Ed Keegan

*uptown/  
downtown/  
out of town!*

*wherever your  
projects take you  
get there in style  
with OMNIA*

**OMNIA**

*Stainless Steel Architectural Hardware that Complements any Style*

Phone: (800) 310-7960 • [www.OmniaIndustries.com](http://www.OmniaIndustries.com) • Available through authorized distributors.

CIRCLE 43 ON READER SERVICE CARD  
OR GO TO [WWW.LEADNET.COM/PUBS/MHAR.HTML](http://WWW.LEADNET.COM/PUBS/MHAR.HTML)



# English Edge<sup>®</sup> Pavers

Classic Elegance  
and Warmth from



Pine Hall Brick

The warmth and elegance  
of the English Edge<sup>®</sup>  
series of pavers  
makes it at home  
in any setting.

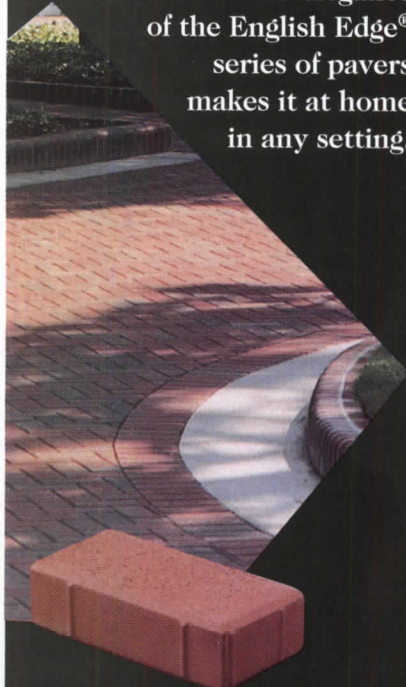

Our full line of pavers meets or  
exceeds ASTM C902 SX Type 1 PX

Call 1-800-334-8689 to talk to one of the  
trained paving specialists on our staff.

English Edge<sup>®</sup>  
AMERICA'S PREMIER PAVER™



Pine Hall Brick Co., Inc.  
P.O. Box 11044  
Winston-Salem, NC 27116-1044

CIRCLE 44 ON READER SERVICE CARD  
OR GO TO WWW.LEADNET.COM/PUBS/MHAR.HTML

## Record News

### AIA names the top 10 green projects for 2004

On Earth Day, April 22, the AIA's Committee on the Environment (COTE) named its seventh annual Top 10 Green Projects, a diverse collection of structures ranging from new construction to renovations, a single-family residence built in modular form to a large office building for a pharmaceutical company.

The top projects hail from seven states and Canada, representing more geographic diversity than last year's winners, half of which were located in California. The winning projects are The **Solaire** in New York City, by Rafael Pelli of Cesar Pelli & Associates Architects; the **City of White Rock Operations Building** in British Columbia, by Busby + Associates Architects; **Factor 10 House** in Chicago, by EHDD Architecture; the **Genzyme Center** in Cambridge, Massachusetts, by Behnisch, Behnisch & Partner; **Greystone Bakery** in Yonkers, New York, by Cybul & Cybul Architects and Maya Lin; the **Herman Miller Building C1** in Zeeland, Michigan, by Krueck & Sexton Architects; **Lake View Terrace Library** in Los Angeles, by Fields Deveraux Architects & Engineers and Greenworks; the **Pierce County Environmental Services Building** in University Place, Washington, by the Miller/Hull Partnership; **The Plaza at PPL**

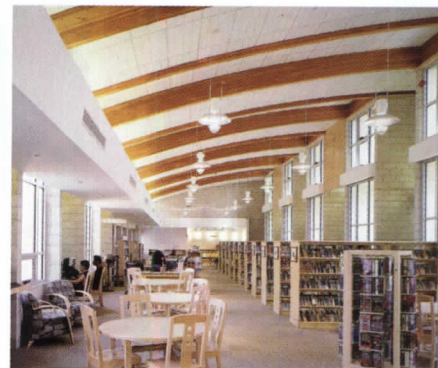

The Lake View Terrace Library in Los Angeles.

**Center** in Allentown, Pennsylvania, by Robert A.M. Stern Architects; and the **Woods Hole Research Center** in Falmouth, Massachusetts, by William McDonough + Partners.

The variety of designers and projects signifies a nascent mainstreaming of sustainability, notes COTE chair Mark Rylander, AIA. "Our



White Rock Building.

emphasis has moved from nature centers and buildings are clearly trying to accomplish environmental goals to a broad spectrum of building types whose programs include strong social and environmental commitments. We want to ensure that COTE isn't viewed as the solar energy wing of the AIA, rather represents the core mission and values of all architecture. Deborah Snoonian, P.E.

### Preservationists lose fight for Two Columbus Circle

A planned redesign of Edward Durrell Stone's legendary but long-vacant 2 Columbus Circle moved one step closer to reality on April 15, when New York State Supreme Court Justice Walter Tolub dismissed a suit brought by local preservation groups. The suit sought to block the planned May sale of the building by New York City to the American Museum of Arts and Design (formerly the Chrysler Museum), contending that the City Landmarks Preservation Commission, by not holding public hearings, had failed to produce the comprehensive environmental impact review required for such property transfers.

Portland architect Brad Cloepfil, AIA, has proposed a renovation for the structure, the former Huntington Hartford Museum of Art, that replaces the existing monolithic marble facade with a semi-translucent cladding of terra-cotta tiles and geometric glazed incisions. The interior would feature new atrium and circulation space, while a basement auditorium would be restored. Kate Wood, executive director of Landmark West, one of the groups that brought the suit, says they are considering their options, which include an appeal, additional lawsuits, and intervention or advocacy from the National Register of Historic Places and the National Trust for Historic Preservation. "The legal story for the building is not over," she says, but "the ultimate venue might be the court of public opinion." *Thomas De Monchaux*



# ROHL

## COUNTRY KITCHEN



Call, or visit [www.rohlhome.com](http://www.rohlhome.com) to locate the nearest independent showroom or to request a ROHL catalog.

If you prefer authenticity, ask for ROHL.

Genuine ROHL Country Kitchen faucets combine traditional craftsmanship and original designs with state-of-the-art technology and performance. Experience authentic luxury with every twist or turn of the handle.

A wide selection of spouts, levers and sidesprays are offered in authentic Tuscan Brass, Satin Nickel, Inca Brass, Polished Nickel and Polished Chrome finishes to enhance the rustic warmth or colonial charm of your distinctive environment.

Accept no substitute. Ask for ROHL.

**ROHL**  
The Experience of Authentic Luxury™

1559 Sunland Lane, Costa Mesa, CA 92626 (714) 557-1933 Fax (714) 557-8635 • New York Metro • San Francisco • [www.rohlhome.com](http://www.rohlhome.com)

CIRCLE 45 ON READER SERVICE CARD  
OR GO TO [WWW.LEADNET.COM/PUBS/MHAR.HTML](http://WWW.LEADNET.COM/PUBS/MHAR.HTML)

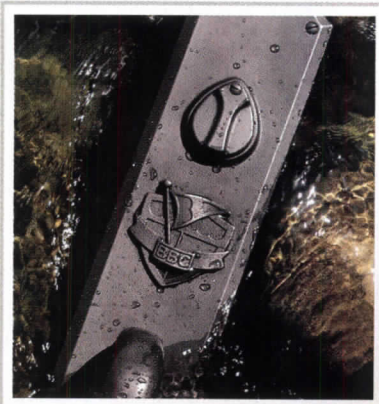

## Stone River Bronze

quality bronze hardware for those with discerning taste

- door hardware
- accessories • hinges
- cabinet hardware
- bath hardware
- window & patio door
- classic series
- designer series

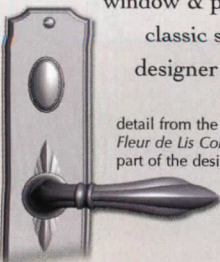

detail from the  
Fleur de Lis Collection  
part of the designer series

StoneRiverBronze.com

CIRCLE 46 ON READER SERVICE CARD  
OR GO TO WWW.LEADNET.COM/PUBS/MHAR.HTML

## Record News

### Holocaust Center's design conjures up difficult memories

The Holocaust Memorial Center in Farmington Hills, Michigan, outside Detroit, opened its controversial new building last month.

The structure, designed by Neumann/Smith & Associates of Southfield, Michigan, uses steel cable wrapped around a redbrick facade to evoke imagery of a Nazi concentration camp. Furthermore, glass and brick towers along the building's periphery give the impression of guard towers, while alternating grays on the facade of some buildings in the complex are meant to remind visitors of the uniforms of Holocaust prisoners.

"I think you need a building that is strong enough to at least make people wonder and to make people want to come inside," says Ken



The Center's walls look like the gates of a concentration camp.

Neumann, a principal at Neumann/Smith. The 50,000-square-foot, two-story building, designed in 2001, replaces the museum's former location in West Bloomfield, Michigan; it was the country's first Holocaust museum. Inside the Memorial Center stand exhibits depicting the horrors of time to the post-Holocaust period. The museum

campus also includes a Museum of European Jewish Heritage, and the International Institute of the Righteous meant to publicize altruistic acts throughout history.

While Neumann acknowledges that the design has prompted some consternation for its brutal and difficult imagery, he says that, overall, people are quite supportive. "It's a shame we've hurt people with the design, but it's violent as time was violent. Most have felt this positive thing. It tells their history. You want to show young people the result of not caring about their fellow man." S



Glass and steel structures are reminders of watchtowers.

### McGraw-Hill hosts construction summit in Beijing

As word spreads that China is undergoing the world's largest construction boom, many more people are taking an interest in the Middle Kingdom. It was in this spirit that professionals from around North America, China, and the world gathered in Beijing's Kempinski Hotel from April 14-16 for the 2007 Global Construction Summit. The conference, convened by McGraw-Hill Construction, ARCHITECTURAL RECORD's parent company, was the first of its kind, bringing more than 500 contractors, developers, designers, and officials together to discuss the opportunities and challenges that lay ahead in the burgeoning Chinese construction market.

The summit's plenary meeting addressed the issues facing the Chinese market in the face of unprecedented growth. Other sessions dealt with how to get work and how to get paid, breaking into the market, creating successful results, and balancing the needs of development and sustainability. ARCHITECTURAL RECORD's editor in chief, Robert Ivy, AIA, led two panel discussions with architects and engineers with considerable experience in China. They shared their experiences, discussing the opportunities, their hopes for the future, and the foreboding challenges, from regulatory differences to the large cultural chasm between China and the West. Daniel Elsea

# TENAYA®

The lighting designer wants  
a spectacular wall-wash  
effect from an in-grade fixture

But...

The landscape architect  
wants fully adjustable  
glare control accessories.

The electrician wants easy  
access to the junction box  
for installation and maintenance

But...

The engineer wants the  
fixture to be completely  
sealed and submersible.

The architect won't be  
happy unless all the  
finish screws are aligned  
**PRECISELY** the same on  
every faceplate

But...

The maintenance crew can't  
even guarantee the faceplate  
will still have screws in it next week.

CIRCLE 47 ON READER SERVICE CARD  
OR GO TO [WWW.LEADNET.COM/PUBS/MHAR.HTML](http://WWW.LEADNET.COM/PUBS/MHAR.HTML)

*You Must  
Dreaming!*



## A third New York high-rise for Meier



Fresh off the completion of his luxury condominiums on Perry Street along the Hudson River, Richard Meier is planning a similar luxury hi-rise (above photo, far right) next door.

The 16-floor, 31-unit tower, at 165 Charles Street, will very closely resemble the architect's two designs at 173-176 Perry, just adjacent. All will be tall, Minimalist luxury buildings made primarily of

glazed glass and steel. Unlike the Perry Street project, Meier will also be designing the 11- to 22-foot-tall interiors of the new building. These will include leather seats similar to those Meier designed for the Getty Center in Los

Angeles. The tower's ground floor will also feature more than 1,500 square feet of commercial space.

"Charles Street gives us the opportunity to further develop and evolve the design of my first two towers," says Meier. "It's like music. One note is nice, but as you add notes, you can create something different." Completion is scheduled for spring 2005. S.L.



## Chipperfield planning museum in Iowa

British architect David Chipperfield is designing his first museum project in the continental United States: the Figge Art Museum (FAM) in Davenport, Iowa (above, at right).

Founded in 1929, FAM, formerly known as the Davenport Museum of Art, has transformed itself from a small-scale local space to an ambitious institution. The new museum, located on the city's downtown Mississippi River waterfront, reflects the change. The building, and its desirable location, will allow it to continue to expand, museum officials say.

The \$34.5 million, 100,000-

square-foot museum will be surrounded almost completely with opaque and transparent glass surfaces and fritted with horizontal banding to define the formal elements. It will have an inner and outer skin: The inner will be composed of double-glazed glass and perforated-metal panels, and the outer will be made of fritted and clear glass and will act as a rain wind screen. An outdoor plaza will provide a sculpture garden and public space. The museum highlights a \$113.5 million initiative to revitalize the city's downtown area. Open scheduled for July 2005. S.L.

# When a hole in your ceiling is *a good thing.*



Kenneth Rice Photography — [www.kenricephoto.com](http://www.kenricephoto.com)

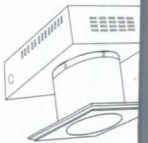

Our "Hole in the Ceiling"

fixtures are plaster/fiberglass castings. They illuminate your space without calling attention to themselves. Call us for more information at 626.579.0943 or visit our website today at [www.elplighting.com](http://www.elplighting.com).

**ENGINEERED  
LIGHTING PRODUCTS**

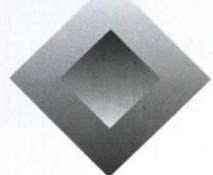



Weber State University – Ethel Wattis Kimball Visual Arts Center, Ogden, UT, USA, Client: Weber State University, Ogden, UT, USA, Architect: Prescott Muir Architects, Salt Lake City, UT, USA

## RHEINZINK® – The Material with a Future

RHEINZINK® is a zinc copper titanium alloy with unmatched longevity and an elegant, aesthetically pleasing appearance, making it an ideal building material. With so many variations possible in its detailing, RHEINZINK® complements both traditional and modern architecture. Curved surfaces can be clad without difficulty due to the material's natural flexibility. At

RHEINZINK, we take great pride in our customer support, providing technical assistance to both architects and craftsmen. Plus RHEINZINK® is readily available. With a large number of installers throughout North America and material stocked in several states, there is never a problem with craftsmanship or order time.

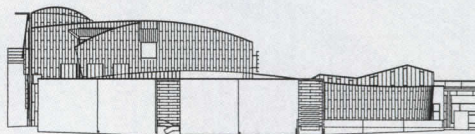

Please visit us at the  
**AIA Chicago**  
 Booth Number 1963  
 (June 10th - June 12th, 2004)



CERTIFIED BY THE  
 ASSOCIATION FOR  
 ENVIRONMENTALLY  
 PROVED BUILDING  
 PRODUCTS NUMBER OF  
 CERTIFICATE Z.RHE102



RZ12705-4C USA

**RHEINZINK**

RHEINZINK America, Inc., 955 Massachusetts Avenue, Suite 770, Cambridge, MA 02139  
 Tel. +1 (617) 871-6777, Fax +1 (617) 871-6780, E-Mail: info@rhein-zink.com, www.rhein-zink.com

**CIRCLE 49 ON READER SERVICE CARD OR GO TO WWW.LEADNET.COM/PUBS/MHAR.HTML**

## News Briefs

### Renovation for Yale Art Gallery

**Gallery** Yale University Art Gallery, the oldest college museum in the U.S., has begun restoration of its main building, originally designed by Louis Kahn and opened in 1953.

The Gallery was Kahn's first significant commission, and is considered one of his masterpieces. The



The Yale Art Gallery will be upgraded.

renovation is being undertaken by Polshek Partnership Architects in New York, which is also working on the master plan for the Yale Arts Area.

The building, known for its

intensely quiet, spiritual atmosphere and signature tetrahedral ceiling, will be closed for the restoration until spring 2006. The gallery will display its collections of American paintings, sculpture, and decorative arts in the Gothic-style wing.

The restoration will address much-needed structural issues, such as window and wall repair and upgrading of the roof, and it will open the building up by removing partitions scattered throughout.

"I was a student of Louis Kahn's in 1954," says partner Jim Polshek in a written statement. "The opportunity to restore this early masterpiece to the architect's original vision and to protect it for the future is extraordinary." S.L.

### Workers begin to install Olympic Stadium roof

After long delays, contractors recently began to install the roof



Olympic roof slides into place.

of the Olympic Stadium in Athens. Designed by Santiago Calatrava, the roof covers 269,000 square feet and is made of massive white steel and tinted Plexiglas. Assembly was completed in mid-April, and now builders are sliding the tubular steel arches into place on top of the stadium.

The stadium was first employed in 1982 and has since been refitted for the games. Calatrava is also designing the sports complex master plan, the roof for the Olympic Velodrome, and landscape and sculptural elements, such as the "Nations Plaza" public space and the undulating "Nations Wall." S.L.

**Finalists named for Vietnam Veterans Memorial Education Center** Four teams have been selected in the second round of competition for the Vietnam Veterans Memorial Education Center, which will complete the assemblage of structures on Washington, D.C.'s National Mall.

The four teams are Ann Behlmer Architects, Architectural Research Office, Michael Graves & Associates, and Polshek Partnership.

According to Jan E. Scruggs, president of the Vietnam Veterans Memorial Fund, the teams are awaiting completion of site analysis before submitting final designs. The 20,000-square-foot facility of exhibition and support spaces is expected to be dug into an elevated area halfway between the memorial and Constitution Gardens. In June, the jury will choose the winning team. The fund hopes to raise \$25 million for the center's construction within three years, break ground in 18 months, and complete the building in 2009. *Andrea Oppenheimer D*

**ENTREPRISES**  
Climbing walls

**800.580.5463**  
**www.epusa.com**

CIRCLE 50 ON READER SERVICE CARD OR GO TO [WWW.LEADNET.COM/PUBS/MHAR.HTML](http://WWW.LEADNET.COM/PUBS/MHAR.HTML)

**20 yrs & 3500+ walls for clients like REI, Nike, ESPN, Galyan**

# Dates & Events

## Upcoming Exhibitions

### Hadid

#### New York City

July 2004

Drawings, and indoor and outdoor objects by the recent Pritzker Prize-winning architect will be featured at Max Protetch Gallery. Call 212/633-6999 or visit [www.maxprotetch.com](http://www.maxprotetch.com) for more information.

### Mid Stone: New Architecture in Concrete

#### Washington, D.C.

December 19, 2004–January 23, 2005

A survey of cutting-edge architecture in which the use of concrete is a central aspect of the design. The exhibition will demonstrate that architects are using concrete to create incredibly varied—some even diametrically opposed—aesthetic objectives. At the National Building Museum. Call 202-272-2448 or visit [www.nbm.org](http://www.nbm.org) for further information.

### Ronan and Erwan Bouroullec

#### Los Angeles

October 20–October 18, 2004

The first North American exhibition focuses on the work of French designers Ronan and Erwan Bouroullec. The brothers have burst onto the international design scene in the past few years with their distinctive furniture, products, and architectural designs. At the Museum of Contemporary Art. For information, call 313/621-2766 or visit [www.moca-la.org](http://www.moca-la.org).

### Under the Box—The Architecture of William P.

#### Denver

### Los Angeles

July 15–October 14, 2004

An exhibition of Will Bruder's work will be on view at A+D Museum. For more information, call 310/659-2445 or visit [www.AplusD.org](http://www.AplusD.org).

## Ongoing Exhibitions

### Rene Burri Photographs

#### New York City

Through June 5, 2004

The exhibition focuses on Burri's architectural photographs, including images of Le Corbusier and his work, such as the Chapel at Ronchamp; the structures of Mexican architect Luis Barragan; Oscar Niemeyer's buildings in Brasilia; and the preparations for the Montreal Expo in 1967. At the Gallery at Hermes. For information, visit [www.hermesofparis.com](http://www.hermesofparis.com).

### Petra Blaisse: Harvey S.

#### Perloff Chair Workshop

#### Los Angeles

Through June 11, 2004

Amsterdam-based designer Petra Blaisse explores a fascination with unique materials through wall coverings and built projects created since 1991 with her firm, Inside Outside. Blaisse holds the Harvey S. Perloff Chair for spring quarter in the UCLA department of architecture and urban design. She conducted a five-day workshop with students, creating a site-specific work that is included in this exhibition. At the Perloff Gallery. Visit [www.aud.ucla.edu](http://www.aud.ucla.edu) or call 310/267-4704.

### Subway Style: Architecture and Design in the New York City Subway

#### New York City

Through June 18, 2004

Light. Ideas. Systems.

# selux®



## Ritorno®

Gracefully Inspired Indirect Architectural Area Lighting

- Excellent performance, no glare
- HID, T6 or QL Lamping
- Die Cast Aluminum Construction

(800) 735-8927 [www.selux.com/usa](http://www.selux.com/usa)

## Dates & Events

Celebrating the 100th anniversary of the New York City subway system, the exhibition explores the aesthetics of the subway, featuring a broad range of historic artifacts, archival documents, drawings, and vintage and contemporary photographs from the collection of the New York Transit Museum. At the UBS Art Gallery. Call 212/713-2885 or visit [www.ubs.com](http://www.ubs.com).

**Drawn by the Architect**  
**Amsterdam**

*Through June 19, 2004*

Now that the computer is changing the way drawings are produced and filed, do architects still sometimes put their ideas down on paper and, if so, in which phases of the design process do they do that? ARCAM collected spectacular original sketches ranging from doodles, notes, and travel impressions to detailed drawings and presentation sketches—sketches done with pencil, paint or felt-tip pen on paper, in notebooks or still on the roll, made for oneself,

clients, or a book. At Architectuurcentrum. Call 020/620-4878 or visit [www.arcam.nl](http://www.arcam.nl).

**Envisioning Architecture: Drawings from the Museum of Modern Art, New York**  
**Washington, D.C.**

*Through June 20, 2004*

The broad spectrum of 20th-century architecture and the depth of its artistic expression are revealed in this selection of works from MoMA's extraordinary collection of architectural drawings. At the National Building Museum. Call 202/272-2448 or visit [www.nbm.org](http://www.nbm.org).

**City Works**  
**Los Angeles**

*Through July 1, 2004*

An exhibition organized by Cityworks Los Angeles Communities Under Construction with participation by all L.A. design and architecture schools. At A+D Museum. Call 310/659-2445 or visit [www.AplusD.org](http://www.AplusD.org).

**The Austrian Phenomenon: Concepts Experiments—Vienna Graz 1958–1973**  
**Vienna**

*Through July 12, 2004*

The exhibition examines this Austrian avant-garde and attempts to come close to providing an overview of the conceptual and experimental tendencies that emerged in Vienna and Graz between 1958 and 1973. At Architekturzentrum Wien. Call 431/522-3115 or visit [www.azw.at](http://www.azw.at) for information.

**Material Trends in Modern Italian**  
**Furnishings**

**New York City**

*Through July 14, 2004*

The region of Lombardy is the center of Italian design ingenuity, with unparalleled excellence in creativity and manufacturing values. The exhibition features recent products in furniture, tiles, consumer electronics, and fixtures from Alias, Artemide, Pierantonio Bonacina, Brionvega, Bticino, Caimi Brevetti, Con&Con, Danese, Flexform, Futura, Gruppo Industriale Busnelli, Kartell, Luceplan, Merati, Nemo, Pao Lenti, Porro, Regia, Tronconi, Serafino Zani, and Zucchi. This exhibition coincides with the 16th Annual International Contemporary Furniture. At Material ConneXion. Call 212/842-2050 or visit [www.MaterialConneXion.com](http://www.MaterialConneXion.com) for more information.

## You're Only 3 Blocks Away From A More Impressive Project



Clayton architectural block products can help your projects meet LEED™ (Leadership in Energy and Environmental Design) credit requirements toward LEED™ Certification.

### Architectural Polished Block

*The tried-and-true choice for great looks and superior durability!*

- Marble-like appearance
- High-performance masonry
- Variety of natural colors and multi-blends
- Cost-effective maintenance
- Exceeds requirements of ASTM C-90

### The Gemstone Collection

EXCLUSIVELY FROM CLAYTON BLOCK

*Earned "Editors Picks" recognition from Architectural Record Magazine for its visual, functional and environmentally compatible qualities!*

- Made with recycled glass for a "gem-like" appearance
- Combines the durability of granite with the versatility of polished block
- Elegant, terrazzo-like finish
- Variety of standard and customized shapes in an array of colors



**Spectra-Glaze II**  
FACTORY-GLAZED CONCRETE MASONRY UNITS

*The rich, semi-gloss surface more building professionals prefer!*

- Ideal for a variety of applications
- Excellent fire, stain and graffiti resistance
- Long-term durability and low maintenance
- Qualifies as sanitary walls
- Unlimited colors, scales and patterns



For more information, click or call Clayton today.  
**1-888-452-9348 • [www.claytonco.com](http://www.claytonco.com)**  
P.O. Box 3015 • Lakewood, NJ 08701

CIRCLE 58 ON READER SERVICE CARD  
OR GO TO [WWW.LEADNET.COM/PUBS/MHAR.HTML](http://WWW.LEADNET.COM/PUBS/MHAR.HTML)



# SĀFTI

Safety and Fire Technology International

## FIRE PROTECTION

### SĀFTI **First** Since 1982

- ◆ **First** with fully code approved fire-rated products from 20 to 120-minutes.
- ◆ **First** with fire-rated wood frames.
- ◆ **First** with an exterior fire-rated curtain wall system.
- ◆ **First** with an engineered aluminum snap-together curtain wall.
- ◆ **First** to manufacture fire-resistive glazing in the USA.
- ◆ **First** to have a hose-stream tested, fire-rated glazing rated up to 120-minutes.
- ◆ **First** to offer a monolithic glazing that substantially reduces the dangers of radiant heat.
- ◆ **First** to provide a safe wired glass that protects K-12 children from injuries due to accidental impact.



A complete line of fire-rated glass and framing at:  
[www.safti.com](http://www.safti.com)

CIRCLE 59 ON READER SERVICE CARD  
OR GO TO [WWW.LEADNET.COM/PUBS/MHAR.HTML](http://WWW.LEADNET.COM/PUBS/MHAR.HTML)

SĀFTI First - Making safety our first priority



USA MFG.

Visit us at AIA Expo Booth 1639

CIRCLE 61 ON READER SERVICE CARD OR GO TO [WWW.LEADNET.COM/PUBS/MHAR.HTML](http://WWW.LEADNET.COM/PUBS/MHAR.HTML)

## Dates & Events

### Dates & Events

202/272-2448 or visit [www.nbm.org](http://www.nbm.org) for further information.

#### **Solos: Future Shack Washington, D.C.**

*Through October 10, 2004*

Architecture for Humanity's Future Shack is a shelter that can be constructed anywhere, very quickly, to address the needs of refugees as well as of victims of natural disasters. Designed by Australian architect Sean Godsell, the prototype will be built in the Cooper Hewitt's Arthur Ross Terrace and Garden as part of the summer Solos series. At the Cooper-Hewitt, National Design Museum. For further information, call 212/849-8400 or visit [www.cooperhewitt.org](http://www.cooperhewitt.org).

#### **Unbuilt Chicago Chicago**

*Through January 16, 2005*

Featuring approximately 90 drawings, plans, and models for architectural projects in Chicago that were never built, the exhibition provides a cross section of projects from the 1880s to the present. Many notable architects are represented, including Dankmar Adler, Daniel Burnham, Alfonso Iannelli, Ludwig Mies van der Rohe, Louis Sullivan, Harry Weese, and Helmut Jahn. At the Art Institute of Chicago. For more information, call 312/443-3600 or visit [www.artic.edu](http://www.artic.edu).

#### **a\_show: Austrian Architecture in the 20th and 21st Centuries Vienna**

*Through 2005*

Due to the expansive nature of its contents, a\_show is subdivided into three sections and presented in three stages. It provides a ramble through historic and contemporary Austrian architecture and explores the most essential factors in establishing a cultural identity. At Architekturzentrum Wien. For more information, call 431/522-3115 or visit [www.azw.at](http://www.azw.at).

#### **A.R.E. Workstation Phoenix**

*Permanent Installation*

The A.R.E. (Architects Registration Exam) Workstation project was inspired by the recent move on NCARB's part to come up with the

ARE Version 3.0. In the AIA AZ Gallery. For further information, call 602/275-6830 or visit [www.durrant.com](http://www.durrant.com).

#### **Aerospace Design: The Art of Engineering from NASA's Aeronautical Research Washington, D.C.**

*Through December 5, 2004*

The exhibition features more than 65 artifacts from NASA's collection, including wind tunnel models and designs for conceptual airplanes. At the Octagon. Call 202/638-3221 or visit [www.theoctagon.org](http://www.theoctagon.org).

### Lectures, Conferences, Symposia

#### **Forum Barcelona 2004 Barcelona**

*May 9–September 26, 2004*

Forum Barcelona is an innovative and creative platform through which to explore and analyze the major cultural and social challenges facing the world of the 21st century. It is a festive journey designed to bring three main themes to life: cultural diversity, sustainable development, and conditions for peace. For 141 days, it is a place where visitors can experience cultures and entertainment from around the world. Performances, lectures, exhibitions, workshops, games, and marketplaces make up this major event. The various activities and events take place all over the city of Barcelona. For more information visit [www.barcelona2004.org](http://www.barcelona2004.org).

#### **Life, Liberty, and the Pursuit of Landscape Architecture Washington, D.C.**

*June 1, 2004*

In a free society, security concerns and other challenges can compromise our ability to live in safe environments. Leonard Hopper, FASLA, past president of the American Society of Landscape Architects and chief landscape architect for the New York City Housing Authority, will address how landscape architects help shape the world and improve the quality of our lives. At the National Building Museum. Call 202/272-2448 or visit [www.nbm.org](http://www.nbm.org).

## Where's Tolomeo? Find Tolomeo and you'll be rewarded!

Tolomeo table task lamp by Artemide is perhaps the most famous lamp in the world today. Designed by Michele De Lucchi & Giancarlo Piretti and awarded with the Compasso d'Oro, Italy's prestigious award for the best in industrial design, Tolomeo has become universally accepted as a modern classic. To be rewarded with a \$20 Rebate Certificate toward the purchase of a Tolomeo, of any model, simply locate the Tolomeo table/task model (as shown to the right of this text) hidden by artist Andrea Baruffi in his "Is daily life fun or what?" illustration and identify the corresponding location

To be rewarded with a \$30 (instead of \$20) Rebate Certificate towards the minimum \$500 purchase of any Artemide luminaire, name at least three of the Artemide luminaire models appearing in the illustration (not hidden), in addition to locating the hidden Tolomeo. To provide your answer(s), along with your name and address go to: [www.wherestolomeo.com](http://www.wherestolomeo.com). You may provide your answer(s) only once and you must do it before July 31, 2004. By e-mailing the correct answer(s) you will receive the \$20 or \$30 Rebate Certificate, via first class mail, within two weeks.



So, where is Tolomeo?  
Start your search today!

Artemide®



2

3

4

5

6

7

8

9

10

11

L

K

J

I

H

G

F

E

D

C

B

A

2

3

4

5

6

7

8

9

10

11

# INTRODUCING WOOD BALANCED DOORS



Wood doors that use the renowned  
Ellison Balanced Door hardware  
and frames are now available.

For information on wood selection  
and door design contact our factory.

**ellison**  
Ellison Bronze, Inc.

800-665-6445

www.ellisonbronze.com

CIRCLE 64 ON READER SERVICE CARD  
OR GO TO WWW.LEADNET.COM/PUBS/MHAR.HTML

## Dates & Events

### **International Greening Rooftops for Sustainable Communities Conference, Awards, and Trade Show Portland, Ore.**

June 2-4, 2004

Experts in diverse fields from around the globe will network and share knowledge about the benefits of green roofs, new research findings, policy developments, and the latest in green-roof products and services. Topics covered in panel discussions will include LEED, plant performance, policy initiatives, smart growth, biodiversity and agriculture, storm-water issues, and design. At the Hilton Hotel. For further information, call 416/686-5887 or visit [www.greenroofs.ca/grhhc/conference.htm](http://www.greenroofs.ca/grhhc/conference.htm).

### **The 2004 Bruce Goff Centennial Celebration Bartlesville, Okla.**

June 5-8, 2004

The 100th anniversary of the birth of Bruce Goff and the 137th of Frank Lloyd Wright will be celebrated by viewing buildings of both Goff's and Wright's design, films of Goff, architectural and other drawings of Goff's, and exhibitions of work by those who learned from him. For further information, call 404/237-8031.

### **Security Workshop Franklin Park, Ill.**

June 7-10, 2004

YSG Door Security Consultants, an architectural hardware and security solutions company, is offering a Security Workshop to provide participants a better understanding mechanical security and electrified hardware to develop a fully integrated locking security system. At the YSG Satellite Training Center. Call 800/438-1951 or visit [www.ysgsecurity.com](http://www.ysgsecurity.com).

### **Wolf D. Prix Washington, D.C.**

June 8, 2004

Coop Himmel(b)lau creates deconstructivist architecture that provocatively breaks away from traditional structures to expose inherent aesthetic and technological tensions. Wolf D. Prix, coprincipal of the Vienna, Austria-based studio, will discuss the firm's award-winning work, including the UFA-Cinema Center in

Dresden, Germany; Vienna's SEG Apartment Tower; the Musée de Confluences in Lyon, France; and the Art Museum in Ohio, their first major U.S. commission. At the National Building Museum. Call 202/272-2448 or visit [www.nbm.org](http://www.nbm.org) for more information.

### **Inspire Customer Loyalty: What Clients Have to Say Chicago**

June 9, 2004

A one-day seminar being held prior to the start of the AIA Annual Convention. Marcy Steinbock, a researcher and author of *The Inside Scoop: Proposals and Interviews from the Client's Perspective*, will provide insight into what triggers customer loyalty and outline research conducted from both a national and regional perspective. At the Metropolitan Club in the Sears Tower. Visit [www.smps.org](http://www.smps.org).

### **The AIA 2004 National Convention and Design Exposition Chicago**

June 10-12, 2004

The premier design and construction industry event with firsthand industry updates and cutting-edge products and services that will shape the future of architecture. At McCormick Place. For further information, call 800/242-3837 or visit [www.aia.org](http://www.aia.org).

### **40th IMCL Conference: Building Cities for Community & Identity London**

June 13-17, 2004

Topics will include traditional town planning, civic values, the built environment and the healthy city, and celebrating the European square. At the University of Notre Dame London Centre. Visit [www.livablecities.org](http://www.livablecities.org) for more information.

### **The First Northeastern Regional Scrap-Tire Conference Albany, N.Y.**

June 15-16, 2004

The goals of the conference are to improve the efficiency of the scrap-tire industry and promote regional cooperation on scrap-tire programs. Topics to be discussed include:

# Meet the Door with a Split Personality

Power operation only when you need it.  
Balanced door operation when you don't.



**POWER**  
**NOW**  
Patent Pending

Power Now is a classic balanced door during manual operation, and opens with power only when needed.

Our revolutionary design eliminates complicated, unsightly surface mounted hardware. A concealed low energy operator and actuating arm provide opening force on demand.

Our standard hardware provides the closing force. When used manually Power Now is pure Ellison.

## ellison

Ellison Bronze, Inc.

[www.ellisonbronze.com](http://www.ellisonbronze.com)

CIRCLE 65 ON READER SERVICE CARD  
OR GO TO [WWW.LEADNET.COM/PUBS/MHAR.HTML](http://WWW.LEADNET.COM/PUBS/MHAR.HTML)

**THE SWITCH**

Power Now opens the door on demand, ellison closes it.

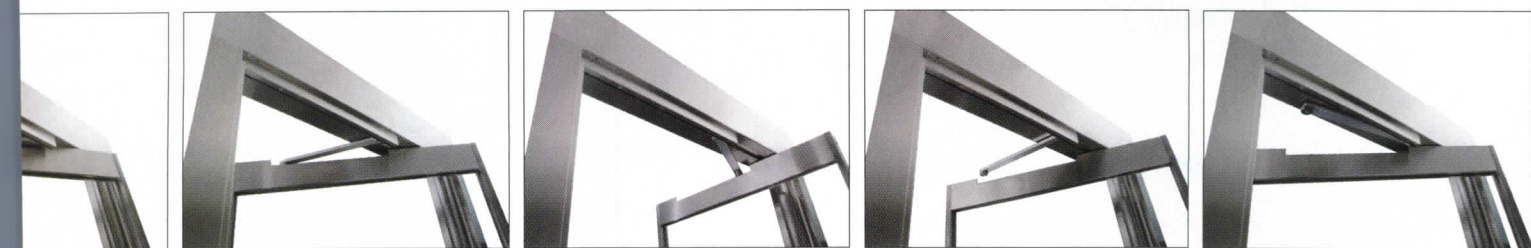



cast bronze architectural hardware

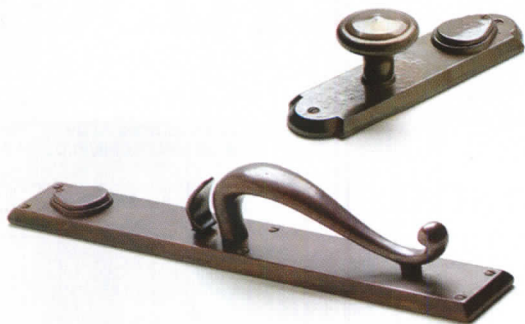

ROCKY MOUNTAIN  
H A R D W A R E

888.552.9497 www.rockymountainhardware.com

CIRCLE 66 ON READER SERVICE CARD  
OR GO TO WWW.LEADNET.COM/PUBS/MHAR.HTML

## Dates & Events

Playgrounds Using Rubber; Rubber Modified Asphalt; Ground Rubber Markets; Regional Generation and Flow of Tires; State Scrap-Tire Programs; Civil Engineering Applications; Business Planning; Tire-Derived Fuel; Funding Sources. At Wolferts Roost. Call 518/432-6400 or visit [www.eba-nys.org](http://www.eba-nys.org).

### **Antoine Predock Washington, D.C.**

June 16, 2004

To celebrate the opening of *Liquid Stone: New Architecture in Concrete*, architect Antoine Predock will discuss his work, which responds in many ways to both the natural and the cultural landscapes. Practicing in Albuquerque, New Mexico, for more than 30 years, Predock is an internationally acclaimed architect who draws from the elemental forces of a site, as well as its history and myth, to create an "architecture of ritual." Predock's Shadow House in Santa Fe, New Mexico, is featured in the exhibition. At the National Building Museum. Call 202/272-2448 or visit [www.nbm.org](http://www.nbm.org).

### **The Mediterranean Medina Pescara, Italy**

June 17-19, 2004

An International seminar aiming at the study of the particular physical characters and the main transformations of the Mediterranean City. The city has built up its identity through the reuse and modification of the previous urban remains. At the Faculty of Architecture of Pescara. Visit [www.unich.it/idea](http://www.unich.it/idea).

### **Building Green Washington, D.C.**

June 21, 2004

To celebrate the summer solstice, Helen English, executive director of the Sustainable Buildings Industry

Council, will discuss ways to help home builders, architects, home owners, and others better locate general information about such topics as community and site planning, energy, energy-efficiency, the building envelope, water use, indoor environmental quality and green materials. This lecture draws on material from *Green Building Guidelines: Meeting the Demand for Low-Energy, Resource-Efficient Homes*, which was developed by homebuilders for homebuilders. At the National Building Museum. Call 202/272-2448 or visit [www.nbm.org](http://www.nbm.org).

### **Their Last Battle: The Fight for the National World War Memorial Washington, D.C.**

June 30, 2004

A casual conversation between a Congresswoman and one of her constituents in 1987 grew into an epic struggle to build the National World War II Memorial—an effort that lasted more than four times as long as it took America to fight the war itself. Nicolaus Mills, Sarah Lawrence College, will recount the struggle and chronicle the development of the Washington Mall, from its origins as swampland to Maya Lin's controversial Vietnam Veterans' Memorial. At the National Building Museum. Call 202/272-2448 or visit [www.nbm.org](http://www.nbm.org).

### **2004 SMPS/PSMA National Conference New York City**

August 11-14, 2004

This conference is the leading forum for business development, marketing, and firm management for the A/E/C industry. This year's conference focuses on helping firms build business in tough economic times. At the New York Marriott Marquis. Visit [www.bu](http://www.bu)



**A** 42-inch standard plasma



**B** 42-inch HDTV-ready plasma



**C** 50-inch HDTV-ready plasma



**D** 63-inch HDTV-ready plasma

There is no wrong answer.  
Samsung's brilliant 3<sup>rd</sup> generation plasmas.



**42", 50" and 63" plasma displays:**

Advanced technology for unparalleled picture quality and control  
Motion Picture and Picture in Picture; PC, video,  
component inputs; HDTV compatibility  
Image processors allow for multiple-plasma tiled  
display configurations (2x2, 3x3, 4x4, 5x1 and 1x5)  
Technical support; two-year standard warranty on-site\*

[www.samsungproav.com](http://www.samsungproav.com) or call 1-866-542-7214

Samsung Electronics America, Inc. Samsung is a registered mark of Samsung Electronics Corp., Ltd.  
Images simulated. \*On-site service subject to regional availability.

With Samsung plasmas, any size you choose is the perfect solution. That's because every one of our plasmas is loaded with the same advanced features you're looking for. Things like high contrast ratios, superior brightness, videowall processors and our proprietary DNLe™ technology for stunning picture quality. Samsung's family of third generation plasmas. There's no guesswork required.



CIRCLE 67 ON READER SERVICE CARD OR GO TO [WWW.LEADNET.COM/PUBS/MHAR.HTML](http://WWW.LEADNET.COM/PUBS/MHAR.HTML)

## Dates & Events

business.org for more information.

### **Houston Mod: Leo Marmol Houston**

August 19, 2004

Leo Marmol, AIA, managing principal of Marmol Radziner + Associates of Los Angeles, will be the second annual speaker of the Houston Mod August lecture. He will give a talk about the preservation of Modern architecture. His firm is responsible for the restoration of Richard Neutra's Kaufmann House in Palm Springs and has been recognized in many national publications. At the MFAH Brown Auditorium. Visit [www.marmol-radziner.com](http://www.marmol-radziner.com) or [www.houstonmod.org](http://www.houstonmod.org).

### **ARMA 2004 Summer Meeting Kansas City, Mo.**

August 24-26, 2004

The Asphalt Roofing Manufacturers Association (ARMA) is the North American trade association representing the manufacturers and suppliers of bituminous-based residential and commercial fiberglass and organic asphalt shingle roofing products, roll roofing, built-up roofing systems, and modified bitumen roofing systems. At the Fairmont Hotel. Call 202/207-0917 or visit [www.asphaltroofing.org](http://www.asphaltroofing.org).

### **Introduction to the 2003 International Building Code for Design Professionals Las Vegas, Nev.**

September 27-28, 2004

The University of Wisconsin, Madison, Department of Engineering Professional Development offers this course, which will provide a broad overview of the key nonstructural components of the International Building Code, focusing primarily on those requirements that deal with fire and life-safety concerns.

At the University of Wisconsin. Contact Jeffrey A Lackney at 608/262-0638 or visit [epdweb.lengr.wisc.edu/webG022](http://epdweb.lengr.wisc.edu/webG022).

### **NeoCon East Baltimore, Md.**

October 6-7, 2004

This year's NeoCon East promises to attract thousands of attendees representing regional architectural design and facilities management communities, as well as federal government designers, buyers, specifiers. New to NeoCon East 2004 is a lighting pavilion and Architectural Stone and Ceramic Tile Exposition. For information visit [www.merchandisemart.com](http://www.merchandisemart.com) or call 800/677-6278.

### **Urban Waterfronts 22: Gathering by the Water Milwaukee, Wis.**

October 14-16, 2004

The annual international conference on waterfront planning, development, and culture will convene 300 people from around the globe from all the varying disciplines involved in this dynamic field. More than 30 speakers will cover a wide range of issues. Visit [www.waterfrontcenter.org](http://www.waterfrontcenter.org) for more information.

### **ISH North America Boston**

October 14-16, 2004

The only consolidated trade show incorporating products and services in Kitchen and Bath, Plumbing, Heating and Air-Conditioning in an expansive hall of over 250,000 square feet of exhibition space. The Boston Convention and Exhibition Center. Visit [www.ish-na.com](http://www.ish-na.com).

## Competitions

### **Excellence on the Water**

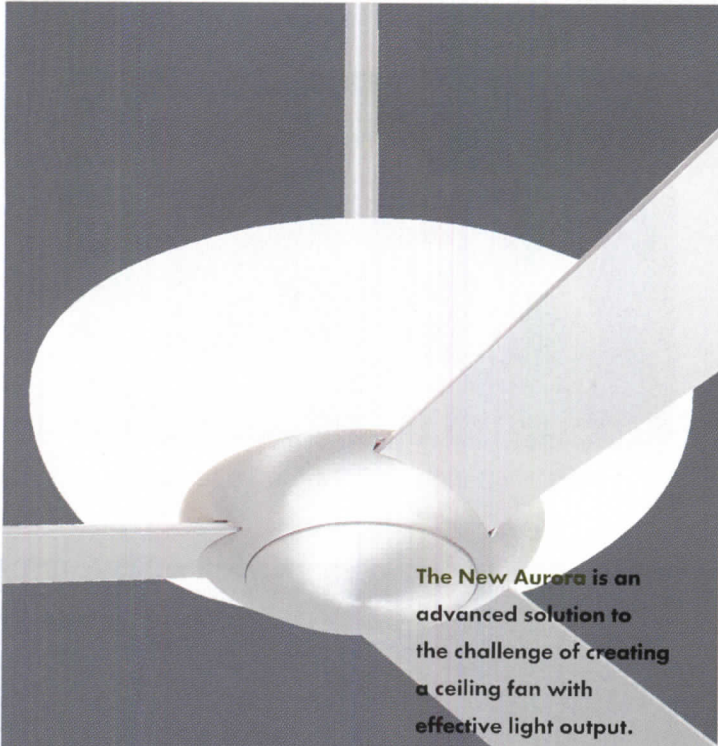

The New Aurora is an advanced solution to the challenge of creating a ceiling fan with effective light output. This poetically simple product gives the equivalent of 175 watts of color corrected, energy saving fluorescent light, both up and down.

888 588-3267

[www.modernfan.com](http://www.modernfan.com)

Cool fans with  
a modern spin!

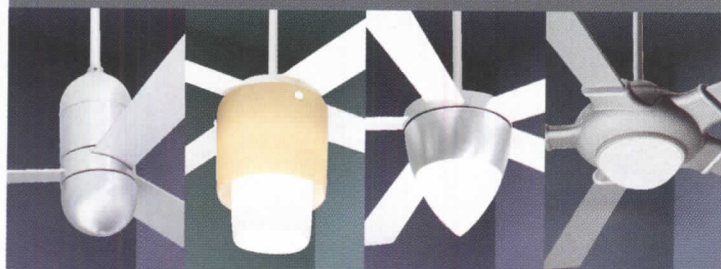

CIRRUS/SHORT

HALO

NIMBUS

UFO

**THE MODERN FAN CO**





An  
important  
difference,  
you can't  
see.

## Introducing environmentally friendly C/S Acrovyn® 3000.

**New PVC-Free Acrovyn® 3000** performs better than traditional Acrovyn Wall Protection. It has the same outstanding impact resistance, Class I fire rating, universal code compliance and comprehensive color range. But the important difference you can't see with Acrovyn 3000 is its built-in protection for our environment. For literature detailing the comprehensive Acrovyn 3000 line - including Wall Covering - and its timely, exciting benefits, call 1-888-621-3344 or visit [www.c-sgroup.com](http://www.c-sgroup.com).



CIRCLE 69 ON READER SERVICE CARD OR GO TO [WWW.LEADNET.COM/PUBS/MHAR.HTML](http://WWW.LEADNET.COM/PUBS/MHAR.HTML)

See us at Booth #1465 - AIA Convention



Morgan State University  
never looked better.

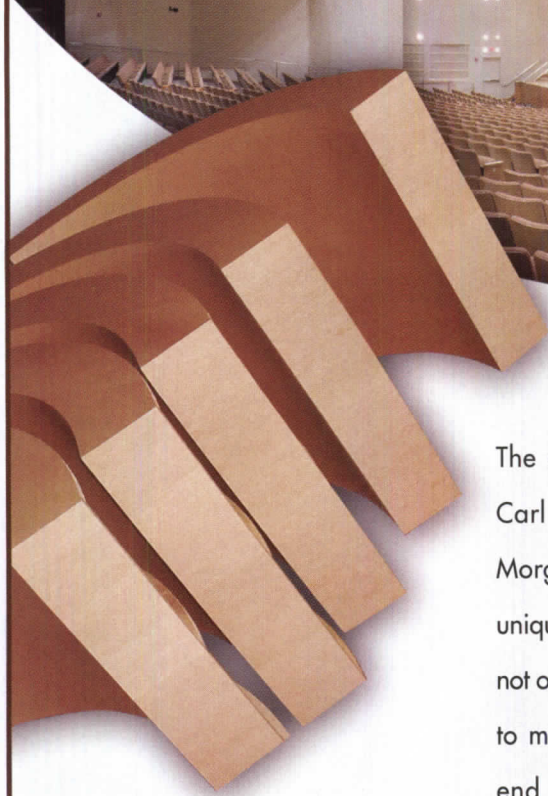

The architect's unique design for the Carl J. Murphy Fine Arts Center at Morgan State University demanded a unique solution. CURVALON® by Rulon not only met the challenges but continues to meet the needs presented by high end designers and architects. Add CURVALON® to your next project and expand your design possibilities!

CURVALON®  
by

Rulon 

[www.rulonco.com](http://www.rulonco.com)

1-800-227-8566

## Dates & Events

### Awards Program

*Deadline: July 15, 2004*

The Waterfront Center's announces its 18th annual international awards program for projects, plans, and grassroots citizen efforts. Visit [www.waterfrontcenter.org](http://www.waterfrontcenter.org) for more information.

### Central Glass International Architectural Design Competition 2004 AsiaFront Village

*Deadline: July 26*

The AsiaFront Village ought to be a place of further promotion of the unique culture interspersed throughout Asia and the enjoyment of its results. It can be located anywhere in the world, in the city or in the suburbs. It can be consolidated into a single facility, or it can be an international conference facility or training center, a lodging facility or a complex. For information and submission requirements, visit [www.japan-architect.co.jp](http://www.japan-architect.co.jp).

### 2004 Texture Design Contest Chandler, Ariz.

*Deadline: July 30, 2004*

Meltdown Glass Art & Design is inviting creative professionals interested in decorative glass to compete in their Texture Design Contest. For further information, call 800/845-6221 or visit [www.meltdownglass.com](http://www.meltdownglass.com).

### Norwalk Housing Design Competition Norwalk, Conn.

*Deadline: August 13, 2004*

In response to the need for below-market-rate housing in the city of Norwalk, the Housing Authority of Norwalk is sponsoring a housing design competition for exemplary site and urban plans for first-time home buyers, entry- and mid-level professionals, and fixed-income seniors. Call 203/857-0200 or visit [www.swinter.com/NorwalkHousingDesignCompetition.html](http://www.swinter.com/NorwalkHousingDesignCompetition.html) for information and submission guidelines.

### The 2004 Ecohouse Design Awards

*Deadline: August 31, 2004*

The competition is open to any student, or group of students, in a school of architecture. The challenge is to design an Ecohouse that can survive without relying on a great deal of fossil fuel. Visit [www.architecturalpress.com/companions/ecohouse](http://www.architecturalpress.com/companions/ecohouse).

# Dates & Events

## Ambience Design Competition

**Deadline: October 31, 2004**  
A Gull Lighting Products, Inc. Ambience Design Competition is designed to honor the innovative, union-driven, and trend-setting applications of ambience low-voltage lighting systems developed by industry trades people, including lighting consultants, designers, contractors, architects, and sales personnel. Visit [www.seagullighting.com](http://www.seagullighting.com) for more information.

## Green Tent Design Competition

**Los Angeles**  
**Deadline: August 11, 2004**  
*Online preregistration required by July 30, 2004, at [www.greententcompetition.com](http://www.greententcompetition.com)*  
Ecoshack announces a competition to design an environmentally sustainable camping shelter—a green tent—for use in the Mojave Desert in and around Joshua Tree National Park. The competition is open to anyone with innovative design ideas inspired by Southern California's green lifestyle; architects, interior designers, product designers, furniture designers, graphic designers, artists, design students, and campers. Collaborative and multidisciplinary design teams are encouraged. Judges for the competition include designer David Huxman of servo, SKDP graphic designer Stephen Huxman, Ecoshack founder Stephanie Smith, and artist Andrea Zittel. Winners will be notified on August 25, 2004. Winning entries will receive cash prizes and will be prototyped on Ecoshack's demonstration site in Joshua Tree, Calif. All entries will be exhibited in Joshua Tree during the Desert Test Sites event October 23–24, 2004. For additional information visit [www.green-tentcompetition.com](http://www.green-tentcompetition.com)

## Home Design and Construction Competition

**Registration: July 15, 2004**  
**Deadline: December 15, 2004**  
The competition will lead to actual construction. Judges will include William McDonough and Randall Stout. Entries will be built with a goal of achieving the standards of sustainability set up in *Cradle to Cradle: Remaking the Way We Make Things*. For more information regarding submission guidelines visit [www.c2c-home.org](http://www.c2c-home.org).

## Wanenchiku Residential Design: House

HAWA - Variotec modular track system allows panels to travel independently and negotiate curves with ease. Supports glass or wood panels up to 330 lbs. per panel.

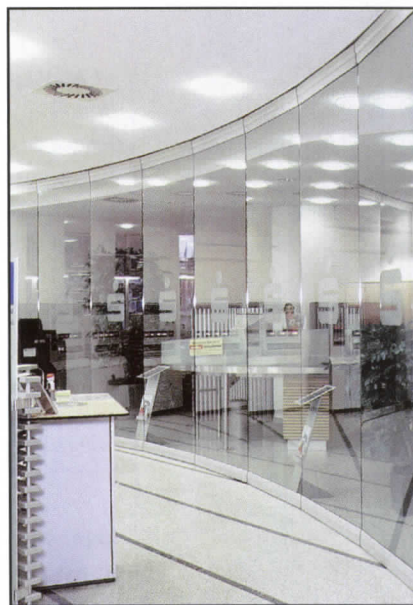

# Innovative Solutions

**Hawa** SWISS Sliding Door Hardware Solutions

# HÄFELE

1-800-423-3531  
[www.hafeleonline.com](http://www.hafeleonline.com)

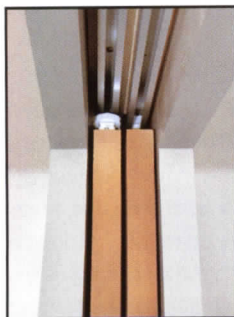

HAWA - Junior puts sliding doors in motion with a minimum of visible hardware. Available for single mount doors or telescopic applications.



CIRCLE 71 ON READER SERVICE CARD  
OR GO TO [WWW.LEADNET.COM/PUBS/MHAR.HTML](http://WWW.LEADNET.COM/PUBS/MHAR.HTML)



## NORFOLK DOWNLIGHTS

Integrating function with style, W.A.C. Lighting's new Norfolk Series features a family of architecturally styled decorative fixtures designed to light modern commercial interiors. Pendants are available in diameters from 14" to 48", and equipped with either incandescent or compact fluorescent lamps. Matching sconces, ceiling mounts and close-to-ceiling fixtures are available with glass or acrylic diffusers and polished brass or brushed nickel metalwork.

Visit Booth #521 at LightFair.



W·A·C | LIGHTING

Experience the value. Value the experience.

Tel. 800.526.2588  
WACLIGHTING.COM

## Dates & Events

### of Multiple Dimensions Competition

*Deadline: September 3, 2004*

Judged by Steven Holl, this competition is looking for the design of a small house of 250 square meters which can act as an experimental probe into an architecture of more than four dimensions. The experiential phenomena of the house will be a crucial factor. The house should also be inhabitable. Materials, from molecular aspects to geometric properties, will be important, as will space and time. The house will act like a "thought experiment." For more information about submitting, visit [www.japan-architect.co.jp](http://www.japan-architect.co.jp).

### Emerging Professionals Guest House/Studio Design Competition

*Registration Deadline: October 1, 2004*

*Submission Deadline: October 18, 2004*

This competition is a special project intended to encourage and recognize the design skills of emerging architectural professionals. The award-winning projects will receive recognition and cash awards. Finalists will become part of a case study demonstrating cooperative projects between industry, schools, and professional practice. This competition is a partnership between EPICconnection.com, the AIA National Housing Committee, and the sponsor, the Whirlpool Corporation. For information and submission requirements, visit [www.epiconnection.org](http://www.epiconnection.org).

### Zhu Jia Jiao Competition

*Registration Deadline: May 30–August 30, 2004*

*Submission Deadline: September 30, 2004*

International Open Competition for new Jiangnan Canal Town. Organized by the City of Shanghai Qingpu District Government, this competition hopes to inspire a new manner of urbanization, one that is neither urbanism nor suburbanism; it intends to provoke a lasting dialogue between Chinese city and contemporary architecture. For more information and submission requirements, visit [www.shzjj.com](http://www.shzjj.com)

*E-mail events and competitions information two months in advance of event or competition submission deadline to [ingrid\\_whitehead@mcgraw-hill.com](mailto:ingrid_whitehead@mcgraw-hill.com).*

## NATIONAL BUILDING MUSEUM AT NBM

### Lectures

**June 8**

**Wolf D. Prix**

co-principal of  
Coop Himmelb(l)au,  
Vienna, Austria



IMAGE BY ARMIN HESS. COURTESY COOP HIMMELBLAU

**June 16**

**Antoine Predock**

principal of Antoine  
Predock Architect,  
Albuquerque, New Mexico

**June 17**

**Takashi Yamaguchi**

principal of Takashi Yamaguchi  
and Associates, Osaka, Japan

**June 21**

**Building Green**

Helen English, executive director of the  
Sustainable Buildings Industry Council

### Exhibitions

**Samuel Mockbee  
and the Rural  
Studio:**

**Community  
Architecture**

through September 6



COURTESY JACQUE MOCKBEE AND FAMILY

**Envisioning  
Architecture:**

**Drawings from  
The Museum of Modern Art,  
New York**

through June 20

**Affordable Housing: Designing  
an American Asset**

through August 8

### National building museum

401 F Street, NW  
Washington, DC 20001  
202 / 272-2448

[www.NBM.org](http://www.NBM.org)



For more information and to register for programs, call or visit our website. Discounts for members and students.

# For and about the new generation of architects

## archrecord2

### FOR THE EMERGING ARCHITECT

This month in **archrecord2** we look at the winners of the American Institute of Architect's 2004 Young Architects Award and examine a project in L.A.'s Skid Row that is high on design and low on cost. In **Design**, get to know the architects, their leadership in design, and their service to the profession. In **Work**, architect Chantal Aquin builds a project with modest financing but bold inventiveness. Learn more by visiting [architecturalrecord.com/archrecord2](http://architecturalrecord.com/archrecord2).

DEPARTMENTS

#### DESIGN

#### Great start in architectural careers

Each year, the American Institute of Architects awarded five architects the 2004 Young Architects Award. Recipients of this award, regardless of age, are at an early stage of their careers, and their exceptional leadership in design, education, and/or service to the profession are all taken into consideration when winners are chosen. The five individuals honored this year each have unique characteristics that show a promising future in architecture. The winners will be presented with their awards at the 2004 National Convention and Design Exposition in Chicago this month.

Licensed to practice architecture in the states of Virginia and Maryland, architect David Jameson, AIA, has made a reputation for himself as a remarkable and imaginative residential architect. With the formation of David Jameson Architect six months ago, the Virginia Tech graduate has had the opportunity to work on projects at both small and large scales. His ability to juxtapose texture, shapes, materials, and colors have become his trademark. With conservative Washington, D.C., as the backdrop for many of his projects, he has been able to successfully create modern spaces in a traditional setting. The architect's work has garnered attention from local and national magazines and has been featured on several programs on Home & Garden Television. His designs have also been recognized by more than 15 local, state, and national awards.

The methodology of Janis LaDouceur, AIA, has brought her and her Washington, D.C.-based firm, Barbour/LaDouceur Design Group, much acclaim. LaDouceur believes that the art of architecture is to tell a story, and she approaches each project with this philosophy. Many of her community-based projects—cultural centers, memorials, and museums—reveal her desire to incorporate her clients' culture into the design. Attention to such detail can be seen in LaDouceur's design of projects like the proposed Ojibwe Cultural Center and the Richard I. Bong World War II Heritage Center in Superior, Wisconsin. Another project, the Science House at the Science Museum of Minnesota [RECORD, August 2003, page 170], is an addition whose form was



#### David Jameson Architect

Examples of David Jameson's award-winning residential designs: (1) Church Street Residence, Washington, D.C.; (2) Push Pull House, Chevy Chase, Md.; (3) Model of Maison Bois Chamois, Suwannee, Fla.

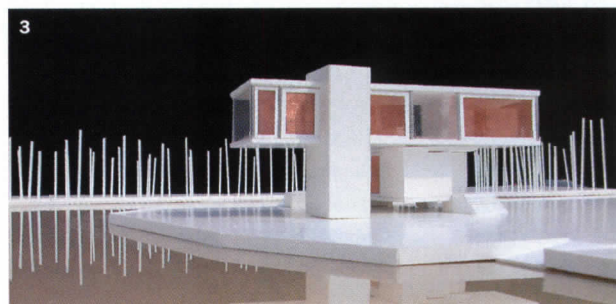

intended to recall the nearby river tugboats. As one of the first outdoor science installations in the nation, the building, which will serve as a greenhouse, a laboratory, and classroom space, will also be an exhibit in itself, as it produces more energy through solar strategies than it uses.

Architect Kevin Sneed, AIA, is a respected figure in the AIA Northern Virginia (NOVA) chapter, and his service and contributions to the chapter have become invaluable. The architect has taken part in numerous NOVA committees and also served on the board in several positions: treasurer, president, and the 2003 president. As a founding member of the NOVA Young Architects Committee, he developed programs that are now used as models for other AIA chapters. Currently the director of architecture at OTJ Architects in Washington, D.C., Sneed's leadership has created bonds with related industries and with surrounding AIA chapters in Virginia and Maryland. His enthusiasm for design can be seen in ventures such as his promotion of the profession at elementary schools and his aid in the organization of Virginia Architecture Week. When Sneed worked with BBGM Architects/Interiors, his client list included Chevy Chase Bank and the U.S. Marine Corps.

Donna Kacmar, AIA, is balancing a career that involves design, teaching, and community service. As founder of architect works in Houston, Texas, she has designed residential and commercial projects that have been widely published and received numerous awards. Kacmar is assistant professor at the Gerald D. Hines College of Architecture at the University of Houston, where she is also the Level I Graduate Design Coordinator, and for the past eight years she has taught at the university's Summer Discovery Program for high school students. She also has a long and varied history in community-based service activities. Since 1998, Kacmar has worked with the Avenue Community Development Corporation, a nonprofit, low-income-housing-development corporation for rebuilding Houston's inner-city neighborhoods.

After graduating from Syracuse University with a B.Arch. degree, John Burse, AIA, moved to St. Louis and now promotes urban renewal in his own community. A senior associate with



1

**Barbour/LaDouceur Design Group** Projects include: (1) The Environmental Experiment Center, "Science House," Minneapolis; (2) The Richard I. Bong WW II Heritage Center, Superior, Wisconsin, Ill.; (3) Battle Point Ojibwe Cultural Education Center, Leech Lake, Minn.



2

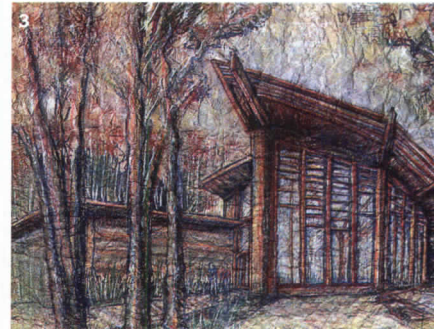

3



4

**BBGM Architects/Interiors** Examples of Kevin Sneed's interior designs: (4) Trizec Regional Headquarters, Washington, D.C.; (5) PHH Arval/Highland Office, Baltimore County, Md.



6

**architect works** Donna Kacmar's recent design work: (6) Round Valley Texas Office Building + Garage,

Belleaire, Tex.; (7) Woods High School's planned Westview Campus, Houston (with Natalye Appel and Associates).



7

# Outdoor Lighting for Transportation Facilities and Bridges

Structural™ Series

3 Sizes

70 - 1000 Watt

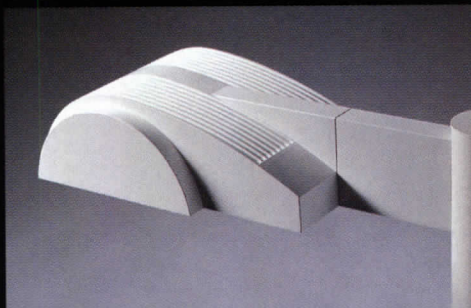

## KIM LIGHTING

16555 East Gale Avenue  
City of Industry, CA 91745  
626/968-5666

[www.kimlighting.com](http://www.kimlighting.com)

Made in America



CIRCLE 278 ON READER SERVICE CARD OR GO TO [WWW.LEADNET.COM/PUBS/MHAR.HTML](http://WWW.LEADNET.COM/PUBS/MHAR.HTML)



**Mackey Mitchell Associates**  
John Burse combines a personal passion for revitalizing the city with urban planning: (1) Future vision for the Old North St. Louis; (2) An example of Burse's award-winning watercolors.

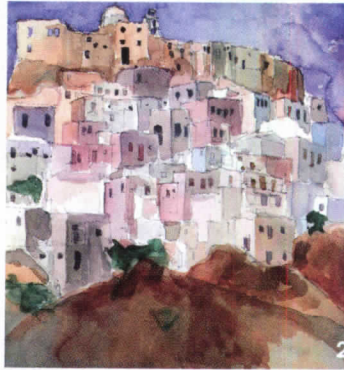

Mackey Mitchell, Burse's work focuses on urban design, using this skill not only to fulfill his work but also to fulfill his passion—revitalizing the Old North St. Louis community, a once-bustling neighborhood. The architect has gone beyond what one might expect in this planning project. Using his personal time to create drawings and renderings of what he foresees for this area, Burse also holds workshops and meets with residents of the neighborhood to explain his vision. His zeal for the project has been contagious, as he has prompted local leaders, developers, and lenders to support this effort to make the area a livable community once again. Burse's design and planning skills have also been essential to his work on other projects, including the Concordia Seminary, the Central Institute for the Deaf, and master plans for international resort communities. *Randi Greenberg*

For more projects and photos of these award-winning architects, go to [architecturalrecord.com/archrecord2](http://architecturalrecord.com/archrecord2)

## WORK

### High design hits the spot

When Los Angeles-based architect Chantal Aquin was asked to design a new service center for the Skid Row Housing Trust, she was faced not only with a low budget, consisting entirely of a HUD grant, but limited practical experience as well. Not willing to sacrifice design, Aquin turned these limitations into assets, making the most of her resourcefulness with ingenuity—a lot of plain old hard work.

Jim Bonar, director of the Skid Row Housing Trust, an organization that provides permanent housing and supportive services for residents of Los Angeles's Skid Row neighborhood, wanted something different for the new Service Spot. Located on the ground floor of one of the organization's resident-occupant hotels, the Service Spot was to be a "user-friendly" center that would offer case management, support-group meetings, educational opportunities, and service refer-

PHOTOGRAPHY: © COURTESY JOHN BURSE (THIS PAGE); LUCY GONZALES (OPPOSITE)





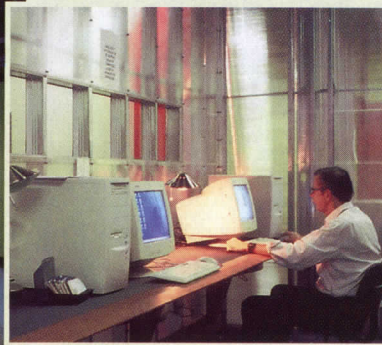

The Service Spot provides a fully functional and well-designed service center for the residents of Skid Row.

ust completed work on another it project with Aquin, Bonar e would be the right person Service Spot into that “some- ferent” he was looking for. en it comes to designing for eless or mentally ill, there’s a very distinct separation public and private spaces,” Aquin. “There is a sense of e, since it’s sometimes difficult pate their behavior—so many centers are designed with bar-

riers. Instead, Jim wanted users to feel a sense of ownership of these spaces. We also wanted the residents to feel as though they were given something precious, not just services contained within blank walls.”

To stretch her limited budget as far as it could go, Aquin, just a couple of years out of SCI-Arc, enlisted help from current students as well as fellow alum Rocio Romero and former SCI-Arc instructor Randall Wilson.

Wilson led an intensive summer

studio in which students designed and built the seating, workstations, filing trolleys, and cabinets for the refurbished storefront. Though Bonar was skeptical of their ability to furnish the space, students received material donations from Home Depot, Anderson Plywood, and Häfele and were able to outfit the entire 2,000-square-foot space.

The reception area is designed as a light box visible from the street to welcome visitors. Inside, the standard syntax of public-to-private space confronted by users of most public service agencies is twisted to create an interweaving of private with public spaces—allowing users to walk freely from one activity to another with no physical obstacles. Transparent and translucent materials allow users to see the activities in which they will ultimately participate with no fears of being engulfed by authorities or institutions. *Josephine Minutillo*

For more information on other projects like this, go to [architecturalrecord.com/archrecord2](http://architecturalrecord.com/archrecord2)

## WITH AN ACCENT ON COLOR.

### INTRODUCING OUR NEW CRESCENT SERIES WALL GUARD AND HANDRAIL.

We believe design versatility is just as important as product durability. That's why we've developed interchangeable vertical accents for our unique Crescent Series. Over 60 different shades, tones and hues - thousands of color combinations on America's most durable wall guards and handrails.

The new Crescent Series. High-impact color. High-impact resistant.



1-800-431-3456

[www.pawling.com](http://www.pawling.com)

# Complete lighting control solutions for stadiums and arenas

With Lutron's flexible and reliable lighting control system, you can control the lighting throughout an entire stadium or arena. The system is easily customizable so that event after event, you can create excitement in the seats, and confidence in the control room.

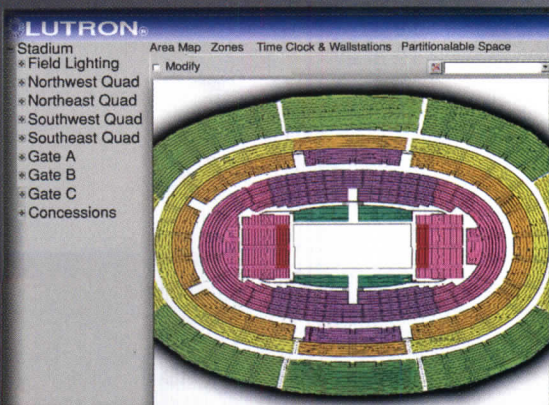
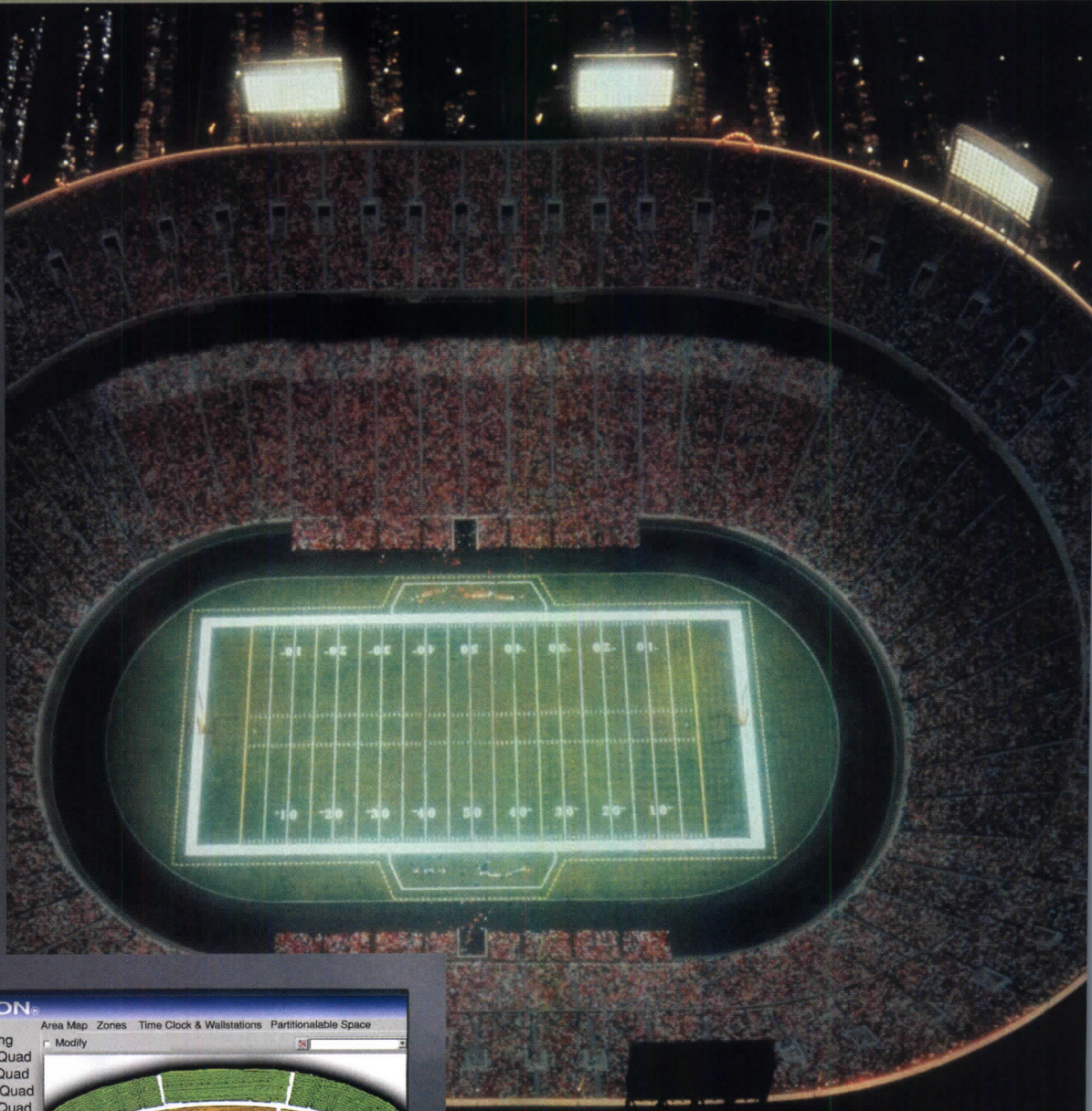

*Lutron dimming and switching panel and customized graphical interface control screen*

Lutron's GRAFIK 7000 system provides switching, dimming and daylight control for stadiums, arenas, convention centers and any other large public space. Find out more at 877-258-8766 or [www.lutron.com/architecturalre](http://www.lutron.com/architecturalre)

 **LUTRON**  
Lutron controls your light...

# Hang on to your old cameras: For some purposes, film is still better than digital

## Practice Matters

By Charles Linn, FAIA

y, practically everybody uses digital technology to make and photographic images. Some recordings of a scene are made on the spot, using digital cameras; others are made indirectly by scanning existing photographs or transparencies that were made in the old-fashioned way, using film. The advantages of photographs made with digital cameras are obvious. They can be previewed on the spot. Desktop printers can produce copies that are as good as photographs for some purposes. You don't need to buy film or have it processed by a lab. Digital images have other advantages: They can be e-mailed instantly and inserted into documents in seconds. Adobe's Photoshop can correct color to a certain extent and add a host of special effects. A complete archive of photos can be stored on a few CDs or a single hard drive and sorted and indexed using file-management software. Digital storage is theoretically permanent, although CDs and disks can get damaged and hard drives can crash. The advantages of digital are overwhelming, and the new technology is so easy to use, that many architects have begun documenting their finished projects exclusively and given up using film and professional photographers entirely. There are still times when conventional medium- and large-format photographs or transparencies are better. Images made with point-and-shoot digital cameras, particularly large prints are needed or

the photos will be viewed up close. Professional-grade, high-resolution digital cameras that accept interchangeable lenses currently cost from \$1,500 to \$15,000.

At least for the moment, there are some applications where film cannot be replaced by digital, such as when long exposures are needed for night scenes. And digital cameras that can correct perspective are still relatively rare. So, don't take the phone number of your trusty architectural photographer out of your Rolodex yet, and hang on to your old camera. True, some professional photographers are switching to digital for some jobs, but most are sticking to film.

"It doesn't matter if you are using a file from a digital camera or something that was scanned. It's the quality of what came out of the camera that determines the quality of the final product," says New York photographer Elliott Kaufman. "Photoshop can do amazing things, but one thing it can't do is make a mediocre image from any source look like an image from a four-by-five," he says, referring to the large negatives and transparencies still favored by many. (See the last page of this article for an illustration of three different film formats.) Kaufman still shoots exclusively with film. So when should an architect choose film over digital? It helps to get an understanding of why the two are so different.

### Digital or film?

Digital and film cameras record patterns of light in entirely different



40 MEGAPIXEL DIGITAL FILE



35MM PRINT

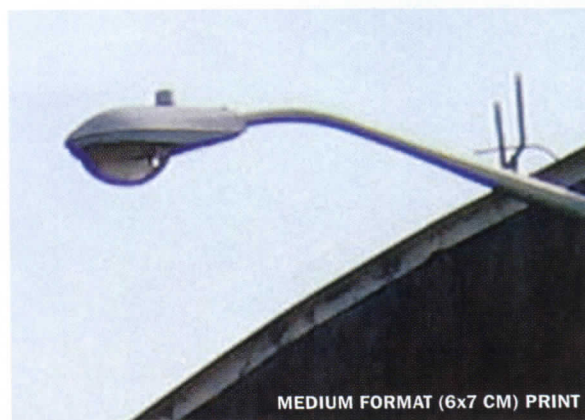

MEDIUM FORMAT (6x7 CM) PRINT

Which do you want in your portfolio? Pixels are starting to show in the enlargement of the digital picture. The 35mm shot is grainy and less sharp. The detail of the medium-format photo is clearly the best of the three.

## Practice Matters

ways. When the chip inside a digital camera is momentarily exposed to a burst of light, millions of bits of information are gathered and recorded as a grid of minute colored squares called pixels. Although some digital cameras allow the user to preview such an image, it doesn't really exist in physical form until it is printed out. The more information captured by the chip, measured in megapixels, the better the image will be.

The film in a camera is analogous to the chip. When light is focused on it, microscopic crystals of silver halide embedded in the film are altered in such a way that a representation of the image is left on it. This becomes fixed during development. The type of film selected by a photographer certainly affects the sharpness of a photograph, as does the physical size of the film. The larger the film,

the more "information" can be captured in a single exposure. And, obviously, large negatives do not have to be enlarged as much as small negatives to get a usable picture. Whether one is talking about digital or film, the quality of the camera's lens and the stability of the camera during an exposure

### ART DIRECTORS AND THOSE WHO MANAGE AWARDS PROGRAMS STILL RECOMMEND PHOTOS MADE THE OLD-FASHIONED WAY.

also influence the sharpness of the images they make.

Some photographers believe that because people don't naturally see the world rendered in pixels, film will always capture an image in a more realistic manner than a digital camera. When enlarged, the colored squares that make up a digital photograph can be seen, just as the grainy appearance of

the halide crystals on the film become visible. New York photographer David Sundberg, who often uses a digital camera says, "With digital there is somehow a different overall look or feel to the image. There is often what I would describe as a colder, harder quality to the photograph."

As a point of comparison, some say five-megapixel cameras, which currently cost about \$500 and up, can produce images with

a resolution that closely approximates one made by a professional-quality 35mm camera. That is, they can both make acceptable 8-by-10-inch prints. But when the images are enlarged much beyond this point, or especially if they must be cropped and magnified even more, either grain or pixels will become noticeable. Does it really matter? That depends on what the

image will be used for.

#### Books and magazines

People supplying images for publication in magazines or books should still expect to supply either large format transparencies, or prints made from large-format negatives, says Douglas Curran, associate editor at Rizzoli International Publications: "I encourage all of our authors and photographers to supply us with transparencies or flat art, rather than digital art, whenever possible. Consistently, the final printed image, when made from a transparency, is stronger, more vibrant and accurate in terms of representing the original than a printed image as made from digital art. I am told that this will change, but to date, I have not seen any evidence that this change is near."

Many art directors prefer to work with original transparencies so that they can see and match the final color to the original color proof supplied by their printers.

## As GREEN As You Can Get When Firestall® or Easy Ply® Roof Deck Tops Off Your Next LEED™ Project



**homasote**  
COMPANY

932 Lower Ferry Road, P.O. Box 7240, West Trenton, N.J. 08628-0240  
609-883-3300 • 800-257-9491 Sales Extension 1500 • Fax: 609-883-3497 • www.homasote.com



#### Call Us For Data and Installation Instructions

Dial Tech Support at 800-257-9491 Ext. 1332

#### Structural Fire-Rated Assemblies

UL® P500 Series: P-518, 535, 536 and Others

#### Daylighting High-Performance for Open Plenums

Reflective or Natural Finishes

#### Commercial Roof Lines

With Residential Looks

#### Combine With Thermasote®

R-30 and More

#### Up to 98% Post-Consumer Recycled Content

Specify Homasote® and Every Day is Earth Day™. America's oldest manufacturer of building products from recycled materials

More than 1,500 architects and specifiers have attended  
AIA-approved, CES, Rethinking Materials in the Context of LEED™.  
Call 800-257-9491 Ext. 1215 for a free presentation at your firm.



ntgarde architecture

with porcelain tiles

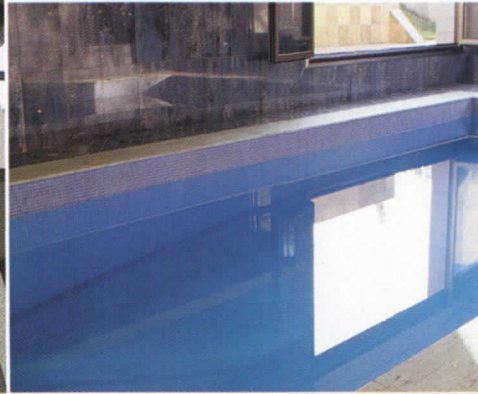

**PAMESA**  
CERAMICA  
**COMPACTO**

[www.pamesa.com](http://www.pamesa.com)

BOOTH NUMBER: 2115

AIA 2004 CHICAGO JUNE 10-12

CIRCLE 81 ON READER SERVICE CARD  
OR GO TO [WWW.LEADNET.COM/PUBS/MHAR.HTML](http://WWW.LEADNET.COM/PUBS/MHAR.HTML)

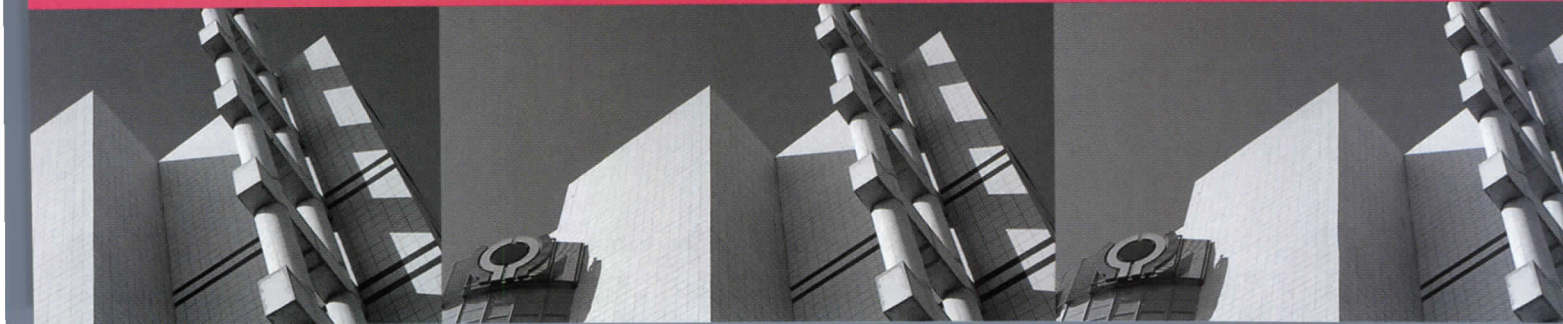

## Practice Matters

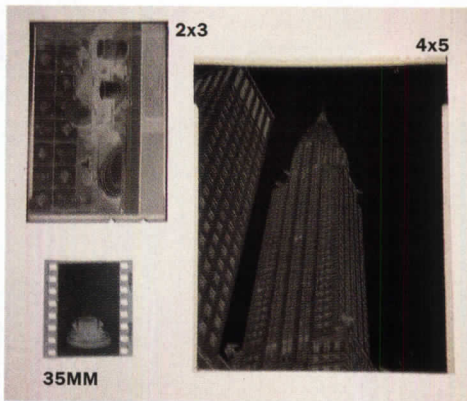

**Most photographers agree that even the best digital cameras can't match the sharpness of the 4-by-5-inch negative.**

Several art directors say that in recent years they have been plagued by contributors who submit digital photography that is unusable because images were scanned at the wrong resolution or supplied on damaged CDs. These problems can be avoided when film originals are

submitted instead of digital files.

Another situation where film seems to have an edge over digital is in awards-program submittals. National AIA Awards director Robin Lee says that recently she's seen many promising award entries fail because their binders relied on poor quality digital printouts instead of large color prints or

slides. She says, "Jurors have been simply appalled at the low quality of some of the submissions that have relied on digital prints." Lee still recommends slides for their brilliant color, sharpness, and because they are easy for groups to view. "Slides are an important

form of presentation that juries consistently appreciate."

### What about PowerPoint?

Almost any mention of slides will bring up one application where digital photography has been quite successful in superceding film, and that is when they are used with presentation software like Microsoft's PowerPoint and Apple's new Keynote. Either digital images, or for that mat-

rate color and sharpness are crucial, go with a slide.

### More changes to come

There is no doubt that high-megapixel digital cameras are going to keep getting cheaper and better. One day a column in this magazine may report that in terms of color and sharpness, they truly have superceded medium- or large-format film, but it will be awhile before the

## ART DIRECTORS STILL PREFER ORIGINAL FILM BECAUSE ITS COLOR CAN BE CHECKED AGAINST COLOR PROOFS.

ter digitized slides, can be dropped into presentations in seconds.

The clarity of the image is probably not as important as it is for other applications, because the amount of resolution that digital projectors are currently able to achieve is quite modest. But the images are usually viewed at a distance, so sharpness doesn't matter as much. Still, if you are doing a presentation where accu-

rate color and sharpness are crucial, go with a slide. kind of equipment is affordable. If then, architects should carefully consider whether digital photography is sufficient for all of their purposes, or whether they'd be better off shooting a few slides of a project with their old camera or, for the big jobs, hire a photographer. Film isn't obsolete yet. ■

*RECORD* editor Jane F. Kolleeny contributed to this article.

## Need Specialty Doors?

 <p><b>Acoustic</b></p> <ul style="list-style-type: none"> <li>• Metal Swinging Doors</li> <li>• Metal Sliding Doors</li> <li>• Fixed Window Systems</li> <li>• Wood Swinging Doors</li> </ul>	 <p><b>Blast</b></p> <ul style="list-style-type: none"> <li>• VLRB, LRB, and MRB Series</li> <li>• High-Range Doors &amp; Windows</li> <li>• Pressure-Resistant &amp; Watertight Doors</li> <li>• Radiation Shielding Doors</li> </ul>	 <p><b>Security</b></p> <ul style="list-style-type: none"> <li>• Attack-Resistant Doors</li> <li>• Bullet-Resistant Doors</li> <li>• High Security Lockers</li> <li>• Security Vault Doors</li> </ul>	 <p><b>Tiger FRP</b></p> <ul style="list-style-type: none"> <li>• UL Fire-Rated Doors &amp; Frames</li> <li>• Non-Fire-Rated Doors and Frames</li> <li>• Pressure-Rated Assemblies</li> <li>• Fixed Window Systems, Louvers &amp; Lights</li> </ul>
---	---	---	--

**OVERLY**  
DOOR COMPANY

Phone: 1-800-979-7300  
Fax: 724-830-2871  
E-mail: [overly@overly.com](mailto:overly@overly.com)  
Web: [www.overly.com](http://www.overly.com)

Phone: 1-888-891-4416  
Fax: 402-346-0561  
E-mail: [info@tigerdoor.com](mailto:info@tigerdoor.com)  
Web: [www.tigerdoor.com](http://www.tigerdoor.com)



CIRCLE 82 ON READER SERVICE CARD  
OR GO TO [WWW.LEADNET.COM/PUBS/MHAR.HTML](http://WWW.LEADNET.COM/PUBS/MHAR.HTML)

# A new event, the Universal Forum of Cultures, helps Barcelona transform an ailing district

## Correspondent's File

By David Cohn

latest recipe for Barcelona urban  
 n, as seen at the site of this  
 ner's Universal Forum of  
 res, a UNESCO-backed inter-  
 nal festival, goes something  
 his: Take the last stretch of  
 covered seafront on the north-  
 ern limits of the city—a zone  
 ed with a sewage treatment  
 a power plant, a garbage  
 erator, and decades of pollu-  
 —clean it up, and upgrade the  
 infrastructures with state-of-  
 art, environmentally friendly  
 ies. Span the now-odorless  
 ge plant with a 27-acre public  
 ade that connects the  
 o new waterfront recreational  
 ies, and crown it with a monu-  
 al photovoltaic pergola to  
 score the environmental  
 e. Stir in a landmark audio-  
 and exhibition hall designed  
 cques Herzog and Pierre de

Meuron, hotels, and a convention  
 center, and set the whole thing to  
 boil with the Forum, invented speci-  
 cally for the occasion, with debates,  
 exhibitions, performances, and hun-  
 dreds of other events that attract  
 millions of visitors to the site from  
 May through September. The result?  
 Voilà! A major eyesore and environ-  
 mental disaster area has been  
 transformed into a new motor of  
 future urban development, and a  
 model for the principles of sustain-  
 able design that the Forum  
 advocates.

Opening in May and running  
 until September 26, the Forum dif-  
 fers from traditional World's Fairs  
 by offering a meeting of cultures  
 rather than nations, explains Mayor  
 Joan Clos. It proposes a platform of  
 debate in which the problems of  
 environmentally sound economic  
 growth, cultural understanding, and  
 world conflict are treated as inter-  
 dependent issues, a debate shaped  
 by Barcelona's particular perspec-



tive as a center of regional cultural  
 identity and economic power  
 within the mosaic of European city  
 regions. Organizers expect five  
 million visitors.

The urban operation of the  
 Forum occupies three landfills  
 reclaimed from the sea: a marine  
 wetlands artificially created for a  
 marine branch of the Barcelona  
 Zoo, still on the drawing boards; the  
 central platform of the Esplanade;

and to the northeast, a coastal park  
 with a new beach, designed by  
 Madrid architects Iñaki Ábalos and  
 Juan Herreros, which features arti-  
 ficial hills that buffer the impact of the  
 power plant, incinerator, and a new  
 garbage sorting and recycling facility.

The major buildings of the  
 Forum are confined to the landward  
 side of the operation. Here, the city  
 has built a convention center, hotel,  
 and office building designed by local

David Cohn is RECORD's Madrid-  
 international correspondent.

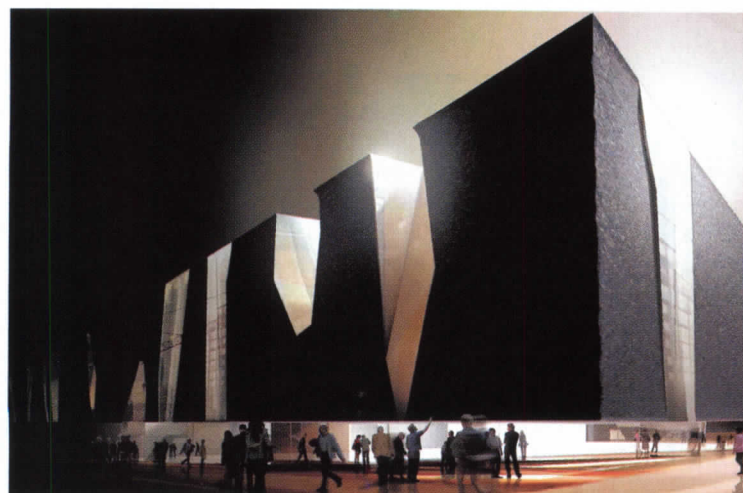

**The plan for the Cultural Forum (above) includes redeveloping a formerly abandoned stretch with an esplanade, convention center, auditorium, exhibition hall, and more. The exhibition hall (left), called the Forum Building, by Herzog & de Meuron, features a massive horizontal slab in the form of an equilateral triangle measuring nearly 600 feet to a side.**

DEPARTMENTS

## Correspondent's File

architect Josep Lluís Mateo, which features a 120,000-square-foot exhibition hall, and the Forum Building, which boasts a 3,200-seat auditorium and 50,000 square feet of exhibition space.

In architectural terms, the Forum is conceived as a territory of activities rather than a conventional urban development. Mateo, who participated in the early sessions of urban design, together with Barcelona chief planner Josep Anton Acebillo, and architects Enric Miralles and Eduardo Bru, among others, describes the early concept for the project as a "magmatic territory that spills across the site."

This idea of a lavalike extrusion is present in the irregular form of the Esplanade, designed by architects Elías Torres and J.A. Martínez-Lapeña, which seems to spread out from the Diagonal (a major cultural thoroughfare) arching over the coastal highway and the sewage treatment plant to end at the sea in a series of escarpments up to 60 feet high. With its surface finished in a patchwork of multicolored asphalt and lawns crisscrossed with expansion joints, the Esplanade establishes the artificial ground plane or geography on which the events of the Forum take place. It will also contain outdoor restaurants and cafés and host future activities such as flea markets, fairs, and public festivals.

To the southeast, an area of artificial dunes and amphitheaters designed by the London-based Alejandro Zaera brings the platform down to the water, where Barcelona architect Beth Galí has designed a paved bathing area, like a swimming pool open to the sea. While crowning the Esplanade on a high point jutting into the Mediterranean is the expressive form of the photovoltaic pergola, the size of a football field, also designed by Torres and Martínez-Lapeña, which produces 1.3 megawatts of electricity, roughly the consumption of 1,000 Spanish

homes. As seen from the water, the Esplanade and pergola, which reaches a height of 200 feet, take on the proportions of an artificial geographic event that marks the northeastern limits of the city, mirroring at a smaller scale the mount of Montjuic that frames Barcelona to the southwest. The Esplanade also marks a departure from the usually staid and conservative Modernism of Barcelona architecture, as seen, for example, in the 1992 Olympic Village [see RECORD, August 1992, page 100], and an opening toward a more earthy, ludic, and dynamic use of form, closer in spirit to Antonio Gaudí and the Catalan artist Joan Miró.

Herzog & de Meuron's Forum Building is the architectural star of the show, a massive horizontal slab in the form of an equilateral triangle measuring nearly 600 feet to a side. Due to its size, the architects have conceived the design not in the traditional terms of composing facades or volumes, but rather as if the building formed part of the Forum's peculiar artificial landscape. The upper mass containing the hall seems to float over the Esplanade to create an unusual shaded plaza, with spectacular cantilevers on all three sides. Its supports and ground-floor enclosures are hidden behind mirrored glass that dissolves in the reflected light of the surrounding plaza. The brilliant contrasts of reflected light and shadow are enhanced by the dark metal ceiling tiles, conceived as a watery surface covered with bubbles, which draw dappled light deep into the space. The auditorium is also partly finished in these liquid tiles; it spills down from the upper mass through one of the plaza's glass volumes to end below grade. A plane of water literally covers the roof, and water trickles down to the plaza through crevices opened in the volume, while the jagged mirrored windows resemble rivulets of spilling water. The rough, sprayed cement facades,

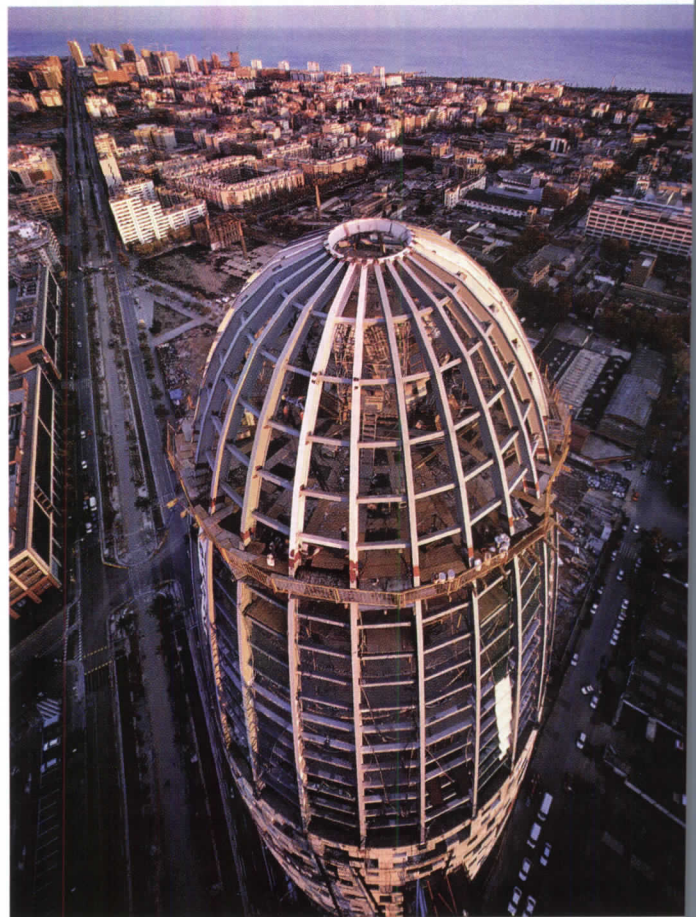

**Jean Nouvel's Agbar Tower is rising near the Forum site in Barcelona. At 474 feet, it is another example of the city's aggressive urbanism.**

painted Yves Klein blue, have disappointed some for their apparent cheapness, but the detailing is actually very fine, and the volume reads like a bright, sophisticated cartoon.

Ascan Mergenthaler, the partner in charge of the project for the firm, comments, "We used the water theme to bring the Mediterranean a little closer. The ceiling had to be attractive, lively, and playful, not this oppressive plane hanging over you. The bubble patterns are computer-generated, and they have direction, like the sea, flowing around the cores."

The Forum was master planned by Barcelona Regional public authority which oversees strategic long-term planning for city and its surroundings. Acebillo who is its director, explains, "The Department of Urbanism deals the daily problems of the city. It leaves them little margin for speculation about the future. What we do is this kind of forward vision Building on the experience of the 1992 Olympics, when planners by Oriol Bohigas used the game to push for major urban improvements, Barcelona Regional has





Design: Gabriele Centazzo

**TEGRITY** | Recyclable • Non-Polluting • Innovative • Low Maintenance • User Friendly • Superior Quality • Craftsmanship  
 • Safety Conscious • Versatile • High Technology • Resource Management • Responsible Manufacturing

**VALCUCINE**



NE North America—Eco Atlantic, Inc. • 212.253.5683 • [www.valcucinena.com](http://www.valcucinena.com)

Chicago	Minneapolis	Ottawa	Toronto
312.242.1712	612.341.4588	613.562.1000	416.364.6477



quiries welcome.

CIRCLE 85 ON READER SERVICE CARD OR GO TO [WWW.LEADNET.COM/PUBS/MHAR.HTML](http://WWW.LEADNET.COM/PUBS/MHAR.HTML)

## Correspondent's File

developed into a remarkable planning instrument, producing comprehensive, integrated programs that cover all aspects of urban and economic development, and that use local and specific actions to achieve general goals.

The Forum, for example, is part of a global strategy to draw future commercial development to the eastern half of the city, away from the prosperous but saturated western districts, and to promote the growth of new high-tech businesses. The Forum stands at the far edge of this area, known as BCN and comprising 120 blocks of underused industrially zoned land that has been updated with the latest communications services and seeded with investment incentives. To reach the Forum, planners extended the Diagonal to the site, effectively opening the area for development. At the head of the new Diagonal,



**The Forum's monumental photovoltaic pergola will have an array the size of a football field.**

Jean Nouvel's spectacular Agbar Tower for the Barcelona water authority will open this winter, "a landmark that locates the operation in the public mind," explains Acebillo. Nearby projects include a cinemplex and plaza by Zaha Hadid, a city museum by Oriol Bohigas, and a district city hall by Madrid architect Federico Soriano.

Farther to the north, a third node of development will focus on the upcoming high-speed-train station at Sagrera. "Almost all our projects originate in infrastructural problems, to which we add an urban dimension," Acebillo concludes. In the immediate area of the Forum, the poor residential neighborhood of La Mina will be restructured with new

housing, public spaces, and municipal services, and a technical university is being planned to encourage research and development in new technologies.

Barcelona Regional is also overseeing the restructuring of V. Acebillo calls the city's "logistical services located on its western flank. Plans include an expanded



# METAL WALL PANELS

## Versatile

## Cost Effective

### See for yourself!

Call today to learn more about the benefits of using metal wall panels in construction or for information on the resources MCA has available for you.

Contact the Metal Construction Association at 847/375-4718 or visit [www.metalconstruction.org/wallpanels](http://www.metalconstruction.org/wallpanels)



American Iron and Steel Institute

Participating Wall Panel Manufacturers and MCA members

Alcan Composites • Alcoa Architectural Products • ALPOUC Mitsubishi Chemical America, Inc. • ATAS • ATOFINA Chemicals • Benchmark Architectural Systems • CENTRIA • Copper Sales • Fabral • Foam Enterprises • Metecno-Aluma Shield • Laminators, Inc. • Metecno-API • Metl-Span • Solvay Solexis • Umicore • Valspar



**2003 MCA President's Award Winner, overall excellence category: Clover Park Technical College, Lakewood, WA. Manufacturer: ATAS and CENTRIA**

CIRCLE 86 ON READER SERVICE CARD  
OR GO TO [WWW.LEADNET.COM/PUBS/MHAR.HTML](http://WWW.LEADNET.COM/PUBS/MHAR.HTML)

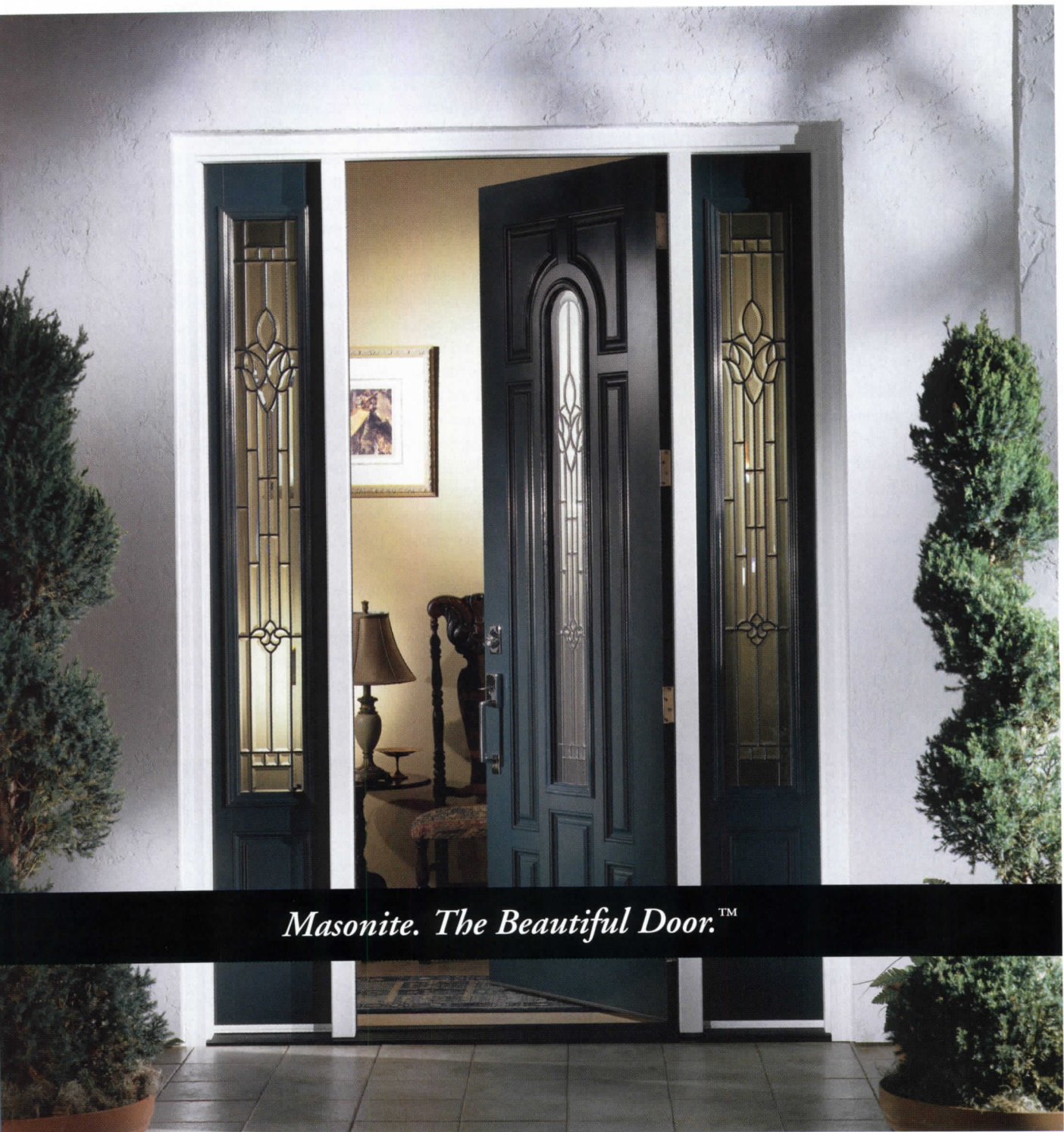

*Masonite. The Beautiful Door.™*

Masonite's products are designed and constructed to exacting standards and specifications. All materials – wood, fiberglass, steel or composites – are engineered and carefully selected to ensure lasting durability and timeless performance. Doors from Masonite's new Belleville™ Fiberglass Door Collection make every home more beautiful, more valuable and more elegant.

*Masonite. The Beautiful Door.™*

[www.masonite.com](http://www.masonite.com)

 *Masonite*®  
Masonite International Corporation

CIRCLE 279 ON READER SERVICE CARD  
OR GO TO [WWW.LEADNET.COM/PUBS/MHAR.HTML](http://WWW.LEADNET.COM/PUBS/MHAR.HTML)

## Correspondent's File



Convention center, hotel, and office building designed by Josep Lluís Mateo.

industrial park associated with the commercial port; Ricardo Bofill's expansion of the airport, with connections to the high-speed train; a second Trade Fair campus designed by Toyo Ito; and a City of Justice being built by David Chipperfield. This area, located outside the city limits in Hospitalet, has attracted commercial developments, including the City Metropolitana office park by

Nouvel, the District 38 mixed-use development by the team of Arata Isozaki and Alejandro Zaera, and a hotel by Richard Rogers.

Barcelona is not the only city in Spain with big ideas. In Valencia, construction will finish this fall on Santiago Calatrava's City of the Arts and Sciences, his most spectacular collection of buildings to date, including the soaring, skeletal

Science Museum; a planetarium in the shape of an eye, complete with a movable "eyelid" brise-soleil; and a reptilian opera hall with a swooping cantilevered tail. In Bilbao, Zaha Hadid has been tapped to master plan a 150-acre urban district on the riverfront in Zorrozaurre. Workers have finished excavating through solid rock for Peter Eisenman's City of Culture in Santiago de Compostela, a multi-building complex largely buried under a hill. In Madrid, additions to three museums forming the city's "cultural axis" are nearing completion: the Reina Sofia Museum of Contemporary Art, by Jean Nouvel; the Prado, by Rafael Mone; and the Museum Thyssen-Bornemisza, by the Barcelona team of BOPBAA, Manuel Baquero Briz, and Robert Brufau Niubo. A fourth museum, a Madrid branch of the Caixa Forum Foundation, is being built by Herzog & de Meuron, and Álvaro Siza heads a team that is restructuring the streets and public spaces of the axis. All across Spain, public authori-

ties are using innovative architecture and planning to bring distinction and vibrancy to the public realm, visible testimony to their commitment to cultural and material progress.

But few can rival Barcelona the scope and ambition of its urban initiatives. The development of the city is historically linked to major international events like the Forum the Universal Exposition of 1888, the International Exposition of 1929, and the 1992 Olympics. Pascual Maragall, the city's former mayor and current president of Catalonia once described Barcelona as "a vital without a country," and the city appears to seek in these periodic feats of self-definition and promotion to compensate for the lack of the cultural and economic advantages of centrality that other European capitals take for granted. If this diagnosis is correct, it has produced a powerful instrument for bringing vibrancy and innovation to the public realm, and made Barcelona a model for other capitals worldwide. ■

T R A D I T I O N .



I N N O V A T I O N .

You can still find  
original concepts  
in contemporary  
street, site and mall  
furnishings.

[www.huntco.com](http://www.huntco.com)

1.800.547.5909

**Huntco**  
SITE FURNISHINGS

# In a city whose political terrain is treacherous, a Gehry project comes up against a wall

## Critique

By Michael Sorkin

ly May, Arnold Schwarzenegger e his first official trip abroad. ng his stops were a visit to s injured in Iraq recovering at pital in Germany, a meeting King Abdullah in Amman, and a nd breaking in Jerusalem with a f government officials. This last or a Museum of Tolerance, a hese of the existing Museum of ance in Los Angeles, which com- exhibitions on the Holocaust ore diffuse installations ned to teach principles of toler- in general. Schwarzenegger een a generous supporter of A. museum, which is known for gh-tech, interactive exhibition ology. And the museum has ned the favor, rising to Arnold's ase when he was tarred with the oast of his father.

The Jerusalem branch of the nization has been designed by k Gehry and may cost some- north of \$200 million to build. It nclude not simply a museum but gress hall for meetings on toler- a movie theater for films about ance, a library of tolerance, and a restaurant. The centerpiece of the ct is its Grand Hall, a titanium ection with a turbinelike plan Gehry compares, in spirit, to a que. The museum, however, will from its L.A. counterpart in not ding its central element: displays ed to the Holocaust. Although exhibits were originally intended, ashem, Jerusalem's historic

Contributing editor Michael Sorkin is head of the urban planning pro- at The City College of New York.

Holocaust memorial, museum, and archive, objected to an invasion of its proprietary territory.

The Museum of Tolerance arrives with high hopes and the strong support of the right-wing Likud government, most prominently Ehud Olmert, former mayor of Jerusalem. The reasons exceed tolerance; the museum's sponsors avow that it "is forecast to become a stimulant for economic, cultural, and educational growth, as well as a boost to tourism resources." Indeed, according to Rabbi Marvin Hier, director of the Simon Wiesenthal Center, the umbrella organization for the Los Angeles museum, with the comple-

its dramatic economic impact—to be almost entirely the outcome of flamboyant architecture, the actual content of the various dream projects seemingly of secondary importance. The easy slide from an art museum to a museum of mass murder is thus accommodated by foregrounding the envelope, emphasizing its meanings over those within. Presumably those millions from around the world will come for the uplift of Gehry's design, not the horrors depicted inside.

The project's reception in Israel has been, to put it mildly, mixed. As the distinguished historian and former deputy mayor of Jerusalem Meron Benvenisti wrote in the Israeli

object. There's no need to waste words on the absurdity of a Museum of Tolerance planted on part of an ancient Muslim cemetery, some of which has long since been turned into a parking lot and will now be topped by spaces in which people are meant to learn about tolerance, mutual respect, and religious coexistence."

Benvenisti's skepticism is echoed by Esther Zandberg, the architecture critic for *Ha'aretz*, who wonders why Kikar Hatulot, a "highly popular urban plaza" that currently supports an ethnic market and a range of informal social activities on the site, is being eliminated for the building. Zandberg takes special umbrage at the Wiesenthal Center's refusal to make plans and images of the project public—despite their having been published in 2002 in the Japanese magazine *GA*—an embargo she claims is designed to forestall opposition and humor potential funding sources. Zandberg also shares Benvenisti's sense of the irony of erecting a "temple of tolerance" in a city so mired in fanaticism.

What better place, it might be argued, for a museum of tolerance? Certainly, the architectural component of Benvenisti's argument is dubious, a matter of taste, especially given the stultifying monotony of so much of modern Jerusalem. Indeed, there was a faction in Bilbao that took the same line about the Guggenheim's aesthetic impropriety. But the center of Benvenisti's objection is telling: Can this building have anything to do with promoting understanding between Israelis and Palestinians? That the answer might

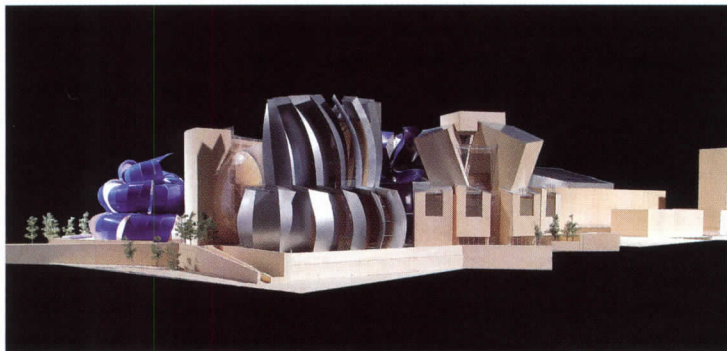

Gehry's design for the Museum of Tolerance features a twisting Grand Hall.

tion of the Israeli project, "the hotels and streets of Jerusalem will be bustling once more with millions of visitors from around the world, many of whom will come especially to see our center as they have come to see the Gehry-designed Guggenheim Museum in Bilbao, Spain."

This so-called Bilbao effect has captured the imagination of municipal authorities around the globe, who understand the phenomenon—with

daily *Ha'aretz*: "It is difficult to imagine a project so hallucinatory, so irrelevant, so foreign, so megalomaniac as the Museum of Tolerance. The mere attempt to stick the term *tolerance* to a building so intolerant to its surroundings is ridiculous. Others have already referred to the extravagant arrogance expressed in the geometric forms that can't be any more dissonant to the environment in which it is planned to put this alien

## Critique

be “no” was dramatically reinforced for me during a trip to Jerusalem in April, when I visited the Israeli “security fence” where it passes through the Abu Dis neighborhood, less than a mile from the site of the new museum. Here was intolerance materialized, a 30-foot-high wall of concrete barricading Palestinians from the center of the city, from jobs, from friends and family, from medical care, and enclosing Israeli Jerusalem in a terrible illusion of security.

The two expensive constructions cannot be separated: Their conflict is clear. A community cannot simultaneously repress its neighbor and proclaim its love of tolerance without hypocrisy. By identifying tolerance with an enormous building with a vaguely defined program, tolerance becomes an object of consumption rather than an act of conscience. More, the idea of constructing a beautiful center in which

people—those invited by the institution—can discuss their differences short-circuits obvious matters of the inequality between those building it and those with whom they might have discussions, furthering the imbalance of power and rights that fuel the conflict. As Herbert Marcuse observed, tolerance can also repress, an effect literalized in the substitution of a controlled environment for an existing public place, a place of both accidental and elective encounters rather than the scene of purely orchestrated and mediated events.

This museum, above all, is a rhetorical project in which a building is substituted for the harder processes of bridge-building, for the myriad acts of fairness that characterize a tolerant society. Gehry's building, in particular, with its familiar fragmentary style, uncomfortably evokes the “deconstruction” of Yasser Arafat's headquarters in

Ramallah into a pile of rubble by Israeli security forces. The painful contrast between these two places makes the absurdity of the new construction (we build shining monuments to our sense of tolerance while we blast your institutions to bits) so much more profound.

### Co-opting tolerance?

But my questions are for the architect. Will an extravagant building advance the cause of tolerance or simply stoke resentments? Is any sectarian attempt to co-opt the idea of tolerance for its political armamentarium worth supporting in an atmosphere as riven as Jerusalem's? What is the real purpose of this project? If it is to try to heat up the Bilbao effect with a museum of genocide, is this really a project an architect of conscience should participate in? Does Gehry think that describing the central hall of the complex as being “like a mosque” will really establish the tolerant credentials of this project?

Although Gehry is generally

gnomic in his political utterances, interview in *GA* revealed that he is not altogether unaware of the local geography of this undertaking. He speaks of his satisfaction that the project was moved from its original site in a more peripheral location because it was opposite a proposed Israeli jail. The new site is opposite a courthouse, a distinction probably lost on most Palestinians who pass through the judicial system, the same Palestinians who will be prevented by the wall—their permanent jail—from visiting the Museum of Tolerance erected to stimulate friendly discourses of difference.

Eminence has its responsibility which extends beyond the realm of professional practice: We have high expectations of our best artists because their work and words carry special weight. It is not possible to build this project without an opinion on larger issues—real issues of tolerance—in the region. What is Gehry's? This is not a question of the use of titanium versus Jerusalem stone. It is one of justice. ■

# Stone Facade Systems

## *Fischer ACT System One-Advanced Curtainwall Technology*

- Stress free undercut anchor suspended on an aluminum sub-frame
- System can span floor to floor without load bearing tiebacks
- Ideal for problem substrates
- Allows for exterior insulation with minimal penetrations of the insulation envelope
- Seismic tested to 9 on the Richter Scale
- Larger panel sizes, higher ultimate loads, reduced panel thickness
- Ventilated, thermally efficient facades
- Panels are interchangeable and repairable

**PROBE**  
CONSTRUCTION PRODUCTS, INC.

Registered W.B.E.

1.973.831.1761 • m.tett@worldnet.att.net

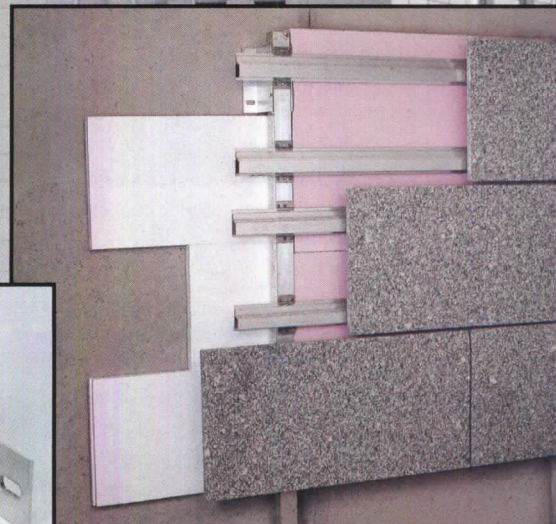
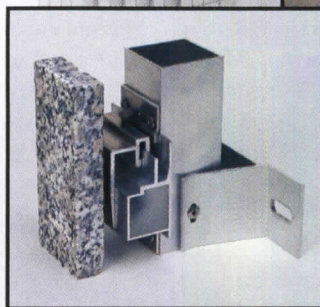

Come see us at the AIA 2004 Design Exposition.....Booth 2211

CIRCLE 90 ON READER SERVICE CARD  
OR GO TO WWW.LEADNET.COM/PUBS/MHAR.HTML

# Art Center College takes design discourse public

## Commentary

By Joseph Giovannini

as Jefferson, who extolled the virtues of the land over what he considered the evils of the city, he promoted the idea of the American West at the University of Virginia and set a lasting tradition of academic removed from the city in a purer form of its own. Design conferences followed suit, famously in Aspen, Colorado, and, recently, at the TED conferences in Monterey, California, in places where clean air presumably gives that extra boost of clarity. In March, the Art Center College of Design in Pasadena, California, challenged all that with its first biennial design conference, *Designations Out of the Ordinary*. In the epicenter of American suburbia, far from the oak-spotted Arroyo Park and the Huntington Library, Richard Koshalek, Art Center president, brought his school's serene hillside campus and its design conferences out of their idyllic hideaways into the grid of the city. The conference inaugurated the first building of the school's new South Campus, accessible to anyone just off the Pasadena freeway or the Gold Line, and Los Angeles's new light-rail station. Koshalek joined what seemed like mutually exclusive spaces: the art world and the ivory tower. In the midst of shaping a new campus in the thick of downtown Pasadena, where he plans to open design to a wider audience

on a daily basis in a complex of old industrial buildings, Koshalek linked the urbanizing polemic of his new building with a conference that brought an international roster of speakers together in a sustained moment of academic extroversion.

He also pivoted the conference in the direction of the neighboring California Institute of Technology, opening up Pasadena's other self-isolated campus just down the road by bringing its scientific discourse into the design loop. Cal Tech president David Baltimore, a Nobel laureate in biology, opened the conference with a breathtaking talk explaining no less than the design of the universe as a self-organizing system of forces. Charles Elachi, director of the Jet Propulsion Lab, closed the conference with an inspiring presentation of the story behind the Mars Rover.

The two-and-a-half-day event took place in a huge wind-tunnel facility recently remodeled by the Santa Monica firm Daly Genik. With images of speakers projected on multiple screens the size of Mt. Rushmore's presidents, the cavernous building conferred grandeur simply through the psychophysics of size.

Bookended by Baltimore and Elachi, speakers ranged from car designers and cartoonists to advertising gurus. Frank Gehry—who is designing a library on the original Art Center campus—Thom Mayne, and Greg Lynn represented architecture. But anyone who came expecting to find architecture billed as the mother of all art, at the top of a design pyramid à la Beaux Arts or Bauhaus theology, was disappointed. As portrayed in

this conference, no such controlling hierarchy exists in design, which has been completely balkanized.

The Art Center is famous for training car designers, and appropriately, General Motors was the main conference sponsor, providing one of the most pointed speakers, Bob Lutz, a GM vice president. A legendary design executive, he stated that Detroit lost its passion and market

in a postmodern era no longer focused on abstraction. But few people sustained the topic beyond lip service, and the occasional references did not add up, even in a Pointillist way, to a larger picture transcending independent disciplines and portraying, as the brochures promised, "design as the core of innovation and the medium in which the stories of our time are told."

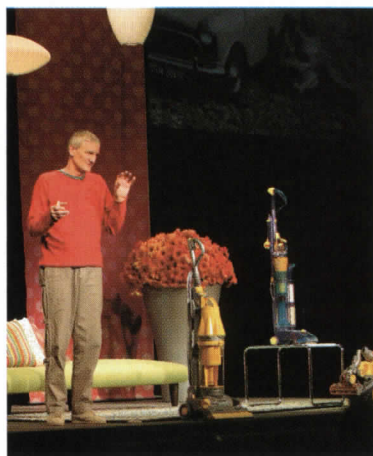

**James Dyson (left), inventor of a see-through vacuum cleaner, spoke of honesty in design. The Art Center, known for training car designers, held the conference in a wind-tunnel-turned-school-building by Daly Genik (right background).**

position when designers were marginalized, and that design actually now makes the defining difference between cars, which otherwise increasingly exhibit the same standards of engineered performance.

Art Center senior vice president Erica Clark and Chee Pearlman, former editor of *ID* magazine, shaped the program as an open system, to cast a wide design net and capture a broad range of figures.

The putative theme of the conference was narrative, a pet subject

Without tight focus, the conference took off with a refreshing, provocative nonlinearity, producing an unpredictable sequence of figures. It was a big tent of designers representing different disciplines and m.o.s. Japanese polymath Eiko Ishioka, who has designed everything from TV commercials to Olympic sportswear and sets for the play *M. Butterfly*, displayed a heroic yet surreal sensibility. In an almost confessional talk, Maira Kalman escorted the audience into her small

Joseph Giovannini is an architect and architecture critic for New York magazine.

## Commentary

studio, where she snuggled up to her subject with the warm introversion that permeates her children's books and *New Yorker* covers. Her subject, in its way, was the sensibility of subjectivity—a far cry from the objectivity of the amphibious robots, for example, created by Berkeley professor Robert Full, who demonstrated that the design of the muscles and skeletal parts of his robots (and by extension, living creatures) themselves determine patterns of movement, not the brain.

Standouts included Cameron Sinclair, charismatic founder of Architecture for Humanity, which organized a design competition for transitional shelters whose very construction builds communities through the training of local labor forces. Lee Clow enchanted the audience with TV ads that were filmic haiku. Clow is the man who created the *Think Different* cam-

paign for Apple after Steve Jobs took back the company and needed to announce its change of ethos—back to creativity—before any new products were developed. Peter Girardi, founder of Funny Garbage, detailed his intellectual biography, from *Mad Magazine*—"vital to my survival"—through cereal boxes and his career as a graffiti artist roaming New York's subway yards. What he calls "crap culture" is the grist for his art.

The great value of the conference was the presentation of a huge amount of material in a raw, virtually unedited flow, sometimes with serendipitous juxtapositions. The downside was an inability to develop chance intersections of serious ideas. Lutz noted that in car design the "passion and emotion essential to good design" belong to the "skilled designer with a skilled clay modeler," but escape computer modeling with

its emphasis on a surface vocabulary. Greg Lynn begged to differ, noting that he had a passionate relationship with his computer. He spoke of new digital technologies coming together as a crucible for "new kinds of synthesis," forging a new moment: "Computers have leveled the field," he said. Other than Lynn's commentary, the computer as the ur-instrument across disciplines was never discussed, even though it provides design a potentially unifying technology, and a consolidated narrative.

Soft-spoken James Dyson, who invented the see-through, bagless, cyclone vacuum cleaner that has humbled Hoover, also took on Lutz implicitly. Dyson champions honesty in design as a direct expression of engineering, not styling.

Thom Mayne advocated design generated by systematic operations rather than composition, a position that theoretically eliminates the author. Yet no one took up the argument, not even Gehry, a master composer. Simmering just

below the surface of all the talk was the issue of subjective versus objective design, the emotional versus the rational.

Graphic designer Bruce Marder delivered *perhaps the only overview of design* in a talk about massive change. He spoke of the abandonment of traditional disciplines like graphics, architecture, and industrial design in favor of a globalized design culture based in broad economies. But his potentially explosive observations remained self-contained. The inability of the event's format to develop these idea intersections across stand-alone talks condemned the evening as a whole to the anecdotal. The conference left the impression that it was less about ideas than energy, not a synthesis of thought but a confluence of figures designing parallel universes. Chee Pearlman said she conceived the conference like a magazine, trying for the stimulating mix. She succeeded. But sometimes you want, and need, to read a book. ■

# Designed To Perform, Built To Last

Since 1926, Bilco access products have featured innovative design, exceptional workmanship and superior performance. Bilco's line of access products includes:

### • Roof Hatches

Their rugged durability, ease of installation, effortless operation and weather-tight construction make Bilco roof hatches the industry standard.



### • Automatic Fire Vents

Bilco fire vents automatically release to vent heat, smoke and gases in the event of a fire. A wide range of vents and a variety of options are available.



### • Floor, Vault and Sidewalk Doors

Heavy duty doors with counter-balanced covers ensure smooth, easy and controlled one-handed operation. A wide variety of models are available.



**Bilco**<sup>®</sup>  
*Building on Our Tradition*<sup>™</sup>

From architects and specifiers to tradesmen and end-users, Bilco's reputation for high quality and product performance is unequalled.

For more information, call (203) 934-6363 or log on to [www.bilco.com](http://www.bilco.com)

© 2004 The Bilco Company



# Design\_Shift: How computers and the architects who love them are changing the world

## Books

**Digital Ground: Architecture, Pervasive Computing, and Environmental Knowing**, by Malcolm McCullough. Cambridge, MA: MIT Press, 2004, 262 pages, \$38.

The pervasiveness of computers and other digital technology is, for Malcolm McCullough, not a curse but a design challenge. In this well-illustrated book, McCullough, associate professor of architecture and design at the University of Michigan, leads us through a well-reasoned argument for embracing good design as a means of offsetting many of the intrusive effects of computers in our lives. There are more of them than there are of us. A decade ago, the number of microprocessors (those tiny chips that run all kinds of electronic gadgets) surpassed the number of humans in the population. Today, computers and other electronic devices are ubiquitous, McCullough argues, because they are now embedded in our world, everywhere, even when we can't see them. They have become like electricity itself—surrounding us, yet invisible, and just as essential. Omnipresent computers change the places and ways we communicate and interact—it can happen anywhere, anytime—and disrupt daily living. This is just one of the reasons that the blabbermouthed cell-phone user next to you on the train or on the sidewalk is so distracting—the context for designing the personal is now public. For McCullough, this is the crux of the situation: The placelessness of digital lives (access from any-

where, to anywhere) makes it even more important for our bodies to be situated in an identifiable space, in a nurturing place. Reading McCullough, I was reminded of Alvin Toffler's observation more than 25 years ago that high tech increases the need for high touch. The more estranged we become from the material here-and-now, the more we need grounding in it.

McCullough's answer is "digital grounding," an approach to architecture that emphasizes place-centered design. He explores these ideas most fully in Chapter 8, the heart of his book. McCullough does not see place as a nostalgic throwback. Instead, place is purposely designed for social interaction. It gives our digitally dominated lives a locus, in which the new conventions of living can be performed. It is not a retreat from technology, but an attempt to balance the unstable digital realm with our human need for stability. "In our age of technological saturation," he observes, "response to place becomes the most practical adaptation strategy of all." This book offers architects, designers, and everyone

else a way to think about how we might intelligently respond to the computer kudzu without letting it take over the garden. *Michael J. Crosbie*

**Next Generation Architecture: Folds, Blobs, and Boxes**, by Joseph Rosa. New York: Rizzoli International Publications, 2003, 240 pages, \$45.

*Next Generation Architecture* looks at the range of work being shaped, rendered, and fabricated by digital technology—work that includes folds, blobs, and morphed boxes. Rosa traces blob construction from its predigital forerunners—Frederick Kiesler, John Lautner, and Buckminster Fuller—to Frank Gehry and the younger blobmeisters (including Greg Lynn, Doug Garofalo, Iwamoto Scott, Jakob + MacFarlane, Kolatan/MacDonald, William Massie, SHoP, and UN Studio). Rosa credits Bernard Tschumi for disseminating digital design by establishing the first paperless design studios at Columbia University in 1994. Rosa notes that most digerati either taught or studied there. He cites Gehry's Experience Music Project in Seattle, completed in 2000, as a "model for what digital blob architecture can be in the 21st century" and Eisenman's 1997 scheme for the Staten Island Institute of Arts and Sciences as a model for the digital fold building.

Digital design, rather than being reductive, writes Rosa, is fusing with other media to generate new types of buildings that can respond to the

human voice, other sounds, and/or physical movement. He observes that digitizing the design process has allowed architects to explore a sort of critical digital regionalism that incorporates conditions of site, program, and culture. Among Rosa's examples are the landscapes and urban design work of Field Operations (Stan Allen and James Corner). Not surprisingly, digital architecture exhibits optimism about architecture's possibilities and is changing the architectural office, which can now exist anywhere designers have access to hard drives.

Many of the projects in this book are unbuilt. Among built exam-

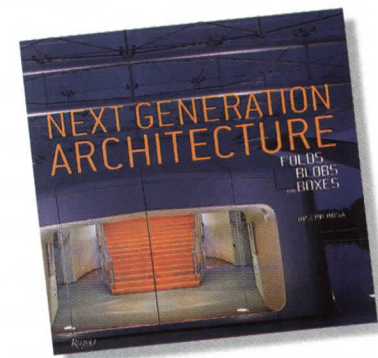

ples is SHoP's temporary structure in P.S. 1 Contemporary Art Center's outdoor courtyard on Long Island City, New York. Completed in 2000, it is a tilting, rolling, blob-shaped surface, made of 6,000 2-by-2-inch cedar strips that incorporate roof, walls, benches, and boardwalk. Visually and physically engaging, it tells me that although digital architects may have replaced such architectural standards as beauty, scale, and proportion with new values that prize the smooth, supple, and morphed, as Rosa writes, their

## Books

surroundings. As examples, they cite Shigeru Ban's Curtain Wall House and his Naked House, both in Tokyo, and OMA's Prada Store in New York.

The book's strength lies in overturning received ideas, but its logic requires some assembly. Its title is inclusive, yet it feels incomplete: Discussions about Minimal architecture during the 1980s and '90s took place primarily in Europe and Japan, so the book includes only the work of 20 European and Japanese Minimalists. One wonders where American architects—such as Gwathmey Siegel, Antoine Predock, and Richard Meier—who remained committed to a Minimal vocabulary during the 1980s and '90s, would fit. The book's logic implies a progression from Essential Minimalism through Meta-Minimalism to Trans-Minimalism, but you wouldn't know it from the authors' text, and their chosen projects don't show an evolution.

One thing is certain: *Minimal Architecture* is provocative, and after closing its covers, you're likely to look at many buildings not included in its pages with a fresh eye. *A.O.D.*

**Masterpieces of Chicago Architecture**, by John Zukowsky and Martha Thorne. New York: Rizzoli/Art Institute of Chicago, 2004, 240 pages, \$65.

This expansive compendium of Chicago architecture highlights the built and unbuilt legacy of a city long renowned for bold achievements in design. Culled from the collection of the Art Institute of Chicago's Department of Architecture, drawings and images narrate the contributions of Chicago architects past and present, including Daniel

Burnham, Stanley Tigerman, and Jeanne Gang, while acknowledging the iconic works of Louis Sullivan, Frank Lloyd Wright, Mies van der Rohe, and other masters.

Art Institute curator John Zukowsky's introduction is an unabashed celebration of the department's efforts to acquire, organize, and exhibit the most significant examples of architectural representation. Indeed, the author and his colleagues have much to celebrate. In a little over two decades, their permanent collection has grown to more than 130,000 drawings, several hundred building fragments and architectural models, and invaluable oral histories.

The bulk of this tome presents a straightforward, chronological look at the built and imagined works of Chicago's architectural canon. Alongside classics such as Sullivan's

Schlesinger and Mayer Store and Mies's IIT campus lie refreshing novelties like Buckminster Fuller's Dymaxion Car, which was designed for the Century of Progress Fair in 1933. Thrown into the mix are SIT McDonald's Floating Restaurant (1983), Tigerman's *The Titanic*, 1978 photo collage commenting on the fall of Chicago's Miesian Modernism, and Dan Wheeler's nautical-inspired North Avenue Beach House (1999). Hand-tinted photographs, watercolor renderings, and digital views all support this broad range of architectural innovation.

In her epilogue, associate curator Martha Thorne addresses Chicago's reputation for conservatism but insists on a millennial move toward nonconformity. Citing Rem Koolhaas's new campus center at IIT, as well as works by rising stars Jeanne Gang and Doug Garofalo, Thorne continues the book's forward trajectory. If the current spate of projects is any indication, the department will soon require more architectural space. *Nick Olsen*

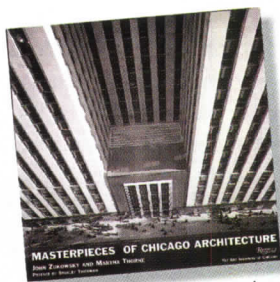

# mailboxes.com

Commercial Mailboxes  
Residential Mailboxes  
Custom Signage





**Contact Us for a  
Free Catalog  
Today!**





1-800-624-5269  
salsbury@mailboxes.com

1010 East 62nd Street  
Los Angeles, CA 90001-1598

# it's a wall.



Break the mold with complete design freedom using translucent, frosted and opaque panels. Countless colors, textures, patterns and gauges will impact any application. Solid thinking.



you can do that.™

Call for samples: **800.726.0126** or visit us at **www.3-form.com**

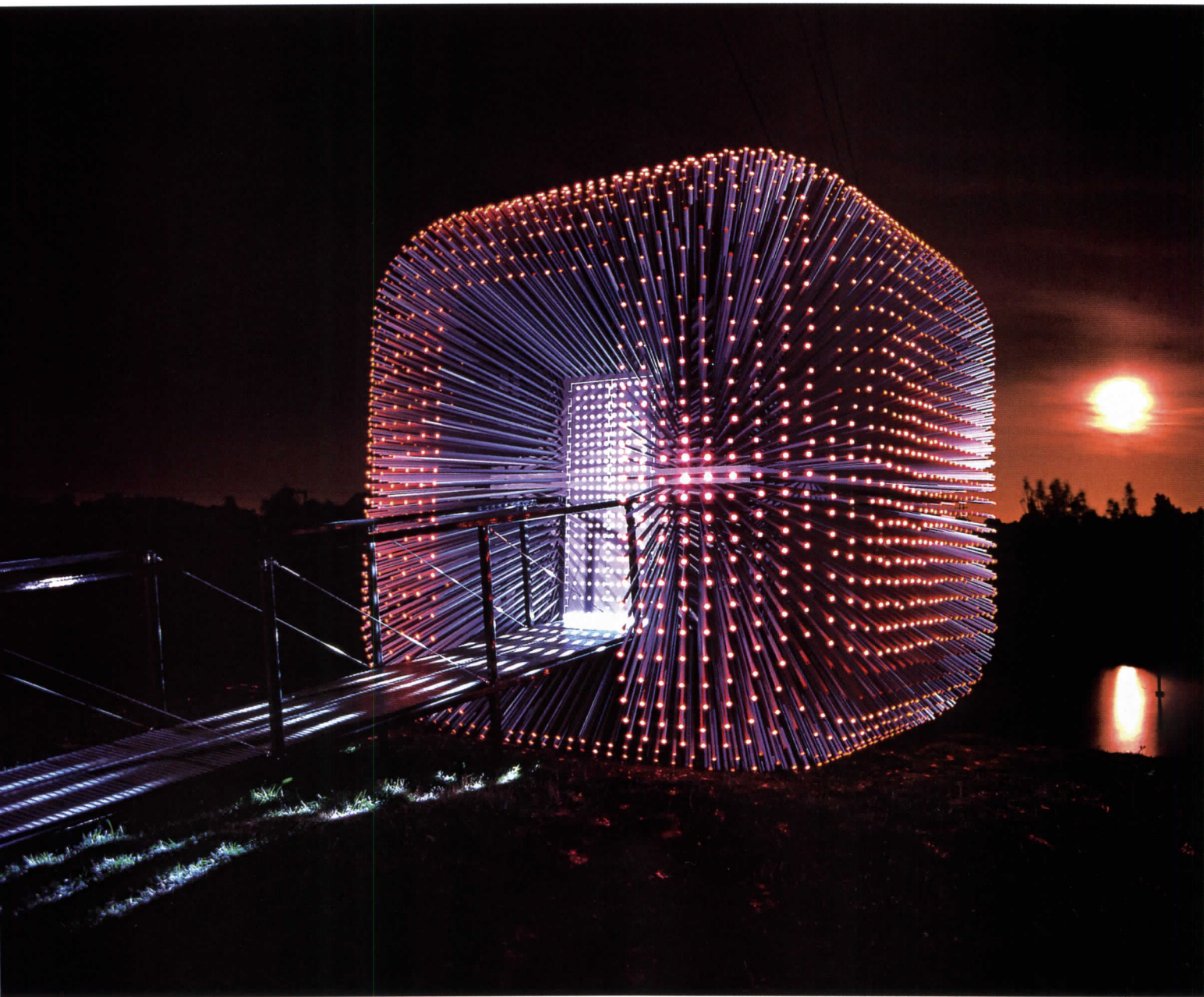

## Thom Heatherwick Richardson

...been compared to a glowing hedgehog, a spacecraft, and in the designer's own words, "a fakir's bed of nails," yet it is one of the most inventively inventive follies ever to grace the English countryside. Now sited at Bernard's Farm, a privately owned sculpture garden in Essex, Thomas Heatherwick's anemone-like aluminum form is, he says, "an experiment in structure and in using many thin pieces to make something strong that could be placed any way up."

Some of the quirkiness is perhaps explained in the origins of the commission, a competition sponsored by English Heritage in 2000 to create a gazebo-like structure known in Scottish parlance as a *sitooterie*, or a place to sit in. The winning designs were constructed as temporary buildings in the wooded landscape of Belsay House in Northumberland. One of the most remarkable to spring, almost literally, from that competition was the fantastical one wrought by the young, London-based Heatherwick and dubbed "The Hairy House": a wooden cube perforated by 5,000 slender oak staves that lifted the structure off the ground, surrounded it in a prickly shroud, and in

## Sitooterie: sculptural folly in the English countryside

Capped with translucent colored acrylic, the Sitooterie's tubes create an orangey glow in daylight and are lit from within at night by a single bulb.

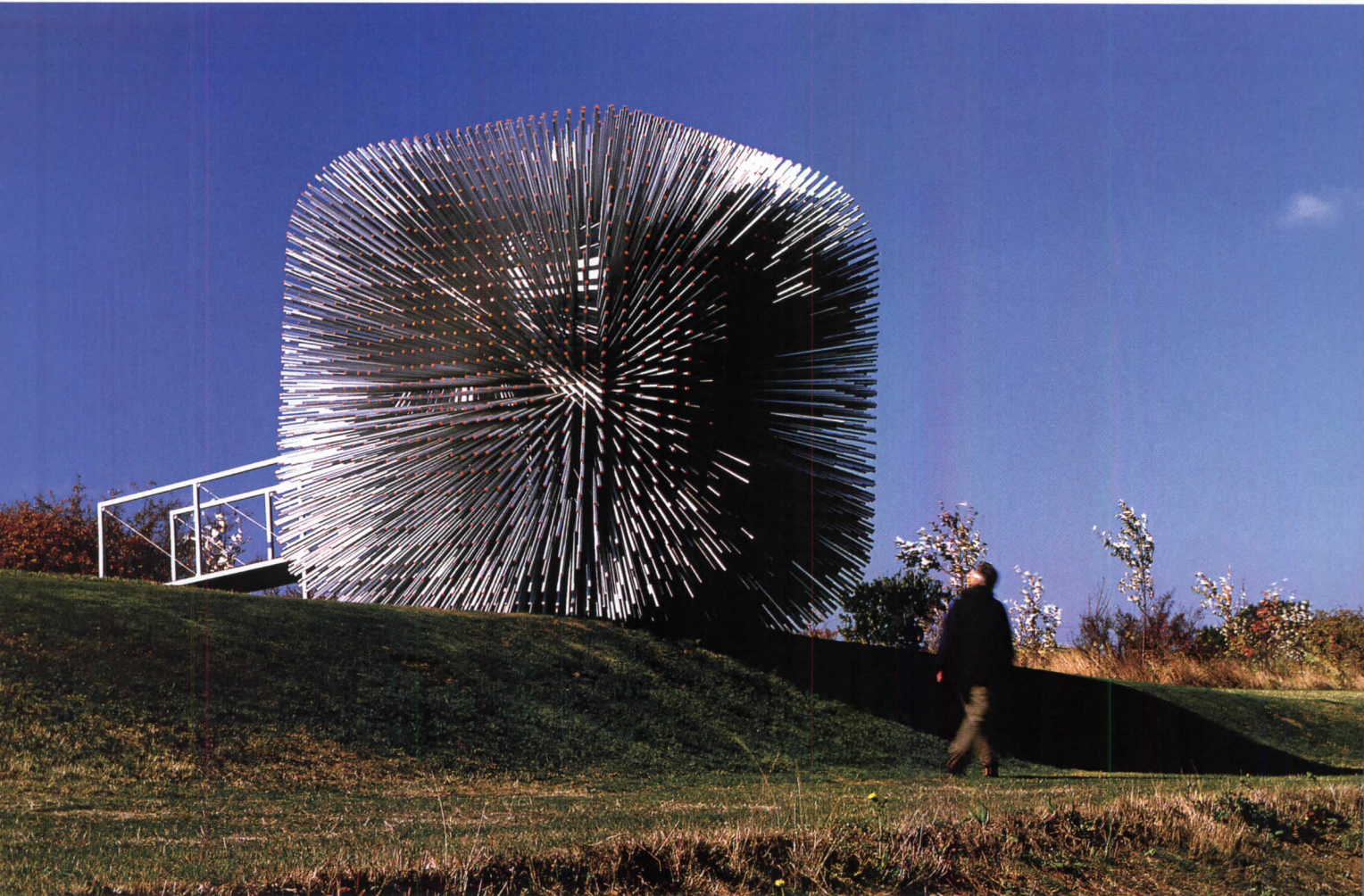

some cases penetrated to the interior to provide wall texture and support for furnishings. It was this toothpick-style version that inspired the owner of Barnard's Farm to commission the permanent structure that now graces his farmland garden.

Wood turned to aluminum, and production moved from timber-milling techniques to metal-fabrication technology. The essential cubic core, with thousands of predrilled holes and a mass supported on a brushlike agglomeration of extruding members, remains. However, the staves have been replaced by long, thin, hollow rectangular pieces that had to be individually machined by an aeronautical engineering company in Southampton before being assembled on-site. The tubes are of different lengths and all point to the center of the cube. Capped with translucent colored acrylic, they effect an orangey glow in daylight and are lit from within at night by a single bulb. The designer admits, "The lighting is very low-tech." However, precision was essential. The aluminum skin is 0.6 inches thick and is pierced by 4,704 tubes adhered to the central 8-foot cube (which can hold about half a dozen adults) through finger joints that are formed at the end of each piece. With each tube having a hollow area of a mere 0.7 inches square, the designer ensured that the overall impression would be of a

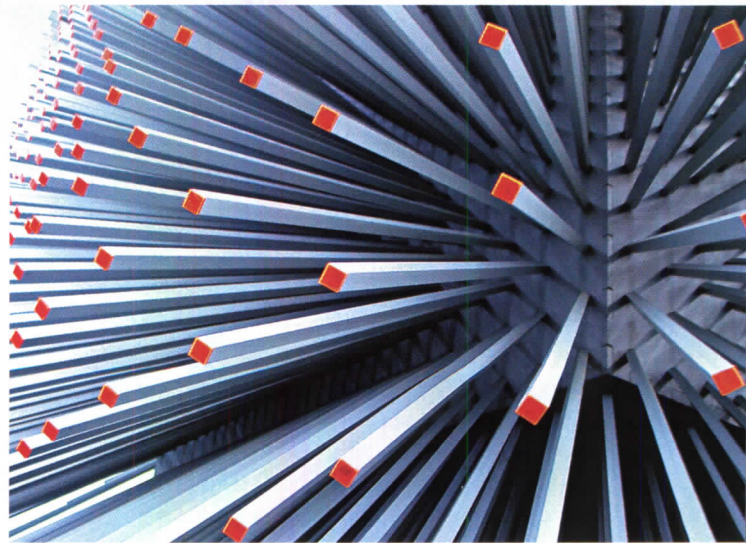

fuzzy, though tactile-seeming solidity that, on closer inspection, reveals an even more tactile multiplicity. Heatherwick, who is in the process of building the U.K.'s tallest sculpture in Manchester, has not just achieved a tale of design virtuosity. The Sitooterie is a demonstration of skilled, cutting-edge craftwork—the artful marriage of imagination and technology. ■

# American Institute of Architects

## 2004 Honor Awards

Architecture	p. 140
Interiors	p. 160
Urban Design	p. 168
25 Year Award	p. 172
Firm Award	p. 176
Gold Medal	p. 184

Excitement was palpable the evening of March 3rd at the National Building Museum, where a festive Accent on Architecture Gala dinner hosted by the AIA was attended by more than 1,000 guests—the largest turnout in the history of the event. They came to celebrate the AIA 2004 Honor Award winners for the Gold Medal, 25 Year Award, and Firm Award in the museum's Great Hall, a marvelous setting of open archways, light, and height for the occasion. When Samuel Mockbee, FAIA, was announced as the Gold Medalist posthumously, his wife, Jackie, received the award on his behalf in a deeply moving speech.

She outlined his life and vision, and spoke of his legacy, both in the continued activities of the Rural Studio and in the careers of his children. In particular, his youngest daughter, Carol, who works at the Rural Studio as an Outreach Fellow, is completing an unfin-

ished project dear to Sambo's heart: a memorial called the Subrosa Pantheon, a place for contemplation "under the roses." It is a fitting legacy of an illustrious career and will be completed in December 2004.

I.M. Pei, FAIA, then received the 25 Year Award for the East Wing of the National Gallery of Art, focusing his comments primarily on the beauty and force of John Russell Pope's adjacent 1941 West Building, which was the inspiration for Pei's contemporary contribution to the National Mall.

Ted Flato, FAIA, and David Lake, FAIA, of Lake/Flato Architects, which received the Firm Award, offered inspired speeches, then invited their entire partnership to the stage for congratulations. On the following pages, these top honorees are joined by 16 architecture, 8 interiors, and 5 urban design project winners, all of which provide stunning and intelligent examples of design excellence. Jane F. Kolleeny

# ARCHITECTURE

**F**rom a tiny chapel that contemporizes traditional style to high-rise megastructures monumentalizing Western culture to houses celebrating the simple virtues of nature, 16 winning projects provide examples of stunning design. Architecture jury chair Adrian Smith, FAIA, describes the projects as diverse in typology, scale, context, economic means, and materiality. Common themes include energy conservation, cultural relevance, client identity, clever use of materials, and seamless integration of building services and structural systems into the fabric of the architecture. In this year's AIA Honor Awards program, young emergent talent and mature repeat winners join together in demonstrating that architecture is alive and well in every generation. Jane F. Kolleeny

1

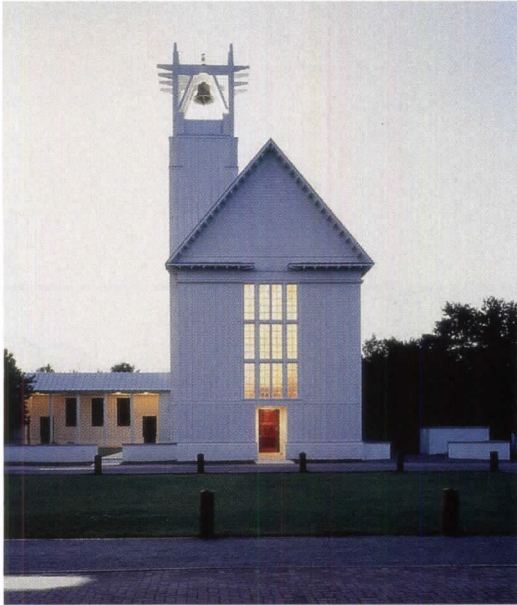

## 1. Seaside Interfaith Chapel Seaside, Fla.

**Architect:** Merrill and Pastor Architects

This charming chapel transforms the town of Seaside from an experiment in New Urbanism into a community. Becoming the physical focal point of the town, the chapel conveys a strong sense of

place, coherence, and spiritual unity. An elegant example of design and construction detail, it exhibits a sensitivity to form, incorporating traditional style into a modern framework. Natural light floods the predominantly white-washed wood interior, with altar walls stained to match the dark floors made of pinewood salvaged from north Florida rivers.

**“Constructed of concrete and wrapped in wood, the chapel is a metaphor of inner strength with a humble exterior and a spiritual core.”**



“A very personal space full of elegant elements of whimsy—a place that is meant to be used and enjoyed.”



**2. The Brain**

Seattle

**Architect:** Olson Sundberg Kundig  
Allen Architects

Aptly named The Brain, this film studio provides office, darkroom, and library space so the owner, a filmmaker, can use it as a retreat

from his adjacent residence to think and create. The cast-in-place concrete box nestles in the woods of a suburban site, providing intimacy and privacy. Floor-to-ceiling industrial steel windows allow plentiful light, modulated by theatrical curtains. The finely tailored building fits the spirit of the owner.

“Clear planning and exquisite detailing of materials combine to produce a project of incredible richness.”



3

**3. The Point House**

*Polson, Mont.*

**Architect:** *Bohlin Cywinski Jackson*

Superbly sited on a secluded peninsula that extends into a large Montana lake, the house establishes a dialogue between land and water. Part of a year-round family compound, it melds gently with the unspoiled natural beauty of the land. Resting among evergreens, the house extends from the rock spine to the edge of the dense wetlands. Building elements are organized along a wall of Cor-Ten steel that slices through the site. Distinctions between inside and out become intentionally blurred with tall walls of glass and large sliding panels.







4

**Chickadee Point Cabin**  
 Eden Lake, Ind.

**Architect:** Olson Sundberg  
 Bergendoff Allen Architects

The lakeside shelter has a large  
 low wall that literally opens  
 the entire living room to the  
 woods and lake beyond. The sim-

ple and durable low-maintenance  
 materials—concrete floors,  
 concrete block, plywood, steel—  
 remain unfinished to age  
 naturally, merging seamlessly  
 with the surrounding landscape.  
 Sleeping 10, this weekend coun-  
 try “cabin” retreat makes big  
 moves with a small palette.

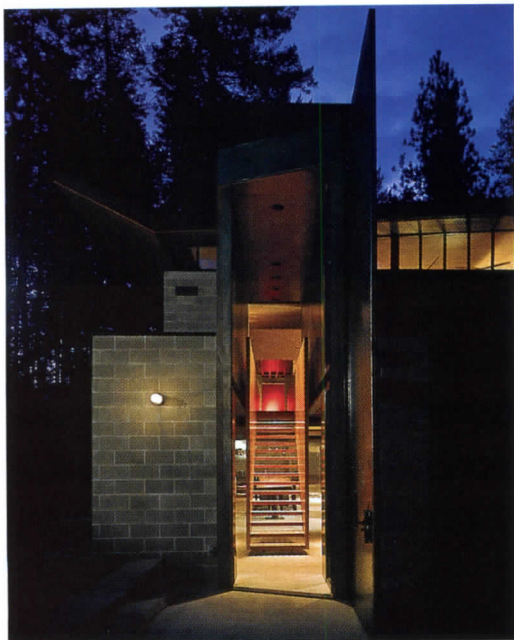

**“There is a clarity and elegance  
 in the detailing of the humble and  
 modest materials that ennobles the  
 project with richness.”**

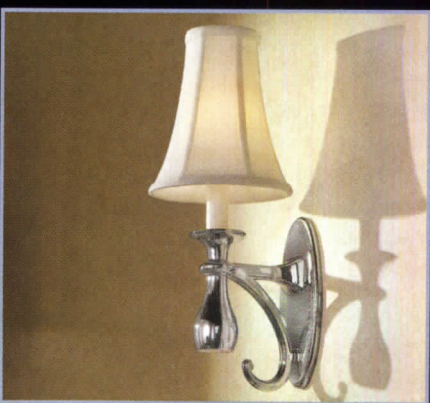
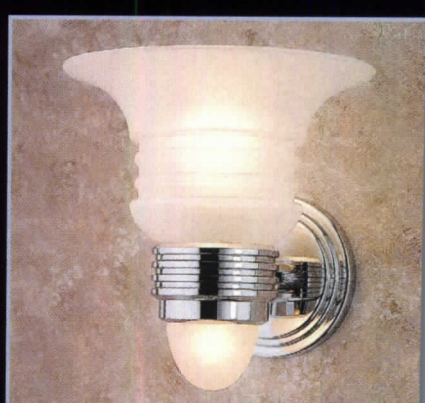

Whether traditional or modern, Ginger sconces are timeless classics. Forged in the finest solid brass, they feature mouthblown glass or fabric shades.

Other configurations and styles are also offered. All sconce lights are UL listed for damp locations; some are ADA compliant. Finishes vary per collection.

*Designed by Victor Hoernig, Masco  
Product Design*



**GINGER**  
*fine bathroom accessories,  
lighting and mirrors*

T. 888.469.6511

F. 803.547.6356

E. [info@gingerco.com](mailto:info@gingerco.com)

[www.gingerco.com](http://www.gingerco.com)

CIRCLE 106 ON READER SERVICE CARD  
OR GO TO [WWW.LEADNET.COM/PUBS/MHAR.HTML](http://WWW.LEADNET.COM/PUBS/MHAR.HTML)

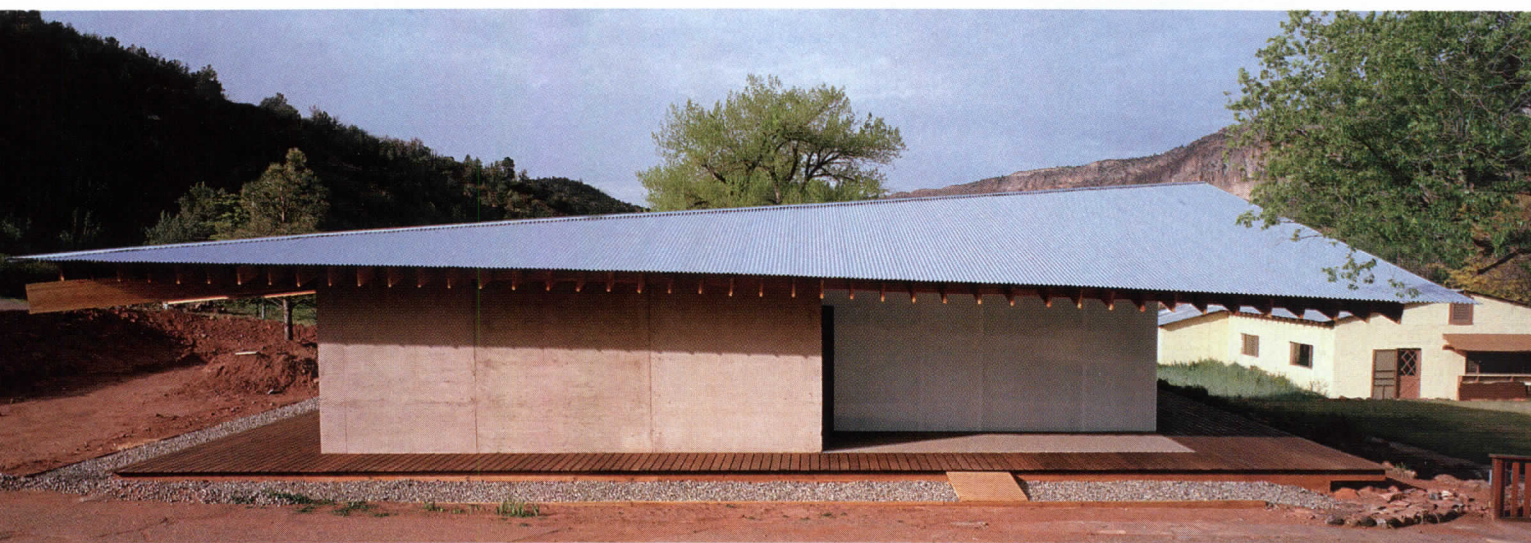

**Center of Gravity Foundation Hall**  
 Zen Springs, N.Mex.  
 Architect: Predock\_Frane  
 Architects

The new, 3,000-square-foot meditation hall serves as the primary teaching and practice space for the Zen Buddhist compound. The building's sliding, folded metal roof sits on purlins that can-

tilver over exterior walking meditation areas. Beams span over the hall, resting on steel columns. Delicate translucent polycarbonate walls intersect massive rammed earth walls. Sliding wood panels open onto the garden, extending the austere interior space out to the landscape, creating a serene but dynamic sanctuary for contemplation.

5



**Simple and mysterious, the organic materials and fine detailing melt the building form and the mission together."**

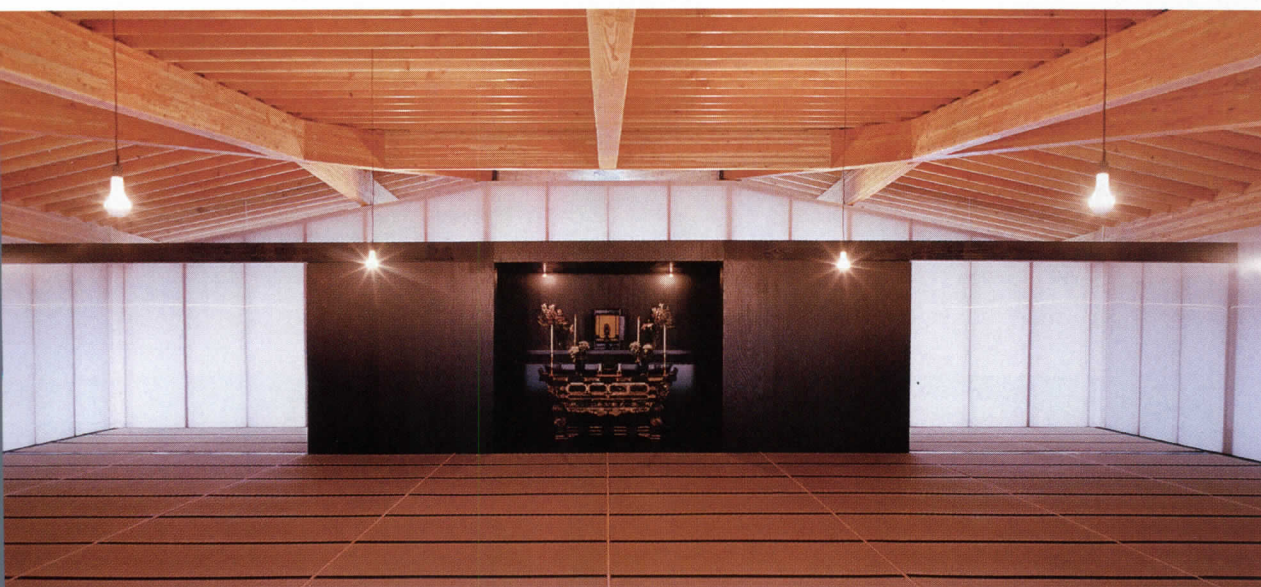

LIGHTING  
IN CONTEXT  
WITH  
ARCHITECTURE.

Bisecting geometric shapes articulate a new vision in building mounted illumination.

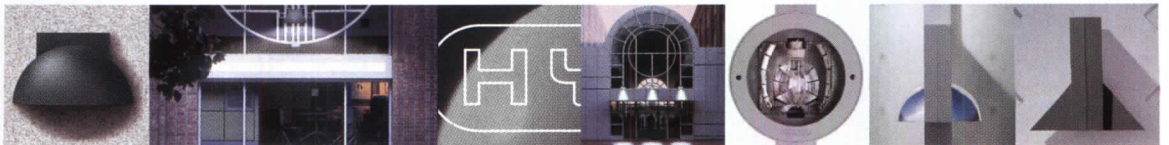

CIRCLE 107 ON READER SERVICE CARD  
OR GO TO [WWW.LEADNET.COM/PUBS/MHAR.HTML](http://WWW.LEADNET.COM/PUBS/MHAR.HTML)

G2™ DESIGNS BY HYDREL

**HYDREL**

An Acuity Brands Company

[WWW.HYDREL.COM](http://WWW.HYDREL.COM)

**Northwestern University West  
Campus Residence Halls**

on  
itect: *William Rawn  
ciates*

lishing these three new  
ence halls to accommodate  
students helps fulfill the  
niversity's transformative vision  
rigorating its threatened

urban presence. The facilities  
create an exciting environment  
for students' personal growth;  
contribute to the university's goal  
of achieving a higher academic  
standing; and energize an urban  
area that has long been unappeal-  
ing. Opening to the front edge of  
a new west campus, the dorms  
engage and unify the university  
with the city.

6



**“Tremendous sensitivity, skill, and  
creativity are shown in the shape  
and arrangement of the buildings  
and the assignment of the portals.”**





Looks that get noticed

Performance that stands up to the crowd



J & J C O M M E R C I A L

*Carpet for spaces that work.*

CARPET: LIQUID | JJCOMMERCIAL.COM | 800-241-4586

CIRCLE 108 ON READER SERVICE CARD  
OR GO TO [WWW.LEADNET.COM/PUBS/MHAR.HTML](http://WWW.LEADNET.COM/PUBS/MHAR.HTML)

NeoCon showroom 10-118

**Case Study - Project MAC**  
 Macomb Township, Mich.  
**Architect:** Thomas Phifer and Partners

To accommodate an accelerated construction schedule, the architect used prefabricated components to build this two-story spec building. To be flexible, the steel frame-shell structure allows interior spaces to change in size for a wide variety of uses. Abundant natural light and localized climate control contribute to the amenities. The cantilevered roof unifies the building with a lightweight canopy. The spatial connectivity of the open-plan interior encourages a collaborative, egalitarian workplace environment for hard work and creativity.

7



**This project shows that it is possible to design a beautiful and elegant spec office building on a modest budget.”**

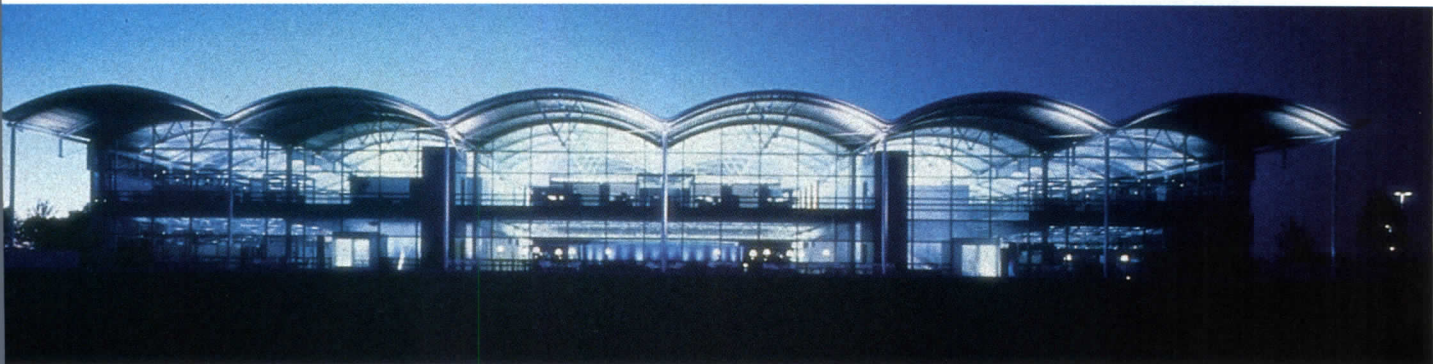

## Reflections are the way life used to be.

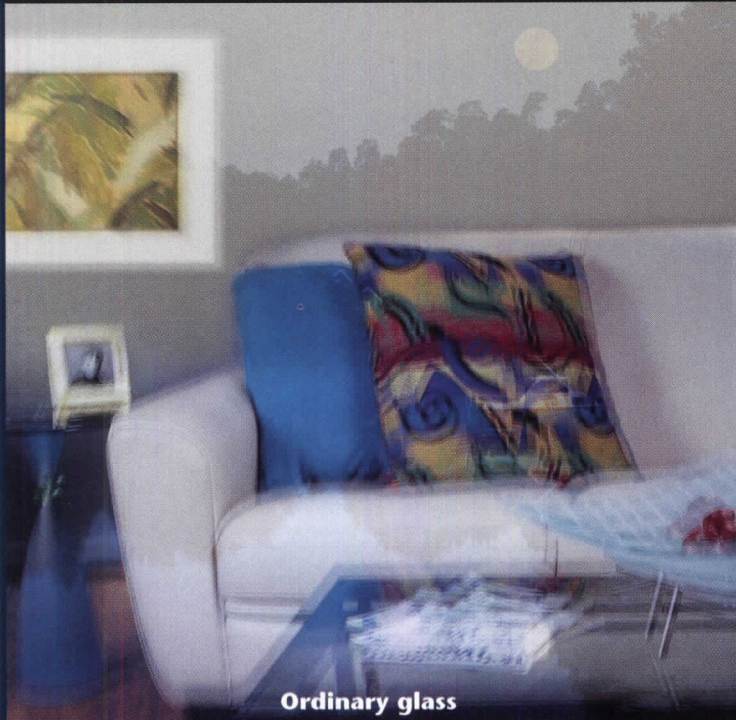

Ordinary glass

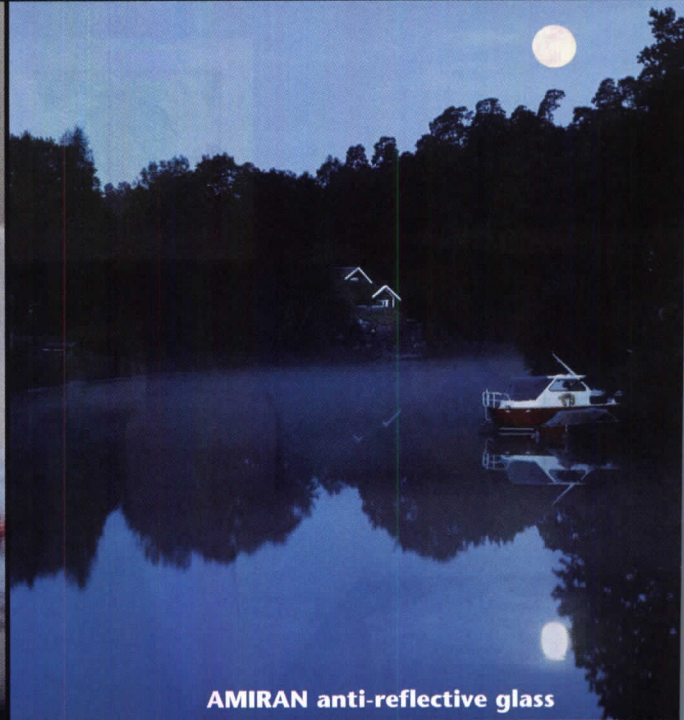

AMIRAN anti-reflective glass

### Amiran® anti-reflective glass gives your residential clients remarkably clear nighttime views.

The sun goes down. The lights go on. The view is still magnificent. Because the anti-reflective glass used in storefronts, sports stadiums and museums around the world is now available for your residential projects. Amiran anti-reflective glass reduces glare in insulated glass to as little as 2% — even at night. Amiran glass can be installed in any frame glazing system you would use for ordinary windows and can be laminated and tempered for safety. It's so effective that some upscale communities, Lake Tahoe for instance, have adapted construction guidelines to suggest the use of anti-reflective glass in all new homes. Of course, Amiran can be used when retrofitting too. Stop by the Schott website [www.us.schott.com/tgd](http://www.us.schott.com/tgd) or call 914-831-2241. And reflect on the way life is going to be with Amiran anti-reflective glass.

©2003 SCHOTT North America, Inc.

©Amiran is a registered trademark of Schott Glas, Mainz, Germany.

**SCHOTT**  
glass made of ideas





**“An icon for the city, the building’s sloping, curving, leaning wall delights all. Walking to the roof garden provides spectacular views of the city and the surrounding mountains.”**

**8. Salt Lake City Public Library**  
Salt Lake City  
**Architect:** Moshe Safdie and Associates

This new, \$78 million library features a five-story administration block next to a triangular main building for the book stacks, with a glass-enclosed public Urban Room and adjoining piazza serving the city. The building contains many dramatic features, notably the glazed curved wall that borders the stacks, accommodates vertical circulation, and overlooks the outdoor plaza. Reading areas for patrons and remote places for study are accessible by bridges. The building provides a gathering place for study as well as a lively destination for public events.





---

OUTGOING ORANGE {SW 6641}

---



---

THERE'S INSPIRATION BEHIND EVERY DOOR. FIND IT

---



Our COLOR system has more than 1,000 original colors to inspire you, and advanced selection tools to help you see the way. See your Sherwin-Williams Architectural Account Executive or call our Architect and Designer Answerline at 1-800-552-7579 for color and product information.



*The Colors. The Paint. The Possibilities.™*

**Powerful in concept and beautifully executed, a glass room emerges from a time-worn wooden barn.”**

**9. DoMa Gallery**  
 Baltimore County, Md.  
**Architect:** *W Architecture and Landscape Architecture*  
 [RECORD, July 2003, page 126]

Two art collectors transformed a historic farm into a place to entertain, live, and display their growing contemporary art collection. A barn ruin with

weathered slats sitting on a stone foundation became the centerpiece of this domestic compound comprising a charming group of outbuildings, cultivated gardens, and meadows. A glazed volume inserted within the original barn structure creates transparency and opens up the interior to the landscape beyond.



**Maghkanic House**  
 Sonoma, N.Y.  
**Architect:** *Thomas Phifer and Partners*  
 [RECORD, April 2003, page 140]

spectacular views open to the Hudson River valley and distant mountains to the west. Finely detailed, the residence provides 360-degree views. A system of operable exterior sunshades modulates sun and shade. The house takes advantage of the topography by tucking the quiet spaces into the land, which forms a base supporting the light-filled areas of the public functions of the house above.

High on a knoll at the edge of woods, this house emerges dramatically as a pavilion of steel and glass set on a plinth. The site borrows a meadow to the south, while

**“There is a seamless flow of outside and inside spaces from the skillful integration of the building into the hill.”**



10





## The Translucence Series™ Waterfall

architectural water elements from the premier maker of indoor waterfalls



Harmonic Environments

[www.HarmonicEnvironments.com](http://www.HarmonicEnvironments.com)

800.497.352

CIRCLE 111 ON READER SERVICE CARD OR GO TO [WWW.LEADNET.COM/PUBS/MHAR.HTML](http://WWW.LEADNET.COM/PUBS/MHAR.HTML)

**Los Angeles Design Center  
and Cisco Brothers Showroom**

Los Angeles  
**Architect:** John Friedman Alice  
Gunn Architects  
[RECORD, July 2003, page 142]

Restoring this furniture design center in South Central Los Angeles sets off a plan to revitalize the distressed area, home to many of the city's furniture manufacturers. Simple, utilitarian materials, color, and signage cheer up this cluster of rundown brick warehouses. A former auto court has been transformed into a rich outdoor center and public event space for the complex. Hiding, revealing, and/or restoring aspects of the original buildings and environment animates the character of the site.



11

**“A project with great energy and bold, artful gestures. A creative way to breathe new life into what are otherwise forgettable fringe buildings.”**



**This highly refined synthesis of architecture and engineering defines the state-of-the-art office tower for Germany.”**

**12. Deutsche Post**  
Bonn, Germany  
**Architect:** Murphy/Jahn

This modern and sustainable office tower consists of two crescent-shaped halves separated by an atrium and rising around a series of nine-story sky gardens, which serve as communication floors and elevator crossovers. A glass outer shell on the building enables natural ventilation and abundant light in all work and circulation areas. Individually controlled, mechanically operated solar shades give this building a human scale and exterior animation that varies throughout the day. In essence, the skin of the building modulates its own climate.



INTRODUCING  
*TREX ACCENTS*

Inspiration from nature.  
Enduring enjoyment  
from Trex.

A rich, natural wood grain surface. With enduring quality and enjoyment at its heart.  
That's the beauty of new *TREX ACCENTS*. Call 1-800-BUY-TREX, ext. 634, or visit [www.trex.com](http://www.trex.com).

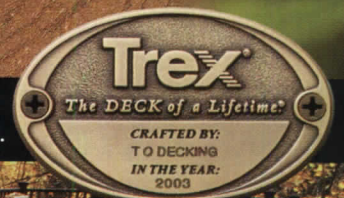

CIRCLE 112 ON READER SERVICE CARD  
OR GO TO [WWW.LEADNET.COM/PUBS/MHAR.HTML](http://WWW.LEADNET.COM/PUBS/MHAR.HTML)

**13. Telenor Headquarters**

Oslo, Norway

**Architect:** NBBJ/HUS/PKA

[RECORD, May 2003, page 222]

This complex of open public spaces, enclosed semipublic spaces, and private atrium living rooms supports flexible workstations. Employees have no permanent offices but are issued a mobile phone and laptop and can plug into any available location in the complex to perform their work. The architecture is experimental, with a rich palate of materials, colors, and textures, creating a poetry which, when combined with the powerful artworks commissioned for the interior, presents a fascinating and satisfying environment.



13

**“There is a wonderful informality about the composition that encourages creative thinking and discussion.”**



**“Simple materials, elegant proportions, sophisticated colors, and skybridges make this tower a delight on the Chicago skyline.”**

**14. Skybridge at One North Halsted**  
Chicago

**Architect:** Perkins & Will

[RECORD, May 2004, page 136]

An icon for urban living in Chicago, this mixed-use project incorporates practical community amenities with an elegantly articulated residential tower. The flexibility afforded residents by intelligent planning provides opportunities for customization of unit size and layout. The glass-enclosed skybridges break up the massing of the building while increasing the number of corner units and views of downtown.

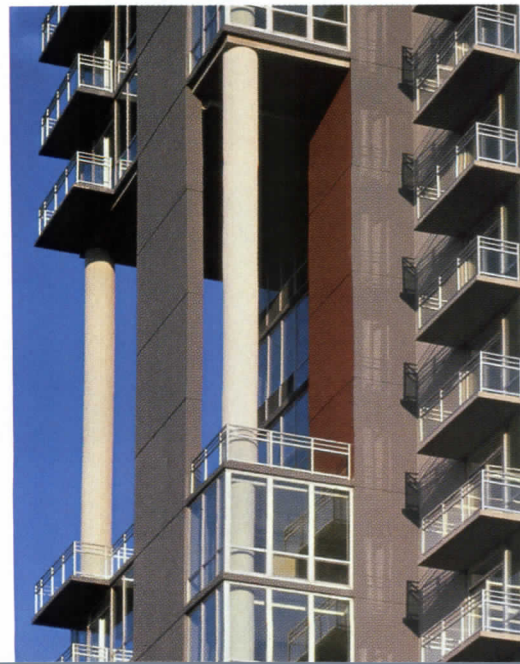

"WE ONLY USE ALUMINUM METAL ROOFING."

— Eugene A. Delmar, FAIA, Delmar Architects, P.A.

**PAC-CLAD**  
Petersen Aluminum  
**Aluminum  
Roofing Panels**



"The cost of aluminum has never been an issue for us. The life cycle cost of aluminum is longer serving than any other material."  
— Tom Hutchins, Principal, Design Group

"The cost of aluminum is not an issue. We quote aluminum per day and never worry about job due to difference in price. The cost is only the real cost of the material."  
— Jim Donohue, Roofing Contractor

For projects in coastal regions and areas susceptible to rain, PAC-CLAD Aluminum is a product of metal roofing solutions. Inherently includes corrosion resistance and ease of installation. PAC-CLAD Aluminum is from Petersen's 35 standard profiles and a wide variety of 580 Class roofing products.

Hill Road Middle School  
Elementary School  
Owner: Prince Georges County  
Architect: Delmar Architects, P.A.  
General Contractor: Petersen Aluminum  
Roofing Contractor: Roofing Contractors  
Profile: Redi-Roof  
Color: Colonial Red

**Petersen Aluminum**

1005 Tonne Road, Elk Grove, IL 60007  
1-800-PAC-CLAD or 1-847-228-7150  
Fax: 1-800-722-7150 or 1-847-956-7968  
[www.pac-clad.com](http://www.pac-clad.com)

**Other Plant Locations:**  
MD: 1-800-344-1400  
TX: 1-800-441-8661  
GA: 1-800-272-4482

CIRCLE 113 ON READER SERVICE CARD  
OR GO TO [WWW.LEADNET.COM/PUBS/MHAR.HTML](http://WWW.LEADNET.COM/PUBS/MHAR.HTML)





**State Street Village, ITT**  
 Chicago  
 Architect: *Murphy/Jahn*  
 RECORD, May 2004, page 130  
 Located across from the college's  
 main quadrangle and Mies van  
 Rohe's legendary Crown  
 Hall, this student residence con-

veys a clear response both to the urban context on one side and the campus on the other. The building successfully and elegantly uses its site restrictions and tight linear space to advantage, connecting separated parts of the campus by becoming a pass-through.

**Bayer**  
 Leverkusen, Germany  
 Architect: *Murphy/Jahn*  
 A semi-elliptical office build-  
 ing engages a park forming an  
 interior courtyard; the opposite  
 end side features a pergola over

the transparent main entrance. The building appears like a crystal case wrapped around the occupied floor plates. Energy-efficient design combines with unparalleled engineering expertise to make the building both stunning and practical.

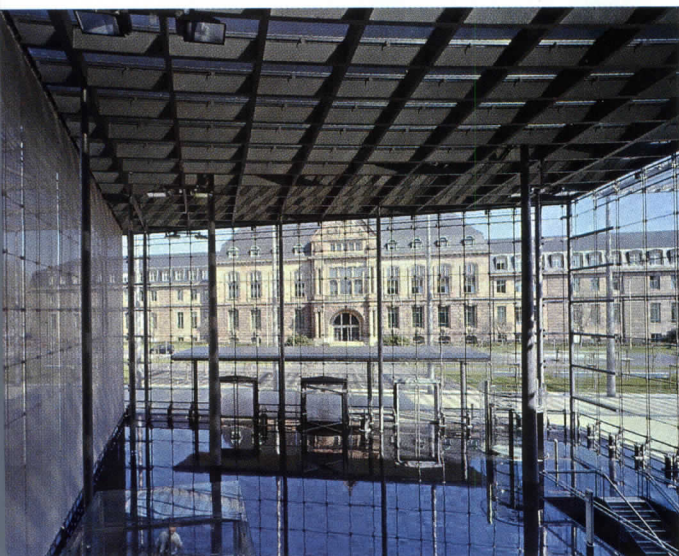

15



**“Rather than designing an innocuous background building, the architect responded with a bold new statement.”**

16

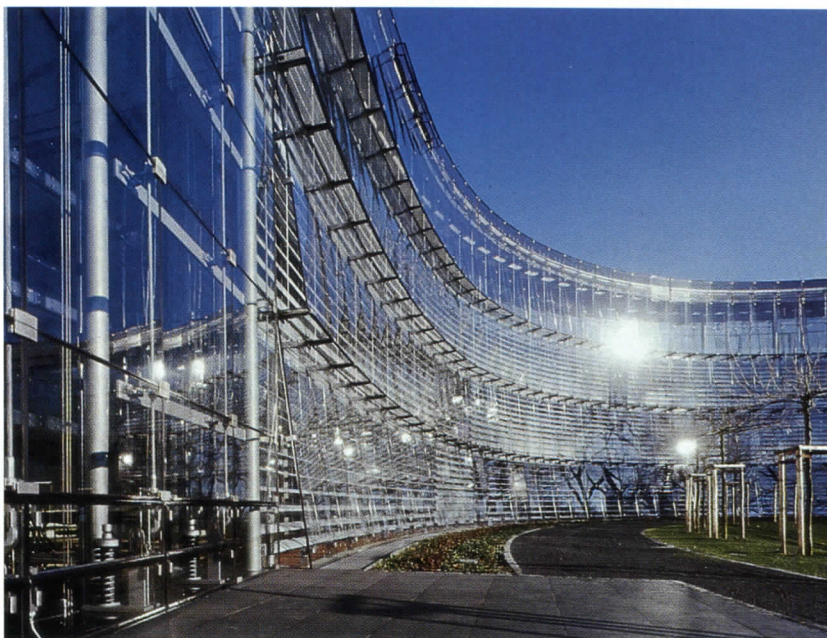

**“Every element of this building is about glass. Where floors, walls, ceilings, and even ductwork could be glass, they are.”**

# INTERIORS

**T**his year's AIA Interiors Honor Award winners share the common thread of renovation and adaptive reuse. These eight projects perform similar transformations, either reinvigorating a historic building or brightening an industrial one. Interior Architecture jury chair Lee F. Mindel, FAIA, remarked that [the jurors] "saw a lot of 'flying schreprels' and 'blobs,' but the projects with simple, bold, elegant ideas stood out." Solutions range from inventive and high-tech to traditional and rigorous. From the clever transformation of a historic church into a performance space using acoustic panels to augment the existing design (below), to relocating and enlivening a modern, welcoming library in a formerly uninviting space, these projects sought and found a high level of personal expression beyond the trendy and predictable. Jane F. Kolleeny

1

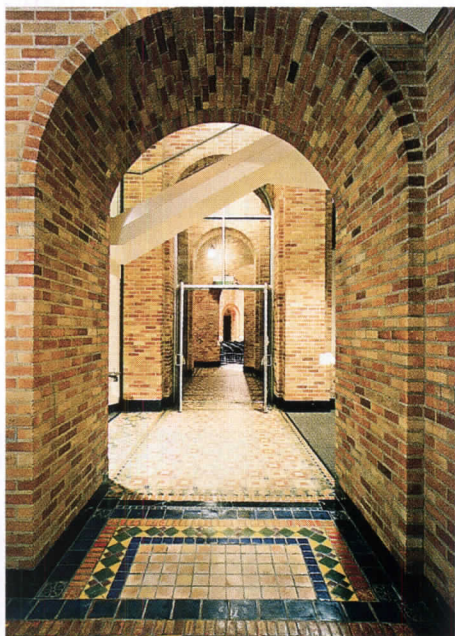

## 1. Carol and Carl Montante Cultural Center

Buffalo

Architect: Cannon Design

With a sensitive series of gestures, the architect adapted this 1926 historic church into a 600-seat, multipurpose performance space at a liberal arts college campus. Building systems were upgraded for contemporary use and acoustics retooled to meet performance criteria. Sound-reflecting surfaces inserted within the domed volume improve the acoustics without detracting from the design. New forms and materials are articulated cleanly and simply to enhance the old.



**“Masterfully handled; the technology becomes a new ornament in an intricately embellished space.”**

**“Christo’s installation of blue tents in Japan became a metaphor for the project’s master plan and an expression of the client’s mission.”**

**2. Pallotta TeamWorks New Headquarters**

*Los Angeles*

**Architect:** *Clive Wilkinson Architects*

This inventive solution resulted from an inspired vision for a new workplace tempered by radical budget constraints. Tent environments personalized a large warehouse space, creating intimate and distinct work neighborhoods and providing containment for cooling, heating, and lighting. Alleviating the need to build structures, the tents, suspended from the roof-support column grid and stretching in different directions according to programmatic needs, are anchored down by inexpensive, prefabricated shipping containers.

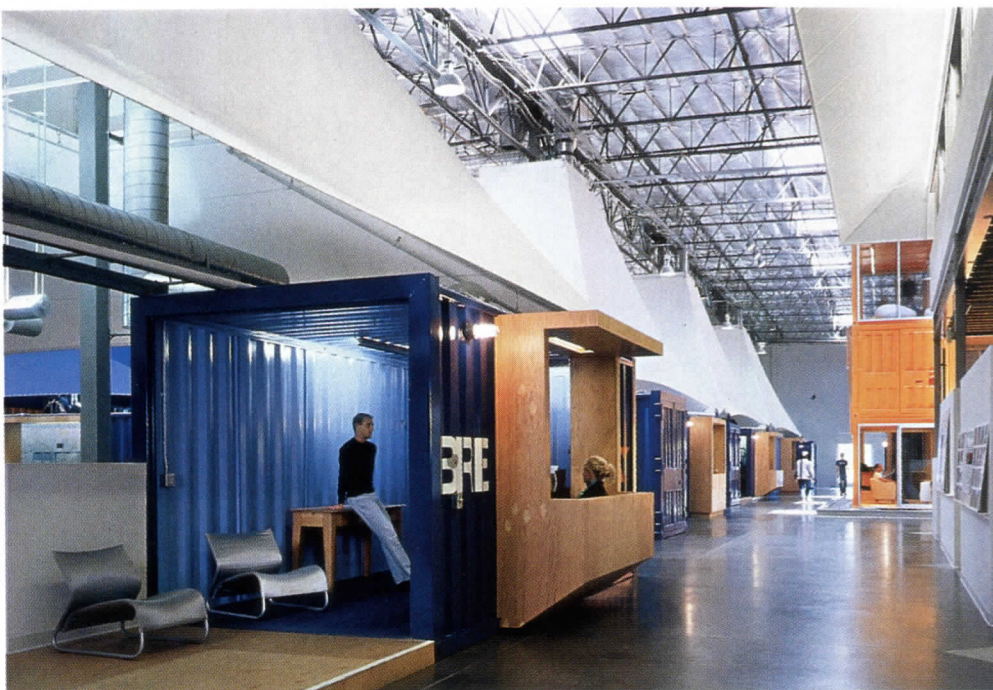

2

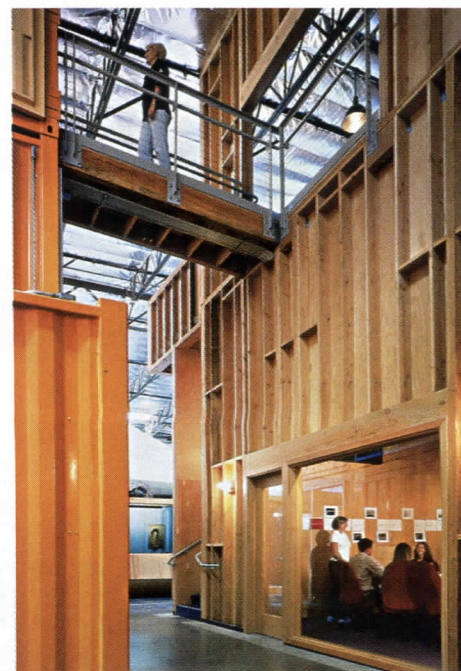

**3. New York City Public School 42,  
Queens, Library**

Arverne, N.Y.

**Architect:** Weiss/Manfredi  
Architects

The architect moved the existing library from its former location on the fourth floor to the first floor, adjacent to the school's main entrance and cafeteria, redefining its place and purpose within the school. Formerly removed from students and remote from community-based activities, the library's new central location makes it visible to pedestrians on the street and within easy access of students. A curvilinear wall shaped by lapped plywood winds through the space, defining it and providing shelving, while deep windows with seats invite users to curl up with a book. A silkscreened transparent curtain can be opened or closed and rolling bookshelves moved to reconfigure the space in various ways.



**“Organized and funded by the Robin Hood Foundation and built by the school board, this pro bono library is part of pilot project to improve New York City’s urban schools.**

3



**“The asymmetry in the architect’s response relieves the pressure of compliance to the existing, A-frame church.”**

**First Presbyterian Church of  
Palo Alto, Calif.**

**Architect:** Trevor Abramson,  
Trevor Abramson Teiger Architects

This unique intervention in an existing 1950s church served two goals—to bring light into the interior and to create a sense of openness and reverie for the congregation. The pews were reorganized in the round and the floor of the chancel was brought forward and lowered to bring the pastor and choir closer to the assembly. Religious symbolism is woven into the design. Light as metaphor is shaped by irregularly shaped volumes that provide multiple illumination from multiple angles. The two facing curved surfaces that shelter the sanctuary give the primary form to the worship space resemble hands in prayer. Other features of the design address key elements of the service.



4





**Evocative of nature's beauty.  
Except for the whole withering up and dying part.**

Everyone knows that nature paints the most beautiful picture. But for maximum profits and beauty that endures, look up and behold Style Solutions™ Ceiling Medallions. Lightweight and very easy to install, they're available in dozens of styles that are so breathtaking, you'll just die. In a good way. 1.800.446.3040 [www.stylesolutionsinc.com](http://www.stylesolutionsinc.com)

CIRCLE 114 ON READER SERVICE CARD  
OR GO TO [WWW.LEADNET.COM/PUBS/MHAR.HTML](http://WWW.LEADNET.COM/PUBS/MHAR.HTML)

 **Style Solutions**  
Inc.

**Exhibition - *Silent Collisions:***  
**Morphosis Retrospective**  
 Rotterdam, the Netherlands  
**Architect:** Morphosis

The exhibition addressed the roads that architects are faced with in the transition from tangible, physical materials and modes of expression—drawings and models—to the digital technologies that increasingly dominate practice, blurring distinctions between form and design process. The architect found Rotterdam,

with its stratified terrain of soil and water, a fitting place to present this dichotomy by means of a luminous fold suspended in space, which moves slowly, almost imperceptibly, changing in the final moments of the cycle into a surface for projected images of the firm's current work. Two decades of drawings and models are presented in a solid, catacomblike structure beneath. The juxtaposed changing and concrete displays of past and present work illustrate the architect's quandary.

**“Conventional notions of ceilings and walls are challenged in this high-tech and poetic exploration of the architect’s process.”**

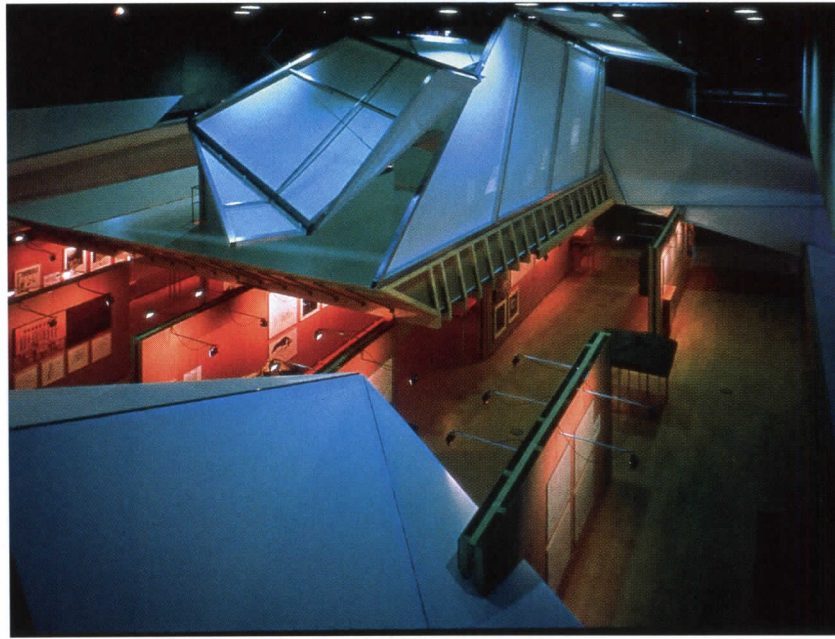

5

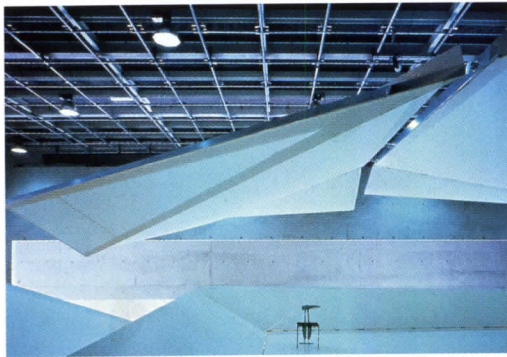

**6. Academic Center for Student Athletes at Louisiana State University**

Baton Rouge, La.

**Architect:** Trahan Architects

[RECORD, November 2003, page 172]

This interior renovation creates a sequence of clean, clear spaces that pare down the 1927 architectural language to its essence. The architect retained the building's symmetrical organization while removing remodeling undertaken over the years that had obscured the original interior. A simple and consistent palette of colors—light for the rooms at the building's perimeter, warmer and darker at the core—minimizes visual distractions for the students and allows the original attributes of the historic building to come forth.

**“A sensitive interior interpretation shows a sophisticated reading of the original building.”**



It's time to look at architectural panels in a whole new light.



800-477-2741 • [www.fabral.com](http://www.fabral.com)

CIRCLE 115 ON READER SERVICE CARD  
OR GO TO [WWW.LEADNET.COM/PUBS/MHAR.HTML](http://WWW.LEADNET.COM/PUBS/MHAR.HTML)



American Meteorological Society Editorial Offices  
 Architect: Anmahian Winton  
 Architects  
 ARCHITECTURAL RECORD, June 2002, page 203]

The architect transformed a historic barn and carriage house previously used for storage and staff meetings to new offices for the company's editorial staff. A brick structure topped by a timber roof supported by thick

square beams and rafters became host to a modern insertion that is both rustic and refined. Materials such as plywood, structural lumber, fiberglass panels, and unfinished steel complement the character of the existing structure.

**“Love of detail is celebrated; this looks like it was built by a master carpenter.”**

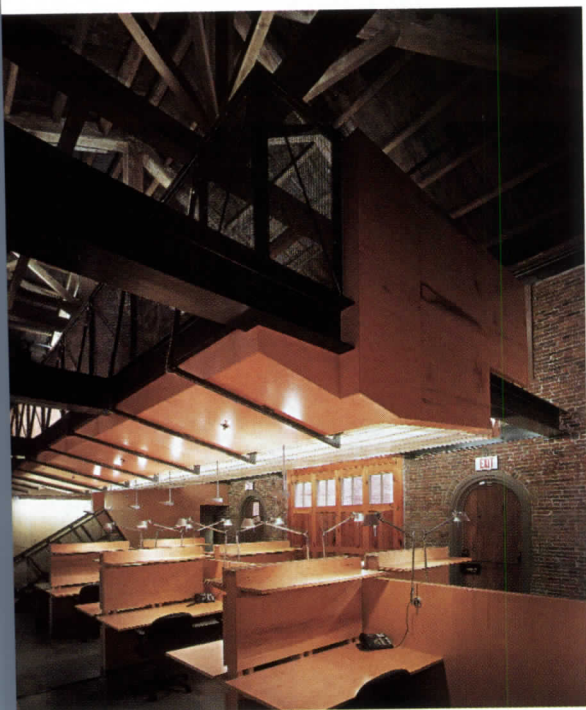

7



Top Editorial  
 Architect: Pugh + Scarpa  
 ARCHITECTURAL RECORD, September 2003, page

**“A dramatic, undulating, wood-paneled wall runs the length of the building, enhancing the light and separating the main area from the darkened editing spaces.”**

8

Architect converted a single-structure, designed by Frank Gehry in 1963, into a multi-level editing facility for the company. Three distinct, freestanding rooms house a conference room, the executive producer's office, and bathrooms, all of which float in the rough space, supported on a neoprene pad above the floor. The architect used color and materials to distinguish each room. Bright rubber sheeting lines the conference room, while the bathrooms feature white interiors and multihued acrylic panels.



# URBAN DESIGN

**P**erhaps the least glamorous of the AIA Honor Award-winning projects are those for urban design. But what they lack in swagger, they possess in importance—without planning, architecture becomes vacant of contextual meaning. The jury sought and found projects combining practicality and invention; restraint and proactivity. The winning plans all demonstrate the possibility of creating compact, pedestrian-friendly, sustainable communities. Transportation also plays an important role in each of the projects, encouraging architects, clients, and communities to consider the automobile as less central to the planning effort. Jane. F. Kolleeny

## 1. Chicago Central Area Plan

Chicago

**Architect:** Skidmore, Owings & Merrill

Chicago's downtown area experienced tremendous growth in the 1990s, with businesses prospering, residential neighborhoods emerging, and tourism flourishing. Along with success comes the need to ask new questions about density, amenities, transportation, buildings, and jobs. SOM's plan addresses these issues, strengthening the downtown economy, improving and extending the transit systems, increasing open spaces and parks, creating new waterfronts areas, and encouraging new mixed-use neighborhoods.

**“This project reveals an understanding of the city as a growing organism.”**

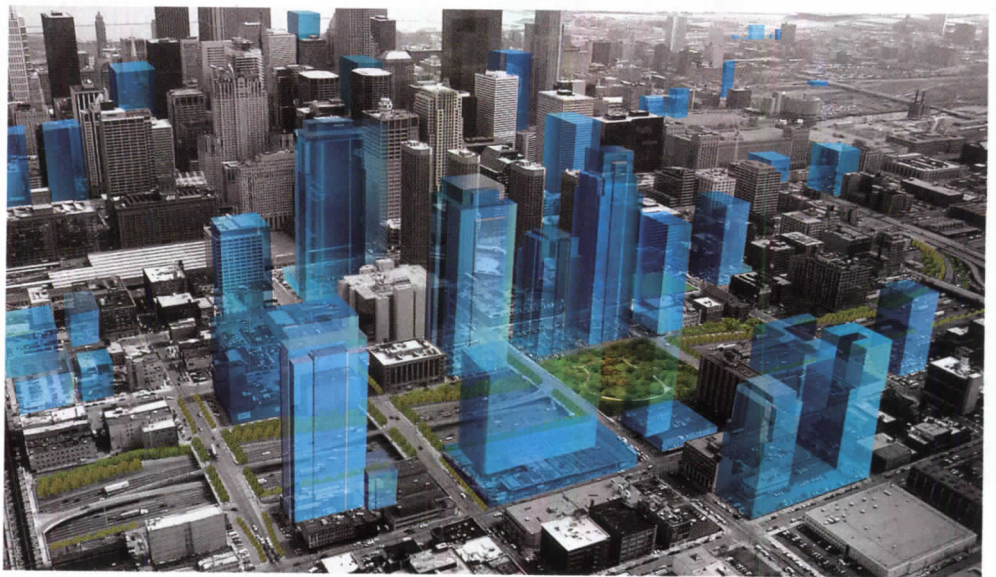

**“Urbanistically, the plan relates to the city as a whole, establishing it's own grid and carrying it forward clearly.”**



## 2. Mission Bay Redevelopment Plan

San Francisco

**Architect:** Johnson Fain

This 303-acre area, the largest undeveloped site in the city, establishes a new neighborhood along the bay adjacent to downtown. Former plans failed to address the real needs of the city. The beauty

of this one is that it incorporates Mission Bay into the structure of San Francisco, seamlessly extending its physical, economic, aesthetic, and cultural life. Creating a mixed-use neighborhood of housing, retail, entertainment, and commercial-industrial properties, the plan integrates the site into the historic fabric of the city.

# Architectural Solutions

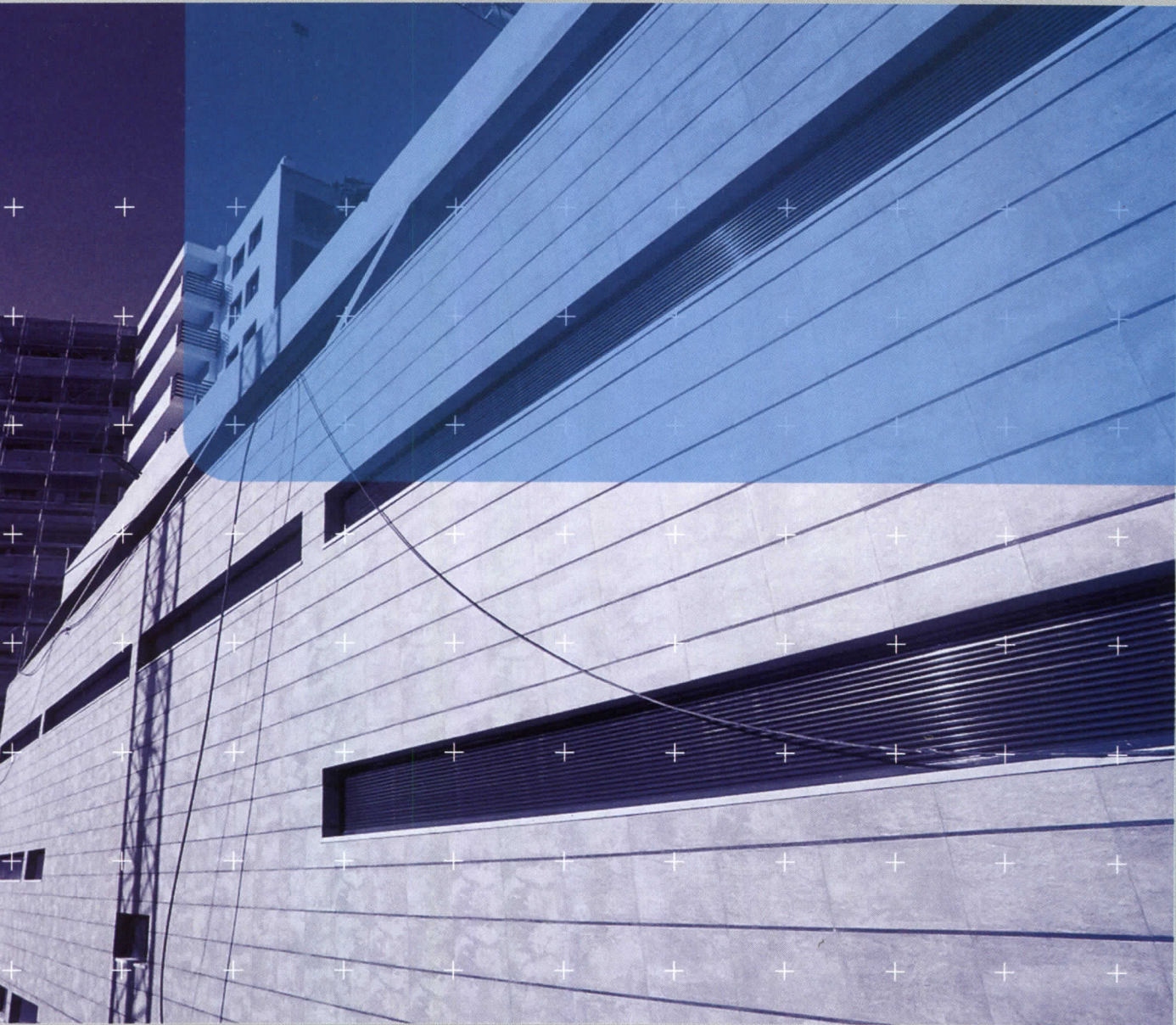

AIA 2004 Chicago June 10 - 12  
Booth number 2115

**Roca**

C · E · R · A · M · I · C · A

CIRCLE 116 ON READER SERVICE CARD  
OR GO TO [WWW.LEADNET.COM/PUBS/MHAR.HTM](http://WWW.LEADNET.COM/PUBS/MHAR.HTM)

**3. UrbanRiver Vision**

*Worcester, Mass.*

**Architect:** *Goody, Clancy & Associates*

In an attempt to respond to the decaying waterfronts in many of the cities of Massachusetts, a state agency created and funded a program to provide local river-

front planning, with the input of key federal, state, and local agencies. This project addresses environmental, economic, residential, transportation, and preservation issues, so all the cities have the tools they need to address their historic waterfronts and the adjacent downtown development areas.



**“Fifty years ago, the river was viewed as undesirable, but now it’s seen as the center of the community.”**



**4. Getting It Right: Preventing Sprawl in Coyote Valley**

*San Jose, Calif.*

**Architect:** *WRT/Solomon E.T.C.*

Coyote Valley consists of 6,800 acres of prime farmland and watershed on the southern edge of San Jose targeted for future

commercial and residential development. An environmental advocacy group contracted this plan to show how the city can accommodate projected growth in a manner that sustains its urban economy, community, and infrastructure, promoting an alternative to sprawl.

**“They took a complex problem, disassembled it, and then reassembled it with great results”**

**5. The Confluence: A Conservation, Heritage, and Recreation Corridor**

*St. Louis*

**Architect:** *HOK Planning Group*

This plan creates a 40-mile-long conservation and recreation corridor that reinforces the confluence of the Missouri and Mississippi Rivers, one of the world’s largest systems. It links St. Louis and other nearby communities to the rivers from which they rose, creating an industry of sustainable ecotourism and providing a plan for comprehensive growth in the future.

**“A nationally significant park will serve as a lasting legacy to the region and to Lewis and Clark.”**

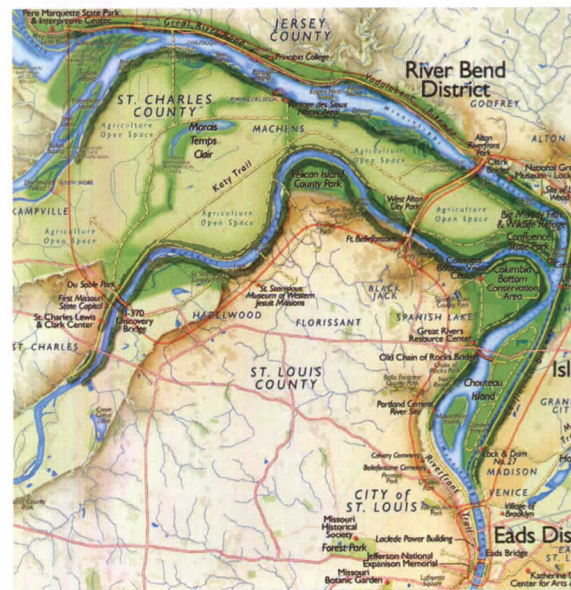
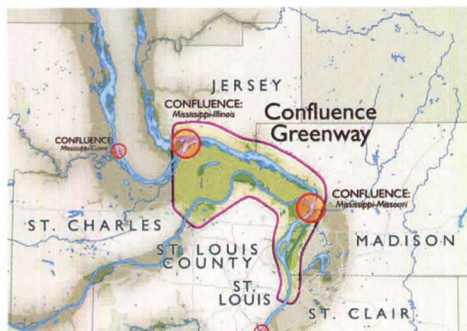

SAMSUNG

*easy on the eyes*

**SPECIFY STARON® THE SOLID SURFACE MATERIAL BY SAMSUNG, AND ENHANCE THE LOOK OF ANY RESIDENTIAL OR COMMERCIAL DESIGN.** It's available in more than 50 colors, plus styles of sinks and bowls. Staron is also an eye-opening value that leaves room in a budget for other key upgrades. Pull up more information about Staron, visit [www.getstaron.com/design3](http://www.getstaron.com/design3) or call 1.800.795.7177 ext. 350.

**staron®**

INTERTOP | ASPEN MINE

© 2004 Cheil Industries Inc.

**CIRCLE 117 ON READER SERVICE CARD  
OR GO TO [WWW.LEADNET.COM/PUBS/MHAR.HTML](http://WWW.LEADNET.COM/PUBS/MHAR.HTML)**

HONOR AWARDS

# 25 YEAR AWARD

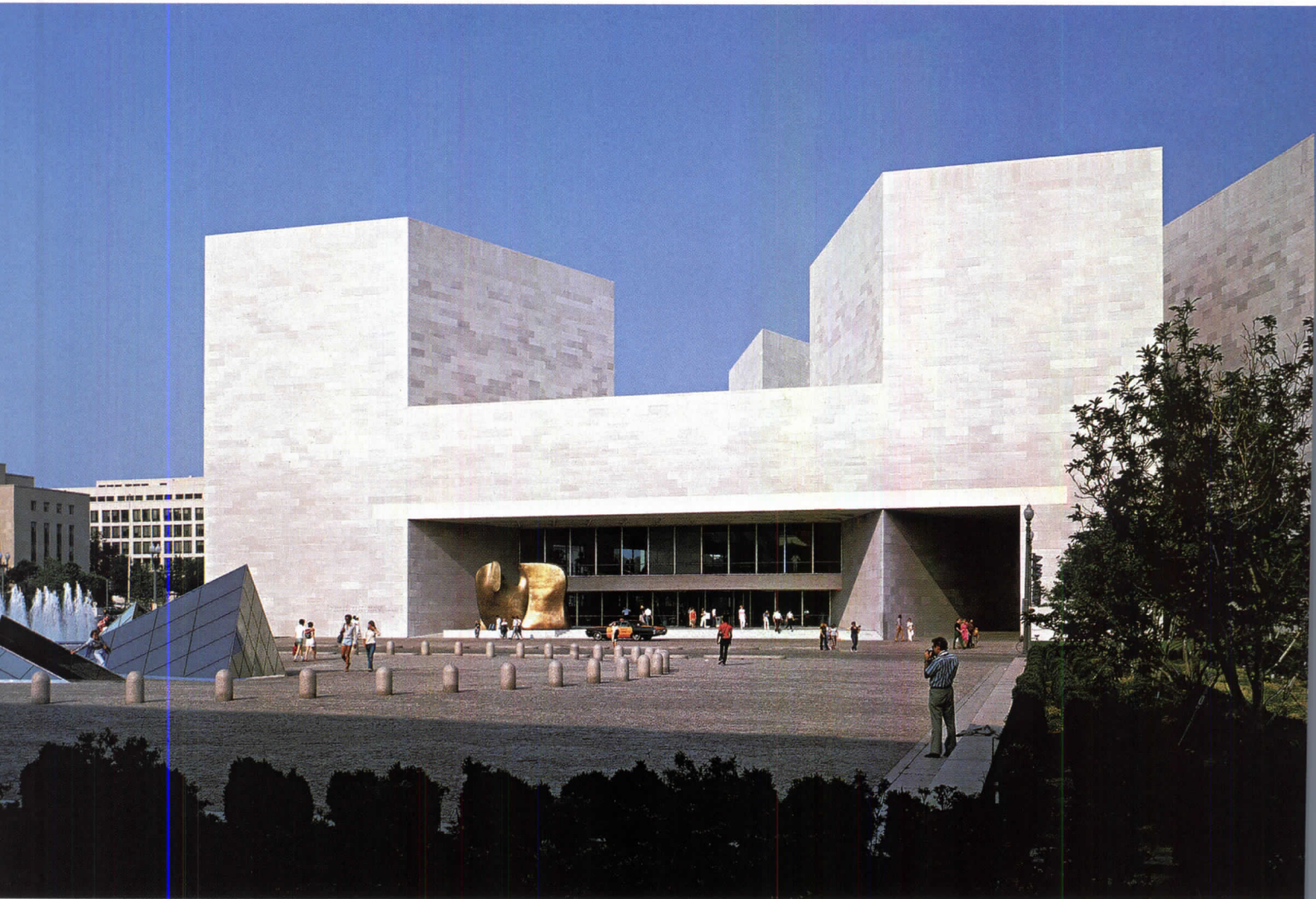

## Modern masterpiece on the Mall

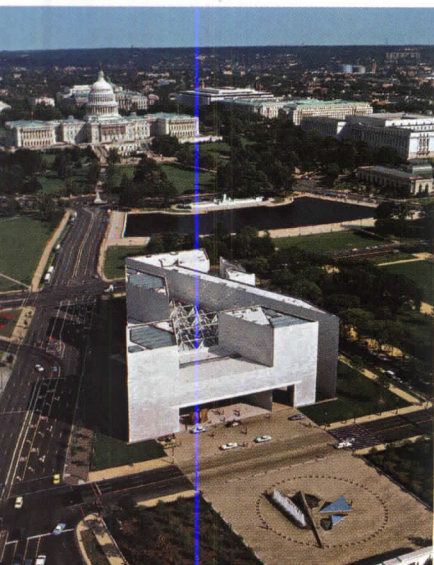

It's not easy being Modern on the National Mall, especially next to John Russell Pope's 1941 West Building of the National Gallery of Art—considered by I.M. Pei to be an exemplar of Neoclassicism. Transforming its proportions and materials into a contemporary idiom for an expansion was a stunning achievement for Pei and a gift to Washington and the nation. Ada Louise Huxtable cried “elitist” when the East Building opened, but she got it wrong. It's our capital city's Modern masterpiece—as powerful an achievement of the 20th century as the artwork it celebrates.

In the 26 years since President Jimmy Carter dedicated it, the East Building has thrived as an art museum while growing into eminence as an elegant, refined example of Modernism. The dual triangles, nestled within the trapezoidal site, remain programmatically intact—one for exhibitions, one for administration and research—and, unlike critics initially feared, the gallery spaces have proved highly flexible, says Victoria Newhouse, author of the forthcoming *Art/Power/Placement* (Monacelli Press). The airy atrium (“one of the most resplendent rooms of all time,” RECORD noted in 1978) enjoys instant

recognition, with its tetrahedron skylights that echo the geometry of the architecture, as well as Alexander Calder's colorful mobile spinning slowly overhead.

Sometimes a blemish connotes reverence. The permanent ring of discoloration surrounding Pei's name on a marble wall in the atrium owes its existence to the millions of visitors who have touched the inscription, says the NGA's director, Earl A. Powell III. The tinged stone makes explicit how indelibly Pei's identity is entwined with this well-loved project. *Deborah Snoonian, P.*

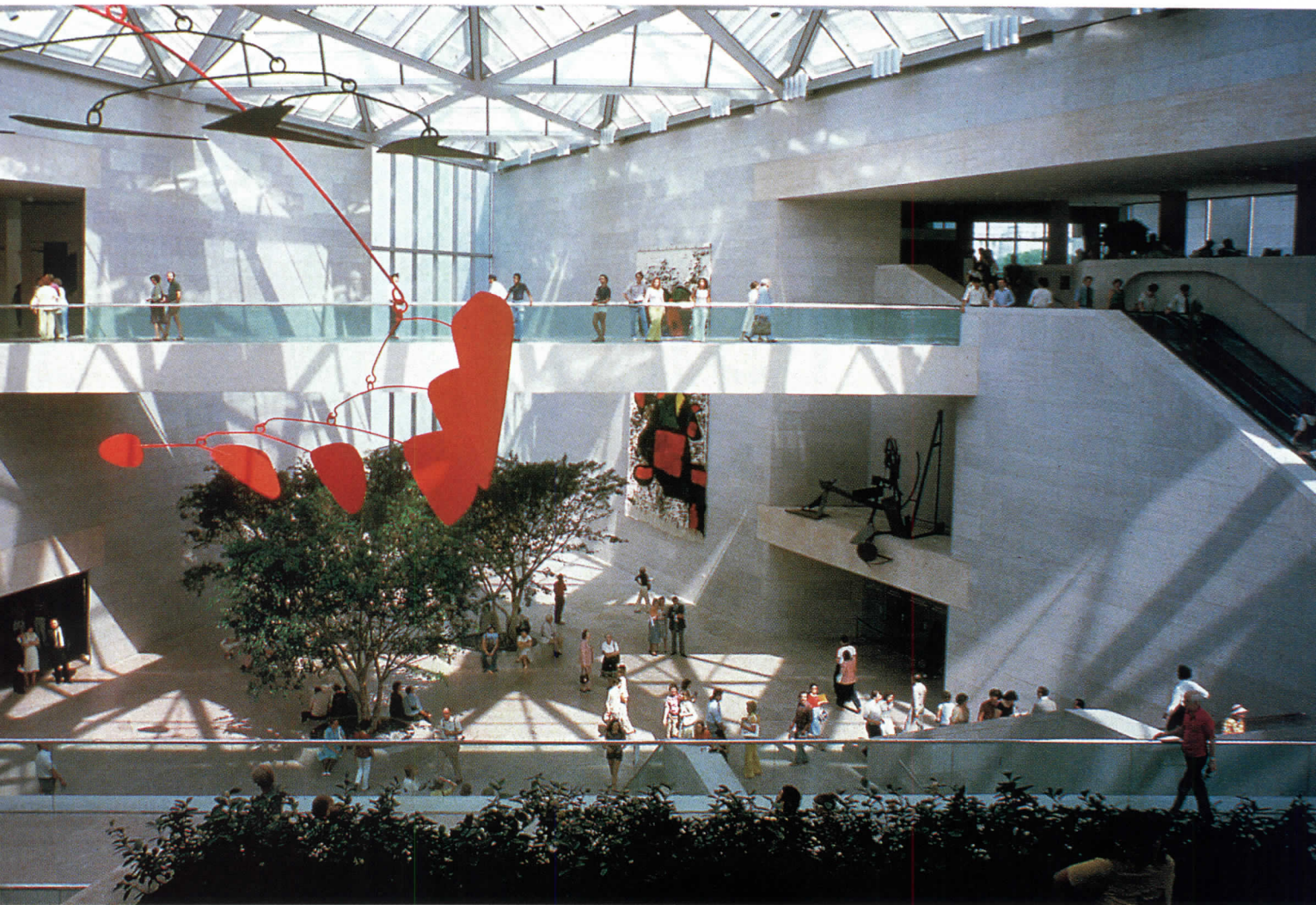

**his icon of contemporary architecture in a city of traditional monuments continues to delight and impress visitors from all over the world.”**

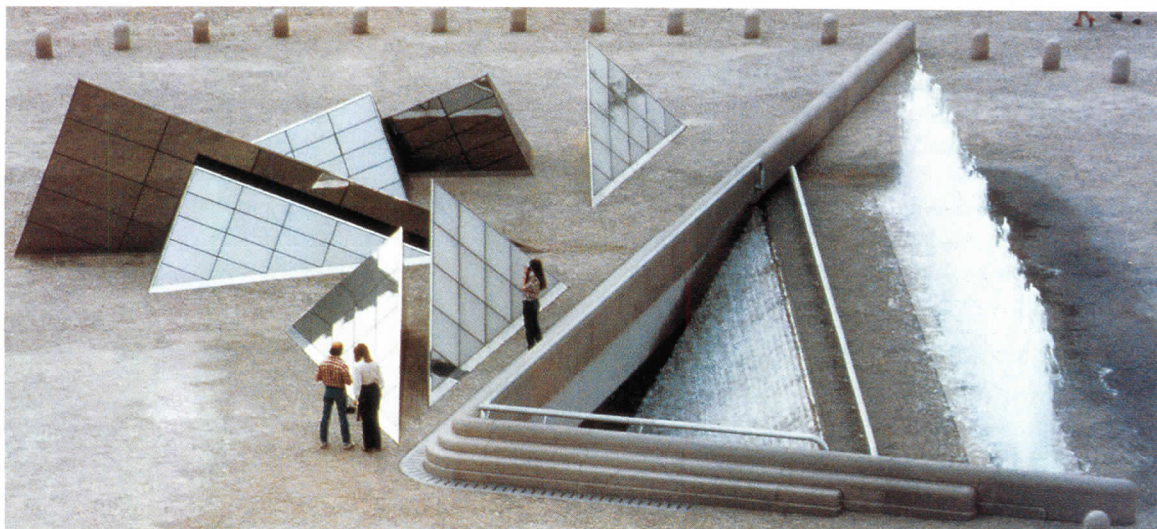
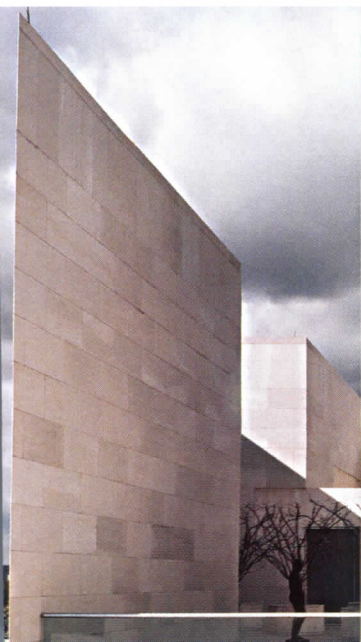

# American Institute of Architects

# Winners and Jurors 2004

## WINNERS

### Architecture (page 140)

**Seaside Interfaith Chapel:** Merrill and Pastor Architects; **The Brain:** Olson Sundberg Kundig Allen Architects; **The Point House:** Bohlin Cywinski Jackson; **Chicken Point Cabin:** Olson Sundberg Kundig Allen Architects; **Center of Gravity Foundation Hall:** Predock Frane Architects; **Northeastern University West Campus Residence Halls:** William Rawn Associates; **Steelcase - Project MAC:** Thomas Phifer and Partners; **Salt Lake City Public Library:** Moshe Safdie and Associates; **DoMa Gallery:** W Architecture and Landscape Architecture; **Taghkanic House:** Thomas Phifer and Partners; **Los Angeles Design Center and Cisco Brothers Showroom:** John Friedman Alice Kimm Architects; **Deutsche Post:** Murphy/Jahn; **Telenor Headquarters:** NBBJ/HUS/PKA; **Skybridge at One North Halsted:** Perkins & Will; **State Street Village, ITT:** Murphy/Jahn; **Bayer:** Murphy/Jahn

### Interiors (page 160)

**Carol and Carl Montante Cultural Center:** Cannon Design; **Pallotta TeamWorks New Headquarters:** Clive Wilkinson Architects;

**New York City Public School 42, Queens, Library:** Weiss/Manfredi Architects; **First Presbyterian Church of Encino:** Trevor Abramson, Abramson Teiger Architects; **NAI Exhibition - Silent Collisions:** Morphosis Retrospective: Morphosis; **Academic Center for Student Athletes at Louisiana State University:** Trahan Architects; **American Meteorological Society Editorial Offices:** Anmahian Winton Architects; **COop Editorial:** Pugh + Scarpa

### Urban Design (page 168)

**Chicago Central Area Plan:** Skidmore, Owings & Merrill; **Mission Bay Redevelopment Plan:** Johnson Fain; **UrbanRiver Vision:** Goody, Clancy & Associates; **Getting It Right: Preventing Sprawl in Coyote Valley:** WRT/Solomon E.T.C.; **The Confluence: A Conservation, Heritage, and Recreation Corridor:** HOK Planning Group

### 25-Year Award (page 172)

**National Gallery of Art - East Building, Washington, D.C.:** I.M. Pei

### Firm of the Year (page 176)

**Lake/Flato Architects:** David Lake, FAIA, and Ted Flato, FAIA

### Gold Medal (page 184)

Samuel Mockbee, FAIA

## JURORS

### Architecture

Adrian Smith, FAIA (Chair), Chicago; Seth Cohen, Assoc. AIA, Philadelphia; Steve Dunlap, AIA, New Orleans; Rand Elliott, FAIA, Oklahoma City; Roberta W. Jorgensen, FAIA, Newport Beach, Calif.; Robert D. Loversidge, Jr., FAIA, Columbus, Ohio; Cheryl McAfee, Fayetteville, Ga.; Sarah Peden, Washington D.C.; David Thurm, New York City

### Interiors

Lee Mindel, FAIA (Chair), New York City; Annie Chu, AIA, Los Angeles; Sarah Grant Hutchison, Des Moines; Mary L. Oehrlein, FAIA, Washington, D.C.; Arthur Smith, FAIA, Southfield, Mich.

### Regional and Urban Design

Ray L. Gindroz, FAIA (Chair), Pittsburgh; George Crandall, FAIA, Portland, Ore.; We Evans Joseph, FAIA, New York City; Elizabeth Chu Richter, AIA, Corpus Christi, Tex.; Sus Williams, Indianapolis



Color.  
Imagined.



**Benjamin Moore**  
Paints

Visit us  
at the  
NeoCon  
World's Trade Fair  
2004  
Booth #H215

1-888-BEN-MOOR or visit [www.benjaminmoore.com](http://www.benjaminmoore.com)

©2004 Benjamin Moore & Co. Benjamin Moore is a registered trademark and the triangle "M" symbol is a trademark, licensed to Benjamin Moore & Co.

**CIRCLE 118 ON READER SERVICE CARD OR GO TO [WWW.LEADNET.COM/PUBS/MHAR.HTML](http://WWW.LEADNET.COM/PUBS/MHAR.HTML)**

# ARCHITECTURE FIRM AWARD

## LAKE | FLATO'S desert architecture partners seamlessly with nature

This Texas firm blends Modernism, regionalism, and sustainability to create architecture that responds to the sun, the shade, and the breezes, collaborating successfully among themselves in the process.

By David Dillon

**D**avid Lake, FAIA, once described himself as a romantic and his partner, Ted Flato, FAIA, as a rationalist. “I prefer eccentricity, and he doesn’t,” he explained. Flato replied that he had “a great fear of doing something trendy that I won’t like after 10 years.”

Lake/Flato Architects of San Antonio, winner of this year’s American Institute of Architects Firm Award, celebrates its 20th year. That delicate balance between romance and invention is intact.

The architects remain physically and imaginatively attached to Texas by virtue of what the late William Turnbull called their “specifically Texas insights,” meaning responsiveness to the imperatives of sun, heat, and wind, the challenge of a vast landscape, and the richness of local building traditions.

“We believe in an organic architecture that springs from its place,” says Lake, “one that acknowledges precedent and that solves basic problems simply and elegantly. That’s what Bill was getting at. Architecture should be comfortable and easy to live with, rather than just eye candy.”

From a familiar and unapologetically romantic base of barns, silos, stone walls, and metal roofs, their work has grown steadily more refined and abstract in ways that show how to make Modernism come to terms with history without lapsing into empty nostalgia.

In the late 1970s, Lake and Flato went to work for O’Neil Ford, the master of midcentury Texas Modernism, who taught them the importance of materials and construction, knowing how things go together instead of how to make arbitrary shapes. “Architecture isn’t sculpture,” he’d preach.



From left: Ted Flato, David Lake (seated); Kim Monroe, Greg Papay, John Grable, Karla Greer, Bob Harris, and Matt Morris (standing).

Contributing editor David Dillon is the architecture critic for The Dallas Morning News.

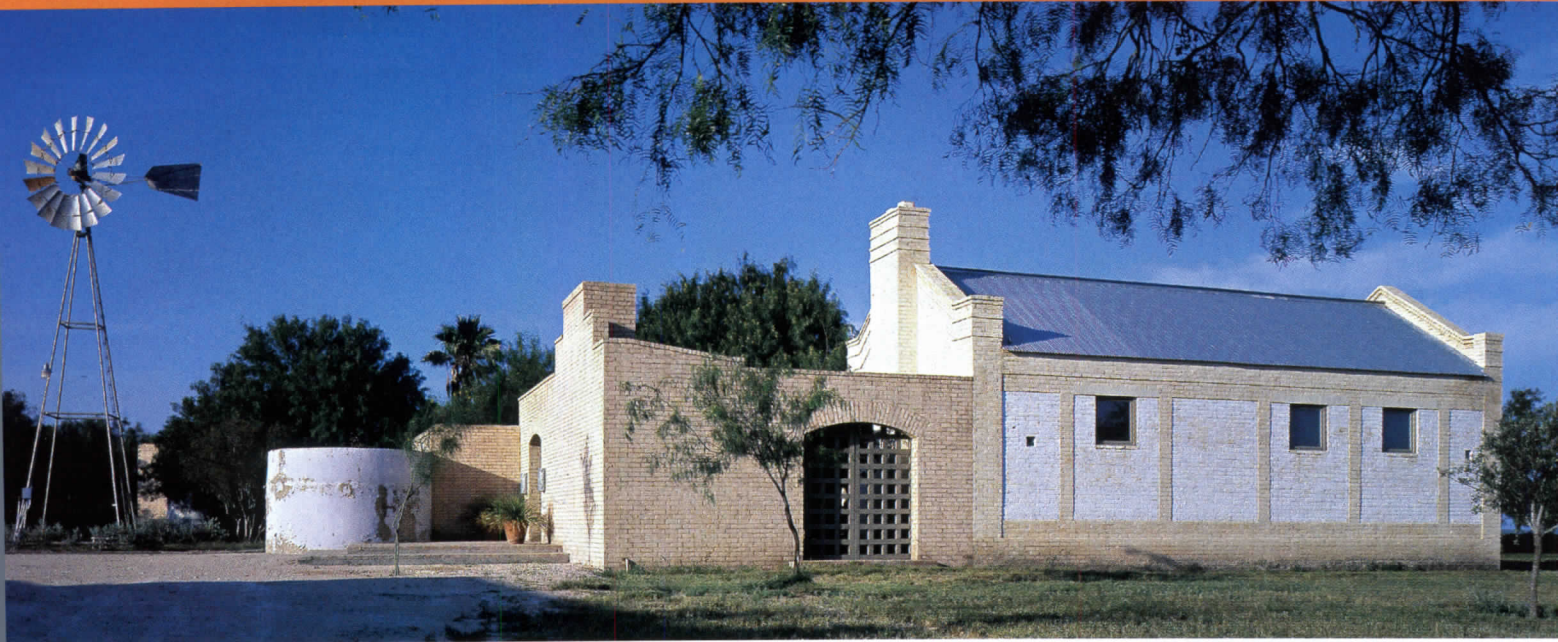

**Estrella Ranch House,**  
*Estrella, Texas, 1989*

**Carraro Residence**  
*Kyle, Texas, 1990*



Consequently, instead of theorizing, Lake/Flato builds, or perhaps one could say they build based on theories about earth instead of air. Like their mentor's, their houses, schools, and churches are intensely sensory and tactile; the first impulse on entering them is to run your hands across walls and doors, to read the architecture through the pores.

Lake started out designing Modern sodbuster houses in the Texas Panhandle, followed by adobe houses in northern New Mexico that evoke dense historic prototypes while remaining remarkably open and bright. In the 1980s, he and Flato teamed up on a series of evocative ranch houses, mostly in South Texas, that combine simple forms and homely materials—corrugated metal, oil-field pipe, cattle fencing—to create culturally and climatically appropriate designs. The individual pieces typically form courtyards with big porches and deep overhangs that offer protection from parching Texas sun and wind.

Attractive, appropriate, skillfully detailed, yet not enough to justify the Architecture Firm Award. The breakthrough came in 1990 with the Carraro residence outside Austin, an abstracted, almost skeletal version of a Texas farmhouse that uses steel salvaged from an abandoned cement plant to create a series of light, airy pavilions for living and entertaining.

"The client had this very romantic notion of a stone barn out in a field, with an old Butler building as the frame,"



**Lasater Residence**  
Fort Worth, 1994

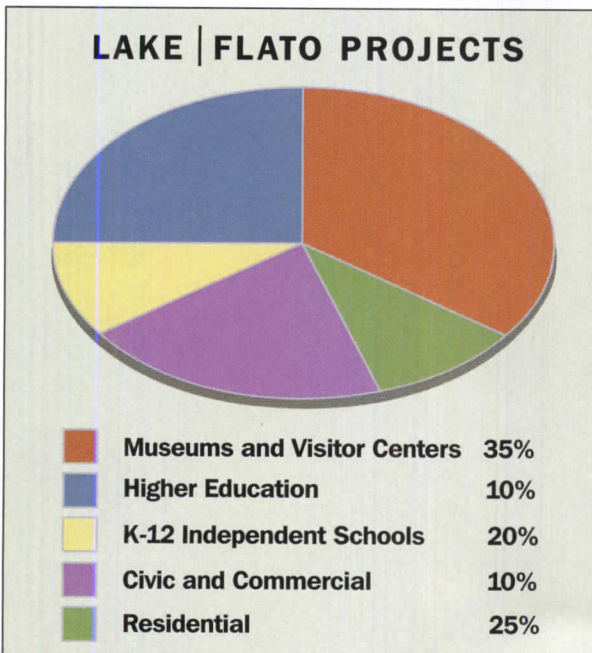

recalls Flato. "We didn't want to get involved with that, so we convinced them to buy this 40-by-180-foot shed and break it into three pieces, with a little stone cube in one for the living quarters. It was a case of using the limitations of budget and the original idea to create a more interesting project."

This combination of light steel frame and heavy stone appears frequently in Lake/Flato's later work, giving the reason/romance paradigm a new tension and edginess. The Carraro house won an AIA National Honor Award, the first of three, and dramatically elevated the firm's profile.



**Great Northwest Branch Library**  
San Antonio, 1994

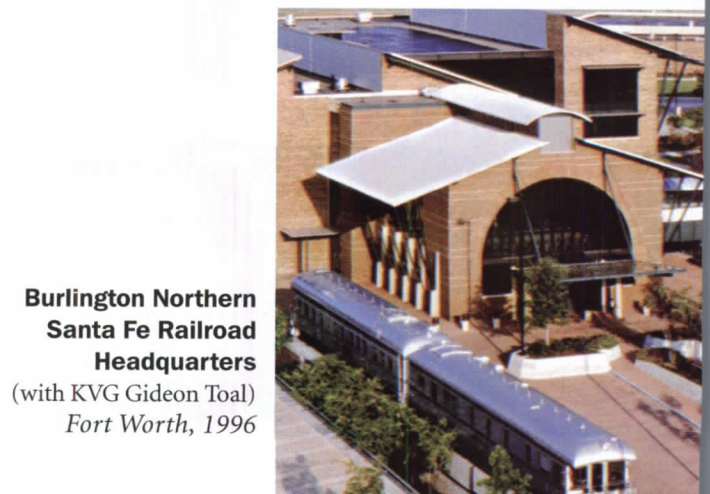

**Burlington Northern Santa Fe Railroad Headquarters**  
(with KVG Gideon Toal)  
Fort Worth, 1996



**Arlington Northern Santa Fe  
Road Headquarters**  
*Worth, 1996*

**Air Barns**  
*San Saba, Texas, 1999*



**Texas State Cemetery**  
*Austin, Texas, 1997*

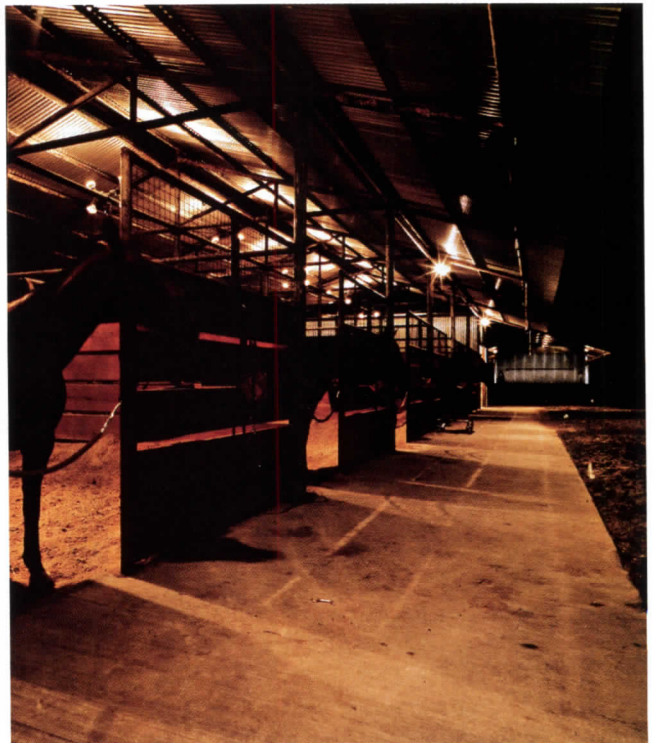

Lake/Flato now employs 45 people, half of them architects, who collaborate as a matter of course. This is another gift from Ford, who gave young designers extraordinary freedom and also surrounded them with a repertory company of craftsmen—masons, weavers, furniture makers, ceramicists—who softened and enriched his special brand of Modernism. The difference between real collaboration and a facsimile is the difference between bringing a covered dish to the supper and cooking together. Lake/Flato cook together.

They also get out of the studio to teach, lecture, and serve on design juries. They sponsor a residency program at the University of Texas at San Antonio and have helped the city's mayor come up with a Smart Growth Plan. A belief in good design as a public responsibility as well as a private passion lies at the heart of their practice. As the firm has expanded, so has the range and complexity of

**“THE FIRST IMPULSE ON ENTERING THEIR HOUSES, SCHOOLS, AND CHURCHES IS TO RUN YOUR HANDS ACROSS WALLS AND DOORS.”**

its projects. In the past decade, Lake/Flato has designed museums, churches, libraries, and corporate headquarters, along with a cemetery, a botanical garden, and a school of nursing.

Scale remains their ally and occasionally their albatross. The sprawling Burlington Northern Santa Fe headquarters in Fort Worth (with KVG Gideon Toal), for example, gets a bit heavy-handed in its evocation of the railroad vernacular. Likewise, the SBC Center, home of the San Antonio Spurs basketball team, is festooned with structural Texana that comes across as forced rather than inevitable. Understatement is their game.

Considerably more successful is the Trammell Crow Visitor Pavilion at the Dallas Arboretum, which opened in 2003 and in many respects epitomizes their earlier work. Here, rugged Texas limestone walls meet light steel and glass pavilions to form a small village with an open central plaza. The pavilions are contemporary abstractions of traditional barns and sheds, their appeal residing in the intimate scale and honest craftsmanship, rather than in bold architectural gestures. And the entire project blends seamlessly with its natural surroundings, enhancing rather than overwhelming them.

The new University of Texas School of Nursing in Houston is Lake/Flato's most ambitious exercise yet in sustainable design. Using 50 percent recycled materials and consuming 40 percent less energy, the building attains a LEED Gold rating without compromising architectural integrity or turning technology into a fetish.

Economy, pragmatism, simplicity, comfort without pretension, elegance without irony, these features distinguish Lake/Flato's best work. Their architecture shows respect for materials and construction, for the values of place and precedent and the needs and aspirations of its users. ■



**Hotel San Antonio**  
Austin, Texas, 2001

**Agudas Achim Synagogue**  
Austin, Texas, 2001





**Harry Ransom Center**  
*Austin, Texas, 2003*



**University of Texas School  
of Nursing and Student  
Community Center**  
*Houston, 2004*

**Trammell Crow Visitor  
Education Pavilion at the  
Dallas Arboretum and  
Botanical Society**  
*Dallas, 2000*





## Fast to the finish with the Rapid Deco® L5® Level 5 Skim-Coated Drywall System.

Take the notion that a Level 5 finish is too costly and time-intensive and blow it aside. The new Rapid Deco® L5® Level 5 Skim-Coated Drywall System makes a Level 5 finish as easy to achieve as a Level 4. That means superior Level 5 results in a fraction of the time. So you'll be fast to the finish and lookin' good. To find out more call **1-800-237-5505** or visit **www.rapiddeco.com**.

**Take Level 5 to the next level.**



Gypsum

www.lafargenorthamerica.com

© Copyright Lafarge North America

CIRCLE 119 ON READER SERVICE CARD  
OR GO TO [WWW.LEADNET.COM/PUBS/MHAR.HTML](http://WWW.LEADNET.COM/PUBS/MHAR.HTML)





MAZING THINGS HAPPEN  
WHEN YOU CHOOSE TO IGNORE  
WHAT EVERYONE ELSE IS DOING.

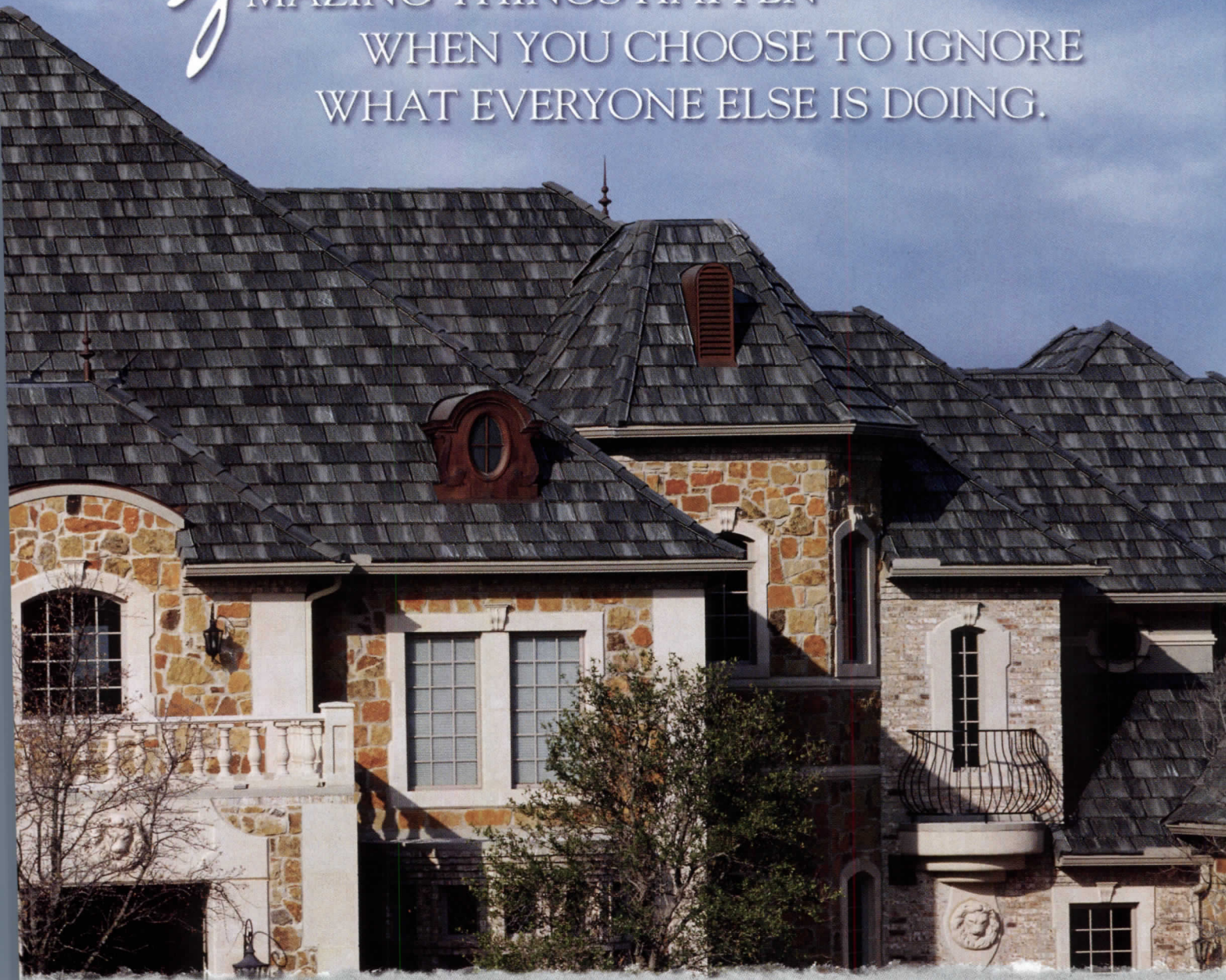

When you stand out people notice. In this case for the right reasons. Choose a MonierLifetile roof for your project. You're choosing a product that distinguishes you from the competition. Not only because we have beautiful colors and colors that complement virtually any architectural design, but also because tile is the most durable roofing material available. Which means your houses are more attractive—both visually and intellectually—to potential homebuyers. So let us amaze you. Learn more about tile by calling 1-800-571-TILE (8453) ext. 169.

1-800-571-TILE (8453) ext. 169  
monierlifetile.com



**MonierLifetile™**

*Changing the way people think about roofs.*

CIRCLE 120 ON READER SERVICE CARD  
OR GO TO [WWW.LEADNET.COM/PUBS/MHAR.HTML](http://WWW.LEADNET.COM/PUBS/MHAR.HTML)

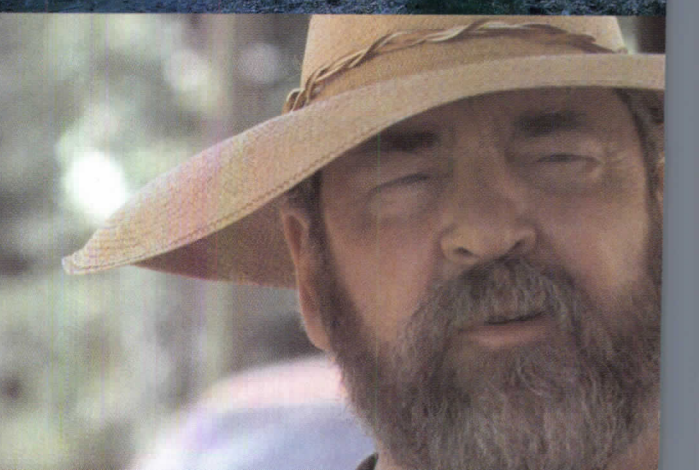
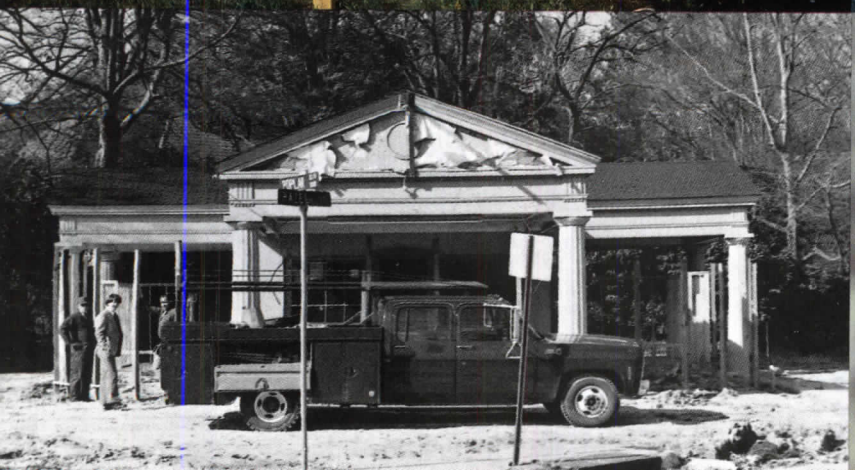
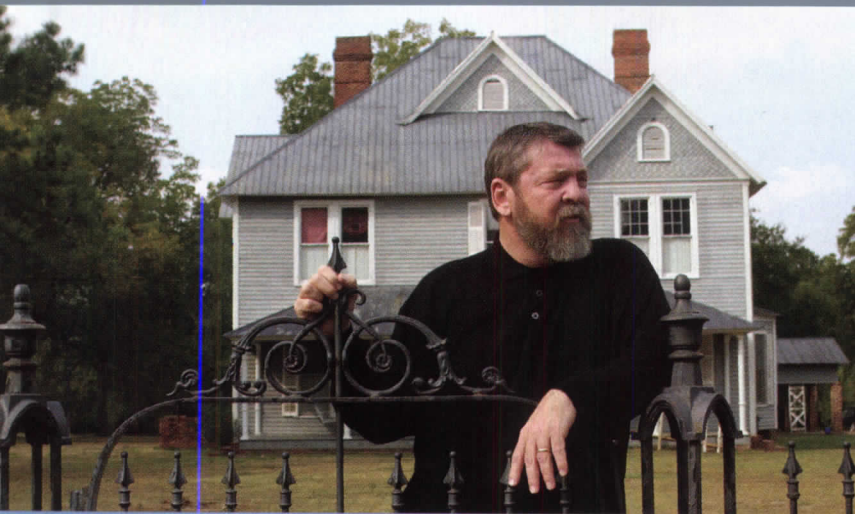



# Samuel Mockbee: A life's work

## AIA GOLD MEDAL WINNER

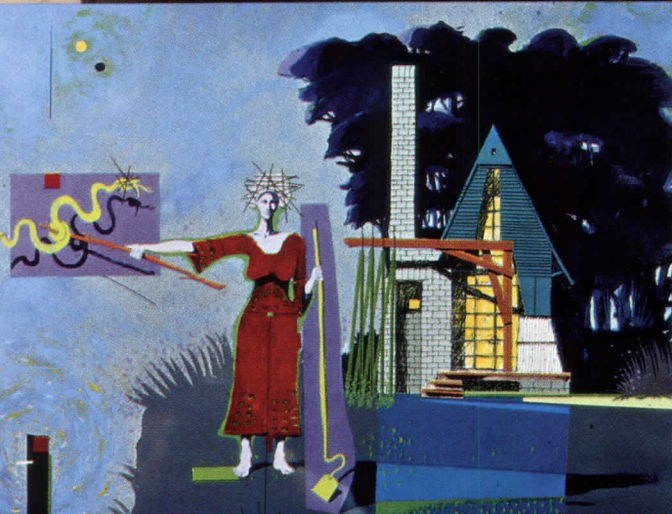

**B**efore there was a Rural Studio, there was an architect named Sambo. He grew up in the heady milieu of Mississippi, a place redolent of earth and growing things, of social disparity, and great literature. Coming of age during the contentious 1960s, Sambo absorbed the world surrounding Meridian, Mississippi, played football, attended Auburn University, and joined the army. Then his worldview shifted.

After a stint working in Georgia, he returned to Mississippi, where, in conjunction with a series of partners, he began to make architecture suited to the geography and culture of the nation's poorest state. Using the simplest materials and familiar forms, he wrested newness from a people struggling to emerge from a rich but historically oppressive past. Great writers from William Faulkner to Walker Percy had succeeded in moving on; uniquely, Sambo took architecture to a new Southern frontier.

While early projects smacked of Postmodernism, very quickly a bevy of buildings, from houses to simple chapels, proclaimed a refreshed, empathetic sensibility. Soon Sambo & Company were redefining what it meant to live and work in the South. Publications took notice, as did the universities.

Ultimately, he found his full voice through other people, particularly at Auburn's Rural Studio, where he and collaborator D.K. Ruth cofounded a residential architectural program that offered a total immersion in the art of building, engaging all of the arts in the service of a specific community. That work continues to flourish to this day.

In naming Mockbee as the 2004 Gold Medalist, the American Institute of Architects not only recognized his gifts, but also espoused Sambo's values, which fiercely and unsentimentally addressed basic human needs. *Robert Ivy, FAIA*

PHOTOGRAPHY: MOCKBEE PORTRAITS COURTESY JEFF ETHERIDGE

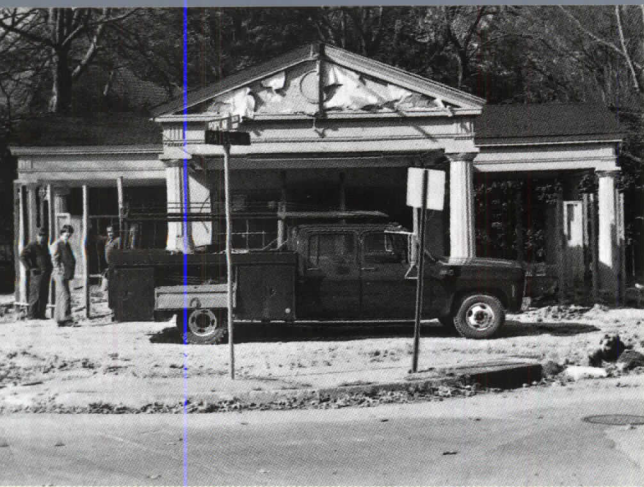

A 1927 Neoclassical service station called the Shady Nook, in Jackson, Miss., became the first office of Goodman and Mockbee, 1979. Mockbee is pictured with contractors; he's in the middle in a sports jacket.

By Andrea Oppenheimer Dean

**B**oth Samuel Mockbee and Frank Lloyd Wright often tongue-lashed their profession. Wright once called architects “high-grade salesmen”; Mockbee labeled them “house pets to the rich.” Yet the American architectural establishment conferred its highest honor, the AIA Gold Medal, on both Wright and Mockbee. That’s not all they had in common: Both were charismatic teachers who pried open the minds of their students with evocative stories and practical lessons instead of dry theory. Wright spoke of Taliesin in Wisconsin as having “simply shaken itself out of my

sleeve.” Mockbee told his students at Rural Studio in southwest Alabama often called Redneck Taliesin—“screw theory; choose the more beautiful.”

But the comparison pretty much ends there. Wright, a surpassing ego, saw himself as the Welch magician bard Taliesin and gathered apprentice rural Wisconsin for his own greater good. Mockbee, humble and unassuming, wanted to do good for others. Wright domineering, while Mockbee applied a light touch, cautioning students that goodness was more important than greatness, compassion more eventful than passion. Wright was the elegant, autocratic Mr. Wright. Mockbee, a bearish, bear sixth-generation Mississippian, was egalitarian and a populist who preferred being called Sambo and drove around in

*Andrea Oppenheimer Dean is a RECORD contributing editor and author with Timothy Hursley of Rural Studio: Samuel Mockbee and an Architecture of Decency (2002).*

## THE EARLY WORK 1970–1980s



1

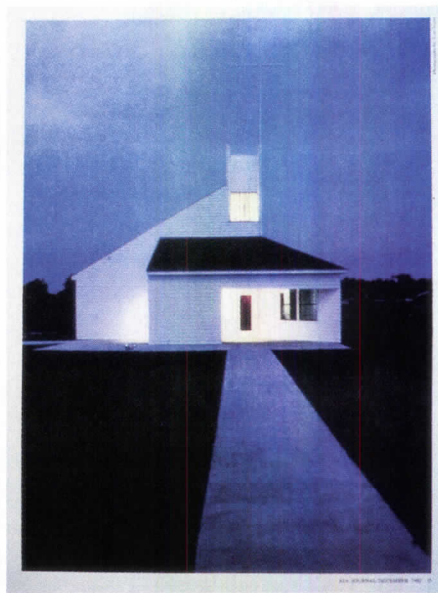

2

1. Christ Community Church, Clinton, Miss., Goodman and Mockbee, 1979

2. Presidential Hills Presbyterian Church, Jackson, Miss., Goodman and Mockbee, 1980.

3. Model of Charity Houses, Madison County, Miss., P/A Award submission Goodman and Mockbee Coker Howorth Architects 1986–87 (not built).

4. Model of the Flautt House, Greenwood, Miss., Mockbee Coker Howorth Architects, 1987 (not built)

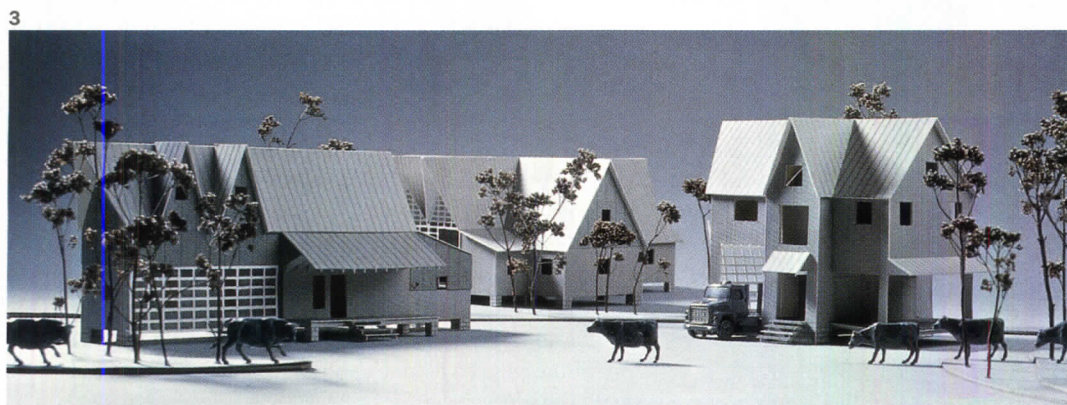

...nty, the Rural Studio's home, in a beat-  
 erd pickup, wearing old clothes and an  
 oun University baseball cap. He viewed  
 himself as an iconoclast and a subversive.  
 e same, of course, was true of Wright.

Mockbee was convinced that  
 everyone, rich or poor, deserves a shelter  
 for the soul" and that architects should  
 be involved in procuring social and environmen-  
 tal change. But he believed they had lost  
 their moral compass. The profession

**MOCKBEE OFTEN TONGUE-LASHED  
 THE PROFESSION, LABELING ARCHI-  
 TECTS "HOUSE PETS TO THE RICH."**

...ded reform, he believed, and education  
 was the place to start. "If architecture is  
 going to nudge, cajole, and inspire a com-  
 munity to challenge the status quo into

making responsible changes, it will take the  
 subversive leadership of academics and  
 practitioners who keep reminding students  
 of the profession's responsibilities," he  
 said. He wanted to get students away from  
 the academic classroom into what he  
 called the classroom of the community.

In a letter nominating Mockbee  
 for the 2004 Gold Medal, Frank Gehry,  
 FAIA, wrote, "There have been few pro-  
 grams as radical as the Rural Studio in

helping students to  
 believe in their role  
 for the future." Peter  
 Eisenman, FAIA, com-  
 mended the studio for

stressing "the ethical dimension of build-  
 ing." Michael Rotondi, FAIA, wrote,  
 "Mockbee represents all that we aspire to  
 be as individuals and as a profession."



**Sambo teaching at the Rural Studio  
 in Greensboro, Ala., 2000.**



5

**5. Tractor shed at Flautt House,  
 Greenwood, Miss., Mockbee Coker  
 Howorth Architects, 1988.**

**6. McGee Church, McGee, Miss.,  
 Mockbee Coker Howorth Architects,  
 1989.**

**7. National Center for Physical  
 Acoustics, University of Mississippi,  
 Ole, Miss., Mockbee Coker Howorth  
 Architects, with HLW, 1989.**

6

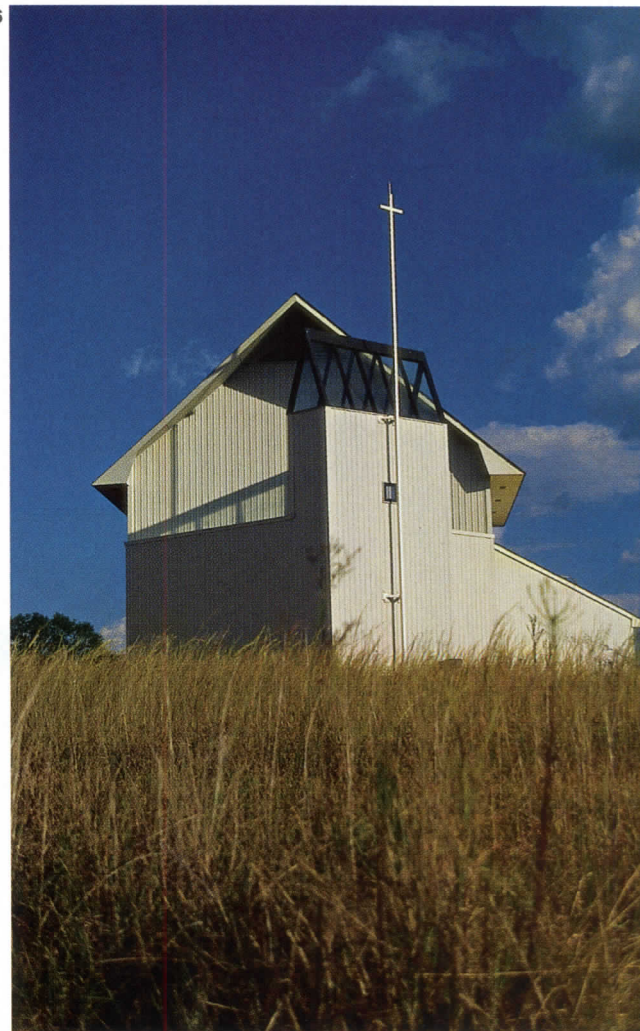

7



Traveling exhibition, Soviet Union, joint venture of Mockbee Coker Howorth Architects and Communication Arts, 1988–1991.

Mockbee's ideas and his aesthetic evolved while he was in private practice, first in a partnership he formed with Thomas Goodman in 1977, then with Coleman Coker in 1983. He described his architecture as contemporary Modernism grounded in Southern culture and drew inspiration from such vernacular sources as overhanging galva-

**MOCKBEE, A BEARISH, BEARDED, SIXTH-GENERATION MISSISSIPPIAN, DROVE IN A BEAT-UP RED PICKUP.**

nized roofs, rusting metal trailers, dogtrot forms, and porches. "I'm drawn to anything that has a quirkiness to it, a mystery to it," Mockbee said. His designs tended toward asymmetry and idiosyncrasy, as seen, for example, in his Madison County,

Mississippi, Barton House (a 1992 Record Houses Award winner) and his Oxford, Mississippi, Cook House (a 1995 AIA National Honor Award winner).

By the early 1980s, convinced that addressing problems and trying to correct them is "the role an artist or architect should play," Mockbee sought opportunities to follow Leon Battista

Alberti's injunction that an architect must "choose between fortune and virtue." In 1982, he helped a Catholic nun move and renovate c

demned houses in Madison County, Mississippi, and then built his first "charity house" there for \$7,000, using donated and salvaged materials and volunteer labor—a model for the Rural Studio. In 1987, his firm won a 1982 P/A Award

**1988–1991**



8. Cook House, Oxford, Miss., Mockbee Coker Howorth Architects, 1991.



9. Barton House, Mockbee Coker Howorth Architects, Madison County, Miss., 1991.



8

... prototype dogtrot-type charity  
... uses but was unable to get a construc-  
... n grant to build them. Hoping to  
... ve to possible patrons the reality of  
... or people ("like you and me, only  
... or"), Mockbee painted strong portraits  
... oil of some of his indigent clients. The  
... al piece for the Rural Studio fell into  
... ce in 1990 when Mockbee visited  
... mson University's architecture pro-  
... m in Genoa, Italy.

In 1992, Mockbee, together with  
... burn architecture professor D.K. Ruth,  
... nded the Rural Studio, which Mockbee  
... ected until his death in late 2001. But  
... ead of planting Auburn's study-abroad  
... gram in a foreign country, they rooted  
... in the hollows and flat fields of  
... bama's second-poorest county, Hale.  
... ckbee was drawn there partly because

of the poverty: The residents obviously  
... needed help, and coming to Hale would  
... force students to test their abstract notions  
... about poverty by "crossing over into that  
... other world, smelling it, feeling it, experi-  
... encing it," he said. He was also attracted by  
... the isolation, which, combined with  
... Mockbee's prohibition of television,  
... would concentrate students' minds on  
... their building projects. Students would  
... also be exposed to the region's architec-  
... tural history, read its literary giants, and  
... absorb Mockbee's lectures on responsibil-  
... ity, fairness, and decency.

Each semester, the Rural Studio  
... brought about 15 second-year students  
... to Hale County to help design and build  
... a house. Fifth-year students stayed for a  
... year, working on a community building,  
... their thesis project. Two years before



**Sambo working on the tractor shed, Flautt House, Greenwood, Miss., Mockbee Coker Howorth Architects, 1988.**



10

**10. Bryant (Hay Bale) House, Mason's Bend, Ala., Rural Studio, 1994.**





Sambo with the Harris family, Mason's Bend, Ala., Rural Studio, 1997.

Mockbee's death, the studio launched an outreach program, accepting a handful of students from other universities and other disciplines to undertake a variety of design and social-work assignments.

Mockbee's Rural Studio represented a vision of architecture that embraced not only practical architectural education and social welfare but also the use of salvaged, recycled, and curious materials and an aesthetics of place. "I want to be over the edge, environmentally, aesthetically, and technically," Mockbee said. His students used hay bales to build walls for the studio's first house, worn-out tires for the walls of a chapel, salvaged Chevy Caprice windshields for the roof of a community center, and waste corrugated cardboard for a one-room dwelling. Transmuting ordinary materials into

extraordinary objects, the studio's buildings were obvious relatives of the Mockbee designed for his private clients.

For his work at the Rural Studio, Sambo Mockbee was awarded the National Building Museum's first Award for Excellence in 1998, and in 2001 he won a MacArthur "genius" grant.

The influence of the Rural Studio is hard to quantify. Darrel Friedman, FAIA, dean of the University of Illinois, Chicago's architecture program, says it has changed architectural education. Bill Carpenter, author of *Learning to Build: Design and Construction in Architectural Education*, observes that in 1992 there were eight or 10 university-based design-build programs, while today there are 30 or 40. He says, "a lot of it [increase] had to do with Sambo."

## 1990-2001



11

11. Yancey Chapel, Sawyerville, Hale County, Ala., Rural Studio, 1995.

12. House on Tennessee River, Shiloh Falls, Tenn., Mockbee/Coker Architects, 1997.



12



ismatic Mockbee and his Rural Studio were featured on network television, including *CBS This Morning* and in numerous national magazines. "It was the first time the public was captivated by an architectural model," Carpenter says.

**MOCKBEE TOLD HIS STUDENTS, "CREW THE THEORY; CHOOSE THE MORE BEAUTIFUL."**

Another influence, he says, is graduation—about 450 by now. Many become precursors of the Rural Studio's approach.

After a founder's death, ventures like the Rural Studio rarely flourish. The death of Taliesin's vitality and creativity, for instance, died with Wright.

I am pleased to report, however, that Mockbee's baby thrives, a tribute to his

ideas. The studio isn't quite the same and isn't without criticism, including from within. "I suspect Sambo would just think it was different and regret being dead and not being there," David Buege, a professor of architecture at Mississippi State University and a friend of Mockbee's, told me. Mockbee understood change and welcomed it. He created the studio as a moving target.

There was almost no transition period, Buege recalls, and there was never a doubt about who should succeed Mockbee. At the time of Mockbee's death, 34-year-old Andrew Freear, a native of Yorkshire, England, and a product of London's Architectural Association, taught the fifth-year program. "Sambo and I were good together," Freear says. "I was a



**Interior of Harris (Butterfly) House, Mason's Bend, Ala., Rural Studio 1997.**



13

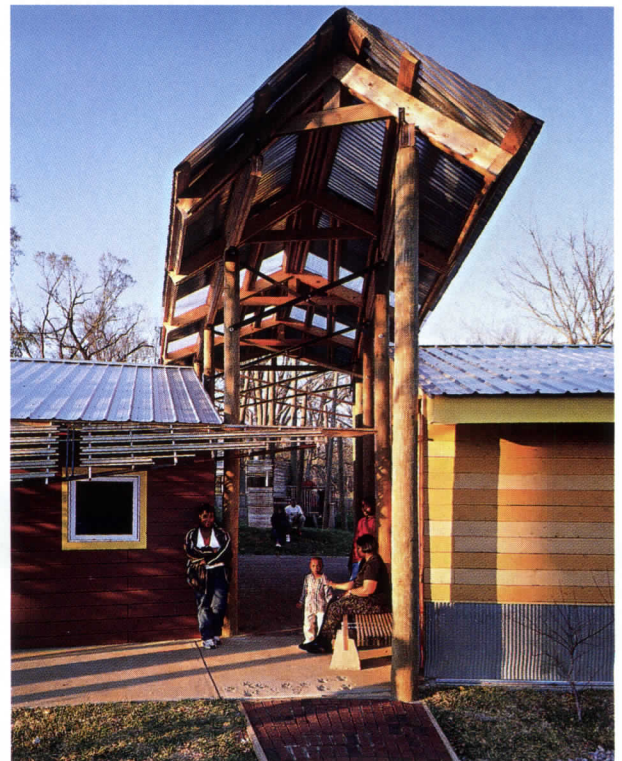

14

**13. Harris (Butterfly) House, Mason's Bend, Ala., Rural Studio, 1997.**

**14. Hero Children's Center, Greensboro, Hale County, Ala., Rural Studio, 1999.**



Detail of one of the Pods (note wall made of license plates), Newbern, Ala., Rural Studio. 1997–2001.

sort of utilitarian socialist and he was the artist who said make it pretty.”

Freear was the obvious successor—the only person, really, who could take over. The studio formed ranks behind him, and Freear carried on, adopting one of Mockbee’s slogans, “Proceed and Be Bold.”

Freear is “a bulldog,” says Buege. “Andrew is smart, brash, ambitious, always on the edge, often over-the-top,

## THE INFLUENCE OF THE RURAL STUDIO HAS CHANGED ARCHITECTURAL EDUCATION.

disciplined, deeply committed, self-confident. Someone without that confidence might well have failed. He’s very respectful of Sambo and his legacy, but he’s

assertive about not being Sambo and the Rural Studio being more than Sambo.

David Hinson, an Auburn associate professor of architecture, adds that Freear has many of the same strengths as Mockbee: Freear lets students realize themselves, has a pragmatism combined with poetry, doesn’t entertain long discussions grounded in abstractions, is kind, and has a penchant for the outrageous. Shortly after Mockbee’s death,

Auburn committed \$400,000 a year to the studio, endowing it with stability for the first time, and in 2002, Freear was appointed codirector of the studio, with Bruce Lindsey, head of Auburn School of Architecture. Freear, however, continues a laser concentration on five-year projects, and during his wa-

## 1997–2002



15

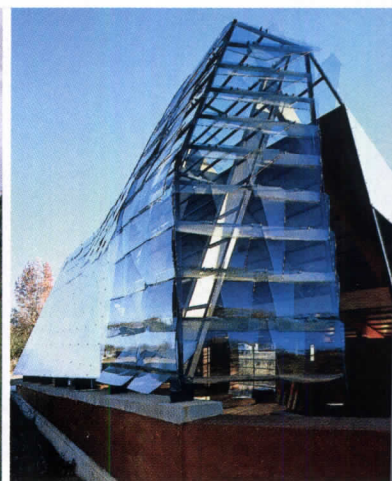

15. Mason’s Bend Community Center, Mason’s Bend, Ala., Rural Studio, 2000.

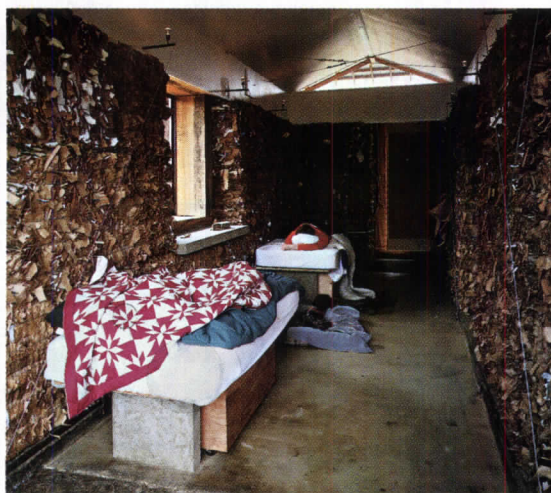
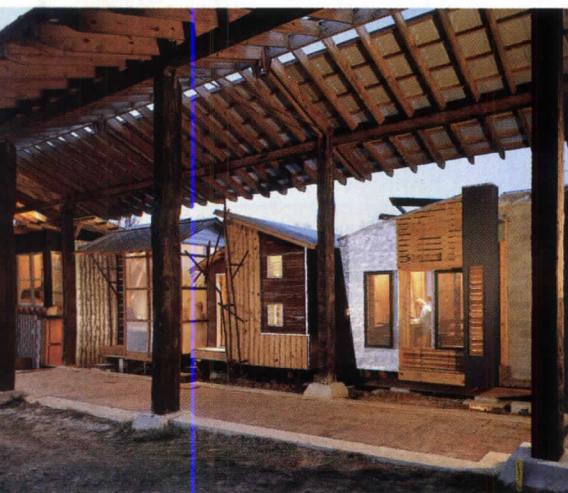

16. Supershed and Pods (left, interior of Cardboard House), Newbern, Ala., Rural Studio, 1997–2001.

studio's focus has shifted more radically from the rural house to community-oriented buildings.

At the same time, the Rural Studio's community buildings have grown larger, more complex, more significant, and more numerous. In the early years, students built one or two, and, at most, two modest community buildings a year. In the two years following Mockbee's death, the studio completed 17 projects. Lindsey thinks tackling so many assignments at once might have been "a bit of therapy" in dealing with the loss of Sambo. "It helps Freear, new and young, needed to give something about the studio about Mockbee, and about himself.

The year Mockbee died, the studio was working on a house plus five

community projects: the Antioch Baptist Church in the countryside about 25 miles northeast of Newbern, the studio's base; a senior center in Akron, 25 miles west of Newbern; a storefront in downtown Greensboro, the county seat; and in Perry County, Hale's neighbor to the west, the studio completed a pavilion in the newly reopened Perry Lakes Park. In addition, a group of outreach students reinterpreted and built one of Mockbee's last designs, called Lucy's House for its owner.

Freear says that if the Rural Studio has changed, "it's because I said we can make the craft better. I want to have high expectations for the students and the client. If we're going to make a glass box [as at the Thomaston Rural Heritage Center], the finish is going to be fantastic." Freear has also honed the



Lucy and Anderson Harris (standing) and son A.J. (seated) at Lucy's House, Mason's Bend, Ala., Rural Studio, 2002.

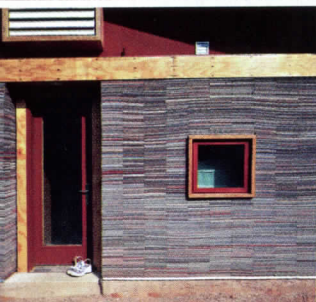

Lucy's House, Mason's Bend, Ala. (walls made of carpet samples), Rural Studio, designed 2001, completed in 2002 (after Mockbee's death).

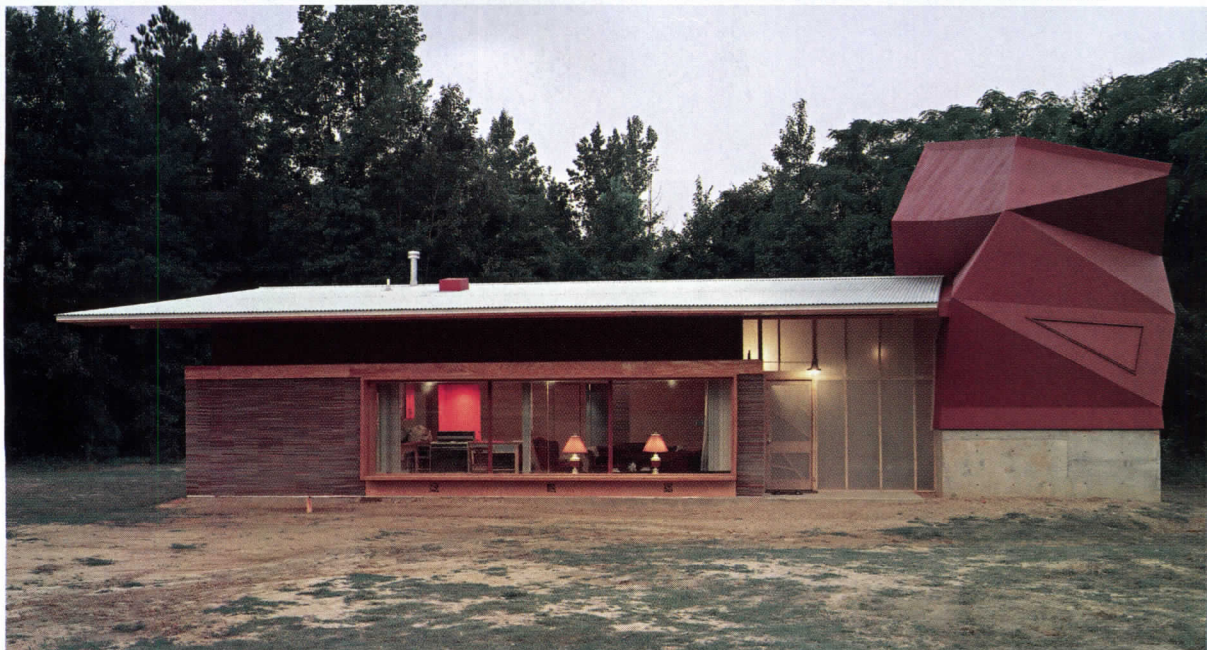



Mockbee in his painting studio in Newbern in the summer of 2001 seated before *The Children of Eutaw Pose Before Their Ancient Cabins*, 1992.

programming of buildings and has encouraged communities to find their own funding, believing that if they provide payment they are more likely to take ownership. Fifth-year students once

**"I'M DRAWN TO ANYTHING THAT HAS A QUIRKINESS TO IT, A MYSTERY TO IT," MOCKBEE SAID.**

chose their own projects, but now community leaders come to the studio seeking design and construction help. As a result, students have become more engaged with town and county leaders.

Freear's stress on craftsmanship has led him away from Mockbee's tendency toward improvisation and letting design evolve during construction. Freear insists on getting things right first.

Drawing, he says, saves time on-site creates better communication among team members and between the team and client. "Design-build should not be a source of responses to screwups made earlier

the project," he says. "I believe in precision, not artfully camouflaged sloppiness." ratcheting up the level of craft has stretched out schedules.

At the end of the academic year 2002–2003, three of four thesis projects remained unfinished; that summer fall graduates returned to finish their work, on their own penny.

Another change, since 2002, has been increased use of steel in construction. John Forney, the outdoor program professor, worries that the students may lose out, because steel requires

## 2002–Present



18

18. Music Man's House (Jimmy Lee Matthews), Greensboro, Hale County, Ala., 2002–2003.

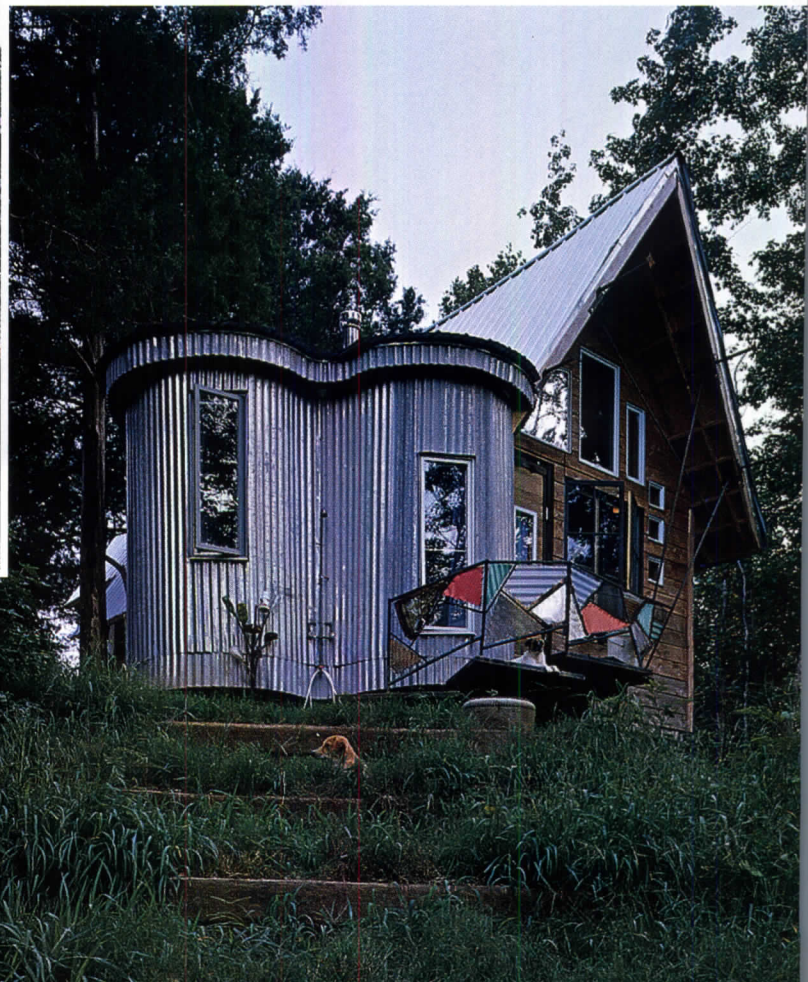



©2004 Johnson Controls, Inc. ADRP-2005

What is the cost of doing business doing to your business?

When the ends meet takes a little creativity. But you don't have to go this far. At Johnson Controls, our integrated systems approach can lower construction costs and save you millions over the life of your facility. Heck, we'll save you 50 cents on the first phone call. 1-800-972-8040 ext. 558.

CONSTRUCTION SYSTEMS INTEGRATION SERVICE SECURITY FACILITY MANAGEMENT TECHNOLOGY ENERGY

CIRCLE 121 ON READER SERVICE CARD OR GO TO [WWW.LEADNET.COM/PUBS/MHAR.HTML](http://WWW.LEADNET.COM/PUBS/MHAR.HTML)

JOHNSON  
CONTROLS

[WWW.JOHNSONCONTROLS.COM](http://WWW.JOHNSONCONTROLS.COM)



**Red Barn, Newbern Design Studio, where Rural Studio currently works, Newbern, Ala., Rural Studio, 2004.**

fabrication by professionals. The problem solved itself: In 2004, students rejected the steel and glass of the past two years. “The students don’t want to do something that’s already been done, and they saw how much of the construction

scrappy materials would seem to hand-in-hand with raising the bar.

As materials have changed has appearance. The Rural Studio buildings under Mockbee were known for their striking angles, winged roofs and wacky details.

## THE STUDENTS CROSSED A THRESHOLD TO A PREVIOUSLY FEARED AND UNFAMILIAR WORLD.

process was taken out of their hands last year and the year before,” Freear says.

new thesis projects, some of which are stunning, tend toward a more neutral, Minimal Modernist vocabulary that wasn’t Mockbee’s.

The thesis projects completed under Freear use some recycled materials, but you’ll find no hay bales, no waste corrugated cardboard, no windshields. He is more interested in durable buildings that require minimal maintenance. A decline in the use of unconventional,

Remember, however, these are not Freear’s buildings. The students reacted to Freear’s critiques and may unconsciously absorb his preferences, but the students were always the authors, and that’s still the case. Freear says he and the students engage in few conversations about how things look. “We talk a

## 2002–Present

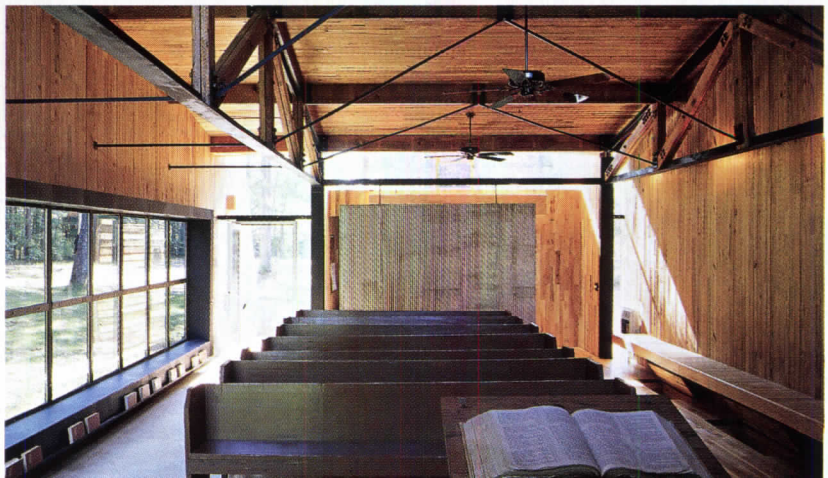
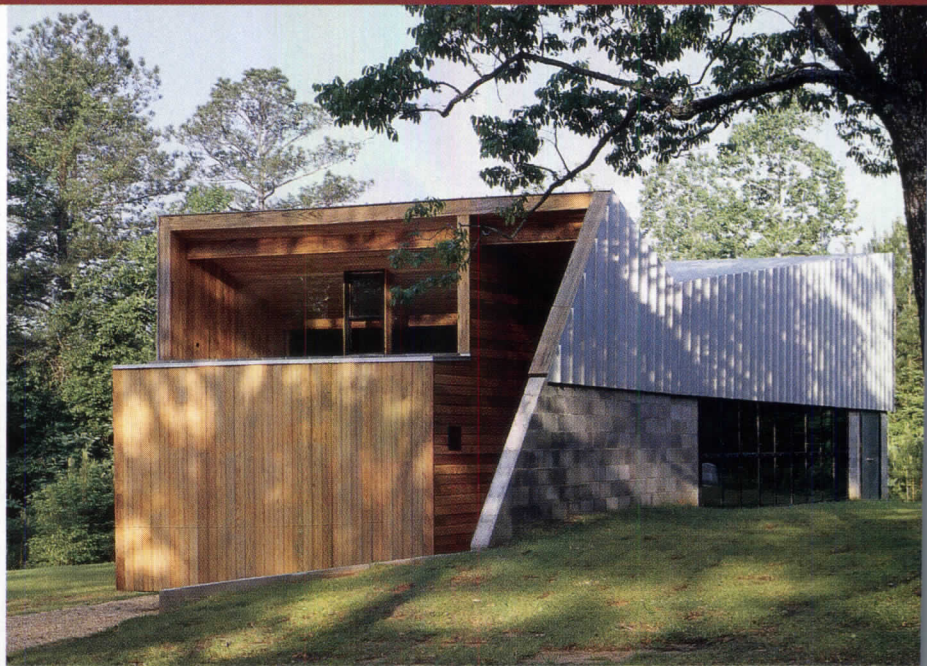
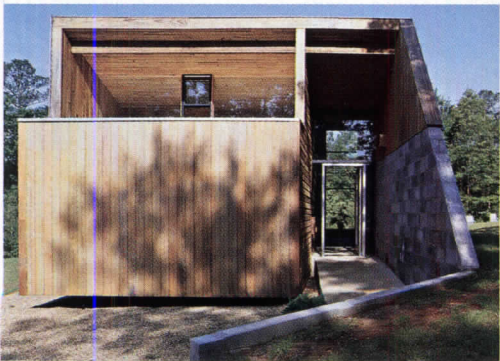
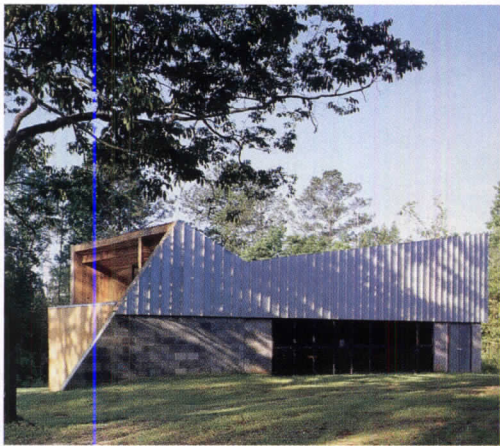

19

**19. Antioch Baptist Church, Perry County, Ala., Rural Studio, 2002.**



WAUSAU WINDOW AND WALL SYSTEMS

ADVANTAGE BY WAUSAU PRE-ENGINEERED WINDOWS

RULES BOUNDARIES CONVENTIONS

---

SEE THROUGH IT ALL

---

WAUSAU WINDOW AND WALL SYSTEMS

1 877 678 2983  
WAUSAUWINDOW.COM

Right  
THE WAY YOU WANT IT

CIRCLE 122 ON READER SERVICE CARD  
OR GO TO [WWW.LEADNET.COM/PUBS/MHAR.HTML](http://WWW.LEADNET.COM/PUBS/MHAR.HTML)

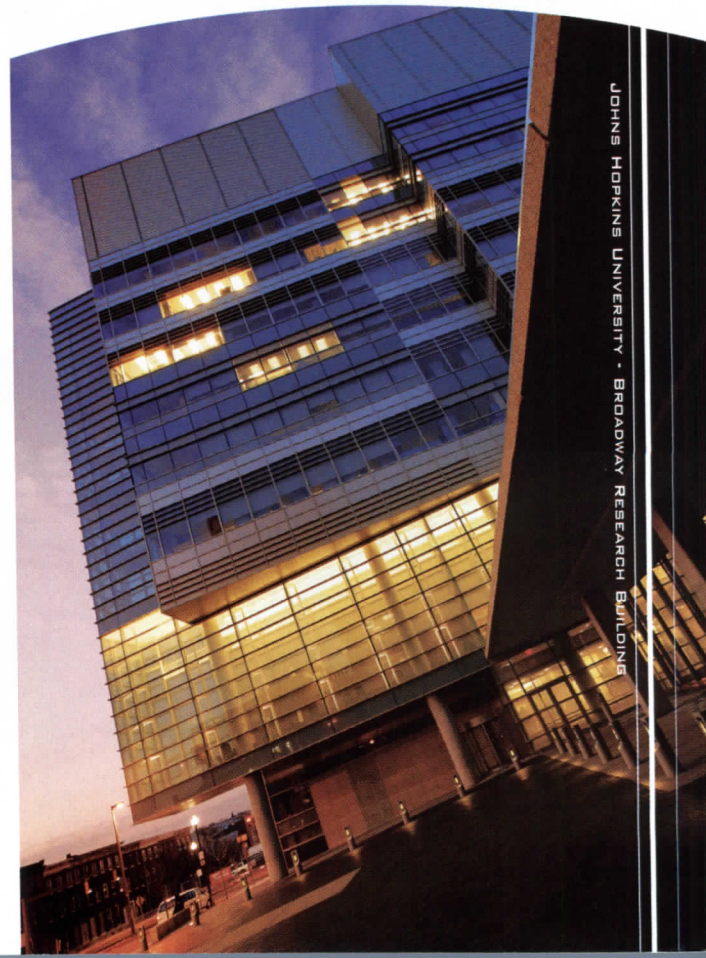

JOHNS HOPKINS UNIVERSITY - BROADWAY RESEARCH BUILDING



Andrew Freer (seated) with Rural Studio thesis students. Red Barn, Newbern Design Studio, Newbern Ala., 2004.

materials and the sustainability of materials, that our clients have no money or time to paint, that we shouldn't use a metal that's going to rust."

Unlike the community buildings, which show an ever-increasing level of sophistication, the outreach program still produces projects with Mockbee-era quirkiness. One example is Cynthia

### FREEAR CARRIED ON WITH THE RURAL STUDIO, ADOPTING ONE OF MOCKBEE'S SLOGANS, "PROCEED AND BE BOLD."

Connolly's organic vegetable stand of 2003, which has movable walls of hog-wire, a patchwork of chicken wire and assorted metal leftovers. John Forney, the program's instructor, has tried to avoid

what he characterizes as the "death mar struggles" of the fifth-year projects.

Mockbee's expressive yet relaxed approach also lives on in the houses designed and built by the second-year program, which has changed much less than the fifth-year program. The first house completed since Mockbee's death, Tra

Shiles's house of 2002, suffers from an overabundance of ideas, formal materials, and finishes, but the second, completed in 2003, by Jimmy Lee Matthews, aka Mr. Man, returned the studio to its roots. As with the studio's first house for Shepard and Alberta Brya middle-class white students and an impoverished black client worked closely together. They bonded, and the student crossed a threshold to enter a previous

## 2002–Present



20



21



20. Newbern Little League Newbern, Hale County, Ala Studio, 2002–2003.

21. Boardwalk and Restroom Facilities, Perry Lakes Park Perry County, Ala., Rural Studio, 2002–2003.



# Be specific!

## Use Certi-label™ Cedar Shakes and Shingles



Inset: Architect: Gary Tabasinske, AIA, Photo: Chris Eden, Center Photo: Celia Pearson, Large Inset: Mission Regional Chamber of Commerce, Designer: Traditions West Designs Ltd., Photo: Kelly Gurney



*Your reputation is only as good as your last project...*

Building a good track record is easy when you build with cedar. **Certi-label** cedar shakes and shingles offer your discerning clients the warmth, beauty, quality and prestige they deserve.

Make the right choice. Select the product that is proven to last over time, is wind and impact resistant, lightweight, and truly, above all else, provides the look that Mother Nature intended.

*Contact us for more details about quality Certi-label cedar shakes and shingles.*



**Cedar Shake & Shingle Bureau**  
tel: 604-820-7700 fax: 604-820-0266  
[www.cedarbureau.org](http://www.cedarbureau.org)



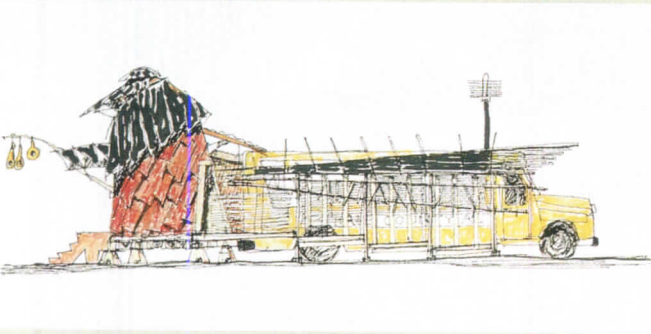

Preliminary sketch: Fabrications, Hale County, Ala., 1997.

feared and unfamiliar world. The students found many of the materials—timber, chicken wire, colored bottles—for the tall, narrow, house with the big tin roof on

balance its more ambitious, big-t buildings against a wish to remain intimate and retain its rural soul? How can it maintain Sambo Mockbee's ch

## MOCKBEE PAINTED PORTRAITS OF SOME OF HIS INDIGENT CLIENTS ("LIKE YOU AND ME, ONLY POOR").

like sense of fun and adventure while laboring on more adult, multi high-pressure projects?

Music Man's property. Boochie Patrick's 1,000-square-foot, modular house of 2004 was conceived as a possible replacement for the region's omnipresent housing form, the trailer. It has a steel frame with bays that can be enclosed with any material at hand, and, as at the Patrick's, can be tailored to a family's needs and the site.

Jay Sanders, second-year instructor from 2002–2004, observes that "Sambo never had a master plan for this place. Maybe his legacy is that it will live on without him, without Andrew, without the students that knew him. If it continues to move forward, in 10 years it may not feel any different like it does today."

The Rural Studio's accomplishments pose questions: How can the studio

proceed boldly. Sambo would love it.

## MOCKBEE THE ARTIST

Clockwise, from right: *Portrait of Gayle*, 1989; *The Children of Eutaw Pose Before Their Ancient Cabins*, 1992; *The Coronation of the Virgin—1730 and 2001, 2001*; *Julius and His Mother Pose Before Their Ancient Cabin*, 1990.



"There are thousands of dream places in the old South. You can sit on a bench in a tiny Confederate Park or flirt on the banks of a levee or stand on a bluff overlooking an Indian settlement, the air soft, still, fragrant, the world asleep and the atmosphere is charged with magical names, epoch-making events, inventions, explorations, discoveries.... It is all over the South was ploughed under."—Henry Miller, 1941, from *The Air-Conditioned Nightmare*. (Sambo attributed these words to



# Parklex<sup>®</sup>, for landmark buildings throughout the world.

Architect: James Dayton Design Photographer: Peter Kerze © 2003  
 Minnetonka Center for the Arts Wayzata, Minnesota  
 Product: Parklex 1000, Eyong Natural (ENP)

**Parklex<sup>®</sup>**  
**1.000**  
 STRATIFIED HIGH-DENSITY TIMBER  
 PANEL FOR EXTERNAL APPLICATIONS



Architect: Koonce Pfeffer Bettis  
 Photographer: Kevin G. Smith © 2003  
 BP Energy Center Anchorage, Alaska  
 Product: Parklex 1000, Eyong Natural (ENP)

Designer: Ken Mori Architect: Twichell Studio  
 Photographer: John Linden © 2002  
 Private Residence Manhattan Beach, California  
 Product: Parklex 1000, Eyong Natural (ENP)

Architect: Edge Studio  
 Matt Fineout/EdgeStudio © 2003  
 Offices Pittsburgh, Pennsylvania  
 Product: Parklex 1000, Eyong Natural (ENP)



Architect: Alchemy Architects/Geoffrey Warner, Minneapolis & San Francisco © 2002  
 Spencer Farmhouse Spooner, Wisconsin  
 Product: Parklex 1000, Ayous Dark Brown (ABP)

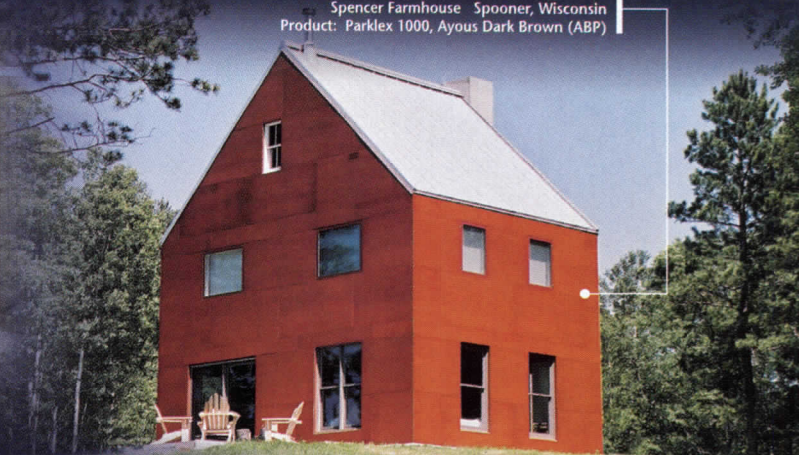

World renowned architects continue to certify Parklex<sup>®</sup> on major projects

Parklex<sup>®</sup>, innovative options in timber for walls and floors that last a lifetime.

**Parklex<sup>®</sup>**  
**2.000**  
 HIGHLY RESISTANT NATURAL  
 WOOD FLOATING FLOOR



Guggenheim Museum (Bilbao) © Eduardo Chillida House, VEGAP, Navarre, 2001  
 Architect: Frank O. Gehry  
 Construction manager: César Calcoya

For more information please contact:

RESIDENTIAL AND COMMERCIAL OFFICE:  
 P.O. Box: 1 • NAVARRA • SPAIN • Tel: 948 625045 • Fax: 948 625015  
 Email: info@parklex.com • http://www.parklex.com

CONTACTS:  
 Color Plywood Corporation - Tel: (310) 396 9991 - www.fcpcusa.com - E-mail: info@fcpcusa.com  
 U.S.A.: 3031 - www.bauendistribution.com • Germany: 49 6171626110 • France: 33 561848078 • Argentina: 54 1147421185  
 U.K.: 44 1223 33607880 • Greece: 30 106644611 • Italy: 39 0444327722 • Korea: 82 32 863 3264 • Luxembourg: 352 789511320  
 Spain: 34 91 626820 • Switzerland: 41 618264646 • Turkey: 90 2122439797 • U.K.: 44 1895831600 • Yugoslavia: 381 113612533

CIRCLE 126 ON READER SERVICE CARD  
 OR GO TO WWW.LEADNET.COM/PUBS/MHAR.HTML



**COMPOSITES GUREA**

# At the twilight of his career, **I.M. Pei** shows few signs of slowing down

Modernism's elder statesman looks back  
over 50 years—and forward to  
finishing new museums on three continents

DEUTSCHES HISTORISCHES MUSEUM



At dusk, the transparent helical staircase glows in the new wing (known as the Schauhaus) of the German Historical Museum in Berlin. Pei's addition provides some 29,000 square feet of space for temporary exhibitions.

**By Robert Ivy, FAIA**

*I.M. Pei's agility with the Modern form has garnered him prestigious commissions for museums and cultural institutions throughout his career, from the East Building of the National Gallery of Art (winner of this year's AIA 25 Year Award, page 172) to an addition and renovation of the centuries-old Louvre to a new wing for temporary exhibitions at the German Historical Museum in Berlin (pictured at left). Although he's been "officially" retired for more than a decade, Pei still has projects on his plate and a twice-a-week-at-the-office habit. Shortly after the AIA Accent on Architecture dinner on March 3 in Washington, D.C., editor in chief Robert Ivy visited Pei at his office in Lower Manhattan, where they discussed the evolution of Pei's design thinking, the importance of working abroad, and his current slate of projects.*

**AR:** *You say you have retired, but you continue to be involved in projects. What are you working on right now?*

**IMP:** I haven't taken any new projects in the past three years—I told myself, if I cannot live long enough to finish it, I don't want it. So I have three projects now. The first one is the Musée d'Arte Moderne in Luxembourg, which is under construction right now. The museum will be located on top of an old, old fortress, Fort Tüngen, which the Austrians built in the 1800s. The client is the State of Luxembourg. I accepted the commission for the project in 1990 or 1991, after I retired, but it began only six months ago—it was stopped altogether five or six years for various reasons. The second project is a museum

1

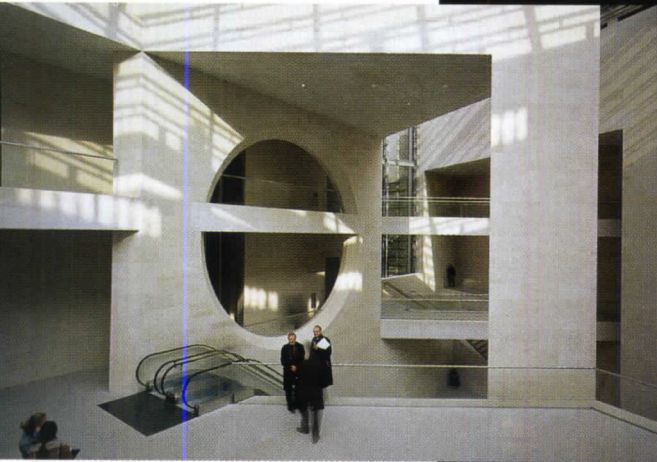

**1. Walkways and openings define space at the new wing (Schauhaus) of the German Historical Museum, Berlin, 2003.**

**2. The sun throws a lattice of shadows from a skylight at the Schauhaus.**

2



in my hometown of Suzhou, China. And I am also designing the Museum of Islamic Art in the Middle East, in Qatar.

**AR:** *So do these projects involve design work, or development work and decisions about construction?*

**IMP:** It's a little bit of each. I just completed the design for the museum in Qatar, which I accepted about two and a half years ago. It's now under construction, but that's an exceptional one, because usually it takes longer than that. I'm doing most of the work on the Suzhou Museum on my own.

**AR:** *That's a very active, demanding schedule.*

**IMP:** I've been active all my life. In 1990 I retired from my firm, I.M. Pei & Partners, and for two years I didn't do much. Then I started to get kind of antsy, so I decided, I'm going to do some more work. And I chose to do work outside the U.S. because I've spent 45 years here and I wanted to learn more about what's happening in the rest of the world. So I travel to the Middle East, I travel to China, I travel to Europe. It's all very rewarding—the only problem is the travel is getting more and more difficult for me now. Ten years ago I would have enjoyed it a lot more.

And my projects have typically taken a long time to complete. Buildings might take on average about five to seven years to finish, but in my case it's been longer, because the projects I have accepted within the past 15 years have been mostly government projects, and those involve some politics and funding issues, and approvals and so forth. So they're slower.

**AR:** *Tell me about the museum you're designing in your hometown in China.*

**IMP:** When this commission came, it was very special. I was born in Suzhou, a city not very far from Shanghai. It's a very interesting town—there is a long artist's tradition there, especially during the Ming and Ching dynasties, which produced many, many scholars and painters and so forth. That's where my family lived for 600, 700 years. When the mayor first came to me about designing a museum, I said no, it's too far away. They invited me to go back six or seven years ago, and I always tried to say no. But finally, a couple of years ago I accepted it. The location could not be more exciting. It's a very special site, surrounded by a wonderful garden. I thought the project would touch on my relationship with my past, my ancestors, my old home. The building is now under construction. It has two more years to go before it's complete.

**AR:** *How about your other projects? Say, the museum in Luxembourg?*

**IMP:** That project came to me after I had completed the Louvre. I was approached by the prime minister of Luxembourg and asked to design a museum for modern art, near the fortress [Fort Thüngen], which is being turned into a museum as well. It wasn't as big of a challenge as

DEUTSCHES HISTORISCHES MUSEUM



**3. Visitors walk next to the local staircase at the Schauhaus.**

4

the Louvre, but I was very interested in it. For instance, I wanted to know why the building would be located on top of a fortress. Luxembourg was and still is today a crossroads, the place where Germany meets the rest of Europe. The country lost part of its territory to Belgium in the 1800s, and during World Wars I and II the German military overran it. The fortress was the natural symbol, the physical symbol of the country. Very few people have visited Luxembourg—when I went there and looked at it, I said, my God, it's built on a rock. And within the rock they had a castle, and within the city there's a network of tunnels so the residents could move around and defend themselves. That was of great interest to me. I was curious to know how Luxembourg remained an independent country—that's why I accepted the commission.

**AR:** *Let's go back and talk about a few of your past projects. Your work at the Louvre represented one of the first instances of an architect being employed by a major government agency in a way that gave you a prominent role in the country's self-image. Could you talk about that? Were you consciously aware of how important the Louvre was to them at that time?*

**IMP:** It was a total surprise that they approached me to do the project. You know the French, not to mention the Parisians—they see the Louvre as their monument, so to come to an American for a project like that is something I never expected. I thought perhaps they were just trying to show interest in different architects to try out the idea. But when President Mitterand asked me to see him, I knew that it was serious. Mitterand was a student of architecture, he had done a lot of research before he called me. He said, "You did something special at the National Gallery of Art in Washington—you brought the new and the old together." But John Russell Pope finished the West Building in 1941, so when the East Building opened it was only about 40 years old. But the Louvre is 800 years old! A much bigger design challenge.

I didn't accept the project right away, excited though I was. Instead, I told Mitterand that I needed four months to explore the project before I could accept it. I wanted that time so I could study the history of France, because what is the Louvre? The first portions were built in the 12th century, and a succession of rulers came, added on, built something, demolished something else. For 800 years the Louvre has been a monument for the French—the building mirrors their history. I thought by asking him for this time it might make him say no, thank you very much, because he was in a hurry—he'd been elected in 1981 and his term would last only seven years, and this was 1983—so there was some pressure for him to accomplish something.

In those four months, I studied. I asked for four visits to the Louvre, one visit each month. And I asked the Louvre to keep things confidential at first, without revealing the fact that I was asked by the president to be involved, so that I could go to France unencumbered and visit the Louvre, assess what's wrong with it, what's right about it, what had to be destroyed or must be saved, that sort of thing. Mitterand agreed to all this. You cannot defend your design without knowing what you're designing for. When I was being questioned by the press about the design later on, all this preparation was very useful.



5

**5. Generous glazing at the Schauhhaus signifies democracy and the joining of East and West Germany that enabled the founding of the museum.**

**6. A new glass roof topping a portion of the Zeughaus complements the glazing of the new wing.**

6



likes to play with geometric sharp angle within the Zeughaus beckons visitors to the Zeughaus, former military depot and museum that is undergoing renovation to house the German Historical Museum's permanent collection.



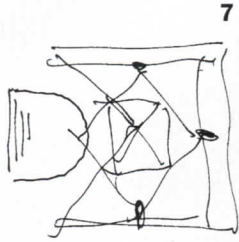

7

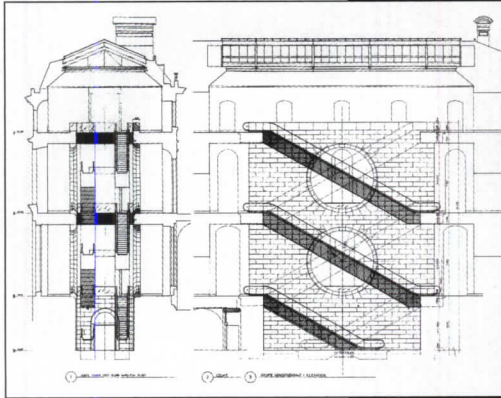

8

7. An early sketch of Pei's re-imagining of the Louvre's entry (Grand Louvre project, Phase I), Paris, France, 1989.

8. Section drawing of the Richelieu addition to the Louvre, which Pei reorganized during Phase II of the project, completed in 1993.

9. Spiral staircase at the Louvre, Paris.

10. The pyramid topping the Louvre's entry got all the headlines, overshadowing Pei's complex program of integrating a museum staff divided into seven fractious departments.

9

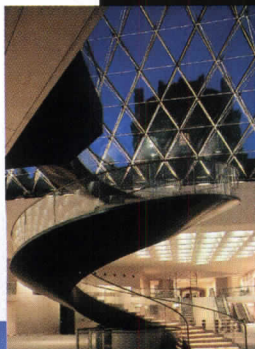

10

**AR:** The scope of the Louvre was so vast. You literally went through layers of history as you exposed and joined its lower levels, as well as designing an immense addition, and all with as little disruption as possible to the institution. No one ever focused on that—everyone just talked about the glass pyramid.

**IMP:** You're absolutely right. Everybody points to the pyramid, but the total reorganization of the museum was the real challenge. Mitterand understood that. Few people know, for instance, that the French Ministry of Finance used to occupy the Richelieu Wing [north wing] of the Louvre. Mitterand was very aware of the importance of the Richelieu Wing, because without it, the Louvre is just a long L-shaped building instead of a U-shaped building. Soon after he became president in 1981, Mitterand commissioned a competition for a new building for the Ministry of Finance in Paris. That gave him justification to move the agency to a new location, and therefore enabled us to claim that space. Without it, I would not have been able to do the project. I probably would not have accepted the commission—I could not have done anything for the museum.

And the biggest challenge of the Louvre was beyond merely architecture. When I first went there in 1983, it was divided into seven departments, and each was totally autonomous. The department directors would not even talk to each other. They were very competitive for space and money. So, architecturally we had to change this situation—make seven departments into one and unify them as a single institution. I'm not so sure Mitterand realized how big a challenge this was; I certainly didn't. But the result worked out. Today the departments are all unified under one president, and they're also unified architecturally. The fact that people don't realize this huge challenge of the Louvre is totally mind-boggling to me.

**AR:** Let's discuss form for a minute. We talk a lot about form—it dominates the discussion of architecture in the media these days. You yourself are a master of form—the East Building of the National Gallery, for instance, is a superior example of your skills, as the AIA recognized this year. But everything you've talked about so far is about the programmatic, complex, deeper issues that reside within projects. How do your formal skills interplay with this programmatic thinking?

**IMP:** Ever since 1990, I haven't been all that interested in form, not at all. To create a work of architecture that looks exciting and different is not the challenge for me anymore. The challenge is for me to learn something about what I'm doing. I've been more interested recently in learning about civilization. I know something about the civilization of China, with my background, obviously, and I think I know something about American history. But that's about all. And I've traveled all over the world, and for a long time I didn't know very much about it, really. When I got the opportunity to do the new wing [the Schauhaus] for the German Historical Museum, for instance, I didn't see it as an opportunity for my own ego, to do something so exciting that every architectural publication would want to put it on the cover. I accepted it because I knew it was going to be a very difficult project, and I wasn't sure I could do something exciting there. Originally the building was to have



11. Interior court with glass roof, Louvre, Paris.

12. A gallery, Louvre, Paris.

13. More drama in glass at Louvre, Paris.

12, 13

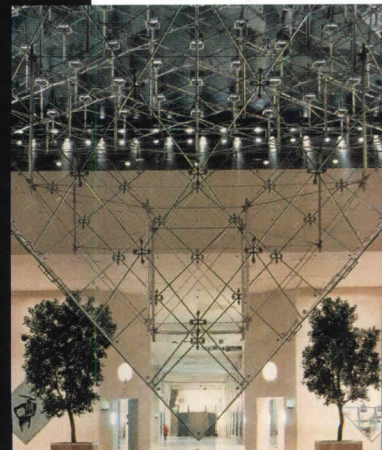
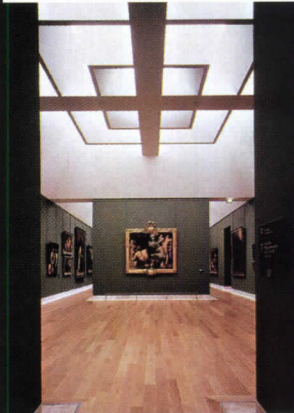



AIA 2004 CHICAGO  
JUNE 10-12  
BOOTH NUMBER: 2115



ROSA  
GRES  
TÉCNICA

[www.rosagres.com](http://www.rosagres.com)

CIRCLE 127 ON READER SERVICE CARD  
OR GO TO [WWW.LEADNET.COM/PUBS/MHAR.HTML](http://WWW.LEADNET.COM/PUBS/MHAR.HTML)

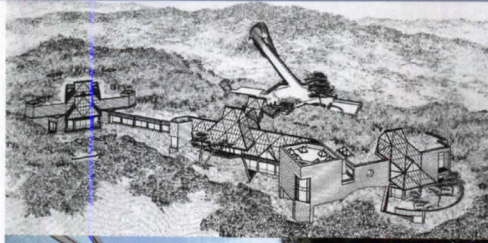

14, 15

14. A sketch of the Miho Museum, nestled in the Shigaraki Mountains in rural Japan.

15. Pine trees line the exterior of the Miho Museum, but 80 percent of its structure is subterranean, as a bow to nature.

16. The bridge and tunnel that guide visitors to the museum span two mountain ridges.

17. Louvered space frames at the Miho Museum, near Shigaraki, Japan, 1996.

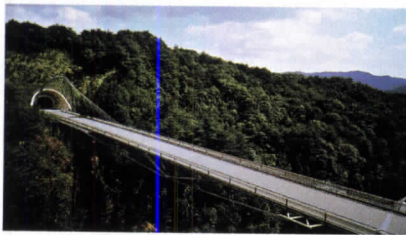

16

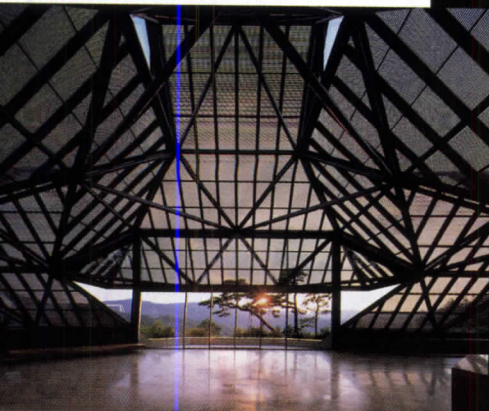

17

been located near the Reichstag, a very prominent site. But ultimately they decided to site this tiny little building behind an enormous military museum [the Zeughaus] dating from the early 18th century, which is very Prussian. I visited that museum, and you'd think that any collection of military artifacts would be all guns and cannons and whatnot, but there's a lot more than you'd expect there—a lot about Prussian history, which of course is the foundation of Germany. [The Zeughaus, a weapons depot before becoming a museum, is now undergoing renovation to house the permanent collection of the German Historical Museum]. This location has much less visibility. I had the idea to do something helical and transparent with the new wing, something that would be symbolic of the unification of East and West Germany. The prime minister personally asked to see some sign of this in the building. When you're asked that by a client, it's an opportunity you just don't waste. So, while it was an exciting challenge, form-making is not the reason I'm still engaged in projects. One of the reasons I took this on was that I wanted to find out as much as I could about Germany's architectural history. The name that kept popping up was Karl Friedrich Schinkel. I've seen his museum, the Altes Museum in Berlin, but I hadn't visited any of his other work until I began designing the new wing. I think his greatest skill was the diversity of projects he achieved, from the very monumental, like the colonnade at the Altes Museum, to the small, domestic skills he brought to the villas he designed in Berlin and elsewhere.

**AR:** How did your museum project in the Middle East come about?

**IMP:** How do I begin? Qatar does not have much history, it's a new emirate. So I couldn't draw on the history of the country; its history is really just being a desert. But I thought, the one thing I must learn about for this project is the Islamic faith. So I read about Islam and Islamic architecture, and the more I studied the more I realized where the best Islamic buildings were. At the beginning, I thought the best Islamic work was in Spain—the mosque in Cordoba, the Alhambra in Granada. But as I learned more, my ideas shifted. To begin with, the climate of southern Spain is not at all like desert, where most Islamic architecture is built. I kept searching, I traveled to Egypt, and to the Middle East many times. I saw early Islamic architecture in Damascus, Syria, where they took some early Christian churches and transformed them into mosques, so they were not pure Islamic—just as in southern Spain, it's no longer pure

Islamic architecture either, because it gets mingled with Christianity. Or in Turkey, where the Ottoman influence is felt, too—it's Islamic but not pure Islamic.

I found the most wonderful examples of Islamic work in Cairo, it turns out. I'd visited mosques there before, but I didn't see them with the same eye as I did this time. They truly said something to me about Islamic architecture. The museum I'm designing is more influenced by the Mosque of Ibn Tulun than any other building. This mosque is very austere and beautiful, its geometry is most refined. You think of Gothic architecture, it's so elaborate. This is the opposite—so simple.

**AR:** It's inspiring to see that you're so engaged with these issues. You're still a student!

18

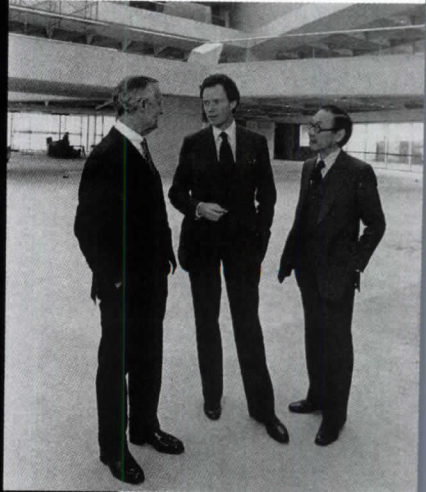
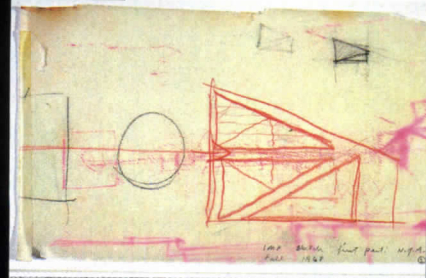

19

18. The famed triangles-with-the-trapezoid sketch of the Building of the National Gallery of Art, Washington, D.C., 1967.

19. Paul Mellon, J. Carter Brown, and I.M. Pei stand in the nearly-complete atrium of the East Building, January 1978.

20. The library and research area at the East Building has windows on the National Mall and the U.S. Capitol Building.

20

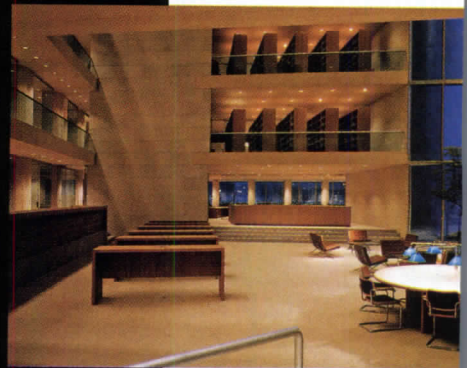



Genzyme Center  
Cambridge, MA

## A Promise Delivered

Turner is the nation's leading builder. We achieved this position through delivering on our promises. A recent promise delivered – the award-winning Genzyme Center – allows Turner to showcase its technical expertise. However, we take even greater pride in being part of the team that made this facility a reality for our client. To learn more about Turner and see how we are building the future please visit [www.turnerconstruction.com](http://www.turnerconstruction.com).

Building the Future

**Turner**

CIRCLE 128 ON READER SERVICE CARD  
OR GO TO [WWW.LEADNET.COM/PUBS/MHAR.HTML](http://WWW.LEADNET.COM/PUBS/MHAR.HTML)

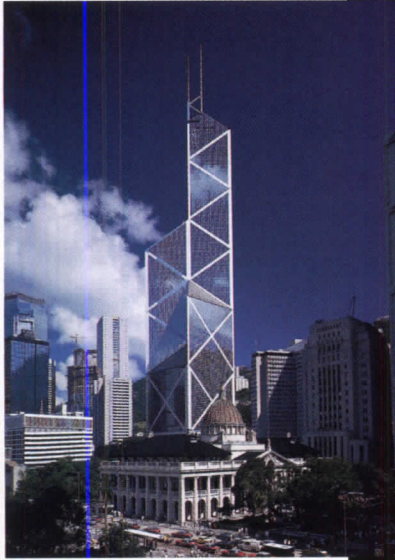
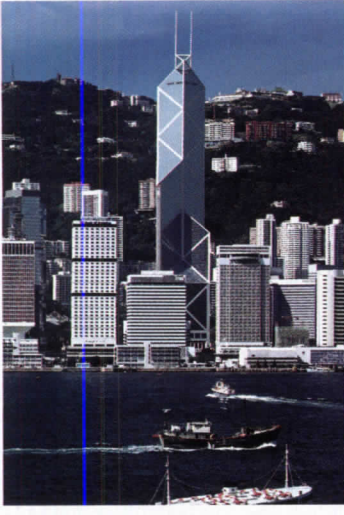

21, 22

21, 22. **The Bank of China Tower**, rising high amid the density of Hong Kong, 1989.

**IMP:** Yes, I am. You always should be. That's what makes life interesting.

**AR:** *We've talked a lot about museums, but there are other building types that you've been involved with. The Bank of China building, for instance, in Hong Kong—a tall building. The issues you faced with that project are a very different set of concerns from those of museums, aren't they?*

**IMP:** That's very true. Actually, many of the projects I'm most proud of are tall buildings, especially the housing projects. In New York I have two: one in Kips Bay and one at New York University. At that time, those projects were most challenging, architecturally—how do you enable redevelopment, foster urban renewal with a tall building? For Kips Bay, I had a wonderful client, William Zeckendorf, who was willing to gamble with me on using concrete and not brick for a high-rise apartment building. That was very innovative at the time.

**AR:** *How old were you when you got the Kips Bay project?*

**IMP:** I came to New York and worked with Zeckendorf in 1948. I was 30 years old. Kips Bay came to me two years later, in 1950. Later I got my first museum project, the Everson Art Museum in Syracuse. That was about 1960, 1961. I was very busy back then. You don't really get a chance to do anything until your mid-40s. I told my sons that: Don't expect to accomplish too much in the early part of your life. I was fortunate—after the war, I left China, in 1944; there was nothing going on for me at the time. I went back to Harvard to teach and to get my master's degree. I thought teaching would give me the most flexibility in case I had to return to China to be with my family. I didn't really practice architecture until I got to New York; I didn't have many qualifications or much experience at all. Becoming a designer is a long process of learning. You make mistakes when you're young. It's important to have the opportunity to make mistakes.

**AR:** *What are your days like when you're not at work?*

**IMP:** At home, I have a wife, fortunately, and my children are all grown, and I have many grandchildren. I spend weekends with my grandchildren; I adore them. On a daily basis, my home life is very simple. I spend about 2 hours every morning reading the newspaper. As my two assistants will tell you, I don't come to work in the mornings, for two reasons. First, I want to be informed—that means I go through *The New York Times* every day, and then I watch some news on television. The second is, mornings are the best time to communicate with my clients abroad. So I communicate with Luxembourg, with Berlin, with Paris—I continue to do work on the Louvre, it didn't end in 1993. So I'm on the phone a lot to my international clients in the mornings, after I get through the news.

Two afternoons a week I come to my office. If I'm not here, I go to my sons' office. I still have two of my projects working through them—the Museum of Islamic Art in Qatar and the Suzhou Museum.

**AR:** *Did you do any conceptualizing for the redevelopment or the memorial in Lower Manhattan?*

**IMP:** No. That project probably will take 10 years, and I didn't want to think about a project that I couldn't finish. That's a kind of temptation. It was the same reason I declined to submit an entry for the U.N. addition in New York, the one that [Fumihiko] Maki is now working on. I thought I wouldn't be able to finish it. One has to realize one's limitations. Why kid yourself? ■

23. **Pei's first museum project**, the Everson Museum of Art, Syracuse, New York, 1968.

24. **University Plaza** (housing), New York University, New York, 1967.

25. **Kips Bay Plaza** (housing), New York, 1963.

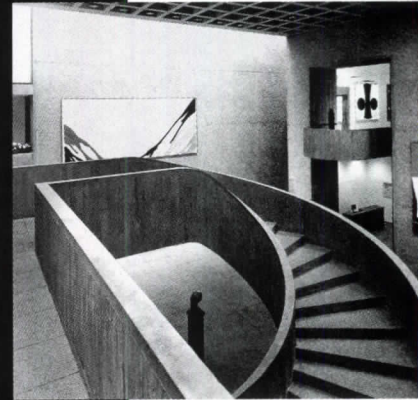

23



24



OPHANE™  
ANE indoor lighting

illuminare®  
New Shape of Light™

Holophane Prismatic Glass

Available in...  
type  
90, 50 & 30

Available for retail stores, schools, municipalities, churches, government buildings and other similar applications, Illuminairé are available in two sizes – large and small – to accommodate various ceiling heights. Available in incandescent, compact fluorescent and up to 400W metal halide.

The fixture to the right is the Quad optic with a mounted ballast and notched cap in a brushed chrome metallic finish.



For more information, contact your local Holophane representative, call (740) 345-9631 or visit [www.holophane.com](http://www.holophane.com), 214 Oakwood Ave, Newark, Ohio

[www.holophane.com](http://www.holophane.com)



wing span 2.5"  
scale = 1:8.8



Egg

Crest

Tri-Egg

Tri-Crest

Quad

type 90

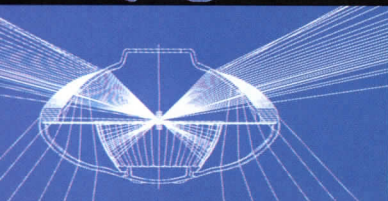

80-100% uplight

type 50

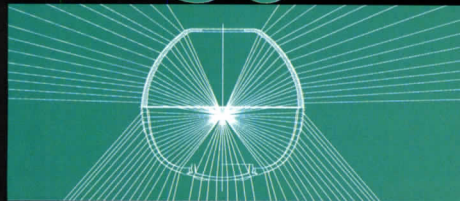

40-60% uplight

type 30

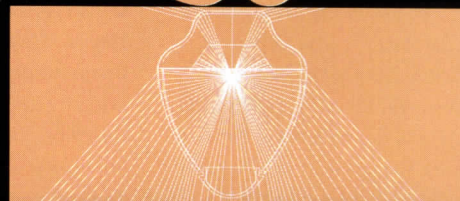

20-40% uplight

CIRCLE 132 ON READER SERVICE CARD  
OR GO TO [WWW.LEADNET.COM/PUBS/MHAR.HTML](http://WWW.LEADNET.COM/PUBS/MHAR.HTML)

# In a city averse to towers, **30 ST. MARY AXE**, the “towering innuendo” by **Foster and Partners**, is a big ecofriendly hit

By James S. Russell, AIA

**L**ondoners were once skeptical of 30 St. Mary Axe, the tapered bullet that has clambered into the skyline over the past two years. It's usually called the Gherkin, a title standing in for a variety of unprintable descriptions, or the Towering Innuendo. But as its sleek, now-complete form bobs and weaves into view around the city, locals have reportedly developed a fondness for the first tall building to be erected in the City of London (its financial district) in 25 years.

At 40 stories, it would not be regarded a large tower in most of America's downtowns, but in the low-rise, finely grained cityscape of London, its 500,000 square feet look gargantuan. How could a tower so unconventional in nearly every respect look like a big, friendly alien rather than a menacing intruder?

This is no airplane-napkin sketch fast-tracked into reality. Formerly, the site was filled by the Baltic Exchange, a low-rise pile that was severely damaged in 1992 by a bomb planted by the Irish Republican Army. A debate about whether the building could be saved went on for a few years. Thanks to its client, Swiss Re, when Foster and Partners came on the scene in 1997, both recognized that a replacement could be proposed only if it was clearly superior. Extensive local consultation led to an approval process that nevertheless consumed another two years.

The curving profiles that have become a signature of Foster's work in recent years, as in London's City Hall [RECORD, February 2003, page 110], respond to local environmental conditions—and the ability of the architect and its consultants to deploy sophisticated computer-aided

**Project:** 30 St. Mary Axe, London

**Owner:** Swiss Re

**Architect:** Foster and Partners—  
Norman Foster, Grant Brooker, Paul  
Leadbeater, Michael Gentz, Stuart  
Milne, Rob Harrison, Jacob Nørlov,  
Robin Partington, Tim O'Rourke,  
Paul Scott, Ben Puddy, Ken  
Shuttleworth, Jason Parker, Francis  
Aish, Simon Reed, Gamma Basra,  
Narinder Sagoo, Geoff Bee, Sebastian  
Schoell, Aike Behrens, Michael  
Sehmsdorf, Ian Bogle, John Small,

Thomas Brune, Robbie Turner,  
Julian Cross, Neil Vandersteen, Joel  
Davenport, John Walden, Ben  
Dobbin, Tim Walpole-Walsh, Paul  
Kalkhoven, Hugh Whitehead, Chris  
Kallan, Richard Wotton, Jürgen  
Küpper, Helen Yabsley

**Consultants:** Arup (structural, fire  
safety); Hilson Moran Partnership  
(mechanical and electrical); BDS  
(environmental engineers)

**General contractor:** Skanska  
Construction UK

PHOTOGRAPHY: © RICHARD BRYANT/ARCAID (THIS SPREAD)



Who could blame London for resisting tall towers, considering the dourness of the few that are there. Now 30 St. Mary Axe has put a striking new shape on the skyline, portending many more, pundits say.





modeling and analytic tools. In this case, the Foster team, including Shuttleworth, who recently left the firm, came to the circular plan tapering section because it lets wind slip by, according to Rob Harriman, an associate partner, which reduces lateral loads on the structure. More important, the shape minimizes the tendency of tall buildings to face gale-force winds on unwitting pedestrians at street level. While the tower puts the largest floors above the prevailing 10-story-high norm, views open across the city in all directions, Foster slimmed the tower on the lower floors as well, which opened the dim, surrounding street

## HOW COULD SO UNCONVENTIONAL A TOWER BOB AND WEAVE INTO VIEW LIKE A BIG, FRIENDLY ALIEN?

daylight. The trim ground floor left space to carve out a handsomely proportioned plaza, offering a shortcut through the City's twisting block of cell-phone wielding dealmakers headed to the Tube. Such sensitivity to the public realm helped the building survive the tough planning requirements.

The diagonally gridded exterior binds the building formally. (Imagine the bulging-gut look it would have with vertical mullions.) It actually emerged as Foster and his team worked out the most remarkable feature of the building, the six-level light wells, six per floor, which spiral continuously upward. According to John Brazier, the project director at Arup, reconciling the 5-degree-per-floor rotation in the light wells generated the diagonal grid of the structure and the cladding ("Building a Tower on the Bias," page 222).

Foster has long designed to achieve a more humanely scaled work environment. In the Commerzbank tower (RECORD, January page 69), he pioneered the use of *skygardens*—restful oases for informal meetings, for sipping a coffee, or just thinking—hovering high above the city. While conventional real estate wisdom might deem the light wells a mere frill, they are integral, in Foster's hands, to a strategy that addresses the chief criticisms of tall buildings as work environments: that the big cakes of space neither offer the amenities highly valued staff want nor encourage collaborative work. For Swiss Re, Foster offset each level with light wells to offer terrace overlooks. The advantage is simple, if abstract: If you see people on other floors of a tall building, you are more likely to feel they are part of your group, and that you are





30 St. Mary Axe pops into view from vantages all over London. Its anomalous form and intricate, beehive-like skin change the notion of skyscraper scale. In coming years, it may anchor a cluster of new towers.

Light wells divide the building vertically into six-story modules. To suit tenants, individual floors can be isolated.

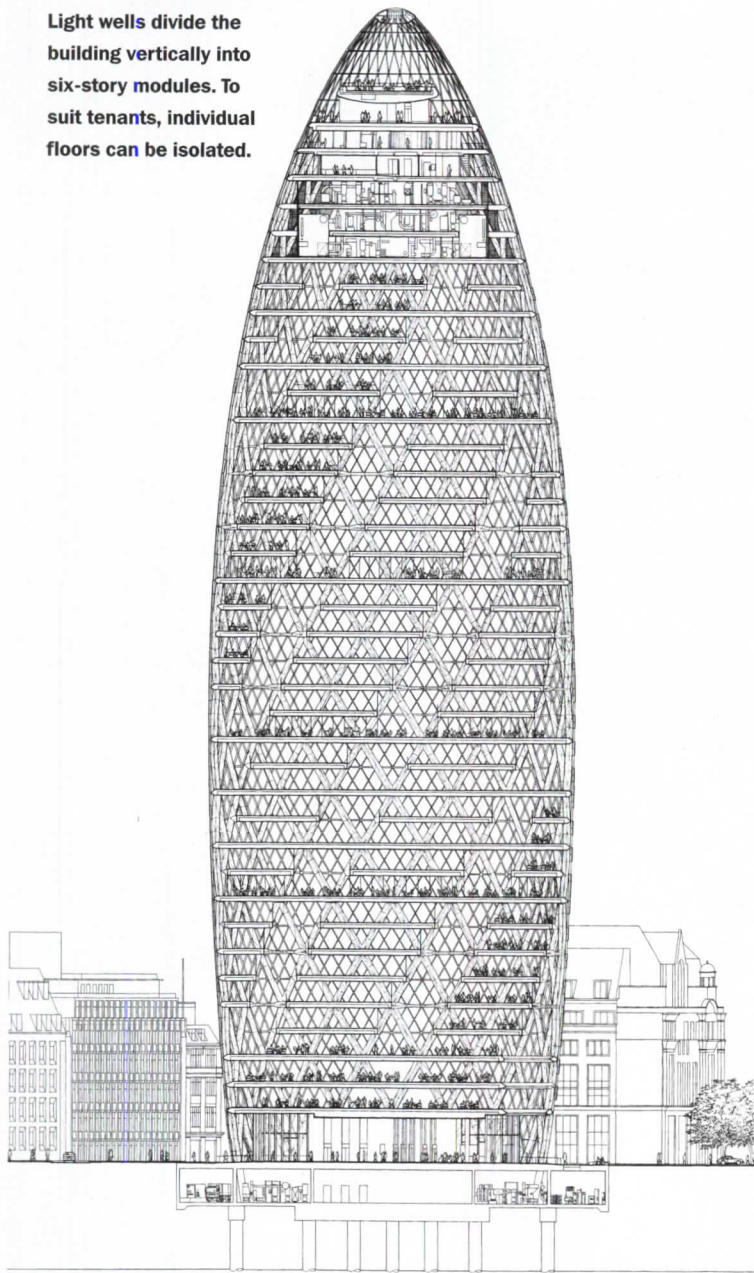

## BUILDING A TOWER ON THE BIAS

The engineers devised a two-story-high triangular structural module for the building: tubular columns running up the exterior that are fire-proofed and clad in faceted, painted metal. (Because cross bars are painted dark and diagonal members painted white, the structural grid only looks like a four-story diamond when it can be seen through the glass from outside.) Computer analysis helped to locate fixing points in three dimensions (diagrams, bottom left). Special fittings at the *diagrid* intersections align adjacent panels to follow the bidirectional faceted geometry. The latticelike structure and curved surface efficiently resist wind forces, which means that floor beams could be sized smaller and the core did not need to be braced, freeing up interior space. (The occupied area is column-free.)

The diamond-shaped glass lites look normally sized but are actually quite large, each spanning a full floor, top to bottom. The glazing mullions are triangular in section as well, to reduce their visual bulk. The

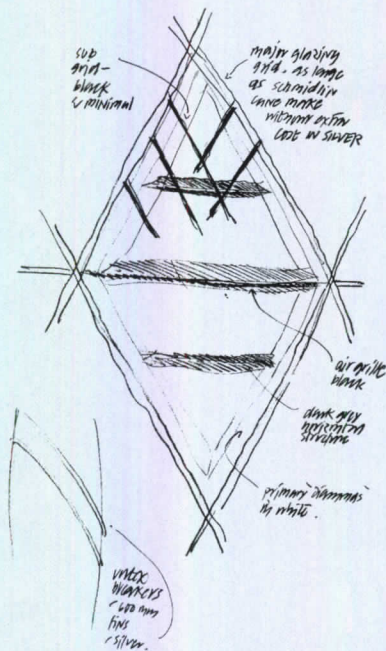

structural diagrid ends at floor 38; slim sections of curtain-wall framing continue upward, arcing delicately into a domed, glazed roof at the top (below), where the glass units are both tinted (to avoid glare) and argon-filled (for insulation).

Inside the column diagrid, an inner membrane of glass leaves an insulating air layer between the outer curtain wall and the occupied space (heated by building-exhaust air as needed). A tapered, horizontal spandrel divides floors. J.S.R.

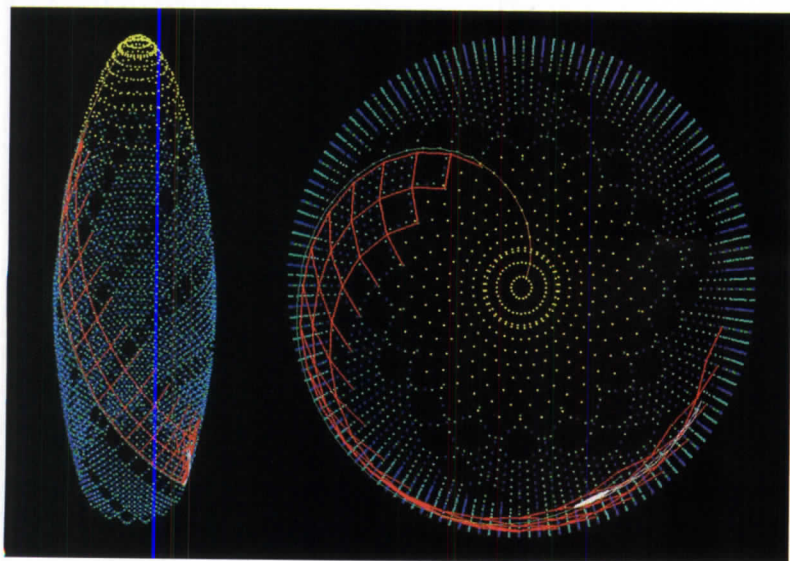

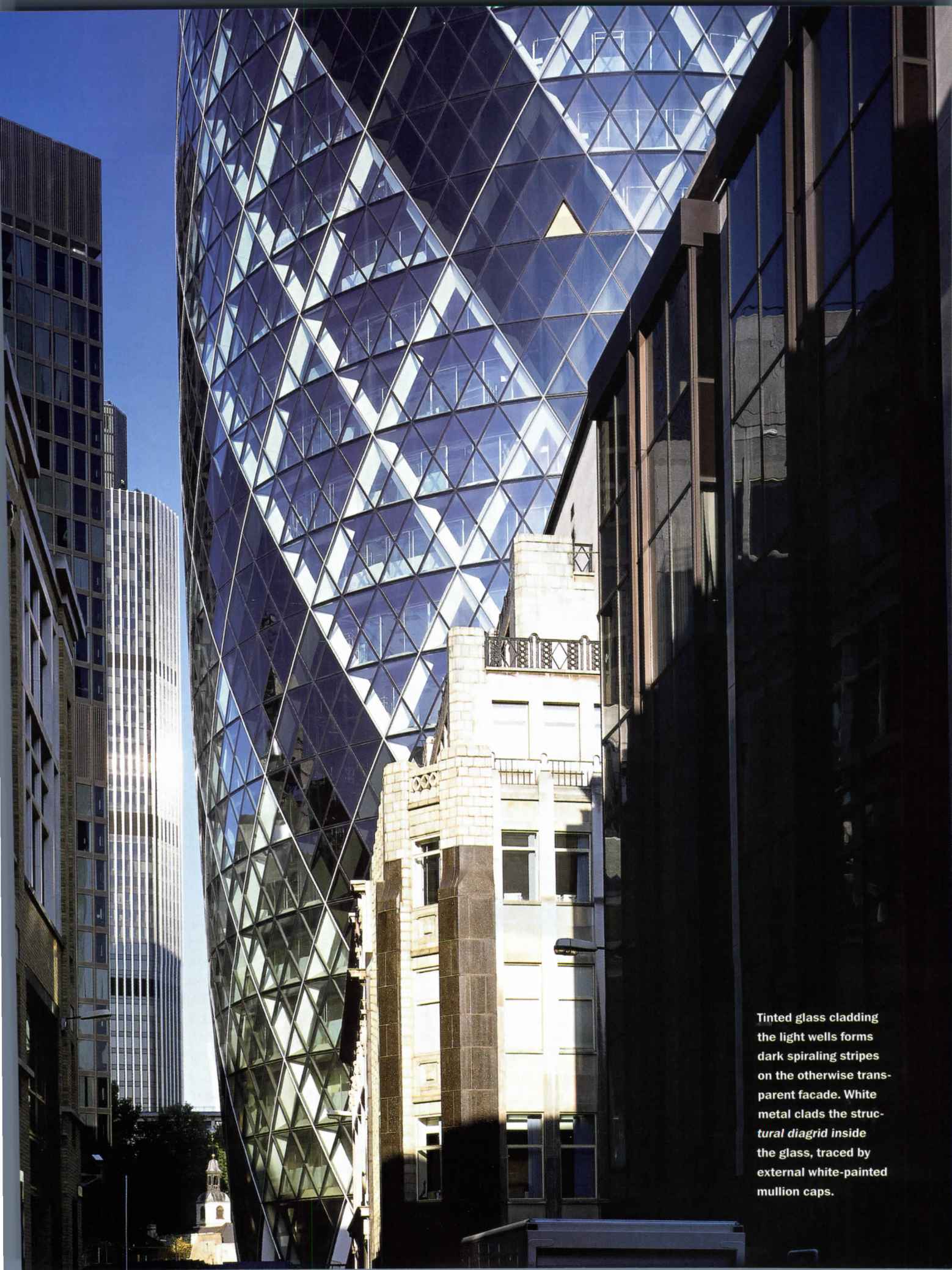

Tinted glass cladding the light wells forms dark spiraling stripes on the otherwise transparent facade. White metal clads the structural diagrid inside the glass, traced by external white-painted mullion caps.



business endeavor together. You'll feel invited to move from floor to floor rather than remaining psychologically sealed in your own area.

On this much tighter site, the social spaces are narrower, more intimate than at Commerzbank. "Everyone's conscious that the balconies and light wells are the best spaces in the building, with great views up and down the streets," said Sara Fox, who has directed the building project for four years after working to build the firm's innovative American branch in Armory Square, New York [RECORD, June 2000, page 144]. These areas are reserved for offices, bars, copy centers, and other informal-gathering functions, rather than spaces devoted to departments. "We spent a lot of time with staff talking about the interconnectivity this makes possible," she said. As people move into the building, she adds, "they come up to me and say, 'Oh, *now* I get it.'"

Workplace quality and energy conservation are inextricably woven together in the building. "We wanted an environmentally responsible building," explained Fox. "We didn't have a checklist; we asked HOK to explore what was possible." The commitment was meaningful for the company well beyond corporate altruism. "We are in the reinsurance business," Fox explained. "For us, sustainability makes excellent business sense because we pay claims on behalf of clients for floods, heat waves, and droughts. To the extent that these claims are related to global climate warming, it is only prudent of us to contribute as little to it as possible."

The light wells bring daylight deep into the space, even to the areas positioned closest to the core. ("That's a lifestyle issue—quality of workplace for staff," explained Fox.) The quality of daylight from floor-to-ceiling exterior windows is also high, because heat gain from the sun is trapped in the space between the external curtain wall and a secondary glass wall placed just inboard of the external column diagrid. The

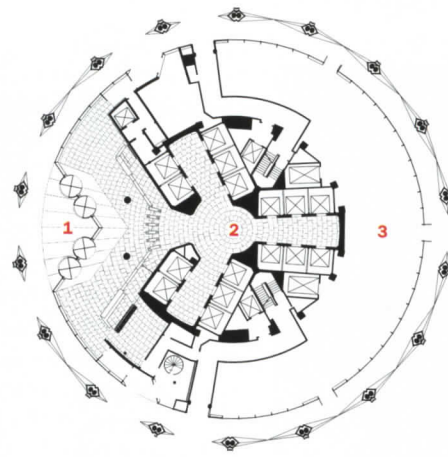
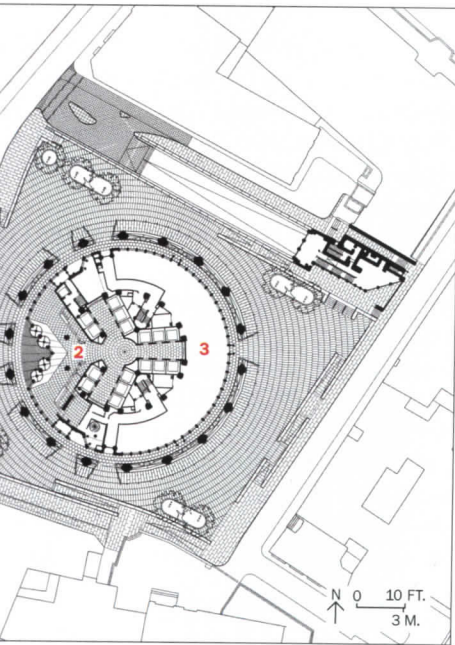

GROUND FLOOR

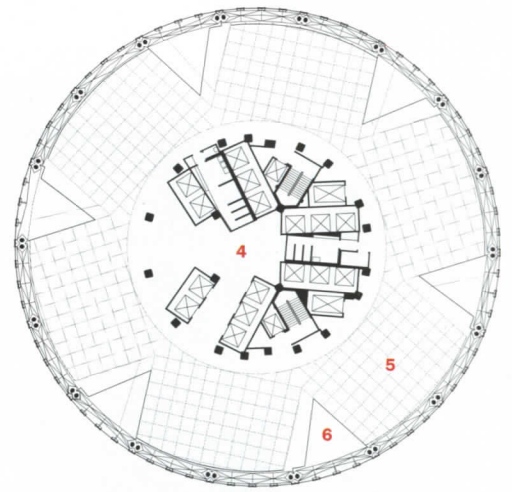

SIXTH FLOOR

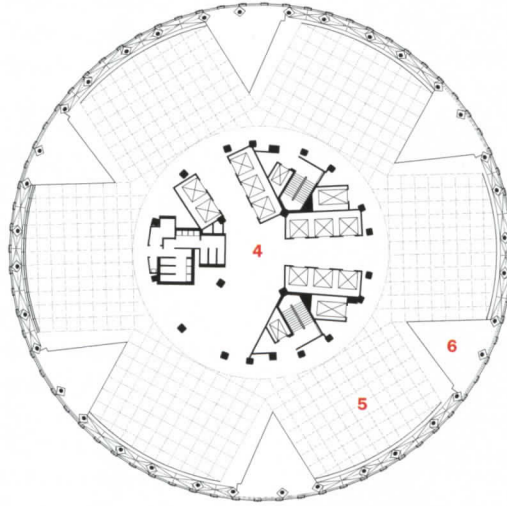

TWENTY-FIRST FLOOR

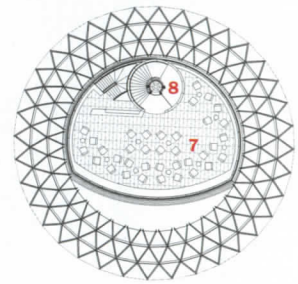

FORTIETH FLOOR

0 20 FT.  
6 M.

try  
obby  
tail  
re  
ice modules  
ht well  
vate dining  
vator/stair

ward taper of  
ver brings sun  
generous plaza  
pens up dark,  
val streets  
ite, top). The slim  
wall forms a  
over a rooftop  
rant nearing  
tion at press  
pposite, bot-  
he diagonal grid  
structure opens  
a recessed  
ce leading to  
y lobby (right).



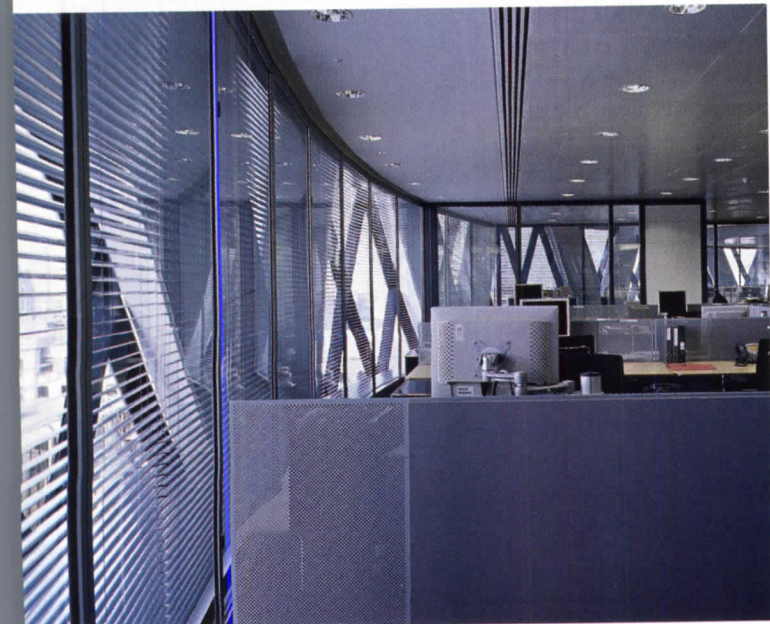

lating layer not only saves energy, it permitted the use of clear glass, protected by blinds in the thermal layer. By contrast, the glass in the light wells needed to be deeply tinted (visible on the exterior as dark, spiraling stripes). The triangular light wells divide the floors into six 2,500-square-foot (on average) rectangular wedges, offering an efficient shape for layout of offices or open-plan workstations.

With automatically opening windows, the light wells contribute to fresh air. The interior glass wall is left out at the balconies, so that fresh air penetrates the entire floor (one much deeper than the naturally ventilated norm) without mechanical assistance. Air warmed by occupants and equipment rises up the chimneylike light wells, drawing in outside air. The round floor plate aids airflow by molding a distinct zone of negative air pressure on the leeward side, which draws in more windward-side air. Although the building is mechanically heated and cooled, the natural ventilation scheme should leave the systems idle much of the time, accounting (with the daylighting) for much of the building's reduced dependence on climate-altering fossil-fuel combustion. (Local

**“IT’S ONLY PRUDENT OF US TO CONTRIBUTE AS LITTLE AS POSSIBLE TO GLOBAL WARMING.” — SARA FOX**

handling units allow mixed-mode use by zone and by floor, as well. According to Brazier, current local guidelines for low-energy offices target electricity use of 175 kilowatt hours per square meter (10.76 square feet). He expects Swiss Re’s new building to knock up to 25 kwh off that.

Swiss Re occupies about half the building; the remainder has yet to be tenanted in a moribund real estate market. Nevertheless, the completion of 30 St. Mary Axe—and its acceptance—portends a deluge of new office buildings, according to pundits. As they vie for height, towers announced to date compete on the basis of amenity, energy responsibility, and aesthetics (the designers are all household names: Piano, Grimshaw, Kohn Pedersen Fox, Rogers, Wilkinson).

None of the long-announced towers has yet begun construction. Fox echoes their developers in claiming that more towers will be built. “London is really the financial center of Europe. Most firms, particularly in financial services, want to be at the heart.”

London and Lower Manhattan, both seeking dominance in global finance, now offer a study in contrasts. “Location is so much more important in the U.K. than in New York,” explained Fox, noting that a consensus has developed that London’s City must grow to remain competitive with New York, which perfected the skyscraper downtown, has ceded building innovation to Europe and Asia. It is far less sure that the proximity enabled by tall buildings still pays off. Will tenants balk at rent elevations that raise rents? Is a horizontal, dispersed business model more prudent in a world wracked by terrorism?

The next few years will tell which model comes out on top. The stakes are certainly high. If a great number of American financial firms start taking meals in Swiss Re’s “nose cone” restaurant (it’s probably sorry), where breathtaking city panoramas open through the spiraling fretwork of the building’s diagrid crown, you can be sure London’s Foster’s lessons won’t be lost. ■

**Sources**

**Curtain wall:** Schmidlin; Waagner Biro

**Glass:** Eckelt; Okalux

**Acoustic wall panels:** Decoustics

**Lighting:** Wila

**Security gate:** Marzorati Roncato  
Gannebo Mayor

For more information on this project, go to Projects at

[www.architecturalrecord.com](http://www.architecturalrecord.com)

Re reserves the  
es in its light  
—and their dra-  
views (looking  
posite; looking  
this page)—for  
ons that trigger  
sharing. The  
painted diago-  
and dark-painted  
ntals both  
se structural  
ers. Making  
floors visible  
reaks down  
cal barriers to  
oration. Ample  
ht for offices  
site, bottom)  
s both from the  
of the exterior  
e wedge-shaped  
wells.







# Roger Duffy of **SOM** weaves together art, architecture, and landscape in a crystalline new upper school at **GREENWICH ACADEMY**

Clifford A. Pearson

Some architects celebrate architecture as a provocative act, forcing people to experience buildings in radically new ways. (Think Rem Koolhaas or Peter Eisenman today or Adolf Loos 100 years ago.)

Roger Duffy, AIA, a design partner in the New York office of Skidmore, Owings & Merrill (SOM), has a very different way of approaching his work, even though it pushes the boundaries of architecture. “A lot of my projects are about resolving differences,” he explains while touring his new upper school at Greenwich Academy. Instead of the shock of the new, he delivers bold architecture with manners. As a foreign-exchange student with great social skills, his buildings stand out but earn high grades for fitting along well with others.

A 45,000-square-foot addition to a private girls’ school in one of the country’s most affluent communities, the new building at Greenwich Academy must fit between a nondescript middle and lower school from the 1970s to the north, a 1990s performing arts center and gymnasium to the south, and a Georgian mansion to the east that originally housed the school but now serves as its administrative center. In addition to this awkward mix of eras and structures, the new upper school had to negotiate a 23-foot drop from the campus’s entry level to that of its playing fields and pond to the west. “We decided to use our building to weave together the two topographies,” explains Duffy. “We saw the project as a landscape connecting the campus.”

Sharon Dietzel, the head of the upper school, admits that SOM was not an obvious choice to design the building, since the firm is better known for its large commercial work. But when the school asked several architects to propose ideas for renovating the existing upper school, SOM recommended tearing it down and building from scratch. “Although it was probably more expensive, we all knew that was the right approach,” Dietzel notes. During initial conversations with the school’s faculty and staff, Duffy and his team helped the client envision a facility quite different from anything already on the campus. “By talking about light and air, and not square footage or style, they helped us think in a different way,” Dietzel.

Integrating landscape and architecture, Duffy and his team

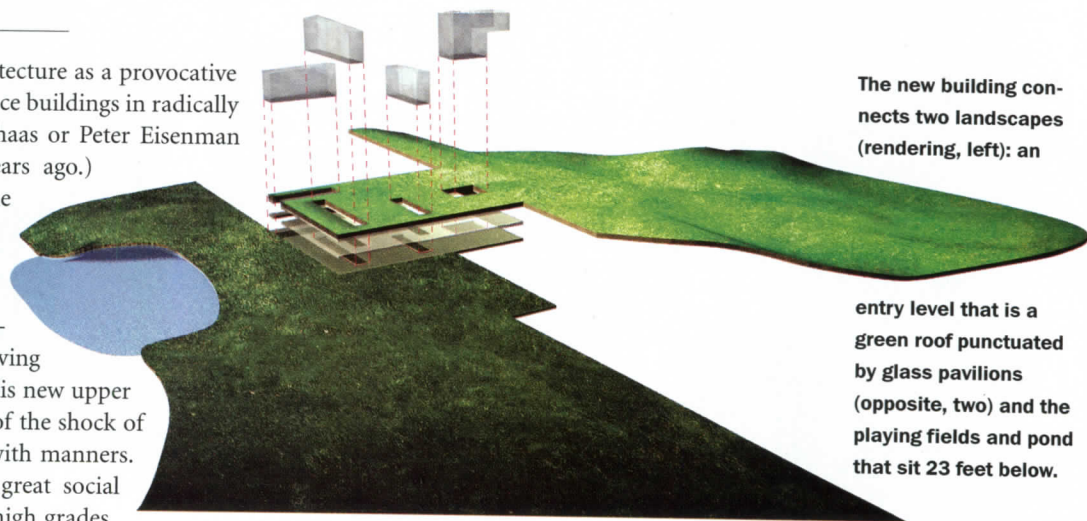

The new building connects two landscapes (rendering, left): an

entry level that is a green roof punctuated by glass pavilions (opposite, two) and the playing fields and pond that sit 23 feet below.

created a grassy lawn on the building’s roof, which serves as the entry level. Glass pavilions (or “light chambers”) emerge from this artificial landscape, bringing daylight into the building, which tumbles down the hillside. As visitors enter the upper school through the largest light chamber, they see only grass, glass, and the woods beyond. Low stone walls, made from rock dug from the site, offer places to sit in good weather and help connect the new building to the earth and the old mansion’s stone base. The new snaps elegantly into place here.

The light chambers—clear glass boxes supported by exposed glue-laminated timbers 4 inches thick—organize the school into its four main components: math/sciences, art, humanities, and learning center (library). Classrooms, faculty offices, and other spaces for each discipline cluster around their particular light chamber, creating a critical mass of activity and a sense of identity. But common spaces flow

**Project:** Greenwich Academy Upper School, Greenwich, Connecticut  
**Architect:** Skidmore, Owings & Merrill/New York—Roger F. Duffy, AIA, design partner; Peter Magill, AIA, managing partner; Walter P. Smith, AIA, education specialist; Scott Kirkham, senior designer; Christopher McCready, AIA, project manager; Marie-Christine

Bellon Manzi, Thibaut DeGryse, Nayareen Chapra, Jon Mark Capps, Javier Haddad Conde, project team  
**Collaborating artist:** James Turrell  
**Engineers:** DiBlasi (structural); Atkinson Koven Feinberg (mechanical)  
**Landscape:** Brown and Sardina  
**General contractor:** Turner Construction

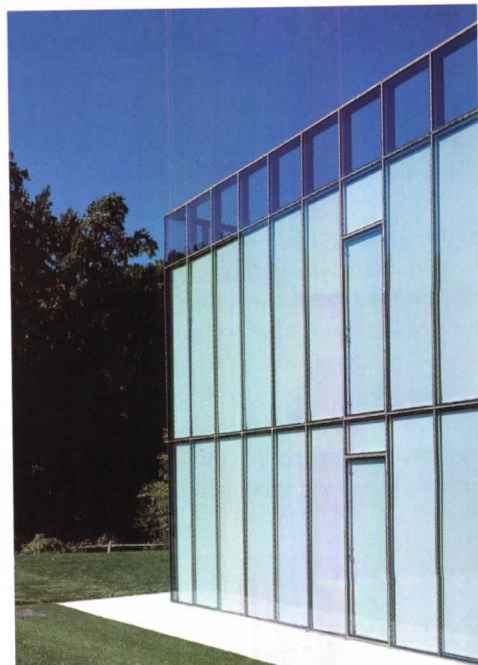
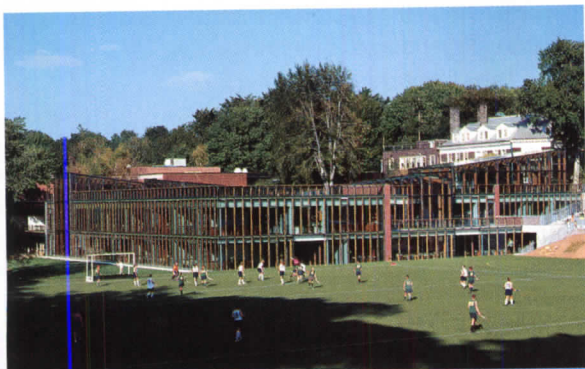

The entry pavilion (above and opposite) also serves as the hub for the math/science department. A translucent glass floor around the entry stairs brings light to the level below. An elegant curtain wall rises above the green roof to become a glass balustrade (left). Shades on the building's perimeter walls let users control the amount of sun that comes inside (far left top and bottom).

thly into one another, so you get a sense of connections, not boundaries, as you walk through the building.

During design development, Duffy invited artist James Turrell collaborate on the light chambers. "It increased the level of difficulty mathematically," says the architect, "but was worth it." Turrell turned the glass containers into colored-light boxes using a combination of fibers and light-emitting diodes (see sidebar, page 232). Turrell's role was more than that of an artist adding an installation to a building; it rotates Duffy. "He was a true collaborator," helping the architects shape glass pavilions and the experience of moving through the building. For example, the artist convinced the architects to torque the roof angle of two light chambers visitors see as they enter the first chamber. "This is how you read the subsequent chambers as volumes, not just as planes," says Duffy.

Beyond the pavilions, the architects carved a series of outdoor spaces from the hillside site to bring daylight in from the north and south. The largest of these spaces—what Duffy calls the "learning center courtyard"—acts as a kind of campus piazza linking the upper school to the elementary and middle and lower schools to the north. "Before, we had a series of disconnected buildings," explains Dietzel. "Now we have an integrated village."

Once upon a time, school architects tried to impress on students the importance of learning by designing buildings that harkened back to classical eras or used heavy materials rooted in historical associations (like brick or Neoclassical stone, for example). SOM tried a different

tack at Greenwich Academy, designing a building so light that it almost disappears in the landscape. To do this, the architects devised a steel-frame structure with a glazed curtain wall for the bulk of the building and glue-laminated timber frames for the light chambers. "The wooden members soften the sharp edges of the boxes," says Duffy. "We didn't want a hard Modernism."

All classrooms enjoy floor-to-ceiling glazing on the outside and daylight coming in from the light chambers on the inside. A translucent

**"THE LIGHT HAS A PHYSICAL AND PSYCHOLOGICAL AFFECT ON PEOPLE; IT RELAXES THEM," SAYS THE SCHOOL'S HEAD.**

glass floor on the upper level of the entry pavilion adds to the sense of light everywhere. Interior and exterior shades allow people to control sun coming in or views from interior common spaces.

The building's architecture has affected the way people behave in it, says Dietzel. "We have 150 adolescents here, but it's always quiet. All the light has a physical and psychological affect on people; it relaxes them." At the same time, the transparency of the architecture has made people less territorial, she notes. Teachers and students interact with each other all over the building, not just in the more formal settings of the classroom and teacher's office. She also reports that attendance is up, even for seniors who have the option of spending some time off-campus. "This building celebrates the potential of children, and so few schools ever do that."



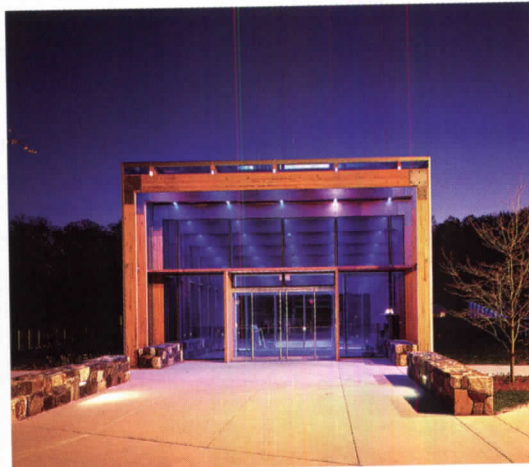
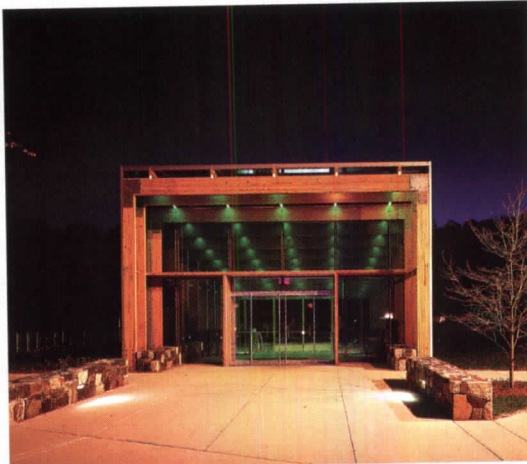
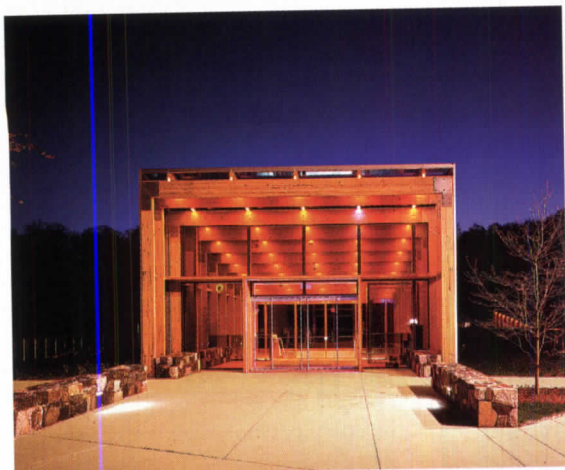

To show how art can be integrated with a learning environment, SOM collaborated with James Turrell on the design of the school's light chambers, turning them into glowing boxes whose colors change slowly during a programmed time cycle. Fiber optic cables are set into channels at the threshold of each chamber and the perimeter of the floor create planes of colored light, while bands of light-emitting diodes (LEDs) on the walls and timber purlins produce "clouds" of color. Each of the four chambers has a different colored frit on its glass, providing a subtle range of hues from pink to blue, green, and white. A computer program controls the changing colors, so light seems to move from one chamber to another. Due to budget constraints, only two of the glass pavilions are fully equipped with the fiber optic cables and LEDs, though all have the channels needed to accommodate the lighting. Photographs (left) show the math/science light chamber, which is the school's main entry, during three phases of the color cycle. C.A.

1. Math/science light chamber and entry
2. Math/science classrooms
3. Faculty offices
4. Art light chamber
5. Administration
6. Student commons
7. Humanities light chamber
8. Humanities classrooms
9. Library light chamber
10. Library
11. Sports terrace
12. Art classrooms
13. Media center
14. Lockers
15. Library courtyard
16. Science courtyard

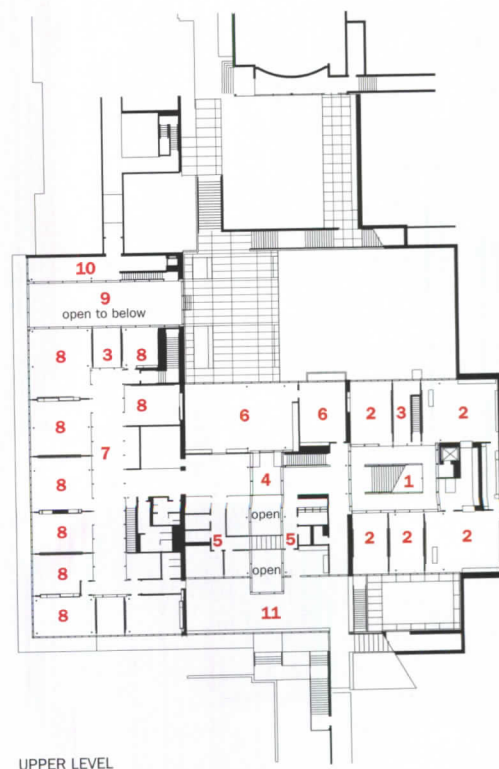
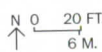



Duffy sees Greenwich Academy as “a pinning,” the first in a series of projects that explore the nature of collaboration and draw a sense of unity out of programs pulled in many different directions by many different forces. Duffy and his studio at SOM are currently finishing work on a public elementary school in Westfield, Connecticut, that opens in August, and they are collaborating again with James Duffy on a building at Deerfield Academy, which will be completed in the summer of 2005. “Instead of bringing him in during design development, we’ve been working together from the very beginning of the project,” notes Duffy with pleasure. Other projects he sees as exploring similar ideas include a performing arts school in Camden, New Jersey, the Skyscraper Museum, a small but dazzling interior space that recently opened in New York’s Battery Park City.

Duffy talks about design that unifies different forces, bringing old and new, upper and lower, indoors and out, into equilibrium and harmony. When discussing collaboration with artists and other designers, he speaks of “conciliation,” a word not found in many architects’ vocabularies. “The kind of work I’m interested in requires a level of trust between collaborators and doesn’t involve the master stroke of the lead architect.” ■

**The library’s light chamber runs on axis with the school’s original mansion (above). The light chamber in the art department (right) leads out to the playing fields.**



**Aluminum/glass curtain wall:** Suntech of Connecticut; Interpane Glass  
**Lighting:** Interpane Glass  
**Glulam-laminated wood:** Unadilla Laminated Products  
**Glazed roof:** American Hydrotech  
**Lighting:** Karatan; Mohawk Commercial

**Interior ambient lighting:** Zumtobel Staff  
**Reception furniture and library desk:** Custom by Skidmore, Owings & Merrill  
**Metal doors:** Suntech of Connecticut  
**Brick walls:** Connecticut Mason/ Joe Capasso Mason

A glittering counterpoint to the dour jumble of Birmingham's downtown, Selfridges rises voluptuously next to the prim neo-Gothic form of St. Martin's Church.

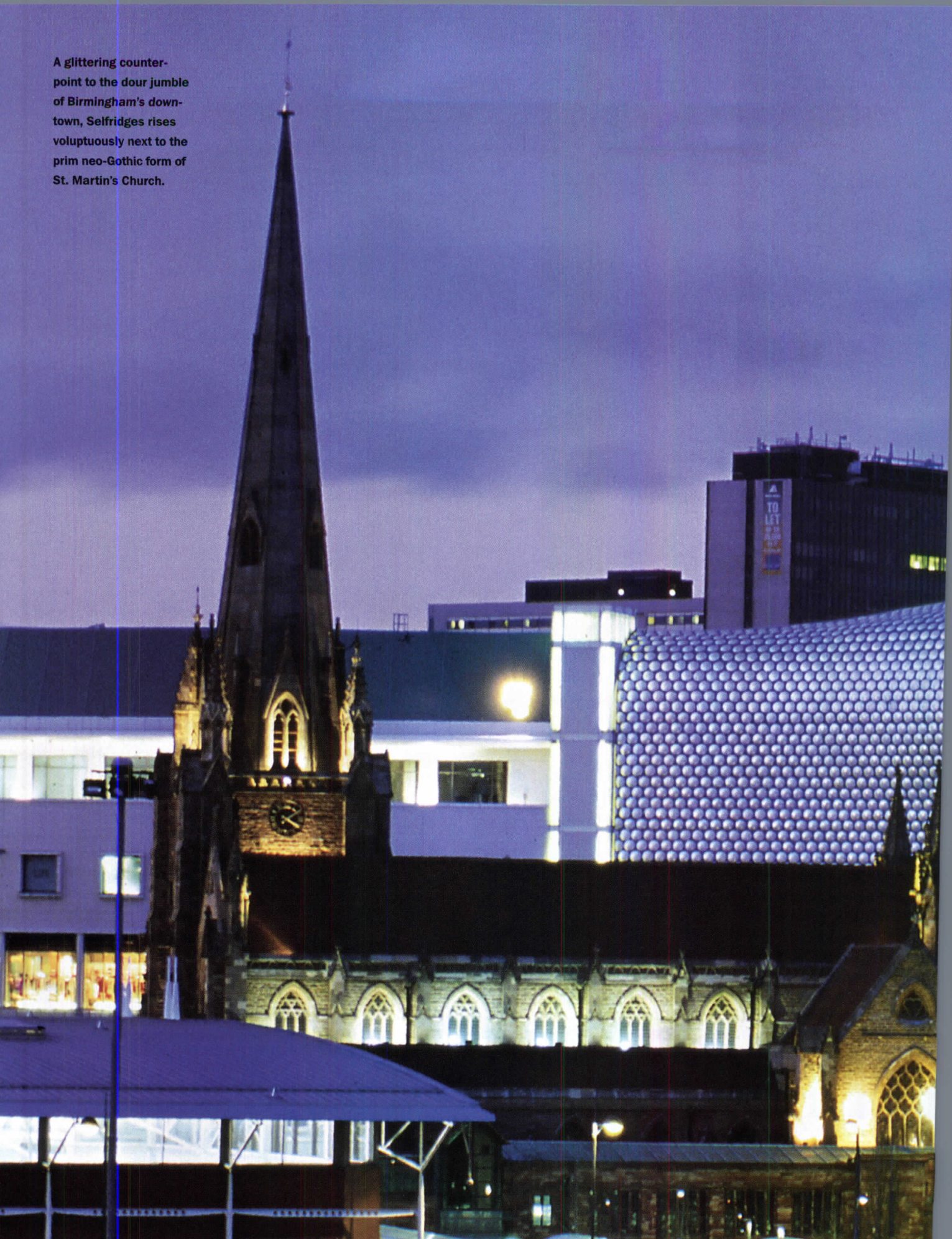

# Future System's curvaceous outpost in Birmingham has helped turn the dowdy **SEFRIDGES** department-store chain into a must-shop destination

James S. Russell, AIA

A clay model in Future Systems' London office could be titled *Reclining Woman's Torso*. It is rough and barely suggests architecture. But it has come to life as the four levels and 240,000 square feet of a Selfridges department store. Sensuously true to form, its rump gently swells outward and upward. And it looks a bit squished at the bottom, creating the same effect the weight of flesh would.

The building has become an instant landmark since it opened in Birmingham, the U.K.'s second-largest city. In the retailing

industry, which had resigned itself to the inevitability of department-store decline, it's a sensation—compared often to the Bilbao Guggenheim. In London, Selfridges flagship store remains a columned, city-block-size palace (designed by Daniel Burnham) on Oxford Street. But Birmingham is the crowning achievement in the transformation of a dowdy, middle-of-the-road chain to a hip, must-shop destination.

Vittorio Radice, an Italian retailer inevitably described as "visionary," refashioned the chain, focusing on younger shoppers who had regarded Selfridges and many of its competitors as the kinds of places

PROJECTS



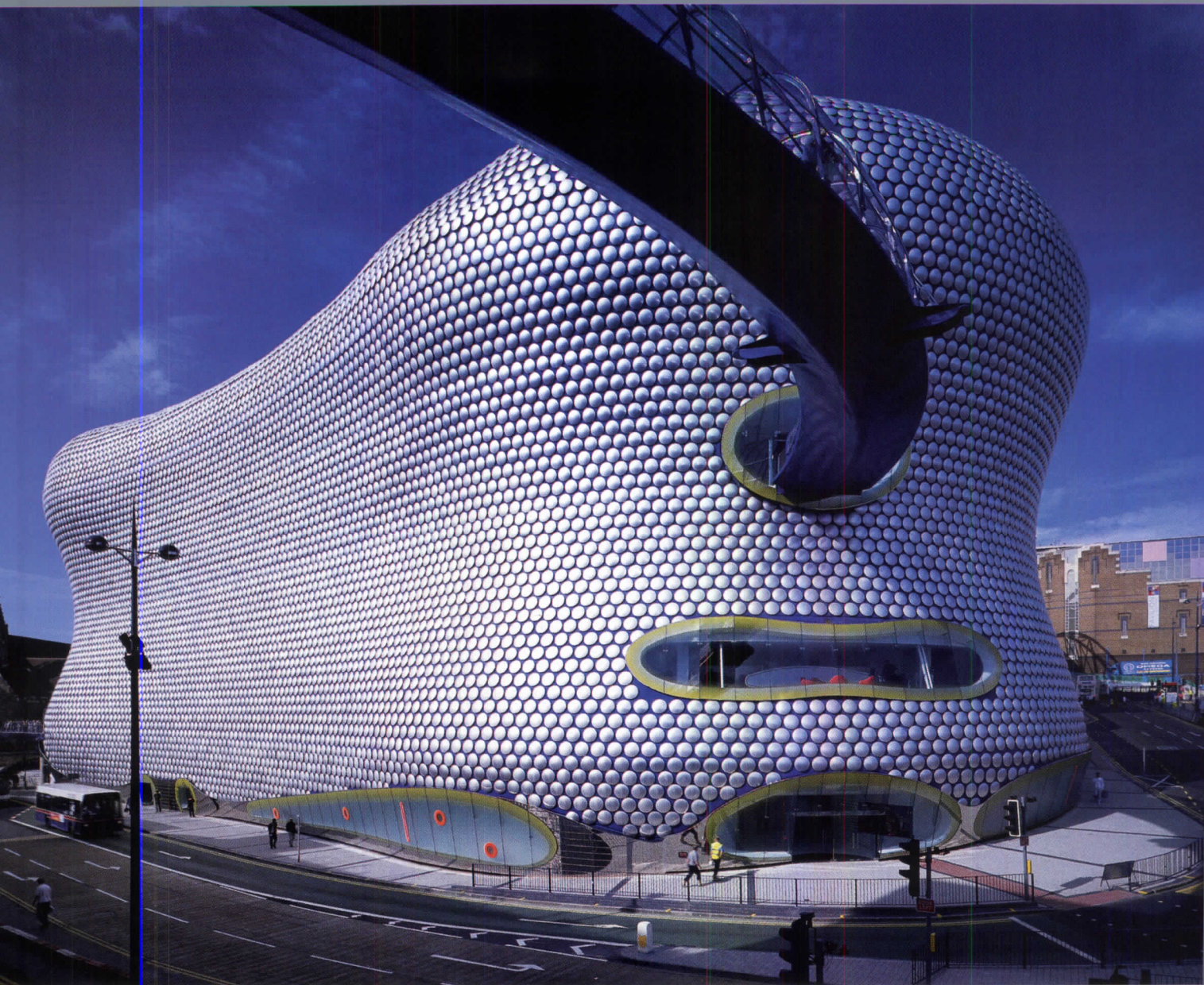

to be visited only with dotting relatives determined to find something practical. Radice brought back the theatricality that had historically defined the department store, turning the London flagship into a shrine to Bollywood, for example. “Body Craze,” another promotion, featured 600 nude volunteers riding up and down the escalators.

In the heyday of the department store, celebratory architecture was part of the appeal. In Birmingham, Radice restored that tradition, too. A developer offered him an à la carte package: a site in a new urban mall at the center of Birmingham’s knot of twisting shopping streets, including a ready-to-go design for a boxy volume wrapped in a queasy mix of Tuscan stripes and Modernist steel beams. Like the rest of the mall, *it was a design intended to appeal to everyone by offending no one.* It was

**Project:** Selfridges Department Store, Birmingham, U.K.

**Architect:** Future Systems—Søren Aagaard, Nerida Bergin, Sarah Jayne Bowen, Lida Caharsouli, Julian Flannery, Harvinder Gabhari, Dominic Harris, Nicola Hawkins, Matthew Heywood, Candis Jennings, Jan

Kaplicky, Amanda Leveté, Iain MacKay, Glenn Moorley, Andrea Morgante, Thorsten Overberg, Angus Pond, Jessica Salt, Severin Soder, project team

**Engineer:** Arup (structural, mechanical, fire protection, facade engineering)

**Project manager:** Faithful + Gould

**General contractor:** Laing O’Rourke





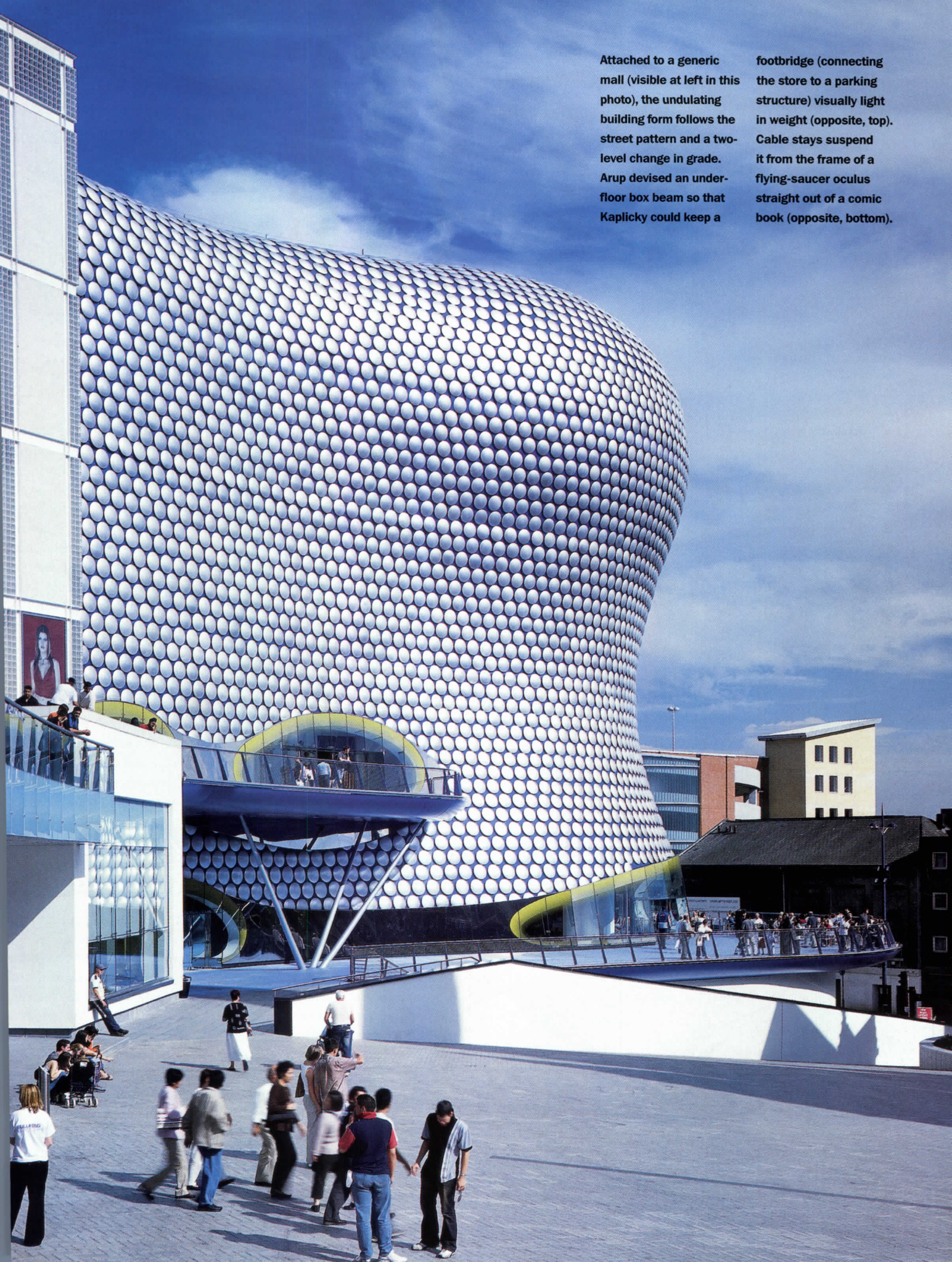

Attached to a generic mall (visible at left in this photo), the undulating building form follows the street pattern and a two-level change in grade. Arup devised an under-floor box beam so that Kaplicky could keep a

footbridge (connecting the store to a parking structure) visually light in weight (opposite, top). Cable stays suspend it from the frame of a flying-saucer oculus straight out of a comic book (opposite, bottom).

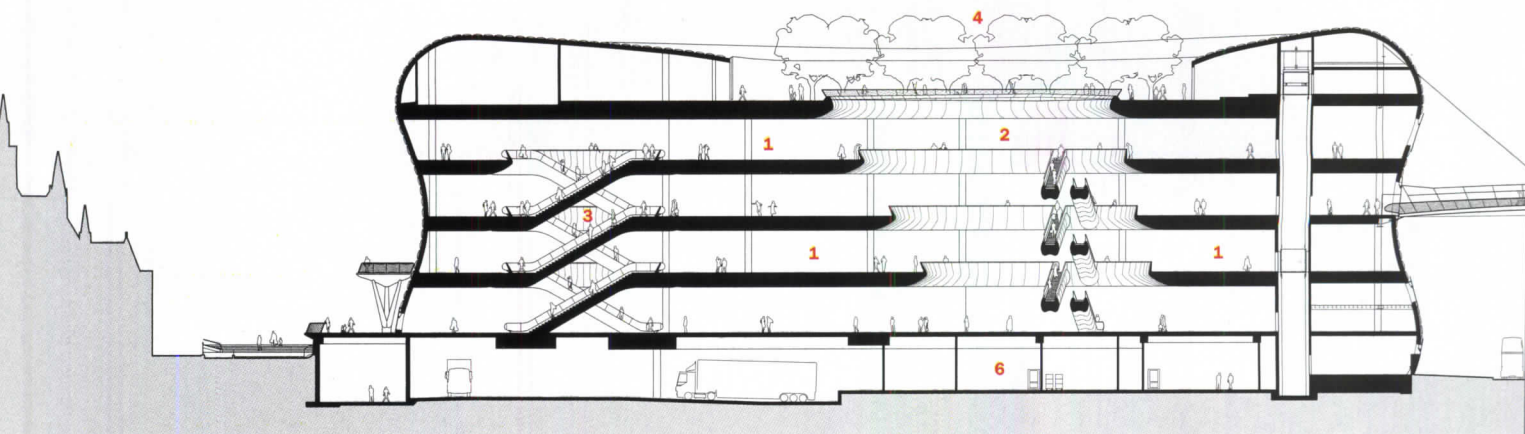

SECTION A-A

0 30 FT.  
10 M.

1. Selling space
2. Atrium
3. Secondary atrium
4. Garden and gym (unbuilt)
5. Bridge to parking structure
6. Loading and service
7. Mall entry below
8. Selfridges
9. Mall
10. St. Martin's Church
11. Parking structure

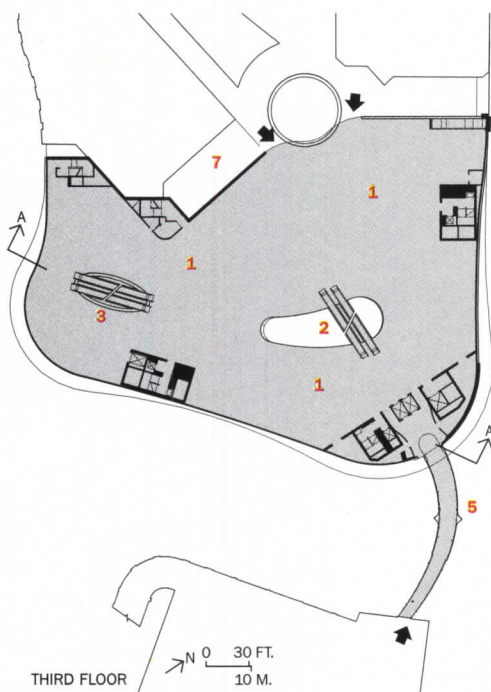

THIRD FLOOR

0 30 FT.  
10 M.

exactly the retail image that Radice had spent years erasing. "He didn't think it was good enough," explained Jan Kaplicky, a partner in Future Systems. "How would you get people there?"

Radice invited Future Systems and two other firms in the process that fit somewhere between an interview and a competition. Going in, Kaplicky and partner Amanda Levet were anything but a success. They had designed much, but built little, though their experience includes small designer boutiques in New York and London. They don't have a "commercial" profile in a retailing industry ruled by last month's sales data. But they proved to have the shopping-culture gene. Levet and Kaplicky prepared sketches and the evocative model to suggest possibilities for Radice. "He understood very well that the image could do what he wanted, which was to draw people from a 30-mile radius," said Kaplicky. It wasn't the building alone, he added, but the promise it signaled of what would be found within.

The memorable exterior is not pure image. It works as a facade because it follows the contours of the streets surrounding the site, which dates from medieval times. "The challenge with the skin was to get a curved profile done for a standard-cladding price," explained Ed Clark, the project manager for Arup. Since the exterior curved both vertically and horizontally, it couldn't be conveniently broken down into panels or "unscrolled" for conventional geometric engineering analysis. The team eventually devised a means to spray concrete over metal lath.

## FUTURE SYSTEMS HAS BUILT AN ANATOMICAL TEASE: ARE THOSE OPENINGS LIPS? IS THAT TRIM MASCARA?

The one-story-high ribbons. The lath was framed to arms projecting scaffolding and hung permanently from brackets extending from the building at the floor edge. Contractors sprayed waterproofing on top of the concrete, then attached an insulating layer, and a finish skin of synthetic stucco painted what Kaplicky calls Yves Klein blue. The 15,000 anodized aluminum disks that cover the surface—giant sequins inspired by a glittering, form-fitting Paco Rabanne dress—attach to fasteners and sit in sockets cast into the sprayed-concrete substrate. Their shiny sheen protects the painted surface and disguises substrate imperfections.

The curving shop windows and entrance openings at the building also pose an anatomical tease: Are those openings lips? Eyes? Can the trim be seen as lipstick? Mascara? The shopper doesn't have to see the spangled exterior as a female form or anything else. Its tactile appeal bypasses the brain. From a distance, the fish-scaled skin looks as if it stretched tautly over that swelling shape, rising tantalizingly out



0 50 FT.  
15 M.

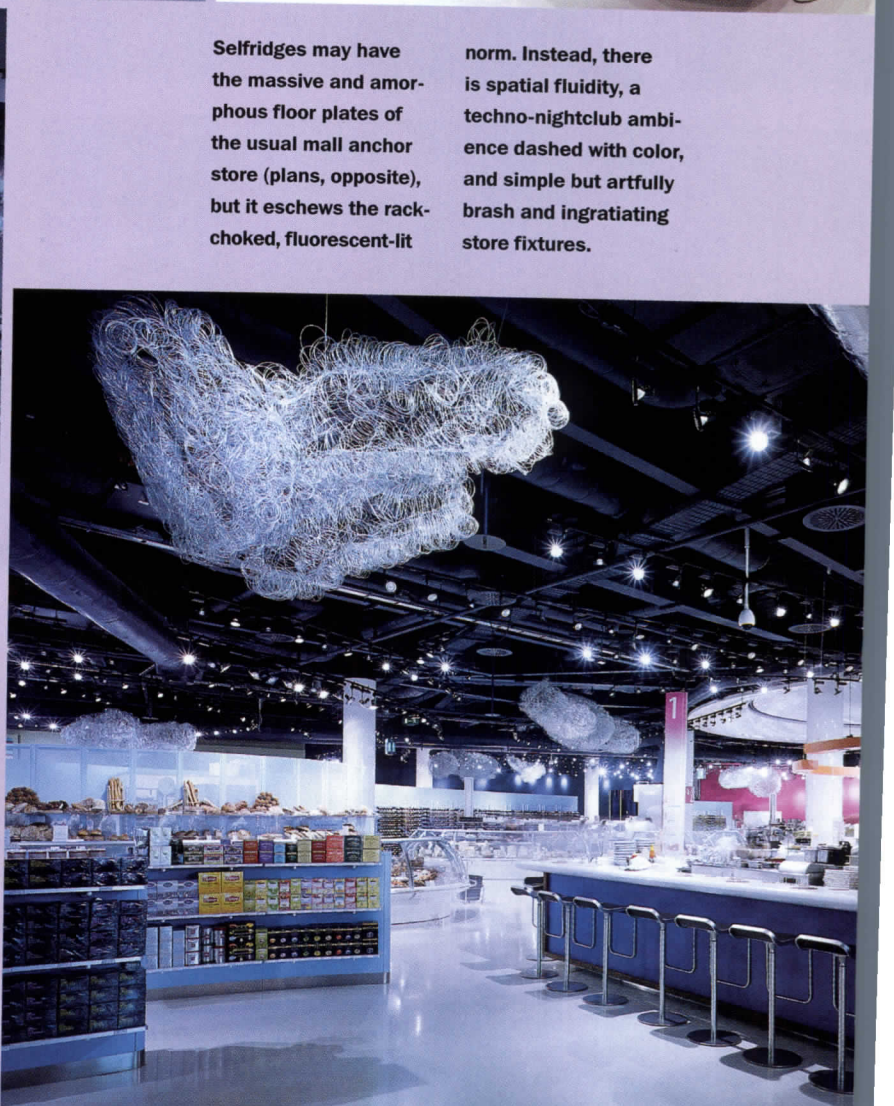

Selfridges may have the massive and amorphous floor plates of the usual mall anchor store (plans, opposite), but it eschews the rack-choked, fluorescent-lit

norm. Instead, there is spatial fluidity, a techno-nightclub ambience dashed with color, and simple but artfully brash and ingratiating store fixtures.



city's prosaic dirty-brick jumble. No sign screams Selfridges.

Conventional retailing wisdom deems daylight a no-no, since it could lure buyers' eyes away from the merchandise. But Kaplicky and Leveté proposed the skylighted, boomerang-shaped atrium from the beginning, and Radice understood its significance: "Orientation," says Kaplicky. "It is a key aspect of the department store." But also, "You want other people shopping, and that's important."

While the firm designed layouts for the lowest-level interior, suspending molded-plastic space-age store fittings from the ceiling—many of the interiors are by others: Eldridge Smerin, Stanton Williams, and Gensler & Partners. Also, Selfridges rents a considerable amount of its store space to brand concessionaires. It is a testament to the chain's merchandising prowess that the store personality is so distinct and so consistent in spite of design diversity. It has traded in the conservative, polished-woodwork formality and the labyrinthine, rack-choked floors of the old-line department store for a clean, crisp spaciousness. There's an endless inventiveness in the design of display racks and low tables, and in the theatrical use of light

## RADICE'S STRIPPED-DOWN DEPARTMENT STORE APPEALS THROUGH ITS FRESH, NERVOUS, INFORMAL YOUTHFULNESS.

which is far more appealing than the unvaried field of fluorescents that defines the conventional department store. The large, unimpeded floor areas tend to blur the borders between brand concessions.

Overall, the spirit is unabashedly contemporary. Radice stripped down the department store to the degree that its appeal lies almost solely in its fresh, nerdy, informal youthfulness. There are lots of kooky blouses and tons of T-shirts, but few ties and only name-brand business vests. Even "classic" lines like Burberry and Ralph Lauren have gone light. Contemporary for this store. Furniture? Midcentury Modern, only if it interests the 18-year-old by not being stuffy," says Kaplicky.

In the 19th century, department stores thrived as one of the primary destinations women were permitted to enter unaccompanied by a man. Now men and women who work long hours have supplanted the ladies seeking leisure, and they have short attention spans. Radice caters to these customers by crafting the same kind of recognizable image that specialty retailers have created. Those who strongly relate to the store's contemporary feel will probably find what they're looking for. Radice's strategy leaves everyone else to competitors. That's where the risk lies, and the strategy—for all the hoopla—has yet to definitively succeed. In a tight economy for retail, Selfridges was recently reported to outperform competitors, declining less than its competitors.

Radice himself has been lured to Marks & Spencer, where he is expected to work his magic again. A John Pawson-designed furniture store has opened. Other M&S projects are said to be in the works by Herzog & de Meuron, Ian Ritchie, and John McAslan. The Selfridges chain was sold to Wittington Investments of Canada, which cancelled Radice's plans for a store in Bristol by Toyo Ito and one by Terry Farrell in Newcastle. An expansion of the London store by Foster and Partners is still planned, however. There's no major retail executive who has not paced Selfridges' line of floors, but the future of Radice's trailblazing vision—and the role its architecture can play in it—has yet to be assured. ■

### Sources

**Spray-on concrete:** Shotcrete  
**Metal discs:** James + Taylor  
**Fiberglass, glass-reinforced plaster:** Diespeker

For more information on this project go to Projects at [www.architecturalrecord.com](http://www.architecturalrecord.com)

theatrical heart of  
the atrium,  
with the move-  
ment of people (right  
side, top). The  
building's generous size  
facilitates retail con-  
sumption by depriving  
the ground floor of selling  
space, but it pays off by  
providing unobstructed  
access to other floors  
(left side, bottom),  
an appealing dis-  
count that can lure shoppers  
to the escalators.  
The structure is clad in  
polished glass and glass-  
reinforced plaster.



**“Some people  
want you to  
believe these  
two walls are  
equal!  
What are they  
thinking?”**

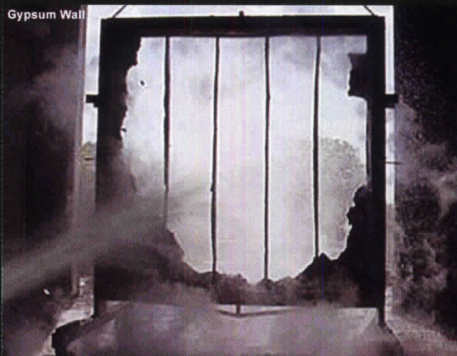
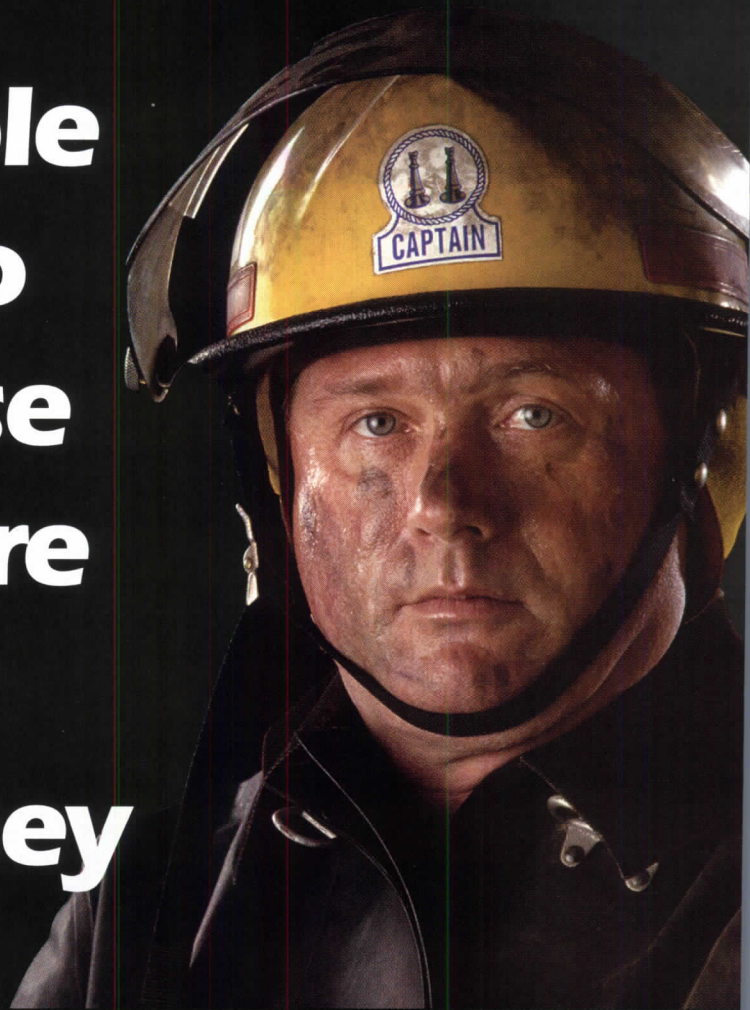

**Not all fire walls are created equal -even if they have the same fire rating. When a hose stream of water is applied to walls after two hours of exposure to heat from a furnace, the real difference becomes clear. Which 2-hour rated wall assembly would you want for protection of building occupants and property?**

**Choose concrete masonry!**

## PEDESTRIAN BRIDGES

# Iconic Connections

**ARCHITECTS ARE PRODUCING STUNNINGLY DESIGNED BRIDGES WITH RADICALLY DIFFERENT SHAPES AND MATERIALS.**

By Suzanne Stephens

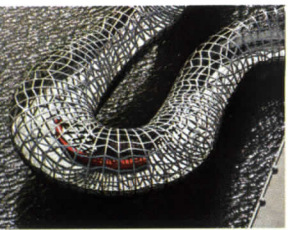

**1. Webb Bridge, Melbourne, Australia; 2. Passerelle on the Areuse, Boudry, Switzerland; 3. Puente de la Mujer, Puerto Madero, Buenos Aires; 4. Memorial Bridge, Rijeka, Croatia; 5. Floral Street Bridge, London, England; 6. Central Bridge, Worcester, Massachusetts; 7. Sail Bridge, Swansea, Wales, United Kingdom; 8. Houghton Park Pedestrian Skyway, Corning, New York.**

For more information on these projects, go to [Projects at architecturalrecord.com](http://Projects at architecturalrecord.com).

One of the most dazzling examples of architectural form-making today is without doubt the bridge. True, the bridges of Robert Maillart have long been a staple of courses in the history of Modern architecture, as has the Brooklyn Bridge, designed by John and Washington Roebling—which Montgomery Schuyler praised in *RECORD*'s pages a hundred years ago. Yet those bridges so admired by architects were executed by engineers. Usually, when architects have been involved in bridge design, their role has been to aestheticize the engineering, a tendency still current. However, many architects are often more involved integrally in the design, bringing a sense of scale, proportion, and elegance to spanning space. They collaborate closely with engineers or, in the case of Santiago Calatrava, are engineers as well.

Pedestrian bridges in particular have lured the architect, as seven of the eight bridges on the following pages attest. (The exception is a railroad bridge.) As Hugh Pearman points out in the introduction to *30 Bridges*, by Matthew Wells (Watson-Guptill, 2002), such bridges, intended for people on foot, cycle, or wheelchair, are designed with an eye to the particular experience of moving relatively slowly through space. This kinesthetic experience makes the most of an architect's contributions in matters of detail, use of materials, and composition of elements.

The bridges shown here serve other functions, as well. In several examples, bridges act as symbolic markers for an urban area undergoing rejuvenation or, in the case of Corning, as a gateway to a corporate complex. In one case, in Rijeka, Croatia, the bridge plays a dual role as both a war memorial and a link. Certain bridges, such as the Floral Street Bridge in London, are almost hidden in their natural or urban contexts, which makes their discovery all the more captivating.

Technical advances enable most of these bridges to be ever lighter and more evanescent, notably those designed by Santiago Calatrava and Wilkinson Eyre Architects. Others were assembled in unusual ways: The Webb Bridge in Melbourne, Australia, was floated on barges to its site, while major portions of a bridge in Boudry, Switzerland, were flown in by helicopter. (For more on the arresting technical accomplishments of certain bridges, see *Building Science*, page 279.)

This building type continues to proliferate, often resulting from competitions, especially in Europe, and from an ever-increasing awareness of its power to attract attention to a site. After Calatrava's first bridge in the U.S. opens in Redding, California, in July, we will be able to see how successfully this architectural form inspires additional arresting connections in the American landscape. ■

# Webb Bridge Melbourne, Australia

1

**DENTON CORKER MARSHALL AND ARTIST ROBERT OWEN SPARK UP THE DOCKLANDS WITH A SERPENTINE PEDESTRIAN AND CYCLIST BRIDGE.**

By Suzanne Stephens

**Architect:** Denton Corker Marshall Architects (architects have policy of not naming team members)

**Artist:** Robert Owen

**Client:** Mirvac Corporation/VicUrban (Melbourne's urban development agency)

**Consultants:** Arup—Peter Bowtell (structural); Arup Lighting—Paul Beale (illumination)

**Span:** 361 feet

**Cost:** \$1.75 million

**Completion date:** November 2002

**Sources**

**Steel:** Geelong Fabrications

Sometimes a bridge is as much a destination as a passage. This seems to be the case with the slinky, glimmering, steel-lattice Webb Bridge in Melbourne, Australia. The pedestrian bridge, designed by artist Robert Owen with architects Denton Corker Marshall (DCM), obviously does not provide the most direct path from the Docklands on the north side of the Yarra River to new residential development taking shape on the south side. But it enhances the transit experience for bicyclists, pedestrians, and the disabled.

## Program

As part of the redevelopment of Yarra's Edge, former wharves and docks near Melbourne's central business district, the Docklands Authority required the developer of the residential complex, Mirvac, to contribute 1 percent of the budget to public art. In this case, the money went for the bridge. Robert Owen, an Australian artist known for his mixed-media installations, and Denton Corker Marshall, architects of the Melbourne Museum (RECORD, January 2001, page 70), won a competition with a writhing, tubular structure that incorporates two segments of the former Webb Railroad Bridge. In addition, the design offers access to the disabled via a ramp linking higher and lower elevations without a steep incline.

## Solution

Owen's and Denton Corker Marshall's

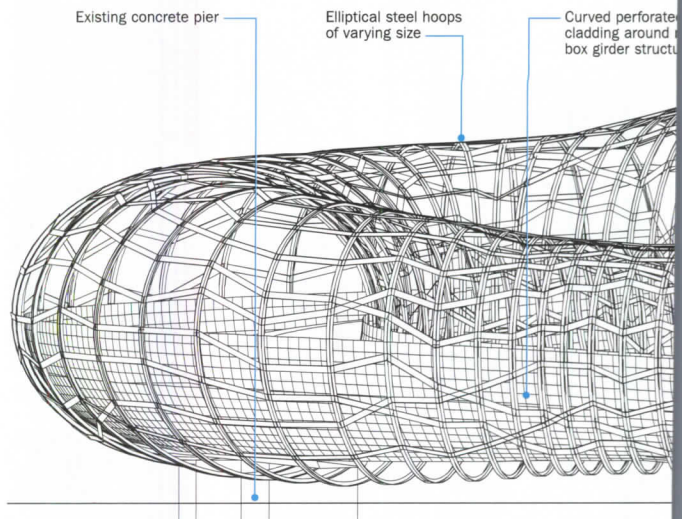

EAST ELEVATION



For more information on this project, go to Projects at [www.architecturalrecord.com](http://www.architecturalrecord.com).



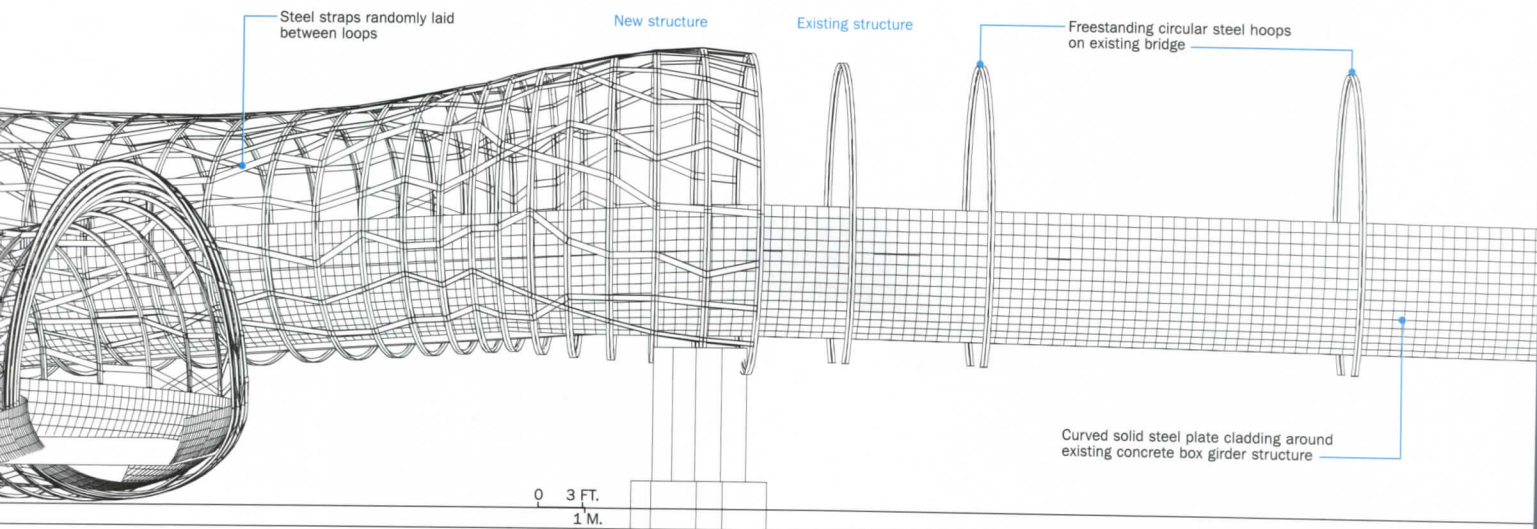
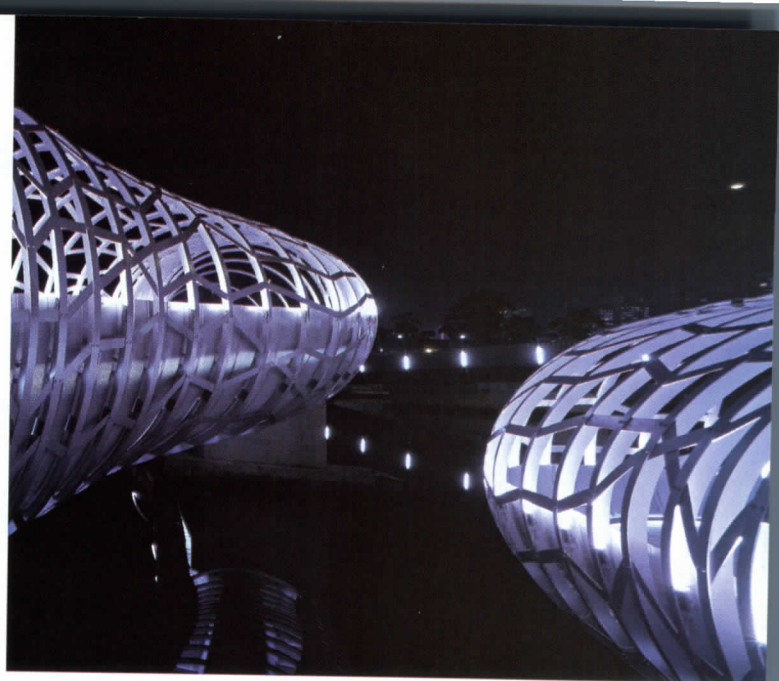
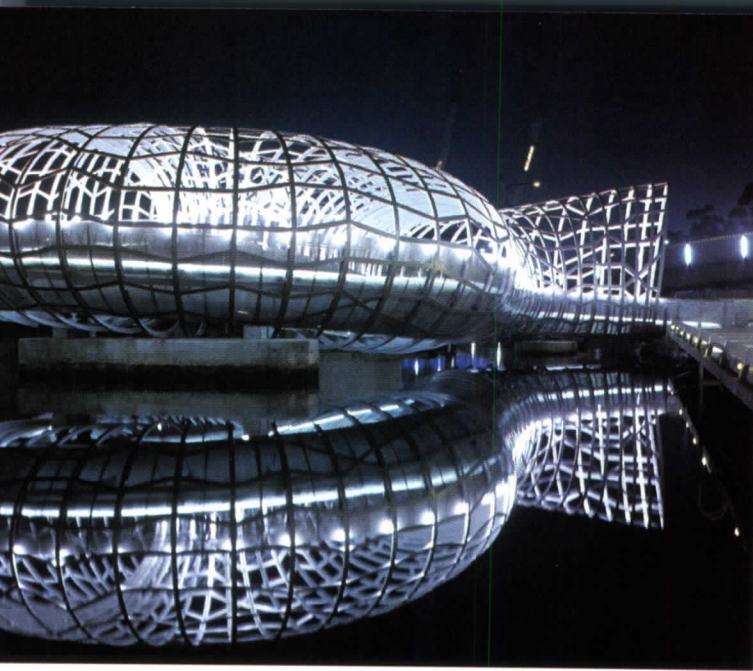

**It doesn't breathe, but the Webb Bridge does come alive by night and day, when its yawning mouth disgorges visitors from the north side of the Docklands to the south side.**



From afar, the elliptical hoop-frame bridge glints by day and glows by night. The tubular web takes visitors from the south entrance (opposite, top) to the north side of the Yarra River.

The design recalls an aboriginal eel trap, except that it is fabricated with a hooped steel frame tied by flat, laser-cut steel straps rather than woven sticks. DCM used computer-aided three-dimensional modeling to arrive at the 20-foot-high hoops of various sizes and spacing, while the Melbourne office of Arup engineers came up with a structural solution of steel box girders, cranked to all a curved form to take shape. The box beams, covered with a concrete slab and encased in perforated-steel cladding, and the loopy, weblike casing were fabricated on two barges in Victoria Harbor, then floated up the river and dropped into place during a low tide. The new structure was then linked with the remaining concrete box girders of the old railroad segments.

By day, the coiled bridge glimmers in a reptilian fashion against the Yarra River; by night, illumination conceived by Arup Lighting causes it to glitter like a silvery roped necklace reflected against a dark mirror. To create an eerily glowing atmosphere within the walkway, Arup backlit the floor with white cold-cathode lights mounted on the side edges. To keep the light from being cast too high in the sky, it installed pairs of 35-watt, PAR38 metal-halide lights at the handrail level that bounce up against the inner surface of the arches.

#### Commentary

A curving bridge shared by both pedestrians and bicyclists suggests that bicyclists may have to move more slowly than they may like. Nevertheless, the biomorphic shape presents a symbolic marker for the Docklands area, as well as a meeting place, and a memorable connection from one area to another. The collaboration between artist, architect and engineer clearly demonstrates the vital public contribution of such arranged marriages. ■

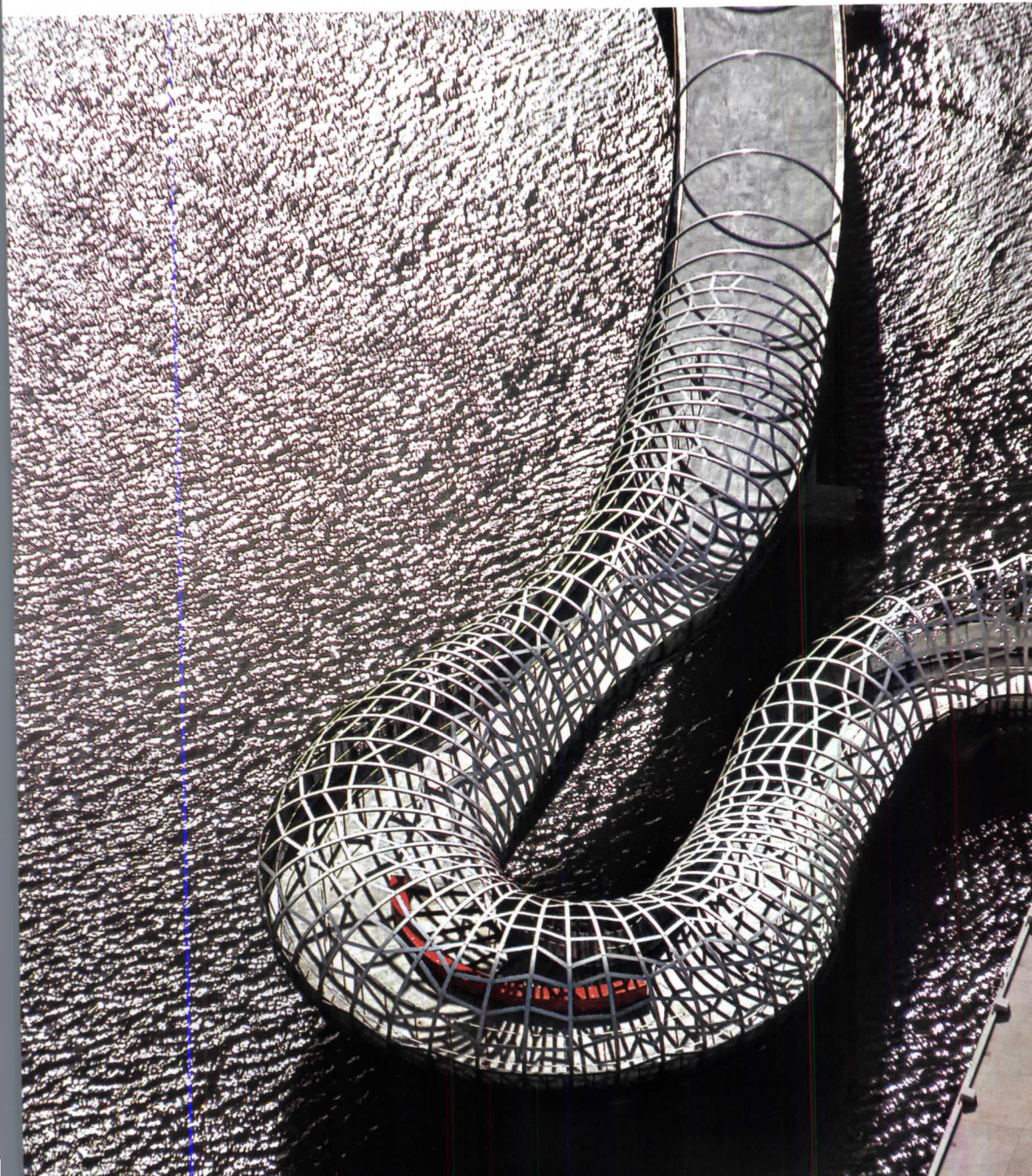



# Passerelle on the Areuse Boudry, Switzerland

## 2

**GD ARCHITECTES CREATES A SINUOUS LINK IN SECTION AND PLAN TO SPAN A SMALL RIVER.**

**By Sarah Amelar**

**Architect:** *GD Architectes—Laurent Geninasca, Bernard Delefortrie, partners; Christine Perla, collaborator*  
**Consultants:** *Chablais et Poffet (civil engineers)*

**Span:** *90 feet*

**Cost:** *\$117,000*

**Completion date:** *April 2002*

#### **Sources**

**Metal fabrication:** *Steiner*

**Wood fabrication:** *Tschäppät*

This heavily wooded site in western Switzerland lies so far from paved roads that architects Laurent Geninasca and Bernard Delefortrie had to prefabricate the main components of their footbridge and fly them in by helicopter. Yet the gorge's wild and remote character was exactly what their firm, GD Architectes of Neuchâtel, sought to maintain.

#### **Program**

Having won an invited competition for the commission, GD Architectes had to reconcile two very different banks along the Areuse River in Boudry: one formed by steep, craggy rocks, and the other by a low, open field. The hikers' footbridge needed to span about 90 feet and arc high enough to accommodate rising water.

#### **Solution**

Working with engineer Laurent Chablais of Chablais et Poffet, the architects created a sinuous span that narrows in width, from 11.5 to 3.8 feet, and constricts sectionally as it approaches the more vertical bank. The structure, a gentle S-curve in plan and elevation, appears to emerge organically from the forest. Finely slatted with blades of dark-stained fir, the bridge's sides and top transparently screen views, rather than obstruct them. The parallel boards filter the sun's rays, much as the branches of trees cast dappled light. With the delicacy of a cricket cage, the thin wooden blades converge toward the



For more information on this project, go to **Projects** at

[www.architecturalrecord.com](http://www.architecturalrecord.com).

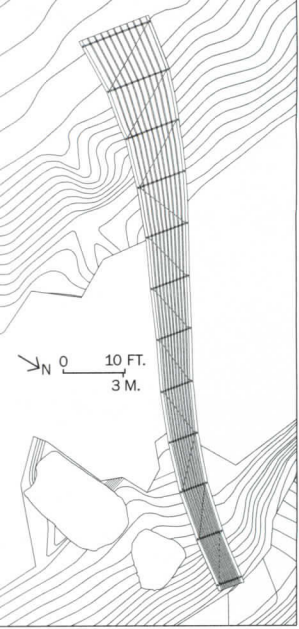

The curving form and converging slats, accentuated by the effects of perspective, give the bridge a gentle dynamism that remains compatible with the woodland setting and rushing water below.

lower end, intensifying the sense of moving momentum.

Deceptively simple, light, and graceful in appearance, the load-bearing, steel-framed structure—essentially a square tube—performs as a box girder, distributing bending and torsion loads through a triangulation system of wood and steel slats on four sides, ultimately transmitting the forces to the ground at either end to accommodate temperature variations affecting bridge length, the bridge support remains fixed at its upper end and mobile at the other, so the loads would be lighter.

Given the variable section, the footbridge was designed, says the architect, with “no two identical slats.” The act of assembling it—a technical challenge in itself—required precise choreography. As the engineer recalls, the process started with pulling two electrical lines out of the gorge, followed by a Tamov Russian contractor delivering the structure’s major components on provisionally erected scaffolding. Then, miraculously, the prefabricated footbridge was assembled in a single day.

#### Concluding Commentary

Structural calculations yielded a form remarkably harmonious with the woodland gorge. Geninasca and the architect, who speak of “listening to a place,” joined forces with the engineer to produce a bridge that is both surprising and completely integral to its natural setting. ■

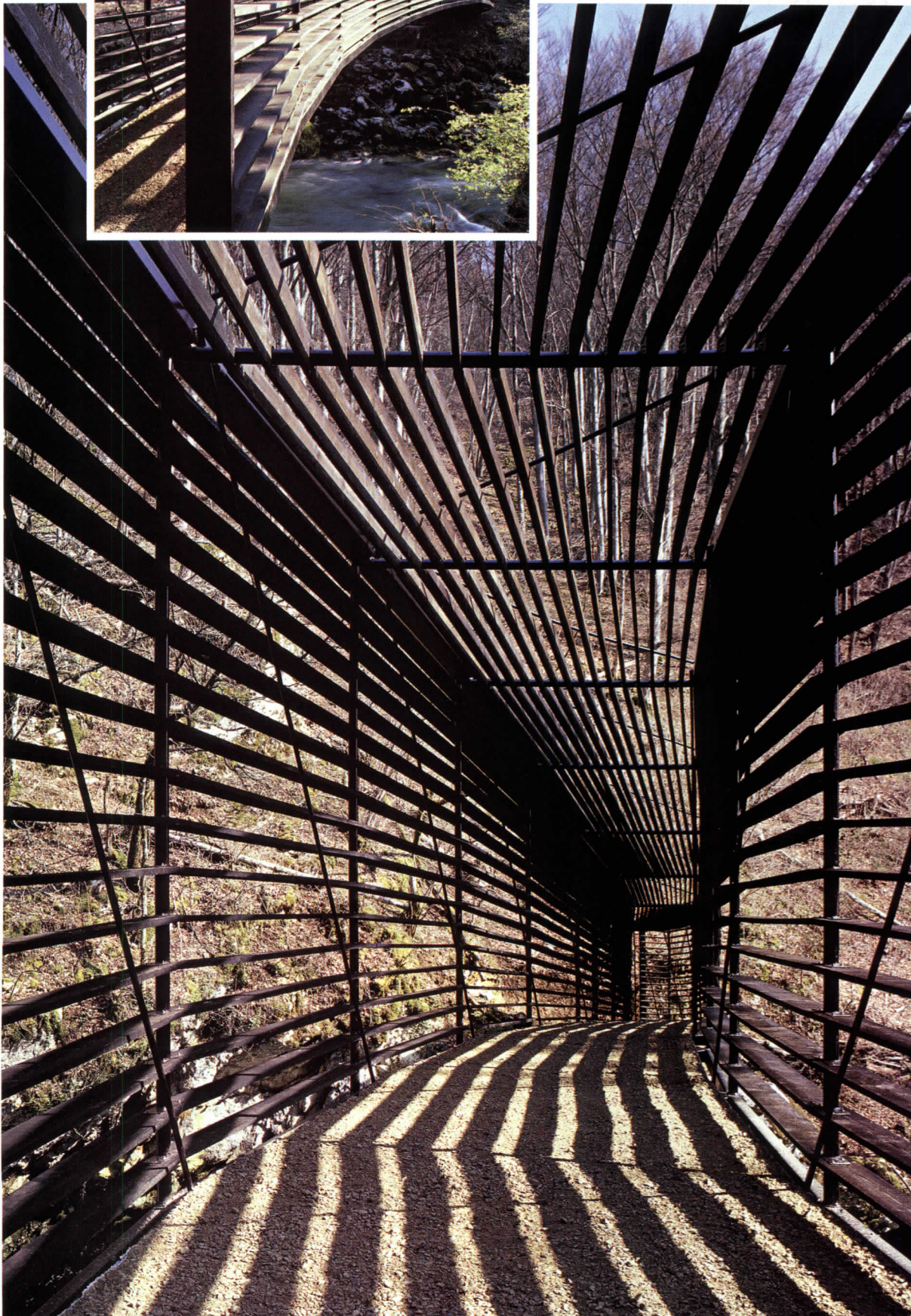

# Puente de la Mujer

## Puerto Madero, Buenos Aires

# 3

**IN ARGENTINA'S CAPITAL, SANTIAGO CALATRAVA GRACEFULLY COMBINES PIVOTING SPAN WITH A SINGLE-PYLON SUSPENSION SYSTEM.**

**By Sarah Amelar**

**Architect/Engineer:** Santiago Calatrava

**Client:** Grupo González

**Lighting:** Santiago Calatrava

**Span:** 525 feet (overall);  
335 feet (rotating section)

**Cost:** \$5 million

**Completion date:** December 2001

#### Sources

**Reinforced concrete:** Galtieri  
Constructions

**Steel contractor:** URSSA, Spain

**Mechanical tower:** DEMAG/  
Mannesmann, Spain (supplier)

Though many of Santiago Calatrava's bridges—nearly 40 built so far—feature inclined pylons or arched forms, each example pushes the limits of structural ingenuity and sculptural grace in a different way. Following his innovative, harplike 1992 Alamillo Bridge in Seville, Spain, for example, this architect/engineer has repeatedly reinvented the possibilities for asymmetrical, single-pylon, cable-stayed suspension systems—most recently with his Sundial footbridge, under construction in Redding, California, and the pivoting Puente de la Mujer at Puerto Madero in Buenos Aires.

#### Program

In 1992, Buenos Aires launched an ambitious and strategic city-planning initiative to reclaim its neglected waterfront—focusing in part on the late-19th-century port of Puerto Madero. The city's phased plan for this district encompasses the preservation of existing warehouses and wharves; the creation of a mixed-use complex with museums, art galleries, and university facilities; and the erection of five new bridges, including the Puente de la Mujer by Calatrava. Here, he needed to span 525 feet across the Rio de la Plata, providing a pedestrian crossing and linking plazas on either embankment while retaining full access by water to a nearby dock.



#### Solution

Although Calatrava has designed a wide range of kinetic structures in the past—including the Mécroc Swingbridge in Bordeaux, France, and the Milwaukee Art Museum

[RECORD, March 2002, page 9] the Puente de la Mujer marks the first integration of a rotating span with an inclined, single-pylon suspension system. Set between two segments, the 335-foot-long c

For more information on this project, go to [Projects at www.architecturalrecord.com](http://Projects at www.architecturalrecord.com).



Time-lapse photography (this page) shows the bridge's potential for multiple positions as it swings open. The span provides a wood-planked crossing for pedestrians (opposite).

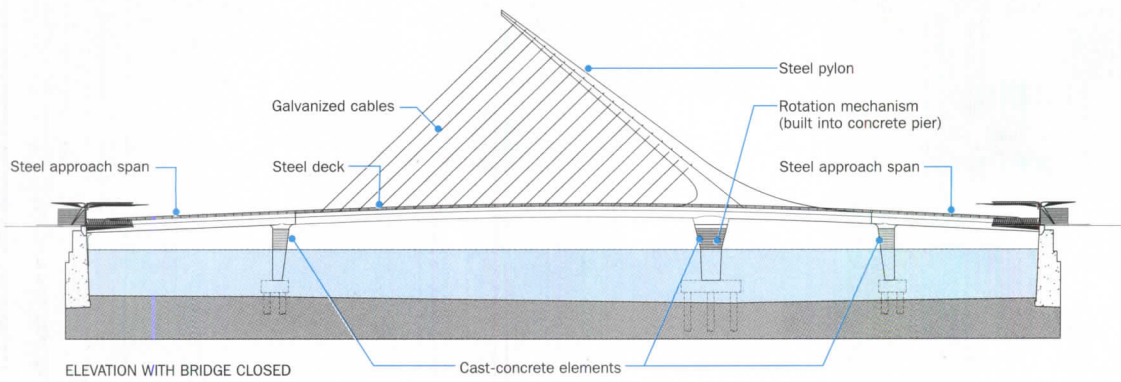

ELEVATION WITH BRIDGE CLOSED

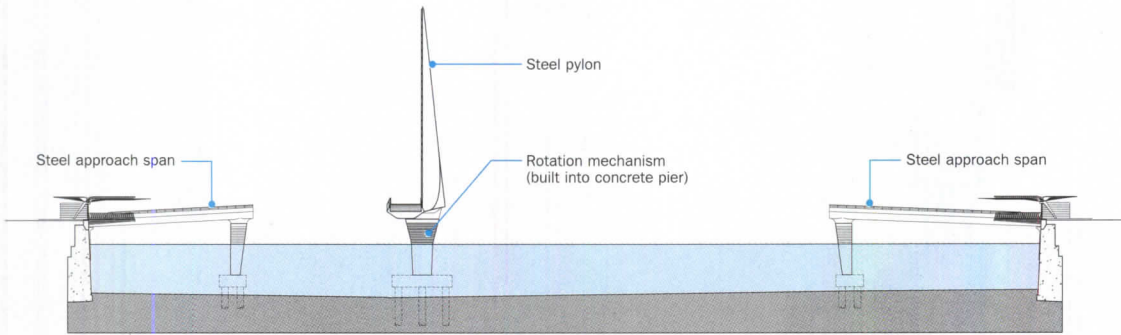

ELEVATION WITH BRIDGE OPEN



tral span of the Buenos Aires bridge can turn 90 degrees to allow tall boat traffic to flow freely. Though it's rarely necessary to open this bridge—"maybe several times a year," according to the architect—he says he designed the structure "to rotate whenever it's needed, even every day."

Dynamic in its sharp, arrowhead precision, the pylon, holding taut the rungs of cables, reaches a height of 128 feet. Its great triangulating V-form leads with a crescendo from the axis of a major avenue, gesturing toward the new, higher part of the city on the opposite bank. In contrast to Seville's Alamillo Bridge, where a stationary, canted-steel vertical element contains concrete to counterbalance the weight of the deck (and eliminate the need for a second set of stay cables), here the steel pylon remains hollow, keeping it relatively light. Where the cable-strung V creates an obtuse angle in Seville, it forms an acute angle in the Buenos Aires structure, with concrete inserted as counterweight just behind its apex. The resulting silhouette, supported by a wood-planked pedestrian walkway, appears remarkably minimalist and deceptively simple.

### Commentary

Occupying a rare position in the architectural world, Calatrava has simultaneously performed as an engineer who is enlightened and an architect who builds bridges (among other structures) prolifically. In the process of revisiting this spanning form, he has managed to distill its essence, providing a clear and poetic—yet fully functional—essay on the meeting of static and dynamic forces. ■

**The bridge rests on cast-concrete supports with a rotating mechanism directly below the pylon's base (left). The V-form widens toward the newer, higher part of the city (opposite site, bottom and top left). The structure is completely open in position (opposite top right) allows all river traffic—including tall ships—to flow freely.**





# Memorial Bridge Rijeka, Croatia

# 4

**3LHD ARCHITECTS CREATE A FORCEFULLY MINIMAL MONUMENT THAT ALSO SERVES AS A FOOTBRIDGE.**

By Sarah Amelar

**Architect:** 3LHD—Sasa Begovic, Marko Dabrovic, Silvije Novak, Tanja Grozdanic, principals in charge; Sinisa Glusica, project architect; Koraljka Brebric, Milan Strbac, designers  
**Client:** City of Rijeka  
**Consultants:** Jean Wolf, Zoran Novacki, Dusan Srejjic, Berislav Medic (structural engineers); Osram—Aljosa Sribar (lighting)

**Span:** 123 feet  
**Cost:** \$1.8 million  
**Completion date:** December 2001

**Sources**  
**Aluminum planks:** Sapa, Sweden (decking)  
**Cast glass:** Ciril Zlobec (prisms)

After violent conflict in the Balkans, the Croatian town of Rijeka, some 30 miles south of Trieste, held a competition for a structure both symbolically charged and functionally efficient: a monument to Croatian defenders, a memorial to an era of death and destruction that would also serve as a footbridge. With a strikingly abstract yet contemplative scheme, the Zagreb firm 3LHD won first prize.

## Program

As the city continues to evolve, this pedestrian bridge/memorial will occupy an increasingly important position, connecting Rijeka's historic center with its former port, an area to the east slated to become a public park. The structure needed to span at least 123 feet across a canal. And a small plaza, or gathering area with benches, at the bridge's east end also comprised part of the program. But the greatest challenge lay in maintaining a balance between the form's utilitarian role as bridge and its commemorative qualities as monument.

## Solution

The architects devised an elegantly thin and distinctive L-configuration that equates the horizontal walking surface with the vertical slab (or memorial) in both importance and materials. The upright leg, rising 29.5 feet on the east bank of the canal, forms a wall with a slot just wide enough for the passage of one person. Reminiscent of a tombstone, the

tall, geometrically pure wall confronts you, demanding that you sidestep or penetrate it, single file. Boldly blocking views, the slab prompts reflection on the nature of a place psychologically transformed. Visually, the monument's stripped-down Minimalism plays starkly against the backdrop of the old city.

3DLH gave the L-form strong continuity by covering both its legs in aluminum-alloy planks, offering a relatively non-skid surface with corrosion resistance. The horizontal component, measuring 154 by 16 feet and a mere 21.6 inches thick, features a steel girder structure, while the vertical element relies on reinforced concrete. Pilotis, also of reinforced concrete, support the walkway, edged by panels of safety glass with teak handrails.

The steel girder, fabricated in a local shipyard, arrived as a single 150-ton piece on a barge especially designed to sink down and release its cargo with changing tides. So the very act of erecting the Memorial Bridge became a major event.

The architects enhanced the structure's floating effects and created a mystical glow at night by inserting LEDs under the handrails and behind cast-glass prisms in the edges of the upright slab.

In the plaza, cantilevered, L-shaped benches of steel and teak

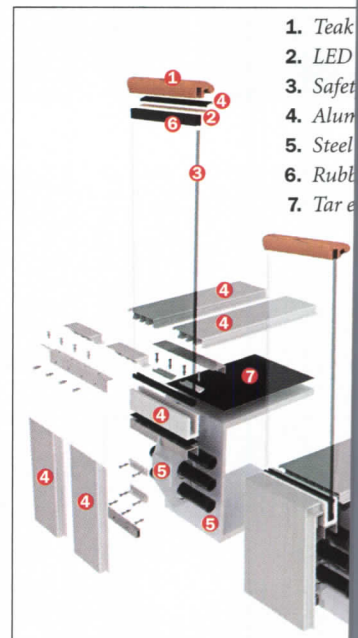

echo the bridge form, while a slot like strip of crushed brick and epoxy resin, incised in the ground, extends from the wall slot—symbolizing Croatia's blood-soaked earth.

## Commentary

While serving as a footbridge, the span is hardly one to hurry across. With its tall, imposing end wall, the structure encourages slow walking, contemplative lingering and gatherings, day and night. 3LHD expanded the project's scope by inviting architects from other disciplines to contribute, exploring concepts of memorial, patriotism, and war. From this launch, participating artists have already launched three films and a book

For more information on this project, go to [Projects at www.architecturalrecord.com](http://Projects at www.architecturalrecord.com).



With abstract geometry and inventive use of LED lighting, the bridge's character evolves over the day (below) and into the night (above).

# Floral Street Bridge

## London, England

# 5

**WILKINSON EYRE HAS GIVEN COVENT GARDEN A SYMBOL OF ARTISTIC ASPIRATION LINKING THE ROYAL BALLET SCHOOL AND THE ROYAL OPERA.**

By Sara Hart

**Architect:** Wilkinson Eyre Architects—Jim Eyre (director in charge); Annette von Hagen (project architect); Martin Knight

**Client:** The Royal Ballet School

**Engineers:** Flint & Neill Partnership (structural); Buro Happold (environmental)

**Consultants:** Speirs and Major (lighting); GIG Fassadenbau GmbH (bridge subcontractor)

**General contractor:** Benson Limited

**Span:** 31 feet

**Cost:** \$1.42 million

**Completion date:** March 2003

### Sources

**Lighting:** AcDc Lighting (LED units); Design Architectural Lighting (low-voltage downlights)

In spite of its diverse practice, London-based Wilkinson Eyre Architects has solidified its reputation internationally as a designer of spectacular bridges. Its Floral Street Bridge at Covent Garden is a fraction of the scale of its award-winning Gateshead Millennium Bridge spanning the Tyne River, but just as powerful.

### Program

Because the bridge spans a mere 30 feet across an unassuming street in London's Covent Garden, one would assume that the program would call for a modest functional footbridge connecting the back sides of two buildings. But these aren't just any buildings. Floral Street separates the Royal Ballet School from the landmark Royal Opera House. Ballet students, faculty, and staff of the school needed a direct link to the stage of the opera house. The client wanted a strong architectural statement—one that would provide an integrated link between the buildings while giving Floral Street a prominent identity.

### Solution

The openings between the buildings are not aligned, making a straightforward orthogonal resolution seem like a jerry-rigged collision between two architecturally distinct structures. To avoid that trap, Wilkinson Eyre conceived a deceptively simple, yet

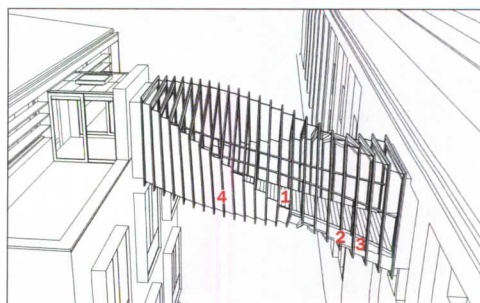
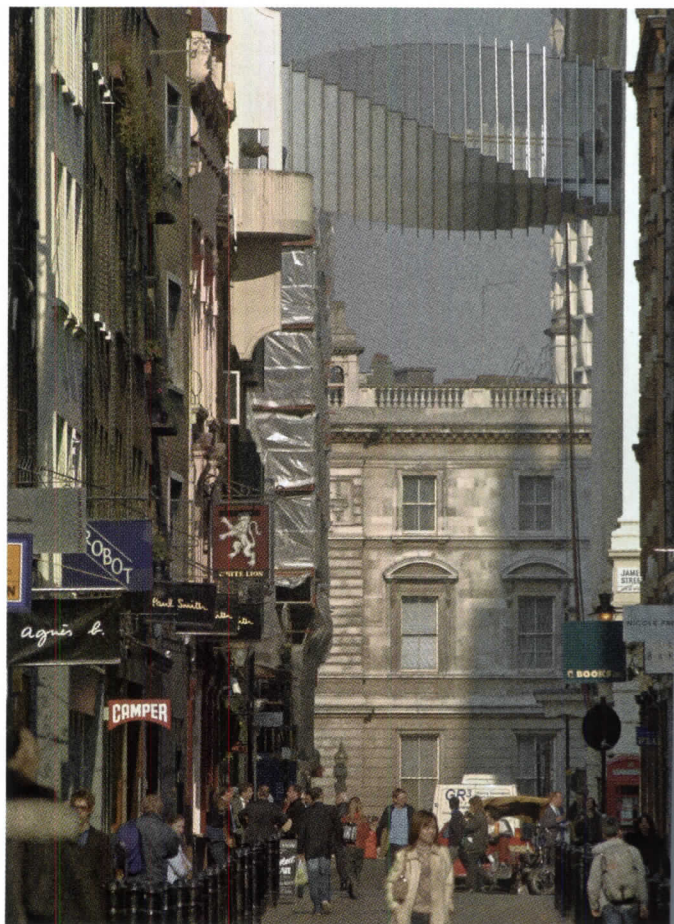

1. Timber deck
2. Aluminum side
3. Structural spi
4. Opaque glazi

For more information on this project, go to Projects at [www.architecturalrecord.com](http://www.architecturalrecord.com).



ed out of aluminum, glass,  
wood, the footbridge, in the  
of a concertina, twists from  
acade to the other, becoming  
sculpture than architecture.

mediately legible design. An alu-  
m spine beam supports a  
er deck and a series of square  
um hoops. Between the open-  
each hoop rotates 4 degrees  
ve to its neighbor and shifts in  
to accommodate the skewed  
ment of the facade openings.  
whole structure twists a quarter  
rom one end to the other.  
A structure as pure as this  
reated a challenge for the  
ng designers. With no soffit in  
fixtures could be mounted,  
ghting team had to find other  
ons. The solution incorporates  
in an L-shaped form attached  
e top corners of the hoops. As  
ult, the bridge glows gently in  
arkness without blurring the  
s of the delicate spiral.

#### mentary

king the form of a concertina  
visting it, Wilkinson Eyre  
ed structural and architectural  
etries into a single unit.  
n appears to be frozen into an  
ct, yet palpable, symbol for  
ollet school. It literally marks  
essage from the practice stu-  
nd classrooms to the stage,  
is why it's informally know as  
ridge of Aspiration." ■



# Central Street Bridge

## Worcester, Massachusetts

# 6

**CENTERBROOK ARCHITECTS CONQUERS GRIDLOCK AND CAPTURES THE SPIRIT OF INVENTION IN A NEW RAILROAD BRIDGE.**

**By Nick Olsen**

**Architect:** *Centerbrook Architects and Planners—William H. Grover, FAIA, James C. Childress, principals in charge; Padraic H. Ryan, Roger U. Williams, AIA, Michelle R. Lafoe, Jonathan G. Parks, project team*

**Client:** *Worcester Redevelopment Authority and the City of Worcester, Mass.*

**Consultants:** *Maquire Group Connecticut (engineering); Warfel Schrager Architectural Lighting (lighting)*

**Span:** *178 feet*

**Cost:** *\$4.5 million (bridge only)*

**Completion date:** *October 1999*

#### **Sources**

**Brick:** *Endicott Clay Products*

**Stainless steel:** *The Henry Group*

Home to Robert Goddard, the inventor of the rocket, the city of Worcester, Massachusetts, also lays claim to breakthroughs as diverse as the Valentine's Day card and the birth control pill. When faced with a problematic railroad crossing on Central Street, its main vehicular artery, the city sought a solution that would reflect its inventive character.

#### **Program**

In recent years, new developments along Central Street, including a civic center and hospital, have brought additional congestion to this busy main corridor, which connects to Interstate 290. The prior on-grade railroad crossing created a traffic nightmare, effectively blocking access to the city with each passing train. Following a master plan by Alex Krieger of Chan Krieger & Associates, Cambridge, Massachusetts, city officials decided to lower the road, raise the tracks, and erect a railroad overpass. This was to be no ordinary work of infrastructure, however. On Krieger's recommendation, local officials enlisted Centerbrook to stretch a limited budget and make a statement about Worcester's rich past and promising future.

#### **Solution**

The formal expression of such a statement sparked contention in the community. Centerbrook architects William H. Grover and James C. Childress designed more than eighty



proposals, some appealingly traditional in style, and each reflecting Worcester's many inventions. Ultimately, a modern expression of a historic novelty prevailed: The winning bridge design takes its inspiration from the calliope, a steam pipe organ developed in the city in the 1850s. The bridge, which spans 178 feet, features broad arches of gleaming stainless steel with radial supports accompanying the traditional safety railings. The steel matrix imitates the alignment of the calliope's pipes and

creates a graduated screen for city that contrasts sharply with brick-clad reinforced concrete p and the abutments emerging fr surrounding earth berms. The s railings feature three different le of polish to vary their reflective. At night, a kaleidoscopic play of lights and signs against the me heightens the effect, hinting at energy of the city ahead. In fact railing structure was constructed the flat ground of Greenville, Tex disassembled, and shipped pie

For more information on this project, go to [Projects at www.architecturalrecord.com](http://Projects at www.architecturalrecord.com).

At night, traffic lights and signage bring the polished stainless steel to life (below). The new bridge eliminates a difficult on-grade crossing.



to Worcester—ironic for a bridge problematic of its setting.

**mentary**

beyond their charge to “deco-  
railroad bridge,” Grover and  
less mined Worcester’s history  
distinctly forward-looking design.  
ting from the monolithic pres-  
of most railroad overpasses, the  
’s glittering steel web alludes  
speed of transportation and  
an appropriate gateway to a  
innovation. ■

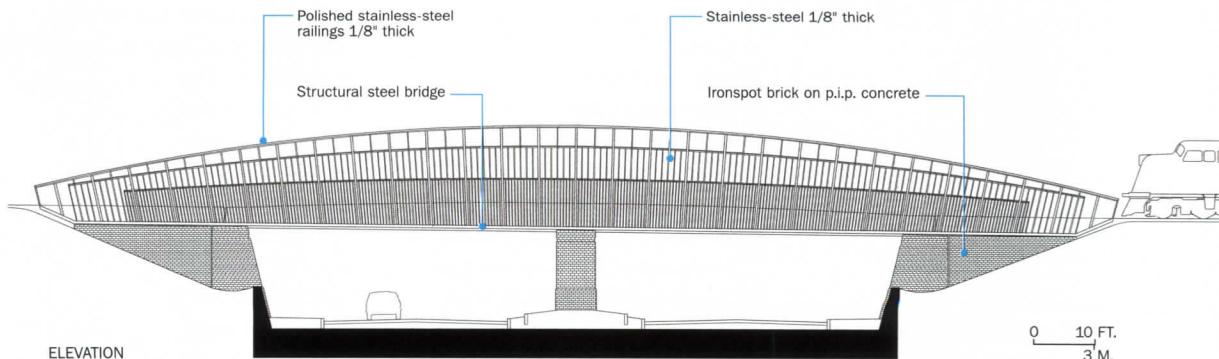

# Sail Bridge

## Swansea, Wales, United Kingdom

# 7

**WILKINSON EYRE'S SAIL BRIDGE SIGNALS TO ALL COMERS THAT THIS PORT CITY IS IN THE MIDST OF AN ENERGETIC ECONOMIC REVIVAL.**

**By Charles Linn, FAIA**

**Architect:** Wilkinson Eyre  
Architects—Jim Eyre, Martin Knight,  
Ben Addy

**Client:** Welsh Development Agency

**Consultants:** Flint & Neill  
Partnership (structural engineering)

**General contractor:** Balfour Beatty  
Construction

**Span:** 465 feet

**Cost:** \$5,300,000

**Completion date:** June 2003

### Sources

**Cable-stayed, steel superstructure:**  
Rowecord Engineering



Swansea's Port Tawe industrial waterfront district is not unlike those in countless port cities throughout the world. Over the past century its shipping and heavy industries became redundant and fell into obsolescence. But this city on the Bristol Channel in southwest Wales is in some ways more fortunate than many others. The British government's Welsh Development Agency (WDA) master planned the area and invested millions of pounds in its redevelopment. It commissioned the Sail Bridge, a pedestrian link spanning the Tawe River and connecting the new Port Tawe Innovation Village with Swansea's business district, as a symbol of the area's revival.

### Program

The purpose of the WDA's redevelopment project at Swansea was to attract businesses at a reasonable price. Yet considering that the area was in need of costly improvements to its infrastructure, one might think the \$5 million spent on the bridge would have been better put into sewers and power lines. But those work pretty much the same way everywhere—they don't give one city a substantial advantage over the next. That demands marketing.

A marketing plan intended to show off a redevelopment

should include a grand gesture, something to turn the heads of prospective tenants and investors and distinguish a particular place from all others. For a city like Swansea, which has a notable maritime tradition, such a focal point might display some element of that tradition, still showing that progress is the

For more information on this project, go to Projects at [www.architecturalrecord.com](http://www.architecturalrecord.com).

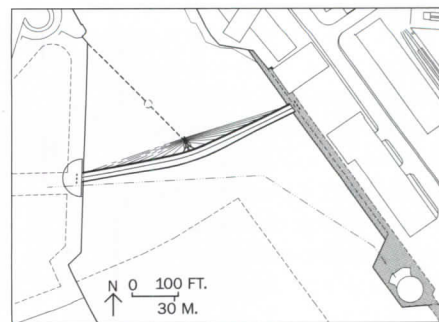





to tell the entire world your city is  
ng a comeback? Build yourself a  
stic bridge in a key location, and  
ublic will flock to your shores.



Appearing to levitate, the curved bridge deck never touches the cast-iron stay mast. Tuned mass dampers prevent it from vibrating.

of the day, and the future is bright. Now, what if that symbol could itself be a crucial piece of infrastructure

### Solution

In Swansea, the grand gesture is the Sail Bridge. Wilkinson Eyre, a London-based architecture firm, was selected for the project based on the strength of its preliminary design, a cable-stayed bridge that departs from conventional designs in several ways. Instead of creating a straight point-to-point span across the river, the deck curves gently around the mast (see plan, page 264). The 110-foot-tall tower leans toward the water at a significant angle, counterbalancing the deck in much the same way that a sailboat in the wind is kept from overturning by the weight in its keel. The bridge's sculptural shape, along with its semiradially fanned stay cables, gives it its distinctive maritime character.

The aluminum-topped deck sections are slender steel box girders designed to resist the torsion forces that develop as a result of the placement of the cables on one side of the deck. Tuned mass dampers keep the deck from vibrating under repetitive impact loads, such as those that might occur when joggers cross the bridge.

### Commentary

Architects often wish for an algorithm that can show clients that the return on investment for an exceptional, but perhaps costly, structure will be much greater than something plain that can perform the job equally well. Unfortunately, though the power of certain objects to attract people is very real, at the moment their return on investment can't be quantified. Clients and the public are extremely lucky when exceptional architects can persuade them that even if a job is only a footbridge, it will be there a long time—and that the grand gesture is worth the money. ■

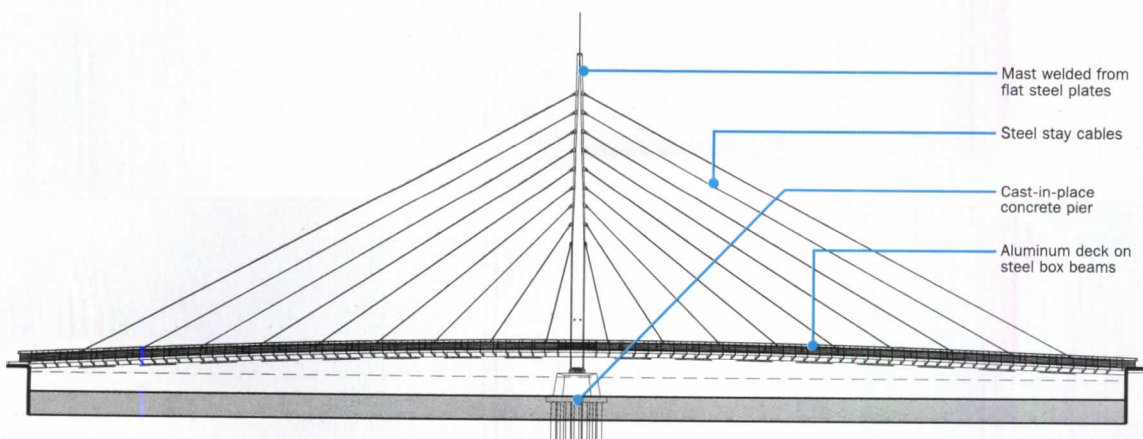

ELEVATION OF SAIL BRIDGE

0 50 FT.  
15 M.



# Houghton Park Pedestrian Skyway Corning, New York

## 8

**HASCUP/LORENZINI REVIVES THE SPIRIT OF THE BAUHAUS WITH AN ENCLOSED GLASS BRIDGE AND VISITORS' PAVILION FOR THE CORNING COMPANY.**

**By Suzanne Stephens**

**Architect:** Hascup/Lorenzini Associates—George Hascup, principal in charge of design; David Lorenzini, principal and project architect; Robert Manchester, Edsel Ramirez, designers; Jeremiah Fairbank, CADD designer  
**Client:** Corning Incorporated  
**Consultants:** Delta Engineers (m/e/p for skyway); Thomas Associates (m/e/p for visitor's pavilion); SureSpan Group (structural for bridge truss); Greg Dende (structural for visitors' pavilion); Amy Nettleton (landscape design for skyway); Trowbridge & Wolf (landscape architects for parking pavilion)

**Span:** 200 feet

**Cost:** \$3.5 million (skyway); \$2.2 million (visitors' pavilion)

**Completion date:** May 2003

#### Sources

**Steel bridge truss:** SureSpan Group

**Glass and metal curtain wall:**

Clayton B. Obersheimer

**Metal roofing and stainless-steel**

**perforated ceiling panels:** AccuFab

For more information on this project, go to Projects at [www.architecturalrecord.com](http://www.architecturalrecord.com).

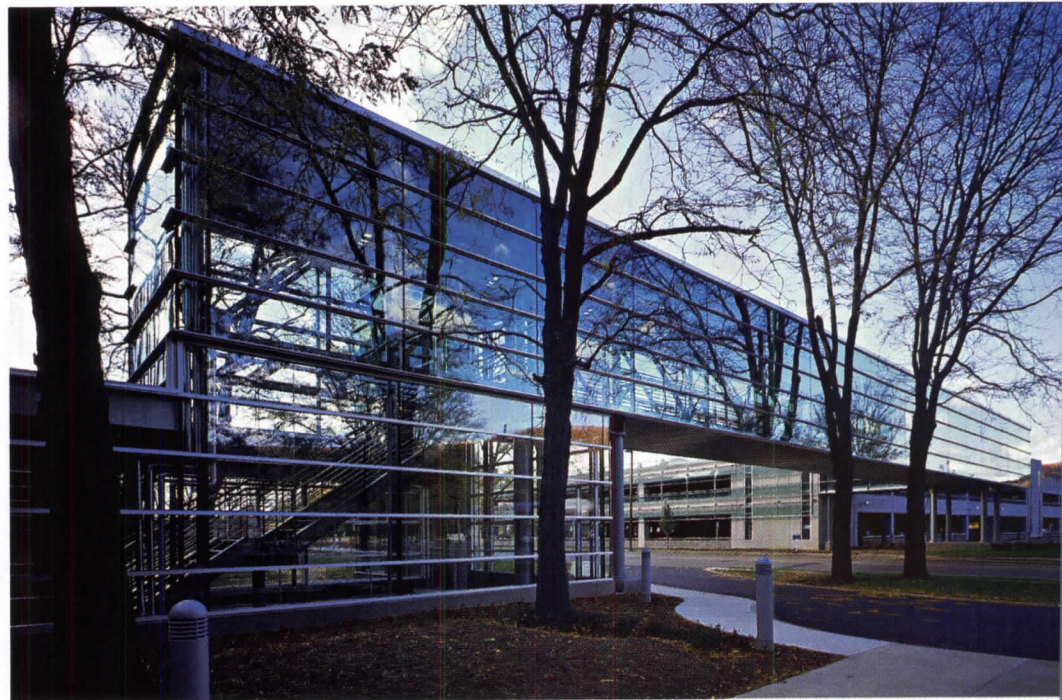

One doesn't usually expect a covered bridge to be made of glass. Unless it belongs to Corning Incorporated: Glass has been integral to the architectural identity of this company, located in upstate New York, since Harrison & Abramovitz designed the Corning Glass Center and Administrative Building in 1950–53. Then Corning bolstered the image with a glass museum by Gunnar Birkerts (1976), plus additional expansions by Smith-Miller Hawkinson (1992–2001), and even a headquarters complex across the Chemung River by Kevin Roche John Dinkeloo and Associates

(1993 and 1999). As the latest installment, Hascup/Lorenzini Associates (now George Hascup Associates and David Lorenzini Associates) designed a pedestrian bridge and a visitors' pavilion as part of the 5-acre Houghton Park, adjacent to the original complex.

Ironically, however, the glass used in the bridge is not made by Corning. The company once known as Corning Glass Works no longer produces architectural glass, having directed its interests to high-tech areas such as telecommunications components, ophthalmic products, and high-performance glass for tele-

vision and information display. Corning Steuben, renowned for its hand-blown-glass luxury objects, still has a factory at this location.

#### Program

Because of the influx of museum visitors in addition to Corning personnel, the company needed a 200-foot-long bridge to take pedestrians from a 700-car garage adjacent to the main boulevard, Poulteney Street, into the Corning campus. The cold, icy weather half the year called for an enclosed bridge. In addition, the company wanted

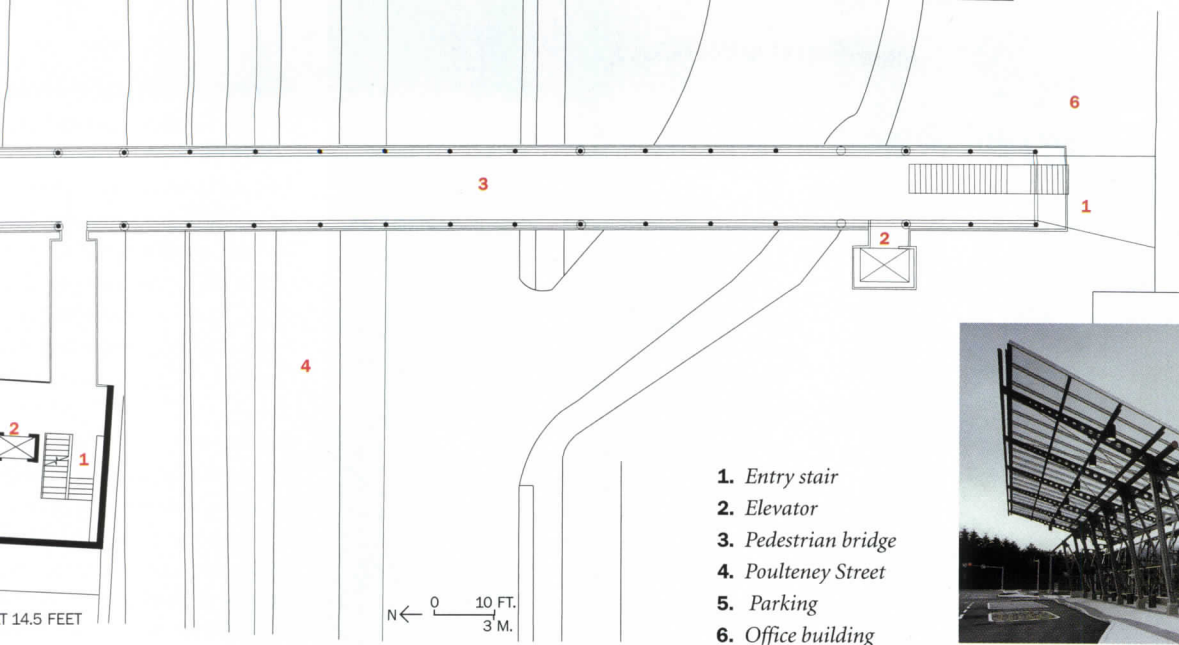

- 1. Entry stair
- 2. Elevator
- 3. Pedestrian bridge
- 4. Poultney Street
- 5. Parking
- 6. Office building



The glass canopy of the visitors' pavilion (above) shelters a triangular glass structure attached to a round concrete bathroom core. The skyway bridge (opposite) cantilevers at the north end (below), next to the parking garage.



The ceiling (above), on which slightly bowed, perforated-steel screens and a spine of crystal louvers are mounted, adds to the luminous effect of the elevated bridge. The long stair (right), with well-proportioned pipe rails and flat balustrade rails, creates a grand entrance at the south end, where the bridge connects to Corning's office buildings.

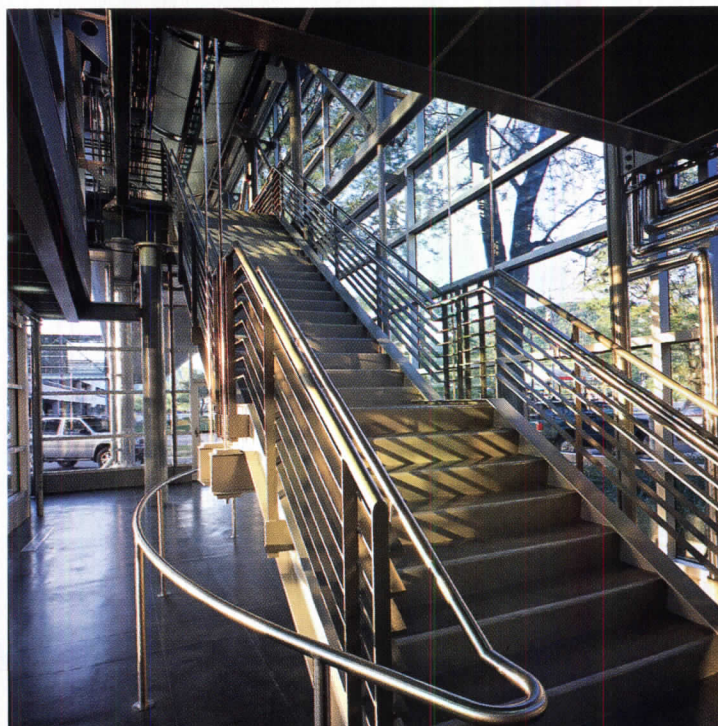

have a 4,500-square-foot visitor pavilion to provide orientation, service facilities, and a shuttle stop for the Roche Dinkeloo-designed headquarters. It turned to George Hascup, a professor of architecture at Cornell University, to provide the clean, modern lines displayed in the firm's Lake Source Cooling Pump Facility for the university (2002).

### Solution

The 3,600-square-foot elongated structure is composed of an 11-foot-square Vierendeel truss the largest size that could accommodate pedestrians yet still be trucked from the factory in West Vancouver, Canada. Horizontal mullions of the curtain wall further reinforce the long linear thrust of the bridge, which is cantilevered in true Bauhaus fashion at one end.

The interior of the 200-foot walkway is made more dramatic through the installation of shimmering perforated-steel screens on the ceiling. A spine of crystal louvers running down the middle refracts the light and emphasizes the sense of movement. "When I apprenticed with I. M. Roche and John Dinkeloo," Hascup says, "I worked on the TWA Terminal renovations at Kennedy Airport. Saarinen's beautifully curved sculpture of the tubular link at TWA fostered a sense of dynamism that I hope to recreate here."

Even though the bridge is insulated, cooled and heated, the ceiling screens reduce heat gain, as do the side panels of pale green glass with a low-e coefficient. "The light green relates the bridge to other Cornell buildings," Hascup says.

### Commentary

While this bridge is not the awe-inspiring engineering feat of, say, long-span bridges held together with threads of steel, the pristine and elegant manipulation of glass and concealing the Vierendeel truss for the bridge is impressive. The architectural contribution is particularly notable for its balance of proportions in such elements as the truss chords, gusset plates and mullions. ■

# The Older your Maple Sports Floor Gets, the Smarter you Look.

Over its long lifetime, MFMA maple sports flooring can cost you up to 40% less overall versus synthetic.\* That's value. But maple's true value goes well beyond longevity and lower cost. It offers unrivaled aesthetic beauty, and unmatched playability, too. And unlike synthetics maple is easily and economically restored. So every year your maple sports floor outperforms synthetics, you'll know you made the rightest choice possible.

*MFMA maple...  
the #1 choice for  
winning value.*

*[www.maplefloor.org](http://www.maplefloor.org)*

Ducker Research Co., Inc.



M F M A

Maple Flooring Manufacturers Association, Inc.



60 Revere Drive, Suite 500, Northbrook, IL 60062 | phone 847-480-9138  
e-mail [mfma@maplefloor.org](mailto:mfma@maplefloor.org) | website [www.maplefloor.org](http://www.maplefloor.org)

©2003 Maple Flooring Manufacturers Association, Inc. All Rights Reserved.

CIRCLE 138 ON READER SERVICE CARD OR GO TO [WWW.LEADNET.COM/PUBS/MHAR.HTML](http://WWW.LEADNET.COM/PUBS/MHAR.HTML)

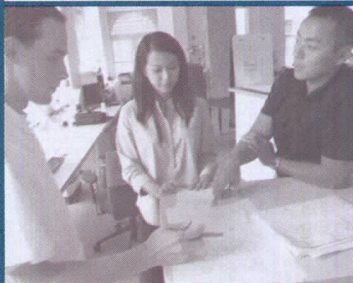

→ Access the latest, most comprehensive information on today's architecture marketplace

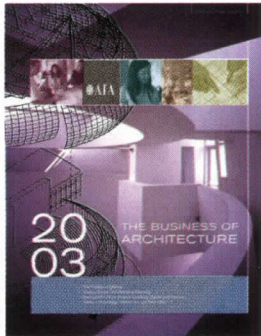

THE BUSINESS OF ARCHITECTURE:  
2003 AIA FIRM SURVEY

*The Business of Architecture* is the most reliable source of information on the business practices of U.S. architects. Responses from architecture firms nationwide have been compiled to bring you the latest financial benchmarks and management strategies of AIA-member-owned firms.

Major topics include:

- Financial Performance
- Services and Sectors
- Marketing Spending
- Professional Liability
- Technology Investment
- International Practice

This all-new report, compiled by The American Institute of Architects, organizes findings by region and firm size and includes charts and tables for fast, easy access to the information you need to stay competitive.

- To order your copy, go to [aia.org](http://aia.org) and click on AIA Store or call 800-365-2724.

AIA members: \$125/PDF, \$150/book  
Retail: \$329

→ Available NOW!

20  
03



# Architectural Technology

Bold results from designers who dare to collaborate, with technology as a common language

## CONTENTS

- 279 **Building Science: A tale of two bridges**
- 289 **Mass transit gets the designer treatment**
- 296 **Zoom In: Bahá'í Temple**
- 299 **Tech Briefs**
- 305 **Tech Products**



Concrete canopies shelter passengers at a light-rail station (289).

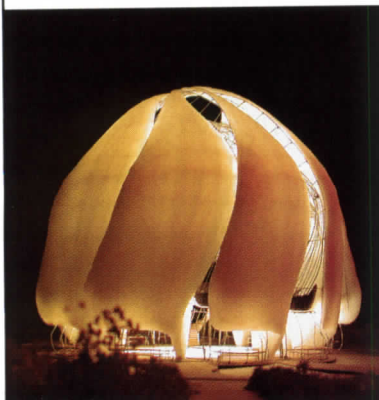

A nine-sided structure, draped in alabaster, takes shape in Chile (296).

**W**hat happens when architects and engineers team up on a design? In the stereotypical scenario, tensions run high in opposing camps. Architects decry how engineers whittle away at design intent and aesthetic quality for the sake of efficiency and budget; engineers, largely trained to analyze the efficacy of a given structure with little regard for its program or overall composition, agitate impatiently as architects ponder options for siting, form, material. Fortunately, this shopworn script has undergone a rewrite by today's best practitioners, who have jettisoned finger-pointing and assumptions about the role of each profession in favor of setting common goals from the outset of a project and staying true to them throughout its execution. Often, technology serves as the starting ground, becoming the basis for experimentation and execution.

This month we highlight the fruits of this collaboration. Bridge design, for instance, has evolved enormously with 3D CAD and advanced structural analysis for nonorthogonal forms. The pedestrian bridges shown in the Building Science feature demonstrate that, far from being simple pathways connecting disparate points, bridges can now define the void space between destinations in unique, even exuberant, ways. The feature on mass transit catalogs options for travel by means other than the beloved-yet-beleaguered passenger vehicle, and showcases transit shelters and stations whose bold forms could be emblems of an emerging trend, one that could be termed "transit density" (even freeway-centric Houston recently opened a light-rail surface transit system). Finally, in Zoom In, we examine a temple whose organic design (an exotic mushroom? a graceful sea creature?) evolved from rigorous computer modeling and analysis by an architect-engineer team in Toronto, with guidance from some technophiles in Los Angeles (we'll let you read who they are).

With projects that imply movement and motion, these designers are shaking up the status quo. *Deborah Snoonian, P.E.*

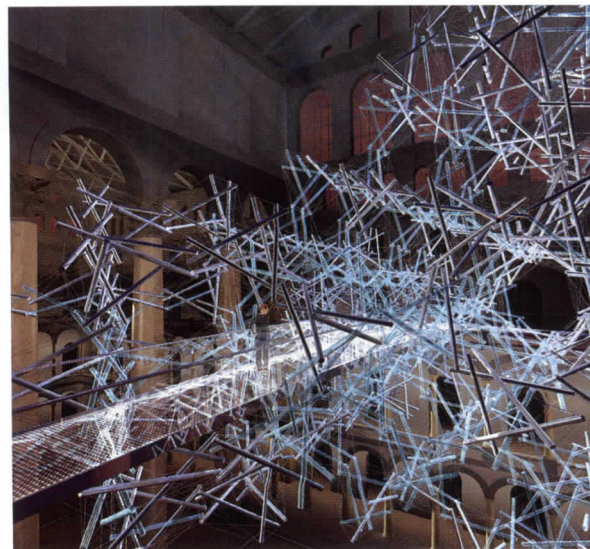

(280)

# ACCESSORIZE



Visit us at AIA Show  
June 12-15 in Booth 1592

Alaco Rolling Ladders  
in any color or in an  
of wood grains and me

Rolling Ladders from Alaco enhance access, safety, style and convenience. They are custom made to your design specifications. Whether you want elegance or utility, Rolling Ladders are an ideal way to accessorize.



## NECESSORIZE

For required access applications, Alaco manufactures sturdy, safe aluminum ladders that satisfy OSHA requirements and meet ANSI standards. To request a free architect's binder and CD, email [sales@alacoladder.com](mailto:sales@alacoladder.com).

CIRCLE 143 ON READER SERVICE CARD  
OR GO TO [WWW.LEADNET.COM/PUBS/MHAR.HTML](http://WWW.LEADNET.COM/PUBS/MHAR.HTML)



**Alaco**  
Ladders  
888.3  
www

# Architects Discover Bridge Design Can Be the Perfect Union of Art and Science

ARCHITECTS AND ENGINEERS ARE TRUE COLLABORATORS IN THIS SUBSET OF ARCHITECTURE

Sara Hart

Most bridges are seen as utilitarian instruments built to traverse an irregular terrain in a regular way. So logical is this process that most bridges can be diagrammed as a straight line announcing the shortest distance between two points. Bridges are all structure—form following function in the most literal way. Yet, despite the obvious connections to engineering, there are numerous examples that suggest bridge design is a subset within architectural building types, as well. When an architect and engineer enter into a true collaboration, where there is design parity, the results are often stunning, as evidenced by this issue's collection of outstanding pedestrian bridges (page 247). Two of them are examined more closely here in order to demonstrate the connection between art and science.

## Arrested movement

The enduring quality of many bridges is their sense of "arrested movement," writes Jim Eyre, partner at London-based Wilkinson Eyre Architects, a firm renowned for its pedestrian bridges. "What can imply more movement than the curved lines of an arch or a suspension catenary? The geometry of the structure is obviously important in this regard, but the sense that all of the various elements are juxtaposed in a dynamic counterpoise—where balance is only just maintained, some-



The Floral Street Bridge in Covent Garden is a "twisted concertina" joining the Royal Ballet School with the Royal Opera House.

## CONTINUING EDUCATION

Use the following learning objectives to focus your study while reading this month's ARCHITECTURAL RECORD/AIA Continuing Education article. To receive credit, turn to page 286 and follow the instructions. Other opportunities to receive Continuing Education credits in this issue include the following sponsored sections: "Window Installation," sponsored by JELD-POWEN, page 311; "Italian Tile," sponsored by the Italian Trade Commission, page 317; and "New Tools for Specifying Architecturally Exposed Structural Steel," sponsored by the American Institute of Steel Construction (AISC), page 323.

## LEARNING OBJECTIVES

- After reading this article, you should be able to:
- Discuss unusual artistic design of recent bridge projects.
- Explain the concept of arrested movement.
- Describe the construction of the box beam used in these bridges.

For more continuing education, as well as links to sources, white papers, and products, go to [www.architecturalrecord.com](http://www.architecturalrecord.com).

where close to the limits—is crucial, too."

Wilkinson Eyre arrested movement artfully with its Floral Street Bridge in London's Covent Garden district (page 260). The bridge connects the Royal Ballet School with the Royal Opera House. Ballet students training to attain a certain dynamic counterpoise of their own will use this walkway four floors above the street to get from the practice studio in the school to center stage at the opera house.

The bridge spans 31 feet, which is not particularly formidable as spans go. However, engineering gets more complicated when the architecture deviates from the orthogonal, as it does dramatically in this case, prompting the figurative description of the structure as a "twisted concertina."

The single structural component that governs all other elements in its construction is the box beam, also called the spine, which runs the distance between the two buildings and supports the deck surface, the secondary structure, and all other loads. Generally referred to as a "simple" beam, the eccentricities of the bridge enclosure required complex 3D modeling to solve the issue of both the slope (about 2 feet) and the rotation of the frames (about 13 feet over the span). In the final solution, the engineers ended up with a beam that is anything but simple. It is defined by thin rectangles at each end, which morph into an equilateral triangle at the center (see section, page 280).

The beam is an aluminum box made up of flat plates welded

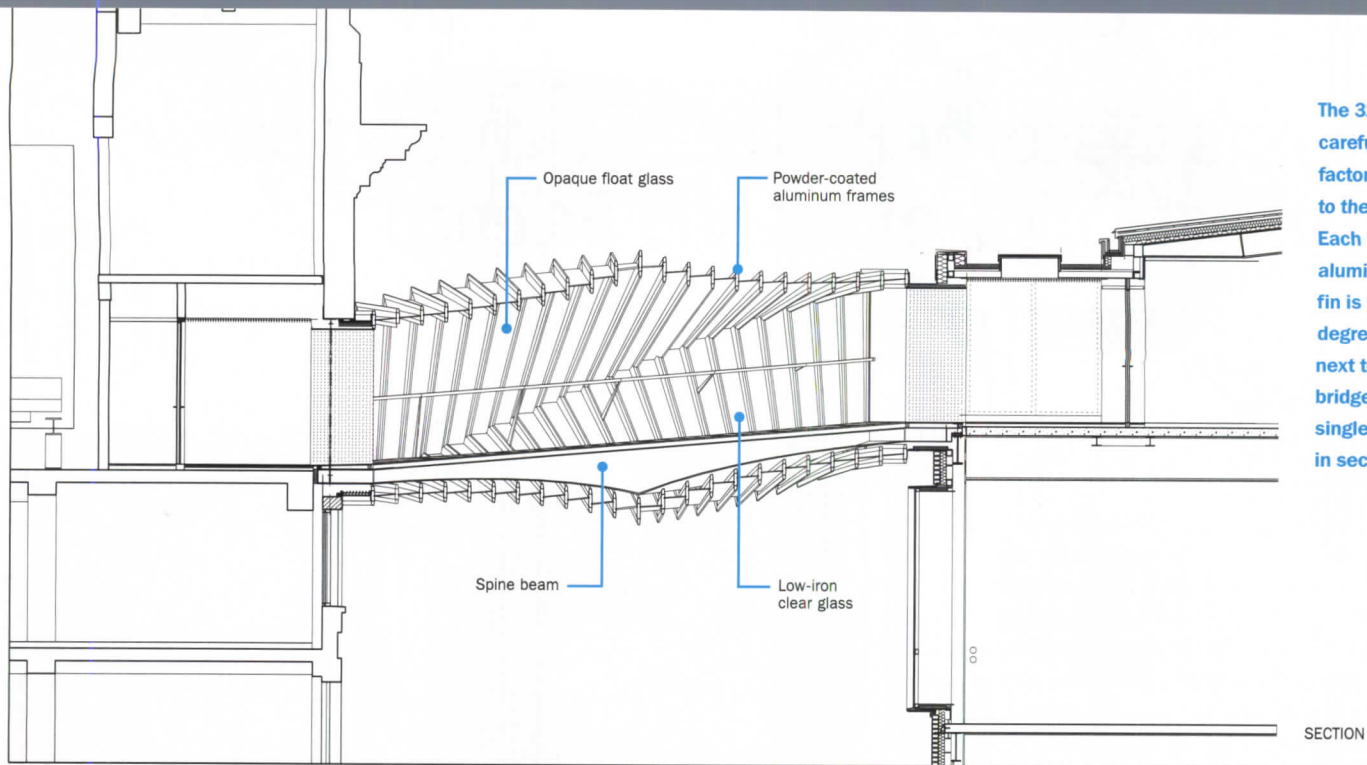

The 31-foot bridge was carefully crafted in a factory and delivered to the site in sections. Each powder-coated aluminum and timber frame is rotated at various degrees from one frame next to it. The bridge is supported by a single box beam in section at the base.

The bridge is lit from within (far right) by LEDs mounted on brackets in the upper corners of the portals.

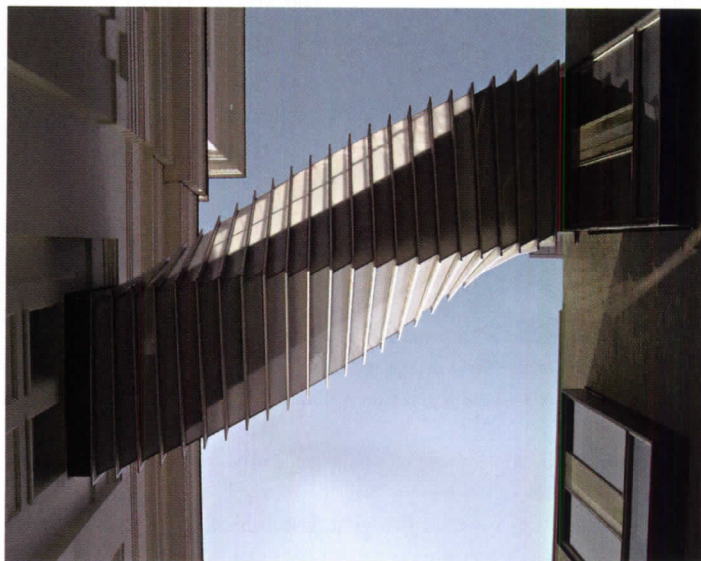

onto extruded sections of varying geometry, which are bolted together to form the complete beam. Before settling on aluminum, which is lightweight and durable, the design team considered other materials. Ian Firth, partner at the London-based Flint & Neill Partnership, the engineers for the project, explains, "The materials had to be lightweight, because there was a limit to the loads that could bear on either building. We considered stainless steel, which could have been thinner, because of its higher strength and stiffness, and, therefore, as light as aluminum." In the end, they rejected stainless steel along with glass-fiber-reinforced polymer, because the cost of both was considerably more than the cost of aluminum.

The beam, fabricated in Austria, was shipped to a factory in West London, where it was clad with powder-coated aluminum and timber frames, also called portals or fins, and then glazed with either opaque float glass or low-iron clear glass. The square frames are attached to the aluminum beam by pairs of simple brackets on each side of the beam. These brackets secure the bottom corners of the frame and have slots to

allow thermal expansion and contraction, as well as ventilation. The panels are fixed between the frames using structural silicone.

Maintenance issues were a large concern, especially considering how integrated all the components are. Because the spine supports the elements, none of the frames is dependent on the one adjacent to it.

**"MATERIALS HAD TO BE LIGHTWEIGHT, BECAUSE THERE WAS A LIMIT TO THE LOADS THAT COULD BEAR ON EITHER BUILDING."**

port or stiffness. This means that individual frames or their glass sections can be replaced if necessary without compromising the overall structural integrity. Early on in the design process, the team realized that achieving this structural objective, as well as ensuring stability within the frames, required that the beam be engineered to absorb live-load deflections in order to minimize movement in the frames.

Factory prefabrication had two advantages. First of all,

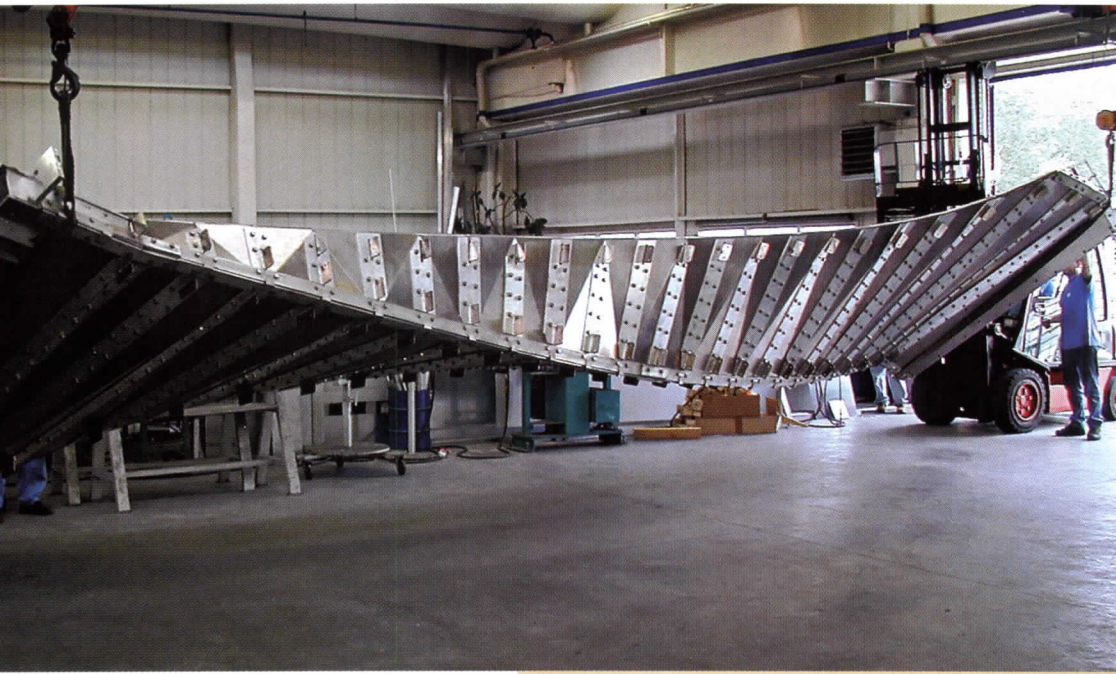

The box beam was fabricated in Austria, then shipped to a factory in West London, where the aluminum and wood fins, or portals, were attached (left and below), then glazed.



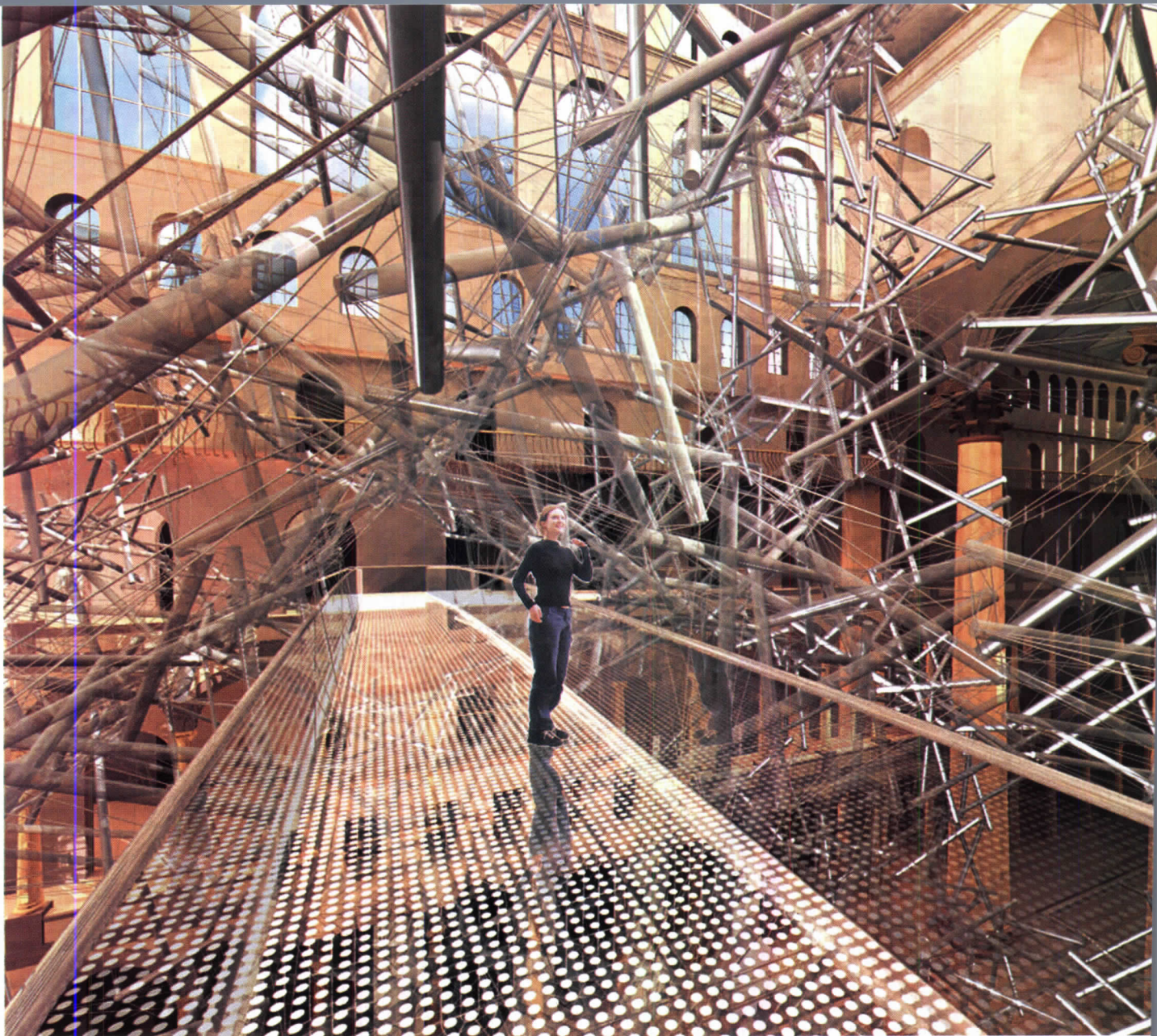

details and the connections have the craftsmanship of fine cabinetry. Secondly, the assembled bridge could be delivered to the site in one piece and installed in 2 hours, limiting disruption of a busy site in central London.

Arrested movement continues to be a theme for Wilkinson Eyre. In a project currently in development, the architects are designing

## A STRUCTURE HAS TENSEGRITY IF ITS ELEMENTS ARE BALANCED IN TENSION AND COMPRESSION AND RESISTANT TO TORQUE.

a bridge to span 116 feet across the giant hall of the National Building Museum in Washington, D.C. The Advanced Geometry unit at Arup's London office is engineering the bridge as a "tensegrity" structure. Buckminster Fuller invented the term *tensegrity* to describe the structural principle behind his geodesic domes; it's the contraction of *tensional integrity*. A structure has tensegrity if its elements are balanced in tension and compression and resistant to torque. Tensegrity structures reappear from time to time, either in commercial applications [RECORD,

May 2002, page 267] or in experimental ones, such as the project at a museum. At this stage, the idea is emerging as a matrix of cable struts equipped with stress gauges, which will record live loads and the signals to a computer, which will turn them into a pedestrian-generated light show.

### Bridge over neglected waters

The Webb Bridge in the Melbourne Docklands (page 248) has a common with the Floral Street Bridge a half a world away—complex geometry, off-site fabrication, the same Austrian bridge subcontractor and a continuous box-beam structural system. It also required a close collaboration between the architect, Denton Corker Marshall (DCM) and the engineer, Arup. Furthermore, the bridge was to incorporate elements of an old railway bridge, abandoned in the River Yarra and no longer attached to the shore.

The Melbourne team also included artist Robert Owen, whose idea for the bridge was inspired by an eel-fishing trap, a reference to a type used by Aboriginal people who lived at the site 200 years ago. At Floral Street, the design process began with 3D computer modeling

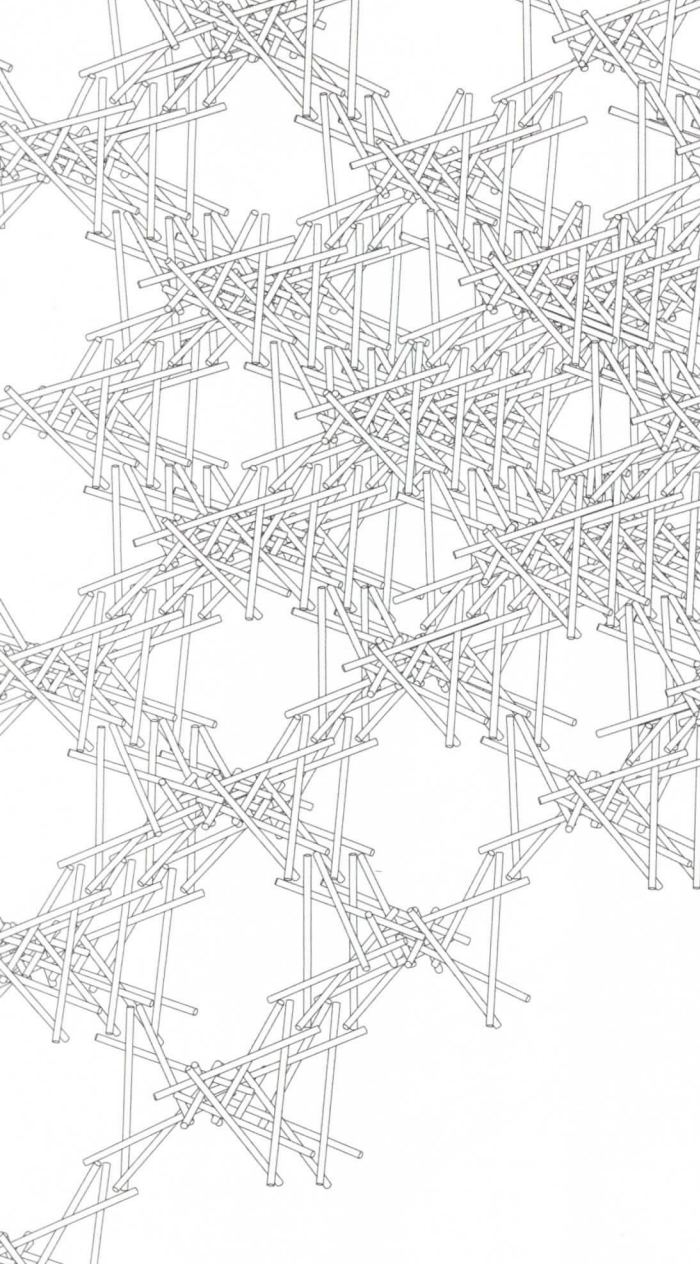

Wilkinson Eyre and Arup are developing a pedestrian bridge to span the 116 feet across the Great Hall at the National Building Museum in Washington, D.C. Still in the conceptual

stage, it will be a tensegrity structure, the physical embodiment of Buckminster Fuller's theory of continuous tension and discontinuous compression, which results in tensile integrity.

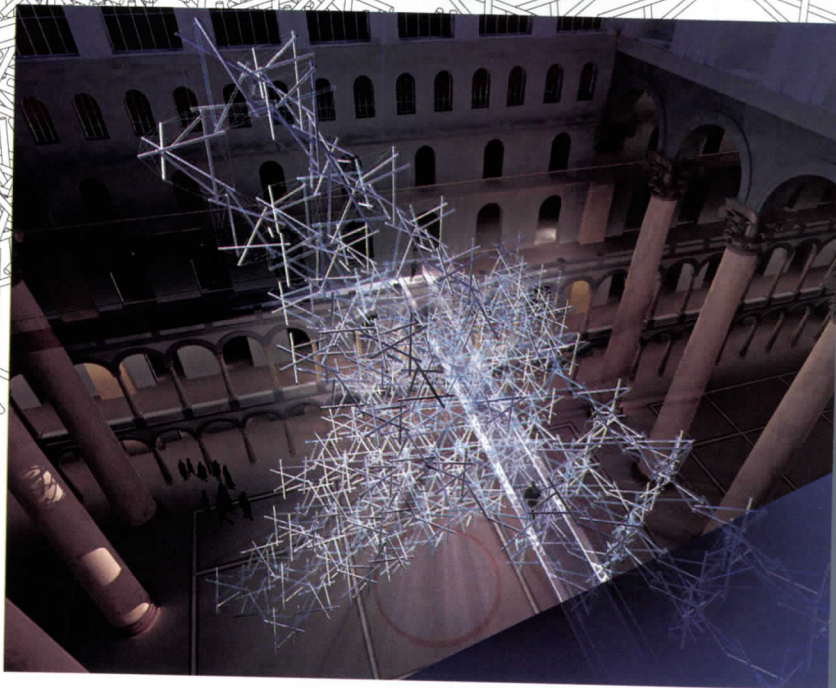

concept—in this case, the artist's sketch.

The new bridge is constructed of a concrete ramp sitting atop a box beam, which, in turn, rests over the existing railway bridge piers. This main structure is then enclosed by an elaborate latticework of curved, flat, laser-cut strips of steel. DCM developed the geometry using parametric modeling to determine the size and spacing of the straps and hoops that made up the open-weave design. Parametric base models were defined by simple physical parameters; the designer can change the parameters and the model updates itself automatically. This allowed the architects to explore multiple iterations rapidly until the desired effect was achieved. The data was simultaneously entered into a CAD model, which was used to locate the hoops along the ramp's path. This tool immediately determined clearances both internally over the ramp and externally over high-tide water level.

The geometry of the bridge, a hairpin ramp of varying width and turning in three-dimensions, enclosed with steel hoops and a cladding of varying radii and spacings, meant that almost every component was unique. The collaboration soon expanded to include a drawing specialist and a fabricator, as it became obvious that their

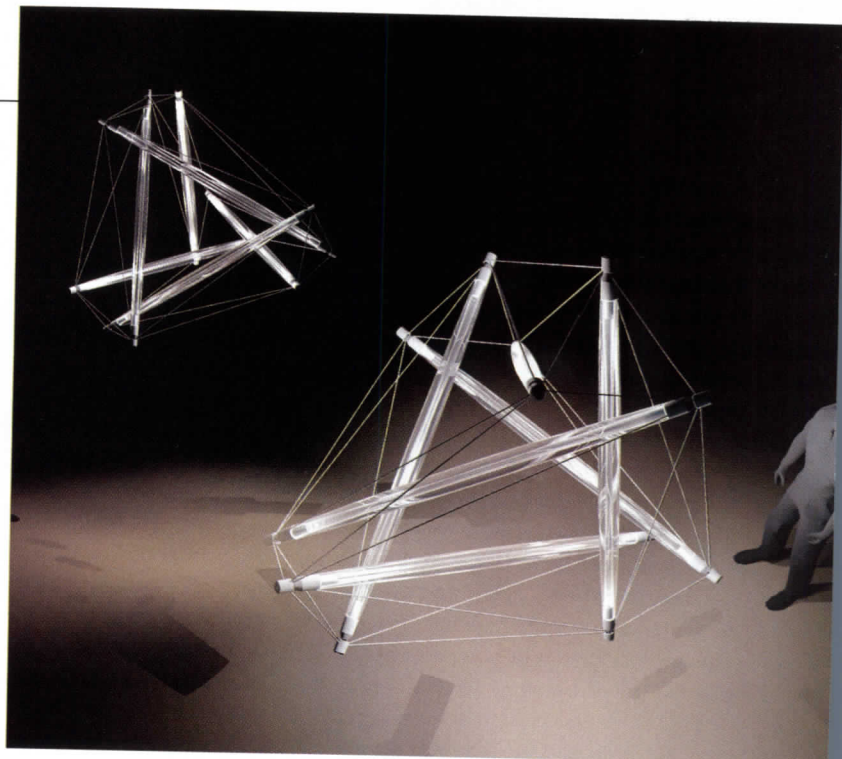

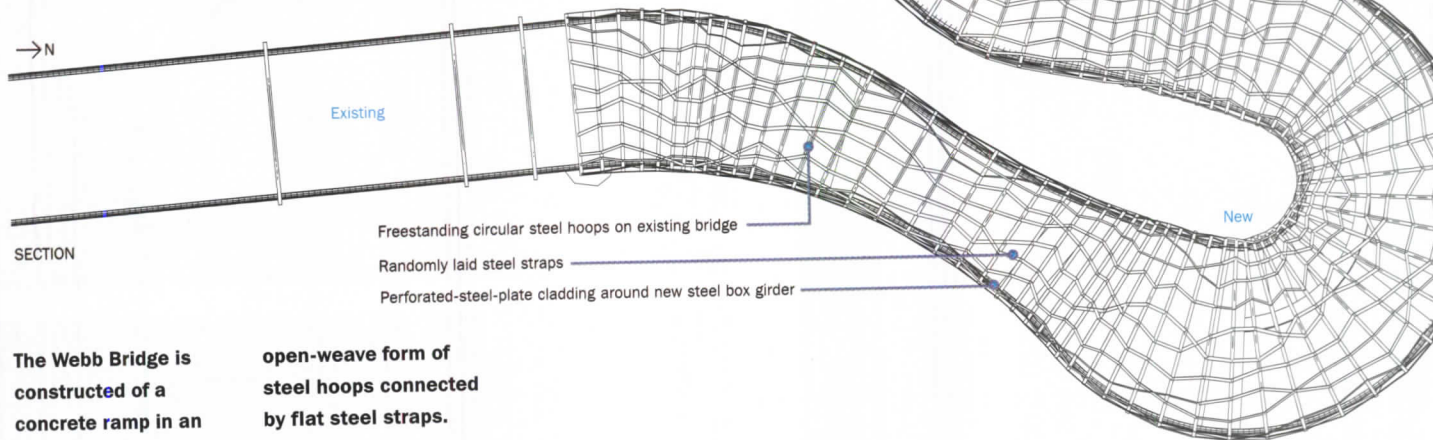
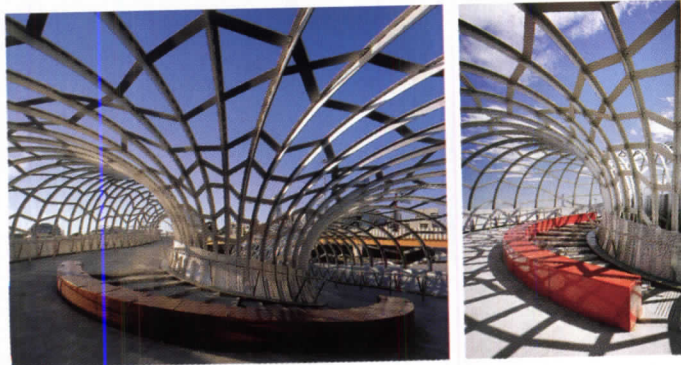
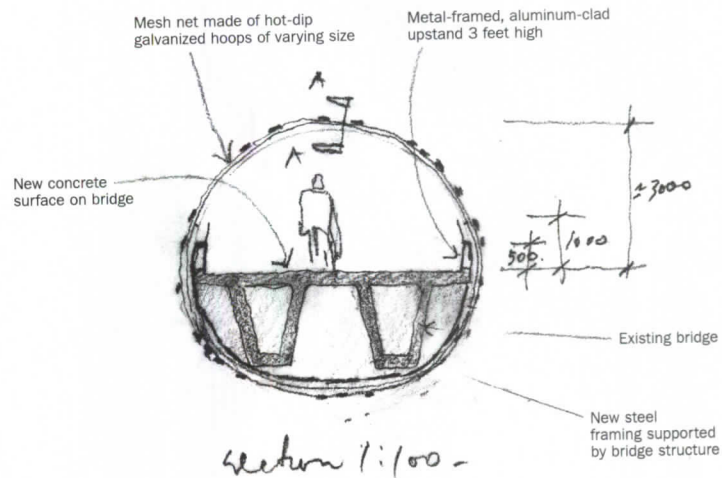

The Webb Bridge is constructed of a concrete ramp in an open-weave form of steel hoops connected by flat steel straps.

expertise would be needed from the beginning.

All team members reviewed and developed the documents through each stage, to ensure the scheme stayed within budget without diluting the design objectives. In this way, the cost of what Australians call “design-development risk” was eliminated from the process. At the same time, the team made sure the steel supplier understood the design’s complexity well enough to keep prices within an acceptable range.

The 3D CAD design model was developed by DCM and passed to the fabricator and his shop-drawing specialist, Precision Design. With the close involvement of Peter Bowtell, principal in Arup’s Melbourne office, the structural components were developed in three dimensions. These consisted of the large steel box girders and primary substructure, and later the hoops, straps, and cladding supports. At all times, the components were reviewed against the architect’s CAD model to ensure the design envelope was not compromised and the design integrity was maintained. Individual shop drawings were created in 3D CAD and used to drive CAD-based plasma cutters.

As with Floral Street, prefabrication was appealing. The steel

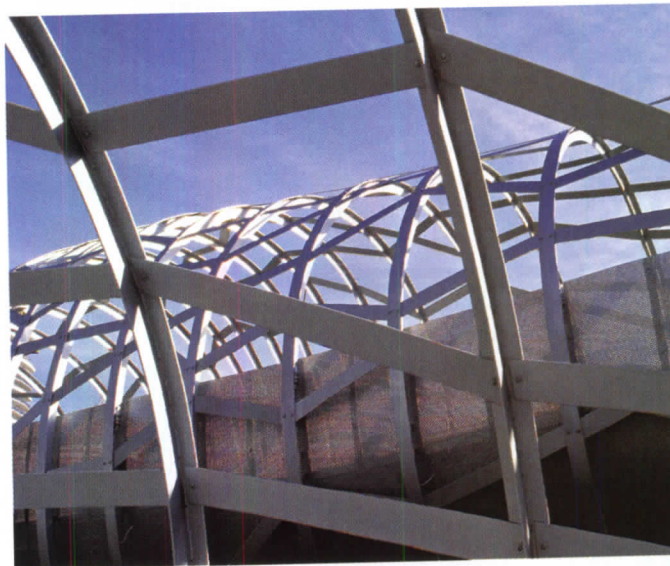



# When it comes to completing projects, it's the complete package.



Revised\_Plans.pdf

Dell recommends Microsoft® Windows® XP Professional for Business

**Dell Precision™ workstations with Adobe® Acrobat® 6.0 Professional software – you couldn't have designed it better yourself.**

Featuring high-performance processors, certified OpenGL graphics, and up to 4GB of memory;<sup>43</sup> Dell Precision workstations are capable of handling most complex engineering software and documents. But it gets even better when you add the latest Adobe® Acrobat® 6.0 Professional, with features to help streamline your document exchange, review and mark-up, as well as get your projects to market fast. Best of all, Dell Precision™ workstations are ISV-certified to run industry-leading CAD applications and backed by dedicated 24x7 service and support. No wonder it's the number one selling workstation in the nation\* Dell Precision™ workstations with Adobe® Acrobat® 6.0 Professional software – the engineering package that was engineered for professionals like you.

## DELL PRECISION™ 360 WORKSTATION

### Maximum Performance, Single Processor Workstation

- Intel® Pentium® 4 Processor with HT Technology at 3.20GHz and 800MHz Front Side Bus
- Microsoft® Windows® XP Professional
- **Adobe® Acrobat® 6.0 Professional (Save \$150)**
- **FREE Upgrade to 1GB Dual-Channel DDR SDRAM for the price of 512MB Dual-Channel DDR SDRAM\***
- 120GB SATA (7200 RPM) Hard Drive
- 8x DVD+RW/+R<sup>41</sup>
- **FREE Upgrade to 128MB NVIDIA® QuadroFX 500 for the price of 64MB NVIDIA® Quadro NVS 280 Graphics Card**
- 3-Yr Next Business Day On-Site Service<sup>42</sup>

Regular Price After \$150 Discount

**\$2249 \$2099**

Monitor Not Included  
Lease as low as **\$56/mo.** (48 pmts.<sup>44</sup>)  
E-VALUE Code: 21989-S40622a

### Recommended Upgrades:

- 3-Yr Same Day (5X10) On-Site Service<sup>42</sup>; add \$199
- 19" Dell™ UltraSharp™ 1901FP Flat Panel Display, add \$699

## DELL PRECISION™ 650 WORKSTATION

### Maximum Scalability, Dual Processor Capable Workstation

- Dual Intel® Xeon™ Processors at 2.80GHz
- Microsoft® Windows® XP Professional
- **Adobe® Acrobat® 6.0 Professional (Save \$150)**
- **FREE Upgrade to 1GB Dual-Channel DDR SDRAM for the price of 512MB Dual-Channel DDR SDRAM\***
- 120GB SATA (7200 RPM) Hard Drive
- 8x DVD+RW/+R<sup>41</sup>
- **FREE Upgrade to 128MB NVIDIA® QuadroFX 500 for the price of 64MB NVIDIA® Quadro NVS 280 Graphics Card**
- 3-Yr Next Business Day On-Site Service<sup>42</sup>

Regular Price After \$150 Discount

**\$3849 \$3699**

Monitor Not Included  
Lease as low as **\$98/mo.** (48 pmts.<sup>44</sup>)  
E-VALUE Code: 21989-S40636a

### Recommended Upgrades:

- 3-Yr Same Day (5X10) On-Site Service<sup>42</sup>; add \$199
- 20" Dell™ UltraSharp™ 2001FP Digital Flat Panel Display, add \$989

Combined offers  
valid 6/10/04 - 7/07/04.

Working more efficiently. Easy as



Click [www.dell.com/smb/adobeoffer](http://www.dell.com/smb/adobeoffer) Call 1-877-983-3355

toll free

at 8a-5p, CT

ons, availability and terms of offer may change without notice. Taxes, fees and shipping charges extra, and vary and not subject to discounts. U.S. Dell Small Business new purchases only. In case of customers leasing under these promotions, please note will be subject to applicable end-of-lease options or requirements. Dell cannot be held responsible for pricing or other errors, and reserves the right to cancel orders arising from such errors. <sup>43</sup>Based on IDC Tracker results. <sup>44</sup>Service may be provided by an will be dispatched, if necessary, following phone-based troubleshooting. Subject to parts availability, geographical restrictions and terms of service contract. Service timing dependent upon time of day call placed to Dell. <sup>45</sup>Monthly payment based on et Value ("FMV") QuickLease and does not include taxes, fees and shipping charges. Your monthly payment may vary, depending on your creditworthiness. QuickLease arranged by Dell Financial Services L.P. ("DFS"), an independent entity, to qualified Small Minimum transaction size of \$500 required. At the end of the FMV QuickLease, you can: purchase the equipment for the then FMV, renew the lease or return the equipment to DFS. Please contact your DFS representative for further details. All terms subject nd availability, and are subject to change without notice. <sup>46</sup>The total amount of usable memory available will be less than 4GB, depending on the actual system configuration. <sup>47</sup>Free memory not to surpass 1GB. <sup>48</sup>DVD+RW and DVD+RW/+R Drives: Discs e may not be compatible with some existing drives and players; using DVD+R media provides maximum compatibility. Dell, the stylized E logo, E-Value, and Dell Precision are trademarks of Dell Inc. Intel, Intel Centrino, Intel Xeon and Pentium are trademarks rks of Intel Corporation or its subsidiaries in the United States and other countries. Microsoft and Windows are registered trademarks of Microsoft Corporation. Adobe, the Adobe Logo and Acrobat are either registered trademarks or trademarks of Adobe d in the United States and/or other countries. ©2004 Dell Inc. All rights reserved.



The Webb Bridge was towed on a barge to the site on the River Yarra.

fabricator suggested towing the completely assembled bridge into position over water. This saved significant money on the anticipated floating-crane costs and site-assembly time. As the project architect recalls, “It was this joint sharing of ideas and approaches that meant that everyone ‘won’ in the process.”

Rather than ship the assembled bridge across Port Philip Bay from Geelong to Melbourne (47 miles), the design team, at the suggestion of the fabricator, decided to assemble the components at an empty quay within the Melbourne Docklands. The box girders, outrigger substructure, ramp deck, hoops, and cladding supports were assembled as a giant

three-dimensional jigsaw puzzle on three connected barges. Much of the straps and all of cladding sheets were left off at this stage.

Very early one morning during high spring tide, the barges were slow-towed to the site by a tugboat. Because the bridge weighed hundreds of tons, coordination and precision became imperative. As the barges were maneuvered into place, and the tide dropped, the bridge lowered into position and rested on the end of the existing bridge, pier, and quayside. The window of opportunity was very small, with only a few hours to complete the process. If they had

secured the bridge in place that day or the next, the tides would be low for the next several weeks. The extensive lighting facilities, steel cladding panels, handrails, concrete deck, and the remainder of the bridge were subsequently installed in a few days.

Bridge design offers the architect a course in craftsmanship. As shown here, detailing bridges involves risk. Expectations of accuracy are higher than in many building types, and as a result, commonly accepted tolerances shrink out of view. Technological and computational advances notwithstanding, bridges offer architects the experience of a raw discipline. ■



## AIA/ARCHITECTURAL RECORD CONTINUING EDUCATION

### INSTRUCTIONS

- ◆ Read the article “Architects Discover Bridge Design Can Be the Perfect Union of Art and Science” using the learning objectives provided.
- ◆ Complete the questions below, then fill in your answers (page 384).
- ◆ Fill out and submit the AIA/CES education reporting form (page 384) or download the form at [www.architecturalrecord.com](http://www.architecturalrecord.com) to receive one AIA learning unit.

### QUESTIONS

1. Bridges are usually described in all of the following ways except which?
  - a. function following form
  - b. a straight line between two points
  - c. a way to traverse an irregular terrain
  - d. form following function
2. Which is the best description of Wilkinson Eyre’s arrested movement?
  - a. the graduated curves of an arch
  - b. balance that is only just maintained
  - c. ballet students training to attain counterpoise
  - d. a twisted concertina
3. The deciding factor in selecting aluminum over stainless steel and glass-fiber-reinforced polymer for the Floral Street Bridge box beam was which?
  - a. light weight
  - b. high strength
  - c. thinness
  - d. low cost
4. The aluminum beam was designed to absorb live-load deflections for which reasons?
  - a. for easy replacement of the glass sections
  - b. to minimize movements in the frames
  - c. to keep adjacent frames stiff
  - d. to keep the glass sections from breaking
5. The advantages of prefabrication of the Floral Street Bridge are all of the following except which?
  - a. high craftsmanship of the connections and details
  - b. delivery to the site in one piece
  - c. less disruption if a busy site
  - d. avoid taxation by shipping from another country
6. Buckminster Fuller’s term “tensegrity” is described as which?
  - a. a combination of tension and integrity
  - b. elements balanced in tension and compression
  - c. resistance to torque and compression
  - d. elements balanced in tension and compression and resistant to torque
7. Which of these elements is true for the Webb Bridge, but not for the Floral Street Bridge?
  - a. it began with 3D computer modeling
  - b. it was prefabricated in Austria
  - c. it incorporates fragments of an old abandoned bridge
  - d. they had to wait several weeks to secure the bridge into place
8. What tool allowed the architect of the Webb Bridge to explore multiple iterations rapidly?
  - a. 3D CAD modeling
  - b. parametric modeling
  - c. laser cutting
  - d. CAD-based plasma cutters
9. The “design-development risk” factor was eliminated from the Webb Bridge by what means?
  - a. a shop drawing specialist and a fabricator were added to the design team
  - b. the team made sure the steel supplier understood the design’s complexity
  - c. all the team members reviewed and developed the documents through each stage
  - d. shop drawings were created in 3D CAD
10. After the Webb Bridge was towed to the site, which of the following happened?
  - a. it was raised into place as the tide came in
  - b. it was lowered into place as the tide went out
  - c. the bridge was positioned onto a new bridge pier
  - d. they had to wait several weeks to secure the bridge into place

# Mass Transportation to Get Sleek and Daring

ARCHITECTS ARE BEING CHALLENGED TO PRODUCE TRANSIT SHELTERS AND STATIONS THAT ARE AS INNOVATIVE AS THE NEW AND IMPROVED SYSTEMS OF MOVING PEOPLE AROUND THE COUNTRY

Barbara Knecht

Strangling traffic notwithstanding, cars are still the preferred mode of transportation, especially in the U.S. And why not? Roadways are, for the most part, smooth and ubiquitous. Internet, telephone, and movies are available at the touch of a button from the comfort of your zone-climate-controlled seat. Even for busy commuters who take public transit from the suburbs into the city, an automobile is required to deliver them to the bus or rail station. Americans, among citizens of the car-dependent nations, are particularly wedded to the convenience of driving, as evidenced by U.S. Department of Transportation statistics, which state that 89 percent of

commuters drive to work alone.

Everyone is aware of the downside to this convenience. Besides the rising cost of gasoline, traffic congestion is a huge drain on both productivity and energy conservation. The average urban rush-hour driver spends about 62 hours a year stuck in traffic, which translates to 5.7 billion gallons of wasted fuel and a cost to the economy of \$70 billion dollars annually.

And yet, innovative technology is emerging that promises to make surface transport on roadways and railways more energy-efficient, reliable, and comfortable—from smoother rides on faster trains to sleeker buses with smart systems to keep them running on time, attractive alternatives to automotive transportation. The architecture of shelters and stations, which supports rail and road transit, is just starting to feed off

Senior ARCHITECTURAL RECORD contributor Barbara Knecht is an architect and writer based in New York and Boston.



Architects Samyn and Partners used a combination of fiberglass and steel fabrics to create canopies for the elevated Erasme Metro station in Brussels, which opened in September 2003.

1. Louvers and glazing
2. Grate
3. Ductal rain trough
4. Ductal canopy
5. Glazing
6. Outriggers
7. Ductal brackets
8. Ductal column

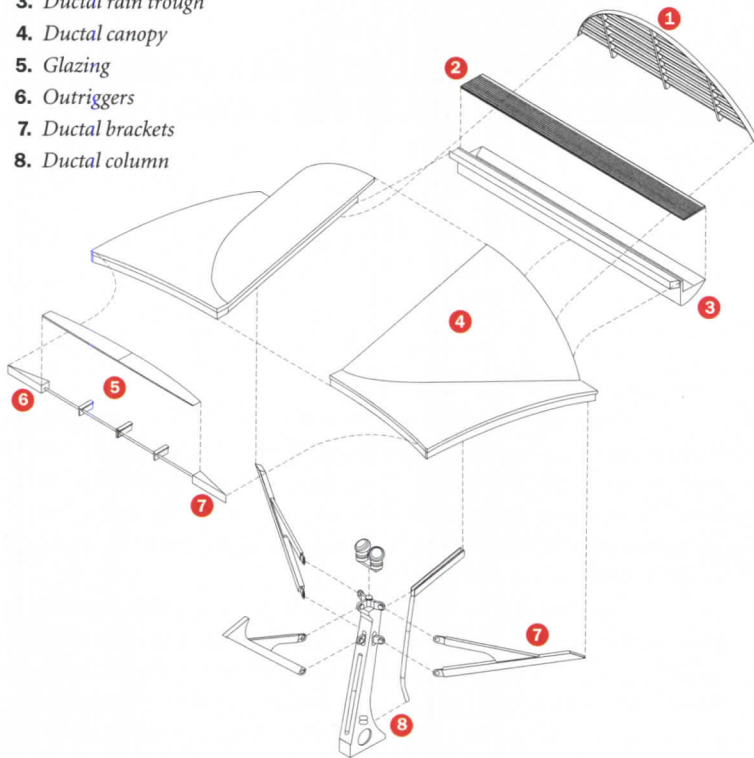

CANOPY MODULE



The Calgary-based CPV Group designed a bold station for an expanded light-rail system in the Shawnessy suburb of Calgary. A series of concrete-shell canopies provide platform coverage. Each canopy section is naturally lit through the louvered clerestories and enhanced with indirect lighting. The modular forms respond to the modest scale and rhythm of the nearby residential neighborhoods.





CPV Group chose a  
series of highly durable  
maintenance-free  
materials, including  
fiberglass and  
stainless steel.

the high-tech momentum that seems to be driving the current surge in advanced applications.

#### Riding (above) the rails

Light- and heavy-rail transit remains tremendously effective for frequent service in heavily traveled corridors. Intercity high-speed links

have been contemplated in states as far-flung as California, Nevada, Florida, Ohio, and are heavily used in Europe, China, and Japan. Denver and Sacramento and St. Louis, among others, have opened successful rail surface systems within the past 10 years. Houston opened one at the beginning of this year. San Juan, Puerto Rico, will open a heavy-rail elevated and underground system this year, and upgrading and expansion are planned on existing systems in New York, Chicago, and Boston.

However, current innovations in rail technology are focused on magnetic levitation, or Maglev, is a system in which a train conquers friction's drag with electromagnetic propulsion. The frequency, intensity, and direction of the electric current controls the train's movement. One type of Maglev system, developed in Germany, is already in use in Shanghai, China, and another version is in development in South Korea. With a top speed of 300 miles per hour, these trains are terrific for long-distance travel between neighboring cities, especially as an alternative to short-haul air travel.

The three components of the system include magnetic coils, a guideway (comparable to a traditional track); guiding magnets on the undercarriage of the train; and an electric power source. The electric coils along the guideway repel the train magnets and levitate

the train .39 to 3.93 inches above the guideway. Electric power supplied to the coils alternates constantly, changing the polarity of the magnets, which pulls the front of the train and pushes it from the back along the guideway.

The route between Pudong Airport and Shanghai opened for commercial service in December 2003 and is the fastest railway system in commercial operation in the world. Designed by Berlin-based Transrapid International ([www.transrapid.de](http://www.transrapid.de)), the train levitates ½ inch above its guideway, and at speeds typically reaching 267 mph, it makes the 19-mile trip in 8 minutes. Unlike a conventional steel-wheeled train, a Maglev train doesn't use fossil fuels. A Japanese system in development is designed to use super-cooled, super-conducting electromagnets, which will save more energy than even the German system.

New and expanding rail systems are offering architects an opportunity to experiment with new materials in the design of stations and shelters. In Calgary, Canada, CPV Group architects designed a station with thin-shell concrete canopies. Enzo Vicenzino, CPV principal, notes, "The community wanted a design that would announce the entrance to its neighborhood and be distinguishable from the more traditional LRT stations. I was certain that the canopies needed to be a thin-shell concrete, and the local supplier recommended a newly developed abrasion-resistant, high-performance concrete material called Ductal ([www.ductal.com](http://www.ductal.com)), which has tensile as well as compressive strength."

In Brussels, Samyn and Partners used a combination of fiberglass and steel fabrics for the equally dramatic elevated Erasme Metro station that opened in September 2003. "This is the new terminus station of a major light-rail system," explained design partner Philippe Samyn. "The client was eager to see this station serve as a city gate as well as

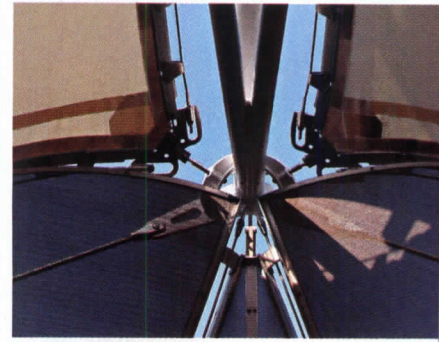

The Erasme Metro station in Brussels, by Samyn and Partners, is a combination of fiberglass and steel fabrics. The fiberglass fabric is

formed into posttensioned "saddles" attached to arched steel frames. The architects chose a stainless-steel mesh,

heretofore used only for sand separation in quarries. It is durable and provides natural ventilation.



linking a major hospital to the city center. It also says, "Look at us! Use public transport!"

The pedestrian approach, entrance hall, and the central platform are covered by a series of posttensioned fabric "saddles" attached to arched steel frames. The fabric was required to resist wind loads and shield passengers from the rain. The fiberglass fabric, with a life expectancy of 30 to 40 years, provides a temperate light during the day and glows at night. The stainless-steel mesh of the side walls is a product employed for sand separation in quarries. Used for the first time in an architectural application, it is extremely durable, breaks the wind, sheds rain, and provides natural ventilation. According to Samyn, the Ministry of the Brussels Capital Region, Administration of Equipment and Transport, while understandably conservative, was very supportive of the use of fabric.

#### Where the rubber hits the road

Roads, too, are a fixed system that can carry individuals virtually where. Believing we can pave our way out of the congestion and gridlock, we have developed a high tolerance for road expansion, one that is higher than our tolerance for rail expansion.

Bus Rapid Transit (BRT), sometimes called a surface subway, is not new. From Curitiba, Brazil, to Ottawa, Canada, communities have invested in highly successful roadway transit systems that use buses separated in dedicated lanes, which have limited stops at identifiable stations where fare is collected prior to boarding and service is frequent. Cast as a substitute for light rail, it has characteristics of both bus and rail. Although it has dedicated lanes, they may either be physically separated or instead may include right-turning or emergency or other buses for other sections of the route. When the BRT bus shares the public road, it communicates directly with the traffic signal system to get priority at intersections. Deviations from the route or changes are easier to implement with BRT than with fixed rails. New technology will further distinguish it from its conventional rail and bus siblings.

This summer, Las Vegas will be the inaugural U.S. site for the Civis bus rapid-transit vehicle manufactured by Irisbus of France. Operated by MAX by its owner and operator, the Regional Transportation Commission of Southern Nevada, it will have all the features of a BRT system except the driver is aided by an optical guidance system which uses cameras to follow painted lines in the road. For a vehicle in a dedicated lane, the guidance system keeps the bus on its course. The driver is a driver who can take over controls with the touch of the hand. Because MAX will share the road with other vehicles, the optical guidance system will be used for precise docking at each station. MAX will stop each bus at the same place in front of the whimsical new shelters designed by Assemblage Studio Architects of Las Vegas.

Looking more like a monorail or a bullet train than a conventional bus, the Civis bus is typical of new-style buses that aim for sleeker

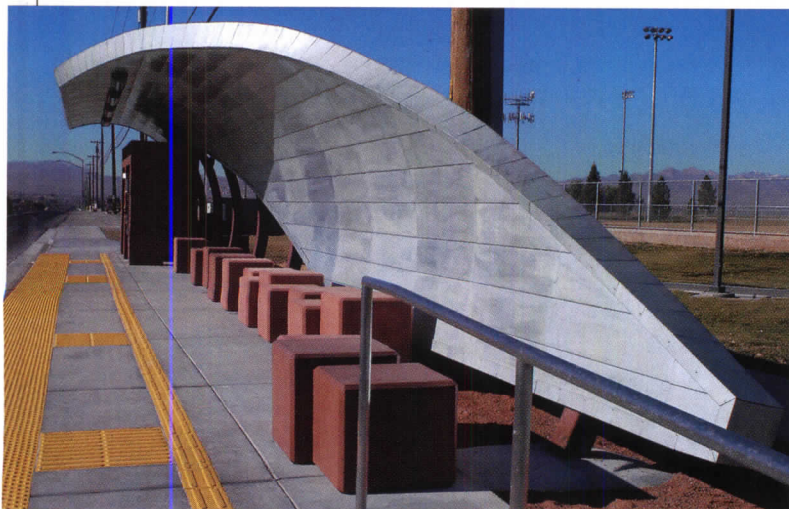

Assemblage Studio Architects of Las Vegas designed a whimsical shelter for a state-of-the-art bus system to be introduced this summer.



Or,



Have all you need to stay in constant contact with your business with a BlackBerry 7510™ from Nextel. Phone with speakerphone, walkie-talkie, email and PDA all in one conveniently sized device. Just another professional power tool that helps you get things done. To speak with a Nextel Representative, call 888-798-1005 or visit [nextel.com/blackberry](http://nextel.com/blackberry).

**NEXTEL. Done.** |™



©2004 Nextel Communications, Inc. NEXTEL and NEXTEL. DONE. are service marks, trademarks and/or registered trademarks owned by Nextel Communications, Inc. The BlackBerry and RIM families of related marks, images and symbols are the exclusive properties and trademarks or registered trademarks of Research In Motion Limited – used by permission. All other product or service names are property of their respective owners. All rights reserved.

CIRCLE 145 ON READER SERVICE CARD OR GO TO [WWW.LEADNET.COM/PUBS/MHAR.HTML](http://WWW.LEADNET.COM/PUBS/MHAR.HTML)

and improved accessibility. Aerodynamic design, hybrid diesel-electric propulsion for fuel economy, and four doors and a low floor for easier loading are typical of advances in bus design. Low-floor buses appeared in Europe at least 10 years ago and came to this country about five years ago when rental car companies began experimenting with them for transporting customers from the terminal to their lots. Dropping the floor of the bus lower to the ground makes it much easier for most people to board, with or without suitcases and packages. On long buses, there is a high central section to clear the axle, which reduces the overall advantages. The Civis bus improves this by removing the central axle and powering each wheel with its own motor, making the entire bus universally accessible.

MAX will have the added advantage of integration with the local bus system. Passengers pay one fare once to ride on any part of the system. If the first transportation choice is always one ride door-to-door, then every time a person changes seats, it must be seamless. Local fare integration and single payment isn't common yet; regional and larger-area integrated fare systems are indeed a rarity. Within 10 years, the experts say, one will be able to change from the Maglev train to the BRT to the local system with a regional-transit-fare card, leaving cash and fumbling at machines or fare kiosks behind. Toll-road technology is at

## “DIMENSIONS TO IMPROVE ‘CONNECTIVITY’ INCLUDE FACILITY DESIGN, SERVICE PLANNING, AND SERVICE CONTROL.”

hand for the transit system. A prepaid device (presumably some kind of card) will automatically calculate and deduct the cost of trip segments. It will be automatically replenished and a record of all transactions will be available on demand.

Seamless transfers mean never having to stop to pay a new fare, and having the bus turn up within minutes of your arrival. If we can't make the trains run on time, how will we ever be able to make the buses run on time and in the places where they are needed? Answers to that question may come, in part, from the research of Professor Nigel Wilson, of Massachusetts Institute of Technology's Center for Transportation and Logistics, and his students. Wilson observes, “Dimensions to improve ‘connectivity’ include facility design, service planning, and service control.” Transit operators are already collecting vast amounts of information about their riders from fare-card readers and automatic passenger counting. Buses are being outfitted with satellite Global Positioning Systems (GPS) that will help control centers track bus locations.

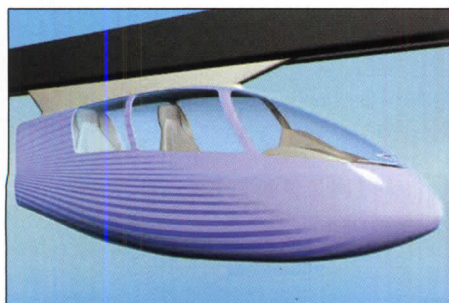

Inventor Doug Malewicki's SkyTran is a concept for a PRT in which two-person cars would be propelled along a monorail at 100 mph using Maglev technology.

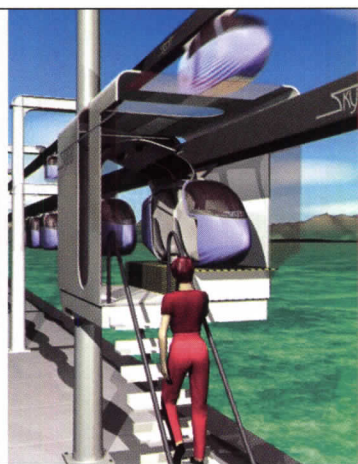

Taxi 2000's SkyWeb Express is a Personal Rapid Transit (PRT) system. Passengers select a destination, purchase a ticket, and enter a vehicle. Guideways take the cars directly to their destination without stopping.



Knowing where the vehicles are at any moment means be able to inform passengers of when to expect the next bus, just as systems commonly do already. It also means that adjustments can be made quickly to respond to emergencies or other short-term events. Collecting information on who goes where and when will improve route and capacity planning for better service design on average. Small buses can run on low-volume routes during the rush hour and higher-volume routes to increase frequency in the nonrush period. Schedules between bus feeders and rail transit can be coordinated to meet expected connections.

### Way down the road

There is, of course, also a system to appeal to those who want their vehicle to go where they want, when they want. Skyweb Express ([www.skywebexpress.com](http://www.skywebexpress.com)), SkyTran ([www.skytran.net](http://www.skytran.net)), and CyberTran ([www.cybertran.com](http://www.cybertran.com)) are just three variations on Personal Rapid Transit (PRT) that comes on demand and takes you to your specific destination—as long as it is on the guideway system. In its most common form, small cars that may hold from two to 20 people run on lightweight elevated tracks or guideways. Stations, which can be located within buildings, are off the guideway, so that traffic moves freely past loading and unloading vehicles. Rather than traveling on fixed routes, passengers program their vehicle, just like an elevator, for pick up and drop off wherever along the network. Proponents cite convenience, safety, energy-efficiency, and low capital costs as advantages. They are still the domain of *The Jetsons*, but someday, in a fully connected transportation network, they may become reality, too.

In the robust transportation system of the future, there will have many surface modes, each doing what it does best: longer distances at very high speeds; medium distances by thoroughly integrated networks; and short distances by bicycle, car hire, self drive, or PRT that reach every door. ■



# form<sup>z</sup>

3D form synthesizer

explore • design • deliver

The right design tools to invigorate your most challenging creative endeavors:  
From sketching, to conceptualizing,  
to highly detailed final designs,  
to rapid prototypes and machined physical models,  
in 2D or 3D, or both.  
Surface or solid modeling or a blend of both  
with photorealistic radiosity based renderings,  
and animation,  
in a cross platform environment: Windows and Macintosh.

Find out more at [www.formz.com](http://www.formz.com)



autodes<sup>ys</sup> inc

CIRCLE 146 ON READER SERVICE CARD  
OR GO TO [WWW.LEADNET.COM/PUBS/MHAR.HTML](http://WWW.LEADNET.COM/PUBS/MHAR.HTML)

011 Riverside Drive • Columbus, Ohio 43221 • phone: (614) 488-8838

PAGE CREDITS: Column by Matthew Holewinski, auto•des•sys, Inc, Columbus, Ohio; Cyber Laser Center by Jason Brown, Austin Veum Robbins Parshalle, San Diego, California, [www.avrp.com](http://www.avrp.com);  
Space Park Bremen by Branislav Hetzel, Sherman Oaks, California, [www.hetzeltdesign.com](http://www.hetzeltdesign.com); Dubai Hotel by STEM 3D, Coventry, United Kingdom, [www.stem3d.com](http://www.stem3d.com).

# Zoom In

## Bahá'í Mother Temple, Santiago, Chile

By Deborah Snoonian, P.E.

When Toronto firm Hariri Pontarini Architects won a competition for a 21,000-square-foot place of worship in South America, it turned to Gehry Technologies to help it achieve a form that was both highly organic and buildable.

Leaders of the Bahá'í Faith, which has five million members worldwide, wanted a nine-sided dome structure with nine entrances to signify openness to all peoples, says principal Siamak Hariri, himself a member of the faith. Hariri and his team developed what he calls "a glowing temple of light" clad with nine graceful, draped "leaves" of translucent alabaster. "We sought symmetry in the form," notes Hariri, not only to signify the faith's ideals of equality and harmony, but also for pragmatic reasons: Symmetrical structures are generally cheaper to build and easier to reinforce structurally (the temple is located in a seismic zone).

Achieving symmetry meant manipulating numerous physical and digital models. With engineers Carruthers and Wallace, the designers used Maya software to model the "leaves," then spent a week with Gehry Technologies in California refining them and analyzing the structure in CATIA. "It was exciting. We came away with a richer understanding of using technology to achieve design goals," says Hariri of working with the Gehry team. The temple will open in 2007. ■



Designers "panelized" the surface of each "leaf" to minimize the number of stone slabs that need to be cut to conform to its curves (above). Circular in plan, the temple will seat 600 people (below).

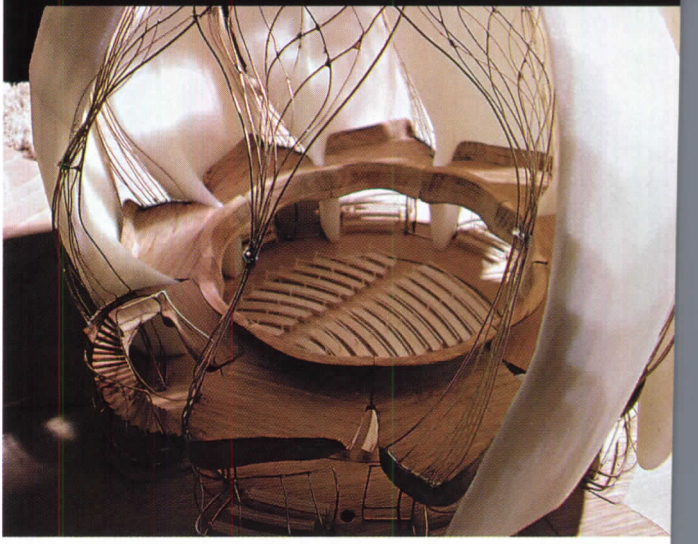

### A structural system that mimics Mother Nature

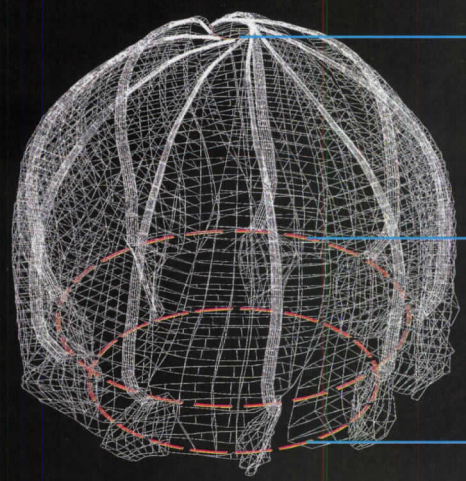
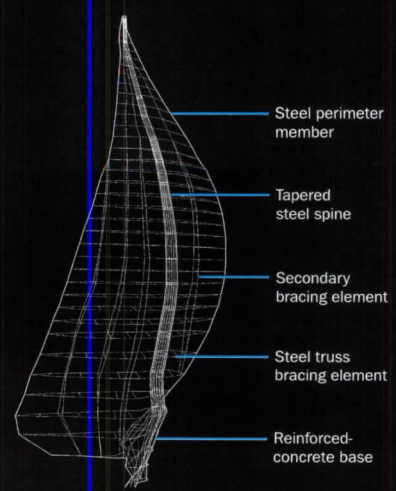

Nine identical curved panels, each anchored to a reinforced-concrete base, enclose the Bahá'í Mother Temple. Structurally, the panels are supported by vertical spines—like leaves—from which branch the secondary steel supports that bear the load of the stone exterior and wood interior rings at the roof, mezzanine, and foundation. The nine panels provide lateral stability.

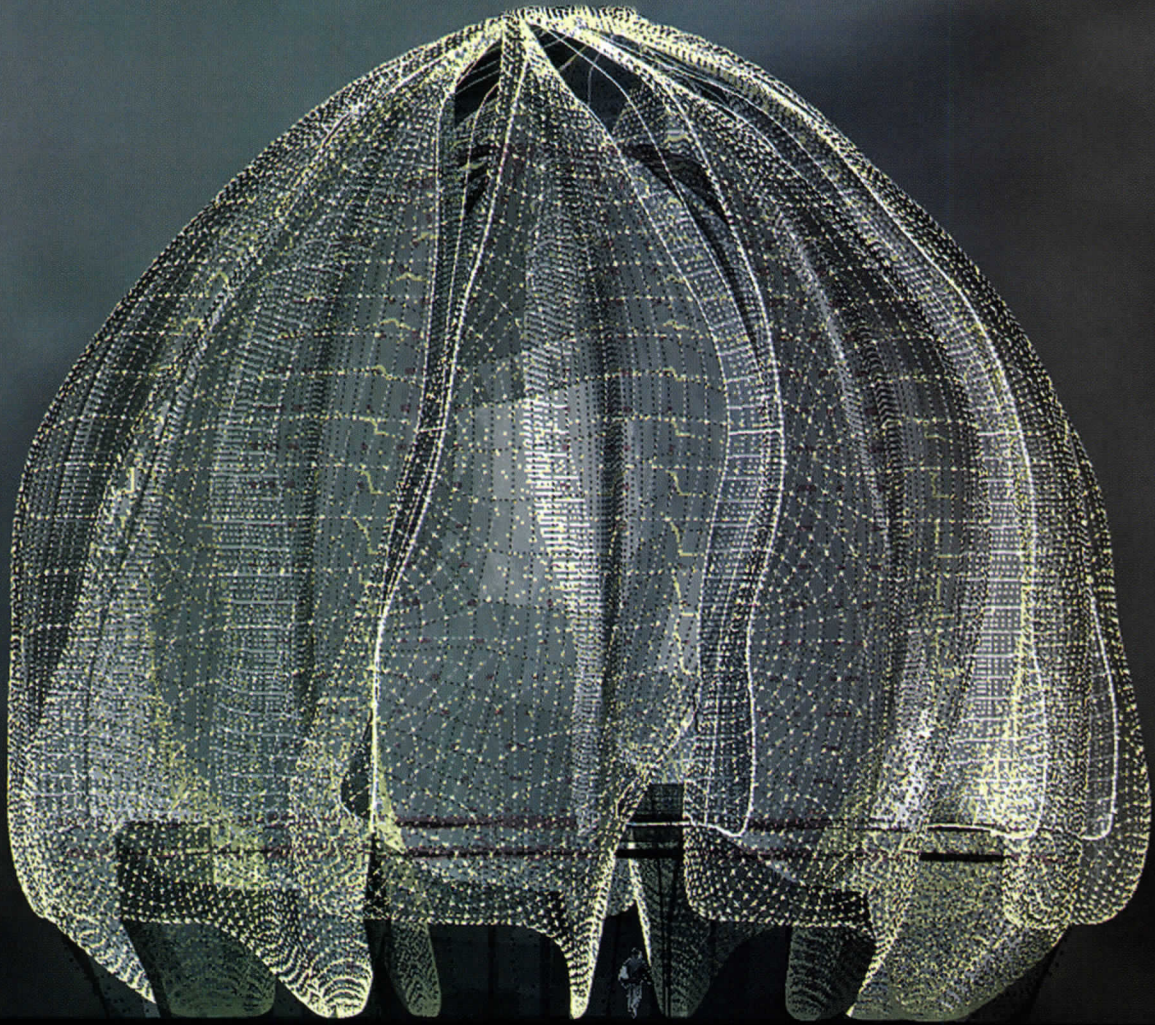

Only nonorthogonal building calls for complex structural analyses made possible by serious number-crunching software. Using CATIA, the design team modeled the temple's form and loads to determine where to add reinforcements and stiffening members for the steel endoskeleton.

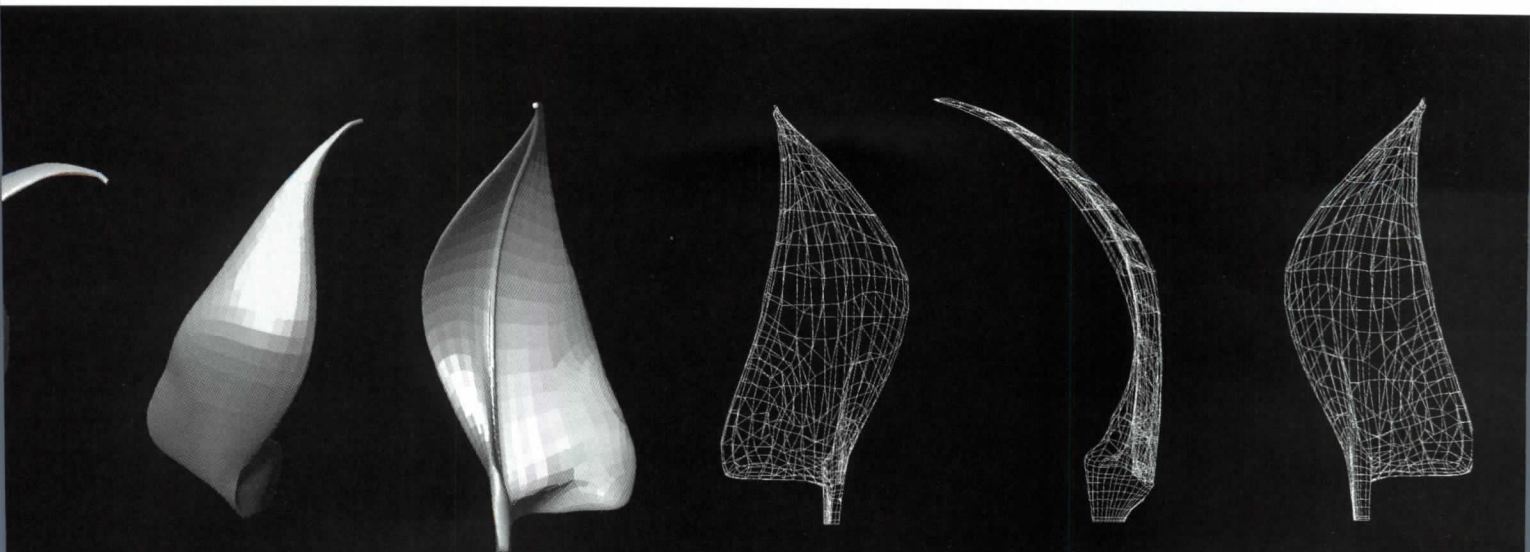

# The best roof money can buy.



TCS II<sup>®</sup> Stainless Terne



You would expect that the U.S. Bureau of Engraving and Printing would re-roof their facility in Washington, DC, with the best that money can buy. After all, a failure could cost them millions of dollars. So naturally, they selected a Follansbee roof. It looks great and it's made to last fifty, eighty, even a hundred years – with absolutely zero rust. Proof positive that the Follansbee roof is as solid as a dollar. By the way, they paid by check.

**Follansbee – for those who demand the very best.**

Call or visit Follansbee online today to learn more.

**800.624.6906 [follansbeeroofing.com](http://follansbeeroofing.com)**

BYTES

and the Department of Energy's National Renewable Energy Laboratory will sponsor the 2005 Solar Decathlon next fall, with 19 university teams designing and building energy-efficient homes on the National Mall in Washington, D.C.

Systems of Austria plans to make a large-scale videoconferencing room in public spaces in London and Vienna this year. The booths are circular, with 360-degree high-definition monitors 10 feet tall and 23 feet in diameter, and will be host to tourist information and other content.

Opening of the Stata Center at MIT in May, Gehry Technologies announced it has demonstrated its new software, CATIA V5, through a design package on Dassault's CATIA V5.

A 1,000-square-foot residential experiment in Cambridge, Massachusetts, called FaceLab is slated to open soon. It will use sensors, embedded microphones, and tiny cameras to collect data on everything from residents' movement patterns to the number of times they open the refrigerator. The project is a joint venture between MIT and a local collaborative research and development company.

A web site launched by the U.S. Green Building Council and the National Center for Environmental Education & Training provides information on GreenerBuildings.com, including case studies, tools, and resources to help companies evaluate the business case for green building.

Researchers at UCLA are perfecting an electroluminescent polymer that glows when an electric charge is applied to it, adding to the blue and green LEDs already available. In time, these LEDs will be used to make flexible, inexpensive displays, they say.

## California tests conventional and "green" products for emissions



**By measuring emissions of paint, furniture, and finishes, California officials aim to develop a list of acceptable products for use in public buildings, such as libraries.**

Weighing the health and environmental effects of building products typically means sifting through incomplete, mismatched, or out-of-date manufacturers' literature, government documents, and lab data. Officials in California, perennially the green-building trendsetter among states, recently stepped into the breach by publishing the results of emissions tests on paint, ceiling panels, carpeting, wall components, flooring, and other indoor products that are manufactured both conventionally and with recycled content. Their work will make it easier for designers to compare available products and anticipate their impact on indoor air quality (IAQ).

The tests were coordinated by two different groups—a state agency, the California Integrated Waste Management Board (CIWMB), and the nonprofit Collaborative for High Performance Schools (CHPS). They were based on the state's special environmental requirements specifications (Section 01350) for sustainable building projects. The tests screened for more than 70 substances, including ammonia,

benzene, chlorine, and toluene. To establish the limits in the specifications, researchers drew up a list of chemical compounds typically found in indoor air, calculated safe exposure levels for a 20-year period, and halved those figures to establish maximum allowable emissions.

So far, the data suggest that conventionally manufactured products and those that contain recycled content have roughly similar emissions profiles. Many of the products failed to meet the state's public health emissions standards for this criterion, most on the basis of a single chemical, according to officials. Big chemical offenders included naphthalene, formaldehyde, and acetaldehyde, which are tied to respiratory and eye problems. The 01350 tests helped counter the perception that products containing significant recycled content are worse for IAQ than standard products, according to Tom Estes, manager of the waste management board's

sustainable building program. "Emissions are really dependent on what you put into the material, regardless of whether it's virgin or recycled," says Anthony Bernheim, FAIA, managing principal and head of green design at SMWM in San Francisco and an adviser for the state's research efforts.

The tests funded by the waste management board were conducted by the California Department of Health Services (DHS), which evaluated 77 samples of interior building products. After a 10-day airing-out period, products were prepared as they would be for assembly or

installation (e.g., adhesives applied to carpets) and tested for 96 hours in a sealed chamber. The measured concentrations are used to model estimated concentrations in typical classrooms or offices, based on assumed spatial dimensions and ventilation rates.

In a concession to manufacturers, vendor and product names have been omitted from the most detailed results, but the testing is

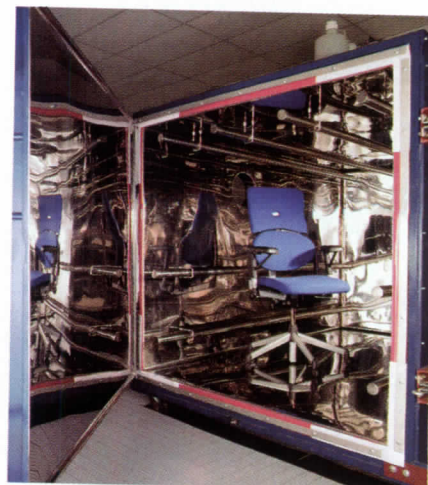

**For emissions testing, products like office chairs (above) are sealed in a chamber where offgases are tested.**

## Tech Briefs



California's push to improve indoor air quality has strong support by the school districts.

yielding useful data. "It's the first time as architect that I have a tool I can take to the manufacturer and say, 'If you don't exceed this level, you're okay,' where the level is based on health," says Bernheim. ASTM officials are considering

adopting the test protocols as standards.

In some cases, the California studies have led manufacturers to reformulate their products or pay closer attention to contributions from raw-material providers and supply-chain partners, something that the green-building community has encouraged for many years.

The waste management board report is available at [www.ciwmb.ca.gov/greenbuilding/specs/section/metstudy.htm](http://www.ciwmb.ca.gov/greenbuilding/specs/section/metstudy.htm), and a list of products that passed the tests for the state's Capital Area East End Complex office project is available at [www.ciwmb.ca.gov/greenbuilding/specs/eastend/](http://www.ciwmb.ca.gov/greenbuilding/specs/eastend/). The DHS is now monitoring the long-term emissions of materials in the East End facility, according to officials.

The Collaborative for High Performance Schools (CHPS) initia-

tive, which is ongoing, relies on independent lab tests arranged by manufacturers. IAQ is an optional but commonly addressed category of CHPS's green school guidelines. The testing program stems from efforts by the Los Angeles Unified School District to list products that meet Section 01350 standards. Qualifying products are added to a Web site,

[www.chps.net/manual/lem\\_over.htm](http://www.chps.net/manual/lem_over.htm), as manufacturers submit their test results.

Officials stressed that the specifications note only emission levels for products, not other environmental measures, such as embodied energy and pollution generated during manufacturing and distribution.

Ted Smalley Bowen

## Building industry professionals gather to pledge commitment to interoperability

In late April, more than 30 industry associations, professional organizations, government agencies, and software companies assembled at the AIA's headquarters in Washington, D.C., to explore opportunities to promote the adoption of open standards for digital data exchange in the design and construction community. By the end of the meeting, each attendee had signed a pledge to work across organizational boundaries toward

the so-far-elusive goal of interoperability—in which hardware and software made by different vendors work together seamlessly, so that users in disparate groups can exchange digital design information effortlessly throughout the life of building and design projects. Achieving this goal, industry leaders say, will allow buildings to be erected faster and cheaper, as well as operated more effectively and efficiently. *(continued on page 18)*

# findcontractors.com



ABC contractors have been building on-time, on-budget, high-quality construction projects

for more than 50 years. Now you can find those contractors across the country—quickly, easily and at no cost to you by visiting [www.findcontractors.com](http://www.findcontractors.com).



4250 N. Fairfax Dr., 9th Floor  
Arlington, Virginia 22203  
Tel: (703) 812-2000  
Fax: (703) 812-8200  
Website: [www.abc.org](http://www.abc.org)



To see our full range of products,  
visit these exceptional showrooms.

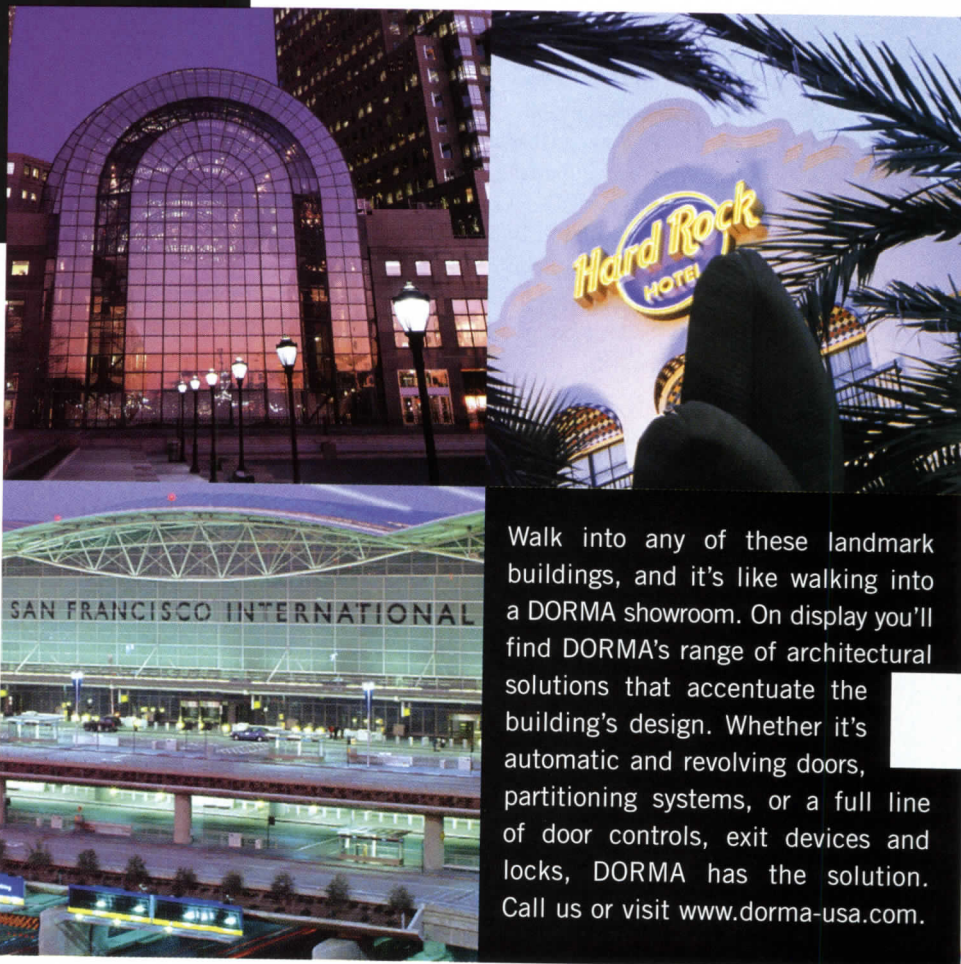

Walk into any of these landmark buildings, and it's like walking into a DORMA showroom. On display you'll find DORMA's range of architectural solutions that accentuate the building's design. Whether it's automatic and revolving doors, partitioning systems, or a full line of door controls, exit devices and locks, DORMA has the solution. Call us or visit [www.dorma-usa.com](http://www.dorma-usa.com).

Architectural Hardware  
800-8483

DORMA Automatics  
877-367-6211

DORMA Glas  
800-451-0649

Crane Revolving Doors  
800-942-7263

Modernfold  
800-869-9685

## Tech Briefs

The gathering differed from past efforts in that organizers emphasized what the participating groups could do as a whole to promote open standards and interoperability, instead of focusing on individual efforts by a single group or company in particular. "These groups are competing within a small community: No one gets sufficient funding or attention to be effective. And up to now, efforts to develop standards have been fragmented and uncoordinated, and the value of interoperability has not been effectively 'sold' to the professional user community," says one of the conference's organizers, Jonathan Cohen, FAIA, the former head of the AIA's Technology in Architectural Practice Committee (TAP).

Perhaps the most significant outcome of the meeting was an agreement to establish a Web site,

[www.building-connections.org](http://www.building-connections.org), to serve as a "one-stop" information source about interoperability for building professionals, including case studies and progress updates on achieving open standards. The site's content will be provided voluntarily by the organizations that attended the congress; it will be launched later this year.

To avoid duplication of effort, two disparate groups that have been working to develop open standards agreed to coordinate their efforts—the National Institute of Building Science (NIBS) and the Open Standards Consortium for Real Estate (OSCRE), a group begun in 2000 by private-sector managers for Cisco, Intel, and other technology companies.

The group will meet again in early June to set forth a more detailed agenda for collaboration. *Deborah Snoonian, P.E.*

## What the Numbers Say

What does your firm spend on IT? Not surprisingly, the 2003 AIA Firm Survey revealed that the costliest IT items are hardware and personnel (top) and that single practitioners and large firms spend more per employee on technology than mid-size firms (bottom).

IT-RELATED EXPENDITURES IN 2002, AVERAGES ACROSS ALL FIRMS

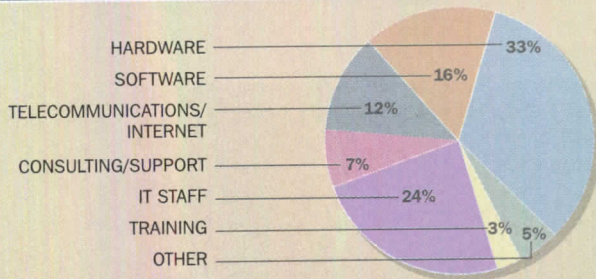

SOURCE: 2003 AIA FIRM SURVEY

SPENDING PER EMPLOYEE, AVERAGE ACROSS ALL ITEMS



SOURCE: 2003 AIA FIRM SURVEY

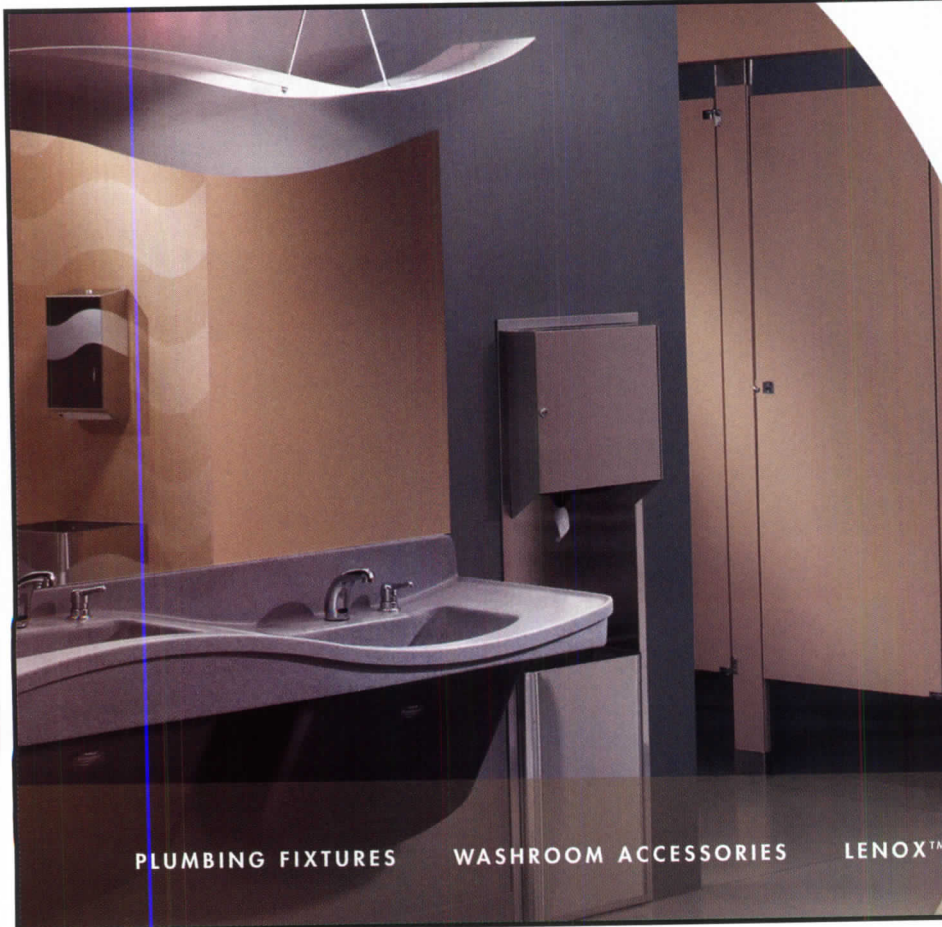

## First Impressions Last.

When you put forth the effort - it shows. Coordinating the needs of fundamental basics along with satisfying aesthetic - the Frequency™ ensemble does it with style and grace. With its unique wave design, the fixture simplifies the task of meeting ADA height requirements by offering two heights in one unit. To view the entire Frequency product line with all its companion elements, visit [bradleycorp.com](http://bradleycorp.com) or call 1-800-BRADLEY.

**Bradley**  
Commercial Washroom Innovation

PLUMBING FIXTURES

WASHROOM ACCESSORIES

LENOX™ LOCKERS

MILLS® PARTITIONS



## Energy tool, CAD updates, a mini-PC

Deborah Snoonian, P.E.

### Green Building Studio

Praxis  
geopraxis.com  
Windows only

Free Web-based service provides an analysis of a building's energy characteristics during the conceptual design phase. Users register for an account at the company's Web site, then download the software plug-in that works with their 3D CAD system (currently Graphisoft's ArchiCAD and Autodesk's current versions of ADT, Revit and Building Systems). After creating a conceptual design, the user enters the building's type, location and clicks a "Submit" button that sends design data to the Green Building Studio Web site, where the structure is analyzed for energy performance. Results can be viewed on the Web site or downloaded as a gbXML file that users can share with consultants or team members for more detailed energy analyses using programs such as EnergyPlus or DOE 2.2.

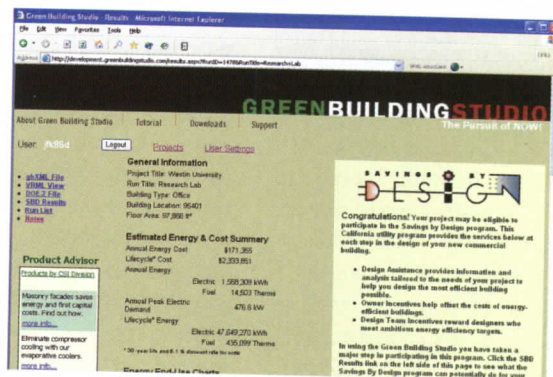

GeoPraxis offers free energy analyses for conceptual designs.

ated within ADT are now compatible with the company's Building Systems software for collaboration and file-sharing purposes, and the interface now supports third-party programmers who wish to create niche applications for engineering analyses. The software also supports the Industry Foundation Classes (IFCs) developed by the International Alliance for Interoperability by way of translation software.

### ultra Personal Computer

OQO  
www.oqo.com  
Windows only

This Windows XP-compatible computer boasts the number-crunching power of a conventional laptop at a fraction of the size and weight (4.9 inches by 3.5 inches by 0.9 inch, weighing 14 ounces). The ultra Personal Computer (uPC) comes equipped with a 1-gigahertz processor, a 20-gigabyte hard drive, a color display screen, and Firewire and Bluetooth wireless capabilities. A USB port lets you add a mouse or another peripheral device; a miniature keyboard, mouse buttons, and thumbwheel allow data input and navigation. When connected to its docking cable, the uPC can be enhanced with audio and Ethernet functions or a second USB or FireWire port. Though it's not souped-up enough to manipulate CAD files, the uPC represents a viable option for those who want to tote more power than a handheld organizer offers, but with a lot less bulk than a laptop. The company says the uPC will be widely available by summer 2004.

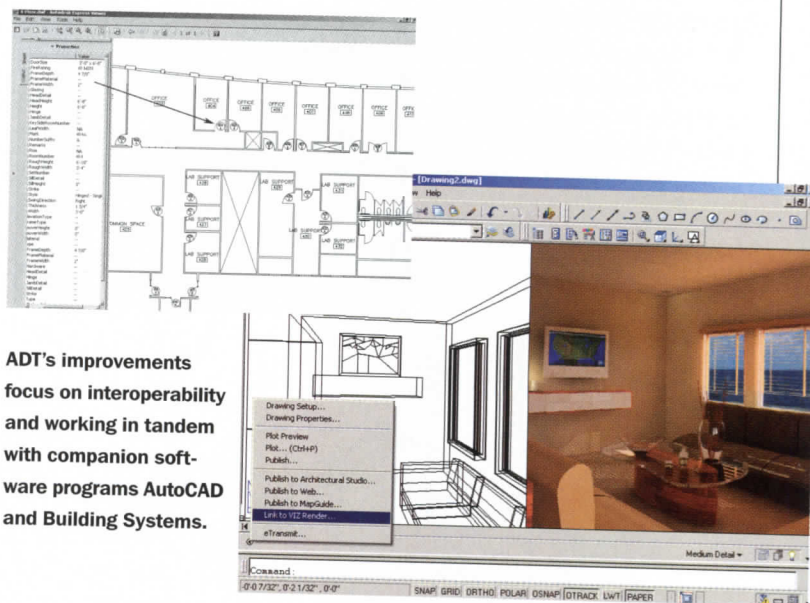

ADT's improvements focus on interoperability and working in tandem with companion software programs AutoCAD and Building Systems.

### Architectural Desktop 2005

Autodesk  
autodesk.com  
Windows only

Autodesk's latest version of ADT, the final 3D CAD program, has a new "details" feature and a library of built-in, editable components, as well as automated tools that help users draw faster and more quickly. Objects created from information on technology products, including reviews, lists, and links, go to [architecturalrecord.com](http://www.architecturalrecord.com).



Only a bit larger than a handheld organizer, OQO's ultra PC packs more computing power.

# Tech Products

## Project 4D and ConstructSim

Common Point  
www.commonpointinc.com  
Windows only

Common Point's founders first began working with simulation construction sites at Stanford's Center for Integrated Facility Engineering (CIFE). Project 4D, its flagship program, adds a fourth dimension—time—to a typical 3D building model so that users can visualize construction activity for a building or group of buildings and manage the schedule accordingly, to ensure that conflicts and delays are minimized. The software uses information imported from a variety of existing CAD and scheduling programs. ConstructSim is a "visual collaborative environment" for a project team, integrating data from Project 4D as well as engineering, procurement, and materials-management software for

a more comprehensive management effort.

## Speech Privacy Predictor

Armstrong World Industries  
www.armstrong.com/speechprivacy  
Windows or Mac

A company known more for ceiling panels than software, Armstrong has created a design aide for predicting the acoustic performance of spaces like offices and health-care facilities where speech privacy is a high priority for occupants. Users enter the dimensions and materials of a space as well as the distance between talkers and listeners. The software returns a Privacy Index (based on an ASTM standard) that tells the user whether a design is achieving the project's speech-privacy goals, as well as options for improving performance.

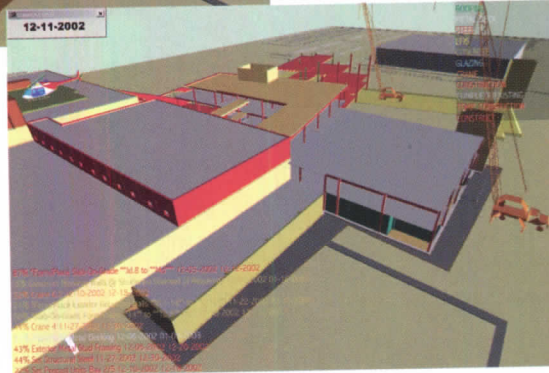
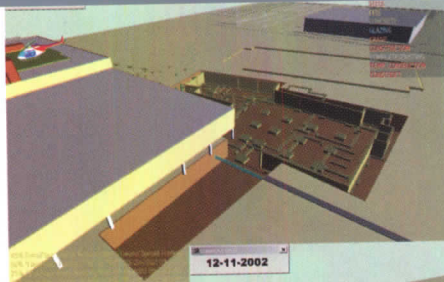

Common Point's offerings allow teams to see how construction will proceed, so they can identify potential conflicts and trouble zones.

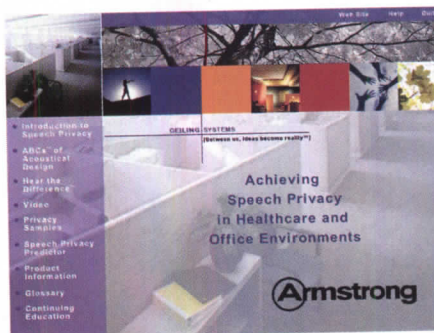

Armstrong's acoustic analyzes room geometry and materials in order to forecast speech privacy.

# Lighten Up!! Ultra-Lite Stone Panels

## The Beauty of Natural Stone Without the Weight



Ultra-Lite Natural Stone Panels weigh 80% less than solid stone. They offer construction speed, reduced labor cost, and structure savings. This honey-comb reinforced natural stone is available in nearly unlimited choice of granites, marbles and limestones.

- Easily & Quickly Installed
- No Heavy Lifting Equipment Needed
- Durable With Extreme Impact Resistance
- Building Code Approved
- Less Weight = Structural Savings
- Renovate Without Adding Structure
- Fully Tested for Exterior Use
- Withstands Acid Freeze Thaw
- Resists Hurricane Missile Impact



100 South Royal Lane • Coppell, TX 75019  
Phone (469) 635-5000 • 1-800-328-6275  
http://www.stonepanels.com

World-Wide Suppliers of Ultra-Lite Marble, Limestone and Granite Panels

OVER 35 YEARS OF INNOVATION IN NATURAL STONE CLADDING

*the* ELEMENTS *are* SIMPLE

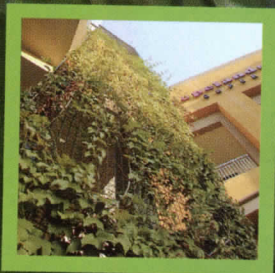
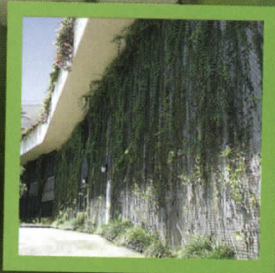

*the* POSSIBILITIES *are* ENDLESS

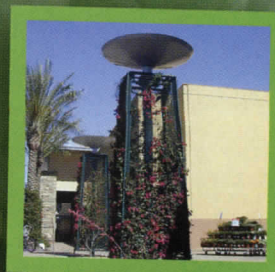

VIEW MORE [www.greenscreen.com](http://www.greenscreen.com)

1743 S. La Cienega Blvd. Los Angeles, Ca 90035  
t - 800.450.3494 e - [sales@greenscreen.com](mailto:sales@greenscreen.com)  
CIRCLE 334 ON READER SERVICE CARD OR GO TO [WWW.LEADNET.COM/PUBS/MHAR.HTML](http://WWW.LEADNET.COM/PUBS/MHAR.HTML)

# Tech Products

## VectorWorks ARCHITECT

Nemetschek NA  
www.nemetschek.net  
Windows and Mac

Improvements in drawing efficiency are the hallmark of Nemetschek's update of its CAD package for architects. A database for notes lets multiple designers share a common set of annotations and text for drawings that are used repeatedly, and new page-layout features let designers compose drawing sheets that combine multiple views of the same design at different scales and sizes, including text and annotations. New building objects, such as a ceiling-grid tool and a stair tool, make enhancements to building details easier to draw and manage. Built-in rendering modes now include options for softening hard-edged drawings so they appear hand-sketched.

## VIZ 2005

Autodesk  
www.autodesk.com  
Windows only

Autodesk says that VIZ is to digital 3D modeling what clay is to physical modeling—a medium for highly mutable, early-stage exploration of design options. One major new feature of the latest VIZ release, the incorporation of mental ray's rendering technology for global illumination, lets ambitious designers create ultra-high-quality photorealistic renderings by capturing subtle lighting effects and shadows within a space. Other new features include an architectural materials library; better editing features for splines, polygons, and patch objects; and improved cross-platform compatibility with other Autodesk products. ■

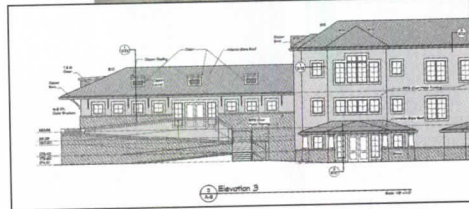

Changes to the latest release of VectorWorks ARCHITECT include libraries of notes and improved page-layout features.

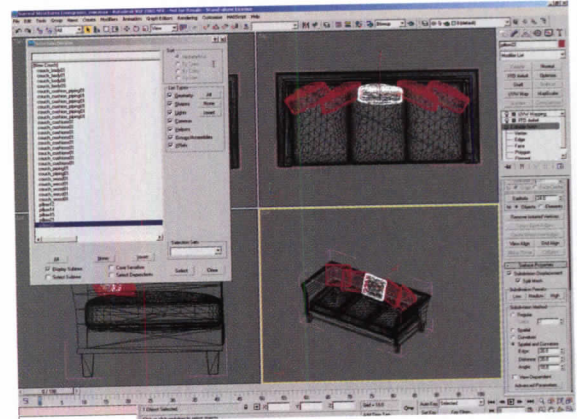

Global illumination lets VIZ users make realistic renderings.

**PEMKO**  
Manufacturing Company

MANUFACTURING QUALITY DOOR  
HARDWARE SINCE 1952

Pemko offers the broadest range of products in the door hardware manufacturing market!

**THRESHOLDS**  
**RAMPS**  
**PEMKOHINGE™**  
**ASTRAGALS AND MEETING STILES**  
**DOOR BOTTOMS**  
**BRUSH WEATHERSTRIP**  
**PERIMETER GASKETING**  
**EDGE SEALING PRODUCTS**  
**FG3000**  
**FLOOR MOLDING AND TRIM**  
**WEATHERIZATION PRODUCTS**

PEMKO MANUFACTURING COMPANY  
P.O. BOX 3780 • VENTURA, CALIFORNIA 93006  
(800) 283-9988 PH • (800) 283-4050 FAX  
P.O. BOX 18966 • MEMPHIS, TENNESSEE 38181  
(800) 824-3018 PH • (800) 243-3656 FAX  
EMAIL: PEMKOSALES@PEMKO.COM

## PEEL & PRESS ADHESIVE BACKED SMOKE and FIRE GASKETING!

# POSITIVE PRESSURE SOLUTIONS

Contact Customer Service today at 1-800-283-9988 to receive your copy of Pemko's new 2004 Adhesive Gasketing Solutions brochure with gasketing samples.

**2 great products Combined into 1**

**AIR INFILTRATION TESTED**  
**ADHESIVE BACKED FOR EASY INSTALLATION**  
**SMOKE AND FIRE TESTED AND LISTED**  
**MORE ECONOMICAL TO USE THAN SPECIALLY MODIFIED DOORS**  
**REVOLUTIONARY NEW PRODUCTS!**

S44D

PK55D

PK33D

SFG45

S88W

S44W

HSS2000X S44

HSS2000X S88

HSS2000

**2 great products Combined into 1**

# Interiors

“Secretarial corridors” may have gone the way of the typewriter, but some offices look back to move forward

## BRIEFS

**French designer Charlotte Perriand** is frequently mentioned as one of the most overlooked Modernist design talents of the 20th century. A long-time collaborator with Le Corbusier, Pierre Jeanneret, and Jean Prouvé, she worked for more than six decades perfecting tubular-style furniture that came to be known as “equipment for living.” (She died in 1999 at age 96.) The **Princeton University Art Museum** spotlights her best work in a major exhibition, *Useful Forms: Furniture by Charlotte Perriand*, on view through July 11. Works in the show include a rare library table designed for the Maison de l'Étudiant in Paris and a free-form desk from 1960. Go to [www.princetonartmuseum.org](http://www.princetonartmuseum.org). W.W.

## CONTENTS

- 334 Eliran Murphy Design Group, New York City**  
*Guillermo M. Gomez Architect*
- 340 Huntsman Architectural Group, San Francisco**  
*Huntsman Architectural Group*
- 347 Clicquot, Inc., New York City**  
*Traboscia Roiatti*
- 352 Grip and Medium One, Toronto**  
*Johnson Chou*
- 357 Product Design**  
*Frank Gehry in Milan*
- 359 Interior Products**

**A** sign of the times, circa 1968: “Although the secretarial pools and the open work areas are both accepted principles in office planning,” wrote author Michael Saphier, “on occasion it is necessary to provide partial privacy for some secretaries.” This text, from a McGraw-Hill book published that year, *Office Planning and Design* (below), accompanied a photo in which secretaries and their bland desks were placed in a corridor and shielded behind 3-foot-wide, floor-to-ceiling sections of drywall, an arrangement that likely would not be considered congenial or productive today. (And don't support-staff personnel prefer the title of executive assistant these days?)

On the plus side, some of the book's tenets regarding office organization seem to hold up even 36 years later. And among the featured projects that were more progressive than the “secretarial corridor” was a private office's “roll-top room” that employed hinged doors powered by a

garage-door mechanism to hide a research area. The automation was primitive, but the solution foretold today's continuing search for flexibility of form and a balance of private and public zones.

Among the offices we present this month, most look back to earlier times for inspiration. San Francisco-based Huntsman Architectural Group settled on Arne Jacobsen's Egg chair as an iconic touchstone for reinterpreting elements of midcentury Modernism for its own offices. Its colorful (dare we say, almost mod?) materials library, with Verner Panton chairs (above), doubles as a space available to community charities. Johnson Chou's conference room at Grip in Toronto is an illuminated “bubble” that evokes the sci-fi optimism of '60s space travel. Guillermo M. Gomez adopts

a Mondrian-like palette for the office of a Broadway ad agency. Looking farther into the past, Traboscia Roiatti meditated on a vintage Veuve Clicquot champagne bottle, its shapely curves and orange label cuing abstract forms for a modern loft office. Times have changed, but the search for connections to shared history has not. *William Weathersby, Jr.*

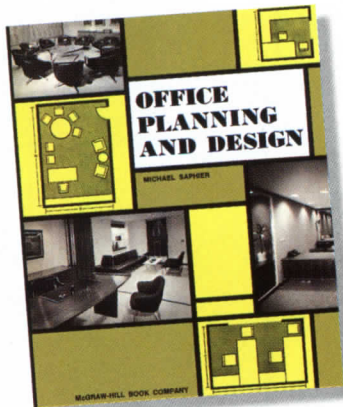

Broadway advertising campaigns are projected on one wall of the EMG reception area as a focal point. Downlights create a play of color along the luminescent flooring, while red chairs rest against a glass wall.



# Guillermo M. Gomez orchestrates color and flexibility for the Broadway advertising agency Eliran Murphy Group

William Weathersby, Jr.

They say the neon lights are bright on Broadway," so the popular song goes. For the New York City-based media firm Eliran Murphy Group (EMG), whose business is designing advertisements and branding campaigns that help to make hits of Broadway shows like *Nine* and *Cabaret*, bright lights, bold colors, and vibrant flashes of creativity are its stock-in-trade. To present the firm's strong suit of design talent and marketing finesse within a new space near the theater crossroads of Times Square, Guillermo M. Gomez (GGA) orchestrated a modern, energetic office that trumpets a new corporate identity.

"From the start, it was very clear what our business was and our goals for the new office were," says EMG president/creative director Ann Murphy. "We wanted our architect to become involved from the very beginning, to bring in his ideas and listen to ours so we could work together to make the relocation project a success."

To foster a collaborative working relationship, Murphy and her C.E.O. Barbara Eliran enlisted GGA principal architect Guillermo Gomez to assist in scouting potential offices for the relocation from several overtaxed floors in midtown. Together they discovered a 10,000-sq-ft, fifth-floor space in a prewar building just south of the theater

district that offered the most potential for programming and design within a modest budget of \$59 per square foot. "The clients sought a design that would spark day-to-day operations by emphasizing light, height, and quality of space, kept within affordable relocation and construction costs," Gomez says.

Besides its Broadway mainstays, EMG also designs media campaigns and materials for New York arts institutions such as City Opera and the American Museum of Natural History, as well as television industry players like PBS/Channel 13. Rather than go over the top with theatrical razzle-dazzle for the office, Gomez delivered the desired high-end visual appeal via inventive, cost-effective design solutions.

At the entry, the architect expanded the elevator lobby and created a view into the reception area with a frameless, acid-etched glass wall sandblasted with the company's logo. Beyond the glass wall, a com-

**Project:** *Eliran Murphy Group, New York City*  
**Architect:** *Guillermo M. Gomez, Architect—Guillermo M. Gomez, principal architect; Luciano Rennis, project designer*  
**Contractor:** *Certified of New York*  
**Audiovisual consultant:** *Ruppert Bohle*





**Private offices along the perimeter are enclosed by acid-etched glass walls and doors, which filter**

**light through to the central core (above). Bands of clear glass offer employees better sight lines (right).**

position of intersecting, Minimalist planes enclosing various zones creates a strong first impression. The same acid-etched glass tops a 6.5-foot-long reception desk set on the diagonal. Luminescent flooring with a pattern of repeating circles shifts from gray to green, silver, and gold, depending on the angle of light cast by ceiling-recessed light fixtures and the position of pedestrians. The agency's work, including television commercials for Tony-winning musicals, is projected against a side wall within view of reception seating, a cluster of Ron Arad's red Tom Vac chairs. "The clients originally planned to show their work on a flat-screen monitor, but we proposed a projector to make the images larger and more theatrical as a focal point for their clients and guests," Gomez explains.

In the main open-office area for creative teams, Gomez simplified the plan by demolishing an existing maze of enclosed offices, raising the ceiling, and opening the central core to accommodate 10 custom workstations. The partial enclosures are constructed of drywall painted in a Mondrian-inspired palette of red, yellow, and orange. Constructing desks, rather than purchasing a modular furniture system, allowed EMG to reuse undercounter filing cabinets and other support units, now painted black to recede from view. Partitions of translucent acrylic are mounted directly onto the drywall in random configurations so no two





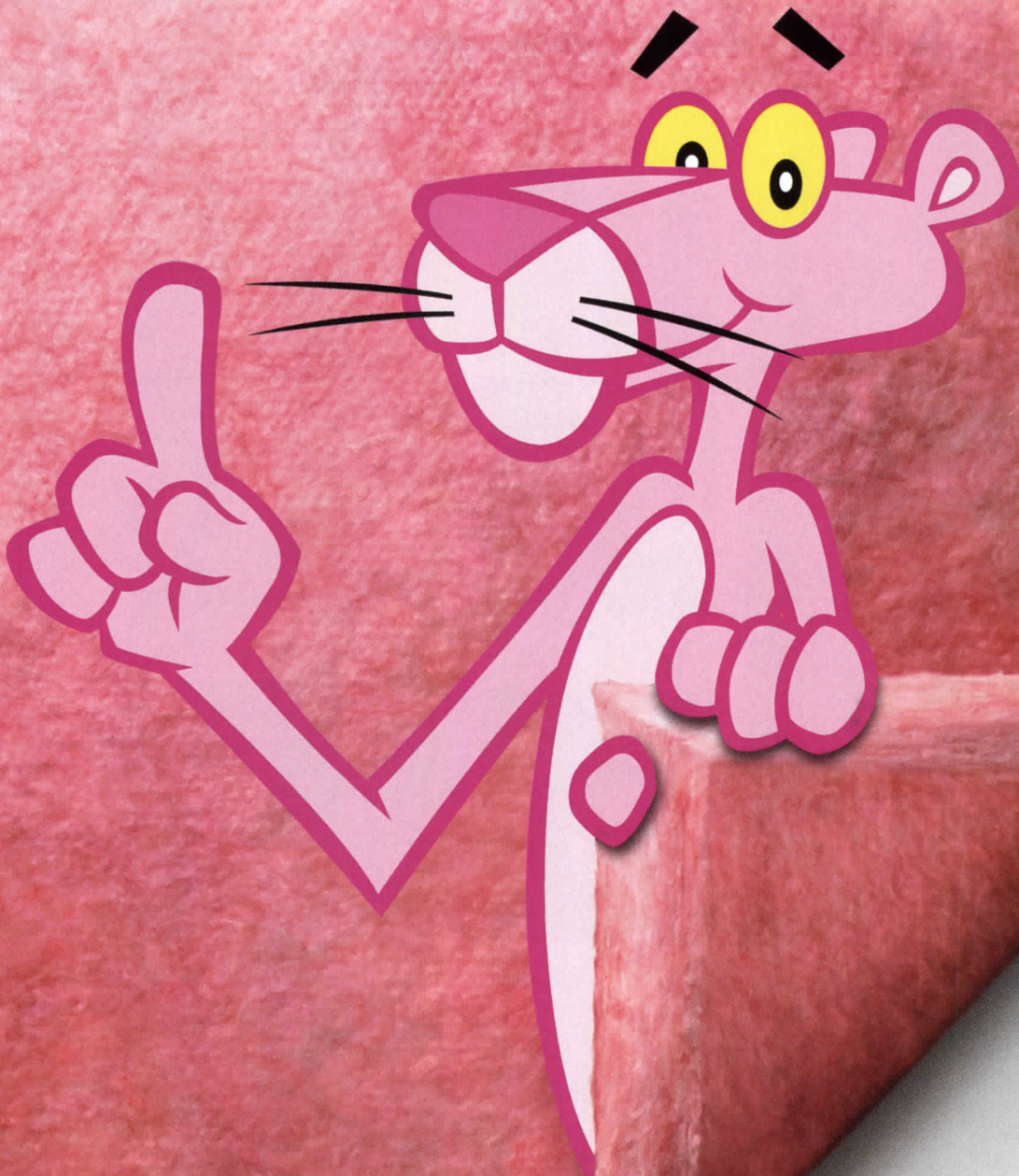

**A security blanket for  
your client's wallet.**

**ct, you know how important the right insulation can be to your client.** Over the life of a home, it can mean substantial savings on the cost of energy. That's why you should specify Owens Corning PINK insulation. We've been a leader in insulation for over 65 years. We have the experience, the knowledge and the range of products you need to dramatically improve a home's thermal envelope. From PINK insulation, to housewrap, to foam sheathing and accessories, Owens Corning's insulation products meet the industry's toughest standards. And our products have been certified for indoor air quality by the GREENGUARD Environmental Institute.<sup>SM</sup> Owens Corning FOAMULAR<sup>®</sup> is the only foam product in the industry to receive GREENGUARD Certification.<sup>SM</sup> When it comes to specifying insulation, **Smart To Think PINK<sup>™</sup>**. To find out more, visit [www.owenscorning.com/insulationproguide](http://www.owenscorning.com/insulationproguide) or call **1-800-GET-PINK**.



INNOVATIONS FOR LIVING<sup>™</sup>

INSULATION



CIRCLE 345 ON READER SERVICE CARD OR GO TO [WWW.LEADNET.COM/PUBS/MHAR.HTML](http://WWW.LEADNET.COM/PUBS/MHAR.HTML)

MANUFACTURED STONE VENEER

ROOFING

SIDING



Galvanized-steel pipes convey power cables to workstations (above left and right). Left unfinished and exposed, they join laminated-wood shelving

cubes, white plastic laminate desktops, translucent acrylic panels, and colorful, painted partitions as an office kit of parts (above and below).



workstations are the same. Linear fluorescents inset atop some partitions enhance ambient uplighting. White laminate desktops, laminated plywood shelving are affordable, attractive contrasts to color-splashed walls. Galvanized-steel pipes, which run power cables from the ceiling and walls to each desk, were left exposed to enhance the kit-parts look. The network of perpendicular colored walls also double as gallery showcase for EMG's colorful posters and advertising artwork.

Private offices for art directors, account managers, and executives rim the perimeter, enclosed by acid-etched glass walls that filter daylight into the open-office core. A clear horizontal band runs through the translucent panels at the eye level of employees seated at their desks.

One client, the musical *The Thing About Men*, incorporated a projection of the EMG office into its production. "They wanted an image of a cutting-edge ad agency," Gomez says, "and said this was the bill." It's a favorable review for GGA's design, an office for creative concern that improves the bottom line of show business.

**Sources**

**Workstation laminates:** Formica Corporation

**Luminous panels:** Lumicore Acrylics

**Flooring:** Chilewich, through Architectural Flooring Research

**Ceilings:** U.S. Gypsum

**Door hardware:** Blumcraft

**Glazing:** Zecca Mirror & Glass

**Signage:** Certified Graphics

**Lighting:** Lightolier

**Reception chairs:** Vitra

**Cabinetry:** Certified of New York

**Paint:** Benjamin Moore

For more information on this project go to Projects at [www.architecturalrecord.com](http://www.architecturalrecord.com).

When you want to make a visual statement,  
it helps to have a large vocabulary.

CULTURED STONE®

is a registered trademark of Owens Corning. Made in U.S.A. The product colors you see are as accurate as current photography and printing techniques will allow. We suggest you look at product  
ect colors. THE PINK PANTHER™ & ©1964-2004 Metro-Goldwyn-Mayer Studios Inc. All Rights Reserved. The color PINK is a registered trademark of Owens Corning. ©2004 Owens Corning.

more textures and colors of ledgestone than we do. So you can use one of today's hottest looks to make the kind of  
t will leave your clients at a loss for words. To see all of our ledgestone textures and colors or to see the rest of the Cultured Stone®  
st a copy of our new Design Solutions® Portfolio by calling 1-800-255-1727 or by visiting [www.culturedstone.com](http://www.culturedstone.com).



INNOVATIONS FOR LIVING™

46 ON READER SERVICE CARD OR GO TO [WWW.LEADNET.COM/PUBS/MHAR.HTML](http://WWW.LEADNET.COM/PUBS/MHAR.HTML)

INSULATION

MANUFACTURED STONE VENEER



ROOFING

SIDING



A custom-designed screen separates a breakout room and informal meeting area from the main corridor (above). The screen,

which rotates and snaps into place with a gentle push, is made of unstained domestic walnut that frames woven paper rush.

# Huntsman Architectural Group in San Francisco designs its office as a study in relaxed Modern style

Andrew Blum

The Barcelona chair designed by Mies van der Rohe is the mezuzah of American architecture firms, installed by the front door as a symbol of devotion to the tribe of Modernism. As a result, it has become a design-office cliché, a placeholder, a signifier that is no choice at all. It is a pleasant surprise, then, to find it missing from the lobby of the new San Francisco quarters of Huntsman Architectural Group, replaced by a trio of Egg chairs, a lesser-known but equally classic icon by midcentury Danish designer Arne Jacobsen. It is fitting, too, because the robin's-egg-blue chairs also signal a devotion to design, yet they convey warmth, comfort, and the atmosphere of informality that envelops each area of this clean-lined office.

"Clients will come in for a meeting, and they are often very comfortable just sitting in one of the reception-area Jacobsen chairs," says Mark Harbick, AIA, Huntsman principal and lead designer for the project. Clients may stretch out in public areas here, but not for long. The 20,000-square-foot office on the seventh floor of a historic 1960s-era downtown building is designed to be accommodating not only to Huntsman's practice but to the local community. The firm frequently hosts large holiday parties and other social functions, frequently opens its office to nonprofit organizations for benefits, and encourages clients (particularly those from out of town) to stop by, plug in a laptop, and help themselves to coffee in the kitchen. And nearly one third of the office is accommodating the staff of 70 is skewed to "public" rooms that feature notes of openness and crisp informality.

The Huntsman practice moved to this location from offices spread over several floors in a nearby historic building designed by architect Julia Morgan. Founded in 1981, when Daniel Huntsman left the firm, the firm focuses primarily on designing architectural interiors in the San Francisco Bay area. After years of ad hoc growth, Huntsman saw the move as a chance to clean its own slate and start afresh. "It was time to design an office that better reflected our personality and expressed the cultural elements that make us different," Harbick says, sitting in a sofa in the living-roomlike lounge off the boardroom. Other project constraints were an inexpensive construction budget, experimentation with modern forms, and the use of sustainable materials.

While the partners signed off on most decisions, key philo-

Andrew Blum is a freelance writer based in San Francisco. He is a regular contributor to ARCHITECTURAL RECORD and The New York Times.

**Client:** Huntsman Architectural Group  
San Francisco

**Architect:** Huntsman Architectural Group  
—Daniel Huntsman, principal  
—Mark Harbick, AIA, design partner  
—Keith Turner, Aaron Turner  
—project managers; Fritz Koenig

**Interior Designer:** Muegenburg, Alison Smith, James Reid, Nick Modroo, design team

**Consultants:** Randall Lamb/Capitol Electric (electrical); GFDS Engineers (structural); Charles M. Salter Associates (acoustical)

**Contractor:** Turner Construction

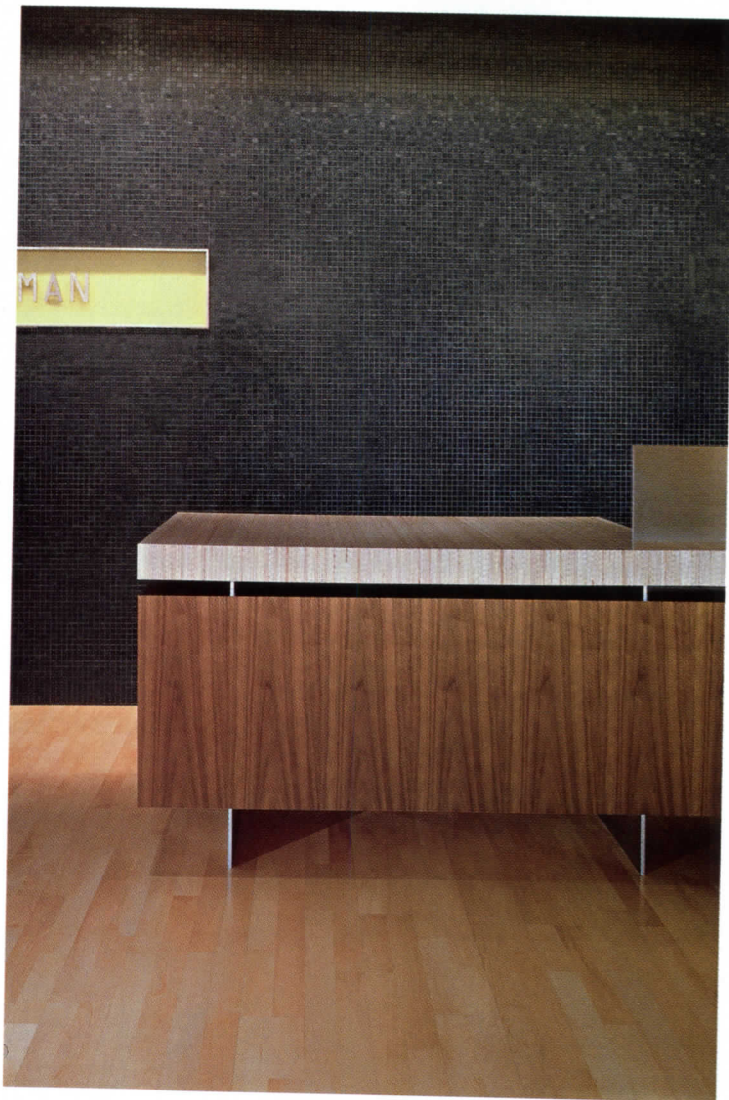

The walnut reception desk is topped by plywood turned on end and laminated. The charcoal mosaic is part of the graphic identity.



The long credenza in the conference room doubles as a buffet and extra seating (above).

Jacobsen's Egg chairs impart a Modern yet casual feeling in the reception area (below).



sophical ideas were put to the firm as a whole in an attempt to d  
cratically capture its corporate personality.

For example, the library in the old offices was beloved  
invariably a mess. "We got so busy and crowded," Harbick says, "wh  
ran out of conference rooms we would schlep our clients back in  
library, and as soon as they got there their eyes got big—they just lo  
see where it all happens." But would a library area work as the focal  
of the new space? The issue was resolved at an "all-hands" meeting:  
library now links the public rooms along the main circulation co  
with a single large studio in the back. Raising the 8-foot ceilings  
library to 12 feet balanced the size of the room and illustrated for  
Huntsman's philosophy of using its office as a combination lab and  
room. (Similarly, the dropped ceiling in the studio has a 6-inch  
demonstrate the "inner workings" of the infrastructure above.) The  
imity of the library to the boardroom means clients can sometin  
found riffling through sample catalogs on their own. The room's f  
tables also make it the area most frequently used by outside gro  
most recently, Pets Are Wonderful Support (PAWS), a San Fra

the Berkshire® Collection.  
could be the most beautiful roof ever.

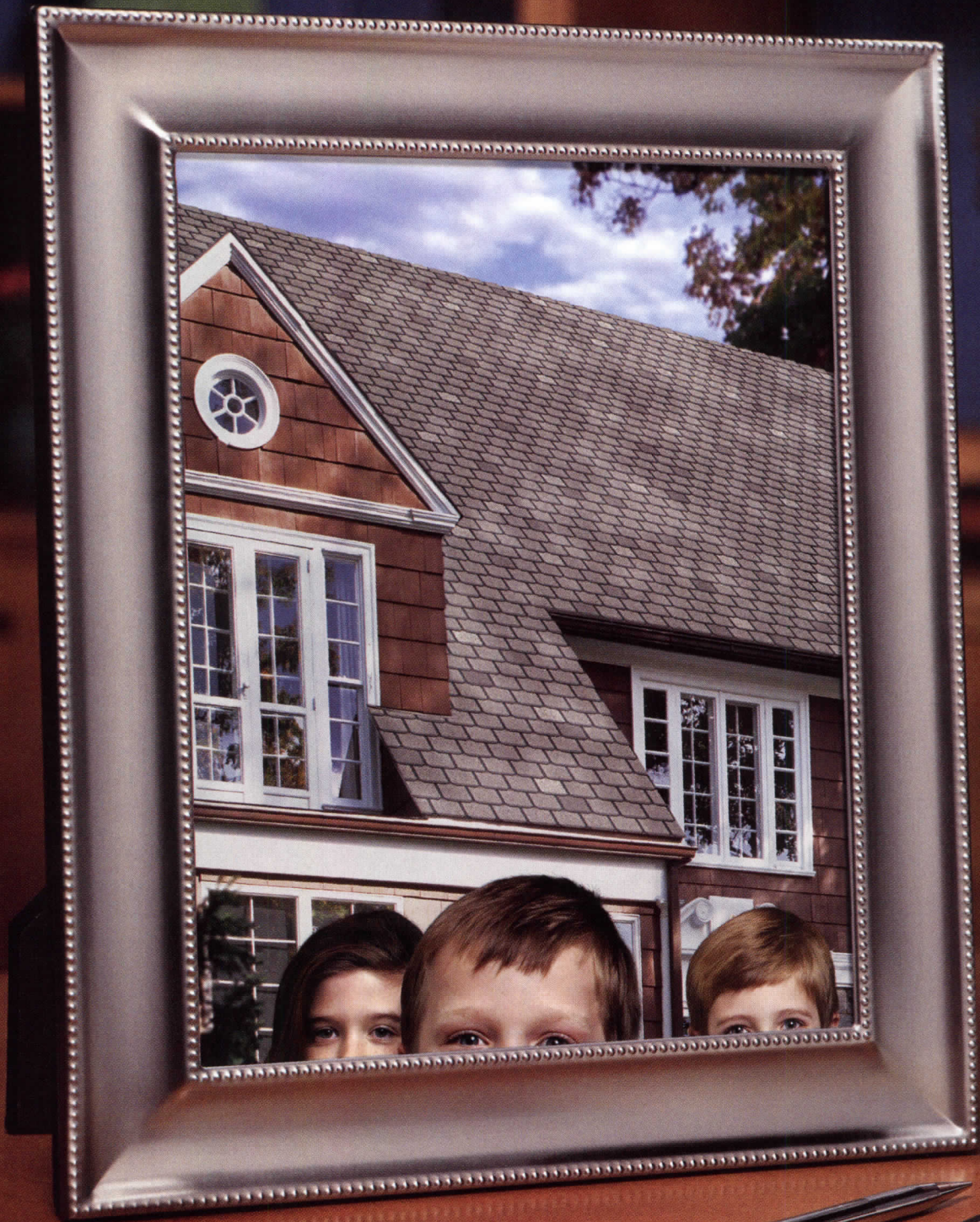

© 1964-2004 Metro-Goldwyn-Mayer Studios Inc. All Rights Reserved. The color PINK is a registered trademark of Owens Corning. ©2004 Owens Corning.

ers will fall in love with our Berkshire® Collection Shingles. And who could blame them? Berkshire shingles give a home beauty that makes a statement. They provide the rich look of slate and are offered in a sophisticated palette of twelve colors by Bedford Bronze, Dover Mist and Concord. Every Berkshire Collection roof also comes with a Limited Lifetime Warranty, the most beautiful thing of all. To find out more, visit [www.owenscorning.com/berkshire](http://www.owenscorning.com/berkshire) or call **1-800-GET-PINK**.



INNOVATIONS FOR LIVING™

INSULATION

MANUFACTURED STONE VENEER

ROOFING

SIDING

CIRCLE 347 ON READER SERVICE CARD OR GO TO [WWW.LEADNET.COM/PUBS/MHAR.HTML](http://WWW.LEADNET.COM/PUBS/MHAR.HTML)





charity that helps people with HIV/AIDS care for their pets.

Huntsman has engaged its office as a “beta testing” site for mock-ups of new furniture and interior products manufactured by companies that include Herman Miller and Peerless Lighting. (The mesh backs of Eames swivel chairs were “road tested” in the conference room.) Serving as a marketing tool and calling card, the office has aided the firm in acquiring new clients, some of whom first became aware of Huntsman while touring the office to see its on-site installations at the invitation of manufacturer representatives, Harbick reports.

One room that captures the form-and-function spirit of the office is the open kitchen, where clients help themselves to coffee, and snacks and wine are served on Friday afternoons. An island is topped by plywood turned on its side and laminated, while the counter is covered in linoleum—inexpensive, strong, and sustainable. When the manufacturer of the latter material refused to warrant it for use on any surface but the floor, Harbick decided to experiment with it anyway. Becoming your own client, he notes, can lead to a windfall of new design solutions. ■

**Sources**

**Wood flooring:** Junkers  
**Carpeting:** Prince Street; Interface  
**Mosaic wall tile:** Bisazza  
**Ceilings:** Armstrong  
**Wall panel system:** Fabrictrak  
**Lighting:** Peerless Lighting; ERCO; RSA; Bella Shades; Selux; Artemide  
**Furniture:** Knoll; Herman Miller;

Sloan Miyasato; Vecta; Steelcase; Cassina; Nienkamper; Mayline; Design Within Reach  
**Fabrics:** Carnegie; Designtex; Maharam; Jack Lenor Larsen; Pollack

For more information on this project, go to Projects at [www.architecturalrecord.com](http://www.architecturalrecord.com).



Huntsman employees applied colored fabric randomly to open-plan office panels for a sense of informality (above). A credenza’s sliding wood top covers recycling bins (left). Cutouts in doors along a corridor create sleek handles without heavy hardware (below).

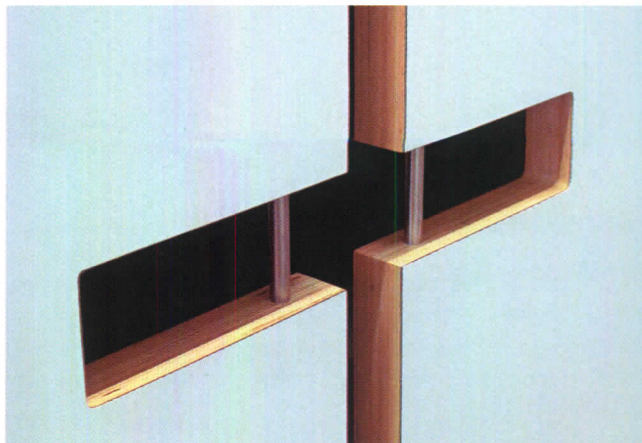



# Traboscia Roiatti introduces a modern point of view to the offices of French vintner Clicquot in New York City

**William Weathersby, Jr.**

**V**euve Clicquot, which translated from the French means “Widow Clicquot,” is the premium champagne and parent company named after the extraordinary woman who was a trailblazing entrepreneur in 19th-century France. Widowed at 28 in 1805, Madame Clicquot took the reigns of her family business and over six decades built a premium brand, exporting champagne to Russia and America, among other precedent-setting destinations. Today, the international bottler and distributor has an expanded portfolio reaching beyond its Champagne district to include wines from the Marlborough region of New Zealand and vineyards in the Pacific Northwest.

Clicquot, Inc., the U.S. subsidiary, is helmed by president and CEO Mireille Guiliano, a woman on whom the tenacious legacy of Madame Clicquot is not lost. When scouting for space to house a new headquarters in Manhattan, Guiliano says she sought a location and interior style that were less traditional than the company’s previous Midtown offices and more in line with its current spirit of modernity and global trade. “In the 1980s and ’90s, the



conventional place for a luxury company to be was on Fifth Avenue,” Guiliano says. “It was time for us to move on from our location there, and we wanted to be where the action is.”

Working with architects Traboscia Roiatti, Clicquot secured a 13,500-square-foot space in the Chelsea neighborhood’s Starrett Lehigh Building, an address that could not be more *au courant*. Converted several years ago for office use, the circa 1931 former railroad depot houses high-end fashion and lifestyle tenants, including

Assouline, Hugo Boss, and Martha Stewart Omnimedia, plus a roster of commercial art galleries and photo studios. Clicquot also uses its office as a venue for entertaining clients, so the location’s dealmaking attraction was an adjoining 4,000-square-foot terrace with two exposures framing views of the Hudson River, the Statue of Liberty, and Midtown landmarks such as the Empire State Building.

curving forms and  
ge accents at  
Clicquot, Inc. (below)  
inspired by the  
er’s champagne  
s (right).



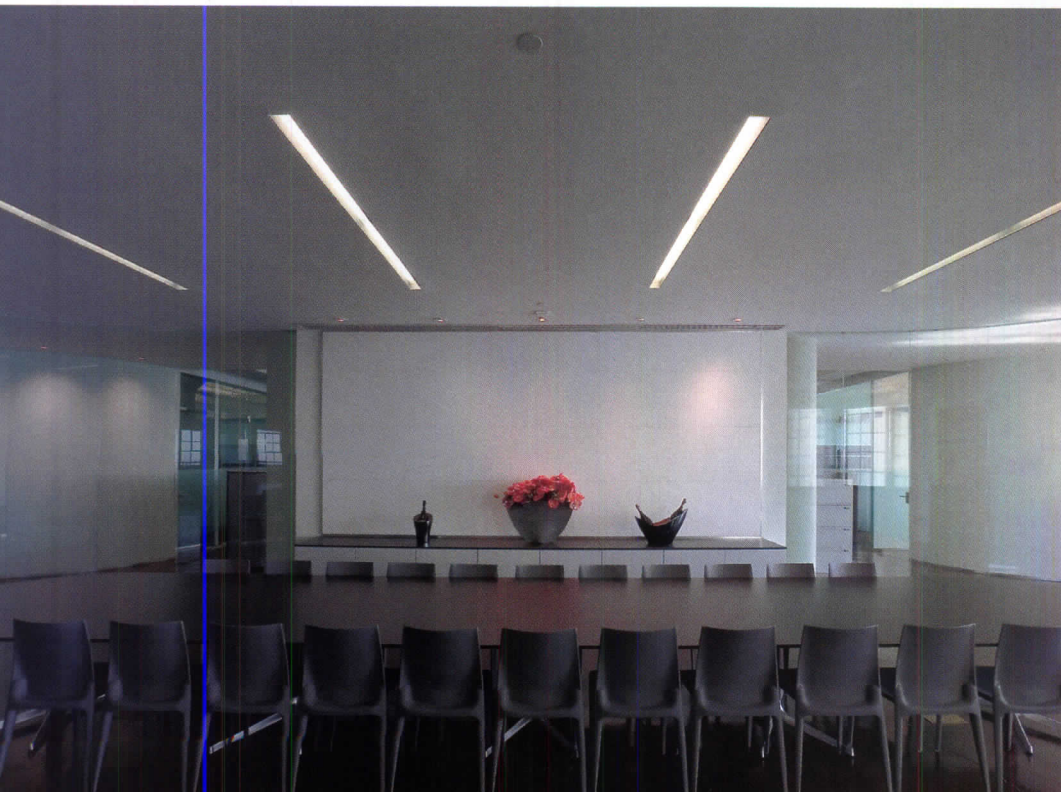



Though their colleagues in France typically work in pastoral chateaux or city town houses lined with rich wood paneling and antique furnishings, Clicquot's New York executives envisioned an office that was "contemporary, open, and light," says principal architect Robert Royatt. The 15th-floor facility was graced with broad expanses of land, factory-style windows, but presented challenges in terms of programming, he notes. To reach Clicquot's corner area and other tenant locations, for example, a new public corridor was needed to connect to one corner of the company's rectangular space. The enclosed executive offices would adjoin the terrace at the end of the space opposite the entrance, circulation between public and private

## ADDITIONAL INTERIORS WERE REPLACED A LOFT WITH OPEN SIGHT LINES AND DRAMATIC VIEWS OF MANHATTAN.

was a grappling point for the design team.

A kitchen, bar, café, and wine-storage area were set requirements. "Flexible, accessible facilities to accommodate special events such as tastings were a key part of the program," adds project partner Robert Royatt, AIA. In terms of circulation, "no one wanted guests to have to rough open office areas to reach the terraces during a party. The design team had to balance the demands of entertainment areas on one side and private office, support staff, and production areas on the other."

**The conference room (opposite, bottom left and top) juts into the bar and café area. The C.E.O.'s private office (above) and another executive's office (opposite, bottom right) are faced with glass walls and doors treated with translucent film.**

To maintain internal sight lines while maximizing daylight and framing the panoramic views, a series of glass-framed enclosures were set within the boxy building envelope. The architects say they were inspired by the classic Veuve Clicquot champagne bottle itself. The shapely container influenced curving glass walls "with a liquid, transparent feeling, which transmit daylight to the core while encouraging a flow of movement," Royatt says. Meanwhile, the bottle's distinctive orange label (called "Clicquot yellow" by employees) was adapted as an accent color.

The office design capitalizes on volume and light to trump the space's vast horizontality. Visitors are greeted at the Clicquot reception area by long views looking diagonally through the glass-enclosed conference room and work spaces beyond; one can see skyscrapers from the outset. Set between the concave front edge of the reception desk and the perimeter of glass doors and windows facing the terrace, the private meeting room becomes a central focal point, with the "fork in the road" it creates in plan presenting two main circulation choices. The floor-to-ceiling glazing of the conference room enclosure is faceted to echo the lines of the Starrett Lehigh Building's perimeter wall. Though its meeting-in-a-fishbowl configuration puts participants on view at center stage, the room is fitted with blackout draperies that can be deployed for privacy.

The beveled line of the building's glazing is reiterated by the outline of the nearby bar (below). The existing concrete floors were stained in a sepialike shade that approximates the color of

vintage Veuve Clicquot wine labels and bottle glass. A café area beyond the conference room is set near windows overlooking the 4,000-square-foot terrace, newly outfitted with pavers (right).



Enclosing executive and management offices, floor-to-ceiling glass walls configured without visible framing seem to dissolve the boundaries of interior spaces. Treated with bands of translucent film, the enclosures afford a degree of privacy while conveying openness. Ceiling tile and wall paneling are made of translucent, tacticable surfaces manufactured from recycled materials also consistent with the firm's progressive culture. To also meet the mandate of low-cost, durable materials, an orange laminate bar and tabletops, in addition to orange accents, approximate the signature Clicquot hue without requiring a full color-matching. Bright, lightweight chairs and bar stools are a perfect spot for guests to perch while toasting the sunset over the skyline.

**Project:** *Clicquot, Inc., New York City*  
**Architect:** *Traboscia Roiatti—Robert Traboscia, Caterina Roiatti, AIA, partners in charge; Diego Otero, Michael Silverman, Andres Tenorio, project team*  
**Consultants:** *Liker Associates (engineer); Jim Willey/International Lights (lighting)*  
**General contractor:** *Celtic General Contractors*

**Sources**  
**Furniture panels:** *Trespa USA*  
**Acoustical panels:** *Tectum; P. Acoustics*  
**Chairs:** *Heller; Vitra*  
**Shelving:** *Rakks*  
**Lighting:** *Atlite; Lucifer Lighting; Selux; Hess America*

For more information on this project, go to Projects at [www.architecturalrecord.com](http://www.architecturalrecord.com).



In this great nation of symbols and power,  
buildings of Indiana Limestone inspire and endure.



**THE NATION'S  
BUILDING  
STONE**

■ It is a testament to the unmistakable durability of Indiana Limestone when the world's leading architects select this limestone for structures of strength and longevity. Expect high endurance from a truly remarkable raw material in architecturally significant public structures built with Indiana Limestone. Its characteristics are solid, and its versatility in color and texture allow for a fluidity of design. For nearly a century, Indiana Limestone Company has been the largest quarrier and fabricator of high quality Indiana Limestone—The Nation's Building Stone. Choose Indiana Limestone, a natural material that will endure for generations.



**INDIANA LIMESTONE  
COMPANY**

For more information about Indiana Limestone for your next project, call 800-457-4026 or visit [www.IndianaLimestoneCompany.com](http://www.IndianaLimestoneCompany.com).

**CIRCLE 350 ON READER SERVICE CARD OR GO TO [WWW.LEADNET.COM/PUBS/MHAR.HTML](http://WWW.LEADNET.COM/PUBS/MHAR.HTML)**



from top:  
Building  
ry, PA  
arters  
is, TN  
ilding  
n, DC  
ilding  
ry, AL  
tagon  
n, VA  
ilding  
k, NY



A layering of steel, glass, and felt panels and screens defines the entry to Grip. Halogens and fluorescents create sparkle

## Transparency, lightness, and a sense of play enliven two Toronto offices designed by architect **Johnson Chou**

By **John E. Czarnecki, Assoc. AIA**

**T**oronto is home to a number of young multimedia design firms whose offices near downtown are often nondescript, with exposed brick walls in renovated warehouse buildings. While the firms may be creative, they can become bland landscapes of standard, open-plan workstations. Taking a different tack, two firms, Grip Limited and Medium One Productions, turned to Toronto architect Johnson Chou to design spaces that better reflect their companies' distinctive, sophisticated styles. Chou, who says he was inspired by the notion that a workplace can help engage both a firm and its client to achieve a creative vision, developed two offices that enhance the industriousness of each company without overemphasizing the industrial nature of the core facilities it occupies.

*John E. Czarnecki, Assoc. AIA, is an acquisitions editor of architectural books at John Wiley & Sons and a former associate editor of ARCHITECTURAL RECORD.*

Since 1999, Chou has built his practice with projects mostly in Toronto that encompass the design of offices, restaurants, and furniture. Like many of his commissions, Grip and Medium One display his innovative use of materials and exploration of transparency and illumination.

Grip, a creative agency focusing on multimedia print and television design, granted Chou broad design freedom, he says. Perhaps best known in Canada for its irreverent TV ads for Labatt Breweries geared toward young men, Grip wanted an office that was neither corporate nor overtly industrial and that reflected a sophisticated rather than sophomoric wit. To find a middle ground, the architect was inspired by Grip's trademark advertisement tableaux, in which a spare number of actors and objects are animated in unexpected ways; he kept that idea in mind as he designed the space.

Located on the third floor of a new mixed-use building in Toronto's youth-oriented Queen Street West, Grip's office employs a minimal palette of materials, textures, and a single color—orange.



Aside from the orange carpet in the lounge (above), floors are a gypsum-based commercial underlay, while ceilings expose the

building's concrete structure (below left). A circular conference room is enclosed by nylon stretched across a steel frame (below).

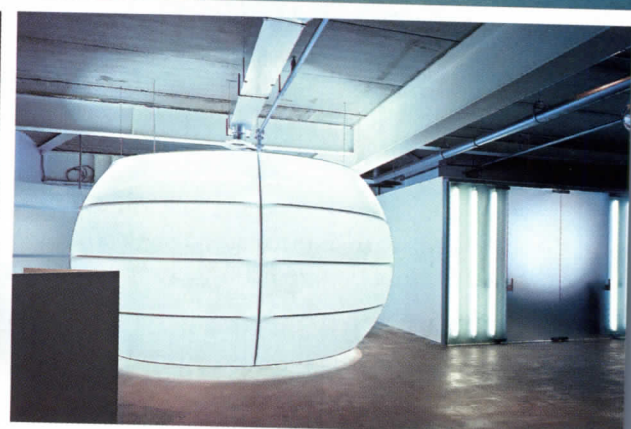

Exploring the power of materiality and translucency at Medium One, Chou designed a long steel

reception desk fronting a glass ramp (below) and steel workstations topped by illuminated acrylic panels (right).



great effect. From the elevator, the sweeping curve of an acrylic wall, which encloses a conference room, leads past the orange Grip logo to the main entrance. A wall, covered in gray felt to dampen sound and add texture, defines the path to workspaces while separating public and private realms.

Programmatically, Chou layered sequences of forms and enclosures within the 6,700-square-foot envelope. The tableaux include a suspended, spherical meeting pod enveloped in nylon fabric stretched on a steel frame. A glass-enclosed lounge features orange carpet (besides the

## AT TWO TORONTO MEDIA FIRMS, GRIP AND MEDIUM ONE, GLASS PANELS AND LUMINOUS SURFACES CONVEY OPENNESS.

signage, the only bright color present) and sofas Chou designed that attract employees taking breaks during and after late-night work sessions. The lounge is also soundproofed for blaring stereos and televisions.

Private offices for Grip managers hug the south wall, with cubicles reserved for account managers. In creative team areas, workstations can be divided for privacy via sliding, galvanized-steel doors. Clear and translucent glass panels throughout convey openness and informality.

A few blocks west of Grip, Medium One is set within a former munitions factory with original wood and rough concrete floors, heavy timber framing, and remarkably beautiful brick walls. Chou's simple

Modern office installation contrasts with the sublime yet aging existing conditions. At the entrance, a stainless-steel reception desk spans the length of a frosted-glass ramp that leads to the creative staff wing. Creative workstations feature steel bases and acrylic enclosures that pivot to open and close. When lit, the workstations appear more like an art installation than standard desks; Chou confirms that he was inspired by the illuminated artworks of James Turrell when tackling this office configuration.

At Grip and Medium One, Chou explores translucency, materiality, and complexity of form. Though each is distinctive, both of the offices express the playful yet professional nature of the creative work at hand.

**Project:** Grip Limited, Toronto  
**Architect:** Johnson Chou—Johnson Chou, Anne-Rachel Schiffman, Steffanie Adams, David Annand Peterson, Seth Matson, Stacie Amo, Parisa Manoucheri, project team  
**Engineer:** Nunn Warden Design  
**General contractor:** MCM 2001

**Architect:** Johnson Chou—Johnson Chou, Michael Lam, Steve Cho, project team  
**General contractor:** Pro-Co

**Sources**  
**Glazing:** CLO Glass; CYRO  
**Furniture:** Keilhauer; Nienkamper  
**Project:** Medium One, Toronto

**Sources**  
**Glazing:** CLO Glass  
**Lighting:** Eurolight

For more information on this project go to Projects at [www.architecturalrecord.com](http://www.architecturalrecord.com)



# At the Milan Furniture Fair, Frank Gehry translates his signature shapes into chairs and door hardware

With major new works such as the Stata Center at MIT, a civic pavilion and bridge at Millennium Park in Chicago, and two recent civic building commissions in Brooklyn, Frank O. Gehry remains dead center on the radar of architects working at full-tilt. (His new bid for the Polish vodka

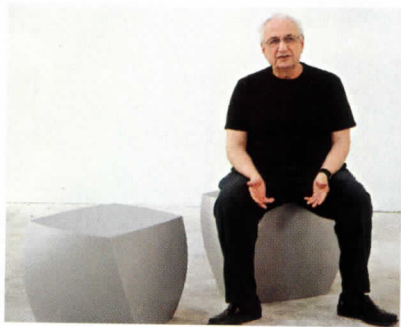

by Wyborowa won over another strain of aficionados in May.) At the Milan Furniture Fair in April, Gehry switched gears to blaze a trail within the world of interior furnishings and fixtures. His furniture designs for American manufacturers Emeco and Heller joined shapely hardware for the Italian company Fusital/Valli&Valli to blanket the show's Pavilion 20 in FOG. Though shown as prototypes with some tweaking to come, the chairs, tables, and door handles captured the architect's signature melding of industrial materials (gray or natural finishes), materials (aluminum, resin, stainless steel), and playful shapes (door handles evoked fish and arrowheads), while Heller's designs seemed like abstractions of his building models. Among the highlights:

The stacking Superlight chair has an optional felt pad supported by an aluminum base. Emeco, Hanover, Penn. [www.emeco.net](http://www.emeco.net) **CIRCLE 251**

For use indoors or out, a series of cubes, tables, and a sofa come in resin. Heller, New York City. [www.helleronline.com](http://www.helleronline.com) **CIRCLE 252**

The FOG Duemilaquattro (abstract fish shapes) and Arrowhead include door and window handles, knobs, and coat hooks in finishes such as polished brass and satin stainless steel. Fusital/Valli&Valli, Italy. [www.vallievalli.com](http://www.vallievalli.com) **CIRCLE 253** *William Weathersby, Jr.*

For more on these designs, plus Gehry discussing his work with Emeco, go to [architecturalrecord.com](http://architecturalrecord.com).



Clockwise, from top left: Gehry perched on his cube for Heller; his sketch for the Superlight folding chair by Emeco; two views of the Superlight chair in brushed/anodized aluminum; the Frank Gehry Furniture Collection by Heller; maquettes of the Heller line; and Fusital/Valli&Valli's door handles in stainless steel (top) and polished brass (bottom).



# strong

# dependable

# durable

MANUFACTURER OF FINE BUILDERS ARCHITECTURAL DOOR HARDWARE



# Trimco

TRIMCO developed Anti-Vandal and Heavy Duty Hardware specially for high traffic, exposed, rough service areas like schools, prisons, parks, public buildings, and rear doors of retail commercial and industrial buildings. Our stylish and rugged designs are currently protecting against break-ins and vandalism in thousands of schools and buildings across the U.S.

CALL US AT 323/262-4191 OR

FAX TOLL FREE 800/637-8746

EMAIL: [INFO@TRIMCOBBW.COM](mailto:INFO@TRIMCOBBW.COM)

CIRCLE 353 ON READER SERVICE CARD  
OR GO TO [WWW.LEADNET.COM/PUBS/MHAR.HTML](http://WWW.LEADNET.COM/PUBS/MHAR.HTML)

## Natural-Look Spanish Tile a Hit at Cevisima

Look of natural stone, weathered oxidized steel, and even simulated wood grain were big trends among the Spanish ceramic tile showcased at the annual Cevisima trade forum in Valencia, Spain, last March. More than 100 exhibitors attracted over 86,000 visitors from 140 countries to view the array of tile for commercial and residential use. Another highlight

was a broader range of tile dimensions, with many companies offering six or more sizes in square or rectangular formats with additional coordinating, mesh-mounted mosaics and bar- or rod-shaped accent pieces. Bright colors, including red, inspired by Pop Art and Art Deco, made a strong return to the market. For more information on these products, Spain's tile industry, or individual manufacturers, visit the Miami-based Tile of Spain Center at [www.spaintiles.info](http://www.spaintiles.info). William Weathersby, Jr.

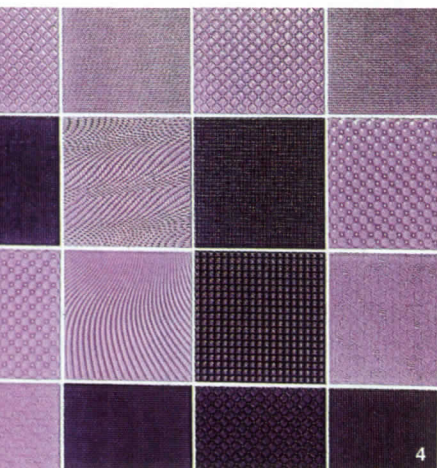
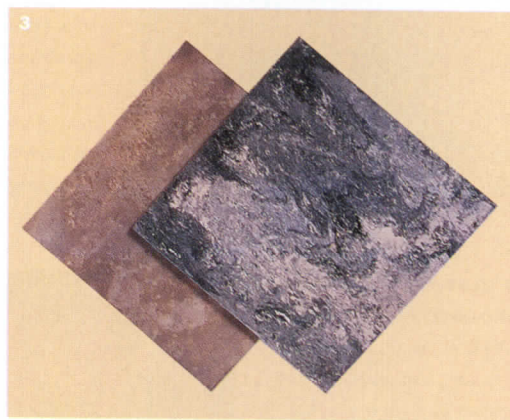
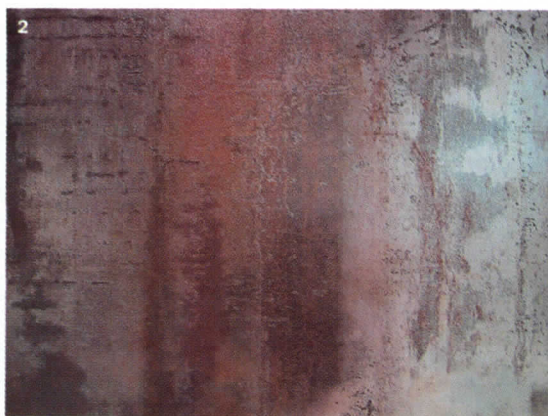
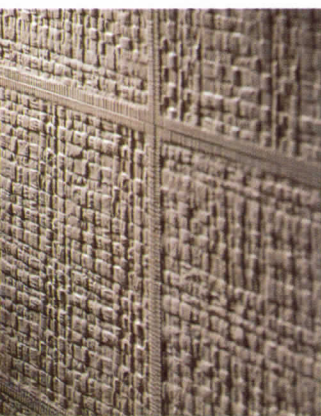

ni from Saloni is inspired by the look of Japanese rice paper. This ceramic tile series encompasses coordinating wall and floor tiles. The wall tile is produced in a 12" x 24" format, while the floor tile comes in 12" x 12" squares. Uchi offers light tones of white, cream, and gray. The series is complemented by a woven-rattan tile named Tatami, offered in 12" x 12" and 3" x 12" formats. Uchi, San Juan de Moro, Spain. [www.saloni.com](http://www.saloni.com) **CIRCLE 206**

inspired by Tau Ceramic replicates the look of naturally oxidized steel widely used in contemporary architecture and sculpture. This porcelain tile

series is offered in 12" x 24" and 24" x 24" formats. It is available in an oxidized dark blue iron finish (Corten B) and a rusty bronze color (Corten A). Tau Ceramic, Castellon. [www.tauceramic.com](http://www.tauceramic.com) **CIRCLE 207**

**3.** Alcalagres specializes in the production of commercially rated porcelain tile. Its Islas Series of double-loading porcelain tile is offered in 16" x 16" and 13" x 24" formats and comes in abstract, nature-inspired hues, including blue, yellow, and green. Options are a polished or smooth matte-satin finish, with coordinating pieces. Alcalagres, Madrid. [www.alcalagres.com](http://www.alcalagres.com) **CIRCLE 208**

**4.** Inalco's Structures, a series of 8" x 8" wall tiles, is produced in 12 colors, including white, gray, and various shades of green, lilac, and blue. This series features 10 design reliefs that can be mixed for added visual impact or used individually for a more subtle installation. Inalco, Alcora. [www.inalco.es](http://www.inalco.es) **CIRCLE 209**

**5.** Altamira is part of Porcelanosa's Ston-Ker collection of all-through body porcelain tiles. Ston-Ker is an extensive program of stonelike tiles with a high slip-resistant surface featuring a smooth, nongritty texture. This feature improves safety with the added value of easy clean-

ing. Altamira is produced in 17" x 17½", 17" x 26", and 6" x 26" formats, and comes in gray, beige, and brown. Porcelanosa, Villarreal. [www.porcelanosa.com](http://www.porcelanosa.com) **CIRCLE 210**

**6.** Keraben's Futura is a commercially rated, all-through body porcelain tile series, engineered for floors and available in a polished, high-gloss finish, a semipolished satin texture, or with a natural matte surface. The tiles are offered in black, white, cream, gray, and mocha. Futura is produced in 16" x 16" and 12" x 24" formats. Keraben, Nules. [www.keraben.com](http://www.keraben.com) **CIRCLE 211**

## Interiors Products Contract Fabrics



### ◀ Cushionlike back fabric

Herman Miller now offers an upholstered-back option to its Mirra office chair. Mirra's new upholstery fabric, Latitude, is placed on the front of the backrest with a trim piece around the periphery. Latitude's spacer-knit technology provides a cushionlike material for the user to sink into without the use of foam. The fabric comes in 17 colors and is made from polyester that is 100 percent recyclable at the end of its useful life. Herman Miller, Zeeland, Mich. [www.hermanmiller.com](http://www.hermanmiller.com) **CIRCLE 200**

### ▶ Ancient look for modern fabrics

The Ceramica collection of Crypton jacquard upholstery textiles was inspired by age-old craft techniques, including raku, terrazzo, and fresco. Crypton, the patented textile-treatment process, is engineered to provide extreme stain, moisture, and microbial resistance. The fabrics are intended for projects including health-care, corporate, and hospitality facilities, as well as the residential market. Pallas Textiles, Green Bay, Wis. [www.pallastextiles.com](http://www.pallastextiles.com) **CIRCLE 202**



### ▼ Working out a better fabric

Burlington Contract Fabrics' (BCF) new Environ fabric (right) is engineered from postindustrial textile chip and is suited for applications where polyester products are currently used for panel and upholstery. One of the newest products from BCF featuring Environ technology is ProKnit (left), a knitted, layered panel fabric and upholstery based on a technology once confined to the performance apparel industry. Burlington Contract Fabrics, Greensboro, N.C. [www.burlingtoncontractfabrics.com](http://www.burlingtoncontractfabrics.com) **CIRCLE 204**

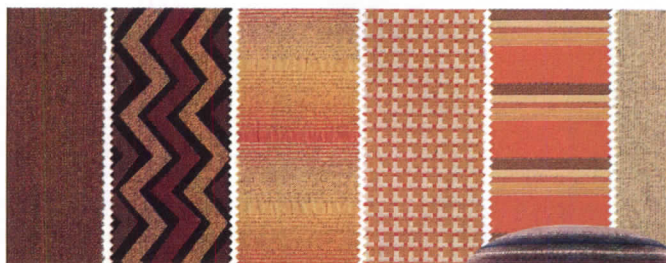
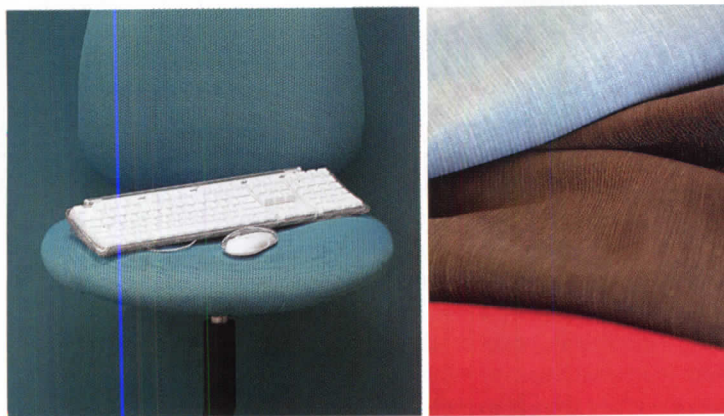

### ▲ Crafty collaboration

Winkraft is a new brand of contemporary textiles, furniture, and accessories launched by the Winkreative design agency and Bernhardt Design. The first offering from Winkraft is the Alp Maritim collection of upholstery fabrics. Created in collaboration with Swiss textile designer Caroline Flueler, the six designs feature colorways that blend a selection of neutrals with splashes of bright oranges, greens, and blues. Bernhardt Design, Lenoir, N.C. [www.bernhardtdesign.com](http://www.bernhardtdesign.com) **CIRCLE 201**



### ◀ Fabrics from the brink

The Brinkman Fabric Collection is not available in the U.S. solely through Roger Arlington's national showroom. Previously, these fabrics were only available to an exclusive group of Anne P. Brinkman's own clients. Brinkman, a Dutch designer/artist/architect/antique dealer, created a collection of jacquard woven fabrics in silk, linen, cotton, and mohair, in response to a need for adequate fabrics for his interior projects. Shown here is Allover, a cotton/linen blend. Roger Arlington, New York City. [www.apbrinkman.nl](http://www.apbrinkman.nl) **CIRCLE 203**

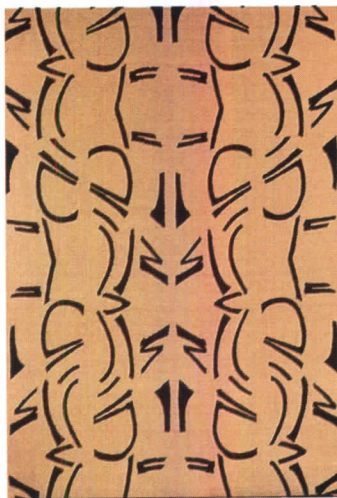

### ▶ Vintage textiles

The name for Keilhauer's new Recho Collection of five textiles came from the desire to address different segments of the market—residential, contract, and hospitality—with a collection of sophisticated fabrics inspired by the couture fashions of the 1950s. The collection includes Divine, a wool blend that features a refined faille weave inspired by elegant French coating fabrics; Coco, an embodiment of the texture found in suits from the house of Coco Chanel; Faux, a faux suede that is durable enough for contract settings; and Aria, a semianiline-dyed cowhide. Keilhauer, Toronto, Canada. [www.keilhauer.com](http://www.keilhauer.com) **CIRCLE 205**



# Products

## Commercial Carpet & Furnishings

The following **carpet & furnishings** are appropriate for an array of commercial interiors, particularly the office setting. It is now standard for furnishings such as chairs to have an ergonomic "brain," and carpets to have an environmental "conscience," reflecting a **trend toward a healthier work environment.** *Rita F. Catinella*

### Practical solutions for when meetings and furniture intersect

According to Herman Miller, while a larger proportion of workplace square footage is being allocated to multipurpose group spaces, collaborative efforts can be impeded by work tools and environments designed mainly to support individual tasks. Herman Miller has responded to this issue with the Intersect portfolio, an offering of flexible, freestanding products designed to be used in open areas. Though primarily intended for settings that support up to six people, Intersect's elements are scalable to accommodate groups of any size.

Intersect is divided into four categories: display products that allow for taking as well as the display of information; tables in different sizes and shapes; stacking lounge seating; and boundary defining products, including four- to six-panel coping screens to divide space,

create standing privacy, and add vertical work space.

Rather than focus on a single design vision, Herman Miller chose to work with an array of designers. Mark Goetz's Idea Exchange Center is a large marker board/display surface that also delineates group space. Jeff Weber contributed the Foldaway mobile table, the Caper chair (an existing product), and the Mobile Easel. Kyle Swen and Danny Peter's Work Island serves as a mobile café or a standing meeting space for two to six people. Ayako Takase and Cutter Hutton's Kotatsu worktable features a functional understructure and a clever center-cutout tray, and when workers need to take a load off, David Pessa's Celeste Lounge Seating offers a soft seating solution. Herman Miller, Zeeland, Mich. [www.hermanmiller.com](http://www.hermanmiller.com) **CIRCLE 212**



The Work Island (above) can serve as a mobile café; detail of the Kotatsu worktable's shelf (top); Mobile Easel features two locking casters (right).



### Colorful lacquered executive furnishings

Out of one of the Fantoni Arch Center's experimental projects, the Stripes collection of executive office furniture was recognized with an award at this year's Salone del Mobile's office exhibition, 2004. Developed in cooperation with Marco Viola, Stripes uses a range of colored bands in three

color schemes, including shades of green (left), multicolor (right), and shades of gray. The system is composed of a bookcase, a desk, and a bench in two width/height combinations. Each element is manually lacquered with high-resistant paint on MDF panels. Luminaire, Miami, Fla. [www.fantoni.it](http://www.fantoni.it) **CIRCLE 213**

### New standard for sustainable carpet tile

C&A Floorcoverings has introduced the Cycle Collection: two coordinating, nondirectional designs of different scales intended for corporate and government settings. Sequence is the first of the two designs to be released, followed by the blocks-on-blocks design of Cadence. The environmentally friendly carpet tile will utilize Honeywell's (formerly BASF) Savant HRC (High Recycled Content) nylon with a minimum of 50 percent recycled content (25 percent postconsumer and 25 percent postindustrial). In addition, a built-in RS tackifier eliminates the use of wet adhesives,

which can contribute to poor indoor air quality. Independent, third-party certification through Scientific Certification Systems has verified the total recycled content of the product as well as its 100 percent recyclability. C&A Floorcoverings, Dalton, Ga. [www.tandus.com](http://www.tandus.com) **CIRCLE 214**



For more information, circle item numbers on Reader Service Card or go to [www.archrecord.com](http://www.archrecord.com), under Resources, then Reader Service.

06.04 Architectural Record 363



is a hardy flooring solution for any zone, thrives in sun or shade, and holds up under heavy foot traffic. Unlimited color palette and design possibilities makes this perennial favorite a must-have, while offering one of the lowest lifecycle costs in the flooring industry.

— a floor that truly performs!

Call at: 1.800.323.9736

Visit at: [WWW.NTMA.COM](http://WWW.NTMA.COM)

CIRCLE 356 ON READER SERVICE CARD OR GO TO [WWW.LEADNET.COM/PUBS/MHAR.HTML](http://WWW.LEADNET.COM/PUBS/MHAR.HTML)

## Terrazzo

A PERFORMING ART

Job Name: Carmel Clay Public Library  
Location: Carmel, Indiana  
Architect: Meyer, Scherer, & Rockcastle, Ltd.  
Designer: Browning Day Mullins Dierdorf, Inc.

## Products

### Commercial Carpet & Furnishings

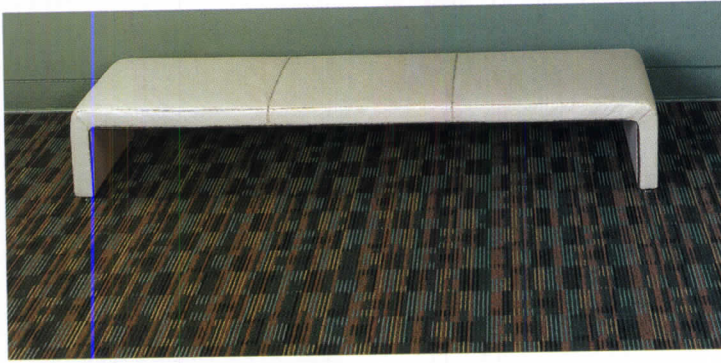

#### ▲ Something to admire while waiting in line

Shaw Tek introduces In Line, a collection of complementary carpet styles designed for

## Products

### Commercial Carpet & Furnishings



#### ▲ Resilient recycled carpet flooring

A low-cost alternative to traditional carpeting or VCT, Finett recycled carpet is a durable solution for high-traffic environments, including airports, schools, malls, and industrial office settings. Offering the look and feel of carpeting, Finett received the highest-class rating for extreme wear in rigorous European wear testing. Finett is sold in 6' to 7' roll widths and some designs are available in modular tile format. Finett has an overall recycled content of 45 percent (postconsumer textile backing). Mats, Stoughton, Mass. [www.matsinc.com](http://www.matsinc.com). **CIRCLE 220**

#### ► Sit and think

Steelcase's new midpriced office chair, Think, is designed with a three-part "brain"; flexors that adapt to the user's movements; a reclining mechanism that creates resistance proportional to the user's individual weight; and an adjustable back selector. The company worked with McDonough Braungart Design Chemistry to give the chair a "conscience," as well. Comprised of 98 percent recyclable content and up to 50 percent recycled material, Think is the greenest office chair on the market to date. Steelcase, Grand Rapids, Mich.



#### ▲ Smarter table shape

The e-table 2 trapezoid is Vecta's newest wire-ready meeting, presentation, and teleconferencing table. The trapezoid

shape of the table gives everyone a better view of the camera and video display during presentations. The table also offers instant tabletop access to extra-large multifunctional utility bays. At the touch of a button, access doors silently glide

open to reveal four electrical outlets, up to 12 voice/data outlets, or a variety of multimedia connectors. Vecta, Grand Prairie, Texas. [www.vecta.com](http://www.vecta.com) **CIRCLE 221**

#### ► Ergonomics for the masses

Allsteel's new midpriced Sum chair features a gas-filled bladder—made of a puncture-proof material borrowed from the biomedical field—to provide automatic, self-adjusting lumbar support. Designed by Marcus Koepke (of Allsteel's #19 chair), Sum offers automatic weight-activated control and provides a universal fit for more than 90 percent of the population. Allsteel, Muscatine, Iowa. [www.allsteeloffice.com](http://www.allsteeloffice.com) **CIRCLE 222**



For more information, circle item numbers on Reader Service Card or go to [www.archrecord.com](http://www.archrecord.com), under Resources, then Reader Service Card.



### Your Single Design/Build Source for Metal Stairs and Railings

Specializing in 05510 pre-engineered and 05500 custom designs



- Budgeting and professional consulting
- Competitive on small and large projects
- Free "never again detail" service available
- Lifetime product warranty
- State of the art facilities
- Bondable for your protection

Quality Stair Technology  
Since 1956

(800)872-7824

[www.americanstair.com](http://www.americanstair.com)

Love Sketching on Napkins?

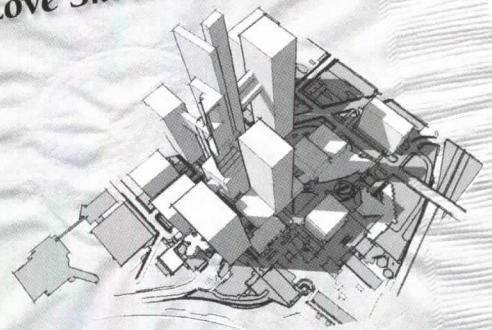

SketchUP

Take a more sophisticated approach with award-winning SketchUp—the fastest way to design in 3D. SketchUp is the must-have tool for AEC professionals working with 3D form creation, modification and presentation. SketchUp plays well with CAD, 3D modeling, illustration and image editing applications. \$495. Mac OSX and Windows.

Download a FREE Demo & plug-ins for ADT® & ArchiCAD® today

[www.sketchup.com](http://www.sketchup.com)

**Make a well-tailored suit for the floor**

Simply Artistic is the latest in a string of nine collections that make up Milliken's expansive Simply line. With almost 330 SKUs, the Simply line provides a wide range of coordinated designs that respond to client requests for simple, yet sophisticated styles. Simply Artistic, a 36" modular line in three designs, features a classic ribbed line as the collection's touchstone. Three patterns—Exhibit, Display and Display—are available in an array of 12 colors for the office market. Milliken Carpet, LaGrange, Ga. [www.millikencarpetsamplestudio.com](http://www.millikencarpetsamplestudio.com) **CIRCLE 223**

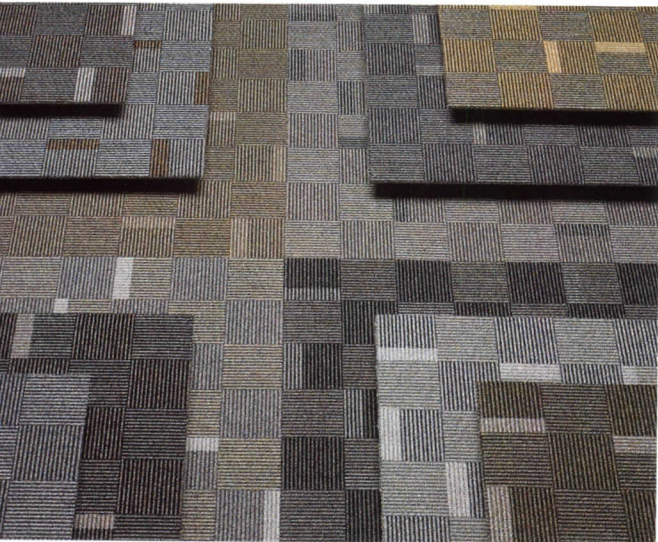

**▲ Look good on paper**

The Paper Collection is one of the newest designs resulting from the collaboration between the family-owned Northern Italian manufacturer Plank and designers Raul Barbieri and Anna Giuffrida. The Paper Collection is available in side, arm, and swivel options and at bar and kitchen heights. Featuring a tubular, steel-polished chrome frame, the molded seat and back are available in colored laminate, aluminum laminate, and veneer. ICF Group, Taftville, Conn. [www.icfsource.com](http://www.icfsource.com) **CIRCLE 225**

**▼ Certifying the certifiers**

Haworth is helping the U.S. Green Building Council (USGBC) in Washington, D.C., meet its own stringent guidelines for LEED CI (commercial interiors) certification with furniture and movable walls from both Haworth and its subsidiary, SMED. Some of the furniture choices meant using wheat-board instead of the industry standard MDF or particleboard. USGBC also chose FSC-certified cherry veneer for SMED's wood casegoods (Masters Series shown below). Haworth, Holland, Mich. [www.haworth.com](http://www.haworth.com)

**CIRCLE 224**



For more information, circle item numbers on Reader Service Card or go to [www.archrecord.com](http://www.archrecord.com), under Resources, then Reader Service.

# Turning Grey Concrete GREEN

These microscopic, glassy spheres are fly ash – and at ISG Resources, we sell millions of tons of them every year.

Produced by burning coal at electric power plants, fly ash might be destined for disposal in a landfill. But when added to concrete, fly ash makes concrete easier to work with, stronger and more durable.

Fly ash also improves the environmental performance of concrete. Mining and manufacturing of other raw materials can be reduced. Greenhouse gas emissions also decrease. In fact, using a ton of fly ash can save almost a ton of CO<sub>2</sub> emissions from being introduced into the atmosphere. In addition to concrete, fly ash is used in mortars, stuccos and a variety of other building materials.

**That's an improvement worth specifying.**

**ISG RESOURCES**  
A HEADWATERS Company

**1.888.236.6236 • [www.flyash.com](http://www.flyash.com)**

Contact ISG for free technical literature and information on how fly ash use benefits the environment.

Member AIA/CES Registered Provider

## 3D Studio Line

# glass:profile

Joel Berman Glass Studios Ltd

Profile is our newest collection of 3-Dimensional cast glass textures. Both structural and functional, panels are available up to 48" x 108" in clear, frosted and unlimited colored finishes.

Visit us at AIA Booth #1257 McCormick Place, Chicago

NeoCon 2004 Visit our Showroom #1173, 11th floor, Merchandise Mart

[www.jbermanglass.com](http://www.jbermanglass.com)  
info@jbermanglass.com  
US + Canada  
1 888 505 4527 x 249

**CIRCLE 359 ON READER SERVICE CARD  
OR GO TO [WWW.LEADNET.COM/PUBS/MHAR.HTML](http://WWW.LEADNET.COM/PUBS/MHAR.HTML)**

**CIRCLE 360 ON READER SERVICE CARD  
OR GO TO [WWW.LEADNET.COM/PUBS/MHAR.HTML](http://WWW.LEADNET.COM/PUBS/MHAR.HTML)**

New Revere  
Liberty Collection

FreedomGray

EverGreen

Bennington  
Shingles

*For over 200 years,  
we've impressed the world  
with the brilliance of Revere Copper.*

Since the dawn of our nation, Revere Copper has stood as a shining example of the American innovative spirit. Our diverse list of architectural products now includes:

**New Revere Copper Alpolic Composite Panels™** - Features a thermoplastic core between layers of pure copper for revolutionary flexibility, flatness, beauty and strength. Ideal for wall cladding, corners, curves or anywhere. To learn more about Alpolic, the latest addition to Revere's family of architectural coppers, call 800-422-7270.

**New Revere Liberty Collection™** - Copper as you've never seen it, with dozens of stylish Rigidized® texture choices. The unique finishing touch for better damage resistance, lower maintenance and enhanced value.

**EverGreen™** - Our famous pre-patinated copper. Offers all the warmth and character of natural patina, without the wait. Provides the elegance of aged copper.

**FreedomGray™** - Tin/zinc alloy-coated copper delivers the advantages of pure copper, in an earth-tone gray. Environmentally friendly and corrosion-resistant for years of durability.

**Bennington Shingles™** - Remarkably lightweight and durable copper roofing system adds value and beauty to any structure. Lower lifetime costs than any other material. For information about Bennington, contact Vulcan Metal Works at 800-240-4089.

Of course, the basis for all our architectural products is **Revere Classic Copper™**. Available in sheets, strips, coils, plates, bars and extrusions, this is copper in its purest form. To learn more about Revere Classic Copper and other innovations, contact your distributor today.

Revere Liberty Collection, FreedomGray, EverGreen, Bennington and Revere Classic Copper are trademarks of Revere Copper Products, Inc. Alpolic Composite Panel is a trademark of Mitsubishi Chemical America. Rigidized is a registered trademark of Rigidized Metals Corporation. Bennington Shingles available under exclusive license agreement with Vulcan Metal Works.

New Revere Copper  
Alpolic Composite Panels



**Revere Copper Products, Inc.**

One Revere Park  
Rome, NY 13440-5561

e-mail: [archcopper@reverecopper.com](mailto:archcopper@reverecopper.com)

**800-448-1776**

Fax: 315-338-2105

[www.reverecopper.com](http://www.reverecopper.com)

**CIRCLE 361 ON READER SERVICE CARD OR GO TO [WWW.LEADNET.COM/PUBS/MHAR.HTML](http://WWW.LEADNET.COM/PUBS/MHAR.HTML)**



## Product Briefs

### Unusual partners

Architectural Systems received the award for the Resin & Acrylic Collection at this year's International Retail Design Show at the retail design show IShop 2004. A surface for vertical and horizontal applications, the finish combines the texture of solid hardwood—such as oak, maple, birch, cherry, beech, maple, alder, ash, and walnut—and acrylic. The thickness of the wood and the width of the acrylic strips can be varied within the design to create a signature look. The finish is available in both a gloss-polished and a frosted, unpolished finish. Architectural Systems, New York City. [www.archsystems.com](http://www.archsystems.com) **CIRCLE 226**

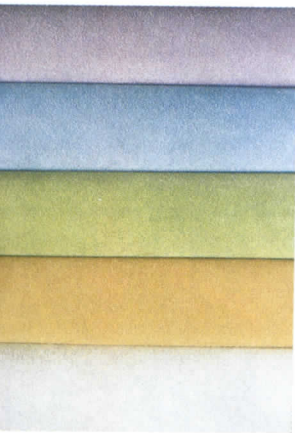
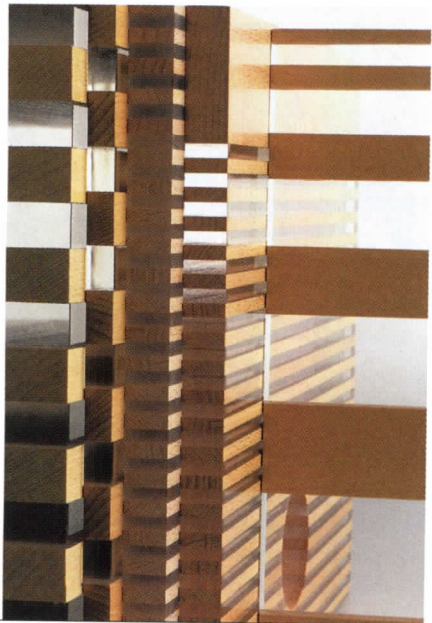

### ◀ Customize your concept

The Concept Series is a new collection of concealed-fastener exterior metal wall panel profiles. Available in 12" and 16" widths, the panels are available in G-90 galvanized steel, aluminum, stainless steel, and Centria's Durallure finish system. Profile options consist of narrow ribs, medium-width ribs, and wide flat surfaces that can be used to create a single repetitive appearance or to generate a pattern or feature on a wall elevation. Centria, Moon Township, Pa. [www.centria.com](http://www.centria.com) **CIRCLE 228**

### American debut

Designer Jean Nouvel makes his American debut with a lounge chair, available from Bernhardt Design. Nouvel, who has worked in the fields of fashion, architecture, and product design, generated a concept for the chair four years ago with his "Rainbow" chair of colored Plexiglas layers for the Museum of Modern Art. Orly comes in its own bright palette of colors in fabric and leather, and has brushed nickel legs and a back cushion that appears to plug into the back of the chair. Bernhardt Design, Lenoir, N.C. [www.bernhardtdesign.com](http://www.bernhardtdesign.com) **CIRCLE 230**



## Product of the Month Ductal Components

The first light-rail transit station constructed with Lafarge North America's Ductal high-performance composite material is expected to open for commuters at Shawnessy Station in Calgary, Canada, at the end of the month. The Ductal components, manufactured for Calgary architect Enzo Vicenzino of CPV Group Architects & Engineers for the City of Calgary, include 24 $\frac{3}{4}$ " thick pre-cast curved canopies (measuring approximately 16 $\frac{3}{4}$ " x 20'), as well as struts, columns, beams, and rain gutters. The composite is significantly stronger than normal concrete: It has a compressive strength of 20,000 psi (six to seven times stronger) and a flexural strength of 4,000 psi (three times stronger).

To validate the performance of the structural system and material, a full-size canopy prototype was sent to the University of Calgary for intensive, full-scale load tests. The results confirmed the Ductal canopy not only surpassed the test criteria, it easily carried full-factored live and dead loads without cracking. Lafarge N.A., Calgary, Canada. [www.imagineductal.com](http://www.imagineductal.com) **CIRCLE 227**



### ▼ A dynamic exhibition of fabric

Transformit, a tension-fabric-structure design, manufacturing, and rental company, has unveiled its new collection of tension fabric structures for exhibition, event, interior, and retail applications. The Dynamics collection, composed of six interchangeable components,

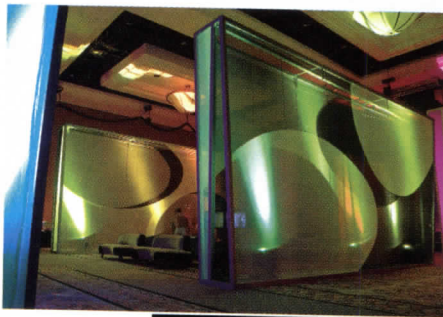

features an aluminum extrusion frame that can hold up to three layers of fabric. Different lighting effects can be used between the layers to achieve visual motion. Transformit, Gorham, Maine. [www.transformitdesign.com](http://www.transformitdesign.com) **CIRCLE 229**

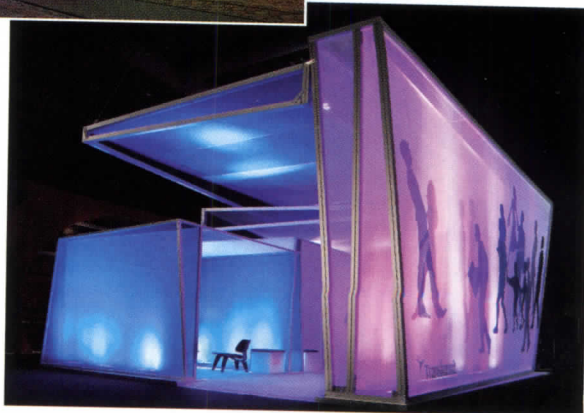

## Product Briefs

### ▼ Exhibitions honoring textile artists

In the past few months, two different New York galleries featured the work of textile artists. The design gallery/store Moss introduced "fossilized textiles" (below right) created by artist/designer Luisa Cevese with light layers of polyurethane and precious fabrics, while Gallery Gen presented the work of master Japanese textile artist, Jun-ichi Arai. Over 30 of Arai's works, including cloths made of a flame-retardant fiber he has been secretly formulating for theater drapery, were on display (left). Gallery Gen, New York City. [www.gallerygen.com](http://www.gallerygen.com) **CIRCLE 231** Moss, New York City. [www.mossonline.com](http://www.mossonline.com) **CIRCLE 232**

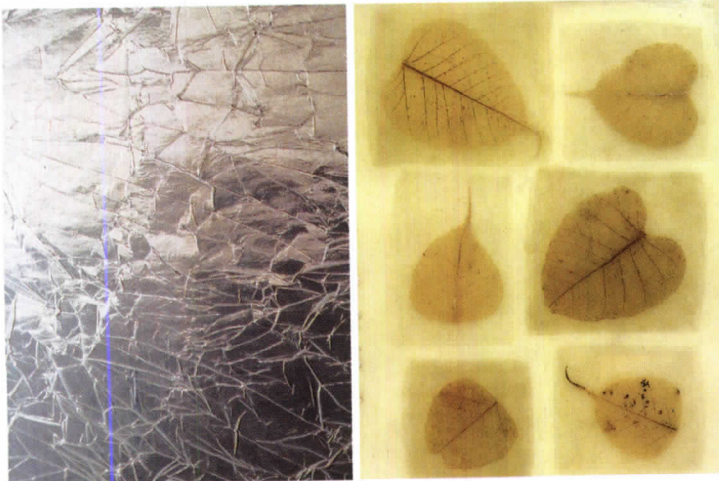

### ▼ Real ivory? Don't be nutty

Providence Artworks new Ivory of Tagua Collection features an ivory look-alike carved from the Tagua Palm Nut. The cabinet knobs—hand-carved by Ecuadorian artisans—look, feel, age, and have the strength of elephant ivory. Used as an



substitute since the Victorian era (mostly buttons), the demand for the Tagua nut declined after the discovery of a less expensive synthetic. Providence Artworks, Venice, Calif. [www.providenceartworks.com](http://www.providenceartworks.com)

**CIRCLE 233**

### ► Concrete masonry units

Made of 10 percent recycled thermoset high-strength plastic powder, Sealtech concrete masonry blocks are 10 percent lighter than (and have a 2-hour fire rating, R value, and U value comparable to) standard concrete block. The water-resistant blocks come in 16 colors, with a split-face or smooth finish, in a standard 4", 8", and 12" size. US Technology, Canton, Ohio.

[www.sealtechblock.com](http://www.sealtechblock.com) **CIRCLE 234**



For more information, circle item numbers on Reader Service Card or go to [www.archrecord.com](http://www.archrecord.com), under Resources, then Reader Service Card

## GREAT LOOKIN' LI'L LEGS

FL5 in Satin Stainless.  
Comes in other finishes.

FL12 wide wheel rotates 360°.  
Polished Aluminum.

FL1 Polished Aluminum  
Shown with TP1 top plate.

FL2  
Polished  
Aluminum.  
Shown  
with  
leveler  
LV1.

Some are straight, some are curved, some are steel, some are aluminum, some have regular glides, some have a variety of excellent levelers. All have our famous quality.

You can see all twelve at [www.mockett.com](http://www.mockett.com). In stock for immediate shipping.

Call **800-523-1269** for our "Latest and Greatest" free catalog.

**MOCKETT**  
DOUG MOCKETT & COMPANY, INC.

BOX 3333, Manhattan Beach, CA  
90266 USA • Fax: 800-235-7743

"Fine Architectural Hardware for Your Fine Furniture."®

**CIRCLE 362 ON READER SERVICE CARD**

## Natural Wood

- Douglas Fir
- Cedar
- Cypress
- Pine
- Redwood
- Ipe

Clear cedar railings, shingles, support beams



Douglas fir flooring

Beams/Timbers, Siding  
Wood Floorings, Fascia,  
T&G Paneling, Shakes/Shingles  
Soffit, Decking/Roof Decking

Specializing in  
Clear Vertical Grain Grains

**Bear Creek Lumber**

[www.bearcreeklumber.com](http://www.bearcreeklumber.com)

(800) 597-7191

fax 509-997-2040

**CIRCLE 363 ON READER SERVICE CARD  
OR GO TO [WWW.LEADNET.COM/PUBS/MHAR.HTML](http://WWW.LEADNET.COM/PUBS/MHAR.HTML)**

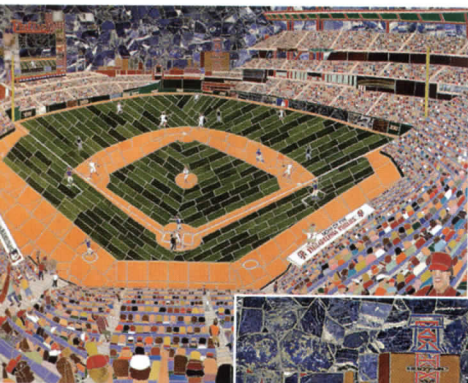

### Day at the park

Artist Jonathan Mandell recently completed an 8' x 6' mosaic commissioned by the Philadelphia Phillies organization as a permanent artwork for the new Citizens Bank Park. Mandell selected an array of semiprecious stones, minerals along with ceramic tile, glass, and metal for the ballpark scene: A candy vendor by the visitor's dugout has cotton candy made of rose quartz; a hot dog cart approaching the outfield wall is made from iridescent glass; and the hot dog stand on the bottom right has a metal hot dog caddy made from nickel tile. In addition to this scene, Mandell also created a 6' x 4' mosaic of Phillies player Ryan Howard at the plate for the stadium. Jonathan Mandell Mosaics, Narberth, Pa. [www.jonathanmandell.com](http://www.jonathanmandell.com) **CIRCLE 235**



### ▼ A rug by any other name

Architect Michael Graves, FAIA, has designed a new collection of Wools of New Zealand Brand rugs from Glen Eden. The collection includes 18 patterns (Rose, below), each embracing Graves's experiences as an architect. All patterns are offered in custom shapes and sizes, and custom colors can be matched from a sample or selected from a palette of 42 standard shades. Wools of New Zealand, Calhoun, Ga. [www.glen-eden.com](http://www.glen-eden.com) **CIRCLE 236**

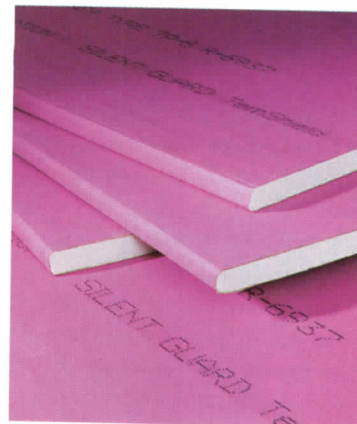

### ▲ New shade of mold-control

Temple-Inland has introduced Silent Guard TS, a mold-resistant version of its existing Silent Guard shaftliner panels. Designed for elevator shafts, stairwells, and area separation walls, Silent Guard maintains the same sound-control and fire-resistance of the traditional product. The TemShield protection system is manufactured in both the core and the surface of the panel and is recognized on the job by a new magenta face paper. Temple-Inland Forest Products, Diboll, Texas. [www.templeinland.com](http://www.templeinland.com) **CIRCLE 237**

For more information, circle item numbers on Reader Service Card or go to [www.archrecord.com](http://www.archrecord.com), under Resources, then Reader Service.

The look of pride...



Available through

**BUECHEL**  
STONE CORP.

Natural Building, Landscape & Cut Stone  
800-236-4473  
[www.buechelstone.com](http://www.buechelstone.com)

**CIRCLE 364 ON READER SERVICE CARD  
OR GO TO [WWW.LEADNET.COM/PUBS/MHAR.HTML](http://WWW.LEADNET.COM/PUBS/MHAR.HTML)**



Off the Wall, Huntington, NY  
**Cascade Coil Drapery**  
800/999-coil  
[www.cascadecoil.com](http://www.cascadecoil.com)

Joseph J. Scarpulla Architect, photo: Chris Bausch

**CIRCLE 365 ON READER SERVICE CARD  
OR GO TO [WWW.LEADNET.COM/PUBS/MHAR.HTML](http://WWW.LEADNET.COM/PUBS/MHAR.HTML)**

## Product Briefs

### ▼ Fabric duct filter system

DuctSox's Final Filter is the HVAC industry's first replaceable in-duct air filter for fabric duct that increases IAQ and energy savings while reducing outdoor air requirements and building maintenance. The cone-shaped Final Filter is designed for supplementing primary filter systems in new or retrofit buildings with DuctSox air dispersion. DuctSox, Dubuque, Iowa.

www.ductsox.com **CIRCLE 238**



### ▲ Cladding alternative

The Fasesc facade system combines wood composite sheathing, a base coat reinforced with glass fiber mesh, and a finish coat available in a range of colors. The system incorporates a lightweight foam resin binder and can be used with either steel or wood frames. Fasesc is constructed with a ventilation gap and can be used for residential and commercial buildings. Facades, Springfield, Mo. www.facadesinc.com **CIRCLE 239**

### ► Coastal-approved roofing

The Met-Tile roofing system is now available in an aluminum substrate with a Meadow Green finish. Though it looks like tile, the roofing consists of the same profile as the standard Met-Tile system:

3' wide panels that are securely applied for wind- and weather-tight performance. Aluminum's superior resistance to corrosion and water makes the product ideal for coastal environments. Met-Tile, Ontario, Calif. www.met-tile.com **CIRCLE 240**

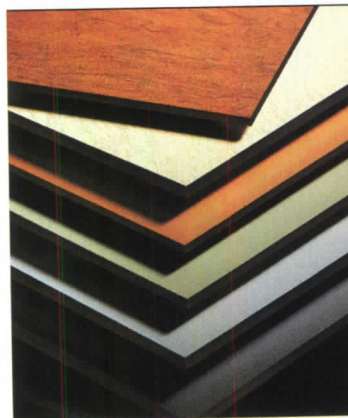

### ◀ Exterior-grade laminate

Used in Europe for more than 20 years, MEG (Material Exterior Grade) from Abet is an exterior high-pressure laminate consisting of layers of kraft paper impregnated with thermosetting phenolic resins. Bonded by heat and high pressure, the core and exterior color are one piece. MEG is graffiti-proof, and custom patterns can be created digitally for building exteriors. Abet, Englewood, N.J. www.abetlaminati.com **CIRCLE 241**

For more information, circle item numbers on Reader Service Card or go to [www.archrecord.com](http://www.archrecord.com), under Resources, then Reader Service Card.

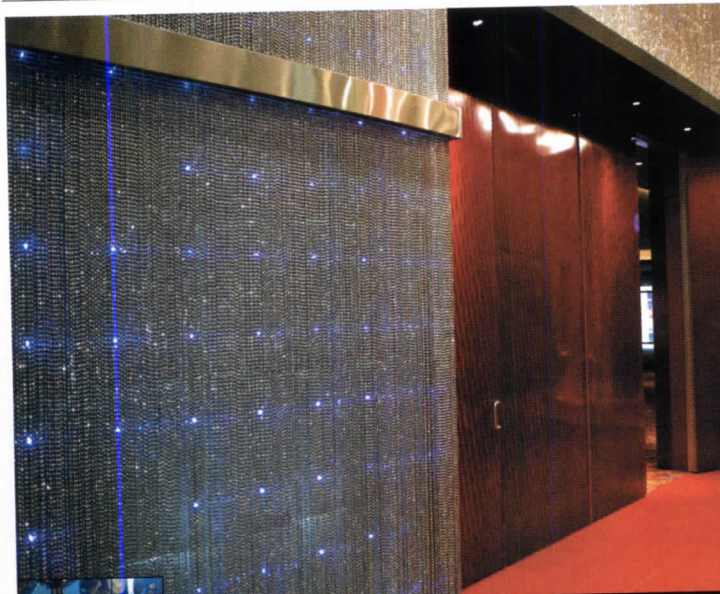

CHANGE THE WAY YOU LOOK  
AT SPACE AND DESIGN.

**ELEMENTS**  
3/8"  
ShimmerScreen™  
sparkling nickel  
plated steel.  
One of over  
150 styles by  
ShimmerScreen.



Create Something.

BCM Architectural 914.664.7500 [shimmerscreen.com](http://shimmerscreen.com)

**CIRCLE 366 ON READER SERVICE CARD**

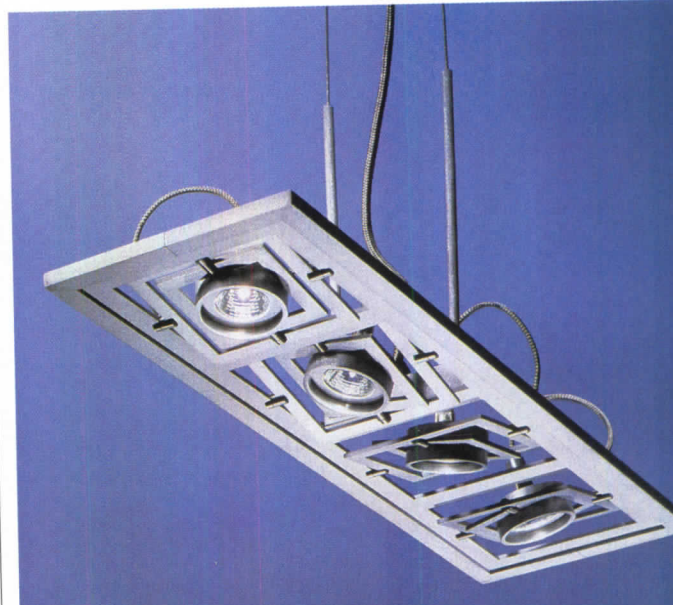

LOOMIS LIGHT FRAMES™

*Loomis*™

Charles Loomis, Inc.  
425.823.4560  
800.755.0471  
425.823.8654 fax  
[loomislights@msn.com](mailto:loomislights@msn.com)

**CIRCLE 367 ON READER SERVICE CARD**  
OR GO TO [WWW.LEADNET.COM/PUBS/MHAR.HTML](http://WWW.LEADNET.COM/PUBS/MHAR.HTML)



## Why the architect loves NJ SmartStart Buildings

"The program pushed the design to the next level."

CFOs, engineers, architects, business managers and owners love NJ SmartStart Buildings — because the program saves money on energy costs.

If you're building, renovating space or upgrading equipment, NJ SmartStart Buildings has everything you need to maximize energy efficiency, including:

**Incentives for efficient equipment design and installation**

**Custom incentives for qualified energy-efficient innovations**

**Multiple measure bonus**

**Design support and expert consultation**

**Technical assistance for premium-efficiency opportunities**

New construction projects, with the exception of K-12 public schools, must be located within a designated Smart Growth area to be eligible for incentives.

NJ SmartStart Buildings is an energy efficiency program administered by the New Jersey Board of Public Utilities and currently managed by Conectiv Power Delivery, Jersey Central Power & Light, New Jersey Natural Gas, NUI Elizabethtown Gas, SE&G, Rockland Electric and South Jersey Gas Company for their commercial and industrial customers.

Don't start a project without NJ SmartStart Buildings! Visit the website today to learn more.

[njsmartstartbuildings.com](http://njsmartstartbuildings.com)

New Jersey  
**SmartStart**  
BUILDINGS®



New Jersey Board of Public Utilities

New Jersey SmartStart Buildings® is a registered trademark. Use of the trademark, without permission of the New Jersey electric and gas utilities is prohibited.

**Incentives for an energy-efficient New Jersey**

**CIRCLE 369 ON READER SERVICE CARD  
OR GO TO [WWW.LEADNET.COM/PUBS/MHAR.HTML](http://WWW.LEADNET.COM/PUBS/MHAR.HTML)**

## SCHOOL OF ARCHITECTURE

MASTER OF FINE ARTS  
PROGRAM IN ARCHITECTURE



Register for Summer Classes  
Now through June 19

Artistic | Experiential | Environmental  
Technical | Professional | Enduring

Over 80% Job Placement  
upon Graduation



Design by N.Y. Papp, AAU MFA Student

ACADEMY of ART UNIVERSITY  
FOUNDED IN SAN FRANCISCO 1929

A GREAT COLLEGE IS NOW A GREAT UNIVERSITY.  
FORMERLY ACADEMY OF ART COLLEGE

79 NEW MONTGOMERY ST. | SAN FRANCISCO, CA 94105

1.800.544.ARTS | [www.academyart.edu](http://www.academyart.edu)

Nationally Accredited by ACICS, NASAD & FIDER (BFA-IAD)

## Product Literature

### Tile competition winners

Ceramic Tiles of Italy has released a new book titled *Ten Years of Design Excellence: Ceramic Tiles of Italy Across America*. Award-winning tile applications, culled from the Ceramic Tiles of Italy Design Competition, are the focus of the 114-page book, which features more than 25 projects. Italian Trade Commission, New York City. [www.italiatile.com](http://www.italiatile.com) **CIRCLE 242**

### Faucet brochure

The 2003 Price Pfister faucet collections are featured in a new 60-page color brochure, which details 48 new faucets in a range of finish options and available configurations. Price Pfister Faucets, Lake Forest, Ill. [www.pricepfister.com](http://www.pricepfister.com) **CIRCLE 243**

### Indoor/outdoor door catalog

Stilewood's 32-page architectural catalog features more than 65 of the company's standard interior, exterior, and custom door designs shown with glass and transom choices and various prehanging options. The catalog illustrates Stilewood's cross-machining capabilities and the many species options available. Stilewood, Port Coquitlam, British Columbia, Canada. [www.stilewood.com](http://www.stilewood.com) **CIRCLE 244**

### NEW SITES FOR CYBERSURFING

Product samples downloadable in MPEG format [www.centria.com/public/products/samplegallery.asp](http://www.centria.com/public/products/samplegallery.asp)

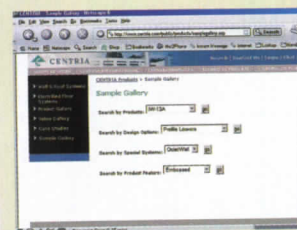

Online reference for the basic stock metal products regularly produced in the U.S. [www.metalreference.com](http://www.metalreference.com)

New site for contemporary kitchen range hoods [www.siriushoods.com](http://www.siriushoods.com)

Site that promotes the sustainability Italian tiles [www.s-tiles.it](http://www.s-tiles.it)

### Guide to greener specs

PPG Industries has outlined its new Ecological Building Solutions collection of glass, coatings, and paint for sustainable design in a new 12-page booklet called *It's Just Our Nature* which provides specific guidance on how PPG products can help architects earn LEED credits for their projects or meet ASTM E 2129 standards for sustainable building. PPG Industries, Pittsburgh. [www.ppg.com](http://www.ppg.com)

**CIRCLE 245**

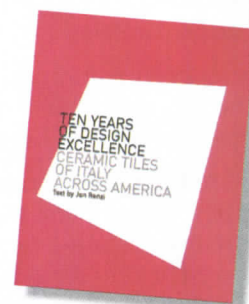
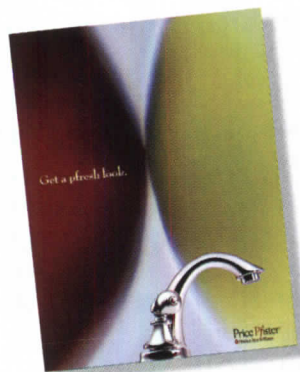

For more information, circle item numbers on Reader Service Card  
[www.archrecord.com](http://www.archrecord.com), under Resources, then Reader



# ARTEC

Stainless Steel Railings



Kettering, OH



Research Triangle Park, NC

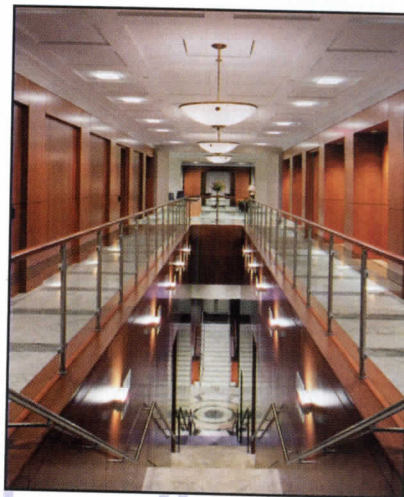

Atlanta, GA



Auburn Hills, MI



Fort Worth, TX



Chicago, IL

Please contact us for more information.  
Binder, Samples, autoCAD-R14 details.

700 Creel Drive, Wood Dale, IL 60191  
Tel: 800-927-7346  
Fax: 630-860-5913  
Web site: <http://www.artec-rail.com>

**Service & Satisfaction  
Is Our Main Objective**

**STOP BY AND SEE US AT AIA EXPO 2004 BOOTH 663**

CIRCLE 371 ON READER SERVICE CARD OR GO TO [WWW.LEADNET.COM/PUBS/MHAR.HTML](http://WWW.LEADNET.COM/PUBS/MHAR.HTML)

# GAGECAST™

gage vertical surfacing

## Product Literature

### Countertop installation CD

The Marble Institute of America (MIA) has released a new training CD-ROM for the natural stone industry. *Natural Stone Countertop Installation Overview* is the first in a series of instructional tools the association is developing for members and others within the stone industry. Marble Institute of America, Cleveland. [www.marble-institute.com](http://www.marble-institute.com)

CIRCLE 246

### Signage system guide

Vista System's new *MCFT Guidebook 2 Signs* includes more than 500 examples of sign types professionals can design with Vista's new Modular Curved Frame Technology (MCFT) system. The 82-page guidebook came as a result of the market's demand for a modular system with custom-fabricated appearance and capabilities. Vista System, Sarasota, Fla. [www.vistasystem.us](http://www.vistasystem.us) CIRCLE 247

### Residential recreations

Rejuvenation's 124-page *Lighting & House Parts 2004 Resource Guide* features hundreds of recreations of original American lighting fixtures and house parts representing styles from 1880 to 1960. Showcased in the guide

is Rejuvenation's new On the Porch collection of products for the front porch including light fixtures, exterior door sets, door bells, brass numbers, and mailboxes. Rejuvenation, Portland, OR. [www.rejuvenation.com](http://www.rejuvenation.com) CIRCLE 248

### Porcelain tile brochures

Illa S.A. offers two new brochures that highlight the firm's San Ignacio and Nevada series of porcelain tiles, inset and listellos through detailed photographs and technical product information. 305/667-7090. Ceramic Consulting Corporation, Coconut Grove, Fla.

CIRCLE 249

### Customizable workstation

Allsteel has introduced several publications to support its new Landscape Surfaces program in partnership with Pantone that allows any color in the system to be applied to Terrace tiles in addition to a *Design Guide* that provides comprehensive offerings of workstation designs using the Terrace workstation. Allsteel offers a *Surfaces and Materials* brochure that features the newest color for Terrace tiles. Allsteel, Muscatine, IA. [www.allsteeloffice.com](http://www.allsteeloffice.com) CIRCLE 250

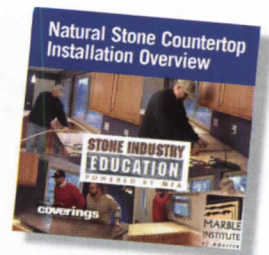
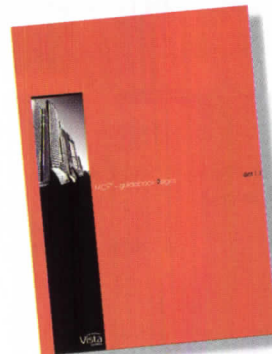
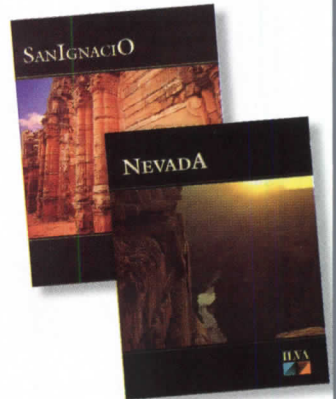
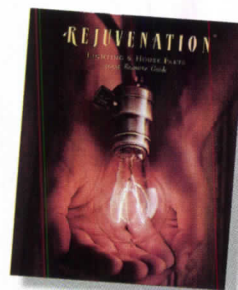

The Gage Corporation  
803 South Black River Street  
Sparta, WI 54656  
800-786-4243 or 608-269-7447  
[www.gageverticalsurfacing.com](http://www.gageverticalsurfacing.com)

CIRCLE 372 ON READER SERVICE CARD  
OR GO TO [WWW.LEADNET.COM/PUBS/MHAR.HTML](http://WWW.LEADNET.COM/PUBS/MHAR.HTML)

For more information, circle item numbers on Reader Service Card  
[www.archrecord.com](http://www.archrecord.com), under Resources, then Reader



7 9 Marvin Windows & Doors  
marvin.com

279 Masonite International Corporation  
masonite.com

390 McGraw-Hill Construction  
construction.com

McGraw Hill Construction (AIA)  
construction.com

391 McGraw Hill Construction Bookstore  
books.construction.com

86 Metal Construction Association  
metalconstruction.org

24 Mitsubishi Chemical America Inc  
alpolc-usa.com

68 Modern Fan Co. The  
modernfan.com

120 **S** Monier Lifetile  
monierlifetile.com

261 **S** Mortar Net  
mortarnet.com

Móz Metal Laminates  
mozdesigns.com

National Building Museum  
nbm.org

133 National Concrete Masonry Assn  
ncma.org

16 **S** National Gypsum Company  
nationalgypsum.com

356 **S** National Terrazzo & Mosaic Assn  
ntma.com

275 Nemetschek North America  
nemetschek.net

145 Nextel  
nextel.com

271 **S** Nixalite of America Inc  
nixalite.com

369 NJ SmartStart Buildings  
njsmartstartbuildings.com

17 Nora  
norarubber.com

6 **S** Oldcastle Glass Group  
oldcastleglass.com

43 OMNIA  
omniaindustries.com

82 **S** Overly Door Company  
overly.com

345 **S** Owens Corning  
owenscorning.com

346 **S** Owens Corning  
owenscorning.com

347 **S** Owens Corning  
owenscorning.com

371 **S** P&P Artec  
artec-rail.com

81 Pamesa Ceramica  
pamesa.com

380 Panel Source International Inc  
panelsource.net

78 **S** Pawling  
pawling.com

335 **S** Pemko  
pemko.com

113 **S** Petersen Aluminum  
pac-clad.com

343 Phaidon  
phaidon.com

44 Pine Hall Brick Co Inc  
pinehallbrick.com

91 **S** Pittsburgh Corning  
pittsburghcorning.com

98 **S** Porcelanosa Grupo  
porcelanosagrupo.com

10 **S** PPG  
ppgglass.com

342 **S** PPG (Coatings)  
industrial-coatings.com

90 Probe Construction Products Inc

41 Prudential Lighting  
prullite.com

260 **S** Rakks  
rakks.com

361 **S** Revere Copper Products Inc  
reverecopper.com

49 Rheinzink  
rheinzink.com

116 Roca Ceramica  
roca-tile.com

66 Rocky Mountain Hardware  
rockymountainhardware.com

45 ROHL  
rohlhome.com

209 127 Rosagres  
rosagres.com

88 70 Rulon Company  
rulonco.com

77, 115 59, 88 **S** SAFTI/O'Keefe's Inc  
safti.com

385 379 Saint-Gobain-Glass Exprover NA

128 96 **S** Salisbury Industries  
mailboxes.com

171 117 Samsung Staron  
getstaron.com

85 67 Samsung Digital Info Tech Div  
samsungproav.com

150 109 **S** Schott Corporation  
us.schott.com

75 57 Se'lux  
selux.com/usa

387 265 Seattle Stained Glass  
seattlestainedglass.com

152 110 **S** Sherwin-Williams  
sherwin-williams.com

361 354 **S** Simpson Strong-Tie Company Inc  
simpsonstrongtie.com

388 266 Slip Tech  
sliptech.com

33 20 **S** Sloan Valve Company  
sloanvalve.com

377 373 **S** Smoke Guard  
smokeguard.com

48, 49 31, 32 Steelcase  
steelcase.com

91 277 Steelscape  
steelscape-inc.com

388 267 Stepstone Inc  
stepstoneinc.com

214 280 **S** Sto Corp  
stocorp.com

306 333 **S** Stone Panels Inc  
stonepanels.com

64 46 Stone River Bronze  
stoneriverbronze.com

164 114 Style Solutions  
stylesolutionsinc.com

246 137 **S** Taiyo Birdair Corporation  
taiyobirdair.com

123 93 TAMKO  
lamarite.com

362 355 **S** Tarkett  
tarkett.com

345 348 Tau Ceramica  
tauceramic.com

4, 5 3 Technical Glass Products  
tireglass.com

387 264 **S** Teragren  
teragren.com

37 23 Tile of Spain  
tilesofspain.com

39 25 **S** TOLL  
toll.com

273 139 **S** TRACO  
traco.com

386 262 Transpo Industries Inc  
transpo.com

156 112 **S** Trex  
trex.com

358 353 **S** Trimco/BBW  
trimcobbw.com

211 128 Turner Construction Company  
turnerconstruction.com

120 **S** USG Corporation  
usg.com

111 85 Valcucine  
valcucinena.com

70 52 Vistawall Architectural Products  
vistawall.com

108 84 **S** VT Industries  
vtindustries.com

20-21 11 Vulcraft, A Division of Nucor Corp  
nucor.com

373 368 **S** W&W Glass Systems Inc  
wvglass.com

90 72 WAC Lighting  
wacighting.com

386 263 **S** Water Structures LLC  
waterstructures.com

197 122 **S** Wausau Window and Wall Systems  
wausauwindow.com

2-3 2 Weather Shield Windows & Doors  
weathershield.com

6-7 4 Williams Scotsman  
williamsscotsman.com

EXECUTIVE OFFICES

James H. McGraw, IV, Group Publisher  
(212) 904-4048 Fax: (212) 904-3695  
jay\_mcgraw@mcgraw-hill.com

Laura Viscusi, VP, Associate Publisher  
(212) 904-2518 Fax: (212) 904-2791  
lviscusi@mcgraw-hill.com

ONLINE SALES

Paul Cannella, Director  
(312) 233-7499 Fax: (312) 233-7490  
paul\_cannella@mcgraw-hill.com

CLASSIFIED SALES

Janet Kennedy, Director  
(212) 904-6433 Fax: (212) 904-2074  
janet\_kennedy@mcgraw-hill.com

NORTHEAST / MID-ATLANTIC

Ted Rzempoluch  
(212) 904-3603 Fax: (212) 904-4256  
rzempoluch@mcgraw-hill.com

MIDWEST

Kevin Carmody (IL, IN, KS, MI, ND, NE, OK, SD, TX, WI)  
(312) 233-7402 Fax: (312) 233-7403  
kevin\_carmody@mcgraw-hill.com

Mike Gilbert (AR, IL, IA, MN, MO, OH, W.PA, WV)  
(312) 233-7401 Fax: (312) 233-7403  
mike\_gilbert@mcgraw-hill.com

Assistant: Mamie Allegro

SOUTHEAST / MID-ATLANTIC

Susan Shepherd  
(404) 843-4770 Fax: (404) 252-4056  
sshepherd@mcgraw-hill.com

Assistant: Pam Crews

WEST (AZ, CA, CO, NM, NV)

Bill Hague  
(253) 858-7575 Fax: (253) 858-7576  
(760) 340-5575 Fax: (760) 340-0439  
bill\_hague@mcgraw-hill.com

WEST (BRIT. COLUMBIA, ID, OR, S. CA, UT, WA)

Bill Madden  
(503) 224-3799 Fax: (503) 224-3899  
bill\_madden@mcgraw-hill.com

INTERNATIONAL

Mark Casaletto (Canada, except Brit. Columbia)  
(905) 668-2149 Fax: (905) 668-2998  
mark\_casaletto@mcgraw-hill.com

Martin Druke (Germany)  
(49) 202-27169-12 Fax: (49) 202-27169-20  
druke@intermediapartners.de

Ferruccio Silvera (Italy)  
(39) 022-846716 Fax: (39) 022-893849  
ferruccio@silvera.it

Katsuhiko Ishii (Japan)  
(03) 5691-3335 Fax: (03) 5691-3336  
amskatsu@dream.com

Young-Seoh Chin (Korea)  
(822) 481-3411/3 Fax: (822) 481-3414

PRODUCT NEWS SPOTLIGHTS / POSTCARD SERVICE

Deidre Allen  
(212) 904-2010 Fax: (609) 426-7136  
deidre\_allen@mcgraw-hill.com

Editorial

(212) 904-2594 Fax: (212) 904-4256  
www.architecturalrecord.com

Subscriber Service

(888) 867-6395 (USA only)  
(609) 426-7046 Fax: (609) 426-7087  
p64cs@mcgraw-hill.com

Back Issues

(212) 904-4635  
phyllis\_moody@mcgraw-hill.com



## Sound and space interface in Christopher Janney's unique world

Interviewed by Jane F. Kolleeny

Christopher Janney's work represents a fusion of his two passions—music and architecture. Three years after graduating in 1973 from Princeton University, where he majored in architecture and sculpture, he entered a master's program for artists at MIT, providing him free reign to experiment with technology. Janney developed a unique form of environmental and participatory architecture, an immersive art form that relies on sound to transform space. When the *New Sound*, New York program of performance, dialogue, and sound installations was launched in New York City this spring, Janney, curator and a visiting professor at Cooper Union, spoke to RECORD.

**Q:** What inspired you to think that music and architecture could be partners in art? All music is fundamentally made of rhythm, harmony, and melody. With many of my installations, such as *Harmonic Run* at the Miami International Airport, I control the harmonic and melodic aspects, but the rhythm is given over to the movement through the particular architectural space. People move through the 180-foot-long concourse, which triggers photo sensors stationed every 10 feet, which send information to computers that shape the rhythm of music piped into the space. I want people to experience my pieces, not just see them.

*Much of your work exists in urban areas. Why?* I feel cities need humanizing. For example, large urban plazas are often designed to respond to adjacent buildings and rarely consider the pedestrian. In an effort to bring intimacy and human scale back to the plaza, I designed something called *Sonic Forest*, part of a series of musical instruments, a theme that characterizes many of my pieces. It is a series of columns placed on a plaza to create scale. Sensors, lights, and speakers in each column respond to the passersby.

*Has the architecture profession embraced your work?* I think architecture embraces my work, but not necessarily the profession; painting the space with sound is something that falls under the normal purview of architecture. A number of factors in the past 10 years have helped to change that, such as the One Percent Program, where public construction budgets dedicated 1 percent to art. In private development, however, art is usually the first thing to go. In the end, it comes down to relationships; you resonate with those that understand and appreciate what you do, and they hire you.

*Do you find that you use your architectural training in creating art?* I am so happy to be trained as an architect. In architecture school, I learned how to convey architectural concepts to a variety of audiences, an invaluable life. Also, sketching and learning CAD have

been extremely useful tools. Since my interest is in making music physical, information from the concrete world that helps me create; to me, that activity in large part results from being an architect. Someone asked Gehry what he believed an architecture student needed to do to succeed in architecture, and he said, "read novels," and I totally agree with him. Architecture is a frame of mind, it's about ideas; the profession is about how to translate those ideas into the real world. Recognizing these two aspects and finding how to bring them together is what it's all about.

**Photography by Andrew French**



# eleven

## Introducing VectorWorks 11

Introducing VectorWorks 11—a milestone in our 21-year development history, version 11 offers enhanced tools and technology that will give your firm an instant boost of productivity. In version 11, we concentrated on making production drafting more efficient, modeling even easier, introduced new and faster rendering modes and added page layout capabilities to help you better communicate your design intent. If you haven't tried VectorWorks lately, now's the time to make the move!

RCLE 275 ON READER SERVICE CARD OR GO TO [WWW.LEADNET.COM/PUBS/MHAR.HTML](http://WWW.LEADNET.COM/PUBS/MHAR.HTML)

- Viewports done right
- New artistic rendering effects
- Smaller file size
- Faster, more robust modeling
- Improved DXF/DWG compatibility
- Superior text tools

Visit our site for more information about BIM technology  
Image courtesy Shook Kelley, Inc.

1.877.202.0493  
[www.vectorworks.net/AR](http://www.vectorworks.net/AR)

Vectorworks

**KOHLER**.com/inspire A place designed just for architects and designers. A place of ideas, information and inspiration.

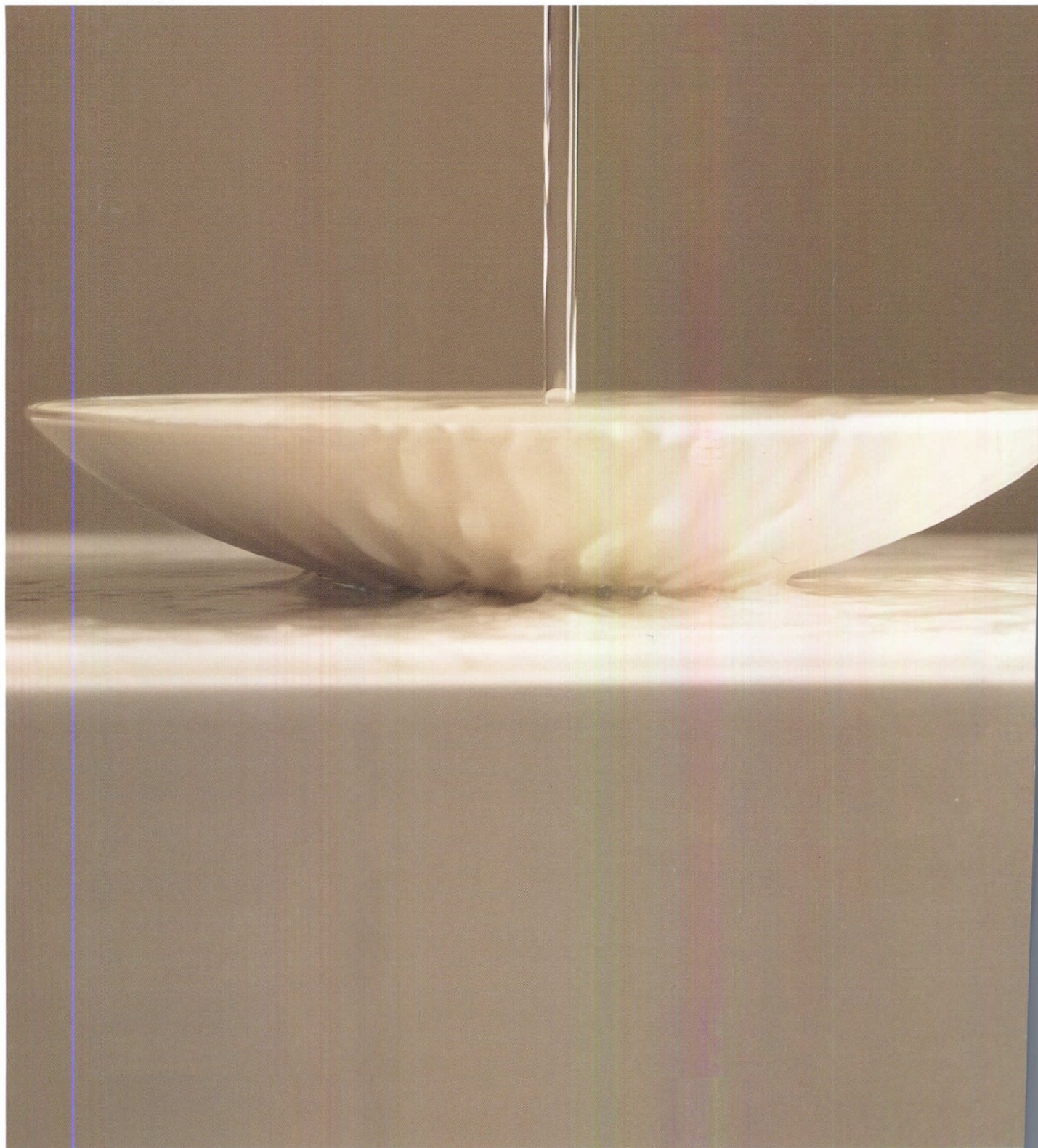

1-800-4-KOHLER

CIRCLE 276 ON READER SERVICE CARD  
OR GO TO [WWW.LEADNET.COM/PUBS/MHAR.HTML](http://WWW.LEADNET.COM/PUBS/MHAR.HTML)

THE BOLD LOOK  
OF **KOHLER**®