

RECORD

COMBINED WITH AMERICAN ARCHITECT AND ARCHITECTURE

FROM DESTRUCTION TO CONSTRUCTION.....	69
An Editorial . . . by Kenneth K. Stowell	
VICTORIAN PROTOTYPES OF THE PRESENT.....	70
By Frances Troy Schwab	
PLANNING FOR AUDIO-VISUAL EDUCATION.....	76
By Adrian L. Terlouw	
UNIT No. 1 OF THE "PREBILT" HOUSE.....	82
House Prefabricated with Laminated Arches, San Anselmo, Calif. Wurster and Bernardi, Ernest J. Kump, Architects Associated	
HOME NOW, GUEST HOUSE LATER.....	86
A Beginning for His Own Estate in Atlanta, Ga. Richard L. Aeck, Architect	
TO SERVE WHILE THE MAIN HOUSE WAITS.....	88
Guest House-Studio for Athos Menaboni, Atlanta, Ga. Richard L. Aeck, Architect	
BUILDING TYPES STUDY No. 105 . . . CHURCHES	90
TRENDS IN CHURCH PLANNING AND DESIGN	90
By Walter A. Taylor, A.I.A.	
CHURCH DESIGNS	95
Desert Chapel, Thermal, Calif. Marsh, Smith and Powell, Archi- tects and Engineers	
St. Margaret Mary's Church, Omaha, Neb. Leo A. Daly Co., Archi- tects	
Valley Community Church, Portland, Ore. Donald W. Edmundson, Architect	
Catholic Church for the Orient. Antonin Raymond, Architect.....	
Designs for the Deep South. Barber and McMurry, Architects.....	
Problem of a Chapel. Junior Chapel, First Methodist Church, Portland, Ore. Pietro Belluschi, Architect.....	
St. Michael Church, Muskegon, Mich. Edward J. Schulte, Archi- tect	
Methodist Church, Junction City, Ore. Sutton, Whitney and Aandahl, Architects	
Church on Amphitheater Plan. Proposed Scheme for a Catholic Church. Paul Thiry, Architect	
Two Economical Postwar Churches. Hills, Gilbertson and Hayes, Architects	
First Church of Christ Scientist, Mankato, Minn. Rollin C. Chapin, Architect	
Church of Our Lady of Victory, New York City. Eggers and Higgins, Architects	
Carmichael Community Church, Carmichael, Calif. Nicholas Tomich, Architect	
Holy Redeemer Chinese Catholic Church, Philadelphia, Pa. Henry D. Dagit and Sons, Architects	
Second Christian Reformed Church, Denver, Colo. Earl Morris, Architect	
TIME-SAVER STANDARDS	113
Pipe Organ Space Requirements	
Electronic Organ and Carillons	
THE RECORD REPORTS	7
BIRTHPLACE OF THE ATOMIC BOMB	10
FOR BETTER BUILDING	20
MANUFACTURERS' LITERATURE	24
REQUIRED READING	120
INDEX TO ADVERTISEMENTS	186



H. JUDD PAYNE, Vice-President in charge of Magazine Division • Copyright 1945 with all rights reserved F. W. DODGE CORPORATION

EDITOR-IN-CHIEF, Kenneth Kingsley Stowell, A.I.A.; **Managing Editor,** Emerson Seble; **Associate Editor,** Douglas Haskell; **Associate in South America,** Edmund J. Whiting, A.I.A.; **Assistant Editor,** Jeffrey H. Livingstone; **Desk Editor,** Florence

A. van Wyck; **Art Director,** W. K. Allen. **CONSULTANTS:** Industry Relations Consultant: Thomas S. Holden. Statistical Consultant: Clyde Shute. Building Economics Consultant: Norbert Brown. Field Research Consultant: Clifford Dunnells, Jr.

Architectural Record (combined with American Architect and Architecture) is published monthly by F. W. Dodge Corporation, 34 No. Crystal St., East Stroudsburg, Pa., with Editorial and Executive Offices at 119 West 40th Street, New York, N. Y. Thomas S. Holden, Pres.; Howard J. Barringer, Vice-Pres. and Treas.; Irving W. Hadsell, Vice-Pres.; Chauncey L. Williams, Vice-Pres.; Sanford D. Stockton, Jr., Secy.; Walter F. De Saix, Asst. Treas.; Edwin H. Freed, Asst. Treas., Member Audit Bureau of Circulation and Associated Business Papers, Inc. Architectural Record is indexed in Reader's Guide, Art Index and

Industrial Arts Index. Subscription rates: United States and Possessions, Canada, Cuba, Mexico, Central and South America, \$3 the year, \$5 for two years, \$6 for three years; elsewhere, \$5 the year; single copy, \$1. Circulation Manager: Marshall Ginn. Every effort will be made to return material submitted for possible publication (if accompanied by stamped, addressed envelope) but the editors and the corporation will not be responsible for loss or damage. Other Dodge Services: Real Estate Record & Builders' Guide, Sweet's Files, Home Owners' Catalogs, Dodge Reports & Dodge Statistical Research Service.

The Self-Cleansing By-Pass in Watrous Flush Valves

- Guards Against Water Waste
- Minimizes Maintenance

... Another
of the many Watrous
Points of Superiority

Water Saver Adjustment

✓ Self-Cleansing By-Pass

Single-Step Servicing

Self-Tightening Handle
Packing

Screenless Silent-Action

Sturdy Brass and Bronze
Construction

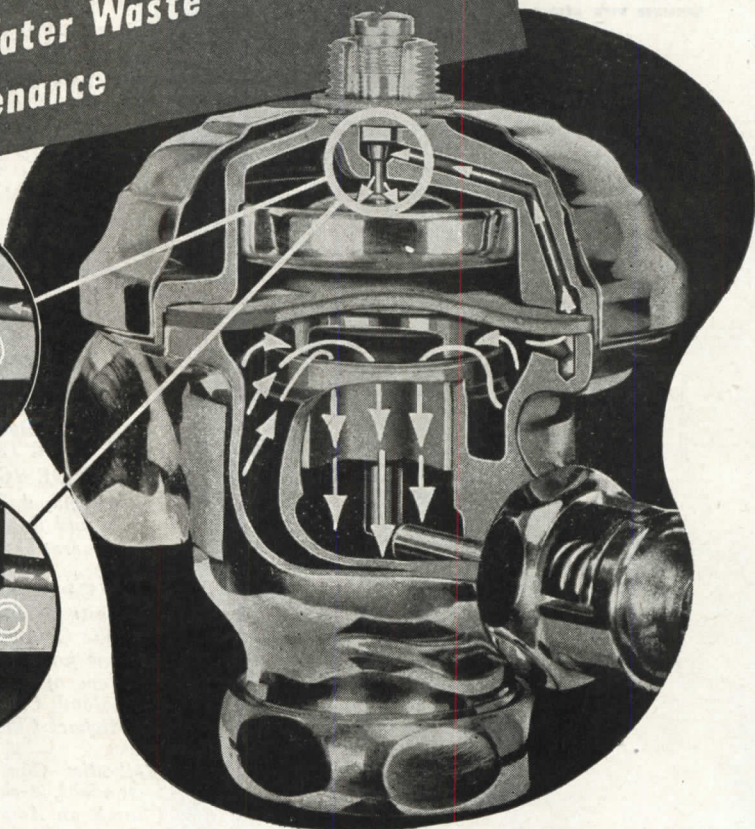
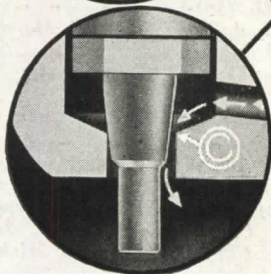
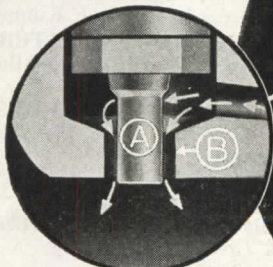

• The by-pass is the control-center of a flush valve. A small stream of water flowing through this by-pass governs the duration of the flushing period.

Watrous Flush Valves, in both diaphragm and piston types, have an automatic, mechanical device which cleanses the by-pass before each flush. This is a time-proven feature that safeguards against prolonged flushing due to foreign matter in the water.

When you specify Watrous Majestic or Imperial Flush Valves you get this important safeguard on every fixture—a safeguard that adds greatly to the economy and dependability of flush valve operation.

Before you select flush valves for your next job check up on the many Watrous points of superiority.

THE IMPERIAL BRASS MFG. CO., 1240 W. Harrison St., Chicago 7, Ill.

How the Watrous Self-Cleansing By-Pass Works

At the start of each flush, plunger (A) is mechanically lifted from its position in the by-pass orifice (B). This greatly enlarges the orifice, momentarily allowing a very large amount of water to flow through it. This effectively washes away any ordinary dirt or sediment which may have become lodged there.

The plunger then drops down again in the orifice, which now has been thoroughly cleansed, and establishes the normal by-pass opening (C). This assures the proper length of flush.

For complete information on Watrous Flush Valves see Sweet's Catalog or write for Catalog No. 448-A. Also ask for Bulletin No. 477 giving a summary of "Architects' Views on Flush Valve Applications."

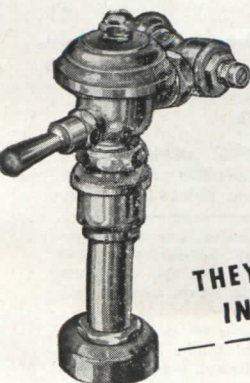

• The exclusive Watrous self-cleansing by-pass is one of the many reasons why the selection of Watrous Flush Valves is a source of constant satisfaction over the years to everyone concerned.

THEY PAY FOR THEMSELVES
IN THE WATER THEY SAVE

Watrous Flush Valves

THE RECORD REPORTS

OWMR Appoints Hugh Potter Construction Coordinator Priorities Puzzle Officials • Congress Eyes Housing Lumber Exports to Drop? • Prices Poke the Ceiling

WASHINGTON is still wondering what the government housing picture will look like in the postwar period. Will the National Housing Agency—a wartime creation—be continued as an over-all coordinating unit in peacetime?

Nobody knows the exact answer, but plenty of straws are blowing in the wind. Whether or not the NHA in its present form will get a permanent lease on life, the wind is heading directly toward a central over-all housing body. These straws are indicative:

1. Chief Snyder of the Office of War Mobilization and Reconversion has appointed Hugh Potter Construction Coordinator, heading the new Inter-Agency Committee, to get building started.

2. The new-born Wagner housing bill would continue NHA.

3. The Taft Committee (the Senate's Postwar Subcommittee on Housing) specifically recommends it.

4. The House Postwar Subcommittee on Public Works and Construction recently suggested a construction policy board for the Executive Office of the President.

Potter Takes Over

When John W. Snyder, Vinson's successor as director of War Mobilization and Reconversion, appointed Hugh Potter Construction Coordinator with the assignment to go out and get building started, he said to him: "Mr. Potter, you have only two bosses in this, myself and the President. We're backing you up."

The directive which, so to speak, is Mr. Potter's charter outlining his responsibilities and his powers to carry them out, satisfied the new Coordinator. As soon as he took the job, which involves forming a committee to include every unit in government with an interest in construction, he got busy. He made appointments weeks ahead with men in industry and in government calling in managements of the big component companies, lumber men, builders and others. Then he rushed out to Texas to wind up his immediate affairs.

The appointment of a Construction Coordinator followed months of agitation within the industry. The House Small Business Committee had been calling for an inter-department committee on lumber. As represented by the

various trade associations in Washington, the industry clamored for such a committee to be headed by someone who would be given supreme powers. They got the ear of Robert Nathan, who works directly with Snyder, who was more than receptive.

The statement of Potter's powers and responsibilities is broad. It creates an inter-departmental committee including representatives of OES, OPA, WLB, FWA, WMC, Commerce and Labor Departments, Smaller War Plants Corporation, and allows the chairman to call in additional members as he sees fit.

The Committee is told to survey the "programs, plans and problems" of each of the agencies responsible on some phase of construction, making recommendations for action to OWM. The work of the agencies, insofar as they bear on construction, are "to be worked into a single program as to volume, timing, geographical distribution and type of work" to promote as much construction as is consistent with the war effort. The individual agencies, meanwhile, are ordered to resolve problems themselves.

When the OWM decided to appoint

a coordinator, its officials asked for nominations. There were, as usual, a great many but in most lists Potter's name appeared. Industry, especially, respects him; in government, his name is not so well known. Potter went to Harvard Law School and for a time sat on the Bench in a Texas court. He developed the "River Oaks" community near Houston which is estimated to value \$30,000,000 and includes not only housing but stores, playgrounds, parks, etc. He is a former president of the National Association of Real Estate Boards and of the Urban Land Institute.

The immediate schedule which Potter set for himself suggested that he considered his first job that of discovering just where the construction bottlenecks are and why they are so tight. Members of the OWM staff assume that he will take the main ones, tracking them to their sources and then propose solutions. During the discussions at the OWM offices it was lack of workers in the lumber camps, in component plants and elsewhere that was most discussed.

Industry men whose advice Potter sought all mention as the main bottleneck "lumber," lack of which holds up most jobs. As for finding lumber, they were prepared to make these suggestions which, they supposed, Potter would have taken anyway:

1. To get the Army to use greater restraint in its purchases. This, they assumed, would be done after a survey

(Continued on page 14)



"Yessir, you just order by number. How big is your congregation?"

—Drawn for the RECORD by Alan Dunn

Oakton Elementary School, Fairfax County, Virginia.
Division of School Buildings, State Dept. of Education.
Architect. E. E. Lyons, General Contractor, Vienna, Va.

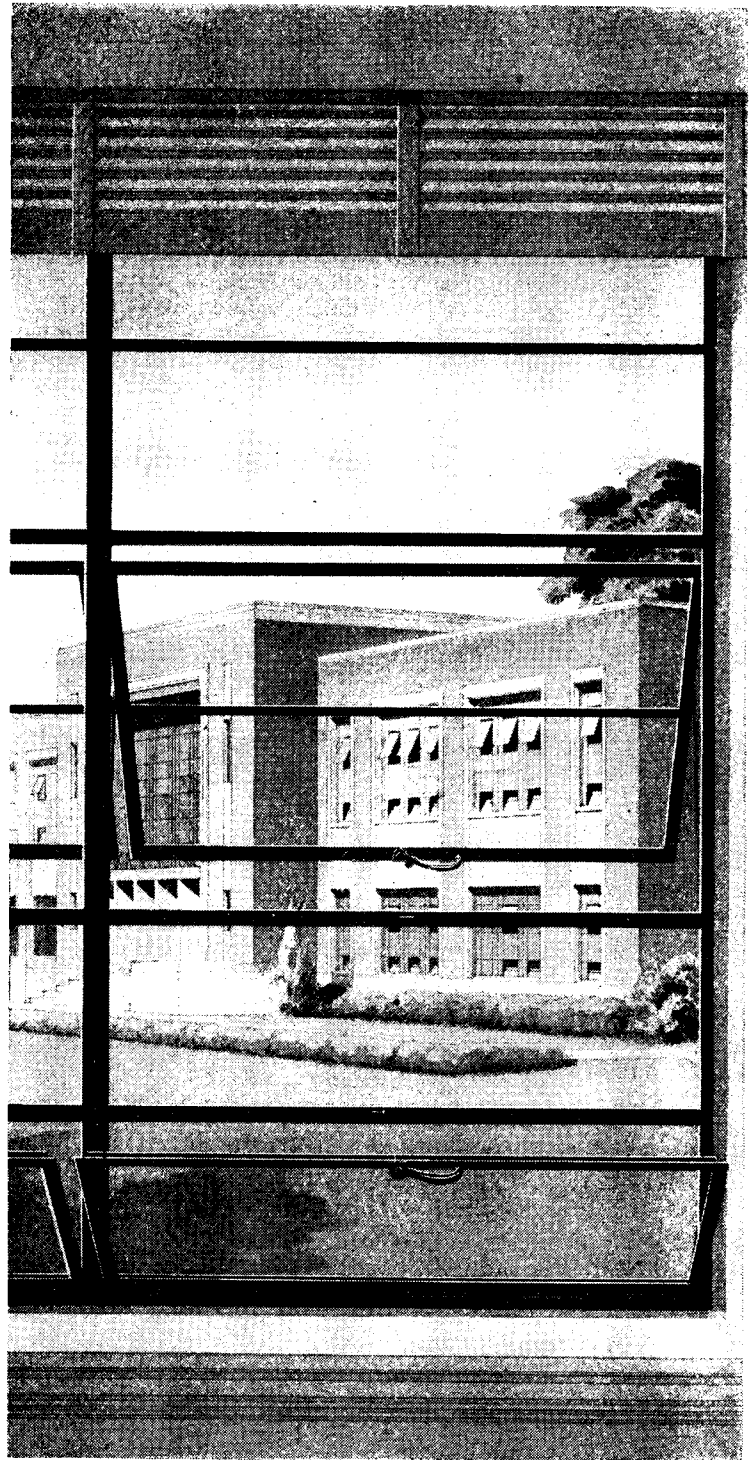

Schools... For cheerful, pleasant classrooms, with abundant day-lighting and easily controlled, natural draft-free ventilation, specify Lupton Metal Windows. Simple in design; rugged in construction; weathertight. The result of more than forty years experience.

See our Catalog of Post War Types and Sizes in Sweet's for 1945, or write today for reprint.

MICHAEL FLYNN MANUFACTURING CO.
E. Allegheny Ave. at Tulip St., Philadelphia 34, Pa.
Member of the Metal Window Institute

LUPTON METAL WINDOWS

FOR CLIENTS WHO DEMAND THE BEST, KITCHENS WITH THESE ELECTRICAL FEATURES WILL HAVE INSTANT APPEAL

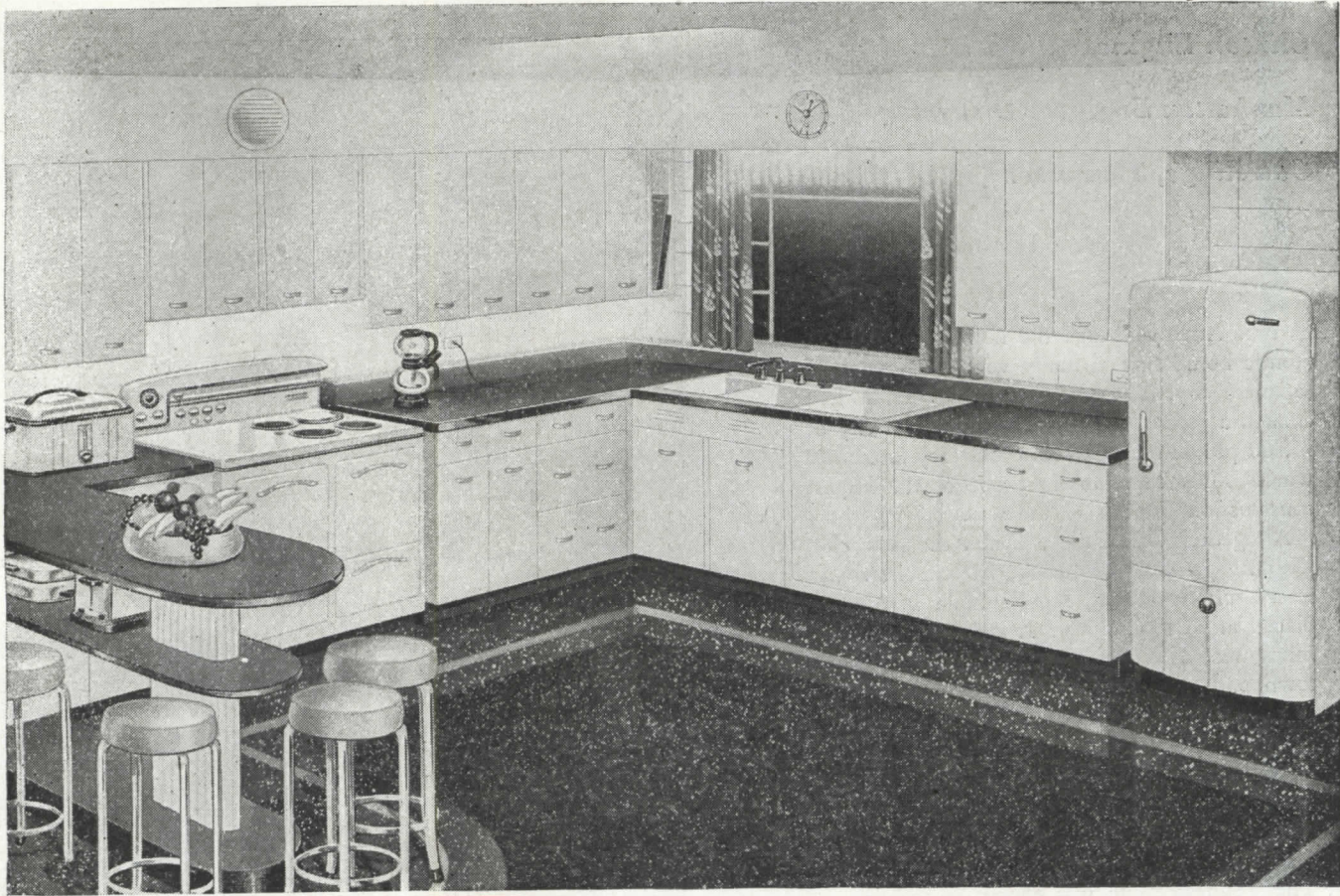

WHAT PEOPLE REALLY WANT IS

Electrical Living

In designing and building new homes for families with good incomes, complete electrical installations must be made. In the efficient kitchen shown here, note the carefully planned work centers; use of fluorescent lamps for valance, ceiling and work center lighting; electrical equipment, including: range, refrigerator, dishwasher, garbage eliminator, ventilating fan, clock, table appliances and plenty of outlets to serve them.

...and all through the house, Better Wiring will pay a profit!

Appealing kitchens are not enough. To give people Electrical Living all through the house means that each room must be planned and wired to meet public demand with enough circuits and outlets, wire of ample size, modern circuit protection and quality materials and workmanship.

The Home Wiring Handbook helps plan and specify Better Wiring accurately for several popular price groups of homes. It contains 120 pages. Ten chapters. Dozens of tables, charts and diagrams. Costs one dollar. Send your money to Westinghouse Electric Corporation, Industrial Relations Dept., 304 Fourth St., Pittsburgh 30, Pa. J-91536

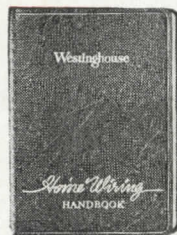

Westinghouse
PLANTS IN 25 CITIES . . . OFFICES EVERYWHERE

Better Homes Department

as a part of its consulting service, offers you the following FREE books: Electrical Living in 194X—Professional Edition; and Manual of Better Home Wiring.

BIRTHPLACE OF THE ATOMIC BOMB

Clinton Engineer Works

Manhattan Engineer District

Oak Ridge, Tennessee

WHEN America heard the news that a single atomic bomb had virtually wiped out a whole Japanese city, it was also disclosed that it had created a "secret city" in this country, a city of 75,000 people busily working on they knew not what. Thus came to light one of the largest construction projects of the war.

Altogether Oak Ridge, Tenn., the new city, with its plants, its housing, its schools, roads, tracks and what not, represents an investment placed at \$1,106,393,300. It is located some 18 miles west of Knoxville, Tenn., and is just the town part of the Manhattan Engineer District, otherwise known as the Clinton Engineer Works. This is a huge government reservation of 59,000 acres. The Manhattan District, whose magic name brought AAA priorities for nearly everything, also includes the 631-square-mile Hanford Engineer Works near Pasco, Wash. The Tennessee site was chosen, of course, for its accessibility to TVA power, accessibility to water, remoteness from the coast and general isolation.

Photos here show some architectural prepossessiveness in certain buildings, but in general Oak Ridge is strictly engineering. Adjectives applied to the whole project include: mighty,



Major General Leslie Richard Groves, officer in charge for the Army

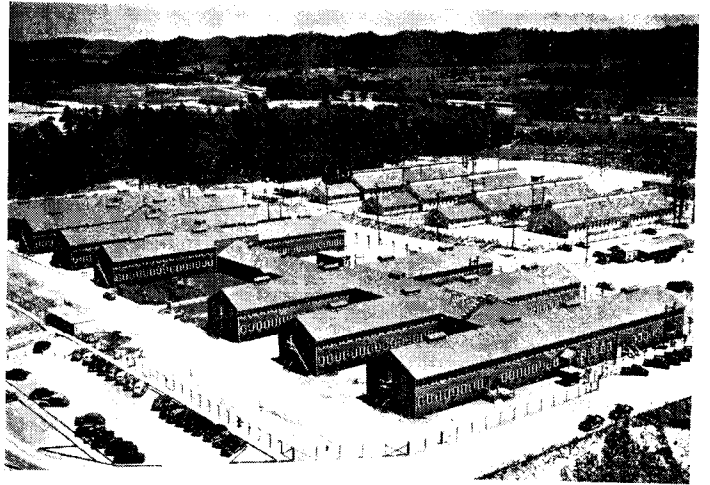

Above: Administration building. Below: air view of production plants

U. S. Army photos

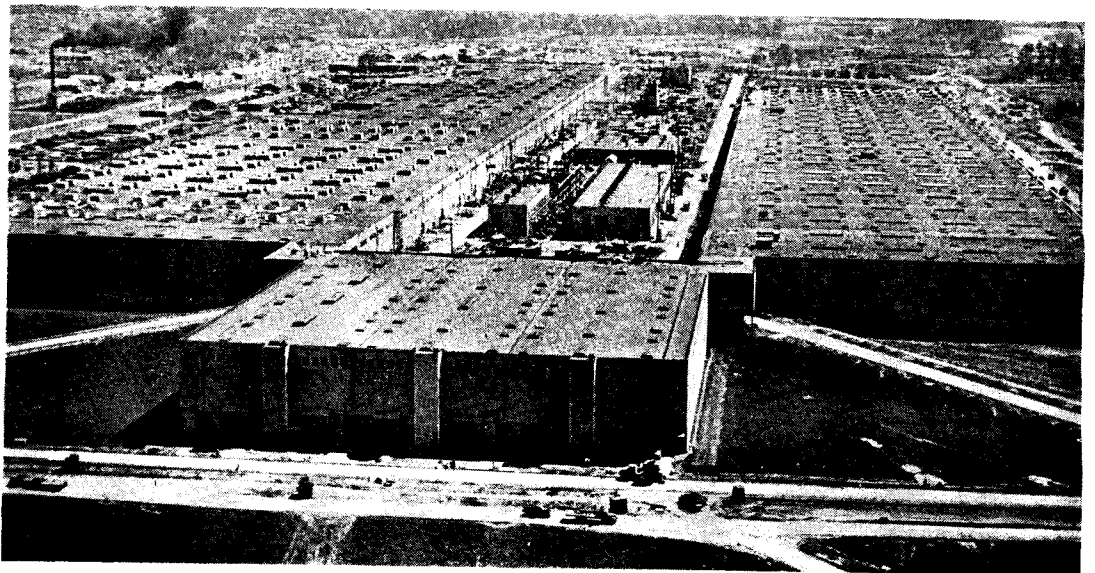

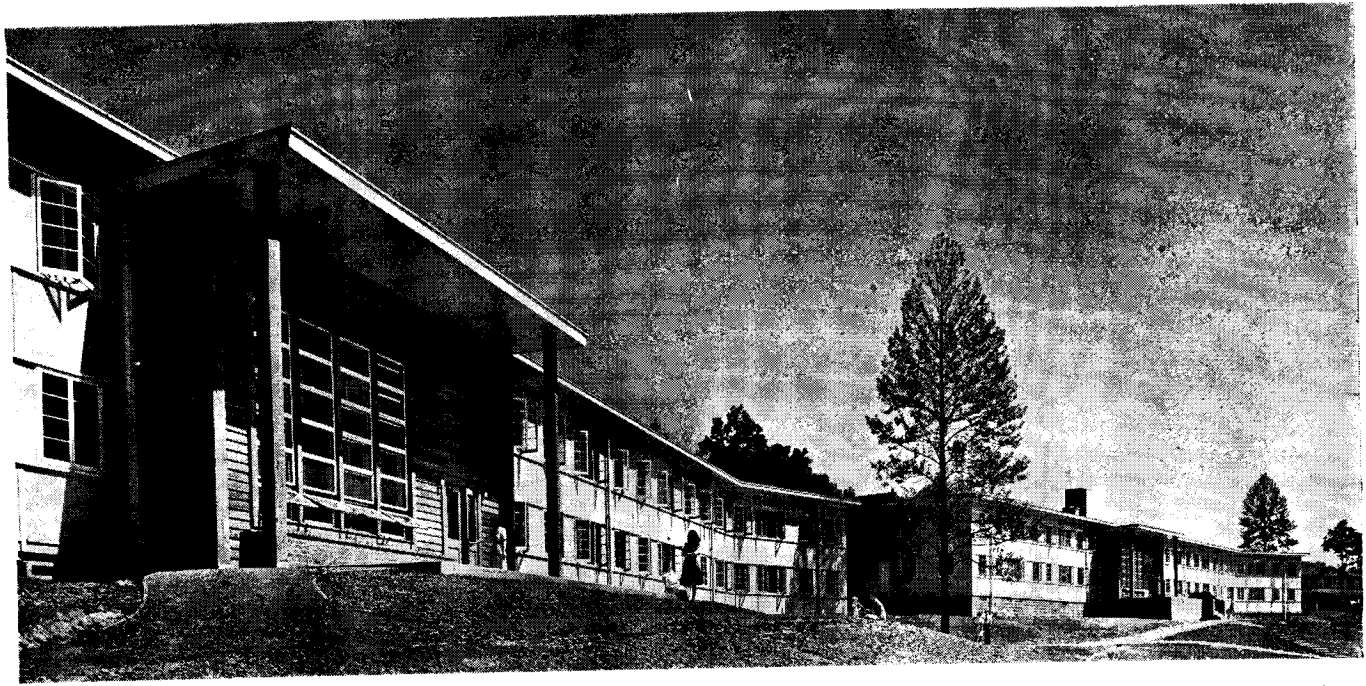

*Hedrich Blessing
Two efficiency-apartment buildings at Oak Ridge are among those with architectural interest*

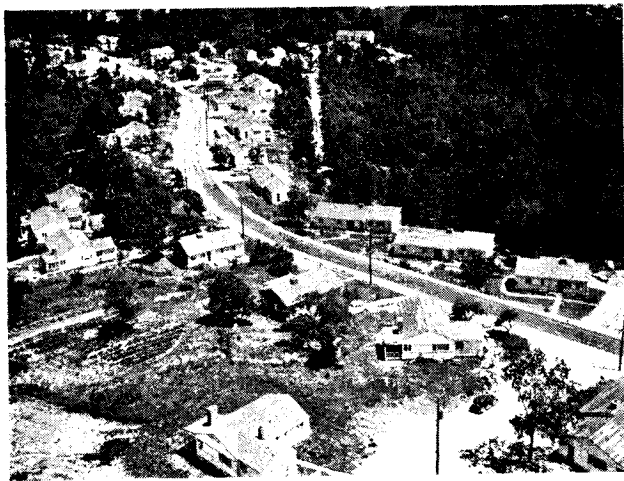

Some of the single-family homes, and two of the elementary schools built at Oak Ridge



staggering, solid, permanent, vast, utilitarian. Probably there is also a frantic note, for here was the greatest scientific race of all time.

What had to be built in this race against time included, besides the plant itself, some 10,000 family units, 13,000 dormitory spaces, 16,000 hutments and barracks units. By June, 1945 (the site was acquired in 1942) there were 11,000 pupils and 317 teachers in the schools; the school buildings throughout the District cost some \$3,700,000. There is also a 300-bed hospital, costing \$1,000,000; and a separate dental service building, \$92,000.

With the bulldozers, the carpenters, plumbers and electricians, also came books, musical instruments, artists' paraphernalia. There is a good-sized library, several theaters, recreation and social centers, athletic facilities and playgrounds. There are more than 300 miles of roadways. Church services began in one little chapel, though some 17 different religious organizations were represented; now there are three church buildings.

The only architectural firm officially mentioned was Skidmore, Owings & Merrill. Architect-engineers listed were the Kellex Corp., subsidiary of M. W. Kellogg Co. A-E-M contractors were Stone & Webster and E. I. du Pont de Nemours & Co.

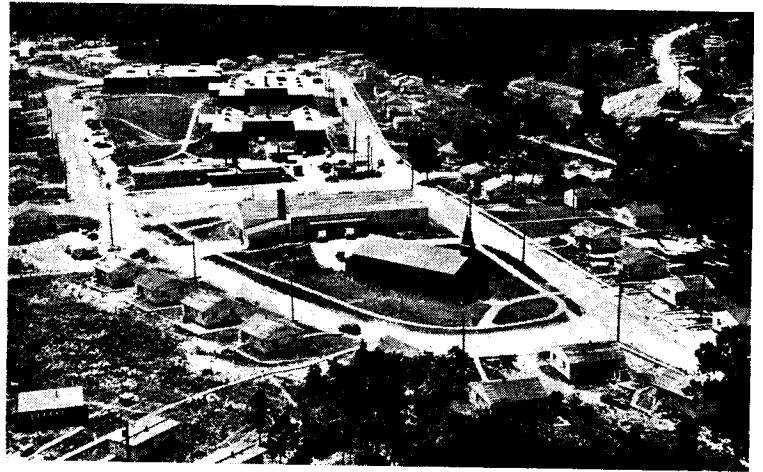
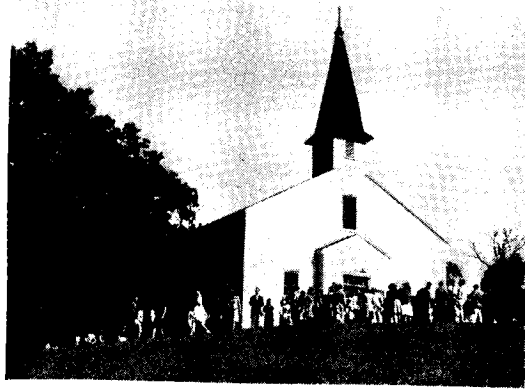

Above: the East Village of Oak Ridge. Below: Jackson Square store group

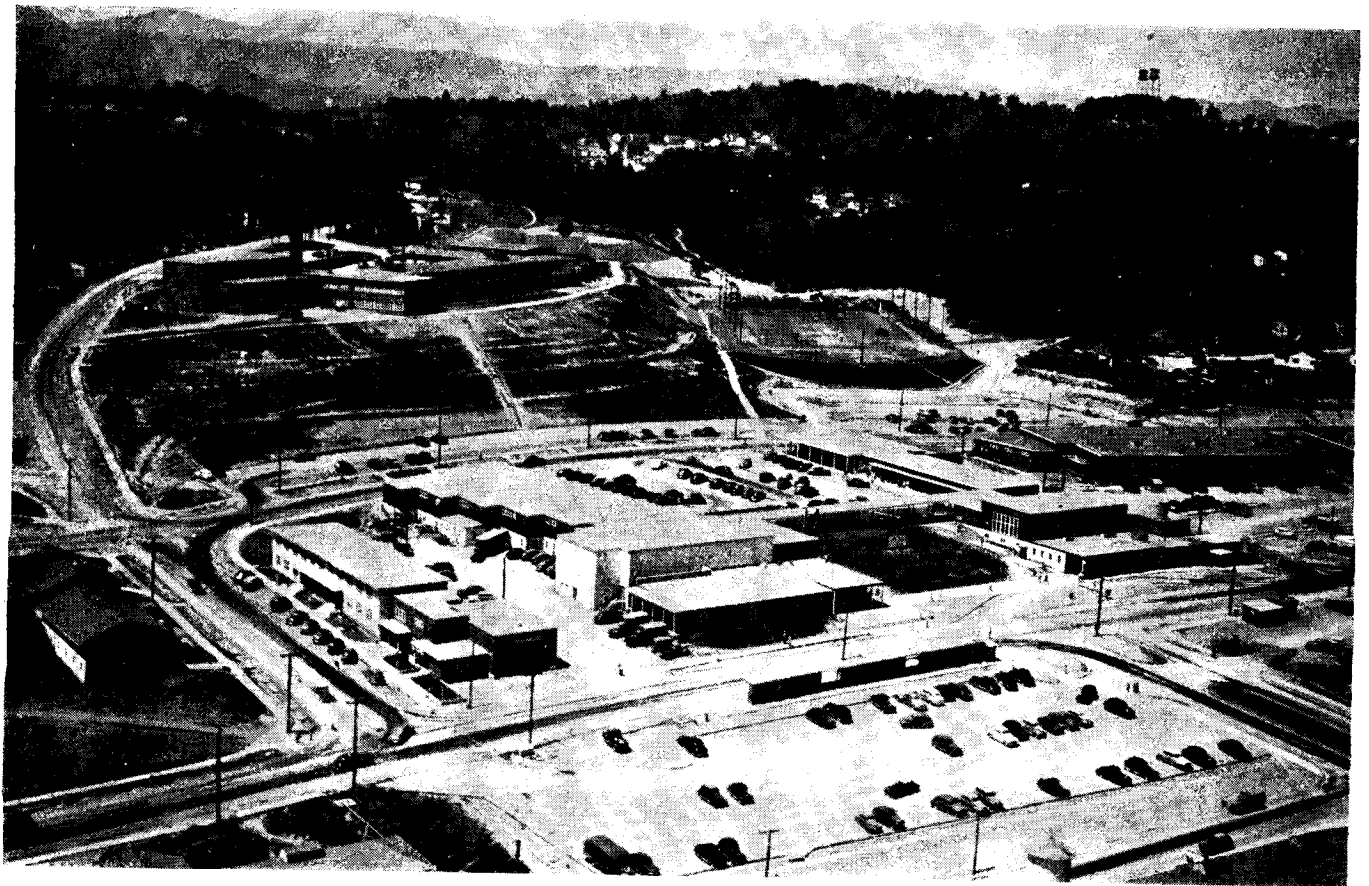

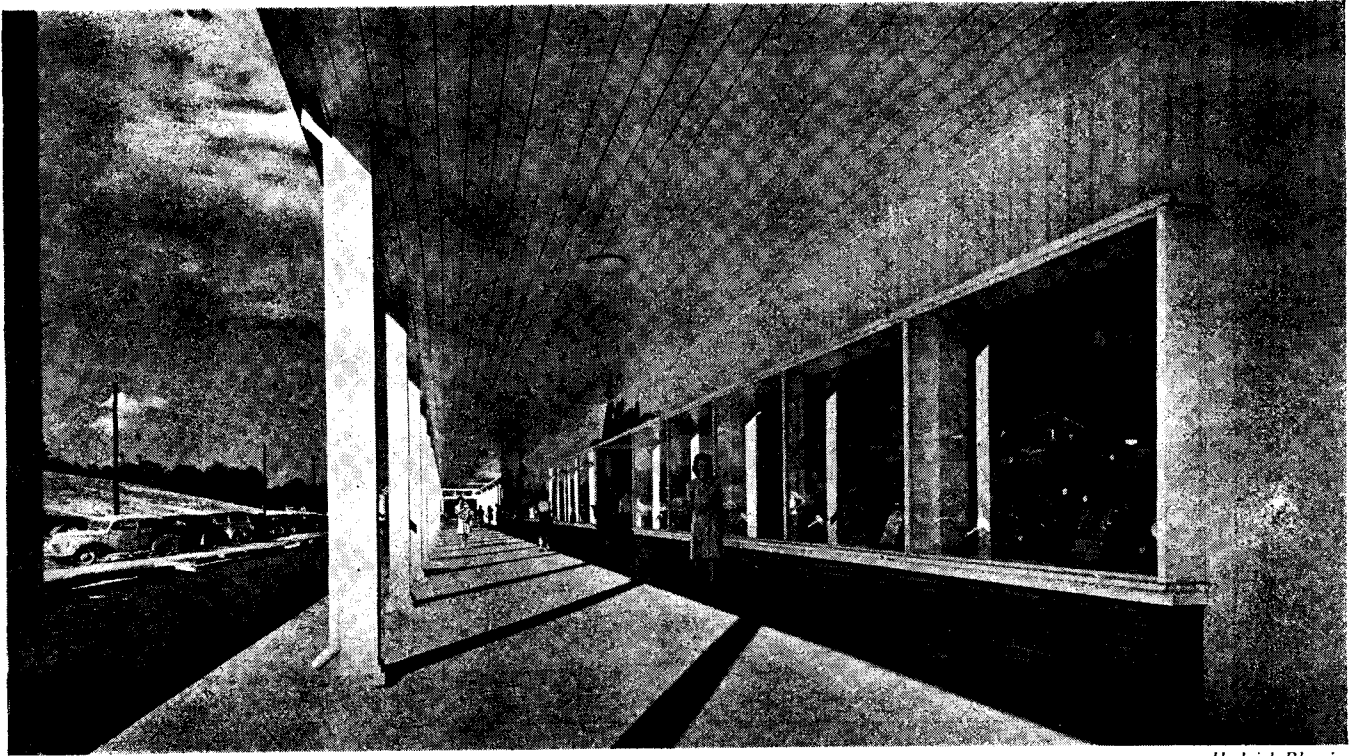

Hedrich-Blessing

Occasionally the functional spirit of Oak Ridge results in interesting design, as in this store group

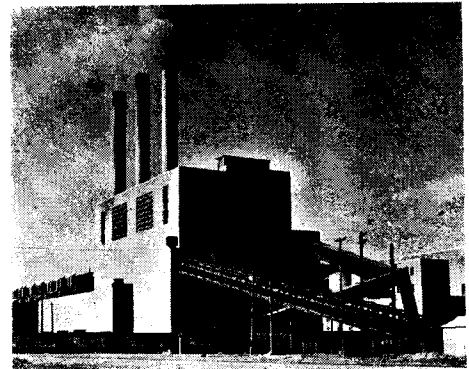

Above: parking lot at Jackson Square, the shopping center. Above right: plant for process steam

The hospital at Oak Ridge follows the design pattern of most wartime hospitals. Dormitory group in the background

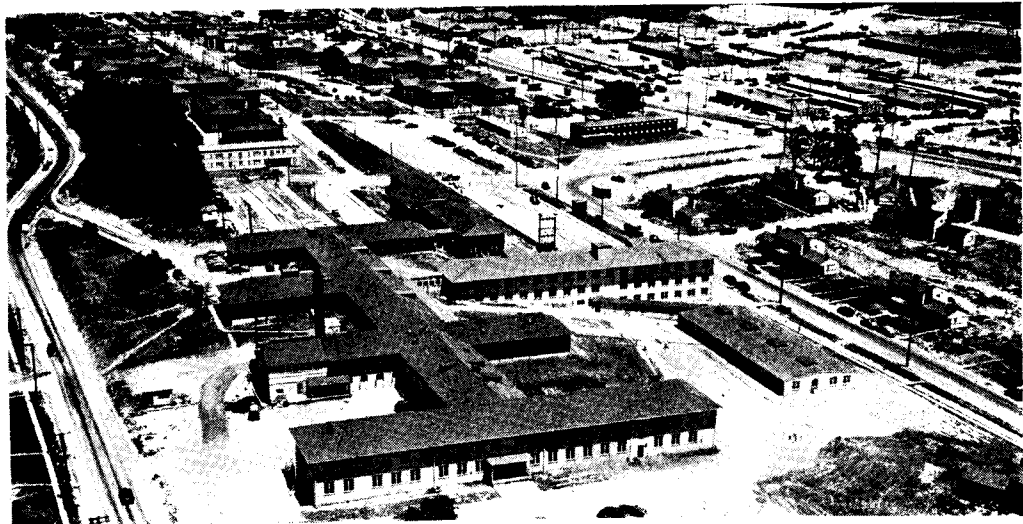

THE RECORD REPORTS *(Continued from page 7)*

had been made of the Army's inventories.

2. To get OPA to raise various prices for particular classes of lumber. Lumbermen have been charging repeatedly that some classes of production, particularly of construction wood, are unprofitable.

Meanwhile, Army officers express complete skepticism that they can reduce either their stocks or their purchases. They say that vast amounts are needed for such things as crating food, munitions, and other supplies being shipped to the Pacific, for constructing the mobile ports that are used in countless Pacific islands, for building new barracks at far-off outposts, etc.

WPB and Reconversion

Snyder and his top aide hold continued conferences with representatives of industry, with government men and

others to rush reconversion. Snyder must tackle two problems: first, that of reorganizing the war agencies; and second, to do whatever he can to help the civilian economy to get started again.

As for the reorganization, to which, incidentally, high ranking government men are giving most of their attention, the trend is toward consolidation. Sections, branches and divisions throughout the WPB hierarchy, for example, are slated for dissolution; their chiefs are peddling them among old line departments, and the Cabinet members are looking them over, turning eyes away from the lemons and squabbling over the good ones.

As this process goes on, Snyder is expected to boss the whole job, especially in helping companies produce civilian goods. Primarily he seeks avoidance of bottlenecks.

The line, which is being pushed by WPB with full sanction by Snyder, is to remove controls whenever doing so won't genuinely hurt war production. The removal of controls, at first, produces new bottlenecks; for example, companies which suddenly learn that they are allowed to produce this or that gadget promptly place orders with all of their suppliers, placing 10 orders perhaps, in the faint hope that one of them will result in actual delivery. WPB treads from old to new bottlenecks, trying, as well as it can to forecast what will come next.

The difficulties created by the removal of controls have not swayed chief government operators. Suppliers who are suddenly swamped with unrated orders ask for priority assistance to fill them; WPB officials point out that priority for them would entail restrictions on their suppliers and on their competing customers. The line is in the other direction.

But in some fields, OWM men feel,
(Continued on page 16)



entrance on the street floor, leading to a private lobby, and each will have the use of private passenger, automatic elevator service to its own floor. Supplementary freight elevator service will also be provided for the transfer of package merchandise not trucked into the building. There will be a completely-equipped garage in the basement, and bus terminal facilities are under consideration. Construction will be undertaken as soon as materials are available.

Diagram (below) of typical floor in proposed commerce center. Note parking areas and ramps leading to street

COMMERCE CENTER

Interior ramps 32 ft. wide to permit trucks and trailers of maximum size to drive direct from the street to any of the 13 floors and a separate passenger elevator for each of the floors, are the main features of the huge Interstate Commerce Center planned for downtown Manhattan.

The \$15,000,000 project, to be built by the Tishman Realty & Construction Company, will cover the four square blocks bounded by Varick, Hudson, Beach and Lighthouse Streets, a plot of about 180,000 sq. ft. Parking and loading areas, accommodating more than 20 trailer trucks on each floor, will be provided. Each floor will contain more than 175,000 sq. ft. of space; unobstructed areas stretching approximately 400 ft. in all directions will facilitate large-scale assembly-line production, with all departments functioning on one floor.

Each organization leasing one or more floors will have its own private

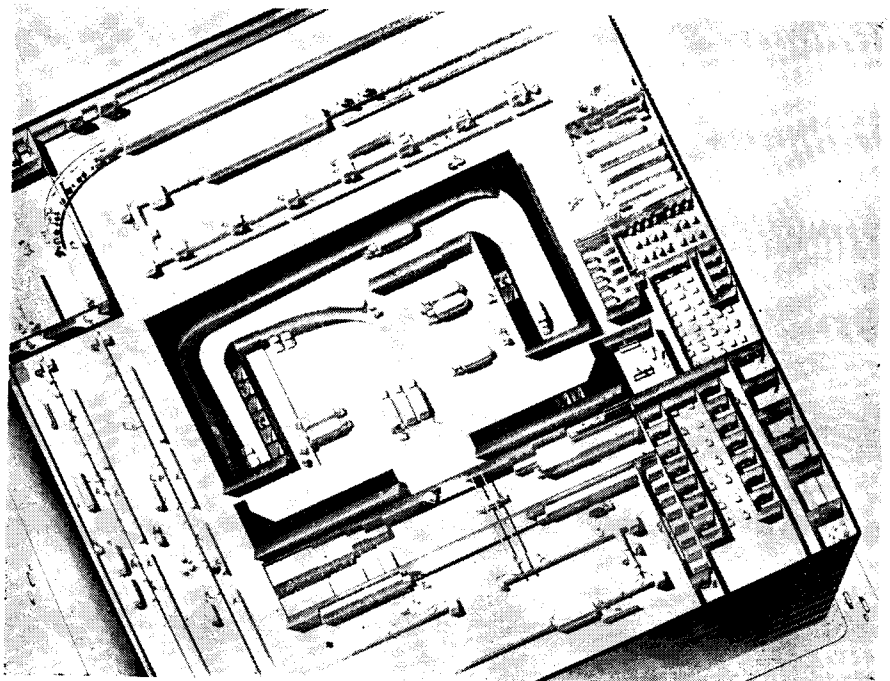

Now ready for you!

● Edwards announces a new and complete line of Clock Systems for schools, colleges, institutions, public buildings, and industry. This addition to Edwards other well-established lines of telephones, alarm and protection systems, now enables architects to specify complete "all-over" signaling systems *from one source*:

- Clock and Program Systems (school signaling)
- Telephone Systems (communication)
- Fire Alarm Systems (protection)

Edwards Clock Systems feature the famous dual motor, Telechron self-starting synchronous movements which operate without contacts, rectifiers, master clocks, relays, pendulums, keys or switches. Unlike ordinary electrical clock systems, which operate by impulse from a master clock, Edwards Systems pulsate with the alternate current — there is no central control clock to be looked after, regulated and serviced.

Investigate Edwards facilities for furnishing you with accurate, complete signaling systems for your postwar building projects.

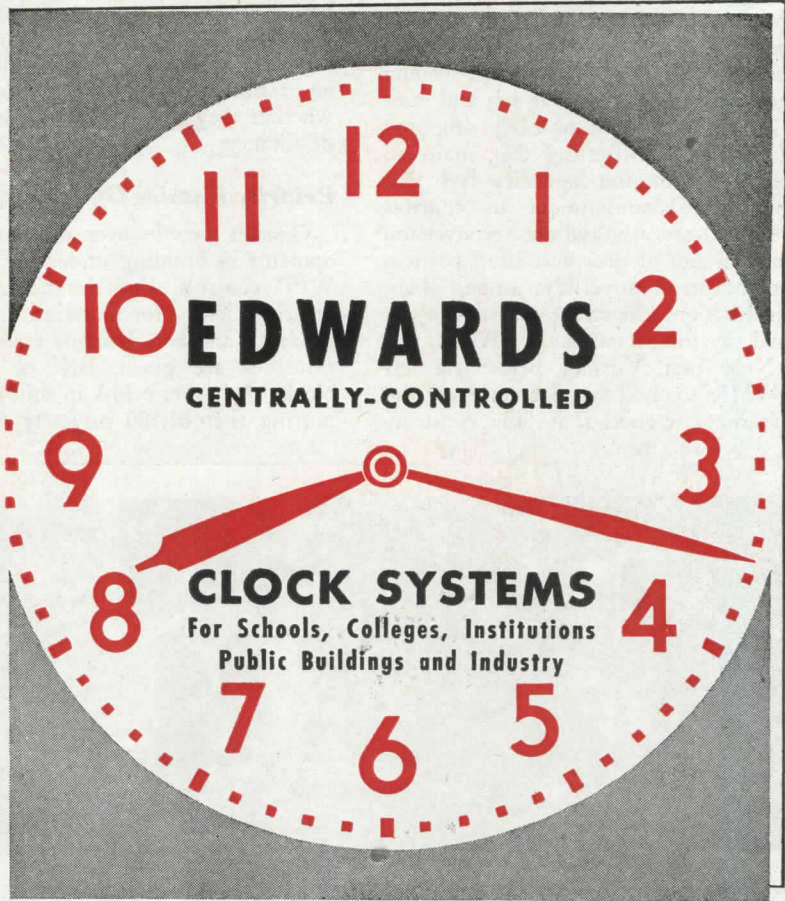

This new catalog will be ready shortly. Write today for your copy.

EDWARDS *and Company*

NORWALK, CONNECTICUT

IN CANADA—EDWARDS & CO. OF CANADA, LTD.

Electrical Signaling Communication and Protection for Homes, Schools, Hospitals, Offices, and Industry

much can be done by negotiating smaller Army purchases, swifter cut-backs of contracts, etc. This is easier for OWM than for WPB since Snyder's office is commonly referred to as the "White House."

OWMR Debates Controls

Under Snyder, the Interagency Committee on Construction could play a focal role in the reconversion period. For one thing, the move to center more power in OWMR may throw to it by the year-end or by V-J Day, the last word on priorities. Within the government itself opinions differ on easing up controls. Many WPB people, feeling that WPB's job is a war job and ends with the war, talk of early dropping of priorities. Offsetting this, many in other Washington agencies feel that any such abandonment of controls would throw the whole reconversion machine out of gear and affect particular industries adversely, among them construction. Hence the pressure to put final say in the hands of OWMR.

Note that Vinson, before he left OWMR to become Secretary of the Treasury, warned that "the construc-

tion industry cannot jump into the breach right away."

Said he: "Hardware, plumbing, and other equipment must be manufactured. Stocks of building supply dealers all over the country must be replenished, and contractors must rebuild their organizations. During this period of reconversion in the construction industry, the government must be particularly careful not to compete with private construction."

Incidentally, he took a poke at the construction industry, asserting that it has "lagged behind" in technological advances and "in progressively reducing the cost of its product." He urged an examination of "restrictive practices, whether they apply to materials, labor, or financing."

Priority Puzzles Officials

Officials puzzle over current developments in building under the relaxed WPB controls. For instance, not all priorities issued for materials are being used; for another, in many cases where priorities are given, lack of lumber blocks their use. NHA in mid-July, reporting that 61,500 privately financed

houses were under construction, advised that priorities for 73,000 more were in the hands of builders for future consideration.

Congress Turns to Housing

Builders may well turn a scrutinizing eye to the over-all housing bill introduced by Senators Wagner and Ellender on the day the upper house recessed to October. This bill, which Senator Wagner hopes to get up for hearings before his Banking Committee in the fall, sets the broad over-all pattern of official thinking on housing, a pattern based on contact with industry and labor, and on surveys of the national need. Its range embraces public and private, urban and rural housing, land acquisition and redevelopment, insurance features (including "yield insurance" for rental housing), veterans' needs, and research provisions.

In a sense, the measure implements the Taft subcommittee recommendations. But certain items in the Taft report need separate emphasis. His committee wants housing costs reduced whether financing, labor, materials or the cost of putting labor and materials together. It opposes so-called "rent certificates" for distribution to the needy on the order of grocery stamps. It wants a comprehensive study made of farm housing and continuation of agricultural agency work in this field. It suggests the need for financing to builders so they can proceed with planning and scheduling of operations without regard to disposal methods. It proposes reduced income taxes on corporations owning housing property, favors Bureau of the Census housing surveys, and last but not least, it would transfer to the National Housing Agency the Federal National Mortgage Association as well as the guarantee of home loans for veterans, and would put under NHA any system of loans or grants for slum clearance.

Of marked interest both in the Taft Report and the Wagner-Ellender bill is the provision for yield insurance. As Senator Ellender puts it, this plan contemplates an additional insurance fund under FHA to guarantee an annual return of $2\frac{3}{4}$ per cent to investors in large scale rental projects on a 50-year investment basis, at a return upon investment of not more than $3\frac{1}{4}$ per cent. He considers that the plan will bring billions in private capital into housing.

Lumber Exports to Drop?

In the midst of the overwhelming demand for lumber, hope is expressed of reducing lumber exports for the rest of 1945, particularly in the fourth quarter. A special U. S. lumber mission

(Continued on page 18)

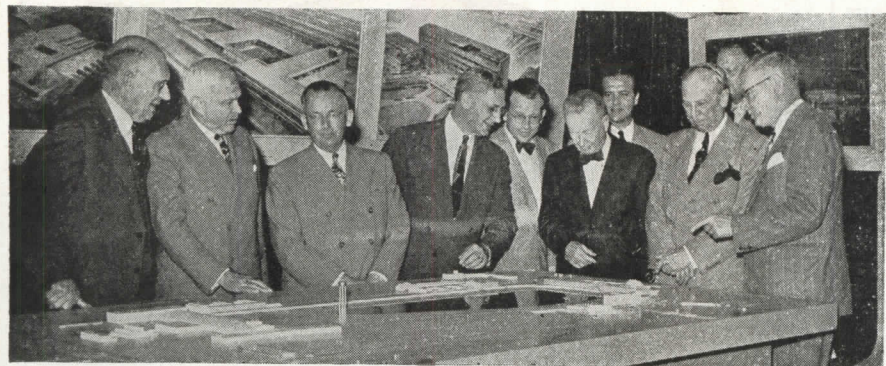

G. M. executives and the project architects look at a scale model of the technical center. From left to right: G. M.'s C. F. Kettering, vice president; C. E. Wilson, president; C. L. McCuen, vice president; B. D. Kunkle, vice president; architects Eero and Eliel Saarinen and J. Robert F. Swanson, of Saarinen and Swanson; G. M.'s Alfred P. Sloan, Jr., chairman; Harley J. Earl, vice president; and W. J. Davidson, executive engineer. Picture was taken at the Waldorf-Astoria luncheon in July

G. M. TECHNICAL CENTER

Announced with much fanfare at a luncheon at the Waldorf-Astoria, New York, late in July, the proposed General Motors Technical Center is one of the largest postwar expansion programs yet made public.

The Center, believed to be an entirely new concept of industrial research, will consist of a group of buildings which will provide facilities for the Corporation's research, advanced engineering, styling and process devel-

opment sections of its general staff activities.

The various buildings comprising the Center will be grouped around a central esplanade within which will be a 7-acre lake. The site, $1\frac{1}{2}$ miles long and about half a mile wide, covering approximately 350 acres, is just outside of Detroit. Construction will start as soon as complete clearance on materials and labor can be obtained. Saarinen and Swanson, of Birmingham, Mich., are the architects.

It's the Moth and the Flame

all over Again



SHEETROCK *Fireproof WALL and CEILING PANELS*

Many people play the game of the moth and the flame. When their house burns, they find out too late that it lacked fire protection. That is why progressive architects and builders constantly seek safer building materials.

One safer way to build is with Sheetrock* wall and ceiling panels. For Sheetrock is made of gypsum, a mineral which cannot burn. In actual fire conditions, it has proved its worth again and again, confining the flame till help could arrive.

Sheetrock rivals the beauty of any wall material. Smooth surfaces, sweeping curves, decorative paneled effects . . . all can easily be had with Sheetrock.

Or, if you want wood-grained effects, choose from Sheetrock's faithful reproductions of knotty pine, bleached mahogany and walnut. This versatility is the reason why Sheetrock has been chosen for more wallboard jobs than any other gypsum wallboard in the world.

*Reg. T. M.



United States Gypsum

For Building • For Industry

Gypsum • Lime • Steel • Insulation • Roofing • Paint

ARCHITECTURAL RECORD • SEPTEMBER, 1945

THE RECORD REPORTS

(Continued from page 16)

to Europe, headed by J. Philip Boyd, Director of WPB's Lumber and Lumber Products Division, uncovered the likelihood that lumber for redeployment and for our occupation forces in Europe can come from German and other European supplies. Certainly if European transport can be restored, no increase in present lumber exports is looked for—the figure now is 2 to 3 per cent of our current production. Europe has almost enough lumber, the mission found, to take care of urgent rehabilitation. Sweden and Germany hold the largest stocks, but the problem of getting the lumber out of Sweden is tough.

Prices Poke the Ceiling

Efforts to increase production of southern pine lumber via an increase of \$2.75 per thousand board feet in maximum prices, failed when Economic Stabilization Director William H. Davis turned thumbs down on the proposal. Data presented, he said, failed to establish that a general price increase was necessary to insure the required minimum production or that the proposed increase would achieve that purpose. He did say, however, that he would "consider favorably any practicable proposal for the relief of marginal producers" of southern pine lumber.

Other OPA price actions include authority to wholesale lumber yards to continue operating retail departments if they were so operated before regulations first established separate selling prices for wholesale and retail distribution yards. Two new regulations have been issued on manufacturers' ceiling prices for construction materials and refractories and specified mechanical building equipment; these regulations are expected to get wide use in the postwar construction period. Also OPA has boosted from 8 to 9 per cent the addition that may be made to ceiling prices for manufacturers' sale of vitrified sewer pipe in eastern and central areas. It has established uniform dollar-and-cent ceilings in the hourly rate to be charged in renting tractors, shovels, graders and other construction and road maintenance equipment.

Planning for Bigger Plots

Suggestions on community methods for assembling land for redevelopment are set forth in a recent NHA bulletin. While the Agency recognizes that there is little experience to be used as a guide, it suggests "means of making available for building two types of

(Continued on page 122)



Get to know

VAN DYKE WEATHERPROOF

— the All-weather Colored
Pencil with Insoluble Lead!

Weatherproof Van Dyke Colored Pencils never fail to make a satisfying first and lasting *impression*. Sturdy, easy-to-sharpen insoluble lead guarantees greater Pigment-to-Paper Writeability... top legibility in 24 brilliant colors. Perfect for charts, drawings — or whenever you need *moisture proof marks*.

SOLD IN SOLID COLORS OR IN 12 OR 24 COLOR EASEL-BOXED ASSORTMENTS

IT'S MADE BY

EBERHARD FABER

Leadership

IN FINE WRITING MATERIALS SINCE 1849

We advise these practical floors for

SCHOOLS

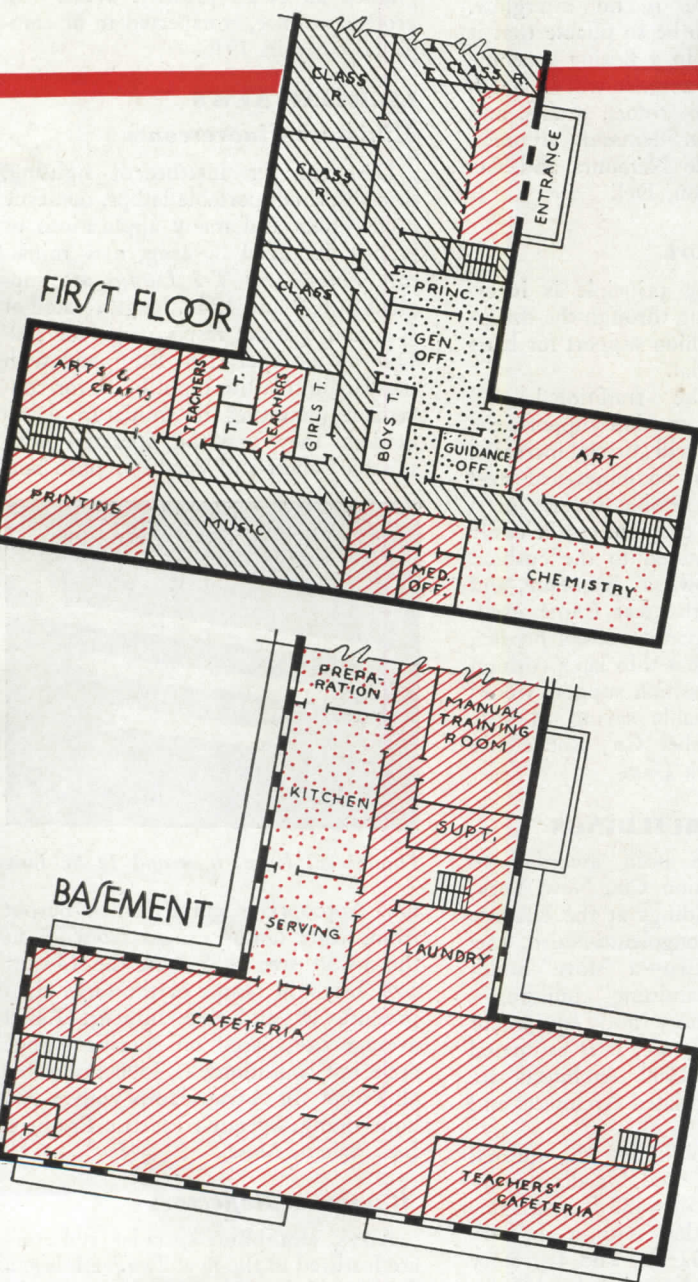

 **Standard Asphalt Tile** provides a good-looking floor—durable and easy to clean—for arts and crafts rooms, shops, and teachers' rooms. It's also especially recommended for entrance halls and basement cafeterias and laundries, because it is not harmed by moisture.

 **Greaseproof Asphalt Tile** answers the need for a floor that will not be affected by spattered grease or oil in kitchens and food-serving areas. Also because it is alkali and acid resistant, it is ideal for chemistry laboratories. Like Standard Asphalt Tile, it can be installed either on or below grade, or on suspended floors.

 **Linoleum**, a companion material, is a resilient floor which is often used for school classrooms and hallways. It's available in a variety of attractive patterns and colors. Ease of maintenance, long wear, and comfort are other advantages which have made this a desirable material for suspended floors in school buildings.

 **Linotile (Oil-Bonded)** combines distinctive appearance with especially high resistance to denting and wear and is ideal for principal's office and general school offices. Armstrong's Linotile comes in a wide range of colors and sizes, offering unlimited design possibilities. For use on suspended floors only.

P.S. For full information about the complete line of Armstrong's Resilient Floors—including Armstrong's Conductive Asphalt Tile, a floor that prevents the accumulation of static electricity, and Armstrong's Industrial Asphalt Tile, a rugged, low-cost floor for factories and workrooms—consult Sweet's or write to Armstrong Cork Co., Resilient Tile Floors Dept., 2409 Duke Street, Lancaster, Pa.

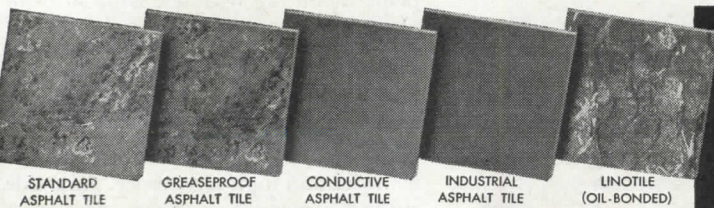

ARMSTRONG'S CORK TILE AND RUBBER TILE CURRENTLY ARE NOT AVAILABLE

ARMSTRONG'S RESILIENT TILE FLOORS

FOR BETTER BUILDING

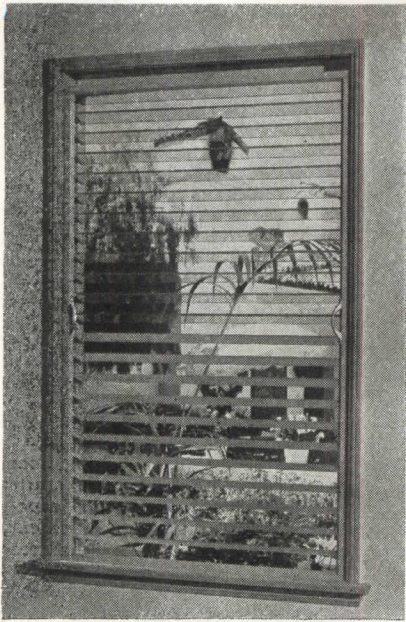

Not a venetian, but a lowered window

LOUVERED WINDOWS

Resembling a venetian blind in appearance, the *Bishop Venta-Glass* window has shutters or louvers made of plate glass for controlled ventilation and maximum light.

The louvers do not raise up and down, but are opened or closed by a slight movement of the front or "floating" frame. Breakage is prevented by a natural cushion of air formed between the overlapping louvers.

When open, the louvers are horizontal, permitting a 90 per cent opening of the window area; when closed, they overlap slightly, creating a water-tight seal. According to the manufacturer, the window can be left open during a rainstorm to allow ventilation, and the louvers can be tilted to any position to provide the desired amount of ventilation while eliminating draft.

The window is manufactured complete, ready to install in place of the usual window sash. It comes in a wide variety of standard window sizes, fits into any regular window frame. It is also made to fit doors, and can be used in ceiling and interior walls. Frosted glass louvers can be used in bathroom windows or in bedroom doors to combine privacy with ventilation and good illumination. Nu-Air-Wa Co., 601 S. Vermont Ave., Los Angeles 5, Calif.

POSTWAR PREVIEWS

Upholstery Fabric

A fire-resistant, plastic-coated upholstery fabric developed for aircraft, tanks and ships is expected to find wide postwar usage in restaurant seats, office

furniture and boats.

Known as *P. C. Cavalon*, the fabric consists of a flameproofed cotton cloth base with a flexible fire-resistant surface coating of synthetic resin. It will char in contact with flame, but will not support combustion; when the flame is withdrawn, there is no afterglow. Cavalon is said to be so pliable that it would not crack in a flexing machine test at 30° below zero. It will be available in a range of colors, grains, and finishes when war demands are met. E. I. du Pont de Nemours and Co. (Inc.), Wilmington, Del.

Cushion Support

The leaf spring principle is incorporated into seating through the design of a new type cushion support for latex cushioning material.

Eliminating the traditional coil springs from the cushion support, the new equipment will bring increased comfort because it combines leaf steel springs and the flexible surface of a diaphragm. Latex cushions can be easily and quickly cemented to the cushion carrier, to be known as *Flx-i-base*, and will be part of the seat frame itself. In theaters, the manufacturers predict, a seating unit with a thin latex cushion set on this thin cushion support would bring an appreciable saving in aisle space. U. S. Rubber Co., Rockefeller Center, New York City.

NEW PLANT BUILDINGS

Contracts have been awarded to Turner Construction Co., New York, for two new buildings at the Kearny, N. J. plant of Congoleum-Nairn, Inc. The cost of the two—a "stove" building and an "examining" building—with the machinery and equipment which they will house, is estimated will exceed \$2,000,000. Architects are Albert Kahn Associated Architects and Engineers.

The "stove" building, an unusual type of structure used for drying linoleum, will be 215 by 132 ft., with one 60-ft. story, together with a six-story section 35 by 132 ft. The two-story "examining" building, 248 by 185 ft.,

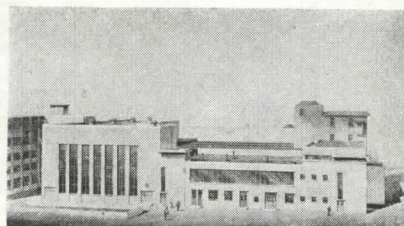

Congoleum's new "examining" building

will house equipment for Nairn's special finishing treatment, and the final examining department where the finished product is inspected and checked against established quality standards prior to rolling, labeling and packaging for shipment.

Both buildings will be of reinforced concrete, brick and structural steel. The WPB has approved the project and granted an AA-3 priority. Work will proceed at once, is expected to be completed early in 1946.

LIGHTING NEWS

Miniature Fluorescents

Designed for instrument lighting, displays, small portable lamps, domestic night lights and many applications of built-in localized lighting, new miniature *Fluorescent T-5 Lamps* are supplied in 6, 9 and 12-in. lengths rated at 4, 6 and 8 watts respectively, for 110-112 volt a-c operation. Equipped with standard miniature bipin bases for convenient mounting in miniature lamp holders, they may be operated with suitable ballast and starter or push but-

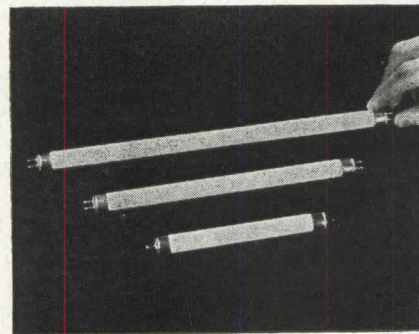

Fluorescent lamps 6, 9 and 12 in. long

ton. Appropriate initial lumen output from white lamps ranges from 73 in the 4-watt size to 580 in the 13-watt size. Daylight lamps of the same sizes produce 68 and 490 lumens. Rated average life, based on specific 3-hour cycle test conditions, is 1500 hours for all except the 4-watt lamp with a 500 hour rating. Sylvania Electric Products Inc., Salem, Mass.

Aluminum Reflectors

Alzak aluminum specular reflectors are featured in the new *Tandemlamp*, a fluorescent fixture which uses an axial plane mounting with one lamp in front of the other instead of a horizontal arrangement. This mounting, the manufacturers say, permits the light from each lamp to be reflected symmetrically from a smaller reflector. Aluminum reflectors were selected to assure permanence and high reflectivity. An oxide coating provides surface protection and the high reflection is the result of a special electrolytic treatment (pat-

(Continued on page 22)

Think in terms of

STRAN STEEL

Designed for gracious living... built around a framework of steel

Whether you are planning along ultra-modern or traditional lines, Stran-Steel framing will give you the permanence of steel construction, with new efficiency . . . flexibility of ideas.

Stran-Steel, with its nailable studs and joists, brings an entirely new perspective to postwar building . . . assures permanence, fire-safety, freedom from warp, sag and rot. These qualities — to the home builder, home buyer or investor — are as salable as grace and beauty of design.

Investigate the possibilities of Stran-Steel . . . shape your building plans around this uniform precision material. Build with Stran-Steel for beauty of design . . . comfort and convenience . . . lasting strength.

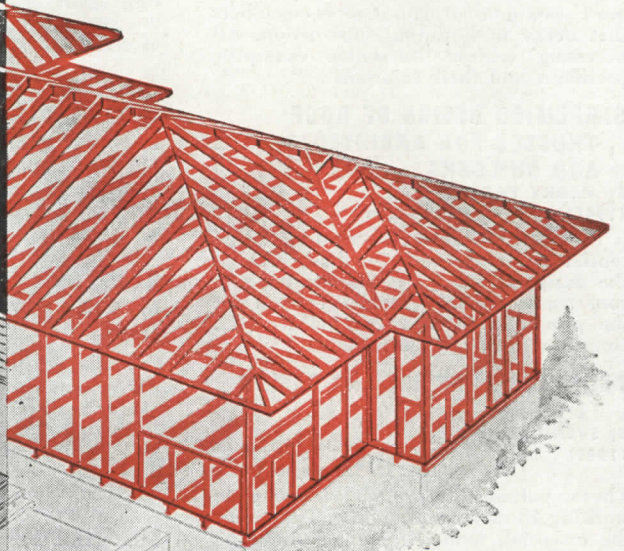
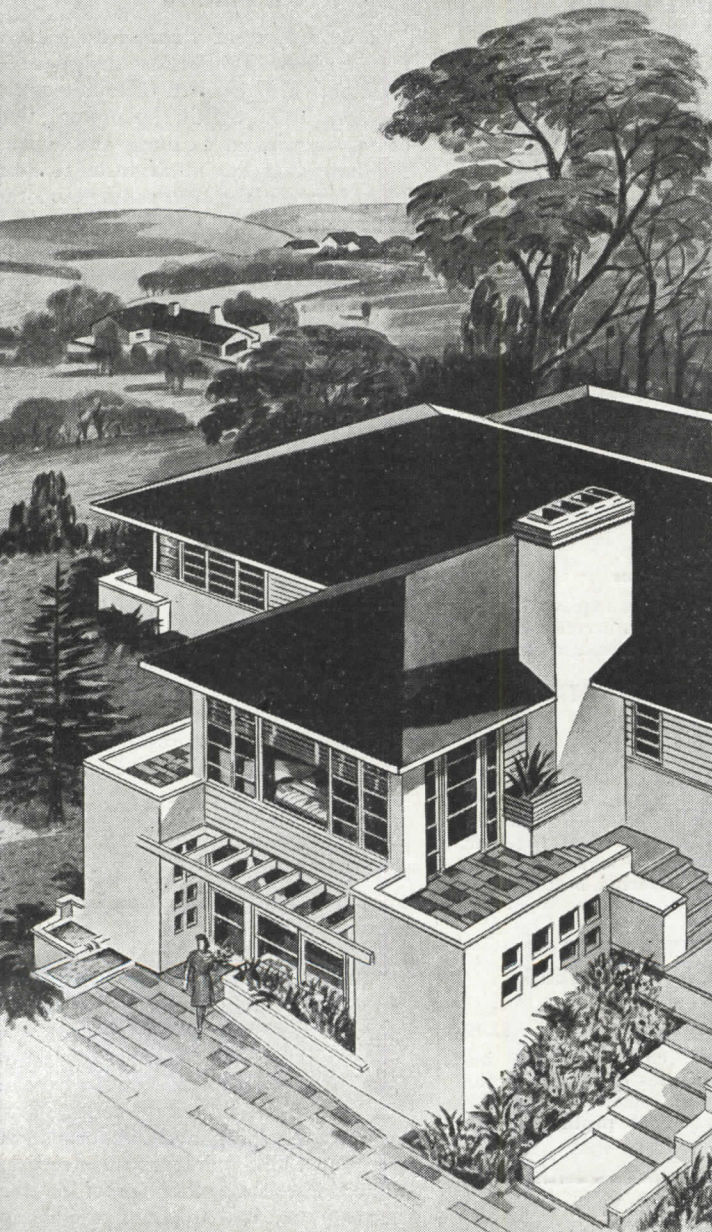

GREAT LAKES STEEL CORPORATION

Manufacturer of the Famous Quonset Hut for the U. S. Navy

STRAN-STEEL DIVISION • 37th FLOOR PENOBSCOT BUILDING • DETROIT 26, MICHIGAN

UNIT OF NATIONAL STEEL CORPORATION

WILEY Books



in ARCHITECTURE

These Wiley Books are practical and authoritative—designed to help you do better work. Whether you want a “refresher” or want to increase your knowledge, look over the important titles listed below. Then make your selection and order from the coupon today.

ARCHITECTURAL GRAPHIC STANDARDS

Third Edition

By Charles G. Ramsey and Harold R. Sleeper

(1941) 344 Pages \$6.00

This architectural “best seller” presents the authoritative and convenient answer to the questions raised in solving the architect’s daily problems. All data, standards, and information are shown graphically, so that pictures tell the story clearly. The essential facts are given without excessive detail or ornament. This book has proved itself an indispensable time- and effort-saver to the draftsman, architect, and engineer.

SIMPLIFIED DESIGN OF STRUCTURAL STEEL

By HARRY PARKER

(1945) 226 Pages Flexible Binding \$2.75

Clear, concise presentation of basic principles and modern methods of structural engineering. Covers the design of the most common structural steel members that occur in building construction. All necessary tables. Illustrative examples, problems and their solutions.

SIMPLIFIED DESIGN OF ROOF TRUSSES FOR ARCHITECTS AND BUILDERS

By HARRY PARKER

(1941) 195 Pages \$2.75

A compact, thorough treatment of the essential principles and methods behind the design of the most common types of roof trusses. Comprehensive enough for the practicing architect or builder . . . simple enough for the beginner.

PLUMBING PRACTICE AND DESIGN (2 Vols.)

By SVEND PLUM

(1943) VOL. I, 315 Pages, \$4.50
VOL. II, 329 Pages, \$4.50

These volumes represent a complete working library on plumbing. They offer the essential, modern data on plumbing in handy reference form.

ARCHITECTS' AND BUILDERS' HANDBOOK

By FRANK E. KIDDER and HARRY PARKER

(1931) Eighteenth Edition, 2315 Pages \$8.00

Contains information on every subject likely to come up for consideration by architects and builders.

MATERIALS AND METHODS OF ARCHITECTURAL CONSTRUCTION

By CHARLES M. GAY and HARRY PARKER

(1943) Second Edition, 636 Pages \$6.00

Now revised, this book gives the modern uses of pressed wood, plastics, and structural glass, as well as recent tables on the strength of materials and properties of structural steel.

SIMPLIFIED DESIGN OF REINFORCED CONCRETE

By HARRY PARKER

(1943) 249 Pages \$2.75

Contains simple, succinct explanations of all the usual reinforced concrete members in buildings. Gives all necessary tables.

STANDARD PLUMBING DETAILS

By LOUIS J. DAY

(1938) 119 Plates \$6.00

Covers every phase of plumbing graphically, with no text description. The drawing tells the whole story—installation, connections, and how they fit together. This valuable book presents sound, reliable information covering best modern practice.

SIMPLIFIED ENGINEERING FOR ARCHITECTS AND BUILDERS

By HARRY PARKER

(1938) 214 Pages \$2.75

A practical book containing the important basic principles employed in the design of structural members in buildings. Features practical problems with their solutions.

FOR BETTER BUILDING

(Continued from page 20)

ented) of suitable aluminum sheet prior to applying the anodic finish. The Doane Products Corp., Meriden, Conn.

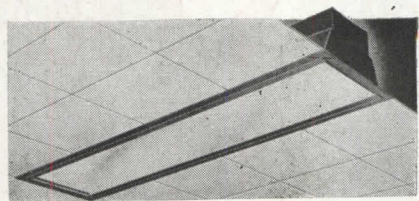

Easily serviced, compact fluorescent

Fluorescent Fixture

A new type of fluorescent fixture, the *Recessed Troffer*, is designed to solve both the problem of architectural harmony in a lighting plan and that of easy service in cleaning and replacing lamps. It fits in as little as 7-in. space between the true ceiling and the false ceiling into which fixtures are recessed, in an opening of 12 by 48 in. Made for both individual installation or continuous runs in open, louvered or ribbed glass models for two, three or four 40-watt lamps with instant start or starter ballasts. It is welded steel construction with inside reflector and louvers finished in 85 per cent reflection polymerized white, infrared baked at 300°. R. & W. Wiley, Inc., 129 Dearborn St., Buffalo 7, N. Y.

Lampholders

Two new lampholders for slimline and circline fluorescent lamps have been announced. The slimline lampholder is designed for use in general lighting fixtures, the circline has many applications for fixtures and portable lamps in commercial and industrial installations.

The slimline lampholders are of the medium, single-pin type for multiple service only. They accommodate the T8 and T6 lamps. They can be mounted to any flat surface and spaced on 2-in. centers minimum. Binding screws are located in the base. Two lampholders make up a pair for one lamp.

The circline lampholder accommodates 12-in. circline fluorescent lamps, and provides electrical connections, positions the lamp and supports it at two points. One point has the electrical connections, the other provides the necessary tension to hold the lamp securely. A lamp is removed by grasping it at the plastic section and lifting pins out of contact. The simplified design permits mounting in the conventional way. General Electric Co., 1285 Boston Ave., Bridgeport 2, Conn.

(Continued on page 130)

—ON APPROVAL COUPON—

JOHN WILEY & SONS, Inc., 440 Fourth Ave., New York 16, N. Y.

Please send me on ten days' approval the books I have checked in this advertisement (or I am attaching to this coupon a separate list of the books desired). At the end of that time, if I decide to keep the books, I will remit indicated price plus postage; otherwise I will return the books postpaid.

Name
Address
City and State
Employed by AR-945

From Destruction to Construction

◆ As this is written the destruction of nation by nation in World War II seems to be about at an end. The advent of the world's most terrifying weapon, the atom bomb, and the entry of Russia in the war against Japan, climaxed the destructive struggle. The devastating potentiality of this new force has changed the thinking of men and nations. It has stimulated the imagination in the direction of harnessing this energy for the constructive use of mankind and the wildest prognostications seem to be possible of fulfillment, if not as soon perhaps, as the optimists believe, at least eventually and by the evolutionary processes of scientific research.

◆ Building and its equipment will not be materially affected by the newly available atomic energy for years to come. But thinking and action have shifted from Destruction to Construction.

◆ While the struggle between nations as between men for survival, for security, for economic advantage, for power and influence will go on—thinking men throughout the world recoil at the picture of possible and probable havoc of unleashed atomic energy, realize the folly of continuing the path that destroys or impoverishes both victor and vanquished and threatens chaotic end to our civilization. Men's minds throughout the world are turned, again perforce, to constructive channels—to reconstruction, rebuilding, planning anew, seeking peaceful means for reaching desired ends. Postwar planning has now become peacetime planning.

◆ Architects, engineers and builders who have played their part, a large and important part, in providing the means of destruction will now devote their energies to the rebuilding of devastated areas and to the building of new and better facilities for all man's activities. The magnitude of this task is not matched by the manpower available. Plans for postwar building, for reconversion, and for supplying the materials have not matured, have been all too few.

◆ But as the challenge of our unpreparedness for war was met and unprecedented production achieved in record time, so can the demands of peace be fulfilled even though the problems involved are more complex and baffling, the processes necessarily more involved, and coordination more difficult to achieve. The creative forces must serve many masters in peace where in war they served one—the government, the single client with unified purpose and unlimited funds and power. But in peace cross-purposes, conflicts of ideas, consequent delays and compromises are to be expected.

◆ The opportunities for significant achievement in city and regional planning, in architecture and building and product design are now practically limitless. Creative talent is called upon as never before. The nation, the region, the community and the family next door need, want, and can afford the best that the designer can produce. And the architect, the engineer and the product designer will meet that demand—for the weight of destruction is lifted from men's minds, the promise of a more lasting peace is a spur to the greatest constructive effort they have ever known.

EDITOR

Victorian Prototypes

OF THE PRESENT

1852

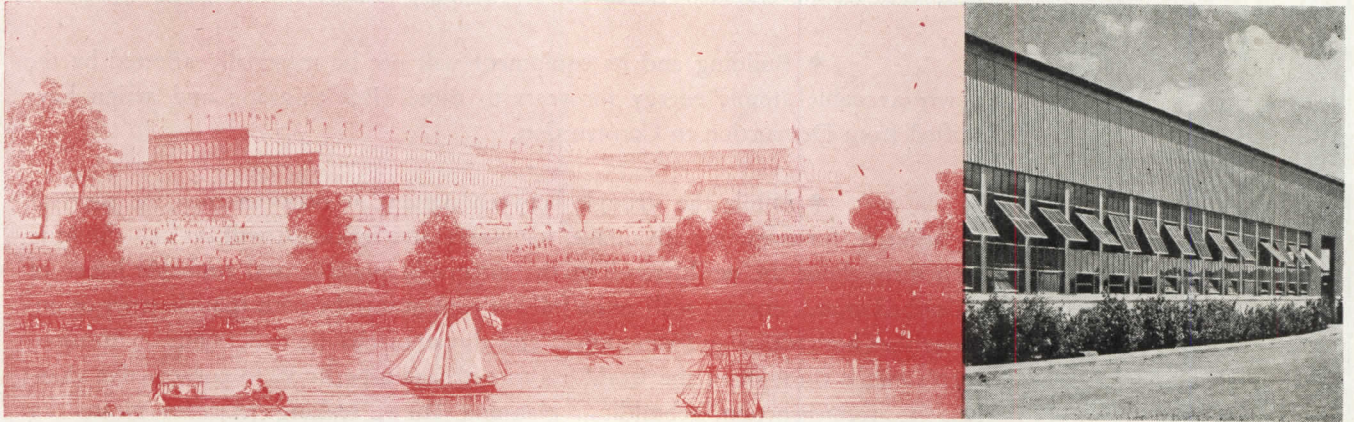

Prefabrication

The Crystal Palace, designed by gardener-engineer Joseph Paxton in 1850, was the world's first experience with large-scale modern building technique. It used mass-produced standardized units assembled on the job; used dry construction; and was demountable. When the first World's Fair, for which the 18 acres of the Crystal Palace had been designed, closed up in Hyde Park, the building was dismantled, moved, and set up again in modified form, on the top of Sydenham Hill. Glass and iron, the two outstanding industrial products of the early Machine Age, appropriately served as construction materials

1868

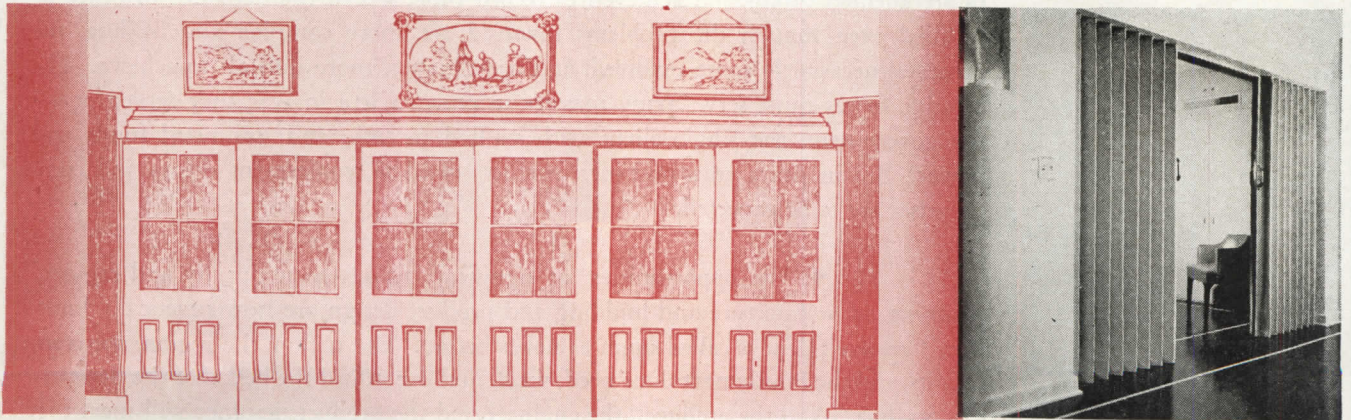

Folding Partitions

The Victorians began to experiment with more open space arrangement by installing sliding doors or portieres between the rooms. Their sliding doors often operated rather reluctantly and occasionally not at all; but they were a good idea. Contemporary design with its open plan has been slow to handle flexible room separation attractively. Flowing curtains, modern adaptation of the Victorian portiere, contribute grace and color; but they leave something to be desired in privacy and sound-killing. These accordion-type flexible partitions provide a practical solution to what the Victorians fumbled

CONTRARY to current belief, the Victorians experimented boldly with design, as boldly as they experimented with transportation, communication, plumbing, heating, refrigeration and engineering. They tried to find new solutions to old problems and appropriate ways to use mechanical procedures. They worked, in fact, on many of the best ideas associated now with contemporary design. Even if some of their experiments evolved somewhat unsatisfactory forms, they showed the rational approach to design we think of so highly today. Perhaps, if the driving passion for historical styles hadn't so thoroughly swamped the early Twentieth Century, the line of continuity might have been maintained between Victorian experimental design and contemporary solutions to the same problems. Much time and toil might have been saved that way. But that was not to be. The Victorians were the

By Frances Troy Schwab

1850

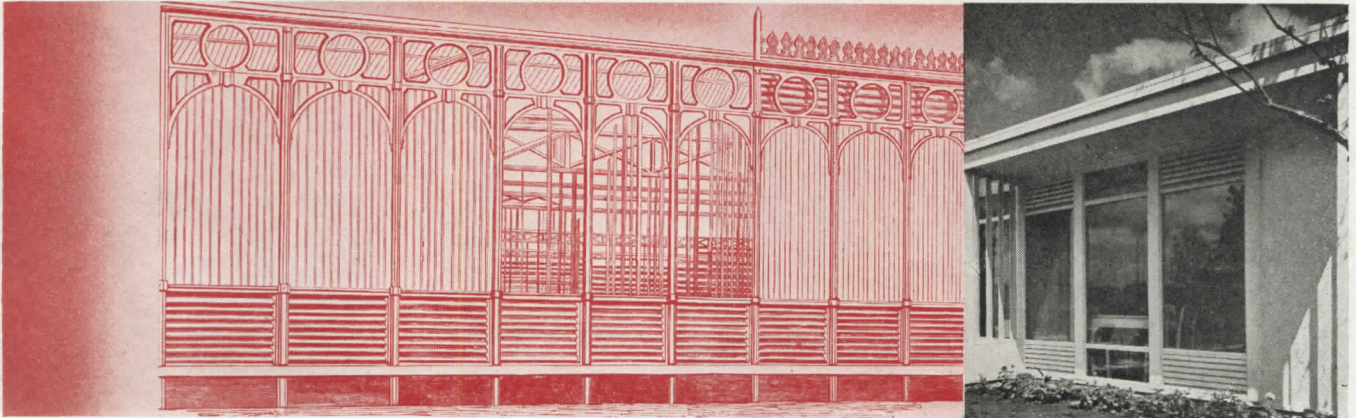

Louved Panels

Prefabrication, amazingly enough, is still news in contemporary building design. It's talked about with awe as something attributable to the accelerated pace of experiment during the war years. Yet the feasibility of using such technique, and how to go about it, was demonstrated dramatically by Paxton and just as competently by James Bogardus in America, ninety-odd years ago, in spite of their scanty choice of materials and a meager supply of production resources. Panels of fixed glass with louvers top and bottom for ventilation find their counterpart in a house of 1944 designed by George Fred Keck

1870

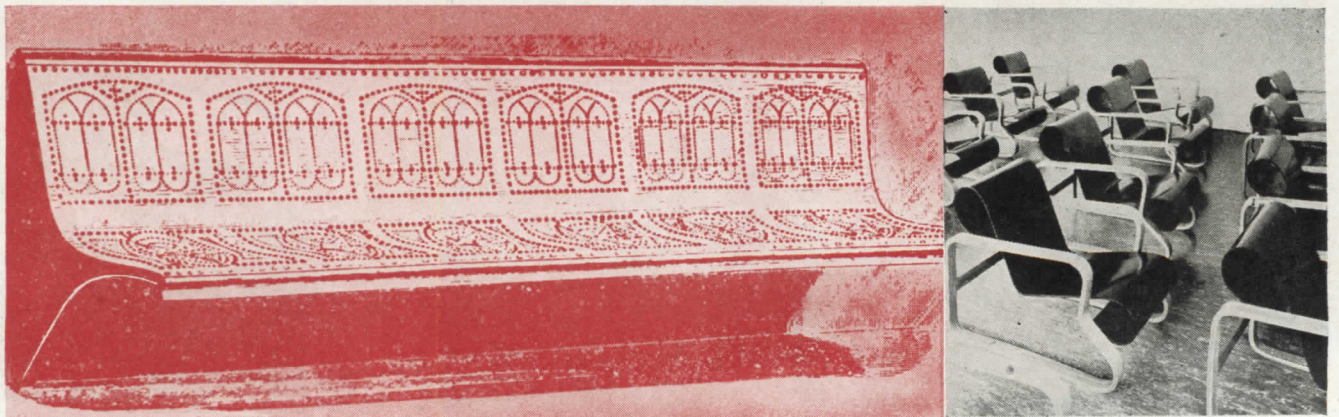

Plywood Furniture

Shortly after the Civil War, several Americans took out patents to laminate layers of wood veneer, opposing the grain of one layer at right angles to the next. George Gardner of Brooklyn, early in the 1870's, began making plywood benches for railway stations, ferry houses, and such. The curves were obtained by bending the material under steam. Left-over pieces, advertised as "perforated seatery" sold as a practical substitute for expensive cane. Today we have the plywood furniture of Alvar Aalto shaped under pressure like their precursors, but suave and light and domesticated

Victorian Prototypes

(CONTINUED)

1851

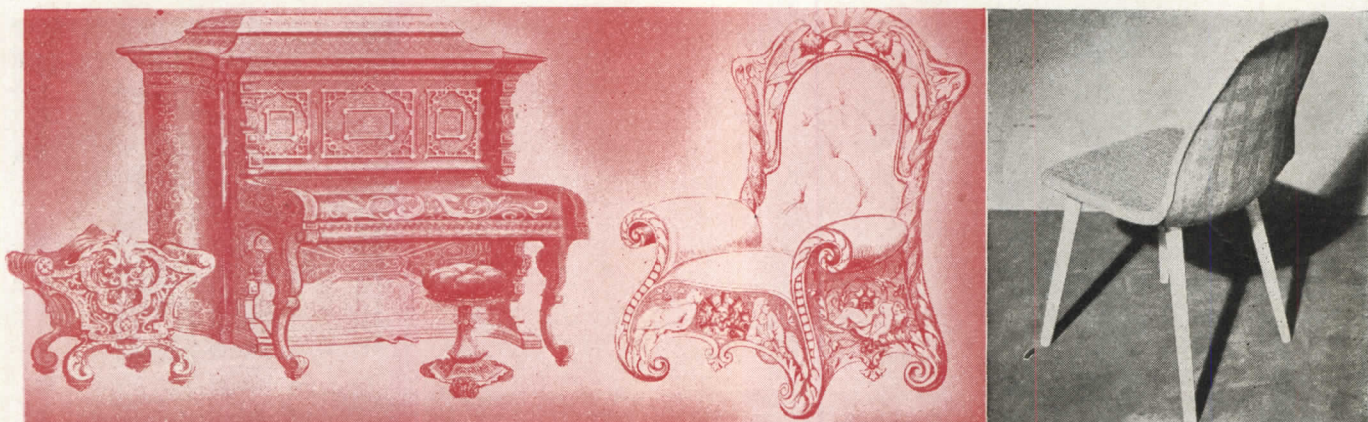

Molded Furniture

Sturdy, but light, cheap to manufacture, easy to maintain, repellent to both water and acid—it sounds like one of the much-heralded new synthetic materials; but it was only a prophecy thereof—papier maché. As employed by the Victorians it functioned as a durable material suited to coach building and furniture manufacture by molding, as witness this fancy piano and ornate chair. Today we use other and better plastics for molding, and such simpler forms as in the design by Saarinen and Eames for mass-production. Happily the scrolls and sculpture have disappeared

1851

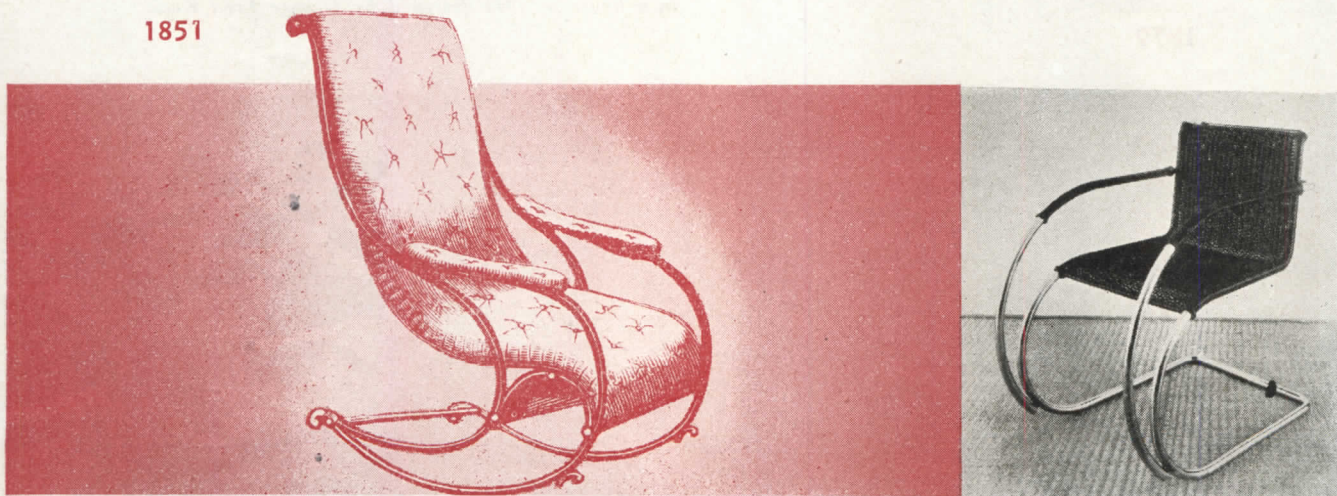

Tubular Chairs

Some anonymous designer created the ancestor of the modern spring-constructed tubular chair, in the Crystal Palace, 1851—without fanfare and without arousing much discussion. The thoroughly radical construction of this chair which utilized bent tubular iron (before the day of tubular steel) escaped comment. Tubular metal chairs were again invented by Marcel Breuer about 1925, improved later by Ludwig Mies van der Rohe when he used the spring quality of bent tubes instead of legs. His chair, shown here, is the early version of the modern spring tubular chairs recently in vogue

first to live out their lives—to invent, create and design—in the Machine Age. And on the whole, they did well with it. Considering that they had to scrap all the old rules—the time-tested conceptions of form and craftsmanship, long before new ones suited to machine techniques could be worked out—they handled the situation with impressive resourcefulness. Sometimes they alternated, it's true, between boldness and timorousness. It occasionally happened, for instance, that an imaginative design—where new materials were utilized and radical forms developed—covered behind a hackneyed facade. Too often Victorian design has been judged by such facades alone. It was also true that their experiments, as likely as not, produced such awkward shapes that we've found it hard to give such designs the benefit of serious scrutiny. Still another thing tended to obscure the inventiveness of Victorian

1867

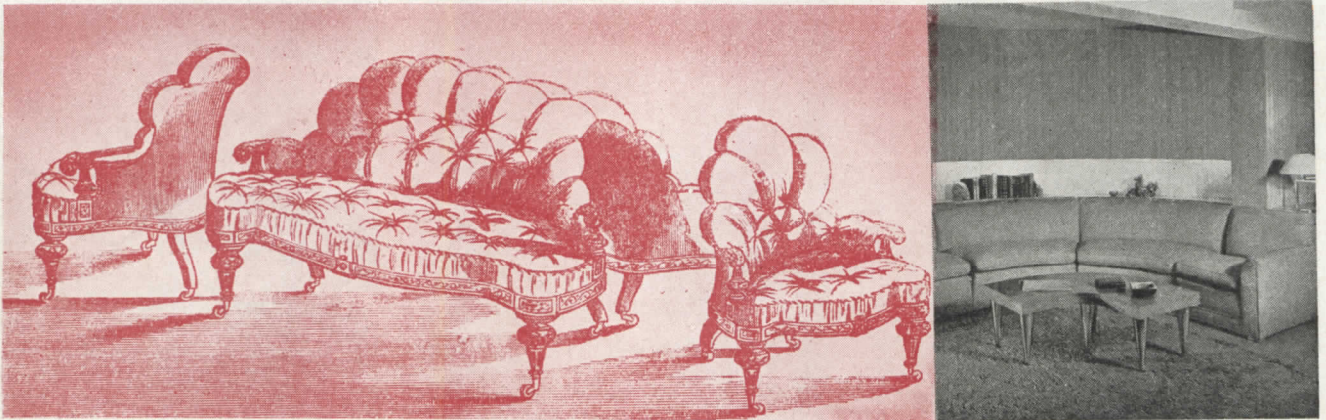

Sectional Furniture

The Victorians were very much charmed by space-saving tricks and double-duty household devices. It is not surprising, then, that the idea of sectional furniture occurred to them. This group, for instance, was on exhibit at the Crystal Palace in London after the Palace had moved up to Sydenham Hill. It appears in a catalog dated 1867. It could be used either as two chairs and two sofas or arranged to make a circular seating arrangement, suitable for balls or formal parties. The blousy shapes and bulbous upholstery needn't obscure the fact that the group represents one expression of a good idea

1880



Glass Walls

Fenestration was another field the Victorians liked to explore, sometimes with horrible results. They often hung bay windows around a building until it appeared to have warts. Out of all their experimental confusion, however, grew two good ideas—the stationary picture window and the horizontal window groupings prophetic of the modern glass wall. The latter, for example, in a Boston building designed by H. H. Richardson in the 1880's. Current developments in both glass and temperature control make outside walls practical, as in the Keck-designed house with its double-thick insulating glass promoting solar heating

Victorian Prototypes

(CONTINUED)

1868

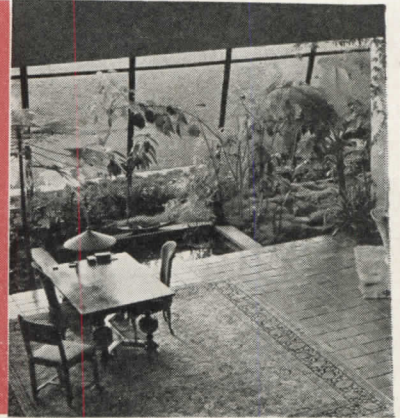
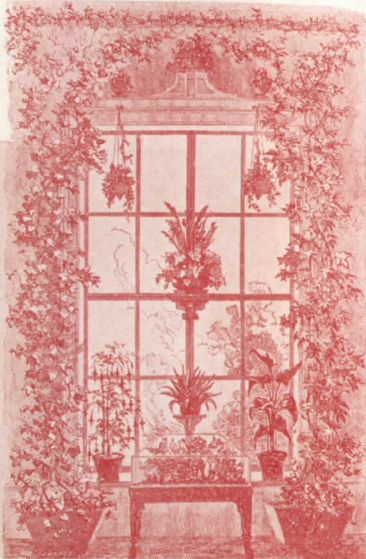

Interior Planting

The Victorians too, loved interior plant life. Nearly every middle class home, from the 1840's through the nineties, had at least one window, bay window, or "conservatory" which was consecrated to greenery and flowers. They treated it as a form of decoration, not just a garden. In the center of the one shown here, which as a matter of extra interest was an arrangement suggested by Harriett Beecher Stowe and her sister, is a Ward Case or miniature hot house. This ingenious Victorian invention enabled the drabest city interior to develop, with the greatest of ease, an oasis of dramatic color and exotic shapes

1870

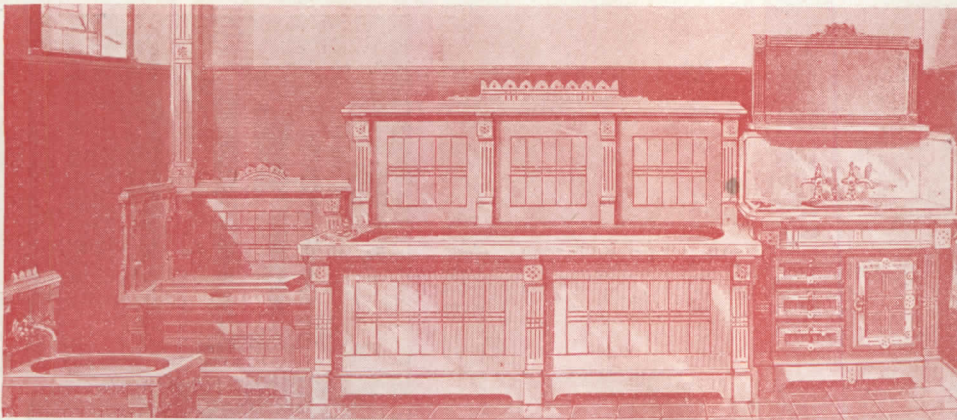

Bathrooms

Of all Victorian innovations, probably, plumbing had the profoundest influence on the modern world. It came in piece by piece. Not until about the 1870's did it rate a room of its own. This picture shows the new room in the moment of its first triumph, complete with Eastlake Gothic cabinet work. Yet no pipes are visible, no naked metal; it is organized, if not unified, and it has storage space too, below the washstand. In the modern bath, storage space has returned to its old place after an absence of about fifty years; and on the floor is that highly practical processed material invented in the Victorian years—linoleum

design—sometimes to hide it entirely. That was their saddest mistake, the introduction of mass-produced ornamental distorted styles. It was Victorian machine-tooled variations of the “antique,” that began a dismal craze. Often, even one of their new materials such as brass tubing or papier maché, fabricated according to their most advanced techniques, ended up as a rendering of the Florentine High Renaissance. This tendency to overdecorate, embellish and desecrate came partly as a reaction against so much in the Victorian age that was too radical to bear, and partly from a naive pleasure in showing off the limitless powers of the new machinery. But behind the fussiness of Victorian design can be seen the value of its inventiveness and its definite progress toward the ideas and ideals of today.

1851

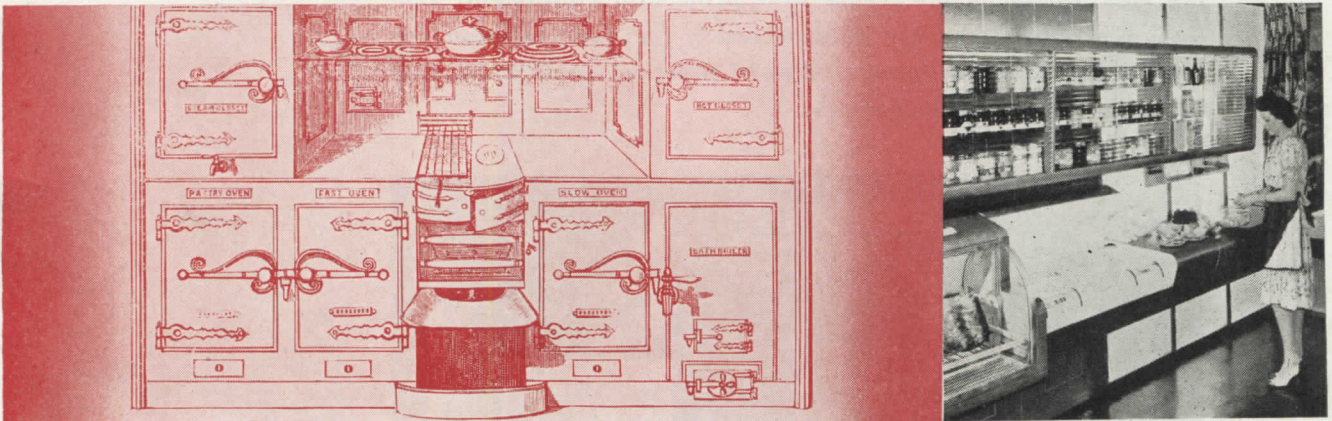

Kitchen Units

Dining was an extensive and complicated matter in Victorian days. The courses were many, most of them were hot and nearly everything had to be cooked right in the family kitchen. The built-in cooking apparatus shown here was on exhibit at the Crystal Palace in London in 1851 to demonstrate what smooth organization of complicated elements could do, especially when designed as integral units. Contemporary kitchens are still struggling with the problem of creating efficient food preparing units in spite of our simplified cooking and packaged foods

SOURCES

Prefabrication, Victorian: Drawing from Tallis History and Description of the Crystal Palace—1852. Present: Aircraft plant, R. L. Weed, Architect; photo by Ben Schnall.

Folding Partition, Victorian: Drawing from American Woman's Home by Beecher and Stowe—1868. Present: Photo by Hedrich-Blessing Studio.

Louvered Panels, Victorian: London Illustrated News, December 7, 1850. Present: George Fred Keck, Architect; photo by Hedrich-Blessing Studio.

Plywood Furniture, Victorian: Modern Plywood by Thomas D. Perry. Present: Alvar Aalto, designer; photo courtesy Museum of Modern Art.

Molded Furniture, Victorian: Official catalogue of the Crystal Palace — 1851. Present: Saarinen and Eames, designer; photo courtesy Museum of Modern Art.

Tubular Chairs, Victorian: Official Descriptive and Illustrated Catalogue of the Great Exhibition of the

Industry of All Nations—1851. Present: photo courtesy of the Museum of Modern Art.

Sectional Furniture, Victorian: Official Guide to the Crystal Palace, London—1867. Present: photo by Emelie Davidson, courtesy House Beautiful.

Glass Walls, Victorian: The Architecture of H. H. Richardson and His Times by Henry-Russell Hitchcock, Jr. 1936. Present: George Fred Keck, Architect; photo by Hedrich-Blessing Studio.

Interior Planting, Victorian: American Woman's Home by Stowe and Beecher—1868. Present: photo by G. E. Kidder Smith.

Bathrooms, Victorian: From files of J. L. Mott Iron Works. Present: Photograph by the makers of Armstrong's Linoleum.

Kitchen Unit, Victorian: Official Descriptive and Illustrated Catalogue of the Great Exhibition of the Industry of All Nations—1851. Present: photo by Hedrich-Blessing Studio courtesy Libbey-Owens-Ford Glass Company.

PLANNING FOR AUDIO-VISUAL EDUCATION

By Adrian L. Terlouw

Projected pictures have played an important part in the training of our armed forces. Adapting similar techniques to peacetime education involves changes in classroom design if present teaching aids are to be integrated with projection equipment. The design problems and the data necessary for their solution are here presented. Additional studies of practical applications will be forthcoming in future issues.



U. S. Army Signal Corps

As I sit and watch my sons busy with their homework, I wonder to what extent they will benefit from the advances in teaching methods pioneered by progressive teachers and greatly perfected by those training our men to fight.

I have had an unusual opportunity to become acquainted with the needs, the dreams, the plans, the problems and disappointments of the teachers who are striving, many times against great odds, to give their students the best education they can. Repeatedly I have been impressed by the many obstacles in the path of the progressive teacher

—not the least of which are the limitations imposed by the classroom itself.

Therefore I feel that the architect has a real responsibility in the advance of education. It is his function to so design the classrooms in the schools to be built that they will allow the teachers full scope in their efforts to stimulate, develop, and instruct their pupils. Here are summarized some of the things the teachers mention about the classroom requirements for the full use of audio and visual aids.

First and foremost, the teacher we are trying to satisfy is an individualist devoted to a job that is constantly changing—changing because each class and each student present new problems; changing because the content of the course he is teaching expands with the advance and growth of the field. To solve the problems presented by this everlasting change, the teacher must be revising his teaching methods constantly; he must use his ingenuity to develop better ways of presenting information and stimulating his students; he must be on the alert for new teaching aids that will help him do a better job. He is seriously handicapped if he is forced to work with a classroom that does not permit him to make full use of the teaching devices available to him. Therefore, I would say that the basic requirement in classroom design is this: *The classroom must be readily adaptable for using all types of teaching devices.*

The more important teaching devices or aids are:

The Blackboard; important as a means of integrating other visual media with the content of the course, thus creating an activity involving participation by both teacher and student.

The Flat Display Area; to which are fastened charts, diagrams, maps, posters, announcements, photographs, and students' work.

The Exhibit; the museum brought into the classroom.

The Demonstration; essentially this is the workshop adapted for the classroom, covering a multitude of activities—the physics or chemistry experiment carried out before a class, the playlet in dramatics or language class, the model address in speech class, etc. It may be a part of—

The Student Activity Center; the class workshop in which students learn by doing. Although student activity is often dissociated from the more formal classroom work by being carried out in special rooms, there is a growing tendency toward a combination classroom-workshop. This has been eminently successful in the elementary grades.

The Projection Program; on one hand, functions as an extension of the blackboard, the flat display area, and the exhibit. On the other hand, it can afford such a close approximation to reality that it is used to extend the scope of classroom demonstrations and the workshop. The projection program includes facilities for showing opaque materials, slides, slidefilms (sound and silent) and motion pictures (sound and silent). Television should be included in this category.

The Audio Program; involves facilities for radio (A.M. and F.M.), for playing records and transcriptions, and for making recordings (either disk or wire).

This is a rather imposing list that would doubtless cause anyone planning schools to ask whether it is necessary to provide every classroom with all these devices. Conversation with teachers reveals that some of them are using all these devices; others are employing only a few. When the latter are asked why they don't use certain teaching aids, we find that there are some who feel they can do as well without them; others (and they are in the majority) bring out the following reasons:

"Material suitable for my course is not available. Some which is available is unsuitable because it disagrees with the textbook or its contents don't fit the syllabus.

"To use the teaching aids, I have to move my class to a special room. This is time consuming and makes integration difficult.



Encyclopaedia Britannica Films, Inc.

The usual classroom seating arrangement does not lend itself to proper screen-viewing angles as some children are too close and some too far to the sides

"It takes too much time to set up the equipment in my classroom. The apparatus is heavy, cumbersome, and troublesome to operate.

"I can't darken my classroom for projection."

If these objections are overcome, we can be assured that a much larger percentage of teachers would use all of the devices mentioned. Some progress has already been made, and further progress lies in four directions: (1) better teaching aids; (2) better teacher-training in methods; (3) better equipment for employing the teaching aids; and (4) better classrooms.

We are here concerned with the last two items. In this direction I plan to devote most of this article to the projection and audio programs because I feel that architectural practices with respect to the other aspects of the visual program are quite well established. I would like, however, to bring up one point that is sometimes overlooked in providing a blackboard for the teacher and facilities for flat display, exhibits, and demonstrations.

The need for maximum visibility of the details of maps, charts, demonstrations, and material written on the blackboard is obvious. Yet, we see schoolrooms in which windows and lighting fixtures are located so that there is surface glare apparent to the students. In other cases the level of illumination on these areas is lower than the general level in the room.

Now it is well known that the attention is naturally attracted to brightly lighted areas, and that details are more readily visible in areas with glare-free illumination somewhat higher than the accommodation level of the room. I believe this principle can advantageously be applied to classrooms by providing auxiliary illumination for blackboards, tackboards, and demonstration tables.

I believe that classrooms of the schools being planned today should permit the ready use of projected teaching aids. In the eyes of many teachers the showing of a series of slides, a slidefilm, or a motion picture is as much a part of classroom activity as displaying an exhibit or discussing a map or chart. Because of a number of limitations, teachers in most existing schools march their classes to the "film room" or the "visual aids room" to show a movie that may last for only eight or ten minutes. This makes integration with the content of the course difficult and

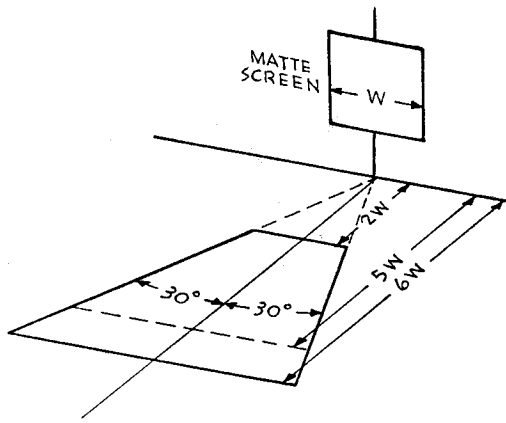

Proper viewing angles depend on the type of screen. Matte screens permit wider angles than beaded screens

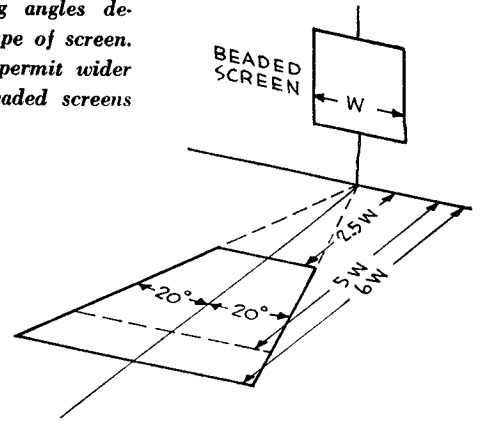

severely limits the extent to which the teachers in the school can employ projected teaching aids.

Classroom projection must be considered as an important school can employ projected teaching aids.

In the assembly room or auditorium films of broad general interest will be shown. In a newer school there may also be a smaller auditorium, seating about 125, in which material of interest to specific groups will be shown. For example, films and slidefilms on vocational guidance would be shown here to the senior class. This room would also be used for P.T.A. meetings at which slides and films of interest to parents would be shown. Finally, there is the classroom in which the teacher will show by projection material directly associated with the course being taught.

There are five types of projection used in the classroom: Opaque, Slides, Slidefilms, Microscopic, Motion pictures (with or without sound).

Opaque. The opaque projector is designed to show material that is ordinarily viewed by reflected light. Thus, a teacher can show a greatly enlarged image of a text book, drawing, or the like. The object shown can be approximately 6 by 6 in.

Several projectors have been marketed in which it was possible to show both lantern slides and opaque material. One projector shows slidefilm as well and even has an attachment for projection of microscope slides.

Slides. Two sizes are in common use— $3\frac{1}{4}$ by 4 in. and 2 by 2 in. There is a strong trend toward the 2 by 2 in. size because of the extensive use of miniature cameras for making color slides. Nevertheless, many school systems have libraries of the larger slides, so projection facilities for both sizes may have to be provided.

Slidefilms are long strips of 35-mm. motion picture film bearing a series of still pictures in proper sequence. They are made in two picture sizes—single frame and double frame—but always on 35-mm. film. Some of the projectors for showing slidefilms also accommodate 2 by 2 in. slides. Classroom use of the still transparency either in form of a slide sequence or a slidefilm is increasing rapidly in volume. It is a definite must in the new classroom.

The sound slidefilm is also growing rapidly in use. In this case a commentary recorded on a phonograph disc accompanies the slidefilm. A number of outfits consisting of a record player and a projector combined in a single case are available for showing sound slidefilms. If a transcription player is already available, only a projector is required in addition. Most of the recordings are played at $33\frac{1}{3}$ R.P.M. instead of the 78 R.P.M., which is common for records for home use.

Microscopic involves projecting a greatly enlarged

image of a microscope slide. In some cases, an attachment to a slide projector is employed; in other cases the projector is one specially designed for this work. This type of projection is likely to be used only in the science room, especially biology.

Motion picture. Only 16-mm. motion pictures need be considered for classroom use, although provision will have to be made for both silent and sound films.

Stereo projection. Some use has been made of vectographs in teaching geometry and navigation. Just how extensively they will come into use in other courses is hard to say at present. The only special requirement from the point of view of the classroom is in relation to the screen and the seating arrangement. An aluminum coated screen must be used, and the audience should be seated within a very restricted angle. Because of the limited use of this type of projection, it is best to treat it as a special case.

CONDITIONS TO BE MET

The problem facing the architect is that of designing the classroom and its appointments so that the teacher can use any of the forms of projection without having to spend a great deal of time getting the room prepared and the equipment set up. Here are the broad specifications the architect will have to meet:

1. The picture must be of proper size with relation to the seating plan in which the front row is not too near the screen, nor the back row too far away, nor the ends of the rows at too great an angle to the screen. (See diagrams.)
2. The picture must be bright enough for good visibility of detail. This means that the light output of the projector and the size and type of screen are properly related, the room well darkened and the screen well shielded from stray light.
3. The sound accompanying the picture must be of good quality and loud enough to be heard distinctly. This implies adequate capacity and range of the sound system, correct speaker location, proper acoustic treatment of the walls and ceiling, and acoustic isolation from extraneous noises.
4. Preparations for projection must be easily and rapidly carried out. No heavy lifting should be required.
5. Ventilation should be adequate.

THE GOVERNING PRINCIPLES

The optical requirements in items 1 and 2 belong together because the type of screen, size of picture, seating plan, and the light output of the projector must be considered simultaneously. The relationship between screen size and type to the seating plan for motion pictures is

Apparent brightness of the beaded screen decreases as viewing angle increases

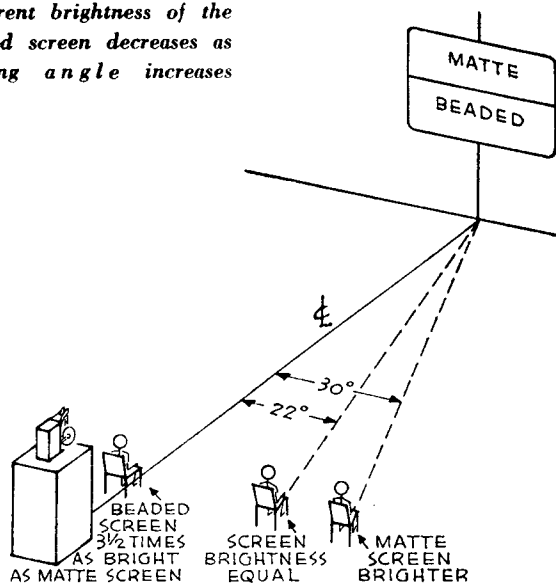

indicated in the diagrams, which follow the recommendations of the Committee on Non-Theatrical Equipment of the Society of Motion Picture Engineers. Notice that all dimensions are given in terms of picture width which is designated as W . Here are some of the reasons for these specifications.

Practical tests indicated that a distance of six times the picture width is the greatest at which a person with average eyesight can see easily all the details of a motion picture. For still pictures a factor of five times is better. As a rule, the image of a slide contains finer detail than a motion picture and furthermore the very nature of a "still" implies detailed study. Therefore, the greater visibility of fine detail that would be provided by the larger image would be desirable. Also, many slides and slidefilms are crowded and small type is used for captions. From a position too near the screen the image appears out of focus even though the projector lens is properly adjusted. Under these conditions the spectator tries to focus a sharper picture than is present on the screen, producing nervous and physical fatigue. With motion pictures, fatigue is also produced by the rapid and extensive movements of the eye attempting to follow motion on the screen. For these reasons, a minimum viewing distance of $2W$ was established. Notice that in the case of the beaded screen this factor is increased to $2\frac{1}{2}$. This is done to insure equal brightness for the entire picture; more of that later.

Viewing Angle. Limitation of the viewing angle is necessitated by the distorted appearance of objects imaged on the screen when the spectator is too far off to the side. The Committee recommends that for school projection the viewing angle be limited to 30° either side of the perpendicular. This condition is approximately fulfilled when no row of seats is longer than its distance from the screen. Notice that this maximum permissible angle is indicated in the sketch for the matte screen, but an angle of 20° is shown for the beaded screen, because the screen brightness of the beaded screen varies with viewing angle.

Screens. The comparative characteristics of the matte and beaded screen are shown in the drawing above. The observer at the axis sees an image on the beaded screen about $3\frac{1}{2}$ times as bright as the one on the matte screen. To the observer viewing the screens at an angle of 22° , they appear equally bright. To the third observer whose

viewing angle is 30° , the matte screen appears somewhat brighter. A viewing angle of less than 20° is therefore necessary to take advantage of the reflection characteristics of the beaded screen.

These same reflection characteristics also necessitate a minimum viewing distance of $2\frac{1}{2}W$ instead of $2W$ as recommended for the matte screen. A person seated at $2W$ and a viewing angle of 20 degrees would find that the near side of the screen-image is much brighter than the far side. If the light output of the projector is adjusted so that the maximum picture brightness is 20 foot-lamberts, the picture brightness on the far side would fall below 5 foot-lamberts which is the minimum recommended by the Committee. At a viewing distance of $2\frac{1}{2}W$ the brightness of the far side of the image comes up to about 5 foot-lamberts.

Another aspect of the difference in performance of the matte and beaded screens comes to light when the light output of the projector is correlated with the points already discussed. The starting point here is the recommendations of the Committee on values for screen illumination.

When a projector furnishes insufficient illumination, the middle tones tend to merge with the darker tones and the highlights lack the sparkle of a properly projected picture. Too bright an image is rarely encountered in a classroom, but when this occurs, the shadows lose their depth and richness and highlight detail appears weak and washed out. A series of practical tests conducted by the Committee on Non-Theatrical Equipment of the S.M.P.E. led to the recommendation that the optical factors in projection be selected to give a picture brightness not greater than 20 foot-lamberts or less than 5 foot-lamberts.

Light Output and Picture Size. It is important to adjust the relation between light output of the projector and the picture size on a beaded screen much more critically than on a matte screen. For example, if a 45 by 60 in. picture is projected on a beaded screen by a projector providing a screen brightness of 104 lumens, persons seated on the center line of the room will see a picture corresponding in brightness to 19 foot-lamberts, while those at a viewing angle of 20° will see a picture corresponding in brightness to 5 foot-lamberts. It is obvious, therefore, that when a beaded screen is employed, the values given in the graph (p. 80) be closely adhered to. Notice that in this graph two curves are given for matte screens, one for 10 foot-lamberts, the ideal, and one for 5 foot-lamberts, the minimum.

Examples. To correlate the various points we have discussed bearing on the optical aspects of projection, let us take as an example the problem of providing for projection in a classroom for 30 students. The first step is to establish the seating plan. Here are the factors—seating allowance per student, 30 in. wide, 36 in. row spacing; maximum viewing angle 30° ; front row 10 ft. from screen—this provides the space desired for class room demonstration. Under these conditions there will be 5 seats in the front row, 7 in the 2nd row, 8 in the 3rd row, and 10 in the last row. The screen distance for the rear of this last row is 22 ft. On the basis of the $5W$ relationship, the picture size would be 54 in. and the front row would be slightly more than $2W$ from the screen. This seating plan falls well within the desired limits.

Or—the students may be seated in pairs at tables 26 by 48 in. The row spacing between tables is 30 in. and the space between the adjacent tables is 12 in. The maximum viewing angle is 30° . To provide adequate space at the

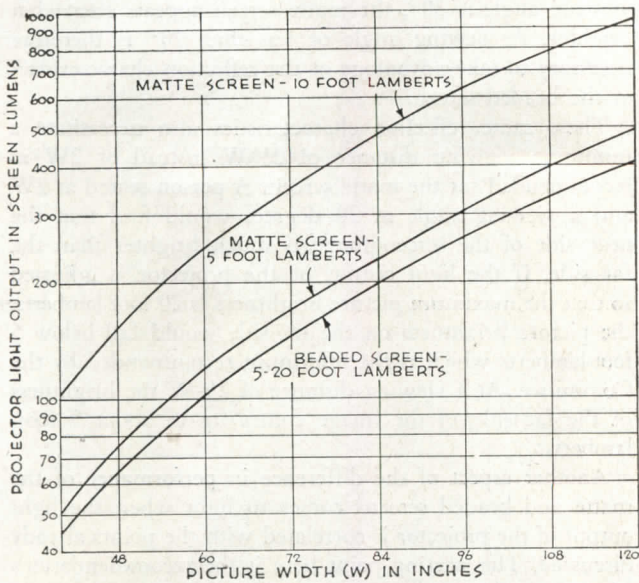

Chart showing maximum picture widths for any given projector light output for either matte or beaded screen

front of the room for classroom demonstration, the front of the table is 10 ft. from the screen. As a consequence, there will be six students in the front row and eight students in the succeeding three rows. The students at the rear row will then be 25 ft. from the screen if we use a 60-in. image size. Students in the front row would be $2\frac{1}{2}W$ from the screen. By forming a center aisle of 3 ft. in the last two rows, positioning of projectors with various focal length of lenses is readily possible. It is clear that this seating plans falls well within the desired limits we have set up and will fit into a classroom 30 ft. wide.

Now, regarding screen illumination, the graph above shows that the matte screen requires 97.5 lumens to provide a 5-foot-lambert level, and 195 lumens to reach the ideal 10-foot-lambert level. Manufacturers' data on light output must now be consulted, in the form of screen lumens for specific lens-lamp combinations. The tables of lens-lamp-screen size screen type combinations are useful for a specific projector but have limited application when several projectors must be correlated or when projectors of different manufacture are to be compared. If we consult a table showing light output for a typical projector fitted with a 2 in. $f/1.6$ lens, we find that when a 750-watt, 25-hour lamp is used it provides 135 screen lumens. This is well above the lower limit of 97.5 and will result in a screen brightness of 6.8 foot-lamberts. By using a 750-watt, 10-hour lamp, 170 screen lumens would be provided, a value only slightly below the ideal. It appears, therefore, that everything is all right so far as projecting motion pictures is concerned, for the 16-mm. projector fitted with a 2 in. lens is located at $5\frac{1}{4}W$ from the screen, a position just behind the back row. Ideally, the other projectors used in this classroom should all form an image of equal size and brightness from a point $5\frac{1}{4}$ to $6W$ from the screen. Unfortunately, however, at the present time, integrated equipment of this kind does not exist.

In some cases the projector may have to be nearer or farther from the screen to form an image of the correct size. In other cases the light output of the particular projector available for us is inadequate. There is little the architect can do in this latter case except point out to those concerned that he cannot overcome these deficiencies

by classroom design. In those cases where the focal length of the projection lens necessitates a projection distance less than $5W$, it will be necessary to revise the seating plan by removing a few of the seats from the center and forming a new row at the rear.

Screen Maintenance. Here are a few practical considerations with regard to the projection screen. The values for screen illumination just given are based on screens in good condition. Unfortunately, screens deteriorate with age and accumulate dust and soot when left exposed. Therefore, screens that roll up within protective cases or can be easily cleaned are recommended. When a matte screen appears dark in comparison with a sheet of white typewriter paper held against it, the screen should be discarded or cleaned.

The design features of the classroom presume good maintenance of the projection screen. Where a matte screen is suitable, a sheet of smooth wallboard can be mounted in a frame that will hold it flat and protect its edges. When painted with a water-soluble matte white paint (such as Texolite 330), it will become a matte screen with excellent reflectance, readily renewed at little cost. Precaution must be taken to design the screen installation for protection from defacement.

Room Darkening. In determining desirable screen brightness the illumination level of the room is important. The values that have been given are based on a general illumination level of $1/10$ foot-candle with the light directed so that it does not fall on the screen. This illumination level is high enough for purposes of discipline yet it does not constitute an accommodation level at which the screen with a brightness as recommended will appear dim by contrast with its surroundings.

A number of teachers have expressed themselves in favor of a well-lighted classroom such as is possible with rear projection on a translucent screen. This idea has been tested in some classrooms and a number of theaters. The theater audiences definitely expressed a preference for the darkened room. This is consistent with good stagecraft, which makes it desirable that any area in the room to which the teacher wishes to direct the attention of the students be illuminated at a considerably higher level than the general room illumination.

In planning the low level room illumination, it is important to provide baffles that will keep the projection screen as dark as possible. In addition, illuminated exit signs which are necessary in the darkened classroom should be so designed that they do not illuminate the screen and their brightness should be kept as low as is permitted by fire and safety regulations. The image on the projection screen should be by far the brightest area within the range of vision of the audience.

Transitional Lighting. The transition from the brightly lighted classroom to the low level required for projection can be quite abrupt without causing much disturbance. The opposite change, that of raising the level of illumination, should ideally be gradual. This will allow some accommodation to take place before the full intensity of normal illumination is reached. The cost of dimmer circuits such as are employed in theaters and auditoriums would be prohibitive for the individual classroom and, they could not be used with fluorescent illumination. An alternate possibility that might be installed at a reasonable cost would be a switch control that would progressively turn on additional banks of lamps. It may be that this

CEILING LIGHTS IN THREE CIRCUITS:

- I - GENERAL ILLUMINATION GRADED AND CONTROLLED TO BALANCE DAYLIGHT BUT ADEQUATE WHEN DAYLIGHT IS ABSENT.
- II - LOW-LEVEL ILLUMINATION ($1/100$ FOOT CANDLE) FOR PROJECTION; DIRECTED TO SHIELD SCREEN.
- III - LOCAL ILLUMINATION FOR FRONT WALL AND DEMONSTRATION TABLE.

LEGEND

- 1 - POWER OUTLET FOR PROJECTORS, 30 AMPERE CAPACITY
- 2 - SPEAKER PLUG
- 3 - CONTROL FOR HIGH INTENSITY ILLUMINATION
- 4 - WALL AND BENCH OUTLETS, TWO SEPARATE LINES FUSED FOR 30 AMPS.
- 5 - SELECTOR SWITCH TO RADIO, INTER-COMMUNICATION OR CLASSROOM SPEAKER
- 6 - SWITCH FOR LOW LEVEL ILLUMINATION
- 7 - SWITCH CONTROLLING CEILING SPOTLIGHTS
- 8 - SWITCHES CONTROLLING CIRCUITS IN "4"
- 9 - CONVENIENCE OUTLETS, 15 AMPERES EACH

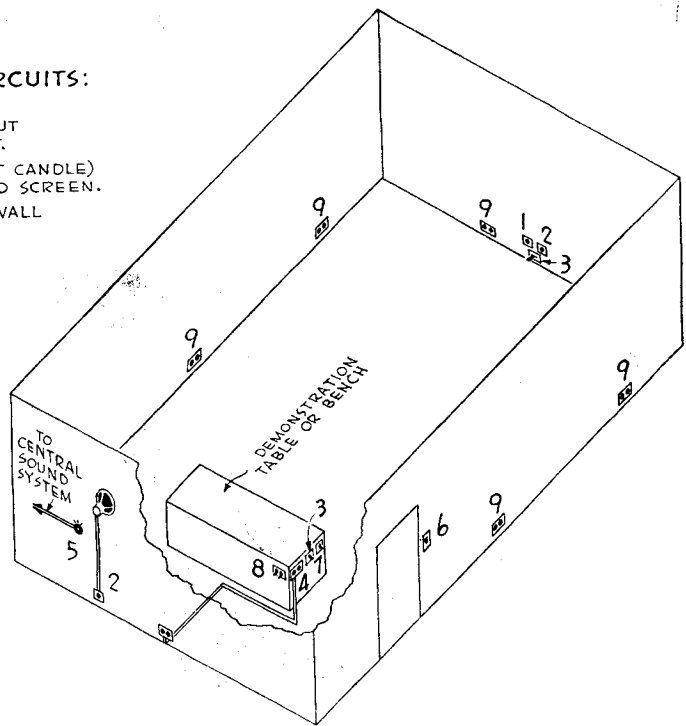

control could be combined with the automatic lamp control that is correlated with daylight intensity.

The location of the switch controlling the lights must be considered. Obviously, it should be possible to turn lights on entering the room. The auxiliary illumination for blackboard, charts, and demonstration desk should be controlled by switches convenient to the teacher at the front of the room. The dimmer device or switch for turning out the high level illumination should be controlled by the projectionist, although the teacher may also wish to control this light change. If cost must be kept down, teacher control at the front of the room is probably best. To limit the number of controlling switches, it might be feasible to have the switch located at the door turn on the low level illumination and the other light controls at the front of the room.

The darkening devices present a serious problem that thus far has probably been most successfully solved by the use of drapes. Window shades running in channels are obviously adapted to certain types of windows only and they have a tendency to jump out of the channels, causing light leaks. The acoustic effect of darkening devices must be taken into account. Proper acoustic conditions in the classroom are achieved by the correct proportion between reflecting and absorbing surfaces. Large areas of drapes would have a strong dampening effect on the sound which would seriously affect the acoustic balance of the room. It might be well to investigate desirable properties of certain fabrics to determine if some opaque drape fabrics are available which have a minimum tendency to absorb sound. The fullness of the drape when drawn across the window will also affect its acoustic behavior.

Ventilation. A comment repeatedly made by those in the Armed Services using visual aids was that instructive value was seriously reduced by the acoustic conditions and especially by the poor ventilation of the rooms in which they were used. Covered windows no longer function in a normal manner as a part of the ventilating system and other provisions must be made for change of air circulating or air conditioning. Students watching projection

are sedentary and require the higher level of air change recorded under those conditions. Air circulating systems affect the acoustic problem in two ways. First, it is important that the noise level be as low as possible since the rumbling or roar of a circulating system interferes with good sound reproduction. Second, the ventilating systems may make acoustic isolation very difficult. When several classrooms are fed by branches from a common duct, music or speech coming from a loud speaker in one classroom may be transmitted to another. Correct reproduction of the dynamic range of an orchestra presumes an apparent match of the original volume level, and as this frequently will be quite high, it is important that the hallways and adjacent classrooms be well insulated.

AUDIO INSTALLATION

The need for good acoustical treatment is not peculiar to classrooms in which audio devices are to be used. Any classroom will benefit by having its reverberation time reduced to a point where it is easy for two people to converse in an ordinary tone of voice when they are at opposite ends of an otherwise empty classroom. A teacher in such a classroom will experience much less fatigue and discipline will be better.

The room should not be made too "dead," as this brings about a lack of "fullness" or "roundness" in music and is oppressive. The damping effect of both the occupants of the room and the drapes used in darkening should be considered.

Conveniently placed electrical outlets are necessary for the operation of audio devices and projectors. Yet, a surprising number of classrooms exist today in which there are no convenience outlets. The schematic sketch above shows the elements that should be considered in this connection as well as a suggested location for switches controlling lights. At the rear of the room an outlet with a 30-ampere capacity is indicated. This outlet should lock the projector-cord in place so that it will not be pulled out by an accidental kick. There may be times when a load of 2,000 watts may be carried by this line.

(Continued on page 142)

UNIT NO. 1 OF THE "PREBILT" HOUSE

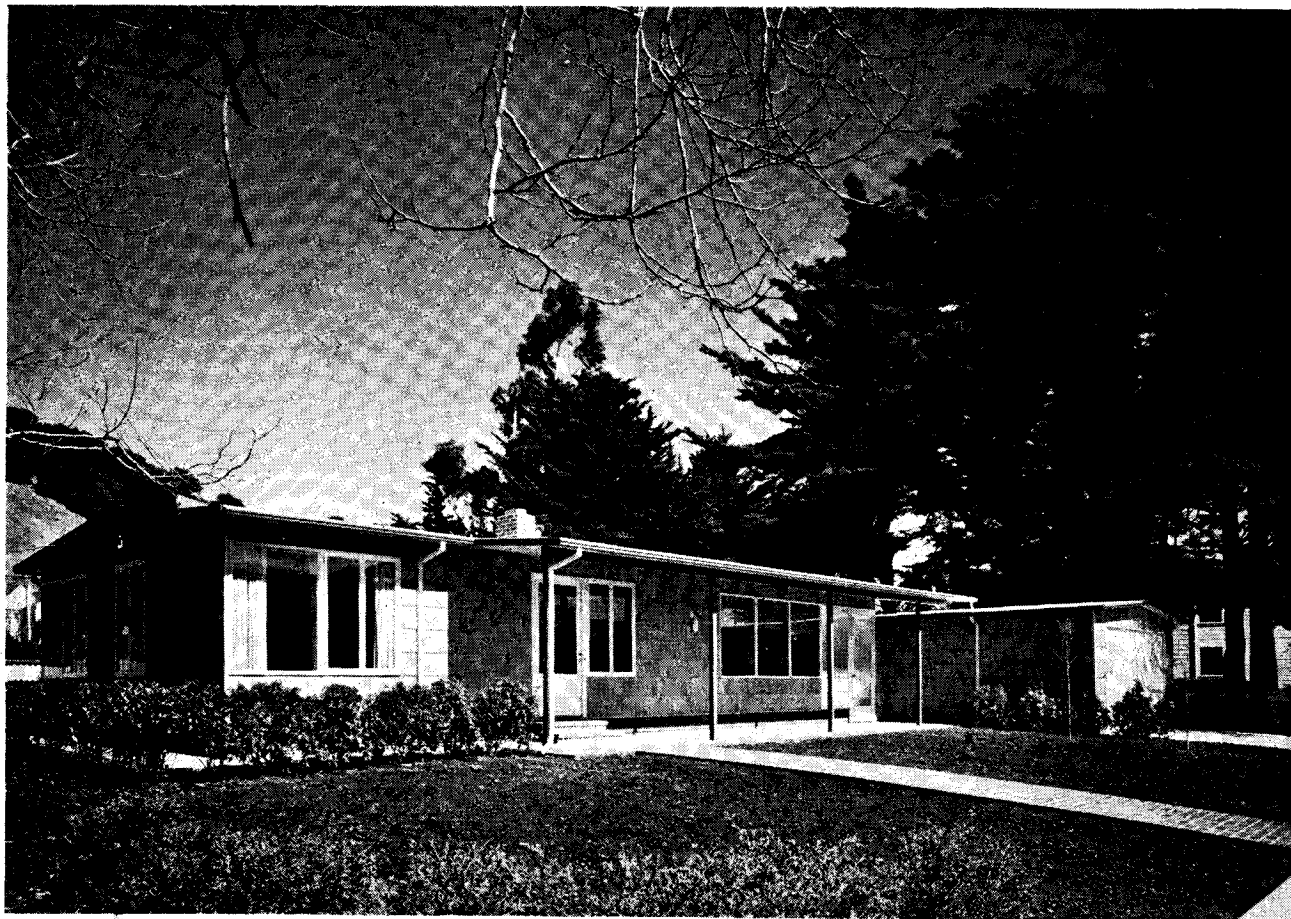

*House prefabricated with laminated arches, San Anselmo, Cal.
Wurster and Bernardi, Ernest J. Kump, Architects Associated
Mark Falk, Structural Engineer; Standard Engineering Corporation,
Licensed Manufacturer; Thomas D. Church, Landscape Architect;
Robert M. Kasper Co., Interior Decorators*

SOMETHING new under the California sun, this house is the first built under the patented "pre-bilt" system described in last month's issue (pp. 96-98). Completely shop-prefabricated, the house follows the laminated arch construction developed by Mr. Kump and Mr. Falk, originally for school buildings.

Key to the system is the separate frame, which makes possible a great flexibility in interior planning or re-planning. In this house the roof and wall panels were up before any interior was installed. "This means," say the architects, "that if we worked with a set of standard panels

an owner could have the framework put up and then he could better visualize the space and decide how he wanted it divided. In case of a concrete or tile floor the plumbing might then prove a problem, although a scheme could be worked out where the slabs were poured after the arches were up." Perhaps a more important possibility of the same flexibility would be the later rearrangement of rooms, as the owner's family situation changed, or when a new owner took possession.

"We imagine the house to be adaptable to all sorts of conditions and situations," writes Mr. Bernardi, "and for

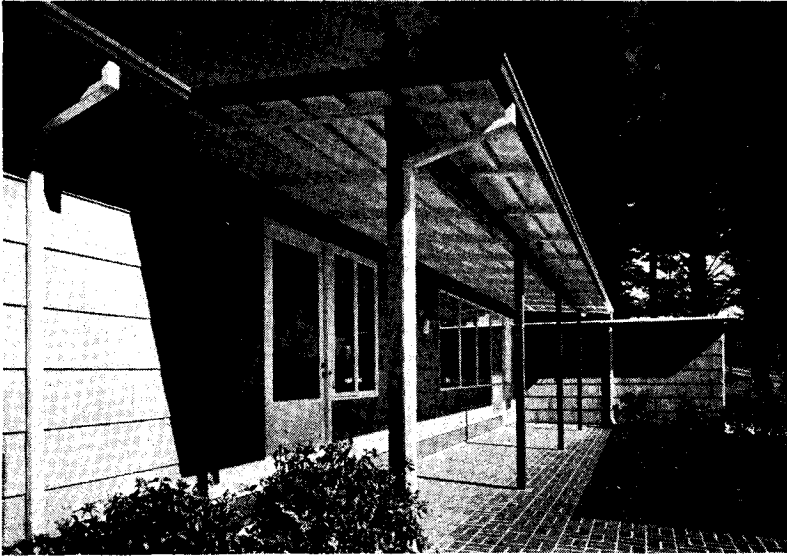

Exterior is chamois colored shingles, white sash and trim. Terra cotta red gutters, posts, beams, and skirting. Brick entrance walk and porch floor; other walks and living terrace in broomed concrete with redwood strips

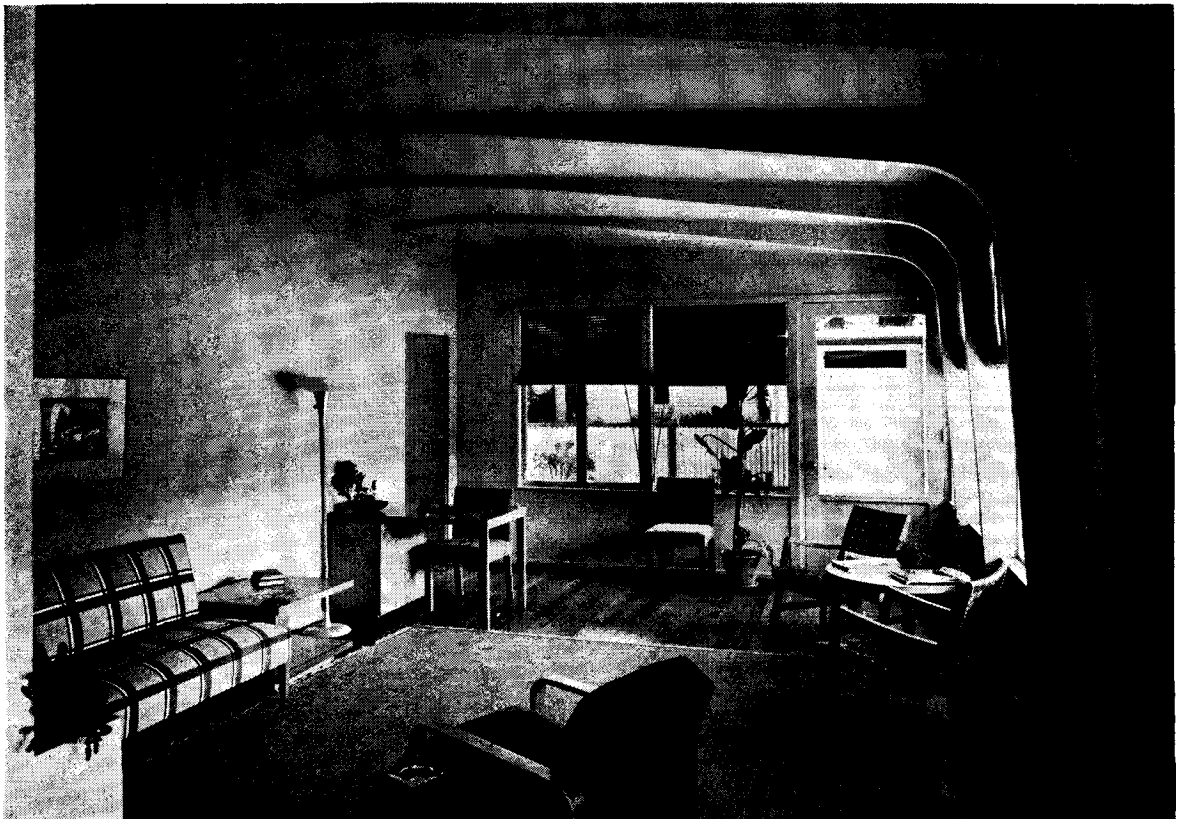
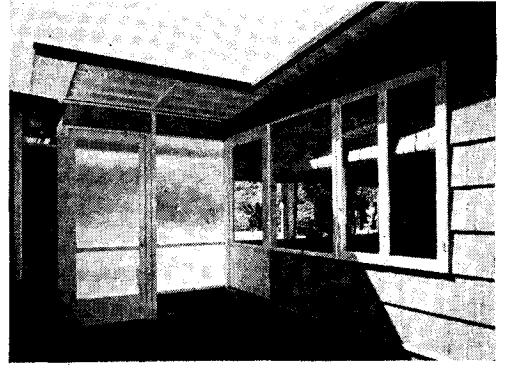

Interior walls are of plywood, except in kitchen, service and bath, which are of glazed surface wallboard. All ceilings of fibreboard. All ceilings and walls, with arches, are painted a light gray; other walls in living room, chartreuse; green or coral in bedrooms

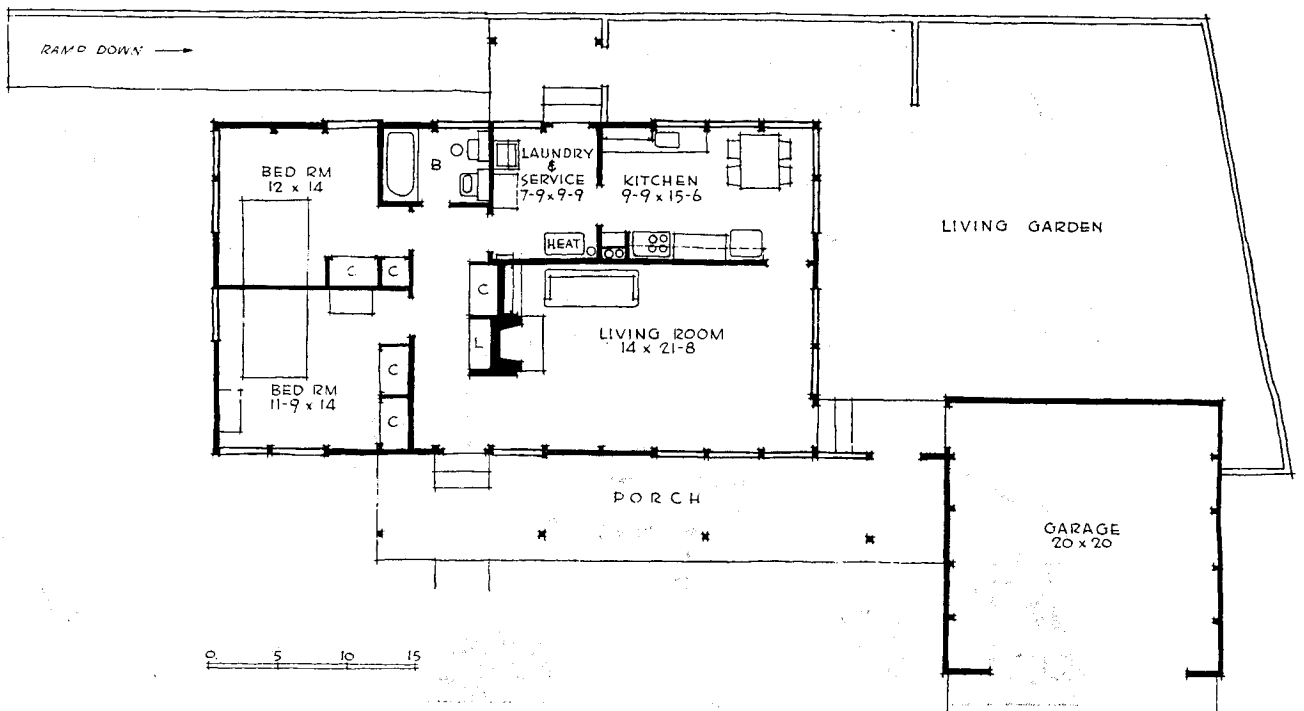
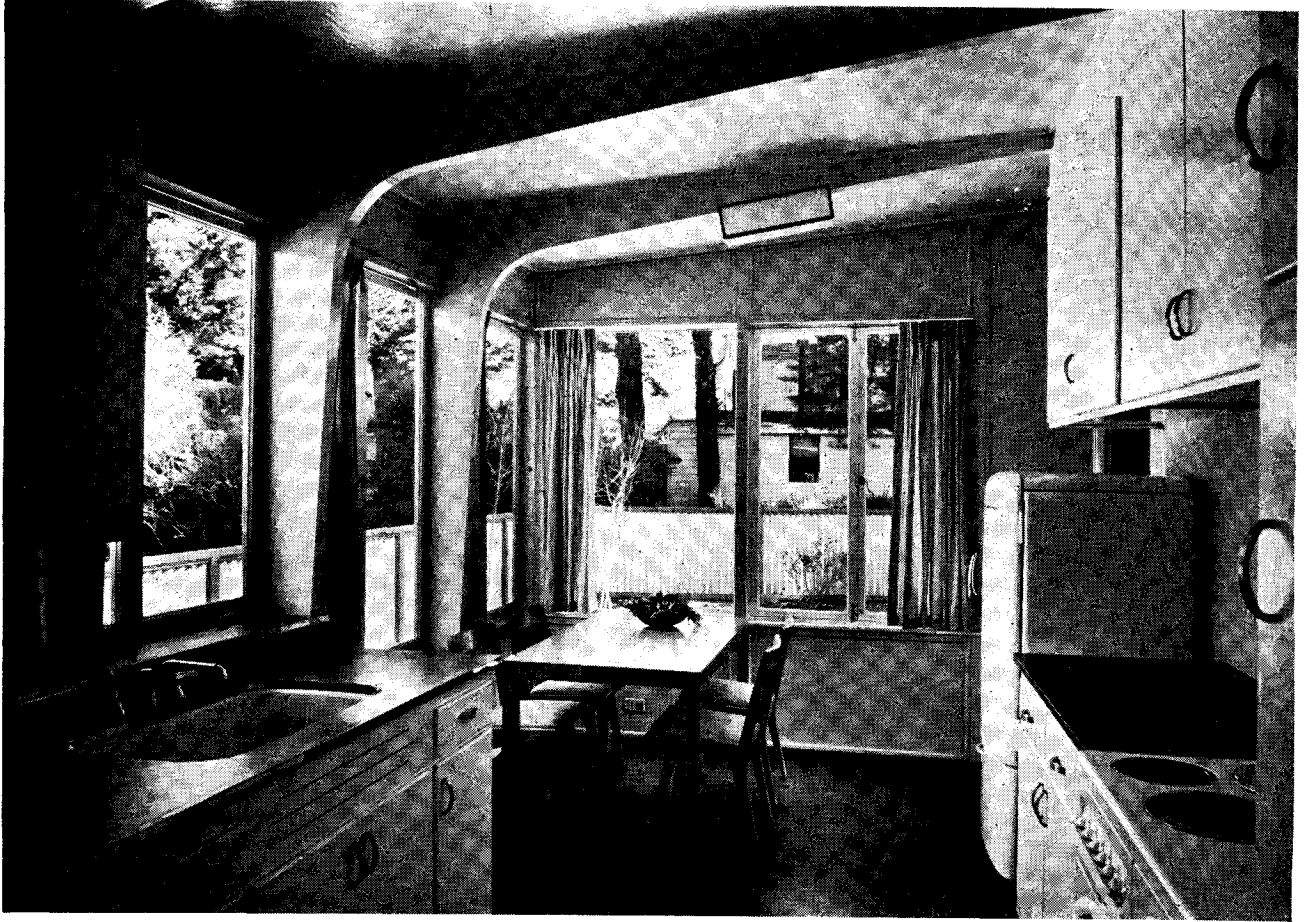

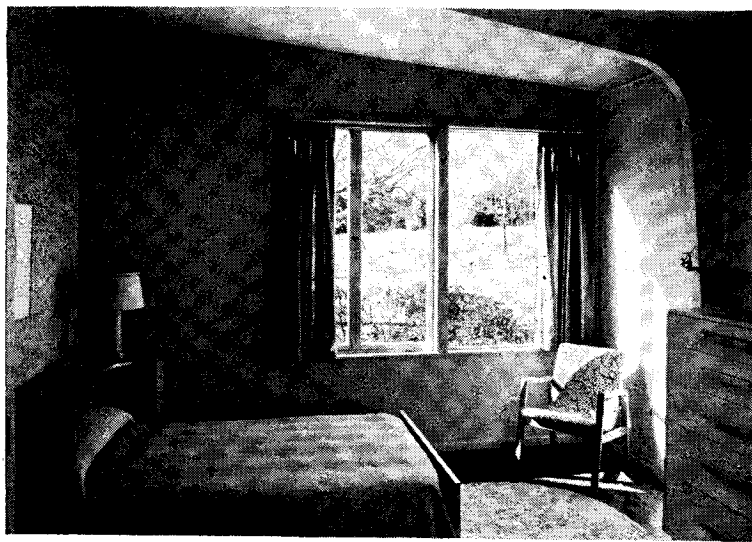
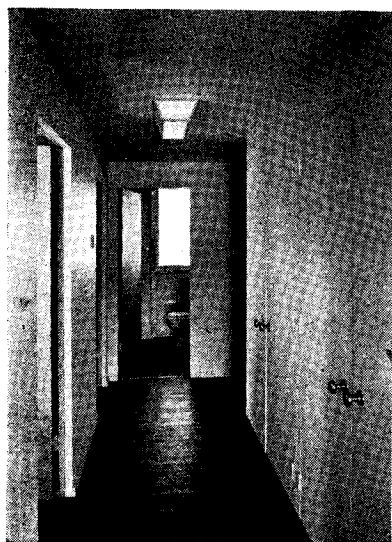
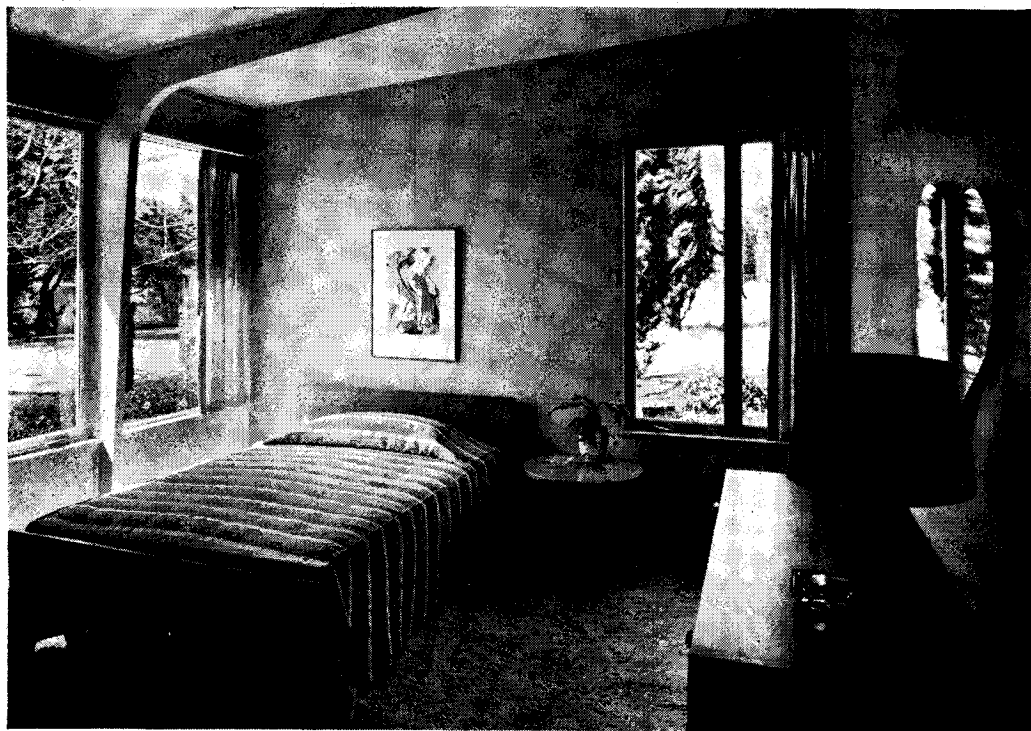

concrete, tile or prefabricated wood floors. On sloping ground there could be a platform supported on underpinning. . . . When materials are readily available, we picture the arches and panels in all sorts of natural woods, or even in metal or plastics."

The exterior material could be varied, of course, by using plywood or vertical boards instead of shingles. The garage here has asbestos cement board on the inside, and "it seems a material that would have great possibilities in any portion of the house, interior or exterior." In another building, for a different purpose, corrugated asbestos

cement was used for the roof. Here just for a fence.

The architects are frank in saying they cannot answer questions about comparative costs. "Our hope is that we will have a house which incorporates a good plan and design, or, in other words, a quality product which for equivalent area, accommodations and equipment, will cost no more than the usual speculative builder's product. We are not yet in a position to say that we have proved it can be done. Where only one unit was involved, as at San Anselmo, our guess is that it cost about the same as an equivalent house in the usual methods of construction."



HOME NOW, GUEST HOUSE LATER

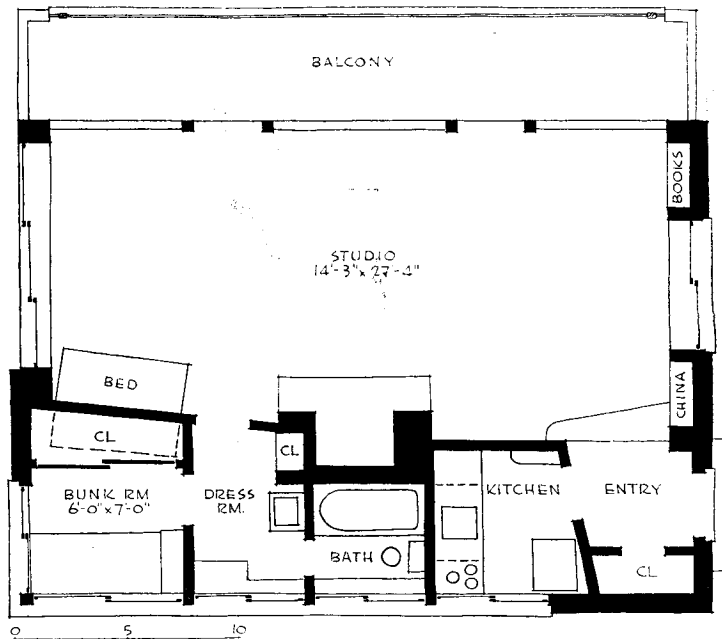



***A Beginning for His Own Estate
in Atlanta, Georgia***

Richard L. Aeck, Architect

THIS house was built as a temporary, year 'round house until later it will serve as a connected guest house when the main house is completed. The main room must serve now for working, eating, living and sleeping. This all does not strain the room as it might seem to, in spite of the owner's drafting table at one end. The built-ins and the half-disappearing bed help in this respect, but the open view across the open porch is what really keeps the room from seeming crowded. And the much-sought-for combination of modern functionalism and pleasing warmth in the design of the interior is a factor not to be missed. Walls are of T & G jointed cypress boards placed horizontally and left unfinished. Ceiling is of resawn boards applied as siding in weather boarding fashion. Fireplace of handmade brick, in warm reds.

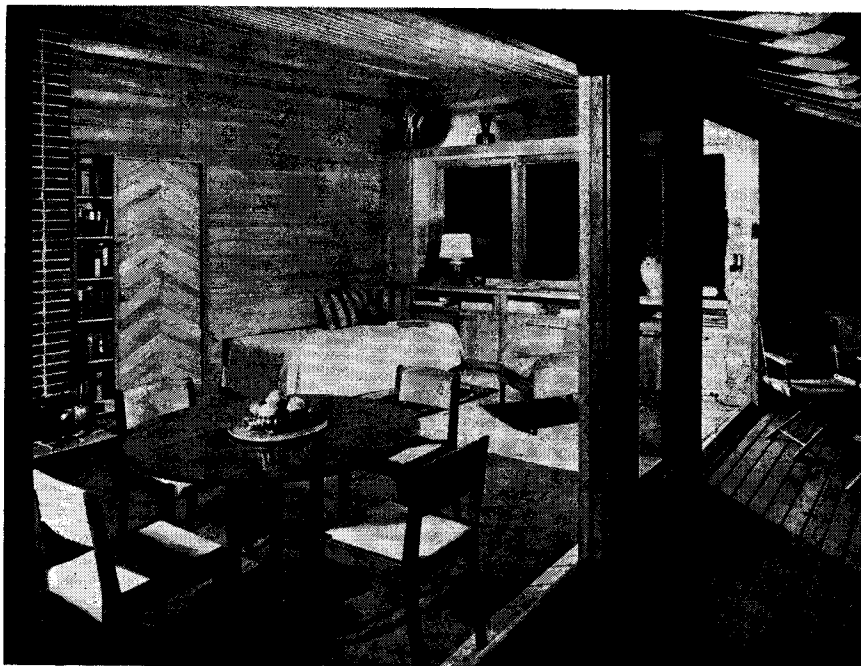
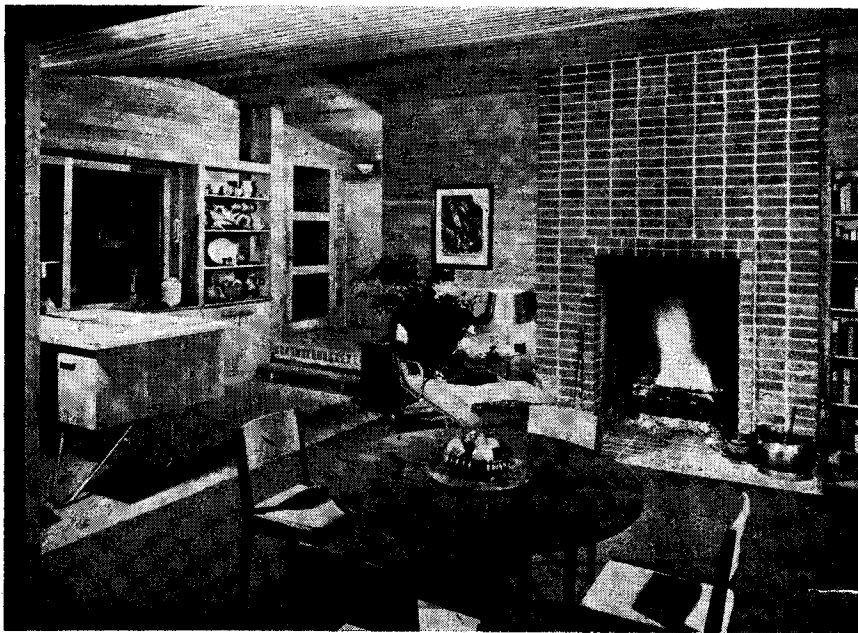

TO SERVE WHILE THE MAIN HOUSE WAITS



Rodney McCay Morgan photos

Guest House-Studio for Athos Menaboni, Atlanta, Ga.

Richard L. Aeck, Architect

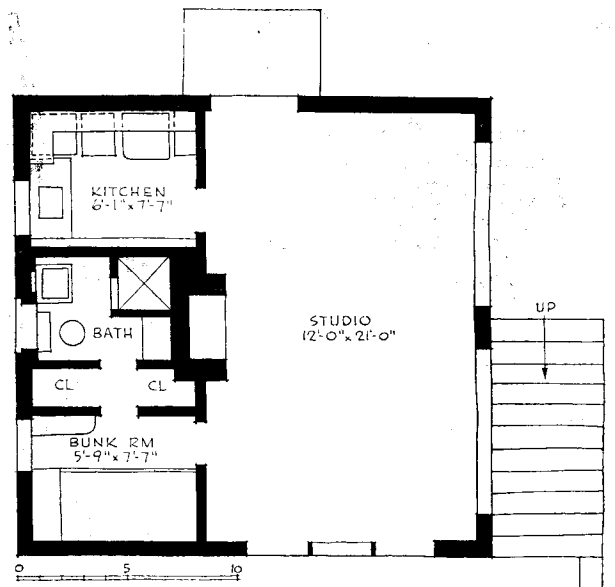



VERY similar in intent to the preceding one, this little house serves as home and studio now, will be a detached guest house later. The owner, a painter of birds, has developed his 5-acre plot as a bird sanctuary, where wild turkeys, ducks, quail and others are at home (there is also an aviary housing rarer species of eagles, hawks, etc.). Large window areas open the whole studio-living room wall to the view, and provide full daylight for the painting. Living room walls are of yellow pine, in alternate widths of 6 and 8 in., V-joint T & G. Plaster board ceiling, taped and painted; asphalt tile on concrete floor. Final plans call for a main house and studio overlooking an artificial lake now being built; also for extensive native planting, trails and stone walls, most of which are already well along.



CHURCHES

TRENDS IN CHURCH

THE 3,616 new church buildings* now being planned will comprise a wide variety of architecture due to differences of location, cost, and denomination, and to many other variables. Wide variation in design may be expected to result from characteristic Protestant independence and individualism. However, during the five to 15-year period of waiting out depression and war there have been some changes in the thinking and activities of the churches, which are sufficiently widespread to be called trends.

Whereas 15 years ago "shop talk" among ministers was about Sunday-school methods, and a decade ago the emphasis was upon the weekday programs of social, recreation and community service activities, today at least the Protestant ministers of the half dozen leading denominations, are reading, writing and talking about what they can do to "vitalize" their services of worship. Roman Catholic and Anglican services have of course been enriched and standardized and represent an established pattern of services and worship. The other problems exist, of course, in all degrees of local variation, and a wide range of activities is regarded as normal for the church, a seven-day-a-week institution.

The younger men, out of the seminaries during the past 10 years, have remarkably similar points of view regarding worship, and are more architecture-conscious than any of their predecessors, outside of the traditionally liturgical churches. They realize that two highly complex, composite arts, worship and architecture, are specially and significantly united in the church edifice. As a result of this intensified interest there will be much unintelligent copyism and little creative designing, in both liturgy and architecture, and some examples of a-little-knowledge-being-a-dangerous-thing. On the whole, however, the ministry has come to rely more and more upon the architect, realizing the subtlety and complexity of what is to be achieved. It is now realized that neither the social hall nor the Sunday school, but rather the Sanctuary, is the power house which activates the whole institution. This puts the emphasis where it should be, in the Sanctuary, which has always been the greatest challenge to the architect, calling for the plus qualities, the priceless ingredients, which distinguish architecture from mere function, engineering or building.

While the minister or priest in most cases provides the educational leadership leading up to the building project, the important decisions in Protestant churches are made by boards or committees of laymen. The minister and the

*Postwar projects reported by F. W. Dodge Corp., June 1945.

*Architectural Record's Building Types Study
Number 105 prepared in collaboration with
the editors of Church Management and
Church Property Administration*

PLANNING AND DESIGN

*By Walter A. Taylor, A.I.A.**

laymen in their desire for the distinctive architectural character of the church naturally lean toward the traditional styles. The church building as a type therefore presents a test case in the matter of style.

The architect who is an ultra-modern zealot, indoctrinated by his professors, or by the professional journals, with the fanatical belief that his architecture must under no circumstances have any resemblance to anything that was ever done before, will find it difficult to get very far with the average Protestant church. Most of these lay committeemen are having their first experience with a sizable building enterprise, the responsibility weighs heavily upon them, they are spending other people's money mostly, and so they are very cautious. They have seen some hideous churches built 50 years ago which they attribute to radical architects taking liberties with the "accepted styles," to which they retreat for safety and respectability.

Consciously or unconsciously their reasoning is based in part on the function of the church to provide stability and continuity in society. Aesthetically they are of the "I-don't-know-anything-about-art-but-I-know-what-I-like" school. It is one thing to sell one such man and his wife a completely modern house, but it takes a supersalesman to convince 15 such men and their wives and the minister, so completely that they will persuade several hundred other people to put their money into a completely non-traditional church structure. They feel that their building must be for them and their fellow-townsmen unmistakably a church. They are definitely not interested in a building which could by any chance be mistaken for Bill's Bingo Bazaar, the fire-engine house or even a concert hall.

People in this frame of mind are easy marks for the ultra-conservative architect whose stock in trade is "pure style" or "authentic tradition." Such an architect has a headstart in selling the church not only what they think they want, but some things they do not need and should not have. He may encourage them in their erroneous belief that Gothic, or what passes for Gothic, is the accepted and specially Christian style, or he may convince them that in their community or for their denomination it would be a sin to use anything but the "purest" Colonial, or the purest of something else. And he will be permitted to try to cram their mid-Twentieth Century program and facilities into a replica of a Thirteenth Century or a Seventeenth Century structure, with poorly related appendages, even with deliberately bad acoustics. He may

*Professor of Architecture and History of Architecture, Syracuse University. Consultant to Interdenominational Bureau of Architecture.

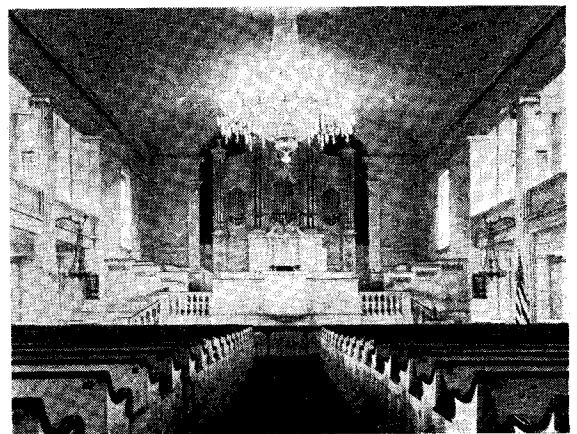
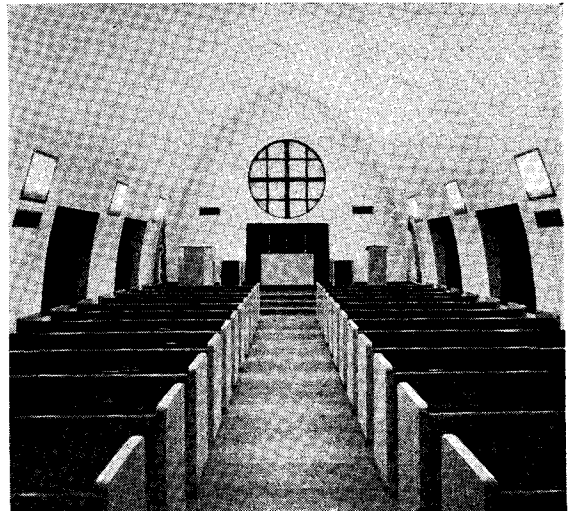
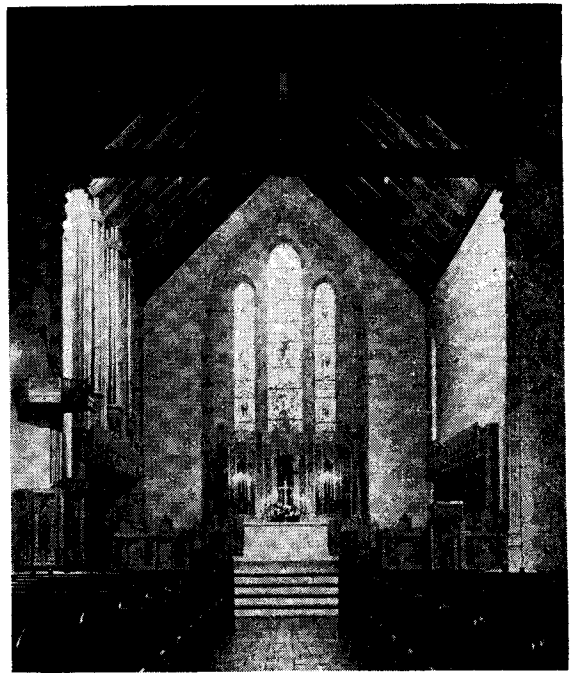

A notable trend in church design is toward the chancel with altar or table on the axis and with lectern and pulpit at either side. A Gothic and a modern interpretation of this trend are shown in the upper photographs. The ornate chancel with pulpit in the center and elaborate organ pipes showing is being superseded

refuse to use reliable modern materials of low maintenance cost, or if he does, will probably try to conceal them or make them look like something else, for the sake of "style."

Between these extremes are the majority of practitioners who are not zealots or purists of either extreme, who want to do well-planned, good-looking buildings, who realize that the church must have distinct, recognizable and somewhat monumental architectural character, and who hope that their designing may be more creative than stuffy. How can the seeming conflicts be resolved for these architects and their church clients? What can be abstracted as the essence of the church's tradition, which even in contemporary materials and details gives the church character and validity?

It may be pointed out that the conservative churchmen and the extreme architects of both kinds are not thinking in terms of real fundamentals. The following statements of principles are suggested as basic, to be pondered by the architect and discussed with his clients.

Styles are labels given posthumously to past building modes, shells left along the sands of time by onward moving civilization and religion, the church often at the front and creating the largest and most beautiful shells. No architectural style is a panacea. Horrible and inadequate buildings have been done in all styles, including the so-called modern. A great deal of unnecessary misunderstanding and controversy is due to the fact that many laymen, architects and publishers think, talk and write about contemporary non-traditional work as if it were *a style and quite new*. The term "modern style" is like the late Holy Roman Empire, which was neither Holy, Roman, nor an Empire. The present impulse has a history of a century, and the resulting work is already more diverse than was the Renaissance, including buildings analagous to Gothic, to Baroque, to Early American.

No architectural style can be proved to be specially Christian; the Early Christian can claim priority of time, the Byzantine unbroken continuity, the Renaissance preponderance of numbers; Gothic as it is known in this country is the importation of a revival and never was indigenous or reasonable. However, history and logic to the contrary notwithstanding, the now familiar forms of the Victorian and Neo-Gothic have become a tradition and are the phrases of architectural language which say "church." While the organic honesty, the architectonic quality of the mediaeval, much emphasized by the protagonists of the Nineteenth Century revivals, provided the intellectual groundwork for the emphasis on those qualities in the Twentieth Century, popular fancy has seized

upon the more obvious trivia and trimmings, the pointed arches and intricate vaulting. The trademarks of the style, whether pointed windows punched in a stud wall covered with shinglebrick and fiberboard, or meaningless buttresses enclosing toilet rooms hung onto the steel frame of a million-dollar pseudo-cathedral, give the lie to the very virtues originally claimed for the style.

Any adequate theory of esthetics must include sentiment and sensation; the sentiment of personal familiarity and romantic recall, the sensations of dramatic emphasis and exaggeration. A church design based only on the pure structural function of shelter achieved by strict engineering will not be permanently satisfying, except perhaps to a congregation composed entirely of civil engineers, mentally equipped to contemplate with satisfaction, Sunday after Sunday, the evidence of the Cosmic Order in the welded steel frame or the parabolic concrete arches.

The real, enduring architectural tradition of the church, a part of the heritage of Catholic and Protestant alike, is a matter of plan, proportion of section, and silhouette, enhanced by dramatic exaggeration and embellishment of the structural system, and at times by decorative splendor. This basic formula has found detailed expression in every major architectural style including Egyptian and Chinese. The basic plan is a rectangle, *dynamic* in its progression from one end to the other, climaxing in a focus of special interest and richness of architectural forms and decoration. This is directly in contrast to the *static* quality of a centralized plan normally related to the dome. There are many examples of the centralized plan in the Renaissance and in Nineteenth Century America, but nearly always with the forced emphasis of one axis and the forcing of a focal point other than the natural focus of the biaxial domed design. The conflict between the centralized and longitudinal is most dramatically exhibited in the evolution of the design of the Basilica of S. Pietro in Vaticano, where the longitudinal, the tradition of the church, finally won out.

The centralized plan is logical for an isolated baptistry or a monumental mausoleum, and even for a Roman Catholic church where the celebration of the Mass may be observed from any and all directions.

The longitudinal plan is practical, logical and psychologically valid both for the Protestant church and for the Catholic church, and to those who are not interested in the architectural tradition of the church, it may be advocated for seven practical reasons.

1. The sermon is still important if not dominant in the Protestant service. In the churches built 30 to 50 years ago it was apparently considered to be more important for

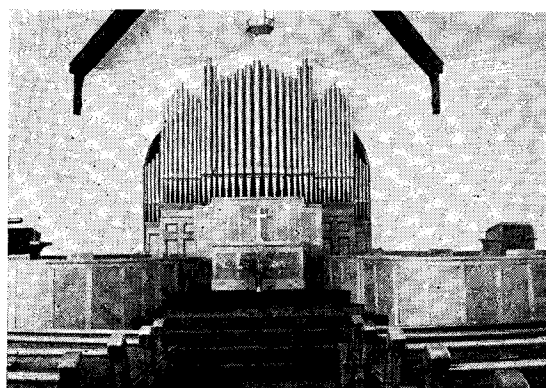
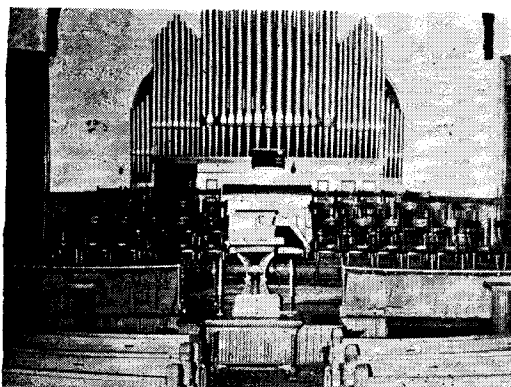

Before and after photographs of the modernization of a church at Webster City, Iowa, show the trend to make the choir less conspicuous

John Scottford photo

COMPARATIVE PLANS AND SECTIONS

PLAN TYPE	C	L	L-1
Area—Sq. Ft.			
Not Incl. Chancel	2850	2850	2850
Fixed Seating	395	450 (14% more than C)	450
Sq. Ft. Per Fixed Seating	7.2	6.33	6.33
Speaker Faces	237-60%	369-82%	382-85%
Span of Trusses: Ft.	58	38	31
Relative Cost Trusses	2.33	1.00	.67 (.29 of Type C)
Ratio Ht./Width: Same Ht.	.66	1.00	1.23
Relative Cubage: Same Ht.	1.00	1.00	.90
Relative Cubage: Same Ratio H/W	1.53	1.00	.70 (.30 of Type C)

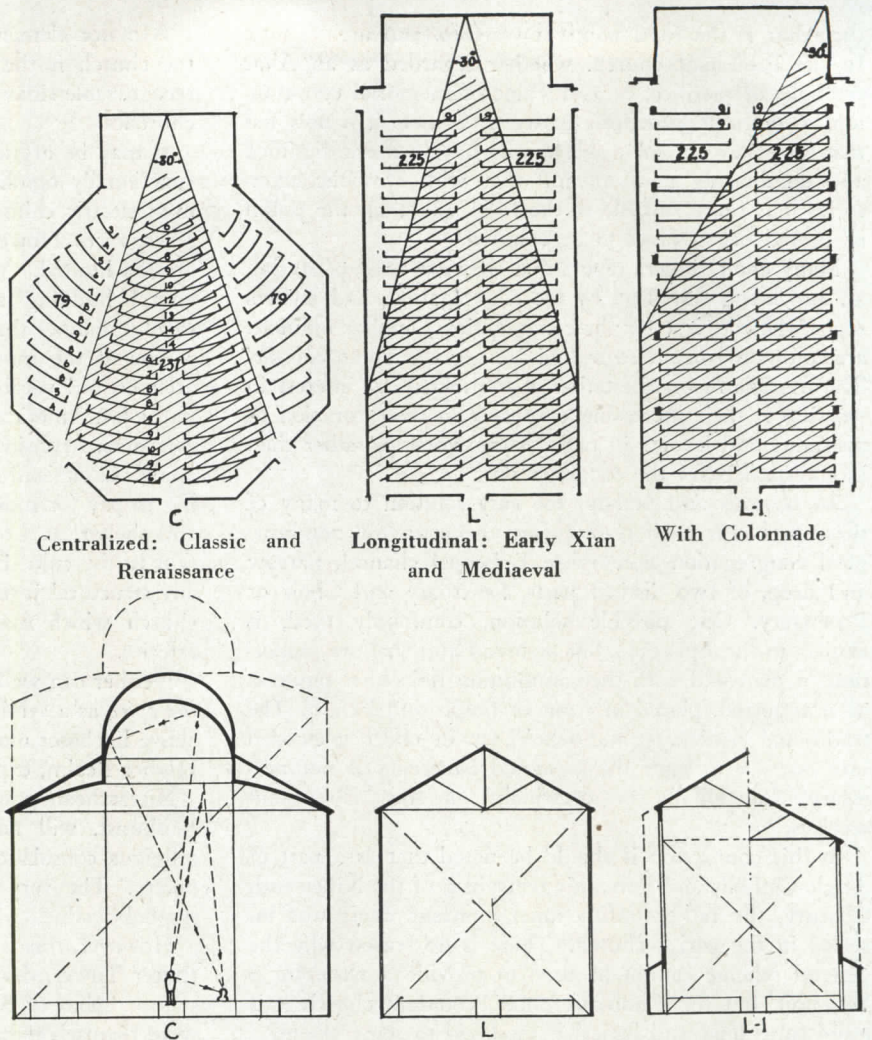

the people to be near the preacher, grouped around him, than to be in front of him. In this plan (Fig. C) the preacher could speak directly only to two-thirds of the assemblage. In the rectangular plan, (Figs. L and L-1) with either center or side pulpit, a much larger percentage is in front of the speaker and also has full direct view of the chancel.

2. The rectangular plan makes more efficient use of the gross area, the rectangular blocks of straight pews permit 14 per cent more seating in the same area, using the same unit spacings.

3. For a given area the roof spans are less and there is economy in the repetition of the simpler units. (Fig. L). Assuming correctness of the rule-of-thumb that cost of trusses is proportionate to the square of the span, the centralized plan costs $2\frac{1}{2}$ to $3\frac{1}{2}$ times as much for roof construction.

4. The repetitive structural system inherent in the longitudinal scheme permits building in successive stages, which is often desired in suburban and mission churches.

5. Volume is a factor in original cost, maintenance and heating. In general, the greater the maximum span the greater the height and hence the greater the volume for a given area.

6. A part of the basic architectural tradition of the church is a proportion of height to width greater than unity. The rectangular plan produces the desired effect of height with less volume, and the effect of height can be further enhanced, or the volume reduced for the same proportion, by the use of the colonnade and clerestory.

(Fig. L-1). The columns, a functional element, also enhance the dynamic, forward-moving rhythm, essential in the church's tradition.

7. Acoustical condition is in nine cases out of ten a matter of exposed materials rather than shape, and in any case can be controlled in advance of construction. However, the plan shape, the large volume, the tendency toward greater height and the often domical ceiling shape of the centralized plan are all conducive to acoustical difficulties. The rectangle, with source of sound at one end approaches the ideal acoustical shape. Contrary to a firmly fixed popular opinion, columns, exposed trusses and other elements which break up volumes and wall areas are a help rather than a hindrance to good acoustics.

In the chancel, the focal point of the design and the working end of the church, the problems of worship and architecture become more acutely involved. In terms of Protestant tradition and temperament there are still a number of unresolved problems, and many possible solutions.

The following typical requests indicate the trend; the minister does not want to be in the spotlight all of the time. He does not want the service of worship to be man-centered, which means that the dominating central pulpit is somewhat in disfavor. The pulpit is quite important, but can be given its proper emphasis if it is used only for preaching and not for the conduct of the entire service. Similarly the reading of scripture is given emphasis by a separate, special lectern.

In the Roman Catholic, Episcopal and Lutheran churches

the Altar is the focal point of worship, and architecture. In the Protestant church, whether regarded as an Altar symbolic of sacrifice, or as a Table of memorial communion, or both, or something between the two, it is now felt that the Altar and/or Table should have a more dignified and dominating position, and that with symbolic accessories it is more suitable in the focal spot than the pulpit or gilded organ pipes to be counted.

Many choir singers report that they are tired of staring at, and being stared at, by the congregation, and laymen report the converse for the congregation. Similar opinions are commonly heard regarding the exposed organ console. The musician's manifestation of the increasing interest in worship is their increasing emphasis on their function as assistants and leaders in parts of the worship, rather than as entertainers for the congregation.

An obvious and perhaps too easy solution to many of these problems is to place before the erstwhile non-liturgical congregation a complete Episcopal chancel, narrow and deep, of two distinct parts, Sanctuary and Choir or Presbytery. One possible solution, commonly used, is similar to the Episcopal, but of broad and shallow proportion in plan and with the communion rail either omitted, or if required, placed in front of pulpit and lectern. The traditional Sanctuary and Choir are in effect telescoped into one space, since the separated Sanctuary is not necessary, functionally or doctrinally in most Protestant services.

In this connection it should be noted that as a part of Anglo-Catholic and Romantic revivalism of the Nineteenth Century, the rather unfunctional monastic choir was inserted in the parish church. There is no reason why the general scheme cannot be used to provide a place for a lay choir, but for a non-sacerdotal Protestant church it is more functional and logical if modified to some extent.

In most Protestant churches the term "Sanctuary" is now generally used to designate the entire place of worship (nave and chancel), to distinguish from the remainder of the church building, and to replace the term "auditorium." A commodious vestibule or narthex is more in demand, since anything more than a minimum of visiting and conversation is discouraged in the sanctuary.

Increased interest in worship extends into the Religious Education facilities, where there is increasing demand for a small formal chapel. This is often placed near a main floor entrance and used by adults for private meditation, weddings, funerals, and other special services involving small numbers of people. There may be instead, or in addition, one or two semi-formal assembly-chapels conveniently related to classrooms, to be used jointly or alternately by departments of the church school.

There is some dissatisfaction with flimsy, portable, altar-like "worship centers" used in assembly rooms and social rooms, and stored away when the rooms are used for other purposes. Such a device is psychologically unsound and tends toward ritualism in the undesirable sense of meaningless form. (Although portable altars are of necessity much used by the armed forces, the psychological validity is supplied by the presence of an ordained minister, which is usually not the case in the younger departments of a church school.)

One possible arrangement, where the general space must be used for several other purposes, is a permanent altar with closing doors, in the manner of a triptych, open for religious services, closed for other gatherings.

A major element of the basic architectural tradition of the church is the tower, which has given the church a recognizable silhouette ever since Christians began to build churches.

It may be argued, with apparent logic, that a tower is functionally obsolete in a church which has no bells, or even electric chimes or loudspeakers, and that it is an extravagance. However, such logic and concept of function are too limited. An important part of the function of the church building is to announce in a more or less monumental manner the institution which it houses. The tower is one of the most universally understood words in the architectural vocabulary, from Constantine's first basilicas to the last American Army chapel. As for its cost, ordinary commercial considerations of investment and return do not apply. Organized religion has always been more than willing to pay for more than minimum essentials of structure and shelter, as a token of the followers' esteem and devotion to the cult. Even so, a tower and spire sans bells or any structural justification, is often good advertising for a church which may be located off of the busiest traffic arteries.

Neither can we dismiss as mere sentiment the claims for the *spire* as a symbol of man's *aspiration*, his desire to rise above his baser motives, pointing skyward to a metaphoric Higher Realm, expressive of his yearning for immortality.

Nietzschean pragmatism, by way of overintellectualized Baukunst, will not succeed in depriving man of these religious consolations, nor architecture of its imagery or poetry. The very "uselessness" of the spire enhances its symbolic value.

However, this is no excuse for a cold crib of the Rouen Butter Tower, draped over a steel form, or for a rubber-stamp replica of Sir Christopher's effective towers, which were themselves radical, free interpretations. The church in its most vital periods has often pioneered in new use of new techniques and materials in the solution of its problem. The tower is a part of the program for very valid reasons. Let us accept it and give it Twentieth Century interpretations. Let us be designers, not, as Claude Bragdon called his contemporaries, "reconstructing archaeologists in difficulties."

The highly organized churches such as the Roman Catholic are so well established in their liturgical and basic architectural traditions that they feel free to introduce variations and versions of the basic theme. As a result, there is a higher percentage of non-traditional designs in new Catholic churches.

The conservative Protestant churchman may be brought to see that in all of the above outlined basic tradition of the church and in special trends of today there is nothing that calls for stylistic copyism. The designer who has a decent sense of the inherent dignity of the church, can work over the basic pattern of the church with the greatest of freedom with completely non-traditional detail, if he so wishes. According to his choice, temperament and skill the resulting church may be *analogous* to Gothic or Romanesque in its organic acknowledgment and dramatic emphasis of structure, or it may have the elegance and refinement of the Renaissance, either naive or sophisticated, or in the hands of another, the dignity and formality of the Classic, ancient or revived. If it fulfills the relatively simple functional requirements, *and* is also the kind of place which, even when empty and silent, causes the man on the street to take off his hat upon entering, it will be a Church.

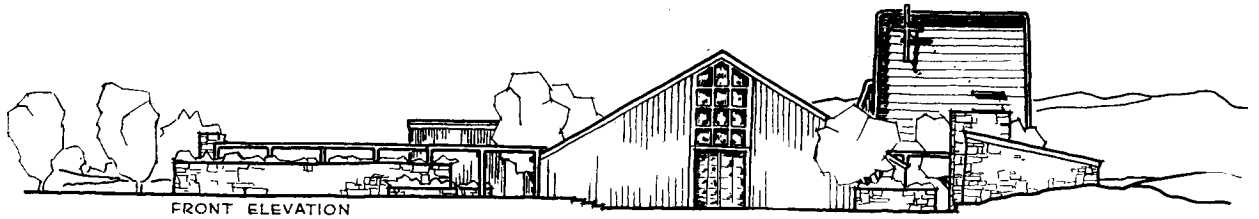

FRONT ELEVATION

DESERT CHAPEL *Thermal, California*

This unusual church was conceived as an oasis in a desert community at Coachella Valley, California. It is planned therefore, around a small open court which would be kept watered and full of green vegetation. A clear-glass window at the head of the chancel opening onto this court conveys the oasis effect to the congregation; the architects suggest flood-lighting the garden for the evening services. The tower would house cooling equipment for air conditioning. The plan recognizes the need for community facilities.

Marsh, Smith & Powell

Architects and Engineers

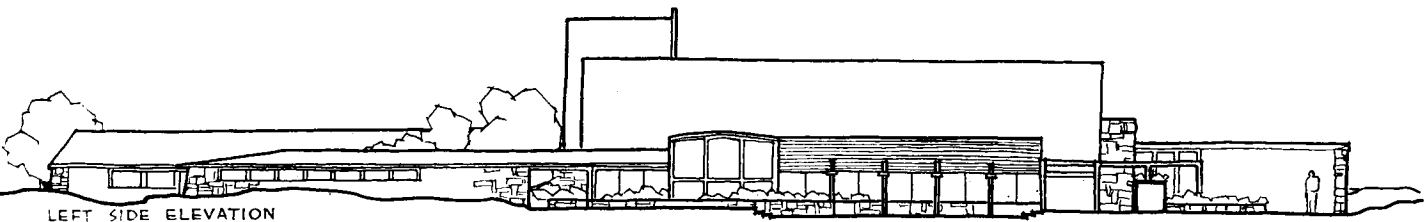

LEFT SIDE ELEVATION

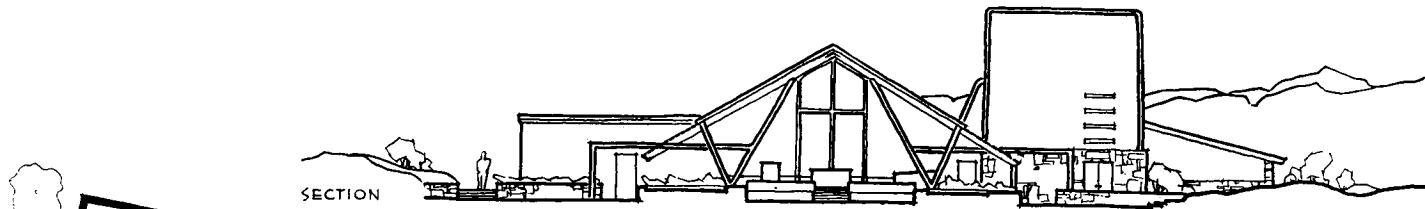

SECTION

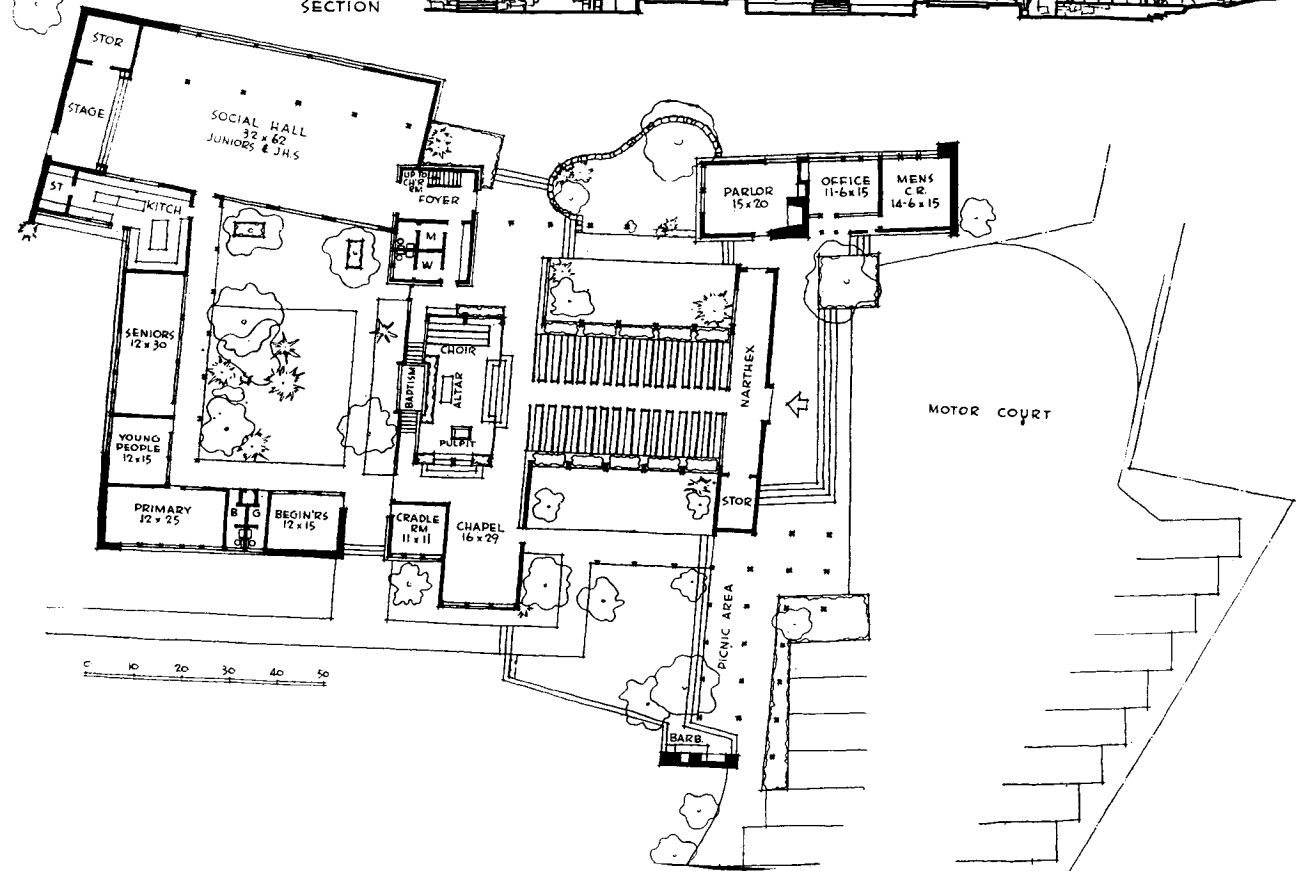

ST. MARGARET MARY'S CHURCH *Omaha, Nebraska*

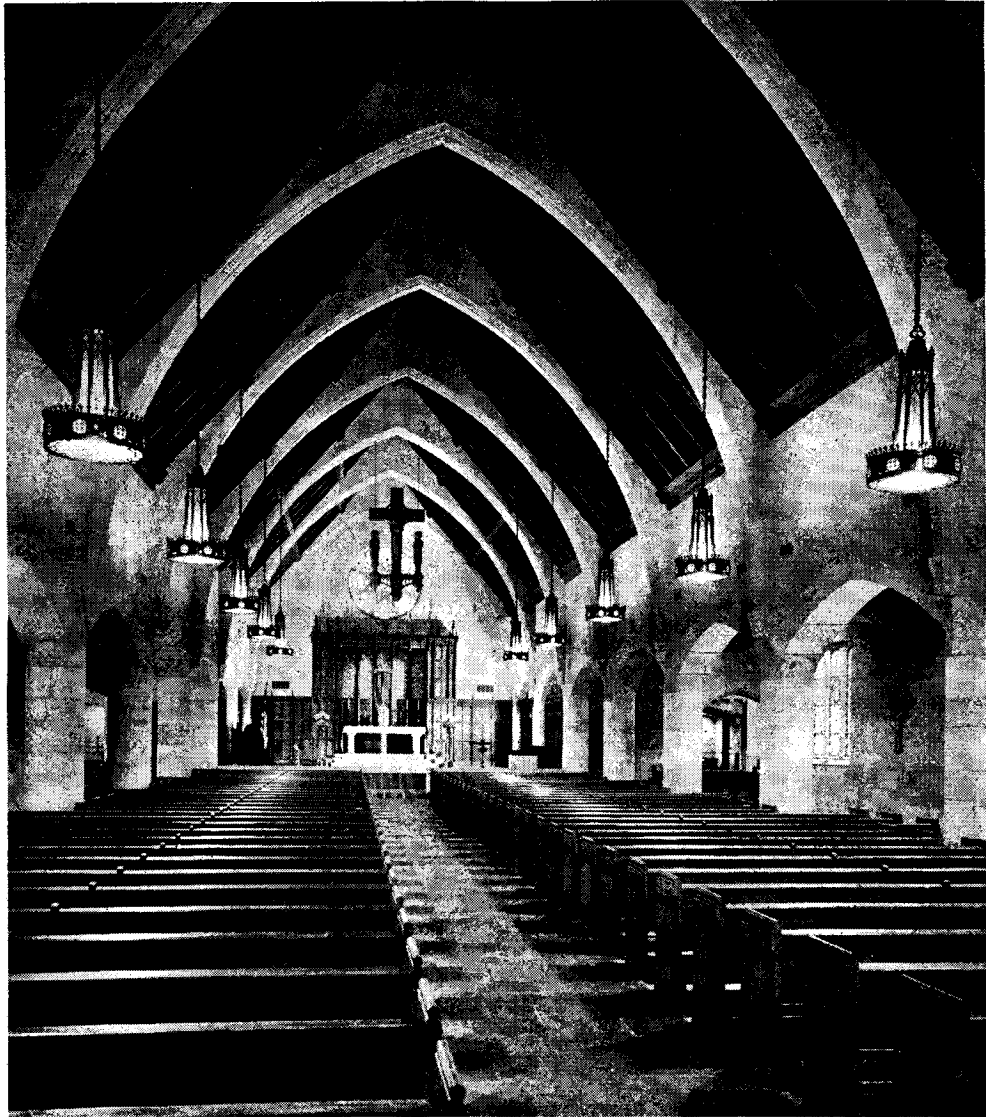

Murray Studio

ALTHOUGH the exterior view on the right shows a church settled quite comfortably on the ground, this is by no means a little country church. It has a seating capacity for 800 citizens of Omaha.

The architect cites as a design objective a "naturalness" to appeal to the layman's eye, mentioning in this connection the "Peace Be Unto You" carved over the doorway. The exterior is of gray limestone, though there is quite a bit of color in the roof. Walks are of flagstones, taken from cast-off slate curbstones from old cobble-stone streets.

Limestone gives a similar note of softness to the interior. Beams on the ceiling are of dark, polished wood, modified with squares of cork. The architect also mentions a studied casualness inside the church, in the lack of shining metal



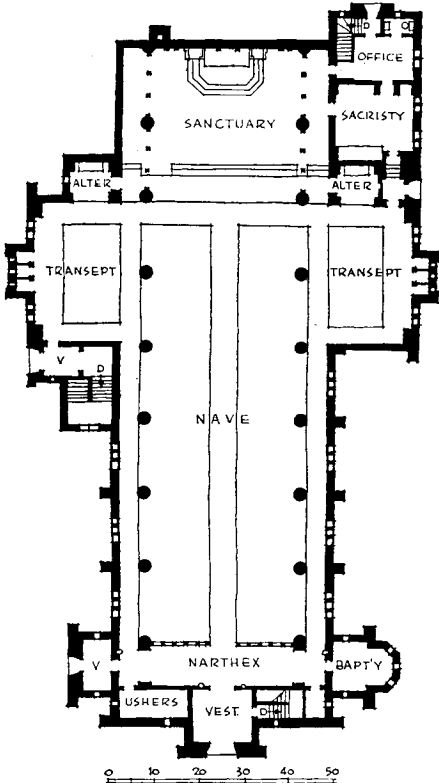
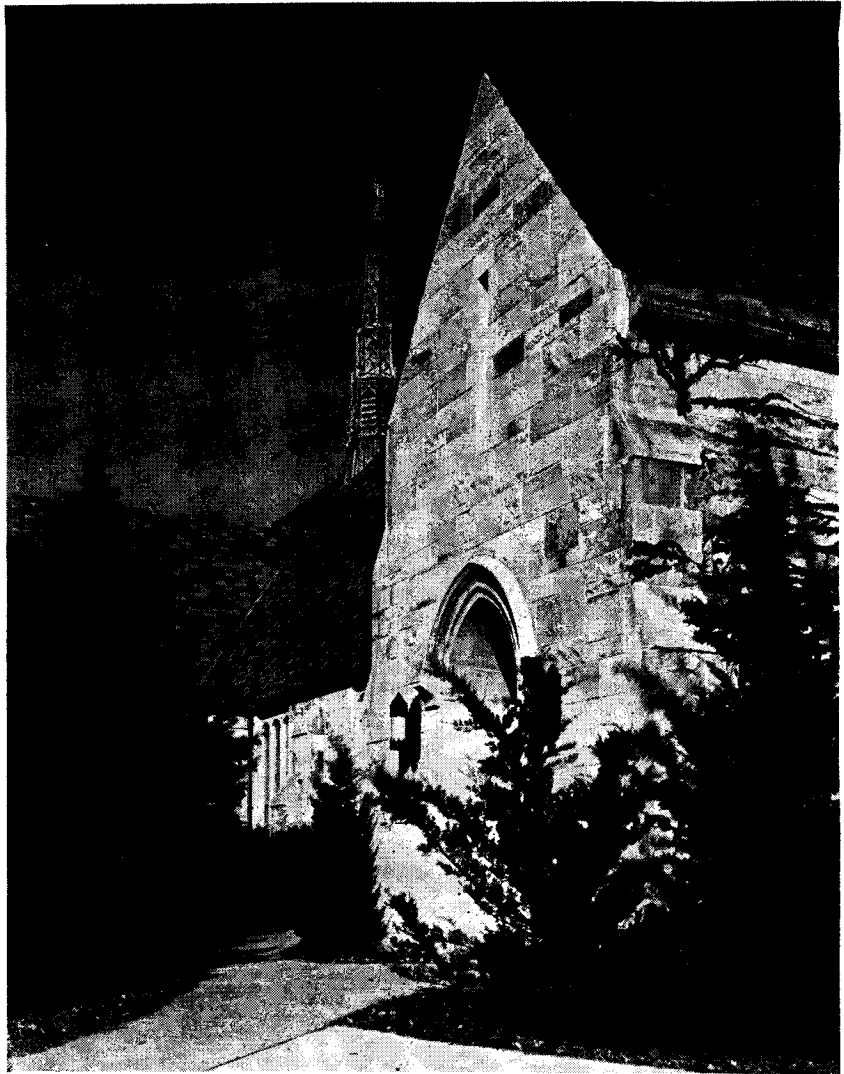

Leo A. Daly Company, Architects

contrasts. Bronze was used for candlesticks on the altar, to keep to the quiet tone, and unpolished copper for other metal pieces, such as poor boxes.

On the reredos of the main altar are fabric panels of red and gold damask. The rose window, above the altar, is predominantly blue. There is color also in other stained glass windows, but in general, color is not very extensively used.

The basement is still unfinished, but will later be used for a kitchen, hall, check room, a room for the servers, and space for a cooling and heating system. The over-all plan for the parish also includes a rectory and a school. The present portion was completed just before the war closed in, and the cost totaled \$125,000.

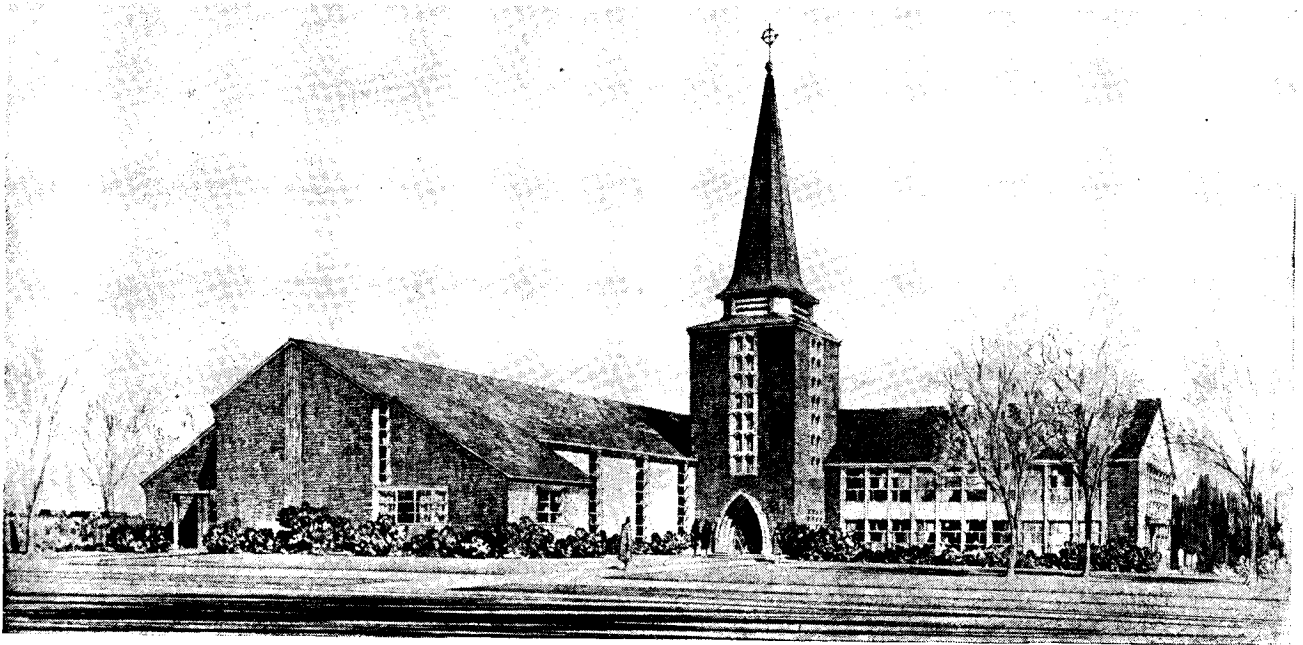

VALLEY COMMUNITY CHURCH *Portland, Oregon*

Donald W. Edmundson, Architect

AN observant student of church design would have little trouble in fixing the locale of this church in the Northwest. For one thing it has such extensive community facilities, not so generally found in new churches in the East. More significant, perhaps, is the freshness of design characteristic of the architecture of the Northwest, where this quality is so often achieved without any violent clash with tradition.

While the entrance is on the level of the nave, the rest of the building takes advantage of a slope for a split-level scheme. The roof of the nave will be framed with laminated arches, with acoustical ceiling.

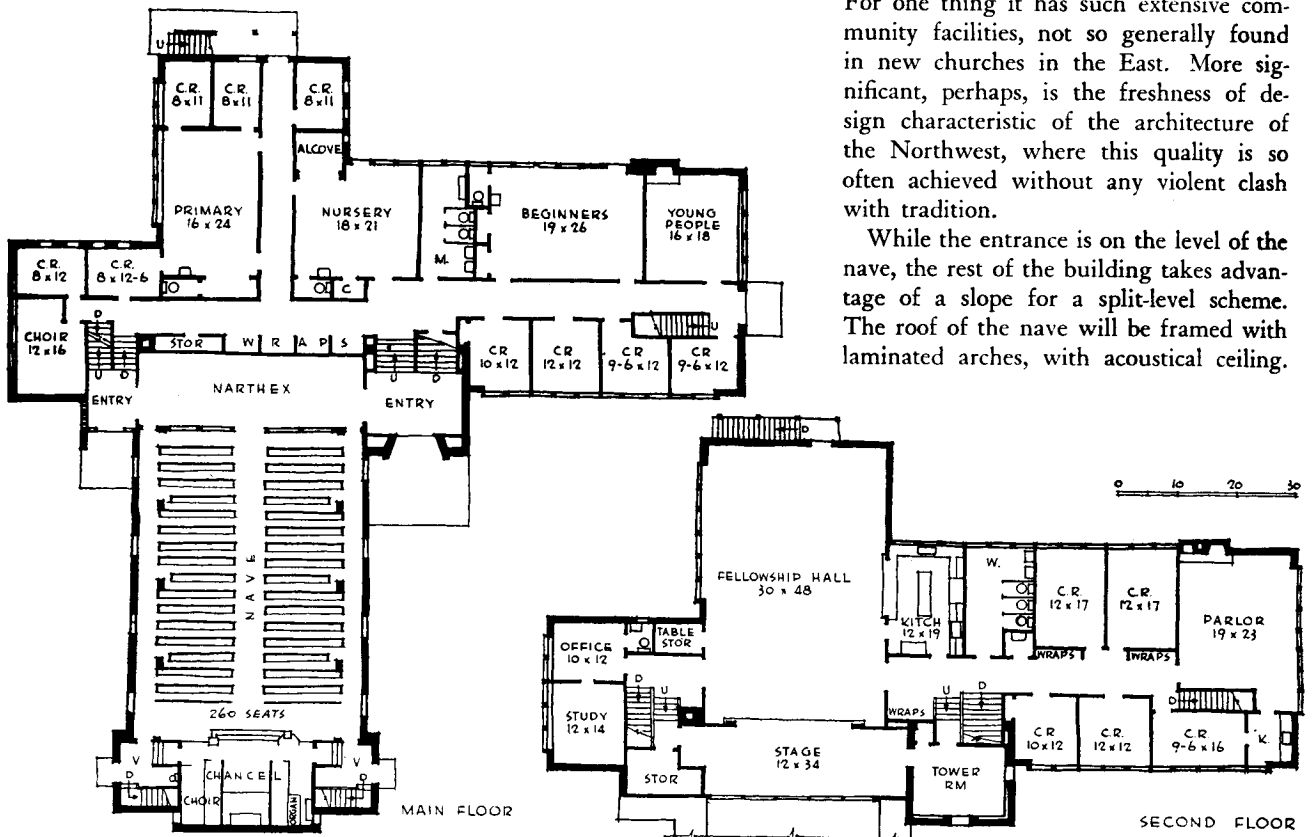

CATHOLIC CHURCH FOR THE ORIENT

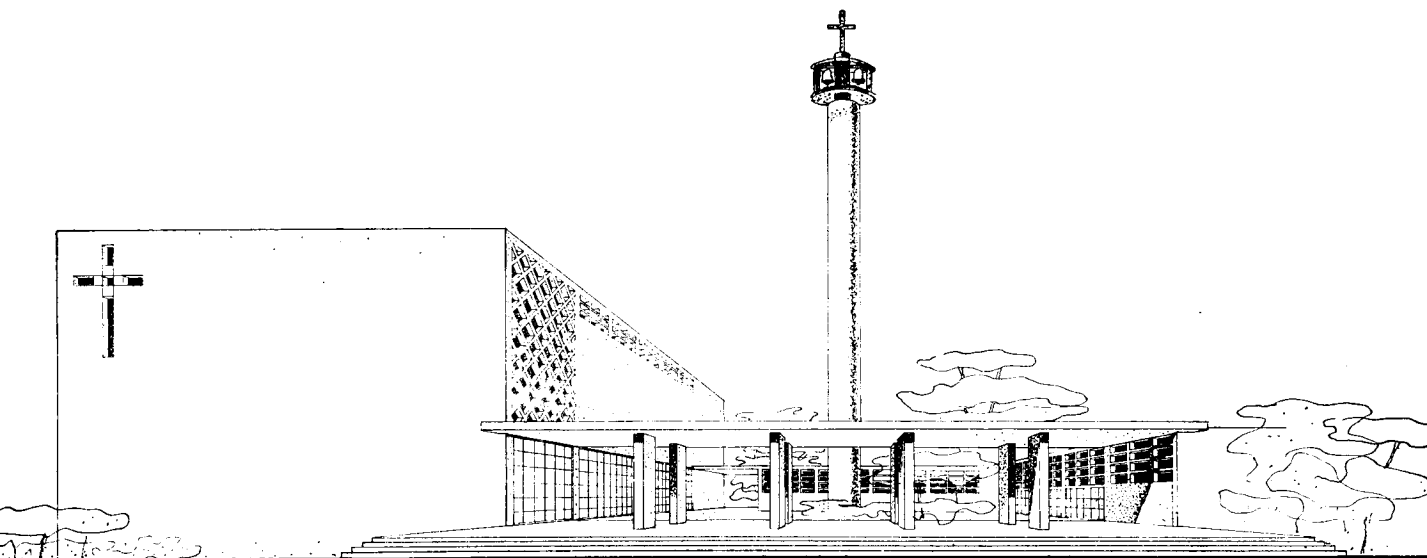

Antonin Raymond, Architect

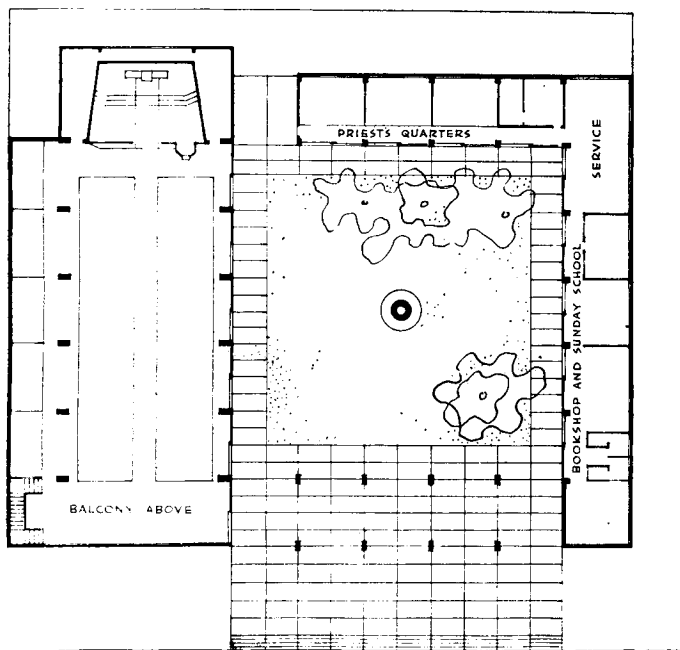

DESIGNED originally for a location in the Orient, this little Catholic church has its contribution to make to current design discussions. Showing the celebration and technology that delight the functionalists, it also exhibits this architect's fond respect for materials, for the possibilities for symbolic meaning, or "romance," that may be found in the form and texture of simple materials. The little church is designed for execution entirely in reinforced concrete, allowing for a number of exterior and interior treatments, including, Raymond points out, the bare concrete, just as it comes from the forms, assuming that the workmanship is first-class.

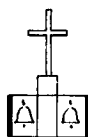

Done for an outpost location, the plan shows emphasis on mission character of the church

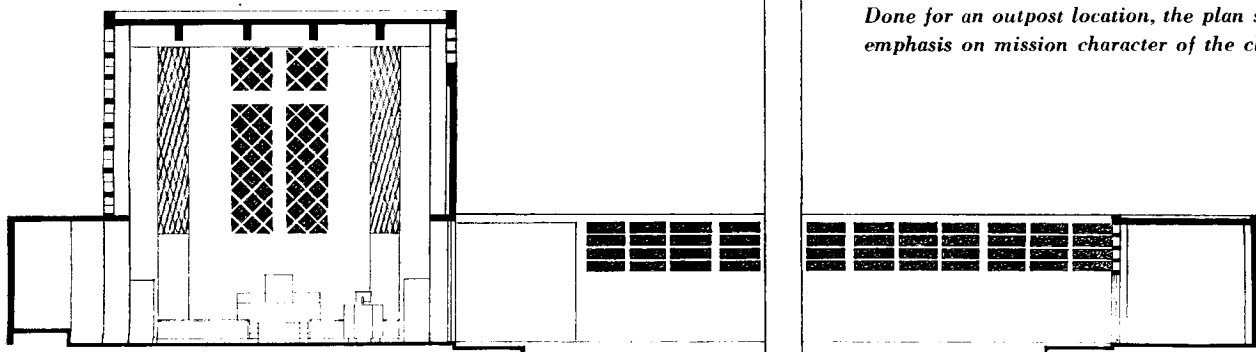

DESIGNS FOR THE DEEP SOUTH



Proposed Methodist Church, Gatlinburg, Tennessee

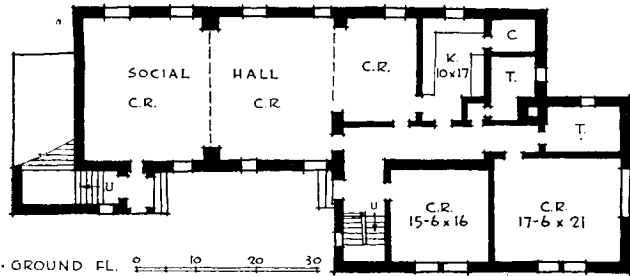
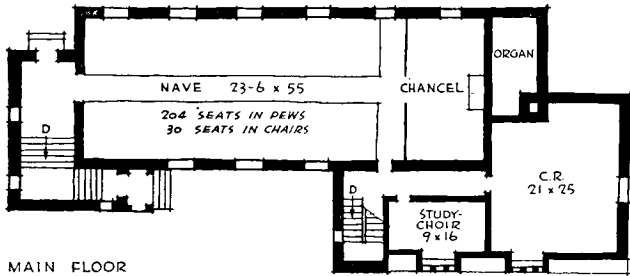

Barber & McMurry, Architects

ARCHITECTS don't really need to be warned (though they frequently are, as in Mr. Taylor's article, page 90) that they are courting a cold reception from church building committees if they try to propagate the faith of modernism in church design. And any who tried it in the conservative southern churches would be exceptionally courageous. The designs of this firm of architects, notably successful in southern churches, are marked by a

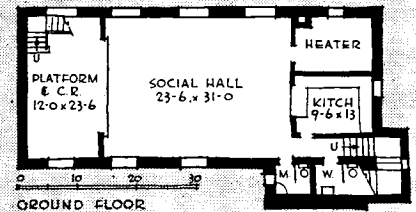
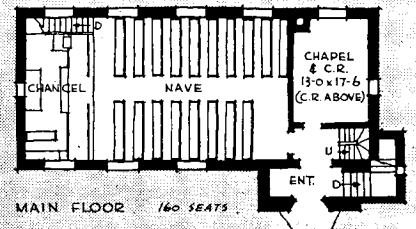

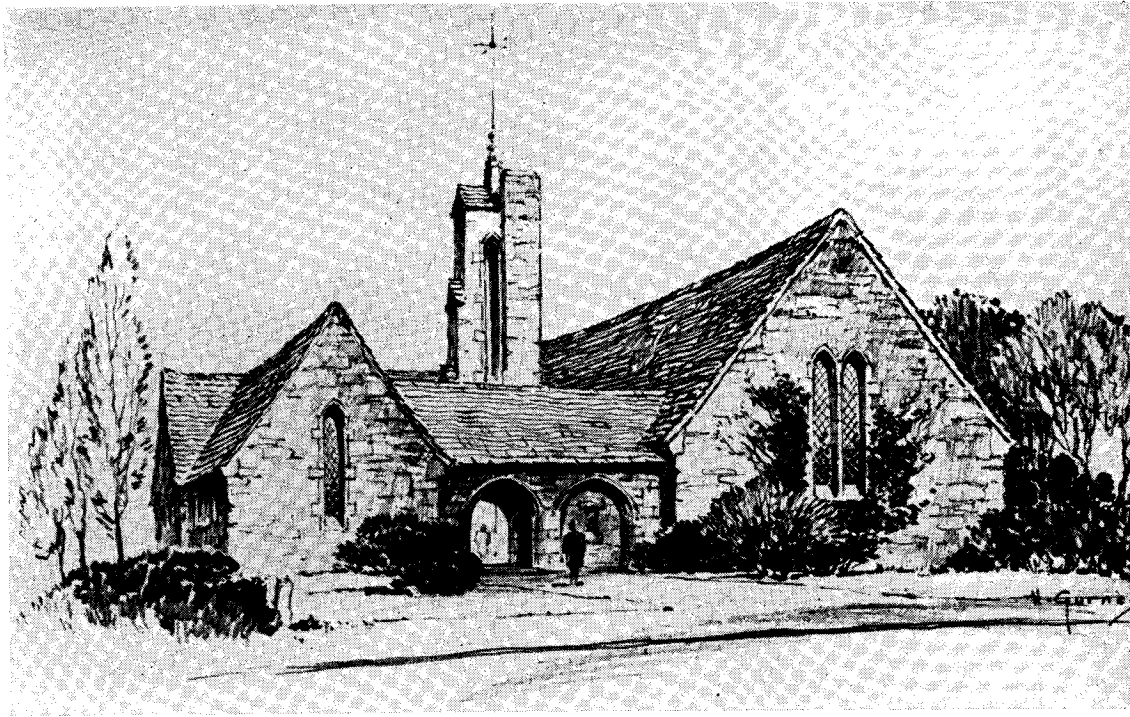

*Proposed Portland Methodist Church,
Portland, Tennessee*

picturesque simplicity in masses that arises directly from the informality of the plans. It would appear, however, that they have had no trouble about eliminating the expensive item of the steeple tower. Indeed all of these three are simple and direct and functional. And building committees without doubt approve their economy as well as their poetry. The little church for Corryton, Tenn., is designed to stay within a budget of \$20,000.

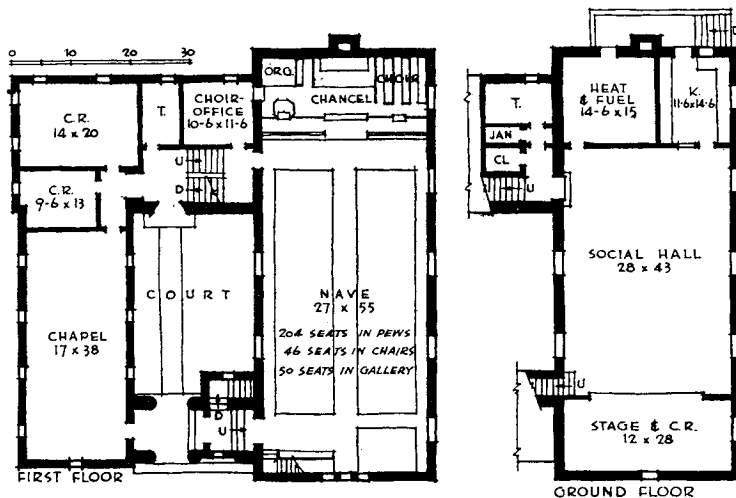

*Proposed Methodist Church,
Corryton, Tennessee*

PROBLEM OF A CHAPEL

Junior Chapel, First Methodist Church, Portland, Ore.

Pietro Belluschi, Architect

HERE the architect has made the solution look so natural and simple that it would be easy to miss the problem. A small chapel, however, is frequently something of a poser, for its space is so limited that it is difficult to give it any impressiveness, any drama. The solution clearly demonstrates the dramatic possibilities of the modern simplicity. The architect's devices are obvious—the composition of plain surfaces focussing on the altar and cross, the maple screen as a highlighting background for the lectern, the striking lighting effects, the strong contrasts.



Leonard Delano

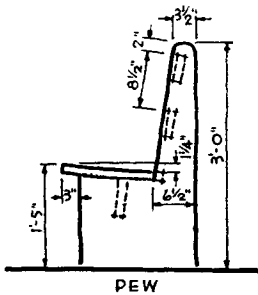

PEW

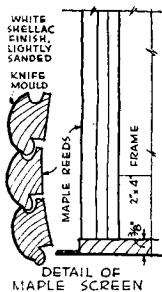

DETAIL OF MAPLE SCREEN

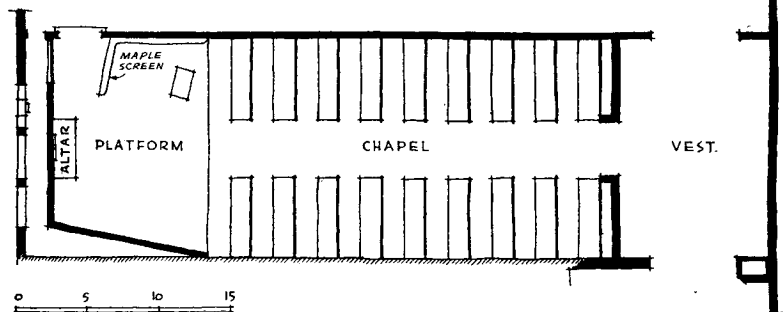

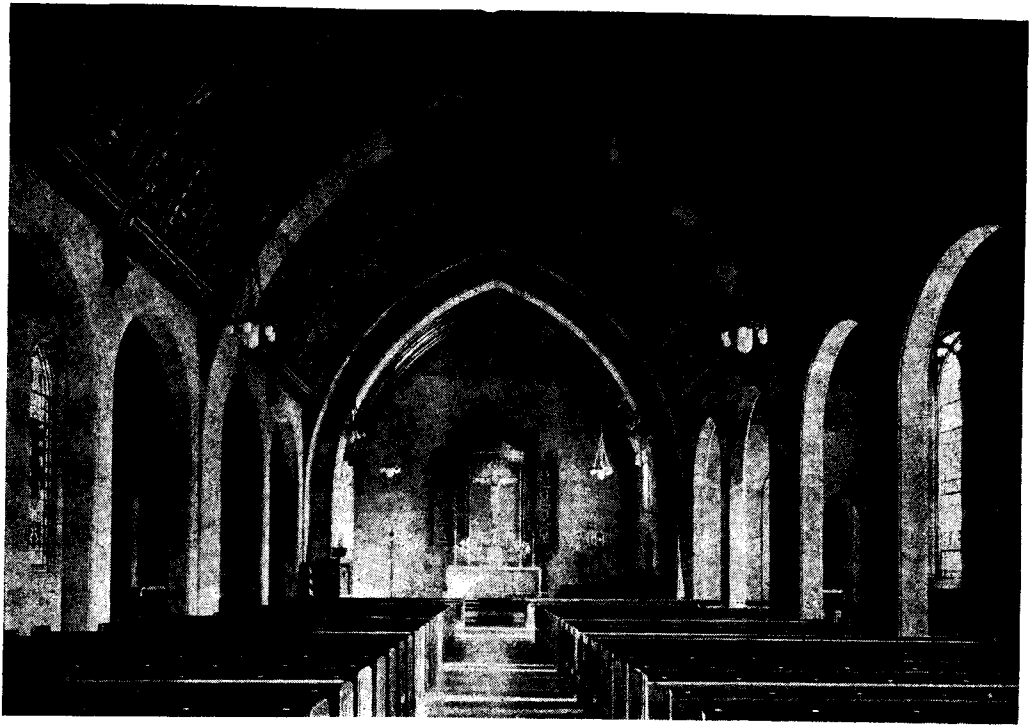

IN ORDER to overcome the rather typical difficulties of limited budget and narrow lot, and yet give an illusion of height and depth, the architects here made effective use of pointed masonry arches. The outside aisles are separated from the nave by a wall forming an arcade, thus narrowing the nave and adding to the feeling of height. The ceiling is stained wood, decorated in color in symbolic design. The exterior is faced with limestone, with shingle tile roof of brownish red. The church, completed in 1943, cost \$140,000, including all furnishings. It has seating for 550.

ST. MICHAEL CHURCH

Muskegon, Michigan

Edward J. Schulte, Architect

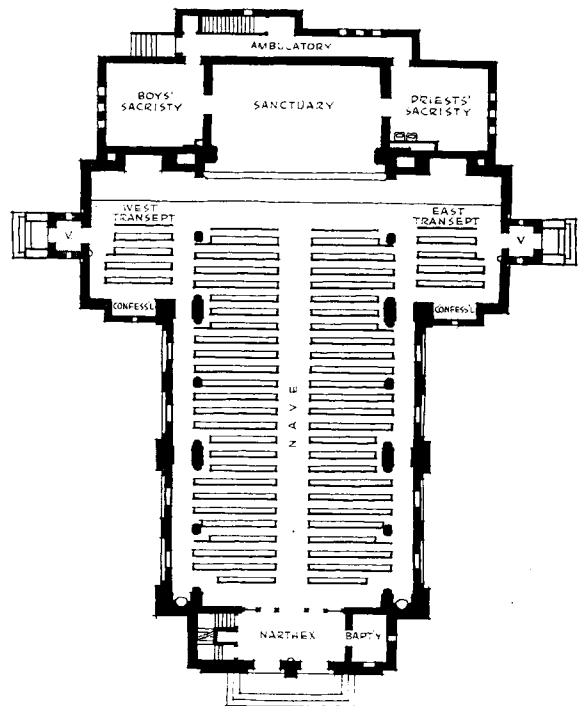
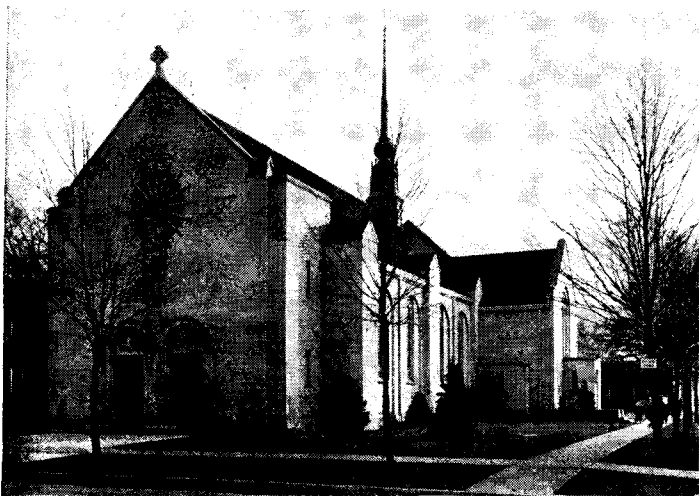

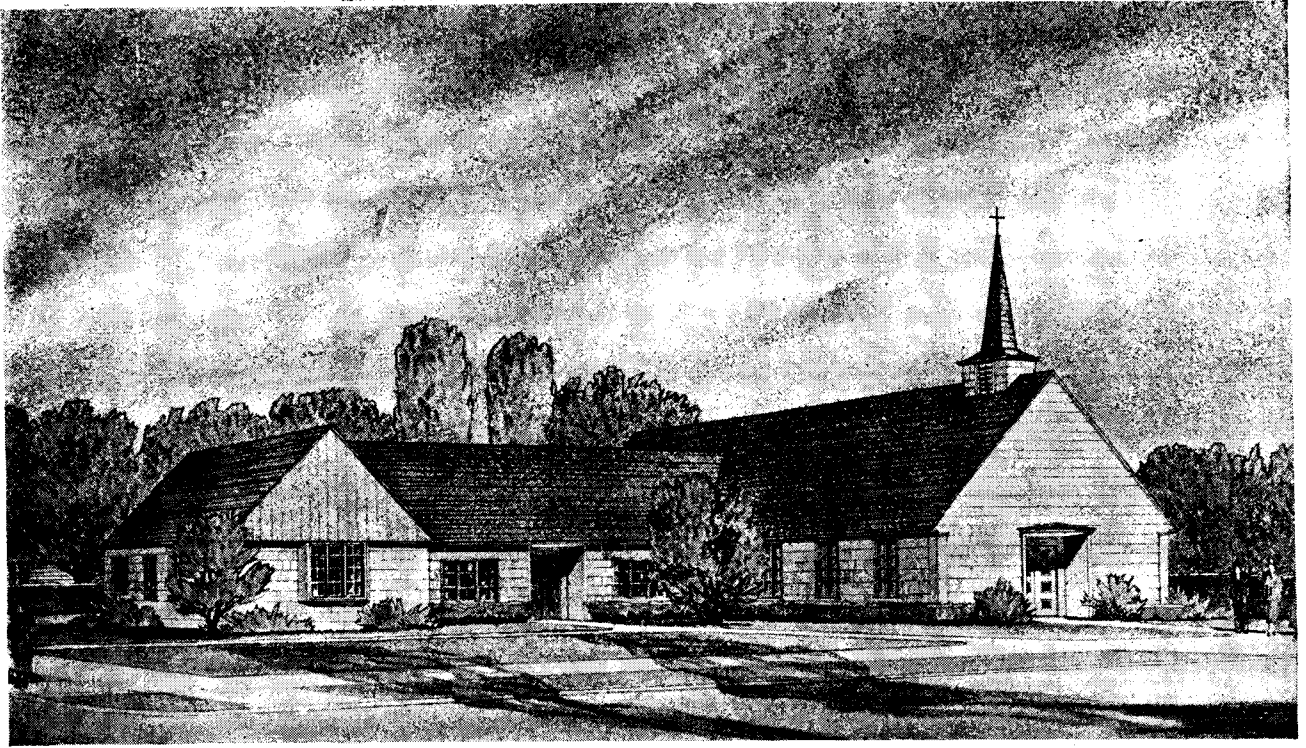

METHODIST CHURCH

Junction City, Ore.

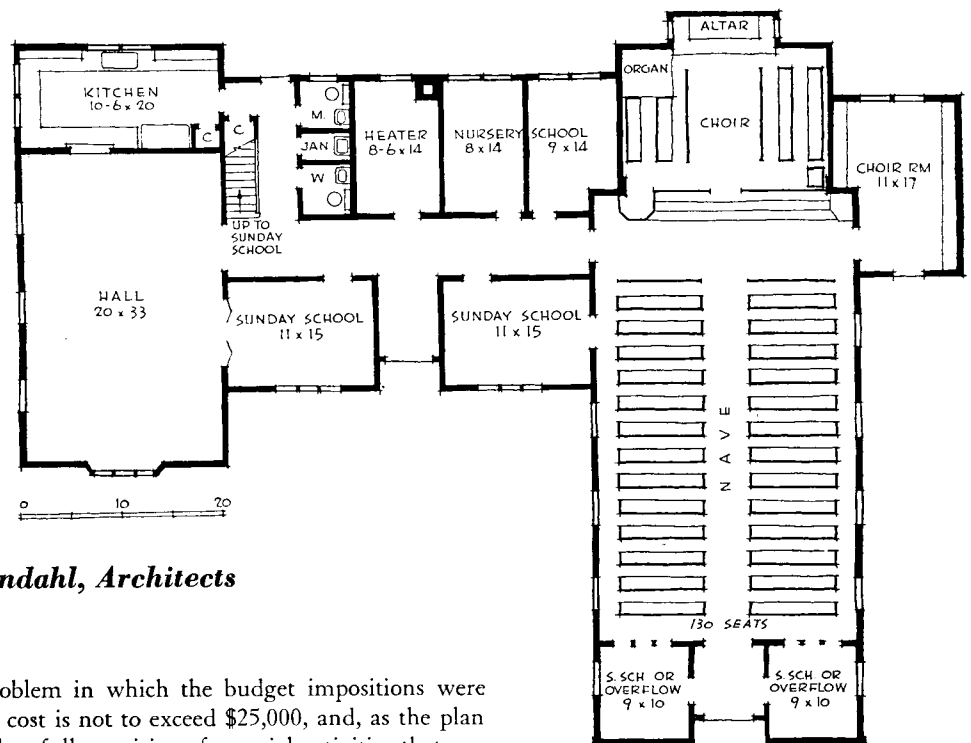

Sutton, Whitney & Aandahl, Architects

HERE is a church design problem in which the budget impositions were unusually severe, for the total cost is not to exceed \$25,000, and, as the plan shows, there are to be the rather full provisions for social activities that are commonly demanded in the Northwest. And for their part the architects felt it incumbent on them to preserve the dominance in the design of the church portion, which did not ease the budget strain. Perhaps, however, it all helped rather than hindered, for it was just that much more logical to be straightforward in design, to avoid monumental ornamentation, and yet to eschew any self-conscious attempt to "go modern."

CHURCH ON AMPHITHEATER PLAN

Proposed Scheme for a Catholic Church

Paul Thiry, Architect

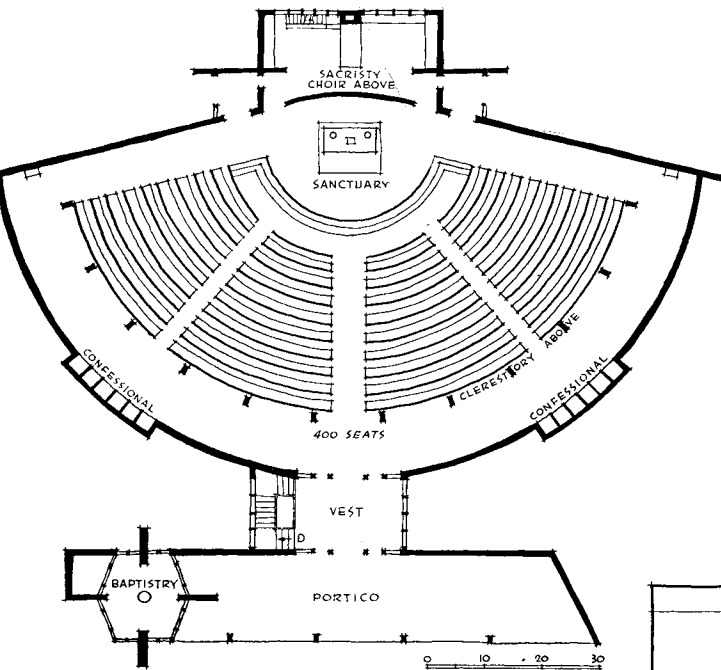
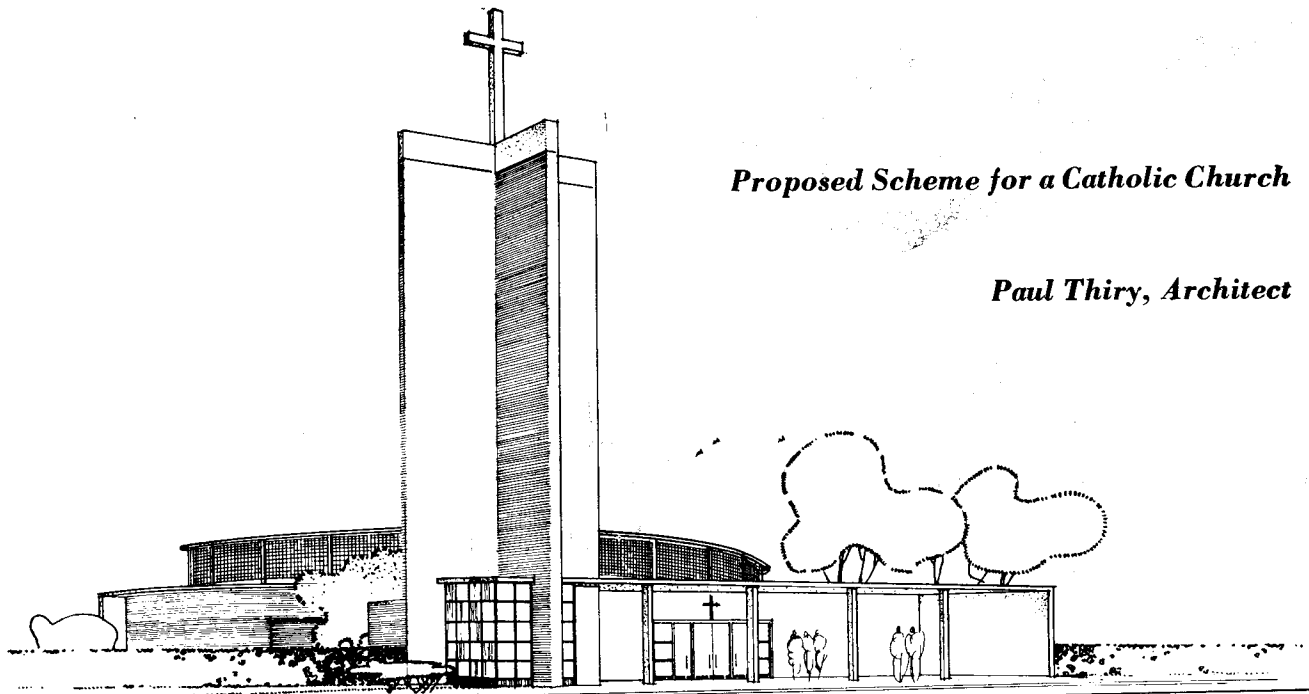

If the amphitheater part of this church seems unusual, which of course it is, it has much to recommend it. It is based strictly, points out Mr. Thiry, on liturgy. The altar is the focal point; all other elements are subordinated, all superfluous forms eliminated. The congregation is grouped as closely as possible around the celebrant; no person is further than 50 ft. away. Any objection to the step formation seems overcome by the improved visibility that results. The plan recognizes the importance of processions. The continuous, wide aisles give them full scope. Separate devotions, such as stations of the cross, shrines, confessionals, are removed from the main body of the church, to the rear in a colonnade, to avoid any conflict with the essential sacrifice of the Mass. A clerestory of glass block directs daylight to the ceiling.

The cross form of the tower "recalls the mission to go forth and preach the gospel to the four corners of the earth"; points of cross represent evangelists

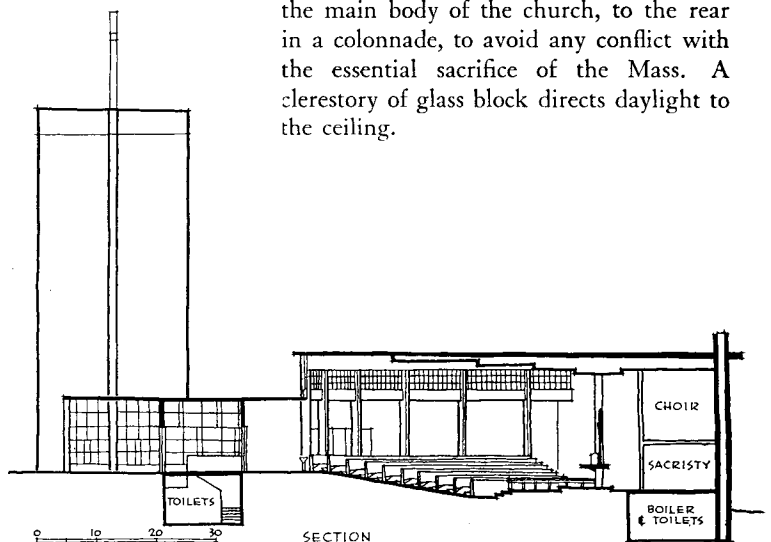

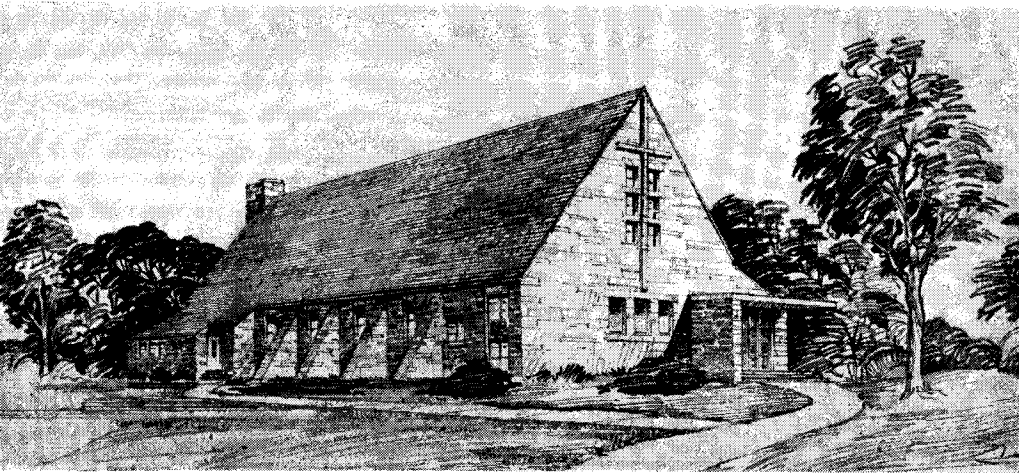

TWO ECONOMICAL POSTWAR CHURCHES

THE small Catholic church above, a postwar project for the Midwest, seems a noteworthy example of a trend in design mentioned a year ago in these pages by Dean Joseph Hudnut. He spoke of a "transitional" design, involving a

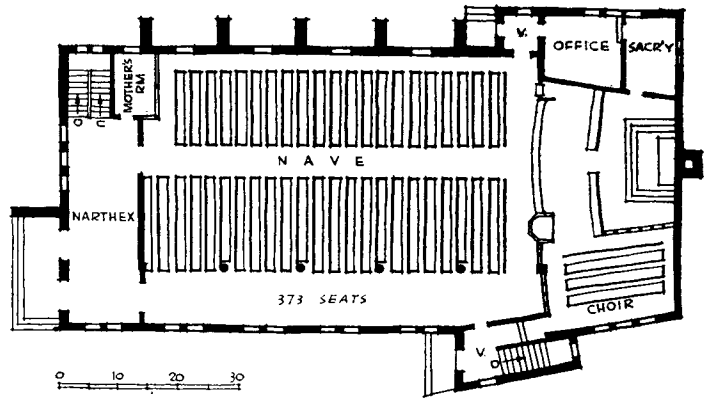

Hills, Gilbertson and Hayes, Architects

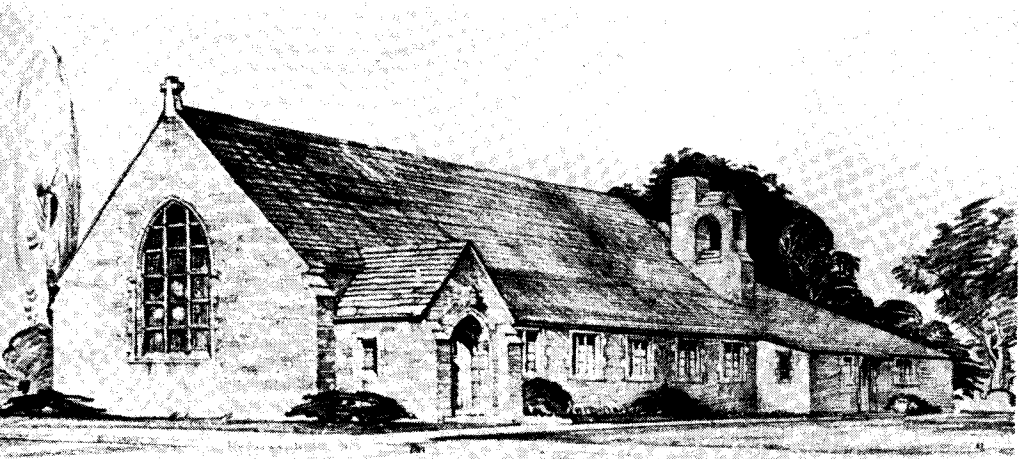

gradual freshening up rather than a sudden break with all traditional church style motives.

The lower one, a postwar proposal for the Church of St. Joseph, Mobridge, S. D., obviously has less of the modern feeling, but about as much of the functional economy in plan and construction. Economical or not, the plans call for a forced hot-water heating system with thermostatically controlled mechanical ventilation, to circulate heated or cooled air as may be required.

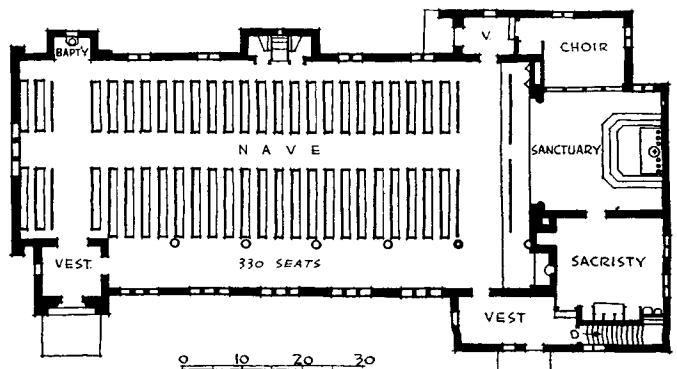

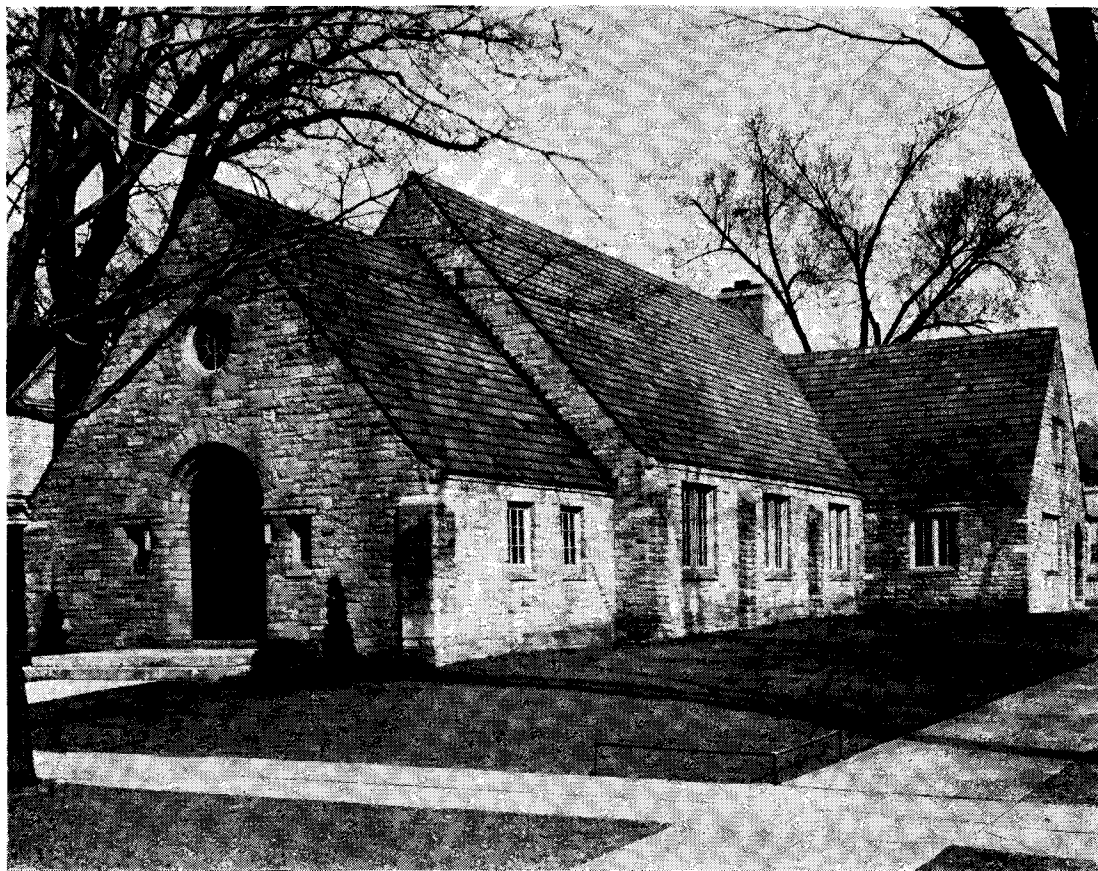

Snow's Studio

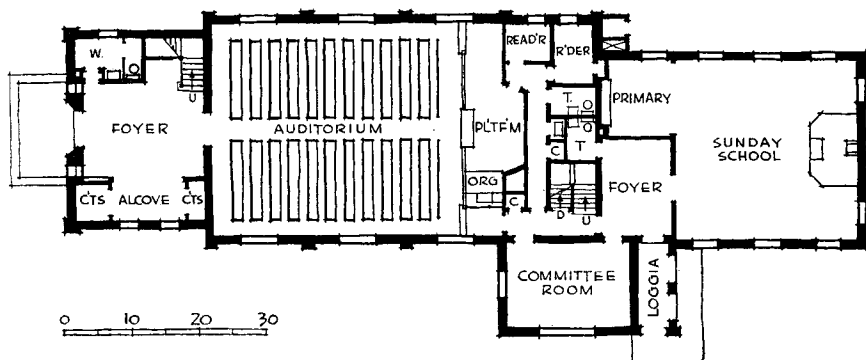

Rollin C. Chapin, Architect

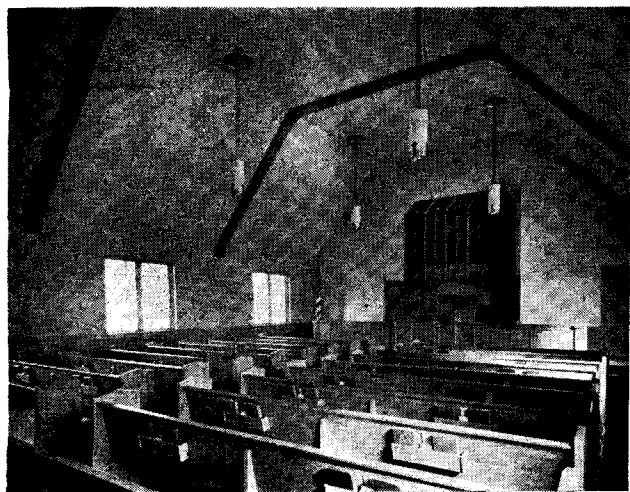

Nor being highly ritualistic, the Christian Science Church does not impose established style patterns on the architect. While these churches do not usually "go modern" any more than others, they do permit at least as much freedom for direct expression of the requirements of the plan.

Here the basic needs are illustrated in a very small church, simply done in both exterior and interior, the architect relying on the natural massing of elements for the principal interest. Worth noting is the space given to the main foyer, where the need for coatrooms gets a recognition that is all too rare.



Peter Juley & Son photo

CHURCH OF OUR LADY OF VICTORY *New York City*

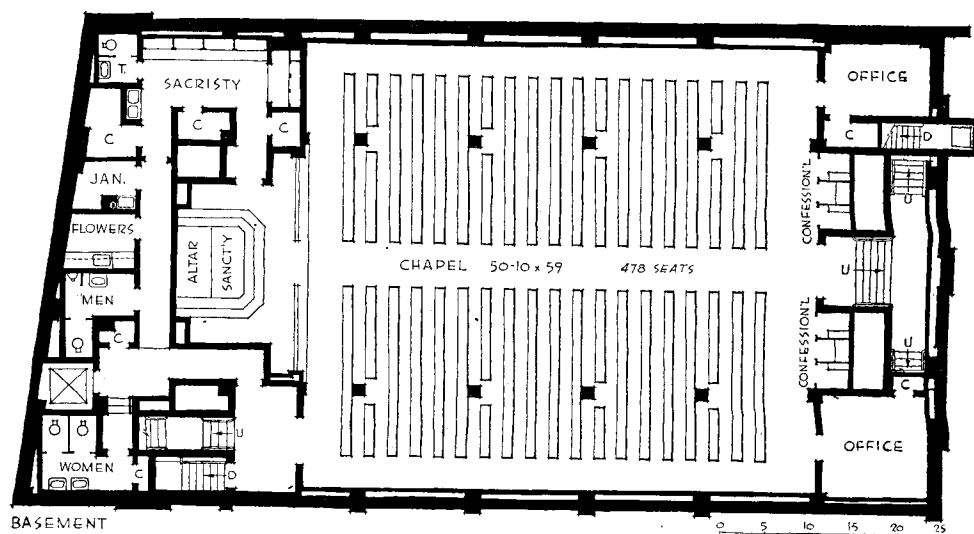

This church, as its name implies, is to be built after the war as a memorial to those who gave their lives for victory. The need for a church in the financial district of New York was long recognized. Available property was limited; a site on the corner of Pine and Williams street was finally chosen as the one nearest the center of the business community to be served.

As designed, there are actually two churches, the main one on the first floor with balcony, the secondary church

in the basement. The rectory is to be located above.

According to the architects, "the greatest problem was to provide for adequate exits, not necessarily according to the building code but according to the usage to which the building will be put, at the same time providing adequate space for an imposing Sanctuary, and provide seating for the maximum number of people." The plans below show how the privacy of the rectory was assured, and the means of egress were controlled.

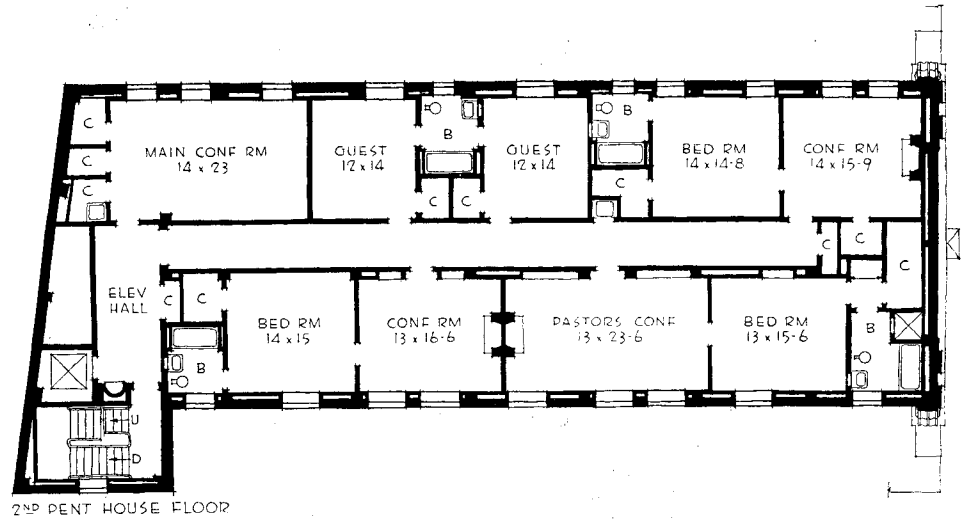

**Eggers & Higgins,
Architects**

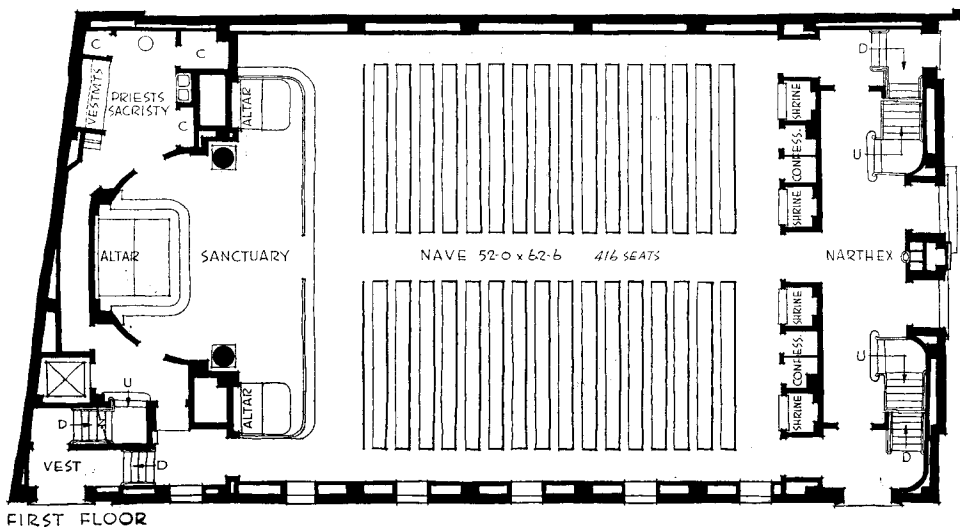
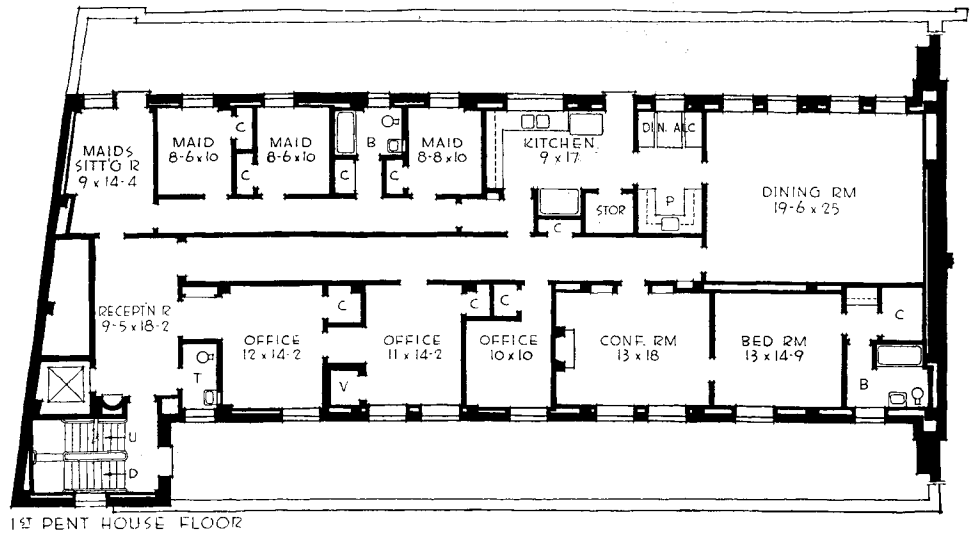

CARMICHAEL COMMUNITY CHURCH

Carmichael, California • Nicholas Tomich, Architect

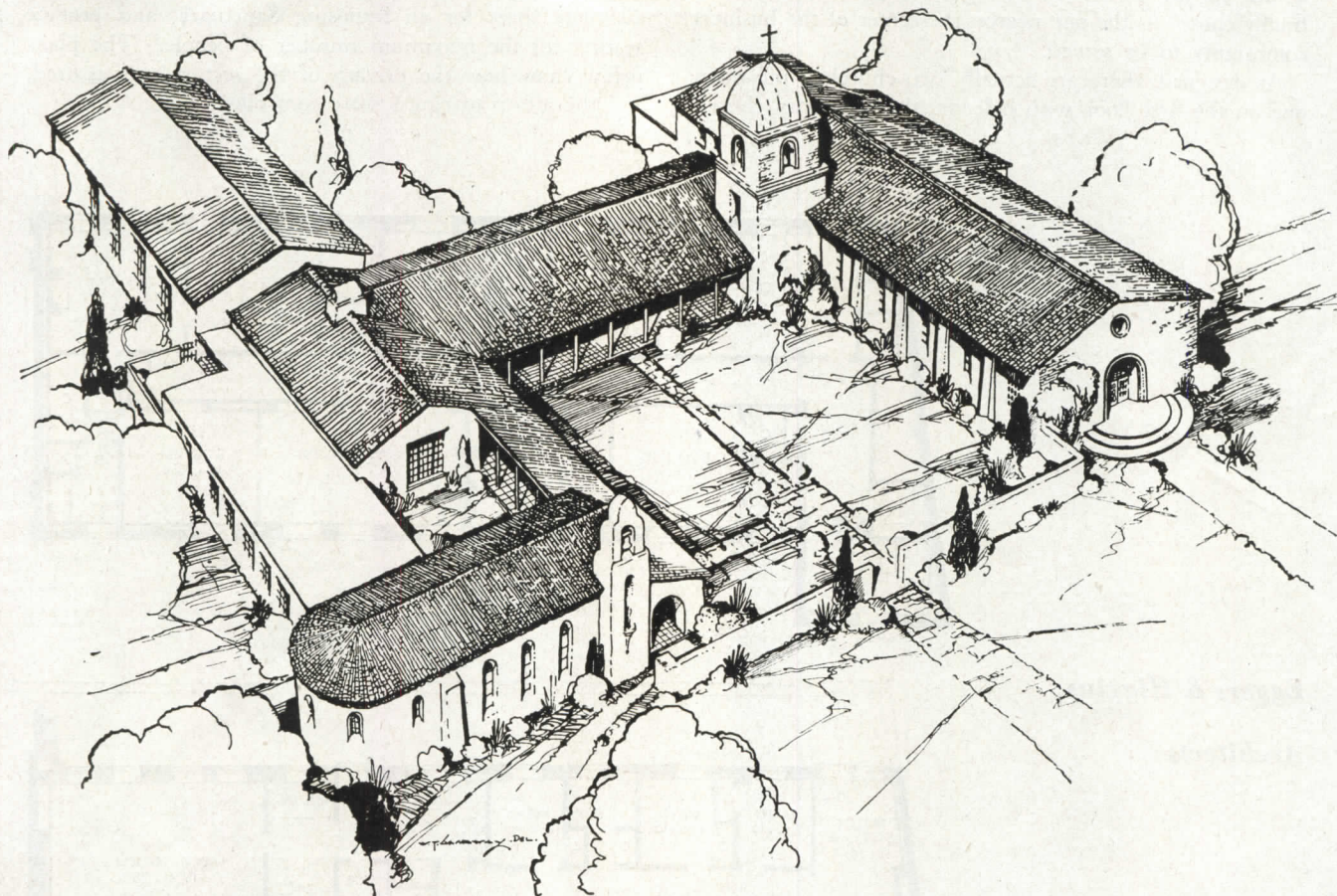

To provide adequate facilities for Sunday School, and for the social life of the young people of the entire community" is the aim of this church. The building, to be built on a "pay-as-you-go plan," will replace an inadequate existing structure.

Wall construction will be largely adobe. The brick is made from a mixture of clay loam, sandy silt, and water with the addition of a petroleum product from homogenized oil known as "bitumul." The high school society has undertaken the responsibility for making the needed brick.

As there are some four acres of land available for the building, still further expansion is possible. For the present, however, a badminton court, a cement tennis court, and a swimming pool will take up much of the available space.

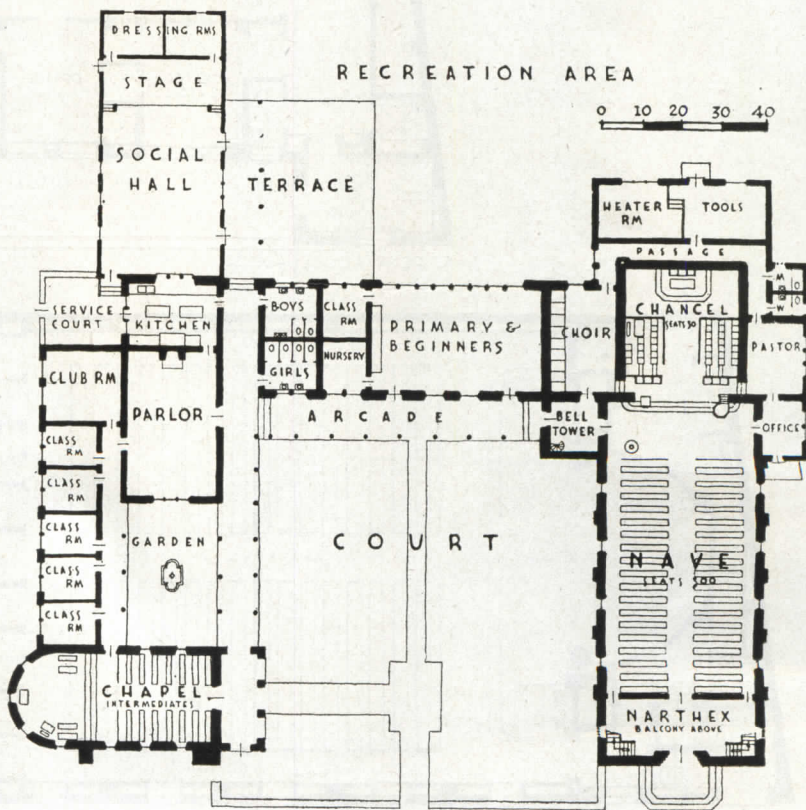

Edward Pilkington photos

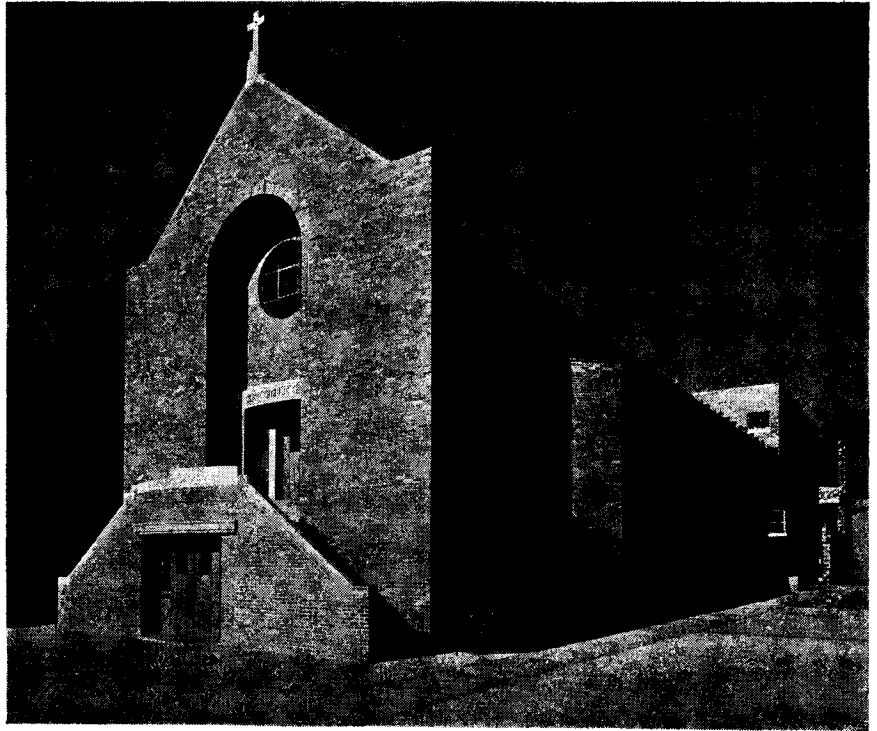

HOLY REDEEMER CHINESE CATHOLIC CHURCH

Philadelphia, Pennsylvania • Henry D. Dagit & Sons, Architects

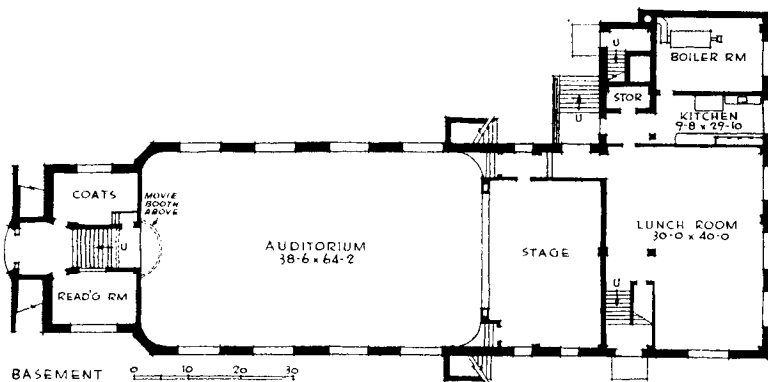
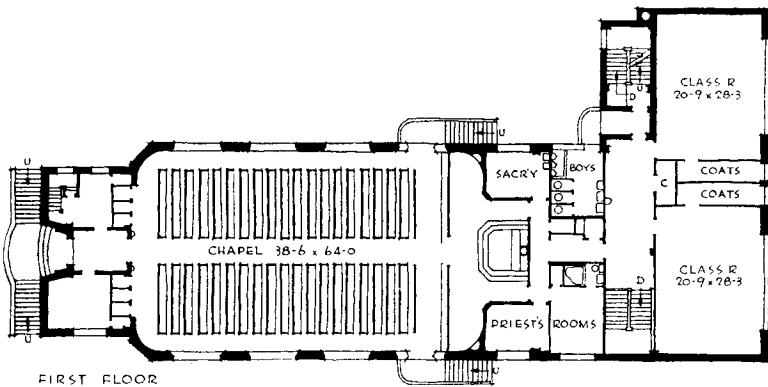

BUILT in Philadelphia's China Town, this church is one of the first Catholic churches built for the Chinese people in America.

The general construction of the building is reinforced concrete. Steel trusses support the roof. The exterior walls are variegated golden colored brick trimmed with Indiana limestone.

The main chapel has a seating capacity of about 300. The floors are asphalt tile with walls and ceilings of sand finished plaster. Lighting is by means of built-in reflectors in the ceiling.



SECOND CHRISTIAN REFORMED CHURCH

Denver, Colorado



Earl Morris, Architect

THE ritual of the Christian Reformed Church permits of no pictorial or sculptural embellishment, limits ornamentation to actual forms of construction. The resulting simplicity and directions here are obvious.

Concrete lintels and belt courses are structural, and were poured in pressed-wood lined forms and left natural, in both exterior and interior work. Interior piers are of warm red brick; walls between plastered and painted a reddish buff.

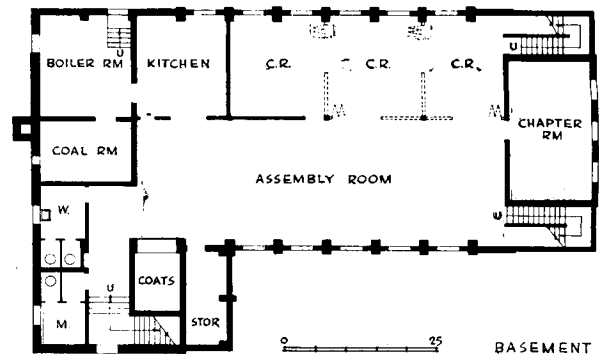
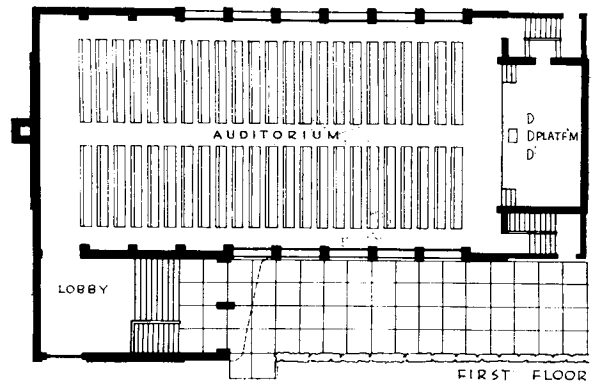

PIPE ORGAN SPACE REQUIREMENTS

This Time-Saver presents essential data for preliminary planning of proper space for a pipe organ. Any organ, because it is a wind driven instrument, must have space to breathe. Its musical value may easily be lost if crowded into inadequate space.

Usually the smallest pipe organ that should be considered for any church should have at least five stops (a "stop" being one complete set of pipes). Such an organ could be used in a church seating up to three hundred people, but its limited variety of tone would be more in keeping with a chapel seating up to one hundred people.

In Table 1, below, church auditoriums have been listed by size together with what normally can be accepted as a minimum and fair size pipe organ. This table is based upon no scientific or musical law and will therefore be a rough guide in early stages of planning. It provides an indication of the minimum number of stops that should be included in the pipe organ for a church of known seating capacity.

TABLE 1
Number of Manual Stops

No. of Seats	Min.	Fair	No. of Manuals
100 or less	5	8 to 10	2
250	6	12 to 15	2
400	8	15 to 20	2-3
600	10	20 to 30	2-3
800	12	25 to 35	2-3-4
1000	15	35 to 40	2-3-4
1500	20	40 to 45	3-4
2000	30	50 to 75	3-4

Table 2 is a specification for a typical pipe organ installation having eleven stops and one independent pedal stop (a large, deep-toned set of pipes played by foot pedals), and perhaps a set of chimes. The names

TABLE 2

Stop Name	No. of Pipes
Great Organ	
8' Diapason	73 Pipes
8' Clarabella	73 Pipes
4' Octave	73 Pipes
8' Tromba	73 Pipes
8' Stopped Flute	From Swell
4' Flute d'Amour	
8' Aeoline	
Chimes	20 Tubes
Swell Organ	
8' Diapason	73 Pipes
16' Bourdon	97 Pipes
8' Stopped Flute	
4' Flute d'Amour	
2' Flageolet	Unit Stop
8' Viole d'Orchestre	73 Pipes
8' Viole Celeste	73 Pipes
8' Aeoline	73 Pipes
8' Oboe	73 Pipes
8' Vox Humana	73 Pipes
Pedal Organ	
16' Bourdon	44 Pipes
8' Flute	From Bourdon
16' Gedeckt	From Swell
8' Stopped Flute	From Swell

of the stops in the specifications are given in the picturesque technical nomenclature of the art. The architect will naturally confer with a qualified organist and organ manufacturers and the budget committee before final decisions regarding the specifications are made.

The recommended height for the organ loft is sixteen feet which includes space for pipes and wind chest. However, it is possible to "squeeze" the organ into a twelve-foot height by mitering some of the pipes. The wind chest will determine the length and width of the organ loft. The average length of each chest is 8 ft. 6 in. There will probably be three or more chests, one for each division of the organ ("great," "swell," "choir," etc.). The chest width varies with the number of stops that must be mounted on it, allowing not less than nine inches for each stop. In addition to the width of the chest itself there should run parallel to it a walkboard not less than fifteen inches wide, for servicing. See Fig. 1. On three sides of the chest it would be well to add one foot for the installation of the bass pipes, which may not be installed on the wind chest because of their large size.

The required space for each division of the organ

TABLE 3

	Pipes	Length	Width	Height	
1. Bourbon	16'	44	13'6"	3'6"	10'6"
2. Open Diapason	16'	44	12'0"	2'6"	19'0"
3. Trombone	16'	44	10'4"	1'4"	12'0"*
4. Violone	16'	44	10'4"	1'5"	19'4 1/2"
5. Diapason	32'	12	18'9"	3'8"	34'9"
6. Bombarde	32'	12	10'3"	2'4"	23'0"*
7. Second Bourdon	16'	44	Same as No. 1 approx.		
8. Metal Diapason	16'	44	8'9"	2'9"	21'0"
9. Bourdon	32'	12	15'3"	2'0"	18'0"

*—Average mitered length.

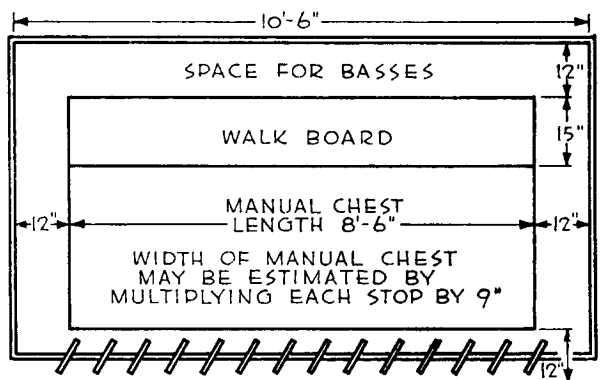
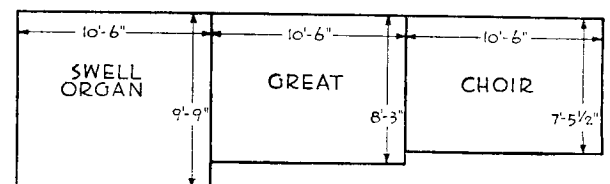
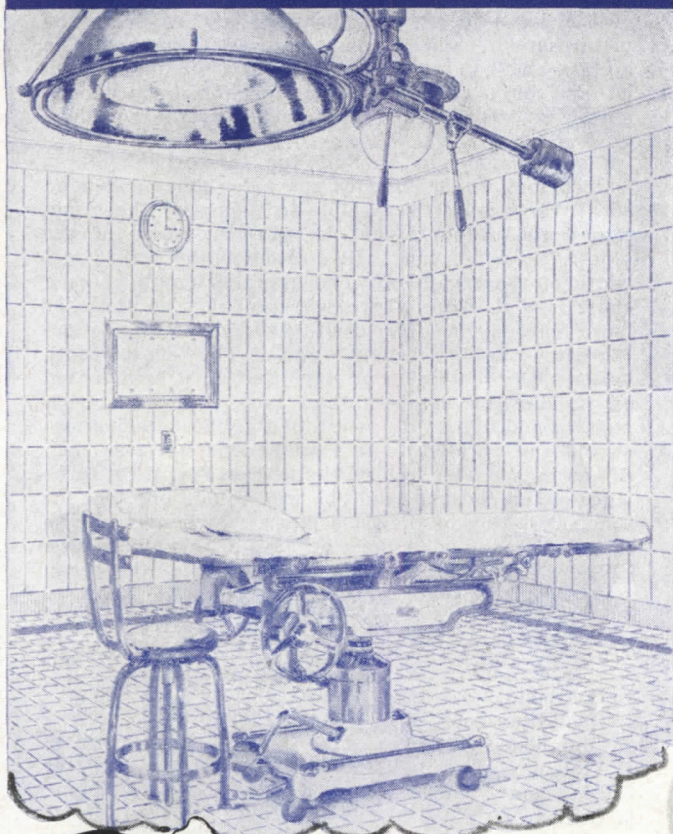

Fig. 1 Above plan is one section of total organ shown below



★ *What they dream about*



"Gee, Doc, let's take a whiff of that ether and dream we're doing all this in a sanitary Suntile operating room."

★ **WHAT THEY SEE...**

Suntile deserves important consideration in planning a modern hospital. Because its installation is verminproof . . . because its surface is non-absorbent and stainproof . . . Suntile is perfect in hospital rooms where cleanliness is of prime importance.

Beautiful color-balanced Suntile adds cheerfulness to the surroundings. Suntile helps cut hospital maintenance costs, too . . . it's so easy to clean and keep clean . . . only minimum upkeep.

Suntile's range of body types, surface finishes, sizes, shapes and colors provides the correct tile for any installation. For permanent beauty and utmost utility, investigate Suntile's advantages for your hospital plans. Suntile will be made again when our war job is finished.



Suntile

The Correct Tile for Any Installation

THE CAMBRIDGE TILE MFG. CO.

MEMBER OF THE PRODUCERS' COUNCIL
CINCINNATI 15, OHIO

★ THIS SERIES IS BASED ON AN IDEA SUGGESTED IN LETTERS WRITTEN BY CPL. LOUIS A. PERKOVIC OF THE ARMY ENGINEERS IN THE SOUTH PACIFIC. A PATRIOTIC IDEA IS TO AVOID UNNECESSARY TRIPS TO OUR ALREADY OVERWORKED DOCTORS BY FOLLOWING THE COMMON SENSE RULES FOR GOOD HEALTH.

PIPE ORGAN SPACE REQUIREMENTS

Fig. 2. Plan of organ console. The average organ console is about 4 ft. 3 in. high. An organ having more than three manuals requires 3 in. additional height for each manual added

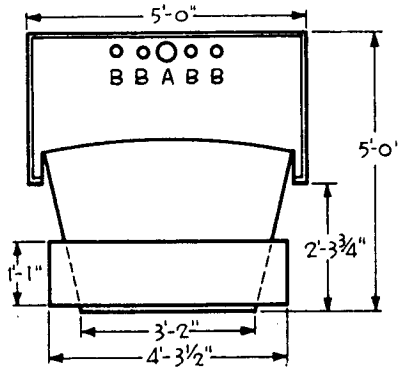

- A 2"-3" CONDUIT, LOW VOLTAGE, CONSOLE TO ORGAN MECHANISM.
- B ONE EACH OF FOLLOWING:
 1"-1 1/2" CONDUIT TO LOW VOLTAGE FEED LINES AT GENERATOR.
 3/4"-1" CONDUIT, MOTOR STARTING LINES FROM CONSOLE TO BLOWER MOTOR.
 CONDUIT, LIGHTS TO CONSOLE.
 CONDUIT TO CHIME OR CARILLON.

can be estimated as follows: (See Fig. 1)

1. Height=12' to 16'
2. Length=8'-16" (Length of wind chest) + 2'-0" (1' on each end for bass pipes), a total of 10'-6".
3. Width=(number of stops) times 9" + 15" (walk-board) + 1' 0" (for base pipes).

These figures would hold good for a pipe organ having up to twelve stops; over that it would be well to allow two feet on three sides of the chest for bass and other large parts that may require extra room.

There still remains for consideration the space that will be required by the pedal organ. Recalling that there should be at least one pedal stop for every six or seven manual stops, it will be necessary to know which stops are most likely to be installed first. Table 3 gives the name and size of the pedal stops in the

usual order. To determine which will be used and the size of the pipes, determine how many pedal stops the manual stops require on the basis of one to six or seven, and then take the required number of pedal stops in order, starting at the top of the list.

In order to supply air to the organ an electrically driven blower, similar to that shown in Fig. 3, will probably be used. From the chart and this diagram it is possible to determine the size of the room required for housing the blower, the weight of the equipment, and the size of the air duct. The horsepower required for the blower will have to be determined by the organ manufacturer. The room housing the blower, usually located below the organ, should allow standing height and a clearance of at least 15 in. on all sides.

Fig. 3. Plans and chart below may be used to determine the space required for blower room

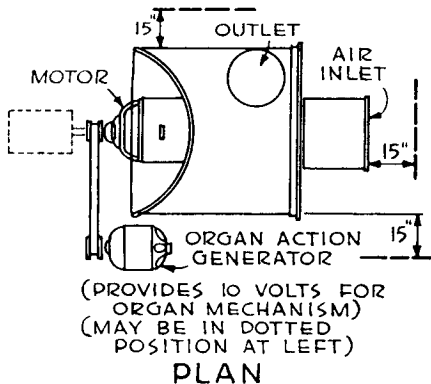
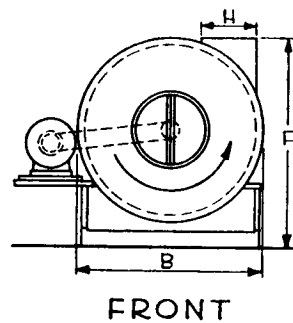
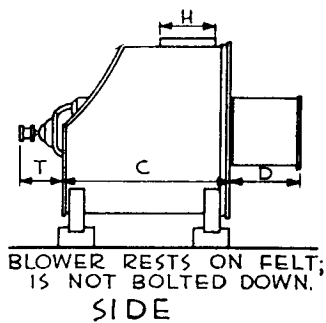

DIMENSIONS IN INCHES

HORSE POWER	1/2 *	3/4	1	2	3	5	7 1/2
B	27	33 1/2	33 1/2	40	40	46	46
C	22	25	28 1/2	31	36	38	38
D	12	15	15	15	15	15	15
F	34	40	40	46	46	53	53
H	8	10	12	12	15	15	15
T	5	5	7	7	9	10	10

WEIGHT IN POUNDS

WEIGHT (LBS)	400	650	700	950	1025	1150	1300
--------------	-----	-----	-----	-----	------	------	------

* SPEED: 1750 R.P.M. ALL OTHER MOTORS: 1150 R.P.M.

Planning a Boiler Job?



When it's time to consider a boiler plant for that home, factory, school or commercial building now on your boards, reach for Vol. 5 of your 1945 "Sweet's" and turn to the H. B. SMITH catalogue.

Here are concise, complete specifications and engineering data designed to help you select the proper boiler for the job whether it requires an output of 20,000 or 20,000,000 B.t.u. If you have a special problem that requires personal consultation, just turn to the catalogue's back page and you will find the address of the nearest H. B. SMITH branch office or sales representative who will be glad to talk things over.

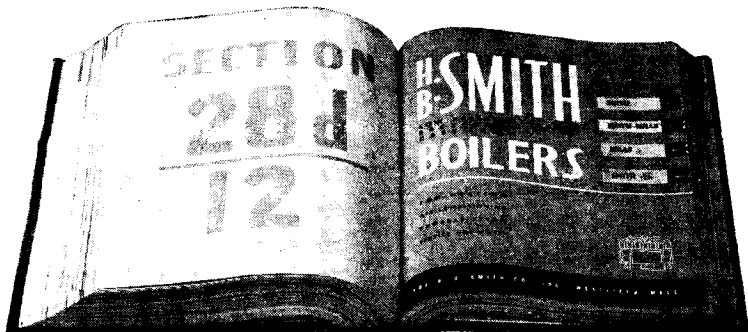

H.B. *Smith*

CAST-IRON BOILERS

THE H. B. SMITH CO., INC., Westfield, Mass.
Branch Offices and Sales Representatives in Principal Cities

ELECTRONIC ORGAN AND CARILLONS

The electronic instruments shown on this page are finding increasing use in churches. The plans below show possible locations for this equipment. As the space requirements are not great, the dimensions given below are outside requirements.

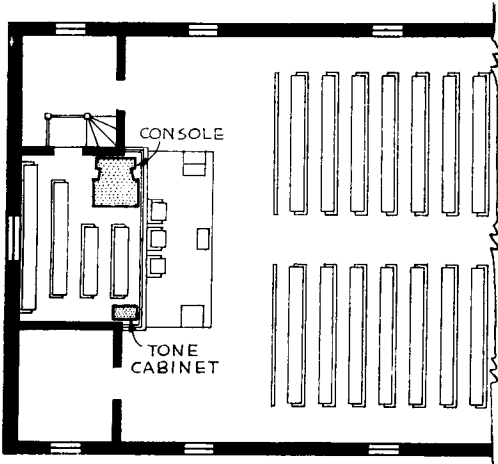

The position of the organ in the plan above places the organist in close proximity to the choir and also lets him see the congregation. The plan below shows additional tone cabinets added, the one at rear of auditorium is for echo effects.

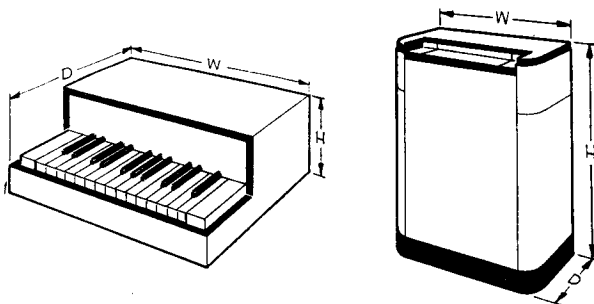
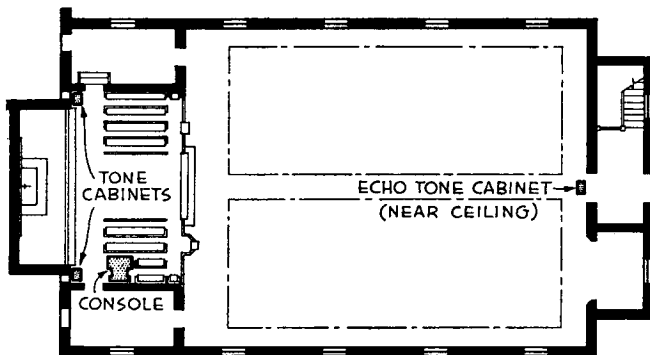

The keyboard for carillic bells may be like either of the arrangements shown above. Keyboard at left is about 17 in. wide, 13 in. deep and 7 in. high. Keyboard at right is about 20 in. wide, 10 in. deep and 30 in. high.

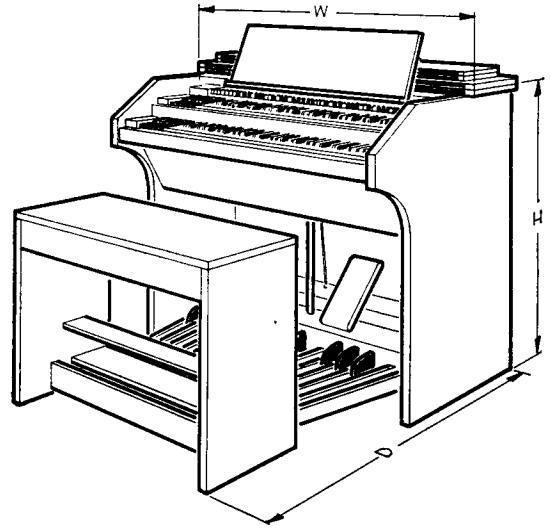

The console size of any electronic organ varies with the manufacturer. Generally speaking, however, any console may be mounted in a space 4 ft. deep and 5 ft. wide. The usual height is 46 in.

SPEAKERS

All electronic equipment shown on this page requires some type of speaker. Its location is dependent upon the acoustics of the building and the desired affect. In the case of an organ type speaker, it may be located as shown in the plans at left, any space 29 in. deep, 37 in. wide and 36 in. high being sufficient. Carillon type speakers may be located in the same relative position as the organ type speakers or in the tower of the church. Maximum dimensions are 17 in. deep, 24 in. wide and 46 in. high.

A carillon, electrically operated but not amplified as the above mentioned equipment, requires space 11 feet square and 7 feet in height.

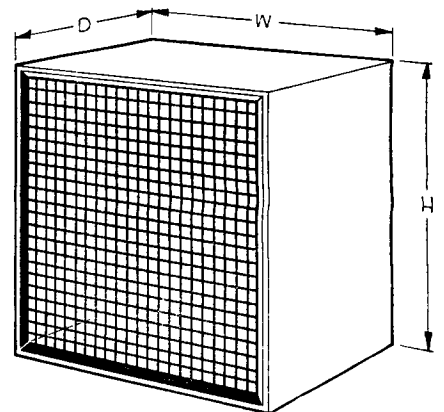

SILV·A·KING

SPECIFICATION

LIFETIME PORCELAIN ENAMELED

fluorescent units

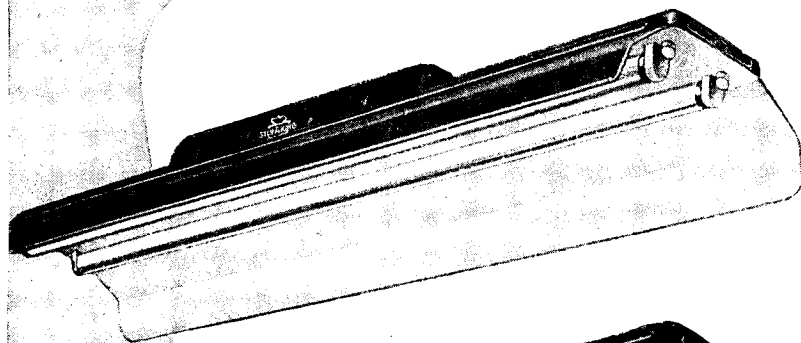

OPEN END UNIT

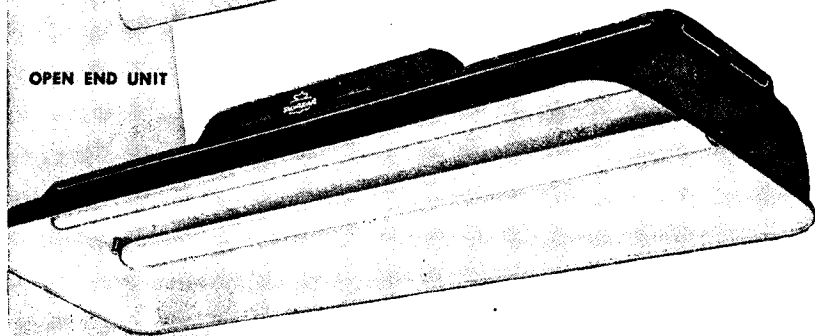

CLOSED END UNIT

Considering that they have *everything* you, yourself, would specify for a top notch lighting unit what better name for SILV-A-KING fluorescent fixtures than SPECIFICATION. First—a porcelain enamel finish that won't discolor . . . won't deteriorate . . . that will maintain initial reflectivity . . . that *really* lasts a lifetime. Second, third, fourth and all of the other reasons why SPECIFICATION leads all the rest are the many SILV-A-KING features incorporated in the unit as illustrated. Study them, compare them. Specify them today.

Write for new bulletin 45FS

All Units U. L. approved and wired A. F. of L. I. B. E. W.



BRIGHT LIGHT
REFLECTOR COMPANY, INC.
METROPOLITAN AND MORGAN AVENUES
BROOKLYN 6, NEW YORK

SILV·A·KING "SPECIFICATION" FEATURES

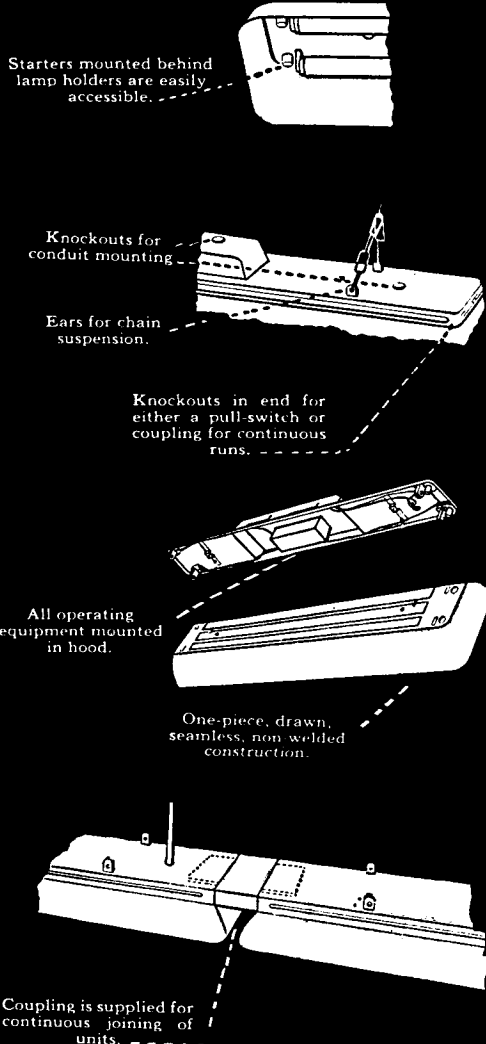

For huge multitier bookstacks or shelving for small libraries Call on SNEAD & COMPANY

Typical SNEAD Library Installations

- U. of Alabama
- U. of California
- Cal. State Library
- Leland Stanford U.
- Library of Congress
- Army War College
- U. of Illinois
- U. of Notre Dame
- U. of Colorado
- Loyola U.
- Harvard U.
- Dartmouth College
- Columbia U.
- Ohio State U.
- U. of Philippines
- U. of Puerto Rico
- Library of Hawaii
- Vatican Library
- Nat'l Museum Nat.
Hist., Paris
- Joint Universities

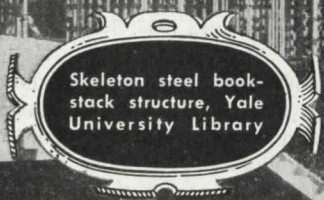

Skeleton steel bookstack structure, Yale University Library

JAMES GAMBLE ROGERS, ARCHITECT

For many generations Snead & Company has been the leader and pioneer in the design and construction of library equipment. Whether you are planning a large multitier bookstack or a library of modest size, it will pay you to contact us for a free consultation.

We will gladly assist in the preparation of plans and specifications, and submit a mutually protective bid. Since proper planning takes time, we suggest that you let us start now, so that your project will be ready for construction when materials are available.

Write for the Snead bookstack catalog containing engineering data.

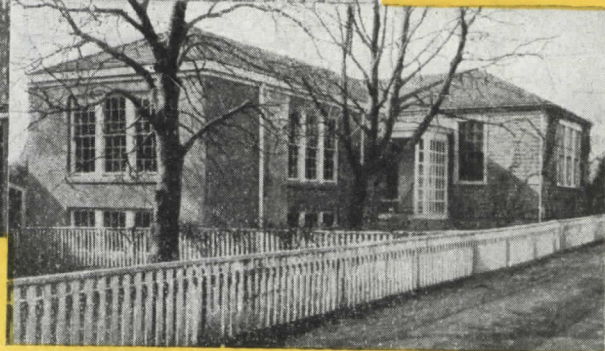

Maria Mitchell Library, Nantucket, Mass., built completely by Snead & Company, including book ranges and other equipment.

Since 1849, the Snead symbol of lasting beauty, quality and progress in metal construction



SNEAD & Company FOUNDED 1849

Designers, manufacturers and erectors of metal equipment

Sales Office: 96 Pine Street, JERSEY CITY 4, N. J.

Main Office and Plant: ORANGE, VA.

REQUIRED READING

CONTEMPORARY SHOPS

In the United States. By Emrich Nicholson. New York 19 (112 W. 46 St.), Architectural Book Publishing Co., Inc., 1945. 8½ by 11 in. 192 pp. illus. \$10.00.

What will be the trend in store design when modernization and new building once again are permitted? In this photographic presentation of 93 shops by 58 architects, there is at least some indication of the answer. The shops selected by Mr. Nicholson were all built in the decade before the war;

they all have proved successful, he tells us, from both the merchant's and the consumer's point of view. This, however, was not the basis for their selection, but rather their "complete understanding of contemporary American merchandizing problems; originality and freshness of design . . . and their contribution to the field of commercial architecture."

Very wisely, Mr. Nicholson allows the photos to speak for themselves, with only a short paragraph of text to

point out their main features. These features include the "open front," increasing differentiation in shop design, thoughtful use of space, adequate and effective lighting.

BUILDING CONSTRUCTION ESTIMATING

By George H. Cooper, New York 18 (330 W. 42nd St.), McGraw-Hill Book Co., Inc., 1945. 6 by 9 in. xiv + 282 pp. illus. \$3.00.

Intended for use in technical and vocational schools, this textbook is complete without being weighed down by superfluous matter. Material ordinarily covered in other courses is largely omitted; where it is necessary to the discussion of estimating, it is treated as briefly as possible. At least two years of architectural drafting are recommended as a prerequisite for the course as outlined.

The background material includes descriptions of the architect's, engineer's and contractor's duties and methods of working, a good treatment of plan reading, and a discussion of contracts. The rest of the book is devoted to a detailed study of estimating, giving a complete working plan for the instructor, and providing all the material needed. Specimen estimate sheets are included in every chapter, and a liberal number of illustrations are used for maximum clarity.

DOELMATIC BOUWEN EN WONEN

(Practical Building and Living). By Paul Bromberg. New York 16 (381 Fourth Ave.), Querido, Inc., 1945. 8 by 10 in. 158 pp. illus. \$3.50.

For anyone who can read the Dutch language, this book offers an interesting comparison of American and Dutch production methods, materials and traditions, and housing needs.

Prefabrication, naturally enough in view of the tremendous amount of rebuilding which Holland will have to do now that the war is over, is Mr. Bromberg's chief concern. Not only does he sketch the organization of the prefabrication industry and discuss the materials that might be used for prefabrication in Holland; he also gives his opinion on the esthetic possibilities of this method of building, and offers concrete suggestions as to how various American systems of prefabrication may be applied to Dutch soil conditions and climate. A final chapter sums up the current trends in interior arrangement, with considerable emphasis on built-in furniture and other space-saving devices.

This book obviously is intended for the Dutch builders just setting out on their task of reconstruction, to whom, with its detailed information and its numerous illustrations, it should prove of real interest and help.

KITCHEN PLAN NO. 27: Twenty-seventh of a series of successful mass-feeding kitchen plans.

To feed more than 1,700 naval students at John Jay Hall, Columbia University, required complete revamping of the whole kitchen. This is the new high speed kitchen plan that has been successfully operating there.

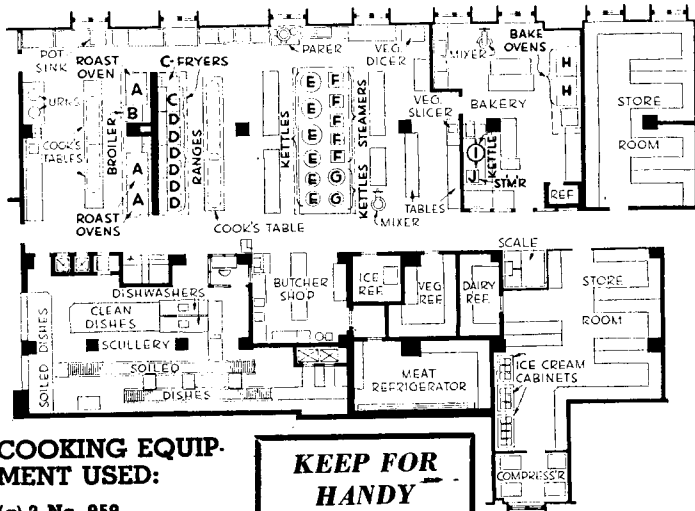

COOKING EQUIPMENT USED:

- (a) 3 No. 959 BLODGETT GAS-FIRED ROASTING OVENS
- (b) 1 hotel broiler
- (c) 2 deep fat fryers
- (d) 6 heavy-duty ranges
- (e) 6 stock kettles—480 gallons total capacity
- (f) 5 vegetable steamers
- (g) 2 stock kettles
- (h) 2 No. 982 BLODGETT GAS-FIRED BAKING OVENS
- (i) 1 stock kettle
- (j) 1 steamer

KEEP FOR HANDY REFERENCE!

Designed by: John Cini, Kitchen Equipment Engineer, Nathan Straus-Duparquet, Inc., New York, N. Y.

THE NO. 959 BLODGETT OVENS used in this installation have a capacity of more than 1,800 lbs. of meat and are used for a wide variety of roasting and vegetable work. The two No. 982 BLODGETT BAKING OVENS handle all the baked goods of a heavy and varied menu. For details and specifications of BLODGETT OVENS, consult your equipment house or write

THE G. S. BLODGETT CO., Inc.
53 MAPLE STREET BURLINGTON, VERMONT

Reprints of this new series will soon be available to architects on request.



Asbestos in Action

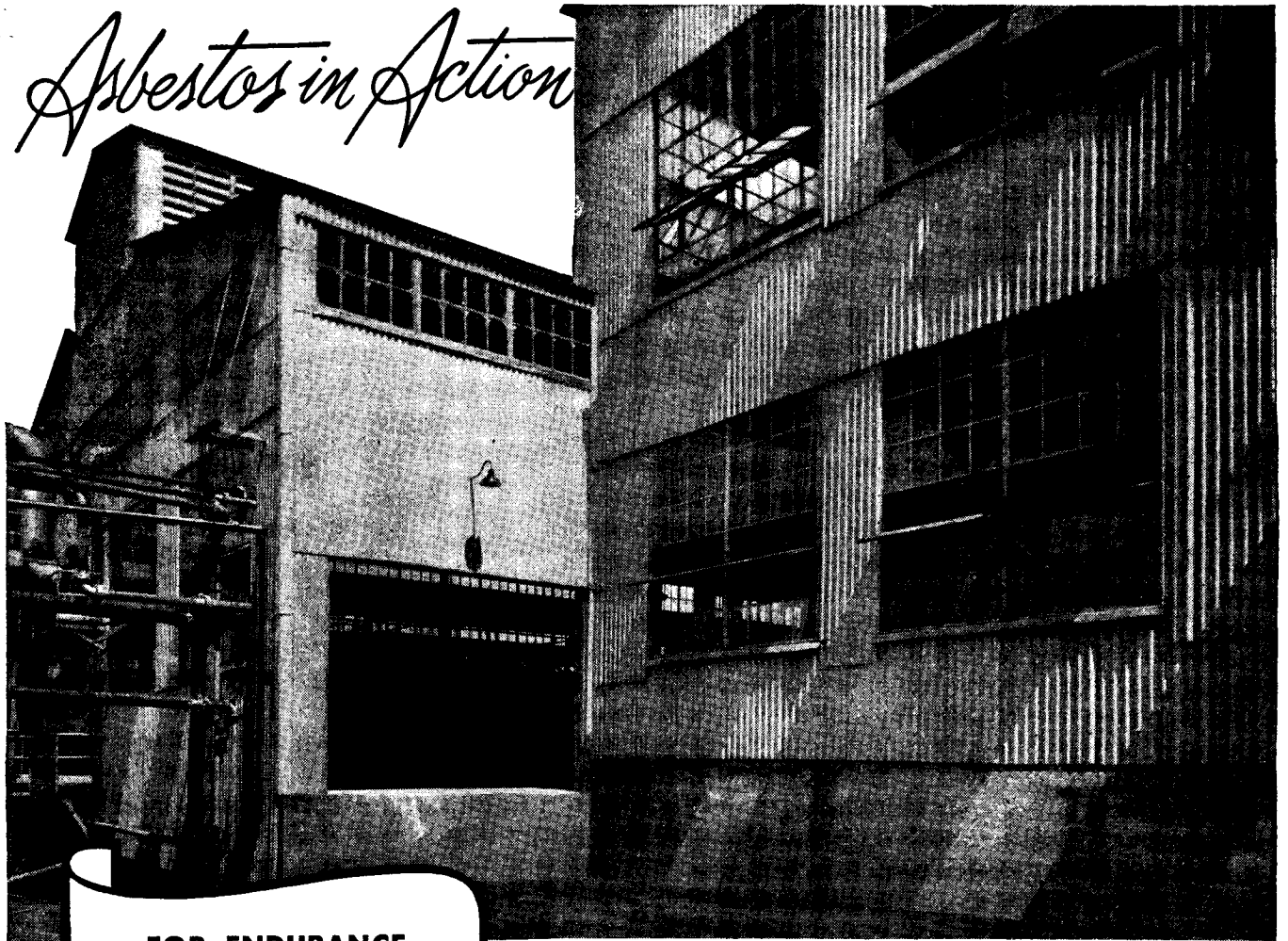

**FOR ENDURANCE
AND LOW
MAINTENANCE COSTS**

**K&M "Century" ASBESTOS
CORRUGATED AND FLAT LUMBER**

Asbestos fibre is tough! Portland cement lasts forever! These are the materials used in K&M "Century" Asbestos Corrugated and Flat Lumber. Combined under tremendous hydraulic pressure, the result is amazing.

No wonder this sturdy material lasts a long time and is low in maintenance cost. It resists corrosion... fire... weather. It is strong... durable... dependable. Paint is never needed for protection.

Installation time is cut to a minimum with K&M "Century" Asbestos Corrugated and Flat Lumber. Not only is "Century" Corrugated ideal for heavy duty roofing and siding but Flat Lumber is well adapted to such interior uses as walls, ceilings, partitions, ducts and fume hoods.

K&M "Century" Asbestos Corrugated and Flat Lumber speeds up construction, and its light gray color is pleasing and permanent. Approved distributors of Keasbey & Mattison will be glad to help you with any special problem you may have in your industrial expansion program.



**KEASBEY & MATTISON
COMPANY • AMBLER • PENNSYLVANIA**

urban districts—the deteriorating and blighted sections that are found near the centers of most urban communities, and the defunct sub-divisions inherited from times past.” This is a subject covered by the Wagner-Ellender housing bill.

NHA purposes (a) a possible write-down in the price of central land by 60 to 70 per cent and (b) use of public credit supplemented by contributions to bridge the gap between the cost of the

land and the estimated return of about 1.6 per cent.

Even though city rebuilding is a clear concern of states and cities, says the Agency, this may be supplemented by federal aid to assemble land covered with bad housing for redevelopment with good homes. The redevelopment task is not alone one for large cities, say officials, since the 1940 census showed that half of all urban dwellings needing major repairs or lacking a private

bath were in cities of less than 100,000 population.

Three “sovereign powers” can be used in land assembly, NHA advises: the police power, the power of eminent domain, and taxation and public credit.

Veterans Want Homes

Housing for veterans remains a matter of official concern. NHA has opened vacant privately-financed war housing to veterans and their families on the same terms as to in-migrant, essential civilian workers. The Bureau of the Budget has recommended to the President, and the President has asked the Congress for, the transfer of \$18,373,000 in war housing funds to carry out the current law for construction of housing for veterans and their families in hardship cases.

Other action on behalf of veterans includes special priorities to build homes, preference for veterans in privately financed housing built under the H-2 program, and eligibility for vacancies in prewar federally-aided low-rent projects.

Mortgage Insurance Mounts

The Federal Housing Administration, which in July got a new Commissioner, Raymond E. Foley, of Detroit, announces that its operations in insuring mortgages on existing houses during the year ended June 30 were the largest in volume in five years. During the fiscal year 1944-45, FHA received 76,650 applications for mortgage insurance representing a dollar volume of \$378,346,000. It issued commitments in 52,119 cases amounting to \$242,079,000.

FHA expects its mortgage authority to be an important factor in carrying out home loan provisions of the GI Bill of Rights. The war housing insurance program, on the other hand, is drawing to a close, although Congressional authorization has been given to continue such insurance operations until next July.

Little change in FHA policy is expected under Mr. Foley, who takes the post left vacant by Abner H. Ferguson. The new Commissioner served as FHA State Director for Michigan almost from the time the office was established.

Washington Notes that—

—FHPA reports formation of a National Association of Rural Housing to develop a program of rural slum clearance and low-cost housing, headed by George B. Hamilton, State Treasurer of Georgia.

—One hundred per cent direct financing from private capital on a low-rent housing project occurred for the first time in July, reports NHA, when New

(Continued on page 124)

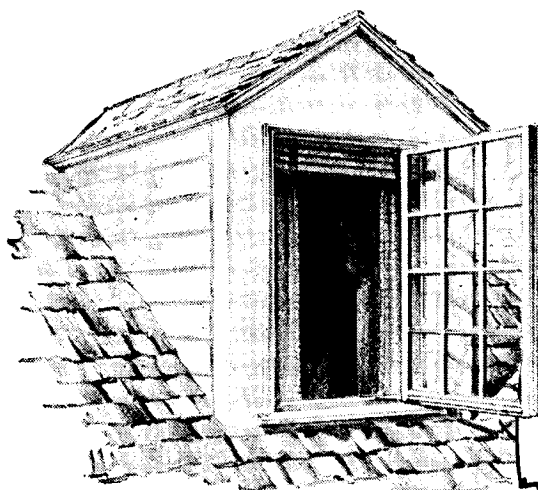

3 LIGHTS WIDE CASEMENT UNITS

.. thanks to special Pella hinge design and rigid steel frame

Here is a line of casement units with full 28" sash openings. Heights run from 2' - 4 1/2" up to 4' - 5 1/4". These attractive stock-size units are helpful in solving many problems of design and proportion.

Pella special design hinges provide an extra long 5 1/2" plate for screwing into the solid wood top and bottom sash rails. Butt plate is riveted to the welded steel inner frame of Pella casement units. Hinge extends to allow washing from inside. Tamper-proof when closed. A special mortise and tenon sash joint gives greater gluing surfaces. Joints are also steel-dowelled. Sash is made from genuine White Pine full 1 3/4" square and toxic-treated. Pre-war installations have demonstrated these 3-light wide Pella casements to be thoroughly practical on all counts.

PELLA 3-LIGHT WIDE SASH easily supports weight of 300 lb. man without springing sash "out-of-true."



Free FOR YOUR FILE!

22 separate pages of scaled Pella casement details for all types of installations. Send for your FREE set today. Write: ROLSCREEN COMPANY, Dept. E-95, Pella, Ia.

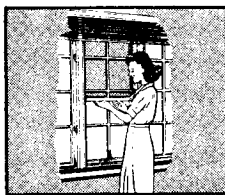
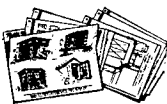

ROLSCREENS — the original roller-type inside screens. The ultimate in screen efficiency and convenience.



DUAL GLAZING—a single panel type that mounts on inside of sash. Inconspicuous. Easily removed for cleaning.

Pella CASEMENT WINDOWS
Made by makers of Famous Pella ROLSCREENS and Pella VENETIAN BLINDS

To Make Definitely Sure..

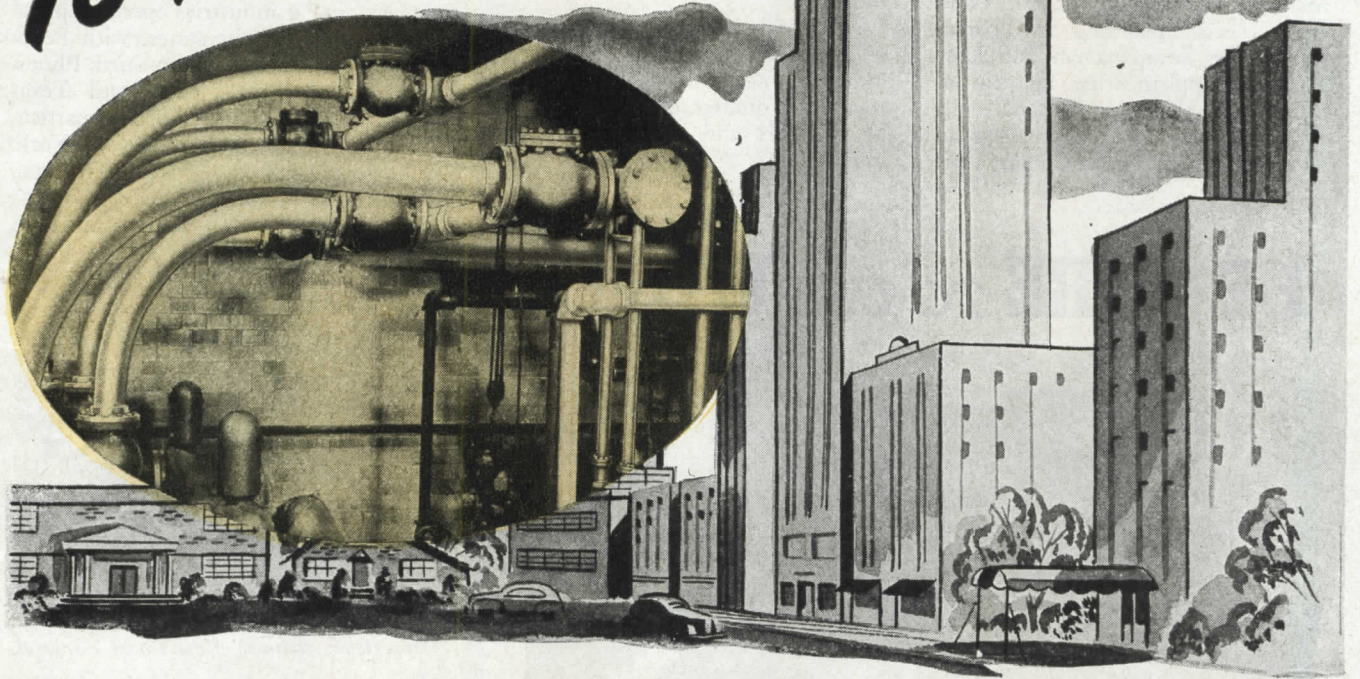

SPECIFY "ONE-PIECE" COPPER AND BRASS PIPE LINES

... with Silbraz Joints—*

You can specify Silbraz valves and fittings with complete assurance that they will "stand-up" under all conditions — and give your clients 100% satisfaction.

These threadless Silbraz fittings are leakproof and permanent — stronger than the pipe itself. They will not creep or pull apart under any shock or pressure which the pipe itself can withstand. Once installed they are good for an indefinite period of maintenance-free service.

Easily installed, Silbraz joints are particularly suited to hot and cold water circulating lines, boiler feed lines, steam return lines, condensate lines, low and high pressure air piping systems, industrial gas piping; and many other applications in hospitals, schools, apartments, commercial, public and industrial buildings.

*Reg. U. S. Pat. Office

WITH THE SILVER ALLOY RINGS

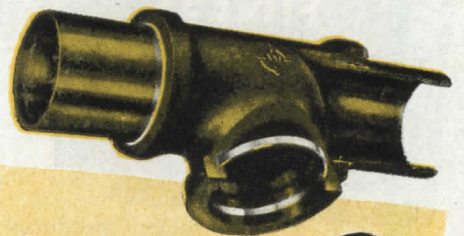

**He is ready to Handle
Your Silbraz Specifications**

Better plumbing and heating contractors already have the special Airco oxyacetylene equipment for making Silbraz parts and the "know-how" to do the job. You can rely on them to install "one-piece" Silbraz copper or brass piping systems.



AIR REDUCTION

General Offices: 60 EAST 42nd STREET, NEW YORK 17, N. Y.
In Texas: MAGNOLIA AIRCO GAS PRODUCTS CO. • General Offices: HOUSTON 1, TEXAS
Offices in all Principal Cities
Represented Internationally by Airco Export Corporation

York City's Clason Point Gardens project long-term bond issue was taken up by a group of investment bankers. —Maj. Gen. Philip B. Fleming, Federal Works Administrator, has taken a firsthand look into public works and housing needs, planning and operations, in the Scandinavian and Low Countries, supplementing his trip of last fall to England and Russia. —Henry A. Wallace, whose Bureau of Foreign and Domestic Commerce is

lining up a staff and generally organizing its new construction division for which Congress recently supplied \$75,000, expects the initial swing of gathering data to get under way in the fall.

—Preferential ratings for construction and equipment materials necessary to industrial reconversion had reached roughly a quarter of a billion dollars by mid-July and were continuing to mount.

—NHA in its annual report points to "a dangerous inflationary trend in urban real estate prices during 1944," and advises that building costs continued to rise during the year.

—WPB has a report entitled "Characteristics of War Manufacturing Facilities" which shows that most of the \$20 billion war expansion came in areas where similar industries operated previously. Ohio led the states, with Pennsylvania second, Michigan third, Illinois fourth, New York fifth, and Texas sixth. Ten large cities netted particularly: Chicago, Detroit, New York, Philadelphia, Los Angeles, Houston, Pittsburgh, Cleveland, St. Louis and San Francisco. Population shifts to these areas were heavy.

BE SURE TO USE WHITE

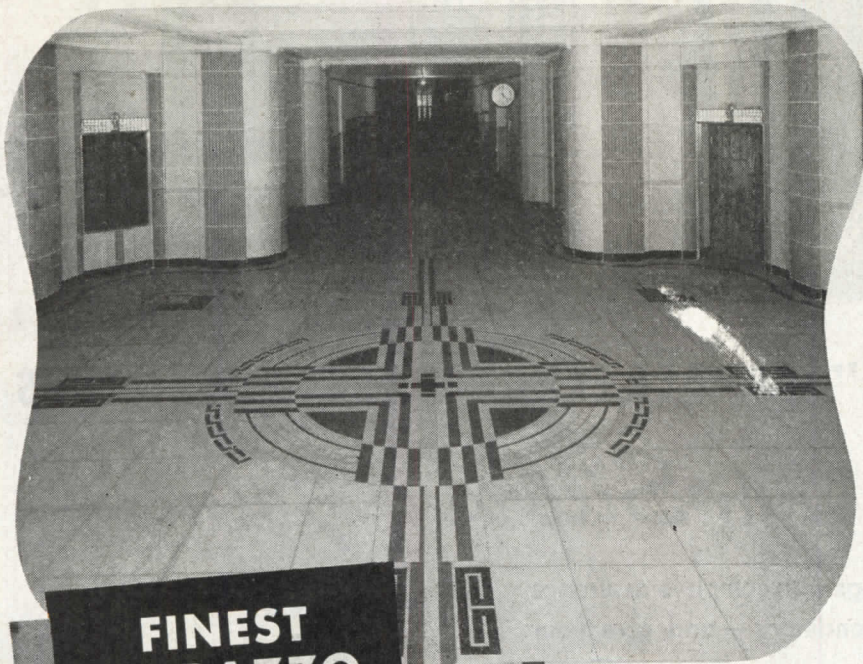

**FINEST
TERRAZZO**
*is made with
white cement*

Architects who know terrazzo advise, "Be sure to use White." They know a clean white matrix brings out the beauty of the chips. They know that only white

cement produces the exact shade of pastel tints or brilliant, strong tones when pigments are used. They know the difference in cost is only a few cents per square foot. Profit by their experience—start with white cement if you want perfect terrazzo. And for your own peace of mind, specify Medusa—the original WHITE Portland Cement, proved by over 35 years of use.

MEDUSA PORTLAND CEMENT COMPANY
1015 Midland Building • Dept. D • Cleveland 15, Ohio



MEDUSA *the ORIGINAL WHITE
portland cement*



American Airlines' West Coast terminal.

AIRLINES TICKET OFFICE

A transportation mural by Robert Bushnell, depicting the part that modern aviation plays in the life of mankind, and a huge wall map showing the airlines routes all over the world, are features of American Airlines' new West Coast Terminal in downtown Los Angeles.

The mural, 10 ft. wide and 16 ft. high, illuminated by hidden lights, forms a backdrop against which travelers will be served at an individually styled ticket counter done in bleached walnut. Behind the counter the diorama world map, 16 ft. high and 30 ft. wide, occupies the entire wall to the ceiling. Representing the ideas of 23 artists who worked closely with American's Hal Laird, an executive of the advertising department, the map achieves a three-dimensional effect with continents floating in a sky of many-toned clouds. American Airlines routes are indicated in red lucite, other airline routes in white. As new routes are opened, they will be added to the map, so that visitors to the new terminal will have a ready picture of air transportation throughout the world.

General color scheme of the new office combines a blue ceiling of acoustical tile and blue front wall with other walls painted a beige gray. Furniture, except for the ticket counter, was

(Continued on page 126)

Non-Fireproof Buildings can be made Fire-Safe

LAST DECEMBER 200 people were enjoying a party in a Baltimore parish hall. Suddenly, flames appeared in the overhead drops at one end of the hall. A frantic scream of "Fire" caused a moment of stunned silence which gave way almost immediately to a mad rush for the main entrance — this, in spite of the fact that there were nine exits from the hall all marked with exit lights. As a result of this frenzied rush of terror-stricken people two were killed and thirty were injured.

Like thousands of others, this hall of non-fireproof construction and entirely devoid of reliable means of fire

protection, which controls fire automatically as soon as it starts, before it reaches dangerous proportions.

In discussions with those responsible for church property, the merits of automatic sprinkler fire protection are oftentimes fully understood and accepted, but there is an unfounded apprehension of the cost, the inconvenience during erection and the unsightliness of the installation.

Let us consider the question of cost first. To replace an existing non-fireproof building today will cost at least 50% more than its original cost. Even full-value insurance will leave you far short of necessary replacement funds. Yet for only a small percent of its value, a non-fireproof building can be made fire-safe by the installation of an automatic sprinkler system.

As for the inconvenience of installation and the resulting unsightliness, the answer can be found in the experience of His Excellency, Most Reverend James E. Cassidy, D.D., Bishop of Fall River, Massachusetts. The accompanying picture of the chapel of Our Lady's Haven, a diocesan institution in Fairhaven, Massachu-



View of Baltimore Parish Hall Fire

protection was a potential death trap to any group that assembled there. The fact that its entire roof was ablaze in two minutes testifies to its extreme fire hazard.

This Baltimore tragedy is selected not as an isolated case, but as a significant example of what can occur without warning in thousands of church properties. Here was a building of non-fireproof construction in which people assembled for religious and social gatherings. According to the belief of those responsible for their safety, means had been provided for the rapid and orderly exit of hundreds of people. Unfortunately, in time of fire people invariably stampede blindly toward one main exit totally disregarding nearby emergency exits. Too often, personal injury and loss of life follow.

"What can be done about it?" is the logical question you may be asking yourself. Fortunately, experience has proved that there is one sure safeguard against fire, which operates automatically, instantly and without human supervision. There is a way to make non-fireproof buildings safe. The answer is automatic sprinkler fire protec-



Chapel of Our Lady's Haven equipped with Automatic Sprinklers

tion, which controls fire automatically as soon as it starts, before it reaches dangerous proportions. sets, shows how inconspicuously the automatic sprinkler system is blended into the room's architecture.

When consideration is given to the fact that church fires in the U. S. occur on an average of three each day, the importance of an adequate, automatic means of protecting life and property becomes increasingly apparent. Those responsible for safeguarding life and property will find much of interest in a booklet "Sprinklers Provide Safety to Life from Fire" reprinted from the January 1945 Quarterly of the National Fire Protection Association. A copy of this booklet may be had by writing to the Grinnell Company, Inc., Providence 1, R. I.

(ADVERTISEMENT)

specially designed by American and manufactured by W. J. Sloane & Co. The upholstery is of a terra-cotta colored leather which matches the border of the blue marbled flooring by Armstrong. A battery of 51 concealed ceiling lights provides over-all daylight illumination at all times.

CONSTRUCTION GAINS

Marked by a pronounced recovery in privately-owned manufacturing building, construction activity in the 37

states east of the Rocky Mountains showed substantial gains in the first half of the year, F. W. Dodge Corp. reports.

All major classifications of construction showed gains over the first half of last year except residential building, which was down slightly more than 3 per cent.

The total of all construction contracts awarded in the 37 states during the first six months was \$1,482,399,000 compared to \$960,221,000 in the cor-

responding period of last year, a gain of 54 per cent.

Nonresidential construction in the first half amounted to \$807,612,000, an increase of 106 per cent. Residential construction declined from \$203,892,000 to \$197,509,000. Public works and utilities totaled \$477,278,000, an increase of 31 per cent.

Manufacturing building construction contracts aggregated \$515,806,000 in the first six months to establish a gain of 162 per cent over last year's \$197,077,000.

Continued improvement in the position of privately owned construction as compared with publicly owned construction was revealed. Privately-owned construction contracts in the first six months totaled \$573,491,000 compared to \$243,543,000 in the corresponding period of last year. Privately-owned construction in the first six months represented 39 per cent of the total of all contracts, as against 25 per cent of the total in the first half of 1944.

CONFERENCE ON PLANNING

The Massachusetts Institute of Technology announces that its ninth annual Conference on City and Regional Planning will be held from October 22 to November 2, 1945. Sponsored jointly by the Institute and the American Society of Planning Officials, it will be open to men and women who have had practical experience in planning or in a related professional field.

Seminars will be held each morning and afternoon, beginning Monday, October 22, and will cover principles and techniques of planning and planning legislation and administration. The staff for the Conference will consist of Frederick J. Adams, professor of City Planning; Flavel Shurtleff, associate professor of Planning Legislation and Administration; Homer Hoyt, associate professor of Land Economics; and Roland B. Greeley, assistant professor of Regional Planning.

Following the Conference, a special 10-weeks training course will be held during which specific projects will be developed in the drafting room, supplemented by library research and round-table discussions. This course, together with the Conference, will be similar in scope to the short training course given at M.I.T. during the spring of 1944, except that particular emphasis will be given this year to problems of urban redevelopment.

Applications for the Conference and requests for further information on the training course should be sent to Prof. Frederick J. Adams, Division of City Planning, Massachusetts Institute of Technology, Cambridge 39. Applications must be received not later than October 1.

(Continued on page 128)

Fuel-Saving Starts With
CONTROL

PLAN TO INSTALL the
BARBER-COLMAN
Econostat

THE SYSTEM THAT AUTOMATICALLY ADJUSTS HEAT-ON PERIODS TO MATCH OUTDOOR TEMPERATURES

APARTMENTS, store and office buildings, factories, hospitals, and churches can achieve greater fuel economy, avoid overheating, and maintain more uniform temperatures by installing the ECONOSTAT. It regulates the heating system of the building directly from the outdoor temperature by supplying the heat at intervals. Comfortable indoor temperature conditions are maintained by varying the "heat on" periods in accordance with outdoor temperature changes. A wide range of adjustments permits the instrument to be adapted to the operating condition of the individual installation. The length of time for each cycle, the operating range, the calibration, the amount of night temperature depression, as well as the morning warm-up, are all adjustable. The result is a simple, compact, and dependable temperature control system which can be easily installed and adjusted to assure economical fuel consumption. Write for new circular giving full details, or see your Barber - Colman representative. Plan **NOW** for next winter's fuel savings.

BARBER-COLMAN COMPANY
1232 ROCK STREET • ROCKFORD, ILLINOIS

GENERAL BRONZE PRESENTS ITS NEW LINE OF PERMATITE

Windows

for hospitals, schools and commercial buildings

DETAILS OF
PERMATITE
ALUMINUM
DOUBLE HUNG
HOPPER VENT
WINDOW
SERIES DHA-3HV

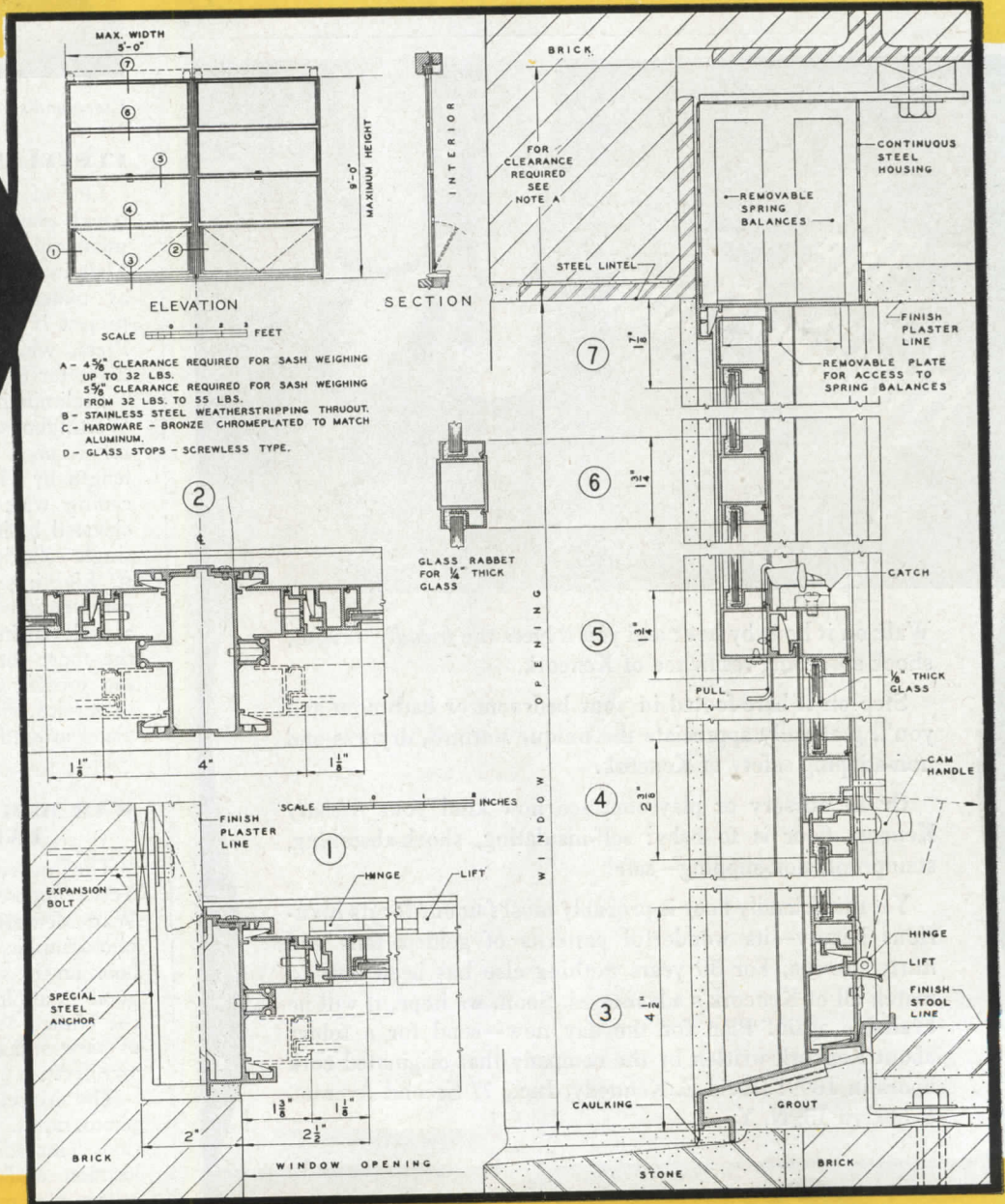

IF you would like a complete set of details of this and other new PERMATITE windows for your files, write us today on your letterhead.

SPECIFY
GB
BUILDING
PRODUCTS

Detailed above is the second of a series of new and improved PERMATITE windows. It embodies all the patented and exclusive features that have made the name PERMATITE representative of the finest in window design and construction. The integral in-swinging hopper in the lower sash is of particular importance in hospital design.

GENERAL BRONZE CORPORATION
34-15 TENTH STREET
LONG ISLAND CITY 1, N. Y.

HOW MANY

LOW-COST HOMES?

Three out of every four houses built in the first year after the war in nine representative cities will be medium or high priced, according to the results of Opinion Surveys conducted in these cities by the Urban Land Institute.

Opinion in the nine cities—Chicago, Cleveland, Dallas, Denver, Houston, Los Angeles, Portland, San Francisco and Seattle—is that 26 per cent of the

first year's crop of houses will be low cost, 61 per cent medium, and 13 per cent high. A tenth city, Memphis, varied strikingly from the general pattern: there the estimates are 60 per cent low cost, 30 per cent medium, and 10 per cent high.

Reasons given for the comparatively small percentage to be built in the low price range in most localities were: (1) the expected tremendous demand for houses costing more than \$6,000

which has been held back due to war conditions; and (2) the expected departure of at least 50 per cent of immigrant war workers who will leave Title VI war housing vacant.

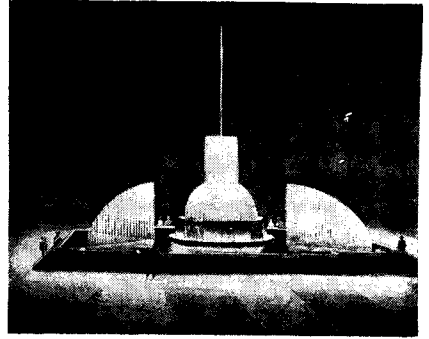

Cleveland's proposed Memorial Fountain

CLEVELAND WAR MEMORIAL

One of the first war memorials for which plans have been announced is a memorial fountain to be built on the Mall in downtown Cleveland as soon as materials become available. The project is sponsored by the Cleveland Press, which is currently backing a drive for \$100,000 to finance it.

Preliminary plans, made by the Westinghouse Lighting Division, call for a pool approximately 130 ft. in length by 110 ft. in width, with cascading water displays grouped in an elevated basin and centering around a single solid jet rising to a height of 70 ft. Lighting effects will vary, as will combinations of water displays, through a cycle lasting 30 minutes. Names of the more than 3000 servicemen from the greater Cleveland area who died in service will be engraved on bronze plates around the top of the main pool wall.

WAR MEMORIALS EXHIBITION PLANNED

The Museum of Modern Art, New York, proposes to hold an exhibition of War Memorials, in both model and photographic form, and to publish a book on the same subject. Broadcasting good examples will show localities in the United States a more varied point of view and encourage a wider use of architects.

The Museum is anxious to secure photographs, dates and full descriptions (including an exact account of location and material) of really excellent war monuments anywhere, but particularly in the United States. Since the smaller monuments are least well recorded, it is these in which the Museum is especially interested. Material should be submitted to the Department of Architecture, Museum of Modern Art, 11 W. 53rd St., New York 19, N. Y.

(Continued on page 138)



Walk on it hour by hour and you'll bless the *friendly*, restful, shock-absorbing resilience of Kencork.

Step on it bare-footed in your bedroom or bathroom and you'll gratefully appreciate the unique warmth, dryness and non-slipping safety of Kencork.

Or in nursery or playroom see how kind your *friendly* Kencork floor is to baby: self-insulating, shock-absorbing, stainproof, non-slipping—safe!

Yet this friendly floor is probably most famous for its luxurious beauty—its wonderful patterns of golden tans and nutty browns. For 30 years nothing else has been able to match all of Kencork's advantages. Soon, we hope, it will be available again. Plan for the day now—send for a folder about Kencork written by the company that originated cork floors in 1899: David E. Kennedy, Inc., 71 Second Avenue, Brooklyn 15, N. Y.

KENCORK
the friendly floor

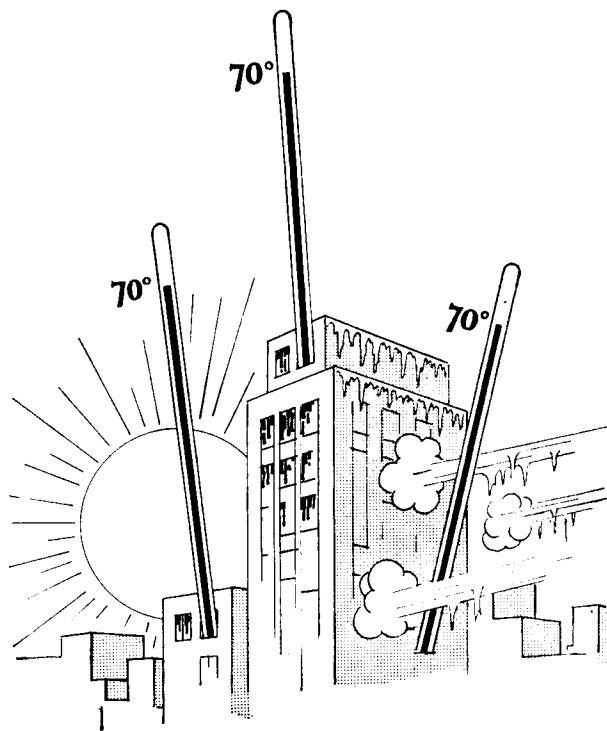

Measure for Heating Values

Even, comfortable temperature—in every room; on every side of the building—in zero weather and on mildest days—with lower fuel bills . . . The value of a Heating System is measured in Comfort balanced against Cost.

The Webster Moderator System of Steam Heating delivers to *each* radiator only the amount of steam required to maintain an even, comfortable temperature regardless of exposure or changes in outside weather conditions. It is an automatic system with automatic controls. It won't overheat. It won't underheat.



The Webster Outdoor Thermostat automatically changes heating rate when outdoor temperature changes.

“Control-by-the-Weather is provided by an Outdoor Thermostat which automatically balances the delivery of steam to agree with every change in outdoor temperature.

More Heat with Less Fuel

Seven out of ten large buildings in America (many less than ten years old) can get up to 33 per cent more heat out of the fuel consumed! . . . A book “Performance Facts” gives case studies—*before* and *after* figures—on 268 Webster Steam Heating installations. Write for it today. Address Dept. AR9

WARREN WEBSTER & COMPANY, Camden, N. J.
Pioneers of the Vacuum System of Steam Heating : : Est. 1888
Representatives in principal U. S. Cities : : Darling Bros., Ltd., Montreal, Canada

Fuel-Saving Starts With CONTROL

AUTOMATIC
Webster
Steam Heating

SMOKE DETECTION

A photoelectric system now available detects the presence of smoke in air conditioning ducts and immediately sounds alarms, turns off blowers, operates automatic dampers, or provides whatever other type of indication or control is required.

The system consists of Photoelectric Control Type A26X and Light Source Type L11RX. The latter may be mounted to project a beam of light

over any distance from 10 to 25 ft. to the "eye" of the photoelectric unit. A sensitivity adjustment on the light source housing permits variation in the intensity of the light beam and may be set so that the photoelectric control will respond to smoke of a predetermined density. Type A26X will then remain inoperative at any other level of illumination, but will be actuated when smoke haze sufficiently reduces the amount of light reaching the photo-

tube. To provide complete protection, Type A26X is so designed that either current or tube failure will cause the control to operate as though the light beam were interrupted.

Both units are available either in Underwriter-approved explosion-proof housings for mounting in Class 1 Group D hazardous areas, or in weather-proof pressed steel housings. Photoswitch, Inc., 77 Broadway, Cambridge 42, Mass.

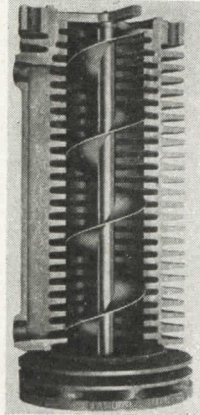

Cutaway of temperature control unit shows cooling fins, helicoid flighting

TEMPERATURE EXCHANGER

A new temperature exchanger based on the principle of heat transfer for air and gas lines offers as a by-product external heating applications and positive purification by centrifugal action.

This specially designed unit, as an after-cooler, is recommended for installation at the compressor discharge point. For accommodating large volumes of air or gas, parallel assemblies may be made, and the design permits tandem installation to any required length. Available for both flanged and screwed-type assemblies; may be provided for either manual or automatic drainage of the sump. The Bird-White Co., 3119 W. Lake St., Chicago 12, Ill.

STANDARDS

Pipes, Ducts

Printed copies of Simplified Practice Recommendation R207-45, Pipes, Ducts and Fittings for Warm Air Heating and Air Conditioning, are now available.

Fittings for both gravity and forced air heating and air conditioning systems are covered, the former including double-wall pipe and fittings. Sketches illustrate the 91 types of fittings, various sizes of which are included in the list, as well as the recommendations as to which items are to be carried in galvanized iron and which in tin.

Copies of the Recommendation may be obtained from the Superintendent of Documents, Government Printing Office, Washington 25, D. C., for 10 cents each.

(Continued on page 132)

Why

SPENCER CENTRAL VACUUM COSTS LESS

Because it cleans better, Spencer Vacuum is sometimes assumed to be more expensive. Architects who have specified Spencer for a quarter century says it costs less because:

1. It is faster.
2. No dirt left to ruin rugs, decorations, equipment.
3. Maintenance is extremely low—for a lifetime of service.
4. Additional uses listed below frequently pay for the installation in a few years.

Ask for the bulletins.

SPENCER
CLEANS
FLOORS
WALLS
CEILINGS
GOODS
MACHINERY
FILTERS
BOILERS
AND
RADIATORS

SPENCER VACUUM
HARTFORD
CLEANING

THE SPENCER TURBINE COMPANY, HARTFORD 6, CONN.

The Ugly Duckling Room gets a Beauty Treatment



AUTY LIKE THIS IN THE BASEMENT IS POSSIBLE WITH STEEL JOIST CONSTRUCTION

CECO STEEL JOISTS BRING LIVINGROOM LOVELINESS TO THE BASEMENT

Now both beauty and efficiency are possible in modern homes because of steel joist construction. Yes, there's new beauty . . . new efficiency ahead, even for basements. That's because steel joists eliminate unsightly supports . . . provide unobstructed floor areas . . . permit neat, trim ceilings.



Beauty of construction is made possible by Ceco steel joists. No special skill or equipment needed in placing them. They are easily moved into position and quickly spaced. After bridging, floor and ceiling are installed.

Bigger buildings point the way!

Ceco drew from its wide experience in the light occupancy building field to bring steel joist construction to home building. For in bigger buildings where both permanence and beauty are desired, builders everywhere turn to Ceco steel joists for flexibility in design, rigid sturdy floors and greater safety too.

Why builders prefer CECO Steel Joists

- | | |
|---|---|
| <ol style="list-style-type: none"> 1. Easy to install—no special skill or equipment required. 2. Eliminate fitting electrical fixtures to chopped-up ceiling areas. 3. Provide convenient tunnel system for pipes and conduits. 4. Provide cooler floors in summer—warmer floors in winter. | <ol style="list-style-type: none"> 5. Eliminate sagging partitions and squeaky floors. 6. Eliminate dry rot and termites. 7. Cut insurance costs by reducing fire hazards. |
|---|---|

Ceco offices in principal cities maintain staffs of construction engineers to serve you. Write Ceco today for information regarding: (1) Ceco open web steel joists, (2) Ceco long span joists, (3) Ceco nailer joists.

CECO STEEL PRODUCTS CORPORATION

MANUFACTURING DIVISION
5701 WEST 26TH STREET, CHICAGO, ILLINOIS
Concrete Engineering Division,
Sheet Steel & Wire Division, Highway Products Division

Solder-Joint Fittings

The proposed simplified practice recommendation for cast brass solder-joint fittings has been approved for promulgation, according to an announcement of the Division of Simplified Practice of the National Bureau of Standards.

The recommendation, identified as R212-45, Cast Brass Solder-Joint Fittings, has been effective since July 1, 1945. It sets up a stock list of cast

brass solder-joint fittings, and sketches illustrate the 37 types of fittings, various sizes of which are listed.

Until printed copies of R212-45 are available, mimeographed copies may be obtained from the Division of Simplified Practice, National Bureau of Standards, Washington 25, D. C.

Stock Fir Doors

Recommended Revision, TS-3963, of Old Growth Douglas Fir Standard

Stock Doors (Second Edition), Commercial Standard CS73-43, has been submitted to producers, distributors and users for written acceptance prior to publication by the National Bureau of Standards.

Plumbing Code

To foster uniformity and simplification of plumbing codes, and as an aid to the vast postwar housing construction program, an American Standard Plumbing Code has been completed under the procedure of the American Standards Association by a nationally representative committee organized under the sponsorship of The American Public Health Association and The American Society of Mechanical Engineers.

Printing and publication of the code is being handled by The American Society of Mechanical Engineers, 29 W. 39th St., New York 18. Inquiries should be addressed to that office. When approved by the Standards Council of the A.S.A., it will be made available in booklet form, as the American Standard Plumbing Code, A40.

Metal Lath

Under United States Department of Commerce, National Bureau of Standards, Simplified Practice Recommendation R3-44 Metal Lath, Expanded and Sheet, and Metal Plastering Accessories are greatly simplified and standardized. This recommendation, promulgated by the Division of Simplified Practice of the National Bureau of Standards of the U.S. Department of Commerce, was approved on April 11, 1944, "to become effective when the critical materials are available."

In a communication of June 19 to all acceptors of this recommendation, the Division of Simplified Practice calls attention to the fact that under the WPB action of May 10, Limitation Order L-59-b, which controlled the manufacture of metal lath and accessories, was revoked and Simplified Practice Recommendation R3-44 may be considered as now in effect.

Copies of R3-44 are available from the Superintendent of Documents, Washington 25, D.C., at five cents each.

Cement Flooring

Acting upon request of the Oxychloride Cement Association, the American Standards Association has announced that it will set up a committee to develop specifications for the installation of oxychloride cement flooring. The standard will cover (1) specifications and methods of test for materials for oxychloride cement floors, and (2) specifications covering the installation of such floors.

REG. U.S. PAT. OFF.
Mo-Sai
ARCHITECTURAL SLABS

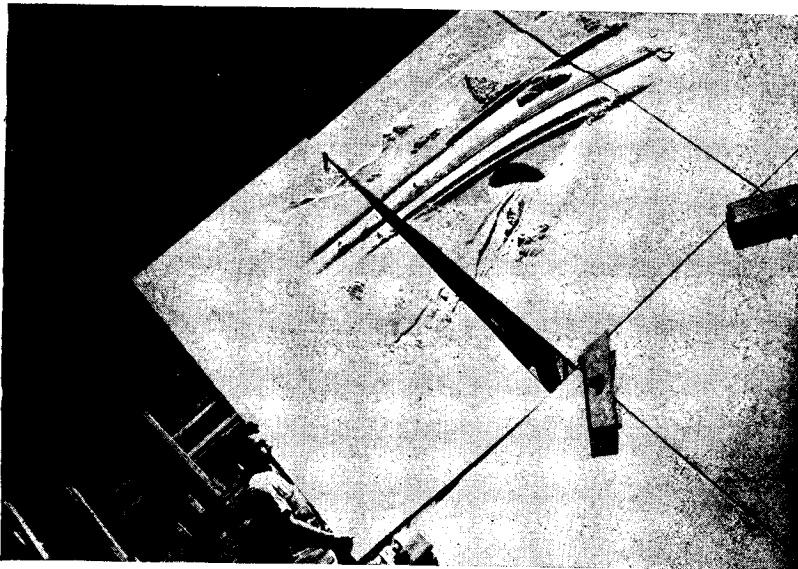

MERRITT PARKWAY BRIDGE — CONNECTICUT

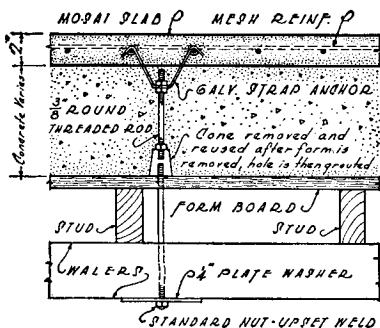

FINISHED PRE-INSPECTED 2 INCH FACING FOR CONCRETE STRUCTURES

Exposed quartz, granite and vitreous aggregate surfaces . . . NO subsequent finishing operations such as rubbing and grouting in . . . MO-SAI acts as the outside form as shown in detail on left . . . ONE-HALF of the slab thickness effective structurally.

See our catalog in SWEET'S.

MO-SAI ASSOCIATES

- New Haven, Conn.....The Dextone Company.....P. O. Box 606
- Boston, Mass.....Cambridge Cement Stone Company.....156 Lincoln St.
- Philadelphia, Pa.....Formigli Arch'l Stone Company.....R. E. Trust Bldg.
- Richmond, Va.....Economy Cast Stone Company.....P. O. Box 1223
- Greensboro, N. C.....Arnold Stone Company, Inc.....P. O. Box 477
- Oshkosh, Wisc.....Badger Concrete Company.....191 Marion St.
- Salt Lake City, Utah.....Otto Buehner & Company.....640 Wilmington Ave.

MO-SAI ASSOCIATES, founded to standardize and improve architectural slabs. The registered trade mark "Mo-Sai" is the property of the Dextone Co.

QUICK QUIZ:

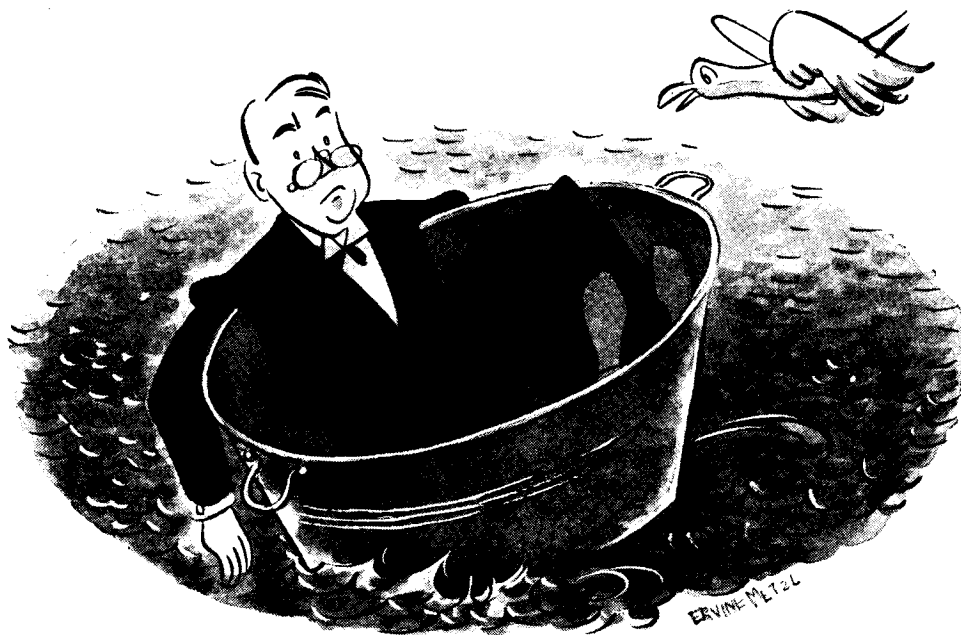

Are you all at sea about these problems?

Selecting air conditioning equipment that uses minimum areas for air distributing systems?

Obtaining air conditioning or refrigeration equipment that fits the exact requirements of the job?

Selecting a system for indi-

vidual room control?

Being sure the system selected will keep operating and maintenance expenses at a minimum?

Being certain that air conditions can be controlled with dependability?

Obtaining uniform distribution of conditioned air to all areas?

EASY ANSWER:

CARRIER will gladly cooperate with you on the most satisfactory solution of these problems...putting at your service 43 years of progressive experience. Carrier is prepared to meet essential current requirements and post-war needs with remarkable developments in modern air conditioning, refrigeration and unit heating. On plans for modernization or new construction, it will be very much to your advantage to learn what Carrier has to offer. See your Carrier representative or write fully.

Carrier Corporation, Syracuse, N.Y.



AIR CONDITIONING • REFRIGERATION
INDUSTRIAL HEATING

Lighting Drafting Rooms. By H. L. Logan. An illustrated article on good seeing conditions, including a brief discussion of finishing walls, floors and ceilings, and some pointers on the choice of a lighting system. 4 pp., illus. "Architexts," April, 1945. Holophane Co., Inc., 342 Madison Ave., New York 17.*

Mercury Arc Converters (Bulletin B6373). Detailed information on

standard mercury arc converters for induction heating operations in the 500-2000 cycle frequency range. 8 pp., illus. Allis-Chalmers Mfg. Co., Milwaukee 1, Wis.*

School Fluorescent Data (Folders 780-783). Four new data-sheets illustrating fluorescent lighting layouts for school classrooms. 2 pp. each. The Edwin F. Guth Co., 2615 Washington Ave., St. Louis 3, Mo.

CREO-DIPT Double -Wall *Zephyrs*

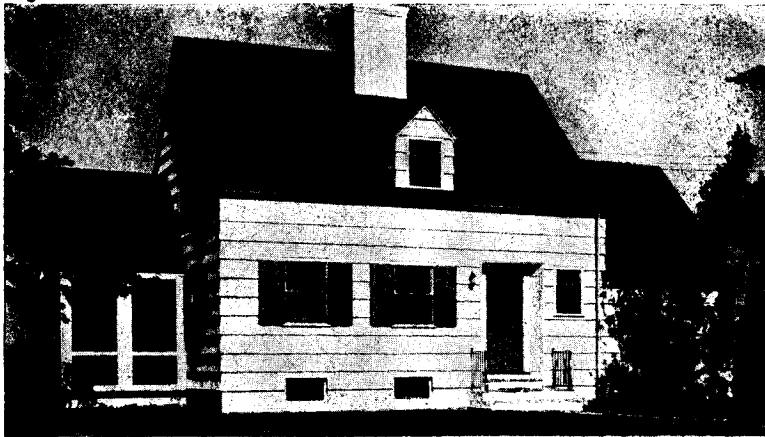

Sides: Zephyrs in Creo-Dipt Double Strength White treatment.
Roof: Regular Creo-Dipt Red Cedar Shingles pre-stained No. 251 Red.

Zephyrs are nature's finest red cedar sidewall shingles, beautifully textured, and stained and preserved in pleasing colors by Creo-Dipt.

Combining double insulation with beauty, Zephyrs are installed over the underwall of moisture resistant Zephyr Insulation Backing Board, a distinct Creo-Dipt feature.

For the Architect's portfolio of photographs and full details about Creo-Dipt Stained Shingles, also Shingle Stains, for roofs and sidewalls, write Creo-Dipt Company, Inc., North Tonawanda, N. Y.  8b/7.

CREO-DIPT *Shingles and Stains*



MAINTENANCE

Floorlife Cleaner. Describes a floor cleaner for wood and linoleum covered floors that cleans and waxes in one operation. 4 pp., illus. Building Products Division, L. Sonneborn Sons, Inc., 88 Lexington Ave., New York 16.*

Klem Kleaners. Cleaning, derusting, phosphotizing, soldering and maintenance processes. Fully describes processes, explains the use of phosphoric acid cleaners, alkali power wash and still tank cleaners, compounds and enamel or paint removers. 8 pp. Klem Chemical Works, 1500-18 E. Woodbridge, Detroit 7, Mich.

PLASTICS

Durez Phenolic Resins. A concise catalog of phenolic molding compounds, oil-soluble resins and industrial resins. 4 pp., illus. Durez Plastics & Chemicals, Inc., North Tonawanda, N. Y.*

Liquid Envelope. Introducing an impervious, peelable plastic film now used to coat war planes for shipment overseas. 16 pp., illus. Better Finishes and Coatings, 168 Doremus Ave., Newark, N. J.

One Plastics Avenue. A catalog of plastics developments by G.E. 20 pp., illus. General Electric Co., 1 Plastics Ave., Pittsfield, Mass.*

PLUMBING

Toilet Compartments and Toilet Room Environments. Five types of all-metal compartments and the "Sanybestos" asbestos-board type of compartment. 16 pp., illus. The Sanymetal Products Co., Inc., 1705 Urbana Rd., Cleveland 12, Ohio.*

What You Should Know About Plumbing. Bathroom and kitchen planning questions answered in simple terms for the home owner. Diagrams and floor plans illustrate principles of layout. 16 pp., illus. Plumbing and Heating Industries Bureau, 35 E. Wacker Dr., Chicago 1, Ill. 5 cents.

Zurn-Bennett Wall Hung Adjustable Closet Drainage Fittings. Description of three types of wall hung fittings, formerly manufactured by The Bennett Fittings Co. and recently acquired by the J. A. Zurn Mfg. Co. Typical layouts and assemblies included. 4 pp., illus. J. A. Zurn Mfg. Co., Erie, Pa.*

PUMPS

Facts You Should Know About Centrifugal Pumps and Impellers. Basic information about various stand-
(Continued on page 136)

**20° to 30°
REDUCTION IN**

**TEMPERATURES
at Working Levels**

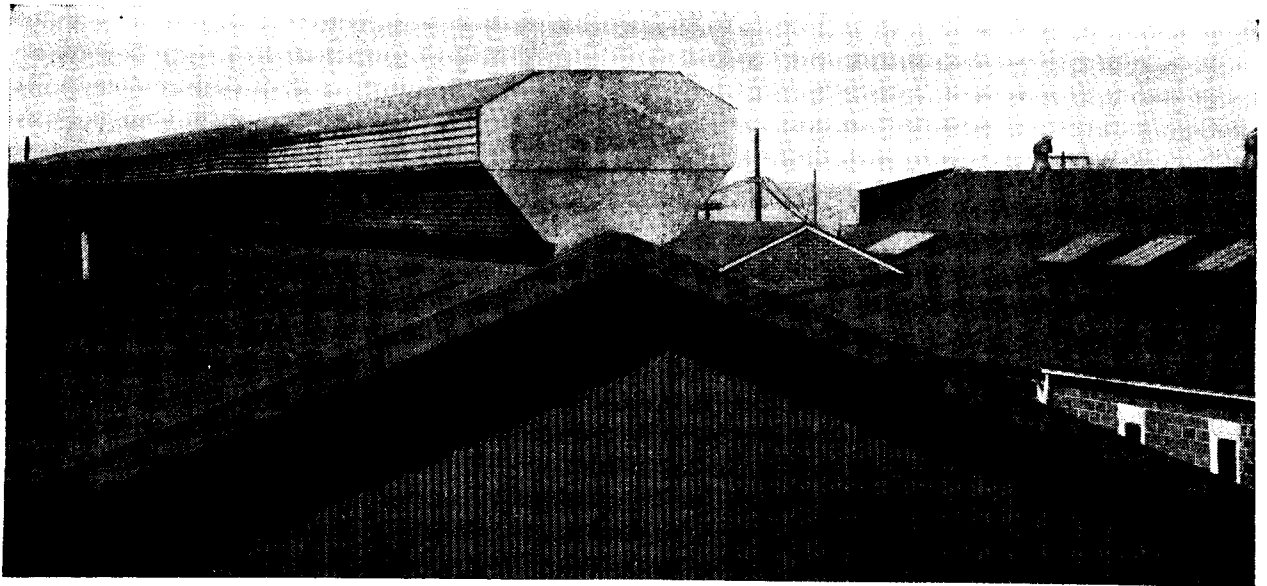

with **BURT MONOVENT Continuous Ridge Ventilator**

Production of vital military parts at this plant was impaired by fumes and oppressive heat from their forging and heat-treating operations. Installation of a BURT Monovent Continuous Ridge Ventilator reduced temperatures at working levels 20° to 30° and eliminated all fumes—completely solved their ventilating problem. A 36" BURT Monovent was used here, along the entire length of the building—189 feet.

BURT'S COMPLETE LINE HAS THE ANSWER TO YOUR VENTILATING PROBLEMS

The BURT line includes fan, gravity, revolving head and continuous ridge type ventilators. Recommendations are made, without bias, for the types that best answer your problems. BURT Ventilators are designed and engineered from the experience of more than half a century of manufacturing ventilators—production know-how that guarantees a high quality product that delivers maximum performance at minimum cost.

For uniform ventilation of large areas the BURT Monovent Continuous Ridge Ventilator is highly efficient and economical. Designed to install along the roof ridge, it harmonizes with roof lines for better appearance than unit ventilators. It is weatherproof, simple to operate and requires almost no maintenance. The BURT Monovent is serving in installations from 1 foot to 1,000 feet in length—from 4" to 72" throat sizes. It may be the answer to your ventilating problem.

BURT engineers will be glad to help you lay out plans and submit specifications without obligation. See Sweet's or write for detailed information.

THE BURT MFG. CO.

ROOF VENTILATORS • OIL FILTERS
EXHAUST HEADS

183 S. Main St., Akron 11, Ohio

SEND
FOR CATALOGS

Burt Engineers
are glad to
help on plans

Vitalize the Message

FROM PULPIT TO PEW—AND BEYOND

WITH

Schulmerich
ELECTRONIC
EQUIPMENT



● More and more churches, realizing the fundamental importance of getting their message heard, are finding in Schulmerich custom-built electronic installations the perfect answer to the age-old problem of church acoustic correction and sound projection.

Out of a quarter-century of wide experience in electronic acoustic research and development have come these exclusive Schulmerich true-to-life electronic systems to vitalize your church program:

TOWER MUSIC SYSTEMS—Projecting a dignified and welcome message to your entire community. Matchless in tone, extremely flexible, this compact installation makes possible tower programs of chimes, organ, choir and recordings at pre-set intervals throughout the day.

VOICE AND MUSIC DISTRIBUTION SYSTEMS—Custom-built, life-like reinforcement and projection of sermon, choir, and organ to every corner of the church and Sunday School.

ACOUSTIC CORRECTION UNITS—Compensates for "dead spots" found in certain pew locations in most churches. Makes complete service distinctly heard from every pew.

ELECTRONIC HEARING AIDS—A boon to your church members who are hard of hearing. No batteries, no unrightly microphones. Compact Schulmerich Ear-Equalized microphone, amplifier, and featherweight earphone in the pew provide perfect hearing for varying degrees of deafness.

All Schulmerich electronic systems are custom-built; and custom-installed only after a thorough analysis of your individual needs has been made by our trained engineers. We guarantee complete satisfaction. For further information write to Dept. AR1.



CHLORALIC BELLS - TOWER MUSIC SYSTEMS - ACOUSTIC CORRECTION UNITS - SOUND DISTRIBUTION SYSTEMS - CHURCH HEARING AIDS
SELLERSVILLE, PA.

Manufacturers' Literature

(Continued from page 134)

ard types of centrifugal pumps. 20 pp., illus. The Deming Co., Salem, Ohio.

Oil Lubricated Turbine Pumps and Niagara Propeller Pumps. Two new bulletins describing the features and sizes of pumps in each of the two lines. 6 pp. each, illus. Fairbanks, Morse & Co., Pomona, Calif.*

Type SHB Horizontal Centrifugal Pumps (Bulletin No. 1011). Describes an improved and augmented line of centrifugal pumps. 4 pp., illus. Yeomans Bros. Co., 1433 N. Dayton St., Chicago 22, Ill.*

STAIR TREADS

Wooster Safety Treads (Catalog 45). Reference booklet on safety treads and other metal walkway safety devices. Tables of standard maximum sizes and complete specifications for selection of proper tread; details of installation; repair procedure. Also contains information on door thresholds for exterior and interior doors, safe edge nosings, curb bars, cast iron window sills, elevator sills, and trench plates. 16 pp., illus. Wooster Products, Inc., Wooster, Ohio.*

STUCCO

A Guide to Finer Stucco. Illustrates many stucco buildings and gives the advantages of the use of both plain and colored stucco. Contains general specifications for making waterproofed Portland Cement stucco and illustrates many different finishes that can be given to this type of material. One page devoted to the use of stucco for remodeling. 12 pp., illus. Medusa Portland Cement Co., 1000 Midland Bldg., Cleveland 15, Ohio.*

WINDOWS

Designer's Reference (Catalog G. C. 45S). Modular planning in respect to steel windows. A comprehensive study including diagrams of layouts, tables of types and sizes, installations details conforming to modular standards, and elements of design for modular window openings. 23 pp., illus. The William Bayley Co., Springfield, Ohio.*

Installation Details for Modular Windows. Installation details for both solid-section steel windows and wood double-hung windows, with diagrams included. Published to supplement American Standards Association Committee A62 article on Modular Planning. 4 pp., illus. Modular Service Assn., 110 Arlington St., Boston 16.

Venus Drawing

Pencils are engineered to give you drafting perfection without failure: accurately graded to assure uniformity in all 17 degrees... strong in performance... smooth and clean in action.



Put VENUS to the test on your drawing board. Send us a postcard or a note for two free samples. Specify degrees wanted.



VENUS
DRAWING PENCILS

AMERICAN LEAD PENCIL COMPANY, HOBOKEN, NEW JERSEY

POSTWAR DETAILS

ADLAKE ALUMINUM DOUBLE-HUNG WINDOWS ARE ESPECIALLY SUITABLE FOR HOSPITALS... SHADES, DRAPES AND VENETIAN BLINDS ARE READILY ADAPTABLE, SO THAT LIGHT AND VENTILATION CAN BE EASILY CONTROLLED

ADLAKE ALUMINUM WINDOWS GLIDE SO EASILY ON THEIR NON-METALLIC WEATHER STRIPPING THAT THEIR OPERATION IS PRACTICALLY EFFORTLESS

ADLAKE ALUMINUM DOUBLE-HUNG WINDOWS ARE CORROSION RESISTING... REQUIRE NO MAINTENANCE EXCEPT OCCASIONAL WASHING... THEIR COST IS REASONABLE IN RELATION TO THE SERVICE THEY GIVE.

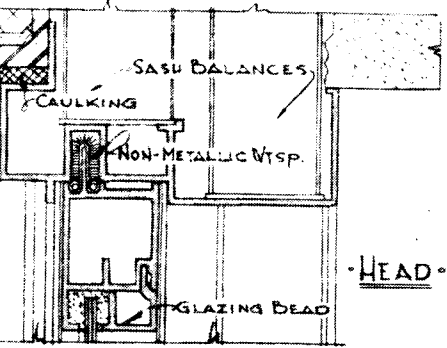

• HEAD •

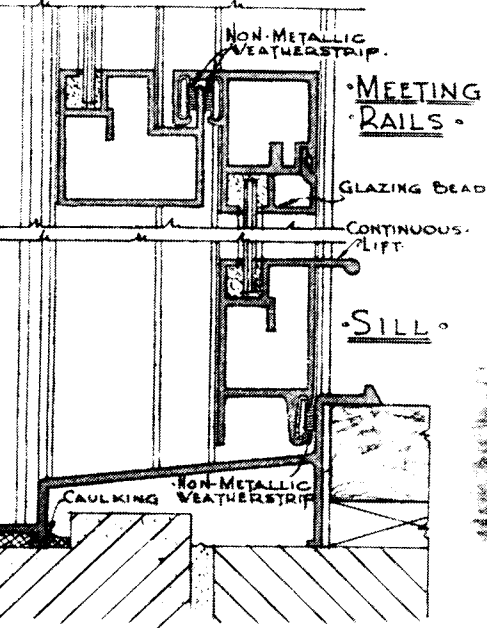

• MEETING RAILS •

• SILL •

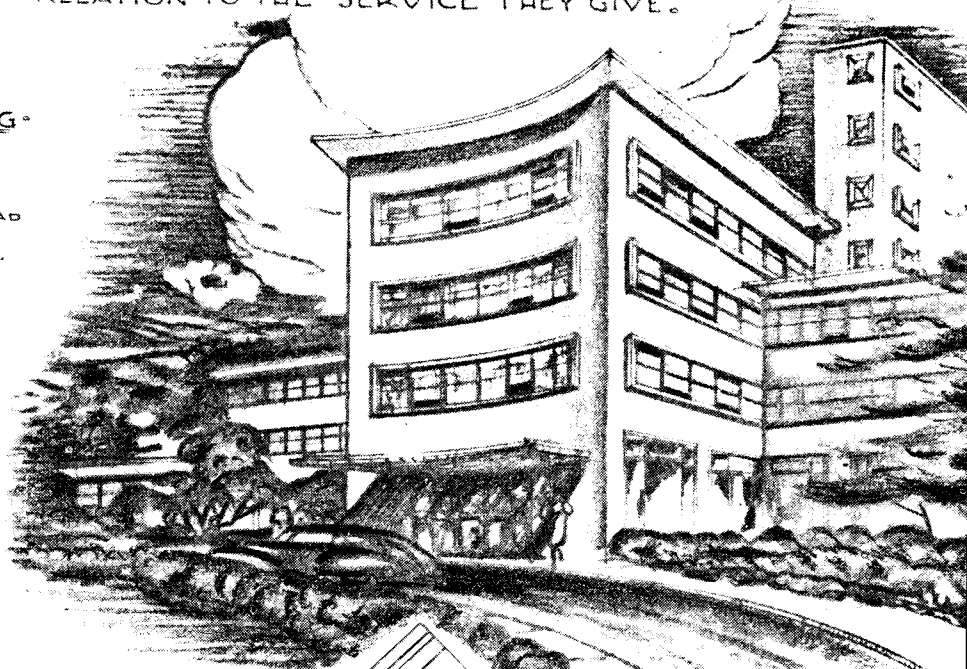

HALF-SCALE DETAILS

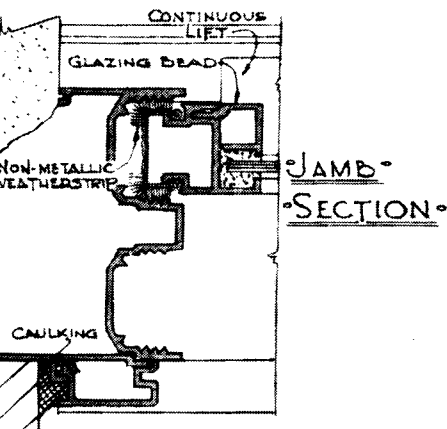

• JAMB SECTION •

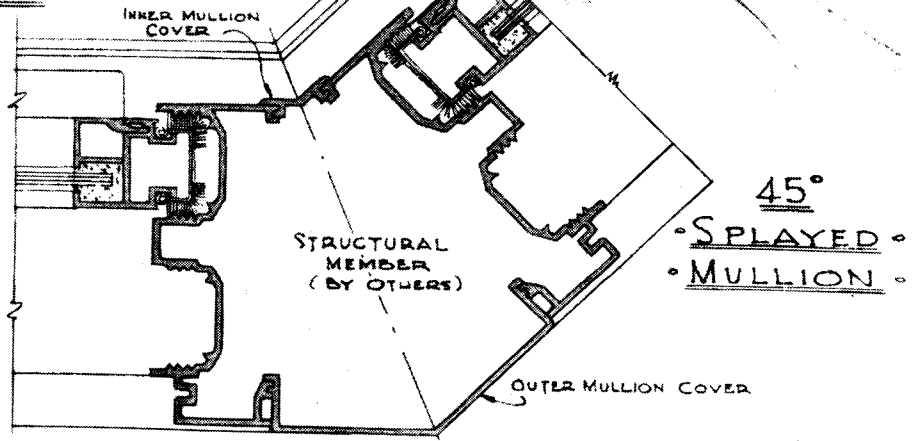

SPECIFY AND DETAIL

Adlake

ALUMINUM DOUBLE-HUNG WINDOWS

THE ADAMS AND WESTLAKE CO.

ELKHART, INDIANA, U.S.A.

**LOW COST
LIFTING**

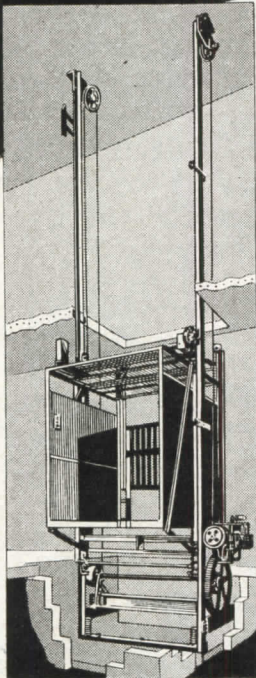

with countless applications

Where service requirements do not warrant expensive elevator installation and the travel limit is within 22 feet, this Montgomery Self-Contained Electric Elevator simplifies many lifting problems. Just a few of its many uses — combination passenger-freight service for 2 or 3-story industrial buildings, furniture stores, funeral homes, utility sections of hospitals, etc.

Electrically operated — requires no penthouse or load-bearing walls — all equipment above pit floor — every part accessible — installation cost low. Load capacity up to 2,500 lbs. and speed up to 25 ft. per min. Car size up to 6'-0" x 8'-0". Write for details and prices.

Montgomery manufactures a complete line of passenger and freight elevators, electric dumbwaiters and special equipment for vertical transportation.

MONTGOMERY
Elevator COMPANY

HOME OFFICE • Moline, Illinois
Branch Offices and Agents in Principal Cities

THE RECORD REPORTS

(Continued from page 128)

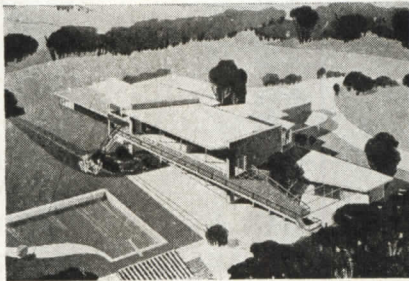

Lester C. Tichy's prize-winning house design, planned for himself and family

PRIZEWINNERS
"House and Garden"

Prize-winners in the national Architectural Award sponsored by *House & Garden* were:

Class A (for seven rooms and over). First prize, Lester C. Tichy, New York City; second, Noerenberg & Cooling, Los Angeles.

Class B (for 6 rooms or less). First prize, Ralph Rapson, Chicago; second, L. Morgan Yost, Kenilworth, Ill.

Honorable Mentions. David J. Abrahams, Boston; William Ainley, Savannah, Ga.; Simon Breines, New York; William T. Dreiss, Los Angeles; Norman B. Entwistle, Pasadena, Calif.; Victorine & Samuel Homsey, Washington, D. C.; Robert Woods Kennedy, Boston; Howard Moise, Berkeley, Calif.; Plan-Tech Associates, New York; Whitney R. Smith, Pasadena, Calif.; Royal Barry Wills, Boston; Wurster & Bernardi, San Francisco.

(Continued on page 140)

TO AID IN EUROPEAN RECONSTRUCTION

Architectural societies and university libraries of France, Holland, Denmark and Belgium have sent us urgent pleas for complete sets of back issues of ARCHITECTURAL RECORD from, and including, 1940.

This is an unusual opportunity to help our fellow architects overseas. If you can spare back issues of the RECORD, whether complete sets or not, please drop us a card telling us which issues you will donate to this vital cause.



There is NO SUBSTITUTE for EXPERIENCE

CAST BRONZE

Our facilities are promptly available for estimates and execution on all types of cast bronze castings — Letters, Name Plates, Tablets, Signs, Memorials, Markers, Sun Dials, etc. Let us figure with you.

DESIGN AND FABRICATION

- Calendar Cases
- Card Frames
- Check Desks
- Collapsible Gates
- Counter Railings
- Doors
- Elevator Cabs
- Entrances
- Gates Grilles
- Letters and Numerals
- Lighting Stands
- Marquise
- Name Plates
- Railings
- Safe Deposit Enclosures
- Signs Tablets Wickets

IN ALL METALS

For details of Metalcraft Service, we refer you to Sweets 1945 Architectural File.



Remember THIS NAME for QUALITY WORKMANSHIP DEPENDABILITY

CINCINNATI METALCRAFTS

Inc.

DEPT. AR, 34TH AND ROBERTSON
CINCINNATI 9, OHIO

THE FORMULA HAS TO BE RIGHT
FOR A LONG, USEFUL LIFE



nubun

A new Insulation for
U. S. Electrical Wires & Cables



Only patient, scientific research could have produced a rubber formula combining all the desirable characteristics of Nubun—U.S. Rubber Company's new insulation for wiring.

Extremely tough as well as flexible, this buna compound assures longer life for the wires and cables used in the coming era of intensified electrification. The high dielectric strength of Nubun

permits reduction of over-all diameters . . . without endangering circuit integrity . . . allows more wires to be encased in a single conduit.

Nubun will be used in innumerable ways . . . for building and industrial wiring, for control and signal systems and for communication services. Nubun is young . . . but Nubun is headed for a bright future in electricity.

Serving Through Science

UNITED STATES RUBBER COMPANY

1230 SIXTH AVENUE • ROCKEFELLER CENTER • NEW YORK 20, N. Y.

SOUND PROOF DOORS

Sound insulating doors—doors which are also fire resisting and abuse repelling—are in growing demand in theaters, moving picture houses, sound stage and music studios, broadcasting studios, hotels, hospitals, schools, as well as in industry. And every installation calls for a special study of the highly scientific subject of decibel reduction combined with ease of operation, etc.

If you are faced with this problem,

GET THIS BOOK



Our engineering department has prepared a complete book of specifications on sound insulating doors for use of the busy architect. This should be very valuable to you, when you have a door closure to plan. Many leading architects endorse these specifications as time and work savers.



FIRECRAFT

The name FIRECRAFT has become a synonym for the correct engineering of difficult door closure problems and for the fine construction of these specially engineered sound-proof doors. Our engineering department is available to assist you, on your request.

Firecraft Door Division
FIRECRAFT CORPORATION
 3321 South Wallace Street, Chicago 16, Ill.

THE RECORD REPORTS

(Continued from page 138)

Beaux-Arts Institute

Winners of the ARCHITECTURAL RECORD prizes in the Department of Architecture, Beaux-Arts Institute of Design, were:

First prize, Miss F. Hernandez-Sol of the University of Pennsylvania;

Second prize, Miss A. Krebs of the University of Illinois.

The problem, by Pietro Belluschi, Portland, Ore., was for a community building and playground for a plant to employ up to 500 men, with housing facilities for the workers.

TEACHERS WANTED

The secretary of the Association of Collegiate Schools of Architecture is compiling a list of available teachers of architectural subjects for immediate and postwar employment on teaching staffs at schools of architecture. Increased enrollments under the various Army Educational Programs are expected and there will be an urgent need for qualified teachers. Those qualified and interested in teaching positions for the next school year should send their personnel records to Prof. Paul Weigel, Secretary, A.C.S.A., Department of Architecture, Kansas State College, Manhattan, Kansas.

OPPORTUNITIES AVAILABLE

ARCHITECTURAL DESIGNERS: STRUCTURAL, HEATING AND VENTILATING, AND ELECTRICAL ENGINEERS. Experienced men for nationally known midwestern firm of architects and engineers.

Box 58, ARCHITECTURAL RECORD, 119 West 40th Street, New York 18, N. Y.

ARCHITECTURAL DESIGNER: Splendid permanent opportunity for an architectural designer in private New York office with national clientele. Congenial working conditions.

Box 60, ARCHITECTURAL RECORD, 119 West 40th Street, New York 18, N. Y.

Business Opportunity

INTERIOR DECORATOR EXPERIENCED IN LAYOUT AND SALE OF FURNITURE, DRAPERIES AND RUGS FOR HOTELS AND PASSENGER SHIPS. WELL ESTABLISHED FIRM WITH OFFICES IN NEW YORK. STATE EXPERIENCE AND SALARY DESIRED.

Box 62,
 ARCHITECTURAL RECORD
 119 W. 40th ST., NEW YORK 18

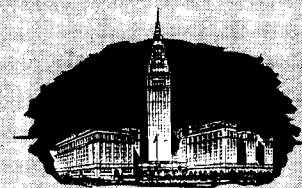

*Cleveland's
 most friendly hotel
 is its most
 convenient one, too.*

Hotel Cleveland

CLEVELAND, OHIO

Directly Connected
 with
 Union Passenger Terminal



VALUABLE
Balsam-Wool
REFERENCE FILE
Free TO YOU!

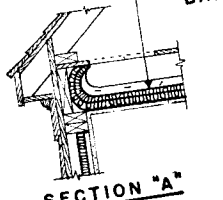
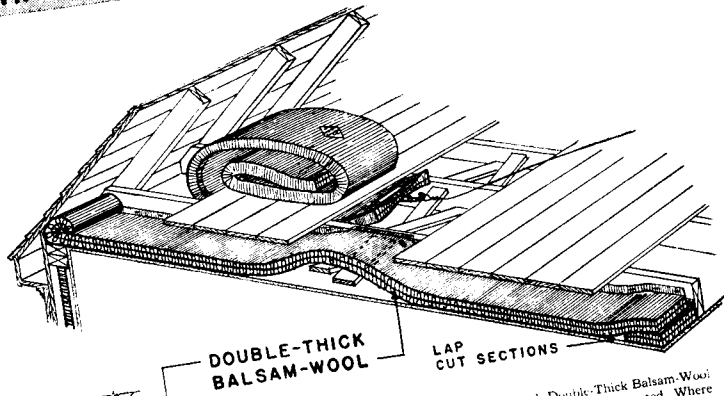

SECTION "A"

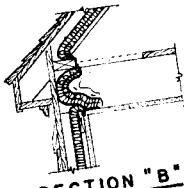

SECTION "B"

WHEN the attic is completely floored, Double-Thick Balsam-Wool may be applied between the floor joists, as illustrated. Where necessary, several floor boards should be removed from each side of the attic room, also over the bridging and at the center of the room. Cut the blanket into lengths half the width of the room, plus 1 to 1½ feet extra for tucking into the corner at the ends and lapping at the center of the room.

To the end of the Balsam-Wool Blanket, clip on an ordinary pants hanger to which is fastened a long wire. Starting at either the side or center of the room, insert the wire under a section of the floor boards and pull the blanket through the joist space. The blanket is carried over the top of the bridging. Balsam-Wool may be laid flat on the plaster base, with the flange stapled to the side of the joist wherever possible.

Tuck the outside end of the blanket tightly into the joist space at the intersection of roof and floor. Where the room is narrow and conditions permit, the Balsam-Wool may be taken direct from the roll and pulled through the entire joist space.

In Platform Frame construction, ends of Balsam-Wool should be fastened, as shown in Section A.

When Double-Thick Balsam-Wool is applied between the rafters, it is important that boards at the side of the room be removed so the space between the joists may be insulated with short pieces of Balsam-Wool tucked in place and stapled, as shown in Section B. Failure to do so will result in heat loss and may cause serious condensation.

WOOD CONVERSION COMPANY
 First National Bank Building
 Saint Paul 1, Minnesota

BALSAM-WOOL Products of Weyerhaeuser **NU-WOOD**

- High Thermal Efficiency
- Built for Permanence
- Non-Settling
- Flame-Proof
- Wind-Proof
- Moisture-Proofed

Balsam-Wool

SEALED INSULATION

- | | |
|---------------------|---------------------|
| 1. WINDPROOF | 4. LASTING |
| 2. MOISTURE-PROOFED | 5. NON-SETTLING |
| 3. FIRE RESISTANT | 6. HIGHLY EFFICIENT |

BALSAM-WOOL • NU-WOOD
 Products of Weyerhaeuser

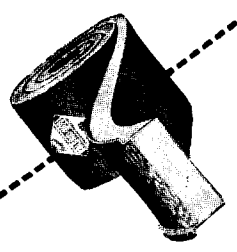

WOOD CONVERSION COMPANY
 115-9 First National Bank Bldg.
 St. Paul 1, Minnesota

Gentlemen:

Please send me set of application data sheets.
 Name
 Address
 City
 State

(Continued from page 81)

The wire should be large enough so that there will be a negligible voltage drop at this load. This same precaution should be observed with the outlets at the front of the room. Low voltage seriously affects the performance of projectors and audio devices.

Notice that this diagram indicates the use of a single speaker for all audio devices. This is possible with an integrated program of all audio devices used in the classroom. It permits the installation of a speaker in an ideal location acoustically and greatly simplifies the sound equipment.

A permanently installed speaker will overcome the inherent limitations in speaker size and weight and size of baffle imposed by keeping all equipment portable. A small speaker with a relatively weak field reproduces low frequencies poorly and distortion is very noticeable as soon as the volume is turned up. This is why a table model radio lacks the quality of a comparable circuit installed in a console with larger speaker and baffle. The performance can be improved still further by installing the speaker in a suitable enclosure.

Speaker position is important in sound quality. If a speaker is placed on the floor at the front of the classroom, the high frequencies will be strongly absorbed by the first few rows with the result that the quality and brilliance of music and the intelligibility of speech will be poor for the rest of the audience. There will also be a marked difference in apparent volume between the front and rear of the audience. By raising the speaker slightly above the head level of the audience a much better balance is secured.

Fortunately, sound distribution is good within the viewing angles specified for projection screens, so a speaker on the projection axis at the screen will give satisfactory performance.

From these considerations it might seem that everything would be in favor of installing a single high quality speaker into which the various audio devices could be fed. Unfortunately, this is not the case. Suppose we install in the classroom, in an appropriate enclosure, a speaker capable of handling 10 to 15 watts and reproducing frequencies from 40 to 10,000 cycles. If this classroom speaker is connected in place of, say, the small speaker of a sound-slidefilm projector there may be excessive hum arising from the design of the power supply of the amplifier. In addition, the sound may be harsh or unpleasant and there may be harmonic distortion in the amplifier.

The designer of the portable equipment should not be blamed for this situation. He had to meet certain requirements of weight, size, and cost. What I intend to show by this example is that the incorporation of certain features in the classroom audio installation must take into account the electrical characteristics of all the audio and audio visual equipment to be used with it.

Here is a thumbnail description of what might be called an *integrated audio program*. A speaker of adequate frequency-range and power-handling capacity is mounted in a suitable enclosure just to one side or just above the projection screen. A selector switch makes it possible to feed into this speaker the output from a central sound

(Continued on page 144)

Angier

OF FRAMINGHAM

OFFERS TWO NEW FOLDERS FOR POST WAR BUILDERS

50th Anniversary
1895-1945



Describing . . .

BROWNSKIN — for Sheathing

Its S-T-R-E-T-C-H sets it apart from ordinary sheathing papers, as does its special treatment against deterioration, passage of water or moisture. As long as a building lasts, so will BROWNSKIN.

BROWNSKIN VAPORSEAL — for Vaporsealing

Protects all kinds of insulation. Use on the warm side of insulation, leaving cold side free to breathe. Thus ideal dry conditions will be maintained.

ECONOMY BROWNSKIN — Protects Flooring

One side is crinkled BROWNSKIN, the other flat kraft. Between flooring, the BROWNSKIN side goes down. Also unexcelled as a protector of finished floor surfaces in rooms where men are working. Here the BROWNSKIN side goes up.

ECONOMY BROWNSKIN REINFORCED

An extra-strong, all-purpose waterproof paper for temporary partitions, coverings, and the protection of all types of floors during construction.

COPPERSKIN — Protects Hidden Places

Electro sheet copper, bonded to BROWNSKIN by asphalt. Use in concealed places to protect insulation, for drip pans, and to flash windows, doors and all exterior openings.

In writing for samples and literature please mention by name this magazine.



ANGIER CORPORATION

CORROSION PREVENTIVE AND WATERPROOF PAPERS
FRAMINGHAM, MASSACHUSETTS



NOW for the return to civilian building

Count as fully as ever upon the dependability of Wheeling Sheet Steel and Wire Products:

Wheeling LONG-SPAN
Steel Floor and TRI-RIB
Roof Deck

Wheeling Metal Lath and
Accessories

Bar-X Partitions

Steelcrete Expanded Metal

Specify "Wheeling"

**WHEELING CORRUGATING
COMPANY**

Wheeling, West Virginia

NEW YORK PHILADELPHIA CHICAGO ST. LOUIS
RICHMOND ATLANTA KANSAS CITY MINNEAPOLIS
BUFFALO LOUISVILLE DETROIT BOSTON NEW ORLEANS
CLEVELAND PITTSBURGH HOUSTON



Two Air Conditioned Operating Rooms at the Waynesboro, Penna., Hospital



Operations are safer with



Air Conditioning



Hospitals are finding year 'round air conditioning an indispensable aid in operating rooms. Patients, doctors, and staff are all greatly benefited by its controlled temperatures and invigorating freshness.

Years of experience in this work have taught us how best to satisfy the special requirements of operating rooms.

High relative humidity is necessary to carry away static electricity; explosion-proof motors and switches are used; fresh conditioned air is admitted in unusually large proportions; controls are automatic, but can be instantly adjusted by the surgeon. Drafts, noise, dust, and unsteady conditions are avoided.

Do the hospitals in which you are interested have air conditioning? Would you like to get literature on the subject? Write to



The operating room at the Detroit Osteopathic Hospital, among many others, has Frick Air Conditioning

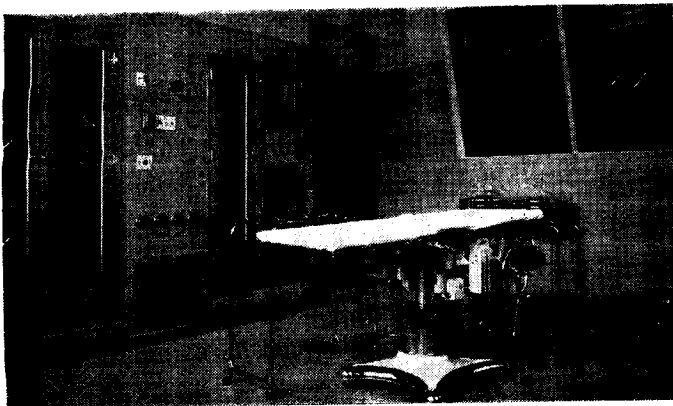

AUDIO-VISUAL EDUCATION

(Continued from page 142)

system, a classroom amplifier, or a motion picture sound projector. The output impedance of these devices and the impedance of the speaker are matched. The output from the motion picture projector and the classroom amplifier can be fed to the speaker from a wall connector at the rear of the room. A similar wall connector at the front of the room makes it possible to use the classroom amplifier there. To play records or transcriptions, a dual speed phono turntable is connected to the amplifier. This takes care of the sound-slidefilm problem. For radio a small tuner, either F.M. or A.M., is connected to this same amplifier.

A system such as this would provide classroom sound of much better quality than would be possible with portable self-contained equipment. It will, however, be more costly. "Is this extra cost justified?" Well, a well-modulated, nicely-pitched voice is a great asset and is gained by practice and imitation. If students are continually subjected to the harsh, strident quality of poorly reproduced sound, they are likely to imitate it. On the other hand, high quality sound reproduction will provide them with an example they can well emulate. The need for sound of the highest quality in speech, dramatics, and music appreciation classes is, of course, obvious.

SUMMARY

In the foregoing I have discussed a wealth of detail and I am somewhat concerned over the possibility that it may have given the impression that providing proper facilities for the teaching devices a teacher wants to use will involve a great deal of specialization in classroom design and increase in cost. I believe it will be well, therefore, to resolve the entire matter in a quick review from the point of view of the classroom.

Basically the prime requirements are a flexible seating arrangement, a room of adequate size that can be darkened, good illumination of blackboard and class display areas, and providing these in the right location is another important consideration. Because of the close relationship between the projection screen and the seating plan, it would be well to make it possible to indicate the seating arrangement for projection by some method of floor marking. Because the teacher has to introduce the various types of teaching devices during the classroom session, everything should be planned for convenience—electrical controls and outlets should be located at the point of use and proper attention should be given to their load-carrying capacity and their design. Adequate storage should be provided in the classroom for the various teaching devices. Some type of projector stand that is readily movable yet stable when placed in position is important. If possible, the teacher should be able to store the projector while it is in place on the stand since sound projectors are necessarily quite heavy.

In closing, I would like to emphasize that all these features should be provided for without making the classroom too specialized by a large number of built-in features. Every teacher is not going to use all of the teaching devices listed and it would be a handicap to her to have the built-in features for devices she is not using. So I repeat, the important thing in classroom design is to make it readily adaptable for use with *all* teaching devices.