

**TRAFFIC JAMS?
ENGINEERING IMAGINATION
CAN LICK 'EM!**

Driveway Punched Through City Block

SPEEDS LOADING, REDUCES TRAFFIC JAM



BIG CITY traffic congestion is increasingly critical. J. C. Penney & Co., Inc., leading department-store chain, decided to do something about it. They tore out part of the ground-floor of their huge New York City warehouse, reinforced the entire structure to carry 350 to 400-lb. loads per sq. ft., built a modern concrete loading dock adjacent to main-building elevators, and concreted a 40-ft. transverse driveway from street to street. Now trucks enter from one street, back into the platform with a quarter turn, unload from both center and rear doors, drive out the other street.

Same kind of planning went into concrete work. The Bell Company, of New York, designed the job with 'INCOR' 24-Hour Cement . . . saved time, overhead and cold-weather costs . . . only one-day curing under hay and tarps. Safe, speedy, sub-freezing concrete work assured by faster thorough 'Incor'* curing. It pays to keep economies like these in mind on cold-weather work.

*Reg. U.S. Pat. Off.

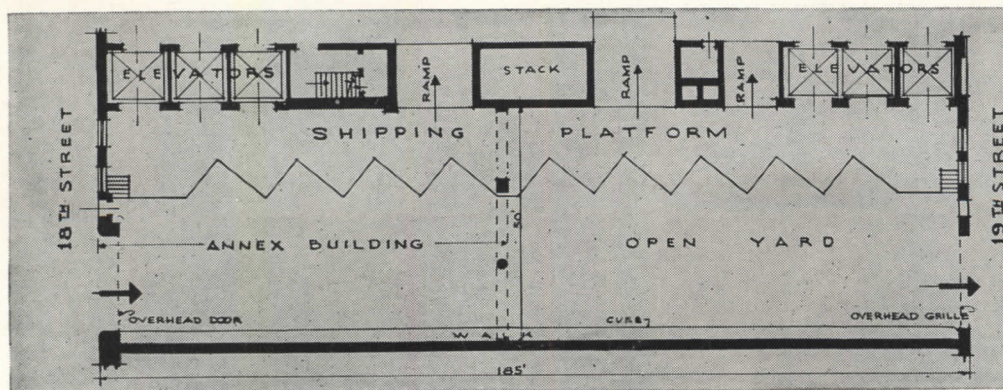

J. C. PENNEY & CO., Inc.,
Warehouse Loading
Dock and Driveway,
New York City. Industrial
Engineers: **THE BELL COMPANY.** Construction
Engineer: **MATTHEW HILLER.** General Contractor:
BUDD CONTRACTING CORP.; all of New York
City.

LONE STAR CEMENT CORPORATION

Offices: ALBANY • BETHLEHEM, PA. • BIRMINGHAM • BOSTON • CHICAGO • DALLAS • HOUSTON • INDIANAPOLIS • JACKSON, MISS. • KANSAS CITY, MO. • NEW ORLEANS • NEW YORK • NORFOLK • PHILADELPHIA • ST. LOUIS • WASHINGTON, D. C.

LONE STAR CEMENT, WITH ITS SUBSIDIARIES, IS ONE OF THE WORLD'S LARGEST CEMENT PRODUCERS: 15 MODERN MILLS, 27,000,000 BARRELS ANNUAL CAPACITY

Practical, attractive glass



"PITTSBURGH'S" LINE of store front products—Carrara Structural Glass, Polished Plate Glass, Pittco Metal, Herculite Doors, and Twindow, the window with built-in insulation—are being used with outstanding success in many "open vision" type store fronts. These materials can be depended upon to meet the most exacting demands made upon them by the new trend in store front designs. Architects: Forsblom & Parks.

COLORFUL, ATTRACTIVE Carrara Structural Glass is the ideal material for walls, stiles and partitions of toilet rooms in commercial buildings. Carrara is sanitary, good looking, impervious to moisture, chemicals, pencil marks. It won't fade or stain or absorb odors and won't check or craze. It is easily kept spotlessly clean and perfectly reflective. Available in ten pleasing colors.



P I T T S B U R G H P L A T E G L A S S C O M P A N Y

Applications in Commercial Buildings

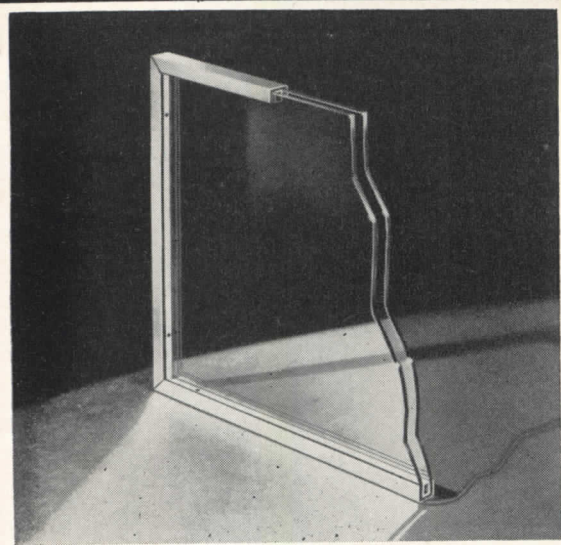

BECAUSE IT HAS BUILT-IN INSULATION, Twindow, "Pittsburgh's" latest window development is ideal for store, hotel and office windows, frozen food cabinets, refrigerated cases. When made of two panes of glass, Twindow cuts heat losses almost in half. And its insulating effectiveness becomes greater as additional panes are added. It virtually prevents steaming or frosting of windows. It minimizes downdrafts near windows. Cuts heating and air-conditioning costs.

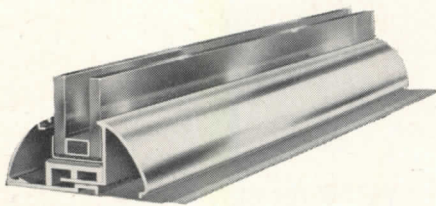

PITTCO STORE FRONT METAL now includes a complete line of bars and sashes for use with Twindow. These members are extruded and assure rugged strength, clear, sharp profiles and a smooth finish, rich in tone and gloss. They can be used with all Pittco De Luxe standard frame mouldings, thus offering latitude of design for top quality store front installations requiring insulated windows. The most commonly used of the Pittco members—two sashes and a division bar—are themselves insulated, thus reducing heat loss through them.

We believe you will find much to interest you in our illustrated booklet of ideas concerning the use of Pittsburgh Glass in building design. Send the coupon for your free copy.

★ Design it better with

Pittsburgh Glass



PAINTS · GLASS · CHEMICALS · BRUSHES · PLASTICS

PITTSBURGH PLATE GLASS COMPANY

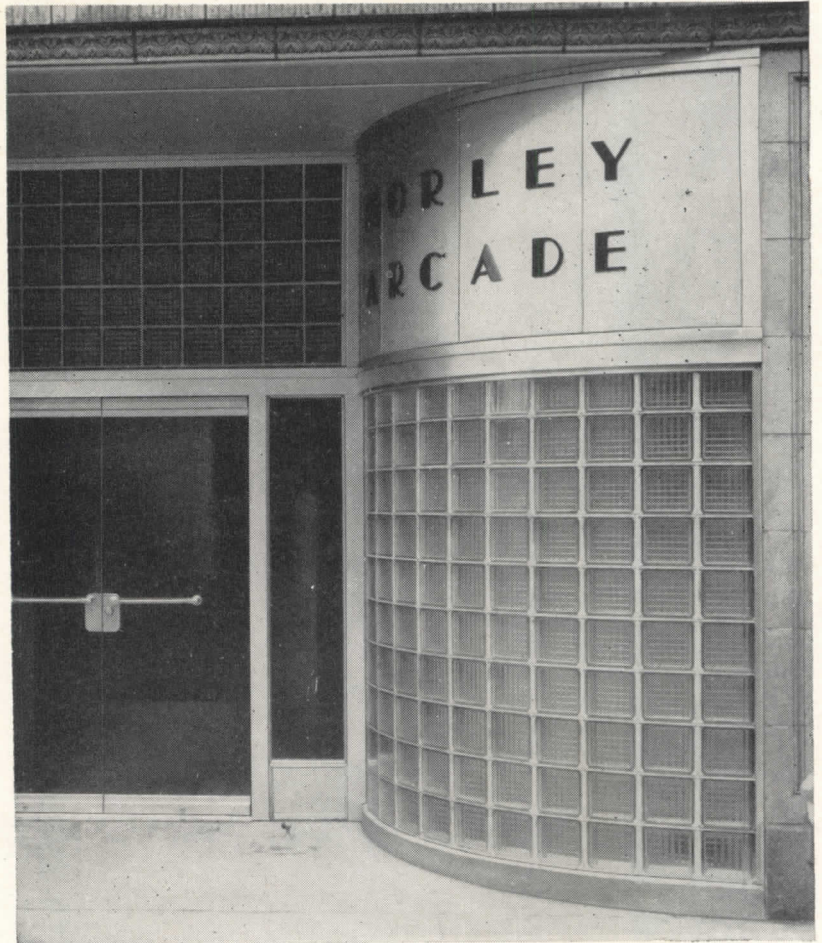

SOME OF THE REASONS why Pittsburgh Corning Glass Blocks have become the mark of a modern building are: because they flood interiors with daylight . . . preserve privacy . . . add smart appearance to any type or style of building. The blocks also aid in temperature control and make heating more economical. 10 attractive patterns to choose from. Architects: Frantz & Spence.

Pittsburgh Plate Glass Company
2025-8 Grant Building, Pittsburgh 19, Pa.

Please send me, without obligation, your free booklet entitled "Ideas for the Use of Pittsburgh Glass in Building Design."

Name.....

Address.....

City..... State.....



CITY NATIONAL BANK BUILDING

HOUSTON, TEXAS

Alfred C. Finn, Architect
 Robert J. Cummins, Consulting Engineer } Associated
 Reg. F. Taylor
 Mechanical Engineer
 C. Wallace Plumbing Co.,
 Plumbing and Heating Contractors

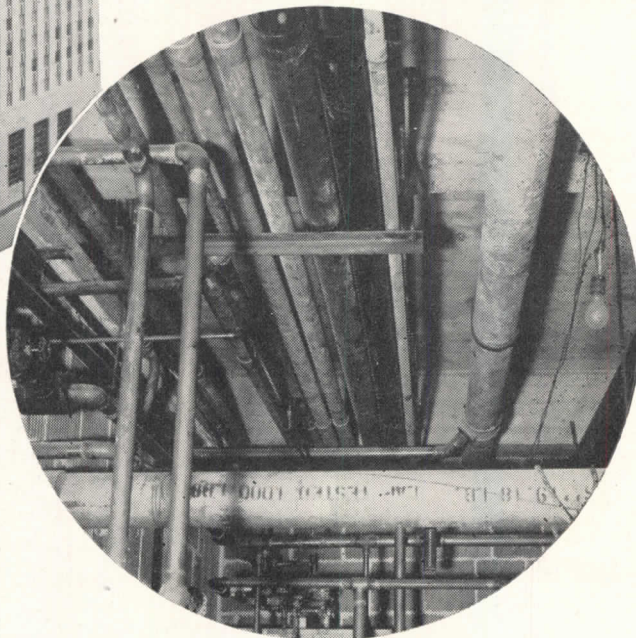

Presenting

a counter-check against corrosion . . .

BYERS WROUGHT IRON PIPE

Another evidence of the widespread revival of large building construction, this new skyscraper is the first large office building to be completed in Houston since early 1941. The designers emphasized corrosion-resistance and maintenance-control in the pipe specifications; all chilled water lines in the air conditioning system, and all hot and cold water lines over 3-inches, are Byers Wrought Iron pipe.

SERVICE-CERTIFIED

The introduction of air conditioning brought a whole new set of corrosion problems, which wrought iron has been successfully solving in all sections of the country. Some of the largest installations, in New York, Baltimore, Chicago, Pittsburgh, Memphis and numerous other centers, use wrought iron for the cooling water lines. Evidence of the superior corrosion-

resistance of wrought iron in water lines can be found in old buildings all over the nation.

WHY WROUGHT IRON LASTS

Wrought iron's durability comes from its unusual character. Tiny fibers of glass-like silicate slag, threaded through the body of high purity iron, halt and "detour" corrosive attack, and so discourage pitting. The fibers also anchor the initial protective scale, which shields the underlying metal. No other material duplicates wrought iron's composition and structure.

WANT MORE INFORMATION?

Our technical bulletin, "Wrought Iron in Refrigeration and Air Conditioning Systems" gives a lot of helpful information on various proven applications for the material. We will be glad to send you a complimentary copy if you will write.

A. M. Byers Co., Pittsburgh, Pa. Established 1864. Boston, New York, Philadelphia, Washington, Atlanta, Chicago, St. Louis, Houston, Salt Lake City, Seattle, San Francisco. Export Division: New York, N. Y.

CORROSION COSTS YOU MORE THAN WROUGHT IRON

BYERS
GENUINE WROUGHT IRON
TUBULAR AND HOT ROLLED PRODUCTS
 ELECTRIC FURNACE QUALITY ALLOY AND STAINLESS STEEL PRODUCTS

ARCHITECTURAL RECORD



Copyright 1947 with all rights reserved F. W. DODGE CORPORATION • Publishing Director, Magazine Division, H. Judd Payne • **EDITORS:** Editor-in-Chief, Kenneth Kingsley Stowell, A.I.A.; Managing Editor, Emerson Goble; Senior Associate Editor, Douglas Haskell; Associate Editors, John W. Ragsdale, Florence A. von Wyck, James S. Graham, Jr.; Western Editor, Elisabeth Kendall Thompson; Associate in South America, Edmund J. Whiting, A.I.A. • **ART DEPARTMENT:** Myron S. Hall, 3rd, Director; Frances Torbert, Assistant; Peter Piening, Consultant; Sigman-Ward, Drafting • **CONSULTANTS:** Industry Relations Consultant, Thomas S. Holden, Statistical Consultant, Clyde Shute; Building Economics Consultant, Norbert Brown; Field Research Consultant, Clifford Dannels, Jr.

COVER: All apartment buildings shown on the cover are included in the Building Types Study, where architects' and photographers' credits will be found.

Architectural Record (combined with American Architect and Architecture) is published monthly by F. W. Dodge Corporation, 10 Ferry St., Concord, N. H., with Editorial and Executive Offices at 119 West 40th Street, New York, N. Y. Western Editorial Office, 2813 Channing Way, Berkeley, Calif. Thomas S. Holden, Pres.; Howard J. Barringer, Vice-Pres. and Treas.; Irving W. Hadsell, Vice-Pres.; Chauncey L. Williams, Vice-Pres.; Sanford D. Stockton, Jr., Secy.; Walter F. De Saix, Asst. Treas.; Edwin H. Freed, Asst. Treas. Member Audit Bureau of Circulation and Associated Business Papers, Inc. Architectural Record is indexed in Reader's Guide, Art Index and Industrial Arts Index. Subscription rates: United States and Possessions, Canada, Cuba, Mexico, Central and South America, and Spain, \$4.50 the year, \$7.50 for two years, \$9 for three years; elsewhere, \$6.50 the year, \$11.50 for two years, \$15 for three years. Single copy, \$1. Circulation Manager: Marshall T. Ginn. Every effort will be made to return material submitted for possible publication (if accompanied by stamped, addressed envelope), but the editors and the corporation will not be responsible for loss or damage. Other Dodge Services: Real Estate Record & Builders' Guide, Sweet's Files, Home Owners' Catalogs, Dodge Reports & Dodge Statistical Research Service.

Vol. 103 • No. 2

February 1948

ON THE STATE OF THE NATION	85
An Editorial . . . by Kenneth K. Stowell	
HEADQUARTERS AND "FRONT" FOR FOOD PROCESSING	86
Richmond Chase Office Bldg., San Jose, Calif. Wurster, Bernardi and Emmons, Architects. Landscaping by Thomas B. Church	
REDEVELOPMENT PLAN FOR GRAND HAVEN	92
Designed by Orville H. Bauer and Robert F. Van Hoef	
TWO HOSPITAL PROJECTS FOR MEXICO	98
1. Hospital General de Coatzacoalcas, Veracruz. Antonio Prastana, Architect; Dr. Ignacio Mora, Medical Consultant	
2. Hospital General de Tuxpan, Veracruz. Antonio Prastana, Architect; B. Yurchenco, Collaborating Architect; Dr. Ignacio Mora, Medical Consultant	
GUEST HOUSE FOR A MOUNTAIN SITE	102
For Mr. and Mrs. John Lockheed, Lake Arrowhead, Calif. Lucille Bryant Raport (Raport & Hicks), Architect. Gordon De Swarte, Structural Engineer	
NORTH COUNTRY HOUSE FOR MANY CHILDREN	106
Walter E. Clark House, Lake Placid, N. Y. Harwell Hamilton Harris, Architect. Russell S. Johnson, Associate	
BUILDING TYPES STUDY NO. 134 . . . APARTMENTS	112
DESIGNED WITH A BUILT-IN PARK	114
Atlantic Gardens, Washington, D. C. Charles M. Goodman, Architect; L. B. Voight, Landscape Architect	
APARTMENTS FOR RECREATION	116
Villa Hermosa, Palm Springs, Calif. Clark & Frey, Architects	
NEW APARTMENTS OVER A DRAFTING ROOM	120
The Office of Pietro Belluschi, Architect, Portland, Ore.	
GARDEN APARTMENTS FOR RENTAL HOUSING	122
Langley Park Project, Montgomery County, Md. Charles M. Goodman, Architect.	
COOPERATIVE APARTMENTS NEAR THE SIERRAS	124
Richard J. Neutra, Architect	
STUDENT APARTMENTS IN TEXAS	126
Page, Southerland & Page, Architects	
VETERANS' COOPERATIVE APARTMENTS IN NEW YORK	128
Charles E. Greenberg, Architect	
A NINETEEN STORY CITY APARTMENT	130
Mayer & Whittlesey and Skidmore, Owings & Merrill, Associated Architects	
IMPROVED HOUSING FOR WASHINGTON, D. C.	132
Development for J. B. Tiffey and Son. Berla & Abel, Architects	
ARCHITECTURAL ENGINEERING Technical News and Research	135
THE WALL OF THIN SELF-FRAMED METAL PANELS	135
By Robert L. Davison, Research Associates; Howard Fisher, Architect	
PRODUCTS For Better Building	140
FIBERGLAS BUILDING	140
TIME-SAVER STANDARDS.	145
Critical Dimensions Governing School Design	
MANUFACTURERS' LITERATURE	150
THE RECORD REPORTS News from the Field	7
CONSTRUCTION COST INDEXES.	26
REQUIRED READING.	28
EMPLOYMENT OPPORTUNITIES	206
INDEX TO ADVERTISEMENTS	218

Plumbing Contractors Vote For Adjustable Flush Valves 20-1

Based upon 508 replies from an unbiased survey made among 1,154 of the country's leading plumbing contractors, including those registered at the 1947 N.A.M.P. Convention.

It's the plumbing contractor who actually puts flush valves to work, and who knows first hand the varying operating conditions under which they must serve. Can there be any more convincing endorsement of the adjustable idea than this practically unanimous approval from plumbing contractors?

Architects, too, in a previous survey, reported a similar overwhelming preference for adjustable flush valves. Everywhere the

verdict is clear and unmistakable.

For the next job that needs flush valves, keep in mind the well-recognized advantages of the adjustable feature—the feature that makes possible more efficient operation of all fixtures, maximum water savings, and maintained efficiency despite years of service and changing operating conditions. Keep in mind, too, that it was Watrous who pioneered the idea, and that *all* Watrous Flush Valves are adjustable.

THE IMPERIAL BRASS MANUFACTURING COMPANY

1240 W. Harrison Street, Chicago 7, Illinois

For complete information on Watrous Flush Valves see Sweet's Catalog, or write for Catalog No. 448-A. Also ask for Bulletin 477 giving a summary of "Architects' Views on Flush Valve Applications."



A few additional words in your specifications, such as: "All flush valves shall have an external adjustment for length of flush," will bring all the above advantages.

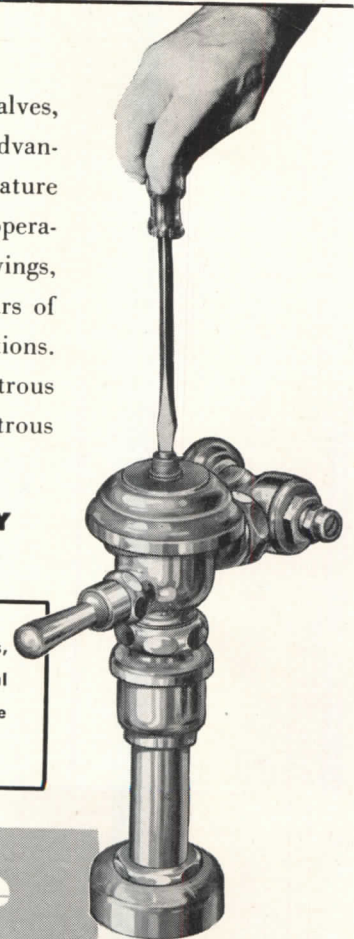

Watrous

Adjustable Flush Valves

BOTH DIAPHRAGM AND PISTON TYPES

THE RECORD REPORTS

FHA Continues to Stress Rental Units • Public Works Program Gains Momentum • Construction Picture Clouded by Marshall Plan Requirements

Those who have been tackling consumer and bank credit problems in the anti-inflation fight wonder increasingly how to fit home financing into the general credit mosaic. The question raised its head officially during the special session of Congress last fall.

Both Administration and Congressional quarters have been plumbing possibilities. Marriner S. Eccles, Federal Reserve Board chief, minces no words: "One of the most inflationary factors — perhaps the most inflationary single factor — in the present situation is excessively easy mortgage credit for housing. . . . Easy credit has greatly increased the effective demand for both old and new housing far beyond the supply and this has greatly inflated prices." He considers it inconsistent to restrict terms on autos, etc., and at the same time stimulate home indebtedness.

Federal Housing Administration records, incidentally, show that mortgage insurance applications through its field offices reached an all-time high in November, covering more than 76,000 dwelling units.

When Congress in December provided an additional \$750,000,000 for NHA Title VI loans, it simply deferred — because the call for added funds was urgent — its consideration of inflationary aspects. If the authority is to continue, action must be taken before the end of March, when the law expires. Leaders feel that the decision must be related to the general credit structure.

Rental Units Favored

As FHA resumed its insurance authorizations following the December enactment, it sought to apply a major portion of its commitments to rental units, and to issue none where prices or rentals were too high. By selective processing Commissioner Franklin D. Richards hoped to "combat inflationary prices."

As to rental units, federal statisticians point to the steady increase in multi-family dwelling units, which, they feel, means better tailoring of construction to housing needs of the population. Part of the increase they attribute to the June removal of rent controls on new building and to wider use of the more liberal FHA financing.

In this connection FHA has issued an illustrated study of rental housing plans, showing poor, fair and good living room, dining room, bedroom and closet

plans as well as project plans. It pictures projects in operation and cites qualities preferred in such projects, including location in a residential area, a unit appealing to long-term rather than temporary occupants, income adequate to assure financial success, and tenants not dependent alone on a single industry in the community.

Housing Study Continued

The Congressional Joint Committee on Housing, as it opened additional hearings in January, included on its agenda suggestions on the best means of financing home purchases and at the same time combating further inflationary tendencies. It sought to learn the extent to which price increases have hampered home production, the role of gray market operations in building materials and the role of export policies, the effects of prewar distribution patterns of manufacturers in upping home prices, and how much voluntary cooperation by labor can increase on-site productivity.

On the latter point, Chairman Gamble announced the appointment of subcommittees to consider labor angles while Richard J. Gray, of A.F.L.'s Building Trades Department, named a corresponding bi-partisan labor com-

mittee representing all parts of the country, which was to cooperate in recommendations and in the make-up of proposed new housing legislation. Similar cooperating committees were sought among building material manufacturers, home builders, realtors and financial interests.

Coincidentally, President Truman was asking the Congress to approve the long-range housing program he proposed last year. In his message on the state of the union he reiterated that this should include "financial aids designed to yield more housing at lower prices. It should provide public housing for low-income families, and vigorous development of new techniques to lower the cost of building." He asked that the rent control law be not only extended but strengthened.

Other Negotiations Proceed

Meanwhile, Federal Public Housing Authority activities in California were coming under the scrutiny of the Publicity and Propaganda Subcommittee of the House Executive Expenditures Committee. Preliminary reports, said Chairman Harness, indicated mismanagement. Too, the House Public Works Committee began an investigation of conspiratorial practices and black markets in the construction industry, with Rep. Macy as subcommittee chairman.

Also in question were activities of the Greater Kansas City Chapter of the National Electrical Contractors Association, against which a federal grand jury returned anti-trust indictments on the Justice Department charge of conspiring to restrain trade in the installation of

(Continued on page 10)

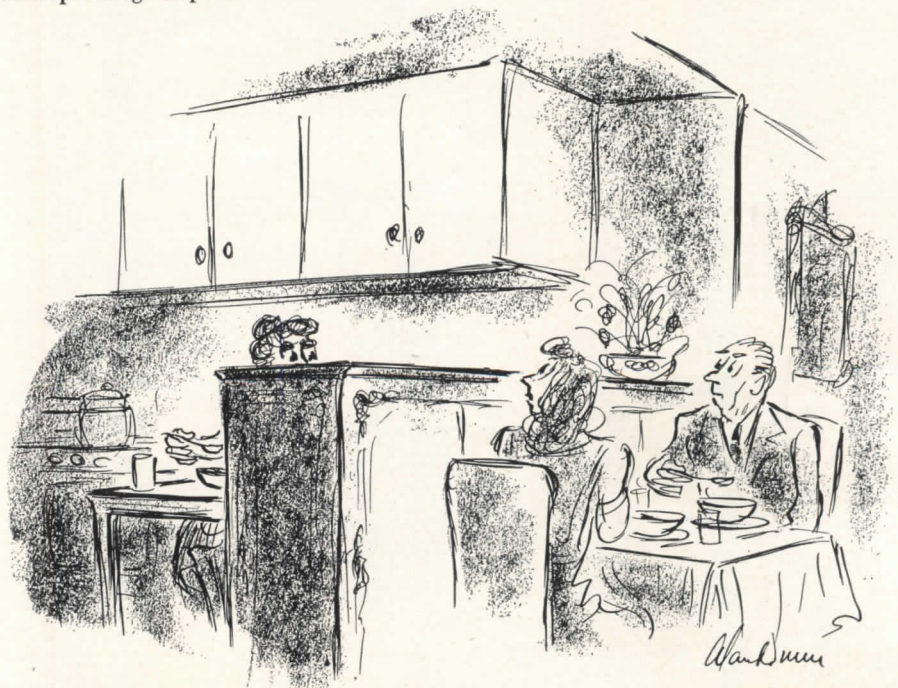

—Drawn for the RECORD by Alan Dunn

Business and professional me



"We consider the Servel All-Year Gas Air Conditioner a worthwhile investment, and do not hesitate to recommend it," says Sam Rubin, jeweler, of 323 De Siard St., Monrovia. "Customers have been attracted to the conditioned space, and we have been able to keep our merchandise in better condition."



"Ideal for efficient work in medical offices," says Dr. Fred. L. Scott, of Huntington Park, Calif., about the temperature and humidity conditions maintained the year round in his offices by Servel.



"Very satisfactory in all respects," agrees W. D. [Name], Vice President and Cashier of the Bank of Beaumont, California, which is kept cool in summer, comfortable and warm when needed, by the Servel unit.

raise all-year gas air conditioner

HEY SAY SERVEL *All-Year* GAS AIR CONDITIONER PROMOTES HEALTH, EFFICIENCY, BUILDS PROFITS

TYPICAL of hundreds of letters in our files from business and professional men all over the country are the testimonials on these two pages. Practically everyone who has a Servel *All-Year* Gas Air Conditioner is more than pleased with the results. In fact, as you'll see on the right, one enthusiastic user has installed *three* units—one in his home, one in his automobile agency, and one in a store he owns!

Everywhere, users agree that this wonderfully efficient year-round conditioner is worth every penny it costs. Some go so far as to declare it will actually pay for itself in a very few years! So you can recommend Servel *All-Year* Gas Air Conditioning to your clients with every assurance that it will perform up to expectations. And that your clients will be glad you brought Servel's advantages to their attention.

Complete in one unit, the Servel conditioner refrigerates and dehumidifies the air in summer. In winter, the same unit heats and humidifies the air. In between seasons, it offers independent air circulation at prevailing temperatures. Year-round, it filters dust, dirt, and irritating pollen from the air. A "flick of the finger" controls all operation.

Check your list of clients today. Determine which are ideal prospects for Servel *All-Year* Gas Air Conditioning. Then ask your local gas company for more detailed information about these types of application. Or, write direct to Servel, Inc., for application data and names and addresses of satisfied users with comparable installations. Address Servel, Inc., 8802 Morton Ave., Evansville 20, Indiana.



"If I could find another place to install Servel *All-Year* Gas Air Conditioning, I would do it," says Frank M. Bowman, Alice, Texas, businessman. He already has three Servel units, one in his automobile agency (above), and one each in his store and home (below).

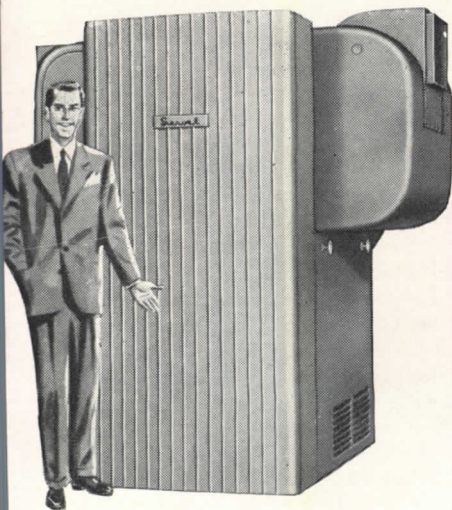
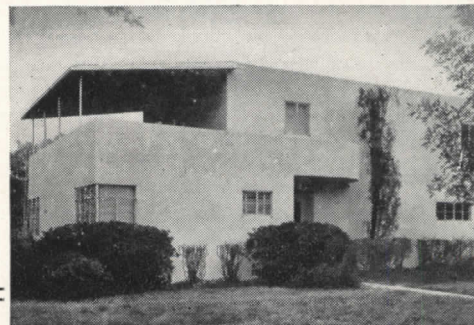

Servel

All-Year GAS AIR CONDITIONER

(Continued from page 7)



The jury for the 1947 Architectural Award program of House and Garden convenes with Mrs. Katherine Morrow Ford, the magazine's architecture editor. Left to right: Louis Skidmore, Mrs. Ford, George Howe, Vernon De Mars, Hugh Stubbins, Cameron Clark

HOUSE AND GARDEN WINNERS ANNOUNCED

West Coast architects took more than their share of the awards in the \$2000 1947 Architectural Award program sponsored by *House & Garden* magazine. Fred Langhorst of San Francisco took first prize in Class I (houses 1800 sq. ft. and under), Richard J. Neutra of Los Angeles first prize in Class B (houses over 1800 sq. ft.), Gordon Drake of Los Angeles second prize in Class I, and Albert Henry Hill of San Francisco second prize in Class B. In addition, honorable mentions went to Neutra and Hill, and to Bliss Moore, Jr., of Seattle, J. R. Davidson of Los Angeles, Clark

& Frey of Palm Springs, and Woodbridge Dickenson, Jr., of Pasadena. Other honorable mentions were given to Johnson & Whitcomb of Cambridge, Mass.; Kenneth Kassler, Princeton, N. J.; Marcel Breuer, New York City; and Alden B. Dow, Midland, Mich.

To ARCHITECTURAL RECORD editors the decision of the judges was most appealing: both of the first-prize winners as well as the second-place winner in Class B are shortly to appear in the RECORD; Marcel Breuer's honorable-mention entry and that of Alden Dow already have been published (Sept. and Nov., 1947).

NOVEL PRODUCTION METHOD SPEEDS CONSTRUCTION

A novel form of house assembly is being used by the Thomas P. Coogan Co. to speed erection of some 600 two- and three-bedroom homes included in the Essex Village development at Hialeah, Fla., a suburb of Miami.

Virtually all lumber for the homes is pre-cut to exact measure in the assembly yard on the project. Walls are assembled in the same yard, one by one, with the

use of a jig. As each is finished it is loaded on a specially-rigged truck (see photo below) which takes the walls four at a time to the site. There the walls are unloaded directly to their position on a prepared foundation. The whole unloading operation, including the work of making the walls fast and tying them together, takes a half hour.

(Continued on page 12)

Fast assembly of Florida homes: walls are loaded four at a time on specially rigged truck (left), taken to site and unloaded directly from truck to foundation (below)

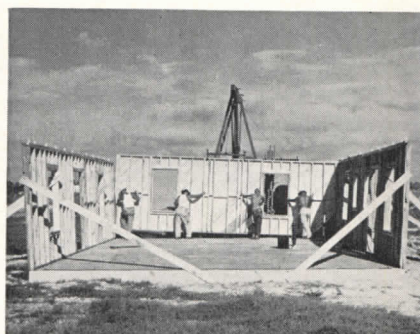

electrical systems in housing. The indictment alleged that, in order to eliminate competition, the defendants "agreed unlawfully upon escalator clauses in bids. They also agreed upon a uniform, minimum mark-up to be charged for labor when selling electrical contracting service and to include in their charges for work on prefabricated houses a sum which would represent the profit they would have made if the electrical materials already in these houses had been sold by them."

Public Works Gain

A boost in public construction over last year is among the predictions emanating from federal offices. While the boost is expected to be moderate, state and local public projects will push ahead at a faster rate than federal because of urgent needs for health, safety and welfare construction in local communities. Percentage boosts are set at from 15 to 20 per cent for federal projects and 25 to 30 per cent for state and local outlays.

All types of public construction presumably will be affected, including sewer and water facilities, schools, hospitals, airports and conservation and development projects. Availability of materials and labor is counted on to make for greater building efficiency, cutting down building time.

The Federal Works Agency points to the huge accumulation of public construction requirements due not only to the depression years and war curtailment but also to the priority given housing and other private construction since the war. FWA estimates the total needs at \$75 billion or more and stresses the importance of a continued advance planning program so that engineering and legal work, land acquisition and structural design can all be completed before and not after the decision to build. It points out that authority for federal aid in project planning lapsed last June 30, removing the impetus for further building up a reserve of completed plans.

What Price the Marshall Plan?

Among uncertainties in 1948 construction is, of course, the Marshall Plan and the resultant call on steel. Under the special session action, allocation came into play, with steel among the commodities falling under the jurisdiction of the Commerce Department. Allocations on a voluntary, industry-wide basis were made possible by the anti-inflation law, and President Truman assigned the various items to four agencies for implementation: farm products

(Continued on page 14)

DOUBLE DUTY

INSULITE

(BILDRITE SHEATHING)

BUILDS... INSULATES



You pay for *one* but you get **TWO . . .** uses. Sheathing **PLUS** *insulation*. Your client gets *more* for his money and is better satisfied. Better construction, stronger bracing, plus *insulation* as a bonus. Specify double-duty INSULITE.

Refer to Sweet's File, Architectural Section 10a/9



INSULATES AS IT . . .
BUILDS AS IT

double-duty
INSULITE
The GENUINE

BUILDS
INSULATES

"Insulite" is a registered trade mark, U.S. Pat. Off.

INSULITE DIVISION PAPER  MINNESOTA & ONTARIO COMPANY
MINNEAPOLIS 2, MINNESOTA

How To Put

EXTRA

**Safety
Economy
Service**

INTO PRODUCTS YOU DESIGN

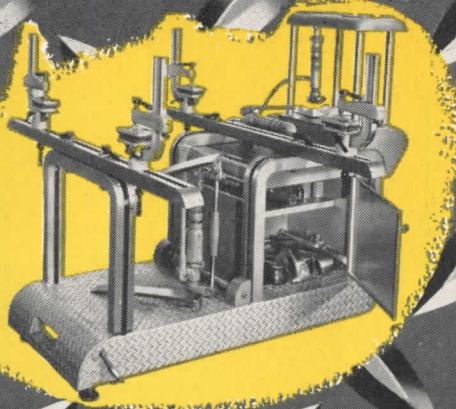

AW SUPER-DIAMOND FLOOR PLATE

**GIVES YOU THE EXTRAS
AT NO EXTRA COST**

TODAY, stationary and mobile equipment designers and manufacturers are specifying AW Super-Diamond Floor Plate for all surfaces on which men walk or climb. The exclusive AW Super-Diamond Pattern provides extra safety for workers which ordinary floor plate does not offer. It grips without a slip preventing costly slipping accidents. It's extra economical—the first cost is low and there is no maintenance cost. Follow the example of leading designers and specify AW Super-Diamond Floor Plate for your products. Write for complete information, and a copy of our catalog.

FREE CATALOG—For your copy, clip and mail coupon below:

AW SUPER-DIAMOND FLOOR PLATES THAT GRIP

Alan Wood Steel Company, Conshohocken, Pa.

Please send me a copy of your informative catalog L-33

Name _____

Company _____

Address _____ City _____ State _____

A Product of **ALAN WOOD STEEL COMPANY**
Other Products: Billets • Plates • Sheets • Carbon & Alloy



GRIP WITHOUT A SLIP!



EASY TO CLEAN!



EASY TO MATCH!



THE RECORD REPORTS

(Continued from page 10)

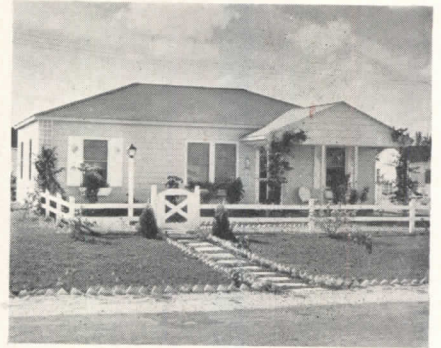

A completed Essex Village home, one of 600 being built by Coogan Davis, Inc.

More than 200 of the homes have been completed since the project was started a year ago, and the current production rate is two a day; most of them are going to veterans. Located on lots 60 by 108 ft., the houses sell for \$6700 for the two-bedroom types and \$7500 for the three-bedroom. Included in the price are electric stove, refrigerator and hot water heater.

When finally completed, the Essex Village project will include, in addition to the one-family houses, 70 duplexes and 112 apartment units as well as a shopping center. Estimated total cost is \$7,000,000. Developers are Coogan Davis, Inc., of Miami.

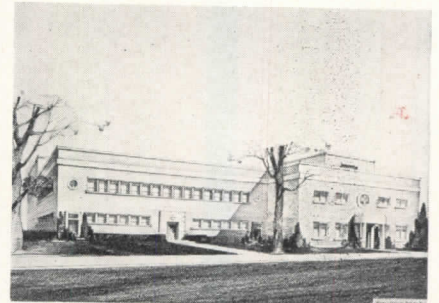

New two-story building for Merck & Co., Rahway, N. J.; George P. Butler architect

ANTIBIOTICS PRODUCTION FACILITIES INCREASED

Plans have been announced by Merck & Co., Inc., manufacturing chemists, for a new two-story building for increasing the finishing and packaging facilities for penicillin and streptomycin. The new \$400,000 unit will be an annex to the present Sterile Techniques Building at Rahway, N. J. It will contain special equipment for weighing and packaging, and will provide increased finishing and storing facilities. George P. Butler of New York is the architect for the new building, and Walter Kidde Constructors, Inc., of New York, the contractor.



What does
FLEUR·O·LIER
 mean to you ?

Fleur-O-Lier fixtures are made to exacting specifications that cover performance, construction and safety. Then they are tested and certified by Electrical Testing Laboratories Inc., as meeting these specifications. A Fleur-O-Lier label on each fixture identifies them.

What's the value of this ?

Fleur-O-Lier fixtures are insurance on your reputation. A Fleur-O-Lier installation assures customer satisfaction—freedom from complaints. With

Fleur-O-Lier equipment you *know* the customer will get fine lighting performance—trouble-free operation.

Fleur-O-Lier is both a Product and a Program. Those rigid specifications, the careful checking, enable you to give the product unqualified endorsement. The promotional program develops the commercial fluorescent lighting market—and raises the standards of lighting to higher levels. You benefit—and the customer benefits.

FLEUR·O·LIER

Manufacturers

2116 Keith Building • Cleveland 15, Ohio

Fleur-O-Lier is not the name of an individual manufacturer, but of a group of fixtures made by leading manufacturers. Participation in the Fleur-O-Lier program is open to any manufacturer who complies with Fleur-O-Lier requirements.

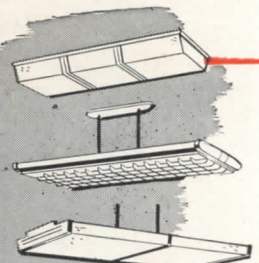

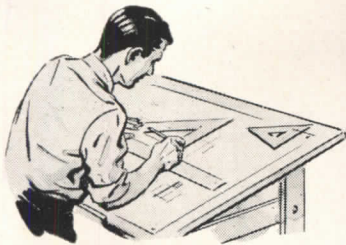

**OVER 40 YEARS
OF ENGINEERING
EXPERIENCE**

Since 1905 Baker has pioneered in many fields of refrigeration and air conditioning. Today its wealth of knowledge is available to find the right answer to your problem.

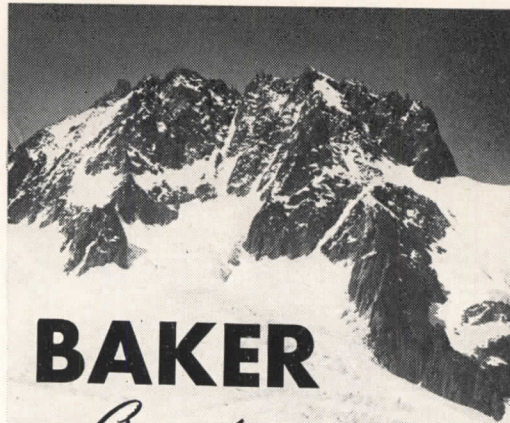

BAKER

a Great name in

**AIR CONDITIONING
AND REFRIGERATION**

~ ~ ~ **SINCE 1905**

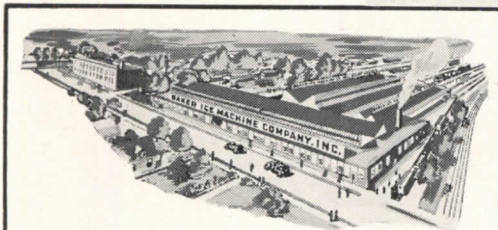

Photo by Keystone View Co. of N.Y., Inc.

**ENLARGED
PLANT FACILITIES**

at South Windham, Me. and Omaha, Neb., are turning out more Baker quality equipment than ever before in the company's history.



BAKER SERVICE IS NEAR YOU!

Company branches and distributors, staffed by experts are located in principal cities from coast to coast. For the name and address of the office nearest you, write: Baker Ice Machine Co., Inc., South Windham, Maine.



BAKER

Zone balanced · Engineered

**AIR CONDITIONING
AND REFRIGERATION**

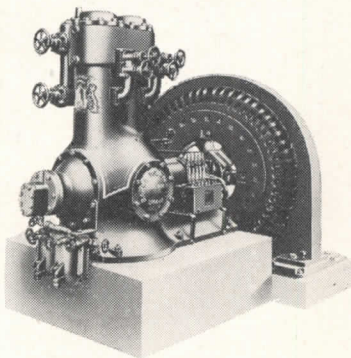
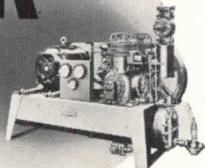

**THERE IS A BAKER UNIT
AVAILABLE FOR EVERY
TYPE OF JOB**

Baker offers a complete line of precision-built Freon and Ammonia equipment. Units in a wide range of capacities for both low and high temperature work.

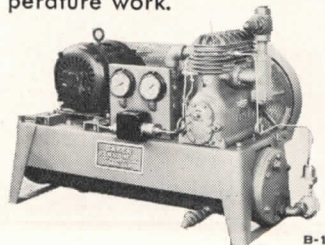

THE RECORD REPORTS

(Continued from page 10)

to Agriculture, fuels to Interior, transportation to ODT, and all others to Commerce. Like the wartime WPB system, the plan includes industry advisory committees, and Commerce promptly called a conference with the steel industry. The four agencies have an overall working committee and a chairman to iron out details of the voluntary agreements.

Another imponderable in 1948 predictions is the growing output of consumer goods which might take away from funds for housing — more new cars, new washers, new furniture. Nevertheless, the Commerce Department's Construction Division feels that the continued high level of construction in November and December augurs well for a good year in 1948. The Labor Department's construction employment studies lead it to predict increasing employment in 1948 with 950,000 new housing starts. It counts on the rising rate of apartment building, which began last May, to keep up but with slight increase in housing for moderate and low-income families.

Commerce's summation for 1947 puts new construction at \$12.8 billion, a 30 per cent increase over the first post-war year of 1946, and new private construction at \$9.8 billion, a 28 per cent rise. Private residential building rose 55 per cent while nonresidential dropped 5 per cent. New public construction gained 40 per cent and highways 72 per cent.

Housing and Taxes

The tussle over taxes in the current Congressional session may and may not reach directly into housing, but Chairman Gamble of the Congressional Joint Committee on Housing is sympathetic to changes in tax laws. He favors accelerated depreciation on new homes, letting the taxpayer benefit from larger deductions. He would abate, up to roughly 3 per cent, the taxes on corporations in the building field. Rep. Gamble also feels that there should be insurance of some minimum yield on new construction and that efforts should be made to get cities to contribute land and help in providing utilities.

Other Developments

1. Priority-built houses under the Veterans Emergency Housing Act no longer are restricted in resales to the maximum sales prices paid for them, the Housing Expediter's Office has ordered. The resale price ceiling, it was found, left some veterans in a squeeze. The new action, too, lets more enforcement time go to violations of original ceiling prices.

(Continued on page 16)

Suntile offers you both

● BETTER TILE

● BETTER INSTALLATION

Suntile offers you *two-way* quality. Quality in the tile itself—and quality in installation.

The *first* is gained through constant research and rigid scientific manufacturing control which gives Suntile beauty—utility—low life-time cost. It's *color-balanced* so that harmonious blends may easily be achieved.

The *second* is gained through careful selection and training of Suntile dealers. These men *know how* to install Suntile and bring out all of its inherent qualities.

For better tile—better installation, let us send you the name of an Authorized Suntile Dealer. He can show you real clay Suntile in 16 wall colors. Also impervious unglazed ceramic mosaic Suntile in 15 colors—and Suntile Camargos in 10 colors—in modular sizes.

See Sweet's Catalog for complete details. The Cambridge Tile Manufacturing Company, Cincinnati 15, Ohio.

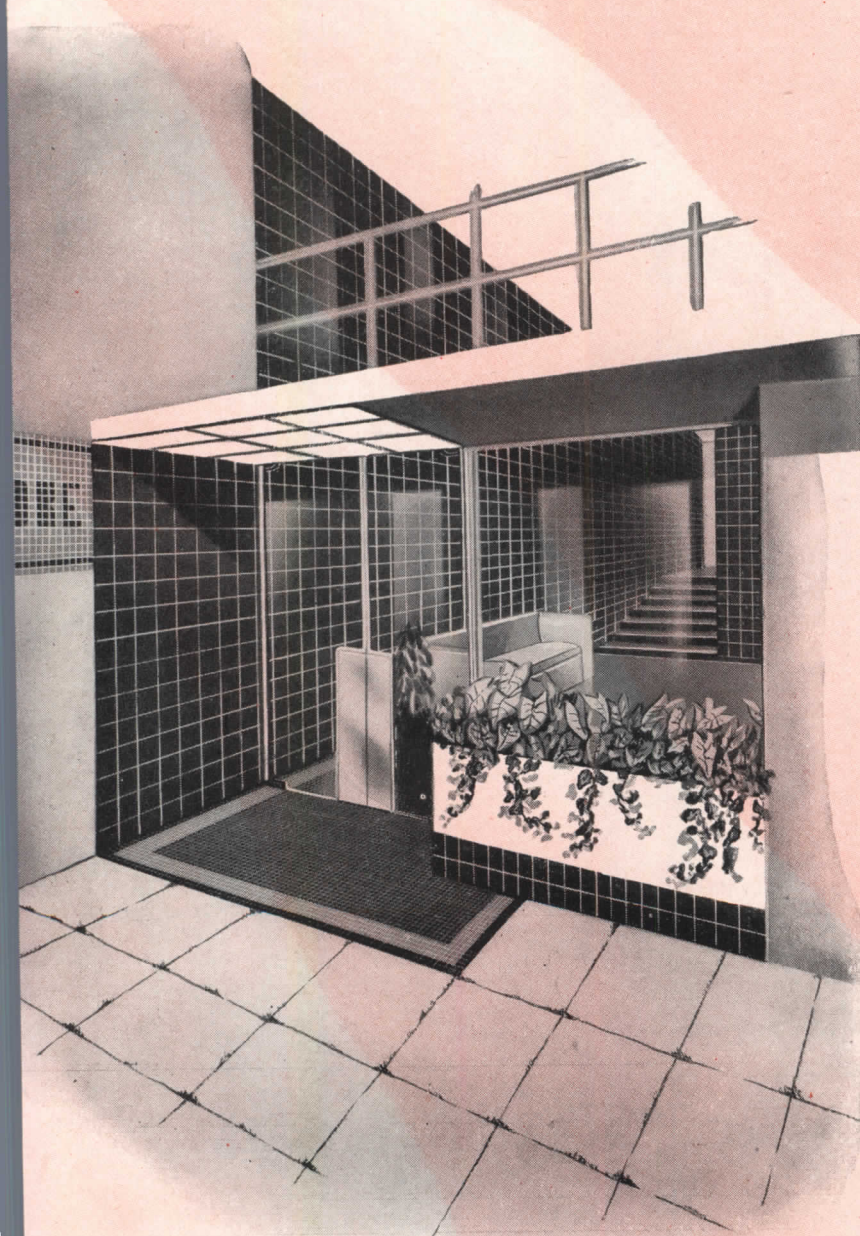

COLOR BALANCED

Suntile

... Bright with color

..... Right for life



Planning a
**Chemical Plant
 Oil Refinery
 Paper Mill?**
 ... or an addition!

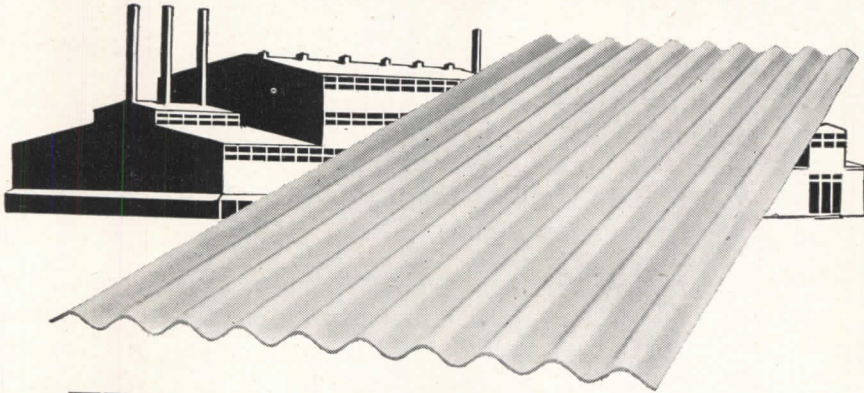

**You can now get
 ASBESTONE**

Asbestos-Cement Corrugated Roofing & Siding

—the lifetime roofing and siding that's fireproof and corrosion-proof. Asbestone can't be damaged by weather, rats, or termites. No painting. No upkeep.

Here are a few of the many prominent users:

- LONE STAR CEMENT CORP.
- CALIFORNIA OIL CO.
- CHAMPION PAPER and FIBRE CO.
- ETHYL CORPORATION
- FREEMPORT SULPHUR CO.
- NEW ORLEANS PUBLIC SERVICE
- MOBILE PAPER MILL CO.
- CROSBY CHEMICALS, INC.
- STANDARD OIL OF N. J.
- UNIVERSAL ATLAS CEMENT CO.

Why we can assure you early delivery

We are concentrating on production of this single industrial product. Stocks are now ample to make some immediate shipments. Free Engineering Service, available on request, shows how Asbestone can be adapted to your needs.

ASBESTONE CORPORATION

5300 TCHOUPITOULAS STREET NEW ORLEANS 15, LA.

Specialists in Asbestos-Cement Building

Products for over 25 Years

THE RECORD REPORTS

(Continued from page 14)

2. The Budget Bureau has been looking into possible refinement of building statistics, including building permits and contracts awarded. Meanwhile a new series on construction activity in suburbs and countryside, where permits are not issued, is being worked up.

3. Insured savings and loans associations in 1947 increased their combined assets from \$7.3 billion to \$8.5 billion, the Federal Savings and Loan Insurance advises. Home owners with mortgages held by these associations, it adds, made repayments on their loans totaling over \$1.5 billion.



ON THE CALENDAR

Jan. 12-March 20: "2500° F. — The Art and Technique of Modern Glass," exhibition of modern glass from 51 American and European manufacturers, The Cooper Union Museum for the Arts of Decoration, New York City.

Feb. 7-26: "French Prints from Corot to Picasso," exhibition of drawing, etching and lithography, School of Architecture and Allied Arts, University of Oregon, Eugene, Ore.

Feb. 11-12: Building Forum and Clinic, Pennsylvania State College, State College, Pa.

Feb. 22-26: Annual Convention and Exposition, National Association of Home Builders, Stevens and Congress Hotels, Chicago.

March 1-4: Planned Lighting Exhibition and conferences, sponsored by the Electric League of Western Pennsylvania, William Penn Hotel, Pittsburgh, Pa.

March 2, 4, 8, 10, 11: Series of public lectures, "Cities in Transition — The Causes and Consequences of Metropolitan Decentralization," Frick Chemical Laboratory, Princeton University, Princeton, N. J.

March 6: Symposium on Educational Buildings, sponsored by the Pennsylvania Society of Architects, Houston Hall, University of Pennsylvania, Philadelphia, Pa.

March 6-20: "Eckbo, Royston and Williams," exhibition of landscape architecture, School of Architecture and Allied Arts, University of Oregon, Eugene, Ore.

March 15-19: 6th Annual A.S.T.E. Industrial Exposition, and 16th Annual Meeting, American Society of Tool Engineers, Cleveland, Ohio.

March 22-24: 1948 Chicago Production Show and Technical Conference, Chicago Technical Societies Council, Stevens Hotel, Chicago, Ill.

(Continued on page 18)

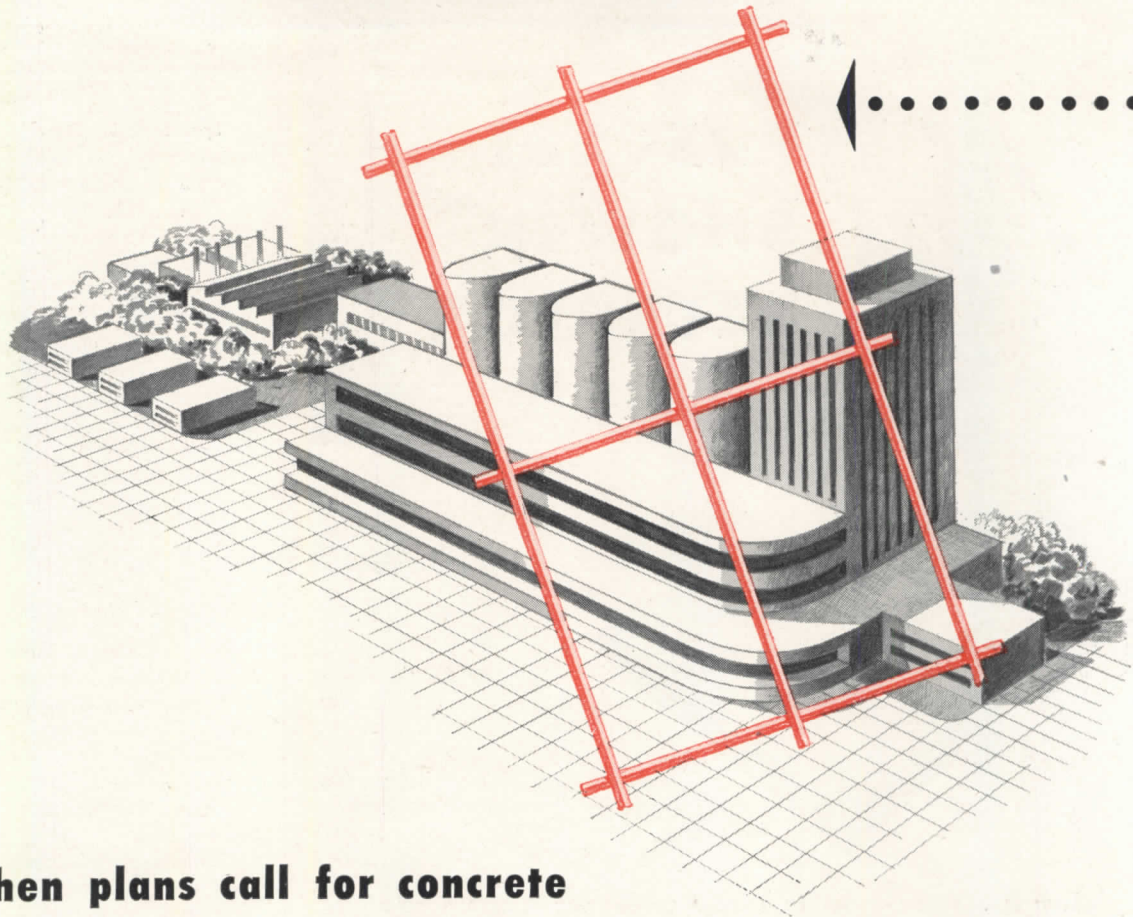

When plans call for concrete

Specify American Welded Wire Reinforcement...

● Architects and construction engineers have helped make American Welded Wire Fabric the world's most widely used reinforcement for concrete.

Closely and accurately spaced, the many high tensile strength steel members of American Welded Wire Fabric fortify all concrete construction against stresses, strains, and impact in all directions.

American Welded Wire Fabric comes to the job in rolls or flat sheets. Both are easily handled, lie flat and stay in place.

For lighter, stronger concrete construction, specify U·S·S American Welded Wire Fabric. It saves labor cost and construction time.

American Steel & Wire Company

Cleveland, Chicago and New York

COLUMBIA STEEL COMPANY, San Francisco,
Pacific Coast Distributors

TENNESSEE COAL IRON & RAILROAD, Birmingham,
Southern Distributors

United States Steel Export Company

UNITED STATES STEEL

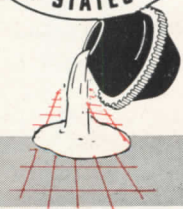

Every type of concrete construction needs American Welded Wire Fabric reinforcement.

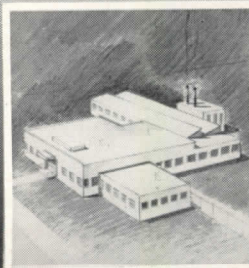

FACTORIES



SMALL HOMES

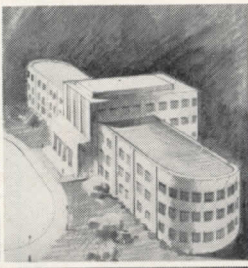

SCHOOLS

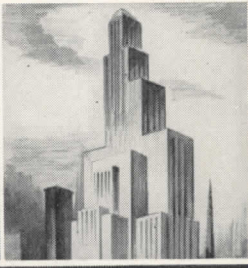

SKYSCRAPERS

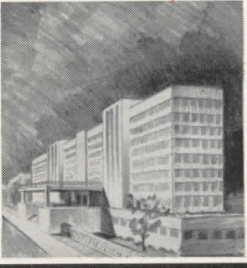

HOSPITALS

THE RECORD REPORTS

(Continued from page 16)

April 5-8: 4th Annual Conference and Exhibition, National Association of Corrosion Engineers, Jefferson Hotel, St. Louis, Mo.

April 7-9: Spring Meeting, American Society of Civil Engineers, William Penn Hotel, Pittsburgh, Pa.

April 7-14: San Francisco National Home Show, sponsored by the San Francisco Real Estate Board and the Associated Home Builders of San Francisco, Inc., Civic Auditorium, San Francisco, Calif.

April 13-16: 18th Annual Safety Convention and Exposition of the Greater New York Safety Council, Hotel Pennsylvania, New York City.

SCHOLARSHIP ANNOUNCED

The Managing Committee of the John Stewardson Memorial Scholarship in Architecture has announced a competition for a scholarship to the value of \$1000, the holder of which is to pursue the study of architecture in this country or abroad as determined by the Committee and under its direction.

Citizens of the United States who shall have studied or practiced architecture in the state of Pennsylvania for at least one year immediately preceding the scholarship award are eligible to compete. Candidates must be not less than 22 or over 32 years of age on February 28, 1948, and must have completed four years of office experience, or three years of office experience and one year of college, or two years of office experience and two years of college, or one year of office experience and three years of college, or four years of college and no office experience.

Applicants are required to forward to the Committee not later than Feb. 28, 1948, the information called for in the Registration Blank which will be provided upon request by the Secretary, Henry D. Mirick, Room 809, 12 S. 12th St., Philadelphia 7, Pa.

AT THE COLLEGES Research Studies Started

Eight research studies concerned with technical advancement in the use and production of brick and tile are under way in seven universities and technical institutions and at the National Bureau of Standards, according to an announcement by Roy A. Shipley, president of the Structural Clay Products Institute. The studies are expected to be completed in 1948, and are being conducted with the aid of a grant from the Office of Technical Services of the U. S. Department of Commerce. The projects are:

University of Texas — tensile strength

(Continued on page 20)



Fiat PRECAST SHOWER RECEPTOR

STANDARD SIZES

- 32" x 32"
- 36" x 36"
- 40" x 40"

... for built up showers with Tile, Plaster or Structural Glass Walls

A Fiat Precast Receptor in a built up shower is assurance of a water tight leakproof job at a considerable saving in cost over a hand fabricated floor using the old lead pan method. Walls are easier to handle with a solid one-piece foundation provided by a Fiat Precast Receptor.

A brass drain for 2" waste and the galvanized steel side wall flange is cast integral with the terrazzo forming a complete one-piece floor that is not affected by shrinkage or movement of supporting wood members.

Section through Fiat Precast Receptor showing cast-in drain connection and typical wall and threshold construction.

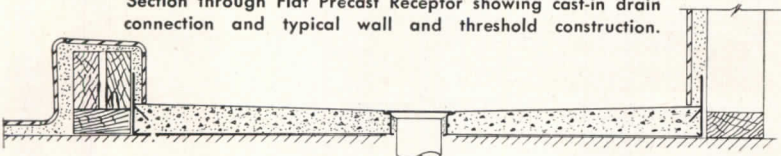

Fiat glass doors make showers more attractive in appearance and have a definite practical value to the user. Three types available: Dolphin, the finest in door construction, solid brass chromium plated frame. Zephyr, a satin finished aluminum frame door in the medium price class. Neptune, a low cost aluminum frame door. All Fiat doors are made for opening 24 inches wide.

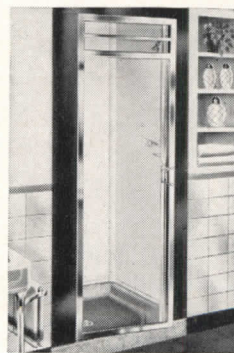

Dolphin or Zephyr Door on built-in Fiat Shower.

In Canada—Fiat showers are made by the Porcelain and Metal Products, Ltd., Orillia, Ontario

Fiat Metal Manufacturing Company

Chicago 13, Illinois

Long Island City 1, N. Y.

Los Angeles 33, Calif.

RIGHT AT HOME ON FIFTH AVENUE . . .



G-E Textolite plastics surfacing blends with the rich modern decor of the St. James Restaurant, Fifth Avenue, New York City.

● Smart appearance invites more customers . . . that's why General Electric Textolite table tops are so popular in restaurants and hotels.

Handsome General Electric Textolite surfacing helps dress up tables and counters in . . . cocktail bars . . . cafeterias . . . soda fountains . . . wherever hard use calls for exceptional durability. The laminated construction of this rugged plastics sheet stands up under shock. It resists scratching better than low carbon steel. And its stainproof luster is unmarred by alcohol, food acids, disinfectants, or scalding liquids. Even a burning cigarette won't blister its smooth finish.

Find out more about General Electric Textolite surfacing. You can choose from many standard colors and designs to match your decorative scheme. Get your free copy of the *illustrated booklet* which shows these standard patterns *in full color*. Just drop us a line, or use the coupon. Your fixture manufacturer will gladly equip your new counters and tables with Textolite surfaces in the pattern you select. Plastics Division, Chemical Department, General Electric Company, 1 Plastics Avenue, Pittsfield, Mass.



GENERAL ELECTRIC
*Reg. U.S. Pat. Off. CD48-D13
EVERYTHING IN PLASTICS

General Electric Co.,
 Section AR-11 -
 1 Plastics Avenue
 Pittsfield, Mass.

Send me a free copy of "Textolite
 Decorative Surfacing Materials for
 Table and Counter Tops."

Name.....
 Business.....
 Address.....
 City.....State.....



Distinctive Floors

to fit distinctive design



Foreground of main office area, S. C. Johnson Co., Racine, Wisconsin, Frank Lloyd Wright, architect.

IN KEEPING with the distinctive design and functional purpose of this modern office building, the floors are Wright Rubber Tile. This modern flooring possesses a lasting beauty, a quiet surface, a gleaming finish and a resistance to scuffing, stain, wear or denting that is almost unbelievable. Furthermore, its non-porous surface makes for the easiest maintenance — the lowest cost upkeep.

Wright Rubber Tile is recognized as *the quality floor*. This tile is uniformly cured, and molded by the most modern processes. No polishing or buffing is used to give it a velvety luster. Because it retains the flexibility and resiliency of its rubber content, its quietness, its durability, its long-time foot comfort, and its resistance to chipping and cracking, go without saying. For complete information on this modern, distinctive flooring for homes, offices, buildings or stores, see your nearest dealer or contractor or write direct to Taylor Mfg. Co., 3074 W. Meinecke Ave., Milwaukee 10, Wis.

WRIGHT RUBBER TILE
Floors of Distinction

THE RECORD REPORTS

(Continued from page 18)

and design of reinforced tile-concrete beams.

Virginia Polytechnic Institute — effect of brick texture on the bond between the brick and the mortar used in building walls; both smooth and rough brick finishes being tested with various mortar formulas.

University of Minnesota — moisture resisting properties of structural facing tile.

University of Illinois — factors affecting variations in the sizes of brick and tile.

Iowa State College — factors affecting lamination of structural clay products.

New York State College of Ceramics — methods of manufacturing the new modular sizes of brick from soft clay.

North Carolina State College — development of light weight structural clay products.

National Bureau of Standards — use of de-aired clay in the manufacture of brick and tile.

Library on Housing

The library on housing belonging to the late Mrs. Edith Elmer Wood, noted pioneer in public housing in the United States, has been given jointly to the New School for Social Research, New York City, and to the Avery Library of Columbia University by Mrs. Wood's sons, Dr. Horace E. Wood II and Dr. Albert E. Wood. The collection consists of books and journals on public housing, and a quantity of pamphlet material; the New School's share runs to at least a thousand items.

Residential Construction

"Housing Research at Work" will be the theme of the third annual Short Course in Residential Construction for Contractors and Builders to be given at the University of Illinois on Feb. 17-18.

The course will center around housing research being carried on at the University, and is being sponsored jointly by the Small Homes Council and the Division of University Extension.

Highlighting the program will be reports on the Industry-Engineered House, seven of which have been built by the University. Another subject will be the construction of concrete slab floors.

Registrations and requests for information are being handled through the Division of University Extension, Urbana.

New Engineering Curricula

A new approach to engineering education has been proposed by Dean Thorn-dike Saville of New York University's

(Continued on page 22)

Specify Corning Lighting Glassware!

*For the Best
in Lighting...*



OUT of Corning Research has come a complete line of scientifically designed lighting glassware to meet your exacting needs. Backed by decades of experience in illuminating engineering, Corning employs every technical and scientific advancement in producing quality lightingware for incandescent and fluorescent fixtures for both commercial and residential applications. Almost every lighting problem can be solved easily and effectively with Corning products.

To bring you up-to-date on these latest Corning developments, five new bulletins have been prepared. They are ready for you now. Covering the characteristics, applications and specifications of each type of ware, they will give you valuable aid in planning your next lighting layout or fixture design.

NEW BULLETINS NOW AVAILABLE!

Bulletin LS-7 describes ALBA-LITE, Corning's new diffusing glassware; Bulletin LS-8, FLUR-O-GUIDE Lens Panels for directing fluorescent light; Bulletin LS-9, PYREX brand Lens-lites for directing incandescent light; Bulletin LS-10, MONA-LITE, a new, dense opal glass for low transmission and high reflection; LS-12, Corning Residential Lightingware. Any one or all of these bulletins available on request. Use coupon now!

Corning Glass Works
Dept. AR-2, Corning, N. Y.

Please send me the Corning Lighting Bulletins checked: LS-7; LS-8; LS-9;
 LS-10; LS-12.

Name _____ Title _____

Company _____

Address _____

City _____ Zone _____ State _____

CORNING
means research in
GLASS



CORNING GLASS WORKS • CORNING, N. Y.
SALES OFFICES: NEW YORK • CHICAGO • SAN FRANCISCO

LIGHTINGWARE

-AND WHEN YOU COME TO THE FLOOR DESIGN

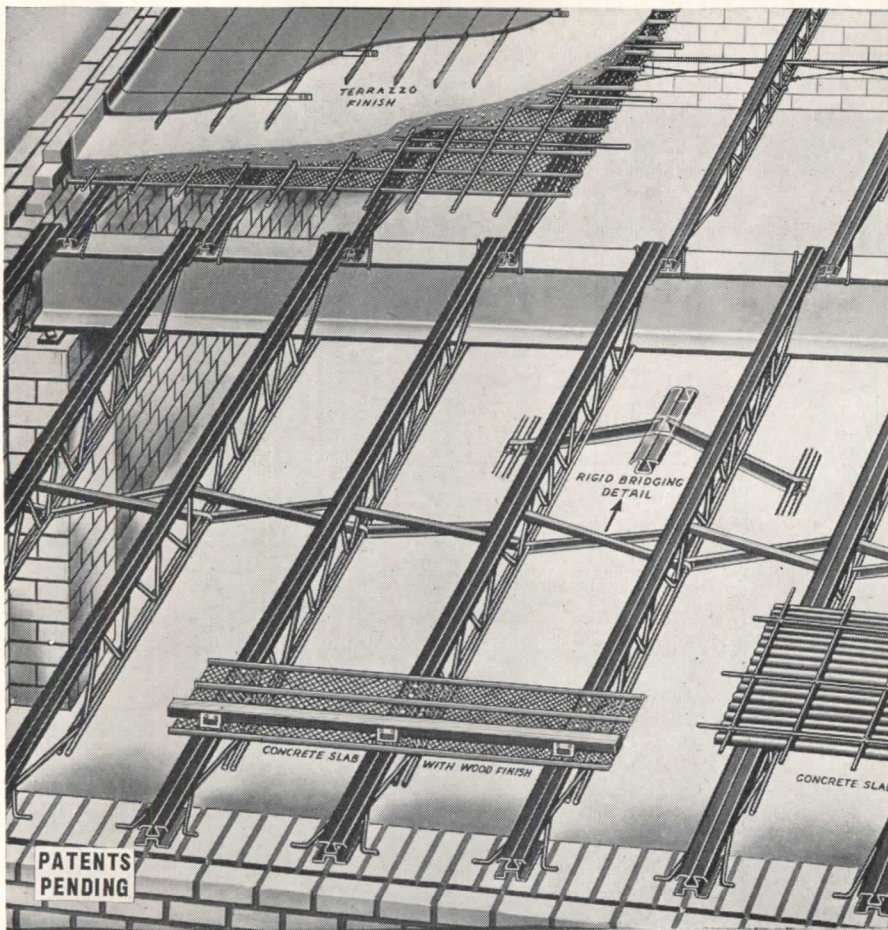

Here's Your Product and **WHY** **MACOMBER V BAR JOISTS**

FOR COMMERCIAL, RESIDENTIAL OR INDUSTRIAL FLOOR SYSTEMS this one steel joist has universal application. Regardless of the floor finish you want—with or without radiant heating—this original Bar Joist will fulfill every structural and mechanical need. Slab forming materials or subflooring are nailed securely into the vise-like groove. The bridging furnished leaves the top chord free for flooring application. And for the designer, a Bar Joist of universal application means one reference to one standard loading table for any joist floor design. Do YOU have the V Bar Joist Catalog of designing details?

V-BAR JOISTS AND PURLINS • V-STUDS • TRUSSES • LONGSPANS • DECKING

MACOMBER

INCORPORATED

CANTON, OHIO

STANDARDIZED STEEL BUILDING PRODUCTS

THE RECORD REPORTS

(Continued from page 20)

College of Engineering.

Under the Dean's plan a general four-year course would be established which substantially all engineering students would take. It would be uniform, or nearly so, for the first three years, and would lead to the degree of Bachelor of Engineering. The first three years would have all of the basic sciences and fundamental engineering subjects now offered, but would add courses in history, public affairs and economics. The senior year would have a considerable number of electives, designed on the one hand for those who expect to terminate their technological engineering education in four years, and on the other for those who will take a fifth year of specialized programs leading to the degrees of A.E., C.E., M.E., E.E., etc.

Chicago Takes Over Laboratory

Effective January 1, 1948, all responsibility for the operation of Clinton Laboratories was transferred from the Monsanto Chemical Company to the University of Chicago, which is operating the Laboratory under the name of "Clinton National Laboratory."

TWO FELLOWSHIPS IN ARCHITECTURE OPEN University of Michigan

The College of Architecture and Design, University of Michigan, has announced that the George G. Booth Traveling Fellowship in Architecture will be offered again this year, and the competition in design will be conducted during the two weeks beginning April 3, 1948. This competition is open to all graduates of the school who have not reached their 30th birthday on that date. Prospective candidates should write immediately to the office of the College of Architecture and Design, University of Michigan, Ann Arbor, Mich.

Princeton University

The School of Architecture, Princeton University, has announced the availability of the Lowell M. Palmer Fellowship in Architecture. Offering a year of advanced study at Princeton, and a stipend of \$700, the Fellowship is open to candidates holding a Bachelor's degree, who are citizens of the United States, and less than 27 years of age on October 1, 1948. Applications for appointment, together with supporting documents, must be received not later than March 1, 1948. Application blanks may be obtained from the Secretary, School of Architecture, Princeton University, Princeton, N. J.

(Continued on page 152)

**Tough
and
resilient**



National advertising in influential home magazines and business publications is informing your clients about Duran. Makers of fine furniture use this tag to identify genuine Duran.

Specify

Duran
ALL PLASTIC

FOR UPHOLSTERY

BEAUTY AND VERSATILITY

Fade resistant decorator colors; lovely grains; soft pliancy. Use for all types of furniture, for booths, tufted walls, doors and panelling.

REMARKABLE DURABILITY

Resistant to wear and scuffing. All plastic, it will not chip or peel. Resists grease, alcohol and perspiration. Washable with soap and water.

With Duran, your clients will get lasting satisfaction. For new, distinctive effects, specify Duran — an exclusive creation of Masland, mastercraftsmen for over 30 years. Samples on request.



THE MASLAND DURALEATHER COMPANY, 3236-90 AMBER STREET, PHILADELPHIA 34, PA.

Duran
resists
grease
and stains



Duran
resists
fire — no
flaming



Duran resists
damage from
spills —
washable





Hang the door problems!

The Hardware Consultant in your locality has the training and experience, not only to take care of specification and price details, but also to suggest hardware designs, qualities and functions in keeping with your buildings.

THE DETAILS of hardware specification mean a laborious job that a busy architect is usually willing to hand over to a good hardware consultant. This is doubly wise because the modern consultant's services go much farther than catalog work. His specialized training highly qualifies him to diagnose, advise and cooperate with you in the most exacting requirements of the structure you are planning.

You can count on his knowledge and judgment in the interpretation of your ideas — providing hardware in keeping with the job in terms of easy installation, fine appearance, faultless functioning and lasting service. You will appreciate his professional

competence all the way — in planning, purchasing, installing and maintenance. Why not make full use of the service he offers in your current building plans?

If you do not know the hardware consultant in your area, a letter to Stanley will put you in touch with him promptly.

STANLEY

Reg. U. S. Pat. Off.

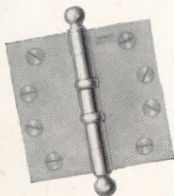

This Stanley Ball Bearing Butt Hinge features: easy seating, non-rising pin — beveled inner edges — ball bearings permanently attached to the knuckles — square corners — precision screw holes — in its entirety, an outstanding example of superior hinge construction.

THE STANLEY WORKS, NEW BRITAIN, CONNECTICUT

The Faster Way to Partition and Panel

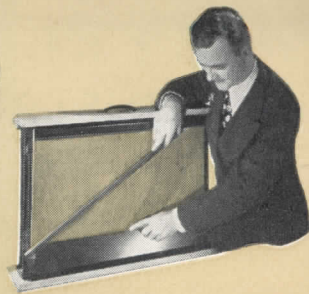

SEE THIS FREE, 10-MINUTE DEMONSTRATION IN YOUR OFFICE.

Get in touch with your nearest M/P Distributor listed below for your private showing.

YOUR M/P DISTRIBUTOR

- ALABAMA
 - Birmingham... Acousti Engineering Co.
 - Mobile... Acoustics & Specialties Co.
- ARIZONA
 - Phoenix... J. B. Matz Co.
- ARKANSAS
 - Little Rock... Acoustics & Specialties Co.
- CALIFORNIA
 - Los Angeles... The Harold E. Shugart Co.
 - Oakland... F. K. Pinney, Inc.
 - Sacramento... F. K. Pinney, Inc.
 - San Francisco... F. K. Pinney, Inc.
- COLORADO
 - Denver... Lauren Burt, Inc.
- CONNECTICUT
 - Hartford... The C. A. Bader Co.
- DELAWARE
 - Wilmington... The W. M. Moyer Co.
 - Wilmington (Eastern Shore)... John H. Hampshire, Inc.
- DISTRICT OF COLUMBIA
 - Washington... John H. Hampshire, Inc.
- FLORIDA
 - Jacksonville... Acousti Engineering Co.
 - Miami... Acousti Engineering Co.
 - Tampa... Acoustics & Specialties Co.
 - Pensacola... Acoustics & Specialties Co.
- GEORGIA
 - Atlanta... Acousti Engineering Co.
- ILLINOIS
 - Decatur... Hugh J. Baker & Co.
- INDIANA
 - Evansville... Hugh J. Baker & Co.
 - Ft. Wayne... Hugh J. Baker & Co.
 - Indianapolis... Hugh J. Baker & Co.
 - Wabash... Hugh J. Baker & Co.
- KENTUCKY
 - Louisville... E. C. Decker & Co.
- LOUISIANA
 - New Orleans... Acoustics & Specialties Co.
- MAINE
 - Portland... Pitcher & Co.
- MARYLAND
 - Baltimore... John H. Hampshire, Inc.
- MASSACHUSETTS
 - Boston... Pitcher & Co.
 - Springfield... The C. A. Bader Co., Inc.
- MICHIGAN
 - Detroit... R. E. Leggette Co.
 - Grand Rapids... Leggette-Michaels Co.
- MINNESOTA
 - Minneapolis... Insulation Sales Co., Inc.
- MISSOURI
 - Kansas City... Hengos Co., Inc.
 - St. Louis... Hengos Co., Inc.
- NEW JERSEY
 - Elizabeth... Jacobson & Co.
 - Trenton... The W. M. Moyer Co.
- NEW MEXICO
 - Albuquerque... The Jay Gear Corp.
- NEW YORK
 - Albany... Collum Acoustical Co.
 - Buffalo... Collum Acoustical Co.
 - Jamestown... Collum Acoustical Co.
 - Rochester... Collum Acoustical Co.
 - Syracuse... Collum Acoustical Co.
 - New York City... Jacobson & Co.
- NORTH CAROLINA
 - Charlotte... Acousti Engineering Co. of the Carolinas
- OHIO
 - Akron... Mid-West Acoustical & Supply Co.
 - Cleveland... Mid-West Acoustical & Supply Co.
 - Columbus... Mid-West Acoustical & Supply Co.
 - Toledo... Mid-West Acoustical & Supply Co.
 - Cincinnati... E. C. Decker & Co.
 - Dayton... E. C. Decker & Co.
- PENNSYLVANIA
 - Altoona... Harry C. Leezer Co.
 - Pittsburgh... Harry C. Leezer Co.
 - Sharon... Harry C. Leezer Co.
 - Harrisburg... The W. M. Moyer Co.
 - Philadelphia... The W. M. Moyer Co.
 - Seranton... The W. M. Moyer Co.
- RHODE ISLAND
 - Providence... Pitcher & Co.
- SOUTH CAROLINA
 - Charleston... Acoustic Engineering Co. of the Carolinas
- SOUTH DAKOTA
 - Sioux Falls... Insulation Sales Co., Inc.
- TENNESSEE
 - Chattanooga... Len Herndon Co.
 - Knoxville... Len Herndon Co.
 - Nashville... Len Herndon Co.
 - Memphis... Acoustics & Specialties Co.
- TEXAS
 - Dallas... S. W. Nichols Co.
 - Houston... S. W. Nichols Co.
 - San Antonio... S. W. Nichols Co.
 - El Paso... The Jay Gear Corp.
- UTAH
 - Salt Lake City... Lauren Burt, Inc.
- VERMONT
 - Rutland... The C. A. Bader Co.
- VIRGINIA
 - Norfolk... John H. Hampshire, Inc.
 - Richmond... John H. Hampshire, Inc.
 - Roanoke... John H. Hampshire, Inc.
- WEST VIRGINIA
 - Huntington... E. C. Decker & Co.
 - Clarksburg... E. C. Decker & Co.
 - Wheeling... Harry C. Leezer Co.
- WISCONSIN
 - Milwaukee... Edw. T. VerHalen, Inc.
 - Green Bay... Edw. T. VerHalen, Inc.
- WYOMING
 - Cheyenne... Lauren Burt, Inc.

Here's what another METLWAL user says:

THE DAVIS CONSTRUCTION COMPANY
GENERAL CONTRACTORS
320 W. TWENTY-FOURTH STREET
BALTIMORE
MORSE 11

"Your Metlwal Partitions recently installed in our office easily surpass any other make in our many years of building experience.

"These partitions have enhanced the attractiveness and impressiveness of our office by their beautiful woodgrain finish and sound-proofing qualities."

Parlett L. Davis

Mr. Parlett L. Davis, President
The Davis Construction Company
Baltimore, Maryland.



These METLWAL features are worth checking!

- Quickly cover interior walls and divide floor space.
- Only a few standard parts — from warehouse stock.
- Readily adaptable to an endless variety of interiors.
- Easily movable without waste.
- Provide an all-flush surface from floor to ceiling.
- Eliminate need for plaster in new construction and for filler boards of other materials at ends or above cornice level.
- Easy to maintain.
- Factory-finished in natural woodgrain reproductions or soft, baked-enamel finishes.
- Will not chip, crack or craze.
- Do not reflect harsh, metallic light.
- Bonderized against rust and corrosion.

WRITE TODAY for your copy of our latest catalog A 2, containing Metlwal specifications, drawings and installation photos. See how Metlwal can help you plan beautiful interiors. Address: Martin-Parry Corporation, Toledo 1, Ohio. Plants: Toledo, Ohio; York, Pa.



MARTIN PARRY
M/P
PRODUCTS

METLWALS

**ALL-FLUSH PANELING
MOVABLE PARTITIONS**

68 Years of Service

ENGINEERING AND ERECTING SERVICE AND
WAREHOUSE STOCKS FROM COAST TO COAST

CONSTRUCTION COST INDEXES — Labor and Materials

United States average 1926—1929=100

Presented by Clyde Shute, manager, Statistical and Research Division, F. W. Dodge Corporation, from data compiled by E. H. Boeckh & Associates, Inc.

NEW YORK

ATLANTA

Period	Residential		Apts., Hotels, Office Bldgs. Brick and Concr.	Commercial and Factory Buildings		Residential		Apts., Hotels, Office Bldgs. Brick and Concr.	Commercial and Factory Buildings	
	Brick	Frame		Brick and Steel	Brick and Concr.	Brick	Frame		Brick and Steel	Brick and Concr.
1920	136.1	136.9	123.3	123.6	122.6	122.8	122.9	108.6	109.8	105.7
1925	121.5	122.8	111.4	113.3	110.3	86.4	85.0	88.6	92.5	83.4
1930	127.0	126.7	124.1	128.0	123.6	82.1	80.9	84.5	86.1	83.6
1935	93.8	91.3	104.7	108.5	105.5	72.3	67.9	84.0	87.1	85.1
1939	123.5	122.4	130.7	133.4	130.1	86.3	83.1	95.1	97.4	94.7
1940	126.3	125.1	132.2	135.1	131.4	91.0	89.0	96.9	98.5	97.5
1941	134.5	135.1	135.1	137.2	134.5	97.5	96.1	99.9	101.4	100.8
1942	139.1	140.7	137.9	139.3	137.1	102.8	102.5	104.4	104.9	105.1
1943	142.5	144.5	140.2	141.7	139.0	109.2	109.8	108.5	108.1	108.7
1944	153.1	154.3	149.6	152.6	149.6	123.2	124.5	117.3	117.2	118.2
1945	160.5	161.7	156.3	158.0	155.4	132.1	133.9	123.2	122.8	123.3
1946	181.8	182.4	177.2	179.0	174.8	148.1	149.2	136.8	136.4	135.1
Aug. 1947	225.5	227.1	215.5	214.9	209.4	185.4	189.3	162.4	161.2	161.4
Sept. 1947	225.9	227.5	216.4	216.0	210.4	185.6	189.5	164.1	162.3	165.0
Oct. 1947	228.7	231.0	218.5	217.4	213.8	186.9	191.0	165.0	163.0	165.8
Nov. 1947	229.1	231.4	219.0	217.8	214.2	187.3	191.4	165.5	163.4	166.2
	% increase over 1939					% increase over 1939				
Nov. 1947	85.5	89.0	67.6	63.2	64.6	117.0	130.6	74.0	67.7	75.4

ST. LOUIS

SAN FRANCISCO

1920	118.1	121.1	112.1	110.7	113.1	108.8	107.5	115.2	115.1	122.1
1925	118.6	118.4	116.3	118.1	114.4	91.0	86.5	99.5	102.1	98.0
1930	108.9	108.3	112.4	115.3	111.3	90.8	86.8	100.4	104.9	100.4
1935	95.1	90.1	104.1	108.3	105.4	89.5	84.5	96.4	103.7	99.7
1939	110.2	107.0	118.7	119.8	119.0	105.6	99.3	117.4	121.9	116.5
1940	112.6	110.1	119.3	120.3	119.4	106.4	101.2	116.3	120.1	115.5
1941	118.8	118.0	121.2	121.7	122.2	116.3	112.9	120.5	123.4	124.3
1942	124.5	123.3	126.9	128.6	126.9	123.6	120.1	127.5	129.3	130.8
1943	128.2	126.4	131.2	133.3	130.3	131.3	127.7	133.2	136.6	136.3
1944	138.4	138.4	135.7	136.7	136.6	139.4	137.1	139.4	142.0	142.4
1945	152.8	152.3	146.2	148.5	145.6	146.2	144.3	144.5	146.8	147.9
1946	167.1	167.4	159.1	161.1	158.1	159.7	157.5	157.9	159.3	160.0
Aug. 1947	207.0	208.6	189.9	189.4	190.1	196.7	195.6	188.9	192.4	190.8
Sept. 1947	207.5	209.0	191.2	190.8	192.3	198.4	196.3	192.5	197.4	195.7
Oct. 1947	210.7	213.0	192.2	191.5	193.4	207.1	206.2	195.4	199.6	198.9
Nov. 1947	212.1	214.0	193.6	192.5	194.5	207.7	206.8	196.2	200.2	199.5
	% increase over 1939					% increase over 1939				
Nov. 1947	92.3	100.0	63.1	60.7	63.4	96.8	108.3	67.0	64.2	71.2

The index numbers shown are for combined material and labor costs. The indexes for each separate type of construction relate to the United States average for 1926-29 for that particular type — considered 100.

Cost comparisons, as percentage differences for any particular type of construction, are possible between localities, or periods of time within the same city, by dividing the difference between the two index numbers by one of them; i.e.:

index for city A = 110

index for city B = 95

(both indexes must be for the same type of construction).

Then: costs in A are approximately 16 per cent higher than in B.

$$\frac{110-95}{95} = 0.158$$

Conversely: costs in B are approximately 14 per cent lower than in A.

$$\frac{110-95}{110} = 0.136$$

Cost comparisons cannot be made between different types of construction because the index numbers for each type relate to a different U. S. average for 1926-29.

Material prices and wage rates used in the current indexes make no allowance for payments in excess of published list prices, thus indexes reflect minimum costs and not necessarily actual costs.

These index numbers will appear whenever changes are significant.

TO FLASH A CORNER QUICKLY...



The corner flashing is put on last, lapping the straight flashings by two corrugations. Note the bent-down weather lip which makes the completed assembly water-tight.

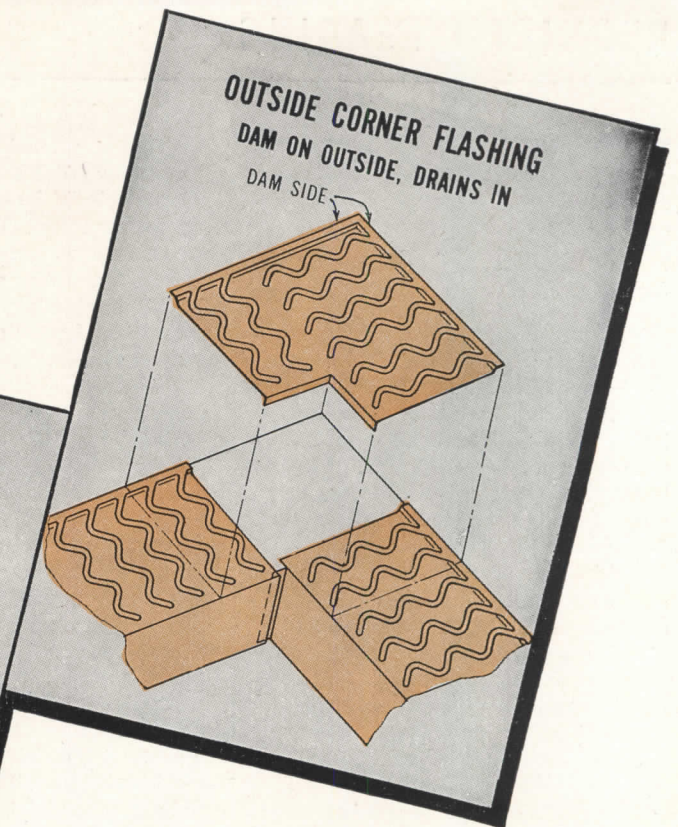

Use ANACONDA Through-Wall Flashing with one-piece, inside and outside, corner flashings

ANACONDA THROUGH-WALL FLASHING is designed to provide positive drainage, a strong mortar bond and long-lived protection ... and also to make the sheet metal contractor's work as easy as possible.

This copper flashing that *drains itself dry* is carried in stock for 8- and 12-inch walls in five-foot and eight-foot straight lengths, together with corner pieces for both inside and outside drainage. These corner pieces are so designed that the corrugations interlock with those of the adjoining straight sections, providing the same thorough drainage, watertight joints and firm mortar bond at the corners as in the main part of the wall. The flat selvage on both straight lengths and corner pieces is an aid in

making neat, sharp bends for counter flashing or for locking to adjacent metal.

For detailed information on Anaconda Through-Wall Flashing, see our catalog in Sweets.

4761



Anaconda
COPPER

THE AMERICAN BRASS COMPANY

General Offices: Waterbury 88, Connecticut
 Subsidiary of Anaconda Copper Mining Company
 In Canada: ANACONDA AMERICAN BRASS LTD.,
 New Toronto, Ont.

REQUIRED READING

THE HOUSE YOU WANT

The House for You to Rent, Buy or Build. By Catharine and Harold Sleeper. Illustrations by Lombard Jones and Henry Diamond. New York (440 Fourth Ave.), John Wiley & Sons, Inc., 1948. 7½ by 10½ in. 295 pp. illus. \$5.00.

Reviewed by TALBOT HAMLIN

Mr. Sleeper has come to the rescue of the house seeker. His book is filled with trenchant comment on the pitfalls awaiting the unwary. Whether one is planning to rent, buy, or build, Mr. Sleeper's book gives warning, advice and enormous amounts of valuable information. It tells what danger signs to look for in renting or buying; it explains the value and place of the experts — bankers, real estate agents, and architects — and it gives, as few other books have given, a sufficient importance to site and community qualities as measures of the desirability of any proposed location.

Mr. Sleeper's chief emphasis is on building, though his advice as to who should build, and when, and how much should be spent, is realistic and wise; no one who reads this book should have any excuse for finding himself saddled

with debts and maintenance costs out of proportion to his income. For those about to build he explains the tasks of the architect, and how the building of a house is a cooperative effort between architect and client. All of this is done in the simplest and most graphic manner, with frequent examples of conversations between architect and client and short tales of happy or disastrous experiences on the part of wise or foolish individuals.

Then follows a detailed consideration of all the factors that go to make up a house — planning, construction types, finishes, materials, equipment. Sections deal with planning for circulation and privacy, planning sleeping areas, and planning kitchens, and another section contains several pages of small "basic plans."

A certain kind of neutrality dictates the author's attitude toward "style" — a neutrality which some architects may feel is dangerous. The implications seem to be that "style" is an additional something applied over a selected room arrangement. Obviously this is not so.

(Continued on page 30)

RÔLES THE ARCHITECT PLAYS



COUNSELOR

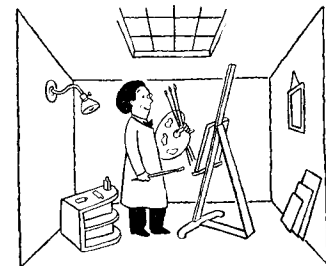

ARTIST



BUSINESSMAN

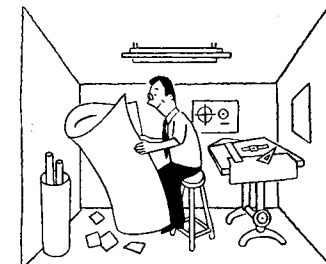

ENGINEER



LAWYER



INSPECTOR

THE MAGIC HOUSE IS ALWAYS ON THE WAY BUT NEVER ARRIVES

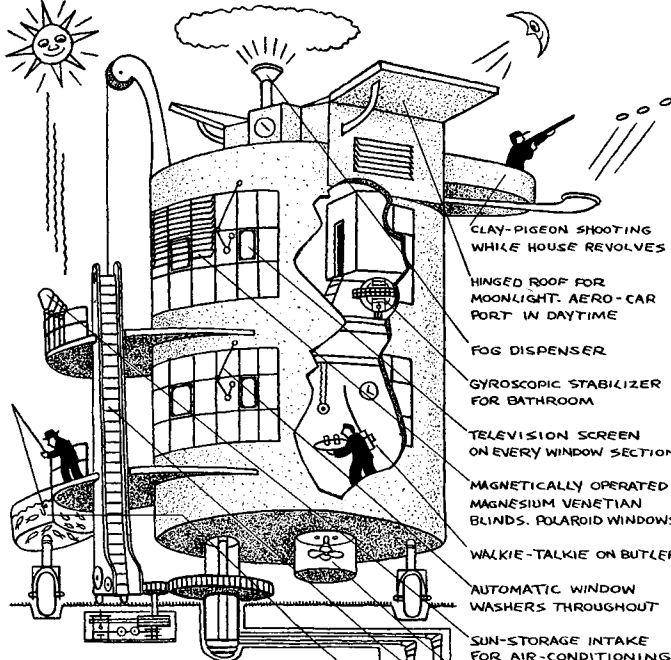

GENERAL FEATURES OF THE MAGIC HOUSE

HOUSE REVOLVES AUTOMATICALLY WITH THE SUN. LIGHTING THROUGHOUT IS BY PHOSPHORESCENT CEILING TUBES CONTROLLED BY ELECTRIC EYES. CEILING LIGHTS GO OFF AUTOMATICALLY WHEN YOU GO TO BED; RADIO IN EVERY ROOM PLAYS IN RESPONSE TO YOUR REQUEST, WITH OR WITHOUT COMMERCIALS. THE MAGIC HOUSE IS SOUNDPROOFED BY RUBBER WALLS AND CEILINGS. ALL PARTITIONS SLIDE BY TIPPING HOUSE - EXCEPT BATHROOM PARTITIONS WHICH ARE GYROSCOPICALLY STABILIZED TO PREVENT SPLASHING

- CLAY-PIGEON SHOOTING WHILE HOUSE REVOLVES
- HINGED ROOF FOR MOONLIGHT. AERO-CAR PORT IN DAYTIME
- FOG DISPENSER
- GYROSCOPIC STABILIZER FOR BATHROOM
- TELEVISION SCREEN ON EVERY WINDOW SECTION
- MAGNETICALLY OPERATED MAGNESIUM VENETIAN BLINDS. POLAROID WINDOWS
- WALKIE-TALKIE ON BUTLER
- AUTOMATIC WINDOW WASHERS THROUGHOUT
- SUN-STORAGE INTAKE FOR AIR-CONDITIONING
- AUTOMATIC HOUSE CLEANER
- RETRACTABLE ESCALATOR ENTRANCE TO DISCOURAGE UNINVITED GUESTS
- SELF-STOCKING FISH POND
- REMOTE-CONTROL AUTOMATIC UNDERGROUND KITCHEN. FOOD AND DRINK PIPED TO DINING-ROOM TABLE AND BREAKFAST NOOK
- ATOMIC GARBAGE PAIL

Illustrations on this page from "The House for You to Rent, Buy or Build"

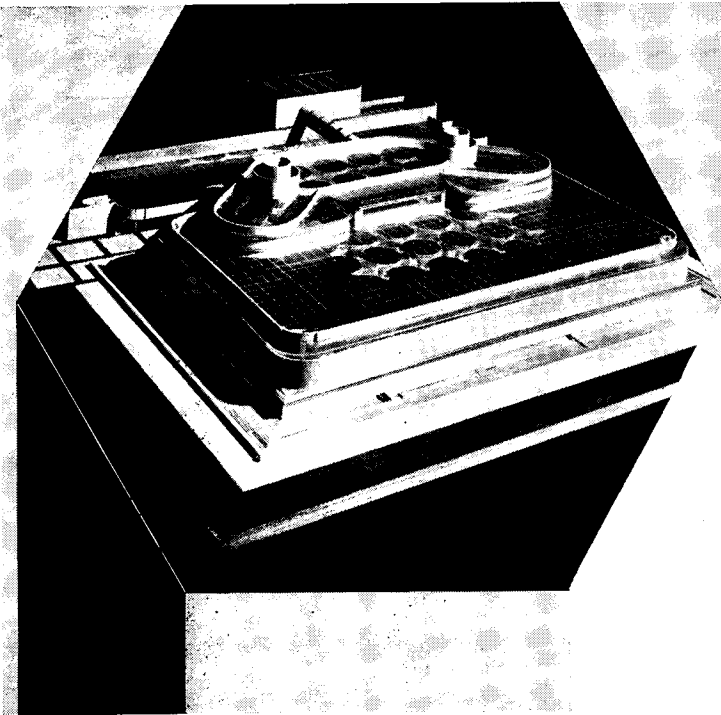

**THANK
YOU,
FRANK
LLOYD
WRIGHT**

CLASS OF SERVICE
This is a full-rate Telegram or Cablegram unless its deferred character is indicated by a suitable symbol above or preceding the address.

**WESTERN
UNION**

JOSEPH L. EGAN
PRESIDENT

1701

448P
NL=Night Letter
LC=Deferred Cable
NLT=Cable Night Letter
Ship Radiogram

The filing time shown in the date line on telegrams and day letters is STANDARD TIME at point of origin. Time of receipt is STANDARD TIME at point of destination.

L WUP 266 13

WUX

PHOENIX ARIZ DEC4 149P

A E HORN PRESIDENT,

A C HORN CO LONG ISLAND CITY NY

SAY FOR ME THAT WE FIND HORN VULCATEX AN ADMIRABLE MASTIC

FRANK LLOYD WRIGHT

VULCATEX

THE COMPANY WILL APPRECIATE SUGGESTIONS FROM ITS PATRONS CONCERNING ITS SERVICE

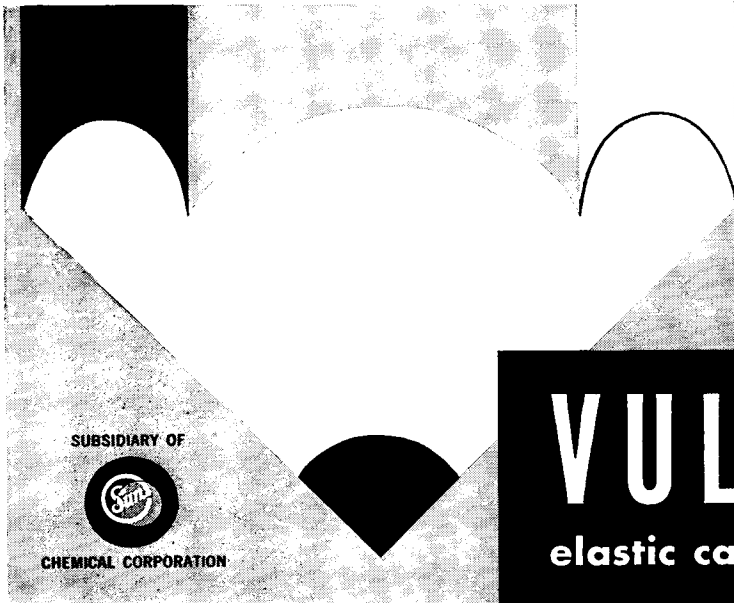

A. C. HORN COMPANY, INC.

Manufacturers of Materials for Building Maintenance and Construction

43-36 10th Street, Long Island City 1, N. Y.

HOUSTON, TEXAS · SAN FRANCISCO, CALIFORNIA

CHICAGO, ILLINOIS · TORONTO, CANADA

SUBSIDIARY OF



CHEMICAL CORPORATION

VULCATEX
elastic caulking compound

ESTABLISHED 1897



50th YEAR

3 way
Service

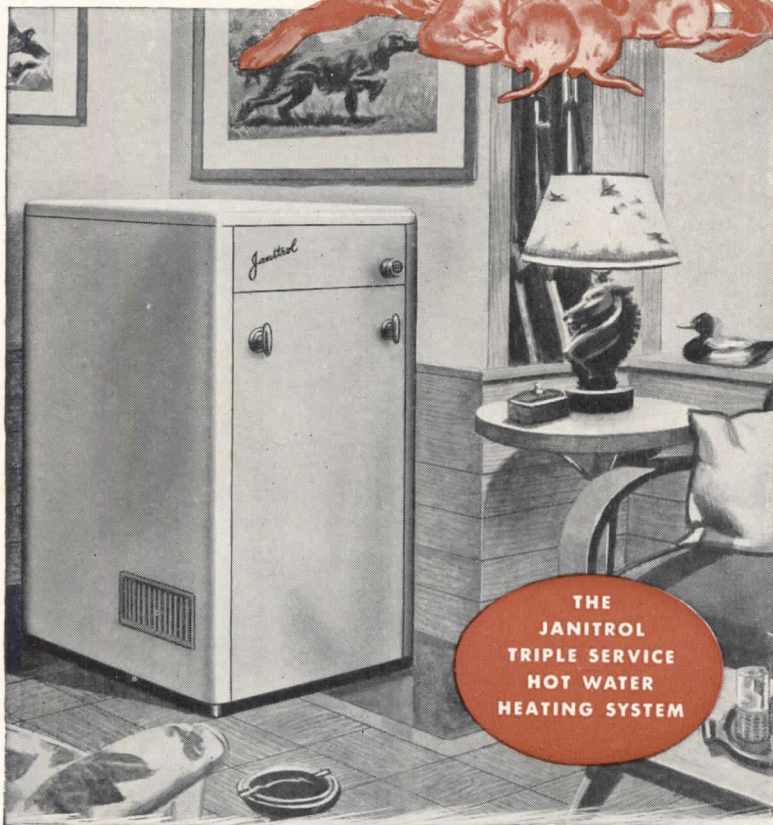

From a New, Single, Modern HEATING UNIT

Supplies all household needs for
hot water and heating

FROM a single Janitrol unit you get three separate supplies of hot water at the right temperatures . . . one for efficient, automatic home heating . . . one for automatic dishwashing and laundry appliances . . . one for bath, shower and lavatory.

This complete Janitrol system, gas or oil fired is so compact and highly efficient, it can be installed in any convenient place in the basement . . . the first floor, in a closet, utility room or adjoining garage . . . even in the attic.

Comfort Heating: The Janitrol hot water system is a complete factory tested package. When used with modern convector radiators the temperature of each room can be individually controlled. Hundreds of radiant panel heating installations in ceilings and floors have also been made, utilizing Janitrol's advanced design for low cost of installation and proved performance.

YOUR OPPORTUNITY TO REDUCE BUILDING COSTS—This new Janitrol heating and hot water system offers you a wonderful opportunity to reduce building costs . . . by giving your clients what they need with extra advantages . . . giving them modern house heating and a hot water heater in one efficient unit, complete, ready for quick, economical installation.

Write today for complete specification data and information on typical installations.

Janitrol
SURFACE COMBUSTION CORP., TOLEDO 1, O.

TRIPLE SERVICE HOT WATER HEATING SYSTEM

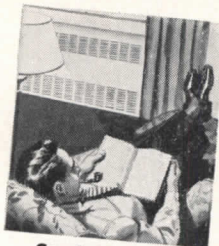

Comfort Heating



Kitchen and Laundry



Lavatory and Bath

REQUIRED READING

(Continued from page 28)

"Style" — Colonial or Spanish or modern or what not — is not the mere frosting on the cake. For style is the result of a whole series of decisions about mass arrangement — size, shape, and type of window and door; plan type; land usage; and so on — each one of which as vitally affects plan and basic conception as it does exterior appearance. It is a failure to recognize this basic architectural principle which makes our less expensive — and some of our more expensive — suburbs the visual shambles they are.

On the whole, this book is a major contribution to the houseless. Its writing is clear, definite, lively. Its illustrations are both witty and graphic and often make vivid use of a kind of cartoon technique. It is all easy to take, despite the wealth of detailed and even technical information. It should help many puzzled Americans to get more useful dwellings. But in this reviewer's opinion the book would have been still more valuable if the author had seized the opportunity to instill into his readers a few basic architectural principles such as the integration of use and form, of plan, interior, and exterior. That would have helped his readers attain not only more comfortable dwellings but houses which might have been examples of a vital architecture for today. For the best modern home is no mere question of style choice; it is the logical result of new living ways, new materials, and a new technology.

WHAT MAKES GOOD APARTMENTS?

Apartment Houses. By Joseph H. Abel and Fred N. Severud. New York (330 W. 42nd St.), Reinhold Publishing Corp., 1947. 8½ by 11½ in. 280 pp. illus. \$10.00.

"To the owner, an apartment building is primarily a means of making money, either through sale or as an investment; to the occupant of one of its units, it is a home; and to the conscientious architect, desirous of doing his duty towards both client and tenant, it is an interesting and often difficult problem." In that succinct opening sentence, architect Joseph Abel has summed up the theme of this book; what follows in every section is aimed at the simultaneous satisfaction of both owner's and tenant's desires, and the consequent satisfaction of the architect. Mr. Abel sees no reason why everyone should not be happy.

Almost two-thirds of the book is given over to Mr. Abel's very competent discussion of the architectural design of the apartment house. A valuable adjunct to the text in this section is the inclu-

(Continued on page 178)

*More Frigidaires Serve
in more American Homes
than any other Refrigerator*

See your Frigidaire Dealer for complete information on Frigidaire Refrigerators — and other Frigidaire products. Or write Frigidaire, 1215 Amelia St., Dayton 1, O. 609 Commercial Rd., Leaside 12, Ont.

REFRIGERATORS • ELECTRIC RANGES
WATER HEATERS • HOME FREEZERS
AUTOMATIC WASHER • ELECTRIC DRYER
ELECTRIC IRONER • KITCHEN CABINETS
COMMERCIAL REFRIGERATION AND
AIR CONDITIONING EQUIPMENT

THIS is more than a mere statement of fact. It's proof that Frigidaire gives people more of what they want in a refrigerator. Specify Frigidaire, and be sure of—

The correct size and type of refrigerator. Frigidaire's full line offers you a size and type for every need.

Important features. For example—a new Frigidaire for small kitchens provides 6 cu. ft. of storage space, in the space usually required for 4 cu. ft. models. The Frigidaire Cold-Wall has chilling coils built into cabinet walls for better food-keeping. All models offer such Frigidaire advantages as Quickube Ice Trays; one-piece, all-steel cabinets; porcelain-finished food compartment, acid-resistant floor; big frozen storage space.

The dependability of the Meter-Miser, simplest cold-making mechanism ever built. Compressor has two simple parts that move . . . uses less current than an ordinary light bulb.

YOU'RE TWICE AS SURE WITH TWO GREAT NAMES

FRIGIDAIRE
MADE ONLY BY
General Motors

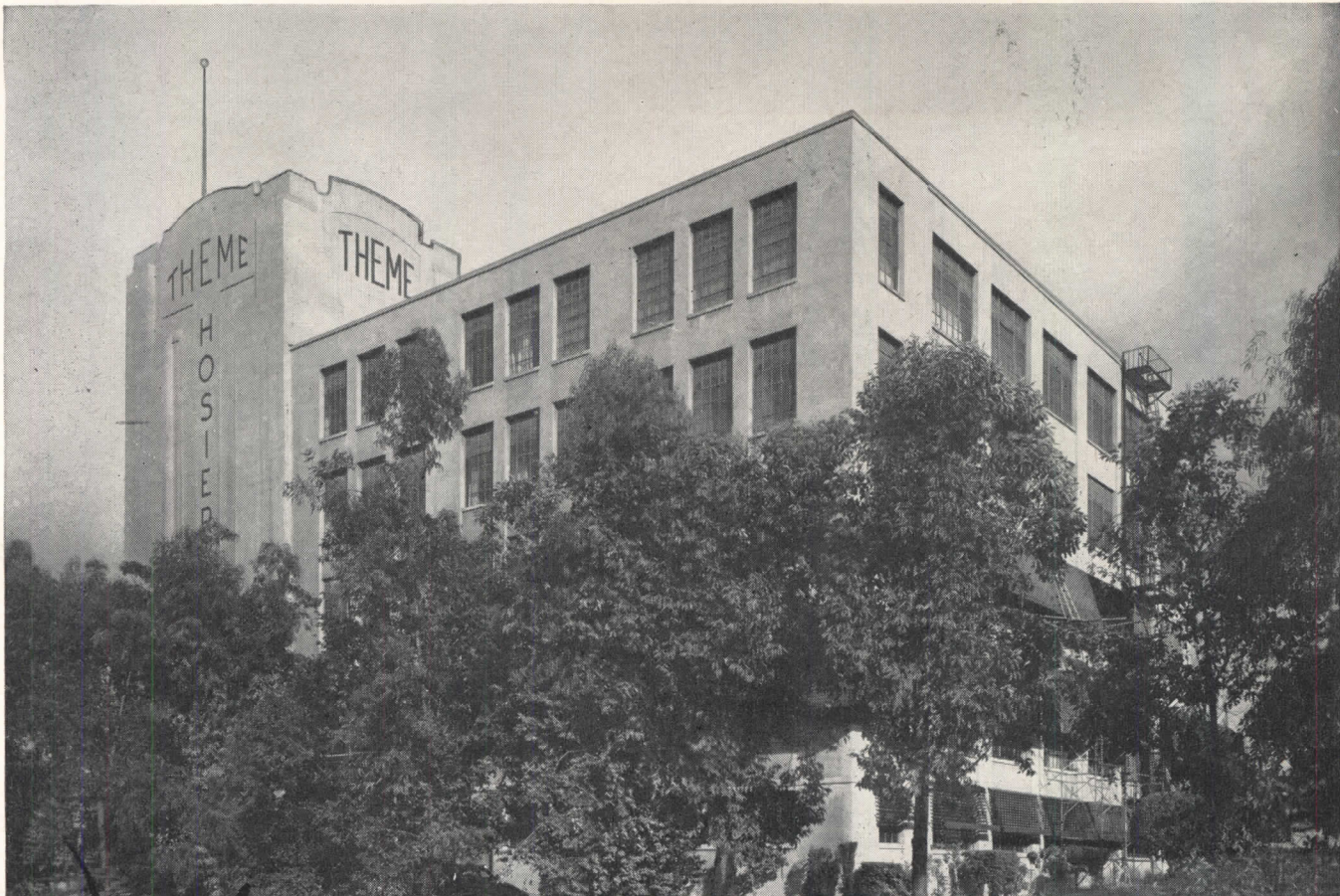

Modern **ENTERPRISE Gas and Oil Burners**
 provide Flexible Heating at Low Cost the Year Round

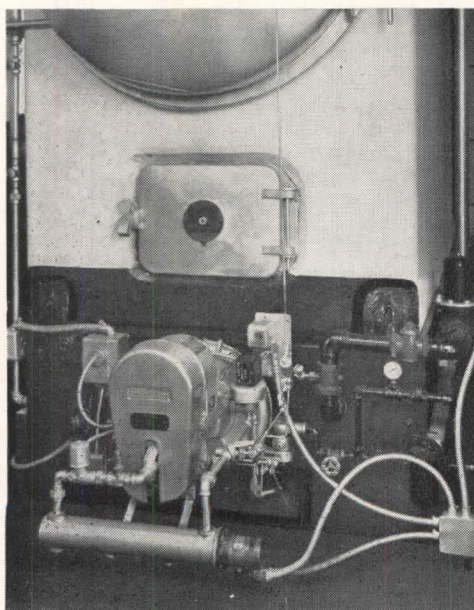

This Enterprise Automatic Combination Gas and Oil Burner provides an even temperature the year round, at low cost, to protect the delicate machinery of one of the west's most modern hosiery manufacturing plants. *Enterprise Burner installed by Hess, Greiner & Pollard, Los Angeles.*

Among the important considerations to be made in the selection of heating equipment are 1: type and grade of available fuels, 2: comparative fuel costs, and 3: possible future change in either cost or availability of fuel. The decision may easily mean large operating savings—or losses through excessive fuel costs.

Theme Hosiery Co. found the economical answer to their fuel problem a year ago when they installed an Enterprise combination gas and oil burner. This compact, efficient unit permits the immediate use of manufactured or process gas, as well as light or heavy oils—whichever fuel is available at the time for the lowest cost. A fuel selector switch allows instant change-over from gas to oil or vice versa, with no heating shut-down.

This feature of flexibility has long been one of the outstanding merits of Enterprise Burners. Investigate the full line of models and sizes for the best in burners for *your* next installation.

The Choice of Heating Experts—Everywhere



BURNER DIVISION OF ENTERPRISE ENGINE & FOUNDRY CO.

18th & Florida Streets, San Francisco 10, Calif.

Distributors in Principal Cities



The feeling is mutual...

There's an affinity, say designers of fine furniture, when discussing the relation between Kencork floors and walls and modern home furnishings. They appreciate how Kencork's golden browns and leafy tans flatter furniture, fabrics and accessories—the decorative contribution of its subtle squares and rectangles—and its interesting, unusual surface. Architects, too, note the physical appeal of Kencork: the comfort of Kencork's resilience—its sound-absorbing qualities—its tendency to insulate against heat and cold. And both architects and builders are often surprised to learn that this cork tile, popularly considered expensive, may now be compared with other floors or wall coverings of equal durability and quality. To learn the entire story of today's Kencork, consult your flooring dealer. Or write the nearest Kencork office for informative Kencork color folder and quotations. David E. Kennedy, Inc., 69 Second Avenue, Brooklyn 15, N. Y.—324 Fourth Avenue, Philadelphia 22, Pa.—1211 NBC Bldg., Cleveland 14, Ohio—1355 Market St., San Francisco 3, Cal.—Bona Allen Bldg., Atlanta 3, Ga.—452 Statler Bldg., Boston 16, Massachusetts—Ring Bldg., 18th & M Streets, Washington, D. C.—18 E. Washington Blvd., Chicago 2, Ill.

KENCORK
® floors and walls

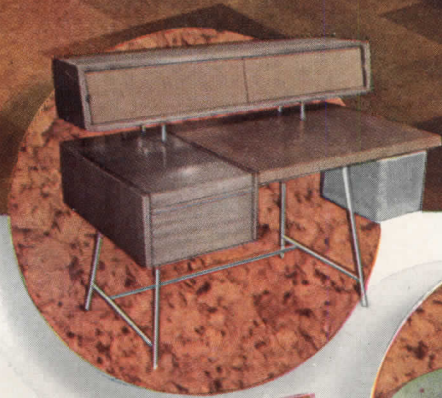



Why should you specify CCC*?

"I FIGURE YOUR VENETIAN BLIND PROBLEM is a lot like mine. That you need the most blind for your money...good looks, smooth operation, easy care, low maintenance cost. Right? Then follow my lead to Columbia for Venetian blind efficiency. For instance..."

RUSTPROOF, DUSTPROOF, FOOLPROOF . . . that's Columbia's completely new headbox. Working parts are designed for greater efficiency...heavy-gauge steel for tougher wear...entirely enclosed for greater protection. The new headbox is handsomer, too; eliminates fascia boards.

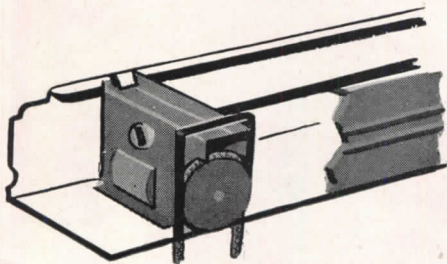
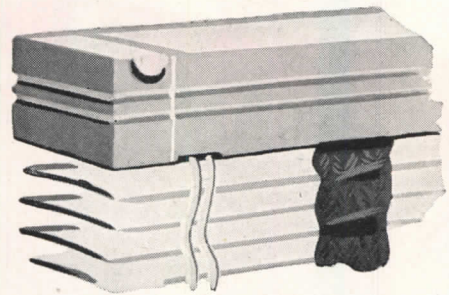

FREE MOVEMENT FOR CORDS AND TAPES . . . all hardware in Columbia blinds has been skillfully engineered to save wear and friction on tapes and cords...tested and re-tested for efficiency. Chalk up another Columbia feature that cuts service calls!

WORKS LIKE A CHARM . . . NEW AUTOMATIC STOP . . . Radically new, radically better...and exclusive with Columbia! Just release the cords, walk away...the blind stops automatically—just where you want it. Tested 10,000 times for dependability!

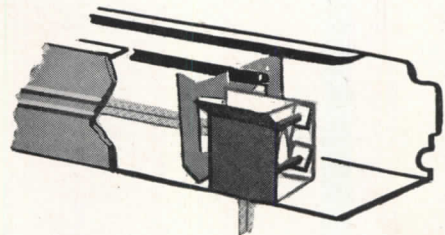

Columbia
VENETIAN BLINDS
AND WINDOW SHADES

Add to the roster: new tiltor prevents cord slippage . . . tape clip-grips for easy removal of tapes to clean or shorten . . . beautiful, hard finish for easy cleaning . . . but let a Columbia dealer SHOW you! He'll prove that "CCC" has produced a superior Venetian blind. Choose steel or aluminum slats. We'll be glad to give you the name of dealer nearest you.

"CCC" means Columbia-Controlled-Construction

THE COLUMBIA MILLS, INC. • 225 FIFTH AVENUE, NEW YORK 10, N. Y.

FOR TOP LIGHTING VALUE
go Aluminum all the way

**HANGERS OF
ALUMINUM**
for lightness

**HOUSINGS OF
ALUMINUM**
for beauty

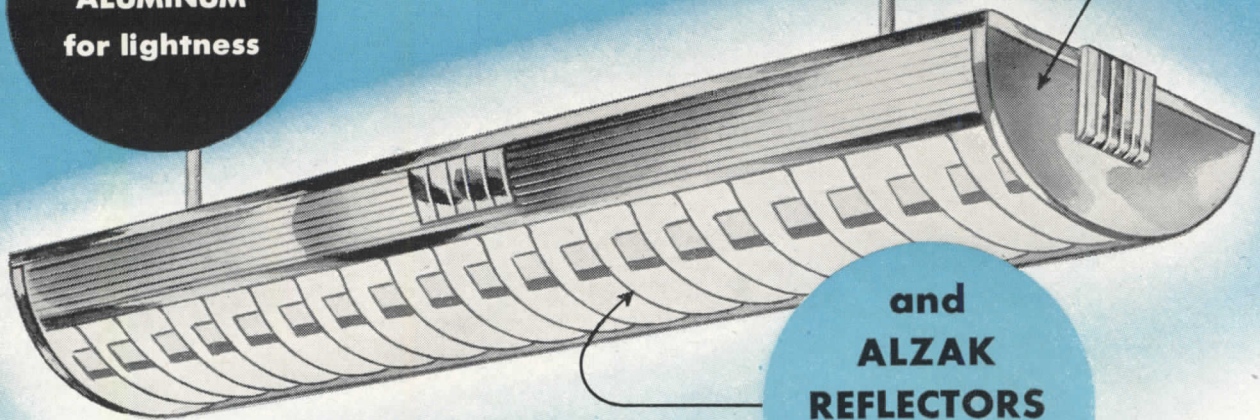

**and
ALZAK
REFLECTORS**
with 87%
efficiency

Specify "Alzak* Reflectors" for the lighting that you buy. You'll get the most lighting efficiency for your dollar . . . reflectivity up to 87%, no attack by most corrosive atmospheres, no spalling if dented, easy to keep clean and bright, available from leading manufacturers of quality lighting equipment.

And order your Alzak Reflectors equipped with lightweight Alcoa Aluminum Housings

and Tubular Hangers . . . they lessen the dead weight on ceilings and joists. Stay bright and attractive without painting or plating.

You can get Alzak Reflectors from leading lighting manufacturers . . . don't forget to specify "ALZAK". For names of manufacturers of Alzak Reflectors, write to ALUMINUM COMPANY OF AMERICA, 1474 Gulf Bldg., Pittsburgh 19, Pa. Sales offices in 54 leading cities.

*Registered trade-mark and patented process

ALCOA **FIRST IN**
ALUMINUM



IN EVERY COMMERCIAL FORM

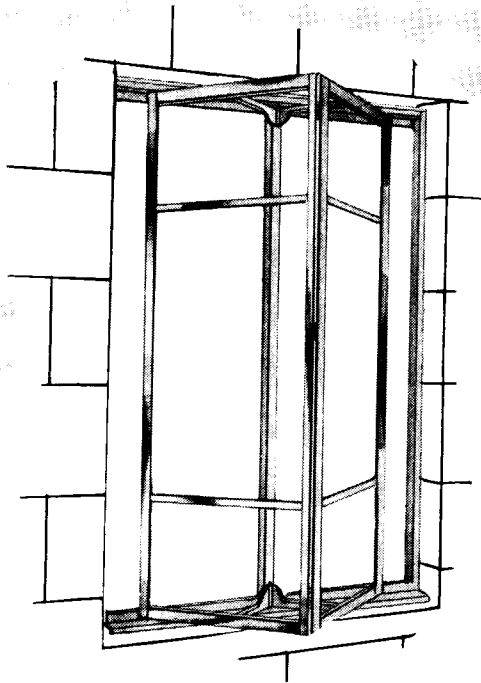

BROWNE FOLDING TYPE WINDOWS

MANUFACTURED EXCLUSIVELY BY
UNIVERSAL CORP.
UNDER THE TRADE-NAME
SEALUXE

TYPES

MONUMENTAL - PSYCHIATRIC
UNDERWRITERS' LABEL
RESIDENTIAL

Through the 32 years of its existence, BROWNE Folding Type Windows have gained the full-hearted approval of architects everywhere, plus the distinction of being installed in outstanding structures all over the nation.

BROWNE Folding Type Windows are absolutely air-tight and permit 100% Controllable draft-free ventilation in any kind of weather. Additional features of the BROWNE window are:

- BOTH SIDES OF GLASS CAN BE CLEANED FROM INSIDE!
- PERMANENT EASE OF OPERATION!
- MAXIMUM LIGHT AND VISION
- MINIMUM MAINTENANCE COST

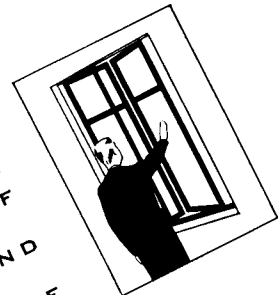

We have the facilities and the organization to meet your requirements on schedule. Your request for special data and/or drafting room standards will receive prompt attention.

BROWNE Folding Type Windows are manufactured by UNIVERSAL CORPORATION in Dallas... manufacturers of building products under the trade-name SEALUXE: Browne Folding Type Windows, Double Hung Windows, Side Hinged Casements, Theatre Display Systems, Thermo Windows and Shades.

"Miracles in Metals"

Refer to SWEET'S
ARCHITECTURAL FILE

YEAR IN AND YEAR OUT
IN ANY KIND OF WEATHER

100%
OPERATING
EFFICIENCY

Universal

J. P. TRAVIS, PRESIDENT

CORPORATION

QUALIFIED SALES REPRESENTATIVES IN EVERY ARCHITECTURAL CENTER

6710 DENTON DRIVE

DALLAS 9, TEXAS

FOR BETTER HOMES IN BETTER TASTE

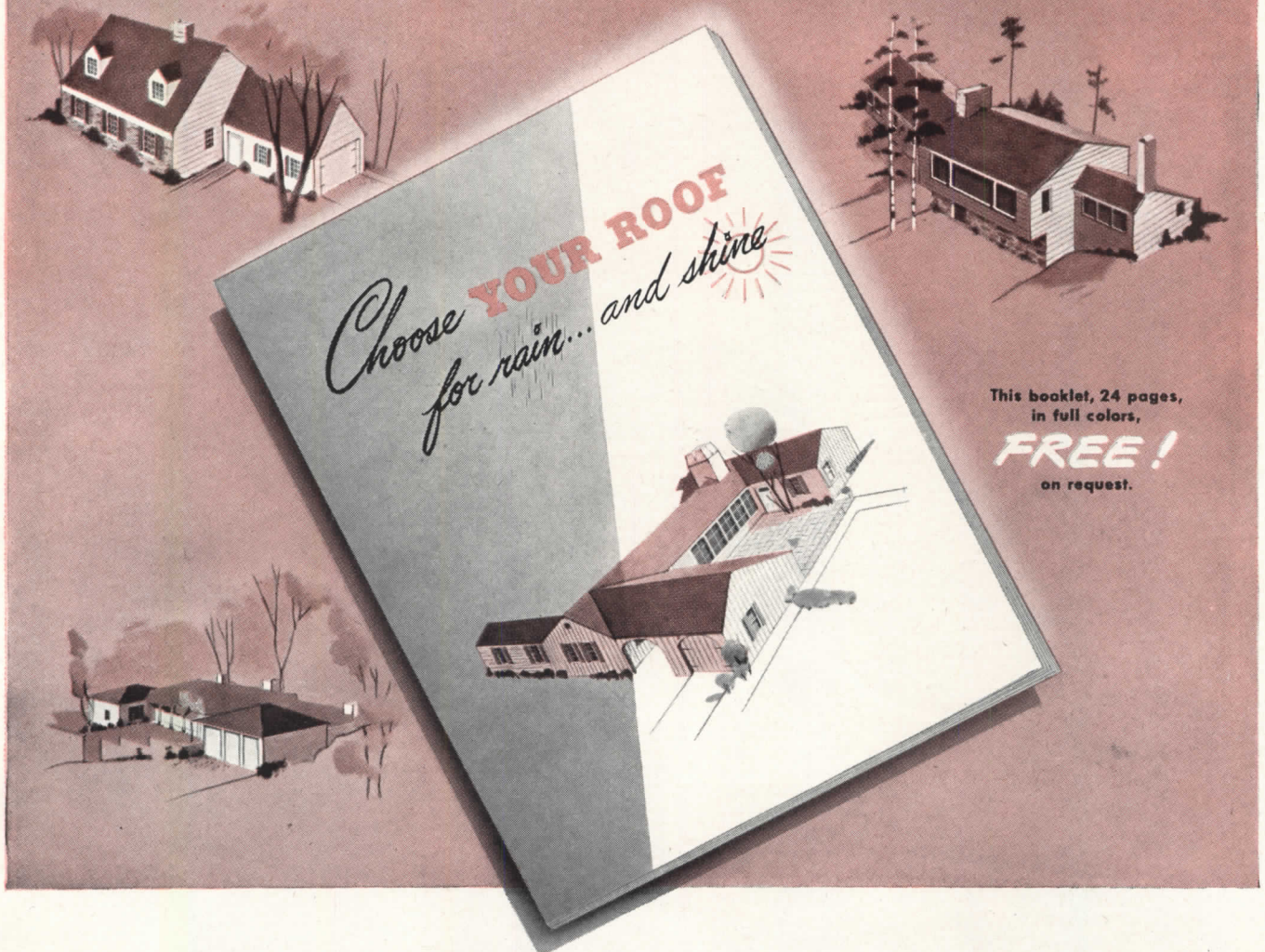

You see two sides of a roof at once in this book!

Above all, a roof must be practical. But it doesn't have to be dull about it. Along with taking the weather, a roof has time to be gay.

The above book, prepared with the help of architects for the home owner, talks both good sense and good taste in roofs. On the practical side, it talks values in weather protection, fire safety, economy. Then, it urges attention to the "fair weather" side where the roof keynotes the mood or color scheme of the entire exterior. The use of color in mass, in accent . . . in harmony, in contrast . . . is discussed by color experts.

With the unmatched values offered today by Asphalt Strip Shingles (wholesale prices at 96.8%*, production at 287%, compared with 1926=100%), it will pay to examine fully their possibilities in terms of current plans.

*U. S. Bureau of Labor Statistics, July, 1947

**CONSTRUCTION'S BIGGEST
DOLLARS WORTH**

ASPHALT SHINGLES

ASPHALT ROOFING INDUSTRY BUREAU

Room 1752 • 2 W. 45th St. • New York 19, N. Y.

Sponsored by 28 Leading Manufacturers of
Asphalt Shingles • Roll Roofings • Sidings
and Built-Up Roofings

COLORFULLY BRIGHT FUNCTIONALLY RIGHT

Simplify Your Specifications WITH Marlite



Avodire Marlite Genuine Wood Veneers and Marsh Mouldings create an office interior of distinction.

plan on Marlite walls

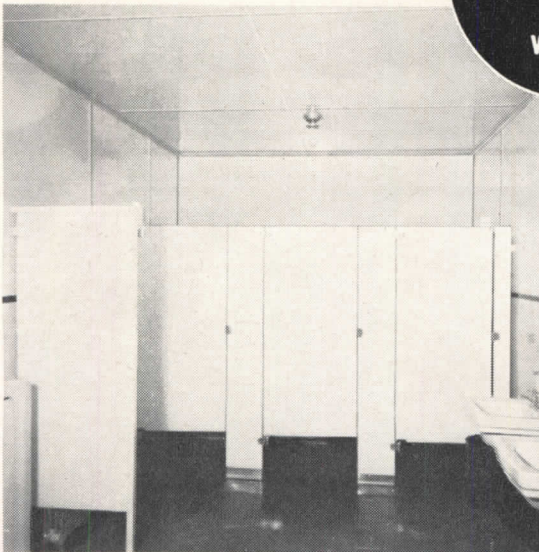

Sparkling, sanitary washrooms are important! Easy-to-clean Marlite is the answer.

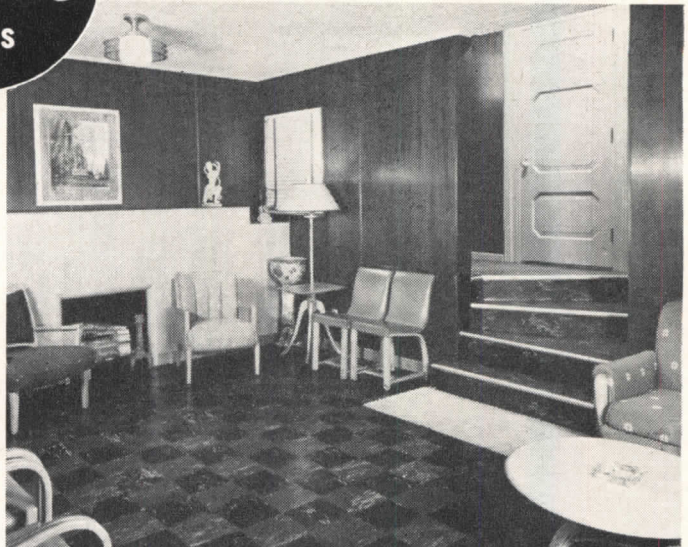

Prima Vera Marlite Genuine Wood Veneer provides a background of quiet warmth and dignity in this doctor's reception room.

Consult Sweet's File, Architectural, for complete information and specifications, or write direct to Marsh Wall Products, Inc., 205 Main St., Dover, Ohio. Although production is greater than ever, Marlite deliveries are still allocated due to the unprecedented demand.



Interiors of sparkling, colorful beauty, or warm, restrained dignity . . . you can create either with Marlite plastic-finished wall and ceiling panels. For new construction or modernization, include Marlite in your specifications and plans on beautiful, serviceable interiors in offices, lounges, lobbies and washrooms.

F O R C R E A T I N G B E A U T I F U L I N T E R I O R S



COURTESY BETTMAN ARCHIVE

We've come a long way since then!

REMEMBER WAY BACK when pot-bellied customers snuggled up to pot-bellied stoves to warm up—one side at a time? They were highly regarded in those days—the stoves, we mean. But contrast those scuttle-stoked stomach scorchers with today's Richmond Winter Air Conditioners. There's real progress!

REAL PROGRESS IN HEATING. In the design and manufacture of winter air conditioners, Richmond has taken full advantage of

experience that dates back dozens of years. You can rely on every Richmond unit to deliver performance and economy.

GUARANTEED. All Richmond gas-fired furnaces and conditioners carry a full year's replacement guarantee and AGA approval. And, of course, all Richmond plumbing fixtures have a full year's replacement guarantee, too.

For details on any Richmond product, write Richmond Radiator Company, Dept. 2-AR, 19 East 47th Street, New York 17, N. Y.



**HEATOMAT
GAS BOILER**

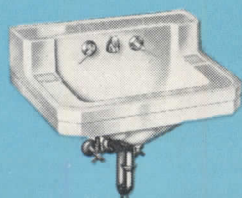

**BROMLEY VITREOUS
CHINA LAVATORY**

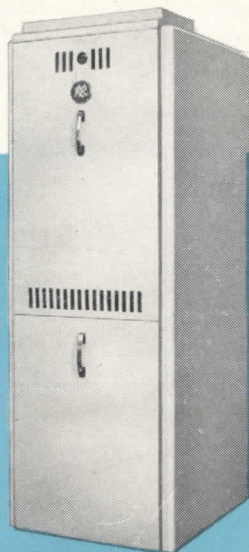

**VERTICAL WINTER
AIR CONDITIONER**



BRESLIN RECESS BATH



**SERVILLA ENAMELED
CAST IRON SINK**



**RICHMOND RADIATOR
COMPANY**
AFFILIATE OF REYNOLDS METALS COMPANY

Enameled Cast Iron Ware • Vitreous China • Perma-Gloss • Gas Boilers • Gas Winter Air Conditioners • Gas Gravity Furnaces • Radiators

Cut Building Costs 3 Ways

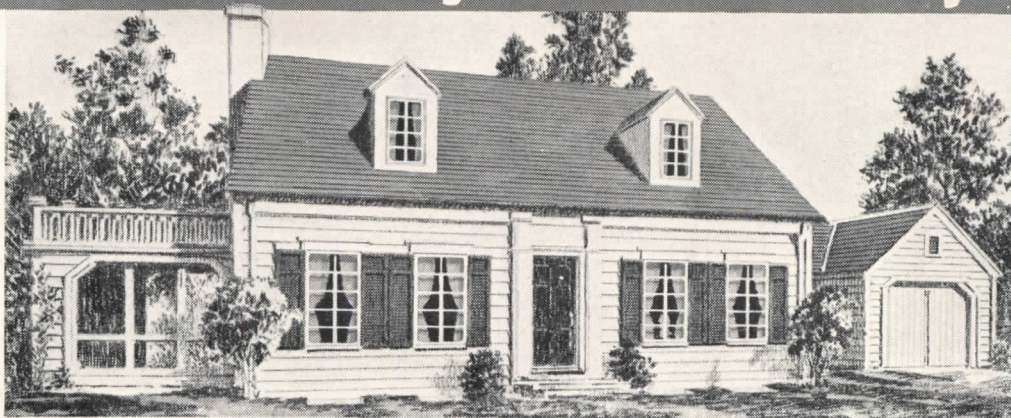

1. STEEL CASEMENTS 2. METAL SCREENS 3. BASEMENT WINDOW

No extra hardware to buy, installation costs cut 80% • Planing and fitting eliminated.

Factory finished, no painting necessary • Precision made, ready to install without fitting.

Standard sizes, ready to install, eliminating work of fitting, trimming and painting.

Have you ever asked yourself "How can home building costs be reduced?" Now, that's a practical question—and here at Ceco we have an answer. Certain Ceco products *will reduce* home building costs. Take steel windows for example: They cost less installed, because there are no hidden costs to overlook, such as hardware, prime coat, accessories, additional labor costs. Then, too, steel windows last, and last, and last. There is no need for repair—they cannot rot... they are Bonderized and painted for protection against rust. And that goes for steel basement windows, too. Another way to save is provided by Ceco metal frame screens. Installed, they actually cost less than old-style screens, are factory finished—need no on-the-job painting, trimming, or fitting. So, to reduce building costs, recommend Ceco metal casements, basement windows, and metal frame screens.

WHY SPECIFY CECO?

Ceco does more than design and manufacture fine construction products. Besides their wealth of technical engineering skill, there is available construction knowledge gained by 35 years of experience on the job. In 23 offices strategically located from coast to coast, Ceco stands ready to help you reduce home building costs. Call on Ceco today!

CECO STEEL PRODUCTS CORPORATION GENERAL OFFICES: 5701 West 26th Street, Chicago 50, Illinois

Offices, warehouses and fabricating plants in principal cities

Other Ceco products include—Combination All-Aluminum Storm Panel and Screen for Wood Windows, Steel Joists, Meyer Steelforms, Reinforcing Steel, Roof Deck, Metal Lath and Accessories, Highway Products, Corrugated Roofing

**CECO
STEEL**

In construction products **CECO ENGINEERING** *makes the big difference*

It's good electrical practice...

to provide ample capacity for present and future needs on distribution systems, service equipment, switches, circuit breakers and other plant electrical equipment



**It's good
Electrical
Practice...**

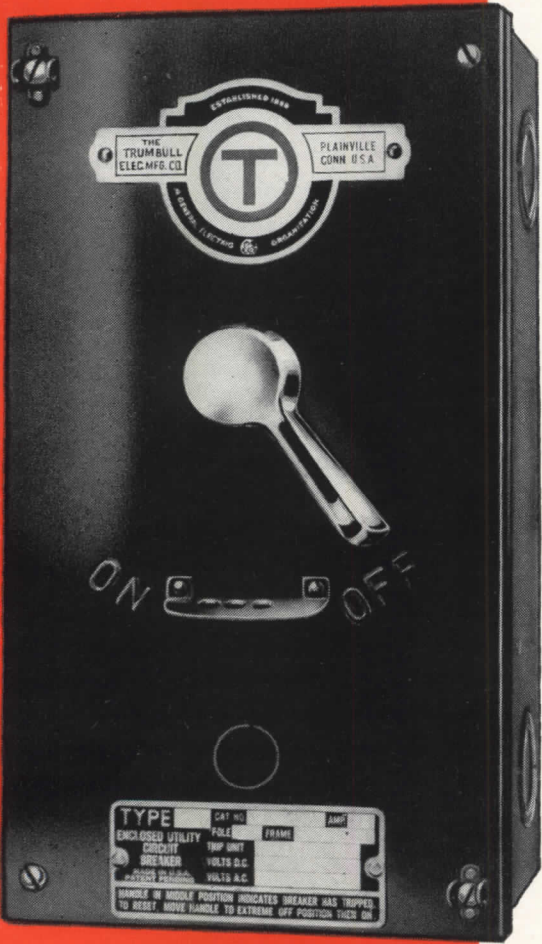

to protect general service light and industrial power circuits with Trumbull "AT" Enclosed Circuit Breakers. A completely enclosed, non-tamperable unit, designed to replace fuses, fused switches and other circuit protection, this device requires no element to renew after circuit interruption.

"AT" Circuit Breakers have adequate wiring space (plenty of room for pulling wires and making connections) . . . liberal number of knockouts, cleanly cut and readily removable . . . semi-dust type construction with felt gasket and a screw on front with provision for sealing . . . also available in cast enclosures for explosion proof and water and dust tight applications . . . locking shelf for 3 padlocks in either the "on" or "off" position. Flexible engaging mechanism eliminates possibility of handle breakage.

It's also good practice to specify Trumbull, the make that protects *your* safe practice, for any of the following equipment — safety switches, switchboards, panelboards, motor controls, control centers, circuit breakers, L.V.D. Busways and FLEX-A-POWER branch feeders. THE TRUMBULL ELECTRIC MANUFACTURING CO., Plainville, Conn. Other factories at Norwood, Ohio, San Francisco, Seattle, N. Hollywood. Sales offices and representatives in all important cities.

**MEN WHO OBSERVE THE
BEST PRACTICES MAKE
IT A PRACTICE TO USE
TRUMBULL**



for LASTING BEAUTY, specify Adlake Aluminum Windows

- **MINIMUM AIR INFILTRATION**, because of nonmetallic weather stripping and serrated guides
- **FINGERTIP CONTROL**
- **NO WARP, ROT, RATTLE**, stick or swell, ever
- **SOLID, LUSTROUS ALUMINUM** construction, requires no painting
- **NO MAINTENANCE** required, except routine washing
- **EASE OF INSTALLATION** is a dominant feature

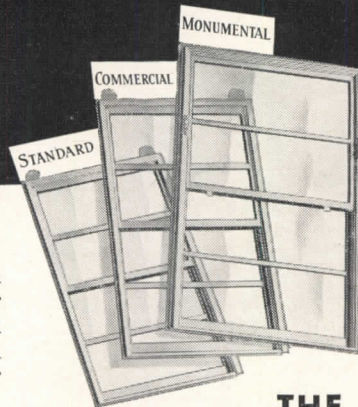
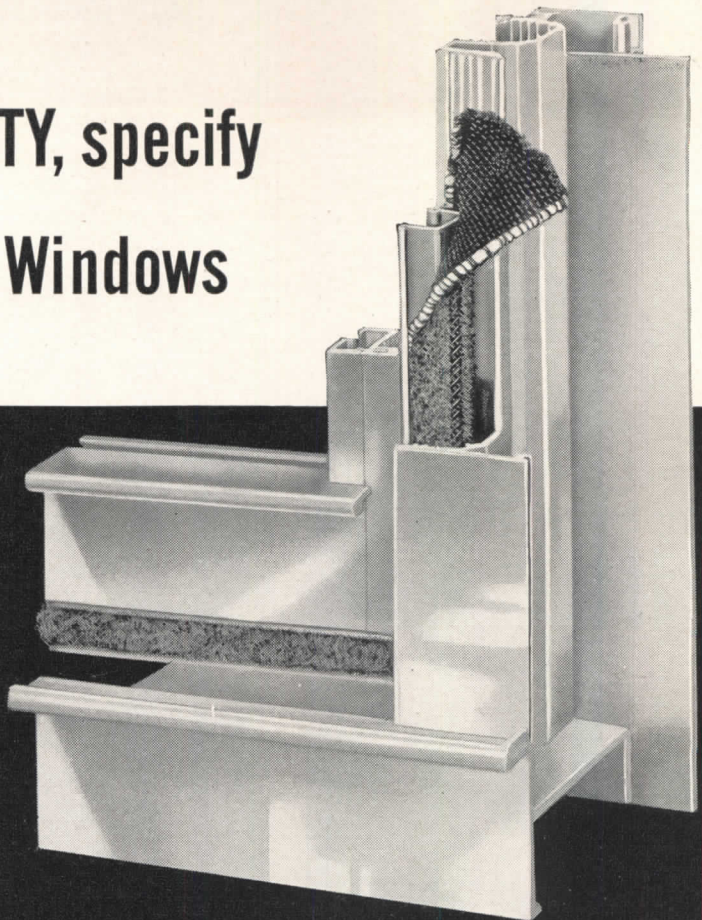

Expertly designed for a lifetime of service, Adlake Aluminum Windows bring lasting beauty to *any* building, modern or traditional. Built of lustrous aluminum, they do away with the cost of painting and maintenance. You install them, you forget them! They look lovely and operate smoothly for years and years.

Only Adlake Windows combine woven-pile weather stripping and serrated guides to assure a minimum air infiltration and absolute fingertip control. And because of their construction (see diagram), Adlake Windows never warp, rot, rattle, stick or swell. Installation is phenomenally easy — you can complete *all exterior work first and then simply set the window in place!*

TELL YOUR CLIENTS about the beauty and long, worry-free service they can expect from Adlake Aluminum Windows. And for complete data, drop us a post card today at 1102 N. Michigan, Elkhart, Ind. No obligation, of course.

THE

Adams & Westlake

COMPANY

Established 1857 • ELKHART, INDIANA
New York • Chicago



Furnishers of
Windows to the Transportation Industry
for Over 30 Years



SPECIFICATION DH-A1

QUALITY

An equivalent of this window has been examined by PITTSBURGH TESTING LABORATORY, conforms in Materials, Construction, Strength of Sections and Air infiltration requirements to ALUMINUM WINDOW MANUFACTURERS ASSOCIATION Specification DH-A1

SPECIFICATION DH-A1

SEAL



MEMBER, ALUMINUM WINDOW MANUFACTURERS ASSOCIATION

COPYRIGHT 1946 BY THE ALUMINUM WINDOW MANUFACTURERS ASSOCIATION

10 QUICK
facts...

...tell why

NATIONAL ELECTRIC

IPI* BUS

raises plant efficiency

* Industrial Plug-In Bus

1. National Electric IPI Bus is a flexible electrical distribution system.
2. Takes the power source to the load.
3. No distribution panel boards required.
4. Machines can be plugged in or disconnected without shutting down production lines.
5. "Plug-In" locations spaced every 13 inches on each side of bus provide staggered load-connection points every 7 1/2 inches... Makes every foot of the system usable.
6. System can be extended or relocated when production requirements change.
7. Bus bars can be changed to increase capacity.
8. "Plug-In" devices may be fused disconnects, unfused or fusible safety switches or circuit breakers.
9. Self-contained, easily installed, 100% salvageable.
10. Fireproof, dust tight and fully approved by Underwriters' Laboratories, Inc.

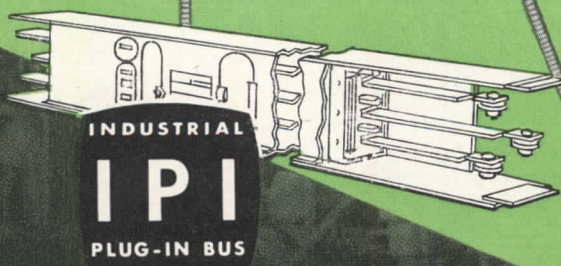

APPROVED & LISTED
BY UNDERWRITERS'
LABORATORIES, INC.



National Electric Products Corporation
Pittsburgh 30, Pa.



1-300 Yorkshire Lavatory

2-131 Laboma Bath

3-140 Oxford Closet

**in hotels and
apartments, too —
top quality means
CRANE quality**

● The word Crane on your hotel or apartment specifications has real meaning to your client. It is the name he associates with fine quality . . . he knows it better than any other name in plumbing.

This quality can be had in Crane bathrooms small and large . . . bathrooms styled for a hotel room as well as for the most luxurious apartment.

In kitchens, too, Crane offers this same wide selection. Besides a complete line of cabinet sinks, you may select small, individual units just right for kitchenette planning.

Kitchen and bathroom plumbing fixtures in all price groups feature the new and exclusive Crane *Dial-ese* controls that operate at the touch of a finger.

Crane fixtures suited for apartment and hotel use are represented in your copy of "Crane Service for Architects." If you are without a copy, your Crane Branch will be glad to supply one.

CRANE

CRANE CO., GENERAL OFFICES:
836 S. MICHIGAN AVE., CHICAGO 5
PLUMBING AND HEATING
VALVES • FITTINGS • PIPE

NATION-WIDE SERVICE THROUGH BRANCHES, WHOLESALERS, PLUMBING AND HEATING CONTRACTORS

THE

2

GREAT

Josam

TOOLS

that give you all the answers on

PLUMBING DRAINAGE PRODUCTS

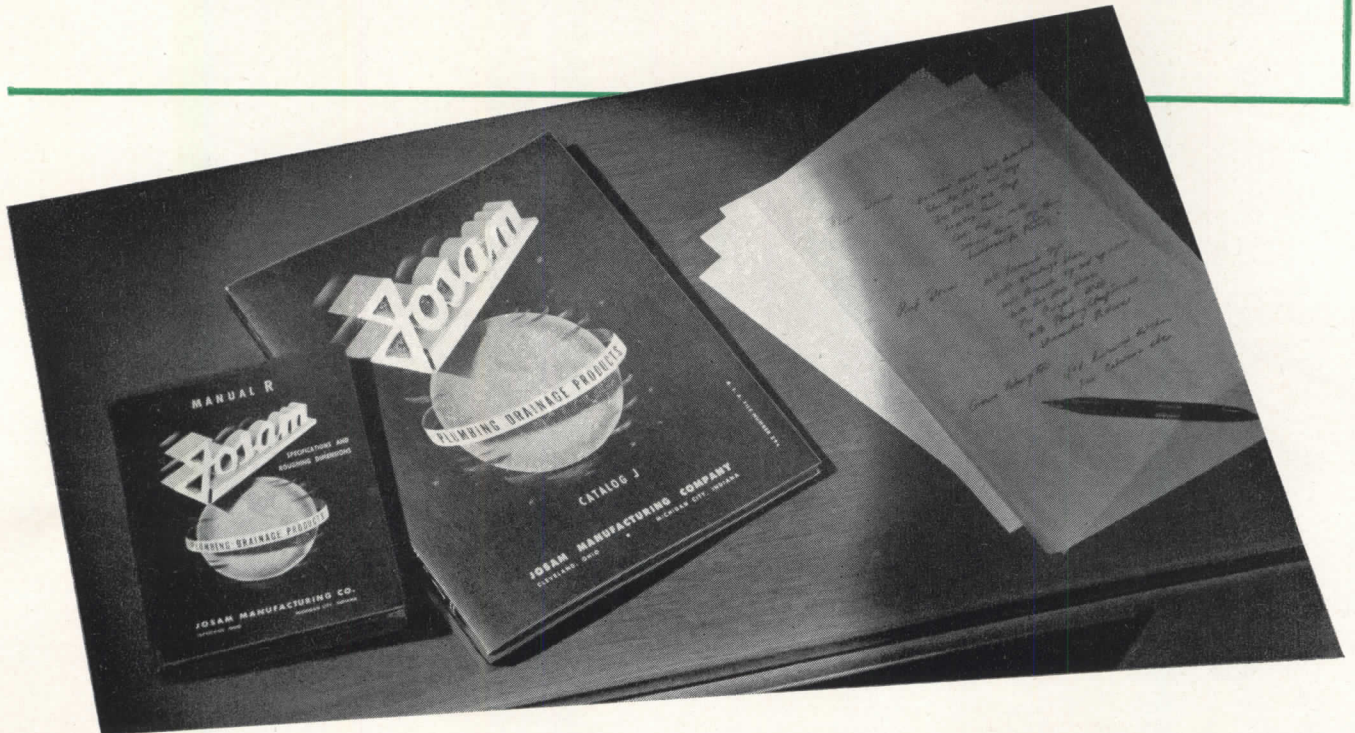

There's no need to let any plumbing drainage problem disturb you today! Two new working tools—exclusively Josam, give you all the answers—the new Josam Catalog "J" and the Josam Manual "R".

Josam Catalog "J" is the authority on plumbing drainage products. Its 224 pages contain everything you need to know about the proper selection, application and specification of drains and plumbing drainage products for all types of buildings. Josam Manual "R" is a handy pocket-size book showing

complete detail drawings and dimensions for the installation of all Josam Products.

These two books cover all types of drains, interceptors, backwater valves, swimming pool equipment, shock absorbers, shower mixing valves and many other products. They will be a constant help to anyone who specifies, orders, or installs plumbing drainage products. Don't delay having these two valuable references at your command when you need them! Send coupon below today.

JOSAM MANUFACTURING COMPANY

General Offices, Ferguson Bldg., Cleveland 14, Ohio • Plant, Michigan City, Ind.

Representatives in all Principal Cities



JOSAM-PACIFIC CO., West Coast Distributors
765 Folsom Street, San Francisco, California

EMPIRE BRASS COMPANY, LTD., Canadian Distributors
London, Ontario

See our Catalog in Sweets'.

Member of the Producer's Council

JOSAM MFG. CO., 302 FERGUSON BUILDING, CLEVELAND 14, OHIO
PLEASE SEND ME JOSAM CATALOG "J" JOSAM MANUAL "R"

YOUR NAME

YOUR OCCUPATION

FIRM NAME

ADDRESS

CITY AND STATE

Here they are...

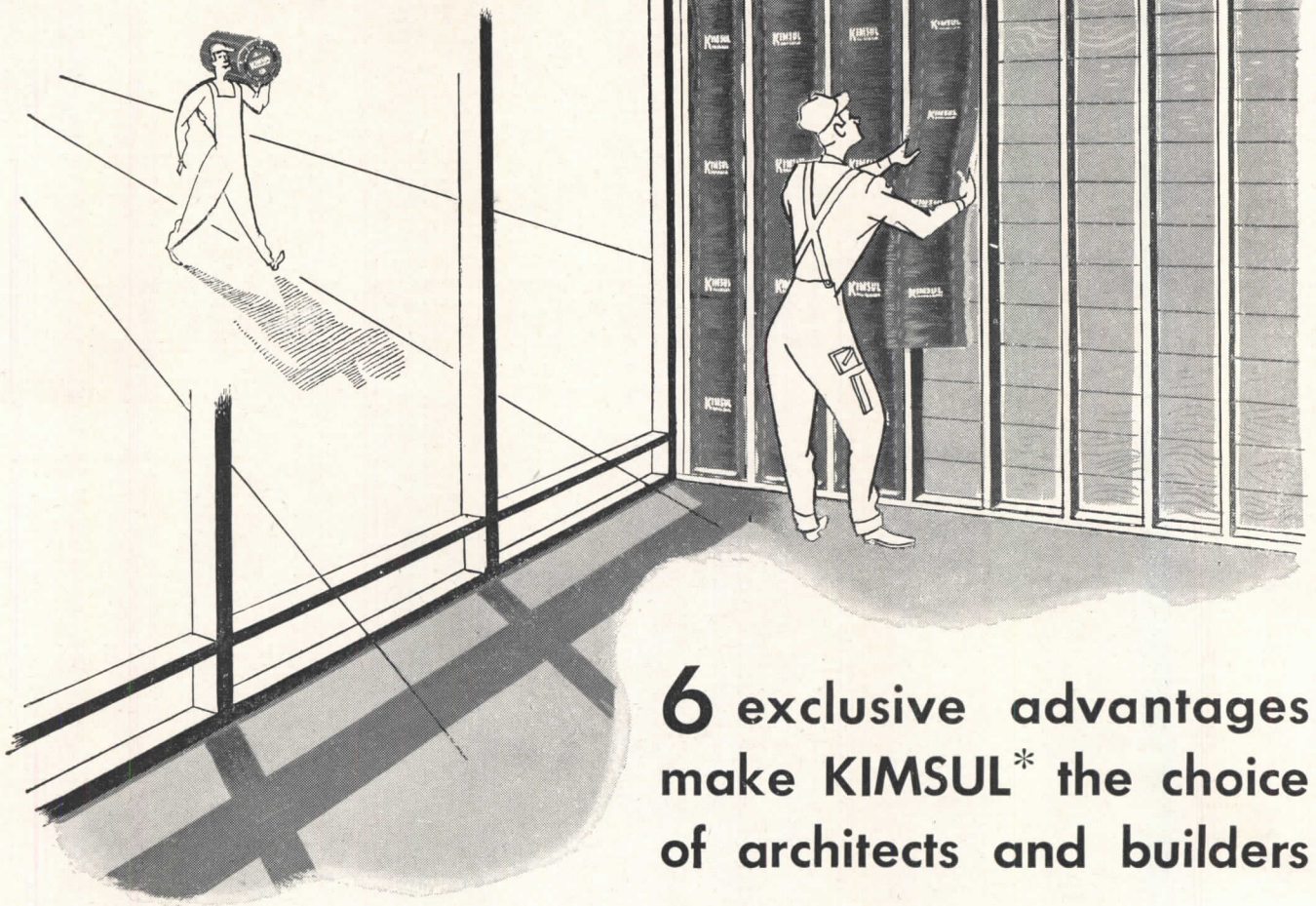

6 exclusive advantages make KIMSUL* the choice of architects and builders

KIMSUL insulation resists fire, moisture, fungi and vermin — is termite-proof. Packaged in easily handled rolls and cut to fit standard stud and rafter widths, it can be installed without expensive machinery or skilled labor. It's light in weight, clean, and odorless . . . no irritating dust or sharp particles to injure workmen's skin.

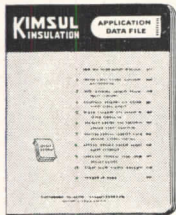

For complete details on how to insulate with easy-to-use KIMSUL, send for this informative Application Data File. Simply forward the request on your letterhead.

KIMBERLY-CLARK CORPORATION
KIMSUL DIVISION • Neenah, Wisconsin

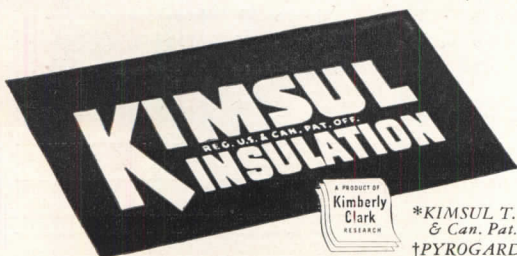

*KIMSUL T. M., Reg. U. S. & Can. Pat. Off.
†PYROGARD trademark

- 1 **Many-Layer Construction.** KIMSUL* insulation is a prefabricated blanket made on the many-layer principle. The many layers create millions of tiny air-cells to give KIMSUL its remarkable insulating efficiency ("k" factor 0.27). And many-layer construction provides dependable, uniform thickness over every square inch of insulated area.
- 2 **PYROGARD† Cover.** Only KIMSUL insulation has the PYROGARD cover — chemically treated, just as the inner layers of KIMSUL are treated, to resist fire.
- 3 **Compressed Package.** Delivered compressed to 1/5th installed length, KIMSUL saves labor, space, and time.
- 4 **Extra Width.** The KIMSUL blanket is made extra wide to provide *fully insulated* fastening edges . . . and to fill extra wide framing spaces.
- 5 **Use For Caulking.** Trimmed pieces of KIMSUL are efficient for caulking around windows and door frames.
- 6 **Flexible Blanket.** *Many-layer* KIMSUL insulation can be easily tucked around obstructions, fitted into non-standard openings, pulled around corners.

TALLEST OFFICE BUILDING IN THE SOUTH HAS

Q-FLOORS

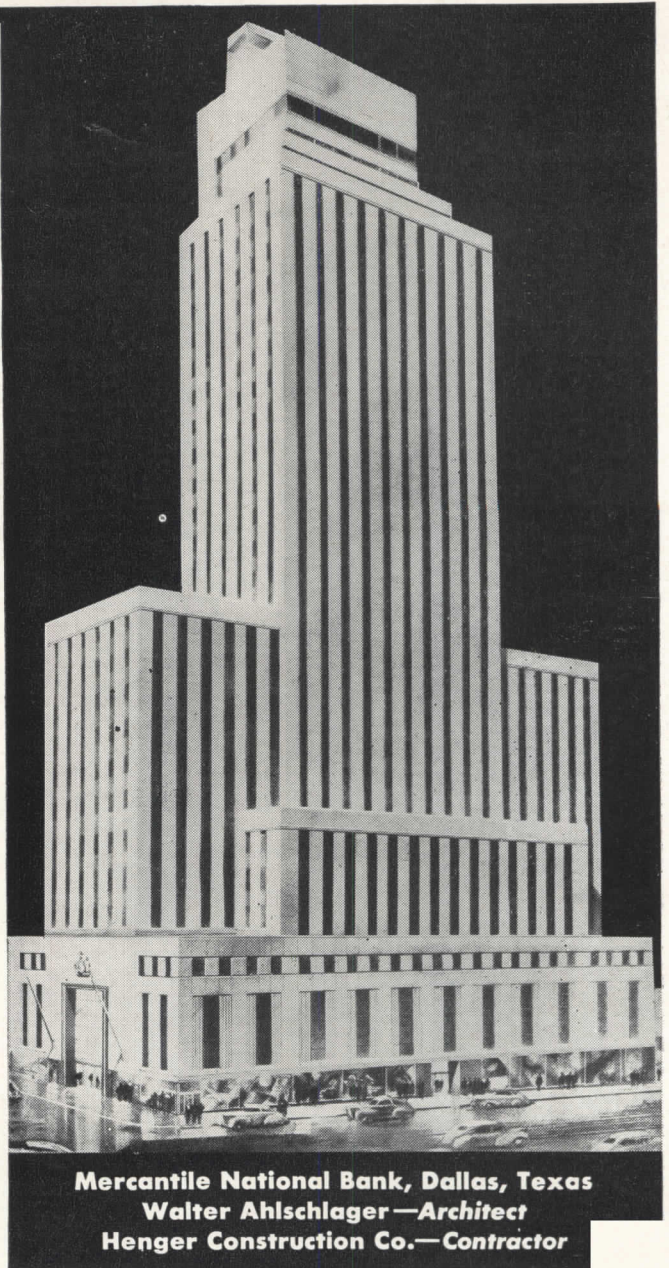

A one-shot testimony, except—the largest office building in New England, the largest postwar banking building in the whole British Empire, the largest all-metal commercial building group in the world—all are to have Q-Floors!

Q-Floors are steel and require a minimum of time to erect. Therefore, their cost can be accurately known in advance. They speed up construction to reduce 20 to 30% off building time. They are dry, noncombustible, clean and free from forms and shoring.

Q-Floors save architects an enormous amount of drafting room work. Outlets and partitions

need not be definitely located until the building is occupied. Every six-inch area of Q-Floor can be tapped for electricity. The steel cells are crossed over by headers carrying telephone, power and other electrical services. An outlet can be established anywhere at any time in a matter of minutes. Any number of outlets can be added at any time. An electrician merely drills a small hole, fishes the wires from the panel box and installs the outlet without muss or trenches.

See Q-Floor fittings at any General Electric construction materials distributor's. For complete details and literature, please write:



H. H. ROBERTSON COMPANY

2404 Farmers Bank Building
 Pittsburgh 22, Pennsylvania



Offices in 50 Principal Cities
 World-Wide Building Service

Ingersoll Utility Unit

Established with Successful

in 211 Cities from Coast

INCREASED FACILITIES IN 1948 WILL MAKE UNIT MORE

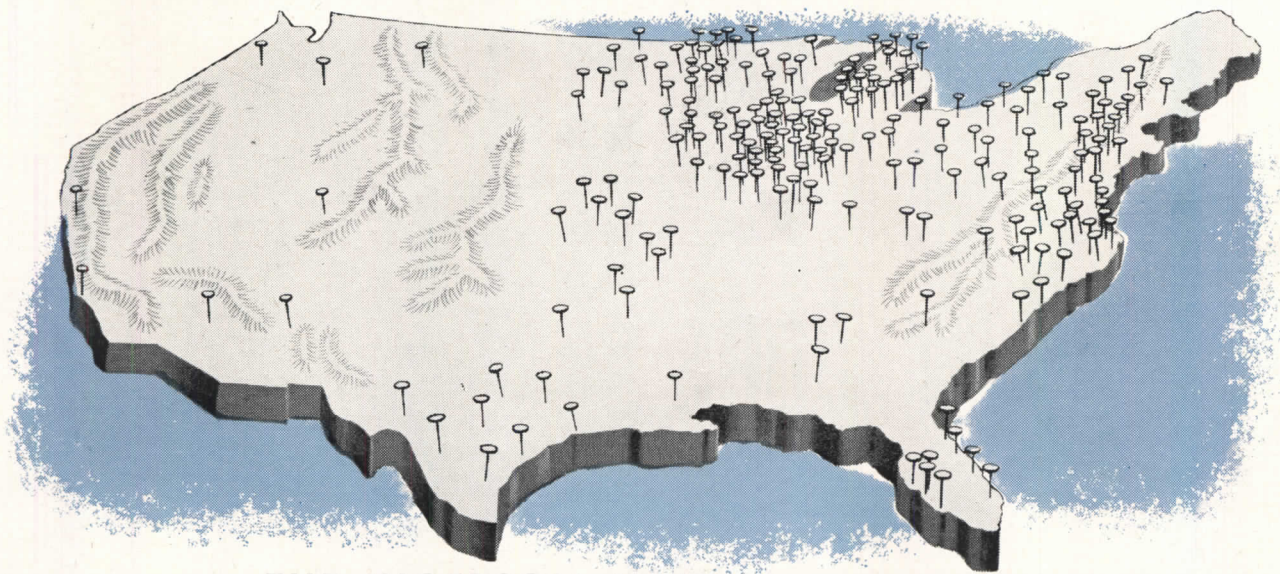

THE INGERSOLL UNIT

One Package, One Purchase, One Installation

The INGERSOLL UTILITY UNIT is a single, engineered assembly of the fixtures, appliances, controls and fittings of Kitchen, Bathroom and Heating Plant plus all interior plumbing and electrical connections.



BATH

Includes tub, combination shower, lavatory, water closet, medicine cabinet, all necessary fixtures and connections.

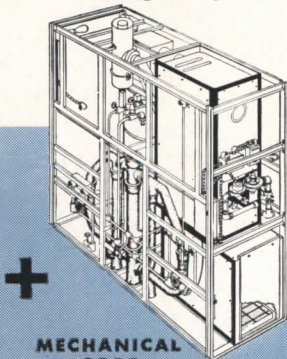

MECHANICAL CORE

Gas or oil furnace, water heater, complete electrical system, sewer stacks and vents.



KITCHEN

Electric refrigerator, porcelain-enamel sink, gas range, steel wall cabinets and drawers, fluorescent light, and all fixtures.

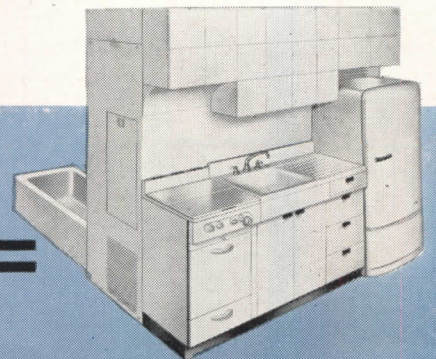

Firmly Installations to Coast!

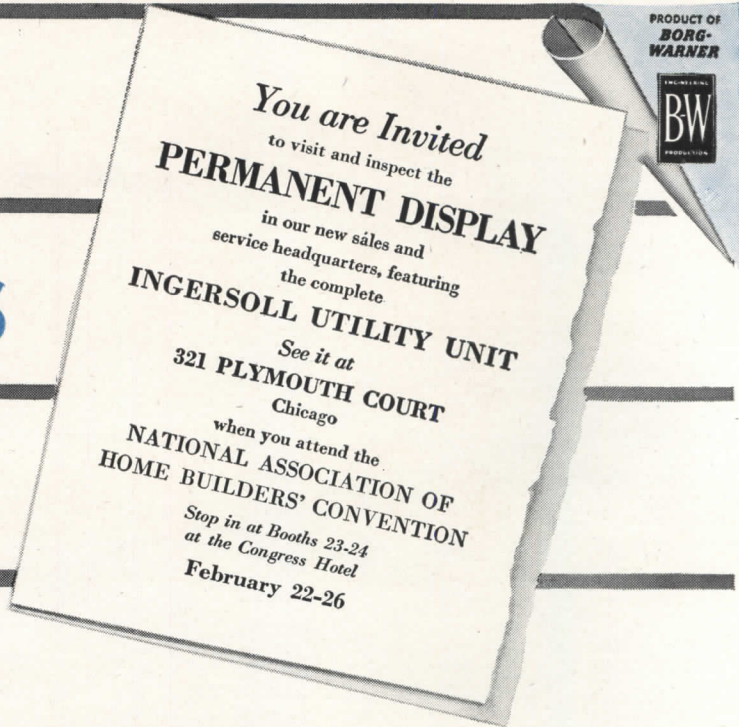

You are Invited
to visit and inspect the
PERMANENT DISPLAY
in our new sales and
service headquarters, featuring
the complete
INGERSOLL UTILITY UNIT

See it at
321 PLYMOUTH COURT
Chicago

when you attend the
**NATIONAL ASSOCIATION OF
HOME BUILDERS' CONVENTION**

*Stop in at Booths 23-24
at the Congress Hotel*
February 22-26

ADAPTABLE TO INDIVIDUAL PLANS AND REQUIREMENTS

Expansion, and consolidation of facilities, now make it possible to produce the Ingersoll Utility Unit more efficiently and to furnish it so that it is more adaptable to individual plans and needs. The improvements in manufacture allow the architect or builder to furnish expanded kitchens, to offer a choice of heating units and to better meet local building requirements.

Only a little over a year ago the Ingersoll unit was new and untried. Proved practical and economical in 211 cities during 1947, it has demonstrated its value in housing projects of every description. It is adaptable to a wide variety of plans in single home and multiple dwellings.

The Ingersoll Utility Unit is compact, requires less than 80 square feet of floor

space and provides more living space for less money. Complete, it eliminates time-consuming specifications — everything comes with one purchase, from one source, right when it's needed. It cuts building time from three to four weeks and can be installed before, during or after construction of building framework.

It will pay you to check the many time and money saving features of the Ingersoll Utility Unit. Send for illustrated brochure and see for yourself how the Ingersoll Utility Unit can fit into your plans for better homes in every housing project.

**INGERSOLL UTILITY UNIT DIVISION of
Borg-Warner Corp., Dept. M-2
321 Plymouth Court, Chicago 4, Ill.**

Please send me complete information of how the Ingersoll Utility Unit is now more adaptable to individual plans and requirements.

Name

Firm

Address

City.....State.....

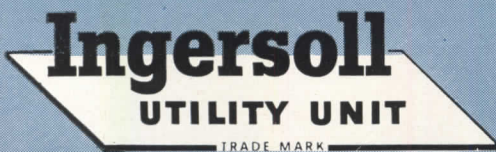

Frank Wynkoop designs a school . . .

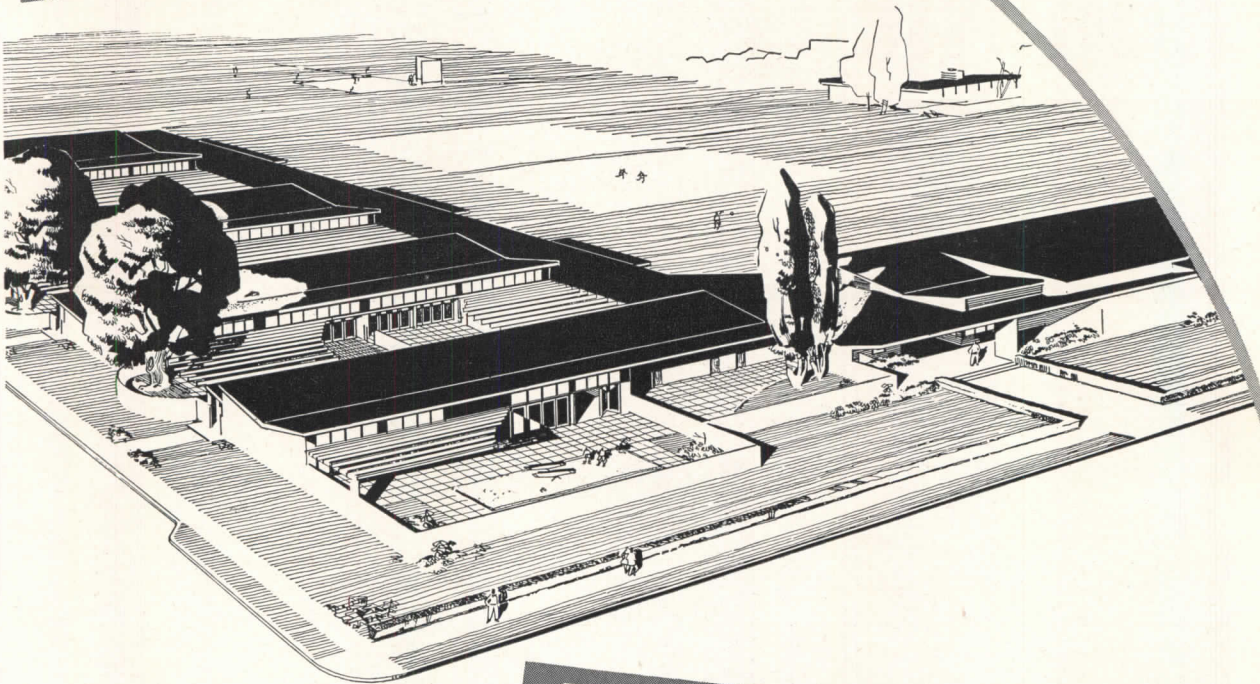

Mesker Steel Windows

"We endorse the use of metal windows, particularly for the warmer parts of California. In these areas of extreme temperatures we have found them most suitable."



Architect
Frank Wynkoop
San Francisco

For your copy of the Mesker Book of School Windows, write Mesker Brothers, 4338 Geraldine, St. Louis 15, Mo.

ANEMOSTAT PRESENTS THE **NEW Universal AIR DIFFUSER**

TYPE C-1



ANY DESIRED AIR FLOW PATTERN WITH THE TURN OF A KNOB

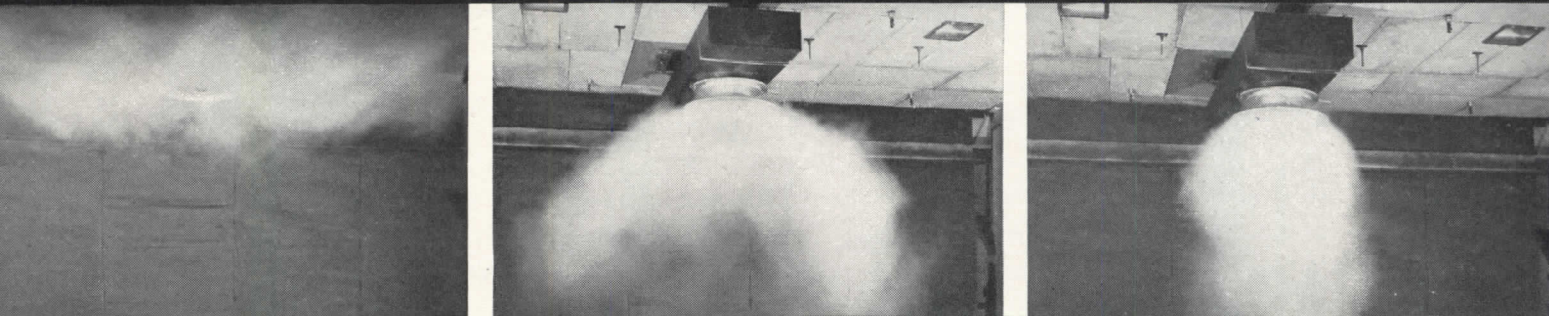

These smoke test photographs show three of an infinite variety of air patterns available with the new Type C-1 Anemostat. A slight turn of the knob raises or lowers the third cone thus varying the air discharge from a draftless horizontal pattern used

primarily in cooling, to an intermediate downward pattern used in ventilating or to a direct downward discharge used in heating. The C-1 Anemostat functions equally well whether installed flush to ceiling or on exposed duct work.

OTHER IMPORTANT FEATURES!

Employs basic Anemostat Aspiration principle • Designed for heating, ventilating, cooling . . . in any combination. Adjustment may be varied to meet changing conditions of room occupancy, seasonal weather variations or special conditions. • System Balancing is far easier because direct CFM readings can readily be taken in the neck of the Anemostat as the inner assembly is instantly removable. • Newly designed method of fastening inner assembly to outer cone cuts installation time by two-thirds. • Automatic or manual remote controls available. • Provision is made for incorporating volume control or lighting fixtures.

WRITE FOR BULLETIN which fully describes the new Type C-1 Anemostat . . . an unusually versatile device.

ANEMOSTAT

REG. U. S. PAT. OFF.

DRAFTLESS AIR-DIFFUSERS

ANEMOSTAT CORPORATION OF AMERICA

10 EAST 39th STREET, NEW YORK 16, N. Y.

REPRESENTATIVES IN PRINCIPAL CITIES

"No air conditioning system is better than its air distribution"

GUARANTEED LIGHTING BEGINS

WITH A FRINK *PLAN-O-LITE*

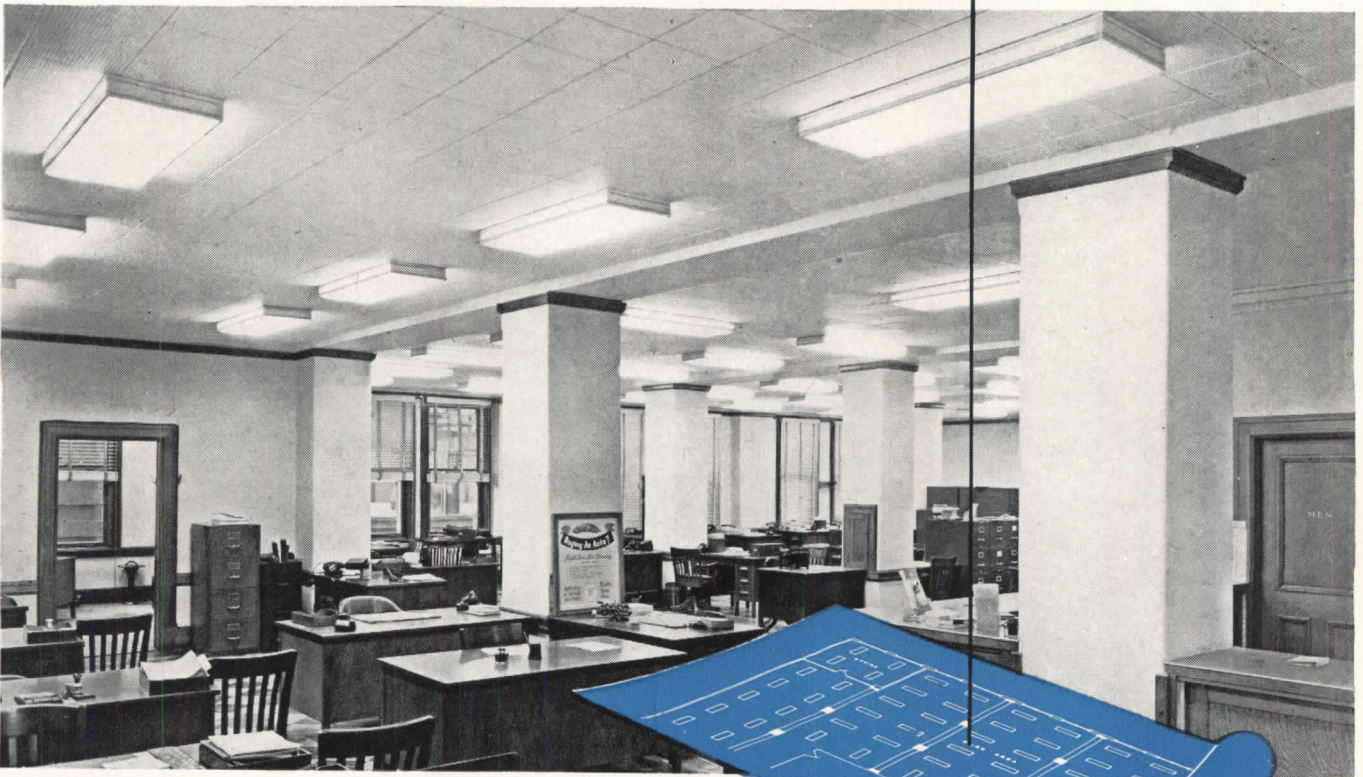

Modern appearance and high-level illumination as attained in the Time Plan Dept., Peoples First National Bank & Trust Co., Pittsburgh, Pa., using 3" deep L-I-N-O-L-I-T-E Series 12 with four 40W lamps, hinged glass bottoms (12-448HG), surface mounted.

Whether you wish to illuminate a bank, an office, a showroom or an entire building, a *PLAN-O-LITE* layout by Frink is the sure approach to *guaranteed* lighting satisfaction. At no extra cost Frink will provide you with a complete *PLAN-O-LITE* fluorescent layout *engineered* to meet your exact illumination needs. Based on Frink's 90 years of experience, it will chart the *custom-designed* installation which can be achieved at *standard-fixture* cost. Most important, it will *guarantee complete satisfaction*, if Frink specifications are followed. The coupon below will bring you an interesting sample packet of *PLAN-O-LITE* fluorescent layouts and the resulting installations. Mail it today.

CLIP THIS TO YOUR LETTERHEAD



THE FRINK CORPORATION
27-01 Bridge Plaza North, L. I. C., N. Y.
Without cost or obligation, send your sample packet of *PLAN-O-LITE* fluorescent layouts and photos to the

Attention of
() also please send catalogue of new Frink fluorescent fixtures. Dept. 2-AR

There's a Frink L-I-N-O-L-I-T-E fixture correctly engineered for every commercial fluorescent lighting need. Seventeen standard designs of highest quality workmanship and materials, each available with matching incandescent down-lights if desired. Check coupon at left for your copy of the Frink catalogue today.



THE FRINK CORPORATION

27-01 BRIDGE PLAZA NORTH, LONG ISLAND CITY, N. Y.

Heat, Ventilate and Air-Condition with . . .

MULTI-VENT

The Only Air
Diffusion
System You
Can't Feel
Can't Hear
Can't See

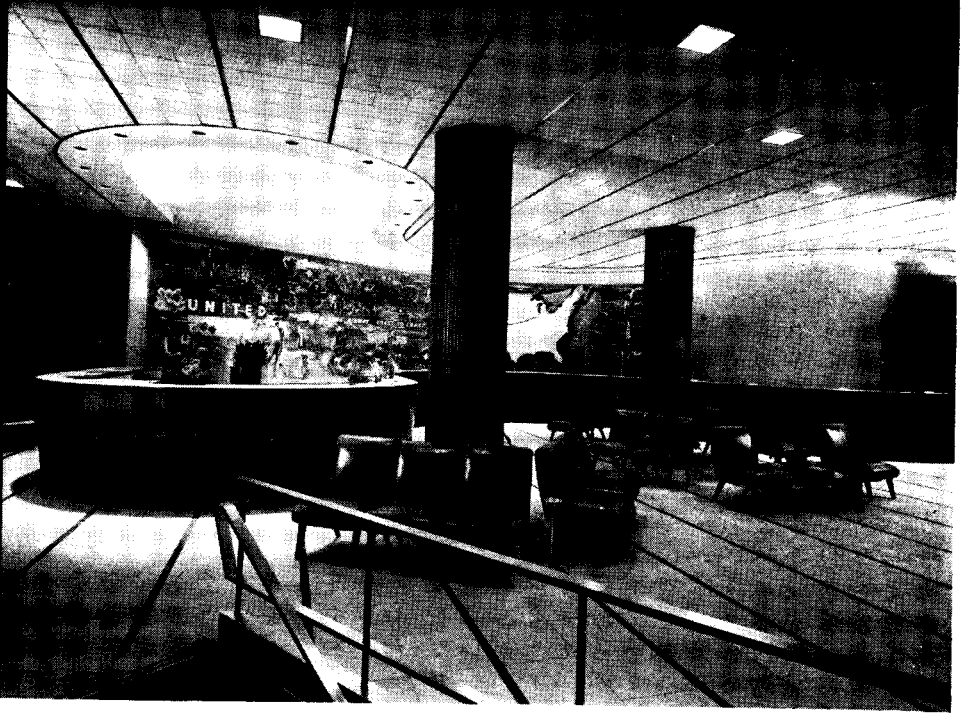

United Air Lines Ticket Office, Chicago. Multi-Vent Panels completely concealed by metal acoustical ceiling.

MULTI-VENT is the only air diffusion system you can't feel because *only* Multi-Vent's exclusively patented total displacement valve and large perforated distribution plate can provide the very low velocity and widespread air delivery necessary to completely eliminate drafts and the subtle, annoying sensations of draft, i. e. uneven room temperatures.

MULTI-VENT is an air diffusion system you can't hear, because Multi-Vent's recommended duct velocities and air volume requirements are so low that no audible friction noise is generated by the entering air. In addition, the sound absorption qualities of the perforated distribution plates actually reduces the noise level in any room.

MULTI-VENT is the only air diffusion system you can't see, because only Multi-Vent can be completely concealed above the square perforated pans in a *metal* acoustical ceiling. Multi-Vent panels can also be lined up with the creases in *fiber* acoustical ceilings for almost complete concealment. In all other types of installation, with exposed or concealed ducts, Multi-Vent panels are less conspicuous than diffusers of any other make.

MULTI-VENT, moreover, is by far the most *effective* and *efficient* air diffuser on the market today! Accurate tests show that Multi-Vent's low velocity air delivery makes possible the use of much

higher diffusion temperature differences without affecting the room occupants' comfort. This in turn greatly reduces the air volume usually required to take care of a given load . . . thereby not only making possible substantial reductions in the tonnage of the basic air conditioning equipment, but also adding greatly to the comfort factor. The result is truly superb comfort. *No drafts . . . no sound of rushing air . . . no protruding ventilating fixtures.* Write for Bulletin for complete information and specifications.

SIMPLE TO INSTALL • QUICK TO BALANCE • EASY TO CLEAN

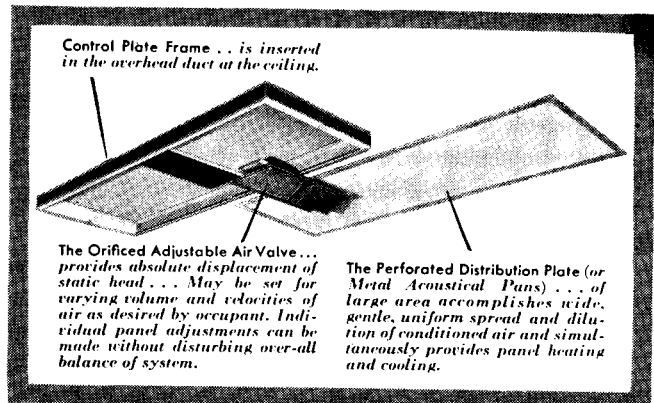

THE PYLE-NATIONAL COMPANY

MULTI-VENT DIVISION—1375 WEST 37th STREET, CHICAGO 9, ILLINOIS

Offices: New York • Philadelphia • Baltimore • Washington, D. C. • Cleveland • Cincinnati • Detroit • St. Louis • Kansas City • Omaha
Denver • Salt Lake City • San Francisco • Greensboro, N. C. • Grand Rapids, Mich.
Canadian Agent: F. W. Chambers and Co., Ltd., West Toronto 5



CONDUIT FITTINGS • PLUGS and RECEPTACLES • TURBO-GENERATORS • LOCOMOTIVE HEADLIGHTS • FLOODLIGHTS

Now . . . SMALLER STORES CAN AFFORD A HIGH QUALITY Electric

**puts first floor traffic
on every floor**

● Small and medium size stores all over the country have long asked for a high quality electric stairway at a price they could afford to pay. Now . . . Westinghouse engineering and research have supplied the answer to their demand.

Priced at a level to make the use of moving stairways profitable in smaller stores, the new Westinghouse "Limited Budget" Electric Stairway is high quality. It has deluxe features proved in years of large stairway operation. Two-step leveling at top and bottom, trip-proof combplates, extended handrails at top and bottom, two brakes . . . all these and many other features assure maximum safety and convenience.

This new electric stairway also has an unmistakably "deluxe" appearance. Its beautiful etched and anodized aluminum balustrades will harmonize with and enhance the eye appeal of any store interior. Roomy in width, generous in capacity, it speeds customers to upper floors effortlessly, swiftly and dependably.

For complete information, write to the Westinghouse Electric Corporation, Elevator Division, 150 Pacific Avenue, Jersey City 4, N. J., on your letterhead please.

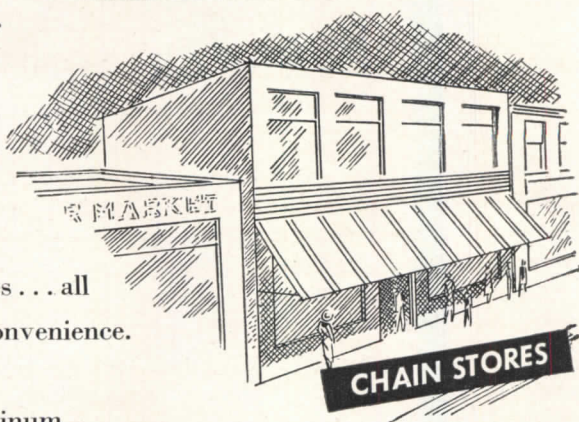

Write to Westinghouse for your copy of "The New Limited Budget Electric Stairway Brings First Floor Traffic to Every Floor." Address the Westinghouse Electric Corporation, Elevator Division, 150 Pacific Avenue, Jersey City, N. J., on your letterhead please.

Westinghouse

ELEVATOR



DIVISION

Stairway

**WITH DELUXE FEATURES AT
A LIMITED BUDGET PRICE**

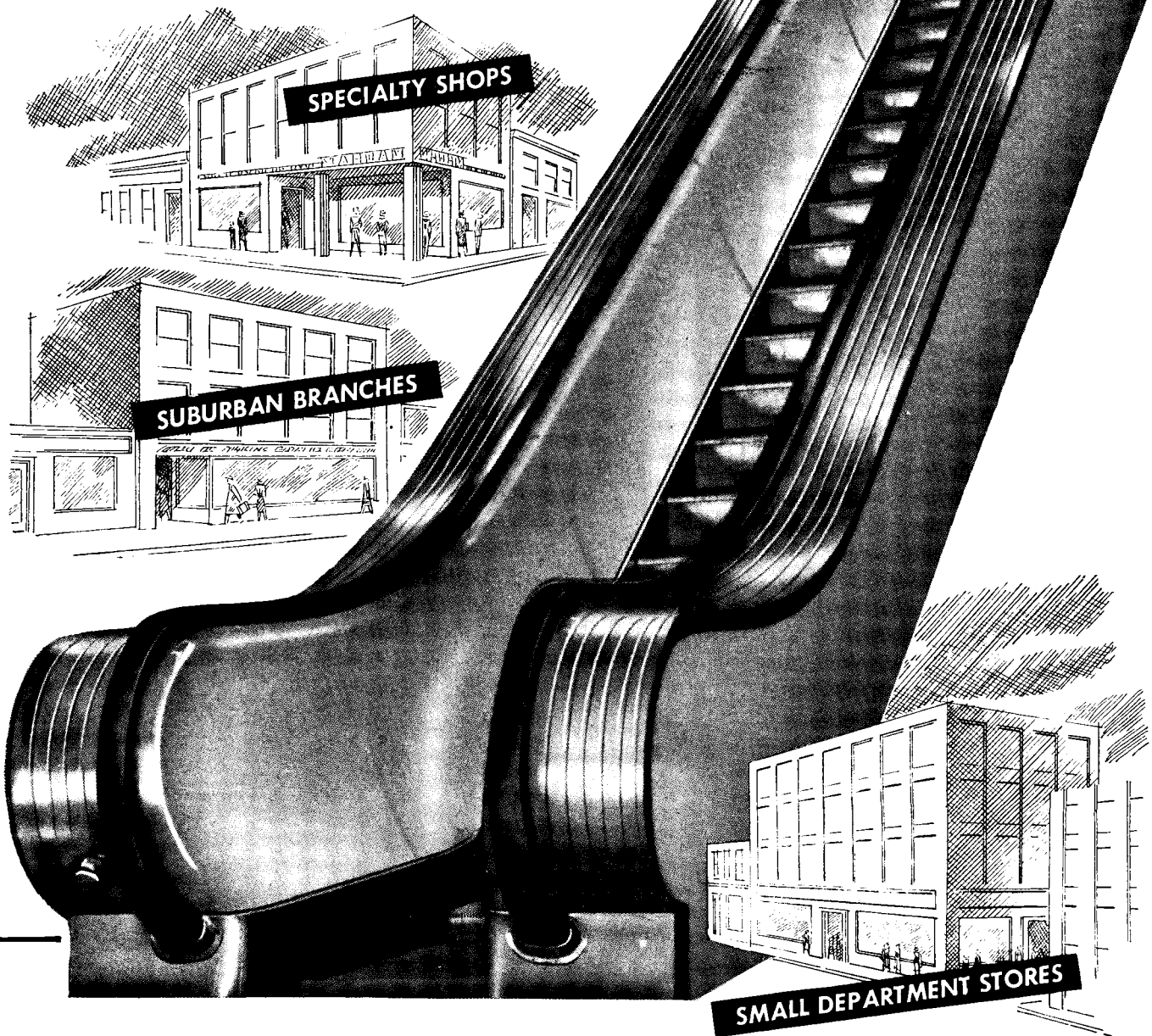

J-98509

at last... a steel heat exchanger

MADE OF 12-GAUGE STEEL

... approximately *three times* minimum A.G.A. requirements. The HEVIGAGE is constructed by the industry's most advanced machine welding process. Individual sections are welded together, front and back, the entire depth of the unit. Number and size of sections vary with the capacities of Bryant equipment in which the HEVIGAGE is installed.

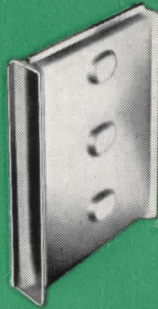
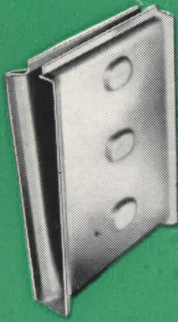
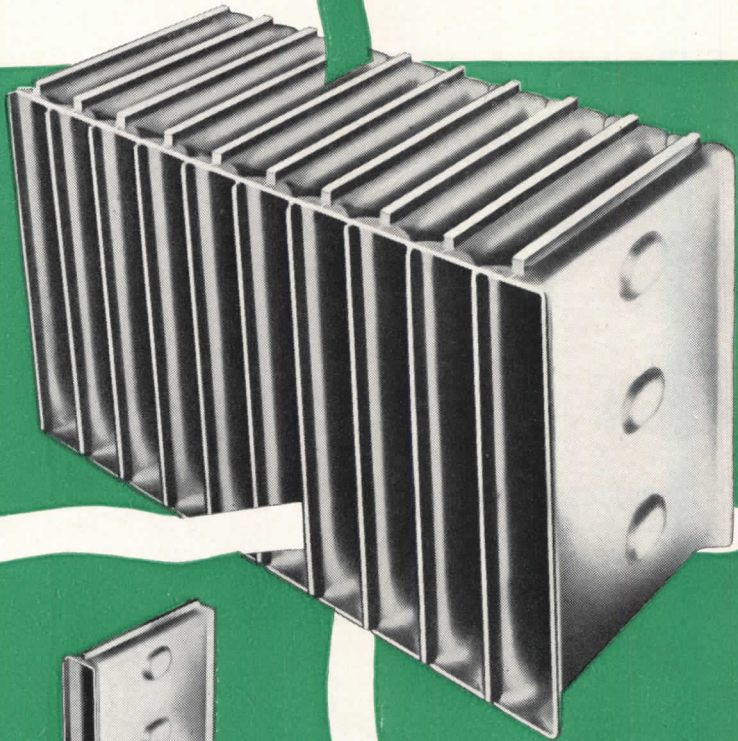

STAMPED FROM A SINGLE STEEL PLATE, sections like this are shaped in one stroke on a huge 2,000-ton press. Oval shapes impressed on sides are to baffle hot gases passing through assembly after sections are formed together as a unit.

MACHINE-WELDED ACROSS TOP. This second operation completes the individual sections that will be assembled into the complete unit shown at top. See how the top weld forms a solid-walled, streamlined air tunnel.

INSTALLED IN BRYANT EQUIPMENT

as shown in cutaway at right, the streamline air tunnels of the HEVIGAGE provide straight-line flow, both horizontal and vertical. Note how flames are directed fully across the bottom of the exchanger, and that *no weld is exposed to flames*. Each original section of the HEVIGAGE is U-shaped, and only the full, unbroken thickness of steel comes into contact with flame.

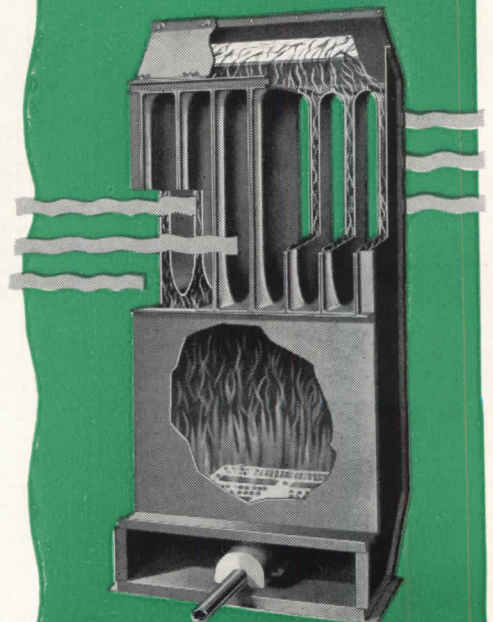

that will LAST... and LAST... and LAST!

THE NEW BRYANT

HEVIGAGE

NOW... years of extra service, without the bulkiness and extra cost of dead metal. Free air-flow, straight-line design with no cooling-pocket twists and turns. Generous heat transmission areas that squeeze the most heat from every fuel dollar spent!

This steel heat exchanger has squelched forever the idea that a good heat exchanger must be large and cumbersome. Blasted the false impression that intricate, honeycombed passageways are necessary for efficient heat transmission. Proved, by use of the right steel and the right design, that today's heat exchanger can be big in performance without being big in size and weight.

Featured IN THE NEW

BRYANT *Modernaire*

WINTER AIR CONDITIONER

Suited for homes, apartments, offices and stores, this compact vertical winter air conditioner is made in six sizes, inputs from 45,000 to 145,000 btu's an hour. Heats, filters, humidifies and distributes the air to do a complete winter air conditioning job.

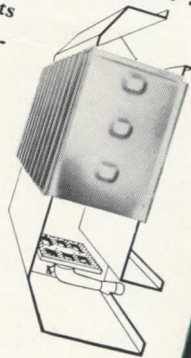

Featured IN THE NEW

BRYANT *Utilaire*

DUCT AND UNIT HEATERS

Newest design in gas-fired unit and duct heaters is this Bryant-engineered unit that delivers warm air quickly, efficiently and economically for all types of commercial and industrial installations. Made in six sizes, from 60,000 to 210,000 btu/hour.

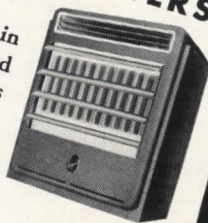
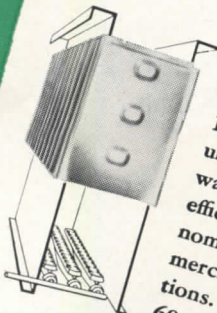

The NEW products come from Bryant

Another Building with **ACOUSTICAL CEILINGS**
Another Building with **AGITAIR TYPE R**

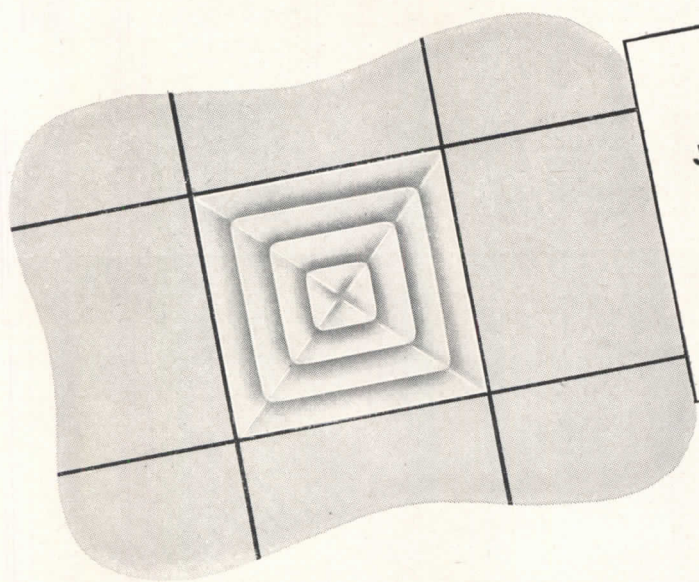

**LARGEST OFFICE BUILDING
 IN NEW ENGLAND**
 John Hancock Mutual Life Insurance Co.
 Boston, Mass.

Architects — Engineers:
Cram & Ferguson
 Contractors:
Turner Construction Co.

Heating, Ventilating,
 & Air Conditioning
 Contractors:
Buerkel & Co., Inc.

**It's The Only Air Diffuser
 Especially Designed For
 ACOUSTICAL CEILINGS**

Ever wonder why you see so many acoustical ceilings with Agitair Type R? Here's the answer: Agitair Type R is the only air diffuser made in standard sizes to fit every acoustical ceiling.

It provides perfect blending with the ceiling pattern . . . eliminates costly on-the-job cutting and trimming of tile . . . saves installation time and money. And, of course, Agitair Type R gives you 100% control of air distribution . . . with no noise, no drafts, no blank corners, no hot spots, no cold spots.

Look around — at big jobs and small ones — chances are wherever you find acoustical ceilings you'll find Agitair Type R.

Write for Complete Data



AIR DEVICES, Inc. • 17 East 42nd Street • New York 17, N. Y.
 CEILING AIR DIFFUSERS AIR FILTERS ROOF EXHAUSTERS

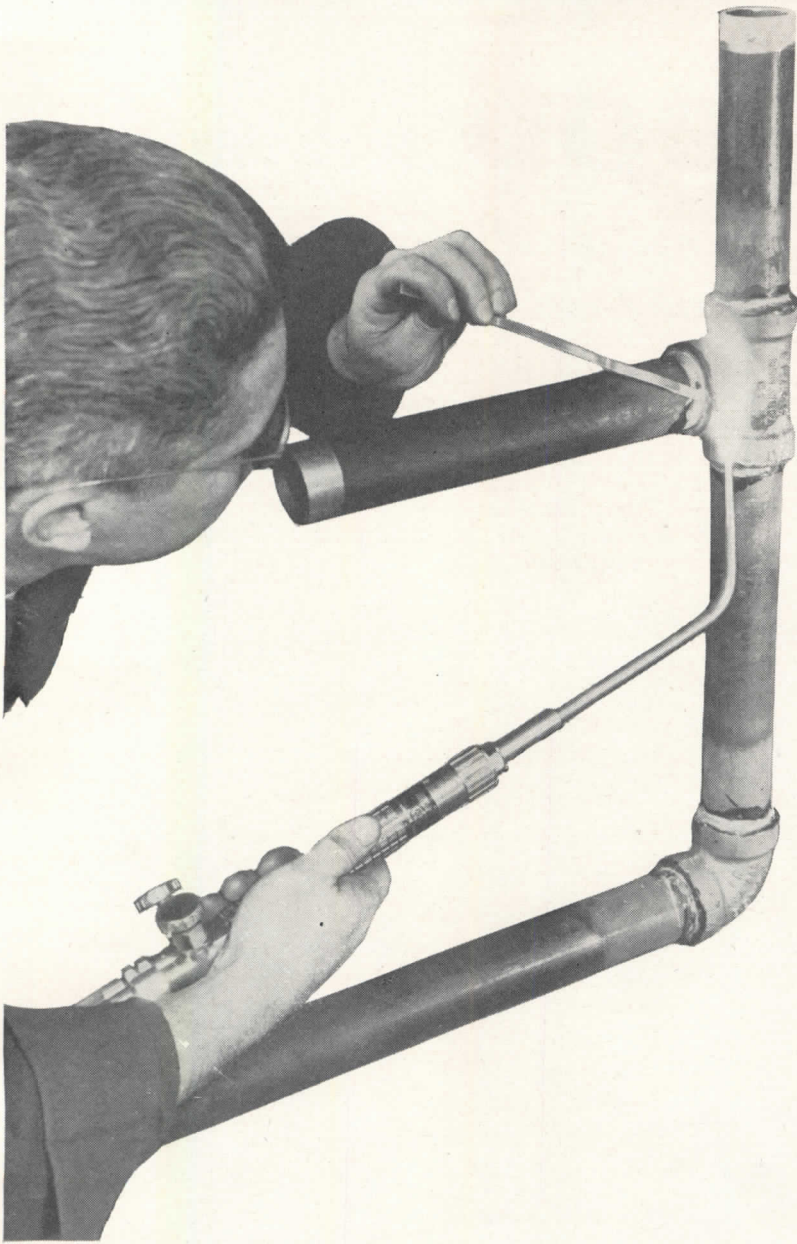

let
*capillary
action*

do
what
strong-arm
methods
can't

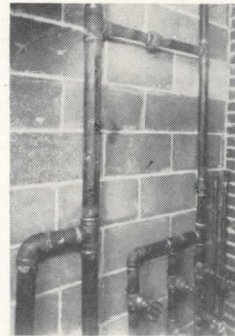

FLAGG-FLOW *Threadless* Malleable Fittings make tough piping jobs easy. They can be positioned to face in any direction — precisely and accurately — then Capillary Action draws the Silver Brazing Alloy into the joint to make a perfect, permanent bond. You eliminate backing-off or taking-up to compensate for faulty threads or measurements; there is no distortion strain from manhandling a pipe wrench.

What is more, FLAGG-FLOW can be installed wherever pipe will go and a torch will reach—in tight spots around machinery, or in awkward corners that defy a wrench. Nor is special skill and experience required to make permanent, maintenance-free joints. Any competent pipefitter can make joints as strong as the pipe itself by observing the simple three-step rule: CLEAN — FLUX — HEAT.

Use FLAGG-FLOW *Threadless* Malleable Fittings wherever standard black steel or wrought iron pipe is applicable. Write today for Catalog giving full details.

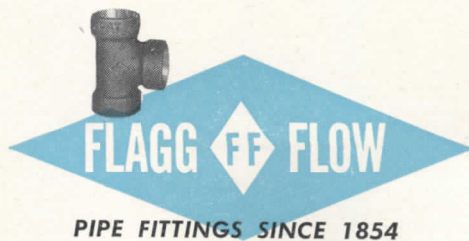

STANLEY G. FLAGG & CO., INC.
1421 Chestnut Street, Philadelphia 2, Pa.

MALLEABLE IRON FITTINGS, STD., EX. HVY. AND AAR • CAST IRON FITTINGS • DRAINAGE FITTINGS • FLANGE UNIONS • FLANGES
GROUND JOINT UNIONS • BRONZE THREADED FITTINGS • BRONZE SOLDER FITTINGS • UNDERGROUND TANK FITTINGS

The Name **HOOD** means

"... unfailing integrity, reliable quality and fair pricing"

Hood . . . the brand name in rubber . . . tested, proved and accepted by the American people . . . is synonymous with top quality and universal customer satisfaction in Resilient Flooring.

Dealers as well as users know the whole Hood story. They know the years of testing and development that make Hood Rubber and Asphalt Tile unexcelled in beauty and performance. They know the

value of the Hood name as one which holds public confidence through unfailing integrity, reliable quality and fair pricing.

Thus, it is no wonder that flooring contractors in ever-increasing numbers are asking to handle the Hood line—choice of flooring experts since 1925. For your copy of the Hood Flooring Catalog in color, write now.

BRAND NAMES FOUNDATION

50 Years of Public Service

Award

Given to Brand Names which have been tested by the judgment of the American people for 50 years or more and have won and held public confidence through unfailing integrity, reliable quality and fair pricing.

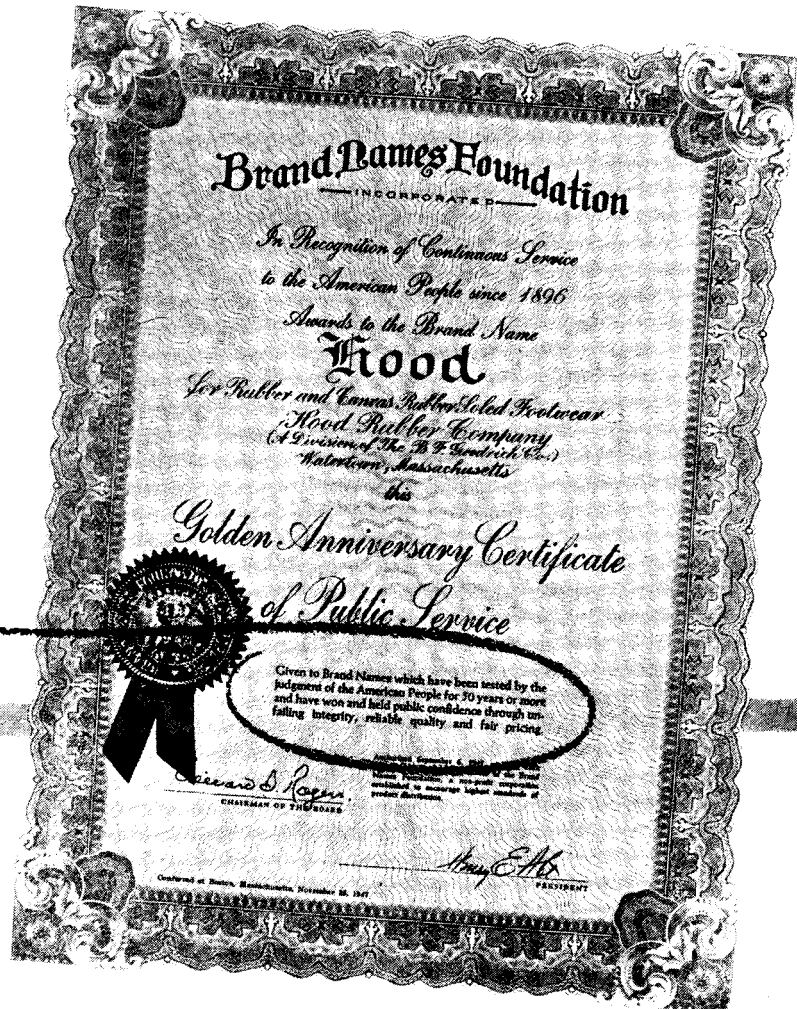

RUBBER OR ASPHALT TILE FLOORING



Hood Rubber Co.
A DIVISION OF

B. F. Goodrich

WATERTOWN, MASS.



Portals ain't acrobats!

**Use the
New**



**Guth
FLOATING HINGE ARISTOLITES**

*The Luminaire that Makes the
Dusting Ladder Obsolete!*



A simple gripper tool on a pole unseats the glass panels. A handy mop at the opposite end of the same pole does the dusting job.

With the revolutionary new GUTH Floating Hinge Aristolite™, the entire dusting operation can be done regularly, easily, safely, right from the floor!

The dangers of cleaning are gone! The bother and bustle of cleaning are gone! Fixtures get dusted regularly when you have GUTH Floating Hinge Aristolites, because it's no trouble to do it. You get more light, better light, more consistent light, from luminaires that get cleaned regularly.

To clean these amazing fixtures, the glass panels are safely and easily swung open and hang securely on the floating hinge. Then follows a quick dusting—and back go the glass panels! So simple—so safe!

Write today for Bulletin No. 812-C, which gives full details about this revolutionary new fixture.

Distributors Conveniently Located from
Coast to Coast



Trade Mark Reg.

Pats. Pending

Leaders in Lighting

Since 1902



THE EDWIN F. GUTH CO.

2615 WASHINGTON AVE. • ST. LOUIS 3

because of Steel Pipe . . .



it's springtime inside!

Now grandma rocks gently through the twilight years . . . warm, comfortable and secure. For to the very old and the very young, year-round warmth is almost as essential to health and peace-of-mind as food or clothing.

Outside the elements may rage but inside it's springtime.

Yes, steel pipe makes it possible!

Uniform, dependable heat in every room in any home is a reality largely because of the economical and plentiful production of *steel pipe*. Whether for conventional hot water or steam heating systems or today's counterpart, the radiant panel method, steel pipe provides a

combination of advantages that makes modern heating available to more people than ever before. Likewise, the heating systems of our great office buildings and industrial plants rely on steel pipe to function smoothly and efficiently . . . to furnish the warmth and comfort so necessary in our daily tasks.

The interesting story of "Pipe in American Life" will be sent upon request.

COMMITTEE ON STEEL PIPE RESEARCH of American Iron and Steel Institute, 350 Fifth Avenue, New York 1, N. Y.

STEEL PIPE MAKES IT POSSIBLE!



. . . better living through pipes of steel for plumbing and heating purposes.

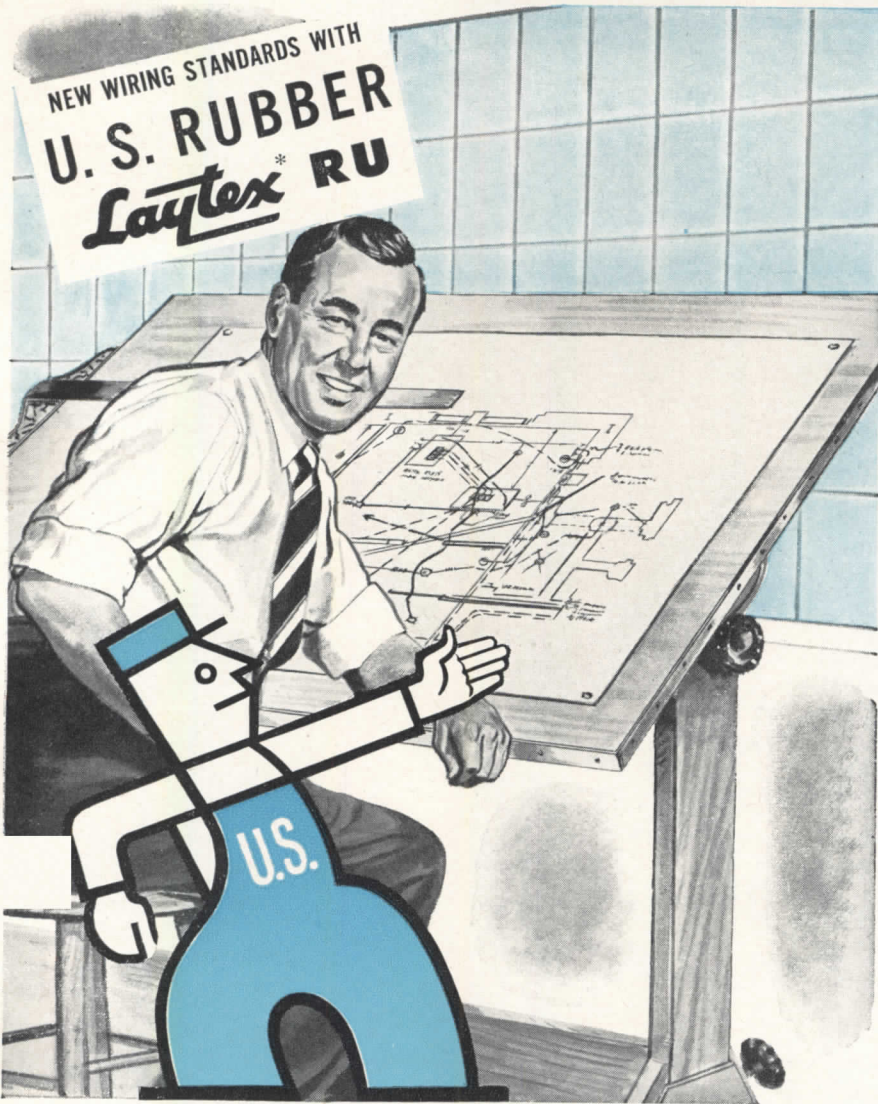

United States Rubber Company's unique dip or pass method applies the insulation in *perfectly uniform* layers. Moreover, this insulation is 90% pure rubber, unmilled in order to preserve its high physical qualities. The extra strength of natural rubber, plus a strong fibrous cover and special finish gives extra protection against mishandling, sharp bends, moisture and flame.

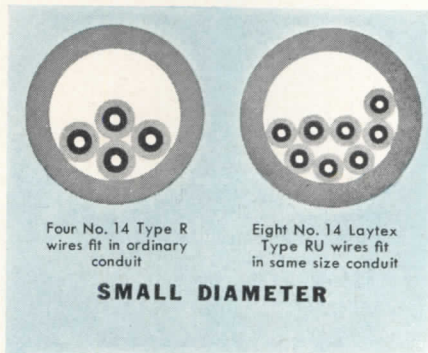

Yet, despite the unusual safety features of Laytex RU, this wire is smaller in diameter and lighter in weight than any other natural rubber covered wire on the market. Not only is Laytex unsurpassed in physical and electrical qualities, but it will also permit *more wires per conduit*.

The tensile strength of Laytex RU is over 7 times that of Type R, and twice that of Type T. Its insulation resistance constant is over 3 times that of Type T, and over 8 times that of Type R. Add all these advantages up, and no wonder Laytex RU is the finest building wire on the market today.

U. S. Laytex RU is labeled by the Underwriters' Laboratories and listed in the National Electrical Code as an all-purpose wire. Send for a sample and free booklet. Write Wire and Cable Department, United States Rubber Company, 1230 Avenue of the Americas, New York 20, N. Y.

**Reg. U. S. Pat. Off.*

"This Wire's got Safety and long Life...It's **Laytex RU.**"



PERFECT CENTERING

So says Mr. USRUBBY, the Wire Engineer. And you, Mr. Architect, will agree with him. For when you specify U. S. Laytex RU, you are

getting a wire that will not suffer from the dangerous thin spots formed on ordinary wires. Why? Because

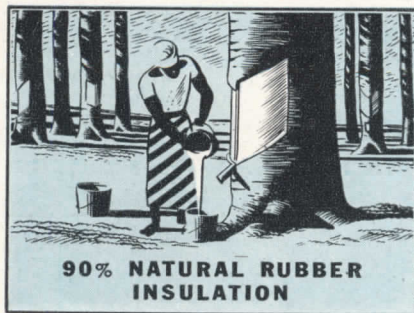

90% NATURAL RUBBER INSULATION



A PRODUCT OF



UNITED STATES RUBBER COMPANY

All wiring with **RU?**

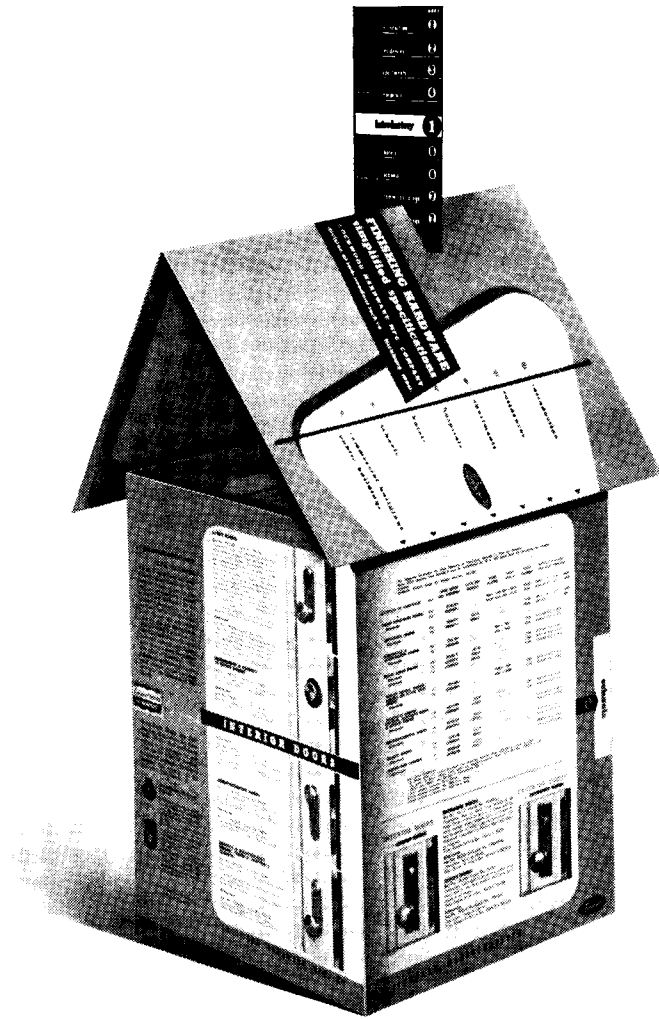

the house that knack built

Working closely with architects for many years developed Lockwood's *knack* for simplifying everything an architect wants to know about Finishing Hardware — and then putting it under one roof!

That's why Lockwood's "Simplified Specifications for Finishing Hardware" can be your stand-by for writing up private dwellings, schools, hotels, hospitals, apartment houses and commercial buildings. And with good reasons. For example, *one* Unit Number selected from

one listing specifies the lockset, hinges, door-stop, kick plate and even the door closer for a particular door. The whole story is there at a glance; yet you still have free selection of design and finish. Nothing could be simpler!

"Simplified Specifications for Finishing Hardware" will be a big help to you again this year. You'll find the new edition bound into Sweet's Architectural File for 1948 — or we'll be glad to send you an easy-to-handle copy for your own individual use. Just ask for it.

Lockwood

HARDWARE MANUFACTURING CO.

Division of Independent Lock Company • FITCHBURG, MASSACHUSETTS

L-81A



YOUR CLIENT CAN END COSTLY NOISE FOR ONLY 3¢ A DAY

When your client is planning to build or remodel a restaurant, include quiet in your design. Quiet builds profits, because patrons like to come back to a place where they can relax and talk, where they aren't disturbed by the din of rattling dishes, clattering trays, and echoing voices. And any restaurant can have that quiet for as little as 3¢ a day.

Just 3¢ a day, figured over three or four years, is all it costs to in-

stall a noise-absorbing ceiling of Armstrong's Cushiontone over the average individual seating area. That small cost is repaid many times over in satisfying old patrons and winning new ones.

Up to 75% of the sound that strikes the ceiling is absorbed by the 484 deep fibrous holes in each 12" square of Cushiontone. And Cushiontone ends noise permanently. Even repainting won't affect its unusually high acoustical efficiency.

Armstrong's Cushiontone is a good reflector of light and is easy to keep clean. It also provides extra insulation. Your local Armstrong contractor will be glad to give you a free estimate that proves the economy of a Cushiontone ceiling.

WRITE FOR FREE BOOKLET, "What to do about Restaurant Noise." It gives all the facts. Armstrong Cork Company, Acoustical Department, 2402 Stevens Street, Lancaster, Penna.

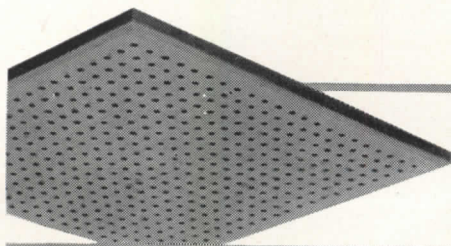

ARMSTRONG'S CUSHIONTONE
Armstrong Cork Company  Lancaster, Pennsylvania

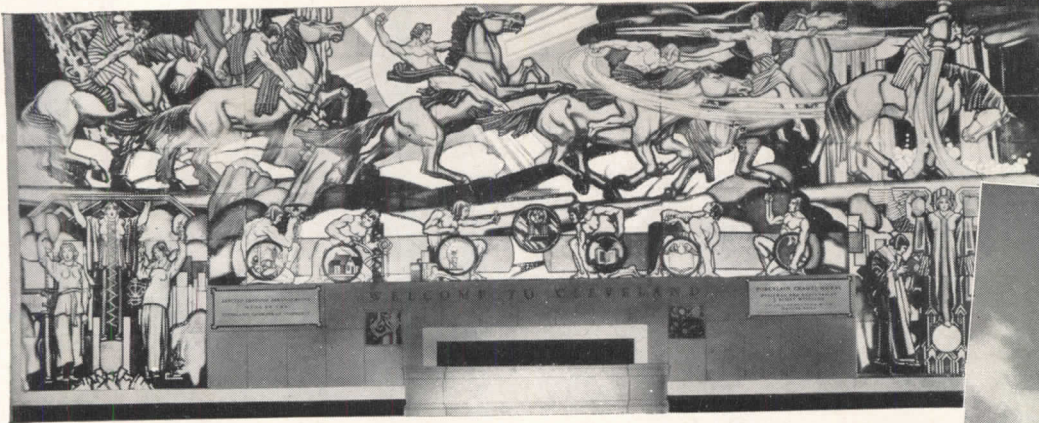

Multi-colored porcelain enamel mural, size 72 feet by 28 feet, given to the Union Terminal, Cleveland, Ohio, by the Ferro Enamel Corp., Cleveland. Designed and executed by J. Scott Williams in Seaporcel's plant.

SATTLER'S DEPT. STORE
Buffalo, N. Y.



Sign by FLEXLUME SIGN CO.
Buffalo, N. Y.

An old FACADE gets a FACE LIFTING JOB



[A New Store Gets an
Eye-catching Sign]



MILES SHOE STORE—34th Street, New York City
Michael Polom, N. Y., Designer

SEAPORCEL PORCELAIN enamel manufacturing techniques and metal fabricating skill produce store and building fronts which are a distinct departure from the commonplace flat surface designs. Today Seaporcel turns out your project in almost any *odd* shape you want . . . be it fluted, reeded, pyramided or serrated like the Miles Shoe Store Building. Here's a building that certainly was given a master face lifting.

THE OLD FACADE—(if we dare say so)—was a wreck. The transformation is a thing of beauty . . . sparkling, colorful . . . 55 ft. high by 25 ft. wide with separate raised letters. Here the designer's ideas were given full sway. Permanence and beauty fully complement other elements of design. Seaporcel can be hung as a curtain to hide outmoded building exteriors.

MR. ARCHITECT, MR. DESIGNER . . . here are new avenues of approach for versatile and flexible design. Seaporcel Porcelain Enamel is available in almost limitless colors—and quite a few textures—that remain lustrous in a material that is practically ageless. Light in weight, Seaporcel is easily handled. Installation is by concealed fastenings.

Write today for catalog showing applications and current jobs.

SEAPORCEL PORCELAIN METALS, INC.

Formerly Porcelain Metals, Inc.

28-02 Borden Avenue, Long Island City 1, N. Y.

*Reg. U. S. Pat. Off.

Offices in Many Principal Cities

Complete American Federation of Labor Enameling and Metal Fabricating Shop

Seaporcel

Member: Porcelain Enamel Institute, Inc.

SEE OUR
CATALOG IN
SWEET'S



Announcing The New
HERMAN NELSON UNIT VENTILATOR
The first post-war contribution to
better schoolroom health and comfort

The first post-war contribution to better schoolroom health and comfort has been incorporated in the new Herman Nelson Unit Ventilator. Knowing that the biggest obstacle to perfect control of unit ventilators was the inability to gradually throttle the steam supply to the heating element and at the same time distribute the steam uniformly throughout the heating element, Herman Nelson research engineers devised a pressure equalizing unit to solve this problem. By bleeding air into the heating element from the return line this unit permits maintenance of an equal pressure when the steam supply is throttled. Together with other Herman Nelson features of design and construction, this development assures maintenance of healthful and comfortable air conditions in the school classroom.

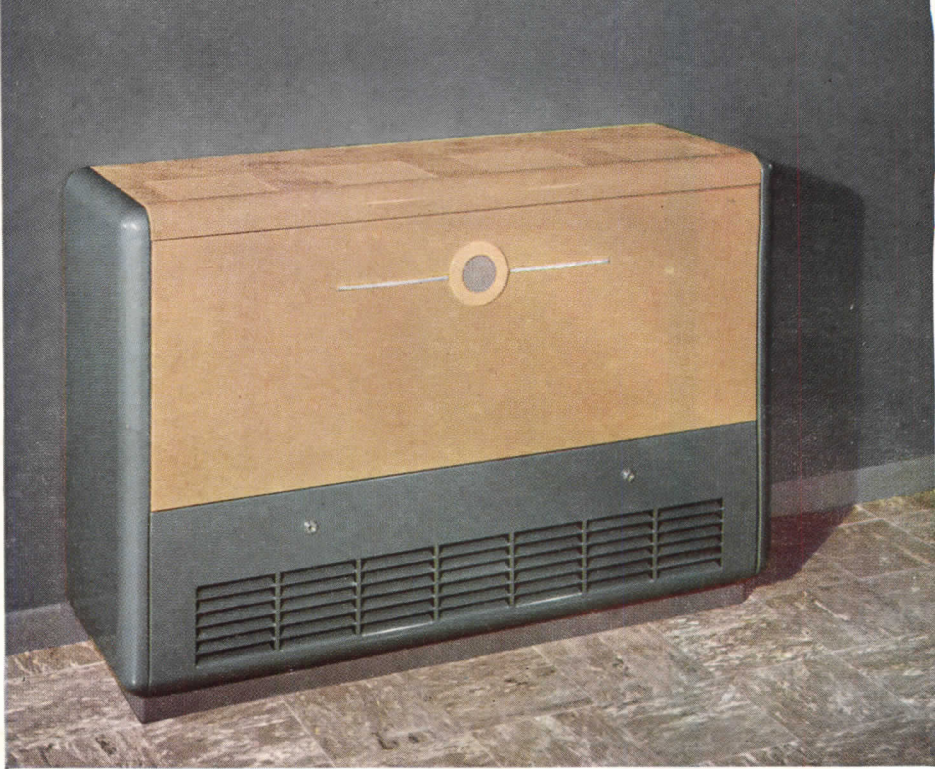

The new Herman Nelson Unit Ventilator

9 IMPORTANT POINTS OF SUPERIORITY contributing to better schoolroom health and comfort

- 1 **SLOW SPEED, DIRECT CONNECTED MOTOR** contributes to quiet operation and assures long, dependable service. Location of motor in end compartment permits use of entire cabinet space for fans and allows them to be placed above heating element. Control unit easily reached through access grille.
- 2 **MODULAR FAN UNITS** assure uniform tip speeds and outlet velocities on all sizes of units. Occupying entire cabinet space, fans are large and quiet. Location of the fans at outlet of unit permits uniform temperature of air introduced into room from each outlet.
- 3 **FLOATING HEATING ELEMENT**, with one end of each tube riding free, cannot be damaged by expansion and contraction. Internal steam distributing tubes assure uniform distribution of steam within heating element. Location in lower section of cabinet permits convection of heat with fans not running.
- 4 **PRESSURE EQUALIZING UNIT** between heating element and return line allows gradual throttling of steam supply. It permits maintenance of an equal pressure when the steam supply is throttled by bleeding air into the heating element from the return line. A special device designed into this unit prevents by-passing of steam.
- 5 **CONDENSATE COOLING SURFACE** prevents flooding of heating element. This extended surface, located in the air stream, permits the trap to function properly so that condensate does not back up in the heating element, preventing even distribution of steam and causing water-hammer.
- 6 **WELDED CABINET CONSTRUCTION** assures modern, structural strength. Front panels and ends are easily removed for full access to all parts during installation. Only a small, easily handled front panel need be removed for changing filter. Directional flow discharge grilles provide proper distribution of air throughout room.
- 7 **AUTOMATIC BACK DRAFT DAMPER** prevents cold air from passing through room air grille. It is held open when unit is not in operation to permit convection of heat. Outdoor air damper is perfectly balanced and of light weight construction, requiring little power for operation.
- 8 **DEMOUNTABLE WALL INTAKE** permits an absolutely weather-tight installation. Louver assembly can be removed from the intake frame which is set in the wall. Intake opening is then accessible for caulking wall opening.
- 9 **INTEGRAL DESIGN OF CABINET** permits the unit ventilator to be used by itself or as a section of a group including utility cabinets and convectors. Utility cabinets can be added at any future date. Any combination of units is always finished on the ends so that it is not necessary to line the entire wall with shelving.

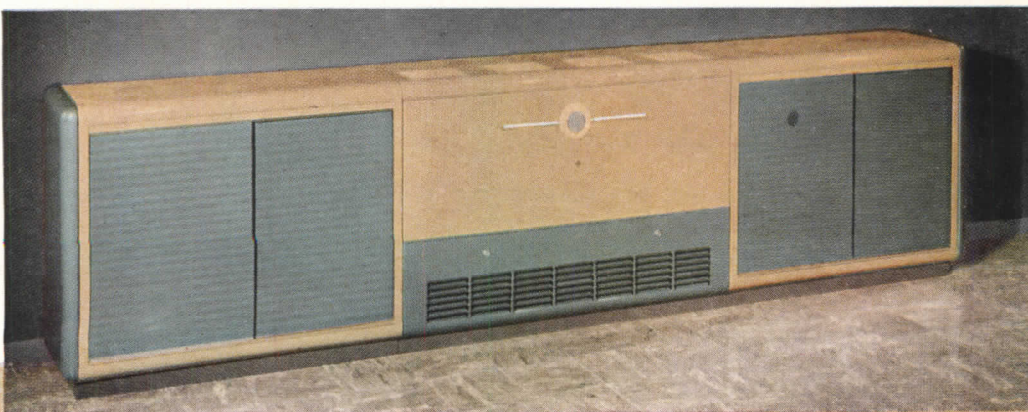

New Herman Nelson Unit Ventilator with Utility Cabinets. Illustration shows how Cabinets or Convectors and Ventilator become one integral unit. Additional cabinets may be added at any time desired.



THE HERMAN NELSON CORPORATION

Since 1906 Manufacturers of Quality Heating and Ventilating Products

MOLINE, ILLINOIS

Rolling Steel

DOORS

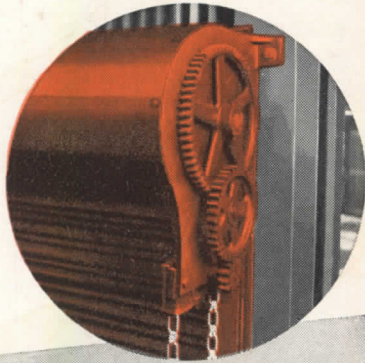

Manually • Mechanically • Power Operated

Vertically operating Rolling Steel Doors are by far the most practical doors for large openings in industrial or commercial buildings . . . they conserve space, require less maintenance, and provide more positive protection throughout a lifetime of trouble-free service. A study of Mahon Rolling Steel Doors will reveal many exclusive developments which are very desirable from a standpoint of daily operation. See Mahon's Insert in Sweet's File for complete information and specifications, or call in a Mahon representative.

THE R. C. MAHON COMPANY

Detroit 11, Michigan • Western Sales Division, Chicago 4, Illinois

Representatives in All Principal Cities

Manufacturers of Rolling Steel Doors, Shutters and Grilles, and Mahon Steel Deck for Roofs, Sidewalls, Partitions, Acoustical Ceilings, Permanent Floor Forms and Oversize Doors.

MAHON POWER OPERATOR

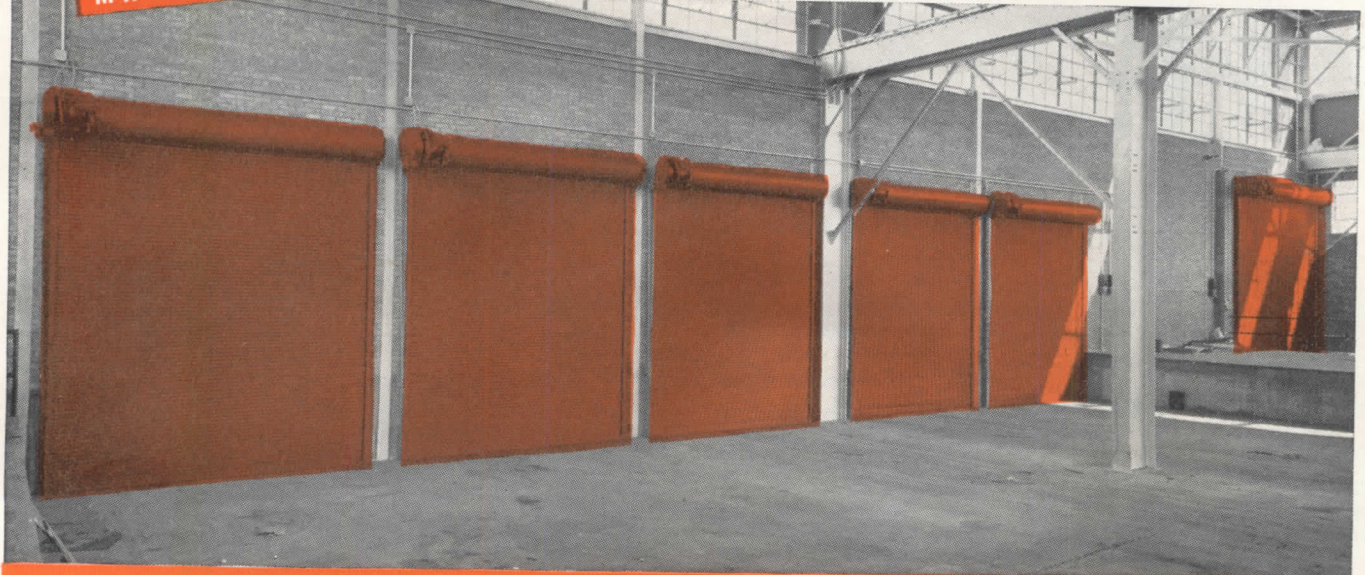

ROLLING STEEL DOORS, SHUTTERS AND GRILLES TO MEET EVERY REQUIREMENT

MAHON

Answer to Washable Tile-like Surfaces at Low Cost!

For jobs on your boards now,

you can specify Upson *Dubl-Thik* Fibre-Tile. Its service record in tens of thousands of baths and kitchens has established this product as deserving your confidence. Stocks are available all over the country.

Consider these advantages: Five plies of tightly compressed wood fibres, laminated to more than $\frac{1}{4}$ " thickness.

Not thin, brittle, rough or spongy. Won't crack, craze or loosen. Comes with specially prepared, smooth, fuzless surface—ready to enamel in exact color desired.

Requires no visible face nailing. Applied with Upson Fasteners (an exclusive Upson feature) which provides for normal structural movement of studs and joists. Can be bought and installed at a fraction of the cost of tile or pre-finished tile-like materials. More details in Sweet's. For samples, write us direct.

← Easily Identified By The Famous BLUE Center

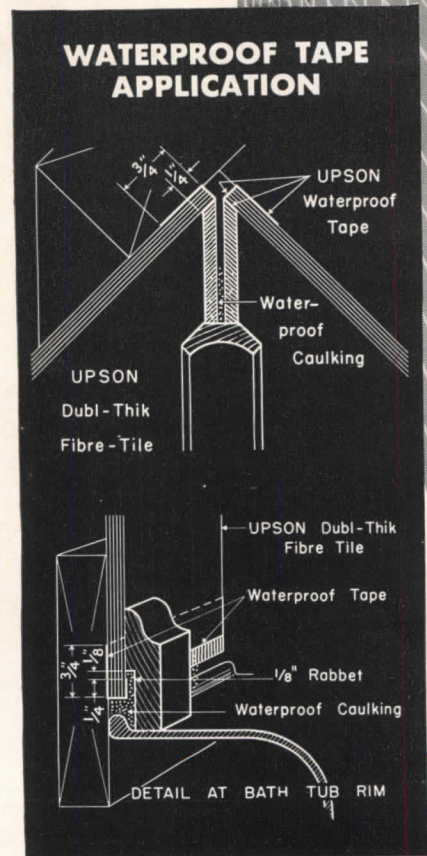

THE UPSON COMPANY, Lockport, New York

Pacemaker in Crackproof Panels. 6 Ply Strong Bilt—for new construction • 5 ply Kuver-Krak—for re-covering cracked plaster • 5 ply *Dubl-Thik* Fibre Tile—for baths and kitchens • 4 ply Upson Board—for general use • 3 ply Easy Curve Board—for displays and industrial uses.



*Newest Video=Radio Station...in the
Modern Structural Material...*

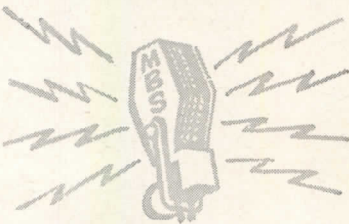

The new Mutual-Don Lee Studio, occupying the entire block bounded by Vine, Fountain and Homewood Avenues in the heart of Hollywood's Radio Center, combines the latest in television, FM and AM radio in what is said to be America's most modern broadcasting station. Of all-concrete construction, the new studio features a contemporary design of horizontal motif.

The first floor contains eight large studios. Four will accommodate audiences of 350 people each. Four will be non-audience studios. In addition, there will be five small studios for newscasting and FM. There will also be about 70 offices and recreation rooms.

This new structure was designed by Claude Beelman, architect, and Herman Spackler, associate. Construction by Wm. Simpson Construction Company.

ARCHITECTURAL CONCRETE

THE new \$2,500,000 home of the Mutual-Don Lee Broadcasting System, now nearing completion in Hollywood, is a three-story-and-basement structure approximately 280 feet square with a floor area of about three acres. It is a building of beauty, strength and permanence because it is built with the modern, versatile structural material—architectural concrete.

This is another example of how the structural and ornamental parts of a building can be cast in one operation with architectural concrete—a valuable point to remember in planning public buildings, schools, hospitals, apartment houses and industrial buildings. Architectural concrete is adaptable to an unusually wide range of architectural styles and decorative treatments.

Moderate first cost, low maintenance expense, long life, fire-safety and **low annual cost** are just a few of the advantages of architectural concrete. Architects and engineers are invited to make full use of our services to secure the maximum advantages of architectural concrete for their projects. See our catalog in Sweet's, section 4e/5.

PORTLAND CEMENT ASSOCIATION

Dept. 2-8, 33 West Grand Avenue, Chicago 10, Illinois

A national organization to improve and extend the uses of portland cement and concrete . . .
through scientific research and engineering field work

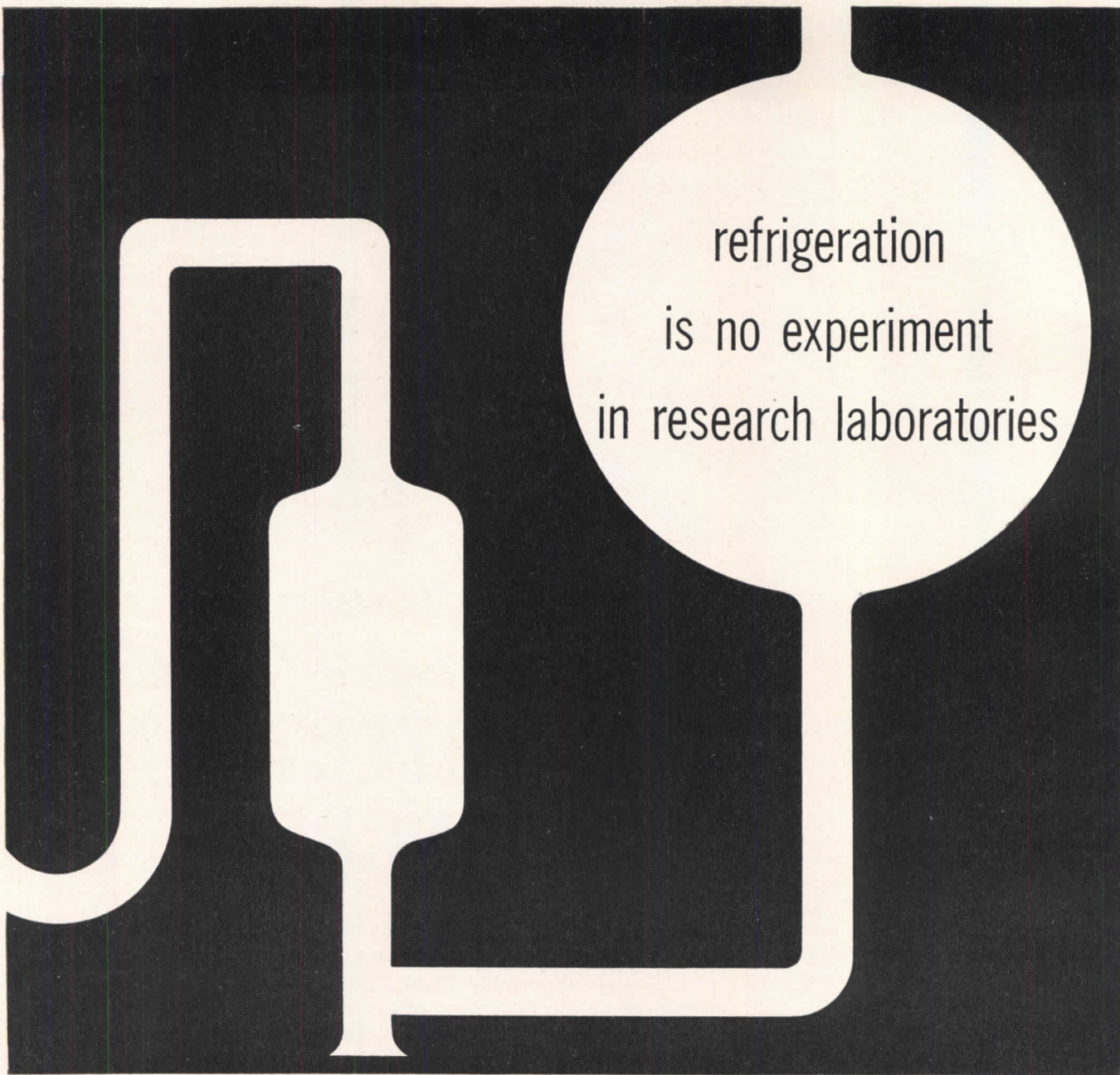

refrigeration
is no experiment
in research laboratories

Control of temperature and humidity is paying its way for modern industrial laboratories in more and better research. Such exacting work demands precise control the year round. That is why so many industrial laboratories choose Carrier centrifugal refrigerating machines for their refrigerating and air conditioning requirements.

Recently Carrier centrifugals have been installed by such companies as Louisiana Division of Standard Oil Company of New Jersey, Sinclair Re-

fining Company, and the B. F. Goodrich Company. Like other corporations operating extensive research laboratories, they find precisely controlled air conditioning and refrigeration permit more exact measurements, promote cleanliness, and help control chemical and biological reactions. And comfort of the research personnel encourages better work.

Compact, dependable Carrier centrifugal refrigerating machines are used all over the world in laboratories,

industrial plants, hotels, office buildings. Their efficient operation, ease of maintenance and lack of vibration make them the choice for refrigeration and air conditioning applications.

Whatever the kind of laboratory or type of construction Carrier engineers will be glad to help you. They're the most experienced in the industrial field. And they've worked for years with architects and consulting engineers to unravel knotty problems. Carrier Corporation, Syracuse, N. Y.

Carrier

AIR CONDITIONING • REFRIGERATION • INDUSTRIAL HEATING

Jenkins PRACTICAL PIPING LAYOUTS 26

How to plan AUTOMATIC SPRINKLER SYSTEM TANK CONNECTIONS

● An automatic sprinkler system using two primary water supplies, gravity and pressure tanks is represented in this layout. It conforms with the code of the National Board of Fire Underwriters.

Tank discharge lines may be carried separately in dead risers down to the lowest point in the system and there connected to the sprinkler supply risers. The tank discharges may be tied together to form the sprinkler supply line, providing this tie-in is made a minimum of 40 feet below the bottom of the pressure tank to prevent air lock in lines after pressure tank is emptied. Air lock would prevent discharge of the gravity tank.

The pressure tank must be installed in a room where a minimum temperature of 40°F. is maintained. The gravity tank is usually located on the roof exposed to weather. A heat exchanger maintains the required 40°F. minimum tank water temperature.

Consultation with accredited piping engineers and contractors is recommended when planning any major piping installation. Copies of Layout No. 26, enlarged, with additional information, will be sent on request. Just mail coupon.

A CHOICE OF OVER 600 JENKINS VALVES

To save time, to simplify planning, to get all the advantage of Jenkins specialized valve engineering experience, select all the valves you need from the Jenkins Catalog. It's your best assurance of lowest cost in the long run.

Jenkins Bros., 80 White St., New York 13; Bridgeport, Conn.; Atlanta; Boston; Philadelphia; Chicago; San Francisco. Jenkins Bros., Ltd., Montreal.

LOOK FOR THIS  DIAMOND MARK Since 1864

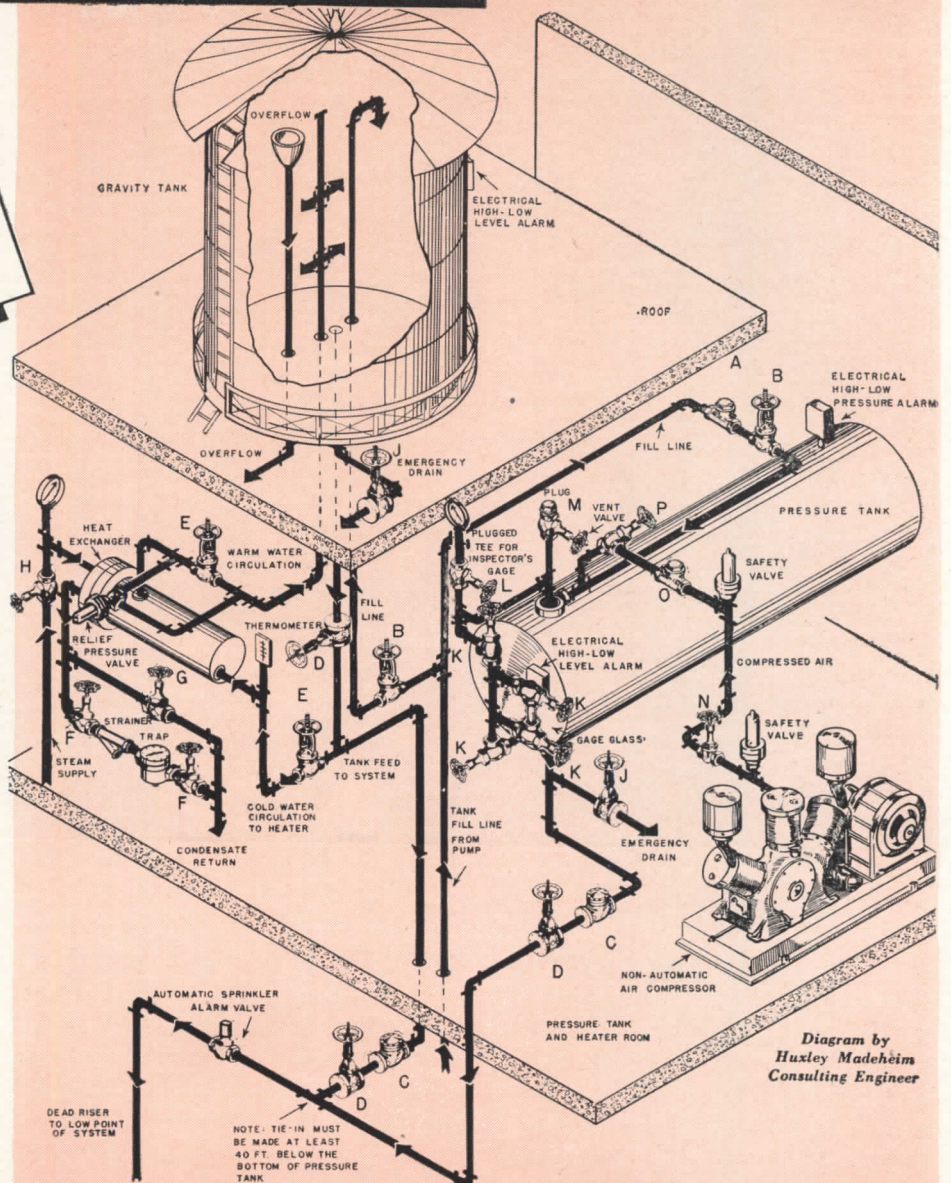
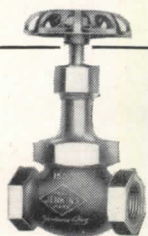

Diagram by Huxley Madeheim Consulting Engineer

VALVE RECOMMENDATIONS
For details and valves to suit varying conditions see Jenkins Catalog.

Code	Quan.	Jenkins Valve	Service	Code	Quan.	Jenkins Valve	Service
A	1	Fig. 352 Bronze Swing Check	Tank fill line	H	1	Fig. 106-A Bronze Globe	Steam admission to heater
B	2	Fig. 275-U Bronze Gate	Tank fill line	J	2	Fig. 825 I.B. O.S.&Y. Gate	Emergency Tank Drain
C	2	Fig. 629 I.B. Swing Check	Tank discharge to sprinkler system	K	4	Fig. 108-A Bronze Angle	Gage glass & pressure test
D	3	Fig. 825 I.B. O.S.&Y. Gate	Tank discharge to sprinkler system	L	1	Fig. 106-A Bronze Globe	Pressure Gage Control
E	2	Fig. 275-U Bronze Gate	Water circulation to heater	M	1	Fig. 106-A Bronze Globe	Air Vent Control
F	2	Fig. 106-A Bronze Globe	Condensate trap shutoff	N	1	Fig. 47 Bronze Gate	Air Compressor Shutoff
G	1	Fig. 106-A Bronze Globe	Condensate trap by-pass	O	1	Fig. 352 Bronze Swing Check	Prevent backflow to compressor
				P	1	Fig. 108-A Bronze Angle	Compressed air shut-off



JENKINS VALVES

For every Industrial, Engineering, Marine, Plumbing-Heating Service... in Bronze, Iron, Cast Steel, and Corrosion-resisting Alloys... 125 to 600 lbs. pressure.

Sold Through Reliable Industrial Distributors Everywhere

JENKINS BROS., 80 White St., New York 13, N. Y.
Please send me a reprint of Piping Layout No. 26.

Name

Company

Address



Designed by Harold Spitznagel

PUT TELEPHONE RACEWAYS IN YOUR SMALL HOME PLANS

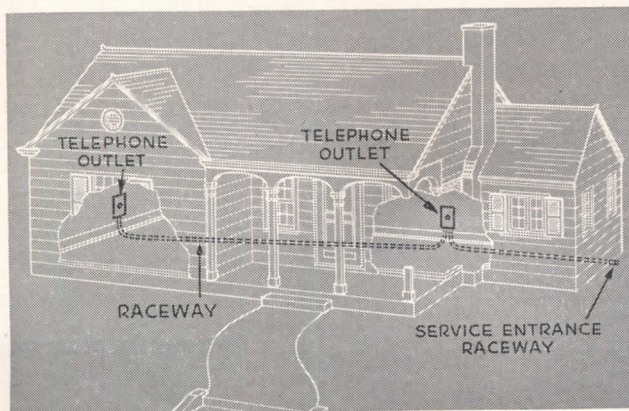

Buyers of small homes as well as larger ones are quick to notice and appreciate any features which add charm and convenience. Telephone raceways are important because they provide a channel *within* walls for telephone wires, avoiding the need to run exposed wires on attractive walls and woodwork.

It is easy and costs little extra to install a raceway during construction. A few sections of pipe or electrical conduit will provide an entrance for telephone wires and passage within walls to convenient telephone outlet locations.

Your Bell Telephone Company will be glad to co-operate with you in planning telephone raceway systems. Just call your Telephone Business Office and ask for "Architects and Builders Service."

BELL TELEPHONE SYSTEM



NEW LIGHTWEIGHT GUTTERS THAT CANNOT RUST OR STAIN... LAST A LIFETIME WITHOUT PAINTING!

**REYNOLDS *Lifetime* ALUMINUM
EAVES TROUGH, CONDUCTOR PIPE
AND FITTINGS**

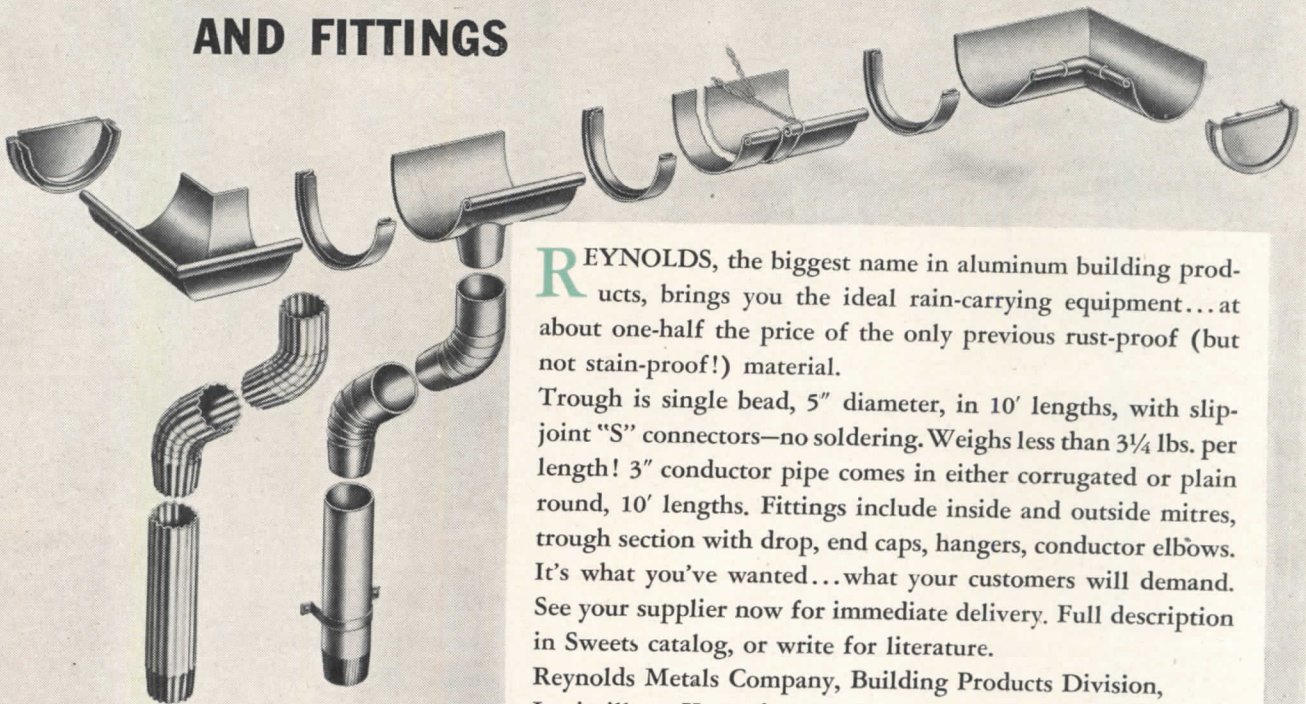

REYNOLDS, the biggest name in aluminum building products, brings you the ideal rain-carrying equipment... at about one-half the price of the only previous rust-proof (but not stain-proof!) material.

Trough is single bead, 5" diameter, in 10' lengths, with slip-joint "S" connectors—no soldering. Weighs less than 3¼ lbs. per length! 3" conductor pipe comes in either corrugated or plain round, 10' lengths. Fittings include inside and outside mitres, trough section with drop, end caps, hangers, conductor elbows. It's what you've wanted... what your customers will demand. See your supplier now for immediate delivery. Full description in Sweets catalog, or write for literature.

Reynolds Metals Company, Building Products Division, Louisville 1, Kentucky.

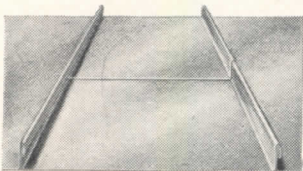

LASTS A LIFETIME WITHOUT PAINTING... LIGHTER TO HANDLE, EASIER TO WORK... TAKES OFF THE SUMMER SUN LOAD

**REYNOLDS *Lifetime* ALUMINUM
STANDING-SEAM ROOFING**

Rolls of stippled-embossed aluminum .019" thick. Two widths, 26½" and 20", nominal coverage 24" and 17¼". Roll lengths to cover two squares. Aluminum nails and clip stock are available with each shipment. Literature on request.

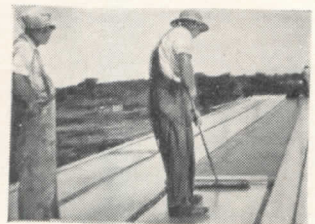

LENGTHENS ROOF LIFE... LIGHTENS ROOF LOAD... KEEPS BUILDINGS COOLER IN SUMMER

**REYNOLDS *Embossed* ALUMINUM
BUILT-UP ROOFING**

.004" aluminum that rolls in as easy as felt—reflects sun heat, seals out air, light, moisture—preserves the life and elasticity of asphalt. Rolls 36" wide, contain 10 squares, weigh about 60 lbs. Ideal for re-caps—a world of new business. Write for specifications on 2- and 3-ply new roofs and re-caps.

IMMEDIATE DELIVERY

PETER COOPER VILLAGE—*Manhattan, New York*

A development of the Metropolitan Life Insurance Co. to provide apartments for 2,495 families. Architects: Board of Design—Gilmore D. Clarke, Chairman; Irwin Clavan, Architect. General Contractors: Starrett Bros & Eken, Inc. Flooring Contractor: John T. Swanson Co.



It's Bruce Block Floors IN PETER COOPER VILLAGE and other big apartment projects

Architects and owners alike give Bruce Block Floors the very highest rating for modern apartment projects such as Peter Cooper Village. There is no floor so satisfactory on these five most important considerations: (1) Easily and economically installed over concrete. (2) A permanent part of a building . . . not a floor that must be replaced every few years. (3) Distinctive, modern and beautiful. (4) Comfortable—warm, resilient and quiet underfoot. (5) Easily maintained in perfect condition. Bruce Blocks

are so popular that production cannot match present demand. Specify this flooring on projects being planned now for future construction. See our catalog in Sweet's.

Large Scale Apartment Projects with Bruce Block Floors Include:

Parkchester, Stuyvesant Town, Hillside, John Hancock Village, Riverton, Fresh Meadows, Clinton Hills, Parkway Village, Peter Cooper Village, Parkmerced.



Reg. U. S. Pat. Off.

E. L. BRUCE CO., MEMPHIS, TENN., World's Largest Maker of Hardwood Floors

The ideal floor over concrete

Bruce Blocks are installed in mastic directly over concrete. No clips, screeds or wood sub-floor used . . . a saving in building height and construction costs.



**BRUCE
BLOCK
Hardwood Floors**

Fashions **CHANGE...**
in circuit protection, too!

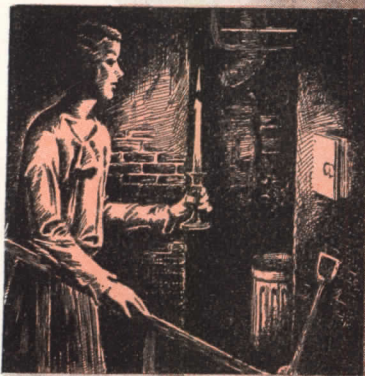

Time was when the lady of the house would plot a dark and perilous course to the cobwebby cellar ... explore its electrical intricacies ... cross her fingers—and hope for the best.

Today ... when current fails ... she knows just where to look! She goes straight to the *accessible* Federal NOARK multi-breaker ... flicks a

convenient switch...and, presto! ...the world lights up again!

Simple, reliable, good-looking Federal NOARK multi-breakers are available in a complete range of ampere ratings — for both indoor and outdoor applications.

Write for a copy of the "FEDERALOG" address Dept. F

NEW!
 TYPE MO-4
 THERMAL
 MAGNETIC
 MULTI-BREAKER

Federal NOARK
Multi-breakers



Executive Offices: 50 Paris Street, Newark 5, N. J.
 Plants: Hartford, Conn., Newark, N. J., St. Louis, Mo., L. I. City, N. Y.

Federal Electric Products Company, Manufacturers of a Complete Line of Electrical Products, including Motor Controls • Safety Switches • Service Equipment • Circuit Breakers • Panelboards • Switchboards • Bus Duct



Floor-to-ceiling areas of plate glass or *Thermopane* let people see into the store. Built-in cases spotlight small items. American Home Appliance Co. in San Francisco. Architects: Igaz & De Martini.

ATTRACTIVE



...in more ways than one!

Store owners want more than fine appearance alone... they want stores that fulfill the *second* meaning of attractiveness—having the power to attract business.

The Visual Front has won wide acclaim for this purpose. It makes the entire store a “walk-in showcase”. It calls attention to the merchandise the owner wants to sell. It is truly functional architecture.

Colorful *Vitrolite** glass facing on solid areas attracts attention. Large areas of plate glass reveal the store interior. Where window condensation is

a problem, *Thermopane** should be specified. *Tuflex** tempered plate glass doors extend a cordial welcome... are now readily available. Because it's all glass, a Visual Front can be kept new looking by cleaning with water and a squeegee. Your L·O·F Glass Distributor has prices and data on all glass products for storefronts.

You'll find our Visual Fronts book helpful in suggesting ideas and color combinations. It contains many designs by leading architects. For your copy, write to Libbey-Owens-Ford Glass Company, 4528 Nicholas Building, Toledo 3, Ohio.

*®

VISUAL
FRONT
© 1943
Libbey-Owens-Ford
Glass Company

LIBBEY · OWENS · FORD

a Great Name in **GLASS**



Pittsburgh Steeltex Lath For Plaster
Gives you

All Enduring, Economy and Safety

The economy and safety of your buildings is permanent when Pittsburgh Steeltex lath is used as a backing for interior finishes. Your homes sell easier. Your reputation as a designer and builder is enhanced because owners quickly sense the value of fire-resistant construction and freedom from plaster cracks and stud marks provided by Steeltex. Many architects specify Steeltex and experienced

builders prefer it because of its ease of installation and the savings in material. They both agree that Steeltex definitely makes possible the finest construction available in homes and other types of buildings.

It will pay you to write today for our illustrated technical booklet which shows how you can assure better construction at low cost with Pittsburgh Steeltex lath for plaster.

STEELTEX for Plaster, Floor Lath, Stucco, Masonry Veneer Available Now at your local dealer

Pittsburgh Steel Products Company

Subsidiary of Pittsburgh Steel Company

Grant Building • Pittsburgh 30, Pa.



A Roof of "PRE-TESTED" QUALITY

built with REVERE COPPER AND COMMON SENSE!

Of all the commonly used sheet metals, copper is the most enduring when exposed to the elements. But experience has shown that while *correct* installation details insure permanence and trouble-free service . . . *incorrect* details can cause unnecessary failures.

So Revere undertook a continuous research program covering every phase of sheet copper construction. Installations were made under conditions simulating those to which actual building installations are exposed. All types of design details and methods of installation were tested and compared, and the findings made available to you in the form of specific recommendations.

You have these recommendations in your copy of Revere's 96-page manual* of sheet copper construction. Use this book as your guide whenever you are faced with a design or installation problem—for you can be sure that every suggestion in it has been "pre-tested" for long-lasting performance.

Revere materials are available from leading distributors throughout the United States. A Revere Technical Advisor, Architectural, will always be glad to consult with you, without obligation.

*"Research Solves Problems of Stress Failures in Sheet Copper Construction."

REVERE

COPPER AND BRASS INCORPORATED

Founded by Paul Revere in 1801

230 Park Avenue, New York 17, New York

Mills: Baltimore, Md.; Chicago, Ill.; Detroit, Mich.; New Bedford, Mass.; Rome, N. Y. — Sales Offices in Principal Cities, Distributors Everywhere.

St. Agnes Church, New York

A. Munder & Son, Inc., roofing contractor

Thomas A. Kelly, Consultant

HOW THE **FA** AC CIRCUIT BREAKER LOAD CENTER *Automatically* SERVES YOU

*When
Short Circuits
Occur...*

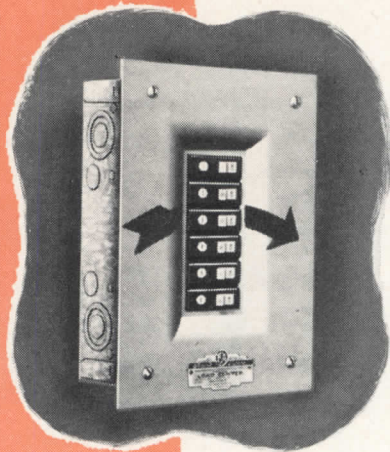

... the improved **FA** Circuit Breaker goes into immediate action. Dangerous current is *instantly and automatically* interrupted and the handle of the circuit breaker trips to the "off" position indicating the circuit in trouble.

FIRST, REMOVE THE CAUSE OF TROUBLE... *then* —

*Simply
Flip the
Handle to
"ON" Position*

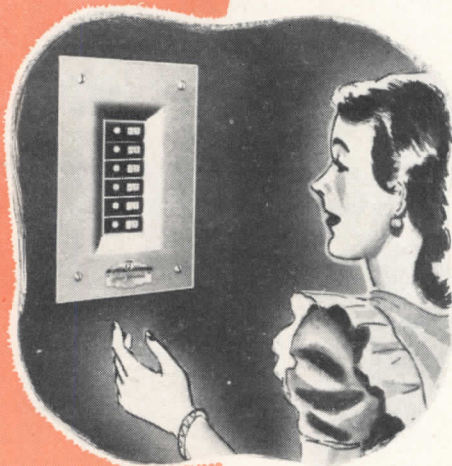

After the cause of trouble has been removed, you simply flip the handle of the **FA** Circuit Breaker back to the "on" position and full electrical service is restored. There's nothing to replace... no danger of shock.

The **FA** Circuit Breaker LOAD CENTER automatically serves you 24 hours a day by eliminating both the hazards and inconveniences of short circuits.

This automatic protection is the result of a positive *thermal-magnetic* action that opens the circuit at the first sign of a short circuit or dangerous overload... yet ignores harmless surges of current.

Shockproof and simple to operate, these modern circuit protectors also provide all the electrical capacity needed for household appliances and future circuits. Available in 2 to 16 poles, 15 to 50 amperes, for 120 volts AC service.

See your electrical contractor for details... or write for Free Bulletin No. 203.



Frank Adam Electric Co.

ST. LOUIS 13, MISSOURI

Makers of BUSDUCT • PANELBOARDS • SWITCHBOARDS • SERVICE EQUIPMENT • SAFETY SWITCHES • LOAD CENTERS • QUIKHETER

Architects: Prack & Prack, Pittsburgh
Contractor: Empire Construction Co., Ltd., San Francisco
Engineers: Taylor & Barnes, Los Angeles

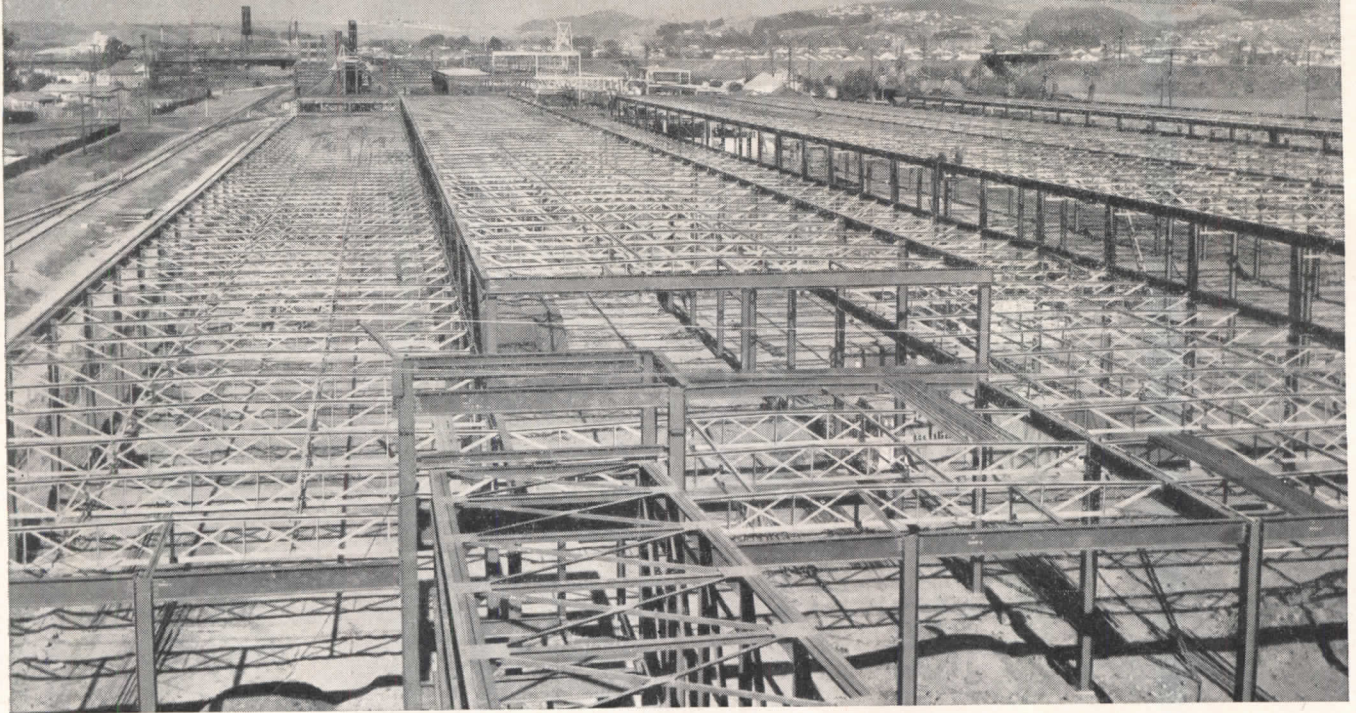

NEW PLANT ON WEST COAST BUILT WITH *OPEN-WEB JOISTS*

Now nearing completion at Richmond, Calif., this one-story manufacturing plant for the American Radiator and Standard Sanitary Corporation has a floor area of more than 296,000 sq ft. To reduce the need for interior columns and thus provide greater clear floor space for manufacturing purposes, 300 tons of Bethlehem Longspan Joists, 40-ft long, were used as roof purlins.

ADVANTAGES OF LONGSPANS

Bethlehem Longspan Joists are excellent for supporting the roofs of factories, warehouses, and similar light-occupancy structures because they can be used to provide column-free floor areas up to 64 ft across. They also help other trades, for pipes, conduits and ducts can be run through the open webs. They accommodate plaster ceilings, too. And when outer walls are of masonry, they reduce the need for pilasters, thus permitting the architect complete freedom in placing doors and windows.

EASY TO INSTALL

Users of Bethlehem Longspan Joists can always count on reduced construction time, for these easy-to-handle joists go into place quickly by means of a lightweight gin pole. Like the Bethlehem Standard Open-Web Joists, they are delivered to the job completely fabricated and clearly marked, ready for use.

36-PAGE CATALOG

Because it contains much factual data; you'll find our illustrated joist catalog of great help when designing with open-web joists. The nearest Bethlehem district office will gladly mail you a copy. Or write to us at Bethlehem, Pa.

BETHLEHEM STEEL COMPANY, BETHLEHEM, PA.

*On the Pacific Coast Bethlehem products are sold by
Bethlehem Pacific Coast Steel Corporation
Export Distributor: Bethlehem Steel Export Corporation*

BETHLEHEM OPEN-WEB JOISTS

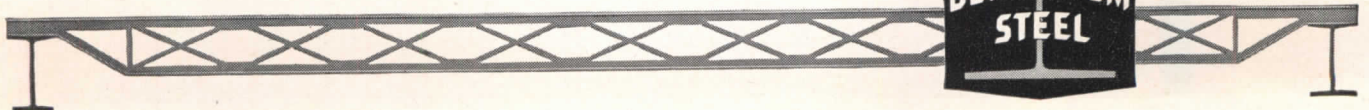

SEE OUR CATALOG
S
SWEET'S FILE

Kawneer's Store-Tested Flush-Glazing Assembly

Hundreds of Outstanding Installations
Have Proved Its Effectiveness

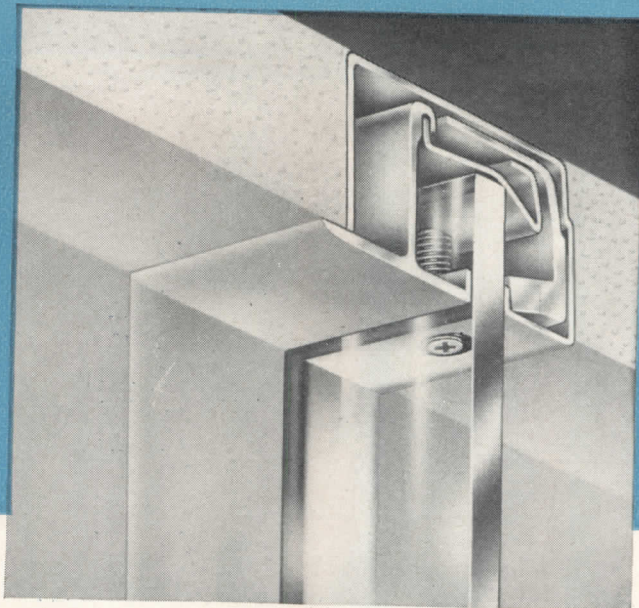

Introduced over a year ago, Kawneer's flush-glazing assembly has made possible the construction of store fronts which truly embody "Full-Vision."

By eliminating projecting sash members, this Kawneer flush-glazing assembly makes glass "disappear" into walls and ceilings. It creates the appearance of a continuous, uninterrupted surface for walls and ceilings . . . yet it provides a metal construction that holds glass in place firmly but resiliently.

Kawneer's flush-glazing assembly has been fully "store-tested" in hundreds of successful installations from coast to coast.

Write today for complete construction details. The Kawneer Company, 778 North Front Street, Niles, Mich., and 23 Dwight Way, Berkeley, Calif.

the little shop

The Little Shop in Niles, Mich.
Designed by
Ketchum, Giná and Sharp,
Architects, New York City

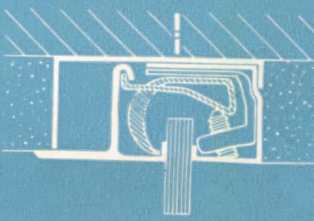

Half-size cross section view of Kawneer's Flush-glazing Assembly.

Kawneer
SALES-BUILDING
STORE-FRONTS

Classic Beauty!

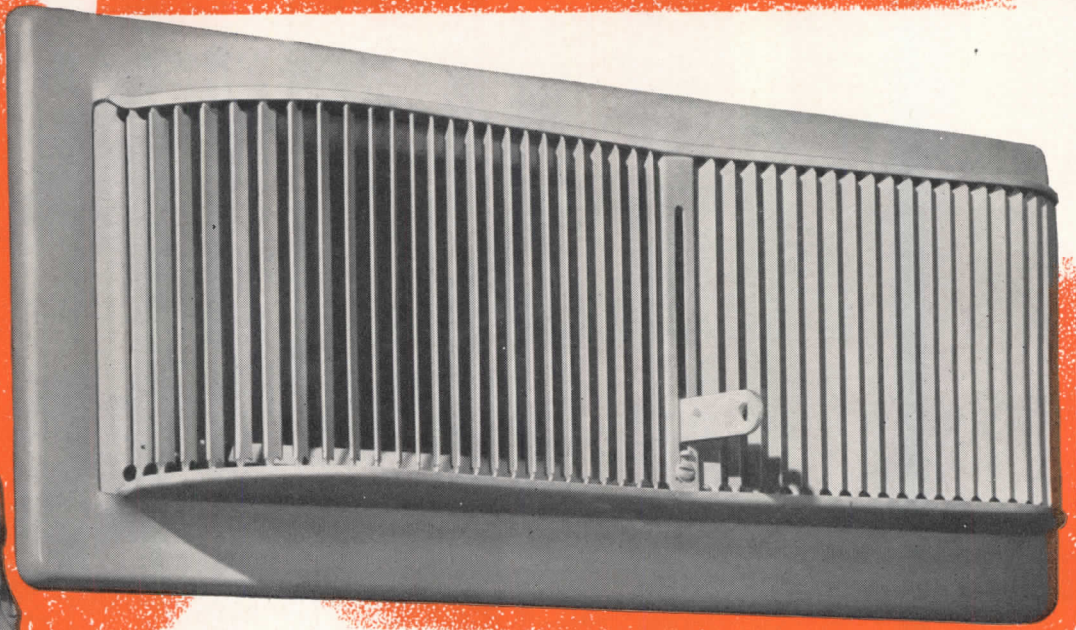

THE **NEW**

HONEYWELL REGISTER!

DESIGN FEATURES

1. Balancing becomes a QUICK, ONE-MAN job.
2. Branch quadrants can be eliminated, when velocities are under 800 fpm.
3. Installation costs are drastically cut.
4. Smart new appearance and functional design.
5. No streaks on walls and ceilings.
6. Manual shut-off for fuel saving and convenience.

BEAUTY in appearance plus "beauty" in performance! . . . This combination is exactly why the new Honeywell Register is such a spectacular improvement over conventional forced air registers.

The handsome, modern lines of Honeywell's Register are designed not alone for appearance. On the performance side, the graceful contour of the extended grille is the real reason for the unbelievably smooth, even air diffusion into every nook and cranny of the room. On either high or low wall installations, temperatures are the same across the room as they are near the register. The air is diffused in every direction instead of being concentrated in a narrow stream. And in addition, the Honeywell Register is functionally designed to eliminate unsightly wall streaks.

Make certain you specify Honeywell's new Register wherever warm air heat is installed. It's another way to provide the homes of your clients with the newest in modern improvements. Minneapolis-Honeywell, Minneapolis 8, Minnesota. In Canada: Toronto 12, Ontario.

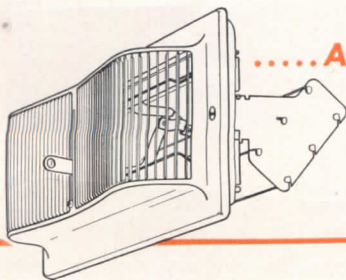

.....Available NOW.....

Self-contained volume dampers accurately meter the air with an adjustable lever at the register itself. Locking feature guards against unbalancing system.

MINNEAPOLIS
Honeywell
CONTROL SYSTEMS

ON THE STATE OF THE NATION

REPORTS on the current "state of the nation" are still being debated: Where are we going? Where should we be going? What measures and means should be used to get there? The reports cover present conditions and proposed programs — political, economic, social — so why not architectural? Is there a significant change in architectural thinking? If so where is it leading us? Is there a threat to the hard-won acceptance of our ideas and ideals of architectural design? Is there an evolutionary, revolutionary or reactionary change abrewing? These questions are up for discussion this month at the Museum of Modern Art's symposium, "What is Happening to Modern Architecture?" with Lewis Mumford as moderator.

The state of the nation — in respect to architectural design — may turn out to be epitomized in the report on "the state of a notion," said "notion" being the established axiom, the revered law and the familiar slogan of Modern architecture — "Form Follows Function." With this thesis in mind (both conscious and subconscious) leading designers have brought about our present revitalized architecture, free of the trappings and trimmings of styles, concerned primarily with design to produce structures expressing simply and directly the physical enclosure of space so arranged and equipped as best to serve specific activities. The emphasis has been on the material and mechanical aspects of building. "Function" itself has been thought of largely in physical terms in the conscious effort to rid architecture of the over-emphasis on the stylistic and merely decorative use of form. Now that that effort has been so highly successful, architects can bend their efforts to a more all-inclusive concept of "function."

There is a growing trend toward an interpretation of the word "function" to include psychological as well as physical purposes and satisfactions, spiritual as well as mechanical needs and desires, human as well as engineering considerations as design criteria. These aspects of function are not mutually exclusive. Without sacrificing structural integrity and economy, form can meet spiritual and psychological needs, and it will, increasingly, in the hands of architects sensitive to human values and familiar with the effects of space in size, shape, scale and proportion — and of the materials, colors, textures and profiles of its enclosure.

This portends a new freedom to design, a greater scope for creative imagination, a new vitality and validity of form, an accelerated evolution of truly functional architecture in its broadest sense. To repeat,* we believe that "There is too much vitality and enthusiasm in our rising architectural talent to warrant any fear that their designs will be dry, and tight and circumscribed. We will see rather a new freedom, a new, more individual expression, brighter, more lively, juicy, and intensely human designs, sincere and studied in conception, bold and stimulating in execution." That to my mind is the state of the nation — form following function to the full.

* "Freedom to Design," page 65, ARCHITECTURAL RECORD, March, 1947.

Kenneth K. Stowell

EDITOR

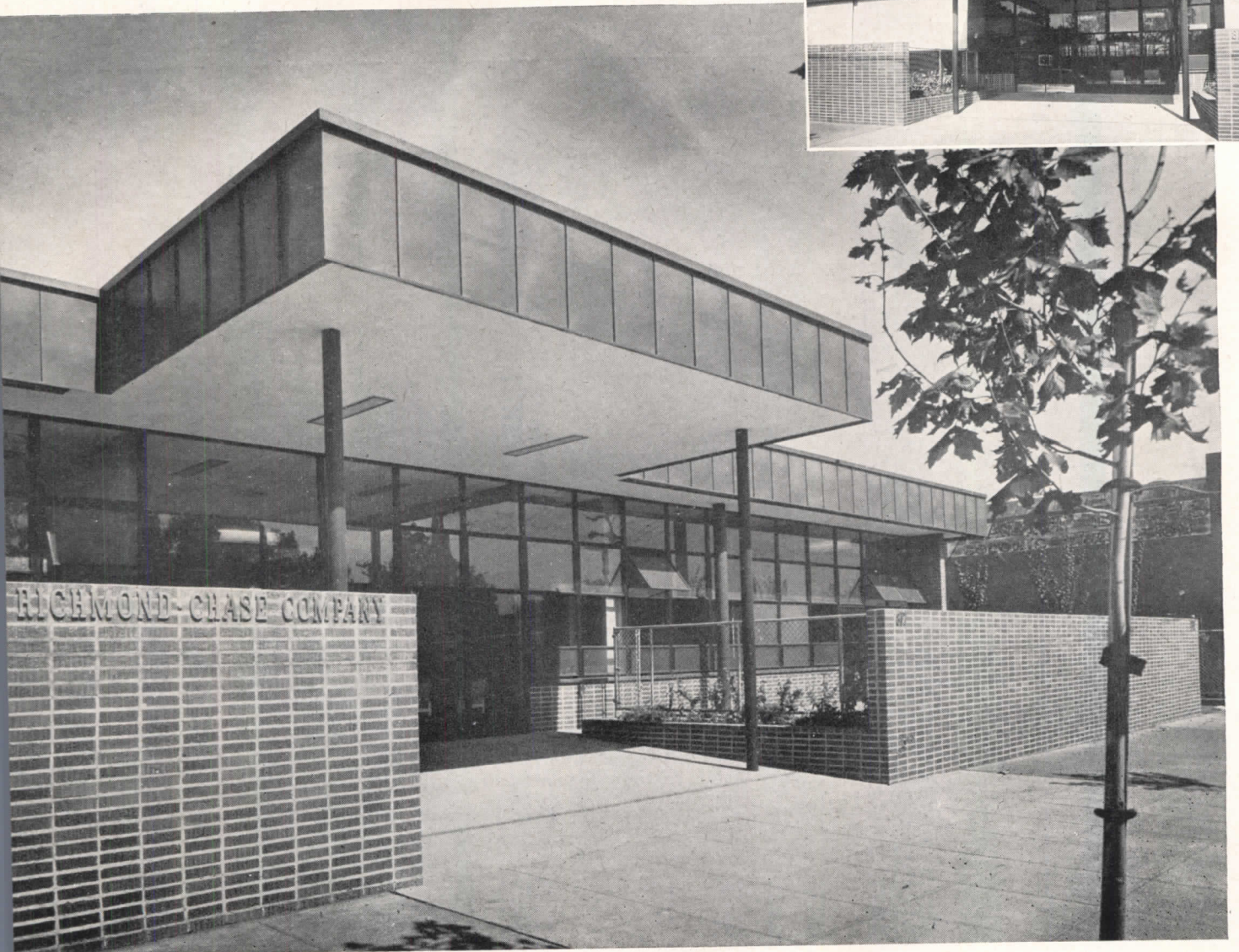

Roger Sturtevant Photos

HEADQUARTERS AND "FRONT" FOR FOOD PROCESSING

Richmond Chase Office Building, San Jose, California

Wurster, Bernardi and Emmons, Architects

Landscaping by Thomas B. Church

SITUATED on the main street of San Jose, this headquarters office building for one of the largest canning companies of the area, with packing plants spotted throughout the fruit growing district, was intended as a "front" and something of a trademark. It has a capacity of a hundred or more office staff, and the possibility of further expansion in the center toward the north. The

garden area in back is for employee recreation, and a cafeteria will eventually be built here. The same architects once designed an office building for another canning company with striking use of horizontal wooden bargeboards as "shutters." The use of tan awnings here is equally gay and perhaps more direct and colorful under the copper facing of the roof overhang.

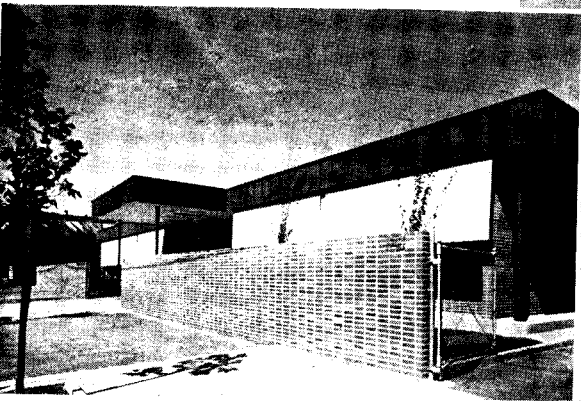

In the two small top views, the awnings may be seen pulled down—the architects say this saves expense of air conditioning. At right they are seen rolled up into the soffit of the overhang. Awnings are tan, pipe columns vermilion, overhang band copper-faced. Walled-in front gardens (right) give executives a pleasant outlook; chain link fences at ends let breezes through. For planting plan, back garden, see p. 90



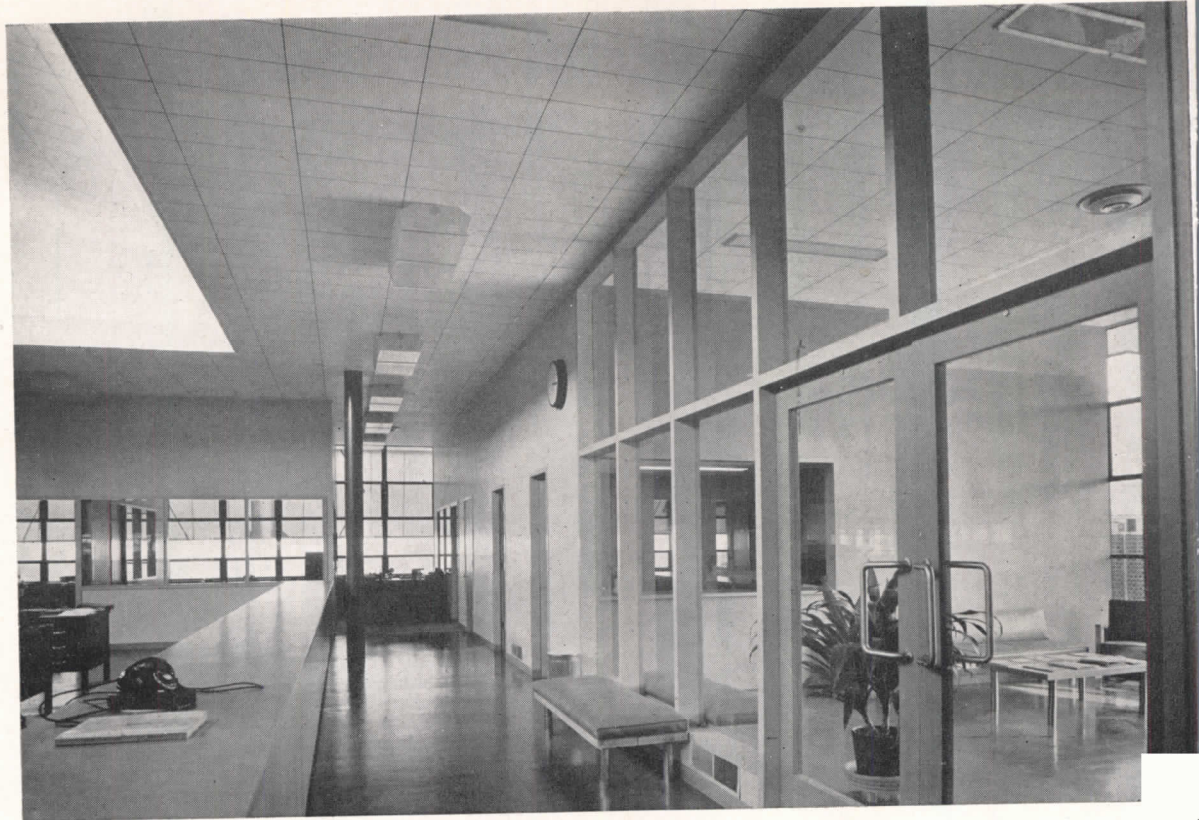



Starting with the view at the upper right corner (the lobby), the photographer has led us back into the building. The second view reveals a second glass screen, opening a view into the spacious skylit interior. In the third (left-hand page), there is seen an adjoining row of outer offices occupied by executives, and, finally, in the two bottom views, the large central office room. Sash and doors are painted dark green, interior walls blue-gray (darker in outer offices). Lighting is fluorescent except for incandescent light in monitor coves. Floors are asphalt tile, ceilings acoustic tile on wood strips (4 in. of rock-wool insulation). Lobby walls and counters in general offices are finished in oak plywood; the sampling room (see plan overleaf) is in natural-finish vertical grain Douglas fir and has stainless steel counter tops. The broken planes of the skylight ceiling absorb noise



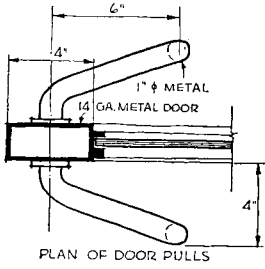
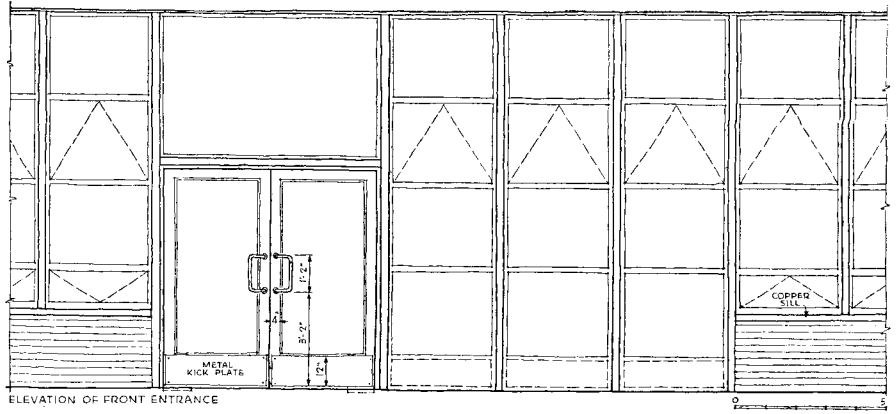
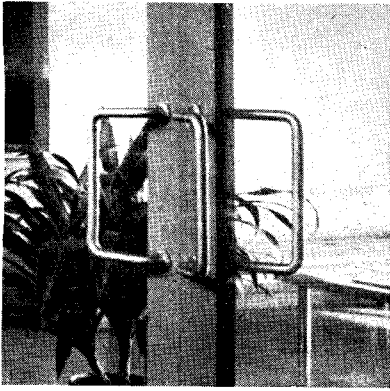

Above: Details of front curtain wall, seen in photo opposite page

Below: Building plan and plot plan. Building plan shows possibility of expansion in the center section. Points on this plan give a clear impression of the fact that the pipe columns are the only vertical elements in the building. Landscaping was by Thomas D. Church, whose planting plan is indicated in the right hand drawing

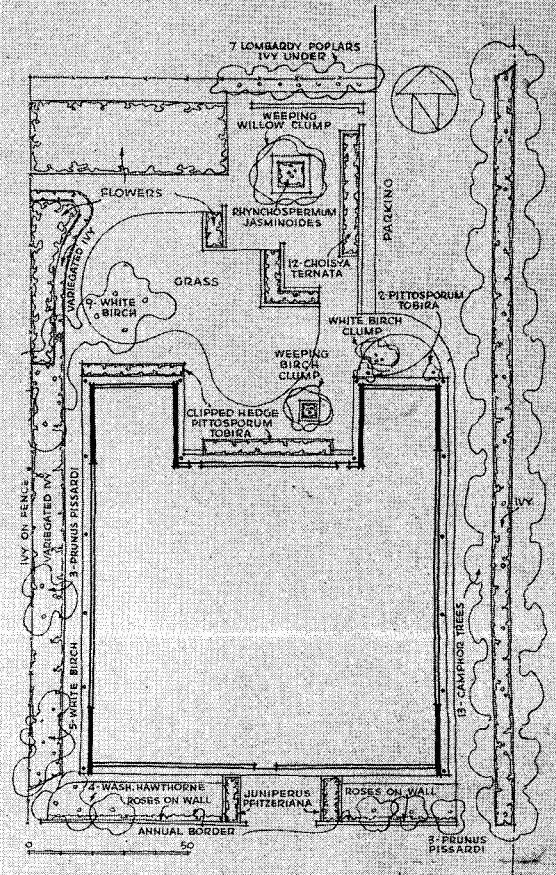
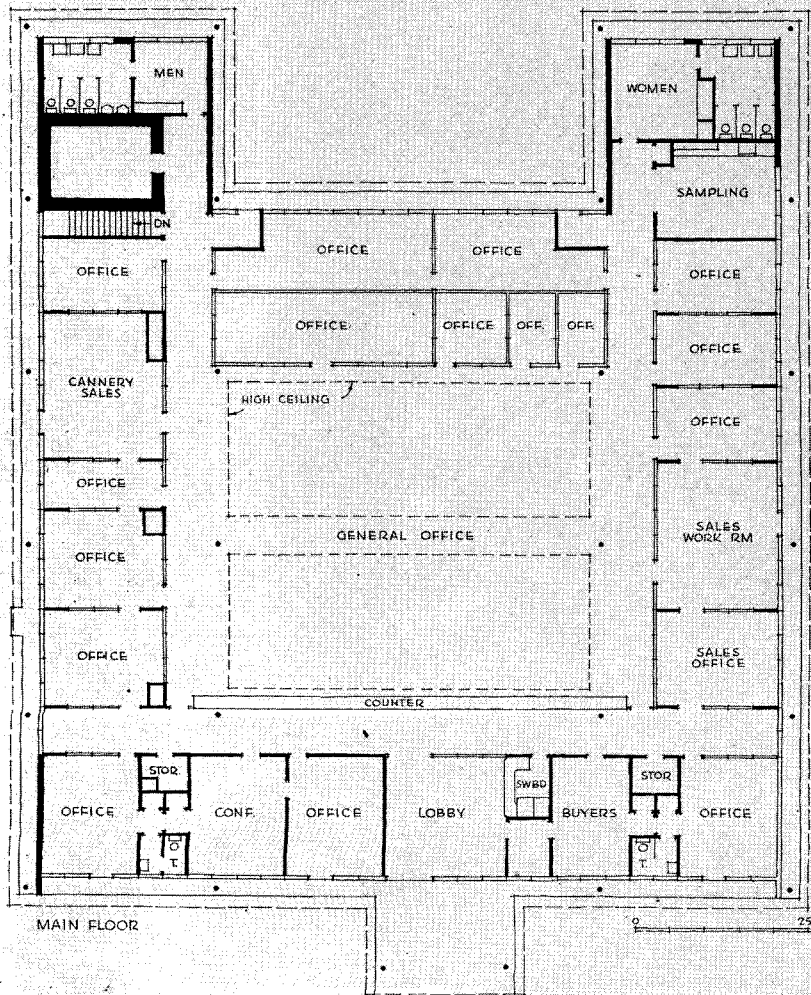

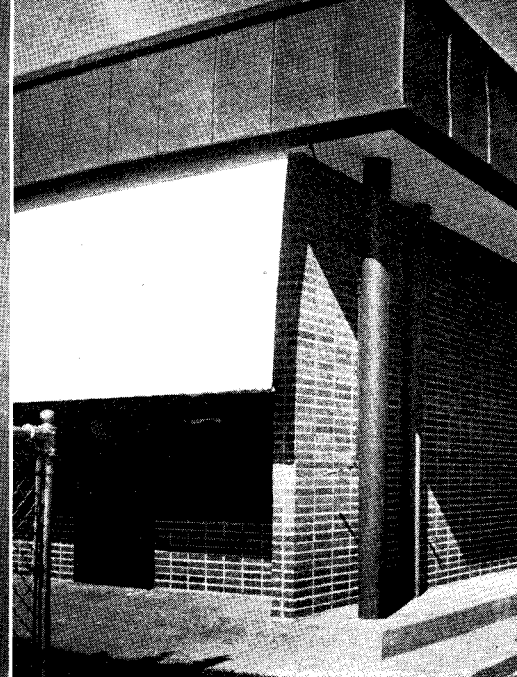

What with the awning above and the parapet wall below, to look at, the executive is given a pleasant view and no sky-glare to contend with. Vines to be added

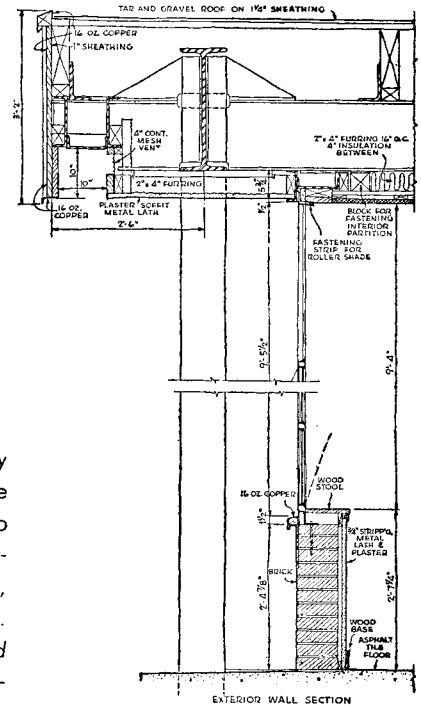
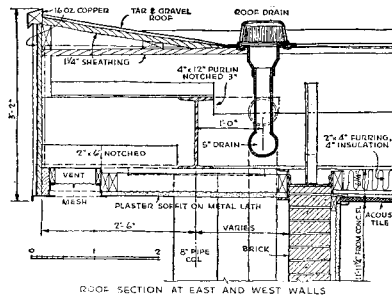

Sawtooth monitor details have been carefully worked out so as to carry heating ducts for the forced warm-air (gas-fired) system and also to provide light-covers for the fluorescent lighting. The structural engineer was A. V. Saph, Jr., the mechanical engineer, James Gayner. The exterior pipe columns are firmly anchored in the concrete base — not only are pipe columns the only vertical supports but the long center span is a partial cantilever

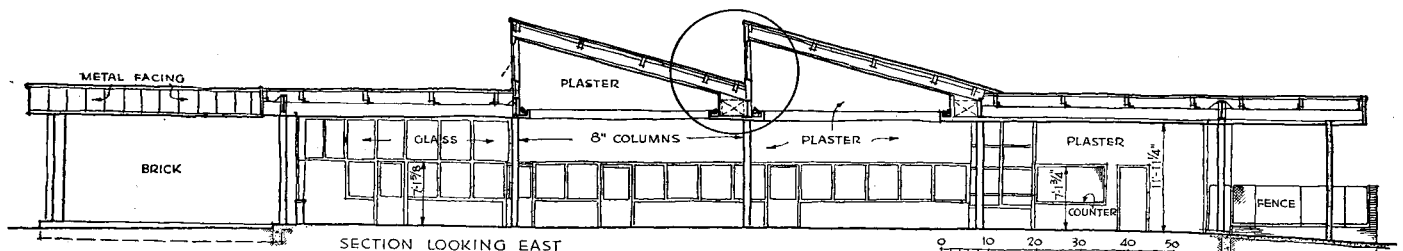
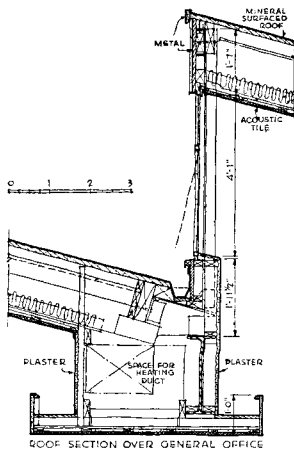

View of the proposed waterfront development from across the Grand River. Recreational areas, public boat docks, pedestrian promenade, parking area, and a new auditorium and sports arena are planned for the waterfront, replacing unsightly warehouses and railroad yards. This new plan enhances the resort and tourist activities of Lake Michigan and coordinates them more closely with the city proper. The proposed waterfront development serves as one terminus of the shopping center

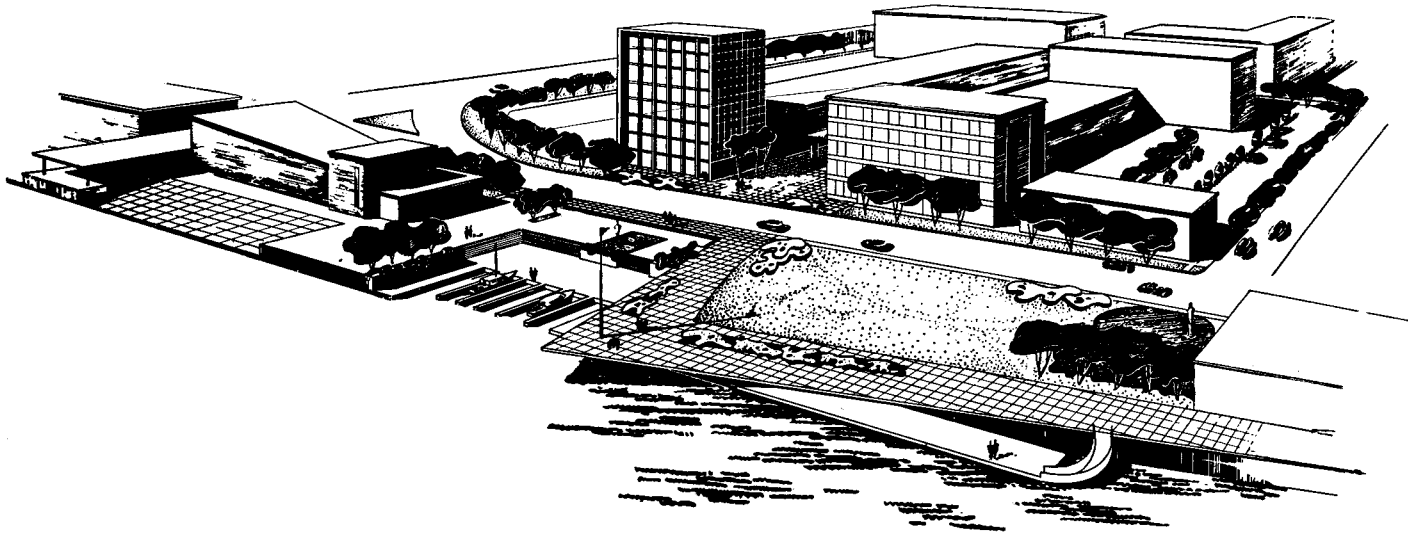

REDEVELOPMENT PLAN FOR GRAND HAVEN

Designed by **Orville H. Bauer, B.S. Arch.,** and **Robert F. Van Hoef, B.S. Arch.**
University of Cincinnati and *University of Cincinnati*
Cité Universit , Paris and *University of London*

THE predicament of Grand Haven, Michigan, is not unique. Rather it is typical of a multitude of America's small cities. Blessed with more than usual natural advantages — lake, river, harbor, state park and land for expansion, Grand Haven has not begun to approach its own potentials for development. One hardly can blame the early settlers and those who followed them in the last century for not foreseeing the changes that would come with the advent of the motor age. Land uses and street systems that seemed logical and adequate for horse and buggy days now cause congestion, confusion, stagnation and frustration. But a thorough analysis of present conditions, present and probable future needs, and of the possibilities of a step-by-step improvement program show what can be done.

This study should prove an inspiration not only to Grand Haven but to many another city that finds itself in a similar plight, for it shows that most of the present facilities can be salvaged, converted and redeveloped practically and economically in progressive stages. As the report, from which these illustrations have been taken, states, "It seems evident that through the re-designing and rebuilding of properties and redistribution of space, sufficient value will be added to property income to pay off the cost of improvement within a reasonable period and to place investors . . . in a position to receive increased income."

The designers express their gratitude to Ernest Pickering, Dean of Applied Arts, University of Cincinnati, and to R. Marshall Rainey, Architect, Cincinnati Planning Commission, for their helpful advice and criticism

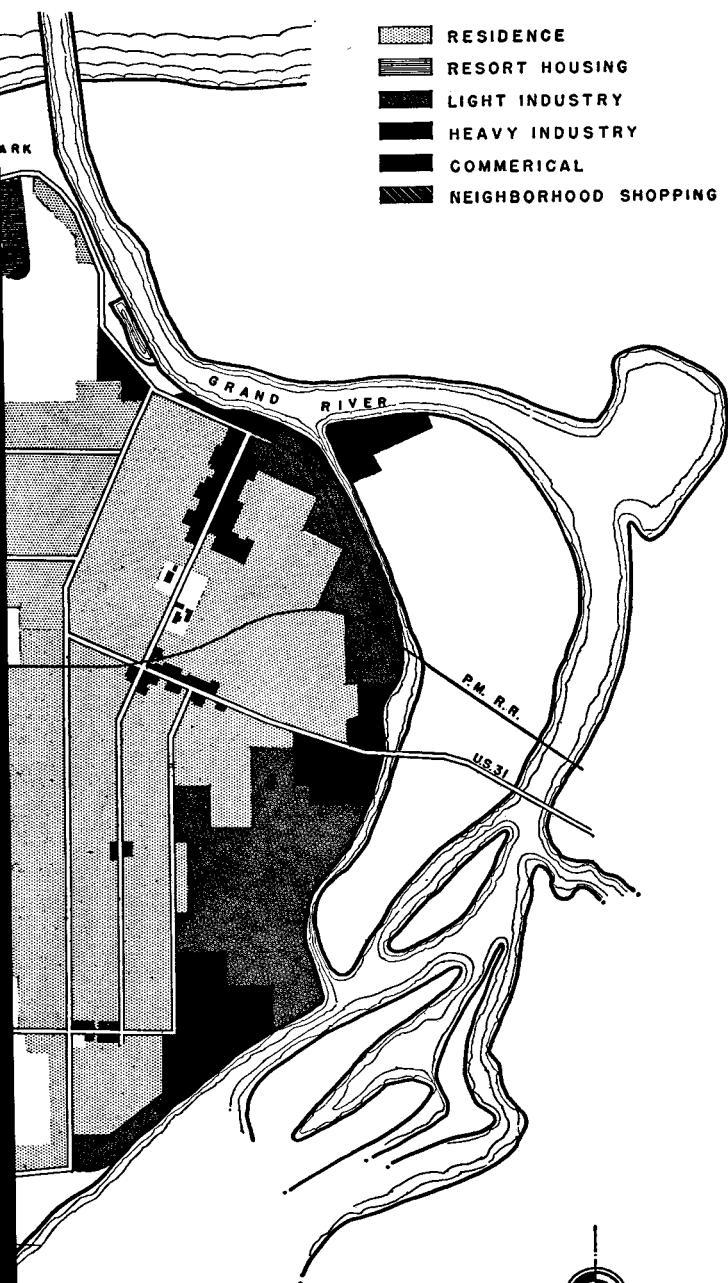

The advantages and the logic of the proposed replanning will be easily seen by a comparative study and analysis of the two plans shown — the existing land use and the proposed changes. While suggested changes may seem radical and daring at first glance, it is surprising that such valuable improvements can be made with a minimum of rebuilding. Existing areas are enhanced with a minimum of structural change and no major relocations of land use are involved with the possible exception of the removal of heavy industry adjacent to the commercial center along the Grand River to a more desirable location suitable for expansion on the island to the north

LAND USE

◀ Existing

◀ Proposed

The commercial and shopping center (with added and adequate parking facilities) is here unified and given logical traffic arteries to facilitate circulation. It starts at the redeveloped recreational and park area along the Grand River and terminates at the southeast in the unified civic center where existing buildings remain in their present locations but are given proper setting in a park area surrounded by the traffic arteries. The industrial expansion of Grand Haven is provided for in its most logical location, adjacent to the Grand River to take advantage of shipping facilities. The railroad has been located to serve this new industrial area instead of practically bisecting the city as at present. Valuable residential area would thus be reclaimed also. Neighborhood shopping centers remain in their present locations but are expanded and coordinated with the traffic plan

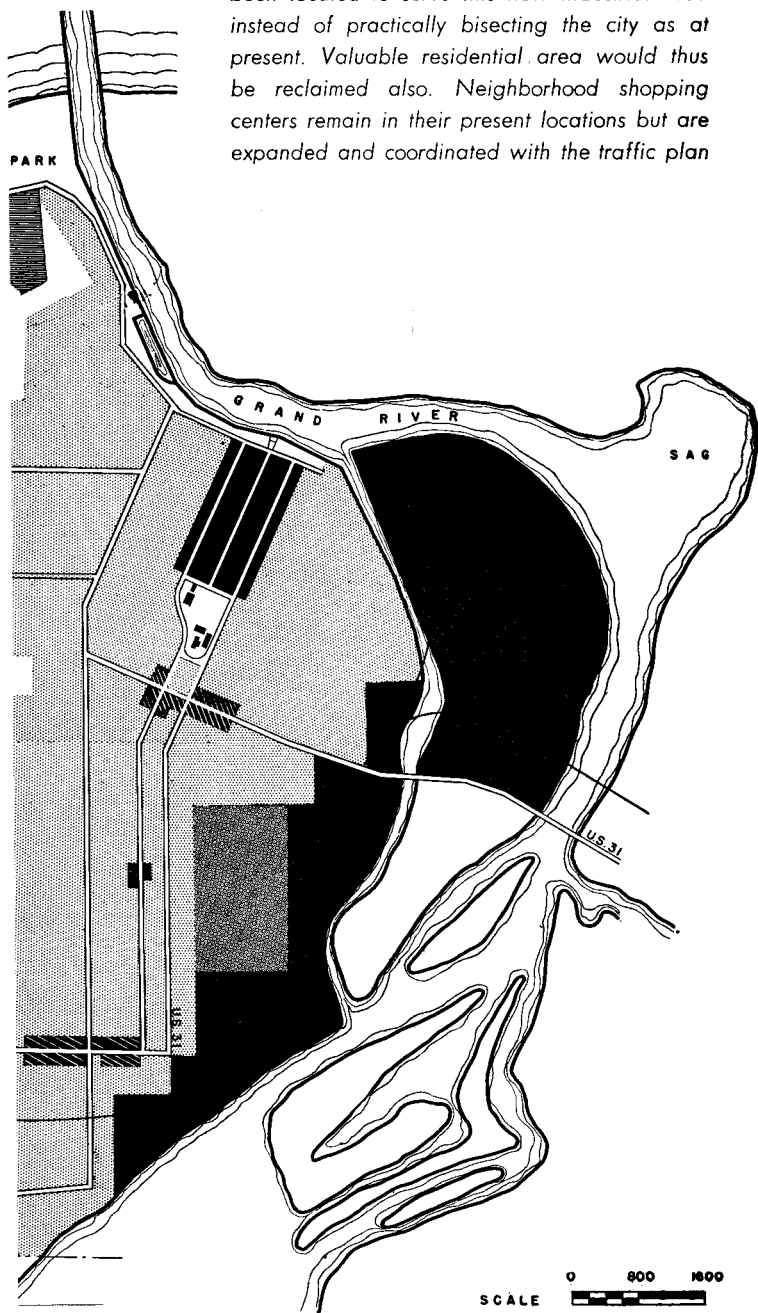

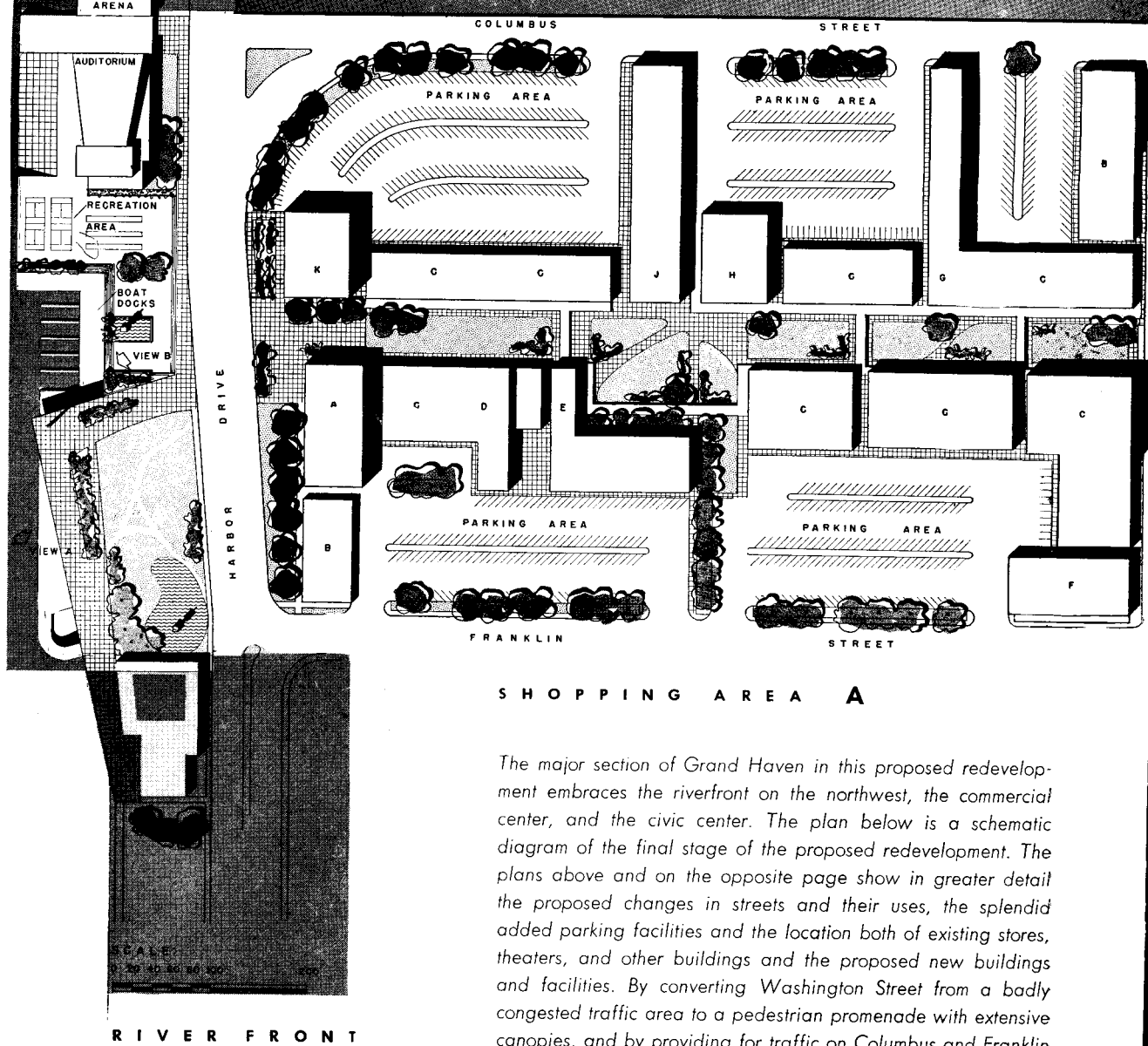

SHOPPING AREA A

The major section of Grand Haven in this proposed redevelopment embraces the riverfront on the northwest, the commercial center, and the civic center. The plan below is a schematic diagram of the final stage of the proposed redevelopment. The plans above and on the opposite page show in greater detail the proposed changes in streets and their uses, the splendid added parking facilities and the location both of existing stores, theaters, and other buildings and the proposed new buildings and facilities. By converting Washington Street from a badly congested traffic area to a pedestrian promenade with extensive canopies, and by providing for traffic on Columbus and Franklin Streets, a pleasant and profitable shopping area is created instead of an ugly, inconvenient and congested area. Traffic would thus be rerouted around the new civic center and shopping district, with about 1300 off-street parking places provided

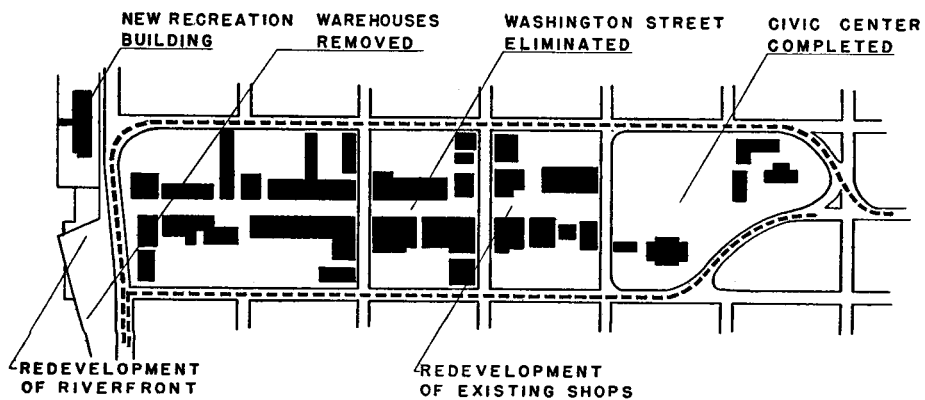

The diagram of the finished stage of the development above shows the loop traffic route circling the civic center and business area. Washington Street has become a planted promenade where customers may shop in quiet, weather-protected, traffic-free areas. Houses and minor buildings in back of the stores on Columbus and Franklin Streets have been eliminated to provide convenient parking areas. At the left the riverfront has been redeveloped and a new recreation building and auditorium have been added. The civic center has been unified by the elimination of streets

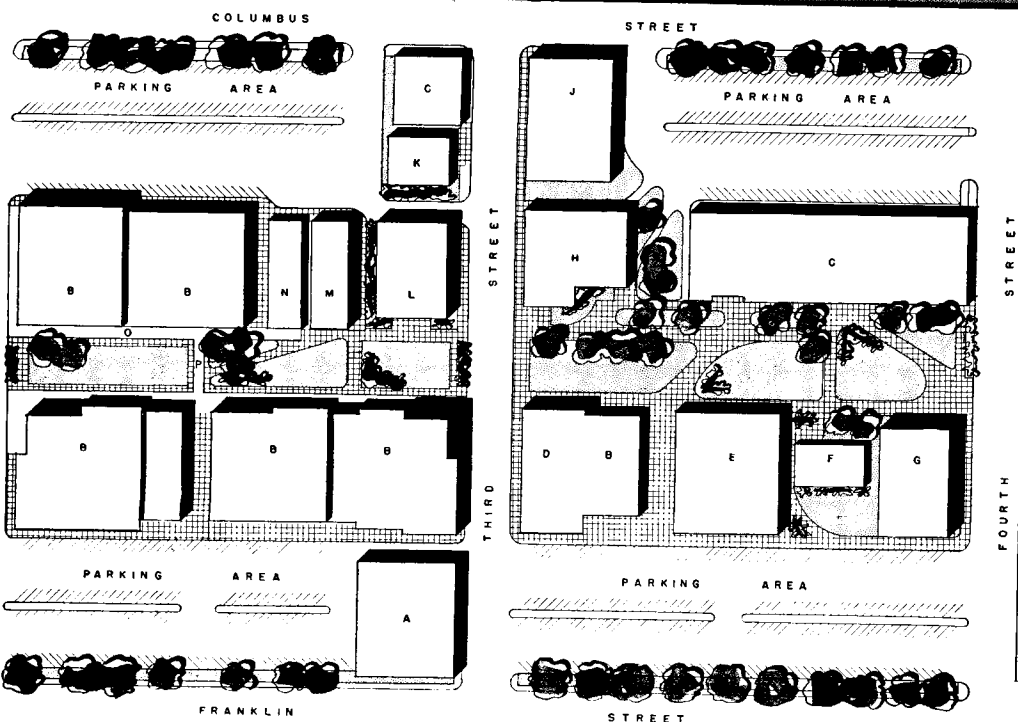

SHOPPING AREA B

Key to A (Above left)

- A. Schuler Hotel
- B. Proposed Shops
- C. Existing Shops
- D. Salvation Army
- E. Grand Theater
- F. Armory
- G. Bowling Alley
- H. Proposed Department Store
- J. Story & Clark Company
- K. Proposed Chamber of Commerce

Key to B (Above)

- A. Elks Lodge Hall
- B. Existing Shops
- C. Proposed Shops
- D. Peoples Savings Bank
- E. Proposed Private Club
- F. Women's Club
- G. Methodist Church
- H. First Reform Church
- J. Ford Motor Sales
- K. Public Library
- L. Post Office
- M. State Bank
- N. Robinhood Theater
- O. Covered Shopping Area
- P. Covered Cross Walk

Key to Plan (Below)

- A. City Hall
- B. City Fire Department
- C. Bell Telephone Building
- D. Amphitheater
- E. Band Shell
- F. County Jail
- G. County Court House
- H. Parking Area
- J. Memorial

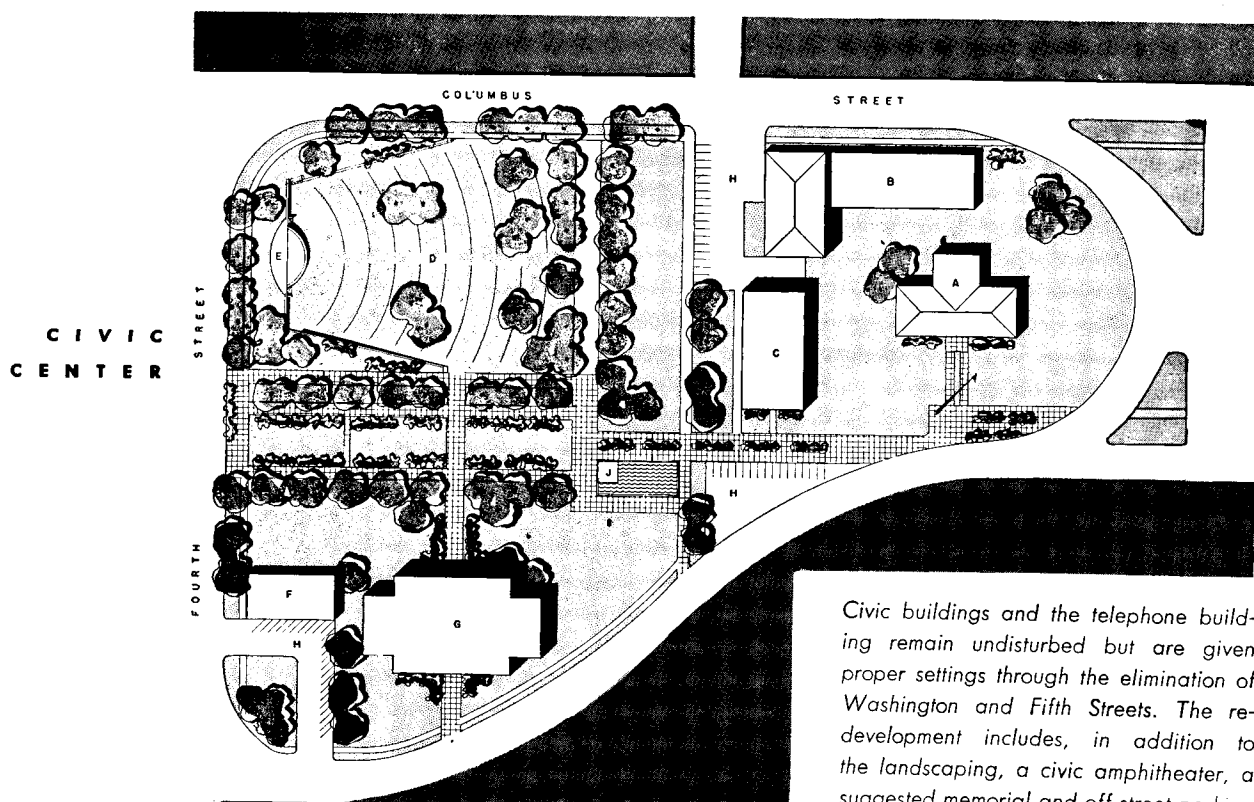

Civic buildings and the telephone building remain undisturbed but are given proper settings through the elimination of Washington and Fifth Streets. The redevelopment includes, in addition to the landscaping, a civic amphitheater, a suggested memorial and off-street parking

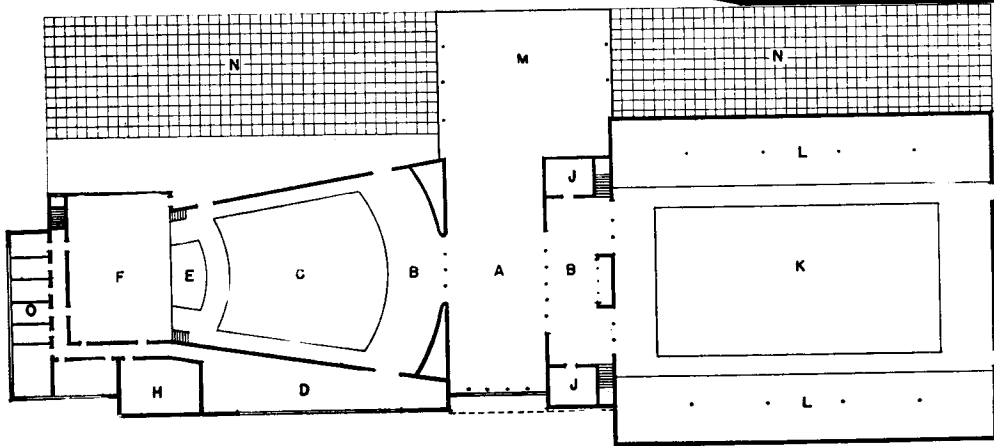

- A. ARCADE
- B. FOYER
- C. AUDITORIUM 1200 SEATS
- D. GREEN ROOM
- E. ORCHESTRA
- F. STAGE
- H. WORK ROOM
- J. OFFICE
- K. ARENA
- L. SPECTATORS 1500 SEAT
- M. OPEN AIR DANCING
- N. DOCK TERRACE
- O. DRESSING ROOMS

Recreational facilities proposed for the riverfront include an auditorium and a sports arena

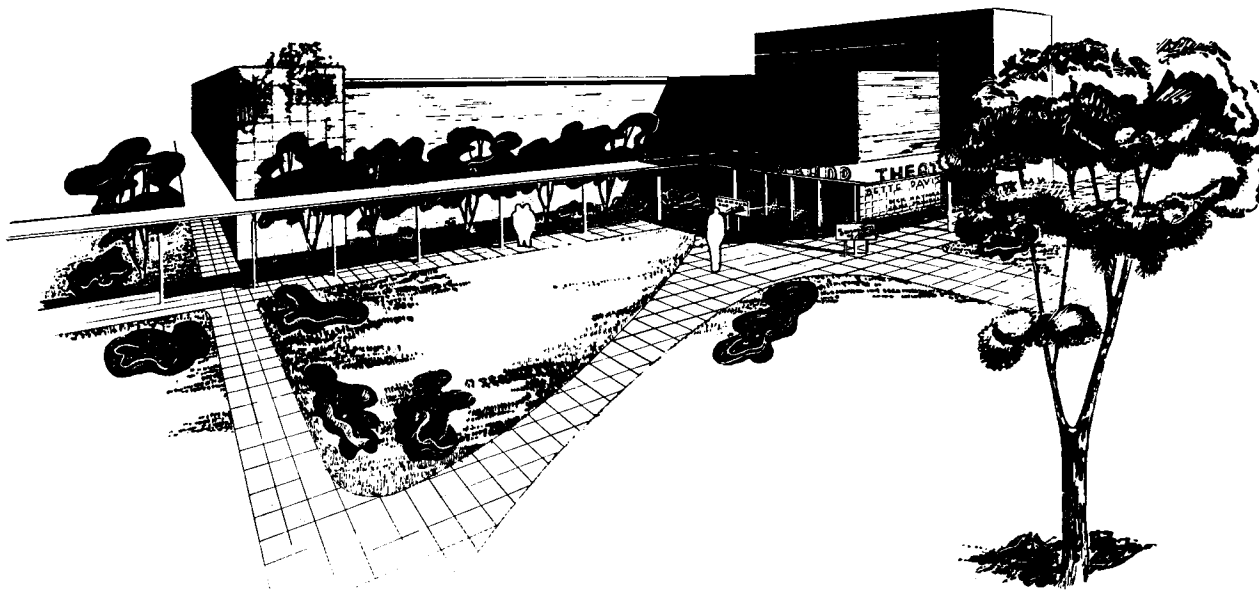



S H O P S



Washington Street, shown in its present condition in the inset at the left, would be converted into a planned promenade for shoppers and the store fronts would be re-designed for more effective merchandising. Covered canopies extend 12 ft. from the stores

I N D U S T R I A L

Grand Haven's industrial expansion is well provided for by utilizing the island for industrial sites and railroad and dock facilities. Thus, Grand Haven could function as a receiving point of both the Saint Lawrence seaway and western United States

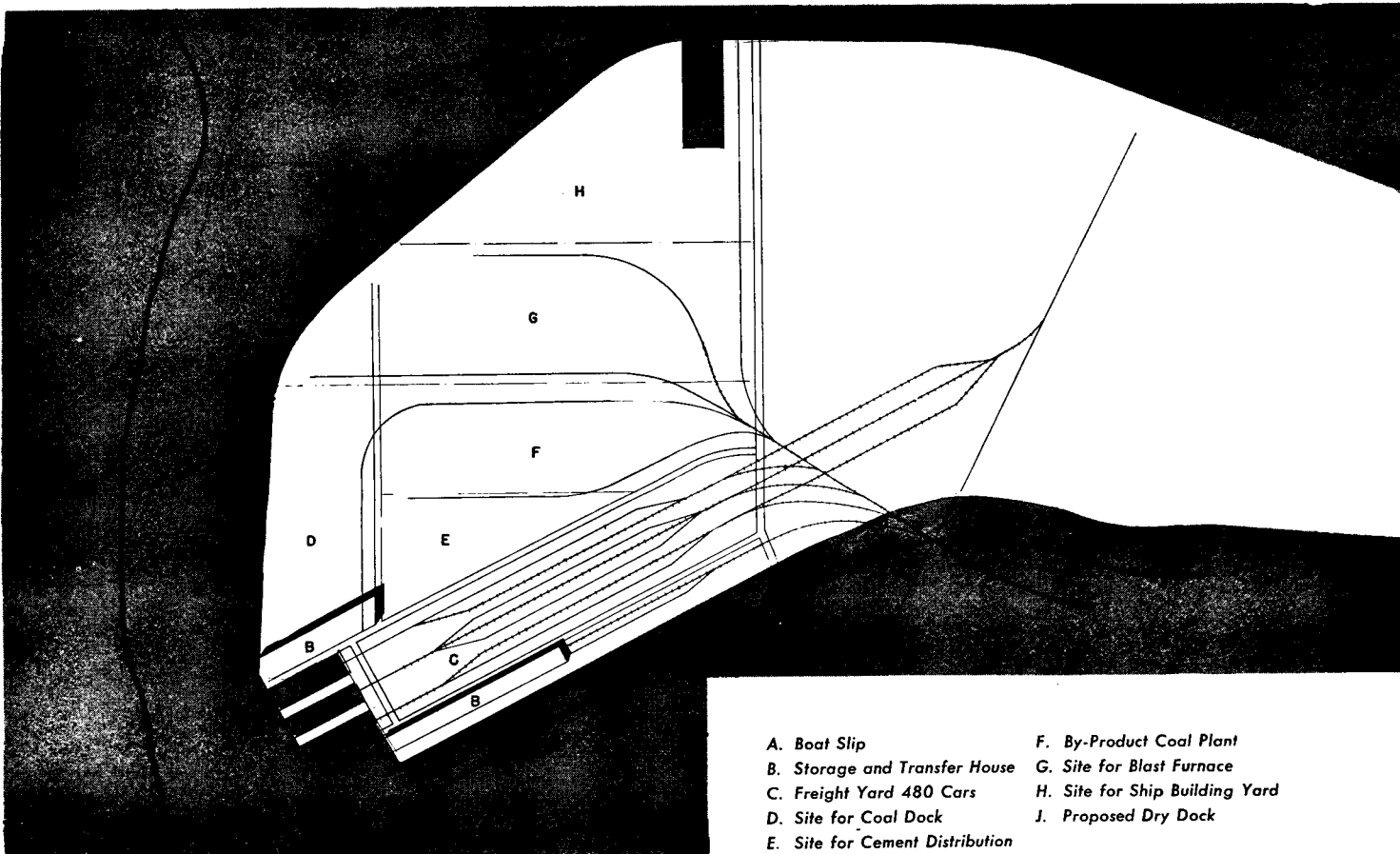

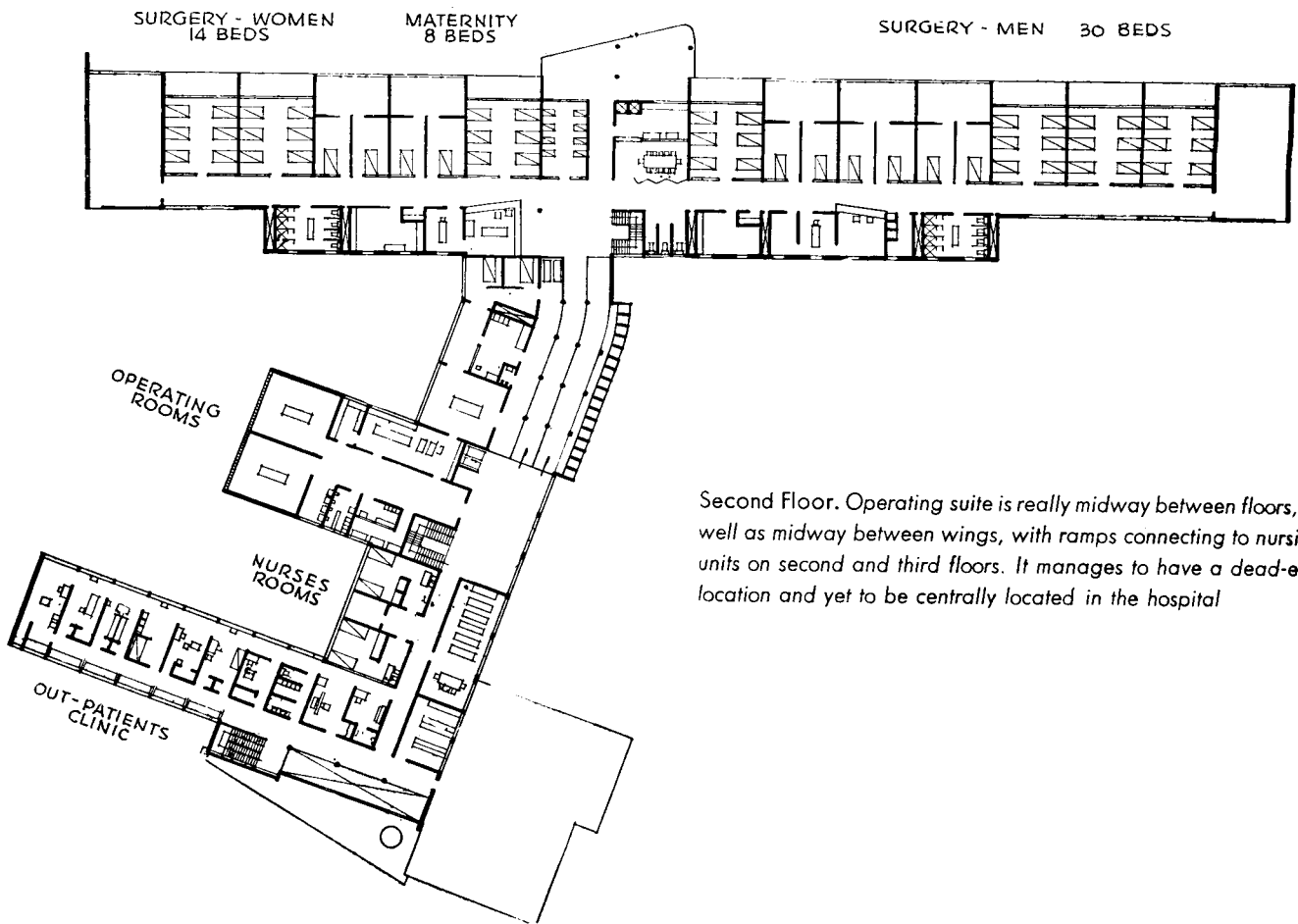

Second Floor. Operating suite is really midway between floors, as well as midway between wings, with ramps connecting to nursing units on second and third floors. It manages to have a dead-end location and yet to be centrally located in the hospital

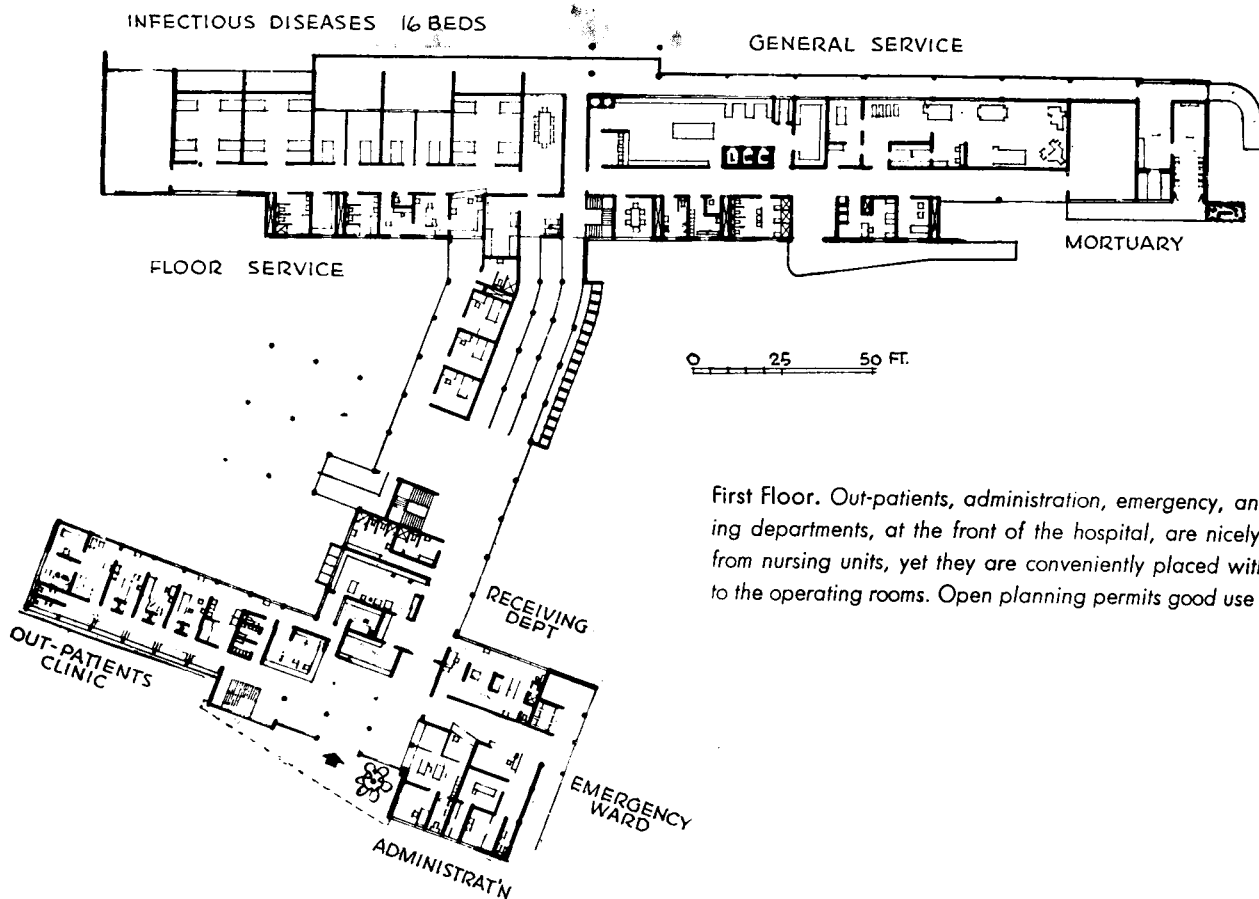

First Floor. Out-patients, administration, emergency, and receiving departments, at the front of the hospital, are nicely isolated from nursing units, yet they are conveniently placed with respect to the operating rooms. Open planning permits good use of ramps

*Antonio Prastana,
Architect;*

*Dr. Ignacio Mora,
Medical Consultant*



Zamora Photos

TWO HOSPITAL PROJECTS FOR MEXICO

1. HOSPITAL GENERAL DE COATZACOALCOS, VERACRUZ

It is perfectly plain here that the free imaginativeness that has characterized much recent work in Mexico is finding its applications in hospital design. This 127-bed general hospital is carefully studied for best placing with respect not only to sun but also to cooling winds, for the climate is tropical and humid. These plans place the nursing units to the northeast to give bed patients the cool breeze. Many planning principles familiar in the United States are seen, such as central services, cul de sac locations for operating suites, good isolation of nursing units. The ramp arrangements are especially notable: the operating wing is really a mezzanine location, giving equally good accessibility to two floors by means of the ramps.

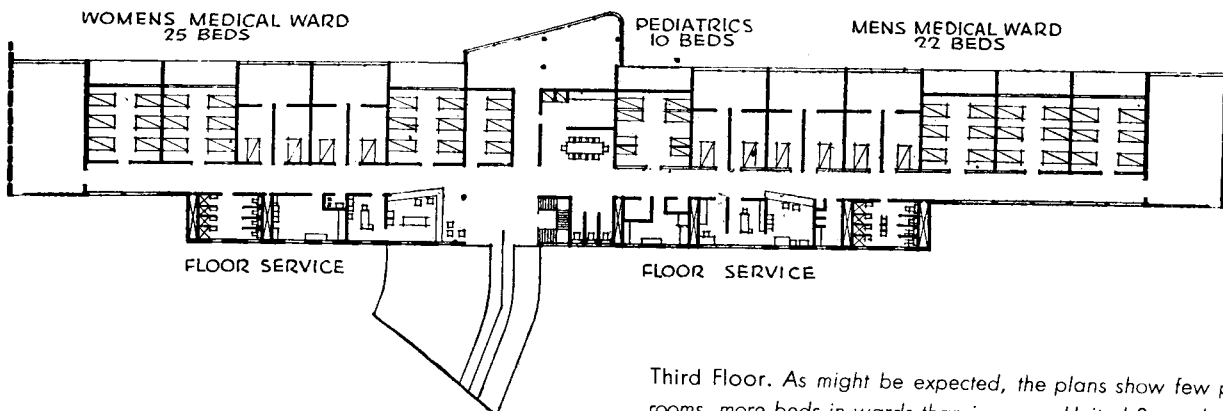
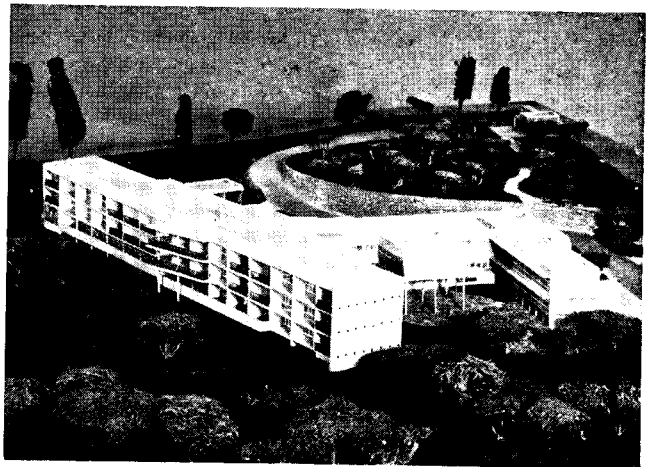

Third Floor. As might be expected, the plans show few private rooms, more beds in wards than in newer United States hospitals

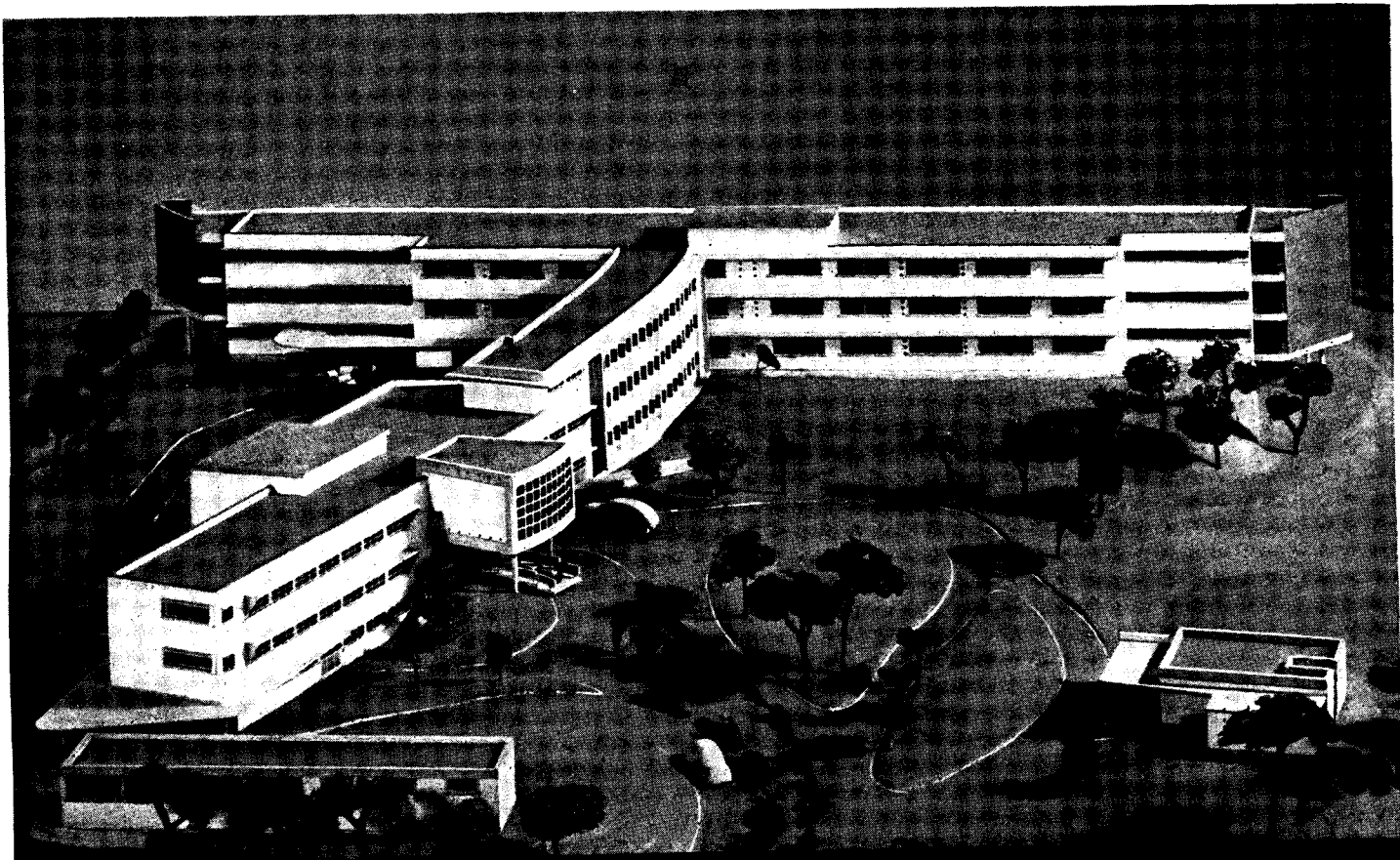
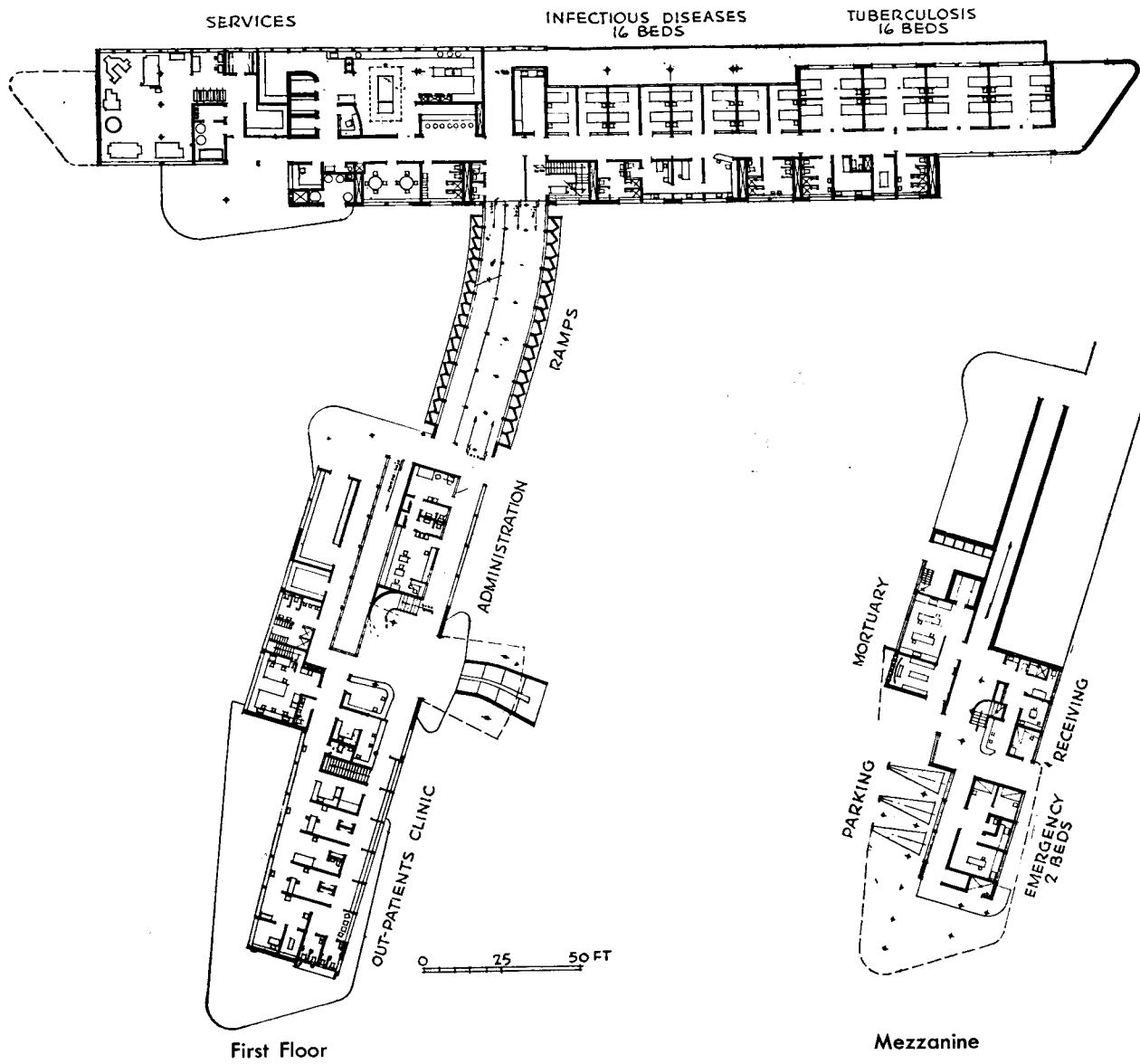

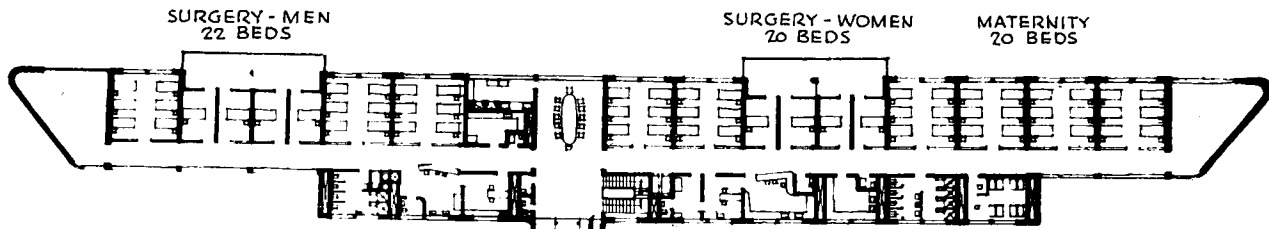

2. HOSPITAL GENERAL DE TUXPAN, VERACRUZ

Antonio Pastrana, Architect

B. Yurchenco, Collaborating Architect

Dr. Ignacio Mora, Medical Consultant

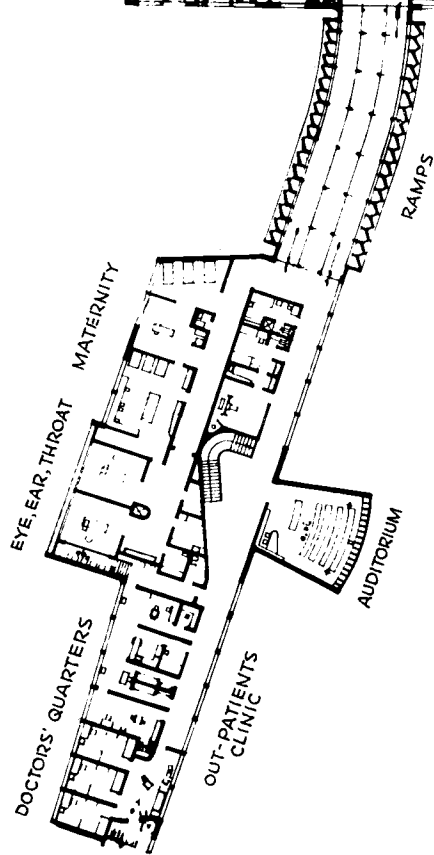

First Floor

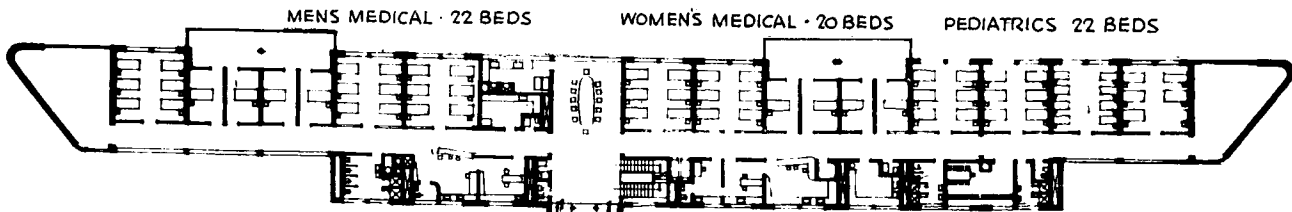
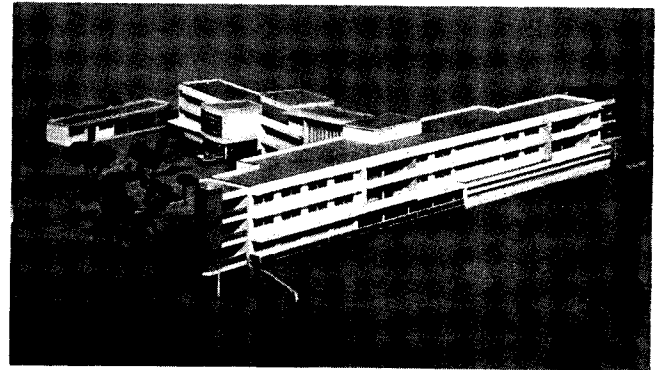

Second Floor

THOUGH this hospital is slightly larger than the preceding one, the architect has developed a similar scheme, and his planning principles are equally clear. The ramps again combine the desirable features of isolation for nursing units and good accessibility to the operating department. Here again the nursing wings are given northeast exposure, to take maximum advantage of cooling winds, although the climate here is some cooler. It is given as "moderately humid tropical climate," and rainfall is not so concentrated in a wet summer season. It will be seen that in Mexico a "general" hospital is more general than in the United States, including wards for infectious diseases and for tuberculosis, and especially extensive out-patient facilities.

GUEST HOUSE FOR A MOUNTAIN SITE

For Mr. and Mrs. John Lockheed, Lake Arrowhead, Cal.

Julius Shulman Photos



Lucille Bryant Raport (Raport & Hicks), Architect;

Gordon De Swarte, Structural Engineer

THE owners of this mountain cabin, a contractor and this family, felt that the only kind of architecture which would express their way of living was that which would develop naturally from conditions of use, economy, weather, site, and a magnificent view, regardless of how unusual the house appeared beside its conventional neighbors.

The site, located just next to the dam at Lake Arrowhead, gives an unobstructed view of the lake to the northwest, and pine-covered slopes to the southeast. The large year-round home, for which designs are now complete, will be placed on the northwest side, along the crest of the lot. A drive will divide the site, with the guest house located downhill from the drive. Only the roof of the guest house will be visible from the drive and from the main house. For this reason all vents have been taken up between roof rafters to the ridge, where

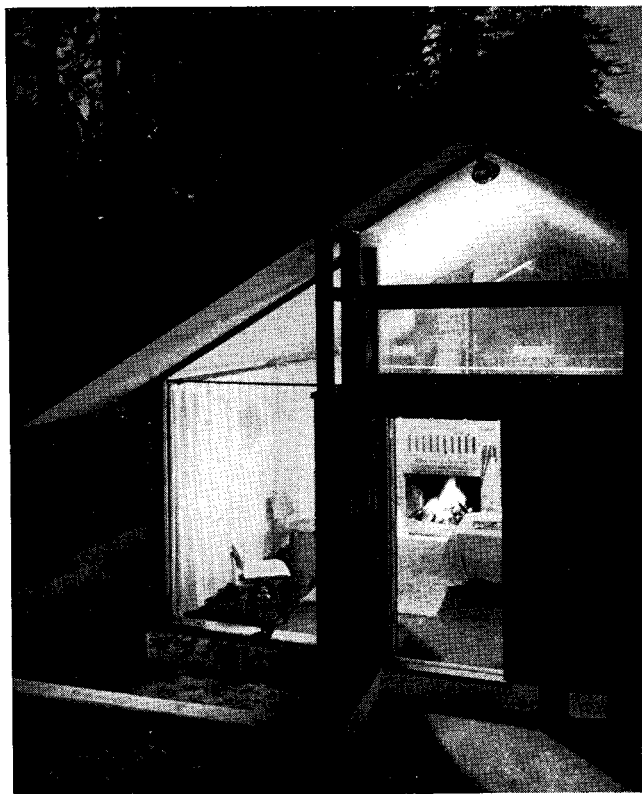

Pitch of the roof (restrictions in the area demanded a pitched roof) was calculated to create visor effect, to permit view of mountain panorama but without any glare from the sky at normal standing height. View opposite page shows tie rods serving also as curtain rods

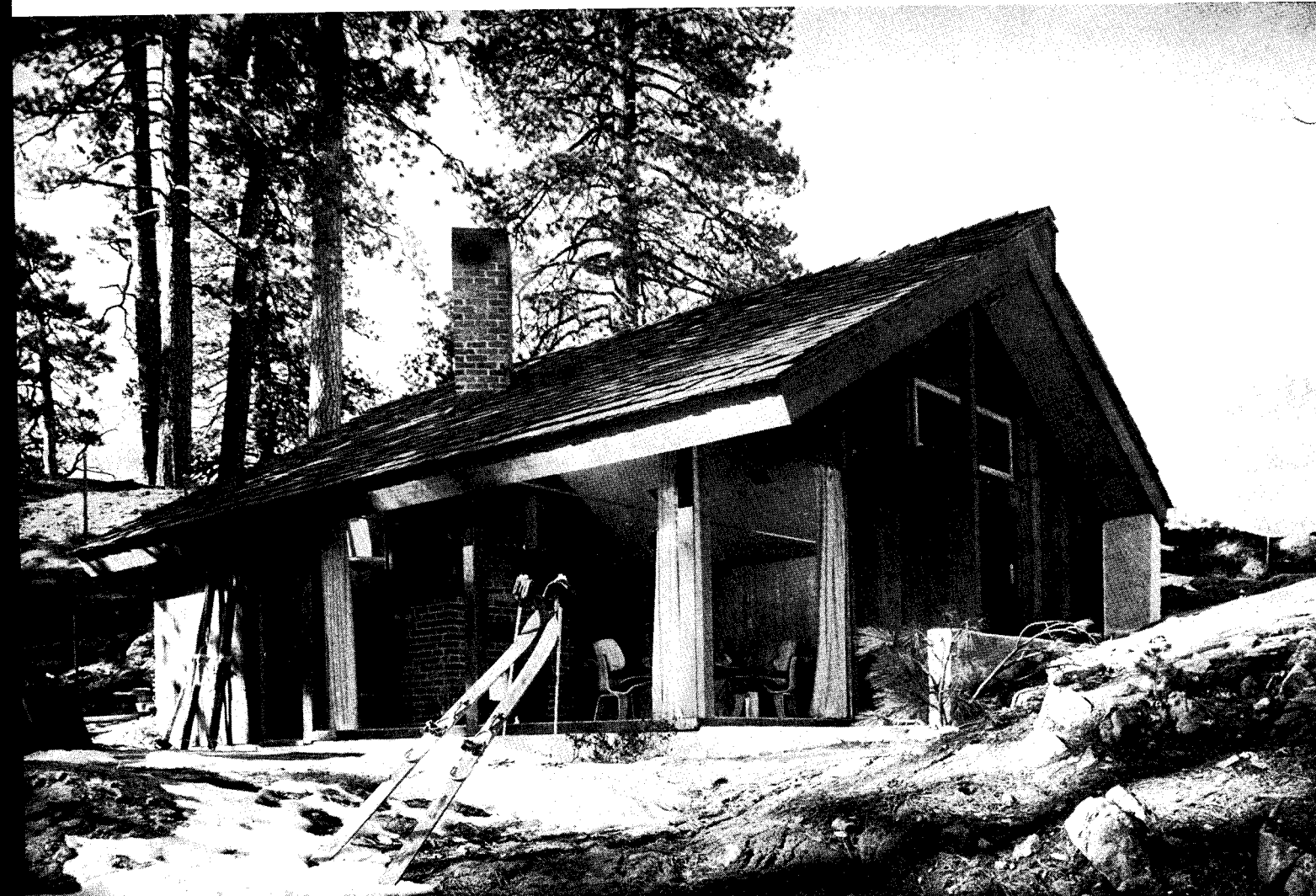

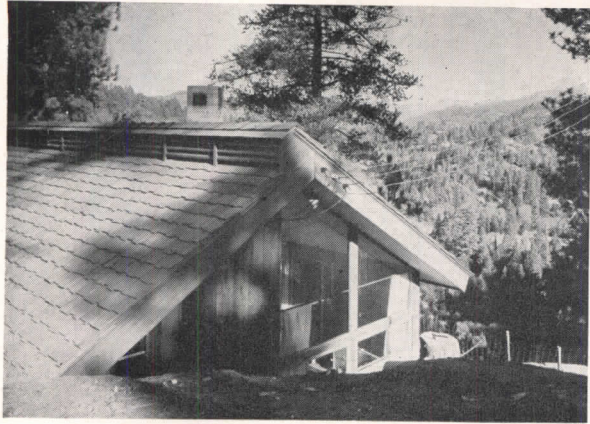

All vents are brought together and hidden behind louvers in extension of the roof. Cabin is nestled against a low cliff and this side will not be visible from main house



Interior of cabin is treated virtually as one area. A low counter (opposite page) separated kitchen area from rest of interior, and serves as back for day bed cushions. Kitchen is fully equipped, even to dishwasher and washer

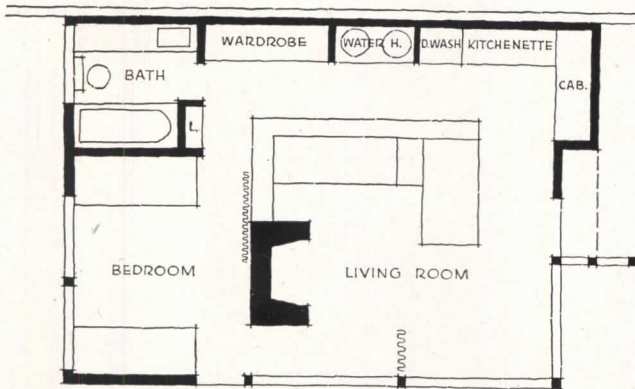

they are hidden by louvers running the length of the ridge. The roof is carried out to provide privacy and shelter for the terrace.

The projected use of the guest house demanded a very flexible plan. It might be used by the owners and their four-year-old daughter, or by a visiting couple, or by as many as eight people during the fishing season.

To create spaciousness in a house of 520 sq. ft., the area was treated as one room with a corner subtracted

for bathroom. This was achieved by having a low bookshelf and counter as back for the living room couches, and running all cabinets and storage areas in a strip along the back wall. The ceiling follows the line of sloping roof rafters, and all glass areas extend up and disappear into the ceiling. Plate glass walls extend the interior space out onto the terrace and beyond to the mountains.

To create privacy for eight, curtains may be drawn which separate the room into three separate sleeping areas. The simple appearance of the roof construction was created by using four tie rods which act as the lower chord of a truss. These rods serve in addition as curtain rods.

When a heavy snowfall threatens, portable horizontal shutters may be placed outside the plate glass walls and hooked to the jambs. These are sectional, so that any depth of snowfall or drift can be accommodated.

The property to the southeast is government owned, thereby requiring no artificial provisions for privacy. The Lockheeds feel that their guests should have more than just a place to eat and sleep; that they should have a place in which to see and enjoy the majestic view at all times, whether indoors or out-of-doors.



Fireplace is buff colored brick, with Heatilator. Floor is asphalt tile on concrete slab, with radiant heating coils in the slab. Ceilings are of fiberboard; walls special finish plywood. Windows are of quarter-inch plate glass, with ventilating sash of awning type. Exterior, redwood vertical siding

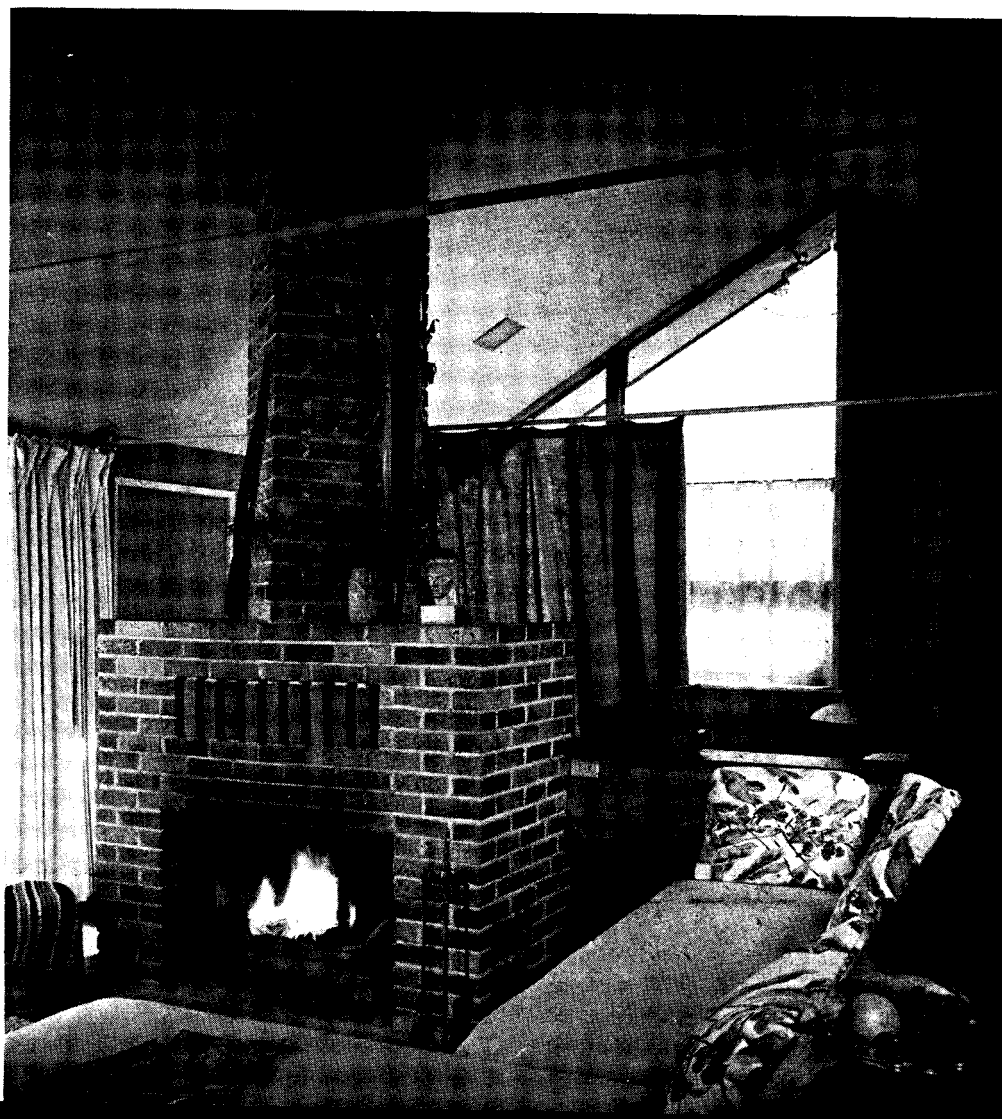



Ezra Stoller Photos

Harwell Hamilton Harris

Architect

Russell S. Johnson, Associate

NORTH COUNTRY HOUSE FOR MANY CHILDREN

Walter E. Clark House, Lake Placid, New York

Compact, surprisingly spacious inside, specially adapted to children, this cold-country house by a California architect serves the head of the North Country School (ARCHITECTURAL RECORD, Dec., 1942), his family, and some pupils, up to a total population of eleven.

With charming practicality it makes extra provision for mud-shedding entrance ways, for life in the kitchen, for well-guided traffic, collected sanitary facilities.



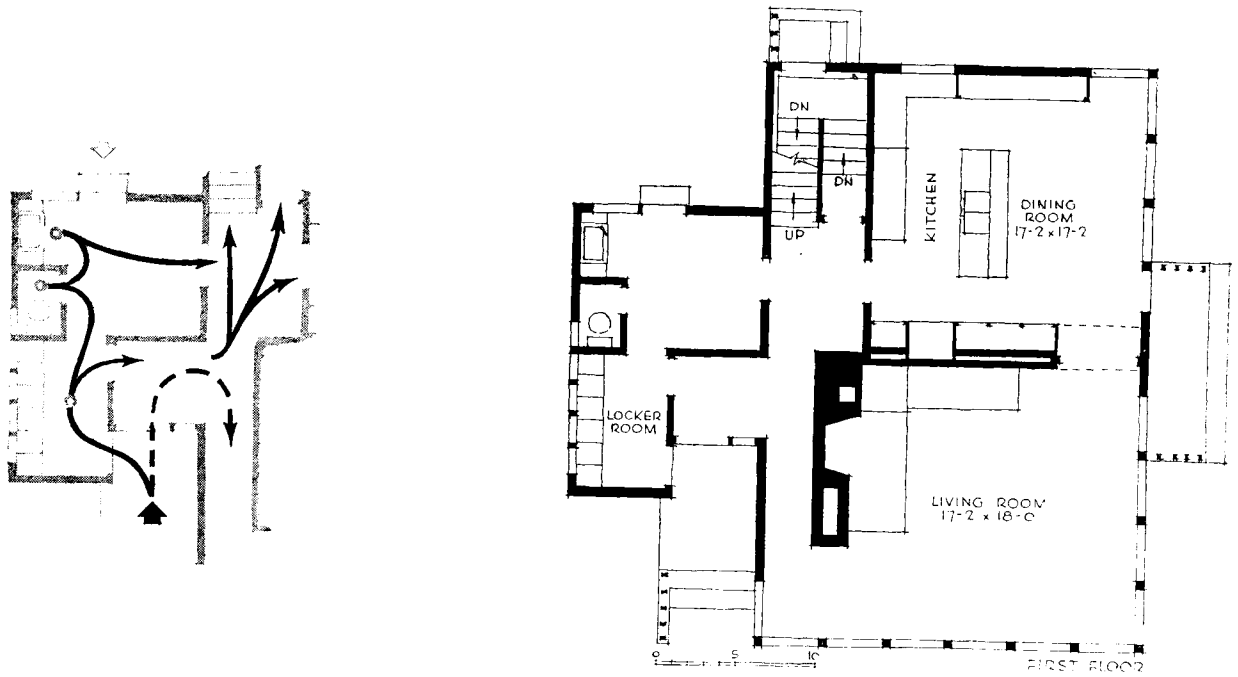

"MUD ROOMS" AND TRAFFIC PATTERN

Of incalculable benefit, in country living, is the entry traffic pattern traced in the plan (top left). Children use side door, shed rubbers and overclothes in open lockers, can proceed into house or else to toilet and wash-up at laundry tub. It is easy not to track mud into the house. Guests entering by main glass door have coats taken into locker room, proceed to living room. Others have easy choice among entrances to kitchen, living room, basement, upstairs bedrooms

LIVING ROOM, facing south and east on magnificent views, is isolated from through traffic. Fireplace is salmon-red brick, partition wall waxed cedar, floor prefinished "factory" oak; couch cover blue; walls peach-colored. Though fireplace opening is 5 ft. high, only 18 in. deep, fires draw perfectly because of tall smoke box, 18 by 18 flue tile





Photo, top left, shows the rear of the house; top right, the kitchen seen from the hall entrance; bottom, the dining room side as seen upon entering from the living room (compare with the view on previous page). Storage of dishes is along outer wall; of food, along the inside partition next to the refrigerator. Kitchen utensils are stored mainly under the sink. This makes for easy food handling, table setting, dish washing. Outside door permits eating on the terrace in favorable weather

"Kitchen living" is especially welcome in a house where the living room is in frequent demand for entertaining callers. This kitchen not only takes care of food preparation and dining but also makes provision for evening reading, study, children's play — the activities of the old-fashioned living room behind the parlor. The floor is salmon linoleum, the home-made cabinet work is of varnished pine and fir plywood.



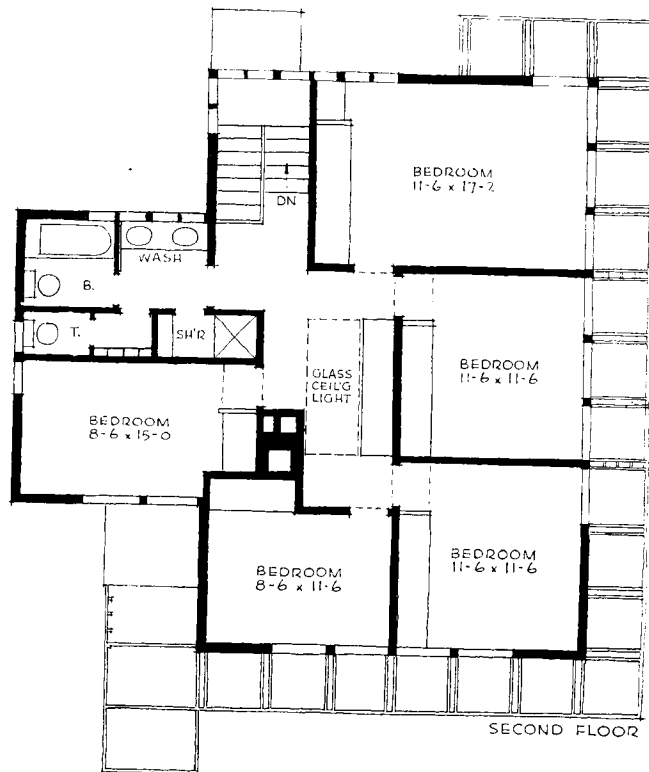
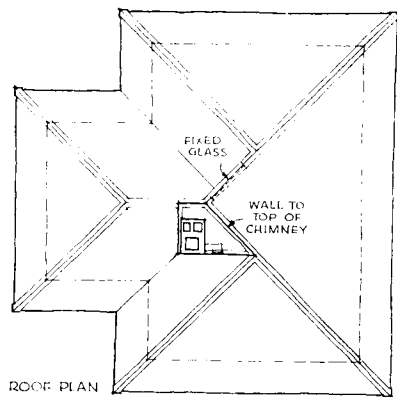

Each of the many bedrooms on the second floor has one full wall devoted to storage, *economically built in*. The dropped ceiling of the hall (view below) carries through above bedroom doors to the front edge of this closet. It forms a dropped soffit of frosted glass. Bulb above it simultaneously lights entry and closet. It lights the room so dimly as to compel turning on adequate desk light for study; can't be hit by pillows.

The wooden tower above the roof (see roof plan and perspective) is so placed and designed that every slope above the roof is a down slope. There is no need for any cricks—an important factor in a region of heavy snow. Air from the second floor is exhausted through this tower by means of ducts. These are wallboard-lined for quiet; are carried out of the rooms above the dropped ceiling of the hall, from above the dropped doorway soffits mentioned in the adjoining text.

The ingenious clerestory window (drawing below) gives daylight to the hall top-light seen in the photograph

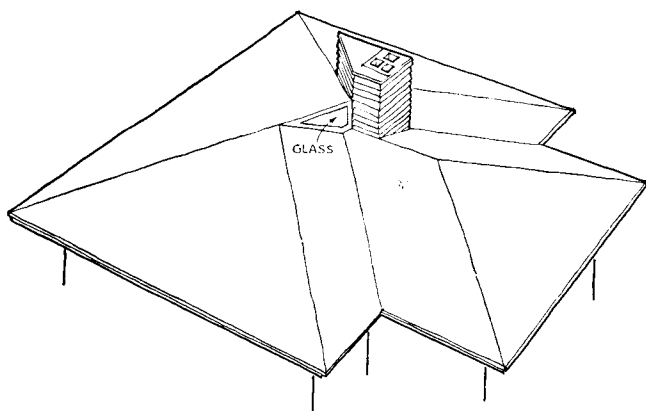
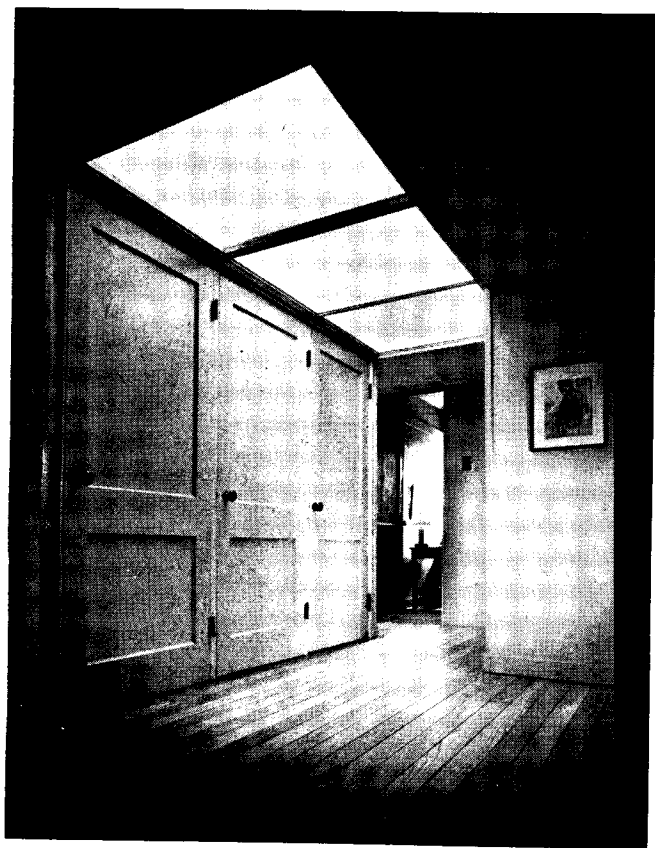

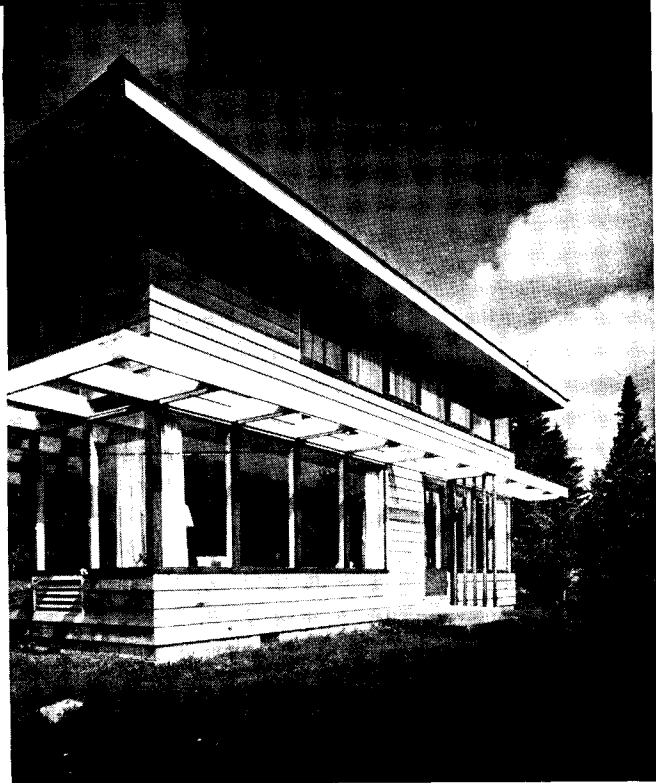

Left: view from southeast. The trellage is to be completed by vanes experimentally adjusted to shade first-story windows; it serves esthetically to prevent the compact two-story structure from becoming a box

Interior view: dressing table recess in the master bedroom. As in all houses by Harwell Harris, this is closely integrated with the storage space so as not to encroach on the room

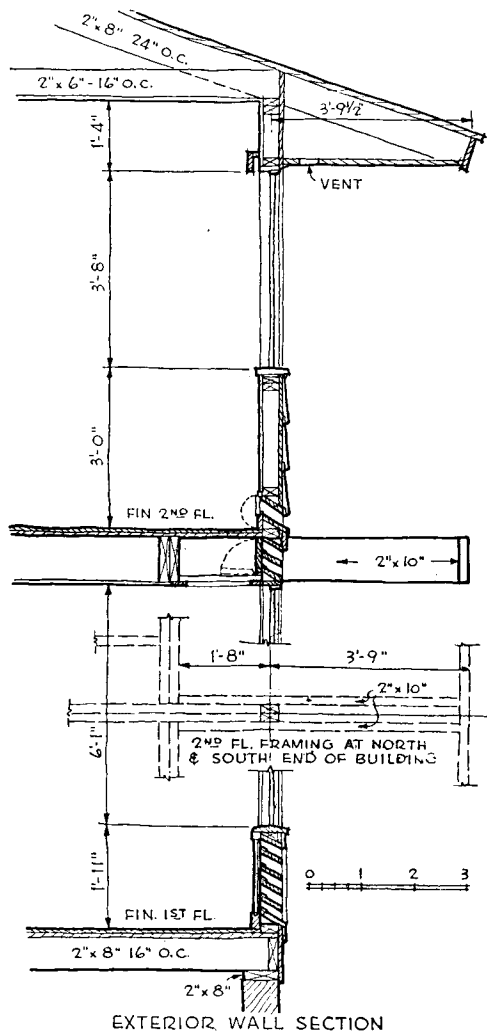

Exterior wall section: this shows the system of ventilation separate from the fixed windows. Intake at first floor is below windows. Intake upstairs is in thickness of ceiling. Intake outdoors is at floor, outlet through ducts above doors. It was found that in summer, with no temperature differential, cross-ventilation is required to make this system work; in cold Lake Placid winters the high differential makes it work "with a vengeance." One window in each room is casement sash for combined safety and auxiliary venting

This compact sanitary facility was already in successful operation before all the fanfare for this idea; is highly practical. Three toilet seats have proved ample for the whole house of eleven occupants. Tooth-brush and wash-cloth lockers are nicely concealed from the entrance. Entire washroom ceiling is frosted glass, removable by simply lifting up the panes. Light bulbs are in simple reflectors in the attic space above. Mirrors are attached to the partition next to the bathroom and to window mullions

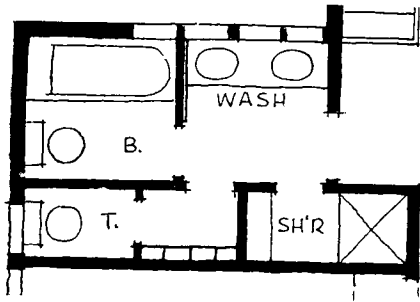
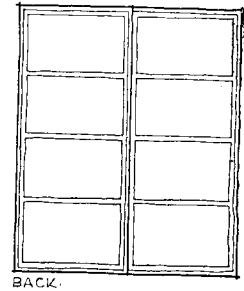
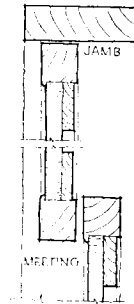
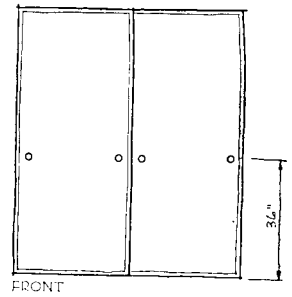
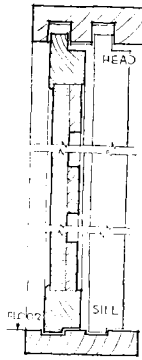

Details of the successful sliding closet door, which requires only two shallow grooves in one of the oak boards of the floor (which accordingly must be laid parallel to the closets). Face of the door is wall-board of one of the tougher varieties; could be of plywood. The light weight is depended on for easy operation

Master bedroom. This is the only bedroom with any north exposure, but on this side the house is shielded by a grove of large trees. Heating of the house is by warm air, and considerable ingenuity was required placing risers in the limited first-floor wall space

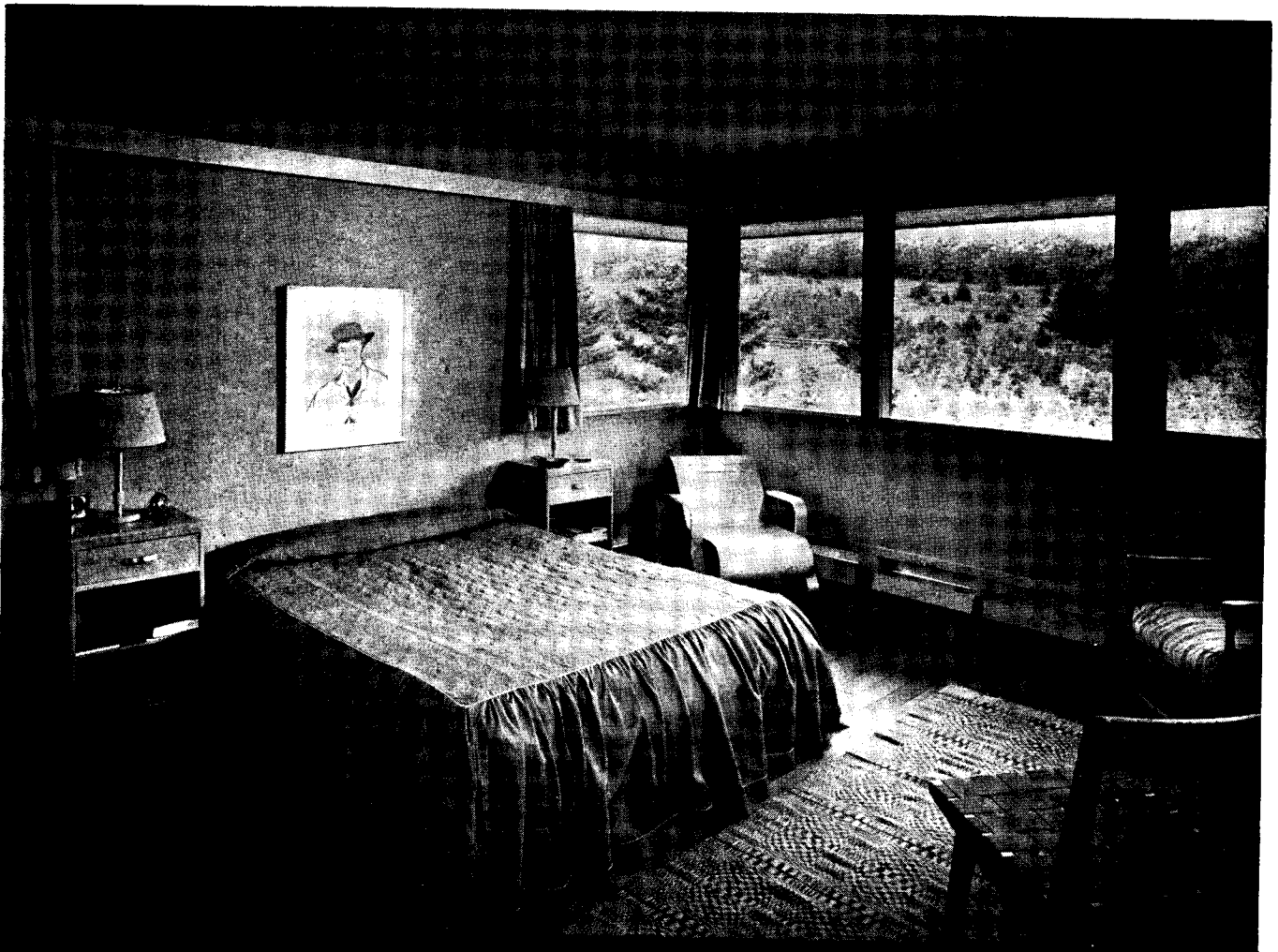

APARTMENTS



Thomas Airviews Photo

Stuyvesant Town and Peter Cooper Village, two developments of the Metropolitan Life

Insurance Company for Manhattan's East Side, will provide apartments for 11,250 families

IN recent months rental housing production has approached record proportions. In defiance of high costs, labor difficulties, persisting materials shortages, the building industry has confounded its critics by pushing up new totals in apartment construction, and swamping FHA offices with new Title VI applications. It now appears that the new Title VI authorizations of \$750,000,000 will be eaten into so rapidly as to pose new financing problems.

Certainly the present situation is more encouraging than at any other time since the RECORD first raised its voice for rental housing.* It might seem time to drop the concern over political and economic aspects of housing and concentrate on design and building. In general that is the spirit of this Building Types Study, which is almost entirely a portfolio of current designs for apartment buildings. It seems inevitable, however, that such a basic necessity as housing must always be affected by the tides of political and economic thought. That is certainly the case today, and there are some considerations that must be touched upon briefly here.

It should be emphasized, first of all, that current high volume of residential construction really began with the lifting of federal controls in the middle of 1947. It would seem that the record of the ill-fated Wyatt program and the following year of persisting controls, plus the progress since controls were dropped, should dispose of the idea that a federal bureau can waggle its finger like a schoolmarm and expect any creative response. Advocates of the disciplinary techniques have not retired, but are now organizing for a further fight.

At the moment housing is being buffeted by another wave of Washington investigation, the topic of which is inflation. In the rather belated concern over inflation, the question is now asked, "Are housing loans inflationary?" This question was raised during hearings on the new Title VI authorizations. Administrator Foley of the HHFA replied:

"I would think that, generally speaking, anything that added unduly to the demand without increasing

the supply might be considered inflationary. We must remember, it seems to me, two things in connection with this proposal:

"One is that continued high production of housing, at a rate as high as we can have it, consistent with an orderly completion of the houses started in the face of our materials and labor situation, is extremely important in combatting inflation while we have a shortage of housing and a high demand.

"The other thing we have to remember is that Title VI financing is a means of production finance rather than exclusively a means of consumer finance, and aids materially in keeping up the rate of production. So that I feel that our recommendations are consistent with both objectives, one, increasing the housing supply so badly needed, and not unduly, at least, adding to the inflationary trends."

The discussion of inflationary aspects (see also p. 7) is important because new authorizations will last but a few months, and financing will be before Congress again almost immediately. In the hearings a suggestion was made that the percentage of loans be gradually reduced from 90 to 80 per cent, whereupon FHA Commissioner Richards disclosed that average commitments now are running only 84 per cent.

Meanwhile FHA is finding its own ways to favor the lower-cost projects, and to favor rental projects against others, by "selective processing" of applications. While these objectives of "selective processing" are obviously commendable, there might be some question whether in the end it might not have a tendency to standardize apartments at a minimal level. Architects have long complained about similar controls by FHA on design, as forcing a standardization on unimaginative styles of garden apartments.

Fortunately, however, all apartment projects need not submit to Washington to get financing, and all buildings are not the stereotyped garden variety. This Building Types Study emphasizes less common types, where architectural ingenuity finds a good outlet.

* ARCHITECTURAL RECORD: May, 1946, "The Case for Rental Housing," pp. 67-76; Feb., 1947, "Rental Housing" by Emerson Goble, pp. 76-80.

"The Rental Housing Mystery" by Miles L. Colean, *Housing Consultant*, pp. 81-85; March, 1947, "The Building Cost Fixation," pp. 85-89.

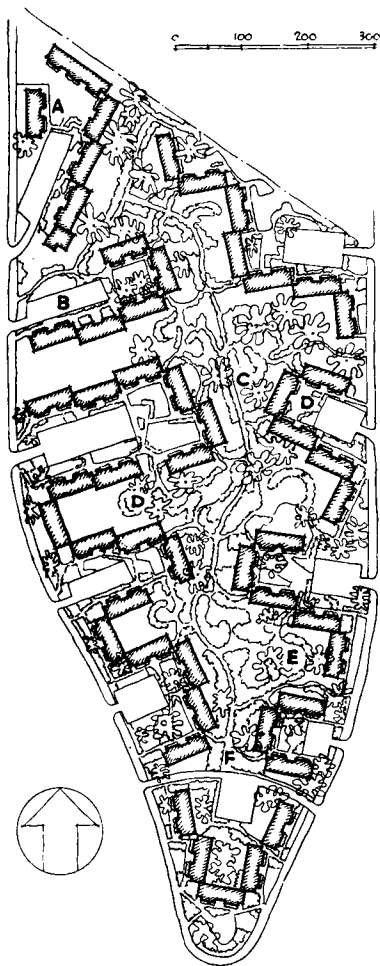
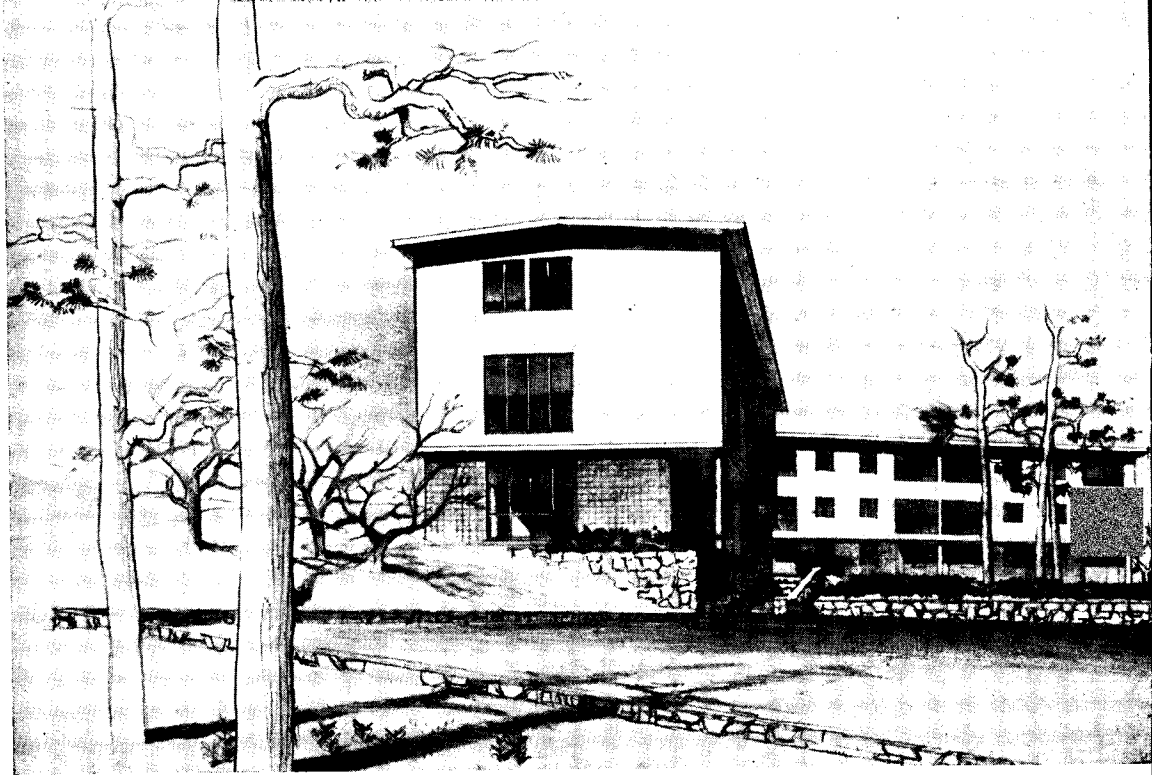

- A. 6-unit apartment building
- B. Parking areas
- C. Interior park, wooded
- D. Sitting areas for adults
- E. Children's play areas
- F. Walks

DESIGNED WITH A BUILT-IN PARK

ATLANTIC GARDENS, WASHINGTON, D. C.

Charles M. Goodman, Architect *L. B. Voight, Landscape Architect*

THE 318-unit apartment project known as Atlantic Gardens, now under construction on a hilly, wooded, 13-acre tract at 4th and Chesapeake Streets in the south-east section of Washington, puts into practice the often talked about but less frequently attained ideals of garden apartment planning. The buildings are informally arranged with their principal living areas facing into an interior park, laid out to afford safe and convenient outdoor play space for children, with restful walks and quiet sitting areas for adults. Each three-story building unit contains two flats on the ground floor and four two-bedroom duplex apartments on the upper floors, all with separate entrances. A ground-floor laundry serves all six families in each building. Red clay tile walls for the ground story contrast with gray brick veneer above. Uncommon features include copper tube radiant heat installed in ceilings and prefabricated aluminum closets with sliding doors, adopted to save space and construction time. Thirty-six units are scheduled for July completion and two years is the estimated time for finishing the entire project.

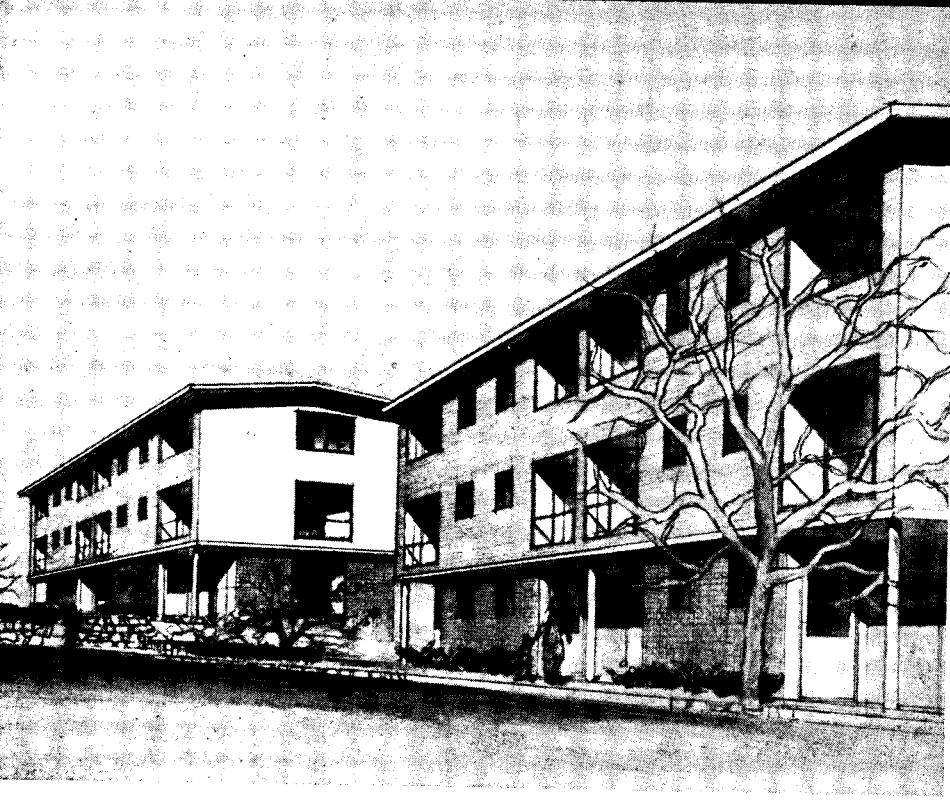

Simplicity and restraint, with good use of materials, characterize the exterior design and will bring a fresh "new look" to an area long accustomed to less imaginative apartment architecture

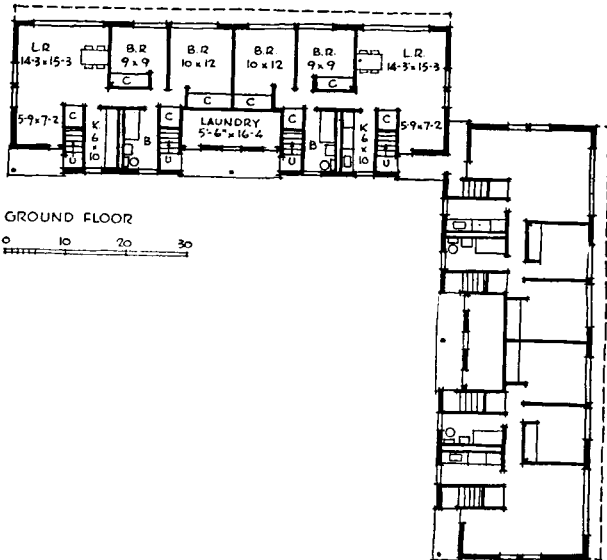
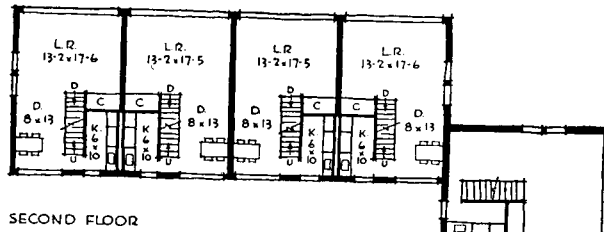
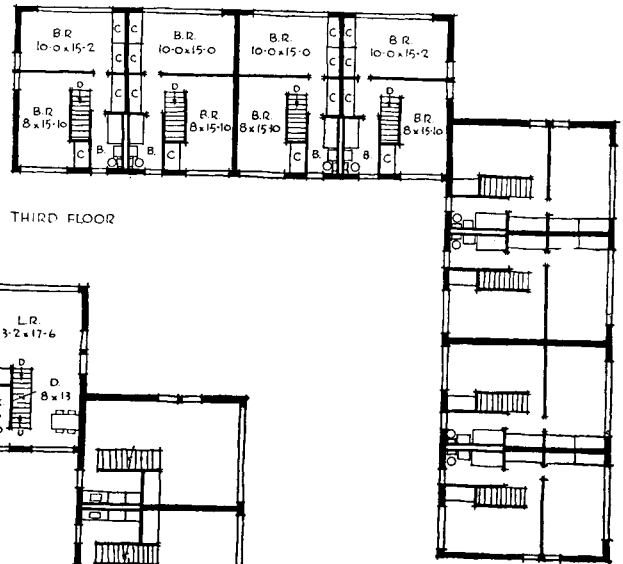



Clark and Frey,

Architects

Julius Shulman Photos

APARTMENTS FOR RECREATION

VILLA HERMOSA, PALM SPRINGS, CALIFORNIA

THE business of catering to the needs and desires of motor tourists and vacationers seeking escape from the city for short or long periods has grown so tremendously since the twenties that more and more architect-designed establishments for this purpose are appearing along American highways, particularly in

the more richly endowed recreational areas. The example shown is perhaps typical of the comparative luxury now being provided in the form of convenient and well-planned apartments grouped around swimming pools and other popular recreational facilities. The frankly romantic setting is skillfully attained.

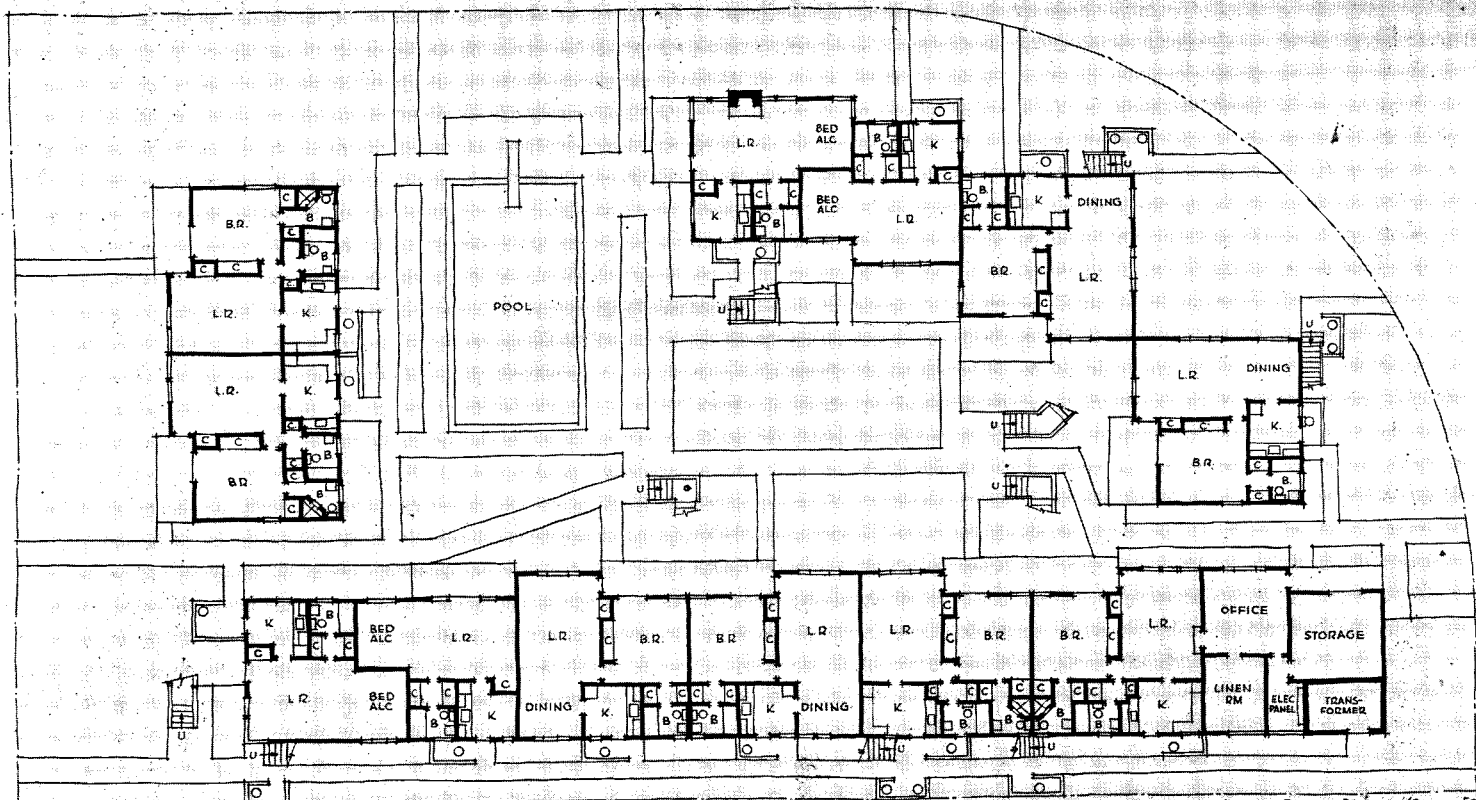

FIRST FLOOR

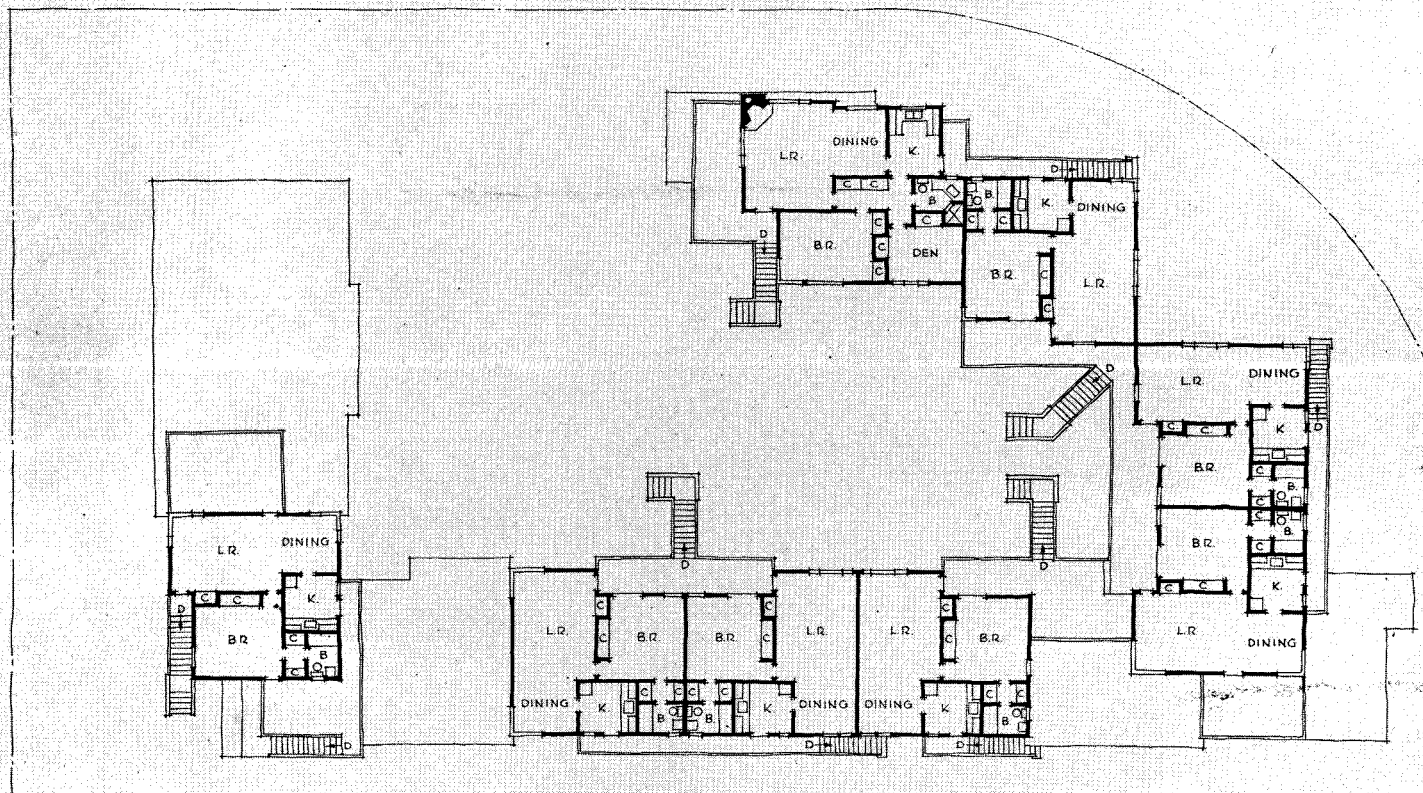

SECOND FLOOR

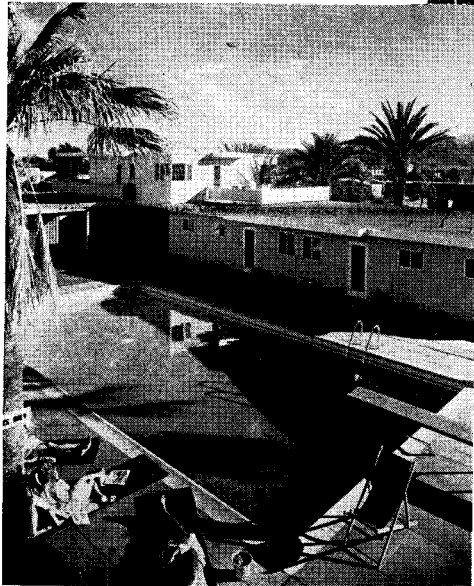
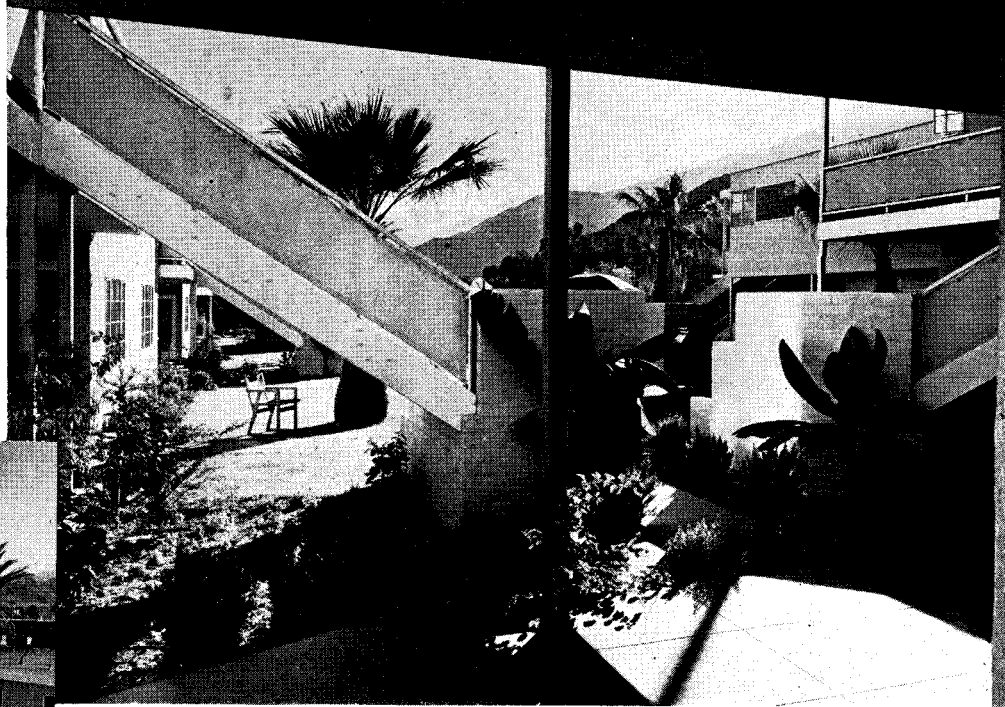

The pool, which is the center of attraction at Villa Hermosa, is readily accessible from every apartment and observable from almost all of the living quarters — perhaps a subtle concession to the old American hankering to know what's going on outside



Wood frame construction with steel sash; cement floors on ground level, wood on second level, all carpeted except kitchens and baths, which have linoleum; composition roofs with aluminum surface; circulating electric heaters; stucco exterior walls



Interiors, as shown below, are definitely on the luxury side and take advantage of modern arrangements for enjoying either complete privacy or outer views of the scenic beauty of the surroundings. Simple, restful furniture of good design and well-considered color scheme contribute to relaxed comfort

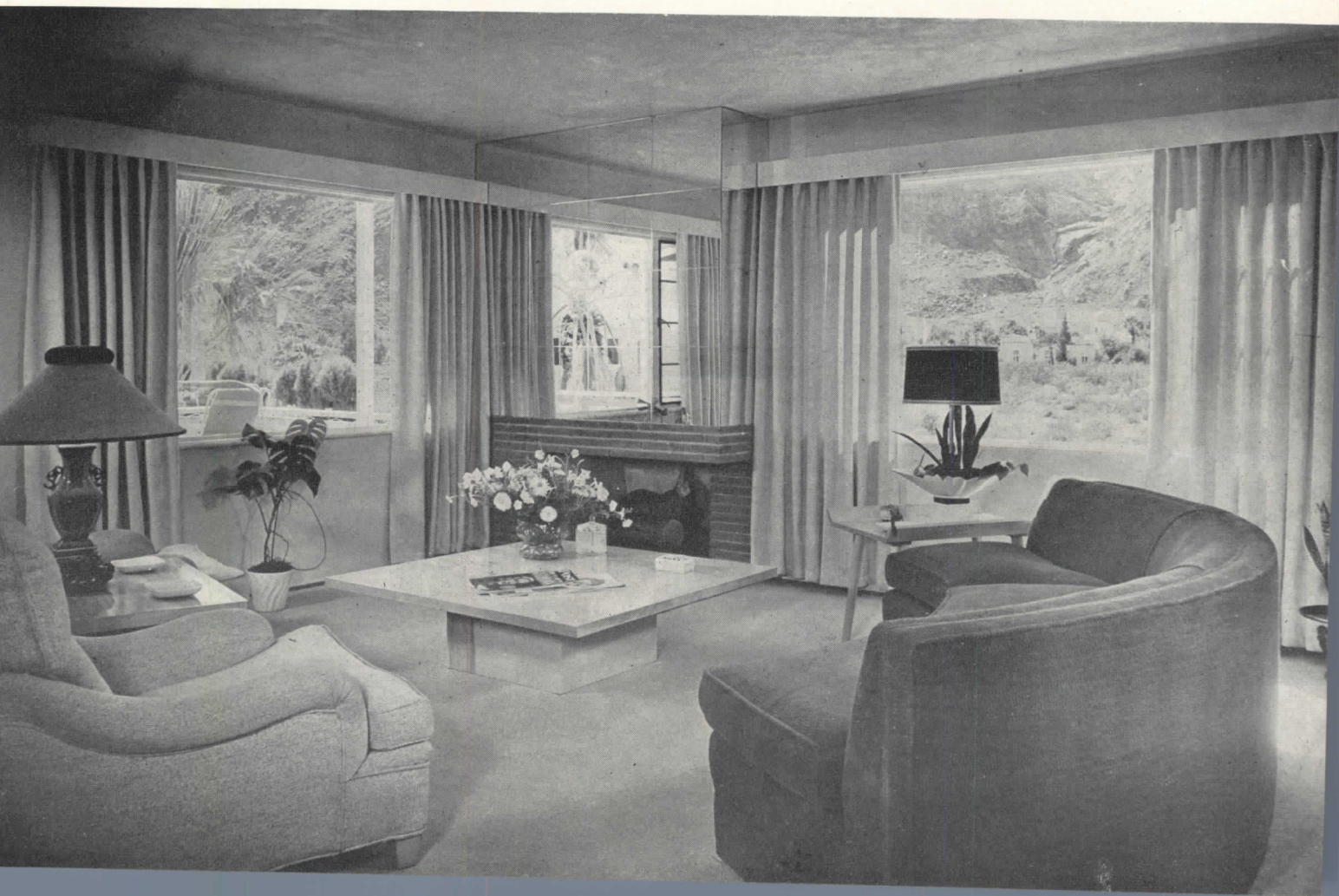

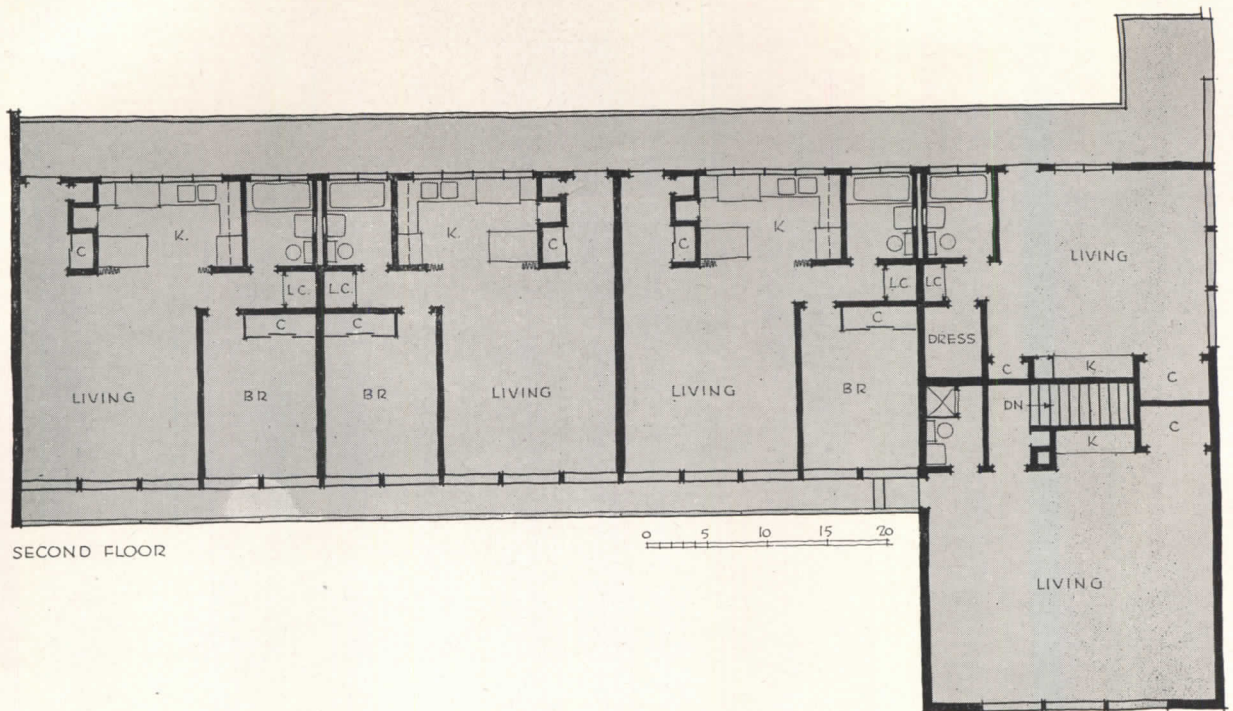

NEW APARTMENTS OVER A DRAFTING ROOM

The Office of Pietro Belluschi, Architects

IN days of housing shortages, apartment additions are often made to existing buildings of other types (where zoning regulations permit) to provide extra living quarters and bring in revenue for the owner. Seldom, however, are such alterations done with the degree of quiet distinction reached in this group of five small apartments built over Mr. Belluschi's offices on the edge of the business center of Portland, Oregon. The original building, at one time a garage, is improved by the added height and the contrasting materials used for the second story. The long row of bedroom and living room windows facing the street is protected by the projecting parapet faced with cedar siding. Access to four of the apartments is from a cantilevered walkway reached from the higher grade level at the back of the building on its western end. The office studio apartment is entered from stairs leading up from the floor below. The drafting room floor level is below grade for most of its length.

View from within the reception office, across the sheltered entrance porch, and along the street side of the building

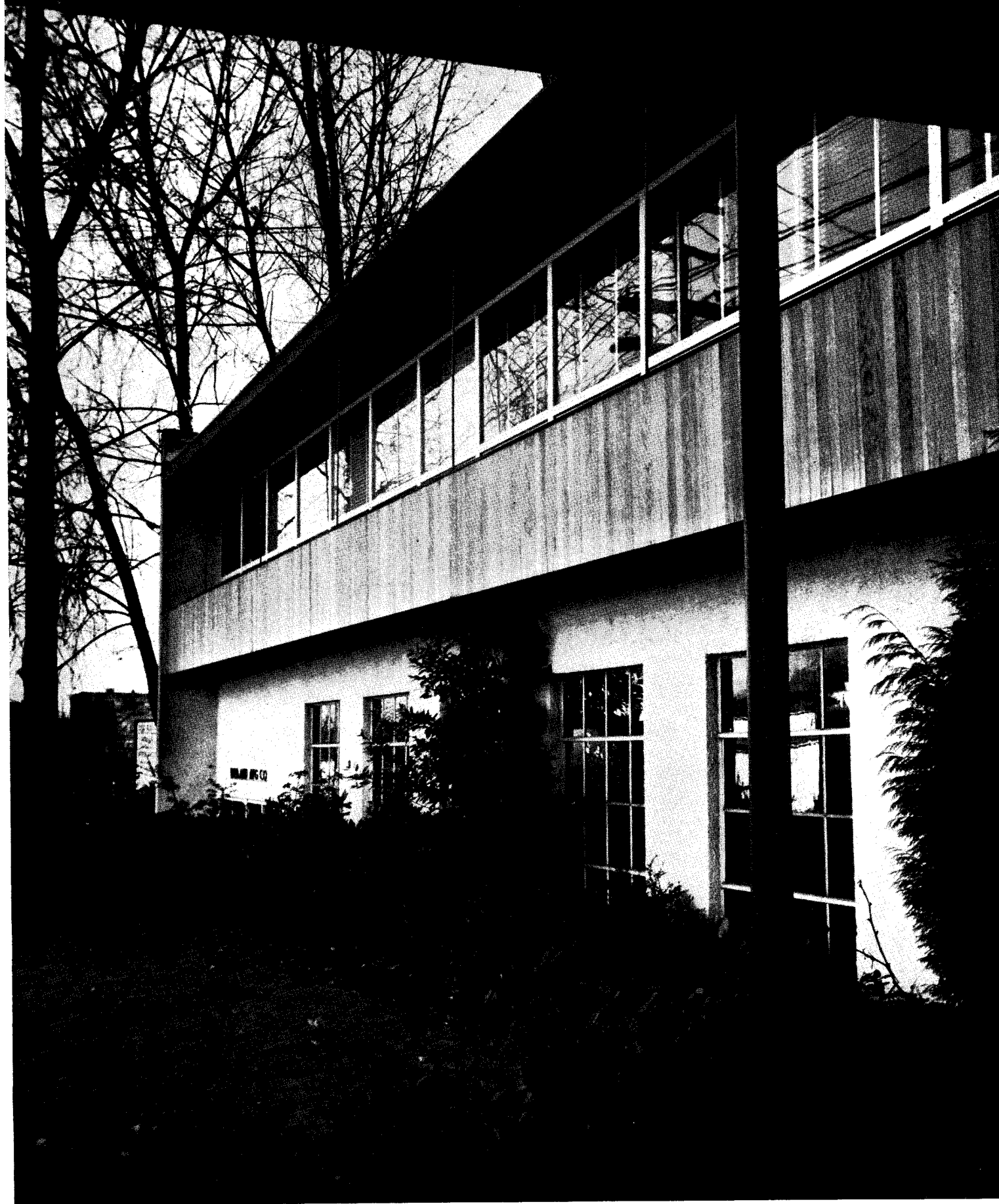

This long face of the building parallels the street, from which it sits back about twenty feet. Full advantage has been taken of this front area for appropriate planting. A portion of the basement at the far end is used by another business tenant whose name appears over the entrance

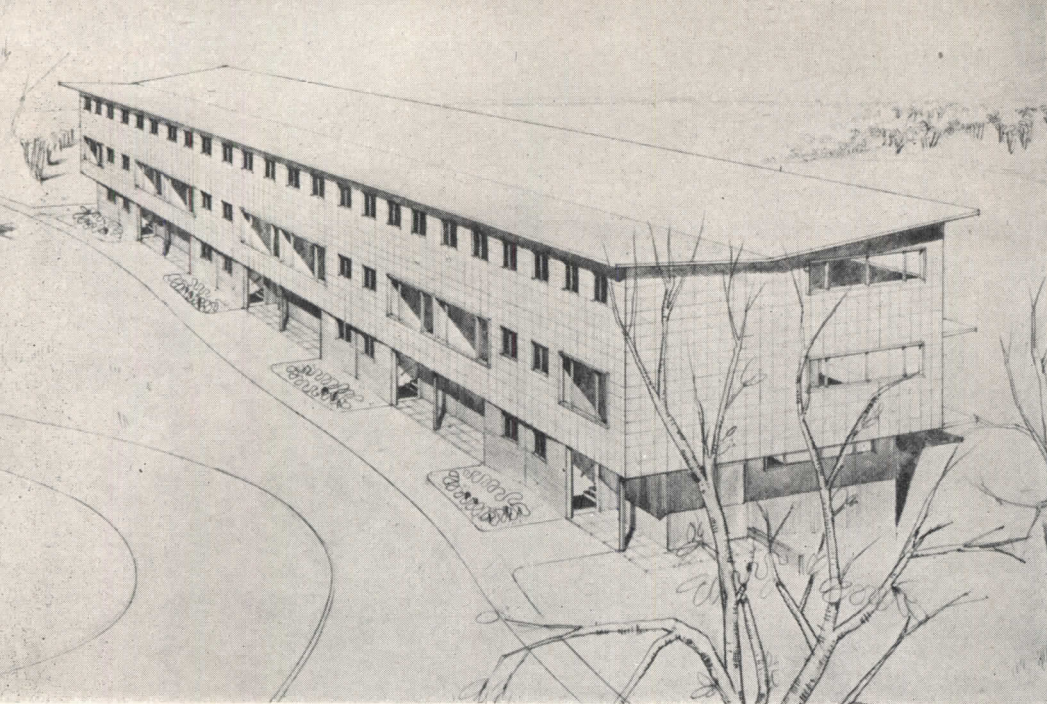

Charles M. Goodman

Architect

GARDEN APARTMENTS FOR RENTAL HOUSING

LANGLEY PARK PROJECT, MONTGOMERY COUNTY, MD.

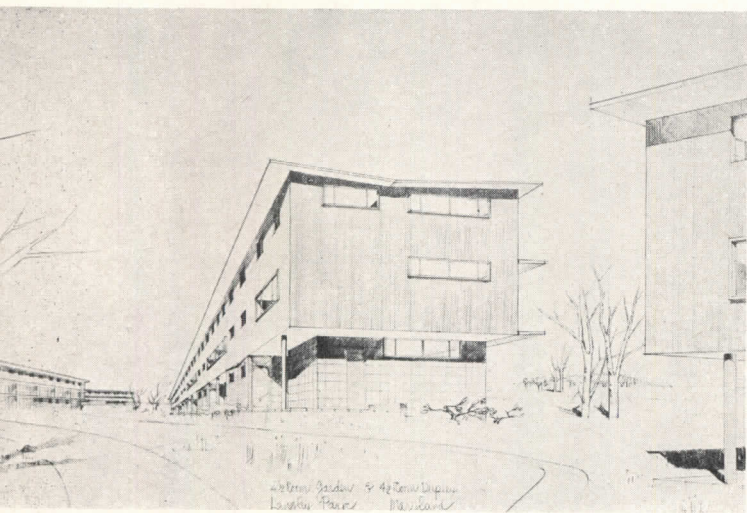

SIMILAR in many respects to the other garden apartment scheme by Architect Goodman in this issue, the Langley Park proposal is much larger, comprising a complete community designed to include 2008 units, distributed on a Maryland tract measuring roughly a mile long by about four-tenths of a mile wide. Unfortunately, in view of the present housing situation, the project is indefinitely postponed due to zoning difficulties. Four types of buildings, made up of different combinations of flats and duplexes, are arranged on the plan to take best advantage of the site. Shopping Center, Community Center, schools, etc., are essential parts of the scheme. Exterior treatment, as suggested by the accompanying sketches, is to be simple, depending on intelligent use of materials and color for its effect.

Sketches below show the semi-detached, 6½-room duplexes that are to be grouped at several parts of the site

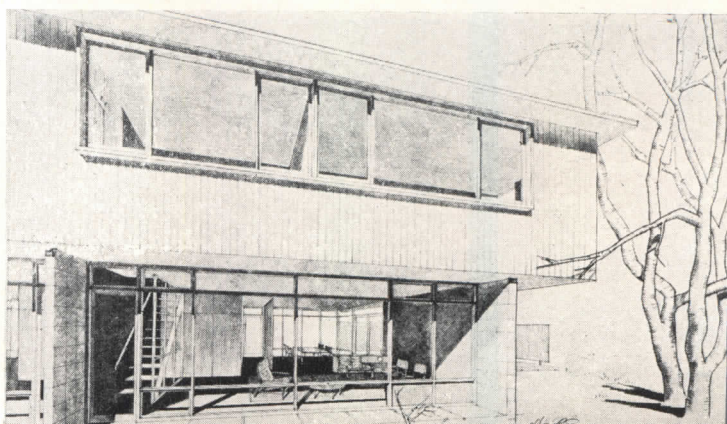
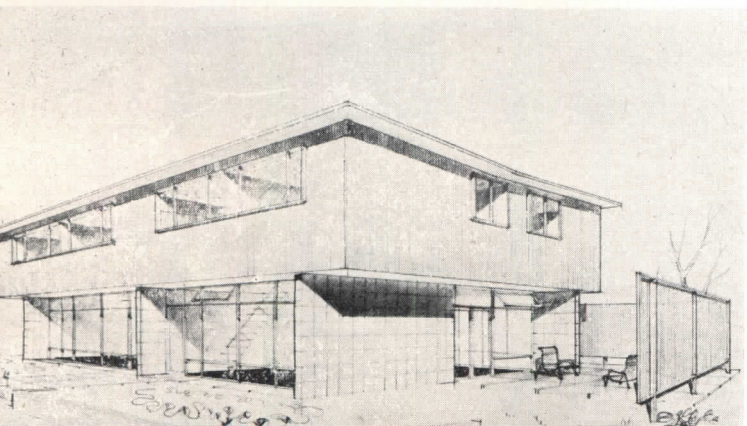

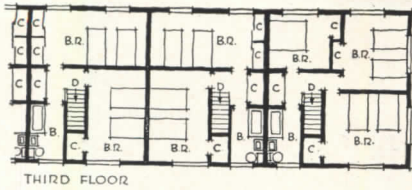

THIRD FLOOR

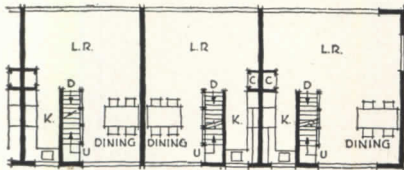

SECOND FLOOR

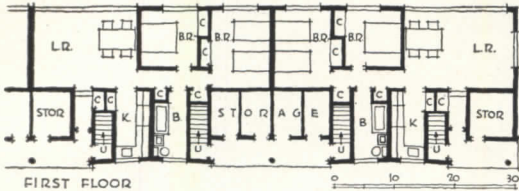

FIRST FLOOR

Most of the buildings are to be made up of combinations of the flat and duplex units shown at the left. A number of semi-detached, two-story duplexes will give variety (see plans at right). 936 4½-room units, 696 5½-room, 306 3½-room, and 70 6½-room are proposed as the proper distribution for the probable tenancy of the entire project

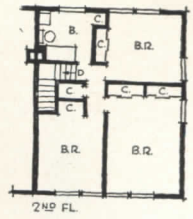

2ND FL

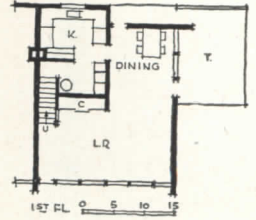

1ST FL

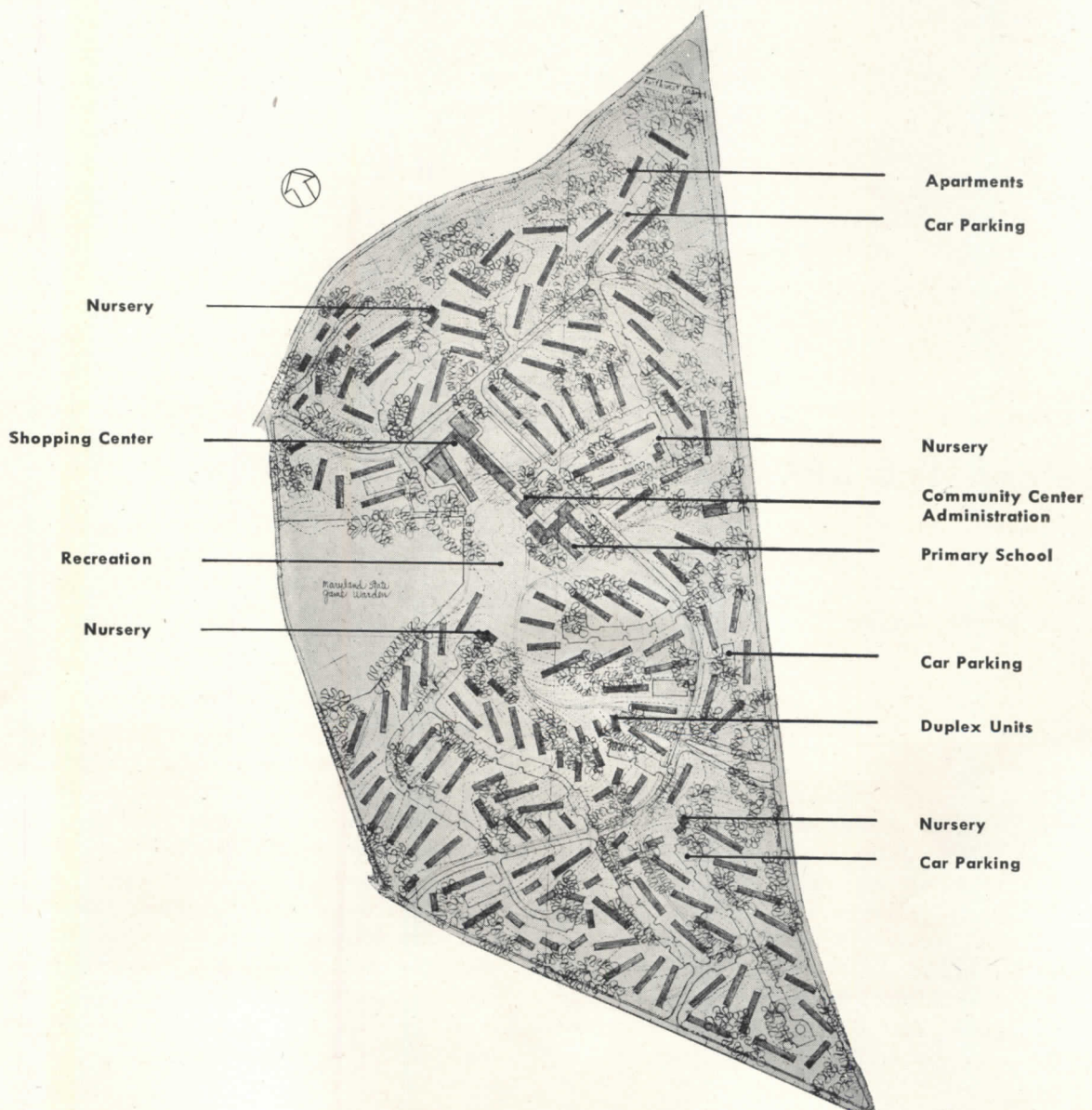

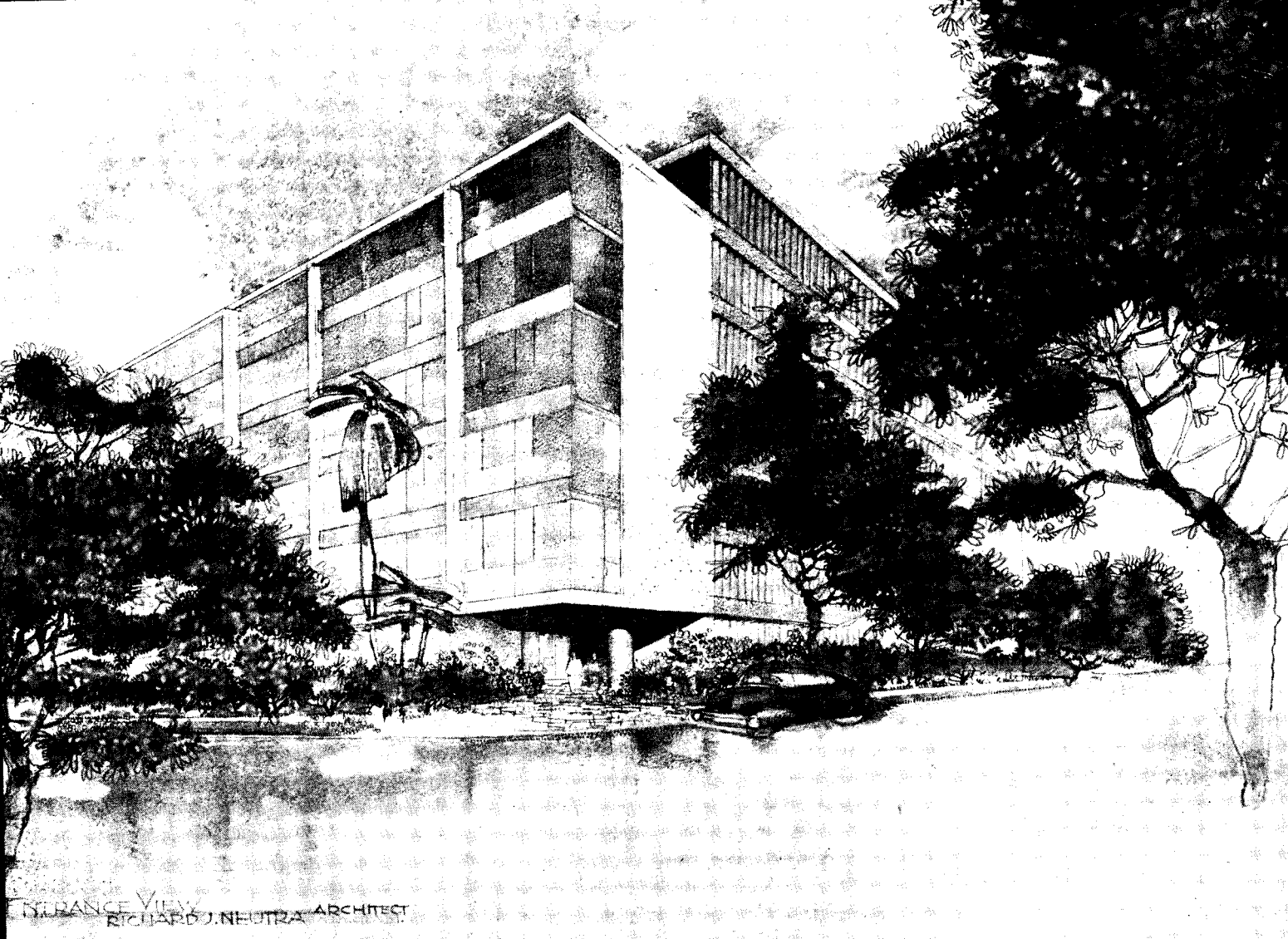

INSURANCE VIEW
RICHARD J. NEUTRA ARCHITECT

COOPERATIVE APARTMENTS NEAR THE SIERRAS

Richard J. Neutra, Architect

THIS project is designed for a site rather centrally located in a residential community at the foothills of the Sierra Madre mountains of Southern California. To take advantage of the available view of Mount Wilson, Mount Lowe, and other notable eminences of the vicinity, Mr. Neutra has projected a seven-story, reinforced concrete building with outer walls largely of glass, within which he has arranged some four dozen apartments of from 3 to 5½ rooms for moderately prosperous families. The plan arrangements are varied and flexible to fit the needs of a diversity of tenants.

Cooperative ownership and management should make the project attractive to families who wish to buy rather than rent yet who prefer apartment living to assuming the responsibilities of house ownership. Inside bathrooms and kitchens, presumably properly vented, permit the full use of the outer walls for glass areas in the living and bed rooms. Conveniences include the usual modern elevators, dumbwaiters, incinerator, basement laundry and storage facilities, servidors from halls to kitchens. A parking area is provided in the angle of the L-shaped plan.

Inside the ground floor corner entrance, a lobby contains a desk for the management, with an office adjacent, and provides for the comfortable transaction of business. It is not intended to be a general lounge

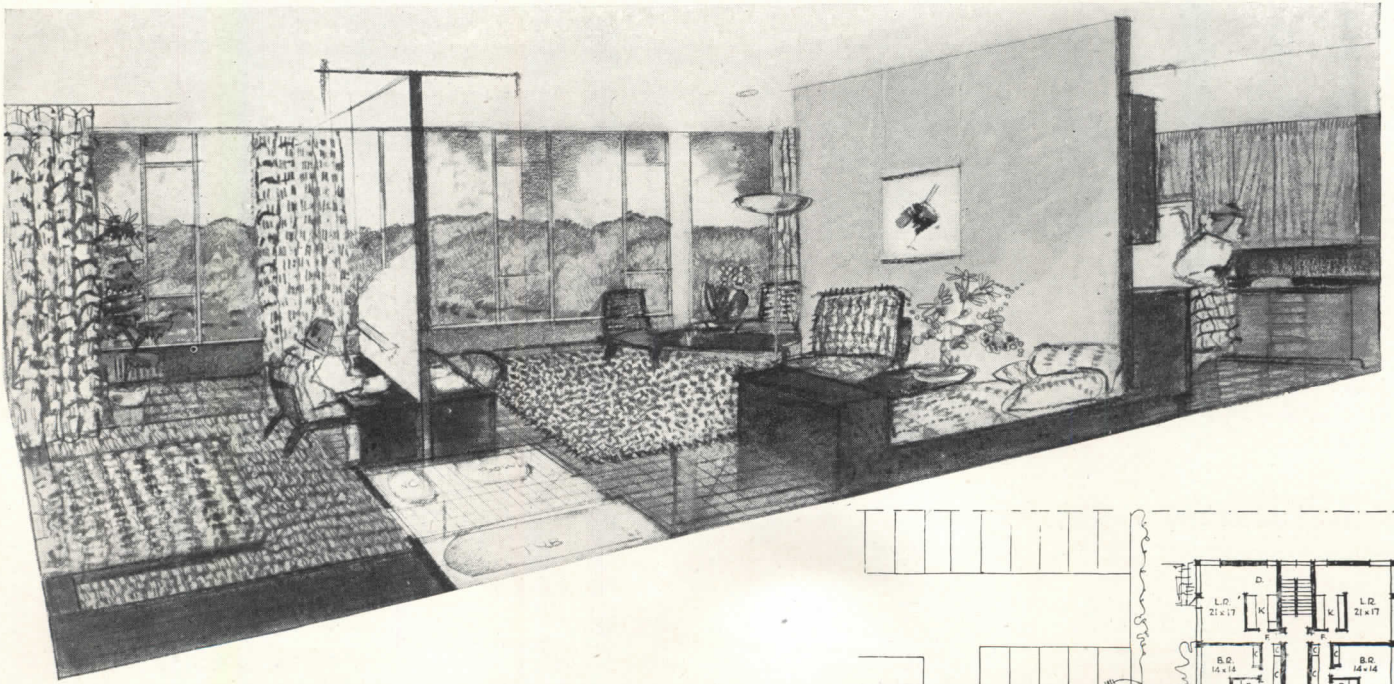
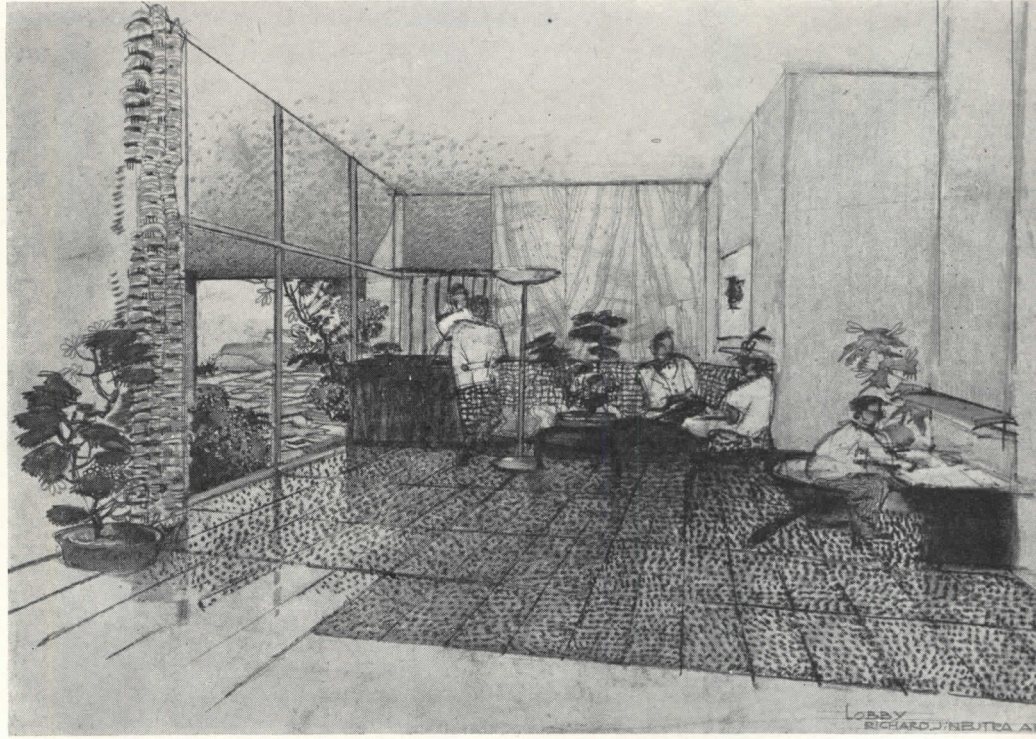

A typical small apartment is sketched here in perspective, indicating the possibilities for flexibility in furnishing and use of space. The large windows will give added spaciousness to already amply sized rooms

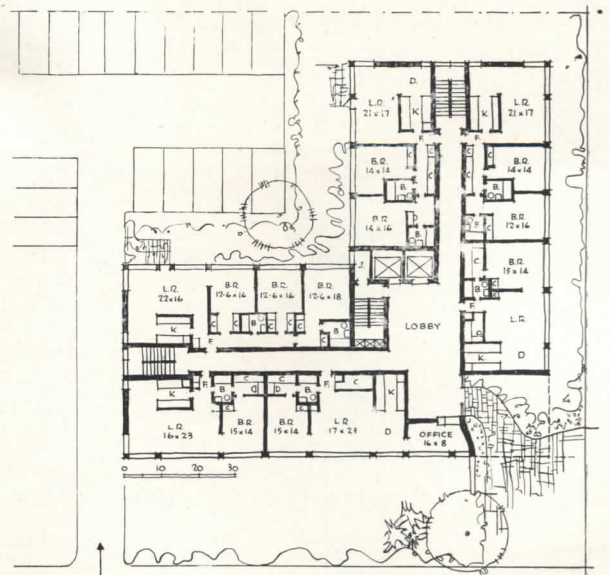

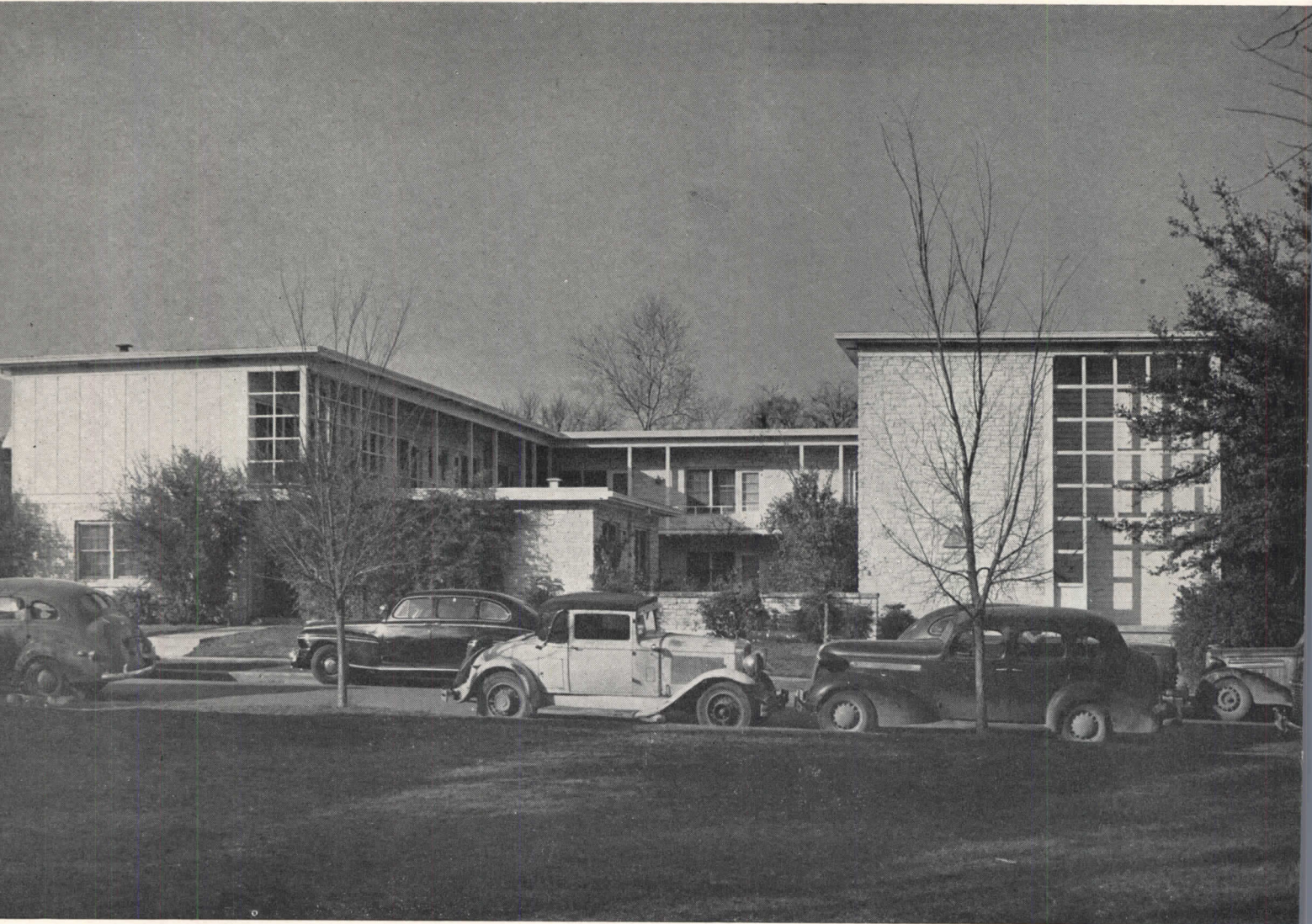

STUDENT APARTMENTS IN TEXAS

Page, Southerland & Page, Architects

An unusual type of student apartment building, built by private individuals near the University of Texas in Austin, might well be adapted for the housing of college students in other sections of the country where crowded conditions are likely to prevail for some time to come at our institutions of learning. This example was completed just before the war. It is of wood frame construction faced with handworked native stone veneer. Each apartment accommodates two students and is fitted with beds, study desks, bookcases, large clothes closets, and a bathroom with stall shower. Ample through ventilation is provided and heating is by nat-

ural gas space heaters. Garages, originally built as shown on the plan, were later converted into additional apartments. Interior walls in the rooms are finished with vertical V-joint pine boards and all woodwork is also pine. Bathroom walls are plaster, with tile wainscot and tile-lined shower stalls. The control office and an apartment for the owner or manager is included in the one-story wing at the entrance to the court. This type of accommodation is popular with the students, who find it superior to the usual dormitory and boarding house sort of thing. Competent architectural design makes such a project an attractive addition to a college vicinity.

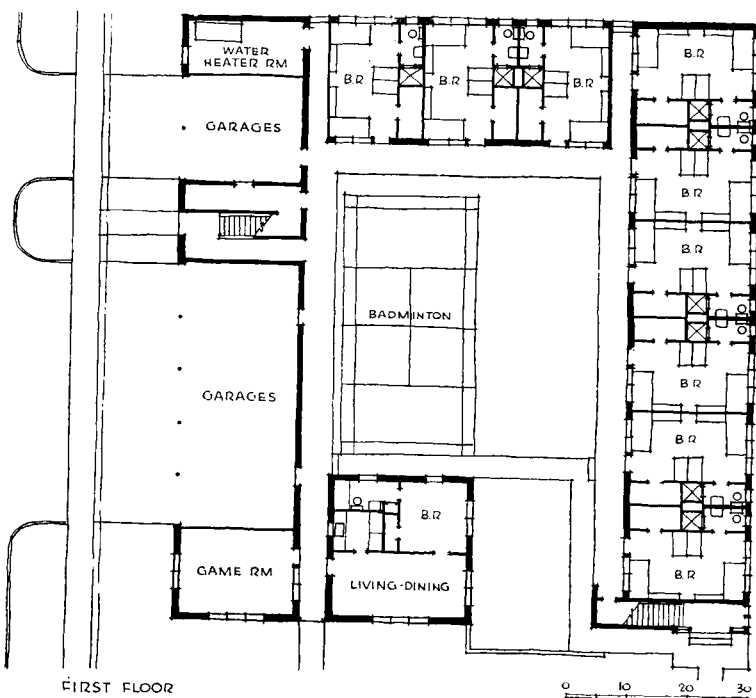

The compactness and simplicity of the standardized individual apartment unit makes for economy of construction. The fact that all the apartments are essentially alike should also be a factor in making the management problems simpler



VETERANS' COOPERATIVE APARTMENTS IN NEW YORK

Charles E. Greenberg, Architect

To provide for the veteran who wants more than minimum housing and is financially able to undertake to buy it, a 600-unit cooperative apartment project has been launched in New York with the full approval of the Veterans Administration. Known as "Great Oaks," it is to be built on an eight-acre wooded site in the Riverdale section of the city. Four 12-story buildings, each with a two-story, 150-car garage attached, will leave 70 per cent of the plot for walks, planting, and playground. Each typical floor will contain 10 4½-room apartments, one 3½-room, one 5½-room, and one 6½-room, all of

the luxury type, for veterans of "better than average income." Monthly carrying charges are estimated to average about \$25 per room per month, including interest, amortization, taxes, maintenance and operating costs. Because the buildings are for veterans, the promoters, the Basic Builders Corporation, anticipate that they will be able to secure materials and equipment without delays and at reasonable prices, the benefits of which savings they promise to pass along to the cooperative corporation. The buildings are designed to be of reinforced concrete construction, with red brick facing.

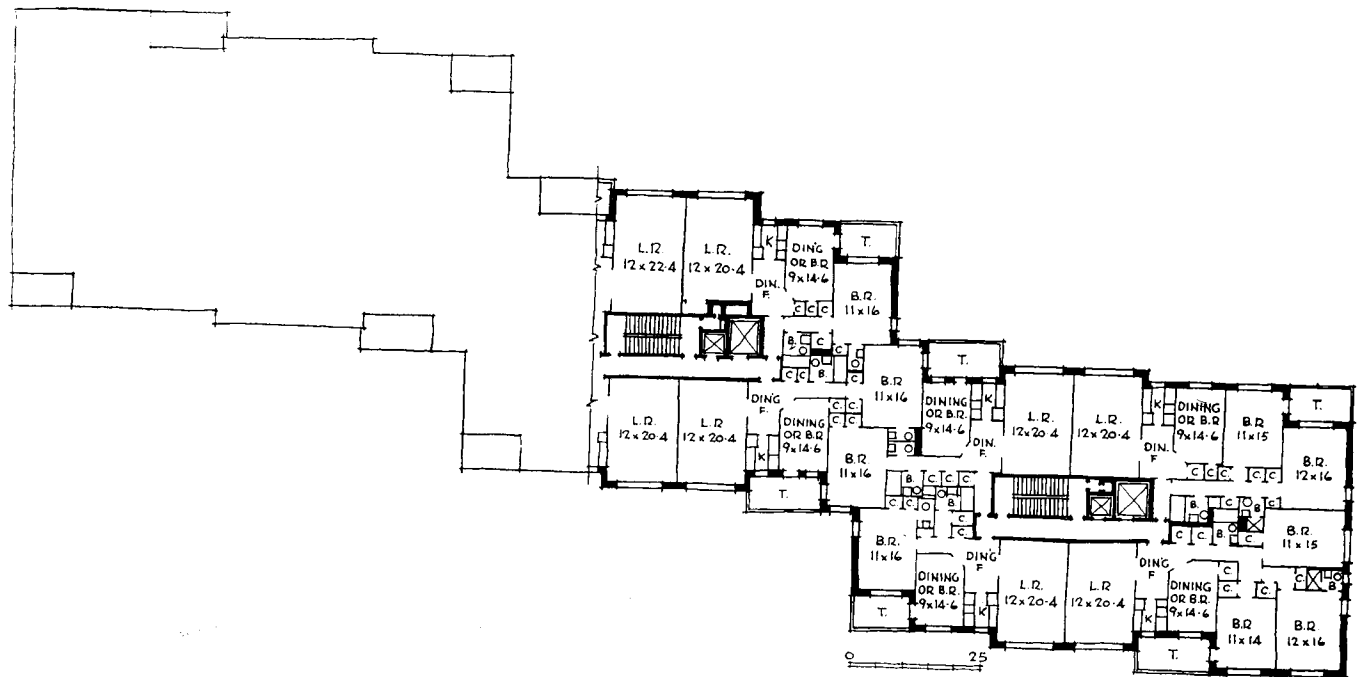

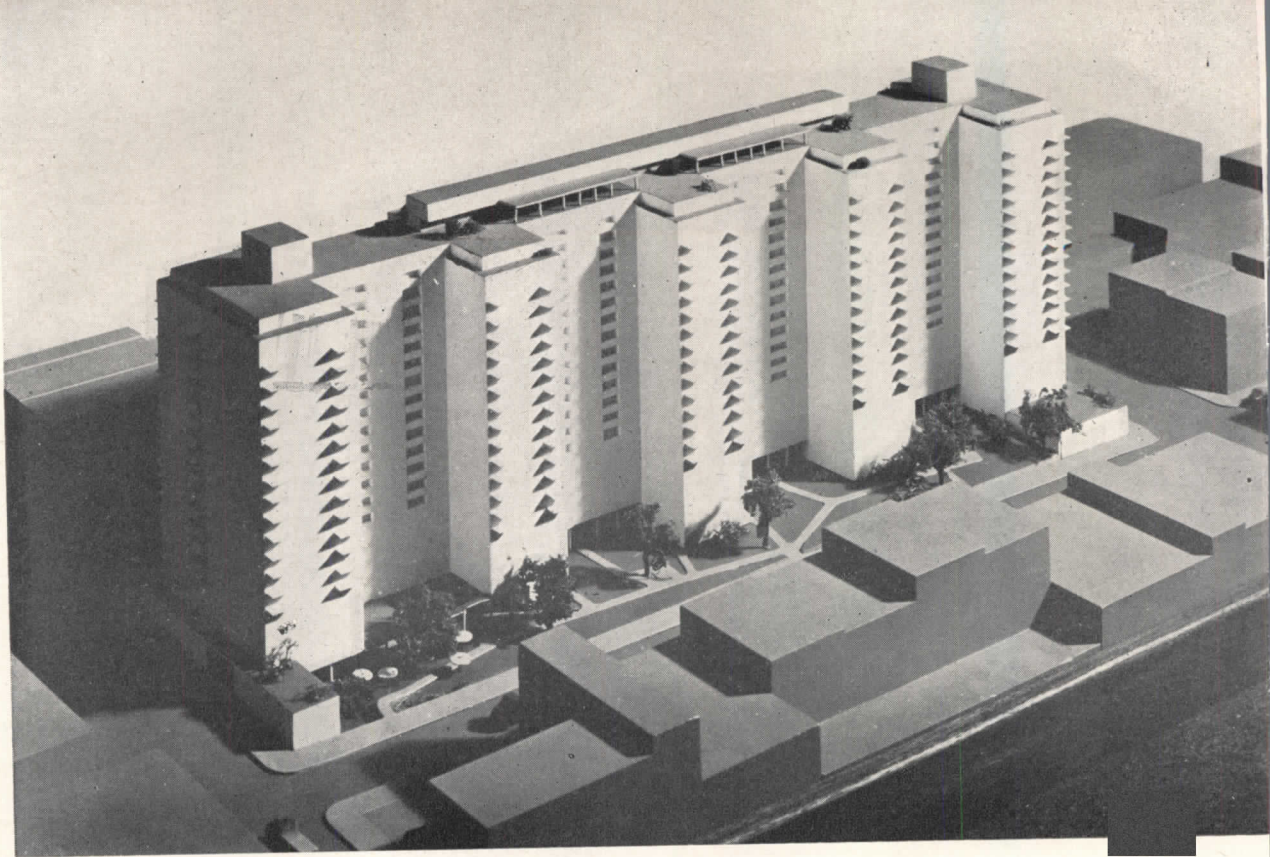

A NINETEEN STORY CITY APARTMENT

Mayer & Whittlesey and Skidmore, Owings & Merrill, Associated Architects

Somach Photo Service

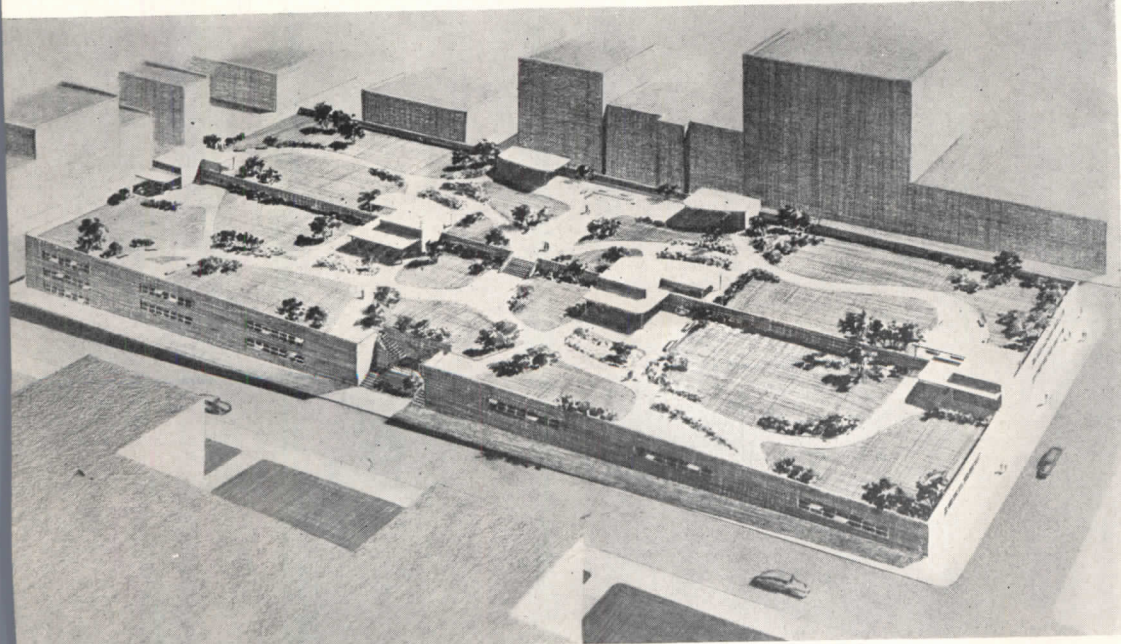

The entire block south of the New York Life's proposed apartment building would be converted into a partly subterranean garage with a landscaped recreational garden on its roof

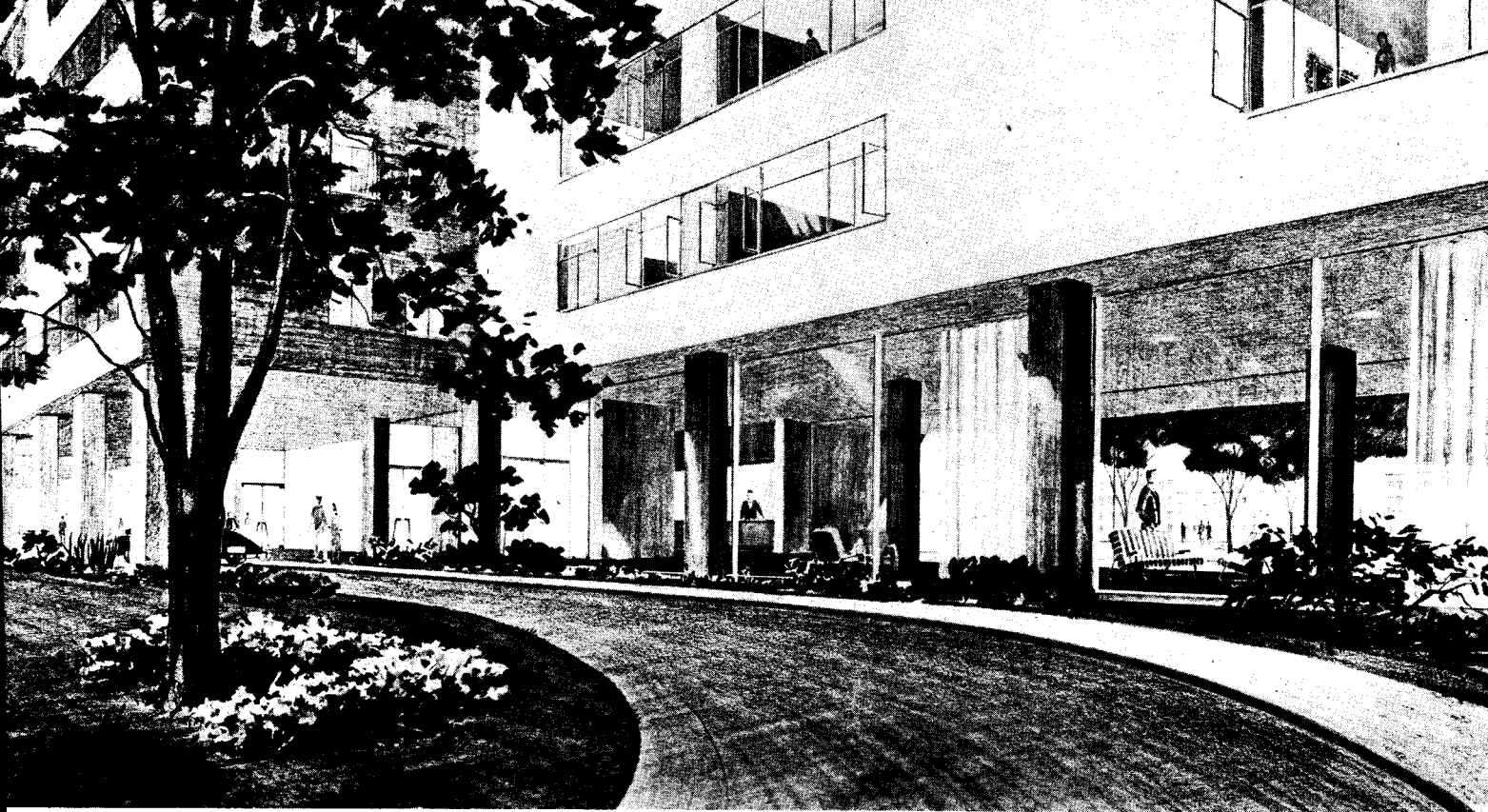

Rendering by George Cooper Randolph

THE use of land in New York residential areas has stuck pretty rigidly to traditional formulas and has seldom been approached with as fresh an eye as was applied by the architects of the New York Life Insurance Company's latest apartment house project. Boldly turning their backs on the usual practice of building along the street lines with open courts in the interior, they have planned for a long, narrow, 19-story building running through the entire middle of

a city block, from east to west, and leaving substantially wide landscaped areas along the streets to the north and south. The sketch model across the page tells the story. Maximum light and air and distance from surrounding structures were the stated objectives. Accompanying the building, and occupying another entire block adjacent to it on the south, would be a 1400-car garage with two stories above grade, surmounted by a park.

Preliminary sketches indicate the probable character of the architectural design that will eventually be built, on the site between Sixty-fifth and Sixty-sixth Streets and Third and Second Avenues



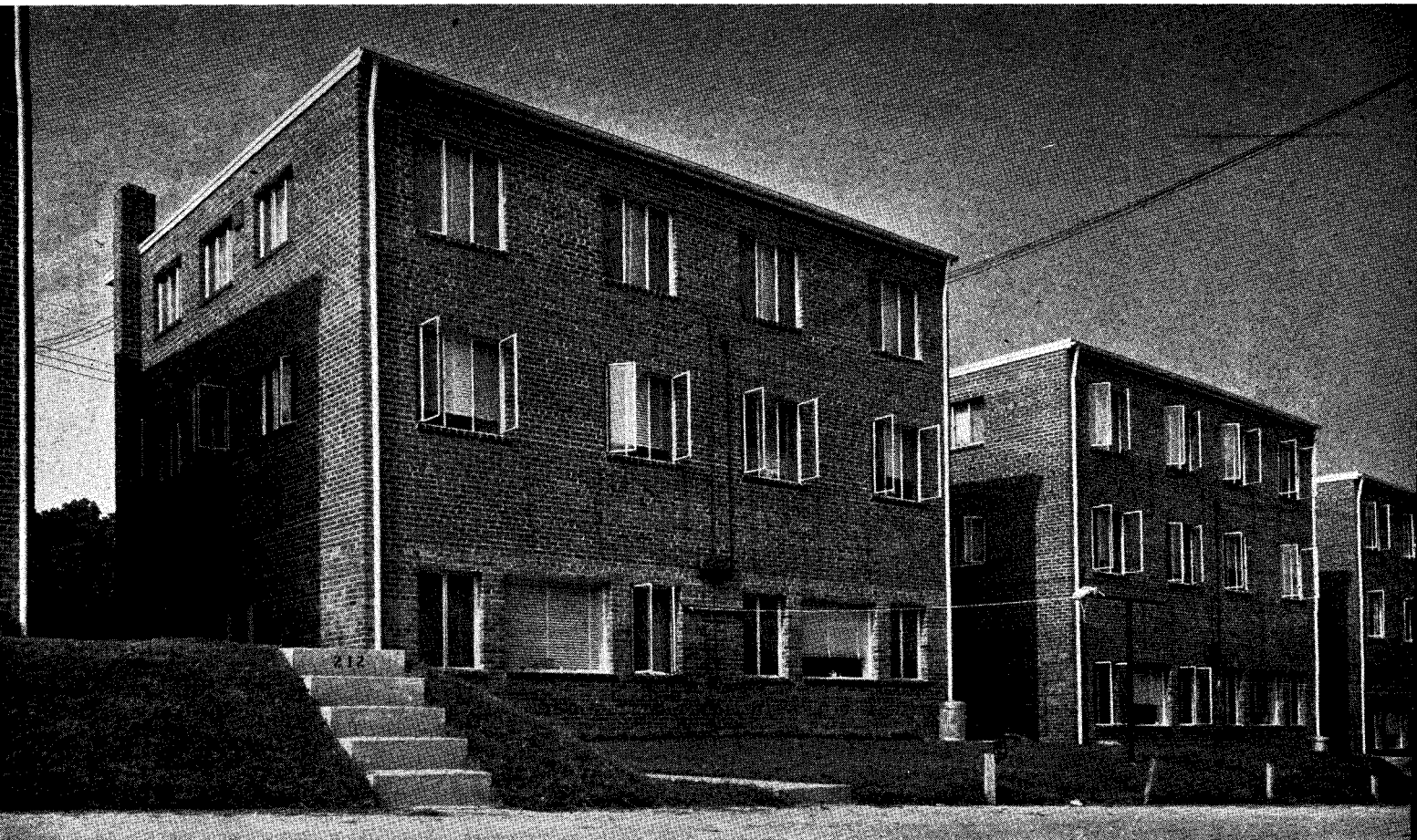

IMPROVED HOUSING FOR WASHINGTON, D. C.

DEVELOPMENT FOR J. B. TIFFEY AND SON

The simple, economical, clean-cut exteriors of the new projects make obsolescent the unsightly, cluttered, stair-dominated older type of project shown below

Berla & Abel, Architects

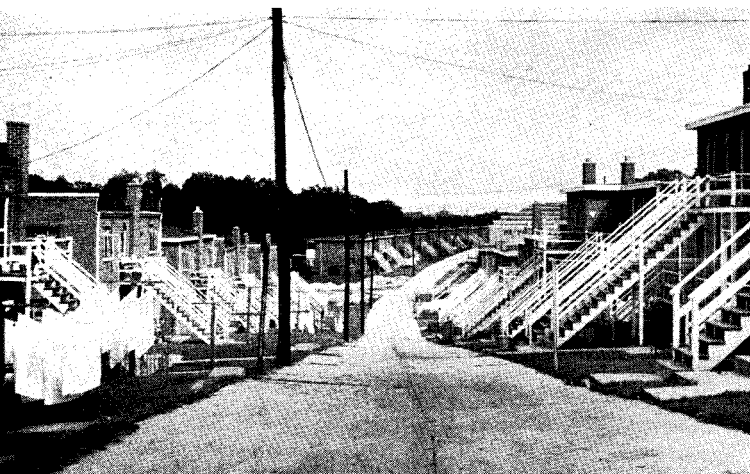

IMAGINATION, ingenuity, and experience made possible a group of most economical housing units that take full advantage of the interesting terrain and the sloping site. A study of the plans on page 134 will show how an inside stair gives access to all floors yet insures privacy for each flat, and no longer are there unsightly exterior stairs like those shown at the left. Apartments are judiciously planned for modern living and tenants have easy access to outdoor terrace and garden areas. Roofs are thoroughly insulated above the plaster ceiling and a continuous screen vent provides ventilation above the insulation.

It is interesting to compare these photographs of the actual project with the preliminary drawings shown in ARCHITECTURAL RECORD for May, 1946.

Richard Garrison, Photos

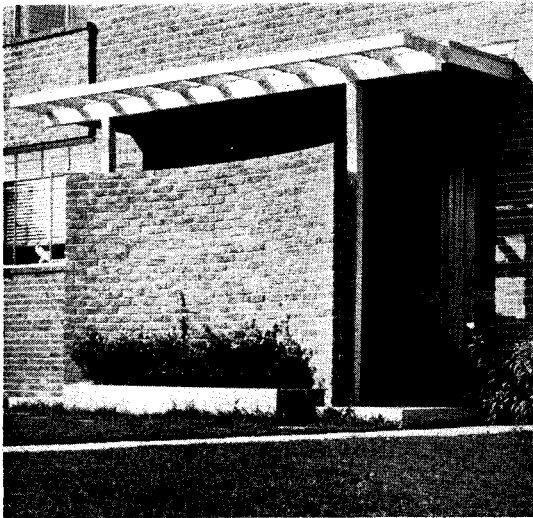

Entrances on the two-story side of the units are given varied character by the use of trellis and curved brick walls. The large windows and Venetian blinds provide floods of easily controlled light

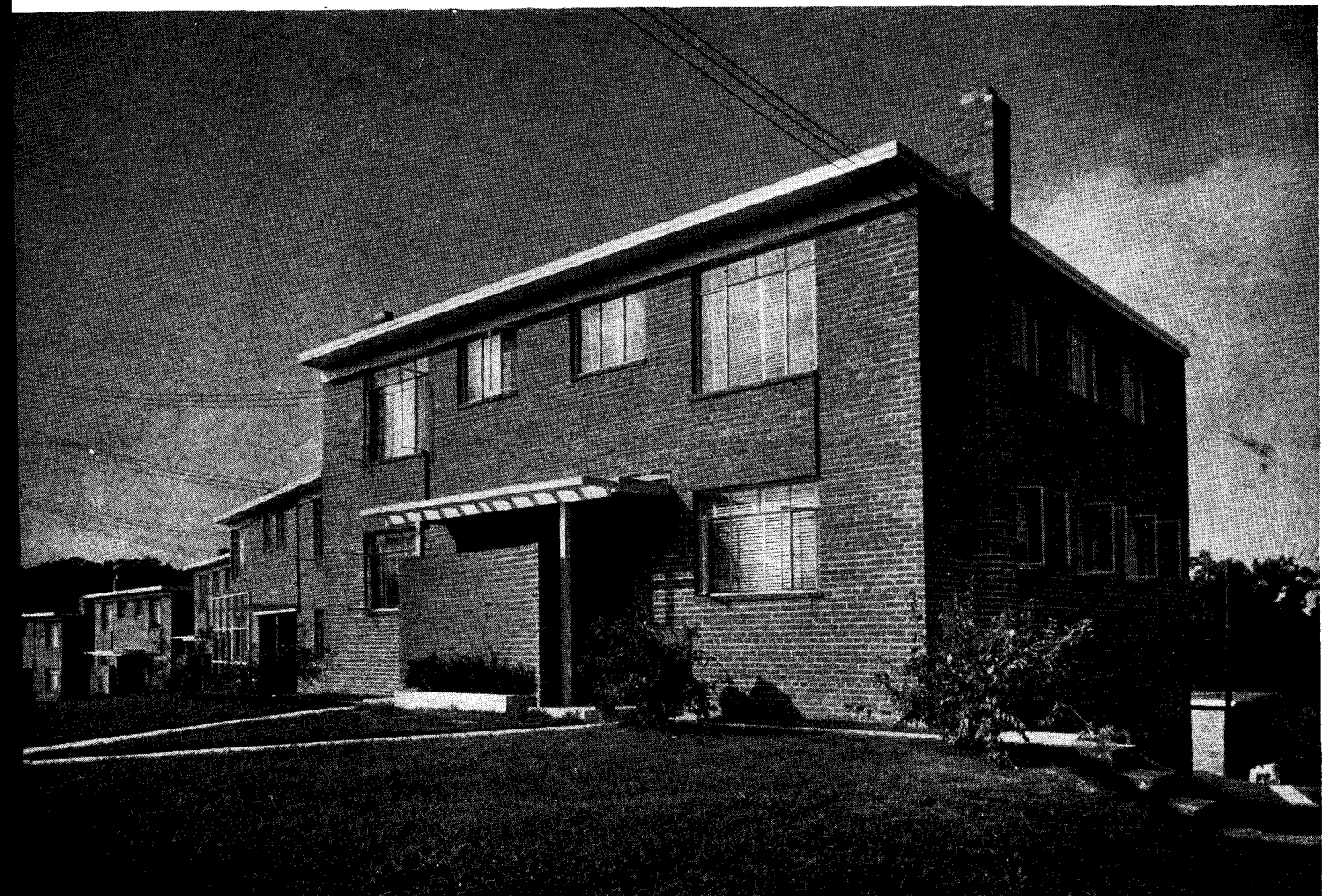



The slope and curve of the access street add to the attractiveness of the approach to the entrances to the apartments



The three-story side of the group opens on terraced lawns with provisions for drying clothes. Below, plan showing duplex apartment with its large living room and kitchen, three bedrooms and bath. Also, the compact top-floor apartment

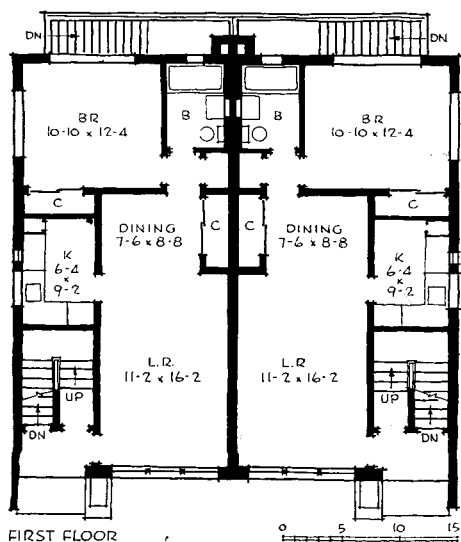
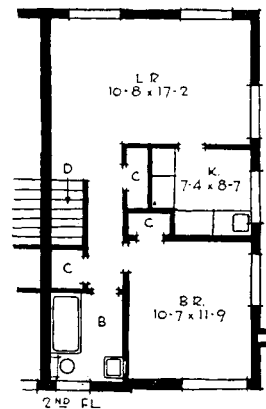
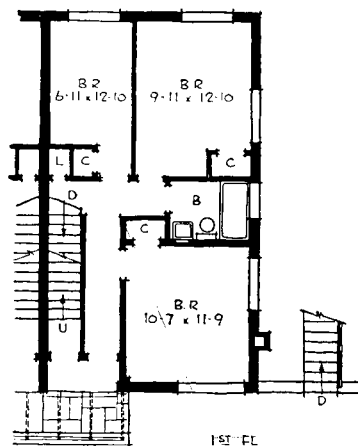
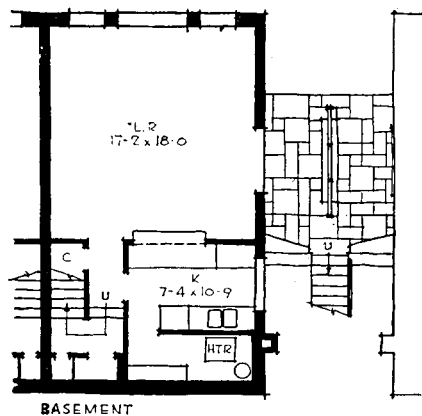

Plan and rear view of a variation in type showing single-bedroom apartments with combined living and dining rooms

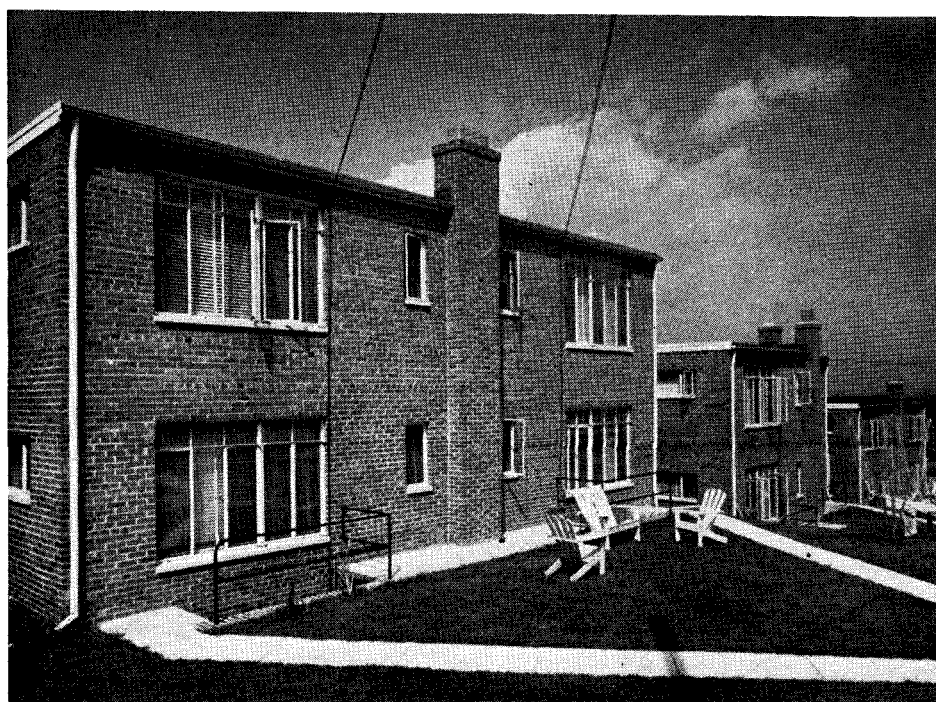

ARCHITECTURAL ENGINEERING

TECHNICAL NEWS AND RESEARCH

THE WALL OF THIN SELF-FRAMED METAL PANELS

By Robert L. Davison, Director of Research, and Howard T. Fisher, Architect

Sponsored by the Department of Commerce,* the research reported herewith was intended to furnish architects and manufacturers with the basic design for a fireproof lightweight wall system which would (1) be applicable to conventional steel or concrete building frames; (2) would satisfy requirements of fire resistance, weather resistance, insulation, lack of condensation; (3) would

*Industrial Research & Development Division in the Office of Technical Services

PROBABLY the major obstacle to the free development of the wall is the recession which took place as the consequence of unbalanced progress one hundred years ago. The cast-iron and glass exterior screens of the crystal palaces were conceptually a hundred years ahead of their time. They were structurally light in weight, prefabricated, quick to erect, durable; yet architects, depending on precedent, had not hit on devices to filter out an excess of sunlight, to retain warmth, or avoid destruction by disastrous fires. When heavy masonry casings came back as fire protection, the treatment of this masonry was doubly honorific in the inherited sense. Codes still require not only masonry encasement of steel, where the need of protection is real, but heavy

masonry spandrels, where the element of fire protection must be considered as wholly imaginary when one recalls that the fire resistance of the adjacent glass is virtually nil, so the total result can scarcely be improved by the fireproof masonry.

Accepting the desirability of an encased skeleton, a great many experimenters have worked on the problem of a thinner, lighter "curtain" or filter wall, producible industrially in larger units ready for assembly by labor easily trained for the simple job.

However difficult it would be, as a matter of sound engineering sense, to justify the high fire resistance required by public authorities in the non-glass areas of this filter screen, designers find it is necessary as a practical first step to

be mainly shop-fabricated, could be easily erected by average contractors at the site; (4) would have a lower first cost and lower maintenance than conventional wall.

As a further development from Mr. Davison's previous work with William Lescaze sponsored by the New York Housing Trust, the present panels dispense with auxiliary studs, employ one joint throughout the entire panel system

meet the existing legal requirements.

Meanwhile the architectural profession has arrived at the point where it can handle thin straightforward filter-screen walls satisfactorily both in function and design.

The research reported in these pages is the latest step in a twenty-five year series participated in by researcher Robert L. Davison, and an experience only slightly shorter on the part of architect Howard Fisher.

In 1946, the last previous step was a careful investigation of the "curtain" or filter-screen exterior wall by Davison and architect William Lescaze, subsidized by the non-profit private New York Housing Trust. Next page shows the spandrel-panel system that was arrived at in 1946, and that constituted the point of departure.

As a practical matter, the research in both instances assumed existing conditions in the skeleton structure and in code requirements. The object was not to create a new skeleton and skin in combination, but to create a skin that could be applied to conventional skeletons, taking into account all possible variations in column spacing, floor-to-floor heights, fenestration. Above and beyond this, in both investigations it was stipulated that the new curtain wall must out-perform conventional masonry functionally and be not only lower in first cost but more profitable to the owner ultimately.

Both investigations resulted in a panel system essentially "horizontal," consisting of two strips, running around the building; the lower ring attached

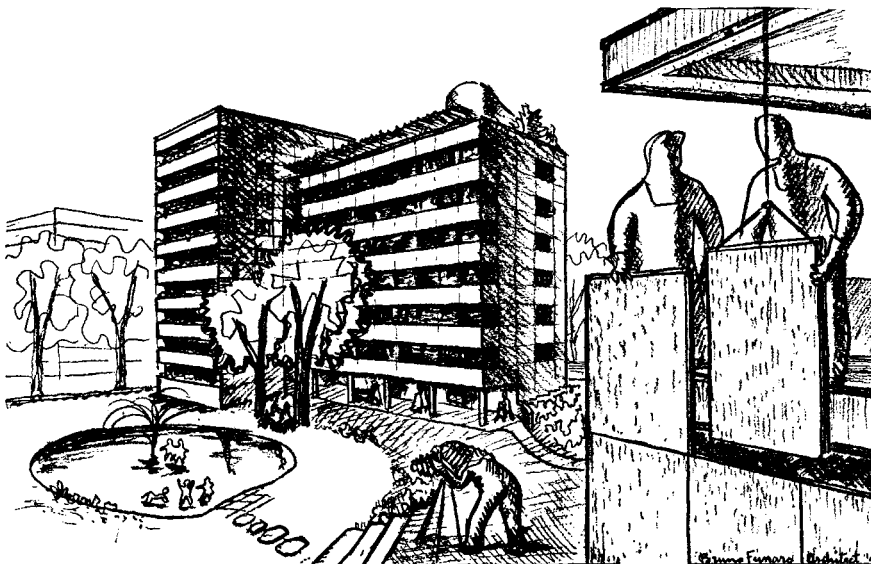

to the spandrel beam and reaching to window-sill height and supporting the upper ring which is composed of any desired combination of window and filler panels.

The greatest difference is that the earlier system required an auxiliary set of lightweight intermediate studs which is eliminated in the later method. (Center of page.) The new system incorporates the required structural strength and wind resistance in the panel frames.

In all possible ways the system has been made independent of variable dimensions in the structural building frame. There is no attachment to vertical columns and no need of conforming to variable column spacing.

The effect of variable floor-to-floor heights is minimized by the avoidance of structural members reaching from floor to ceiling; there is a full break at the window sill. For low-cost housing applications, the research assumed an average floor-to-floor height of 8 ft. 8 in., and use of steel casement sash having a vertical dimension of 4 ft. 2 $\frac{7}{8}$ in., leaving a spandrel height of approximately 4 ft. 4 in. Spandrel widths were taken at 4 ft., conforming to dimensions of most facing materials. The resulting panel dimension of 4 ft. by 4 ft. 4 in. was within the limits demanded for easy handling. Using foamglas as an insulating material in metal-clad panels, a thickness of 3 in. was found adequate for a 1 $\frac{1}{2}$ -hour fire rating, or a thickness of 4 in. for a 2-hour rating. Structurally the 3-in. panel was still intact under test at the end of 4 hrs. These dimensions yielded more than adequate, but not wasteful, structural strength and insulation.

Overall objectives:

1. A spandrel thinner than the conventional masonry wall, creating added floor area within the building line.
2. A wall lighter in weight than conventional masonry walls, permitting reductions in structural framing sizes and in foundations.
3. Prefabrication of spandrel wall in units of the largest size that can be handled efficiently and can be adapted easily to varying building designs.
4. A wall so designed that it can be easily and quickly placed, employing a minimum of special equipment and skilled labor.
5. The new wall should be completely prefinished, inside and out.
6. It should be capable of being placed entirely from the inside, so that outside scaffolding may be eliminated.
7. It should have strength, durability, weather resistance, and fire resistance adequate for its needs, but not wasteful.

THE CONCEPT OF THE THIN CURTAIN OR FILTER WALL

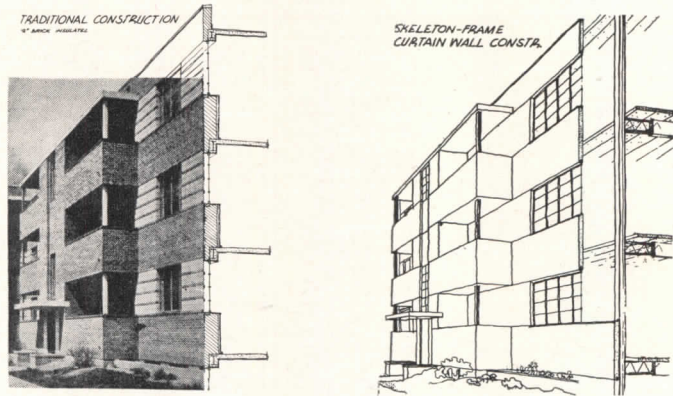

Thick masonry walls (left) reappeared in taller buildings, as a code requirement, after the "unbalanced" progress one hundred years ago resulting in cast-iron and glass walls. The thin "filter-screen" wall (right) is said to overcome obstacles, including fire

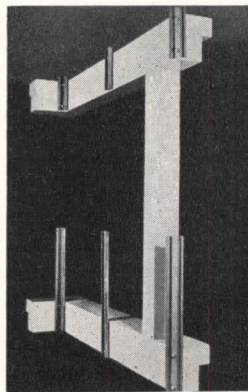

A 1946 research of R. L. Davison with Wm. Lescaze resulted in this system of auxiliary studs. In the present research, 1947, these are replaced by self-contained frames

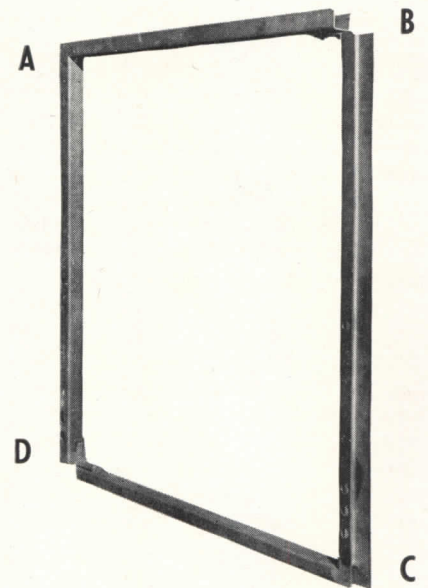

8. The new wall should be practical for any multi-story building regardless of floor plan, window arrangement, or structural framing system.
9. The wall should have better than conventional insulation value.
10. The spandrel wall should cost less than conventional construction.

Method of Attack

In accordance with the plan of attack described above, a key drawing was first made, showing all of the conditions likely to be encountered in actual use and designating each type of panel and

each joint with a letter or number symbol.

The first joint studied was the connection between the spandrel panel and the building frame. Previous thinking had called for a separate structural member to be attached to the building frame and to which the spandrel panels were later fastened. In order to reduce the number of parts and the number of field operations to a minimum, it was decided to incorporate the structural member in the frame of the panel. In order to reduce the length of the cantilevered portions of the structural mem-

ber, the connections to the building were spread as widely apart vertically as possible, being made at the top and bottom of the steel beam (with 2 in. of fireproofing), or a 12-in. reinforced concrete beam. Provision was made for variation in the depth of the spandrel beam in increments of 2 in.

Instead of attempting to level each spandrel panel separately, a continuous steel angle is first anchored to the building structure, at the top of the spandrel beam, and levelled, plumbed and trued by conventional building techniques, such as shims, grout, and slotted holes. A similar continuous angle at the bottom of the spandrel beam is then placed by jig from the upper angle. These two members form an accurate framework to which the spandrel panels are then attached. (Step 2 and 2a, page 139.)

The vertical joint between adjacent spandrel panels was attacked next. The general requirements of a joint are to

(a) keep adjacent panels together, (b) keep panel surfaces in perfect alignment, (c) prevent the passage of water, vapor, and fire, and (d) prevent panels from rattling. Another requirement, to allow tolerance for variation in panel size, was finally adopted, but only after serious consideration had been given to a type of interlocking joint in which each panel, as it is placed, is automatically pulled up tight against the adjacent panel. This type of joint results in a non-modular design in which the cumulative error due to the variation in panel size must be taken up by special corner or filler pieces. This scheme was considered practical only for buildings with large perimeters and few breaks in plan. Manufacturing tolerance for panels has been assumed to be plus or minus $\frac{1}{16}$ in. A modular type of design was adopted in which this variation is taken up in the width of the joint, resulting in a joint nominally $\frac{1}{8}$

in. wide, which may actually vary from $\frac{1}{16}$ in. to $\frac{3}{16}$ in. A thorough study was made of various types of joints: spline, tongue and groove, and lap. The solution as finally developed consists of two interlocking channels, insulated from each other and weather sealed at the faces by spring metal strips or rubber gaskets, or by caulking, if necessary. Through conductivity of metal between inner and outer faces has been avoided in all cases. This prevents condensation on the inner face and improves the fire-resistive qualities of the wall.

In the first try (which was designated "Scheme A") the different joints at the top and bottom of the spandrel panel were so designed that either a window or an intermediate panel could be installed at choice. In this scheme the joints were varied to obtain the best individual solution for every new condition, as for example at sills, window heads, etc. Panels could be positioned easily and erected beginning at any point; but the variety of joints, and especially of corners, would cause complication in manufacturing. (No photos.)

Therefore a new approach was taken. Since the vertical joint between panels appeared to be an excellent joint, interlocking and self-aligning, it was decided to use this basic design for all joints. This resulted in a heavier panel frame than was theoretically necessary, but permitted great simplification and economy in fabrication. The joint was modified and spring metal strips were added to make it tight fitting. No field connections are required other than to the building structure (1 bolt per 17 sq. ft. of wall). Windows are installed at the factory in a frame having the standard interlocking joint. Window panels are then placed in the wall like any other panel, without need for mastic, field drilling, or careful setting. The resulting system, designated Scheme B, seems to eliminate entirely the disadvantages of Scheme A: it has no extra parts and no field connections, and is reasonably simple to manufacture.

Scheme B, although it represents a considerable overall improvement, has its own disadvantages: because of the tight joint it is difficult to position the panels accurately; erection must be continuous from the bottom of the building to the top; the joints surrounding windows present an asymmetrical appearance. Present effort is being concentrated on the elimination of these points without sacrificing the advantages that have been gained. Field erection tests of full-size panels, which will be held shortly, will be an important part of this study.

Present designs are based upon a panel having perfectly smooth faces inside and out, and with no exposed fasten-

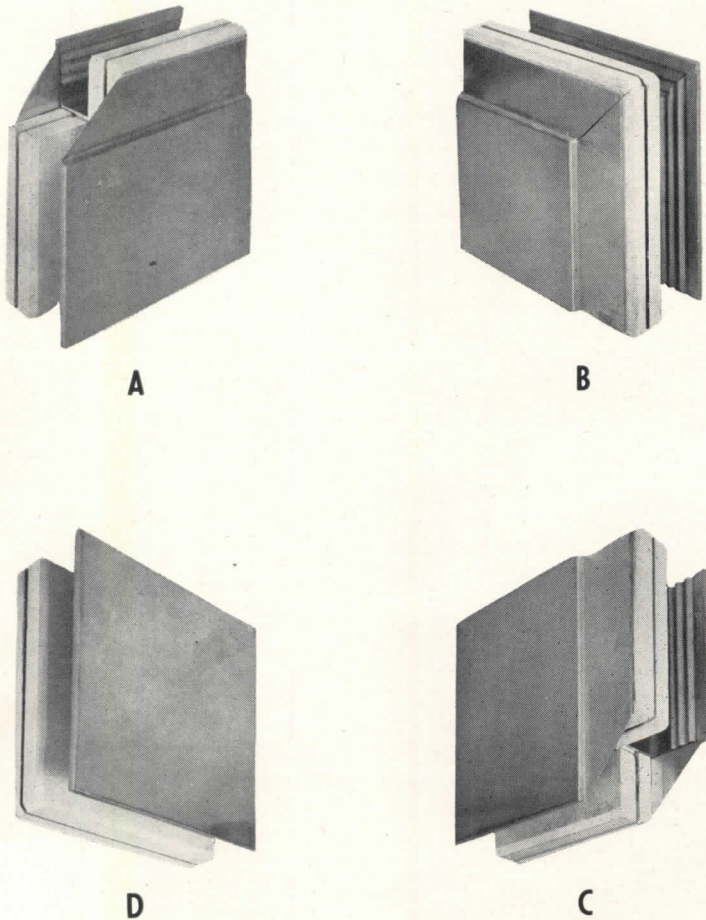

Each "spandrel" panel or other panel of the new system is manufactured in a self-contained frame. The four corners, pictured above, are lettered to correspond with the full view (across-page). Though structural and wind-bracing strength are slightly excessive, uniform frames are easier to fabricate and to assemble

ings. This has been done with the idea of imposing the least amount of design restriction upon the use of the new wall. Since a corrugated or otherwise rigidized face may eventually prove to be more economical, or desirable for other reasons, it may be advisable to market a series of stock patterns from which the architect may select; or the architect may create his own design at the cost of a new die for the panel face. It was felt that there might be some resistance on the part of the public to either smooth metal faces or mechanically regular patterns. There was therefore developed an irregular all-over texture which can be used for aluminum, stainless steel, copper or porcelain enamel sheets.

Materials to be used for the wall are not yet finally determined. Present specifications for the standard model call for cold-rolled steel frame and 24 gauge steel faces — stainless on the exterior and baked lacquer finish on the interior. Fireproofing around the frame is of "marinite." Core insulation may be "foamglas," "calcilite," vermiculite with sodium silicate binder, or asbestos or glass fiber with a foam binder. Probably a choice of finishes and insulation will be offered commercially for various applications. Aluminum, copper, and porcelain enamelled steel are other possibilities for facing material.

Although a solid type of insulation is assumed to fill completely the space between the inner and outer faces, the panel is not designed as a stressed-skin sandwich-type panel. A substantial steel frame forms the four edges of the panel; this frame is designed to take the entire load, without help from the core or the faces. This conservative approach was felt to be advisable until the new wall has obtained some measure of acceptance under the building codes of the major cities. It also facilitates the selection of materials for core, faces, and adhesive since their structural properties are less important in this type of design.

With steel faces and with "foamglas" insulation weighing 11 lb. per cubic foot, a 3 in. spandrel panel (17 sq. ft.) weighs 138 lb., and a 4 in. spandrel weighs 152 lb. With aluminum faces, the panel weight would be 22 lb. less, or only 116 lb. for 3 in. thickness, and 130 lb. for 4 in. thickness. The reduction of dead load by the use of such a wall in a tall building would yield pronounced savings in column and footing sizes.

An overall heat-loss of about 0.13 Btu/hr./sq. ft./° F is anticipated for the 3 in. wall, and 0.10 for the 4 in. wall. This is more than three times as good insulation as a conventional 12 in. masonry wall plastered (0.34) or an 8 in. wall furred and plastered (0.32).

A UNIFORM FIREPROOF JOINT, NO THROUGH-CONDUCTION

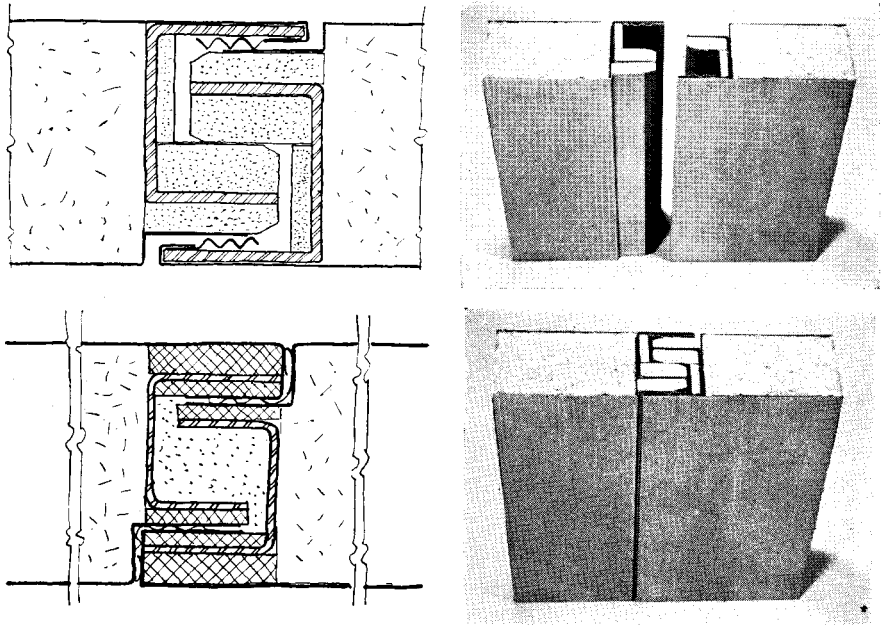

Drawing (top left) corresponds with the photographs on this page. It displays the basic scheme of two interlocking C's of metal, isolated from one another by strips of "marinite" to provide insulation, prevent through-metal heat conduction and the resultant condensation. (Lower drawing shows a later modification intended to insulate the metal channels from the exterior and interior panel faces.) Photos at top of page show the basic joint. At bottom of page: panel with built-in window frame (left pair); corner strip (center pair); corner strip with filler panel (right pair). ("Marinite" is a fireproof composition board that has long been used on ships)

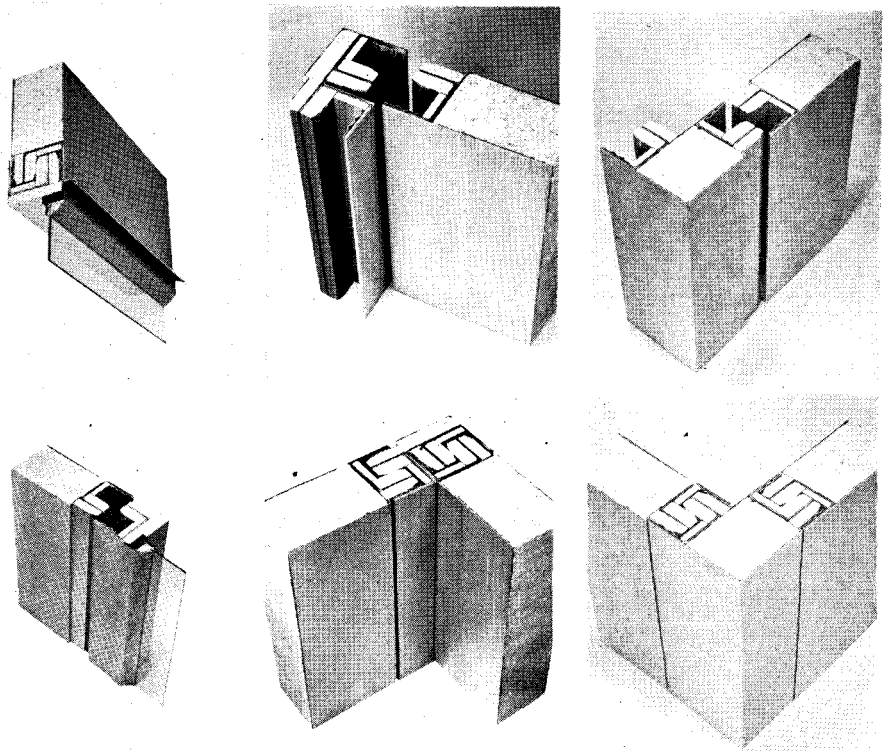

ERECTION IS WORKED OUT CONTINUOUSLY FROM BOTTOM TO TOP

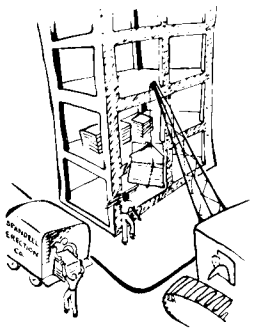

1

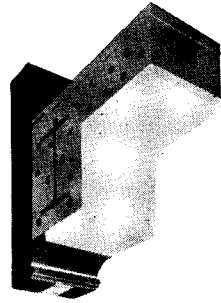

6

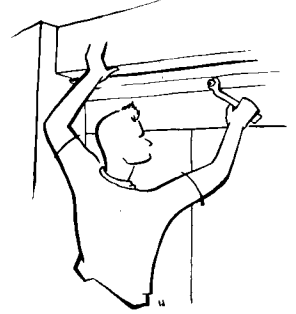

7

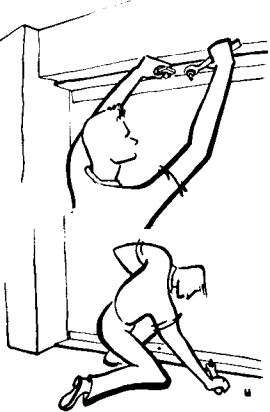

2a



2b

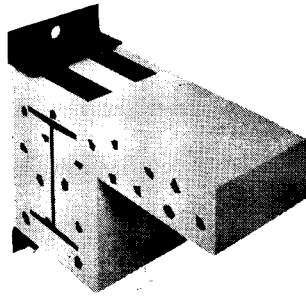

3

1, Materials stacked ready for use; 2, a & b, continuous angles are leveled, shimmed, and bolted to top and bottom of spandrel beam; 3, panels power-hoisted; 4, first panel held to top of beam by hollow bolt at flanges; 5, adjoining corner of second panel bolted through hollow bolt of first panel; 6, process repeated at bottom of spandrel beam; 7, 8, integral window panels, or filler panels, bolted and held temporarily by a strap jig; 9, strap jig removed as next spandrel panel is placed; 10, possible portable scaffold and lift for large-scale work

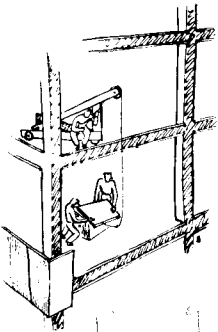

8

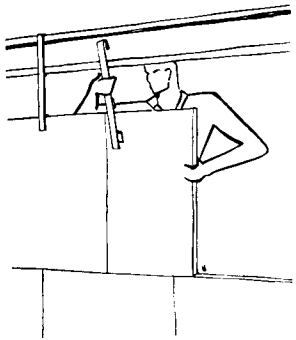

9

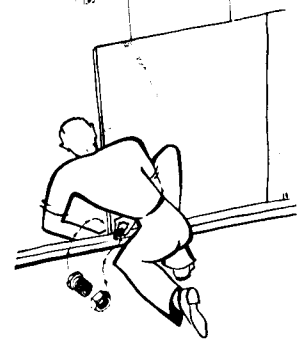
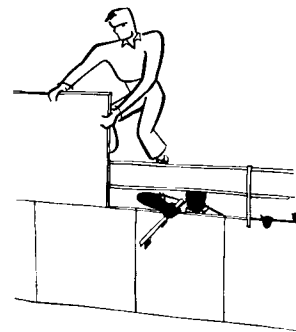

4

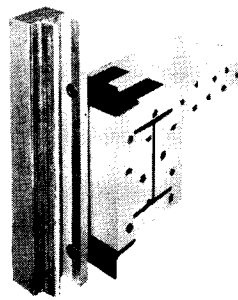
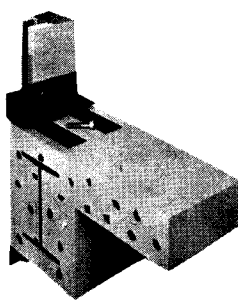

5

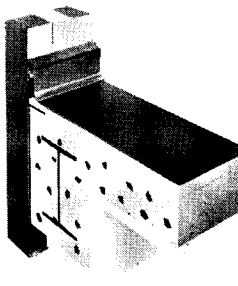
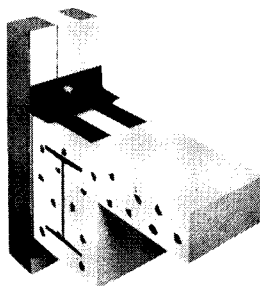

10

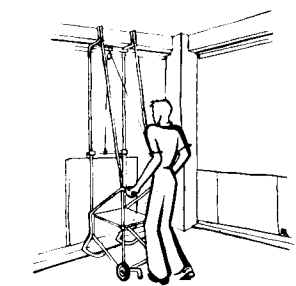

FIBERGLAS BUILDING

MORE than a score of Fiberglas materials, ranging from air filters, thermal insulation batts, acoustical blankets and tiles, to glass yarns for fabrics, are used in the new building of Owens-Corning Fiberglas Corporation, shown at the right. The building, a completely remodeled brownstone, houses the firm's New York staff and serves as a finished demonstration of the architectural uses of glass in fiber form.

The architects, Skidmore, Owings and Merrill, were asked to use Fiberglas materials wherever practical, regardless of whether they had been used before in an

office building. Several of the acoustical wall and ceiling treatments, for example, were designed originally for industrial plants.

Structural use of Fiberglas is in the form of a fabric impregnated with asphalt, used as a waterproofing membrane between the limestone face and the brick backing. Fiberglas insulation is installed under all floors and beneath the roof. The building is completely air conditioned, with banks of Fiberglas air filters for straining out dust and pollen. Air ducts and steam piping are Fiberglas-insulated.

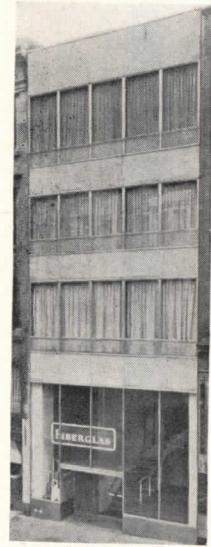

Open office area and reception group. Acoustical wall treatment consists of an aluminum grille backed by a dark Fiberglas mat over Fiberglas batts between furring strips. The suspended ceiling (Miller system) is Fiberglas acoustical board resting on fluorescent light troffers, as shown at right, across-page



Below, private office. Walls are surfaced with resin-impregnated Fiberglas mats cemented to plasterboard. Below right, for a sound-absorbent ceiling acoustical Fiberglas blankets are hung on a platform of Fiberglas cords, beneath which will be white fabric of woven Fiberglas yarns



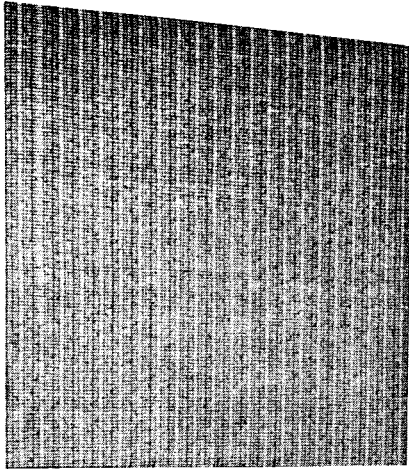

Another executive office. One wall is paneled and "padded" with acoustical blankets covered with black and white Fiberglas-wool fabric, close-up at left. Ceiling is Fiberglas acoustical tile (Securitee system)

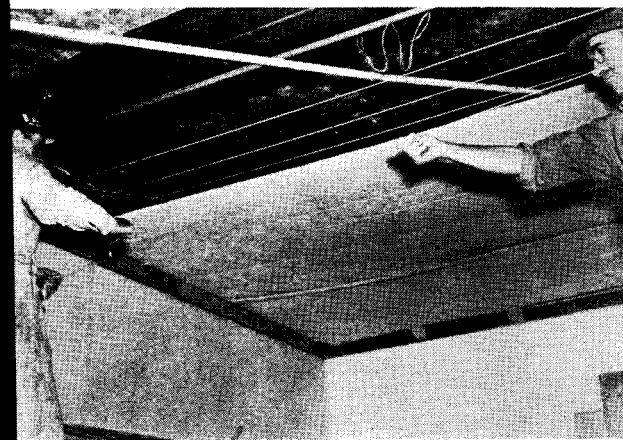

Below, reception area. Here, as elsewhere throughout the building, Fiberglas yarns are incorporated in upholstery fabrics. For room quiet, since typewriter desks adjoin, the wall is faced with perforated aluminum sheets fastened to furring strips, with Fiberglas batts between. Installation is shown in photo, below left

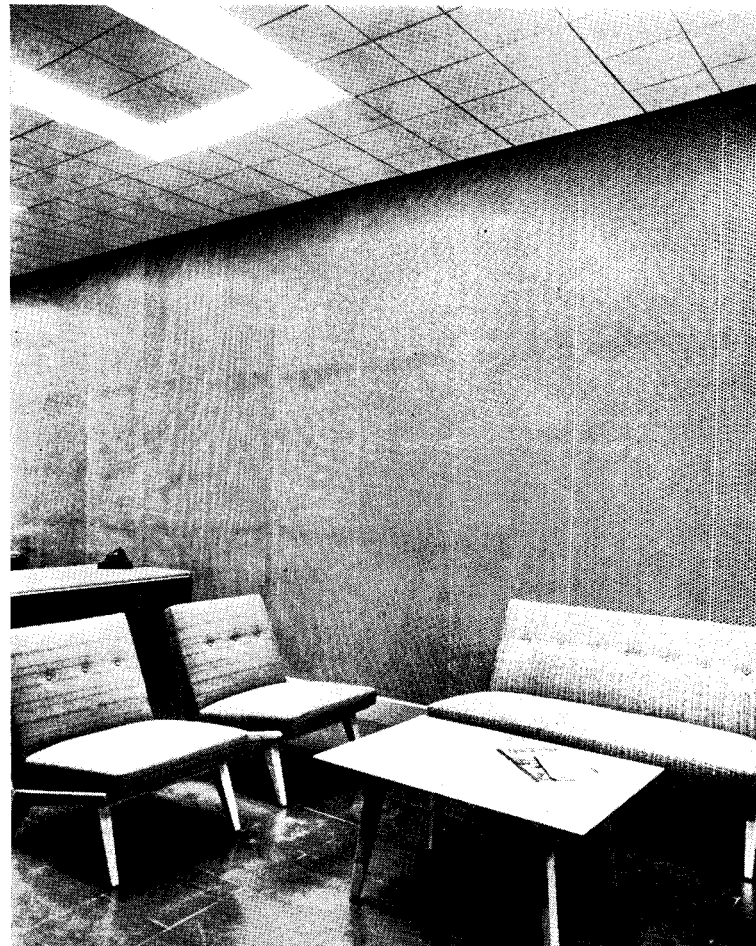

PRODUCTS for Better Building

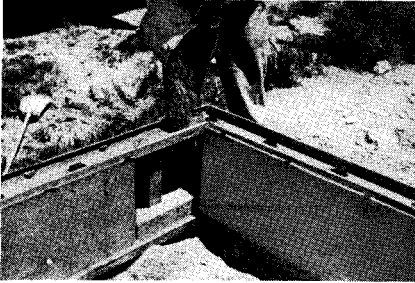

Concrete skeleton system of house construction. Above, basic elements are concrete-filled steel channels and square tubes, to which are clipped side panels of insulating board. Below, wall removed to show steel-encased concrete framework

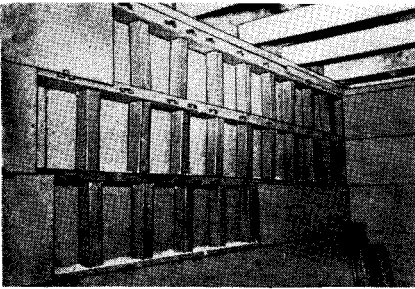

CONCRETE STRUCTURAL SYSTEM FOR HOUSES

A concrete skeleton system of construction is being used for low-cost mid-west houses. Using two types of light-weight interlocking metal members, to which side panels of insulating board of plywood are secured by metal clips, the new process enables unskilled workers to erect walls of steel-encased concrete framework without the use of heavy

machinery. Assembly is as follows: first, cement is poured into channels placed along the top of the footing or basement wall. Sections of insulating board are then fastened on each side of this bottom channel by means of metal clips. The second channel strip is clipped to the top edges of the insulating board, square tubes inserted into openings in the channel, and cement poured into the tubes. The lower ends of the tubes hang slightly above the channel base below so that concrete spreads out at its base. The process is then repeated as the wall rises, level by level. The Modern-Wall Co., Box 266, Osborn, Ohio.

GLASS-LAMINATE PANELS OF VARYING WIDTHS

An unusual new glass and plastic laminated building material has been introduced under the name of *Prest-Glass*. While retaining the sheen and permanence of glass, it is flexible for shaping to curved surfaces, non-brittle, and elastic in the sense that it snaps back to original shape after bending. *Prest-Glass* comes in corrugated panels of varying widths and heights up to 8 ft.; translucent or opaque, dull or glossy, and in a choice of 15 colors. It is said to have great dimensional stability, showing no measurable changes in size over a wide temperature range, so that cracking, bending, or buckling is eliminated. Its fire rating is noncombustible. The material can be cut with shears and power tools, and can be nailed, stapled, punched, trimmed, and cemented, lending itself readily to a number of architectural treatments. *Prest-Glass, Inc.*, 8 E. 12th St., New York, N. Y.

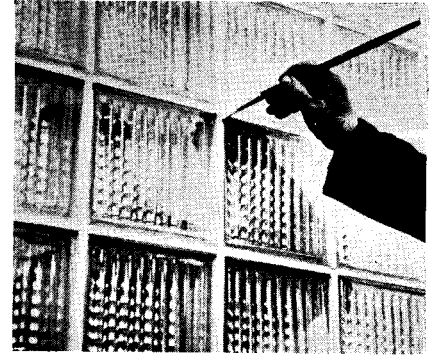

Mortar sealant for glass brick walls

SEAL FOR GLASS BLOCKS

A new mortar sealant has been formulated especially for glass block mortar joints. Since glass is nonporous, ordinary mortar often fails to form a good mechanical bond. When the mortar shrinks, cracks appear, leaving an opening for moisture penetration. The new mortar sealant, known as *Klee Sealant*, is of plasticlike consistency, rubbery when dry, and is said to bond tightly to mortar, glass, tile, brick, metal, and wood. Application is by caulking gun, or with a brush when the sealant is thinned with suitable solvents. Limited quantities are available; in white or colors. The American Fluresit Co., 635 Rockdale Ave., Cincinnati 29, Ohio.

ROOFING NAILS

Several manufacturers are offering umbrella-head, screw-type, and straight nails with *Gora-Lee neoprene washers* already in place, for fastening metal roofing and siding. Principal attributes of the washers are quoted as (1) long-lasting resilience, (2) the effective sealing of tiny cracks and crevices around nail holes, and (3) the elimination of corrosion resulting from contact between dissimilar metals. Accordingly, pro-

(Continued on page 164)

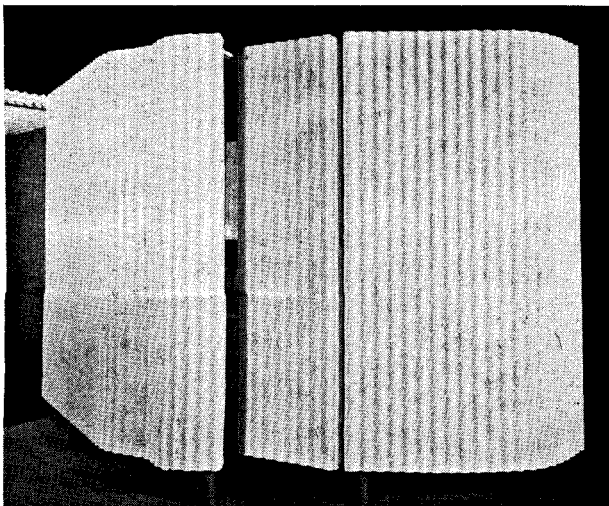

Glass-and-plastic laminated panels are flexible and can be bent to fit curved surfaces; come in colors, translucent or opaque

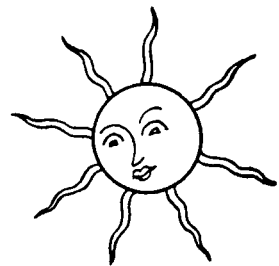
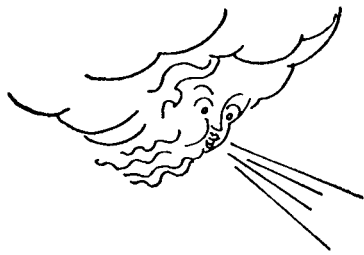

it goes on the **ROOF...**

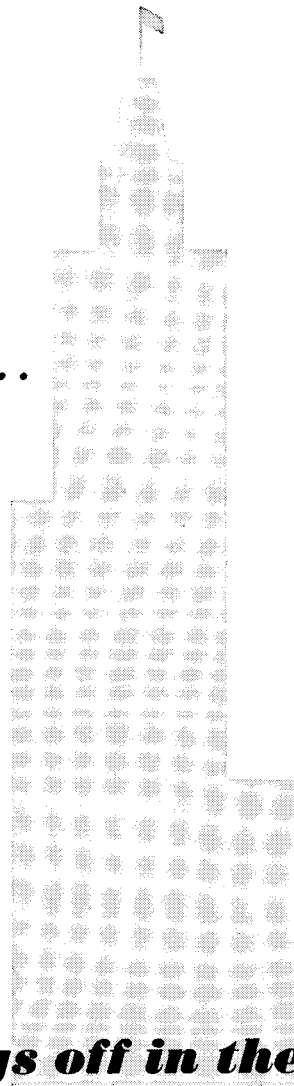

but pays off in the **BASEMENT...**

One thing this winter has demonstrated in thousands of buildings across the country, is the outstanding *fuel-saving* efficiency of a great new Celotex product—

CELOTEX PRE-SEAL ROOF INSULATION

This improved, rigid cane board material . . . pre-coated at the factory with asphalt on both surfaces and all edges . . . provides a uniform, high thermal insulation *plus* protection against all moisture conditions—before, during, and after installation.

YOU ARE INVITED to ask for comparative costs and thermal values on Celotex Pre-Seal Roof Insulation products. Please write direct to our Chicago office . . .

THE CELOTEX CORPORATION, CHICAGO 3, ILLINOIS

In the meantime, you'll find detailed specifications on all Celotex products listed in Sweet's file.

CELOTEX *The Greatest Name in Insulation*
REG. U.S. PAT. OFF.

BUILDING BOARD . . . INSULATING SHEATHING AND LATH . . . CELO·ROK ANCHOR LATH AND PLASTER
CEMESTO . . . CELO·ROK WALLBOARD . . . INTERIOR FINISH BOARDS . . . TRIPLE SEALED SHINGLES . . . FLEXCELL

OPTICALLY
ENGINEERED---

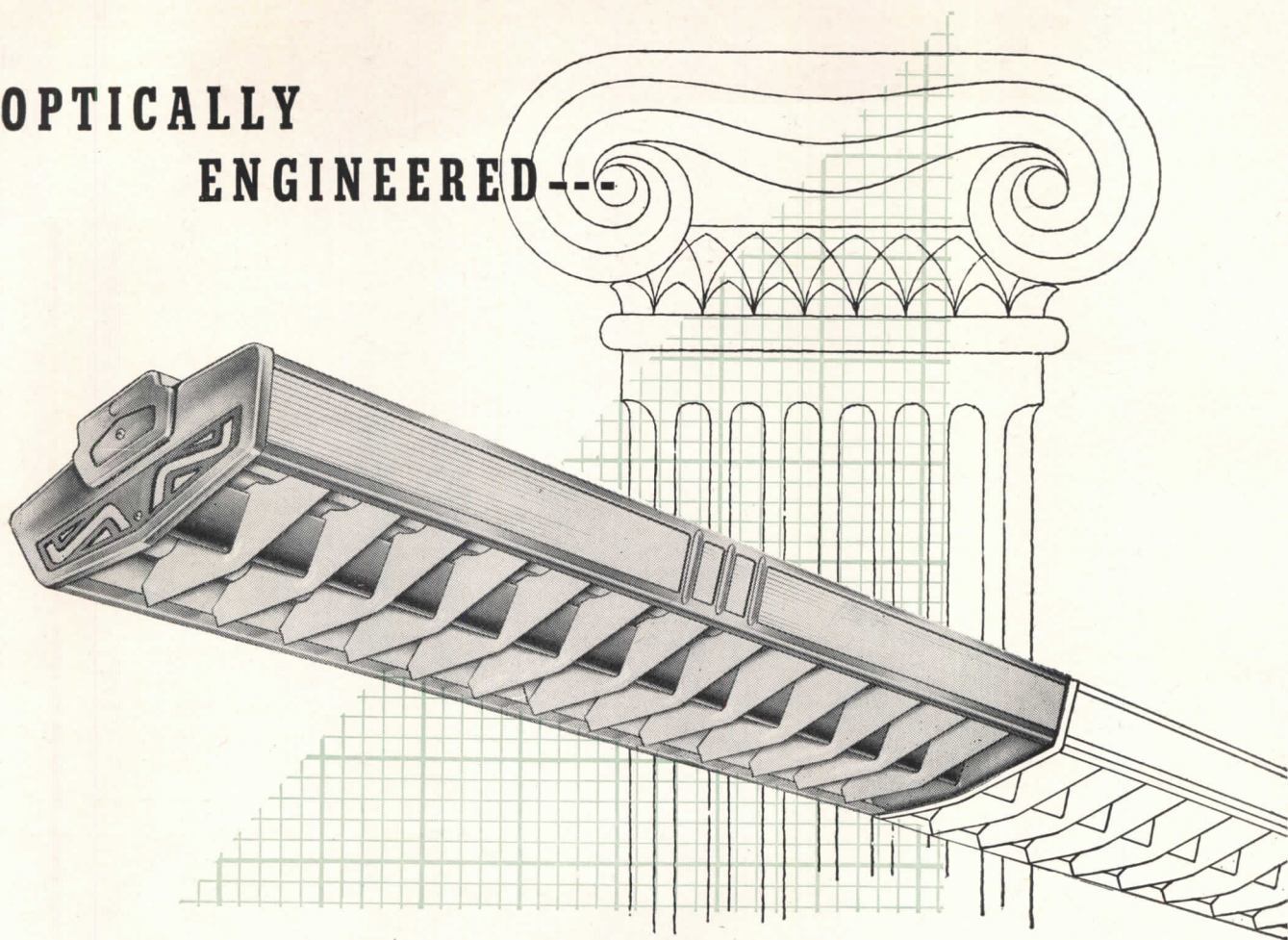

...For greater Beauty

Day-Brite Fluorescent Fixtures have been designed to meet the trend of modern architecture. They combine functional lighting efficiency with artistic simplicity. Our engineering service will be glad to suggest lighting layouts best suited to deliver the desired maintained intensity and harmonize with your architectural treatment.

Your near-by Day-Brite representative will be glad to assist you with your needs.

The **VIZ-AID** for surface or suspension mounting . . . unit or continuous installation. Designed for two 40- or two 100-watt lamps, U. S. Patent Nos. D-138990, D-143641 and 2411952.

Day-Brite Lighting, Inc., 5465 Bulwer Avenue, St. Louis 7, Mo.
Nationally distributed through leading electrical supply houses.

In Canada:
address all inquiries to Amalgamated Electric Corp., Ltd.,
Toronto 6, Ontario.



990

IT'S EASY TO SEE WHEN IT'S

DAY-BRITE
Lighting

AIR SUPPLY BY NATURAL VENTILATION *with special reference to schools.*

(Adapted from "Space for Teaching," by William W. Caudill,

Bulletin of Agricultural and Mechanical College of Texas)

Air movement around the building

Air movements inside any building depend on the velocity and direction of air movement outdoors.

Every locality has its own characteristic "wind rose" showing the average velocity and direction of prevailing breezes month by month throughout the year. In some localities the prevailing direction as well as the velocity varies with the season; in others the direction may be relatively constant. For most localities data are obtainable from the Weather Bureau.

Site factors qualify these general averages. Trees, tall buildings and other major obstructions must be studied at each site.

Pressure and suction effects

Only a small fraction of the air blowing against the face of a building effects an entry; the remainder is forced around and over the structure and creates a suction area above the building and on the emergent side. The air is pushed in on the windward side or sides and pulled out on the other sides and at the top.

Air movement within the building

To obtain efficient natural ventilation within a building it is necessary that inlet openings and outlet openings have approximately the same area. Rooms having windows on two exposures (preferably opposed sides) will have far better ventilation than those having windows on a single exposure. Again, if prevailing breezes blow at right angles to building walls ventilation will be better than in buildings having their long walls placed at an acute angle to prevailing winds.

The fresh air supply per minute per student, measured in cubic feet, may be computed as follows:

$$\left\{ \begin{array}{l} \text{Fresh air supply} \\ \text{per minute} \\ \text{per student} \\ \text{(in cubic feet)} \end{array} \right. = \frac{\text{Area of inlet (sq. ft.)} \times \text{Wind velocity (ft. per min.)}}{\text{Correction factor (K)} \times \text{Volume (per child)}}$$

Typical problem

Assume two classrooms, each having sufficient volume to allow 250 cu. ft. per child. Classroom "A" faces south and has 100 sq. ft. of screened inlet opening and 35 sq. ft. of outlet opening. Classroom "B" faces south-east and has an outlet opening equal to the inlet opening of 100 sq. ft. What is the air supply per pupil per minute in each classroom if there is a 5-mile per hour wind from the southeast?

Supply in Classroom "A"

The inlet in Classroom "A" is approximately 3 times the area of the outlet. From the Correction Factor Table above we find the value of K to be 18. Wind velocity in m.p.h. may be changed to feet per minute by multiplying by 88; thus (5 x 88) the wind is 440 ft. per min. Applying these values to the formula we have:

$$\text{Air supply} = \frac{100 \times 440}{18 \times 250}$$

Each child will receive approximately 9.8 cu. ft. of fresh air per min.

Supply in Classroom "B"

The inlet in Classroom "B" is equal to the outlet. From the Correction Factor Table we find the value of K to be 4. Other conditions are similar to those in room "A." Applying these values to the formula we have:

$$\text{Air supply} = \frac{100 \times 440}{4 \times 250}$$

Each child will receive 44 cu. ft. of fresh air per min., or roughly four times as much fresh air as in Classroom "A."

NATURAL VENTILATION CORRECTION FACTORS		
VALUE FOR K		
Ratio of Openings A is area of inlets A' is area of outlets	Perpendicular to wind	Diagonal to wind
A equals A'	2	3
A equals 2A'	4	6
A equals 3A'	6	9
A equals 4A'	8	12
A equals 5A'	10	15

If screens or louvers are used over inlets, multiply the value of K by 2; if both screens and louvers are used, multiply the value of K by 4.

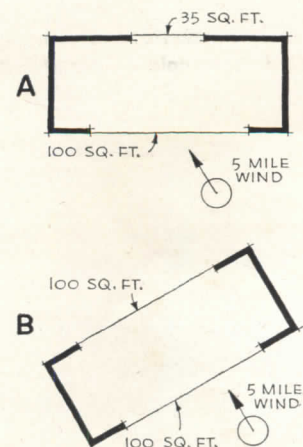

STRAIGHT AHEAD *for* 62 YEARS

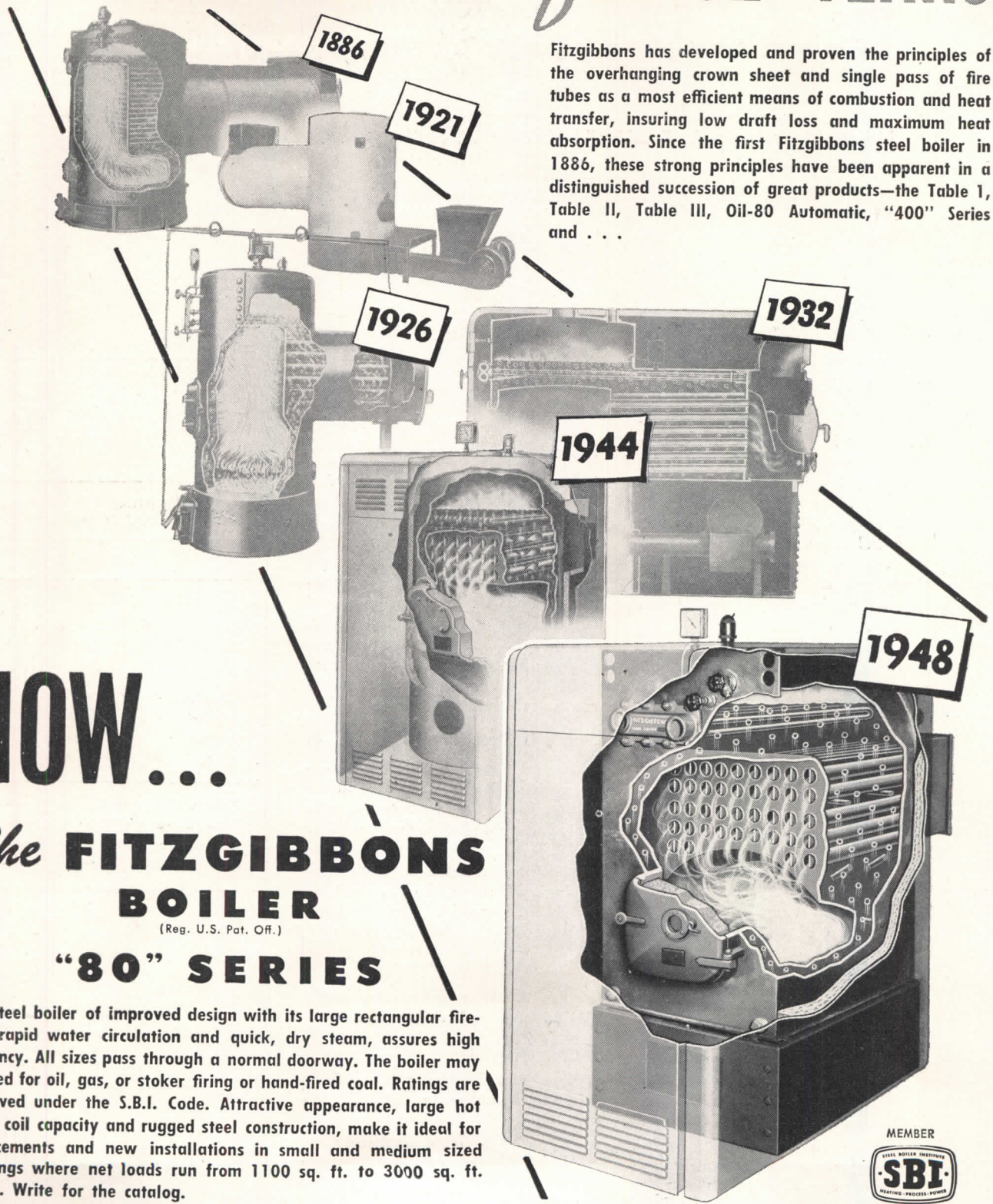

Fitzgibbons has developed and proven the principles of the overhanging crown sheet and single pass of fire tubes as a most efficient means of combustion and heat transfer, insuring low draft loss and maximum heat absorption. Since the first Fitzgibbons steel boiler in 1886, these strong principles have been apparent in a distinguished succession of great products—the Table 1, Table II, Table III, Oil-80 Automatic, “400” Series and . . .

NOW...

The **FITZGIBBONS** **BOILER**

(Reg. U.S. Pat. Off.)

“80” SERIES

This steel boiler of improved design with its large rectangular fire-box, rapid water circulation and quick, dry steam, assures high efficiency. All sizes pass through a normal doorway. The boiler may be used for oil, gas, or stoker firing or hand-fired coal. Ratings are approved under the S.B.I. Code. Attractive appearance, large hot water coil capacity and rugged steel construction, make it ideal for replacements and new installations in small and medium sized buildings where net loads run from 1100 sq. ft. to 3000 sq. ft. steam. Write for the catalog.



Reg. U.S. Pat. Off.



Fitzgibbons Boiler Company, Inc.

101 PARK AVENUE, NEW YORK 17, N. Y.

Manufactured at: OSWEGO, N. Y.

Sales Branches in Principal Cities

CRITICAL DIMENSIONS GOVERNING SCHOOL DESIGN

(Adapted from "Space for Teaching" by William W. Caudill, Bulletin of the Agricultural and Mechanical College of Texas)

1. Bodily dimensions of children

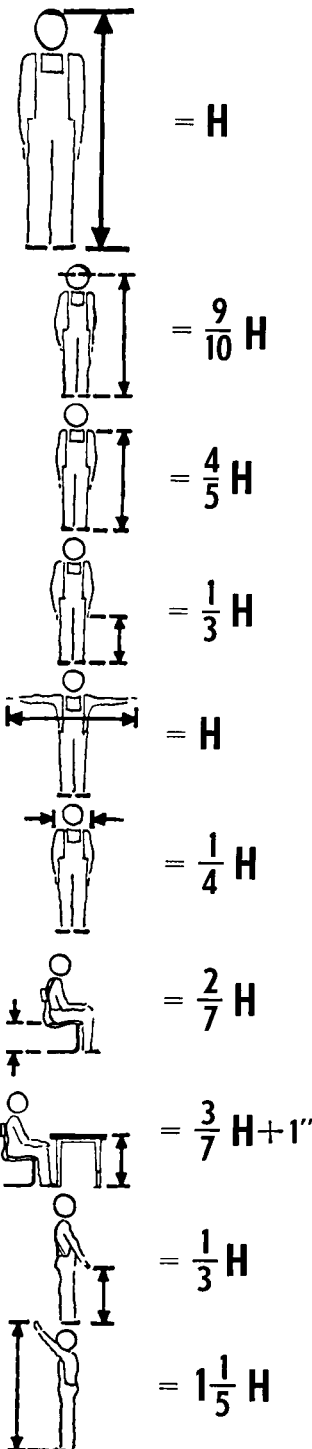

YEAR	H
5	43"
6	45"
7	47"
8	49"
9	51"
10	53"
11	55"
12	57"
13	59"
14	61"

2. Minimum widths of school exits and corridors

Dimensions in diagrams are National Board of Fire Underwriters' minimum for buildings to be emptied in 2 minutes. Example: a building, or building wing, housing 200 pupils must have an exit at least 80 in. wide (6 ft. 8 in.) and a corridor at least 12 ft. wide in the clear. Width of any lockers, plus open locker door, must be added

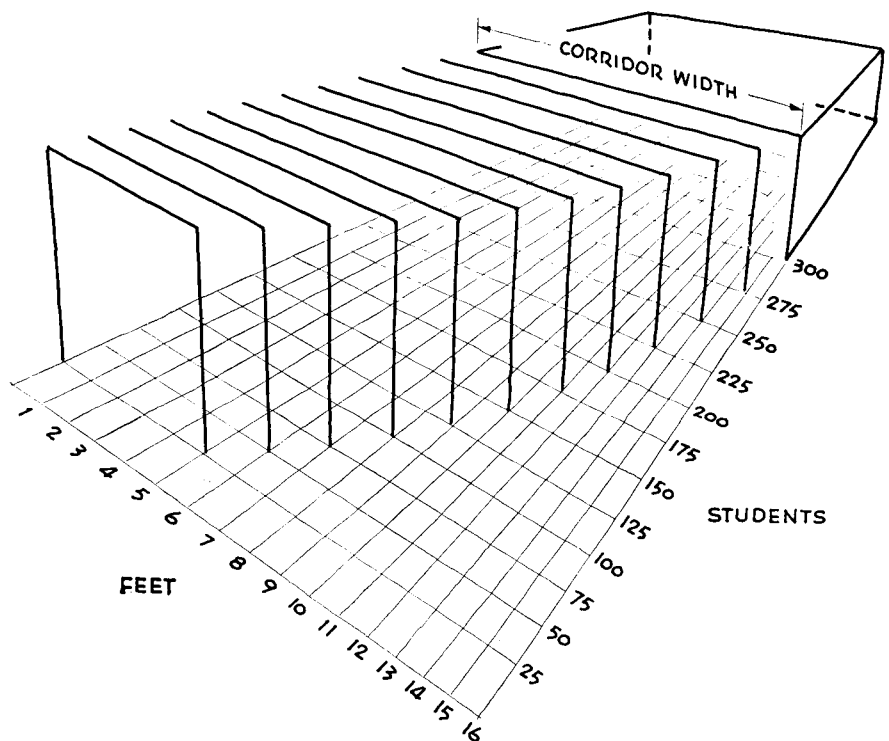
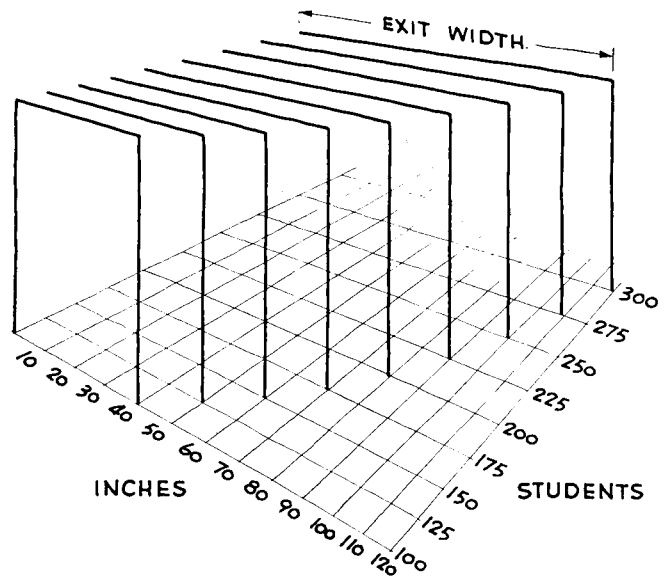

KNOCK-OUT NEWS

THE SENSATION OF THE NEW YORK HEATING SHOW

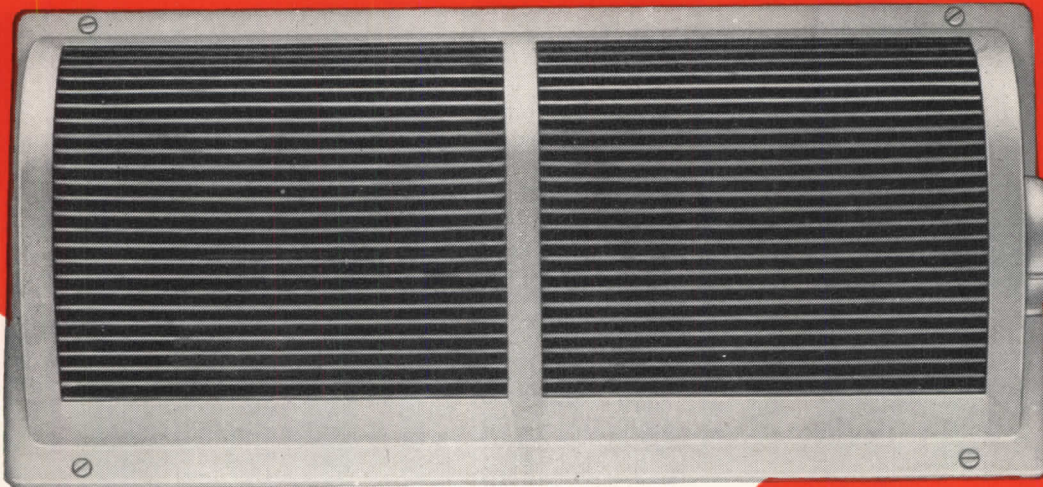

TEMPERATURE
SELECTOR DIAL

PATENTS PENDING

Individual Room Temperature Control—AUTOMATICALLY

The New **DOLE**
THERMO-MATIC
(REG. U. S. PAT. OFF.)
REGISTER

for Forced Warm Air Heating Systems

DOLE manufactures AIR and VACUUM VALVES for heating systems and WATER MIXERS for domestic use

- Operates thermostatically from room air.
- Very sensitive: Modulating effect: Output is regulated to meet heat losses.
- Completely self-contained; no wires to run —no bulbs to locate—very simple to install.
- Simple setting of the thermo-dial assures room temperature control — as desired — corrects many unsatisfactory heating installations: Materially improves any forced warm air system.
- A zone control for every room.

The Dole Valve Company
1933L Carroll Avenue
Chicago 12, Illinois

Please send me facts about the New Dole Thermo-Matic REGISTER for forced warm air heating systems.

NAME _____
FIRM _____ Classification
 Dealer Jobber Architect
 Builder _____
ADDRESS _____
CITY _____ ZONE _____ STATE _____

Post Yourself
ON THIS NEW DEVELOPMENT

SEND THE
COUPON
NOW

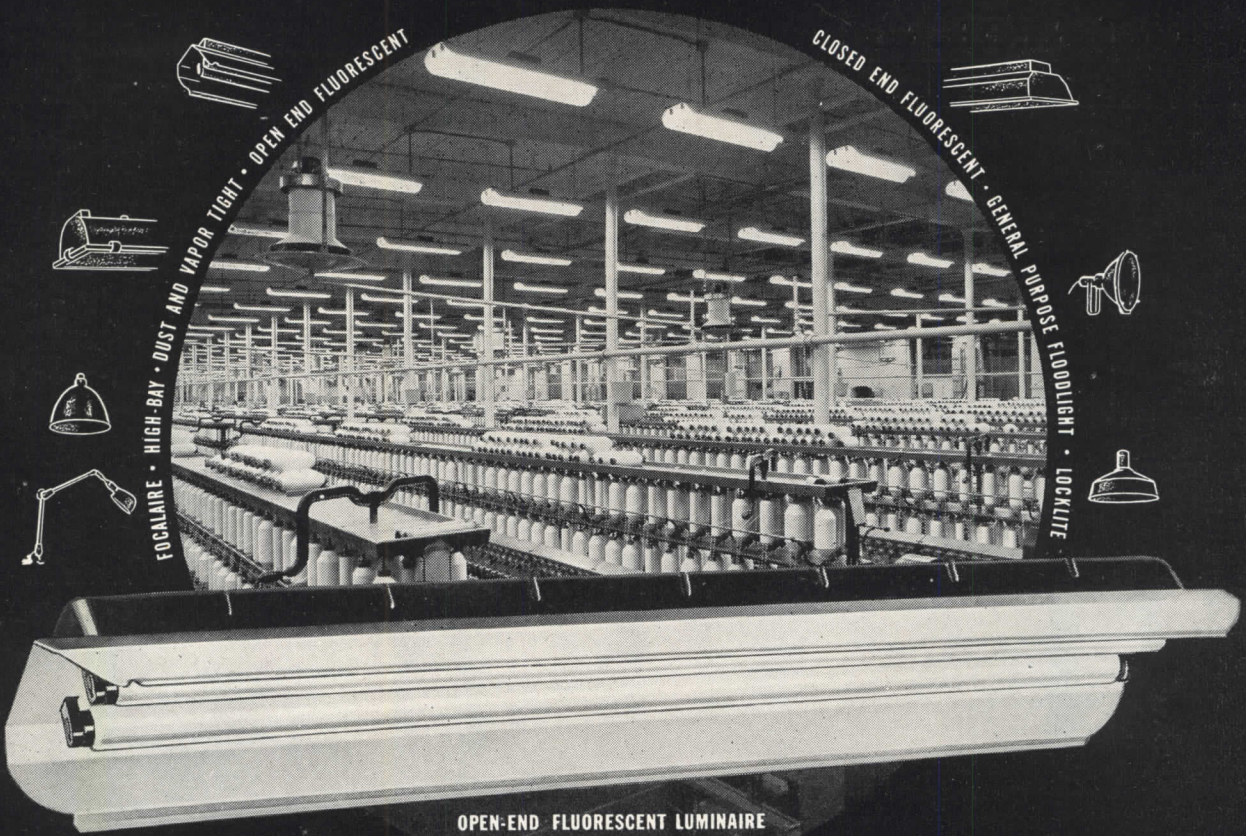

OPEN-END FLUORESCENT LUMINAIRE

For Factories WESTINGHOUSE PLANNED LIGHTING PAYS

... WITH INCREASED PRODUCTION ... LESS SPOILAGE AND REJECTS

HERE'S WHY. You get the right quality and quantity of light for every industrial task. The result: more production per worker . . . greater accuracy . . . better inspection . . . less spoilage and rejects . . . a safer plant and better labor conditions. No wonder Westinghouse *Planned Lighting Pays*.

THE RIGHT EQUIPMENT. Take a close look at the new Westinghouse Industrial Fluorescent: Built for long life . . . easy to install . . . easy to maintain . . . 9 mounting methods . . . enclosed hood protects ballast; improves appearance and rigidity . . . starters are easily, quickly accessible; readily identified . . .

there is a complete line with open or closed ends; for individual or continuous strip mounting.

No matter what your lighting problem, you will find the answer in the wide range of Westinghouse fluorescent, incandescent and mercury-vapor equipment. A Lighting Sales Engineer will be glad to study your problems and help with a plan. For information call your nearest Westinghouse distributor, or send for a copy of B-3955. Westinghouse Electric Corporation, P. O. Box 868, Pittsburgh 30, Penna.

J-04155

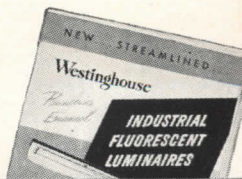

Your local power company and electrical contractor will be glad to help with your planning



Westinghouse

PLANTS IN 25 CITIES OFFICES EVERYWHERE

Westinghouse Electric Corporation • Lighting Division • Cleveland, Ohio
COMMERCIAL • INDUSTRIAL • FLOODLIGHTING • STREET • AVIATION

Services of a Lighting Sales Engineer are available through your near-by Westinghouse distributor

MANUFACTURERS' LITERATURE

ACOUSTICAL CEILINGS

Nailock Method of Suspended Ceiling Construction (Catalog N-1).

Describes the use of Universal Nailing Channels for the mechanical fastening of acoustical ceiling materials, or other nailable materials, to steel, concrete, or masonry. Included are details showing methods of fastening to carrying members by saddle wire tie, spring lock clip, welded lath, or imbedding in concrete; also, specifications, and results of load tests. 12 pp., illus. The Sanymetal Products Co., Inc., 1705 Urbana Rd., Cleveland 12, Ohio.*

DOOR FRAMES

Universal Knock Down Housing Frames (Service Sheet R-8).

Specifications for steel door frames for the low-cost housing field; working drawings; photographs showing installation steps; and standard frame opening sizes. 8 pp., illus. The Richmond Fireproof Door Co., Northwest Fourth St., Richmond, Ind.*

ATTIC VENTILATION

Attic Ventilation Code. Booklet listing basic requirements of satisfactory attic ventilation; covering variations in house structure, location of ventilating unit, air changes per minute, air velocities, discharge vents, and installation and operating suggestions. 7 pp. Propeller Fan Manufacturers' Assn., 5-208 General Motors Bldg., Detroit 2, Mich.

LIGHTING

The Science of Light Conditioning (Catalog 17). Booklet presenting a series of data sheets for the selection of incandescent and fluorescent fixtures for commercial and residential projects. Charts and tables are furnished for the solution of problems of light distribution and intensity for each type of unit. 32 pp., illus. Condi-Lite Corp., 889-891 Broadway, New York 3, N. Y.

WINDOWS

Pomeroy Double-Hung Metal Windows. Details and construction features of zinc-treated rolled-steel windows of the "Standard Type" and "Superior Type." 12 pp., illus. S. H. Pomeroy Co., 25 Bruckner Blvd., New York 54, N. Y.*

PARTITIONS

Transite Movable Asbestos Walls. Booklet containing photographs, detail drawings, and short specification forms

for movable walls in a variety of panel sizes. The "Imperial Type" consists of asbestos Transite panels on steel studs. Panel backs have metal buttons which fasten into slots on stud faces. The "Universal Type" is a wood core faced on both sides with asbestos Transite, locking together at the ends. 24 pp., illus. Johns-Manville Sales Corp., 22 E. 40th St., New York 16, N. Y.*

WELDING SYMBOLS

Standard Welding Symbols 1947.

Welding symbols have been simplified and brought up to date to include 34 of the various welding processes, presented in a step-by-step lecture-type form. The addition of 45 illustrations shows various applications of the symbols, and a chart provides a compact summary of their use for ready reference. 69 pp., illus. American Welding Society, 33 W. 39th St., New York 18, N. Y. 50 cents.

LIFTS

Sedgwick Dumbwaiters and Elevators (Catalog WR).

Describes electric and hand-powered dumbwaiters, residence elevators, and other specialties, and announces an advisory service for the selection of correct equipment, space requirements, and specifications writing. 8 pp., illus. Sedgwick Machine Works, 150 W. 15th St., New York, N. Y.*

HEATING

Fyro-Place Circulates Heat Through Your Home.

Folder describing a steel form for fireplaces, with intakes and outlets for improved air circulation; also, fireplace accessories such as louver-type grilles, grilles with electric fans, and fireplace cranes. 4 pp., illus. Price Fireplace Heater & Tank Corp., Buffalo 7, N. Y.

Modine Heating Coils (Catalog 348).

Booklet presenting a new and extensive line of heating coils for air handling equipment used in heating, ventilating, air conditioning, and specialized drying applications. Coils are of standard steam, non-freeze booster, and hot water types, each in a variety of tube and fin combinations and casing sizes. Booklet includes piping diagrams and tables for heating coil selection. 48 pp., illus. Modine Mfg. Co., Racine, Wis.*

What About All-Year Gas Air-Conditioning?

The story of automatically controlled gas-fired air conditioning, including charts showing gas

consumption by months for a typical residential installation in Chicago, Kansas City, Los Angeles, Houston, and other cities. 25 pp., illus. American Gas Assn., 420 Lexington Ave., New York 17, N. Y.

PLUMBING DRAINAGE

Josam Catalog "J". Guide to the selection, application, and specifications of drains and drainage products, covering all types of drains, interceptors, backwater valves, swimming pool equipment, shock absorbers, shower mixing valves, etc. 252 pp., illus. Josam Mfg. Co., Dept. A, Ferguson Bldg., Cleveland 14, Ohio.*

BATHROOM

ACCESSORIES

Marsh Bathroom Accessories.

Catalog of a new line of chrome-finished shelves and brackets, towel bars, holders, hooks, and grab bars. Fixtures are designed for flush or recessed mounting. 4 pp., illus. Marsh Wall Products, Inc., North Main St., Dover, Ohio.*

CARPET SHOWROOMS

Planned for Selling.

A new book prepared primarily for Smith-Masland carpet dealers by Robert Heller Associates, industrial designers, serves as a guide to effective merchandise presentation and modernization of existing floor covering departments. Suggested plans are based on national field surveys, and innovations in cabinets, fixtures, lighting, and display are featured, with actual working drawings. 48 pp., illus. Alexander Smith and Sons Carpet Co., 295 Fifth Ave., New York, N. Y. \$2.00.

WALL TILE

Armstrong's Veos Wall Tile.

Brochure in color shows various color effects possible with porcelain-on-steel wall tile for bathrooms and kitchens. 16 pp., illus. Armstrong Cork Co., Building Materials Division, Lancaster, Pa.*

CONCRETE

Johnson Concrete Plants: Portable and Stationary.

Booklet presenting a summary of the latest developments in concrete plant operating techniques and equipment, to help in the planning of new plants or modernizing old ones. 34 pp., illus. The C. S. Johnson Co., Champaign, Ill.

Pozzoloth for Better and More Economical Concrete.

Booklet describing the cement dispersing action of Pozzoloth, an admixture designed to increase the durability, strength, and watertightness of concrete structures by eliminating excess water from the mix. Includes test results, and photographs of projects in which dispersed cement

(Continued on page 176)

* Other product information in Sweet's File, 1948.

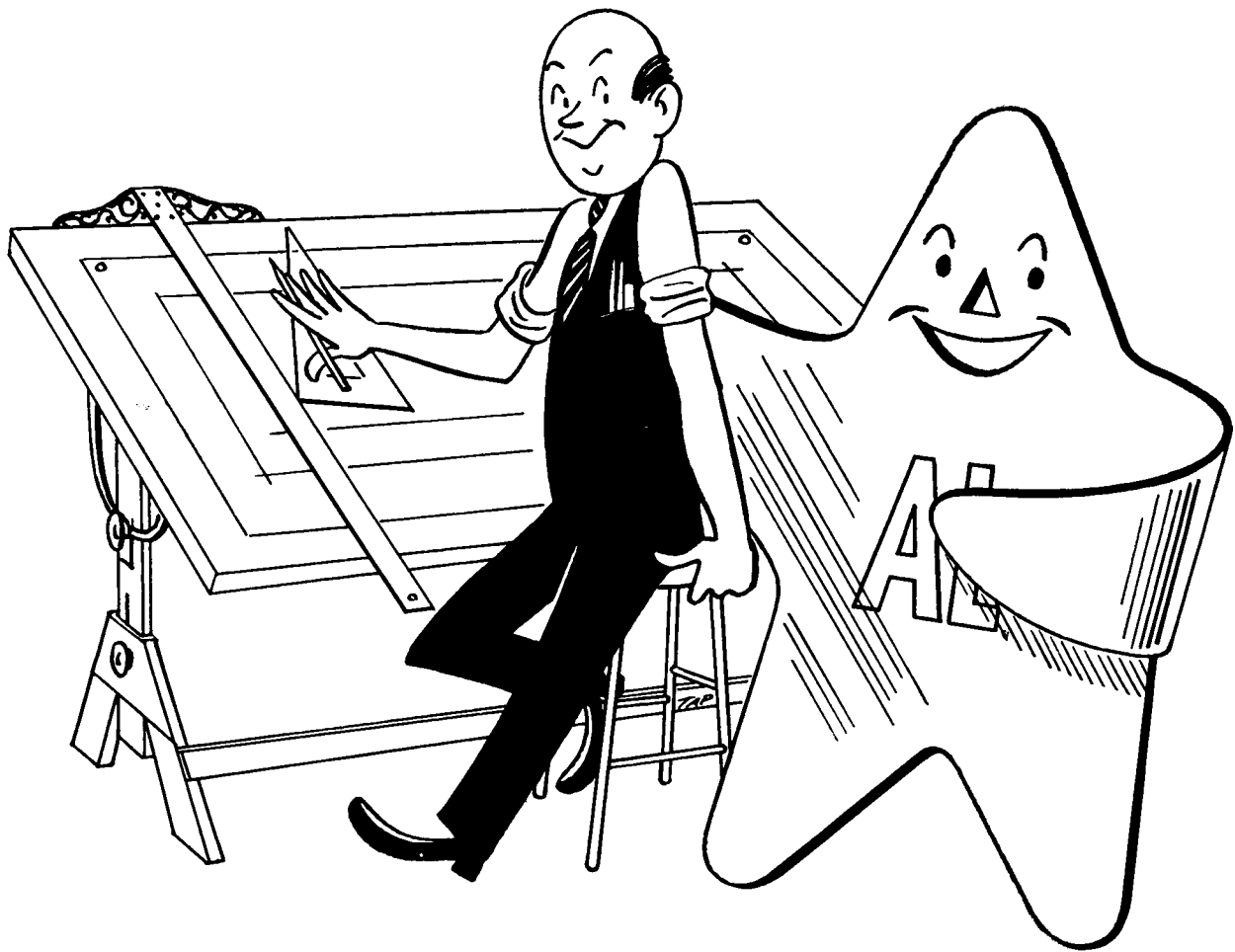

● Why not design for beauty and permanence? Stainless Steel is in better supply than carbon steel—you can get ALLEGHENY METAL, and we produce it in every form or shape you may need.

Complete technical and fabricating data—engineering help, too—yours for the asking.

ALLEGHENY LUDLUM STEEL CORPORATION



PITTSBURGH, PENNA. • OFFICES IN PRINCIPAL CITIES

Allegheny Metal is stocked by all Jos. T. Ryerson & Son, Inc. Warehouses

(Continued from page 22)



**Slowly revolving outlets
distribute the heated air
continuously downward
in a constantly changing
direction, completely and
thoroughly covering the
working area**

Write for details

L. J. Wing Mfg. Co.

154 W. 14th Street
New York 11, N. Y.

Factories: Newark, N. J. and Montreal, Canada

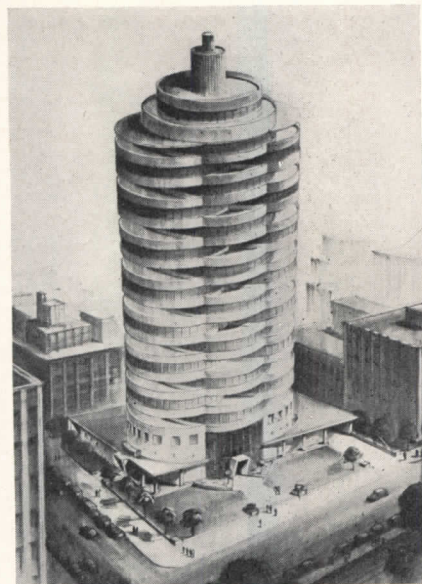

Apartment house by Wolff and Phillips of Portland, Ore., designed for southern U.S.

CIRCULAR APARTMENTS

To answer the unusual requirement that each apartment should have a large outdoor terrace and a complete view, Architects Wolff and Phillips of Portland Ore., came up with the unusual design shown above. Planned for an

(Continued on page 154)

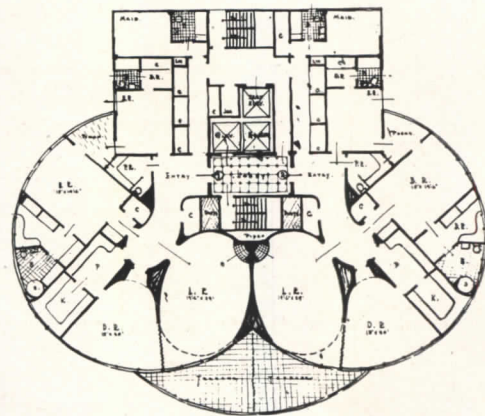

Each apartment will have its own terrace

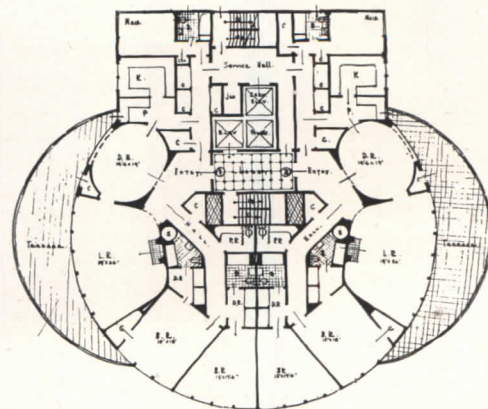

All over the house

Curtis makes it...

Home!

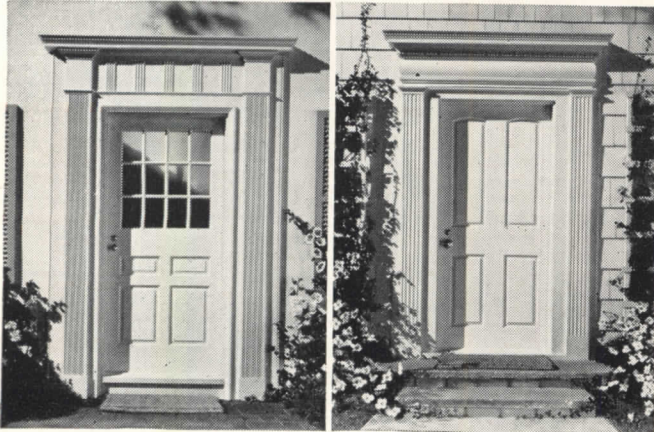
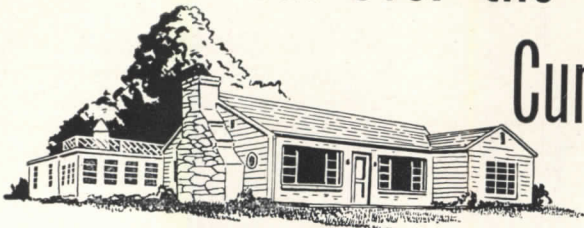

SUNNY WELCOME: No matter how small the home or how modest the building budget, you can add the charm of a Curtis entrance. Always in good taste, built to precision standards, Curtis entrances are made in a wide variety of styles. Entrance at left is Curtis No. C-1731, a design by Willis



Irvin, architect. Second from the left is C-1730, the work of H. Roy Kelley, architect. Entrance in the stone wall is C-1701, designed for Curtis by architect George W. Stoddard. The fourth design, C-1724, is by Cameron Clark. All Curtis entrances are toxic, water repellent treated.



STORAGE PLUS CHARM! For books, prized china and *objets d'art*, Curtis china cabinets provide ideal storage. Shown here are only two of eighteen styles made by Curtis. Useful for dining rooms, living rooms and bedrooms. At the left is Curtis design C-6505, by Cameron Clark, architect; at right, C-6526, a design by architect H. Roy Kelley.



WARM HOSPITALITY! In today's homes, there's a trend away from the stark and bleak—a trend toward warmth and cheer. A Curtis mantel makes the utility of a fireplace beautiful. Curtis mantels "wear well" because they were soundly designed by leading architects, and have correct proportions and fine detail. At left is mantel C-6059, at right C-6049.



When in New York, visit the Curtis Woodwork Display at Architects' Samples Corporation, 101 Park Avenue

SEND FOR THE CURTIS WOODWORK BOOK!

Curtis Companies Service Bureau
AR2W Curtis Building
Clinton, Iowa

Gentlemen: Please send me your book on the new Curtis Woodwork line.

Name.....

Address.....

City.....State.....

I am () Architect, () Contractor, () Prospective Home Builder, () Student.

(Please check above)

Don't Overlook MICHAELS PRODUCTS in Your Building Plans



The manufacture of ferrous and nonferrous metal building products has always been a major part of our business. And now that restrictions are lifted, and materials obtainable, we offer to architects and builders a variety of bronze, aluminum and nonferrous metal products. For specific requirements Michaels craftsmen will faithfully reproduce in metal the most intricate architectural designs. If your plans include metal products, write us.



MICHAELS PRODUCTS

Fixtures for Banks and Offices
Welded Bronze Doors
Elevator Doors
Elevator Enclosures
Check Desks (standing and wall)
Lamp Standards
Marquise
Tablets and Signs
Name Plates
Astragals (adjustable)

Railings (cast and wrought)
Building Directories
Bulletin Boards
Cast Radiator Grilles
Grilles and Wickets
Kick and Push Plates
Push Bars
Cast Thresholds
Extruded Thresholds
MI-CO Parking Meters
Museum Trophy Cases

THE MICHAELS ART BRONZE COMPANY, 234 Scott St., Covington, Ky.

Member of the National Association of Ornamental Nonferrous Metals Manufacturers

THE RECORD REPORTS

(Continued from page 152)

exclusive neighborhood in the southern part of the United States, the building will face a park and lake. Each floor will have two apartments, as shown on the plans on page 152. The top floor and penthouse will form a separate apartment reached from a private entrance on the side street and a private elevator. Special entertainment rooms and help quarters will occupy the second floor.

Construction will be steel frame with aluminum and heat absorbing type glass exterior walls. The building will be completely air conditioned.

WILLIAMSBURG BUILDING TO BE RESUMED

The trustees of Colonial Williamsburg have authorized resumption of its building program looking toward the completion of the physical restoration which was interrupted by the war. While it is estimated that to complete the entire program will take from five to ten years, and at today's prices will cost upwards of \$10,000,000, the immediate program as authorized by the Board of Trustees covers work scheduled for the next two years. The goal is first to complete the restoration of upwards of 100 additional buildings in the restored area, and second to provide augmented facilities to meet the growing demand for expanding business in the city.

The schedule of work in the Duke of Gloucester Street area during 1948 will include the reconstruction of the Guard House at the Public Magazine and extensive rehabilitation of the structure known as the Debtor's Prison.

ARCHITECTS HONORED

Two architects were among the 11 new members recently elected to the National Institute of Arts and Letters. Elected to the Department of Art, the two men so honored are Harrie T. Lindeberg, A.I.A., of New York and Locust Valley, L. I., and James Kellum Smith, F.A.I.A., of New York.

Mr. Lindeberg, a native of New Jersey, started his architectural career in the offices of McKim, Mead and White in Philadelphia, and has had his own office in New York since 1906. He was appointed advisor and consultant to the State Department on Foreign Buildings in 1934, advising on the Embassy Building in Moscow, the American Consulate in Shanghai and the Legation in Helsingfors. Among the buildings which he has designed are the R. T. Vanderbilt Laboratory at Norwalk, Conn., and the Astor Memorial Building at Rhinebeck, N. Y.

Mr. Smith, born in Pennsylvania, re-

(Continued on page 156)

INCONSPICUOUS SAFETY because

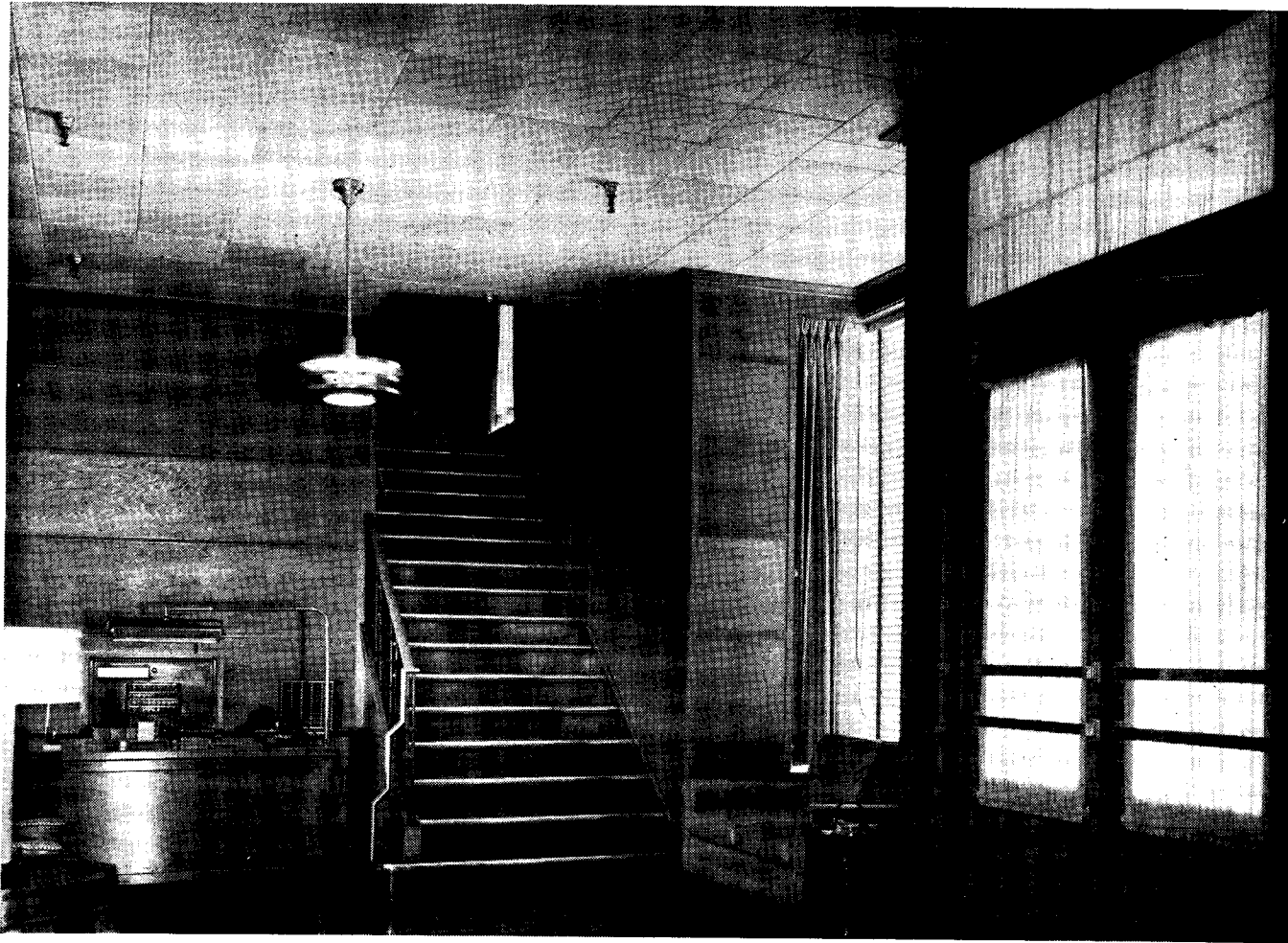

Fire Protection WAS PLANNED FROM THE START

Grinnell Engineers Are Always Ready To Help You Plan Fire Protection As A Blended Part of Functional Design.

Experienced architects know that nearly every kind of building needs fire protection. For even though the structure itself may be so-called "fireproof", its contents are not.

For the sake of retaining attractive interiors, the *time* to plan for fire protection is at the start — with a Grinnell Automatic Sprinkler system. While your plans are still in the drafting stage, get in touch with Grinnell, for there is a Grinnell System to meet the design requirements of every type

of commercial, industrial, and institutional building. Grinnell engineers, long experienced in working with architects, are always ready to help you. Grinnell Company, Inc., Providence 1, R. I. Branch Offices in Principal Cities.

GRINNELL

Automatic Sprinkler Fire Protection

A BLENDED PART OF YOUR BUILDING'S DESIGN

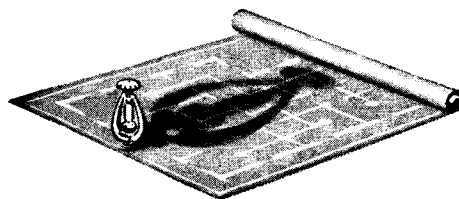

BURT FREE-FLOW FAN VENTILATORS

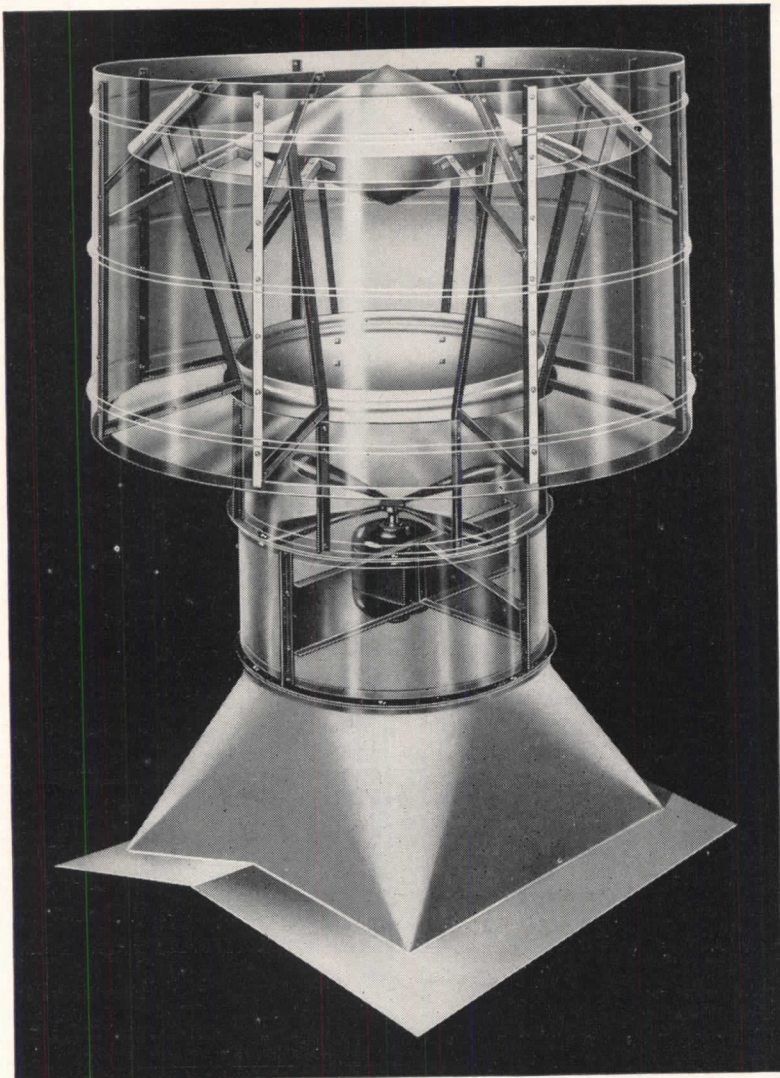

Energize PRODUCTION

Bad air, whether stale and stagnant or heavy with noxious fumes, definitely slows down production. Rejects, absenteeism—even accidents—also are fostered by such conditions. Adequate planned ventilation is as important to economical, competitive production as proper lighting, tools and machines.

The Burt Free-Flow Fan Ventilator illustrated here will normally exhaust about six times as much air as gravity types. It moves a tremendous amount of air in a very short time. Yet, in some installations its greater capacities are unnecessary. Other, less expensive units will be entirely adequate.

Burt has a size and type of ventilator for every need. On *any* ventilating problem, Burt engineers are available—without obligation—to submit recommendations and specifications. See Sweet's, or write now, for data and catalog sheets.

WRITE FOR CATALOGS AND DATA SHEETS

The BURT MFG. Co.

48 E. South Street

Akron 11, Ohio, U. S. A.

VENTILATORS • LOUVERS • OIL FILTERS AND SHEET METAL SPECIALTIES

THE RECORD REPORTS

(Continued from page 154)

ceived a John Stewardson Memorial Traveling Fellowship in 1919 and the Prix de Rome in Architecture in 1920. He joined McKim, Mead & White in 1924, and has been a member of the firm since 1929. Among the buildings which he has designed are the City Hall, Schenectady, N. Y.; and the U. S. Army Infantry School at Fort Benning, Ga. He has been a trustee of the American Academy of Rome since 1933.

(Continued on page 158)

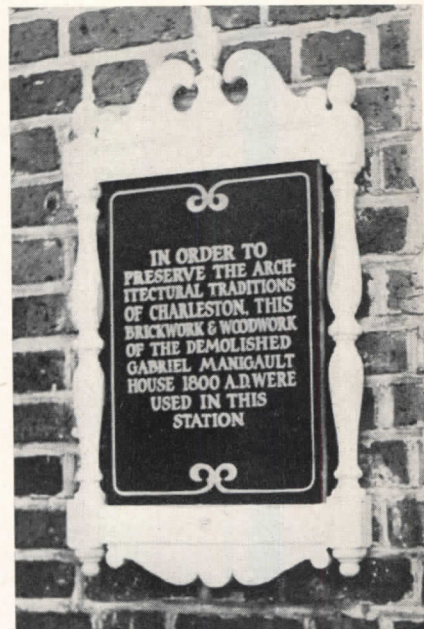

Photographed by Architect Atlee B. Ayres in Charleston last summer: a plaque on a filling station (above) and a nice tribute to a Charleston architect (below)



FIRST

in heating and plumbing

any way you judge them!

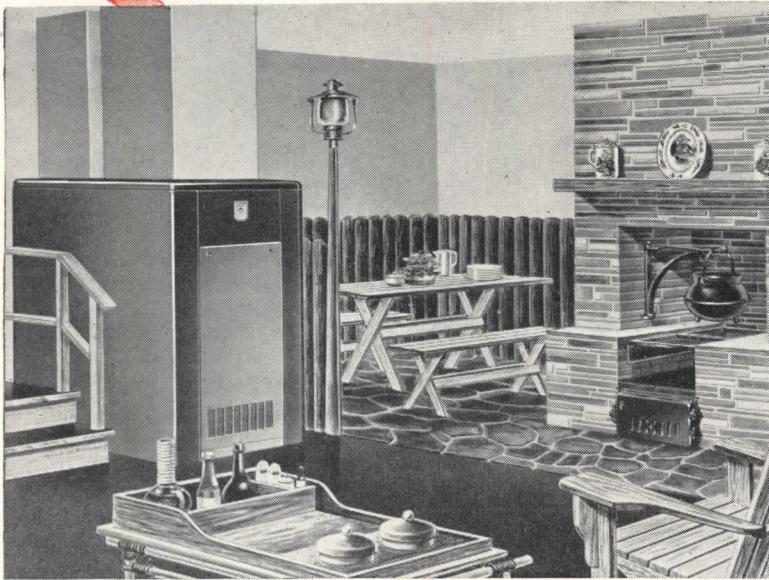

This downstairs grill proves that basements can be more than just places to put the furnace. With its inviting fireplace and dining alcove, the room fairly breathes hospitality. And such a room is made possible by installation of the colorful, compact SARATOGA Winter Air Conditioner. The oil fired Saratoga is from American-Standard's famous Sunbeam line of warm air furnaces and winter air conditioners for every type of home . . . and for every kind of fuel.



The ROYAL HOSTESS Sink in this smart combination kitchen and breakfast nook provides striking beauty with the latest labor-saving conveniences. Its deep, roomy sink compartment, drainboards, and back ledge for fittings are all one-piece constructed of rigid cast iron for long service, and finished with a heavy coating of acid-resisting enamel for lasting beauty. Fittings are finished in gleaming, non-tarnishing Chromard.

HOW do you judge heating equipment and plumbing fixtures? By good looks? Sound engineering? Sturdy construction? Any way you judge them, American-Standard products are first! Proof of their dependability and public acceptance is found in the fact that more American homes have heating and plumbing by American-Standard than by any other single company.

For details of the complete line, contact your Heating and Plumbing Contractor. **American Radiator & Standard Sanitary Corporation**, P. O. Box 1226, Pittsburgh 30, Pennsylvania.



AMERICAN-Standard
First in Heating and Plumbing

LOOK FOR THE MARK OF MERIT—It identifies the world's largest line of Heating and Plumbing Products for every use . . . including Boilers, Warm Air Furnaces, Winter Air Conditioners, for all fuels—Water Heaters—Radiators, Convectors, Enclosures—Gas and Oil Burners—Heating Accessories—Bathtubs, Water Closets, Lavatories, Kitchen Sinks, Laundry Trays, Brass Trim—and specialized products for Hospitals, Hotels, Schools, Ships and Railroads.

Just as
fine chinaware patterns
are set against **WHITE...**

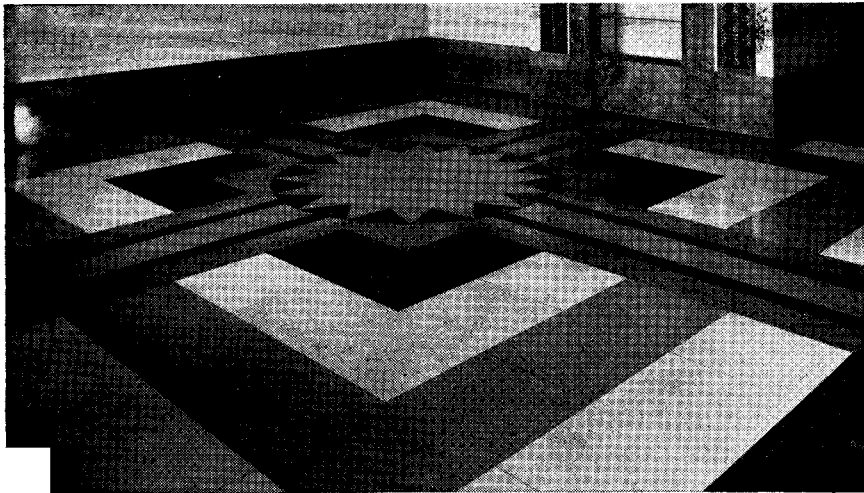

Terrazzo Floor: Samuel Gompers Industrial High School for Boys, Bronx, New York.

Concrete craftsmen choose Atlas White Cement

Delicate colors and intricate patterns of fine chinaware stand out most strikingly against a white background. So, too, a matrix of Atlas White Cement sets off better the color values of pigments and aggregates in Terrazzo, Stucco, Cement Paint and Architectural Concrete Slabs. Such a background has the uniform clarity to complement the desired color overtones, whether in contrast or blend.

Atlas White complies with Federal and ASTM specifications for portland cement. It has the same advantages for concrete and is used in the same way. Atlas White concrete gives a clean, fresh appearance. Cleaning is easy. Maintenance costs stay low.

For further information on the uses of Atlas White Cement, see SWEET'S Catalog, Sections 12B/7 and 13B/7, or write to Atlas White Bureau, Universal Atlas Cement Company (United States Steel Corporation Subsidiary), Chrysler Building, New York 17, New York.

FOR BEAUTY AND UTILITY

ATLAS WHITE CEMENT

FOR TERRAZZO, PAINT, SLABS, STUCCO

"THEATRE GUILD ON THE AIR"—Sponsored by U. S. Steel Subsidiaries
Sunday Evenings—ABC Network

THE RECORD REPORTS

(Continued from page 156)



The 7360-page Sweet's Architectural, 1948

1948 SWEET'S IS OUT

The largest collection of manufacturers' catalogs ever assembled in prefilled form is being distributed to 12,000 selected offices of architects, engineers and contractors engaged in building operations by Sweet's Catalog Service Division of F. W. Dodge Corp.

Bound in five volumes, the 1948 Sweet's File, Architectural, contains 7360 pages comprised of 924 catalogs of 780 manufacturers of materials, equipment and devices used in building dwellings, apartment houses, commercial, manufacturing, educational and other types of residential and nonresidential buildings.

Distribution of the seven 1948 Sweet's Files, including the Architectural, will reach 83,000 offices with a combined total of 2143 catalogs comprised of 16,936 pages. In addition to the architectural file, the others distributed by Sweet's are: Engineering, Builders, Power Plants, Product Designers, Mechanical Industries and Process Industries.

BIDS ASKED ON HOSPITAL

The Department of Public Works, State of Ohio, will receive bids until 2 p.m., Wednesday, March 3, for the construction of a 600-bed hospital on the campus of Ohio State University at Columbus.

The General Assembly of Ohio has appropriated about \$8,000,000 for construction of the hospital, plans for which have been prepared by Skidmore, Owings and Merrill, Architects, of Chicago and New York. Copies of the architects' drawings and specifications are on file at: Office of the Department of Public Works, Columbus; Office of the University Architect, Ohio State University; Builders Exchange, Columbus; F. W. Dodge Corp. offices in Columbus, Cleveland, Cincinnati and Chicago; and the

(Continued on page 160)

GOLD SEAL

Award Winners

SECOND INTERNATIONAL LIGHTING EXPOSITION



Four Gold Seal winners (out of twelve) and many Merit Award winners used Pittsburgh Permalector Equipment in the installations which won them recognition in the Planned Lighting Competition held in conjunction with the Second International Lighting Exposition.

Here is conclusive evidence that practically and creatively Pittsburgh Permalector Fluorescent and Incandescent Lighting Equipment is superior in performance and design.

Write today for complete details on how you too can achieve custom-designed illuminating results with this standard equipment.



Gold Seal Merit Award to:
C. B. Marsh
Marsh Electric Co.
Entry: Klein's Dept. Store

Gold Seal Merit Award to:
J. L. Phillips
Consulting Engineer
Entry: Family Reserve Insurance Bldg.
Architect: Warren, Knight & Davis

Gold Seal Merit Award to:
Lucian Kight & John Martin
Duquesne Light Co.
Entry: Royer's Dept. Store
Architect: Brandon Smith

PITTSBURGH REFLECTOR COMPANY

OLIVER BUILDING • PITTSBURGH 22, PENNSYLVANIA

PITTSBURGH PERMALECTORS ARE DISTRIBUTED BY
BETTER ELECTRICAL WHOLESALERS EVERYWHERE

Lighting Engineers in All Principal Cities

offices of Skidmore, Owings & Merrill in New York and Chicago.

Bids shall be sealed and addressed to Department of Public Works, State of Ohio, c/o Business Manager, Ohio State University, 200 Administration Bldg., O.S.U. Campus, Columbus 10, Ohio.

AWARD ANNOUNCED

Lt. Gen. R. A. Wheeler, Army Chief of Engineers and wartime Deputy Supreme Allied Commander of the South-

east Asia Command, has received from the Moles, New York society of tunnel and heavy-construction men, its annual award to a non-member of the organization for his "outstanding contribution to construction progress." The award — a bronze plaque and citation — was presented on February 4.

The Moles award (frequently referred to as the "Pulitzer prize of the construction industry") has been given only twice before to military men — to Lt.

Gen. Brehon Somervell and wartime Army Chief of Service Forces, and Rear Admiral Ben Moreell, wartime Chief of Navy's Bureau of Yards and Docks.

COMPETITION DETAILS

Further details have been released on the International Competition for the Design of Low-Cost Furniture, which was first announced several months ago (see ARCHITECTURAL RECORD, Dec., 1947, p. 138). The competition opened on Jan. 5, will close at midnight, Oct. 31, 1948.

Two main categories of furniture are being covered: (1) seating units for one or more persons, such as upright and lounge chairs, sofas, day beds, etc.; and storage units for household or personal effects or for both. Competitors may submit entries in either or both; and there is no restriction on the total number of entries. In each group there will be a first prize of \$5000, a second of \$2500, and a third of \$1250.

Requests for entry blanks and further information should be addressed to Edgar F. Kaufmann, Jr., Director, Department of Industrial Design, Museum of Modern Art, 11 W. 53rd St., New York 19, N. Y.

ELECTIONS, APPOINTMENTS

Walter S. Dayton, of Bayside, N. Y., has been named chairman of the executive council of the Realtors' Washington Committee of the National Association of Real Estate Boards of 1948.

Helen Gacesa, of New Brighton, Pa., has been elected assistant secretary of F. H. McGraw & Co., Hartford, Conn. One of the first women ever to hold office in a major construction company, Miss Gacesa formerly was associated with the Beaver County, Pa., Housing Authority.

George S. Hunt has been appointed regional manager of the Los Angeles branch of Raymond Loewy Associates, industrial designers.

Joseph P. Wolff, Commissioner of the Department of Buildings and Safety Engineering of the City of Detroit, has been elected chairman of the board of governors of the Building Officials Foundation for 1948. Mr. Wolff has been commissioner of the Detroit building department since 1930. He is a member of the Engineering Society of Detroit, and a director of the Building Officials Conference of America, Inc.

Carl L. Gardner has been appointed executive director of the Chicago Plan Commission, succeeding H. Evert Kincaid, whose resignation became effective on January 15. Mr. Gardner, formerly in charge of all land planning operations for the FHA in Washington, D. C., has been director of the planning division of the Chicago Commission for the past three years.

(Continued on page 162)

Vermont Marble Stands Supreme

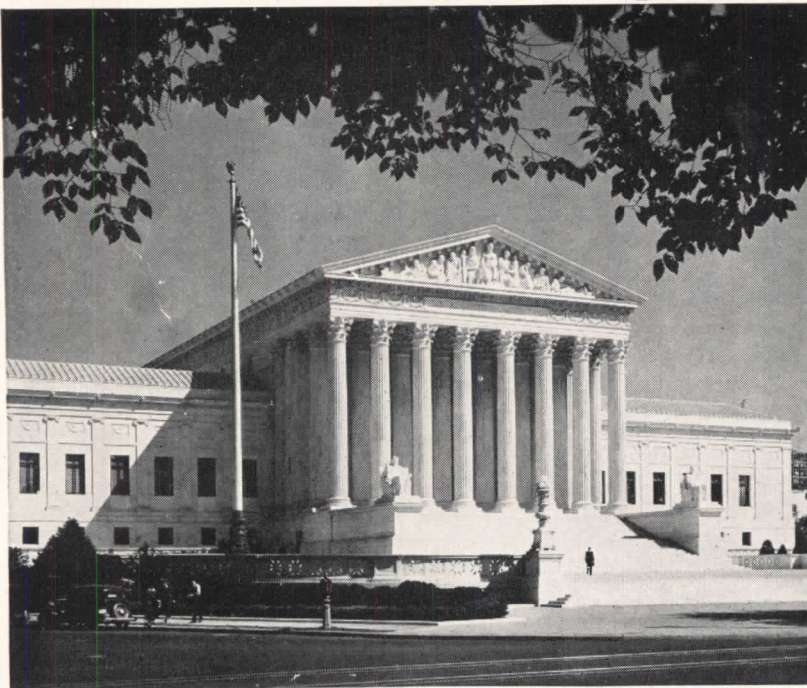

Supreme Court Building, Washington, D. C. Cass Gilbert, Architect. Imperial Danby Marble

From Washington to San Francisco — from the Supreme Tribunal of the Land to the resting place of one of its citizens, Vermont Marble stands—a Temple of Justice and a Temple of Peace.

Yet marble is so adaptable that the simplest store or office, and the humblest cemetery may also be marked and dignified by this durable marble of crystalline beauty.



Nager Mausoleum, Lawndale, California
B. S. J. Cahill, Architect. Imperial Danby Marble

COLOR • CHARACTER • PERMANENCE • LOW MAINTENANCE

VERMONT MARBLE

VERMONT MARBLE COMPANY • PROCTOR, VERMONT

Branch Offices:

BOSTON • CHICAGO • CLEVELAND • DALLAS • HOUSTON • LOS ANGELES • NEW YORK • PHILADELPHIA • SAN FRANCISCO
Ontario Marble Co., Peterboro, Ontario



*A triumph
of engineering*

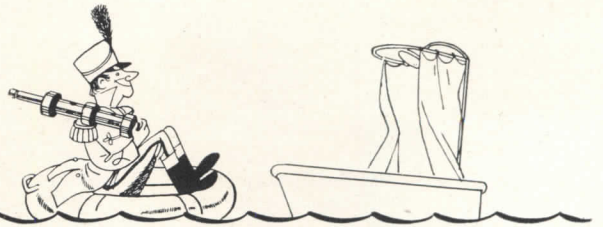
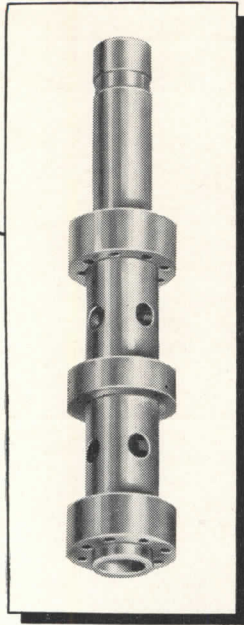

THE F-L-O-A-T-I-N-G SENTINEL
that holds shower temperature steady!

SPEAKMAN

SENTINEL BALANCE SHOWER MIXING VALVE

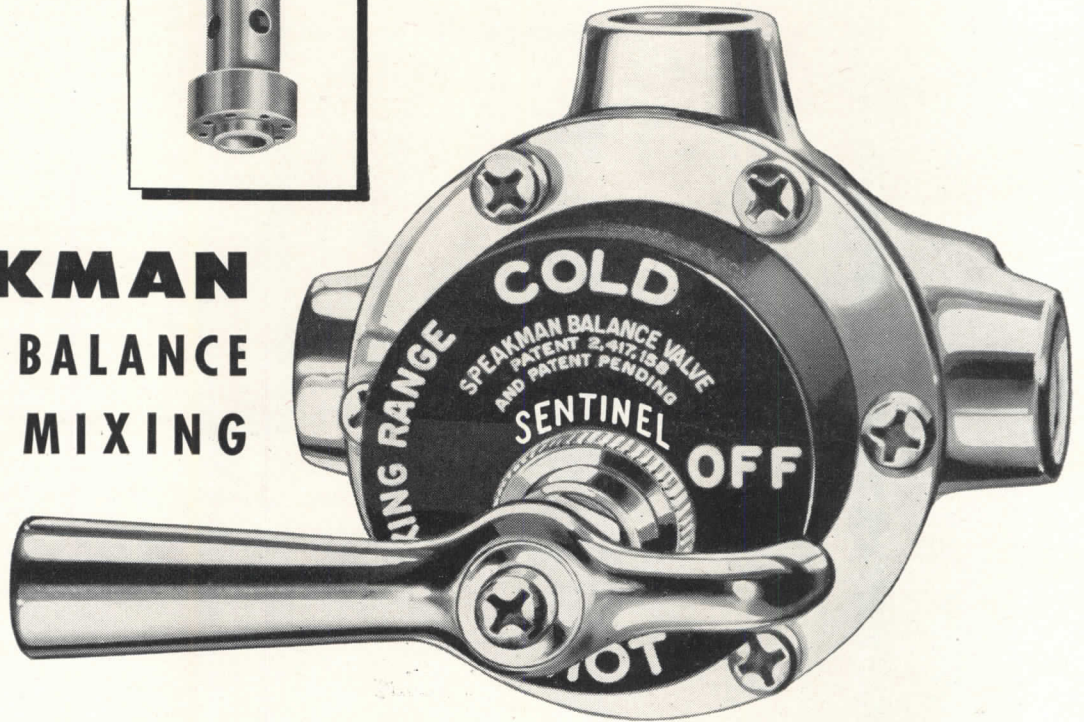

FOR a long time everyone has wanted a shower that didn't change to scalding hot or freezing cold every time someone turned on the water "down the line."

Now Speakman brings it to you . . . with the *Sentinel Balance Mixing Valve* that positively maintains the water temperature set by the bather.

The patented valve with the removable f-l-o-a-t-i-n-g piston, readily accessible, automatically maintains original temperature by compensating for "down the line" water stealing. And the bather never knows anything is happening! In case of a severe drain upon the supply of either hot or cold water, the f-l-o-a-t-i-n-g *Sentinel* immediately cuts down the high pressure side flow port and opens up the low pressure port—thus maintaining the original temperature as set by bather. Thus, sudden

chilling or scalding is impossible. When pressure returns, the *Sentinel* automatically restores the flow to the head . . . at the same temperature as before!

The f-l-o-a-t-i-n-g *Sentinel* has no thermostats, rockers, springs, or other gadgets likely to get out of order. It works on water pressure alone! If excessive alkali ever coats the f-l-o-a-t-i-n-g *Sentinel*, it can be cleaned readily by merely shutting off the *Sentinel* valve. . . . it is not necessary to shut off the Hot and Cold supply to the *Sentinel* Shower Valve. This is a great help where shut-off valves may be located at some distant point and perhaps control the whole bathroom.

We'd be pleased to send you complete detailed information on this new safety *Sentinel Balance Mixing Valve*. Write to Department BV.

"Established in 1869"
SPEAKMAN
SHOWERS AND FIXTURES
SPEAKMAN COMPANY, WILMINGTON 99, DELAWARE

From England comes word that Mark Hartland Thomas, F.R.I.B.A., has joined the Council of Industrial Design to take charge of its industrial section, which is directly concerned with offering a practical service to industry on design problems, and particularly with helping industries set up their own design centers. He is also a member of the Board of the Association for Planning and Regional Reconstruction and chairman of the Architectural Science Board of

the Royal Institute of British Architects.

Recently elected to the National Board of Trustees of the American Designers' Institute are: Ruth Gerth of San Francisco, Henry Glass of Chicago, Harper Richards, Chicago; C. E. Waltman, Chicago; Scott Wilson, New York; Edward Wormley, New York; John Vassos, New York; George Kosmak, San Francisco; and Fritz Foord, New York.



Through the doors of Jamestown Metal Corporation have come hollow metal products for many of the country's finest buildings.

Main office and factory of Jamestown Metal Corp.



5 ACRES OF ONE-FLOOR FACTORY
designed for straight line, efficient production

As specialists in the fabrication of bronze, aluminum, steel and stainless steel, we offer our services wherever hollow metal doors, interior trim, elevator enclosures, office partitions, cold rolled mouldings and metal specialties are required.

HOLLOW METAL
JAMESTOWN METAL CORPORATION
104 Blackstone Avenue Jamestown, N. Y.

OFFICE NOTES

Offices Opened, Reopened

Leslie J. Greenwald, Architect, and Jules G. Mirot, Architect, have opened an office at 127 N. Dearborn St., Chicago 2, Ill., under the firm name of Greenwald and Mirot.

M. De Witt Grow, Architect, has opened an office for the practice of architecture at 4125 Monroe St., Toledo 6, Ohio.

F. Albert Hunt has opened an office for the practice of architecture at 4 Purdy Ave., Rye, N. Y.

George Nelson has announced the opening of an office for the practice of architecture and industrial design at 343 Lexington Ave., New York 16, N. Y.

Joseph Groo Weir, A.I.A., has opened an office at 6 W. Putnam Ave., Greenwich, Conn.

New Addresses

The following new addresses have been announced:

Maurice Bouchard & Pierre Rinfret, Architects, Boulevard Bldg., 400 Blvd. Charest, Quebec City, Canada.

Neil J. Convery, A.I.A., 1060 Broad St., Newark 2, N. J.

Cooper & Perry, Architects and Engineers, 211 W. Hill Ave., Knoxville, Tenn.

George Dress, Architect, 205 E. 85th St., New York 28, N. Y.

Gifford E. Sobey, Architect, 9 Post St., San Jose, Calif.

Firm Changes

John Porter Clark and Albert Frey have announced that Robson Chambers, Architect, is now a partner in the firm of Clark & Frey, Architects, Palm Springs, Calif.

Morgan Stedman, Furber Libby and Dorothy Gray, Registered Architects, have formed a partnership under the firm name of Stedman, Libby and Gray, with temporary offices at 180 University Ave., Palo Alto, Calif.

CORRECTION

In the table entitled "Preliminary Analysis of Hangar Trusses" on page 118 of the April, 1947, ARCHITECTURAL RECORD, the illustration of the "Steel Rib Arch" bears a credit to Bethlehem Steel Co. for use of the photograph. The structure itself is an example of a steel arch structure designed by Arch Roof Construction Co., Inc., of New York, and based on patents owned by that company.

ADDITION

The article by Alden Dow in the November ARCHITECTURAL RECORD ("Planning the Contemporary House," pp. 89-91) was originally prepared as a paper for the Dayton Conference, and was read there.

What good is a house without heat?

This winter is proving many modern houses to be obsolete, due to conditions no one thought possible one year ago.

They cannot be adequately heated because of shortages of certain fuels.

It is predicted that shortages in those fuels will exist for several years.

INVESTMENTS and loans on houses that may become "fuel orphans" are imperilled by inadequate provisions for heating just as the health and comfort of their occupants are endangered.

Now is the time that houses are being designed, loans on projects being discussed, investments in developments being considered.

To maintain the value of all new con-

struction, provision should be made for the storage and use of anthracite (hard coal), the clean, smokeless, abundant, domestic fuel.

In following issues of this magazine, we shall bring you news of modern developments in heating with anthracite—information that you can use to give modern buildings modern heating.



ANTHRACITE INSTITUTE

101 PARK AVENUE • NEW YORK 17, NEW YORK

(Continued from page 142)

ducers claim roofing and siding installed with such nails will not tend to "pull" the nails, and will give longer leak-free service. The Gora-Lee Corp., Stamford, Conn.

GARAGE DOORS

From the outside, the overhead *Calder garage door* presents a smooth unbroken surface except for hardware and inconspicuous panel joints. There are no visible screws and bolts since the cover-

ing sheets of aluminum alloy are joined by a lock seal arrangement. Door sections are built up of a combination wood and aluminum frame work. Lifting mechanism is counterbalanced by tempered springs; door sections lift overhead, riding rubber-tired rollers for quiet operation. Size of opening is 8 ft. wide by 7 ft. high; clearance required, 12-in. headroom beyond opening and 4 in. at each side. Calder Mfg. Co., 638 N. Prince St., Lancaster, Pa.

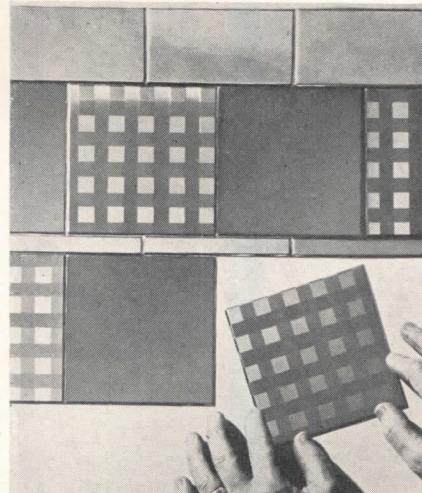

Chromium-plated and aluminum wall tiles

WALL TILE

Two new types of all-metal wall tiles have been introduced: a chromium plated zinc tile and a colored aluminum tile. Chrome tiles have a striped, bright, checked, or satin finish; colored tiles come in black, gold, maroon, royal blue, and sage green. According to the manufacturer, color is applied by a special process that makes it integral with the metal. Tile-O-Chrome Corp., 4421 N. Clark St., Chicago 40, Ill.

FIRE-RESISTANT PAINTS

A new line of fire-resistant finishes can be applied over old paint or used as an original finish. Known as *Fyr-Kote*, the finish is said to resist fire in three ways: (1) by releasing carbon dioxide to smother flames, (2) by forming a tough fusion film to protect wood fibres beneath, and (3) by the use of a non-inflammable resin base. *Fyr-Kote* is available in three types of finishes: Interior Flat Finish, which is washable and comes in white and pastel colors; Brilliant Base Coat, a white interior undercoat; and Brilliant Finish, a lustrous white enamel. The *Fyr-Kote* Co., 1823 Washington Ave., St. Louis, Mo.

ASPHALT ROOFING

The Asphalt Roofing Industry Bureau has been working toward standardizing application specifications for asphalt roofing. Distinction is now made between standard and "wind-resistant" conditions. Roll roofing, when applied by the usual exposed nail method, and even 36-in. wide sheets with concealed nails, probably will no longer be recommended for exposed windy locations. Double coverage rolls and 18-in. sheets with concealed nails should be used.

The popular three-tab square-butt strip shingle ordinarily is applied 5 in. to the weather and secured with six nails, but when a heavier roof is wanted this

(Continued on page 166)

Alumitile Permanently FIREPROOF

Besides being fireproof — not affected by heat — Alumitile is water-proof, chip-proof, impervious to alkali, resists stain and won't crack or peel. Light as a feather, Alumitile is unbelievably economical — cost much less than conventional tile.

There is no end to the advantages of Hastings Alumitile . . . the amazing ceramic-like tile . . . so easy to apply and lasts the lifetime of the home

Water proof
Chip proof
Stain Proof

Available in 14 beautiful colors: Gleaming White, Cream, Peach, Dubonnet, Apple Green, Dark Green, Canary Yellow, Black, Light Blue, Dark Blue, Ivory, Grey, Flame Red and Rose — from which virtually unlimited color combinations are obtainable.

Sizes: Field Tiles, 5" x 5"; Trim Tile Cap., 2 1/2" x 5"; Stripe, 3/4" x 5"; Base 5" x 5". Also outside corners and wall plates for electrical outlets available in matching colors

Architects — Include Alumitile in your next plans. It's your best bet in 1948.

METAL TILE PRODUCTS CO. HASTINGS, INC. MICHIGAN.

WRITE TODAY to the Metal Tile Products, Inc., Hastings, Michigan, for full information regarding the greatest and most durable Bathroom and Kitchen Tile that has been perfected as a result of wartime needs and research.

Free!

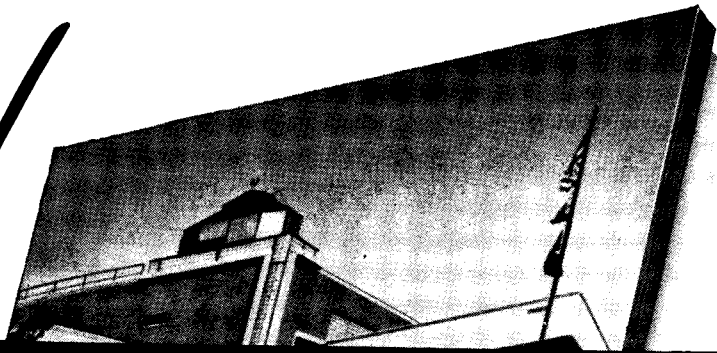

Books of facts about PC Glass Blocks

[A MODULAR PRODUCT]

Send the coupon
for your copies

THE INDUSTRIAL BOOK treats comprehensively of the use of PC Glass Blocks in a wide variety of industrial plants to distribute light, to insulate, to exclude harmful dust and grit, to reduce maintenance and fuel costs.

THE COMMERCIAL BOOK deals with the use of PC Glass Blocks in office and public buildings, stores, cafes, schools and hospitals.

In each informative book you will find complete engineering data, charts, specifications and complete information on the application of modular coordination to the basic principles of Glass Block installations. Each book contains many photographs of actual PC Glass Block jobs. And there are also photographs of the various patterns of PC Glass Blocks and descriptions of their various functions.

Whether you are planning modernizing or new construction projects, you need this latest information on PC Glass Blocks. Why not send the coupon today and get these helpful books? Remember, they're free. Pittsburgh Corning Corporation also makes PC Foamglas Insulation.

PC GLASS BLOCKS

... the mark of a modern building

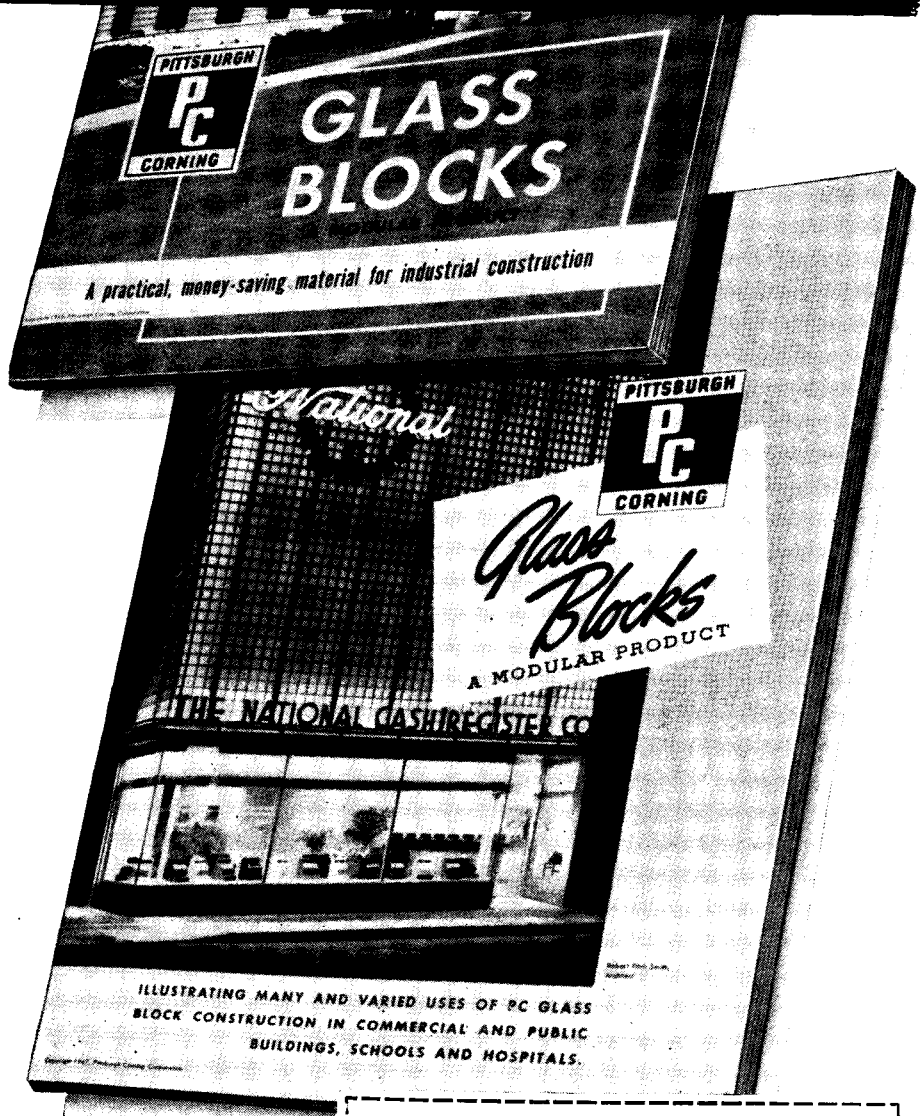

ILLUSTRATING MANY AND VARIED USES OF PC GLASS BLOCK CONSTRUCTION IN COMMERCIAL AND PUBLIC BUILDINGS, SCHOOLS AND HOSPITALS.



GLASS BLOCKS

Distributed by PITTSBURGH PLATE GLASS COMPANY

by W. P. Fuller & Co. on the Pacific Coast and by Hobbs Glass Ltd. in Canada

FOR ADDITIONAL INFORMATION SEE OUR INSERTS IN SWEET'S CATALOGS

Pittsburgh Corning Corporation
Room 612-8, 632 Duquesne Way
Pittsburgh 22, Pa.

Please send along my free copies of your books on the use of PC Glass Blocks for industrial and commercial buildings. It is understood that I incur no obligation.

Name

Address

City..... State.....

(Continued from page 164)

same shingle can be applied 4 in. to the weather to increase weight by 25 percent and make a triple coverage roof. When the 5-in. exposure is used, "practically certain" protection against wind can be obtained by cementing down shingles with asphalt cement. Two- and three-tab hexagon strip shingles can be windproofed in the same way.

Other recommendations cover nailing methods, design of the substructure, roof venting, and type of roofing for

various pitch of roof decks. Asphalt Roofing Industry Bureau, 2 W. 45th St., New York, N. Y.

LIGHTING Industrial Fixtures

For industries where high humidity conditions prevail, a fluorescent fixture has been given a special finish for protection against rust and oxidation of the metal parts. Other improvements include hook slots for easier mounting

and latches for removing the reflector for cleaning and inspection. The unit, known as the *HF-100*, is a 2-lamp 40-watt fixture, equipped with a pair of knockouts to provide for another lamp if desired. Sylvania Electric Products, Inc., 500 Fifth Ave., New York, N. Y.

Accent Lighting

The *Prismatic Hy-Liter* provides spot-lighting for special effects, using an 8-in. Corning lens and a 150-watt lamp. They are made in recessed or surface types, the latter trimmed with reeded aluminum side ornaments. Reflectors are aluminum. Edwin F. Guth Co., St. Louis, Mo.

HOT WATER SYSTEM

The functions of two separate heating units are combined in the single *Janitrol Triple Service Heating Unit*, oil- or gas-fired, for supplying (1) water at controlled temperatures for house heating, (2) hot water for automatic home laundries, dishwashers, etc., and (3) tempered water for lavatory, tub, and shower. Since the water is mechanically circulated, either convector or radiant panel heating can be used; and mechanical circulation permits the unit to be located where most convenient: basement, utility room, closet, or attic. The system is offered as a "package," with the heat-generating unit assembled and ready to operate. A complete set of convectors (free-standing or recessed type) is furnished, and all necessary tubing, fittings, straps, etc., even the solder and flux for installation. Models are available in three sizes: 100,000, 150,000, and 210,000 Btu per hr. input, A.G.A. ratings. Janitrol Div., Surface Combustion Corp., Toledo 1, Ohio.

GARBAGE DISPOSAL

Although original building plans may not call for an *FA-3 Disposall*, the automatic garbage disposal unit for installation beneath the kitchen sink, provision can be made during construction for possible future installation. The accompanying roughing-in sketch from General Electric Company shows a suggested plumbing arrangement with a reserve drain outlet provided below for possible future use. Appliance and Merchandise Department, General Electric

Co., Bridgeport 2, Conn.

ASTRONOMY CLASSROOMS

"Dramatizing the panorama of the heavens on the ceilings of classrooms," a small planetarium projector is now available for depicting images of the stars for classroom study. Designed by Armand Spitz, director of Museum Education at Philadelphia's Franklin Institute, the 3-ft. high portable unit can be used with flat walls or ceilings but

(Continued on page 168)

A Schlage Installation because...

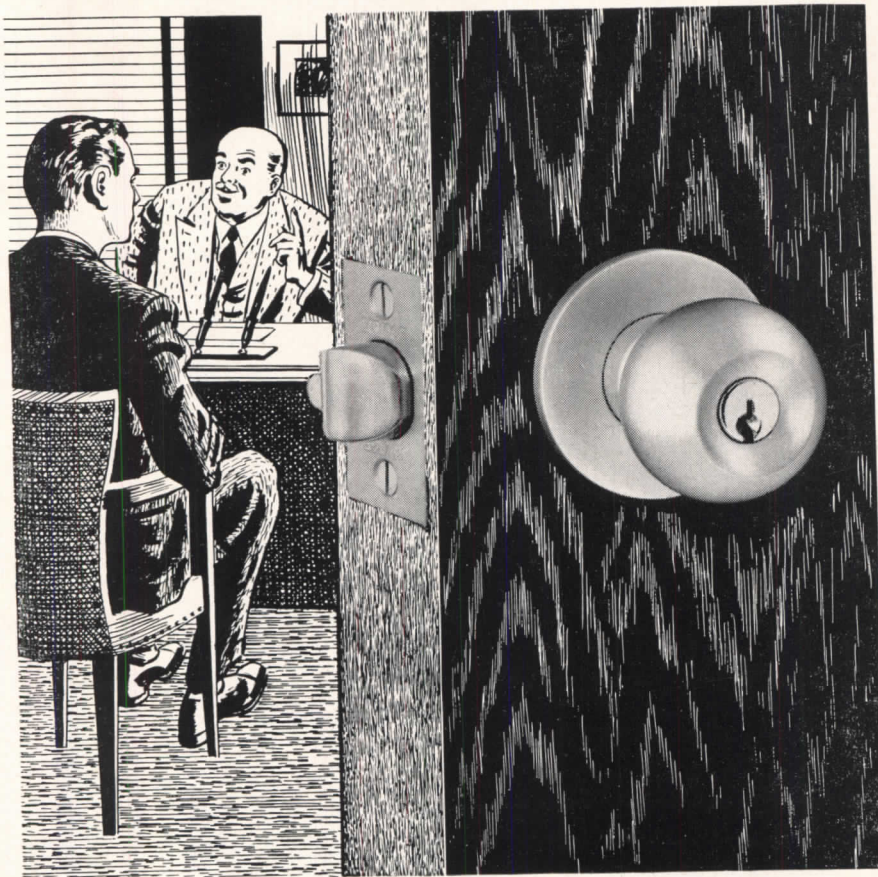

Schlage is reversible

Mr. Clark didn't foresee changes in the use of his offices, but the architect did. He specified Schlage locks because they can be easily reversed or interchanged to meet changing door usage. This flexibility of Schlage locks is only one of their many economy features.

See Schlage
in Sweets Architectural
File



SCHLAGE
LOCK COMPANY
SAN FRANCISCO NEW YORK

ORIGINATORS OF THE CYLINDRICAL LOCK



SLASH UPKEEP COSTS

with windows
of Alcoa Aluminum

When you figure window costs, add in upkeep expense as well. Then you'll see how quality aluminum windows save you money all along the line.

Painting costs are eliminated. Repair and replacement costs are cut to the bone. Aluminum windows can't rot or warp. They keep their snug fit and trim appearance.

For modern buildings that will stay modern, specify windows of Alcoa Aluminum. They are available now in types and sizes for all commercial, industrial, and residential uses. For information on any application of aluminum, write to ALUMINUM COMPANY OF AMERICA, 1867 Gulf Building, Pittsburgh 19, Pennsylvania.



**MORE FOR
YOUR MONEY**

Quality windows of Alcoa Aluminum give you these money-saving advantages:

- No Painting
- Less Repair
- Less Replacement
- Snug Fit
- Easy Operation

ALCOA **FIRST IN**
ALUMINUM

REG. T. M.



IN EVERY COMMERCIAL FORM

(Continued from page 166)

works best with a portable dome or specially designed domed ceiling. The Bulkley Co., 61 Cliff St., New York 7.

MODULAR MEASUREMENTS

To assist in the layout of modular building projects, *Modultapes* are tape measures with special eyelets for marking modular spacings on a story pole or layout strip. *Modultape* No. 1 has eyelets spaced 4 in. centers for horizontal layout and vertical coursing of most

brick, tile, and block; *Module* No. 2 has eyelets spaced $2\frac{2}{3}$ in. centers for vertical coursing of $2\frac{2}{3}$ -in. brick, giving the modular standard three courses to 8 in. or six courses to 16 in.; and *Modultape* No. 3 has eyelets spaced 3.2 in. centers for vertical coursing of 3.2-in. brick, and laying up five courses to 16 in. The tapes are colored differently for quick identification, and come in 4-, 8-, or 12-ft. lengths. Fred Heath, McLean, Va.

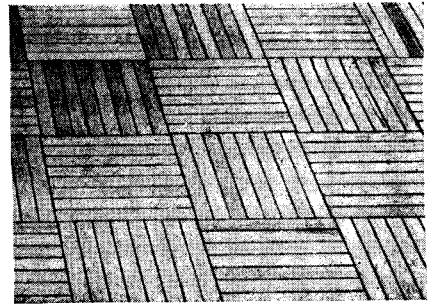

Prefabricated hardwood flooring squares

FLOORS

Wood Flooring

Castle Square Flooring comes in 9-in. squares, made of kiln-dried hardwood boards, 1 in. wide and $3\frac{3}{8}$ in. thick, insulated on all four edges by a latex-filled strip of nonskid fibrous material. The fiber strips between individual boards are to serve as expansion joints; while a backing of the same material lends a certain amount of resilience to the flooring. The squares are applied, at right angles to one another, to the sub-floor, cement slab, or old flooring by means of a mastic glue. At the edges of the rooms, the squares are cut to fit room size and allow for pipes, etc. At present the flooring is made from selected and unmatched Tennessee oak; future plans call for the addition of birch, beech, maple, and walnut hardwoods. Newcastle Industries, Inc., 300 W. 56th St., New York 19, N. Y.

Rubber Plastic Flooring

A new type of Goodyear rubber floor covering, described as a calendered vinyl product, is announced as resistant to stains, scars, and fire. The material, in a wide range of colors and marbled patterns, can be installed in strip or tile form, and also lends itself to the covering of kitchen drainboards and sinks. Thermoplastic properties permit the material to be turned around sharp corners and other indentations without cracking. To simplify installation, Goodyear has developed an electrically controlled heater which will heat the entire lap area for perfect seams. The Goodyear Tire & Rubber Co., Akron, Ohio.

Resilient Tile

Sharper, brighter tones and two additional colors, red and blue, have been added to the *Linotile* line of linoleum-like resilient tile. The color range now includes ten colors, and allocation restrictions have been lifted due to increased production. Armstrong Cork Co., Lancaster, Pa.

Asphalt Tile

The manufacturer of *Kentile asphalt tile* announces the lifting of light-color restrictions and the offering of a wide

(Continued on page 170)

SPECIFY

Satisfaction



WITH *Amtico* RUBBER TILE

WHEN you specify Amtico Rubber Tile, you are putting your client's best interests first. It will give many years of hard service and its gleaming surface is easy to maintain. Its beautiful colors go all the way through; there's no danger of marring from wear or cigarette burns. It's so satisfying to walk on -- quiet and resilient underfoot.

Lustrous beauty is there, whether for an auditorium or just a powder-room, and its ability to wear and wear makes it the number one material for floors.

With thirteen beautiful, marbled colors at your command, you have an almost unlimited palette to use in creating distinctive and unusual designs. Write for literature and samples. You'll please your clients, and add to your reputation for knowing the best the market offers.

AMERICAN TILE & RUBBER COMPANY
Foot of Perrine Avenue, Trenton 2, N. J.
Send samples and illustrated folder showing
Amtico Rubber Tile in colors.

Name.....
Street.....
City.....State.....

AMERICAN TILE & RUBBER CO. • TRENTON, N. J.

Manufacturers of "AMTICO" RUBBER TILE FLOORING—Marble & Terrazzo Effects, "AMTICO" SHEET RUBBER FLOORING—By the Roll, Plain and Marbled Colors
RUBBER MATS & MATTING—Plain & Designed Effects. RUBBER STAIR TREADS AND NOSINGS

SAVE 50% OR MORE BY INSULATING WITH SISALATION at about \$25* per 1000 square feet

*Contractors' Price

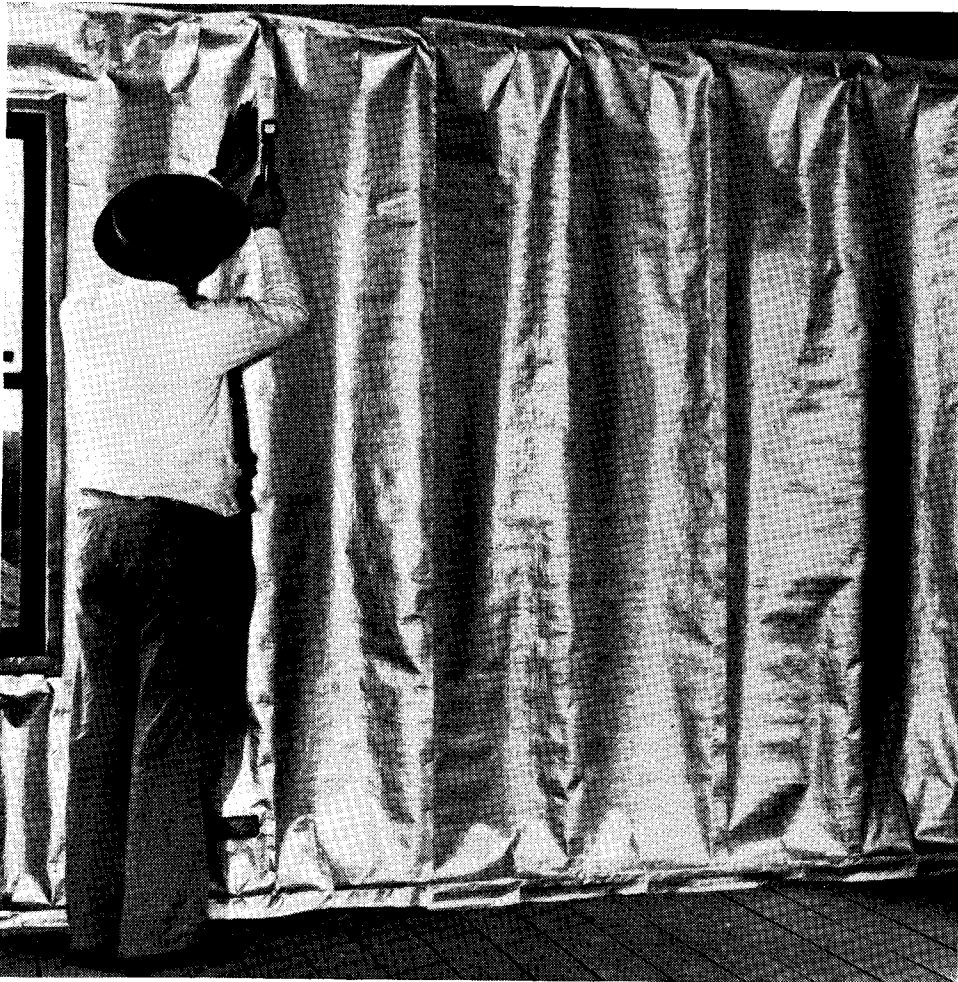

1 You get insulation that is completely effective, since SISALATION, properly applied, is equivalent in heat-saving values to approximately $\frac{3}{4}$ " of flexible or rigid types of good insulations most commonly used...based on M.I.T. tests on sidewalls constructed with a single layer of reflective SISALATION.

2 SISALATION acts as an air-tight moisture-vapor barrier, thus protecting against dry-rot, paint failure, condensation. Exceeds FHA requirements as a vapor-barrier.

3 SISALATION, reinforced with steel-like sisal fibres, is so strong that one man can apply it over two stud-spaces at one time without danger of having the SISALATION rip or tear (see illustration). This makes for low application costs.

4 SISALATION does two jobs at one application cost . . . provides insulation *and* a vapor-barrier both at the same time.

5 SISALATION is AVAILABLE NOW for prompt delivery through your lumber or building supply dealer.

The SISALKRAFT Co.
205 W. Wacker Dr., Chicago 6, Ill.
New York 17, N. Y.
San Francisco 5, Calif.

For complete information,
use coupon below or write

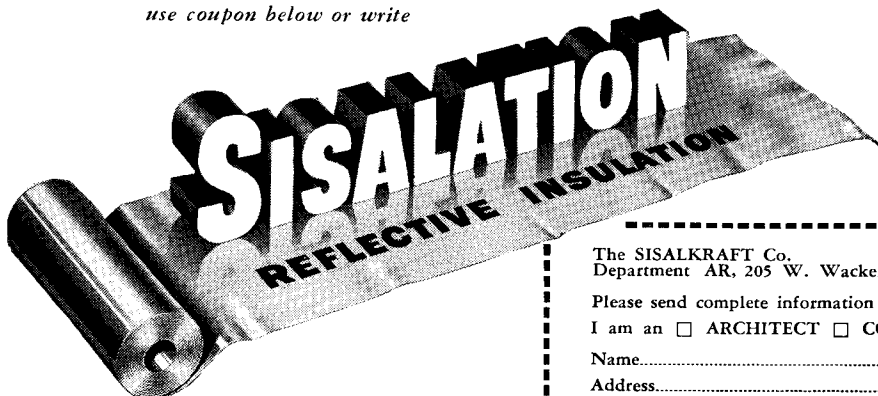

The SISALKRAFT Co.
Department AR, 205 W. Wacker Drive, Chicago 6, Ill.

Please send complete information and tell me where I can buy SISALATION.

I am an ARCHITECT CONTRACTOR OTHER.....

Name.....

Address.....City, Zone & State.....



(Continued from page 168)

range of color effects in asphalt tile. Each of the colors, ranging from white through cream, light blue, beige, gray, green, and tan, is marbled with two other colors. David E. Kennedy, Inc., 58 Second Ave., Brooklyn 15, N. Y.

SEATING

A specialized engineering service for architects has been announced to help them with public seating problems in the design of schools, theaters, and

churches. The service covers floor layouts, inclines, sight lines, location of ventilators, etc. American Seating Co., 1776 Broadway, New York 19, N. Y.

AIR CONDITIONER

A new Frigidaire air conditioner occupies only $7\frac{1}{2}$ sq. ft. of floor space, yet has a 5-ton capacity, said to be sufficient to cool several office rooms, or a small store or restaurant. Conditioners may be used in multiple, or

operated with a simple duct system. Operation is controlled thermostatically, actuated by temperature of room air entering the conditioner. A heating coil may be added for winter use. Frigidaire Div., General Motors, Dayton 1, Ohio.

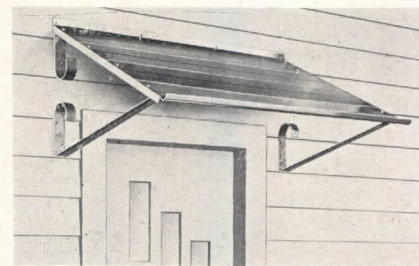

All-aluminum canopy for doors or windows

DOOR CANOPY

Hollywood canopies are of all-aluminum construction for installation over doors or windows of houses for protection against rain, snow, or sun. Brackets and panels are heavy-gauge, and will support a snow load of 235 lb. Finish is satin aluminum, which need not be painted unless desired. Dimensions are 42 in. wide by 32 in. deep. Colgate Mfg. Co., Amityville, Long Island, N. Y.

TELEVISION

For built-in installation in lounges and clubrooms, the RCA Victor Clubman television unit has a 15 by 20 in. viewing screen. Pictures are locked in focus by a synchronizer that reportedly eliminates electrical interference from elevators, etc. Both screen and FM speaker can be mounted flush with the wall. The chassis is designed so that the entire wall unit can be rolled out for maintenance. RCA Victor Div., Radio Corp. of America, Camden, N. J.

HOME BAR

The Home Club Bar is furnished complete with built-in refrigeration, plugging into any standard outlet, and provides "extras" in the way of a large frozen food compartment and a normal storage compartment for foods and beverages that require chilling only. A third section serves for the unrefrigerated storage of bar appurtenances. Front and sides are upholstered in Masland Duran, resembling leather; the top is colored Formica. Haldorf Mfg. Co., 1435-37 N. 31st St., Philadelphia, Pa.

ADDOMETER

Architects, engineers, and construction foremen are offered a portable adding machine, known as the Addometer, for adding and subtracting feet and inches up to 999,999 ft. $11\frac{7}{8}$ in. A stylus carried with the machine is used for turning dials, to the right for adding and to the left for subtracting. Weight is

(Continued on page 172)

For Quality In
Every Detail

SPECIFY
THE
STANDARD

Your reputation is safe and your clients' best interests are served when you specify the Weisway Standard Cabinet Shower, now available in square or corner entrance models. Quality built, of service-tested materials, by the pioneer manufacturer in the field, Weisways are guaranteed leakproof, have Foot-grip, No-slip floor of vitreous porcelain enamel—safe, and easy to keep clean. For details write

HENRY WEIS MANUFACTURING CO., INC.
203 WEISWAY BUILDING, ELKHART, INDIANA

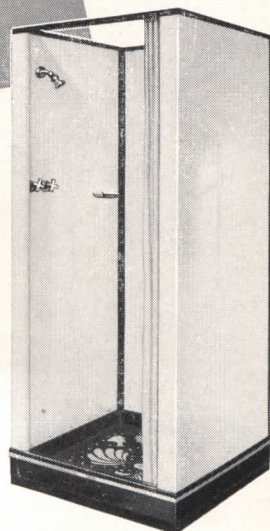
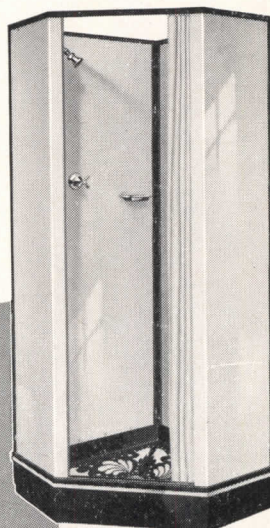

Weisway
CABINET SHOWERS

Solution to an Elevator Problem!

THE PROBLEM

To provide economical elevator service for a three-story manufacturing plant of functional design. All movement of raw and finished materials in plant to be handled by fork lift trucks which are to be carried on elevator in process of loading and unloading. Architect's visualization calls for building without elevator penthouse to break streamlined contour.

THE SOLUTION

The architect analyzed his problem as follows: (1) Since no elevator penthouse was desired, a push-up type elevator should be used. (2) Loading by power vehicles called for unusually accurate landing stops and for an elevator of very strong construction. (3) Initial cost of elevator, including construction provisions, must be held to a minimum . . . elevator operation and maintenance expense must be low. **Result: A Rotary Oildraulic Elevator was selected because it met all these requirements.**

Elimination of Penthouse Streamlines Building Design

The Oildraulic Elevator requires no costly, unsightly penthouse because it's pushed up from below by a powerful hydraulic jack . . . not pulled from above. This also makes possible a lighter shaftway structure . . . no need for heavy load-bearing supporting columns to carry the elevator and its load. No special machine room necessary either . . . the compact power unit can be located in any convenient space on any floor.

Oildraulic Controller Insures Accurate Landing Stops

Where loading and unloading is done by power vehicles, the Rotary Oildraulic Elevator is first choice. Guided by a highly efficient mechanism called the Oildraulic Controller, it operates smoothly and rapidly, stops at floor landings with accuracy, and holds the landings. Also important for this type of service is the rugged construction of the elevator car, with its heavily reinforced sling and platform.

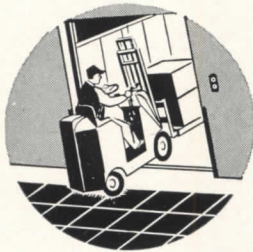
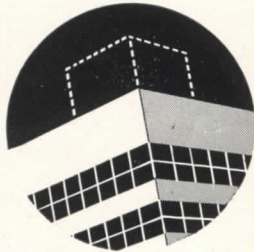
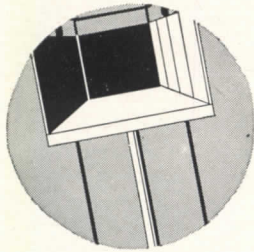

For data to help solve
your elevator problems

ROTARY LIFT CO.
1102 Kentucky
Memphis 2, Tenn.

Send data on Rotary Oildraulic
Elevators to:

Name.....
Address.....
City and State.....

Streamline your building designs and make sizeable savings in construction costs by specifying Rotary Oildraulic Elevators for 2, 3 or 4-story structures. Coupon at the right will bring you complete information and Architect's Preliminary Layout Data.

Rotary

OILDRAULIC ELEVATORS

The Elevator that's PUSHED up

(Continued from page 170)

14 oz., and construction is of steel to withstand rough treatment on the job. Reliable Typewriter and Adding Machine Co., Chicago, Ill.

DRAWING PENCILS

Manufacture of *Castell drawing pencils* has been resumed, now that processed graphite is again obtainable from Bavaria. A micrometric milling process is being used as heretofore. A. W. Faber-Castell Pencil Co., Newark, N. J.

CONDENSATE RETURN

A new condensate return system is said to eliminate individual traps on steam operated equipment and to provide a constant flow of steam and rapid return to the boiler of high temperature condensate. This system is also adaptable to the handling of process liquids. It is claimed that all water fed to the boiler through the system is deaerated by liberation of free oxygen and non-condensable gases detrimental to metal under

heat and pressure. Available for steam pressures up to 250 lb. and in a range of boilers from 10 hp up. Said to increase production of steam heated equipment up to 30 per cent with savings from 13 to 27 per cent in fuel. W. M. Acker Organization, 3167 Fulton Rd., Cleveland, Ohio.

RADIATORS

A portable automatic electric radiator equipped with Mercoid automatic thermostat and pressure controls, called the *Roller-Radiator*, has been announced. It plugs into any 110 v. ac outlet and is said to provide regulated heat for a space of average height up to 15 by 20 feet. A 4-column, 10-section Arco cast iron radiator produces 4750 Btu. per hour. Mounted on swivel casters, the Roller-Radiator can be moved easily. It weighs 90 lb. and has 18.7 sq. ft. of radiation. Approved by Underwriters' Laboratories. Terminal Hardware Co., 411 Linden Ave., Wilmette, Ill.

HOSE VALVES

A radically new design in hose valves, for use in industry, which cuts water consumption in some cases up to 50 per cent, has been announced. Palm-size, it works on an old hydraulic principle—the operating parts being a plunger and controlling ball. At 50 psi hose pressure, less than 10 lb. finger pressure on the button opens the valve. Available for standard hose sizes from 1/4 in. to 1 in., delivering up to 75 lb. per sq. in. line pressure. Made of Monel for maximum resistance to corrosion and wear. Rubber-coated body prevents scratching of interior surfaces of equipment being cleaned. Can be used with long extension nozzles. Adapted for use in paper mills, breweries, dairies, packing plants, etc. Paul Valve Corp., 683 Third Ave., New York City.

INTER-COM SYSTEMS

A new two-way inter-communication system sold as a "package" consists of a master unit, one sub-station and 50 ft. of cable and is suitable for installation in homes, professional offices, stores, farms, etc. Can be used as either "private" or "non-private"; two-way conversation can be originated from the master or sub-station. Master station only connected to 110-115 v. ac-dc; extra cable up to 2000 ft. available, Underwriters' approved. Talk-a-Phone Co., 1512 S. Pulaski Rd., Chicago 23.

LAMPS

A new 200 watt radiant flood lamp for service stations, homes, industrial plants, stores, ships, piers, etc., is now available. Made of heat resisting glass, it has a sealed-in-silver reflector which gives maximum light output. The glass resists moisture, sleet, insects and vibra-

(Continued on page 174)

Stop Waste of Floor Space!

SPECIFY VANISHING DOORS

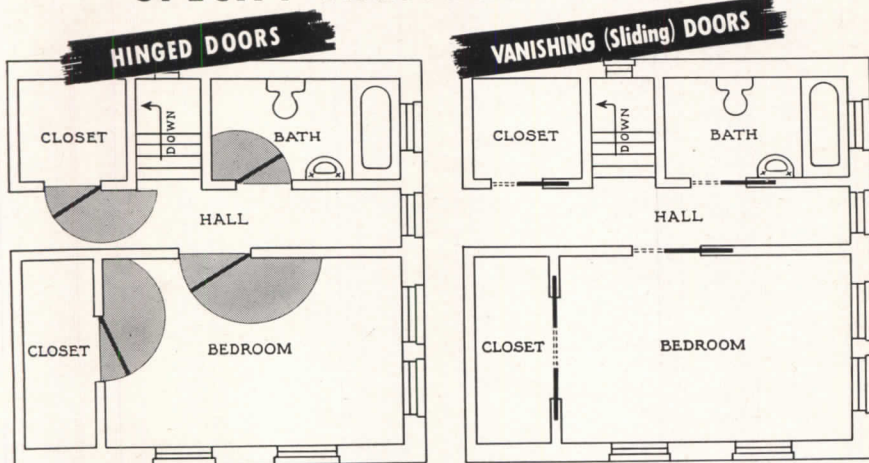

Shaded Areas are "Dead" Space

No "Dead" Space Here

Floor plans above show the same bedroom, closet and bath arrangement with hinged doors and with vanishing doors. Note absence of "dead" areas in plan utilizing vanishing doors.

Whether it's a spacious mansion or the tiniest kitchenette apartment, wasted floor space is wasted money! And every hinged door wastes the floor space covered by its swinging arc. With vanishing doors there's no floor area lost... furniture, pictures and fixtures can be placed correctly and conveniently; rugs can be laid close to the wall line; color harmony is not disturbed by the "wrong side" of an open door. For all interior doors, it's smart and economical to install vanishing doors.

Specify R-W Vanishing Door Hangers and Wood Lined Track

For smooth, quiet vanishing doors, be sure to specify Richards-Wilcox Vanishing Door Hangers and Wood Lined Track. Compact and noiseless in operation, R-W Vanishing Door Hangers are equipped with Oilite self-lubricating bearings. Hanger wheel rolls in "V" shaped groove in wood lining of steel track to keep wheel centered at all times—no metal-to-metal contact to cause noise or friction. Get complete details from your nearest Richards-Wilcox office—free consultation available without obligation.

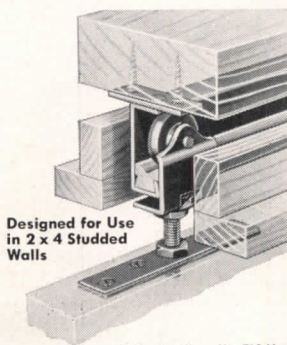

Richards-Wilcox No. 719 Vanishing Door Hanger and Wood Lined Track installation in ordinary 2 x 4 studded house partition, showing application of hanger and track to header and door.

Richards-Wilcox Mfg. Co.

"A HANGER FOR ANY DOOR THAT SLIDES"
AURORA, ILLINOIS, U.S.A.

Branches: New York, Chicago, Boston, Philadelphia, Cleveland, Cincinnati, Washington, D. C., Indianapolis, St. Louis, New Orleans, Des Moines, Minneapolis, Kansas City, Los Angeles, San Francisco, Omaha, Seattle, Detroit, Atlanta, Pittsburgh

1880 1948



OVER 68 YEARS

This is the Wakefield

STAR

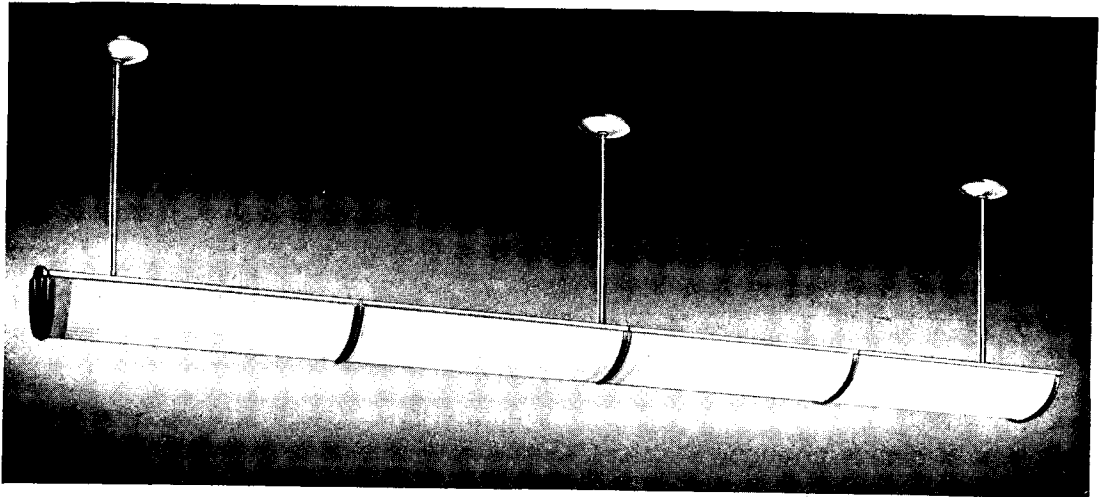

. . . with the **PLASKON Reflector** that Insures
UNIFORM LIGHT DISTRIBUTION

Modern artificial lighting strives for two objectives: first, an even distribution of light intensity, and second, the elimination of brightness contrasts. The Star utilizes a molded translucent Plaskon reflector of such density that the lighted luminaire is of approximately the same brightness as the illuminated ceiling. When Star units are used in continuous runs, spaced in accordance with Wakefield engineering specifications, uniform distribution of light is secured, with no deep shadows or sharp contrasts and without distracting glare from the light source.

Easily Installed and Maintained—Each 4' Star section utilizes two 40W fluorescent lamps which are accessible from the top of the reflector. The Plaskon reflectors and end caps are light in weight, non-electrostatic, non-shatterable, non-combustible and are readily slid in and out for maintenance purposes without disassembly of the line. All visible metal parts are finished in satin aluminum.

The Star may be used singly in corridors or small rooms, or mounted in continuous rows. Continuous runs may be obtained from jobbers' stocks of bodies, reflectors, stems and end caps. Single units have twin suspension. Detailed installation instructions accompany each assembly.

MINIMUM REQUIREMENTS

The following table sets up the minimum requirements:

CONTINUOUS ROW INSTALLATIONS

Spacing	Room Index A	Large Rm. 48' x 96'	Room Index D	Med. Room 24' x 38'	Room Index G	Small Rm. 12' x 24'
	No. Rows	Fcs.	No. Rows	Fcs.	No. Rows	Fcs.
4' 0"	12 of 22*	79	6 of 10*	58	3 of 5*	43
4' 4"	11 of 22	72				
4' 9"	10 of 22	66	5 of 10	48		
5' 3"	9 of 22	59				
6' 0"	8 of 22	52	4 of 10	38	2 of 5	29
6' 9"	7 of 22	46				
8' 0"	6 of 22	39	3 of 10	23		

*Units per row.

Photometric Chart

Impartial tests by electrical testing laboratories to determine the candlepower efficiency of THE STAR in various planes have been plotted as a curve which demonstrates what may be expected from this unit. Data showing the estimated footcandles in service on various spacing arrangements are available. For further details, consult Sweet's File or write to

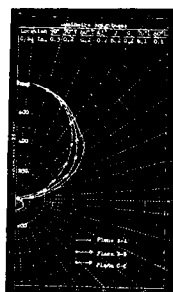

THE F. W. WAKEFIELD BRASS COMPANY
Vermilion, Ohio.

Wakefield Over-ALL Lighting

FOR OFFICE • DRAFTING ROOM • STORE AND SCHOOL

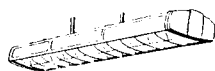

THE GRENADEIER II



THE GRENADEIER IV



THE COMMODORE



THE DIPLOMAT



Here it is
**COMPLETE
 INFORMATION
 on
 FIRE ALARM
 SYSTEMS**

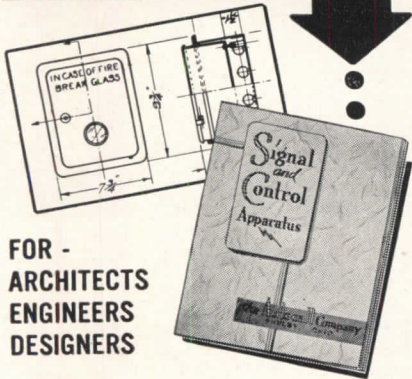

**FOR -
 ARCHITECTS
 ENGINEERS
 DESIGNERS**

Send for it TODAY

Invaluable for quick reference, this catalog contains illustrations, sketches, and wiring diagrams for all types of Fire Alarm Systems, for any building.

Suggested electrical specifications for your information and convenience are also supplied.

Specific Information on complete Fire Alarm Systems, Boxes, Signals, Punch Registers, Printing Recorders, etc., at your finger-tips.

Ask for your copy today!
 There is no obligation.

the Autocall Co.

221 TUCKER AVE., SHELBY, OHIO

ALSO MFRS. PAGING AND
 SPRINKLER ALARM SYSTEMS

**ARCHITECTURAL
 ENGINEERING**

TECHNICAL NEWS AND RESEARCH

(Continued from page 172)

tion without cracking. Radiant Lamp Corp., Newark 8, N. J.

WATER HEATERS

An automatic water heater engineered to use butane, propane or any mixture of liquefied petroleum gases has been announced. Offered in three sizes, 20-, 30- and 45-gal. capacity, this heater features an all-steel atmospheric burner. Air makes free contact with the flames to assure complete combustion. The new Grayson "Unitrol" consolidates the thermostat, safety shut-off valve, main gas cock, gas flow control valve and pilot valve in one unit. Manufacturer claims fuel costs for this heater are considerably less than electricity in most areas. Coleman Co., Inc. Wichita 1, Kan.

ELECTRIC HEATERS

Westinghouse Electric announces a new floor model electric heater with a built-in thermostat which heats by both radiation and convection. Available in 2, 3 or 4000 watt capacities, all units are 19 in. high and operate on 230 volts ac. Westinghouse Electric Corp., Pittsburgh, Pa.

STORM SASH

A metal storm window installed on the inside and combining the casement and screen to make a complete window unit is offered by the manufacturers of Fenestra steel casement windows. An extruded rubber gasket is attached to the storm window frame to prevent metal-to-metal contact and to act as a quick seal for the whole opening. It is interchangeable at same-size windows, is made of formed steel, bonderized, with baked-on coat of paint. Installation of this storm window is said to provide an insulating air space between the windows, reducing heat loss and preventing fogged or frosted windows. Detroit Steel Products Co., 3113 Griffin St., Detroit 11, Mich.

SWITCHES

A new mercury switch for homes and commercial buildings, with a 10 amp. T-rating at 125 volts has been developed by General Electric Co. Mercury is contained in a metal enclosure, which consists of mercury-to-mercury contacts enclosed in two metal alloy disks glass-sealed in a ceramic barrier. Hydrogen gas in the "button" prevents oxidation of the mercury and cools and quenches the arc when circuit is broken. General Electric Co., Bridgeport, Conn.

CORRECTION

Trade name for the house intercommunication system of Webster Electric Co., Racine, Wisc. (ARCHITECTURAL RECORD, Dec., 1947, p. 152) is *Telehome*.



LOOK-One Hand!

A. W. Faber's quick-action
 (black or colored)

LOCKTITE

refill
 works
 the thumb
 drawing pencil
 with a flip of

- 1). Patented collet to hold lead in bulldog grip.
- 2). One-hand clutch operation to avoid touching lead and smearing fingers.

These are but two exclusive features which make LOCKTITE the favorite of professional men. Collet prevents lead breaking or slipping. Try this clean, balanced, sturdy mechanical beauty and you will surely want to own it.

Holds all standard graded drawing or retouching leads. Winner Techno-TONE No. 1930 assures best results.

ALSO AVAILABLE IN RED, BLUE, GREEN, YELLOW, CARMINE, ORANGE and WHITE —holding hardy WINNER Techno-TONE crayon leads for coloring, sketching and checking.

BLACK in degrees 4B to 9H. Sold at Stationers', art and drawing supply stores, photo supply shops and Blueprinters.

**GUARANTEED
 OF COURSE!**

AW. FABER-CASTELL
 PENCIL COMPANY INC. NEWARK 4, N. J.

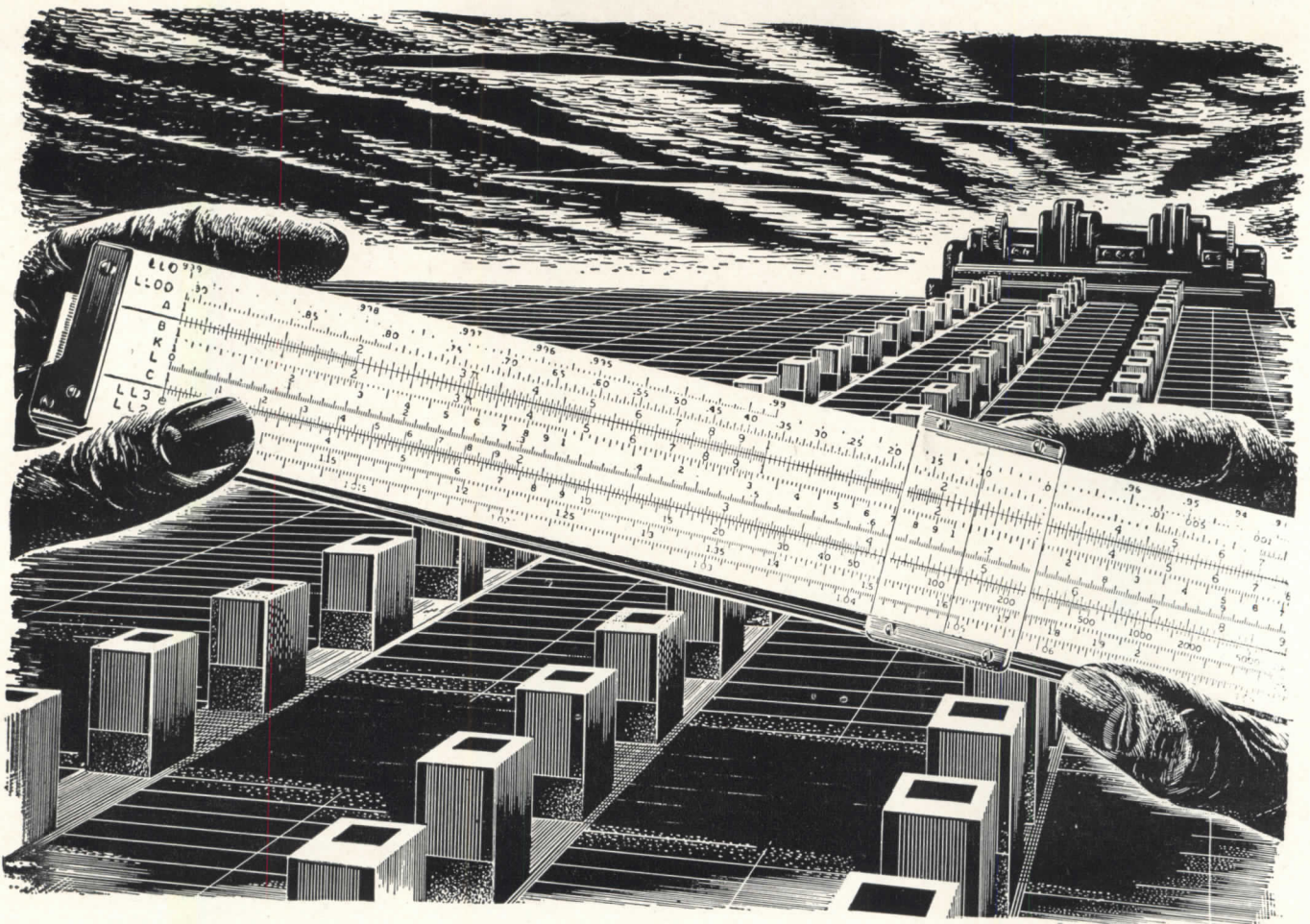

TRANE HEATING and AIR CONDITIONING -- Engineered Products for Engineered Systems

Complete air conditioning systems provide heating as well as cooling. More than that, they provide humidification, dehumidification, filtering, and air circulation. Obviously, no two applications require exactly the same combination of all of these functions . . . thus mass-produced air conditioning often provides too much of one factor and too little of another.

Architects, engineers, and contractors — who know that each job calls for a specially designed system — find their solution in the complete Trane line of heating and air conditioning products. They combine Trane engineered products — built with the economy

of line production — into systems that meet exact requirements in every way.

Because Trane manufactures a *complete* line, architects, engineers, and contractors can plan entire Trane systems, obtaining all the necessary elements from one source, with one responsibility. Trane Field Offices in 85 principal cities offer these men their entire cooperation.

* * *

The Convector-radiator—modern successor to the old-fashioned cast iron radiator—has been engineered by Trane for universal application to steam and hot water heating systems, and is being produced in quantity so you can now secure it from local distributors' stocks.

TRANE

Manufacturing Engineers of Equipment for
HEATING AND AIR CONDITIONING

THE TRANE COMPANY, LA CROSSE, WISCONSIN • Also TRANE COMPANY OF CANADA, LTD., TORONTO, ONTARIO



**EMPHASIZE
THE BEAUTY OF
Natural
Wood**



Cabot's Creosote Stains provide a variety of interesting and practical colors for wooden siding, clapboards, and shingles... clear brilliant hues to weathering grays and browns. Cabot's Stains actually dye the wood, bringing out all the natural beauty of the grain. And Cabot's Stains are made with 60% to 90% pure creosote oil, the best wood preservative known.

Cabot's Stains are inexpensive... cost less than half as much as good paint. Go on quickly and easily. Won't peel or blister, even on green lumber.

Write Today for free booklet, "Stained Houses" and color cards. Samuel Cabot, Inc., 2181 Oliver Building, Boston 9, Mass.

**Cabot's
Creosote
Stains**

**ARCHITECTURAL
ENGINEERING**

TECHNICAL NEWS AND RESEARCH

(Continued from page 150)

was used. 32 pp., illus. The Master Builders Co., Cleveland 3, Ohio.

PAINT COLORS

Devoe Color Comfort. Condensed specifications for Devoe paints, and a short guide to the selection of colors for room interiors on a scientific basis. Colors are grouped in four series of color types, keyed to the four natural exposures — north, south, east, and west. 44 pp., illus. Devoe & Reynolds Co., Inc., 787 First Ave., New York 17.*

STEAM TURBINE

Whiton Steam Turbines. Booklet on engineering features of a solid rotor type steam turbine, including engineering drawings and dimensional data for use in selecting the size and type of turbine needed for specific applications. 8 pp., illus. The Whiton Machine Co., New London, Conn.

METAL MANUFACTURERS

The Bluebook of Stamping Manufacturers. Booklet containing a listing of member companies of the Pressed Metal Institute, divided geographically and alphabetically, with a general description of their products. 8 pp. Pressed Metal Institute, 829 Union Commerce Bldg., Cleveland 14, Ohio.

LITERATURE REQUESTED

The following individuals and firms request manufacturers' literature:

Alfred Greif, Jr., Engineer, Department of Agriculture, Kansas State College, Manhattan, Kansas.

Hart, Igleburger, Wurst & Associates — Architecture, Land Planning, Engineering — Mutual Home Bldg., Dayton 2, Ohio.

C. H. MacMahon, Jr., A.I.A., 18330 Kelly Rd., Detroit 24, Mich.

Daniel Moskowitz, Student, 2243 62nd St., Brooklyn 4, N. Y.

R. L. O'Steen, Jr., Architectural Draftsman, 12 Coffee County Bank Bldg., Douglas, Ga.

Max Ratner, Architect, 45 N. Prospect, Oberlin, Ohio.

Gordon D. Rust, R.A., 107 W. Nelson Ave., Alexandria, Va.

Lawrence T. Smith, Principal Architectural Engineer, Division of Hospital Construction and Administration, State of Maryland Dept. of Health, 2411 N. Charles St., Baltimore 18, Md.

Perlter & Soring, Engineers, 108 West 6th St., Los Angeles 14, Calif.

Yingman Architectural Engineering Office, 45 Yenking Rd., Shanghai 18, China.

HOW TO WRITE

**LONGER
LIFE--
MORE
PROTECTION**

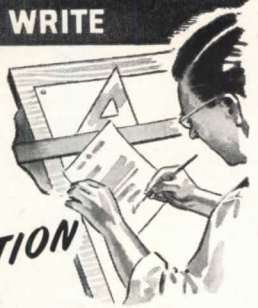

INTO YOUR FENCE SPECS!



SPECIFYING Anchor Chain Link Fence is the answer to that one... whether you're handling industrial, institutional or residential jobs! For years, leading architects have been relying on exclusive Anchor features like these to insure lasting fence protection for their clients:

1. *Deep-Driven Anchors*, which hold the fence erect and in line, in any soil or weather, yet permit easy relocation at any time;
2. *Square Frame Gates*, amazingly free from warping and sagging;
3. *U-Bar Line Posts*, self-draining, rust-free and rigid;
4. *Square Terminal Posts*, which improve strength, durability and appearance.

Your A.I.A. File 14-K isn't complete if you don't have detailed information on Anchor Chain Link Fence. So write for your free copy of our latest booklet today! It shows types and uses of Anchor Fence... prominent installations... structural diagrams and specifications. Write to: ANCHOR POST FENCE DIV., Anchor Post Products, Inc., 6600 Eastern Ave., Baltimore 24, Md.

Anchor Fence
Nation-wide Sales and Erecting Service

House & Garden—trend-setter



House & Garden creates new trends in living for an audience that thousands of others follow. Prestige stores display these trends...knowing that acceptance by the people who influence other people is the key to multiple sales. House & Garden's far-reaching influence...through key people...and key stores...becomes a powerful force at the point of sale. This is the golden touch.

House & Garden

© 1948, The Condé Nast Publications Inc.

alert management uses House & Garden's golden touch in the golden markets

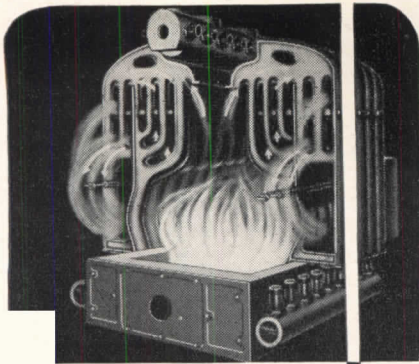

How many boilers do you see?

The nine-section Mills 44 boiler illustrated above is actually 18 boilers, guaranteeing you 18 times as much security as any other type boiler. If, for any reason, a section becomes disabled, 17 other boilers continue to function, without interruption!

Why so? Header type construction makes each section a separate boiler — each receives returns uniformly from return drums and each discharges to a steam drum. A cracked section can be temporarily blocked off by simply cutting its supply and return nipples and plugging the drums. The replacing section can then be installed when convenient.

There's a place for Smith-Mills boilers wherever *continual, uninterrupted, economical* heating is necessary. Other unique and exclusive advantages of Smith-Mills boilers are described thoroughly in the H. B. Smith Catalog . . . write for it.

H. B. *Smith*

CAST-IRON BOILERS

THE H. B. SMITH CO. INC.,
67 Main St., Westfield, Mass.

Offices and Representatives
in Principal Cities

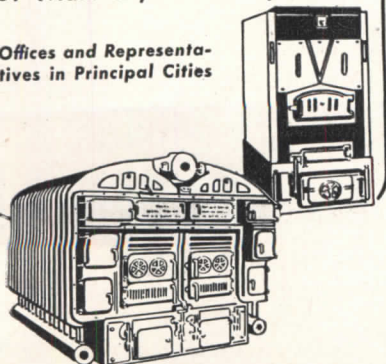

REQUIRED READING

(Continued from page 30)

sion of a generous number of site plans, floor plans and photographs of existing buildings in widely scattered parts of the country. Whimsical little sketches are used throughout to illustrate the points made.

One of the best chapters in the section on design is the last, which has to do with current trends. As Mr. Abel's firm (Berla & Abel, of Washington, D. C.) is one of the country's most active in the apartment field, he is in a position to know just what is wanted and what is being built.

Part 2 of the volume, "Structural Design," has been prepared by Fred N. Severud, whose work, like Mr. Abel's, is thoroughly familiar to RECORD readers. This section discusses framing and framing systems and wall construction, winding up with a chapter entitled "pitfalls." Diagrams and detail drawings are used liberally throughout.

In the last section of the volume are three special chapters: "Heating and Air Conditioning," by Clifford Strock, editor of *Heating and Ventilating*; "Elevators," by H. M. Nugent and W. H. Easton, Jr., of the Otis Elevator Co.; and "Landscaping," by Alfred Geiffert, landscape architect.

CITY PLANNING

A STUDY OF METHODS

The Case for Regional Planning, with special reference to New England, by the Directive Committee on Regional Planning, Yale University, Yale University Press, 1947. 94 Pages, 9 by 12 in. \$10.00.

This book could convince almost anyone that state boundaries are arbitrary, artificial and anachronistic.

The purpose of the study, however, is more to outline methods of intelligent planning than to change maps, for, the authors maintain, "exact planning for the achievement of national objectives is fully accepted in principle and practice today by the partisans of all political faiths."

Planning, says the report, has long been a tradition in American business, and more recently in the federal government, but neither of these can achieve the expression of the individual as can planning through such smaller organic units as the neighborhood, the district and the region.

Using New England as an example, the study shows the conditions which make it possible for the people of a region to plan for better homes and character-building institutions (termed

(Continued on page 180)



Costly wall sweating this inexpensive way

• Bird Neponset Black Vapor Barrier applied on the warm side of insulation prevents "in-wall" moisture damage—it repels vapor, keeps insulation at peak efficiency and stops other condensation evils.

Bird Neponset Black Vapor Barrier costs only about \$20.00 to protect a \$10,000 house. Consult Sweet's Architectural File, 9b-2. For sample write Bird & Son, inc., 180 Washington Street, East Walpole, Mass.



Specifications — Roll width: 36"; square feet: 500; approximate weight: 50 lbs. Asphalt saturated. Coated both sides with glossy asphalt surface. Meets Federal Specifications UU-P-536 Grade B.

BIRD NEPONSET BLACK VAPOR BARRIER

BIRD & SON, inc., East Walpole, Mass.
Chicago • New York • Shreveport

A Beautiful Blonde joins a Famous Family



She's light . . . she's bright . . . she's beautiful. She has a warm, honey-colored complexion, and a beautiful figure . . . both stripe and some cross-fire.

Her name is *Korina* . . . and she's the newest beauty in the famous family of Weldwood Hardwood Plywoods.

But don't get us wrong. *Korina* is not expensive, and she's far from flamboyant. This new decorative beauty is right at home any place . . . in the best shops, the finest homes.

And *Korina* is now being shipped to lumber dealers all over the country in a good range of sizes and thicknesses.

When it comes to price, there's another pleasant surprise. *Korina* closely resembles Prima Vera.

It finishes every bit as well . . . yet costs one-third less! In addition, *Korina* is cleaner, sounder and runs to wider flitches.

If you haven't yet seen *Korina*, make a date to meet this new beauty at your favorite lumber dealer. You'll find all the familiar features of Weldwood Plywood . . . so popular with clients and architects alike.

Mail the coupon for complete information.



MAKE A DATE TO MEET KORINA

It's easy. Just clip out and mail the coupon.

UNITED STATES PLYWOOD CORPORATION
55 West 44th St., New York 18, N. Y.

Gentlemen: Please send me complete specifications on your new Weldwood Hardwood Plywood . . . *Korina*.

Name _____
Company _____
Address _____
City _____ State _____

WELDWOOD Plywood

Weldwood Plywood and Mengel Flush Doors are products of

UNITED STATES PLYWOOD CORPORATION
New York 18, N. Y.

THE MENDEL COMPANY
Louisville 1, Ky.

Distributing units in Baltimore, Boston, Brooklyn, Chicago, Cincinnati, Cleveland, Detroit, Fresno, High Point, Los Angeles, Newark, New York, Oakland, Philadelphia, Pittsburgh, Rochester, San Francisco, Seattle. Also U.S.-Mengel Plywoods, Inc. distributing units in Atlanta, Dallas, Jacksonville, Louisville, New Orleans, Houston, St. Louis. In Canada: United States Plywood of Canada, Limited, Toronto. Send inquiries to nearest point.

Weldwood* Hardwood Plywood
Douglas Fir Weldwood
Mengel Flush Doors
Douglas Fir Doors
Overhead Garage Doors
Molded Plywood
Armorply* (metal-faced plywood)

Tekwood* (paper-faced plywood)
Flexmerl*
Weldwood Glue* and other adhesives
Weldtex* (striated plywood)
Decorative Micarta*
Flexwood*
Flexglass*
Firzite* *Reg. U. S. Pat. Off.



**Plastics and Wood
Welded for Good**

Weldwood Plywood is made in both interior and exterior types, the former bonded with extended urea resins and other approved bonding agents; the latter with phenol formaldehyde synthetic resin.

IN-SINK-ERATOR

AUTOMATIC GARBAGE DISPOSER

**ALWAYS
ONE JUMP
AHEAD!**

THIS IS IT, DOC!

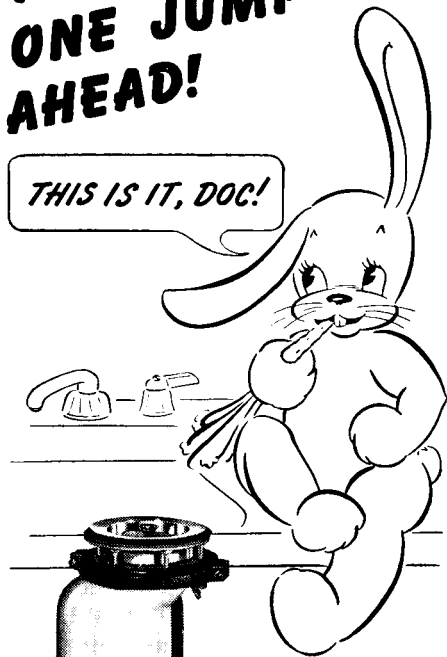

With

**THESE
OUTSTANDING
FEATURES**

- REVERSIBLE ACTING ROTOR SHREDDER

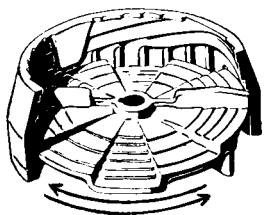

- TWO-DIRECTIONAL SHREDDING ELEMENTS
- GLEAMING WHITE FINISH
- STREAMLINED, COMPACT DESIGN

Add to all these a distribution set-up that pleases the man who makes the installation—the plumber—and you've got a garbage grinder you will own with pride, specify with confidence.

FOR FURTHER INFORMATION—WRITE DEPT. R

IN-SINK-ERATOR
MANUFACTURING CO. RAGINE, ILL.

Specializing Exclusively in the Manufacture of Automatic Garbage Disposers Since 1938

REQUIRED READING

(Continued from page 178)

basic components), for larger production, and for more efficient services. The problems of the region are analyzed, and a program of action is recommended which would begin with the formation of a Regional Development Administration, established by parallel authority of federal and state governments, and include the modernization of laws and institutions, and organization at the neighborhood and district levels.

CHICAGO

An Opportunity for Private and Public Investment in Rebuilding Chicago. Chicago, Ill., Metropolitan Housing Council, 1947. 62 pp., 8½ by 11 in.

This plan for the Central South Side of Chicago is presented frankly as an invitation to investors to consider the possibilities of urban redevelopment. It is sponsored, not by the city, but by six private and public organizations: the Illinois Institute of Technology, the Michael Reese Hospital, the South Side Planning Board, the Metropolitan Housing Council, Pace Associates (architects), and the Chicago Planning Authority. Walter H. Blucher has been retained as planning consultant, and Walter Croupius as architectural consultant.

Since the area studied is needed by the city for residential purposes, the first redevelopment step will be the construction of housing in one section of the area. Industrial facilities will be developed later in an isolated section. The recommended housing units give maximum light, air and living space, and yet are economically designed to permit low rents.

HOUSING NEEDS

Residential Areas. An Analysis of Land Requirements for Residential Development, 1945 to 1970. City Planning Commission, Cincinnati, Ohio, 1947. 8½ by 11 in. \$1.00.

As a part of its Metropolitan Master Plan Study, the Cincinnati City Planning Commission has made an exhaustive study of Cincinnati's housing needs. An inventory was made of existing housing, and about 19 per cent recommended for early demolition and other parts for repair or protection. A study of housing trends shows the areas where dwellings are being built, and studies of available land show where building should be encouraged. The committee recommends continued research, means of reducing building costs, redevelopment of certain areas and rehabilitation of others, temporary housing for displaced tenants, and reform of codes and ordinances.



Hillyard Non-skid Floor Treatments, and Economy Maintenance Materials properly care for and make attractive all types of floors in every type of institution... give entire satisfaction with less labor. Write for our new "Job Specification" Booklet, it is sent FREE upon request.

HILLYARD SALES CO'S

DISTRIBUTORS
HILLYARD CHEMICAL CO. ST. JOSEPH, MO.
470 Alabama St., San Francisco, Calif. 1947 Broadway, New York 23, N. Y.

Why EVERYBODY'S looking into BASE-RAY—a practical approach to radiant panel heating

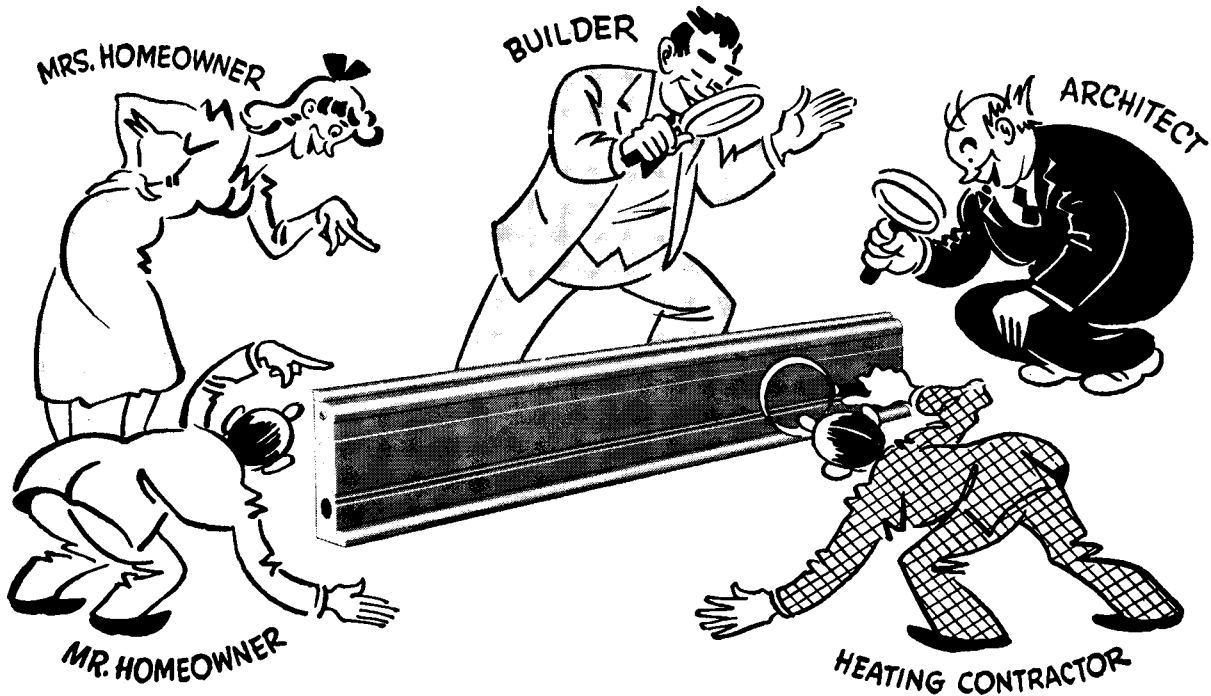

Remember, it was Burnham who pioneered the development of radiant baseboard panel heating. Burnham's BASE-RAY* Radiant Baseboards have now been on the market for nearly three years.

As time passes, Mr. & Mrs. Home Owner are going to be more and more frequently asking for your opinion of this sensational new method of radiant heating.

There are sound reasons why you can confidently recommend BASE-RAY Radiant Baseboards.

Our experience has given us ample opportunity to iron out

the "bugs" which are usually present in any radically new product—and to work out installation procedures that time has proven are simple, practical and economical. Yes, Burnham's BASE-RAY Radiant Panels are an accepted and established product. They have already been installed in thousands of homes and have demonstrated their ability *in actual use* to live up to every claim we have made for them.

*Reg. U.S. Pat. Off.

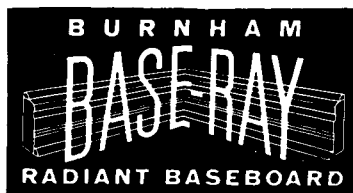

Mail coupon below for Booklet which gives ratings and installation data on BASE-RAY Radiant Baseboards.

Burnham Corporation

"PIONEERS OF RADIANT BASEBOARD HEATING"

IRVINGTON, N. Y., Dept. AR-28



Burnham Corporation Dept. AR-28
Irvington, New York
Please send me copy of "Ratings and Installation
Guide on BASE-RAY Radiant Baseboards."

Name.....
Address.....
City.....State.....

What type of work does your firm handle?

Sweet's File S architectural	Sweet's File S architectural	Sweet's File S architectural	Sweet's File S architectural	Sweet's File S architectural	Sweet's File S for builders	Sweet's File S engineering	Sweet's File S engineering
contractors and special services 1 foundations 2 structural systems 3 masonry 4 wood 5 metals 6 glass 7 roofing and siding 8	waterproofing 9 heat insulation 10 sound control 11 wallboard, lath and plaster 12 flooring and wall covering 13 paints and finishes 14	doors 15 windows 16 hardware 17 door and window equipment 18	partitions, wirework and fences 19 store fronts 20 skights and ventilators 21 sanitary equipment 22 kitchen and food service equipment 23 furnishings and special equipment 24 elevators 25	pipe and fittings 26 water supply and drainage 27 electrical distribution 28 air conditioning and heating 29 lighting 30 communication 31	builders' equipment and tools 1 building materials 2 structural equipment 3 mechanical and electrical equipment 4 household appliances 5 special services 6	construction equipment and services 1 structural systems 2 building materials 3 structural equipment 4	mechanical equipment 5 electrical equipment 6 plant utilities 7 service equipment 8

SWEET'S FILE, ARCHITECTURAL

SWEET'S FILE for BUILDERS

SWEET'S FILE, ENGINEERING

You need information on certain kinds of building materials and equipment, according to the type of work handled by your firm. Other firms, active in other types of projects, need information on products, some of which are of little or no interest to you.

To give each firm of architects, engineers, contractors or builders the product information it requires, and to do so without wasting the money of the manufacturers who pay for this catalog service, Sweet's issues three separate files of catalogs. These three catalog files — *Architectural*, *Builders* and *Engineering* — are distributed in accordance with the type of work done, and the volume of such work.

Thus, a firm of architects designing commercial, educational, institutional, public, religious, recreational or residential buildings (other than small houses) receives Sweet's File, Architectural. Another architectural firm, active almost exclusively in the small house field, receives Sweet's File for Builders, which is compiled especially for designers and builders of light structures.

Architects predominantly active in designing industrial type buildings receive Sweet's File, Engineering. Firms of engineers, contractors or builders are similarly qualified in directing the distribution of the files.

We ask all recipients of Sweet's Files to consider that this service can be effectively rendered only with the cooperation of hundreds of manufacturers. Although some of them have products for all types of buildings, many have more restricted markets. For these, the economies of employing Sweet's service would be lost in excessive distribution of their catalogs. Specialized catalog distribution in three major divisions of the building market serves the interests of all concerned—building designers and constructors on one hand, and manufacturers of building materials and equipment on the other.

Sweet's is working constantly to get more catalogs and better catalogs in each of the files. One of the first things manufacturers want to be sure of is that their catalogs in Sweet's will be placed, without waste, in the right hands.



Sweet's Catalog Service

division of F. W. Dodge Corporation

119 West Fortieth Street, New York 18, New York

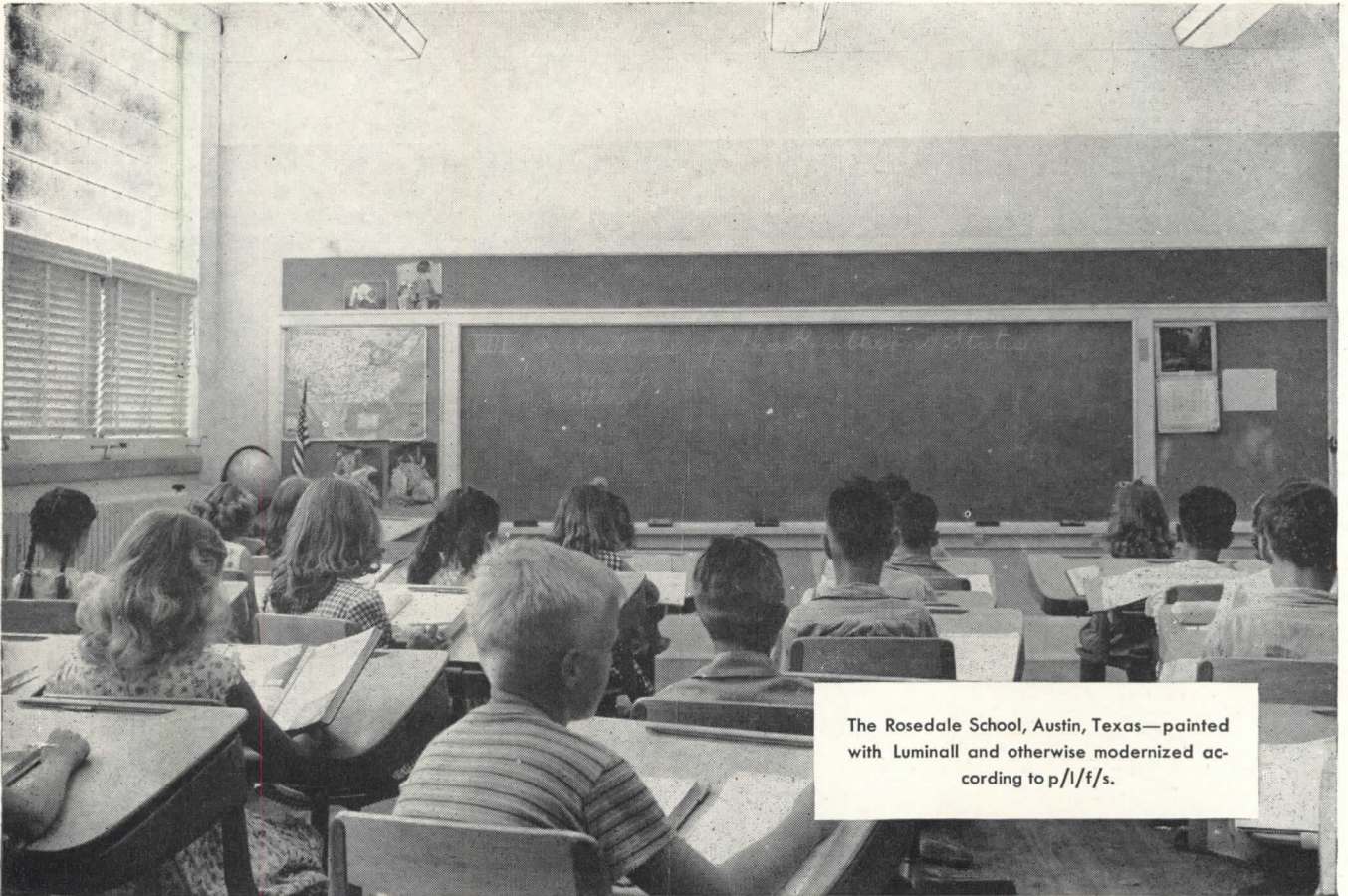

The Rosedale School, Austin, Texas—painted with Luminall and otherwise modernized according to p/l/f/s.

The Advantages of LUMINALL PAINT in the Harmon Technique

For convenience, p/l/f/s is used here as an abbreviation of "painting, lighting, fenestration and seating as coordinated according to the Dr. Darell B. Harmon Technique."

When schoolrooms are modernized according to this technique, a profound improvement is noted in the educational progress of students as well as improvements in their physical well-being. The cost of p/l/f/s modernizing an old schoolroom has been as low as \$40 in some areas. This type of modernization is applicable to many factories, workrooms and offices.

Luminall paint is ideal for painting walls and ceilings in a p/l/f/s job. It is highly light-reflective—up to 90.6%

for white. It maintains this reflectivity because it does not "yellow" or discolor from age and exposure. It diffuses reflected light thoroughly. Luminall paint was used in the Mexia, Texas, Rosedale (Austin, Texas) schools which played such an important part in the development and testing of p/l/f/s.

Ask for a copy of Dr. Harmon's "LIGHT ON GROWING CHILDREN," reprinted from Architectural Record. On receipt of sketches showing dimensions and details of schoolroom, specifications will be furnished according to the Harmon Technique without cost or obligation. NATIONAL CHEMICAL & MFG. CO., 3617 S. May Street, Chicago 9.

Use Luminall to Save Time

Use Luminall paint for finishing new work or remodeling jobs. You can apply it over damp plaster without damage to either plaster or decorating. Lets you deliver a complete job sooner. Luminall is a Casein base paint. Thins with water. Sold by more than 3000 leading paint merchants.

LUMINALL

the light-reflective
paint for interiors



"I'LL HAVE TO RUSH BACK TO THE OFFICE; I FORGOT
TO LOCK UP MY COPY OF ALAN DUNN'S
THE LAST LATH!"

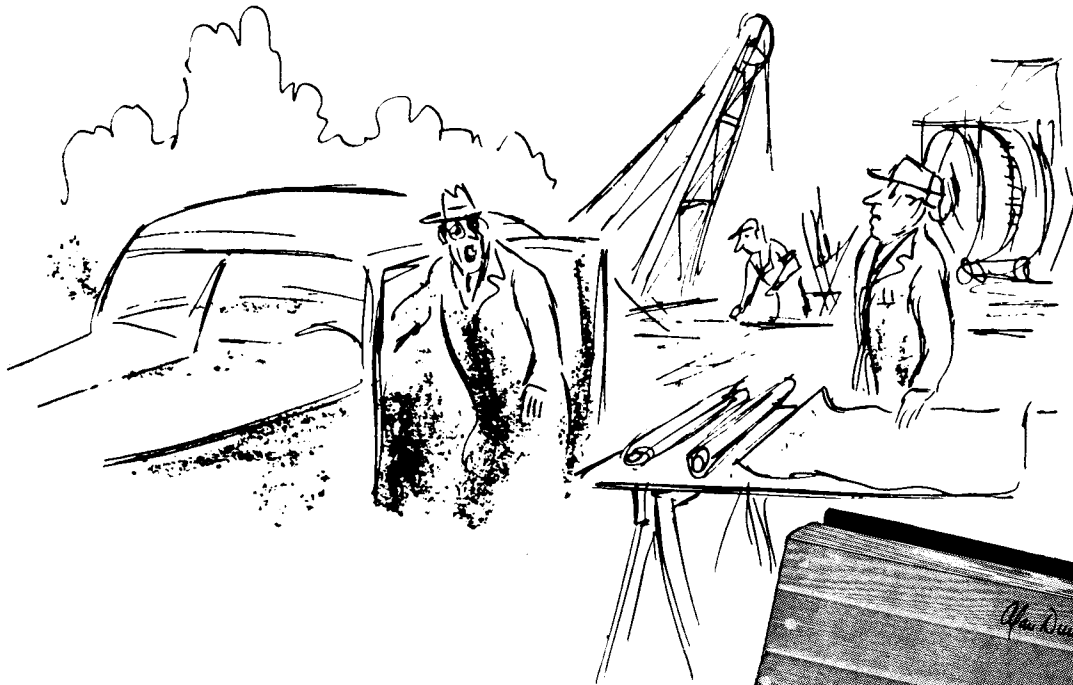

We know how the gentleman feels. After waiting all these years for a collection of Alan Dunn cartoons about building, he doesn't want **THE LAST LATH** to slip through his fingers—and neither will you when you see it!

THE LAST LATH contains 152 canny cartoons (120 from the *Record*—32 new ones) about architects, carpenters, clients, roofers, real estate people and plumbers, by a *New Yorker* artist who knows (and ribs) the problems and patter of the whole building industry.

Here's a book for every architect's reception room, as "preparation for a proper architect-client relationship," to quote Lewis Gannett in the *New York Herald Tribune*, and to quote him again, "what's the use of trying to describe Mr. Dunn's imagination in words?"

Use the coupon at the right to order your copy and see for yourself! Only \$2.50 for 152 cartoons, 96 pages (8 x 10), heavy picture covers!

ARCHITECTURAL RECORD BOOK DEPT.
119 West 40th Street, New York 18, N. Y.

Please send me copies of **THE LAST LATH**.
I enclose \$.....

1 to 5 copies \$2.50 each. 6 to 100 copies \$2.25 each.
Over 100 copies \$2.00 each.

(Add 2% Sales Tax for N. Y. C. delivery)

Name.....

Address.....

City.....Zone.....State.....

How to give your clients the most for their money

LOOKING DOWN PATH

Leading to front entrance of 10-year-old Murray residence at Broadway and Clinton Ave., Irvington, N. Y. Monel solarium and dormer roofs, gutters, downspouts, chimney flashings and other metal work are still in excellent condition after 10 years of hard service.

• • •

MONEL WEATHERS ATTRACTIVELY.

(See inset) On the vertical sides of the gutter, and on fascia around the solarium, the Monel surfaces have acquired a soft patina which blends harmoniously with the Indiana limestone exterior.



This is the home of the Joseph Norris Murrays, in Irvington, N. Y.

It was built in 1938.

Look at it today. Though located on the crest of a hill where it takes a beating from the weather, its gutters, leaders, downspouts and chimney flashings are like new.

And that's only natural. For all these vital parts are made of corrosion-resistant Monel* Roofing Sheet, the most enduring of all commonly-used roofing materials. Approximately two-thirds nickel and one-third copper, it is stronger and tougher than structural steel. Its hard, smooth surfaces resist wear and erosion from snow, ice and rain water.

Yet, tough as it is, Monel Roofing Sheet is easy to fabricate. Contractors readily cut, bend, form it to the

irregular contours of cornices, gutters and skylight frames; they solder, braze and weld it by ordinary methods.

What about price? Actually, Monel Roofing Sheet can save money for your clients. The principal reasons are: 1) Monel's strength and rigidity permit use of thinner gauges; 2) Monel's dependable protection acts as a "life-of-the-building" safeguard for the home-owner's maintenance budget.

Our illustrated booklet *Monel For Permanent Roofs* contains further information on this subject. We think you'll find it both interesting and helpful. Write for it now, using the handy coupon below. We'll get your free copy into the mails promptly.

* Reg. U. S. Pat. Off.

MONEL...FOR MINIMUM MAINTENANCE

Send for
this FREE Booklet

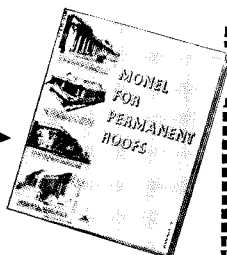

The International Nickel Company, Inc.
67 Wall Street, New York 5, N. Y.

Without obligation, send me a copy of *Monel for Permanent Roofs*.

Name.....

Company.....

Street.....

City..... Zone..... State.....

EMBLEM OF SERVICE



THE INTERNATIONAL NICKEL COMPANY, INC.
67 Wall Street, New York 5, N. Y.

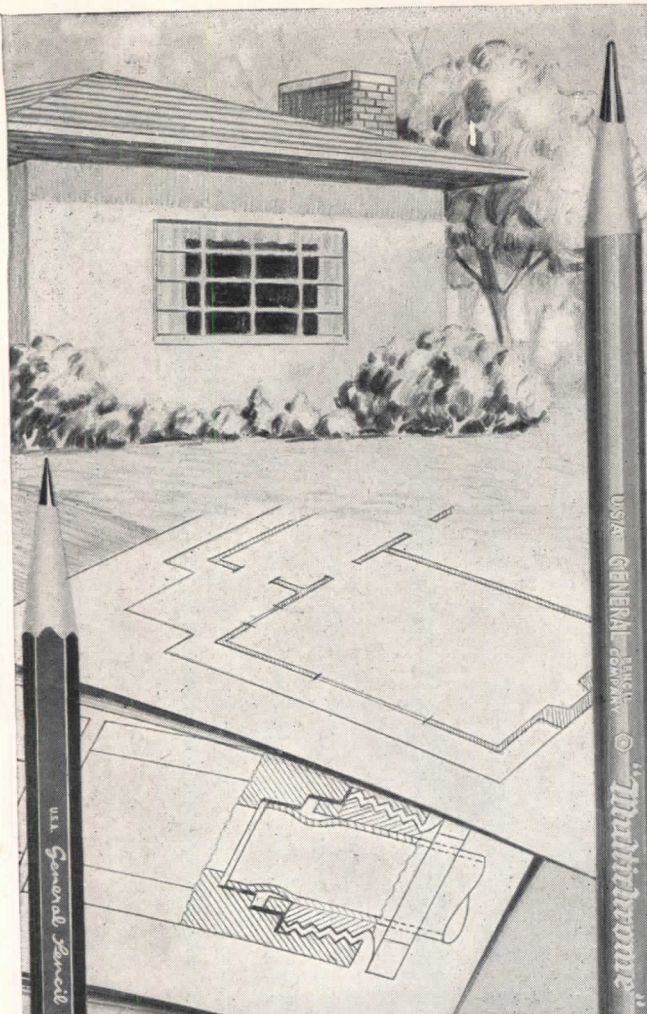

Performance COUNTS

Try Kimberly Drawing Pencils. See how quickly details and tracings respond to their crisp, opaque blacks. . . . Enjoy drafting at its best with Kimberly.

Use Multichrome's 50 brilliant colors. Make a few renderings . . . notice how easily the splendid colors can be handled . . . how satisfying are the results.

Here are distinctive pencils, correctly suited to every drawing purpose. Buy Kimberly and Multichrome from your dealer today.

KIMBERLY DRAWING PENCILS
22 degrees, 6B to 9H, Tracing 1-2-3-4
Extra B layout pencil

MULTICHROME COLORED DRAWING PENCILS
50 brilliant colors
Also 12-24-36-48 assorted colors to the box



Makers of Fine Pencils since 1889

GENERAL PENCIL COMPANY

67-73 FLEET STREET . . . JERSEY CITY 6, N. J.

3-Way Protection for the buildings you design



...with "CZC"-treated wood

You can give the buildings you design additional long life by including "CZC"-treated wood in your plans. Wood that has been pressure-impregnated with "CZC" resists decay, repels termites, and is resistant to fire.

"CZC"-treated wood is paintable, odorless, clean and safe to handle. It has all the advantages of untreated wood, plus these other life-extending features.

Wherever "CZC"-treated wood is used, maintenance costs are lower, safety is greater. Your clients will find that Du Pont Chromated Zinc Chloride pays for itself many times.

For additional information on this wood preservative that makes wood last longer, write E. I. du Pont de Nemours & Co. (Inc.), Grasselli Chemicals Department, Wilmington 98, Delaware.

DU PONT CZC

Chromated Zinc Chloride

MAKES WOOD RESIST DECAY • REPEL TERMITES • RETARD FIRE



REG. U. S. PAT. OFF.

BETTER THINGS FOR BETTER LIVING
... THROUGH CHEMISTRY

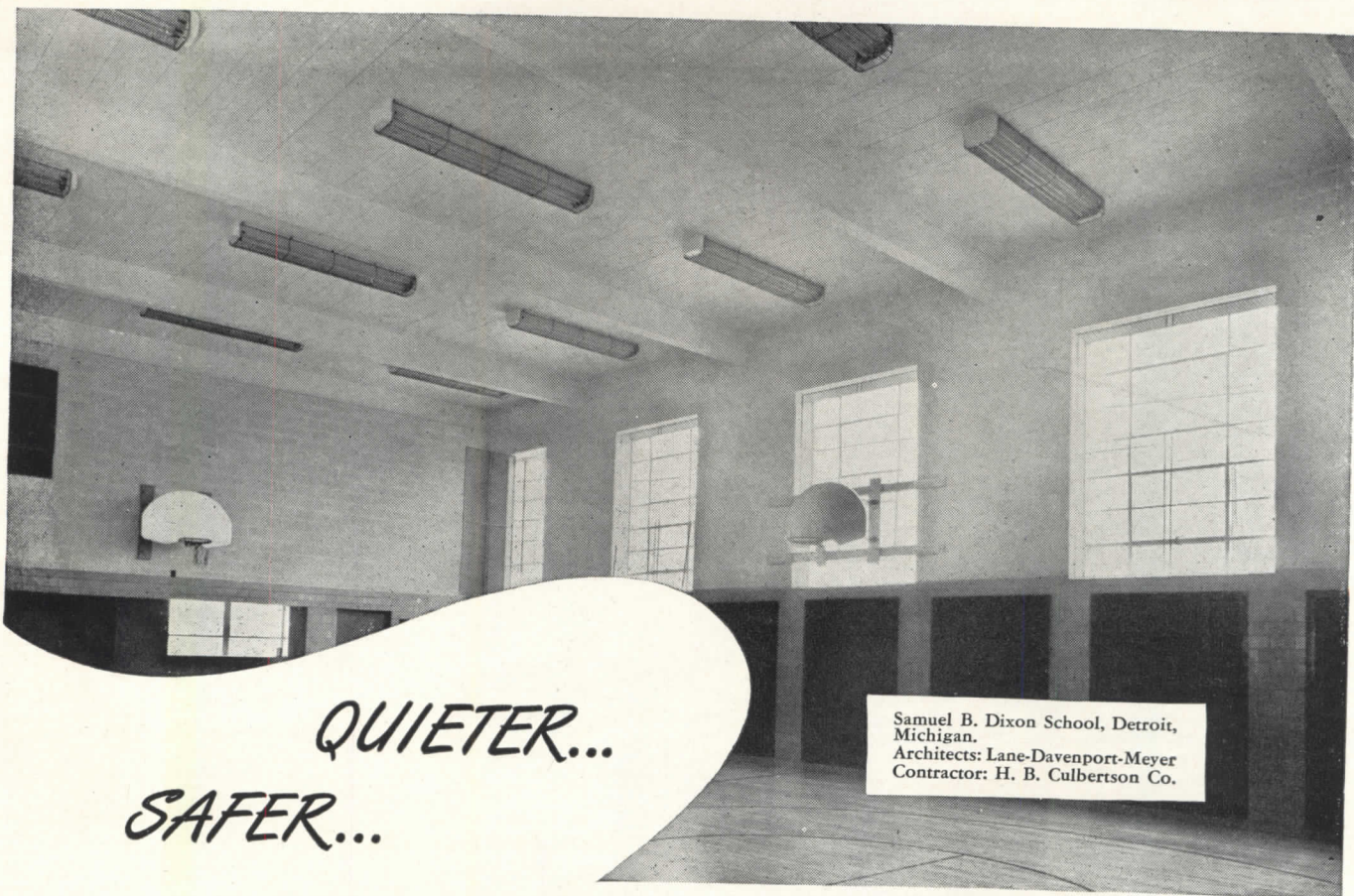

QUIETER...
SAFER...

Samuel B. Dixon School, Detroit,
Michigan.
Architects: Lane-Davenport-Meyer
Contractor: H. B. Culbertson Co.

acoustical ceiling of noncombustible *Fenestra* **STEEL PANELS**

This Detroit school gymnasium illustrates the versatility of Fenestra Building Panels. Here is a combination ceiling and roof that provides desired quietness and firesafety, and does it by economical construction methods.

Fenestra Type AD Panels, 17' long, are laid directly on the beams, eliminating purlins and rafters. The result: a clean, unobstructed ceiling.

This long-span panel is capable of carrying either roof or floor load between beams. The smooth, bottom face is perforated and backed up with fibre glass or rock wool, inserted within the cells, for sound absorption. Wiring for lights is also concealed in these cells. Insulation and roofing, applied to the top surface, completes the roof unit. When used for floors, the Type AD Panels are combined with concrete or other floor surfacing materials of your choice.

Type AD Panels, available in lengths up to 20', are ideal for construction calling for two flat surfaces. Also available are Fenestra Type C and D Panels, as well as Holorib Roof Deck. These metal panels provide an economical and timesaving means of building floors, walls, ceilings, roofs and partitions. You'll find data on all types in Sweet's Architectural File. Or mail the coupon.

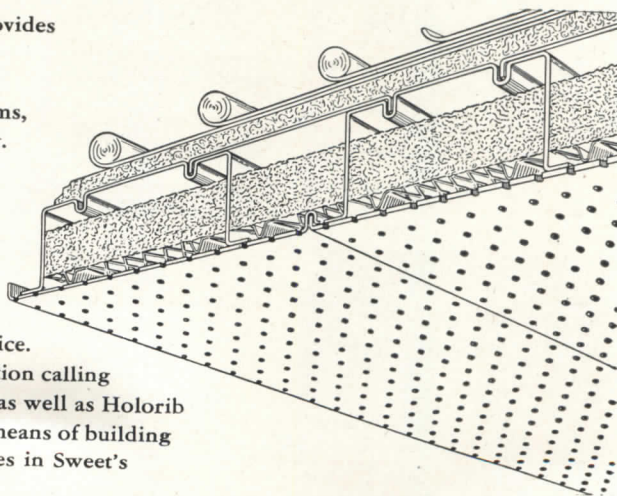

Fenestra
BUILDING PANELS FOR

ROOFS

WALLS

FLOORS

DETROIT STEEL PRODUCTS COMPANY
Building Panels Division
Dept. AR-2, 2252 E. Grand Boulevard
Detroit 11, Michigan

Please send me, without obligation, information on Fenestra Building Panels.

Name

Company

Address



*Here's Beauty with
Safe, Lasting Service
in Step Treads —*

**Now —
Heavy Duty
Molded SAFETY**

Step Treads in marbled blue-gray and tan patterns give appealing beauty with long-lasting service. . . . MELFLEX SAFETY Treads are molded $\frac{3}{8}$ inch thick of special "frictioned" rubber compound to cover both the tread and step-edge. Approved by Underwriters Laboratories, Inc. (No. SA 833) as a SAFETY feature, this molded tread applies without requiring metal strips or screws. It stays "put", won't buckle or blister when applied simply with MELASTIC Water-Proof Cement to wood, stone, metal or composition steps. . . .

**Molded in One-Piece To
Cover Approach Edge . . .**

It cushions step edge as well as provides sure-gripping tread safety, *wet or dry*. These Treads, also available in black compound, may be applied on inside or outside steps with equal safety and service.

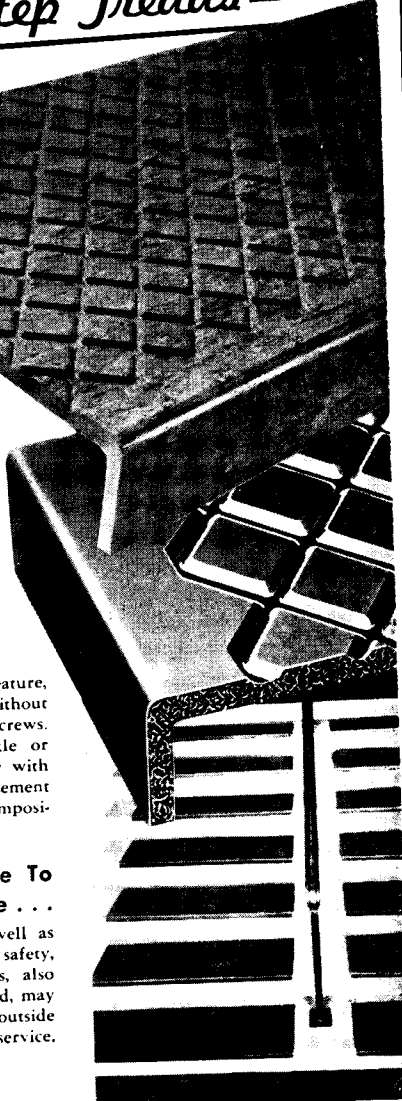

**MEL-ISLE Heavy Duty
Ribbed Rubber Runner . . .**

Compounded of special "frictioned" rubber for hard wear and slip-proof service, MEL-ISLE makes the ideal covering for aisles, runways, corridors, locker rooms. Available in black only $\frac{1}{8}$ " and $\frac{3}{8}$ " thick, 36" wide and cut to any specified lengths. High ribbed pattern facilitates cleaning and keeps tread surface slip-proof. MEL-ISLE Molded Mats, for entrances, $\frac{3}{8}$ " thick and in 5 stock sizes have beveled edges to prevent tripping. Slip-Proof *wet or dry*. . . . Durable, Economical.



MELFLEX PRODUCTS CO., Inc.
L. E. Warford, Pres.
410 S. BROADWAY . . . AKRON 8, O.
In Canada: P. O. Box 411, Ft. William, Ont.

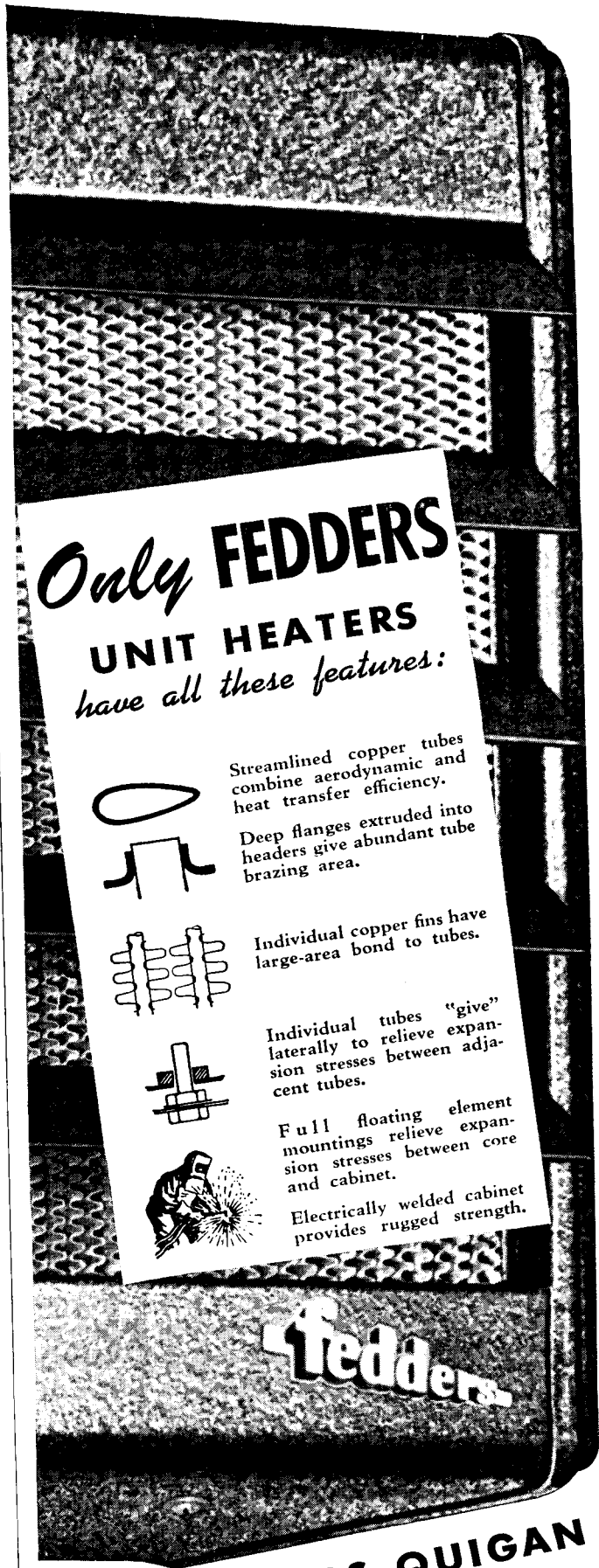

Only **FEDDERS**
UNIT HEATERS
have all these features:



Streamlined copper tubes combine aerodynamic and heat transfer efficiency.



Deep flanges extruded into headers give abundant tube brazing area.

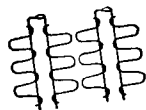

Individual copper fins have large-area bond to tubes.



Individual tubes "give" laterally to relieve expansion stresses between adjacent tubes.



Full floating element mountings relieve expansion stresses between core and cabinet.

Electrically welded cabinet provides rugged strength.

Fedders

FEDDERS-QUIGAN
CORPORATION
BUFFALO 7, NEW YORK

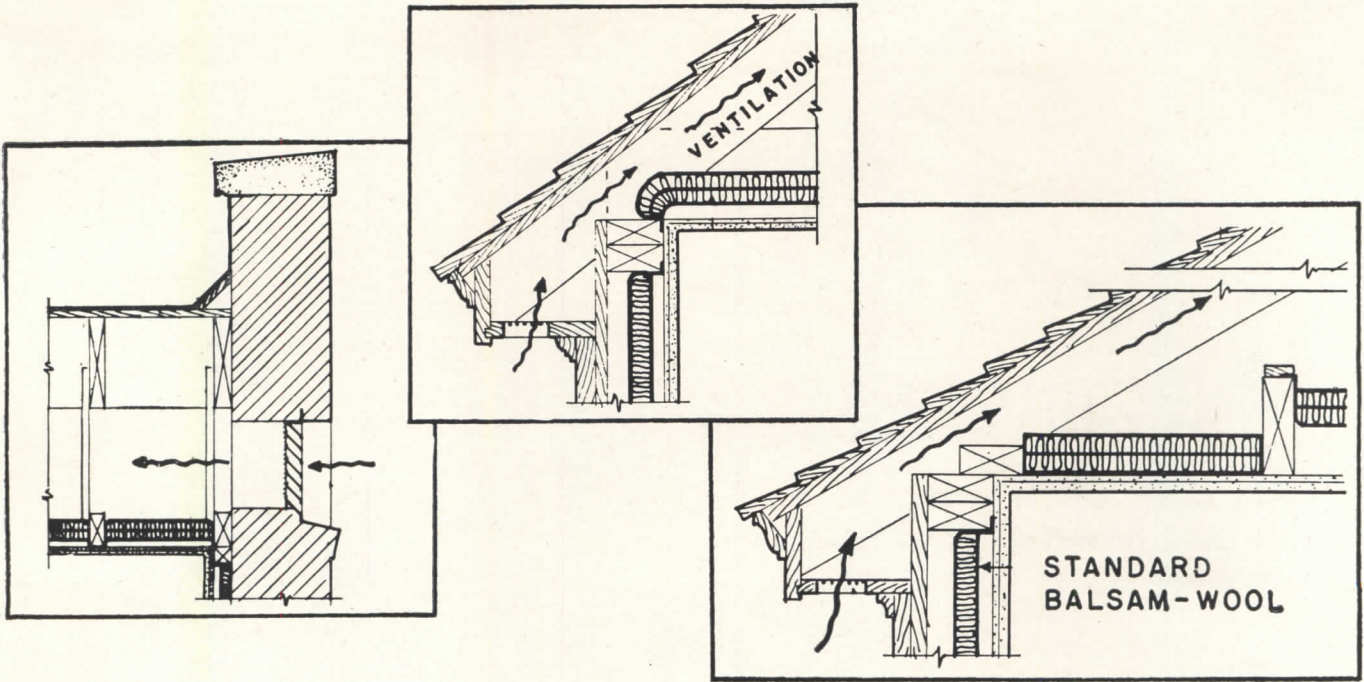

Flat, Hipped or Pitched... Insulating Them is Simple with VERSATILE *Balsam-Wool*

● Flat-roofed, hip-roofed or pitched roofed homes—you can insulate them easily and effectively with versatile Balsam-Wool. You'll find scientific "pointers" on such applications in Balsam-Wool Data Sheets—a veritable library of useful data on correct application practice.

Balsam-Wool Data Sheets were prepared to give you ready information on a wide variety of insulation problems. Designed to fit your A.I.A. file, they help conserve your valuable time. Send today for *your* set—enclosed in an attractive file folder. There's no obligation, of course.

MAIL THE COUPON FOR YOUR BALSAM-WOOL DATA SHEETS

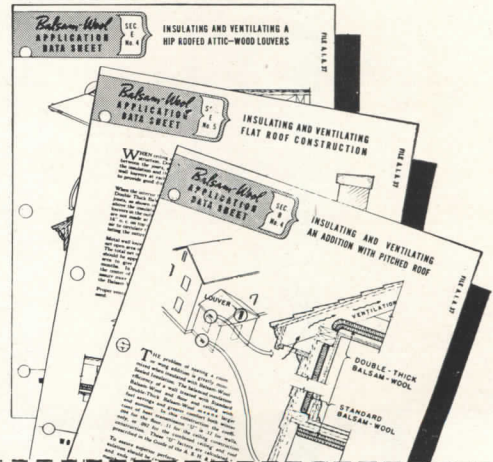

Balsam-Wool

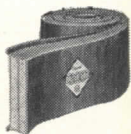

SEALED INSULATION

*REG. U. S. PAT. OFF.

BALSAM-WOOL • Products of Weyerhaeuser • NU-WOOD

WOOD CONVERSION COMPANY
Dept. 115-28 First National Bank Building
St. Paul 1, Minnesota

Please send me a set of Balsam-Wool Application Data Sheets.

Name

Address

City State



CUTTING CORNERS ?

We need more homes, for more people, more than ever before—and we salute all who put their shoulders to the wheel, to devise the ways and means to help this nation build faster than ever.

But, in the hue and cry of this strenuous period of post-war adjustment there is one grave danger. We must not only build, we must also build durably and well.

In our hurry we should not discard old and proven materials merely for the sake of "cutting corners".

Lime plaster is one of those materials that have served us for centuries. Yet no better material for finishing walls and ceilings has so far been devised. Its monolithic character is without equal. It is durable and fire-resistant. So don't "cut corners" the wrong way. Only a first class plastering job takes care of walls and ceilings, and of all the corners the right way.

When it comes to a choice of finishing lime consider the brands shown here, long known for consistent quality, always uniform, scientifically processed from the world's purest dolomitic limestone. Look for the red zig-zag stripes, your guarantee of quality.

The Ohio Hydrate & Supply Co., Woodville, Ohio



For Every Application "STREAMAIRE" CONVECTORS by YOUNG

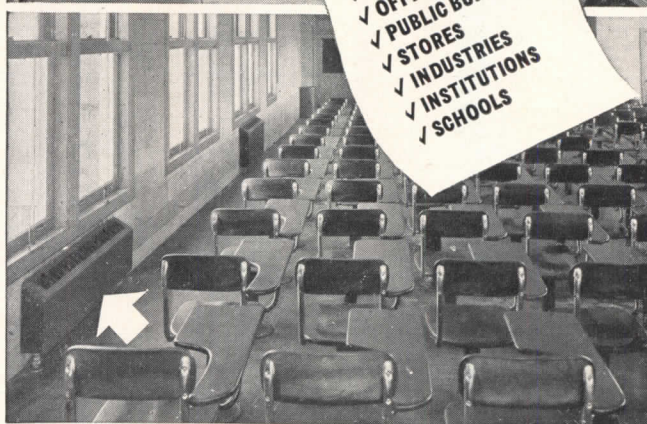
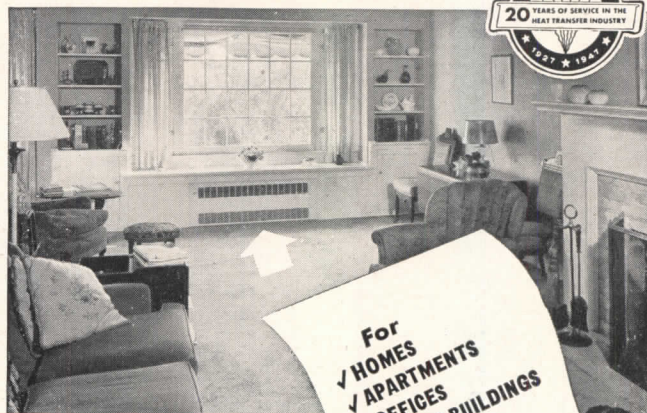

- For
- ✓ HOMES
- ✓ APARTMENTS
- ✓ OFFICES
- ✓ PUBLIC BUILDINGS
- ✓ STORES
- ✓ INDUSTRIES
- ✓ INSTITUTIONS
- ✓ SCHOOLS

• An increasing number of architects and contractors are specifying "Streamaire" Convectors because they give extras that spell heating satisfaction. "Streamaire" Units are highly efficient and truly economical. They respond instantly to modern thermostatic controls . . . are engineered to circulate warm air by controlled convection, to level off temperature peaks by natural radiation. "Streamaire" Convectors are easy to specify, easy to install because they're standardized in four types, packaged individually to prevent damage. To aid identification, cartons are marked with model number and size. "Streamaire" Cabinets enhance the beauty of modern interiors. Fronts are removable for cleaning. Write today.

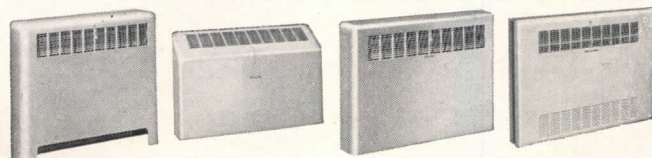

Free Standing, Type C, no wall recesses required. Wall Hung, Type WS, sloping top, no blocking of air. Wall Hung, Type W, easy to clean, one-piece panel. Partially Recessed, Type S, easy to install in recesses.

YOUNG HEAT TRANSFER PRODUCTS



YOUNG RADIATOR CO.
Dept. 518-B Racine, Wis., U.S.A.

AUTOMOTIVE AND INDUSTRIAL PRODUCTS

Gas, gasoline, Diesel engine cooling, radiators • Jacket water coolers • Heat exchangers • Intercoolers • Condensers • Evaporating coolers • Oil coolers • Gas coolers • Atmospheric cooling and condensing units • Supercharger intercoolers • Aircraft heat transfer equipment

HEATING, COOLING AND AIR CONDITIONING PRODUCTS

Convectors • Unit Heaters • Heating coils • Cooling coils • Evaporators • Air conditioning units •

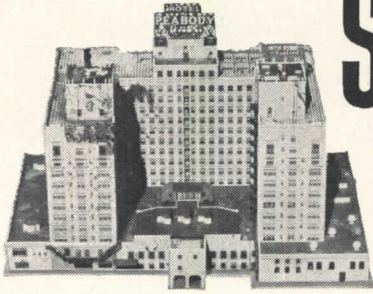

skylines ... by Otis

In Memphis, for example, 510 Otis elevators have helped create one of America's great skylines. Among the city's finest are the newly modernized elevators in the famed Peabody Hotel (left).

FRESH THING!

We hasten to add that the lady refers to the elevator's air, not its attendant. It's all due to ultra-violet lamps that purify the air and keep the bacterial count low (don't worry about the attendant — rays are indirect so passengers can't get "sunburned"). Manhattan's Lane Bryant Store and the new Tishman office building at 445 Park Avenue have them; so do leading hospitals.



GOODBYE TO BUTTERFLIES.

That sinking feeling you sometimes experience in an elevator, strangely enough, isn't due to its speed. It's because of excessive or uneven acceleration. To assure smooth, accurately controlled acceleration, Otis pioneered the first elevator application of a unique electrical principle — Unit Multi-Voltage. Now, with UMV, you're scarcely aware you're starting or stopping.

HOW TO RAISE A FORK

(truck, that is). The extra strain and wear that power trucks put on freight elevators call for something extra tough in elevator construction. Otis makes the only standardized line of elevators built specifically to withstand continuous, slam-bang punishment of heavy, quick-stopping fork and lift trucks. If you'd like to know more about these extra-rugged elevators, the coupon below will bring you an interesting bulletin.



ELEVATOR COMPANY

Offices in All Principal Cities

PLEASE SEND ME Pow-R-Truck Elevator Bulletin 705C

Name _____

Address _____

City _____ Zone _____ State _____

Clip and mail to Otis Elevator Company, 260 Eleventh Avenue, New York 1, N. Y.

Quality is here in
TILETONE'S

**MODERN DESIGN
SHOWER CABINETS**
Model 75

Here is quality in shower cabinets that's never been known before. Tiletone has designed new modern machinery to manufacture shower cabinets of MODERN DESIGN! Tiletone's Model 75 is the result of better manufacturing methods. It's unexcelled in quality with improved receptor base—longer lasting finish.



MODEL 75

Sizes: 32" x 32" x 80",
36" x 36" x 80" and
40" x 40" x 80" Corner
cabinet.

Terrazzo receptor.
White Dura-Bond
enameled aluminum
cabinet. Interior lights.
Anodized aluminum
glass doors. Adjust-
able shower head.
Dial type mixing valve.

TILETONE
Shower Cabinets

TILETONE COMPANY

2323 WAYNE AVENUE • CHICAGO 14, ILLINOIS

A
Justifiable Specification!



CINCO
Sto-a-way

**ALUMINUM COMBINATION
SCREEN AND STORM SASH**

- THEY INCREASE HOME COMFORT . . . PROVIDE WELCOME CONVENIENCES AND PROTECTION
- THEY ARE SELF-STORING . . . END SEASONAL CHANGING OF STORM SASH AND SCREENS
- THEY PROVIDE YEAR 'ROUND, RAINPROOF, DRAFT-FREE, FILTERED-SCREEN VENTILATION
- THEY ARE DESIGNED TO GIVE EXTRA BEAUTY TO ANY TYPE HOME
- THEY NEVER REQUIRE REFITTING...PATENTED THERMOLOK* FRAME ASSURES PERMANENT WEATHERTIGHT FIT AND ALIGNMENT

Every client will welcome your specification of Cinco Sto-a-way Windows. He knows about them through Cinco's extensive national advertising. For more detailed information, consult Sweet's Files for Architects and Builders or write direct.

manufactured by

The Cincinnati Fly Screen Co.

division of

THE F. C. RUSSELL COMPANY

6408-AR Herman Ave. • Cleveland 2, Ohio

NEW MODINE COILS GIVE YOU BIG, NEW BONUS FEATURES!

Four
Types, 1236
coils
to choose
from!

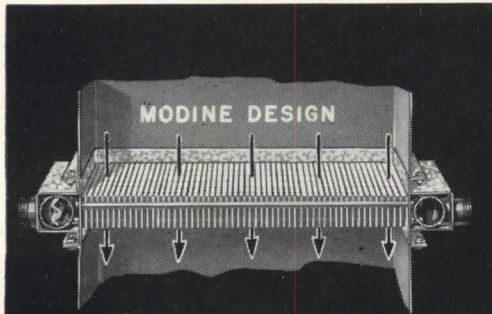

MODINE DESIGN

MODINE design eliminates baffles . . . gives you smooth, uniform airflow, low friction loss. All surface within casings is heat transfer surface, permitting smaller duct connections.

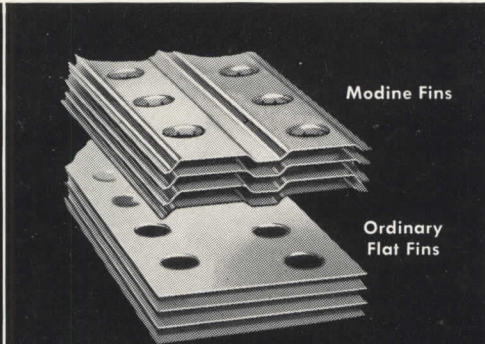

Modine Fins

Ordinary Flat Fins

MODINE copper fins compel air to "wipe" both fin surfaces and thoroughly mix before leaving coil. This greatly increases heat transfer per square foot of coil face area.

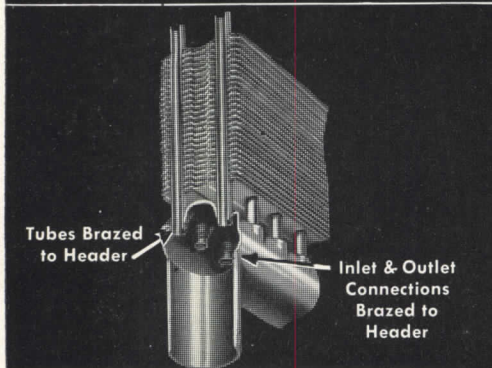

Tubes Brazed to Header

Inlet & Outlet Connections Brazed to Header

MODINE copper tubes and piping connections are brazed to headers under controlled time and temperature conditions. Result — a pressure-resisting assembly, no mechanical joints.

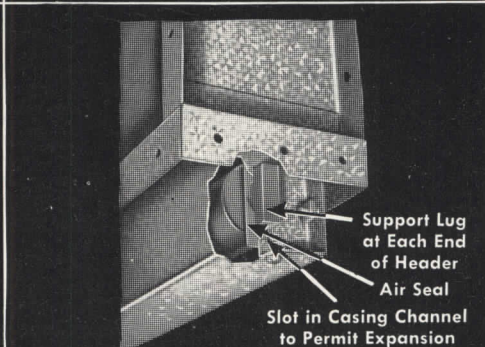

Support Lug at Each End of Header
Air Seal
Slot in Casing Channel to Permit Expansion

MODINE floating condenser principle permits coil to "grow" as it expands, retreat to normal size as it contracts . . . gives you full protection against expansion stresses, fatigue and fracture.

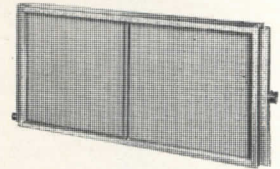

STANDARD COILS
595 individual coils

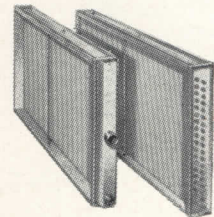

NON-FREEZE COILS
510 sizes and models

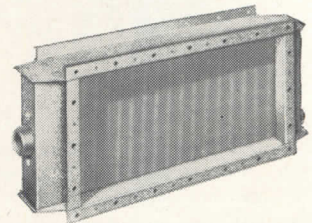

BOOSTER COILS
46 different sizes

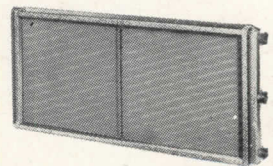

HOT WATER COILS
85 individual coils

Step Ahead With Modine Coils!

Important Modine design improvements give you better performance, greater structural strength and easier installation at no extra cost. Check the many plus-features . . . note the top quality construction . . . and you'll see why it pays to specify the new Modine Heating Coils.

Get all the facts about Modine Heating Coils. Write on your letterhead for new 48-page catalog No. 348, or call the Modine Representative listed in the "Where-to-Buy-it" section of your phone book. *Modine Manufacturing Co., 1510 Dekoven Avenue, Racine, Wisconsin*

**NEW
CATALOG
READY NOW**

Order your copy!

Modine HEATING COILS

ARCHITECT AND OWNER STAND TOGETHER ON

Moultile Floors

When the time comes to select the floor material, owner and architect can agree quickly and completely on the choice of Moultile. In every respect, Moultile admirably satisfies the requirements of the modern floor.

Moultile gives free rein to the architect's creative imagination. Being a tile-set floor, it lends itself to an endless variety of original designs. Full expression can be given to decorative ideas with the ample range of Moultile colors . . . fresh, lustrous, clear, subtly interwoven with crisp, distinct veining.

Frequently the owner expresses surprise that so beautiful a floor can be had at such economical cost. And his enthusiasm for Moultile grows with the years. Its beauty remains undimmed . . . costly periodic refinishing is never necessary. He also finds that Moultile is a friendly floor to live with . . . quiet, comfortably buoyant underfoot, non-slippery.

Moultile lends itself to all types of construction . . . over wood or cement, in conjunction with radiant heat, or on cement in contact with the ground. If you are not already acquainted with Moultile, write today for free samples . . . and ask for a copy of our complete catalog. THOS. MOULDING FLOOR MFG. CO., 165 W. Wacker Drive, Dept. AR-2, Chicago 1, Illinois.

THOS. MOULDING

Moultile

**Flexible-Reinforced
MASTER ASPHALT TILE**

The colorful, attractively designed Moultile floor helped to transform an old-fashioned office into this modern suite for Cruttenden & Eger, Chicago, Arthur A. Ehrlich, designer.

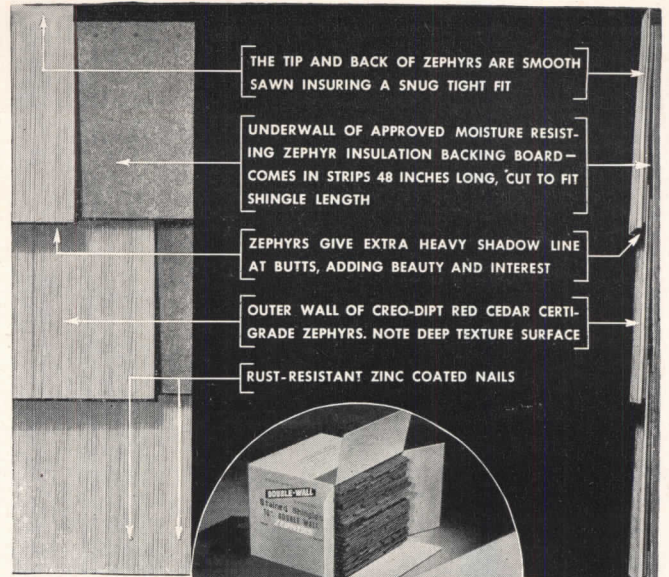

THE TIP AND BACK OF ZEPHYRS ARE SMOOTH SAWN INSURING A SNUG TIGHT FIT

UNDERWALL OF APPROVED MOISTURE RESISTING ZEPHYR INSULATION BACKING BOARD—COMES IN STRIPS 48 INCHES LONG, CUT TO FIT SHINGLE LENGTH

ZEPHYRS GIVE EXTRA HEAVY SHADOW LINE AT BUTTS, ADDING BEAUTY AND INTEREST

OUTER WALL OF CREO-DIPT RED CEDAR CERTI-GRADE ZEPHYRS. NOTE DEEP TEXTURE SURFACE

RUST-RESISTANT ZINC COATED NAILS



Double Care

A Zephyr unit covers 100 square feet of siding.

GOES INTO THE MANUFACTURE OF CREO-DIPT ZEPHYRS

Double Wall Zephyrs are made from genuine certi-grade red cedar shingles, applied over Zephyr moisture resistant insulating backing board and secured by Creo-Dipt special zinc coated nails.

Zephyrs have all the characteristics of hand split shingles—deep grooved surfaces, with butt thickness that produces heavy shadow lines. The top portion of each shingle is smooth sawn, butts are square and sides parallel insuring a snug and even fit.

Zephyr shingles are available in a wide range of colorful shades. Stained under exclusive processes using only the finest linseed and binding and preserving oils, Zephyrs are doubly able to resist weather conditions.

Zephyr approved backing board applied under Zephyrs increases insulating values 35% over ordinary wooden siding, and 42% over stucco.

When you use Double Wall Zephyrs for sidewall construction you gain double beauty, double insulation and doubly satisfied home owners—double value in every way.



Send for your copy of Creo-Dipt's new booklet on Zephyr Double Walls.

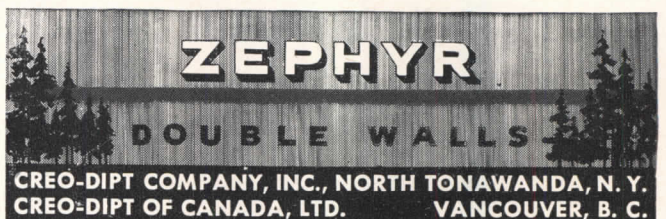

THE ORIGINAL SHINGLE STAIN—FIRST AND BEST!

A SUGGESTION TO EVERY ARCHITECT



Conceal the Door Closers Up Here Where They're Safe and Dry

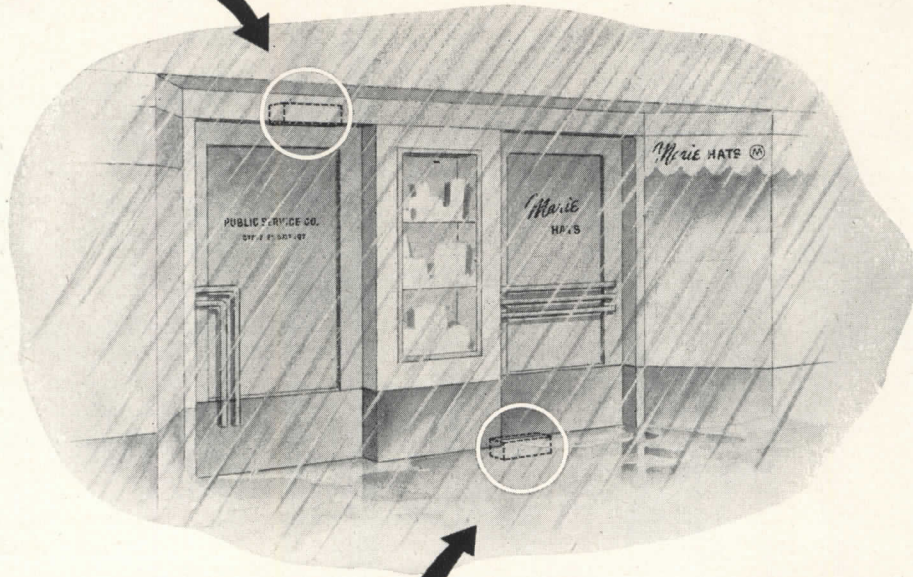

...Not Down Here Where They're Abused

Rain, snow, dust, floor dirt, scrub water—all of these are mortal enemies of good precision machinery such as the door closers you buy.

You can avoid such abuses, save money on original cost and on maintenance, and get far better door control, by specifying LCN Overhead Concealed Closers for every door where good appearance counts.

The LCN Overhead Concealed Closer (one type shown in phantom view below), because of its location over the door, delivers better performance at a lower

total cost than any floor type closer. A strong claim, but not a biased one. We make LCN Floor Type Closers in three series, and have supplied thousands of them to satisfied users. But we know that the overhead closer does a better job, size for size, and largely avoids the handicaps of any floor closer.

It is simple to install. No chiseling of floors; no interference with pipes or conduits; no need for boxed or cut thresholds. Job cost and total cost are less. Upkeep is less, as the closer is hidden up in the head frame where weather, floor dirt and scrub water cannot reach it. Yet adjustments are easily made without removing anything. May we send you LCN Catalog 11-a, a handbook of good door control? Address LCN, 466 W. Superior St., Chicago 10, Ill.

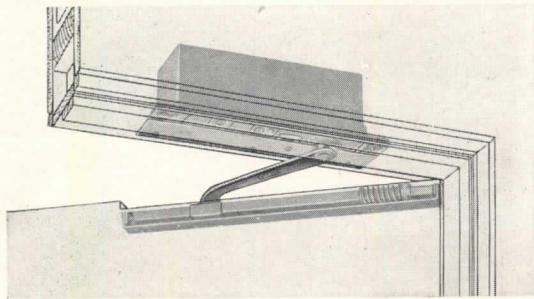

← At left — phantom view of LCN 204 Closer concealed in head frame over the door, safe from fouling.

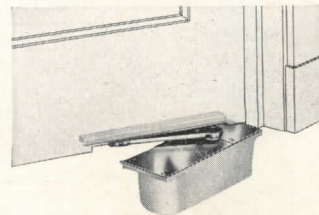

At right — phantom view of LCN 4 Closer, the best floor type for butt-hung doors.

LCN Catalog 11a Sent on Request—No Obligation

LCN

Overhead and Floor Type Concealed and Surface Type Door Closers



THEY'RE MODERN —

designed for utmost dignity and symmetry of line, with a high-lustre finish.

THEY'RE VERSATILE —

suitable for any type of wall paneling or surface covering.

THEY'RE DURABLE —

made of a special-formula alloy that assures long-wearing quality.

THEY'RE DIMENSIONALLY ACCURATE —

precision-manufacturing holds Chromtrim to rigid tolerances.

THEY'RE EASY TO INSTALL —

packaged in convenient sizes, that can be cut, shaped and installed with minimum effort.

THEY'RE AVAILABLE —

in extremely accurate profiles, designed in matching groups to serve every installation need.



Sold only through a nationwide distributor organization. See insert in Sweet's Architectural File.

Write today to Dept. AR, for Chromtrim Catalog No. 2, containing full information on the line.



R. D. WERNER CO., INC.
 295 Fifth Ave. · New York 16, N. Y.
 CANADA: R. D. WERNER COMPANY, LTD., Port Dalhousie, Ont

how do you select ROOF DRAINS

size
 number
 spacing
 purpose

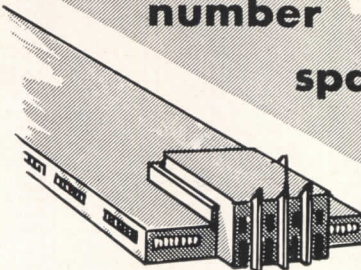

We do more than make a complete line of highest quality roof drains. We want to make sure WADE DRAINS are USED RIGHT — properly chosen, located, installed. So we have printed authentic, useful specifications on built-up roofing and drainage in a handy folder. An exclusive feature is a maximum hourly rainfall map of the U.S. with tables for area drained, outlet sizes, etc. Copies are available without charge to architects, engineers, building and plumbing contractors.

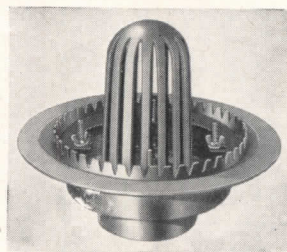

ALL-PURPOSE DRAIN

The W-3100 has extra-heavy cast iron body locking non-tilt strainer. flashing ring with gravel stop. brass toggle bolts for easy installation. For all types of roof decks.

FOR COOLER ROOFS

The W-3100-D incorporates a cylindrical dam of varying height to hold a predetermined depth of water on flat roofs for summer cooling. Dams can also be added to existing WADE installations.

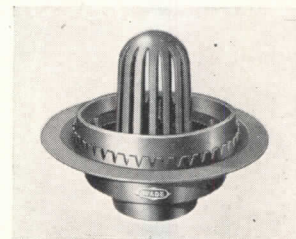

Send for your copies of ROOFING and DRAINAGE bulletin FC-1 today . . .

WADE DRAINS it's another WADE plus value!

. . . And . . . our brand-new, completely illustrated catalog and price list of the entire WADE line of drains and plumbing specialties is on the press. Better let us know the number of copies you can use.



85 NORTH STATE ST.

ELGIN, ILLINOIS



The
JACOB RIIS HOUSES
CITY & FEDERAL

Architects
JAMES C. MACKENZIE SIDNEY I. STRAUSS
WALKER & GILLETTE

NEW YORK CITY HOUSING AUTHORITY
FEDERAL PUBLIC HOUSING AUTHORITY

**1768 NEW
APARTMENTS
with Gold Bond Solid
Partition System!**



Seven percent more living space in this Jacob Riis project was achieved through modern construction methods. This huge group of apartments now under way in lower Manhattan is one more major project using Gold Bond solid partitions of fireproof gypsum plaster and metal lath.

Compared with old style walls, these streamlined partitions save approximately 4 inches per wall. Multiply that by the number of walls in each apartment and then multiply that by 1768 apartments and you have a quick appreciation of the overall saving.

The resulting Gold Bond walls are fireproof and effectively subdue noise transmission. As for durability, it

would be hard to name a better combination for super strength than solid plaster and metal lath.

All products needed for this system are Gold Bond — ceiling runners, metal lath, plaster, lime and the famous flush type metal base. With these 100% Gold Bond walls the entire responsibility for the performance of all integral products is centered with one manufacturer—National Gypsum.

You'll find the Gold Bond Solid Partition System fully described in Sweet's. For a 15 minute demonstration by your local Gold Bond representative, just say the word. No obligation, of course.

**You'll build or
remodel better with
Gold Bond**

**NATIONAL GYPSUM COMPANY
BUFFALO 2, NEW YORK**

Over 150 Gold Bond Products including gypsum lath, plaster, lime, wallboard, gypsum sheathing, rock wool insulation, metal lath products and partition systems, wall paint and acoustical materials.



LAWSON
Announces the NEW
"60" LINE
OF LIGHT
FIXTURES

MORE light . . . more styling . . . more distinction—that's the new Lawson "60" Line of Light Fixtures. Four tubular shades—held in beautiful chromium-plated brackets—insure glareless, perfectly balanced illumination. And Lawson provides this new, de-luxe styling at moderate prices. Write for catalog today!

*World's Largest
 Builder of
 Bathroom Cabinets*



131 YEARS
 OF QUALITY
Lawson

THE F. H. LAWSON CO.

802 EVANS STREET . . . Cincinnati 4, Ohio



GREAT ARTISTS
 THE WORLD OVER
 AGREE THAT NO
 ORDINARY
 PENCIL HAS EVER
 MATCHED
 MATCHLESS

Koh-i-Noor



The RIGHT pencil for the RIGHT job
 KOH-I-NOOR PENCIL COMPANY, INC., BLOOMSBURY, NEW JERSEY

If you are associated with one of these . . .

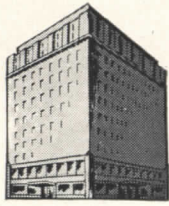

RETAIL STORE



RESTAURANT

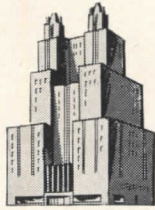

HOTEL

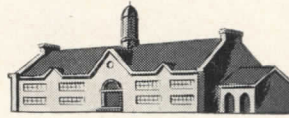

SCHOOL



CHURCH

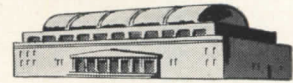

AUDITORIUM

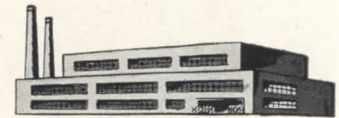

FACTORY

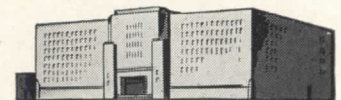

HOSPITAL



. . . then you have a **SOUND** problem that we can help you solve!

Today a sound distribution system is a *must* in most buildings. But simply "distributing" sound is not enough. In this era of sound, listeners have come to expect the *very highest quality* reproduction of music and speech.

For many years Western Electric has led the way in such quality installations for buildings of every type.

Frankly, we're interested in tough problems that no "packaged" system can solve. For each Western Electric system is completely engineered by Sound

Specialists to meet specific needs. Choosing from a full line of *standard* Western Electric components—all designed to work together—they *custom-tailor* each installation to do a superb job.

Western Electric Sound Distribution Systems are sold and installed by authorized dealers from coast to coast. For the name of the one nearest you, call Graybar Electric Company (distributor, with offices in 95 principal cities), or write Graybar at 420 Lexington Avenue, New York 17, N. Y.

DISTRIBUTORS: IN THE U. S. A.
Graybar Electric Company.
IN CANADA AND NEWFOUNDLAND
Northern Electric Company, Ltd.

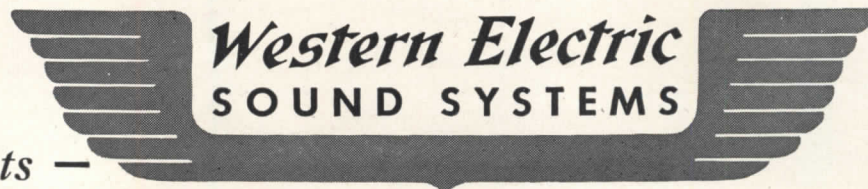

— Quality Counts —

FOR PERFECT FIREPLACES IN MODERN HOMES . . .



Photo by
Ezra Stoller



BENNETT *Fresh-Aire* FIREPLACE UNIT

An ordinary fireplace pumps 200 cubic feet (2 to 3 large rooms full) of already warmed air out of the house each minute. In tightly constructed homes, replacement air can't come in from outdoors in sufficient quantity to supply the chimney draft. Result—partial vacuum . . . back-puffs . . . smoke.

The *Fresh-Aire Fireplace Unit* is manufactured to help you—in designing Fireplaces for modern, fully weather-stripped homes with central heating. It draws replacement air from outdoors, into the heating chambers, and circulates it, comfortably warm, through the living quarters. No uneven temperatures, no interference with heat controls—and a net gain in evenly distributed warmth.

Here are four more reasons why so many *Bennett Fresh-Aire Fireplace Units* are specified:

1. Thoroughly ventilates and "refreshes" the air.
2. Complete freedom to design the mantel . . . normal brick firebox sidewalls . . . no floor grilles.
3. A complete form for *smoke-free* internal proportions of throat, damper, smoke chamber and shelf—assurance that the fireplace will be *built* as you *designed* it.
4. Small first cost is quickly offset by savings in construction and fuel.

Bennett Warm-Aire Units—for perfect fireplaces in camps, southern homes, playrooms, etc. Draws cool air from the floor, heats and recirculates it evenly throughout the room, and to adjacent rooms or upstairs.

Write us at 248 Maple St. for Catalog—or see Sweet's.

MAKERS OF FLEXSCREEN
Reg. U.S. & Canada Pat. Off.

BENNETT-IRELAND INC.
Chartered in 1906
NORWICH, NEW YORK

Why Do It The? HARD WAY?



GRAND RAPIDS
Invisible
SASH BALANCE

HERE'S WHY . . .

1. **RECOGNIZED PUBLIC ACCEPTANCE**
Completely invisible . . . known quality leadership . . . backed by nation-wide advertising, it's easier to sell.
2. **EASE OF OPERATION**
Finger touch control with full opening of both upper and lower windows appeals to every customer.
3. **SIMPLIFIED INSTALLATION**
Just drive in two fasteners . . . screw in one screw . . . 10 sizes fit 95% of all new or old windows.
4. **LOWER COST**
Eliminates weight boxes and mortises. No special frame preparation.
5. **NOTHING TO EXPLAIN AWAY**
No tapes . . . no cables . . . no exposed tubes . . . no corrosion . . . no sticking . . . no squeaking.

ADVERTISED TO 134,445,000 READERSHIP
IN SUCH CONSUMER MAGAZINES AS—



Better Homes and Gardens,
American Home, Farm Journal,
Small Homes Guide, etc. . . . the
bulk of the home building market.

FOR COMPLETE SPECIFICATIONS AND INSTRUCTIONS

Write today for new fully illustrated, specification and installation catalog. See how Grand Rapids Invisibles fit into your next set of plans!



GRAND RAPIDS HARDWARE COMPANY
Grand Rapids, Michigan

Quality Leaders in Sash Hardware for 50 Years

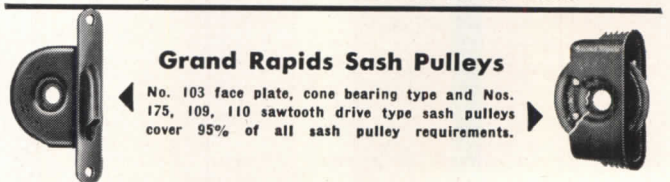

Grand Rapids Sash Pulleys

No. 103 face plate, cone bearing type and Nos. 175, 109, 110 sawtooth drive type sash pulleys cover 95% of all sash pulley requirements.

FOR **PLANNED**
RECORD **PROTECTION**
call in a **HERRING-HALL-MARVIN SPECIALIST**



EFFICIENT planning provides adequate protection for irreplaceable records in daily use.

For expert counsel on these matters, the Herring-Hall-Marvin representative is your man. He's a trained specialist in this field. He has at his command the cumulative experience of more than a century.

Without cost or obligation, he will survey your client's needs . . . help you determine proper vault classification, size of vault door opening, capacity of vault, ventilation control and location for greatest protection and convenience.

You will receive a detailed recommendation that can save you long hours of tedious research and costly experimental planning. Write, telephone or wire us today.

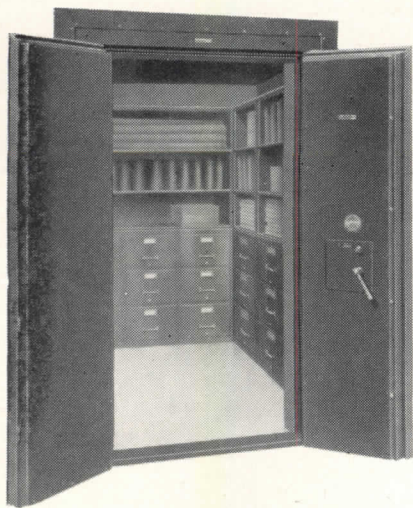

HERRING · HALL · MARVIN SAFE CO.

For detailed information on certified vault entrances turn to our catalogue $\frac{24g}{2}$ in your Sweet's File. Your Herring-Hall-Marvin dealer also carries our complete line of safes, money chests, and fire-resistive filing cabinets.

General Offices
HAMILTON, OHIO
BRANCH OFFICES
In New York, Chicago, Boston, Washington, St. Louis, Atlanta, Houston, Philadelphia, San Francisco, Los Angeles, Detroit, Pittsburgh, Omaha, Indianapolis, Minneapolis, Charlotte
OTHER AGENCIES ALL OVER THE WORLD

TIME

PROVES

Galvanized (ZINC-COATED) Sheets Stay Stronger Longer

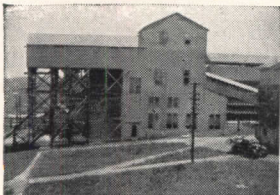

34 YEARS . . . Erected in 1913, and covered with heavy gauge galvanized sheets, this Tennessee concentrating plant of the A/Z Company, pictured at left, is still in excellent condition after more than three decades of service. Painted with Gray Metallic Zinc Paint in 1932.

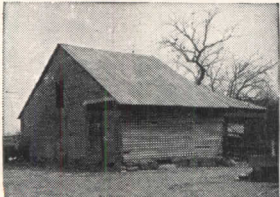

50 YEARS . . . The galvanized metal roof on this old Missouri farm building has outlasted the building itself, and is still in good condition after half a century of service. Industry and the farm have long depended on galvanizing to protect iron and steel against costly rust. Builders know that as long as iron or steel is zinc covered, it *cannot rust*.

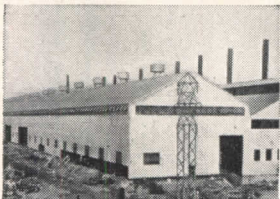

In building for the future, look to the past for proof of a building material's strength . . . durability . . . service. With *galvanized* (zinc-coated) roofing and siding you get the strength of steel . . . the rust protection of Zinc. So for low-cost, long-time service choose the building material that's proved by TIME itself . . . galvanized sheets. Send coupon for information about Zinc and how it helps keep buildings and equipment *stronger longer*.



This "Seal of Quality" is your guide to economy in buying galvanized sheets. Sheets bearing it carry at least 2 oz. Zinc per sq. ft.



American Zinc Institute
ROOM 2602 • 35 E. WACKER DRIVE, CHICAGO 1, ILL.

FREE BOOKLETS!

Send me without cost or obligation the illustrated booklets I have checked.

- Repair Manual on Galvanized Roofing and Siding
- Facts about Galvanized Sheets
- Use of Metallic Zinc Paint to Protect Metal Surfaces

Name _____
Address _____
Town _____ State _____

The Restoration of Colonial Williamsburg

A Reprint of the December, 1935 Issue of ARCHITECTURAL RECORD



The Colonial Williamsburg Number of ARCHITECTURAL RECORD—issue of December 1935—was sold out soon after publication but the entire editorial contents have been reprinted and bound in permanent book form with blue cloth covers.

Many thousands of these Williamsburg reprints have been sold but the demand continues unabated.



104 pages, bound in cloth
\$2.00 per copy

ARCHITECTURAL RECORD
119 W. 40th Street, New York, N. Y.

Enclosed is \$..... for which send..... copies of your reprint, THE RESTORATION OF COLONIAL WILLIAMSBURG, bound in cloth, at \$2.00 per copy. (Add 2% Sales Tax for New York City deliveries.)

Name.....

Address.....

City and State..... A.R. 2-48

Large-scale housing, too, needs reliable, low-cost oil heat

— *in short*, **PETRO!**

In large-scale housing — where heating equipment must fully justify its selection — architects specify the oil burning systems they *know* they can depend on to keep heating costs down year after year. That's why Mr. Hohausner — and a host of his colleagues as well — prefer Petro.

Sound engineering in every detail identifies the recognized superiority of Petro Oil-Fired Equipment. Thermal Viscosity Control, for example, represents just one Petro improvement typical of many. This truly automatic method of burning pre-heated oils, successfully used for many years, promotes maximum combustion efficiency . . . eliminates frequent manual adjustment . . . provides welcome economies for your client in reliable automatic operation.

Excellent basic design — dependable performance based on over 40 years' oil heat experience — extensive facilities of the world's largest, oldest exclusive maker of oil burning equipment — these assure your client's complete satisfaction with Petro.

INDUSTRIAL MODELS: No. 5 or No. 6 fuel oil; manual, semi-automatic or automatic operation; 8 sizes to 450 bhp. Thermal Viscosity preheating.

DOMESTIC MODELS: No. 3 or lighter oils; "conversion" and combination-unit types, 7 sizes. Patented "Tubular Atomization."

FULL DATA on Petro Industrial Burners are in catalog files of Sweet's and Domestic Engineering. Details on Petro Domestic Burners available in separate catalog. Copy of either sent gladly on request.

PETRO

REG. U.S. PAT. OFF.

cuts steam costs



Among the most recent projects planned by William I. Hohausner, New York architect, are the 1,337-family Stephen Foster Houses at Fifth Avenue and 115th Street, and the 20-story co-operative apartment at Fifth Avenue and 68th Street, both in New York City. Other outstanding projects include the Kheel Tower, Riveredge Apartments, 307 Fifth Avenue Building, Franklin Towers Hotel, all in Manhattan; the Clinton Theater and Granada Hotel in Brooklyn; Avon Theater in Stamford; Kensington Gardens in Buffalo; and Manchester Gardens in Manchester, Conn. Mr. Hohausner also designed the complete reconstruction of the Anderson Galleries, the Park Avenue Theater, and the 487 Park Avenue Office Building, in Manhattan.

Based on long experience with oil heating for both large-scale housing and non-residential buildings, Mr. Hohausner says:

"In my opinion oil heating maintains its superiority for both housing developments and for theaters and hotels and commercial structures, in short, wherever cleanliness, convenience, and economy are essential.

"Where Petro systems are in use, from experience I know that fuel costs are very favorable in comparison with coal, and labor costs have resulted in a saving of at least 15%, and from there up.

"The wide range of Petro Oil Burning Systems can be considered a common denominator for any type of building. They are sturdy in construction and extremely efficient in operation."

Specify **GENUINE LALLY COLUMNS**
IN GARDEN-TYPE APARTMENT CONSTRUCTION

GENUINE LALLY COLUMNS are ideally adapted for use in Garden-Type Apartment Construction. Combining great strength, durability and fire resistance with small diameters, they fit neatly within partitions thereby saving valuable floor space and expensive boxing. Manufactured in single or multiple story lengths and equally adaptable to Wood, Concrete or Steel Construction.

SEND FOR CATALOG OF
CONSTRUCTION DETAILS

LALLY COLUMN COMPANY

Originators, Sole Manufacturers, Genuine Lally Columns

Erie and Albany Sts.
Cambridge 39, Mass.

211 Lombardy St.
Brooklyn 22, N. Y.

733 West 64 St.
Chicago 21, Ill.

Parkway Village, Housing Project for United Nations. Constructed by George A. Fuller Company, Leonard Schultze and Associates, Architects. Over 2,000 Genuine LALLY COLUMNS SPECIFIED AND USED.

Only \$2600* BUYS THIS
BEAUTIFUL MODERNFOLD DOOR

ACCORDION-TYPE



for

BATHROOMS, CLOSETS, BEDROOMS, KITCHENS, ETC.

It's true! The cost of beautiful Modernfold with its amazing utility has been brought down to a price comparable to the conventional swinging door. Remember, in figuring the cost of Modernfold, you do not consider the price of trim, jamb, hardware, painting, etc. Then, too, Modernfold gives you so much more—the beauty of its fabric covering, conservation of valuable floor and wall space. Write for full details.

* Price (F.O.B. Factory) of door 2' 4" wide x 6' 8½" high. Other doors at correspondingly low prices.

Consult your telephone directory for the names of our installing distributors

NEW CASTLE PRODUCTS • NEW CASTLE, IND.



MONARCH

5 Star

SASH
CENTER

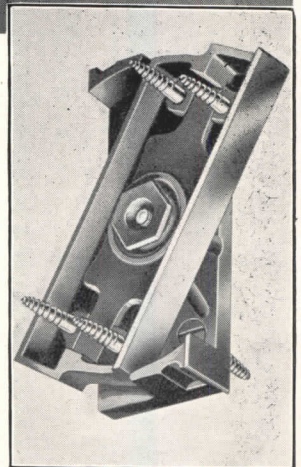

- ★ Weatherproof, foolproof—Adjustable spring tension.
- ★ Square end, easy mortise installation.
- ★ Side, top or bottom pivot for transoms and sash.
- ★ Five HOLD-FIRM sash angle positions.
- ★ 100% opening, complete washing from inside.

Write for descriptive literature.

CLAYTON & LAMBERT MFG. CO.
1705 DIXIE HIGHWAY • LOUISVILLE 10, KY.

The new Chicago office and plant building of "Power House" Candy Bars (Walter H. Johnson Candy Co.) features Insulux Glass Block to direct daylight deep into interior. Note clear windows for vision and ventilation. Bruce A. Gordon Co., Engineers; S. N. Nielsen, General Contractor; Frank Millers Sons Fireproofing Co., glass block installation.



Notes on bending light

A NEW approach to daylight control in offices, laboratories, precision manufacturing plants and classrooms lies open.

Insulux Glass Block No. 351 actually bends light rays. Light is thus directed to ceiling for even distribution deep into the room.

Combined with Insulux Block No. 350 (pattern spreads light evenly through horizontal plane) brightness

contrasts are sharply reduced, and light is more evenly distributed throughout the room.

American Structural Products Company is a wholly owned subsidiary of the Owens-Illinois Glass Company. It has taken over the manufacture and sale of Insulux Glass Block and other Owens-Illinois structural products. For data on Insulux write Dept. E-3, American Structural Products Company, P. O. Box 1035, Toledo 1, Ohio.



See how a combination panel of Insulux Glass Blocks No. 351 (a) and 350 (b) directs light into a room. No. 351 turns major part of light transmitted upwards, has a greatly reduced brightness when viewed from below. No. 350, used below eye-level, diffuses light evenly over horizontal plane; has low surface brightness at all angles.

INSULUX

GLASS BLOCK

AMERICAN STRUCTURAL PRODUCTS COMPANY

Subsidiary of

OWENS-ILLINOIS GLASS COMPANY

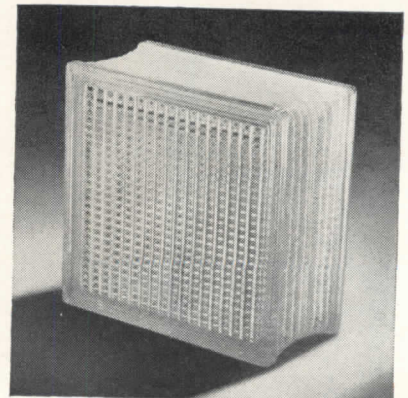
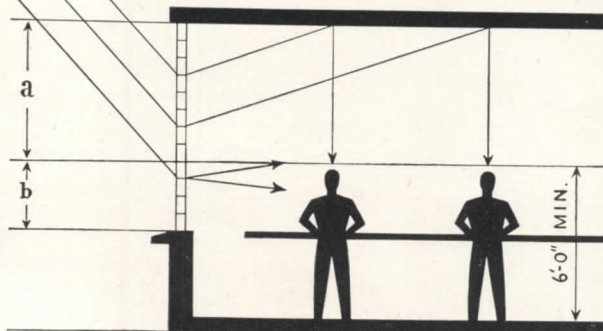

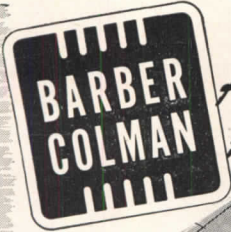

*A New Approach to
Air Distribution*

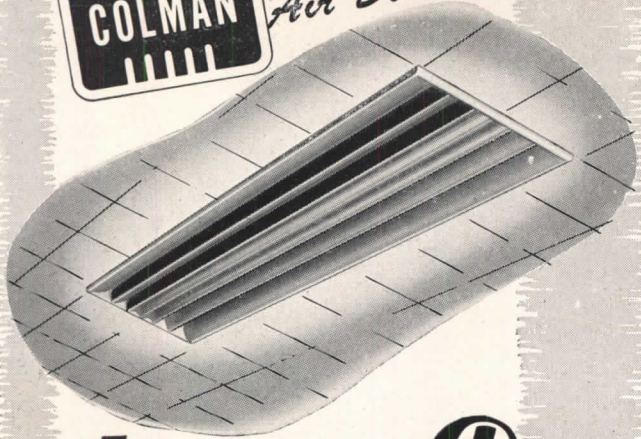

Line-o-flo

CEILING OUTLETS

A new approach to air distribution — *line-type* outlets that can be used singly or end-to-end in continuous strips. Keyed to modern architectural concepts, they provide a vital contribution to continuity of design. High diffusion efficiency results in rapid induction of room air into the primary stream, quickly equalizing the temperature differential. Made in Model "LS" (shown) and Model "LL" (designed to receive M21118 DAY-BRITE Lighting Unit).

PERFORMANCE DATA

THROW IN FEET FROM CENTER LINE OF UNIT
 A — No. of Outlets Required
 B — Pressure Drop in Inches of Water (Blank indicates negligible pressure drop)
 C — Sound Level in Decibels (Blank indicates no perceptible sound)

CFM	12			14			16			18			20			CFM
	A	B	C	A	B	C	A	B	C	A	B	C	A	B	C	
350	1	.006	-	1	.007	-	1	.009	-	1	.012	3	1	.014	7	550
400	1	.007	-	1	.009	-	1	.012	3	1	.014	7	1	.016	9	600
450	1	.009	-	1	.012	3	1	.014	7	1	.016	9	1	.019	12	700
500	1	.012	3	1	.014	7	1	.016	9	1	.019	12	1	.022	15	800
550	2	.004	-	1	.016	9	1	.019	12	1	.022	15	1	.025	17	900
600	2	.004	-	2	.005	-	1	.019	12	1	.022	15	1	.025	17	1000
650	2	.005	-	2	.006	-	2	.006	-	1	.028	19	1	.032	21	1100
700	2	.006	-	2	.006	-	2	.007	-	2	.009	-	2	.009	-	1200
750	2	.006	-	2	.007	-	2	.007	-	2	.009	-	2	.012	6	1300
800	2	.006	-	2	.007	-	2	.007	-	2	.009	-	2	.012	6	1400
850	2	.006	-	2	.007	-	2	.007	-	2	.009	-	2	.012	6	1500
900	2	.006	-	2	.007	-	2	.007	-	2	.009	-	2	.012	6	1600
950	2	.006	-	2	.007	-	2	.007	-	2	.009	-	2	.012	6	1700
1000	2	.006	-	2	.007	-	2	.007	-	2	.009	-	2	.012	6	1800
1050	2	.006	-	2	.007	-	2	.007	-	2	.009	-	2	.012	6	1900
1100	2	.006	-	2	.007	-	2	.007	-	2	.009	-	2	.012	6	2000

**A PORTION
OF THE DATA FROM WHICH LINE-O-FLO OUTLETS
CAN BE ACCURATELY SELECTED**

Knowing the CFM available and the THROW required, the number of standard units needed is quickly obtained from performance data tables such as the one shown in part above.



WRITE FOR COMPLETE DATA...

Ask for Bulletin F-2741 and get full performance data, dimensions, description, principles of operation, typical installation methods, and suggested uses. Write today.

BARBER-COLMAN COMPANY
 1232 ROCK ST. • ROCKFORD, ILLINOIS
 Engineered Air Distribution with Guaranteed Performance

REPRESENTATIVES IN ALL PRINCIPAL CITIES

EMPLOYMENT OPPORTUNITIES AVAILABLE

Advertising rates on request

ARCHITECTURAL DESIGNER-DRAFTSMAN. Must be registered. Experienced in public buildings, schools, hospitals, and functional design of industrial buildings. Excellent opportunity for hard working and sober man. All replies confidential. P.O. Box 2192, Atlanta 1, Ga.

WANTED — Capable, head draftsman or job captain experienced in fine building. Box 298, ARCHITECTURAL RECORD, 119 W. 40th St., New York 18.

TEXAS ARCHITECTURAL AND ENGINEERING FIRM — Wants one experienced architect and one experienced architectural engineer for permanent positions in old established firm doing major industrial, commercial and institutional practice in seven states. Positions also open for several junior architects and engineers who desire an opportunity to join an experienced organization. Positions in either Beaumont or Houston, Texas offices. Applicants to state education, practical experience and starting salary. Stone & Pitts, Architects & Engineers, 1872 Calder Avenue, Beaumont, Texas.

SENIOR ARCHITECTURAL DRAFTSMAN familiar with various phases of Architectural work. Work diverse and interesting. Long established medium sized office. State education and experience. Salary commensurate with ability. Finger and Rustay, 711 National Standard Building, Houston, Texas.

EXPERIENCED ARCHITECTURAL DESIGNER and Draftsman — Top salary and best working conditions with firm of well-known architects. Replies confidential. Box 300, ARCHITECTURAL RECORD, 119 W. 40th St., New York 18.

JUNIOR ARCHITECTURAL DRAFTSMEN: Positions wanted for Technical School graduates thoroughly trained in all phases of Architectural work. Apply REGISTRAR, Columbus Technical School, 106 West 63rd Street, New York 23, New York.

ARCHITECTURAL DESIGNER: experienced — work on schools, hospitals, churches and other public buildings. Excellent opportunity. Permanent position for the right man. Information as to education, age, experience, and salary required. Britsch & Munger, 531 Nicholas Building, Toledo, Ohio.

ASSOCIATE. Architect, Registered, 15 years' experience in private practice desires to associate as partner with established architect, firm of architects or engineers. Graduate architectural engineer. Experienced in construction of schools, banks, hospitals, churches, factories, houses, etc. Prefer management, construction, supervision of construction, and sales part of work. Box 302, ARCHITECTURAL RECORD, 119 W. 40th St., New York 18.

WANTED: Two qualified architectural men, structural engineer, specification writer, by well established Mid-South firm on commercial and industrial work. Submit complete experience record and personal history. Personal interview will be arranged. Box 304, ARCHITECTURAL RECORD, 119 W. 40th St., New York 18.

"You adjust the temperature
to suit yourself sir!"



...it's easy with **General Electric**
Flexible Air Conditioning

FOR EXAMPLE, General Electric's *Personal Weather Control* for multiple-room buildings provides:

Localized control of temperature. Each room can be cooled or heated to individual taste.

Flexibility. Fits easily into your present building designs or into plans for new buildings. After installation, room layouts can be changed without disrupting the air conditioning system.

Filtering. All the air can be filtered, not just a part of it.

Dehumidification. Equipment is sized to do a good job even in humid Southern areas.

Simplicity. A simple piping system served by a central plant in the basement can provide each room with cooling in summer, heating in winter.

Fresh Air . . . Ventilation. Fresh air can be introduced directly through room units, by hall ducts, or by a central plant. Adaptable to ventilation needs of each space.

This is one of *many* types of General Electric Equipped Air Conditioning Systems. Whether the need is large or small, simple or complex . . . there's a General Electric System designed to give your client *Better Air Conditioning*. General Electric Co., Air Conditioning Dept., Section 8442, Bloomfield, N. J.



GENERAL  **ELECTRIC**
Better Air Conditioning

**Every Architect
should have these
STEWART CATALOGS**

Catalog 82, Standard Iron Fences (with Channel Rails, Gates and Arches)

Catalog 80, Standard Iron Fences (with Angle Rails)

Catalog 83, Standard Chain Link Wire Fences and Gates

Catalog R-38, Railings, Pier Lanterns, Interior Gates, Veranda Work, etc.

Catalog W-40, Window Guards, Wire Mesh Partitions, Folding Gates, etc.

Catalog I-42, Industrial Fence Specifications Manual

These catalogs contain complete information on Stewart Iron and Wire Products. Check your file of Stewart literature. If you do not have all the catalogs listed above, we shall be glad to send them to you. Stewart also manufactures the following jail and prison equipment: Steel Cells, Bunks, Hinge and Sliding Type Doors, Locks and Locking Devices, Iron Stairways, Gratings, etc. Complete information on request.

Stewart IRON and WIRE THE STEWART IRON WORKS CO., Inc.
FENCES 1565 Stewart Block CINCINNATI 1, O.

Versatile

in Performance
as in Design

Fabron
REG. U. S. PAT OFF

THE FUNCTIONAL WALL FINISH
structural - decorative - practical - economical

completes the structure—decorates the wall
withstands hard usage—resists impacts
reinforces plaster—prevents cracks
acts as a fire spread preventive

tested and listed
Underwriters' Laboratories, Inc.
SPONSORED BY
National Board of Fire Underwriters

FREDERIC BLANK & COMPANY, INC.

Established 1913

230 Park Avenue

New York 17, N. Y.

Infra Accordion Aluminum

is the name for
INSULATION

- ... that's MOST EFFICIENT
- ... that's LIGHT-WEIGHT
- ... that's EASIEST TO HANDLE,
STORE, TRANSPORT
- ... that's SAFE, CLEAN, SANITARY ALWAYS
- ... that's EASIEST TO INSTALL
- ... that's PERMANENT
- INFRA KEEPS HEAT
WHERE IT BELONGS!

Write for 16-page booklet,
"SIMPLIFIED PHYSICS OF
THERMAL INSULATION".

Thermal C Factors Stamped on
Every Infra Carton

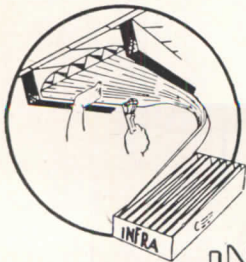

REJECTS
INFRA-RED RAYS
INFRA
Insulation INC.
10 MURRAY STREET · NEW YORK, N. Y.

ALUMINUM AND TRIANGULAR
AIR CELLS
CONSERVE WINTER HEAT
REPEL SUMMER SUN

natcor
METAL FOR STORE FRONTS
FULLY EXTRUDED
ALUMILITED ALUMINUM

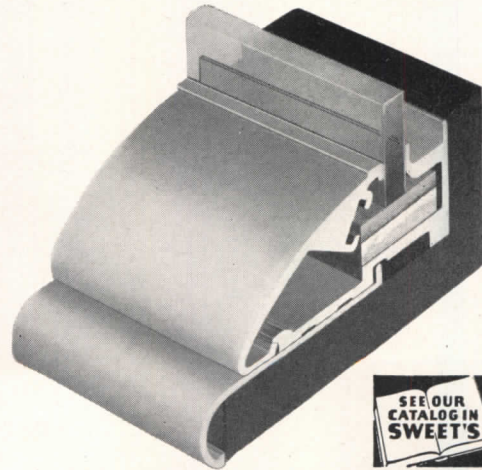

SEE OUR
CATALOG IN
SWEET'S

FOR DETAILS WRITE

natcor STORE FRONTS
PROVIDENCE 9
RHODE ISLAND

2nd Printing

The Complete . . . Authoritative up-to-the-minute Handbook

"Hospital Planning"

by CHARLES BUTLER, F.A.I.A., and ADDISON ERDMAN, A.I.A.

A Case-Study Analysis of Modern Hospitals

With tremendous energy and insight Charles Butler and Addison Erdman, distinguished architects and hospital consultants, have made a nation-wide survey of the current adaptation of hospital architecture to changing practices in hospitalization.

The fruits of their study are set forth in "Hospital Planning" — a completely new treatise of present-day practices, based on a painstaking study of hundreds of institutions from which have been selected fifty-one modern hospitals, representing the creative efforts of more than thirty architectural firms, for illustration and discussion.

"Hospital Planning" presents a textual summation of the outstanding problems in hospital architecture and shows how these problems have been met in actual practice. Generous use of illustrations, including perspectives, floor plans, elevations and photographs, make solutions abundantly clear and afford sound, applicable principles for innumerable problems to come.

**For Hospital Administrators . . . Superintendents
. . . Doctors . . . Architects**

This 232-page, fully-illustrated volume, carefully organized for both reading and reference, is designed for architects and hospital groups alike. It will help trustees, administrators and doctors to visualize their problems in terms of their community needs . . . show how others are meeting similar problems . . . provide them with a basic understanding of hospital architecture so that they may intelligently discuss their problems with the architect.

It will help architects and engineers to learn of the great advances made in hospital architecture . . . to acquire a working knowledge of medical problems and hospital procedure . . . to avoid the many pitfalls which beset the hospital planner.

Order Your Copy Now

With this second printing "Hospital Planning" is again temporarily available at the price of \$15. It is offered with the full knowledge that it may be worth incomparably more to you than its cost — so much more that cost is no valid consideration.

So use the convenient coupon below to make sure to get your copy of "Hospital Planning" before the second printing is sold out. The book will be sent promptly, prepaid.

Mail this coupon today

ARCHITECTURAL RECORD BOOK DEPARTMENT
119 West 40th Street, New York 18, New York

Enter my order for copy(s) of the new printing of "Hospital Planning" by Charles Butler and Addison Erdman at the price of \$15 a copy. I enclose payment of \$ (For New York City delivery, add 30 cents for Sales Tax — \$15.30 in all.)

Name

Address

City Zone State

A FEW of the architectural firms whose works were selected for discussion and illustration include . . .

Coolidge, Shepley, Bulfinch and Abbott
Samuel Hannaford & Sons
Schmidt, Garden and Erickson

Jamieson and Spear
Charles B. Meyers
James Gamble Rogers
Mayers, Murray and Phillip
Eggers and Higgins
Crow, Lewis and Wick



232 pages . . .
size 8½ x 11 inches . . .
17 chapters . . .
profusely illustrated . . .
thoroughly indexed . . .
detailed table of contents . . .
stiff cloth binding . . .
Price \$15

Hundreds of Illustrated Case-Studies

"Hospital Planning" presents the plans of fifty-one selected modern hospitals . . . represents the creative efforts of 30 architects. Includes 32 photographs . . . 11 site plans . . . 187 floor plans . . . 38 special unit plans of rooms, wards and departments . . . numerous construction details.

THE AUTHORS—Perhaps no other two authors are so well qualified by background and experience to write a volume of such broad scope and magnitude as those selected for this authoritative and technically difficult work.



Charles Butler has been closely associated with hospital planning throughout his broad professional career. As architect or consultant, his works include St. Luke's International Medical Center, Tokyo; War Demonstration Hospital at Rockefeller Institute; Goldwater Memorial Hospital.



Addison Erdman, holder of the A.I.A.'s Langley Fellowship for two successive years, is a consultant on hospitals for a number of architectural firms. His works include the Mobile Hospital Unit for the British Army in Egypt, the Private Patient Pavilion, Methodist Hospital of Brooklyn. Recently appointed as one of the five architects consultants for the Veterans Administration.

HOSPITALS selected for illustration include — Cornell-New York Medical Center, New York; Goldwater Memorial Hospital, Welfare Island, New York; Methodist Hospital, Brooklyn; General Hospital, Cincinnati; Saint Vincent's Hospital, New York; Community Hospital, Battle Creek; Saint Mary's Hospital, Rochester, Minnesota; American Memorial Hospital, Reims, France; Mallinckrodt Institute of Radiology, Saint Louis; Royal Victoria Hospital, Montreal; Rochester Municipal Hospital, Rochester, New York; Potts Memorial Hospital, Livingston, New York; Fort Sill Hospital, Fort Sill, Oklahoma. Saint Luke's Hospital, Spokane, Washington; Massachusetts General Hospital, Boston and many more.

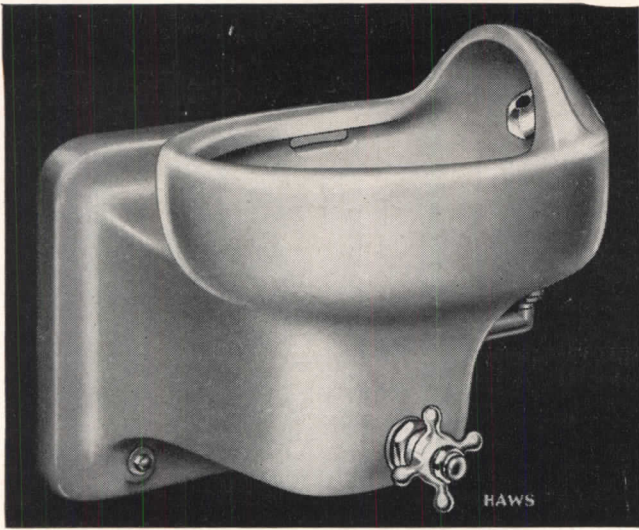

MODERN DEPENDABILITY

● YOU assure modern dependability in drinking water facilities when you specify *HAWS Fountains*. Simple maintenance, lasting durability and complete sanitation means real client-satisfaction. And your recommenda-

tions are backed by a company which has built superior drinking fountains since 1909. Write for catalog, today.



HAWS DRINKING FAUCET CO.
FOURTH and PAGE STREETS (Since 1909) BERKELEY 2, CALIFORNIA
Agents and Sales Representatives in All Principal Cities

THERE IS ONLY ONE CLIPPER BLOWER
FOR KITCHEN CEILING VENTILATION

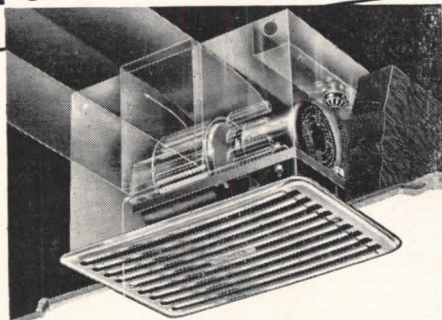

This patented, proven Clipper Kitchen Ventilator mounts between ceiling joists directly above the stove, and is vented out-of-doors. The powerful squirrel cage blower (not a fan) creates a stream of fast-moving pressure-charged air which keeps kitchens free of cooking grease, heat and odors. Also for dens, bathrooms, laundries and other small rooms. Specify the Clipper and be sure of adequate ventilation. Stocked and sold by electrical dealers coast to coast.

Write us today for complete details.

Trade-Wind Motorfans, Inc.
5707 S. Main St., Los Angeles 37, Calif.
Send complete information on the Clipper

Name _____

Address _____

The Clipper is easily installed in the ceiling and vented through a side wall or roof

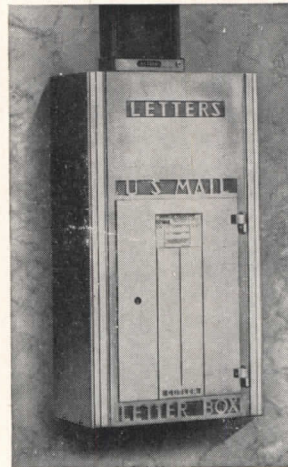

No. 4740

A CUTLER MAIL CHUTE should be specified for every eligible office building, public building, hotel, apartment or hospital.

Any building not now equipped can be modernized at small expense without serious inconvenience, noise or dirt.

Catalog in Sweet's

ESTABLISHED 1883

Cutler Mail Chute Co.
ROCHESTER 7, N. Y.

STOP that **WATER**
with **FORMULA # 640**

A Clear Liquid Waterproofing for Old or New Construction

PENETRATES deeply—one inch or more—is not a surface treatment. Brush, spray, or float on stone, cast stone, concrete, mortar, stucco, tile, brick, plaster, wood, wall board—any absorbent material.

WATERPROOFS, preserves, prevents dusting of floors, surface dirt washes away in rain.

FORMULA No. 640 is a balanced formula of seven different waxes and resins in a hydrocarbon solvent.

ACID-ALKALI proof—does not oxidize, unchanged by temperature.

PERFORMANCE—It is our opinion it will last as long as the concrete, mortar, stucco, etc., lasts.

OIL PAINT saponifies on cement unless sealed first with Formula No. 640.

APPLY to either side: **The pressure side, or opposite side**—it is equally effective.

HYDROSTATIC PRESSURE—A 20 foot head has been held by Formula No. 640.

CUTS WATERPROOFING COSTS because it applies three times as fast as paint, requires no special technique. No preparation—comes ready to apply. Eliminates necessity of furring. Concrete floors and walls need no membraning.

KEEPS IN ALL CLIMATES ● **HARMLESS TO USE**
GOOD COVERAGE ● **MODERATE PRICE**

WRITE OUR ENGINEERING DEPARTMENT for office test kit, technical data, or regarding any special problem.
J. Wilbur Haynes, Engineer

OTHER PRODUCTS: Formula No. 640 Toxic, combines waterproofing with termite and fungus protection; cement hardener; cement paint; floor mastic; roof coatings, etc.

HAYNES PRODUCTS CO.

4007 FARNAM STREET ● OMAHA 3, NEBRASKA



"Welding permitted fewer supporting columns . . . gave more unobstructed floor area"

DUFFIN IRON COMPANY, FABRICATORS & BUILDERS
DE LEUW, CATHER CO., DESIGNERS

They added: "When designing this Coach Repair Shop for the Chicago, Rock Island and Pacific Railway Company, maximum unobstructed floor area was a prime requisite. Welded construction gave the freedom in architectural and structural design needed. Further, it reduces weight and cost of structural members without decreasing rigidity or structural strength."

For further details about welded construction write for "Manual of Design for Arc Welded Steel Structures" — a 300-page work that brings you information covering design, and engineering control of welding and related operations.

See this invaluable manual for yourself — mail us your check for \$2.00, and we will send the book to you . . . look it over for ten days; if at the end of this period it does not completely live up to your expectations, return the book to us and we will return your money.

Write today! Address: Dept. 8091, Air Reduction, 60 East 42nd St., New York 17, N. Y. In Texas: Magnolia Airco Gas Products Co., Houston 1, Texas. On West Coast: Air Reduction Pacific Company, San Francisco 4, Calif. International Representatives: Airco Export Corporation, New York 18, N. Y.



AIR REDUCTION

Offices in All Principal Cities

HEADQUARTERS FOR OXYGEN, ACETYLENE AND OTHER GASES . . . CARBIDE . . . GAS WELDING AND CUTTING APPARATUS AND SUPPLIES . . . ARC WELDERS, ELECTRODES AND ACCESSORIES

Eye-light

YOUR MERCHANDISE

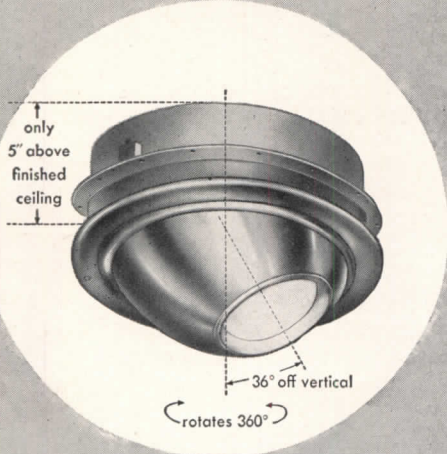

Cat. No. 351, semi-recessed eyeball. \$36
(150 watt reflector bulb)

CENTURY Lighting Equipment is ENGINEERED Lighting Equipment

CENTURY LIGHTING, INC.

419 West 55th Street, New York · 626 N. Robertson Blvd, Los Angeles

S A R C O

HEATING SYSTEMS

For more than thirty years, leading architects in all parts of the country have made sure of completely satisfactory heating of buildings of all types—commercial, industrial or institutional — by specifying SARCO.



For Your Data Files

To assist your heating engineer in selecting the best system for any building under consideration, we have compiled the manuals illustrated.

Why not place these handy books in your reference files now. In writing for them, please specify type of building and heating system in which you are interested.

220

SARCO SARCO COMPANY, INC.
Empire State Bldg., New York 1, N.Y.
SAVES STEAM SARCO CANADA, LTD., TORONTO 5, ONTARIO

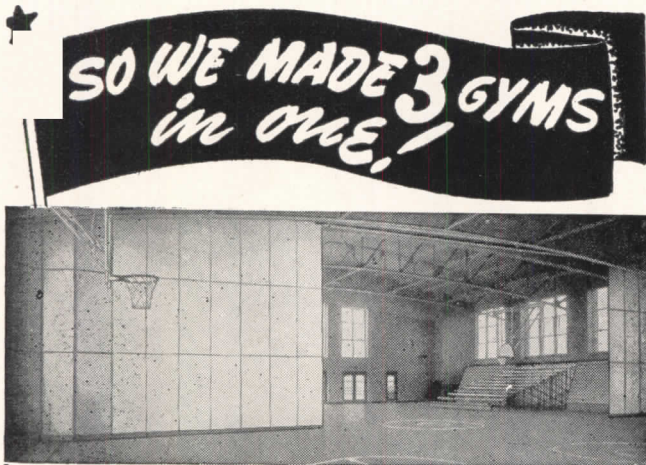

**HORN FOLDING
PARTITIONS
HORN FOLDING
BLEACHERS**

FOR COMPLETE INFORMATION WRITE

HORN BROTHERS CO.

FORT DODGE, IOWA
ESTABLISHED 1909

it's permanent

it resists
corrosion

it resists
heat, flame



...it's **OKOBESTOS**

"The cable with the asbestos suit" is equally at home in hot spots or wherever you find corrosive fumes, chemicals, oil and solvents.

Here's the layer-by-layer story of this mechanically strong cable: (1) Felted asbestos, impregnated with heat- and moisture-resisting compound applied directly over conductor, (2) Varnished cambric in a number of wrappings to provide high dielectric strength, (3) Felted asbestos to form a flame- and heat-resistant barrier, (4) Asbestos braid, impregnated with a black moisture-resisting compound to form a protective coating.

Bulletin OK 2061 describes the many designs of Okobestos cables available for specific needs. The Okonite Company, Passaic, N. J.



OKONITE SINCE 1878
insulated wires and cables

5050

"Pittsburgh's" new

HERCULITE DOOR-FRAME ASSEMBLY

AVAILABLE IN 12 STANDARD STYLES
TO FILL ALMOST ANY REQUIREMENT

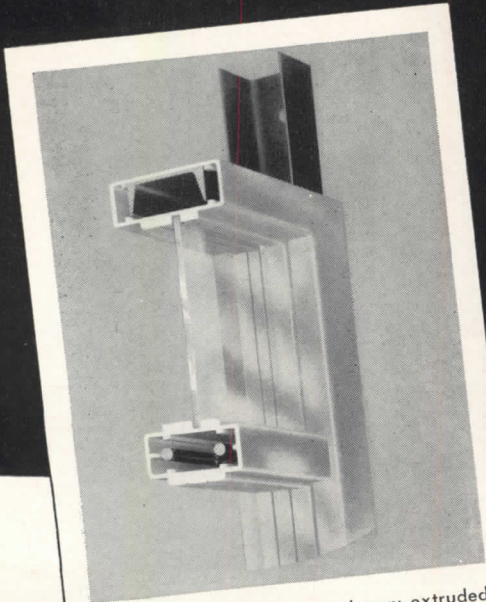

The frame is made of extra-heavy extruded aluminum, highly polished and anodized. It is heavily reinforced with steel channels and tie rods, as partially shown here.

CONSTRUCTED to accommodate standard Herculite Tempered Plate Glass doors, "Pittsburgh's" new Herculite Door-Frame Assembly is supplied complete with checking floor hinges and top pivots, ready to bolt into the rough building opening. All clearances on the frame and doors are controlled by accurate factory gauges. These features combine to make possible the greatest simplicity of installation. When the building is ready to receive the doors, they are simply set on the hinge pivot, the top pivot is dropped into the top channel, and the entire structure is complete.

This new and unique Door-Frame Assembly is a handsome, rugged and easily installed unit — in a "packaged" construction. It eliminates all problems of setting and fitting; does away with time- and labor-consuming details about clearances and other bothersome matters usually encountered in such installation. It replaces the complicated custom-made frames which required scores of different materials and the services of many trades to install. And there are twelve standard styles available to meet almost any need.

To obtain further information about this revolutionary, prefabricated Herculite Door-Frame Assembly, fill in and return the coupon below. Do it now.

Pittsburgh Plate Glass Company
2031-8 Grant Building, Pittsburgh 19, Pa.

Without obligation on my part, please send me your descriptive literature on "Pittsburgh's" new Herculite Door-Frame Assembly.

Name.....

Address.....

City..... State.....

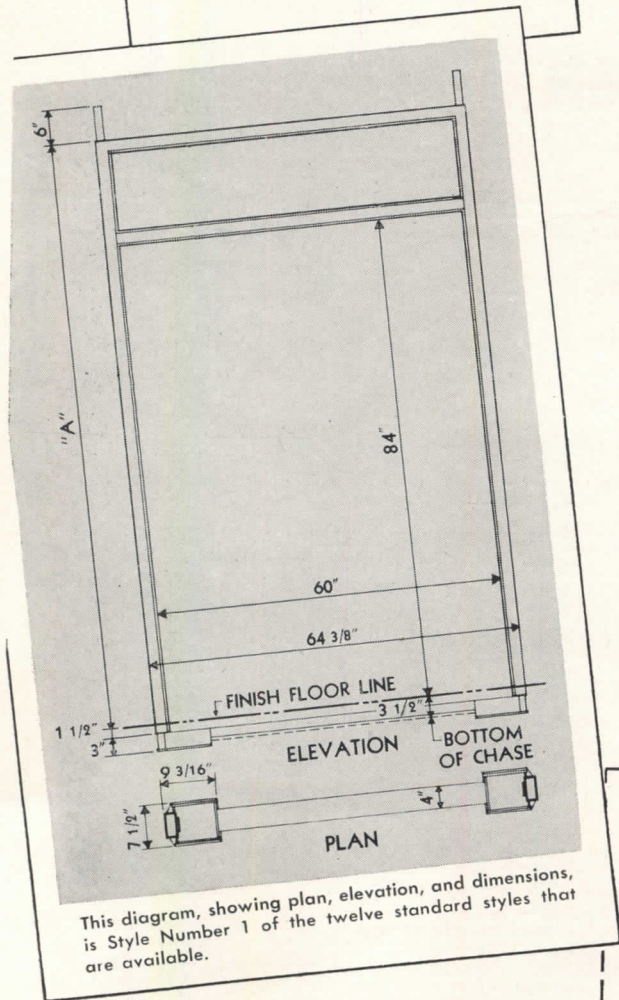

This diagram, showing plan, elevation, and dimensions, is Style Number 1 of the twelve standard styles that are available.



PAINTS • GLASS • CHEMICALS • BRUSHES • PLASTICS

PITTSBURGH PLATE GLASS COMPANY

An Organ Builder Testifies: "... there are no finer Chimes available today, regardless of price or manufacturer"

"It is my honest opinion, both as an organist and organ technician, that there are no finer Chimes available today, regardless of price or manufacturer. Their tone is pure and flawless; devoid of 'stray' harmonics and unwanted overtones, their action is quick and reliable year in and year out.

"Six years ago I decided to donate a set of Chimes to the Church in which I play, as a memorial to my Mother. I carefully investigated, tried and compared practically every well-known make of Chimes and finally settled my choice on Maas. I have never regretted the choice."

JOHN M. MARKOE
Bloomfield, N. J.

When you specify MAAS you specify genuine tubular cathedral chimes—not imitative, mechanical devices. Available in ten models, adaptable to any building design. . . . For the leading genuine cathedral chime on the market today, specify MAAS. It will not fail you.

MAAS CATHEDRAL CHIMES

Dept. 21, 3015 Casitas Ave.

Los Angeles 26, Calif.

AEROFIN

FIN-TYPE COILS

For
Fast, Efficient

HEATING

and

COOLING

*Write for
Information*

**AEROFIN
CORPORATION**

S. Geddes St. Syracuse 4, N.Y.

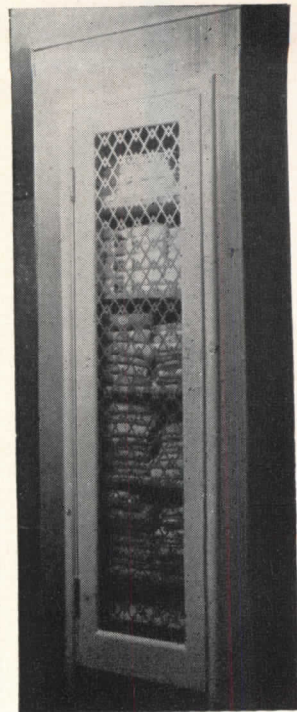

Hendrick Grille
in linen closet door

In The Futura House, Portchester, N. Y., the architect used Hendrick Grilles (without glass) in doors of linen closets to permit full circulation of air to prevent mildew. Note attractive decorative effect.



Perforated Metals
Perforated Metal Screens
Architectural Grilles
Mitco Open Steel Flooring,
"Shur-Site" Treads and
Armorgrids

HENDRICK
Manufacturing Company
38 DUNDAFF STREET, CARBONDALE, PA.
Sales Offices in Principal Cities

NEW BEAUTY IN INTERIOR

Cold Cathode

LIGHTING

DECORATIVE and FUNCTIONAL

CUSTOM-MADE COLD CATHODE interior lighting especially designed and manufactured to fit your architectural design and interior decorating scheme.

Consult us regarding your lighting problems and the installation of a cold cathode lighting system which is adequate to your needs either for illumination or decoration, or both combined, in your home, office or factory. We are now working with architects on many projects and can tell you of a number of successful, satisfactory installations.



Send us your plans and description of decorative motif and use of rooms for an estimate of the cost of a CUSTOM-MADE COLD CATHODE installation. We do the entire job or you can have your own electrical contractor install the Ideal System under our direction. *We guarantee our work for one year against all mechanical defects.*

IDEAL LIGHTING COMPANY

2219 63rd Street

• Kenosha, Wisconsin

Available

Again

TIME-SAVER STANDARDS

Architectural Record's
ten-year collection . . .
all in one volume

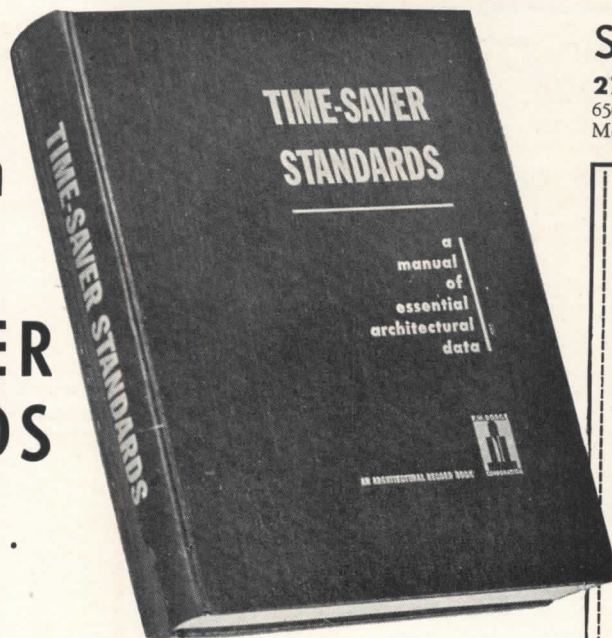

Second Printing

277 Time-Saver Standards —
656 Pages; 12-Page Master Index; Size 8½ x 11.
More than 1,000 illustrations, charts, diagrams

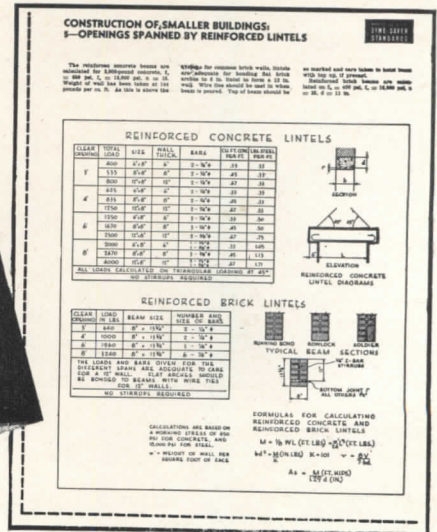

IN RESPONSE to insistent demand for more copies, here, reprinted again in one volume of encyclopedic size, are virtually all the Time-Saver Standards ever published — 277 of them — exactly as they appeared originally in *Architectural Record* and *American Architect* during the past ten years — with one 12-page master index!

Just off the press, for immediate delivery to you, is this work of 656 pages, with a mailing weight of 4½ lbs., containing a complete collection of these now famous authoritative monographs on technical aspects of construction dealing with

- Architectural Design
- Materials Technology
- Engineering Data
- Building Practice

Designed for the practical guidance and every-day use of architects, engineers, specification writers and building technicians, TIME-SAVER STANDARDS will bring you a wealth of detailed information on design and building practice . . . carefully selected from the works of the nation's leading building designers and engineers.

Well-Organized 12-page Index

This wealth of data is carefully organized and painstakingly presented. It is so thoroughly indexed that there are 1,856 references and cross-references . . . occupying *twelve pages* of closely set print.

Experience shows that a single item in TIME-SAVER STANDARDS can well save hundreds of dollars in economy construction . . . save many hours of *your* valuable time. Yet you can now place this concise and well-organized planning data at your command for the nominal sum of \$12.00 — provided you act now.

Order Your Copy Now

The first printing of TIME-SAVER STANDARDS last November was sold out almost before publication. Now an unanticipated flood of re-orders — for extra copies and multiple copies — on top of new orders indicates the second printing will soon be snapped up.

So get your copy now. Don't get caught on a long waiting list. Simply fill out the coupon at right, attach your check or money order for \$12.00, and mail today. Your copy will be rushed to you without delay.

These telescopic outlines of only a very few of the 277 Standards give a quick idea of the detailed treatment accorded each subject.

Dry-wall Construction. Materials applicable. Fiber board. Fiber insulation board. Planks and tileboards. Hardboard, Gypsum wallboard. Plywood. Cement asbestos. Plastics. Composite and self-supporting walls and partitions . . . Advantages. Handicaps. Costs. Terminology. Classifications and sizes. Framing and furring. Joints. Nailing and cementing. Flexible fasteners. Finishing. Simplified practices. Uses. Applications. References.

Heating—Unit Heaters. Typical Heat sources. Boiler capacity. Characteristics. Location. Selection data. Capacities. Controls. Fresh Air connections. Pipe connections. Louvres. Grilles. Deflectors.

Basement Waterproofing. Impermeability of concrete cracks and joints in masonry. Hydrostatic pressure. Recommended concrete mixtures. Effect of curing time on permeability. Integral and membrane methods. Plastic and iron coating. Cement-base coatings.

Folding Partitions. Center hung doors. Pair-operated doors. Pockets. Passage through closed partitions. Door construction and soundproofing. Rolling partitions. Folding fabric partition.

Lighting. Recommended levels of illumination. Fixtures for filament and mercury lamps. Luminaire spacing. Room index. Coefficients of illumination. Layout suggestions. Conformity with structural design. Computed values of illumination. Lumen output of lamps.

Noise Reduction Acoustical Materials. A rule-of-thumb answer to what noise coefficient to use. Special applications. Materials for plastic application. Costs. Appearance. Design. Fire resistance. Light reflection. Heat transmission. Lighting. Pre-cast materials. Effect of paint. Acoustical Units: Wood framing; metal suspension systems.

ARCHITECTURAL RECORD BOOK DEPARTMENT
119 West 40th Street, New York 18, N. Y.

Enter my order for _____ copies of
the second printing of the 656-page TIME-SAVER
STANDARDS at \$12.00* a copy. I enclose \$ _____

* Add 24 cents for New York City delivery — \$12.24 in all.

Name _____

Address _____

City _____ Zone _____

State _____

The Oldest Name in Door Closers

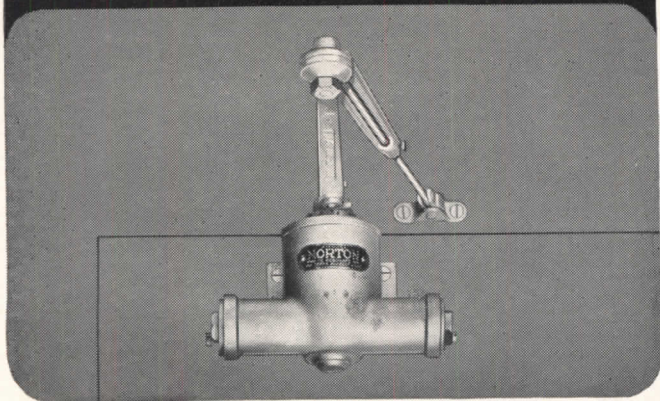

NORTON DOOR CLOSERS

Built Up to an Exact Standard
Not Down to a Cut Price

NORTON

NORTON DOOR CLOSER COMPANY
Division of The Yale & Towne Mfg. Co.
2900 N. Western Ave., Chicago 18, Ill

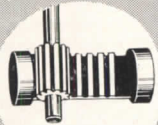

Steel Precision Jack and Pinion



Plan for "human efficiency" with adequate thirst-relief

It's a known fact that most people drink less water than they should. That's why it's important that your plans call for electric water coolers at enough convenient locations to remind, and invite, building occupants to drink the water they need. And you get best re-

sults when you specify OASIS Electric Water Coolers. In addition to maximum thirst satisfaction, they assure the long life and low-cost dependability you expect from the world's largest maker of electric drinking water coolers. Models for every need. Write for details.

The EBCO Manufacturing Co. • Columbus 8, Ohio

NEW!

OZALID STREAMLINER

- Reproduces architectural drawings in 25 seconds—also anything typed or printed on translucent paper.

- Moderately priced—designed for architects who want these extra values at no extra cost.

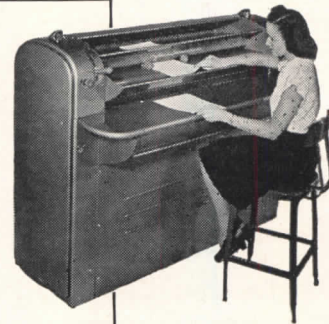

Efficiency. You get positive (not negative) prints direct from your tracings, which can be up to 42" wide, any length.

Economy. 8½ x 11-inch reproductions cost only one cent. Ozalid Streamliner soon pays for itself in day-to-day savings.

Versatility. Make 16 different types of Ozalid prints—each in the same manner, in seconds.

Simplicity. Anyone can feed originals and Ozalid sensitized material into Streamliner.

Compactness. Only 11 square feet of floor space is required.

Write today for free booklet No. 21 containing 16 types of Ozalid prints.

OZALID

Division of
General Aniline and Film Corp.
Johnson City, New York

Ozalid in Canada
Hughes Owens Co., Ltd., Montreal

The Trade Mark

is found on quality

Functional Beauties FOR ACCURATE ROOM TEMPERATURE CONTROL

T-70 METROTHERM accurate, remote, positive, snap action Thermostat. Low & line voltage. Encased in ivory plastic. Louvres & dial accented by bright chrome. Available in ten models.

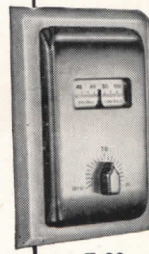

T-80 Trimtherm

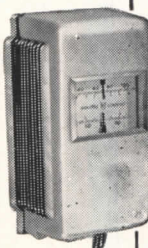

T-70 Metrotherm

T-80 TRIMTHERMS' harmonizing dull chrome cover is thermally responsive mechanism, unhoused & exposed to immediate radiant heat & temperature change. Ivory plastic base acts as blanket to thermally isolate instrument from wall. Extends only 7/8" from wall.

Request Service & Instruction Manual & new Catalog of Automatic Pressure, Temperature & Flow Controls.

GENERAL CONTROLS
801 ALLEN AVENUE GLENDALE 1, CALIF.

FACTORY BRANCHES: PHILADELPHIA • ATLANTA
BOSTON • CHICAGO • KANSAS CITY • NEW YORK
DALLAS • DENVER • DETROIT • CLEVELAND • HOUSTON
SAN FRANCISCO • SEATTLE • PITTSBURGH
DISTRIBUTORS IN PRINCIPAL CITIES 17-4

The **COLOR** is here!

No more "fumbling" with colors! Time is saved, controversies are averted when you have the Moleta COLOR GUIDE. This handsome book is winning round-the-world honors . . . serving users in Europe, Arabia, Africa, China, all over the globe!

The Moleta COLOR GUIDE gives a page-by-page display of 150 beautiful colors . . . each tint from the palest to the darkest shown on a large page (9" x 15"). The correct mixing formula is given on the reverse of each page.

Write for your copy of the Moleta COLOR GUIDE
—\$5.00, delivered anywhere in the U. S. A.

MONROE, LEDERER & TAUSSIG, Inc.
606 N. American St., Phila. 23, Pa.

Moletq
ARCHITECTURAL

The Truly Washable
FLAT OIL PAINT



Available Now!

**CHENEY
FLASHING**

3-Way Bond

16 OZ. COPPER

**CHENEY
FLASHING
REGLET**

16 OZ. COPPER

WRITE FOR
DESCRIPTIVE FOLDER Dept. R

CHENEY INDUSTRIES, Trenton, N. J.

CHENEY FLASHING is again being made by the original inventor who pioneered the art of thru-wall flashing eighteen years ago.

No thru-wall flashing can operate successfully unless it has the two very important features that are found in CHENEY FLASHING—proven weep-hole drainage and the three-way bond, vertical as well as longitudinal and lateral.

Remember, the inferior two-way flashings, crimped copper and membranes, have neither the vertical bond nor do they drain moisture from the wall fast enough. Furthermore, their first cost advantage has disappeared because today Cheney Flashing is no longer a specialty—it's a standard commodity.

Most Dependable Self-Operating Regulator Made

One of Our Many Types of Water Temperature Control

NO. 11 TEMPERATURE REGULATOR

POWERS

ENGINEERING SERVICE FOR WATER TEMPERATURE CONTROL

HOT WATER OUTLET—
POWERS DIAL THERMOMETER—
POWERS No 11 REGULATOR—
HOT WATER STORAGE HEATER—
STEAM SUPPLY—
STRAINER—

When you have a problem requiring dependable regulation of water temperatures, consider the following advantages when you call Powers:

Over 55 Years of Experience gained in supplying temperature controls for almost every purpose in all types of buildings and industrial plants.

Most Complete Line of Controls Made—If you want control for closed or open tanks and vats . . . or if you want to thermostatically regulate the mixing of hot and cold water to deliver a mixture at a predetermined temperature . . . Powers can help you whether the flow of water is 1 gal. or 10,000 gals. per minute.

Service on Installed Equipment. With competent engineers in 47 cities, we are able to give prompt and efficient service whenever required . . .

CHICAGO 14, ILL. 2752 Greenview Avenue
NEW YORK 17, N. Y. 231 East 46th Street
LOS ANGELES 5, CAL. 1808 West Eighth Street

447A

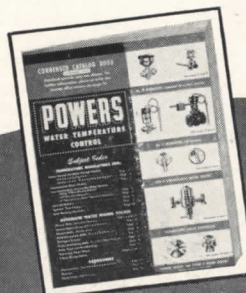

THE
POWERS
REGULATOR COMPANY

Phone or write
for Catalog 3035

Offices in 47 cities • See your phone book

INDEX TO ADVERTISEMENTS

Catalogs of concerns marked (s) are filed
in Sweet's File, Architectural (1948)

s Adam, Frank Electric Company.....	81	General Aniline & Film Corp.....	216	s National Gypsum Company.....	197
s Adams & Westlake Company.....	42	General Controls.....	216	Nelson, Herman Corporation.....	67-68
Aerofin Corporation.....	214	s General Electric—Air Conditioning.....	207	s New Castle Products.....	204
Air Devices, Inc.....	58	General Electric—Plastics.....	19	s Norton Door Closer Company.....	216
Air Reduction.....	211	General Motors Co.....	31		
Alan Wood Steel Company.....	12	General Pencil Company.....	186	Ohio Hydrate & Supply Co.....	190
Allegheny Ludlum Steel Corp.....	151	s Grand Rapids Hardware Company.....	200	s Okonite Company.....	212
s Aluminum Company of America.....	35-167	Graybar Electric Company.....	199	s Otis Elevator Company.....	191
s American Brass Company.....	27	s Grinnell Company, Inc.....	155	s Owens-Illinois Glass Company.....	205
s American Radiator & Standard Sanitary Corporation.....	157	Grasselli Chemicals Department.....	186	Oxalid Products Division.....	216
American Steel & Wire Company.....	17	Guth, Edwin F., Co.....	61		
American Structural Products Company.....	205			s Petroleum Heat & Power Company.....	203
American Telephone & Telegraph Co.....	74	Haws Drinking Faucet Co.....	210	s Pittsburgh Corning Corporation.....	165
s American Tile & Rubber Co.....	168	s Haynes Products Company.....	210	s Pittsburgh Plate Glass Company.....	2-3-213
s American Zinc Institute.....	202	s Hazard Insulated Wire Works Division.....	212	s Pittsburgh Reflector Company.....	159
s Anaconda Copper Mining Co.....	27	s Hendrick Manufacturing Company.....	214	s Pittsburgh Steel Products Company.....	79
s Anchor Post Products, Inc.....	176	s Herring-Hall Marvin Safe Co.....	201	s Portland Cement Association.....	71
s Anomast Corporation of America.....	51	s Hillyard Sales Co.....	180	s Powers Regulator Company.....	217
Anthractite Institute.....	163	s Hood Rubber Co.....	60	Pyle-National Company.....	53
s Armstrong Cork Company.....	65	s Horn, A. C., Company, Inc.....	29		
s Asbestos Corporation.....	16	s Horn Brothers Co.....	212	s Revere Copper & Brass, Inc.....	80
Asphalt Roofing Industry Bureau.....	37	House & Garden.....	177	s Reynolds Metals Co.....	39-75
Auto-Call Co.....	174			s Richards-Wilcox Mfg. Co.....	172
		Ideal Lighting Company.....	214	s Richmond Radiator Company.....	39
Baker Ice Machine Co., Inc.....	14	s Imperial Brass Mfg. Company.....	6	s Robertson, H. H., Company.....	47
s Barber-Colman Company.....	206	s Independent Lock Co.....	64	s Rotary Lift Co.....	171
s Bell Telephone System.....	74	s Infra Insulation, Inc.....	208	s Russell, F. C., Company.....	192
Bennett-Ireland, Inc.....	200	s Ingersoll—Utility Unit Division.....	48-49		
s Bethlehem Steel Company.....	82	s Inland Steel Products Company.....	220	Sarco Company, Inc.....	212
Bird & Son, Inc.....	178	In-Sink-Erator Mfg. Co.....	180	s Schlage Lock Company.....	166
s Blank, Frederic, & Co., Inc.....	208	s Insulite Division.....	11	s Seaport Porcelain Metals, Inc.....	66
Books.....	184-202-209-215	International Nickel Company, Inc.....	185	s Serval, Inc.....	8-9
s Borg-Warner Corporation.....	48-49			s Sisalkraft Co.....	165
s Bruce, E. L., Co.....	76	s Jackson & Church Company.....	3rd Cover	s Sloan Valve Company.....	4th Cover
s Bryant Heater Company.....	56-57	s Jamestown Metal Corporation.....	162	s Smith, H. B., Co., Inc.....	178
Burnham Corporation.....	181	Jenkins Bros.....	73	s Speakman Company.....	161
s Burt Mfg. Co.....	156	s Josam Manufacturing Co.....	45	s Stanley Works.....	24
Byers, A. M., Co.....	4			s Stewart Iron Works Co., Inc.....	208
		s Kawneer Company.....	83	s Surface Combustion Corp.....	30
s Cabot, Samuel, Inc.....	176	s Kennedy, David E., Inc.....	33	Sweet's Catalog Service.....	182
s Cambridge Tile Mfg. Co.....	15	s Kimberly-Clark Corporation.....	46		
s Carrier Corporation.....	72	Koh-I-Noor Pencil Co., Inc.....	198	Taylor Manufacturing Co.....	20
s Ceca Steel Products Corporation.....	40			s Tiletone Company.....	192
s Celotex Corporation.....	143	L.C.N. Door Closers.....	195	s Trade-Wind Motorfans, Inc.....	210
s Century Lighting, Inc.....	212	Lally Column Company.....	204	s Trane Company.....	175
Certified Equipment Manufacturers.....	13	s Lawson, F. H., Co.....	198	s Trumbull Electric Mfg. Co.....	41
s Cheney Industries.....	217	s Libbey, Owens-Ford Glass Company.....	78		
s Cincinnati Fly Screen Co.....	192	s Lockwood Hardware Mfg. Co.....	64	s United States Plywood Corp.....	179
s Clayton & Lambert Mfg., Co.....	204	Lone Star Cement Corporation.....	1	United States Rubber Company.....	63
s Columbia Mills, Inc.....	34			s United States Steel Corporation Subsidiaries.....	17-158
Committee on Steel Pipe Research.....	62	Maas Organ Company.....	214	s Universal Atlas Cement Company.....	158
Corning Glass Works.....	21	s Macomber Incorporated.....	22	s Universal Corporation.....	36
Crane Co.....	44	s Mahon, R. C., Company.....	69	s Upson Company.....	70
s Creo-Dipt Company, Inc.....	194	s Marsh Wall Products, Inc.....	38		
s Curtis Companies Service Bureau.....	153	s Martin-Parry Corporation.....	25	s Vermont Marble Company.....	160
s Cutler Mail Chute Co.....	210	Masland Duralcath Company.....	23		
		s Melflex Products Co., Inc.....	188	Wade Manufacturing Co.....	196
s Day-Brite Lighting, Inc.....	144	s Mengel Company.....	179	s Wakefield, F. W., Brass, Company.....	173
s Detroit Steel Products Company.....	187	s Mesker Brothers.....	50	s Weis, Henry, Manufacturing Co., Inc.....	170
Dole Valve Co.....	148	s Metal Tile Products, Inc.....	164	Werner, R. D., Co., Inc.....	196
Dresser Industries.....	56-57	Michaels Art Bronze Co.....	154	Western Electric.....	199
DuPont, E. I., de Nemours & Co.....	186	s Minneapolis-Honeywell Regulator Co.....	84	s Westinghouse Electric Corporation.....	149
		s Minnesota & Ontario Paper Company.....	11	s Westinghouse Electric Corporation—Elevator Division.....	54-55
Ebco Manufacturing Co.....	216	s Modine Manufacturing Co.....	193	s Wing, L. J., Mfg. Co.....	152
Employment Opportunities.....	206	Monroe, Lederer & Taussig, Inc.....	217	s Wood Conversion Company.....	189
Enterprise Engine & Foundry Co.....	32	s Moulding, Thos., Floor Mfg. Co.....	194	s Worthington Pump & Machinery Corp.....	219
Faber, A. W.—Castell Pencil Company, Inc.....	174	s Natcor Store Fronts.....	208		
Fedders-Quigan Corporation.....	188	s National Chemical & Mfg. Co.....	183	s Young Radiator Co.....	190
s Federal Electric Products Company.....	77	National Electric Products Corporation.....	43		
s Fiat Metal Manufacturing Co.....	18				
s Flitzgibbons Boiler Company, Inc.....	146				
Flagg, Stanley G., & Co., Inc.....	59				
Fleur-O-Lier.....	13				
s Flintkote Company.....	2nd Cover				
Frigidaire.....	31				
s Frink Corporation.....	52				

NEW YORK—H. Judd Payne, Publishing Director; Robert F. Marshall, Business Manager; Tom Tredwell, Advertising Mgr.; Benton B. Orwig, Creative Service Manager; M. A. Murphy, Advertising Production Manager 119 West 40th Street; BOSTON—Harry M. Horn, Jr., 855 Park Square Bldg.; CHICAGO—Jack Casey, C. B. Riemersma, 700 Merchandise Mart; CLEVELAND—John C. Jackson, 321 Hanna Bldg.; LOS ANGELES—Bob Wettstein, Room 816, 816 West 5th St.; PHILADELPHIA—Tom Tredwell, 1321 Arch St.; SAN FRANCISCO—Bob Wettstein, 1003 TWA Bldg., 240 Stockton St.; SEATTLE—Bob Wettstein, White Bldg.

This *NEW* Hermetically-Sealed COMPRESSOR

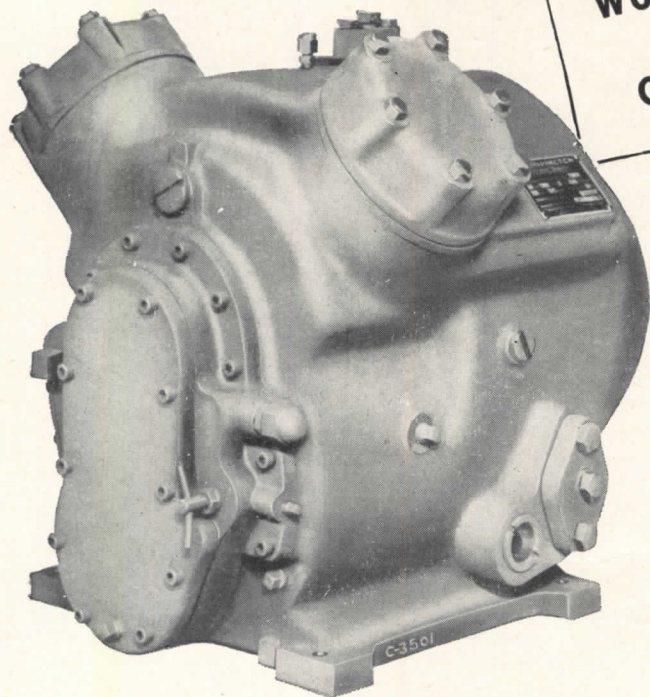

Makes This
WORTHINGTON
AIR
CONDITIONER

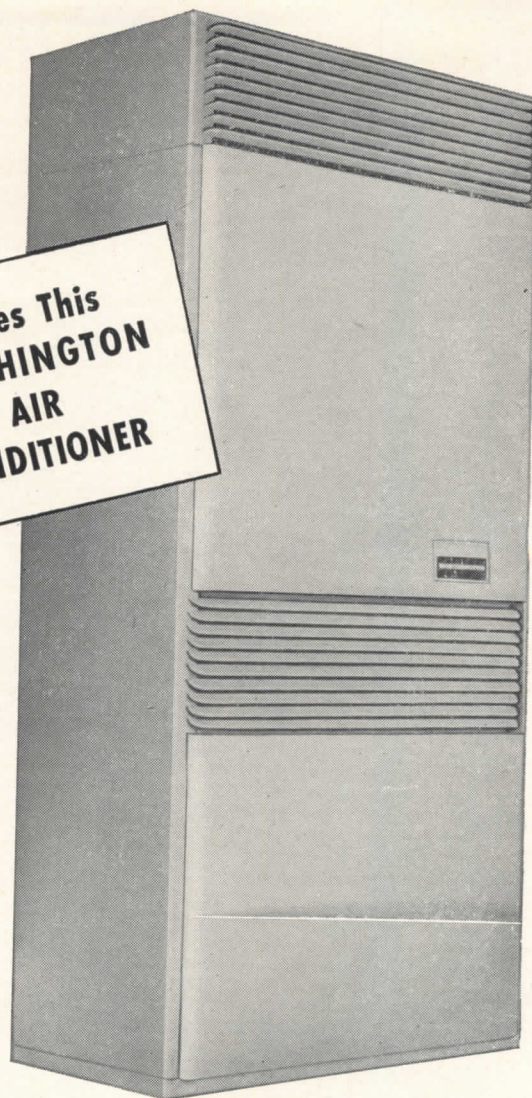

the Outstanding SELF-CONTAINED Unit

It's the most modern of its kind—completely new, designed throughout for quiet, vibrationless operation and field serviceability.

Motor and compressor are combined in one piece of equipment (eliminating belts, pulleys, fly wheels and couplings) and hermetically sealed against dirt and moisture. There are no shaft seals, and it is never necessary to oil the motor or make adjustments. When necessary, the equipment is readily accessible for servicing in the field.

Other features: dynamically balanced crankshaft, crankcase with removable cover, positive

displacement gear-type oil pump, large oil filters in the lubricating oil line, pistons equipped with four piston rings, removable cylinder liners, Worthington Feather* Valves, refrigerant-cooled cylinder walls and refrigerant-cooled motor.

Models are available now in 3-ton and 5-ton sizes.

Get ahead with Worthington's Self-Contained Air Conditioner—the air conditioner with *all* the new features, that's going out front in 1948. *Worthington Pump and Machinery Corporation, Harrison, N. J. Specialists in air conditioning and refrigeration for more than 50 years.*

*Reg. U. S. Pat. Off.

SEE IT AT
International Heating and
Ventilating Exposition —
Worthington Booths
30-31 and 44A-45.

WORTHINGTON



AIR CONDITIONING AND REFRIGERATION

A-7-27

Formerly Milcor Steel Company

...now

Inland Steel Products Company

...the same Milcor service and quality as always

From now on, you will continue to see the familiar Milcor trade mark on products of this company—but the *company name only* has been changed from Milcor Steel Company to Inland Steel Products Company.

This change is being made now for two reasons:

1. This company is not, and never has been, a steelmaker. The new name more accurately describes its business.
2. Since 1936, this company has been a subsidiary of Inland

Steel Company. The new company name merely gives formal expression to this relationship of more than ten years' standing.

The Milcor trade mark on material purchased from Milcor dealers will continue to stand for the same high quality and outstanding value which you have come to expect over the years. Remember, *nothing is changed but the company name.*

Specify "Milcor" as always in describing any of this company's products.



INLAND STEEL PRODUCTS COMPANY

FORMERLY MILCOR STEEL COMPANY

MILWAUKEE 1, WISCONSIN

BALTIMORE 24, MD. • BUFFALO 11, N. Y. • CHICAGO 9, ILL. • CINCINNATI 25, OHIO • CLEVELAND 14, OHIO
DETROIT 2, MICH. • KANSAS CITY 8, MO. • LOS ANGELES 23, CALIF. • ROCHESTER 9, N. Y.