

Koroseal[†] Tile

The finest resilient flooring available, for residential, office and shop installations requiring distinctive beauty and durability. It resists wear, fading, indentation, grease and alkalis . . . Easy to install on any properly prepared sub-floor . . . Gives a lifetime of service and luxury.

Available in 1/8" gauge, 9" x 9" squares and other sizes, in 18 clear, permanent colors and Marbledone* and Crystallone* patterns.

†Koroseal is a registered trade-mark of the B. F. Goodrich Company

Linoleum Tile

A colorful resilient flooring that is the economical answer to residential, commercial and institutional installations where traffic is relatively light. It is a durable light-weight floor covering in a wide range of colors . . . is easy to maintain. Its Marbledone pattern makes possible many varied and unique designs and effects.

Available in 3/32" gauge, 9" x 9" squares, in 9 brilliant colors and an over all Marbledone pattern.

Texfloor* Tile

A new tile developed by Sloane-Blabon for use in residential, office and shop installations. It's an entirely new idea—has a luxurious soft-woven look never before achieved in a smooth floor covering. This tile has excellent wearability . . . can be used on any suspended sub-floor . . . is a colorful medium for creating striking interiors.

Available in 3/32" gauge, 9" x 9" squares, in 5 blendable colors and the distinctive softly woven jaspé pattern.

*Trade-mark

Rubber Tile

Tough, wear-resistant, yet quiet and comfortable underfoot, this rubber tile—a new addition to the Sloane-Blabon line—ideal for heavy traffic areas such as homes, schools, hospitals, and public buildings. It's a floor covering that can be installed on any suspended sub-floor but should not be installed on sub-floors on or below grade.

Available in 1/8" gauge, 9" x 9" squares, in 19 colors with a Marbledone pattern.



**WHERE and WHY
to specify
Sloane Quality Tile!**

Asphalt Tile

An economical material for use in stores, office buildings, lobbies, and residential installations. It's an extremely durable floor covering that can be used on any sub-floor. It can even be used on concrete floors in contact with the ground, on or below grade (except where such sub-floors are subject to hydrostatic pressure).

Available in 1/8" and 3/16" gauge, 9" x 9" and 18" x 24" sizes in 18 colors with a Marbledone pattern.



Write today for your free file folder containing samples and information on all Sloane Quality Linoleum Products. Dept. R-3.

Enduro Tile

A new and extremely durable industrial flooring for use in machine shops, factories, shipping rooms, locker rooms and other areas subjected to abnormally heavy wear. The main features of this new flooring are its heavy-duty durability, non-skid safety and economy. It's an all-purpose flooring that is sturdy and easy to maintain.

Available in 1/4" gauge, in 12" x 12", 18" x 18", 18" x 24", 24" x 48" and 36" x 36" sizes and three unpatterned colors; black, brown and green.



SLOANE-BLABON CORPORATION
295 FIFTH AVENUE, NEW YORK 16, N. Y.

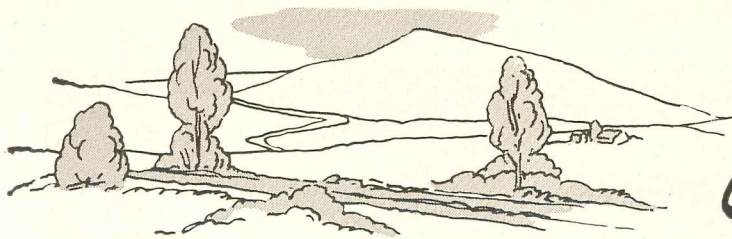

Countryside **Today...**



When *Speed* is the Need... Use **CECO**

One day you pass a new development in the making, ground is broken, home foundations are in. Then, in just a short, short time, where once there was open countryside, a whole community, spick-and-span new, "has sprung up overnight." Chances are the stores, the school, the theatre... yes, most of the light occupancy buildings... were constructed with Open-Web Steel Joists. For that is the fastest way ever to build. There's no temporary formwork necessary... nothing to take down later on. Open-Web Steel Joists are self-centering... are placed on the wall structure and right away rib lath can be laid and concrete poured to form the floor. And while all this is going on, other building

**CECO
STEEL**

In construction products **CECO ENGINEERING**

a *Community* **Tomorrow**

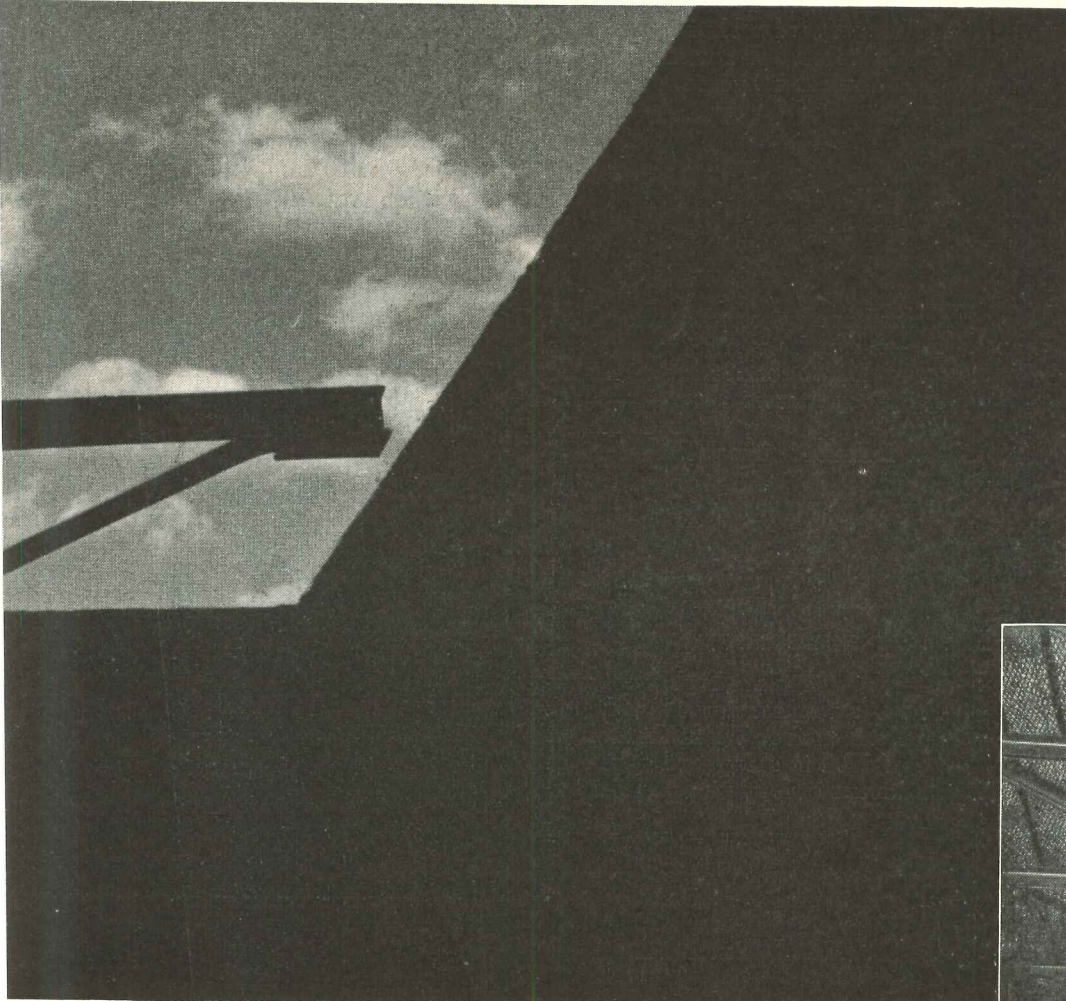
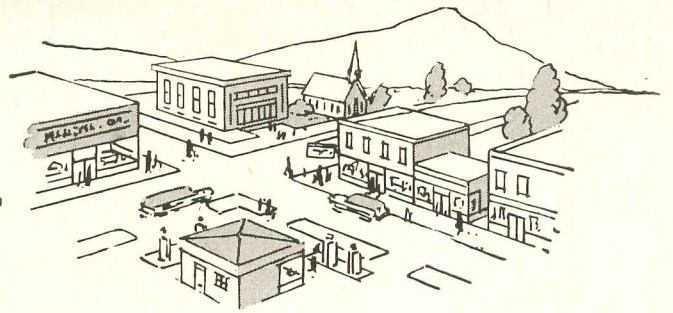

Economical — Ceco Open-Web Steel Joists are self-centering. The form work for the concrete slab—usually metal rib lath or steeltex—rests directly on the steel joists without other support from the underside.



Open-Web Steel Joists

trades can be on the job doing their special work such as installing steel windows, electric wiring, plumbing and heating. So, when speed gets the call, specify CECO OPEN-WEB STEEL JOISTS. They are fabricated to exact size in the factory, come to the job tagged, ready to install... provide low cost fire resistive buildings. Ceco assures you fast service from five plants: Birmingham, Chicago, Houston, New York and Wheeling, W. Va.

Conceals Conduits — Ceco Open-Web Steel Joists provide a ready means of concealing ducts, wiring and piping. Space is saved by direct attachment of ceilings to joists. Time and materials are saved, too.

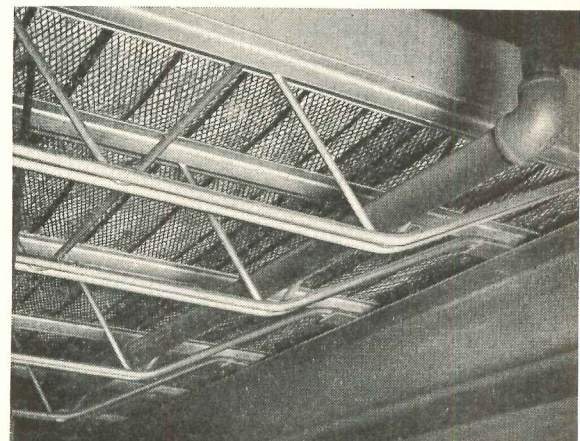

CECO STEEL PRODUCTS CORPORATION

General Offices: 5601 West 26th Street, Chicago 50, Illinois

Offices, warehouses and fabricating plants in principal cities

makes the big difference

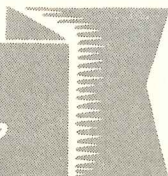

*There's a Maintenance Threat
in all these services...combat it with*
BYERS WROUGHT IRON PIPE

If you have any of these piping services in prospect—watch out for corrosive attack! It's always a threat, and failure to use proper safeguards may mean early and costly maintenance.

Byers Wrought Iron pipe has made some outstanding records for durability in every one of these applications. We'll be glad to give you specific examples on request.

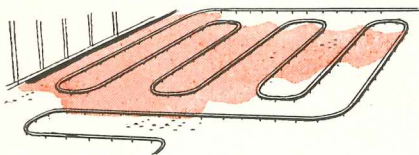

RADIANT HEATING

Wrought iron is now serving in thousands of installations, of all sizes. The superior durability of the material is demonstrated by its comparative service in skating rinks—where conditions are even more severe.

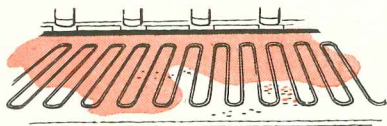

SNOW MELTING

Widely used not only because of its corrosion resistance, but because its mechanical strength protects it from crushing during installation and use.

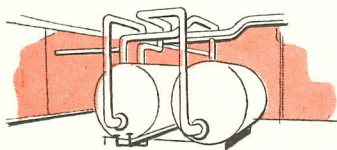

STEAM RETURN LINES

Condensate is always aggressive. Wrought iron return lines, properly installed, have proven remarkably effective in eliminating excessive repairs and replacements.

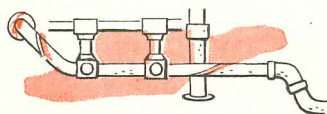

WASTE AND VENT LINES

Corrosive sewage gases quickly gnaw away any vulnerable mate-

rial. Surveys of old buildings reveal wrought iron still serving after periods of up to 50 years.

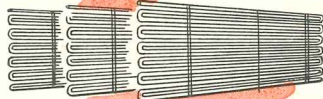

CONDENSERS

Users have reported service life of 30—40 and even 50 years from wrought iron condensers. One study of 32 condensers showed wrought iron served over twice as long as low first-cost material.



AIR CONDITIONING

Many services are highly corrosive . . . and replacements are difficult and expensive. Wrought iron has been used to safeguard operations in dozens of large installations.

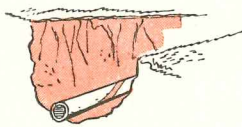

UNDERGROUND LINES

Whether in trench or tunnel, corrosion is always a hazard to underground lines. Here, again, users have reported wrought iron service of over half a century.

The corrosion resistance of wrought iron comes from its unique composition and structure, which halts and disperses attack. Ask for bulletins on any services in which you are interested.

A. M. Byers Company, Pittsburgh, Pa. Established 1864. Boston, New York, Philadelphia, Washington, Atlanta, Chicago, St. Louis, Houston, Salt Lake City, San Francisco. Export Division: New York, N. Y.

CORROSION COSTS YOU MORE THAN WROUGHT IRON

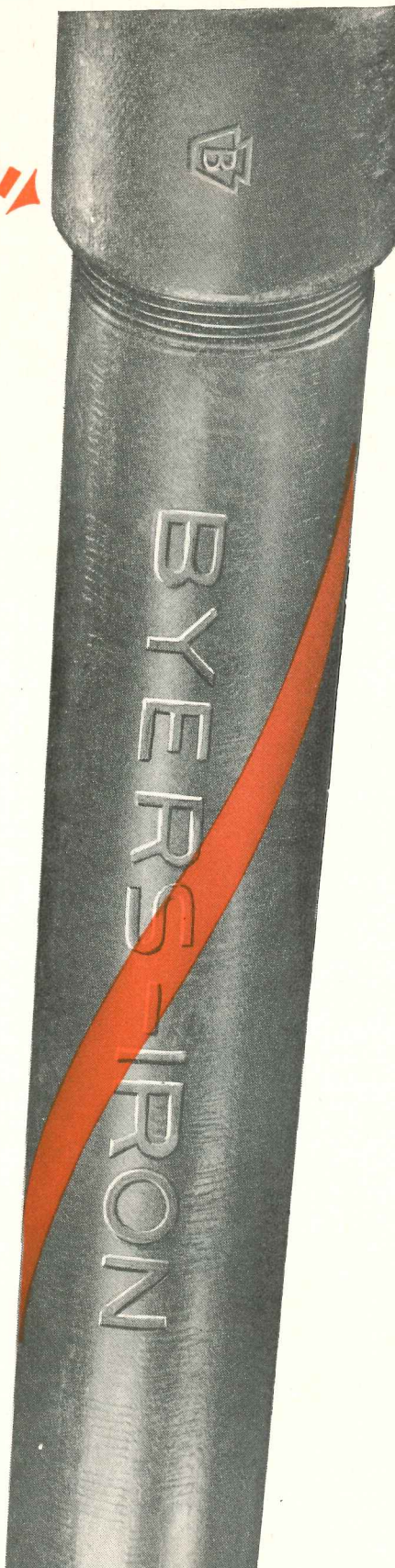

BYERS
GENUINE WROUGHT IRON
TUBULAR AND HOT ROLLED PRODUCTS
ELECTRIC FURNACE QUALITY ALLOY AND STAINLESS STEEL PRODUCTS

ARCHITECTURAL RECORD



Copyright 1950 by F. W. DODGE CORPORATION, with all rights reserved • Publishing Director, Magazine Division, H. Judd Payne • **EDITORS:** Editor-in-Chief: Harold D. Hauf, A.I.A., A.S.C.E.; Managing Editor, Emerson Goble; Senior Associate Editor, Frank G. Lopez, A.I.A.; Associate Editors, Robert E. Fischer

(Engineering), Florence A. van Wyck; Washington News, Ernest Mickel; Contributing Editor, Frederic A. Pawley; Western Editor, Elisabeth Kendall Thompson; Special Editorial Representative, Western Section, William C. Rodd; Associate in South America, Edmund J. Whiting, A.I.A.; Editorial Assistants, Jeanne Davern, Dorothy C. Jackson, Herbert L. Smith, Jr. • **ART DEPARTMENT:** Design Consultant, M. Peter Piening; Assistant, Frances Torbert; Drafting, Sigman-Ward • **CONSULTANTS:** Chairman, Editorial Board, Kenneth Kingsley Stowell, A.I.A.; Industry Relations Consultant, Thomas S. Holden; Statistical Consultant, Clyde Shute; Field Research Consultant, Clifford Dunnells, Jr.

Architectural Record (combined with American Architect and Architecture) is published monthly by F. W. Dodge Corporation, 10 Ferry St., Concord, N. H., with Editorial and Executive Offices at 119 West 40th Street, New York, N. Y. Western Editorial Office, 2813 Channing Way, Berkeley, Calif. Thomas S. Holden, Pres.; Howard J. Barringer, Vice-Pres. and Treas.; Irving W. Hadsell, Vice-Pres.; Chauncey L. Williams, Vice-Pres.; Sanford D. Stockton, Jr., Secy.; Walter F. De Saix, Asst. Treas.; Edwin H. Freed, Asst. Treas.; Irving B. Safin, Asst. Treas. Member Audit Bureau of Circulation and Associated Business Papers Inc. Architectural Record is indexed in Reader's Guide, Art Index, Industrial Arts Index and Engineering Index. Subscription rates: United States and Possessions, Canada, Cuba, Mexico, Central and South America, and Spain, \$4.50 the year, \$7.50 for two years, \$9 for three years; elsewhere, \$6.50 the year, \$11.50 for two years, \$15 for three years. Single copy \$1. Circulation Manager: Marshall T. Ginn. Every effort will be made to return material submitted for possible publication (if accompanied by stamped, addressed envelope), but the editors and the corporation will not be responsible for loss or damage. Other Dodge Services: Real Estate Record & Builders' Guide, Sweet's Files, Home Owners' Catalog, Dodge Reports & Dodge Statistical Research Service.

COVER:

House in Massachusetts designed by The Architects Collaborative (pages 128-136). Photo by Lionel Freedman — Pictor.

THE RECORD REPORTS.....	9
Progress in Reverse: An Editorial.....	11
News from Washington. By Ernest Mickel.....	15
News from Canada. By John Caulfield Smith.....	16
Construction Cost Indexes.....	26
REQUIRED READING.....	28
SITE AND SYMBOLISM DICTATE DESIGN.....	101
Southern Brookline Community Center — Temple Emeth, Brookline, Mass. Isidor Richmond and Carney Goldberg, Architects	
POWER PLANT PROGRESS.....	108
Sewaren Generating Station, Public Service Electric and Gas Company. Walker & Poor, Consulting Architects	
SMALL TEXAS OFFICE BUILDINGS PLANNED FOR UPTOWN SITES.....	114
1. Page, Southerland & Page Building, Austin. Page, Southerland & Page, Architects.....	114
2. Thornhill-Craver Office Building, Houston. MacKie and Kamrath, Architects.....	116
3. Technical Instrument Company, Houston. MacKie and Kamrath, Architects.....	117
4. Remington-Rand Building, Dallas. George L. Dahl, Architects & Engineers.....	118
SUN, SHADOW AND SILHOUETTE.....	120
United Nations Secretariat. Louis B. Schlivek photos	
BUILDING TYPES STUDY NO. 161 . . . HOUSES	
DO SMALL HOUSES AFFORD A SATISFACTORY PRACTICE?	124
Conclusions reached after many months of interviewing architects, builders and owners	
I. ARCHITECTS AND INDIVIDUAL CLIENTS.....	128
Examples: Four New England houses by The Architects Collaborative; their office organization, methods of practice, results	
II. ARCHITECTS AND OPERATIVE BUILDERS.....	137
Examples: The Revere Quality House Program — a résumé of the experiences of architects from San Francisco to Boston, Chicago to Dallas, in designing eighteen houses for builders, plus a New Jersey development by Petroff & Clarkson	
III. ARCHITECTS AND PREFABRICATION.....	152
Example: History of The Acorn House; deductions from the experience of the protagonists, Carl Koch, John Bemis and their associates	
ARCHITECTURAL ENGINEERING	
TECHNICAL NEWS AND RESEARCH	
SITES MOVED TO OFFICE BY AIR PHOTOS.....	159
By Walter L. Weitner	
HOUSE PANEL-CONVECTION HEATING SYSTEMS... ..	163
By Zay Smith	
LOCKER ROOM CONCENTRATES ON EFFICIENCY... ..	165
Rust Engineering Company	
TECHNICAL NEWS.....	166
PRODUCTS . . . for Better Building.....	167
MANUFACTURERS' LITERATURE.....	168
TIME-SAVER STANDARDS.....	171
Graphical Symbols: (1) Piping; (2) Heating and Ventilating; (3) Air Conditioning	

A DRAMATIC NEW TO LARGE-SCALE

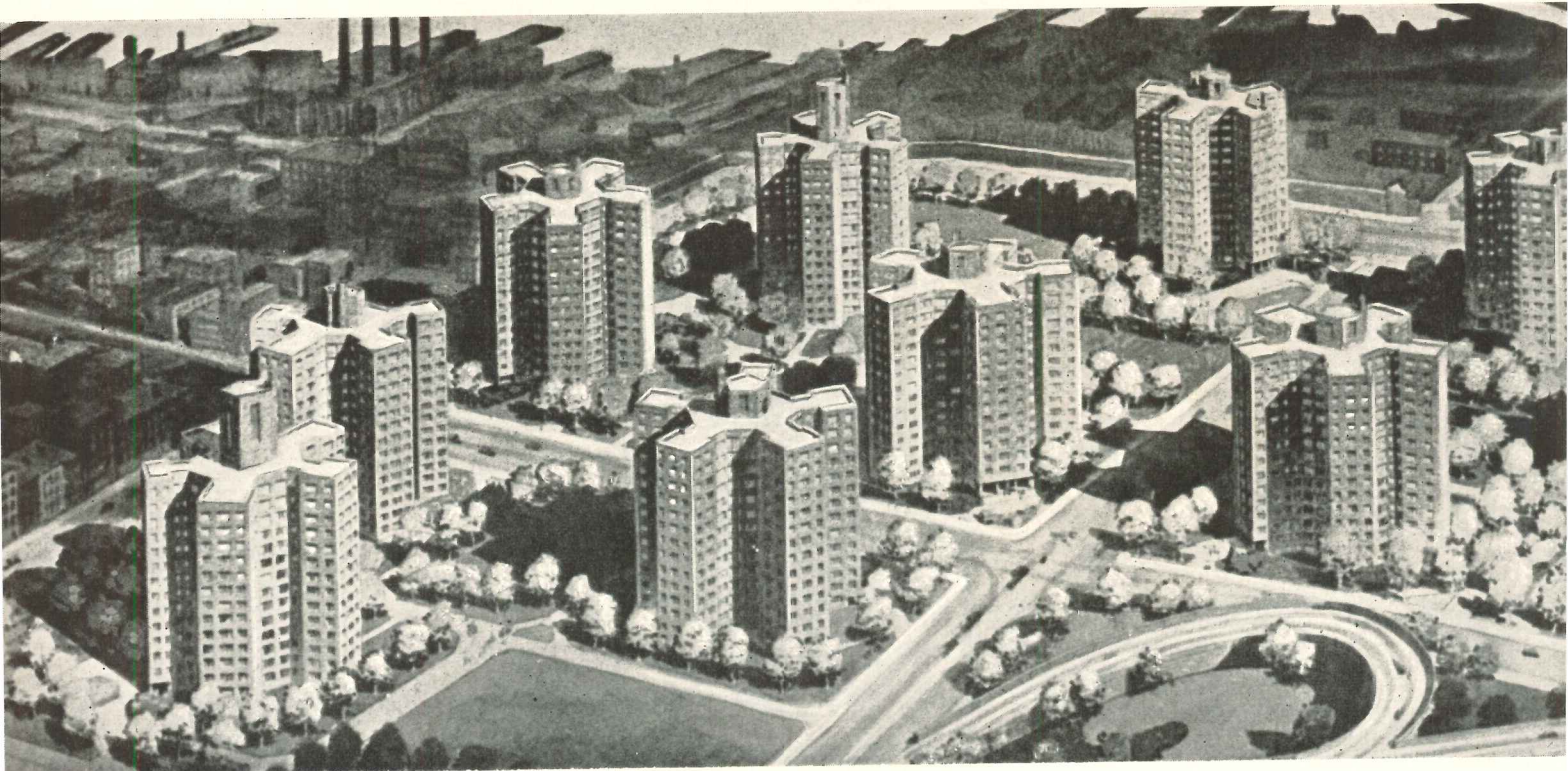

The ten 14-story pentagonal structures above show the Farragut Housing Units in Brooklyn, N. Y. as they will appear when completed. This newest addition to New York City's housing will provide living quarters for 1400 families. At this printing the New York City Housing Authority has awarded contracts for seven of these impressive units to John A. Johnson & Sons, Inc.



Louis E. Jallade and William T. Koch, Architects

Pictured above are three units of the extensive 14-story Melrose Houses. This 1023 apartment project, of which the first section is now under construction by John A. Johnson & Sons, Inc., is under the direction of the New York City Housing Authority with the cooperation and state-aid of the New York State Division of Housing.

PROVIDING REQUIRED HOUSING IN MANY AREAS

Other housing construction now under way or completed by Johnson during 1949, in addition to Farragut Houses, Brooklyn; Melrose Houses, Bronx; and the Mount Vernon Housing Authority's apartment buildings illustrated, include substantial projects at New Rochelle, Schenectady, Troy and Hempstead, L. I. Also in process of construction or completed during 1949 by John A. Johnson & Sons, Inc. are housing projects of one million dollars and upwards in Hartford, Conn., Andrews Field, Md., Oak Ridge, Tenn. and Cold Springs, Ky.

APPROACH HOUSING

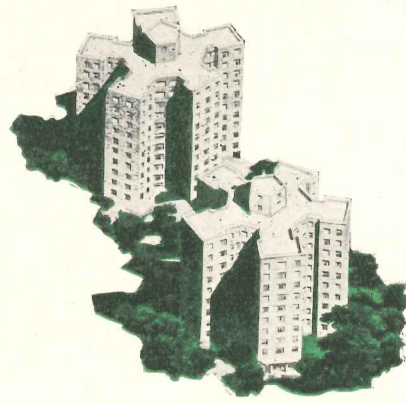

Fellheimer, Wagner & Vollmer, Architects

Thanks to the dynamic thinking behind the conception and construction of these various Johnson-built Housing Units, all rooms enjoy unobstructed views, there is maximum light and air, minimum ground coverage and minimum exterior wall surface, the latter being an important factor in cost reduction. Shown above are two of the five Mount Vernon apartment structures now nearing completion. These modern housing units are being erected by John A. Johnson & Sons, in cooperation with the Mount Vernon Housing Authority.

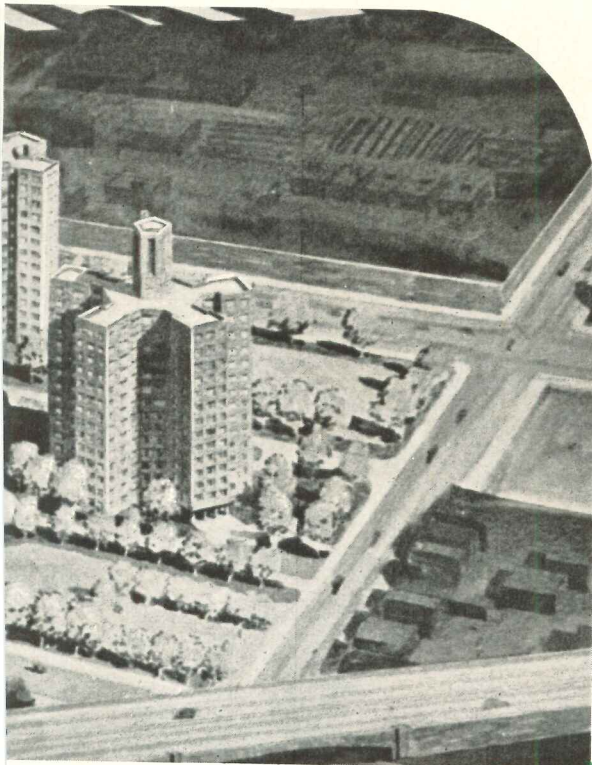

Fellheimer, Wagner & Vollmer, Architects

The New York City Housing Authority and The Division of Housing of the State of New York are to be congratulated upon the notable progress they have made both in quality of design and construction, as well as the substantially lowered costs recently announced by the Executive heads of the Authorities.

ENTIRE COMMUNITIES

Johnson's successful bidding on some twenty projects now under way has been predicated upon a broad background of construction, embracing, in some cases, entire communities, including not only large-scale housing, but also waterworks, power and heating plants, utilities, and all necessary facilities.

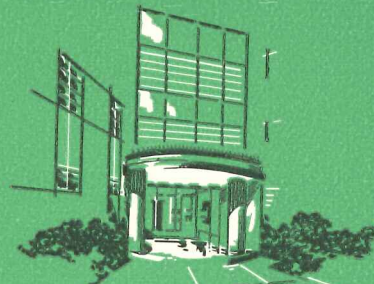

These ultra-modern entrances introduce a definite touch of elegance to the pentagonal-type apartment unit designed for middle income families as well as those in the higher income bracket.

More and more public housing authorities are turning to John A. Johnson & Sons in the interest of efficiency, know-how, speed and economy . . . Let us show you why.

John A. Johnson & Sons Inc.

BUILDING CONSTRUCTION . . . "A FIRM FOUNDATION SINCE 1896"

NEW YORK • BROOKLYN • PEMBERTON • WASHINGTON
COLUMBUS • OAK RIDGE • ATLANTA

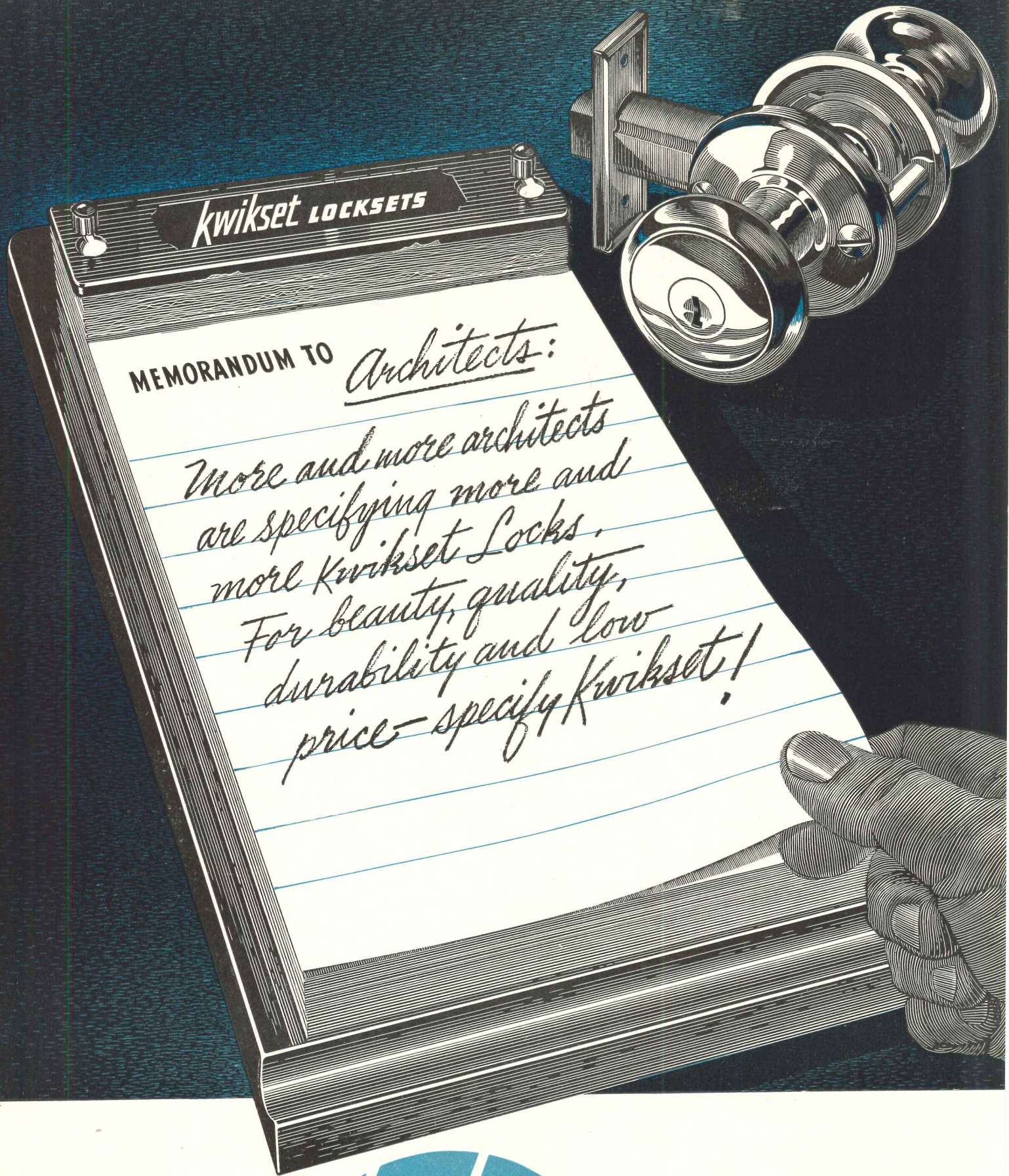

MEMORANDUM TO

Architects:

More and more architects
 are specifying more and
 more Kwikset Locks.
 For beauty, quality,
 durability and low
 price—specify Kwikset!

Feature For Feature....
 Dollar For Dollar.....
 You Can't Beat Kwikset!



NEW CATALOG AVAIL

A new full color catalog describes Kwikset pin-tumbler, cylindrical locks. Write for your copy today! Address inquiries KWIKSET LOCKS, INC., Dept. AR, Anaheim, California.

SOLD BY LEADING HARDWARE WHOLESALERS. JOBBERS AND DEALERS FROM COAST TO COAST

THE RECORD REPORTS

EYES ON WASHINGTON AS A.I.A. HOLDS 82ND ANNUAL CONVENTION

“Urban Planning” and “Lighting and Illumination” Featured On Busy Agenda; Also Offered: Elections, Amendments, Tours

ONE OF THE BIGGEST and busiest meetings ever takes shape as The American Institute of Architects gathers at the Hotel Mayflower in Washington, D. C., May 10-13 for its 82nd annual convention.

Urban Planning and “Lighting and Illumination” will be featured in speeches and symposia throughout the four-day meeting; and group discussions on schools, housing and hospitals have been scheduled.

A tour of the White House reconstruction and a bus tour of Washington featuring urban development are also on tap; and for the first time in years, a symposium will deal with the practical affairs of the architect's office, when David C. Baer, chairman of the Committee on Standard Accounting Methods for Architects, leads a discussion on The Institute's Standardized Accounting System on the opening day.

Award Winners

Highlights of the convention will be the awarding of the Gold Medal to Sir Patrick Abercrombie of England and the conferring of Fellowships at the annual dinner on the night of May 12. Other awards to be made at the convention will bring the Fine Arts Medal to Edward Steichen, photographer; the Craftsmanship Medal to Joseph Gardner Reynolds, artist and designer of stained glass windows; and honorary memberships to F. Stuart Fitzpatrick, manager of the Construction and Civic

Development Department of the Chamber of Commerce of the United States, and Miss Harlean James, executive secretary of the American Planning and Civic Association. Jose Alvarez Calderon, “the most distinguished practicing architect of Peru,” will be made an honorary corresponding member.

Bylaw Changes

Affairs political will gain extra stimulus when the first morning's session has placed before it a change in the bylaws and in the Charter of the Institute, which will permit addition of two regional districts and two additional regional directors, as well as the new amendment in the bylaws which would provide for election of a president-elect each year.

Actual balloting for officers and directors will not take place until the second day and announcement of results is scheduled for the final session Saturday morning.

Sir Patrick Abercrombie leads off the Urban Planning symposia with the first major speech of the convention. Other participants in the planning phases spotted throughout all four days will include Perry Coke Smith, Albert Mayer, Dr. Helmut Landsberg, Sen. Ralph Flanders of Vermont, Paul Windels, Kenneth Wischmeyer, Arthur C. Holden and Lewis Mumford.

Physical factors in planning, climatology and planning, decentralization, and regional planning in smaller communi-

ties are among the special aspects of planning which will be considered. “The Federal City” will be the topic of a luncheon session with the Joint Committee on the National Capital.

“Lighting and Illumination” symposia will include sessions on “Basic Factors of Vision,” “Designing with Light,” and “Functional Illumination.” Listed to carry this phase of the program are Lawrence B. Perkins, C. L. Crouch, Ernest J. Kump, W. W. Caudill, Prof. R. L. Biesele Jr., Stanley McCandless, Howard Sharp and Morris Ketchum Jr.

Seminars Scheduled

Louis Justement, Ernest Kump and Slocum Kingsbury will act as moderators at the Thursday evening seminars on housing, schools and hospitals.

At the opening session on May 10, announcement will be made of the 1950 National Honor Awards for Architecture and the 2nd Product Literature Competition Award.

Changes in the bylaws to come before the convention include a proposal to make United States citizenship a requisite for Institute membership.

Post-convention tours offer four options: a five-day air cruise to Bermuda, an eight-day air cruise to Bermuda, a two-day trip to Colonial Williamsburg and a two-day tour to National Bridge, Monticello and Ashlawn. Tours of Washington have also been arranged to follow adjournment on the final day.

Left to right: Edward Steichen, Joseph Reynolds, Sir Patrick Abercrombie, Miss Harlean James, F. Stuart Fitzpatrick

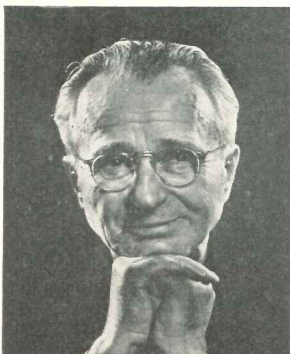

Karsh photo



Harris-Ewing photo



Blackstone Studios

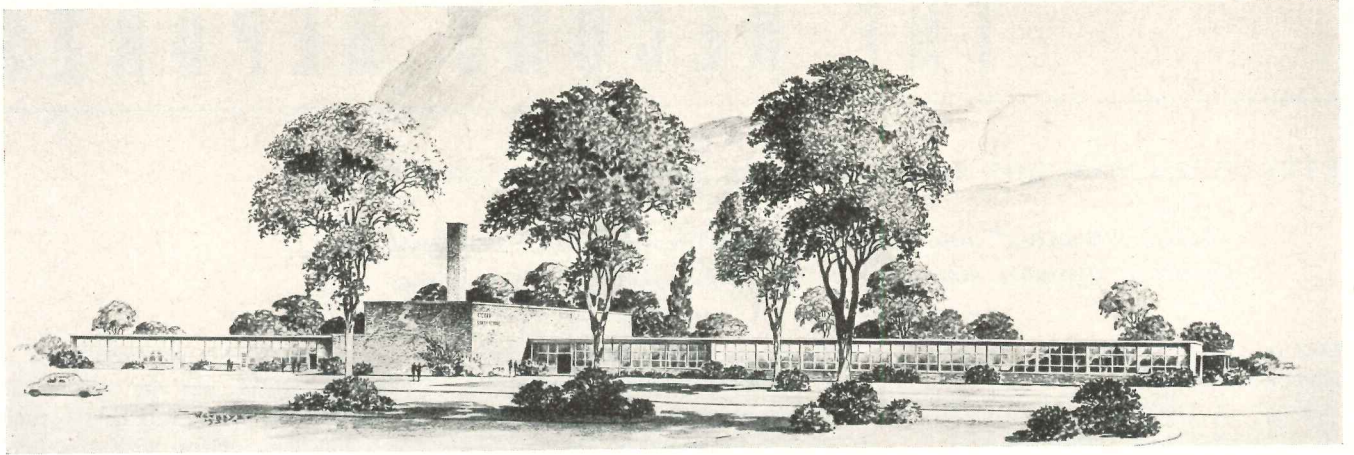

CICERO SCHOOL PLANNED FOR LOW-COST BUILDING

A NEW ELEMENTARY school for the North Syracuse (N. Y.) Central School District (photo of rendering above) is now under contract to cost about 71½ cents per cu ft.

The Cicero School, which will house kindergarten through sixth grade, is "definitely not minimum construction," say the architects. Corridors have terrazzo floors and glazed tile wainscot. All trim and cabinet work is birch and all rooms are plastered.

The kindergarten, first and second grades are separated from the higher grades by the play and administration facilities. Each classroom has its own toilet room and, above third grade, a toilet room for each sex. Of special interest in the classroom plan are the "work centers," commodious cabinets and cork boards, and the location of

typical classroom wardrobes in the corridors.

Architects are the associated firms of Harry A. and F. Curtis King and Sargeant-Webster-Crenshaw & Folley.

MARCH BUILDING VOLUME REACHES ALL-TIME HIGH

SETTING A NEW all-time high for monthly construction volume, the March total of building and engineering contracts awarded in the 37 states east of the Rocky mountains was \$1,300,201,000, according to the F. W. Dodge Corporation's monthly report.

Last month's figure was 74 per cent ahead of March 1949. The previous record, set in June 1942, was \$1,190,264,000.

Dodge figures also showed a new first quarter record, with totals for the period of \$2,810,586,000 and 245,207,000 sq ft of new building space.

Biggest gain was registered by residential building, up 128 per cent for March; next was non-residential.

NEW FILM SERIES BEGINS WITH FEATURE ON HOMES

"INTRODUCTION to Architecture—American Homes," an eight-minute film featuring houses by some of America's best-known architects, has been produced by the Strick Film Company as the first of a series on architecture.

Designed not only for the school field but for the architect, the film stresses the role of the architect in any well-designed house.

Carl Lerner and Joseph Strick directed the film, which was shot in almost every region of the United States, including the Southwest, the Central States, the Middle Atlantic States and New England. Main advisers were Dean Arthur B. Gallion of the School of Architecture at the University of Southern California, Robert McMillan of the Architect's Collaborative, Cambridge, Mass., and Matthew Ehrlich of Philadelphia.

Later films in the series would cover other building types, bridges, and the architecture of foreign countries.

Below: photographs from the Strick Film Company's new movie. At left, model of a house by Richard Neutra; at right, diorama by Burdick of a house by Edward Stone

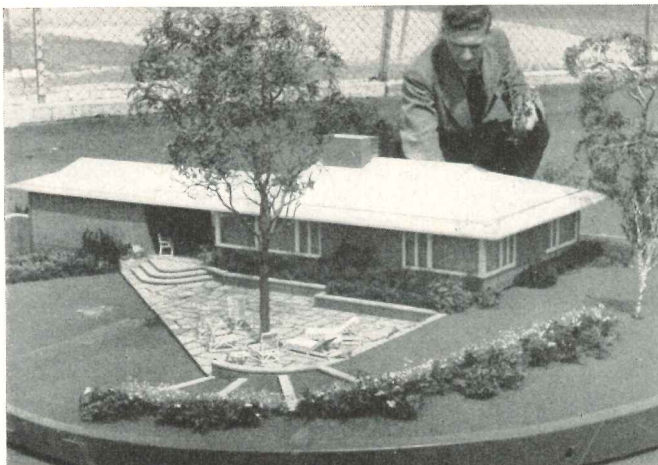

A.I.A. SEMINAR IS PLANNED WITH HOSPITAL CONFERENCE

ANOTHER GROUP of architects will have an opportunity to exchange ideas with the people who operate hospitals on May 18 and 19, when the Minneapolis and St. Paul chapters of The American Institute of Architects sponsor a two-day seminar on hospital planning. The seminar is being held in Minneapolis in conjunction with the Upper Midwest Hospital Conference, an annual event attended by some 2000 hospital administrators and allied specialist groups.

Executive Editor Robert Cunningham of *Modern Hospital* will serve as moderator of the first morning's session on "Programming a Hospital," with Thomas F. Ellerbe describing the architect's role and James Hamilton of Minneapolis, the consultant's.

At the afternoon session on hospital construction, speakers will include Dr. Helen Knutson, director of the Section of Hospital Facilities in the Minnesota Department of Health; Carl Erikson, of Schmidt, Garden & Erikson, Architects, of Chicago; Dr. Willmar M. Allen, president of the American College of Hospital Administrators.

With Carl Erikson as moderator, the second morning session will offer discussions of "The Nursing Unit," by Miss Margaret Filson, assistant professor and director of nursing service, University of Minnesota; "Facilities for the Care of the Newborn," by Dr. John Adams, pediatrician at University Hospitals and General Hospital, Minneapolis; "Aseptic Technique," by Dr. Carl Walter, teacher of surgery at Harvard and chief surgeon, Peter Bent Brigham Hospital, Boston.

A talk on operating room materials and planning by Robert Cutler of Skidmore, Owings and Merrill will open the final session, which will have Marshall Schaffer, chief of the Technical Services Branch, Division of Hospital Facilities, U. S. Public Health Service, as moderator. Hospital service departments and fire safety design are on the agenda, as well as a talk on functional relationships of departments by W. H. Tusler.

The committee organizing the seminar is under the co-chairmanship of Roy N. Thorshov of Long and Thorshov, Minneapolis, and Thomas F. Ellerbe, Ellerbe & Co., St. Paul. Other members of the committee include W. H. Tusler, Victor C. Gilbertson, Arnold I. Raugland and Eugene D. Corwin. Edward H. Noakes, Minneapolis, is executive secretary of the Committee.

PROGRESS IN REVERSE!

Veterans Administration Frowns on Modular Design

JUST as this issue of ARCHITECTURAL RECORD goes to press, we learn that the Veterans Administration considers it "to be to the best interest of the government to continue the use of non-modular sized materials in the design of Veterans Administration Hospitals regardless of location." If the VA stands its ground in enforcing this ill-advised precept (which was laid down first when it refused to open the specifications for the Oklahoma City Veterans Administration Hospital to modular-sized brick), architects will have a new and powerful argument for the return of the design of VA projects to private firms.

When the Veterans' hospital construction program was initiated shortly after World War II, the design of the hospitals was under the supervision of the U. S. Army Corps of Engineers, which contracted with private architectural and engineering firms to develop the designs. The Chief of Engineers addressed a memorandum to all contracting architectural and engineering firms urging them to design their projects on a modular basis.

The attitude of the Corps of Engineers was clearly stated by H. B. Zackrisson in an address to the A.I.A. convention in Grand Rapids in 1947. He said in part, "The Chief of Engineers and his staff have . . . considered the various ways by which our total costs of construction might be reduced. One of these was the use of modular products and the application of the principles of modular design to Veterans Administration hospitals. . . . It is the belief of the Chief of Engineers that the use of modular products and modular design should result in economies of construction."

The Corps of Engineers is not alone in the belief that modular coordination offers an industry-wide basis for increasing the efficiency of building design and construction. The 81st Congress appropriated funds for studies on dimensional coordination which are being carried on by the Housing and Home Finance Agency. In addition, plans have recently been completed by the A.I.A. and the Producers' Council to retain a specialist to promote the use of modular coordination. Obviously, the stand taken by the VA is inconsistent with current progressive opinion.

The VA states that "Because of the inability of industry nation wide to adopt the modular sizes in the manufacture of their products, and since *the Veterans Administration construction program is nation wide*, it has been necessary for the Veterans Administration to adopt the policy of designing for regular non-modular sizes."

This is one of the best arguments we have heard for returning the design of veterans' hospitals to private architectural firms who are thoroughly conversant with local conditions. Such a policy would remove arbitrary restrictions governing the use of modular products.

As modular products become increasingly available at the local level throughout the country, every inducement should be provided to promote their use. It is hoped that the VA will support this policy.



Editor-in-Chief

VICTORY FOR "MODERN": WHERE ECONOMY REIGNS

A ROUNDABOUT VICTORY for modern architecture has been won by Little Rock architects Brueggman, Swaim & Allen, whose First Methodist Church for North Little Rock is now under construction.

To build a sanctuary, chapel and educational building for the funds made available by the membership required departing from any traditional style of architecture to a purely functional one. Now, the architects report, many people who first accepted the design for economy only are coming to approve its mass and lines. Although there have been complaints that "it doesn't look like a church," the architects can find a certain triumph in the fact that "so far no layman has confused it with a building constructed for any other purpose."

Height was omitted in the main sanctuary, and there is no cut or cast stone in the building. The church was designed to fit a site which, although spacious,

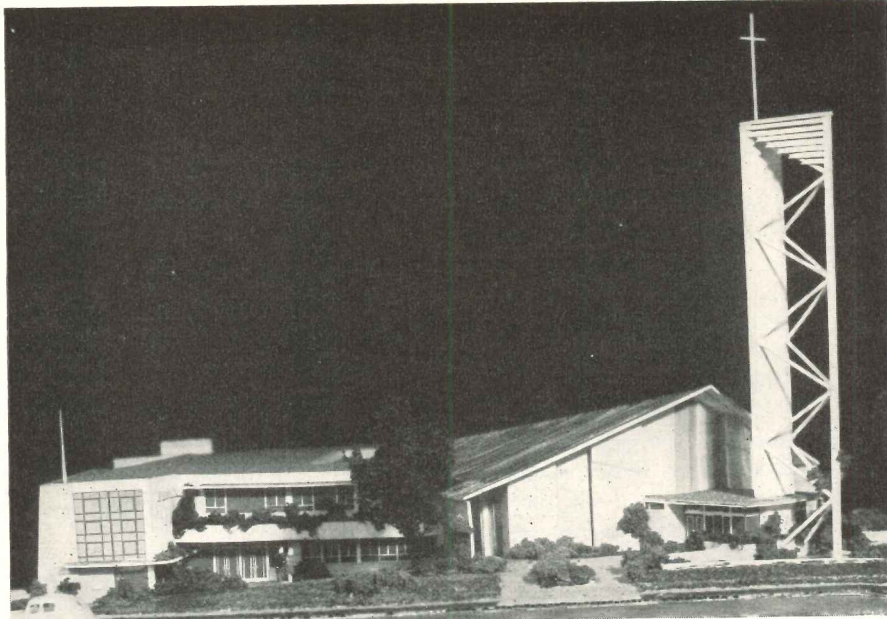

Earl Saunders Photo

has a 35 ft contour drop from front to rear. The carillon tower, constructed simply and economically of aluminum, is at the entrance corner on the highest

point of ground. Ramps lead directly into any part of the building except the top floor, and there is off-street parking for 87 cars.

WINDOWLESS WALLS FOR SUN CONTROL USED FOR DALLAS OFFICE BUILDING

WINDOWLESS WALLS are used above second-floor level on three sides of the Great American Reserve Life Insurance Company's Home Office Building in Dallas, Tex. The lower stories have walls of glass.

Omission of windows on all sides of the upper stories except the east exposure was planned to minimize an undesirable western sun.

Facing on all facades is Texas shell stone, except for first floor columns, which are faced with Texas pink granite.

Some innovations which proved both space- and cost-saving came out of the architects' efforts to plan for the owners a building both modern and economical.

It was decided in the beginning stages of the building planning to have the machine room on the first floor. Although first floor space is usually very valuable, the location of this building is such that it was felt space on the first floor could be used for a machine room without disadvantage. This location means there is easy access to the machine room.

Because of the low ratio of window area to outside wall area, it was decided to dispense with radiation underneath the windows and use tempered air as the means of heating the building. To supplant the radiation under the windows, tempered air is introduced just above the window and blown downward over the glass area. This offsets the cold air currents that normally originate at the windows.

Both heating and cooling of the building are done through the same ducts and outlets. The building is so zoned that each section can be controlled separately in order to provide uniform conditions throughout the entire structure. Each zone has a separate air duct leading back to the central air handling units.

For the sake of economy and convenience, common coils were used for both cooling and heating. This is accomplished by circulating chilled water through the coils for cooling in the summertime and circulating hot water through them for heating in the winter.

Except for rental space on the ground floor, the building will be owner-occupied.

George L. Dahl, Architects & Engineers, of Dallas are the architects.

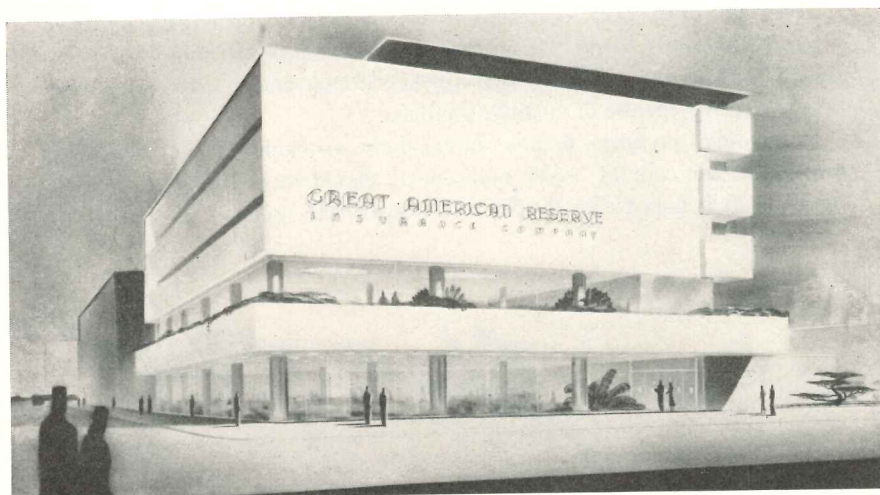

ALL AUTHORITIES AGREE—

Radiation Causes 65% to 80% Heat Loss Or Heat Intrusion in Wall Spaces

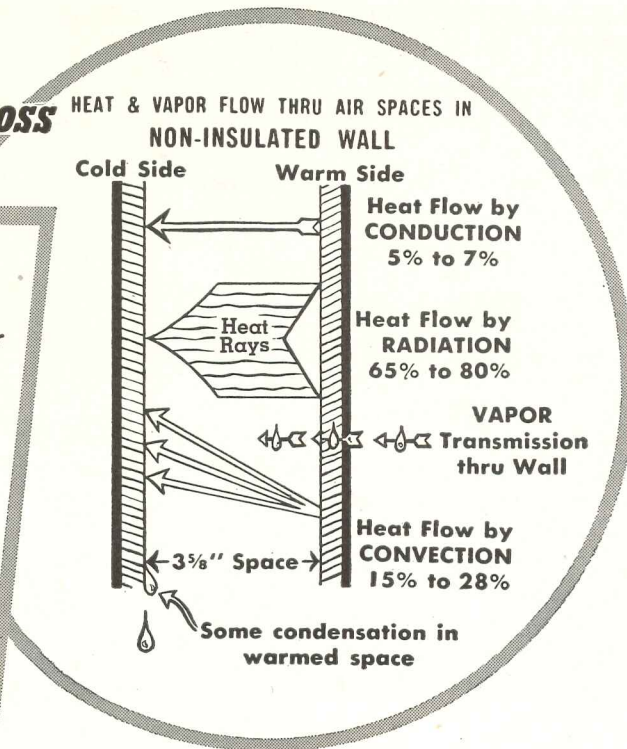
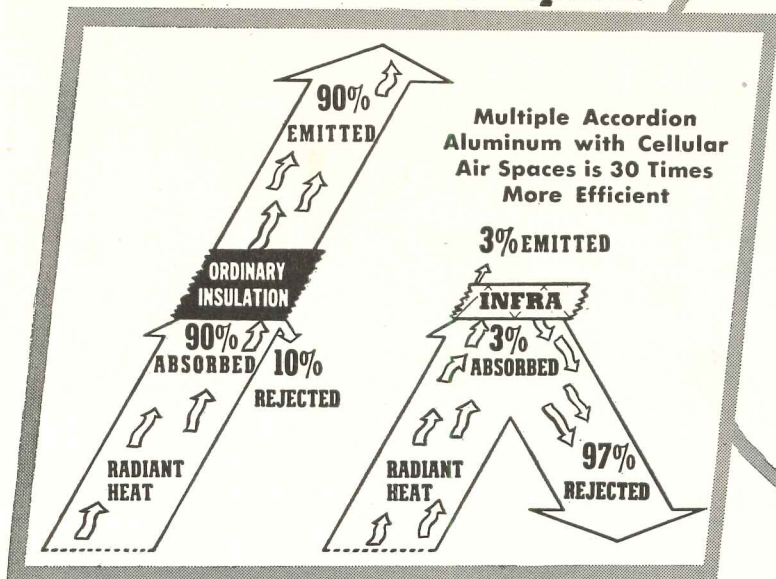

Prof. E. R. Queer, of Penn. State College, in "Importance of Radiation and Heat Transfer Thru Air Spaces," published by the Amer. Society of Heating and Ventilating Engineers, states:

"It has been generally supposed that most of the heat lost through air spaces of building structures was by conduction and convection. However, this is not the case; most of the heat transferred between conventional building materials is by radiation.

"Approximately 75% of the total heat transfer is by radiation."

Convection through air spaces in walls combined with conduction accounts for 20% to 35% of heat flow. Most of the flow, winter or summer, from warm wall to cold, is radiant, effectively barred by multiple layers of accordion aluminum permanently compartmented with cellular reflective spaces. Their slight mass and the spaces bar conduction, their construction blocks convection.

Multiple Accordion Cellular Aluminum Reflects 97% of Heat Rays; Emits 3%

Thick aluminum is absolutely impervious to water vapor, and pushes out fortuitous vapor.

The commercial form of multiple sheet accordion aluminum with permanent reflective cells is Type 4 and Type 6 Infra Insulation, costing respectively, less than 7½¢ sq. ft. and 9¢ sq. ft., material and labor, in new construction between wood joists.

THERMAL FACTORS, TYPE 6 INFRA
 Down-Heat C.044, R22.72 equals 7½" DRY Rockwool
 Up-Heat C.080, R12.50 equals 4" DRY Rockwool
 Wall-Heat C.073, R13.69 equals 4½" DRY Rockwool
VAPOR PERMEABILITY equals ZERO

INFRA INSULATION, INC.
 10 Murray Street New York, N. Y.
 Telephone: COrtlandt 7-3833

FREE! PROF. QUEER'S BOOKLET ON RADIATION

INFRA INSULATION, INC.
 10 Murray Street, New York, N. Y. Dept. R5
 Please send Prof. Queer's booklet on Radiation.

Name _____

Firm _____

Address _____

Send Prices of Infra Insulations Send Sample

Fine Flush Valves for Fine Buildings

For complete information on Watrous Flush Valves write for Catalog No. 449-A.

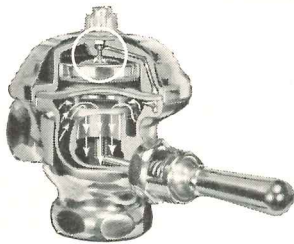
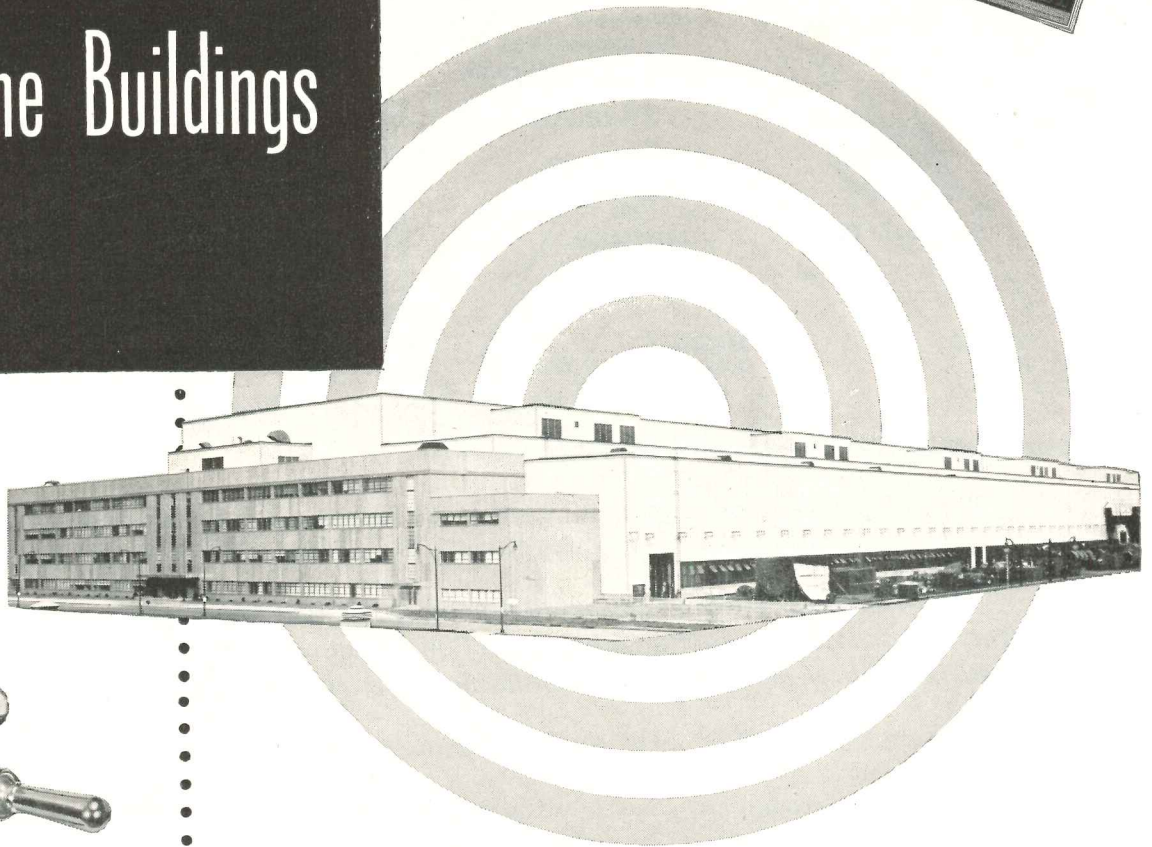
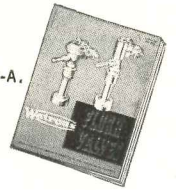

Among Watrous Fine Features

Self-Cleansing By-Pass . . .

It's the by-pass that governs the length of flush. Watrous design includes a special mechanical device which results in cleansing of by-pass during each flush — a safeguard against prolonged flushing due to dirt or sediment in water.

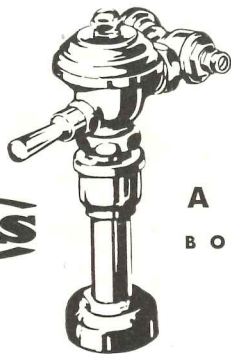

Watrous

GENERAL ELECTRIC TURBINE PLANT

Schenectady, N. Y., one of the many fine buildings in which Watrous Flush Valves are installed.

STONE & WEBSTER
Architect & Mechanical Engineer

A. J. ECKERT CO.
Plumbing Contractor

ADJUSTABLE FLUSH VALVES
BOTH DIAPHRAGM AND PISTON TYPES

THE IMPERIAL BRASS MANUFACTURING COMPANY
1240 W. Harrison Street, Chicago 7, Illinois

NEWS FROM WASHINGTON by Ernest Mickel

11 Technical Projects Inaugurate HHFA Research Program, Foley Names Advisory Group; Co-op Plan Beaten; Military Housing Applications Due for Revision; Deny Increase in Hospital Funds; Reorganization Proposals Under Debate

THE PHASE of the federal housing program referred to by Administrator Foley as being the most important is research. The most complete investigative probe into housing this country has ever known was authorized by Congress last year in the Housing Act of 1949. Just now the tangible results of that action are beginning to show. During the first quarter of 1950 the Housing and Home Finance Agency announced 11 agreements had been made with private and government bodies covering a rather narrow range of technical problems, principally those that have already seen some research work. This was but the beginning, however, of an accelerating program. The agency is expected to announce new agreements more frequently throughout 1950.

This is what has been accomplished up to April 1:

In mid-March HHFA first announced a series of 11 projects involving investigations in the fields of plumbing and sewage disposal systems, heating and ventilation, chimneys and flues. These are to be carried out by the National Bureau of Standards, the U.S. Public Health Service and the University of Illinois. By April 1, the agency had arranged four more projects, the investigations to be made into deterioration from water vapor in frame walls and the destructive effects of mold and fungi caused by soil moisture in the crawl space of basementless houses. Here, HHFA contracted with Pennsylvania State College and the U.S. Department of Agriculture to do the actual research.

Thus, the private construction industry agreed Foley's new Division of Research, headed by Dr. Richard U. Ratcliff, had made a creditable initial showing in the spread of funds appropriated to expand this activity. Entire purpose of the program is to lower housing costs and encourage home production, to give the simple definition. Of course the ramifications are many and minute, reaching into areas of improved building

codes; modular coordination; standardized methods for assembling houses, materials and equipment; improved design and construction; new material types; and the investigations may even relate to appraisal, credit, housing needs, demand and supply, land costs, use and improvement, as well as related technical and economic research.

Research Details

Functioning in this broad span only vaguely outlined by Congress, the agency gave the following details on the projects first announced:

Plumbing — The investigations to be made for the HHFA by the National Bureau of Standards and the University of Illinois on plumbing installations are intended to develop authentic test data which are now lacking for certain phases of plumbing hydraulics. Such data are needed to reconcile different standards and requirements prevailing in the industry and in local codes and enable

code officials and the industry to develop more uniform practices and requirements for housing purposes on a sound, safe and economical basis. The studies supplement earlier extensive tests in this field sponsored by HHFA with industry and government cooperation. The further studies will be concerned with the hydraulic flow through plumbing installations, and will cover the loading effect of fixtures, determination of the limits of ventings, the effectiveness of traps and the testing of simplified piping arrangements and reductions in the size of piping.

Septic Tanks — A large proportion of the housebuilding since the end of the war has occurred in suburban and outlying areas which urban sewerage facilities do not serve and where individual or project installations are necessary. More than two-fifths of the non-farm housing built in 1949, for example, was in unincorporated areas. Septic tanks have therefore become a significant service and cost factor in such housing construction, and also in maintenance of adequate sanitary standards in these areas. Studies thus far made by the U.S. Public Health Service for the HHFA have shown that more efficient septic tank installations than those previously installed can be built at substantially lower cost. The present project is for continuation of these studies at the Environment Health Center of the U.S. Public Health Service at Cincinnati, Ohio. The studies are being made on methods and effects of compartmentation; effect of depth and of



"Yes, Mrs. Truman . . . Yes, Mrs. Truman . . ."

— Drawn for the RECORD by Alan Dunn

THE RECORD REPORTS

WASHINGTON

(Continued from page 15)

variation of inlet and outlet arrangements; investigations and tests on the determination of soil clogging characteristics; and methods of determining absorption of effluents by various types of soil.

Chimneys and Flues — Chimneys and flues constitute an important safety factor for houses and the neighborhood as well as a significant cost item in housing construction. More exact information is needed in this field with respect to materials and design in actual housing use as to safety, performance and cost. The proposed investigations, to be carried out by the National Bureau of Standards, will study the entire range of conditions to which chimneys are subjected in actual use and will test the effect of these conditions on materials and performance in order to develop a rational design basis for masonry chimneys in accordance with conditions of housing use.

Heating and Ventilation — The rapid development of new types of heating systems in housing and of new structural and insulating materials has expanded the need for research data in this field with relation to comfort and economy in housing design and construction. The proposed study of thermal conductance to be made by the National Bureau of Standards is intended to develop accurate heat transmission data for materials and assemblies under conditions of actual use in housing and to establish design factors more nearly reflecting actual conditions.

Studies to be made by the National Bureau of Standards of small heating systems are to be directed toward the development of more consistent relations between the required capacity of the equipment and the actual output of the equipment, in the interest of greater efficiency and economy, particularly in small houses.

Investigations by the National Bureau of Standards on ventilation will establish accurate data for calculation of air changes in dwellings and minimum requirements for comfort and health, and will include determinations of air flow through various ventilating devices used in houses.

(Continued on page 18)

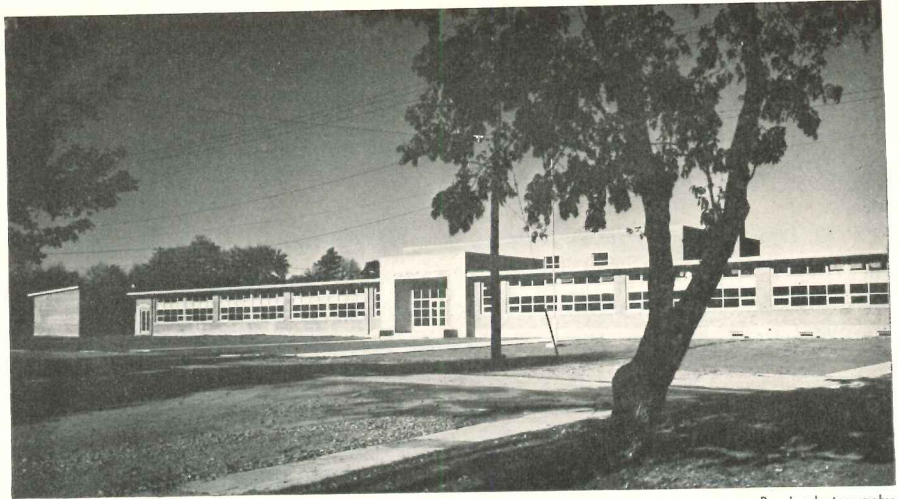

Panda photography

Pictured above is Gananoque High School, recently completed at Gananoque, Ontario. View is from the Southwest. Architects were Drever and Smith, a Kingston, Ontario, firm

NEWS FROM CANADA by John Caulfield Smith

February Building Volume Sets Record for Month

REVERSING January's sharp drop, construction awards in February set an all-time record for the month at \$64.7 million.

While this figure represented a gain of \$1.4 million over February 1949, MacLean Building Reports points out that the cumulative total for the year is still \$14.6 million behind that of the first two months of 1949.

— And What's Ahead?

With a carryover of 58,000 units from 1949, this year promises to be another big year for home building, Ottawa reports. N.H.A. approvals were 50 per cent ahead of 1949 in January, and early February returns were proportionately higher.

However, the possibility that the present building boom might be slowing down is evident both from government sources and from an independent coast-to-coast survey made by the *Financial Post*.

Ottawa notes that married quarters for men in the defense services have been trimmed back, and veterans housing is in less demand.

The *Post*, in questioning realtors and property owners' associations, found that demand for housing — even low-cost housing — is easing generally. Prices and rents are lower across the country, with some high rental apartments going begging. Only in Edmon-

ton, Calgary and Regina does the oil boom promise to keep construction at record levels. General indications are that 1951 may be a lower volume building year in Canada.

Builders and employers fear that the 1950 building program may be jeopardized by another round of wage increases. The Toronto plumbers' union seeks a 25-cents-an-hour increase. Although they have been turned down by the Ontario Conciliation Board, they are threatening to strike unless their demands are met.

Employers are resisting just as firmly, taking the position that any wage rise would scuttle the cost stability won in 1949.

"The construction industry's desire to hold the cost line is not based on any intention to gain advantages at the expense of labor," says President Robert Drummond of the Canadian Construction Association. "It is based on the sincere desire to retain the stable cost position which was achieved last year . . . a position which must be maintained if the industry is to continue in the market for a large volume of construction and provide the employment that goes with it."

E. J. L. Stinson, president of *Daily Commercial News and Building Record* of Toronto, predicts that building volume will hold steady through 1950, while costs continue to level off.

In a recent address before the London

(Continued on page 208)

Here's how you can design a fine, low-cost shopping center for your new housing development

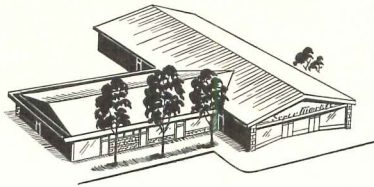

**YOU PROVIDE
THE ARCHITECTURE**



**WE PROVIDE THE
STANDARD STEEL FRAME**



*You save time, effort and expense all along
the line — from planning to final erection*

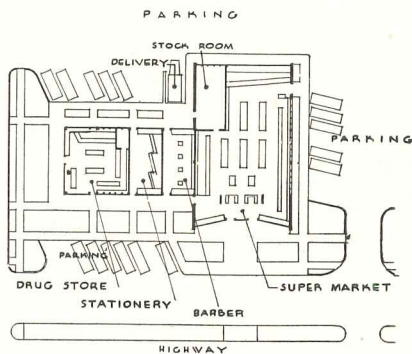

Plan includes two Luria Standard Buildings. Supermarket, 60 feet wide and 100 feet long with 16-foot eave height. Shops, 40 feet wide and 80 feet long, with an eave height of 12 feet.

Practically all of the components that go into your building designs have long been *standard*, except the most important part of all—the structural steel frame. Until recently, that was the toughest part of any designing job—requiring special planning and engineering and adding greatly to the overall cost.

But now you can design *any* single-story building around a Luria *Standard Frame*—a low-cost, permanent structure that offers you all the advantages of standardization, without the usual limitations. The fine, low-cost shopping center rendered above is a typical example.

Luria Standard Structures are

already engineered for you, in design loads calculated to meet the requirements for any part of the country. What's more, they leave you the fullest possible freedom of design and architectural treatment. You can put doors and windows, of any type, wherever you want them. And you can use whatever collateral materials you choose—from corrugated metal to masonry walls and built-up roof.

Luria Buildings are available now—many sizes carried in stock, completely fabricated, ready for fast, easy erection.

For the complete Luria story, mail the coupon below.

Standard Buildings by LURIA

LURIA ENGINEERING CORPORATION

500 Fifth Ave., New York 18, N.Y., Dept. D57

Gentlemen: Please send me a copy of your new catalog (AIA File 14i).

NAME.....

COMPANY.....

ADDRESS.....

CITY.....STATE.....

Additional Projects

Explanation of the subsequent arrangements for studies on water vapor and mold damage told of new problems resulting from the construction of more tightly-built houses. A trend toward new materials that now virtually seal up unit space, and toward the multiple construction of basementless houses spells out the need for added research in this direction. Architects and builders have

been aware of increasing problems due to moisture collection in roofs, walls and under floors. In an effort to gather more information on causes and results, the Pennsylvania State College will amass data on water vapor accumulation within wood frame walls exposed to actual weather conditions and to temperature and humidity conditions considered realistic for living habits of occupants.

The first project in this category will provide new knowledge on water vapor characteristics under controlled interior conditions of temperature and humidity, and actual weather conditions on the exterior surface. This is an extension of previous work carried on at Penn State.

A second phase of the water vapor program embraces study of actual temperature and relative humidity ranges found in various types of small dwellings. Special emphasis here will be on living habits of occupants. At least 15 separate dwelling units will be studied.

Projects to Come

Agriculture's part will be undertaken by the Bureau of Plant Industry and Agriculture Engineering. It breaks down into two phases: (1) development of an inexpensive and durable cover for placing over the soil in crawl spaces to prevent the escape of moisture into the air, and (2) determination of methods of design and construction that will prevent rotting and deterioration of frame structures resulting from crawl space moisture. The Bureau will investigate existing conditions in crawl spaces with different moisture conditions. Moisture content will be measured with moisture meters and the structures will be examined for destructive varieties of mold and fungi.

First quarter expenditures for research out of appropriated funds are the best indication of what has been done and what lies immediately ahead. Total commitments on the 11 projects announced for the first three months come to only \$222,254, yet HHFA has \$1,333,000 to pour into such research agreements before the end of the fiscal year June 30. Within its own shop, the Division has allocated the total amount roughly as follows: \$600,000 for contracts covering the so-called sociological aspects of research—markets, economics, etc.—and \$700,000 for technological explorations.

Bound by the law to make use of other government facilities, Foley's agency is working on agreements with the Census Bureau for inter-census housing counts—tabulation of housing inventories between the regular decennial censuses—and with the Bureau of Labor Statistics for general improvement and firming up of its efforts to secure more complete housing statistics.

General Areas Detailed

More than 50 universities and colleges have contacted the federal housing
(Continued on page 20)

*are you sure the
fireplaces you design will
be constructed properly?*

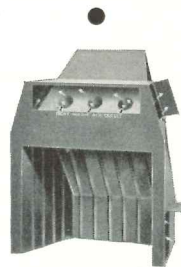
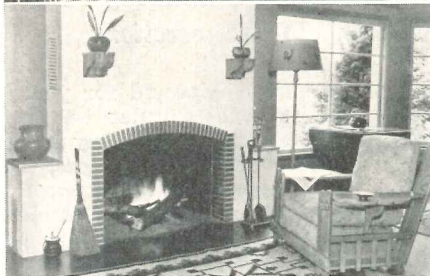

HEATFORM*
is
your answer

*—it is a complete unit
(hearth to flue) and a
perfect guide around
which anyone can easily
build a fireplace of your
design.*

HEATFORM consists of firebox, throat, dome and damper—which saves on other materials. Builders claim it saves up to 6 hours labor time.

HEATFORM retains the cheerfulness of the open hearth and above all it captures a large percentage of heat ordinarily lost up the chimney and circulates it uniformly throughout the room and even warms adjoining rooms.

HEATFORM allows wide flexibility in the placement of cool air inlet and warm air outlet grills.

For more complete information—see SWEET'S Catalog, section 299-8 and Western States AEC catalog or write

SUPERIOR FIREPLACE CO.
1706-C EAST 15th STREET LOS ANGELES 21, CALIF. 601-J NORTH POINT RD. BALTIMORE 6, MD.

HEATFORM*

The Superior Heat Circulating Fireplace
• most efficient and durable of all •

*TRADE MARK REG.

"ORIGINATORS AND WORLD'S LARGEST MANUFACTURERS OF FOLDING PARTITIONS AND BLEACHERS!"



FROM Fairbanks to Capetown, Paris to Tokyo **HORN FOLDING BLEACHERS AND PARTITIONS** are specified. A **HORN INSTALLATION** carries the assurance of 40 years' experience.



● **HORN FOLDING PARTITIONS** are designed to utilize space and offer a long lasting, efficient operation. Manufactured in a new, modern factory according to specifications a Horn Folding Partition is factory installed to insure maximum operating life. There is a Horn Folding Partition for every problem!

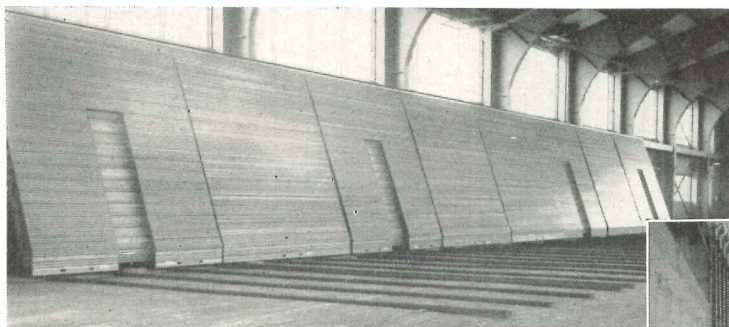

**OMAHA UNIVERSITY
OMAHA, NEBRASKA
SELECTS HORN FOLDING BLEACHERS**

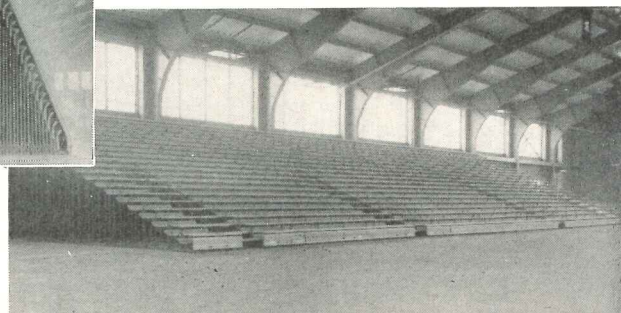
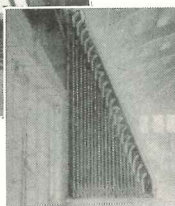

● **HORN FOLDING BLEACHERS** are approved from coast to coast for their many features. You can meet the exacting requirements of present day gymnasium construction and operation when you specify the carefully engineered **HORN FOLDING BLEACHERS**. Ample leg room with approved safety construction offers maximum seating capacity when extended or maximum "playing" space when folded back. Compact, easily maintained and operated the Horn Folding Bleachers offer greater comfort and safety!

NEW

The **HORN FOLDING STAGES**
Designed to save space and labor.



Offices in all Principal Cities



● **HORN FOLDING STAGES** — Mobile open or closed. Non-marring wheels. Available in various widths from 6 feet to 16 feet. Heavy steel understructure, beautiful natural wood finished with two coats of Bakelite Sealer. WRITE FOR FREE DESCRIPTIVE FOLDERS.

● **HORN BROTHERS CO.** ● DIVISION OF HORN INDUSTRIES ● FORT DODGE, IOWA, USA ●

agency since Congress authorized the program last year. Some have had specific proposals for working out research projects; others have merely inquired as to how they might participate.

In selecting colleges and universities for research agreements, Dr. Ratcliff's division is seeking to place contracts that will further investigative work by the educational institution itself. It is hoped that each project given a school

will serve to stimulate more work in the housing field at that particular location; research beyond that specified in the contract.

Architects can expect announcement of new college and university agreements covering the following areas:

1. Cost accounting in the building field aimed at the development of a more satisfactory system for the small builder.

2. A general study of the whole financing structure from the builder's point of view seeking to find out what specific financial burdens constitute barriers and what can be done about them.

3. Rental housing with emphasis on big apartment construction. This may embrace a study of the investment market as it relates to large apartment development and may deal with tenant mobility, etc.

4. Marketing of building materials — a thorough study of all aspects of distribution.

5. The economics of home construction as such. The contribution of the building profession to national life, and other research along these lines.

6. Mortgage markets and their influence on home building at the local level.

7. Sociological studies; research on types of people constituting the housing market. Which type predominates? What are the sizes of families seeking homes? What are their stated needs? The researchers hope to find answers to these and similar questions that can be translated into definite formulas for the industry.

8. Minority groups — a subject closely allied with Point 7, but one to be treated separately. Here, the best housing markets for certain types of housing will be catalogued.

9. Labor and economy. Not to be a study of productivity, but rather an investigation of new labor-saving devices and how they can be better applied.

Task forces are busy now lining up these projects. Many more will be added as new areas are defined and the program accelerates. With a 30 per cent cut in appropriations in view for fiscal 1951, the agency division is extremely active in trying to arrange its research schedules by midyear.

Foley Names Advisory Group

As the research division got up a full head of steam, Administrator Foley named an Advisory Committee on Housing Research to work with Dr. Ratcliff and his staff. The first committee meeting was held in Washington April 17. The body was established to obtain information and advice of experts in appropriate fields, Foley explained. In connection with the appointments, he said:

"This committee, which covers a broad range of experience in the economic, finance, consumer and technical

(Continued on page 22)

try
ETCHwood
for sales
magic



SAYS RAY HOMMES
prominent So. California
Builder of quality homes



Drop us a line for your sample kit of the 3-dimensional plywood in which the soft wood is burnished away, leaving hard surfaces of raised grain. Write direct to manufacturer, Davidson Plywood & Lumber Co., 3136 E. Washington Blvd., Los Angeles 23, Calif.

"The minute my prospects see the effect my architect gets with ETCHwood panelling across one living room wall, I know the sale is made."

Add at least a dash of this sales magic when you are designing your next house; use ETCHwood as a wood panel for walls, or for cabinets and built-ins for playrooms, dens or to set off the fireplace.

**SOLD NATIONALLY
THROUGH LEADING
PLYWOOD WHOLESALERS**

"WE SAVED HOURS OF TIME BY SPECIFYING KNAPP METAL TRIM FOR THIS HOSPITAL!"

Writes Mr. L. W. Penn, Chief of Technical Services of the firm of Charles B. Spencer, St. Louis, Mo.

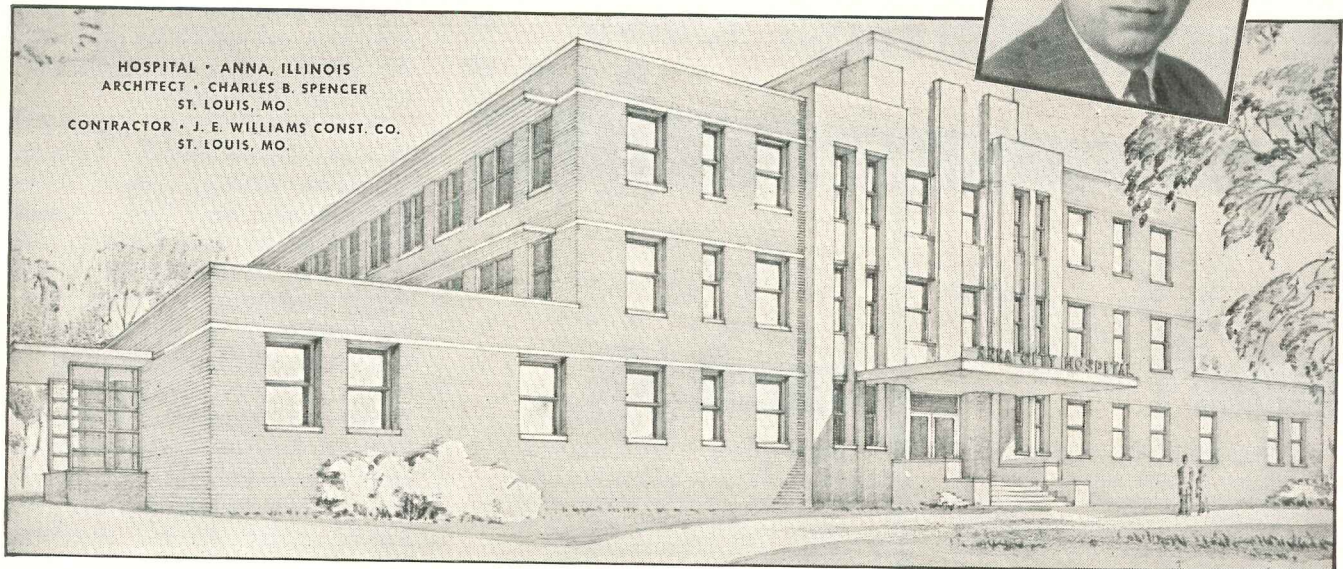

Mr. Penn, Chief of Technical Services for the firm of Charles B. Spencer, St. Louis, Mo., takes pride in selecting the proper trim for the buildings the firm designs. Mr. Penn knows that he can count on Knapp Products to meet his exacting requirements. Knapp is accustomed to handling metal trim specifications that demand the highest quality products—and have been for over half a century. They have continued

to study every problem of design, quality and practical usability of their product.

FILL ANY BUILDING NEED

Today, as always, the Knapp line offers standard items of guaranteed precision and quality to satisfy the strictest, most exacting architectural specifications for virtually every metal trim requirement. In custom made, metal trim specialties, too,

Knapp standards are second to none.

GREATLY EXPANDED FACILITIES

Right now, tremendously increased facilities enable Knapp to bring an even better service to architects and contractors. They pride themselves with the fact that each job, no matter how small or large, must be handled with the utmost care and efficiency. They are dedicated to creating "trim feeling" into metal.

WRITE FOR COMPLETE DETAILS TODAY!

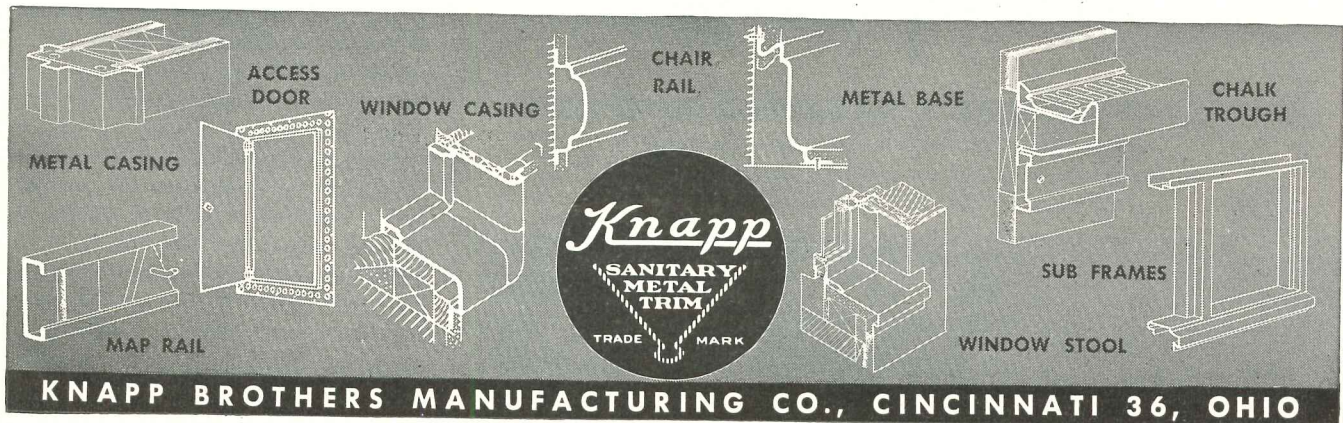

KNAPP BROTHERS MANUFACTURING CO., CINCINNATI 36, OHIO

WASHINGTON
(Continued from page 20)

All architects should know these facts about pressure-treated lumber

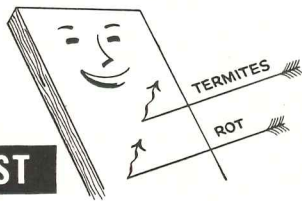

FIRST

PROTECTION—Treating of lumber preserves it—just as alloys preserve metals. The purpose is to protect lumber against costly rot and termite damage.

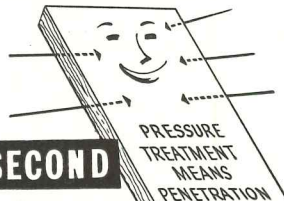

SECOND

PRESSURE TREATMENT vs. Surface Application—Authorities say that pressure treatment provides the only *sure, lasting* protection to lumber.



THIRD

OTHER QUALITIES TO LOOK FOR—For greatest usefulness, preservatives also should be *clean, odorless, paintable, non-leaching and non-corrosive.*



For complete information about **WOLMANIZED*** Pressure-Treated Lumber, write for free booklet.

*Reg. U. S. Pat. Off.



FOURTH

WOLMANIZED Pressure-Treated Lumber combines all these requirements—*lasts 3 to 5 times longer* than untreated wood, because it's treated under 150 lbs. pressure per square inch. Protection is deep in the wood fibers. It's clean, odorless, paintable, non-leaching, non-corrosive. Wolmanized Pressure-Treated Lumber has been proved in use for over 25 years. It will prove its value to you, too.

AMERICAN LUMBER & TREATING COMPANY

General Offices: 1650 McCormick Bldg., Chicago 4, Illinois

Branch Offices: Baltimore, Boston, Jacksonville, Fla., Little Rock, Ark., Los Angeles, New York, Portland, Ore., San Francisco.



It pays to use...

WOLMANIZED
PRESSURE TREATED LUMBER

aspects of housing, will give advice and guidance on the entire housing research program. It will serve as a continuing board of review on the progress of the program. It will also assist in the evaluation of research proposals, and the coordination of housing research activities, both public and private, and aid in the promotion and application of results of the program, with a view to effectuating cost reductions in housing."

Persons invited to be members of the Housing Research Advisory Committee include the following: James C. Downs Jr., president, Real Estate Research Corp., Chicago; John Edelman, CIO, Washington, D. C.; Herbert Emmerich, Public Administration Clearing House, Chicago; Ernest M. Fisher, professor, Urban Land Economics, Columbia University; F. Stuart Fitzpatrick, U.S. Chamber of Commerce, Washington, D. C.; E. Franklin Frazier, social scientist, Howard University, Washington, D. C.; Walter Gehrke, president, First Federal Savings & Loan Association, Detroit; Richard Gray, AFL, Washington, D. C.; Alvin W. Hansen, professor of economics, Harvard University, Cambridge, Mass.; Wallace K. Harrison, architect, New York City; Harold D. Hauf, editor-in-chief, ARCHITECTURAL RECORD, New York City; Henry T. Heald, president, Illinois Institute of Technology, Chicago.

Also Bryn J. Hovde, president, New School for Social Research, New York City; Philip M. Klutznick, American Community Builders, Inc., Chicago; Dorothy S. Montgomery, managing director, Philadelphia Housing Association; Admiral Ben Moreel, president, Jones & Laughlin Steel Corp., Pittsburgh; Paul Oppermann, executive director, San Francisco City Plan Commission; C. F. Rassweiler, vice president, Johns-Manville Sales Corp., New York City; Tyler S. Rogers, Owens-Corning-Fiberglass Corp., Toledo; Walter S. Schmidt, realtor, Cincinnati; Donald S. Thompson, vice president, Federal Reserve Bank of Cleveland; Ralph T. Walker, president, The American Institute of Architects; Maude M. Wilson, professor, Home Economics Research, Oregon State College, Corvallis, Ore.; C. E. A. Winslow, professor emeritus, Yale University; Louis Wirth, Depart-

ment of Sociology, University of Chicago; Donald Woodward, second vice president, Mutual Life Insurance Co., New York City.

Congress Defeats Co-op Plan

Biggest housing news on Capitol Hill this Spring was the elimination of the cooperative housing titles from the 1950 legislation by both the Senate and the House. Major battles were fought in both bodies on this issue. Strongly supported by labor and organized veterans groups, the plan to set up a new national mortgage association for housing cooperatives and other non-profit corporations was voted down by the Senate 43 to 38, and rejected by the House 218 to 155. The action definitely meant the end of this proposal as far as the current session of Congress is concerned; but advocates of the low-interest federal government loan scheme immediately let it be known they would carry the matter into the fall Congressional campaigns as a live issue.

Committee conferees had to work out several major differences in the two bills. The more important were:

1. Title I (National Housing Act) improvement and repair loans. Senate continued only until July 1, 1952; House made permanent.

2. Low-cost suburban housing. Senate permitted maximum mortgage amount (as contained in Sec. 102) to be \$4750, or up to \$5500 in high cost areas. House version had no special provision for FHA mortgage insurance for low-cost housing in outlying areas. Total insurance authorization of \$250 million for this program was allowed.

3. Title II Authorization. Senate increased the total by \$750 million immediately, providing added \$1 billion on recommendation of the President. House increased this authorization by \$1.25 billion with an additional \$1.5 billion on approval by the President.

4. Sales Housing. Senate liberalized and expanded FHA mortgage insurance provisions of Sec. 203 (b) (2) but the House bill contained no such provisions.

5. Both bills modified the Title II permanent rental housing mortgage insurance program with Sec. 207 expected to catch the activity formerly centered under Sec. 208 of Title VI, which Congress permitted to expire March 1.

6. Cooperative housing mortgage insurance; not to be confused with the defeated cooperative housing loan plan. The Senate added a new Sec. 213 to the National Housing Act to provide mort-

(Continued on page 24)

How to make provision for attic fans in your homes

It is a simple matter to plan new homes so that they can be made comfortable throughout hot summer months. The two steps described below will save

money for owners by providing for inexpensive installation of package attic fans, the most economical and practical means of cooling an entire house.

Step 1. Frame for ceiling opening over hallway.

By framing and installing fan when home is built, no extra construction expense is involved. If installation is to be made later, framed opening can be temporarily plastered over or closed with plywood.

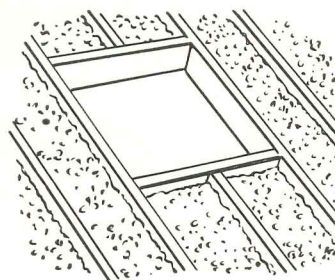

Step 2. Provide adequate louvres in proper location.

On new construction it costs very little to include ample exhaust openings to handle attic ventilation. These may be gable louvres or porch, soffit or basement exhausts, depending on the design of the house.



Installation of Hunter Package Fan can then easily be made when home is built, or later

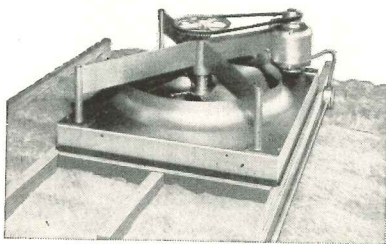

This new fan is a compact unit, with built-in fan, motor and suction box. Fits low-clearance attics. Certified air delivery ratings for any size home or climate.

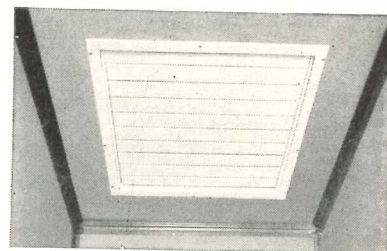

Automatic or pull chain shutters are quiet, tight-closing. Fit narrow hallways. Soft ivory finish (baked enamel) harmonizes with the color scheme of any room.

MAIL FOR COMPLETE CONSTRUCTION DETAILS

Hunter Fan and Ventilating Company, 396 S. Front St., Memphis 2, Tenn.
Send copy of "How to Cool for Comfort" to:

Name.....Firm.....

Address.....City & State.....

Hunter Package Attic Fans

WASHINGTON
(Continued from page 23)

gage insurance of cooperative housing projects, but the House made no such move.

7. Secondary market purchase authorization in Federal National Mortgage Association. House authorized immediate increase of \$500 million and additional \$250 million on approval of the President. The Senate deferred action because its Banking Committee was considering the entire secondary market problem.

8. Both branches permitted Sec. 608 rental housing insurance authorization to expire as of March 1. The Senate version transferred \$400 million from the government war housing mortgage insurance fund over to Sec. 608 to permit processing of applications received up to February 1. The House version provided an additional \$600 million and sought to have all applications received up to March 1.

Military Housing Gets Attention

There was almost unanimous agreement that the Title VIII (Wherry Act) military housing program has been in a state of ill health since before the first of the year. The Secretary of National Defense clamped down on applications for sponsorship of housing projects under Title VIII as early as last December 16, and no satisfactory substitution for the original plan had been put into effect by April 1. But prospects were much brighter for an early resumption of applications under a revised system which would give architects the consideration they deserve.

Up to this point each service had been trying to administer its own military housing program. Confusion and inefficiency resulted. With the requirement that prospective sponsors submit fairly complete plans and specifications with their offers, the architect stood to lose heavily. There were reports of underpayment even in instances where sponsor-bidders got the job.

The Defense Department and Federal Housing Administration now, however, have worked out a new agreement between them under which the military will be responsible for selecting an architect for each project, then take competitive bids from builders on the plans

(Continued on page 176)

Reminder to Architects and Fabricators

EXTRUDED SHAPES for thresholds, jambs, sills, etc. Both standard and special designs.

SHEET is available plain or with embossed, corrugated and perforated patterns.

TUBULAR PRODUCTS, like other standard items, may be ordered from a warehouse in your area.

STRUCTURALS in all forms: angles, channels, tees, etc. Also rod and bar stock.

OTHER ALUMINUM BUILDING MATERIALS—Gutters, Downspouts, Reflective Insulation, Roofing and Siding, Built-up Roofing, Nails, Windows, Roll Formed Shapes.

ORNAMENTAL CASTINGS produced to your specifications by independent foundries from Reynolds aluminum ingot.

Reynolds OFFERS YOU COMPLETE ALUMINUM SERVICE!

● Aluminum costs less, does more than other architectural metals. Its natural beauty, strength, light weight and freedom from rust make aluminum the logical choice for scores of building applications. To meet increased demands, Reynolds has created a sales and distribution service to satisfy "on-the-job" requirements of both architect and fabricator.

A phone call to the Reynolds office listed under "Aluminum" in your classified phone book will start the ball rolling. An architectural specialist will work with you on new designs. He will follow through with the fabricator on delivery of standard items from a Reynolds Distributor warehouse... or expedite shipment of specials to meet building schedules.

FOR YOUR FILES

Reynolds Architectural Folio includes complete data and drawings you can use for direct tracing. Write to Reynolds Metals Co., 2572 South Third Street, Louisville 1, Kentucky.



REYNOLDS Architectural ALUMINUM

A COMPLETE ALUMINUM SERVICE TO ARCHITECTS AND FABRICATORS

MEDART

STEEL

LOCKERS

5 POINT SUPERIORITY



1

SECURITY because the door locking mechanism is *pickproof* . . . dual-latch . . . concealed in the channel lock rod it is pre-locking, positive latching. Operates whether door is slammed or gently shut. Exclusive Medart patent.

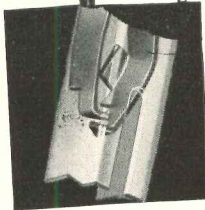

2

STURDY BOTTOMS . . . to take punishment. Full width $\frac{1}{4}$ inch flange of bottom rests solidly on heavy 16 gauge steel frame member. No possibility of breaking or sagging. Be sure to compare this Medart feature with ordinary type locker bottoms.

FMSO-4

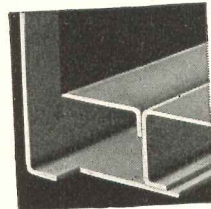

3

LONG LIFE because of channel frame construction . . . 16 gauge steel, top, bottom and side frame members ensure rigidity and added strength. All parts electrically welded into solid square frame to assure proper fitting of door.

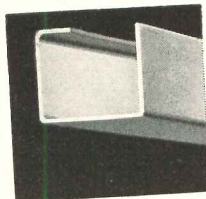

4

ADJUSTABLE LEGS that can be raised or lowered to compensate for unevenness of floor. Legs are correctly spaced every two or three lockers (depending on locker width) to facilitate cleaning under lockers.

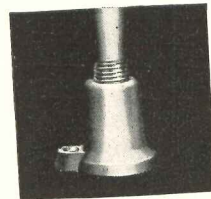

5

STYLING . . . for efficiency and modern streamlined appearance. Absence of hinge bolt-heads on doors, styling of louvers, handle and legs give Medart Lockers that smart modern "functional" look. Simplicity that bespeaks smooth operation.

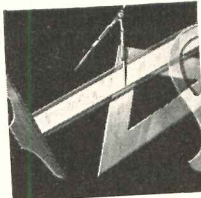

MEDART STEEL LOCKERS available in all standard types and sizes . . . either recessed or free standing. Write for descriptive literature . . . Send your plans for suggestions.

FRED MEDART PRODUCTS, INC.
3540 DEKALB ST. ST. LOUIS 18, MO.
Leadership for Over 75 Years in School Equipment

P.S.

Wire Basket Shelving and Wire Baskets for use where the privacy of Steel Lockers is not required. Write for descriptive literature.



Medart Steel Lockerobes with "Simultaneous Opening - Master Door Control" for elementary school use. Write for descriptive literature.

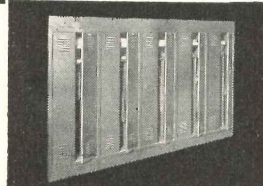

THE RECORD REPORTS

CONSTRUCTION COST INDEXES

Labor and Materials

United States average 1926-1929 = 100

Presented by Clyde Shute, manager, Statistical and Research Division, F. W. Dodge Corp., from data compiled by E. H. Boeckh & Assocs., Inc.

NEW YORK

ATLANTA

Period	Residential		Apts., Hotels Office Bldgs. Brick and Concr.	Commercial and Factory Bldgs. Brick and Concr.		Brick and Steel	Residential		Apts., Hotels Office Bldgs. Brick and Concr.	Commercial and Factory Bldgs. Brick and Concr.		Brick and Steel
	Brick	Frame		Brick	Steel		Brick	Frame		Brick	Steel	
1925	121.5	122.8	111.4	113.3	110.3		86.4	85.0	88.6	92.5	83.4	
1930	127.0	126.7	124.1	128.0	123.6		82.1	80.9	84.5	86.1	83.6	
1935	93.8	91.3	104.7	108.5	105.5		72.3	67.9	84.0	87.1	85.1	
1939	123.5	122.4	130.7	133.4	130.1		86.3	83.1	95.1	97.4	94.7	
1940	126.3	125.1	132.2	135.1	131.4		91.0	89.0	96.9	98.5	97.5	
1945	160.5	161.7	156.3	158.0	155.4		132.1	133.9	123.2	122.8	123.3	
1946	181.8	182.4	177.2	179.0	174.8		148.1	149.2	136.8	136.4	135.1	
1947	219.3	222.0	207.6	207.5	203.8		180.4	184.0	158.1	157.1	158.0	
1948	250.1	251.6	239.4	242.2	235.6		199.2	202.5	178.8	178.8	178.8	
Dec. 1949	242.4	238.9	241.4	244.5	237.8		184.5	185.5	178.6	178.1	175.3	
Jan. 1950	242.8	239.4	242.3	245.2	241.2		184.5	185.5	179.2	178.6	177.7	
Feb. 1950	244.1	240.9	243.2	245.9	242.0		185.8	187.0	180.1	179.3	178.5	
Feb. 1950	97.7	96.8	% increase over 1939				% increase over 1939			84.1	88.5	
			86.1	84.3	86.0		115.3	125.0	89.4			

ST. LOUIS

SAN FRANCISCO

1925	118.6	118.4	116.3	118.1	114.4	91.0	86.5	99.5	102.1	98.0
1930	108.9	108.3	112.4	115.3	111.3	90.8	86.8	100.4	104.9	100.4
1935	95.1	90.1	104.1	108.3	105.4	89.5	84.5	96.4	103.7	99.7
1939	110.2	107.0	118.7	119.8	119.0	105.6	99.3	117.4	121.9	116.5
1940	112.6	110.1	119.3	120.3	119.4	106.4	101.2	116.3	120.1	115.5
1945	152.8	152.3	146.2	148.5	145.6	146.2	144.3	144.5	146.8	147.9
1946	167.1	167.4	159.1	161.1	158.1	159.7	157.5	157.9	159.3	160.0
1947	202.4	203.8	183.9	184.2	184.0	193.1	191.6	183.7	186.8	186.9
1948	227.9	231.2	207.7	210.0	208.1	218.9	216.6	208.3	214.7	211.1
Dec. 1949	220.7	218.9	214.6	218.2	215.7	214.0	208.0	215.7	220.4	215.8
Jan. 1950	220.3	218.4	214.7	218.4	216.5	213.3	207.0	216.7	220.6	216.9
Feb. 1950	222.7	221.3	215.6	219.0	217.4	215.3	209.2	217.8	221.4	217.9
Feb. 1950	102.1	106.8	% increase over 1939			% increase over 1939			81.6	87.0
			81.6	82.8	82.7	103.9	110.7	85.5		

The index numbers shown are for combined material and labor costs. The indexes for each separate type of construction relate to the United States average for 1926-29 for that particular type — considered 100.

Cost comparisons, as percentage differences for any particular type of construction, are possible between localities, or periods of time within the same city, by dividing the difference between the two index numbers by one of them; i.e.:

index for city A = 110
index for city B = 95
(both indexes must be for the same type of construction).

Then: costs in A are approximately 16 per cent higher than in B.

$$\frac{110-95}{95} = 0.158$$

Conversely: costs in B are approximately 14 per cent lower than in A.

$$\frac{110-95}{110} = 0.136$$

Cost comparisons cannot be made between different types of construction because the index numbers for each type relate to a different U. S. average for 1926-29.

Material prices and wage rates used in the current indexes make no allowance for payments in excess of published list prices, thus indexes reflect minimum costs and not necessarily actual costs.

These index numbers will appear whenever changes are significant.

DESIGNED FOR

Comfort?



Then remember
the best design
and all the heat
in the world
won't make a
home comfortable
unless it is
properly controlled

CHRONOTHERM

ELECTRIC or ELECTRONIC CLOCK THERMOSTAT — Automatically reduces to lower fuel-saving temperature at night and restores daytime comfort in the morning before you arise.

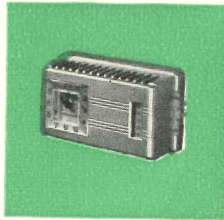

TIME-O-STAT

CLOCK THERMOSTAT — for semi-automatic day-night temperature control. Set it at bed time for lower fuel-saving temperature. Automatically starts your heating plant in the morning.



ACRATHERM

PLAIN TYPE THERMOSTAT — maintains uniform comfort temperature 24 hours a day. Finger-tip dial permits easy setting for lower night temperature. Combines low first cost with precision performance.

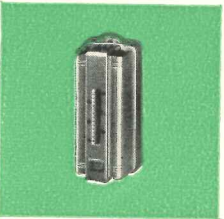

YES, control means everything when it comes to heating. And there is a Honeywell control or control system to meet the requirements of every home and every condition of climate. In larger homes, or homes of the ranch type, more than one thermostat may be required to maintain uniform temperature throughout.

Whether you specify the fully automatic Chronotherm, the semi-automatic Time-O-Stat or the plain type Acratherm—all operate on the special "Comfort" principle that maintains practically straight-line temperature under all weather conditions. So, to be sure of maximum comfort, convenience and economy, always specify Honeywell controls.

Use the coupon to get your free copy of the consumer booklet "How to Choose Your Thermostat," which is now being ordered by thousands of families through Home Owners' Catalogs and Honeywell's national advertising.



MINNEAPOLIS-HONEYWELL REGULATOR COMPANY
2600 Fourth Avenue South Minneapolis 8, Minnesota
Please send free copy of booklet "How to Choose Your Thermostat."

Name _____
Address _____
City _____ Zone _____ State _____



77 BRANCHES FROM COAST TO COAST WITH SUBSIDIARY COMPANIES IN: TORONTO • LONDON • STOCKHOLM • AMSTERDAM • BRUSSELS • ZURICH • MEXICO CITY

REQUIRED READING

IN SUMMARY . . .

European Architecture in the Twentieth Century. Vol. 1. By Arnold Whittick, Published by arrangement with the incorporated Association of Architects and Surveyors. Crosby Lockwood & Son, Ltd. (39 Thurloe St., London S. W. 7) 1950. 7¾ by 9½ in. xx + 249 pp. illus. 30s.

The first of a three-volume history (volumes II and III to be published) of *European Architecture* spans the years 1900 and 1924, is divided into two parts. "In part one," says author Whittick, "it is my purpose to give a general idea of the architectural background at the beginning of the century and to review the principal developments before the First World War." A broad treatment of the main European trends begins the book (Part I: Historical Background and the Early Years of the Century), then narrows into more detailed analysis at 1914's onset (Part II: Transition from War to Peace).

"To explain the history of architecture we must study techniques of building construction and social purposes for which the buildings are erected to serve." Whittick has sought for explanations of changes in the appearances of buildings mainly in the developments of the craft of building, the science of construction and the satisfaction of social needs. He convincingly knits into his history the political, sociological and economic influences in architecture.

Mr. Whittick summarizes traditions in the beginning of his work, describes the search for a style — l'Art Nouveau — that culminates in an expression or at least endeavor towards simplicity. He then goes on to new aspects of construction — iron, reinforced concrete, steel, etc. He talks of architecture and social progress, housing developments, garden and industrial cities, and finally winds up with *The Foundations of a New Architecture*.

Rebuilding in the wake of war devastation, urban overcrowding and resulting planned expansion, experiments in house construction comprise the first chapters in the second part. The last seven chapters are divided roughly in two categories which may be headed "tradition" and "functionalism." Tradition, romanticism, simplicity and originality are dealt with in three chapters; functionalism, new forms and experiments in the remaining. The

architectural examples from representative Europe are diversified; he includes ecclesiastical and industrial buildings.

Besides giving a commendable historical analysis, Mr. Whittick has compiled a fine architectural "who's who" — to which might be added — and why. His roster includes such names as Labrouste, Schinkel, Persius, Voysey, Webb, Shaw, Behrens, Van der Velde, Horta, to mention but a few.

The volume is as well executed in format as content. In addition to numerous plates, there are drawings and plans, to say nothing of complete index and bibliographies.

KITCHEN PLANNING

Handbook of Kitchen Design. A Report of an Investigation in Space Use conducted by the University of Illinois Small Homes Council and Agricultural Experiment Station. Technical Series. Index Number C5.32R. Issued by the Small Homes Council, University of Illinois (Urbana, Ill.) 1950. 8¾ by 10 13/16 in. 73 pp. illus.

Here is a useful handbook — a guide to designing small kitchens. It presents diagrams for kitchen assemblies which fulfill both planning and storage requirements while making use of factory-made kitchen equipment.

The kitchen plans, which show more storage cabinets than are found in many small homes today, may, according to the Small Homes Council, be liable to criticism on the ground of extravagance. Two factors of space and equipment must be balanced to achieve a well-planned, economical kitchen.

The familiar types of assemblies are cited: one-wall, corridor, "L," "U," Broken "U," as well as separate "work centers." Because plans for the ideal kitchen hinge primarily on window and door location, area, shape, and required storage, each of the 30 sheets gives, according to three basic plans — one each for "liberal," "medium" and "limited" storage. Most sheets also show variations for these plans.

A discussion of Planning Standards precedes the work sheets. Considered here are work centers and their sequence; counters; size and clearance of, and distance between appliances. In addition, the book contains score sheets for judging kitchen designs.

Handbook of Kitchen Design is intended primarily for the architect and builder of low and moderate cost houses.

FROM SWEDEN

Swedish Cooperative Union and Wholesale Society's Architect's Office. Part I, 1935-1949. Part II, Housing 1925-1949. Edited by Kooperativa Förbundets Arkitektkontor. Trans. by William Cameron. Kooperativa Förbundets Bokförlag (Stockholm) 1949. 8½ by 11¼ in. Part I, 164 pp. illus. Part II, 191 pp. illus. 18 Sw. Kroner.

The Architect Office of the Cooperative Union, organized in 1924 as an architects' collective, has published in these two volumes a collection of pictures of buildings which have been put up to serve the Swedish Cooperative Movement. The buildings represented were erected between the end of World War I and 1949. They include houses, shops, restaurants, department stores, industrial buildings, warehouses.

Where Part II is limited to housing, Part I is concerned with other types of construction. Each includes a defining essay — the first on Cooperative Architecture; the second on the Aims and Activities of the cooperative pioneers.

In addition to photographs of housing (single houses, housing units, etc.), Part II has a good bit of text. Developed here are "Space Considerations in the Home," a section on furniture, Stockholm housing competitions, several housing projects built for the Swedish cooperatives and combined shop-living quarters (the dwelling in the shop building; the shop in the flat block).

Photographs, drawings, plans in each volume are numerous; extensive use of color enhances the books, lends a buoyant Scandinavian touch to well-presented subject matter.

NEW EDITIONS

TRELLISES AND TEAHOUSES

Chinese Houses & Gardens. By Henry Inn. Edited by Shao Chang Lee. Rev. Ed. Hastings House. (41 East 50th St., New York 22, N. Y.) 1950. 9¼ by 12¼ in. xii + 148 pp. illus. \$10.00.

In format and content the second edition of *Chinese Houses & Gardens* is very similar to the first (1940) with its 147 photographs, 113 line drawings and text which includes treatises on Chinese philosophy and culture.

Part I contains articles by prominent
(Continued on page 30)

Rolling Steel

DOORS

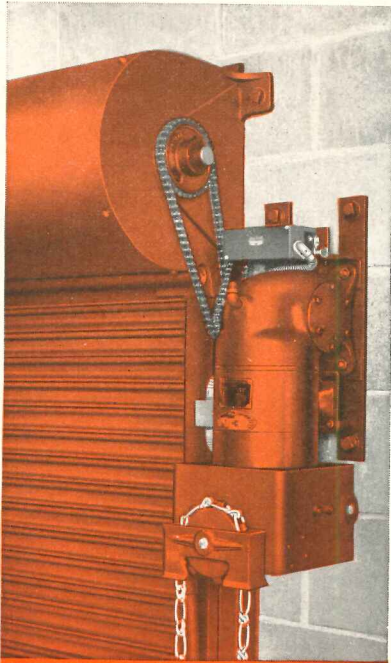

**MAHON STANDARD
POWER OPERATOR 920-P**

Manually, Mechanically, or Power Operated

For industrial and commercial buildings, the space saving, vertically acting, rolling steel door offers more desirable features than any other type of door . . . open or closed, it occupies no usable space either inside or outside the opening. Its permanent, all-metal construction provides a lifetime of continuous trouble-free service and maximum protection against intrusion or fire. Compact, reliable mechanical and power operators, with controls to meet any requirement, insure quick, timesaving door operation. When you select Mahon Rolling Steel Doors, you are assured the latest developments in doors of this type. See Sweet's Files for complete information, or write for Catalog No. G-49.

T H E R . C . M A H O N C O M P A N Y

Detroit 11, Michigan • Western Sales Division, Chicago 4, Illinois

Representatives in all Principal Cities

Manufacturers of Rolling Steel Doors, Grilles, and Automatic Closing Underwriters' Labeled Rolling Steel Doors and Fire Shutters; Insulated Metal Walls, Steel Deck for Roofs, Partitions, Acoustical Ceilings, and Permanent Concrete Floor Forms.

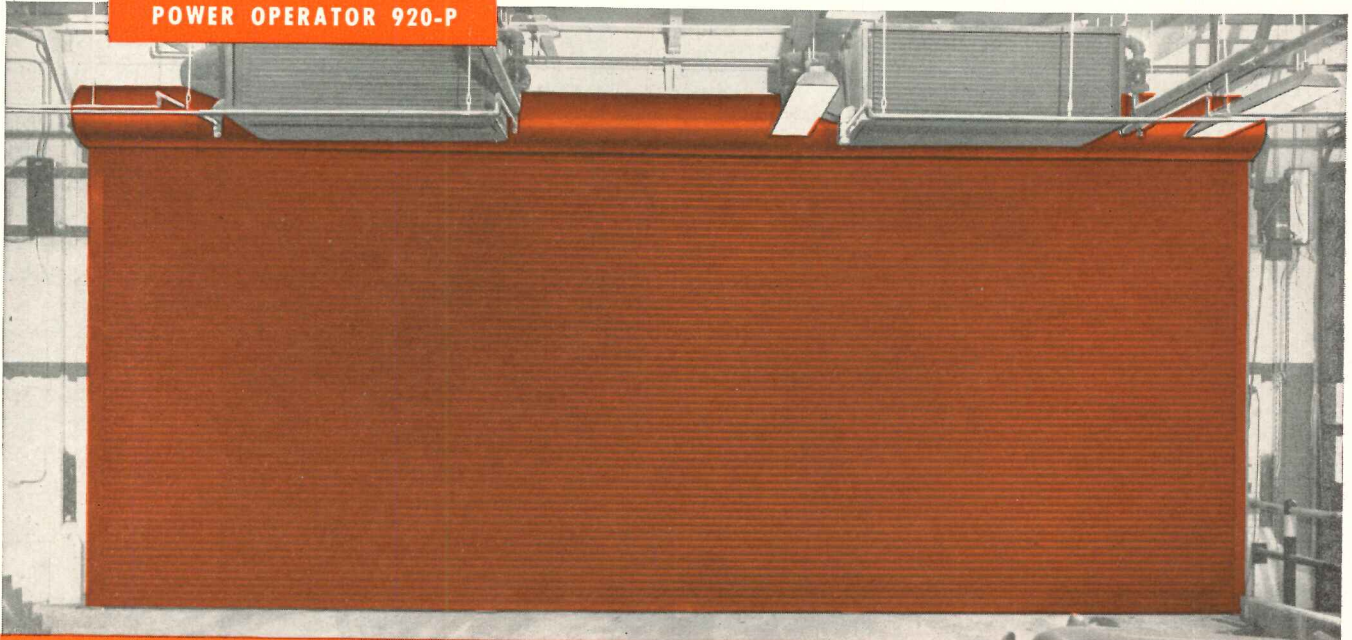

ROLLING STEEL DOORS, SHUTTERS AND GRILLES TO MEET EVERY REQUIREMENT

Mahon Power Operated Rolling Steel Door installed in an opening 37' 0" x 14' 9". A total of seventy-six Mahon Rolling Steel Doors are installed in this midwestern industrial plant.

MAHON

Heats one room, suite or building!

NEW STEWART-WARNER

"SAFETY-SEALED" HEATING UNIT!

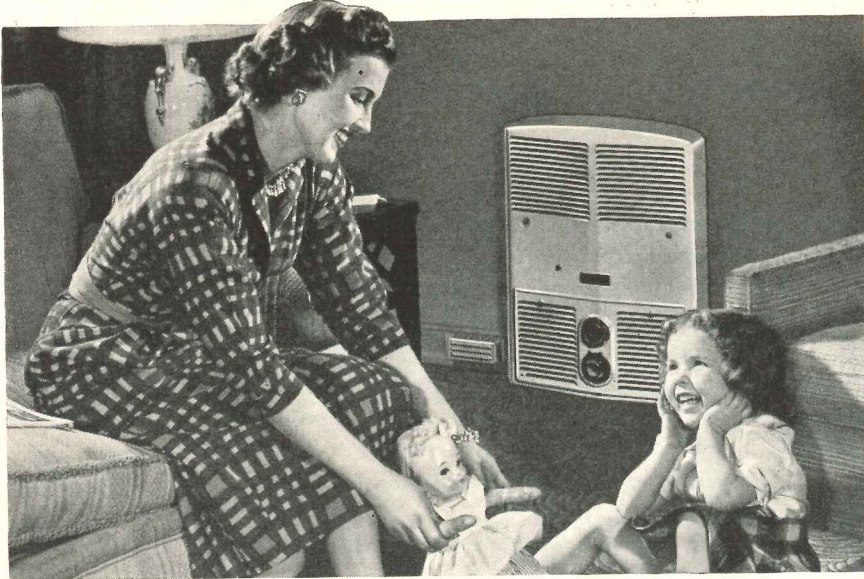

This adaptable new "packaged" unit solves your most difficult heating problems with new ease and dependability. Stewart-Warner's "Safety-Sealed" Saf-Aire unit is a completely automatic, independent gas heating system. Versatile in application, this compact unit provides safe, reliable heat for an entire building, remote zone, or a single hard-to-heat room.

No closet, floor or basement space is wasted. No chimney, ducts or electricity are required for installation in any exterior wall of wood, brick, stucco or cement-block construction.

Exclusive "Safety-Sealed" construction seals all combustion air and products from contact with heated room air. The patented exterior wall vent draws in outside air for combustion, then vents all combustion products outside *through the wall!*

Now available with manual or thermostat control, Saf-Aire operates on natural, manufactured or LP gas. Has *no moving parts* to maintain or replace. WRITE NOW FOR COMPLETE, FREE SPECIFICATIONS!

SAF-AIRE fits easily into any exterior wall of wood, brick, stucco or cement-block construction. Interior wall panel connects directly to the small exterior wall vent. Needs no chimney, ducts or electricity!

Model 991-14
14,000 BTU/HR
18" x 24" x 4"

Model 992-20
20,000 BTU/HR
18" x 38½" x 4"

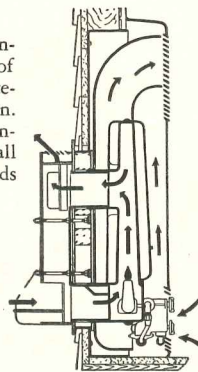

These Stewart-Warner Heaters are "Safety-Sealed," too!

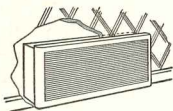

South Wind Zone Heating System

Installed in any inside or outside wall. Single or double grille units. Two suitcase-size units heat average home. Automatically modulated flow of heat. Thermostat control.

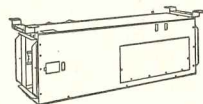

South Wind Zone Furnace

Compact, forced-air unit. Easily tucked away under the floor, in a closet or any convenient space. Short ducts from centralized installation. Thermostatic heat control.



Approved by American Gas Association

STEWART *Safety Sealed* **WARNER**
DOMESTIC HEATING

STEWART-WARNER CORPORATION

South Wind Division • 1516 Drover Street • Indianapolis 7, Indiana

REQUIRED READING

(Continued from page 28)

Chinese: two architects, an historian and professors of philosophy and Chinese culture. Part II is composed of Mr. Inn's photographic illustrations and drawings.

Its value to the reader, states Edgar Schenk in his introduction, is twofold — "the war in the Far East has given the book importance as a record of architecture and gardens which are gone forever . . . through it the Western reader can see and understand a relationship between house and garden which for two hundred years has influenced, in one way or another, our own home and garden planning."

Such a record of now obliterated Chinese architectural and landscape material so carefully compiled by author Inn and editor Lee may be considered as a source book and useful addition to anyone's library.

SQUARES AND LOGS

Inskip's Tables, Squares and Logarithms. In Three Parts. By George D. Inskip. Berzinskip (1769 East 19th St., Brooklyn, N. Y.) 1949. 5½ by 8½ in. Part I, 665 pp.; Part II, 144 pp.; Part III, 510 pp. Parts I & II, \$7.50. Part II, \$4.50. Complete Tables (Parts I, II & III in one volume), \$11.00.

The new edition of tables of squares and logs, divided into three parts, includes (Part I) squares and logarithms by 32nds of inches to 170 feet. Logarithmic trigonometric functions, logarithms of numbers and other tables are contained in Part II. The last section gives tables of coordinates and slopes (solutions of right angled triangles for any bevel); roof formulae and graphics for hip and valley construction.

A unique feature of the tables of logarithms is the computation of circular arcs as a one-step operation, by means of a special card device that accompanies each book.

WELDING

Welding Handbook. Third edition. Prepared under the direction of the Welding Handbook Committee. American Welding Society (33 West 39th St., New York 18, N. Y.) 1950. 6¼ by 9½ in. x + 1651 pp. illus. \$12.00.

The third illustrated edition covers welding and cutting processes currently in industrial use. The welding of ferrous and non-ferrous metals and alloys, welding metallurgy, the physics of welding, A.W.S. standards, etc. are included.

for

extra whiteness

use Trinity White Cement

Whenever whiteness is called for in masonry, specify Trinity white—the whitest white cement. Use it in architectural concrete units, stucco, terrazzo, cement paint. Trinity is a true portland cement that meets ASTM and Federal specifications. Trinity Division, General Portland Cement Co., 111 West Monroe Street, Chicago 3; 305 Morgan Street, Tampa 2; Volunteer Building, Chattanooga 2; Republic Bank Building, Dallas 1; 816 West 5th, Los Angeles 5.

As white  as snow

TRINITY WHITE
Portland Cement

plain or waterproofed

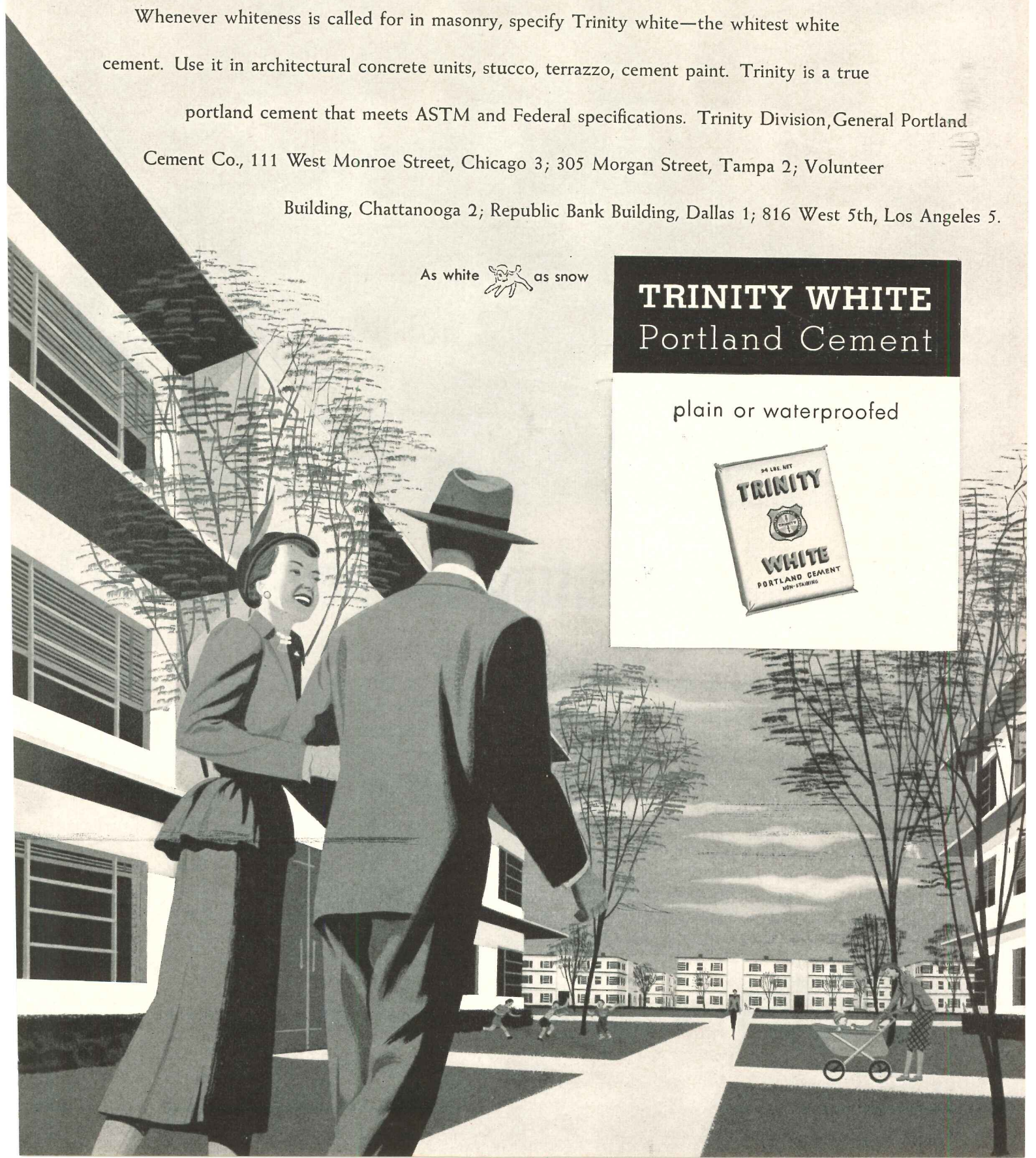



who said **inspiration** meant **perspiration**?

Not here it doesn't. Not in the Sinclair Refining Company's two new Research buildings. In the Laboratories building Carrier Duct-type Weathermasters are used to maintain a constant temperature and humidity despite highly variable heat loads, keep research equipment and research workers at peak efficiency. In the Administration building, on the other hand, Carrier Conduit Weathermasters permit the occupant of every office to dial his own weather.

Both systems are supplied by a Carrier Centrifugal Refrigerating Machine in the Laboratories building. Both systems give you: year-round air conditioning; heating and cooling combined in one system; centralized mechanical elements. That adds up to: health and comfort; savings on fuel and maintenance costs; simpler servicing; undivided responsibility. If you are considering a heating, refrigerating or air conditioning installation, call Carrier. Carrier Corporation, Syracuse, N. Y.

Carrier

AIR CONDITIONING • REFRIGERATION • INDUSTRIAL HEATING

Corning FOTA-LITE combines the advantages of louvers with flat glass

In many lighting installations, high level illumination and uniform brightness control are desirable, but difficult to achieve due to space limitations, cleaning difficulties and problems of decor. For lighting the Barton's Bonbonniere, Corning Fota-Lite afforded the ideal solution. With four-foot panels of Fota-Lite each with 12-40 watt 3500° lamps, excellent foot candle and brightness values are realized. Highlighting is provided by PYREX brand Lenslites illuminated by 150 watt lamps. Every light fixture is recessed. Cleaning is greatly simplified.

FOTA-LITE is a revolutionary lighting medium. Without bulky, hard-to-clean materials, light distribution is controlled by louvers photographically sealed in a thin panel of glass. Fixtures can be made shallow and dust-tight. Initial efficiency remains unimpaired.

The cell size of Fota-Lite louvers is many times smaller than in conventional louvering materials. This gives it the appearance of an opal diffusing glass. However, vertical light is unrestricted by the clear sections and surface brightness is reduced by the 45° cut-off of the diffusing louvers.

The versatility of Fota-Lite gives it an unusually wide range of application. It will pay you to investigate. Send for a sample demonstration card today.

◀ Barton's Bonbonniere, New York City

Designer: Hans Weiss and William Basser, New York City
Fixture Manufacturer: Neo-Ray Products, Inc., New York City
Electrical Contractor: Bigman Brothers, Brooklyn, N. Y.
Glass: Corning Fota-Lite (note photo below) and Pyrex brand Lenslites

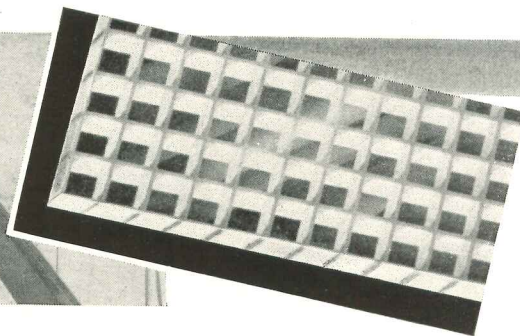
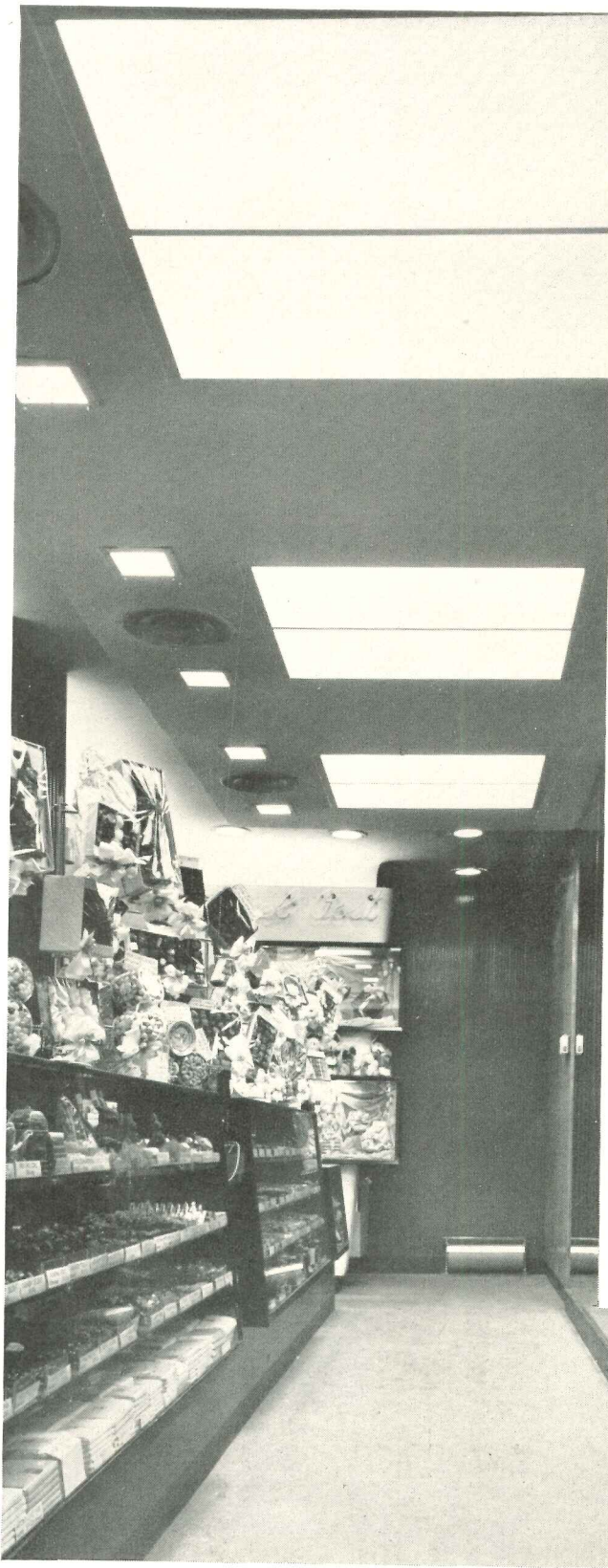

CORNING GLASS WORKS

CORNING, NEW YORK

Corning means research in Glass



FOR EFFICIENT, ATTRACTIVE LIGHTING . . .

CORNING ALBA-LITE for diffusion of fluorescent light . . . CORNING FOTA-LITE for high level illumination . . . CORNING brand LENS PANELS and PYREX brand LENS LITES for prismatic light control

FREE—FOTA-LITE sample on request.

CORNING GLASS WORKS, Dept. AR-5, Corning, N. Y.

Please send me your FOTA-LITE demonstration card showing how FOTA-LITE diffuses and cuts off light at 45°

Name _____ Title _____

Company _____

Address _____

City _____ Zone _____ State _____

5000 BRIGGS BATHROOMS IN COLOR



William J. Levitt . . . dynamic spark-plug of Levitt & Sons, Builders, Manhasset, Long Island.

*world's biggest builder
knows what it takes
to sell houses*

WHATEVER Levitt does . . . it's always BIG! When they start building houses—a city of 40,000 springs up almost overnight. When they overhear people say that they want colored bathroom fixtures—they order them by the thousand.

Five thousand, to be exact . . . and every single one of them Briggs Beautyware!

Knowing Levitt, there must be good reasons for this big change in contract. And knowing Briggs, there are!

First, Briggs is the only plumbing ware manufacturer whose methods of making fixtures is as modern and streamlined as Levitt's way of making houses. That's why Briggs alone can sell a complete set of colored fixtures (including brass fittings) for only 10% more than white.

Second, Briggs colored fixtures have style appeal. They look smart and *expensive*—without adding any expense worth mentioning to the overall cost of the house.

And last, they have the famous lightness of weight and exact dimensions of all Briggs fixtures. Installations are faster, easier, “right on the nose” every time.

Yes! Levitt & Sons know and act on a good thing when they see it. And when they saw Briggs Beautyware in color they knew homeseekers would act on it—with *cash!* Why not start cashing in on it yourself, today!

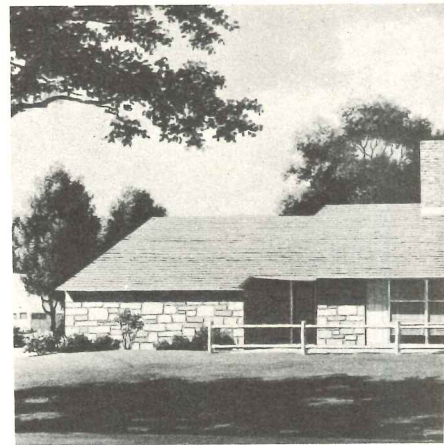

Country Club district features spacious, individual homes like this. There will be a select 500 of them built this year at prices from \$17,500 to \$22,500—each furnished with two de luxe Briggs bathrooms in color.



"You should see their faces light up when the women first walk into this bathroom. There's no doubt about it, the luxury-look of Briggs Sandstone fixtures is a deciding factor in many a 'one look' sale." That's what Bill Levitt says about the Exhibit Home bathroom shown here. All the other houses in this class have the same modern layout and enamel tiling *plus* Briggs ultra-modern Sandstone fixtures.

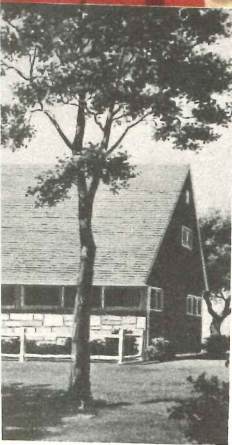

BRIGGS

Sea Green Ivory Sparkling White Sandstone Sky Blue

Beautyware

**PLUMBING
FIXTURES**

Whether you choose the Sandstone now being used in Levittown, or any other one of Briggs beautiful decorator colors, you will find that it adds immeasurably to the quick-sale value of all your homes. Briggs Manufacturing Co., 3001 Miller Ave., Detroit 11, Michigan.

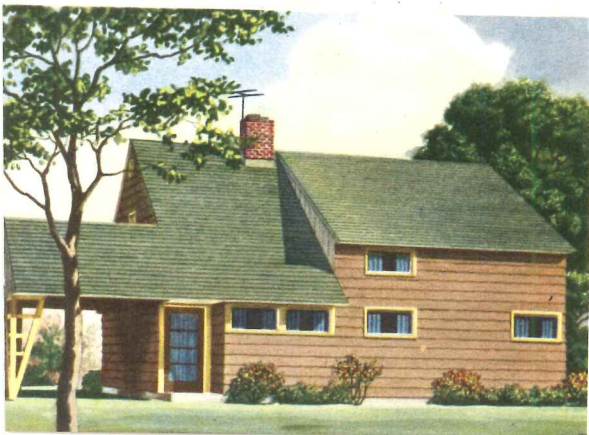

Typical of Levitt & Sons latest full-size houses on a pint-size budget. 4000 of these \$7990 homes are going up now, all equipped with television and Briggs Sandstone fixtures.

1
COMMERCIAL

2
INDUSTRIAL

3
INSTITUTIONAL

4
RESIDENTIAL

all 4 call for **CONSOWELD**

There's a mighty good reason why "Consoweld" is being written into more and more specifications. For *Consoweld*, the versatile molded plastic, adds functional beauty to both horizontal and vertical surfaces. Resistance to heat, moisture, abrasion, alkalis and acids virtually eliminates maintenance. Attractive colors, in interesting patterns, make your color-scheming client-pleasing.

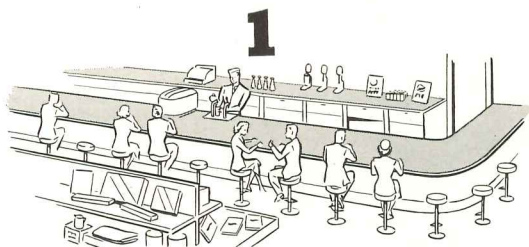

Nothing better for food-beverage preparation and service than *Consoweld*. Pleasing colors perk up appetites . . . smooth, hard *Consoweld* wipes clean and fresh in a jiffy.

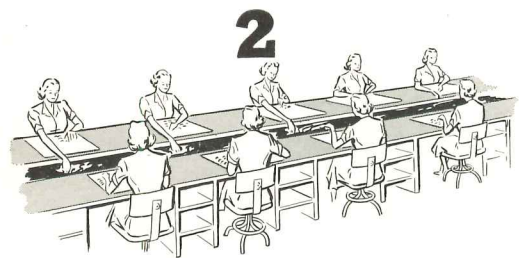

Bread and butter . . . candy or cosmetics—wherever sanitation is a requirement—*Consoweld* is the answer. Low absorption factor, ability to withstand wear and tear, makes *Consoweld* the sensible surface.

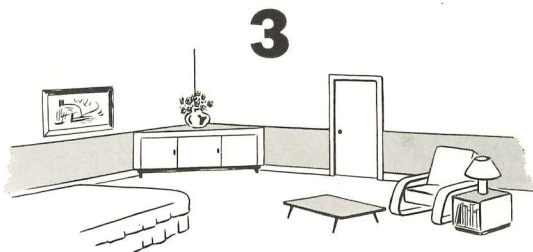

Hotel work centers, public and guest rooms . . . all call for the long, maintenance-free life of colorful, durable *Consoweld*.

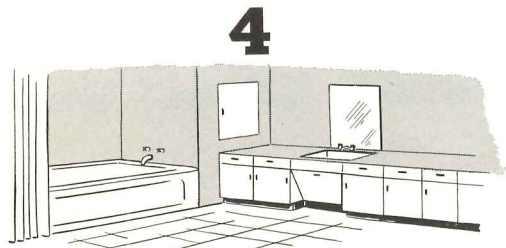

No problem in keeping cheerful *Consoweld* bathrooms sparkling clean and gleaming. Just a swish of a damp cloth, and water spots vanish like magic.



LOOK!

Big *Consoweld* panels—up to 16 feet long—are ideal for large wall surfaces and long counters where joints would be unsightly.



SEE!

. . . Sweet's File, Architectural, 14a/1a, for detailed information—specifications, panel sizes, packaging, full-color installation views, reproductions of colors and patterns.



FREE!

There's a useful *Consoweld* Color-Ring and a copy of the complete Bonding and Fabrication booklet reserved for your request. Write today!







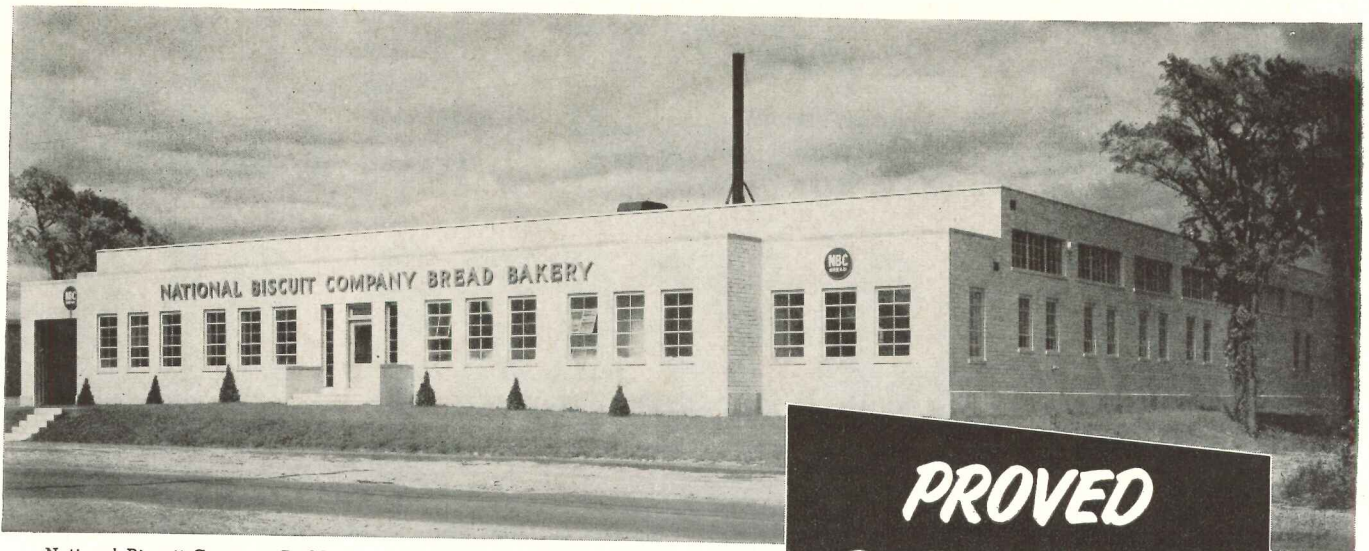



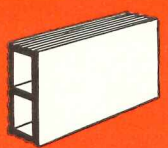

Good for a colorful lifetime!

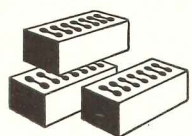
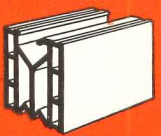
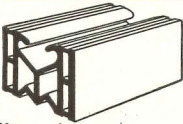
PLASTICS DIVISION
CONSOLIDATED WATER POWER & PAPER COMPANY
WISCONSIN RAPIDS 10, WISCONSIN

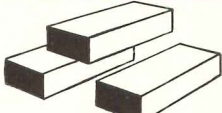

National Biscuit Company Building, at Plattsburg, New York. Natco Manganese Spot Dri-Speedwall Tile for Exterior Walls. T-series Ceramic Glaze Vitritile for Interior Walls. Contractors—Wright and Morrissey.

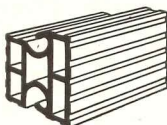
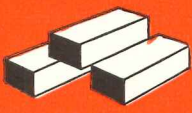
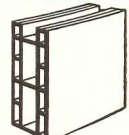
**PROVED
DEPENDABLE
FOR EVERY
STRUCTURAL NEED**

 <p>Ceramic Glazed Vitritile 8" x 16" Nom. Face Size</p>	 <p>Ceramic, salt and clear Glazed Vitritile 5 1/3" x 12" Nom. Face Size</p>	 <p>Ceramic, salt and clear Glazed Vitritile 5 1/3" x 8" Nom. Face Size</p>
 <p>Salt Glazed Brick 2 1/2" x 8" Nom. Face Size</p>	 <p>Red Shale Dri-Speedwall Tile 8" x 12" Nom. Face Size</p>	 <p>Buff Unglazed Manganese Spot Salt Glazed, Red Textured Dri-Speedwall Tile, 5 1/3" x 12" Nom. Face Size</p>
 <p>Tex Dri-Wall Tile Red Range, Flashed Red Range, Buff Range 4" x 12" Nom. Face Size</p>	 <p>Split-Tex Roman Face Brick Red Mingled and Buff Mingled Shades 2" x 12" Nom. Face Size</p>	 <p>Raggle Blocks Red Mingled Shades 4" x 5 1/2" x 12" Nom. Size</p>
 <p>Loadbearing Tile scored and unscored 12" x 12" face size in standard wall thicknesses</p>	 <p>Non Loadbearing Tile scored and unscored 12" x 12" face size in standard wall thicknesses</p>	 <p>Speed-A-Backer Tile For backing Brick Faced Walls 12" long Varying Heights</p>
 <p>Face and Common Brick</p>	 <p>Salt Glazed Segmentile 12" x 12" Face Size in 6" and 8" thicknesses</p>	 <p>RadianTile For warm air Radiant Panel heating systems</p>

NATCO Structural Clay Tile meets all modern building requirements for strength, permanence and architectural beauty . . . and gives added advantages of low cost erection with practically no maintenance for the life of the building.

The fact that architects for many prominent manufacturers have specified Natco Structural Clay Tile in plant buildings all over the country attests to its reliability for continued satisfactory service and life.

Natco Structural Clay Tile is adaptable for every structural purpose both exterior and interior—for buildings of every type—commercial and industrial, schools and colleges, hospitals and public institutions, farm buildings and homes. Write for a copy of Catalog SA-50 for detailed information or see Sweet's Section 4 D-8.



NATIONAL FIREPROOFING CORPORATION

GENERAL OFFICES: PITTSBURGH 22, PA.

Branches: New York • Chicago • Philadelphia • Detroit • Boston
Syracuse • North Birmingham, Alabama • Toronto, Canada

HERMAN MILLER'S IS 19 YEARS OLD

**Laid in 1931, this Bruce Block
Floor in Chicago's Merchandise Mart
still looks like it's brand new!**

WHEN officials of Herman Miller Furniture Company looked over the space for a new showroom in the Merchandise Mart, they had a pleasant surprise. The floor of Bruce Hardwood Blocks, despite 19 years of constant use, was in perfect condition except for a few stains and scratches in the finish.

So, instead of spending several thousand dollars on a new floor or floor covering, they had the Bruce Block Floor refinished at a cost of only a few hundred dollars. In their own words: "We were both surprised and pleased that the Bruce Block Floor in the Merchandise Mart space could be so handsomely used for our display at so low a cost."

Floor dramatizes modern furniture

The modern block design gives a clean, fresh look to the Herman Miller showroom. An ideal setting for beautiful furniture is provided by the natural beauty of oak, with its interesting grain pattern and rich, mellow coloring. Although the floor is decorative, it is also a "good mixer," blending with and complementing the smooth, functional beauty of Herman Miller's fine modern furniture styles. Small rugs are used to accent furniture groupings, leaving complete latitude for future changes.

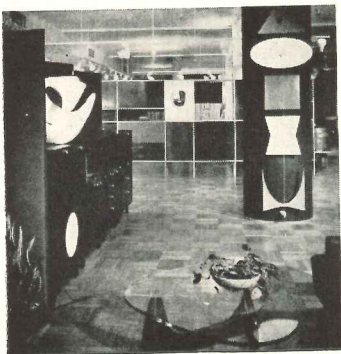

Designer Nelson calls Bruce Floor "the most attractive and impressive design element."



George Nelson, who plans all Herman Miller showrooms, says: "We were able to refinish this old floor so that it became perhaps the most attractive and impressive design element in the whole architectural ensemble. Seen in relation to the floor, Herman Miller furniture looks better than it has in combination with any other flooring material we have used in showrooms. From the expense standpoint, had we carpeted the showroom, the cost would have been from \$3,000 to \$5,000. The cost of refinishing the old floor so that it looked like new was less than \$500. In other words, we not only got a more attractive showroom, but there was a substantial saving to boot. I might add that in the New York showroom, currently being redesigned, we are moving some of the existing floor covering to put in a section of Bruce Blocks."

How to make 4,000 sq. ft. do the job of 6,000

By completely avoiding conventional room settings, Designer Nelson turned the Herman Miller space into one of the most attractive showrooms in the Merchandise Mart. Basically, the solution was a one-room scheme with dividers in the form of curtains and low partitions, a sharp deviation from conventional furniture showrooms. The room has no color except in the furniture itself, the floor with small rugs, and the hanging draperies. Ceiling and walls are painted white. An ingenious lighting system consists of hanging ducts on which fixtures can be snapped at any point.

'NEW" BRUCE FLOOR

Nineteen years of constant use haven't marred the beauty of this Bruce Block Floor in the Chicago showroom of Herman Miller Furniture Company. Photograph taken March, 1949.

Photo by Hedrich-Blessing

This modern floor is ideal for homes, offices and other areas.

Homes, apartments, schools, stores and offices all become beautiful "showrooms" when you use Bruce Hardwood Blocks. These distinctive floors provide a perfect background for furniture and furnishings . . . whether modern or traditional. They make possible substantial savings on decoration because their natural beauty is at its best when used with small scatter rugs. But the most important saving is in the lifetime durability and easy, economical upkeep of Bruce Block Floors.

This modern hardwood floor is also most practical from a construction standpoint.

Bruce Blocks can be laid in mastic directly over concrete—without nails or splines. Or they can be nailed over wood subfloors or old wood floors. Installation is fast and economical. Where *prefinished* Bruce Blocks are used, no sanding or finishing on the job is required. And you get the finest finish ever given a hardwood floor!

Over 100 million feet of Bruce Blocks are now giving most satisfactory floor service in homes and buildings throughout the nation. You'll find these "floors that last a lifetime" in beautiful small homes and in largest housing developments.



**Write for
New Booklet
in Color ●**

Write "O. K. Bruce" on your letterhead or a postcard, and we'll send you the new full color booklet on Bruce Block Floors. Every architect and builder will find it valuable for reference on all types of jobs.
E. L. BRUCE CO., MEMPHIS 1, TENN.

See our catalog in Sweet's

BRUCE BLOCK

Hardwood Floors

Bruce also makes Ranch Plank and Strip Floors, Finishes and Waxes, Terminix

Demand proved dependability —

and get it by specifying

FRIGIDAIRE AIR CONDITIONERS!

(powered by famous Frigidaire Compressors)



The **Frigidaire Compressors** that power Frigidaire Self-Contained Air Conditioners have passed test after test—from the first careful inspection of materials to the final underwater and “run-in” tests. Their *proved dependability* makes them a big reason for specifying Frigidaire Air Conditioners, because it means years of low-cost, trouble-free service.

Styling by Raymond Loewy gives Frigidaire Self-Contained Air Conditioners their smartly modern appearance. Their two-tone gray finish harmonizes with any surroundings.

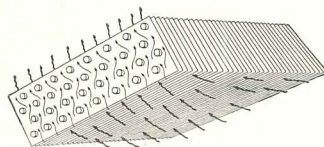

Multipath Cooling reduces room temperature and humidity extra-fast, extra-evenly. High-efficiency cooling unit assures smooth, economical operation.

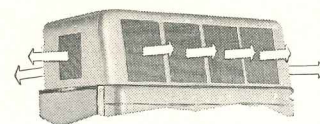

Controlled Airflow is provided by Frigidaire’s 4-Way Hood, which can be set to deliver air in any or all four directions. This means greater ease in locating units and simplified installation of ducts, where needed.

Simple Control Panel is concealed for beauty and protection — contains merely an “On-Off” switch and a positive temperature regulator which gives you, at the touch of a finger, the kind of “weather” you desire.

Ask your Frigidaire Dealer about *all* the advantages of Frigidaire Self-Contained Air Conditioners... about Frigidaire Room Conditioners and Central Systems, too. Look for his name in your Classified Phone Book, under “Air Conditioning” or “Refrigeration Equipment.”

FRIGIDAIRE AIR CONDITIONING

Over 400 Frigidaire commercial refrigeration and air conditioning products — most complete line in the industry.

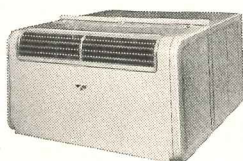

FOR INDIVIDUAL ROOMS in homes, offices, hotels and hospitals, specify Frigidaire Window Conditioners. They’re easily installed, powered by the famous Meter-Miser. Frigidaire also offers large central systems.

HERE’S A FAST, LOW-COST WAY TO AIR CONDITION EXISTING BUILDINGS!

For air conditioning existing buildings — and new buildings, too — a Frigidaire Single or Multiple-Unit Installation is fast and simple. Since it employs the compact, self-contained unit shown above, installation costs are remarkably low. And operating costs are equally low, because individual Frigidaire units can be turned off or on as needed — can be serviced without affecting other space.

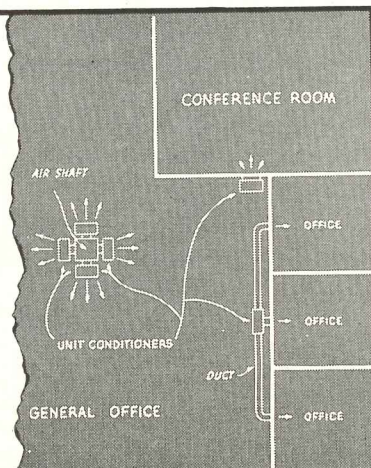



don't get the wrong impression

It's easy to get the distorted idea that stainless steel is a "miracle metal," but after all, stainless is a *family of alloys*, and careful consideration must be given to the *right* analysis to use . . . or stainless won't live up to advance notices. Crucible, pioneers in the development of these specialty steels, makes freely available to you an alert metallurgical staff to help you put Crucible Stainless to work most efficiently in your application.

Crucible's half century of specialty steel leadership is based on a keen devotion to detail in every industry-posed problem. That's why Crucible built, from the ground up, one of the first integrated mills designed specifically for the hot and cold rolling of stainless steels. Take full advantage of Crucible's specialty steel experience. Call us in to work for you. CRUCIBLE STEEL COMPANY OF AMERICA, Chrysler Building, New York 17, N. Y.

CRUCIBLE

first name in special purpose steels

STAINLESS STEELS

fifty years of Fine steelmaking

STAINLESS • HIGH SPEED • TOOL • ALLOY • MACHINERY • SPECIAL PURPOSE STEELS

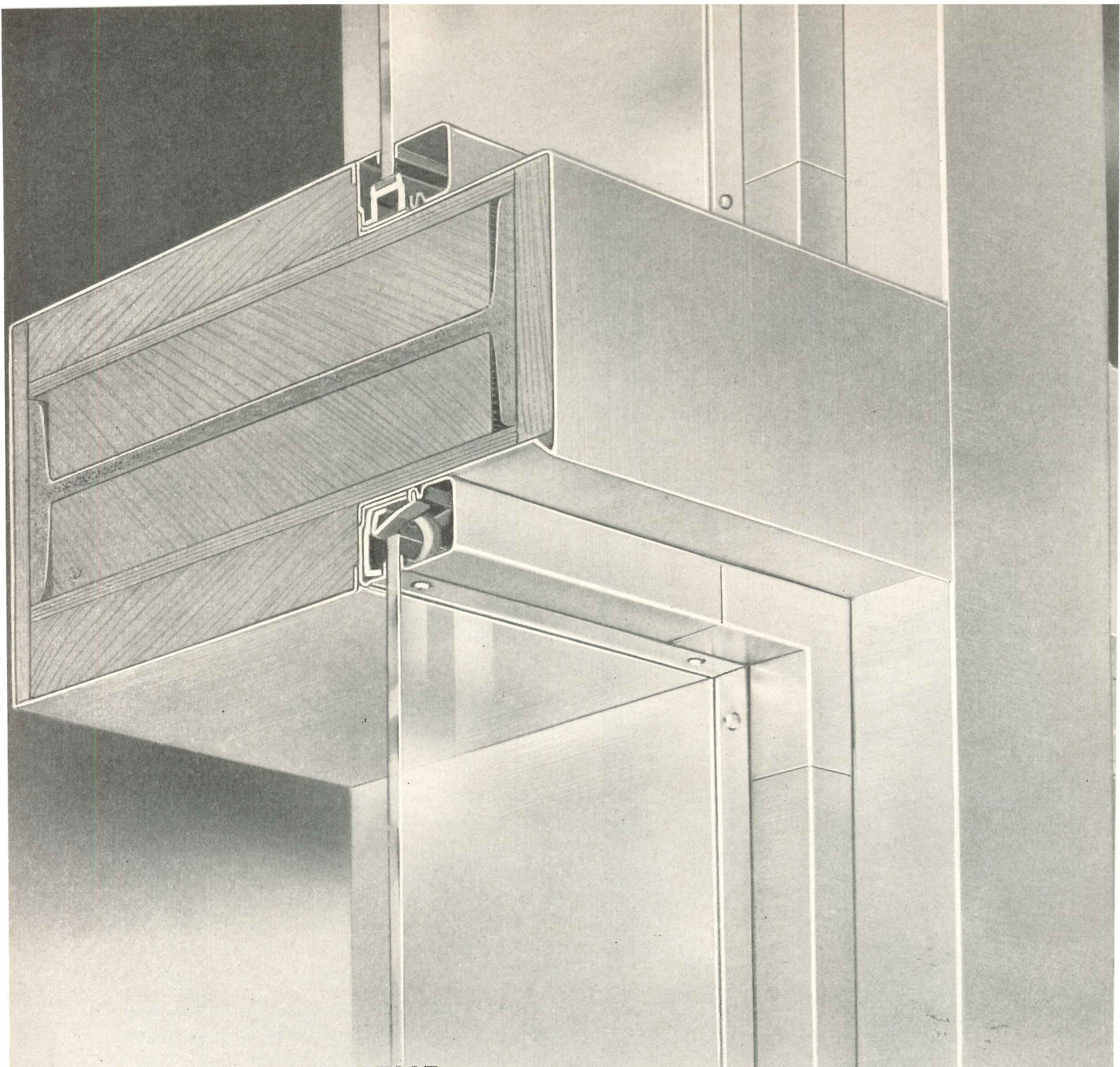

**YOU ACHIEVE
COMPLETE FREEDOM IN DESIGNING...
AND REDUCE BUILDING COSTS
THROUGH THE IMAGINATIVE USE OF
KAWNEER STORE FRONT METALS**



Herpolsheimer's, Grand Rapids, Mich.

Architectural talent and ingenuity result in outstanding modern store fronts when Kawneer Metals are used with skill and imagination.

Striking proof is offered by this department store designed by Perry, Shaw and Hepburn, Architects, Boston, Massachusetts for Allied Stores Incorporated, George L. Ely, Store Designer.

Combining simplicity, good taste, and originality, this handsome front arrests the attention of shoppers, displays merchandise, and invites people inside to shop.

Kawneer Metals and Entrances, styled and engineered to the highest contemporary standards, were used extensively. One of the stock assemblies specified was the cleanly-designed glazing sash pictured at left. Selected from the wide variety of Kawneer Stock Mouldings, this unit holds glass securely and resiliently in place in the giant four-story show window

(as pictured) and in the large sidewalk show windows.

The use of well-designed Kawneer Stock Metals meets your clients' demands for lower building costs, because these units cost less than special, made-to-order assemblies. Your own operating costs are also reduced by eliminating drafting and detailing.

For information consult your Portfolio of Kawneer Details, Sweet's Catalog, or write 223 N. Front St., Niles, Mich., or 2583 8th St., Berkeley, Cal.

THE
Kawneer
 COMPANY

ARCHITECTURAL METAL PRODUCTS

Store Front Metals • Aluminum Roll-Type Awnings

Modern Entrances • Aluminum Facing Materials

A SHADE-Y STORY

YOU CAN TELL ANYWHERE!



WE HEARD IT THIS WAY:

Seems there's a fellow in New York—a building contractor—who has gone crazy on the subject of Pyroxylin Shades. Says he never thought *any* shade could be so good. To get at the root of this enthusiasm, we asked him to tell us why he thinks Columbia's Pyroxylin is a "super-shade".

HERE'S WHAT HE SAYS:

PROFITABLE INVESTMENT—Fine quality and long-life Pyroxylin shades cut maintenance costs to the bone.

WASHABILITY—A magic word for window shades. You can scrub Pyroxylin shades with soap and water . . . they laugh at rain, steam and dampness of all sorts.

GOODBYE PINHOLES—Loosely woven shades with lots of filler, often develop pinholes. Not Pyroxylin shades. They're impervious to such things.

NO MORE DULL COLORS—Take your pick of Columbia colors—including smart new pastels or popular decorator darks. Or select revolutionary new printed shades. Some colors come in duplex combinations, too.

SMOOTH OPERATION—It's a safe bet to specify Columbia, when it comes to rollers. They're quiet as a purring kitten—serve you long and faithfully.

SIZE IS NO PROBLEM—Don't hesitate to ask your Columbia Authorized Dealer for shades in any size you need, from midget to giant. He positively enjoys the unusual.

WON'T FADE—Columbia Shades are laboratory tested . . . show no appreciable change of color after 80 hours in a scientific Fadeometer.

Columbia Window Shades and Venetian Blinds are sold only through Columbia Authorized Dealers in leading department and furniture stores and shade shops.

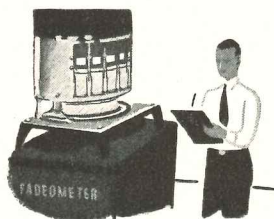
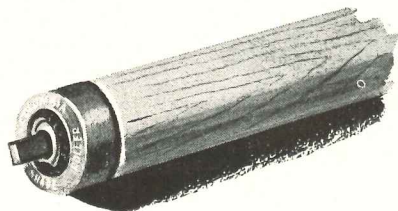

Columbia
WINDOW SHADES
and VENETIAN BLINDS

THE COLUMBIA MILLS, INC. • 428 SOUTH WARREN ST., SYRACUSE 2, N.Y.

We will gladly submit *specifications* for shades that can become a part of the General Contractor's bid. This includes a recommendation for correct type of fabric and mechanism; method of manufacture and proper installation. Let us call on you and discuss your particular problems.

RIC-WIL PREFABRICATED INSULATED PIPING SYSTEMS ARE



PERFECTLY MATCHED TO SPECIFICATIONS

It is no secret that insulated piping systems, thoroughly engineered and properly prefabricated of high-grade materials, are less costly to install and provide higher operating efficiency. The highly skilled and complete Ric-wiL engineering service made available to architects, engineers, and contractors eliminates time-wasting and costly "cut-fit-and-try" methods of field-fabricated piping systems.

Forty years of engineering, designing, and

producing insulated piping systems brings to you a most practical solution to problems involving underground or overhead installations. Prefabricated of the finest known insulating and protective materials, Ric-wiL straight units are assembled in modern plants under ideal conditions.

Our representative will be glad to provide without charge or obligation detailed Ric-wiL technical information as related to your specific problem.



For full technical information on Ric-wiL Insulated Piping Systems, call or write the Ric-wiL office nearest you or Dept. 9-W in Cleveland, Ohio.

RIC-WIL

INSULATED PIPING SYSTEMS

OVERHEAD

THE RIC-WIL COMPANY • CLEVELAND, O.

UNDERGROUND

FOR FORTY YEARS THE GREATEST NAME IN INSULATED PIPING SYSTEMS

Macy*

San Francisco



gets

extreme flexibility

to handle load changes and future load growth

low installation cost

everything was shipped complete—as a unit—and easily installed

safety to personnel

no exposed circuits; metal encloses all current-carrying parts

plenty of “IC”....with

100,000 amperes interrupting capacity, adequate to handle all short circuits

GENERAL ELECTRIC

HERE'S WHY . . . “In the department store business we cannot take any chances with power outages or potential fire hazards. We must also plan for expansion. That's why we wanted our power distribution system to be safe, to have adequate feeder and branch-circuit capacity, plus flexibility. General Electric switchgear gave us all these requirements.”

E. L. MOLLOY, VICE PRESIDENT
MACY'S, SAN FRANCISCO

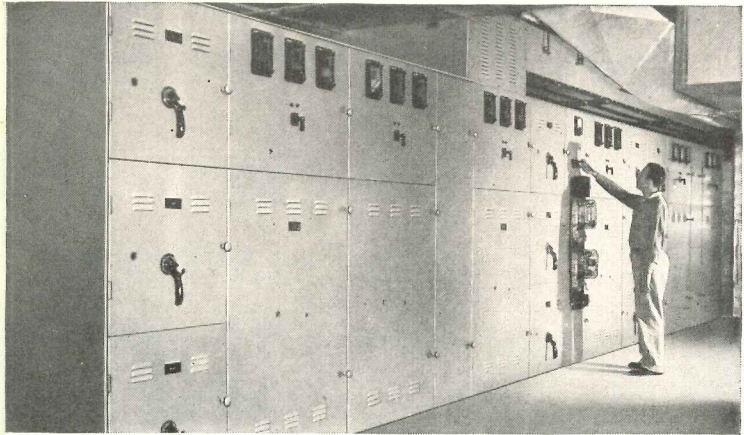
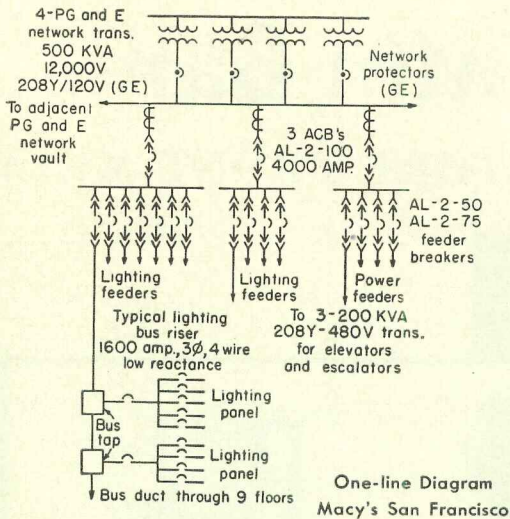

G-E metal-enclosed switchgear handles the incoming 120/208-volt power. The equipment is divided into three sections, two for lighting, one for power. Breakers (cascaded) are of the drawout type for ease of inspection and maintenance.

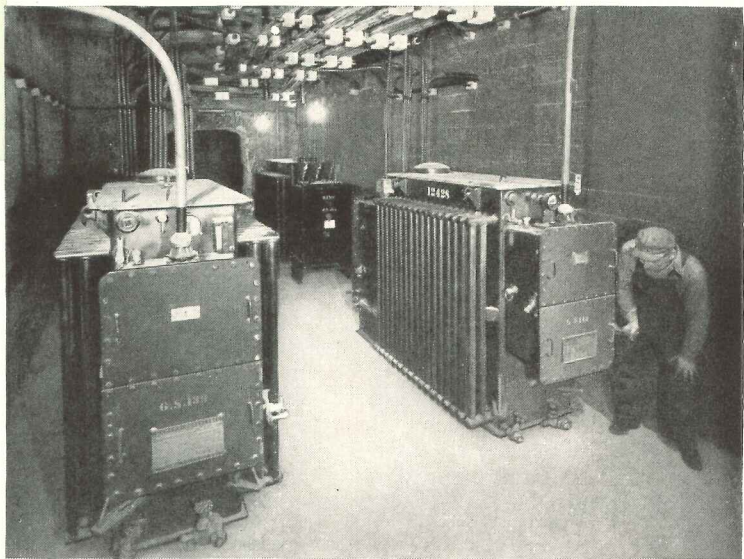

Four G-E network units, rated 500 kva, 12,000-120/208 volts in a Pacific Gas and Electric Company vault serve the building. Macy's 2500-kva load represents one of the largest loads added to PG&E's downtown network in recent years.

This, the largest switchgear installation to date in any San Francisco commercial building, adequately handles the power requirements that average four watts per square foot (nearly 500,000 square feet). Flexibility of the feeder system permits load changes without increasing the load on the switchgear. The 4000-ampere breakers have induction relay tripping.

Macy's installation is a complete General Electric project—switchgear, three 200-kva transformers for elevators and escalators, power and lighting panels, motors, and control for ventilating and boiler-room auxiliaries. One source of responsibility plus the very best in co-ordinated planning, engineering, manufacturing, and service facilities to give maximum savings and efficiency to the customer.

low-voltage SWITCHGEAR

Modern industrial power distribution systems using G-E switchgear are applicable to any industrial plant or commercial building where you want proper voltage for top performance of equipment, an extremely flexible setup to take care of expanding or changing loads, adequate short circuit protection, safety to personnel, and low installation and maintenance costs.

Be sure to see the "More Power to America" full-color sound slidefilm "Modern Industrial Power Distribution." Ask your G-E sales representative to arrange a showing for your organization.

Investigate today the many advantages of using General Electric switchgear in *your* plant for efficient, flexible power distribution. Contact your G-E sales representative for further information—and write for the helpful bulletins listed below. *Apparatus Department, General Electric Company, Schenectady 5, N. Y.*

- | | |
|---------------------------------|-----------------------------------|
| GEA-4966 Low-voltage Switchgear | GEA-3083 Metal-clad Switchgear |
| GEA-3642 Air Circuit Breakers | GEA-3592 Load-center Substations |
| GEA-2017 Network Protectors | GEA-3758 Load-center Distribution |

GENERAL  ELECTRIC

860-39



A NEW, LIGHT-DUTY Muntin Bar

IN PITTCO STORE FRONT METAL

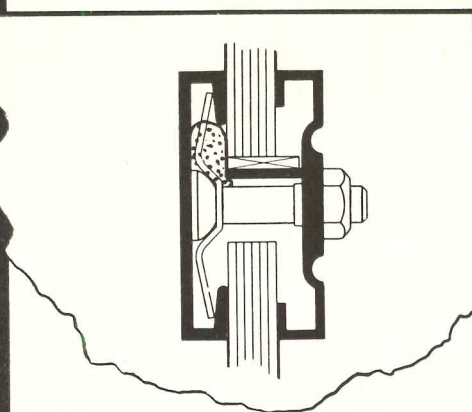
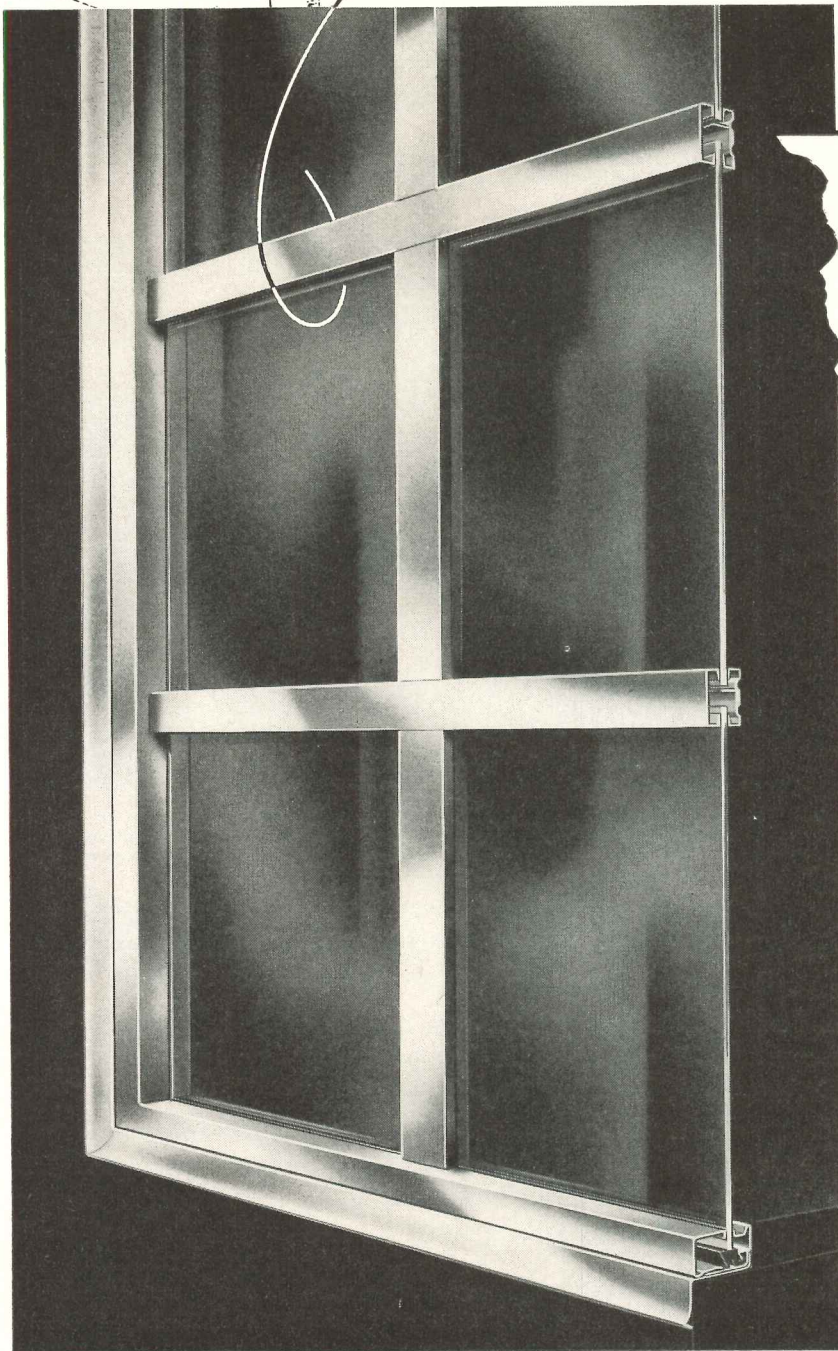

● This new Muntin Bar (No. 32) was designed in answer to numerous requests for a light-duty bar. It can be reinforced with all standard Pittco stiffeners, and may be used both horizontally and vertically. A concealed connecting strap fastens intersections securely. Because of its shallow profile, this Muntin Bar is ideal for the Colonial-type store front with its small rectangular lights, and in other installations where heavy supports are not required.

Muntin Bar No. 32 possesses the same rich, satin-smooth finish, sharp profile and rigid strength found in all other Pittco extrusions.

You can examine this bar and all the principal Pittco members in the Pittco Metal Sample Case, which our representative will gladly show you. See Sweets Architectural Catalog for the address of our nearest office.



PITTCO STORE FRONT METAL

PAINTS · GLASS · CHEMICALS · BRUSHES · PLASTICS

PITTSBURGH PLATE GLASS COMPANY



NEW Double-Duty INSULITE*

Interior Finish Products

Ideal for finishing attics, amusement rooms . . . public and commercial interiors.

Forget your old conception of interior boards! Here is a fresh new line with imaginative improvements—designed to do a better job—faster—easier—and with flattering results.

NEW COLORS—Chosen by Faber Birren, nationally known consultant, based upon research to measure the preference of today's buying public. These colors are accurately keyed to buying opinion.

AMAZING NEW SURFACE RESISTANCE TO WEAR! Test it yourself. Durolite plank, for example. Rub it, scrub it *hard* with brush, soap and water. You've never seen anything like it. That surface is there to give years of service—and still look fresh and attractive.

FAST AND EASY TO APPLY—Just use nails or staples direct to framework. No skill required—anyone can do it. Saves time, cuts application costs, and the finished result is beautiful and attention-getting.

NEW INSULITE FLANGED T & G JOINT assures firm, uniformly level application that stays securely in position. Concealed fastening. Application is fast and easy with nails or staples.

SIZES: Tile, 12" x 12", 16" x 16", 16" x 32". Interior Board: 4' width by 6', 7', 8', 9', 10' and 12' lengths. Plank: 8", 10", 12" and 16" widths by 8', 10' and 12' lengths.

From any point of view—Architect, Dealer, Builder—THESE ARE THE IDEAL MATERIALS for finishing attics, amusement rooms . . . public and commercial interiors. And remember: Not only will these new products finish and beautify, but they also *insulate*.

LUSTERLITE TileBoard and Interior Board

Colors: White, Ivory White. Texture: Smooth . . . high light reflecting. Joint: TileBoard employs new Insulite flanged T & G Joint. Interior Board has square edged joint.

DUROLITE Plank and Interior Board

Colors: Ivory, Pale Green, Woodtone Light, Woodtone Dark. (The two woodtones in the Plank are cartoned, half light and half dark, to provide variegated effect in application.) Texture: Rough . . . highly durable. Joint: Plank employs new Insulite Joint: Interior Board has square edged joint.

WEVELITE Interior Board

Color: Ivory White. Texture: Rough surface. Joint: Square edged.

SMOOTHLITE Interior Board

(Formerly SMOOTHCOTE.) Color: Natural. Texture: Smooth. Joint: Square edged.

ACOUSTILITE 3/4" and FIBERLITE 1/2"

Colors: White. Texture: Porous, giving a travertine stone effect. Joint: Butt joint edges beveled and kerfed. Applied With: Cement.

Refer to Sweet's File, Architectural Section 10a/8

*Reg. U. S. T. M.

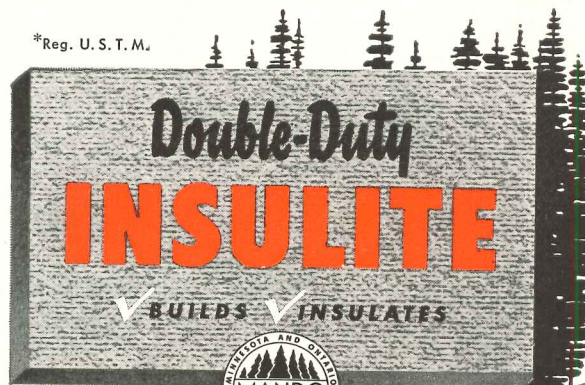

INSULITE DIVISION PAPER COMPANY MINNESOTA AND ONTARIO 4-50
MINNEAPOLIS 2, MINNESOTA

YOU CAN BE **SURE**.. IF IT'S

Westinghouse



REAL HELP!

... FOR YOUR POWER SYSTEM PLANNING

Designing a new plant? Expanding an old one? Changing production lines? If so, *have you planned the power distribution system?*

The success of the new production areas depends on this planning. Choose the "one best system" for the plant you're designing. And before you choose . . . get the complete story on modern *system planning*.

Make money-saving decisions. See why initial cost is a minor factor. Choose the system with the lowest *long-range* cost . . . the one that will *really* save money for your client. Be sure it will handle present AND future loads.

Selecting such a system can be easy! Our engineers have met and answered power distribution problems for *all* types of industries. This broad experience is available to help you adapt distribution systems to the plants you're designing.

And as a further service, we've prepared this valuable information in the form of . . .

- **A New 34-Page Booklet:** "Industrial Plant Distribution Systems", B-4045. Fact-filled pages and colorful diagrams completely explain the eleven basic systems most widely used in industry today. It will pro-

vide answers to many of your problems that have gone unsolved.

- **A System Selector:** A wealth of information condensed to a pocket-sized selector. In a matter of minutes you can make preliminary decisions on the system that best answers the requirements *you've* got to meet.
- **A Full-Color Movie:** Get all the facts visually! This 16-mm sound movie is a 20-minute dramatization that will clearly point the way to new economies in plant power distribution. Ask your Westinghouse representative for a free showing. No obligation, of course.
- **A Network Demonstrator:** Operating display for meetings shows how a plant network system actually works—and what it does—under any load condition. Find out from your Westinghouse representative when there will be a demonstration in your area.

Get this key information on system planning NOW. Call your nearest Westinghouse office. Westinghouse Electric Corporation, P. O. Box 868, Pittsburgh 30, Penna. J-94790-A

Westinghouse
SYSTEM PLANNING SERVICE



Build *any style* of fireplace around the *proved* HEATILATOR* FIREPLACE UNIT!

Assures correct execution of any design

The Heatilator Unit is a complete fireplace from hearth to flue, around which any kind of decorative masonry in any desired form can be built. It consists of:

1. A scientifically designed firebox
2. A properly proportioned throat to insure proper draft
3. A removable damper with adjustable poker control
4. Extra wide down-draft shelf made of heavy steel
5. Complete metal smoke dome to speed passage of smoke into chimney

By pre-building these vital parts, the Heatilator Unit insures a fireplace that draws properly and will not smoke. By eliminating the need for guesswork and rule-of-thumb methods on the part of masons, it permits unsupervised construction.

Original economy

—Long-run savings!

Because the Heatilator Unit is ready to install, with no extra parts to buy or build, it saves mason time and labor. It saves on expensive firebrick. Thus, a completed Heatilator Fireplace costs little, if any, more than an ordinary fireplace. And in addition, your client can count on the dollars-and-cents savings of smokeless, trouble-free operation.

Heatilator Fireplace Gives More Comfort, Greater Pleasure!

A Heatilator Fireplace draws in air from floor level, heats it, and circulates it to

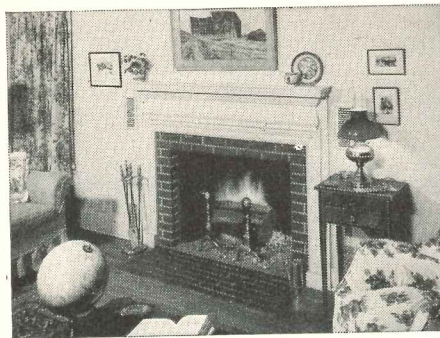

The white warm air grilles of this Colonial Fireplace blend with the woodwork.

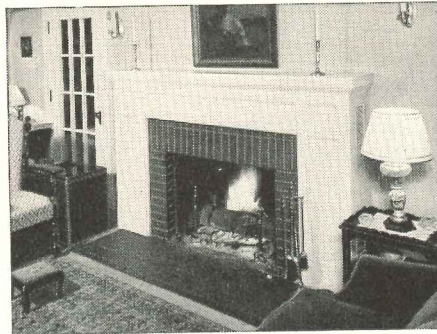

An example of warm air outlet grille placement in a fireplace with projecting mantel.

every corner of the room, and to other rooms as well. By utilizing heat that is ordinarily wasted, it makes furnace operation unnecessary on cool Spring and Fall days.

In mild climates, it is the only heating equipment needed—saving the cost of expensive heating plants that are used only a short time each year.

The Ideal Way to Heat Camps and Cabins

Heatilator Fireplaces make camps and cabins usable weeks longer in Spring and Autumn. It solves the heating problem in basement recreation rooms without unsightly pipes and radiators.

Heatilator Fireplace Units are not a new, unproved idea. Perfected over twenty-two years ago, they are in successful use in hundreds of thousands of American homes.

No Limit to Ingenious, Decorative Ways of Placing Outlet Grilles

The Heatilator warm-air outlet grilles are easily placed to blend with the general fireplace design . . . to provide points of decorative interest. Or, in many cases, they can be completely hidden in cupboards or bookcases. They can even be placed in an upstairs or adjoining room!

Give clients the advantages of a genuine Heatilator Fireplace. Write today for complete specifications and illustrations showing the unlimited variety of architectural styles possible with Heatilator Fireplace Units. Heatilator, Inc., 615 E. Brighton Avenue, Syracuse 5, N. Y.

*Heatilator is the reg. trade mark of Heatilator, Inc.

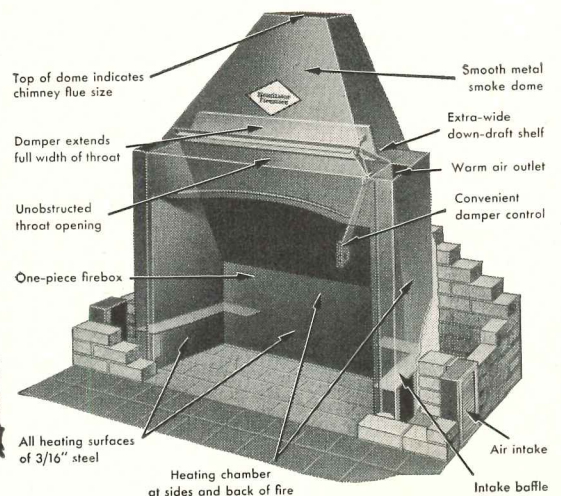

HEATILATOR *America's Leading* FIREPLACE

T.M. REG. U.S. PAT. OFF.

... those heavenly carpets by **LEES**



Make an extra special date with yourself this spring to see the new carpet fashions Lees has loomed for you. Browse through all the lovely patterns and textures. Get acquainted with Lees new *Companion Carpet* plan—showing you how to carpet your home in a perfect symphony of co-ordinated colors. Don't miss Lees famous twists—starting with handsome Mint Green

New Pebbleweave shown here. You'll wonder at the high style and wide price-range of these 100% imported wool hard-twists—that never show foot-prints and keep their youth and beauty through long, hard wear and countless shampoos. See the new embossed and carved effects—the luscious new Lees colors, patterns and weaves at your favorite store.

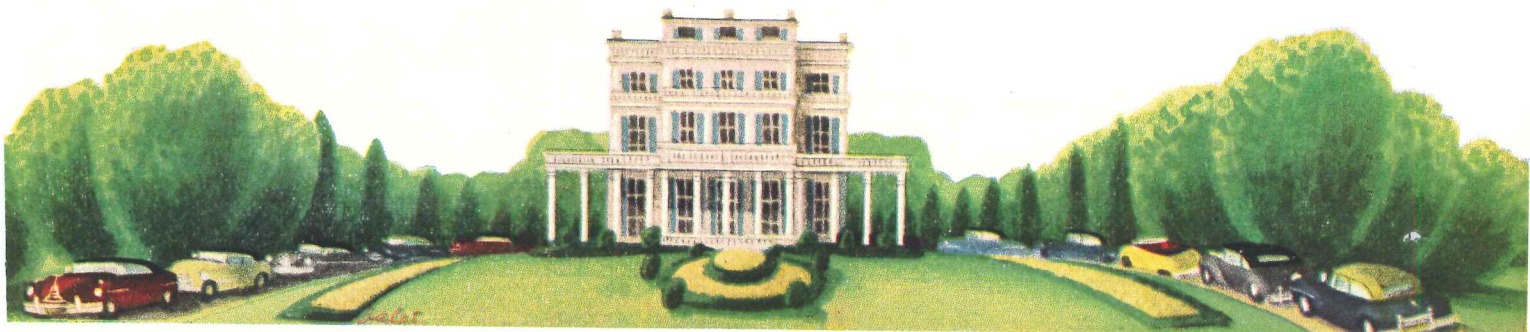

LEES AND SONS COMPANY, BRIDGEPORT, PA., MAKERS OF LEES CARPETS AND RUGS, COLUMBIA AND MINERVA HAND-KNITTING YARNS

Reading this one page
can help you design
LONGER LASTING ROOFS
and **GUTTERS**

When metal roofs and gutters expand and contract, due to temperature changes, this movement sets up stresses in the metal that correspond to the loading of a structural column. Unless the stiffness of the metal section is sufficient to transmit these stresses from the fixed end to an expansion joint, the metal will buckle; and where it repeatedly buckles, it will soon crack.

Thus, one basic factor in non-ferrous* sheet metal construction usually determines how long the installation can last . . . and this factor is the stiffness, or columnar rigidity, of each section.

WHAT GOVERNS COLUMNAR RIGIDITY?

The columnar rigidity of a sheet metal section is determined almost entirely by the shape of the section and the thickness of the metal. Studies have proved that such factors as tensile strength of the metal are either of no importance or of relatively minor importance in determining columnar rigidity of a sheet metal section.

The amount of stress which builds up in any section depends, of course, on the length of the section. Thus, when length and columnar rigidity are in balance, there will be no buckling of the metal and the installation will last indefinitely.

"COPPER AND COMMON SENSE"

Revere's manual of sheet copper construction, "Copper and Common Sense", describes in detail the research upon which the above statements are based. It is complete with charts, illustrations and detailed information so arranged that you can read and apply final figures that insure the finest sheet metal construction.

"Copper and Common Sense" has been widely distributed to architects and sheet metal contractors, and there is probably a copy in your files. In addition, a Revere Technical Advisor will always be glad to consult with you without obligation.

*Erosion and corrosion seldom cause premature failures in sheet copper construction. When failures do occur, 9 out of 10 of them are due to lack of balance between the length and columnar rigidity of the section.

REVERE
COPPER AND BRASS INCORPORATED
Founded by Paul Revere in 1801
230 Park Avenue, New York 17, New York

Mills: Baltimore, Md.; Chicago, Ill.; Detroit, Mich.; Los Angeles and Riverside, Calif.; New Bedford, Mass.; Rome, N. Y.—
Sales Offices in Principal Cities, Distributors Everywhere

Consider the advantages of UNIT HEATING

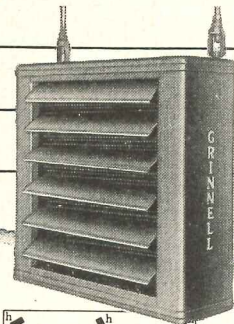

Heating comfort Unit heaters provide quick heating from a cold start. Desired temperatures are easily maintained within a close range. Heat is uniformly distributed in the working zone by forced air circulation. It is a very flexible system because different or changing heating requirements are easily satisfied by means of different models, a range of capacities, single- or two-speed motors and individual thermostatic controls.

Low first cost Unit heaters are so efficient and so compact that their heating capacity is often equivalent to the capacity of cast iron radiation or pipe coils of twice the cost. Additional savings are effected because the system requires a proportionately smaller amount of pipe, fittings and accessories.

Economy of operation Heat is forced down to the working level . . . not banked uselessly at the ceiling level. Heat is turned on and off merely by throwing a switch either manually or automatically by simple thermostatic controls. The rapid response means that heat is furnished only when and where it is wanted . . . no heat is wasted.

Adaptability to equipment and floor layout Unit heating is widely used in industrial plants and warehouses, garages, stores and public buildings. The units and the simple piping are overhead where they do not interfere with arrangement of operating machinery or equipment and do not take up valuable floor or wall space. Units are easily relocated at any time to meet changes in layout.

Thermolier unit heaters have important construction advantages The design of Thermolier unit heaters is the product of Grinnell Company's ninety-nine years of heating experience. Those responsible for heating like Thermolier's durability, freedom from maintenance troubles and dependable operation. Typical of its construction features is the patented internal cooling leg which permits the use of a plain thermostatic trap, the simplest, least expensive kind of trap. Other features are built-in drainage, continuous rated capacity and provision for expansion of U-tubes.

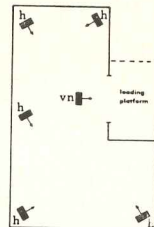

H = horizontal delivery
VN = velocity nozzle

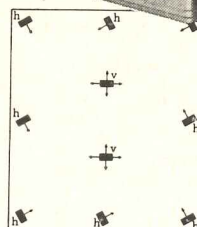

H = horizontal delivery
V = vertical delivery

equivalent capacities



weight 200 lb

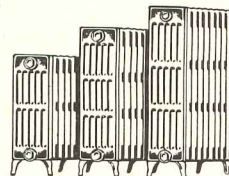

weight 4000 lb

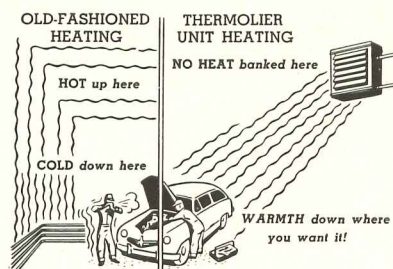

GRINNELL

Thermolier unit heaters

Grinnell Company, Inc., Providence 1, R. I. Warehouses: Atlanta • Buffalo • Charlotte • Chicago • Cleveland • Cranston • Fresno • Kansas City • Houston • Long Beach • Los Angeles • Milwaukee • Minneapolis • New York • Oakland • Philadelphia • Pocatello • Sacramento • St. Louis • St. Paul • San Francisco • Seattle • Spokane

IOWA ELECTRIC LIGHT and POWER COMPANY

FINDS UNISTRUT
THE MOST FLEXIBLE
MEANS OF SUPPORTING
HEAVY CABLE AND CONDUIT

Like a giant Erector set, completely adjustable Unistrut simplifies the most difficult problems of supporting heavy cable and conduit used in distribution systems—permits fast, on-the-job framing assembly where all adjustments are easily made by just loosening a bolt, and supporting members added as work progresses. No drilling, no welding, no special tools or equipment—saves time, cuts costs. A trial of Unistrut on your next job will show you how much quicker, better and more economically the work can be done.

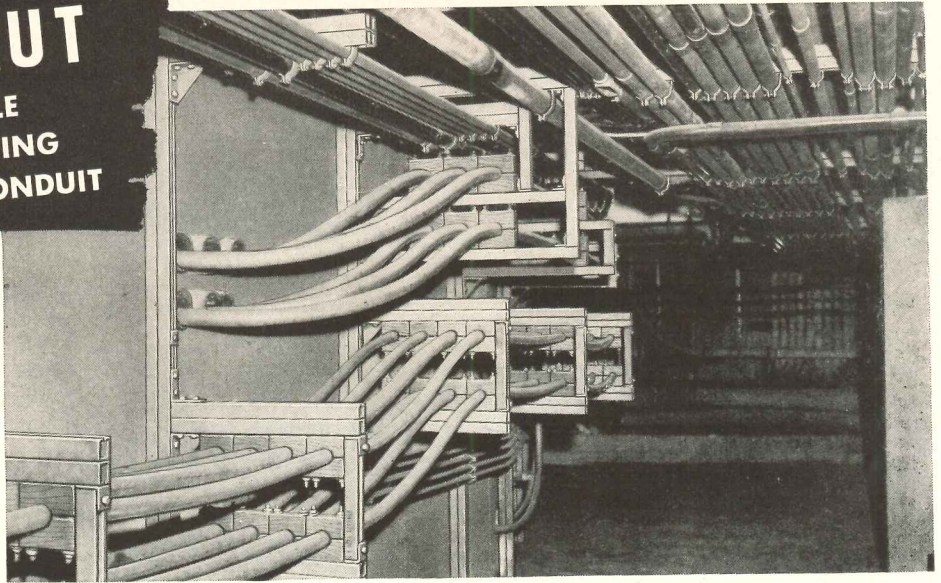

Notice Unistrut's trim steel framework. Note too the Unistrut porcelain and maple clamps that hold the heavy cable and conduit firmly in place.

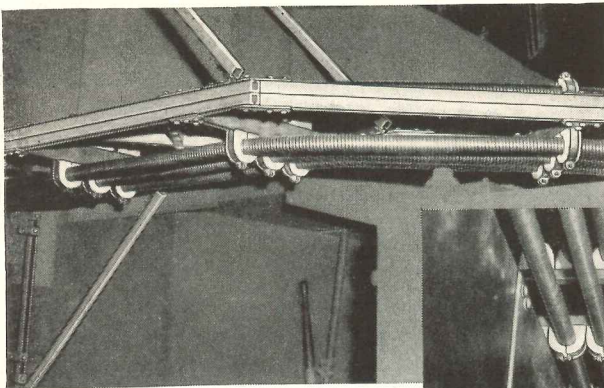

An unusual bracing arrangement utilizes standard Unistrut channel and fittings in attaching the cable-supporting Unistrut framework to wall.

Rows of heavy armored cable are quickly installed and easily supported with completely adjustable Unistrut channel and porcelain cable clamps.

Write today for Free Sample of Unistrut and these catalogs:

- Cat. 500: Construction Uses of Unistrut—supports, frames, mounts, etc.
- Cat. 600: Materials Handling Uses of Unistrut—racks, bins, etc.



THIS IS UNISTRUT!

Unistrut is metal channel with a continuous slot. You simply insert the Unistrut spring nut into the channel at approximate point where attachment of another framing member is desired, slide to exact location and bolt to Unistrut fitting. Unistrut includes concrete inserts, pipe and cable clamps, roller pipe supports, brackets, and many other standard parts which in combination provide the world's most flexible system of support or suspension.

Unistrut is trim framework—provides great strength without bulk. It's easy to work with, lasts indefinitely, and the finished structure assures neat and orderly appearance. With it you can build practically everything—all types of framing, mounts, shelving, racks, tables and benches, cable, conduit, pipe and tubing hangers and supports, fluorescent fixture supports and many other structures with only a hacksaw and a wrench.

THE 3 QUICK UNISTRUT STEPS



1. Insert nut into channel
2. Locate fitting and nut
3. A turn of the wrench—it's done

UNISTRUT PRODUCTS CO.

1013 W. Washington Blvd., Chicago 7, Ill., Dept. R5

Please send free sample of Unistrut and catalogs checked below without obligation.

Catalog 500 Catalog 600

Name _____

Company _____

Address _____

City _____ Zone _____ State _____

U. S. Patent Numbers

2327587 2380379
 2363382 2345650
 2329815 2405631

Other patents pending



The World's Most Flexible
 All-Purpose Metal Framing

Prompt delivery from Warehouse Stocks in Principal Cities. Consult your Classified Directory.

UNISTRUT PRODUCTS COMPANY

1013 W. Washington Blvd.
 Chicago 7, Illinois

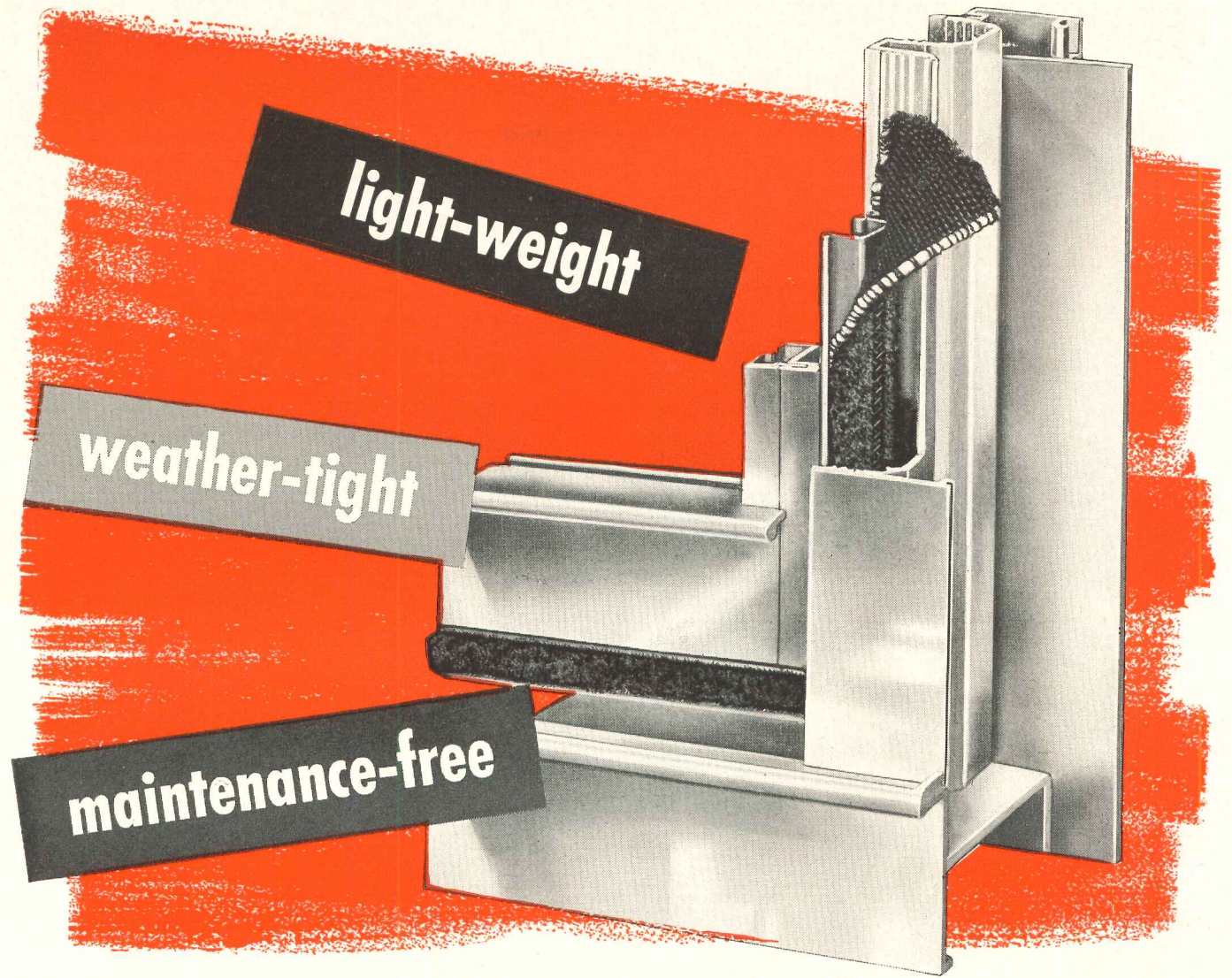

Adlake aluminum windows are ideally suited to curtain wall construction

Although designed for a lifetime of service in *any* building, modern or traditional, Adlake Aluminum Windows are a "natural" for curtain wall installations. Built of lightweight aluminum, they do away with the cost of painting and maintenance, and keep their smart good looks and finger-tip control for the life of the building!

What's more, only Adlake Windows combine woven-pile weather stripping and serrated guides to assure minimum air infiltration. Adlake Windows never warp, swell, rot, rattle or stick, and installation is amazingly simple: *you can complete all exterior work first and then simply set the window in place!*

For complete information, please drop us a card today. Address The Adams & Westlake Company, 1102 N. Michigan, Elkhart, Indiana. No obligation, of course.



THE **Adams & Westlake** COMPANY — *Adlake*
TRADE MARK

Established 1857 • ELKHART, INDIANA • New York • Chicago

When all nations sit down under one roof...

They will sit down under a Barrett* roof. For the architects of the great new building now rising in New York for the United Nations Secretariat chose a Barrett Specification* Roof for its protection.

It often seems as if there were no other roof in the world—at least, no other roof worthy of consideration in those cases where only the best will do! Wherever men build for permanence, wherever an important or monumental building is planned—whether it be a government or office building, a hotel or a huge factory—the architects and builders almost automatically select a Barrett Specification* Roof.

Throughout 95 years, this universal recognition of Barrett superiority has made Barrett the most famous name in roofing. It's your guide to roofing satisfaction. Consult with us, or your local Barrett Roofer, on any roofing or waterproofing problem.

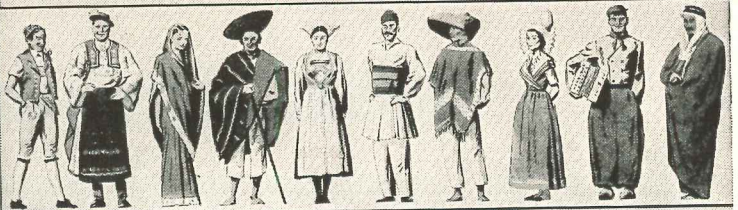

General Cont'r.: Fuller-Turner-Walsh-Slatery, Inc. Arch.: United Nations Headquarters Planning Office. Roofer: The New York Roofing Co. All of New York City.

See Barrett's Catalog in "Sweet's"

THE BARRETT DIVISION
ALLIED CHEMICAL & DYE CORPORATION
40 RECTOR STREET, NEW YORK 6, N. Y.



36th St. & Gray's Ferry Avenue
Philadelphia 46, Pa.

205 West Wacker Drive
Chicago 6, Ill.

1327 Erie Street
Birmingham 8, Ala.

In Canada: The Barrett Company, Ltd.
5551 St. Hubert St., Montreal, P. Q.

*Reg. U. S. Pat. Off.

Designed by
Paul Morris, Hammond, Ind.

Brasco
SAFETY-SET
STORE FRONTS

The
**PERFECT
SETTING**

For
SPARKLING

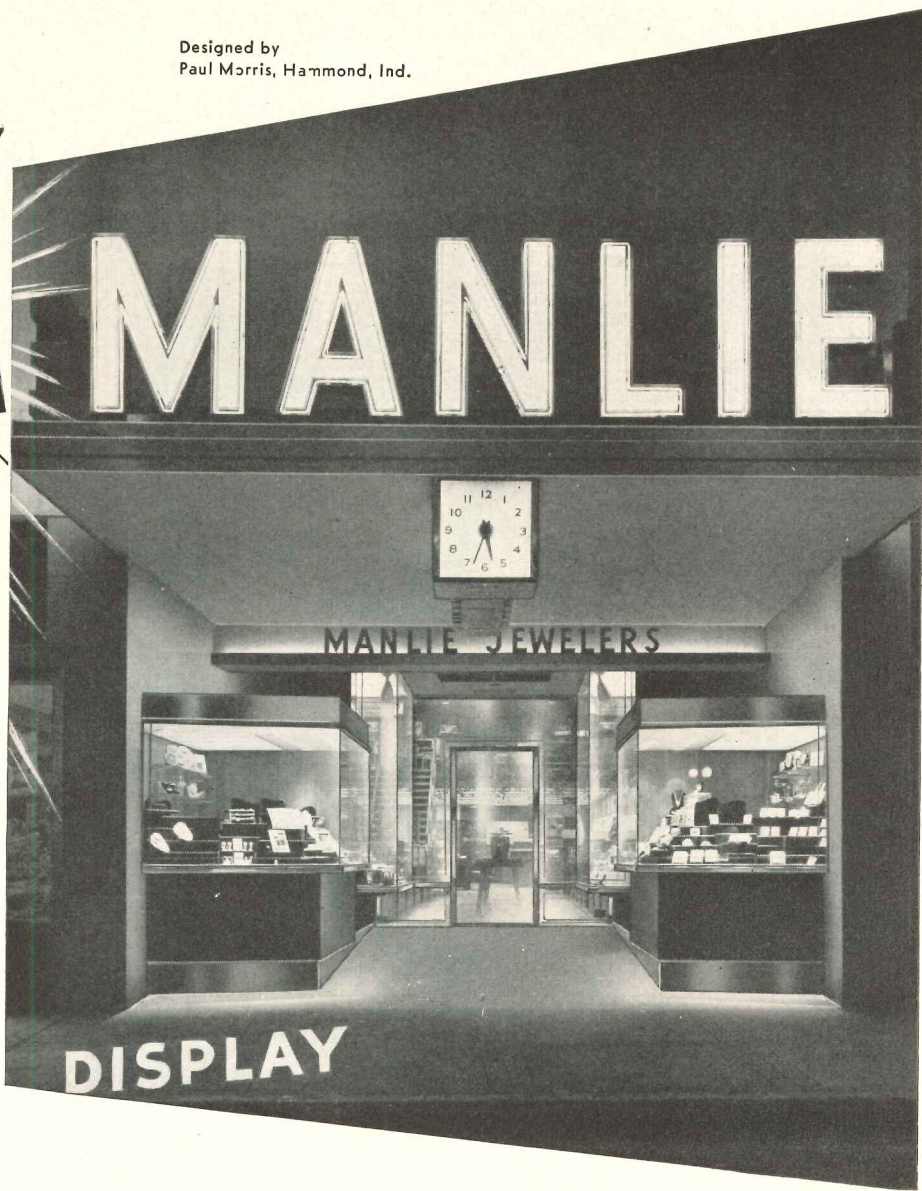

AS the full glory of a precious gem is revealed in its perfect setting, a handsome Brasco Front displays the store's attractions to best advantage. The Brasco setting provides the vital spark that not only commands attention but stirs active interest in the store and its merchandise.

In keeping with modern *Sellevision** design the lower height of Brasco store front sections exposes larger expanses of glass to provide maximum areas of visibility. At the same time the deeper, safer Brasco grip on the glass is fully maintained for positive protection.

Our wide variety of attractive and interchangeable units permits interesting, novel and individualized effects with standard stock members. In handsome stainless steel or anodized aluminum, Brasco Construction will serve admirably regardless of the type of store you are planning. There is a Brasco distributor to render intelligent cooperation wherever you are located. Write for his address. *©



★ ★ A COMPLETE LINE FOR EVERY DESIGN ★ ★

BRASCO MANUFACTURING CO.

HARVEY • (Chicago Suburb) • ILLINOIS

Specialists in Metal Store Front Construction for more than 40 Years

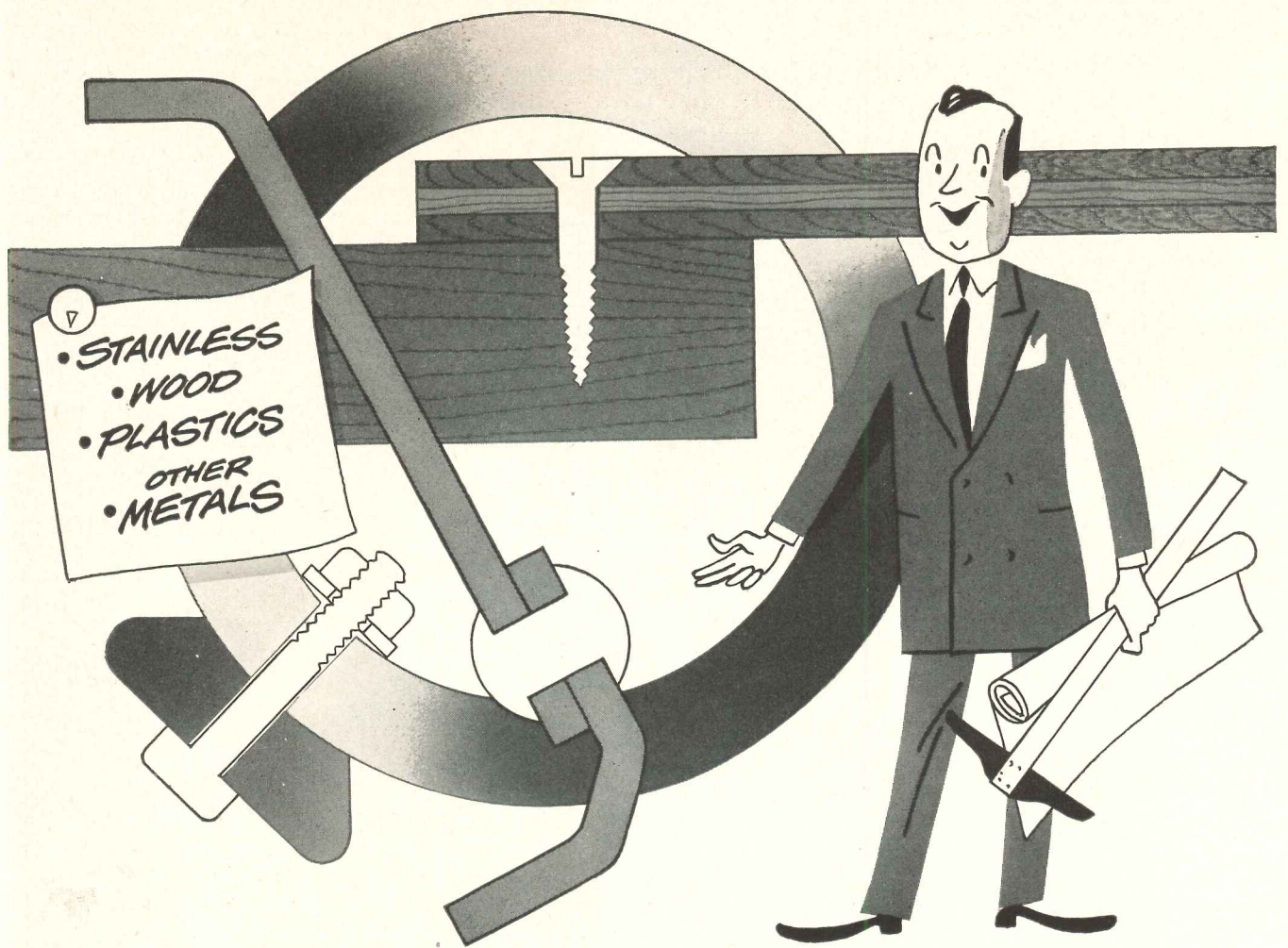

Fasten it with **STAINLESS STEEL**
for Better Looks - Longer Life

**LEADING PRODUCERS
 OF FASTENERS USE
 ALLEGHENY METAL**

A complete line of stainless steel fasteners—all types and sizes of bolts and nuts, rivets, wood and machine screws, cotter pins, washers, etc.—are made of Allegheny Metal by the leading manufacturers in this field. Get in touch with them for catalogs and prices, or write us direct.

ADDRESS DEPT. AR-5

Allegheny Metal fasteners are non-rusting, non-staining. They will last as long as, or longer than, the materials they join. You can count on them to stand up through the years—both in strength and in bright good looks.

Best of all, stainless steel fasteners can be used anywhere. It isn't necessary that the materials to be joined are stainless—these corrosion-proof fasteners are the perfect answer for joining other metals, woods, or plastics. And Allegheny Metal fasteners are available in complete variety—you can obtain exactly what your job requires.

For improving quality and reliability wherever they're used—and for the economy of lifetime service—specify fasteners made of the time-tested stainless steel, *Allegheny Metal*.

**ALLEGHENY
 ALUDLUM**
STEEL CORPORATION
Pittsburgh, Pa.

*Nation's Leading Producer
 of Stainless Steels
 in All Forms*



W & D
 2558

**ALLEGHENY METAL is stocked by all
 Joseph T. Ryerson & Son, Inc. warehouses**

Leading
architects
specify
STANLEY
BALL
BEARING
BUTT
HINGES

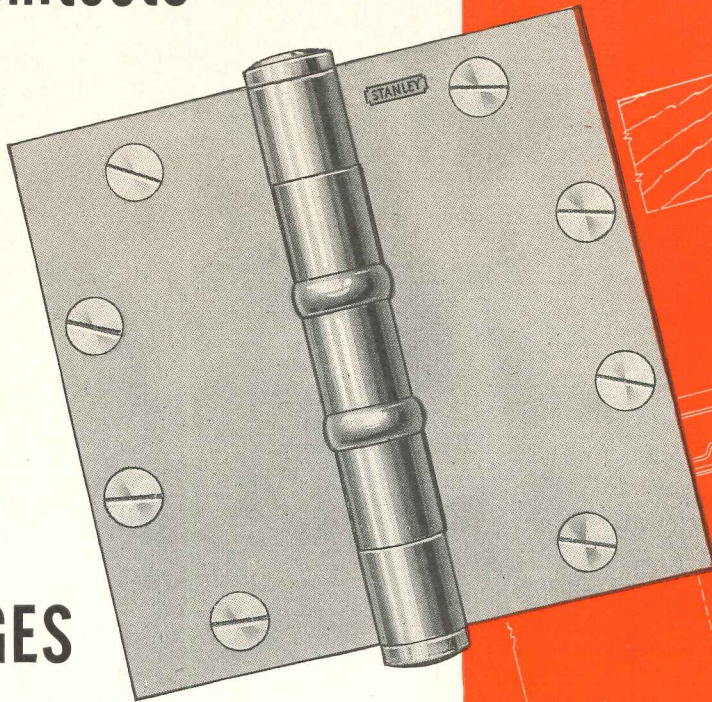

There are two reasons why — to provide easy, quiet, trouble-free door operation, and to hinge doors for the *life* of the building.

Specify Ball Bearing Butt Hinges on all heavy doors and doors receiving high frequency service.

Specify Ball Bearing Butt Hinges on any door using a door closer and on all hollow metal or kalamein doors.

Stanley Ball Bearing Hinges reduce door maintenance to a minimum. Three Ball Bearing Butt Hinges on every door prevent binding and assure satisfactory latch and door operation for the life of the building.

Stanley Ball Bearings are permanently lubricated for life and being thoroughly protected from the elements are ideal for all exterior doors.

Made in extra heavy and standard weights, in full mortise, full surface and half surface types. Obtainable in wrought steel, brass, bronze, stainless steel and aluminum.

For lasting client satisfaction, specify Stanley Ball Bearing Hinges for all industrial, commercial and institutional doors, as well as for exterior doors on every home you plan.

THE STANLEY WORKS, NEW BRITAIN, CONNECTICUT



Reg. U.S. Pat. Off.

HARDWARE • TOOLS • ELECTRIC TOOLS • STEEL STRAPPING • STEEL

REMEMBER



THREE HINGES TO A DOOR

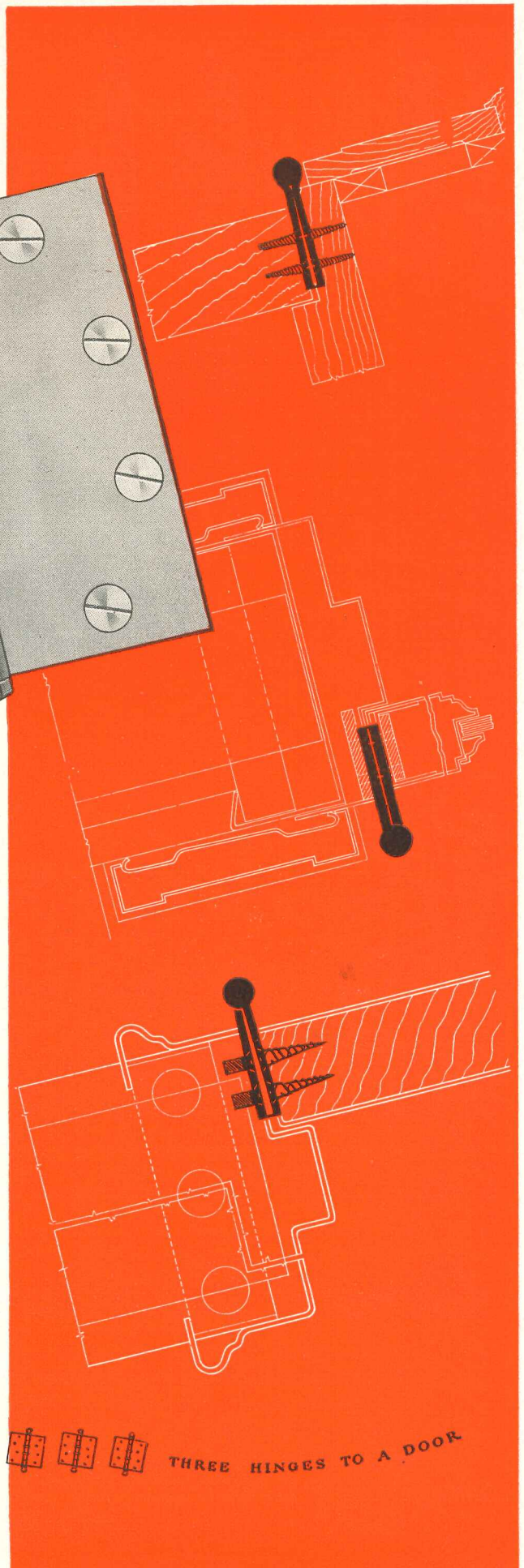

Here's how to start



This St. Louis sales riot is not an unusual event. Rather, it is the typical success pattern of builders all over the country. From Maryland, Colorado, New York and other sections come

similar enthusiastic reports of builders who install General Electric Kitchens. Why not let General Electric help sell *your* houses faster, too?

General Electric offers you all this :

- Tested merchandising programs that have helped so many other builders enjoy phenomenal sales results.
- The brand of electrical appliances that people prefer to all others.
- Assistance in designing and improving kitchen layouts for your houses.
- One source of supply for matched equipment . . . a full line of cabinets and appliances.
- And most important: G-E equipment is world-famous for its dependability! Remember, you can put your confidence in G-E!

a sales riot!

"Rather than spend money to sell our houses, we installed complete General Electric Kitchens so that people would *buy*. Result: We sold 109 houses the very first day!"

Mr. N. R. SCHUERMAN of Schuermann Building & Realty Co., St. Louis, Missouri

Today, more than ever, people want houses that include all-electric living.

They want *low-priced* homes that have kitchens in which dishes are washed and double-rinsed automatically—where there's a Disposall® for food waste.

They want plenty of hot water at all times . . . and they want an electric range that takes the trouble and guesswork out of cooking, and a family-size refrigerator.

What Schuermann did

The Schuermann Building and Realty Company offered the people of St. Louis, Mo., that kind of a house for the full price of \$8995 . . . with less than \$1000 down!

You can see from the photograph at the left what happened. Hundreds of people were waiting to enter the General Electric equipped house at 10:00 a.m. More than 7000 people came out

to see the Schuermann home on opening day. 109 people bought houses the very first day!

A suggestion for you

We would like to work hand-in-hand with you to achieve similar results for *you* in your area. We can help you *pre-sell* your houses just as we have for so many other builders throughout the United States.

Get complete facts about the G-E "Kitchen Package" through your local General Electric distributor, or write to the Home Bureau, General Electric Company, Bridgeport 2, Connecticut.

As little as \$4.80 more a month!

You can include General Electric Kitchens in your houses for as little as \$4.80 a month extra when the G-E "Kitchen Package" is included in the long-term realty mortgage.

Furthermore, the slight increase in monthly payments may be offset by the economical operation, low maintenance and long life of General Electric appliances!



The new Schuermann home and its General Electric Kitchen made a deep impression on future home buyers of St. Louis. It includes: Dishwasher, Disposall®, Refrigerator, Electric Range, and Steel Cabinets. Think how this type of worksaving electric kitchen would stimulate sales of *your* houses!

You can put your confidence in—

GENERAL  ELECTRIC

J. C. PENNEY CO. STORE
 Clearwater, Florida
 Roy W. Wakeling—*Architect*
 R. M. Thompson Co.—*Builders*

*Striking example of today's
 practical use of Enduro-
 Ashlar Architectural Terra
 Cotta. Color is sea green,
 in units 24" x 24".*

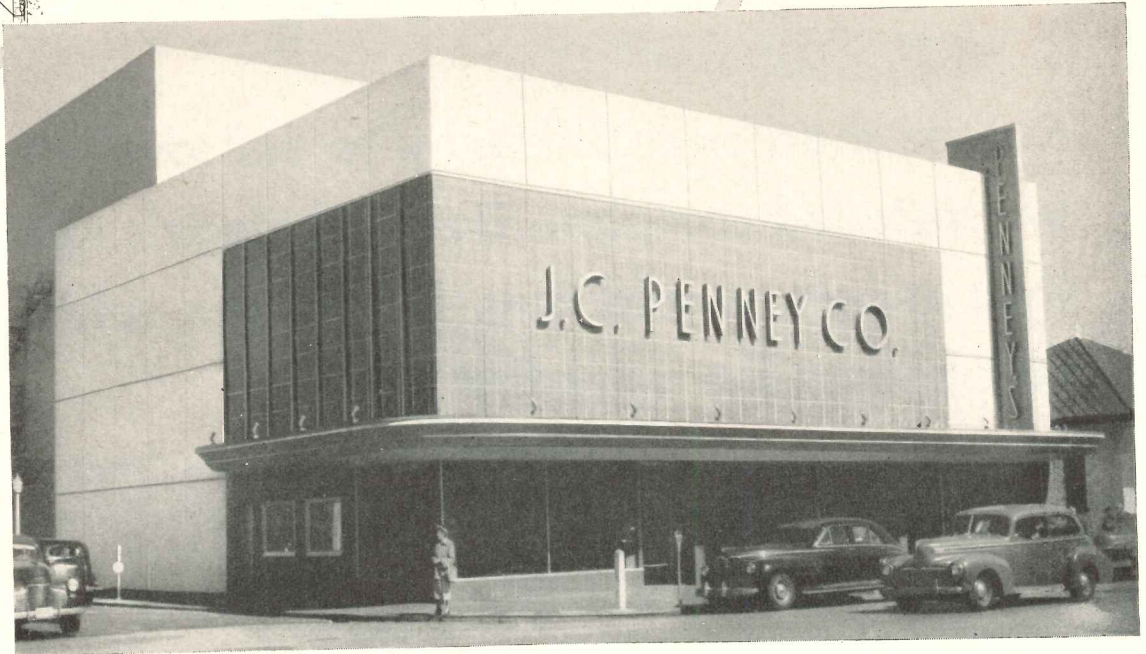
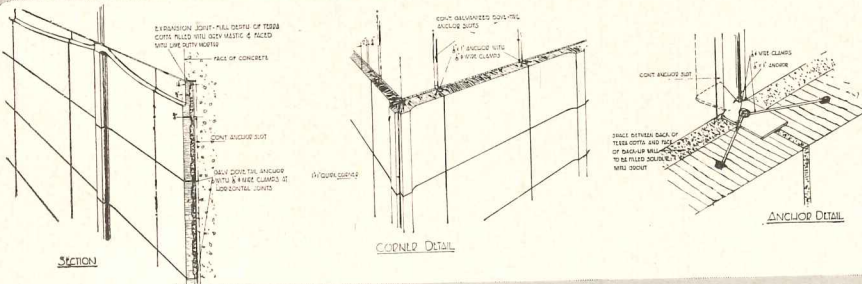

You enjoy complete creative freedom

when you design with

ENDURO-ASHLAR ARCHITECTURAL TERRA COTTA

You can achieve any desired effect with Enduro-Ashlar Architectural Terra Cotta, for it possesses remarkable plasticity of form, color and texture. This time-proved terra-cotta is tailor-made to meet your most exacting requirements—severe surfaces or decorative sculpture, brilliant colors or delicate tints, individual units large or small. This explains why more and more architects are specifying Enduro-Ashlar Architectural Terra Cotta to highlight the modern motif in architecture—for mercantile, industrial and monumental construction, and for modernization. Besides providing maximum appearance, it assures minimum maintenance . . . its original richness and beauty can be retained indefinitely by simple soap and water washings.

Construction detail, data, color samples, estimates, advice on preliminary sketches, will be furnished promptly without charge. Send your inquiry today.

FEDERAL SEABOARD TERRA COTTA CORP.



10 EAST 40th STREET, NEW YORK 16, N. Y.
 PLANTS AT PERTH AMBOY AND SOUTH AMBOY, N. J.



MENDEL

*means QUALITY
in Hollow-Core*

FLUSH DOORS

- 1** Balanced seven-ply construction to provide controlled reaction in changing weather conditions.
- 2** Hardwood construction throughout—stronger, more durable, free from grain-raising, more easily and economically finished.
- 3** Exclusive Insulok grid core material has inherent resiliency, cannot cause warping, nor transfer grid pattern to faces.
- 4** Greater strength. Adequate core stock surface area provides maximum gluing surface and resistance to warpage.
- 5** Precision key-locked dove-tail joinings of stiles and rails add strength and stability.
- 6** Ready to finish. Door faces are smoothly belt-sanded. Stiles are machine-planed at factory—prefit to standard book sizes.
- 7** Fully guaranteed. Each door must meet rigid quality control standards and constant inspection throughout manufacture.
- 8** Mengel Flush Doors are economical—no mouldings to paint—no corners to collect dirt. Smooth hardwood surfaces are less absorbent and less costly to finish—easier to clean and longer-lived.

Write for complete specifications. Use the coupon.

Also see—
MENDEL STABILIZED SOLID-CORE DOORS
the finest products of their type on the market.

The Mengel Co., Plywood Division
2314 South Fourth Street, Louisville, Ky.

Gentlemen: Please send me, without obligation,
full specifications on Mengel Hollow-Core Flush
Doors; Mengel Stabilized Solid-Core Doors.

Name _____

Street _____

City _____

State _____

KENTILE

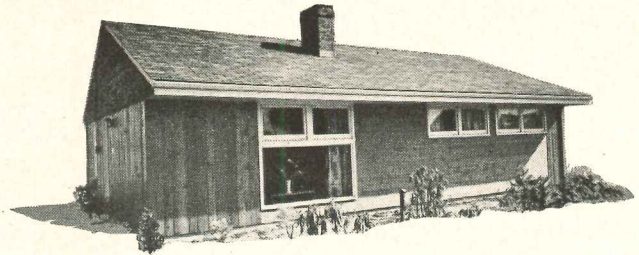

One of the 100 New Low-Cost homes with Kentile throughout. Built by Gordon Bronson, C. E. in New Brunswick, New Jersey. Kentile installed by Tucker Linoleum Co., Newark, N. J.

Helped Cut Costs of Ranchero Villa!



Beautiful low-cost flooring

used throughout this model home is KENTILE. Chosen for its quality, durability and low cost—Kentile offers small-home builders unlimited design possibilities plus every advantage that helps make new homes more saleable on today's competitive market. Ideal for use in every room, from the living room to bath and kitchen... Kentile provides the perfect flooring for economy-minded architects, builders, and contractors.

Specify Kentile for "On Grade" Installations

As the diagram shows, Kentile can be installed on concrete in direct contact with the earth... another saving feature for builders of the popular non-basement homes. All fillers, binders and pigments used in Kentile have high resistance to alkali in concrete. And, Kentile's asbestos filler helps insulate against the cold and dampness of concrete floors. Kentile is highly recommended for radiant-heated floors, too. It can also be installed over double T&G wood floors, or over plywood.

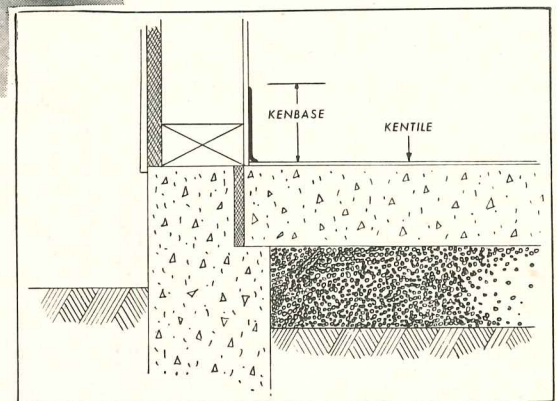

Specify Kentile for Quick, Cost-Cutting Installation...

... Because Kentile is laid tile by tile, it can be installed faster and with less labor cost. Construction work is not held up as it can be walked on as soon as it is laid. Kentile "seats" well, will not curl from moisture or dampness.

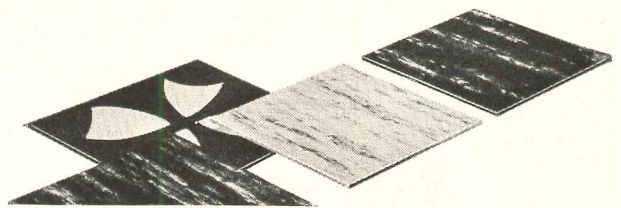

KENTILE®

The Asphalt Tile of Enduring Beauty



DAVID E. KENNEDY, INC., 58 Second Avenue, Brooklyn 15, N. Y.

RESILIENT FLOORING FOR OVER FIFTY YEARS... KENTILE • RUBBER TILE • KENCORK



LNT1P Panelboard with "sequence bussing"

INSTALLATION AND INSPECTION TIME HAVE BEEN REDUCED to a minimum in the re-designed FA LNT1P PANELBOARD with "sequence bussing."

This method of bussing cuts installation time . . . speeds up inspection time due to the simplified sequence arrangement of circuits . . . and provides better balance of load because adjacent circuits are of opposite polarity.

Also featured in the improved LNT1P is a new 4-circuit standardized section with heavy-duty, 30-amp. single pole tumbler switches and plug fuses.

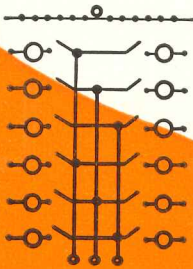

**provides
better
balance
of load**

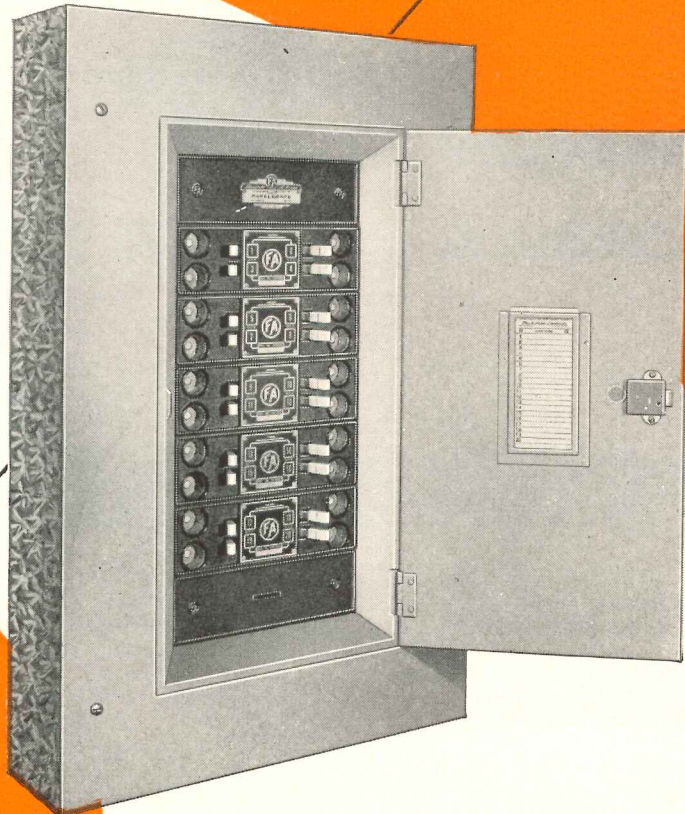

All parts, including switches, are applied from the rear to make the LNT1P a safety-type panelboard under all operating conditions . . . no removable covers to become loose or fall off due to tampering.

Capacities: 30 amp., 250 volt switches, 4 to 40 branches for 3 or 4 wire solid neutral mains . . . 200 amp. maximum capacity . . . with main lugs or safety type main fuse disconnect.

For more information about this lighting panelboard and other FA Panelboards, contact your nearest FA Representative (he's listed in Sweet's) . . . or write for Bulletin 301.



Frank Adam Electric Co.

ST. LOUIS 13, MISSOURI

Makers of BUSDUCT • PANELBOARDS • SWITCHBOARDS • SERVICE EQUIPMENT • SAFETY SWITCHES • LOAD CENTERS • QUIKHETER

IN CHICAGO
as elsewhere

Wheeling is

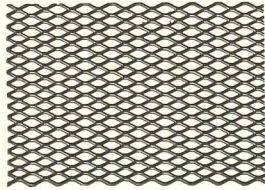

Wheeling Diamond Lath
Standard and Bantam Mesh

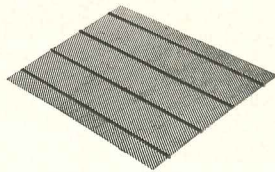

Wheeling Bar-X-Lath
With solid steel ribs



Wheeling Flat Rib
Metal Lath

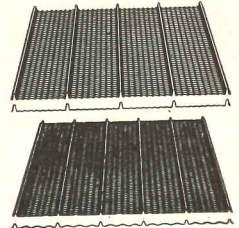

Wheeling $\frac{3}{4}$ " and
 $\frac{3}{8}$ " Rib Lath

A FULL LINE OF HIGHEST QUALITY STEEL BUILDING PRODUCTS TO CHOOSE FROM.



Wheeling Corner Lath
An improved cornerite



Wheeling Strip Lath
For strengthening joints

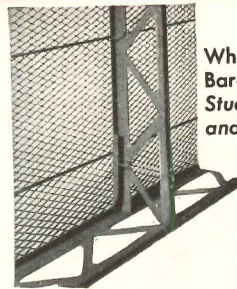

Wheeling
Bar-Z-Partitions
Studs, track,
and Shoes

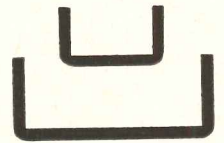

Wheeling Cold
Rolled Channels

WHEELING PRODUCTS ARE ALWAYS QUICKLY AVAILABLE AT 15 CONVENIENT

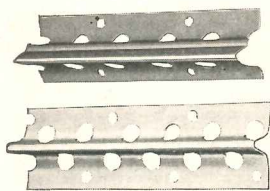

Wheeling Curved and
Straight Point Base Screed

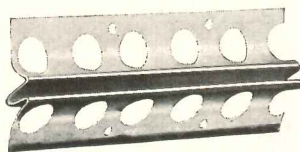

Wheeling Metal
Picture Mould



Wheeling Bull
Nose Bead

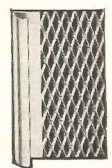

Wheeling Casings
and Corner Grounds

WRITE FOR FREE BULLETINS... SPECIAL INFORMATION ABOUT YOUR PROBLEMS...



Wheeling Flattened
Expanded Metal

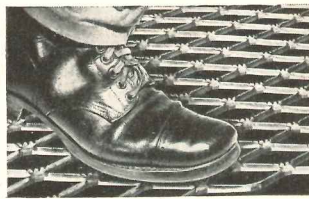

Wheeling Anti-Skid,
Expanded Metal



part of the skyline

Why Leading Architects in Every City Turn to Wheeling...

Architects and builders everywhere know that the best design and workmanship require the finest materials. 60 years of skill and experience are behind each product that bears the well known Wheeling Red Label. Without exception, Wheeling products are completely dependable, give complete satisfaction.

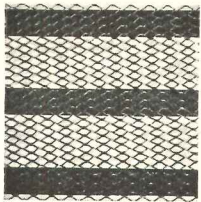

Wheeling Combination Lath. Diamond or Bar-X-Lath

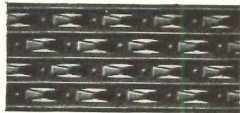

Wheeling Arch Lath For extra fire resistance

YEARS OF RESEARCH AND SKILL BACK EACH WHEELING-DESIGNED PRODUCT.

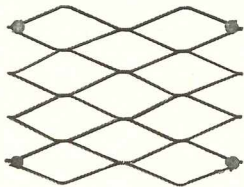

Wheeling Stucco Binder Mesh

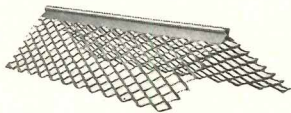

Wheeling Expansion Corner Bead



Wheeling Flat Apron Corner Bead



Wheeling Scallop Edge Corner Bead

WAREHOUSE POINTS • CARRIED BY LEADING BUILDING MATERIAL DEALERS EVERYWHERE.

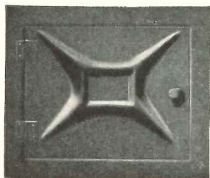

Wheeling Ashpit and Clean-out Doors



Wheeling Coal Doors

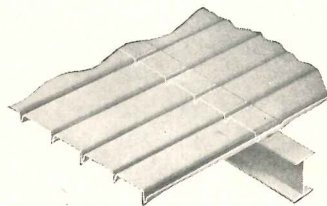

Wheeling Tri-Rib Roof Deck



Wheeling Expanded Metal

OR COMPLETE SATISFACTION, SPECIFY WHEELING

WHEELING CORRUGATING COMPANY

BUILDING MATERIAL DIVISION

WHEELING, WEST VIRGINIA

ATLANTA BOSTON BUFFALO CHICAGO CLEVELAND COLUMBUS DETROIT KANSAS CITY
LOUISVILLE MINNEAPOLIS NEW ORLEANS NEW YORK PHILADELPHIA RICHMOND ST. LOUIS



Your Right-Hand Man

FOR EVERY SOUND CONDITIONING PROBLEM!

YOUR local distributor of Acousti-Celotex products is an expert in modern Sound Conditioning—ready, willing *and able* to help any time your need arises. His professional training and experience encompass every type, size and technique of acoustical installation. His complete, quality line of products includes the best possible solution for every Sound Conditioning requirement.

Why guess, when this qualified member of the world's largest and most experienced Sound Conditioning organization is yours to consult *without obligation*? For any requirement, specification or building code, your Celotex distributor has the job-proved

methods and materials you want. And it pays to contact him in the "planning stage." He can assure you the lasting beauty and quiet of *correct* Sound Conditioning—in *advance*!



ACOUSTI-CELOTEX
TRADEMARK REGISTERED U. S. PAT. OFF.

Sound Conditioning Products

PRODUCTS FOR EVERY SOUND CONDITIONING PROBLEM

120 S. La Salle St., Chicago 3, Illinois
Dominion Sound Equipments, Ltd., Montreal, Quebec, Canada

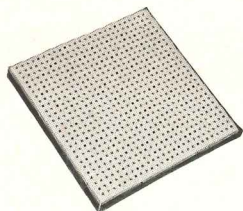

ACOUSTI-CELOTEX*
CANE FIBRE TILE

A lightweight, rigid unit, combining acoustical efficiency with a durable, smooth surface. Perforations (to within $\frac{1}{8}$ " of the back) assure repeated paintability, easy maintenance. Available in a variety of sound-absorbent ratings. Dry rot proofed by exclusive Ferox* process.



ACOUSTI-CELOTEX*
MINERAL TILE

Made of mineral fibre, felted with a binder to form a rigid tile with a universal rating of incombustibility. Perforated with small holes extending almost to the back, this tile provides high acoustical absorption plus unrestricted paintability by either brush or spray method.

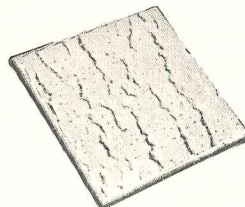

ACOUSTI-CELOTEX
FISSURETONE*

A totally new mineral fibre acoustical tile. Attractively styled to simulate travertine. It beautifies any interior and effectively controls sound reverberation. Lightweight, rigid and incombustible, it is factory-finished in a soft, flat white of high light-reflection rating.

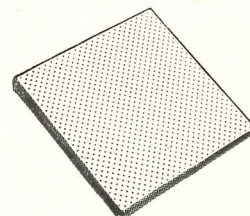

ACOUSTEEL*

Combines a face of perforated steel with a rigid pad of sound-absorbing Rock Wool to provide excellent sound-absorption, together with attractive appearance, durability and incombustibility. The exposed surface of perforated steel is finished in baked-on enamel. Acousteel is paintable, washable, cleanable.

*Trademarks Reg. U. S. Pat. Off.

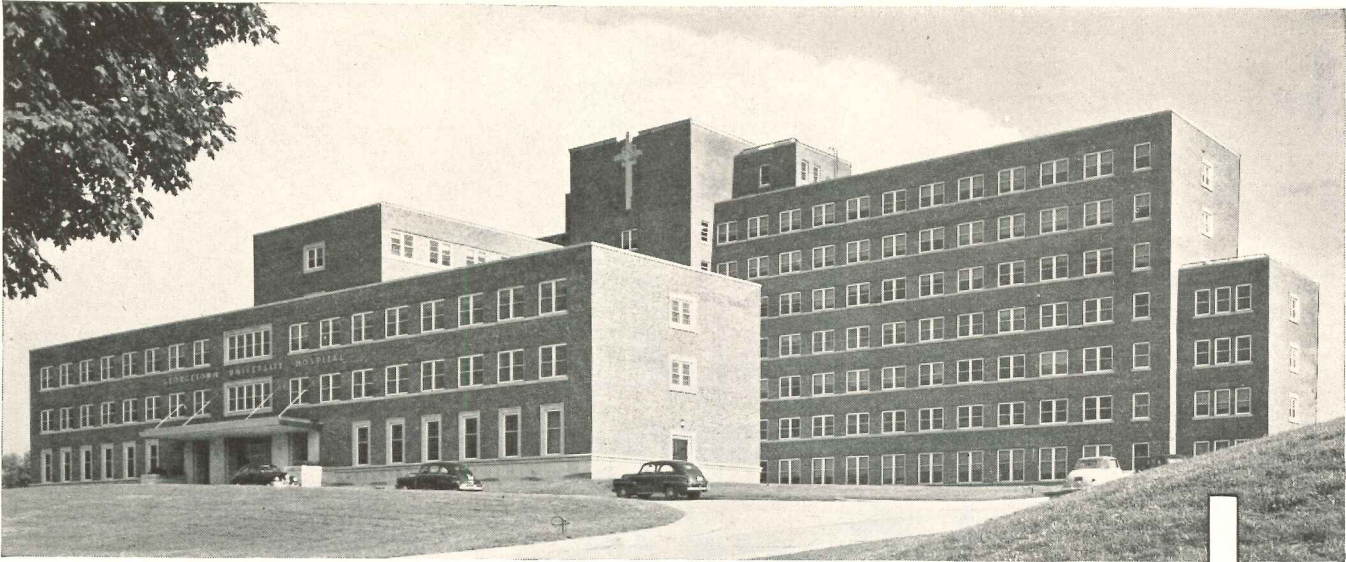

Georgetown University Hospital, Washington 7, D. C. Heated by 4-zone Webster Electronic Moderator System of Steam Heating. Architects: Kaiser, Neal & Reid, Pittsburgh, Pa. Consulting Engineer: F. J. Firsching, Pittsburgh. General Contractors: John McShain Co., Washington, D. C. Heating Contractors: Standard Engineering Co., Washington, D. C.

3-Year Heating Record

Report of Chief Engineer Sam S. Shepherd Georgetown University Hospital

"In my opinion, the Webster Moderator System embodies the best features to be found in controls for heating systems.

"As we have it here, the Webster Moderator System coupled with a properly installed zone system makes it possible for us to prevent underheating in severe weather and—even more important—we do not overheat in mild weather or during days with a normal variation in the outside temperature.

"My records show clearly that with the Moderator in use, the consumption of fuel for heating purposes follows very closely the degree day demand.

"This is encouraging to the operating engineer because he knows that here is a means to prevent waste of fuel from the very sources which are most prevalent in uncontrolled heating systems.

"Our installation is reasonably new. We are now in the third year of operation. Very few parts have been replaced and the control system is operating at peak efficiency."

at Georgetown University Hospital

How the Webster Moderator System meets comfort requirements without wasteful overheating has been demonstrated in the new Georgetown University Hospital.

With the Webster Electronic Moderator System, this well-managed institution enjoys "Control-by-the-Weather" comfort. Each of the 779 radiators gets heat in the amount needed.

The report on the effectiveness of the Webster Moderator System was made by Sam S. Shepherd, Chief Engineer of the Hospital since its completion in 1947 and prior to that Chief Engineer of Georgetown University. Careful operation and a vigilant maintenance program have been important factors in the success of the heating installation.

In choosing the Webster Moderator System, designers of Georgetown University Hospital did not experiment. Similar Webster Moderator Systems serve in such outstanding institutions as the U.S. Naval Hospital, Bethesda, Md., Delaware Hospital, Wilmington, Del., Our Lady of Lourdes Hospital, Camden, N. J., and many others.

For further information, address Dept. AR-5

WARREN WEBSTER & COMPANY

Camden 5, New Jersey : : Representatives in Principal Cities

In Canada, Darling Brothers, Limited, Montreal

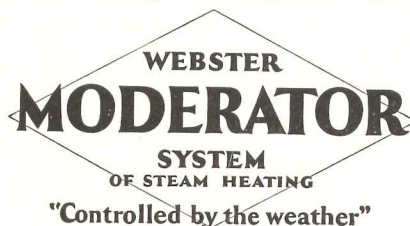

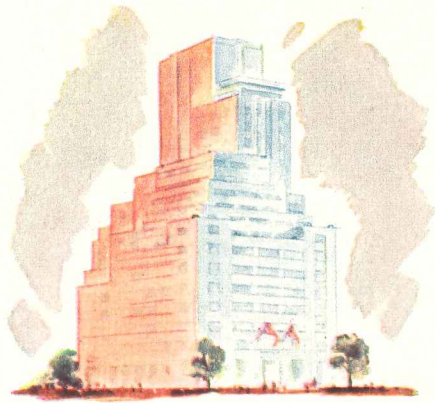

CROWELL-COLLIER'S New Headquarters Are

Patterned for Progress

MILLS MOVABLE METAL WALLS

Can be Rearranged Quickly and Easily to Fit
Changing Space Requirements



Mills Walls create pleasant, efficient environments. Baked-on enamel finishes require no maintenance but occasional washing to keep fresh new look. Air conditioning, light and phone lines are in separate lay-in raceways in panel connections, cornice, base.

THE walls throughout this modern building are Mills Walls — as beautiful, solid and permanent as walls can be. They are distinguished by the refinement of their architectural design, their structural stability, their pleasing soft colors, their glareless finishes.

Yet they can be moved in a matter of hours to fit new office layouts without interrupting business routine. Complete changes can usually be made overnight or during a weekend.



Maximum mobility with minimum labor is the result of 30 years experience, all-welded panel prefabrication. Wall sections are moved intact, all parts reused.



Dignity and beauty are keynotes of Mills Walls for executive offices. All surfaces are perfectly flush and specially treated to eliminate harsh light reflection, walls completely insulated and sound-proof, lifetime finishes available in any shade or color. Complete responsibility for design, construction, installation is characteristic of Mills service.

*for Tomorrow
as well as today*

★ **MILLS** *Movable* **METAL WALLS** ★

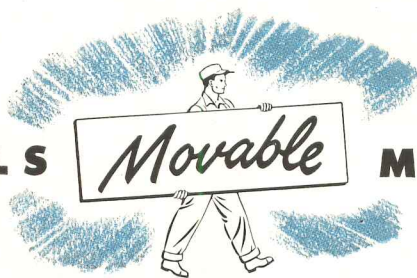

● Crowell-Collier Building
640 Fifth Avenue, New York
Architects: Leonard Schultze and Associates
Builders: Starrett Brothers & Eken, Inc.
Photographs: Hans Van Nes

complete information, descriptive literature write: **THE MILLS COMPANY • 961 WAYSIDE ROAD • CLEVELAND 10, OHIO**

STEEL FRAMING A CHURCH WITH MACOMBER NAILABLE STEEL TRUSSES AND JOISTS



MACOMBER NAILABLE ROOF TRUSSES

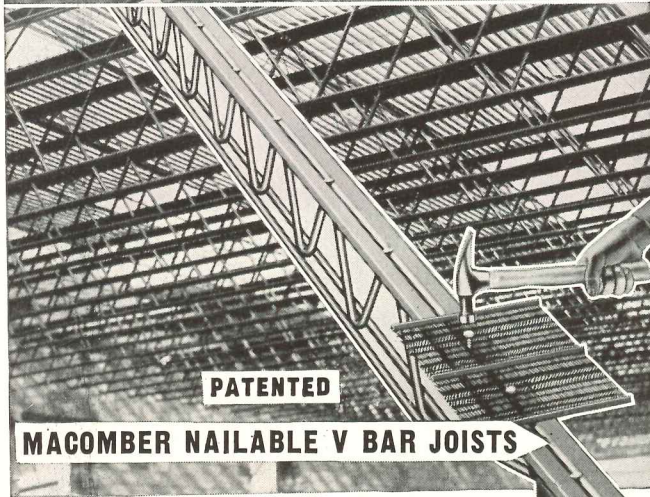
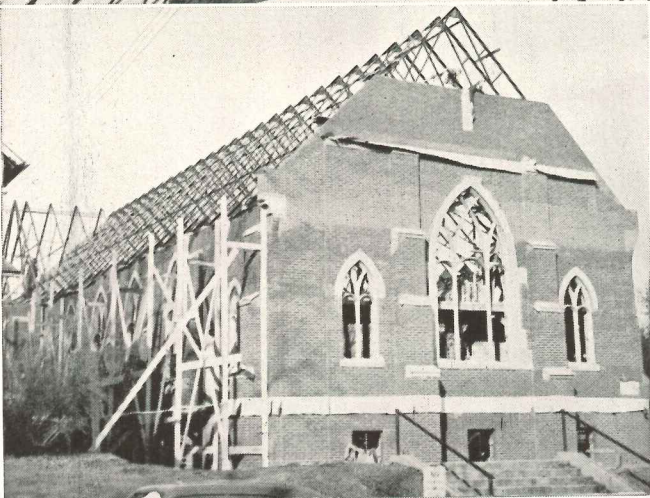

PATENTED

MACOMBER NAILABLE V BAR JOISTS

FOR SPANS 4 TO 40 FEET

Here is an example of Macomber Light Steel Framing as produced for Apartment Houses, Schools and Churches.

The light steel trusses and open web rafters are fabricated from the Macomber Nailable V Section, providing secure nailing for roof and ceiling finishing materials.

In the village church job shown here, designed in the form of a cross, trusses were centered at four feet and braced into a rigid, rugged structural plan.

Macomber 40 foot Nailable Steel Joists span the width of the auditorium and support the floor slab.

These framing systems provide an abundance of strength without excessive weight and bring overall costs down to a minimum. Write for further information.

Send for. NAILABLE V JOIST CATALOG.

STANDARDIZED STEEL BUILDING PRODUCTS

MACOMBER • INCORPORATED

CANTON, OHIO

**IN CANADA, SARNIA BRIDGE CO., LIMITED, SARNIA, ONT.
IN MEXICO D. F.—MACOMBER DE MEXICO S. A. CEDRO 500**

V BAR JOISTS • LONGSPANS • BOWSTRING TRUSSES • STEEL DECK



YOU CAN BE **SURE**.. IF IT'S
Westinghouse

Specify **BUS DUCT**
 for Hotels

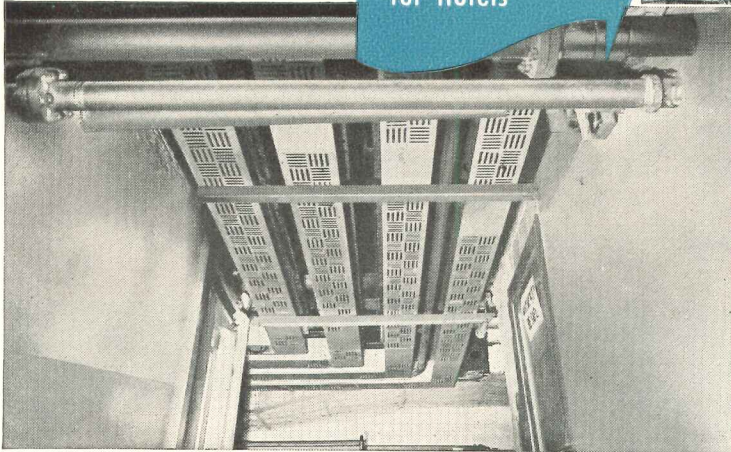

*Rice Hotel, Houston, Texas
 Architect: Kenneth Franzheim, Houston
 Mechanical Engineer: Reg. F. Taylor, Houston
 Electrical Contractor: Fischbach & Moore of Texas,
 Inc., Houston
 Load: 3,000 kva for power and lighting to serve 1,000
 guest rooms, ballrooms, banquet rooms, dining rooms*



Rice Hotel *REMODELS and SAVES* with **Low Impedance Bus Duct**

While the basic advantage of using bus duct is to secure more adequate secondary power distribution, the choice of bus duct should not stop there.

Take the case of the installation limitations at the Rice Hotel, Houston. The problem: to completely remodel and air condition from basement to penthouse—and without interruption of “business as usual”.

The answer: Westinghouse Low Impedance Bus Duct. Its compact design and freedom from protruding members permitted passage in places where dimensions were critical. Limited space, because of pipe and air duct systems, ruled out

ordinary wiring, as well as other makes of bus duct.

Ask your nearby Westinghouse representative to tell you all the advantages of Westinghouse Bus Duct, available in four popular types. Or write Westinghouse Electric Corporation, P. O. Box 868, Pittsburgh 30, Pennsylvania. J-30012

Westinghouse



BUS DUCT

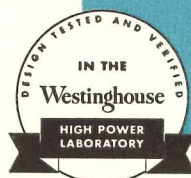

Wood Gutter of Douglas Fir

Wood Gutter of Douglas Fir is another Special 4-Square Lumber Product that can admirably serve designers of good homes. It is a superior building product that delivers greater value, longer life and substantial beauty.

In the New England states, Wood Gutter has been a preferred material since Colonial days. It is also widely used on the West Coast. Put into place when the cornice is built, Wood Gutter becomes a permanent part of the house structure . . . with durable

West Coast Douglas Fir, the first cost is the last cost except for an occasional coat of paint. Replacement is rarely necessary.

Wood Gutter completes a wood house. Architects find in this durable product a valuable aid in creating modern homes. Wood Gutter becomes a graceful, permanent unit that contributes much to the finished appearance of a fine home. Architects who specify 4-Square Wood Gutter find it to be a time proved product which is readily installed, at low final cost.

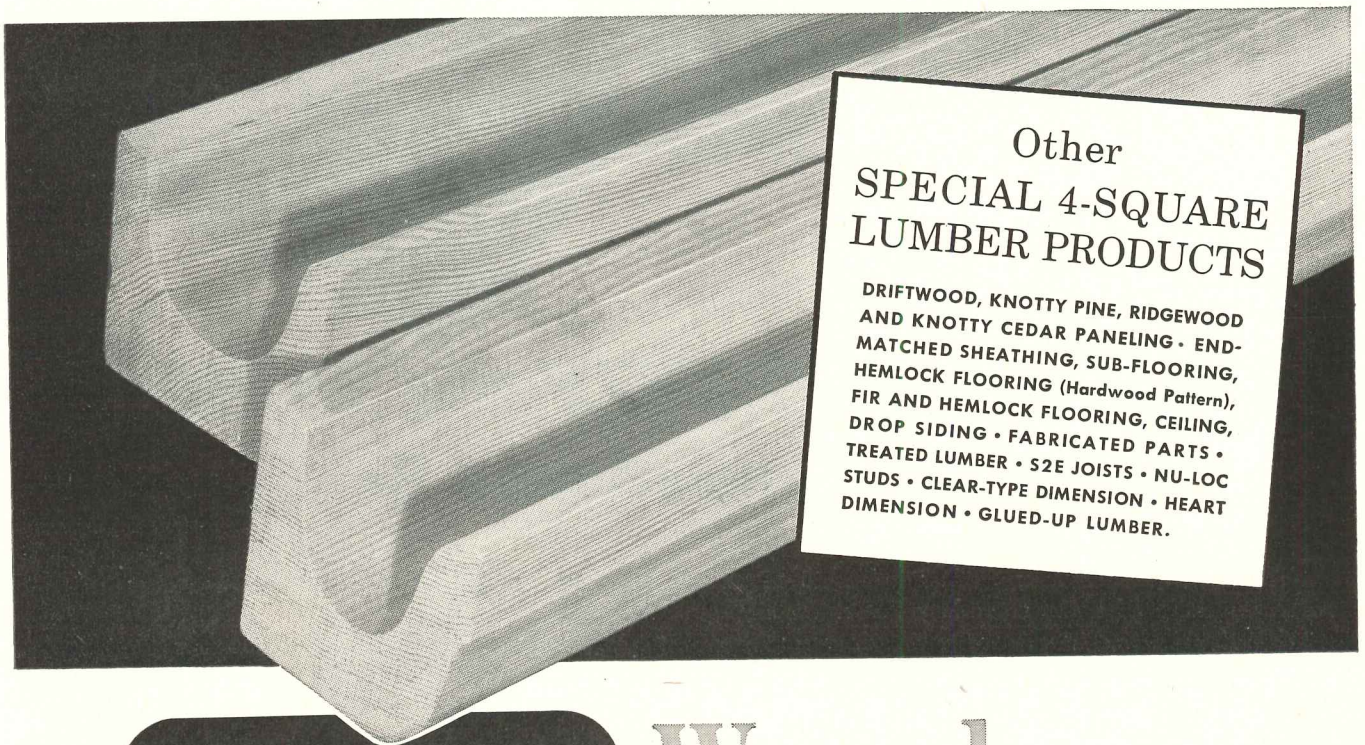

Other SPECIAL 4-SQUARE LUMBER PRODUCTS

DRIFTWOOD, KNOTTY PINE, RIDGEWOOD
AND KNOTTY CEDAR PANELING • END-
MATCHED SHEATHING, SUB-FLOORING,
HEMLOCK FLOORING (Hardwood Pattern),
FIR AND HEMLOCK FLOORING, CEILING,
DROP SIDING • FABRICATED PARTS •
TREATED LUMBER • S2E JOISTS • NU-LOC
STUDS • CLEAR-TYPE DIMENSION • HEART
DIMENSION • GLUED-UP LUMBER.

Design for
COMFORT, BEAUTY
and ECONOMY
with
**SPECIAL 4-SQUARE
LUMBER PRODUCTS**

Weyerhaeuser 4-Square

LUMBER AND SERVICES

WEYERHAEUSER SALES COMPANY
ST. PAUL 1, MINNESOTA

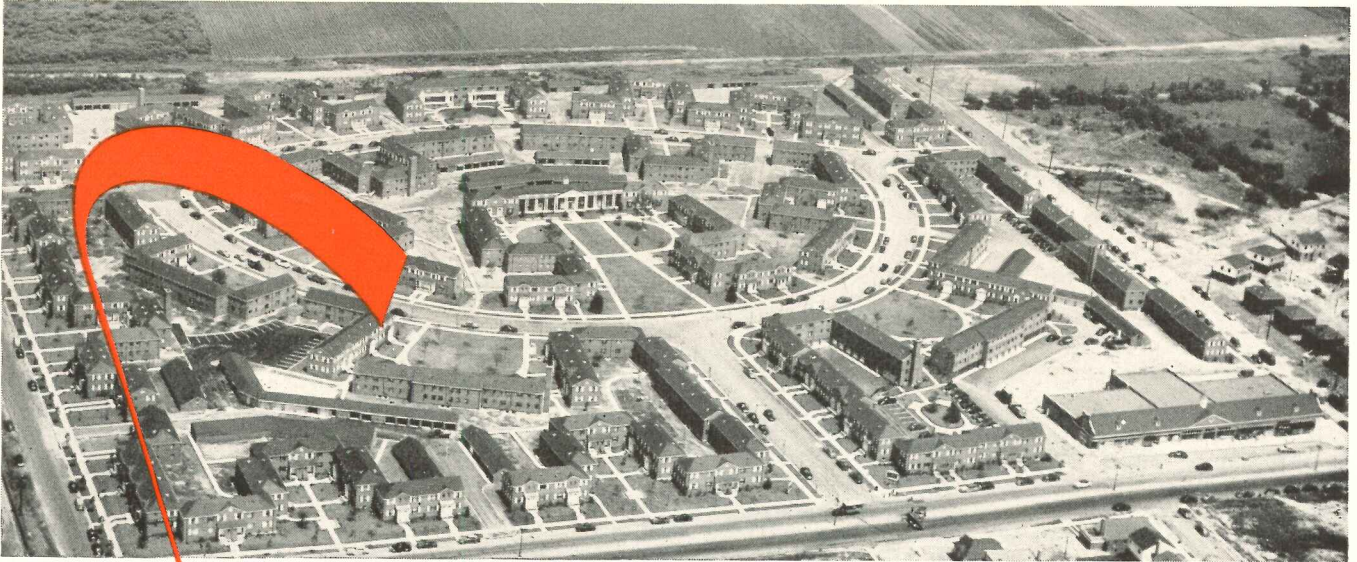

576 families live in this modern housing development in Queens, N. Y. The entire project is heated by a B & G Hydro-Flo System supplied by sixteen boilers in eight boiler rooms.

NO JOB TOO **BIG** OR TOO **SMALL** FOR B & G *Hydro-Flo** HEATING

It is not just happenstance that the popularity of B & G *Hydro-Flo* Heating grows steadily, year after year. You find this *forced hot water* system in buildings of every size and character, simply because it offers completely outstanding advantages.

B & G *Hydro-Flo* Heating is amazingly economical in operation—delivers years of trouble-free service—and provides the kind of comfort *obtainable only with controlled radiant heat*. And B & G *Hydro-Flo* Heating is competitive in price with heating systems worthy of the name!

The close temperature regulation possible with *forced hot water* means that fuel is never wasted in supplying unnecessary heat. Indoor temperature is maintained by accurate controls at the comfort level, regardless of how sharply the weather changes.

Whether radiators, convectors, baseboards or radiant panels are used, B & G *Hydro-Flo* Heating sets the pace for efficiency, low maintenance and comfort.

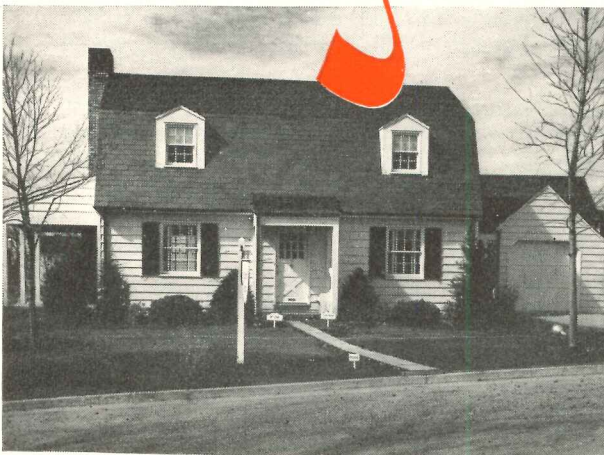

This modest residence enjoys the comforts of controlled radiant warmth from a B & G *Hydro-Flo* System.

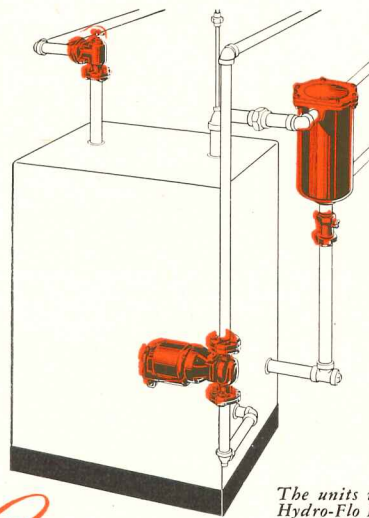

Best for any kind of radiation



The units required for B & G *Hydro-Flo* Heating are few and simple. They can be applied to any hot water heating boiler, whether oil, gas or stoker fired.



BELL & GOSSETT

Dept. BM32, Morton Grove, Ill.

Company

* Reg. U. S. Pat. Off.



5 fixture per hour rate
 proves how easy it is to install
LITECONTROL units

GEORGE'S MARKET, Watertown, Conn.

Engineer: Raymond Mills, Connecticut Light and Power Co., Waterbury.
 Electrical Contractor: Walter Greason, Oakville, Conn.
 Lighting Equipment: Litecontrol No. 4124, 2-lamp louvered fixture, surface mounted.
 Lamps: 40 watt, white, fluorescent.
 Watts per fixture: 100.
 Watts per square foot: 2.9.
 Average intensity in service: 50 footcandles.

IN ONLY TWO DAYS . . . 16 hours in all . . . three men installed all eighty fixtures in this Connecticut supermarket.

It's not surprising though, for Litecontrol fixtures are designed for *faster installation* as well as for *better lighting results*. Their extra sturdiness eliminates sag . . . makes the contractor's job easier and ensures longer service for the owner. Smart design features speed assembly . . . speed cleaning and relamping.

Litecontrol engineers are experts in planning *better* fixtures. Experts, too, in planning installations that display products to best advantage to boost both sales and profits. Why not write today for the Litecontrol catalog . . . for help in planning *your* lighting layouts?

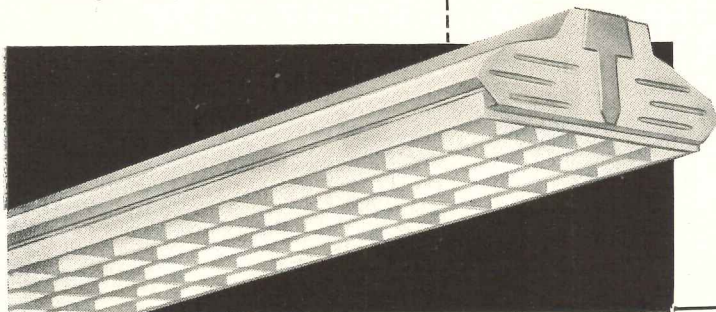

The LITECONTROL No. 4124 fixture . . .

is a shallow unit well suited for stores, offices, etc. Though moderately-priced, it has the smart, graceful lines that ensure good-looking lighting installations. Sturdily constructed, it is electrostatically sprayed with white enamel to give a high reflection factor. Mount it on the ceiling or on pendants, singly or in continuous runs.

Cat. No.	No. of Lamps	HOUSING			Approx. Ship. Weight
		Length	Width	Height	
4124	2-40W	49"	12"	5 1/4"	33 lbs.
4044	4-40W	49"	16"	5 1/4"	44 lbs.



LITECONTROL

Fixtures

KEEP UPKEEP DOWN

LITECONTROL CORPORATION

36 PLEASANT STREET, WATERTOWN 72, MASSACHUSETTS

DESIGNERS, ENGINEERS AND MANUFACTURERS OF FLUORESCENT LIGHTING EQUIPMENT DISTRIBUTED ONLY THROUGH ACCREDITED WHOLESALERS

HOME BUYERS
WANT...

COLOR

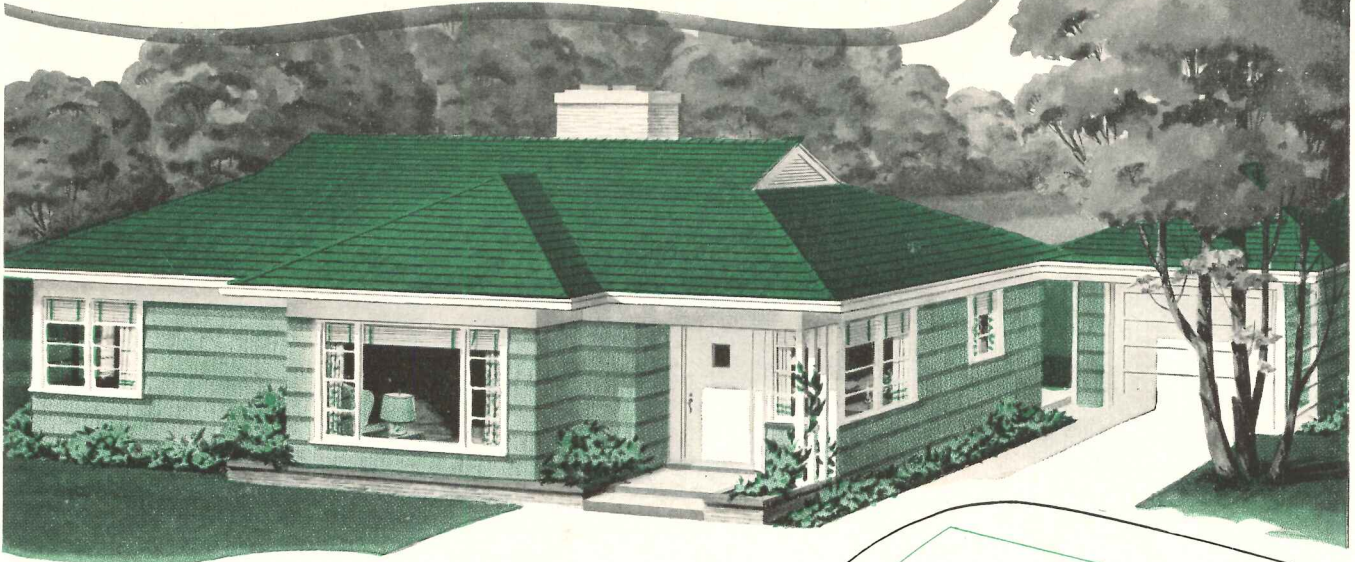

**PRE-STAINED
CEDAR SHAKES**

ARE COLORFUL, BEAUTIFUL, ECONOMICAL

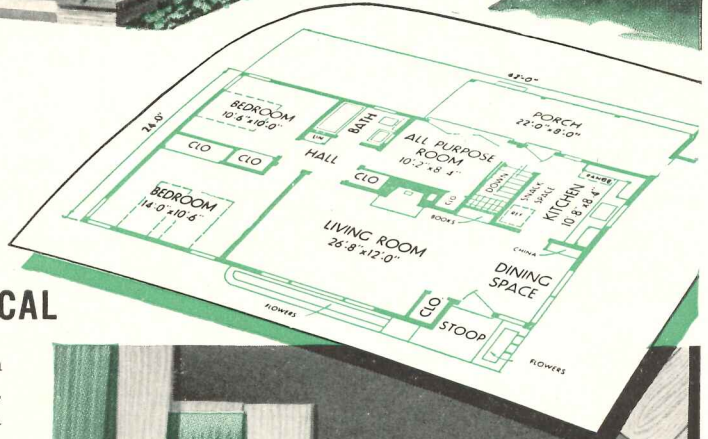

THERE'S NO SECRET about the phenomenal increase in demand for pre-stained cedar shake walls. Architects, Builders and Retail Lumber Dealers all over America report that in this age of color, *pre-staining* has made cedar shingles and shakes easier to use and easy to sell.

As the powerful advertising campaign of the Stained Shingle & Shake Association informs more and more of the home-buying public about the beauty, color and economy of shake walls, it becomes increasingly obvious that no other material has such wide popular acceptance.

If you design homes and have not used pre-stained cedar shakes, refer to the complete specifications in Sweet's File 8b/9. The combed texture, clean-cut parallel edges and squared butts of pre-stained processed shakes will interest you. Specify shakes for full walls, gables or other details.

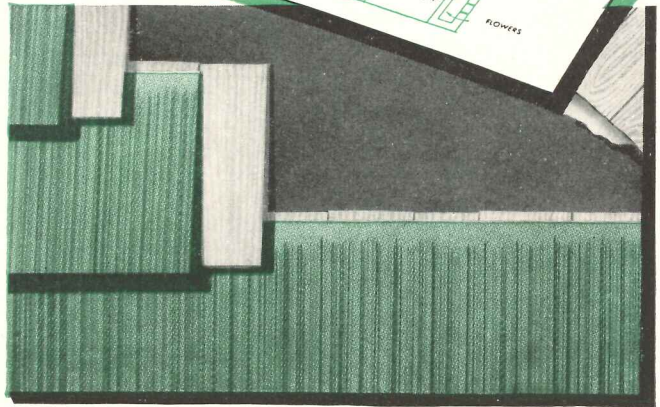

FOR DOUBLE-COURSED WALLS

Pre-stained cedar shakes are applied over inexpensive courses of low-grade cedar shingles. The double thickness permits greater weather exposure of the quality shakes, builds a beautiful, durable exterior wall, in a wide range of colors, at a cost that is within the reach of all new home builders. For remodeling, cedar shakes are applied right over virtually any existing surface.

CERTIGRADE SHINGLES

GROOVED BY MACHINE

SCIENTIFICALLY STAINED

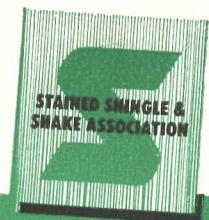
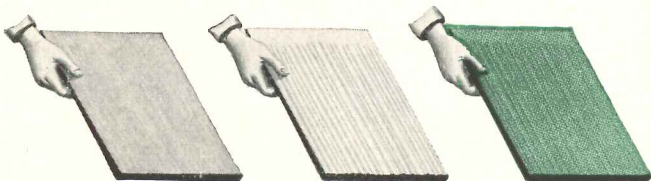

STAINED SHINGLE & SHAKE ASSOCIATION • 835 CENTRAL BLDG. • SEATTLE 1, WASH.



KEWANEE

STEEL BOILERS

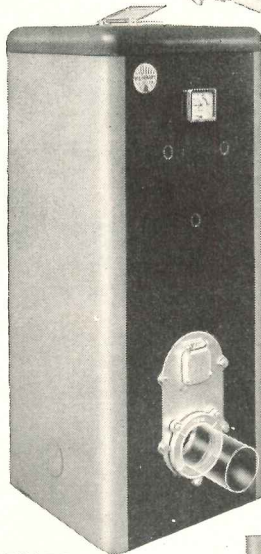

KEWANEE Cottage Boiler
Vertical Tubestyle for hot water heat in small homes.

Whether heated with conventional radiators, wall, floor or ceiling panels, or radiant baseboard . . . with oil, gas or coal (hand or stoker fired) . . . there is a Kewanee Steel Boiler just right for the purpose. And each size and type provides that extra dependability with economy of fuel which has made Kewanee Boilers famous for more than 80 years.

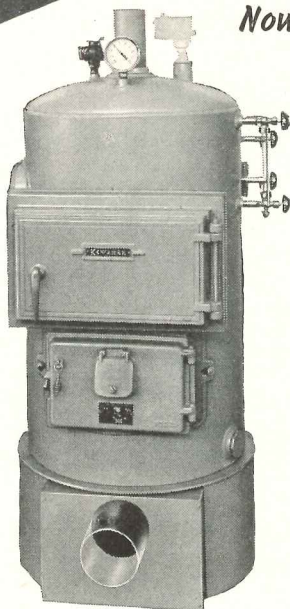

KEWANEE Round Type "R"
330 to 900-sq. ft. steam radiation. Jacketed or un-jacketed.

Now—for the budget home there is the new Kewanee Cottage Boiler; a sturdy steel vertical tube unit in a smart two-tone green, insulated jacket. Rated to produce 77,000 Btu, this Kewanee is capable of producing enough extra heat to take care of overloads of 50% and more.

As an additional feature, a built-in copper coil water heater provides an abundance of hot water for kitchen, bath and laundry. Yet, with all of these "big boiler" characteristics, the Cottage Boiler is so priced that it comes well within the limits of the modest budget.

For Large Homes and Medium Size Buildings

Type "R" Square Heat fills a long felt need. It is built in 8 sizes to heat 740 to 3000-sq. ft. steam radiation; or 1180 to 4800-sq. ft. water radiation; and capable of operating at full efficiency whether the boiler is just "loafing along" in mild weather or being pushed far beyond its rated capacity when temperatures tumble below zero.

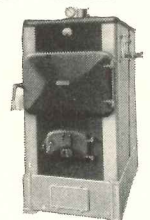

KEWANEE BOILER CORPORATION

BOILERMAKERS 80 YEARS KEWANEE, ILLINOIS
Branches in 60 Cities—Eastern District Office: 40 West 40th Street, New York City 18
Division of AMERICAN RADIATOR & STANDARD SANITARY CORPORATION

Serving home and industry

AMERICAN-STANDARD • AMERICAN BLOWER • CHURCH SEATS • DETROIT LUBRICATOR • KEWANEE BOILERS • ROSS HEATER • TONAWANDA IRON

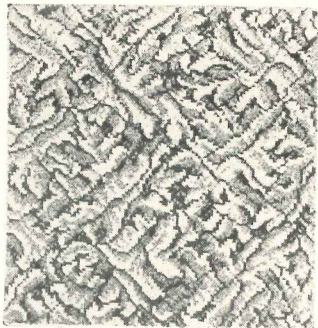
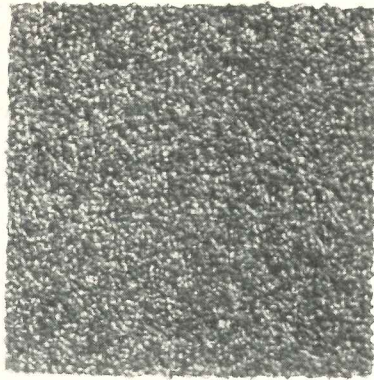

**Business is on the carpet
and carpet is our business**

You want the best carpet your clients' money can buy. You want the right weave, for the wear the carpet must take. You want the right color and design, for the decorative effect you have in mind. Your local Alexander Smith-Masland carpet contractor will show you the different carpet weaves, and tell you the wear you can expect from each. He will show you the dozens of patterns and colors Alexander Smith and Masland offer you in contract carpeting. He will estimate the cost, for you, of any carpet installation. He is a contract carpet specialist. Let him help you. Call him, today..



**Alexander Smith
and
C.H. Masland**

CONTRACT CARPETS
295 Fifth Ave., New York 16, N. Y.,



TRUSCON
Double-Hung
STEEL
WINDOWS
SERIES 138

solve *quality*
 problems...

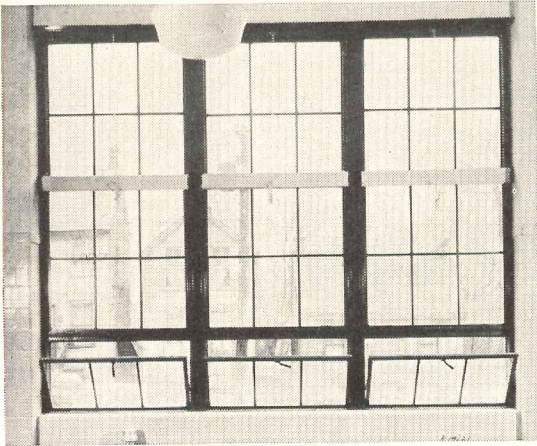

(Left) Interior and exterior views of Truscon Series 138 Double-Hung Steel Windows in North Street School, Hagerstown, Maryland. A. J. Klinkhart, Architect. N. S. Early & Son, General Contractor. Top photo shows window with sill ventilator. Bottom photo also shows Truscon Donovan Steel Windows used in school gymnasium. Truscon Series 138 Double-Hung Steel Windows in Park Lake Apartments, Hempstead, Long Island, New York. Samuel Paul Associates, Jamaica, New York, Architects. Sol G. Atlas, Great Neck, New York, Contractor.

with *economy* prices

The Truscon Series 138 Double-Hung

Window has a high-style appearance with a common-sense price. It is so smart, so sensible, so dollar-saving that in standard designs it may be used with a generous hand in any size or type of residential structure. The sill-vent design is particularly adaptable for use in schools. Sash members are of welded tubular construction. Long, quiet, trouble-free action assured by motor-type spring balances with tapes of Republic Enduro Stainless Steel. Complete factory weatherstripping in stainless steel. Modular standards. Wide range of types and sizes offers unusual design opportunity.

Free illustrated literature on request.

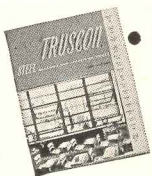

FREE book on Truscon Steel Windows, write for it. The Truscon Steel Company manufactures a Complete Line of Steel Windows and Mechanical Operators... Steel Joists... Metal Lath... Steel-deck Roofs... Reinforcing Steel... Industrial and Hangar Steel Doors... Bank Vault Reinforcing... Radio Towers... Bridge Floors.

TRUSCON STEEL COMPANY
 Subsidiary of Republic Steel Corporation
 YOUNGSTOWN 1, OHIO
 Warehouses and sales offices in principal cities

Aerofuse on STATE STREET Chicago



AEROFUSE IN BASKIN'S
(Home of Hart, Schaffner & Marx Clothes)



AEROFUSE IN BOND CLOTHES



AEROFUSE IN SPIEGEL, INCORPORATED



AEROFUSE IN F. W. WOOLWORTH COMPANY

At vital point of air delivery on the outstanding air conditioning jobs along Chicago's busy State Street — and as a matter of fact throughout the Windy City — Aerofuse Diffusers are specified and installed. From their own experience, the men responsible for the efficient performance of these installations know they can depend on Aerofuse to meet the most rigid requirements of air distribution. From the standpoint of appearance, they agree that Aerofuse Diffusers are styled to harmonize with the most modern architectural design.

For details of the complete Aerofuse line, size selection information and engineering data . . . write for Catalog 102.

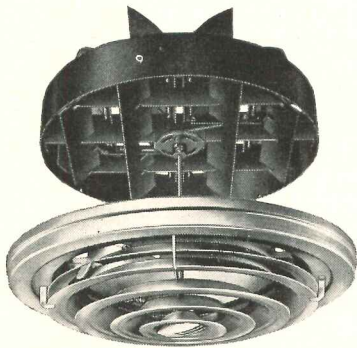

TYPE EAC

Typical of advanced Aerofuse engineering, Type EAC, equipped with manually-operated auxiliary effective area control ring, provides a simple method of varying performance by on-the-job adjustment of throw. No. 4 Control Unit insures minute regulation of volume.

OTHER TYPICAL AEROFUSE INSTALLATIONS IN CHICAGO

- Carson, Pirie, Scott Co.
- Sears Roebuck & Co.
- The Merchandise Mart
- The Chicago Tribune
- Kraft Foods Co.
- Walgreen Co.
- Blue Cross Plan for Hospital Care
- Bonwit-Teller Co.
- University of Illinois
- Wieboldt Stores, Inc.
- Wm. Wrigley, Jr. Co.

TUTTLE & BAILEY inc

NEW BRITAIN, CONNECTICUT

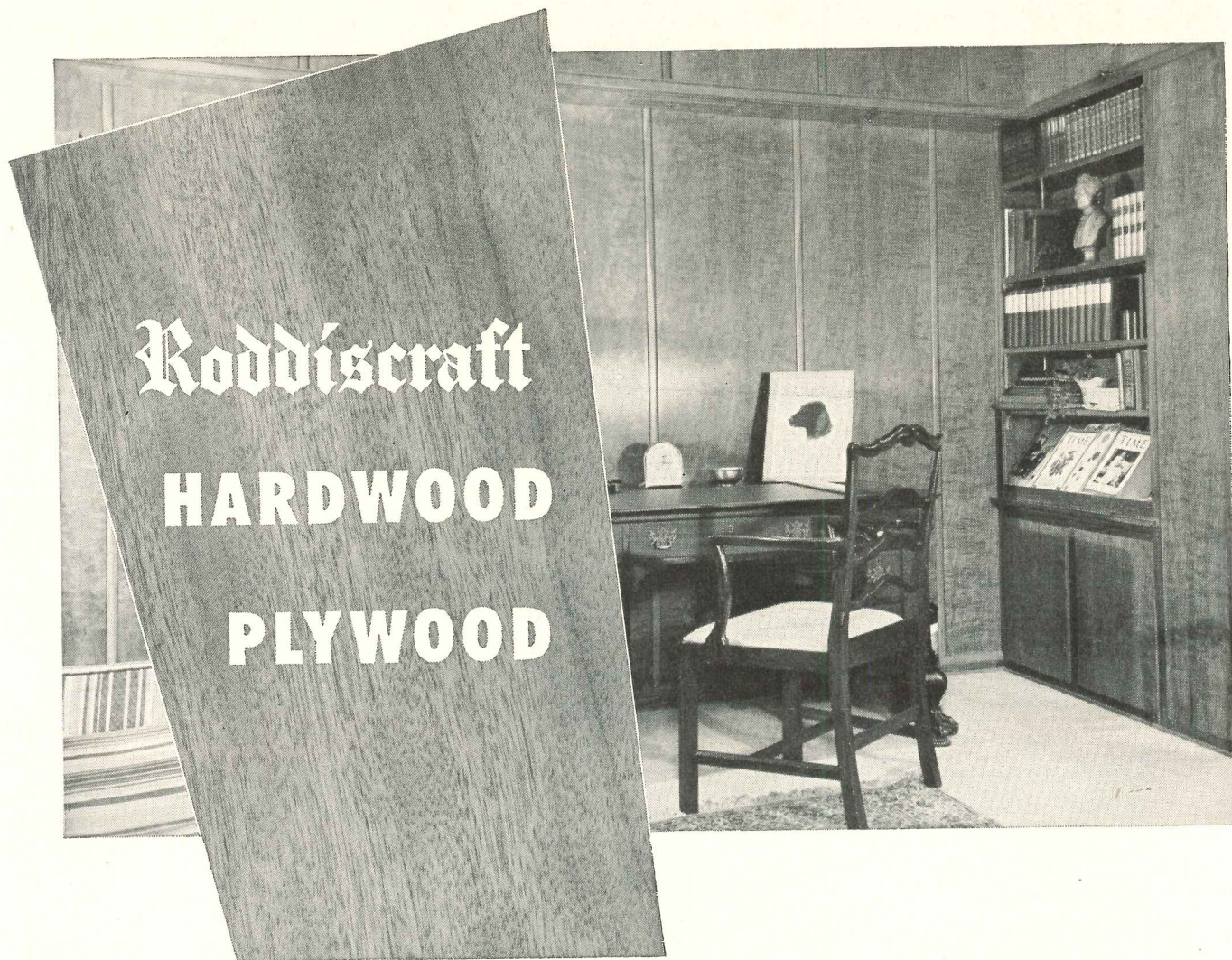

Roddiscraft Paneling Invites the Question . . . WHO IS YOUR ARCHITECT?

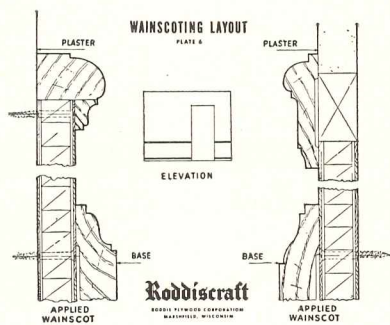

Large detail drawings of this item and other wainscoting layouts are available on request. Write for wainscoting layout charts Nos. 10-15.

There's a lot of extra value built into the home designed and supervised by an architect — things you can't see. But there are extras you can see, too.

Plywood paneling is often the hallmark of the architect-designed home. Plywood by Roddiscraft, with its beautiful figure, carefully selected for uniformity and exact matching around the room, just naturally invites the question — "Who is your architect?"

When you specify Roddiscraft hardwood plywood, you are sure of a quality product, fashioned by craftsmen — carefully made. You know that its true-cut edges and satin smooth finish will insure an installation that reflects credit on you.

Roddiscraft has prepared architect-approved details showing various methods of panel installation. Your nearest Roddiscraft warehouse has these drawings which are yours for the asking. Just drop them a line.

NATIONWIDE Roddiscraft WAREHOUSE SERVICE

Cambridge 39, Mass. • Charlotte, N. C. • Chicago 32, Ill. • Cincinnati 2, Ohio • Dallas 10, Texas • Detroit 14, Mich. • Houston 10, Texas • Kansas City 3, Kan. • L. I. City, N. Y. • Los Angeles 11, Calif. • Louisville 10, Ky. • Marshfield, Wis. • Milwaukee 8, Wis. • New York 55, N. Y. • Port Newark 5, N. J. • Philadelphia, Pa. • St. Louis, Mo. • San Antonio, Texas • San Francisco 24, Calif.

Roddiscraft

RODDIS PLYWOOD CORPORATION
Marshfield, Wisconsin

An Important Statement by BENJAMIN

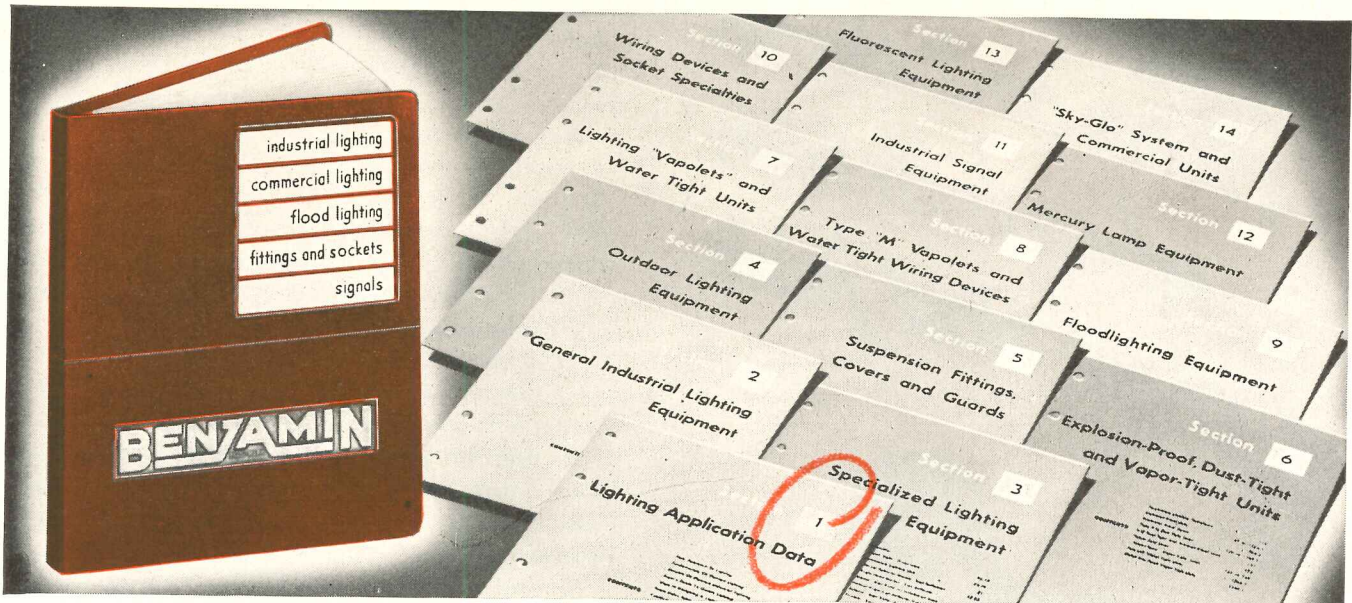

Concerning the NEW BENJAMIN CATALOG REPRINT

For architects... engineers... electrical contractors
and others having repeated need for lighting equipment data.

The Benjamin Catalog is generally accepted as the most complete and authoritative presentation of industrial and commercial lighting equipment. As the leading source of information, the demand for copies has long exceeded the supply. The expense of production of a book of this magnitude has of necessity limited the number printed. Further to those who recommend, plan or specify lighting equipment, the new reprint contains much

additional information of extreme value, such as:

- An Entirely New 32-Page Section 1 on Lighting Equipment Application.

New specification data and listings of all New Benjamin Lighting Equipment Advancements such as:

- "Sky-Glo" Luminous Louvered Ceilings.
- "Magna-Flo 75" Fluorescent (for new 96" lamps)
- "Vapor-Tite", "Sealed-Flo 40" and TX Units for damp and dusty location lighting.
- Recessed Mounted Fluorescent Units.
- "Shield-Flo" Fluorescent.
- "Spring-Lox" Lampholders.

DISTRIBUTION of the new 424-page catalog reprint has been in progress since last January. You may have received your copy upon the request of a Benjamin Representative or Distributor. However, if you did not

receive it as yet, may we restate our previous announcement: "Benjamin wants everyone who has repeated and continuous use for the catalog to have one without cost or obligation of any kind. Distribution is restricted solely to insure such persons obtaining their copy."

Further, we are most anxious that such persons SECURE THEIR COPIES IMMEDIATELY to avoid disappointment through the exhaustion of our limited supply. To insure your obtaining your copy, please send in your request immediately, on your company letterhead, giving your full name, title and department.

Section 1 of the Catalog Reprint is Available in Booklet Form

All those interested in Planned Lighting
and all those whose present Benjamin catalog data is not up-to-date or sufficient
are urged to obtain a FREE COPY.

So that no one may be without the valuable information contained in the new Section 1 of the Reprint Catalog, this 32-page section is being made available without cost or obligation to all who write for it.

Entitled "Manual of Lighting Application Data", the booklet brings you the principles and data needed to develop good planned industrial lighting installations. Shows how to insure success of Planned Lighting through proper application of 12 basic Benjamin Light-



ing Systems; how to provide required illumination levels from 10 to 150 footcandles; how to apply the 12 systems to solve specific lighting problems; how the use of the 12 systems simplifies planning, helps determine proper equipment selection. Replete with tables, charts and layout suggestions. No one interested in lighting should be without the assistance and information contained in this Section 1 of the Catalog and now available in separate booklet form. Write today.

BENJAMIN ELECTRIC MFG. CO., Dept. Q-1, DES PLAINES, ILLINOIS

R-5045

Makers of BENJAMIN LIGHTING EQUIPMENT Sold Exclusively Through Electrical Distributors.

Floors can't shrink
when built with
these steel joists

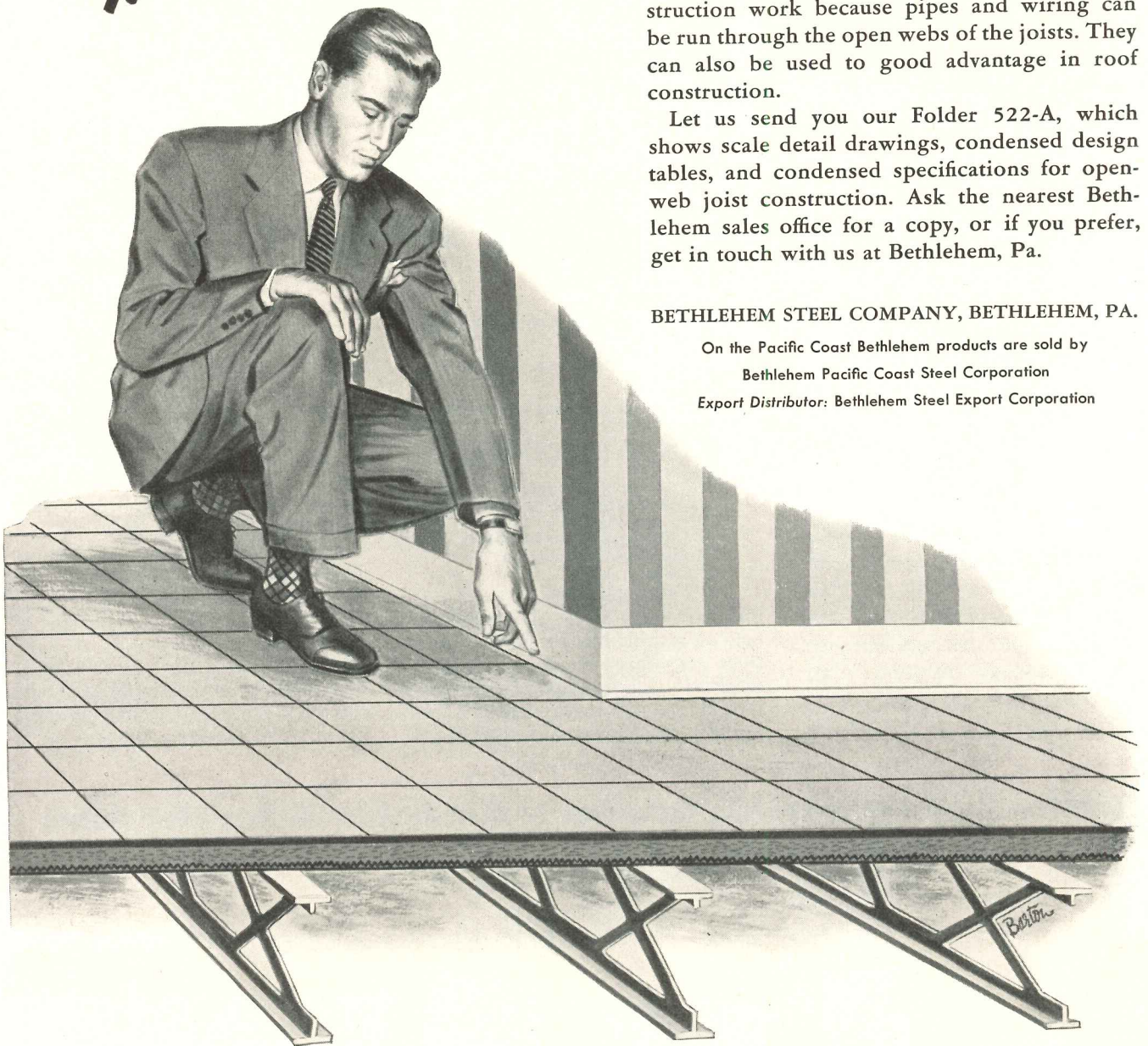

All too often, floors shrink to cause wide, unsightly cracks between floor and baseboard—cracks which catch dirt and provide excellent breeding places for insects and vermin. This defect can be avoided in new buildings by using open-web steel joists in the floor construction.

Bethlehem Open-Web Steel Joists are ideal for use in homes and light-occupancy structures because, when combined with concrete floor slab and plaster ceiling, they provide a type of floor construction which can't shrink. Floors built with these joists stay firm and true for the life of the structure.

Bethlehem Open-Web Joists are also non-combustible. They minimize vibration, and are immune to attack by vermin. They simplify construction work because pipes and wiring can be run through the open webs of the joists. They can also be used to good advantage in roof construction.

Let us send you our Folder 522-A, which shows scale detail drawings, condensed design tables, and condensed specifications for open-web joist construction. Ask the nearest Bethlehem sales office for a copy, or if you prefer, get in touch with us at Bethlehem, Pa.

BETHLEHEM STEEL COMPANY, BETHLEHEM, PA.

On the Pacific Coast Bethlehem products are sold by
Bethlehem Pacific Coast Steel Corporation

Export Distributor: Bethlehem Steel Export Corporation



BETHLEHEM OPEN-WEB JOISTS

2 NEW RICHMOND WARM-AIR UNITS

Designed for Economical Gas Heating of Low-Cost Homes—

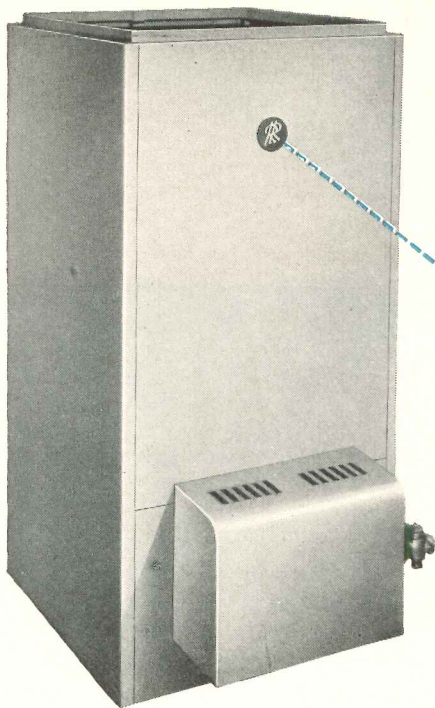

This well-known Richmond Seal, proudly attached to every unit shipped, is your guarantee that Richmond standards in design, materials and craftsmanship are rigidly maintained.

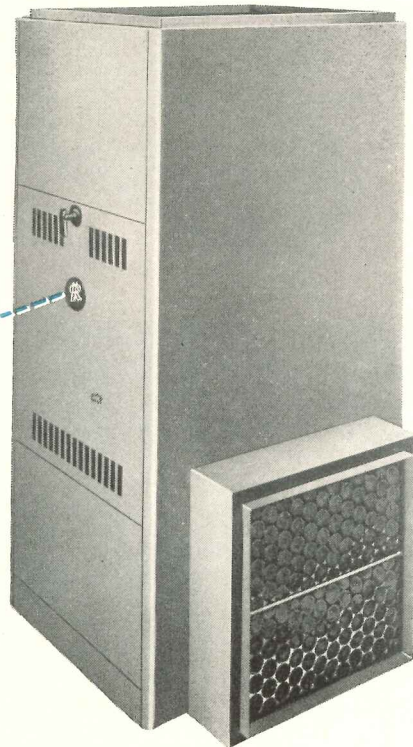

Model SG—Gravity Warm-Air Unit—Made with heavy-gauge steel heat exchanger—finished in light-green hammertone baked enamel. Easily assembled. Simple, economical and trouble-free in operation. Made in two sizes: 70,000 and 90,000 Btu input per hour. A.G.A. approved.

Model SU—Forced Warm-Air Unit—Sturdy, rounded-corner casing. Made with heavy-gauge steel heat exchanger and finished with a light-green baked enamel steel jacket. Shipped assembled; two sizes: 85,000 and 110,000 Btu input per hour. A.G.A. approved.

Both Units Made in Two Sizes . . . giving you four new GAS-FIRED, high-quality, efficient heating units, ideally suited for use in low-cost competitive homes and home developments. Use the handy coupon at the lower right to get detailed data and specifications.



RICHMOND

RICHMOND RADIATOR CO. — AFFILIATE OF REYNOLDS METALS CO.



Vitreous China



Gas Boilers

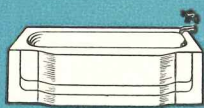

Enameled Cast Iron Waza

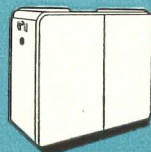

Winter Air Conditioners
Gas—Cast iron or steel
Oil—Steel

See your wholesaler or Mail Coupon Today:

Richmond Radiator Company AR-5
19 East 47th St.
New York 17, N. Y.

Please send me additional information and literature on the new Richmond gas-fired, warm-air heating units. No obligation, of course.

Name

Company

Address

THE BEST SEAT IN THE

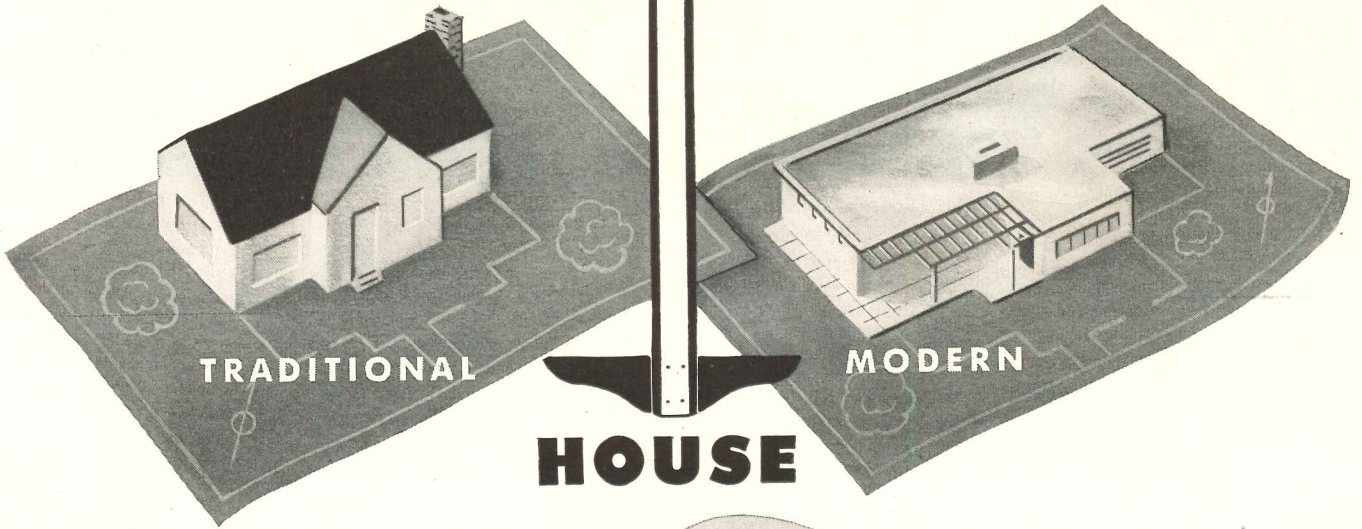

Traditional or Modern . . . whatever the architectural style, you can be sure that Church Seats will add distinction to the bathroom. And Church Seats mean satisfied clients, because they'll always keep their gleaming, attractive appearance. The first cost is the last cost.

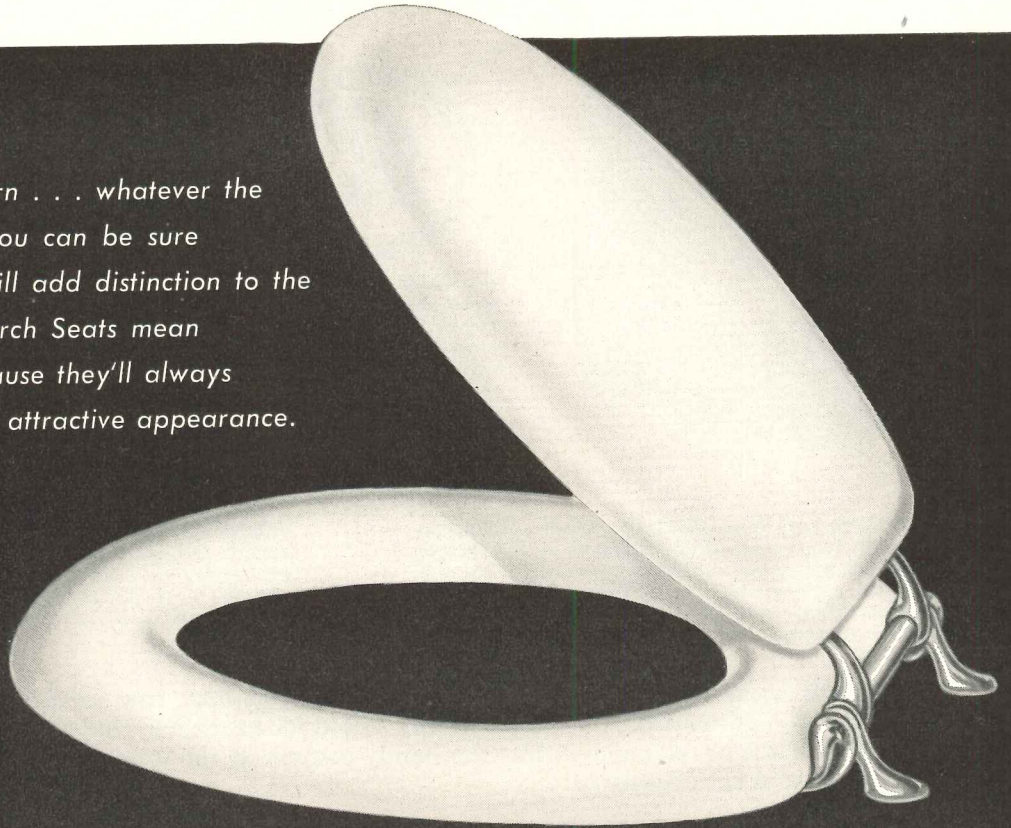

Church Mol-Tex
No. 900

Church Seats

C. F. CHURCH MFG. CO. HOLYOKE, MASS.
Division of AMERICAN RADIATOR & Standard Sanitary CORPORATION

Serving home and industry: AMERICAN-STANDARD • AMERICAN BLOWER • CHURCH SEATS • DETROIT LUBRICATOR • KEWANEE BOILER • ROSS HEATER • TONAWANDA IRON

DON'T WORRY...IT'S



Floors and walls *stay* good-looking . . . despite little heroes with big bats and sharp cleats. Genuine Clay Tile advantages are *all* hits! No scrubbing, waxing or polishing . . . defies stains, scratches, burns and scars . . . good for a lifetime . . . rich decorator colors . . . wide variety of patterns . . . low cost . . . *fired-in* colors . . . never needs replacement . . . best of all—you no longer have to talk “substitutes.” Genuine Clay Tile is available *now!*

The Tile Council of America, Room 3401: 10 East 40th Street, New York 16, New York. Room 433: 727 West Seventh Street, Los Angeles, California.

PARTICIPATING COMPANIES:

American Encaustic Tiling Co.
Angeleno Tile Co.
Architectural Tiling Company, Inc.
Atlantic Tile Manufacturing Co.
B. Mifflin Hood Co.
Cambridge Tile Manufacturing Co.
Carlyle Tile Company
General Tile Corporation
Gladding, McBean & Co.
Mosaic Tile Company
Murray Tile Company, Inc.
National Tile & Manufacturing Co.
Olean Tile Company
Pacific Clay Products
Pacific Tile and Porcelain Co.
Pomona Tile Manufacturing Co.
Robertson Manufacturing Co.
Summitville Face Brick Co.
United States Quarry Tile Co.

THE MODERN STYLE IS CLAY TILE



**When FLEX-A-POWER goes UP
... costs come DOWN**

Standardized construction and flexibility of FLEX-A-POWER busways reduce investment. No costly investment to anticipate future needs. Low cost to install pre-fabricated sections. LVD (low voltage drop) used as main feeder.

Make your Power plan
economical to begin with
and everlastingly flexible

**Always room for
ADDITIONAL loads**

Take-offs at frequent intervals permit loads to be added or rearranged without disturbing the feeder system. FVK (secondary feeder) has 15 outlets in every 10-ft. section; LTG (light duty) is a potential outlet its entire length.

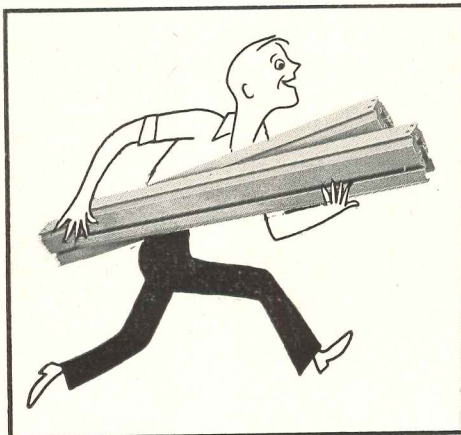

**FLEX-A-POWER never
grows old**

Whenever a major relocation of outlets is required, the entire FLEX-A-POWER system can be dismantled, removed to another location and re-installed with practically 100% re-use of materials.

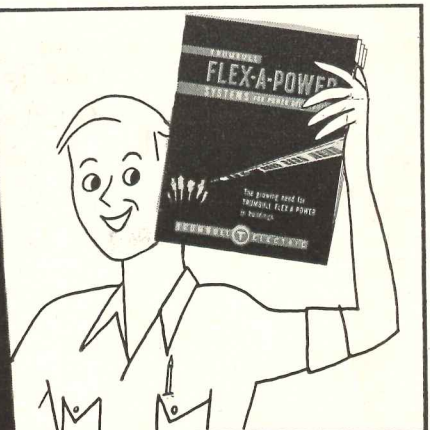

**How to make your
clients POWER-HAPPY**

This free booklet tells more about economical FLEX-A-POWER—the modern power distribution system used, for example, in Atlanta's Candler Building, Cincinnati's General Hospital, Houston's Shamrock Hotel, Gimbel's Milwaukee store. Write for Bulletin TEM-1. THE TRUMBULL ELECTRIC MANUFACTURING COMPANY, Plainville, Conn.

TRUMBULL  ELECTRIC

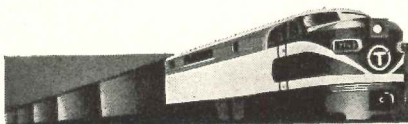

TRUMBULL'S TRAINLOAD OF NEW PRODUCTS

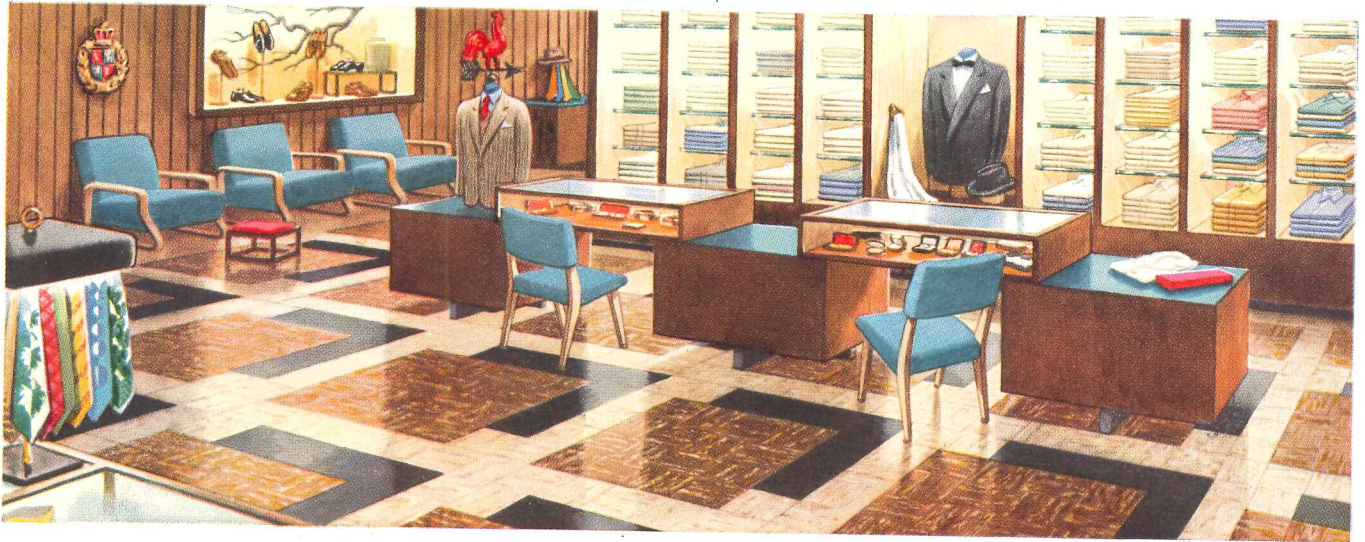

*They're all
Armstrong's Floors*

This is Armstrong's Rubber Tile. This flooring is widely specified for areas where an atmosphere of luxury is desired. It has an unusual clarity of color and graining which gives a rich appearance to the floor. The 21 high-style colors offered in Armstrong's Rubber Tile permit an almost endless variety of flooring effects. It is also often specified for its exceptional underfoot comfort and for its long wear. Armstrong's Rubber Tile is made in two thicknesses, 1/8" and 3/16".

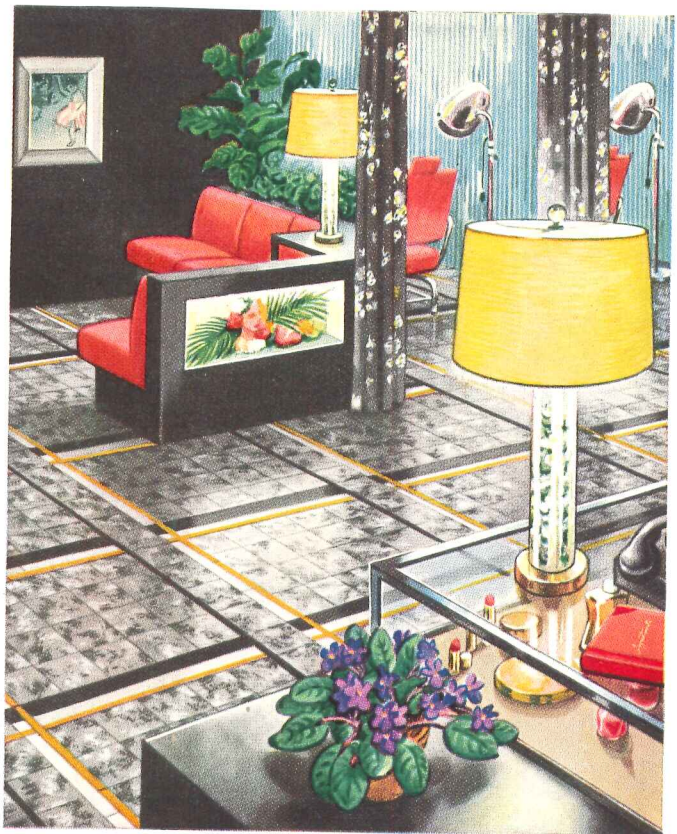

This is Armstrong's Linoleum

No other Armstrong Floor is so widely used in stores and offices as Armstrong's Linoleum. There are many reasons why it is often the first recommendation of architects. It offers the widest selection of decorative effects. It is moderate in first cost, easy to maintain, and gives long service. Armstrong's Linoleum is manufactured in three thicknesses and six types—Plain, Jaspé, Marbelle®, Spatter, Embossed Inlaid, and Straight Line Inlaid.

For additional data on Armstrong's Resilient Floors for business, industrial, and residential uses—Rubber Tile, Linoleum, Asphalt Tile, Linotile®, Arlon Tile, and Cork Tile—consult Sweet's Architectural File, section number 13e, catalog number 2. For samples and specifications for the various types of Armstrong's Resilient Floors or help in solving unusual flooring problems, architects are invited to get in touch with the nearest Armstrong Office or write directly to Armstrong Cork Company, Floor Division, 2405 State Street, Lancaster, Pennsylvania.

This is Armstrong's Asphalt Tile

When it is necessary to keep first cost to a minimum and still have an attractive and colorful floor, Armstrong's Asphalt Tile is a logical choice. Though low in price, this floor is noted for toughness and durability. It is made in a variety of marbled and plain colors. It is not harmed by alkaline moisture and is especially recommended for on-grade and below-grade sub-floors. Made in Standard and Greaseproof types in two thicknesses—1/8" and 3/16".

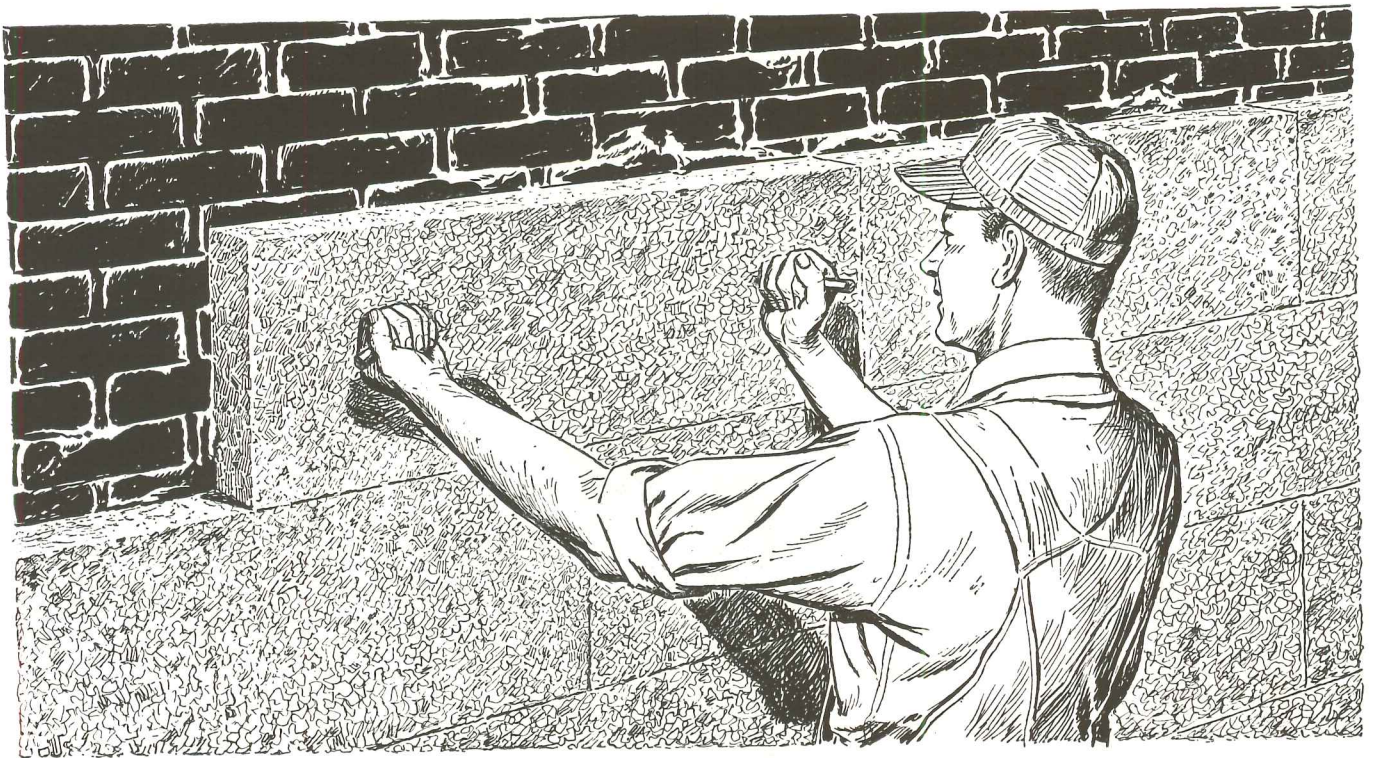

What's wrong with this picture?

This picture shows one of the most serious mistakes that can be made in cold room construction. Back plaster has been omitted, and the insulation is being erected directly against a primed brick wall.

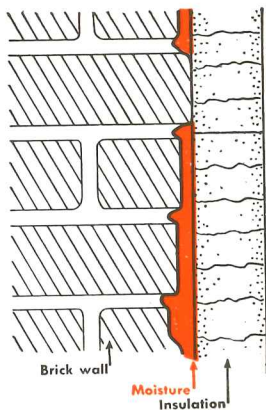

WRONG

When you leave out back plaster, insulation adheres only to the high spots of the irregular wall surface. The bond will be weak. Even more serious, moisture coming through the wall will collect in the hollows behind the insulation. Then it will work its way into the insulation material, and heat will pour through because moisture is a heat conductor. If that moisture freezes, the insulation will bulge from the wall.

These dangers can be avoided by making the wall true and even with back plaster. It fills all voids and hollows, provides a smooth surface for

a tight insulation bond, and cuts down air flow. Add a good vapor seal of asphalt paint and hot asphalt and a truly moisture-resistant material, such as Armstrong's Corkboard, and the job will last years longer.

Portland cement back plaster is just one of the things Armstrong engineers recommend to keep moisture out of low-temperature insulation. In almost 50 years in the insulation business, the entire Armstrong organization has learned the answers to the moisture problem. The next time you have an insulation job, take advantage of this knowledge. Call the Armstrong office nearest you or write to Armstrong Cork Company, 2405 Concord St., Lancaster, Penna. 

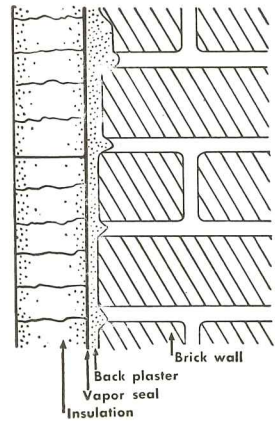

RIGHT

ARMSTRONG'S INDUSTRIAL INSULATIONS

MATERIALS - INSTALLATION

FOR ALL TEMPERATURES FROM 300° F. BELOW ZERO TO 2800° F.

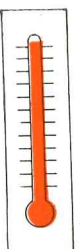
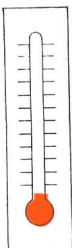

MODERN DOOR CONTROL BY *LCN* • CLOSERS CONCEALED IN HEAD FRAME

GENERAL OFFICES OF A. B. DICK COMPANY, NILES, ILLINOIS

LCN CATALOG 11-E ON REQUEST OR SEE SWEET'S • LCN CLOSERS, INC., 466 WEST SUPERIOR STREET, CHICAGO 10



The Austin Company, Engineers and Builders

Walter Dorwin Teague, Designer

HOW MUCH

is this Floor Space worth if Uncomfortable?

if Comfortable?

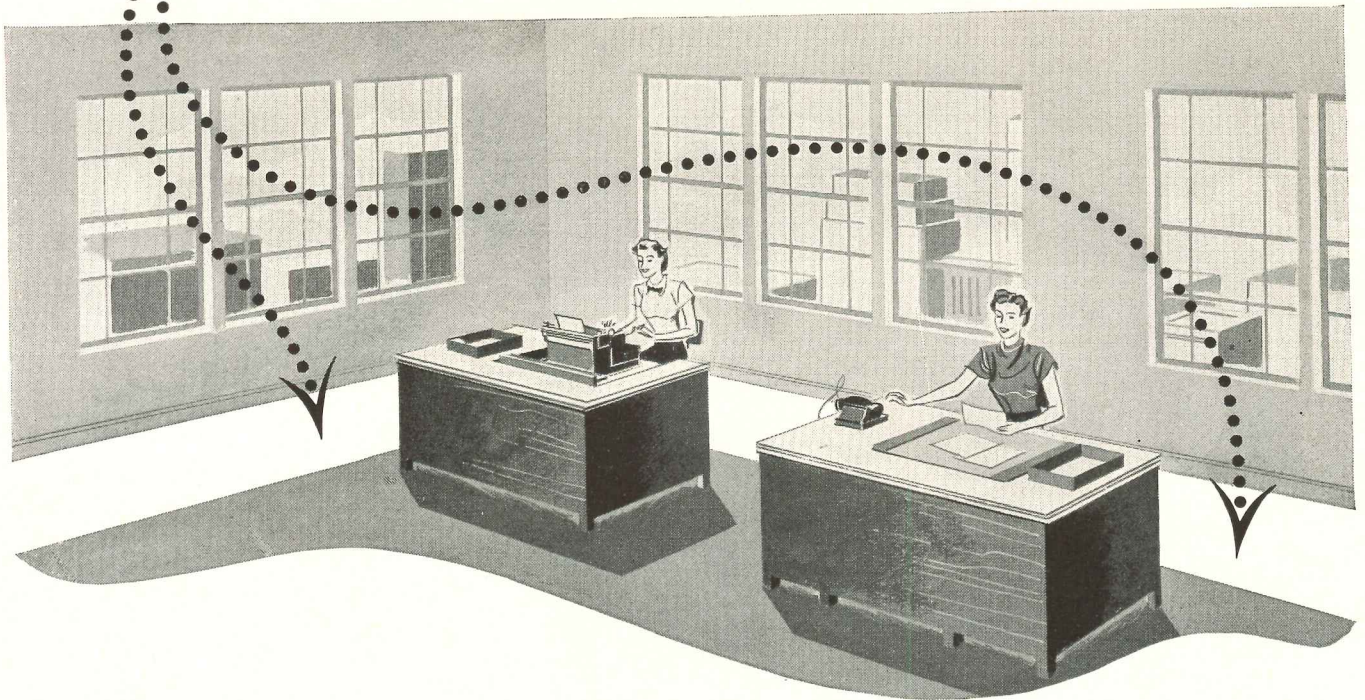

Warm windows in winter make the difference between comfort and *discomfort* in this marginal floor zone. And comfort makes the difference between having the space usable or *unusable*. With *Thermopane** insulating glass, the comfort zone extends right up to the windows. The half-inch insulation provided by the dry air sealed between two panes of plate glass makes *Thermopane* an insulated wall area.

tenants get more income space

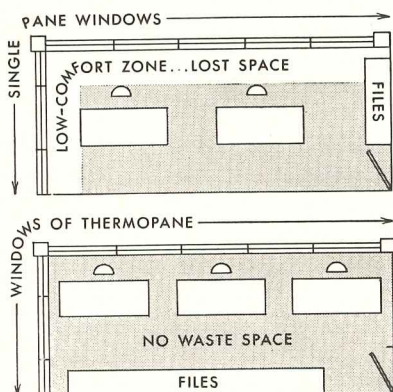

Owners and managers of new buildings see in *Thermopane* an answer to the high rentals necessitated by today's construction costs. More desks, worktables or machines—more people—can be put in floor space kept comfortable in winter by *Thermopane*. When that fact is pointed out to prospective tenants, the rental becomes more favorable than is the case in single-glazed buildings in which window-side space must be wasted, though paid for.

Substantial savings in winter heating and summer air-conditioning costs are also realized when windows are insulated with *Thermopane*. With all cost factors considered, you will find *Thermopane* as a wall material gives you more usable floor space and lower operating costs.

May we send you latest information on standard sizes and on sash that is available for *Thermopane*? *®

FOR BETTER VISION SPECIFY **THERMOPANE**
MADE WITH POLISHED PLATE GLASS

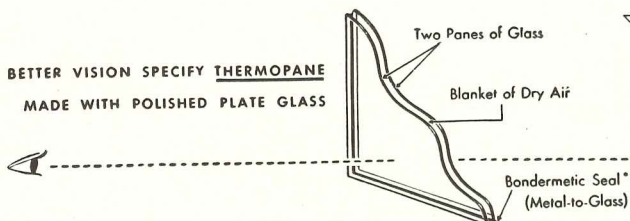

Thermopane

MADE ONLY BY LIBBEY-OWENS-FORD GLASS COMPANY
5655 Nicholas Building, Toledo 3, Ohio

WESLOCK[®] CYLINDRICAL LOCKS

... for every door in the house

Completeness of line is one of the reasons that many Architects and Builders are standardizing on WESLOCKS. This fine line has high styling plus wide acceptance and is priced to meet the most modest budgets. Why don't you standardize on WESLOCKS...they'll meet all of your requirements. Send for a complete catalog today.

WESTWOOD

MANUFACTURING CO.
1420 So. Evergreen Avenue
Los Angeles 23, California

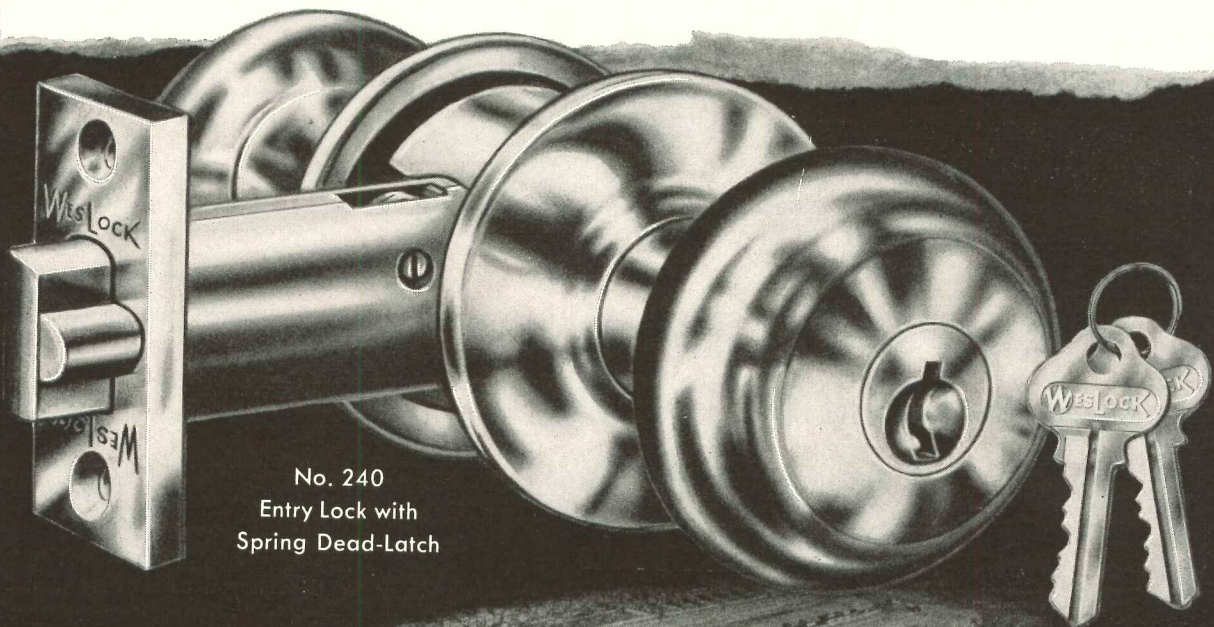

No. 240
Entry Lock with
Spring Dead-Latch



Another WESLOCK installation—
7,000 Westlake Homes, San Mateo County, Calif.—FHA Insured
Architect: Builder's Architectural Staff
Builder: Henry Doelger, Inc. Hardware Contractor: F. G. Norman & Son

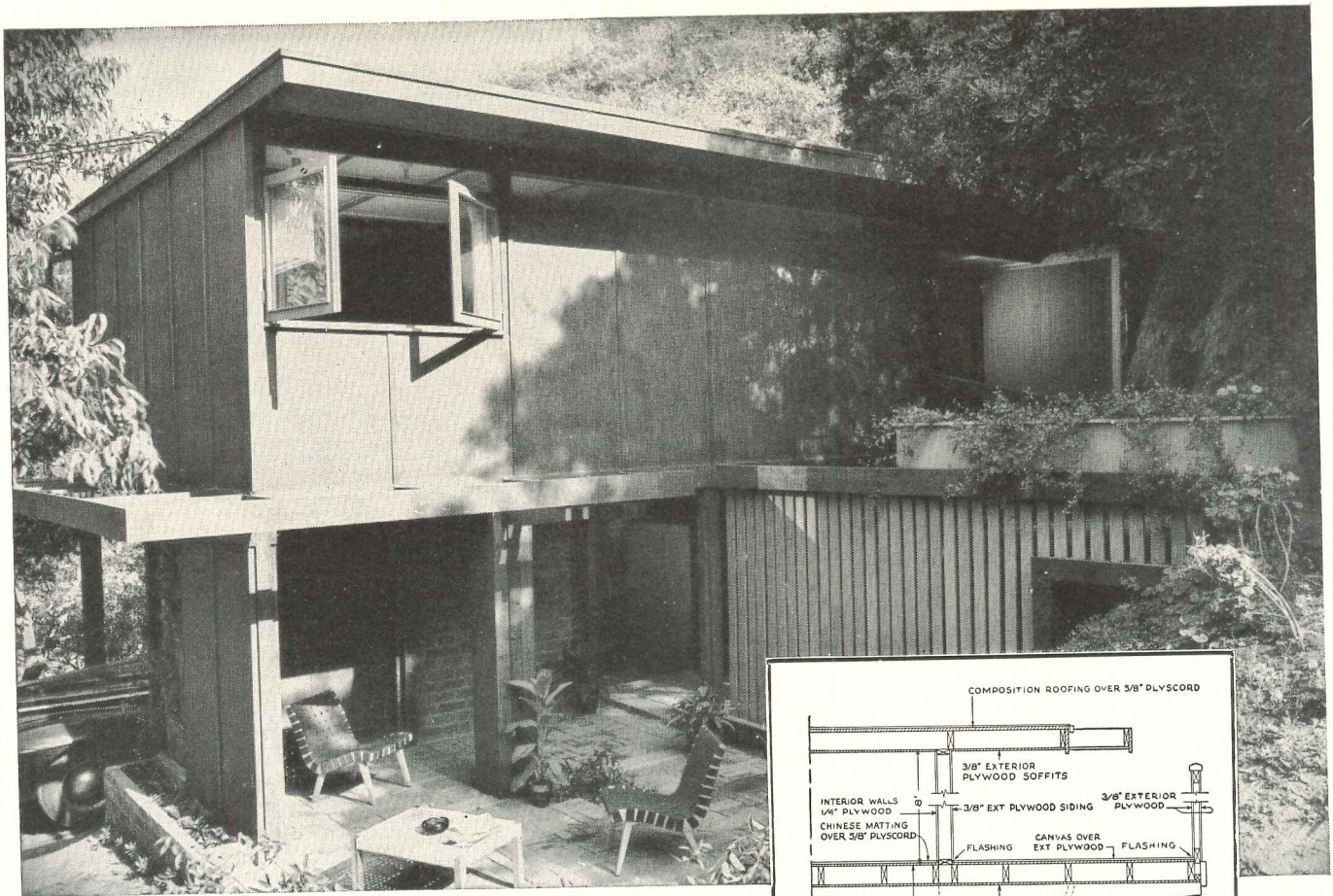

"With Plywood, Design and Structure Can Be Treated as a Single, Integrated Unit,"

Says Architect Gordon Drake

AN excellent example of the contemporary search for more livable, more economical design is this award-winning Los Angeles home by Architect Gordon Drake of Carmel and San Francisco.

In its conception, design becomes structure . . . structure becomes design—a simplification of approach made possible by the unique properties of Douglas fir plywood.

Mr. Drake says: "Because plywood is at once a structural and a finish material, offering both strength and beauty, many construction economies were effected in this home. Plywood makes possible new architectural conceptions, enabling the designer to concentrate on essentials without sacrifice of beauty, charm or utility."

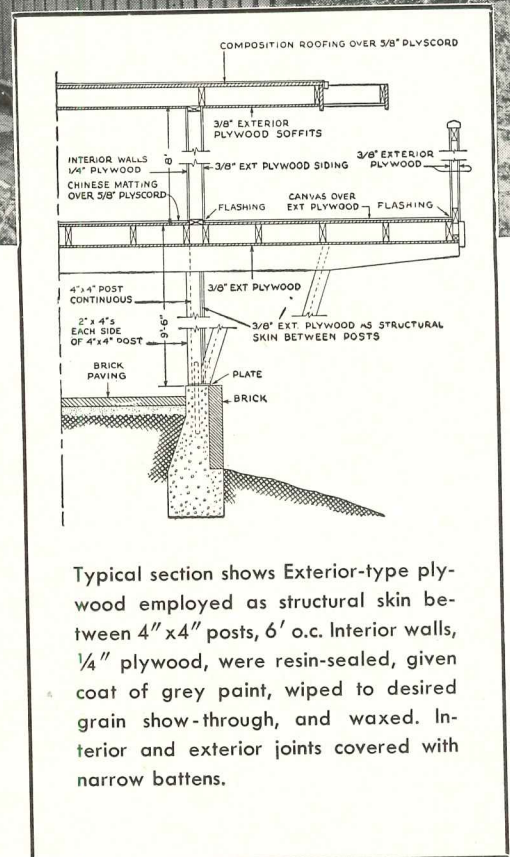

Typical section shows Exterior-type plywood employed as structural skin between 4" x 4" posts, 6' o.c. Interior walls, 1/4" plywood, were resin-sealed, given coat of grey paint, wiped to desired grain show-through, and waxed. Interior and exterior joints covered with narrow battens.

Douglas Fir
Plywood

AMERICA'S

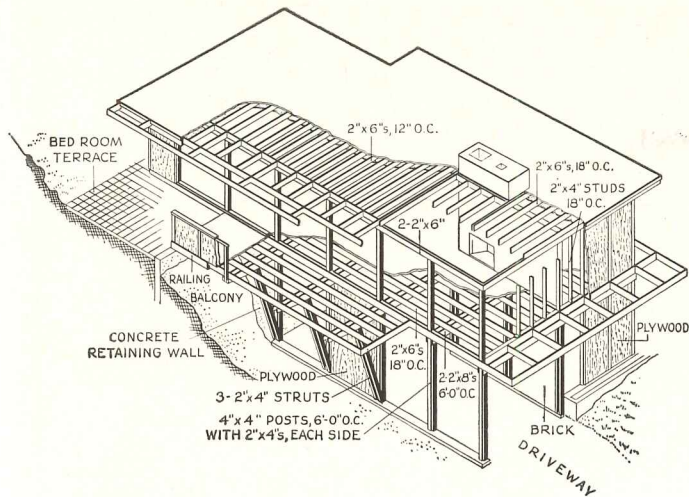

Progressive Architecture said this about the house: "Seldom does one see work in which structure, site and clients' needs merge so completely. Conditioned by the particular circumstances, the construction system here is also the esthetic concept." Isometric shows elements of the wood post-and-girder construction, employing plywood as a structural diaphragm for floor and roof and as a structural skin for walls.

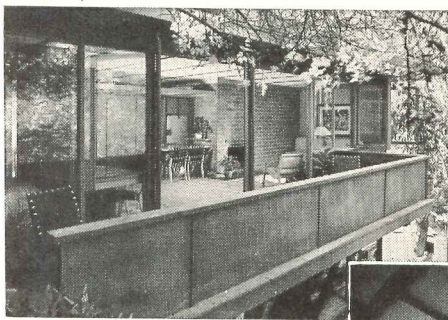

Plywood exterior treatment is both simple and dramatic. Contemporary design is a "natural" for this modern panel material.

Charming simplicity keynotes the interior treatment, blending glass and plywood walls to achieve warmth and spaciousness.



Large, Light, Strong Real Wood Panels

DOUGLAS FIR PLYWOOD ASSOCIATION:
Tacoma Building, Tacoma 2, Washington;
848 Daily News Bldg., Chicago 6, Illinois;
1232 Shoreham Bldg., Washington 5, D.C.;
500 Fifth Avenue, New York City, 18.



USIEST BUILDING MATERIAL

These Grades of Plywood Will Prove Most Useful in Home Construction

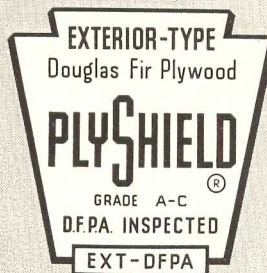

PlyShield is the siding grade of Exterior-type plywood. Fits any architectural style; can be utilized for flush surface, lap siding, wide siding, board and batten.



PlyScord is the unsanded construction grade—for strong, rigid wall and roof sheathing and subflooring. Use it for basement and foundation forms, too; can be stripped and re-used for sheathing on the same job.

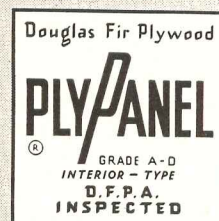

PlyPanel is the "one-side" grade of Interior-type plywood—for real wood paneling, cabinets, built-ins. Provides a smooth, firm underlayment for wall-to-wall floor coverings, too.



For complete data on Douglas Fir Plywood, including information on other grades, see Sweet's File, Architectural, or write for basic catalog—sent free to any part of the United States. Just write any of the offices listed at the left.



ROBERTSON

snowwhite
FOR PURITY

Pure white! You don't know how *really white* a tile can be until you've used Robertson Snowwhite. Pure quality, too . . . perfect size and shape; perfect uniformity; perfect eggshell finish.

Robertson Snowwhite meets the demand of hospitals, food processors, dairies, restaurants for the utmost sanitation with the least maintenance. Snowwhite meets the demand of housewives for surfaces which keep their spick-and-span appearance for a lifetime.

Write on your business letterhead for your *free* samples.

ROBERTSON
MANUFACTURING COMPANY
TILE DIVISION
TRENTON 5, NEW JERSEY

There are a lot of good cars . . .

but there



is only one **CADILLAC**

There are a lot of good violins . . .

but there is only

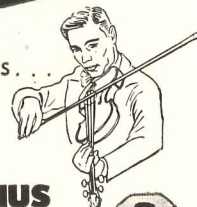

one **STRADIVARIUS**

There are a lot of good drawing pencils

but there
is only
one

CASTELL

with the *Genuine*
IMPORTED
CASTELL
lead

So smooth,
so free-flowing—it's an in-
spiration for genius. Yes, it costs a few
pennies more, but it lasts so much longer
than ordinary pencils—it's more eco-
nomical in the long run. 18 exact tones
of black—7B to 9H.

NOTE: CASTELL does away with the
irritation of point breaking. It takes
needlepoint sharpening without snap-
ping. Order from your Dealer today—
and don't allow yourself to be talked
into a substitute.



AW FABER-CASTELL
PENCIL COMPANY INC., NEWARK 4, N.J.

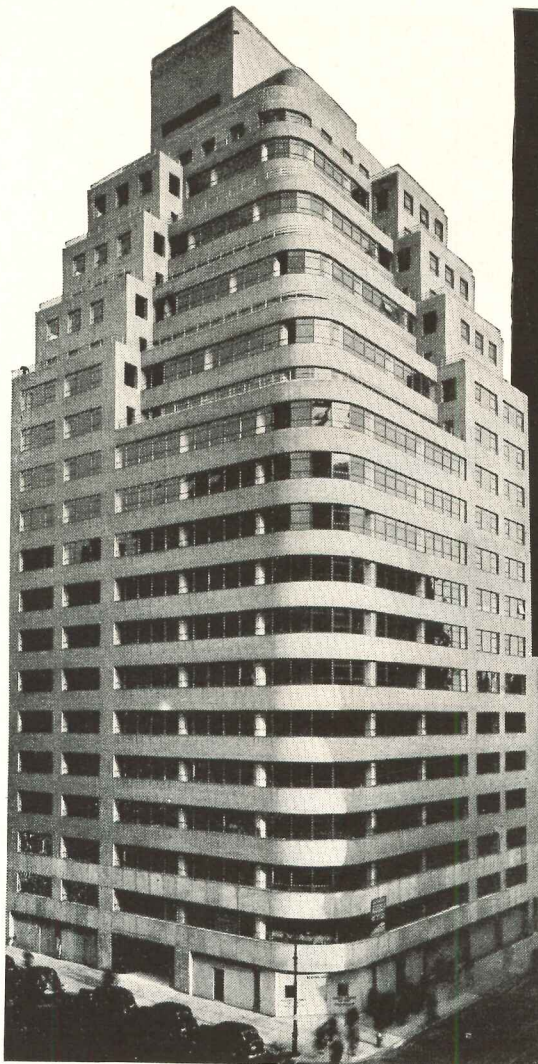

Office—Office Building, New York City.
 Architect: Emery Roth & Sons, New York.
 Contractor: Uris Bros., New York.

These Architects had different problems

*...but they found an
 answer in common!*

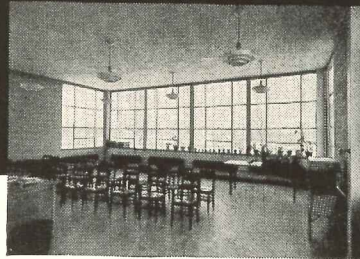

School—Robert N. Mandeville High School,
 Flint, Michigan.
 Architect: Bennett & Straight, Dearborn.
 Contractor: Karl B. Foster, Flint.



Restaurant—Seattle-Tacoma Airport Restaurant.
 Architect: G. T. Treadwell, Seattle.
 Contractor: Lease & Leigland, Seattle.



Laundry—Laundry, Bloomington, Indiana.
 Contractor: Harlos Building Service.

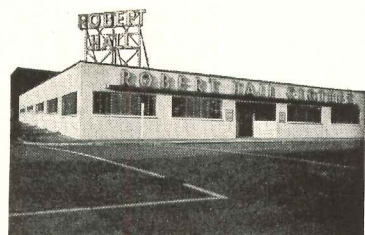

Clothiers—Clothiers, Seattle, Washington.
 Architect: G. T. Treadwell, Seattle.
 Contractor: Lease & Leigland, Seattle.

For one, the problem was to create an atmosphere gay and gracious for dining travelers. Another needed a stream of fresh, clean air to wash a laundry free of steam and smell. Daylight and ventilation they all had to have . . . an *extra* amount.

The answer: beautiful Fenestra* Intermediate Steel Windows. Because slender muntins permit extra glass area. Because ventilators are arranged to permit controlled ventilation in any weather. Open-in vents deflect air upward, shed the rain outside . . . open-out vents form canopies to guard the openings.

Each building has a cleaner, trimmer look—inside and out—because Fenestra Windows are slim-lined and neat. They are made from rolled

casement sections of advanced design and quality hardware is used throughout. Workmanship is by the skilled craftsmen of America's oldest and largest steel window manufacturer.

Fenestra Windows are economical in three important ways: *Low first cost*—standardization of types and sizes plus volume production. *Low installation cost*—modular sizes coordinate with wall materials. *Low maintenance cost*—precision fabrication of high-quality materials.

Where extra daylight, fresh air, beauty, quality and low cost are factors—specify Fenestra. For further information, call your Fenestra Representative (listed in the yellow pages of your telephone directory), see Sweet's Architectural File, Section 17 b/7, or mail the coupon. *®

Fenestra

WINDOWS • DOORS • PANELS

DETROIT STEEL PRODUCTS COMPANY,
 Dept. AR-5,
 2252 East Grand Blvd.,
 Detroit 11, Michigan

Please send me data on types and sizes of the new Intermediate family of Fenestra Windows.

Name _____

Company _____

Address _____

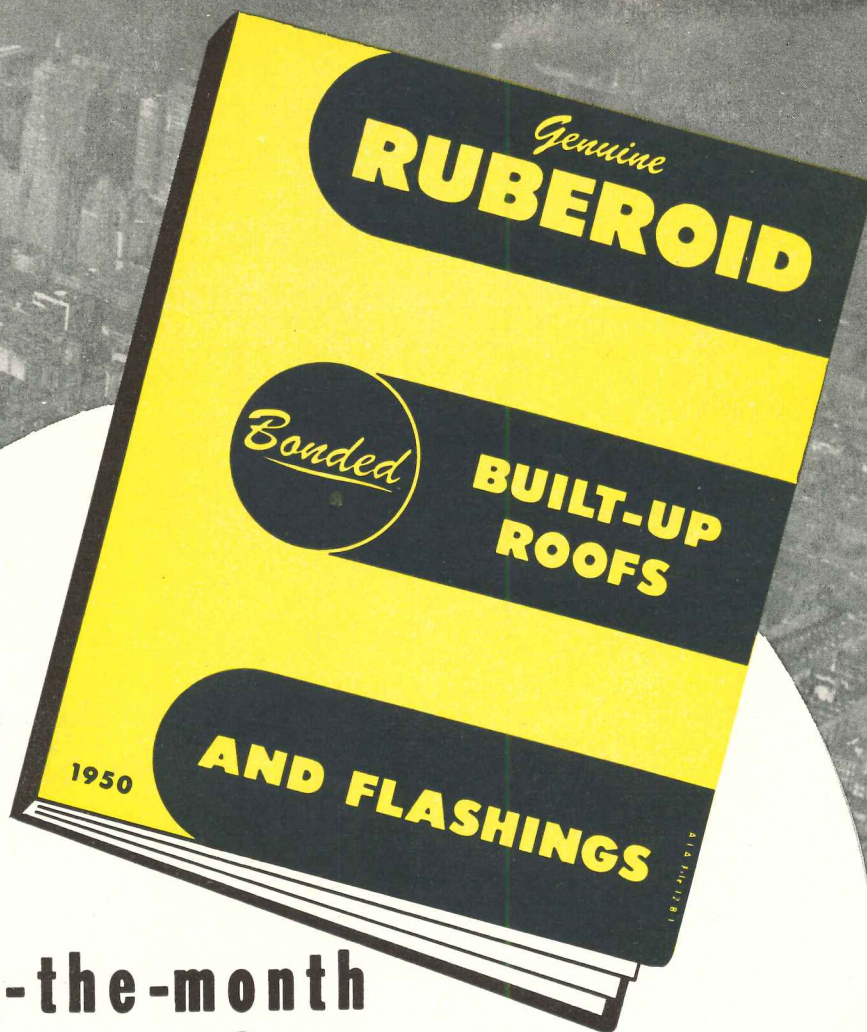

book-of-the-month

Every Month!...

The *right* roof specification at your fingertips every time . . . that's what this new edition of Ruberoid's Built-Up Roof Specification Book provides. Whether it's the special treatment required for a Garden roof or Parking Space roof . . . the latest in flashing details for low parapet walls . . . or a question about choice of base felts . . . you'll find *every* answer you need in this comprehensive file. Doubly indexed and tabbed for most convenient reference, it's a book you'll reach for as often as roof problems occur. A note on your letterhead will bring your free copy to you promptly.

The RUBEROID Co. built-up roofings

Building Materials for Industry, Home and Farm • Executive Offices: 500 Fifth Avenue, New York 18, N. Y.

The right roof for any job—from ONE source!

Ruberoid makes every type of built-up roof—Smooth Surfaced Asbestos, Coal Tar Pitch with gravel or slag surfacing, or smooth or gravel-and-slag surfaced asphalt . . . in specifications to meet any need. Ruberoid Approved

Roofers are not prejudiced in favor of any one type. You are assured of one source for all materials, centralized responsibility, smoother operation, uniform quality

Sales Offices: Baltimore, Md., Bound Brook, N. J., Chicago, Ill., Dallas, Tex., Erie, Pa., Millis, Mass., Minneapolis, Minn., Mobile, Ala.,

SITE AND SYMBOLISM DICTATE DESIGN

Southern Brookline Community Center — Temple Emeth, Brookline, Mass.

Isidor Richmond and Carney Goldberg, Architects

Haskell Photo



ANYONE walking or driving along any of the seven approaches to Temple Emeth has his attention immediately drawn to the graceful open court which is the Temple's heart. That focal point was determined by architects Richmond and Goldberg after careful study of the various approaches; about it the entire plan of the building was organized, with the chapel wing reaching, as liturgy required, to the east, and the school wing stretching to the southwest. Linking the two are the administrative and Rabbi's offices. All are entered directly from the court.

The natural slope of the site was used to give

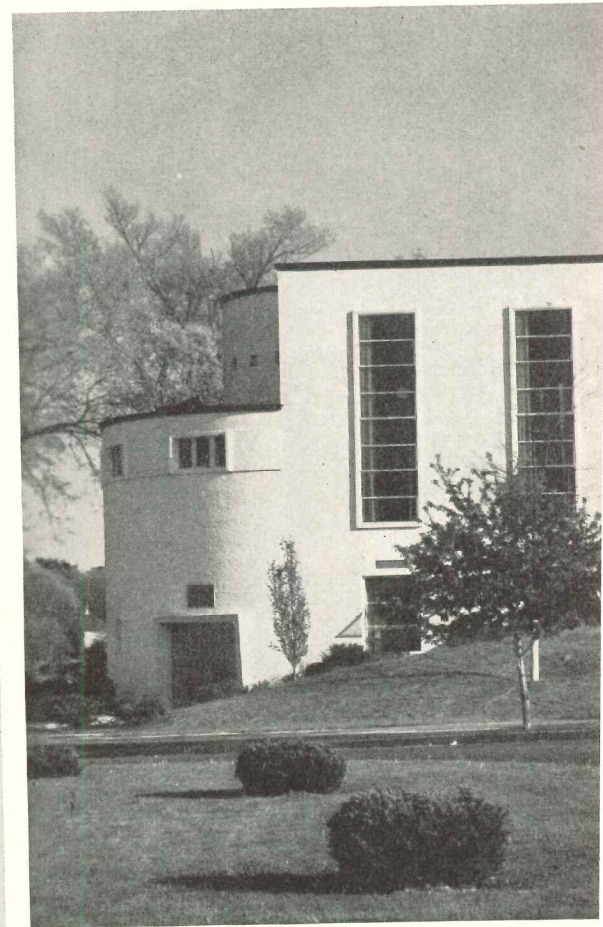
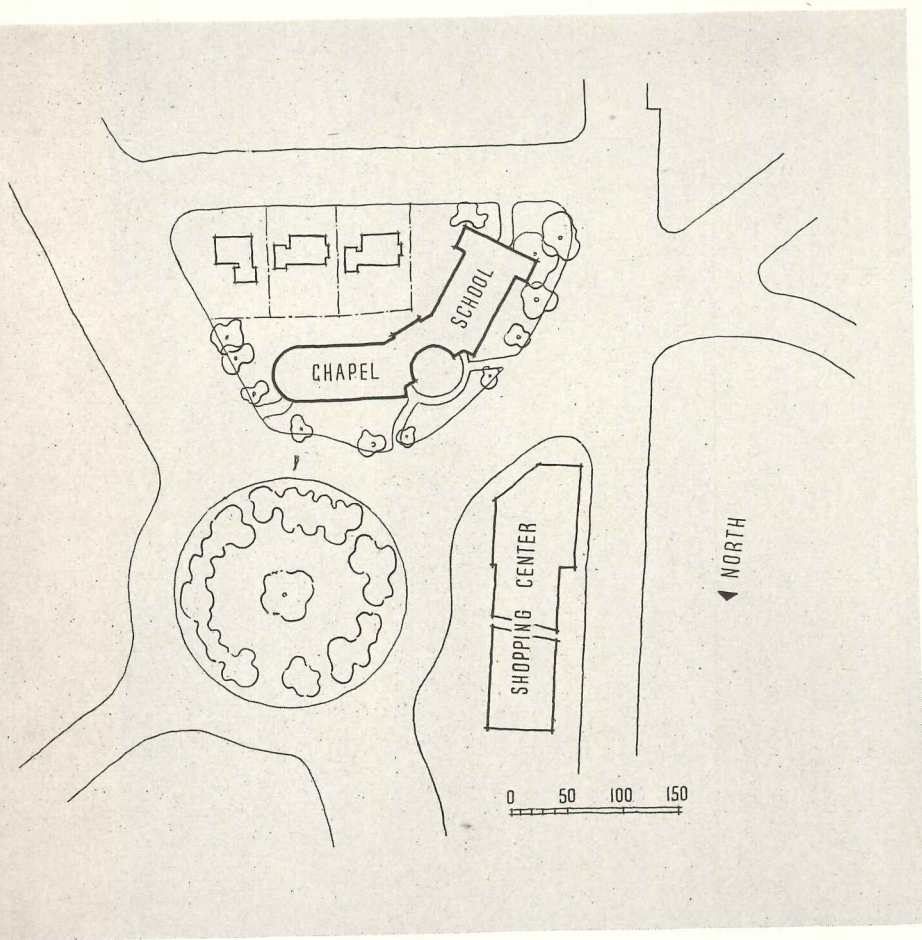

the vestry, located below the chapel, its own entrance from the parkway to the east. Because the vestry may be rented for weddings, receptions, etc., it is planned so that it can be locked off from the rest of the building but still have free access to kitchen and coat rooms (see plans, page 104).

Exterior of the building is common brick, painted, and backed up with cinder concrete units. Floors in chapel and classrooms are reinforced concrete beam and slab.

Haskell Photos

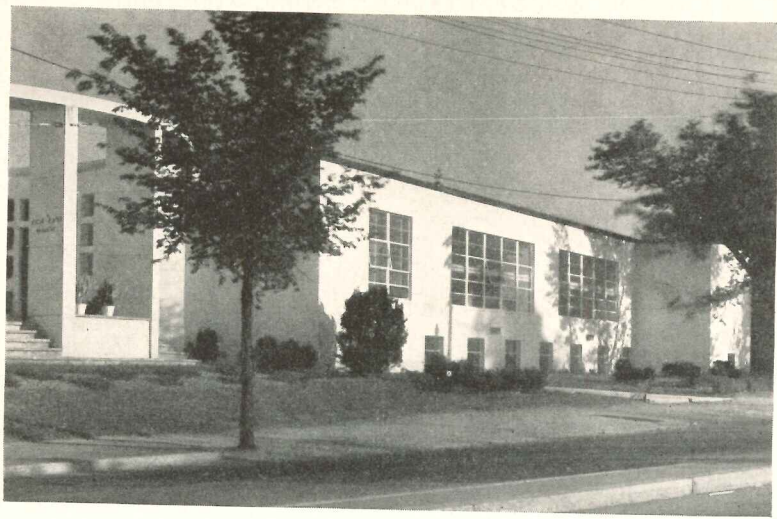

Fay Foto Service

The rotunda, Rabbi Zev Nelson of Temple Emeth explains, conveys the message that "religion embraces the whole round globe"; the tree in its center is the tree of life; the 39 small windows represent the 39 books of the Bible from Genesis to Chronicles. The 10 large windows of the Chapel symbolize the Ten Commandments.



MAY 1950

TEMPLE EMETH

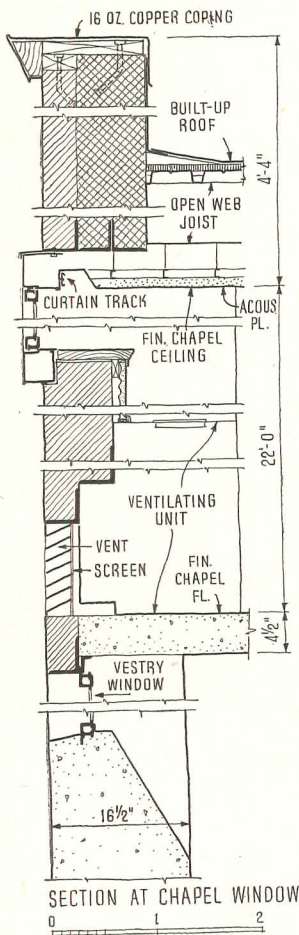
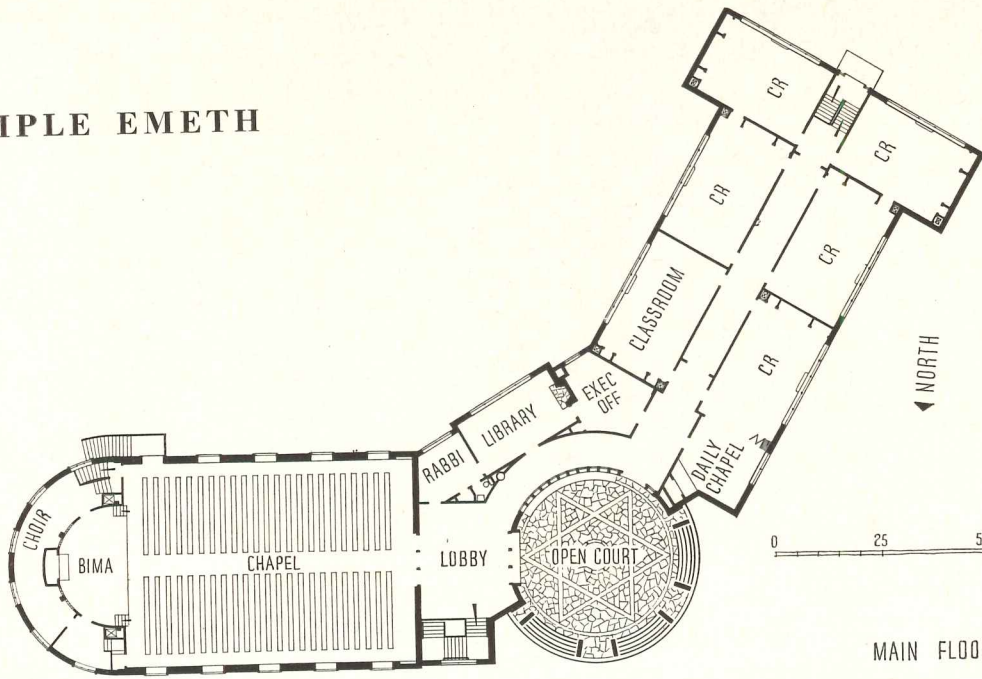

Plans were worked out to give all parts of building direct access from entrance court and yet to segregate various activities. Semi-circular bima in chapel and enclosed choir posed unusual problems in acoustics. Curved wall surface was broken up into panels for sound control (as in radio studio design) and vertical louvers were set in on either side of Arc to permit choir to be heard (details at right, photos opposite). Chapel seats 560

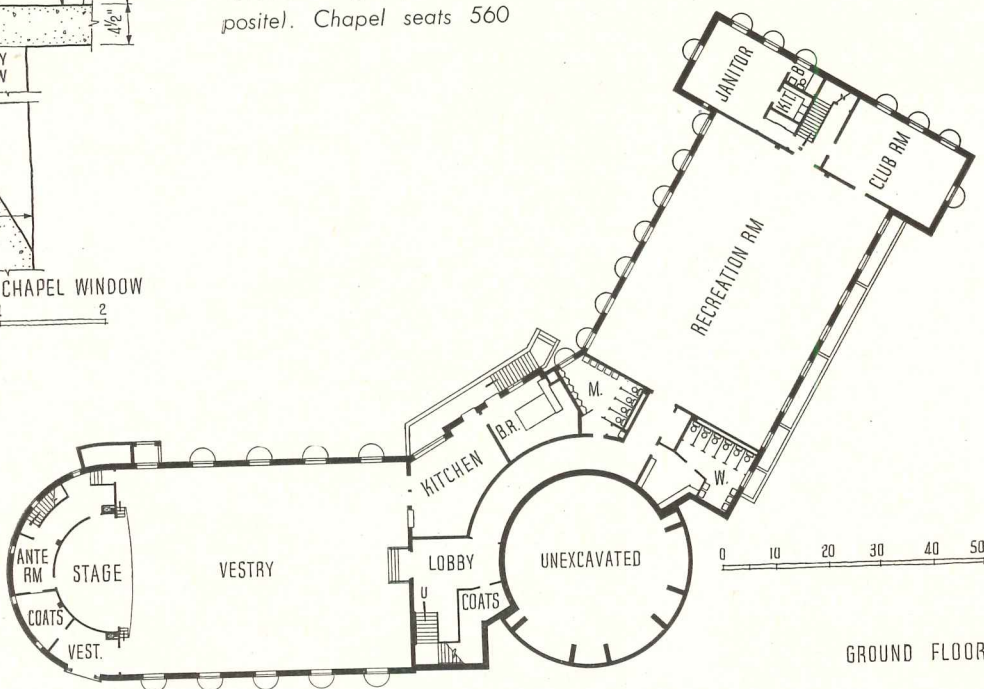
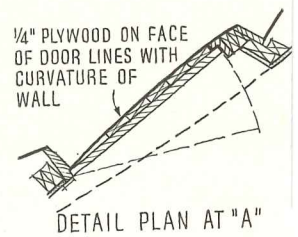
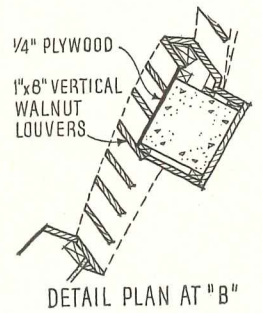
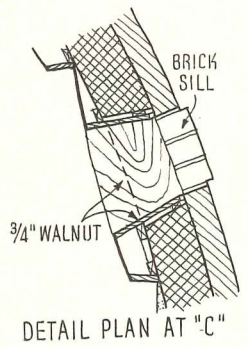
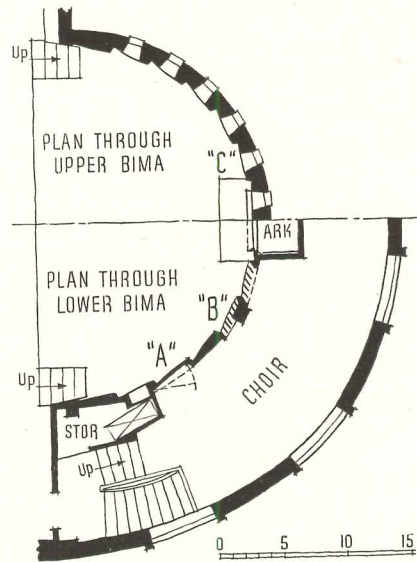

Haskell Photos



The chapel has no projecting lighting fixtures; ceiling is light-studded and washed with indirect light from troughs between the windows along side walls. Paneled walls of the bima are walnut, stained and waxed. The 12 windows above Arc represent the 12 tribes of Israel



TEMPLE EMETH

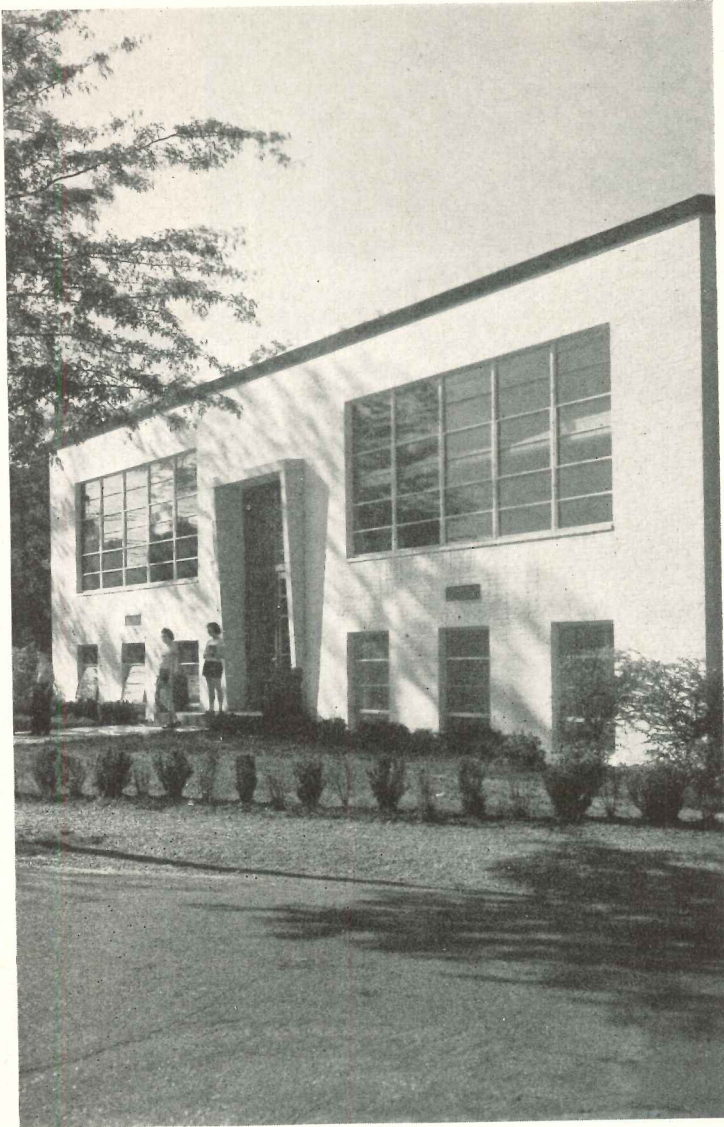

Haskell Photos

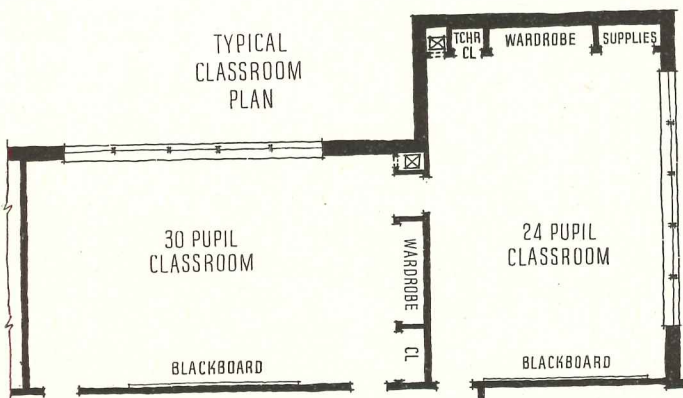
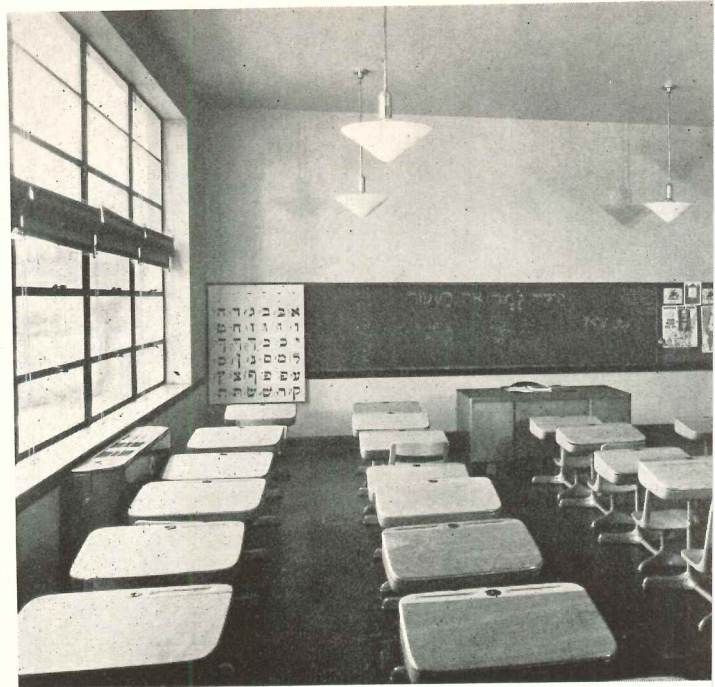

The Southern Brookline Community Center — Temple Emeth is a Jewish religious-cultural organization which considers the school almost as important as the chapel. The school wing provides (see plans, page 104) six classrooms, each with its own wardrobe. There are two pairs of classrooms capable of seating 30 pupils each; folding partitions between them can be opened to convert each pair into a single large room. The two smaller rooms seat 24 pupils each. In addition, the two clubrooms on the lower floor of the school wing also may be used for classes.

Temple Emeth won for its architects (ARCHITECTURAL RECORD, Feb. 1950, p. 11) the Harleston Parker Medal for 1949, presented by the mayor of Boston for "the piece of architecture within the limits of the City of Boston" judged the most beautiful by the Boston Society of Architects.

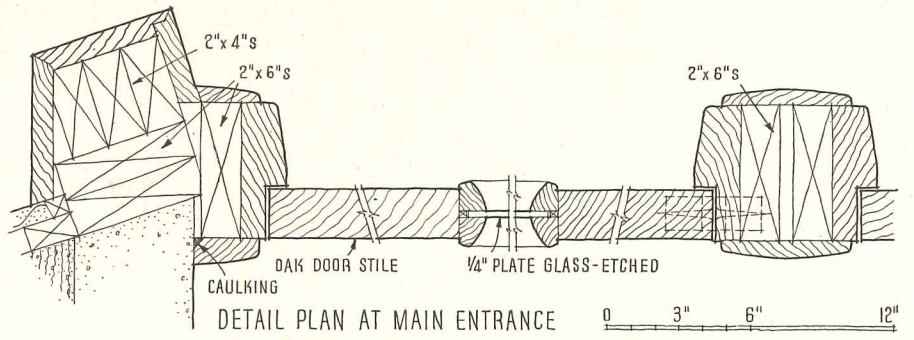

Haskell Photos



Main doors to chapel (below) depict the holidays of the Jewish calendar year. Detail above is one quarter of vertical panel at left in photo, below, of entrance court

Fay Foto Service

John J. Harty
Structural Engineer

White Construction Co.
General Contractor

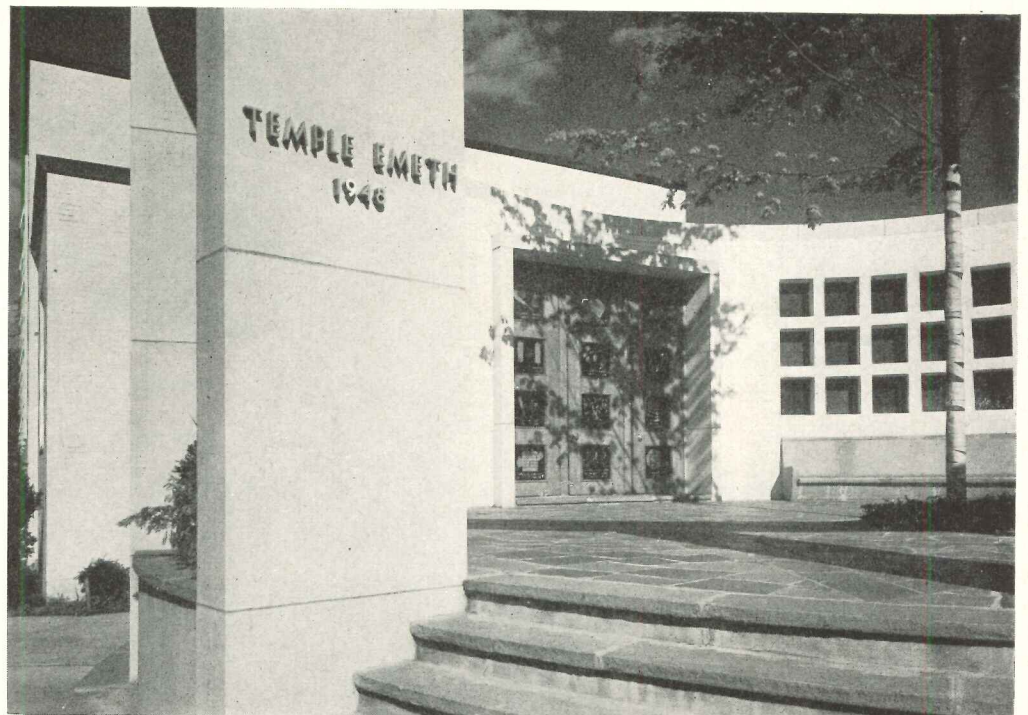



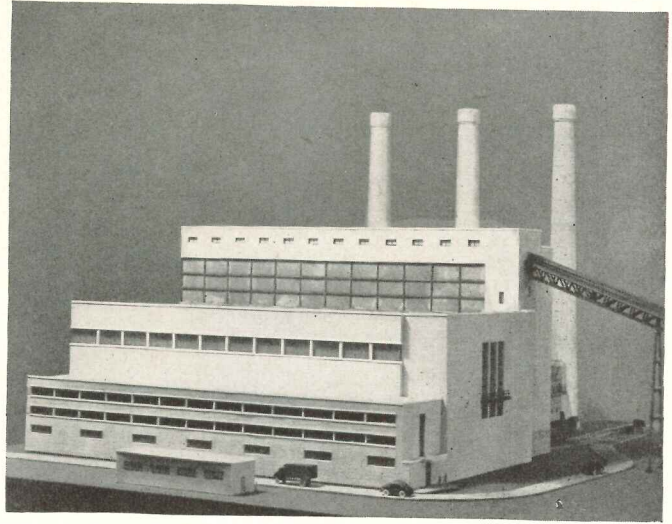
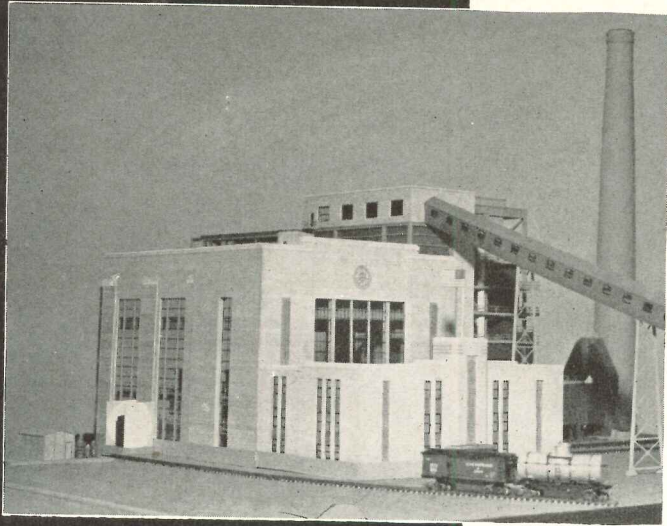

POWER PLANT PROGRESS

Sewaren Generating Station
Public Service Electric & Gas Company,
Owners and Engineers

Walker & Poor, Consulting Architects

United Engineers & Constructors, Inc., Builders

A FAVORITE modern theme, the natural compatibility of contemporary architecture and basic engineering, here finds expression in a huge electric generating plant (see also Corn Products plant, ARCHITECTURAL RECORD, Nov. '49). A power plant, with its great boilers, stacks and turbine room, has good elements for visual interest, but older precedent seems to dictate that they be housed in Greek temples. When architecture begins to use those elements, instead of covering them, the result becomes something to express the pride of the engineers as well as the architects.

In this case the power plant engineering was done in advance (model picture above left). The architect's assignment was "the orderly disposition of the main elements . . . and to clothe the whole complex fabric in a new simple, functional building" (model right above).

The elements were arranged in a series of steps with the lowest, the three-story service building, nearest to and parallel with the water, turbine room next, then the highest portion, the coal bunker and boiler house. The rear side has the stacks, 225 ft high, for accents (the architects introduced entasis as well as taper).

It would have been possible, of course, to continue the building at the rear to enclose the boilers completely. But why build a nine-story building for boilers, and then have to ventilate it against boiler heat, when nature will do it for you?

Richard Garrison Photo

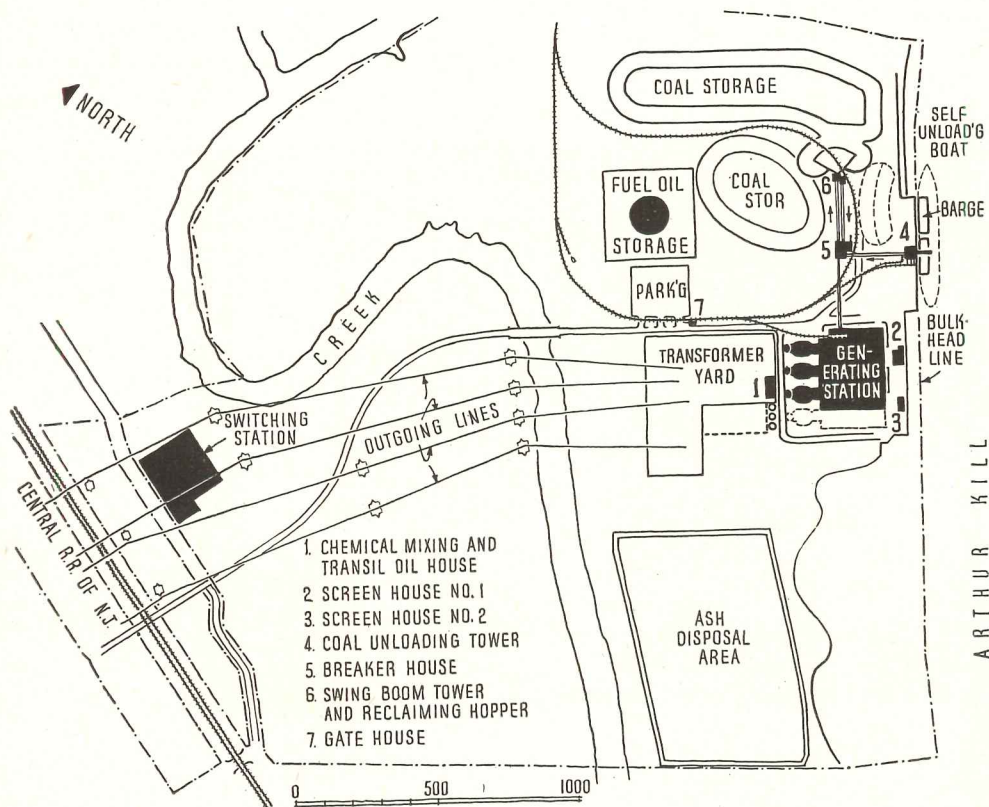
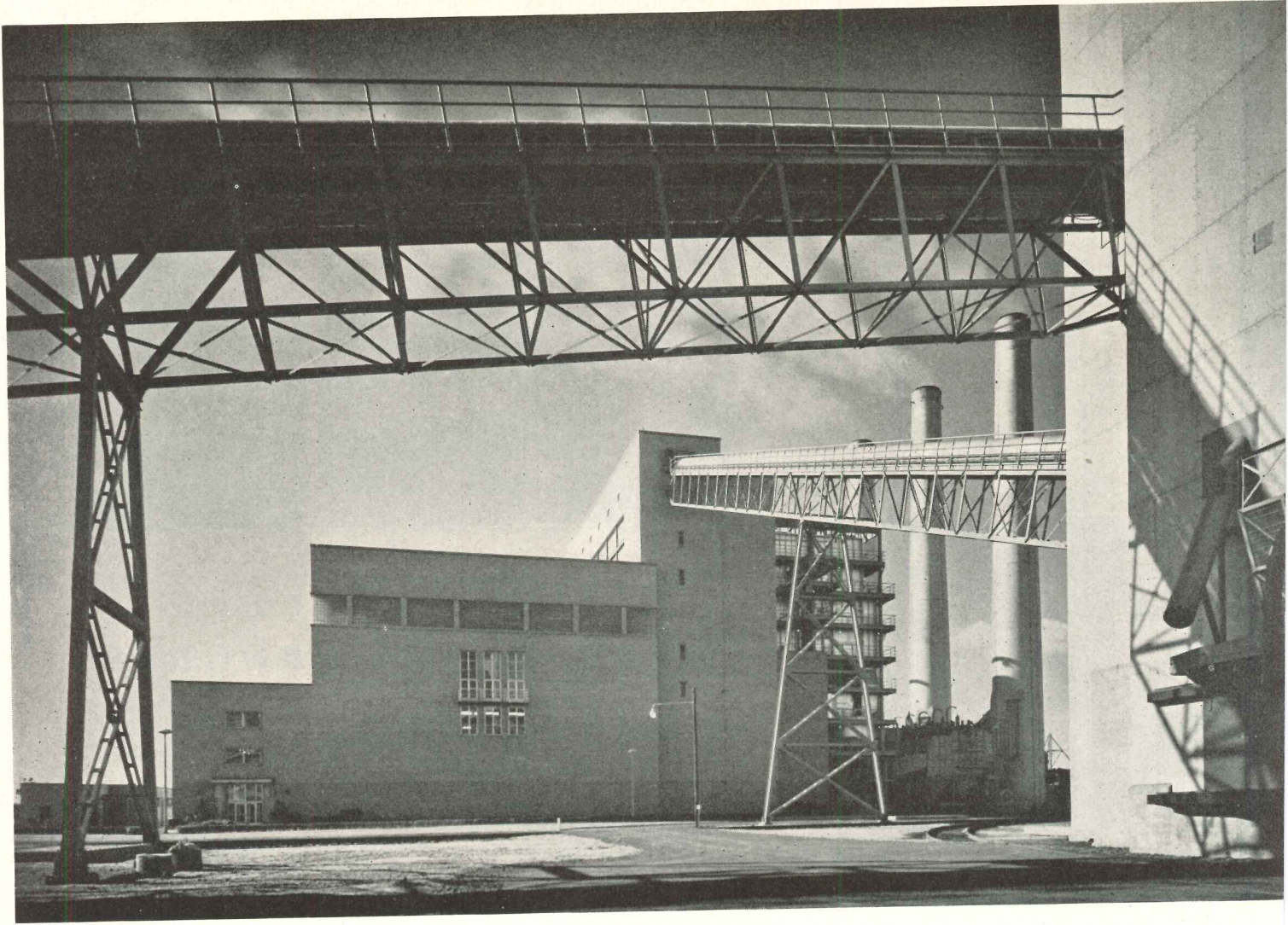

Site for Sewaren Station was 150 acres of salt marsh bordering on Arthur Kill. 55 acres were filled for the station with sand and gravel dredged from the kill. Buildings and machinery are supported on wood pile foundations covered with a concrete mat. The kill provides water transportation for coal and oil, also supplies cooling water for the condensers. At present the station has three 110,000 kw turbine generators; a fourth of 125,000 kw capacity will be added next year. Boilers operate at 1500 psi, 1050 F

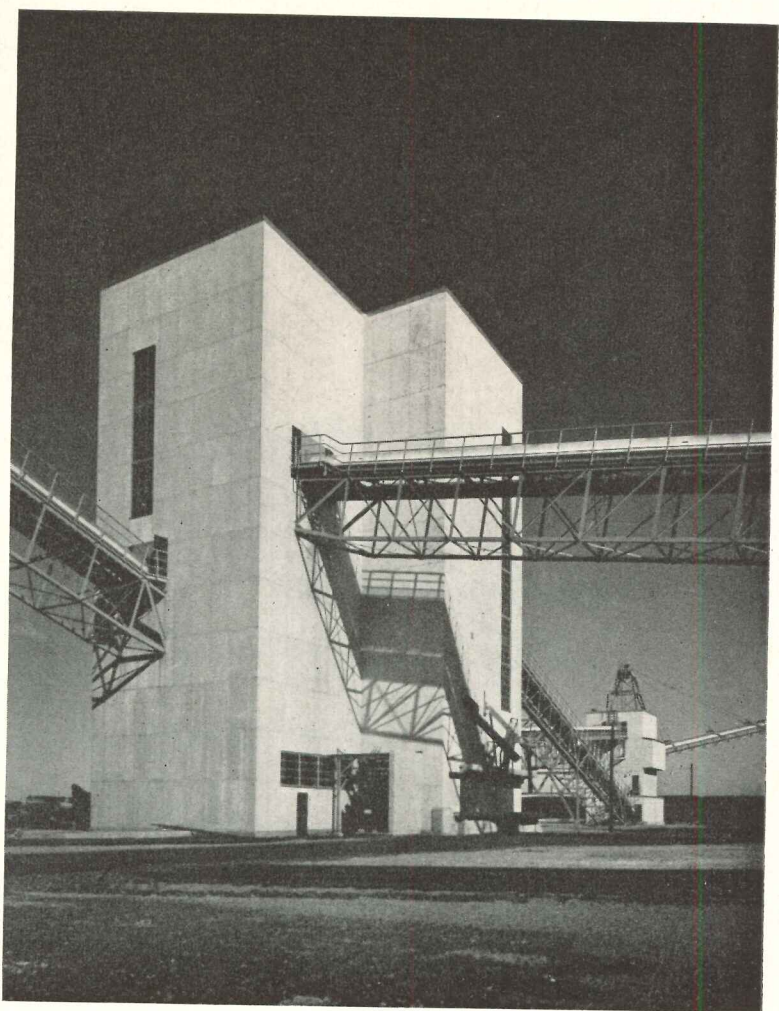
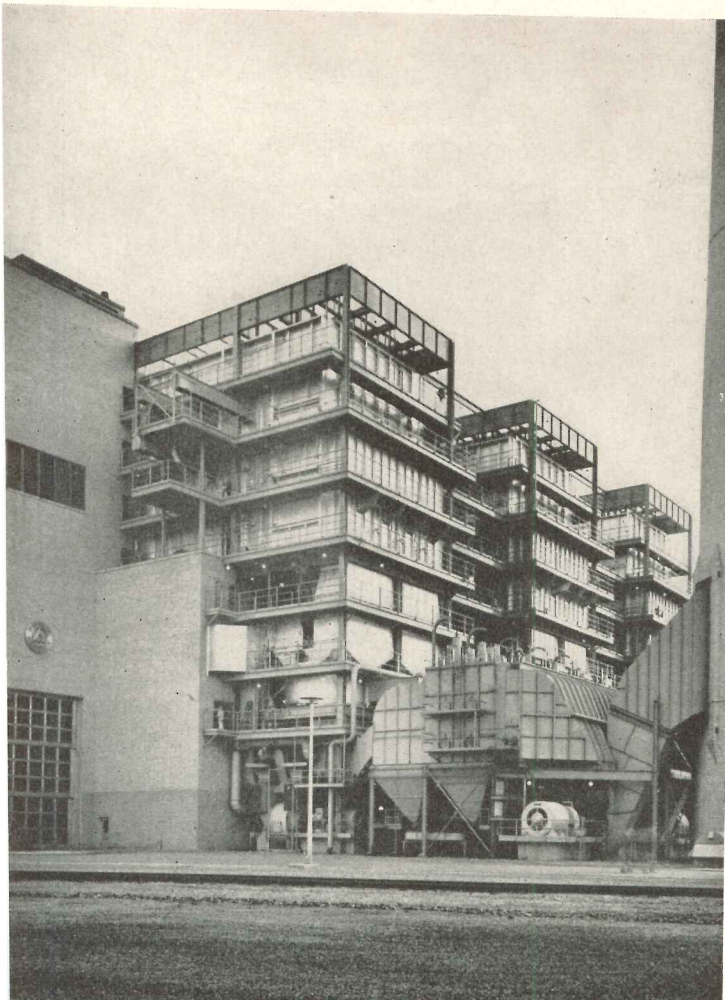

Richard Garrison Photos

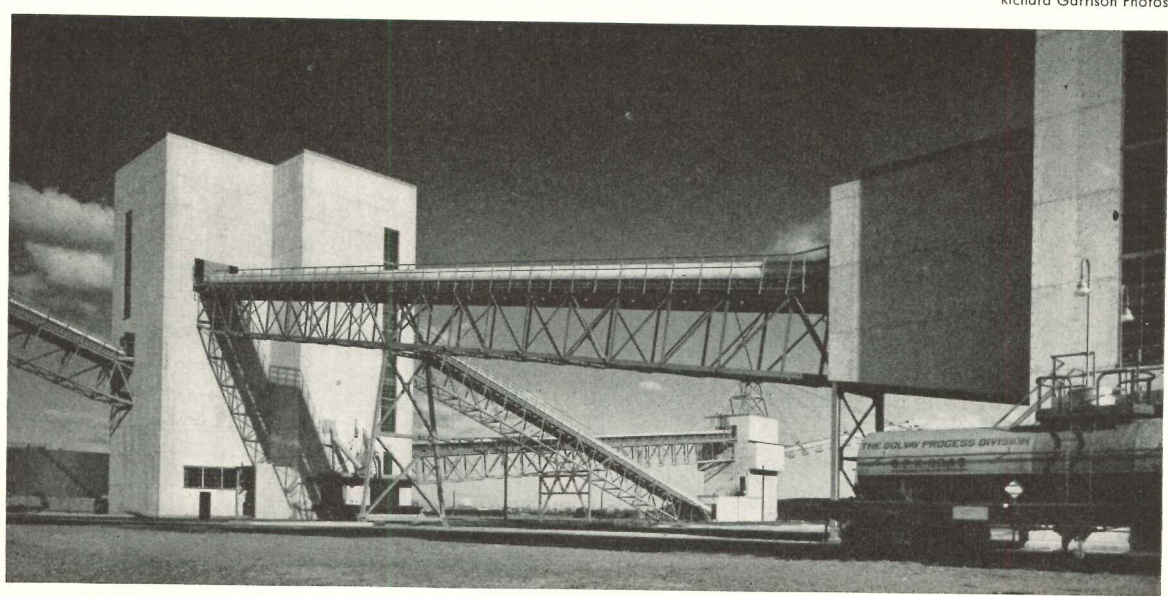

Richard Garrison Photos

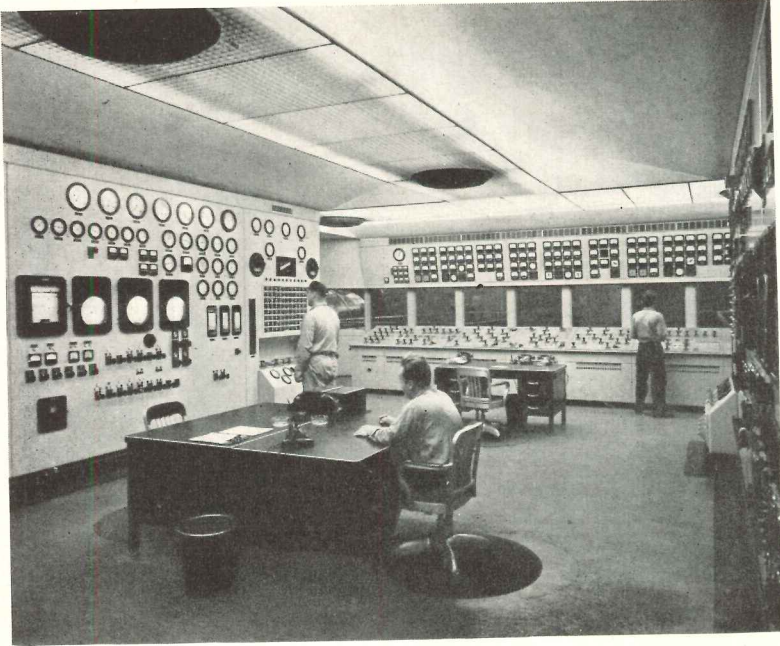

Where outside light was needed it is provided by continuous rows of glass block in the turbine room and continuous sash in the service building. Otherwise the composition uses large unbroken masonry walls. Main building is gray brick, with limestone window surrounds and copings. As low maintenance cost was a factor in design, all sash are aluminum; the large windows in the turbine room, main entrance doors and the large triple-lift door are stainless steel. For ease in cleaning, interior walls in boiler house are 5 by 12 salt glazed tile, in turbine room 8 and 16 gray ceramic tile. Coal handling structures are steel frames covered with flat Transite. Conveyor belts on bridges are sheltered by stainless steel hoods

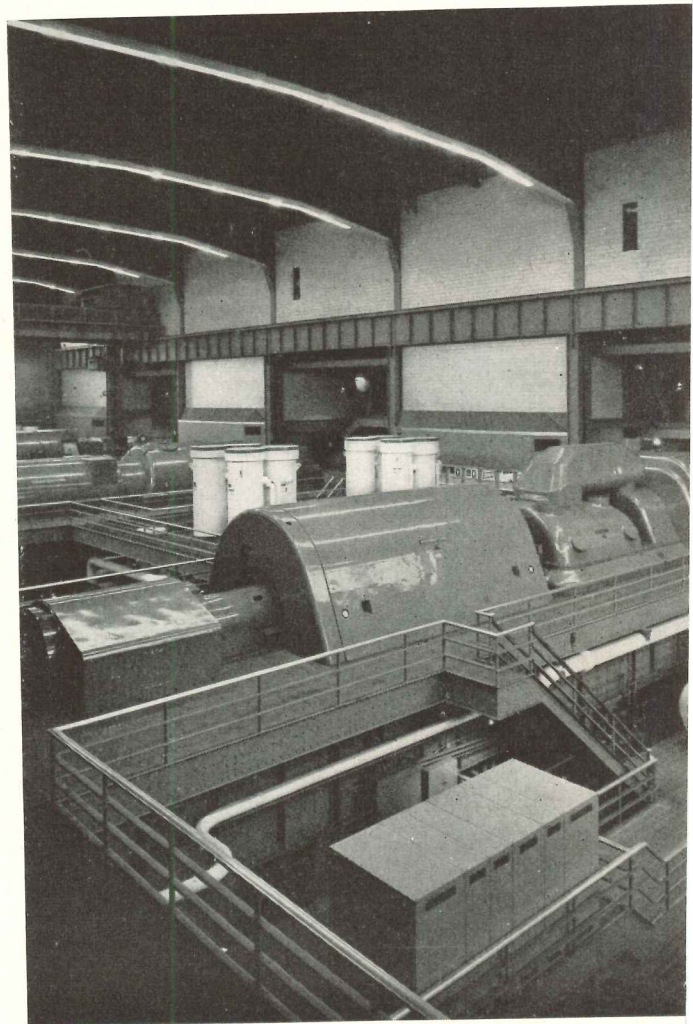
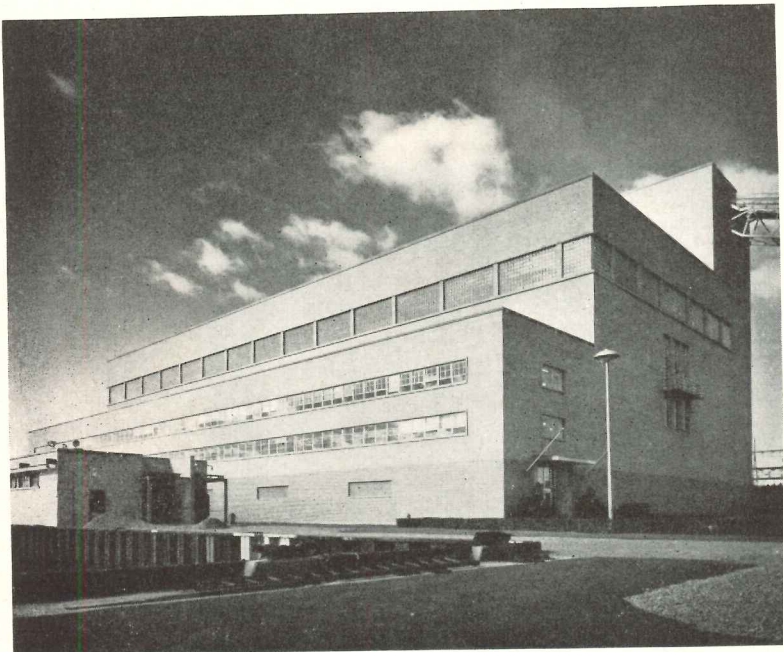



SMALL TEXAS OFFICE BUILDINGS PLANNED FOR UPTOWN SITES

1. Page, Southerland & Page Building, Austin, Texas

2. Thornhill-Craver Office Building, Houston, Texas

3. Technical Instrument Co., Houston, Texas

4. Remington-Rand Building, Dallas, Texas

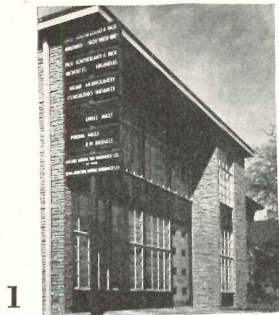

1

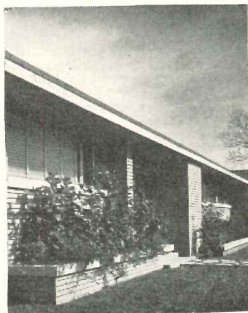

3



2



4

These four Texas buildings were cited briefly in the January, 1950, Building Types Study. Because of the excellence of their design, it was felt that they deserved a fuller coverage than was possible in the previous article.

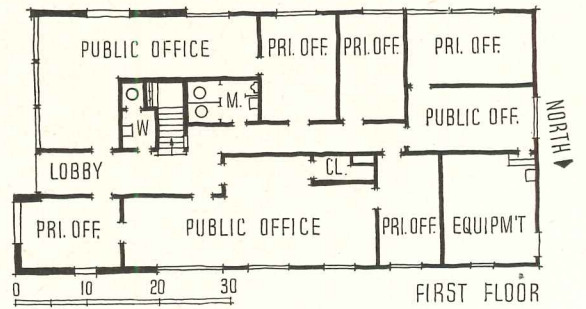

Mears Studio Photo

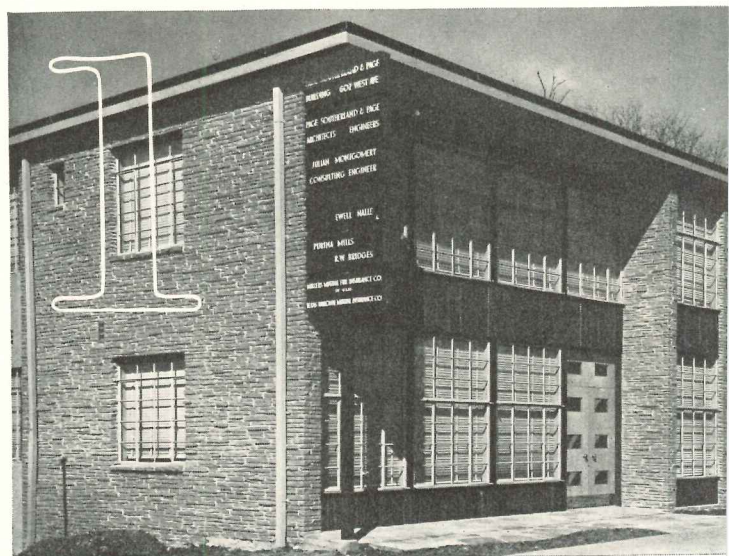

PAGE, SOUTHERLAND & PAGE BUILDING

Austin, Texas

Page, Southerland & Page, Architects

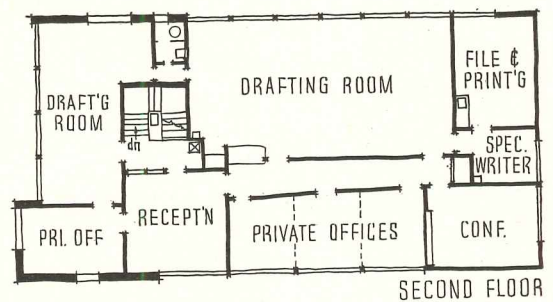

Interiors are finished for ease of upkeep. Entrance hall (right) is staggered behind stairs to avoid shot gun effect. Dropped ceiling in reception room (far right) houses ducts, lights



THE four buildings presented here represent varying solutions to the problem of housing office and light manufacturing space in less expensive, low density building areas. Planned occupancy varies from a single company to an assemblage of individual offices. Each of the structures is an outgrowth of the principles of planning small office buildings, as given in the January 1950 Building Types Study. Land values were paramount in determining building heights, site coverage and exterior exposure for offices; rental values served to determine location of tenant office spaces. All these buildings have certain features in common: low to moderate cost; ease of maintenance; some use of native materials; and deference to the climate, with air conditioning, insulation and sun shades or blinds. Advertising values for each occupant were carefully considered in the designs. Decorative effects have been achieved in a

logical fashion by contrast in building masses and materials.

The Page, Southerland & Page Building was specifically planned to provide quarters adapted to the needs of the architects, which could be amortized for the amount of rent normally paid for a similar space. For economy, the plan was based on a central corridor, flanked by exterior offices. The more rentable first floor was allocated to manufacturers' sales offices and an insurance agency, the second to the designers and an engineering firm with whom they have frequent business. An exterior sign, integrated as a design feature, lists all occupants of the building. The structure is wood frame with ledgestone and stucco exterior, cotton batt insulation. Interiors have acoustical tile and fiberboard ceilings, textured plaster-board walls, asphalt tile on oak floors. Parking space at rear allows future addition.

Studman Photos

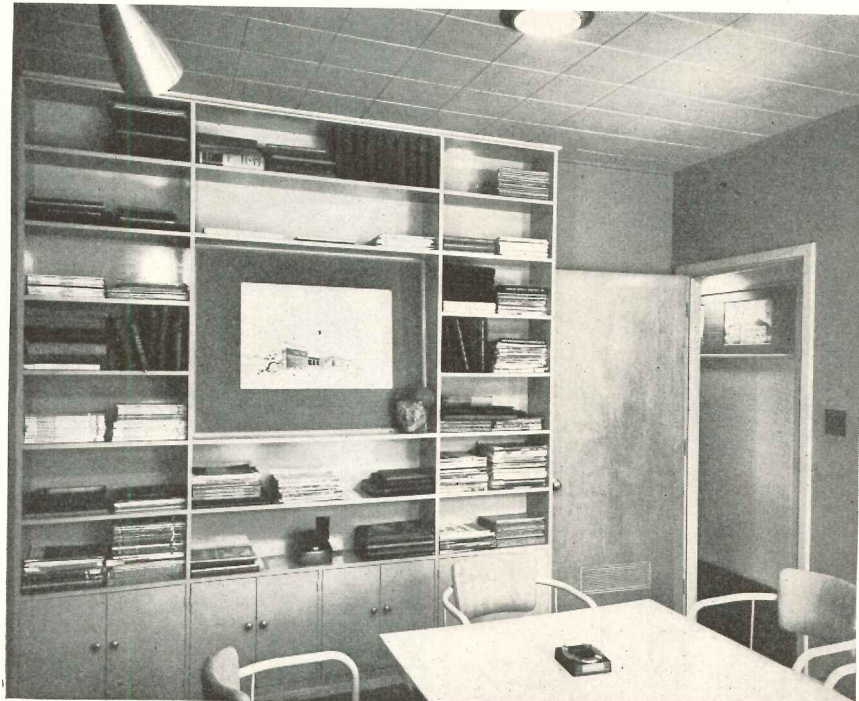

Three private offices are divided by curtains for flexibility: they can be used as extra drafting room, or partitioned for renting. Conference room (right) doubles as completely private work space

THORNHILL-CRAVER BUILDING

Houston, Texas

Mackie and Kamrath, Architects

THE simplest problem of the four is typified by this building: that of providing offices for a single company in a semi-residential neighborhood. It has been handled in an honest and straightforward manner. Plywood walled offices flank a corridor in a long, narrow plan. Each has ample daylight and sun protection with wide overhangs. The straight, wood frame and brick veneer facade is relieved by planting and a break emphasizing the entrance.

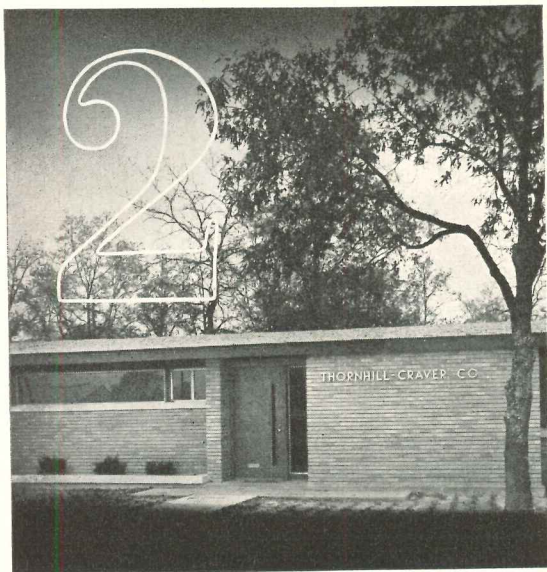

Mears Studio Photos

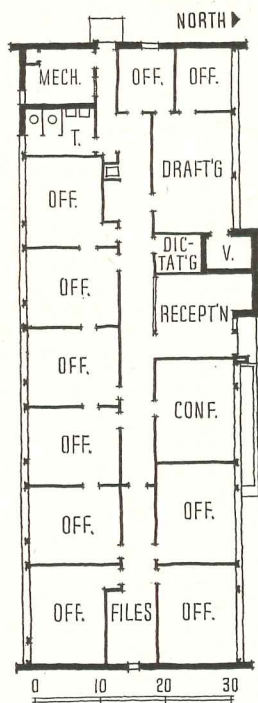

Domestic character has been imparted to the design by small scale and low, pitched roof. Projecting fins of the end walls give unity with roof, serve as decorative elements

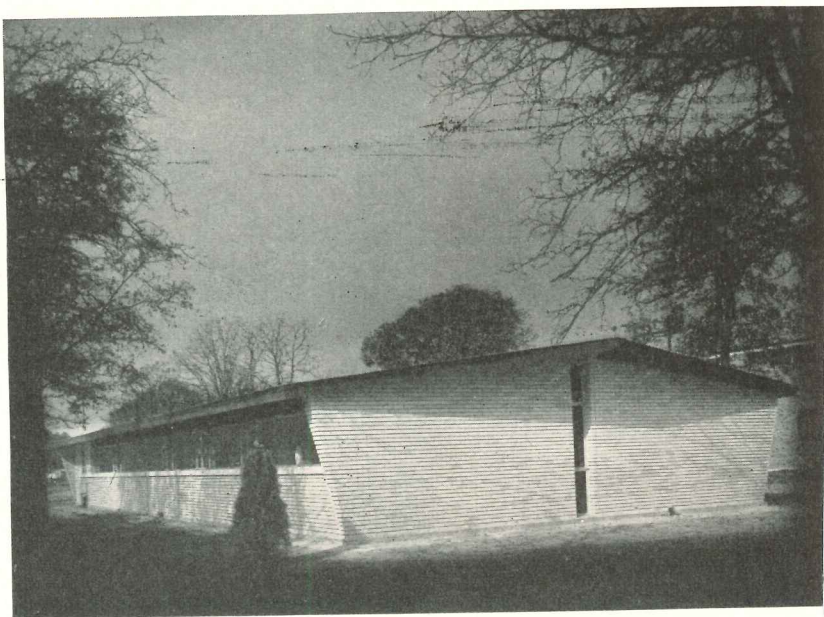
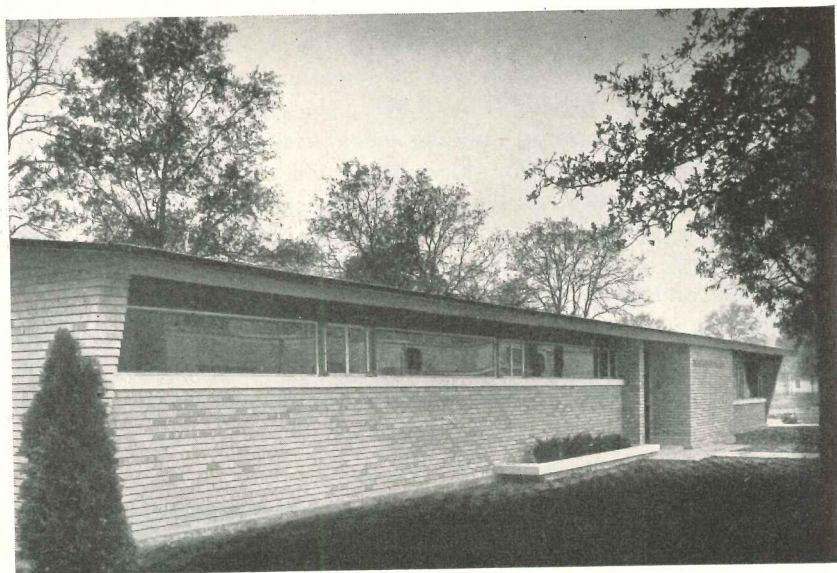

TECHNICAL INSTRUMENT COMPANY

Houston, Texas

MacKie and Kamrath, Architects

DESIGNED to house shop and testing rooms for light precision manufacturing, as well as company offices, this building employs an L-shaped plan with services grouped in the center. Offices are given choicer front areas, shops are relegated to the rear. The structure has concrete block and brick veneer bearing walls, interior pipe columns, bar joists and built-up tar and gravel roof. Interior walls are sand-finished plaster.

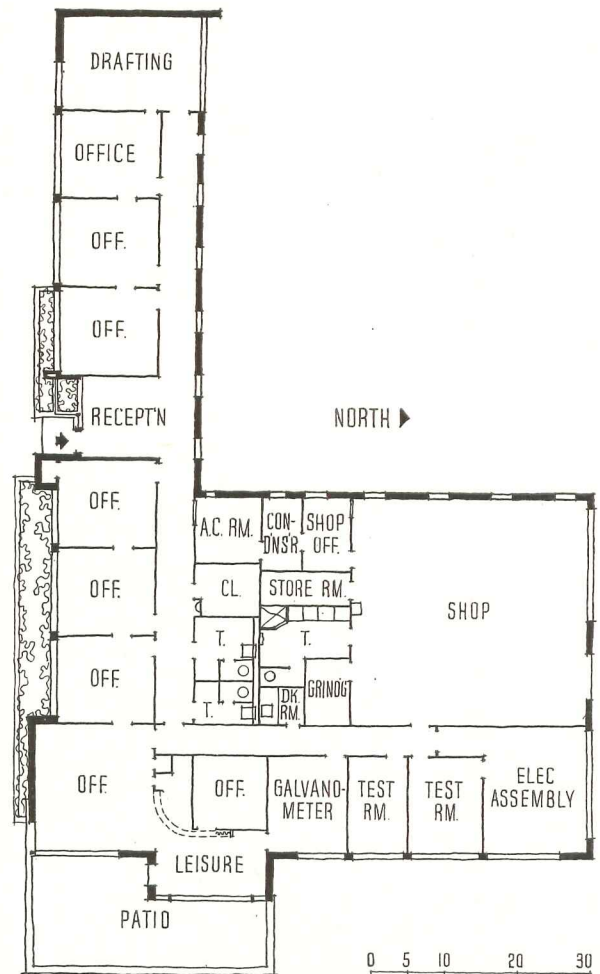
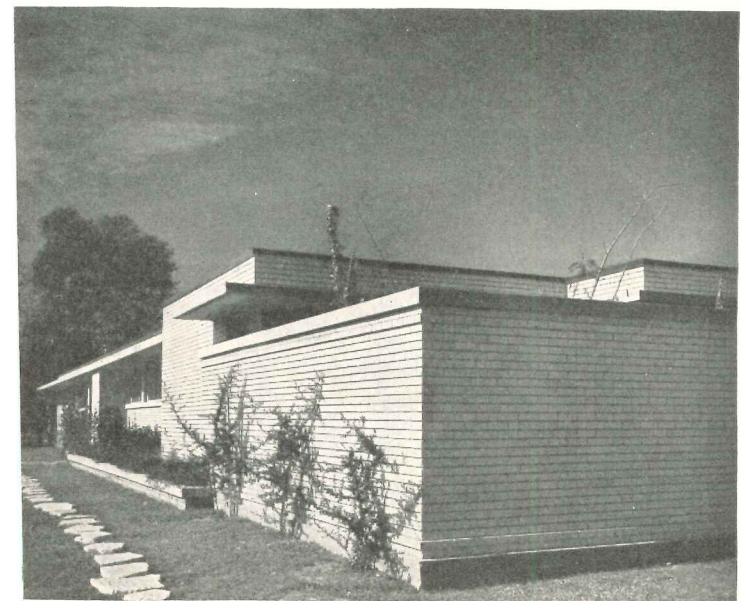
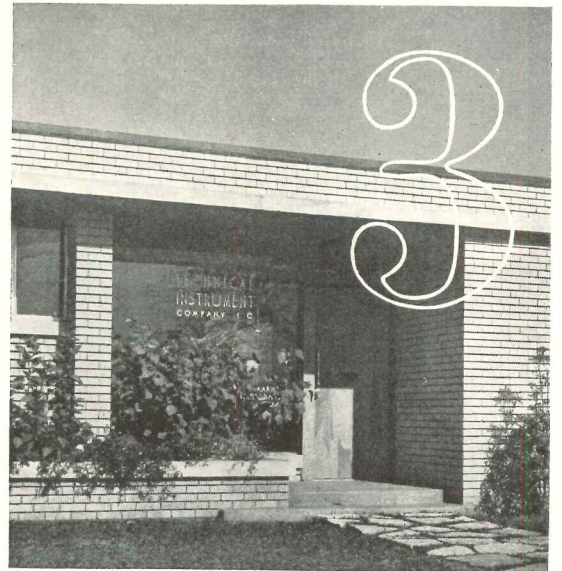

The exterior design utilizes play of intersecting overhangs, building projections, patio walls and unified planting



Location of the building in a semi-residential neighborhood permits use of planting and indoor-outdoor relationships suitable to the semi-tropical climate. Reception lobby (above) has plant box continuing on the interior. The office below adjoins lounge space and patio for entertaining clients. The bar can be closed off by a sliding partition

Lindenthal Photo

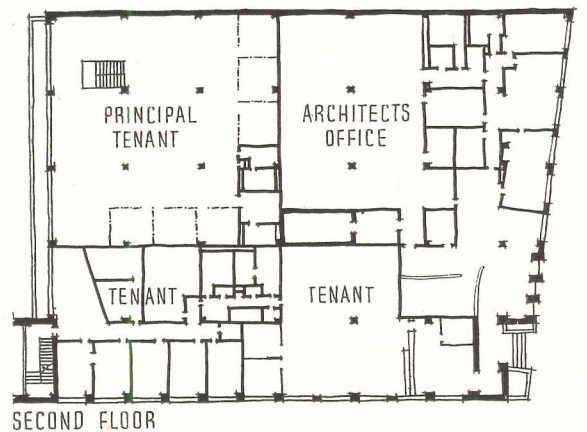
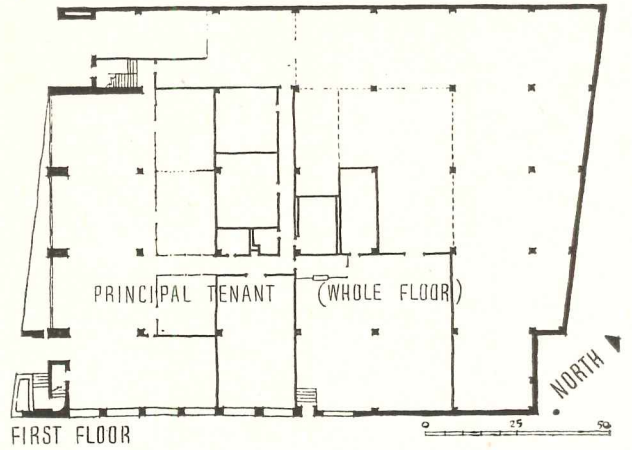
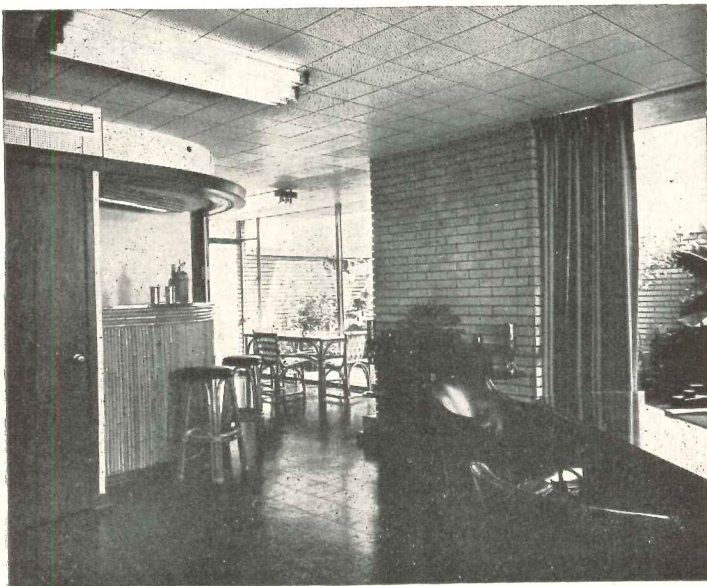



REMINGTON-RAND BUILDING

Dallas, Texas

George L. Dahl, Architects & Engineers

INGENIOUS use of a sloping site gives individuality, separation and private entrances to owner, architects and tenants of this building. The lot faces two important streets, permits entrances at two levels. Remington-Rand occupies the two-story portion of the facade shown. The large glazed block points up stairs leading to upper floor offices of the Music Corp. of America. On the next street (see photograph ARCHITECTURAL RECORD, Jan. 1950, p. 109) are entrances to the Associates Investment Co. and the architects' quarters. Reception room, library and drafting room of the latter are shown here. Office spaces are mostly interior, and make use of clear glass and folding partitions; controlled air, light and sound. Exterior walls contrast brick, cordova shell stone and ledgerstone.

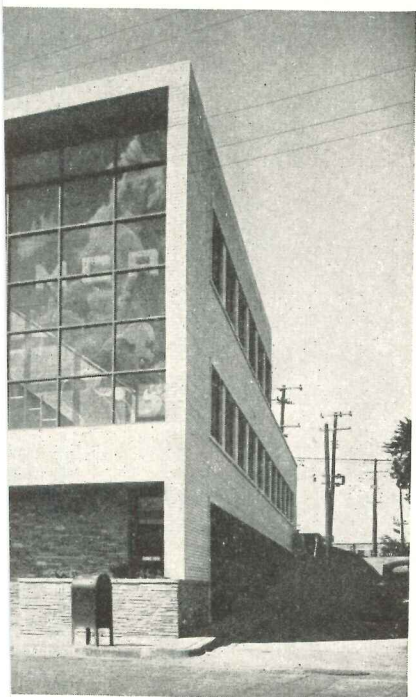

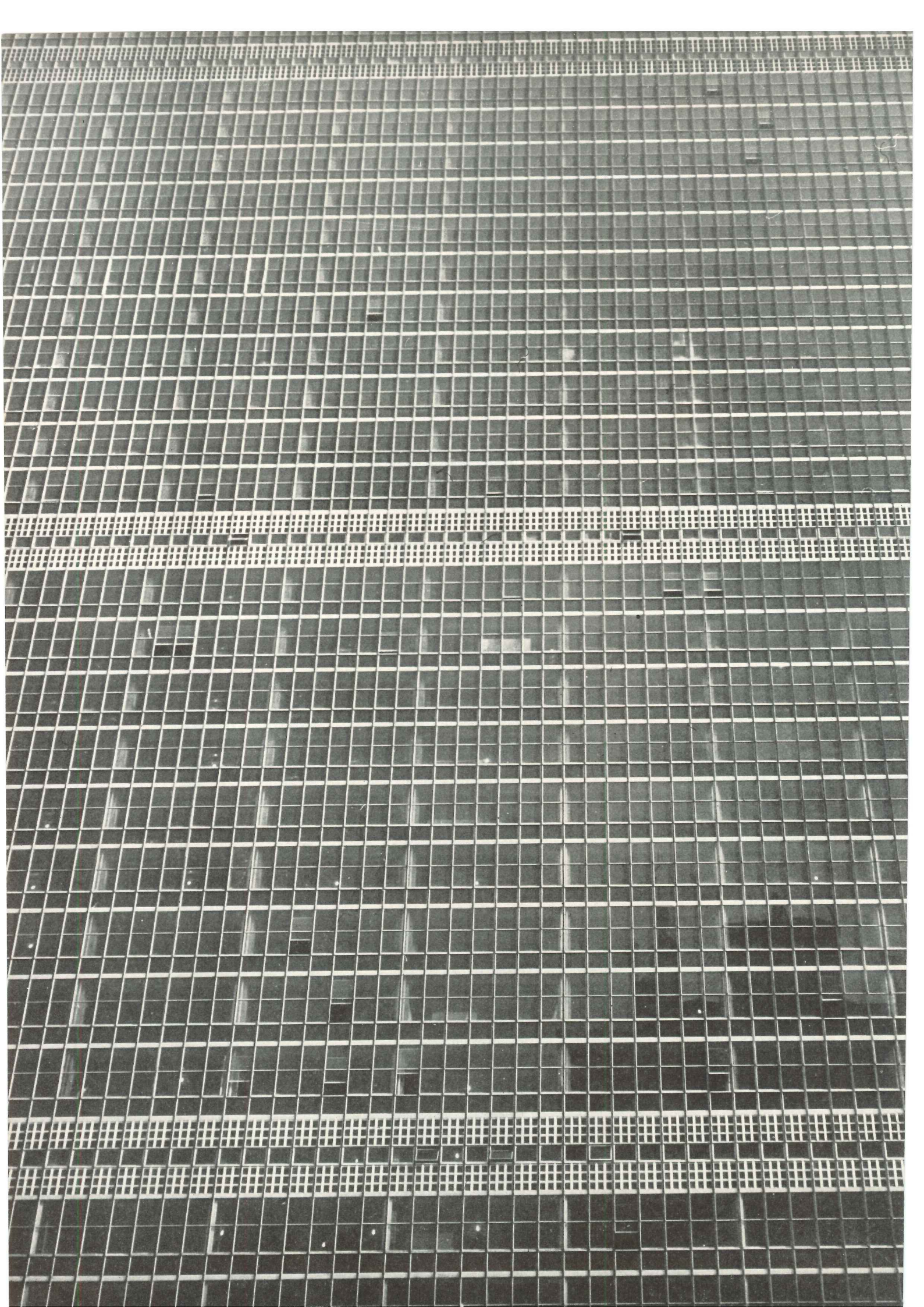

SUN, SHADOW AND SILHOUETTE

UNITED NATIONS SECRETARIAT



Louis B. Schlivek photos

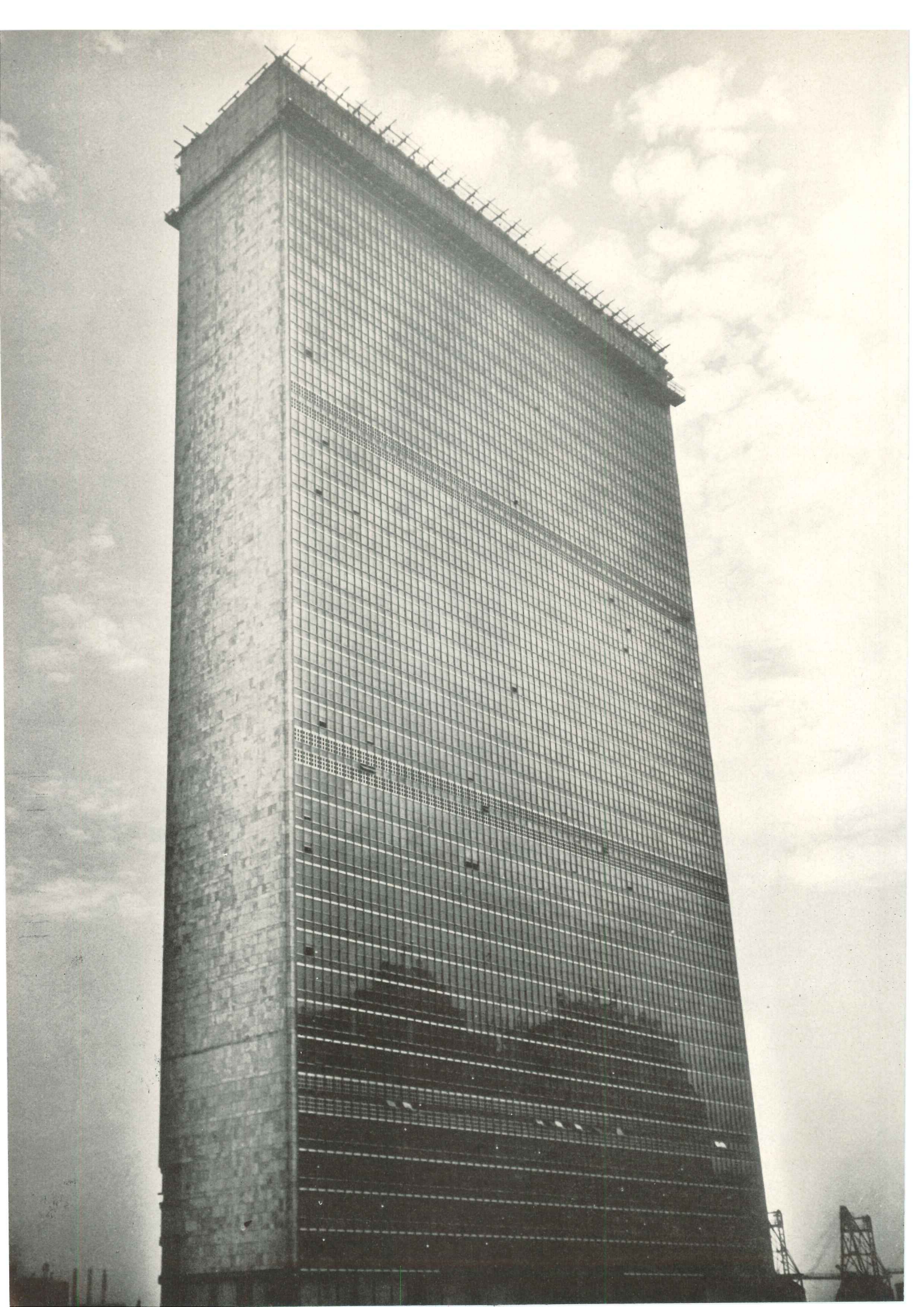

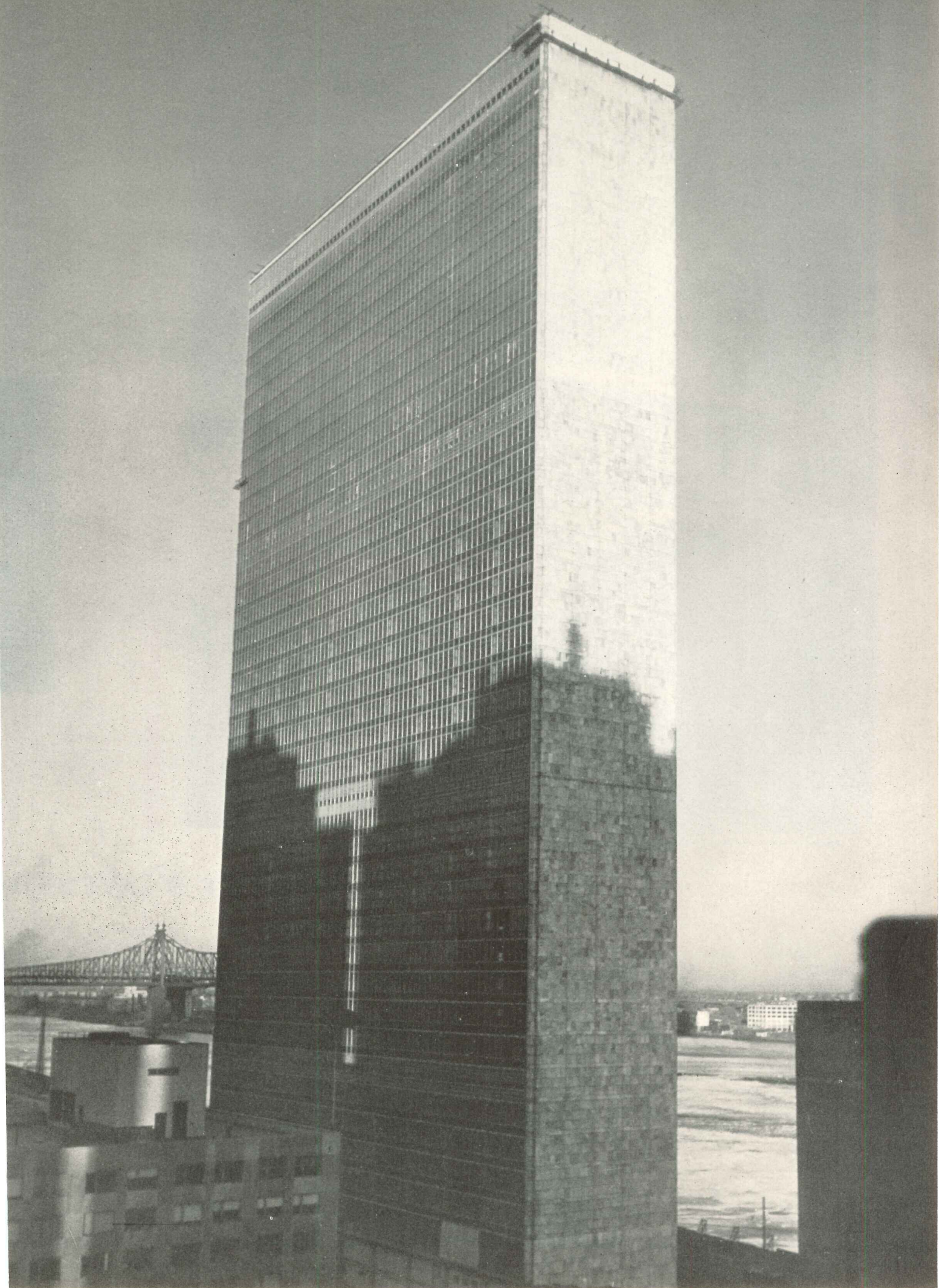

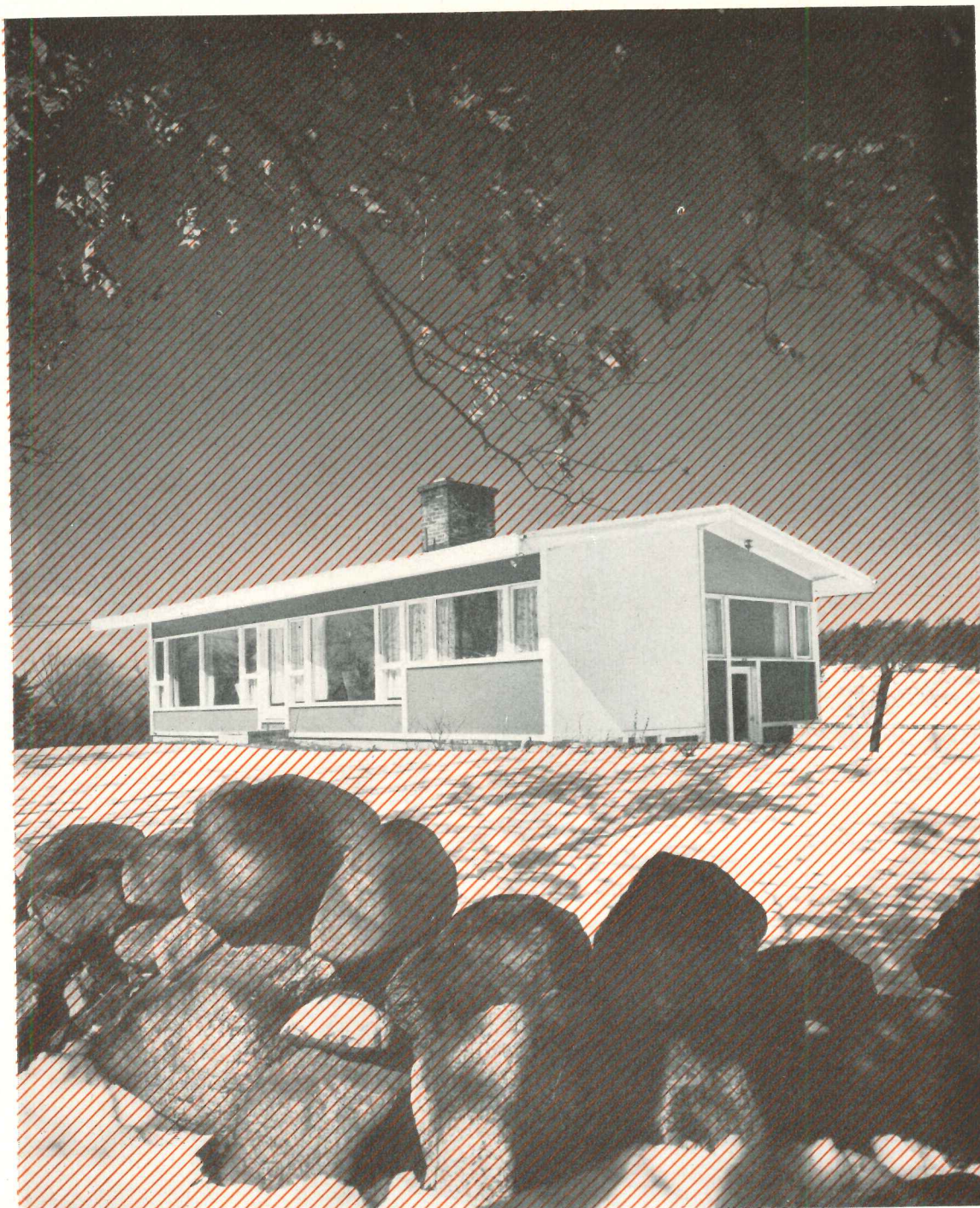

Lawrence House, by Architects Collaborative. Photo: Freedman Pictor

BUILDING TYPES STUDY NUMBER 161

DO SMALL HOUSES AFFORD

Revere Quality Builders' House, by J. A. Grove, Jr. Photo: A. Church

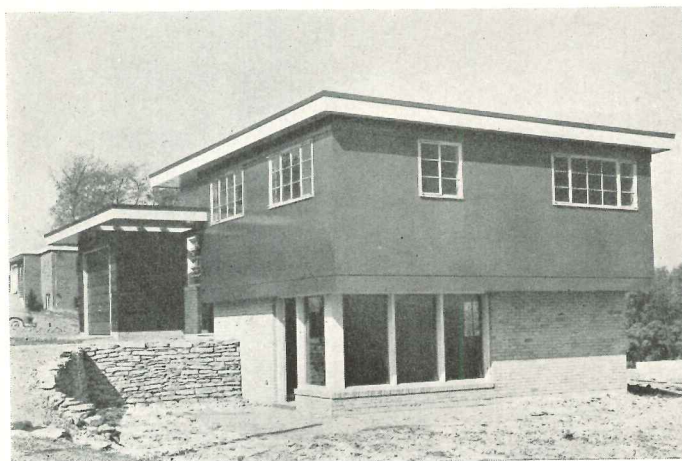

ARCHITECTURAL RECORD'S

This Building Types Study has a somewhat broader objective than many of its predecessors. Here we are concerned not only with design, materials, equipment and construction; concurrently we are reporting on the small house as a field of architectural practice. The demand is tremendous; in 1948, 766,500 one-family houses, averaging \$7,850 in cost, were started. Exact figures are not available for 1949, but it appears that over 840,000 were started last year. In January 1950, 60 per cent more dwelling units were started than in January 1949, and, according to Housing and Home Finance Agency estimates, we shall have to build at a much higher rate until 1960 to catch up. Yet the returns in this field are generally considered inadequate by architects. Builders and owners also have complaints.

This report is based on interviews with architects, builders and householders throughout the nation. Obviously we could not talk to every participant in an activity of such proportions; we have selected them representatively, with regard for geographical distribution and above all for integrity of performance. We wish to acknowledge with thanks the cooperation of The Revere Quality House Division of Southwest Research Institute, whose entire program is reviewed here, and of the individual architects, builders and owners whose patience as we pried into their intimate affairs has helped make this an honest evaluation.

WHEREVER you go among architects you find them talking shop. "Now when you've got a client like Smitty . . ." and ". . . that Johnny Bell, good builder if he gives you the right foreman . . ." and "Listen, we couldn't get finish carpenters on the job when . . ." Or else, "This mill construction, that's all it is, on the Verona house . . ." or ". . . way we did the Jones house, wrapped around this big oak, with the view . . ." And again, "We're working quickly, see, getting the board of education along with us, so the new school and the shopping center'll both be handy — why, there's twenty-five, maybe forty, houses to go right out there where the Planning Commission . . ."

Since last summer we've been talking shop with house architects all over the U. S., and with builders and owners. Much of this was done in person, a lot through our own representatives, a lot through The Revere Quality House program. The individual houses concerned range in cost from \$9,500 to \$20,000; all are small houses; and although only about twenty-five actual houses are shown here in part or in whole, they represent several thousand. We've found many praiseworthy things as well as a number of faults; some of the shortcomings are decidedly surprising — and this applies not only to architects, builders and owners, but also to our financing institutions. To obtain a realistic view of small house practice, we must consider, in addition to architects' beliefs, what the other participants in this field think and do.

The Architect-Builder Relationship

Exciting to architects is an increasingly apparent, and apparently sincere, understanding of the benefits

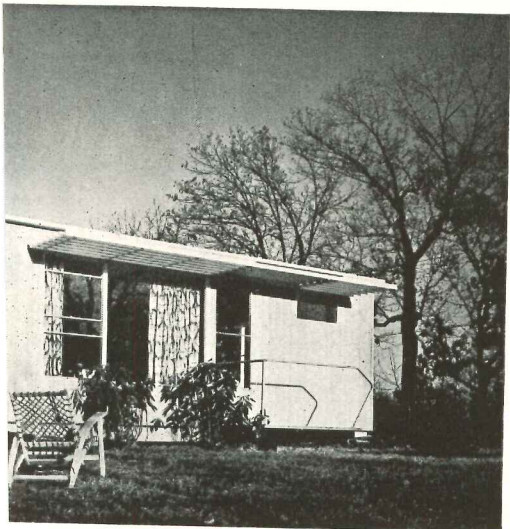

Prototype Prefab, by Acorn Houses. Photo: Stoller-Pictor

ATISFACTORY PRACTICE?

THE ARCHITECT

and

Houses for individual clients

Houses for sale

Prefabricated houses

obtainable through the application of architectural talent to "builders' houses." On the other hand, here and there one finds the attitude which architects have for years resented: that the architect is an interloper whose seal may be required but whose activity must be curbed. But in general, builders are groping to comprehend the architect for a very practical reason. In nearly every instance builders have told us that an architect-designed house stimulated interest in an entire subdivision, directly benefiting the builder even when the architected house itself did not sell quickly. Most architect-designed houses have sold exceedingly well. A few did not, because they were too extreme in handling, because the builder raised the selling price to get his money back — with, of course, a profit — or perhaps due to a particular set of circumstances.

This brings us squarely up against the builder's most severe, most cogent criticism of architects, one which applies with nearly equal force to architects of individual houses, of houses for sale, and of prefabricated houses. Too many builders are saying, "*The architect lacks the common touch.*" He does not talk a language instantly comprehensible to builder and owner or buyer. The architect requires a fee ranging from 6 to 15 per cent of construction cost. To the operative builder, who knows little of the cost of preparing plans and specifications (ignoring supervision for the moment), this looks like a sizable hunk of gravy. He considers what he hopes to make on one house and calls the architect a chiseler. If the architect would take the trouble to explain his costs for drafting, materials and overhead; to convince the operative builder that, once he has received enough fee to cover his architectural investment on a first house in a subdivision, subsequent variations in design might be obtained for a substantially smaller unit fee; and to demonstrate that the sum of architectural fees for an entire subdivision, when prorated among all the houses, amounts to something quite reasonable per house — then builder-architect relations would be substantially improved.

In dealing with both custom and operative builders, many house architects have been guilty of designing beyond the builders' capabilities. For example, consider the use of 4 by 4 posts and large expanses of fixed glass set between them, without casing or trim other than a glass mold — theoretically, a satisfying, direct, inexpensive detail. In practice, this requires perfect stock, well protected against marring in transit and storage (you realize how, and how many times, framing timbers are handled?); it means careful supervision by a superior foreman and painstaking work by framing carpenters (who after all aren't finish carpenters though they get nearly as much pay); after installation it means protection from the elements and against abuse during construction. Nine times out of ten such a detail is more costly than a conventional casing around the glass.

A recent survey confined to houses built for individual owners, conducted by Better Homes and Gardens with the aid of F. W. Dodge Corp., turns up the following figures: of over 1400 houses all over the U. S., only 15 per cent were architect-designed and supervised; 7 out of 10 houses cost \$10,000 or more (greatest percentage cost \$10,000-\$15,000); "ranch" and "contemporary" houses constituted 42 per cent of the sampling; median age of head of building family was 40.5 years.

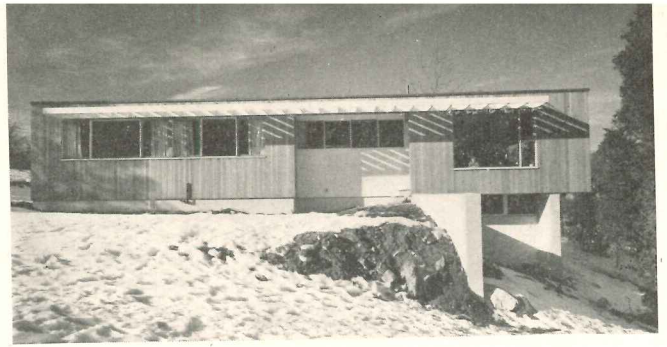

Comparing siting, living space, kitchens, in individual and builder houses. Top row, left to right,



Joseph Molitor Photo

The Builder, the Owner, the Financier

An architect who wishes to do good, sound, contemporary houses must be prepared to educate, even to wheedle, not only the builder and the owner or buyer, but also the finance institution involved, into proceeding with the job. Not so long ago fenestration and the cyma reversa constituted the architects' refuge from reality. How many times recently have you told a client about multi-purpose space instead of saying, "You can't afford both a guest room and a den," or spoken knowingly of insolation when you meant to warn him against the heat of a western sun? How often have such exotic words bred bewilderment, not the hoped-for understanding? And to project the idea beyond spoken words, how well, really, does the exotic, extreme house fit the average mundane owner? And if it doesn't fit its owner, is it truly good architecture?

On the other hand, the understanding of many developer-builders is far advanced beyond that of our cautious financial institutions, governmental and private. One builder, typical of several, told us that he could sell modern houses like hotcakes; people kept asking for them; he kept building Cape Cods because the local FHA office wouldn't insure anything else. Then there was the insurance company representative who went grudgingly, in line of duty, to inspect a modestly modern subdivision house; his company, he asserted, never lent on anything so wild; the home office must be crazy; he'd quit before he'd okay such a risk himself. (P.S. — after the inspection the representative reversed his stand completely. What he thought he had seen in blueprints and heard described was not at all what he found in the flesh.)



Valley, Providence and Neill houses, all by Architects Collaborative. Below, New Jersey subdivision

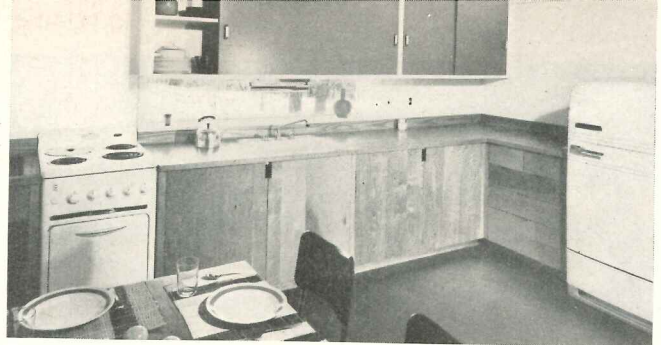

(see p. 148), Petroff & Clarkson; two views, Revere Quality House, San Francisco, by Joseph Esherick



It is very heartening to record wide public acceptance of contemporary design. Evidence to this effect comes from the Kansas City area, from conservative upstate New York, from a middleclass development near San Francisco. The Architects Collaborative, in Cambridge, Mass., was astonished by an elderly lady who demanded a radically modern house for her sole occupancy. A suburban housewife told our West Coast editor she'd never dreamed that a modern house meant a house so enjoyable. A purchaser paid a New Jersey developer a substantial premium to incorporate into a standard design a flat roof, sun-shades, banks of large windows, and numerous contemporary interior refinements.

In the face of such interest, coupled with a more selective attitude on the part of purchasers now that the frantic buying of the early postwar years has begun to abate, operative builders are finding they have to turn to good architects. At the recent Chicago convention of the National Association of Home Builders appreciation of architectural talent was overwhelmingly evident, as we reported in our April, 1950 issue (p. 9). Nor do big-time operators alone appreciate it; a rural New England builder told us frankly that he needed no architect for a Colonial house but modern houses, which sold better to more desirable customers — well, he wanted to build a lot of custom modern jobs to get the hang of them so he could start a modern subdivision.

Almost any builder will tell you he's a business man. Truth is, he has to be a gambler and a craftsman above all. He gambles on weather, on materials deliveries, on labor productivity, and on the whim of the buyer. The craftsman tradition retains its strong hold despite prefabrication, site assembly of large repeated units, and

other progressive techniques. So strong are these influences that, by and large, builders have almost no conception of modern cost accounting; it is reliably estimated that over 85 per cent of the country's house builders, custom and operative together, cannot tell until a house is finished what the job must bring to afford a reasonable profit. Ergo, in a bull market houses are over-priced; in a bear market, builders go broke. True, most builders keep records and many do know from day to day what their jobs cost; but when we dug into this question we found that roughly four out of every five builders who did know their costs had been painstakingly taught how by architects or financing institutions or both. And the number of cases in which the architect functions as job expeditor, placing materials orders, telephoning suppliers, standing at the elbow of the mediocre foreman — particularly in dealings with smaller builders, this headache drives the architect to the nearest bar.

To air one more complaint, this time against architects: seldom does the architect working with an operative builder realize that the builder in this case is his client. The developer-builder cannot be ordered to do this or that; he himself pays the bills; he can be advised but not coerced.

So far this report has contained few hints as to how the architect can make a profit, monetary or less tangible, designing small houses, not much discussion of prefabrication. Some architectural firms *do* make money in this field, and something *is* doing in prefabrication. For the how, the why, and the what we refer you to the following pages.

— Frank G. Lopez

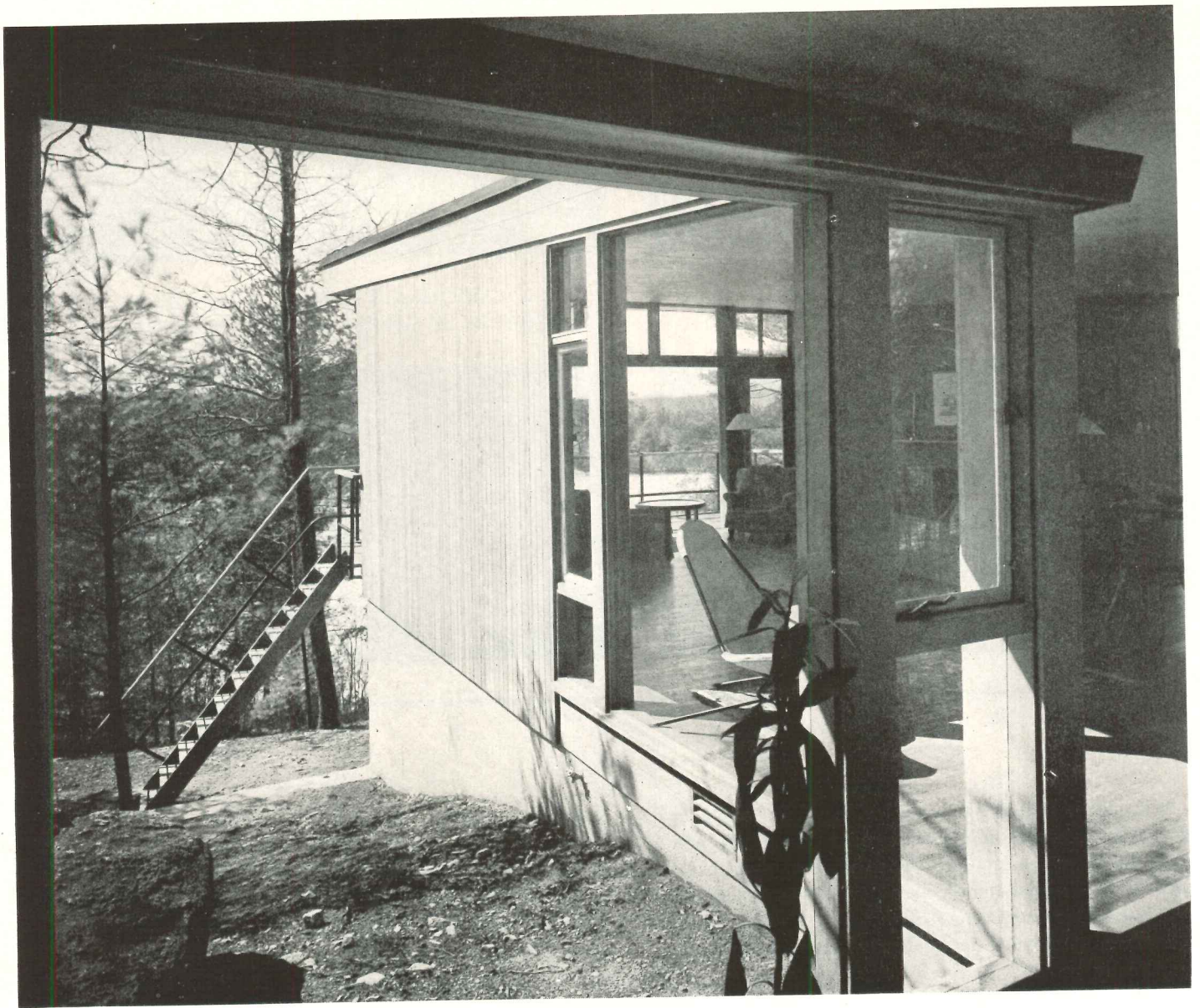

I—THE INDIVIDUAL HOUSE: PRACTICE OF THE

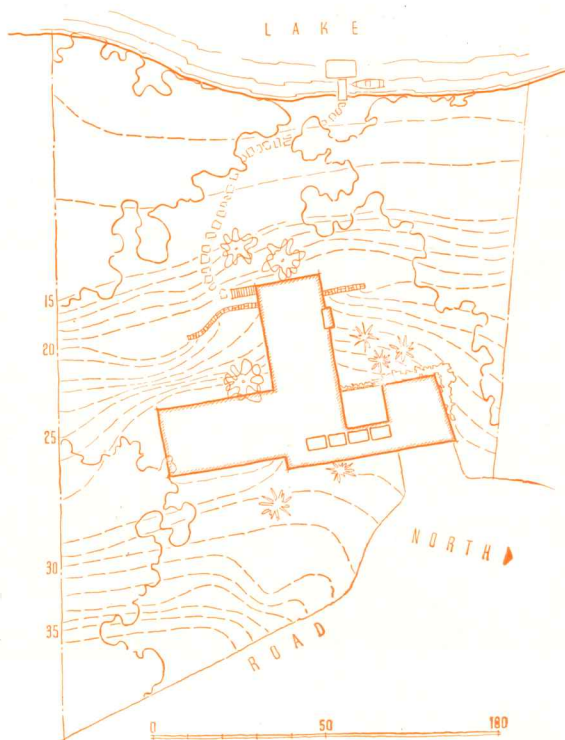

THE Architects Collaborative is more than an ordinary partnership or association. In it, Jean and Norman Fletcher, Walter Gropius, John and Sarah Harkness, Robert McMillan, Louis McMillen, and Benjamin Thompson share responsibilities, authority, and profits. In addition, TAC, as it is becoming known, employs a number of people, all young. The office has yet to refuse a job, residential or not, however small; and it has consistently furnished its co-equal members a fair living. None expect to get riches out of TAC, but most of them have built, or are now building, houses of their own. So natural does it seem to them to make money on houses even smaller than the Catheron job (see photos) that they are somewhat puzzled to realize that many architects cannot afford to take such work.

TAC's success in this chancy field is due principally, we believe, to their method of handling their relatively large staff like a group of one-man offices, and yet of

The house shown in detail here, for Mr. and Mrs. Alan Catheron, in Foxboro, Mass., was selected as a good, representative job of reasonable cost, produced by this comparatively new yet flourishing Massachusetts office

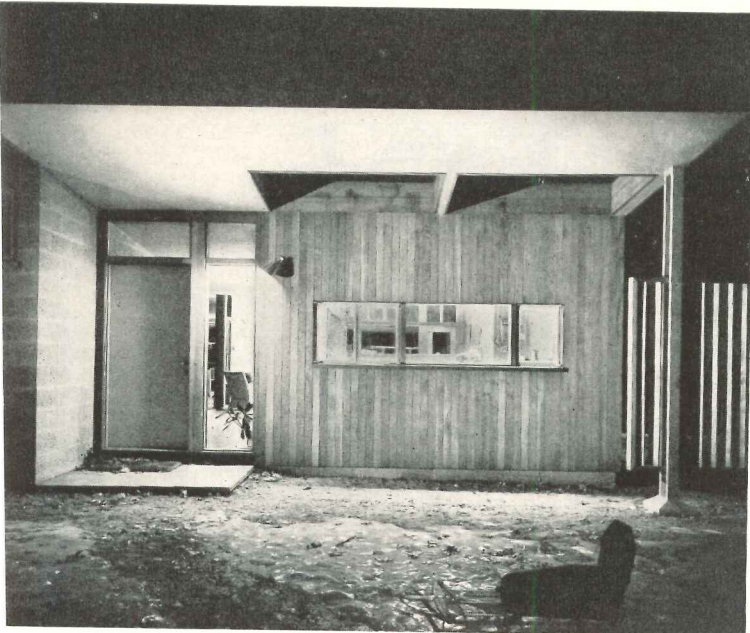

Photos: Lionel Freedman — Pictor

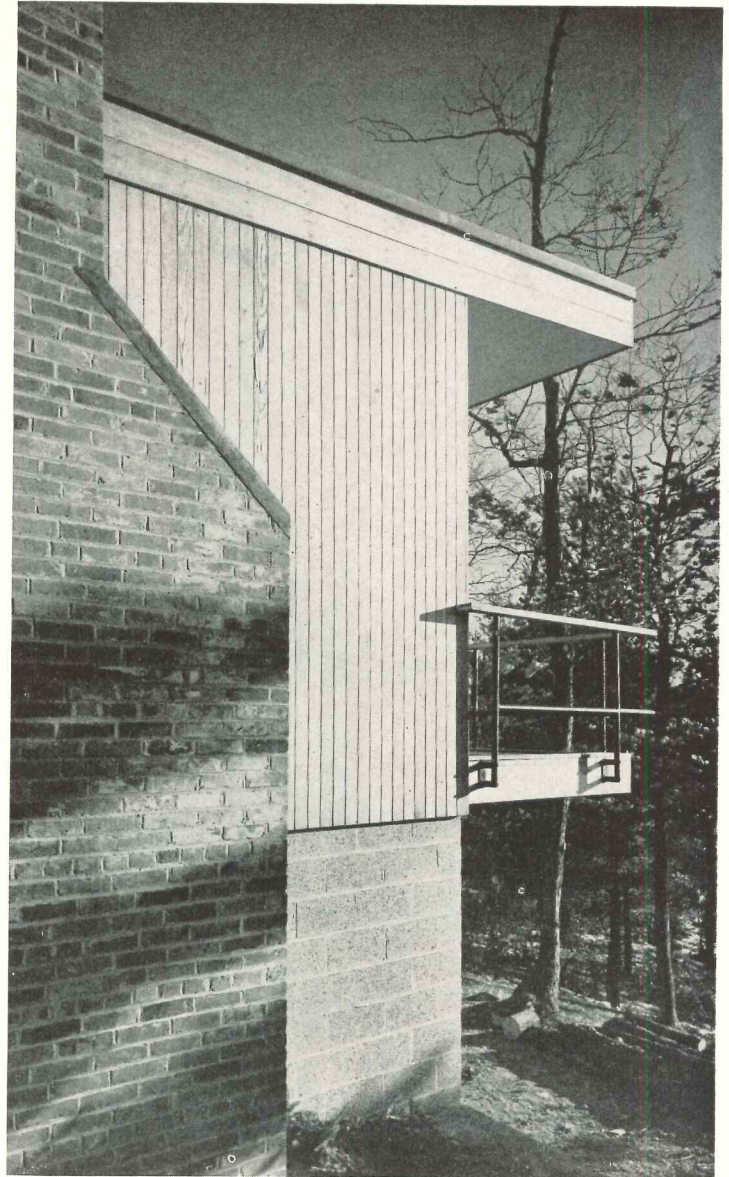

ARCHITECTS COLLABORATIVE

The Catheron house, so situated among evergreens that a comprehensive exterior photo could not be taken, is oriented to take full advantage of the view over a small lake. It displays many standard details and materials used by these architects on inexpensive houses

retaining their group identity. We all know that a just-licensed architect can do a small house on his kitchen table at home with profit, and conversely that the larger the office, the larger the fee per job must be. When a job comes in to TAC it is assigned to a design team which is made up of roughly three members of the office. These people work on the design and are responsible for working drawings, specifications, supervision, and all client or builder contacts. When preliminaries are completed the entire office sits in general criticism. The team's work to date is criticized openly; but any suggestions made are not mandatory — they may be adopted or not. For control, every job has a sheet on which its time schedule is set, hours being allotted, on the bases of experience and expected fee, for each stage of the work. Against this time goal are entered daily the actual hours spent, so that at a glance one knows accurately the state of a job's health.

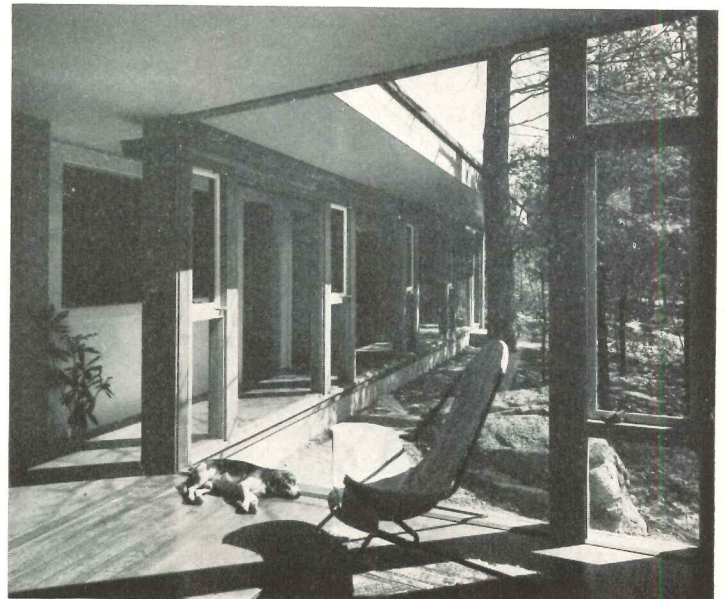



Drawing at right, of window wall in Catheron house (shown from within and without in large photographs), illustrates simplicity of TAC detailing and concessions to usual building practices

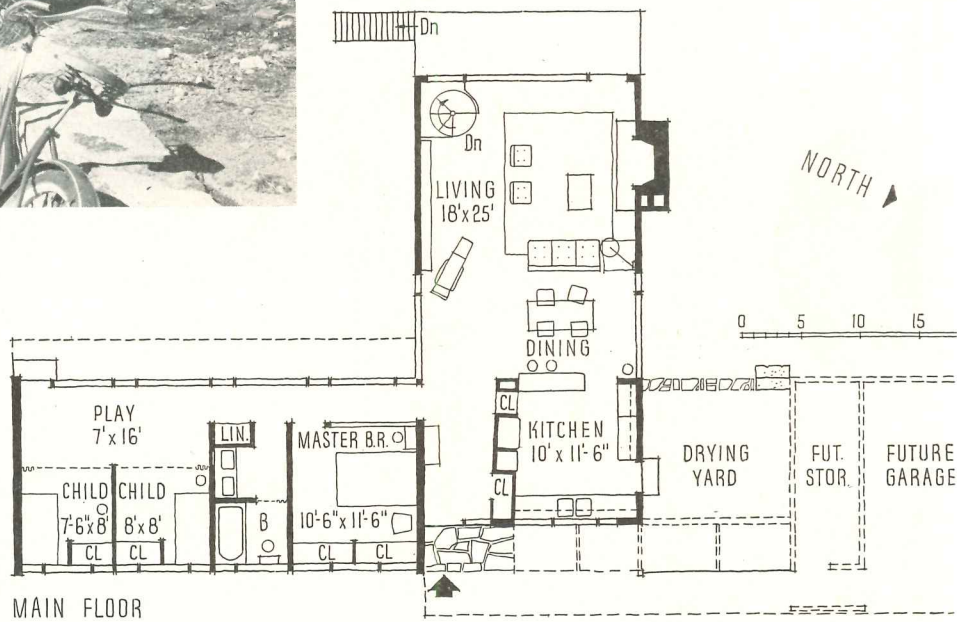
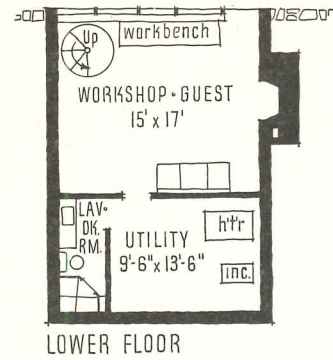

Below, circular stair to lower floor multi-use room; right below, north exterior

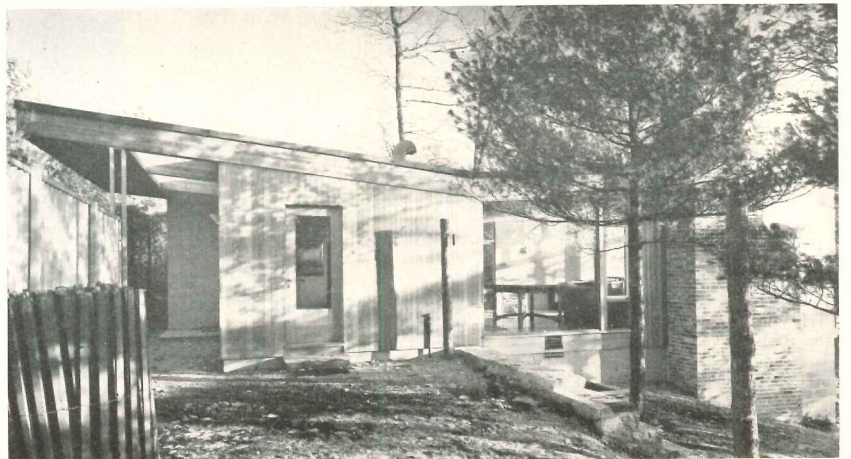

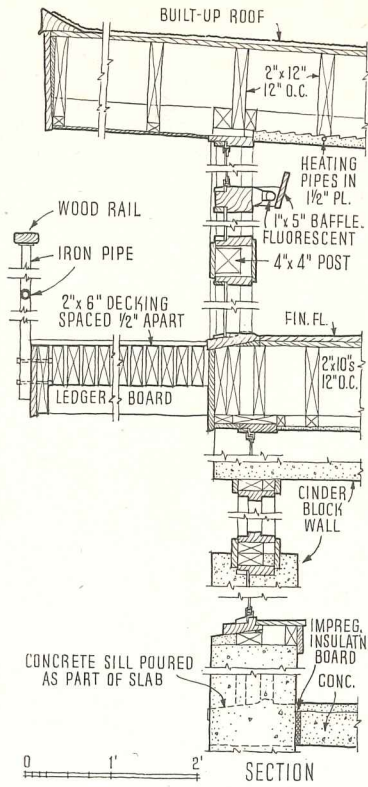

House clients of The Architects Collaborative, above the average in architectural awareness, come to the firm with contemporary design in mind, often from college circles. Occasionally a client is put out by TAC's system of allotting available firm members to a job. Frequently the client's desires increase during design and construction, but this seldom becomes unreasonable; TAC does not delude its clients, and when more building money is really needed it has usually appeared. Many clients need guidance in selecting furnishings; TAC is beginning to wonder if it should not set up a decorating service on a commercial basis. TAC's friendliness with most of its clients speaks worlds for the firm's sincerity, understanding and tact.

This is more impressive when you consider that TAC is one of our most advanced architectural offices, producing houses far out of the ordinary in design and soundness of construction. It is important, too, that in such offices much experimentation — with design, materials, methods, equipment — takes place initially, later to win acceptance by speculative builders. At most, only in 15 per cent of the nation's houses can ideas be thus tested; there are no accurate figures on number of custom houses vs. builder houses, but the influence of custom house design is admittedly great.



Lionel Freedman—Pictor: Photos

THE ARCHITECTS COLLABORATIVE

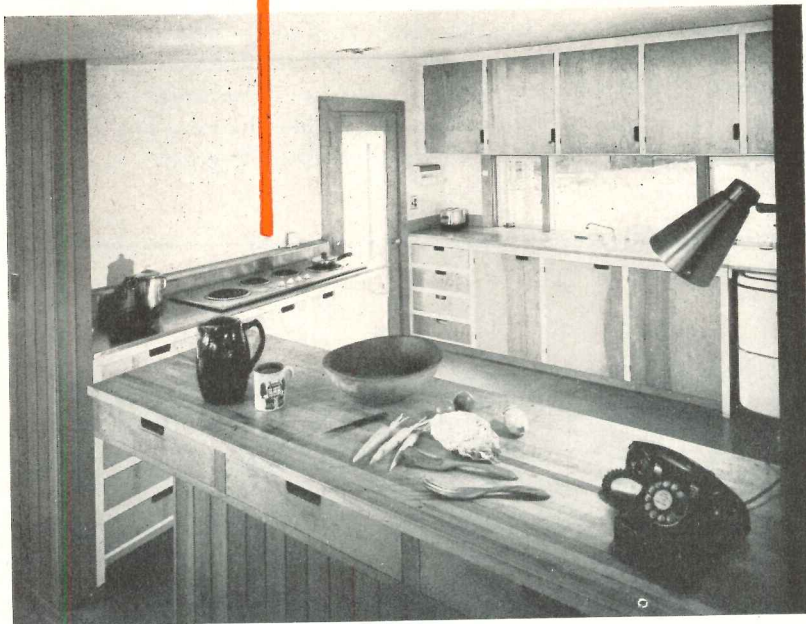
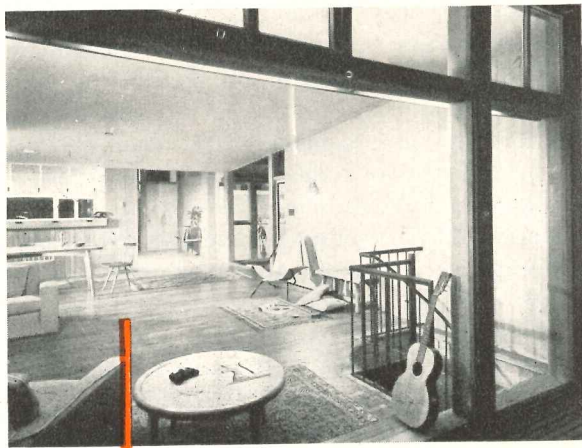

Lionel Freedman—Pictor: Photos

There is very little of the bizarre in the materials, structure, details, or equipment which TAC habitually employ. They do insist upon high quality of materials and workmanship, and to get good workmanship without undue expense they stick pretty closely to conventional procedures. For instance they early found that they could not use bare framing members, without trim, inexpensively. Yet each of their houses has an individual character although all are unmistakably TAC products — a double paradox since each TAC job is the result of one design team's effort within the group framework. Perhaps this TAC character grows partly from their use of standard details — of eaves, windows, vertical boarding, etc. — which were adopted both as time savers and to insure good craftsmanship, and which are constantly being refined. Certainly the glazed wall shown above is typically TAC, with its wide expanses of fixed glass separated by paired posts which embrace operable sash. This simple device affords a satisfying sense of structural security and any reasonably competent builder can build it. Similar reasoning underlies

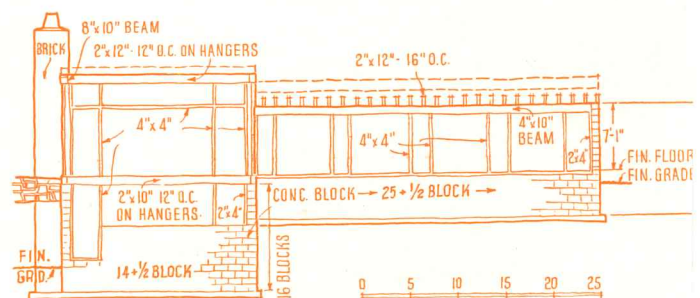

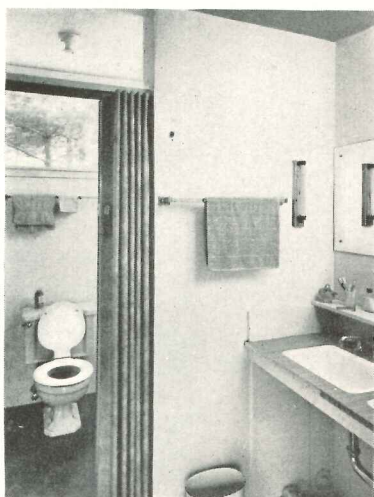
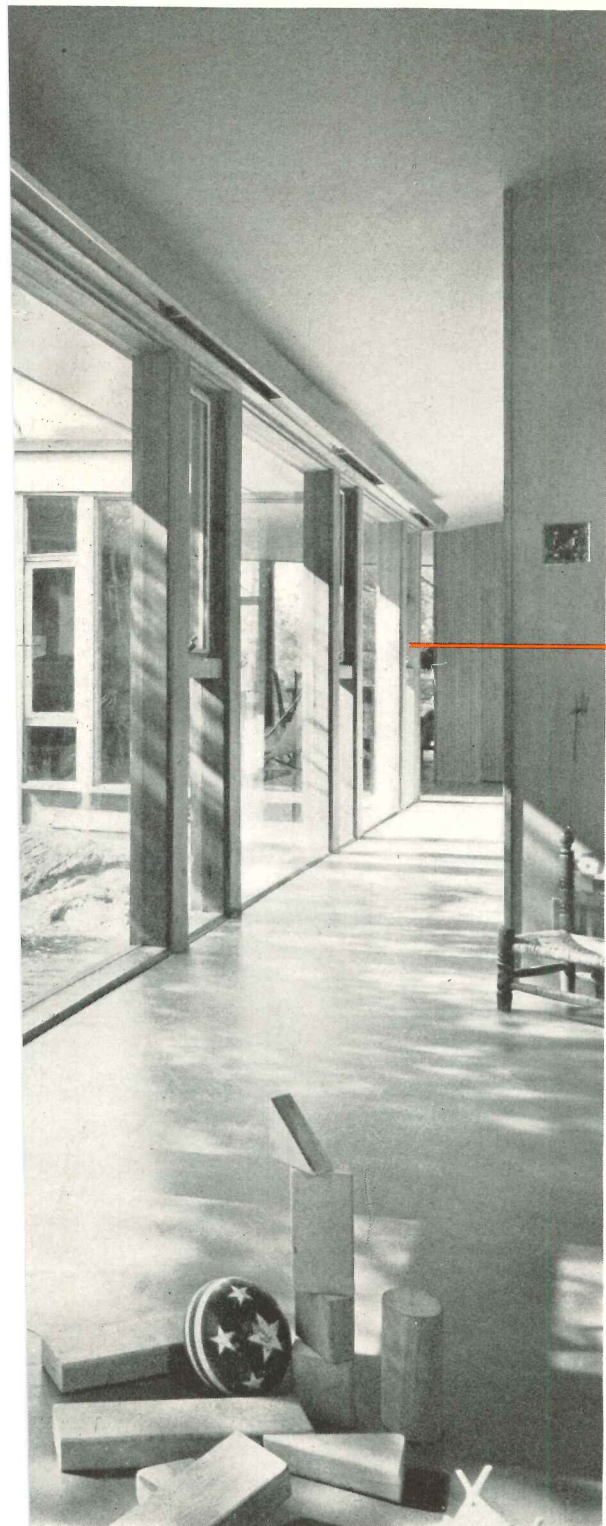

Every room in the Catheron house has its view. From the kitchen one can look past the serving counter through the living room's glazed end (far left); from bedrooms (above), through windows and folding walls across the glazed-in corridor (center left) which is also the children's play-room. Bath (left) has twin lavatories, other fixtures in separate compartment

their detailing of gravel stops and drip molds, their selection of equipment such as radiant floor heating. However, much of this character also derives from careful planning and siting to fit each family and each piece of property.

TAC's relations with builders are in general excellent. They work with several, not favoring one in particular. All their builders, now experienced in contemporary work, seem not to fear it — though there is suspicion that some builders exact more profit than the market will continue to bear. (One TAC member is currently acting as his own general contractor, on his own house, to determine what the profit margin is.) Each builder, they find, has his good and bad points: one does a fair job quickly; another, slower, is better on details; and so on.

All this adds up to a fairly successful though young practice. The members of TAC are friends with most of their clients and builders; they live well if modestly; they enjoy their small houses; and they are currently moving their office to better quarters.

One type of drawing furnished the builder by TAC is the quarter-inch-scale structural elevation like that on the facing page. Simple yet complete, its accurate block coursing, framing sizes and positioning help the foreman visualize his work. Unusual conditions are detailed at larger scale

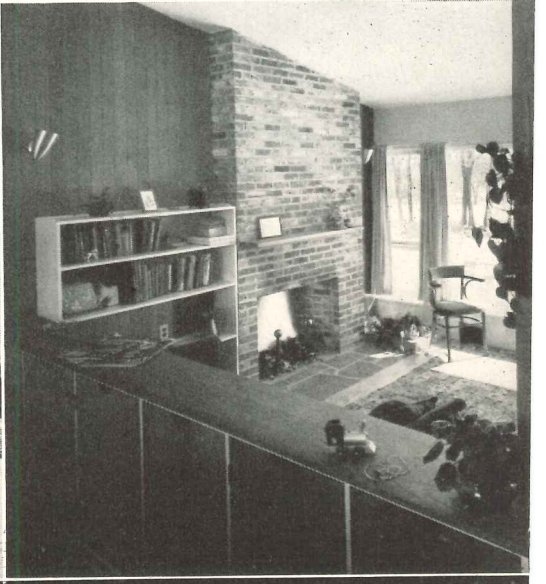

Photos: Lionel Freedman - Pictor

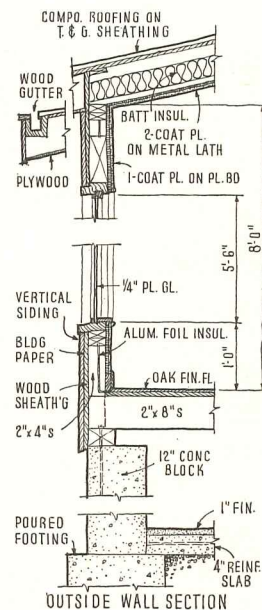
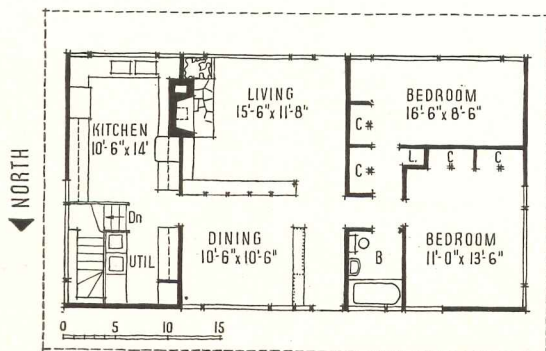
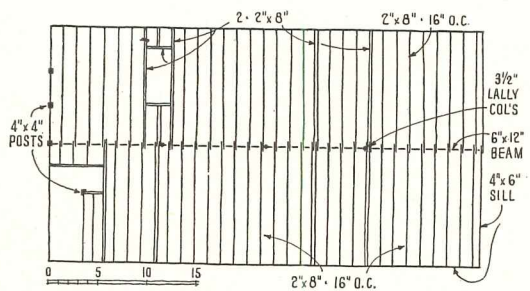
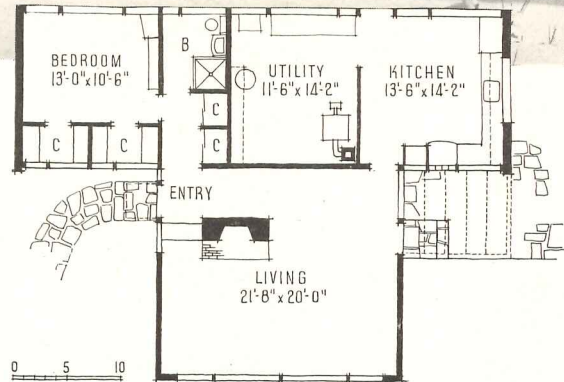
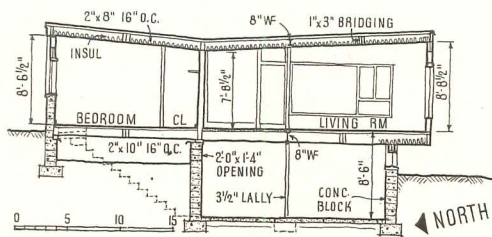

Consistency of design in two houses by The Architects Collaborative: photo and drawings above, Neill House, Andover, Mass.; left and opposite page, Lawrence House, Lexington, Mass. Another is shown on the next page. Character is achieved by adroit handling of familiar things, not by straining for something different



Freedman Pictor

THE ARCHITECTS COLLABORATIVE

In the Providence House TAC design talent is also unmistakably present even though its similarity to many West Coast houses is evident. The sloping site demanded such a treatment, made the broad planked deck a "natural"

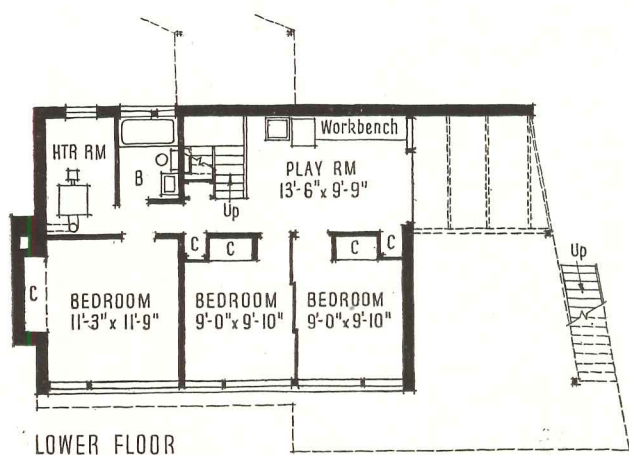
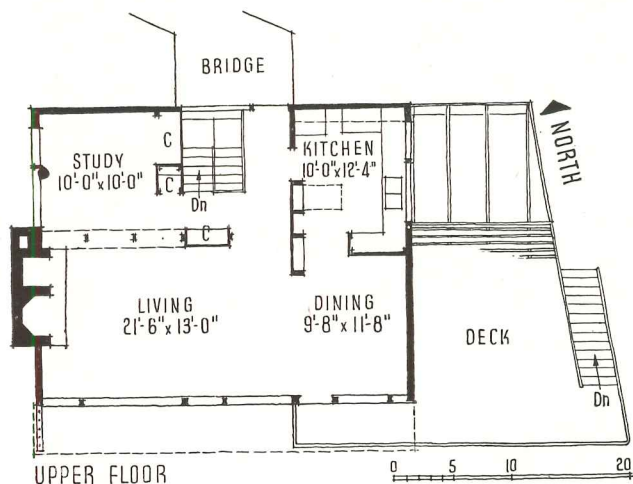

II—ARCHITECTS AND

Revere Quality House Division of Southwest Research Institute — now in its third year, with about 20 widely scattered exhibition houses (representing several thousand) built or building — is engaged in proving that quality design, materials, workmanship and equipment pay off in speculative houses. To earn the Quality House seal of approval, a house must be part of a multi-house subdivision, architect-designed, built by a reputable builder to certain minimum design and materials standards; the builder must guarantee construction for a year; the house must cost less than \$20,000, preferably less than \$15,000. The builder gets publicity and prestige from participation in the program which should add up to more and quicker sales.

Southwest Research Institute is an endowed, non-profit research organization. Its Revere Quality House Division, the principal members of whose staff are listed above, has a large board of advisory counselors who represent architects' and builders' organizations, researchers, publications, financing agencies and educators. As criteria for awarding approval, emphasis is placed on site planning; use of space; planning for health, convenience, livability, privacy; orientation; planning for outdoor living and future needs; quality materials, construction methods, equipment. It is everlastingly to the credit of the Quality House program that ways have been found to translate these rather ephemeral criteria into practical, everyday terms.

Builders have traditionally relied on gadgets to sell houses; architects have pushed, when they could, the less tangible virtues. The Revere Quality House Division has found the greatest obstacle to architect-builder collaboration to be lack of mutual understanding. A typical builder may regard an architect as an expensive esthete, an exterior decorator — a source of plans (when laws require) more expensive than the free ones he could get elsewhere. He regards this cost as unnecessary overhead. Some builders, more knowing, recognize the salability of good house design and will pay for it — but not much. More architectural firms now than ever before and several plan services are designing houses that will sell. But true collaboration, genuine regard of the builder as the architect's client, is still extremely rare.

Revere Quality House Division's first step is to convince the builder he should hire the best architect he can get, pay him well, and expect close collaboration. On the other hand, even the sincere, capable architect often does not recognize that his builder-client may well know more about house building than he; that close work with the builder, at every step, is essential; that he, the architect, must design a product that will sell.

OPERATIVE BUILDERS: REVERE QUALITY HOUSES

In the next pages we review the experience of Revere Quality House Division in promoting good speculative house design. In addition to members of ARCHITECTURAL RECORD'S staff, the following have rendered unusually valuable assistance: John E. Mitchell of Dallas; Alfred Moore of Syracuse, N. Y. and John W. Ragsdale of Denver, Col. — all members of F. W. Dodge Corp. We particularly wish to thank C. W. Smith, Director; John Hancock Callender, Architectural Consultant; and Virginia Caldwell, Manager, Building Relations Program (all of Revere Quality House Division of Southwest Research Institute) for facilitating our efforts to obtain a true picture of builder-architect cooperation



Above are 16 of the Revere exhibition houses; most of these and some others appear in greater detail on subsequent pages. Locations, completion dates, architects and builders are: 1, Alexandria, Va.; 1949; Charles M. Goodman Assoc.; Hollin Hills, Inc. 2, South Bend, Ind.; 1948; L. Morgan Yost; Place & Co., Inc. 3, Houston, Tex.; 1948; MacKie & Kamrath; Frank W. Sharp. 4, Denver, Colo.; 1950; Eugene Sternberg; Edw. B. Hawkins. 5, Phoenix, Ariz.; 1950; Roy Flesh; Clarence A. Suggs. 6, Pittsburgh, Penn.; 1949; John A. Grove, Jr.; Noble S. Clay Co. 7, Kansas City, Mo.; 1949; David B. Runnells; D. H. Drummond. 8, Cleveland, Ohio; 1948; W. D. Riddle; M. J. Fishman. 9, Boston, Mass.; 1948; Samuel Glaser; Arnold Hartmann. 10, Sarasota, Fla.; 1948; Twitchell

& Rudolph; Lamolithic Industries. 11, Springfield, N. J.; 1948; Kenneth Kassler Assoc.; Suburban Properties, Inc. 12, Dallas, Tex.; 1949; De Witt & Swank; American Home Realty Co. 13, San Bruno, Calif.; 1948; Joseph Esherick, Jr.; Williams & Burrows, Inc. 14, Seattle, Wash.; 1948; Chiarelli & Kirk; Albert Balch. 15, Salt Lake City, Utah; 1949; W. Rowe Smith, of the office of Fred Markham; Federal Homes, Inc. 16, Syracuse, N. Y.; 1949; Gordon Schopfer; Mayer & Rebhahn.

Other exhibition houses, not shown above, have been built in Detroit, Mich.; 1949; James B. Hughes; Ranch Homes, Inc.; Bethesda, Md.; 1949; Sweeley, Heap & Gauger; Carl M. Freeman, Inc.; and Cincinnati, Ohio; 1950; John R. Schott; Joseph Dillon

REVERE QUALITY HOUSES

In Hollin Hills, Alexandria, Va., every effort has been made to preserve the virtues of a wooded, rolling site. Plots are fairly large. When conditions demand, architect Charles M. Goodman (top right) and Robert C. Davenport, president of Hollin Hills, Inc., builders (below) have not hesitated to use unconventional floor layouts. Photo below, plan right, show a one-floor house; other photos, plan on facing page, for sloping site. Davenport has worked with several architects; is building 50 houses a year; uses site fabrication of some woodwork, shop fabrication of structural elements; believes money is well invested in architectural services because resulting houses sell from blueprints

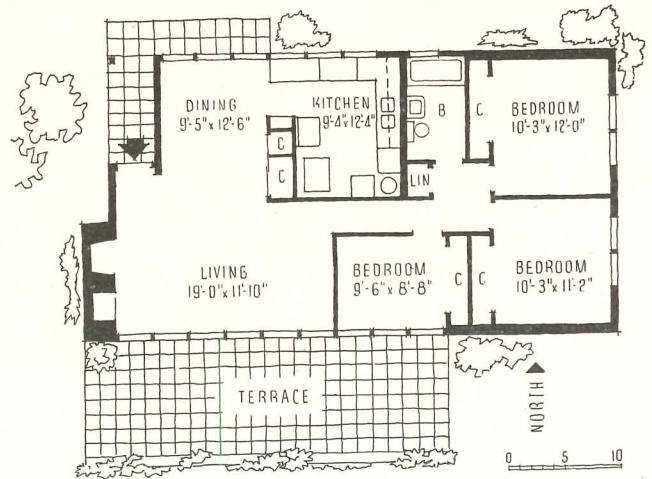

Bob Lautman Photos



One of the best examples of builder-architect teamwork is in Hollin Hills — teamwork which, Revere Quality House Division points out, was thoroughly established well before they certified the house. Architect Goodman has done over 330 houses for several builders, starting with analyses of land, neighborhood, probable satisfactory sales price, space needs. His fee depends upon what of the following he performs: subdivision layout, house design, house siting, cost budgets (quantity take-offs and cost estimates, a valuable service to builders), revisions for buyers, interior and outside decoration — all of which approximate custom design. He goes into construction methods, lays out sub-assemblies for mass fabrication and offers consultation on bids. For thus nursing a project Goodman gets a percentage of the cost of each original house, an increment on every identical house, cost plus for revisions and additions, and a bonus

for construction cost savings. Goodman works only with one builder in a given area. Davenport, who has worked with several architects, is well pleased. His houses sell before construction starts; since they are all “costed” before building he reduces the speculative gamble. (A common indictment of builders is under-financing and over-extension, always making tomorrow’s job pay for yesterday’s; Davenport sells lots and arranges payments so each job pays its own way.) For 2½ years FHA would not give an adequate valuation on Hollin Hills houses; they were too modern. The VA would, however; and all but one of the large insurance companies offered loans when local banks would not. Buyers can obtain changes in design with ease; perhaps the only serious criticism is lack of storage. However, it was a deliberate decision to put everything possible into living space, and to offer unheated outdoor storage sheds at extra cost.

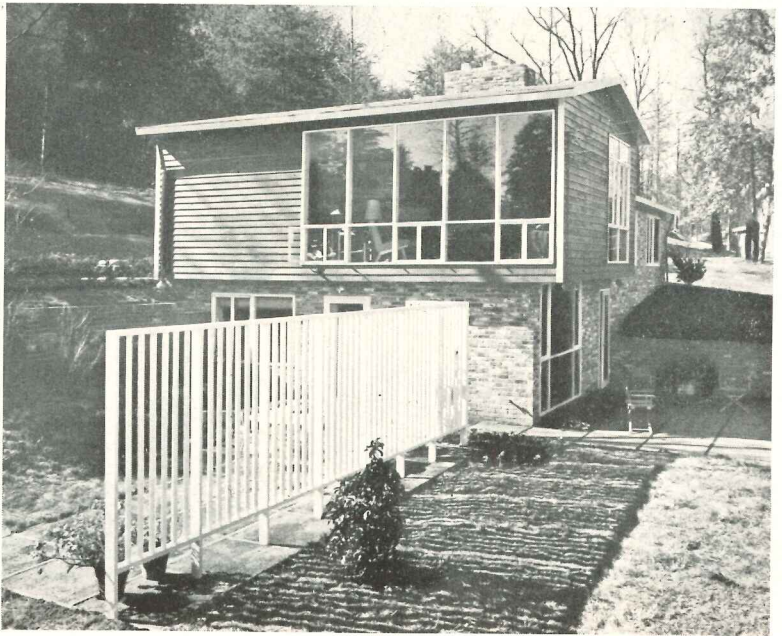
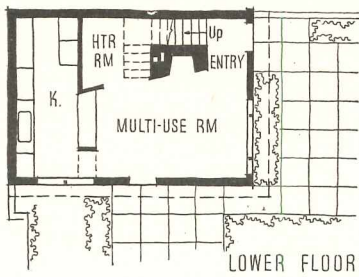

The office of Charles M. Goodman Associates helps the builder develop raw land from time it is acquired, even advises on worth of land



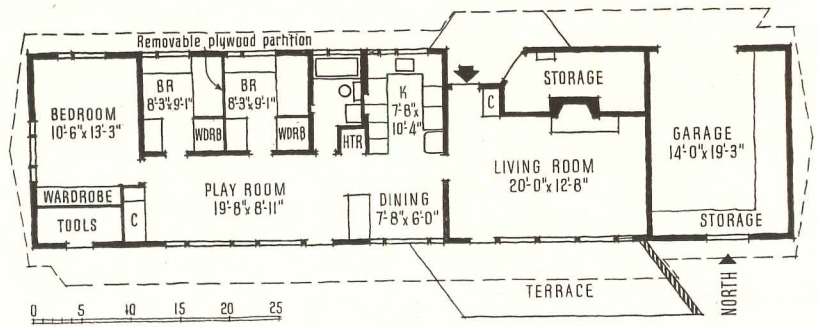

South Bend, Ind. house; L. Morgan Yost, architect, top left; below, Andrew S. Place, builder. Even though Yost, working from his Kenilworth, Ill. office, could not supervise construction closely, the house is eminently livable. Below left, terrace; right, living room



Houston, Tex. house; below, Karl Kamrath and Frederick J. MacKie, Jr. (MacKie & Kamrath, architects); Frank W. Sharp, builder

Due to folding partitions between recreation, dining and living rooms, the Houston house affords variation in use of living space



Paul Peters Photo

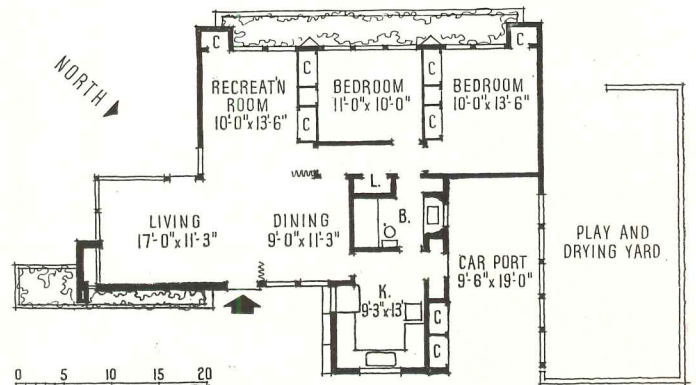



Denver, Col. house by Eugene D. Sternberg, Associate Professor of Architecture and Planning, University of Denver. Builder Edward B. Hawkins is starting Arapahoe Acres development with nine minimum houses using one basic plan

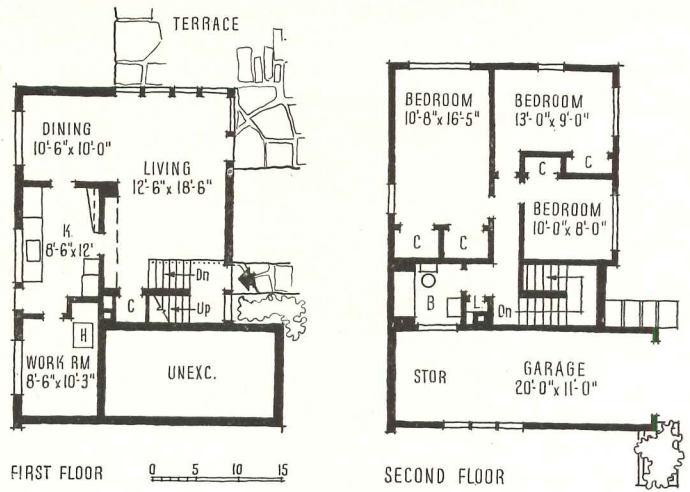
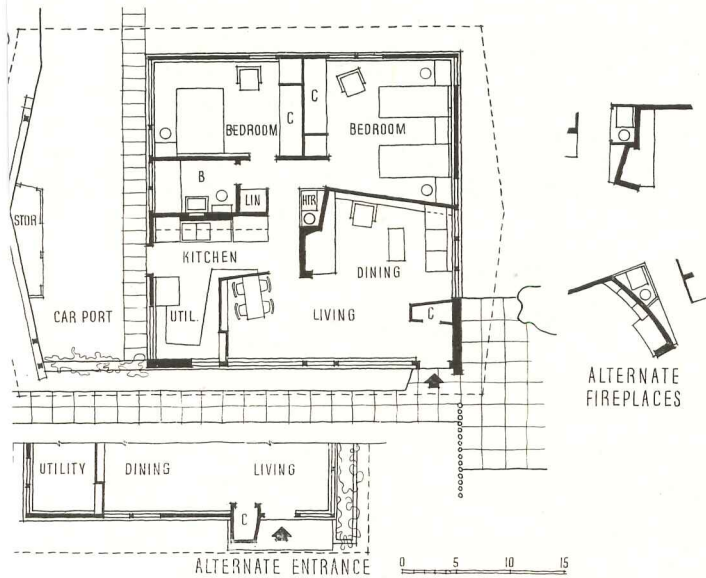

In Pittsburgh, Pa. architect John A. Grove, Jr. (left below) and builder Noble S. Clay (right below) produced a two-story house. Though the architect received an adequate fee and considers it a step in the right direction, he feels that all that was achieved was the familiar speculative house with flat roof and picture windows

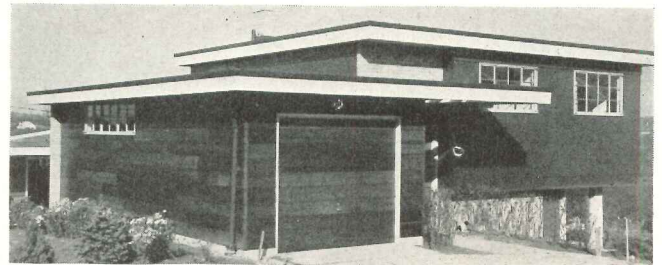

Bethesda, Md.; left, Robison Heap of Sweeley, Heap & Gauger, architects; bottom, Carl M. Freeman, builder

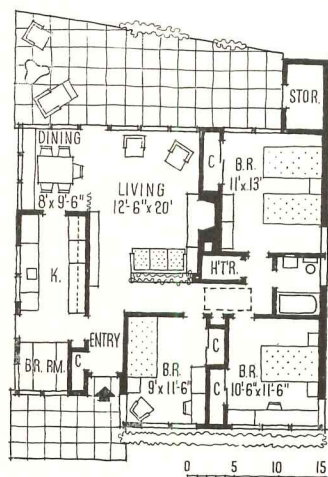
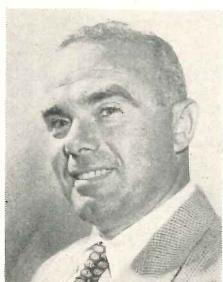

The Denver house was a first experience in collaboration for both builder and architect; the architect's office for the South Bend house was miles away; architects of the Bethesda house worked at an hourly rate (based on their required yearly income, with total hours necessary estimated in advance) and visited the site twice during construction — hardly full collaboration, yet the builder felt he got full value. Criticisms of Denver and Bethesda houses in particular: small space, notably in bedrooms, especially for families with children; builders' cost accounting could be improved; kitchen, living and dining layouts generally good. Denver house, it was felt, was \$1000 overpriced at \$11,500, though better looking than adjacent non-architected houses; it was FHA-approved up to \$9500, close to the figure the architect aimed at; it has radiant, warm air floor panel heating, fairly good storage space.

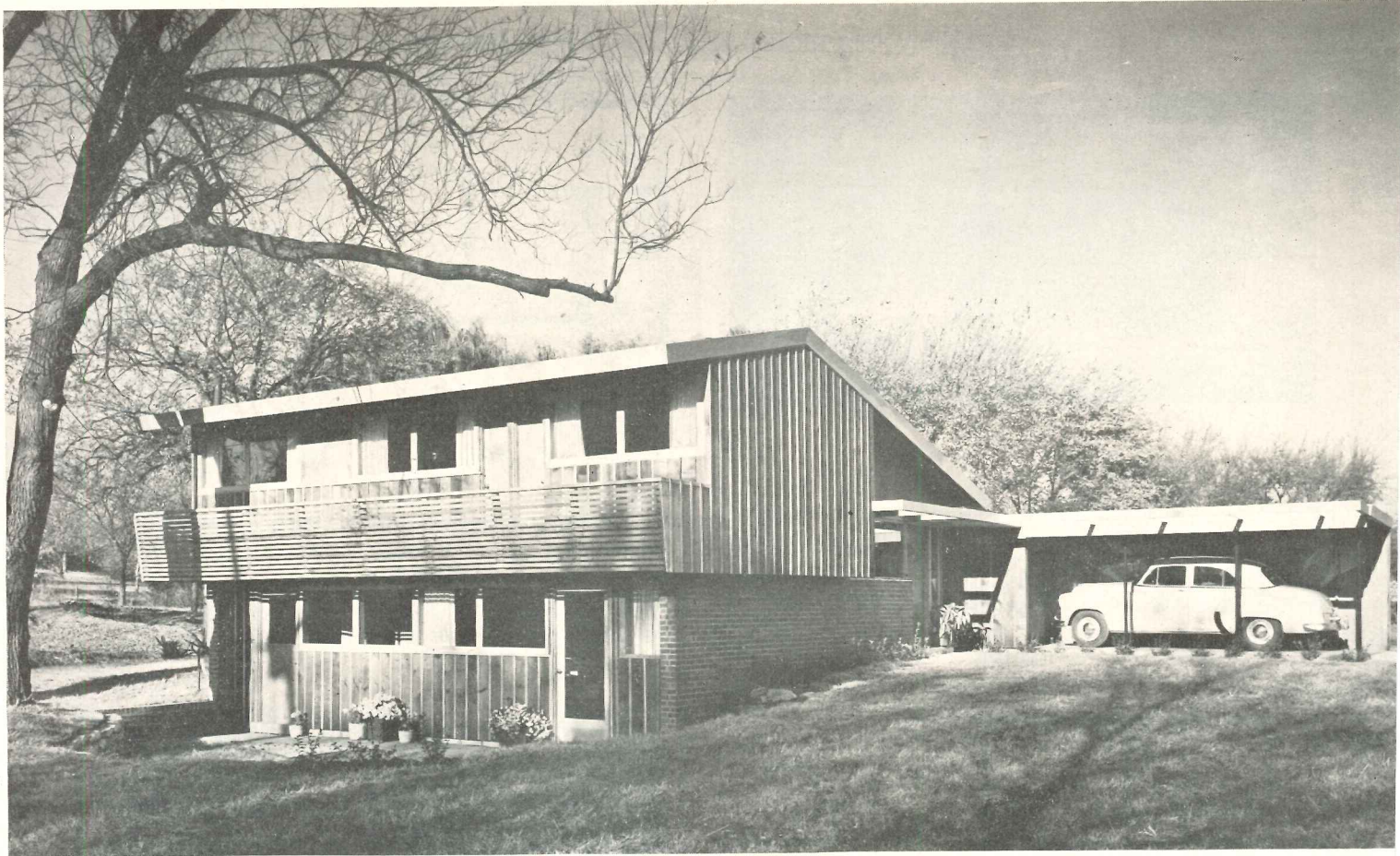

Of all the Revere Houses, that in Kansas City, first of contemporary builders' houses of moderate cost in the area, opened for exhibit in the fall of 1949, is probably most significant. It was built on land subdivided by the powerful J. C. Nichols Co., whose name is widely respected as a synonym for good, sound Colonial houses. It was designed for a moderate-income family, for a standard minimum lot (60 by 125 ft), to comply with local subdivision zoning practices and building codes — but not without struggles.

The builder found the Revere Quality House program well worth while even though there were only 3000

paid admissions (at 40¢ each, for charity) to the house exhibition; from it he obtained orders for seven houses "ahead of foundations," and expects to find a delayed stimulation to sales this summer. The seven orders have given him security; by making capital of architectural services he is reducing the risk of speculative building.

Builder Drummond finds it difficult to get a top-rank local architect to work with him. In this case, architect Runnells was paid \$2000, maintains he lost



Berline photo

KANSAS CITY HOUSE

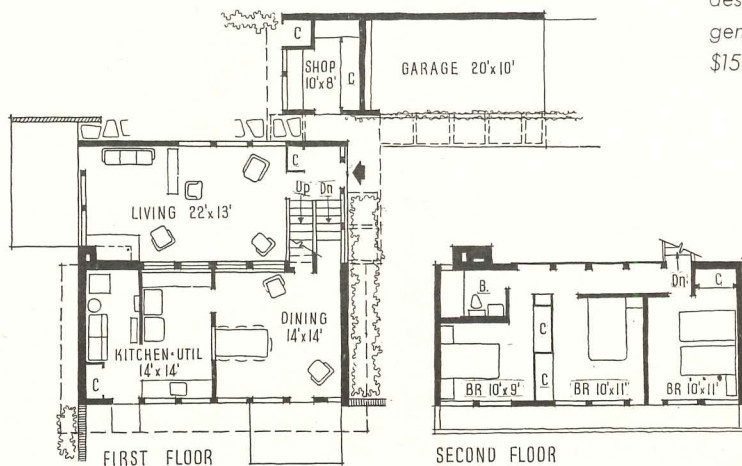

Architect, David B. Runnells, top left; builder, Donald H. Drummond, lower left. House is split-level, designed for a variety of sites in gently rolling country. House sells for \$15,100 with landscaped plot

Architect of Cleveland house (facing page), W. D. Riddle, top; builder, Maurice J. Fishman, bottom, has built 44 Revere houses on one varied plan, uses pre-assembled roof trusses



Above and left below, living room, Kansas City house; right below, bedroom

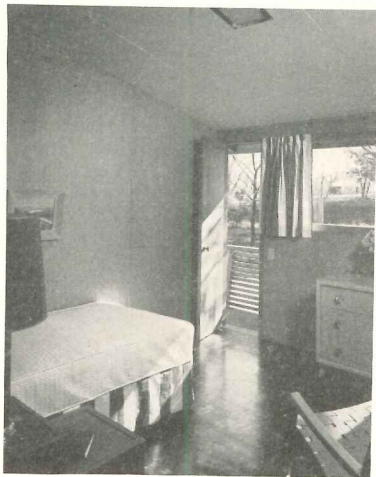
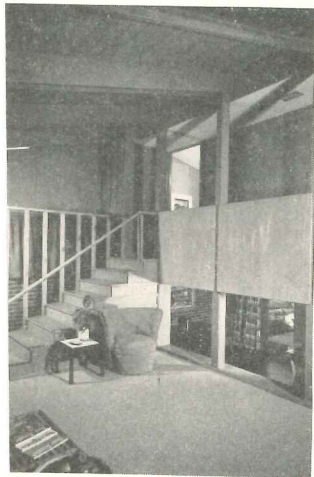

money on the job (this may be due to circumstances detailed below) and agreed reluctantly to design more although the builder, well aware of the value of a good architect, has built up a demand for both less expensive and more expensive contemporary houses. The builder wants to work closely with his architect, to get "space, beauty and utility at a price the market will bear," to use his own words. He wants the architect's respect for his own knowledge of costs and public desires.

Drummond would build the same house elsewhere in the same subdivision at the same price, but not 5 miles away at any price, because he might lose the profit on his initial group through being out of touch with it at a crucial moment — which is a comment emphasizing the craftsman's approach characteristic of the whole housebuilding business. The original design of the house met all building code requirements, but (again we quote Drummond), "We did have one devil of a time with J. C. Nichols Co. on esthetic grounds. The original butterfly roof had to be changed. FHA based their approval on approval by Nichols. Since the success of the Revere House we have received permission from Nichols to build two trial flat-roofed homes. This should be recorded as a smashing, completely unprecedented victory."

At first FHA approved a \$10,600 loan; when several had been sold, FHA promptly raised the amount to \$11,600. The Veterans Administration set a fair sales price. The Topeka FHA office has brought numerous visitors to the project and seems, privately, pleased with itself for permitting it. The only serious hitch in the proceedings came when the architect, after consulting with Revere Quality Houses, sold a set of plans to another builder who said he would build in another city, but built not ten blocks from Drummond's project.

CLEVELAND HOUSE



Miller-Entler photos

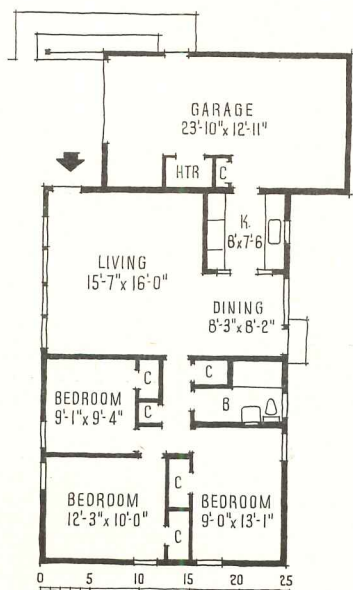

BOSTON HOUSE



Egone photo

Architect, Samuel Glaser, above left; builder, Arnold Hartmann, above right. Boston house, another split-level plan (entry, heater, etc. below bedrooms) designed to sell for \$15,500

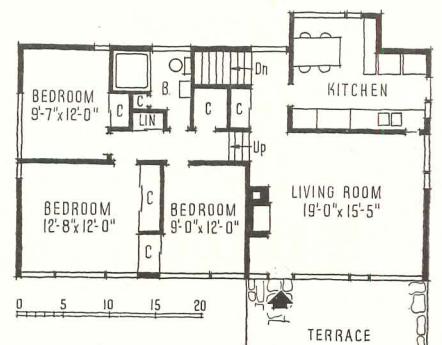



Meisel Photo

Here trusses and certain wall sections were prefabricated. Builder has worked often with DeWitt & Swank, builds 175 architect-designed houses in a good year. Architects find compensation on cost-plus-fixed-fee basis, proportioned according to number of houses built from one plan, satisfactory

Angus G. Wynne, Jr., American Home Realty Co., builder of the Revere house in Wynne-wood, Dallas, Tex., employs architects to obtain good planning and prestige; is noted for his accurate cost accounting. Architects were DeWitt & Swank, who have done 400 houses for Wynne



Hayes Photo

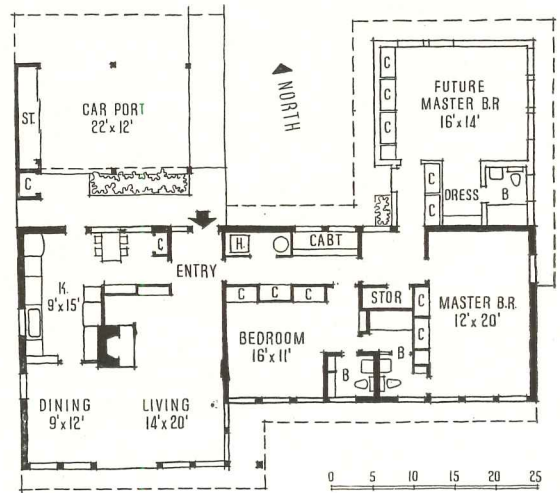

Springfield, N. J. house, built by Hawley Jaquith (left below) and W. T. Smith, Jr. (right); architect, Kenneth Kassler (center). Like many Revere houses, it is built on a concrete slab, has radiant panel heating, oil burner, glass fiber insulation

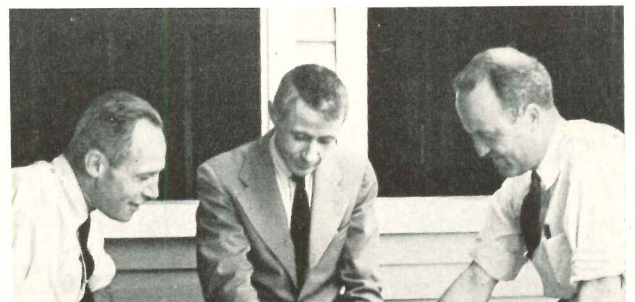
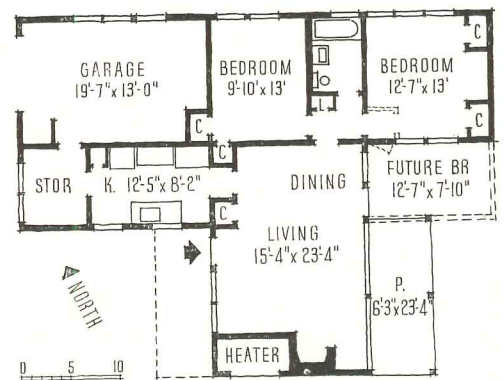



Steinmetz photo

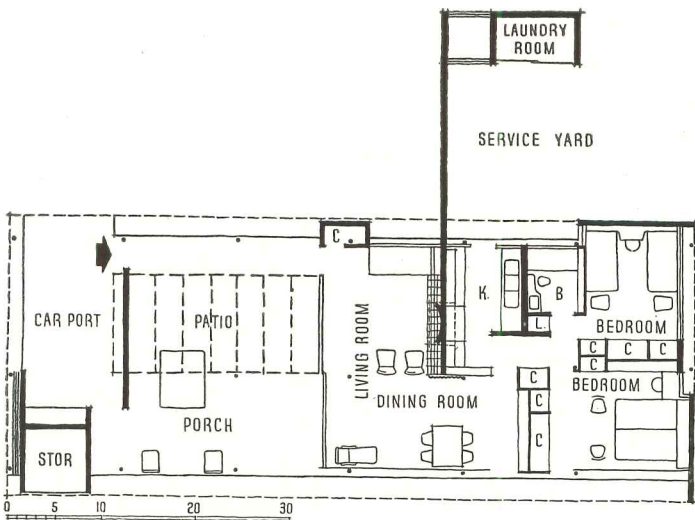

Lucia Photo

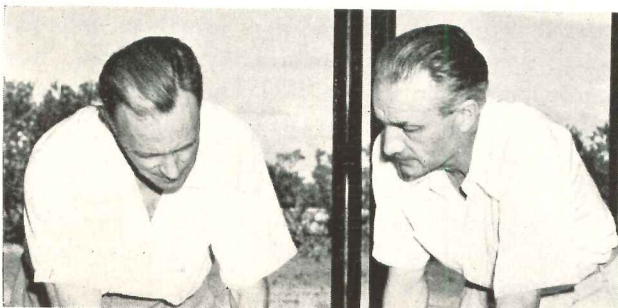

The Sarasota, Fla. Revere house, designed by architects Twitchell & Rudolph (Twitchell at right below) and built by J. E. Lambie, Jr., Lamolithic Industries (left). House, monolithic concrete, was produced on location by a portable field plant (automatic high-capacity mixers, conveying and handling machinery) and modular steel forms which permitted complete flexibility in design. A mobile cabinet-making plant turned out finished woodwork on the site. House is carefully designed for the climate



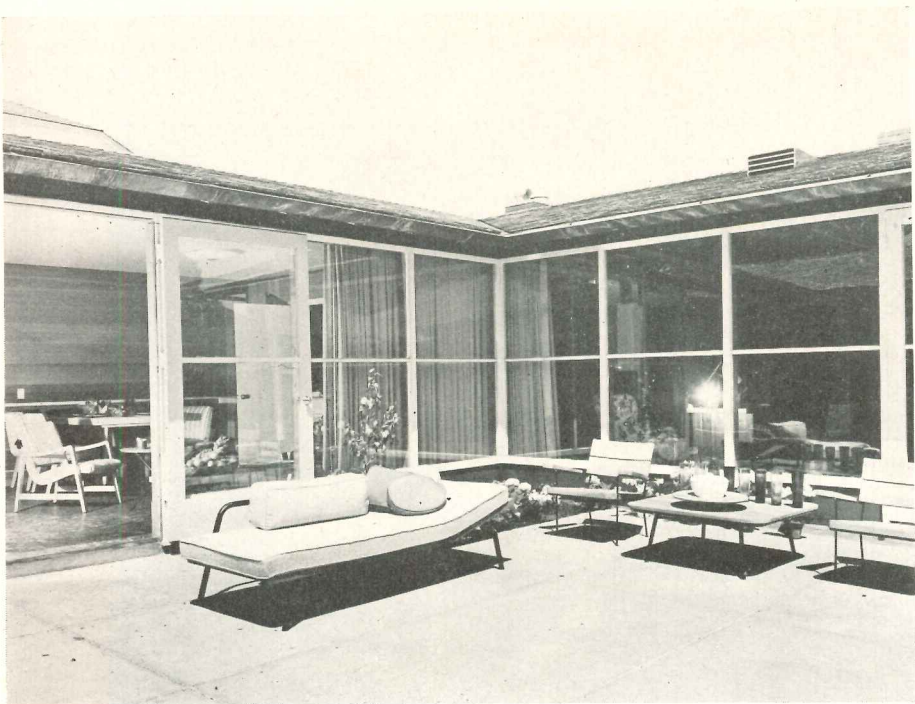

Foreman's Photo

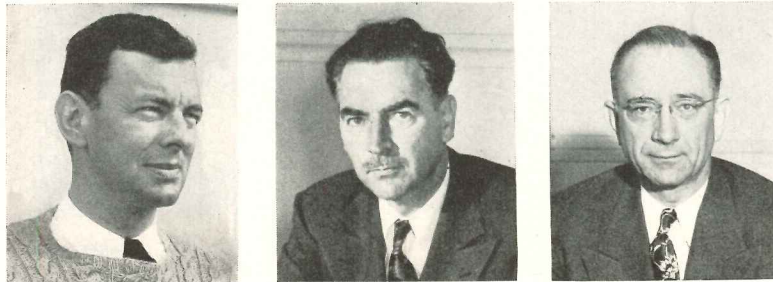
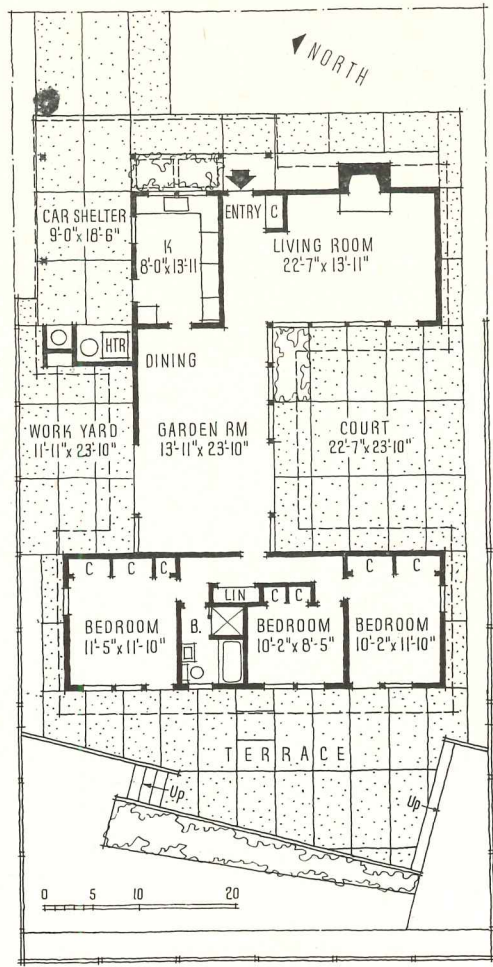

The Tintype, Foreman's Photos

San Francisco house, Joseph Esherick, Jr., architect (left above), George F. Williams and Frank F. Burrows, builders (center and right), tackles the most difficult subdivision problem: a small interior lot, 50 by 100 ft. Plan encloses much of the area to form a private outdoor living room. Builders are enthusiastic about architectural services, land planning, engineering; have found such services cost little. Architect's story is different: because the problem was so difficult, requiring so much time, drafting and overhead consumed his entire fee



Revere Quality Houses have certain common characteristics: they are mostly basementless, solidly built, wood framed, with radiant or forced air heat, gas or oil furnaces; they are openly planned, employ lots of glass, are in general well oriented, sited, and insulated. In many cases complete laundry and kitchen equipment from refrigerator through garbage disposer is included in the mortgage. One builder, Davenport in Alexandria, Va., even makes modern furniture available at the builders' discount.

Buyers' reactions: in Syracuse, 84 per cent of people queried would do without basements if that would save money. In San Francisco, of the 27-28,000 people who viewed the Revere House, more than half emphatically liked its layout. The San Francisco buyers don't mind the small bedrooms, because they use them only for sleeping; spacious living area, indoor and out, has revolutionized their way of life. Their children have places where they can play without interfering with adult activities. In San Francisco the housewife does find asphalt tile over concrete hard on her feet (probably because there is no radiant heating), and the roof overhang on the sunny side isn't wide enough. Nevertheless she loves the house.

REVERE QUALITY HOUSES

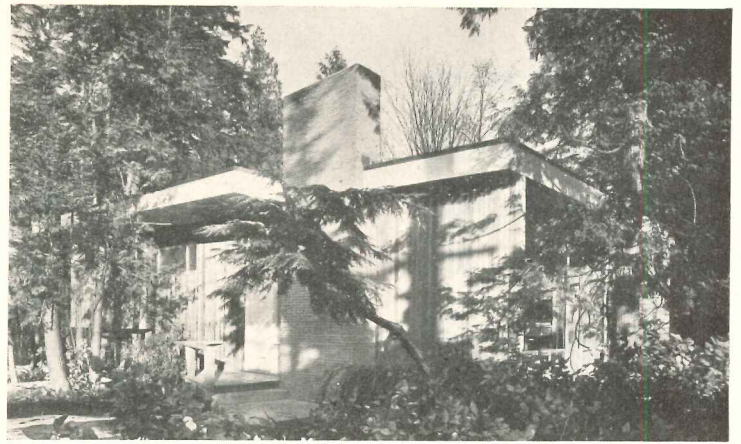
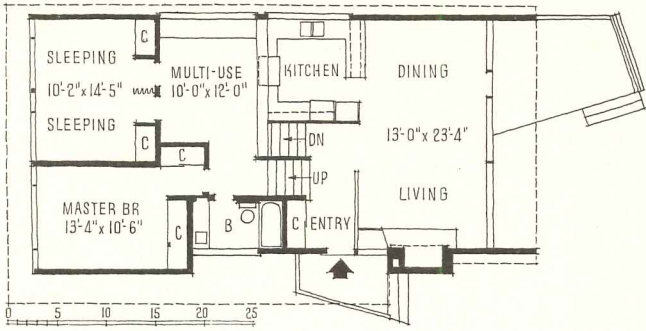

In Seattle, architects Chiarelli & Kirk (center and right) and builder Albert Balch, Community Builder, did several Revere houses. Plan and photo above show first model, a good house though high priced. Below, plan and rendering, Revere House No. 2, surprising for \$9500; well liked but has not sold. Same architects are now doing Little Revere House No. 3 with a pitched roof

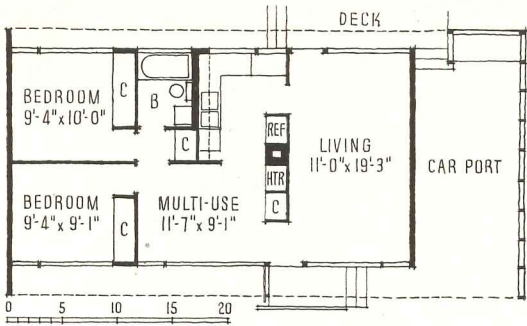

Brown Photo

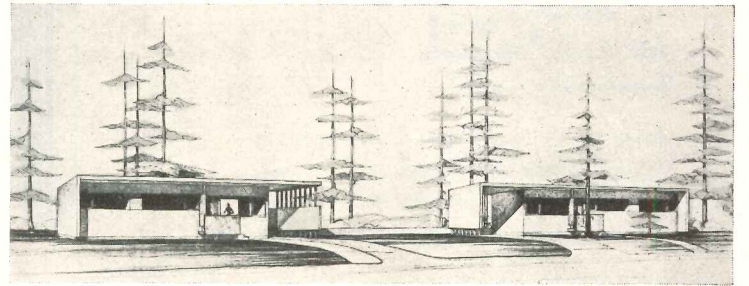

Only two of Seattle House No. 2 were built; flat roof scared off buyers

Architect in Salt Lake City was W. Rowe Smith of the office of Fred Markham (first photo below); builder, Alan Brockbank, Federal Homes, Inc. (bottom). This house was shown in greater detail in ARCHITECTURAL RECORD for January, 1950. There were two typical plans to suit varying conditions

Biddulph Photo

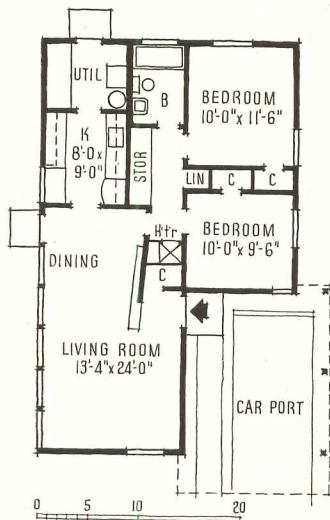

Syracuse, N. Y. house, Gordon Schopfer, architect (first below), Andrew Mayer, Mayer & Rebhahn, builder (bottom), has brought both architect and builder valuable publicity in spite of numerous competing local attractions. The architect has designed 65 speculative houses for this contractor

Brewster Photo

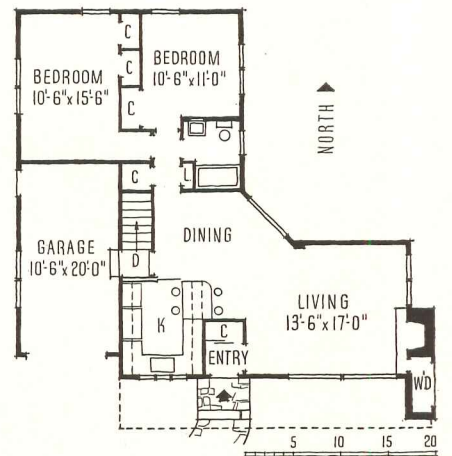

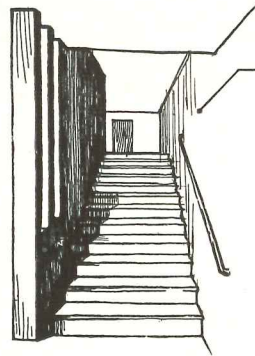
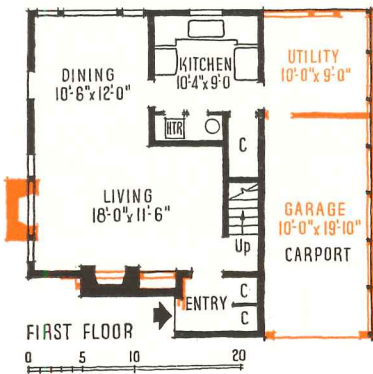
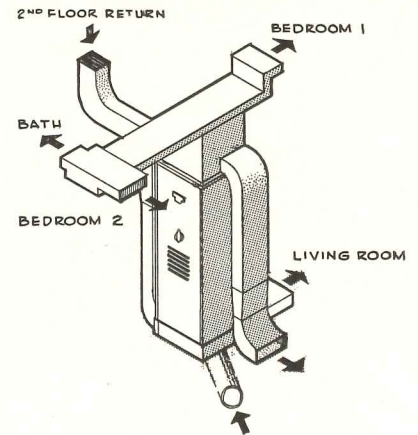
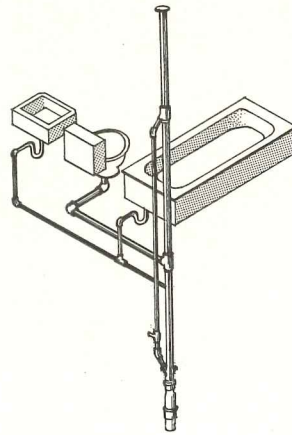

Preassemblies used: left above, shop-fabricated copper plumbing "tree"; framing is designed around it to minimize cutting. Left below, prefab stair; above, warm air heater and complete prefab ducts; chimney is also prefab. Below, heater in kitchen closet



Black lines show basic two-bedroom house (\$9990) at The Highlands; red, additions forming three-bedroom model (\$12,140); over 20 variations are available

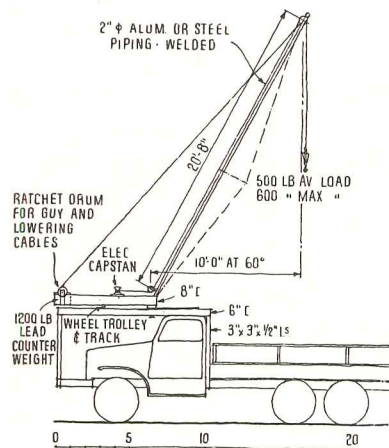
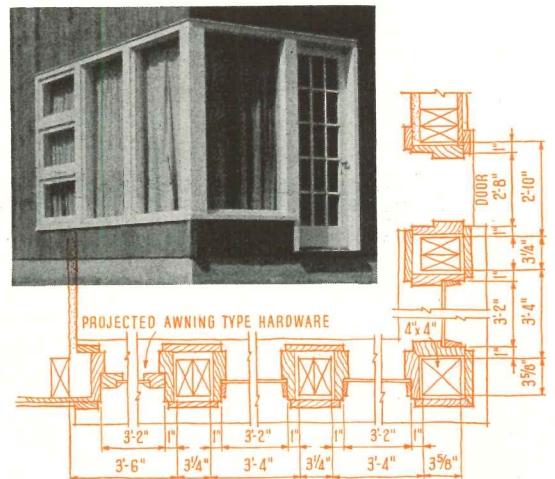
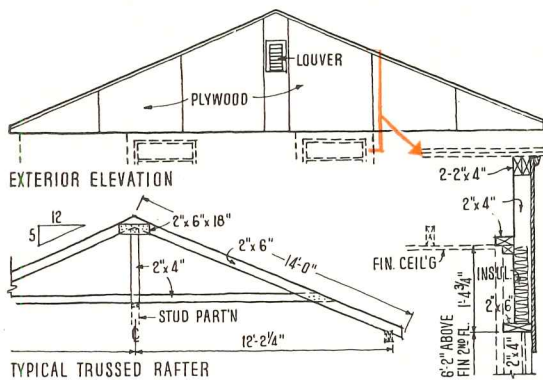

More preassemblies: left above, trussed rafters and gable ends erected by special truck-mounted aluminum crane designed by the architects; right, large windows (optional) with shop-fabricated rough frames, site-applied casings

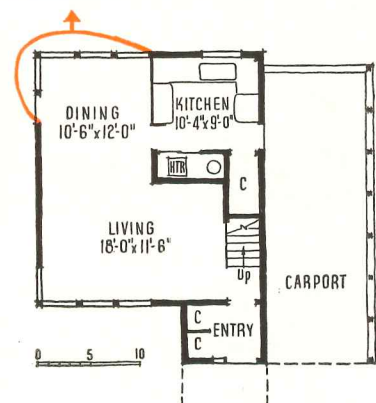

CASE STUDY: 250-HOUSE N. J. DEVELOPMENT

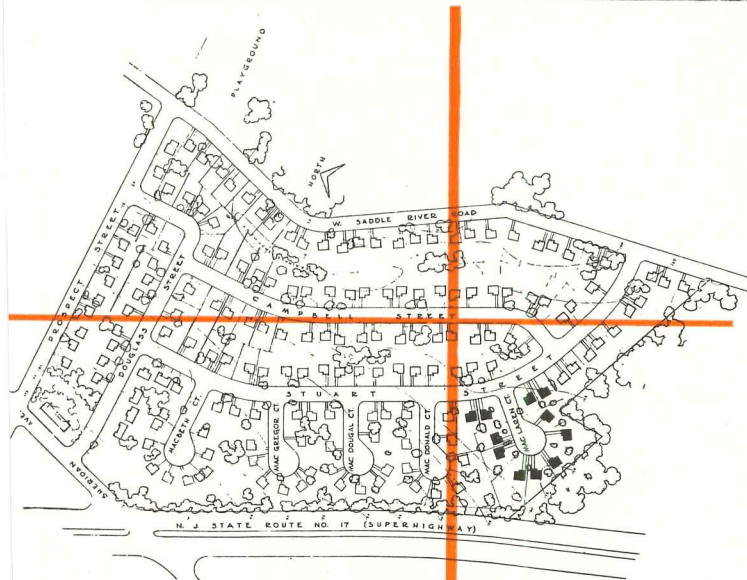

The Highlands, Waldwick, N. J.; Petroff & Clarkson, architects; Zamore Builds, Inc., developer and builder; A. Carl Stelling Assoc. and John R. Tregenza Assoc., site planners; Canger, Bailey & Assoc., site engineers.

In its recent approval of this entire subdivision Revere Quality Houses cited the excellent site plan, quality of construction, technical advance; buyer participation, under developer's control, in decisions on exterior treatment; and architect-builder cooperation. When completed The Highlands will have 185 houses; there is a plan for extending it to the adjacent Saddle River. Under a comprehensive builder-architect agreement, the architects render services starting with advice on site selection; also, promotion to aid in obtaining financing; site planning and development; design of a job shop to become, later, a shopping center (and other buildings required); drawings for and consultations on newspaper advertising; design of a basic house and numerous variations; consultations with house buyers on exterior painting, etc. For this the builder pays them a flat fee for preliminary studies (advice, research, organization of data, preliminary design); a site planning fee prorated according to number of houses contemplated; a flat fee per house built; an hourly rate for working drawings of all non-dwelling structures and for consulting services rendered to builder and purchasers; and reimbursement for unusual travel and subsistence, and fees for special consultants (landscaping, etc.). This arrangement permits the builder to make full capital of all the architects' abilities and assures the architects fair compensation. It also insures top-notch results: The Highlands won first place in its class in the recent subdivision contest conducted by National Association of Home Builders — the only eastern development so honored in the contest.



Molotov photo

Only shed-roofed house in Highlands cost owner a reasonable premium for variations. Builder Zamore gives 90-day warranty, has excellent reputation for making good any defects



Above left, dining area; right, living area, specially treated in shed-roofed house (see previous page)

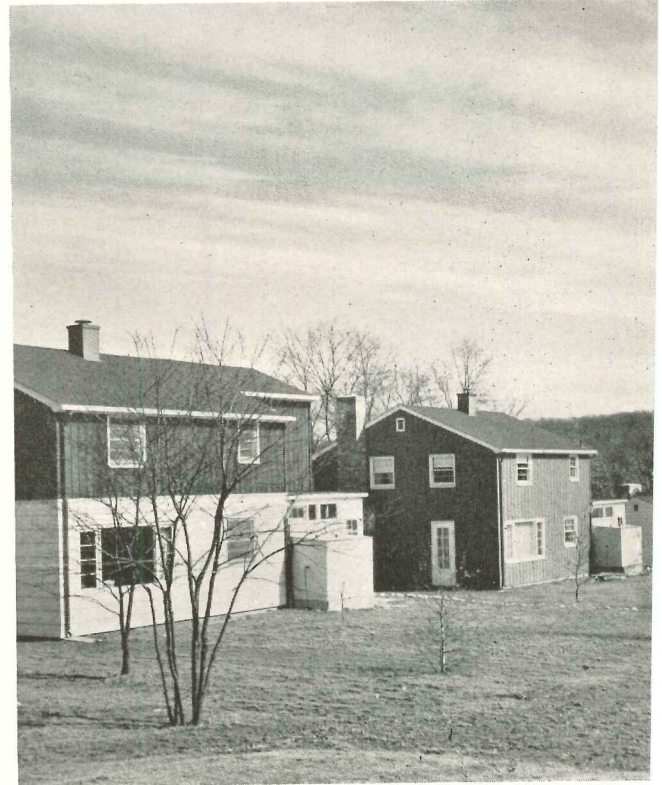

Joseph Malitor Photos

CASE STUDY: NEW JERSEY DEVELOPMENT

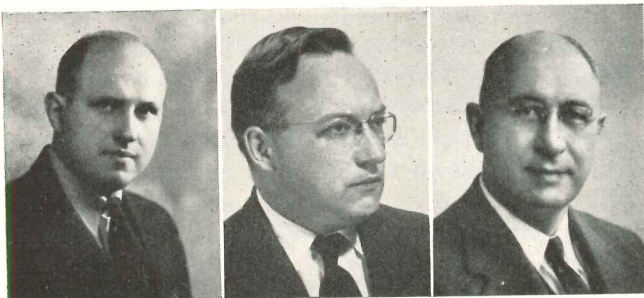

Photos by Chidnoff, da Silva, Master Portrait

Left and center, architects Serge P. Petroff, Harvey Clarkson; right, builder B. V. Zamore, whose sons David P. and Richard W. Zamore are associated with him

The several owners interviewed are mostly professional and business people with good incomes. Cars are plentiful so distance to shopping is no problem; number of children from Highlands homes is limited, but Town of Waldwick provides special school bus service to the area. With a normal increase in child population normal difficulties will probably arise and be solved. About individual houses, owners are well satisfied. One, an electrical engineer, was especially pleased to find, when he snooped around during building, construction sounder than he expected. The open, L-shaped living area and large, sunny windows are particularly appreciated; only one housewife was wistful about lack of

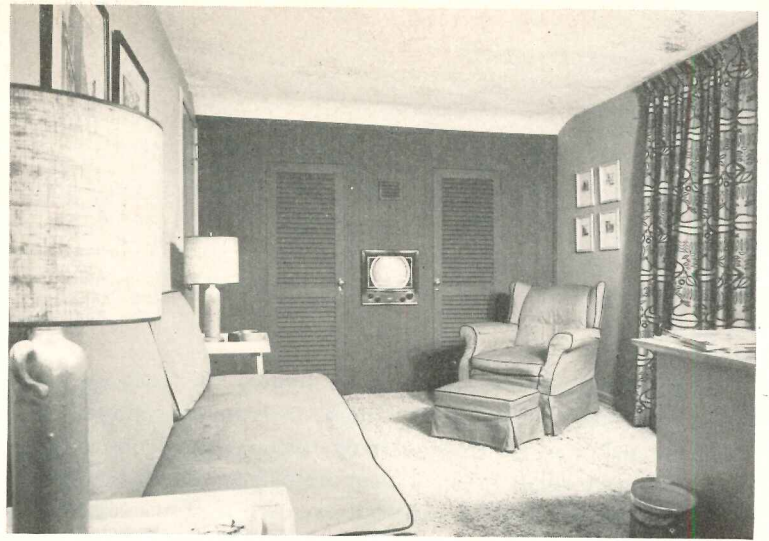

Above left, typical bedroom; right, third bedroom used as guest room-study—both in average houses



Individual houses, though close together and rather similar in appearance, benefit from carefully informal siting

separate dining room, and two owners with north-facing picture windows said they'd rather pull drapes during a cold blow than lose the rural view. More bath space is sometimes wanted; several downstairs toilets are going into utility rooms. Kitchens seem adequate, though one woman wanted more space. Storage, which seems skimpy, appears adequate to most owners (possibly because there are relatively few children); utility rooms are being used as darkrooms, panelled studies, workshops or laundries, as well as for utility functions. Above-ground fuel oil tank enclosures (photo right) are being replaced by buried tanks now that possible use of gas for heating has been ruled out.



III. PREFABRICATION: THE ACORN HOUSE

LATE IN 1948 a trailer truck hauled the package — roughly 8 ft wide, 9 ft high, 23 ft long — shown at left below to an apple orchard on the edge of Concord, Mass. A small crew of men unfolded wall, floor and roof panels and by nightfall the Acorn House on the opposite page was ready for tenants. For over a year it has been lived in by a “guinea-pig” family who have carefully tested its livability under all sorts of conditions. Now, in early 1950, components of a smaller version of this prototype Acorn House are being produced in quantity to fill orders for summer cottages and motels.

Of course the story begins well before 1948. Before World War II was over, Carl Koch, well-known architect who was then still in the Navy, was engaged in a long-distance collaboration with civilian architects John Hancock Callender and Huson Jackson, working on the principle of the folding house. In 1946 John Bemis, M.I.T.-trained engineer, added his talents. (Callender and Jackson, not now active in Acorn Houses, retain interest though they are otherwise occupied.) In the interim the country has seen a rash of interest in prefabs of which little is now evident beyond an occasional itch. Konrad Wachsmann’s promising General Panel Corp. ran into difficulties with panel joints. Lustron has

produced many porcelain-on-steel houses, has had ample publicity and some success in creating favorable opinion, but early this year suffered an apparently incurable attack of financial sickness. Most recently the John B. Pierce Foundation of Raritan, N. J., long-time prefab researchers, has made preliminary announcement of a new prefab system. That Acorn has kept going doggedly while the fortunes of so many in this uncertain field were rising and falling is due chiefly to the work and faith of Koch, Bemis, Calvin P. Bartlett, the corporation’s general counsel and Winsor Gale, salesman. It has cost a lot of money, though nowhere near as much as distended Lustron swallowed.

No thoughtful person can help but admit, on a purely rational basis, the validity of the familiar arguments for house prefabrication; boiled down, these are essentially the principles enunciated by Henry Ford for mass-producing horseless carriages. No one can deny, either, that fanatic faith in industrial production of houses has done both harm and good to the concept. Many a businessman today feels like saying, “I told you so!” when reminiscing about federal aid to prefabs in the immediate postwar years. Prefabricators still active,

(Text continued on page 158)

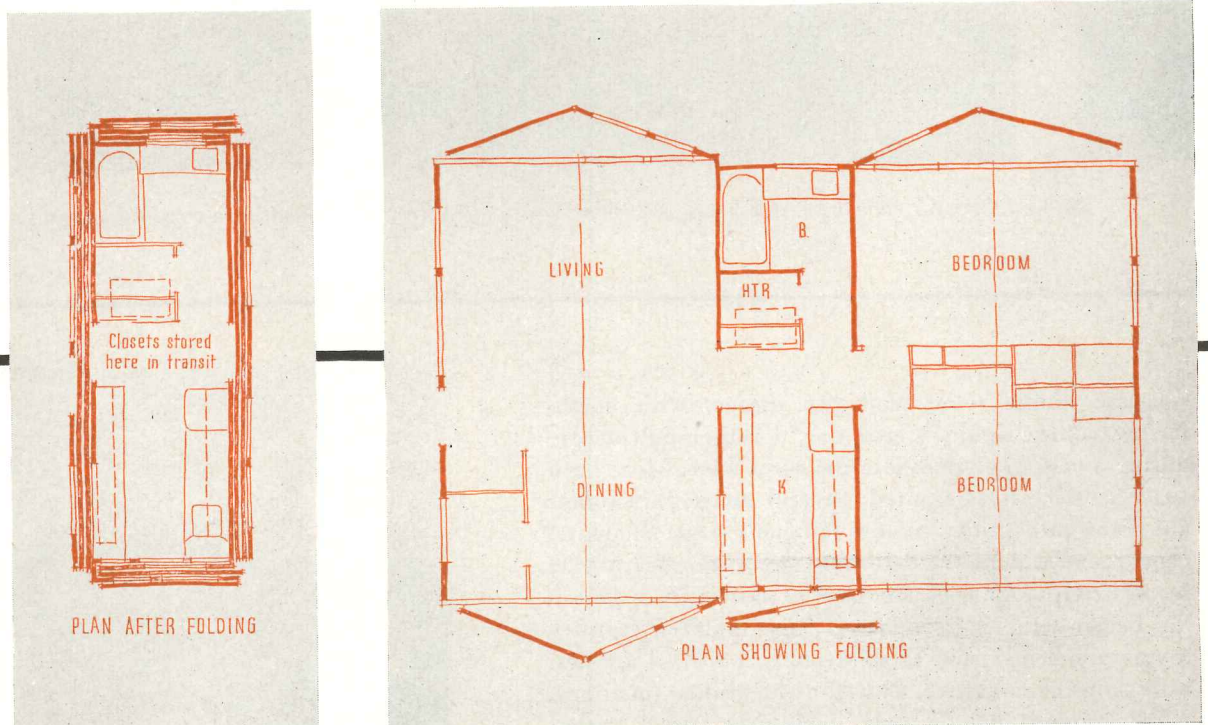

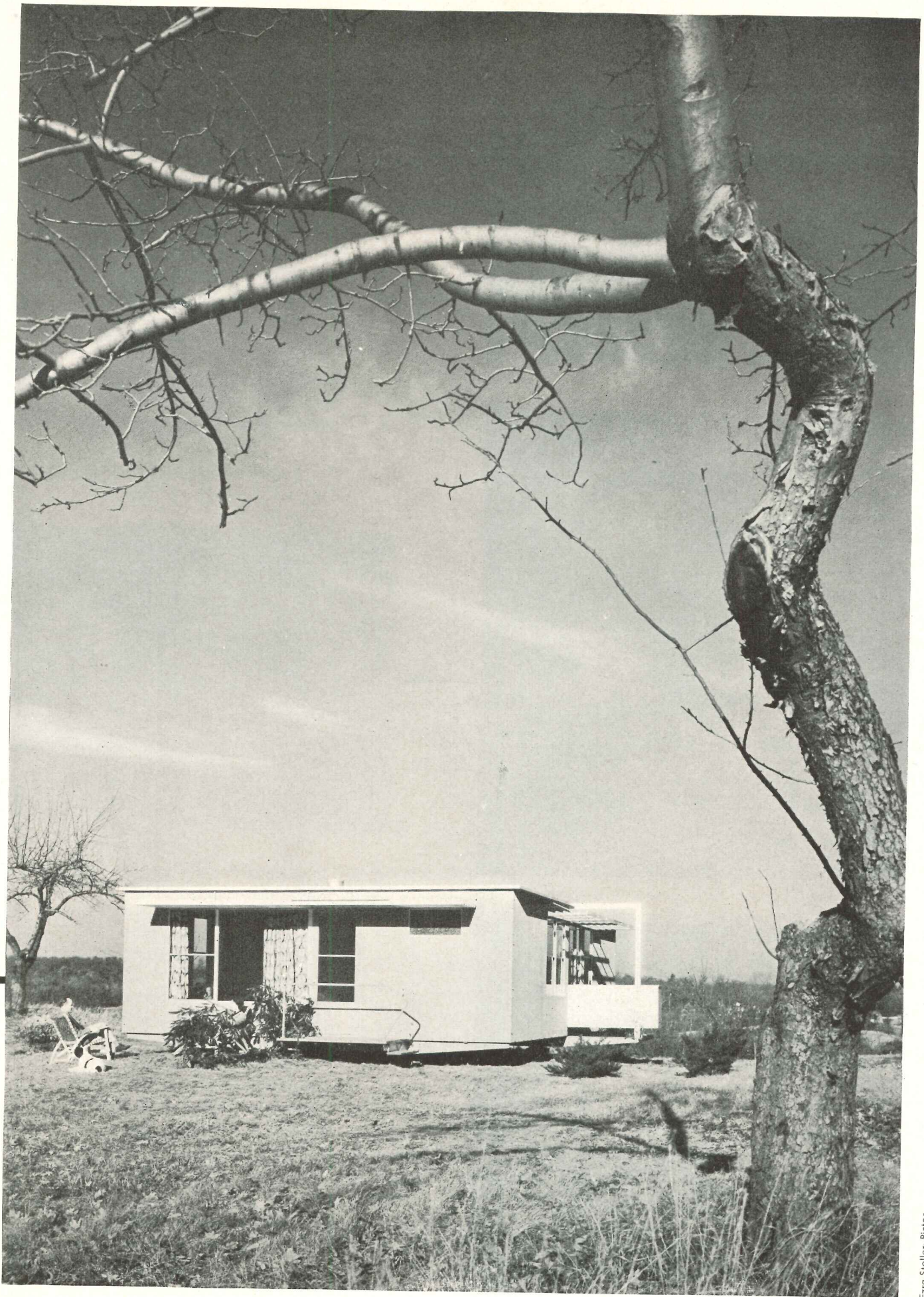

Ezra Stoller: Pictor



THE ACORN HOUSE

Space within The Acorn House may seem small, but when we visited the demonstration model one day this past winter we discovered that there is no cramped feeling. Perhaps this is partly because so much furniture and equipment, ordinarily portable, is built in. Photos at left: top, living room; center, living room showing prefabricated fireplace; bottom, dining area. Note

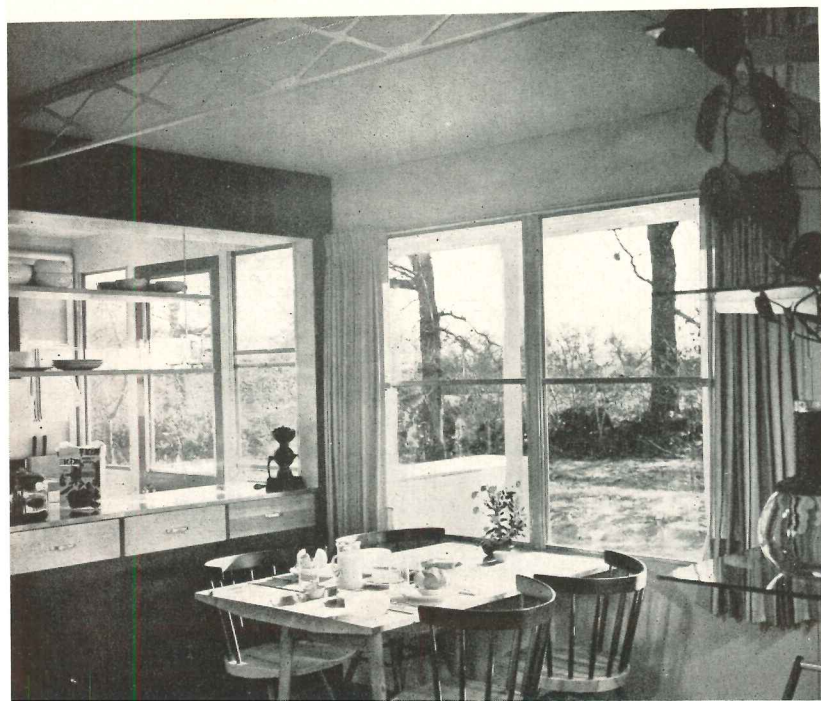
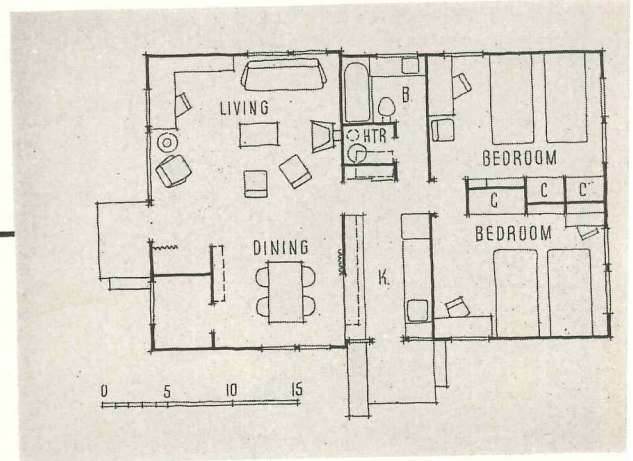
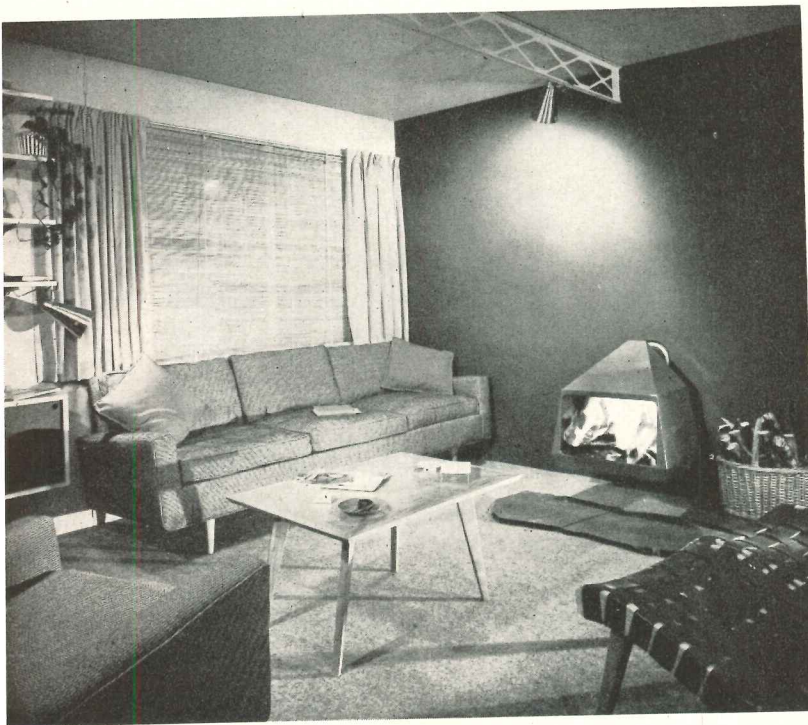

the exposed open-web joists used as ceiling trusses; also the intimate relationship between kitchen and dining — another factor which makes the house livable. We had expected some sense of impermanence but, pleasantly, found little such evidence; floors were no more springy than in the average house; windows, other details were small in scale and enhanced the feeling of spaciousness

Below are some items of built-in equipment which contribute substantially to The Acorn House. Top left, storage units (capacity 230 cu ft) separate bedrooms, are built of wood frames and tempered hardboard, have sheet metal drawers. Drawer runners are steel, sliding door tracks, hardwood (metal was found too expensive). Bath, upper right; lavatory vent, chrome-plated, forms the shower curtain rod; heat duct passes beneath tub, warming its bottom

Ezra Stoller: Pictor

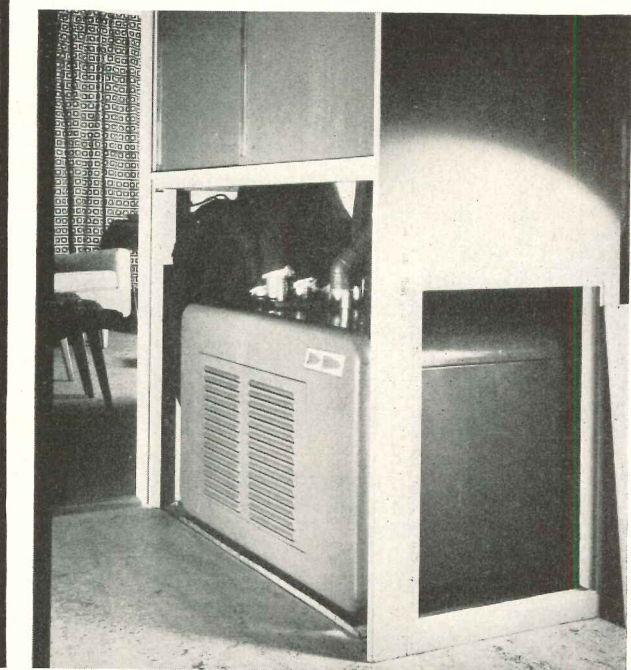

Kitchen, lower left, extremely compact, has recently-developed individual electric cooking units built into stainless steel top, separate oven set at eye level (no stooping), drawer-type refrigerator, wood and tempered hardboard cupboards, total of 103 cu ft of storage. Heater, lower right, is jet-type hot air, oil fired, set in a closet over a utility pit

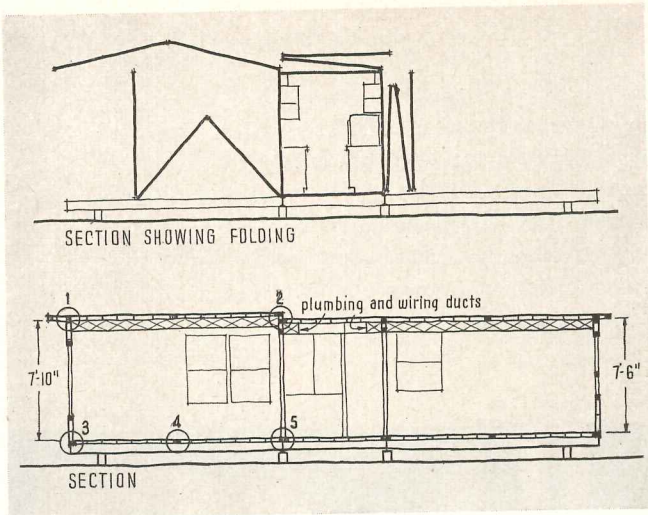

Diagrammatic section shows how The Acorn House is unfolded after placement on its light steel subframe. Typical joint details at right also show standard panel construction, corrugated

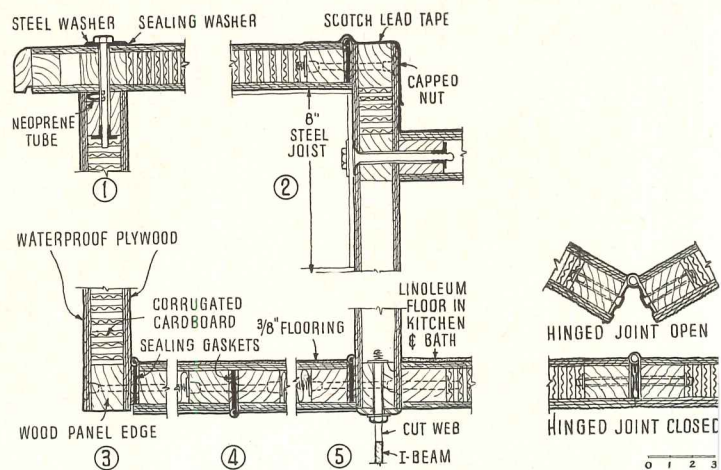

paperboard with alternate layers in opposing directions. Facing is waterproof plywood; edging strips, wood; adhesive, phenolic resin. Roof-joint taping has been improved for later models

Photos below show transportation to the site, placement, and foundation work. Top row, left to right: complete house package leaving factory on a single trailer; en route; extent of foundation work; arrival at site ready for unloading.

State highway clearance requirements are a controlling factor in design. Note minimum foundation work: a few post holes, one small pit, under utility area. Bottom row: leveling steel subframe on temporary blocks preparatory to

bolting it together; house, folded, on site with subframe steel alongside; suspending precast foundation piers from steel subframe; pouring grout around piers to form footings. Photos at right: top row, unfolding starts, aided by



THE ACORN HOUSE

Ezra Stoller: Pictor

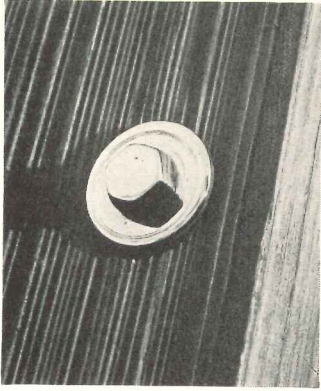

Bolts are retractable so house can be disassembled



Carl Koch, architect (left), is president of Acorn Houses, Inc.; John R. Bemis (right), treasurer; Calvin P. Bartlett (not shown), general counsel

simple boom and one-man winch; center row, placing open-web roof joists and roof panels; bottom row, house nearly erected, roof joints being sealed. Total man hours: for erection, 32; for site preparation, 20

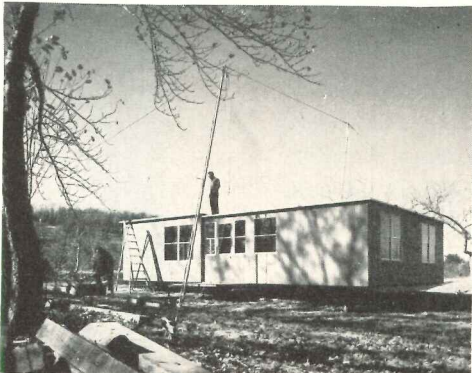
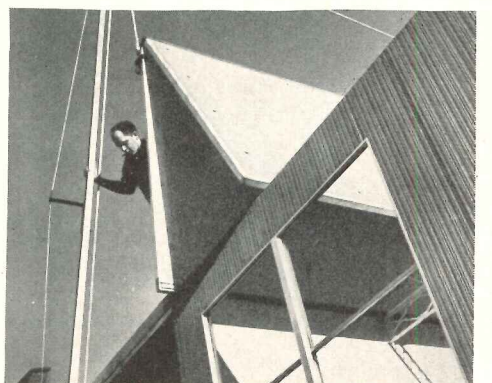
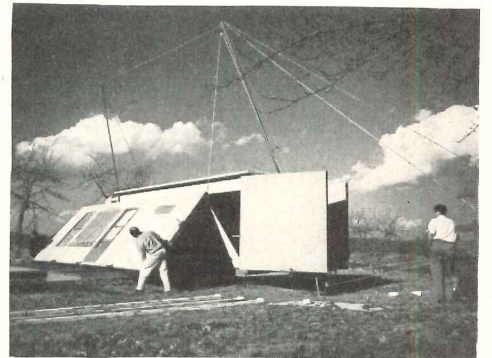
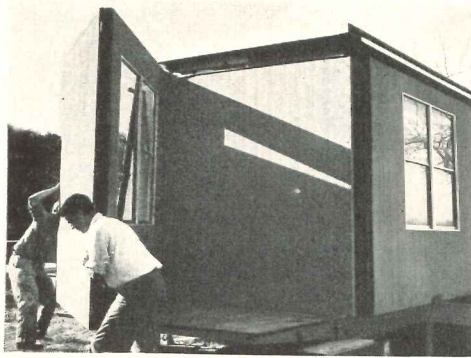
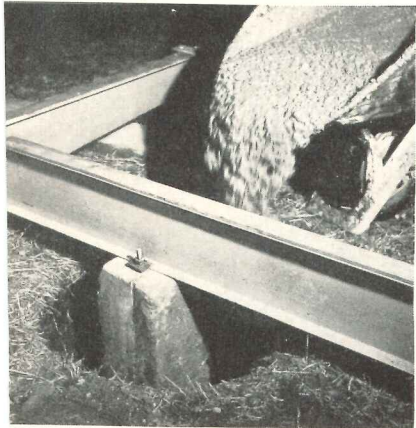
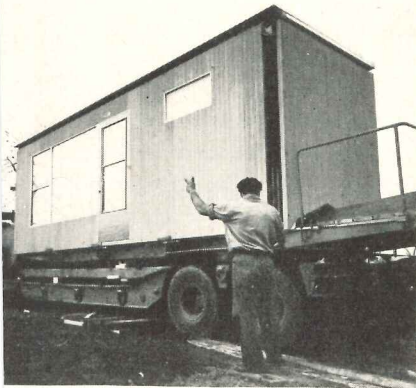

THE ACORN HOUSE

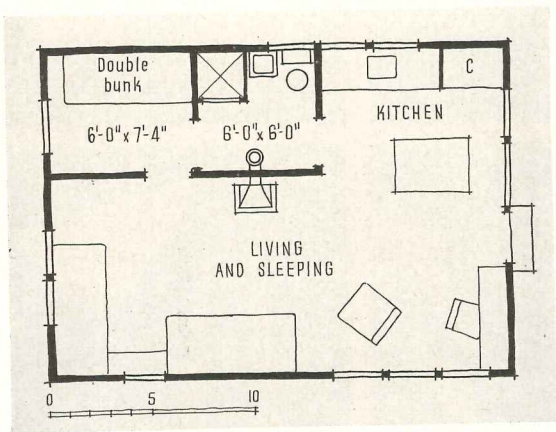
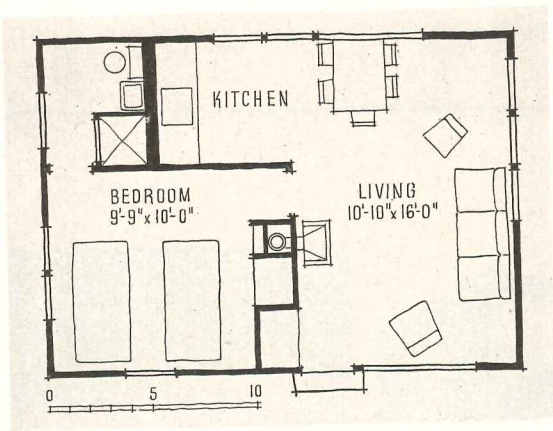
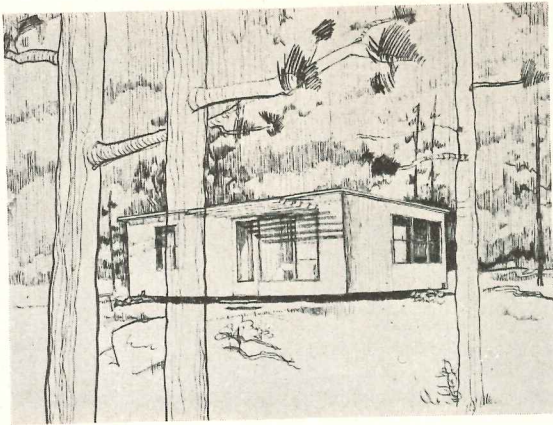

Above, rendering and two plans showing variations possible with the Acorn Cottage, small version of The Acorn House, now in production. Shell of the house, on foundations, sells for under \$2000 FOB plant; partitions, plumbing, etc. are extra. Panel manufacturing problems have deterred producers of such products as conventional plywood from undertaking their manufacture. Photos at right show porcelain-enameled prefab fireplace, waist-high electric oven, in kitchen of large Acorn House. These may be bought as extras for the Cottage

including Acorn, can count on little governmental help. FHA and HHFA have their hands full with day-to-day problems arising out of conventional house-building practices; their primary interest is getting the bugs out of age-old materials such as brick, licking condensation with conventional materials and material combinations, not fooling around with anything out of the ordinary.

In the seller's market which has existed now for some time, and without the materials shortages which gave new developments such an importance immediately after the war, preoccupation with conventional housing is to be expected. The climate is unhealthy for experimenters, particularly for such an organization as Acorn Houses. The normal channel of operations through FHA is not readily adapted to assist them through the development phase. No funds or facilities are available for careful analysis, testing and evaluating of new materials, nor will a mortgage-insuring agency readily accept new techniques without such tests. An untested product requires such high sales expense that it takes itself right out of the market. So it is virtually impossible, without extensive financial backing, for private enterprise to contribute appreciably toward development of improved housing techniques and materials. Acorn Houses is tackling this problem directly. Its panels are a honeycomb sandwich — corrugated resin-impregnated paper core faced with plywood both sides, phenol glued — which has been tested neither in production nor in use except in the one prototype house and by Forest Products Laboratory in their test house constructed three years ago. Forest Products tests, both field and laboratory, are as extensive as any new material usually receives. Acorn Houses had a builder ready to sign a firm order if production could be assured; a manufacturer almost ready to start production if a firm order could be obtained — but the gulf between the two remains uncrossed. So, gritting its teeth, Acorn Houses has gotten orders for the small cottage version shown at the left, has purchased manufacturing space, has designed and built a bag press, and by early summer will have 15 or 20 16- by 24-ft cabins built. These should prove or disprove the system's soundness. As far as one can predict, its prospects, though tough, look good for the long run.

Stoller Pictor

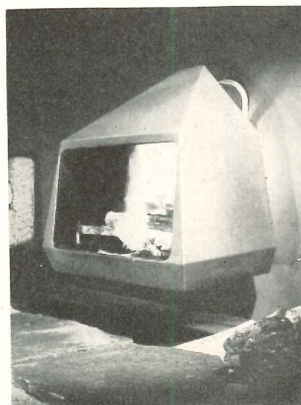

SITES MOVED TO OFFICE BY AIR PHOTOS

By Walter L. Weitner

THERE'S a new twist to the old expression, "Bringing the mountain to Mahomet." Through new applications of aerial photography, this saying could just as well read, "Bringing the site to the architect." Site study, selection and planning can be done right in the office with aerial photos. They can permit effective, comfortable work, while saving many trips to the site and increasing the architect's practical radius of operation and volume of work.

There are two phases — *simple aerial photography* which consists of ordinary oblique and vertical views, of great use in site selection, preliminary study, demonstration to interested parties, positioning of buildings with reference to existing terrain features, etc.; and *photogrammetry*, the process of obtaining accurate ground measurements and topographical surveys from controlled aerial photographs.

Use of Aerial Photos

Simple aerial photographs show fine details of a site and its immediate surroundings, such as trees, foliage, stone walls, lakes, swamps, existing buildings, roads, drives or paths, and other terrain features which are of vital importance in planning ingress and egress drives, parking areas, and determining positions of buildings, their design and construction.

Such photos show conditions just as they are, not as information from outdated surveys or word of mouth information would have you believe. Thus

By studying aerial photos, the architect can do his preliminary planning and start designing before visiting the site. As in the case of this site for a department store close to New York City, the building can be located to present the best view from the main roads. Other information learned is indicated on the drawing

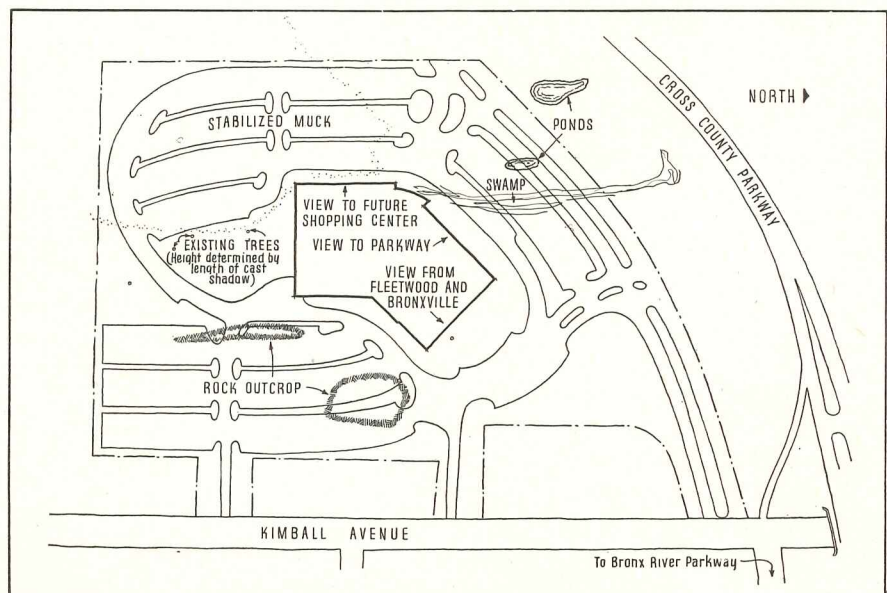
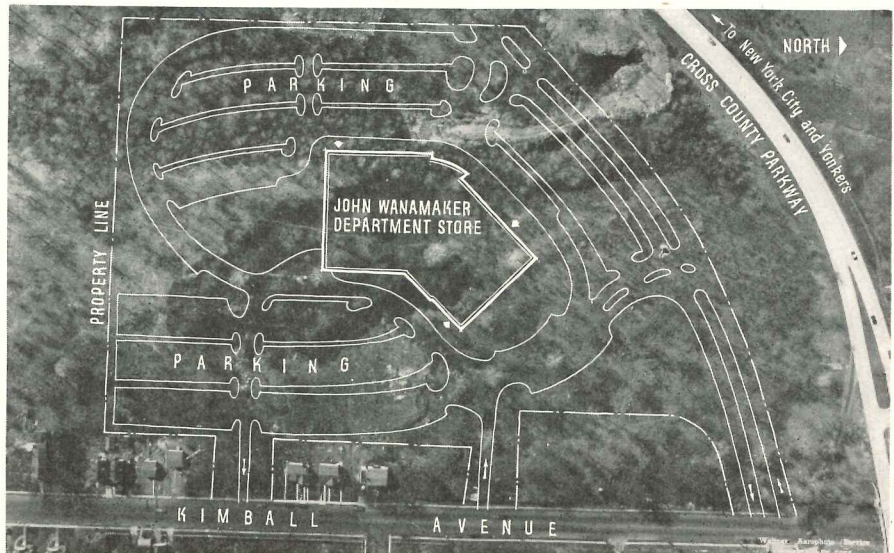
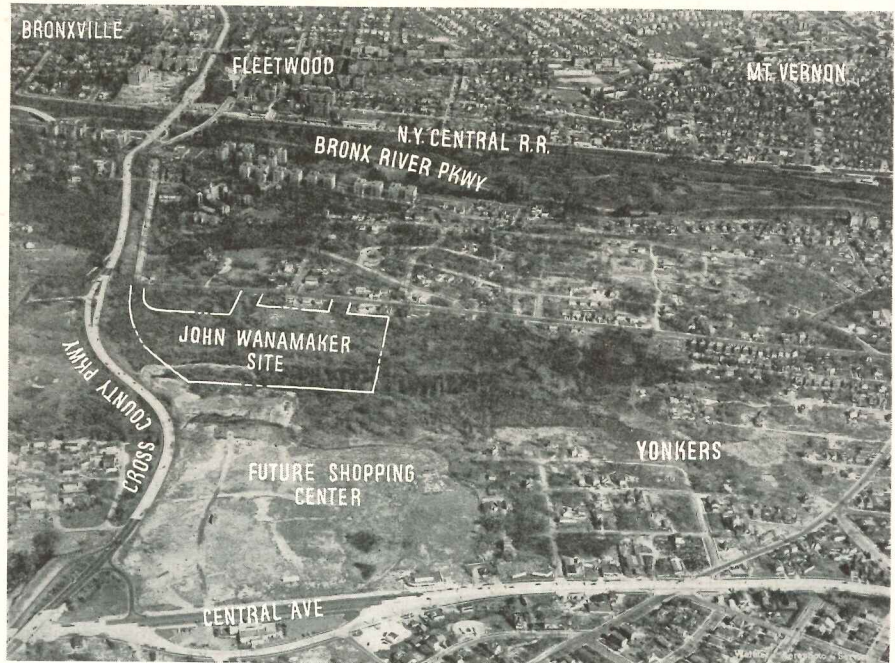

preliminary work estimates can be much more accurate than other methods allow.

Few laymen understand plans or blueprints very thoroughly. When a drawing of a proposed building or project is done on the actual site (on a photograph) in its authentic surroundings, however, it is very realistic. Misunderstandings and misapprehensions about the project can be eliminated at the start in this way.

architect, of Scarsdale, N. Y. were asked by Tourinns, Inc. of New York City to design several modern motor courts at Allentown and Pittsburgh, Pa. and Fort Wayne, Ind., as the first of a trans-continental chain.

Our firm was engaged to do a group of oblique and vertical views of these sites, which was accomplished within 10 days, and study and planning of the sites were done from those photographs with 40 scale enlargements. Much

out approximated 1950 census figures of people living within 10 miles of this site.

The architects superimposed a perspective drawing on an oblique view of the property, and a plot plan on a vertical view. Using these photographs for demonstration purposes, the architects assured store executives of the value in locating branches in this development. Planning of the project is now well under way and is enlarged considerably over the original version.

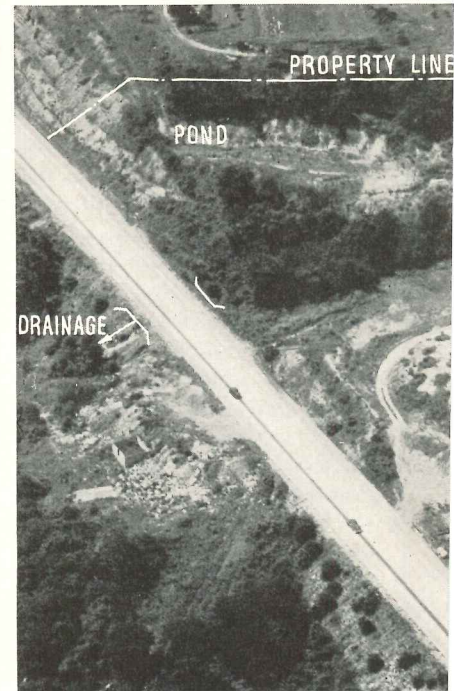
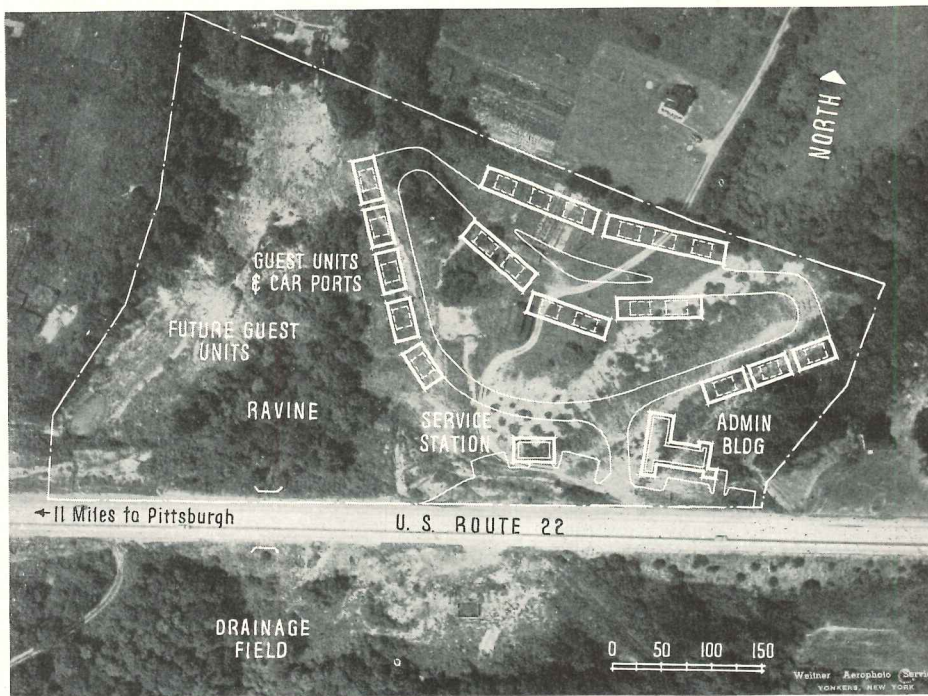

This is the site for a group of motor courts to be built near Pittsburgh. With aerial photos, the architects were able to lay

out the buildings and roads so as to take advantage of the flat areas available, minimizing cutting and filling. The ad-

Vertical photos enlarged to working scales, such as 1 in. to 40 or 100 ft are very useful in determining tree foliage spread, existing road or building positions, etc., and overlays can be moved around to determine best building placement, drainage, etc. to retain and use the best features of the site.

Examples of this type photography are in the files of many architects.

As one example, Malcolm Duncan, architect, and W. Lee Moore, landscape

The author, head of Weitner Aerialphoto Service, Yonkers, N. Y., and the editors wish to thank the architectural firms of Malcolm Duncan and W. Lee Moore, both of Scarsdale, N. Y., and Lathrop Douglass, New York City, for their assistance in preparation of this article. Thanks are due to J. Leroy Reilly for drawings.

time, travel and money were saved in the course of this work, and the architects were able to have designs and planning begun before setting foot on the sites.

Another example is that of a shopping center at Great Neck, L. I. by Lathrop Douglass and W. Lee Moore. A prospective client was interested in building a shopping center in this progressive town, but needed assurance of renting space before proceeding. We did a group of photographs of the site itself and the general area, the former for preliminary planning and the latter for market research, to show graphically the population concentration to bear

Photogrammetry

Topographical surveys are generally required in any type of land development. Here, precisely controlled aerial photographs from which accurate horizontal, elevation and declination measurements can be made — photogrammetry — come to the fore. Photogrammetry, a word which is rapidly gaining wide usage in map making and contour or topographical surveying, is the process of surveying group areas accurately from aerial photographs, employing the principle of stereoscopy (seeing the same subject from adjacent photographic viewpoints). Measurements to as small as 1-ft contour intervals can now be

made using precision optical and mechanical instruments.

You may recall the vivid and realistic effects gained by seeing photos through a stereoscope, giving depth to otherwise flat pictures. The same principle is used in photogrammetry. Successive photos (stereo pairs) are taken from an airplane using precision aerial cameras, each successive photograph overlapping the former by 50-60 per cent. Then, using several known points of elevation

ing machines trace out contours from the photos at approximately several acres per hour. These contours (usually at a scale of 1 in. to 100 ft and in increments of 5 ft) are actual and not interpolations of a grid as done in ground methods, since every foot of ground is seen on the photos through the machines. Hence, more accuracy.

Where heavy wooded areas are encountered, or steep grades, swampland, etc., the human error of a ground party

example, requiring 5-ft contour intervals at 1 in. to 100 ft scale might cost \$30 to \$40 per acre by ground methods, and take a month for delivery, while the aerial survey of this same area would probably cost \$15 to \$20 per acre, and be delivered in a week to 10 days. Prices vary, of course, with specification requirements, terrain, size and location of a site.

In conjunction with such a survey, a photo-mosaic can be produced as a by-

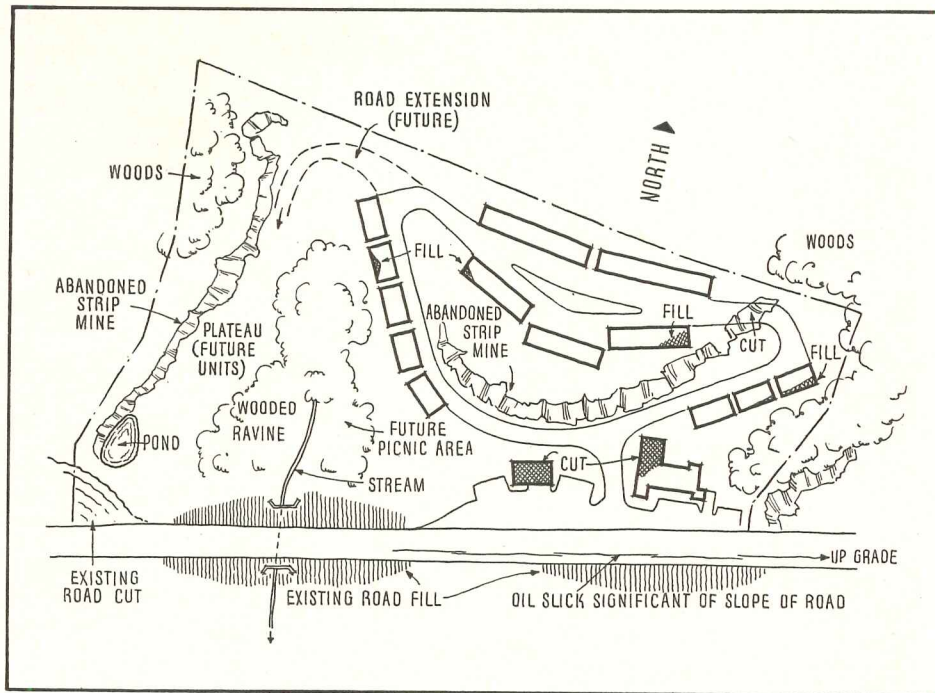
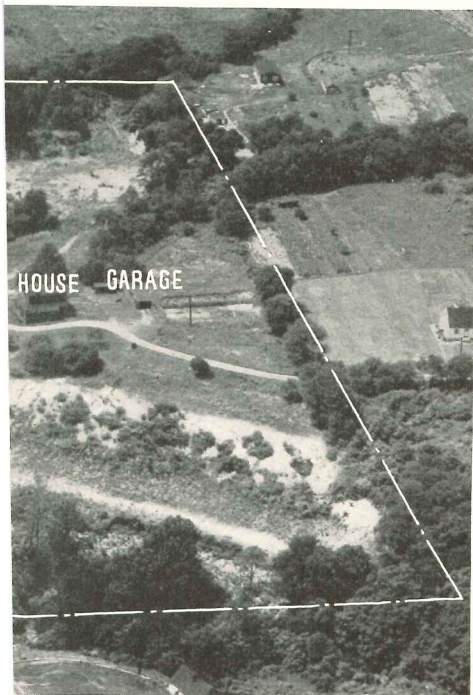

ministration building and service station were located for convenient access from the highway. The oil slick on the highway

came from cars pulling up grade. Photos like these illustrate sites to planners who otherwise could refer only to the surveys

and horizontal positions established in the area, all other points and contours of the subject area can be obtained with accuracy similar to—and in many cases exceeding—that of ground surveys.

The advantages of aerial surveys are numerous. They are quicker, and generally more economical and accurate than can be done otherwise. It is no longer necessary to have a ground party in the field over a length of time in good or bad weather and poor terrain, since several points on or near the property or area can be established quickly by two men.

Once these points are available, plot-

operating under uncomfortable or hazardous conditions is usually greater than photogrammetric methods might produce under the same circumstances, as a result of the ground being partly obscured by such heavy growth. Heavily wooded areas should be photographed with foliage at a minimum, of course.

This type survey is usually practical from 20 acres upward. Below this size the cost of a minimum amount of required flying, lab work and engineering (contour plotting) and drafting usually exceeds that of ground methods. From this size upward, however, the savings will increase proportionately.

The survey of a 200-acre plot, for

product of the photographs used at reasonable extra cost. This is actually the flat mounting of the most central portion of each photograph. Cross reference may then be made between the tracing of the contour survey when completed, and the actual ground areas as shown in the mosaic.

What would be the procedure if, for example, you required a contour survey of a 450-acre property for a housing development or subdivision? The first thing needed would be a detailed map of the area. Let us say the total cost is set at \$4500 or \$10 per acre, which is normal. What steps are then taken?

Several men are sent out to establish

points on the property as to horizontal and vertical locations. Six or eight points are sufficient in this area. The photographic crew takes a group of successive pictures, using a Cartographic camera providing 9 by 9 in. negatives. Great care is taken to keep the camera level at the instants the photographs are taken. If this property is, say, about 4500 ft in length, the plane must be flown so that 1 in. on the negative covers 500 ft on the ground. Then we must plan 60 per cent overlap of each picture. Five or six exposures will nicely cover this area, for our purposes, but several such strips are flown while the crew is in the air for precaution. To make the map, the finished photos are mounted in the contour plotting machine, "bench marks" or known points are located in the pictures and set into position at the tracing arm end of the machine, and a trained operator proceeds to trace the contours as he follows them on the photos through the lenses of the stereo machine.

National, state, and local governments are regular users of photogrammetric surveys and maps, in for example such projects as the Pennsylvania Turnpike, the Big Inch pipe line, the New York to Buffalo Throughway now under construction and in many other ways in geology, soil conservation, development of camps and recreation areas, arterial planning. The architect and engineer concerned with these and smaller projects can likewise benefit, and experience has shown that for both large or small developments, the use of aerial photographs and photogrammetry is of great service.

Top: the architect can superimpose a perspective drawing on an oblique air photo to show the client very realistically how the project will look when finished. The drawing on this photo (bounded by the cross roads and the apartments in the background) is of a proposed shopping center for Great Neck, L. I. Bottom: how contour maps are made with air views. Successive photos are taken with precision aerial cameras, each photo overlapping the other by 50-60 per cent. With several elevations known, an operator places these photos in a machine which employs the stereoscope principle, and he uses it to trace out a contour map

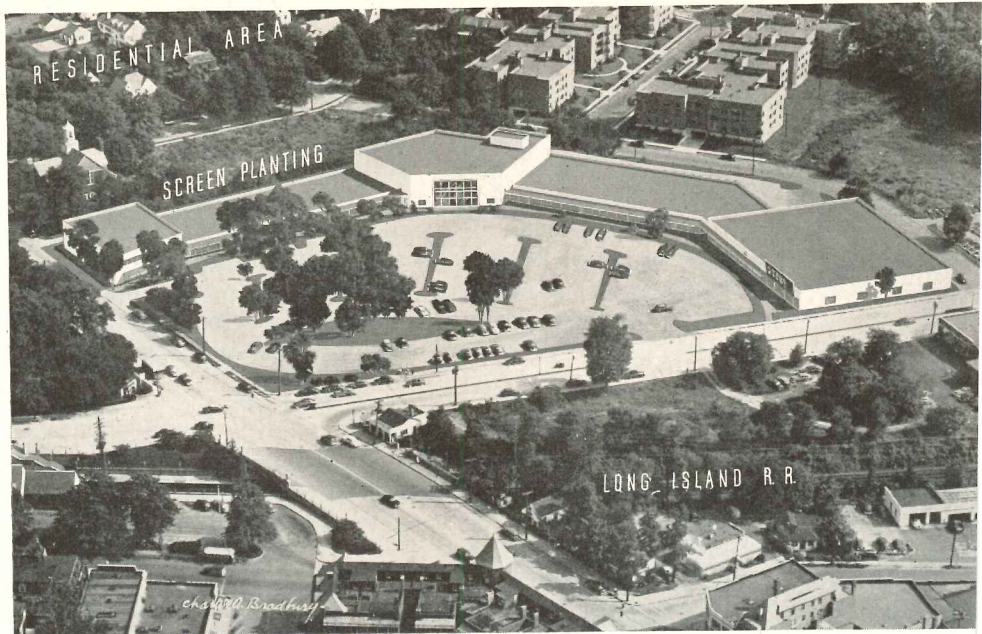
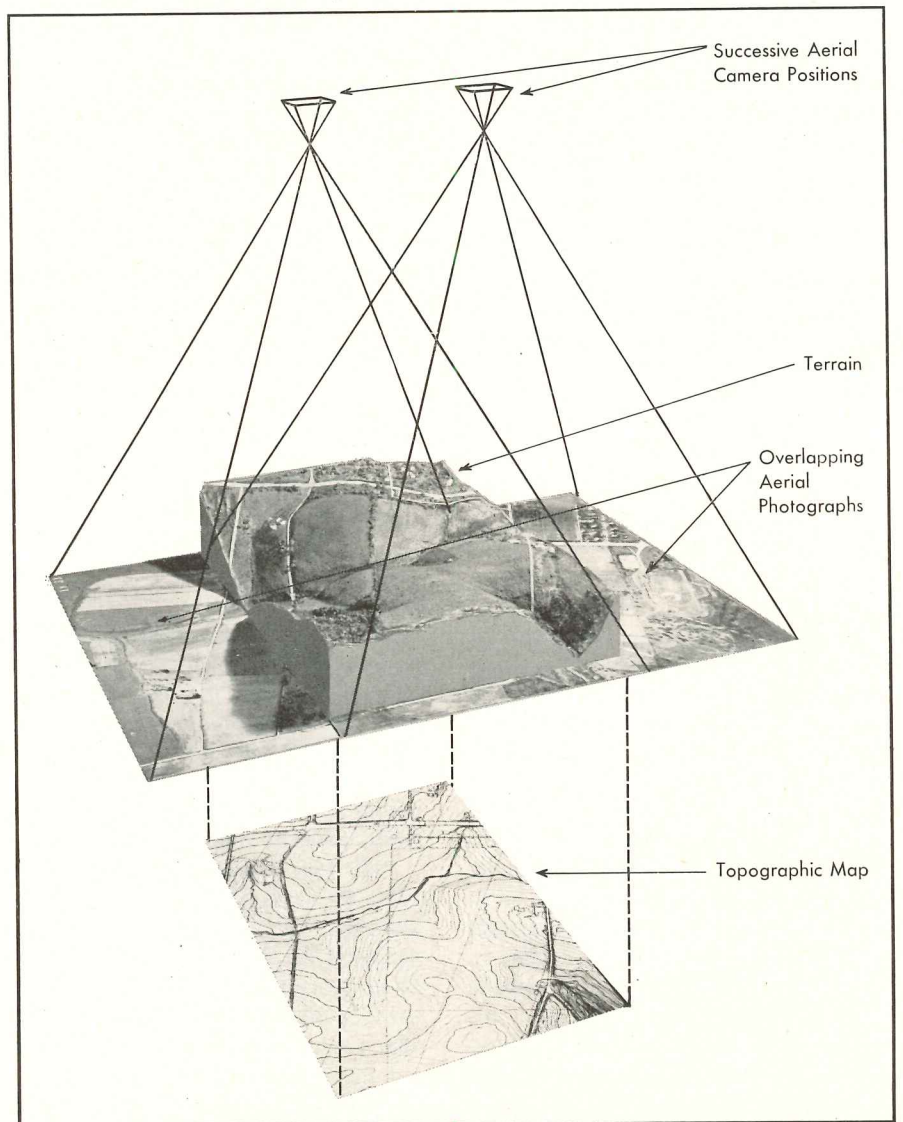

Photo Courtesy Lockwood, Kessler & Bartlett



HOUSE PANEL-CONVECTION HEATING SYSTEMS

. . . that stress comfort, economy, simplicity

By Zay Smith, Architect and Engineer *

A YARDSTICK for evaluating any house heating system logically would include such questions as:

1. Does it provide adequate heat?
2. Does it respond quickly to weather changes?
3. Is the heat even?
4. Are floors and outside walls warm?
5. Are there drafts resulting from the system?
6. Does it provide clean warm air, of desirable humidity, in winter and can it supply cool air in summer?
7. Do controls provide for a flexible system?
8. Is the system easy for the owner to operate?
9. Is it economical to install, operate and maintain?

It was inevitable that we, as other offices throughout the country must have done, should attempt to combine the good points of radiant panel heating

* Zay Smith Associates, Chicago, Ill.

and convection heating into one system that would rank high when measured by the yardstick of the ideal.

Combined Systems Designed

The performance of our first installation which employs precast hollow core concrete slabs has been very encouraging. We also have designed such systems using ordinary hollow tile and, for a low cost small residence, a ductless system using the frame floor as the top of an extended plenum chamber. The latter promises to be interesting because all duct work has been eliminated and the only cost is for the furnace itself and grille work.

The only application far enough along to warrant performance tests is the one using precast hollow core concrete slabs for the floor construction. It is a one-story five room residence with full basement, nearing completion in Palos Park, Illinois. Except for the concrete base-

ment and hollow core slab first floor construction, the structure is of 2 by 4 in. stud framing with redwood siding and shed roof. Walls and ceiling are well insulated, and double glazed or storm windows are specified throughout.

The furnace, of conventional design with blower, filter and humidifier, is located in the basement near the middle of the house. Ducts of large area carry the conditioned air to the under side of the inside ends of the hollow-core slabs. Holes in the bottom of each core directly over the open topped duct permit the air to enter the slabs (there are two cores to each 12 by 6 in. slab). The air passes through the entire length before it enters the room through a continuous grille fitted with dampers between each two studs. Both dampers and grille were made on the job by the carpenter.

The dampers are of Masonite hardboard and require no hinges or hardware except perhaps a small screw-eye or hole

Right: simple grille arrangement for hollow core slab system. Ordinary half rounds and trim mold nailed directly to the studs form the grille work; adjustable dampers between studs can be plywood or hardboard. Grille runs length of the room

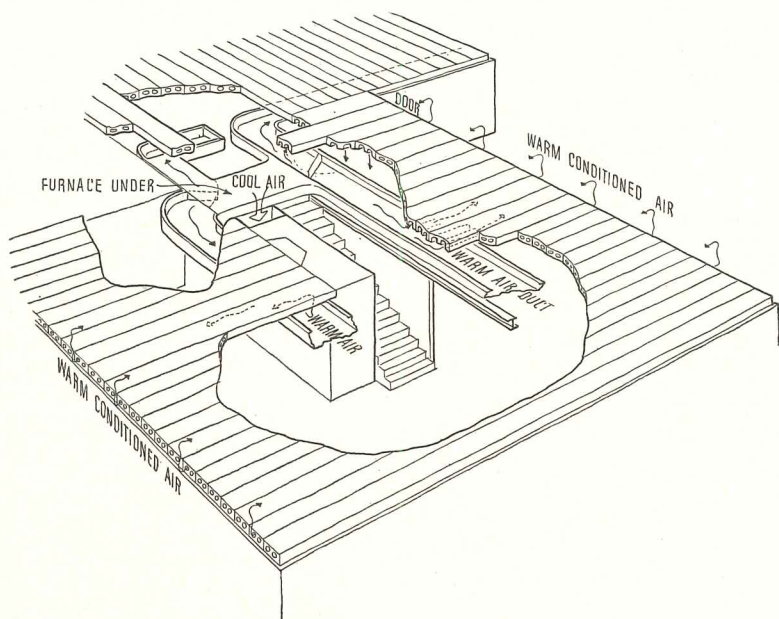

Above: warm air enters under sides of hollow core slabs from open topped ducts, heats up the slabs, and then passes into the room. Slabs near doorways and other obstructions have closed ends; may be opened on bottom to heat basement

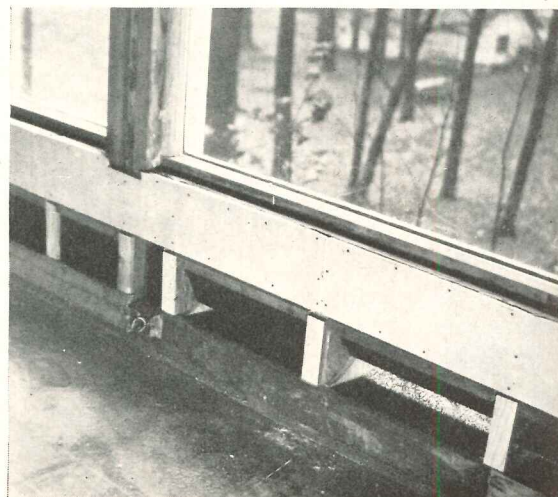
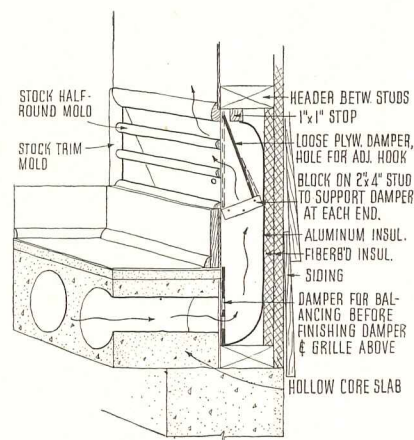

at the base into which a wire hook may be inserted for closing. The grille is 6 in. high and runs the entire length of the room immediately above the baseboard. It is formed by nailing half rounds directly to the studs and framing the whole with trim mould. Each damper operates independently and when open forms a baffle to deflect the air into the room. When closed it prevents the replacement of warm air in the slab and thus reduces the temperature of the floor in that one slab. Due to lag and conduction from the adjacent warm slab the unheated slabs do not show an unpleasant difference in temperature; however, an appreciable difference (about 4 F) was noticed during tests which indicated the control possible.

The system was designed to maintain normal temperature in the living area, warmer than normal temperature for the bathroom floor, and slightly cooler than normal temperatures in the sleeping areas. In order to provide this three sets of controls were designed.

To balance the zones, dampers were provided in the main ducts; to balance each section of the room (it was feared that short circuiting of air might overheat one section and starve another section) partial stoppers were designed for the ends of the cores; and for individual control of each foot of grille, the wall registers already described were provided. The wall registers alone provide all the control the owner needs.

The performance tests on this job were so near what was desired that the second set of controls — those intended to be built into the job at the ends of the cores — seemed unnecessary. Any possible unbalance that may develop later can be corrected by existing controls.

Heating Tests

One of our tests was conducted with an outside temperature of 18 F, with constant air circulation, and with some of the storm windows and room registers in place. Except for the bathroom, where a warmer than normal floor was desired, the maximum difference in temperature was only 4 F, and this occurred in one room on the north side of the house. The floor of the bath was 82 F while air at 5 ft was 72 F. For all practical purposes the temperature can be said to have been 73 F (the thermostat setting) throughout the first floor rooms, except the bedroom wing which was the desired 68 F.

For the desired number of air changes per hour the large grille area made possible a very low velocity at the register. Smoke tests showed that the air "oozed" out the registers and moved up the outside walls about 4 ft before moving into and filling the room, after which it found its way to the large return air grille designed as part of the end of the mantel in the entry hall directly above the furnace. Air is also permitted to return to the furnace down the basement stairs and through the basement. This air plus heat from the surface of the hollow core slab ceiling provides the only heat for the basement at present. However, certain cores unable to empty their air into the room above because of doorways and other necessary obstructions will be opened to the basement to permit the slab to pass warmed air to the basement. At present the basement floors register 63 F and the air 5 ft above remains constant throughout at 69 F.

It is difficult to obtain exact comparison of cost between the hollow core slab and either hot water radiant or conven-

tional convection because of the many factors which only can be evaluated rather than measured exactly. The table below, however, gives a fair idea of our cost.

Construction Cost (December 1949)

Estimated costs for the hollow core slab system are:

1. Furnace and Controls	\$450.00
2. Metal Ductwork	300.00
3. Continuous dampered grilles:	
Insulation, fiber & foil	15.00
Moulding & trim, Plywood	12.00
Labor, carpenter	60.00
	<hr/>
	\$837.00

The cost of the floor construction (98 cents per sq ft) is not included above because it would have been used regardless of the type of heating.

Other Combined Systems

As mentioned before, we also have designed a ductless system, as well as one using hollow core tile.

In the ductless system, the furnace delivers warm conditioned air from the bottom and supplies it directly into a sealed crawl space under the entire floor which becomes in effect the top of a huge plenum chamber. The conditioned air is admitted into the room through registers on the outside wall after it has passed under the floor and up between the wall studs to headers above the register tops. Static pressure, necessary to force air to the farthest outlet, is obtained by presetting certain registers to limit maximum delivery. The owner may reduce delivery at any register by closing the register, but he cannot open it more than the limit set to insure constant pressure in the extended plenum. Obviously the outer walls of the plenum as well as those of the house, are well insulated and the continuous foundation walls run below frost line so that practically all heat reaches the interior.

In the hollow tile application the conditioned air is forced through a large supply trench running the length of the basementless single floor. The hollow tiles supported by a concrete slab, run off from the trench at a 45 degree angle in line with the flow of air. Finished floor tile with integral hollow cores may be used, thus eliminating further floor covering. In our application ordinary hollow wall tile was used and covered with a finish floor tile. Dampered registers formed of glazed wall tile and flat sheet metal were spaced continuously around the outer walls on 12 in. centers.

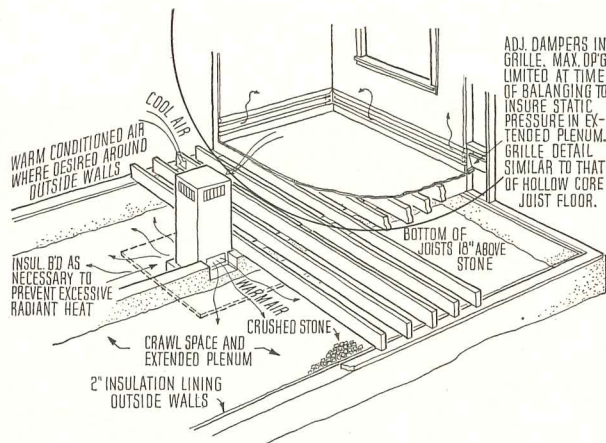

Warm air from the bottom of the furnace fills the crawl space and heats the floor in this ductless system. Grilles with adjustable dampers around outside walls admit air to the room

LOCKER ROOM CONCENTRATES ON EFFICIENCY

Rust Engineering Co., Pittsburgh, Pa.

HERE is a locker room, ideal for use in industrial, commercial and institutional buildings, that is highly efficient in both use of space and materials. Concentration of all sanitary facilities in a central mechanical core makes this possible.

The sanitary core consists of a 3-ft wide, double-partitioned, plumbing access well which houses the pipes, drains, valves, fixture hangers, etc. Attached to the walls of this core are all of the sanitary fixtures — the lavatories, urinals, water closets and showers.

These units are divided into four sections so that each quarter of the locker room has access to all types of fixtures. It reduces circulation to a minimum — there is no cross flow.

In addition to distributing the fixtures evenly, this scheme is notably economical, since all plumbing work is grouped so that a single vent and drain have the maximum fixtures hooked to them. Moreover, all odors and vapors are concentrated so that, through louvers spaced properly on the walls, and with the partitioned core acting as a plenum, the fixture area can be exhausted adequately with a single fan. Since this core contains all fixtures with water or vapor conditions, it is recommended that this wall be made of glazed tile for ease in cleaning. There is almost no other exposed wall since the lockers themselves cover much of this area.

All fixtures are wall hung, and the toilet partitions are hung from the

ceiling, so that the floor is kept unobstructed for sanitation. Waste disposal units are designed to be totally recessed in the wall with removable sections for emptying.

At the ends of locker corridors, from base to ceiling and for the full width of the aisle, glass block is suggested for cleanliness and cheerful atmosphere.

The plastered ceiling is furred down to the heads of lockers and finished flush with their face. A blower fan forces air into the locker room through ceiling outlets and exhausts the air out through each locker. The air movement into the locker is through slots at the bottom and

out through ducts individually connected to the top of each locker. Air is tempered through heating coils in winter. Drying action is definitely noticed on clothes properly hung in the locker.

Radiant heating pipe coils are located in the floor. The floor has a separate top finish of either cement, terrazzo or quarry tile. Generally 5 by 12 in. face color, ceramic-glazed wall tiles are used. All lighting fixtures are recessed into the plaster ceiling.

This locker room plan has been used in several Rust Co. designs during the past three years, including a plant for the Container Corporation of America.

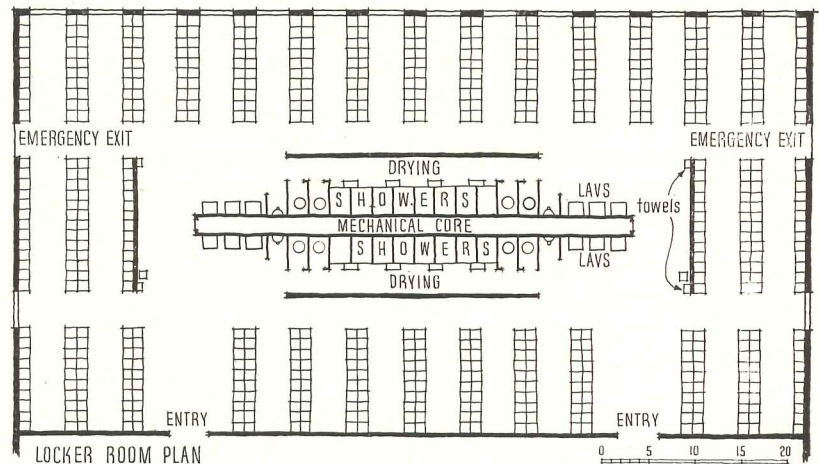

Use of centralized mechanical core in locker room cuts circulation to a minimum. Photos: locker building of Container Corporation of America, Fernandina, Fla.

Torkel Korling Photos

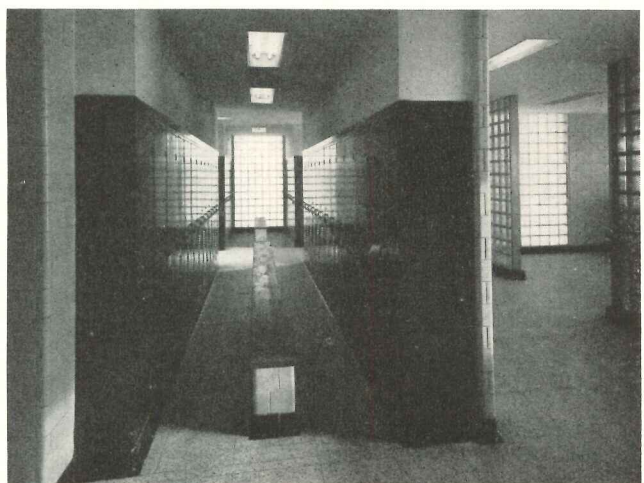
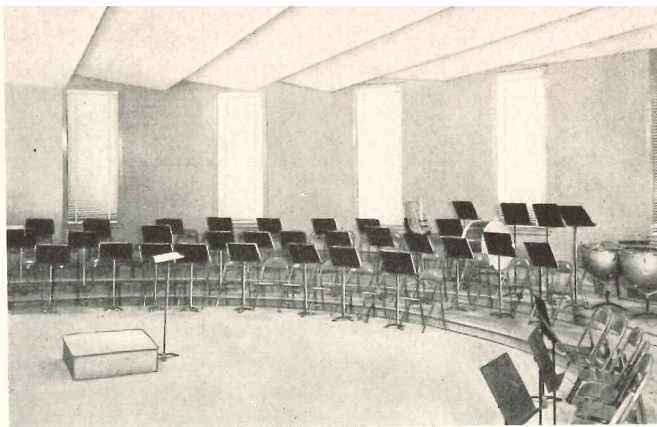

Photo of the band room, Shasta Union High School, Redding, Calif., and plan of music department for Harper Elementary School, Evansville, Ind., are from *Music Rooms and Equipment*. Architects are, respectively, Charles F. Dean and Ralph Legeman



A guide to planning

SCHOOL MUSIC ROOMS

"PLANNING the physical plant for music has perplexed many an administrator, architect, and supervisor of music . . . However, experience and scientific investigations at the present time are producing some helpful information and principles about the kind of rooms and equipment which will facilitate the progress of musical study and performance in our schools."

This introduction to *Music Rooms and Equipment*,* a new bulletin (No. 17) of the Music Education Research Council

* *Music Educators National Conference, 64 E. Jackson Blvd., Chicago 4, Ill. \$1.50.*

indicates the type of material to be found in this publication.

Compiled by Dr. Clarence J. Best, Head Music Education Dept., Texas Christian University, the report covers: location, size and types of music rooms; storage facilities; acoustics; lighting; heating and ventilating; auditorium stage; band shells. Descriptive and specification type material is included along with plans, illustrations and a bibliography. The acoustics section was prepared by Dr. Richard H. Bolt of M.I.T., co-author of the RECORD's current series, "Architectural Acoustics."

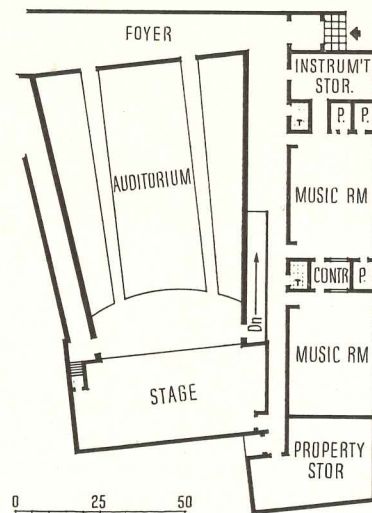

ARTIFICIAL SUN—ARTIFICIAL SKY

AN artificial "sun" (called the *solar-scope*) and a "sky" have been devised by Australian scientists for studying sunshine and daylight in relation to building problems.

The solarscope demonstrates the fall of sunshine on buildings in different latitudes for different seasons and times

of day. In contrast to other such devices, reflected light ("sun") projects onto the model from a mirror at one end of an arm on the solarscope. A spotlight is at the other end.

The model building remains immobile on a platform which neither rotates nor tilts; instead the arm revolves about the

platform simulating movement of the sun.

The artificial sky permits the study of daylighting conditions within a model under a constant light source. Ultimately this apparatus may be used to determine sufficient data for the calculation of reflected light values, as now can be done with direct daylight.

Australian Official Photograph

Scientists of the Commonwealth Experimental Building Station, Sydney, Australia, demonstrate artificial "sun" (left) and "sky" (right). When full-scale "sky" is built, models will be placed in center of inverted bowl, 24 ft across. Continuous fluorescent tube will replace the adjustable lights used for development



PRODUCTS for Better Building



Motor or hand operated drapery traverse uses no cords, turns corners or curves. Below: clockwise rotation of rod moves drapery carriers to left; counter-clockwise, to right. Varying the pitch of the ball roller shafts determines speed and direction of carriers. For divided curtains, opposite pitches are used

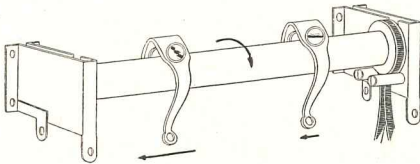

Cordless Drapery Traverse

The *Bradley Beauty-Fold* rotary drapery traverse uses an interesting device to distribute drapery in equal folds during all stages of traversing. It also permits synchronized movement of unequal width panels over unequal distances as is often found in corner window installations. The system employs a rotating tube, cut to size and hung like a roller shade in a choice of mounting brackets. Carriers, equipped with ball

type rollers, hook over this tube. Movement of the carriers is produced by rotating the tube manually or by motor, and is the result of angular settings of the shafts in the ball type rollers. The relative speed and direction of each carrier is established by calculated variations of this angular setting. The system may be used in either large or small installations. A special spring coupling is available which allows traversing around curves of any radius. The *Bradley Rotor Traverse Co., Inc.*, 92 Jewett Ave., Staten Island 2, N. Y.

Joist Bridging

An extremely simple installation that requires no tools is featured by the *Snap-In Bridge*. The unit consists of two metal channels, one of which telescopes into the other and locks into holes located for either 16-, 12- or 8-in. center joists. When first joined, the two units form an angle. Ends of the bridge are pointed, and are engaged on one joist about $\frac{1}{2}$ in. below the sub-floor, and on the adjacent joist near the bottom. Pressure is then applied upward at point of fulcrum until the bridge snaps into place in a straight line. This last action drives the end points into the joists and locks the bridge in place. The unit is made of 20-gage steel, treated with a rust-proofing material. It is manufactured by the *Snap-In Bridge Co.*, Whitehall, Mich. National Sales Representative is the *Welco Co.*, 952 Addison St., Chicago, Ill.

Aluminum Window

The *Lupton Master Aluminum Window* is a new projected type window designed especially for schools, hospitals and office buildings. The Unit features extra deep sections, welded construction and precision weathering. The win-

dows can be glazed inside or outside, depending upon individual requirements, and will accommodate glass up to $\frac{1}{2}$ in. thick. All hardware is made of aluminum. Aluminum screens are also available. *Michael Flynn Manufacturing Co.*, 700 E. Godfrey Ave., Philadelphia 20, Pa.

Lightweight Steel Cantilevers

A novel use of lightweight structural steel is employed in the roof overhangs of the *Horace Mann School* in Austin, Ohio. Architect *Arthur F. Sidells* devised a roof framing system of 12-in. *J & L Junior Beams* 30 ft long, spaced 4 ft o.c., which are notched over lintel beams and cantilevered 3 ft beyond outside walls to provide a permanent sun shield over classroom window walls. The lightweight members were installed with a ginpole and hang rigging. Connections are field bolted and the steel roof deck is welded to the beams. Use of such a system is claimed to permit relatively wide roof overhangs that are fire-safe. *Jones & Laughlin Steel Corp.*, 3rd Ave., & Ross, Pittsburgh 30, Pa.

(Continued on page 220)

Notched lightweight steel beams simplify cantilevered roof-overhang construction



Package Programs For A.I.A. and Producers' Council Meetings

A series of panel meetings on building construction problems have been prepared by the *Producers' Council, Inc.*, national organization of building products manufacturers, with the assistance of the *Dept. of Research and Education of the A.I.A.* The programs are planned

for any joint Chapter meeting of the *A.I.A.* and the *Producers' Council*, or any *A.I.A.* Chapter where there is not a *Producers' Council*. Panels available include: *Modern Rest Room Planning*, presented by the *American Radiator & Sanitary Corp.*, *J. A. Zurn Mfg. Co.*, and *Sanymetal Products Co., Inc.*; *Modern Methods of Fastening*, by *Miracle*

Adhesives Corp., *Stemco Corp.*, and the *Nelson Stud Welding Div. of the Morton Gregory Corp.*; and *Indoor Climate Control*, by *Minneapolis-Honeywell*, *Libbey-Owens-Ford*, and *Owens-Corning Fiberglas*. Actual demonstrations and slide films are used to illustrate lectures. *Producers' Council, Inc.*, 815 15th St., N. W., Washington 5, D. C.

MANUFACTURERS' LITERATURE

Powder-Actuated Fastening Tool

Raising the Curtain on the Amazing Drive-It Powder-Actuated Fastening Tool. Folder and inserts describe a lightweight tool for inserting a variety of drivepin fasteners in concrete, masonry or steel. Full size details are given for the drivepins available for different uses and materials. Accessory equipment data and notes on typical jobs employing the tool are included. 9 pp., illus. Tempo Products Co., 1900 Euclid Ave., Cleveland 15, Ohio.

Wall Furnace

The New Domestic 2-Way Wall Furnace. Bulletin describes a furnace designed to be located in an 18-in. wall or partition. Features of the unit are discussed, and suggested installations are shown in sketches. Specifications for the unit are covered, along with data on the automatic pilot. 2 pp., illus. Domestic Manufacturing Co., 201 Westlake Ave. North, Seattle 9, Wash.

Elevator Doors

Security Elevator Doors. Catalog presents freight elevator doors, motor operators, car gates and dumbwaiter doors. Details, drawings and specifications are given for the several models available. Construction and operation features are noted. Detail drawings are also included for correct frame construction to insure proper door installation. 16 pp., illus. Security Fire Door Co., 3100 Lambdin Ave., St. Louis 15, Mo.*

Electric Stairways

The Proved Solution To Modern Business Traffic-Flow Problems — Westinghouse Electric Stairways (Booklet B-4403). Covers features and suggested uses, with illustrations, of the electric stairways. Non-technical sketches, photographs and "under the hood" pictorializations explain the construction and operation of the mechanisms. A special section is devoted to layouts, de-

sign details and dimensions for use in the preparation of preliminary architectural plans. 48 pp., illus. Westinghouse Electric Corp., Elevator Div., 150 Pacific Ave., Jersey City, N. J.*

Built-up Roofs and Flashings

Ruberoid Bonded Built-Up Roofs and Flashings. Booklet covers five main types of built-up roofing construction: pitch and felt; asbestos and asphalt; asbestos and gravel; combination roofs; and mineral surfaced roofs. Each is presented with several illustrated variations, and gives specifications for laying roofing, workmanship and materials. Special sections also treat traffic and promenade roofs, flashings, construction details and application requirements. 124 pp., illus. The Ruberoid Co., 500 Fifth Ave., New York 18, N. Y.*

Glass Louvers

Clearview Plate Glass Lower Venetian Windows in Aluminum Frames. Folder describes features and operation of the louver-windows. Sketches and details show the component parts of the unit and installation cross sections in several types of construction. A table of standard window sizes is also included, along with illustrations of typical installations. 4 pp., illus. Clearview Venetian Window Co., 101 Park Ave., New York 17, N. Y.

Packaged Chimney

Vitroliner Type "E" Flue. Describes features and construction of a fabricated flue and chimney assembly. A cross section detail giving installation data is supplemented by notes and step-by-step photographs. Cut-away drawings show casings and insulation, and method of ventilating attic. Photographs demonstrate installed appearance in small houses. 6 pp., illus. Condensation Engineering Corp., 122 S. Michigan Ave., Chicago 3, Ill.

Lighting Fixtures

Lighting (Catalog No. 1). Presents an extensive line of contemporary lighting fixtures. Types include: recessed down-

lights with a variety of lenses, louvers and reflectors; surface mounted downlights; recessed eyeball fixture; suspended ceiling fixtures; wall or ceiling lamps with a variety of mountings, swivels and shades; and holders for fluorescent lights. All types are shown in section, with dimensions and description. 19 pp., illus. Ledlin Lighting, Inc., 49 Elizabeth St., New York 13, N. Y.

Asphalt and Plastic-Asbestos Tiles

Picture Your Floors and Walls in Tile-Tex. Model home installations of asphalt and plastic-asbestos floor and wall tiles are illustrated in full color in this booklet. Design suggestions are included for such room types as foyers, recreation rooms, bedrooms, baths and kitchens. Descriptions, color charts and maintenance product lists are given for the materials presented. 18 pp., illus. The Tile-Tex Div., The Flintkote Co., 1232 McKinley Ave., Chicago Heights, Ill.*

Aluminum Copings and Gravel Stops

Copings and Gravel Stops of Alcoa Aluminum. A recently revised brochure giving details, installation methods and features of several types of aluminum copings and gravel stops. A table gives dimensions and weights. Long and short specification forms and test results on how the aluminum stands up in different atmospheres are included. 18 pp., illus. Aluminum Company of America, Gulf Building, Pittsburgh 19, Pa.*

Bank and Office Lighting

Planned Lighting For Modern Banks and Offices. Pictures a range of general and executive offices, bank lobbies and interiors illuminated with fluorescent or incandescent equipment, or a combination of both. The text is devoted to influences of properly maintained foot-candle levels with reference to efficiency, working accuracy and visual comfort. 12 pp., illus. Pittsburgh Reflector Co., 402 Oliver Bldg., Pittsburgh 22, Pa.*

(Continued on page 246)

*Other product information in Sweet's File, 1950.

2 for Cleveland

COPPER
ROOF
BY
Overly

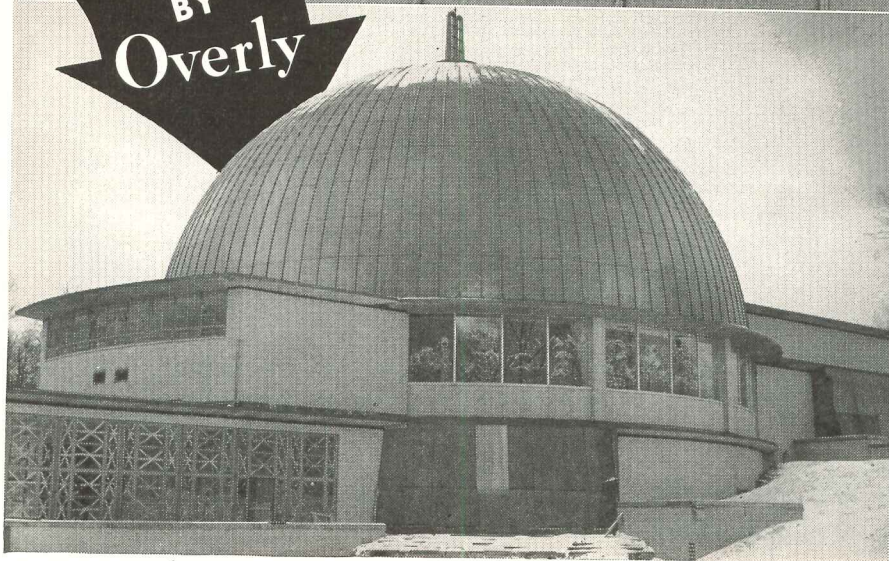

ALUMINUM
SPIRE
BY
Overly

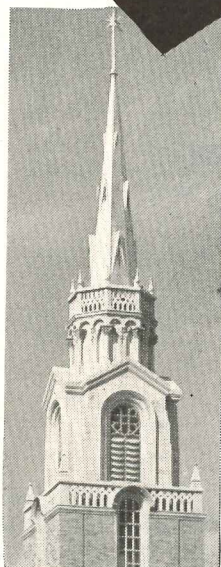

LEFT—First Hungarian Reformed Church, Cleveland, Ohio, showing tip of star 157' above ground. *Architect:* Herman W. Maurer, registered in Ohio and Pa. Aluminum cover on spire is octagonal 6' 8" across flats; 40' high from base to top of aluminum star. All parts of cover were prefabricated by Overly. Intricate sheet metal work achieved on spire, visible railings, trim, and star shows Overly's fine craftsmanship. Spire glistens in sun and is spotlighted at night.

ABOVE—Park Synagogue, Cleveland Heights, Ohio, was under construction when these photos were taken, but roof was completed. *Architect:* Eric Mendelsohn, A.I.A., San Francisco, Calif. *General Contractor:* The Leonard H. Krill Co., Cleveland, Ohio.

The dome—a 100' diam., reinforced concrete shell supported by only 6 columns—is

an outstanding architectural and structural accomplishment. The 4" thick Gunitite shell was applied pneumatically over a 2" layer of cork lining fastened to formwork. The exterior concrete surface of the dome was covered with asbestos felt and 20 oz. copper, using Overly Goodwin Batten Type Metal Roofing, applied directly over the felt.

OVERLY GOODWIN BATTEN TYPE METAL ROOFING is custom made to job specifications in aluminum, copper, monel metal, or stainless steel. *Advantages:* mechanical interlocking joints, permanently watertight; ample provision for expansion and contraction; can be applied over any type of roof deck, old or new . . . to any roof having a pitch of at least 1½" in 12"; eliminates roof maintenance or repairs; lighter weight design relieves stress on roof supports.

Send for detailed information on any of the following: Overly Roofing, Coping, Metal Door Frames, Kalamein and Tin Clad Doors, Skylights, Ventilators, or related metal products.

OVERLY MANUFACTURING COMPANY

Dept. AR, Greensburg, Pa.
Phone Greensburg 154

• Sales Representatives
in All Principal Cities •



OVERLY MANUFACTURING COMPANY OF CALIFORNIA

Dept. AR, 2943 Gleneden St.
Los Angeles 39, California
Phone Olympia 2948

OVERLY ARCHITECTURAL SHEET METAL PRODUCTS ARE DESCRIBED IN SWEET'S FILE

*Designed
for tomorrow's
buildings
... today!*

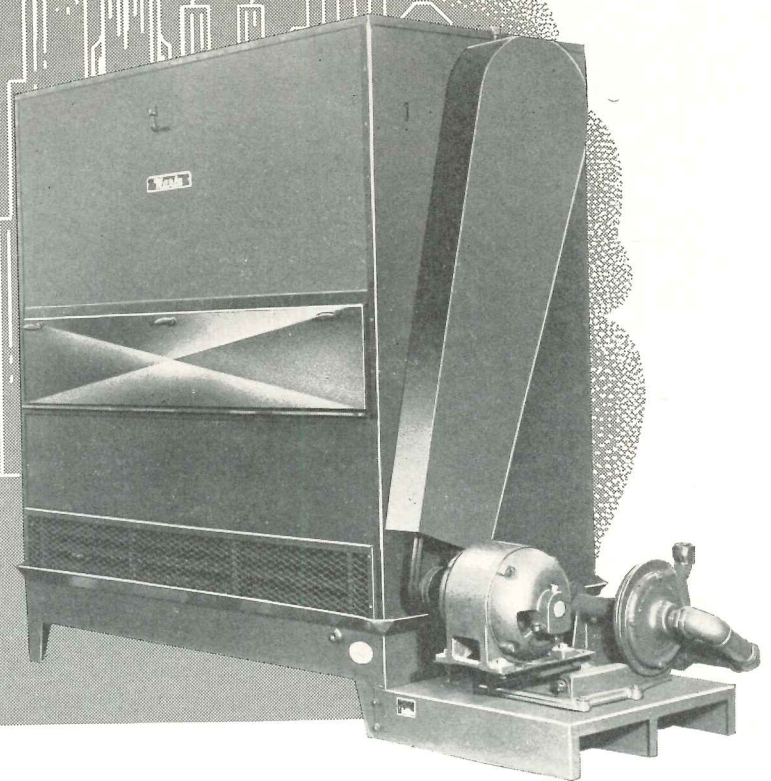

modern *Marlo* cooling units

They Save the Skyline

BELOW-THE-PARAPET DESIGN

of Marlo Cooling Towers preserves the smooth, unbroken contour of buildings.

They're Efficient

MARLO UNITS SAVE UP TO 95% of the normal water demand through more effective recycle cooling.

They're Quiet

SOUND-DEADENING INTERIORS

plus silent V-belt drive — assure low noise-level operation of Marlo Evaporative Condensers and Cooling Towers.

They're Durable

ALL GALVANIZED CONSTRUCTION

resists corrosion . . . insures long, dependable service.

Write for information on the complete Marlo line

MARLO-HEAT TRANSFER
Since 1925

Marlo COIL CO. • 6135 Manchester Rd. • St. Louis 10, Mo.

GRAPHICAL SYMBOLS: 1-Piping

These sheets reproduce sections of American Standards Z32.2.3-1949 and Z32.2.4-1949 approved in 1949 by the American Standards Assn., Inc., 70 E. 45th St., New York 17, N. Y. The project was sponsored by the American Institute of Electrical Engineers and the American Society of Mechanical Engineers.

AIR CONDITIONING

Brine Return 

Brine Supply 

Circulating Chilled or Hot-Water Flow 

Circulating Chilled or Hot-Water Return 

Condenser Water Flow 

Condenser Water Return 

Drain 

Humidification Line 

Make-Up Water 

Refrigerant Discharge 

Refrigerant Liquid 

Refrigerant Suction 

HEATING

Air-Relief Line 

Boiler Blow Off 

Compressed Air 

Condensate or Vacuum Pump Discharge 

Feedwater Pump Discharge 

Fuel-Oil Flow 

Fuel-Oil Return 

Fuel-Oil Tank Vent 

High-Pressure Return 

High-Pressure Steam 

Hot-Water Heating Return 

Hot-Water Heating Supply 

Low-Pressure Return 

Low-Pressure Steam 

Make-Up Water 

Medium-Pressure Return 

Medium-Pressure Steam 

PLUMBING

Acid Waste 

Cold Water 

Compressed Air 

Drinking-Water Flow 

Drinking-Water Return 

Fire Line 

Gas 

Hot Water 

Hot-Water Return 

Soil, Waste or Leader (Above Grade) 

Soil, Waste or Leader (Below Grade) 

Vacuum Cleaning 

Vent 

PNEUMATIC TUBES

Tube Runs 

SPRINKLERS

Branch and Head 

Drain 

Main Supplies 

(Continued on page 173)

This is an



HI-BOND Reinforcing Bar

It not only meets but exceeds the minimum standards set up by ASTM A305-49. Its proper ratio of bearing to shearing area provides greater bond between the steel and concrete thus providing more efficient transfer of stress at splices and reducing the size of tension cracks. This means a more efficient and better looking structure.

It saves your client's money. In many instances, end hooks can be completely eliminated which means a saving in steel, fabricating and placing costs. Because a single wire loop holds HI-BOND firmly in place—even during pouring of concrete—there are savings in wire and tying time.

It is available for prompt shipment from the Ryerson Company and other leading steel warehouses throughout the middle and far west.

It costs *no more* than ordinary reinforcing bars!

Specify Inland HI-BOND—the reinforcing bar with the built-in anchorage.

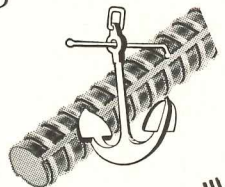

**INLAND
STEEL COMPANY**

38 South Dearborn Street

• Chicago 3, Ill.

HEATING		VENTILATING	
Air Eliminator		Access Door	
Anchor		Adjustable Blank Off	
Expansion Joint		Adjustable Plaque	
Hanger or Support		Automatic Dampers	
Heat Exchanger		Canvas Connections	
Heat Transfer Surface, Plan (Indicate type such as convector)		Deflecting Damper	
Pump (Indicate type such as vacuum)		Direction of Flow	
Strainer		Duct (1st figure, side shown; 2nd side not shown)	
Tank (Designate type)		Duct Section (Exhaust or Return)	
Thermometer		Duct Section (Supply)	
Thermostat		Exhaust Inlet Ceiling (Indicate type)	
Trap, Boiler Return		Exhaust Inlet Wall (Indicate type)	
Trap, Blast Thermostatic		Fan and Motor with Belt Guard	
Trap, Float		Inclined Drop in Respect to Air Flow	
Trap, Float and Thermostatic		Inclined Rise in Respect to Air Flow	
Trap, Thermostatic		Intake Louvers on Screen	
Unit Heater (Centrifugal fan), Plan		Louver Opening	
Unit Heater (Propeller), Plan		Supply Outlet Ceiling (Indicate type)	
Unit Ventilator, Plan		Supply Outlet Wall (Indicate type)	
Valve, Check		Vanes	
Valve, Diaphragm		Volume Damper	
Valve, Gate			
Valve, Globe			
Valve, Lock and Shield			
Valve, Motor Operated			
Valve, Reducing Pressure			
Valve, Relief (Either pressure or vacuum)			
Vent Point			

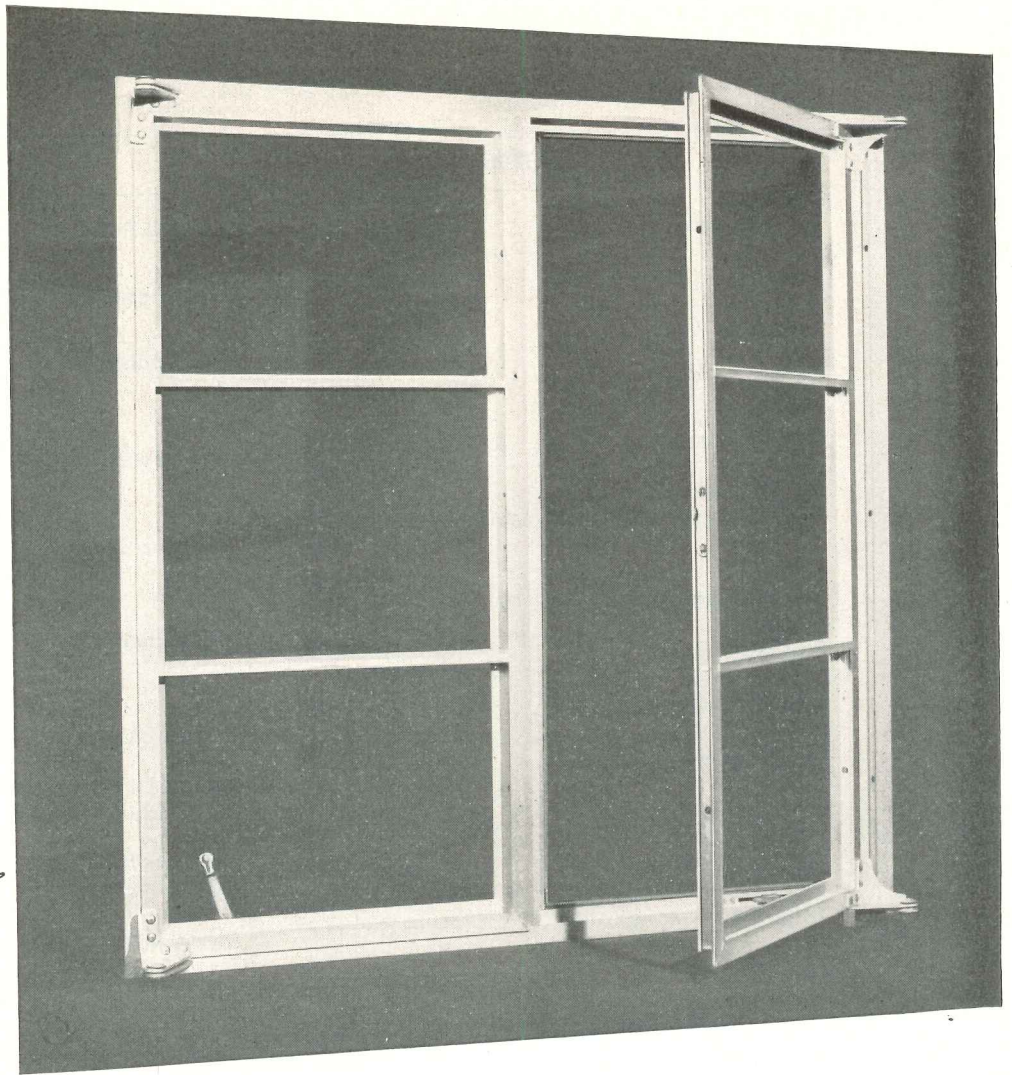

Window shopping stops here...

The most intensive of all "window shopping"—that of the architect and builder—must stop at the sight of Reynolds Aluminum Casements.

Their superiority in design and especially in *finish* is outstanding.

Their flash-welded corners assure maximum rigidity and weathertightness. Their roto-operation is smooth and dependable. And of course they have the basic advantages exclusive to aluminum windows: rustproof permanence with no need for protective painting, narrow frames of neutral tone to harmonize with any concept.

Reynolds supplies residential casement, fixed and picture windows in all combinations, standard and western types...also Reynolds Aluminum Screens to fit these and all metal casement windows.

Stop right here and write for complete descriptive literature in A.I.A. file form. **Reynolds Metals Company**, Building Products Section, 2015 South Ninth Street, Louisville 1, Ky. Offices in 32 principal cities.



Window Specifications Start Here...

"...as manufactured by Reynolds Metals Company...made of solid extruded aluminum shapes of not less than 1/8" in thickness...special alloy of not less than 17,000 pounds tensile strength psi...Frames shall be Zee sections 1" in depth and 7/8" in cross section, and will provide continuous double contact...All corners shall be electrically flash welded...Satin type finish and protective lacquer coating..."

**REYNOLDS ALUMINUM
RESIDENTIAL CASEMENT FIXED
AND PICTURE WINDOWS**

REYNOLDS ALUMINUM

GRAPHICAL SYMBOLS: 3—Air Conditioning

(Continued from page 173)

Capillary Tube		Motor-Compressor, Enclosed Crankcase, Rotary, Direct Connected	
Compressor		Motor-Compressor, Sealed Crankcase, Reciprocating	
Compressor, Enclosed, Crankcase, Rotary, Belted		Motor-Compressor, Sealed Crankcase, Rotary	
Compressor, Open Crankcase, Reciprocating, Belted		Pressurestat	
Compressor, Open Crankcase, Reciprocating, Direct Drive		Pressure Switch	
Condenser, Air Cooled, Finned, Forced Air		Pressure Switch With High Pressure Cut-Out	
Condenser, Air Cooled, Finned, Static		Receiver, Horizontal	
Condenser, Water Cooled, Concentric Tube in a Tube		Receiver, Vertical	
Condenser, Water Cooled, Shell and Coil		Scale Trap	
Condenser, Water Cooled, Shell and Tube		Spray Pond	
Condensing Unit, Air Cooled		Thermal Bulb	
Condensing Unit, Water Cooled		Thermostat (Remote bulb)	
Cooling Tower		Valve, Automatic Expansion	
Dryer		Valve, Compressor Suction Pressure Limiting, Throttling Type (Compressor Side)	
Evaporative Condenser		Valve, Constant Pressure, Suction	
Evaporator, Circular, Ceiling Type, Finned		Valve, Evaporator Pressure Regulating, Snap Action	
Evaporator, Manifolder, Bare Tube, Gravity Air		Valve, Evaporator Pressure Regulating, Thermostatic Throttling Type	
Evaporator, Manifolder, Finned, Forced Air		Valve, Evaporator Pressure Regulating, Throttling Type (Evaporator side)	
Evaporator, Manifolder, Finned, Gravity Air		Valve, Hand Expansion	
Evaporator, Plate Coils, Headered or Manifold		Valve, Magnetic Stop	
Filter, Line		Valve, Snap Action	
Filter & Strainer, Line		Valve, Suction Vapor Regulating	
Finned Type Cooling Unit, Natural Convection		Valve, Thermo Suction	
Forced Convection Cooling Unit		Valve, Thermostatic Expansion	
Gauge		Valve, Water	
High Side Float		Vibration Absorber, Line	
Immersion Cooling Unit			
Low Side Float			
Motor-Compressor, Enclosed Crankcase, Reciprocating, Direct Connected			

TIME-SAVER STANDARDS
Architectural Engineering

There's something **SPECIAL** about bathrooms when accessories are **HALL-MACK**

HALL-MACK

TRADE MARK REG. U.S. PAT. OFF.

In Hall-Mack's complete selection of bathroom accessories you'll find unique special accessories like these—made to add the final touch of convenience and appearance to any bathroom...

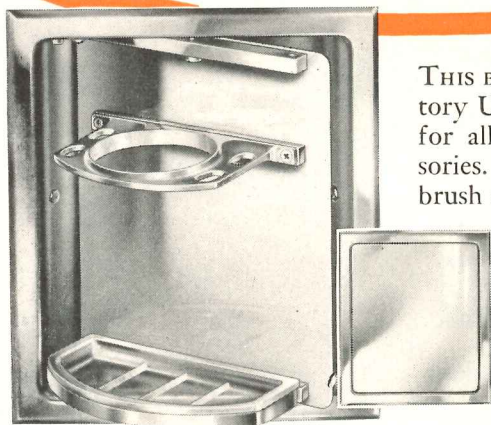

THIS BEAUTIFUL Concealed Lavatory Unit is a perfect companion for all other Hall-Mack Accessories. Soap, tumbler and toothbrush are ready at the touch of a finger—yet smartly concealed when not in use. These bathroom necessities are mounted on a revolving panel, and only a polished chrome surface flush with the bathroom wall is visible when the unit is closed...

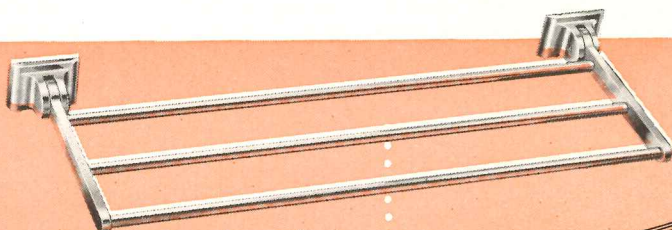

AND HERE is a three-bar Adjustable Towel Rack—a real space-saver. It's instantly adjusted to any of three positions (horizontal, 45°, or down) and is ideal for drying hosiery, for displaying guest towels, and for bath towel storage. Drops down out of the way when not in use, yet provides so much extra convenience when needed.

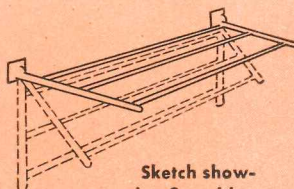

Sketch showing 3 positions of Towel Rack

LOOK FOR all of the extra qualities in bathroom accessories—and you'll choose Hall-Mack! Remember—there is a complete line to give you the right accessories for every bathroom need. Hall-Mack also makes a full selection of fine Medicine Cabinets and other recessed specialties. Write for details. Hall-Mack Company, 1344 W. Washington Blvd., Los Angeles 7, California.

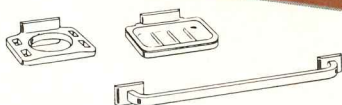

THE RECORD REPORTS

WASHINGTON

(Continued from page 24)

drawn. FHA will have a much more important role under the new system than it practiced under the old. It will guide the projects from an earlier stage. Architects' fees are assured and there will be more coordination from the beginning.

Shelter Needs Acute

Just as the housing agency and the military were working out final terms of their administrative plan, Congress turned its attention to the dire need for additional shelter for Army, Navy and Air Force personnel. Sen. Lyndon Johnson (D-Tex.) started subcommittee hearings March 13 to explore the entire field. He set the stage by commenting, "We have been sitting here since last August and have hoped for something besides trailers and shacks for military personnel." He then suspended hearings awaiting further information from the services on their housing needs.

Meanwhile, the House Banking Committee approved a bill amending last year's Wherry Act. This would protect the interests of architects by assuring their fee payments in full and would permit the new FHA-military agreement to function. In short, all parties agreed the "new deal" for military housing would shortly bring something far more substantial than the trailers and shacks to which Senator Johnson referred. The Senate was expected to accept the House version of the amendment, speeding the measure on through without the necessity of Senate hearings.

As of April 1, however, the ban on applications still was in effect.

Deny Hospital Fund Increase

Although Congress last year authorized doubling of the \$75-million-per-year figure for hospital construction grants, the House Appropriations Committee refused to add a penny in its report for the fiscal year 1951, starting July 1. Reporting the omnibus appropriations bill to the House, the committee said it had to weigh the matter in relation to all other essential government programs.

This action seemed to reflect an attitude of "let well enough alone" on the part of the House group, for it reported:

(Continued on page 178)

RADIANT *heating*

IS SIMPLE, PRACTICAL, ECONOMICAL WITH JANITROL



Warm Air

RADIANT CEILING PANELS

The system of using warm air for radiant heating offers many advantages . . . it's simple . . . it's practical. It permits greater freedom in planning room and furniture arrangements for there's no warm air or return registers. Janitrol ceiling panel installations have proved so efficient that it is possible to hold living room temperatures to a single degree difference between floor and ceiling.

Owners living in gas-fired Janitrol ceiling panel radiant heated homes report winter comfort unmatched by their previous experience with older forms of heating.

Cleveland, Ohio: Attractive home from plans by George H. Burrows Associates and built by Maynard R. Sheldon. Janitrol gas unit is located in hallway closet on first floor, ceilings are used as the warm air radiant heating panels.

Warm Air

RADIANT FLOOR PANELS

There's no guesswork about the solid comfort and economical operation of 80 Janitrol warm air floor radiant heating installations made 4 years ago in houses similar to the photograph at the left. Since the heating system is tied into the design and construction of these low cost houses, installation of the gas-fired Janitrol units and other building costs were materially lowered. Yet, these home owners enjoy the finest gas heating and the proven performance of Janitrol care-free comfort.

Kew Gardens, Beren, Ohio: One of nearly 100 three bedroom basementless houses designed by Mellenbrook, Foley and Scott and built by Taft and Blockman. The extremely compact Janitrol Winter Air Conditioner uses only a floor space of 22" x 22" in the utility room.

**GAS
FIRED**

Janitrol

WINTER AIR CONDITIONERS • GRAVITY FURNACES
BOILERS • TRIPLE SERVICE SYSTEMS • UNIT HEATERS

Write for complete "Kew Gardens Construction Story" and bulletins on ceiling panel heating installations.

SURFACE COMBUSTION CORPORATION • TOLEDO 1, OHIO

FLUORESCENT GOES FLEXIBLE!

**Now! For the First Time —
Circles! Curves! Any Angle!**

Sensationally new in concept, quality-built in the Day-Brite tradition, PLEXOLINE is making headline news. Since its recent debut, lighting experts have discovered and praised Plexoline's unprecedented ability to achieve unlimited custom-lighting effects without premium cost.

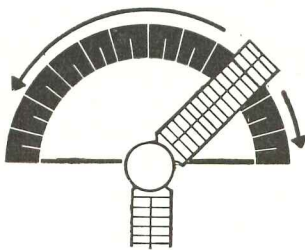

SIMPLE, PRACTICAL PRINCIPLE

Three basic elements form the PLEXOLINE system: 1. Linear section; 2. Circular accent unit; 3. Adapter fitting. The two illustrations show how the elements are used in combination to form any lighting pattern desired. All elements are complete in themselves, may be used individually.

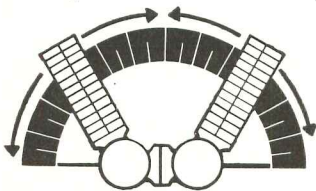

THE PLEXOLINE SYSTEM

LINEAR SECTIONS—For Slimline and standard Fluorescent, 2- and 4-light, 4', 6', and 8' lengths, surface or suspension mounted. Albalite glass side panels, interlocked steel louvers, finished in HOT-BONDED SUPER WHITE enamel.

CIRCULAR ACCENT UNITS—15" and 21" diameter, with fixed Controlens* or adjustable spot mechanism. Luminous sides. Surface mounted only.

ADAPTERS — Uniform, die-formed, all-steel—in two sizes to fit circular units.

*©Holophane Co.

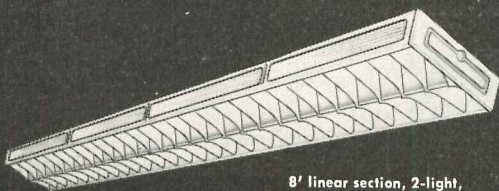

8' linear section, 2-light,
Slimline or standard Fluorescent



15" Adjustable circular accent unit



Adapter for use with 15" circular unit

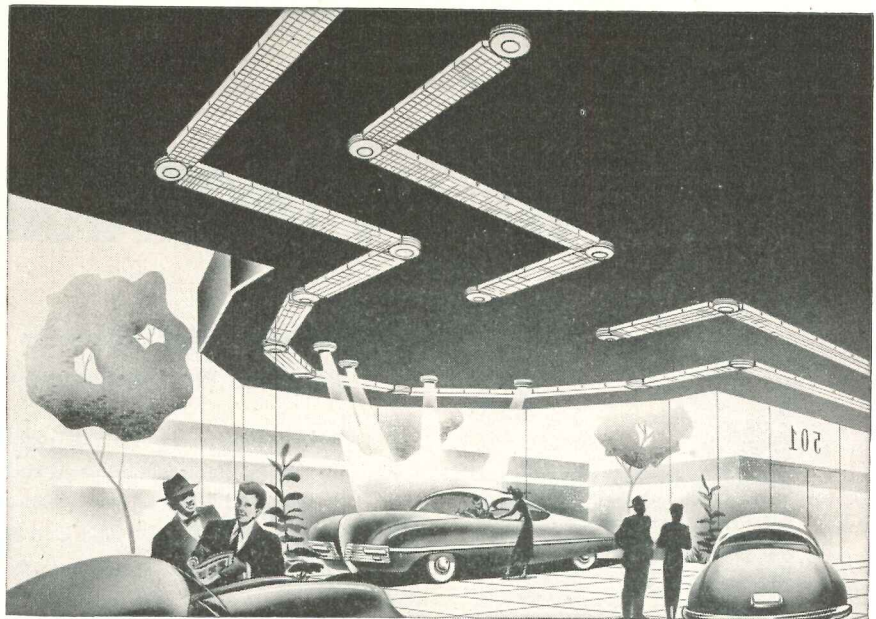

PLEXOLINE AND IMAGINATION—AN UNBEATABLE SELLING COMBINATION!

Never before such wonderful possibilities for store and showroom lighting! Dramatic, beautiful PLEXOLINE creations put light where you want it . . . how you want it! Straight linear sections for offices, schools, colleges, banks, public buildings.

DAY-BRITE'S Plexoline

THE ONLY LIGHTING SYSTEM WITH TRULY UNLIMITED "FLEX-ABILITY"

What does PLEXOLINE mean to you? It means new freedom for your imagination. It means a line of light following a gently curving wall contour . . . angular patterns of light . . . circles . . . *any* design. It means—for the first time in history—all the advantages of custom-lighting with

all the economies of a mass-produced system of fixtures.

Today, send for the whole amazing story of PLEXOLINE. Fill out and mail the coupon below. See for yourself what PLEXOLINE's unique "flex-ability" can do for you!

"DECIDEDLY BETTER"

DAY-BRITE
Lighting Fixtures

029

Day-Brite Lighting, Inc.
5465 Bulwer Ave., St. Louis 7, Mo.
In Canada: Amalgamated Elec. Corp., Ltd.,
Toronto 6, Ontario

Please send me your FREE booklet,
"PLEXOLINE—IMAGINATION AT WORK"

Name

Address

City.....State.....

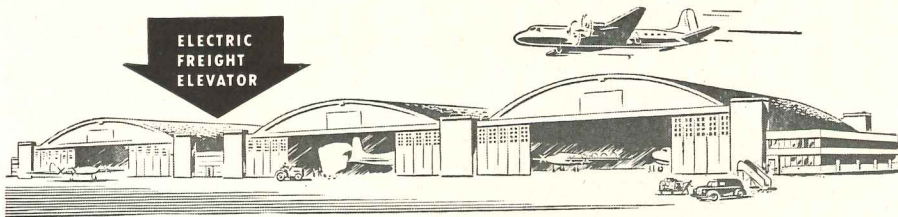

THE PORT OF NEW YORK AUTHORITY • NEW YORK INTERNATIONAL AIRPORT

Fits into 10'-3⁷/₈" Headroom

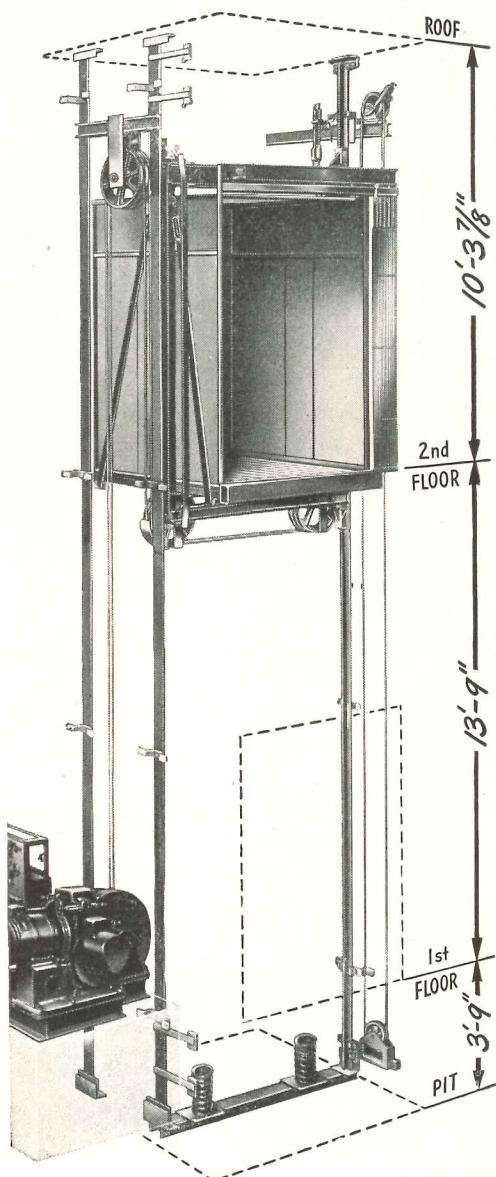

Electric Freight Elevator Requires No Penthouse

Freight elevator service was required for the 2nd floor cafeteria and kitchen in the West Center Lean-to between newly built Hangars 3 and 4 at New York International Airport. Lean-to design set concrete roof beams 10'-3⁷/₈" above the second floor. Hangar steel prevented a break-through for a penthouse. At the 1st floor, water existed approximately 4 feet below the grade level. In all, a tight squeeze for an elevator installation.

But not difficult for a standard Otis Self-Supporting Freight Elevator. As illustrated, the installation stops at the under side of the roof. *No penthouse is required.* Guide rail connections at each floor and the roof take care of light horizontal thrusts. *No overhead supports are required.* The guide rail structure transfers all vertical loads to the bottom of the pit. *No building reinforcing is necessary.*

Otis Self-Supporting Freight Elevators have 1,500, 2,000 and 2,500 lb. lifting capacities. Any rise up to 35' 0" —sufficient for a 3 story building. Speed is 25 feet a minute. Write for Booklet B-720-F or phone your Otis office. Otis Elevator Company, 260 11th Avenue, New York 1, N. Y.



ELECTRIC FREIGHT ELEVATORS

SELF-SUPPORTING • POW-R-TRUCK • GENERAL PURPOSE

THE RECORD REPORTS

WASHINGTON
(Continued from page 178)

by the Reconstruction Finance Corp. through state agencies to local school bodies.

But good as this proposal looked to most observers, it was criticized by the American Association of School Administrators as being inadequate to meet the staggering demand for more school space.

A spokesman for A.A.S.A. said the proposed grants-in-aid constitute the only substantial portion of the new legislation because a great many of the distressed school districts already have borrowed to their legal capacities and could not "borrow a thin dime from the government or anyone else." This left the remaining \$300 million in federal assistance in the form of grants standing as a feeble attack on an immense problem. It is estimated \$10 billion to \$12 billion will be required in the next decade to keep up with essential school building needs.

It is hard, said A.A.S.A., to see how \$300 million can even prime the pump throughout the nation.

Reorganization Plans

While Congress was tussling with all these problems, it faced the necessity of a decision on President Truman's proposal to shuffle the construction activities of various agencies more or less in line with Hoover Commission recommendations. For one thing, the Chief Executive would take the advance planning and war public works program away from the General Services Administration and give them to the Housing and Home Finance Agency. The more important to architects, the advance planning loans, was revived by Congress last October after it had lapsed since July 1, 1947. It authorizes the making of repayable loans to state and local governments for preparing plans and specifications on non-federal public works to be shelved as a reservoir for emergency purposes and to meet the needs of the community.

The old Federal Works Agency, and later the G.S.A., always have held the reins on this program, doling out the loans on which repayment without interest must start when construction begins.

(Continued on page 182)



A Great Name Since 1896

**ANNOUNCES
NEW
Baseboard Radiation
with Exclusive
Directional Louvers
& Anti-Streak Covers**

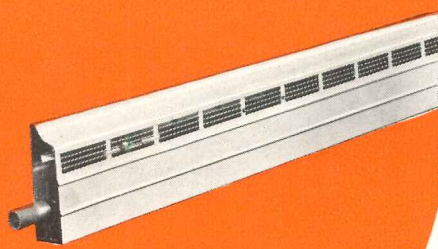
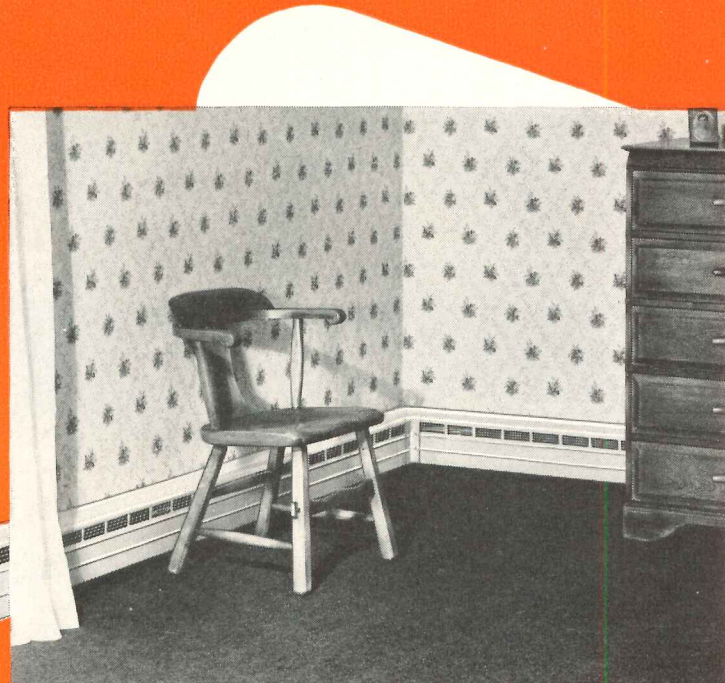

Showing compact installation of Fedders Baseboard Radiation occupying little more space than ordinary wood baseboards.

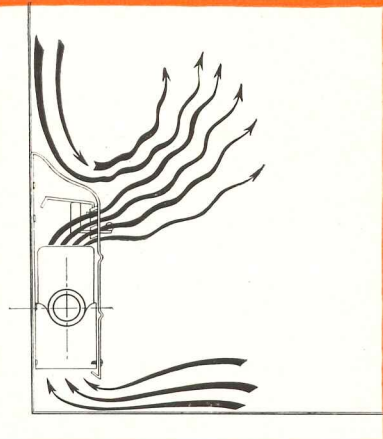

Cross-section shows how air is directed out away from walls by means of exclusive directional louvers and curved, anti-streak covers.

● Fedders offers two new and exclusive features (Patents Pending) that architects, interior decorators, contractors and home owners have been waiting for. Drawing shows how warm air is directed out into the room by Fedders built-in angular louvers in front face of cover. Cool air flows down from the wall and is directed out into the warm air stream by specially designed curved top of cover. These features greatly reduce streaking of walls and contribute to uniformity of temperature from floor to ceiling.

Write for Bulletin

**FEDDERS-QUIGAN CORPORATION
BUFFALO 7, NEW YORK**

fedders - Quigan

Crowded school conditions have you in "hot water"?

Install **R-W DeLuxe**
FoldeR-Way Partitions
 FULLY AUTOMATIC • ELECTRICALLY OPERATED

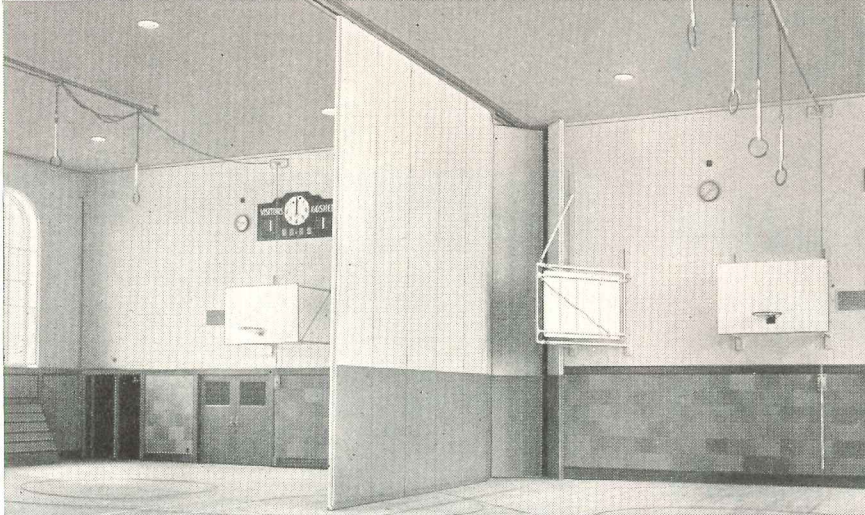

R-W DeLuxe FoldeR-Way Partition, Central School, Goshen, New York. Robert R. Graham, Architect.

Because of its high standard of excellence and performance, the R-W DeLuxe fully automatic electric soundproof folding partition is now specified by leading School Architects and demanded by progressive Boards of Education as the best solution to current problems of space and expenditure.

In the installation shown above, both side-jambs are insulated against the transmission of sound by the correct application of rubber gaskets. The clearance gap between the top of the doors and the underside of the

ceiling-track is effectively soundproofed by rubber seals. Duck-covered, sound insulated, acoustically designed doors provide the ultimate in "sound-stifling" construction. Doors are positively locked to the floor without the use of any floor bolts, tracks, or mechanically operated devices. Electrically operated—you just turn the switch-key and R-W does the rest. The DeLuxe FoldeR-Way Partition goes into motion smoothly and silently—opening or closing automatically!

R-W Offers a Complete Line of Single and Multiple Action Classroom Wardrobes

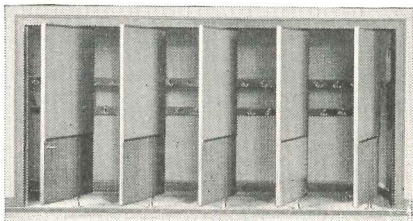

R-W No. 833 Multiple Action-Master Control Door Wardrobe

Richards-Wilcox Classroom Wardrobes are outstandingly popular because they are designed to give maximum space for pupils' wraps without overcrowding—because simplicity of design and installation in wall recess means low cost. Wardrobes are available in Single or Multiple Action-Master Control Door units with chalkboards or cork boards. Each door opening accommodates eight to ten pupils.

Also...

Uninterrupted R-W Service to HOME, INDUSTRY and FARM

Since 1880

- In industry, conveyor systems to solve any overhead handling problem.
- In the home, R-W Silver Streak Vanishing Door Hangers and Aluminum Track afford quick, economical conversion to space-saving Disappearing Doors. Complete hardware for modern overhead garage doors.
- For the farm, barn door hardware up to any size, gable door fixtures, stay rollers, latches, etc; that perform up to par year after year.

Get all the facts about Richards-Wilcox cost-cutting, space-saving FoldeR-Way Partitions and Classroom Wardrobes now—write today or call your nearby branch office for complete information without obligation.

Richards-Wilcox Mfg. Co.
 "A HANGER FOR ANY DOOR THAT SLIDES"
 AURORA, ILLINOIS, U. S. A. • Branches in all principal cities

1880  1950
 OVER 70 YEARS

THE RECORD REPORTS

WASHINGTON
(Continued from page 180)

President Truman's message transmitting his reorganization plan to Congress explained that HHFA, responsible for slum clearance and community development, must maintain constant liaison with local officials, appraise accurately and thoroughly the capacity of communities to finance the projects authorized by the Housing Act, and acquire a detailed knowledge of the legal authority of each participant to build various categories of public works. These, he continued, are essentially the kinds of knowledge and relationships which are essential to the successful administration of advances for non-federal public works.

The President's Position

On this premise the President argued that a single responsible agency will be able to assure that the authority under both statutes will be used to full advantage of all parties concerned.

"... The emergence of a single community development agency will make it possible for public bodies to deal with fewer federal officials in the advance planning of their public facilities, the elimination of blighted areas, and the promotion of well-balanced residential neighborhoods. The plan will consequently lead to improvements in one important sector of federal-state and federal-local relations." So ran the Truman message.

Opposition to the proposed change appeared rather quickly with the U.S. Chamber of Commerce complaining that HHFA is not the agency to receive the new responsibility. It would be all right to take the administration of the loans away from General Services, said the Chamber, but "it should not be attached and subordinated to an agency designed to stimulate the production of housing with little or no consideration of current economic conditions." And it was the Chamber that called attention to the Hoover Commission's proposal that the advance planning loans be given to the Interior Department, not to HHFA.

Another reorganization plan was opposed strongly when the American Legion spoke out against severing certain Veterans Administration functions. The Legion opposed taking away

(Continued on page 184)

*In General Petroleum's
new Los Angeles home . . .*

Architects: Welton Becket
and Wurdeman & Becket

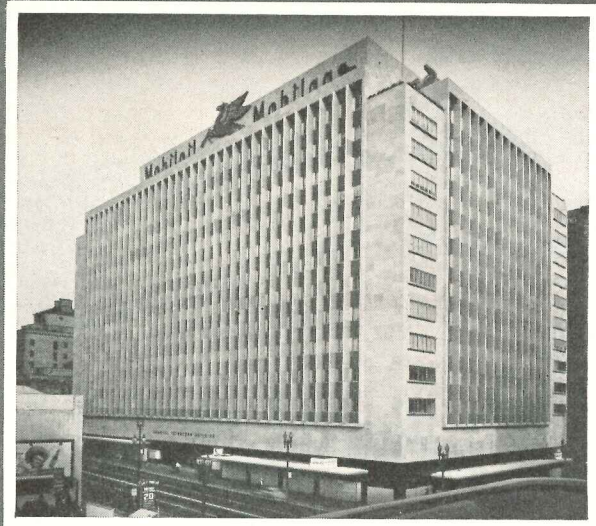

Towel Cabinet (Scott #945) is recessed flush with wall. It's handy for users . . . helps maintain streamlined styling in the washroom.

Waste Receptacle (Scott #945) is built-in, too. Set at a handy waist-level . . . it's Scott's contribution to washroom beauty and convenience.

SCOTT RECESSED FIXTURES add beauty and convenience to modern washrooms!

When Welton Becket and Wurdeman & Becket designed the washrooms for this new General Petroleum building, they followed the current trend in architecture by recessing fixtures wherever possible.

Scott helped make the job easy . . . by offering the services of thoroughly trained consultants, plus all the priceless experience and knowledge gained while servicing over 300,000 washrooms.

Do yourself and your client a real favor by taking extra care in the planning of his personal service rooms. Your reputation will benefit . . . your client will be rewarded through the added good will of washroom users. To get Scott on your team . . . just contact "Washroom Advisory Service," Scott Paper Company, Chester, Pennsylvania.

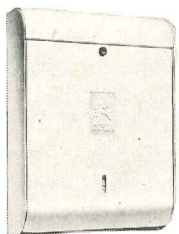

SCOTT

Symbol of Modern Washrooms

Trade Mark "Washroom Advisory Service" Reg. U. S. Pat. Off.

Send for 945 dimension and installation drawing today!

WASHROOM ADVISORY SERVICE, Dept. C
Scott Paper Company
Chester, Pennsylvania

Please send me your 945 dimension and installation drawing.

Name _____

Company _____ Title _____

Address _____

City _____ Zone _____ State _____

Your architectural plans

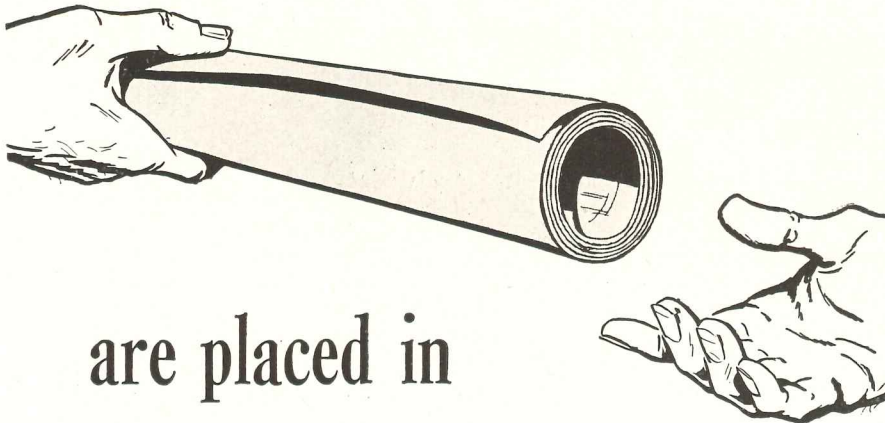

are placed in
competent building hands

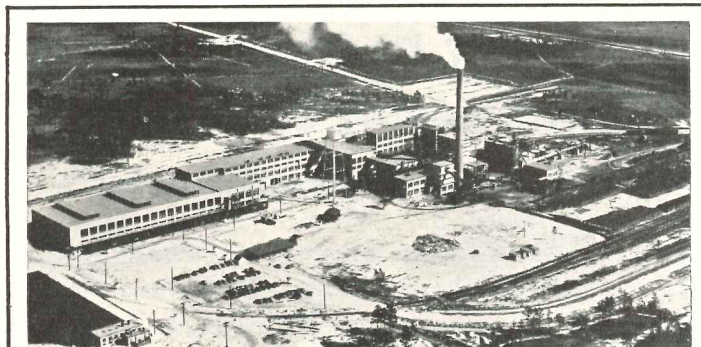

For the Hudson Pulp & Paper Company, Merritt-Chapman & Scott constructed all buildings, purchased and installed equipment in this new plant at Palatka, Fla. J. E. Serrine Company—designing engineers.

when you call in

MERRITT-CHAPMAN & SCOTT

When your construction project is assigned to Merritt-Chapman & Scott you can depend on close cooperation to insure that, completed, it becomes an enduring tribute to your technical knowledge and creative thought. To each job, *large or small*, M-C & S brings an organization with extensive experience in every building field...specialized facilities that assure speed, economy, and full attention to detail. You can count on Merritt-Chapman & Scott to work hand in hand with you in solving any construction problem.

MERRITT-CHAPMAN & SCOTT CORPORATION

Founded in 1860 . . . now in our 90th year

GENERAL OFFICES

17 Battery Place, New York 4, N. Y.

BOSTON • CLEVELAND • NEW LONDON • PASADENA, TEXAS



THE RECORD REPORTS

WASHINGTON

(Continued from page 182)

from VA the huge hospital construction program and placing it, along with other hospital building activities, in a new United Medical Administration. The veterans group also came out against any transferral of the G.I. home loan guarantee program now administered under the G.I. Bill of Rights by VA. It has been suggested that this be given to HHFA also.

Shorts

- The number of veterans learning construction trades in vocational schools under the G.I. Bill has tripled over the past three years. In the same time, total number of veterans learning construction trades as on-the-job trainees has fallen off by nearly one half. Veterans Administration based these estimates on surveys comparing course-by-course enrollments. There were 31,300 vocational school enrollees in 1949. Sharpest increase has taken place in bricklaying courses.

- The Office of Business Economics reports that total construction activity in January and February rose to a point five per cent above the December 1949 volume. An advance in private investment in fixed capital was attributed both to the advance in residential building activity and to the firming in business outlays for plant and equipment. This stemmed the downturn in this segment which had been evident in the last half of 1949.

- Rep. Daniel J. Flood (D-Pa.) has brought to the attention of the Civil Aeronautics Administration new problems in airport runway design posed by the increasing use of jet-propelled aircraft. CAA Administrator D. W. Rentzel replied that his agency is aware of the changing demands and is closely watching military tests in connection with improving runway pavements. He acknowledges jet aircraft requires generally longer runways and pavements capable of resisting damaging effects of jet fuel spillage, high exhaust temperatures and high blast forces.

(Continued on page 190)

Notice how more folks notice heating more ?

She had been impressed by the modern kitchen. He had grinned as he surveyed the spacious recreation room. But, it was when both eyed the Bryant automatic gas heating installation that they knew *this* was their house . . . a quality home throughout!

In most every part of the land, there's growing excitement about automatic gas heating. It is the blooming of an idea which Bryant planted nearly a half century ago with installation of the first home heating truly designed to "let the pup be furnace man!"

Four modern factories now hum day and night to supply the demand for this famous equipment. Fifty distributors and thousands of dealers offer Bryant products in a selection unmatched by any other single brand.

Bet your bottom dollar that Americans want the *best* in automatic gas heating . . . the kind you give them when you specify or install equipment bearing the Bryant nameplate.



Let the pup be furnace man
... and water boy, too!

bryant

AUTOMATIC HEATING

The most complete line of gas heating equipment in the nation

Bryant Heater, Dept. 232,
17825 St. Clair, Cleveland, Ohio
() Send me the new booklet that tells
the Bryant story. () Have your dis-
tributor call on me.



Name _____

Company _____

Address _____

City _____ State _____

New **KAYLO** FIREDOOR



KAYLO^{*}
Firedoor

This KAYLO Firedoor has a solid mineral core of KAYLO structural block combining these advantages:

- INCOMBUSTIBILITY
- LIGHT WEIGHT
- DIMENSIONAL STABILITY
- INSULATION
- HIGH STRENGTH

*Trade mark reg.
OWENS-ILLINOIS GLASS COMPANY - TOLEDO 1, OHIO

... Look for this emblem which identifies metal- or wood-faced fire doors made with a Kaylo core.

The Beauty of Natural Wood
- plus rated fire protection

... the only type of wood-faced door with an Underwriters' 1-hour fire rating

Rich beauty, great stability and rated fire protection are all combined in the amazing new Kaylo Firedoor.

Carrying a one-hour fire rating from Underwriters' Laboratories, Inc., the Kaylo Firedoor also provides this remarkable combination of advantages—

Handsome Appearance—The wood veneer-faced Kaylo Firedoor equals the richness of the most striking conventional wood doors, providing rated fire protection without sacrifice in beauty.

Great Dimensional Stability—A Kaylo Firedoor does not warp, swell or shrink—even when subjected to extremes of heat or cold, dampness or dryness.

High Insulation Value—Installed in an exterior opening with weather stripping, the Kaylo Firedoor insulates more effectively than a conventional door, plus a storm door.

ior opening with weather stripping, the Kaylo Firedoor insulates more effectively than a conventional door, plus a storm door.

Light Weight plus Strength—A standard 3'4" x 7' Kaylo Firedoor weighs only 90 lbs., but can support an 8,000-lb. distributed load with only 1/2-inch deflection while loaded. After unloading, the door returns to its original position. Test doors have withstood 2,000,000 cycles of normal openings and closings, without breakdown.

Kaylo Firedoors offer many advantages for both public and residential buildings—including hospitals, schools, hotels, apartment houses, office buildings, factories and homes.

Get the facts now about the revolutionary new Kaylo Firedoor.

Each Kaylo Firedoor bears this label, showing that Underwriters' Laboratories, Inc., has given it a one-hour fire rating for Class B and C openings.



The Inside View OF A KAYLO FIREDOOR

The Kaylo Firedoor is built around closely fitted core sections of inorganic Kaylo material—a chemical composition which is incombustible; rot-proof and termite-proof, and resistant to damage by water.

Waterproof phenolic glue is used to bond veneer cross banding to the Kaylo core and face veneer to cross banding. Edge bandings are strips of solid hardwood, which has been treated with Protexol Class A fireproofing agent.

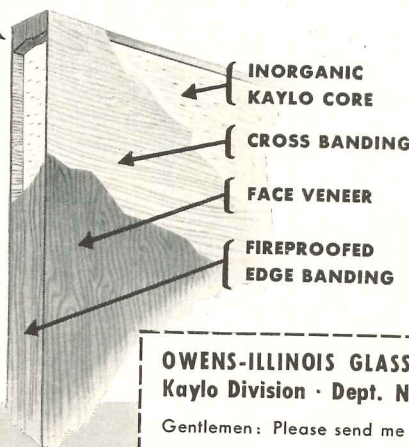

Send coupon for complete information on the Kaylo Firedoor

OWENS-ILLINOIS GLASS COMPANY
Kaylo Division · Toledo 1, Ohio

Sales Offices: ATLANTA · BOSTON · BUFFALO · CINCINNATI · CHICAGO
DALLAS · MINNEAPOLIS · NEW YORK · PHILADELPHIA
PITTSBURGH · ST. LOUIS · TOLEDO · WASHINGTON

OWENS-ILLINOIS GLASS COMPANY
Kaylo Division · Dept. N-21, Toledo 1, Ohio

Gentlemen: Please send me literature on the Kaylo Firedoor.

NAME

FIRM

ADDRESS

CITY..... STATE.....

They're **NEW!**
 They're **YOURS**
 for the asking!

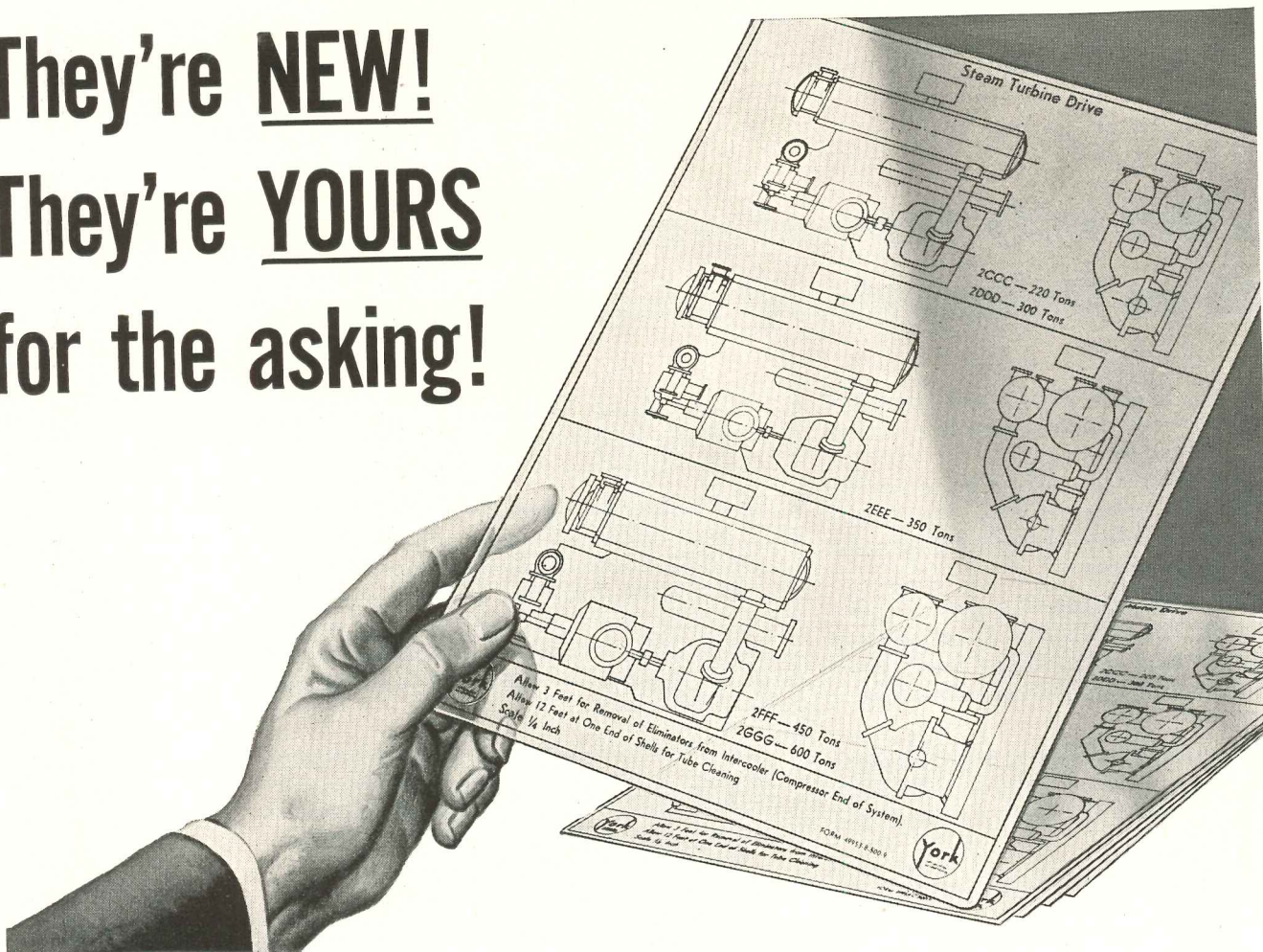

Templates for York Turbo Systems!

Motor Drive - Steam Turbine Drive

Slash hours of tedious drafting from your next turbo system job. Specify "York"... and use York's new templates in both $\frac{1}{8}$ " and $\frac{1}{4}$ " scale for York's line of Turbo Systems ranging from 220 ton to 1500 ton capacity.

Another example of "York's business is improving your business!"

Act Today

Supplies of these new templates are limited. To assure getting yours without delay, better get in touch with your York District Office now. And remember, your York-trained representative is an able, fully qualified engineer. His technical experience can save you valuable time in detail work. York Corporation, York, Pa.

"See Your Architect, Engineer, Contractor, First"

York believes in channeling contract work through you, and York gives you unequalled support in providing the very finest central station systems possible:

- a complete line of equipment
- competitive prices
- accurate, dependable product ratings
- technical assistance based on "case histories"
- cooperation with architects, engineers, and contractors
- practical help from York-trained engineers
- a national organization
- continuous product research and development
- certified maintenance

York's complete line of refrigeration and air conditioning products are the result of 65 years of know-how and research. Your clients have faith in the name.

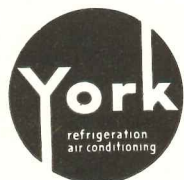

The big advances come from

YORK

Headquarters for — Refrigeration and Air Conditioning

YOU CAN BE **SURE**.. IF IT'S
Westinghouse

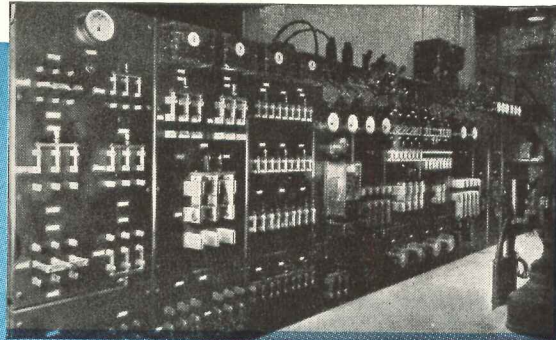
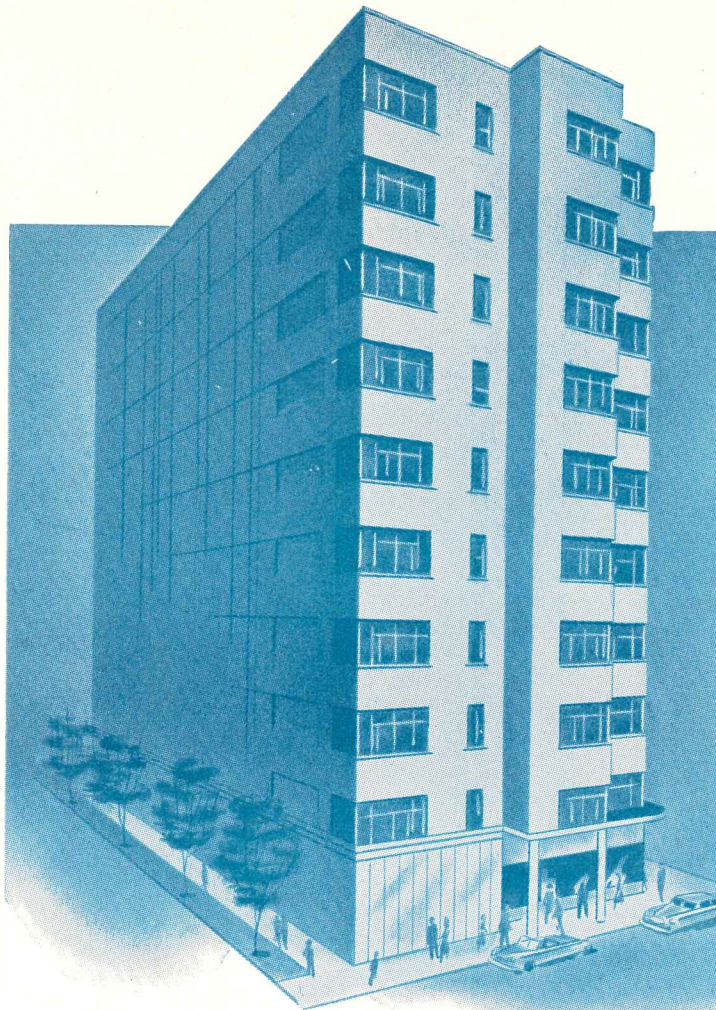

THE OLD WAY . . . live-front, with fuses, knife switches and air circuit breakers—a disorderly arrangement of equipment that introduces problems of safety, flexibility and service continuity.

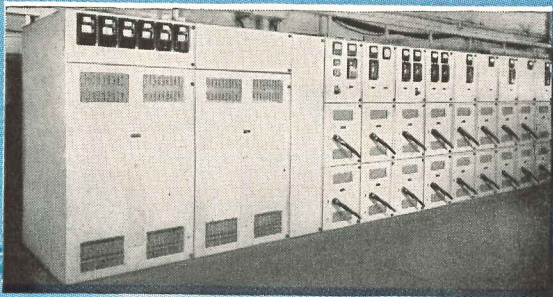

THE MODERN WAY . . . Westinghouse "Unitized", Low-Voltage Switchgear. Metal-enclosed air circuit breakers speed servicing . . . are interlocked for safety. All operations accomplished without exposing live parts.

Kerosene lamps in the lobby?

The question probably amuses you—for it suggests an incongruity one would hardly expect to find in today's fine new buildings. Yet . . . *electrical equipment, almost as out of date as the kerosene lamp, is often specified, purchased and installed in buildings under construction today!*

We refer to electrical control equipment, which—in view of the many services dependent upon electricity—is truly the functional heart of any modern building. Here, you must be *sure* . . . for the protection of costly equipment, the safety of personnel, and all-important continuity of service are at stake.

Westinghouse Low-Voltage, Metal-Enclosed Switchgear offers the kind of dependability you need for controlling and distributing vital electrical power. This is the modern way . . . the way that assures adequate interrupting capacity . . . that eliminates fire hazard. Breakers and all associated equipment are completely enclosed in convenient, self-supporting,

"Unitized" structures. The result is safety . . . flexibility . . . reliability. Contrast this with the old-fashioned installation shown above—a type which is still being specified—and ask yourself this question:

Which type of installation will best fit the buildings I design?

For complete information on Westinghouse Low-Voltage Switchgear, send for booklet B-2296-D; Address: Westinghouse Electric Corporation, P. O. Box 868, Pittsburgh 30, Pa. J-60734

Westinghouse
LOW-VOLTAGE
SWITCHGEAR



ON THE CALENDAR

May 10-13: 82nd Annual Convention, The American Institute of Architects, Washington, D. C.

May 12-17: National Citizens Conference on Planning for City, State and Nation, conducted by the American Planning and Civic Association with the

American Institute of Planners cooperating, Washington, D. C.

May 15: Final Gold Medal Exhibition, Architectural League, 115 E. 40th St., New York, N. Y.

May 17-July 16: Exhibition of entries to the International Competition for Low-Cost Furniture Design, Museum of Modern Art, New York, N. Y.

June 4-7: 37th Spring Meeting, American Society of Refrigerating Engi-

neers, Hotel Muehlebach, Kansas City, Mo.

June 12-15: 43rd Annual Convention, National Association of Building Owners, Olympic Hotel, Seattle, Wash.

June 26-30: 53rd Annual Meeting and Ninth Exhibit of testing apparatus and related equipment, American Society for Testing Materials, Chalfonte-Haddon Hall, Atlantic City, N. J.

OFFICE NOTES

Offices Opened, Reopened

• William Hudson Borthwick has announced the opening of an office for the practice of architecture at 43 Kenneth St., Hartford 6, Conn.

• Charles W. Deichmann, Architect and Engineer, announces the opening of offices for the practice of architecture and engineering at 128 W. Solomon St., Griffin, Ga.

• The First United States International Trade Fair has opened an office on the lobby floor of the Hotel Warwick, 65 W. 54th St., New York City.

• Charles E. King, Architect, has opened an office at 19a N. Illinois St., Belleville, Ill.

New Firms, Firm Changes

• Ivan A. Bickelhaupt has joined John W. Harris Associates, Inc., of New York and Chicago, as Washington representative. A captain in the U. S. Navy Civil Engineering Corps Reserve, Mr. Bickelhaupt was public works officer in charge of construction for the Fifth Naval District until his return to civilian life in 1946.

• Robert T. Colburn has been made a member of the firm of Charles T. Main, Inc., of Boston, Mass.

• Coleman & Coleman, Architects, have announced the formation of a new partnership with John W. Greiner, A.I.A., under the firm name of Coleman, Greiner & Coleman, P. O. Box 248, Landisville, Pa.

• Rolf E. Decker, A.I.A., and Waldo B. Christenson, A.I.A., together with their associates, J. Emil Anderson, A.I.A., and Edward E. Sands, A.I.A., announce the consolidation of their architectural offices. The new firm,

(Continued on page 192)

ONLY NUTONE
OFFERS ALL THESE FEATURES IN
KITCHEN VENTILATORS

TOP PERFORMANCE Moves more grease-laden air than any model at same price.

EASIEST TO CLEAN Housewives love the removable center grille. (U. S. Patents pending.)

GUARANTEED Motor unconditionally guaranteed for five years. (9" and 10" Models)

EASIEST TO INSTALL A screw driver is the only tool required for low cost installation.



Model NCF-10

NUTONE

TRADE MARK

Model NF-10

U. S. Design and Mechanical Patents Pending

NON-CORROSIVE Bright chrome finish grille and baked enamel inside and out.

SILENT POWER Engineered for quiet, effective operation.

MODERN STYLING Designed for perfect blending with any interior.

✓ 19 MORE FEATURES

Send for complete specifications. A. I. A. FILE NO. 30-D-1; 31-H-5. Nutone, Inc. Dept. AR-4, Cincinnati 27, Ohio.

Also available — Model NF8 — in 8" ventilator. (With one year guarantee.)



Electric Door Chimes

Low Voltage Transformers



Electric House Numbers



Luminous Pushbuttons



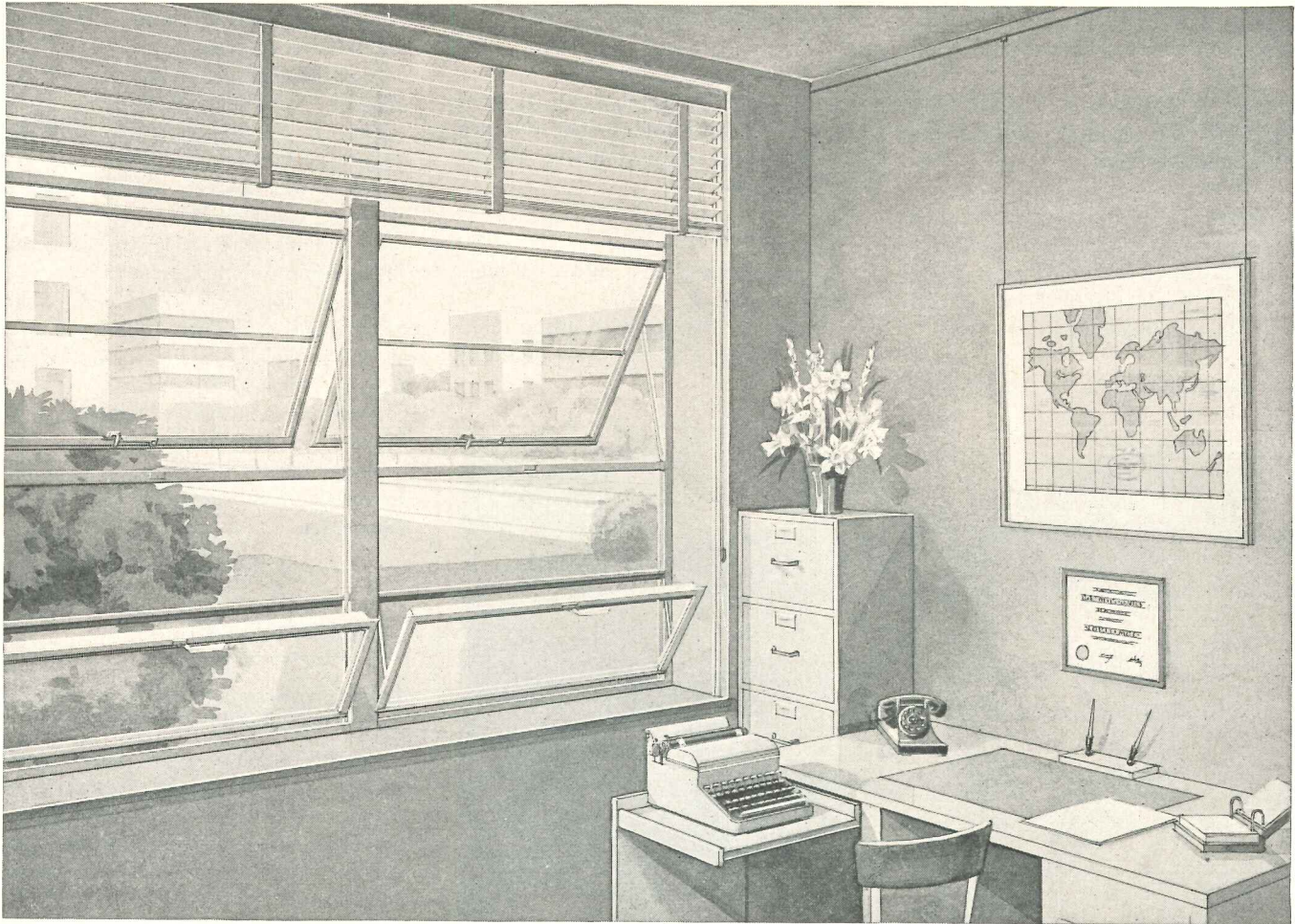

NEW LUPTON "MASTER" ALUMINUM WINDOW

Check These
4 Advantages Of
The New Lupton
"Master"

Aluminum Window

1. NEW DEEP SECTIONS—
Both frames and ventilators
1 5/8 inches—sturdier without
sacrificing lightness. Added
strength.
2. PRECISION WEATHER-
ING—Ventilators fit snug
and tight—naturally—with-
out forcing. Full 5/16 inch
overlapping contact.
3. SPECIAL HEAT TREATED
ALUMINUM ALLOY used
in this new Lupton Window
eliminates painting and
costly repair and maintenance.
4. STURDY CONSTRUCTION
Welded ventilator corners
—strength where strength is
needed.

Here is the newest member of a great family of metal windows — the new Lupton "Master" Aluminum Window — especially designed for hospitals, schools and office buildings. Here are new opportunities in window planning . . . new standards of high durability and low maintenance costs.

Lupton Metal Windows are the result of more than forty years of constant development of new designs, new materials and new production techniques. Include the strength and beauty of this newest Lupton Window — the new Lupton "Master" Aluminum Window — in your 1950 plans for hospitals, schools and office buildings. Write for Data Sheets today.

MICHAEL FLYNN MANUFACTURING COMPANY
700 East Godfrey Avenue, Philadelphia 24, Penna.
Member of the Metal Window Institute

LUPTON METAL WINDOWS

THE RECORD REPORTS

(Continued from page 190)

Decker & Christenson, A.I.A., Architects, has offices at 1411 Fourth Avenue Bldg., Seattle, Wash.

- William J. Fedeli has withdrawn from the firm of Michaelson and Fedeli. The practice will be continued by Irvin Michaelson, Architect-Engineer, at 1507 Fox Bldg., Philadelphia 3, Pa.

- Walter J. Hubbard, A.I.A., Architect,

and Stephen M. Stoltz, Associate, have announced the establishment of a new practice, with offices at 404 W. 4th St., Ottumwa, Ia.

New Addresses

The following new addresses have been announced:

Peter W. Bruder, Consulting Engineer, 200 E. 37th St., New York 16, N. Y.

Victor L. Cheek, Engineer, 7 Linwood St., Winchester, Tenn.

Egger & Higgins, Architects, 100 E. 42nd St., New York, N. Y.

Sam J. Glaberson, A.I.A., 200 E. 37th St., New York 16, N. Y.

Albert M. Goedde, Architect, 1452 State St., Chicago, Ill.

L. I. Janik, Architect, Rm. 435, 224 S. Michigan Ave., Chicago, Ill.

Robert Johnstone, Architect, 1033 South Blvd., Oak Park, Ill.

M. Michael Kane, Architect, 1457 E. 68th St., Chicago, Ill.

Nemeny and Geller, Architects, 100 W. 42nd St., New York 18, N. Y.

Porter, Barry & Switzer, Consulting Engineers, 545 LaFayette St., Baton Rouge, La.



SAVE
UP TO
\$5,000
ON AIR
CONDITIONING!

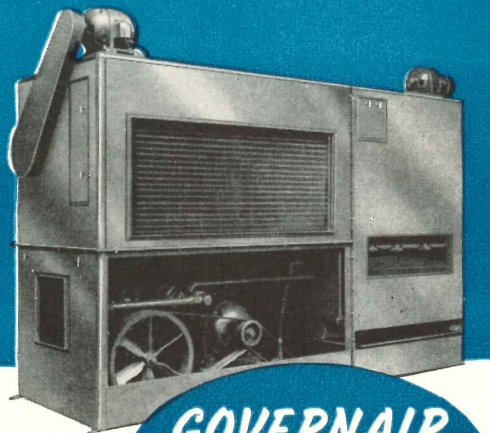

GOVERNAIR
COMPLETELY PACKAGED
AIR CONDITIONER

PAT. NO. 2,297,928

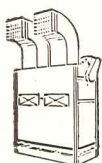

UNIT COOLERS



EVAPORATIVE CONDENSERS



AIR CONDITIONERS

Save water! Save space! Save installation time and money! Save operating costs! Yes, install Governair and save from \$50 to \$200 for each ton of the completely packaged Governair unit designed to fit your needs! Experience proves Governair can save you up to \$5,000 on

a 50-ton Governair unit that gives greater dependability and more "engineered efficiency" than ever before!

If you want the best—if you want the most economical and reliable air-conditioning unit on the market... CHOOSE GOVERNAIR and SAVE!

ORIGINATORS OF COMPLETELY
PACKAGED AIR CONDITIONERS

GOVERNAIR

Governair Corporation • 313 N. Blackwelder • Okla. City



BLAST COILS
FOR HEATING
& COOLING

EXHIBITIONS

Contemporary Furniture Stars At Philadelphia Art Alliance

"Inside — 1950" — the most comprehensive exhibition of contemporary furniture ever shown in Philadelphia — got under way at the Philadelphia Art Alliance April 24th. It continues until June 4th.

The exhibition has been designed and executed by Lott-Neagle Design Associates of Philadelphia.

To illustrate 1950 living, the Art Alliance has transformed a complete gallery into a 4-room apartment, entirely furnished with articles "designed to get the most out of living."

Visitors are encouraged to make themselves at home with the exhibit — to sit on chairs and sofas, walk on rugs, open drawers, adjust lamps.

Say the designers: "It has been our aim to show how the available space can be made to work efficiently without looking crowded. This has been accomplished in two ways: by the method in which the space has been broken up and by the choice of furniture, which is properly scaled. 'Inside — 1950' is not a forecast of trends. It is a statement of some of the best contemporary design available."

A.I.D. and Mural Painters Collaborate on Exhibition

Room settings designed by leading decorators around paintings by leading muralists were featured in an exhibition presented March 17–April 8 by members of the American Institute of Decorators in collaboration with members of the

(Continued on page 194)

HIGH RUST-RESISTANCE PLUS EASY WORKABILITY

... stretches sheet metal dollars

Yes, your client's sheet metal dollar buys more real, long-lasting value when you specify Toncan Iron. Toncan is the *alloy iron* which consistently outlasts other ferrous sheet metals because it so stubbornly resists rust.

Made from highly-refined open hearth iron, it is remarkably free from rust-inviting impurities. It contains copper—twice as much as ordinary copper-bearing steels or irons—plus the exact amount of molybdenum necessary to make this double dose of copper most effective. Finally, its surface is protected with a zinc coating.

Toncan Iron is extremely ductile, and easy to work

by all standard methods. What's more, fabrication does not affect its ability to fight rust. Toncan is rust-resistant through and through.

Economical to fabricate . . . long-lasting in service . . . Toncan Iron starts paying back its slightly higher initial cost almost immediately, and continues to stretch sheet metal dollars through the years.

See Sweet's Architectural File, or write us for more information.

REPUBLIC STEEL CORPORATION
GENERAL OFFICES • CLEVELAND 1, OHIO
 Export Department: Chrysler Building, New York 17, N. Y.



Here's the story

COPPER-BEARING STEEL

Open hearth steel + Copper = Ordinary copper-bearing sheets

TONCAN IRON

Open hearth iron + Molybdenum in proper proportion + Twice as much copper = TONCAN IRON SHEETS, most rust-resistant ferrous sheets in their price class!

Republic

TONCAN COPPER MOLYBDENUM IRON

— for ducts, gutters, conductor pipes, roofing, siding, tanks, ventilators, skylights, hoods and other sheet metal applications requiring rust-resistance — and for corrugated metal drainage products.

THE RECORD REPORTS

(Continued from page 192)

National Society of Mural Painters at the National Arts Club, 15 Gramercy Pk., New York City.

Organized and coordinated by Joseph Mullen, A.I.D., the exhibit presented 17 settings, each with its own mural, its furniture, fabrics, floor covering and accessories. Color schemes ranged from bold to subdued, mural techniques from traditional to three-dimensional.

1952 Lighting Exposition Scheduled for Cleveland

Plans to hold the Fourth International Lighting Exposition and Conference in Cleveland May 6-9, 1952, have been officially approved by the Industrial and Commercial Lighting Equipment Section of the National Electrical Manufacturers Association.

Cleveland's Municipal Auditorium,

site of many national conventions, will house the Exposition and Conferences. The Planned Lighting Merit Award Competitions which have been major attractions at previous lighting expositions again will be held.

AWARDS

New York Engineers Have Student-Designed Emblem

H. H. Graves, a student at Pratt Institute in Brooklyn, has received the \$100 first prize offered by the New York Association of Consulting Engineers for his design of an emblem for the Association.

Second prize of \$25 went to R. Corbelli, also a Pratt student; and five honorable mentions of \$10 each were awarded to George Van Geldern, Howard Seltzer, Robert Press, Allen C. Roth and James Parkes, all students.

The competition, which was open to architects, architectural draftsmen and architectural students, was approved as a secondary competition by the Committee on Competitions of The American Institute of Architects.

Members of the Jury were: Max Abramovitz, architect; Morris Ketchum, architect; Philip C. Johnson, director, department of architecture and design, Museum of Modern Art; Frank G. Lopez, senior associate editor, ARCHITECTURAL RECORD; Darl Hunt, mechanical engineer; John Pickworth, structural engineer; William Eipel, president, New York Association of Consulting Engineers.

Prof. Olindo Grossi, chairman of the Department of Architecture at Pratt Institute, was professional adviser.

(Continued on page 196)

Below: Sketch of emblem to be adopted by New York Association of Consulting Engineers. Design was judged best of 74 submitted as expression of association's work; will appear on stationery, publications

ECONOMICAL SAFE AND CLEAN

Specify
Corruform

Economical Strength
100,000 psi
One quality, uniform standard.

Patented CORRUFORM
is your guarantee for safe
construction.

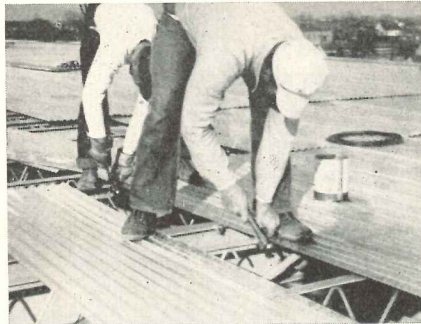

1. SAFE—Light rigid sheets and attachments easily placed. A secure form for trades and concrete. No stretch or side pull on joists, beams or walls.



2. ECONOMICAL—Light high-strength — 100,000 psi—steel to take construction abuse. No sag or material waste, concrete placed and finished by common practice on firm stable CORRUFORM.

HIGHEST STANDARD — LOWEST COST — Patented Tough-Temper Corruform for concrete in joist floors and roofs sets new standards of appearance and safety. Corruform permits material and labor savings sufficient to reach minimum-cost joist construction.

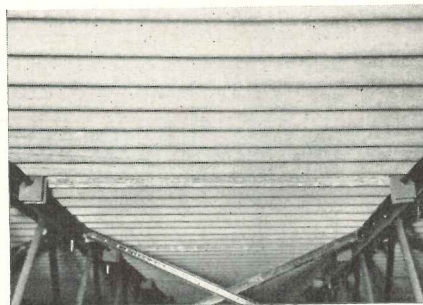

3. CLEAN—No cleanup on floors below, no unsightly leakage, true and level. Bright decorative corrugated pattern for exposed ceilings, vinylprimed for painting, or galvanized.

CORRUFORM SPECIFICATION—Standard-weight Corruform with 2-3/16 inch wide 1/2 inch deep corrugations, weight .72 lbs. per sq. foot, has a guaranteed average strength of 100,000 psi and single-test minimum strength of 95,000 psi.

SEND FOR
AIA FILE
TODAY



GRANITE CITY STEEL CO.

Granite City, Illinois

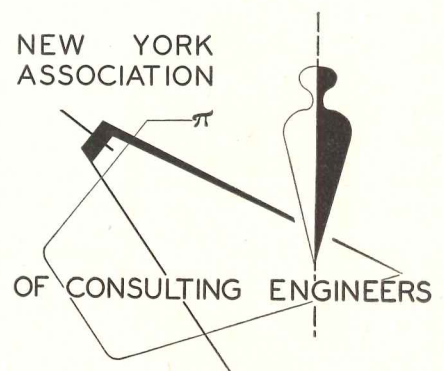



RUST can be stopped

... stopped easily, surely, economically!

RUST-OLEUM is the answer. For 25 years it has proved its capacity to stop and prevent rust at sea, in fume-choked industrial areas, on railroad rolling stock, bridges and signaling equipment.

RUST-OLEUM... an exclusive formula... protects metal with a tough, long-lasting pliable film that dries to a hard, firm finish that defies rain, snow, salt air, fumes and weathering. It adds years of extra use to metal roofs, tanks, sash, fences, stacks, gutters, downspouts, machinery and other metal surfaces.

RUST-OLEUM decorates as well as protects. It is available in all colors, aluminum and white. It can be applied to metal where rust has already started. You don't have to remove all the rust.

RUST-OLEUM is stocked and sold by Industrial Distributors in most principal cities. See our complete catalog in Sweets, or write for full information.

RUST-OLEUM CORPORATION

2511 Oakton Street, Evanston, Illinois

(Continued from page 194)

37th Paris Prize Awarded To William H. Sippel, Jr.

The 1950 Lloyd Warren Scholarship, 37th Paris Prize in Architecture of the Beaux-Arts Institute of Design, carrying a stipend of \$5000, has been awarded to William H. Sippel, Jr. of Pittsburgh.

Mr. Sippel, who is a graduate of the Pennsylvania State College at present attending the graduate school of Princeton University, was selected in a national competition from among 76 contestants in 12 different architectural schools in the United States.

William J. Scheidmantel of Forest Park, Ill., a student at the University of Illinois, is the alternate.

The award was made by a jury of architects under the chairmanship of L. Bancel LaFarge, and included Philip G. Bartlett, Charles W. Beeston, Harmon H. Goldstone, Otto Teegen, Gordon Bunshaft, Walker O. Cain, J. Gordon Carr, Alonzo W. Clark III and E. A. Van Name.

Final exercise, of one week's duration, required design of a bank building with shops and drive-in teller facilities.

Mr. Sippel will study and travel abroad for a year; in this country six months.

• William F. Little has been named by the Illuminating Engineering Society, national technical organization, to receive the 1950 Gold Medal of the Society at ceremonies during the National Technical Conference at Pasadena,

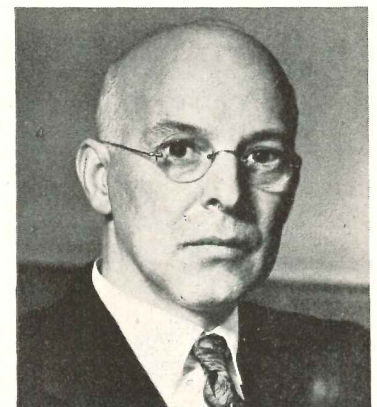

Calif., August 21-25. The Gold Medal, highest honor in the field of illumination, is awarded "for meritorious achievement conspicuously furthering the profession, art or knowledge of illuminating engineering."

(Continued on page 198)

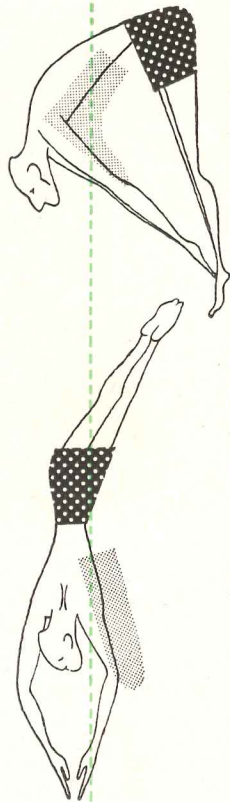
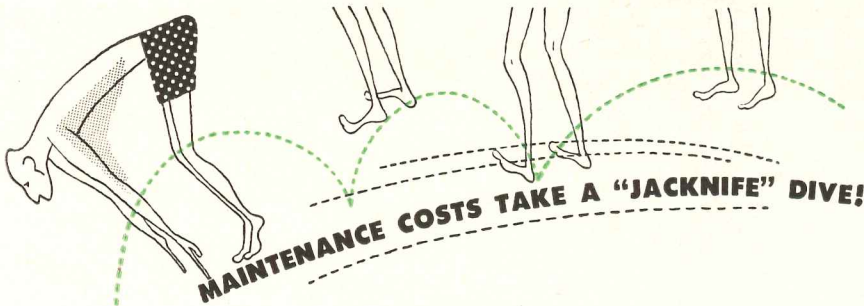

NEW
4 foot
SLIMLINE
GUTHLITE*

sets all-time low in upkeep!

It's downright economical how the patented GUTHLITE "jackknifes" down and its single-pin 4-FT. SLIMLINE lamps are changed with a quick push-pull. Even easier than replacing incandescent bulbs—and it's all done right from the floor without ladders:

Maximum use of light you pay for: 4-FT. SLIMLINE GUTHLITE'S lamps are so accessible—cleaning so practical—you can keep light-stealing dust on lamps to a minimum.

No starter switches, so no starter troubles—saves extra parts, maintenance and lamps.

Light-at-the-click-of-the-switch—starts in two quick, positive steps. And 4-FT. SLIMLINE GUTHLITES bring you the latest development in high-efficiency light sources—4 FT. SLIMLINE lamps.

May we send Bulletin 845-SA with full details?



LIGHTING

THE EDWIN F. GUTH COMPANY ST. LOUIS 3, MISSOURI

Leaders in Lighting Since 1902



LIGHTING SIMPLIFIED

NEW GUTH 4-FT. SLIMLINE SYSTEM is now available in every 2 and 4—40W fixture in our complete line. For the whole story, call in your nearest GUTH Resident Engineer or write us.

*®

TO BE TRULY MODERN A BUILDING MUST BE AIR CONDITIONED

Chrysler Airtemp air conditions the Shore Club Hotel

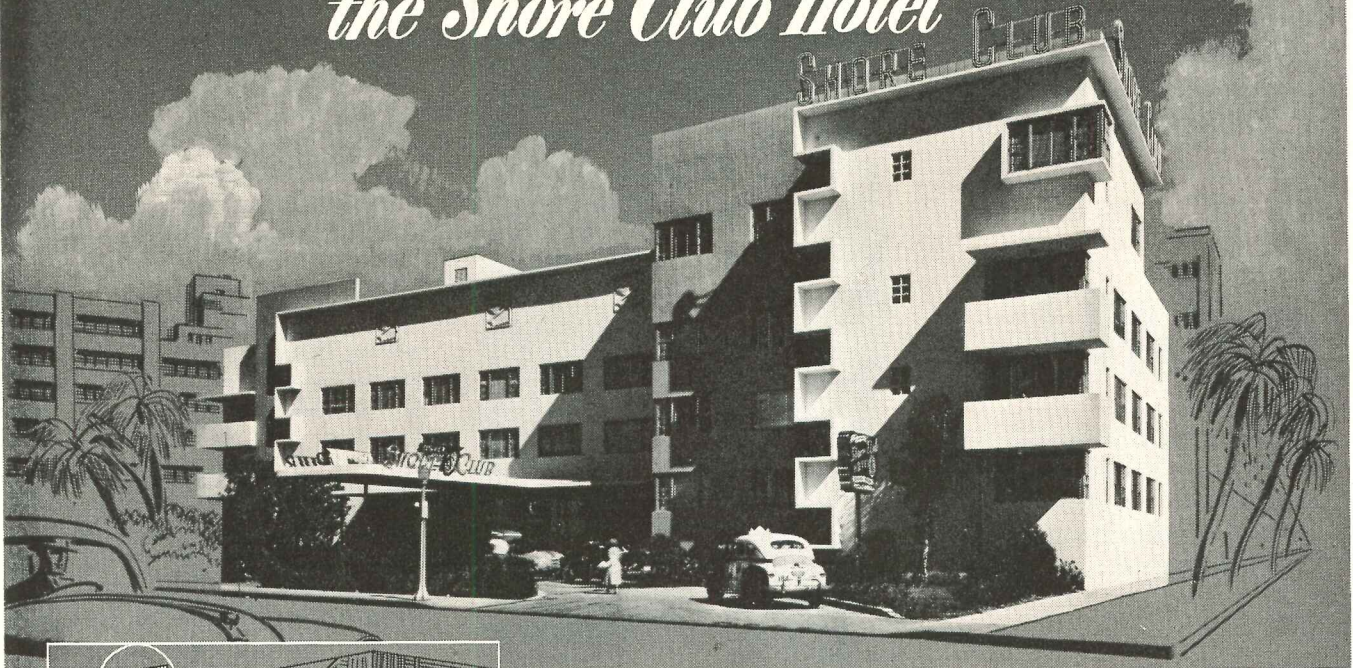

Architect: Albert Anis. Builder: 1901 Collins Corp., Irving Kipnis, President. General Contractor: Robert L. Turchin

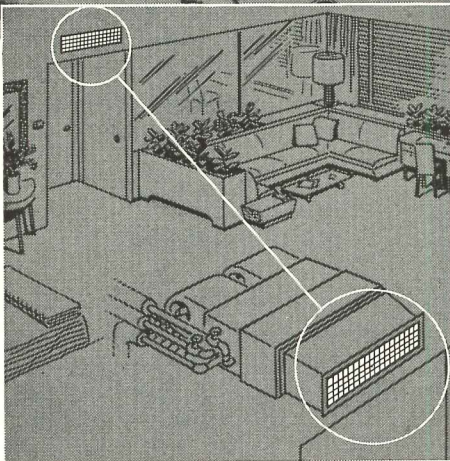

Chrysler Airtemp Individual Room Units in the Shore Club Hotel are placed within the entrance ceiling with only the controls mounted on the wall.

INDIVIDUAL ROOM UNIT SYSTEM GIVES GUESTS CUSTOM CLIMATE

The new, ultra-modern Shore Club Hotel, at Miami Beach, offers a new degree of luxury and comfort for its guests. Each of the 150 rooms—as well as all public areas—have individually controlled units—for both heating and cooling. Fresh outside air is filtered and dehumidified for continuous circulation through this system. Chrysler Airtemp equipment was selected for this automatic control of indoor weather.

Here is another instance where Chrysler Airtemp has cooperated with architects, builders and contractors to give their clients the finest in air conditioning. Through regional offices and dealers in principal cities—Chrysler Airtemp offers trained engineers to aid you with any heating or cooling operation—from the initial plans to the final installation.

When desired, Airtemp Construction Corporation—wholly owned subsidiary of Chrysler Corporation—will assume complete responsibility for all or any part of your air conditioning project. You'll find additional information on Chrysler Airtemp service and products interesting—and rewarding. Mail coupon today for full details.



Chrysler Airtemp

AIR CONDITIONING • HEATING • COMMERCIAL REFRIGERATION

**3 BASIC SYSTEMS TO MEET EVERY
AIR CONDITIONING NEED—
CENTRAL SYSTEMS • INDIVIDUAL ROOM UNITS • "UNITEMP"**

AIRTEMP DIVISION OF CHRYSLER CORPORATION, Dayton 1, Ohio

We would like the story of Chrysler Airtemp service and products.

Name _____

Address _____

City _____ Zone _____ State _____
A-5-50

READY!

Takes less than 30 seconds to prepare RAMSET TOOL with power charge and choice of 65 coated steel fasteners.

RAM!

Place light, compact tool against work, locating fastening point as accurately as desired. Then tap lightly and the fastener is . . .

SET!

Instantly, tightly, cleanly, easily. No drilling, chipping or plugging. Less than a minute from start to finish.

FAST . . . RELIABLE RAMSET SYSTEM SLASHES COSTS . . . AND TIME . . . FOR FASTENING INTO STEEL AND CONCRETE

Every day, thousands of users are making startling economies in money and time with RAMSET FASTENING SYSTEM. For practically any kind of fastening jobs into steel, concrete, masonry, RAMSET does the work faster, better, cheaper.

Let us show you, by comparison with ordinary methods, how you can cut costs up to 60% and do your fastening work in $\frac{1}{5}$ the time with the modern, reliable, proved RAMSET SYSTEM. Send for details and address of nearest RAMSET Specialist.

STEMCO CORPORATION

12117 Berea Road • Cleveland 11, Ohio
PIONEER IN POWDER-ACTUATED FASTENING

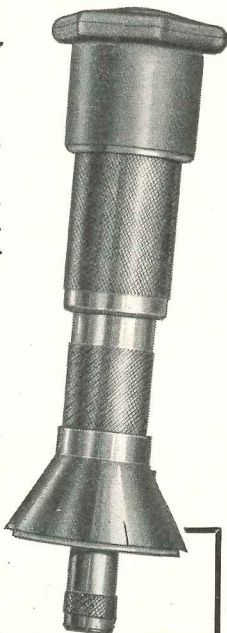
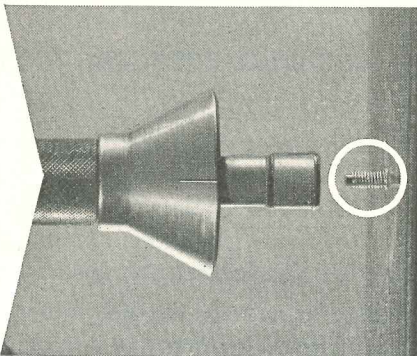
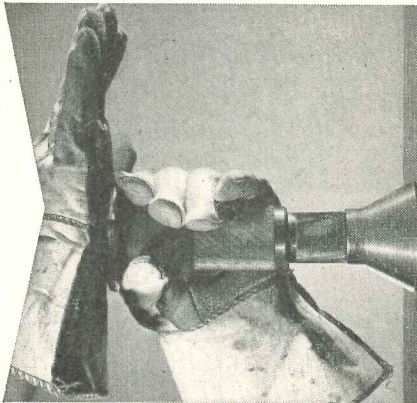

THE RECORD REPORTS

(Continued from page 196)

• Joseph Amisano, a graduate of Pratt Institute, Brooklyn, who is associated with the firm of Ketchum, Giná and Sharp, New York City, has been awarded the Rome Prize Fellowship in architecture for 1950-51. A fellowship in landscape architecture has been awarded to Dale H. Hawkins, a graduate of Iowa State College and now director of planning, Nashville, Tenn., Housing Authority.

The total estimated value of each fellowship is approximately \$3000, including stipend, travel allowance and free residence for one year at the American Academy in Rome.

• Robert H. Brown, chief of chemical metallurgy at Alcoa's research laboratories in New Kensington, Pa., has been chosen by the National Association of Corrosion Engineers to receive the Whitney Award for 1950 "in recognition of his outstanding contributions to the science of corrosion." The Whitney Award is international in scope, and is one of the highest honors in the field of corrosion engineering.

ELECTIONS APPOINTMENTS

• Karl Bock of New York was elected president of the American Institute of Decorators at that organization's annual conference in New York City last month. Other officers for 1950 are: Theodor Muller, New York, chairman of Board; William MacArthur, Milwaukee, first vice president; Ross Thiele, La Jolla, second vice president; Berenice D. Fligman, Chicago, third vice president; Elisabeth C. Draper, New York, secretary; Newby Murray, New York, treasurer; Genevieve Hendricks, Washington, D. C., assistant secretary-treasurer.

• Officers for 1950 elected by the Chicago Region Chapter of the American Institute of Planners are: Claire E. Oneal, Chicago, president; Kenneth L. Schellie, Indianapolis, vice president; Jack Meltzer, Chicago, secretary-treasurer.

• Carlton S. Proctor, New York consulting engineer, has been elected chairman of the Construction Industry Ad-

(Continued on page 200)

CHECK ✓ HERE

- Steam Radiators
- Unit Heaters
- Pipe Coils
- Down-feed Risers
- Condensing Radiators
- Blast Coils
- Ends of Mains
- Cookers, Dryers
- Sterilizers
- Storage Water Heaters, etc.

**for EVERY TRAP YOU NEED...
... from ONE COMPLETE LINE**

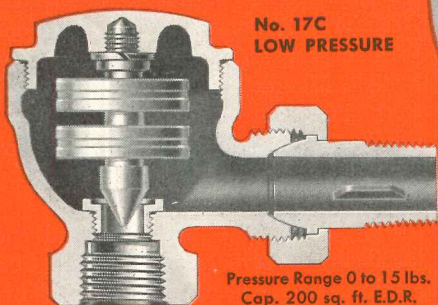

**No. 17C
LOW PRESSURE**

Pressure Range 0 to 15 lbs.
Cap. 200 sq. ft. E.D.R.



No. 400 DIRT STRAINER

Protects seating surfaces of traps, pressure reducing valves, temperature and pressure control valves, self cleaning.

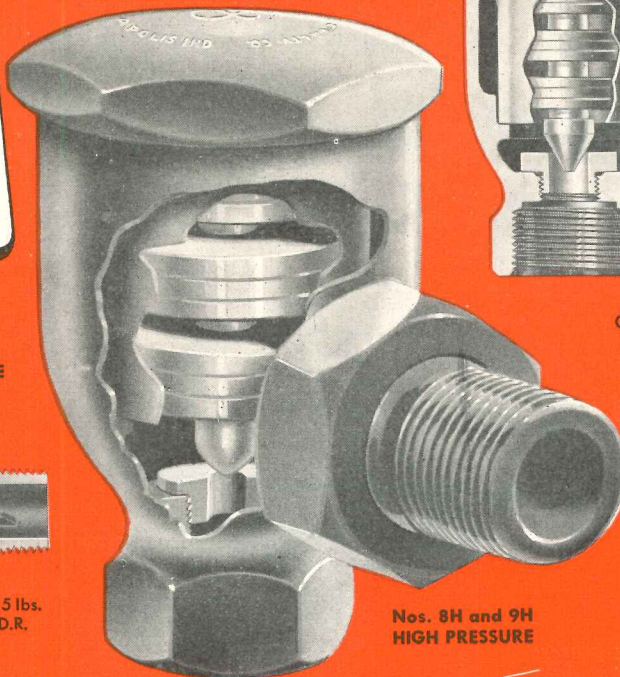

**Nos. 8H and 9H
HIGH PRESSURE**

Pressure Range 0 to 125 lbs.
Cap. from 235 to 1250 lbs. con. p.h.

Removable thermal units are a distinguishing feature of Hoffman Traps, greatly simplifying clean-out and inspection work.

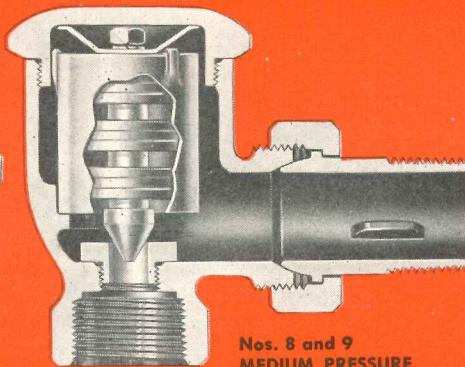

**Nos. 8 and 9
MEDIUM PRESSURE**

Pressure Range 0 to 50 lbs.
Cap. from 100 to 850 lbs. con. p.h.

HOFFMAN THERMOSTATIC TRAP PATTERNS AVAILABLE

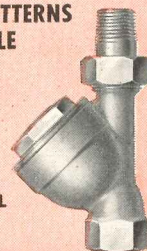

**VERTICAL
17C**

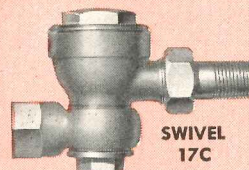

**SWIVEL
17C**

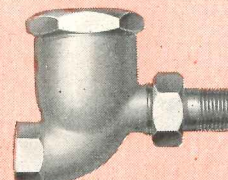

**STRAIGHTWAY
8, 8C and 8H**



**R.H. and L.H.
8 and 8H**

Specifying Hoffman Traps for every spot on the Check List is good business for you. First, you are assured uniform operating efficiency; second, it saves your Buyer's time; third, it provides one uniform guarantee from a single, recognized source. And in addition, engineers are quick to appreciate the sound Hoffman features that cost no more than ordinary traps . . . and they *also buy* companion Hoffman products that assure economical, carefree operation throughout. There's a Hoffman Trap for every job on your books—in $\frac{3}{8}$ ", $\frac{1}{2}$ " and $\frac{3}{4}$ " size connections—capacities to 1250 lbs. condensate per hour—and patterns to suit piping requirements. Write for Bulletin No. 149 and specify Hoffman on that next modernizing job.

HOFFMAN *Steam* TRAPS

Famous for HOFFMAN VALVES, TRAPS, VACUUM AND CONDENSATION PUMPS, FORCED HOT WATER HEATING SYSTEMS—Sold by Leading Wholesalers of Heating and Plumbing Equipment.



HOFFMAN SPECIALTY COMPANY, Dept. AR-5, 1001 York St., Indianapolis 7, Ind.

ACTUAL CHECK PROVES

No other Copying Process offers you

OZALID'S ECONOMY!

HERE'S PROOF!

See how 4 other most popular copying methods compare with the money-saving versatility of Ozalid.

	OZALID	METHOD A	METHOD B	METHOD C	METHOD D
Prints ready for immediate use	✓	✓	✓		✓
No size restrictions	✓			✓	
No special plates, stencils, or inks	✓		✓		✓
No need to make negative	✓	✓			
Additional copies immediately available	✓				
Easily makes duplicate masters	✓				

WHAT IS OZALID?

• Ozalid is a *speedy copying process* that uses sensitized paper to reproduce anything typed, drawn or written. You get perfect copies of letters, records, reports, photographs, index files, drawings—anything.*

WHAT ARE THE ADVANTAGES OF THE OZALID PROCESS?

- **No size restrictions**—Ozalid copies can be made in *any* size, in sheets or continuous rolls.
- Copying errors are eliminated. There's no *check-back* to the original.
- Changes easily made. Add new material to create a "composite master". No need to re-create an entire piece.

OZALID PAPER IS UNEQUALLED FOR QUALITY, TOO!

- For years, Ozalid has been established as the "Standard of Quality" among sensitized papers.
- Ozalid's "speed" is the same, month in and month out—stepping up production.
- Controlled product quality gives more prints at lower labor cost.
- Longer shelf-life—means less waste.

Cut Copying Costs...Use OZALID!

A DIVISION OF GENERAL ANILINE & FILM CORPORATION. "FROM RESEARCH TO REALITY"

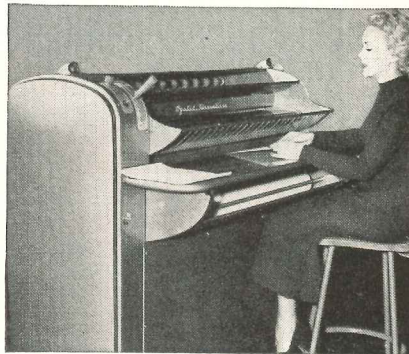

Imagine asking for "ten copies in three minutes" . . . and getting them. Thus releasing your typists for important work, while a file clerk runs the machine!

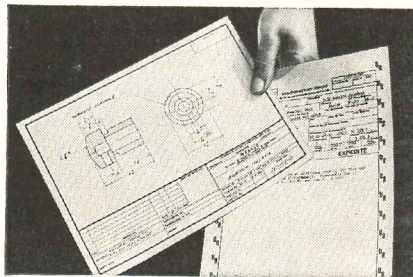

You get dry, positive, exact duplicates in a fraction of a minute and at a fraction of your usual cost.

*If light won't shine through, an inexpensive intermediary step is taken.

OZALID, Dept. E2
Johnson City, New York
Gentlemen: Please send free illustrated booklet that fully explains the Ozalid process.

Name.....

Company.....

Address.....

Or call your local Ozalid distributor listed in the classified telephone book.

THE RECORD REPORTS

(Continued from page 198)

visory Council for 1950-51. He succeeds James R. Edmunds Jr. of Baltimore, a past president of the American Institute of Architects.

• Officers of the Louisiana Engineering Society elected at the Society's annual meeting are: Lionel J. Cucullu, New Orleans, president; Harry P. Newton, New Orleans, first vice president; John A. McNiven, New Orleans, second vice president; John P. Fernandez, New Orleans, secretary-treasurer. The Board of Direction also includes: Austin J. Mary, president, Baton Rouge section; Ray E. Burgess, president, Lake Charles section; E. M. Freeman, president, Shreveport section; R. T. Sessums, president, Monroe section; and Michael C. Abrahm, Arthur M. Hill, Charles P. Knost, H. L. Lehmann and R. Mallard Seago.

• Appointment of five technical specialists to serve as a Board of Consultants to the New York State Building Code Commission in drafting of a one- and two-family dwellings code, and later a comprehensive code, has been announced by Col. Edward J. McGrew Jr., Commission chairman.

The appointees are: John O. Merrill of the architectural firm of Skidmore, Owings & Merrill, and director, revision of the Chicago Building Code; George E. Strehan, consultant to the Building Officials Conference of America, Inc., New York; George N. Thompson, chief, Codes and Specifications Section, National Bureau of Standards, Washington, D. C.; Walter C. Voss, head, Department of Building Engineering and Construction, M. I. T., Cambridge, Mass., and chairman, Standing Committee on Building Codes, A.I.A.; Ralph E. Winslow, head, Dept. of Architecture, R.P.I., Troy, N. Y.

• Mrs. Samuel I. Rosenman, former chairman of the Board of the National Committee on Housing and a former director of the Urban Land Institute, is chairman of an advisory committee appointed by the Public Education Association to study modern school building needs.

Architect members of the committee include: Max Abramovitz, Wallace K. Harrison, Ely Jacques Kahn, William Lescaze, Louis Skidmore.

(Continued on page 202)

THE MOST *Beautiful* INDIRECT INCANDESCENT LUMINAIRE



The New Curtis SNO-FLAKE

DECORATIVE ❄️ **EFFICIENT** ❄️ **ECONOMICAL**

Curtis SNO-FLAKE presents an entirely new concept of design for indirect incandescent illumination. It combines startling beauty with many functional features. The SNO-FLAKE'S high efficiency and economy in installation and maintenance make this excellent new unit ideal for school rooms, offices, stores, and other commercial interiors. The die-cast aluminum louver follows a pleasing geometric pattern that blends with any decorative scheme. Open top and bottom, this louver requires a minimum of maintenance. Original efficiency of the luminaire is regained with each relamping. The SNO-FLAKE utilizes either 300 or 500 watt silvered bowl lamps which assure the high efficiency demanded for modern illumination.



Full technical details and specifications on the SNO-FLAKE are illustrated and described in Bulletin No. 8. Write Dept. SF 52 for your free copy to supplement your Curtis Catalog.



LIGHTING, INC., 6135 W. 65TH ST., CHICAGO 38, ILLINOIS



REMEMBER... for real economy, lasting beauty—Terrazzo
made with **ATLAS WHITE CEMENT**

You give your client the most for his money when you suggest Terrazzo made with Atlas White Cement.

A beautiful Terrazzo floor made with a matrix of Atlas White is moderate in original cost . . . costs far less when you figure the years upon years of wear-resistance such a floor provides. The floor stays bright and colorful with little maintenance, except cleaning. That's real, *lasting beauty*, real economy!

Outstanding in uniformity and whiteness, a matrix of Atlas White Cement shows color pigments and aggregates at their best, in contrast or blend. Infinite variety of color tones and shadings is possible.

Atlas White complies with ASTM and Federal Specifications for portland cement. It has the same advantages when used for concrete and is used in the same way. Terrazzo, stucco, architectural concrete slabs and portland cement paint made with Atlas White Cement all provide a clean, fresh appearance and give true low-cost-per-year service. For further information on the uses of Atlas White Cement, see SWEET'S Catalog, Section 4e/7a and 13c/5, or write to Atlas White Bureau, Universal Atlas Cement Company (United States Steel Corporation Subsidiary), Chrysler Building, New York 17, N. Y.

The attractive Terrazzo job above was specified by architect Ezekiel Levinson, of Philadelphia, for Goodman Auto Sales Co., Phila. Terrazzo contractor: Italian Marble Mosaic Company, Philadelphia.

AR-T-16

FOR BEAUTY AND UTILITY
ATLAS WHITE CEMENT
FOR TERRAZZO, PAINT, SLABS, STUCCO

"THEATRE GUILD ON THE AIR"—Sponsored by U. S. Steel Subsidiaries
Sunday Evenings—NBC Network

THE RECORD REPORTS

(Continued from page 200)

AT THE COLLEGES

Contemporary Arts Festival Is Held at U. of Illinois

One of the largest and most popular exhibits in the University of Illinois third annual Festival of Contemporary Arts, Feb. 28-Apr. 2, featured contemporary work in architecture, landscape architecture and city planning.

Included were several groups of plans and photographs representing city planning and landscape architecture by Illinois and Federal agencies.

Ten large mounts showing the proposed civic center for Chicago were loaned by the Chicago Plan Commission. The exhibit included a plan of the addition to Park Forest, Chicago suburb, showing 2500 home sites and the entire town plan. Views of the United Nations secretariat building also were shown.

M.I.T. Plastics Conference Scheduled for June 19-21

Plastics and their mechanical properties as viewed from the standpoint of research, engineering, and architecture will be the subject of a three-day conference at the Massachusetts Institute of Technology on June 19-21.

Sponsored by the M.I.T. Plastics Committee, the program will provide an opportunity for those interested in but not directly associated with plastics to hear and join in discussions of their many properties and uses. Research workers in the field will report their findings for discussion by others engaged in research as well as by engineers involved in plastics applications.

Prof. A. G. H. Dietz of the M.I.T. Department of Building Engineering and Construction is chairman of the conference's sponsoring committee. Other M.I.T. faculty members on the committee include Prof. E. A. Hauser, chemical engineering; Prof. W. M. Murray, mechanical engineering; Prof. E. R. Schwarz, textile technology; and Prof. W. H. Stockmayer, chemistry.

Of special interest to architects is the program for the third day of the conference, which was specifically arranged for architects not directly concerned with plastics manufacture but concerned with the properties of plastics as those affect their utilization.

(Continued on page 204)

“You can’t miss
when you design
with
Carrara Glass”

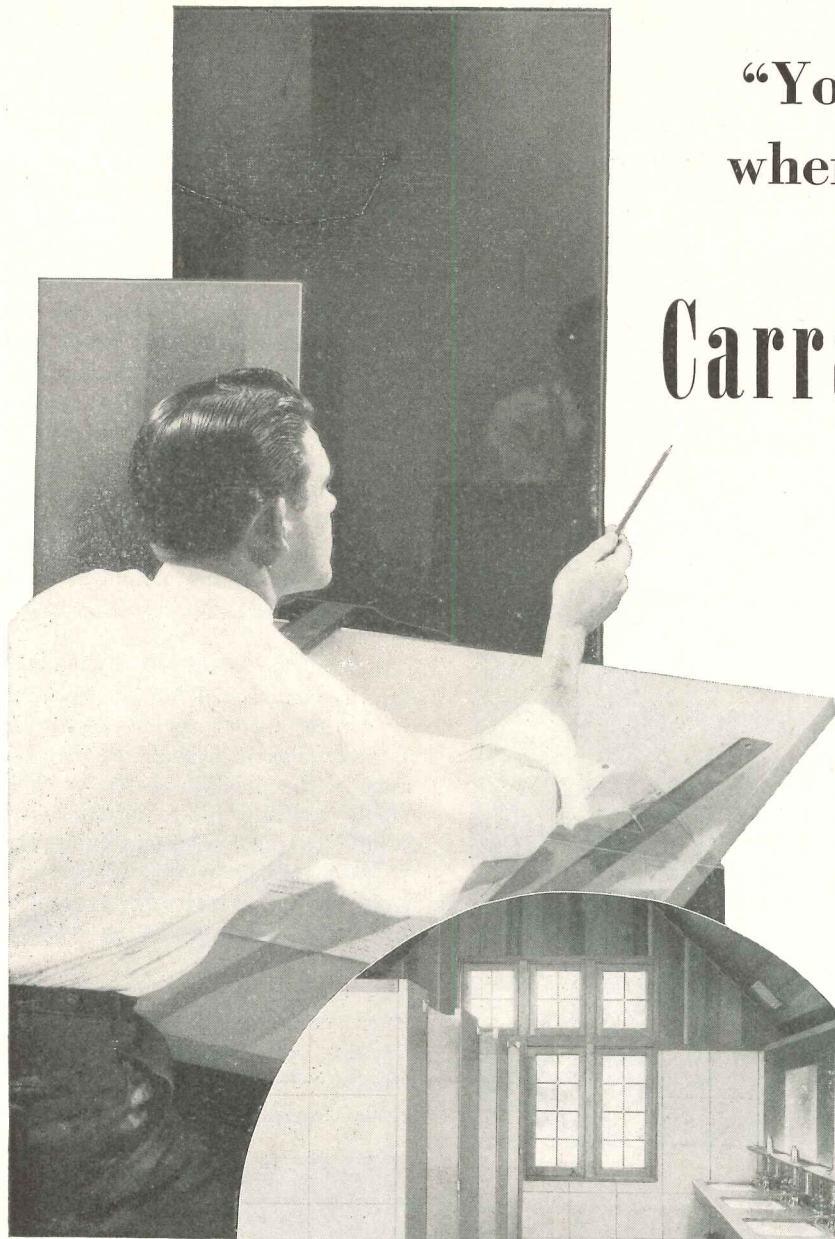

Whatever the architectural problem may be, you can rely upon Carrara Glass to help you create structures of unmatched beauty, originality and permanence. Architects have proved this for themselves in thousands of instances. There are many reasons for this: Carrara is *quality* structural glass. It is the product of exhaustive Pittsburgh research into ways and means of solving architectural problems by supplying materials that will look well and perform well under field conditions.

Carrara Glass is a finely-machined product, homogeneous, flawless. There is no lippage; joints are true and even. It's free from warpage. Every piece of Carrara Glass, whatever its color or thickness, is mechanically ground and polished. Carrara Glass is very easily handled. It can be decorated by sand-blasting, fluting, shading, or painting for ornamental purposes. It is impervious to moisture, weather, chemicals, grease, pencil marks. It won't check, craze, fade or stain. Why not give your designs the added distinction of this quality structural material? Your clients will thank you for it.

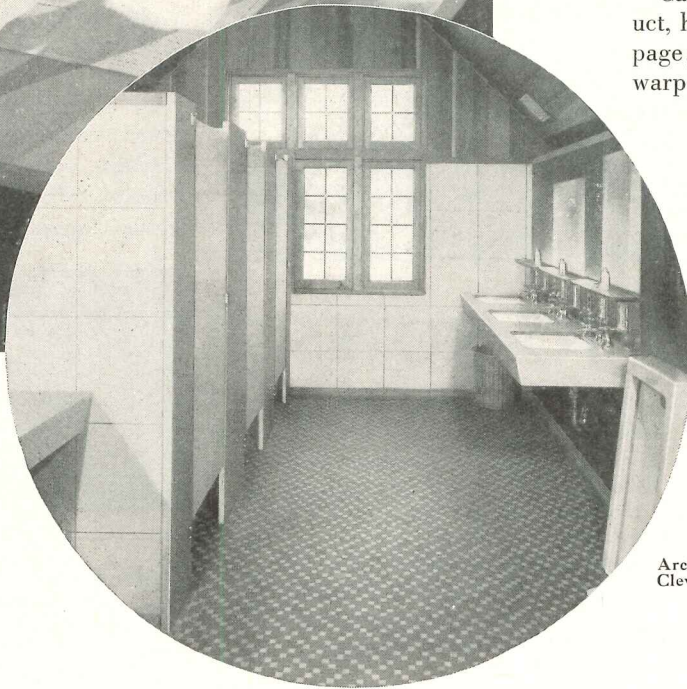

Architects: Cutting, Ciresi & Associates,
Cleveland, Ohio.

Carrara *the quality structural glass*



PAINTS • GLASS • CHEMICALS • BRUSHES • PLASTICS

PITTSBURGH PLATE GLASS COMPANY

THE RECORD REPORTS

(Continued from page 202)

Dual Exhibit Features House by Gregory Ain

A house designed by Gregory Ain to show that good architectural design is possible in a typical suburban real estate development will be on exhibition in the garden of the Museum of Modern Art in New York City from May 19 through October 19.

The three-bedroom house, planned for a lot 60 ft by 120 ft, was built under the

joint sponsorship of the Museum and the publication, *The Woman's Home Companion*.

Philadelphia A.I.A. Studies Research Foundation Idea

The idea of stimulating and disseminating the results of research in the building industry seems to be much in the air these days. On March 31, the Philadelphia Chapter of The American

Institute of Architects brought together a representative group of the "industry" to discuss the possible formation of a "Foundation for Research in the Construction Industry."

This Foundation as proposed by the Activities Committee of the Philadelphia Chapter, Beryl Price, chairman, would serve the metropolitan Philadelphia area and have the following activities: (1) Perform basic research in developing new materials and methods; (2) Investigate and develop existing materials and methods; (3) Establish a reporting statistical agency; (4) Set up a building materials exhibit; (5) Establish classes, seminars and lectures on construction procedures. The Foundation would be housed and administered by the Franklin Institute, according to this proposal.

In discussion from the floor, the chapter was commended for its efforts to develop better construction practices in its area. General feeling was that the scope of the program should be thoroughly studied to insure including such facilities as would be of maximum service to metropolitan Philadelphia and avoid duplication with existing agencies conducting and coordinating building research.

Below (left to right): Philadelphia A.I.A. President Louis McAllister; Franklin Institute's Dr. H. B. Allen; and Chapter Activities Committee Chairman Beryl Price

Executive Dining Room, Chase National Bank, 18 Pine St., New York City



FROM Soup TO NOTES

WE are not privy to the subjects discussed in the Williamsburg Dining Room at Chase National Bank headquarters. But it is conceivable that the conversation could range from "soup to notes". However, there is something we can refer to with authority, and that's the versatility of Bergen Cabinet aged-in-the-wood craftsmanship.

Whether its panelling, or an especially designed piece of furniture (see photo above), or an entire store floor, or bank . . . you can bank on Bergen to translate the designer's plans into enduring reality.

And, it is this *enduring quality* of Bergen's wood-wizardry that makes your budget take a bow for achieving decades-trouble-free economy.

Write to Dept. A for our Portfolio of "Jobs Well Done." It's worth seeing

Bergen—sure the success of your modernization program with

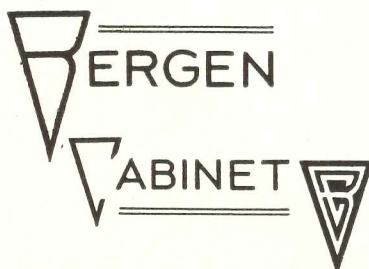

Architectural woodwork that makes the designer's plan an enduring reality

1552-56 BERGEN STREET, BROOKLYN, N. Y.

Phone: PResident 2-3121



Addenda

• Pictured in the Wurlitzer advertisement on page 331 of the April issue of the RECORD was the Church of Christ the King, Seattle, Wash. Paul Thiry was architect for the church.

• Photographic credits were inadvertently omitted in the presentation of the University of Michigan School of Business Administration (ARCHITECTURAL RECORD, March 1950, pages 87-93). The photographers who should have received credit are: Hedrich-Blessing, the University of Michigan News Service, the State of Michigan Building Dept. and David Reider of the University.

Johns-Manville Terraflex

REVOLUTIONARY NEW FLOORING!



PLASTIC-ASBESTOS Floor Tile!

Has clearer, brighter colors... lasts twice as long... is extremely resilient



... unaffected by greases, oils, alkaline moisture.

● For the first time, an all-purpose flooring that combines in one material practically all the advantages that could be desired in the ideal floor! TERRAFLEX is plastic-asbestos tile—an entirely new type of decorative floor covering, pioneered and developed by Johns-Manville.

Terraflex is unaffected by greases, oils, alkaline moisture, and mild acid solutions . . . Is remarkably resilient under foot, yet will outwear other types of decorative flooring *two to one* . . . Tile-like units come in clearer colors, more stable than ever before obtained in resilient flooring . . . Can be safely used on concrete floors in direct contact with the ground . . . Flexibility permits Terraflex to withstand normal movement of wood floors without breaking.

See your J-M Approved Flooring Contractor, who will gladly tell you more about J-M Decorative Floorings (Terraflex and Asphalt Tile). Write for our new Terraflex brochure. Johns-Manville, Box 290, New York 16, N. Y.

Johns-Manville TERRAFLEX

*Reg. U. S. Pat. Off.

OTHER J-M PRODUCTS: Asphalt Tile—Acoustical Ceilings—Transite* Movable Walls—Corrugated Transite*—Built-Up Roofs—Etc.



WIRING NEWS

A PERIODICAL DIGEST OF WIRING IDEAS FROM THE GENERAL ELECTRIC CONSTRUCTION MATERIALS DEPARTMENT

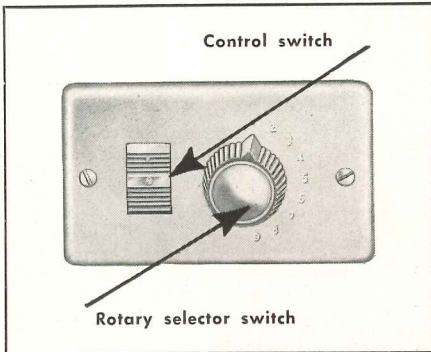

Master Selector Switch Increases Versatility Of Remote Control!

Here's the newest addition to General Electric's increasingly-popular remote-control wiring system—an addition that makes practical a wide variety of new applications. Replacing separate ON and OFF controls for each circuit, this compact master selector switch provides instant, positive control of *up to 9 different circuits*—and, very simply, too!

To Control Individual Circuits

Turn rotary selector switch to the desired circuit and then press the control switch for ON or OFF.

To Control All Circuits

Merely press the control switch ON or OFF while rotating the selector switch through all nine positions.

Plan to use it as a selling tool... for unobtrusive bedside control of home lighting circuits... for sure, certain emergency light control in warehouses, banks, office buildings... for varying the lighting of display areas... or wherever else one-point, multi-circuit control is needed.

The G-E master selector fits all standard mountings for flush devices. See it at your local General Electric distributor's or check box (A) below.

Free Guide Speeds Box Selection

To make your next job an easy, certain one, General Electric offers free a new switch and outlet box chart. With this handy specification aid, you'll know at a glance the proper outlet, switch, or utility box for any wiring job.



Printed in color and carefully illustrated this new *Box Buyer's Guide* gives the dimensions of all standard boxes. It shows the number of conductors—by wire size—permitted by the National Electrical Code for the various box sizes and types.

Get your copy today—order some for your contractors, too—just check box (B) in the coupon.

PVX For Better Profit!

That's right, General Electric PVX® nonmetallic-sheathed cable answers the problems of decreasing the time and costs of wiring—without sacrificing either quality or permanence.

When "roughing in" commercial or residential jobs, the light weight and small diameter of PVX pays off in faster handling. You'll like the easy way it strips clean for ready connection.

In "finish wiring", the small-diameter conductors leave more working room in boxes. In addition, the bright colors of PVX insulation assure quick, certain circuit identification. Use it on your next job. Check box (C) if you would like additional information.

Can You Afford To Save On Switches?

Why gamble? Replacements and service calls often cost many times the small savings made on lower-grade switches. So, when your plans call for switches, insist on G-E specification-grade switches.

The All-purpose Raceway—G-E Flexible Steel Conduit

Here's an all-purpose raceway that has all the advantages of a cable method of wiring. Yet, in installed cost, it compares favorably with other raceway systems. Available in long, continuous lengths, in many standard sizes, it has the ability to stand up under the most severe operating conditions.

G-E flexible steel conduit is made of galvanized strip steel, which, if properly installed, provides an unbroken low-resistance path to ground. It requires no tools for bending or threading, and only a few simple fittings are necessary in its installation.

General Electric flexible steel conduit saves time and money—its smooth interior surface makes wire pulling easy. For information on "flex" check (D) in the coupon.

Tough Cords For Rough Jobs!

Whether it's for a powerful portable saw... heavy-duty floor sander... or light hand drill—you'll do well to get a hard-working General Electric flexible cord to keep it operating with uninterrupted power.



All General Electric cords are built to absorb the rough handling and abuse customary at construction sites. There are cords for every purpose—cords that can take repeated hard knocks and flexing... cords that resist water, oils, alkalis, grease, and sunlight... cords that can also withstand abrasion and kinking.

G-E flexible cords are made in a variety of types and sizes for medium- and heavy-duty use. Look into their advantages before you make any cord replacements. For further information, check box (E) in the coupon below.

Section K7-55

Construction Materials Department, General Electric Company, Bridgeport 2, Connecticut

Please send me free information on:

- A Remote Control Master Switch
- B Box Buyer's Guide () copies
- C PVX Cable
- D Flexible Conduit
- E Flexible Cords

Name _____ Title _____

Company _____

Address _____

City _____ Zone _____ State _____

GENERAL ELECTRIC



there's a rainbow in the kitchen



when you specify **Curtis Cabinets!**

If Mrs. Homeowner prefers shell pink, sage green or powder blue in her kitchen cabinets, she can have what she wants—when you specify Curtis wood cabinets. For these sturdy, lifetime-lasting cabinets are finished two coats at the factory—ready to paint in the color of the owner's choice. Colors can be changed at will, quickly and inexpensively.

Curtis cabinets arrive on the job in dustproof cartons—ready to fit together, quickly and easily, into any size or shape of kitchen. Built like fine furniture, these cabinets have modern refinements and conveniences—easy-sliding drawers—

greater storage space—special cabinet units that fit “around a corner”—expert machining and workmanship—a place for everything! Hardware is furnished for each unit.

Curtis cabinets have a wide range of use in schools, church kitchens, laboratories, libraries, hospitals, laundries and clubs. Domestic science departments in schools and colleges find Curtis cabinets an aid to better teaching.

For true kitchen flexibility—in colors and arrangement—specify Curtis wood cabinets.

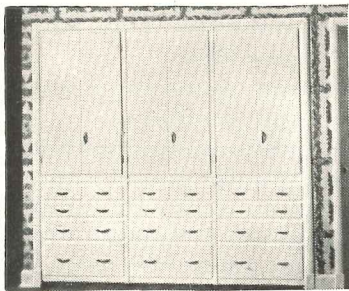

A Curtis “cabinet wall” will insure ample storage space in the home. These standard Curtis Units will find a useful place in storeroom, laundry, sewing room, rum-pus room, nursery, hall or bathroom.

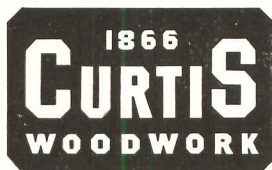

Curtis makes a complete line of architectural woodwork for the modern home. Make your next house “all Curtis.”

Curtis Companies Service Bureau
AR-5K Curtis Building
Clinton, Iowa

Gentlemen: Please send me literature on Curtis kitchen cabinets and other Curtis Woodwork.

I am architect contractor prospective home builder
 student.
(Please check above)

Name.....

Address.....

City.....State.....

THE RECORD REPORTS

CANADA (Continued from page 16)

Builders' Exchange, Mr. Stinson pointed to the rise in construction from 1945, when 48,000 units were built, to 1949, when 93,000 houses were erected. He felt Ottawa's decision to continue rent control indicates that demand still exceeds supply. N.H.A. regulations permitting smaller down payments should help insure that 1950 construction will equal 1949's, he said.

It's high time, Mr. Stinson declared,

for construction men to stop using that war-born phrase "Don't build now" — and to start selling the idea of immediate building, at current cost levels.

Ontario Legislature Gets Low-Cost Housing Bill

"It is much more desirable for people to buy their homes than to rent them; it gives them a stake in the country," said Ontario's Premier Frost when the

new Housing Development Act was introduced in the legislature.

The bill is designed to help the average working man to buy a house within his means. Down payments will be determined by the purchase price, and it is expected they will range from \$700 to \$1000. There will be no veterans' preference.

The bill, which follows recent federal legislation, provides that the provincial and federal governments work as partners in buying the land, building the houses, and sharing any losses on a 75-25 basis.

Crown company Central Mortgage and Housing Corp. has been selected to supervise the housing program, and contracts are to be granted to private builders.

Municipalities wishing to participate must first prove their need and then provide land at a fair price. Where a subsidized rental program is more advisable, municipalities must share costs with the province. These projects are to be managed locally. No definite rents have yet been agreed upon.

London and Kingston are already discussing the program with provincial authorities, and other Ontario municipalities are planning to participate.

Parallels Are Found in Housing Laws Abroad

How comparable are Canadian measures providing for public assistance to housing to those taken in other countries?

In some measure they parallel steps taken in Australia, according to the latest issue of "Housing Progress Abroad" released by the Central Mortgage and Housing Corp.

In Australia the initial cost of public housing projects is advanced by the Commonwealth Government, and losses are shared 60 per cent by the Commonwealth and 40 per cent by the state. In Canada, 75 per cent of the initial cost is financed by the federal government, 25 per cent by the provinces. Losses are shared on the same basis.

Subsidized housing is a municipal concern in Sweden, although it is assisted financially by the central government. Local municipalities provide the land for housing projects. Rentals are low, and rebates based on family size are made by the central government. To assist borrowers in making down payments, the Swedish government grants

(Continued on page 210)



PROTECTION FOR A PRECIOUS PACKAGE

What a reassuring feeling! Proud father experiences it when he views his helpless new offspring in the protective care of a well trained nurse. His friend, an architect, experiences it too, but for a different reason. For the community's new hospital he specified the "protection" of Fiberglas* Acoustical Tile ceilings. Combustible ceilings in hospitals can be tragic—as experience has shown.

Here's why he selected Fiberglas Acoustical Tile. The material is universally recognized by insurance interests as being non-combustible. This is based on Underwriters' Laboratories Incorporated's listing and as tested under Federal Specification SS-A-118a. Underwriters' Laboratories Incorporated's listing also shows smoke developed is negligible... no panic hazard, no toxic fumes.

Your own comparison will prove that Fiberglas Acoustical Tile, either Textured or Perforated, offers many other extra values, such as, dimensional stability and high sound absorbing efficiency in a material that is inherently sanitary and moisture resistant. Write us today for our A.I.A. File No. 39-B, "Fiberglas Acoustical Materials", or refer to Sweet's Architectural Files. Owens-Corning Fiberglas Corporation, Department 68-E, Toledo 1, Ohio.

*FIBERGLAS is the trade-mark (Reg. U. S. Pat. Off.) of Owens-Corning Fiberglas Corporation for a variety of products made of or with glass fibers.



BUILDING INSULATION • ACOUSTICAL TILE • ROOF INSULATION • MEMBRANE FABRIC

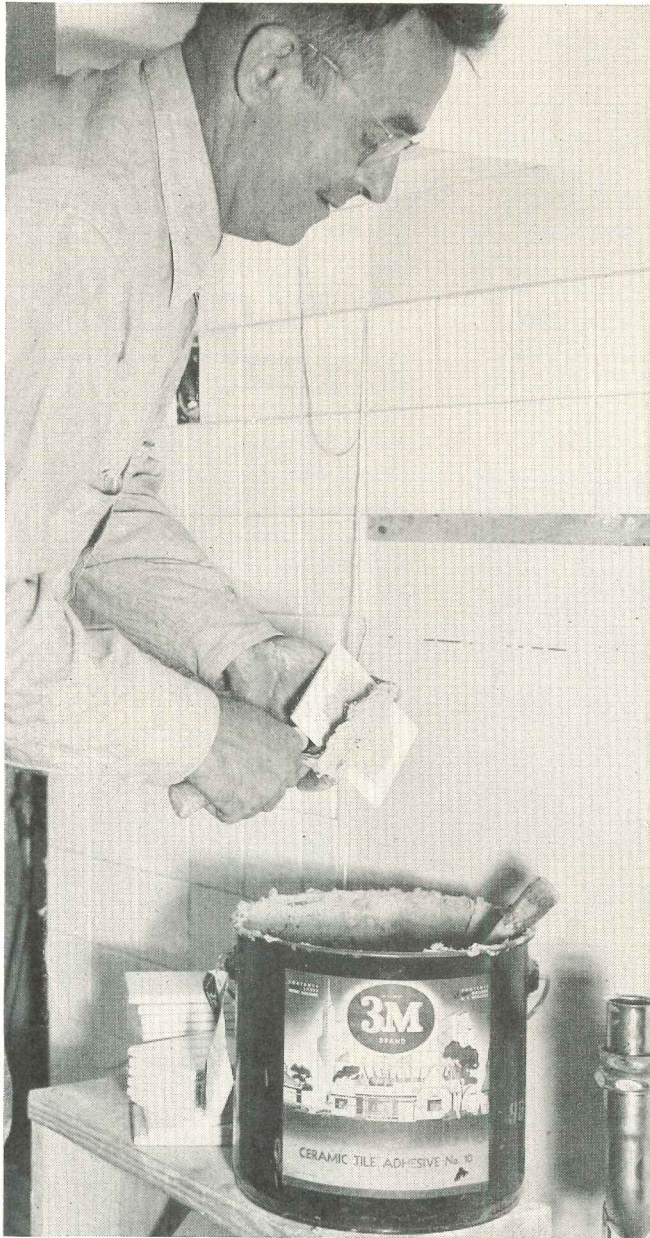

"BUTTERING" TILE at "Hathaway Hills", a quality home project in St. Louis, Mo. Method is recommended when cutting, trimming and fitting is necessary. 3M Ceramic Tile Adhesive can also be used for the faster "floating" method.

CONSTRUCTION TIME CUT 20%

**3M Ceramic Tile Adhesive sets tile
on 30,000 square feet of dry walls**

Eight hundred kitchens and bathrooms tiled faster with 3M Ceramic Tile Adhesive! Over 30,000 square feet of tile set on plasterboard walls at "Hathaway Hills" in St. Louis, Mo. And analysis shows a timesaving of 20% over mortar-type construction.

This creamy adhesive combs on smoothly, contains no water to complicate cold-weather operations. Consistency is perfect for quick application. Rubber-base adhesive is resilient, waterproof. You can lower construction costs with 3M Ceramic Tile Adhesive. Just write Adhesives & Coatings Division, Dept. AR-550, Detroit, Mich.



SPECIFICATIONS called for tiled kitchens and baths in this 400-unit housing project. Dry-wall construction was used. Tile was set safely with 3M Ceramic Tile Adhesive, even in bathroom tub recesses and on recessed ceilings.

OTHER 3M TIMESAVERS

- RUBBER TILE ADHESIVE
- LINOLEUM ADHESIVE AND WATERPROOF SEALER
- GLASS TILE ADHESIVE
- PLASTIC TILE ADHESIVE
- METAL TILE ADHESIVE

WRITE TODAY for full information on the complete line of 3M Building Adhesives. They're strong, resilient, and designed to lower specification costs. Whatever your design problem, there's probably a 3M Building Adhesive to speed the job! Write Dept. AR-550, Detroit, Mich.



Made in U.S.A. by MINNESOTA MINING & MFG. CO., ADHESIVES AND COATINGS DIV., 411 Piquette Ave., Detroit 2, Mich. Also makers of "Scotch" Brand Pressure-sensitive Tapes, "Scotch" Sound Recording Tape, "Underseal" Rubberized Coating, "Scotchlite" Reflective Sheeting, "Safety-Walk" Non-Slip Surfacing, "3M" Abrasives. General Offices: Saint Paul 6, Minnesota. General Export: Durex Abrasives Corp., New Rochelle, N. Y. In Canada: Canadian Durex Abrasives, Ltd., Brantford, Ontario.

THE RECORD REPORTS

third mortgages. Similarly, under the recently liberalized N.H.A., Canadians are assisted through increased mortgage loans and resulting lower down payments.

Architects Represented at Contemporary Art Exhibit

Architects had every reason to be proud of their fine representation at the recent Exhibition of Contemporary Arts

CANADA (Continued from page 208)

held at the Art Gallery of Toronto. Gordon S. Adamson was chairman of the R.A.I.C. committee in charge of the architectural section of the show.

Settings depicting the home, the school, the church and the office were grouped around the fountain of the Sculpture Court and were, in turn, surrounded by a generous selection of photographs and models. The photographs showed buildings of every con-

ceivable type, all — with the exception of churches — testifying to growing adoption of the modern philosophy of design. Though eye-popping examples of radical genius were few, the contemporary approach was apparent in most shelter problem solutions. Those that did not fall within this category were at least transitional in spirit.

The models exercised their usual fascination. Noteworthy were houses by Gordon S. Adamson and James A. Murray; schools by Page & Steele and Shore & Moffat; and a home for the aged by Rounthwaite & Fairfield. Marani & Morris showed an addition to the head office of a large insurance company and the new C.N.E. grandstand. Interiors included the clever reproduction of a main banking room by Mathers & Haldenby, Beck & Eadie, and a chapel by W. L. Somerville, who also contributed a hospital intriguingly modeled in transparent plastic.

Below: Gordon Adamson, exhibit chairman



UNPROTECTED STAIRS CAN BE A hazard FOR UP TRAFFIC!

Specify FERALUN* Safety Treads In At Least 4" Widths to Prevent Slipping and Wear

As the illustrations show, UP traffic needs the underfoot "grip" of abrasive particles embedded in a tread *at least 4" wide*. DOWN traffic needs the same safety feature on the tread nosings as well.

Feralun treads are made to provide full protection from this "double traffic" all stairways must serve. They always have abrasive granules in the nosings — for the *down* traffic, and should be wide enough (at least 4") to protect the *up* traffic as well. *Note action photos showing points of foot contact which are also points of slipping and wear.*

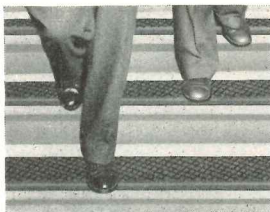

Not only do these sturdy cast iron abrasive treads give underfoot safety *up* and *down*, but they also give protection from wear as well. Installations of Feralun treads are still giving maintenance-free safety after more than a quarter century of continuous use.

For full information on Feralun and other underfoot safety products, see Sweet's File, Architectural, Sec. $\frac{13a}{10}$, or write to:

AMERICAN ABRASIVE METALS CO.

463 Coit Street • Irvington, New Jersey

USE FERALUN TREADS AND BE SAFE... "UP AND DOWN"

*Reg. U. S. Pat. Off.



Varied Problems Discussed At Planners' Convention

Talks by Town Planning Consultant Dr. E. G. Faludi, George Prudham, M.P., parliamentary assistant to the Minister of Resources and Development, and Miss Catherine Bauer, vice president of the National Housing Conference, highlighted the recent joint convention of the American Institute of Planners and Canada's Institute of Professional Town Planners.

Dr. Faludi led a discussion on the problems of planning a new town. It must be located where people wish to live, he said, and every effort should be made to retain as many natural features as possible. He advocated provision of a rural belt a few miles wide and mentioned the need for care that the site

(Continued on page 212)

These high-quality, low-cost Door Units take the Toughest Treatment... *and still look like new!*

STADIUM—Fenestra Entrance Doors in the Stadium at Grand Rapids, Michigan.

Architect: Wilfred P. McLaughlin,
Grand Rapids

Contractor: George Datema & Sons
Builders, Inc., Grand Rapids

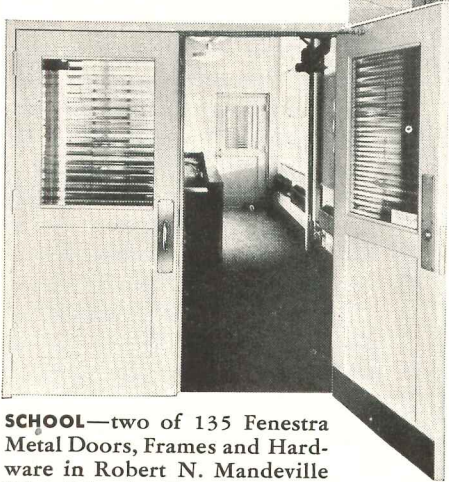

SCHOOL—two of 135 Fenestra Metal Doors, Frames and Hardware in Robert N. Mandeville High School, Flint, Mich.

Architect: Bennett & Straight,
Dearborn, Mich.

Contractor: Karl B. Foster, Flint, Mich.



SUPER MARKET—Fenestra Entrance Doors, Frames and Hardware in Eberhard's Super Market, Grand Rapids, Mich.

Same Architect and
Contractor as Stadium.

A stadium entrance jammed with jostling crowds. School kids opening classroom doors with their feet. A super market seething with shoppers. In and out . . . out and in . . . all day long. That's tough treatment! And that's one of the reasons why Fenestra* Hollow Metal Doors were selected for those spots. They won't sag, warp, swell, shrink or splinter . . . an occasional coat of paint makes them look like new.

Some of the other reasons:

- 1. High Quality**—Fenestra Hollow Metal Doors are made by craftsmen long skilled in steel fabrication. Each door is insulated for quiet performance. Each comes wrapped to protect the gleaming finish.
- 2. Complete Unit**—Door, strong steel frame and shining hardware, designed as an attractive unit, ready to install.
- 3. Low Cost**—Standardized, Fenestra Doors can be produced in great volume for maximum manufacturing efficiency. Mortising, drilling, tapping and prime painting are all done *at the factory*. To install, builders just bolt the frame together, attach frame to floor and anchor to walls, screw on template locks and hinges, hang the door.
- 4. Delivery in 2-3 weeks**—Action is taken upon receipt of your order. Local stocks can usually deliver immediately.

Fenestra Doors with the Underwriters' B Label are also available. Call your Fenestra representative, listed in the yellow pages of your telephone directory or . . .

*Trademark

Fenestra

DOORS • WINDOWS • PANELS

MAIL THIS COUPON

DETROIT STEEL PRODUCTS COMPANY

Door Division
Dept. AR-5, 2252 E. Grand Boulevard
Detroit 11, Michigan

Please send me, without obligation, information on
Fenestra Stock Hollow Metal Doors.

Name _____

Company _____

Address _____

THE RECORD REPORTS

CANADA (Continued from page 210)

is not so isolated it cannot be connected with the general transportation scheme.

Recommending deliberate planning to avoid segregation of population groups by income, Dr. Faludi pointed out that all types and income groups of society must be attracted, and there must be bungalows and apartment buildings, large houses and small, to meet the life cycle of the different fam-

ilies and the needs of all income groups. The developing agency should be ready to step in at any time to encourage certain types of new industry, or discourage others, to secure the best balance of population, he said.

The town design must be economically sound, he warned, adding that capital cost of development is less important than the operative cost.

What is good for the town is good for

the nation. That was the message brought to the convention by Mr. Prudham, who said Canada is now organizing her resources and planning her future growth, through the resources development program, much as a town planner organizes a community. Heavy expenditure on resources development is one of the main features of Canada's 1950 investment program.

Today's new freedom for the planner was hailed by Miss Bauer, who noted that social and economic segregation is no longer taken for granted in building. Architects now are designing new housing for various income groups and there is no reason why these groups could not be mixed together, she declared. Miss Bauer remarked that racial segregation, too, is being questioned in the northern United States.

Discussing various ways of handling modern metropolitan sprawl, she said one method is prohibition of haphazard decentralization and building up of central densities. Another she mentioned as popular in England is grouping of new residential areas and industries in relatively independent communities well away from the city.

Miss Bauer urged research to give planners a clearer idea of how people live and how they want to live. Such research has been used by industry and the armed forces, but scarcely at all in the fields of housing and city planning, she pointed out.

Breuer Talk Well Received

People who heard the recent address by Marcel Breuer at the Museum Theater in Toronto, under the sponsorship of the Architectural Club of the University of Toronto, were amply rewarded.

Mr. Breuer, who was introduced by Prof. James A. Murray, gave an account of his philosophy of design within the terms of reference established by residential architecture.

A plan should be fluid, not necessarily flexible, said Mr. Breuer, in order to use space with maximum efficiency and interest. Not only walls but roofs and floors as well could be employed to achieve the desired results, he noted.

Mr. Breuer expressed his belief that functionalism is not the be-all and end-all of design and listed as other essential factors to be considered economy, construction and esthetics. For example, he said, a beautiful view might indicate the need for a window; but the window

(Continued on page 214)

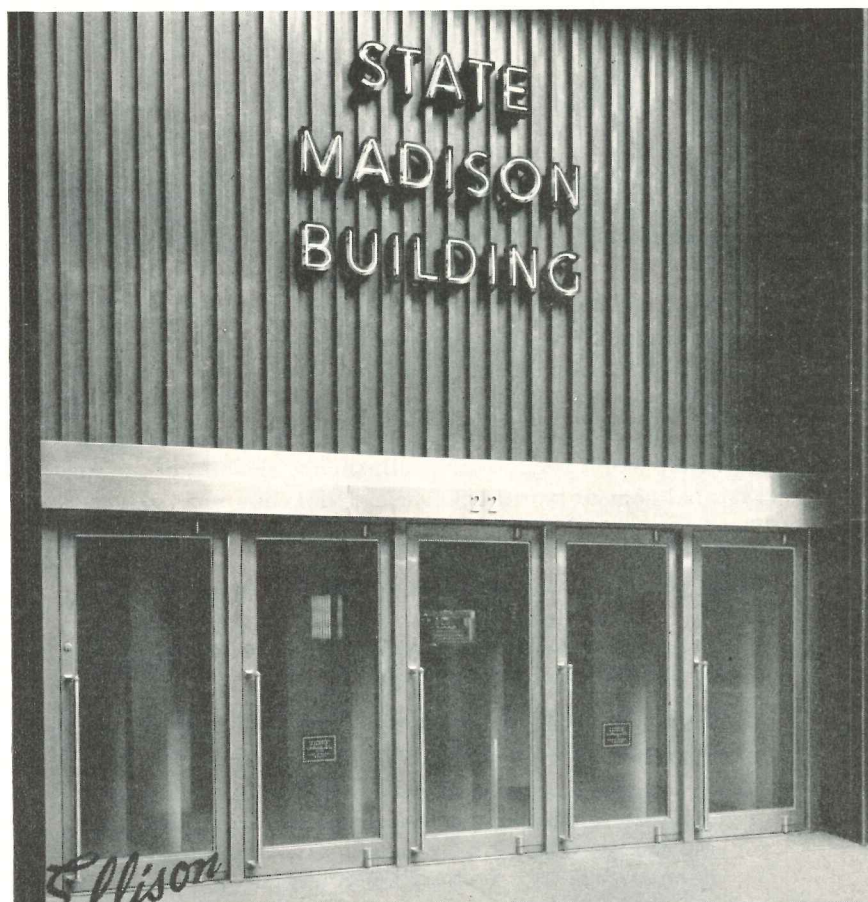

the Balanced Door in THE STATE-MADISON BLDG., Chicago, Ill.

Architects Holabird, Root & Burgee

The Door that lets

TRAFFIC through QUICKLY



Ellison
the **BALANCED DOOR**

ELLISON BRONZE CO.

Jamestown, New York

representatives in 71 principal cities

3 way stretch

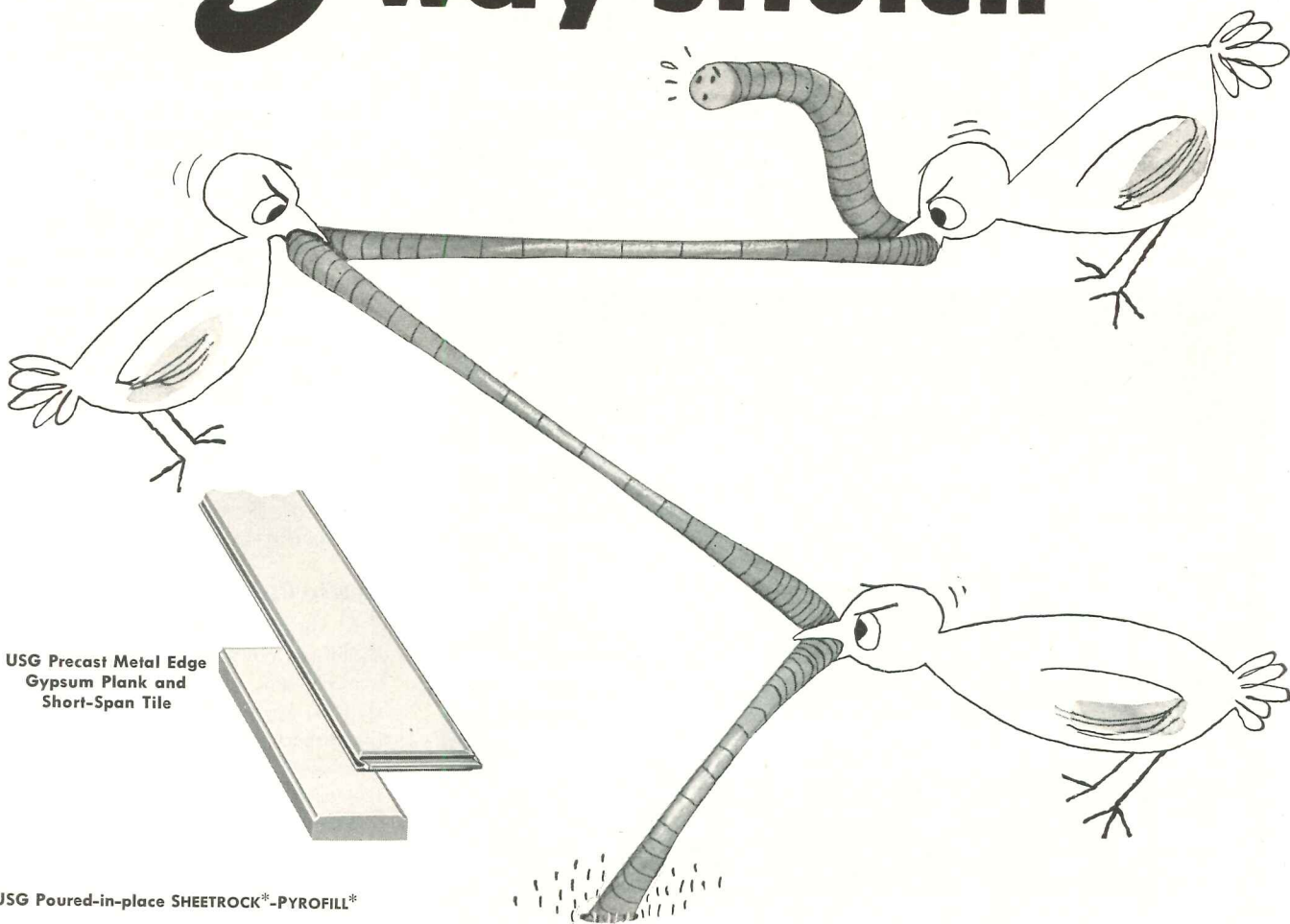

USG Precast Metal Edge Gypsum Plank and Short-Span Tile

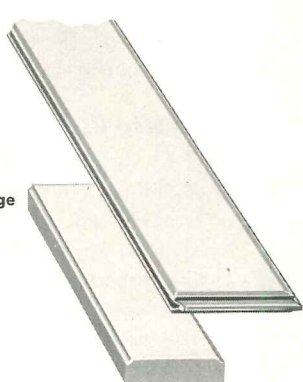

USG Poured-in-place SHEETROCK®-PYROFILL*

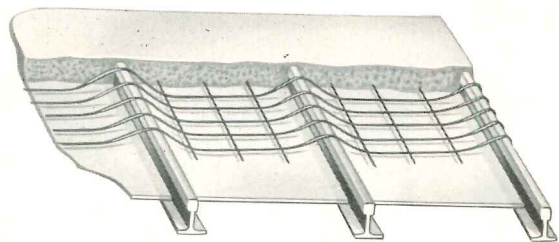

USG Steel Roof Deck



*T. M. Reg. U. S. Pat. Off.

What does "3-way stretch" mean to you, as an architect?

Plenty! . . . for this term suggests the *completeness* of the U.S.G. line of roof decks. With poured-in-place gypsum, precast gypsum and steel deck, the U.S.G. line has the *flexibility* to cover any of your plans, whether they call for a pitched, flat or curved roof.

Your U.S.G. representative will give you complete information about U.S.G. roof decks—phone or write him today. If you have a specific problem, he will gladly go over it with you and come up with a dependable recommendation—one that's completely unbiased *because United States Gypsum offers all three types of roof decks.*

All U.S.G. roof decks are incombustible, lightweight, strong, quickly installed and easy to maintain. Be *sure* of your next roof deck—*consult U.S.G. . . . specify USG.*



United States Gypsum

For Building • For Industry

Gypsum • Lime • Steel • Insulation • Roofing • Paint

THE RECORD REPORTS

need not be a single expanse of glass if the cost were out of line, the principles of good building violated, or the appearance of the house marred.

Building Settlement Studied

The soil mechanics section of the Division of Building Research, National Research Council, Ottawa, is studying the problem of settlement of buildings.

CANADA (Continued from page 212)

In several Canadian cities, compression of foundation soils has caused structural strain and damage. Soils are being analyzed from various areas through consolidation tests; and it is hoped, when more information is available, that their characteristics will be evident through routine tests. A two-unit consolidometer to test samples 2½ in. in diameter is now being built, and construction of apparatus to test

larger samples is already being planned.

A portable water leveling device has also been created and built for use in this important study, and early surveys show that levels can be read with this instrument to a precision of 0.01 in.

To learn how much gradual deformation can be withstood by different types of structures, a survey is to be conducted, checking the condition and age of buildings, and the amount of settlement they have undergone.

P.Q.A.A. Launches Talk Series

Problems of traffic and transit as they affect town planning and building formed the subject of the first of a series of evening talks planned by the Province of Quebec Association of Architects at the Arts Club of Montreal.

The speaker was C. E. Campeau, master plan engineer of the City Planning Department and secretary to the Board of Research on Traffic and Transportation Problems.

Revise Building Code

A simplified and revised National Building Code for smaller areas has been worked out and will be distributed shortly, according to an announcement by Robert F. Legget, director of the division of Building Research, National Research Council.

This is the first step in the big job of revising the entire code in the light of present-day construction methods and materials.

(Continued on page 216)

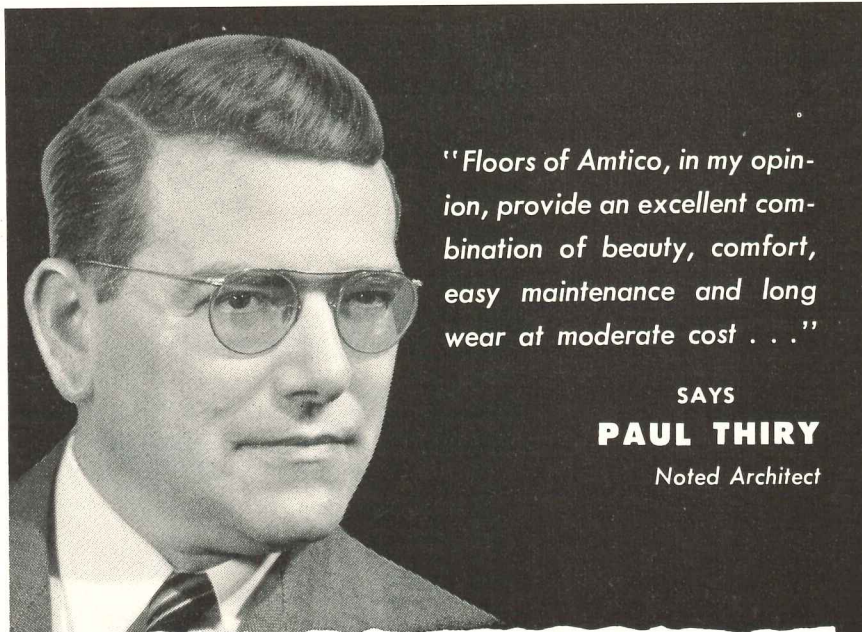

"Floors of Amtico, in my opinion, provide an excellent combination of beauty, comfort, easy maintenance and long wear at moderate cost . . ."

SAYS

PAUL THIRY

Noted Architect

AMTICO is first choice of many architects for durability, easy maintenance, comfort, quiet, fire-resistance and design flexibility. Twenty-two smart stock colors; color matching on special orders. AMTICO is the product of specialists in rubber flooring exclusively who have spent 30 years bringing it to its present perfection.

SAMPLES ON REQUEST

A free box of 4" x 4" samples of Amtico in standard 1/8" gauge and all 22 colors sent, with illustrated literature, on request. (Write Dept. AR-3)

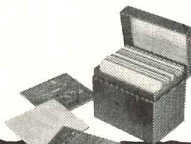

Amtico
RUBBER FLOORING

AMERICAN TILE & RUBBER COMPANY, TRENTON 2, N. J.

In Canada—American Tile & Rubber Co., Ltd., Sherbrooke, Quebec

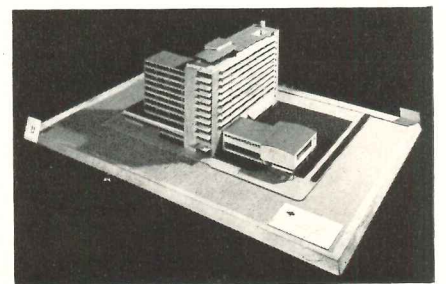
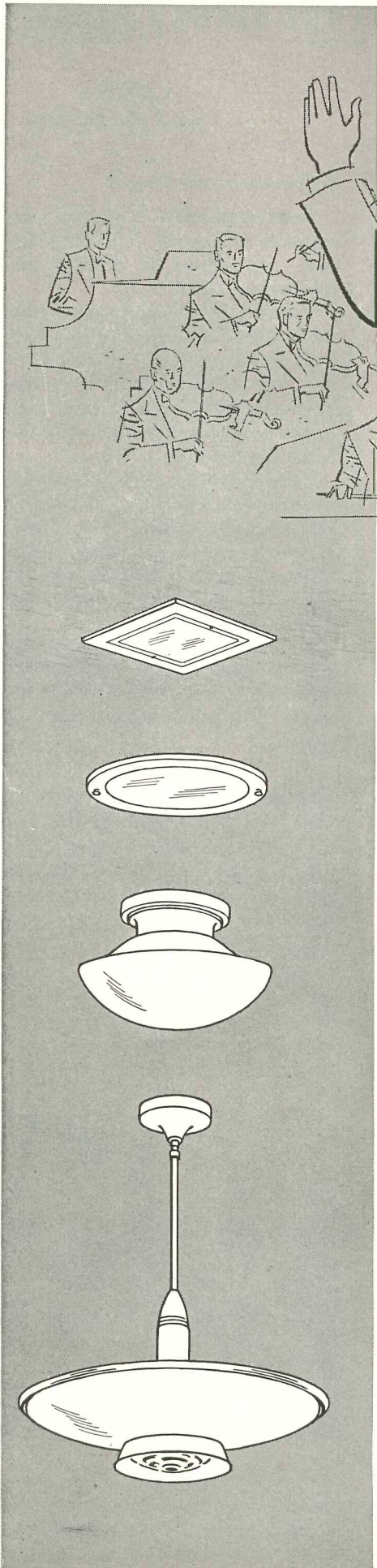

Photo: Eaton's College Street

Photo above shows model of hotel for London, Ontario, designed by Edward Hagarty. The model is one of a group of architectural students' models currently on display at Eaton's Department Store in Toronto. They are the work of the first graduating class of student veterans at the School of Architecture, University of Toronto. The 28 projects in miniature range from a city hall to a zoo, from a television station to a yacht club. The exhibit has been the focus of wide interest



**You strive for harmony, too . . .
you can achieve it with**

UNIFIED LIGHTING

Because harmony in architectural design is so essential to a pleasing result, architects and engineers quickly appreciate the advantages of Unified Lighting.

Unified Lighting is a broad grouping of lighting equipment meeting all commercial applications . . . suitable to the varying needs of different locations . . . yet each unit harmonizes in style characteristics and in finish to blend into conformity of design.

Send today for the Art Metal Catalog containing concise and pertinent engineering information.

Write to:

THE ART METAL COMPANY • CLEVELAND 3, OHIO

Manufacturers of Unified Lighting Equipment for Office, Store, School, Hospital and Hotel

WHAT UNIFIED LIGHTING IS

It's a complete line of fluorescent and incandescent lighting equipment, the symmetry of style and finish relating each harmoniously with the other.

Now Weisway Cabinet Showers in

5 COLORS and White

INCLUDING RECEPTOR AS WELL AS WALLS



Now you can meet your clients' individual tastes in bathroom planning by specifying Weisway Cabinet Showers in gleaming colors which harmonize with other colored bathroom fixtures.

Weisway colors are

- Camellia
- Mist Blue
- Ivory
- Spring Green
- San-Tan
- White

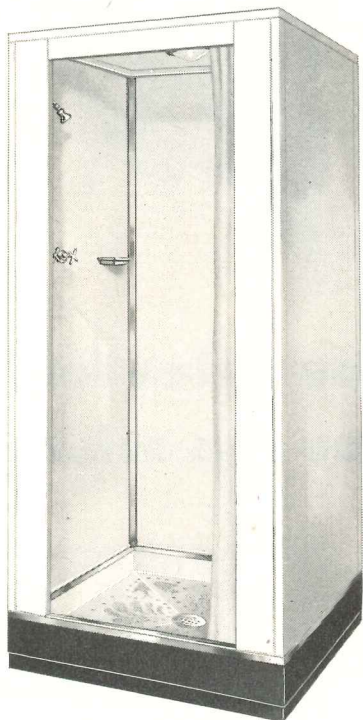

Weisway

CABINET SHOWERS

The trend to color in all bathroom fixtures and the rapidly growing demand for separate shower baths can both be met by specifying Weisways — the *quality-built* Cabinet Showers.

Complete Weisway cabinets, including the exclusive Foot-grip, No-Slip vitreous porcelain floor, are now offered in a selection of appealing colors — chosen after careful study of public preference as revealed in the actual purchase of bathroom fixtures.

Your reputation is safe when you specify Weisways — safe as to quality, safe as to installation, with nothing left to chance at the job site; safe as to client satisfaction through the years. Many thousands of Weisway owners have testified to this satisfaction during the past 25 years.

Mail Coupon Now FOR NEW CATALOG IN COLOR

Contains detailed information and specifications on the complete Weisway line, including samples of the five sparkling colors in which Weisways are now available. This new catalog should be in your files — mail coupon or write for it now!

HENRY WEIS MFG. CO., INC.
503 Weisway Building, Elkhart, Indiana
 Please send your new catalog of the complete line of Weisway Cabinet Showers.
 Individual _____
 Firm name _____
 Address _____
 City _____ State _____

THE RECORD REPORTS

CANADA
 (Continued from page 214)

In Builders We Trust?

The United States is to erect a new consulate on Toronto's University Avenue — and without the formality of a city building permit.

Normally, plans must be approved by the buildings department before a permit is issued and construction can begin. But Washington requested the unique privilege in this case on the ground that certain secret features will be embodied in the new consulate.

Uncle Sam didn't get his way without an argument. Buildings Commissioner Kenneth Gillies huffed, "How are they going to keep the builders from knowing what goes into the building? Are the builders to be considered more loyal than civic employees?"

But Toronto's Board of Control conceded that among 7000 civic employees there might be a disloyal few — and the U. S. Government now needs no permit.

Engineering Graduates Seen Likely to Top 1949 Record

Figures collected by the Ministry of Labor suggest that 1950 engineering graduates will be even more numerous than in record-breaking 1949, when there were 3200 graduates.

Questionnaires have been sent to about 10,000 employers in an effort to find suitable jobs for this year's graduates. Wider canvassing of smaller firms is expected to turn up new openings.



Above: Photo of rendering of city hall for Peterborough, Ont. The all-stone building is designed in T-shape. Marani and Morris of Toronto, Ont., are architects

Nothing heats better than Modine Convector. Radiation . . . NOTHING LOOKS MORE BEAUTIFUL IN A BEAUTIFUL ROOM



Design and Mechanical Patents Pending

To find out why the new Modine Convector is the *better* way to heat apartments, homes, schools, offices or hospitals, call your Modine Representative. He's listed in the "Where-to-Buy-it" section of your phone book. Ask to see a sample, or write direct. Modine Mfg. Co., 1510 Dekoven Avenue, Racine, Wisconsin.

Send for New Modine Convector Catalog Today!



Modine CONVECTORS

R-1061

R
The Richmond Fireproof Door Co.

Industrial and commercial door service for:

- large
- medium
- small
- light
- heavy
- steel
- aluminum
- wood
- glass

Richmond automatic fire doors and hardware	1
Richmond hollow doors	2
Richmond industrial steel doors	3
Richmond unit steel frames	4

how much

1 Richmond automatic fire doors 169

Richmond automatic fire doors

Richmond automatic fire doors are available in a variety of sizes and finishes to meet the needs of any building. They are constructed of heavy steel and are fireproof to the extent that they will protect the contents of a building for a period of one hour.

Application

Richmond automatic fire doors are used in a wide variety of buildings, including hotels, hospitals, schools, and government buildings. They are also used in industrial plants and warehouses.

Construction

Richmond automatic fire doors are constructed of heavy steel and are fireproof to the extent that they will protect the contents of a building for a period of one hour. They are also equipped with a self-closing device which will automatically close the door in the event of a fire.

Specifications

Richmond automatic fire doors are available in a variety of sizes and finishes to meet the needs of any building. They are constructed of heavy steel and are fireproof to the extent that they will protect the contents of a building for a period of one hour.

1 Richmond automatic fire doors 169

Richmond automatic fire doors

Richmond automatic fire doors are available in a variety of sizes and finishes to meet the needs of any building. They are constructed of heavy steel and are fireproof to the extent that they will protect the contents of a building for a period of one hour.

Application

Richmond automatic fire doors are used in a wide variety of buildings, including hotels, hospitals, schools, and government buildings. They are also used in industrial plants and warehouses.

Construction

Richmond automatic fire doors are constructed of heavy steel and are fireproof to the extent that they will protect the contents of a building for a period of one hour. They are also equipped with a self-closing device which will automatically close the door in the event of a fire.

Specifications

Richmond automatic fire doors are available in a variety of sizes and finishes to meet the needs of any building. They are constructed of heavy steel and are fireproof to the extent that they will protect the contents of a building for a period of one hour.

2 Richmond hollow doors 169

Richmond hollow doors

Richmond hollow doors are available in a variety of sizes and finishes to meet the needs of any building. They are constructed of heavy steel and are fireproof to the extent that they will protect the contents of a building for a period of one hour.

Application

Richmond hollow doors are used in a wide variety of buildings, including hotels, hospitals, schools, and government buildings. They are also used in industrial plants and warehouses.

Construction

Richmond hollow doors are constructed of heavy steel and are fireproof to the extent that they will protect the contents of a building for a period of one hour. They are also equipped with a self-closing device which will automatically close the door in the event of a fire.

Specifications

Richmond hollow doors are available in a variety of sizes and finishes to meet the needs of any building. They are constructed of heavy steel and are fireproof to the extent that they will protect the contents of a building for a period of one hour.

2 Richmond hollow doors 169

Richmond hollow doors

Richmond hollow doors are available in a variety of sizes and finishes to meet the needs of any building. They are constructed of heavy steel and are fireproof to the extent that they will protect the contents of a building for a period of one hour.

Application

Richmond hollow doors are used in a wide variety of buildings, including hotels, hospitals, schools, and government buildings. They are also used in industrial plants and warehouses.

Construction

Richmond hollow doors are constructed of heavy steel and are fireproof to the extent that they will protect the contents of a building for a period of one hour. They are also equipped with a self-closing device which will automatically close the door in the event of a fire.

Specifications

Richmond hollow doors are available in a variety of sizes and finishes to meet the needs of any building. They are constructed of heavy steel and are fireproof to the extent that they will protect the contents of a building for a period of one hour.

3 Richmond industrial steel doors 169

Richmond industrial steel doors

Richmond industrial steel doors are available in a variety of sizes and finishes to meet the needs of any building. They are constructed of heavy steel and are fireproof to the extent that they will protect the contents of a building for a period of one hour.

Application

Richmond industrial steel doors are used in a wide variety of buildings, including hotels, hospitals, schools, and government buildings. They are also used in industrial plants and warehouses.

Construction

Richmond industrial steel doors are constructed of heavy steel and are fireproof to the extent that they will protect the contents of a building for a period of one hour. They are also equipped with a self-closing device which will automatically close the door in the event of a fire.

Specifications

Richmond industrial steel doors are available in a variety of sizes and finishes to meet the needs of any building. They are constructed of heavy steel and are fireproof to the extent that they will protect the contents of a building for a period of one hour.

4 Richmond unit steel frames 169

Richmond unit steel frames

Richmond unit steel frames are available in a variety of sizes and finishes to meet the needs of any building. They are constructed of heavy steel and are fireproof to the extent that they will protect the contents of a building for a period of one hour.

Application

Richmond unit steel frames are used in a wide variety of buildings, including hotels, hospitals, schools, and government buildings. They are also used in industrial plants and warehouses.

Construction

Richmond unit steel frames are constructed of heavy steel and are fireproof to the extent that they will protect the contents of a building for a period of one hour. They are also equipped with a self-closing device which will automatically close the door in the event of a fire.

Specifications

Richmond unit steel frames are available in a variety of sizes and finishes to meet the needs of any building. They are constructed of heavy steel and are fireproof to the extent that they will protect the contents of a building for a period of one hour.

does Sweet's service cost?

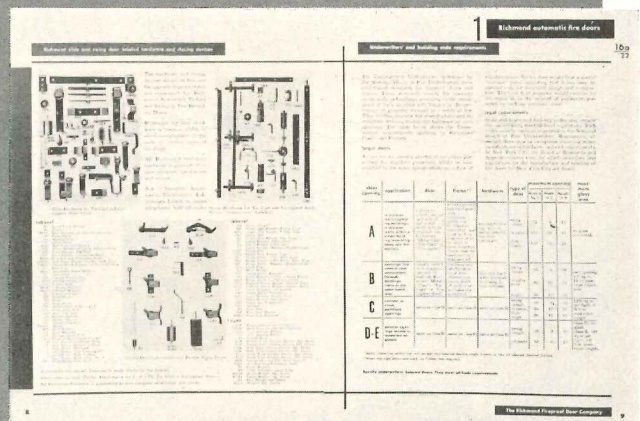
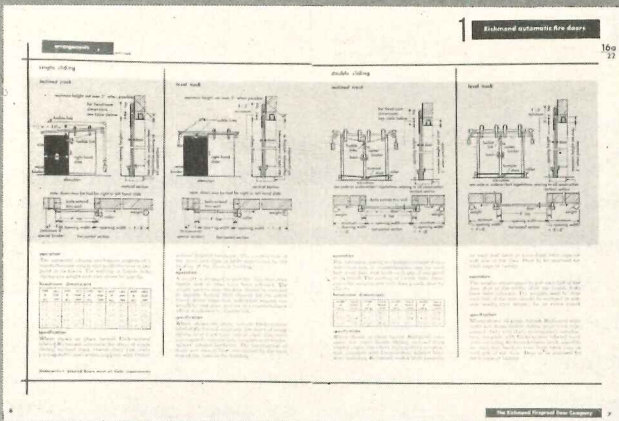

"I'd like to have all manufacturers put adequate catalogs in Sweet's File — but it must cost them a pile of money."

We have heard that from a number of architects. Maybe you have had the same idea.

The cost of Sweet's service is surprisingly low, especially when you consider that the charges include catalog preparation, printing, filing, distribution and a year's maintenance in recipients' offices.

For example, a manufacturer can have Sweet's design, produce and deliver 17,000 copies of a 20-page, two-color catalog in Sweet's File, Architectural, for 27 cents a copy. If he wishes Sweet's to distribute additional copies to other groups in the building

field, the cost per copy is substantially lower. The same economy applies proportionately to smaller or larger catalogs.

In most cases, Sweet's service charges compare favorably with the many cost items involved in individual handling. The important point is that the manufacturer who employs Sweet's has the assurance that every copy of his catalog is always instantly accessible in the right place. Thus he serves your convenience and at the same time, his own interests.

Under Sweet's plan of distributing manufacturers' catalogs in bound files, everybody gains.

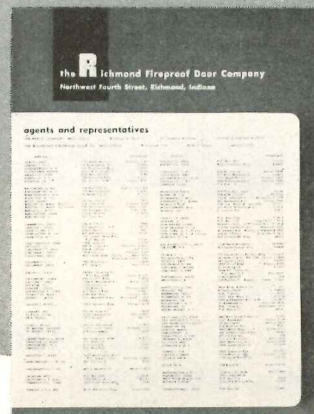
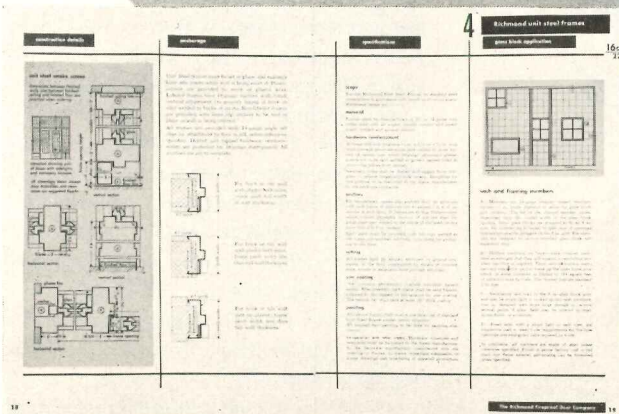

Sweet's Catalog Service

division of
F. W. Dodge Corporation
119 west 40 street, N. Y. 18

PRODUCTS

(Continued from page 167)

Portable Electric Plant

Designed for applications needing a portable source of electric power, the *Onan Model O4AH* electric generating plant is said to operate for five hours on a single gallon of gasoline. The unit is 400 w, 60 cycle, a-c, and is adapted and equipped to operate low-wattage, motor driven equipment. The manufac-

turers recommend it for lighting and for appliances in homes, stores, trailers, farms, etc, located in rural areas. The generating plant is 19 in. long, 14¼ in. wide and 16¼ in. high. The units are available in manual or remote starting models. D. W. Onan & Sons, Inc., 498 Royalston, Minneapolis, Minn.

Prediction of Building Acoustics

According to scientists at Armour Research Foundation of Illinois Institute of Technology, prediction of acoustics of a structure before it is built is now

possible through ultrasonics. The method was used in a study of future acoustical properties in the new music pavilion, designed by Holabird, Root and Burgee, to be built this spring for the Ravinia Festival.

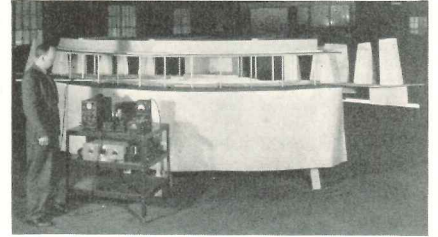

Ultrasonic sound tests on scale model predict acoustics of proposed structure

When You Design for Efficiency . . .

all of your experience, training and skill are put to use. You make every effort to avoid waste . . . in motion, in time, in the materials to be handled and utilized within your structure. You achieve this same efficiency in flow control when you specify **KENNEDY Valves**. Since 1877 they have been recognized by major valve users for their uniformly high quality, long life, and dependable performance. Write for the complete catalog.

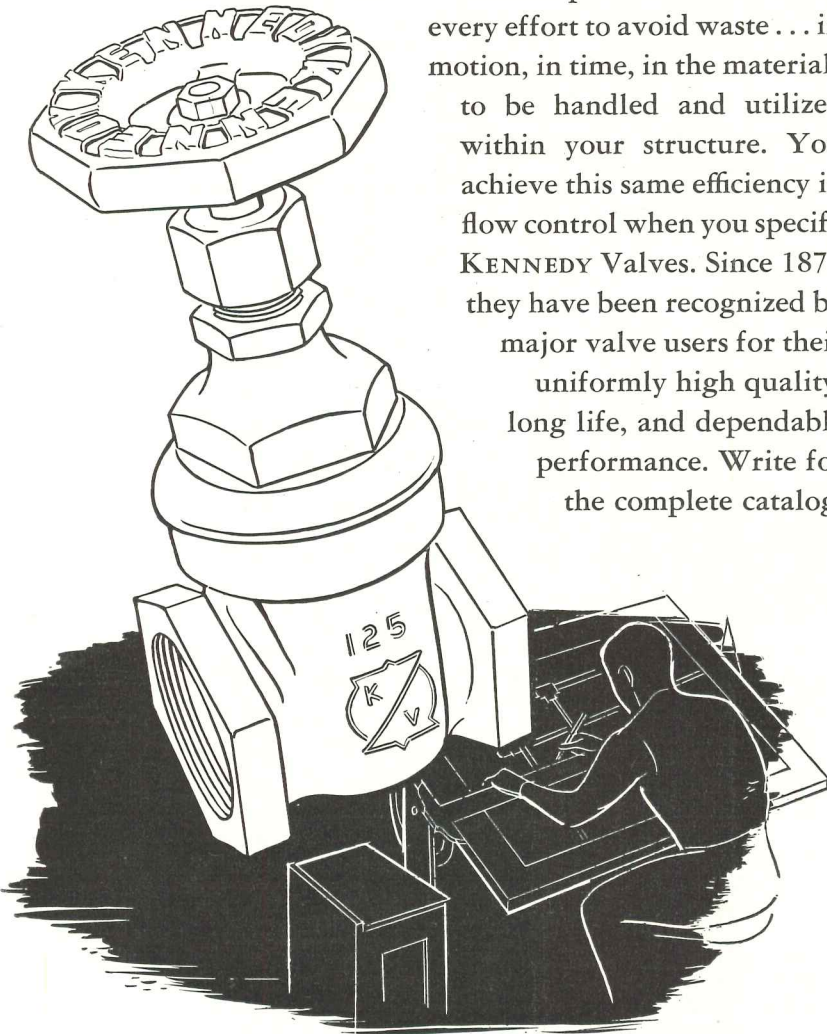

Established 1877

The KENNEDY VALVE MFG. CO.
ELMIRA, NEW YORK

VALVES • PIPE FITTINGS • FIRE HYDRANTS

The studies were based on the theory that the use of sound waves in proportion to the size of a scale model would give accurate acoustical information. A scale model 1/20 the size of the proposed pavilion was used with ultrasonic test sounds 20 times the frequency of an average orchestra's music. To simulate the sound absorbing qualities of an audience, a blanket of superfine glass wool was crumpled over the auditorium area. An intermittent, ultrasonic note was emitted from the band shell and tested throughout the pavilion by a microphone on the end of a pole. The spread of sound, reverberation and echoes were checked in turn. In general, the tests proved the structure to have very satisfactory acoustics, but led to the design of curved surfaces for the sides of the bandshell to divert more sound to the far edges. Illinois Institute of Technology, 3300 S. Federal St., Chicago 16, Ill.

Decorative Fabrics

The designers of a new line of modern printed fabrics, the *Campagna Collection*, were chosen to represent various geographical areas of the U. S. in such fields as architecture, engineering, interior design and sculpture. These designers include: Paul Rand, graphic designer; Dr. A. J. Durelli, engineer; Jens Rison, furniture designer; Paul Thiry, architect; Elsie Krummeck, interior designer and sculptor; Serge Chermayeff, architect; Don Smith, designer; and Alvin Lustig, designer. All designs will be exclusive with the Campagna Collection. L. Anton Maix, Inc., 162 E. 59th St., New York, N. Y.

(Continued on page 222)

WORTHINGTON

AIR CONDITIONING REPORT

WORTHINGTON PUMP AND MACHINERY CORPORATION
HARRISON, NEW JERSEY

Specialists in air conditioning
and refrigeration
for more than 50 years

We're Part of the HOSPITALITY at the Westward Ho

If ever the name of a hotel suggested an invigorating atmosphere, it's the spectacular Westward Ho in Phoenix.

Internationally famous as a resort hotel, the Westward Ho gives its guests the year-'round comfort of air conditioning, furnished by Worthington equipment.

Five years ago, when the hotel wished to expand its air conditioning,

a Worthington centrifugal compressor was installed, with the original unit put aside for stand-by service.

Last year, an annex to the hotel was built, and Worthington equipment was again selected: two Freon reciprocating compressors and one condenser.

Distributor: Frank Harmonson Co., Phoenix.

Worthington Makes a Hit in Sangamo's Auditorium



Auditorium in plant of Sangamo Electric Co., a leading manufacturer of electric measuring and control equipment, Springfield, Illinois.

The modern auditorium built by Sangamo Electric Corporation to be used as a meeting place for employee training courses, sales conferences, and employee organizations, provides the year-'round comfort of Worthington air conditioning.

The equipment, installed by Henson Robinson Co. of Springfield, Ill., includes a 3HF6 Freon-12 compressor, an AVY air conditioning unit, and an ECZ evaporative condenser. The system is rated at 15 tons and handles 4500 cfm. 95% of the condenser water is saved for re-use.

Here's how the system operates. A single off-on wall switch controls the entire system, with inter-locks for proper sequence of operation. A room-type cooling thermostat actuates a solenoid valve in the Freon liquid line. A heating thermostat actuates a modulating-type steam valve and modulating-type motor connected to air conditioning face and by-pass damper.

A manual modulating-type control and motor secure the desired mixture of fresh and recirculated air entering the unit (maximum 3000 cfm). Automatic change-over from heating to cooling cycle, or vice versa, is provided.

In order to prevent freezing of water in the evaporative condenser, located in the equipment room, a duct arrangement with temperature controller and damper motor was installed. This insures trouble-free operation when outside temperature falls below 35 F, since the evaporative condenser supply air is taken from the equipment room.

Westward Ho is Phoenix' largest hotel. It is completely Worthington-conditioned.



La Mina Room, one of the several dining rooms in the Westward Ho.

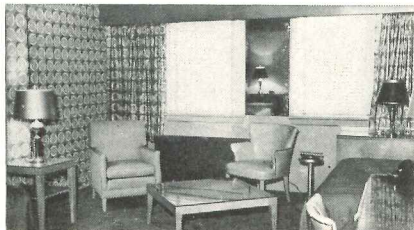

Cool, comfortable air, Worthington-supplied, adds to the charm of this typical suite in the Westward Ho annex.

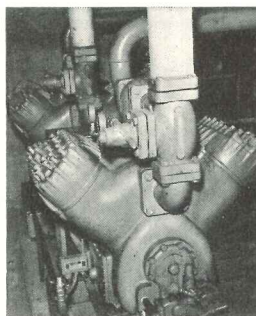

Two Worthington Freon-12 6HF4 Compressors installed in the new annex.

Now They Trade in Comfort on the New Orleans Exchange

New Orleans Cotton Exchange—completely air-conditioned by Worthington.

Consulting Engineers—Leo S. Weil and Walter B. Moses.

Contractor—Mayer Godchaux



During its nearly 80 years, The New Orleans Cotton Exchange has undoubtedly observed many scenes of feverish trading, but since 1948 the air, at least, has maintained a moderate temperature.

Worthington centrifugal refrigeration makes the difference. The Worthington system has a capacity to cool 420 gpm of water from 55.6 F to 46 F when supplied with 545 gpm of condensed water at a maximum of 87 F. Capacity rating for the entire system is 160 tons.

WORTHINGTON



AIR CONDITIONING AND REFRIGERATION

A complete line . . . in which all the vital components are made, not just assembled by Worthington. For more worth with Worthington, see your nearby Worthington distributor (consult Classified Telephone Directory).

PRODUCTS
(Continued from page 220)

Wall Covering

A new vinyl plastic wall covering, *Wonder Wall*, is reported to be flexible, smooth and easy to handle, and to be resistant to abrasion, wear, alcohol, alkali and stain. The material is available in eight colors, 10 pastel tints and two wood grains: Prima Vera in blonde,

gray, tan, dark and mahogany; Walnut in blonde, dark and gray. *Wonder Wall* is said to be easily installed around inside or outside corners. Plastic Division of Pulpaper Co., 52 Vanderbilt Ave., New York 17, N. Y.

Plywood From Wood-Waste

Novopan three-ply panels made from wood waste are said to have many of the properties of plywood. The shavings from which panels are made reportedly give the product great strength and dimensional stability as well as pleasant

appearance. *Novopan* is a composite board of three layers, two surface layers of wood shavings and the core of wood chips. These are impregnated with resin and finished in hot plate presses. Panels can be made in thicknesses from $\frac{5}{16}$ to $\frac{1}{4}$ in. and in sizes of 4 by 8 ft or 6 by 12 ft. The material can be worked into curved shapes, can take nails and screws easily, and can be cut, sawed, sanded, planed and painted. Its use is indicated for furniture, panels, doors, as a flooring when faced with oak, and as an inexpensive core for thick plywood. United States Plywood Corp., Weldwood Bldg., 55 W. 44th St., New York 18, N. Y.

Built In Griddle

A new addition to the Thermador Bilt-In Electric Range line, the *Bilt-In Electric Griddle*, is designed to be mounted in existing counter tops as an auxiliary unit for cooking grilled foods.



Freedom in kitchen planning is permitted by built-in counter-top cooking units

The unit is set in a stainless steel frame 25 in. long by $17\frac{1}{2}$ in. wide. The rough-in box is $23\frac{1}{2}$ in. long, $16\frac{1}{8}$ in. wide, $6\frac{1}{2}$ in. deep. The grid itself is of thick aluminum, ribbed on the underside for even distribution of heat. Flush handles are provided on the grid to simplify removal for cleaning. A removable, recessed grease cup is set in one corner. Heat is provided by ceramic-insulated, nickel chrome wire coils. The switch is a reciprocal type with five heat positions. A neon type indicator light glows whenever the switch is turned on. The unit operates on 2,000 watts, 240 volts, a-c. Thermador Electrical Manufacturing Co., 5119 District Blvd., Los Angeles, Calif.

(Continued on page 226)

**THE
RIGHT
COLOR**

CABOT'S

Collopakes

Write Today for your Cabot Collopakes Color Card. Ask about our special color matching service for architects.



Architect and owner:
Joseph Allen Stein, San Francisco



Architect: Irwin Jones, New York



Architect: Richard A. Morse,
Tucson, Arizona

Cabot's House Paints (Gloss Collopakes) are available in a choice of 32 colors, many unique and obtainable from no other source. These colors have been carefully selected to meet the needs of modern domestic and industrial design. Many of our current standard colors were first manufactured on special order for architects, and therefore have been chosen by the architectural profession itself. Others have been matched to famous buildings or to characteristic regional colors . . . Williamsburg Blue, Moravian Gray.

SPECIAL COLORS FOR ARCHITECTS

In most cases, you will be able to select the right combination for any design in any site from the wide choice offered in our standard colors. If you do not find the shade you require, we will manufacture for you in any quantity colors to match your own specifications. This service is offered to architects at no extra charge.

All colors, standard and special, are manufactured under the patented Collopping process which reduces pigments to submicroscopic size and inseparably unites them with the vehicle. Our laboratory ensures the correct chemical combination of pigments in any color we manufacture.

Samuel Cabot, Inc., 549 Oliver Bldg., Boston 9, Mass.

One of many full color illustrations in *The Color Book Of Tile*. See color schemes, alternate patterns, bathroom accessories, inserts, decorative tiles.

NOW
it's **EASY**
to
Specify
Tile

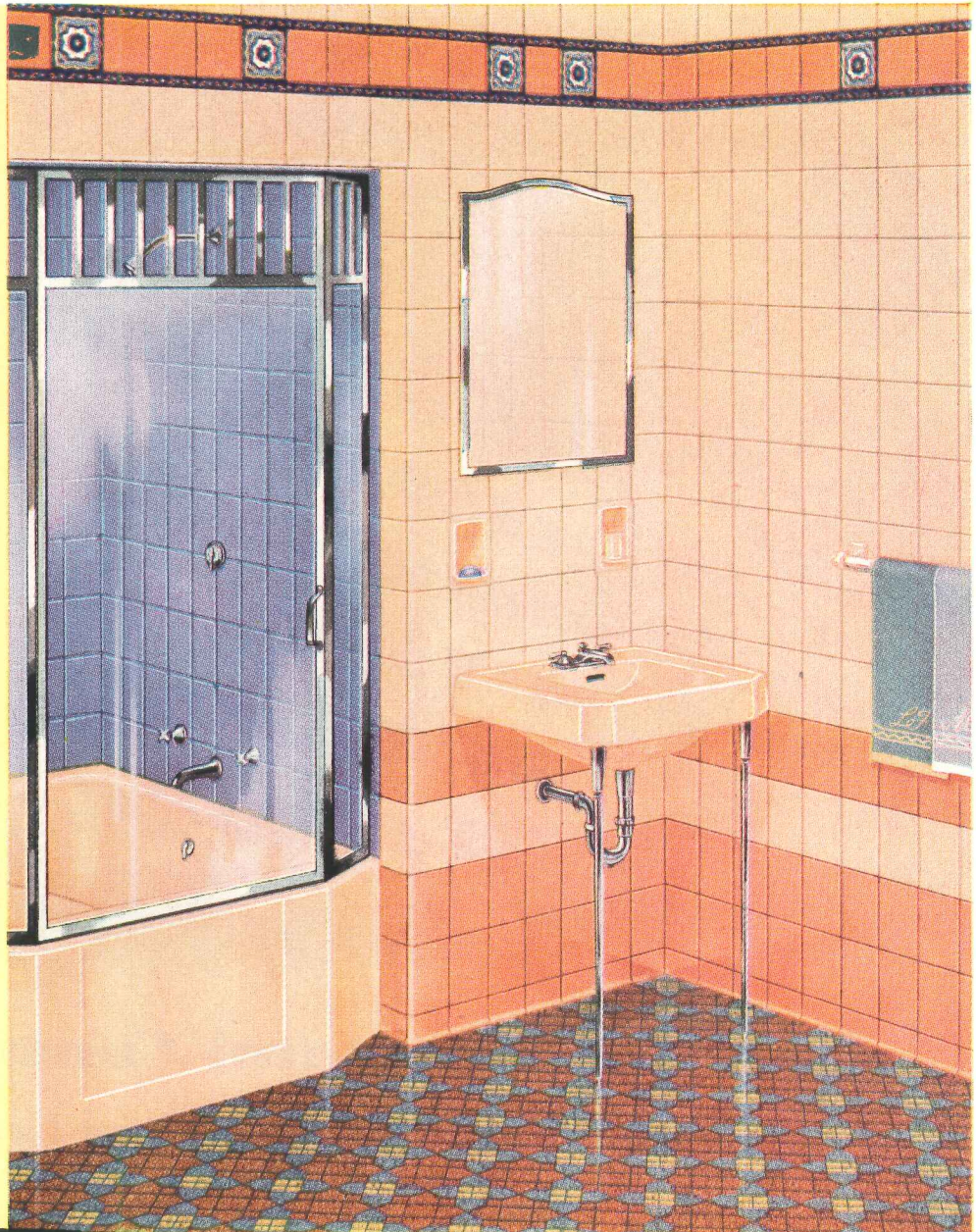

SEE it... in
COLOR

IN THE **NEW** COLOR BOOK OF

TILE

Here now, ready for big and little home planning, are complete bathroom, kitchen, and game room installations in American-Olean's Color Book of Tile.

Here are full color illustrations in easy-to-use form. Tile selections of all kinds are conveniently arranged... offer side-by-side comparison of alternate color and pattern choices.

American-Olean's Color Book of Tile lets your clients visualize the finished installation... lets you plan it by simply copying a 42 word specification (you can choose colors later)... helps the tile contractor satisfy you and your client with exact follow-through of your specifications.

Use The Color Book of Tile for every job. See how easy, how time saving, how sure, specifying tile can be.

American-Olean Tile Company

Executive Offices

925 Kenilworth Ave., Lansdale, Pennsylvania

Free TO EVERY
ARCHITECT

American-Olean Color Book of Tile

The most complete, most helpful tile book ever produced. 100 pages, including 30 full color plates of typical installations, also color charts of wall and floor tile, trim, and hand-decorated inserts. Full architectural data and ready-to-use specifications. If you do not have a copy, or if you need another, write us at once.

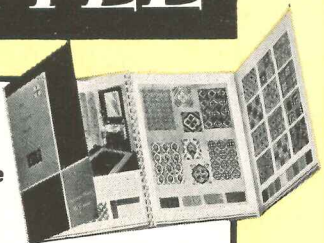

IT'S REAL CLAY TILE

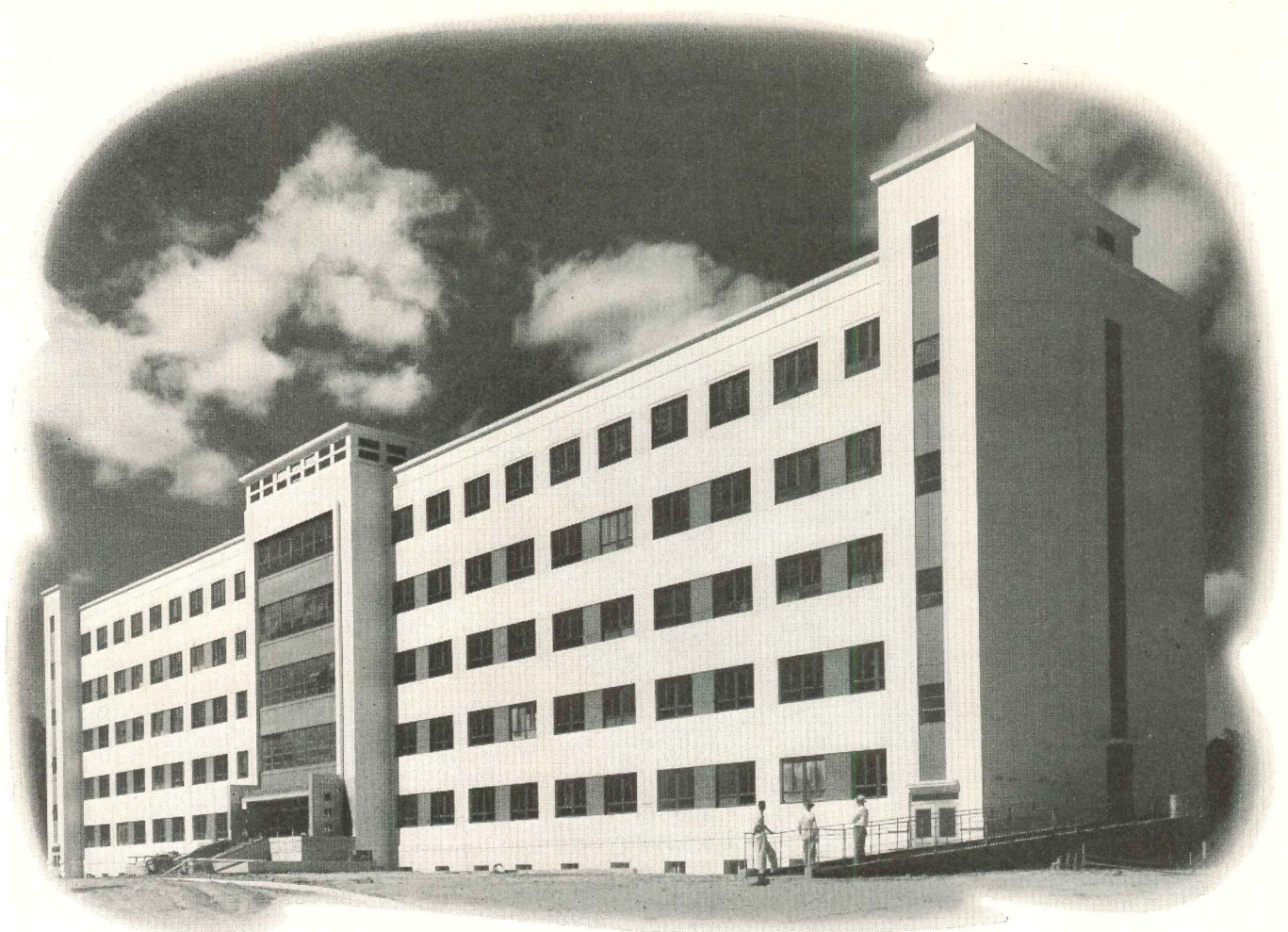

Choose *A*rchitectural Concrete for Individuality, Lasting Beauty and Long Life

MUNICIPAL HOSPITAL in Tallahassee, Fla., illustrated above, is an excellent example of the modern structural beauty that can be achieved by designing in architectural concrete. Structures like this are distinctive in appearance yet their imposing character and individuality is only the outward mark of the many other desirable qualities of architectural concrete.

Architectural concrete structures are firesafe. Being moderate in first cost and requiring little maintenance over a long life, they render true **low-annual-cost** service.

Besides being ideal for clean, sanitary and easy-to-care-for hospitals, architectural concrete is equally adaptable for apartments, schools, public buildings, theaters, factories, stores and commer-

cial structures. It has great strength and unusual durability, yet can be molded economically into either bold or delicate ornamentation of any style.

By applying the time-tested principles of quality concrete construction architects can design long-lasting architectural concrete buildings with every assurance of lasting satisfaction to client, investor, taxpayer and designer alike.

For helpful information in obtaining quality concrete structures write for free, 70-page booklet, "*Design and Control of Concrete Mixtures.*" Distributed only in the United States and Canada.

Municipal Hospital, Tallahassee, Fla., is a five-story, 150-bed structure, 48 x 284 ft. in size. Yonge & Hart, architects and engineers; Southern Builders, Inc., contractor.

P O R T L A N D C E M E N T A S S O C I A T I O N
DEPT. 5-8, 33 WEST GRAND AVENUE, CHICAGO 10, ILLINOIS
A national organization to improve and extend the uses of portland cement and concrete through scientific research and engineering field work

Here's the
LOCK & LATCH SPEC.

that goes over big with cost-conscious, quality-minded . . .

- HOME OWNERS
- BUILDERS
- CONTRACTORS

*Corbin tubular
locks & latches
throughout the house*

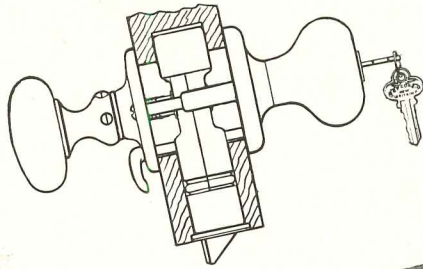

NOW

A complete line of budget-priced **CORBIN** QUALITY TUBULAR locks and latches . . . REVERSIBLE . . . for right and left-hand doors . . . opening IN or OUT.

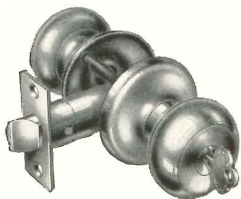

FOR EXTERIOR DOORS No. 320 Series
Operates by knob from either side and by key from outside when locked by inside lever.

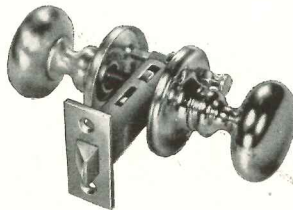

BATH - BEDROOM SET No. 359
Privacy locking button, inside — with emergency entrance feature, outside.

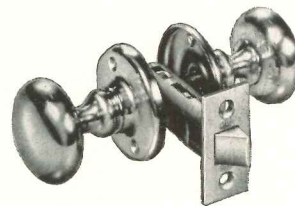

INSIDE LATCH SET No. 345
Operates by knobs from either inside or outside.

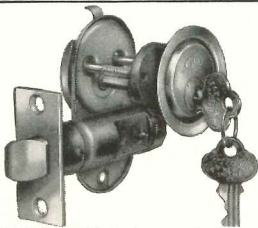

STANDARD NIGHT LATCH for doors opening IN No. 646
Functions by key from outside and thumb knob from inside. Inside slide lever holds bolt retracted.

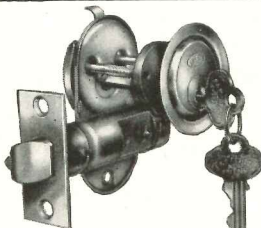

STANDARD NIGHT LATCH for doors opening OUT No. 646 1/2
Operates same as No. 646 except that it features Auxiliary Latch protection.

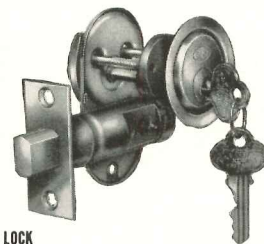

DEAD LOCK No. 650
Operates by key from outside and turn knob inside.

- Distinctive finishes on enduring brass or bronze.
- Cast brass cylinder 5-pin tumbler protection. May be MASTERKEYED if desired.
- Choice of attractive metal or glass knobs to match inside trim.

P. & F. Corbin

DIVISION
THE AMERICAN HARDWARE CORPORATION
New Britain, Connecticut

GOOD BUILDINGS DESERVE GOOD HARDWARE



PRODUCTS
(Continued from page 222)

All-Weather Conditioner

The *Bryant Model 576 All-Weather Conditioner* is designed to provide summer cooling and automatic control of humidity, as well as automatic gas heating during cold weather. The unit is equipped with special controls consisting of thermostat, humidistat, and a

"manual" to "automatic" ventilation switch. The blower alone operates on temperate days; blower and refrigeration unit on hot days; blower, refrigeration unit and heat exchanger on humid days; blower and heat exchanger on cool days; and blower and heating unit at full capacity on cold days. Maximum heating capacity is 150,000 Btu per hour input. Water supply can be either from city mains, well or cooling tower. Bryant Heater Div., Affiliated Gas Equipment, Inc., 957 Saw Mill River Road, Yonkers 2, N. Y.

Roller Screens

Screen-O-Matic is a disappearing window screen, designed for permanent installation. The unit consists of a length of plastic screen attached to an aluminum roller which is installed

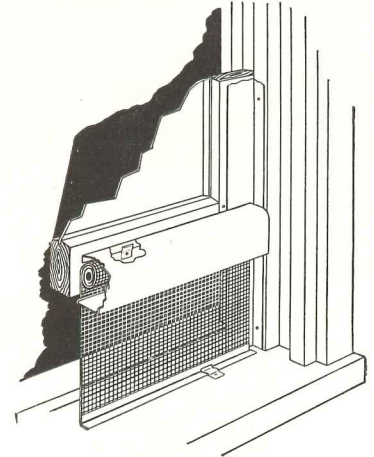

Plastic screen automatically rolls into housing as window is lowered, appears in place as window is raised

**The FUME HOOD
of the FUTURE ..
is Yours Today**

**Kewaunee's New
LOW VELOCITY
FUME HOOD for
Handling RADIO-
ACTIVE ISOTOPES**

Design Approved for Use
by the OAK RIDGE
INSTITUTE of
NUCLEAR STUDIES

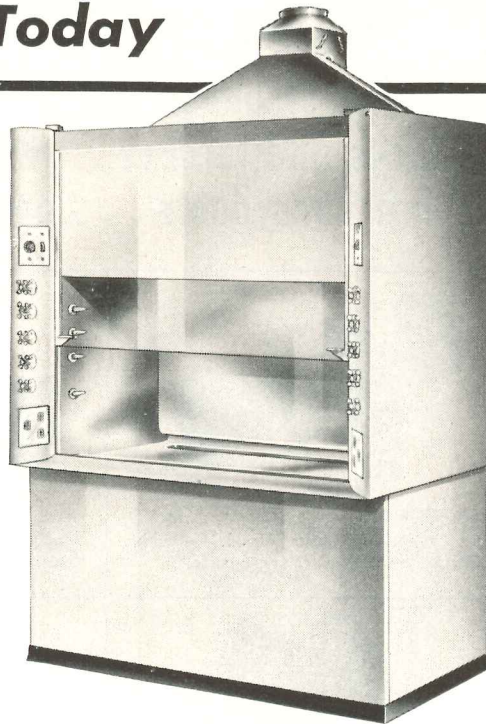

No. 3600—Kewaunee's
"FUME HOOD of the FUTURE"

The Hood is made with stainless steel interiors and ducts throughout and incorporates a stainless steel working surface and trough. The working surface will support a load of 4,000 pounds. The Hood incorporates a new system of airfoils, baffles and ducts which provides a uniform flow of air over the entire face of the Hood, thus assuring evacuation of gases at extremely low velocities without interference from reverse eddies or turbulence. No auxiliary duplicate duct system for incoming air is required.

Write for Descriptive Literature and Drawings available now on
Kewaunee No. 3600—"The Fume Hood of the Future"



C. G. Campbell, President

Representatives
in Principal Cities

5046 S. Center Street Adrian, Michigan
Manufacturers of Wood and Metal Laboratory Equipment

in a compact aluminum housing. This housing is attached to the outside of the bottom rail of a double-hung window sash. The bottom of the screen is attached to the sill by two clips. As the window is raised, the screen unrolls from the housing. The sides are held in aluminum guides. When window is lowered, the screen rolls back into the housing. The screening never covers the window glass, and is said not to rust, stain or require painting. The units are available for all standard double-hung windows in glass sizes from 14 to 46 in. The standard screen length is 28 in. Extra lengths are available. Lockhart Manufacturing Corp., 6350 E. Davison Ave., Detroit 12, Mich.

Shower Head

The *Hydrajet* shower head offers a choice of 5 shower patterns, from a needle spray to a very soft spray, by a simple lever adjustment. The shower head may be adjusted while in operation. The unit is claimed to be ruggedly and simply constructed, low in cost, economical in operation, and designed so that it will not clog or lime-up. It will operate on only 10 lb pressure. Repeal Brass Manufacturing Co., 2109-15 E. 27th St., Los Angeles, Calif.

(Continued on page 228)

BRANCH OF FEDERAL RESERVE
BANK OF SAN FRANCISCO . . .

Seattle, Washington

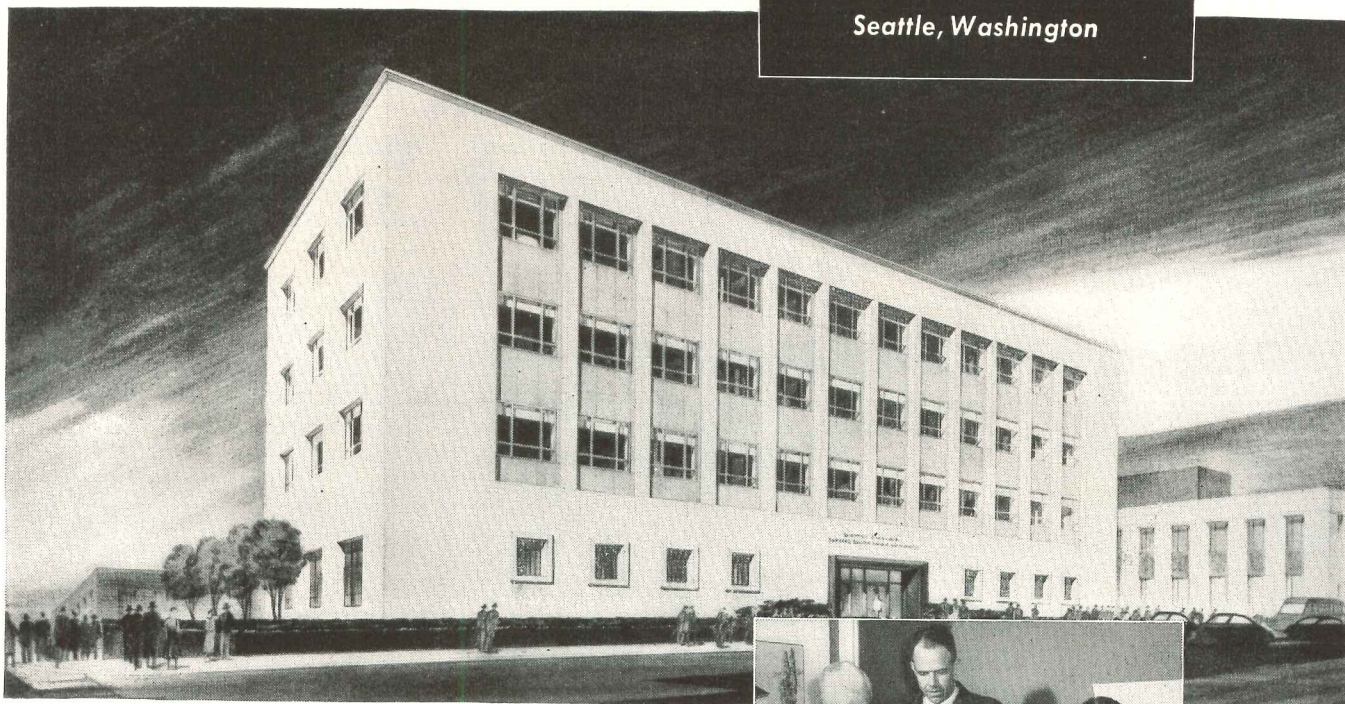

NARAMORE, BAIN, BRADY & JOHANSON, A.I.A.
Architects and Engineers

KUNEY JOHNSON CO., Contractor

Q-FLOORS

add another reserve

Q-Floors give this building a reserve of electrical adaptability sufficient for any number of years, decades or centuries. No matter how the electrical requirements may be complicated and increased, this building will meet the new demand in a matter of minutes and at virtually no cost.

The architects needed no fixed electrical layout; no rigid plan for partitions; no preset inserts. Q-Floors solved all the modern office electrical requirements.

Q-Floors also have structural advantages which, totaled, amount to cash savings, time savings, and a great deal of on-the-job freedom from customary headaches. They result in occupancy from 15 to 20% sooner. Such a consideration translates into appreciable dollar savings for your client.

Are you familiar with all the financial and structural as well as electrical advantages of Q-Floor construction?

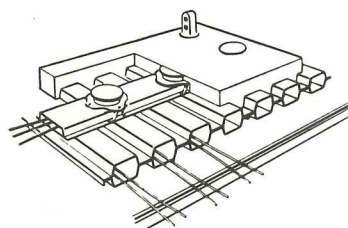

Write for Free Q-Floor Catalog

H. H. ROBERTSON CO.

2404 Farmers Bank Building
Pittsburgh 22, Pennsylvania



Offices in 50 Principal Cities
World-Wide Building Service

PRODUCTS
(Continued from page 226)

Photographic Murals

Full color photographic reproductions for use as murals are available in a choice of four West Coast scenes, 3 ft-4 in. by 5 ft in size, at a very low cost. These *Foto Muralettes* are an addition to a line of wall-sized sepia or black and white photographic murals. The Mural-

ettes are designed to be mounted directly to the wall like wall paper, or to panels of wallboard, plywood, etc., for temporary installation. Each comes equipped with an unpainted mitered frame. Foto Murals of California, 672 S. Lafayette Park Place, Los Angeles, Calif.

Another firm is offering sepia-toned photo murals, also at a low price, in three sizes: 2 ft by 3 ft-8 in.; 3 ft by 4 ft; and 3 ft-4 in. by 5 ft. The murals are available in a choice of 90 stock scenes from throughout the U. S., or

from your own negative if it is 2¼ by 3¼ in. or larger of clear, reproducible quality. Each is printed on portrait paper and mounted on 5/16 in. wallboard, with wall fasteners, ready to hang. The surface is coated with varnish for protection. RCS Studios, 123 N. Wacker Drive, Chicago, Ill.

Steel Sun Shades

Auburn Window Visors are louvered steel awnings designed in stock sizes to fit single windows or windows in a row. A special aligning device is attached to the support arms to permit even line-up of units and close jointing. The louvered panels overlap slightly to admit air and light, keep out rain. The visors are bonderized and coated with a rust-proofing compound. Finish is baked enamel in green, red, blue or neutral gray. Matching door canopies are also available. Auburn Shank Co., Auburn, N. Y.

Sink and Lavatory Faucets

Moen Finger-Tip fixtures feature greatly simplified control operation. A single handle is moved to left or right for hot or cold water mixtures, and is lifted or depressed to turn water on or off. Water can be kept at a constant temperature throughout repeated operations. There are no screw threads or washers in the operating mechanism. All working parts are stainless steel. The faucets are supplied with a variety of spouts, ranging from 4 to 9 in. long. Each comes with an aerator to prevent splashing. All spouts are interchangeable and can be furnished with hose-bib connections. Special spouts are available for doctors' and dentists' needs. The faucets are made with either deck or wall type mountings. Ravenna Metal Products Corp., 6518 Ravenna Ave., Seattle, Wash.

New faucet control-lever is turned on or off a touch of the finger or elbow

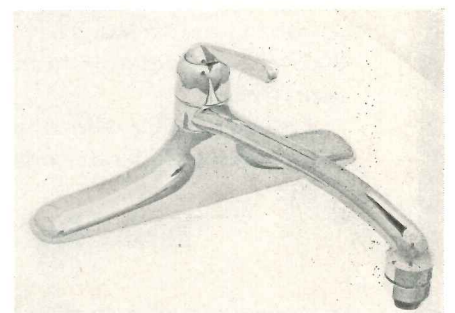

(Continued on page 230)

WEATHER STRIPS FOR SLIDING DOORS

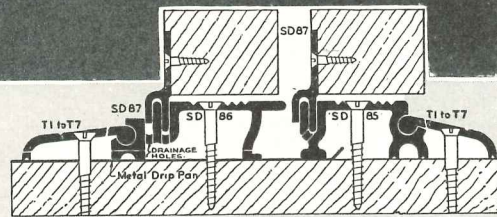
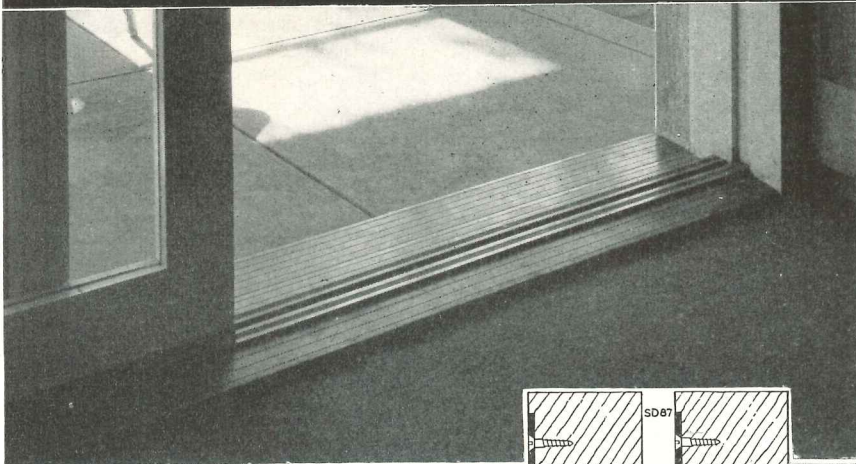

SADDLE NO. 850-A FOR ONE OR TWO PAIRS OF SLIDING DOORS

**MORE
AND MORE
PROPERTY OWNERS WANT
SLIDING DOORS**

Doors that lead outdoors. Doors that need no "swing back" wall space. Doors that are 100% weather and termite proof. *But*, doors that glide open and shut smoothly, quietly, easily.

"Accurate" patented Metal Weather Stripping for sliding doors definitely answers every requirement. All over America, "Accurate" Sliding Door Weather Stripping is the recognized material to do this job *right*.



Write us for working drawings to fit your immediate needs. Or, if you prefer,

ASK FOR ILLUSTRATED FOLDER

ACCURATE METAL WEATHER STRIP CO., Inc.

215 EAST 26th STREET, NEW YORK 10, N. Y.

Announcing the Miller NEW YORKER

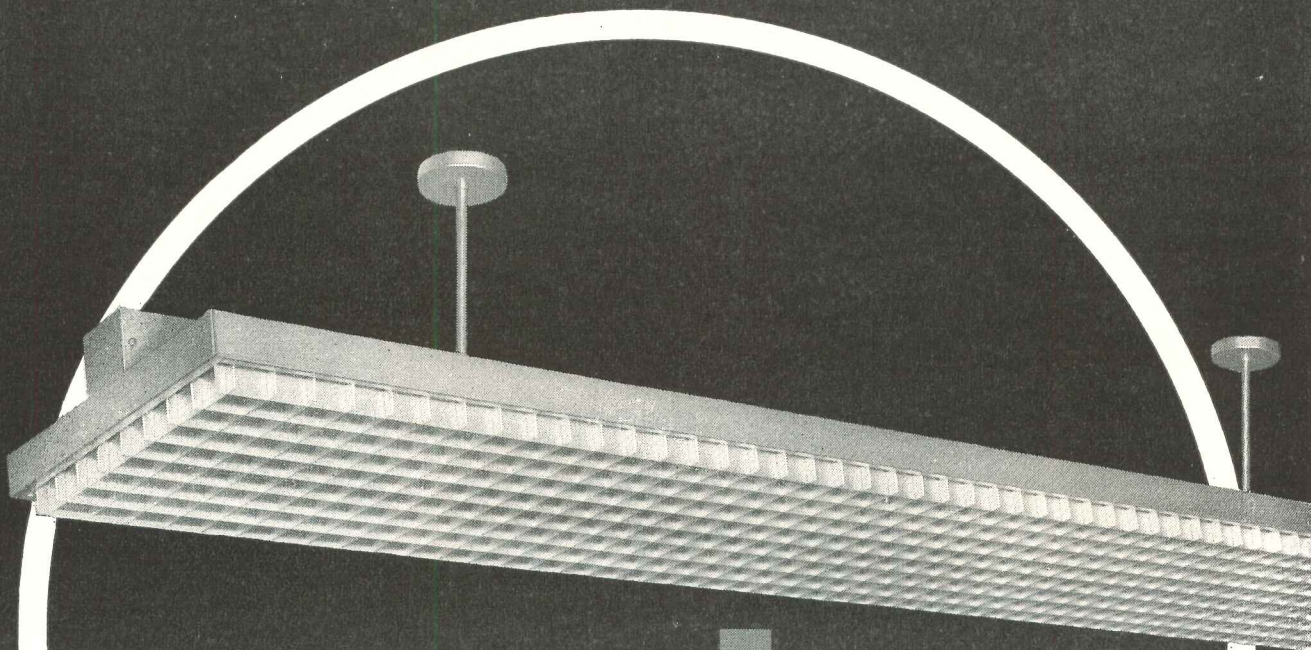

Gene Cook

"Painting Toward Architecture"
—a book about The Miller
Company's collection of abstract
paintings related to architecture.
Leading book stores have it.



The Miller NEW YORKER is today's foremost in fine Fluorescent lighting fixtures. Its new architectural styling places it in a class by itself — lends a distinction to any commercial interior. Rates high in lighting performance. Has engineered construction features that simplify installation and maintenance, and make for **LOW OVERALL COST**. In the 8 foot size — in the 4 foot size — with general line or with Slimline fluorescent lamps — or in combination with the Miller spotlight for accent lighting, it is unquestionably today's finest in fluorescent lighting. Write for the NEW YORKER catalog. Miller engineers and distributors are conveniently located to serve you.

THE miller COMPANY
SINCE 1844

ILLUMINATING DIVISION, MERIDEN, CONNECTICUT

ILLUMINATING DIVISION: Fluorescent, Incandescent, Mercury Lighting Equipment; HEATING PRODUCTS DIVISION: Domestic Oil Burners and Liquid Fuel Devices; ROLLING MILL DIVISION: Phosphor Bronze and Brass in Sheets, Strips and Rolls

PRODUCTS
(Continued from page 228)

Tile Cement

Acorn Thinbed Tile Cement, a new product for setting clay and ceramic tile by the thin setting bed method, is a combination of mineral hardener and a liquid binder, packaged together and job-mixed to form a white waterproof cement. The product is said to crystal-

lize rapidly, permitting quick completion of a job. The cement is further claimed to set hard in any depth, to fill in irregularities of the backing, and to compensate for unevenness of tile thickness.

The material is reported fireproof and not affected by cosmetics, ordinary drugs, food acids and hot utensils. The manufacturers also recommend the product for repairing cracks in concrete floors, stucco, etc. Acorn Adhesive & Supply Co., 1011 W. Eleventh St., Los Angeles 15, Calif.

Wall Vents For Condensation Control

A new item has been introduced to help combat moisture condensation caused by tight exterior walls that have no breathing qualities. The unit, called *Damp-Vent*, is basically a short, rust-proof cast aluminum tube, 3/4 in. diam., flanged on one end. Rain blocks and

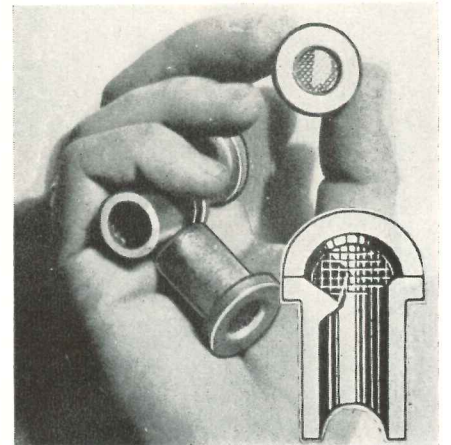

Small vents help rid exterior wall spaces of moisture and relieve condensation

screens are built in for protection from wind-driven rain and insects. The vents relieve condensation by allowing the exchange of moisture through walls without creating free-air movement or circulation. Installation requires only the drilling of a 3/4-in. hole through siding or stucco, and insertion of the unit. The manufacturers recommend that the vents be installed 2 in. above floor level, and between each stud. Damp-Vent Co., P. O. Box 203, Bettendorf, Iowa.

Electric Water Heater

A new line of *Hotpoint* electric water heaters features a dial for selecting temperatures. This *Magic Dial* is said to allow the user to set the temperature by turning the dial to the position that meets the hot water requirements in his home. This permits personal choice of water temperature, and easy change with the presence of guests, for different seasons, or following the installation of new equipment. The dial has three colored settings marked vacation, average and extra hot. The water heaters are made in 30-, 40-, 52-, 66-, and 82-gal cylindrical models and in 30- and 40- gal table-top sizes. A square model

(Continued on page 232)

THEY ALL NEED GLARE PROTECTION
available in Glare Reducing
COOLITE GLASS
by **MISSISSIPPI**



Blinding sun rays that cause eye fatigue and lead to inefficiency and production declines are turned aside or absorbed by Glare Reducing COOLITE Glass.

Glare Reducing Coolite admits only softly diffused, comfortable daylight... reduces the transmission of solar heat radiation and lightens the load on air conditioning equipment. Temperatures inside are reduced, working conditions are improved. Eliminated are painted glass, makeshift shields and bothersome blinds.

Used either in new construction or in modernization and replacement work, the installation of Glare Reducing COOLITE Glass is an investment in greater production and decreased maintenance cost.

Specification Data—Glare Reducing COOLITE Glass			
Pattern	Thickness	Max. Width	Max. Length
Hammered	1/8"	34"	132"
Hammered	1/4"	34"	144"
Hammered WIRE	1/4"	34"	144"



Send for new, informative catalog, "Coolite Heat Absorbing and Glare Reducing Glass."

For further data see Sweet's Architectural File or contact your nearby distributor of quality glass. Samples on request.

MISSISSIPPI Glass COMPANY

SAINT LOUIS 7, MO.
NEW YORK • CHICAGO • FULLERTON, CAL.

WORLD'S LARGEST MANUFACTURER OF ROLLED, FIGURED AND WIRED GLASS



BANISH "Booby Trap Showers"

with the **DOUBLE** safety of



THERMOSTATIC SHOWER MIXERS

Why be "Half-Safe" with mixers that only protect bathers from scalding caused by *pressure* changes? No mixer is really safe or non-scald that does not give *double* protection against both *pressure* and *temperature* changes in water supply lines... plus a *complete* shut off on cold water failure.

Regardless of (1) *temperature* or (2) *pressure* changes in water supply lines, a Powers thermostatic mixer holds the shower temperature constant. Failure of cold water instantly and *completely* shuts off the shower. Bathers can really relax and enjoy their showers.

May we send Bulletin 358-H?

- For new showers or when modernizing obsolete showers — play safe, use Powers Thermostatic Shower Mixers. Phone our nearest office or use coupon below. There's no obligation.



The Powers Regulator Co.

2752 Greenview Ave., Chicago 14, Ill.

- Please send Bulletin 358-H and prices.
- Have an engineer call.

Name _____

Title _____

Address _____

BTH



Right: Type H Mixer for Concealed Piping has 6" diameter dial. Mixer for exposed piping has 3 1/4" dial.

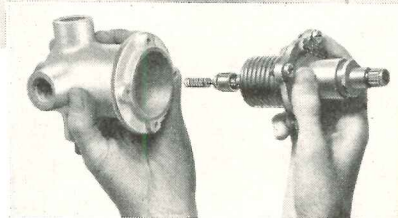
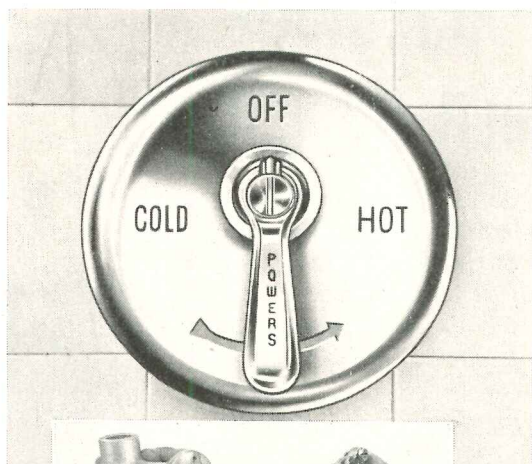

ONLY ONE MOVING PART, easily accessible from the front. Minimum of maintenance, simple, rugged construction. Parts subject to wear have hard chromium finish.

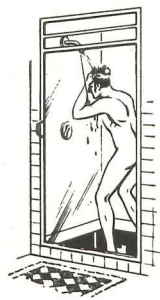

MODERN SHOWERS require the safest shower regulator made ... POWERS.

Just ONE Accident may cost Many Times More than Powers Thermostatic Shower Mixers

PRODUCTS
(Continued from page 230)

with a capacity of 52 gal is being introduced for houses which do not have basements. Hotpoint, Inc., 5600 W. Taylor St., Chicago 44, Ill.

Hot Water Heating Boiler

Designed for use with radiant heating systems in small homes, or zoned heating systems in larger homes, the *Hot-*

stream Model H-193 automatic gas-fired hot water heating boiler can be adapted to all types of gravity or forced circulation installations requiring up to 346 sq ft of radiation.

The boiler is claimed to be low-cost, compact and efficient in operation. The unit is housed in a welded steel cabinet finished in baked gray or white enamel, and insulated with metal-shielded asbestos. The heating unit consists of a raised port burner with twin air mixer. The heating element is of heavy copper coils. Other accessories include an auto-

matic pilot, gas-pressure regulator, temperature limit control, and automatic gas-control valve.

The same unit can also be used as a large volume water heater for residential, commercial or industrial hot water supply. Models are available for both natural and LP gas. The Hotstream Heater Co., 2363 69th St., Cleveland, Ohio.

Steel Access Panels

The *Knapp Steel Access Panels* are fabricated in a range of 16 sizes, up to 24 $\frac{3}{8}$ by 36 $\frac{3}{8}$ in., to meet varied requirements of the building trades. Special sizes are made to order. The doors are made of galvanized steel, with extra reinforcement and a wide plaster flange. It is finished with a baked-on prime coat of special paint. Captive screw pivots permit doors to open to 102 deg. Doors may be removed by raising pivots in saddles. A special device is said to assure positive locking and closing action. Adjustable anchors are furnished when specified. Knapp Bros. Manufacturing Co., Rossmoyne, Ohio.

Undercounter Dishwasher

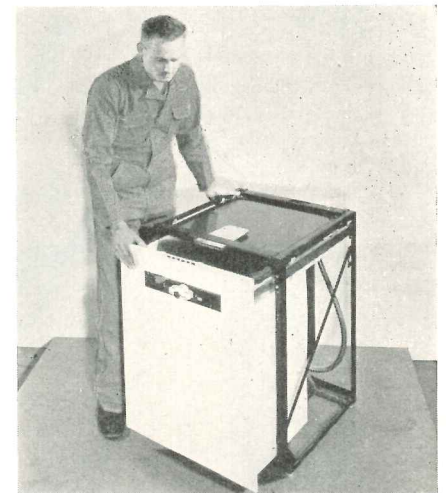

Drawer-type dishwasher is designed for use with custom-built kitchen cabinets

The *Westinghouse* undercounter dishwasher is designed to be built into new buildings or slid under existing work surfaces. The unit is front opening, and top-loading, slides out like a drawer. Installation is claimed to be simple and inexpensive since existing drain plumbing can be used in almost every case.

(Continued on page 234)

Follansbee Seamless Terne Metal Roofing

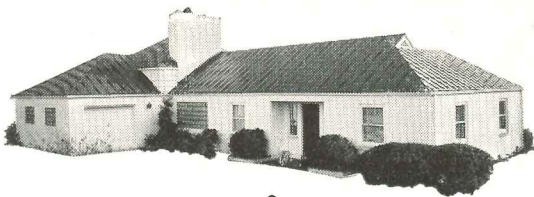

for
harmony
in modern design

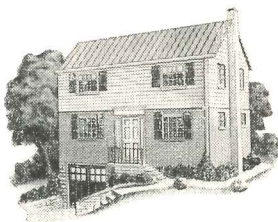
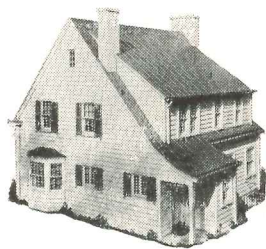

In modern housing the versatility of Follansbee Seamless Terne Metal Roofing permits harmonious design detail to conform to architectural styling. That's one of the advantages of Follansbee Terne Metal Roofing—it belongs in any period and any specialized roof construction.

Color harmony is another important feature of a Follansbee Terne Metal Roof. Your client can select any trim color and the roof can be finished in contrasting shade, or in the same shade. This permits change of color scheme, anytime—just the sort of flexibility you like to suggest to a client.

Then, when you point out that terne metal roofs are lifetime roofs, in addition to being harmonious in color and design, you can specify Follansbee Terne Metal Roofing with assurance of satisfaction.

If you haven't received your file of architectural details be sure to write Terne Metal Dept. A., Follansbee Steel Corporation.

FOLLANSBEE STEEL CORPORATION

GENERAL OFFICES, PITTSBURGH 30, PA.

COLD ROLLED STRIP • ELECTRICAL SHEETS • POLISHED BLUE SHEETS • SEAMLESS TERNE ROLL ROOFING

Sales Offices—New York, Philadelphia, Rochester, Cleveland, Detroit, Milwaukee. Sales Agents—Chicago, Indianapolis, St. Louis, Kansas City, Nashville, Houston, Los Angeles, San Francisco, Seattle; Toronto and Montreal, Canada. Plants—Follansbee, W. Va.



FOLLANSBEE METAL WAREHOUSES

Pittsburgh, Pa. • Rochester, N.Y. • Fairfield, Conn.

Two Valves In One!

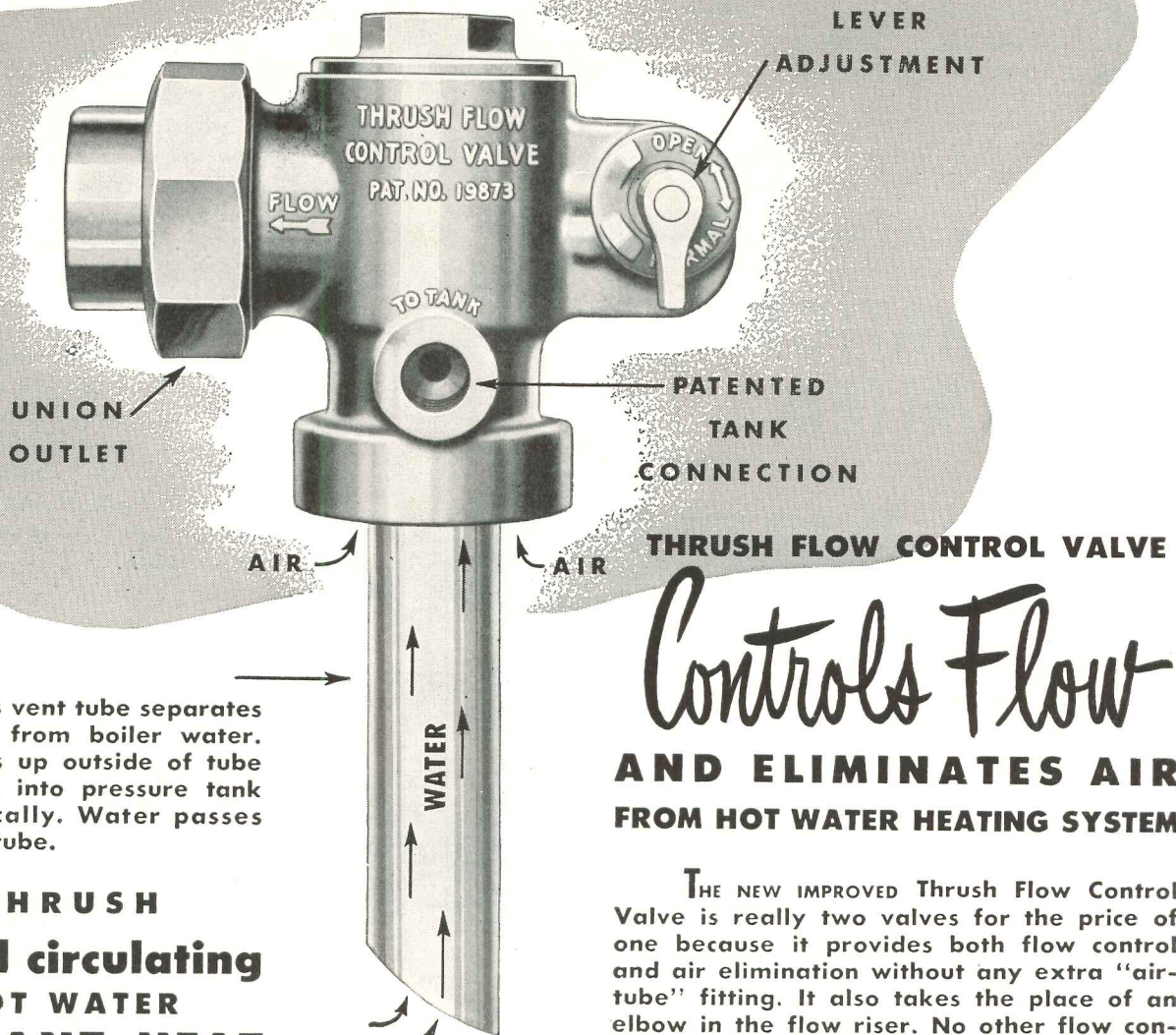

Brass vent tube separates air rising from boiler water. Air passes up outside of tube and vents into pressure tank automatically. Water passes up inside tube.

THRUSH
forced circulating
HOT WATER
RADIANT HEAT

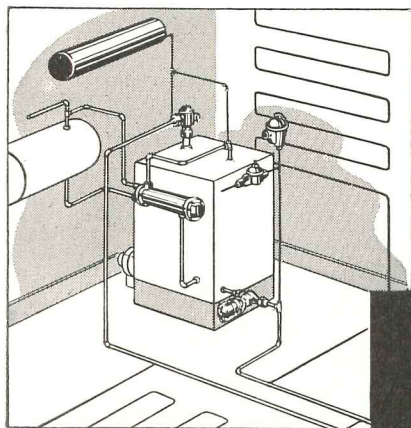

COMPLETE CONTROL FOR
 AUTOMATIC HOT WATER HEAT

THRUSH FLOW CONTROL VALVE
Controls Flow
AND ELIMINATES AIR
FROM HOT WATER HEATING SYSTEM

THE NEW IMPROVED Thrush Flow Control Valve is really two valves for the price of one because it provides both flow control and air elimination without any extra "air-tube" fitting. It also takes the place of an elbow in the flow riser. No other flow control valve has all these outstanding value features. Get the facts now.

Highest boiler temperature occurs when the Flow Control Valve is closed. Air and gases which are liberated as the water is heated, vent directly into the pressure tank. Water which passes into the flow main, is always free of air. Result—greater heating efficiency—more uniform heat. You save material cost, save installation time, and reduce inventory requirements by specifying Thrush "T" Flow Control Valves. (They are also available without tube.) For more information, see our catalog in Sweet's or address Dept. J-5.

H. A. THRUSH AND COMPANY
 PERU, INDIANA
 MANUFACTURER OF HOT WATER HEATING EQUIPMENT FOR MORE THAN A QUARTER CENTURY

PRODUCTS
(Continued from page 232)

The dishwasher has no drain valve. Used water is pumped up to the drain. It is said that all the unit needs is the proper space, a "T" connection with existing hot water line, and a new tail pipe (furnished by the manufacturer) to be added to the sink outlet.

The washing and rinsing action is created by an aluminum impeller blade

and a diverter mounted above it. A heating element is used to speed drying of dishes. The dishwasher is also available in a free standing 24-in. cabinet model, and in combination with a 48-in. electric sink. Westinghouse Electric Appliance Div., Mansfield, Ohio.

Aluminum Garage Doors

The *Taylor-Made Knock-Down* aluminum garage doors feature a door face which is an integral part of the frame. This is claimed to make the door stronger and lighter in weight. The door

has horizontal sections which come demounted. Shipping size is 28 by 96 by 5 in. It is said to be easily assembled by bolts and nuts through pre-drilled holes. The doors are of the receding type, made for either 8 ft by 7 ft, or 9 ft by 7 ft openings. Two lock catches are provided on either side of door for tight closure. Insulation to prevent heat loss in heated garages is available. R. L. Taylor, Inc., 12480 Evergreen, Detroit 28, Mich.

Packaged Windows

Trim-Set Metal Windows come complete with frame, sash, sill, trim, glass, and hardware, factory assembled as an integral unit. The manufacturers claim that it is simply installed in a 5 minute operation. They are available as awning or casement type windows, or with fixed glass and metal louvers at the bottom, sides or top. In the latter type, louvers are equipped with a glazed cover on the inside, bottom friction hinged, and a bronze fly screen. Louver heights may be had to suit ventilation requirements. The windows can be glazed with insulated, plate or crystal glass. Ventilators can be insulated and weather-stripped.

Even for limited budgets ---

IMAGINATION UNLIMITED

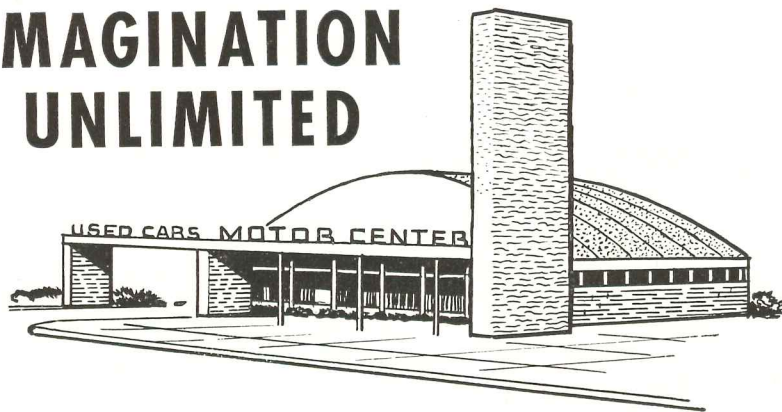

Your imagination has free reign when you develop a building design around Rilco Arches and Trusses. These sturdy glued-laminated wood framing members are engineered for rugged strength and swift, economical construction. But more than that, they give your building an inherent architectural integrity and style that's fresh and exciting.



Standard Rilco Arch and Truss designs cover a wide and satisfying variety of uses . . . and Rilco engineers work constantly with architects to develop special structural members for specific projects. Rilco units combine excellently with other materials . . . they come to the job site ready to put up . . . and often when left exposed inside, their handsome wood tones make a striking interior feature.

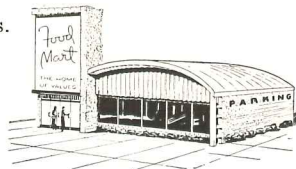

The sketches shown here illustrate just a few of many possible adaptations of Rilco Arches and Trusses. If you want more information see our 12-page catalog in Sweet's or drop us a line.



RILCO WORKS WONDERS WITH WOOD
Laminated **PRODUCTS, INC.**
1670 First National Bank Building • Saint Paul 1, Minnesota

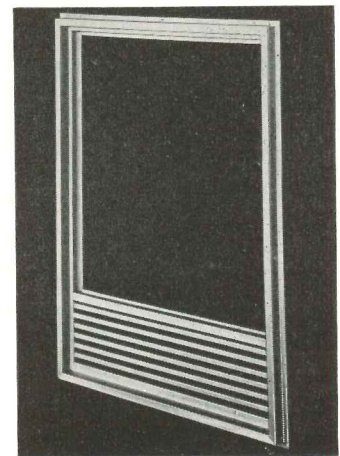

Ventilation louvers form integral part of metal frame in package window unit

All the windows are available in a great range of stock sizes in either steel or aluminum. The steel windows are bonderized and have one baked-on coat of paint. Aluminum windows are alumilited to protect against corrosion. Fentron Steel Works, Inc., Trim-Set Corp., 2801 Market St., Seattle 7, Wash.

(Continued on page 236)

HOW TO SAVE \$20,000

ON AN \$11,000 INVESTMENT

HOW TO SAVE \$4,000

ON A \$7,500 INVESTMENT

These are actual Case History Savings

HOW MUCH CAN YOU SAVE

BY INSTALLING A **STEAM-PAK** GENERATOR



SAVE ON FUEL – with oil, gas or combination firing
 SAVE ON LABOR – with a completely automatic unit

Steam-Pak Generators, similar to the one illustrated at the right have incorporated in them many exclusive features which produce automatic and highly efficient operation in producing steam.

Substantial savings result from Steam-Pak efficient 3-pass boiler construction, automatic operation with varying loads, rapid steam production and many others including . . .

IRIS SHUTTER, the patented precise metering device which produces an even flame with practically perfect control of burner air. The correct volume of air is metered to match the firing rate. Air-oil adjustment is accurately synchronized through the entire burner firing range.

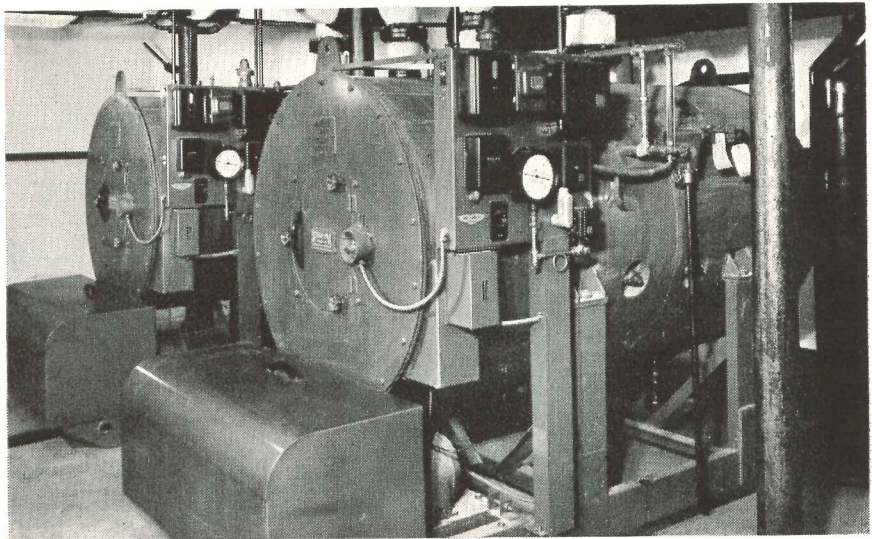

Steam-Pak Generators are built in capacities from 15 H.P. up, for low or high pressure steam or hot water, for light or heavy oil, combination gas and oil or straight gas.

Can you save money with a Steam-Pak? There is one way to find out . . . ask a qualified heating Engineer. Your York-Shipley Distributors are thoroughly qualified to analyze your problem and determine savings. See your nearest York-Shipley Distributor, or write, wire or phone.



YORK-SHIPLEY

INDUSTRIAL DIVISION

519 Jessop Place

York, Pennsylvania

'Phone 7861

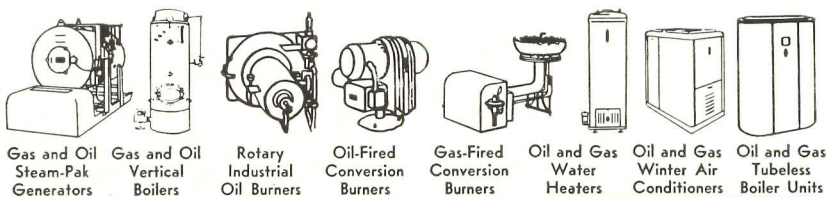

Gas and Oil Steam-Pak Generators Gas and Oil Vertical Boilers Rotary Industrial Oil Burners Oil-Fired Conversion Burners Gas-Fired Conversion Burners Oil and Gas Water Heaters Oil and Gas Winter Air Conditioners Oil and Gas Tubeless Boiler Units

YORK-POWER INDUSTRIAL DIVISION

YORK-HEAT RESIDENTIAL DIVISION

Write for
 Case Histories on
 how others save
 money

PRODUCTS

(Continued from page 234)

Patterned Asbestos Board

The Flexboard line of utility sheet materials made of asbestos and cement has been augmented by a decorative panel, called *De Luxe Flexboard*. The new sheet is made 1/8 in. thick, 4 ft wide and up to 8 ft long. It features a linen-like fabric pattern and is available in six colors. This finish is said to be

fused into the base sheet through the use of heat and pressure, to be hard and smooth to the touch, and not to peel or blister. It is also claimed to be alcohol and grease proof, and highly resistant to acids, alkalines, household chemicals, burning cigarettes. The board may be applied by adhesives or mechanical fastenings and can be worked with ordinary tools. Johns-Manville, 22 E. 40th St., New York 16, N. Y.

Recessed Lighting Fixtures

Greatly reduced cost of installation

is claimed for the new Kirlin recessed incandescent fixtures. It is stated that the minimum 4 ft of asbestos wire called for by many codes is not required, the design permitting rubber covered wire to be run directly to the fixture. An insulated junction box on the side of the fixture is said to keep the heat below 60 C limit for rubber covered wire. Need for carpenter work is reportedly eliminated by mounting ears on the boxes and the use of bar hangers which simply staple to the joists. The lack of roughing-in work would make it simple for the electricians to mount the fixtures.



**THIS MAN IS
PAID TO HELP
ARCHITECTS AND
THEIR ENGINEERS!**

He is a specialist in planning and engineering RCA Sound Systems for every type of building: Schools . . . Hospitals . . . Hotels . . . Factories and Offices . . . Churches . . . Department Stores . . . Airports and Terminals . . . Warehouses and Garages . . . Auditoriums . . . Recreational Centers . . . Institutions . . . Stadiums . . .

No matter what size or type of job you have on your drawing boards, you can get practical help from RCA in fitting RCA Sound Systems to your architectural plans. No obligation, of course.

Contact your nearest RCA Sound System distributor or write: Sound Products, Department 3E, Radio Corporation of America, Camden, New Jersey.

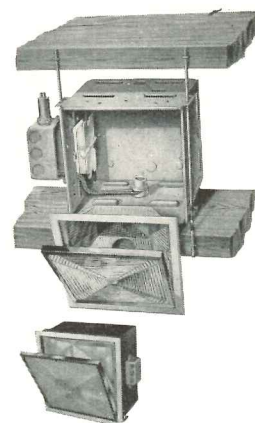

Built-in support bars simplify installation of new recessed lighting fixtures

The recessed fixtures are made in a range of sizes, square or rectangular, and also for fluorescent lighting. All use aluminum reflectors and have spread-type or concentrating lens set in hinged doors. The Kirlin Co., 3435 E. Jefferson Ave., Detroit 7, Mich.

Kitchen Equipment

American Central line of steel kitchen units, designed by Raymond Loewy, features clean lines and the elimination of projecting handles or ornamentation on wall cabinets and base cabinet drawers. The line includes eight different sinks; 30-in.-high base cabinets in widths from 15 to 36 in.; and wall cabinets, 18 in. high, in widths ranging from 18 to 36 in. All doors are held firmly open or shut by double action spring hinges. Drawers slide on nylon glides. Counter tops and backsplashes are made in one piece, covered with vinyl plastic. They are available in black and four colors. All the cabinets are made of baked white enameled

(Continued on page 238)



SOUND PRODUCTS
RADIO CORPORATION of AMERICA
ENGINEERING PRODUCTS DEPARTMENT, CAMDEN, N. J.

In Canada: RCA VICTOR Company Limited, Montreal

ARCHITECT
Edward Sears Read & Associates
Boston, Mass.

BUILDER AND DEVELOPER
Kelly Corporation
Arlington, Mass.

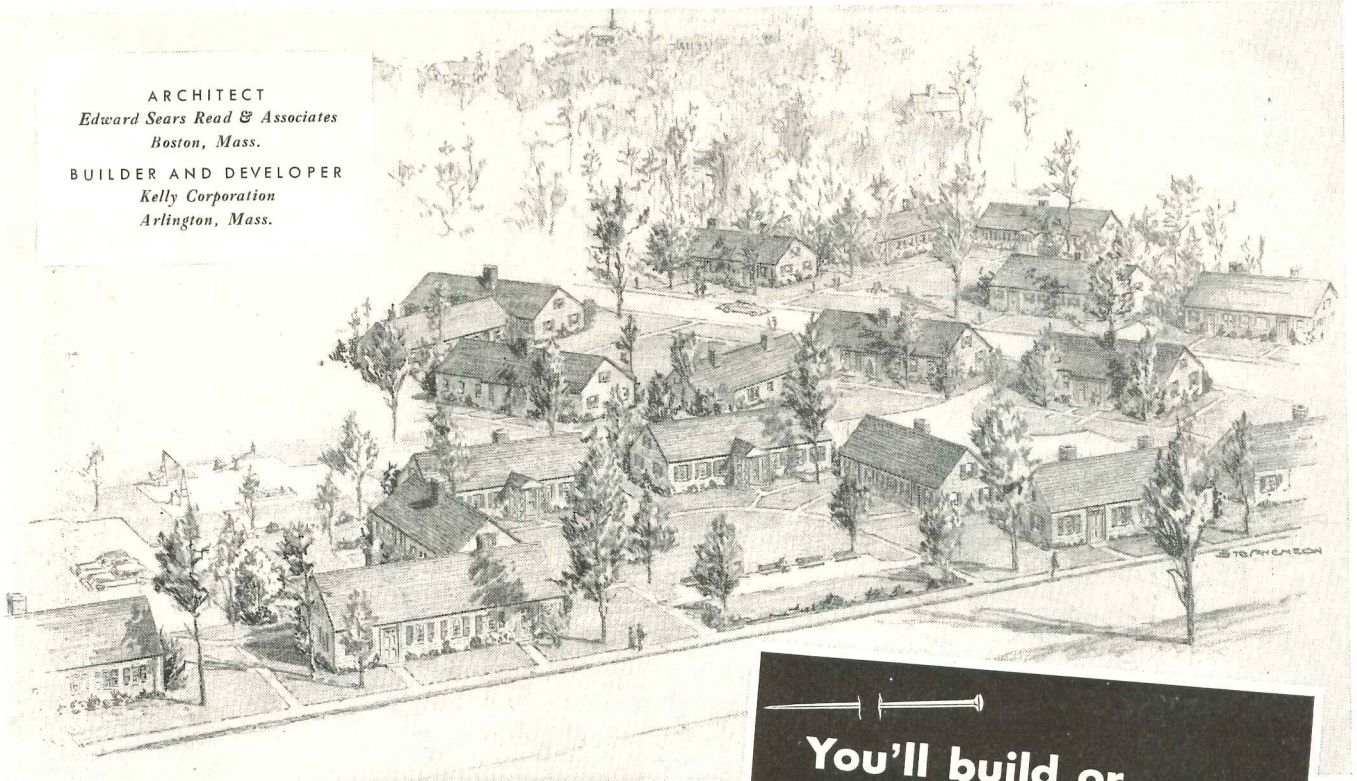

"HIRAMAR" Hyannis, Mass.

You'll build or
remodel better with
Gold Bond

They pinned the responsibility on us!

YES, the architect and builder on this big 120 unit Hirammar job solved one big problem right away. They pinned responsibility for performance of materials on National Gypsum by using Gold Bond Building Products all the way—Gold Bond Rock Wool Insulation, Gypsum Sheathing, Gypsum Wallboard and perforated Tape Joint System and Gold Bond Sunflex Paint.

You get two big advantages when you specify

Gold Bond *exclusively* on your jobs. First, you know you're getting products that are specifically engineered to work together. Second, you avoid divided responsibility when the performance of *all the materials* is guaranteed by *one reliable Manufacturer*—National Gypsum Company. So on all your jobs from now on, whether residential or commercial, specify and use Gold Bond products all the way. They're all fully described in Sweet's.

NATIONAL GYPSUM COMPANY
BUFFALO 2, NEW YORK

Fireproof Wallboards, decorative Insulation Boards, Lath, Plaster, Lime, Sheathing, Wall Paint, Rock Wool Insulation, Metal Lath and Sound Control Products.

WIZARDS WITH WOOD



FIRZITE

—tames wild grain and checking on fir plywood



Wild grain and checking are just about the only troubles in using fir plywood. The one sure way to

insure a perfect finish is to start with FIRZITE. It tight-seals the pores, virtually prevents grain rise and checking, readies the surface satin-smooth for paint, stain, enamel. (For blond, pickled, wiped or tinted effects on any wood, use White Firzite.)

SATINLAC

—newer than shellac or varnish... and better!



For "natural wood" finishes on paneling, there's nothing like Satinlac. Brings out and preserves the natural grain and color beauty of any plywood and solid wood. Avoids that "built-up" look yet gives full protection; and will not turn yellow or darken with age. "Water-white", easy to brush or spray, dries ready for next coat in 3 or 4 hours.

Write for suggested specifications.
UNITED STATES PLYWOOD CORPORATION
Dept. 56, 55 W. 44th St., New York 18

Architectural Engineering

PRODUCTS

(Continued from page 236)

steel. In addition to the basic units, many accessories are included in the line, such as built-in lights under wall cabinets, and special corner utility bins. American Central Div., Avco Manufacturing Corp., Connersville, Ind.

Disappearing Beds

Holmes "Modernized" disappearing beds are claimed to be designed for concealment without any sacrifice of bed comfort or utility. There are 10 types of beds in the line, designed to fit varying sized closets. Each model is made in single, twin and double bed sizes, and use full-length standard mattresses. The beds are simple and low in design, and have no footboards. Headboards come in light or dark finished hardwood, and fold with a full width piano hinge to hold pillows in place. The chassis is welded steel tubing. Concealed folding

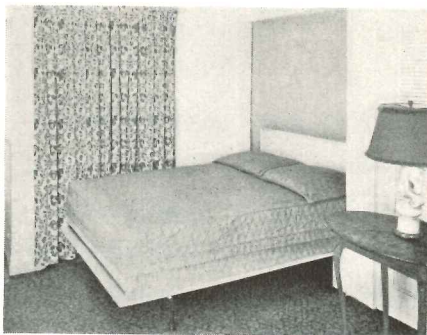

Space-saving concealed beds feature balanced, easy operation and simple lines

legs operate automatically and are said to rest firmly on floor when bed is lowered. Raising, lowering and swinging mechanisms employ ball bearing pivots and spring balances. Mountings are available for side door jambs, doors, recesses, drop panels and pivot panels. Holmes Manufacturing Co., 211 N. Madison Ave., Los Angeles 4, Calif.

(Continued on page 240)

KAYLINE

the one source lighting line



for dependability

and

price

Kayline calls your attention to the most important fluorescent development in many years! Kayline fixtures are now available to take the new 4-foot single pin slimline lamps.

Yes! You can now specify the economical, new 4-foot slimline in any Kayline fixture. It lights at the flick of the switch, and it's easy to handle... just push-pull and its single pin locks the lamp in or out of the socket.

Write for complete price information!

Listed in Sweet's Architectural File for 1950, Sec. 31A-12

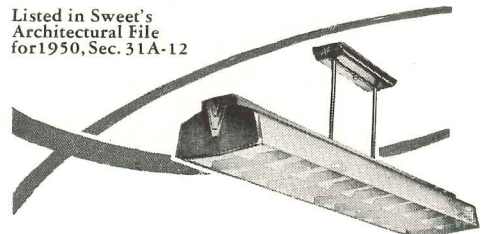

KAYLINE

the one source lighting line

THE KAYLINE CO.
2480 East 22nd St.
Cleveland, Ohio

CRANE

the preferred plumbing

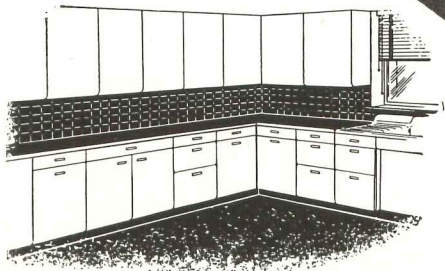
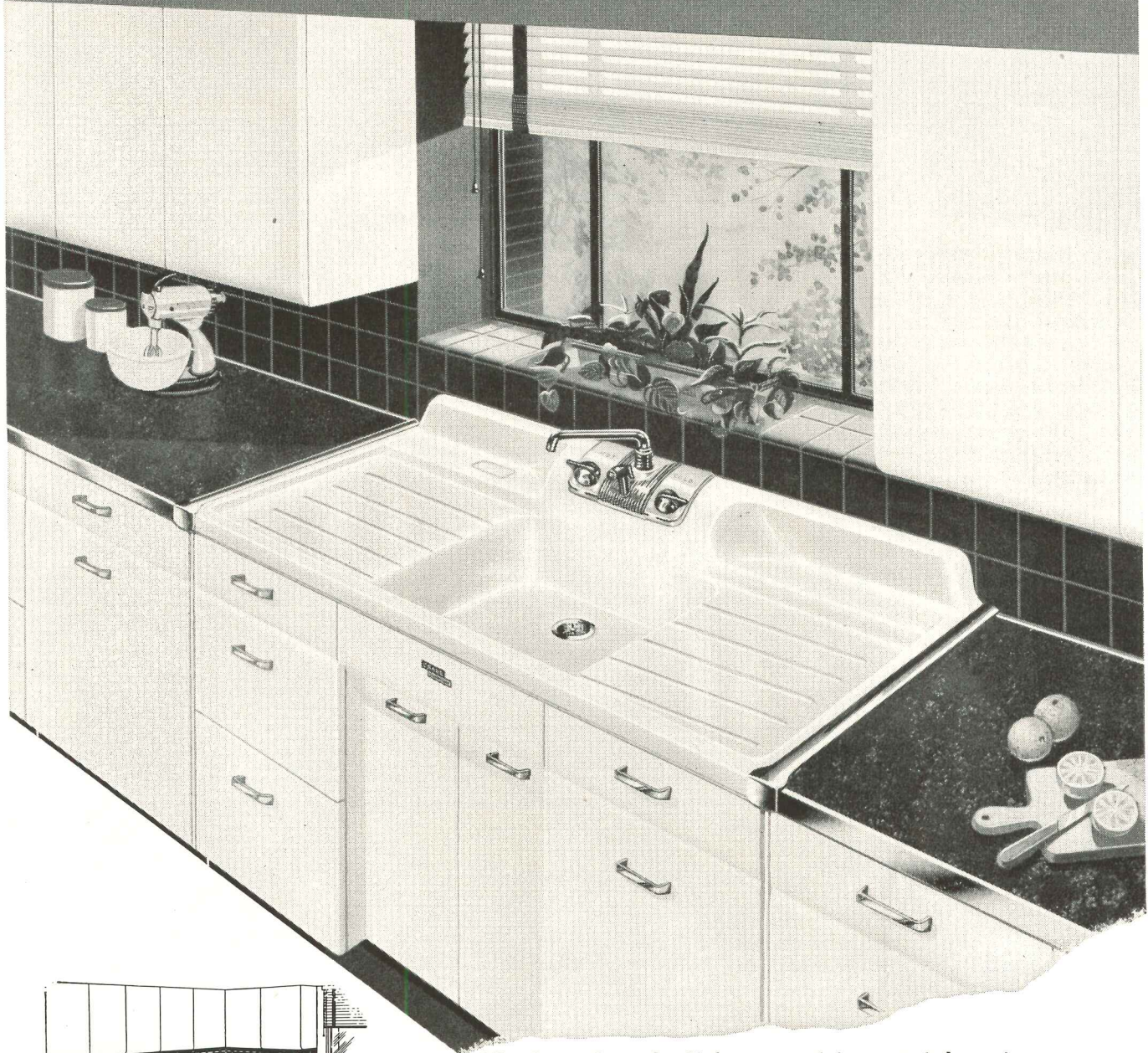

The Crane *Sunnyday* Sink . . . porcelain enameled cast iron . . . in white and eight Crane colors. Single basin, double drainboard. 54" or 60". Also available, a complete line ranging from 36" to 72", all with Crane *Dial-ese* controls. Complete selection of matching wall and base cabinets. Consult your Crane Branch or Crane Wholesaler.

CRANE

CRANE CO., GENERAL OFFICES:
836 S. MICHIGAN AVE., CHICAGO 5

PLUMBING AND HEATING
VALVES • FITTINGS • PIPE



for FRENCH DOORS



CASEMENT WINDOWS



DUTCH DOORS



STALL DOORS

ADAMS-RITE
patented bolts are
stronger, easier to
install, keep their
original finish

Adams-Rite, the originators of the exclusive extruded design in Surface, Slide and Cremone Bolts, is still the only source for all styles! This patented construction with concealed guides eliminates all unsightly straps and scratching. Solid brass throughout. Four screws to each bolt insure rigid strength. Installation is easy and error proof and adjustments are made on the job without taking the bolt apart. Spring tension gives uniform pressure at all points.

RITE SURFACE BOLTS

All 3 widths of rods— $\frac{3}{8}$ ", $\frac{1}{2}$ " and $\frac{5}{8}$ "—have the extruded design. Lengths to 48". Harmonizes with any architectural design. Mortise and rim strikes furnished. 10 standard finishes.

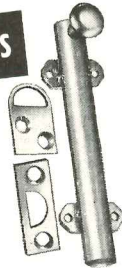

RITE SLIDE BOLTS

Extruded design in 2 sizes— $2\frac{1}{2}$ " x $\frac{1}{2}$ " and 3 " x $\frac{3}{4}$ ". Ideal for stall and Dutch doors and for use in place of mortise and gem bolts. Surface, rim and mortise strikes furnished. 10 standard finishes.



RITE CREMONE BOLTS

New narrow, modern design enhances French windows and doors. Especially suited to very narrow wood or metal styles. Rods, all with extruded design, in 3 widths— $\frac{3}{8}$ ", $\frac{1}{2}$ " and $\frac{5}{8}$ ". Reversible as to hand. One or 2 handles available. Thumb button deadlock optional. Mortise, rim, angle and surface strikes furnished. 7 standard finishes.



50TH
ANNIVERSARY

1900—1950

ADAMS-RITE MANUFACTURING CO.
540 WEST CHEVY CHASE DRIVE, GLENDALE 4, CALIFORNIA U.S.A.

Architectural Engineering

PRODUCTS

(Continued from page 238)

Plastic Coating

Calvoseal is one of a new line of ready-mixed, abrasion and corrosion resistant vinyl plastic coatings announced under the trade name of *Calvinac*. This particular coating was created particularly for concrete, masonry, textured and plain wallboards, asbestos shingles, plaster and like products. It is claimed to dry with the evaporation of water, and once dry, to be impervious to moisture penetration. *Calvoseal* comes in clear or color for use as a decorative as well as protective coating. James Lithgow Company, Inc., Registered Chemical Engineers, Los Angeles 22, Calif.

Hollow Metal Doors

Diebold Hollow Metal Doors feature long life and an extra margin of fire safety and security for home use. The doors and frames are prefabricated and shipped in single units. No assembly on the site is required. They are made of welded 20-gage steel finished with a rust-inhibitive coating, said to assure good paint adhesion and be chip-resistant.

The units are said not to warp, crack or shrink, and may be used as interior or exterior doors. Sliding closet doors are also available in the line, which is produced in a wide range of standard sizes and styles. Diebold, Inc., Canton, Ohio.

Plastic Surfacing Material

A new textured pattern, called *Regent*, has been added to the large selection of patterns and plain colors available in *Texolite* plastic surfacing materials. The *Regent* pattern is produced in bright red, green, blue, yellow, and a medium gray. The surfacing is claimed to resist heat, alcohol, fruit juices, scratches and other severe uses. The sheets come in standard thicknesses of $\frac{1}{16}$ in., in widths of 24 to 48 in., and in lengths up to 108 in. Other sizes are available on request. The surfacing can be trimmed to any shape with a metal cutting saw. Chemical Dept., General Electric, 1 Plastics Ave., Pittsfield, Mass.

Need a NEW TOWN?

We delivered . . .

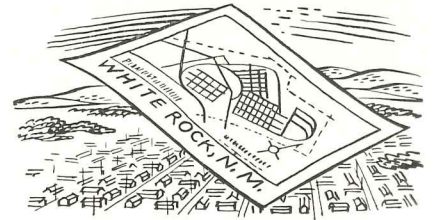

the town of White Rock, New Mexico (Los Alamos). That one has 489 ENGINEERED HOUSES designed for comfortable, individualistic living—at economical prices.

VERSATILE!



For instance, this is typical of 120 varied-size houses we delivered to Camp Hood, Killeen, Texas. Engineered Houses are not canned—they're fitted to your plan or ours. Pre-cut and panelized by mass-production methods for savings . . . big, small, gables, flat-top—any style!

For any climate!



105 Pueblo style went to sand-and-sunshine country in White Sands. But if blizzards are your problem, or dripping skies, or quick changes, we'll engineer one or more for you . . . or adapt your plan. Engineered Houses are flexible . . . livable . . . economical! Write, phone or wire for full details!

**TEXAS HOUSING
COMPANY**



9001 DENTON DRIVE
PHONE D4-2601 DALLAS, TEXAS



WHOA!

“Hold your horse, Paul! Home-planners buy what they see in Home Owners’ Catalogs!”

And alerted building products manufacturers see that home-planners in the custom-built housing market get *detailed* buying information.

Why? Because home-planners have money in their pockets and building products on their minds.

How? Simple! Just let Home Owners’ Catalogs distribute your consumer sales literature. Here’s a marketing service which locates, identifies and pre-sells home-planners who are *impelled to buy* building products.

When? Right *now* is the time to get on *your horse* and round up profitable sales in a rich market! As a building products manufacturer, you owe it to yourself to get the latest facts about Home Owners’ Catalogs.



See Standard Rate & Data Service (Consumer Magazine Section) for complete information on Home Owners’ Catalogs.

Home Owners’
CATALOGS

119 West 40th Street, New York 18, N. Y.

F. W. Dodge Corporation’s
Consumer Catalog Distribution Service

PROTECT LIVES AND PROFITS! SPECIFY...



MODEL 10EL
10,000 WATTS

Onan Emergency Electric Plants provide power for all essential needs . . .

LIGHTS • REFRIGERATION • VENTILATING SYSTEMS • COMMUNICATIONS • OIL BURNERS • STOKERS • ELEVATORS

* When storms, floods or breakdowns interrupt commercial power, Onan Standby Plants start automatically and take over the power load within seconds, stop when power is restored. Operating and maintenance costs are negligible. Widely used in hospitals and other institutions, radio stations, hatcheries, theaters, industrial plants . . . wherever power interruptions would be dangerous and costly. Available from 1000 to 75,000 watts.

What size Standby Plant will your project need?



Send coupon below for folder on Onan Standby Plants. It will help you specify the right size plant and the necessary accessories. If you have an unusual problem write our engineering department.

D. W. ONAN & SONS INC.
5143 Royalston Ave., Minneapolis 5, Minn.



Please send me your Standby Folder

Name.....

Address.....

City.....State.....

ONAN STANDBY POWER

Architectural Engineering

LITERATURE

(Continued from page 168)

Remote Control Wiring

Remote Control Wiring System. Booklet discusses features and operation of a lightweight-wire remote control system for lighting and electrical outlets. Component parts of the system and installation details are illustrated and described. Tables give ratings of the elements, and diagrams present dimensions and circuit layouts. 15 pp., illus. General Electric Co., Construction Materials Dept., Bridgeport 2, Conn.*

Plywood

Douglas Fir Plywood (1950 Catalog). Covers types, properties and uses of plywood. Tables give data on such qualities as: nail bearing loads, sound insulation, bending radii, strength and rigidity, thermal insulation values, and vapor transmission. Information is also given on the application and finishing of plywood for various uses. 20 pp., illus. Douglas Fir Plywood Assn., Tacoma Bldg., Tacoma 2, Wash.*

Wood Preservation

Before You Build or Buy. Booklet summarizes use of penta-chlorophenol in protecting wooden parts of buildings against decay, fungi and termites. A diagram and notes cover the various parts of a house subject to attack. Notes are also given on how wood is treated with the solution and the cost. 16 pp., illus. The Dow Chemical Co., Midland, Mich.

Ornamental Metal Work

Stock Elements For the Fabrication and Assembly of Ornamental Metal Work (Catalog No. 6). Describes line of stock elements for the fabrication and assembly of ornamental metal work. Seven sections cover such items as: railings; treillage; saddles and nosings; mouldings; tubing and rods; ornaments and miscellaneous steel door hardware, plastic materials and metal working machinery. Dimensioned sketches are included for each of the items. 112 pp., illus. Julius Blum and Co., Inc., 532-540 W. 22nd St., New York 11, N. Y.*

(Continued on page 244)

YOU SPECIFY THE OPENING SIZE



TAYLOR WILL FURNISH THE GARAGE DOOR



JACK-KNIFE DOORS



RECEDING DOORS

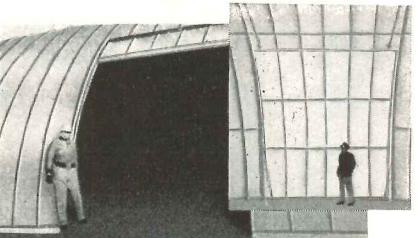

CURVED DOORS FOR QUONSET

Got a door problem? No matter what size the opening—how difficult the operation may be, you can close it with a TAYLOR-MADE Door.

Available with four distinct types of operational hardware—jack-knife, receding, canopy or sliding—TAYLOR-MADE Doors are engineered and manufactured by practical garage door men, backed by years of actual manufacturing and installation experience. We make insulated doors to control heat loss.

SEND SPECIFICATIONS FOR ESTIMATES



Write for
Bulletin

**R. L. TAYLOR
INC.**

12480 EVERGREEN ROAD
DETROIT 28, MICHIGAN

D-S-S-T IT'S LOTS EASIER, QUICKER AND LESS EXPENSIVE TO INSTALL A **JOSAM GREASE INTERCEPTOR** WITH THE PLUMBING AND DRAINAGE INSTITUTE SEAL OF APPROVAL!

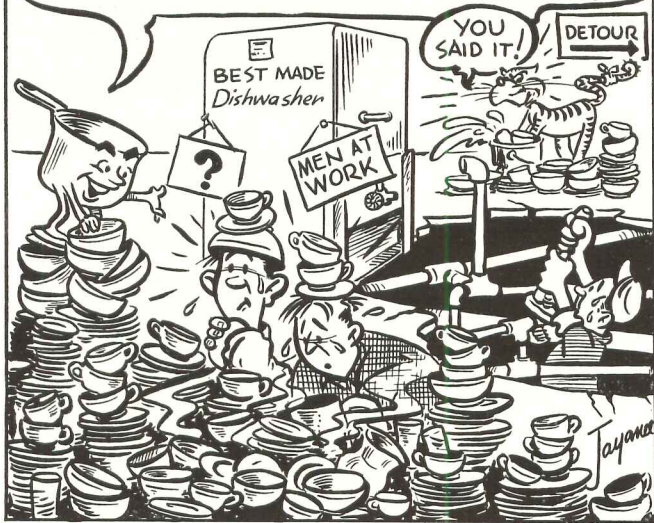

Seriously speaking—grease from sinks and dishwashers will eventually clog drain lines causing trouble and delay. Josam Grease Interceptors are easy to sell because you can assure your customers that they will remove over 90% of the grease from waste water before it enters the drain lines. Write for free copy of Manual B today.

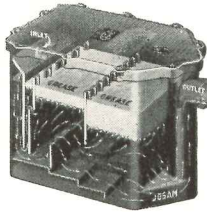

Josam Manufacturing Co.

302 Josam Building Cleveland 13, Ohio

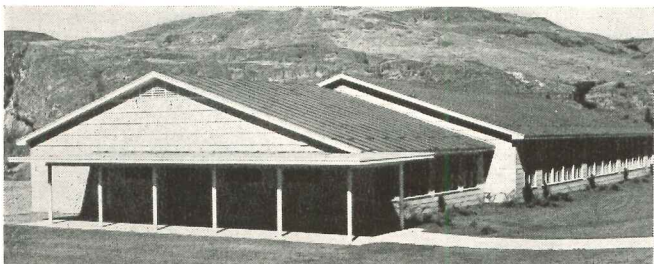

Coulee Dam Elementary School
Coulee, Washington

ELECTRIC RADIANT HEAT with HEATSUM CABLE

provides low cost, safe heat, eliminates maintenance and fuel storage — is now being used in these schools

Union Elementary School—Union, Washington
Redwood Elementary School—Fort Dick, California
Encinal School—Cougar, California
McKinley School—Susanville, California
Enterprise Elementary School—Redding, California
Toyon Elementary School—Summit City, California
Sequoia Elementary School—Redding, California
Coulee Dam Elementary School—Coulee, Washington

Send for Folder No. 25 — also New Insulation Data Sheet

L. N. ROBERSON CO.

1539 East 103rd Street

Seattle 55, Washington

Exclusive...

**4-SPEED CONTROL MEANS
TOP EFFICIENCY
UNDER ALL CONDITIONS**

with
**Russwin
"400"
Door
Closer!**



No other door closer you can specify offers this exclusive feature! Four combinations of closing speeds let the Russwin "400" work at top efficiency under any conditions of door weight, inertia, frequency of use or strong drafts.

Add the "400's" compactness, its special, patented "Silence Adjustment", the hold-open device for 18 different positions, and its precision construction throughout, and you have the answer to trouble-free door control in your buildings over years of service. Send for details on the "400" Door Closer today. Russell & Erwin Division, The American Hardware Corp., New Britain, Conn.

SINCE 1839
RUSSWIN
DISTINCTIVE HARDWARE

No Other Door Closer Gives You This 4-Speed Control!

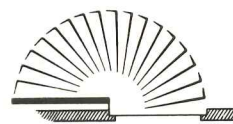

UNIFORM SPEED
Silent Closing

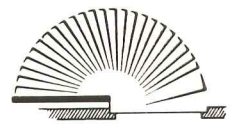

FAST — SLOW
Silent Closing

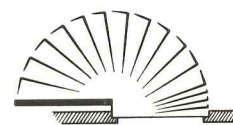

SLOW — FAST
Forceful Closing

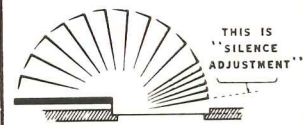

SLOW — FAST — SLOW
Silent Closing

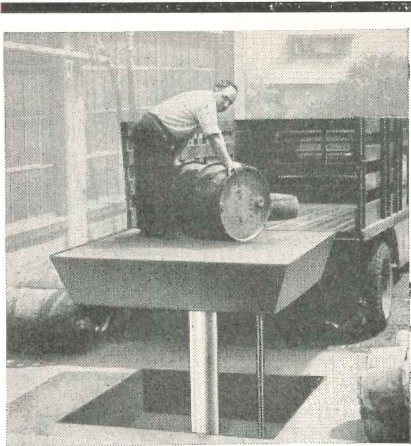

GLOBE LOADING LIFT

You can specify some real cost reductions for your industrial clients with this Globe Platform Lift. For plants and warehouses, it speeds-up loading and unloading... raises and lowers goods, in half the usual time, with half the work.



Eliminates need for ramps, gang-planks, up-hill hand trucking... saves costly hand-lifting... reduces injuries and breakage. Accurate Air/Oil or motor pump. Simple installation, inside or outside. Recesses flush with floor when not in use. Quickly pays for itself in time and work savings. Mail coupon today for specifications and complete details.

Whenever lifting or materials handling installations are involved, experienced Globe Lifting Engineers will be happy to offer suggestions or estimates. Mail coupon for New Illustrated Catalog showing Globe materials handling Lifts of all types.

MAIL COUPON TODAY

GLOBE HOIST COMPANY
1000 E. Mermaid Lane
Philadelphia 18, Pa.

Please send New Catalog A550 showing illustrations and specifications on Globe Loading Lift and other Globe materials handling Lifts.

Company.....
Name..... Title.....
Street..... City..... State.....

GLOBE HOIST COMPANY

Des Moines 6, Iowa Philadelphia 18, Pa.



Architectural Engineering

LITERATURE

(Continued from page 242)

Metal Raceways and Fittings

Wiremold Catalog and Wiring Guide (No. 18). Lists extensive line of conduit-like surface metal raceways, continuous outlet systems, fittings, switches and outlets for electrical wiring systems. Each item is covered with description, sketch, dimensioned cross section and wire capacity table. Installation and fastening methods are given for the various systems and layouts presented. 112 pp., illus. The Wiremold Co., Railroad Elmwood P.O., Hartford 10, Conn.

Water Softener

Why Permutit? Booklet presents features of a compact, automatic water softener for use in homes. Each of the elements making up the unit are separately pictured and described. Charts and diagrams give operation principles and performance ratings; notes discuss installation methods. 20 pp., illus. The Permutit Company, 330 W. 42nd St., New York 18, N. Y.*

Furniture and Accessories

Raymour Lamps, Tables, Clocks, Accessories (1950 Catalog). File folder catalog illustrates a wide line of contemporary table and floor lamps, small tables, clocks, ashtrays and cigarette boxes. A complete description is included for each of the items. Swatches are given for materials available for shades of the various lamps. 62 pp., illus. Richards-Morgenthau Co., 225 5th Ave., New York 10, N. Y.

Daylighting Classrooms

Better Classroom Daylighting. The minimum requirements for daylighting classrooms are outlined, with notes on control by such means as orientation, reflective surfaces, window size, blinds, special glasses, interior finishes and seating arrangements. Diagrams are given for test results on illumination and brightness for various orientations. A bibliography is also included on the subject. 15 pp., illus. Detroit Steel Products Co., 3113 Griffin St., Detroit 11, Mich.*

(Continued on page 246)



Tibbals, Crumley, and Musson, Architects
George Sheaf, Contractor
Columbus, Ohio



- For faithful reproduction of your designs
 - For close attention to your detailed specifications
- SPECIFY**

Ornamental Iron by Artcraft

Be assured of the finest, most exacting hand wrought ornamental iron custom work. Artcraft also produces a complete line of stock items: Stoop railings, porch columns, hand rails, mail box standards, screen door grilles and chimney initials.

Send in your specifications direct for custom work, order stock items from our catalog. Two weeks delivery on custom work, immediate delivery on stock items. All work fully GUARANTEED. We ship to all points in U. S. and Canada.

SEND FOR OUR FREE LITERATURE AND CATALOG

New A.I.A. File No. 14 and 15 folder on stock and custom work is just off the press. Also our new 40 page catalog "ART IN IRON" is free on request. Write today for your copies.

Write to Dept. R

**ARTCRAFT
ORNAMENTAL IRON CO.**
724 E. Hudson St., Columbus 11, Ohio



Smoke, grease-laden steam and odors are definitely an architect's problem... The best solution is Blo-Fan, the only ventilator with the patented combination fan and blower blade, plus a nine-position switch that allows Mrs. Home-maker to control the rate of ventilation in her home as easily as she regulates the thermostat on the kitchen range.

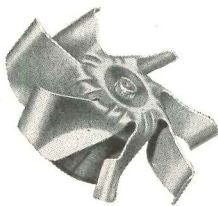

*Trade Mark Reg.

FACTORIES: Pomona, Calif.; Newark, New Jersey
WAREHOUSES: Los Angeles, San Francisco, Chicago



A postcard will bring you complete Blo-Fan information.
Manufacturers of Pry-Lites—the modern recessed lighting fixtures with snap-on fronts.

PRYNE & CO., INC., Box R-5, Pomona, Calif.

NOW! BETTER INSULATED ON-THE-GROUND FLOORS

Cost Less...Easier to Install

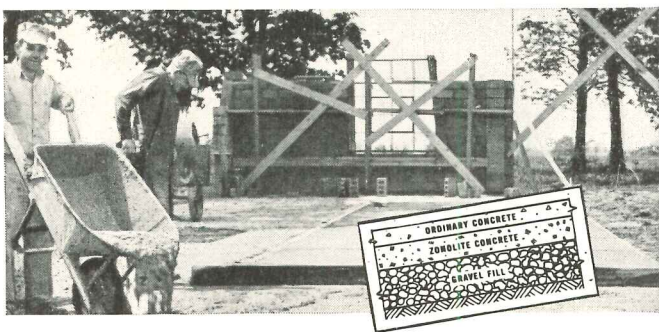

Here's that amazing product that solves one of the biggest troubles with basementless homes... cold, clammy floors. Concrete made of Zonolite* vermiculite aggregate and Portland cement blocks condensation and prevents heat loss.

Under radiant heat floor systems, Zonolite concrete provides a warmer house, quicker control of room temperature, more economical heating plant operation. Zonolite aggregate weighs only 8 pounds per cubic foot for easier handling, faster application. Can be poured right on the ground! Write for full information today! Sold by lumber and building material dealers.

*Zonolite is a registered trademark



ZONOLITE COMPANY
135 S. LaSalle St., Chicago 3, Ill.

GRANT SILENT

sliding door hardware

resulting from over half a Century of Pioneering & Engineering Research

Grant No. 16 & No. 17 hangers offer these exclusive features:

Center hung doors
Three adjustments
Self-aligning pendant bolt

Nylon ball bearing rollers
Hanger cannot jump track
Meet low headroom requirements

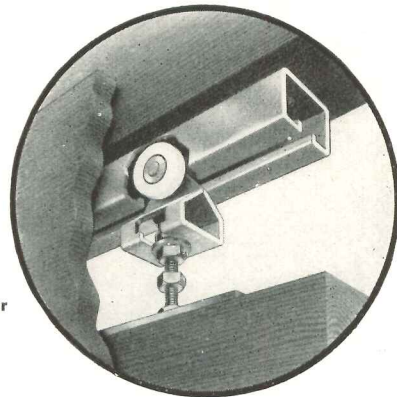

GRANT
No. 16 Hanger

Grant No. 16 single track sliding door hanger incorporates Nylon outer race ball bearing rollers for absolute silent and smooth operation.

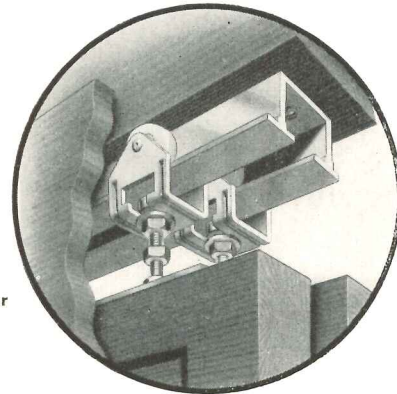

GRANT
No. 17 Hanger

Grant No. 17 sliding door hardware features ball bearing Nylon wheels. The double track arrangement allows simplified installation of multiple unit doors.

GRANT DRAPERY & CURTAIN HARDWARE

Designed for PERFORMANCE as well as APPEARANCE. Years of research has resulted in the ease of operation of the Grant traverse track, the assurance of quiet smooth operation, plus the added advantage of streamlined appearance and concealment of operating parts from view when the curtains are drawn.

GRANT ALSO MANUFACTURES:

- Sash Pulleys
- Drawer Slides
- Hospital Cubicle Hardware
- Stage Curtain Hardware
- Sheaves & Track

Write Dept. R5 for complete illustrated literature

the foremost name in sliding devices



GRANT PULLEY & HARDWARE CO.
33-37 57th STREET • WOODSIDE, L.I., N.Y.

Representatives in all major cities

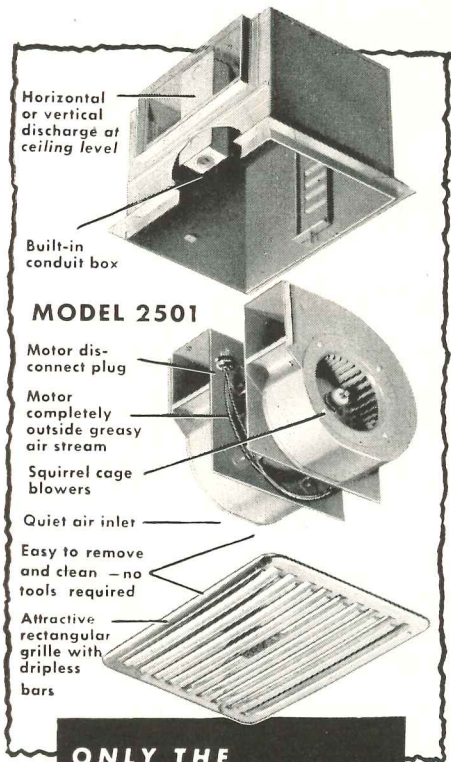

MODEL 2501

**ONLY THE
TRADE-WIND
CLIPPER
HAS ALL THESE
ADVANTAGES**

FOR the best method of ventilating kitchens, bathrooms, laundries, dens or other small rooms specify and install the Trade-Wind Clipper. This proven ventilator is the only small room unit that gives the home owner every worthwhile advantage.

Squirrel cage blowers, accepted and used in air conditioning systems and for forced air heating, are used exclusively in the Trade-Wind Clipper. This forced air discharge, located at the ceiling, traps all unwanted air and expels it instantly. Trade-Wind also has located the motor completely outside the greasy air stream. The motor stays clean indefinitely—requires far less service—and is guaranteed for 5 years. No other small room ventilator combines all these outstanding advantages. In addition, Trade-Wind Clippers are easy to install—they are competitively priced*—and they make every new owner another salesman for the Trade-Wind line.

Get the complete story from your local supply source, or mail the coupon today.

*Important price reduction has just been made on Model 2501.

MAIL THE COUPON TODAY

TRADE-WIND MOTORFANS, INC.
5707 S. Main St., Los Angeles 37, Calif.

Please send me the complete story on the Trade-Wind Ceiling Ventilator.

Name _____

Address _____

Architectural Engineering

LITERATURE

(Continued from page 244)

Disposal Unit

The Calcinator Automatic Home Disposal Unit. Folder presents features, construction and operation of the incinerator-type, cabinet model, garbage disposal units. Three standard models and actual installations in kitchen, basement and garage are pictured. 44 pp., illus. Calcinator Div., Valley Welding and Boiler Co., Bay City, Mich.

LITERATURE REQUESTED

The following individuals and firms request manufacturers' literature:

J. G. Auffant, 1065 Gonzalez Ave., Rio Piedras, Puerto Rico.

Bernard Bennett, Draftsman, % I. Weiss & Sons, 445 W. 45th St., New York, N. Y.

Hugo R. Broleman, Jr., Architect, 101 Pine St., Orlando, Fla.

Joseph Coel, Professional Engineer, 51 Dauntless Lane, Hartford, Conn.

District Public Works Officer, 9th Naval District, Building 1-A, Great Lakes, Ill.

Sam A. Ferguson & Associates, Electrical Engineers, 1226 Bull Street, Columbia, S. C.

M. Lindsey Hagood, Box 4309, Virginia Technical Station, Blacksburg, Va.

H. Reid Hearn, Jr., A.I.A., 1306 Main St., Columbia, S. C.

Walter J. Hubbard, Architect, Stephen M. Stoltz, Associate, 404 W. Fourth St., Ottumwa, Iowa.

Idaho State College, The Library, Pocatello, Idaho.

Charles Loomis Jones, Architect, 3923 South St., Seaford, N. Y.

S. L. Kasparian, Engineer-Architect, % American Legation, Beirut, Lebanon.

Irvin Michaelson, Architect-Engineer, 1507 Fox Building, Philadelphia 3, Pa.

Charles A. Rubinelli, Architect, 4814 W. Crystal St., Chicago 51, Ill.

John Weyl, Student, 711 Oakland, Ann Arbor, Mich.

August E. Woegemann & Assoc., Consulting Civil Engineer, 821 Market St., Room 758, San Francisco, Calif.

The
RESTORATION
of
COLONIAL WILLIAMSBURG

A Reprint
of the December, 1935
Issue of

ARCHITECTURAL RECORD

104 pages, bound in cloth
\$2.50 per copy

The Colonial Williamsburg Number of ARCHITECTURAL RECORD — issue of December 1935 — was sold out soon after publication but the entire editorial contents have been reprinted and bound in permanent book form with blue cloth covers.

Many thousands of these Williamsburg reprints have been sold but the demand continues unabated.

ARCHITECTURAL RECORD
119 W. 40th Street, New York, N. Y.

Enclosed is \$..... for which send..... copies of your reprint, *The Restoration of Colonial Williamsburg*, bound in cloth, at \$2.00 per copy. (Add 2% Sales Tax for New York City deliveries.)

Name.....

Address.....

City and State..... 5-50

Catalog No. 50-A

Wakefield.
Over-ALL Lighting

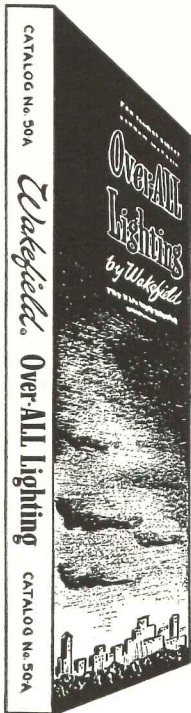

- DISTRIBUTION CURVES
- WORKING DRAWINGS
- DESIGN DATA
- COMPUTATION METHODS

The factors that produce effective lighting for schools, offices, drafting rooms and stores are illustrated and described in this 40-page catalog of the complete Wakefield line of fluorescent and incandescent fixtures. Write for your copy.

THE F. W. *Wakefield* BRASS COMPANY
VERMILION, OHIO

NATIONALLY KNOWN BUILDERS
ACCLAIM AMAZING NEW
International FURNACES
SAINT LOUIS

...for Better Heating
at Lower Costs!

Revolutionary New Oil and
Gas Counter-Flow Furnaces
Provides Warm Floors
by Radiant Heat
plus Circulated
Warm Air

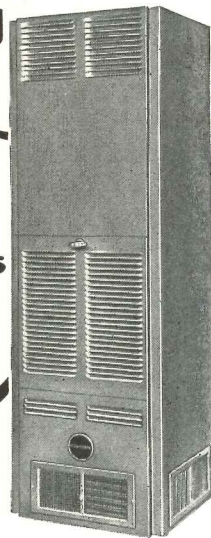

What the building industry has been seeking! International furnaces are giving builders and heating contractors these terrific advantages—at an actual saving in cost! Heat delivered at floors provides warm floors with a blanket of heat at outside walls . . . minimum ducting and installation expense . . . closest floor-to-ceiling uniformity . . . absolute quietness of operation with exclusive patented spring-suspended blower . . . space saving (requires less than 2' x 2' floor space).

Here's what Builders are saying about the NEW
INTERNATIONAL WAY OF HEATING!



"Sensational heating, with unusual uniformity of temperature from floor to ceiling" . . . GENERAL INDUSTRIES HOMES in Ft. Wayne, Indiana—featured in February "Living" magazine.



"Low cost heating installation with even distribution of heat—plus unbelievably low operating costs—International M7 furnace helps us sell houses" . . . PLACE & CO., South Bend, Indiana (featured in August, 1949 edition of "Architectural Forum").



"We have tried several different types of forced air heating plants in our prefabricated basementless houses, and have had better results with International's R-9 than with any others. The R-9 furnace is more economical to operate, easier to install, and keeps an almost perfect uniform temperature in our houses. Customers praise it" . . . MIDWEST HOUSING CORPORATION, Janesville, Wisconsin (developer of the radiant perimeter method of heating).

SEND IN THIS COUPON—for complete brochure on how these and other builders have solved their low cost heating problems with Internationals!

To Furnace Division
INTERNATIONAL OIL BURNER CO.
3836 Park Ave., St. Louis 10, Mo.

Send full details and prices with brochure showing how nationally known builders are adopting International heating to their needs.

Name

Address

City Zone State.....

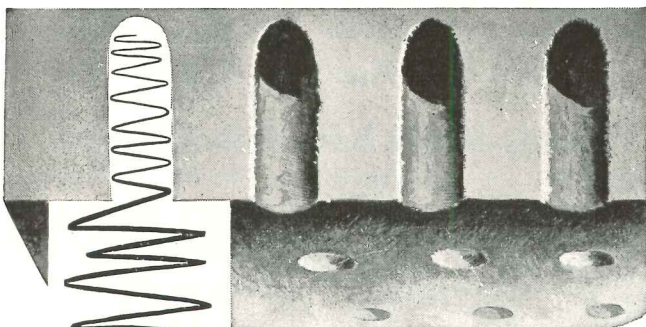

THE CEILING
with a hundred thousand
"NOISE TRAPS"

Send for Free, Fascinating Brochure: Tells you about Fibretone*, the acoustical ceiling, and how its thousands of scientifically-designed noise traps help eliminate unwanted noise—in offices, restaurants, banks, schools, factories, and recreation centers. Write Johns-Manville, Dept. AR-5, Box 290, New York 16, N. Y.



*Reg. U. S. Pat. Off.

Johns-Manville
FIBRETONE



IN THOS. MOULDING **M**oultile
THE CREATIVE DESIGNER FINDS

The Keynote of Colorful Floor Beauty



Architect John J. Flad created this appropriately striking MOULTILE floor design for the sanctuary of St. Mary's Home, Dubuque, Ia. . . . providing more than warmth to the eye, for this MOULTILE floor is installed over radiant heat.

The modern trend in ecclesiastical architecture gains expression even in the floor design. In MOULTILE Asphalt Tile, your creative imagination finds both stimulating challenge . . . and the completely satisfying answer! At your finger-tips is a "keyboard of color" . . . 33 bell-clear hues in tones that ring out joyously or whisper softly. The crisp, clear veining adds a subtle accent of beauty. Because MOULTILE is laid tile-by-tile, possible design variations are limitless. Only the cost is limited, for with MOULTILE special designs involve no costly special fabrication.

For enduring floor beauty . . . plus buoyant comfort, low first cost and rock-bottom maintenance economy . . . it's MOULTILE, the flooring with an impressive record of proving-by-doing in stores, offices, schools, hospitals, churches and homes. For detailed information consult Sweet's, or write for full-color catalog to: THOS. MOULDING FLOOR MFG. CO., 165 W. Wacker Drive, Dept. AR-5, Chicago 1, Ill.

FLOORS of Achievement by...
Thos. Moulding

FITZGIBBONS

"The best in steel boiler heat"

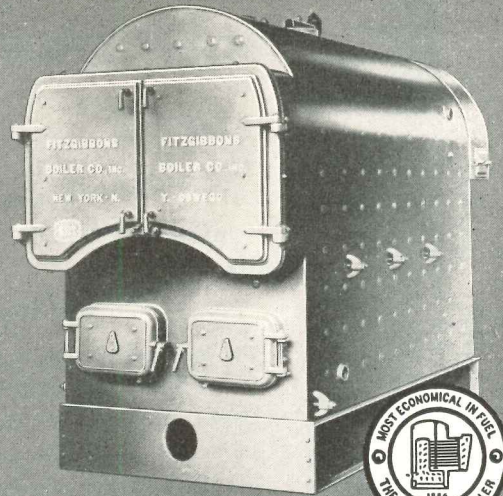

A.S.M.E. code constructed

Hydrostatically tested

Hartford insurance inspected

S.B.I. code rated

Residential and commercial steel boilers in sizes from the small home to the largest structure.

Fitzgibbons Boiler Company, Inc. 101 PARK AVE. NEW YORK 17, N. Y.

For Trouble-Free
Bath Tub Edges

Specify
LUCKE

Leak-Proof Bath-Tub Hangers

No Leaks • No Cracks • No Repair Expenses

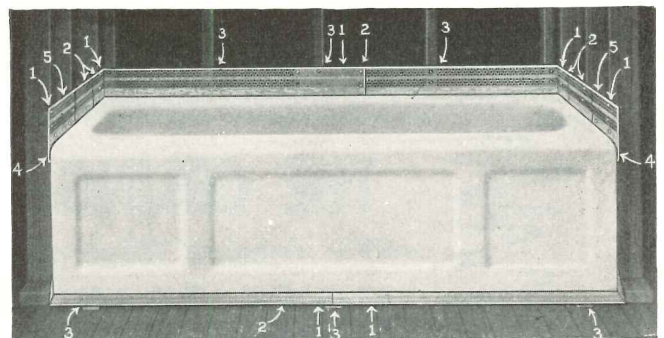

A Necessity For All Housing Projects

There is no excuse for cracks or leaks or repair expense in good building. Leading architects specify LUCKE to overcome this problem. Lucke Hangers build tubs into wall.



Sold by Leading Plumbing
Supply Houses

MANUFACTURED BY

W. B. LUCKE, Inc.

Wilmette

Illinois



Just Published!

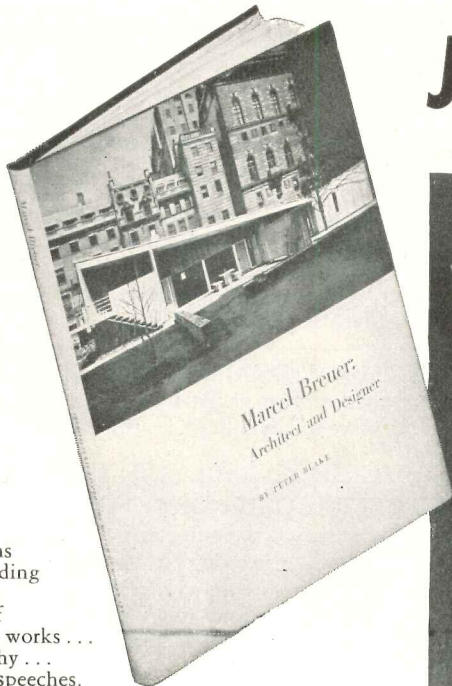

128 pages,
Fully indexed
196 illustrations
Stiff, cloth binding
Size 8½ x 11
Includes list of
Breuer's major works . . .
full bibliography . . .
excerpts from speeches.

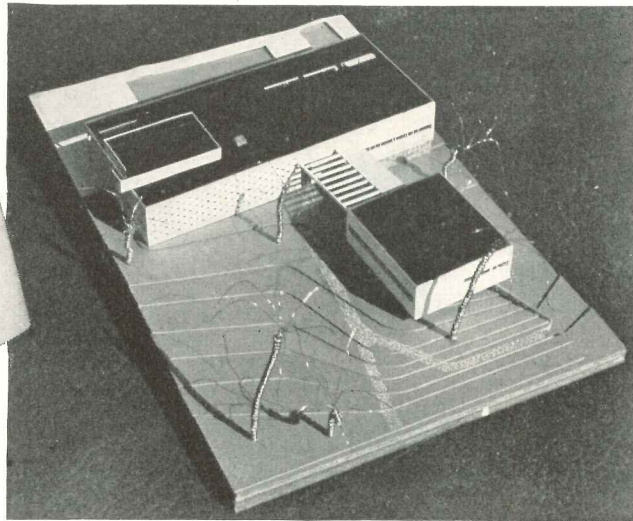

The Inspiring Life Story of a Great Contemporary Architect . . .

"Marcel Breuer: Architect and Designer"

by PETER BLAKE

"In addition to being a most accomplished artist in his own right, Marcel Breuer has formed a link between the turbulent days of the early twenties, when many of the technical and esthetic ideas that have produced the new architecture were first formulated, and the present day with its increasingly widespread acceptance of those ideas in this country and abroad. This book is an attempt both to document Breuer's own work and to emphasize the main points in the message he is trying to convey."

Peter Blake

Curator of Architecture and Design, Museum of Modern Art.

PETER BLAKE'S "*Marcel Breuer: Architect and Designer*" is that rare publishing achievement — a biography which captures *wholly* the essence and spirit of its subject.

The essential meaning of Breuer's career is made clear in this significant and well-documented book as his life and works are traced from his initial contributions to architecture and design at the famous Bauhaus School in Germany to the present time. Considerable space, incidentally, is devoted to the Bauhaus experiment under Walter Gropius which has been responsible for so many notable advances in architecture and design.

Includes Many Reproductions

Fortunately, the author realized that actual reproductions of Breuer's work would explain his growth more graphically than words. Thus, the book is profusely illustrated with plans, drawings and designs made at every stage of

the architect's career. In all there are 196 illustrations, giving fascinating glimpses of Breuer's talents in action; showing his increasing interest in architecture, as distinguished from furniture design, and his later pre-occupation with American techniques. The illustrative material includes not only Breuer's designs, but also the works of those who inspired him: the expressionists, Kandinsky and Klee as well as the rationalists, Maholy-Nagy, Albers and Gropius.

* * *

It is inconceivable that anybody could read Peter Blake's book without learning a great deal. But instruction is not its main concern, nor does it account for the book's intrinsic charm. That charm, rather, lies in its magical unfolding of the drama of a great human being — in the development of a talent which ripened with each new challenge.

Whether you read "*Marcel Breuer: Architect and Designer*" out of professional interest or for sheer enjoyment, your time will be well invested. Handsomely bound in stiff, cloth binding, distinctively illustrated, this 128-page book will be an important new addition to your library.

To obtain your copy, simply fill in and return the coupon below. Just off the press, printed in a limited edition, the book is now available to you at the price of \$4.00, including postage.

BOOK DEPARTMENT, ARCHITECTURAL RECORD
119 West 40th Street, New York 18, N. Y.

Enclosed is \$_____ for _____ copy(s) of "*Marcel Breuer: Architect and Designer*," by Peter Blake, at the price of \$4.00 per copy. (For N. Y. C. add 2% sales tax.)

Name _____

Address _____

City _____ Zone _____ State _____



UTMOST SIMPLICITY AND HEATING COMFORT *with* SARCOTHERM

The heart of the Sarcotherm System is a simple mixing valve which has been proven in service for a quarter of a century. The mechanisms are strictly mechanical — no electricity or compressed air. Nothing could be simpler or more dependable.

NO "COLD SEVENTIES"

and no "on and off" control with Sarcotherm. It's a simple proportioning three way valve that mixes hot water from the boiler with the cooler return water, giving modulated control at all times.

RADIANT HEAT

Continuous circulation with modulated control is ideal. Inside control is by the exclusive Sarcotherm heat-loss thermostat. Thirty years of experience with Radiant Heating is built into every Sarcotherm job.

CENTRALIZED PANEL CONTROL SYSTEMS

Sarcotherm has available completely automatic centralized panel control systems for apartment houses, schools and other public buildings. Complete control programs furnished to suit particular requirements.

Architects and Heating Engineers like Sarcotherm because it is so flexible. Split systems, automatic night set-back and morning pick-up are easily arranged. Lower boiler temperatures, less fuel used and invariably a lower cost of installation, make Sarcotherm the ideal for engineers who are in daily competition.

Ask for the new catalog,
engineering data and sales helps.

Sarcotherm

SARCOTHERM CONTROLS INC. • Empire State Bldg. • NEW YORK 1, N. Y.



EMPLOYMENT OPPORTUNITIES AVAILABLE

Advertising rates on request

Positions Open

WANTED: Architect with building construction experience or an architectural engineer to advise in preparation of plans, review drawings, supervise construction, etc., under Hill-Burton Act. State experience, age and salary required. Address: The Commissioner, Tennessee Department of Public Health, 420 Sixth Avenue, North, Nashville, Tenn.

ARCHITECTURAL DRAFTSMAN: with some design ability; must be good draftsman. Partnership interest possible. Midwest location. Give full details. G. H. Bugenhagen, Minot, North Dakota.

ARCHITECTURAL CHIEF DRAFTSMAN: With at least ten years' drafting experience, competent to lay out and develop work of office handling several contracts simultaneously and to take charge of drafting room. References required as well as samples of work. State salary expected. Position will be permanent for qualified person. Box 483, *Architectural Record*, 119 W. 40th St., New York 18.

UNUSUAL CAREER OPPORTUNITY: for young woman as designer of room interiors to illustrate national advertising of well-known manufacturer. Applicant should have architecture or fine arts training with enough actual experience to prove creative flair and ability to design outstanding residential interiors. Must be able to make good presentation sketches. Write Box 484, *Architectural Record*, 119 W. 40th St., New York 18.

WANTED: Senior Architectural Draftsman and Mechanical Engineer. Give full information regarding experience, salary, etc. in first letter. Box 485, *Architectural Record*, 119 W. 40th St., New York 18.

ARCHITECT-ENGINEER. CHICAGO. CAN ASSOCIATE AND ASSIST PROCURING JOBS. SCHOOLS, Public Housing, Power Plants, Industrial, Etc. Go to any State. All or part, designs, drawings, spec's, contracts, supvn. 25 years' exp. Can also provide association with nationally famous firms. Box 486, *Architectural Record*, 119 W. 40th St., New York 18.

ARCHITECTURAL DRAFTSMAN: with initiative and pleasing personality for opening in small office New Haven, Conn. Diversified practice in contemporary design of residences, commercial buildings and housing projects. Permanent position. Possibility for partnership. Present duties to assist in the development of preliminary drawings and take complete charge of working drawings. Salary \$85 to \$100 depending on qualifications. Reply care Box 487, *Architectural Record*, 119 W. 40th St., New York 18, stating age, education, experience and when available.

GRADUATE ARCHITECTS OR ARCHITECTURAL DRAFTSMEN: Minimum of five years' experience, desirous locating suburban town Western Pennsylvania, diversified practice. Permanent position to right man. Box 488, *Architectural Record*, 119 W. 40th St., New York 18.

TEXAS ARCHITECTURAL & ENGINEERING FIRM: wants experienced senior architectural draftsman for permanent position in old established firm doing major industrial, commercial and institutional practice in seven states. Applicants to state education, practical experience, starting salary and when available. Address replies to: Stone & Pitts, Architects & Engineers, 1872 Calder Avenue, Beaumont, Texas, Telephone 2-2567.

(Continued on page 252)



A new member
of an old family!

THE LITTLE COOLER
FOR LITTLE
PEOPLE!

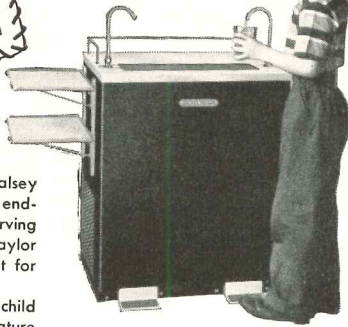

Foot-pedal control permits child to fill glass with water while holding tray. Greater convenience, time saving.

In school cafeterias, or other places where children gather, this latest Halsey Taylor development eliminates endless confusion and speeds serving time. It's the new Halsey Taylor LO-LEVEL, just the right height for children.

Architects, design with the child in mind . . . get our latest literature on the LO-LEVEL, featuring the usual Halsey Taylor hygienic safeguards!

The Halsey W. Taylor Co.
WARREN, OHIO

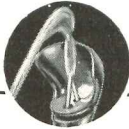

A-3

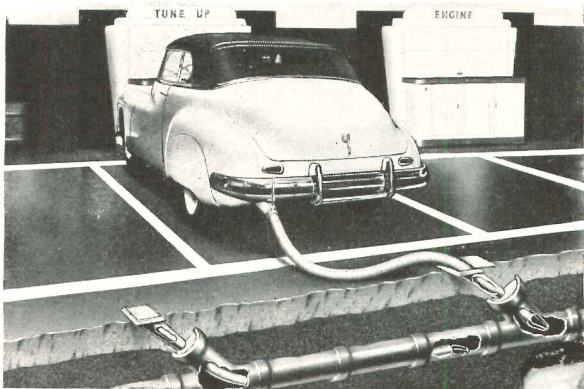

YOU GET FOUR IMPORTANT ADVANTAGES
WITH Kent-Moore

MONOXIVENT
EXHAUST ELIMINATING FIXTURES

If you were to sit down and write out a description of the "perfect" exhaust eliminating system for a service department, chances are you'd end up with a word picture of the Kent-Moore J 2980 MONOXIVENT Set. It's designed for use with any underfloor system, and its four important advantages are: **LOW INSTALLATION COST**—Readily installed in upturned "Y" section of main duct. No individual "T's" or branch duct required. **CONCEALED HOSE ASSEMBLY**—Asbestos packed flexible stainless steel tube and special tailpipe adapter slide down under floor for safe keeping when not in use. No storage problem, no unsightly hoses hanging from overhead. **QUICK, CONVENIENT USE**—Just lift the floor cover-plate and MONOXIVENT is ready for use . . . quickly, easily attached, detached and stowed. **LONG LIFE, LOW COST OPERATION**—Fully protected against damage, can't get lost or "borrowed". Minimum frictional losses assures efficient, economical operation. Complete installation data furnished upon request . . . write for it today!



KENT-MOORE ORGANIZATION, INC.
GENERAL MOTORS BUILDING • DETROIT 2, MICHIGAN

Engineers and Manufacturers of Special Automotive Service Tools and Equipment  Sales and Service Engineering Representatives in Principal Cities Coast-to-Coast

ROTARY LEVELATOR GIVES

Built-In Efficiency

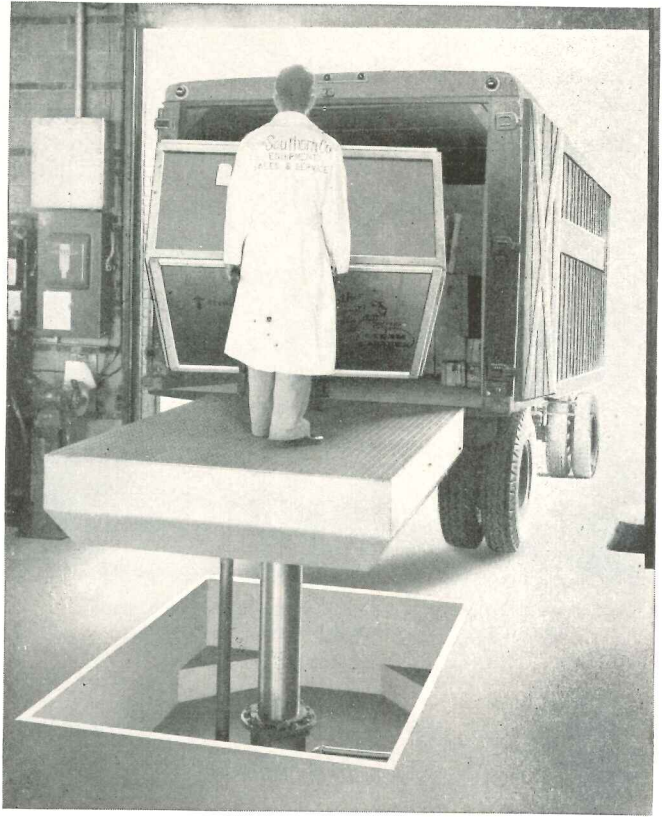

**Saves Space, Eliminates Ramps,
Speeds Materials Handling**

Levelator Oildraulic Lifts make it possible to handle materials directly from plant floor to other levels. They save at least 400 square feet of ramp space, frequently eliminate loading docks altogether. You can simplify building designs by using Levelator Lifts. Plant floors can be located at grade or other most economical levels.

Mail coupon below for new Levelator booklet. It contains complete design and performance data, illustrates how these labor-savers are being used by thousands of cost-conscious industrial concerns.

Rotary Lift Co., 1105 Kentucky, Memphis 2, Tenn.

Rotary
Levelator
OILDRAULIC LIFT

Mail coupon
for data file

ROTARY LIFT CO.,
1105 Kentucky, Memphis 2, Tenn.
Send complete information on
Levelators to:

Name _____

Address _____

City _____

State _____

"School for Thought"

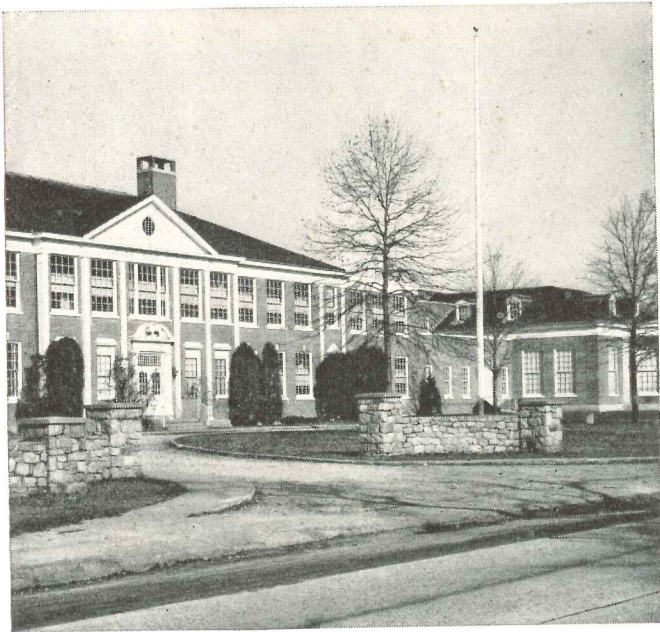

Staples School, Westport, Conn., Architects: Reginald Marsh & Starrett & Van Vleck. Danby Vermont Marble Trim.



Here is a classic example of the arresting beauty of marble. When Vermont Marble is specified for the trim at entrances, sills and lintels of windows, water-tables and other projecting members exposed to the weather, buildings literally beam with beauty.



Even though a limited budget may dictate your neighbor's decision to specify cheaper material for plain wall surfaces, you would criticize his judgment if he should use, for the most conspicuous and exposed parts of his building, material that's subject to decay.

So, act upon your own criticism. In the interest of economy, beauty, and durability, specify Vermont Marble trim.

crystalline

VERMONT MARBLE

VERMONT MARBLE COMPANY • PROCTOR, VERMONT

Branch Offices

Boston • Chicago • Cleveland • Dallas • Houston • Philadelphia • Los Angeles • New York
San Francisco

In Canada: Ontario Marble Company, Ltd., Peterboro, Ontario and Toronto, Ontario.
Brooks Marble & Tile Company, Ltd., Toronto, Ontario.



EMPLOYMENT OPPORTUNITIES AVAILABLE

Advertising rates on request

(Continued from page 250)

ARCHITECTURAL ASSOCIATE WANTED: to assume responsibility for production of working drawings in busy architect's office. Qualifications: College graduate in Architecture; about 35; good health; thorough knowledge of working drawings and building construction; excellent feeling for contemporary design; pleasing personality; executive ability. Extraordinary opportunity in one of the fastest growing regions of the United States. Must desire to do excellent work. If qualifications cannot be met, please do not apply. Write or call Golemon & Rolfe, Architects, 915 Woodrow Street, Houston, Texas.

Positions Sought

ARCHITECT-DESIGNER: Interested in partnership possibility in the West. Twenty years' experience. 6 years' private practice in area of stagnant economy. Strong contemporary designer with historical training. Detailed plans, specifications, supervision, sketches. Two degrees at leading university. Pleasing personality, drive and initiative. Active in organizations. Age 40, Box 489, *Architectural Record*, 119 W. 40th St., New York 18.

ATTENTION ARCHITECT OFFICES: in Southern Ohio & Northern Kentucky. Want to do Architectural Designing for you; Commercial, Residential, Churches, Hospitals. Box 490, *Architectural Record*, 119 W. 40th St., New York 18.

ARCHITECT: Desires a definitely promising connection in Washington, D. C., vicinity with a small progressive firm of seasoned men that can use his varied experience, insight and cooperative ability to mutual advantage. Age 42, registered in D. C. and Florida. Competent in all phases, including handling of drawings and jobs from start to finish. Box 491, *Architectural Record*, 119 W. 40th St., New York 18.

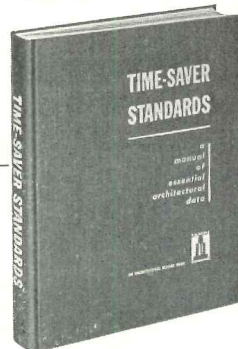

USE this treasury of authoritative planning data

Architectural Record's monumental 10-year collection of

"Time-Saver Standards"

- the manual of essential architectural data on: Architectural Design; Engineering Data; Materials Technology; Building practice.
- 277 complete "Time-Saver Standards," as selected month by month from the masterworks of the nation's leading architects and engineers.
- 656-page encyclopedic volume with
 - 1,000 illustrations
 - a 4-page Classified Table of Contents
 - a 12-page Master Index of 1,700 subjects!

SAVE TIME
SAVE MONEY

designing
drafting
specification
writing

START NOW ▶

ARCHITECTURAL RECORD BOOK DEPARTMENT
1119 West 40th Street, New York 18, N. Y.

Enter my order for copies of the 656-page "Time-Saver Standards" at \$12.00 a copy. I enclose \$ (For New York City delivery add 24c for sales tax—\$12.24 in all.)

Name _____

Address _____

City _____ State _____ Zone _____

ARCHITECTURAL RECORD

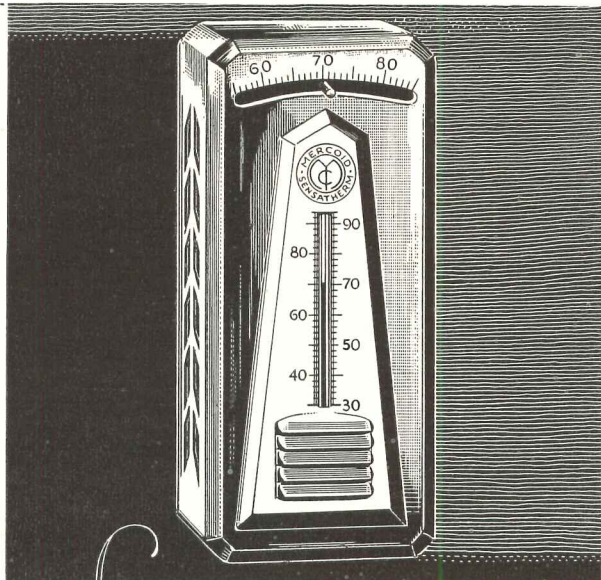

MERCOID

Sensatherm

IT HAS WHAT YOU NEED IN A THERMOSTAT

It maintains a home in ideal comfort at any desired temperature. It operates on a variation of $\frac{1}{2}^{\circ}$ above or below the point set. It is a corrosion-proof mercury switch contact equipped control. It performs perfectly for years without any servicing attention. It is a masterpiece in mechanical precision, design and appearance.

Complete catalog sent upon request

THE MERCOID CORPORATION, 4201 BELMONT AVE., CHICAGO 41, ILL.
Manufacturers of dependable automatic controls for a quarter of a century

**NEW LOW GLAZING COSTS!
NEW HIGH GLAZING QUALITY!**

**SPECIFY
TREMGLAZE
MASTIC GLAZING COMPOUND
IN COLORS**

Requires No Painting

**Aluminum
Windows
Steel or Wood
Windows**

- Specify Tremglaze Aluminum color. It bonds to aluminum, requires no painting—ever. Proven on actual jobs for over ten years. Meets Aluminum Window Manufacturers Association standards.

- Specify Tremglaze yet pay no more for completed window installations than with a putty job. Save on the paint contract; specify—"Paint first—then Tremglaze". Put paint on the window where it belongs—Tremglaze requires no paint. Save on cost of cleaning glass also.

NC-102

Consult your local Tremco Representative or write to:

THE TREMCO MANUFACTURING CO.
CLEVELAND 4 • TORONTO

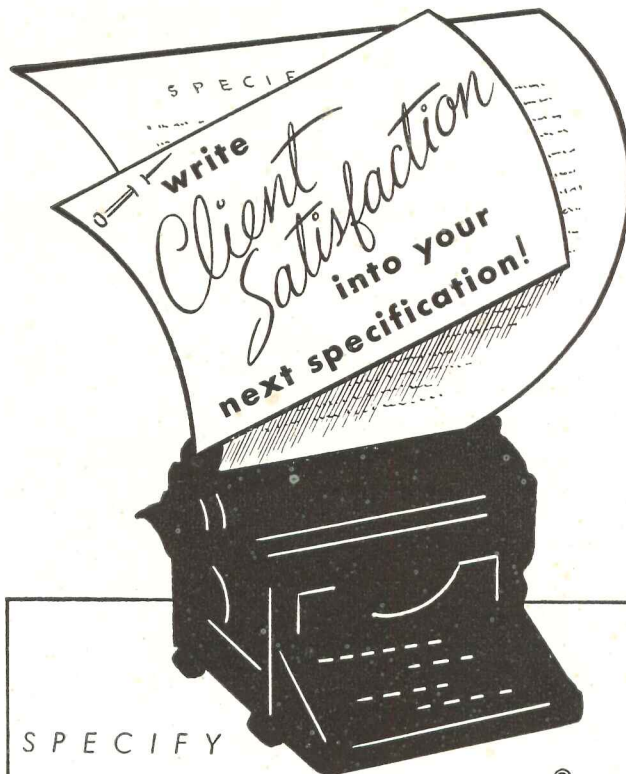

SPECIFY

**Win-Dor[®]
HARDWARE**

—Quality Since 1906—

The three Win-Dor devices shown below are the elements that help assure client satisfaction with your *out-swung wood casement window installations*. Each one performs a specific important function—and does it *better!* Together, they furnish the most satisfactory control that quality manufacture and the engineering experience of almost half a century can provide.

See Sweet's file $\frac{18b}{16}$ for details.

Series 48 "Snugger" Closer:

Reaches out and pulls casement tight at top. Automatic closing and re-

lease. Furnished in steel or brass,

with 6 or 8-lb. spring. Reversible.

"Snuggers" also available to

provide automatic closing of all

doors—especially cabinet and

wardrobe doors where "whip" is

encountered. Eliminates latching

devices. No mortising.



Series 75

Extension Hinges:

Provide 4" clear-

ance between

open sash and frame

to permit cleaning outside of

glass from within the room. Re-

inforce sash corners



Series 30 Wood Case-

ment Operator (reversible):

Permits close housing for trim

detailing, and when concealed

under stool, eliminates all hard-

ware obstruction above it. Over-

size $\frac{3}{4}$ " bronze worm, bronze

bushing. Steel arm, channel, and

integrated housing.

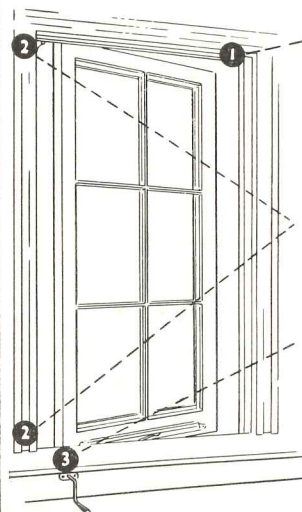
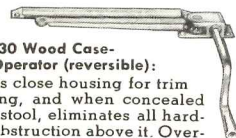

THE CASEMENT HARDWARE CO.

406 N. Wood St., Dept. J, Chicago 22, Illinois

**ARCHITECTS & BUILDERS
FIRE "RICHARD" ...
HIRE "ROLY" TO
"OPEN THE DOOR"
*Roly Does More For Less!***

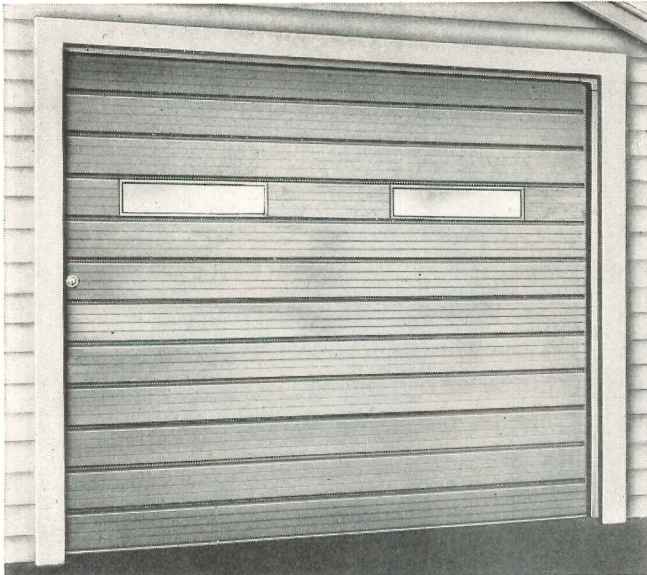

Because the sensational new MORRISON Roly-Door - the first and only four-sectional, all-steel overhead residential garage door—has *every* wanted feature It opens the door to *everybody's* satisfaction!

The architect specifies the MORRISON Roly-Door because it conforms to all styles of architecture — because its beautiful simplicity is a welcome addition to new as well as old homes.

The builder chooses the MORRISON Roly-Door because it costs less to install . . . because it's individually packaged.

And the home owner is more than satisfied because the MORRISON Roly-Door costs less to own — and is built for a lifetime.

But that's not all . . . because no other overhead garage door has ALL THESE FEATURES:

- | | |
|---|---|
| ★ Four-Sectional | ★ Weatherproof |
| ★ Costs Less to Own | ★ Completely Painted |
| ★ Costs Less to Ship | ★ "Touch-'n-Go" Operation |
| ★ Costs Less to Store | ★ Quiet and Safe |
| ★ Costs Less to Install | ★ Lock Keyable to Home |
| ★ Low Headroom Bracket | ★ Minimum Field Assembly |
| ★ Welded at Factory | ★ Individually Packed |
| ★ Trouble-Free (Patented Pend.) Hinging | ★ Conforms to all Architecture and Building Codes |
| ★ Built to Last | |

Write for Bulletin D50-1-A

MORRISON STEEL PRODUCTS, INC.
ROLY-DOOR DIVISION
647 AMHERST ST. BUFFALO 7, N. Y.

**Creative Hands use
PHOTO-MURALS**



Use Photo-murals to create atmosphere at reasonable costs. Custom-made to any size, in black and white, sepia or color.

Write — for our colorful 24-page booklet "Photo-Murals"

West-Dempster Co.
 100 W. Lyon Grand Rapids, Mich.

What
OTHER HEATING METHOD CAN
Match

all
THESE BENEFITS

DRAVO
Counterflo **HEATERS** *Offer...*

- LOW FIRST COST...Users report savings of 50% to 65%.
- WORKING-ZONE WARMTH...Units heat 4,000 to 20,000 sq. ft.
- NO FUEL WORRIES...Burn oil or gas—readily converted.
- LOW OPERATING COST...80-85% efficiency.
- AUTOMATICALLY CONTROLLED...On-off or modulating controls.
- EASY INSTALLATION...Only fuel, electric and exhaust connections.
- LONG LIFE—LOW MAINTENANCE...Stainless Steel chamber.
- TESTED—APPROVED...AGA and/or UL seal.
- AVAILABLE...Immediate delivery, no delays.

**FOR FULL INFORMATION . . . DROP A CARD
OR A LETTER FOR BULLETIN BD-523-24A**

DRAVO CORPORATION
 DRAVO BUILDING, PITTSBURGH 22, PA.
 Sales Representatives in Principal Cities
 Mfd. and Sold in Canada by Marine Industries, Ltd., Sorel, Quebec



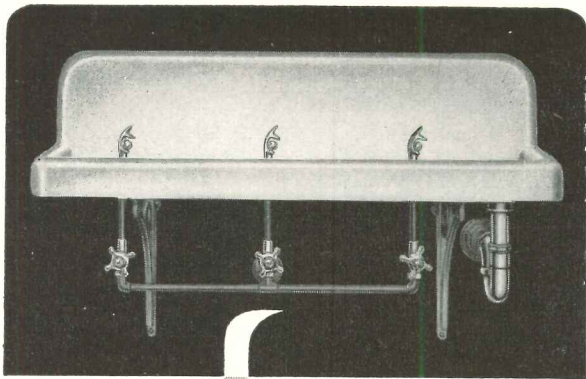

Always specify

HAWS

for Highest
Quality

Sanitary Drinking Fountains

Electric Water Coolers

Drinking Faucets, Equipment,
Filters and Accessories

• A reputation for reliability
since 1909. Check in Sweets
or write for HAWS catalog.

HAWS DRINKING FAUCET CO.

1441 FOURTH STREET (Since 1909) BERKELEY 10, CALIFORNIA
Agents and Sales Representatives in All Principal Cities



Glued Laminated Beams

...for Durable Construction at Low Cost

Buildings of moderately wide span are erected quickly and economically using glued laminated beams from Timber Structures, Inc. Formed of structural quality kiln dried material welded together under pressure with permanent glues, these members will never shrink, check, twist or warp. Beams of dimensions like those above are highly fire resistive.

When sanded and finished and left exposed, glued laminated beams add a beautiful architectural effect. Cambered and tapered, they frequently are used as primary structural roof members. For complete information on glued laminated beams and other structural members see the Timber Structures office nearest you, or write directly to...

TIMBER STRUCTURES, INC.

P.O. BOX 3782A, PORTLAND 8, OREGON

Offices in Boise, Idaho; Eugene, Oregon; Kansas City, Missouri;
Lawrenceville, N.J.; Chicago; Dallas; New York; Seattle; Spokane

TIMBER STRUCTURES, INC. OF CALIFORNIA, Oakland, Sacramento and Santa Rosa
Local Representatives Coast to Coast

PARKWOOD

Decorative

SPECIFIED



Employees' Cafeteria

NEW John Hancock Building

PARKWOOD DECORATIVE was specified by the John Hancock Insurance Co., and their decorators, for all genuine wood veneer plastic table tops used in their huge, modern employee cafeteria. Daily, 3,800 people lunch here in just 2½ hours — mute evidence of the sanitary and indestructible qualities of PARKWOOD DECORATIVE.

many diverse applications

The John Hancock Building contains hundreds of PARKWOOD DECORATIVE genuine wood veneer plastic table tops of diverse woods for use in executive committee rooms, dining rooms, employees' recreation and lounge rooms, as well as for restaurant and library counter tops.



IF YOUR REQUIREMENT
IS BEAUTY AND DUTY...

specify

PARKWOOD *Decorative*

For beauty, PARKWOOD DECORATIVE offers a wide variety of genuine wood veneers... plus the new three-dimensional patterns, PARKWOOD Pebble-Tex and Stardust — in an attractive range of beautiful colors.

For duty, these beautiful laminated plastic table tops wear indefinitely and are resistant to alcohol, fruit juices, cigarette burns and the usual cleaning chemicals. With PARKWOOD there's no replacement problem!

See Our Full-Color Catalogue
Sheets in Sweet's 1950 Index 14A-8

SEND NOW—FOR OUR BEAUTIFUL KODACHROME BROCHURE



Parkwood Corporation

21 Water St., Wakefield, Massachusetts



BASEBOARD RADIATION

is responsible for the heating comfort of thousands of home owners

Yes, Vulcan Baseboard Radi-vector offers what every homeowner wants most . . .

COMFORT Vulcan Baseboard installed along outer walls and beneath spacious window areas provides the smoothest heat available. **RADIANT** heat for floor-level comfort . . . **CONVECTION** heat, providing an insulating blanket of warm air from floor to ceiling for luxurious all-over heating comfort.

ATTRACTIVENESS Vulcan Baseboard is a modern heating installation. It easily fits into modern home design from drawing board to the final interior decoration where Vulcan is no more conspicuous than an ordinary baseboard. Attractive covers assure complete satisfaction.

ECONOMY Vulcan is economical because it is so easy to install . . . responds quickly to heating controls . . . requires no maintenance.



A Vulcan installation can be planned to fit the specified budget from the speculatively built housing unit to the custom-built home.



THE VULCAN RADIATOR COMPANY
26 FRANCIS AVE. HARTFORD 6, CONN.

Complete information on Vulcan Standard and Vulcan Baseboard Radiation for residential heating in Sweet's Architectural File.



25 YEARS

A LEADER IN FIN-TUBE RADIATION

CEMENT SPECIFICATIONS

are highly important!

Get complete information on these Medusa Cements before you build:

- Medusa Waterproofed Gray
- Medusa White
- Medusa Waterproofed White
- Medusa Stoneset
- Medusa Brikset
- Medusa High Early Strength

MEDUSA PORTLAND CEMENT CO.
1015-4 Midland Building, Cleveland 15, Ohio

You can build **BETTER** with
MEDUSA PRODUCTS



Reg. U. S. Pat. Off.



You can make it easy for your client to set up
A SCHOOL PROGRAM SCHEDULE IN 3 OR 4 MINUTES!

Today the school has more of everything *except time!*

Standard Synchronous Master-Program Controller and Clock System *saves* time. Paper tapes plainly marked in hours and minutes can be punched and installed in a very few minutes and will last for years. Any signal can easily be placed in any schedule desired by simply changing the position of its plug on the bell control board.

Bulletins and complete engineering service are available to architects.

c-1



SYNCHRONOUS PROGRAM CONTROLLER AND CLOCK SYSTEM

The Standard Electric Time Co.

81 LOGAN STREET • SPRINGFIELD, MASS.

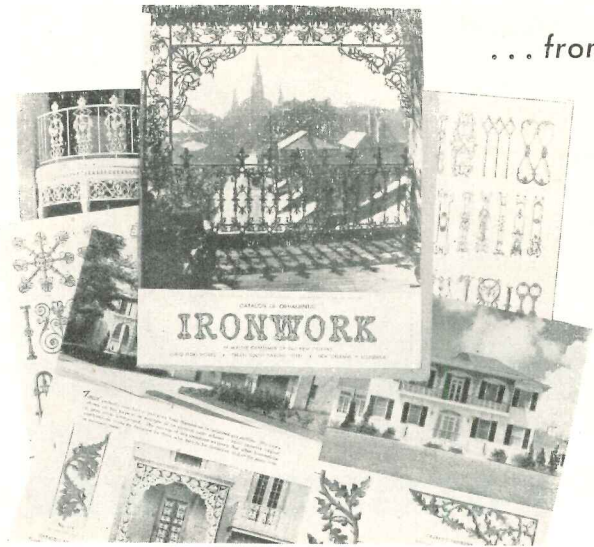

... from the beautiful, original lacework
of historic OLD NEW ORLEANS

WE PRESENT A COMPLETE PICTORIAL CATALOG OF

ORNAMENTAL CAST IRONWORK

Every known pattern to be found among historic Vieux Carre (New Orleans) buildings and antebellum homes are faithfully reproduced by LORIO master craftsmen... cast in the finest quality iron obtainable.

LORIO IRONWORK installations can be seen on homes, hospitals, university buildings, doctors' clinics and other types of buildings... in the very finest of modern or traditional architectural taste.

WE OFFER A COMPLETE SERVICE IN
PRODUCING CUSTOM-MADE PATTERNS
FROM YOUR OWN DESIGNS . . . OR
SPECIAL CASTINGS OF ANY KIND.

Send for this handsome NEW 48-PAGE CATALOG

Available, for the asking, to architects and builders who are interested in—

- AUTHENTIC HISTORIC PATTERNS
- CREATIVE REPRODUCTIONS OF NEW DESIGNS
- HIGHEST QUALITY OF MATERIALS AND WORKMANSHIP
- EXCELLENCE IN ARCHITECTURAL TASTE

All of the famous New Orleans designs and many new ones are illustrated in this 1950 LORIO Catalog. And beautiful, large, photographic reproductions of various installations throughout the United States are shown.

LORIO IRON WORKS

738-756 South Gayoso Street • New Orleans 19, Louisiana

Throughout the
**AIR CONDITIONING
Industry—**

**AEROFIN FIN-TYPE
HEAT-TRANSFER UNITS**
do the job Better,
Faster, Cheaper

AEROFIN CORPORATION
410 South Geddes St., Syracuse 1, N. Y.

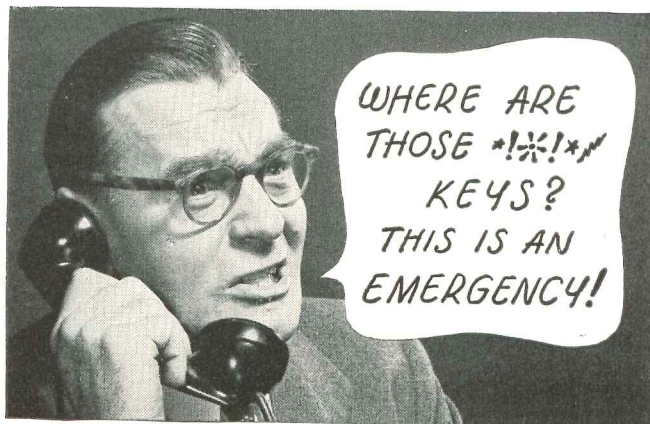

Read how **MOORE KEY CONTROL*** can save money and man-hours

You owe it to your client to investigate this modern system of key control. It saves money year in and year out by eliminating expensive repairs and replacement of locks and keys. What's more, it guarantees security, convenience and privacy. No wonder more architects every year now specify Moore Key Control for use throughout schools, institutions, hospitals, hotels... in all factories and buildings where keys are used.

***TELKEE**
TRADE MARKS®

Mail Coupon
today for
Free Booklet

P. O. MOORE, INC., Dept. A-1
300 Fourth Ave., New York 10, N. Y.

Please send me special architect's manual for my A.I.A. file on MOORE KEY CONTROL.

Name.....

Address.....

City, State.....

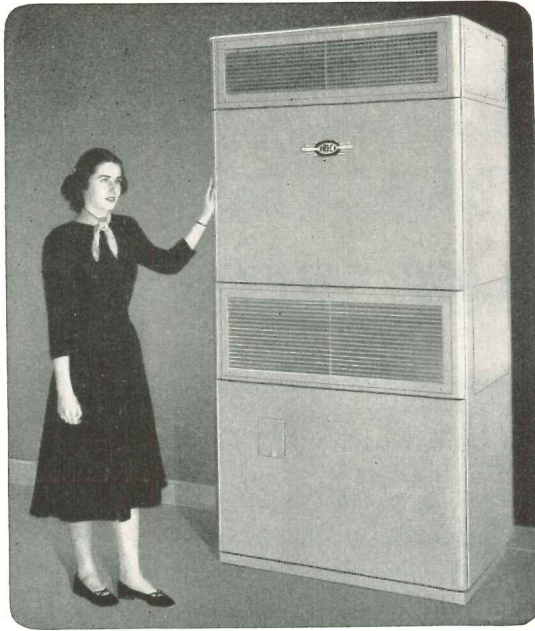

BUILD BUSINESS WITH



UNIT AIR CONDITIONERS

People like the refreshing coolness and freedom from humidity these Units bring to your restaurant, office or shop.

Frick Air Conditioners have the features you want: large cooling capacity, quiet operation, excellent economy, sealed refrigerating unit, variable-speed fan, self-cleaning filter, adjustable air outlets, and beautiful glazed blue-grey finish.

Frick Unit Conditioners installed in the 'Thirties are still good for years of service. Get full details: ask for Bulletin 522.



The Hill Cafe in Harrisburg, Penna., Has Used Three Frick Unit Air Conditioners Eleven Years.

DEPENDABLE REFRIGERATION SINCE 1882

FRICK Co.

WAYNESBORO, PENNA. U.S.A.

Also Builders of Power Farming and Sawmill Machinery

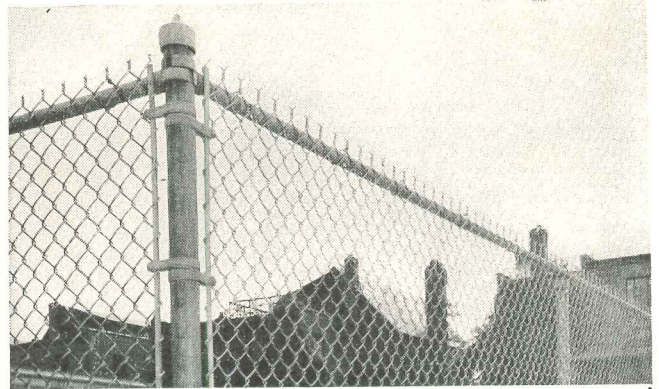

BE ON THE SAFE SIDE . . . SPECIFY REALOCK FENCE

Put your property on the safe side of a tamper-proof Realock® Fence. You'll get permanent protection against trespassing, vandalism and other hazards.

Made of steel wire, heavily galvanized, Realock Fence is nationally known for its rugged good looks, indestructibility, and long-lived economy.

WRITE NOW FOR FREE ESTIMATE



WICKWIRE SPENCER STEEL DIVISION
361 DELAWARE AVENUE · BUFFALO 2, NEW YORK
THE COLORADO FUEL AND IRON CORP.
CONTINENTAL OIL BUILDING · DENVER 2, COLORADO
THE CALIFORNIA WIRE CLOTH CORP.
1080-19TH AVENUE · OAKLAND 6, CALIFORNIA

BRANCHES & DISTRIBUTORS IN KEY CITIES EVERYWHERE

SUSPENSION UNIT . . .

Oil or Gas!

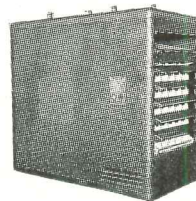

WITH AN OUTSTANDING LINE OF BOTH OIL AND GAS-FIRED SUSPENSION TYPE HEATERS, J-C COVERS THE FIELD WITH THIS INCREASINGLY POPULAR TYPE OF FURNACE.



J-C GAS-FIRED SUSPENSION UNITS, fan or blower operated, have outputs of 68,000 to 172,000 BTU. Designed and built for performance and long life, the J-C gas fired suspension heater is ideal for heating, ventilating . . . for residential, commercial and industrial applications.

J-C OIL-FIRED SUSPENSION UNITS have outputs of 112,000 to 450,000 BTU. An efficient heater requiring less space than any furnace of its type and rating. Units feature greater heating efficiency with less heating surface . . . due to an exclusive design of ducts and baffles. Ease of installation is a feature—and ready access facilitates servicing.



... AMERICA'S LARGEST AND MOST COMPLETE WARM AIR HEATING LINE . . .



A PRODUCT OF JACKSON & CHURCH COMPANY, SAGINAW, MICHIGAN
WORK WELL DONE SINCE '81

**PLAN YOUR KITCHENS YOUR WAY
WITH VERSATILE AKRON ELECTRIC EQUIPMENT**



436 RANGE

621-02 OVEN

621 RANGE

For years architectural thinking and planning of kitchens for large estates and institutions has been limited by the availability of only standard size ranges and ovens.

Now, for the first time, the Akron line offers architects a wide flexibility in kitchen planning. Akron Engineered Electric Ranges and Ovens—production models all—can be easily adapted to fit the architects plan for "built-ins", extra service features and exterior surface finishes to harmonize with the planned surroundings.

Akron ranges and ovens are the finest the market affords and are fully equipped with automatic controls for convenient, trouble free and economical electric cooking in the large residence or institution.

Write today for full details about Akron's custom service for architects. There's a wealth of ideas for you in the planning of kitchens for fine homes and institutions.

**AKRON
ASSOCIATED PRODUCTS, INC.**

2nd National Bank Bldg. • AKRON, OHIO
20 S. Ontario St. • TOLEDO, OHIO

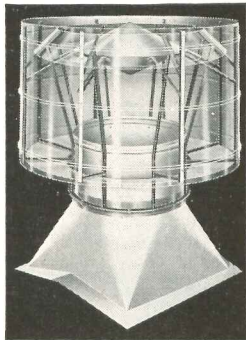

**THIS BURT VENTILATOR
CAN'T GET OUT OF ORDER**

The Burt Free-Flow Gravity Ventilator has no moving parts. Its construction is simple — offers no service problem whatever. Yet its efficient application of the Air Flow principle provides greater capacities and efficiency with marked economy. The Free-Flow is one of Burt's *complete* line of ventilators.

See Sweet's or write for catalogs and data sheets on the entire line.

THE BURT MFG. CO.
ROOF VENTILATORS • OIL FILTERS
EXHAUST HEADS

48 E. South Street, Akron 11, Ohio, U.S.A.

SEND
FOR CATALOGS

Burt Engineers
are glad to
help on plans

HAR-VEY
ROLLING DOOR HARDWARE
-- made from the Quality Products of
America's Leading Manufacturers

TRACK BY REYNOLDS

Produced by Reynolds Metals, the aluminum alloy extrusion used for the Har-Vey track is specially designed for smooth, silent rolling -- and specially processed for lifetime wear.

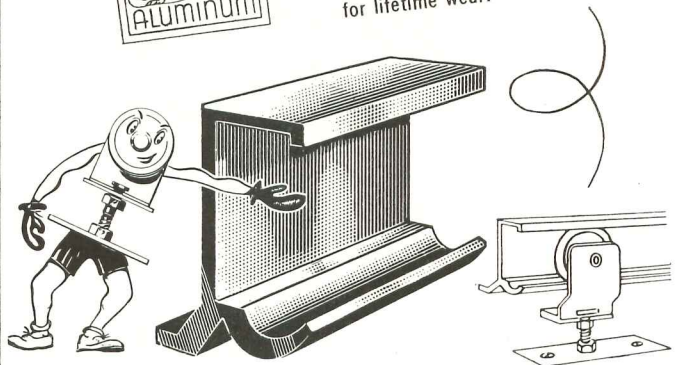

**It's the nation's leaders giving their best
that puts Har-Vey Hardware ahead of the rest!**

It's leading concerns such as

THE CHRYSLER CORPORATION,
ANACONDA COPPER, FORMICA,
AND REYNOLDS METALS

-- all contributing the best of materials and workmanship as producers of component parts for Har-Vey Hardware -- that makes Har-Vey first in its field for quality.

Yes, and it's advanced design that gives Har-Vey *engineering* leadership -- with new features that make it completely rustproof and assure positive locking -- with superlative ease of installation -- and with smooth, silent rolling that's sure to last for a lifetime.

CHAMPION
QUALITY



Check all the facts yourself! Send today for free folder giving full information on Har-Vey Hardware and varied uses of rolling doors -- with installation details.

Address: **Hardware Division T**

METAL PRODUCTS CORPORATION

807 N. W. 20th St. Miami, Florida



Please send me your free folder on rolling doors & Har-Vey Hardware

NAME _____

COMPANY _____

STREET _____

CITY _____ STATE _____ T

YOUR DEALER'S NAME _____

NOW LAWSON

BATHROOM CABINETS

BONDERIZED

AFTER FORMING!

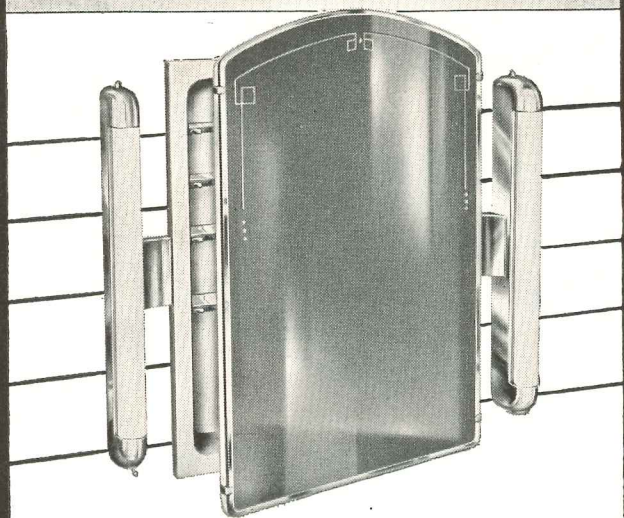

BONDERIZED AFTER FORMING is an important new feature added to all Lawson Bathroom Cabinets! The bonderizing process is applied **AFTER** all shearing, drilling and forming is completed. It provides 100% **BONDERIZED** protection against rust and corrosion . . . assures longer life for all Lawson Cabinets!

AND . . . Lawson Cabinets, BONDERIZED AFTER FORMING, cost no more!

**ARCHITECTS SPECIFY
LAWSON BATHROOM CABINETS . . .**

BECAUSE they have: *one-piece drawn steel body*, stainless steel hinge and shelf supports, first-quality mirror . . . and now, they are **BONDERIZED AFTER FORMING!**

Write today for catalog of bathroom cabinets and chrome accessories.

**WORLD'S LARGEST BUILDERS
OF BATHROOM CABINETS**

THE F. H. LAWSON CO.

802 EVANS ST.,

CINCINNATI 4, O.

Lawson
**BATHROOM
CABINETS**

134 YEARS

**TO PREVENT THE
POSSIBILITY OF
POISONOUS CARBON
MONOXIDE IN THE
BUILDINGS YOU
DESIGN**

Specify

"NATIONAL"

**The Approved Garage
Ventilation Equipment**

Standardized engineering simplicity that lends perfectly to new garage buildings — efficiency, appearance, economy of installation and shop working conditions. The method of exhaust gas removal used by "National" is recommended by health departments, insurance companies, architects, building contractors and building codes in most cities and states. 4 different types of systems to choose from. Complete packaged units — ready to install. Nothing else to buy — low in cost.

Illustration shows sectional view of "National's" underfloor disappearing tube installation. Note that tube disappears without entering main trunk line — for balanced flow of air through main duct and perfect exhaust gas removal. Write for complete literature and costs.

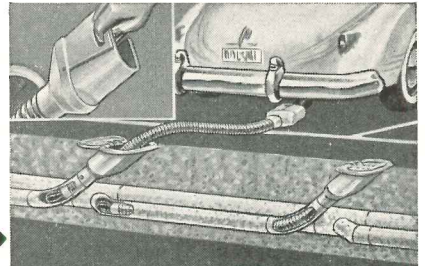

THERE ARE MORE "NATIONAL" SYSTEMS IN OPERATION IN THE UNITED STATES AND CANADA THAN ALL OTHER TYPES OF SIMILAR SYSTEMS COMBINED. LITERATURE AND FULL INFORMATION ON REQUEST.

THE NATIONAL SYSTEM OF GARAGE VENTILATION

World's Largest Manufacturers of Exclusive Garage Ventilation Equipment

Dept. 10C, 318-330 N. CHURCH STREET

DECATUR, ILLINOIS

**LONE STAR
CEMENTS**

**COVER EVERY
CONSTRUCTION NEED**



**LONE STAR PORTLAND
CEMENT**

for concrete of outstanding quality in all types of construction

'INCOR'* 24-HOUR CEMENT

America's **FIRST** high early strength Portland Cement — saves time, cuts costs

**LONE STAR MASONRY
CEMENT**

The modern masonry cement, for really great job performance

*Reg. U. S. Pat. Off.

LONE STAR CEMENT CORPORATION

Offices: Albany • Bethlehem, Pa. • Birmingham • Boston • Chicago • Dallas
Houston • Indianapolis • Jackson, Miss. • Kansas City, Mo. • New Orleans
New York • Norfolk • Philadelphia • St. Louis • Washington, D. C.



EARLY AMERICAN
Hardware
and Lighting
Fixtures

**The Finishing Touch of Quality for
Colonials, Ranch Houses, Game Rooms**

Old Guilford Forge reproduction hardware and Early American lighting fixtures are now available to architects for use in homes where the "touch of distinction" is required. Not just another black iron line, Old Guilford Forge offers a complete complement of faithfully hand-reproduced hardware, with lighting fixtures in pewter, brass and wrought iron to match.

Despite their quality, Old Guilford Forge reproductions are sensibly priced — well within the budget of the moderate cost home. Custom work in ornamental iron and hardware is invited. Write for quotations.



Write for New Illustrated Catalogue

Old Guilford Forge

34 BROAD STREET

GUILFORD, CONNECTICUT



BEAUTY—STRENGTH—DURABILITY



Extruded Alumilited Aluminum Storefront Metals

* * * *

Extrud-a-line Factory Assembled Entrances and Narrow
Stile Aluminum Hollow Metal Doors.

ALUMILITED FINISH

For further information, write to:

THE ALUMILINE CORPORATION
339 Eldert Street Brooklyn 27, N. Y.



**THE GRILLE OF SUPREME
AIR DISTRIBUTION**

**PERFORMANCE
at New Low Prices**



Illustrated above—
TITUS AIRFOIL #276

Airfoil
**4-WAY MULTI-SHUTTER
REGISTER...**

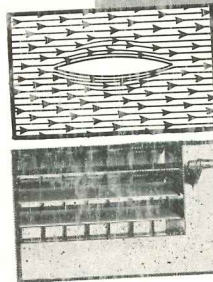

**SOLID SECTION
AIRFOIL LOUVER**

At left—AIRFOIL louver knives air in wind tunnel tests. Note how turbulence has been almost completely eliminated. Glass-smooth surface of louver gives complete air control.

LEVER OPERATOR

Inconspicuous lever in frame controls damper operation. Removable lever furnished at no extra charge.

Draft-free air distribution performance of the #276 makes any air conditioning system better. The two banks of revolutionary new streamlined AIRFOIL louvers handle air with minimum turbulence and noise. Damper blades interlock to provide complete shutoff. First 2 sets of louvers are individually adjustable.

Each #276 grille is a masterpiece of precision building—not an assembly job. Extra-strong frame gives longer life—greater value.

Specify AIRFOIL air conditioning outlets for highest efficiency.

NOTE THESE OUTSTANDING FEATURES

- Extra louver depth for better air control.
- Air-tight rubber gasket.
- Extra-strength frame.
- Positive volume control.

CHECK TYPE OF GRILLE ON WHICH INFORMATION IS DESIRED

- Air conditioning outlets
- Perforated ornamental grilles
- Return air grilles & registers
- Door ventilators
- Volume controllers
- Special made-to-order grilles

TITUS MANUFACTURING CORP. • WATERLOO, IOWA

___ Rush information on No. 276. ___ Send complete catalog.
___ Send literature on above checked items.

NAME _____
ADDRESS _____
CITY _____ STATE _____

SHEPARD



**HIGH DEPENDABILITY
GREATER ECONOMY
LESS MAINTENANCE**

Built up to a quality — not down to a price. SHEPARD Elevators offer you high dependable service at low maintenance costs. For that new elevator you're planning or the old one you're modernizing — consult SHEPARD Engineers. Write for 58 page Elevator Planning Book.

THE SHEPARD ELEVATOR CO.
2442E Colerain Ave., Cincinnati 14, Ohio

ELEVATORS

Your Clients Appreciate This

ADDED SAFETY...

**THE BIGGEST SINGLE
IMPROVEMENT YOU CAN
OFFER HOME BUILDERS**

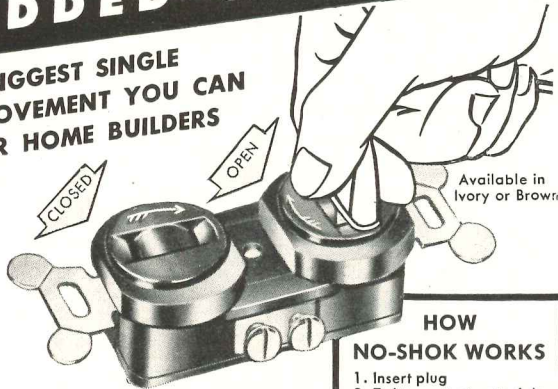

Available in
Ivory or Brown

**HOW
NO-SHOK WORKS**

1. Insert plug
2. Twist quarter turn to right
3. Push in
4. Rotary cap snaps shut when plug is withdrawn. Prevents insertion of metal & wire objects... keeps out dust and dirt.

NO-SHOK

Safety DUPLEX WALL OUTLETS

SELF-CLOSING OUTLET Positively PREVENTS SHOCKS, BURNS and SHORT CIRCUITS from insertion of wire, metal, etc.

- Positive contact always
- Lifetime spring action
- Thick double walls of bakelite separate and insulate heavy duty terminals.
- APPROVED FOR R.E.A. SPECIFICATIONS.

Nationally advertised in leading consumer publications.

WRITE FOR FULL PARTICULARS



BELL ELECTRIC COMPANY
1844 W. 21st St., Chicago 8, Ill.



U. S. MAIL CHUTES

are essential in progressive apartments and hotels.

This little Miss prefers to mail her own letters and so do her parents.



*This equipment may be leased
if desired*

ESTABLISHED 1883

Cutler Mail Chute Co.

ROCHESTER 7, N. Y.

Mars Lumograph

America's **ONLY**

Imported Drawing Pencil

**COSTS LESS BECAUSE
IT LASTS LONGER**

Everything you want in a drawing pencil is in Mars Lumograph. It gives you the precise thickness and blackness of line you need for crisper, cleaner prints.

PROVE BY TRYING

Accurately graded in 19 degrees from EXEXB to 9H—now packaged in metal boxes. If your dealer cannot supply you, write us.

Send coupon today for **FREE** sample.

J. S. STAEDTLER INC.

53 WORTH STREET NEW YORK 13, N. Y.

J. S. STAEDTLER, INC. AR
53 Worth Street, New York 13, N. Y.

Send me **FREE** Mars Lumograph Drawing Pencil
(_____ Degree)

Name _____ Title _____

Firm _____

Address _____

City _____ State _____

Dealer's Name _____



**SEND
FOR
FREE
SAMPLE**

STOP *that* WATER *with* FORMULA # 640

A clear liquid sealer which penetrates deeply into masonry surfaces.

The hydrocarbon solvent in Formula No. 640 evaporates, leaving the pores filled with a balanced formula of seven different waxes and resins.

For complete specifications and a description of our other products—cement hardener, floor mastic, rubberized enamel, foundation coating, plaster bond, etc.—see our catalog in Sweet's Architectural File 9a/8 under "Waterproofing and Dampproofing."

WRITE OUR ENGINEERING DEPARTMENT for office test kit, technical data, or regarding any special problem

J. Wilbur Haynes, Engineer

HAYNES PRODUCTS CO.
4007 FARNAM STREET • OMAHA 3, NEBRASKA



ORDINARY TYPE



NEO-RAY



Specify
NEO-RAY
"ONE MAN"
INSTALLATION

No other line of lighting fixtures offers all the patented and exclusive features of NEO-RAY.

NEO-RAY PRODUCTS, INC.
315 East 22nd St.
New York 10, N.Y.

SEND FOR NEW 64 PAGE CATALOG Gives complete engineering data and lighting tables for each item in our complete line of fluorescent, slimline, and incandescent fixtures.

PLUS New simplified spot lamp tables for computing light intensities in show windows and all highlighted areas.

HERE'S HOW TO FIT SALES APPEAL INTO YOUR PLANS

at low cost

use **BURNHAM'S BASE-RAY RADIANT BASEBOARDS**

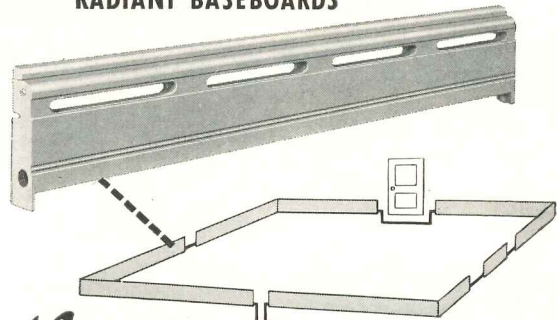

use **THIS SERIES HOOKUP**

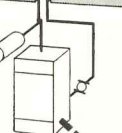

use **THE PACEMAKER OIL-FIRED BOILER**

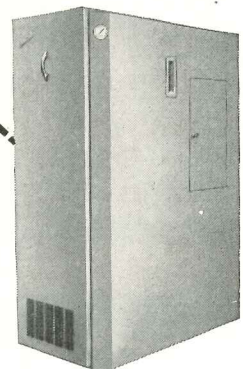

Here's a modern heating combination that home buyers today are going for "in a big way." Burnham BASE-RAY* Radiant Baseboards are *every* woman's choice. Connected in series, the installation saving in dollars is substantial. Hooked up with Burnham's sensational, oil burning PACEMAKER, lowest cost cast-iron boiler on the market, you'll save dollars *again*. Result: A modern, efficient radiant heating installation that actually costs no more than most ordinary heating systems. Try it for *Sales Appeal*. Use the coupon for full information.

*Reg. U. S. Pat. Off.



CAST IRON — Both BASE-RAY Radiant Baseboards and PACEMAKER are made of cast iron, the metal which combines excellent heat conductivity with life-long service. Its durability has proven it to be superior to all other metals. Many cast-iron Burnham Boilers are still giving dependable service after more than a half century of use.

Burnham Corporation

"PIONEERS OF RADIANT BASEBOARD HEATING"

IRVINGTON, N. Y.



BURNHAM CORPORATION Dept. AR-50
Irvington, New York

Please send literature giving complete information on BASE-RAY Radiant Baseboards and PACEMAKER Boiler.

Name

Address

EFFICIENCY AT LOW COST!

Combination
METAL WEATHERSTRIP
SASH BALANCE

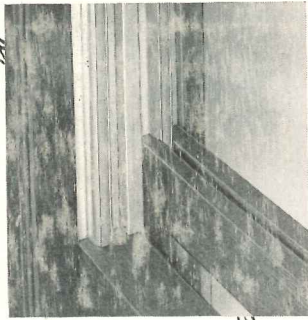

ZEGERS *Dura-seal*

Dura-seal is a combination of metal weatherstrips and sash balances...*in one unit!* Provides complete weather protection *plus* smooth, noiseless, finger-tip window operation. Eliminates paint-stuck windows.

Quickly and easily installed, Dura-seal is used with a stock plank frame and stock sash.

Plank frames permit use of narrow mullions and trim providing more glass area. Less expensive than weatherstripping combined with any other type of sash balances.

WRITE FOR INFORMATION

OR



SECTION
19b
7

ZEGERS INCORPORATED
8092 South Chicago Ave., Chicago 17, Ill.

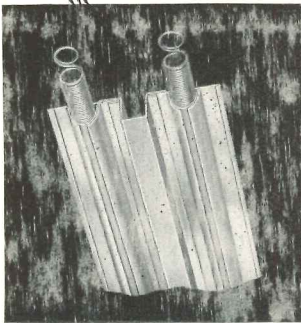

GLOBE
SPRINKLERS



FIREMEN EVERY 10 FEET

Carelessness or indifference. Nearly all FIRES are the result of carelessness. Install GLOBE Automatic Sprinklers to stop these FIRES. That some plant owners WON'T do this isn't carelessness, it's indifference... and that's worse.

GLOBE AUTOMATIC SPRINKLER CO.

NEW YORK... CHICAGO... PHILADELPHIA
Offices in nearly all principal cities

THEY PAY FOR THEMSELVES

INVESTIGATE!
GET THE FACTS!

SAVE MONEY AND SPACE

AGT AIR®
AIR and GREASE
FILTERS

Highest Efficiency!
Lowest Cost!

Convince Yourself —
Write for Bulletin FM101-2

AIR DEVICES, Inc.
17 East 42nd St. • New York 17, N. Y.

ORNAMENTAL BRONZE

We invite your inquiries on fine-quality bronze and wrought iron lighting fixtures, lanterns, grilles, gates, railings, and other similar building products. Write for our illustrated portfolios. Please specify products of particular interest to you. We shall be glad to quote on your requirements.

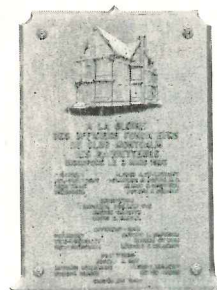

**GENUINE
BRONZE**
Name Plates
Honor Rolls
Memorials
Portrait
Tablets



MEIERJOHAN • WENGLER

METALCRAFTSMEN

1102 W. 9th St. CINCINNATI 3 OHIO

**Insist
on this
Seal...**



**when you specify
ALUMINUM
WINDOWS**

This seal assures windows that, when tested by the independent Pittsburgh Testing Laboratory, meet the A.W.M.A. quality specifications for materials, construction, strength of sections, and minimum air infiltration requirements.

For complete specs covering "Quality-Approved" aluminum windows—double-hung, casement and projected—and names of approved manufacturers, consult Sweet's or write to Dept. R.

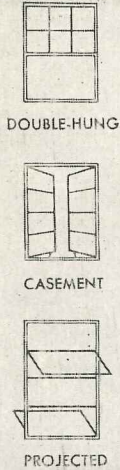

ALUMINUM WINDOW MANUFACTURERS ASSOCIATION
74 Trinity Place, New York 6, New York

COOLING TOWERS

GAS EQUIPMENT

AIR-COOLED HEAT EXCHANGERS

Producers of
QUALITY
Specialized Process
EQUIPMENT

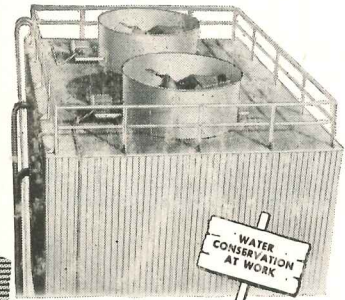

**SAVE WATER!
SATISFY CLIENTS!
SPECIFY PRITCHARD!**

Pritchard Cooling Towers are

- Always manufactured of highest quality materials
- Adequately sized, thoroughly engineered
- Available in fireproof construction
- Adaptable to your specifications
- Available in any size for any capacity

Write for FREE Bulletins



District Offices: Chicago • Houston • New York
Pittsburgh • Tulsa • St. Louis
Representatives in Principal Cities

The Prize Winning Designs . . .

free to Architects

**Eight Family Garden-Type Apartments
of Wood Frame Construction**

The Timber Engineering Company's architectural competition, approved by the A.I.A., produced 276 entries from 34 States and Canada. Now a booklet of prize-winning designs for your library is ready for you . . . and you may have, free of charge, large scale prints for detailed study.

Here is the answer to attractive housing in suburban atmosphere for middle income families . . .

America's most popular and rapidly developing types of housing . . . the suburban apartment that's really a home!

Architects' specification sheets for Trip-L-Grip anchors and Teco trussed rafter designs for the popular ranch-type and other one-story houses are available too . . . just send the coupon.

TIMBER ENGINEERING COMPANY
1319 - 18th St., N. W.
Washington 6, D. C.

Please send me:

- Check (✓) Prize Winning Apartment Designs
 Specs for T-L-G Anchors
 Modern Home Planning

Name:
Street:
City:

AR

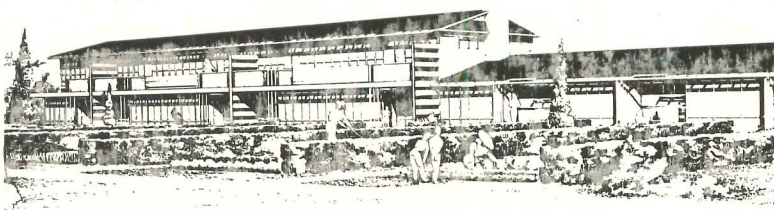

INDEX TO ADVERTISEMENTS

a	Accurate Metal Weatherstrip Co., Inc.	228
abe	Adam, Frank Electric Co.	67
a	Adams-Rite Mfg. Co.	240
a	Adams & Westlake Company	57
	Aerofin Corporation	257
	Air Devices, Inc.	264
a	Airtemp Division	197
	Alan Wood Steel Co.	178
a	Allegheny Ludlum Steel Corp.	50
abe	Allied Chemical & Dye Corp.	58
a	Alumiline Corporation	261
abe	Aluminum Window Manufacturers Assn.	265
ae	American Abrasive Metals Co.	210
	American Hardware Corp.	225-243
ab	American Lumber & Treating Co.	22
ab	American-Olean Tile Co.	214
a	American Tile & Rubber Co.	214
ae	Armstrong Cork Company	91-92
	Art Metal Company	215
	Aircraft Ornamental Iron Co.	244
	Associated Products, Inc.	259
abe	Barrett Division	58
	Bell Electric Company	262
ab	Bell & Gossett Company	77
	Benjamin Electric Mfg. Co.	85
	Bergen Cabinet Co.	204
a	Bethlehem Steel Company	86
	Books	246-249-252
a	Brasco Manufacturing Co.	59
	Briggs Manufacturing Co.	34-35
ab	Bruce, E. L. Co.	38-39
ab	Bryant Heater Dept.	185
	Burnham Corporation	263
ae	Burt Mfg. Co.	259
	Byers, A. M. Company	4
ab	Cabot, Samuel, Inc.	222
ae	Carrier Corporation	32
	Case, W. A. & Son Mfg.	3rd Cover
a	Casement Hardware Co.	253
ab	Ceco Steel Products Corporation	2-3
abe	Celotex Corporation	70
	Chrysler Corporation	197
abe	Church, C. F. Mfg. Co.	88
ae	Colorado Fuel & Iron Co.	258
a	Columbia Mills, Inc.	44
a	Consolidated Water Power & Paper Co.	36
	Corbin, P. & F. Division	225
	Corning Glass Works	33
b	Crane Co.	239
	Crucible Steel Co. of America	41
	Curtis Companies Service Bureau	207
	Curtis Lighting, Inc.	201
a	Cutler Mail Chute Co.	262
	Davidson Plywood & Lumber Co.	20
a	Day-Brite Lighting, Inc.	179
abe	Detroit Steel Products Company	99-211
	Dodge, F. W. Corporation	218-219
a	Douglas Fir Plywood Assn.	96-97
	Dravo Corporation	254
a	Ellison Bronze Co.	212
	Employment Opportunities	250-252
	Faber, A. W.-Castell Pencil Co., Inc.	98
a	Fedders-Quigan Corporation	181
	Federal Seaboard Terra Cotta Corp.	64
	Fitzgibbons Boiler Company	248
abe	Flinkkote Company	2nd Cover
abe	Flynn, Michael Mfg. Co.	191
a	Follansbee Steel Corporation	232
	Frick Co.	258
ab	Frigidaire Air Conditioning	40
	General Aniline & Film Corp.	200
ae	General Electric Co.—Apparatus	46-47
ab	General Electric Co.—Home Bureau	62-63
a	General Electric Co.—Wiring	206
ab	General Motors Co.	40
a	General Portland Cement Co.	31
	Globe Automatic Sprinkler Co.	264
ae	Globe Hoist Company	244
	Governair Corporation	192
	Granite City Steel Co.	194
ab	Grant Pulley & Hardware Co.	245
ae	Grinnell Company, Inc.	55
	Guth, Edwin F. Co.	196
a	Hall-Mack Company	176
a	Haws Drinking Faucet Co.	255
a	Haynes Products Co.	263

ab	Heatilator, Inc.	52
a	Hoffman Specialty Co.	199
	Home Owners' Catalogs	241
a	Horn Brothers Co.	19
abe	Hunter Fan & Ventilating Co., Inc.	23
a	Imperial Brass Mfg. Co.	14
	Infra Insulation, Inc.	13
ae	Inland Steel Company	172
a	Insulite Division	49
a	International Oil Burner Co.	247
a	Jackson & Church Co.	258
ae	Johns-Manville	205-247
	Johnson, John A. & Sons, Inc.	6-7
ae	Josam Manufacturing Co.	243
a	Kawneer Company	42-43
a	Kayline Co.	238
ae	Kaylo Division	186-187
a	Kennedy, David E., Inc.	66
	Kennedy Valve Mfg. Co.	220
	Kent-Moore Corporation	251
ab	Kewanee Boiler Corporation	80
a	Kewaunee Mfg. Co.	226
a	Knapp Brothers Mfg. Co.	21
ab	Kwikset Locks, Inc.	8
a	L.C.N. Closers, Inc.	93
ab	Lawson, F. H. Co.	260
	Lees, James & Sons Company	53
abe	Libbey-Owens-Ford Glass Co.	94
	Litecontrol Corporation	78
	Lone Star Cement Corporation	260
	Lorio Iron Works	257
a	Lucke, W. B.	248
	Luria Engineering Corporation	17
a	Macomber, Incorporated	74
ae	Mahon, R. C. Company	29
	Marlo Coil Company	170
a	Medart, Fred Products, Inc.	25
a	Medusa Portland Cement Co.	256
	Meisrjohan Wengler	264
ab	Mengel Company	65
a	Mercoid Corporation	253
	Merritt-Chapman & Scott Corp.	184
a	Metal Products Corporation	259
	Miller Company	229
ae	Mills Company	72-73
	Minneapolis-Honeywell Regulator Co.	27
	Minnesota Mining & Mfg. Co.	209
ab	Minnesota & Ontario Paper Co.	49
ae	Mississippi Glass Company	230
ae	Modine Mfg. Co.	217
ae	Moore, P. O., Inc.	257
	Morrison Steel Products, Inc.	254
ae	Moulding, Thomas Flooring Co.	248
abe	National Fireproofing Corporation	37
a	National Gypsum Company	237
	National System of Garage Ventilation	260
a	Neo-Ray Products, Inc.	263
	NuTone, Inc.	190
	Old Guilford Forge	261
a	Onan, D. W. & Sons, Inc.	242
ae	Otis Elevator Company	180
ae	Overly Manufacturing Co.	169
ae	Owens-Corning Fiberglas Corp.	208
ae	Owens-Illinois Glass Co.	186-187
	Ozalid Division	200
a	Parkwood Corporation	255
abe	Pittsburgh Plate Glass Company	48-203
a	Portland Cement Association	224

MANUFACTURERS' PRE-FILED CATALOGS

Symbols "a", "b", and "e" indicate that catalogs of firms so marked are available in Sweet's Files as follows:

a	Sweet's File, Architectural, 1950	
b	Sweet's File for Builders, 1950	
e	Sweet's File, Engineering, 1950	
	Powers Regulator Co.	231
e	Pritchard, J. F. & Co.	265
a	Pyne & Co., Inc.	245
	Radio Corporation of America	236
a	Republic Steel Corporation	82-193-267
abe	Revere Copper & Brass, Inc.	54
ae	Reynolds Metals Company	24-87-174
ae	Richards-Wilcox Mfg. Co.	182
ab	Richmond Radiator Company	87
ae	Ric-Wil Company	45
a	Rilco Laminated Products, Inc.	234
	Roberson, L. N. Co.	243
ae	Robertson, H. H. Company	227
a	Robertson Manufacturing Co.	98
a	Roddis Plywood Corp.	84
a	Rotary Lift Co.	251
ae	Ruberoid Co.	100
	Russell & Erwin Division	243
ae	Rust-Oleum Corporation	195
a	Sarcotherm Controls, Inc.	250
ae	Scott Paper Company	183
	Shepard Elevator Co.	262
ae	Sloan Valve Company	4th Cover
a	Sloane-Blabon Corporation	1
	Smith, Alexander & C. H. Masland	81
	Staedler, J. S., Inc.	262
a	Stained Shingle & Shake Association	79
	Standard Electric Time Company	256
a	Stanley Works	61
ae	Stemco Corporation	198
	Stewart-Warner Corporation	30
	Surface Combustion Corporation	177
ab	Superior Fireplace Co.	18
	Sweets Catalog Service	218-219
ae	Taylor, Halsey W. Co.	251
	Taylor, R. L., Inc.	242
	Texas Housing Company	240
ab	Thrush, H. A. & Company	233
a	Title Council of America	89
	Timber Engineering Co.	265
ae	Timber Structures, Inc.	255
ab	Titus Manufacturing Corp.	261
ab	Trade-Wind Motors, Inc.	246
abe	Trane Company	268
a	Tremco Mfg. Co.	253
a	Trinity Portland Cement Division	31
ae	Trumbull Electric Mfg. Co.	90
abe	Truscon Steel Company	82
ab	Tuttle & Bailey, Inc.	83
	Unistrut Products Company	56
a	United States Gypsum	213
ab	United States Plywood Corp.	238
ae	United States Steel Corporation Subsidiaries	202
a	Universal Atlas Cement Company	202
a	Vermont Marble Company	252
a	Vulcan Radiator Company	256
ae	Wakefield, F. W. Brass Company	247
ae	Webster, Warren & Co.	71
a	Weiss, Henry Manufacturing Co., Inc.	216
	West Dempster Company	254
abe	Westinghouse Electric Corporation	50-51-75-189
	Westwood Manufacturing Co.	95
	Weyerhaeuser Sales Company	76
ae	Wheeling Corrugating Company	68-69
ae	Wickwire Spencer Steel Div.	258
a	Worthington Pump & Machinery Corp.	221
ae	York Corporation	188
	York-ShIPLEY	235
ab	Zegers, Incorporated	264
abe	Zonolite Company	245

NEW YORK—H. Judd Payne, Publishing Director; Robert F. Marshall, Business Manager; Tom Tredwell, Advertising Mgr.; Benton B. Orwig, Creative Service Manager; M. A. Murphy, Advertising Production Manager, 119 West 40th Street; BOSTON—Harry M. Horn, Jr., 855 Park Square Bldg.; CHICAGO—C. B. Riemersma, Robert T. Franden, John M. Cogan, 700 Merchandise Mart; CLEVELAND—John C. Jackson, David K. Bortz, 321 Hanna Bldg.; DALLAS—O. O. Pausell, 412 Construction Bldg.; LOS ANGELES—Bob Wettstein, 672 South Lafayette Park Place; PHILADELPHIA—Tom Tredwell, 1321 Arch St.; PORTLAND—Bob Wettstein, 907 Terminal Sales Bldg.; SAN FRANCISCO—Bob Wettstein, 1003 TWA Bldg., 240 Stockton St.

ENDURO — FLASHING WITH NEW IDEAS

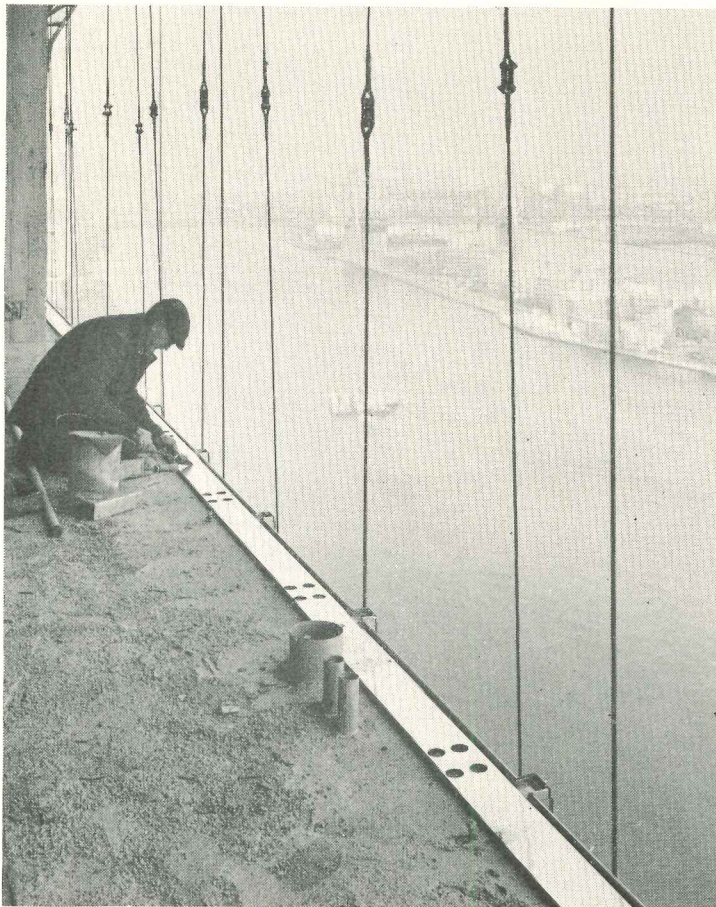

UN SECRETARIAT BUILDING

— 39 Stories High —
and Every One
Flashed with ENDURO



Rising high above the East River in New York City is this unusual structure with the two narrow sides of marble, the two wide sides a myriad of glass windows. To retain condensate and leakage, to divert it into window weep holes and thus prevent drainage down the mullions, ENDURO was pre-formed and soldered into continuous strips on every floor. The sketch below shows details of installation. The photo at the left demonstrates soldering of four-foot sections into continuous spandrel flashing. Holes shown accommodate vitreous ferrules of Nelson studwelds used to anchor windows.

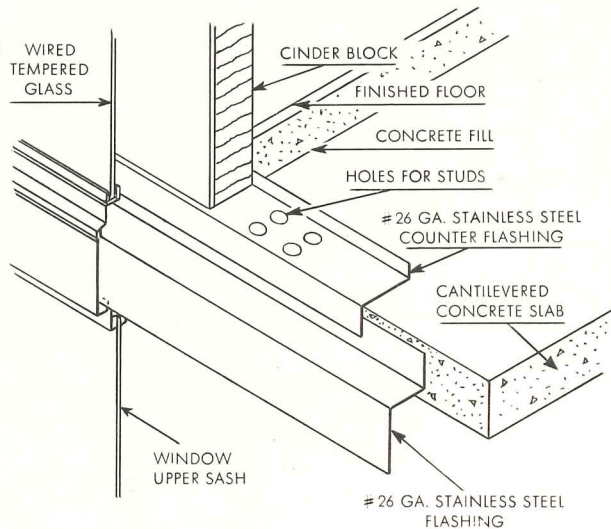

There seemingly is no limit to the useful applications for Republic ENDURO Stainless Steel in architectural design, in building construction.

Here you see it used for flashing between floors of a famous building. You probably have seen it used, too, for mullions and spandrels, windows, curtain wall panels, entrance doors, stair railing, elevators, roof drainage materials, spires, marquees and countless other component parts of a building.

That's because ENDURO is so versatile . . . because it gives the designer a vast medium for expressing his ideas . . . because it gives the engineer a sound construction material.

ENDURO ranges in finish all the way from a soft, satiny lustre to the brightness of a polished mirror. It may be used both for harmonizing and contrasting

effect. It cleans easily. It is sanitary. Its striking beauty lasts indefinitely.

Functionally, it is tough and strong — with a high strength-to-weight ratio that permits safe use in thin sections. It resists rust and corrosion. It is equally strong at elevated or sub-zero temperatures. It cuts maintenance and replacement costs to lowest levels.

ENDURO is easily obtainable — readily workable. Distributors carry stocks and competent fabricators are located in principal cities.

Now, wouldn't you like to know more about this "magic metal" and the ideas it may bring to you? See Sweet's—or write us.



Enduro **STAINLESS STEEL**

RUST-RESISTANT • CORROSION-RESISTANT • HEAT-RESISTANT • ATTRACTIVE • SANITARY • EASY TO CLEAN
EASY TO FABRICATE • STRONG • LONG-LASTING • LOW IN END COST • What more can be desired in a material?

REPUBLIC STEEL CORPORATION • Alloy Steel Division, Massillon, Ohio • GENERAL OFFICES, CLEVELAND 1, OHIO

Export Department: Chrysler Building, New York 17, N. Y.

TRANE

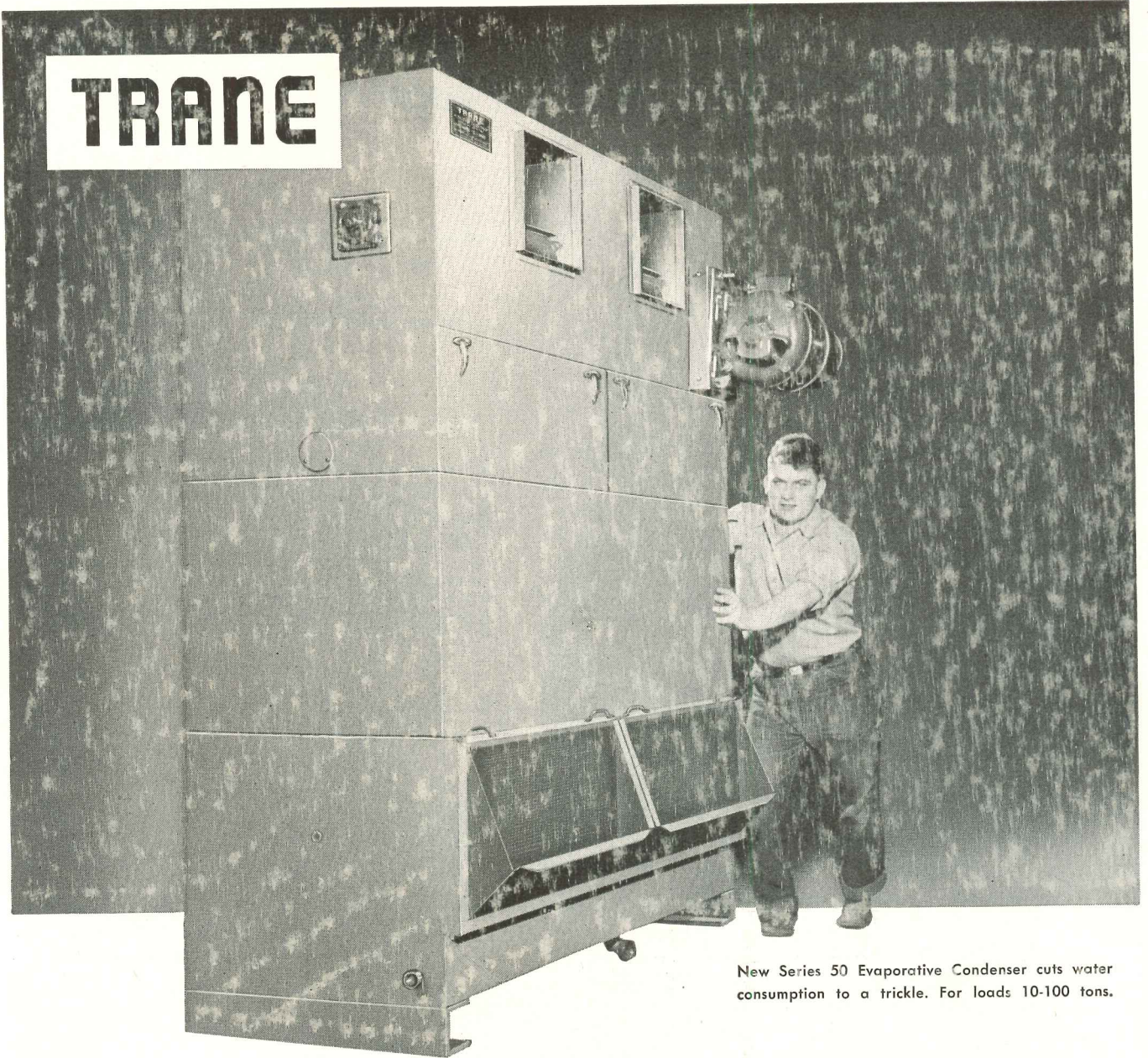

New Series 50 Evaporative Condenser cuts water consumption to a trickle. For loads 10-100 tons.

ANNOUNCING A NEW WATER SAVER

Here's a fluid answer to solid regulations restricting the use of water for air conditioning. Sleek, new Trane Evaporative Condensers **SAVE WATER** and use it over and over again.

New Series 50 units—rated according to ASRE standards. Quality features include condenser coils made of everlasting copper tubing. Non-ferrous spray trees. Non-clogging nozzles. Hot-dip galvanized fan wheels and scrolls. Extra heavy shafts permit two-bearing, self-aligning assembly. Sturdily constructed for either indoor or outdoor installation.

See data Bulletin DS-350 for details on the complete line of Trane Evaporative Condensers.

THE TRANE COMPANY... LA CROSSE, WIS.

EASTERN MANUFACTURING DIVISION, SCRANTON, PA.

Manufacturing Engineers of Heating, Ventilating and Air Conditioning Equipment—Unit Heaters, Convector-radiators, Heating and Cooling Coils, Fans, Compressors, Air Conditioners, Unit Ventilators, Special Heat Exchange Equipment, Steam and Hot Water Heating Specialties ... IN CANADA, TRANE COMPANY OF CANADA, LTD., TORONTO.

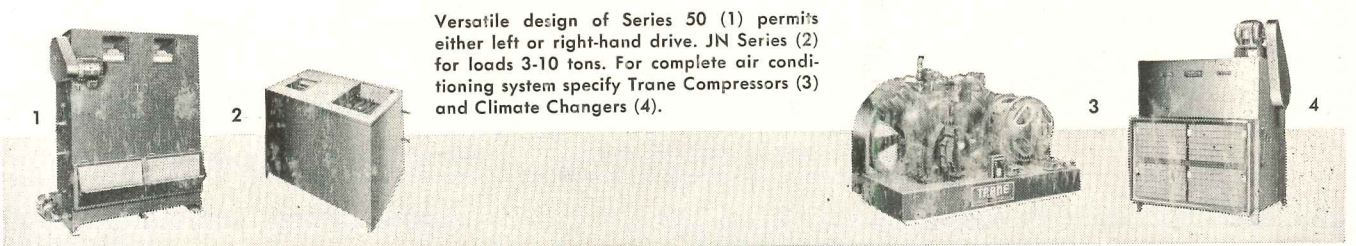

Versatile design of Series 50 (1) permits either left or right-hand drive. JN Series (2) for loads 3-10 tons. For complete air conditioning system specify Trane Compressors (3) and Climate Changers (4).