

MAY 1952

ARCHITECTURAL RECORD



EKDALE HOUSE, SAN PEDRO, CALIF.

Sumner Spaulding — John Rex, Architects

Compare

NUTONE VENTILATING FANS GIVE YOU MORE

NuTone Offers you . . . NOT ONE . . . but FOUR exclusive features that make NuTone Ventilating Fans your best buy in any price range.

1. GRILLE QUICKLY REMOVABLE
Easily Cleaned! Patented.

2. REMOVABLE MOTOR, SNAPS IN
Simple, Quick — No Tools Required

3. GREATER AIR DELIVERY
Special Pressure-Type Blade and Venturi Tube.

4. LOW COST INSTALLATION
No Loose Screws — Only Few Parts to Handle.

performance

features

price

THE MOST COMPLETE LINE IN THE INDUSTRY

NuTone Ventilating Fans come in 15 wall and ceiling models . . . for large or small rooms . . . priced low to fit any budget.

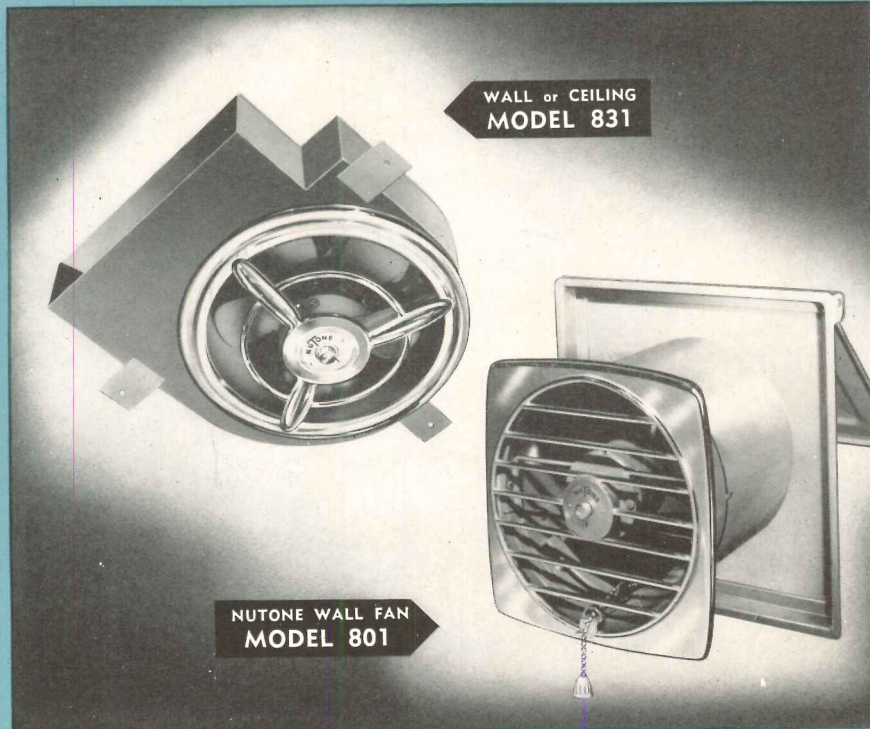

**EVEN THE LOWEST PRICED HOUSES CAN
AFFORD THESE TWO LOW-COST MODELS**

NUTONE, INC., Dept. AR 12, Cincinnati 27, Ohio

FREE

Write for free literature, specifications, diagrams and data for installing NuTone Ventilating Fans, Door Chimes, and Electric Ceiling Heaters.

NAME _____
 COMPANY _____
 ADDRESS _____
 CITY _____ STATE _____

NUTONE

®
Ventilating Fans



DOOR CHIMES



HEAT-A-LITE

ARCHITECTURAL RECORD



Copyright 1952 by F. W. DODGE CORPORATION, with all rights reserved • Publishing Director, Magazine Division, H. Judd Payne • Business Manager, Robert F. Marshall • **EDITORS:** Executive Editor, Joseph B. Mason; Managing Editor, Emerson Goble; Senior Associate Editor, Frank G. Lopez, A.I.A.; Associate Editor, Florence

A. van Wyck; Associate Editor (Engineering), Robert E. Fischer; Associate Editor, Herbert L. Smith, Jr., A.I.A.; Western Editor, Elisabeth Kendall Thompson; Assistant Editor (News), Jeanne M. Davern; Contributing Editors, Ernest Mickel (Washington), John Caulfield Smith, M.R.A.I.C. (Canada); Editorial Assistants, Carl Scarenco, Enid Belding, Elizabeth Davey, Jeanne G. Whitbeck • **DESIGN:** Consultant, M. Peter Piening; Director, Frances Torbert; Assistants, Joseph D'Amato, Donald Ervin; Drafting, Sigman-Ward • **CONSULTANTS:** Industry Relations Consultant, Thomas S. Holden; Statistical Consultant, Clyde Shute; Field Research Consultant, Clifford Dunnells, Jr.; Public Relations Consultant, Samuel C. Pace.

Architectural Record (combined with American Architect and Architecture) is published monthly by F. W. Dodge Corporation, 10 Ferry St., Concord, N. H., with Editorial and Executive Offices at 119 West 40th Street, New York, N. Y. Western Editorial Office, 2877 Shasta Road, Berkeley 8, Calif. Chairman of the Board, James McV. Breed; Vice-Chairman of the Board, Paul Abbott; President, Thomas S. Holden; Vice-President and Treasurer, Howard Barringer; Secretary, Sanford D. Stockton, Jr.; Vice-Presidents, Irving W. Hadsell, Chauncey L. Williams, H. Judd Payne, T. Oliver Morgan; Assistant Secretaries, George W. Morgan, William C. Breed, Jr.; Assistant Vice-Presidents, Clyde Shute, Clifford G. Dunnells, Jr., Howard M. Thompson, Marc Wayne, Robert F. Marshall; Assistant Treasurers, Walter F. DeSaix, Edwin H. Freed, Irving B. Satin; Regional Vice-Presidents, Carl S. Bennett, Ralph M. Hairston, Julius T. Little, Richard H. Ray. Member Audit Bureau of Circulation and Associated Business Papers Inc. Architectural Record is indexed in Reader's Guide, Art Index, Industrial Arts Index and Engineering Index. Subscription rates: United States and Possessions, Canada, Cuba, Mexico, Central and South America, and Spain, \$4.50 the year, \$7.50 for two years, \$9 for three years; elsewhere, \$6.50 the year, \$11.50 for two years, \$15 for three years. Single copy \$2. Circulation Manager: Marshall T. Ginn. Every effort will be made to return material submitted for possible publication (if accompanied by stamped, addressed envelope), but the editors and the corporation will not be responsible for loss or damage. Other Dodge Services: Real Estate Record & Builders' Guide, Sweet's Files, Home Owners' Catalogs, Dodge Reports & Dodge Statistical Research Service.

Cover: Residence of Mr. and Mrs. Arch Ekdale, San Pedro, Calif. Photo by Julius Shulman

| | |
|--|----------------|
| THE RECORD REPORTS | 11 |
| News from Washington. By Ernest Mickel | 11, 17, 26, 38 |
| News from Canada. By John Caulfield Smith | 28 |
| Construction Cost Indexes | 42 |
| REQUIRED READING | 46 |
| BUILDING TYPES STUDY NO. 186 . . . HOUSES | |
| DIAGONAL TRUSSES PERMIT FOUR-WAY VIEW | 115 |
| Residence of Mr. and Mrs. Arch Ekdale, San Pedro, Calif. Sumner Spaulding-John Rex, Architects | |
| HOUSE ON MOUNTAIN RIDGE | 122 |
| Residence of Mr. and Mrs. Edward H. Bennett, Tryon, N. C. Schweikher and Elting, Architects | |
| SITE CHOSEN FOR VIEW DESPITE DRAWBACKS | 127 |
| Residence of Mr. and Mrs. Joseph G. Poetker, Mt. Adams, Cincinnati, Ohio. Garriott, Becker & Bettman, Architects | |
| DESERT HOUSE WITH VIEW TO SOUTH | 131 |
| Residence of Dr. and Mrs. Paul Palmer, Phoenix, Ariz. A. Quincy Jones, Architect | |
| HOUSE TURNS INWARD ON PATIO FOR PRIVACY | 135 |
| Residence of Dr. and Mrs. William S. Beck, Los Angeles, Calif. Thornton M. Abell, Architect | |
| HOUSE FOR A SUBURBAN CORNER LOT | 139 |
| Residence of Miss Agnes Palley, Scarsdale, N. Y. Sanders-Malsin-Reiman, Architects | |
| HOME FOR CARTOONISTS' FAMILY | 143 |
| Residence of Stanley and Janice Berenstain, Elkins Park, Pa. Norman N. Rice, Architect | |
| DEVELOPMENT HOUSE OF HIGH QUALITY | 145 |
| Eichler Homes, Palo Alto, Calif. Frederick E. Emmons-A. Quincy Jones, Architects | |
| ORGANIC ARCHITECTURE LOOKS AT MODERN ARCHITECTURE | 148 |
| By Frank Lloyd Wright | |
| PORTOLA JUNIOR HIGH SCHOOL | 155 |
| El Cerrito, Calif. Miller and Warnecke, Architects | |
| INSURANCE COMPANY OFFICES IN HONOLULU, T. H. | 164 |
| Security Insurance Agency, Ltd. Cyril W. Lemmon, Architect | |
| EXPANDABLE PLANT FOR GROWING FIRM | 169 |
| Manufacturing Unit for the Powers Regulator Co., Skokie, Ill. Sessions Engineering Co., Architects and Engineers | |
| MEDICAL CENTER FOR OHIO STATE | 173 |
| Ohio State Health Center, Columbus, Ohio. Skidmore, Owings and Merrill, Architects | |
| NAVAL AIR BASE IN NORTH AFRICA | 184 |
| Mackenzie, Bogert and White, Architects | |
| PREVIEW OF C.B.S. TELEVISION CITY | 190 |
| Gilmore Island, Los Angeles. Pereira and Luckman, Architects | |
| WISCONSIN HOTEL PROVIDES MOTEL FACILITIES | 194 |
| Hotel Mead, Wisconsin Rapids, Wis. Donn Hougen, Architect | |
| THE BIG NEWS IS THE BIRTH RATE | 199 |
| By Thomas S. Holden, President, F. W. Dodge Corporation | |
| ARCHITECTURAL ENGINEERING | |
| TECHNICAL NEWS AND RESEARCH | |
| INDIVIDUAL APARTMENT HEATING FOR MULTI-STORY HOUSING | 203 |
| By Robert K. Thulman and Robert L. Davison | |
| LIGHT AND COLOR IN ELEMENTARY SCHOOLS | 210 |
| By N. L. Engelhardt, Jr. | |
| ADVANCES IN ARTIFICIAL LIGHTING | 213 |
| By John O. Kraehenbuehl | |
| NEW WALL, ONE BRICK WIDE | 214 |
| PRODUCTS . . . For Better Building | 215 |
| LITERATURE FOR THE OFFICE | 216 |
| TIME-SAVER STANDARDS | |
| PLANNING OCCUPATIONAL THERAPY DEPARTMENTS IN HOSPITALS | 219 |
| By Alonzo W. Clark, A.I.A., with the collaboration of the American Occupational Therapy Association | |
| INDEX TO ADVERTISING | 6 |

INDEX TO ADVERTISING

MANUFACTURERS' PRE-FILED CATALOG
 Symbols "a", "b", and "e" indicate that catalogs
 of firms so marked are available in Sweet's Files
 as follows:

- a—Sweet's File, Architectural, 1952
- b—Sweet's File for Builders, 1952
- e—Sweet's File, Engineering, 1952

| | | | | | |
|---|---------------|--|-------------|---|------------|
| a Accurate Metal Weatherstrip Co., Inc. | 342 | Guth, Edwin F. Company | 370 | Powers Regulator Co. | 33 |
| abe Adam, Frank Electric Co. | 67 | a Haertel, W. J. & Company | 303 | Preferred Utilities Manufacturing Corporation | 361 |
| a Adams & Westlake Co. | 369 | a Hall-Mack Company | 99 | ab Pryne & Company | 265 |
| Aerofin Corporation | 365 | Hamilton Manufacturing Company | 381 | RLM Standards Institute, Inc. | 357 |
| a Aelma Steel Products Corp. | 281 | Hari & Hegeman Division | 255 | Radio Corporation of America | 300 |
| Air Devices, Inc. | 379 | ae Hauserman, E. F. Company | 108 | ae Ramset Fasteners, Inc. | 274 |
| Alan Wood Steel Company | 256-257 | a Haws Drinking Faucet Co. | 354 | Remington Arms Company, Inc. | 24-25 |
| a Alberne Stone Corp. of Virginia | 365 | ab Healtitor, Inc. | 310 | Republic Industries, Inc. | 357 |
| a Allen, W. D. Manufacturing Co. | 326 | ae Heinemann Electric Company | 346 | a Republic Steel Corp. | 217 |
| b AllianceWare, Inc. | 71 | ae Hendrick Manufacturing Co. | 374 | Resolite Corporation | 292 |
| Aloe, A. S. Co. | 378 | a Herring-Hall-Marvin Safe Company | 268 | ae Revere Copper & Brass Inc. | 374 |
| Alsynite Company of America | 267 | a Hillyard Sales Co. | 327 | ae Reynolds Metals Company | 61-83-252 |
| a Alumiline Corporation | 362 | ae Holophone Company, Inc. | 43 | ae Richards-Wilcox Mfg. Co. | 36 |
| ae American Abrasive Metals Co. | 332 | ab Homasote Company | 330 | Richkraft Company, The | 376 |
| ab American Billrite Rubber Co. | 314 | ab Hunter-Brothers Company | 331 | Richmond Radiator Company | 61 |
| ae American Blower Co. | 68 | ab Hunter-Douglas Corporation | 102-321 | a Rilco Laminated Products, Inc. | 328 |
| a American Brass Company | 55 | ab Hunter Fan & Ventilating Co., Inc. | 322 | a Rixson, The Oscar C. Company | 341 |
| ab American Hardware Corporation | 58-59-246-247 | abe Ilg Electric Ventilating Co. | 93 | Roberson, L. N. Co. | 355 |
| b American Radiator & Standard Sanitary Corp. | 293 | ae Imperial Brass Manufacturing Co. | 15 | a Roberts Co. | 359 |
| abe American Structural Products Co. | 333 | a Infra Insulation, Inc. | 15 | ae Robertson, H. H. Co. | 79 |
| Ames Iron Works | 379 | ae Inland Steel Company | 248-249 | Robinson Construction | 260 |
| Amplex Corporation | 278 | abe Insulux Glass Block | 333 | ae Roddiss Plywood Corporation | 76 |
| ab Andersen Corporation | 100-101 | International Nickel Company, Inc., The | 353 | Roebbling's, John A. Sons & Company | 223 |
| a Anemostat Corporation of America | 7 | ab Jackson & Church Co. | 353 | ae Rotary Lift Company | 96-97 |
| Architectural Record | 262-263 | ae Jenn-Air Products | 370 | ae Rowe Methods Inc. | 370 |
| Ardmore Products Co. | 376 | ae Johns-Manville | 289 | ae Ruberold Company | 114 |
| abe Armstrong Cork Company | 337 | ab Kalistron | 253 | ab Russell & Erwin Division | 246-247 |
| Arrow-Hart & Hegeman Electric Co. | 255 | a Katzenbach & Warren, Inc. | 362 | ab Russell, F. C. Company | 230-231 |
| Arl Metal Company | 280 | a Kawneer Company | 90-91 | a Sarco Company Inc. | 354 |
| ab Atlas Plywood Corporation | 294 | abe Kaylo Division | 77 | a Schieber Sales Company | 375 |
| a Auth Electric Company, Inc. | 299 | ab Kentile, Inc. | 373 | a Schlage Lock Company | 105 |
| ae Barber-Colman Company | 70-363 | ae Kent-Moore Organization | 356 | ae Scott Paper Company | 345 |
| ae Bayley Company, William | 35 | ab Kewanee Boiler Corporation | 356 | a Seaport Metals, Inc. | 56 |
| ab Bell & Gossett Electric Co. | 226-227 | ab Kwikset Sales & Service Company | 1 | a Sedgwick Machine Works | 390 |
| Benjamin Electric Mfg. Co. | 104 | a LCN Closers, Inc. | 307 | a Servicised Products | 358 |
| ae Bethlehem Steel Company | 234 | LaSalle Products, Inc. | 282 | Shwayder Bros., Inc. | 66 |
| Bifuminous Coal Institute | 297 | ab Lawson, F. H. Co. | 349 | Silvray Lighting, Inc. | 319 |
| Blank, Frederic & Company, Inc. | 362 | ae Lees, James & Sons Company | 62-63 | Sjostrom, John E. Company | 377 |
| Books | 37 | abe Libbey-Owens-Ford Glass Co. | 272 | Skylike Lighting Inc. | 319 |
| Bestwick Steel Lath Company | 82 | ae Litecentral Corporation | 295 | ae Sloan Valve Company | 4th Cover |
| Briggs Manufacturing Co. | 331 | ab Ludman Cement Company | 237 | a Smith, H. B. Co., Inc. | 3rd Cover |
| ae Brown Company | 367 | ab Louisville Corporation | 49-50-51-52 | Solar Light Manufacturing Company | 363 |
| ae Brown Products Company | 103 | ab Ludowici-Celadon Co. | 75 | Spart Faraday, Inc. | 347 |
| ab Bruce, E. L. Co. | 236 | ae MacMillan Company | 378 | Square D Company | 366 |
| Bryant Heater Division | 222 | ae Macomber, Incorporated | 74 | ab Standard Dry Wall Products | 305 |
| a Buckingham-Virginia Slate Corp. | 239 | ae Mahon, R. C. Company | 47-113 | a Standard Electric Time Co. | 355 |
| Bulldog Electric Products Company | 287 | a Marble Institute of America | 224 | ae Stark Ceramics, Inc. | 269 |
| a Bundy Tubing Company | 369 | a Marlo Electric Products, Inc. | 282 | a Steelbilt, Inc. | 27 |
| Burnham Corporation | 372 | a Marlo Coil Company | 296 | ab Sterling Hardware Mfg. Co. | 351 |
| ae Burl Manufacturing Co. | 372 | a Mastand Duraloather Company | 315 | Structural Clay Products Institute | 107 |
| a Byers, A. M. Company | 4 | a Masonite Corporation | 288 | Struthers-Wells | 380 |
| a Cambridge Tile Mfg. Co. | 235 | a Matel, D. A. Inc. | 381 | a Summerbell Roof Structures | 374 |
| Canvas Awning Institute Inc. | 313 | McKenna, Jay G. Inc. | 110 | a Sylvania Electric Products, Inc. | 220 |
| ae Carrier Corporation | 84-329 | McQuay, Inc. | 89 | ae Taylor, Halsey W. Co. | 363 |
| Case, W. A. & Son Mfg. Co. | 264 | a Medart, Fred Products, Inc. | 53 | ab Thrush, H. A. & Company | 290 |
| Cast Iron Soil Pipe Institute | 298 | a Medusa Portland Cement Company | 285 | Timber Engineering Company | 348 |
| ab Ceco Steel Products Corporation | 94 | a Mercoird Corporation | 370 | a Timber Structures Inc. | 351 |
| a Cedar Rapids Block Company | 381 | a Metal Products Corp. | 355 | ae Titus Manufacturing Corp. | 65 |
| abe Celotex Corporation | 54 | ab Metal Tile Products, Inc. | 377 | Titusville Iron Works Co. | 380 |
| abe Certain-lead Products Corporation | 279 | a Midget-Louwer, Inc. | 375 | Todd Shipyards Corporation | 373 |
| ae Church, C. F. Mfg. Co. | 302 | a Miller Company | 64 | ae Trane Company | 258-259 |
| Cipco Corporation | 354 | ae Mills Company | 366 | a Tremco Mfg. Co. | 361 |
| a Cleaver-Brooks Company | 275 | a Minneapolis-Honeywell Regulator Co. | 30-31 | a Trinity Division General Portland Cement | 371 |
| Combustion Equipment Division | 373 | a Minwax Company Inc. | 364 | Truck Mixer Manufacturers Bureau | 38 |
| a Concrete Reinforcing Steel Institute | 8-9 | ab Miracle Adhesives Corp. | 72 | ab Truscon Steel Company | 217 |
| a Congoleum-Nairn Inc. | 240-241 | ae Mississippi Glass Company | 320 | a Tuttle & Bailey, Inc. | 2-3 |
| Connor, W. B. Engineering Corp. | 362 | ae Modine Manufacturing Co. | 78 | Union Insulating Co. | 380 |
| a Consolidated Water Power & Paper Co. | 284 | ae Moore, P. O. Inc. | 371 | Unistrut Products Co. | 111 |
| Corbin Division, P. & F. | 58-59 | ae Morgan Company | 60 | ab United States Plywood Corp. | 253-308 |
| b Crane Co. | 106 | ab Mueller Brass Co. | 354 | United States Rubber Co. | 69 |
| ae Crawford Door Co. | 378 | National Clay Pipe Manufacturers, Inc. | 88 | ae United States Steel Corp. Subsidiary | 338 |
| a Curtis Companies-Service Bureau | 335 | National Cotton Council | 313 | a Universal Atlas Cement Company | 338 |
| a Curtis Refrigeration Machine Division | 378 | a National Gypsum Company | 86 | a Upco Co. | 366 |
| a Cutler Mail Chute Co. | 369 | National Lock Co. | 312 | a Uvalde Rock Asphalt Co. | 350 |
| a Dant & Russell, Inc. | 48 | National Plastic Products Company | 109 | a Valley Metal Products Co. | 57 |
| ae Dicks-Pontius Co. | 347 | a National Terrazzo & Mosaic Association | 358 | ae Viking Corporation | 361 |
| Dor-O-Matic Division | 357 | a Neo-Ray Products, Inc. | 291 | Vilter Refrigeration & Air Conditioning | 357 |
| ae Dravo Corporation | 367 | ae Nesbitt, John J. Inc. | 229 | a Vulcan Radiator Co. | 371 |
| a Duriron Company, Inc. | 318 | a New Castle Products | 323 | ae Wakefield, F. W. Brass Company | 366 |
| a Duro-O-Wall Products | 381 | ae Norcor Manufacturing Company | 373 | Wall Trends, Inc. | 34 |
| Eastman Kodak Company | 85 | ab Nova Sales Co. | 43 | a Waylite Co. | 306 |
| a Electro Manufacturing Corp. | 283 | ab Nutone, Inc. | 2nd Cover | a Wayne Iron Works | 359 |
| Employment Opportunities | 358 | Ohio Hydrate & Supply Co. | 368 | ae Webster, Warren & Co. | 218 |
| Faber, A. W. Castell Pencil Co., Inc. | 368 | a Otis Elevator Company | 266 | a Weis, Henry Mfg. Co., Inc. | 316 |
| ae Facing Tile Institute | 261 | a Overy Manufacturing Co. | 311 | a Wesco Waterpaints, Inc. | 340 |
| a Farr Company | 372 | abe Owens-Illinois Glass Co. | 77-333 | Western Pine Association | 353 |
| ae Federal Cement Tile Company | 33 | Ozalid Division | 334 | abe Westinghouse Electric Corporation—Apparatus | 95-273 |
| Federal Seaboard Terra Cotta Corp. | 23-375 | ab Paine Lumber Co., Ltd. | 365 | ab Westinghouse Electric Corporation—Electric Appliance | 73-244-245 |
| a Fenestra Building Products | 92-276-339 | ae Parkway Incorporated | 336 | a Westinghouse Electric Corporation—Elevator | 44-45 |
| ab Fiat Metal Manufacturing Co. | 250-251 | ae Pennsylvania Wire Glass Company | 286 | Westwood Manufacturing Co. | 317 |
| a Fitzgibbons Boiler Company | 377 | ae Philippine Mahogany Association, Inc. | 304 | ae Wheeling Corrugating Company | 80-81 |
| abe Flynn, Michael Manufacturing Co. | 10 | ab Pittsburgh Plate Glass Company | 87-243-309 | e Wing, L. J. Mfg. Co. | 349 |
| a Formica Company | 358-382 | ab Pittsburgh Plate Glass Company (Paint Div.) | 87 | a Worthington Pump & Machinery Corp. | 359 |
| ae Frigidaire Division | 98 | ab Pittsburgh Steel Products Co. | 301 | a Wright Manufacturing Co. | 324 |
| ab Gate City Sash & Door Co. | 379 | a Plastic Products Company | 352 | ae York Corporation | 270 |
| General Aniline & Film Corp. | 334 | a Portland Cement Association | 254 | a Young Radiator Company | 112 |
| abe General Electric Co., Air Conditioning Division | 325 | | | | |
| a General Electric Co., Chemical | 271 | | | | |
| a General Electric Co., Const. Materials | 374 | | | | |
| ab General Electric Co., Home Bureau | 20-21 | | | | |
| ae General Motors | 98 | | | | |
| a General Portland Cement Co. | 371 | | | | |
| a Georgia-Pacific Plywood Company | 39-40-41 | | | | |
| a Glide Windows Inc. | 344 | | | | |
| a Globe Automatic Sprinkler Co. | 32 | | | | |
| a Goodyear Tire & Rubber Co., Inc. | 29 | | | | |
| abe Granco Steel Products Co. | 367 | | | | |
| a Grant Pulley & Hardware Co. | 364 | | | | |

NEW YORK—H. Judd Payne, Publishing Director; Robert F. Marshall, Business Manager; Tom Tredwell, Advertising Mgr.; Benton B. Orwig, Creative Service Manager; M. A. Murphy, Advertising Production Manager, 119 West 40th Street; BOSTON—Harry M. Horn, Jr., 855 Park Square Bldg.; CHICAGO—C. B. Riemersma, Robert T. Franden, David K. Bortz, 700 Merchandise Mart; CLEVELAND—John C. Jackson, Joseph F. Palmer, John W. Setear, 321 Hanna Bldg.; DALLAS—Joe Sanders, 2909 Maple Ave.; LOS ANGELES—Bob Wettstein, 672 South Lafayette Park Place; PHILADELPHIA—Tom Tredwell, 1321 Arch St.; PORTLAND—Bob Wettstein, 1220 S.W. Stark St.; SAN FRANCISCO—Bob Wettstein, Howard Bldg., 209 Post St.

THE RECORD REPORTS

ENJOYING NEW YORK IS MAJOR ITEM ON A.I.A. CONVENTION AGENDA

A STREAMLINED PROGRAM for the 84th annual convention of the American Institute of Architects June 24-27 in New York City was fast taking shape last month, as Arthur C. Holden, F.A.I.A., and his committee planned a schedule that will allow visiting architects a maximum of time for private enjoyment of the Institute's first New York convention in 27 years.

It was already known that Hugh Ferriss, New York architect, will give the convention's closing address on "The Architect and the Improvement of American Cities." At the annual banquet August Perret of France, who will receive the A.I.A. Gold Medal for 1952,

will discuss the significance of progress in reinforced concrete design. Other speakers were to be chosen to contribute to the convention's general theme — the importance of architecture in forming environments for human activity.

Medalists Named

Topics to be covered in the convention's technical seminars include prestressed concrete; thin-shell vault and dome construction; prefabricated structural unit construction in concrete; reinforced brick masonry; aluminum as a structural frame material; and trends in structural design theory applied to reinforced concrete and steel.

The annual awards besides the Gold Medal will bring the Craftsmanship Medal to George Nakashima, furniture maker and designer, of New Hope, Pa.; the Edward C. Kemper Award to William Stanley Parker, architect, of Boston; and the Fine Arts Medal to Marshall Fredericks, sculptor.

A series of exhibits intended to focus public attention on architecture as well as to interest visiting architects will be held throughout the New York metropolitan area, with the major show, "Engineering Contributions to Architectural Design, 1851-1951," scheduled for display at Lever House.

(Continued on page 12)

THIRD QUARTER STEEL ALLOTMENTS CONFIRM NPA PROMISE ON COMMERCIAL CONSTRUCTION

THIRD QUARTER STEEL ALLOTMENTS allowing considerably more than twice as much structural steel for commercial construction as available in the second quarter have been welcomed as definite implementation of the National Production Authority's new relaxed policy on construction.

The Facilities and Construction Bureau, which processes applications for commercial building, got 40,000 tons of structural steel for the third quarter, against 16,285 tons in the second and 12,179 in the first. School and hospital building also got a push, with an increase of the allotment to the Federal

Security Agency from 29,235 tons in the second quarter to 40,000 in the third for schools, and 18,315 in the second quarter to 25,000 in the third for hospitals.

More Easing to Come

According to NPA, before the third quarter begins, another adjustment in CMP Regulation 6 governing construction will up the self-authorization allowance for primary and secondary schools from five to 50 tons of carbon steel (including seven instead of two of structurals) and from 200 lb of copper or, as a copper substitute, 100 lb of aluminum, to 1000 lb of copper and 1000 lb of aluminum.

As expected, the Federal Communications Commission lifted its ban on new television channels. NPA had promised to make materials available for new stations; and relaxation of the strict ban on the whole category of amusement construction was being considered.

SCHOOL PLANTS: SATISFACTORY, FAIR, UNSATISFACTORY

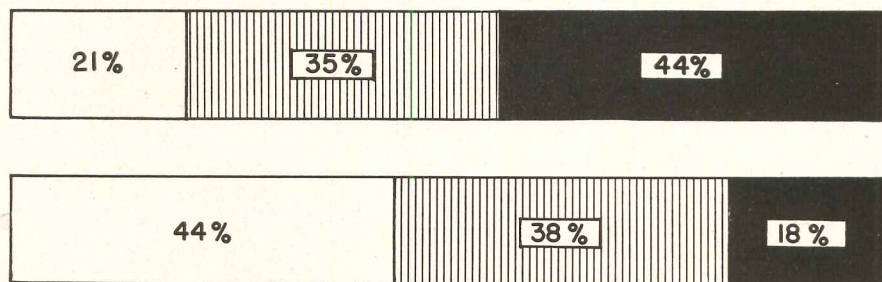

Charts from Federal Security Agency's report on School Facilities Survey give some idea of potential in school construction field. Above: top line, elementary schools, bottom line, secondary; white box means satisfactory; vertical lines, fair; black box, unsatisfactory. Right: top line for elementary, bottom for secondary; boxes show (left to right) less than 11 years; 11-20 years; 21-30 years; 31-50 years; and over 50 years

AGE OF SCHOOL BUILDINGS

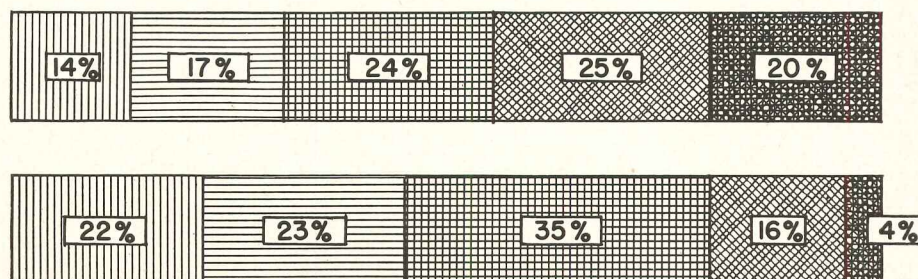

1952 CONVENTION (Cont. from p. 11)
39 New A.I.A. Fellows Named

Max Abramowitz, New York — Design; C. Storrs Barrows, Rochester, N. Y. — Public Service; Welton D. Becket, Los Angeles, Cal. — Design; Kenneth C. Black, Lansing, Mich. — Service to the Institute; Walter Carlson, Wilmington, Del. — Public Service; George Wallace Carr, Chicago — Design and Science of Construction; Birge Malcolm Clark, Palo Alto, Cal. — Public Service and Service to the Institute.

Pendleton S. Clark, Lynchburg, Va. — Service to the Institute; Charles P. Crowell, Bangor, Maine — Public Service; Herman L. Duhring, Germantown, Pa. — Design and Education; Max Foley, New York — Service to the Institute and Science of Construction; Robert Benjamin Frantz, Saginaw, Mich. — Public Service and Service to the Institute; James Herbert Gailey, Atlanta, Ga. — Education; M. Edwin Green, Harrisburg, Pa. — Design and Public Service; Lawrence Hill, University City, Mo. — Design; Robert Hutchins, New York — Design; Francis B. Jacobberger, Portland, Ore. — Public Service; Eugene Herbert Knight, Birmingham, Ala. — Public Service and Education; Thomas Hall Locraft, Washington, D. C. — Design.

Maynard Lyndon, Los Angeles — Design; Walter Frederic Martens, Charleston, W. Va. — Service to the Institute and Public Service; Dale Robert McEnary, Minneapolis — Service to the Institute and Public Service; Robert McLaughlin, New York — Design and Science of Construction; Warren D. Miller, Terre Haute, Ind. — Public Service; Harold Henry Munger, Toledo — Public Service.

Allan H. Neal, Pittsburgh — Service to the Institute; Addison Stayton Nunn, Houston — Public Service; James O'Connor, New York — Design; Noah Webster Overstreet, Jackson, Miss. — Design; Clyde Collins Pearson, Montgomery, Ala. — Design; Alfred Easton Poor, New York — Design and Public Service; Antonin Raymond, New York — Design and Science of Construction; Arthur Neal Robinson, Atlanta, Ga. — Service to the Institute; Eero Saarinen, Bloomfield Hills, Mich. — Design; Harvey A. Schwab, Pittsburgh — Service to the Institute; Cyrus Edgar Silling, Charleston, W. Va. — Service to the Institute; Delos Hamilton Smith, Washington, D. C. — Education; Lucius R. White Jr., Baltimore — Public Service and Service to the Institute; L. Morgan Yost, Kenilworth, Ill. — Design.

IN 1952 AS IN 1925,

Ezra Stoller

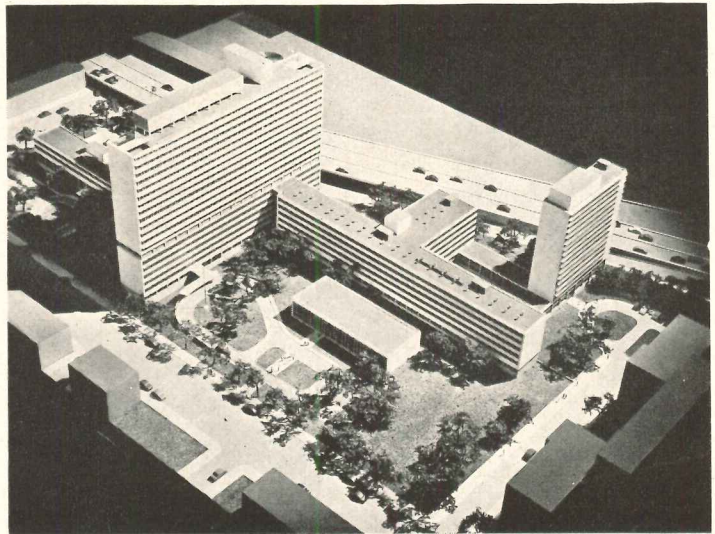

Lawrence G. Heinrich

New medical centers: 1925, Columbia Medical Center (immediately above), James Gamble Rogers, Architect; 1952, New York University Medical Center (photo of model, top, shows how it will look at completion); Skidmore, Owings and Merrill, Architects

Sigurd Fischer

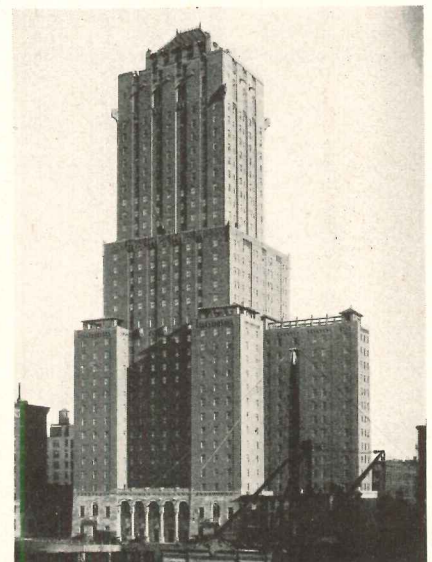

New hotel, 1925: Hotel Shelton, Lexington Avenue and 49th Street, won two gold medals—one from the Architectural League of New York and one from the American Institute of Architects; Arthur Loomis Harmon, Architect

VISITING ARCHITECTS LOOK FOR THE NEW BUILDINGS

Architectural Record



Michael Miller



High on the list of most architects who come to New York for the A.I.A. convention in June will be their own personal tours to new buildings in the area.

The buildings they'll make sure to see will vary with different interests, necessities and energies, although two — the United Nations Building and Lever House — are pretty sure to be on everybody's list.

The RECORD has dug into its 1925 files to turn up some New York buildings which were big news when the last New York convention of the A.I.A. was held. Photographs of some of these, together with photographs of some buildings that are sure to rate visitors from this year's convention, are reproduced on these pages.

Sigurd Fischer

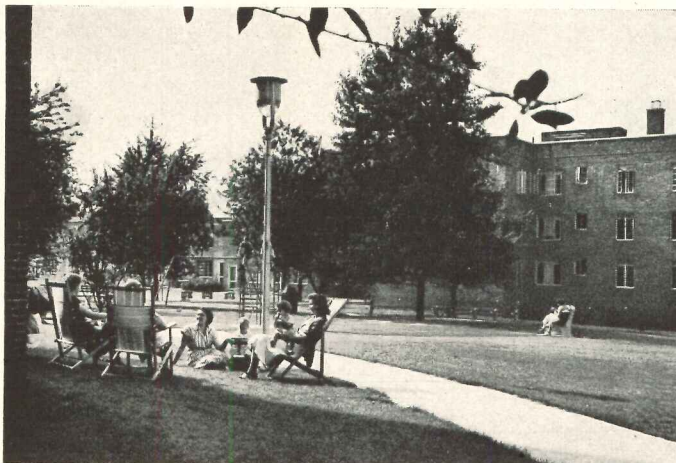

News in 1925 was the Steinway building (center in photo above left); Warren & Wetmore, Architects. One of today's many new office buildings (above right): 101 Park Avenue; Kahn & Jacobs, Architects. Left: Fresh Meadows (Queens, N. Y.), a new housing development designed for people; Voorhees, Walker, Foley & Smith, Architects. Below: designs for monumentality. 1925 — facade of Theodore Roosevelt Memorial wing, American Museum of Natural History; John Russell Pope, Architect; 1952, United Nations building, looking toward newly completed Conference Building; United Nations, Headquarters Planning Commission, Wallace K. Harrison, Director, Architects

American Museum of Natural History

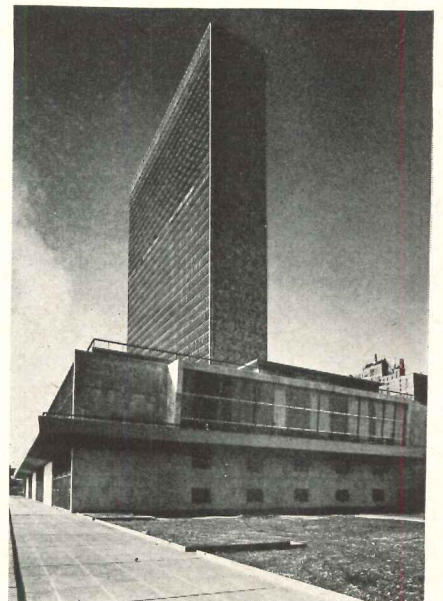

Joseph W. Molitor



Tommy Webber

"HONESTLY ARROGANT" F.L.L.W. RESTATES LIFELONG CREED

Frank Lloyd Wright, in New York to oversee preliminaries to his Guggenheim Museum, was guest of honor at luncheon given by Thomas S. Holden, president of F. W. Dodge Corp. Wright, who remarked "I early decided that an architect must be either honestly arrogant or hypocritically humble," noted that his Credo, written 58 years ago and first published in ARCHITECTURAL RECORD in 1908, has never changed (see pages 148-154). At left: Mr. Holden; A.I.A. Regional Director Arthur Holden; Mr. Wright; and Francis Keally, New York A.I.A. Chapter president

NEW ENGLAND ARCHITECTS MEET TO NOMINATE REGIONAL DIRECTOR

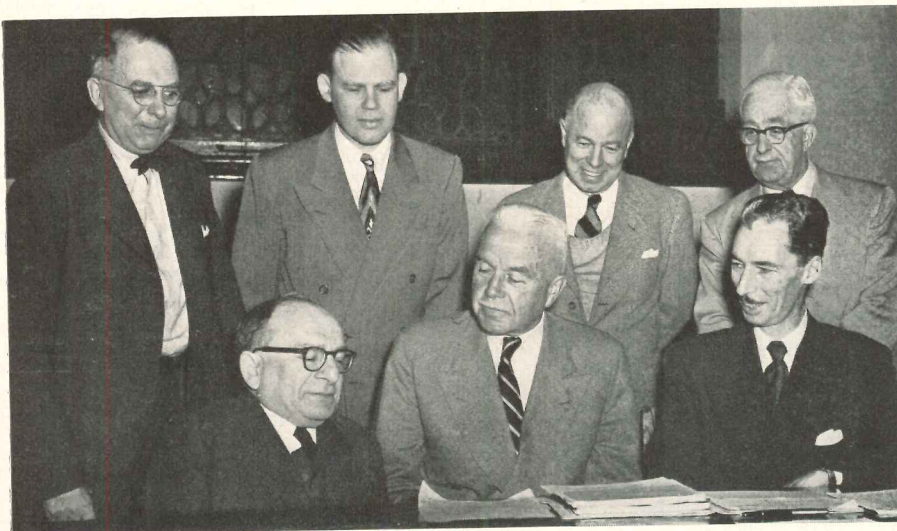

Lenscraft

At last month's Boston meeting of the New England Council of Architects Philip Creer was nominated for New England Regional Director of A.I.A. In photo at left above: (seated) Samuel M. Morino, Rhode Island Chapter president; Harold B. Willis, retiring regional director; Eugene Kennedy, Massachu-

setts Chapter president; (standing) Alonzo Harriman, Auburn, Maine; Eugene Magenau, New Hampshire Chapter president; Preston Cole, Vermont Chapter president; and William J. Provost, Connecticut Chapter president. At right above: Mr. Willis congratulates Mr. Greer, also new Council secretary-treasurer



Piaget Studio

ARCHITECTS AND PRODUCERS GET TOGETHER IN ST. LOUIS

St. Louis Chapter of the American Institute of Architects kicked off a lively new activity program by holding a joint dinner meeting with the local chapter of the Producers' Council. Against backdrop provided by building products exhibit: Robert Elkington, St. Louis A.I.A. secretary; William A. Grolock, St. Louis A.I.A. president; A. Naughton Lane, national president of the Producers' Council; Edmund R. Blaschke, president of the St. Louis Chapter of the Producers' Council

No waterproofing will prevent wet concrete floors

"Dampness on concrete floors is more often due to moisture from the air than from the ground. No amount of waterproofing beneath the slab will prevent this trouble."

From a "Progressive Architecture" Research Report, "Insulation for Concrete Floor Slabs on Grade."

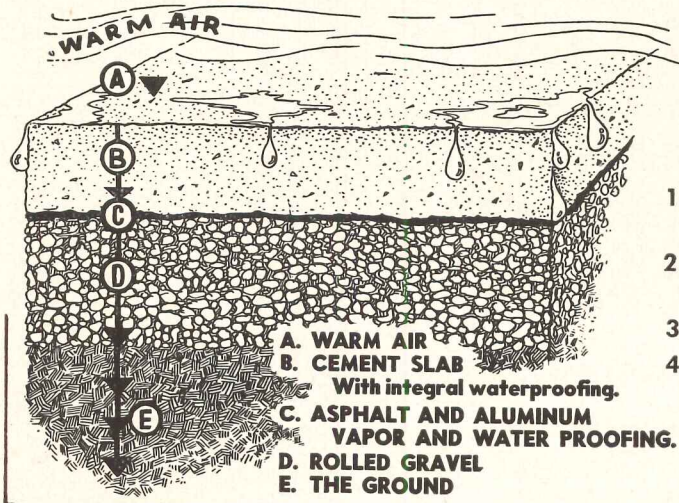

1. The air (A) in immediate contact loses heat by conduction to the concrete (B).
2. The concrete (B) conducts heat through the layer of asphalt AND aluminum (C) to the gravel (D).
3. The gravel (D) conducts heat to the ground (E).
4. As the contacting air (A) loses heat, its capacity to retain water vapor is diminished. The excess condenses on the upper surface of the concrete floor.

THE EXPLANATION:

- (1) Cold air can support little vapor. The excess falls out as water, or condensation, dew, etc.
- (2) By direct conduction through and between solids, heat flows through the concrete floor into the earth, the flow in conduction being from warm to cold.
- (3) Similarly, by conduction, heat flows out of the air in immediate contact with the colder concrete. That layer of air can no longer support all the vapor in it, so the excess condenses.
- (4) The process of extracting heat out of the air at the upper surface of the concrete is continuous, and so is the formation of condensation.

Multiple sheets of accordion aluminum, *underneath* the floor, reflect back 97% of RADIATION. The air spaces permit only about 5% heat flow by CONDUCTION. There is of course no CONVECTION downward. Therefore with practically no heat loss, the concrete tends to follow air temperatures, and remains above the dew point. Ordinary insulations, being dense, are better conductors of heat. They are made more dense, still better conductors of heat, by the crushing weight of concrete, by inner condensation formation, and by ground dampness.

The commercial forms of multiple sheets of accordion aluminum are Infra Insulation Type 6, Type 4 and Type 4 Jr. (The built-in reflective air spaces are permanent.)

For new and inexpensive techniques in insulating floors and concrete slabs against heat flow loss, and condensation, as well as ceilings and walls, obtain FREE the revised fifth edition of "Simplified Physics of Vapor and Thermal Insulation." Use coupon below.

INFRA THERMAL FACTORS, DOWNHEAT FLOW

Type 6 C.044 R22.72 equals 9" DRY Rockwool
Type 4 C.065 R15.38 equals 6" DRY Rockwool
Type 4 Jr.* C.097 R10.30 equals 4 1/2" DRY Rockwool
*In 1" Space

INFRA INSULATION, INC.
525 Broadway, New York, N. Y.
Phone: WO 4-2241

INFRA INSULATION, INC.
525 Broadway, New York, N. Y.

Dept. R5

Please send FREE "Simplified Physics of Vapor and Thermal Insulation."

Name _____

Firm _____

Address _____

Send Prices of Infra Insulations Send Sample

Installation and Specification Data

Watrous Flush Valves for...

THE NEW WALL-HUNG

Sanistand

FIXTURE

Latest version of the American-Standard
urinal for women's toilet rooms

Here are the Watrous Flush Valve Combinations recommended for use with the new wall hung Sanistand urinal made by American Standard. They have been worked out in cooperation with the fixture manufacturer to provide the proper flush and refill.

These Watrous Combinations are available for manual or foot pedal operation, for either exposed or concealed installations. All exposed parts are heavily chrome-plated; concealed valves are rough finished.

The flush valves themselves, of course, offer all those basic Watrous superiorities — water-saving adjustment, self-cleansing by-pass, self-tightening handle packing and single-step servicing. Screenless silent action can be furnished at slight additional cost.

Write for Type "S" data sheets covering
Watrous Flush Valves for both wall hung
and floor model Sanistand Fixtures.

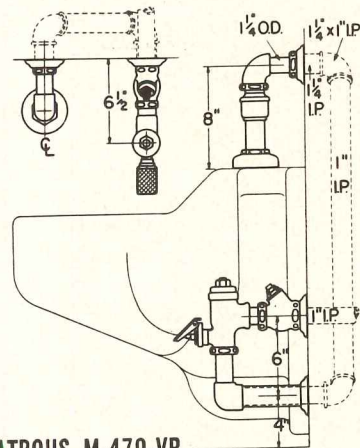

WATROUS M-479-VB
Pedal-operated exposed flush
valve, top spud connection.

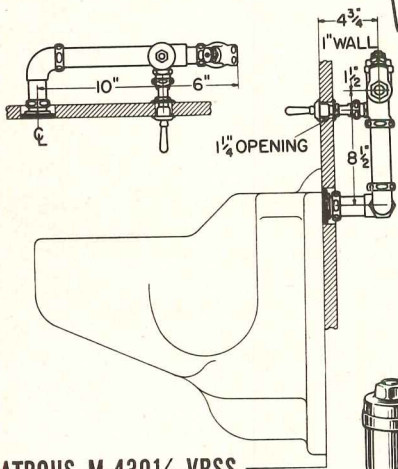

WATROUS M-439 1/2-VBSS
Manually-operated concealed flush
valve, back spud connection.

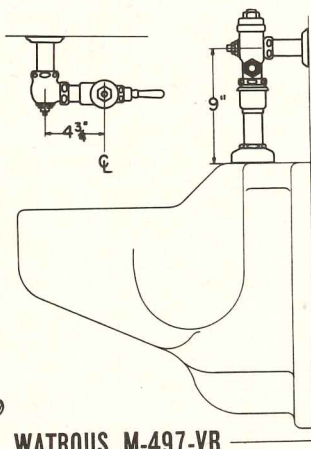

WATROUS M-497-VB
Manually-operated exposed flush
valve, top spud connection.

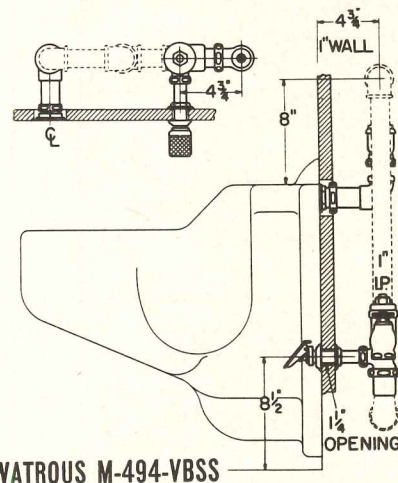

WATROUS M-494-VBSS
Pedal-operated concealed flush
valve, back spud connection.

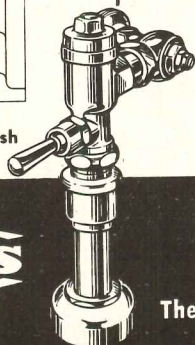

Watrous

ADJUSTABLE FLUSH VALVES
BOTH DIAPHRAGM AND PISTON TYPES
The Imperial Brass Manufacturing Co., 1240 W. Harrison St., Chicago 7, Ill.

**BUILDING COORDINATOR:
VICTORY COMES LATELY**

AS THE CONTROLS OUTLOOK EASES, Defense Production Administration policy has at last incorporated the recommendation most frequently urged upon it by all segments of a bewildered construction industry in the darkest days of building curbs.

The appointment of John H. Martin, president of the United Lumber Yards of Modesto, Calif., as deputy administrator in charge of construction and resources expansion for DPA provides the instrument for coordination of DPA policy on construction vigorously sought in a long series of industry efforts led by the American Institute of Architects.

The office Mr. Martin heads has until now been known as "Office of Resources Expansion" and the addition of the word "Construction" to the title is the explicit expression of the industry's belated victory.

Barring the movement of the economy into more stringent circumstances requiring tightened controls, however, the victory is more nostalgic than significant. For since the time industry segments were plumping for this coordination of policy on construction, a series of actions by the controlling agencies has greatly relaxed the regulations over the building of commercial types and some industrial projects. Further lifting of bans on structural and carbon steel were expected for third quarter operations, extending into the home construction field.

Policy Function Stressed

In announcing Mr. Martin's appointment, DPA Administrator Manly Fleischmann said one of the most important functions of the new office will be that of acting for him (Fleischmann) in all DPA areas of industrial expansion and construction "for the development of policies within these fields."

The DPA announcement made it clear that the former office of resources expansion had been changed to the new title — including construction for the first time — to encompass the new activities of this DPA division and its own administrator.

King Takes New Post

Mr. Martin succeeded James F. King. It was expected that Mr. King would move into the office of Gabriel J. Ticoulat, who had ended his term (starting October 2, 1951) as deputy DPA administrator for international activities and defense materials.

REAL ESTATE DEVELOPER PROVIDES ARCHITECTS' PRIZES

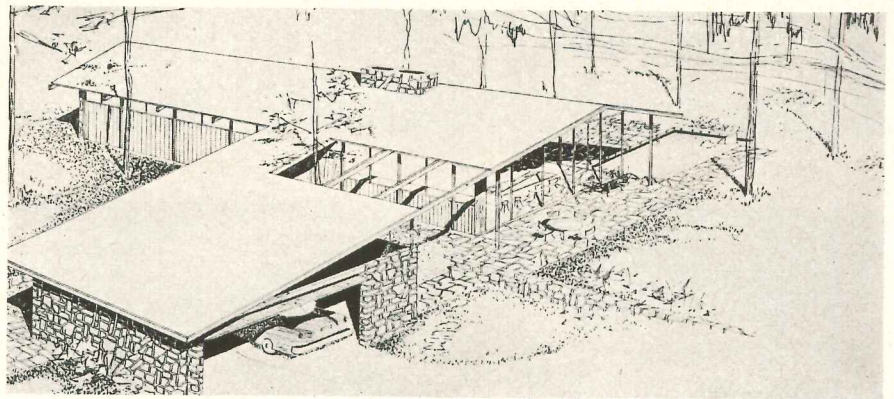
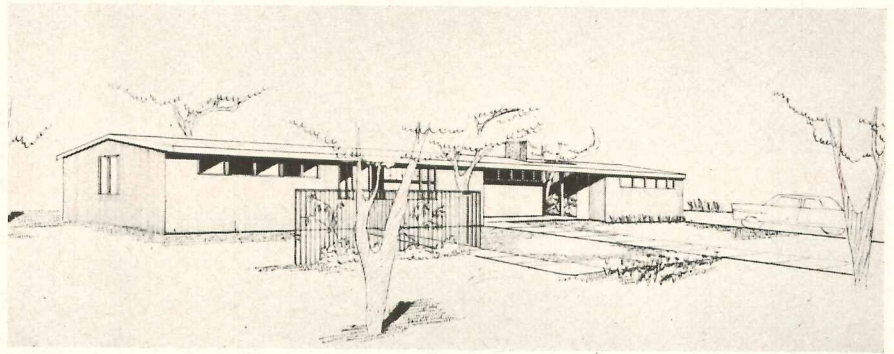

\$1400 in prize money contributed by a Birmingham, Mich., real estate developer, Howard T. Keating, made possible the Small House Competition recently sponsored by the Michigan Society of Architects. First prize entry (top photo) was submitted by Gordon A. Sheill, A.I.A., and Harold Binder, designer, both of the office of Albert Kahn Associated Architects and Engineers. Second prize winner (directly above) was the design of Charles D. Hannan, A.I.A., and Herbert L. Hawthorn, designer. Third prize went to Morris Jackson of Smith, Hinchman and Grylls, Architects and Engineers

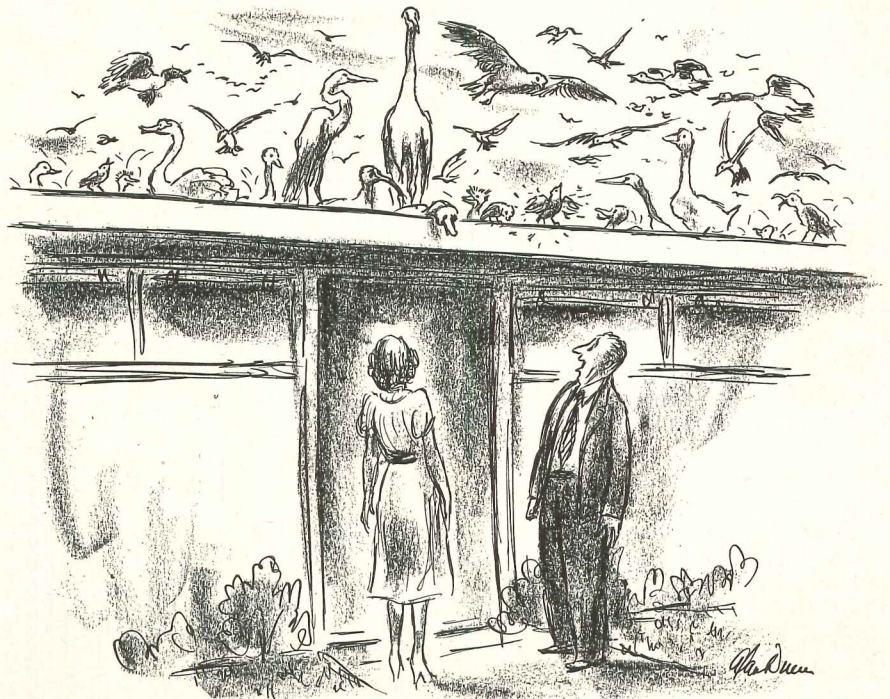

— Drawn for the RECORD by Alan Dunn

"Is this a water-cooled roof or a bird bath?"

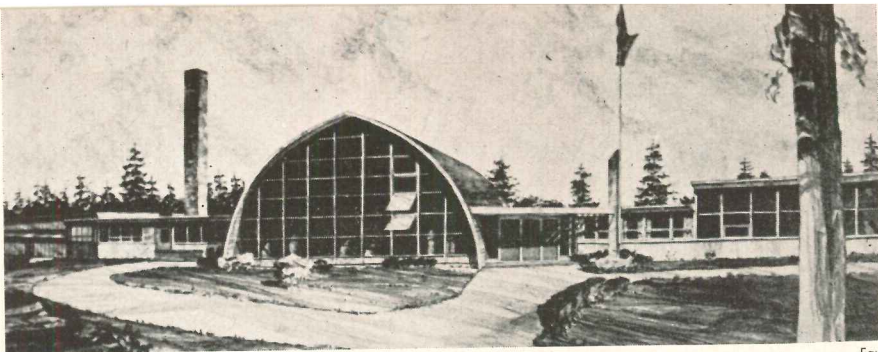

1

Foy

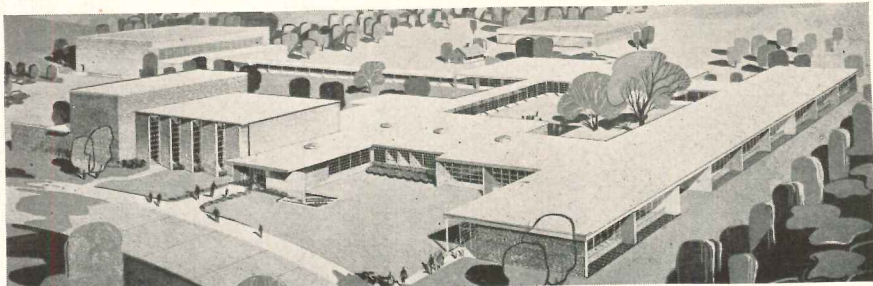

2

Alt-Lee

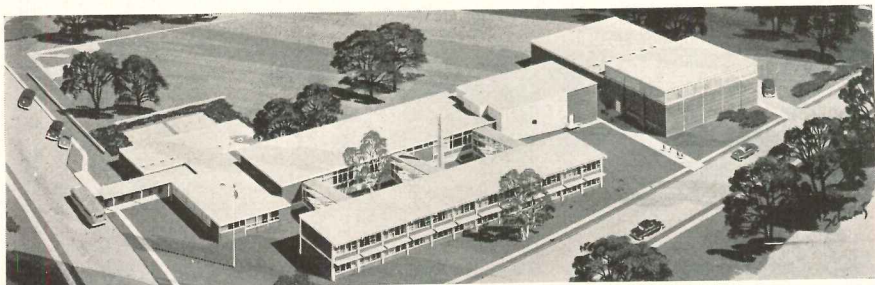

3

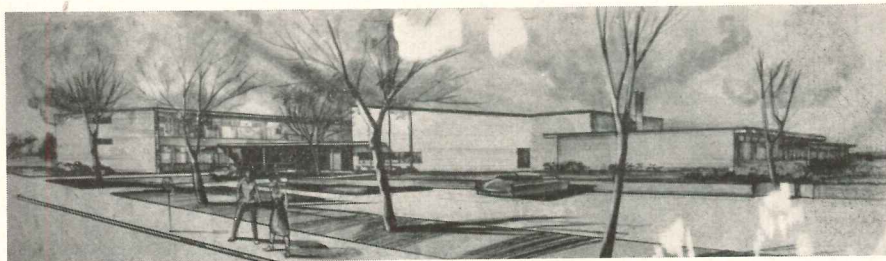

4

Foy

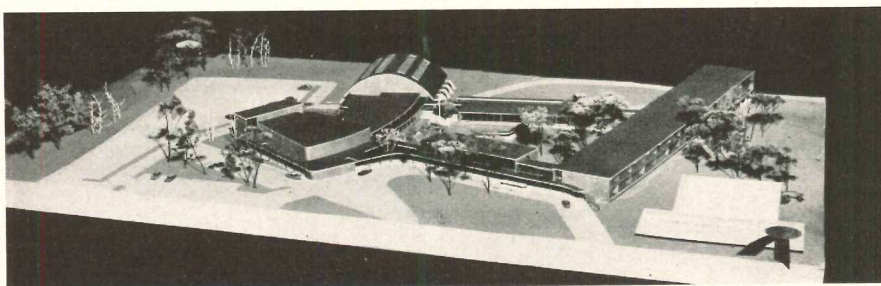

5

Foy

Julius Shulman

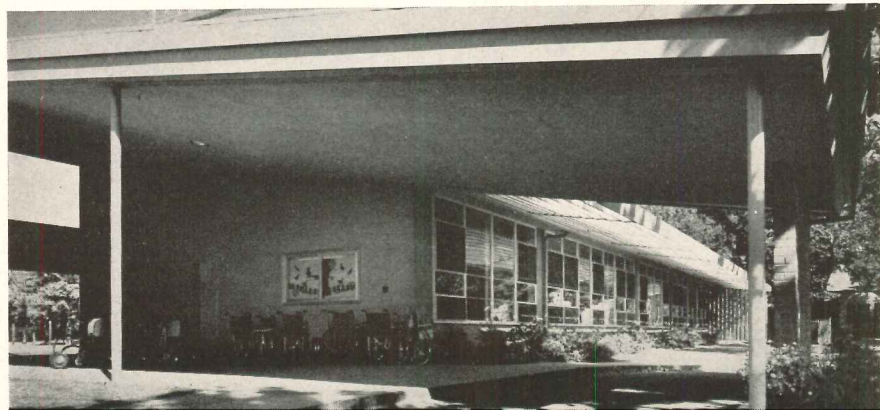

6

SIX SCHOOLS GET AWARDS IN AASA BOSTON EXHIBIT

THE LAST OF THREE regional meetings was held last month at Boston by the American Association of School Administrators, which holds regional meetings instead of a national convention every third year. This year's series held architectural exhibits, co-sponsored by A.I.A., with each meeting. A.A.S.A. had previously held only one such exhibit at a regional convention.

Architects across the country were free to submit their projects in any or all of the three exhibits; and one school (see below) in fact won Awards of Merit in all the regional contests.

Projects which received Awards of Merit in the Boston exhibit are shown on this page. Awards of Merit were given at the earlier meetings as follows:

St. Louis — Westwood Elementary School, Stillwater, Okla., Caudill, Rowlett & Scott, architects; Sunshine School, Fresno, Cal., David Horn & M. D. Mortland, architects; Clayton, Mo., High School, William B. Ittner Inc., architect; Oak Ridge, Tenn., Senior High School, Skidmore, Owings & Merrill, architects; Lee Elementary School, Manhattan, Kans., F. O. Wolfenbarger & Assocs., architects.

Los Angeles — William Penn Elementary School, Whittier, Cal., William H. Harrison, architect; Sunshine School, Fresno, Cal., David Horn & M. D. Mortland, architects; Katherine Delmar Burke School, San Francisco, Donald Beach Kirby and Thomas Mulvin, architects; John Muir Elementary School, Contra Costa County, Cal., John Lyon Reid, architects; Long Beach, L. I., Elementary and Junior High School, Reisner & Urbahn, architects.

Award of Merit winners at the Boston meeting are shown at left (top to bottom): 1—Bar Harbor, Me., Elementary School, Alonzo Harriman, architect; 2—Langley-Bath-Clearwater High School, Aiken County, S. C., Lyles, Bissett, Carlisle & Wolff, architects, Engelhardt, Engelhardt & Leggett, associates; 3—Meadow Drive Elementary School, Albertson, N. Y., Ketchum, Gina & Sharp and Louis Shulman, architects; 4—Chandler Street Junior High School, Worcester, Mass., The Architects Collaborative and G. Adolph Johnson, architects; 5—East Hartford, Conn., High School, Nichols & Butterfield, Perkins & Will, architects; 6—Sunshine School, Fresno, Cal., David Horn and M. D. Mortland, architects

Look at this!
We're going to
have to put new
floors in the plant
and executive
offices, too.

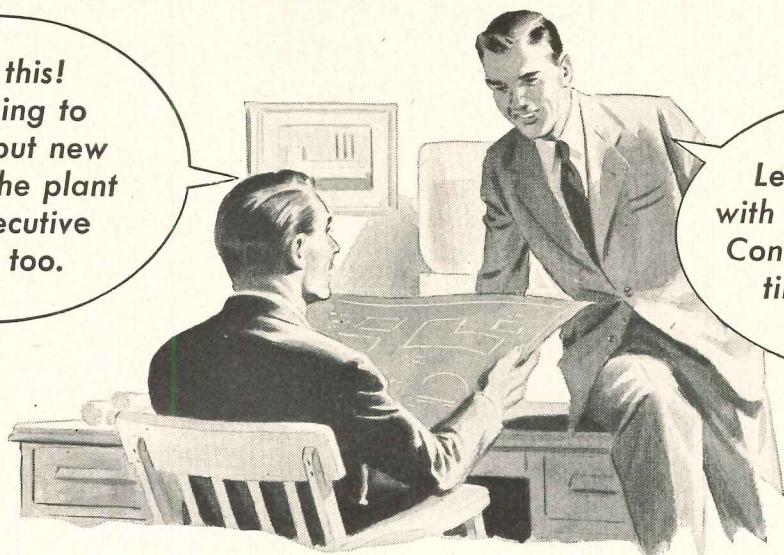

Let's get in touch
with the Kentile Flooring
Contractor. He'll save us
time and money.

You and your client both profit when you call in the Kentile Flooring Contractor

THE MOST important differences between various types of flooring are those that don't appear on the surface... that's why it takes an expert to decide whether a certain floor belongs in a certain installation!

The Kentile Flooring Contractor is that expert... a technically trained and experienced man who is fully qualified to select just the right floor... the one floor that will provide the longest life at the lowest cost...

as well as minimum maintenance expenses.

Whether your flooring problem is one room in a home or store... or thousands of square feet in a factory, warehouse or office, it will pay you to call in the Kentile Flooring Contractor. For his name, look under FLOORS in the classified pages of your phone book... or write Kentile, Inc., 58 Second Ave., Brooklyn 15, New York. In Canada, T. Eaton Co., Ltd.

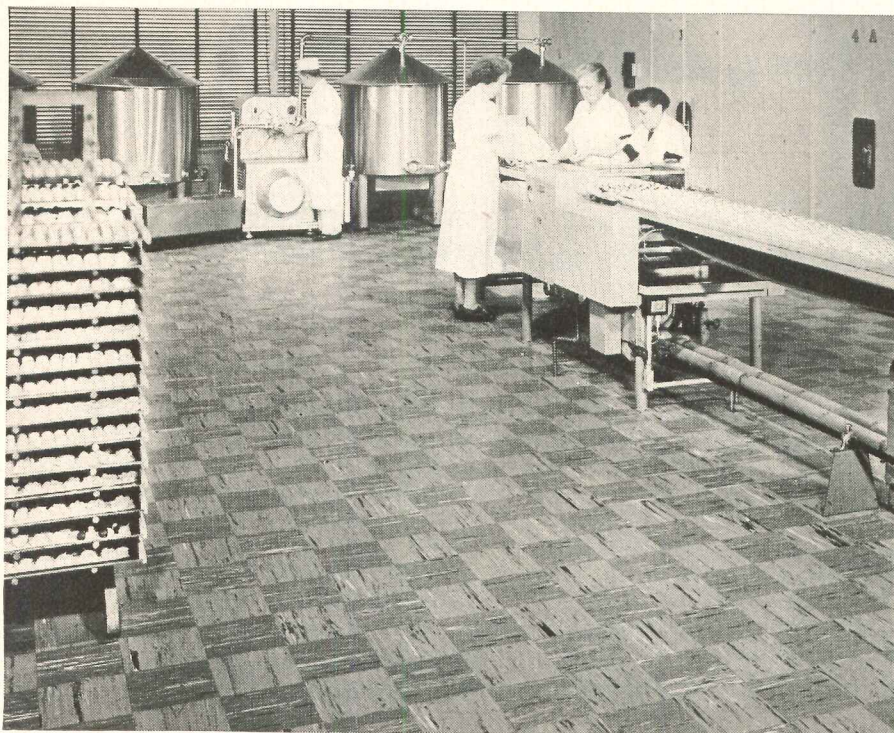

- Where rugged, extra-heavy duty flooring is required, the first choice is SPECIAL (grease-proof) KENTILE... its colorful beauty resists the wear of constant exposure to industrial and cooking greases and oils, alkali, alcohols and most acid solutions. It is of special value in providing long-range economies in installations like the one shown here; restaurants and cafeterias; light manufacturing areas; laboratories; and garages. SPECIAL (grease-proof) KENTILE can be installed over any smooth, firm interior surface... even below grade over concrete in direct contact with the earth.

KENTILE • SPECIAL (greaseproof) KENTILE • KENRUBBER • KENCORK



KENTILE INC.

KENTILE, INC., 58 Second Avenue, Brooklyn 15, New York • 350 Fifth Avenue, New York 1, N. Y. • 705 Architects Building, 17th and Sansom Streets, Philadelphia 3, Pennsylvania • 1211 NBC Building, Cleveland 14, Ohio • 225 Moore Street, S.E., Atlanta 2, Georgia • 2020 Walnut Street, Kansas City 8, Missouri • 1440 11th Street, Denver 4, Colorado • 4532 South Kolin Avenue, Chicago 32, Illinois • 1113 Vine Street, Houston 1, Texas • 4501 Santa Fe Avenue, Los Angeles 58, California • 95 Market St., Oakland 4, Calif. • 452 Statler Building, Boston 16, Mass.



“Sold 125 G-E houses—each with G-E Kitchen-Laundry!”

Here's Mr. Arthur Oman of Weymouth Heights, Mass. who sold 125 houses within 10 days. He says: "I'm sold on the G-E Kitchen-Laundry in new homes just as Mrs. Duffy is!" Mrs. Duffy (also above) says: "All my friends wish they had a G-E Kitchen-Laundry for just that extra \$3.50 a month!"



His General Electric equipped projects won an N.A.H.B. award!

Mr. Herbert Tandy (above) and his associates, Messrs. Norman Tandy and Alan D. Allen, are builders of the Saddle-Wood Hills Development in Hillsdale, New Jersey. N.A.H.B. stated: "The projects presented were a great credit; sound planning, ingenuity, and market-appeal were *all* in evidence."

Again in 1952, architects and builders are specifying and featuring the G-E Kitchen-Laundry!

Your plans and houses will have much greater acceptance when women see all the wonderful, timesaving equipment, and learn that it adds as little as \$3.50 a month extra to regular monthly mortgage payments!

Here you see photographs of six successful builders from various sections of the country calling back on women who purchased houses from them months previously.

"Call-backs" convinced these builders—*more than ever*—that it pays to feature the G-E Kitchen-Laundry in the houses they build.

We believe success stories such as these definitely indicate that G-E Kitchens and Laundries should be specified and built into all new homes, *regardless of price range.*

Isn't it time you, too, took a good look at these facts?

1. You know that most women want—and expect—convenient, timesaving kitchen and laundry appliances in their new homes.

2. When these appliances bear the General Electric

nameplate, prospects become more quickly sold on the plans and house because they're well-acquainted with General Electric products. They know they are the very finest appliances available. They associate the quality of the appliances with the entire specifications and construction of your houses.

3. Even families with \$50-a-week income enjoy the comfort of a G-E equipped Kitchen-Laundry! That's because . . .

4. The buyer pays as little as \$3.50 a month more on his regular monthly mortgage payments.

Whether you plan or build 1 or 1000 houses . . .

. . . they will have greater acceptance if they're equipped with *matched* General Electric appliances.

Complete specifications for General Electric Kitchen and Laundry equipment are given in Sweets Catalogue, Section 24.

See your local G-E distributor, or write to the Home Bureau, General Electric Co., Louisville 2, Kentucky.



"G-E equipment gives us a distinct advantage over competition!"

Here's Mr. Clarence M. Lemon, builder of Wichita, Kansas homes who says: "We sold our entire project of 49 houses the very first day. We included the General Electric Kitchen-Laundry because we felt it gave our homes a distinct advantage over others selling in about the same price range."



"It's the clincher that helped us close 156 contracts!"

Mr. Edwin I. Abbott of Lyons, Illinois says: "The complete G-E Kitchen-Laundry in our 'House of Charm' homes was the clincher that helped us close 156 contracts in one week end. A woman is really sold when she sees General Electric Appliances included as a part of the complete house package."

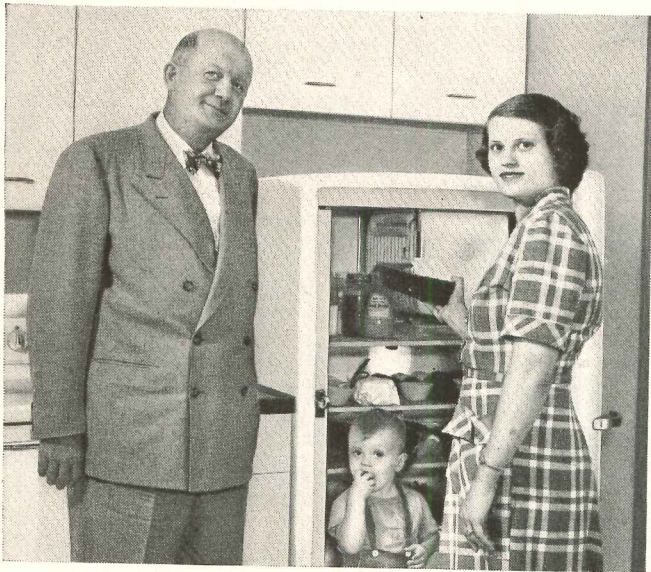

"Sold 100 G-E houses—mostly to people with \$50 to \$70 incomes!"

Here's Carl B. Anderson of Virginia, Minn. who sold 100 houses with G-E Kitchen-Laundry during the past three years. He says: "It was the kitchen-planning service offered by the local G-E distributor that first interested me in including the G-E Kitchen-Laundry in my houses."



"57 sold the first day . . . rest sold themselves!"

Here's Mr. Chas. A. Mohr, president of the Builders Assn. of Maryland. He says: "No matter what the price range may be, women *do* expect to see General Electric equipment in the kitchen, or else they're not keenly interested. It's no secret: G-E Kitchens sell my houses!"

GENERAL  **ELECTRIC**

DESIGN TRENDS: THE "GEOMETRIC" AND THE "ORGANIC"

Museum of Modern Art

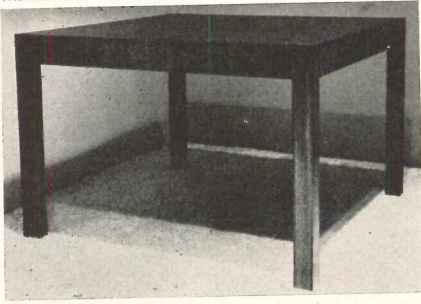

Edith Hernandez & Co. Interiors

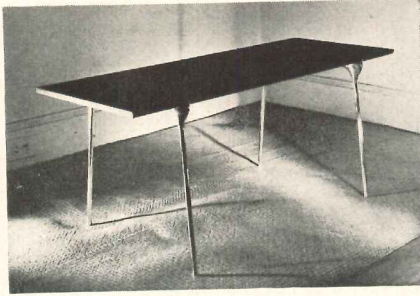

Museum of Modern Art

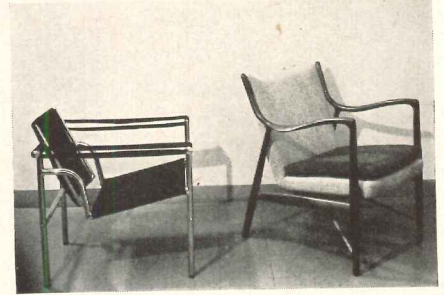

New York's Museum of Modern Art has taken a reflective look at modern design and come up with a small but provocative exhibit (current till June 1) which it calls "Design Trends." It consists of 11 pairs

of objects, one of each set designed 20 years or so ago and one quite recently, which the Museum suggests reflect a trend in design from purely geometric to "expressive, organic shapes." Above: far

left, Ludwig Mies van der Rohe's mahogany table (1930) and (next) slate and bronze table by Edith and William Hernandez (1949); chairs by Le Corbusier (1928) and (at right) Finn Juhl (1946)

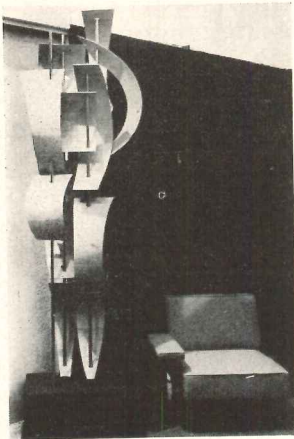

EXHIBIT SHOWS SCULPTURE IN EVERYDAY SETTINGS

THE SCULPTORS' GUILD used its 1952 annual exhibition, which begins a nationwide tour this month, to show how sculpture can be used in ordinary surroundings—a forthright approach to the problem of accustoming at least some portion of the public to the idea that sculpture does not belong exclusively in museums and palaces.

Settings designed by eight architects and decorators for the New York showing at the American Museum of Natural

History included an airport waiting room, a motion picture theater lobby (photo below), two contemporary living rooms, a chapel, a hall, a store window and a garden.

Architects who did settings were Victor Proetz, William Lescaze, and William McKnight Bowman, all of New York; Leo A. Daly, Omaha. Other designers: William Pahlmann, Jessie Earnshaw and Gene Moore, all of New York, and Christopher Castou, Townshend, Vt.

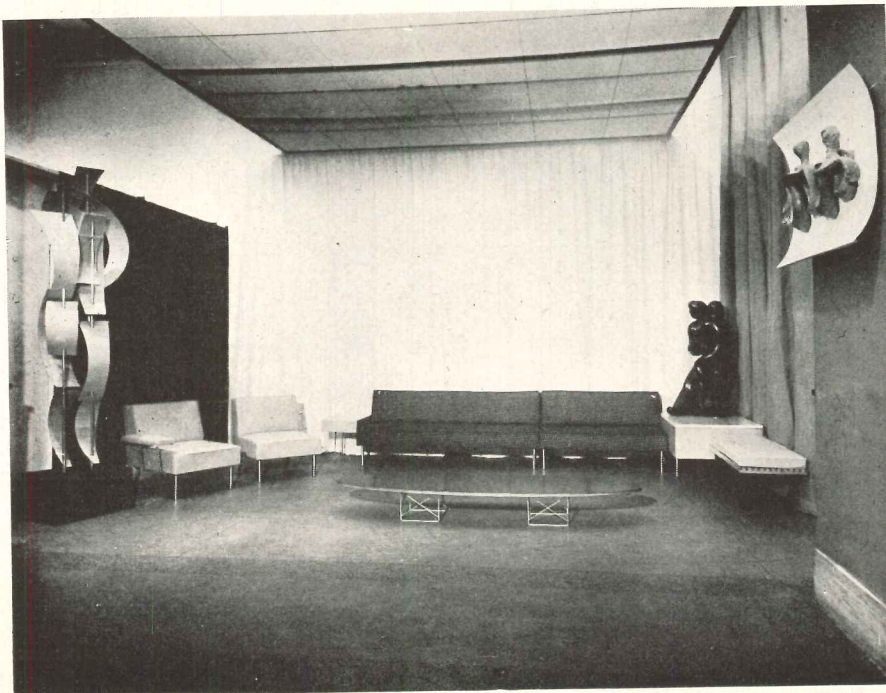

Erich Kastan

Lescaze used three pieces of sculpture in theater lobby (above). Photos of individual pieces show (top) plywood "sailor" by Harold Ambellan; (top right) plaster "Dancers" by Joseph Konzal; (below right) rosewood "Mother and Child" by Humbert Albrizio

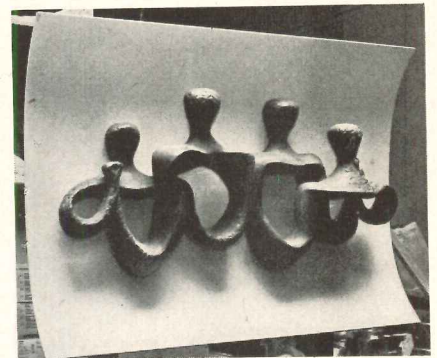

It's the Staying Power that Counts!

... and in a Roof Deck

ONLY STRUCTURAL CONCRETE HAS THAT STAYING POWER

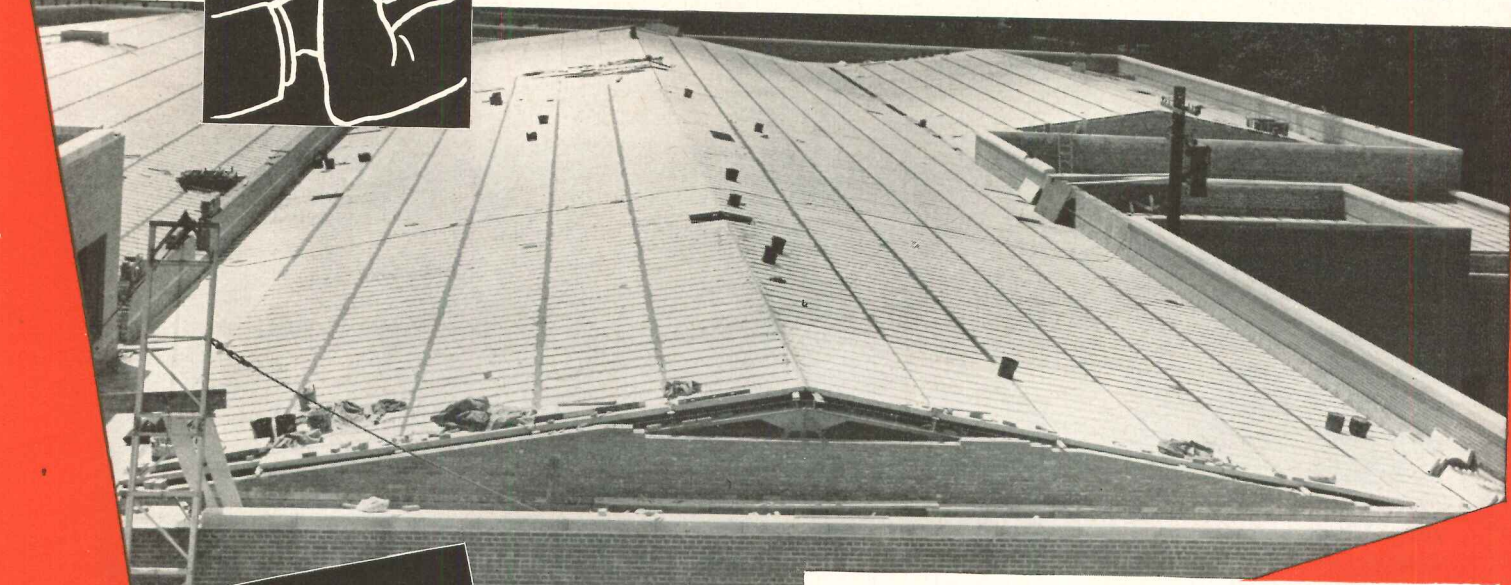
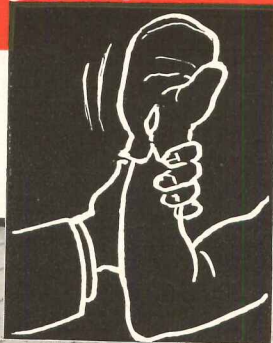

FEDERAL- *Featherweight* PRECAST STRUCTURAL CONCRETE ROOF SLABS

Chicago Transit Authority Bus Garage with an area of 68,000 sq. ft. of Federal Featherweight STRUCTURAL CONCRETE Precast Roof Slabs. Archt. Battey & Childs; Contr. Joseph J. Duffy Co., both Chicago.

Your first requisite for a good roof deck must certainly be STRUCTURAL soundness. In the battle against the destructive forces of both man and the elements—steam, smoke, cinders, gases, fumes, water, heat and cold—there just is no place for a roof deck of impermanent materials.

Because Federal-Featherweight STRUCTURAL CONCRETE Precast Roof Slabs are completely impervious to all of these effects, it is evident that these slabs will far outlast any roof deck that is subject to deterioration.

Federal is unaffected by moisture within or without the building. It cannot rot, rust or disintegrate. THERE IS NO MAINTENANCE, EVER! It is not only strong, but lightweight, firesafe, and with a beautiful, satin-smooth underfinish. It has no equal today for true, overall economy. *Catalog on request.*

CHANNEL ROOF DECK SLABS for use with composition covering. NAILING CONCRETE SLABS to hold securely, slate, tile, copper or other ornamental roof.

St. Joseph School, Chicago, covered with 8,000 sq. ft. of Federal-Featherweight STRUCTURAL CONCRETE Precast Roof Slabs. Archt. Edo S. Belli, Chicago; Contr. Herlihy Mid-Continent Co., Chicago.



ANY BUILDING—INDUSTRIAL OR INSTITUTIONAL—IS A BETTER BUILDING WITH A FEDERAL ROOF!

MADE, LAID AND GUARANTEED BY

FEDERAL CEMENT TILE COMPANY

EXECUTIVE OFFICES: 608 SOUTH DEARBORN STREET • CHICAGO 5, ILL.

FOR FORTY-FIVE YEARS

SALES OFFICES IN

Texas construction firm by setting



New 18-story office building for the Prudential Insurance Company of America, where Straus-Frank Co. used Remington Stud Drivers for fastening air ducts to concrete ceilings.

*It's fast, easy and safe to operate
the Remington Stud Driver*



Simply hand-assemble stud and power cartridge, load as a unit in easy-to-open Remington Stud Driver, and close.

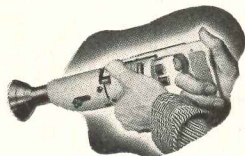

Press loaded Stud Driver firmly against surface, depress safety lever and pull trigger. Explosive charge imbeds stud solidly.

LOOK AT ALL THESE FEATURES

COMPACT AND PORTABLE—Weighs only 5½ pounds, ideal for overhead work in inaccessible places.

SPEED—One man can set as high as 5 studs per minute on repetitive work at depths up to 2¾ inches, depending on material.

ELIMINATES INVESTMENT in outside power—completely self-powered.

FOUR WAYS SAFE—Plainly visible red dot indicator shows when Stud Driver is cocked; safety lever must be depressed before and during squeezing of main trigger; permanently attached safety shield must be compressed against work before Stud Driver will operate. If tilted at more than a slight angle, Stud Driver will not fire. Slight recoil. Low noise level.

RUGGED—All working parts of the Stud Driver are made of selected steels, cased in a strong aluminum-alloy housing. Lining of safety shield is a solid block of tough, resilient Du Pont neoprene.

PRICE for Model 450 Remington Stud Driver, complete in rugged steel carrying case—only \$119.50.



saves over \$8,000

fastening studs with

NEW Cartridge-Powered Model 450

REMINGTON STUD DRIVER

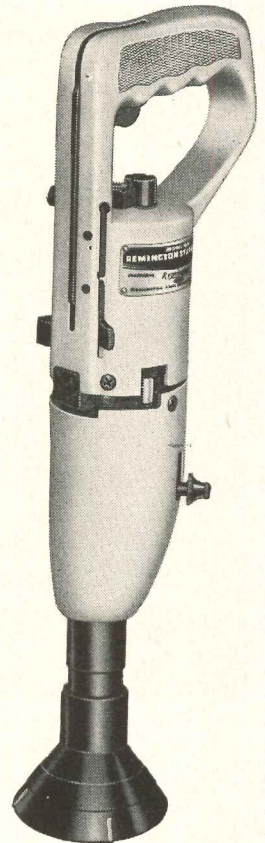

**Revolutionary new tool sets studs
in seconds... and does it safely!**

Construction job speeded at a substantial reduction in labor costs! That's the report from Straus-Frank Co., Houston, Texas, whose contract division used Remington Stud Drivers on a recent building project. In setting fastening studs for overhead air ducts, the Stud Drivers outproduced older methods eight to one... averaged 50 studs per hour, *including down time!*

Completely self-powered, the Remington Stud Driver needs no outside power source or extra equipment. The hinged construction of this lightweight fastening tool permits easy one-step loading—without the time loss of handling separate parts. Workmen like the Stud Driver's simple operation and safety features... Contractors like its lightning speed in firmly fastening steel or wood sec-

tions to concrete or steel. Studs have pull-out resistance as high as two tons!

The Model 450 Remington Stud Driver is made by Remington Arms Company, Inc., *America's oldest and foremost sporting arms manufacturer.* To obtain detailed information on this time- and money-saving tool, and for the name of your nearest distributor, mail the coupon below.

Speed all these jobs... with Remington studs designed for the job!

1. Fastening electrical fittings to concrete, steel and brick.
2. Hanging steel sash to concrete and brick.
3. Anchoring stadium and theatre seats to concrete.

4. Fastening wood to steel.
5. Anchoring wood plates to concrete floors and ceilings.
6. Hanging steel radiator housings to concrete or brick.

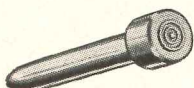

Only Remington studs are identified by this target trademark on the head.

STANDARD HEAD

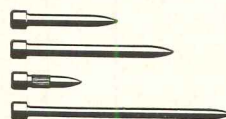

BREAK-OFF HEAD



INTERNAL THREAD



EXTERNAL THREAD

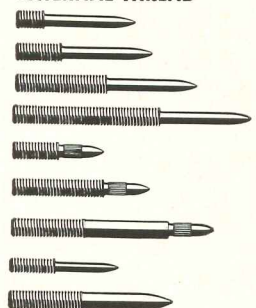

Remington Arms Company, Inc.
Industrial Sales Division, Dept. CE
939 Barnum Ave., Bridgeport 2, Connecticut

I am interested in obtaining detailed information on the Model 450 Remington Stud Driver.

Name _____

Firm _____

Position _____

Address _____

City _____ State _____



Above: photo of scale model of five-story reinforced concrete office building, hotel or hospital type, typifying bomb damage. Below: "typical" bomb-damaged two-story and basement row house



CLIENT: FCDA; PROBLEM: DESIGN OF DESTRUCTION

THE RESCUE TRAINING CENTER now under construction for the Federal Civil Defense Staff College, Olney, Md., presented a unique problem — in a sense, design and construction in reverse.

Architects McLeod and Farrara of Washington, D. C., have designed a street of "destroyed" buildings for the FCDA's rescue-team training program. It includes a two-story and basement wood-frame house; two-story and basement row house; two-story office, store and theater building; three-story and basement office and apartment building; and a five-story reinforced concrete structure.

The design utilizes results of study of effects of high-explosive bombings in Great Britain and Germany and atomic bombings at Hiroshima and Nagasaki as well as post-war test explosions.

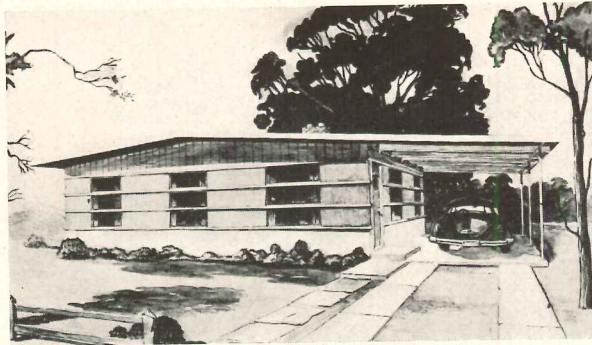

Gresham Construction Company, Santa Clara, Cal., and Knox Corporation, Thomson, Ga., sponsor identical unit—expandable two-bedroom house (left and below) consisting of two gable-end sections that can be carried on a low-bed truck to site, expanded with stressed-skin plywood panels to 25 x 32 ft

HHFA HOLDING TEST RUNS ON DEMOUNTABLE HOUSING

THE HOUSING AND HOME FINANCE AGENCY is testing mobile and demountable housing for the defense program.

By the middle of this month, each of seven types will have had field tests in the first phase of the trial run program directed by Ralph Kaul, special advisor in the office of the Administrator.

"Temporary" housing that could be moved from areas of passing need to become acceptable long-term housing is what HHFA is after.

The units being tested in the current program were selected from the submissions of 36 producers who had been invited to supply information about their products. The houses chosen "conformed substantially," HHFA said, to specifications and requirements set up by the Agency.

Prices in the group range from \$7000 to \$8500, relocation cost estimates from \$1.12 to \$2.25 per sq ft, estimated man-hour requirement for relocation from "less than 200" to "355 or less."

Two of the units being tested are shown on this page. Other producers whose houses were accepted for trial are: Mobilhome Corporation of America, Bakersfield, Cal.; Nicoll Lumber Company, Redwood City, Cal.; Pressed Steel Car Company, Chicago, Ill.; Transa-Housing, Inc., Long Beach, Cal.; and South Bend Fabricating Company, Seattle, Wash.

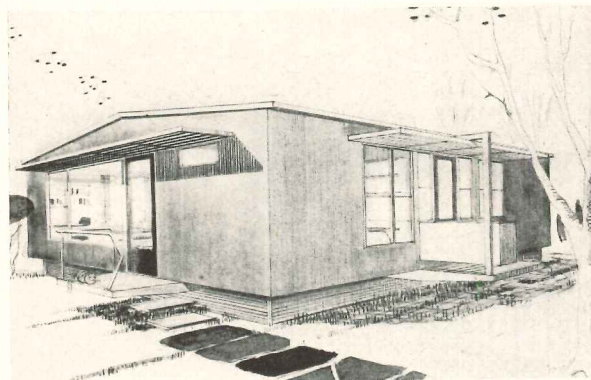

Portable folding-type house which can be transported as 8 x 24 ft package is offered by Acorn; hinged panels unfold at site from central mechanical core, making two-bedroom unit with more than 800 sq ft. Panels are plastic-impregnated, corrugated paper layers covered with stressed-skin plywood

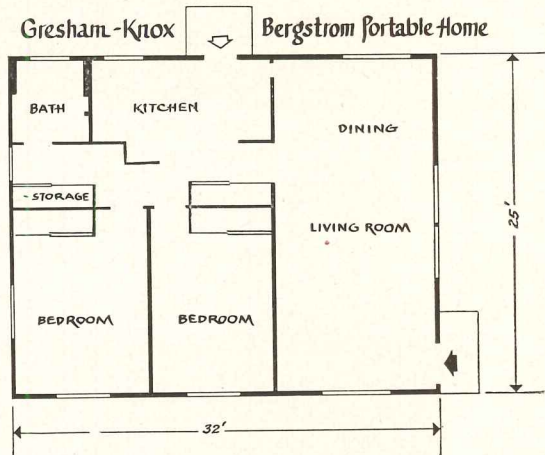

Gresham-Knox estimates \$7000 cost, 355 man hours for erection, \$2.25 per sq ft for relocation. Erection cost of \$8000 is estimated by Acorn; redeployment 100 miles at \$1.12 per sq ft, under 200 man hours

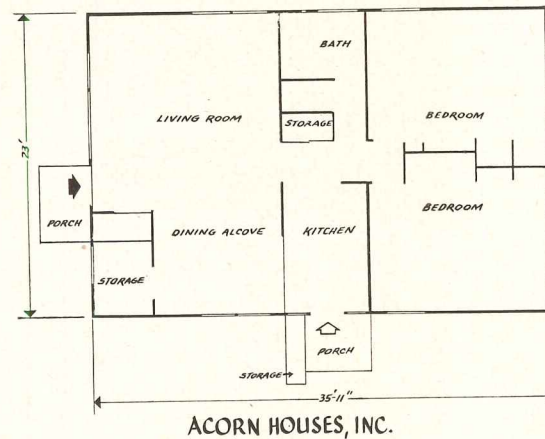

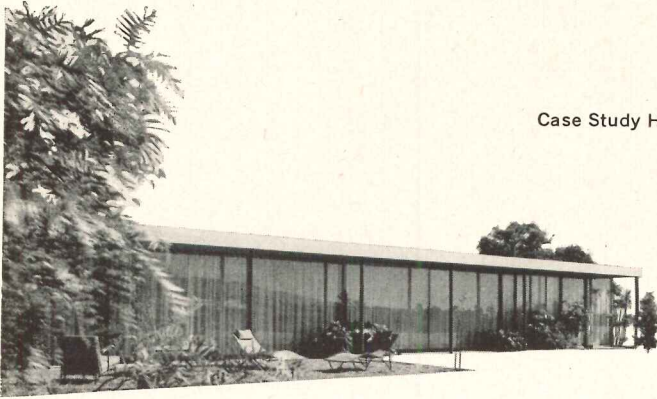

1

Case Study House 1948

designed by J. R. Davidson

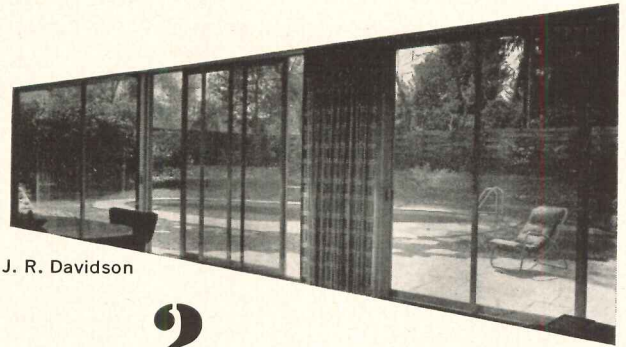

2

Case Study House 1949

Wurster, Bernardi and Emmons, architects

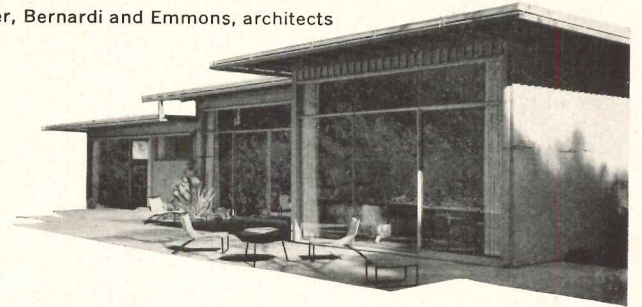

3

Case Study House 1950

Raphael Soriano, architect

Case Study House 1952 designed by Craig Ellwood

STEELBILT

4

TIME WINNER

ARTS & ARCHITECTURE MERIT SPECIFICATION AWARD

"My specification of Steelbilt sliding glass doorwalls for the 1952 Case Study House is based on extensive experience with their functional and design superiority.

"The advantages of Thermo-glaze for climate and acoustical insulation make it an obvious choice."

Craig Ellwood

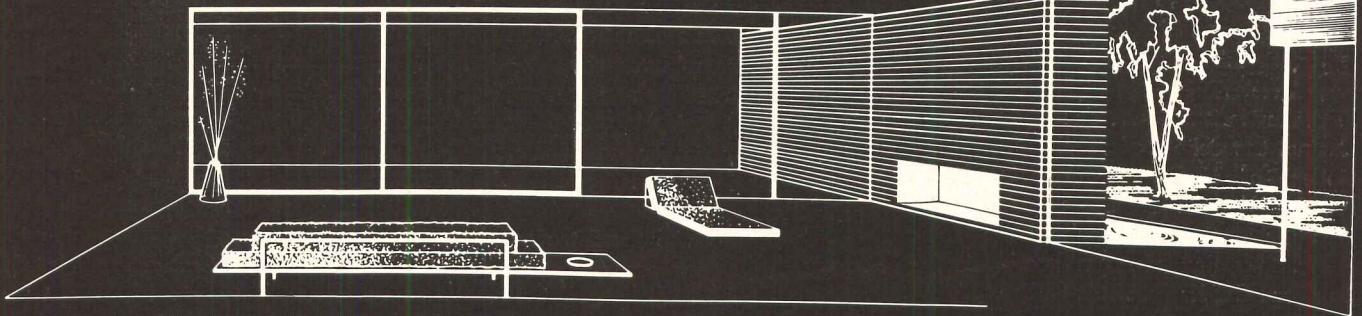

Delineation showing sliding glass units of living room facing city and sea. Dining terrace and view of mountains from Bel-Air is to right of fireplace.

Craig Ellwood has specified Steelbilt sliding glass doorwalls for three and one half elevations in the 1952 Arts & Architecture Case Study House. He has also chosen Steelbilt's "Thermo-glaze" (dual glazed on the job) as an insulating partition. Thus for the fourth time Steelbilt merit has been recognized and specified for this significant design and construction program.

For 18 years, Steelbilt design and engineering has paced its industry. Mr. Ellwood's choice is another expression of a general recognition of Steelbilt leadership.

If you contemplate using sliding glass doorwalls or windows, single or dual glazed, you should know about the important exclusive advantages Steelbilt offers.

Valuable information as well as installation and full scale cross-sectional details will be gladly sent on request.



STEELBILT INC.

4805 EAST WASHINGTON BOULEVARD

LOS ANGELES 22, CALIFORNIA

SUMNER SPAULDING DIES AT 59; FELLOW OF A.I.A.

SUMNER SPAULDING, 59, a Fellow of the American Institute of Architects and former head of the A.I.A.'s Slum Clearance and Urban Redevelopment Committee, died April 10.

Mr. Spaulding, who was a practicing architect in California for 27 years, had been associated since World War II with the firm of Sumner Spaulding, John Rex, architects, C. C. De Swarte, structural engineer, of Los Angeles.

Mr. Spaulding received a B.A. degree at the Massachusetts Institute of Technology in 1916. He studied in Europe from 1921 to 1926.

Mr. Spaulding's early work was largely residential and his interest in house design continued throughout his career (see pages 115-121, this issue). He had done many college buildings, including the designs for the men's campus at Pomona College.

For the last ten years, Mr. Spaulding devoted much time to the field of slum clearance, urban rehabilitation and community planning. He served as chairman of the committee of the Southern California Chapter of the A.I.A. which from 1937 to 1943 was engaged in designing the Los Angeles Civic Center.

Mr. Spaulding's work included the Los Angeles Municipal Airport, with J. C. Austin, the Santa Catalina Island Casino, the School of Medicine at the College of Medical Evangelists, Los Angeles, and the new State Exposition Building, also at Los Angeles.

Mr. Spaulding was a past president of Southern California A.I.A. Chapter.

WOMEN'S GROUP INVITES QUERIES ON NEW UNITS

WOMEN ARCHITECTS and wives of architects throughout the country have been invited to consider the possibility of forming new chapters of the Women's Architectural League as auxiliaries to local chapters of the A.I.A.

W.A.L., which has functioned in the nearly 12 years of its existence in California as an extremely active medium for increasing public awareness of architects and architecture, now has a chapter for each of the nine A.I.A. chapters in California. Its effectiveness and its potentialities were recently recognized in the election of an officer from the membership of the California Council of Architects for liaison with the League.

Information on formation of new chapters of the League in other states can be obtained from Mrs. Bolton White, Route 2, Box 869B, Los Altos, Cal.

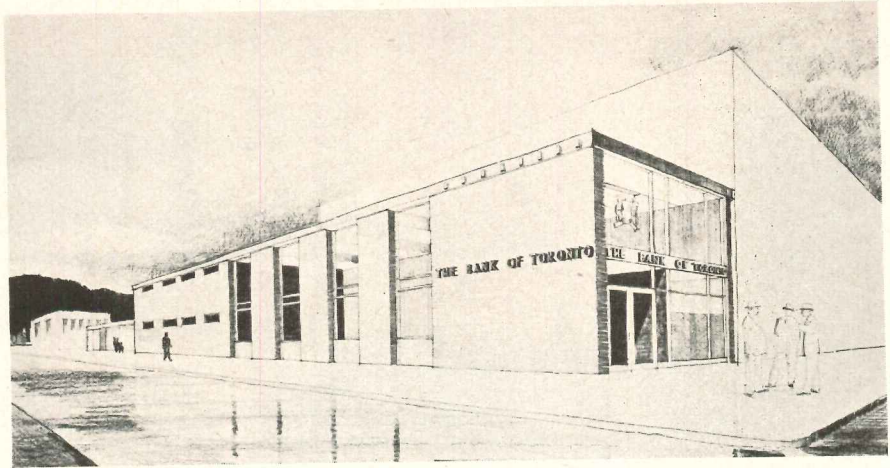

Photograph of rendering shows branch building for Bank of Toronto at Orangeville, Ont. The simple contemporary design reflects a growing trend in Canada away from the "fortress-type" bank building. The architects are John B. Parkin Associates

NEWS FROM CANADA by John Caulfield Smith

323 Builders' Loans Approved For Defense Workers' Housing

Latest figures from Central Mortgage & Housing Corp. show builders' loans for 323 houses have been approved under the defense workers' housing scheme.

All are earmarked for employees of the A. V. Roe plant at Malton, Ont. Terms are 10 per cent down for houses financed under the National Housing Act at an approved sales price.

Recent additions to the list of certified defense plants whose staff members

qualify under the scheme are John Bertram & Sons Ltd., Dundas, Ont.; Canadian Pacific Airlines (repairs), Calgary, Alta.; and Canadian Steel Improvements Ltd., Etobicoke, Ont.

In addition, divisions of Canadian Arsenals Ltd., at Quebec City, Valcartier, St. Paul L'Ermite, St. Dominique and Valleyfield in Quebec, and Lindsay, Long Branch and Scarborough in Ontario, have also been certified.

(Continued on page 32)

CANADIAN CONSTRUCTION 1940-1951

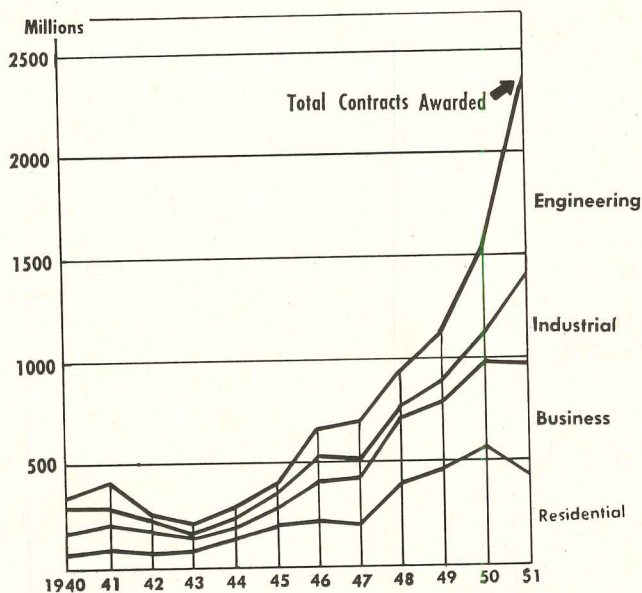

Phenomenal growth of building industry in Canada is well illustrated in graph showing dollar volume of contracts awarded in Canada in the last 12 years. Graph: courtesy "The Financial Post"

*New—the only
Pre-Polished Flooring!*

**Never
needs
waxing!**



**Designed Exclusively for
Modern Commercial Architecture**

Choose a high-styled flooring designed to compliment modern commercial architecture. For any flooring area your clients will enjoy VINYL-TILE's lifetime beauty, lifetime economy—beauty and economy offered by no other flooring.

ACKNOWLEDGED by architects and decorators to be "The World's Most Beautiful Flooring," VINYL-TILE is wonderfully rich and warm and lovely to behold. But VINYL-TILE offers more than beauty—

FOUR NEW EXTRAS

VINYL-TILE never needs waxing because

it comes pre-polished to a lifetime luster. Year after year it retains its installed-today look—without waxing. And with just a minimum of ordinary cleaning effort.

VINYL-TILE looks sparkling clean and fresh after years of even severe service because its gorgeous colors are built into the wearing surface—colors that defy fading, won't scrub off or "walk off."

VINYL-TILE is resistant to the actions of greases, fats, oils, mild acids, commercial cleansers, waxes. Thus it is

ideal for practically any type of commercial installation.

VINYL-TILE is easy to install, perfect for showcase jobs, lends itself to "personalized" floors of your own original design.

So when you specify VINYL-TILE, you specify a most remarkable flooring whose beauty, ease of maintenance and economy must win your clients' approval. See VINYL-TILE, in either sheet or tile, at flooring dealers' and contractors' everywhere. For specification data, write to Goodyear, Flooring Department, Akron 16, Ohio.

"World's Most Beautiful Flooring"

Vinyl-Tile

BY

GOODYEAR

Makers of Wingfoot Rubber Flooring

Wingfoot—T. M. The Goodyear Tire & Rubber Company, Akron, Ohio



... and for temperature control, I'll insist on Honeywell!

Looks like the budding architect in Steig's cartoon wants to be sure his "make-believe" building is going to be comfortable! For, as his older architect friends probably advised him, he knows the *surest* way to make any building comfortable is to insist on Honeywell controls.

If you have a control problem, Honeywell can help you solve it. We can provide the proper thermal environment for any client—anywhere—in any kind of structure.

A large staff of well-informed control engineers—in 91 different Honeywell offices across the nation—are experienced in doing just that. Or—there's

a lot of literature that's yours for the asking—on the automatic control of heating, ventilating and air conditioning.

So, why not *talk to Honeywell?* Why not *write to Honeywell* about *your* control problem?

Honeywell controls are available for all buildings—large, small, commercial or residential. See the facing page for interesting facts about some of these fine Honeywell controls.



For help with any control problem talk to Honeywell

for offices, stores, restaurants, laboratories

Specify Honeywell Electronic Air Conditioning Control

*Give your clients the ultimate in comfort—and
increased efficiency, lower maintenance costs*

Now, with this completely new type of air conditioning control, you can offer clients comfort and operating efficiency never before possible!

You see, this new Honeywell system electronically "feels" temperature changes as they occur and then gives fast, accurate modulating control over heating and air conditioning dampers or valves.

And because it is *electronic*, it's 100 times more sensitive than conventional systems! This means faster reaction to changes in load; no temperature "overshoot"; no waste of either warm or cool air.

It allows new methods of operation so equipment can be utilized at peak efficiency at all times! For example, change-over from heating, ventilating and cooling is accomplished smoothly without "jumps" in the control point. Its flexibility allows selection of the most economical sequencing of valves and dampers. And the simplicity of Honeywell's electronic thermostat cuts maintenance costs to a bare minimum.

Your selection of this new Honeywell *electronic* air conditioning control is sure to produce greater client satisfaction, once they experience its wonderful comfort and low maintenance costs!

MINNEAPOLIS Honeywell



First in Controls

*and for help with the
temperature control, I'll
talk to {your firm name}*

FREE—personalized cartoon. For your 8½" x 9" reproduction of this Steig cartoon (incorporating your name or the name of your firm), fill out and mail coupon today.

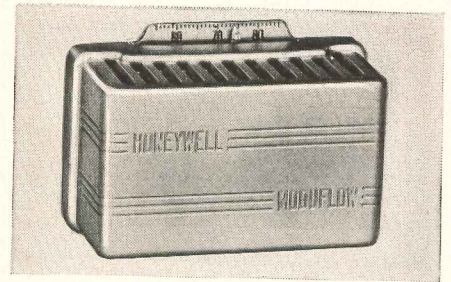
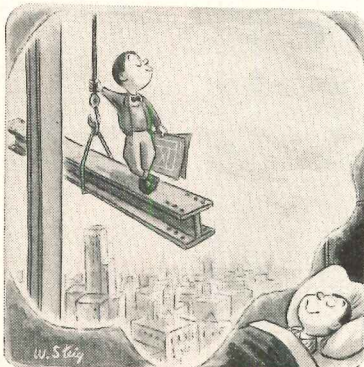

Room Thermostat. No moving parts to wear out or get out of adjustment.

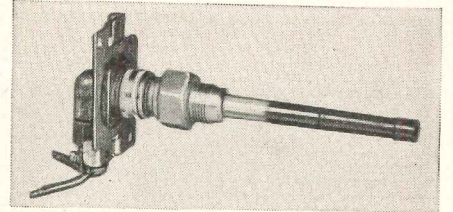

Duct and Immersion Thermostat. Measures temperatures accurately from -50 degrees to 300 degrees F.

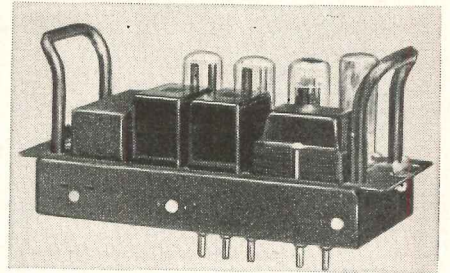

Electronic Relay. Here's the famous "brain" that measures thermostat signals, operates the valves and dampers.

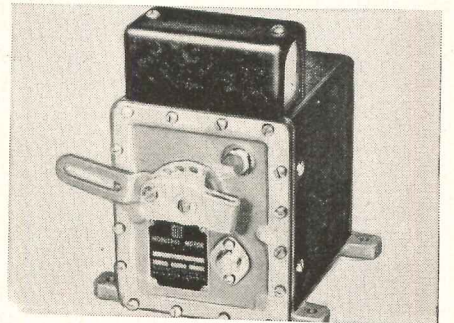

Modulating Motor. Slightest temperature fluctuation causes motor to change valves or dampers.

MINNEAPOLIS-HONEYWELL REGULATOR CO.
Dept. AR-5-115, Minneapolis 8, Minnesota

Gentlemen:

Please send me your booklet "New Horizons of Comfort with Honeywell Electronic Air Conditioning Control."

Please send me a free personalized reproduction of the Steig cartoon,

inscribed with following name _____

Name _____

Firm Name _____

Address _____

City _____ Zone _____ State _____

THE RECORD REPORTS

CANADA

(Continued from page 28)

J. G. Workman Public School, Scarborough, Ont., has covered play area for inclement weather. The architects were Murray Brown and Elton of Toronto



Legion Housing Conference Asks Big Low-Rent Program

Heavy emphasis was laid on subsidies and controls at the housing conference recently sponsored by the Ontario Command of the Canadian Legion in Toronto.

Significance of the conference findings is that they will form the basis of representations to be forwarded by the Legion at its national convention this month to the Federal Government. Experience shows that the powerful veterans' organization is heard with respect at Ottawa. The policies it espouses therefore deserve close scrutiny.

Housing Need Stressed

The conference opened with agreement that necessity for a large scale housing program at this time dwarfs all other considerations, including those of national defense and inflation. Spiritual, moral, social and human values should, it was said, precede financial and material considerations.

In short term category, immediate action was called for to provide not less than 100,000 new low rental houses in 1952. They would be 100 per cent publicly financed, with non-interest bearing loans made by the Federal and Provincial Governments amortized over a long period.

To stimulate home ownership, 90 per cent federal loans bearing 3½ per cent interest (present National Housing Act rate is 5 per cent) were urged. These mortgages would be repaid on a long term basis, and would be available only to persons earning \$4000 or less per year.

Some Curbs Urged

To make a large-scale house building program possible, the conference would curtail "non-essential and deferrable

(Continued on page 34)

GLOBE SPRINKLERS



FIREMEN EVERY 10 FEET

DETECT, STOP FIRE . . . AUTOMATICALLY

FIRE can't do much damage of any kind if GLOBE Automatic Sprinklers are on guard . . . for they *discover and stop FIRE*. Moreover, GLOBE protection means lower cost for insurance . . . year after year. GLOBE means *SAFETY plus SAVINGS*.

GLOBE AUTOMATIC SPRINKLER CO.
NEW YORK . . . CHICAGO . . . PHILADELPHIA
Offices in nearly all principal cities

THEY PAY FOR THEMSELVES

Associated Architects: Mayer & Whittlesey • Skidmore, Owings and Merrill

Consulting Engineers: Jaros, Baum & Bolles

Heating Contractor: J. L. Murphy, Inc.

Owned and Managed by
NEW YORK LIFE INSURANCE
COMPANY

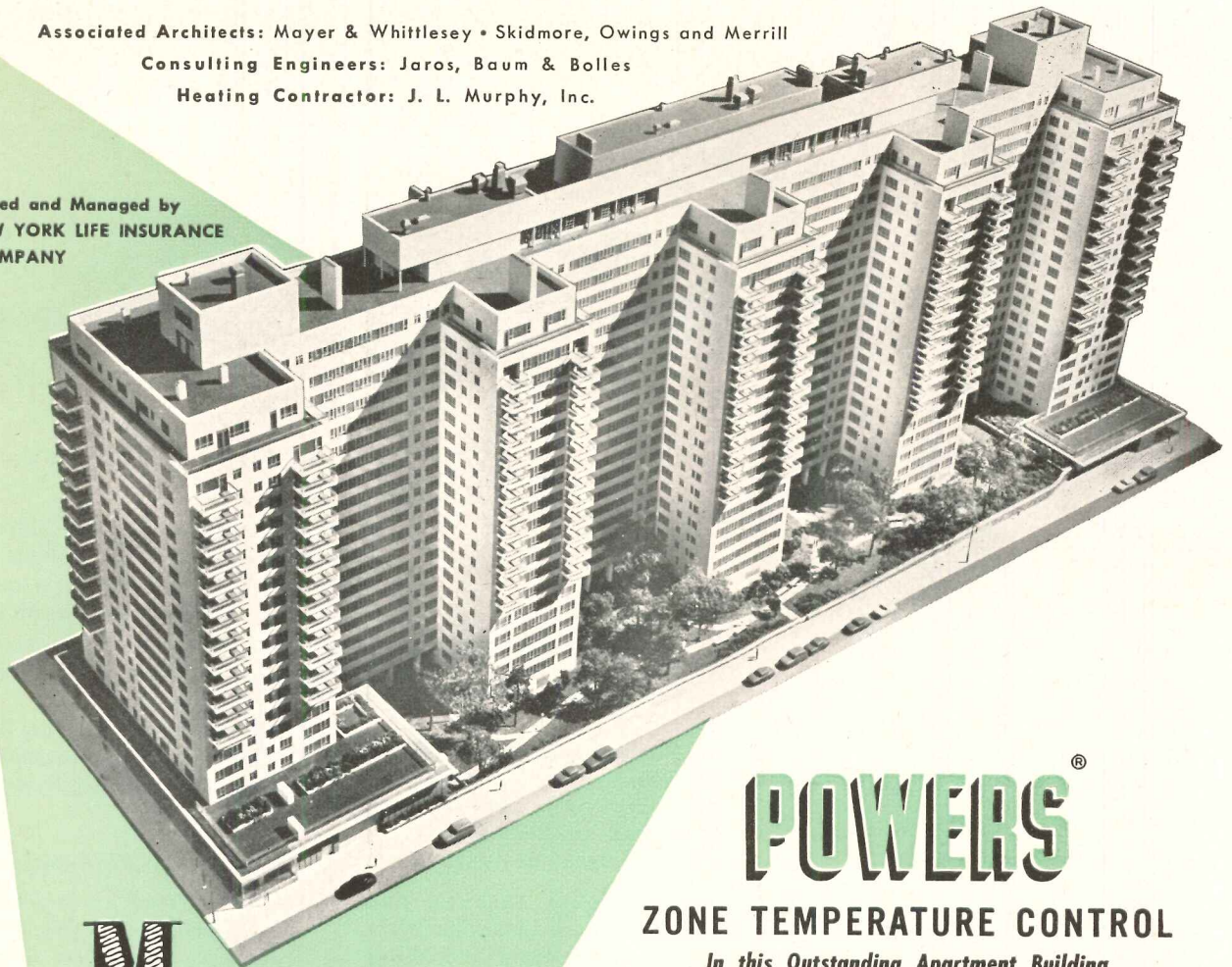

Manhattan House

—with 582 modern, carefully planned apartments occupies an entire block at 66th and 2nd Ave., New York City. Comfort and fuel savings obtained here, year after year, will yield a handsome return on the investment in POWERS control.



Type D Room
Thermostat

(a.77)

POWERS[®] ZONE TEMPERATURE CONTROL

*In this Outstanding Apartment Building
Assures Comfort, Dependability, Lowest Maintenance Cost*

Temperature of hot water supply to convectors in this modern building is controlled by a Powers MASTROL System.

How It Operates—A Powers Master Thermostat with its sensitive bulb in a special housing for sun-wind effect and outdoor temperature is located on outside wall of zone being controlled. It operates in conjunction with 4 Room Thermostats on the 4th, 9th, 14th and 19th floors of each zone through Averaging Relays to establish the control point for Series 100 Sub-Master Controllers. A manually operated switch on the main control panel is provided to raise or lower the control point when desired.

A program clock automatically reverts the controls to night operation during which period the outdoor Master Thermostat readjusts Series 100 Sub-Master Controller to a lower control point than used during day operation. Other types of Powers controls regulate various fans supplying heating and ventilating to other spaces in the building.

Experience gained by Powers in all types of prominent buildings will be helpful to you. When problems of temperature and humidity arise, contact our nearest office. THE POWERS REGULATOR COMPANY, Skokie, Ill.

OVER SIXTY YEARS

OF AUTOMATIC TEMPERATURE AND HUMIDITY CONTROL

OFFICES IN OVER 50 CITIES

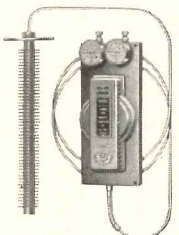

Outdoor Master Thermostat



Averaging
Relay

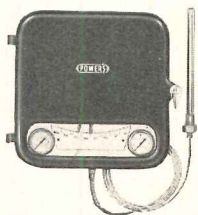

Indoor Sub-Master
Controller



METAFLOW
Control Valve



ACCRITEM
Regulator



Damper Motor



Pneumatic
Switches



AIRSTREAM Thermostat



FLOWRITE Control Valve



THE RECORD REPORTS

CANADA

(Continued from page 32)

Factory building for Ernest Leitz (Canada) Ltd. has been built at Midland, Ont. The architect for the building was E. C. S. Cox of Islington, Ont.

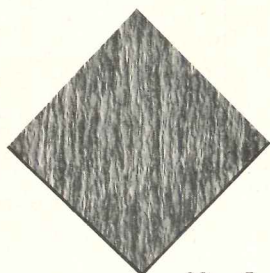

now you can specify dramatic,

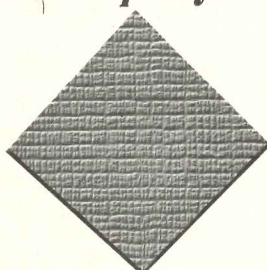

tri-dimensional wall covering

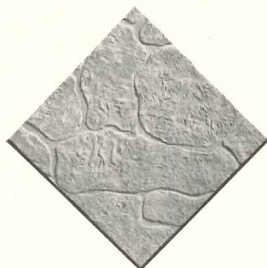

LINKRUSTA

ORIGINAL — IMPORTED

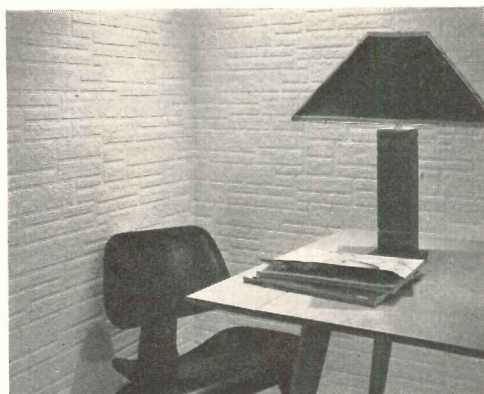

**eliminates repapering,
painting ... forever!**

Not wallpaper, not fabric, Linkrusta is a rugged, plastic-type wall covering with unique tri-dimensional patterns etched in bas-relief.

Thoroughly washable and sunfast too, Linkrusta withstands repeated scrubbing without injury to its textured beauty. So sturdy, so resistant to abuse, it's practically indestructible! Linkrusta is permanent — eliminates repapering and painting forever — lasts the life of the wall itself. Linkrusta actually strengthens walls and prevents plaster cracks.

The play of light across its plastic forms creates dynamic contrasts in highlight and shadow. For hotels, hospitals, restaurants, theaters, smart shops, public buildings and homes. Choose from 21 distinctive styles in muted, in-laid colors or natural for painting . . . available in convenient rolls hung like wallpaper.

FREE! Get all the details about this wall covering wonder! Write today for Specification Sheet A.

Wall Trends, inc.

*Manufacturers of hand printed
wallpaper and Stylon wall canvas*

Showroom: 509 Madison Avenue
New York 22, New York

construction," initiate controls to prevent the export of building materials and to allocate materials and stabilize prices. Municipalities would be relieved of the cost of servicing land and providing educational facilities for new housing projects.

Destruction of existing houses for business or traffic improvement schemes should, it was decided, be postponed.

Long-Range Planning Sought

The conference also urged:

- (1) A national inquiry into building costs to determine what can be cut.
- (2) Establishment of a National Re-development Commission to plan new housing areas and the distribution of industry and power.
- (3) Accelerated research in construction methods and materials.
- (4) Governmental and municipal cooperation in modernizing building codes.
- (5) Planning, in cooperation with organized labor, the expansion of the construction labor force.
- (6) Encouragement of new sources of building supplies, subsidizing them if necessary.

Mortgage Money Stays Tight: How Finance Canada's Housing?

What can be done to loosen investment purse strings insofar as National Housing Act mortgages are concerned? Would higher interest rates or bigger government guarantees help?

The *Financial Post* comments that these changes would have some effect. But neither would alter the fact that, generally speaking, Canada's lending institutions feel they have quite enough of their money in mortgages. They entered the postwar period with an imbalance in their investment portfolios.

(Continued on page 36)

Where the *other* services also count—it's always BAYLEY WINDOWS



Fulton School, Springfield, Ohio
Marley W. Lethly, Archt., Springfield, Ohio
Geo. Sheaf & Company, Contractor, Columbus, Ohio

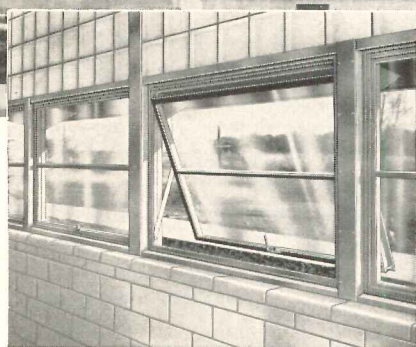

Highlights of this New Exclusive BAYLEY Product

- Carries Quality Approved Seal of the Aluminum Window Mfgs. Ass'n for materials, construction, strength of sections and air infiltration.
- Modern, ribbon-line appearance.
- Maximum air, light and vision.
- Typical Ventilation—



Other layouts available.

- Sub-frames and imposts integral, incorporate separate window units.
- Installed in prepared openings or built into masonry.
- White bronze and stainless steel hardware.
- Permanent, carefree aluminum construction—Requires no paint.

**73 Years of
RELIABILITY**



New Bayley *AirVUE* Window *Scientifically Designed for Modern Schools*

A fine quality product is only the *first* essential to a truly satisfactory relationship. Better cooperation and extended services through all the building stages—going even beyond full performance demands—is even more important. Known for a policy that's founded on this fact is why Bayley is so regularly preferred by discriminating Building Designers.

The new Bayley AirVUE Window is tangible evidence of this policy. To contribute scientific design improvements in a school window, Bayley did not pursue the conventional. They studied the problem from the building's inception to the student's comfort. They collaborated with school Architects and Educational Authorities.

As a result the Bayley AirVUE Window fulfills today's professional diagnosis of a proper window for modern school buildings. In addition it complements the Bayley Aluminum Projected Window, and also it incorporates construction features made possible only by Bayley's years of specialized window experience.

You too will find *extra values* in discussing your window problems—whatever they may be—with Bayley. Write or phone.

See Bayley in *Sweet's*. Complete catalogs on *Aluminum Windows*, 17a/BA; *Steel Windows*, 17b/BAL; *SAF-T-GARD Hospital Detention Window*, 17b/BAY.

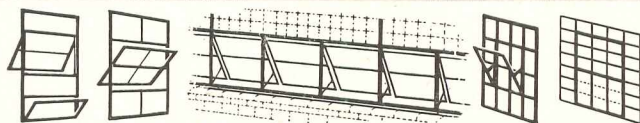

PROJECTED PIVOTED AirVUE GUARD SAF-T-GARD

THE WILLIAM BAYLEY COMPANY
Springfield, Ohio

District Sales Offices:

Springfield, Ohio Chicago 2 New York 17 Washington 16

R-W Garage Door Operators

- **Convenient**
- **Practical**
- **Efficient**

For every need—two R-W controls, designed and engineered for smooth sure performance

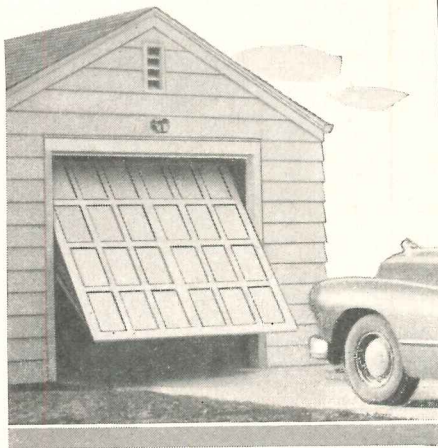

**No. 1251
Standard control**
—operates from drive-side key-switch

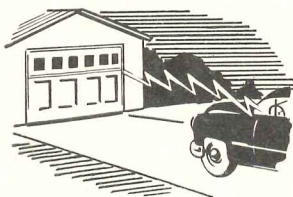

No. 1504 Radio control
—battery operated radio with dash control button opens and closes doors within 75 feet.

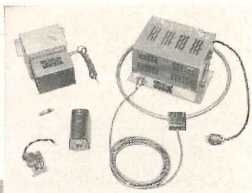

And . . . R-W 999 Garage Door Hardware

Complete overhead garage door hardware conveniently packed in one box! For single doors up to 200 lbs.; double doors up to 375 lbs. Write for folder giving full details.

Check these important R-W features!



- ✓ **Easy to install**—Completely assembled, including track, in a single carton at the factory.
- ✓ **Easy to service**—Simple adjustments, requiring no special tools, keep the doors working smoothly.
- ✓ **Safe**—A large friction clutch prevents operational failures with resulting damage to property. In power failure, doors may be operated manually.

For complete information on R-W AuT-o-DoR line see your nearest dealer or write for catalog number A-87

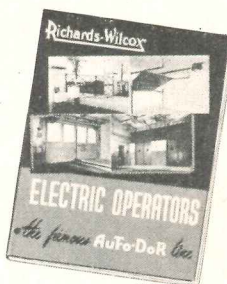

1880
RICHARDS
WILCOX
AuT-o-DoR
1952
OVER 72 YEARS

Richards-Wilcox Mfg. Co.

"A HANGER FOR ANY DOOR THAT SLIDES"
AURORA, ILLINOIS, U. S. A. • Branches in all principal cities

THE RECORD REPORTS

CANADA

(Continued from page 34)

Now balance has been restored. As a result, most institutions are content to merely reinvest mortgage principal repayments along with sufficient new income to maintain their present ratio of mortgages to total assets.

This poses another question. Where is the money coming from to finance the large scale housing program necessitated by Canada's economic development?

Policy Change Unlikely

There are two possibilities: a change in the investment policies of the lending institutions, or the entry of Central Mortgage & Housing Corp. into the direct lending field (the Corporation is already involved on this basis in defense workers' and certain other types of housing). Neither of these possibilities is likely to mature at present.

On one hand, the lending institutions are loath to change their conception of what is a "desirable" proportion of mortgages, arrived at over many years. On the other hand, direct lending by CMHC would create an artificial credit situation which might increase the cost of construction.

(Continued on page 364)

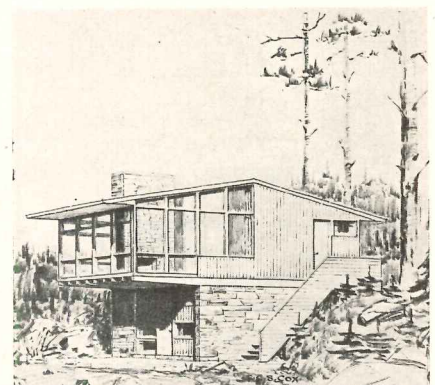

This summer cottage for Georgian Bay, Ont., was planned by the architect, E. C. S. Cox, for himself. It capitalizes on sloping site, uses native materials and large glass areas

more meshes per sheet with *Bostwick*
Diamond Mesh Metal Lath

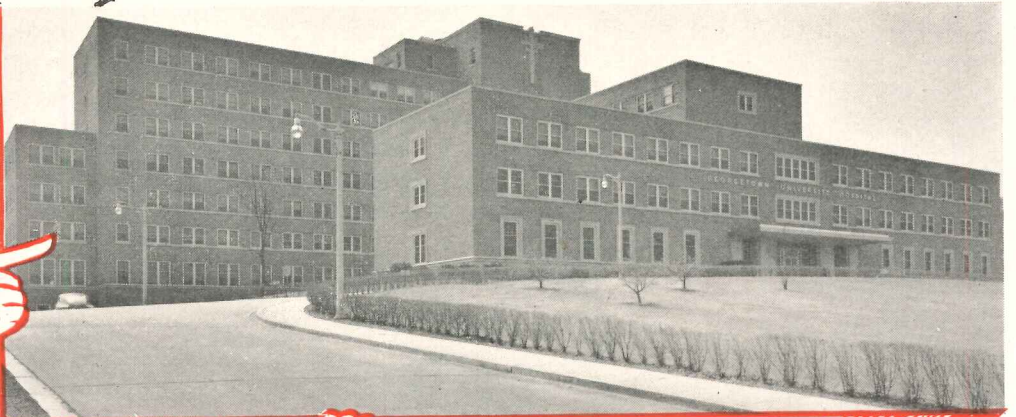
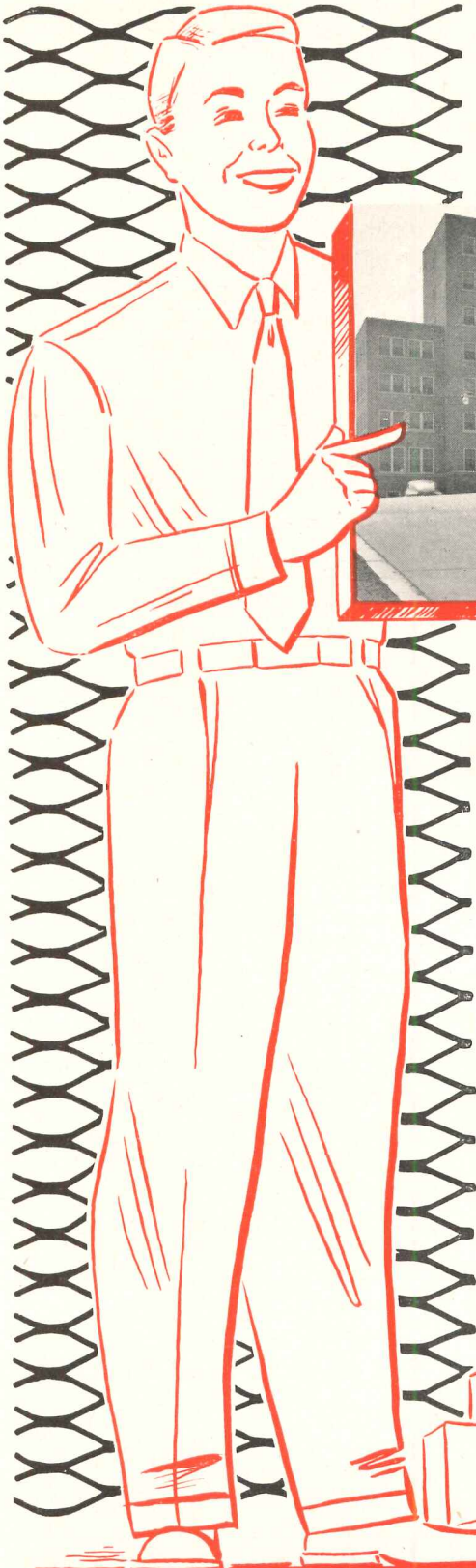

Bostwick METAL LATH
FOR FLEXIBILITY IN DESIGN

• Georgetown Hospital at Washington, D. C., was designed by Kayser, Neal and Reed, Pittsburgh, Pa. As the job progressed from rough preliminary sketches to finished plans and specifications no adjustments in dimensions were required by limitations of the lath or corner bead.

Metal lath has always met the structural, decorative, and functional designs of every decade. That's why Bostwick metal lath has been used in the finest structures for over a half-century.

Hence, when you are down to details on your next job, why don't you investigate Bostwick metal lath, corner bead, casings and accessories. We'll gladly send you specification data.

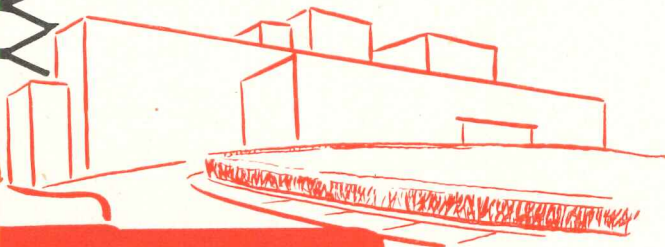

THE

Bostwick

105 HEATON AVE. • NILES, OHIO

STEEL LATH COMPANY

**New Methods, New Designs:
U. S. Surveys School Plant**

THE FIRST PROGRESS REPORTS in the school facilities survey of the Federal Security Agency's Office of Education carries some pointed comments on the need to update designing methods.

It notes that increasing emphasis on health and physical fitness programs calls for all-weather schoolhousing at

elementary and secondary levels.

A site of adequate size is required, furnished with at least certain basic equipment and facilities.

It cites the modern emphasis on the educational process of "learning by doing," which implies necessity for larger spaces so that boys and girls have room to try things themselves rather than sit passively by to hear or read.

Community Uses Noted

From the report:

"Modern school plants must be designed to provide for numerous community uses. Activities which often must be incorporated into schoolhousing plans include adequate space for community and educational meetings; shops in which farm machinery can be repaired by the farmer himself; community libraries; community canning; evening classes of various kinds; youth organizations; and facilities for community physical education and recreation, both indoor and out.

"The demands for educational change and improvement made upon the schools are such that many schoolhouses have rapidly become as obsolete as a one-mule plow. In many of them it is impossible to have a modern educational program at all, and they are of a design and in such condition that it is no longer economically feasible to remodel or rehabilitate them. Their replacement is essential."

This report includes data from 25 states, covering phases of present plant inventory, discussing age, adequacy, size, fire resistance, water services, etc.

Subsequent parts of the survey will take up state by state requirements in greater detail as the Office of Education completes the work on inventory and swings over to the analysis of need. Eventual aim is establishment of a 10-year goal for adequately modernizing the American school plant.

(Continued on page 318)

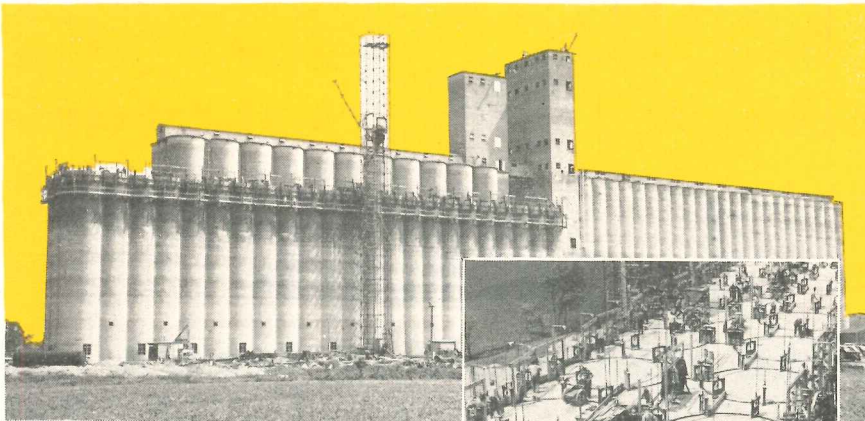

337' x 48' slip-form deck used to pour addition to Farm Bureau grain terminal at Canal Winchester, Ohio. Once a minute, 192 screw jacks were turned to raise entire forms 15/100". Carts, served from central hopper, distributed concrete to the continuously rising forms.

How to pour a 1,200,000 bushel basket - in one piece

By a continuous pour of 6,000 cu. yds. of ready-mixed concrete, into slip-forms raised on jackrods at the rate of .15" every minute, this elevator addition was completed in 168½ hours. The 24 bins, each 20' in diameter and 127' high, and interstitial walls, covering a 337' x 48' area, form one monolithic structure without joint or seam.

Because concrete design envisions a homogeneous material, of numerous elements completely mixed, the ready-mixed concrete industry certifies by Rating Plate those truck mixers and agitators which have the proper design, capacity, drum speed, mixing action and water control necessary to produce a homogeneous concrete of uniform strength.

Look for this Badge of Dependability on Truck Mixers:

You have a right to insist on this Rating Plate on any truck mixer that serves your jobs. It is available to all who comply with the quality standards established by the National Ready Mixed Concrete Association and the Truck Mixer Manufacturers Bureau.



These member manufacturers comply with Bureau standards:

- | | | |
|---------------------------------------|--|--|
| BLAW-KNOX DIVISION Pittsburgh, Pa. | CONCRETE TRANSPORT MIXER CO. St. Louis, Mo. | THE T. L. SMITH COMPANY Milwaukee, Wis. |
| CHAIN BELT COMPANY Milwaukee, Wis. | THE JAEGER MACHINE COMPANY Columbus, Ohio | WORTHINGTON PUMP & MACHINERY CORP. Dunellen, N.J. |



John H. Martin, new deputy administrator, Construction & Resources expansion, DPA

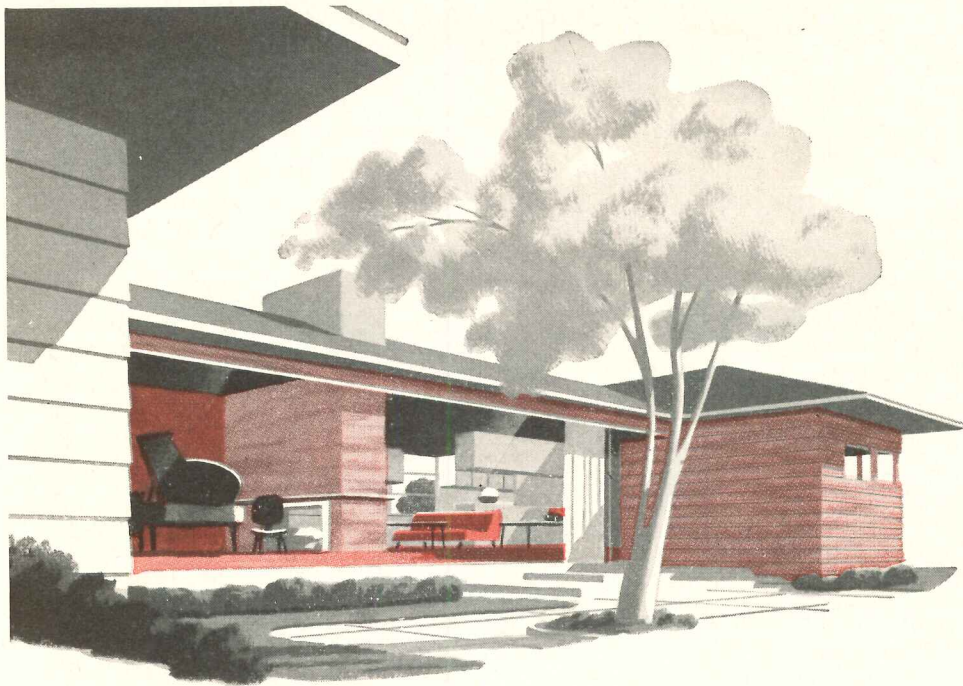

GPX ... food for thought

GPX, the plywood and plastic sandwich that inspires new forms of architectural expression, offers you food for thought.

Tough, smooth, rugged . . . interesting in color and texture . . . lightweight, yet strong . . . GPX provides cost-cutting solutions to many problems.

Natural Grade GPX offers the warmth of wood beauty, plus extreme resistance to abrasion, acids, molds, fungi, heat and water. GPX Paint Grade . . . White for *interior* use . . . Brown for *exterior* use . . . presents a superior paint surface, with no checking, little or no grain-raise and requires no undercoat.

GPX plays a leading role in such diverse uses as repetitive concrete forms, exterior house siding, boat decks and bulkheads, built-in cabinets, display fixtures, outdoor furniture, and hundreds of other industrial and construction uses. You'll like its versatility, durability and economy, too. Ask your dealer about GPX, or send for descriptive GPX folder and product sample.



GEORGIA—PACIFIC
PLYWOOD COMPANY

608-5 North Capitol Way, Olympia, Wash.

OFFICES OR WAREHOUSES IN: Augusta, Birmingham, Boston, Chicago, Columbia, Detroit, Lancaster, Louisville, Memphis, Nashville, Newark, New Hyde Park, Olympia, Orlando, Philadelphia, Pittsburgh, Providence, Raleigh, Richmond, Savannah, Vineland.

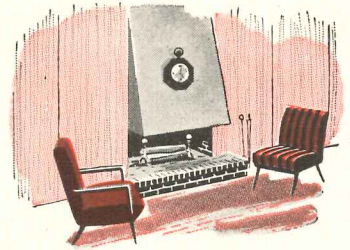

GPX NATURAL GRADE

Beautiful, satin-smooth panels of GPX are ideal for dramatic natural wood wall paneling. Use it for sliding doors, built-in cabinets, flush panel cupboard doors, wainscoting garage doors and siding—wherever a permanently finished wood surface is specified.

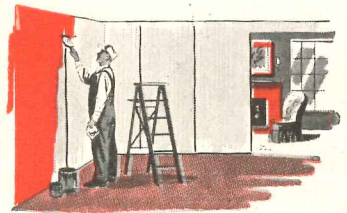

GPX WHITE PAINT GRADE (INTERIOR)

Manufacturers of kitchen cabinets and cupboards have saved as much as 5¢ a foot and cut labor time in half with GPX White Paint-Grade. GPX's prefinished surface eliminates sanding and priming—one coat of enamel usually covers! Use GPX for all painted surfaces such as shelves, table tops, closets, laundry and workroom cabinets.



GPX BROWN PAINT GRADE (EXTERIOR)

GPX Brown Paint Grade for exterior uses fits today's trend toward ranch style homes. It can be sawed into wide widths and applied as lapped siding, or the lightweight, easy-to-install panels can be used with horizontal or vertical battens to vary architectural treatment. Laboratory tests indicated that GPX's smooth, hard surface covers evenly with less paint, extends its life 50%.

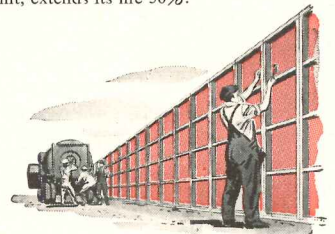

GPX CONCRETE FORM GRADE

Users of GPX for concrete forms obtain up to 50 repeated uses of one side of a GPX panel, with similar results from the other side! And GPX doesn't stop cutting costs there: ceilings poured into GPX forms set so smoothly that costly hand finishing is virtually eliminated, and no plastering is necessary before painting.

Now

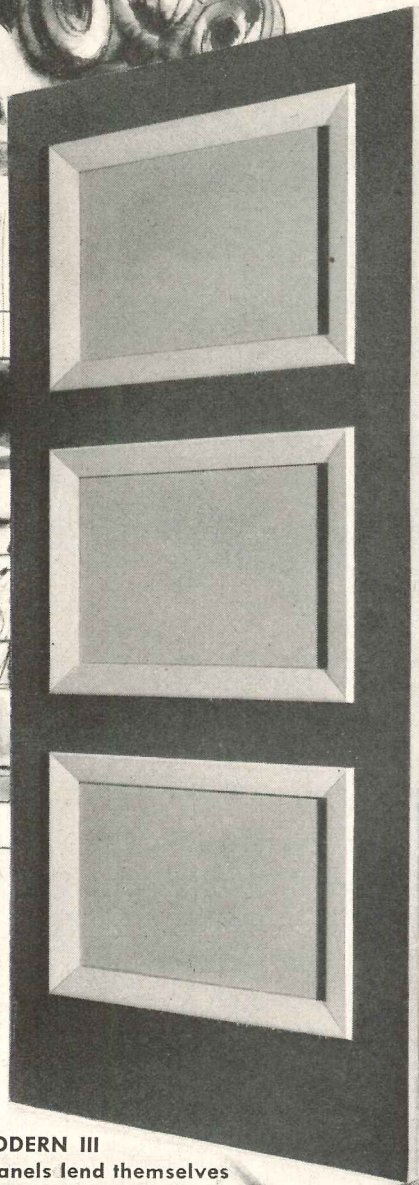

THE MODERN III
Three panels lend themselves
to striking color treatments.

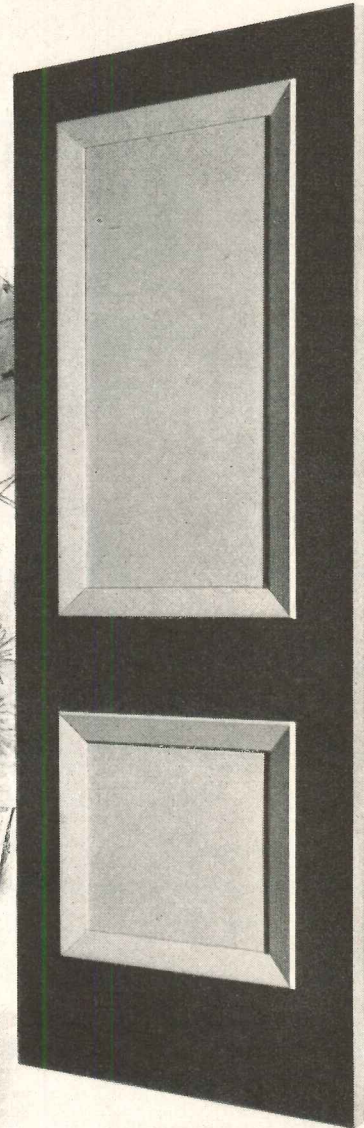

THE MODERN II
Two contrasting panels
add interest to the unity
of this design.

... a custom-styled panel door in tune
with modern design.

The G-P Decorator Door

Georgia-Pacific's *Decorator Door* offers a new design concept in which the door plays a new, important part.

G-P Decorator Doors blend with modern design . . . add style and dramatic accents to traditional homes, stores or offices. They lend themselves beautifully to dramatic color effects. You can specify G-P Decorator Doors for *exterior* entrances or *interior* use. There are three basic designs in a complete range of sizes and grades.

Give your clients the extra style and beauty of G-P Decorator Doors at a *new low price*. Georgia-Pacific's quality control makes possible a door that is custom-styled in appearance and quality yet available at a price far lower than custom-door prices.

Beauty and Quality at a New LOW COST

Be sure to see the G-P Decorator Doors yourself before you start your next job. If your lumber dealer doesn't stock them yet, write for our new Decorator Door folder. Georgia-Pacific Plywood Company, 617-5C North Capitol Way, Olympia, Washington.

TESTED AND PROVEN

The United States Testing Company subjected G-P doors to a series of exacting tests. After 500,000 hard slams (equal to 137 years of normal use) there was virtually no sign of wear.

Available in either raised or flush molding

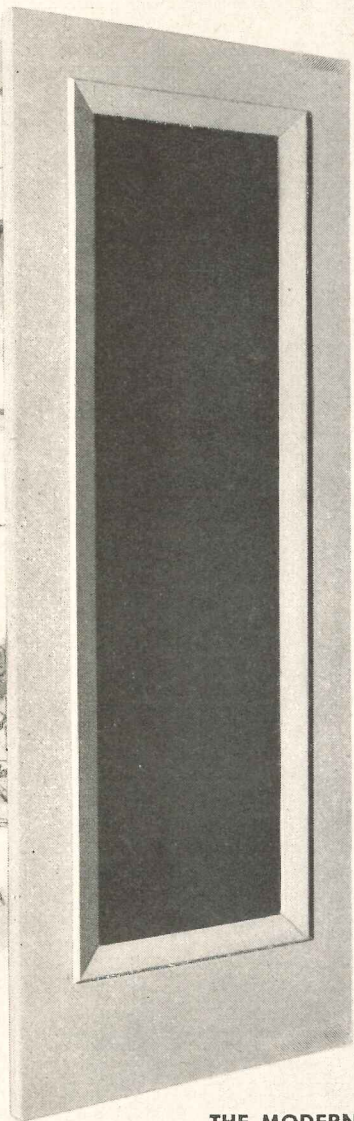
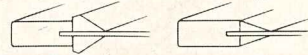

THE MODERN I
The single panel creates an effect of height in traditional and modern settings.



GEORGIA — PACIFIC PLYWOOD COMPANY

OFFICES OR WAREHOUSES IN: Augusta, Birmingham, Boston, Chicago, Columbia, Detroit, Lancaster, Louisville, Memphis, Nashville, Newark, New Hyde Park, Olympia, Orlando, Philadelphia, Pittsburgh, Providence, Raleigh, Richmond, Savannah, Vineland.

DOUGLAS FIR PLYWOOD • HARDWOOD PLYWOOD • GPX
SOUTHERN & WESTERN LUMBER • DOORS

CONSTRUCTION COST INDEXES

Labor and Materials

United States average 1926-1929 = 100

Presented by Clyde Shute, manager, Statistical and Research Division, F. W. Dodge Corp., from data compiled by E. H. Boeckh & Assocs., Inc.

NEW YORK

ATLANTA

| Period | Residential | | Apts., Hotels Office Bldgs. Brick and Concr. | Commercial and Factory Bldgs. Brick and Concr. | | Brick and Steel | Residential | | Apts., Hotels Office Bldgs. Brick and Concr. | Commercial and Factory Bldgs. Brick and Steel | |
|-----------|-------------|-------|---|--|-------|-----------------------|-------------|----------------------|---|---|-------|
| | Brick | Frame | | Brick | Frame | | Brick | Frame | | Brick | Frame |
| 1925 | 121.5 | 122.8 | 111.4 | 113.3 | 110.3 | 86.4 | 85.0 | 88.6 | 92.5 | 83.4 | |
| 1930 | 127.0 | 126.7 | 124.1 | 128.0 | 123.6 | 82.1 | 80.9 | 84.5 | 86.1 | 83.6 | |
| 1935 | 93.8 | 91.3 | 104.7 | 108.5 | 105.5 | 72.3 | 67.9 | 84.0 | 87.1 | 85.1 | |
| 1939 | 123.5 | 122.4 | 130.7 | 133.4 | 130.1 | 86.3 | 83.1 | 95.1 | 97.4 | 94.7 | |
| 1940 | 126.3 | 125.1 | 132.2 | 135.1 | 131.4 | 91.0 | 89.0 | 96.9 | 98.5 | 97.5 | |
| 1946 | 181.8 | 182.4 | 177.2 | 179.0 | 174.8 | 148.1 | 149.2 | 136.8 | 136.4 | 135.1 | |
| 1947 | 219.3 | 222.0 | 207.6 | 207.5 | 203.8 | 180.4 | 184.0 | 158.1 | 157.1 | 158.0 | |
| 1948 | 250.1 | 251.6 | 239.4 | 242.2 | 235.6 | 199.2 | 202.5 | 178.8 | 178.8 | 178.8 | |
| 1949 | 243.7 | 240.8 | 242.8 | 246.4 | 240.0 | 189.3 | 189.9 | 180.6 | 180.8 | 177.5 | |
| 1950 | 256.2 | 254.5 | 249.5 | 251.5 | 248.0 | 194.3 | 196.2 | 185.4 | 183.7 | 185.0 | |
| 1951 | 273.2 | 271.3 | 263.7 | 265.2 | 262.2 | 212.8 | 214.6 | 204.2 | 202.8 | 205.0 | |
| Dec. 1951 | 274.4 | 272.5 | 264.9 | 266.6 | 263.8 | 216.1 | 219.0 | 207.9 | 205.0 | 208.9 | |
| Jan. 1952 | 278.5 | 275.3 | 270.3 | 274.2 | 270.0 | 217.5 | 219.8 | 210.1 | 208.1 | 211.5 | |
| Feb. 1952 | 278.3 | 275.1 | 270.1 | 274.1 | 270.4 | 217.8 | 220.1 | 210.5 | 207.7 | 211.1 | |
| Feb. 1952 | 125.3 | 124.8 | % increase over 1939 | | | 152.4 | 164.9 | % increase over 1939 | | | |
| | | | 106.7 | 105.5 | 107.8 | | | 121.3 | 113.2 | 122.9 | |

ST. LOUIS

SAN FRANCISCO

| | | | | | | | | | | |
|-----------|-------|-------|----------------------|-------|-------|-------|-------|----------------------|-------|-------|
| 1925 | 118.6 | 118.4 | 116.3 | 118.1 | 114.4 | 91.0 | 86.5 | 99.5 | 102.1 | 98.0 |
| 1930 | 108.9 | 108.3 | 112.4 | 115.3 | 111.3 | 90.8 | 86.8 | 100.4 | 104.9 | 100.4 |
| 1935 | 95.1 | 90.1 | 104.1 | 108.3 | 105.4 | 89.5 | 84.5 | 96.4 | 103.7 | 99.7 |
| 1939 | 110.2 | 107.0 | 118.7 | 119.8 | 119.0 | 105.6 | 99.3 | 117.4 | 121.9 | 116.5 |
| 1940 | 112.6 | 110.1 | 119.3 | 120.3 | 119.4 | 106.4 | 101.2 | 116.3 | 120.1 | 115.5 |
| 1946 | 167.1 | 167.4 | 159.1 | 161.1 | 158.1 | 159.7 | 157.5 | 157.9 | 159.3 | 160.0 |
| 1947 | 202.4 | 203.8 | 183.9 | 184.2 | 184.0 | 193.1 | 191.6 | 183.7 | 186.8 | 186.9 |
| 1948 | 227.9 | 231.2 | 207.7 | 210.0 | 208.1 | 218.9 | 216.6 | 208.3 | 214.7 | 211.1 |
| 1949 | 221.4 | 220.7 | 212.8 | 215.7 | 213.6 | 213.0 | 207.1 | 214.0 | 219.8 | 216.1 |
| 1950 | 232.8 | 230.7 | 221.9 | 225.3 | 222.8 | 227.0 | 223.1 | 222.4 | 224.5 | 222.6 |
| 1951 | 252.0 | 248.3 | 238.5 | 240.9 | 239.0 | 245.2 | 240.4 | 239.6 | 243.1 | 243.1 |
| Dec. 1951 | 255.4 | 252.0 | 241.8 | 244.3 | 242.0 | 246.9 | 241.3 | 242.4 | 245.3 | 245.5 |
| Jan. 1952 | 256.1 | 252.9 | 241.9 | 244.4 | 242.2 | 248.0 | 242.7 | 242.6 | 245.4 | 245.8 |
| Feb. 1952 | 255.9 | 252.7 | 241.6 | 244.2 | 242.0 | 247.6 | 242.3 | 242.1 | 245.0 | 245.4 |
| Feb. 1952 | 132.2 | 136.2 | % increase over 1939 | | | 134.5 | 144.0 | % increase over 1939 | | |
| | | | 104.7 | 103.8 | 103.4 | | | 106.2 | 101.0 | 110.6 |

The index numbers shown are for combined material and labor costs. The indexes for each separate type of construction relate to the United States average for 1926-29 for that particular type — considered 100.

Cost comparisons, as percentage differences for any particular type of construction, are possible between localities, or periods of time within the same city, by dividing the difference between the two index numbers by one of them; i.e.:

index for city A = 110
 index for city B = 95
 (both indexes must be for the same type of construction).
 Then: costs in A are approximately 16 per cent higher than in B.

$$\frac{110-95}{95} = 0.158$$

Conversely: costs in B are approximately 14 per cent lower than in A.

$$\frac{110-95}{110} = 0.136$$

Cost comparisons cannot be made between different types of construction because the index numbers for each type relate to a different U. S. average for 1926-29.

Material prices and wage rates used in the current indexes make no allowance for payments in excess of published list prices, thus indexes reflect minimum costs and not necessarily actual costs.

These index numbers will appear regularly on this page.

another **HOMASOTE FIRST** — designed to reduce the cost of building

SHEATHING and SHINGLING in ONE Operation

with the revolutionary Nova Insulated Sidewalls and Roofs

Wide exposures—up to 12" on roofs and 14" on sidewalls—with $\frac{3}{4}$ " shadow lines—have long been accepted as the highest standard in architectural design and exterior beauty.

Now you can give your client these big advantages—plus complete sheathing—together with major savings in materials, time and labor.

Three fully tested products make possible this revolutionary new method of shingling and sheathing at one and the same time . . . First, the patented Nova Shingling Clip. Second, a panel of *weatherproof* insulating-building board. Third, a shingle of the finest cedar. Installation time: more than $\frac{1}{3}$ less. Two men can sheathe and shingle the sidewalls of the average small home in one day!

Obviously, the details of a system as revolutionary as this, cannot be covered on a single page. Let us send you a fully illustrated folder with complete construction details. The coupon below will save your time.

Another group of NOVASCO PRODUCTS

IN PREPARATION: THE NOVA SYSTEM FOR ASBESTOS SHINGLES

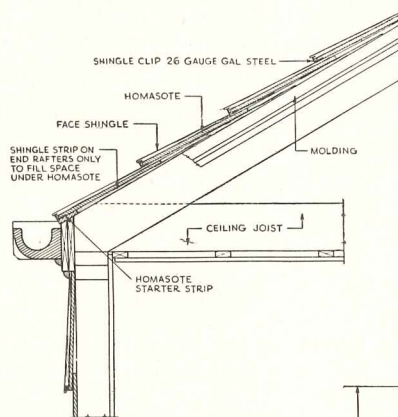
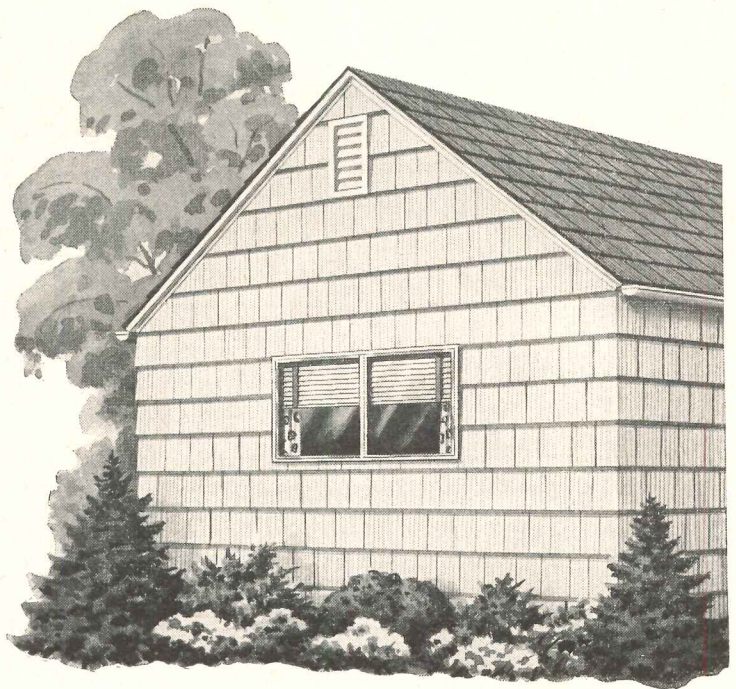

NOTE: The window pictured above is the wholly new Nova-Vita Insulated Sliding Window—the Thermopane window with reinforced Neoprene frame and Fibreglas track — that has its own screen and requires no storm sash. For details address Department NV.

By this method . . .

- 14" EXPOSURES FOR SIDEWALLS
- 12" EXPOSURES FOR ROOFS
- DEEP SHADOW LINES
- NO NAILS IN SHINGLES
- MAJOR SAVINGS IN MATERIALS, TIME AND LABOR

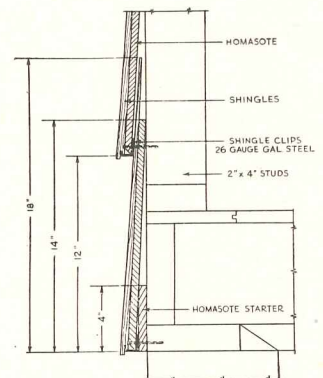

NOVA SALES

Co. TRENTON 3, N. J.



A wholly-owned subsidiary of Homasote Company—manufacturers of the oldest and strongest insulating-building board; wood-textured and striated panels.

NOVA SALES CO., Trenton 3, N. J., Dept. 73A

Send full details on Nova Insulated Sidewalls and Roofs.

NAME

ADDRESS

CITY & ZONE STATE

My lumber dealer is

Another Westinghouse First...

A Balanced Vertical Transportation Population of 10,000...

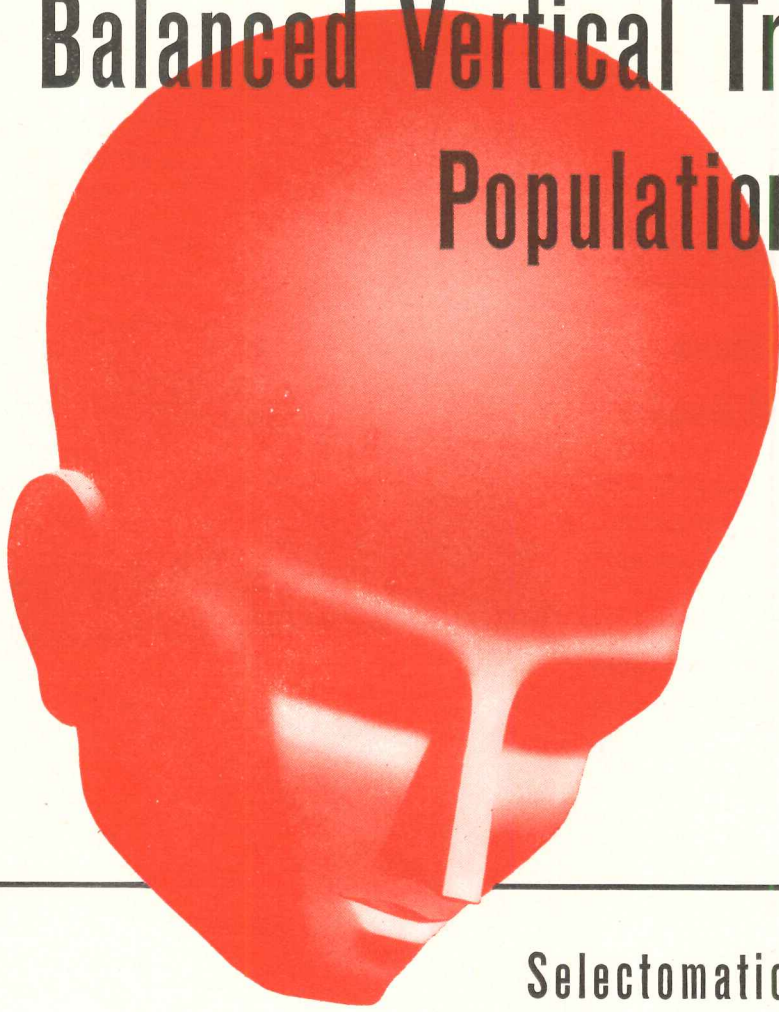

*Now — Selectomatic
Elevators without
operators combine with
Electric Stairways to
set new standards
in economical, efficient
vertical transportation*

Selectomatic Without Operators

- Automatic elevators, those which run without attendants, have for years proven successful in apartment house and hospital installations.
- Now the advantages of automatic elevator operation are available with a Westinghouse Selectomatic System. Selectomatic is the amazing elevator control that matches calls, cars and floors . . . reduces waiting time to a minimum . . . increases passenger handling capacity . . . provides fast, accurate landings with Synchro-Glide Landing Control.
- *Operating costs are reduced*, since no attendants are needed to run the cars.
- *Tenants learn quickly* to operate Selectomatic elevators without operators. Their use in single occupancy buildings is proving both popular and efficient.

TUNE IN ON HISTORY! Only Westinghouse brings you complete coverage of four-month political campaign over CBS television and radio.

System that Handles a Building **AUTOMATICALLY**



The General Accounting Office Bldg., Washington, D. C.

Facts About The Building—This huge 7-floor building has a population of 10,000 with a basement and sub-basement parking area for 800 automobiles. It has about 1,000,000 sq. ft. of floor space and a third-floor cafeteria—the largest one room dining area in the world.

The Problem—What would be the most efficient, most economical system of vertical transportation to handle this building's tenants?

The Solution—Westinghouse installed a balanced combination of 12 *Selectomatic elevators to run without operators* and 16 Electric Stairways.

The Results—This balanced Westinghouse transportation system gives General Accounting Office *all* these benefits and savings:

1. \$800,000 investment saving over an all-elevator system (40 elevators would have been required).
2. \$200,000 annual saving in operating costs—this system utilizes only 2 starters as opposed to 60 attendants for an all-elevator system requiring operators. Also, Stairways cost less to operate than do elevators.
3. 30,000 square feet additional usable floor space made available by the in-

stallation of this balanced system over an all-elevator system.

4. *Maximum availability*—Electric Stairways provide no-wait, ready-to-step-on service.

You, too, can benefit by the Westinghouse principle that the vertical movement of people in a building should be treated as an "overall problem." For years Westinghouse has developed and tested the products that bring this principle to life. Send for Folder SA6446 for more facts about Westinghouse Balanced Vertical Transportation. Westinghouse Electric Corp., Elevator Division, Dept. D-1, Jersey City, N. J.

Westinghouse

YOU CAN BE SURE...IF IT'S

J-98641

REQUIRED READING

Below: Central Hall at the Dresden Exposition of 1906 marked the culmination of decorative line in Van de Velde's style

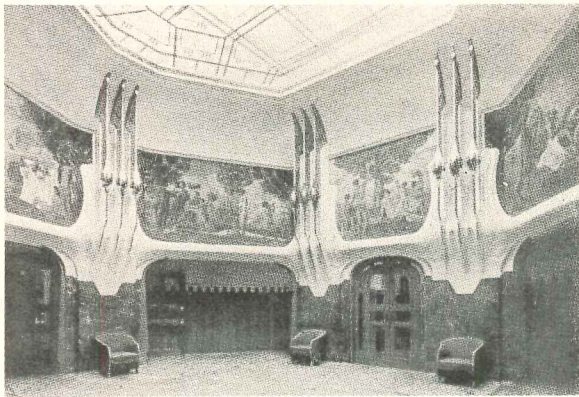

Right: School of Applied Arts at Weimar, also designed by Van de Velde, was completed in 1905

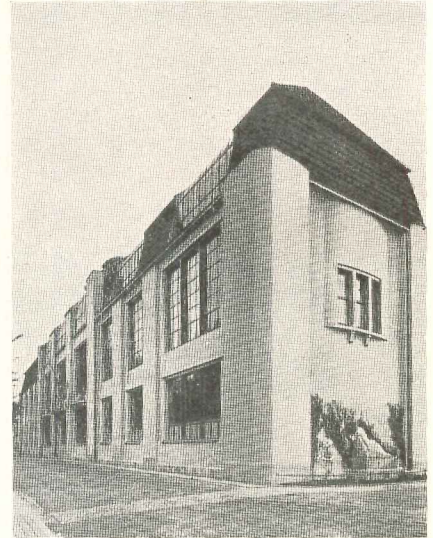

THE ART NOUVEAU

The Art Nouveau. By H. F. Lenning. Published by Martinus Nijhoff (The Hague, Netherlands), 1951. 8 by 10¾ in. 143 pp., illus. \$5.50.

REVIEWED BY ROBERT A. MCKELVEY*

Mr. Lenning's book comes along at a time when the origin, history, architectural and cultural significance of the Art Nouveau movement have been nearly forgotten. The term "Art Nouveau," when used now to describe modern sculpture and architecture, has come to imply derision. Those who have no more than a passing acquaintance with the significance of the movement often misuse the term to belittle any design that is curiously individual and that cannot be explained in terms of the logic of its color, texture, structure and form.

As a study of Mr. Lenning's bibliography will indicate, there has been very little written in book form about this incipient stage in the development of modern design principles. With the exception of profusely and indiscriminately illustrated books showing interior decor and furniture executed in Paris in the prevailing Art Nouveau fashion, the balance of the information must be sought out in magazines and periodicals

on art, decoration and architecture which were contemporary to the era when the style flourished.

The author believes that the value of the movement lay in its theories and principles and not in the flippant and flamboyant exhibitionism of its designers. The essential flaw in the style, he thinks, was the fact that the "artist" would not submit to discipline and over-emphasized the spontaneous sensuous reaction evoked by "line" alone. He feels further that because it was over-cerebral it was likely to degenerate rapidly once out of the hands of Van de Velde.

To this reviewer the real importance of the movement is the fact that it produced a concentration on the lineal aspects of form and hence on an analysis of structure. As a result interior planning was more imaginatively conceived to permit a freer flow of space. It also resulted in an occasional effort to make a conscious adaptation of plan to site and function. Out of it developed an appreciation of the use of iron and its alloys; steel columns no longer had to be disguised. Finally, it helped to make the public amenable to such functional innovations as built-in furniture and boldly defined wall areas.

Mr. Lenning concludes with his belief that it was Van de Velde and his fol-

lowers that erected the indispensable bridge between 19th century eclecticism and the International Style of the 20th century. It might also be added that they forecast the experiments now being made in developing lightweight network and crystallographic structures.

The author's attempt to be all-embracing in his discussion of the derivation of the movement, although admirable, is at times labored, and his conclusions in this connection become diffuse. It might have been advantageous if he had discussed in a total way the relationship of the curvilinealism of the Art Nouveau movement to the growing consciousness of the fact that the straight line was a formalism devised by man to measure distance and magnitude, and that such lines were not natural to the true quality of organic life being discovered by the scientist.

These, however, are minor shortcomings. This is an excellent book. It provides important background material for that particular part of the history of modern art and architecture about which not much is generally known. The fact that it is the first book published in English treating the Art Nouveau style in a broad and comprehensive way makes it an important contribution to a better understanding of the history of modern architecture.

* Mr. McKelvey is a designer and former fellowship student at Taliesin West.

(Reviews continued on page 48)

Rolling Steel

DOORS

Manually, Mechanically, or Power Operated

In warehouses and other buildings with high ceiling clearance where maximum usable floor area is the prime consideration, Rolling Steel Doors occupy a minimum of space . . . their vertical roll-up action occupies no usable space inside or outside the opening, or above the lintel level. No other type of door offers such space economy. In the particular installation below, Mahon Underwriters' Labeled, Automatic Closing Rolling Steel Doors were employed in openings in a dividing wall between an inclosed loading dock and the warehouse proper. In case of fire, any doors in the open position will close automatically. Rolling Steel Doors are permanent—their all-metal construction assures you maximum protection and a lifetime of trouble-free service. Whether you buy standard doors or Underwriters' Labeled type for fire protection, you will find that you get a greater dollar value in Mahon Rolling Steel Doors . . . a study of Mahon Specifications covering materials, application of protective coating, operating mechanisms, and other extra-value items, will convince you. See Sweet's Files for complete information—including Specifications, or write for Catalog No. G-52.

THE R. C. MAHON COMPANY

Detroit 34, Michigan • Chicago 4, Illinois • Representatives in all Principal Cities
Manufacturers of Rolling Steel Doors, Grilles, and Automatic Closing Underwriters' Labeled Rolling Steel Doors and Fire Shutters; Insulated Metal Walls and Wall Panels; Steel Deck for Roofs, Partitions, and Permanent Concrete Floor Forms.

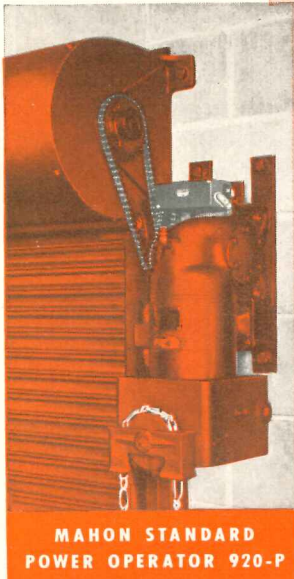

**MAHON STANDARD
POWER OPERATOR 920-P**

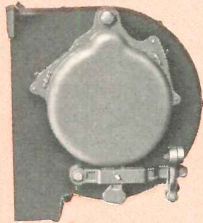

Mahon Release Device and Governor on the Automatic Closing Mechanism of a Mahon Rolling Steel Fire Door. Fusible links release the mechanism in case of fire and the door closes automatically.

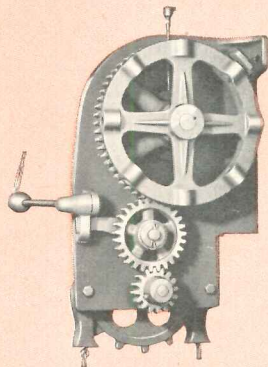

Mahon Release Device for Chain-Gear Operator on Mahon Mechanically Operated Rolling Steel Fire Doors. Fusing of the Fusible Link, which releases the Automatic Closing Mechanism, simultaneously disengages the Chain-Gear Operator.

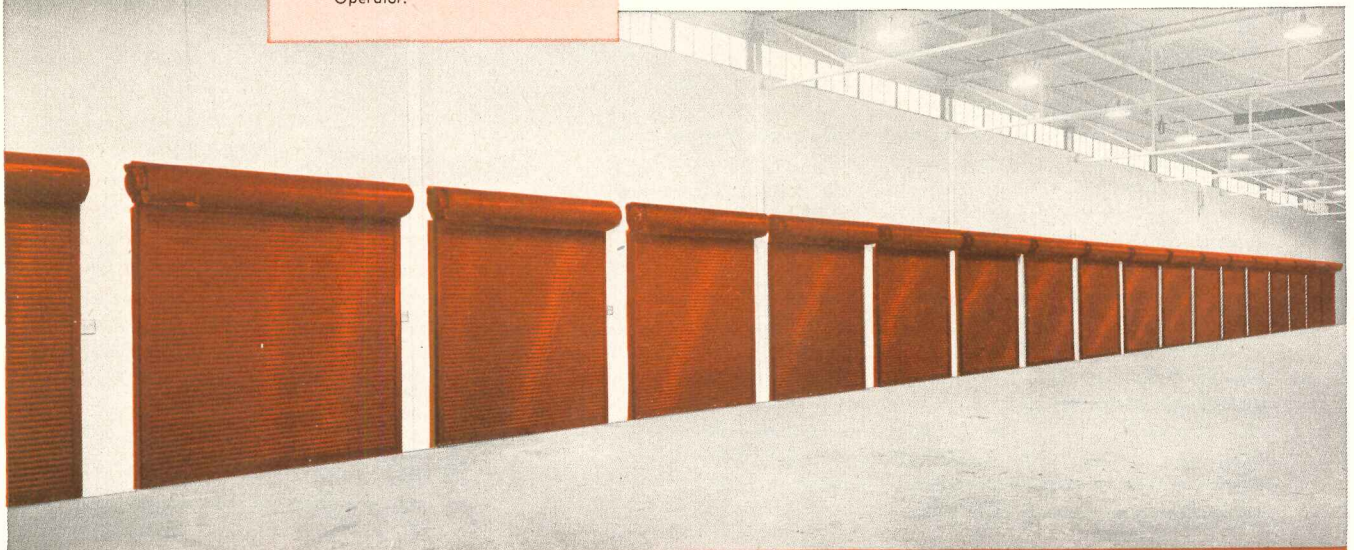

ROLLING STEEL DOORS, SHUTTERS AND GRILLES TO MEET EVERY REQUIREMENT

Twenty-Four Mahon Automatic Underwriters' Labeled Doors installed in a new Warehouse for Food Warehouses, Inc., Detroit, Mich. Two Mahon Power Operated Rolling Steel Doors 17'-0" x 22'-0" are installed in railroad openings in this same building. Louis G. Redstone, Architect, Campbell Construction Company, General Contractors.

MAHON

**THERE'S
GOOD
PROFIT**



IN FINISHING ATTICS OR BASEMENT ROOMS

FIND AND CONVERT WASTE AREAS

Have you overlooked profitable business in altering homes to new needs? Lots of people can't afford new homes yet. But old home remodeling can and is being afforded, through added rooms or waste space conversion. This continued demand should be cashed to the limit. Specify Fir-Tex for these saved-space jobs. It builds as it insulates as it finishes — all at one cost, the cost of insulation alone.

ATTIC OR BASEMENT ROOMS

Nine out of ten basements can be altered to rumpus, play or sometimes sleeping rooms. Attics offer possibilities for sleeping, spare or study rooms. With Fir-Tex, because it seals out cold, seals in warmth, and shushes sound, you can provide comfort quickly. Because of Fir-Tex finish, rooms are attractive, too.

BETTER PLASTER BASE

Lath by Fir-Tex provides an ideal base for plaster and completely seals the room likewise. Fir-Tex eliminates lath marks — plaster cracking is reduced to a minimum. To Fir-Tex lath, plaster sticks like glue.

EXTERIOR SHEATHING

Fir-Tex sheathing seals any building from heat or cold, dust, wind or noise. Being asphalt impregnated, Fir-Tex sheds weather. It increases bracing strength when used on pitched roofs, exterior side walls.

FIR-TEX
INSULATING BOARDS

DANT & RUSSELL, Inc.,
Exclusive Sales Distributors
Equitable Building,
Portland, Oregon

REQUIRED READING

(Reviews continued from page 46)

COLLECTOR'S ITEM

American Furniture: Queen Anne and Chippendale Periods. By Joseph Downs. The Macmillan Company (60 5th Ave., New York, N. Y.), 1952. 9 by 12 in. Introduction, 400 illustrations + Index. \$17.50.

REVIEWED BY ANN RUGGLES,*

At Winterthur, in the gentle country beyond Wilmington, Delaware, Henry Francis du Pont has assembled the most extensive collection of furniture and furnishings made in America during the 17th and 18th centuries. The furniture and interiors mark the transition from the hand-hewed heaviness of the first colonists' oak and pine to the elegant refinement of American cabinetmakers' 19th century adaptations of Sheraton and Hepplewhite.

Now, Joseph Downs, curator of the Winterthur Museum, has culled from this vast store more than 400 examples of Queen Anne and Chippendale furniture to make up a remarkable pictorial catalog. While technically this is a catalog, it is in reality a research book on the manners, customs and social history of the colonies in the 18th century. In a twenty-six page introduction to the book, Mr. Downs describes the effect of thriving trade on both architecture and furniture design from New England to Charleston. He discusses regional characteristics of cabinet work and the interesting variations within a region or even within a family of cabinetmakers like the Goddards or Townsends of Newport, R. I. Mention is given to the colonial terminology of furniture as recorded in account books and inventories.

"It is a perennial cause for admiration and wonder," says Mr. Downs, "that, in the confines of the small colonial towns and cities, the contributions in the limited realm of furniture should be so great; no other period of time in our history has matched the accomplishment in the decorative arts of the second and third quarters of the 18th century." The books on design by such Englishmen as Chippendale, Ince, Thomas Johnson and Robert Manwaring were, according to Mr. Downs, as useful to American cabinetmakers as were the books on architecture by Robert Morris, Isaac Ware, Langley.

(Reviews continued on page 376)

*Miss Ruggles is Home Furnishings Editor of the New York World Telegram and Sun.

Designed

for appearance, performance
and a lifetime of trouble-free
operation.

The beautiful, modern
Drayton Arms Apartments,
Savannah, Georgia
Architects: Cletus W. and
W. P. Bergen, A.I.A.,
Savannah, Georgia



Auto-lok
AUTOMATIC LOCKING
PATENTED

Aluminum
WINDOWS

COMBINE THE BEST FEATURES OF ALL WINDOW TYPES

Tightest closing window ever made!

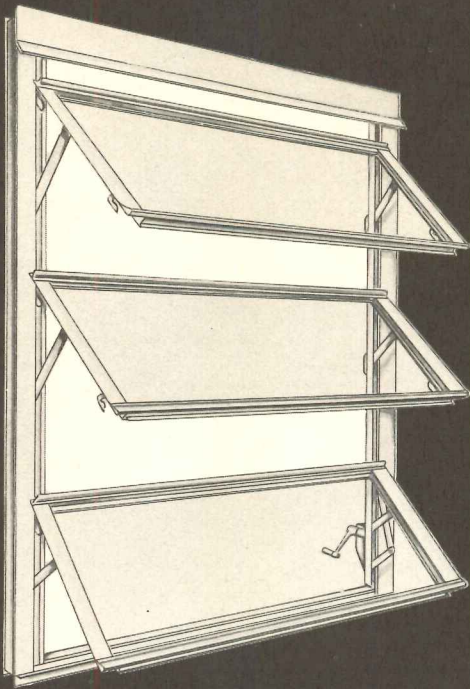

Auto-Lok
AUTOMATIC LOCKING
 PATENTED

Aluminum
WINDOWS

**SPECIFIED FOR THE *BIG* JOBS
 BY LEADING ARCHITECTS...**

because AUTO-LOK is the *first* and *only* window made that successfully meets all window requirements *without a single compromise!* AUTO-LOK Windows are designed and manufactured to specifically answer the demands of architects for windows that lend themselves to greater flexibility in the planning stage...save time and costs in installation...give a lifetime of trouble-free service!

**LOW FIRST COST...
 LOWER MAINTENANCE**

Their first cost compares favorably with competing products offering fewer advantages. They are time-proven...you can't buy a better window at any price! AUTO-LOK's simplified operation eliminates wearing parts...no periodic adjustments are ever necessary...gives you a window guaranteed to keep maintenance costs at a minimum.

LUDMAN Corporation

BOX 4541, MIAMI, FLORIDA

Sales Offices in all Principal Cities

**THE
 FIRST
 WINDOW
 TO**

MAKE

Weather
TO ORDER



**FRESH AIR WHILE IT'S
 RAINING...** no more running to close windows. Rain can't enter through slanting sash!



WARMER IN WINTER
 ...because it seals itself like a refrigerator... keeps heat in, cold out!



COOLER IN SUMMER
 ...because it opens widest...scoops air in and up...luxurious ventilation, but no drafts!

**Performance Factors
 Of Aluminum Awning-Type
 Windows**

Every day, more and more architects and contractors are turning toward aluminum awning-type windows. These newer, more modern windows are being specified for all types of construction, including factories, commercial buildings, apartments, hotels, schools, hospitals and homes. Over a period of years, the aluminum awning-type window has been subjected to rigid and exhaustive tests to determine its performance characteristics and operating efficiency under every known weather condition. This research has been carried on by the leading manufacturers in cooperation with leading architects.

The "Open" Window

One important advantage in favor of the aluminum awning-type window is that it can remain "open" to provide ventilation and fresh air circulation even when it is raining. Slanting sash is the answer. One aluminum awning-type window, the Ludman Auto-Lok, goes a step farther in this respect. The bottom sash of the Auto-Lok window is designed to remain slightly open, while the upper sash are closed tight and automatically locked. This feature allows for night ventilation and limited ventilation during inclement weather.

**Better Ventilation...
 Easier To Clean**

Because of their outward projection, the vents in aluminum awning windows provide maximum possibility of attaining 100% ventilation. While not all awning windows can be opened to nearly 90 degrees (almost straight out) the degree of their opening can be predetermined by checking the manufacturer's specifications. In their wide-open position awning-type windows can be cleaned from the inside. This very important maintenance factor cannot be underestimated. However, the basic design of the window must be checked. For, on certain of these types, where vents are pivoted on a fixed point, the top vent cannot be cleaned from the inside. The Ludman Auto-Lok window can be cleaned *completely*... all from the inside, top sash, too. This feature is accomplished by Ludman's uniquely designed operating hardware, in which the hinge points of the top sash float down with the mechanism when the window is opened to provide a convenient 6" opening between the top sash and the window frame.

Air Infiltration

Paradoxically, the use of aluminum awning windows has for many years been retarded because of their generally unsatisfactory performance on the score of tight closure and elimination of air infiltration. Yet, today, the tightest closing window ever made is an awning-type window. This unit is Auto-

LUDMAN LEADS THE WORLD IN WINDOW ENGINEERING

Lok, developed by Ludman Corporation after many years of research. Its tight closing performance is made possible by its patented hardware, a self-locking device which automatically seals the window tight when closed. Auto-Lok hardware provides a closure *ten times tighter* than the popular established standards for casement windows and projected sash. Pittsburgh Testing Laboratory tests reveal that air infiltration through a standard, assembly line Auto-Lok window amounts to only 0.095 cubic feet per minute...a degree of weather-tightness heretofore thought impossible in any window. Though the Auto-Lok locking action is exclusive with Ludman, other manufacturers are beginning to use a vinyl plastic weatherstripping material similar to that which Ludman uses to weatherstrip the Auto-Lok unit.

Simple Operation

The "one-hand" operation of aluminum awning-type windows is another feature that is very well accepted...and, in many instances, one of the important deciding factors in the selection of these windows. For example, this feature is important to hospitals, where busy nurses with a tray in one hand can still open or close the windows with their free hand...saving time and trouble.

Each individual manufacturer utilizes a distinct type of operator to actuate the window operating hardware. Usually they have large gear boxes to generate the great amount of force required to actuate the torque bar window mechanism. Because of their size they extend over the face of the window sill into the room. Some have removable cranks and extension drives. A study of the operating hardware of all aluminum awning-type windows reveals the fact that Ludman, maker of the Auto-Lok Window, has the most efficient mechanism from the standpoint of easy operation and trouble-free service. The automatic, self-locking principle of the patented Auto-Lok operating device eliminates torque strain required to force the hinges in order to pull individual sash in tight against the frame. In fact, the Auto-Lok mechanism is so perfectly balanced and requires so little pressure that a child can operate the windows.

The Ideal Window For Any Installation... In Any Climate

The aluminum awning-type window is practical from every standpoint. Installations all over the world, in all climatic extremes, have proven their practicability. Their attractive horizontal lines make them entirely adaptable to all types of architectural design from cottage to skyscraper. Their rapidly growing acceptance is having a marked influence on architectural designs because their clean horizontal lines fit admirably into modern architectural styles.

Seals itself shut like a refrigerator

THE FIRST WINDOW TO *Answer* EVERY PERFORMANCE REQUIREMENT

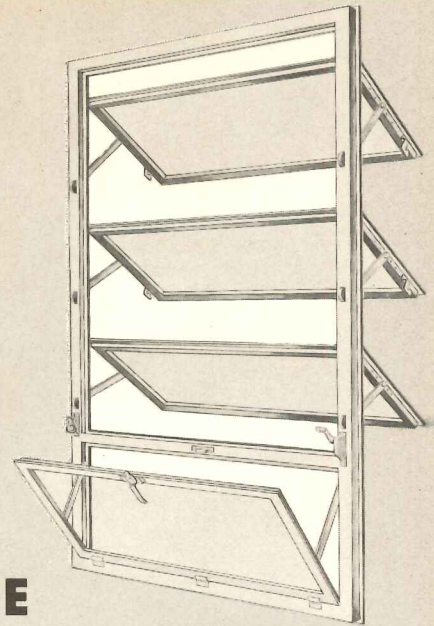

Read this check list for opening sash...

- ✓ AMOUNT AND QUALITY OF VENTILATION? **AUTO-LOK checks:** 100% ventilation, draft-free! Vents open almost 90°, entering air is scooped in and up.
- ✓ POSSIBILITY OF VENTILATION CONTROL? **AUTO-LOK checks:** You make your own weather! Perfect control in all positions from a slight crack of one vent to full opening of all vents.
- ✓ IS THE WINDOW EASILY OPERATED? **AUTO-LOK checks:** Friction-free, precision balanced "no wear" operation. Fingertip control with roto-type operator...no interference with screens, drapes or blinds. AUTO-LOK windows never stick.
- ✓ WEATHER PROTECTION WHEN WINDOW IS OPEN? **AUTO-LOK checks:** Awning-type design provides the luxury of healthful, refreshing ventilation even when it's raining.
- ✓ WEATHER-TIGHTNESS WHEN WINDOW IS CLOSED? **AUTO-LOK checks:** AUTO-LOK is the tightest closing window ever made! Closes many times tighter than any other window. Patented self-locking device plus elastomeric vinyl weatherstripping automatically seals window tight and isolates weather to a degree heretofore believed impossible.
- ✓ WHAT OBSTRUCTIONS TO VIEW (RAILS AND MUNTINS)? **AUTO-LOK checks:** Extremely narrow yet extra strong rails and muntins are made possible through the use of adeptly engineered extruded aluminum sections.
- ✓ FIRST COST? **AUTO-LOK checks:** Initial cost compares favorably with competing products providing many less advantages. You cannot buy better window performance at any price.
- ✓ MAINTENANCE COSTS? **AUTO-LOK checks:** Simplified operation eliminates wearing parts. No periodic adjustments necessary. Ludman engineering leadership combines the best in design, materials and workmanship to produce a window that will give no-wear operational ease with a minimum of maintenance.
- ✓ CAN ALL WINDOW GLASS BE CLEANED FROM INSIDE? **AUTO-LOK checks:** Window can be completely, comfortably and easily cleaned *entirely* from inside, including top vent, too. No gadgets to disengage.
- ✓ HOW DOES THE WINDOW FIT IN WITH PLANS FOR SCREENS, STORM SASH, BLINDS, ETC.? **AUTO-LOK checks:** Interchangeable *inside* screens and storm sash can be placed or removed easily...just flip the clips, no tools required.

Auto-lok
AUTOMATIC LOCKING
PATENTED
Aluminum
WINDOWS

LUDMAN
Corporation

BOX 4541, DEPT. 1B, MIAMI, FLORIDA
SALES OFFICES IN ALL PRINCIPAL CITIES

LUDMAN LEADS THE WORLD IN WINDOW ENGINEERING

Auto-lok

AUTOMATIC LOCKING
PATENTED

THE WINDOW THAT SETS A NEW STANDARD FOR WINDOW PERFORMANCE

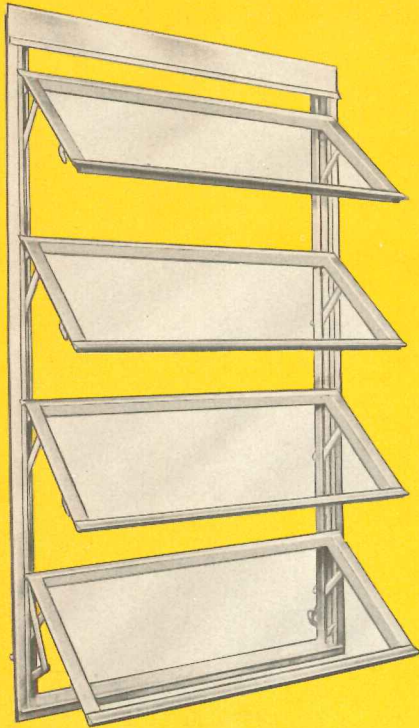

WIDE RANGE OF STOCK SIZES AND ARCHITECTURAL TYPES TO FIT EVERY REQUIREMENT...

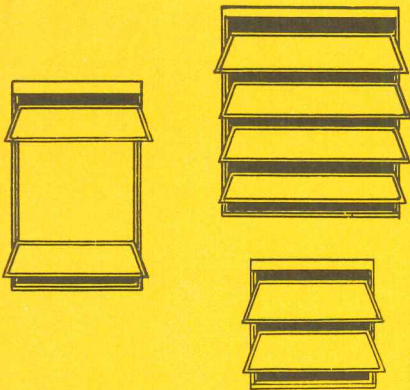

The design of AUTO-LOK Aluminum Windows and the development of their patented, self-locking operating device, are the results of years of research by men who know windows and window problems. The materials that go into the manufacture of AUTO-LOK are the finest produced. The exacting workmanship is your final guarantee of windows that will meet the broadest specifications...with many features to spare!

Only Auto-lok gives you

AUTOMATIC LOCKING
PATENTED

ALL THESE FEATURES...

FRESH AIR WHILE IT'S RAINING



No more running to close windows...rain can't enter through slanting sash!

WARMER IN WINTER...



Seals itself shut like the door of your refrigerator...keeps heat in...cold out!

COOLER IN SUMMER...



Opens widest...scoops air inward and upward...luxurious ventilation, but no drafts!

PRACTICAL BEAUTY...



Narrow horizontal lines and graceful tilt of sash in every open position add distinction to any home...lend themselves to a wider variety of architectural arrangements.

EASIEST TO CLEAN...

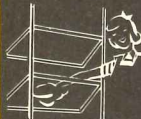

Nothing to lift out...no sash to remove...no gadgets to disengage. Simply open wide and clean all glass from the inside...top sash, too!

INTERCHANGEABLE SCREENS AND STORM SASH...



Can be handled all from the inside. Just flip the clips...no tools required. Reduce a day's work to an hour!

FRESH AIR NITE-VENT...



Bottom sash opens slightly for night ventilation, while upper sash remain securely locked...fresh air circulation during bad weather, too!

FINGER-TIP CONTROL...



for a lifetime. Perfectly balanced, friction-free mechanism operates window at the touch of a finger. No adjustments ever necessary...never sticks, never rattles!

CONCEALED HARDWARE...



No unsafe, unsightly mechanism exposed to collect dust. Compact roto-type operator handle does not interfere with drapes, blinds, etc.

mail this **COUPON** today!

LUDMAN Corporation, Box 4541, Dept. 1 B, Miami, Florida

Please send me complete information regarding:

- | | |
|--|---|
| <input type="checkbox"/> Auto-lok Aluminum Windows | I am a . . . Architect <input type="checkbox"/> |
| <input type="checkbox"/> Auto-lok Wood Windows | Builder <input type="checkbox"/> |
| <input type="checkbox"/> Windo Tite Jalousies | Dealer <input type="checkbox"/> |
| <input type="checkbox"/> Ludman Jalousie Doors | <input type="checkbox"/> Other _____ |

Also, send your free booklet, "What Is Important In A Window."

NAME _____

ADDRESS _____

CITY _____ STATE _____

LUDMAN LEADS THE WORLD IN WINDOW ENGINEERING

other **LUDMAN** products

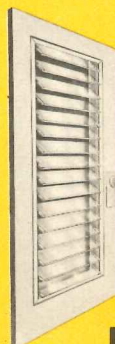

LUDMAN
JALOUSIE
DOORS



WINDO TITE
JALOUSIES

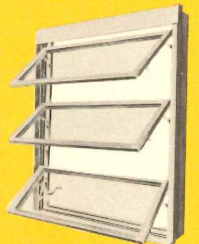

AUTO-LOK
WOOD
WINDOWS

LUDMAN Corporation

BOX 4541, MIAMI, FLORIDA

World's Largest Manufacturer of Awning Windows and Jalousies

KNOX COLLEGE MEMORIAL
GYMNASIUM, Galesburg, Ill.
Architects: Skidmore, Owings
& Merrill, Chicago

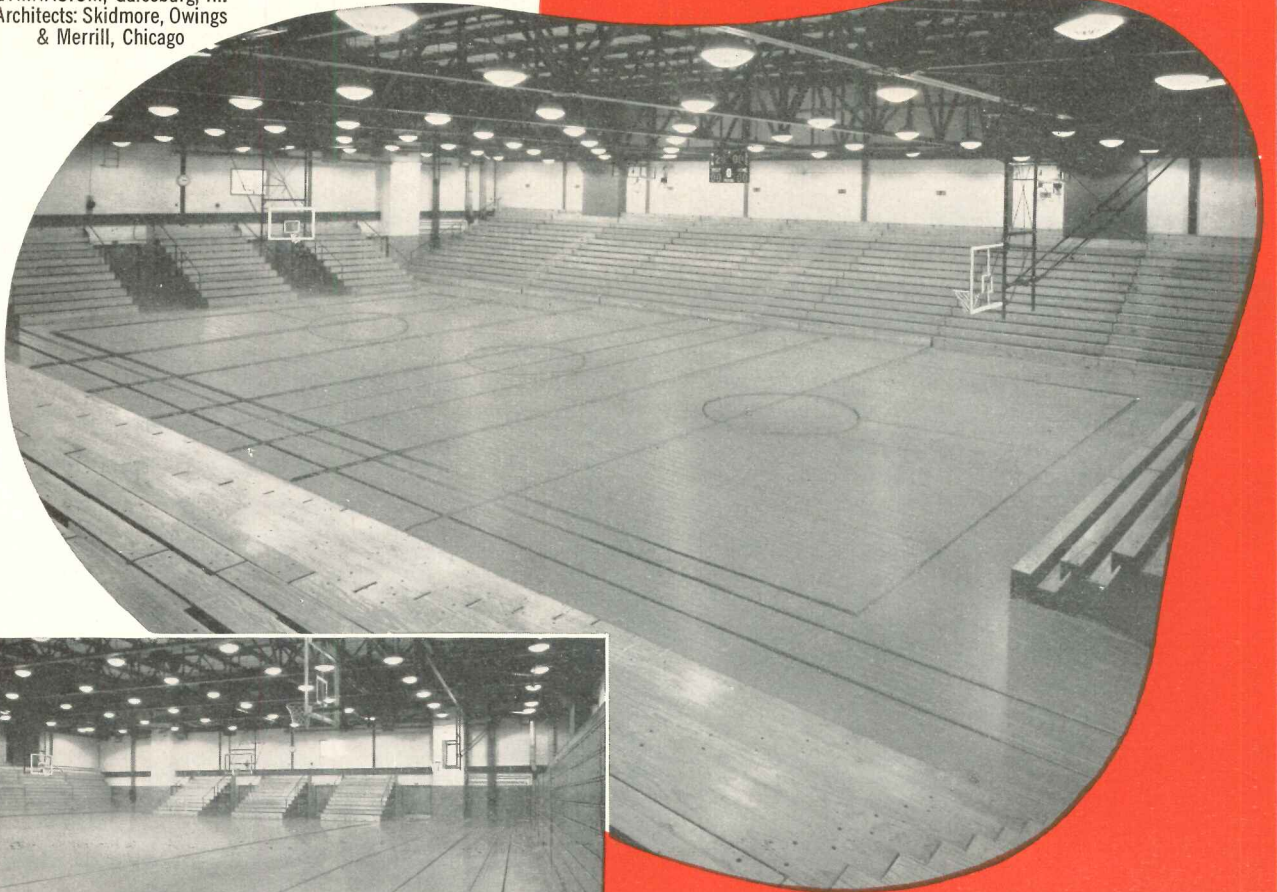

**5,948 Extra Square
Feet Of Usable
Floor Space With**

*MEDART

TELESCOPIC* GYM SEATS

Take a close look at the pictures above. At the top, all the Medart Seats are in open position ready to comfortably and safely accommodate a packed-to-the-rafters audience of 3,200! The inset shows side seats closed, and seats at one end still open.

These two pictures explain why this gym, with seating capacity for 3,200 persons, requires a building virtually no larger than one without seats for spectators! Imagine what the size of this building would be, and the startling extra cost, if 3200 expensive fixed seats had been installed!

Here is an example proving how Medart Telescopic Gym Seats actually regain the use of 5,948 square feet of extra floor space for daily class activity—evidence of the tremendous savings in building costs made possible by better utilization of space.

Convenience and Ease-of-handling are important factors too. Because of Medart's exclusive "Floating Motion" design, it takes little effort and only a few moments to completely open or close Medart Seats. If all the seats are not needed, only one row, or as many rows as required, can be provided and remaining rows left closed.

Safety is assured, even under loads of 400 Lbs. per lineal foot. Medart's steel understructure is a complete free-standing assembly. Solid, one-piece wood seats, risers and footboards add extra strength and are not used to tie together the steel understructure members. Each row of seats is supported from the floor by four vertical steel members.

Many Other Exclusive Features make Medart Telescopic Gym Seats a "best buy". If you have a seating problem, write Medart.

**Medart Telescopic Gym Seats are fully protected by U. S. Patents*

Send for The **NEW** Medart Catalog

FRED MEDART PRODUCTS, INC. 3540 DE KALB STREET
ST. LOUIS 18, MISSOURI

World's Only Complete Single Source For Gymnasium Equipment

Telescopic
Gym Seats

Lockers & Wire
Basket Shelving

Lockerobes
& Grade-Robes

Basketball
Backstops

Physical Fitness
Apparatus

Basketball & Football
Scoreboards

Physical Therapy
Equipment



In a City of Beautiful Buildings

Celotex Roof Insulation is proving itself where it counts most: **ON THE JOB!**



In roof insulation, as in everything else, *the payoff is in performance!* And no other roof insulation can challenge the *job-proved* record for quality, durability and economy set by Celotex Roof Insulation through over 25 years of actual use in all types of installations, all over the country.

Celotex Roof Insulation is low in initial cost, easy to handle, exceptionally durable. It speeds application, reduces labor costs, helps assure a superior, long-lasting roof that requires less maintenance.

So why take risks with untried materials? For complete satisfaction, always specify Celotex Roof Insulation. There's a type to meet every job requirement. Write now for complete technical data! The Celotex Corporation, Dept. AR-52, Chicago 3, Illinois.

It pays to specify genuine

CELOTEX

REG. U. S. PAT. OFF.

ROOF INSULATION

The Celotex Corporation
Chicago 3, Illinois



KASS BUILDING, WASHINGTON, D. C. *specified Celotex Roof Insulation*

Architect: James F. Hogan

Roofing Contractor: Easterday-Duckworth Company
Owner and Builder: Kass Realty Company, Inc.

Only the finest of materials were specified for the ultra-modern Kass Building — one of the newest office buildings in the nation's capital. Among these, naturally, was Celotex Roof Insulation.

Celotex PRESEAL Roof Insulation

- Has 0.33 Btu conductance ("c") for nominal 1" thick material.
- Both sides, all edges asphalt coated for complete moisture protection in storage and on the job.
- Controlled application of asphalt at mill protects insulation value by preventing further penetration during mopping.
- Smooth, asphalt-coated surface insures positive bond to both roof deck and roofing felt.
- Comes in a range of thicknesses to meet specific insulation requirements of each job.

OTHER TYPES of Celotex Roof Insulation—Preseal "30" and Regular—also available. Write for details.

1. High Insulating Efficiency means greater comfort the year 'round, plus reduced heating and air conditioning costs.

2. Low in Cost all three ways: initial, applied, maintenance.

3. Quick, Thrifty to Apply: installed with less time, work and cost because it's light and easy to handle. Strong and rigid—doesn't have to be "babied" on the job.

4. Provides Excellent Bond for hot mopped roofing felts of either the asphalt or coal tar pitch type.

5. Durable, Long-Lasting. It is the *only* roof insulation made of long, remarkably strong Louisiana cane fibres—and protected by the *exclusive* patented FerroX® Process from dry rot and termite attack.

FACTS ABOUT COPPER'S ECONOMY

Model showing food-cooling system with underground condenser grids of copper tubing.

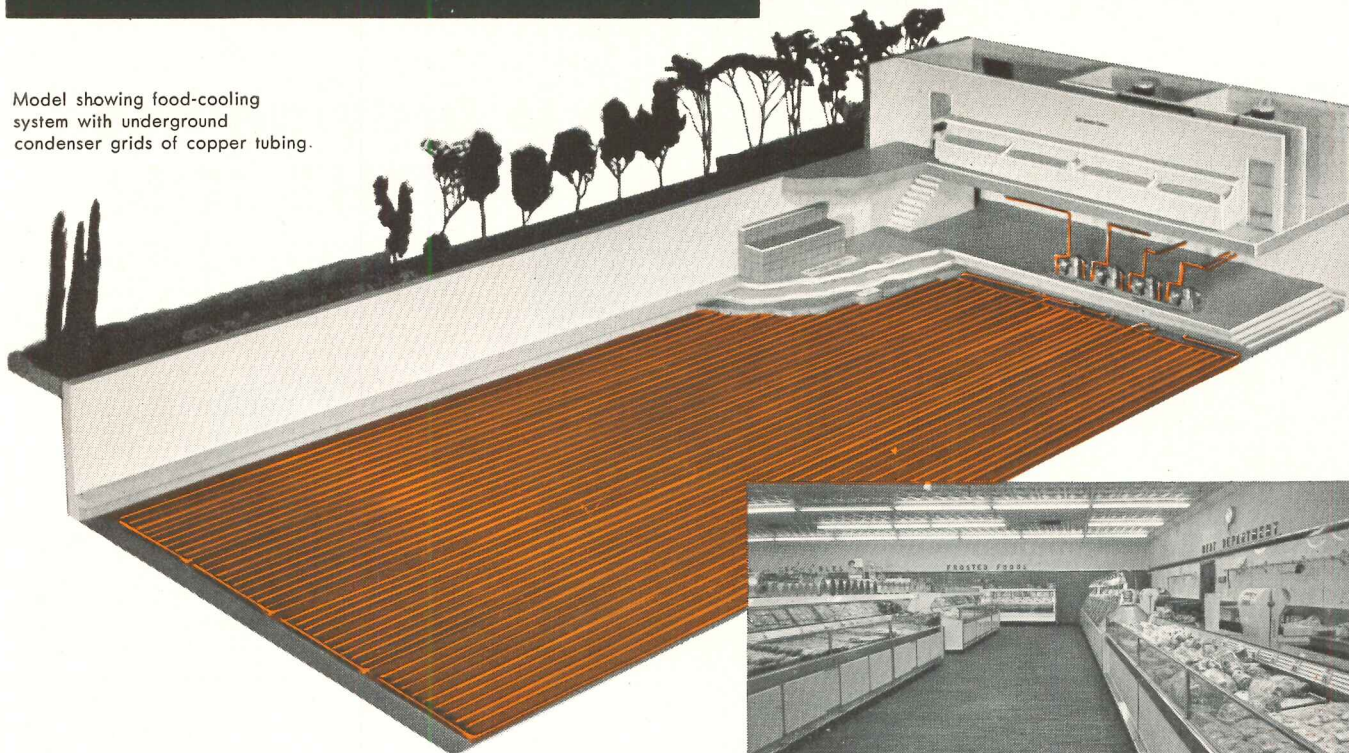

copper tubes

form underground

refrigeration condenser



Heat from these display cases is disposed of through tubing buried below basement floor.

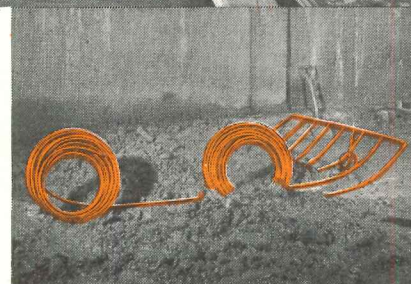

Installing condenser grid in wet clay prior to pouring basement floor.

When discussing the refrigeration system of a planned new supermarket, the owner stipulated:

- 1—Low operating costs
- 2—Minimum use of city water
- 3—Dry basement storage facilities

The Charlton brothers of the Temperature Equipment Company, Hartford, met all 3 requirements very successfully and to the owner's complete satisfaction.

The system was devised so that earth instead of water is used as the cooling medium. Copper tube grids, installed in the ground before the concrete basement floor was poured, serve as the condenser. The surrounding damp earth efficiently absorbs the

heat and enough warmth reaches the basement floor to prevent the accumulation of moisture on its surface.

In the first year of operation the owner estimates a saving of \$750 in water charges alone, plus the added savings afforded by the dry basement in eliminating moisture damage to stored goods. It's another example of the versatility of ANACONDA Copper Tubes for all types of plumbing, heating and refrigeration piping.

A complete description of this installation will be gladly forwarded on request. The American Brass Company, Waterbury 20, Connecticut. In Canada; Anaconda American Brass Ltd., New Toronto, Ont.

5226

modern plumbing calls for **ANACONDA**[®] copper tubes

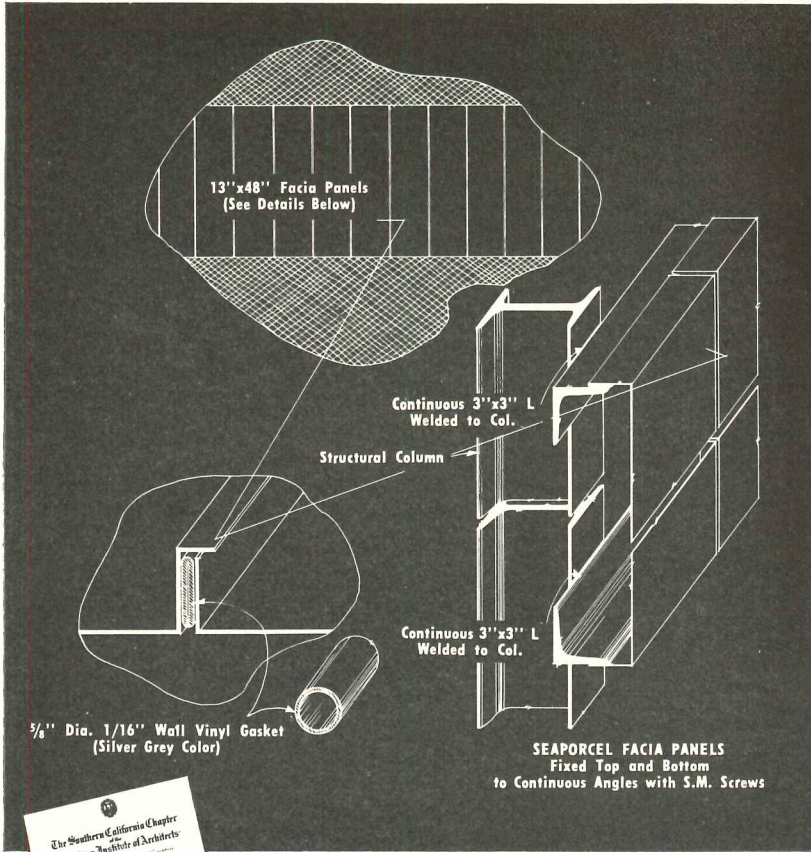

In Every Detail...

SO

Simple!



It won honors from the American Institute of Architects!

See for yourself how simple the architectural and engineering details of a building can be . . . when you specify **SEAPORCEL PORCELAIN ENAMEL** . . . the facing material used on this striking Multi-Deck Building, which building won a Certificate of Honor Award from the American Institute of Architects! Note also what The Magazine of Building reports: "So many engineers, architects and civic officials dropped by to see the new ideas . . . that Vice-Pres. Austrian found himself spending full-time as a guide . . ."

SEAPORCEL ARCHITECTURAL PORCELAIN ENAMEL is so simple to use because it's custom-fabricated to specifications—in all contours, forms and sizes—including "shaped" parts from stock dies. Remember also that Seaporcel renders the fullest scope of textures and colors.

Write today for detail specification brochure.

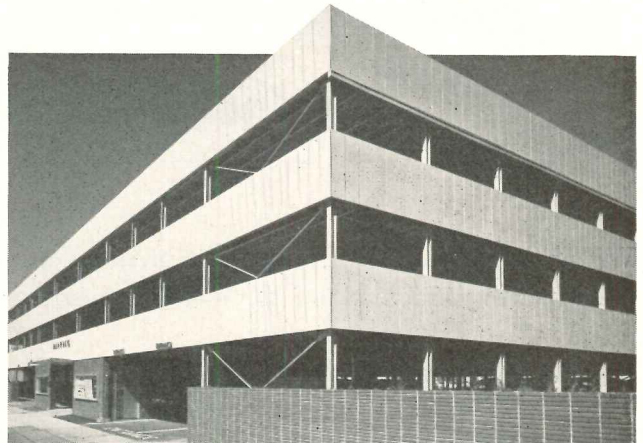

*Multi-Deck Building, Beverly Hills, California, designed by Pereira & Luckman, Architects of Los Angeles; General Contractors: Multi-Deck Corp., L.A.
Seaporcel Porcelain Enamel in terra cotta cream, semit-matte.*

SEAPORCEL METALS, INC.

28-02 Borden Ave., Long Island City 1, N. Y.
Complete A. F. of L. Metal Fabricating & Enameling Shop

ALSO MANUFACTURED ON THE WEST COAST BY

SEAPORCEL PACIFIC, INC.
1461 Canal Ave., Long Beach 13, Calif.



Seaporcel

Architectural Porcelain Enamel

Member: Porcelain Enamel Institute

Complete Engineering and Erection Departments

MUELLER BRASS CO.



AND

VALLEY METAL PRODUCTS CO.

VAMPCO

HAVE JOINED FORCES TO SERVE YOU BETTER!

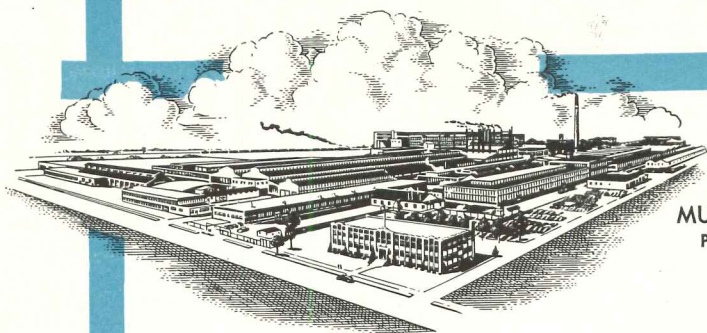

MUELLER BRASS CO.
PORT HURON, MICH.

When two well known names in the building trade consolidate under the same management, it means many extra benefits to you. The Mueller Brass Co., originator and sole manufacturer of STREAMLINE copper tube and solder-type fittings for plumbing and heating, and Valley Metal Products Co., manufacturer of VAMPCO life-time aluminum windows, have recently joined forces for this reason.

By combining our extensive engineering "know-how"—our production facilities, our sales coverage and capital, we are now in a position to do a bigger and better job for you. Write today for complete details of the products and services available.

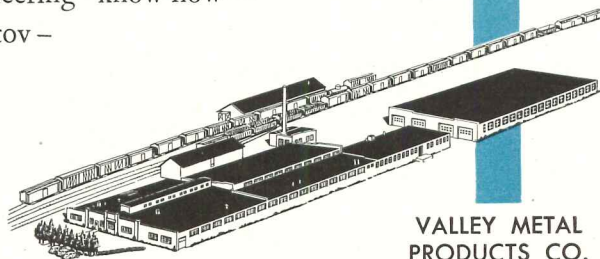

VALLEY METAL
PRODUCTS CO.
PLAINWELL, MICHIGAN

VALLEY METAL PRODUCTS CO. PLAINWELL, MICHIGAN

A SUBSIDIARY OF

MUELLER BRASS CO., PORT HURON, MICHIGAN

**You provide 3 extra-quality features
when you specify**

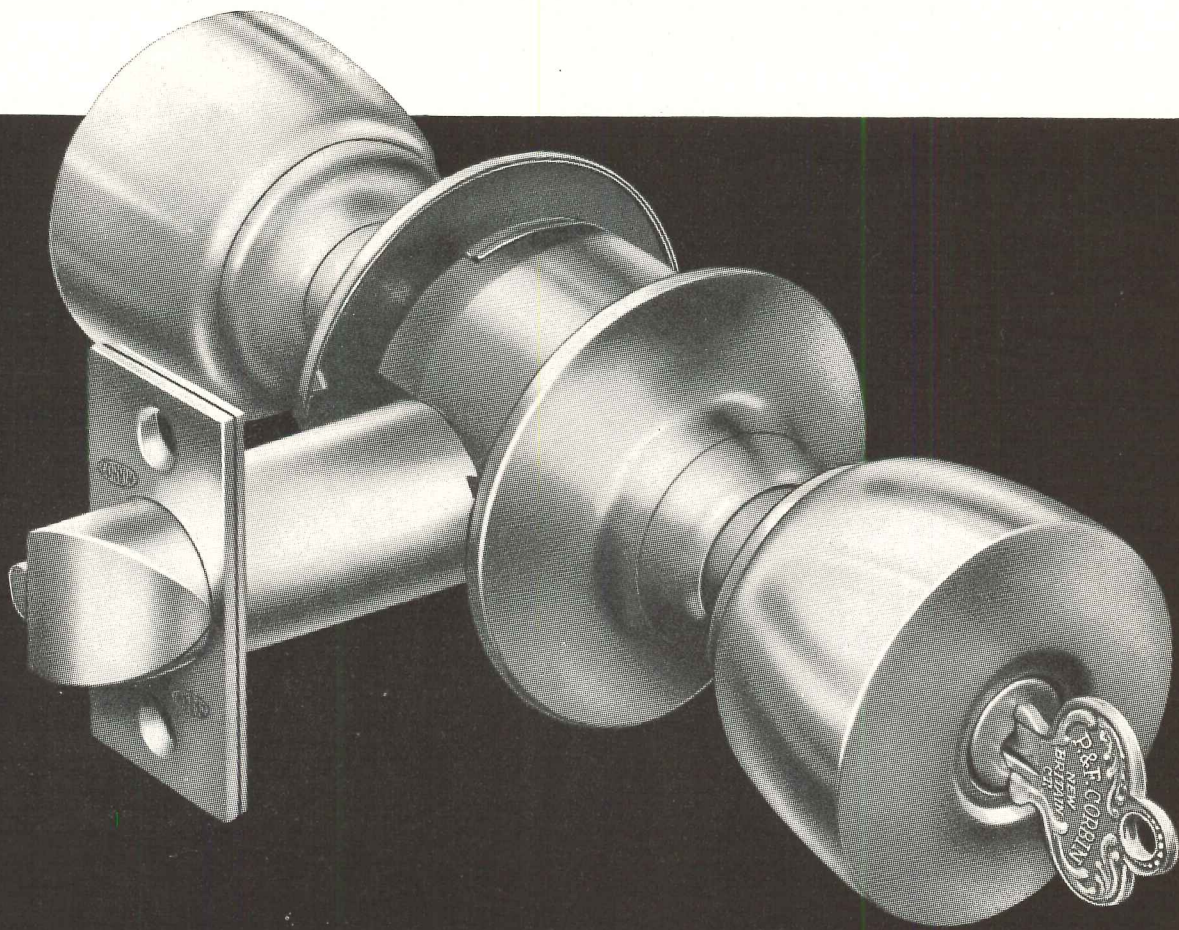

GOOD BUILDINGS DESERVE GOOD HARDWARE



P. & F. CORBIN Division
The American Hardware Corporation
New Britain, Connecticut, U.S.A.



HEAVY-DUTY CYLINDRICAL LOCKS!

- **5/8 inch throw** insures secure locking even on doors that shrink or warp!
- **for extensive master-key systems** the Corbin master-ring cylinder doubles the number of possible key changes!
- **if keys are lost,** the cylinder can be removed readily, from inside, for fast, easy replacement or for re-keying.

Every fine building deserves these extra-quality features provided by Corbin Cylindrical Locks. Compare these locks point by point, feature by feature, with any other cylindrical locks you have ever used. You will find that Corbin offers all the standard features *plus* extra quality advantages that mean more satisfactory operation — longer wear with less maintenance — fast, low-cost installation.

Corbin Cylindrical Locks are furnished in four designs — each made in the 13 functions most frequently used in schools, hospitals, apartments, offices, public buildings and fine residences.

There is a Corbin Distributor or Corbin Representative in your vicinity who will gladly give you complete information about Corbin Cylindrical Locks and assist you with specifications for any type of installation. If you do not know his name and address, we shall be happy to furnish them.

**YOUR CORBIN DISTRIBUTOR
IS A GOOD HARDWARE MAN!**

Corbin distributors are selected for their ability to work with you constructively on builders' hardware specifications. Corbin helps them by conducting two builders' hardware schools each year for distributors' employees.

The quality of their service, together with the fine quality of Corbin products, has made Corbin the most widely used builders' hardware in the world!

My Morgan Kitchen Suits Me to a "D"

"D" is for Door . . . and for Depth . . . for Detailing . . . for Design. Morgan TRI-PANEL has all 3! Here is the "Picture" door with sculptured beauty, creating ever-changing proportioned patterns of clean, sharp hi-lites and deep, soft shadows. Here is the modern touch to break the monotony of flat, plain, uninteresting surfaces. Grace the openings, make the rooms "sing" with Morgan TRI-PANELS.

This is the
MORGAN TRI-PANEL
Door of Dimension

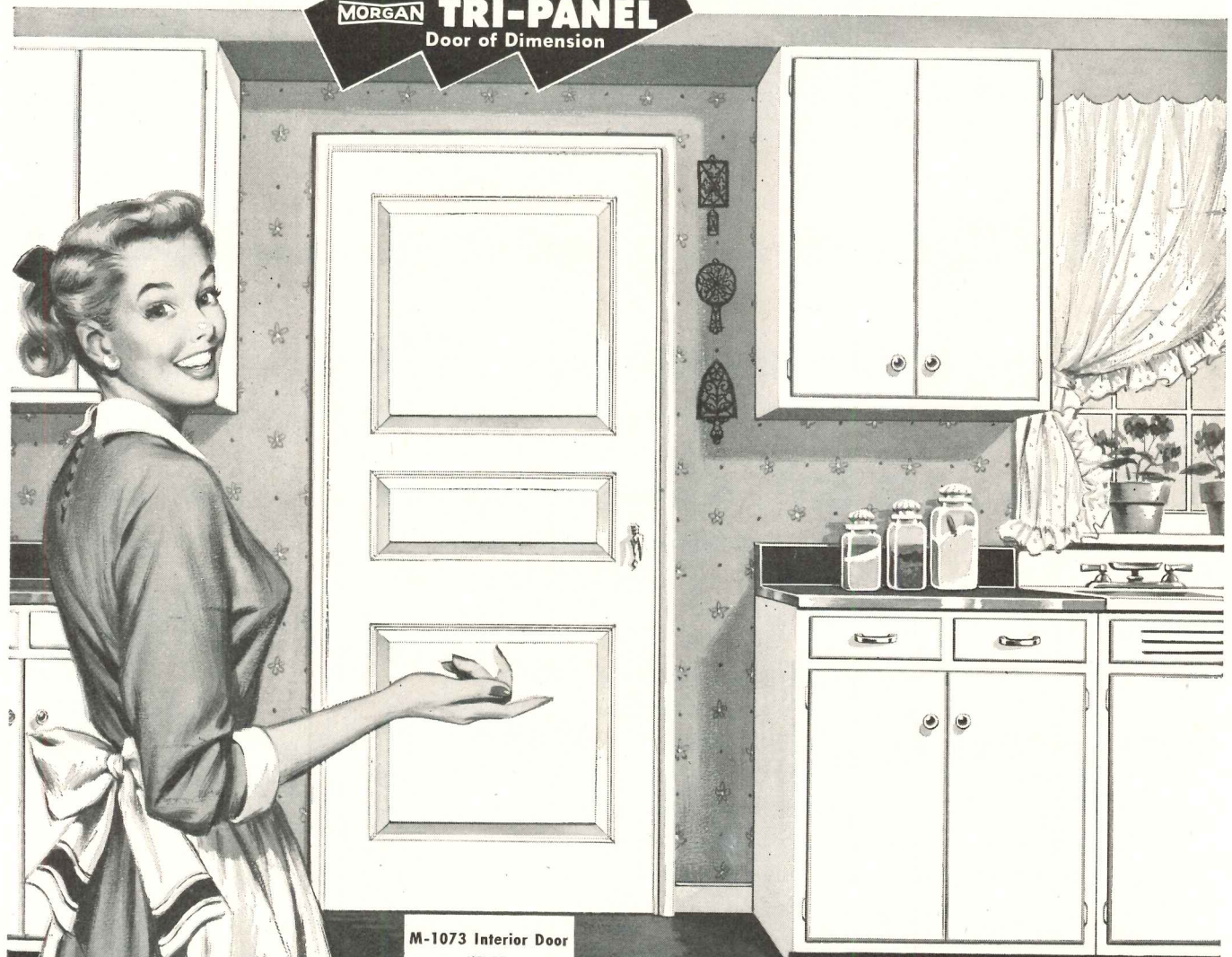

M-1073 Interior Door

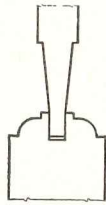

1 3/4" Thickness
with 3/4" Hip-Raised
Panels—2 sides

This is a Modern Morganized Kitchen

Above: M-1073 Tri-Panel and Assembly of Morgan Kitchen Cabinets

Companion to M-1073 Interior Door is Morgan M-117 Exterior Door, 1 3/4" thick with 1 1/4" hip-raised panels, 2 sides. Both available in standard sizes. Keep your Woodwork File up to date. Write for Morgan Catalogs.



MORGAN COMPANY • Oshkosh, Wisconsin

**A Great Name in Woodwork for 97 Years • Doors • Entrances • Stairwork
Mantels • Corner Cases • Kitchen Cabinets • Morganwalls • Sash • Trim**

SU-30-G
85,000 BTU
input per hour

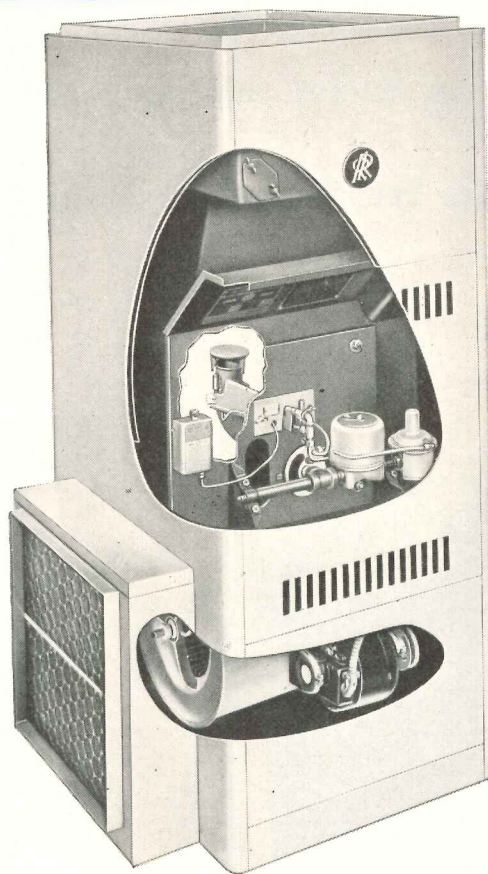

SU-35-G
110,000 BTU
input per hour

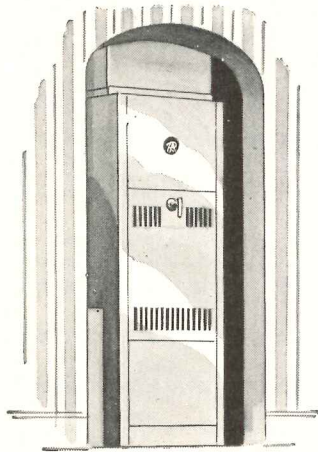

AGA Approved!
**for alcove and
closet installation**



Gas-fired **RICHMOND** winter air conditioner

Where space is tight, use the Richmond SU-G, gas-fired, vertical winter air conditioner... ideal for the small ranch-type installation.

Now the SU-G is approved by the AGA for alcove and closet installation. When ordered for this type of installation our standard unit is especially adapted to meet the rigid AGA requirements. When ordering the Richmond SU-G for closet or alcove use, be sure to state that fact.

Remember that the SU-G can be furnished with a bottom filter rack as optional equipment at no extra charge. And remember these special features: Remote pilot igniter (standard equipment) for convenience and safety in lighting burner from outside of furnace... burner and controls quickly and easily removable as mounting plate is held securely in place with four nuts. When space and economy count... count on the Richmond SU-G.



RICHMOND

RICHMOND RADIATOR CO.—AFFILIATE OF REYNOLDS METALS CO.

See your wholesaler or Mail Coupon Today

Richmond Radiator Company AR/5
19 East 47th Street, New York 17, N. Y.
Please send me full information on Richmond SU-G
gas-fired winter air conditioners.

Name.....

Company.....

Address.....

A flying trip through Lever House on those heavenly carpets by Lees!

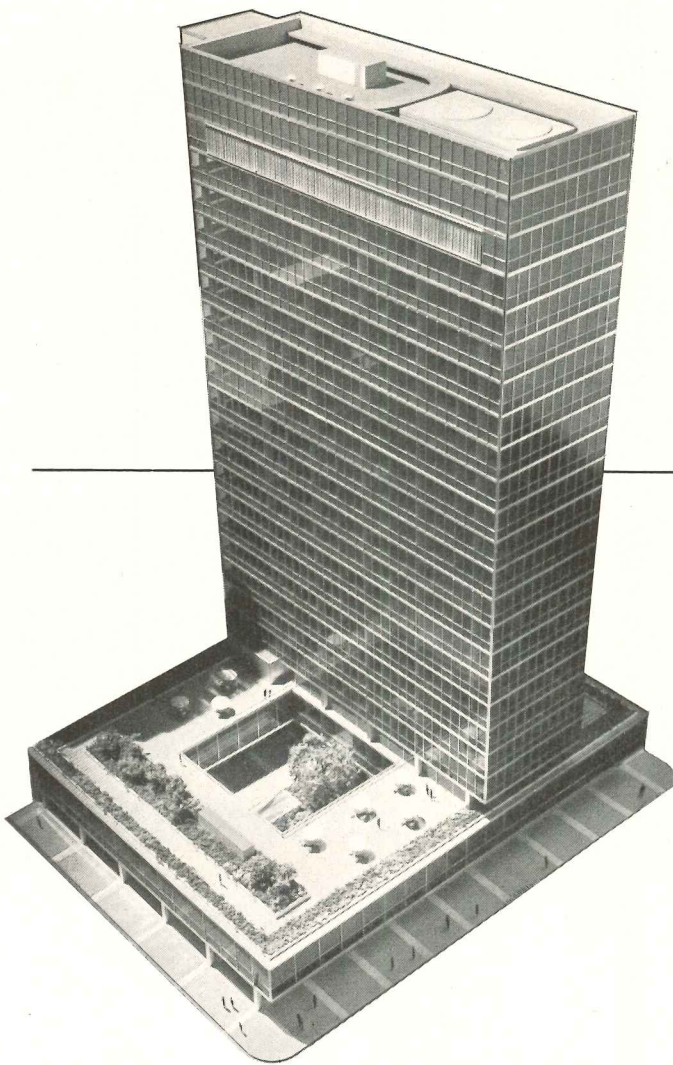

Park Avenue Elevation of magnificent new Lever House, where Lees Contract Carpets set the decorative keynote. Interior installations by the Contract Division of W. & J. Sloane, New York. Raymond Loewy Corporation, Interior Designers.

Lever House elects Lees! Engineered for tomorrow, Lees Contract Carpets make the perfect floor covering for Lever Brothers' spacious new glass-walled wonder-of-the-world! As visitors travel from floor to floor, from one handsome area to another, they say they get the feeling of being out in stellar space! Here—air, light and perfectly co-ordinated color effects—open the door to a vast new architectural world. Lees Carpets fit perfectly into this great new design for industry. Specially constructed to withstand wear and steady traffic, they come in a wide range of colors, patterns, textures, and custom designs for special interiors. Send for specific information from James Lees and Sons Company, Contract Carpet Division, Bridgeport, Penna., or offices in principal cities.



JAMES LEES AND SONS COMPANY
BRIDGEPORT, PENNSYLVANIA
MAKERS OF LEES CARPETS AND RUGS

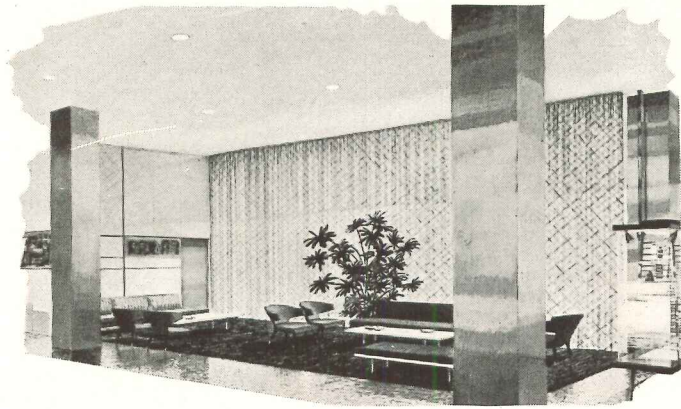

Your first greeting is the long vista of the spacious main lobby. The carpet is a rich textured Wilton specially designed for this impressive space.

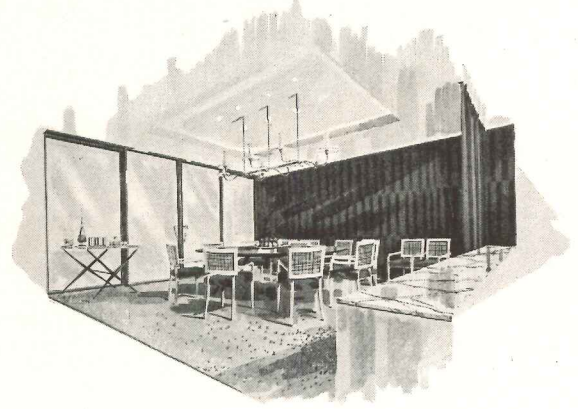

Durable dramatic Lees Darlington, designed for tomorrow, sets the informal decorative scheme for the Lever House Executive Dining Room on the scenic 21st floor.

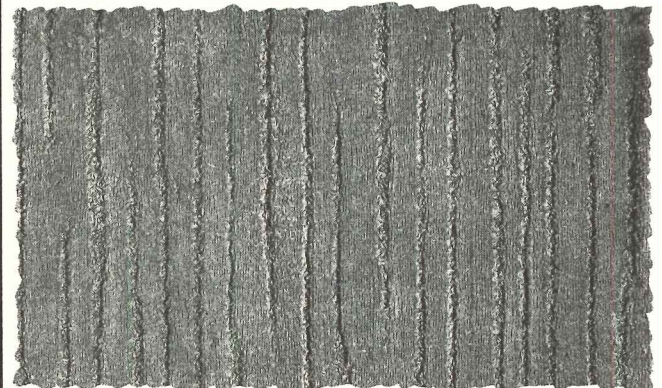
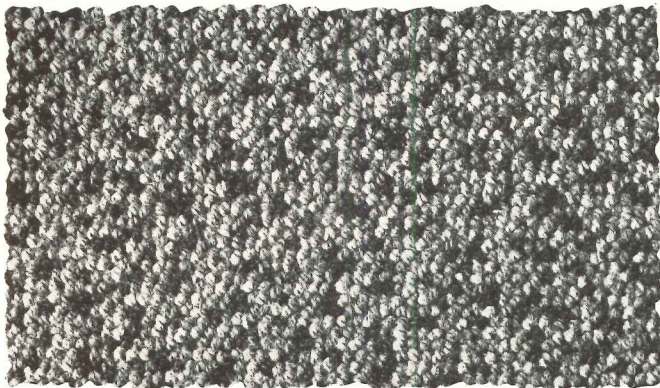
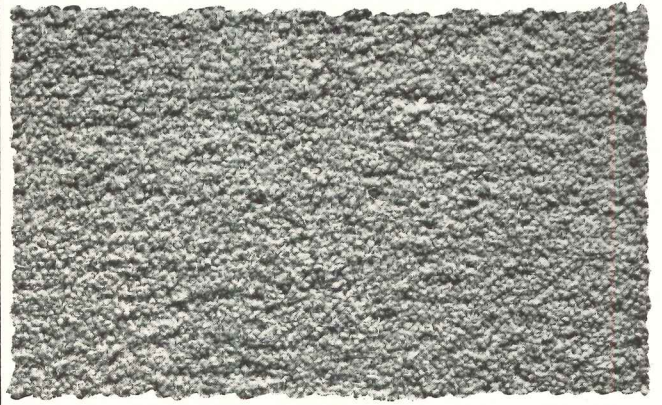
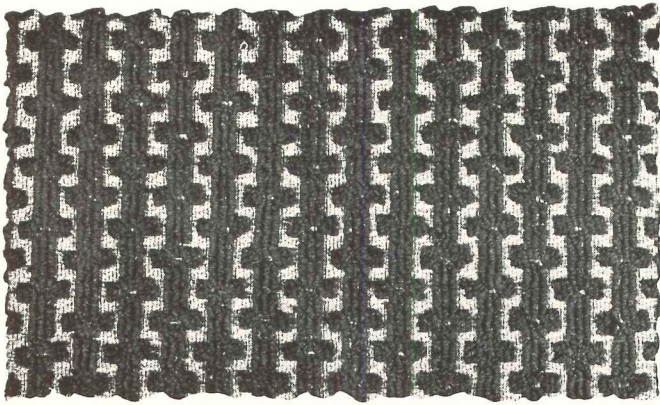

A glimpse into Harriet Hubbard Ayer Buyers' Salon gives the visitor a feeling of fashion and feminine delicacy. The carpet is Lees Locksett in soft dusty pink.

Gracious Glowtuff by Lees, an embossed effect Wilton carpet, spreads hospitality and gentle color over the broad expanse of the 21st floor reception plaza.

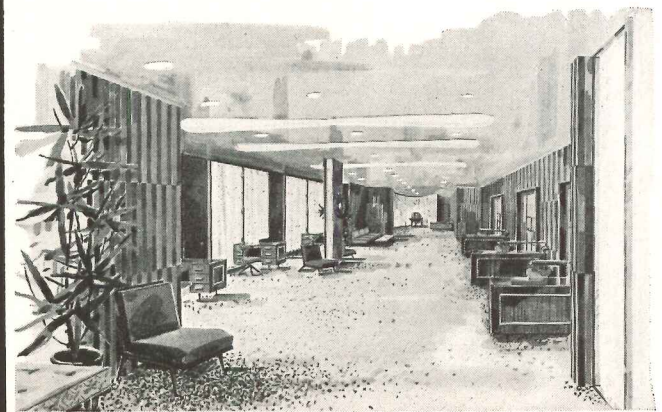
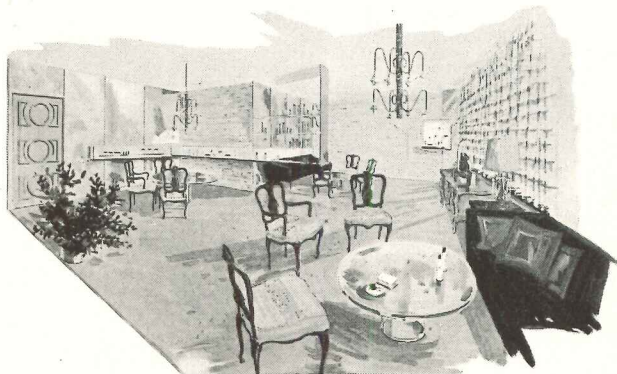

millers luminaires

— the soundest investment of lighting dollars



Miller Portland Luminaire

millers
leaders in lighting
since 1844

factories
offices
schools
stores
public buildings

The advantages Miller Luminaires offer are many—first they are built to provide good light for easy seeing, for best work and avoidance of errors and accidents...Easy installation...Low maintenance...Long, trouble-free service. For 108 years Miller has pioneered in GOOD LIGHTING with a complete line of luminaires—Fluorescent, Incandescent and Mercury for industrial and commercial lighting requirements. They have been proven in thousands of installations. Light with confidence the proven Miller way. Don't compromise on lighting that is "almost" right. When you buy, or specify, Miller luminaires, you are sure of getting all you seek—lighting equipment built on an exacting 8-Point QUALITY standard—the product of advance illumination engineering—the soundest investment of your lighting dollars. Miller field engineers and distributors are conveniently located for nation-wide service.

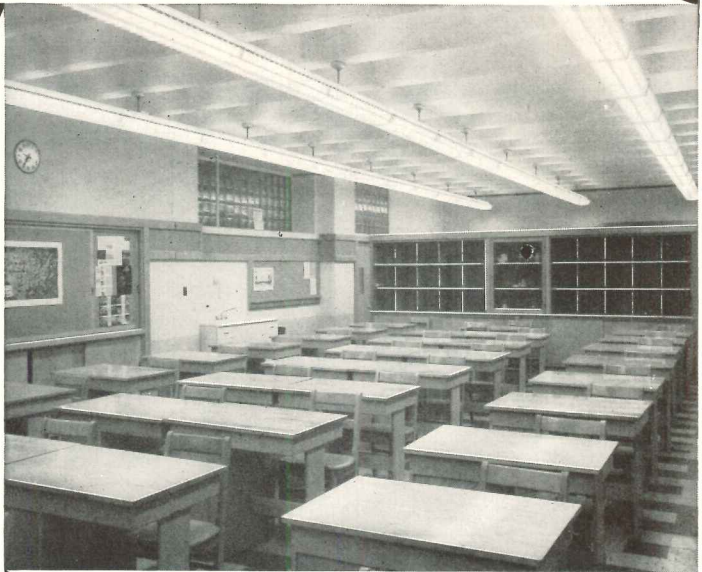

Interior shown is South Mountain Jr. High School, Allentown, Pa. Architects; Heyl, Bond and Miller, Allentown, Pa. Consulting Engineers; Eggly—Furlow, Philadelphia, Pa. Electrical Contractor; Howard P. Foley Co., Allentown, Pa.

THE miller COMPANY MERIDEN, CONN.
SINCE 1844

ILLUMINATING DIVISION: Fluorescent, Incandescent, Mercury Lighting Equipment
HEATING PRODUCTS DIVISION: Domestic Oil Burners and Liquid Fuel Devices
ROLLING MILL DIVISION: Phosphor Bronze and Brass in Strips and Rolls

NEW

CUTS COST UP TO

35%

DOOR and PARTITION GRILLE

NO SEE-THRU

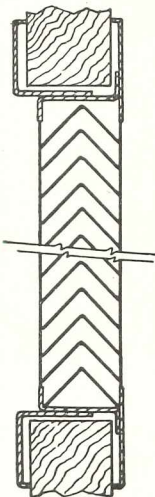

● Cut-a-way view shows new auxiliary frame. Quickens installation—makes a smoother appearance.

NEVER BEFORE SUCH A DOOR GRILLE FOR THE MONEY. It's so far ahead in design, construction and performance that it's guaranteed to open your eyes.

Skilled Airfoil designers drew, tested and built it to give architects, contractors and engineers the *finest door grille possible*. It's made to **OUTLAST—OUT PERFORM.**

First—*it's more rugged.* Will withstand heaviest use and abuse for years and years. Second—*it's low in cost,* competitively priced. Third—*it's good looking.* Will add beauty every time it is installed. Fourth—*lowers are absolutely secure.* Do not rattle when door is slammed.

- **HEAVY GAUGE STEEL. REINFORCED ON EITHER SIDE.**
- **ADAPTABLE TO ANY DOOR WIDTH...MADE TO ANY SIZE.**
- **73% FREE AREA.**
- **ONE-PIECE FRAME.**

● **CUTS DAMAGE AND REPLACEMENT COSTS. NO EXPENSIVE CALL BACKS.**

Airfoil

AIR CONDITIONING OUTLETS

FREE



CHECK TYPE OF GRILLE ON WHICH INFORMATION IS DESIRED

- Air conditioning outlets
- Return air grilles and registers
- Volume controllers
- Perforated metal and ornamental grilles
- Industrial grilles
- Special made-to-order grilles

TITUS MANUFACTURING CORP., WATERLOO, IOWA

- RUSH information on new door and partition Grilles.
- Send complete catalog.
- Send literature on above checked items.

NAME _____

ADDRESS _____

CITY _____ STATE _____

GET THE COMPLETE INFORMATION ON THESE AND ALL AIRFOIL GRILLES TODAY

*Easy, Low-Cost Solution To Every Architect's
Public Seating Problems*

Samson Folding Chairs



Congregation Beth Yeshurun, Houston

Handsome Appearance . . . Posture-Designed For Comfort . . . Ruggedly Built For Low Upkeep And Long Life!

A RCHITECTS everywhere are finding that Samson Folding Chairs allow quick, easy conversion of almost any room to a variety of uses—with complete seating comfort and at low cost.

Strong enough to stand on! Tubular-steel construction, cross-braced and electrically welded, means long life, low upkeep. (Gauge of steel meets U. S. Bureau of Standards specifications.)

Comfortable! Generously proportioned seats. Posture-curved backs. Noiseless, cushioned rubber feet.

Safe! Perfectly balanced—won't tip, tilt or wobble. Safety-guard seat hinge prevents finger injuries.

Easy handling! Samson Chairs open and fold as easily as a book. They stack compactly, conserve storage space.

Special low prices on quantity purchases. Ask your Samson distributor for quotation, or write us direct.



FREE TRIAL! Write us on your letterhead, describing your public seating problem. We will send you, express prepaid, for examination *in your office*, the Samson series 2600 folding chair—America's number one public seating buy!

**Leading Users Of
Public Seating
Everywhere Choose
Samson Folding Chairs!**

Carl Schurz High School
Chicago, Illinois
Pan American World Airways
System
Claremont Hotel
Berkeley, California
Columbia Broadcasting
System, Studio 21
New York City
Veterans Memorial Building
Detroit, Michigan
Wanamaker's
Philadelphia, Pennsylvania
Dinner Key Auditorium
Miami, Florida
Harvard University
Cambridge, Massachusetts
Indiana State Teachers College
Terre Haute, Indiana

THERE'S A **Samson** FOLDING CHAIR FOR EVERY PUBLIC SEATING NEED

Shwayder Bros., Inc., Public Seating Div., Dept. J-4, Detroit 29, Michigan

ALSO MAKERS OF FAMOUS SAMSON FOLDAWAY FURNITURE FOR THE HOME AND SMART SAMSONITE LUGGAGE FOR TRAVEL

MODERN CIRCUIT PROTECTION and EXTRA COMFORT



for all types of Homes
is provided by

these  products

They're as Modern as Tomorrow...
these  Load Centers, Service Equipment
and Built-in Electric Quikheters.

Made specifically for use in homes —
large and small — and other buildings,
these sturdily built units embody all the
latest features in design and construction.

They're safe, efficient, dependable, eco-
nomical, long-lasting and will provide years
of trouble-free service. Too, they are approved
by the Underwriters' Laboratories, Inc.

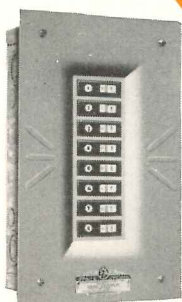

The next time you design a residence or
other small building, include  Load Centers,
Service Equipment and Electric Quikheters in
your specifications.

Your nearest  representative, listed in
Sweets, will be glad to give you complete
information, or write to headquarters for
bulletins.

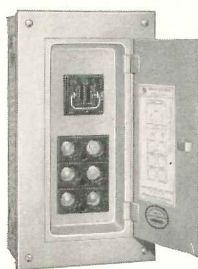

 Load Centers and Service
Equipment with thermal-magnetic
trip Add-On Circuit Breakers are
ideal for residential use . . . available
in 2 to 20 circuit assemblies.



 SEPF Fuse-Type Service Equip-
ment with safety-type  Pulfuz-
switch main disconnect and plug fuse
connections is excellent also for use
in homes. Available in 30, 60 or 100
ampere main connections and plug
fuse branches. Also range circuits.



 Main and Range Service Units
provide fuse protection in a dead front,
safety type unit and feature non-inter-
changeable  Pulfuzswitches for main
and range disconnects. Available in 60 and
100 ampere "series" and "parallel" main
connections — 4 to 8 branches, with or
without water heater circuit.

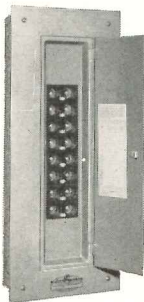

 Type R Enclosed Cutouts are
popular safety-type fuse boxes for homes
and other similar size buildings. Fur-
nished with 2 to 20 circuits.



Built-in  electric Quikheters with
built-in control switch or thermostat,
supply heat that will quickly change a
cold, shivery bathroom or other room into
one that's warm and cozy — and at a
small cost. Quick acting, odorless and noise-
less in operation. Available in capacities of
1,000 to 3,000 watts. Separately mounted
thermostic control available at extra cost.

Frank Adam Electric Co.

P. O. BOX 357 ST. LOUIS 13, MISSOURI

Makers of BUSDUCT • PANELBOARDS • SWITCHBOARDS • SERVICE
EQUIPMENT • SAFETY SWITCHES • LOAD CENTERS • QUIKHETER



American Blower... a time-honored name in air handling



Tampa, Fla., has a conveniently located American Blower Office to provide you with data and equipment for air handling. You can reach American Blower in Tampa by calling 2-2506. In other cities, consult your phone book.

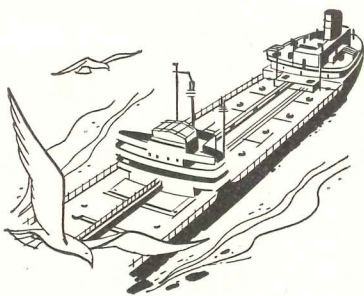

BON VOYAGE

The very fact that the cargo is *potentially* dangerous requires every precaution for safety on an oil tanker. American Blower fans and blowers more than meet the rigid specifications for ventilating equipment on these vessels. American Blower ventilating equipment includes explosion-proof motors, spark-proof fan wheels and housings and carries Certified Ratings. If this touches on a problem you're facing, our nearest branch office will be glad to help you.



HOSPITAL COMFORT

A new Veterans' Hospital recently completed on the west coast is going to be mighty comfortable for patients — at least from the standpoint of good ventilation. American Blower Sirocco

Fans are largely responsible. These fans deliver more air per revolution than any other type of fan, operate at lower tip speeds, are quiet, and require only minimum space for installation. Our branch office personnel are experienced engineers who will be glad to furnish complete data on American Blower equipment. Why not call today?

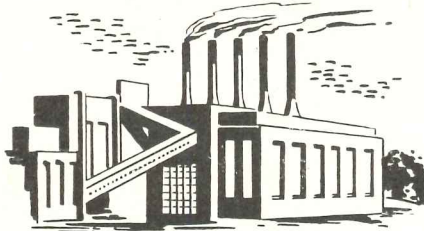

POWER PLANT NEWS

An American Blower Type ST Fly Ash Precipitator was purchased recently by a leading public utility for installation on the world's largest boiler now under contract. It is a pulverized-fuel fired, dry-bottom type boiler having a continuous rating of 1,450,000 lbs. of steam per hour capacity. The boiler is expected to burn about 147,000 lbs. of coal per hour with a gas volume of 600,000 cfm going into the American Blower Collector. At this rating, approximately 13,000 lbs. of fly ash per hour will be caught in hoppers and transported to storage tanks.

If you're planning to enlarge or expand your facilities, if you're changing from civilian to military production, let American Blower supply you with air handling products to improve comfort and boost efficiency. Phone or write our nearest branch office.

AMERICAN BLOWER CORPORATION, DETROIT 32, MICHIGAN
CANADIAN SIROCCO COMPANY, LTD., WINDSOR, ONTARIO

Division of **AMERICAN RADIATOR & Standard Sanitary** CORPORATION

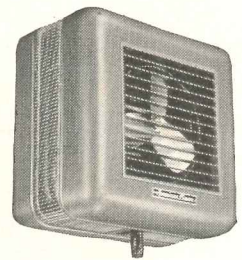

Unit Heaters

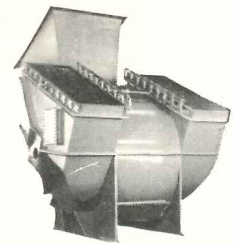

Mechanical Draft Fans



Dust Collectors

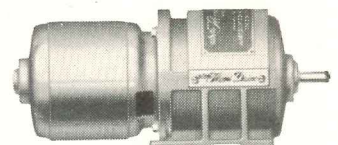

Gýrol Fluid Drives

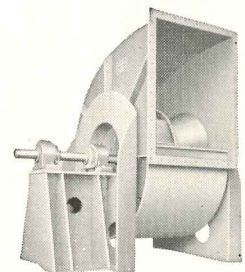

Industrial Fans

YOUR BEST BUY

AMERICAN BLOWER



AIR HANDLING EQUIPMENT

Serving home and industry: AMERICAN-STANDARD • AMERICAN BLOWER • ACME CABINETS • CHURCH SEATS • DETROIT LUBRICATOR • KEWANEE BOILERS • ROSS HEATER • TONAWANDA IRON

How the WORD gets around!

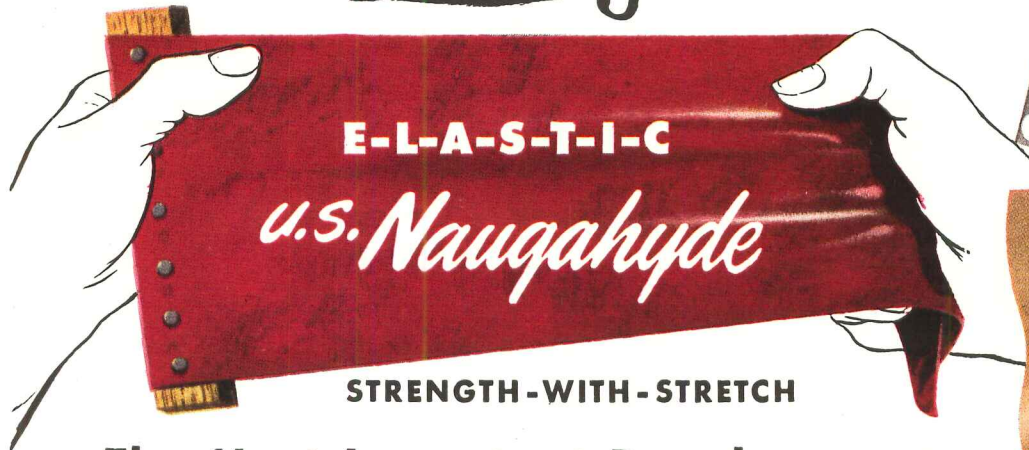

The Most Important Development in the History of Vinyl Upholstery!

Step-by-step Proof of the EXTRA ADVANTAGES of strength-with-stretch



Backed with a strong, knitted, stretchable fabric, Elastic Naugahyde is a sturdy, vinyl upholstery material that stretches evenly in every direction.



Tacks hold firmly without tearing; seams, staples won't pull out. No special tools or techniques needed.

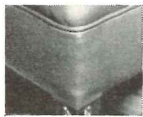

Elastic Naugahyde is rugged and strong—yet so pliant that it can be smoothly fitted to the most "difficult" designs.



Elastic Naugahyde hugs the contours of furniture, offering customers eye appeal from every angle.

Your Customers will be looking for this tag. They know the advantages of Elastic Naugahyde for long, trouble-free wear. Here, indeed, is tomorrow's upholstery fabric—today!

PICTURE-PROOF of the immediate, enthusiastic acceptance of the tough Elastic Naugahyde* by leading furniture manufacturers! And no wonder. Just see how Elastic Naugahyde in its rainbow of magnificent colors adds new beauty to Modern... exciting, new customer sales appeal to Traditional Pieces.



*Patent Applied for



UNITED STATES RUBBER COMPANY

Coated Fabrics Department • Mishawaka, Indiana

1. Franklin Furniture Co. 2. Addison-Wade Co. 3. A. Brandt Co., Inc. 4. Century Furniture Co. 5. Beachley Furniture Co.
 6. Kenmar Manufacturing Co. 7. Shaw Manufacturing Co. 8. Imperial Leather Furniture Co. 9. J. L. Chase Co.
 10. Tomlinson of High Point





Attractiveness **PLUS Easy Working**
Weathertight Closing **Long Life**

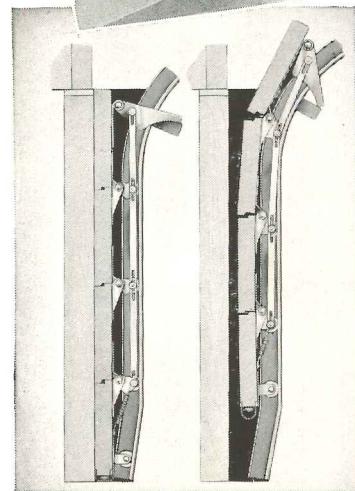
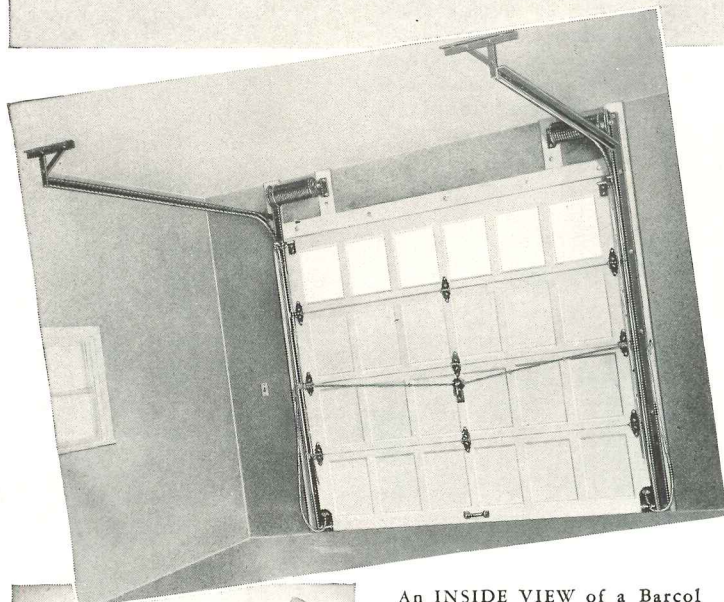

An INSIDE VIEW of a Barcol OVERdoor, showing sturdy tracks with continuous vertical track brackets, twin springs, strong but light sections designed against warping or twisting, dual self-latching bolts.

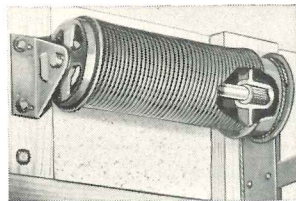

Close-up of one of the twin tailored counterbalancing coil springs that help make Barcol OVERdoors so easy working. Airplane steel cable runs from drum *direct* to bottom of door. Roller bearings insure smooth, easy, and quiet operation. Separate adjustments insure exact equal tension on both sides of door.

This is how the exclusive Barcol Closing Action works. Right, door closing (moving downward), lever engages stop on track, pulls roller plates up, moves door to left. Left, door closed, roller plates up, door pressed uniformly top to bottom against jamb. Reverse of action gives immediate release on opening.

Barcol OVERdoors

have
**HIDDEN as well as
 VISIBLE VALUES**

It takes a lot more than just what you can see *from the outside* to total up the sum of Barcol OVERdoor advantages. Barcol OVERdoors can be made in almost any exterior design desired. Take the special pecky cypress doors shown above — they make a beautiful blend into the design scheme; but the real reasons they *work* well as much as they *look* well — those reasons are *inside* the building. Look at the “inside” pictures and diagrams — here, in the mechanisms and in the hardware, the distinctive qualities of the Barcol OVERdoor are found. Here are the *hidden values* that mark the superior features and the superior performance of the Barcol OVERdoor. Look *inside* as well as outside to learn the whole story. Only then can you know how satisfactory the Barcol OVERdoor can be — *in every way*.

BARBER-COLMAN COMPANY

102 MILL STREET, ROCKFORD, ILLINOIS

FACTORY-TRAINED SALES AND SERVICE REPRESENTATIVES IN PRINCIPAL CITIES

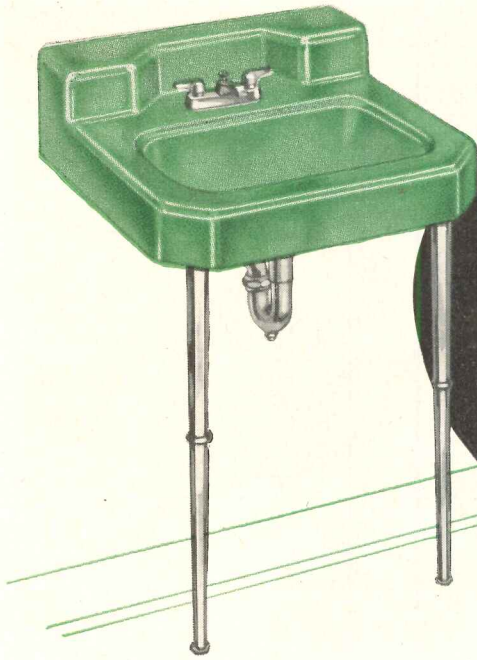

AllianceWare
NOW FEATURES COMPLETE
BATHROOM ENSEMBLES
in Color!

Shelf-back lavatory, porcelain-on-steel Model L-2018 has a bowl of generous capacity with a deep apron at front and sides that creates an unusual smartness in style. May be wall-hung or installed with legs as illustrated.

AllianceWare porcelain-on-steel BA5 bathtub combines three important selling features—(1) an attractive panelled front (2) a wide seat with roll-rim and (3) a convenient height of 15 ½ inches.

For details of these AllianceWare units, write for complete specification sheets.

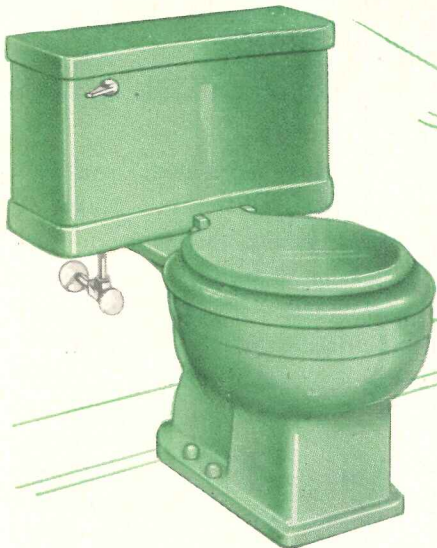
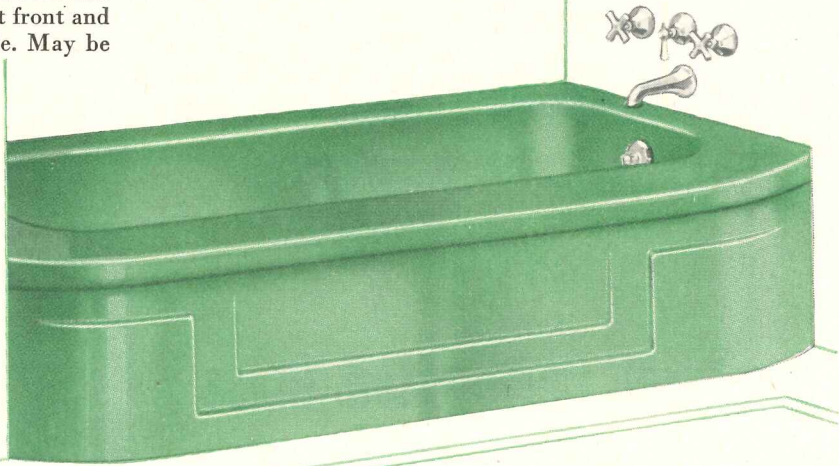

Close coupled reverse trap closet combination in a smartly-styled unit. The design incorporates quiet, efficient, whirlpool jet flushing.

WITH the recent addition of vitreous china closet combinations of recognized quality to the AllianceWare line, you can now install a complete AllianceWare bathroom in any of four decorator color selections—blue, pink, green, and suntan—as well as white.

With stainproof surfaces, modern styling and choice of units matched in color, AllianceWare also possesses practical details of construction and ease of installation that win the praise of architects and builders everywhere. Builders who plan quality homes of long-lasting attractiveness find AllianceWare fixtures offer both *builder* satisfaction and *owner* satisfaction.

AllianceWare
PORCELAIN ON STEEL

ALLIANCEWARE, INC. • Alliance, Ohio
 Bathtubs • Lavatories • Toilet Combinations • Sinks

Bright Idea



A wall of light brightens this basement recreation room, adds a modern note of sparkling hospitality to bar (at right.)



Structural Corrugated Glass Adds Glamor to Rathskeller

This inviting basement room is a mecca for entertaining or family relaxation. The beauty and utility of rhythmic Structural Corrugated glass by Mississippi creates an atmosphere of spaciousness and comfort difficult to achieve in a rathskeller. The entire basement is flooded with "borrowed light," yet garage and storage space are hidden by the translucent glass partitions.

In contemporary construction, architects and designers everywhere are recognizing the place of translucent, light diffusing glass, the modern material. Mississippi Glass is available in a wide variety of patterns and surface finishes wherever quality glass is sold. Consider this fresh, dramatic material to add sparkle to your ideas.



Write today for free new booklets, "Modernize Your Home With Decorative Glass" and "Figured Glass by Mississippi." Photographs of actual installations. Many ideas on ways to use this exciting new medium.



MISSISSIPPI *Glass* **COMPANY**
 88 ANGELICA ST. SAINT LOUIS 7, MO.
 NEW YORK • CHICAGO • FULLERTON, CALIF.



WORLD'S LARGEST MANUFACTURER OF ROLLED, FIGURED AND WIRED GLASS

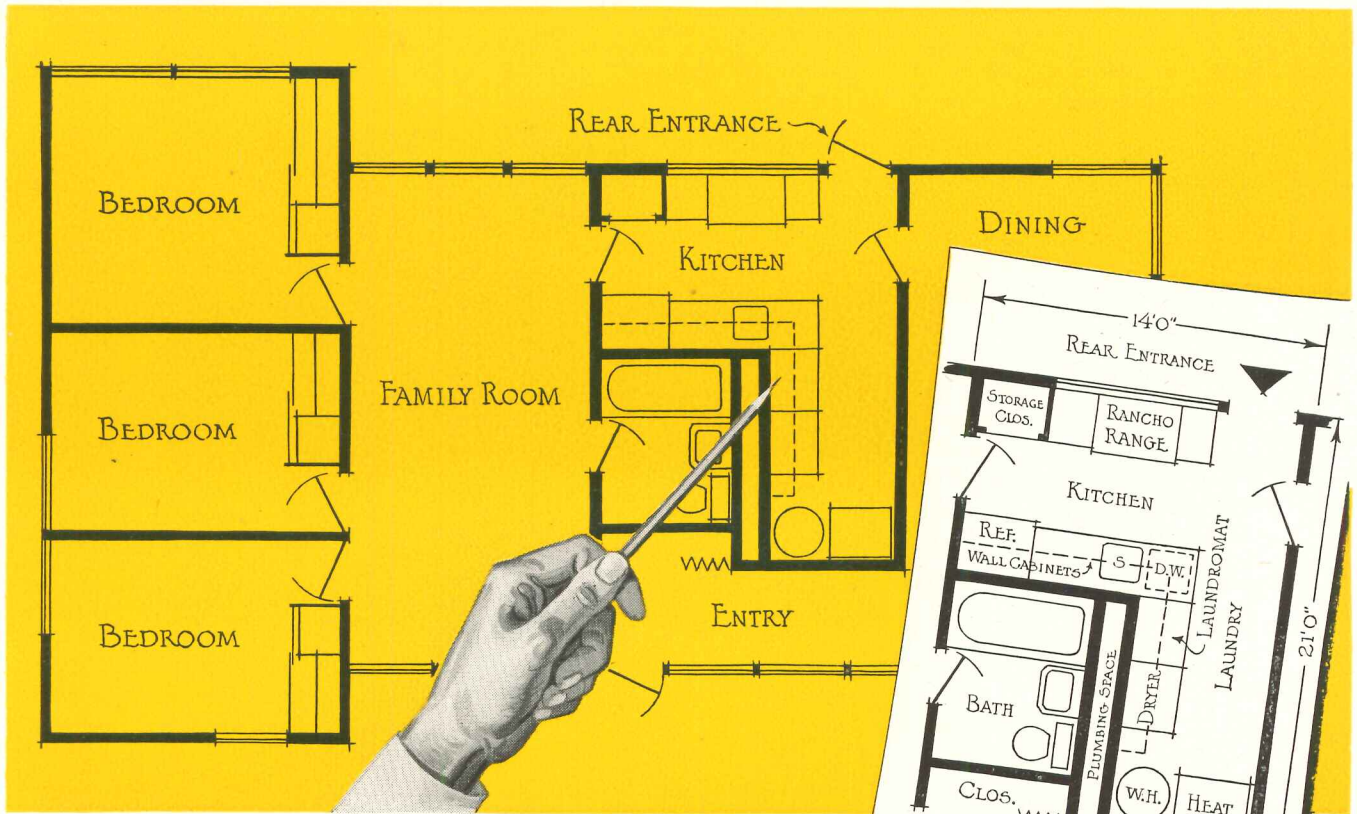

HERE'S AN IDEA for Compact, Economical Appliance Installation

For greatest economy and efficiency, the appliances required for truly modern living, should be PLANNED into the home while it is still on the drawing board.

The appliances needed to give a homeowner the maximum freedom of living include an electric refrigerator, range, dishwasher, food waste disposer, clothes washer and dryer, water heater and kitchen ventilating fan.

In the layout above, all bathroom, kitchen and laundry equipment have been planned around a plumbing "core" ... and all are but a few feet distant from the electric water heater that serves them.

It's easy to plan Westinghouse Appliances into homes. There are models and sizes for all situations ... for homes in ALL price ranges. What's more, each has a crisp, sparkling style of its own yet a "family" resemblance to each other, all of which tends to enhance the interior appearance of any home.

Send for your copy of the Westinghouse Appliance catalog mentioned in the coupon below. Learn for your-

self why Westinghouse Appliances are preferred by millions of homeowners, *specified* by leading architects and builders everywhere.

... of course, it's electric!

Westinghouse Electric Corporation
Electric Appliance Division
Mansfield, Ohio

Gentlemen:

Please send me a Westinghouse Appliance Catalog.

Name _____

Street _____

City & State _____

AR-5

YOU CAN BE SURE..IF IT'S Westinghouse



FROST-FREE



VENT FAN



LAUNDROMAT



DRYER



ELECTRIC SINK

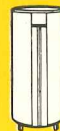

WATER HEATER



WASTE-AWAY



RANGE

FOR THE ARCHITECT, THE BUILDERS AND THOSE WHO INVEST



ONE OF THE MACOMBER GROUP
OF MODERN FABRICATING UNITS

THESE MODERN FACILITIES WILL AMPLY QUALIFY AS YOUR SOURCE FOR STEEL BUILDING PRODUCTS

Here under many roofs is tangible evidence of what men in construction want in their steel source . . . advanced engineering practice; coordinated fabricating beamed at honest delivery dates; ample established credit among suppliers and a clean sales policy. Investigate MACOMBER from any standpoint—in person—if you can and we believe your decision will make Macomber your steel source.

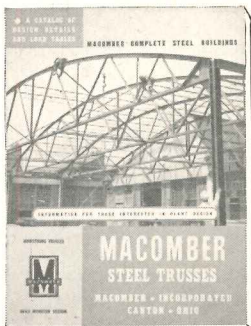

STANDARDIZED STEEL BUILDING PRODUCTS
MACOMBER • INCORPORATED
CANTON, OHIO

V BAR JOISTS • LONGSPANS • BOWSTRING TRUSSES • STEEL DECK



LUDOWICI

tile roofs are modern roofs

The very basis of contemporary architecture as applied to small home design is living *convenience* with the economy of *quality*. If the choice of a roof shares in this kind of thinking, then tile must be evaluated because it is one material that best meets functional requirements.

1. Ludowici Tile roofs are permanent; never need the inconvenience of periodic maintenance be considered.
2. Economy is obvious. Being completely weatherproof and fire-proof the first cost is a lifetime investment.
3. From the standpoint of design the textures and various color combinations not only conform to modern design but enhance the typical severity.
4. With correctly engineered construction including truss technique a tile roof for the average home requires no more structural support than any other roofing material.



Simplified truss construction with spans up to 25' or 30' for low-pitched roofs offer safe support for tile at minimum structural costs



Williamsburg Shingle Tile

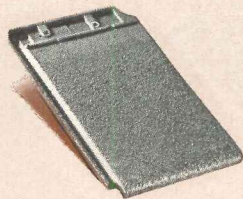

Lightweight Shingle Tile



Interlocking Tile Stones

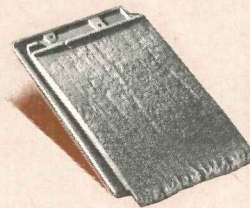

Early American Shingle Tile

Ludowici Roofing Tiles of today with their adaptable shapes are not the traditional pattern of yesterday. They are consistent with the modern motif and have been used in the work of many outstanding architects. See our catalog in Sweets. Further information and samples will be gladly sent on request.

LUDOWICI-CELADON CO.

Suite 1201, 75 East Wacker Drive, Chicago 1, Illinois

New York 17, N.Y. -
565 Fifth Ave.
Washington 5, D.C.
740 - 15th St., N.W.

Dallas 9, Texas
4801 Lemmon Ave.
Cleveland 20, Ohio
12734 Woodland Ave.

For tough assignments, specify Roddiscraft solid core flush doors

For
HOSPITALS
SCHOOLS
APARTMENTS
HOTELS
INSTITUTIONS

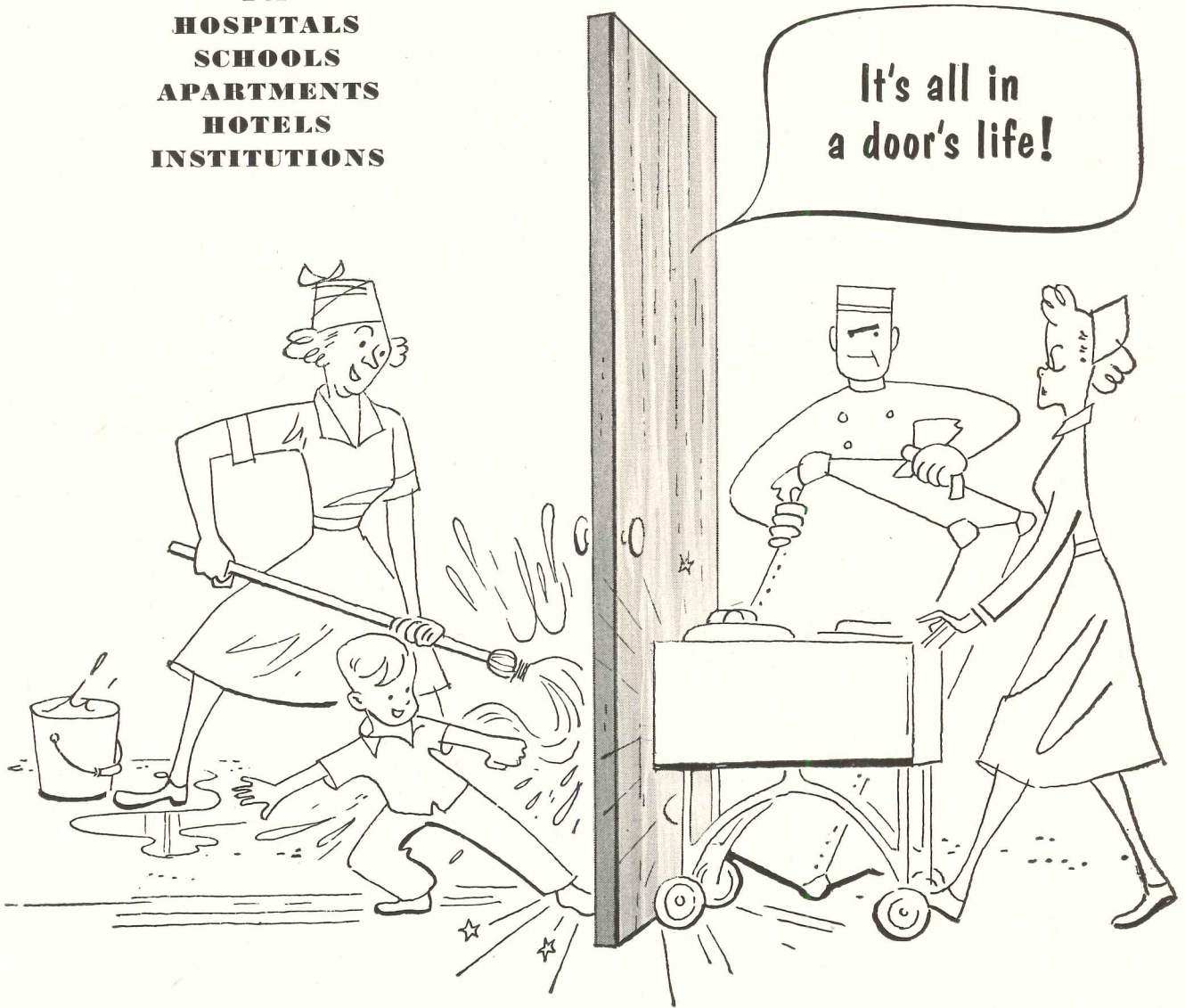

Doors lead a tough life in public buildings. Roddiscraft Solid Core Flush Veneered Doors are built to take it.

FIRE RESISTANT — exceed a regular fire test for over 40 minutes. Provide extra protection where needed in multiple and single dwelling units.

SOUND RESISTANT — develop an average sound transmission loss of 30.9 decibels — only a little less than specially constructed sound retardant doors of much greater cost.

RESISTANT TO ABUSE — core, crossbandings and face veneers welded into a single unit with the inherent strength of true plywood construction.

WATERPROOF — for exterior and interior use. Phenolic resin glue provides two completely waterproof shields over entire area of the door on each side of the core.

STANDARD THICKNESS FACE VENEERS — provide greatest resistance to checking and abuse — permit better matching.

Specify Roddiscraft Solid Core Flush Veneered Doors for the tough assignments.

NATIONWIDE Roddiscraft WAREHOUSE SERVICE

Cambridge, Mass. • Charlotte, N. C. • Chicago, Ill. • Cincinnati, Ohio • Dallas, Texas • Detroit, Michigan • Houston, Texas • Kansas City, Kan. • New Hyde Park, L. I., N. Y. • Los Angeles, Calif. • Louisville, Ky. • Marshfield, Wis. • Milwaukee, Wis. • New York, N. Y. • Port Newark, N. J. • Philadelphia, Pa. • St. Louis, Mo. • San Antonio, Texas • San Francisco, Calif.

Roddiscraft

RODDIS PLYWOOD CORPORATION

Marshfield, Wisconsin

15 ACRES of AMERICA'S FINEST ROOF DECK

American Stores Co.,
New Warehouse and Bakery
Philadelphia, Pa.

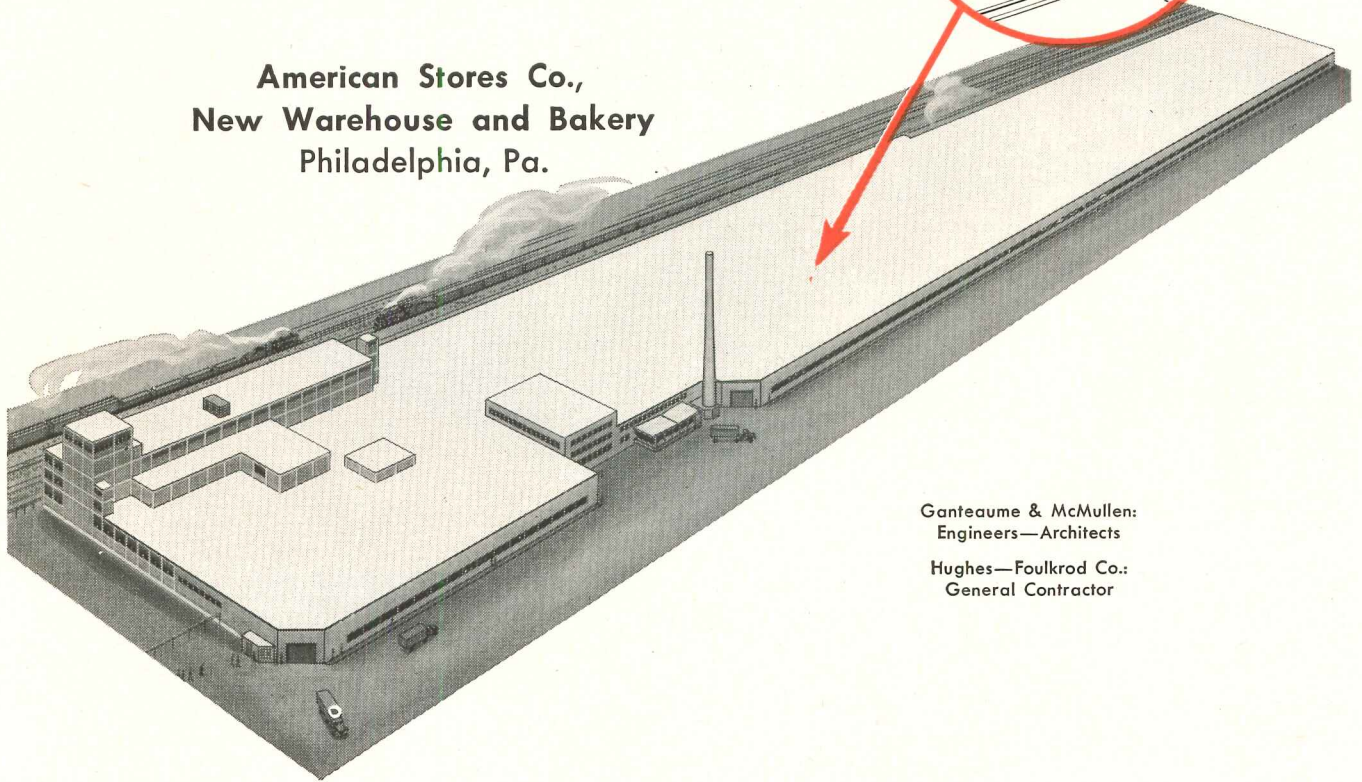

Ganteaume & McMullen:
Engineers—Architects

Hughes—Foulkrod Co.:
General Contractor

... It's Kaylo Roof Tile — Lightweight,
Strong, Insulating and Incombustible!

Kaylo Insulating Roof Tile is hydrous calcium silicate—the lightweight structural material that offers numerous advantages. Although Kaylo Tile *exceeds* the strength requirements for typical roof loads, a Kaylo roof deck weighs *only* 6 pounds per square foot. This means lighter foundations, a lighter supporting structure . . . substantial savings of structural steel.

The insulating value of Kaylo Tile, equal to one and one-half inches of standard insulation board, saves on heating and cooling costs. Since Kaylo Tile

is incombustible, it offers protection against fire. The tile resists moisture damage and it is rot-proof.

A Kaylo roof deck also forms a completed ceiling. The tile's near-white underside reflects light and requires no painting. Kaylo Tile is easily handled and placed, thus saving construction time.

These are just a few of the facts to show Kaylo Insulating Roof Tile's ideal combination of qualities—advantages which offer you economical construction, permanence and all-around satisfaction.

WRITE FOR FREE BOOK—"Kaylo Insulating Roof Tile." Address: Dept. N-214, Owens-Illinois Glass Company, Kaylo Division, Toledo 1, Ohio.



KAYLO

... first in calcium silicate

...pioneered by OWENS  ILLINOIS Glass Company

MAIN OFFICE: TOLEDO 1, OHIO — KAYLO SALES OFFICES: ATLANTA • BOSTON • CHICAGO • CINCINNATI • CLEVELAND • DETROIT
HOUSTON • MINNEAPOLIS • NEW YORK • OKLAHOMA CITY • PHILADELPHIA • PITTSBURGH • ST. LOUIS • WASHINGTON

Don't let old-fashioned radiators stymie modernization plans

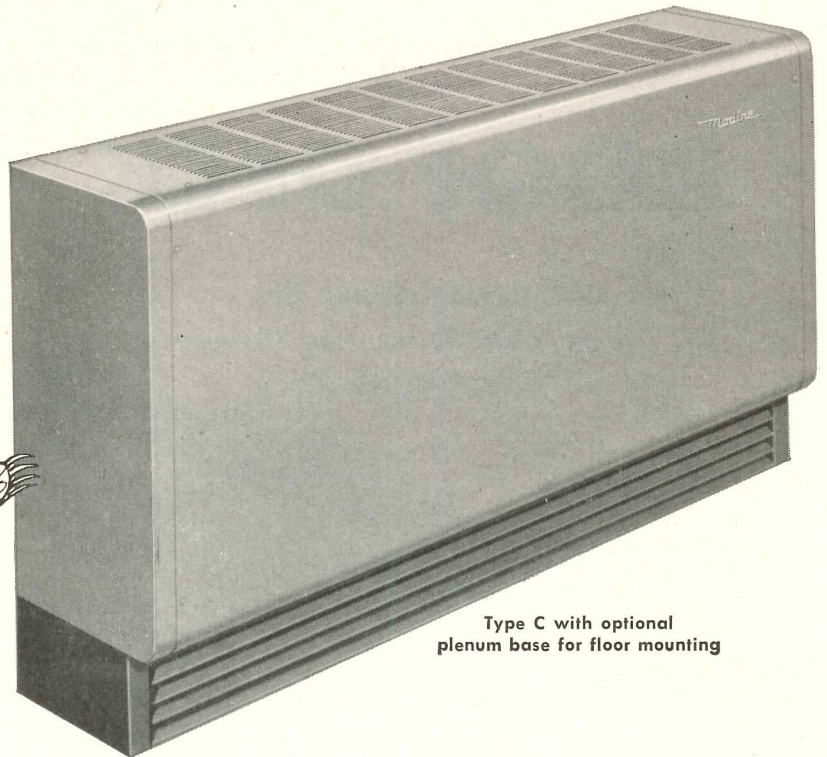
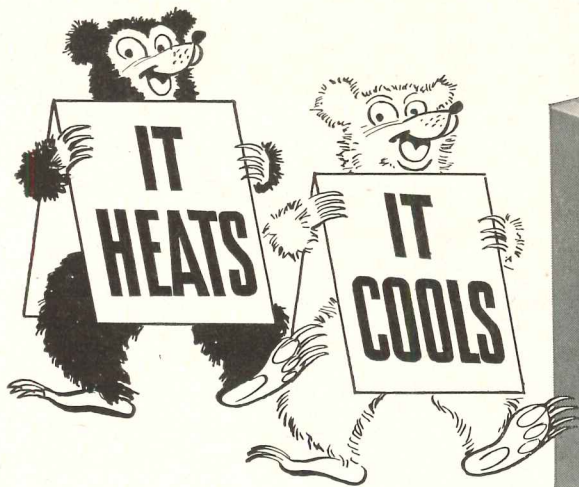

Type C with optional plenum base for floor mounting

IDEAL FOR STORES, SHOWROOMS, SCHOOLS, BANKS, HOTELS, HOSPITALS, THEATERS, CHURCHES, OFFICES, VESTIBULES AND OTHER COMMERCIAL AND PUBLIC BUILDING AREAS

Modine Cabinet Units simplify remodeling... save space... permit addition of cooling

| WHAT YOU GAIN when you replace old-fashioned radiators with Modine Cabinet Units | |
|--|---|
| SPACE | Cabinet Units occupy only a portion of space taken by radiators. |
| CONCEALMENT | Cabinet Units can be built-in or installed outside of rooms served. |
| COOLING | You can have both heating and cooling in a single unit. |
| VENTILATION | Attachment of optional plenum-damper base permits fresh air introduction. |
| AIR CIRCULATION | Quiet blower fans provide positive air distribution. |
| APPEARANCE | Attractively styled cabinets blend with modern decor. |

THERE'S no need to accommodate unsightly, existing radiators in modernization work. One attractive Modine Cabinet Unit can replace up to three or more radiators... frequently with no change in piping.

Mounted on the floor, wall or ceiling, Cabinet Units take little space. When installed with ducts they can be completely concealed above a false ceiling or behind a partition.

Where desired, chilled cooling and hot water heating can be provided with a single unit for year 'round comfort. Other models for steam or hot water heating only. Fresh air introduction is possible through use of an optional plenum base.

Not as elaborate or expensive as unit ventilators or air conditioners, Modine Cabinet Units are economical to use. What's more, the scrap value of the radiators they replace defrays part of their cost. (For example, a 280 lb. Modine Cabinet Unit replaces 3200 lbs. of cast iron radiation.) Available in five sizes from 120 to 640 Edr.

For complete information write for free illustrated Bulletin 550. Modine Manufacturing Company, 1510 De Koven Ave., Racine, Wis. C-1149

WRITE FOR FREE BULLETIN 550



Modine
CABINET UNITS
FOR HEATING & COOLING

Time is your variable

ROBERTSON PRE-ENGINEERED MATERIALS CUT CONSTRUCTION COST

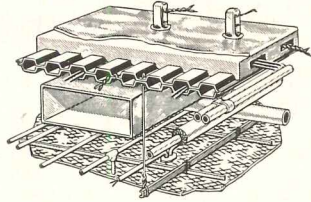

Q-FLOORS

two men can lay 32 sq. ft.
in 30 seconds!

These are steel subfloors. They are installed as fast as the frame is erected. Therefore they form immediate and permanent platforms for all subcontractors. By properly organizing the work, a contractor can cut 15 to 20% off over-all construction time. The architect saves a great deal of drafting time.

The steel cells of Q-Floor become raceways for all electrical systems. An electrician drills only a small hole and installs an outlet on any six-inch area of floor in a matter of minutes. Desks, business machines and partitions can be located with complete freedom, after tenants move in.

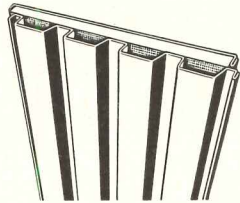

Q-PANELS

50 sq. ft. of insulated, finished
wall in 9 minutes!

Q-Panels are only 3" thick but have greater insulation value than a 12" masonry wall. They arrive at the site cut to fit and are quickly attached to the steel frame.

The inside surface is a metal sheet, then comes insulation, then the outer skin of fluted aluminum, Galbestos, stainless or metal-coated steel, depending upon the utility and architectural requirements.



GALBESTOS

METAL SIDING & ROOFING
enables workmen to cover up to 2½
times as much area as competitive
materials.

Galbestos metal is the ideal material for corrosive industrial exposures, withstanding the most extreme climatic conditions, and requires no maintenance.

Galbestos is steel to which asbestos felt is metallically bonded. The felt is then impregnated with asphalt and weatherproofed. Available in various forms, in two standard widths and in lengths up to 12 feet. Galbestos has been tested and classified by Underwriters' Laboratories, Inc., and Factory Mutual Laboratories. It is available in black or maroon or can be field painted.

Galbestos roofing and siding is fastened by the exclusive Robertson Top-Speed Method, a completely new system which eliminates all interior scaffolding. This is why Galbestos is faster to erect. It can be insulated by an equally fast method, greatly reducing construction cost for heated buildings.

WHAT WE REALLY MAKE IS TIME

WRITE FOR THESE FREE CATALOGS

1. Q-Floors
2. Q-Panels
3. Galbestos
4. Top-Speed Fastening for Galbestos
5. Top-Speed Insulation for Galbestos

H. H. ROBERTSON CO.

2404 Farmers Bank Building
Pittsburgh 22, Pennsylvania



Offices in ALL Principal Cities
in the U. S. A. and Canada

World-Wide Building Service



Wheeling



ExM Vault Reinforcing

For the Federal Reserve Bank of San Francisco's newest branch in Portland, Oregon, it's a solid concrete vault reinforced with Steelcrete ExM Vault Reinforcing.

Not woven, not welded, but pierced and stretched from a single plate of solid steel, ExM proves the most easily placed and most highly resistant reinforcing known for modern bank vaults. Vault Reinforcing is but one of many materials for which architects, engineers and

builders turn to Wheeling. The Wheeling line of building materials includes: Steelcrete Reinforcing Mesh • Expanded Metal • Metal Lath and Metal Lath Accessories • Tri-Rib Steel Roof Deck • ExM Angle Frame Partitions. Wheeling Steelcrete Vault Reinforcing supplied and erected by SOULE STEEL COMPANY. Architect: PIETRO BELLUSCHI; Consulting Engineer: MILES KAYE COOPER; General Contractor: ROSS B. HAMMOND CO.

WHEELING CORRUGATING COMPANY • BUILDING MATERIAL DIVISION

ATLANTA BOSTON BUFFALO CHICAGO COLUMBUS DETROIT KANSAS CITY LOUISVILLE MINNEAPOLIS NEW ORLEANS

FEDERAL RESERVE...

Here in this close-up is seen the sturdy interlaced reinforcing that Steelcrete gives to concrete walls.

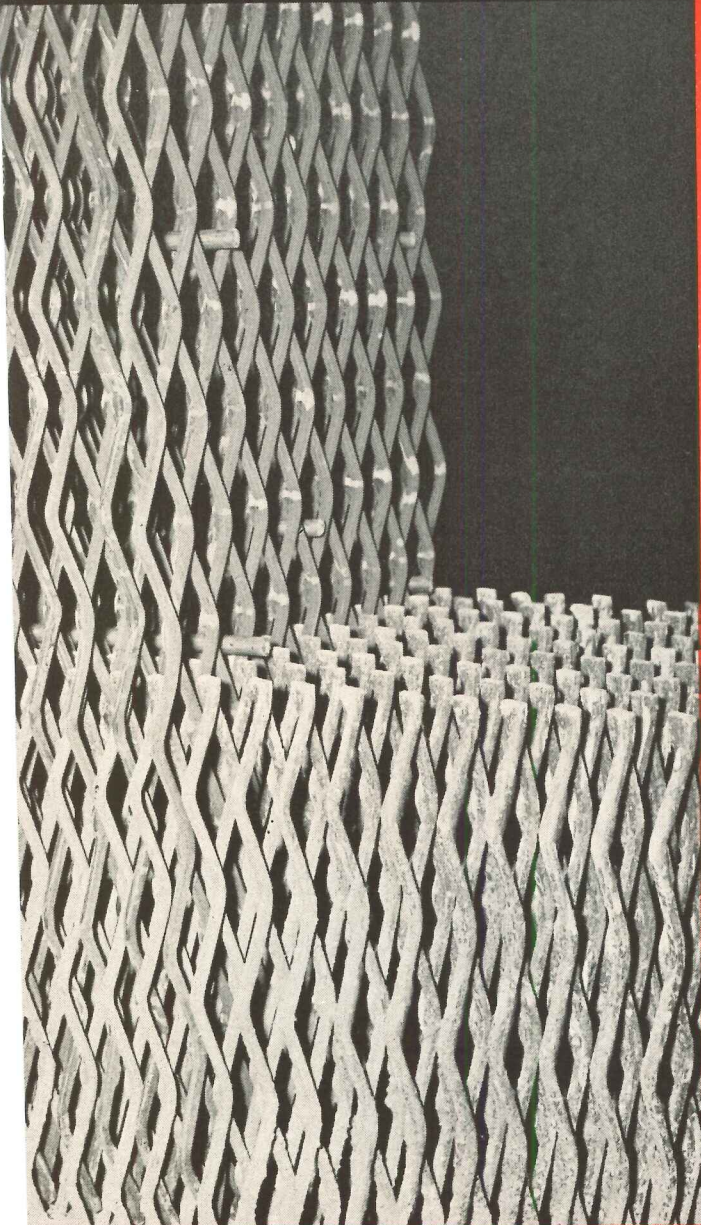

In this photograph the simplicity of Steelcrete assembly is readily seen.

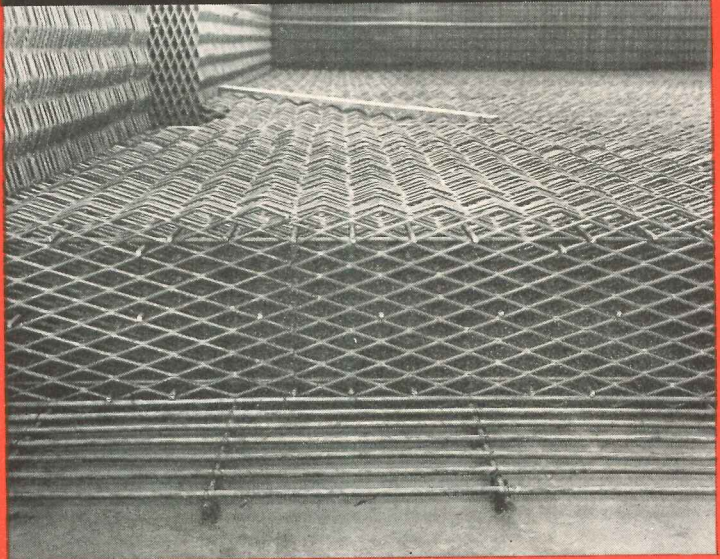

In the roof view, note the relatively long spans made possible by Steelcrete's lateral stiffness.

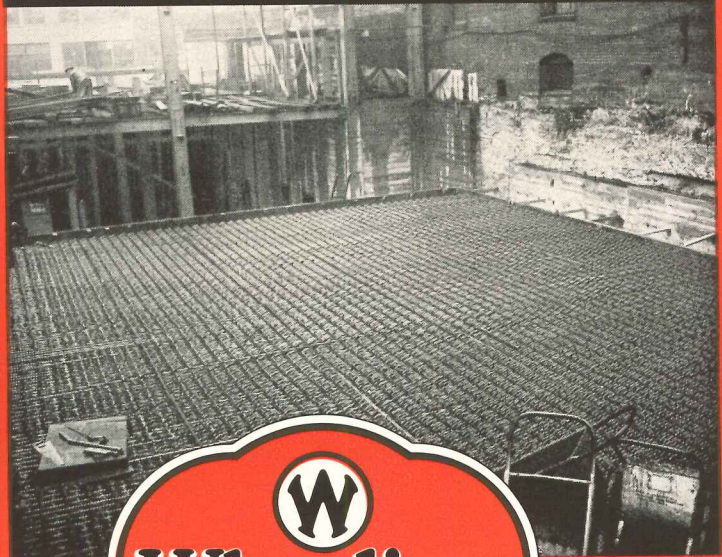

WHEELING, WEST VIRGINIA
NEW YORK PHILADELPHIA RICHMOND ST. LOUIS





none of this with a Briggs bathtub—it's leakproof!

No dripping ceilings under Briggs Beautyware bathrooms! These revolutionary die-formed steel fixtures take care of this problem—and untie every *other* knot in the business! Briggs bathtubs are *lighter*—(only 110 pounds), and stronger. Briggs tubs are *safer*—thanks to the patented Safety-Bottom, the helpful hand grip. Briggs tubs give you *uniform quality*: every tub is furnished in stainproof (acid-resistant) porcelain enamel. Briggs fixtures fit *exactly*—because of their close tolerance engineering. Yet with *all* these extras, Briggs fixtures are modestly priced! Write now for new catalog featuring Briggs plumbing fixtures and Briggs brass. Briggs Manufacturing Company, 3027G Miller Avenue, Detroit 11, Michigan.

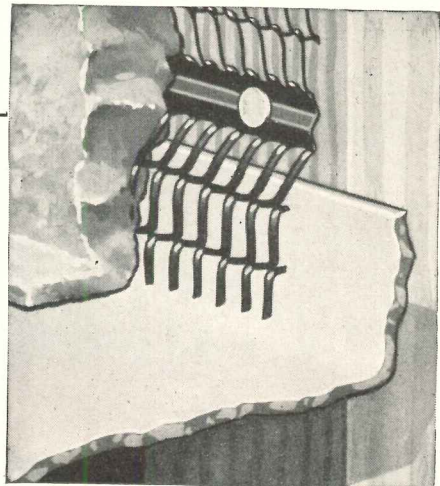

Briggs solves the danger of leaks at tub-wall line—with an integral lip flange. This provides a perfect flashing—a permanent water seal—tub to walls.

BRIGGS *Beautyware*

Architectural Service

Modern Store Fronts

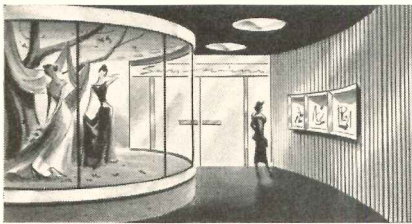

No metal offers greater flexibility in design than aluminum—one of the reasons why Reynolds Aluminum is so often used in the design of modern store fronts. In addition, aluminum blends well with other materials, does not streak or stain other surfaces, stays bright and keeps its trim neatness. Extruded and roll-formed aluminum shapes for structural and trim and aluminum fasteners are available for most requirements. Special shapes are easily and inexpensively extruded.

All Type Doors

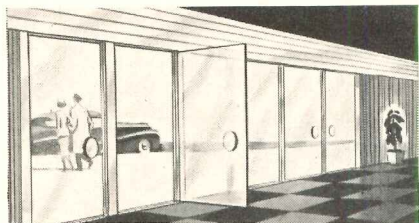

Lightweight, rustproof aluminum offers architects the ideal metal for exterior and interior doors—hinged doors, pivot doors, revolving doors, overhead roll-up doors, combination storm-screen doors—in fact, practically all types for commercial and domestic use. The strength, attractiveness, low cost, versatility of extrusions and other characteristics of aluminum provide architects with unlimited possibilities for achieving the most in utility, appearance and durability in doors of both standard and special design.

Efficient Lighting



Aluminum's high reflection efficiency, natural beauty and unlimited applications in architectural design also make it ideal for most lighting installations. Aluminum reflects up to 85% of light. It polishes to a mirror brightness for highlighting or can be etched for soft diffusion and indirect lighting. Its neat appearance is not marred by time and cleaning. Standard factory assembled units are suitable for many installations and aluminum sheet and extrusions provide wide flexibility for special designs. Write to Reynolds for details on these and any other architectural aluminum applications.

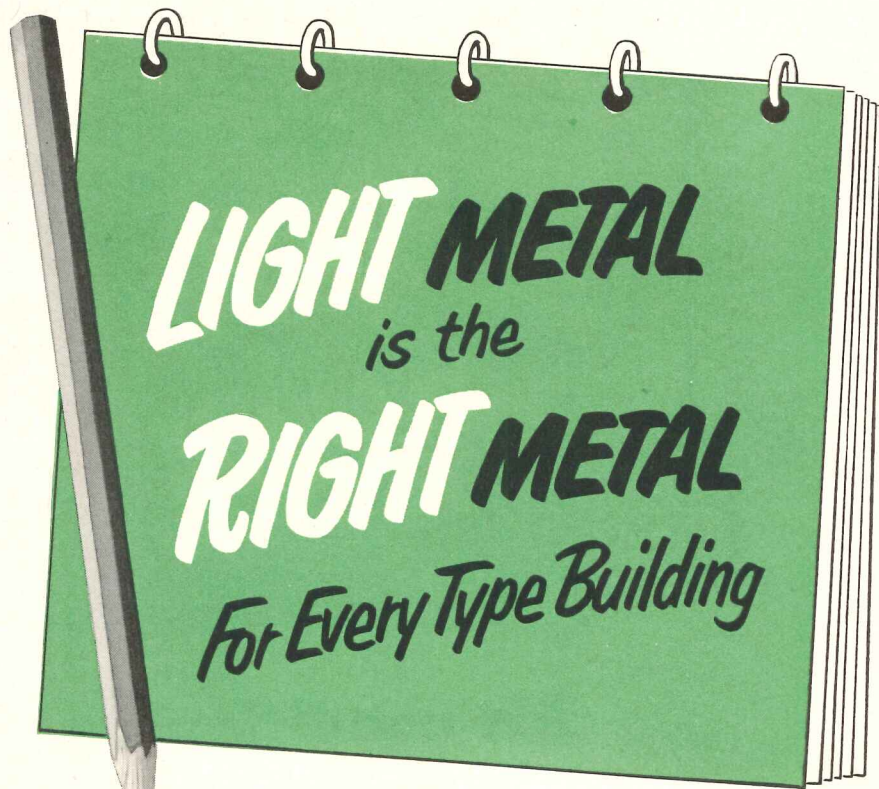

Put Reynolds Architectural Service to Work on Your Design



You need a "sharp pencil" today to keep building costs within the client's budget and still maintain your reputation. Part of the answer comes in building better and building faster with aluminum—the *only mass-produced metal that costs less today than before World War II.*

Aluminum is flexible in design, light but strong and easy to work with standard carpenter tools. To give you the most from aluminum—Reynolds, besides supplying this high quality metal, also offers specialized help through the Reynolds Architectural Service.

This service is available to architects for the asking. It is set up to answer aluminum design and construction questions and to help contractors in building better, building faster with aluminum—the *light metal* that's the *right metal* for every type of construction.

For complete information call the Reynolds office listed under "Aluminum" in your classified telephone directory or write direct.

FREE BOOKLET!

Send for your copy of Reynolds Architectural Folio today! A complete, up-to-date kit on architectural aluminum. In loose leaf form with drawings for direct tracing. Free when requested on business letterhead. Write to Reynolds Metals Company, 2572 So. Third St., Louisville 1, Ky.

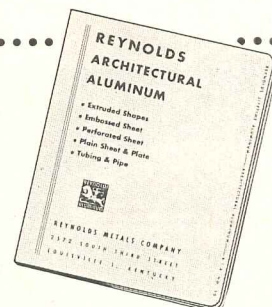

REYNOLDS ALUMINUM

MODERN DESIGN HAS ALUMINUM IN MIND

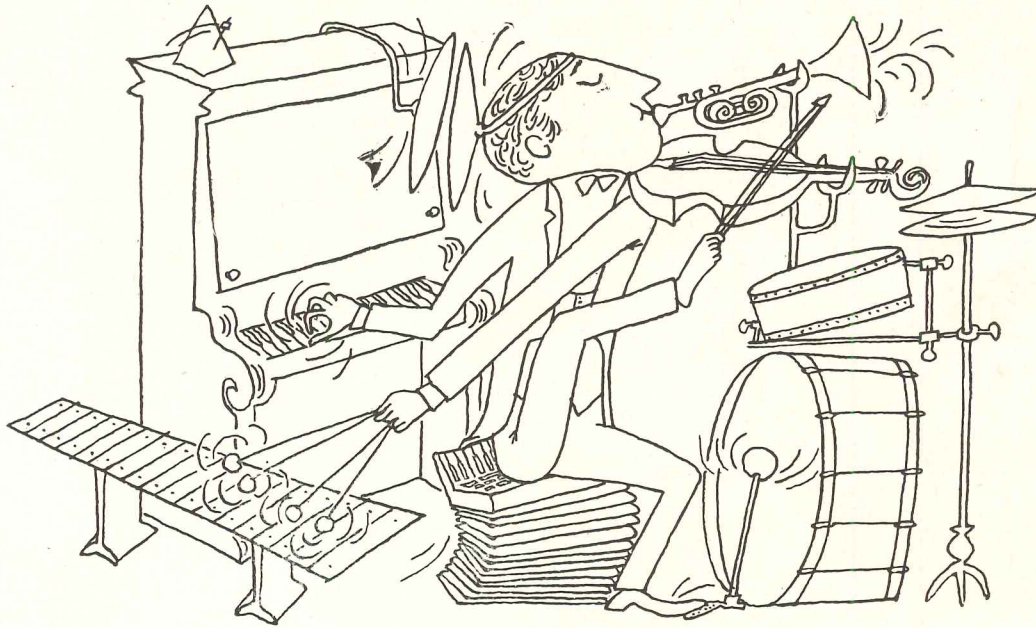

Air conditioning can be in concert too

If you've had problems air conditioning buildings that have a variety of heat loads, here's news that'll be music to your ears.

Our new Zoning Weathermaker is a year-round air conditioning unit that gives accurate temperature control of several different zones at the same time. A blow-through fan coil system, there are 14 possible zones available, each zone having a hot and cold damper placed at 90 degrees to each other, so one is closed when the other is open. And any degree of modulation is possible.

Sectionalized for easy installation, the Zoning Weathermaker can be suspended from the ceiling or floor mounted. And for greater flexibility of application, all piping connections can be made from either side.

This new Weathermaker joins Carrier's great family of products . . . products matched in size and performance to work together . . . products to meet every industrial or comfort air conditioning requirement your client may have. Carrier Corporation, Syracuse, New York. . . . for 50 years — the people who know air conditioning best.

Carrier

AIR CONDITIONING
REFRIGERATION
INDUSTRIAL EQUIPMENT

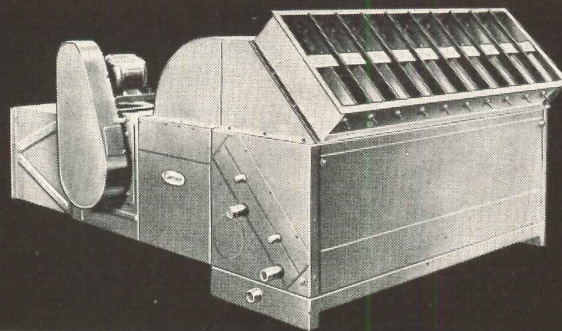

The Carrier Zoning Weathermaker, available in 5 sizes with cooling coils in 4 or 6 row direct expansion . . . or 4, 6 and 8 row cooling coils for brine or chilled water. Cooling capacities from 15 to 80 tons, 4100 to 16,400 cfm.

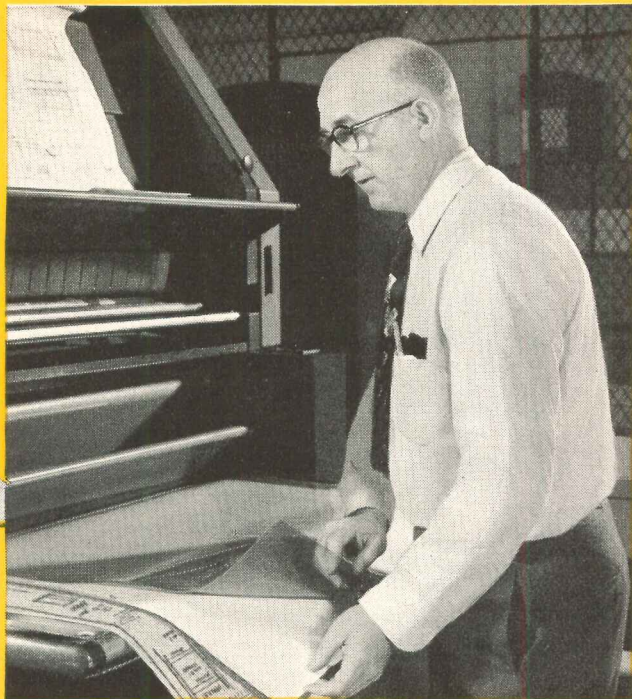
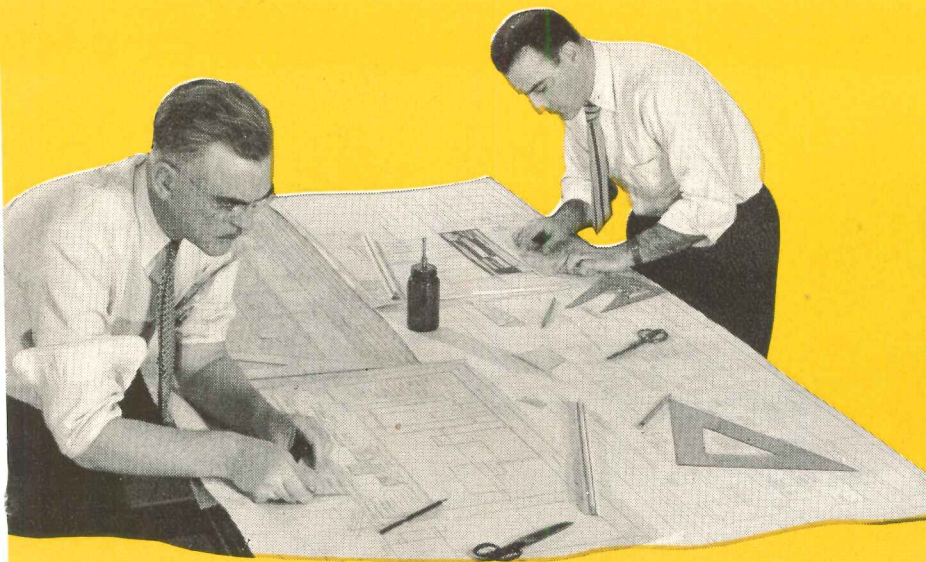

The American Brass Company, Waterbury, Conn., reports

Plant layout speeded

with Kodagraph Autopositive Paper

THE engineering and drawing reproduction departments of The American Brass Company must keep pace with the constant plant-layout demands of ten manufacturing divisions. *And here's how Autopositive Paper saves time and dollars in this work.*

First, paper cutouts of machines and equipment are pasted in position on a whiteprint of the proposed layout. From this opaque pasteup, a positive reproduction on Autopositive Paper is made *directly*. There's no negative step, no darkroom handling with this revolutionary photographic intermediate material. Just exposure in a

standard whiteprint machine . . . processing in standard photographic solutions.

Then, the Autopositive intermediate—with dense photographic black lines on a durable, evenly translucent base—is used to produce the desired number of prints. These are sent to the branch involved to be studied and returned with comments.

This procedure may be repeated half a dozen times until complete agreement is reached on the final layout. And *every time* revolutionary Autopositive Paper saves time and dollars!

Other important uses of Kodagraph Autopositive Paper at American Brass

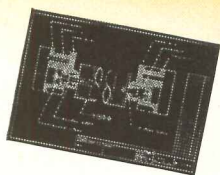

. . . to reproduce the blueprints and direct-process prints which the various divisions receive from vendors. The Autopositive intermediates are then used to produce any number of shop prints.

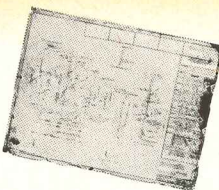

. . . to reclaim old, soiled, or worn drawings. Autopositive Paper intensifies line details . . . drops out smudges, creases—delivers intermediates which produce clean whiteprints and blueprints.

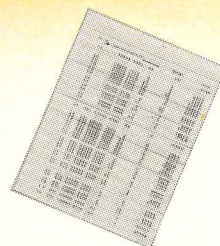

. . . to speed print service to all departments. Autopositive reproduces production reports, parts lists, documents of every type. And opaque originals can be copied as readily as translucent ones.

Kodagraph Autopositive Paper

"THE BIG NEW PLUS" in engineering drawing reproduction

Learn how Kodagraph Autopositive Paper is simplifying routines in thousands of concerns. Write today for a free copy of "New Short Cuts and Savings" for interesting facts about companies you know . . . and a revolutionary new product *you should know*.

MAIL COUPON FOR FREE BOOKLET

EASTMAN KODAK COMPANY, Industrial Photographic Division, Rochester 4, N. Y.
Gentlemen: Please send me a free copy of your new illustrated booklet, "New Short Cuts and Savings."

Name _____ Position _____

Company _____

Street _____

City _____ Zone _____ State _____

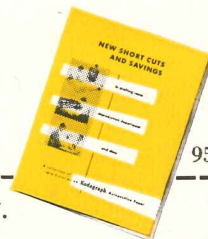

95

Kodak
TRADE-MARK



Waiting Room — Southeastern Greyhound Bus Terminal, Birmingham, Alabama

These monolithic ceilings were sound-conditioned with a trowel

HERE'S how to speed up many jobs and keep costs down — specify Gold Bond Acoustical Plaster and let your contractor sound-condition and decorate the ceilings in one easy continuous operation. Gold Bond Acoustical Plaster is:

ECONOMICAL. Provides incombustible acoustical treatment at low cost.

ARCHITECTURALLY FLEXIBLE. May be applied to flat or curved surfaces. Also to existing ceilings after applications of an asphalt emulsion bonding coat.

EASY TO APPLY. Gold Bond Acoustical Plaster can be applied by any journeyman plasterer to the regular base coat of gypsum plaster. It's light on the hawk, extremely easy to work.

ATTRACTIVE. Gives the beauty of plaster—a smooth, unbroken surface that may be troweled or floated. Furnished in five colors... oyster white, ivory, cream, buff and caenstone.

FIRE RESISTANT. Basically a mineral product, Gold Bond Acoustical Plaster is incombustible.

NON-GLARE LIGHT REFLECTION. Oyster white...70%.

NOISE REDUCTION. .55 to .60 floated or troweled to finish.

PAINTABILITY. Tests with six coats sprayed-on paint showed no loss in acoustical efficiency.

Gold Bond Acoustical Plaster Technical Folder, A.I.A. 39-B-1 supplied without charge upon request.

NATIONAL GYPSUM COMPANY • BUFFALO 2, N. Y.

Lath, Plaster, Lime, Sheathing, Gypsum Roof Decks, Wall Paint, Textures, Rock Wool Insulation, Metal Lath, Sound Control Products, Fireproof Wallboards and Decorative Insulation Boards.



Lunch Room — Southeastern Greyhound Bus Terminal, Birmingham, Alabama

**You'll build or
remodel better with
Gold Bond**



Private office of W. H. Upson, president of The Upson Company, after modernization and painting according to COLOR DYNAMICS.

Experience proves
Pittsburgh COLOR DYNAMICS
 produces these 4 important results—

1. lessens eye fatigue
2. stimulates concentration and improves efficiency and morale
3. reduces absenteeism
4. simplifies housekeeping problems

COLOR IN OFFICES is gaining in importance as knowledge increases of its psychological and physical effect on those who work in them. Science has proved that some colors excite and stimulate; others soothe and relax; still others depress, fatigue and irritate.

● **Pittsburgh** has put this knowledge of the *energy in color* to practical use in its painting system of COLOR DYNAMICS. That's why more and more operators, architects and builders of private and commercial office buildings are using this method to select colors for interiors that are

more comfortable to work in as well as more attractive to look at.

● **Typical of the comments** of executives who have successfully applied COLOR DYNAMICS in their offices are these of W. H. Upson, president of The Upson Company, Lockport, N. Y., one of this country's leading manufacturers of fibre wall panels.

● **"After more** than a quarter-century of use our offices had become cramped and out-of-date," says Mr. Upson. "We engaged Walter Dorwin Teague, noted industrial designer, to modernize our facilities. Results have exceeded our utmost expectations. Our

space is better utilized. Changes in lighting fixtures give us better illumination. The new colors, chosen according to the principles of COLOR DYNAMICS, aid those who use these offices to see better, work better and sell better, besides giving them greater pride in their surroundings.

● **"These offices** have also become a definite business asset as they lend prestige to our company and products. They serve as model salesrooms in which we have our best opportunity to demonstrate to jobbers, dealers and contractors the beauty, utility and efficiency of our various panel materials for walls and ceilings."

We'll Make a Color Engineering Study of Your Offices — FREE!

● For a complete explanation of COLOR DYNAMICS and what it can do for your offices you are planning or building, send for our *free* booklet containing many practical suggestions. Or better still, let us make a color engineering study of your building, or any portion of it, *free and without obligation*. Call your nearest Pittsburgh Plate Glass Company branch and arrange to have one of our trained color experts see you at your convenience. Or send this coupon.

SEND FOR A COPY OF THIS BOOK!

Pittsburgh Plate Glass Co., Paint Div.
 Department AR-52, Pittsburgh 22, Pa.

Please send me a FREE copy of your Booklet "Color Dynamics."

Please have your representative call for a Color Dynamics Survey without obligation on our part.

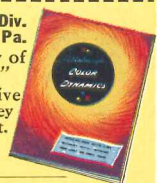

Name _____

Street _____

City _____ County _____ State _____

PITTSBURGH PAINTS
 PAINTS • GLASS • CHEMICALS • BRUSHES • PLASTICS

PITTSBURGH PLATE GLASS COMPANY

CLAY PIPE-ESSENTIAL ★ ECONOMICAL ★ EVERLASTING

New housing facilities are being constructed wherever defense expansion is underway. In Jones Mills, Arkansas, a huge new Aluminum Castings Plant will provide jobs for many new residents.

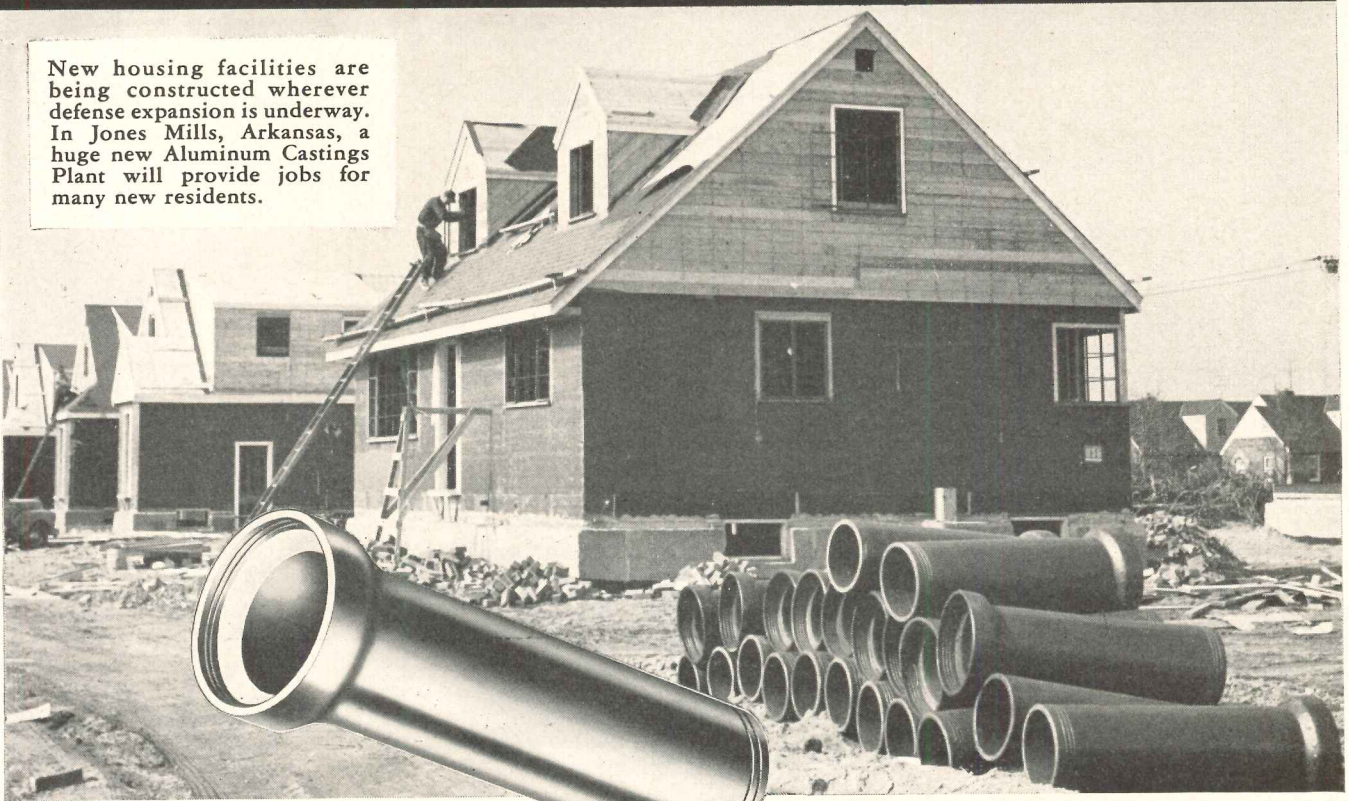

Take advantage OF PLENTIFUL CLAY PIPE

TO MEET DEFENSE HOME BUILDING DEADLINES

When you write specifications for building sewers or drains, you can count on Vitrified Clay Pipe to help keep the job on schedule. It's the one *plentiful* pipe that has proven its worth through year after trouble-free year of performance. It's the one non-critical material that's *sure* to last.

Clay Pipe is readily available and has a matchless reputation for permanent, everlasting service. Protect your own good name by using it to meet today's hurry-up

building deadlines. It's the only pipe you can *rely* on to resist acid, rust, rot, and decomposition—tomorrow, and fifty years from now. It never wears out.

NATIONAL CLAY PIPE MANUFACTURERS, INC.

206 Connally Bldg., Atlanta 3, Ga.

100 N. LaSalle St., Rm. 2100, Chicago 2, Ill.

703 Ninth & Hill Bldg., Los Angeles 15, Calif.

311 High Long Bldg., 5 E. Long St., Columbus 15, Ohio

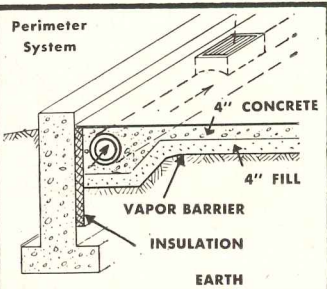

NEW HEATING SYSTEM WORKS BETTER — COSTS LESS

Check the advantages of Vitrified Clay Bell and Spigot Pipe heating ducts for low-cost, efficient heating of basementless buildings. Pour the concrete foundation-slab right on top of your Clay Pipe network—it's unaffected by moisture, furnace gases, or lime . . . and it combines all the advantages of direct and radiant heating. Write to your nearest NCPMI office for details.

C-352-4A

Vitrified

CLAY



PIPE

IN 8 MODELS
*up to 65 tons cooling
 capacity...15,675 Cfm...
 2,200,000 Btu per hour
 heating capacity*

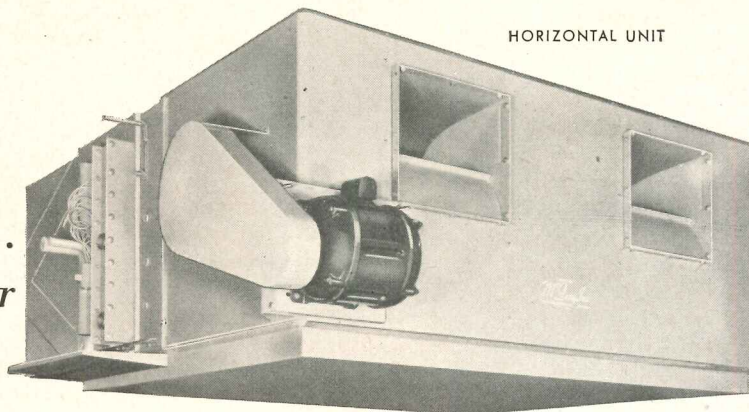

HORIZONTAL UNIT

McQuay CENTRAL STATION AIR CONDITIONERS

*...with **RIPPLE-FIN** construction to give you
 unequalled heat transfer efficiency!*

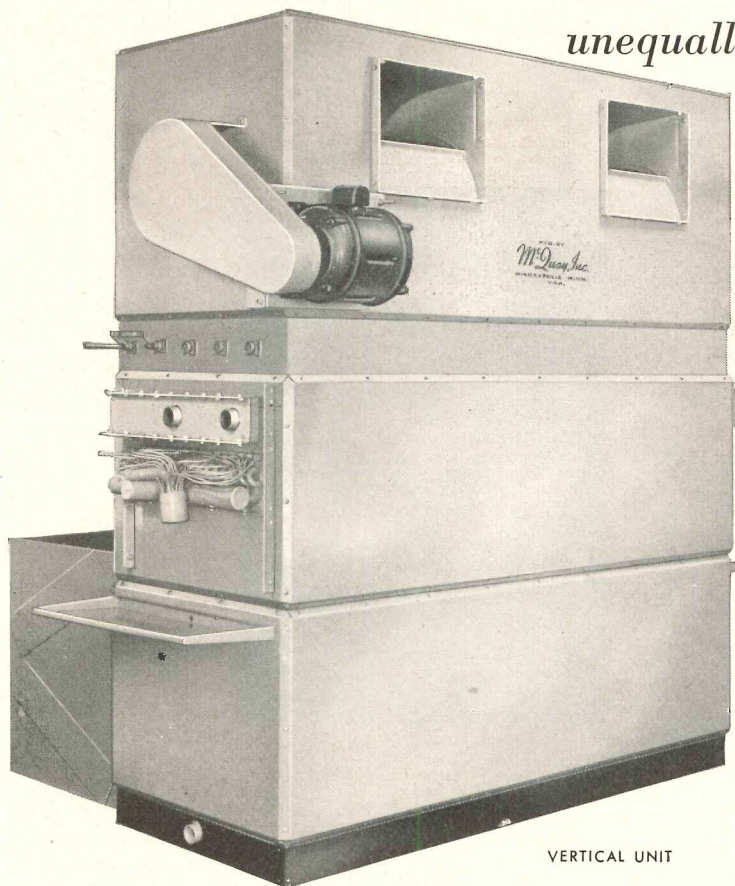

VERTICAL UNIT

Both the horizontal and vertical Central Station Air Conditioners provide year 'round comfort with cooling and dehumidification, heating and humidification, positive ventilation, and air filtering.

Each of eight models are sectionally built to give complete flexibility of arrangement and all parts are readily accessible to allow for ease of installation and service.

The famous McQuay Ripple-Fin Coils assure unmatched heat transfer efficiency. Also, because of the wide range of Cfm and Btu capacities offered, every normal heating and cooling application can be accurately met with McQuay Central Station Air Conditioners.

Auxiliary features available include: direct expansion, water, and steam coils, mixing box with dampers, "V" type and flat filter sections, humidifiers, and internal face and by-pass damper sections.

Representatives in principal cities. Write for Bulletin 502. McQuay, Inc., 1605 Broadway St. N. E., Minneapolis 13, Minnesota.

McQuay INC.

HEATING • REFRIGERATION • AIR CONDITIONING



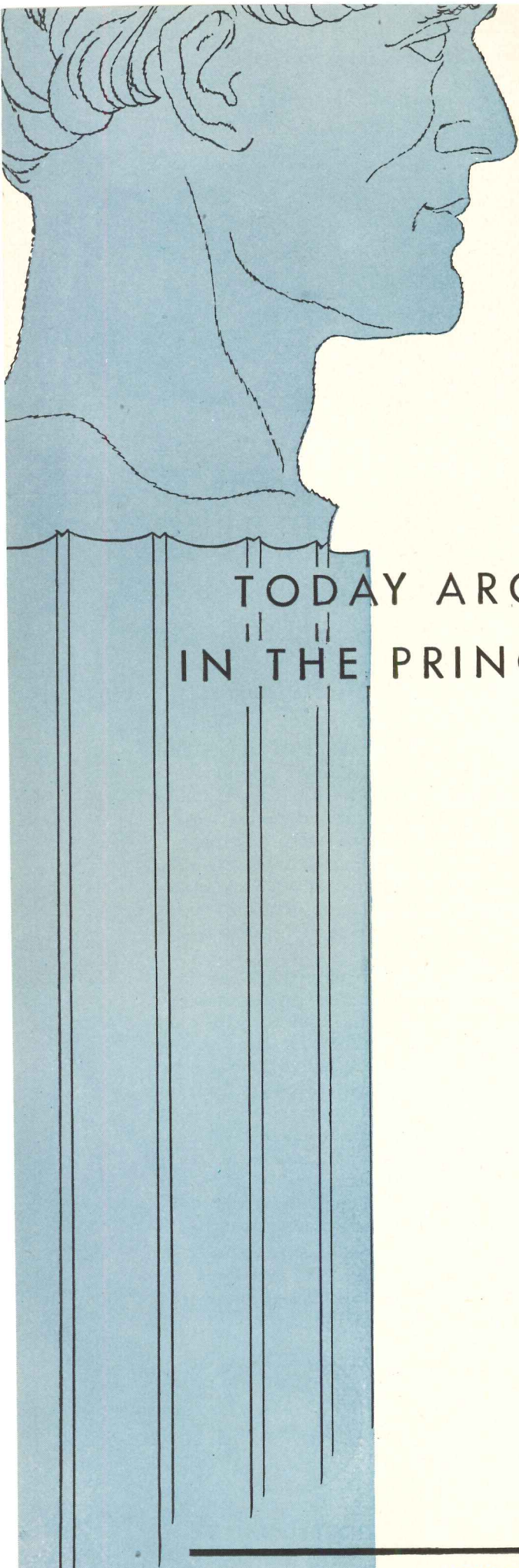

*Two thousand years ago the
great Roman architect, Vitruvius,
wrote: Architecture should
meet three requirements:
unity, strength, beauty.*

TODAY ARCHITECTS STILL BELIEVE
IN THE PRINCIPLES OF VITRUVIUS.....

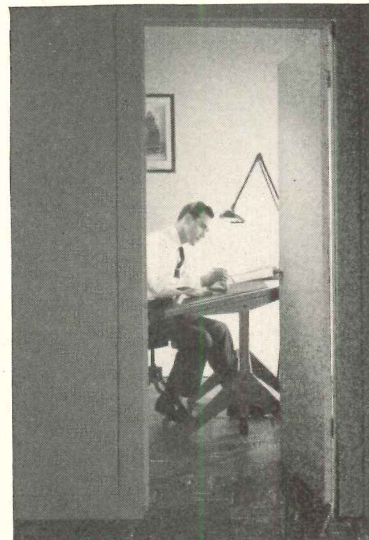

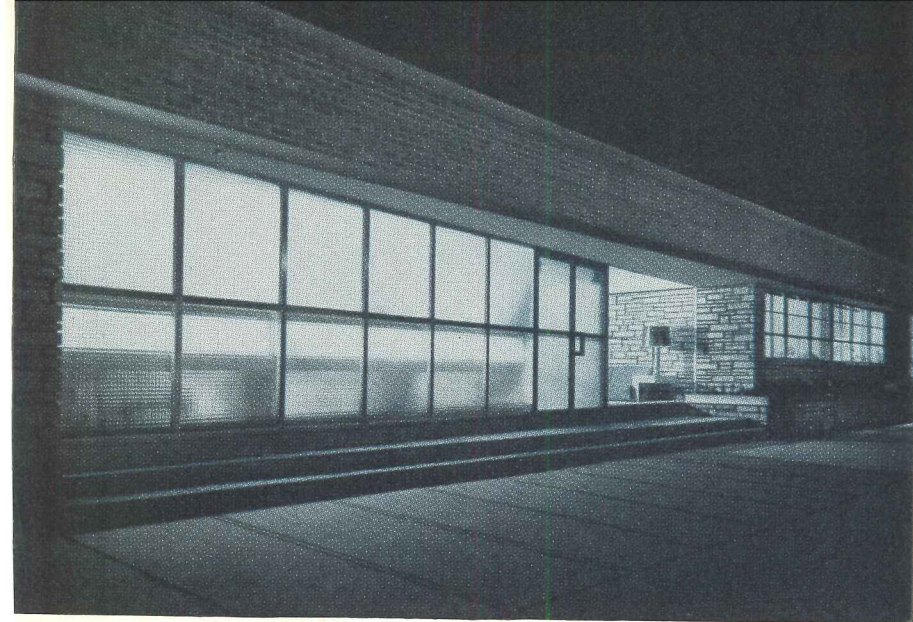

Kawneer Glazing Sash and Entrances:
Whitaker Guernsey Studio, Chicago, Ill.
Harper Richards, Architect.

... **THE FUNDAMENTAL TRUTHS OF ARCHITECTURE** are as eternal as the profession itself. Modern architects, whether designing a commercial building, store, or civic building—still honor the principles of unity, strength, and beauty. And they find that Kawneer architectural metal products have been painstakingly engineered and styled to help them achieve these goals.

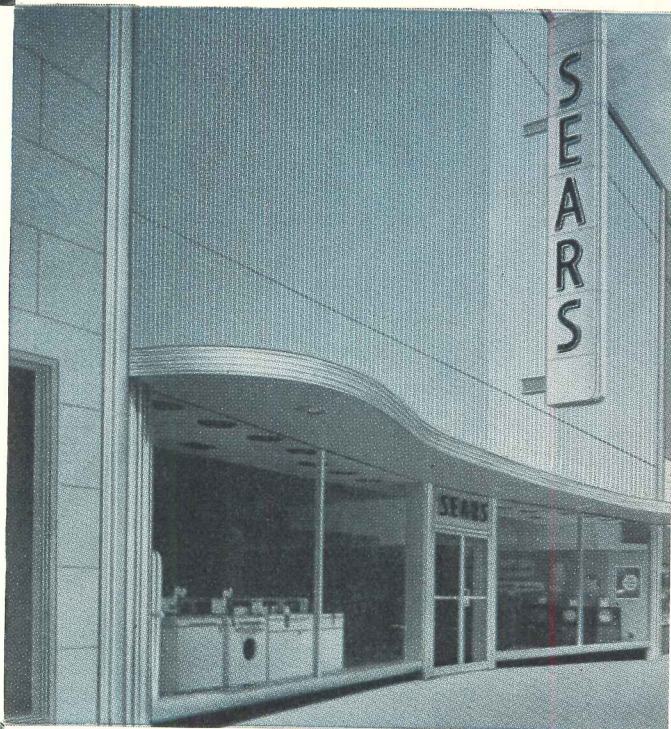

Kawneer Porcelain Enameled Zourite used in two colors as a facade covering, Kawneer entrances, glazing sash, trim: Sears, Roebuck Store, Port Huron, Mich. Wyeth & Harmon Architects.

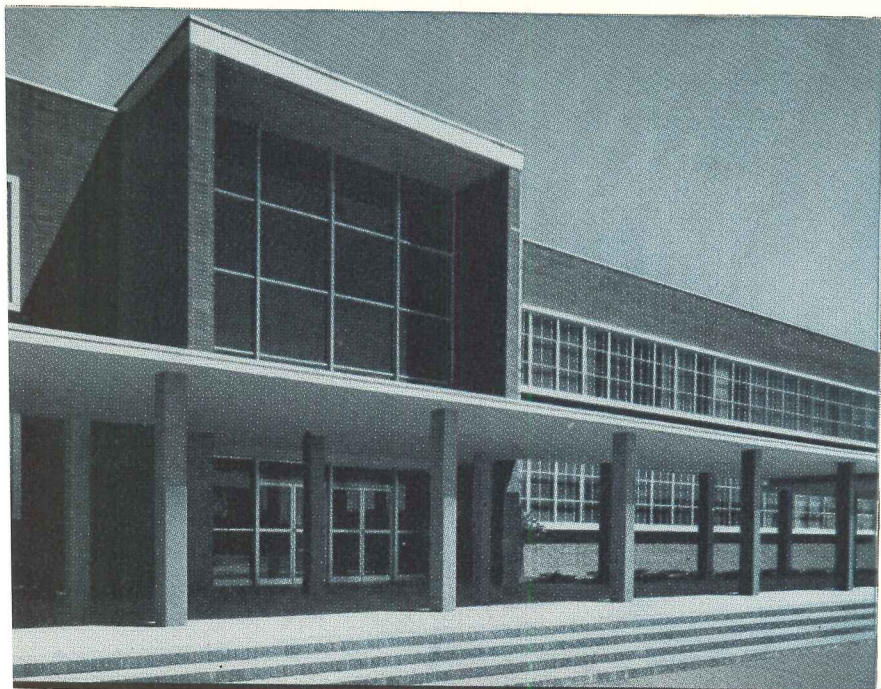

Kawneer mullion construction, entrances, trim: Hall of Justice, Richmond Civic Center, Richmond, Cal. Elmer J. Freethy, Architect, Designers of Center: Milton H. Pflueger and Timothy L. Pflueger, Architects.

SHOWCASE DOORS • ALL-ALUMINUM FLUSH DOORS • ENTRANCES

THE
Kawneer
COMPANY
ARCHITECTURAL METAL PRODUCTS

CONSULT KAWNEER DETAIL PORTFOLIO, SWEET'S CATALOGS OR WRITE DEPT. AR-100
1105 NORTH FRONT STREET, NILES, MICH., OR 930 DWIGHT WAY, BERKELEY, CAL.

INSTALLED COST CUT WAY DOWN

...with these
Door-Frame-Hardware Units!

Each beautiful Fenestra* Hollow Metal Door comes complete with pre-fitted frame and handsome hardware . . . all in one package . . . ready to go in the wall. No cutting, no fitting, no mortising, no prime-painting, no expensive time and labor wasted.

And what doors! Clean, modern lines, velvety finish. They are even insulated for quiet performance. They can't shrink or warp, or swell or splinter. And they can't burn.

These low cost Fenestra Door-Frame-Hardware Units are the result of long years of metal fabricating experience . . . the help of master craftsmen . . . tremendous plant facilities and unique manufacturing methods.

You can get Fenestra Door-Frame-Hardware Units in a wide variety of sizes . . . in three types ingeniously designed for versatile use. Each door may be hinged right or left, swing-in or swing-out.

Get full details and prices. Call your Fenestra Representative—or write to Detroit Steel Products Company, Dept. AR-5, 2252 East Grand Blvd., Detroit 11, Michigan. *®

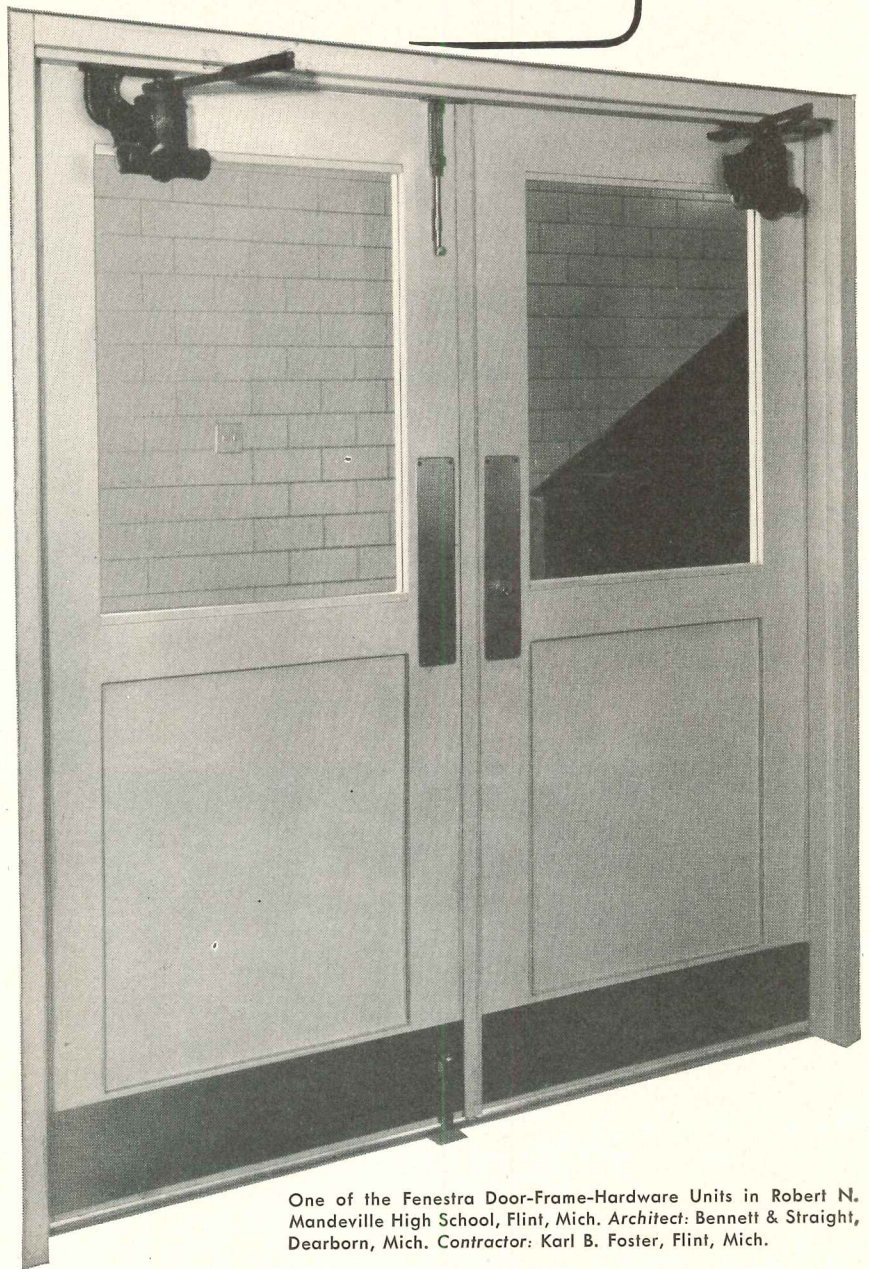

One of the Fenestra Door-Frame-Hardware Units in Robert N. Mandeville High School, Flint, Mich. Architect: Bennett & Straight, Dearborn, Mich. Contractor: Karl B. Foster, Flint, Mich.

Fenestra HOLLOW METAL DOOR • FRAME • HARDWARE UNITS
save building time, labor, materials and money

How to ventilate a shopping center

...on the roof...

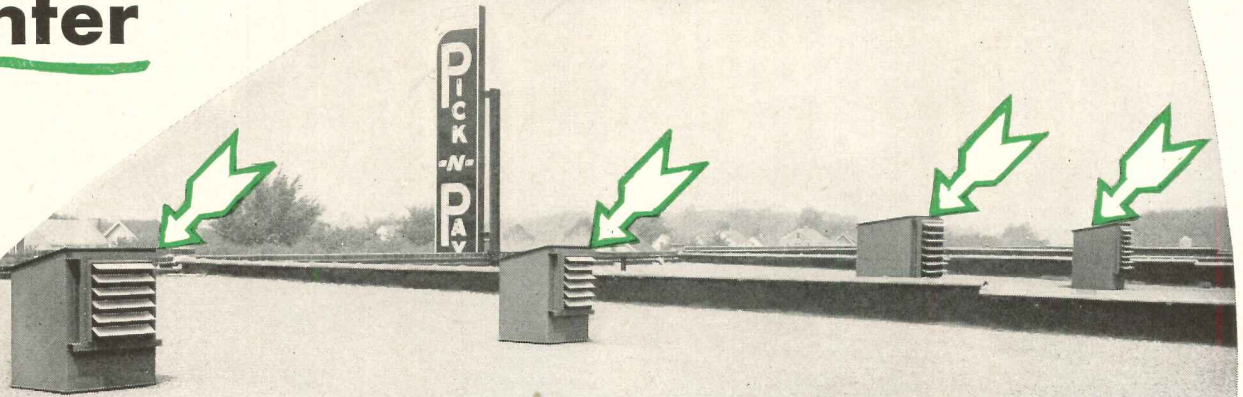

of every store in the shopping center!



Positive action, quiet Power Roof Ventilators

Through an inconspicuous grille mounted in the ceiling, each store in this Cleveland shopping center is provided with a 5-minute air change. Larger stores have two, smaller stores one ILG Power Roof Ventilator. Each ventilator is composed of an ILG Self-Cooled Motor Propeller Fan, with an Automatic Shutter, in a weatherproofed, steel Penthouse. Units are positive in action, assuring all-weather ventilation the year 'round, regardless of changes in temperature or wind direction and velocity. Easy to install, simple to service and maintain, the ILG units are backed by a "One-Name-Plate" Guarantee, covering fan, motor, shutter, and penthouse as a unit. Get complete data—phone nearby Branch Office (consult classified directory) or send coupon today.

VENTILATION

ILG ELECTRIC VENTILATING CO.
2818 North Crawford Ave., Chicago 41, Illinois
Offices in more than 50 Principal Cities

Free! Engineering data bulletin 149-12 contains all essential data—sizes, capacities, dimensions, ratings. Send coupon now.

Send free bulletin 149-12

Firm Name _____

Individual _____ Title _____

Address _____

City _____ State _____



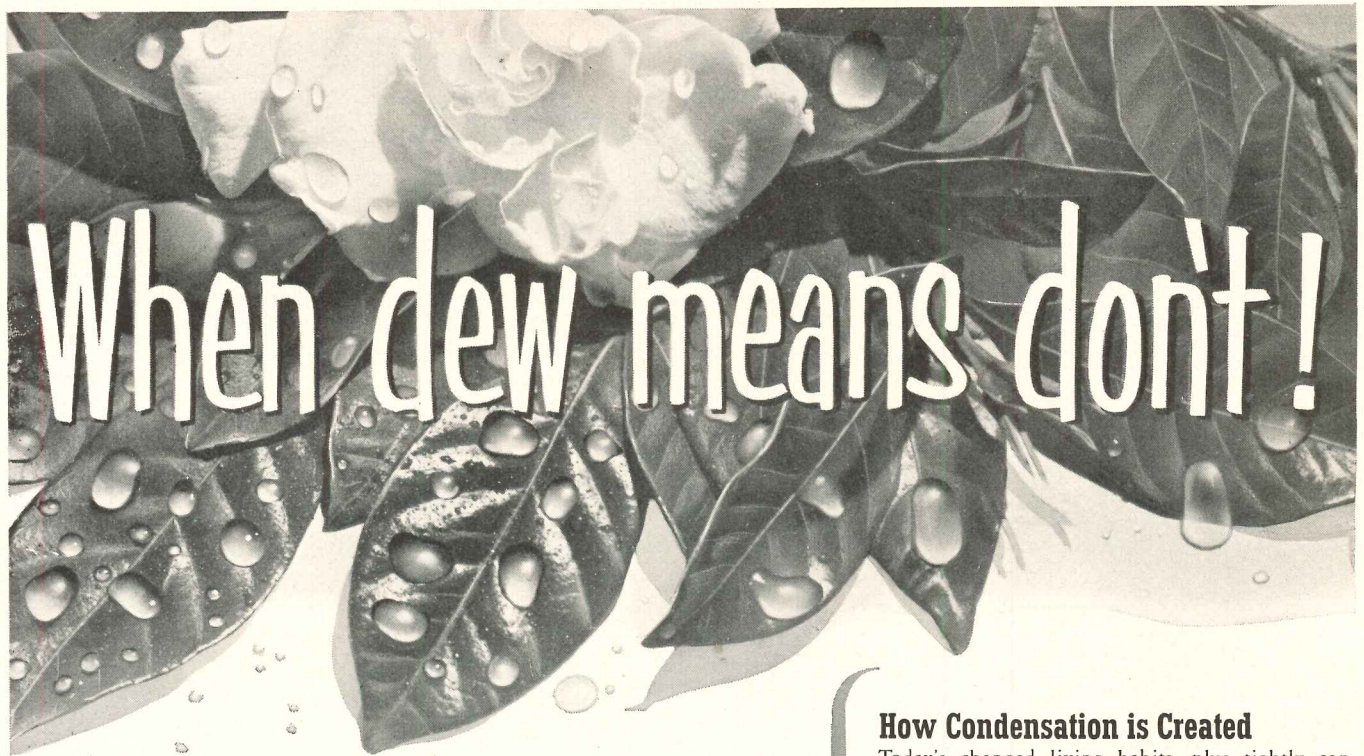

DEW has been lauded in lyrical poetry—artists have painted its shimmering beauty. Yes, in some places dew looks good.

But not on windows—here it is a *warning*.

Here it means DON'T—don't blame windows and don't delay getting at the real cause, for when the "dew-point" is reached water is at work dangerously . . . staining walls, attacking paint, and rotting structural timbers.

Do Windows Cause Condensation?

NO!

Ceco Aluminum Double-Hung Windows

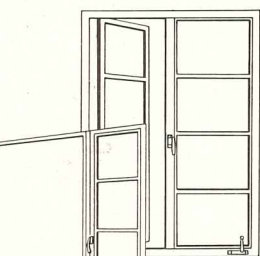
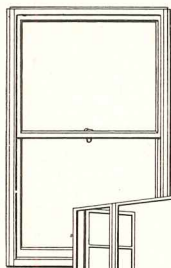

Ceco Steel Casements

Ceco Picture Windows

RIGHT OFF—consider this—windows do not *cause* condensation—they merely *reflect* the first effect of it. Condensation is caused by an overabundance of moisture vapor in the air—when the saturation point meets the proper temperature it becomes water.

Send for booklet on how to control condensation.



CECO STEEL PRODUCTS CORPORATION

General Offices: 5601 West 26th Street • Chicago 50, Illinois

Offices, warehouses and fabricating plants in principal cities

**CECO
STEEL**

How Condensation is Created

Today's changed living habits, plus tightly constructed, compact homes have much to do with causing condensation. Here are some sources.



Washing left-over dishes and cooking can release as much as 5.76 pounds of moisture.



Washing and drying clothes at home can release as much as 30.73 pounds of water.



Two shower baths can add a pound of moisture to the air, while two tub baths can build up 0.24 pounds.

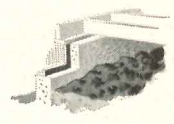

External vapor generated by uncovered earth in crawl spaces may be greater than all other sources combined.

How to Control Condensation

The home-owner can do much toward decreasing condensation. Here are four methods of control.

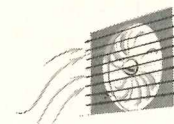

Exhaust fans control moisture in kitchens in addition to eliminating cooking odors.



Windows in the laundry room should be opened slightly when laundering.



Moisture can be controlled in the bathroom by opening windows and keeping the door shut after bathing.

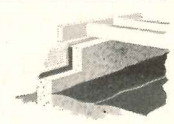

Ventilation of crawl space and covering earth with roofing felt is another condensation control method.

In construction products **CECO ENGINEERING** makes the big difference

Save with **SAFER...SURER**
AB BREAKERS

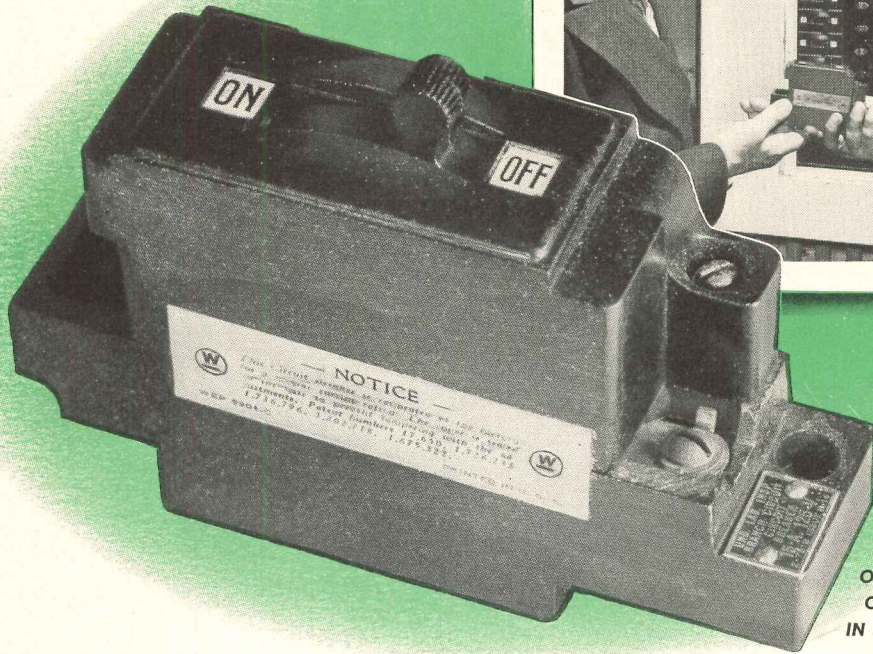

ONE OF 2500 WESTINGHOUSE
CIRCUIT BREAKERS INSTALLED
IN THE GULF BLDG., PITTSBURGH

18 YEARS OF CONTINUOUS SERVICE without failure, replacement or maintenance

2500 thermal-type branch circuit breakers, installed and then forgotten, in the Gulf Building, Pittsburgh, Pa., have written an unparalleled story of circuit protection. B. E. Moore, Building Superintendent, reports that after 18 years of service without failure, replacement or maintenance, these breakers were recently checked in random tests and were found to be "as good as new". On both overload and short circuit protection, they performed precisely to their original specifications. And on inspection, mechanical parts and contacts were found to be in "excellent condition".

What better proof can we give you that when you install Westinghouse Circuit Breakers you install the

finest in dependable, grief-free equipment. They are miserly with maintenance time, too—when trouble is cleared from the circuit, a flip of the breaker handle restores power instantly. No running after fuses, nothing to replace, nothing extra to buy.

For assistance on any circuit protection problem, contact your nearest Westinghouse office, or write for Bulletin No. DB-29-060, Westinghouse Electric Corporation, Box 868, Pittsburgh 30, Pa. J-30049



YOU CAN BE **SURE**.. IF IT'S
Westinghouse

AB CIRCUIT BREAKERS
THE COMPLETE LINE



Rotary Oildraulic

the modern elevator

NORTHWESTERN MUTUAL FIRE ASS'N

Los Angeles, Calif

Architect: Richard J. Neutra

Contractors: C. W. Driver, Inc.

Rotary Oildraulic Elevator (passenger)
installed by Elevator Maintenance Co., Ltd.

Photos by Julius Shulman

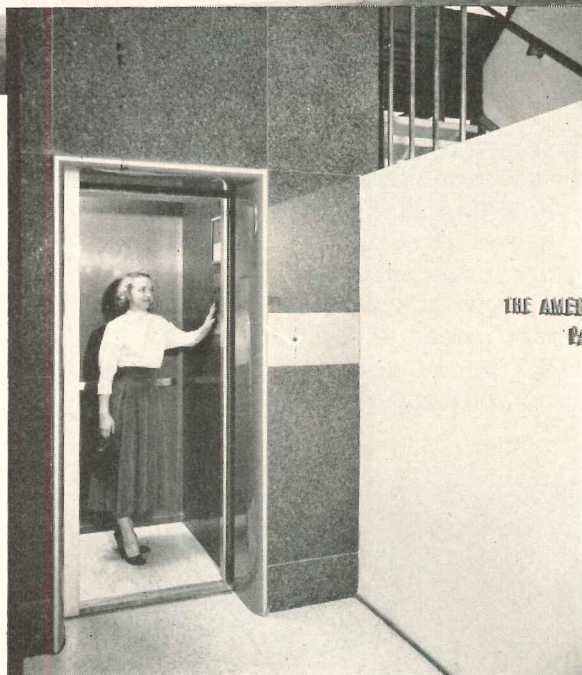

Oildraulic Passenger Elevators

The velvet-smooth fluid operation of the Oildraulic system is ideal for passenger elevator service. You can depend on gentle starts, cushioned stops and accurate landings. Any desired types of cabs, doors and controls can be supplied.

No penthouse or heavy supporting sidewalls needed

The Rotary Oildraulic Elevator is moved and controlled by oil under pressure, the most powerful and practical of all methods of lifting heavy loads. The elevator car and its load are supported by the hydraulic system—not by the building structure. This makes possible a substantial lightening of the shaftway structure, with savings in construction costs. There's no need for heavy, load-bearing sidewalls, supporting columns and footings ordinarily required to carry the overhead machinery, the car and the load.

No penthouse is used with an Oildraulic Elevator and, in many cases, a machine room is unnecessary. Rotary's compact power unit can be located on any landing, on any side of the hatchway—anywhere within 50 feet of the elevator. This saves valuable space.

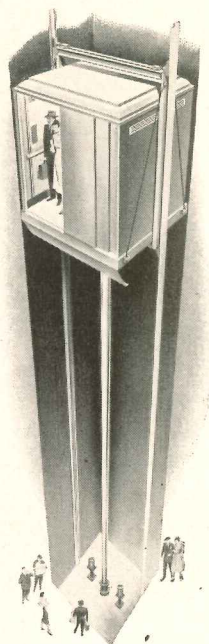

for modern 2, 3 and 4-story buildings

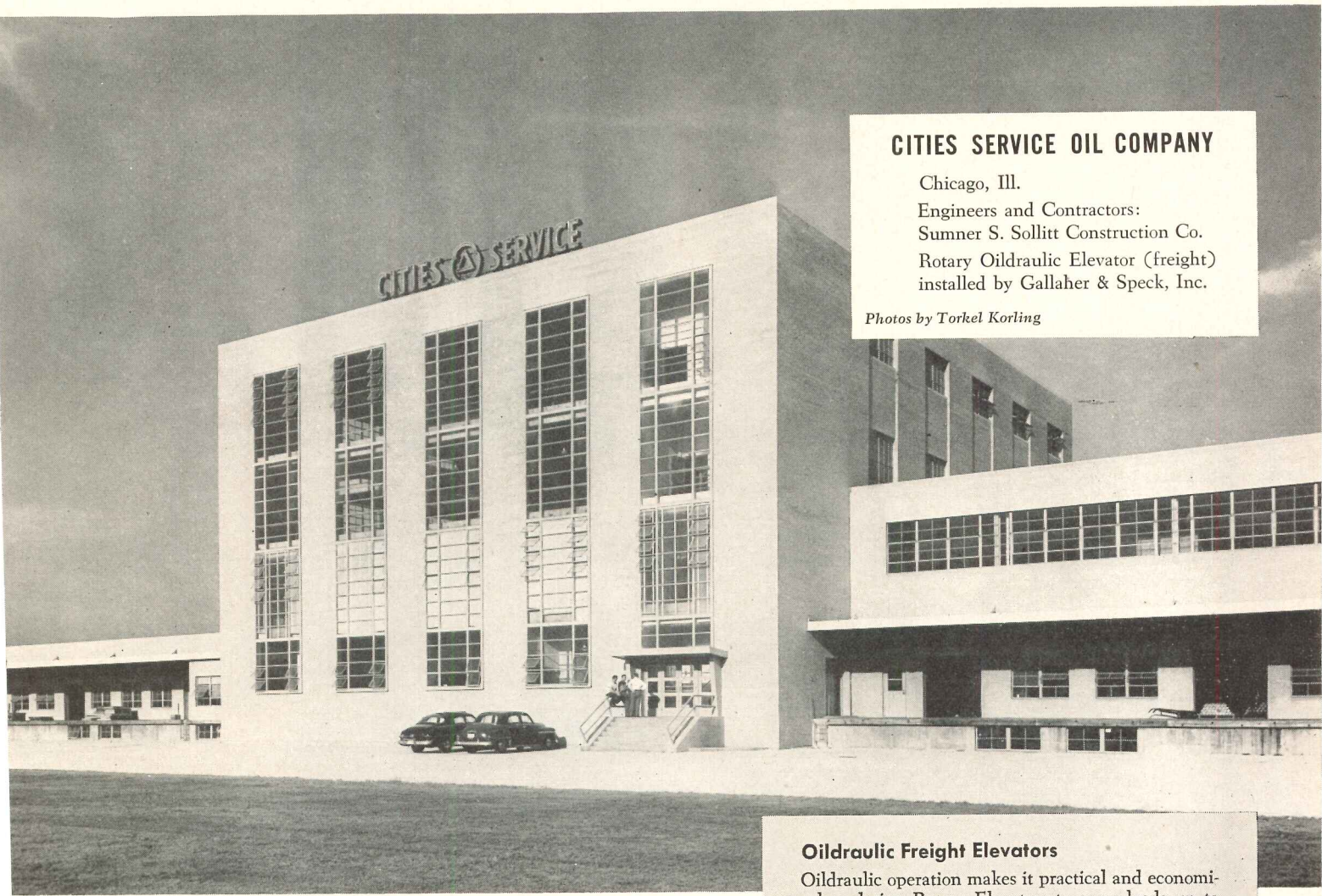

CITIES SERVICE OIL COMPANY

Chicago, Ill.

Engineers and Contractors:
Summer S. Sollitt Construction Co.

Rotary Oildraulic Elevator (freight)
installed by Gallaher & Speck, Inc.

Photos by Torkel Korling

Rota-Flow power system gives smooth, quiet, low-cost service

A revolutionary oil hydraulic power system moves Rotary Oildraulic Elevators on a smooth, continuous column of oil. Combined with the efficient Rota-Flow power unit to give perfect operation is the Oildraulic Controller. This engineering marvel handles the functions of seven separate control valves, simplifies adjustments and maintenance.

Smooth starts and stops are a feature of these modern elevators. Oildraulic automatic floor leveling positions the car to each landing with exactness— $\frac{1}{4}$ " accuracy is guaranteed!

Over 65,000 Rotary Oildraulic elevators and lifts are serving leading companies from coast to coast. Our Engineering Department will be glad to assist you. Write for catalog and complete architectural data.

ROTARY LIFT COMPANY • 1104 KENTUCKY • MEMPHIS 2, TENN.

Rotary[®]

OILDRAULIC[®] ELEVATORS

Engineered and built by Rotary, the world's oldest and largest maker of oil hydraulic elevators

SEE OUR CATALOG IN SWEET'S FILES

Oildraulic Freight Elevators

Oildraulic operation makes it practical and economical to design Rotary Elevators to carry loads up to 100,000 lbs. Oildraulic Freight Elevator cars have extra-rugged construction essential for rough, tough freight service and power truck loading.

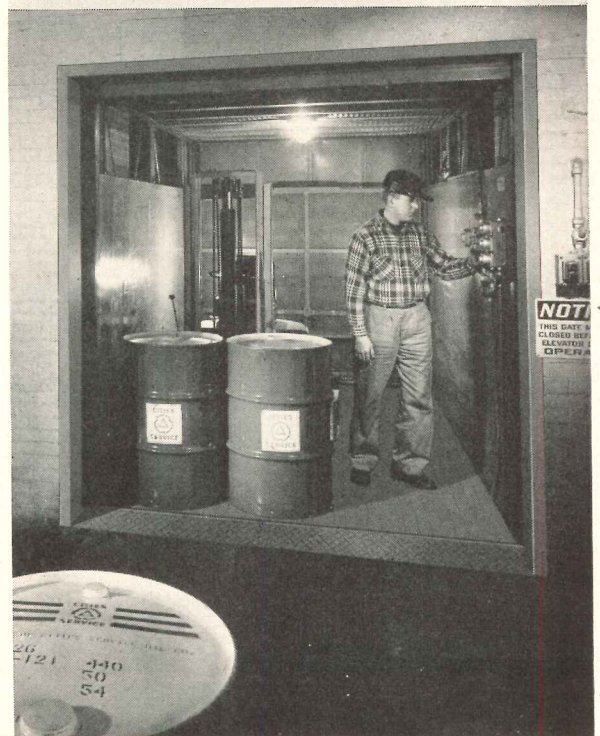

UNIQUE INSTALLATIONS of standard Frigidaire equipment

solve air conditioning problems with maximum economy

Economical air conditioning of problem areas, whether in homes, offices or small plants, can be solved satisfactorily in many instances with "unconventional" installations of Frigidaire Room Air Conditioners.

Discarding the erroneous impression that these units can only be used effectively in double-hung windows, many architects and builders are discovering many different ways of adapting them to meet a variety of air conditioning problems. And, in many commercial installations, they've saved customers considerable money by eliminating duct-work and plumbing.

The installations shown on this page illustrate the use of a certain amount of ingenuity and imagination.

Home—Here the unit is installed in a steel casement window. In this case the ventilators (swinging window sections) and the center mullion have been removed, a new member has been bolted across the frame, and the space above the unit filled in with a fixed glass panel. Since the unit itself provides adequate ventilation, there is no disadvantage to the fixed glass arrangement.

Motel—Where no window is available, the unit may be installed in a special opening provided in an outside wall. This permits choice of optimum location, such as near the ceiling, which saves space and gives ideal air distribution.

Factory—Where neither window or outside wall location is feasible, units can be installed above or below the conditioned area and connected to it by supply and return air ducts, as shown in this unique factory installation.

Offices—A wide variety of unusual installations is possible in offices. One such, shown below, has the entire window removed and the space around the unit filled in with attractive glass blocks. The other illustrates a novel use of two units installed side by side in a single window to provide the desired capacity.

For expert help in planning installations of this kind—or in solving any air conditioning or refrigeration problem—call the Frigidaire Dealer, Distributor or Factory Branch that serves your area. Look for the name in the Yellow Pages of your phone book. See Frigidaire catalogs in Sweet's Files or write Frigidaire Division of General Motors, Dayton 1, Ohio. In Canada, Leaside (Toronto 17), Ontario.



Casement window problem solved with unique use of fixed glass panel.

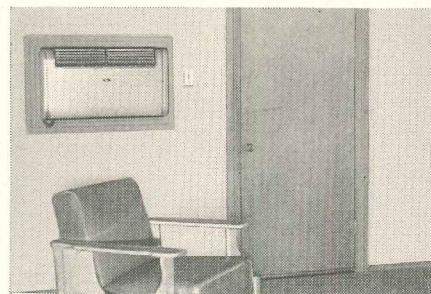

Wall installation points up flexibility of locating these easily installed units.

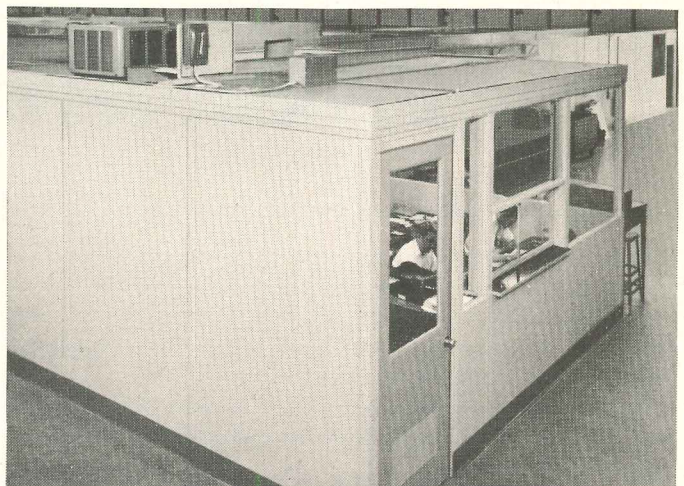

Overhead placement overcomes one of the more unusual problems of air conditioning an office within a factory area.

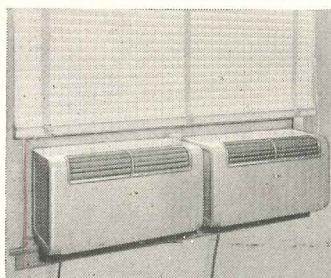

Battery of window-type units gives abundant cooling—saves space.

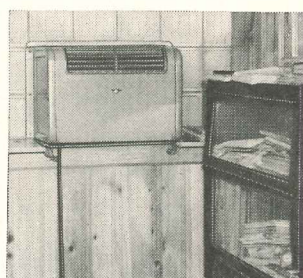

Entire window removed and replaced with modern glass bricks.

FRIGIDAIRE Appliances— Refrigeration and Air Conditioning Products

Refrigerators • Electric Ranges • Home Laundry Equipment
Food Freezers • Water Coolers • Electric Water Heaters
Air Conditioning • Commercial Refrigeration Equipment
Electric Dehumidifier

Frigidaire reserves the right to change specifications, or discontinue models, without notice

ORIGINALITY OF IDEA

THIS CONCEALED LAVATORY UNIT is a good example of Hall-Mack quality expressed through originality of idea.

Like the good servant it is, this practical Hall-Mack accessory provides soap, tumbler or toothbrush at fingertip command—yet remains tastefully in the background when not in service. Only the shining chromium plated panel is visible when the unit is closed.

Here's a new and better answer to a standard bathroom accessory need. It demonstrates how Hall-Mack quality begins with a better basic idea and is carried out in every detail of construction and finish. It's another reason why Hall-Mack is recognized as the only answer in Quality Bathroom Accessories!

HALL-MACK

*...the BEST
answer to
quality bathroom
accessories*



YOU BUILD A BATHROOM for a lifetime of use. Make sure you build with Hall-Mack's lasting quality and style. Within four popular lines—Crystalcrome, Coronado, Tempo and China-Vogue—you can select Hall-Mack accessories for every bathroom style and budget!

HALL - MACK COMPANY

1344 W. Washington Blvd., Los Angeles 7, California

7455 Exchange Ave., Chicago 49, Illinois

HALL-MACK®

Quality
ACCESSORIES

*For Every Bathroom
Style and Budget*



Home at Lake Skaneateles, N.Y., Hawley McAfee, Architect

**PLENTY OF FRESH AIR
THROUGH GLASS WALLS...**

ANDERSEN
*Windowalls**



KEY TO COMFORT in the modern glass wall is usually the operating windows. Andersen WINDOWWALLS, like these Casement Window Units, bring plenty of fresh air into the picture. Yet they also serve as an efficient wall to moisture, dust and wintry cold. Their

wood construction adds warmth and beauty both as window and as wall.

Andersen Casements are now available in a new series of sizes, with sash $4\frac{1}{2}$ " wider than the units illustrated above. *TRADEMARK OF ANDERSEN CORPORATION

Andersen Corporation • BAYPORT, MINNESOTA

FAMOUS FOR COMPLETE **WOOD** WINDOW UNITS

Write for Detail Catalog or Tracing File of Installation Details or see Sweet's files for specification data. WINDOWWALLS sold by millwork dealers.

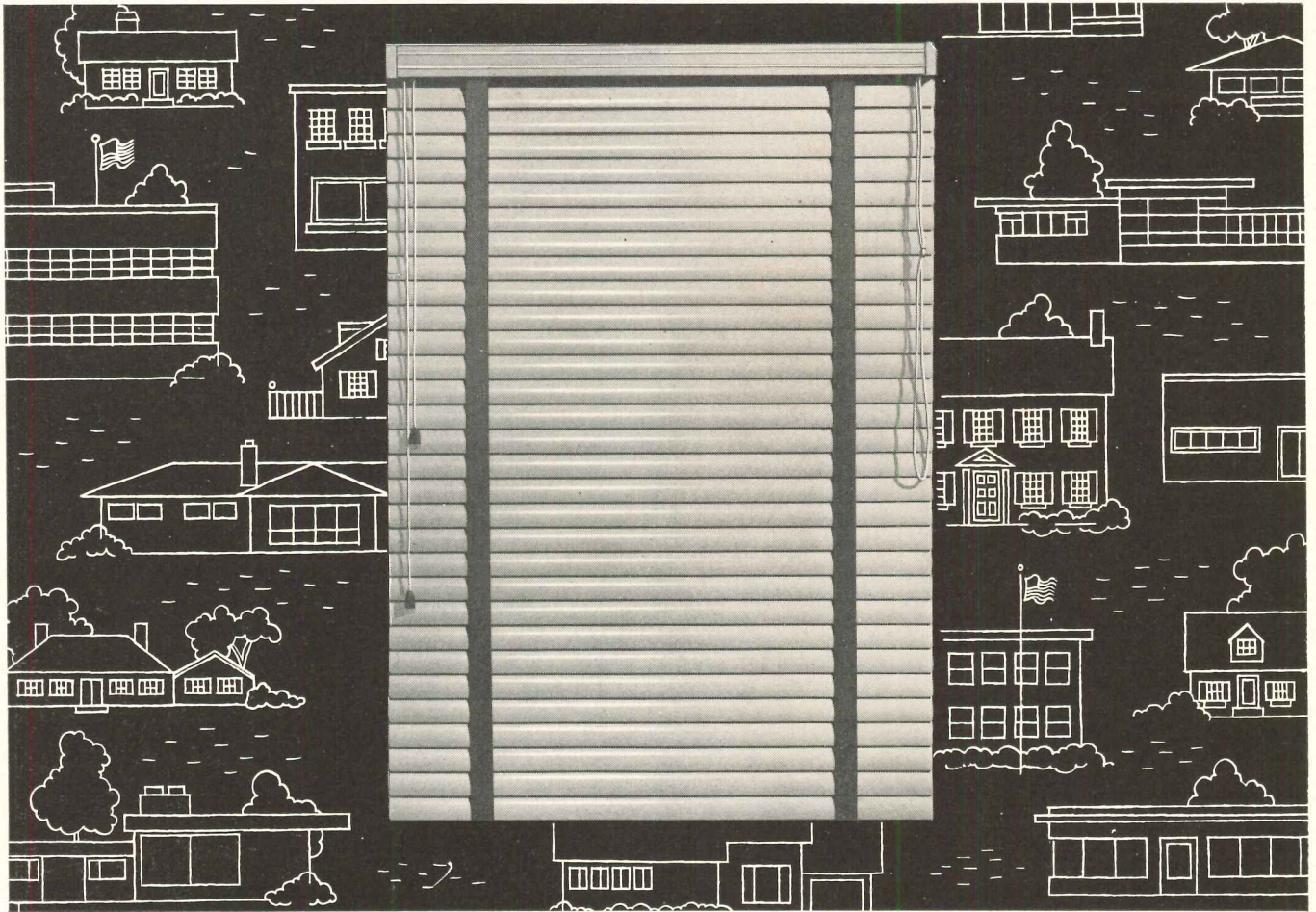

out front wherever top quality is a must:

the all- *Flexalum*[®] blind

stays new, beautiful... clean!

new decorating possibilities!

uniform quality... recognized quality!

Never before... a blind that stands so far ahead of the rest in quality and beauty, yet costs so little to maintain!

- Flexalum tapes are non-porous plastic. Wipe clean with a damp cloth, last for years, won't fade, shrink, stretch or fray.
- cords are wipe-clean plastic too. Retain their tensile strength, wear longer without fraying or breaking.
- slats are sleek aluminum, spring-tempered for greater resilience, will keep their shape. Mar-proof finish won't chip, crack, peel, rust.
- sturdy top and rigid bottom bar also mar-proof finished.
- sealed-in-steel, friction-free mechanism is lubricated for life.
- plastic tassels are noiseless, unbreakable.
- extended top bar holds draperies too, without extra hardware.
- complete versatility of cord arrangement: Flexalum cords can be installed wherever most convenient.
- complete and perfect color-matching of every part... or choice of dramatic color contrasts.
- one and only one reputable manufacturer is responsible for every part of the all-Flexalum blind... your assurance that every Flexalum blind will be of the same superior quality.
- National advertising has convinced your customers of Flexalum quality. Let Flexalum help convince them of the quality of your building!

Write for free 8-page catalogue containing full details on the all-Flexalum blind.

HUNTER DOUGLAS CORPORATION, Riverside, California or 150 Broadway, New York 38 Canada: Hunter Douglas Ltd., Montreal, Que.



New Heavy-Duty Industrial Floor

CUTS COST OF FLOOR UPKEEP
INCREASES EFFICIENCY OF WORKERS

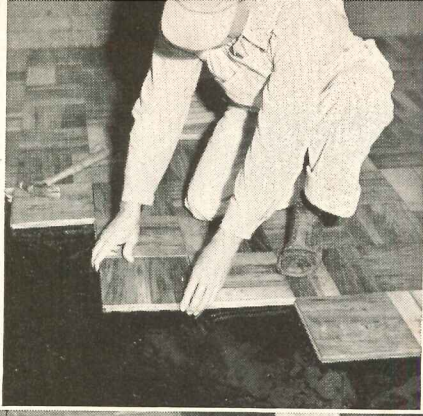

**TOUGH, DURABLE
HARDWOODS**
(Hickory and Pecan)

EXTRA THICK
(33/32 INCH)
(Tongued and grooved)

TOXIK* PRESERVED
(For durability and
protection)

**INSTALLED IN
MASTIC OVER
CONCRETE**

A Bruce Dura-Wood Block Floor will give long, economical service

Withstands roughest wear

Dura-Wood Blocks are made of tough, long-wearing Hickory and Pecan . . . close grained, heavy hardwoods that resist wear and abrasion. A floor of this type will last indefinitely. It will not powder, dust, crack or wear away like many hard-surfaced floors.

Less fatiguing

Workers find this hardwood floor far more comfortable underfoot—much less fatiguing than unyielding floors of concrete or other hard materials. No more cold feet . . . less lost time from colds.

No powdering

Because a Dura-Wood Floor won't powder or dust, this eliminates a source of discomfort and irritation to workers. No

abrasive dust to get into machines or machined parts. Floor maintenance is simple. Usually dry sweeping is all that is required. Blocks damaged by extreme service are easily replaced without interruption of work.

Less damage to equipment

Plant engineers report far less damage to tools and machined parts when accidentally dropped on wood floors than on hard surfaced floors. There's less wear and tear on power trucks and other rolling equipment, too.

Simple installation

Dura-Wood Blocks are laid in mastic over concrete slab. Where service is the principal consideration, it is unnecessary to sand or finish the floor as the *Toxik* treatment preserves and protects the surface.

E. L. BRUCE CO., MEMPHIS 1, TENN.
World's largest maker of hardwood floors

BRUCE *Dura-Wood*
BLOCK FLOORS



Bruce also makes 33/32" Dura-Wood Strip Flooring
See Sweet's File for Technical Data

*Trademark

MAIL FOR LITERATURE

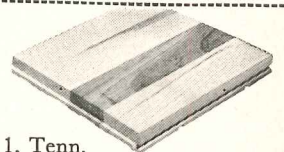

E. L. BRUCE CO.
1676 Thomas St., Memphis 1, Tenn.
Send us literature and complete information on
Dura-Wood Blocks for industrial floors.

Name _____

Address _____

City and State _____

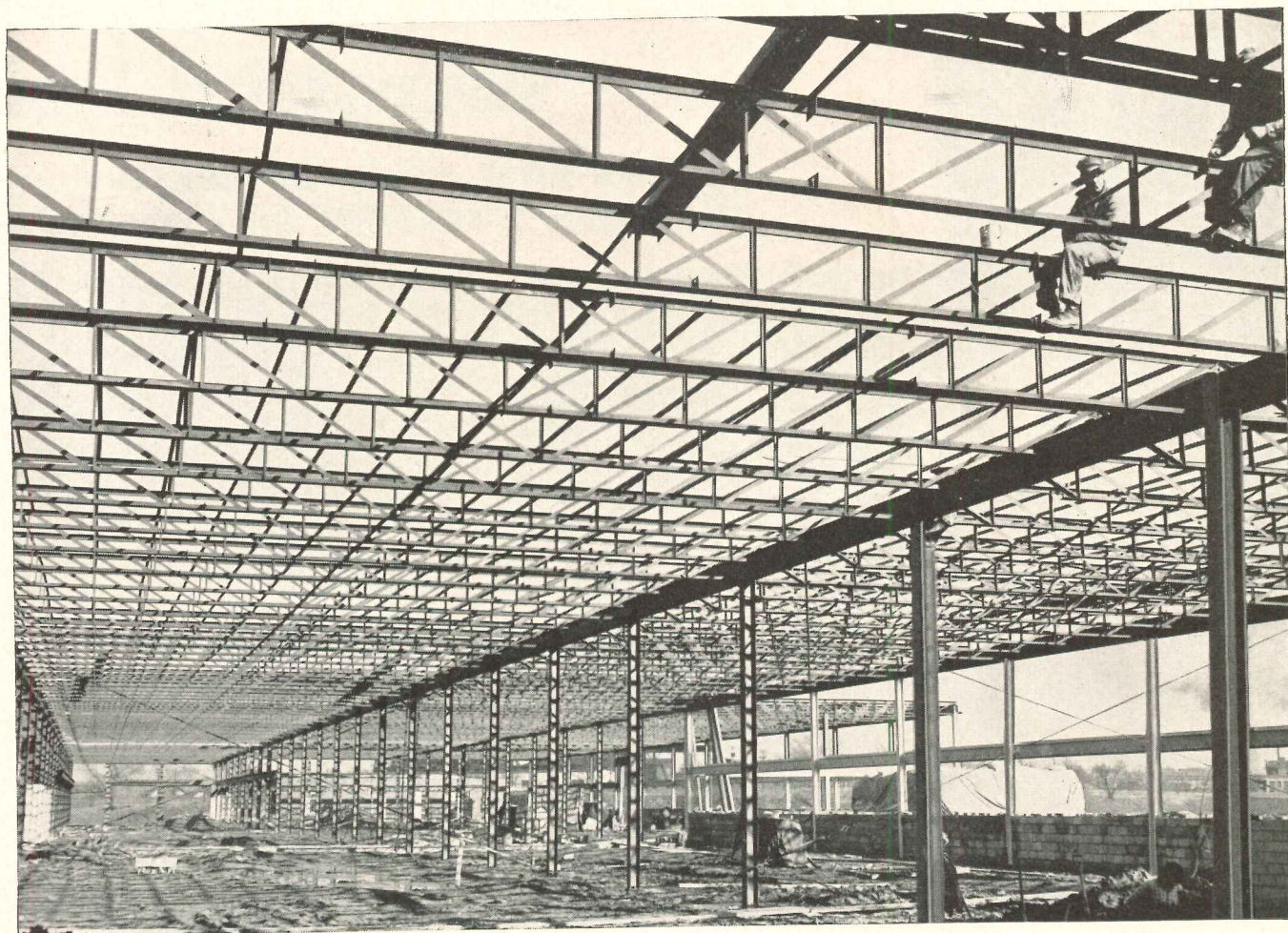

Bethlehem Longspan Joists in S. K. Wellman factory, Bedford, Ohio. Architect: Charles Bacon Rowley and Associates, Inc., Cleveland. Contractor: A. M. Hingley Company, Cleveland.

Less Waste Space... More Work Space with **LONGSPANS**

Used as roof supports in any light-occupancy building—factory, warehouse, garage, store—Bethlehem Longspan Steel Joists can help you save valuable floor space for work and storage.

Longspans enable you to plan unobstructed floor areas with spans up to 64 ft or more. Machinery, fixtures, stockpiles and partitions can be arranged with less interference from columns.

Another advantage: Longspans used at close spacings reduce the need for pilasters which often interfere with wall design. Installed as either roof or floor supports, these joists save construction time because pipes, conduits and ducts can be run through the open webs.

Longspan Joists reach the job completely fabricated and clearly marked, ready for placing. They come in two types: underslung con-

struction with top-bearing ends and bottom-bearing construction with square ends.

Remember Longspan Joists the next time you design an industrial building. The nearest Bethlehem representative will be glad to furnish more information. Or send your inquiry to us at Bethlehem, Pa.

BETHLEHEM STEEL COMPANY, BETHLEHEM, PA.

*On the Pacific Coast Bethlehem products are sold by Bethlehem Pacific Coast Steel Corporation
Export Distributor: Bethlehem Steel Export Corporation*



BETHLEHEM LONGSPAN JOISTS

SCHLAGE LOCKS

DISTINCTIVE appearance
TIME-PROVEN performance

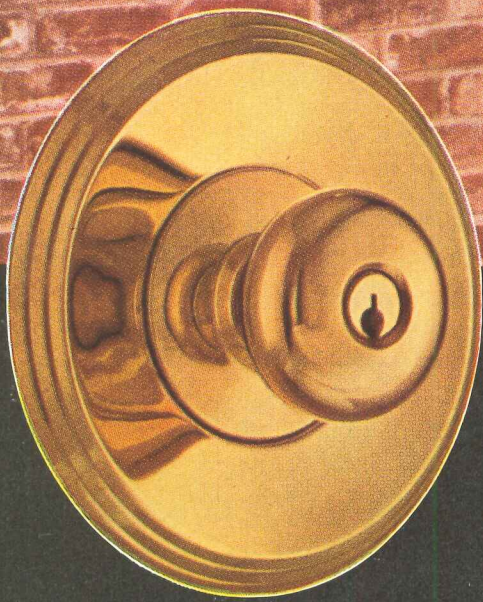
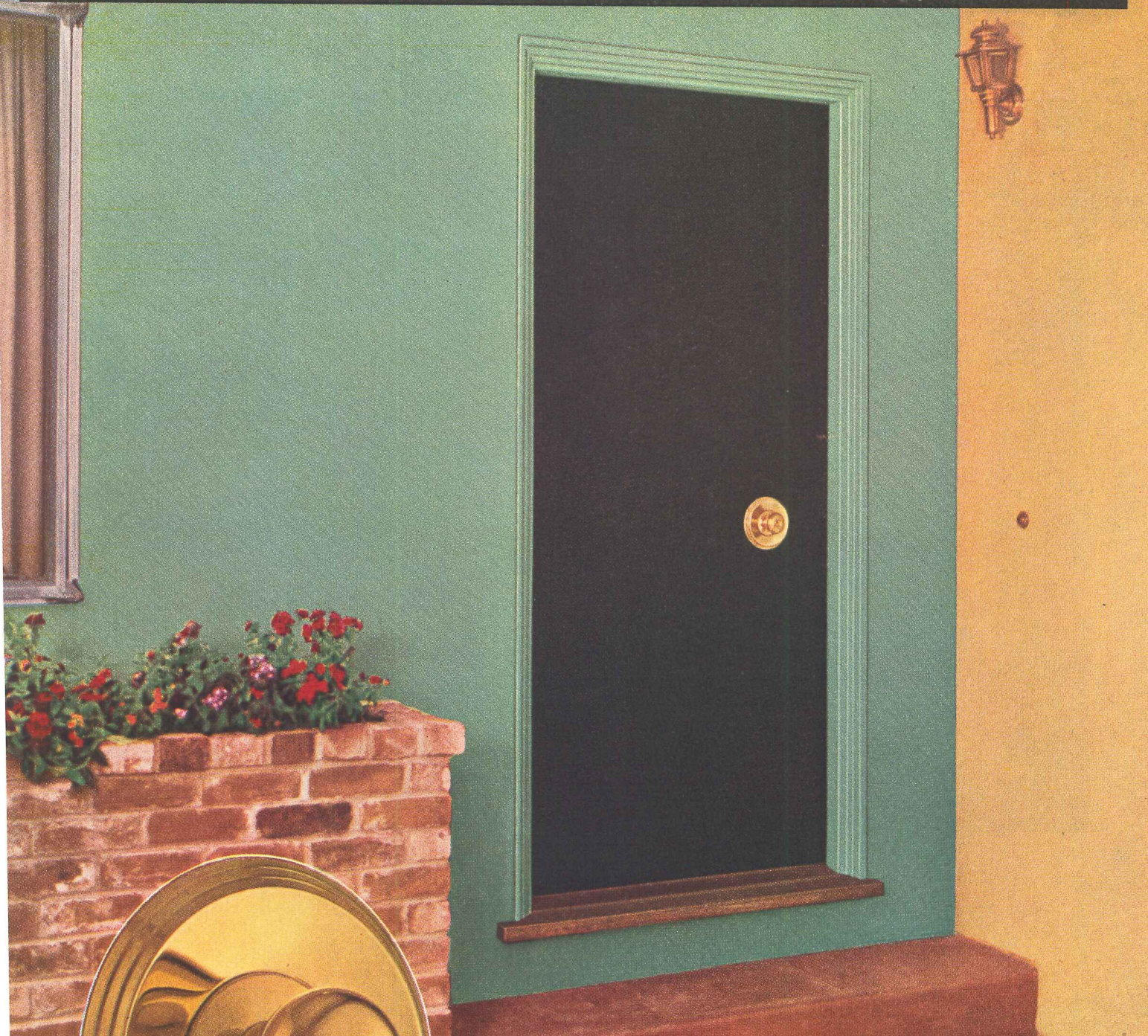

*The quality of Schlage cylindrical locks is clearly evident
...in their beauty and in their trouble-free operation...
time-proven for more than a quarter of a century.*

SCHLAGE PLYMOUTH DESIGN
with Riviera escutcheon

Write for full-color brochure showing distinctive
and economical entrance locks.

SCHLAGE®

THE Time-Proven CYLINDRICAL LOCK

SCHLAGE LOCK COMPANY · 2201 BAYSHORE BOULEVARD, SAN FRANCISCO, CALIFORNIA
SCHLAGE LOCK COMPANY OF CANADA, LTD. · VANCOUVER, B. C.

Find the "Radiator"—

A Sale-able Idea in Heating



Find the "radiator"! Crane radiant baseboard heating is inconspicuous, efficient, does away with drafty currents. Easily installed in new or existing homes. Readily matched to any interior decorating scheme.

How Crane ideas for radiant baseboard panels help your clients get the most out of the homes you plan

The idea here is to take full advantage of the plans you draw. With radiant baseboard heating you can do it. Your clients can arrange their furniture for best effect and comfort, free of the limitations imposed by conventional radiators and warm air ducts.

This is one of the new ideas demonstrated in Crane's new "Sketchbook of Ideas," a basic part of Crane's new service to Architects who specialize in designing homes. This remarkable book includes suggestions and floor plans for kitchens,

bathrooms and utility rooms . . . and it's written and illustrated to help you get client approval for new ideas and arrangements.

If you want further information on any of the rooms in the Sketchbook, we can furnish suggestions for room arrangements and decorating.

This service is available through your Crane Branch or Crane Wholesaler. Call them today.

COME TO CRANE FOR IDEAS

CRANE CO. GENERAL OFFICES: 836 SOUTH MICHIGAN AVE., CHICAGO 5
VALVES • FITTINGS • PIPE
PLUMBING AND HEATING

NEW . . . BEAUTIFUL . . . CUTS COSTS

Introducing

SCR brick*

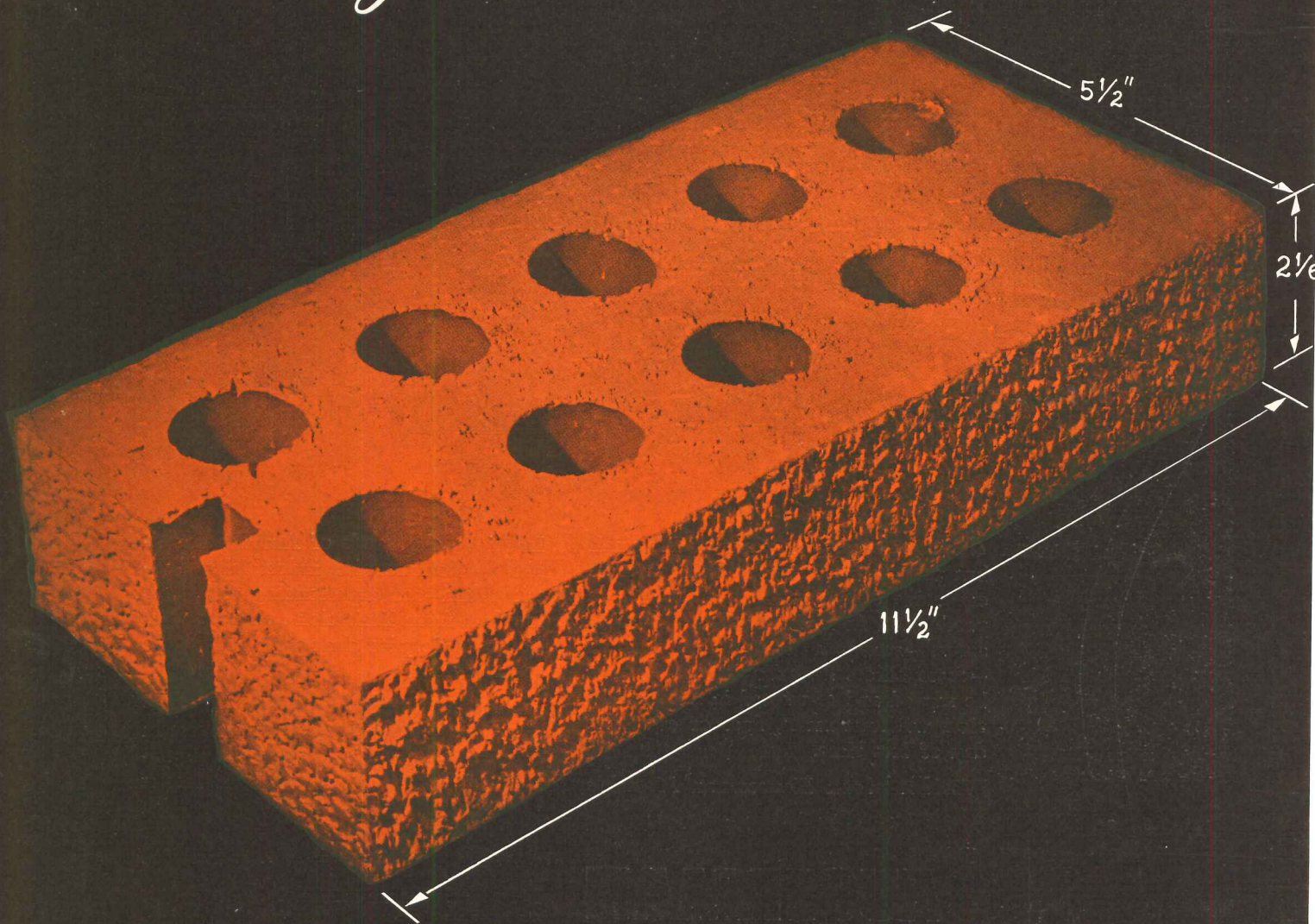

*Reg. TM, SCPRF, Patents Pending

Now . . . BUILD SOLID BRICK HOMES OF PREMIUM APPEARANCE AT A COST COMPETITIVE WITH FRAME

the "SCR brick" is a THRU-THE-WALL UNIT



The "SCR brick" is a new product developed by the Structural Clay Products Research Foundation.

CUTS COSTS: eliminates materials and builds the wall with a single unit.

SAVES TIME: normally a mason can build 100 sq .ft. of "SCR brick" wall per day . . . an increase of 60%—100%.

Your inquiry for complete, detailed information is invited.

STRUCTURAL CLAY PRODUCTS INSTITUTE
1520 18th Street, N. W., Washington 6, D. C.

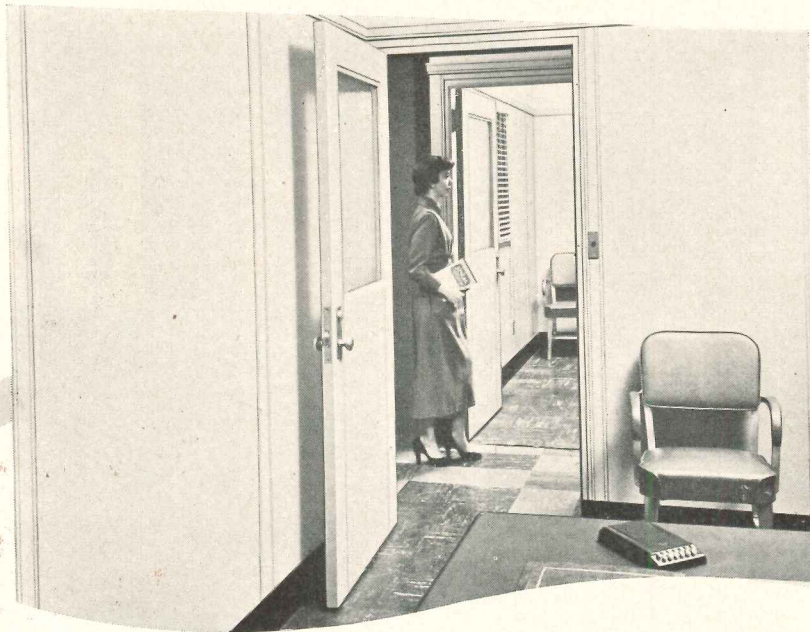

This office was planned for livability—not limitation

● Future expansion plans of this small but progressive company call for these executive offices to be a part of the production floor. And when that time arrives—next year or five years from now—these offices *including the walls* will be moved and re-erected in a new location without muss, fuss or even one day of lost time.

With modern Hauserman *Movable*

HAUSERMAN
Movable Interiors

OFFICES • SCHOOLS • LABORATORIES
 HOSPITALS • INDUSTRIAL PLANTS

Korweld*—the non-metallic panel construction which combines the best features of all types of interior partitions—is an exclusive Hauserman development. Ask your Hauserman Representative for facts about this revolutionary new product.

*Trademark

Interiors, thousands of American businesses—commercial, industrial and institutional—are experiencing this same freedom from limitation . . . *permanent livability* despite changing floor space requirements.

Although present demand for Hauserman *Movable* Interiors is the greatest in our almost 40-year history, recent expansion of production facilities makes it possible to meet delivery schedules with earlier *on-time* erection by Hauserman's own nation-wide service organization.

Now, before you remodel or expand, is the time to plan for the many space-saving, time-saving, money-saving advantages of Hauserman *Movable* Interiors. Your nearby Hauserman Representative will gladly furnish you with complete information . . . or write today to The E. F. Hauserman Company, 7168 Grant Avenue, Cleveland 5, Ohio.

NEVAMAR[®]

makes living easier

NEVAMAR is a high-pressure laminate—a hard, pre-finished surfacing material that's designed for lifetime service. It builds extra beauty, durability and value into any installation—never needs painting or refinishing, easy to care for. Would you like to see samples of NEVAMAR?

DISTRIBUTOR: THE NEVAMAR COMPANY, BALTIMORE-30, MARYLAND



The NATIONAL Plastic Products Company

Manufacturers of Nevamar Decorative and Industrial Laminates • SARAN FILAMENTS • Wynene Molded Products

ODENTON, MARYLAND • NEW YORK: EMPIRE STATE BUILDING • LOS ANGELES: 2252 EAST 37th STREET

This is
NEVAMAR[®]

... a high-pressure laminate surface, designed for long life and lasting beauty. Nevamar is not affected by grease, alcohol, fruit acids, ammonia, bleach, ink or similar substances. It will not craze, crack or peel. Nevamar is resistant to cigarette burns and withstands boiling water. Nevamar may be cleaned with soap and water.

● To keep your Nevamar surface beautiful... Don't use abrasive cleansers. A protective pad should be used beneath hot vessels, electric toasters and similar appliances. Don't use your Nevamar surface as a cutting or chopping board.

REPLACEMENT OR A REFUND OF MONEY
Guaranteed by
Good Housekeeping
IF NOT AS ADVERTISED THEREIN

The NATIONAL Plastic Products Company
ODENTON, MD. • NEW YORK, N. Y. • LOS ANGELES, CAL.



WILL YOU BE...

Building or Waiting?

the difference can be

KENNATRACK prompt shipment

When wasted time means wasted dollars, save with KENNATRACK prompt shipment of sliding door hardware. There is a KENNATRACK for every interior use of sliding doors.

Available Now!

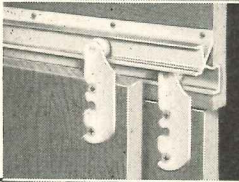
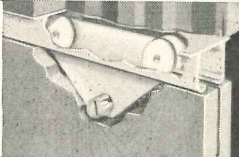
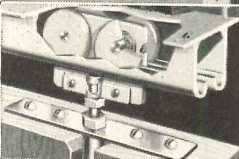
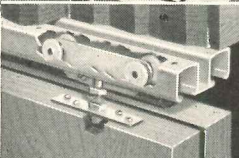
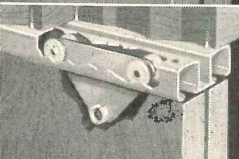
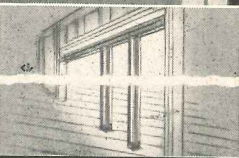

Kennatrack Sliding Door Hardware Selection Chart

| SERIES | | USE | APPLICATION | HEAD ROOM |
|------------|---|---------------------------------|--|-----------|
| 250 |  | 3/4" to 1 1/8" by-passing doors | Cabinets, fixtures and light wardrobes. | 2-5/16" |
| 300 |  | 3/4" to 1 3/8" doors | By-passing, converging, open pocket and closed pocket doors. | 1" |
| 400 |  | 1 3/8" | Closed pocket doors. Finest quality track available. | 2-11/16" |
| 600 |  | 1 3/8" by-passing doors | Double track for by-passing wardrobe doors. Adjustable hanger. | 2-1/16" |
| 650 |  | 1 3/8" by-passing doors | Double track for by-passing wardrobe doors. 1" head room. | 1" |
| 800 |  | 1 3/8" doors | Prefabricated pocket metal frame. Warp proof. | 2-11/16" |

See your Kennatrack dealer or jobber today. Phone, write or wire for name and address of jobber nearest you.

JAY G. McKENNA, INC.
ELKHART, INDIANA

JAY G. McKENNA (Canada) Ltd., 104 Jarvis St., Toronto, Canada

Specializing exclusively in the Manufacture of Sliding Door Hardware

typical UNISTRUT® framing applications

TO SUPPORT, SUSPEND AND MOUNT ALL KINDS OF ELECTRICAL EQUIPMENT

No drilling, no welding, no special tools or equipment — versatile UNISTRUT framing permits adjustments, changes or additions to be made at any time.

The UNISTRUT method conserves steel, reduces manpower hours, cuts overall costs.

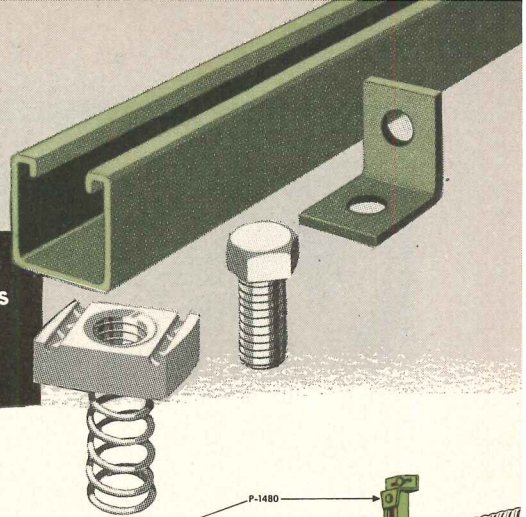

Two examples of how UNISTRUT concrete inserts, channel, fittings and maple insulating clamps support heavy overhead cable.

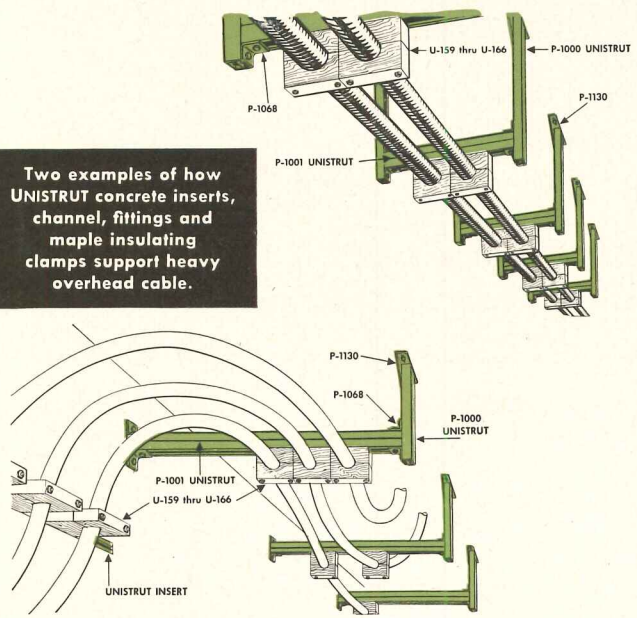

Here maple and porcelain cable clamps insulate conduit in UNISTRUT column-mounted assembly (at left) and cable in horizontal wall mounting (above).

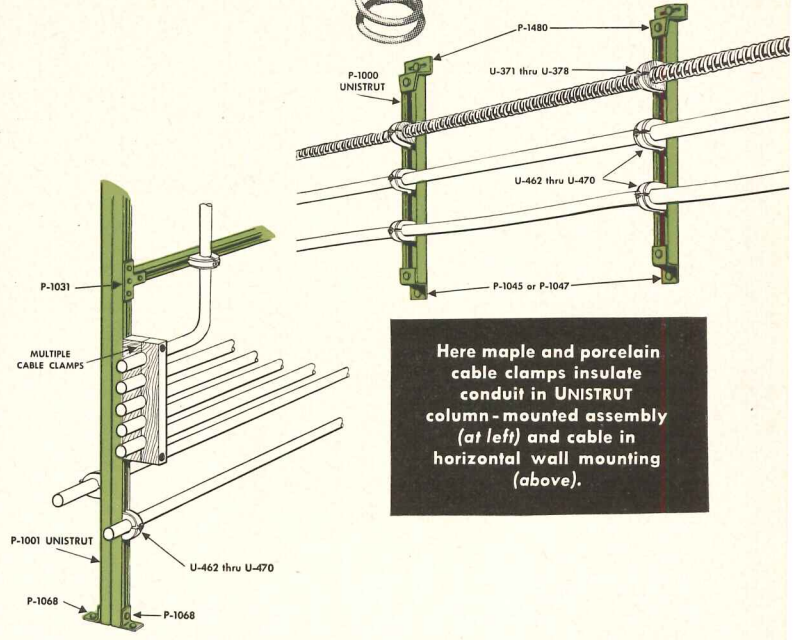

UNISTRUT framing assembly (trapeze hanging and vertical rise) supporting heavy conduit. Note how pipe clamps hold conduit firmly.

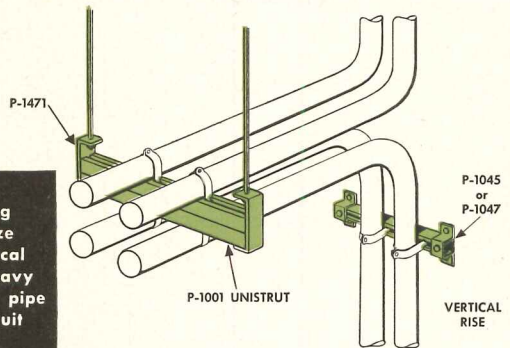

Here UNISTRUT beam clamps, pipe clamps, channel and fittings combine to suspend heavy conduit securely and compactly.

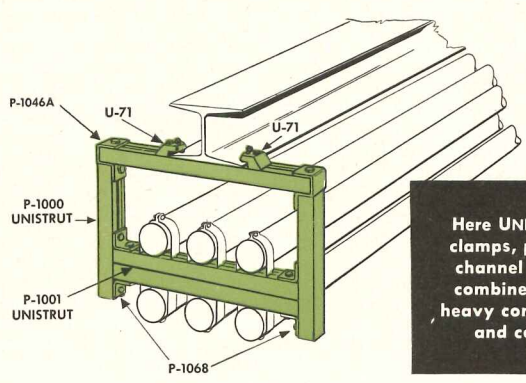

Only UNISTRUT

offers this Spring-Held Clamping Nut which ties together both sides of the slotted channel and forms a Box Section at points of connection for greater load strength.

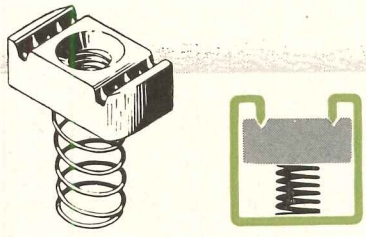

UNISTRUT Products are Bonderized

For Defense Production—Every day the value of UNISTRUT products is being proved by their use in Defense Industries and Armed Services installations where flexibility, and assembly and erection speed count most.

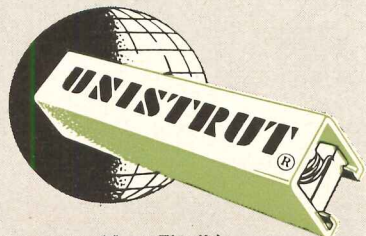

The World's Most Flexible All-Purpose Metal Framing

Write today for your FREE Copy

of New 78-page Catalog No. 700! Includes above drawings and countless other examples of how to mount, rack, frame, suspend and support all kinds of electrical and mechanical equipment.

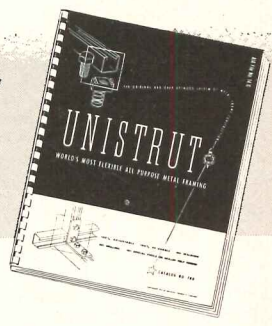

UNISTRUT PRODUCTS COMPANY
1013 W. Washington Blvd.
Chicago 7, Illinois, Dept. R5

Please send without obligation the items checked below:
 Catalog No. 700 UNISTRUT Sample Wall Chart
 Name _____
 Company _____
 Address _____
 City _____ Zone _____ State _____

DON'T WORRY!...USE

Young Convector

WITH PUBLISHED APPROVED* RATINGS

Steam Capacity Data

54 Ft. EDR (One Sq. Ft. EDR Equals 240 BTU Per Hr.)
215° F Steam — 65° F Entering Air

| DEPTH | LENGTH | TYPE | TYPE | TYPE | TYPE | TYPE | TYPE |
|-------|--------|------|------|------|------|------|------|
| 20 | 20 | 10 | 12 | 14 | 16 | 18 | 20 |
| 24 | 24 | 12 | 14 | 16 | 18 | 20 | 22 |
| 28 | 28 | 14 | 16 | 18 | 20 | 22 | 24 |

*The ratings of these convectors have been determined in conformance with Commercial Standard CS140-47, as developed cooperatively by the trade and the National Bureau of Standards, U.S. Department of Commerce, and the said ratings have been approved by the Convector Rating Committee."



The ratings of these convectors have been determined as developed cooperatively by the trade and the National Bureau of Standards, U.S. Department of Commerce, and the said ratings have been approved by the Convector Rating Committee.

In accordance with the provisions of Commercial Standard CS140-47, the percentages listed below in Table 12 have been added in the steam and hot water capacities for heating effect.

| Cabinet Height (Inches) | 16 | 20 | 24 | 28 | 32 |
|-------------------------|----|-----|----|-----|-----|
| Types "F", "R", "FR" | 4 | 2.7 | 10 | 3.5 | 2.5 |
| Type "S" | | | | | |

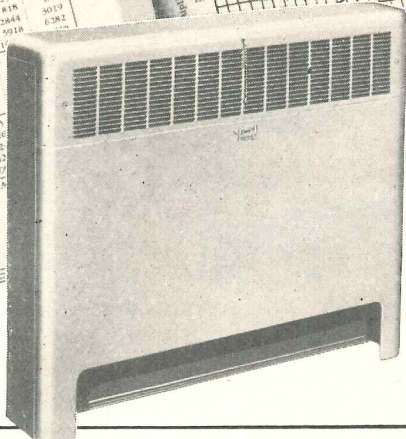

Reliability of ratings is a real boon when it comes to specifying any heating equipment. When you are in the market for convectors—for any hot water or two-pipe steam system—you'll find it pays in the long run to use convectors with *approved ratings*. Young convectors—free-standing, wall-hung, semi-recessed, bathroom, and low-level models—are rated and *approved* in conformance with Commercial Standard CS140-47—your guarantee of reliability. See your nearest Young Representative or write for full details.



YOUNG

Heating, Cooling, Air Conditioning Products for Home and Industry.
Heat Transfer Products for Automotive and Industrial Applications.

YOUNG RADIATOR COMPANY

Dept. 612-E • RACINE, WISCONSIN
Factories at Racine, Wisconsin and Mattoon, Illinois
Sales and Engineering Offices in All Principal Cities

If you think all convectors are alike, you'll find Catalogs No. 4049 and 4150 revealing. They give full details, including illustrated features of Young Convector, approved ratings, dimension data, etc. Be sure to have a copy in your catalog file. It will be sent you without obligation.



STEEL DECK

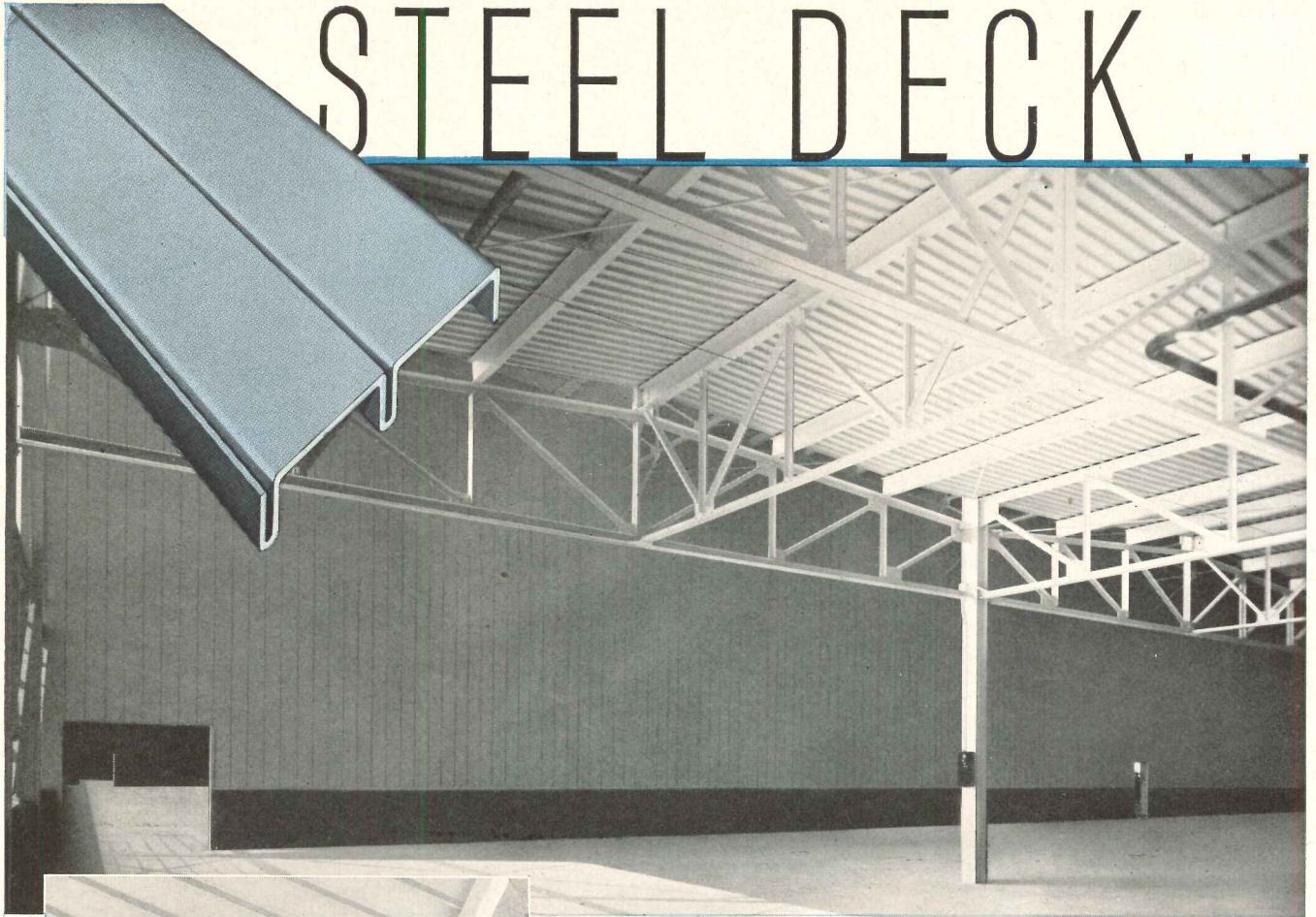

Mahon Steel Deck and Mahon Insulated Metal Wall Panels employed in New Building for L. A. Young Spring & Wire Company, Detroit, Mich. Christian W. Brant & Associates, Archts.; Barton-Malow Co., Gen. Contr.

Selected for Building with Insulated Metal Curtain Walls and Interior Dividing Walls!

The view above shows a Mahon Steel Deck Roof together with Mahon "Flush Type" Insulated Metal Wall Panels employed in the construction of interior dividing walls. Mahon "Fluted Type" Insulated Metal Wall Panels were employed for exterior curtain walls in this same building. No matter how you compare the different types of roof construction and materials, you will find that Steel Deck is the most economical, permanent, firesafe roof material available today. It's light weight, and the fact that it can be insulated to produce the specific thermal properties required in any given locality, reduce total roof cost to an absolute minimum. Mahon Steel Deck is available in Galvanized or Enamel Coated Steel. In the enamel coating process, the metal is chemically cleaned and phosphated to provide paint bond, and the synthetic enamel is baked on at 350° F. prior to roll-forming. This is just one of the extra-value features of Mahon Steel Deck. See Sweet's Files for complete information, or write for Catalogs B-52-A and B.

THE R. C. MAHON COMPANY

Detroit 34, Michigan • Western Sales Division, Chicago 4, Illinois

Representatives in all Principal Cities

Manufacturers of Steel Deck for Roofs, Partitions, Ceilings and Permanent Concrete Floor Forms; Insulated Metal Walls of Aluminum, Stainless or Galvanized Steel; Rolling Steel Doors, Grilles, and Underwriters' Labeled Rolling Steel Doors and Fire Shutters.

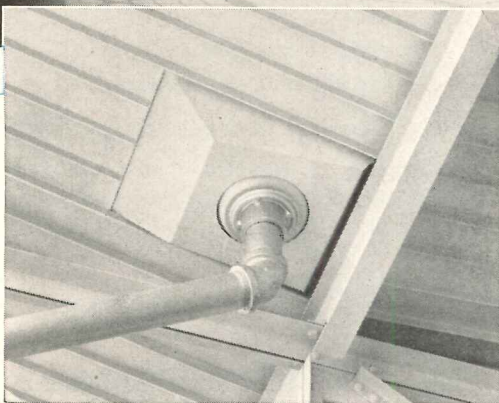

BUILT-UP SADDLES ELIMINATED

Built-up saddles are eliminated in Steel Deck Roofs. Purlins can be set to create valleys at sump locations in the drainage area. Steel Deck can be warped to conform. No additional deck plates are required—no cutting or fitting necessary.

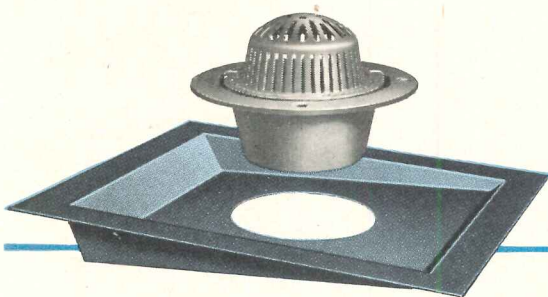

SUMP RECESSES and SUMPS

Mahon Roof Sump Recesses for use with Mahon Steel Deck can be furnished to fit any roof pitch. Mahon Cast Iron Sumps can also be furnished for 4", 5", and 6" conductors.

MAHON



© Ezra Stoller

YOUR *roof* MADAME

Under this Ruberoid roof pass the fashion leaders of Dallas, Texas. For it's Neiman-Marcus' new "Station Wagon Store." Throughout the Southwest, Neiman-Marcus is recognized as the undisputed arbiter of style and fashion. And now they bring their unique combination of luxury and informality to suburban customers in Preston Center. In the mysterious world of *haute couture*, we wouldn't know a flounce from a ruffle . . . but when it comes to roofing, Ruberoid has the answer to every problem—from factory to exclusive specialty shop.

That's why DeWitt & Swank, Dallas architects, chose a tested Ruberoid

specification for this smart modern store. Layers of coal tar pitch and tarred felt applied according to Ruberoid's complete instructions assure long years of satisfactory service. For like every Ruberoid roof, it's backed by over half a century of experience in the roofing business.

You'll find the right roof for your next job in "Ruberoid Bonded Built-Up Roofs and Flashings," the complete catalog of roofing specifications to meet every need. If you'd like a copy of this handy book, write us on your letterhead. Or refer to Sweet's Architectural Catalog 8A/RU. The Ruberoid Company, 500 Fifth Avenue, New York 36, N.Y.

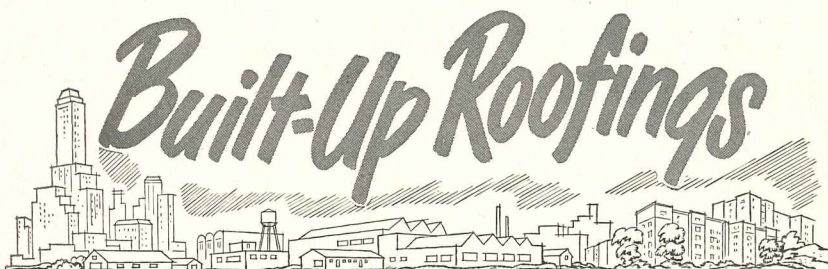

The **RUBEROID** Co.

ASPHALT AND ASBESTOS BUILDING MATERIALS

NEIMAN-MARCUS STORE Preston Center, Dallas, Texas

Architects:

DEWITT & SWANK, DALLAS

General Contractor:

A. J. RIFE CONSTRUCTION CO.,
DALLAS

Roofing Contractor:

ACE ROOFING CO., DALLAS

RUBEROID RECOMMENDATION

Precast or Monolithic Masonry Decks with Flush or Open Eaves—with or without Insulation.

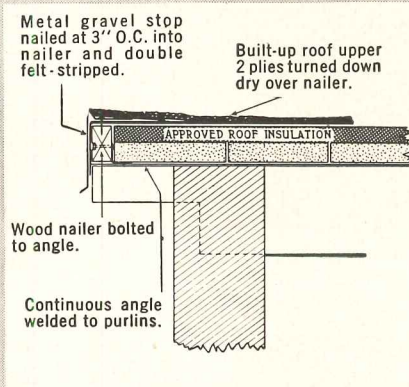

THE RIGHT ROOF FOR ANY JOB — FROM ONE SOURCE

Ruberoid makes every type of built-up roof — Smooth Surfaced Asbestos, Coal Tar Pitch with gravel or slag surfacing, and smooth or gravel-and-slag surfaced Asphalt . . . in specifications to meet any need. Ruberoid Approved Roofers are not prejudiced in favor of any one type. You are assured of centralized responsibility, smoother operation, uniform quality with Ruberoid built-up roofings.

Julius Schulman



ARCHITECTURAL RECORD'S
BUILDING TYPES STUDY NO. 186 **H O U S E S**

DIAGONAL TRUSSES PERMIT FOUR-WAY VIEW

Prepared by John Hancock Callender

Residence of Mr. and Mrs. Arch Ekdale, San Pedro, California

Sumner Spaulding—John Rex—Architects

C. Gordon DeSwarte—Structural Engineer

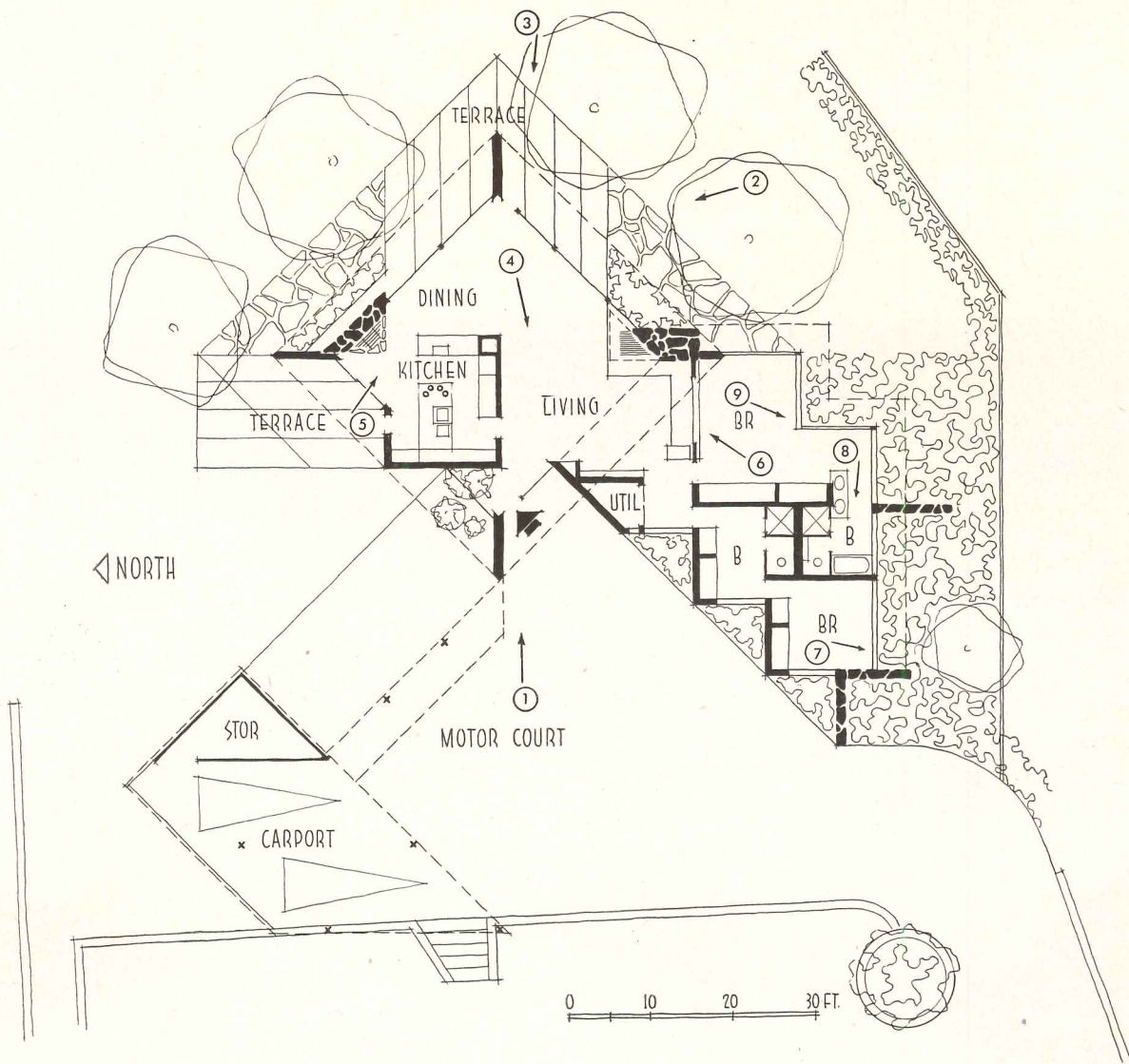

HOUSE WITH FOUR-WAY VIEW

1

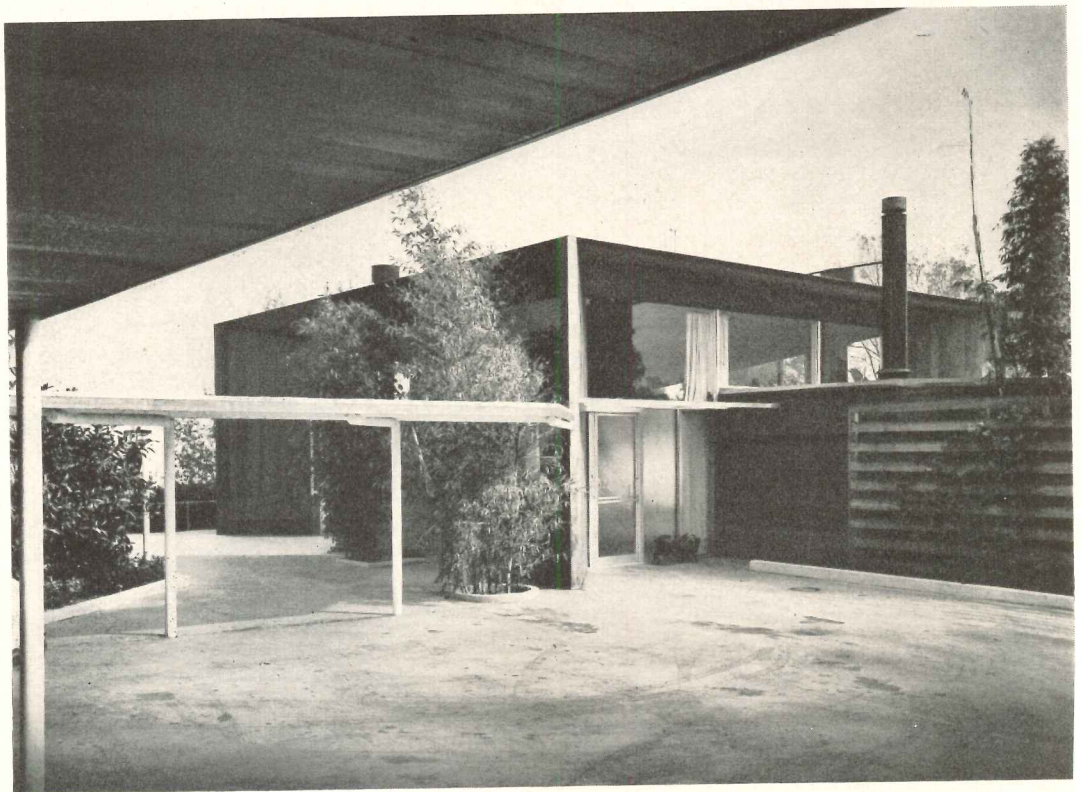

Julius Shulman

THE SITE, high in the palos Verdes hills, commands a panoramic view in almost every direction. Given a free hand by the owner, the architect met these rare conditions by designing a high, square, glass-walled enclosure for the living area, and subordinating the other parts of the house to this dominant element. The boxiness of this unit is relieved by a roof of unique design — an inverted pyramid with its apex suspended over the center of the room and its sides sloping upward and outward until they meet the eaves 6 ft beyond the glass walls. The roof is formed by two diagonal steel trusses, supported at the four corners of the room. Solid wall fins extend from the corners out to the ends of the trusses, providing structural bracing and visual interest. The effect of this roof on the interior space is to emphasize its loftiness and its four-directional view.

High square glass-walled bay dominates the design. Bedroom wing kept low and attached to living area where it does least harm to view. Bedrooms stepped back in plan for cross ventilation and better view

2

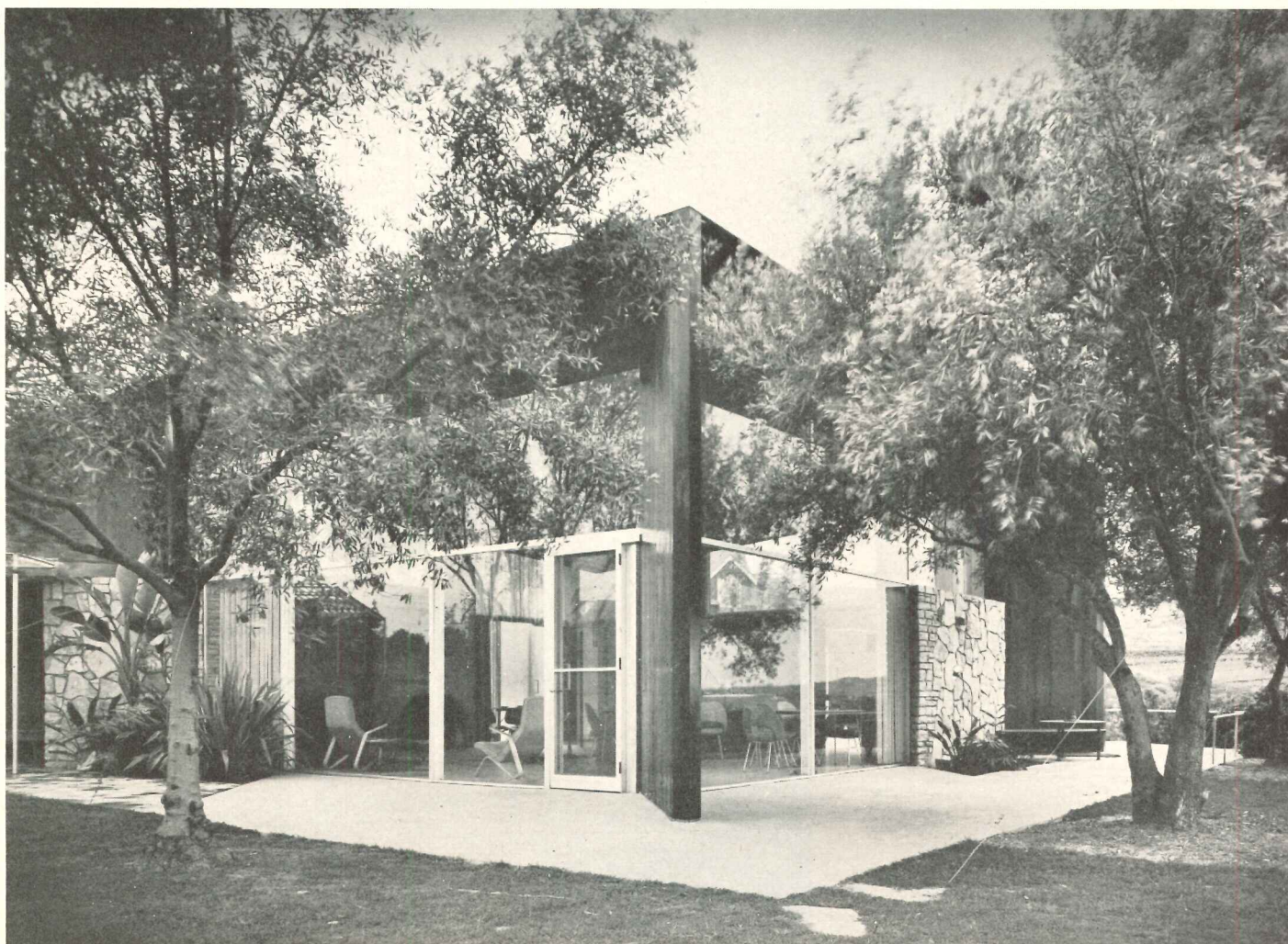

4

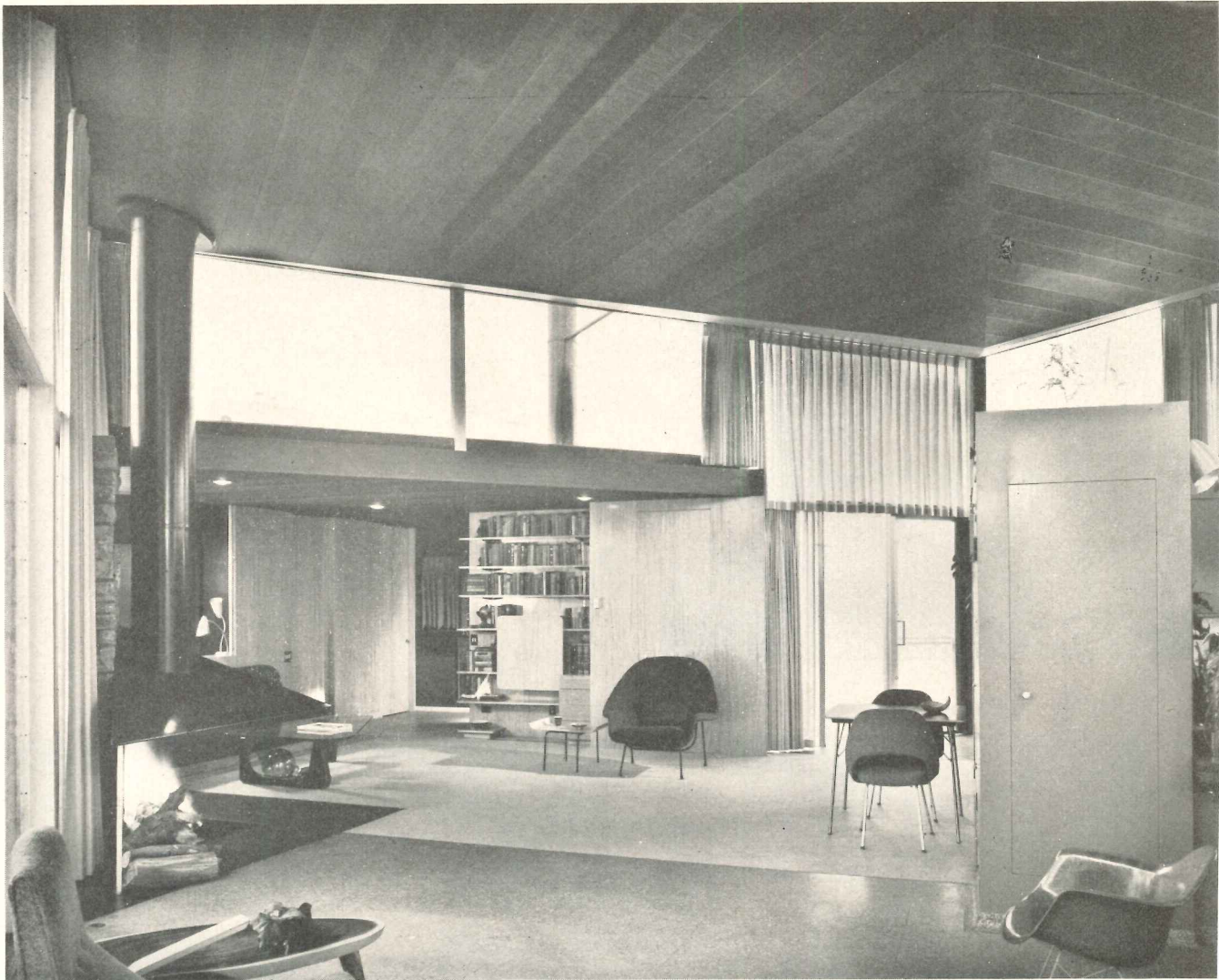

Julius Schulman

Above: living room extends back into low-ceiling bedroom wing. Right: charcoal grill supplements kitchen range; not shown is soda fountain, another feature of kitchen

5



Below: southeast elevation. Exterior materials are redwood and fieldstone picked up on site. Carpentry is by shipwrights; all finish materials screwed and doweled

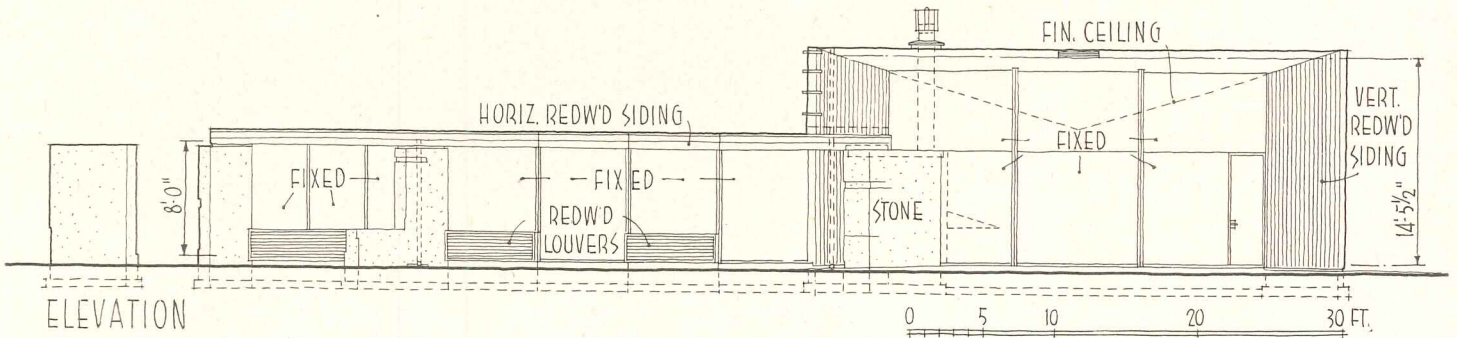

Below: sliding panels open master bedroom to living room. Sun lamps are installed in ceiling over each bed, and an inter-communication system is incorporated in headboard



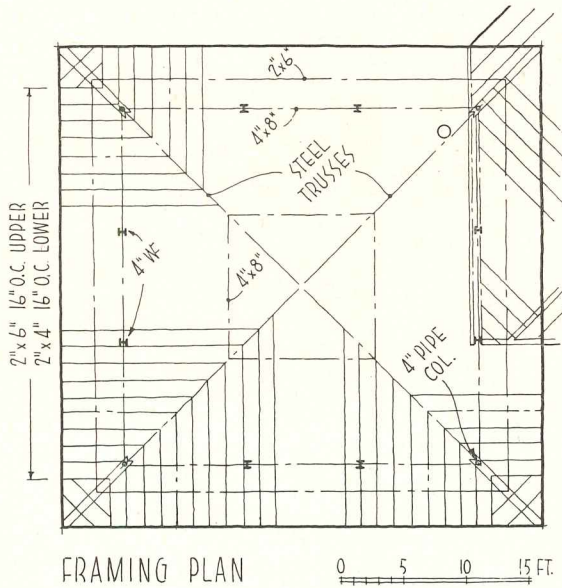
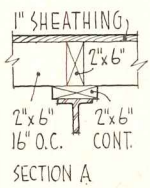
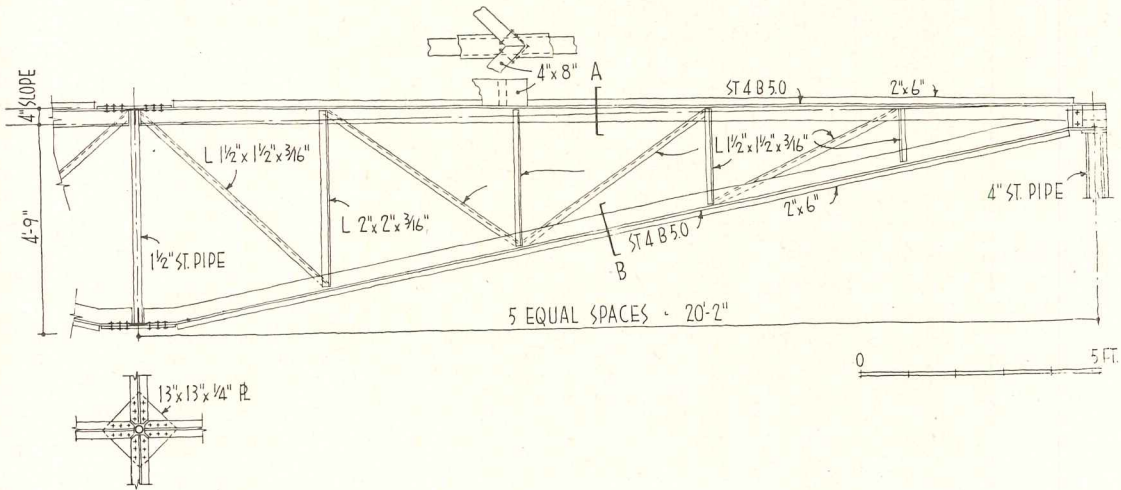

Left: roof framing plan and detail of truss. Roof is 39 ft square, enclosed area 28 ft square. Ceiling 9 ft 7 in. at center of room, 13 ft 6 in. at walls. Bedroom ceilings 8 ft. Below: guest room. Opposite page, above: master bath; floors and walls terrazzo; hot water pipes form towel bars. Opposite page, below: master bedroom, looking toward lavatory. Terrazzo floors used throughout house for easy maintenance. Bedrooms ventilated by sliding panels below fixed glass. Heating is forced warm air, oil fired

HOUSE WITH FOUR-WAY VIEW

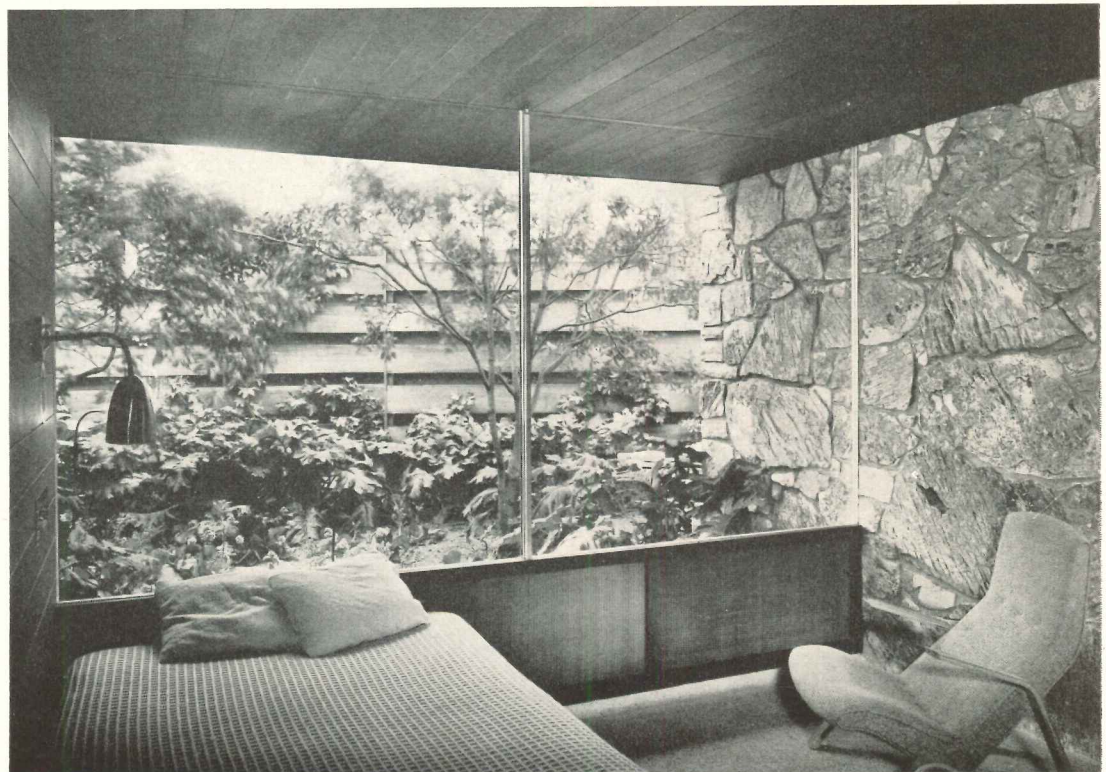

8



Julius Shulman



9



HOUSE ON

*Samuel R. Lewis and Associates
Mechanical Engineers*

*Edward H. Bennett
Landscape Architect*

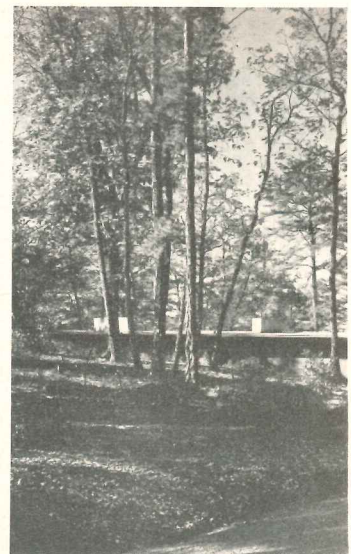

*Living room and terrace from west, shown above
in detail and below in relation to rest of house*

Joseph Molitor



MOUNTAIN RIDGE

Residence of Mr. and Mrs. Edward H. Bennett

Tryon, North Carolina

Schweikher and Elting, Architects

THIS house in the mountains of North Carolina was designed for the winter use of a semi-retired city-planner and his wife. The sloping site is heavily wooded and commands a fine view to the west across a valley to the mountains. The plan permits all major rooms to enjoy the view. Separate but adjoining apartments, each with a fireplace, are provided for the owners. They share a terrace on the east, screened from the motor court by a brick wall. The big living room with terrace on two sides, has distinct areas for dining, lounging, and study. The maid's room, at the end of the service wing, has a fireplace and is practically a duplicate of the master bedroom at the other end of the house. There is no garage nor any carport in the usual sense. Instead, a projecting roof along most of the entrance side of the house, can shelter several cars at once. It also provides a covered walk to the entrance door. Entrance side of house has no glass except at dining area. The roof pitches in a single direction, upward from the entrance side. The masonry walls opposite the entrance and between study and pantry are carried above the roof to the same height as the chimneys.

Left: general view of entrance side of house seen from drive. Service wing at right, bedroom wing at left. Below: main entrance, with skylight over dining area. In foreground, terrace outside bedroom wing, separated by brick wall from entrance court

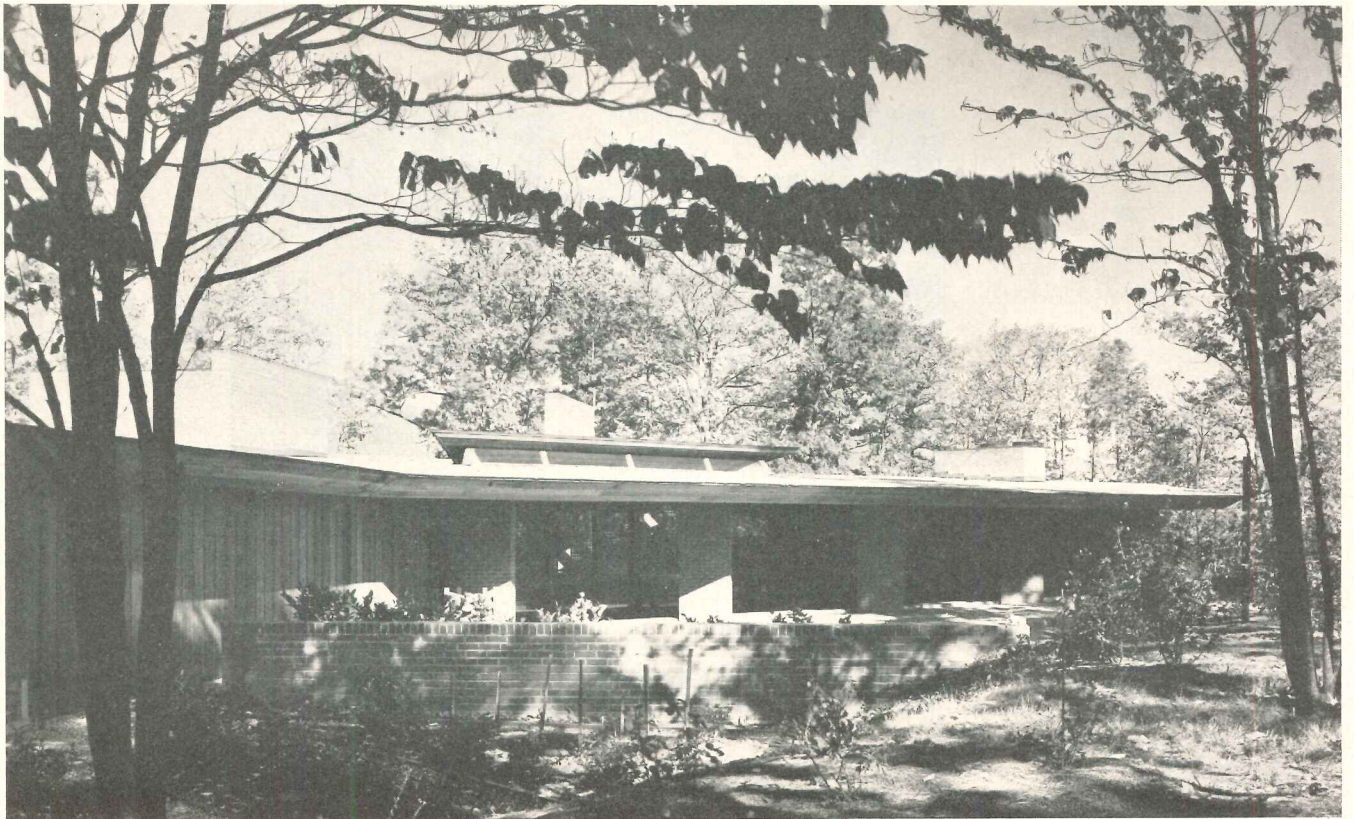

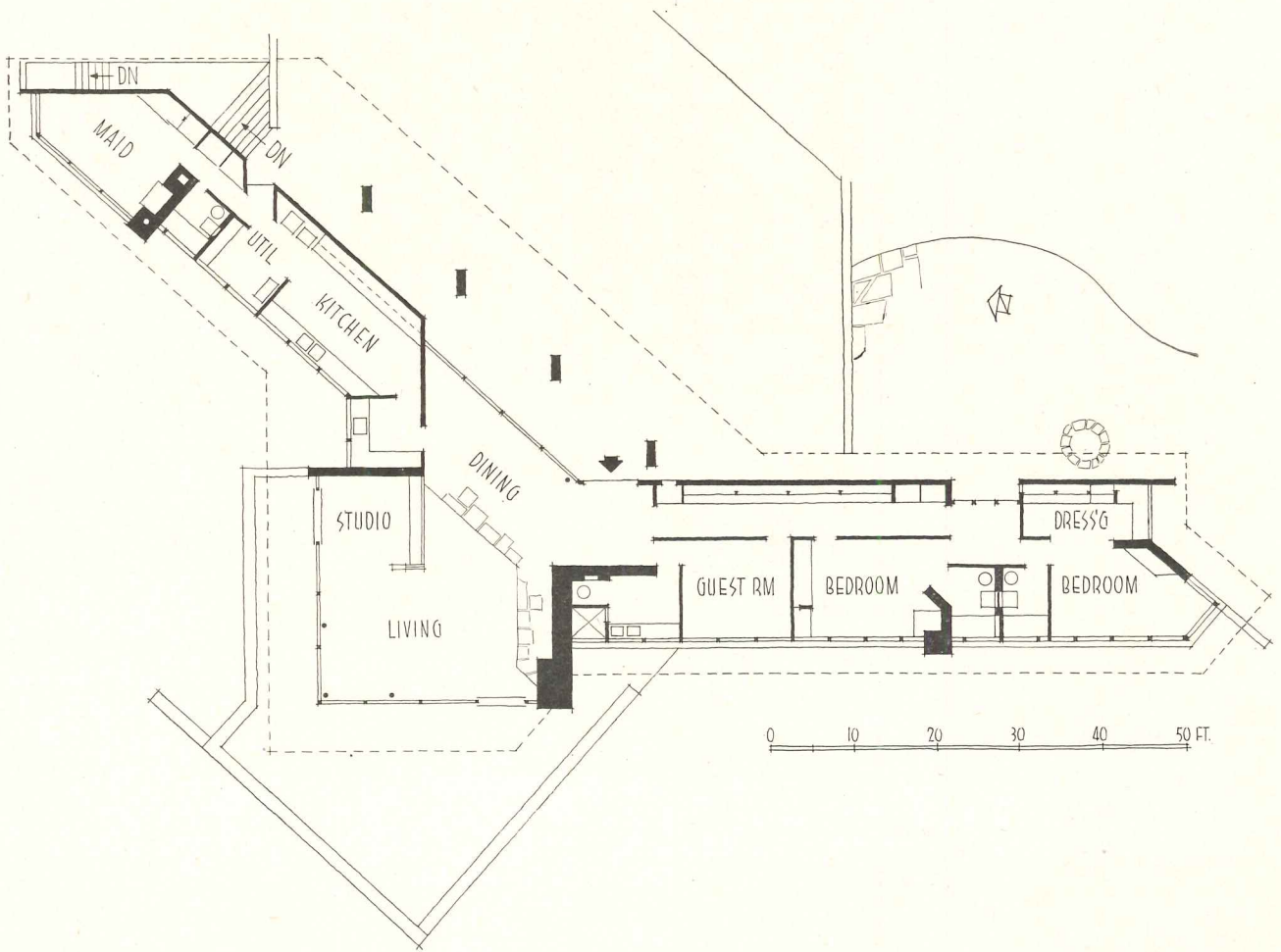

Ventilation in bedroom wing is through single giant louver below the windows. Bottom-hinged doors on interior drop down to hang flush with wall

HOUSE ON MOUNTAIN RIDGE

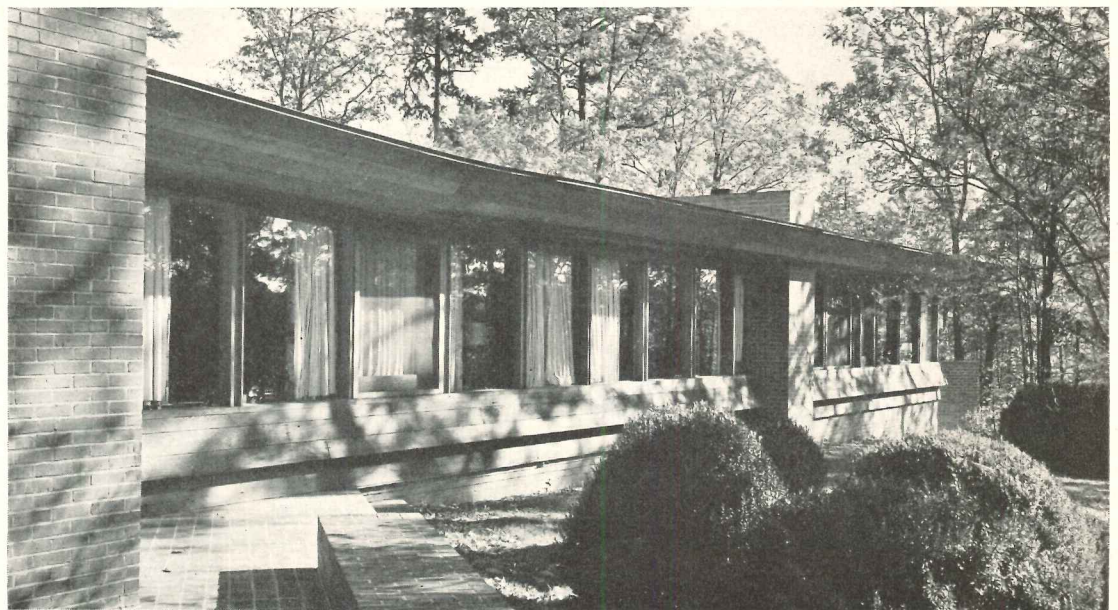

Joseph Molitor

Right: living room fireplace, terrace beyond. Below: dining area overlooking entrance court. Since roof extends almost 18 ft beyond glass wall, skylight is provided. Door to pantry at left. In both views intersecting ceiling boards give illusion of ridge or mitre; ceiling is actually one plane





End of bedroom wing, seen from outside (above) and inside (below). Bottom of page: living room terrace. Fore-shortened wall is same shown on p. 122



Joseph Molitor

HOUSE ON MOUNTAIN RIDGE

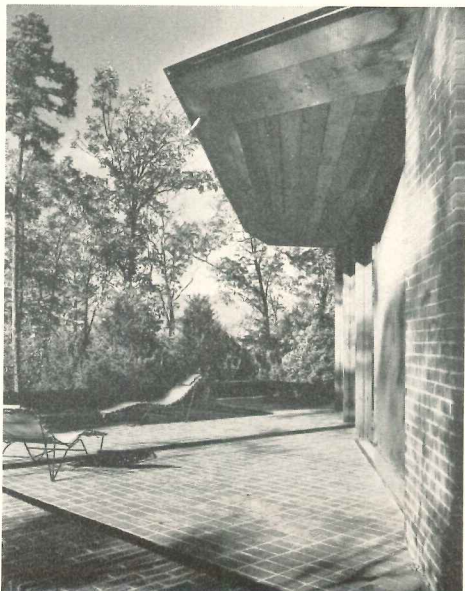

SITE, OWNER'S REQUIREMENTS AND BUDGET —
SOMETIMES IDEAL, ALWAYS A CHALLENGE

Since buildings must be designed for use, restrictions of one sort or another are an inseparable part of architecture. The conditions imposed by the site, the requirements of the owner, and the limitations of the budget are all restrictions in a sense. When we speak of an architect's design as a "solution," we are referring to the problem presented by these restrictions.

Although architecture without restrictions is inconceivable, too many restrictions can easily stifle it. Up to a certain point, restrictions may actually be beneficial, by challenging the architect to do his utmost. But where the restrictions are so severe that they dictate the design of the building, they may be fatal to architecture.

In residential design the deadliest of all restrictions is an insufficient budget. This in itself is a serious obstacle, but normally not insurmountable. It is the indirect effect that is most to be feared. Where the owner must borrow heavily in order to build, the resale value of his house becomes all-important. In such a case the design of the house is often determined, not by the architect and not by the needs of the owner, but by the mortgage lender's idea of its resale value.

On the brighter side is the fact that now and then an architect has the good fortune to be able to carry an architectural idea through to fulfillment without having to compromise on any essential point. If the architect is clear in his own mind as to what he wants to say and if he has the skill to say it clearly, the result will be interesting architecture, at the very least. If what the architect has to say is important, the result may be great architecture.

The Ekdale house is a brilliant example of what can happen when site, client, and architect are all exceptional, and restrictions are not severe. A clear-cut architectural idea has been skilfully stated and carried through without compromise. The same is true of the Bennett and the Palmer houses. The Poetker house differs from these only in that its successful result was achieved in spite of extreme difficulties. Possibly this is a case where the numerous obstacles stimulated the architect and resulted in a better design than would otherwise have occurred.



Hedrich-Blessing

SITE CHOSEN FOR VIEW DESPITE DRAWBACKS

Residence of Mr. and Mrs. Joseph G. Poetker

Mt. Adams, Cincinnati, Ohio

Garriott, Becker & Bettman, Architects

O. W. Motz, Mechanical Engineer

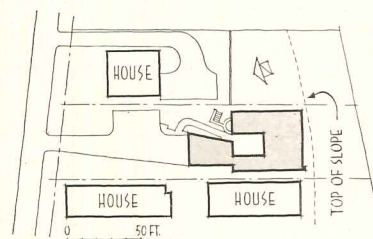

DESIGNING A HOUSE to exploit the dramatic view afforded by a site high above the city, presented many difficulties. The narrow, deep lot, in a built-up and by-passed section of the city, was hemmed in on the west by two high and ungainly frame tenements. To the east, however, lay only the unused backyard of a house built close to the street. The U-shaped plan with entrance through the court, blank west wall, and bedroom facing east, was the direct result of these site conditions.

The partially covered entrance court, adopted by

necessity, proved to be one of the pleasantest features of the house. The small sheltered area is an effective contrast to the big living room with its magnificent view. The view can be enjoyed even from the court, as shown in the illustration on page 130.

Floors and walks are paved with an old local brick of a dark purplish red color. In addition to hot-water radiant heat in the floor slab, a separate hot-air system blankets the 40-ft glass wall in the living room from slots in the floor. An 8-ft roof overhang keeps out the summer sun.

SITE CHOSEN FOR VIEW



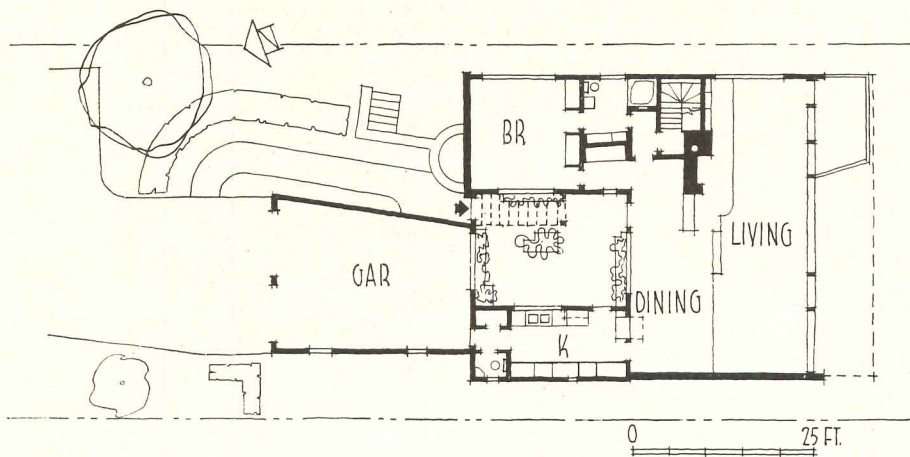

Hedrich-Blessing

House is at rear of 50 by 200 ft lot, giving privacy from street and scope for landscaping by florist owners. Turn-around and parking space for several cars is provided, shown in part at upper left of plan above. Right: entrance court seen from entry. Below: main entrance, bedroom wing at left. Opposite page: living room with view for which house was built





Hedrich-Blessing

Left: entrance court with view through entry and living room to distant river and beyond. Kitchen at right. Trellis marks entrance walk and protects privacy of high bedroom windows from adjacent building. Below left: kitchen seen from dining room. Breakfast table folds up to close pass-through completely. Below right: dressing table in master bath

SITE CHOSEN FOR VIEW

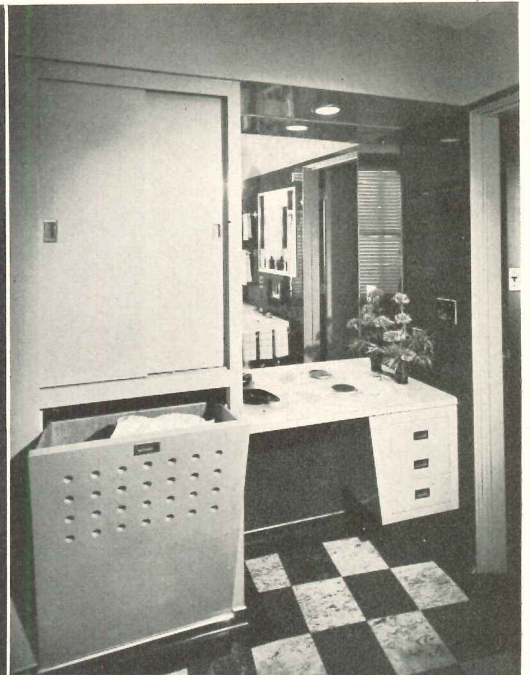
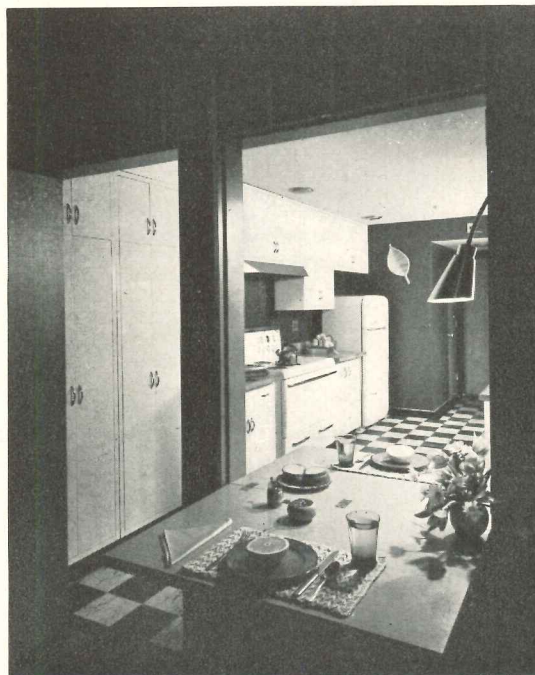

DESERT HOUSE WITH VIEW TO SOUTH

Residence of Dr. and Mrs. Paul Palmer

Phoenix, Arizona

A. Quincy Jones, Architect

Edgardo Contini, Engineer

THE DESERT SITE slopes down from Camelback Mountain on the north. To the south there is a pleasant view of the valley and the distant city. The approach is from the north, which makes it difficult to take advantage of the view of the mountain without sacrificing privacy.

The house was designed for a doctor and his wife and their two sons and three daughters. Facilities are provided for full family life, or complete separation

of the two generations. A huge living-dining-playroom is the center of family life. However, if this room has been taken over by the teen-agers, the parents can entertain their friends comfortably in the study-sitting room adjacent to the master bedroom.

Alcove partitions in children's wing extend only to door-head height, facilitating future rearrangement as living needs change.

Each wing has its own outdoor living area.

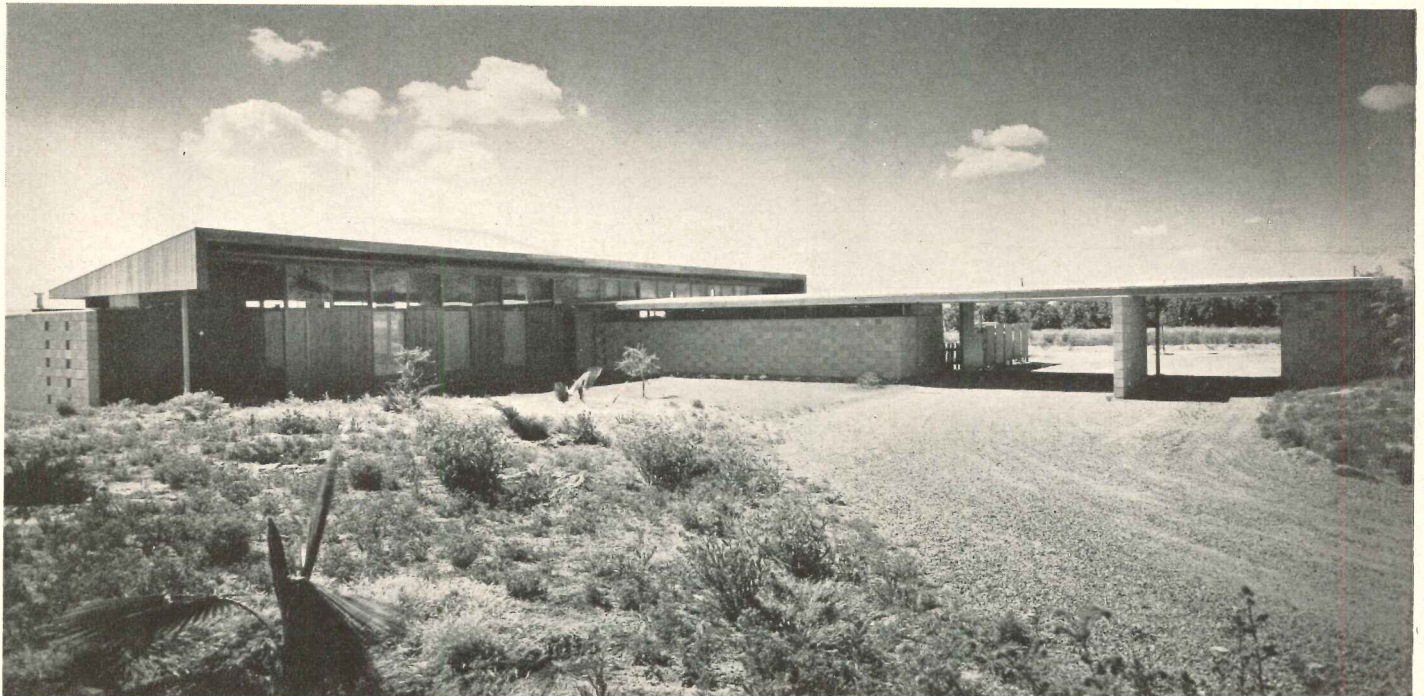

Stuart A. Weiner

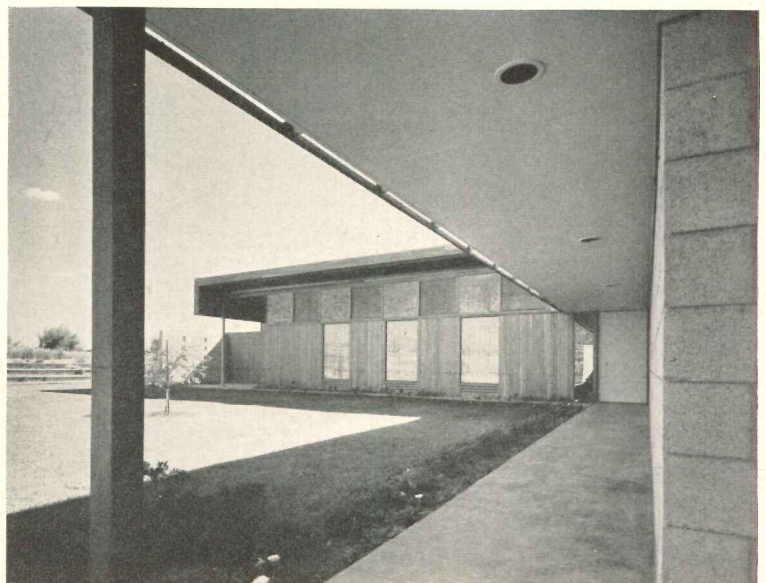

DESERT HOUSE



Stuart A. Weiner

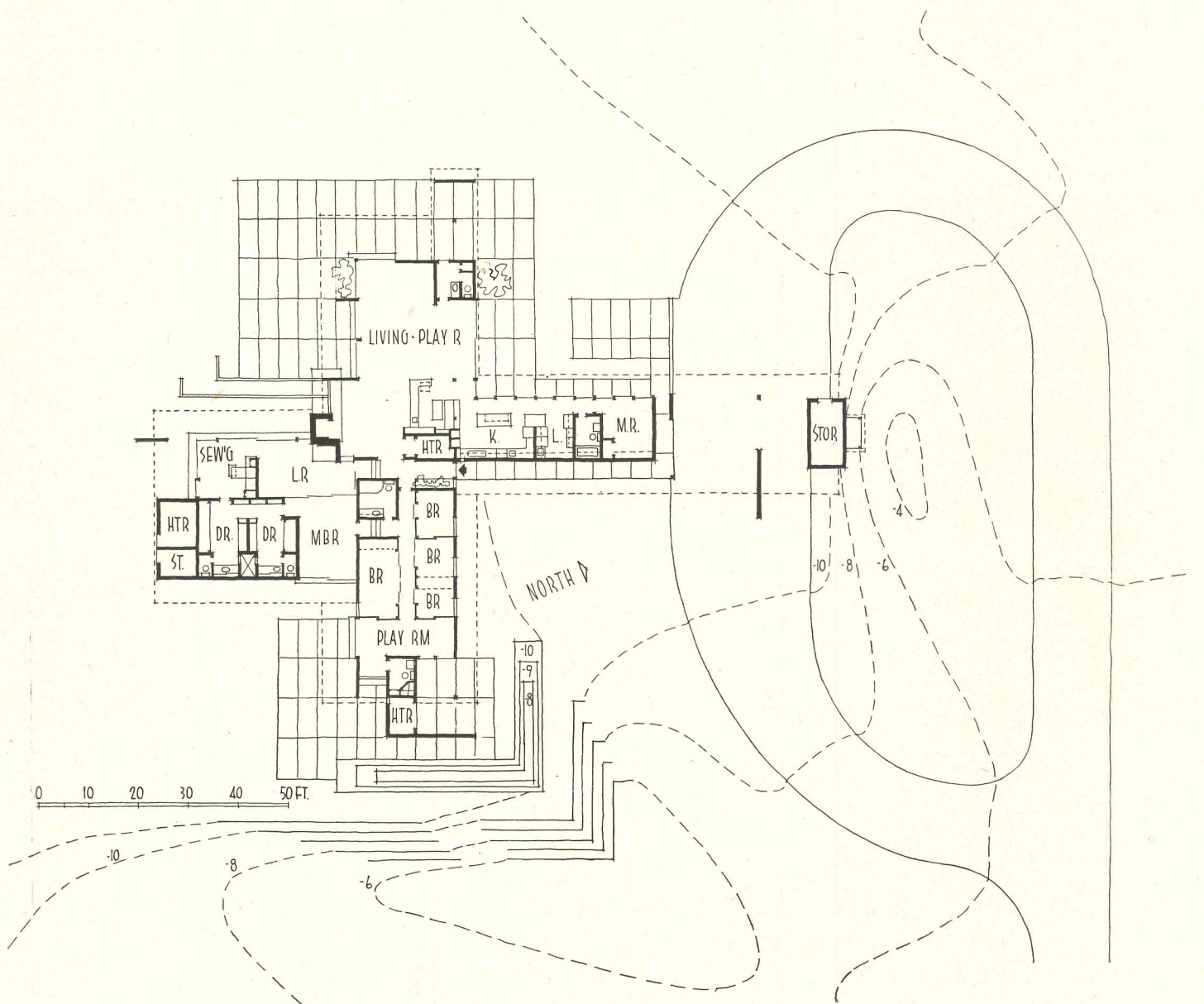

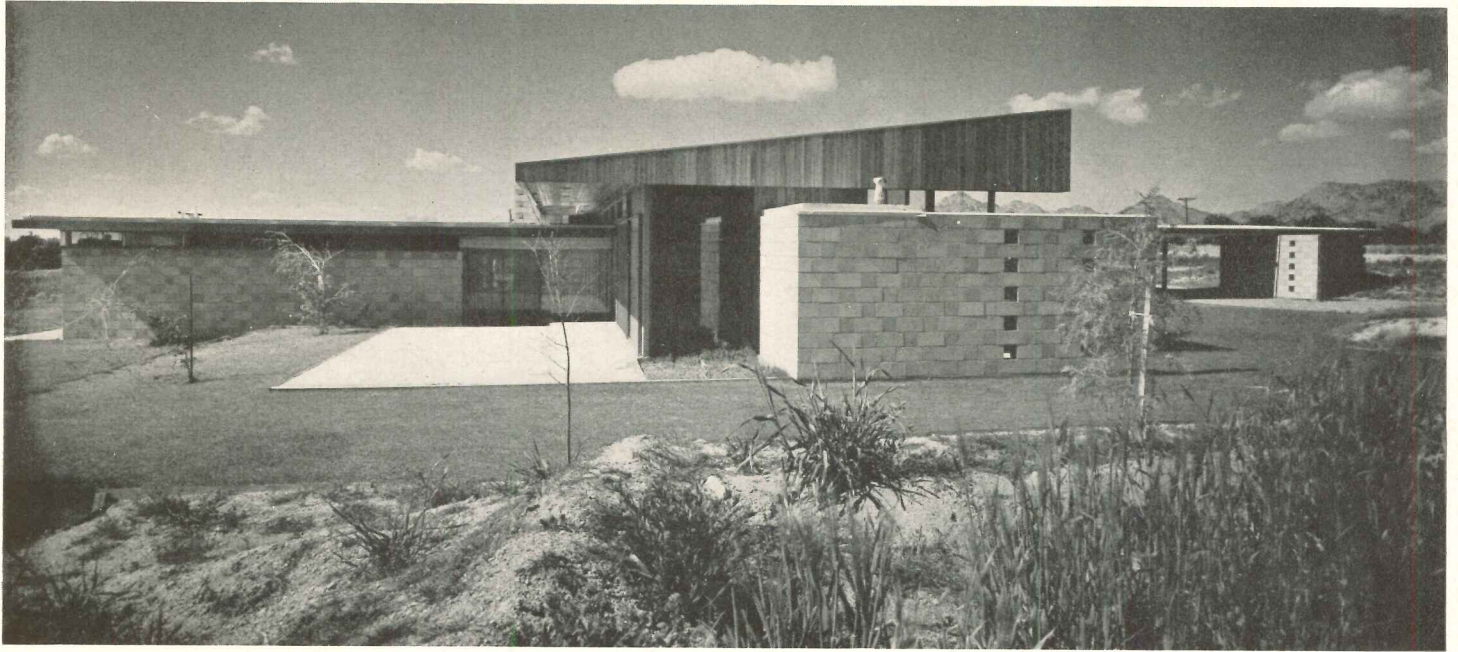

Opposite page: living room terrace, master wing on right. Outdoor dining is to north of living room where it is shaded from the afternoon sun and enjoys the view of Camelback Mountain. Above: children's wing and terrace. Below right: terrace outside master wing

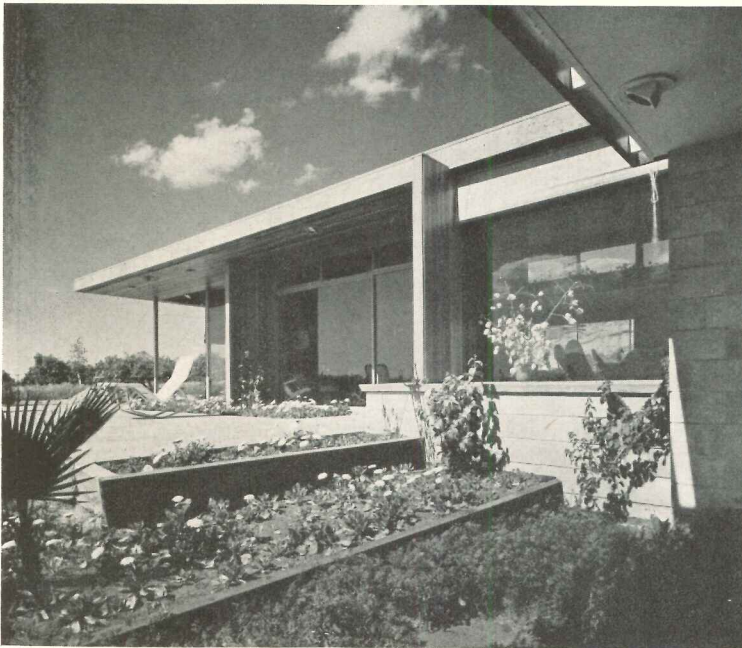

On the plan (opposite page) separate functions are clearly expressed in the four distinct wings. The house is fully air conditioned by means of three separate package units. White gravel roofs, ceiling insulation, and large overhangs reduce the cooling load

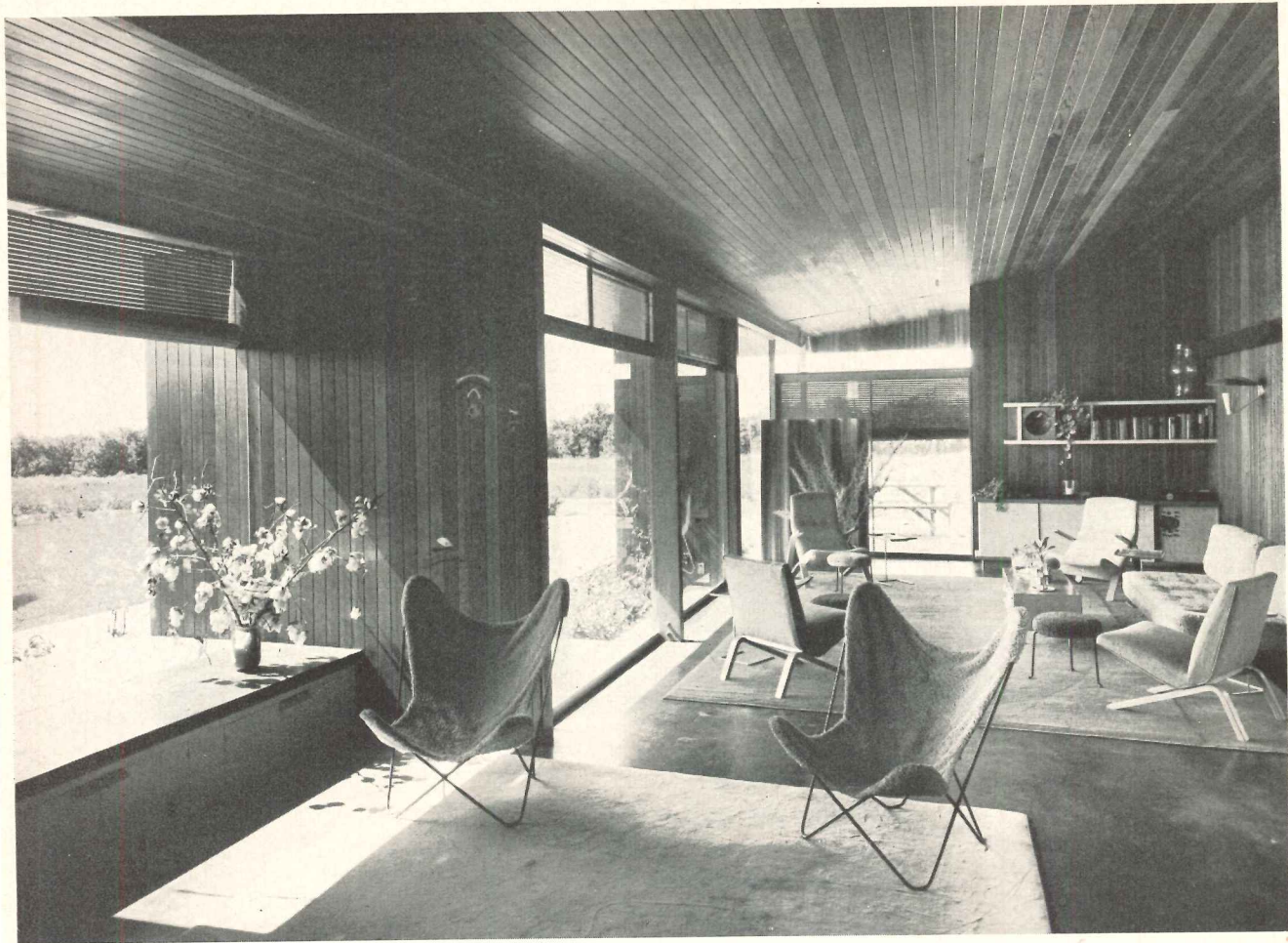

Stuart A. Weiner

DESERT HOUSE

Floors are concrete, cork in the children's wing, asphalt tile in kitchen and baths. Interior finish is natural redwood or painted plywood. Behind curtains (right) sliding glass doors open to outdoor dining area. Handles in ceiling operate sliding clerestory windows

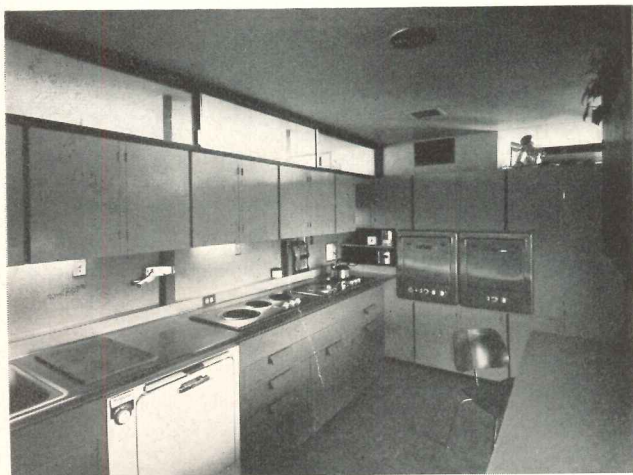
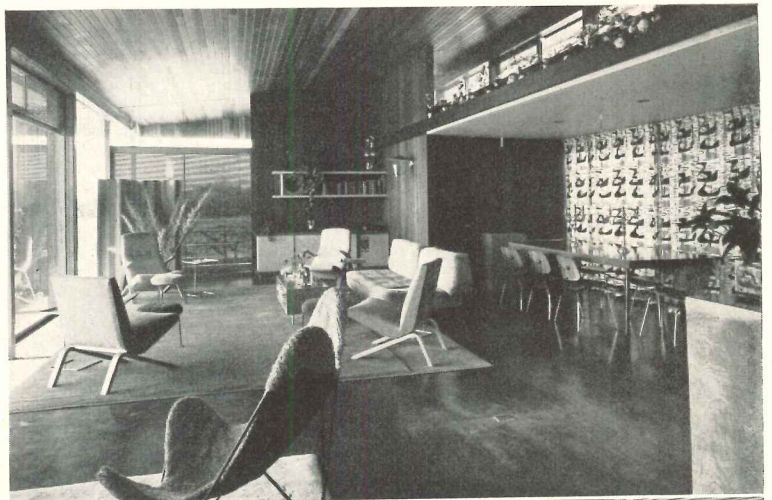

HOUSE TURNS INWARD ON PATIO FOR PRIVACY

Residence of Dr. and Mrs. William S. Beck

Los Angeles, California

Thornton M. Abell, Architect

Hillman & Nowell, Structural Engineers

THE HOUSE WAS DESIGNED for a young doctor, his wife and their two small children. The master bedroom is also a study, intended for serious work. This large, comfortable room with its own fireplace can readily be used as a second living room in the future when the children entertain their friends in the main living

room. The children's bedrooms open onto their private play yard in front of the house, protected from the street by a high fence. Children can also play in the patio under supervision from the kitchen. A bedroom and bath near the entrance can be used either as a guest room or a servant's room.

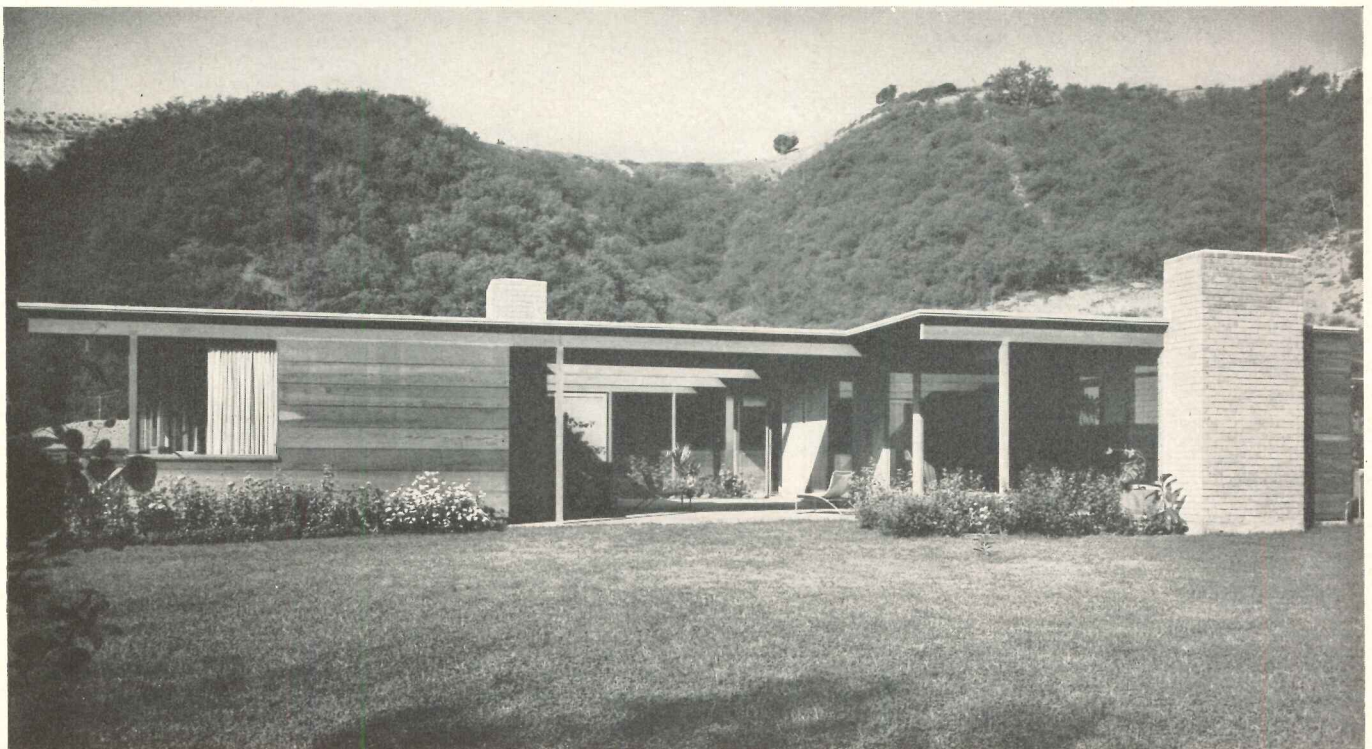

Julius Schulman

With neighbors close by on each side, the house turns inward upon its patio and also opens out to the rear, which is entirely private. Seen from the street, the house is completely closed (right). In striking contrast is openness as seen from rear (above)

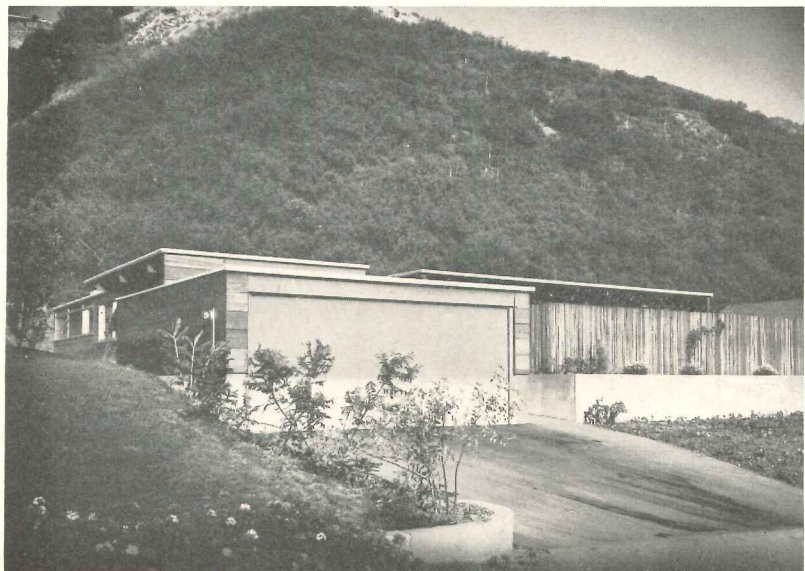

PATIO HOUSE



Julius Shulman

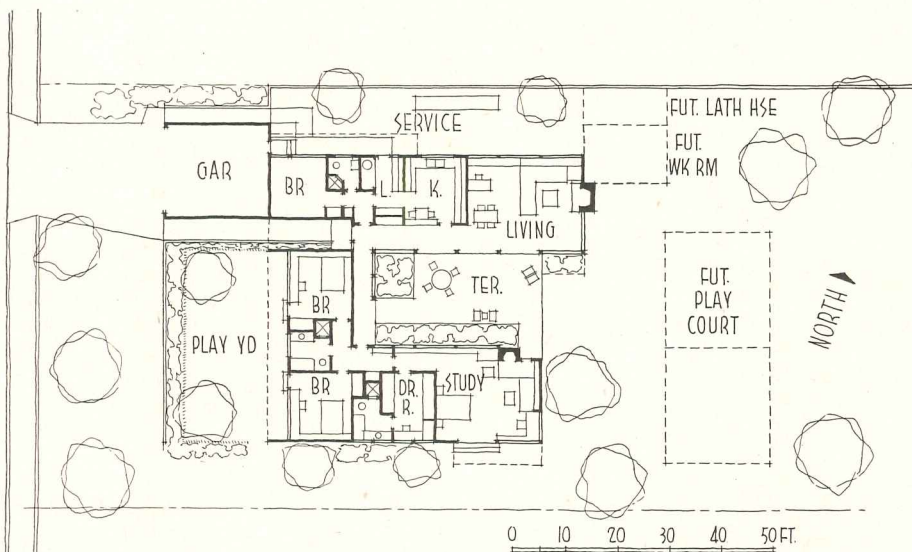

Locally popular patio plan is ideal solution for narrow lot between existing houses. U-shaped plan opens to rear (east) where property extends high up side of wooded canyon. Principal rooms open onto partially covered patio, used most of year as outdoor living room. Construction is plank and beam on exposed posts in 8 by 18-ft bays. Concrete slab floor with radiant heat

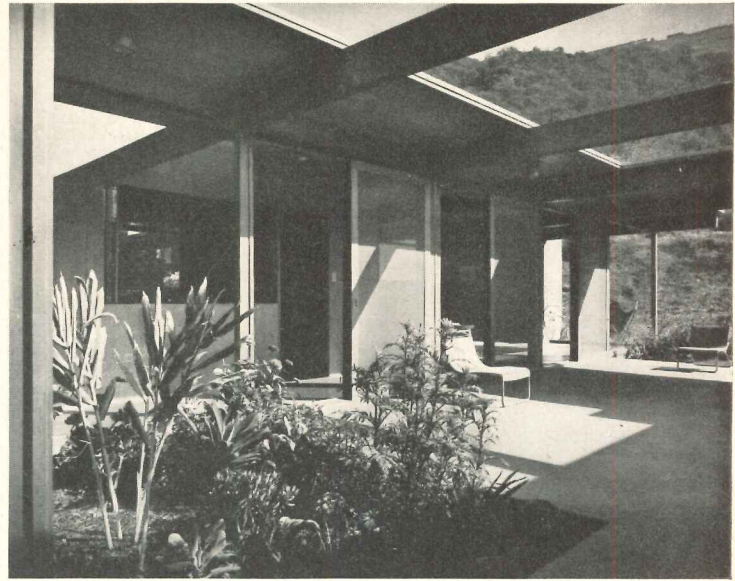
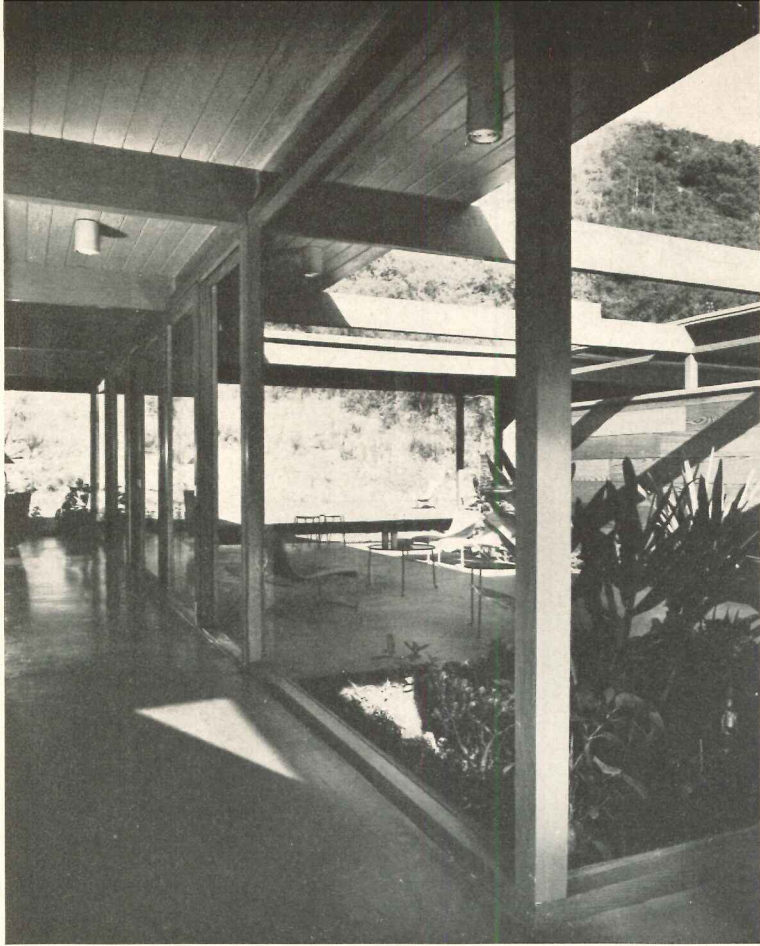

Above and opposite: three views of "outdoor living room." Absence of draperies brings indoor and outdoor rooms into closer relationship. Below: obscure glass provides privacy on other wall of living room

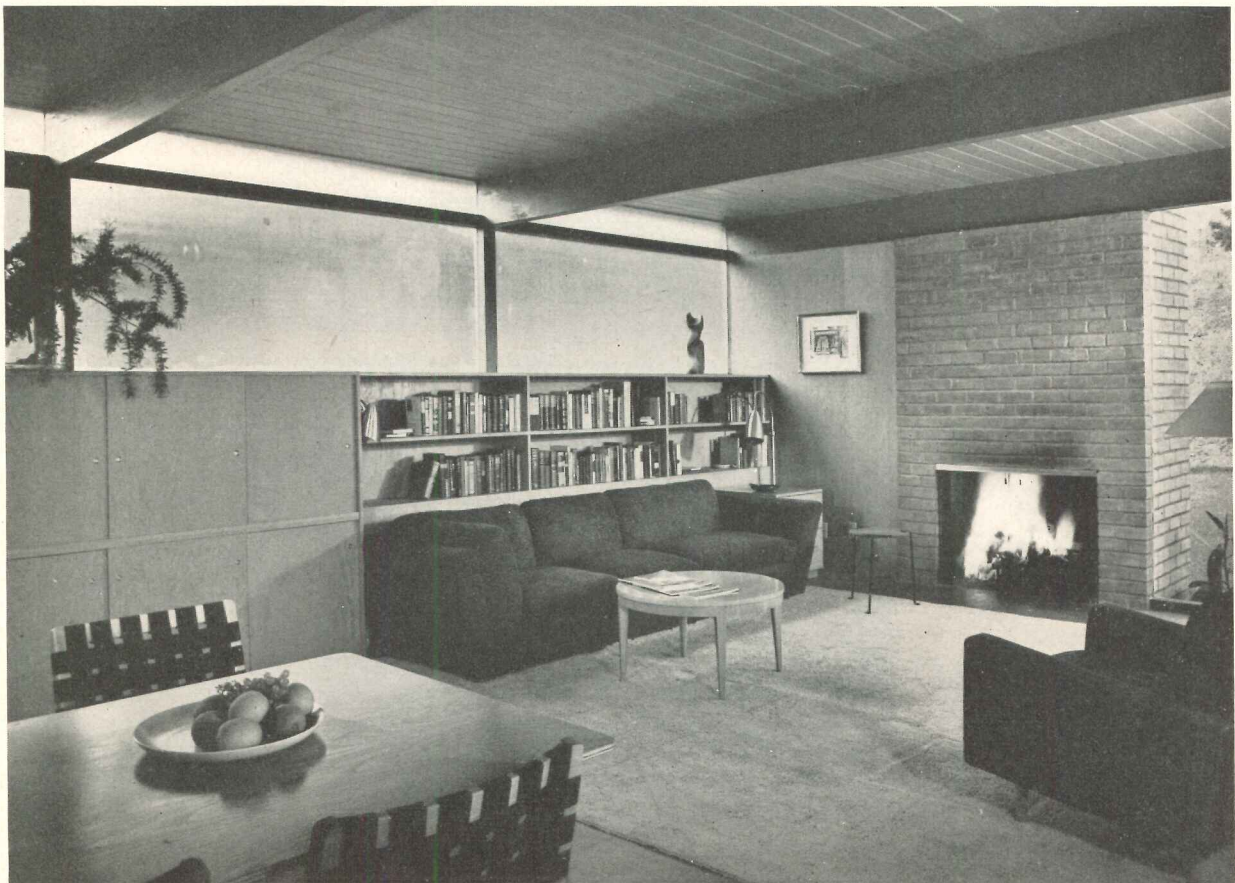

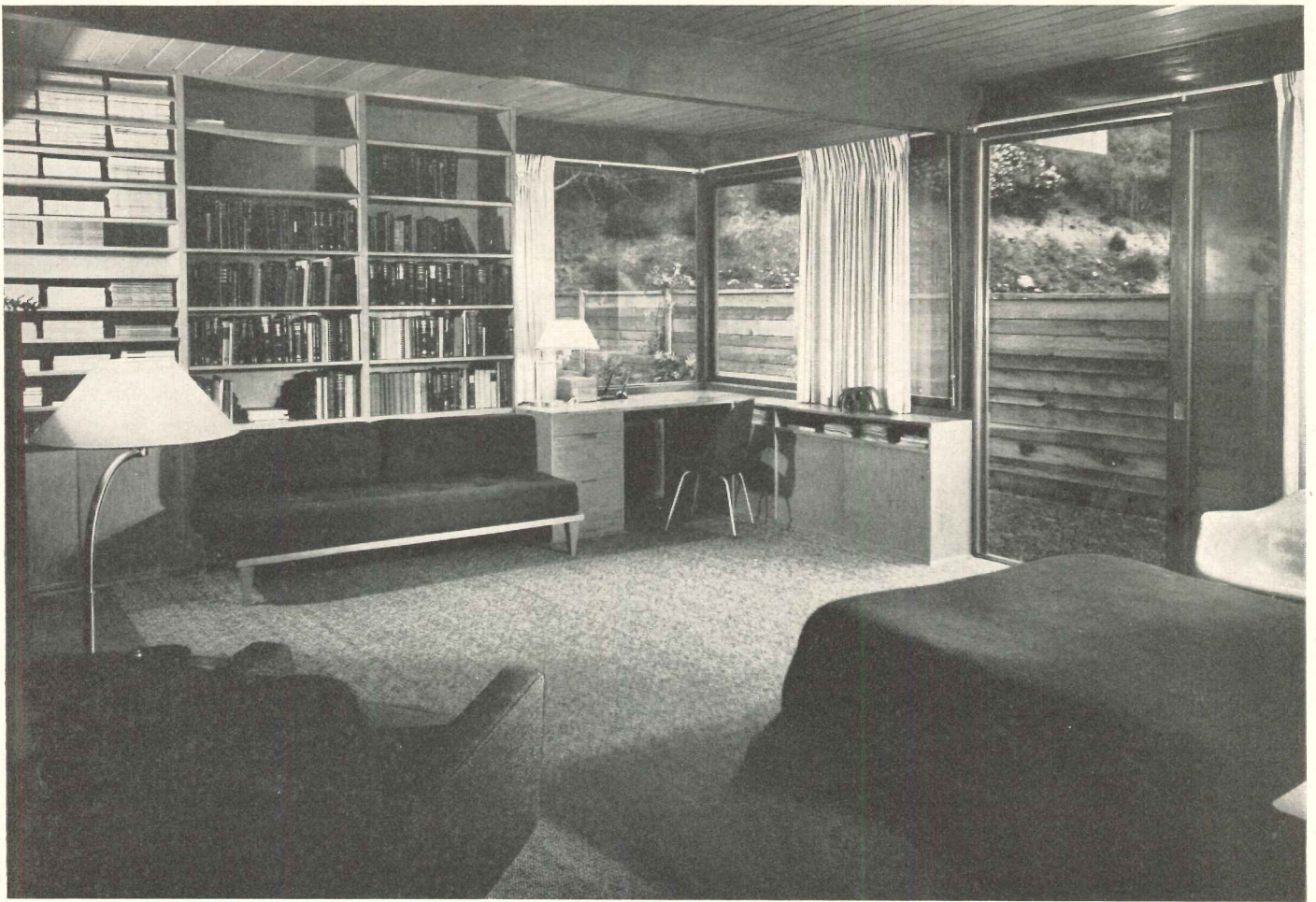

Above and below: master bedroom and study. Interior finish natural redwood or plywood stained yellow. Ceiling plank stained light turquoise. Structural frame, windows and doors, stained deep gray-green. Floors gray

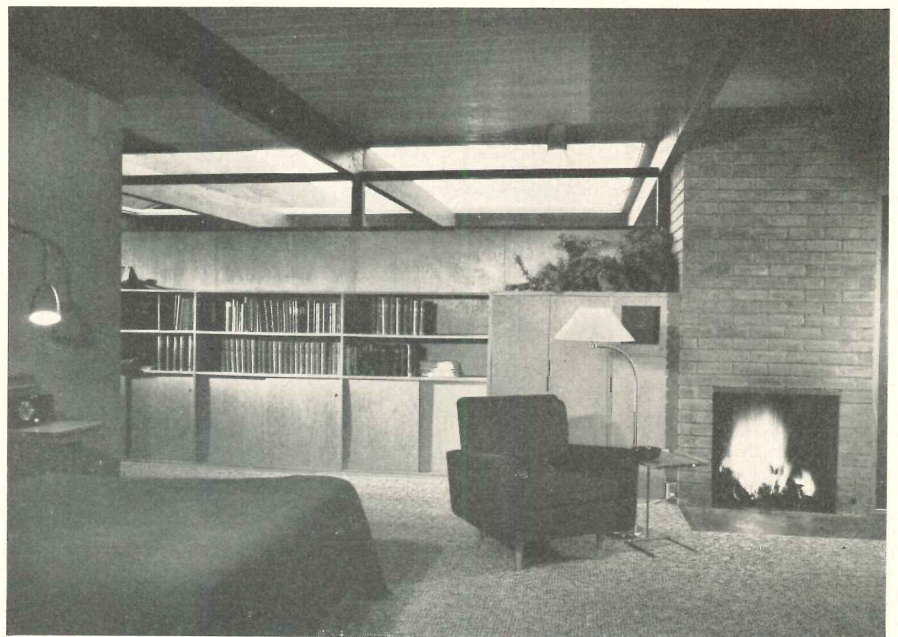

Julius Shulman

PATIO HOUSE

HOUSE FOR SUBURBAN CORNER LOT

Residence of Miss Agnes Palley

Scarsdale, New York

Sanders—Malsin—Reiman, Architects

THE SITE is a corner lot in a highly conservative suburban community. With streets on the south and west sides of the property, the architect's problem was to provide favorable orientation along with a reasonable degree of privacy.

The house proper is a compact rectangle, 32 by 42 ft, with its shorter dimension facing the street. Needed length has been given to this elevation by means of a continuous roof across house and garage. This provides a covered walk between garage and service entrance, a convenient location for the basement stair, and on the rear a screened porch conveniently located for outdoor dining.

Concrete block walls are kept almost free of openings which is economical and also improves their appearance. Windows and doors are concentrated in wood walls, whose lightness is in pleasing contrast to the unbroken planes of masonry. The change of materials is emphasized by projecting the ends of the concrete walls beyond the plane of the wood and glass walls.

Gas-fired warm-air heater and domestic hot water heater are located in partial basement under front part of house, the remainder of the house being built over crawl space. Roof is topped with marble chips and edged with copper. Wood siding is stained fir.



Ben Schnall

View from southwest. Living room and terrace on right and service entrance on left are screened by planting

SUBURBAN HOUSE

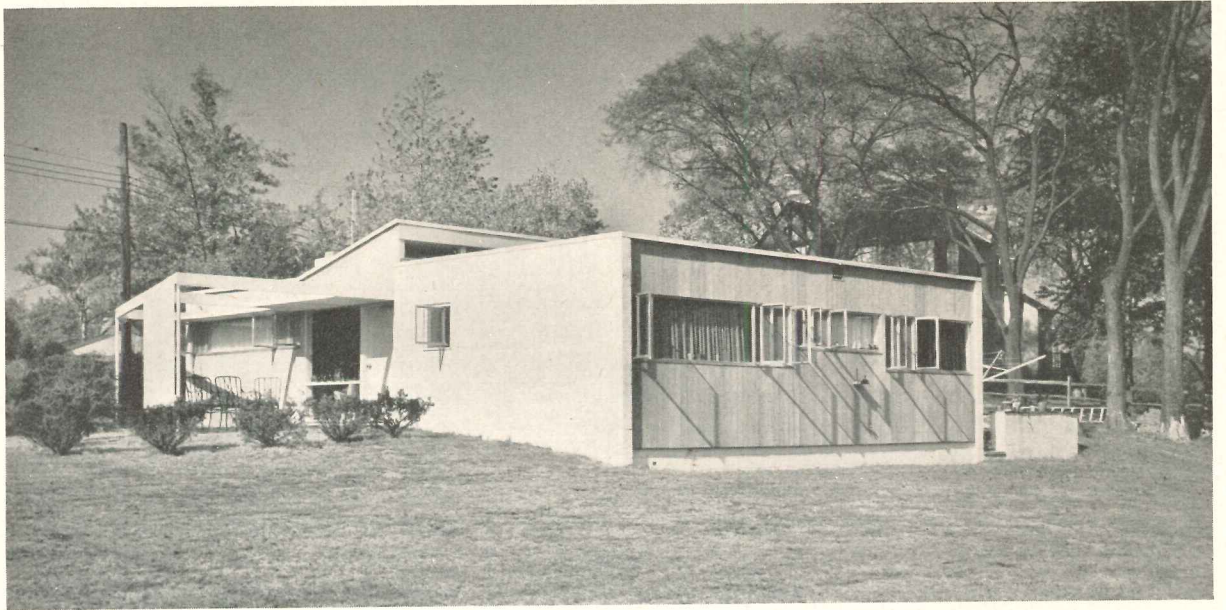

Above: view from southeast, showing rear elevation of wood and glass contrasted with almost unbroken masonry wall on south. Skylight and terrace sunshades add interest to exterior appearance and help to avoid boxy look often seen in small flat-roofed houses. Plot plan (below) shows house located near north property line in order to provide maximum privacy on south. Garage screens house on north. Bedrooms are on rear facing east. Living room is on south and opens onto terrace, screened from street by fence. Right: built-in seat utilizes structural column

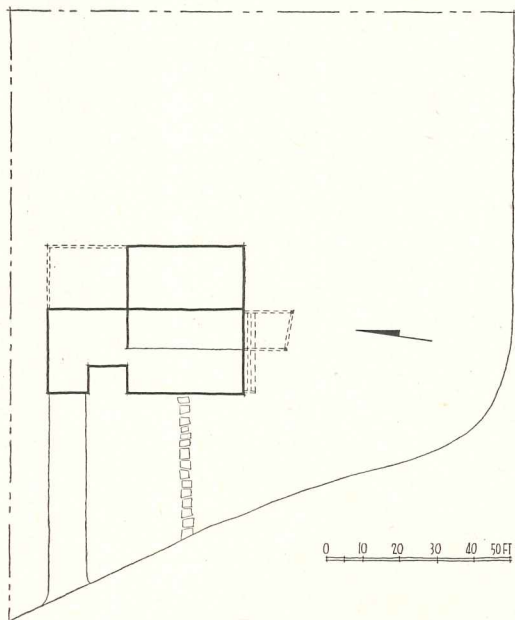

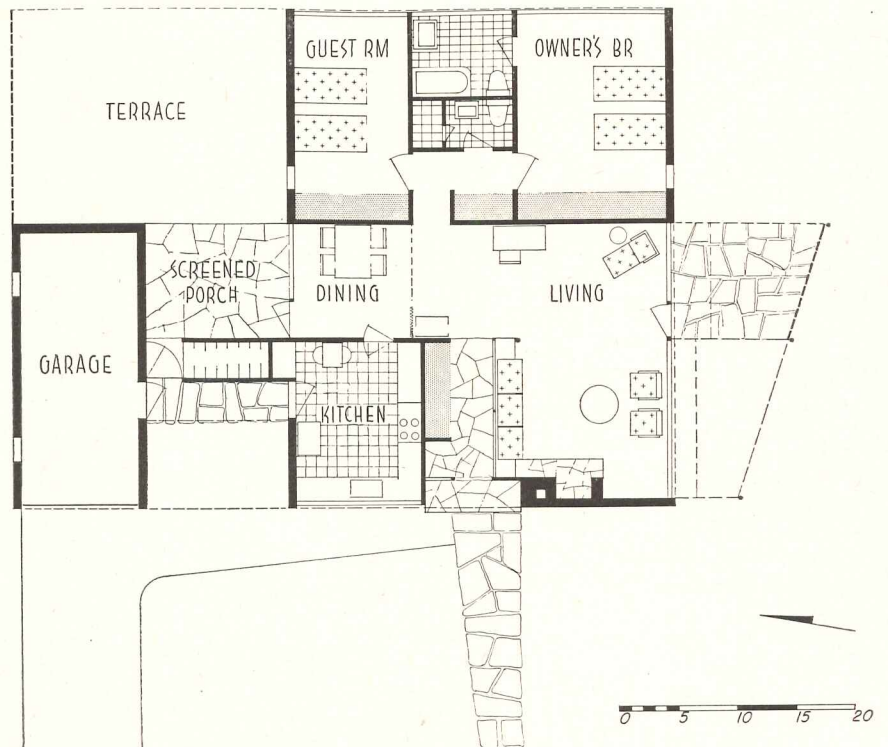
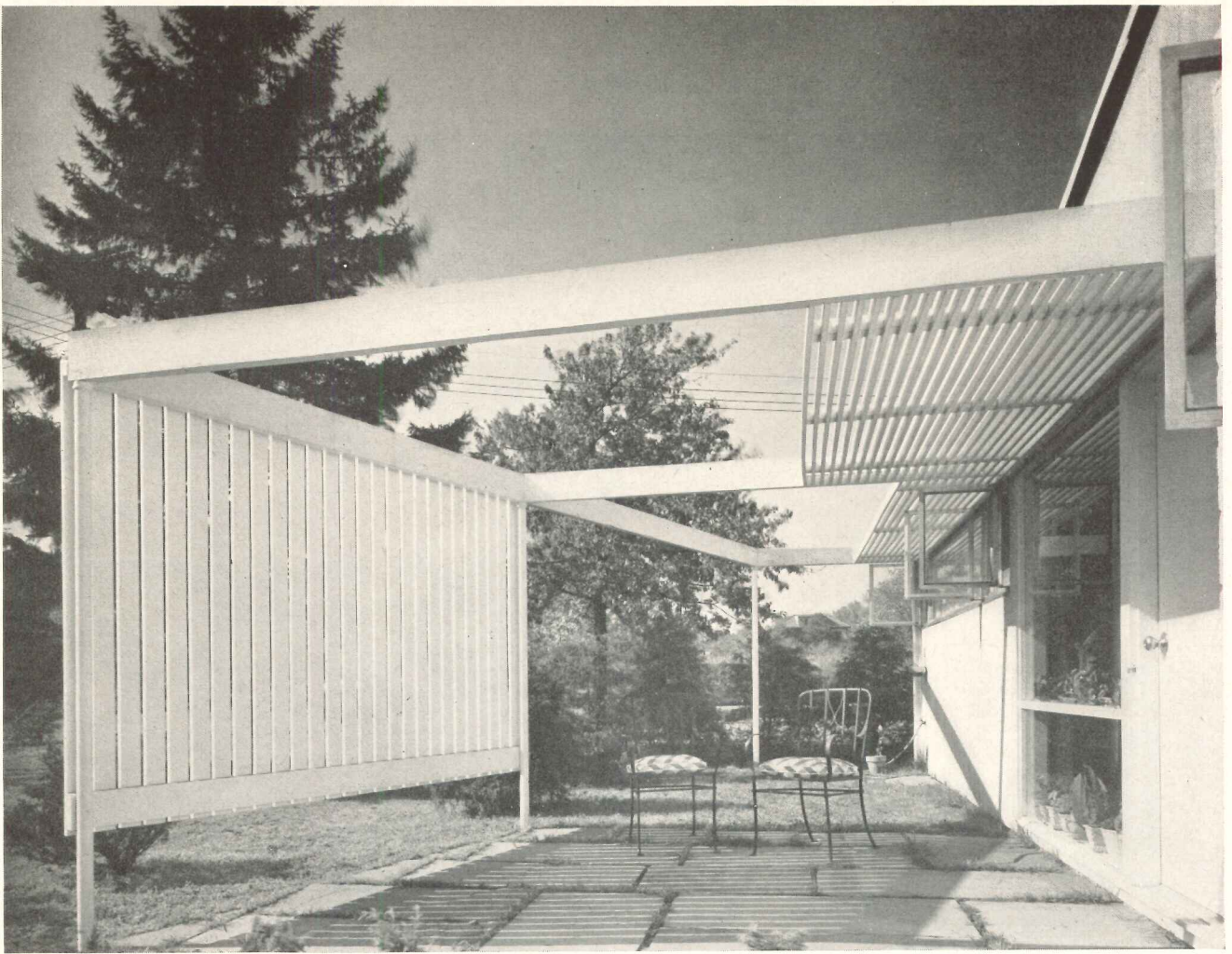

Privacy for terrace is provided by planting on west and fence on south. Fence and large trees provide afternoon shade. Louvered sunshades protect living room glass. Beams support sunshades, brace fence, furnish frame for future awnings, and tie whole together to form interesting spatial composition

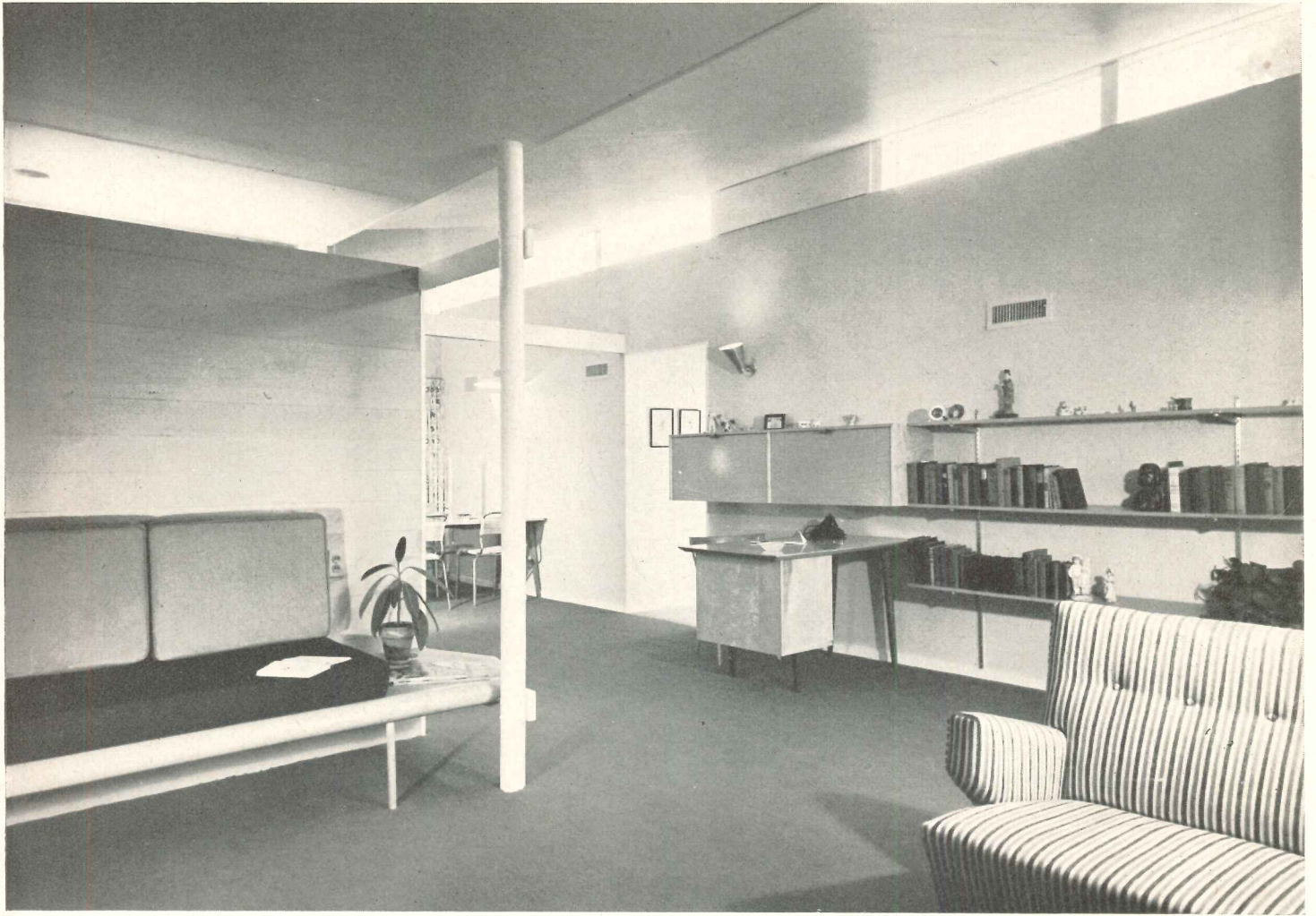

SUBURBAN HOUSE

Continuous clerestory at rear of living-dining area provides extra light and ventilation, also adds interest and height to low-ceilinged room. Screened dining porch can be seen beyond dining room (right)

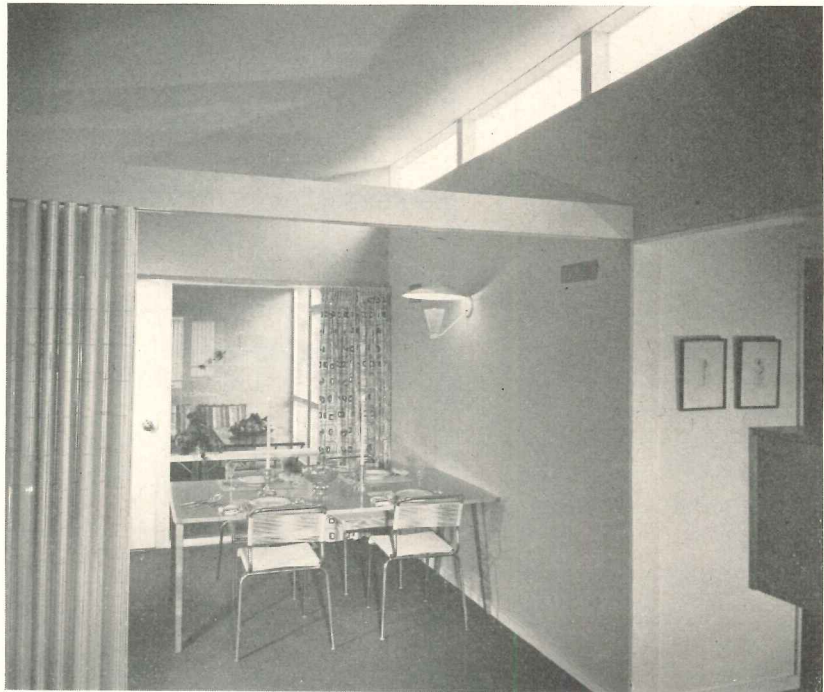

Ben Schnoll

HOME FOR CARTOONISTS' FAMILY

*Residence of Stanley and Janice Berenstein
Elkins Park, Pennsylvania
Norman N. Rice, Architect*

THIS HOUSE for the well-known cartoonists and their young son, was built on a 75 ft suburban lot with existing houses close by. By setting the house well back and angling it in relation to the street, direct view of the neighboring houses was avoided and a pleasant southerly exposure provided for the living area. This also permitted the studio to face more nearly north.

At the 1951 Exhibit of the Philadelphia Chapter, A.I.A., the house received the Home Builders' Association award as "the most distinguished suburban house by a Philadelphia architect."

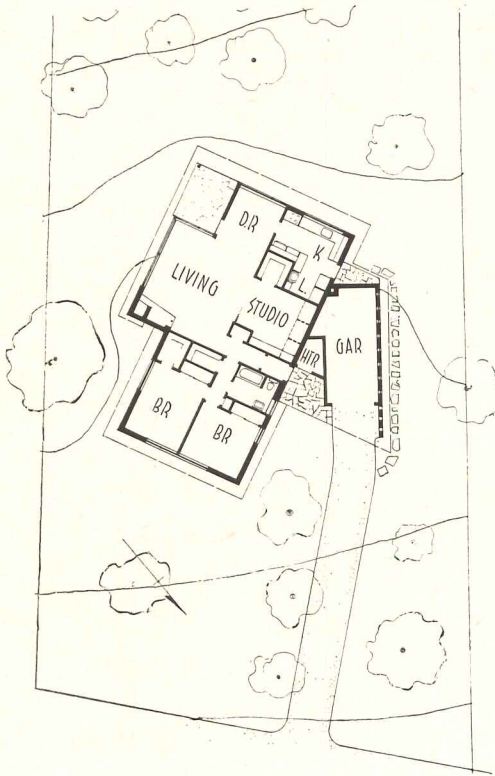

Dan Moerder

Exterior walls are waylite block or cedar siding. Interior mahogany plywood

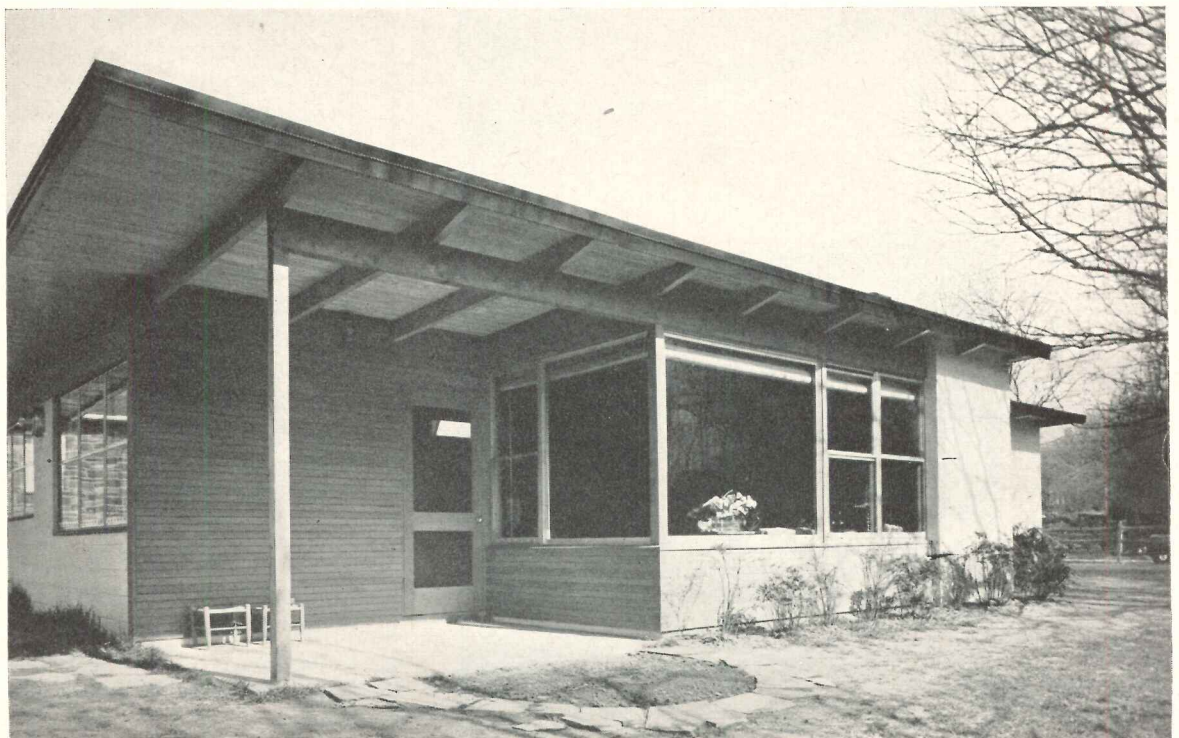



Plan was kept compact by making studio inside room with skylight and window-type air-conditioner. Studio walls natural redwood. Below: studio can be opened to living room for spacious entertaining

CARTOONISTS' HOUSE



Don Moerder

SUBURBAN SITES AND MODEST BUDGETS

INCREASE DESIGN RESTRICTIONS

The last four houses, all built on suburban lots and on modest budgets, have more restrictions to contend with than the first four. This may make them less interesting perhaps as architecture, but more interesting probably to architects, since they are nearer to the type of problem most often encountered by the residential designer. In these houses the emphasis shifts from exploiting a view to protecting privacy. While larger houses can rely upon remoteness for privacy, suburban houses must resort to such devices as high windows, obscure glass, planting and fences.

Of the suburban group, the Beck house is remarkably successful. It accepts its limitations gracefully, states its ideas clearly, and carries them out skilfully. The design is notable for its easy confidence and the absence of any straining for effect. There is no pioneering here, but instead the calm assurance that comes from working in a well-established tradition.

The house designed for sale has special limitations, in addition to having usually very stringent site and budget restrictions. Designing a house that will be suited to the needs of a large number of unknown families is more difficult than tailoring one to fit a single family. In this case the architect's client is an operative builder; he is not interested in living in the house, but in selling it. His first requirement from the architect is a house that will sell.

This is a field which architects have generally avoided in the past. But in recent years, with encouragement from Southwest Research Institute, the National Association of Home Builders, and the American Institute of Architects, many leading architects have entered this field. Another way of saying the same thing is that many operative builders are beginning to realize the value to them of good architectural services. In this connection it is interesting to note that while some builders are still avoiding architects entirely and others are shopping in the basement of the profession for the "cheapest" architect they can find, Eichler Homes is currently employing two of the West Coast's most distinguished architectural firms.

An unusual opportunity is presented in these pages to compare the work of one of these architects, A. Quincy Jones of Los Angeles, in two very different fields of residential design — a large custom-designed house for the Arizona desert and a small house designed (with Frederick E. Emmons) for a builder's development in northern California. Each of these houses is notably successful within its own field, and in spite of the great disparity between the two, there are perceptible similarities which mark their common origin.

DEVELOPMENT HOUSE OF HIGH QUALITY

Eichler Homes

Palo Alto, California

Frederick E. Emmons — A. Quincy Jones, Architects

Anshen and Allen, Architects: Site Planning

THIS is the model house for a 94-house development known as Fairmeadow. Four other models are offered, each with several variations. Prices for these three-bedroom, two-bath houses range from \$14,750 for the model shown here to \$15,750 for a model with an extra "all-purpose" room. Prices include the lot (6000 sq ft minimum), concrete terraces, redwood fences, electric range and refrigerator. Deducting \$2500 for the lot, the cost of the house itself is less than \$10 per square foot.

The circular site plan was an effort to give interest to a flat, treeless site. It resulted in 50 fewer lots than in the conventional grid scheme.

This development and three others by the same architects and builders were recently cited by the Housing Research Foundation of Southwest Research Institute as "the developments built during 1951 which best express the aims of the Quality House Program." These aims (see ARCHITECTURAL RECORD, May 1950, pp. 125-127) are briefly to improve the quality of the houses built by speculative builders. From the beginning the Institute has emphasized that this can come about only by getting good architects to work closely with good builders. Fairmeadow, already highly successful, is convincing proof that such collaboration is beneficial to architect, builder, and the public.



Randal Partridge

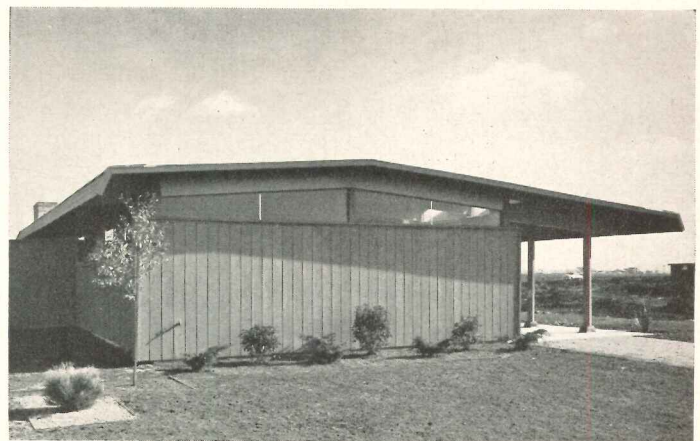

High bedroom windows face the street

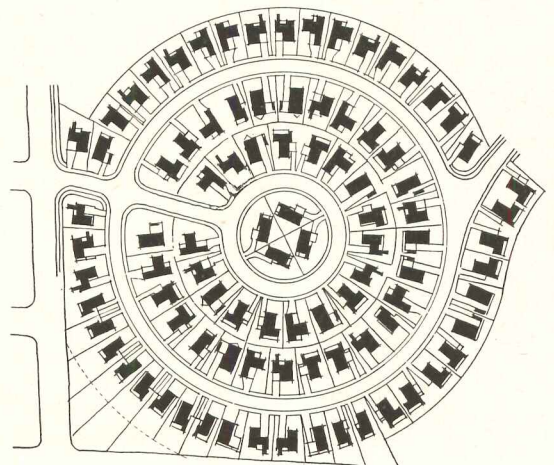

DEVELOPMENT HOUSE

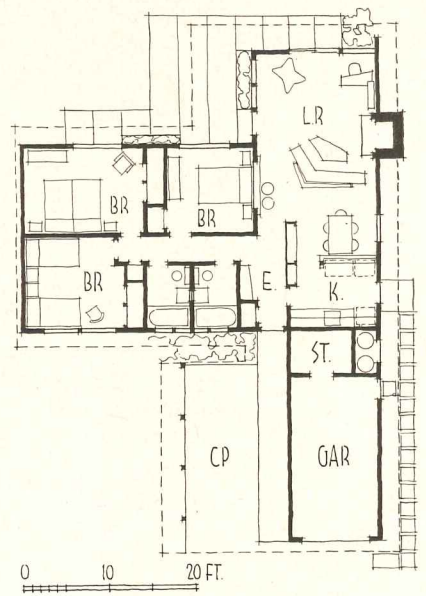
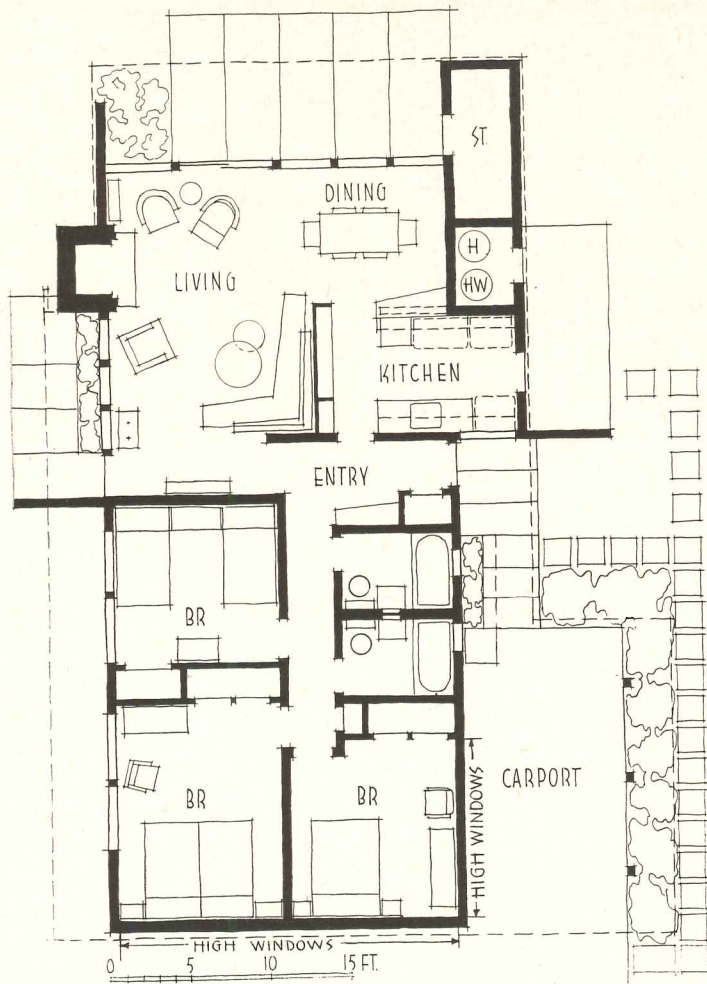

Rondal Partridge

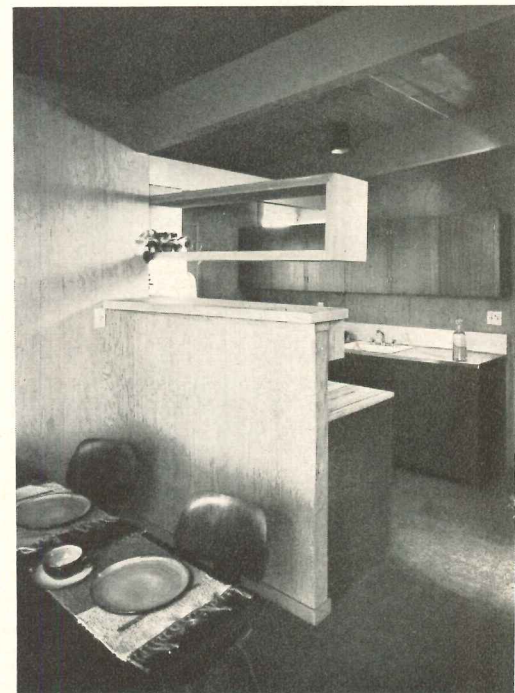

Construction is plank and beam on radiant heated slab. Exterior finish stained redwood siding. Interior finish, redwood plywood, mahogany plywood (kitchen cabinets in view above), or redwood siding. Outlets provided for telephone and television. Roofs tar and gravel, built-in gutters. All models have fireplaces

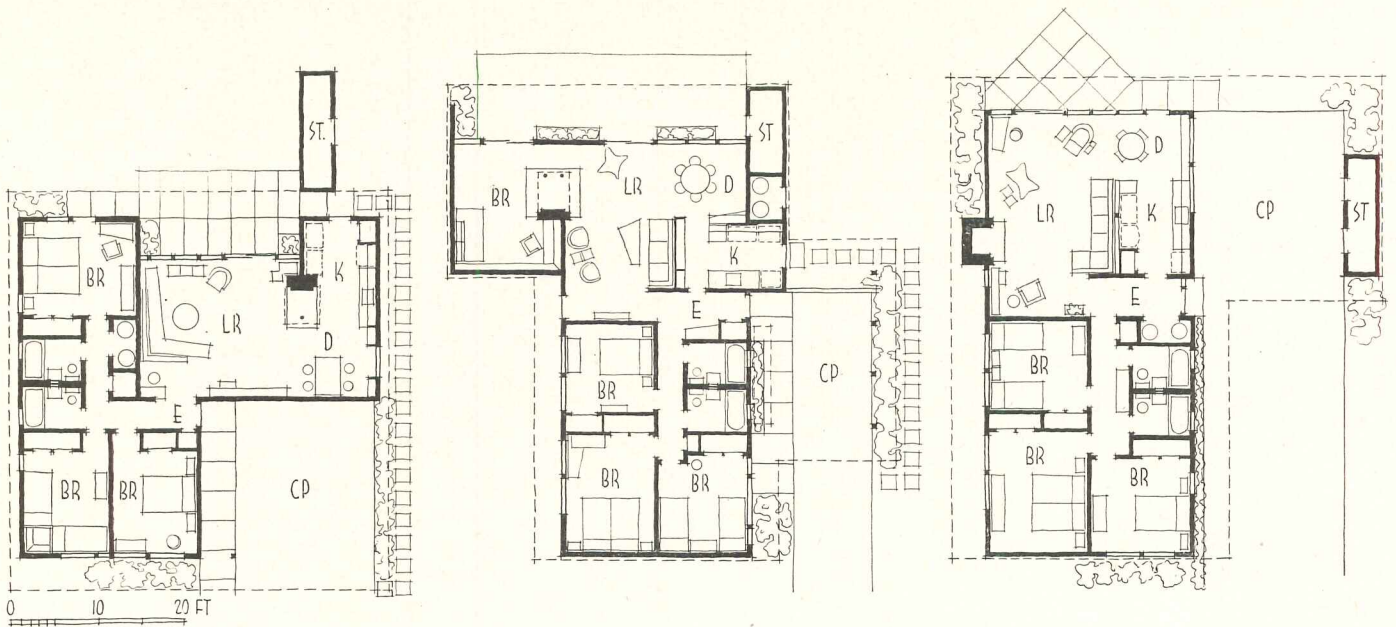

Plan of model house, opposite page, extreme left. Plans of the four other models above. All have bedrooms on street side, living areas at rear opening out to terraces, fenced for privacy

All models have entries, all but one have completely private internal circulation. Below: six-foot overhang makes terrace into porch. Glass wall at left of fireplace opens onto side terrace

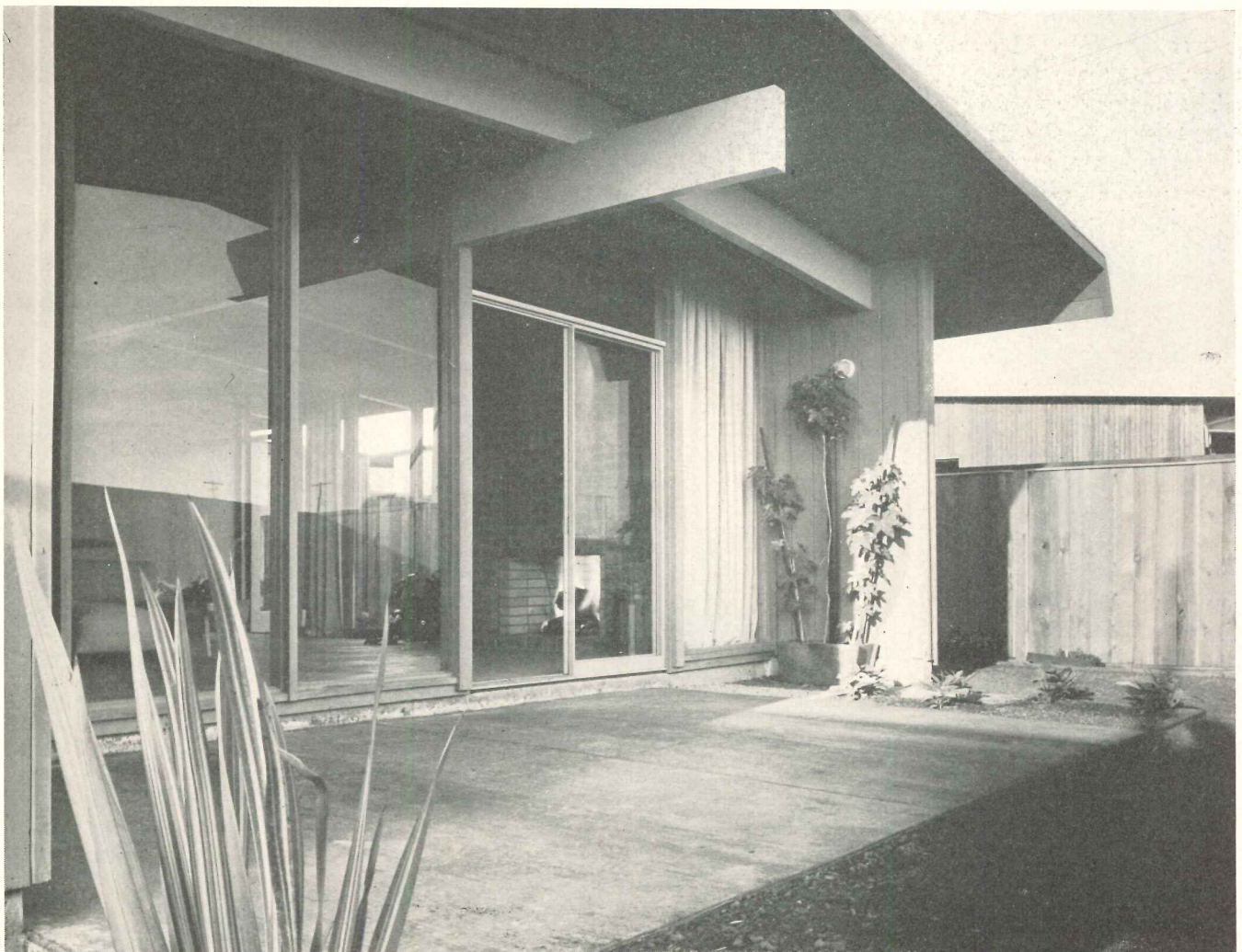

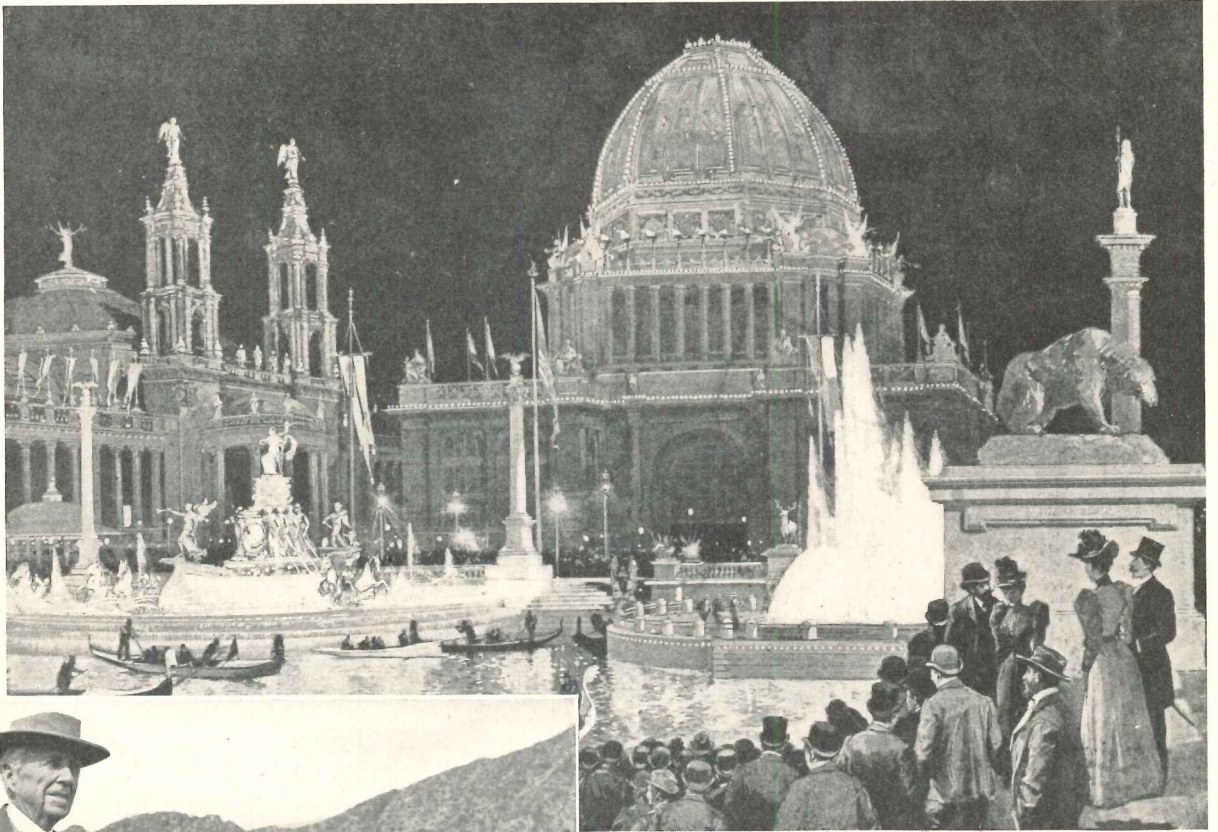

Frank Lloyd Wright never went to see the Chicago Fair (Columbian Exposition, 1891–93). Nevertheless the view of it, above, is typical of the time in which he formulated his principles of architectural design — 1894. State Street in Chicago, where Wright began, looked like the drawing below



Few realize that the principles of Wright's "organic architecture" were actually written in 1894. They were first published in an article by Wright in ARCHITECTURAL RECORD, March 1908, and are republished here (top of succeeding pages), along with his current article. His credo, dated 1894 but difficult to improve upon today, is important background for his criticism of the contemporary architectural scene.

ORGANIC ARCHITECTURE LOOKS AT MODERN ARCHITECTURE

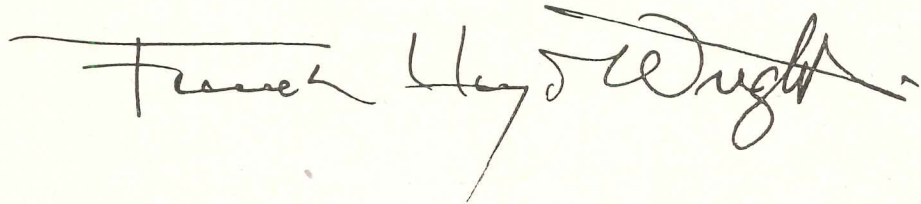
A handwritten signature in black ink that reads "Frank Lloyd Wright". The signature is written in a cursive, flowing style with a long horizontal line extending to the left of the first letter.

MODERN-ARCHITECTURE is the offspring of Organic-architecture: an offspring, already emasculate and commercialized, in danger of becoming a Style. Having suffered many styles since Old Colonial washed up on eastern and Mission reappeared on western shores, this country takes over another one — this time the 58th variety — derived from its own exported Organic-architecture.

Organic-architecture was Middle West. Out of the "Cradle of Democracy" at the end of the nineteenth and the beginning of the twentieth century, came this new sense of architecture. Gradually, over a fifty-year period, a period of ambiguous acceptance and university adversity, it planted and established fertile forms and new appropriate methods for the natural (machine) use of steel, glass, plastics (like concrete) and provided more ample freedom in shelter for the free new life of these United States than any "style" had ever provided or even promised. Organic-architecture thus came of America — a new freedom for a mixed people living a

new freedom under a democratic form of life. Susceptible of infinite variety, it changed the proportions of building throughout the world. The Machine was dedicated to it. Grandomania dead of it — or dying.

Organic-architecture was definitely a new sense of shelter for *humane* life. Shelter, broad and low. Roofs either flat or pitched, hipped or gabled but always comprehensive Shelter. Wide flat eaves were sometimes perforated to let trellised light through upon characteristic ranges of windows below. Ornament was non-existent unless integral. Walls became screens, often glass screens, and the new open-plan spread space upon a concrete ground-mat: the whole structure intimate and wide upon and of the ground itself. This ground-mat floor eventually covered and contained the gravity-heating system (heat rises naturally as water falls) of the spaces to be lived in: forced circulation of hot water in pipes embedded in a broken stone bed beneath the floor slabs (soon misnamed "radiant-heat"). Other new

Part of the 1894
Chicago scene,
not by Wright



Beitman Archive

IN 1894, with this text from Carlyle at the top of the page — “The Ideal is within thyself, thy condition is but the stuff thou art to shape that same Ideal out of” — I formulated the following “propositions.” I set them down here much as they were written then, although in the light of experience they might be stated more completely and succinctly.

I. Simplicity and Repose are qualities that measure the true value of any work of art.

But simplicity is not in itself an end nor is it a matter of the side of a barn but rather an entity with a graceful beauty in its

FRANK LLOYD WRIGHT'S PROPOSITIONS OF 1894

ORGANIC ARCHITECTURE LOOKS AT MODERN ARCHITECTURE

techniques, new forms adapted to our inevitable machine-methods appeared in these new structures. The economics of continuity and cantilever-structure were realized. Even the walls played a new role or disappeared. Basements and attics disappeared altogether. A new sense of space in appropriate human scale pervaded not only the structure but the life itself lived in it was broadened, made more free because of sympathetic freedom of plan and structure. The interior space to be lived in became *the reality of the whole performance*. Building, as a box, was gone.

The integral character of the third dimension was born to architecture.

Here came to America by way of its own architecture a natural concept of cultural human growth as an integrity comparable to growth of trees or a plant to grace the already disgraced landscape and liberate the individual from the sham of classicism.

By way of the integral quality of depth due to the third dimension and new sense of space as contrived by the new formulas of continuity and cantilever in devising construction, a new countenance emerged. The clear countenance of principle. The old post-and-beam formula was now too wasteful. Hard and clumsy, it seemed like a rattling of the bones. The cut-slash-and-butt construction of the old camouflaged box of the

Museum of Modern Art

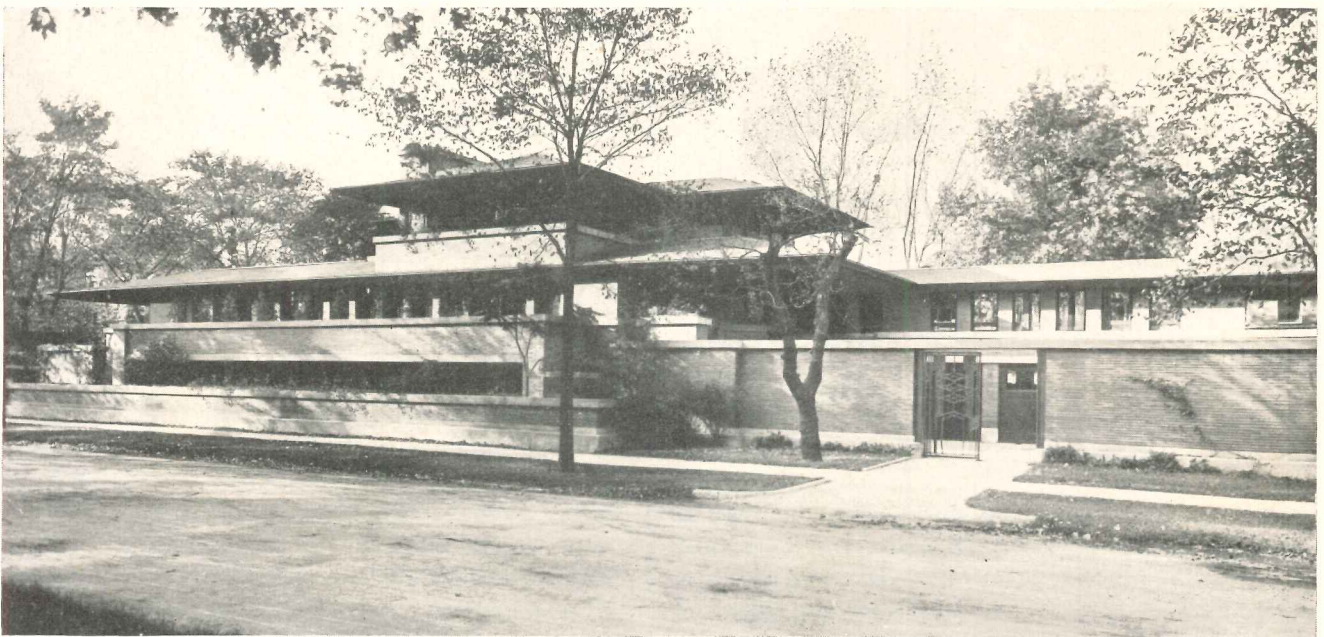

Some critics have called this one of the best of Wright's early “prairie” houses — Robie house, Chicago, 1908

integrity from which discord, and all that is meaningless, has been eliminated. A wild flower is truly simple. Therefore:

1. A building should contain as few rooms as will meet the conditions which give it rise and under which we live, and which the architect should strive continually to simplify; then the ensemble of the rooms should be carefully considered that comfort and utility may go hand in hand with beauty. Beside the entry and necessary work rooms there need be but three rooms on the ground floor of any house, living room, dining room and kitchen, with the possible addition of a "social

office"; really there need be but one room, the living room, with requirements otherwise sequestered from it or screened within it by means of architectural contrivances.

2. Openings should occur as integral features of the structure and form, if possible, its natural ornamentation.

3. An excessive love of detail has ruined more fine things from the standpoint of fine art or fine living than any one human shortcoming — it is hopelessly vulgar. Too many houses, when they are not little stage settings or scene paintings, are mere notion stores, bazaars or junk-shops. Decoration is dangerous

Renaissance or otherwise seemed harsh or trivial. Ugly and false. Each organic building (an integument rather than a box) became as one with its site and occupancy. Nor could these buildings be imagined anywhere else nor for any other purpose whatever than where and for what they were built.

Thus by 1893–1900 a great negation transpired in America, entirely free of European influences. *But this sweeping negation was only the platform upon which to affirm* these new principles of life and economic building-construction. Naturally this negation had novel aesthetic aspects but wore the countenance of principle.

As a matter of course, these novel aspects of countenance were striking *effects*: startlingly clean, "streamlined" "effects." Soon these effects were elsewhere seized upon, in Germany particularly, where years later they appeared at the Bauhaus.

Organic-architecture as built in America during the years 1893 to 1909 was first extensively published in Europe by Germany, 1910, owing to the insistence of Professor Kuno Francke, "Exchange Professor of Aesthetics" at Harvard. (It had been published in England years before.) Reaching Paris soon, it there became, by way of journalistic ability and our own provincial museums, again the Box. But, the box nude! Duly dedicated to Machinery.

The original and elemental affirmative characteristics or the original negation made by Organic-architecture in three dimensional structure, *the Machine dedicated to it*, now reappeared as a bare two-dimensional facade *dedicated to the Machine!* The streamlined novelty of the original negation became thus a fit fad for Fascism. But our provincials began to import it because the culture-mongrel of our country and our museums believes, and will continue to believe, that American "culture" is a bastard. "Culture comes from Europe."

Well, this import was not an affair of construction at all but a mere "aesthetic," a painter's, not an architect's. Soon a cliché. The fruitful *affirmative negation*

made by Organic-architecture in three dimensions now reappeared as a two-dimensional affair. *All* ornament was scraped off. A high box would be contrasted with a long low box or square boxes were placed together alongside very tall boxes. Or on came the nude box cut open or set up in the air on posts without pants. But always, nevertheless and notwithstanding — the BOX. Thus surfaced the box was invariably painted white to emphasize the fact that it did not intend being a becoming feature of the ground upon which it was put. By maintaining a white sepulture for unthinking mass-life, individuality was soon leached from the performance. Otherwise no such cliché could have been made so useful

Museum of Modern Art



A prairie house with a pool — the Coonley House, Riverside, Illinois, circa 1910

unless you understand it thoroughly and are satisfied that it means something good in the scheme as a whole, for the present you are usually better off without it. Merely that it "looks rich" is no justification for the use of ornament.

4. Appliances or fixtures as such are undesirable. Assimilate them together with all appurtenances into the design of the structure.

5. Pictures deface walls oftener than they decorate them. Pictures should be decorative and incorporated in the general scheme as decoration.

6. The most truly satisfactory apartments are those in which

most or all of the furniture is built in as a part of the original scheme considering the whole as an integral unit.

II. There should be as many kinds (styles) of houses as there are kinds (styles) of people and as many differentiations as there are different individuals. A man who has individuality (and what man lacks it?) has a right to its expression in his own environment.

III. A building should appear to grow easily from its site and be shaped to harmonize with its surroundings if Nature is manifest there, and if not try to make it as quiet, substantial and organic as She would have been were the opportunity Hers.

FRANK LLOYD WRIGHT'S PROPOSITIONS OF 1894

ORGANIC ARCHITECTURE LOOKS AT MODERN ARCHITECTURE

to our American mass-education or serve our standard practice of quick commerce.

This sterilizing performance was duly dedicated to machinery, as any cliché should be, not *machinery dedicated to it* as in Organic-architecture. So, here came a kind of tapeworm into the entrails of Organic-architecture. Because of the novel effects of the original organic negation made for organic purposes this mixture of negation with negation is, as of today, what is called "Modern-architecture."

Any two-dimensional cliché is too easy to commercialize or teach. To educationists and the commercial capitalist it was providential — just what both wanted because so shallow an affair of surfaces. The Box now, sometimes of glass, say, but always a post-and-beam affair even if not rattling its bones, became more and more evident in standard education. Buildings began gradually to appear intermixed with the "effects" of Organic-architecture — to be now called "Modern-architecture."

The imported cliché was not only easy to teach. "Less is more" unless less, already little, becomes less than nothing at all and "much ado about nothing."

Now, because of a much too shallow aesthetic (a painter's), the original affirmative negation made by Organic-architecture (an architect's) seems too soon in danger of losing, under the name of Modern-architecture, its humane characteristics and original poetry. Confused with architecture superficially fashioned in two dimensions we have a superficial imitation of the original profound negation made by Organic-architecture itself.

Easy to practice, easier still upon the resources of human science and imagination, the Box, ornamental camouflage (the "Classic") scraped off — *but old thought unchanged* — again rises — educational and fashionable: The cliché of a new STYLE!

Regardless, the old box comes back. The crate now consecrate.

In it we see high and low purposes all packaged or banked alike.

Architectural careers thus become quick. The true amateur, sterilized owing to this revival of the box-facade by accredited schools — and names — is thus made "safe." Grateful for this sterilization, if for no other reason, our leading universities together with realtor "developers" and our swelling bureaucratic government are all ready to "take over" "Modern-archi-

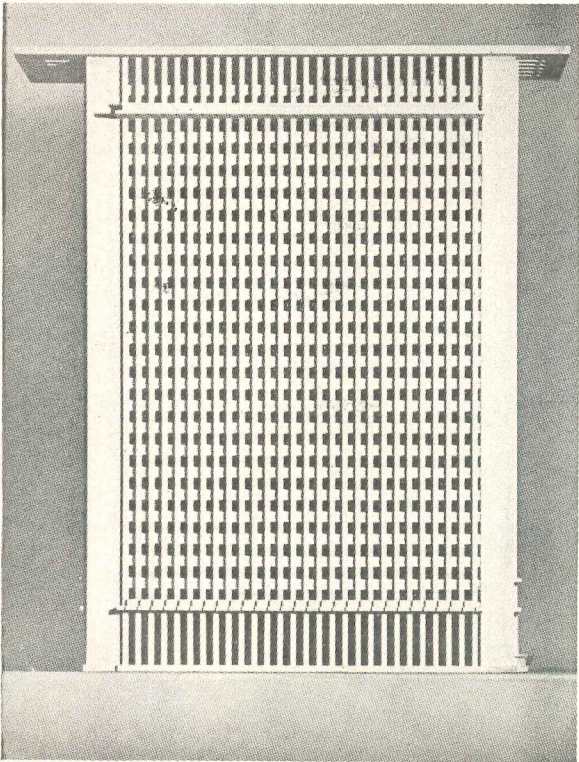

Project, never built, for an office building in San Francisco, done by Wright in 1912

We of the Middle West are living on the prairie.* The prairie has a beauty of its own and we should recognize and accentuate this natural beauty, its quiet level. Hence, gently sloping roofs, low proportions, quiet sky lines, suppressed heavy-set chimneys and sheltering overhangs, low terraces and out-reaching walls sequestering private gardens.

IV. Colors require the same conventionalizing process to make them fit to live with that natural forms do; so go to the

** In this I had in mind the barren town lots devoid of tree or natural incident, town houses and board walks only in evidence.*



Another pre-Wright vision of Chicago

Bettman Archive

ecture." It goes everywhere the educational institution and especially the Museum happens to be or to go. The Museum-as-Education and Education-as-the-Museum have found just what could easily be handled in the name of culture: culture must come from abroad! That is where the cliché came from.

Now, the moral nature of the Cuckoo (to be sure) characterized much if not most of the ambitious subscribers to this go-getter rush for the band-wagon. Any honest aspirant had small chance of recognition and none

of genuine success. Any aspirant, tough or callow, could more easily exploit the Box bare than take time and pains to go deeper into the principles of Organic-architecture.

Organic-architecture based upon fundamental human and structural principles insisted upon *integral method and always significant form true to structure throughout. Or none.* It was profound — too slow for popular purposes. Therefore preparation for architectural practice would

Interior of circular library, Florida Southern College, Lakeland, Fla.

Ezra Stoller

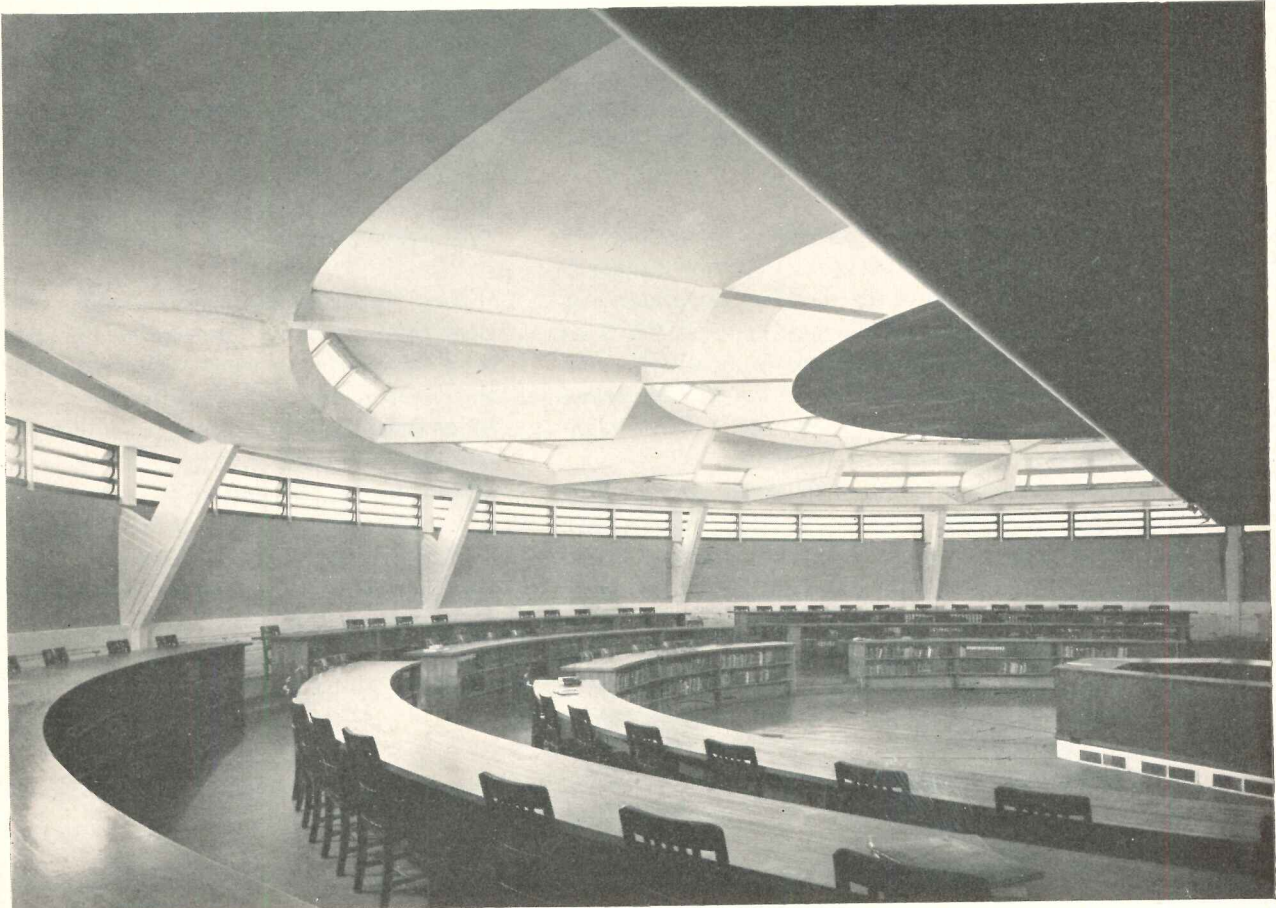

woods and fields for color schemes. Use the soft, warm, optimistic tones of earths and autumn leaves in preference to the pessimistic blues, purples or cold greens and grays of the ribbon counter; they are more wholesome and better adapted in most cases to good decoration.

V. Bring out the nature of the materials, let their nature intimately into your scheme. Strip the wood of varnish and let it alone — stain it. Develop the natural texture of the plastering and stain it. Reveal the nature of the wood, plaster, brick or stone in your designs; they are all by nature friendly and beautiful. No treatment can be really a matter of fine art when these

natural characteristics are outraged or neglected.

VI. A house that has character stands a good chance of growing more valuable as it grows older while a house in the prevailing mode, whatever that mode may be, is soon out of fashion, stale and unprofitable.

Buildings like people must first be sincere, must be true and then withal as gracious and lovable as may be.

Above all, integrity. The machine is the normal tool of our civilization, give it work that it can do well — nothing is of greater importance. To do this will be to formulate new industrial ideals, sadly needed.

FRANK LLOYD WRIGHT'S PROPOSITIONS OF 1894

ORGANIC ARCHITECTURE LOOKS AT MODERN ARCHITECTURE

be not only slow but far too difficult. Also, a discerning client was needed rather than a fashionable one. There are still a few discerning ones developing in America.

Being truly individual, Organic-architecture lacked the journalist. America is nothing if not journalistic.

Writing as of 1952, the old Box — undressed — seems coming back again. The white-paint-men thrive on choice ways of setting it up on top of the ground. Regardless. They set it up tall, endwise; put it over there, down crosswise. Set it on the bias? Likely enough set it up on top of posts or anything else. Soon they will pivot it. Tyros slash and stripe its fascistic facades horizontally or vertically or checker-wise the fronts. Soon diagonally? They stamp it to look thick or stamp it to look thin: put lids on it — or none. Lids either square or askew, projecting or flush. The professors make a drum of it and beat it for dismal accord with the soulless character of an Era.

Thus Modern-architecture is Organic-architecture deprived of a soul. Therefore architecture is now so easy to grasp that any boy of three months' experience can practice it and appear with a dose of it on the front page of the local newspaper next month, or within a year (or two) be heralded in color by the market-magazines of building-materials as the new "It." The "plan-factory" now has shows in Art-Museums.

I fear the history of creative art down the ages thus repeats itself in our own modern times and again we have categories of names. Names! But now names all essentially *unlike* for performances as *alike* as any two peas.

So this is Modern-architecture! Well — if so — this affair, too, will pass as matter of intelligent choice. St. Augustine once observed, "The harvest shall not be yet." Perhaps what is left behind when we sicken of it all will be better (I so believe) than what came of similar betrayal of principles in times past. Better, because of

what is left of the character of integral form and proportion — the plastic humanitarian space in building which Organic-architecture has already made. Probably the humanly significant forms belonging to Organic-architecture now camouflaged or betrayed and called "modern" will come back from the gutter of Fashion toward which they now seem headed: come back and — deepened by experience — start all over again.

The timeless war of Principle with Expediency will go on and on, in our country especially, because more than ever human nature here is habituate. Like vegetation. Or the parasite. To really change human habituation (even to the cigarette degree) would require more than one try in any one century. While nailing up a box in different ways is so easy, why should a Get-rich-quick Society like ours take time and the extreme pains necessary to make an organism of anything? A cultural organism (like any other true organism) must *grow*. Growth is slow. It cannot be had like a box nailed up by the tyro internationally. The answer is yet to come.

Any "international style" would probably be a cultural calamity fit for Fascism but intolerable to democracy. Meantime so-called "Modern-architecture" runs the gamut of the old Box stripped and trying to assume forms originated by Organic-architecture. As this pretentious shell, empty of true organic significance, goes rapidly toward the gutter of fashion — let us observe . . . "there goes to the gutter the architecture of this modern era from which succeeding generations will probably perceive what was missed and begin to build again on the basis of what was lacking when the gutter was reached."

I hope. And I believe.

Frank Lloyd Wright—Taliesin West—February 1952

It was Wright's ability to draw that earned him his attention from Louis Sullivan, his first job with Adler and Sullivan, then doing the Chicago Auditorium. Here are some early drawings, and some later ones

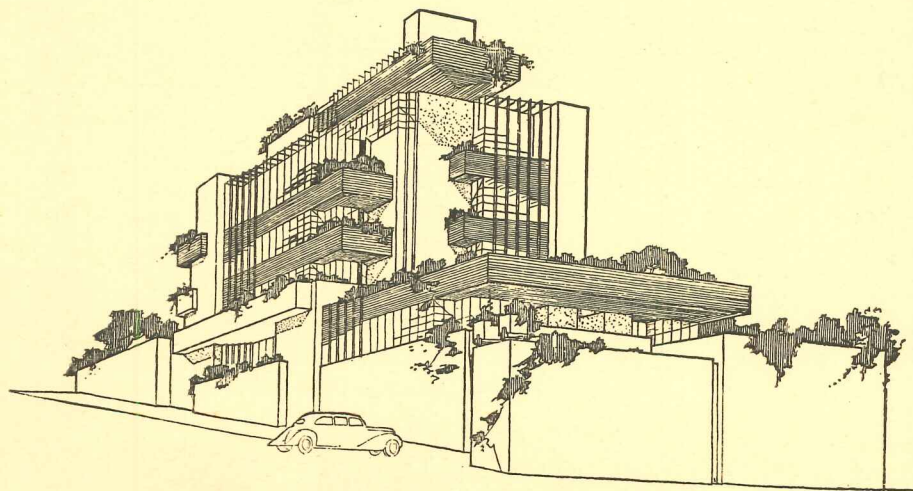
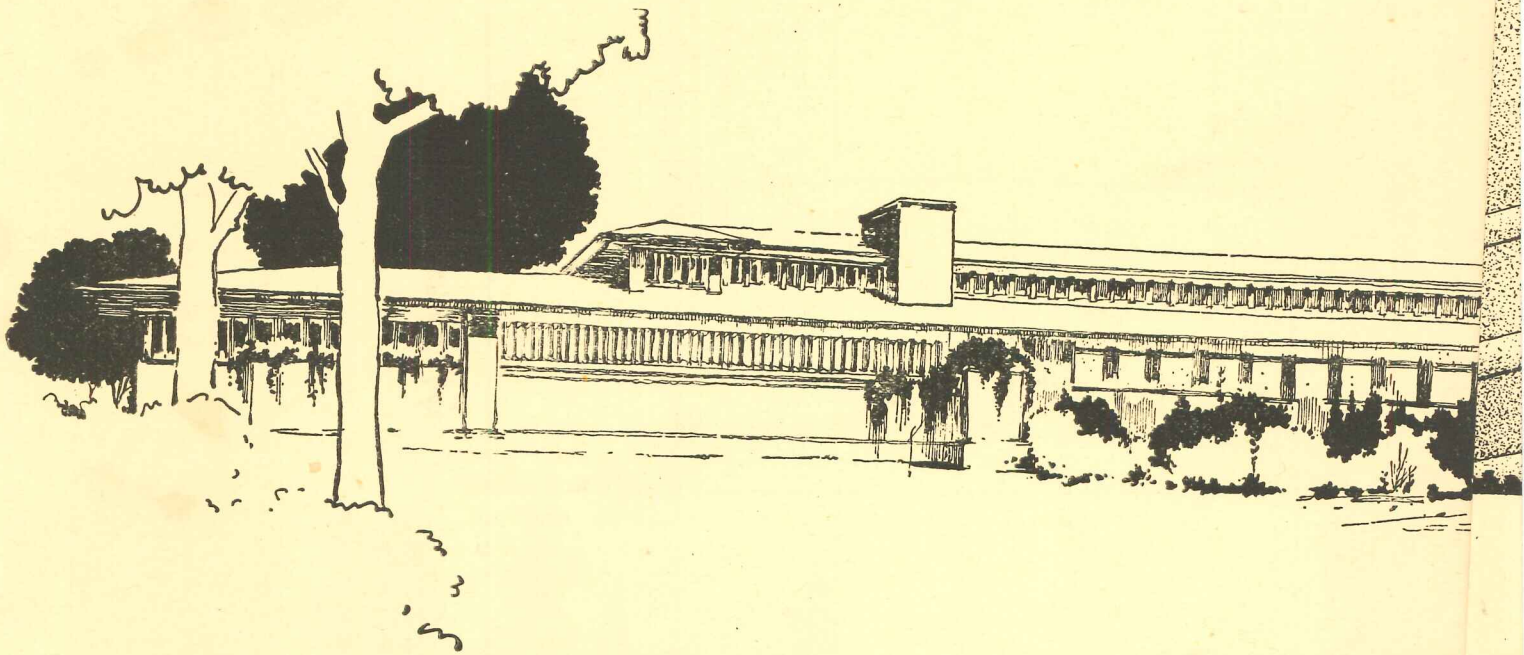

Elizabeth Noble Apartment House, Los Angeles 1929

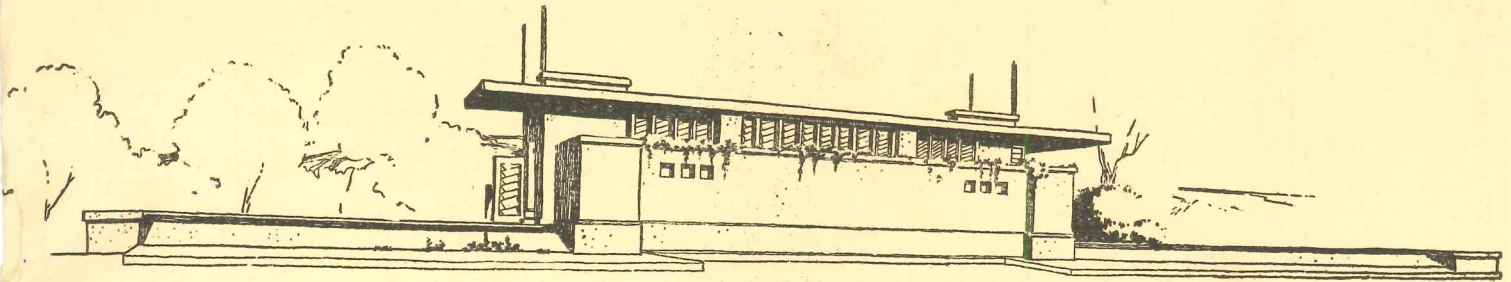

Yahara Boat Club, Madison, Wis. 1902

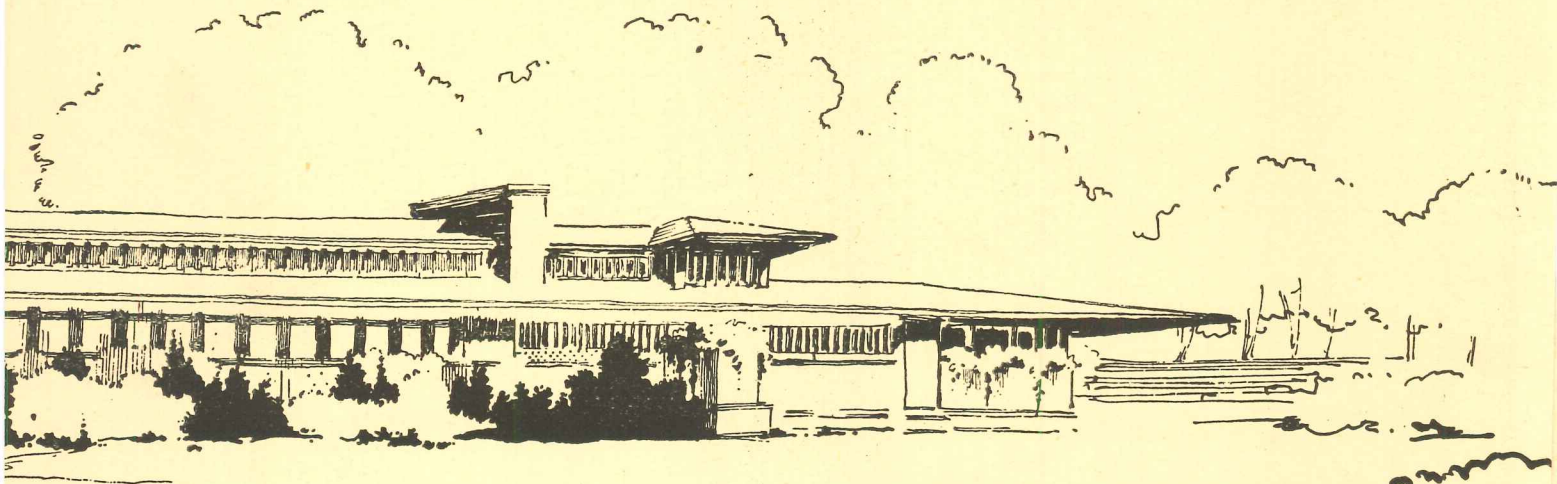

Pavilion at Banff 1911

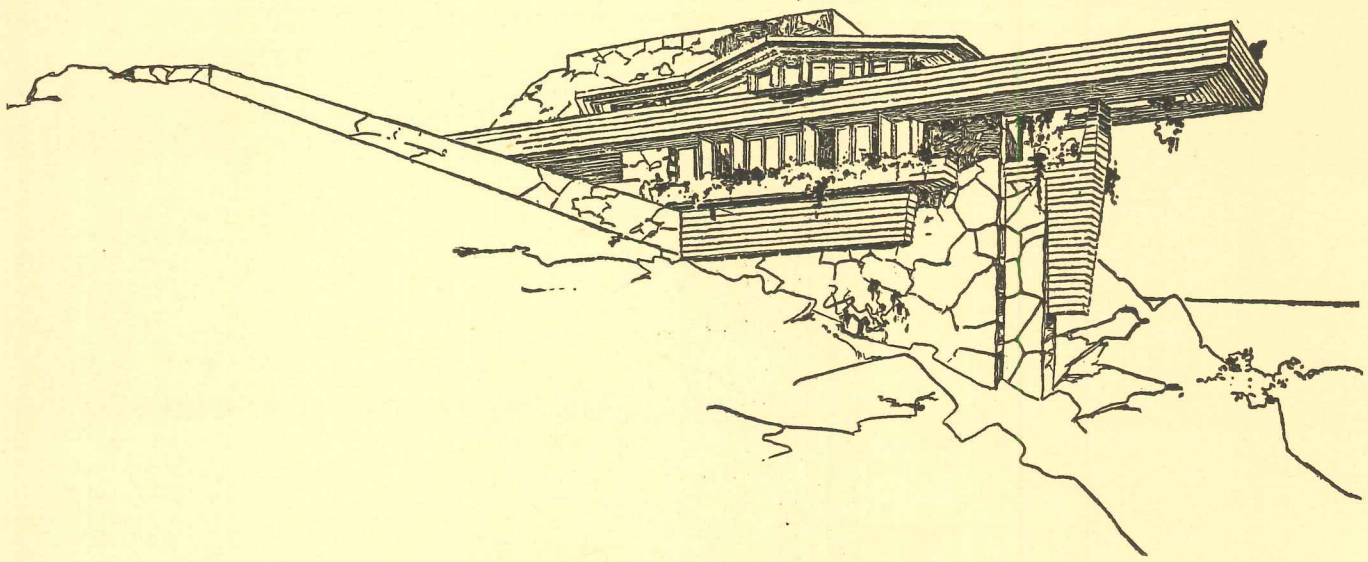

Arch Obeler House, Los Angeles 1940

PORTOLA JUNIOR HIGH SCHOOL

El Cerrito, Calif.

Miller & Warnecke, Architects



F. L. Copeland (air views)

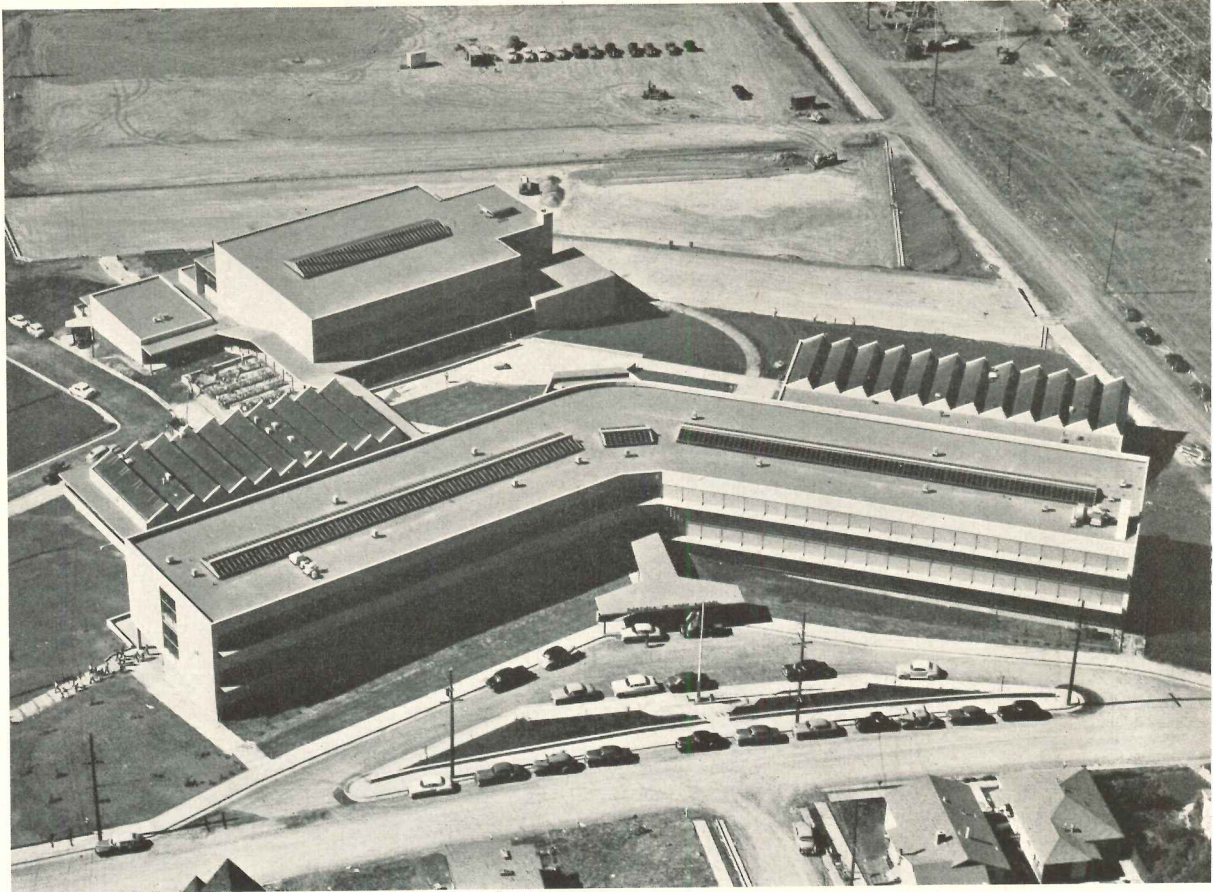

PORTOLA JUNIOR HIGH SCHOOL

PORTOLA Junior High School is a departure from the usual recent California school. It has not a finger plan because its 11-acre site slopes steeply to the west (overlooking San Francisco's Golden Gate) and hardly provides room for the buildings and recreational spaces its 1500 students require. Hence the classroom building is a two-story structure with a basement which is fully exposed and utilized on the downhill side. Two shop buildings and a gymnasium are at successive lower elevations, and the relatively flat area at the bottom of the site contains three playgrounds.

This solution of the site problem required the classroom building, a long, flattened V in plan, to have east and west exposures for all classrooms, which meant that sunlight control was essential. In both exposure and use of glass block the school is also an exception to California practice. Architect John Carl Warnecke made tests of the fenestration system in an actual local installation before it was accepted. Eckbo, Royston & Williams were the landscape architects; Hall & Pregnoff, structural engineers; G. M. Simonson, mechanical and electrical engineer. Total cost was \$1,560,000.00 or \$12.20 per sq ft.

R. L. Copeland (air views)



East side of Portola Junior High School, at top of sloping site, is main approach. Construction is reinforced concrete for all buildings. Exterior walls are painted above the brick-veneered basement. Interior walls are plaster, with tile in toilets and corridors. Floors are asphalt tile; ceilings, acoustic tile; fenestration, projecting sash with metal sunshades and glass block; heating, radiant floor panels in classroom building, warm air in gymnasium and shops. Lighting is incandescent in classrooms, fluorescent in shops

Julius Shulman

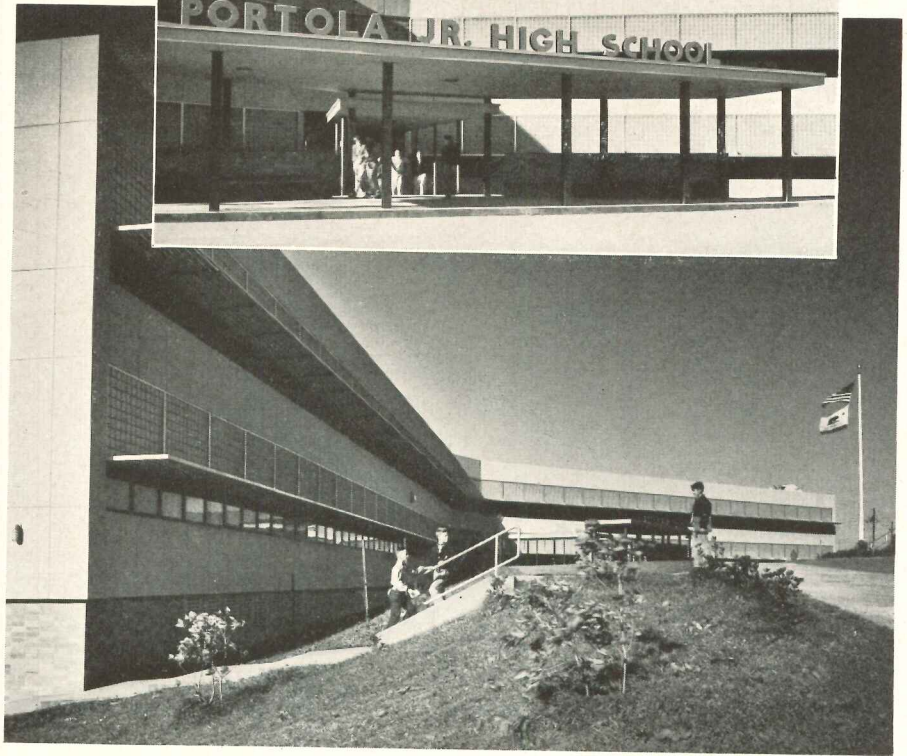

Julius Shulman





PORTOLA JUNIOR HIGH SCHOOL

Downhill side of basement floor contains cafeteria (above), library (below) and similar areas. Unfortunately the placement of gymnasium building somewhat limits the superb view from the cafeteria, although the Golden Gate can be clearly seen from classrooms on upper floors

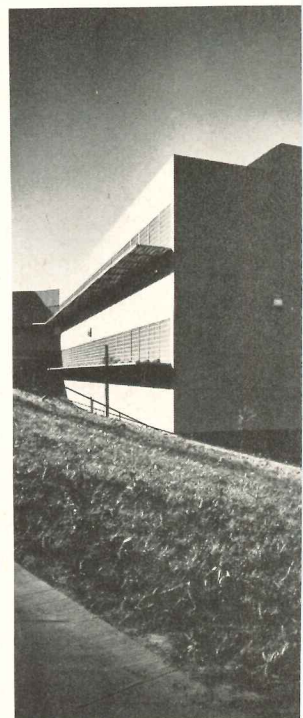

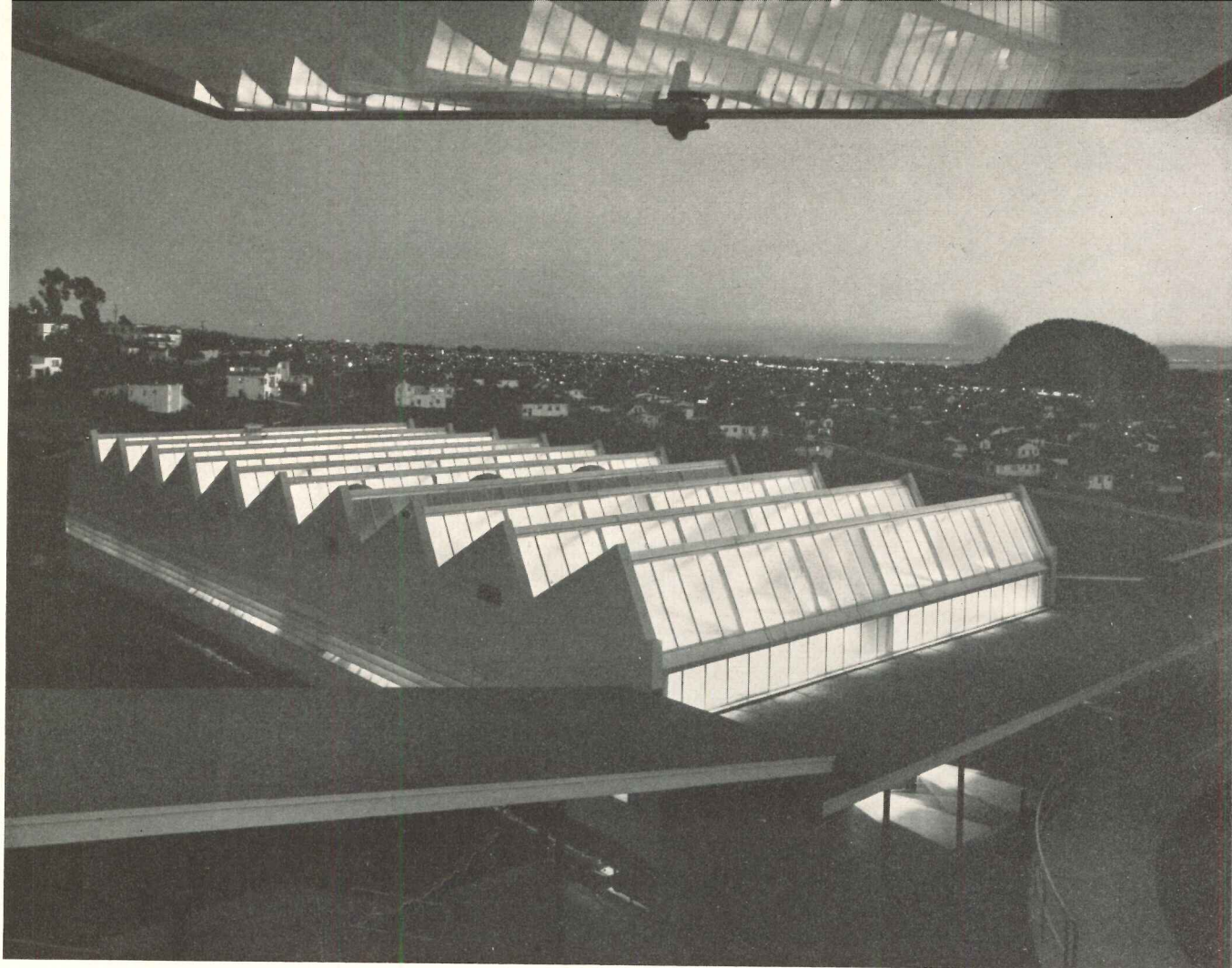

Julius Shulman photos

Of the two shop buildings, both with sawtooth monitor skylights, the one shown above contains art and domestic science rooms (see interior below) and is called the Laboratory Building. All buildings are connected by stepped paths and roofed walkways

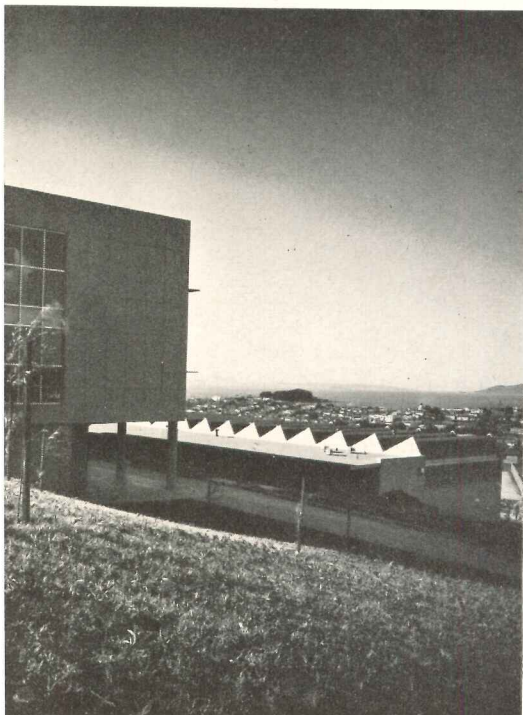

C L A S S R O O M B U I L D I N G

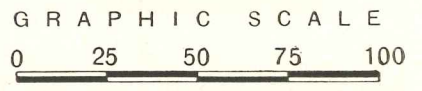
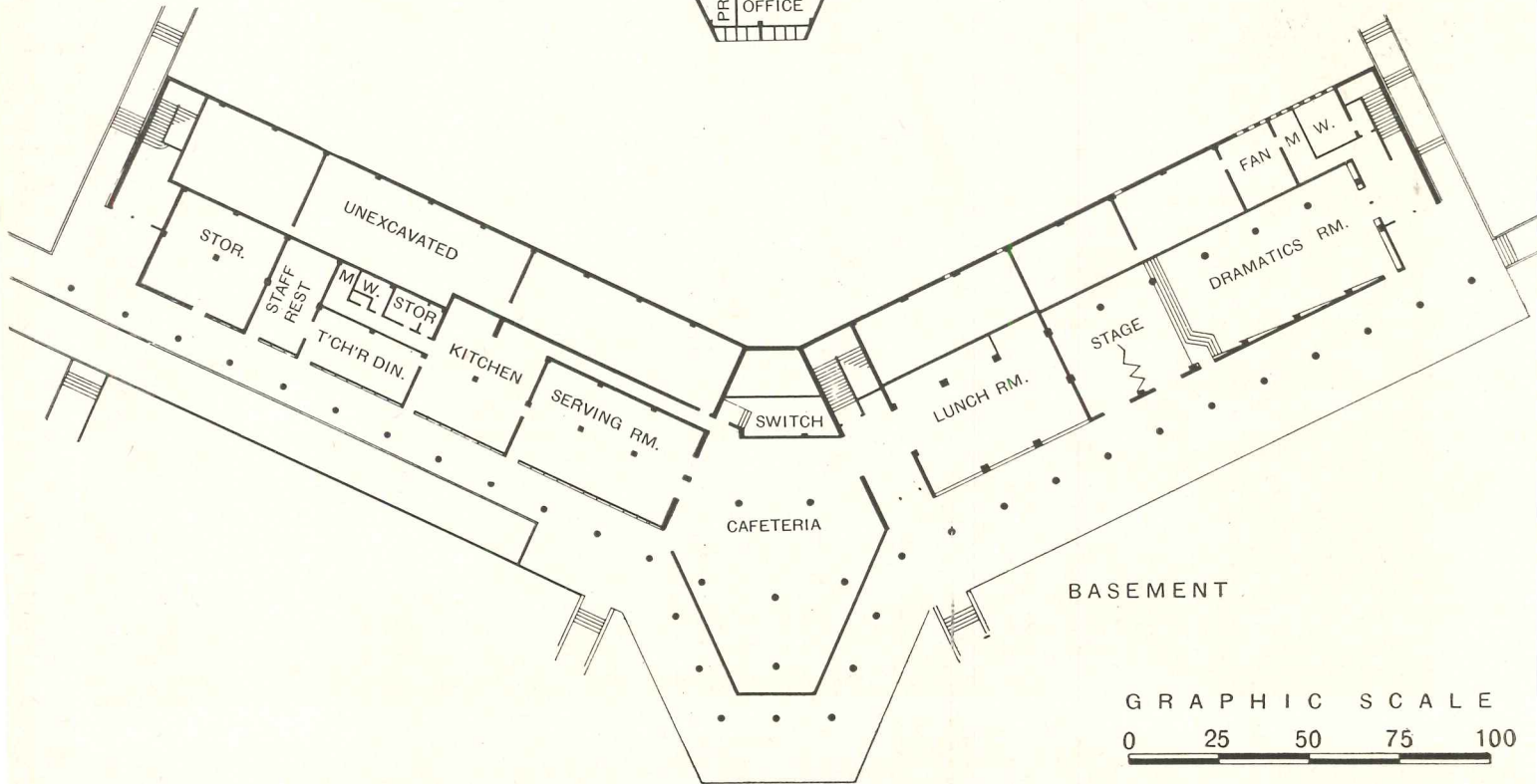
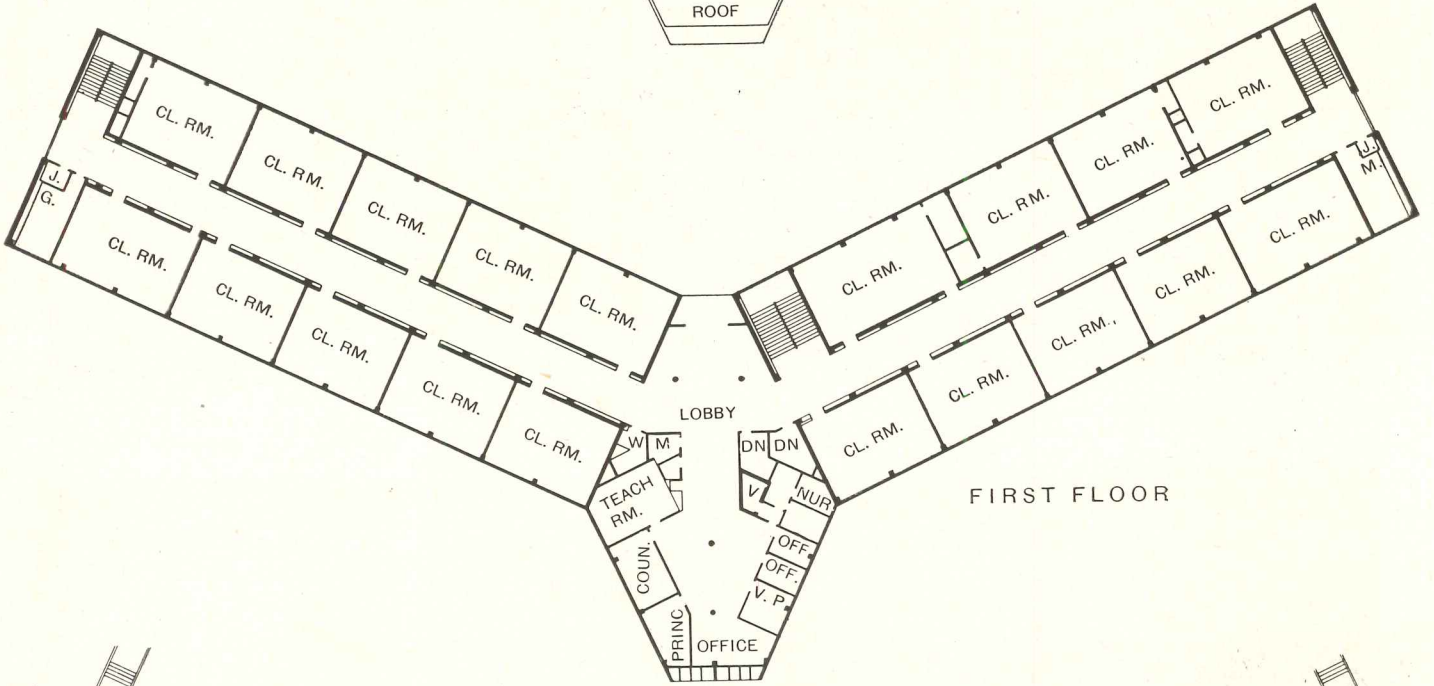
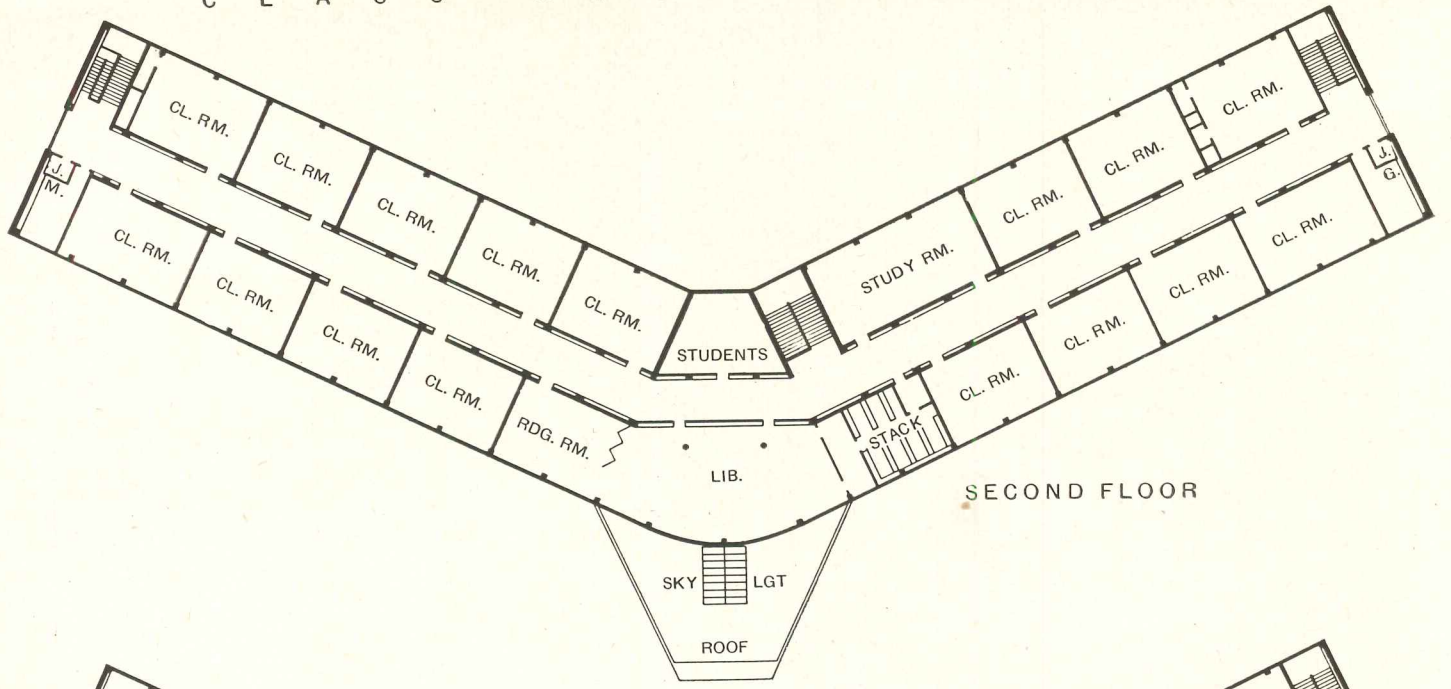

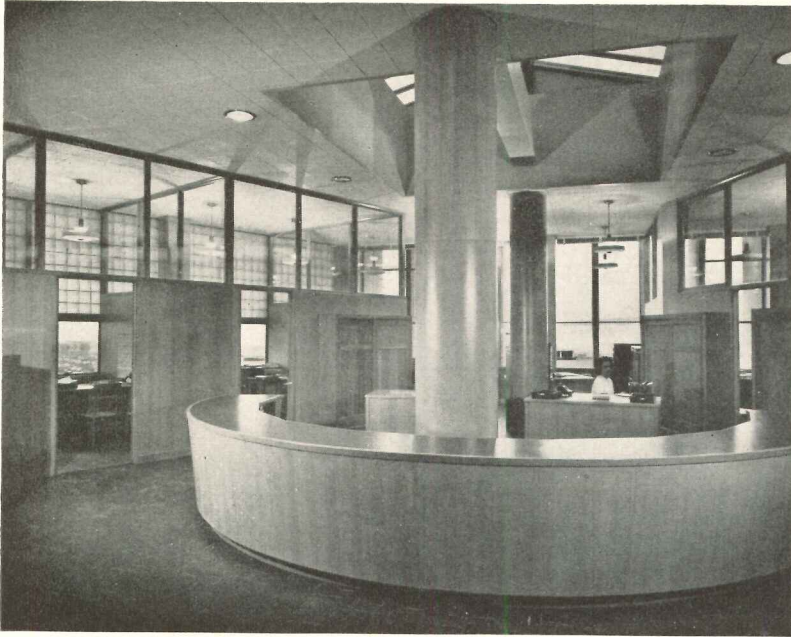

Julius Shulman

In classroom building, double-loaded corridors serve 36 classrooms, library, administration suite. Photo above: circular desk in center of administration unit; right, top-floor corridor; below, typical classroom. Rooms facing west have cool colors, blue or green chalkboards; east rooms, warm tones and brown boards



Rondal Partridge

Julius Shulman

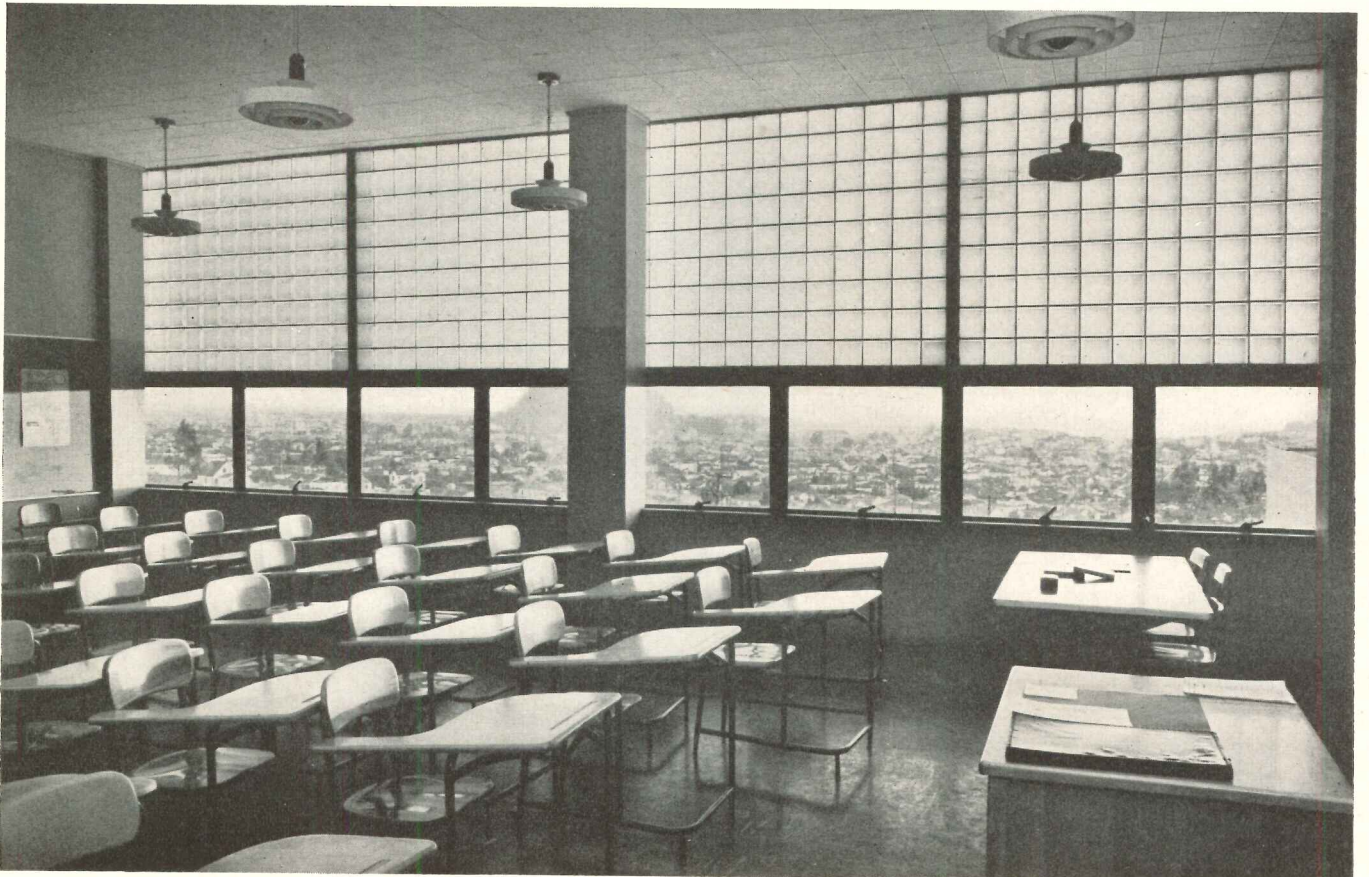

PORTOLA JUNIOR HIGH SCHOOL

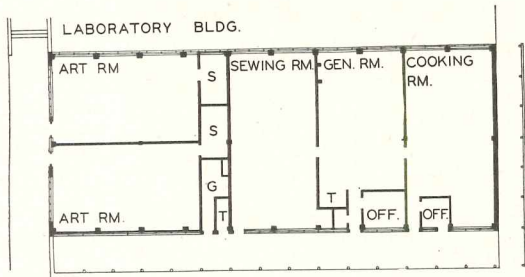

SHOP BUILDINGS

Plan of domestic science and art building is above; photos are on preceding pages. Below is plan of industrial arts shop; photo at right. Horizontal vanes control light at east and west windows. Monitor skylights face north

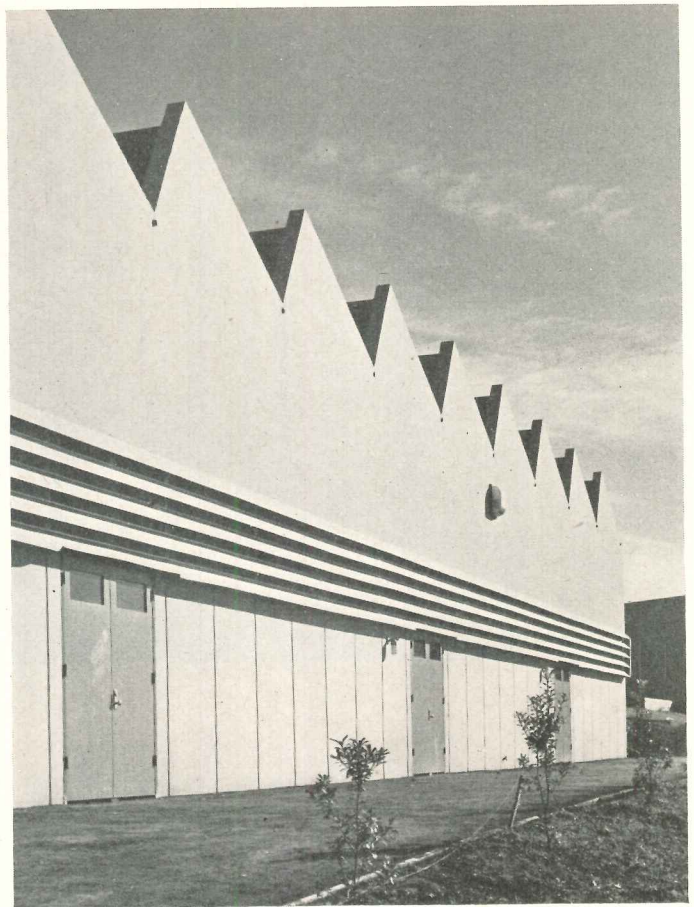
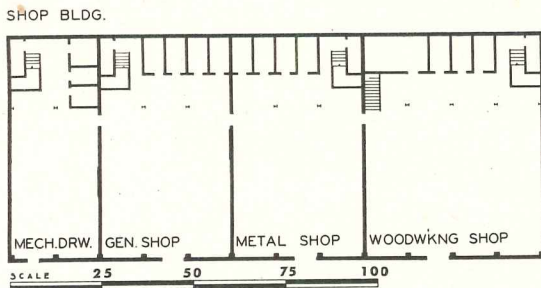

Rondal Partridge

GYMNASIUM

The gymnasium building at Portola has a stage so it can be used as an auditorium, and an adjoining music room which can also serve as an anteroom to the stage. Here, and in the dramatics room in the classroom building as well, the stage is fully equipped. A complete, multi-use public address system permits programs in gymnasium and dramatics room to be heard in all classrooms

Julius Shulman

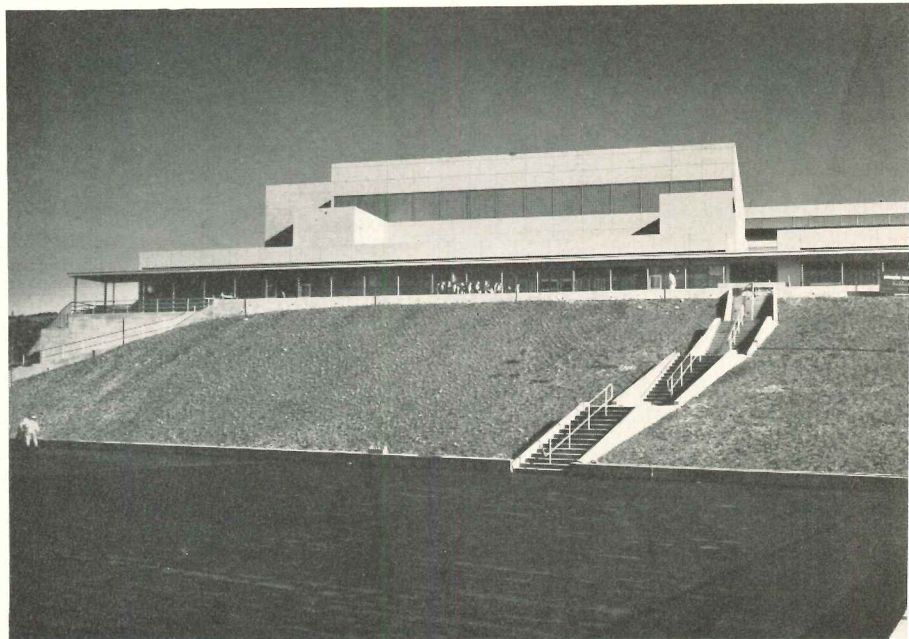

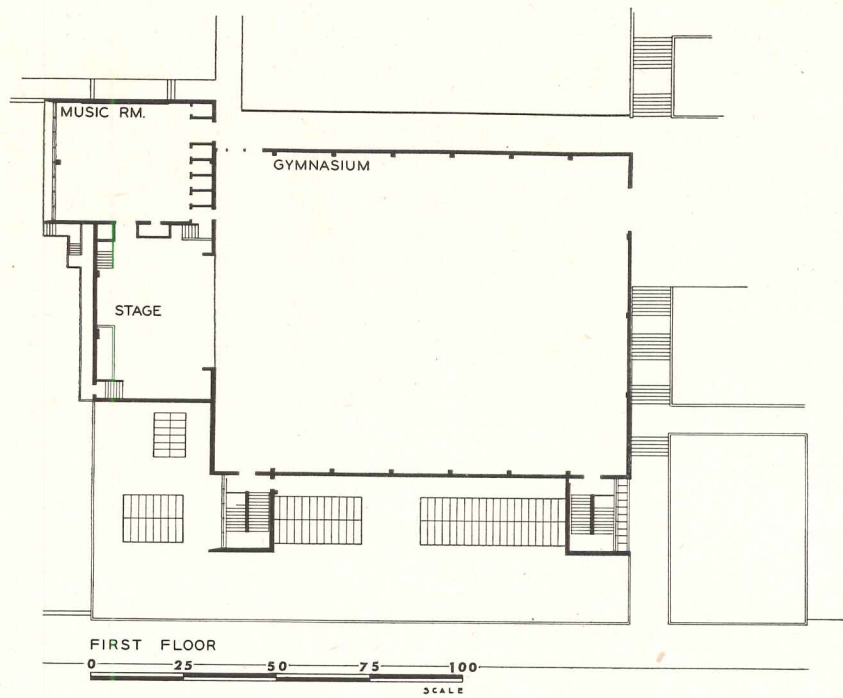

Plan shows only the main floor of the gymnasium building. The lower floor contains boys' and girls' locker rooms, showers, a community room, and a boiler room for the entire school. Gymnasium has both glass block panels and a skylight. All skylights are of aluminum, puttyless, glazed with heat-absorbing wire glass

Rondal Partridge



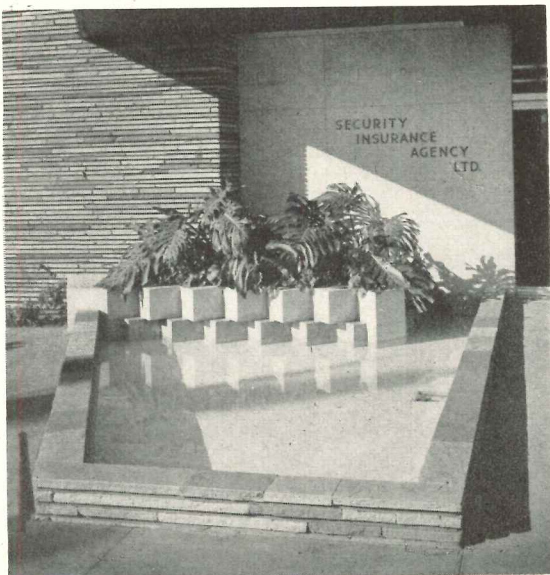
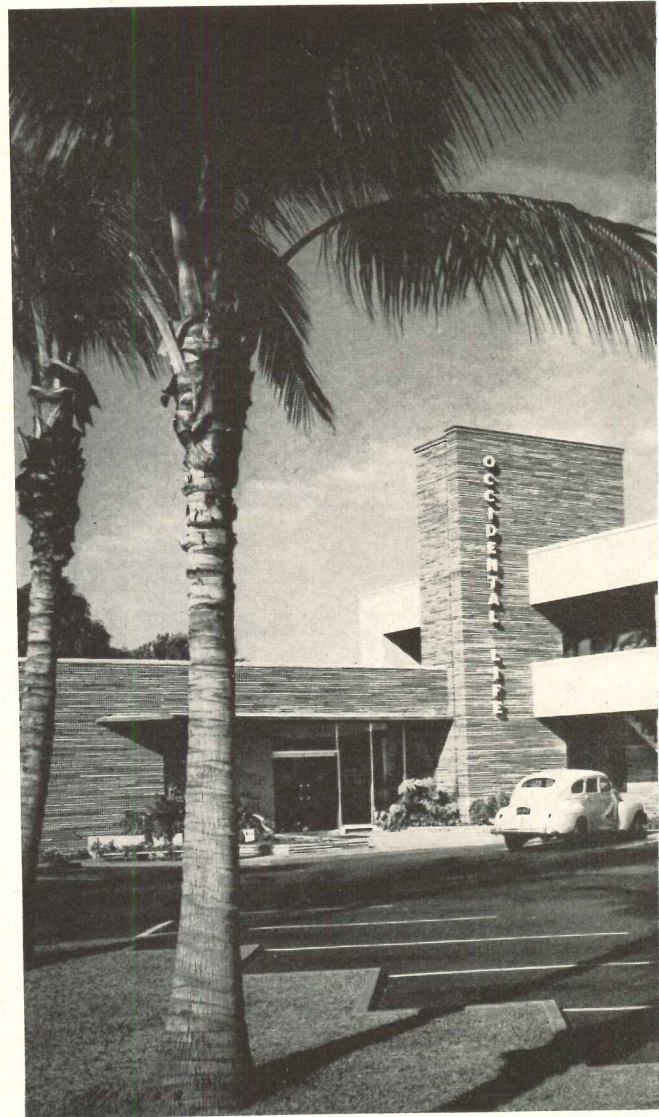

INSURANCE COMPANY OFFICES IN HONOLULU, T. H.

*Security Insurance Agency, Ltd., Agents for
Occidental Life Insurance Company of California*

*Cyril W. Lemmon, Architect; Douglas Freeth, Associate
Ernest H. Hara, Associate Architect
Thompson and Thompson, Landscape Architects*



R. Wenkam

WHILE THIS BUILDING was in the early planning stage the architects made a careful analysis of the office needs of the 40 agents on the staff. Individual desks were ruled out: they would have required an area of about 2400 sq ft, in use for only a small part of the day. The owners recommended a series of conference tables to which the agents could take their documents and papers from individual filing cabinets; this idea was vetoed by the architects because a large room full of unused conference tables "could easily be somewhat institutional in appearance," and because the large tables would have been in the way when the space was needed for general meetings.

The solution to the problem was based on the fact that, except in rare instances, not more than eight or



Main entrance (opposite page) faces landscaped parking area, at each end of which are stairs leading to lanai connecting second-floor offices. Building is reinforced concrete with exterior walls of Arizona sandstone and plaster

ten agents would need desk space at the same time. Eight reference tables were ranged along the wall of the corridor leading to an agents' lounge. The tables are for reference only, and do not have drawers — the architects reasoned that this would prevent an agent from staking a claim to a particular table, and would force him to return his papers to his own individual file. If more than eight agents need reference space at one time, the large table in the school room at one end of the lounge can be pressed into service.

For discussions between agents and their clients, the architects felt strongly that an informal and friendly atmosphere must be provided. Hence the large and airy lounge where several agents may hold conferences at the same time. With the furniture rearranged and sup-

INSURANCE BUILDING

plemented by folding chairs (stored in cabinets along the wall), the lounge can be converted to a meeting room with a seating capacity of 110. Three small conference rooms, a file room and a secretaries' office are also provided.

The balance of the ground floor is given over to private and general offices, lobby and a library. Doctors' and dentists' offices and a laboratory occupy the second floor. Stairs at each end of the parking area, and an elevator adjacent to the main entrance, lead to a lanai-corridor serving the entire second floor.



R. Wenham

Switchboard-reception desk faces main entrance

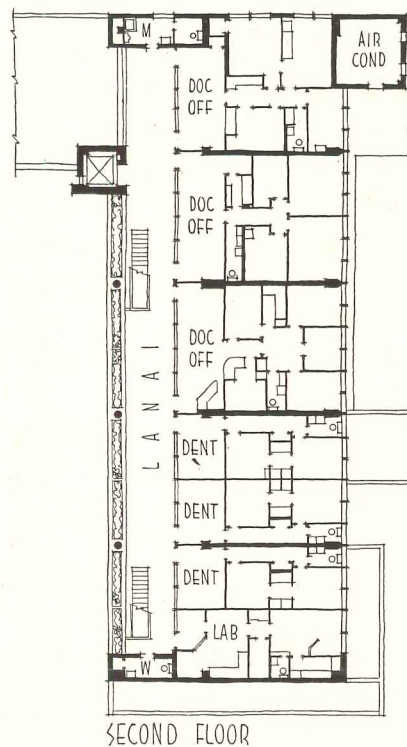
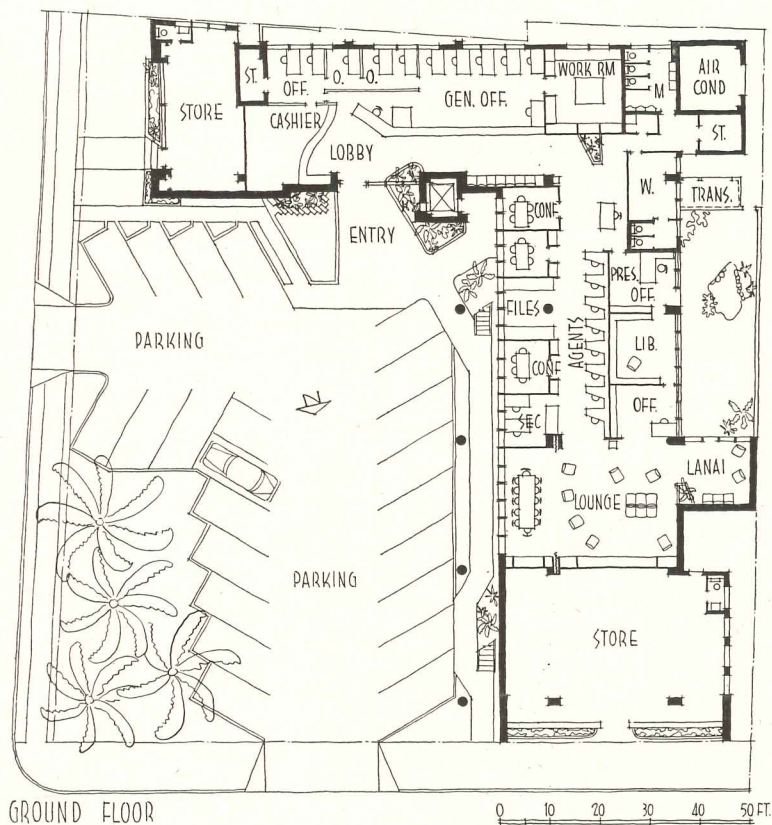



Above: left, cashier's desk; right, general office.

Below: agents' tables, secretaries' office and phone booths

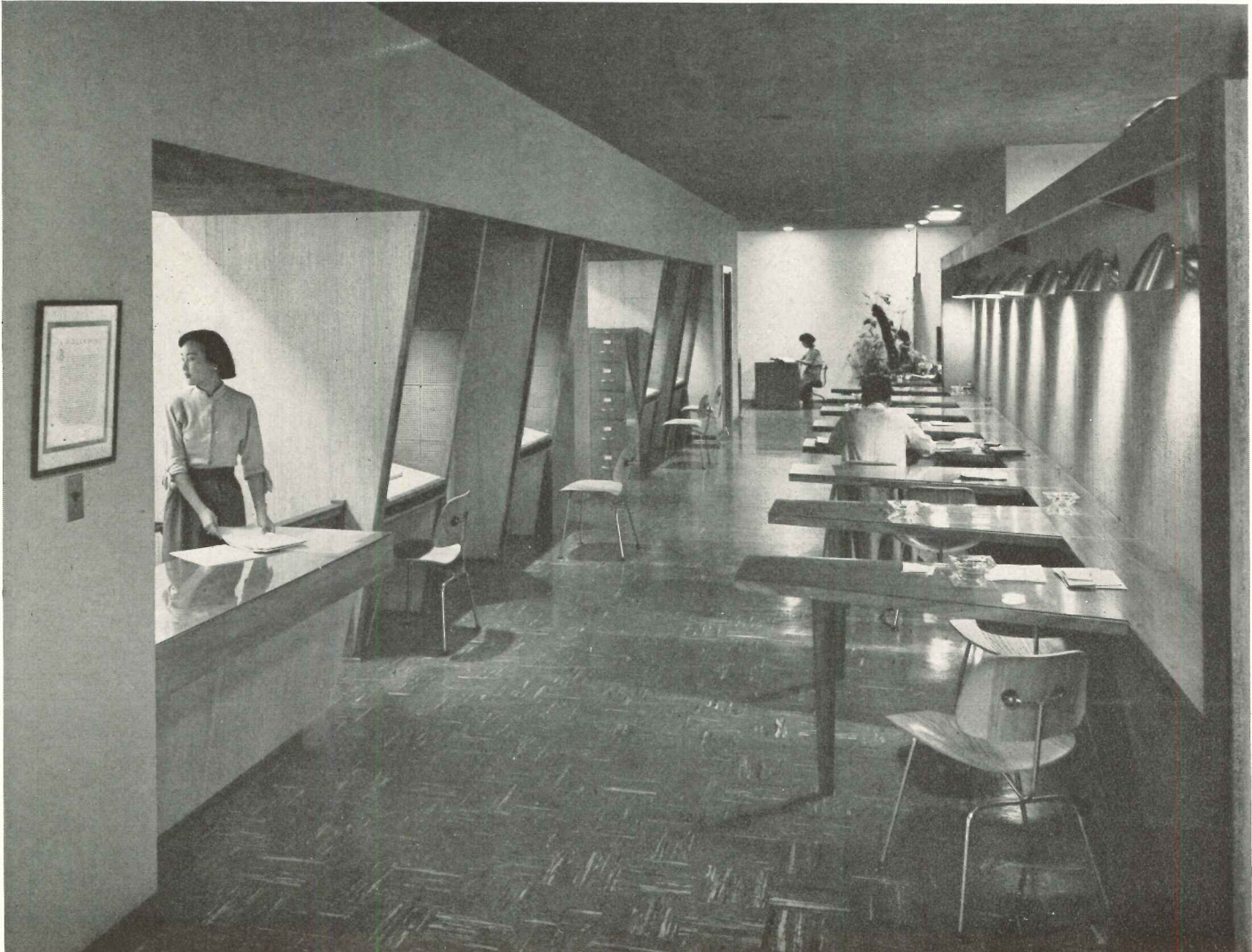

INSURANCE BUILDING



R. Wenkam

Above, left: another view of agents' quarters with lounge in background, president's office at left. Above, right: president's office has own small reception area. Below, left: school at end of agents' lounge can be closed off by folding doors, or left open for agents' use. Below, right: reference tables do not have telephones; instead, sound-proofed telephone alcoves are provided outside adjacent conference rooms

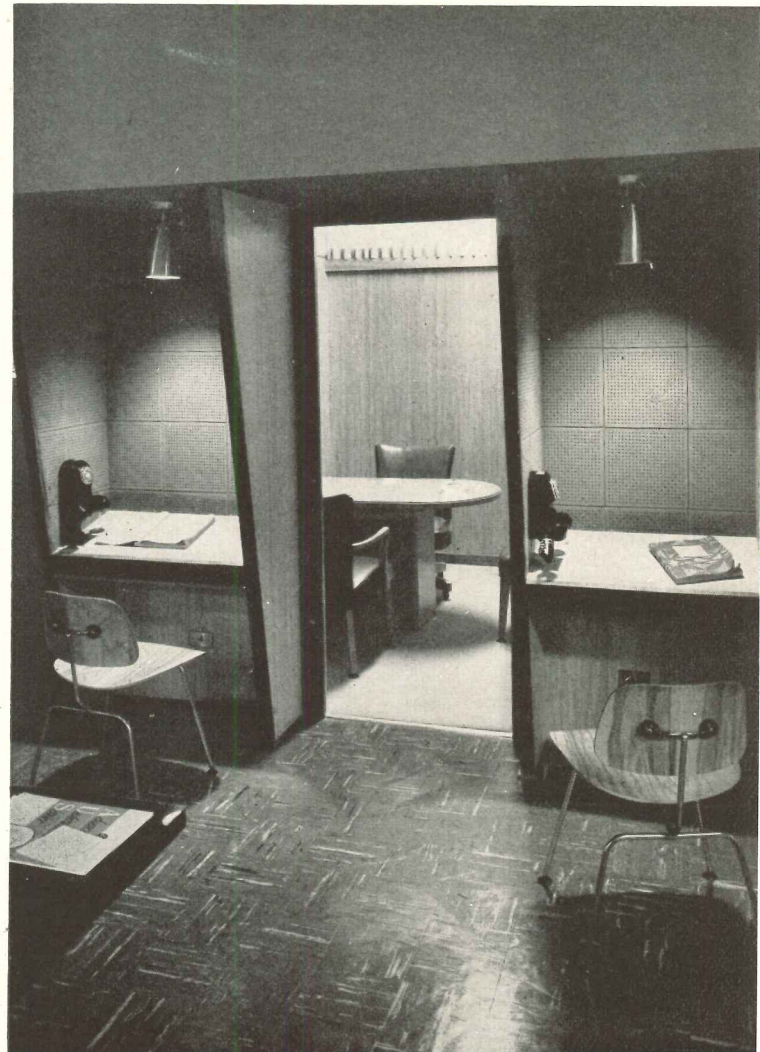
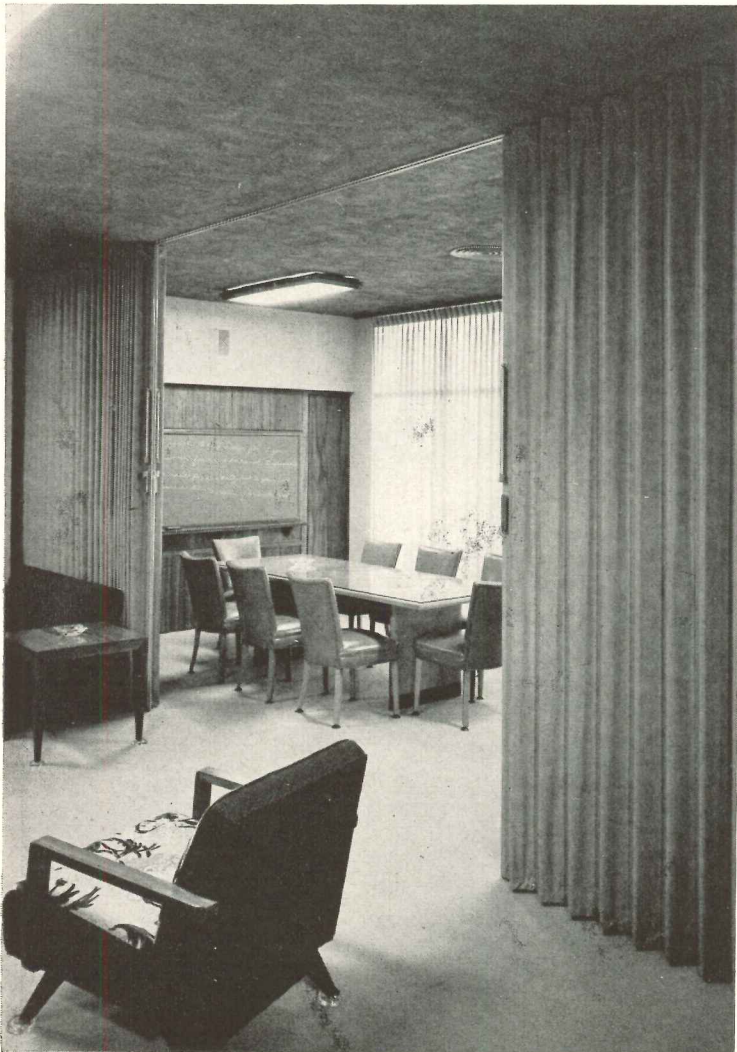

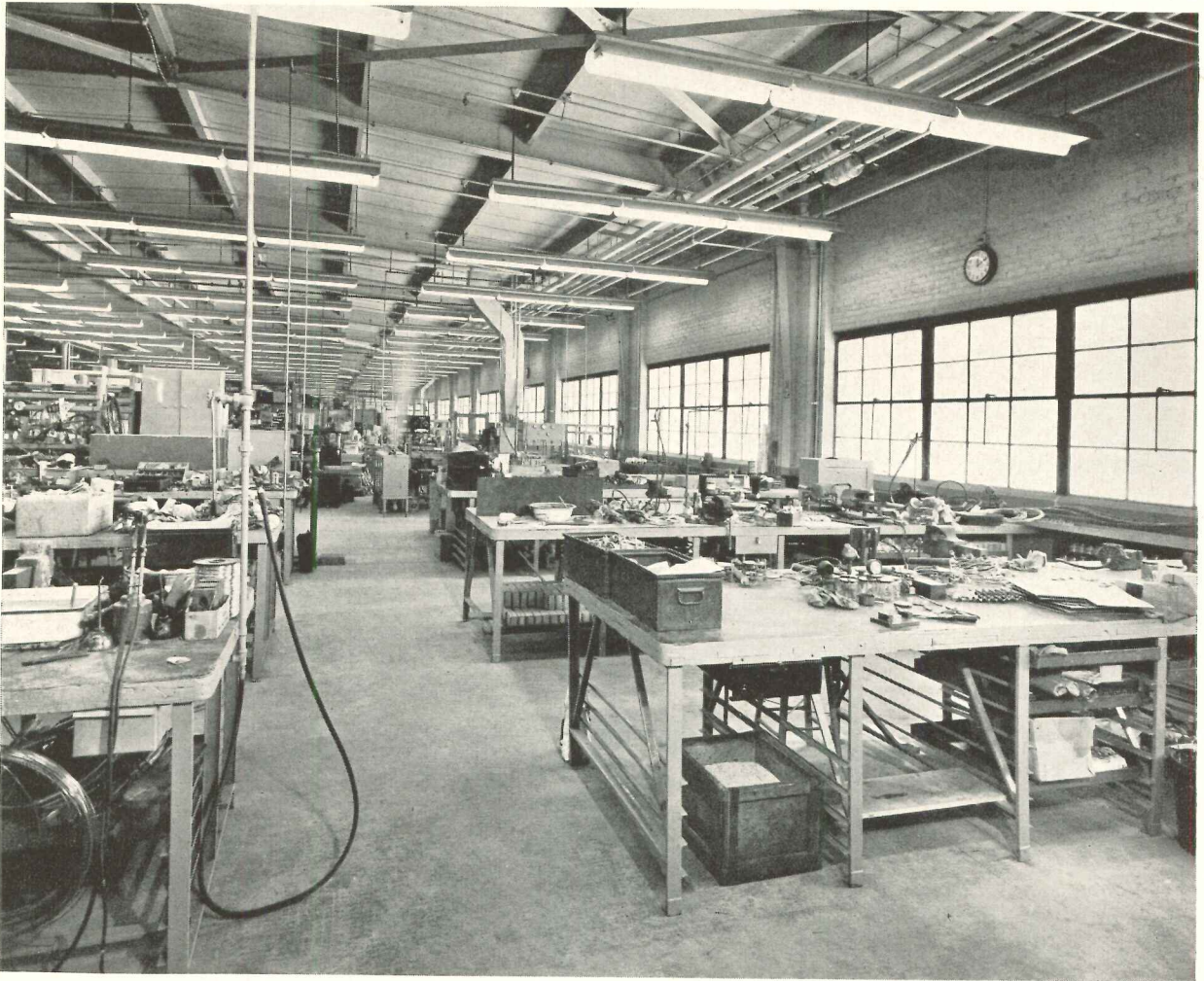

EXPANDABLE PLANT FOR GROWING FIRM

Manufacturing Unit for The Powers Regulator Company

Skokie, Illinois

Sessions Engineering Company, Architects and Engineers

A PRIME CONSIDERATION in the design of this plant was provision for expansion. In 1940 and again in 1943 the company — manufacturers of air conditioning, heating and ventilating controls — had added materially to its facilities; a few years later both office and factory space were again insufficient.

The new plant was planned to allow relatively easy factory expansion without disturbing the office layout. The building is T-shaped, with a 290-ft-long two-story office and laboratory section across the front. The fac-

tory section is one story in height, 200 ft wide by 460 ft long. Manufacturing departments are located around the outside walls, and are fed from the storage areas in the center of the plant. Truck docks are adjacent to the shipping department and stock rooms. Work and material flow problems were studied with three-dimensional scale models of all plant equipment, placed on a large-scale floor plan; staff members could visualize their departments before the plant layout was approved, and were able to help actively in the planning.

EXPANDABLE PLANT

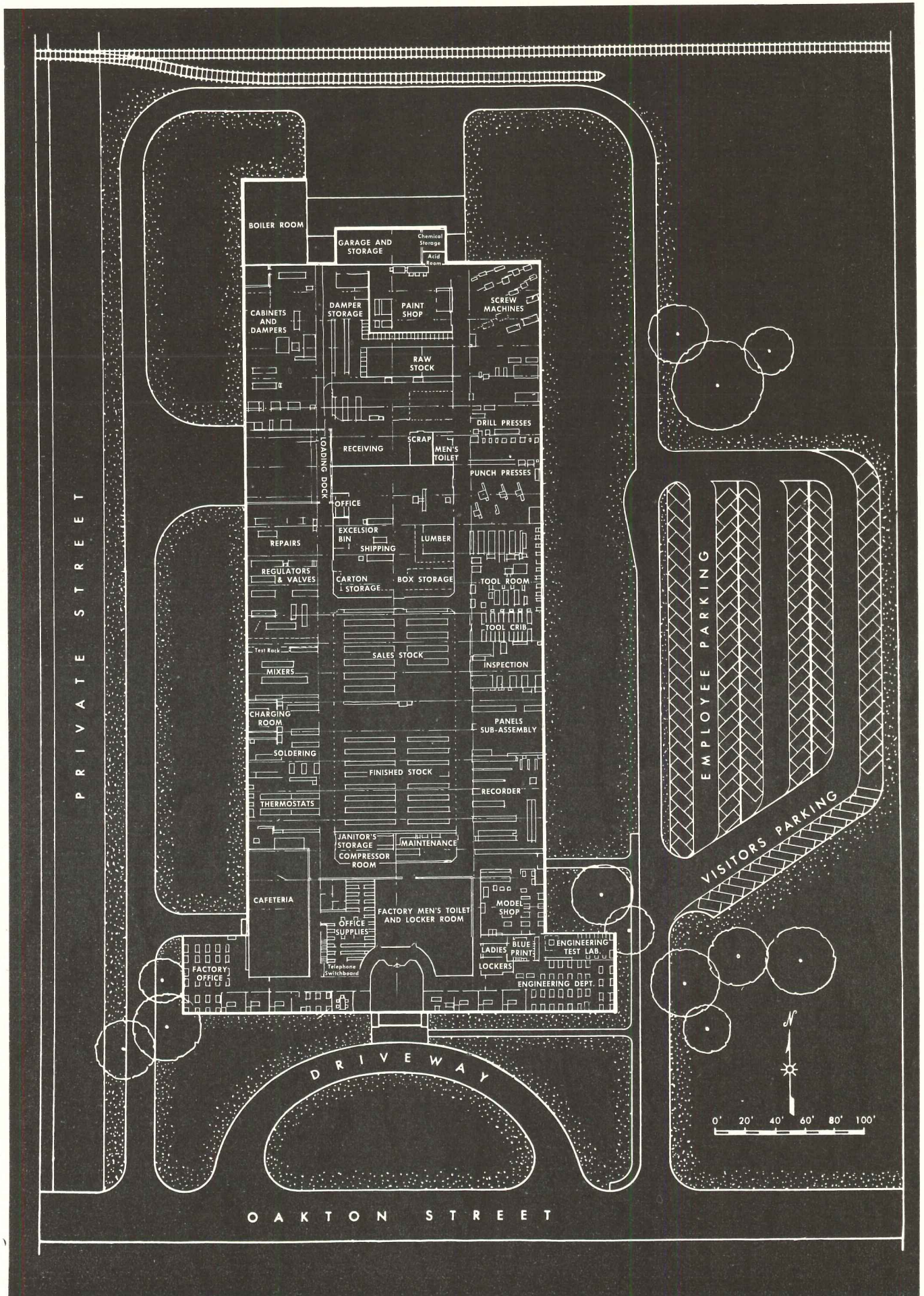

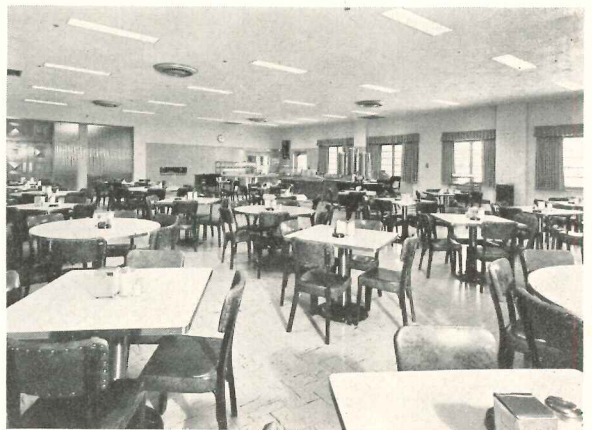
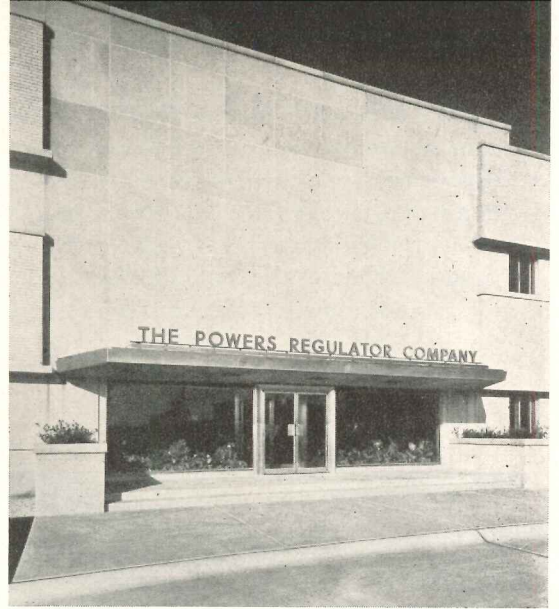
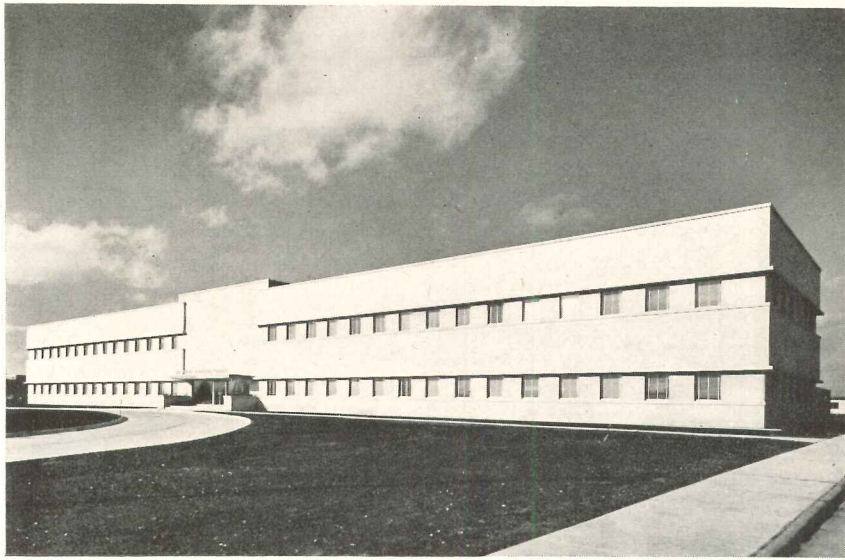

Above: left, president's office; right, employees' cafeteria seats 500, has movie screen and amplifiers

Below: testing section of research laboratory. Here as in factory, rubber matting on floor reduces noise, vibration

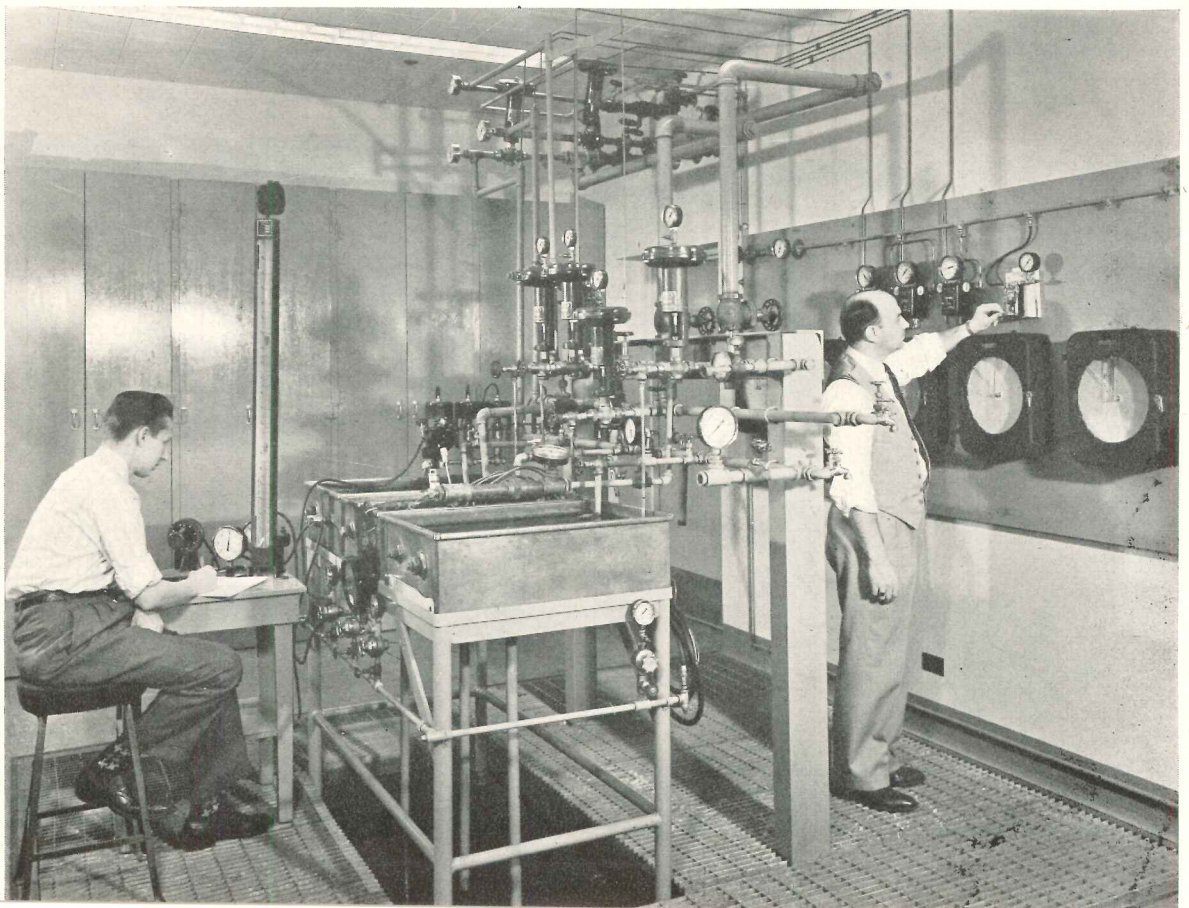

EXPANDABLE PLANT

Welded steel construction resulted in a low steel weight per square foot of area, speeded up construction, and allowed wide, unobstructed bays. A well-insulated roof, elimination of skylights, and heat-resistant glass in all windows combined to permit reduction of the heating system by about 50 per cent. The factory section is heated with a hot water circulating system through unit

heaters and radiators under all windows. The office area is completely air conditioned.

Exterior walls are buff-colored brick with limestone trim and steel sash. Floors are asphalt tile in the office section, reinforced concrete treated with iron floor hardener in the factory area. Offices and cafeteria have acoustic ceilings. Lighting throughout is fluorescent.



Chicago Architectural Photographing Company

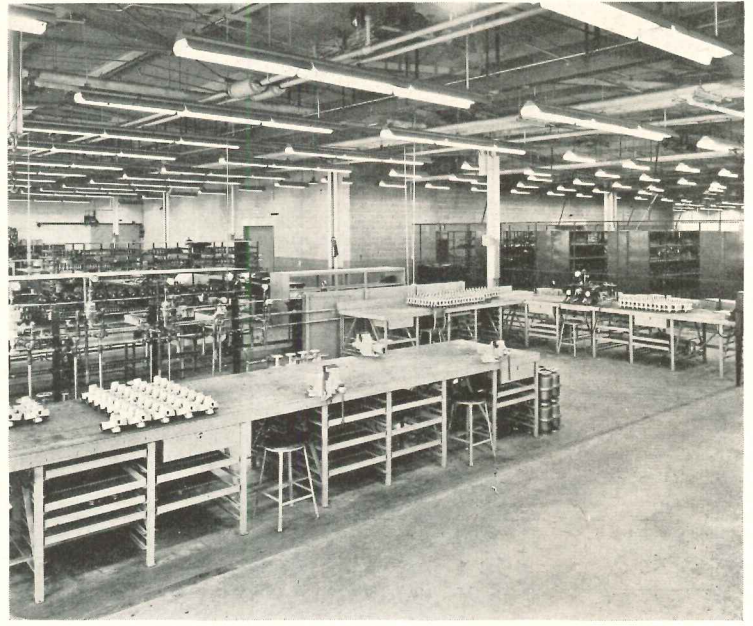

Center bays (above and above right) are used for storage, shipping and painting. Aisles are 10 ft wide to accommodate fork lift trucks. An electrified mono-rail hoist system delivers material from receiving dock to raw stock room. Entire building is sprinklered

Below, left: boiler room contains two oil fired boilers; underground tanks provide oil storage capacity for three coldest months. Below, right: control panel for heating and air conditioning. Walls are glazed tile, floors asphalt tile for easy maintenance

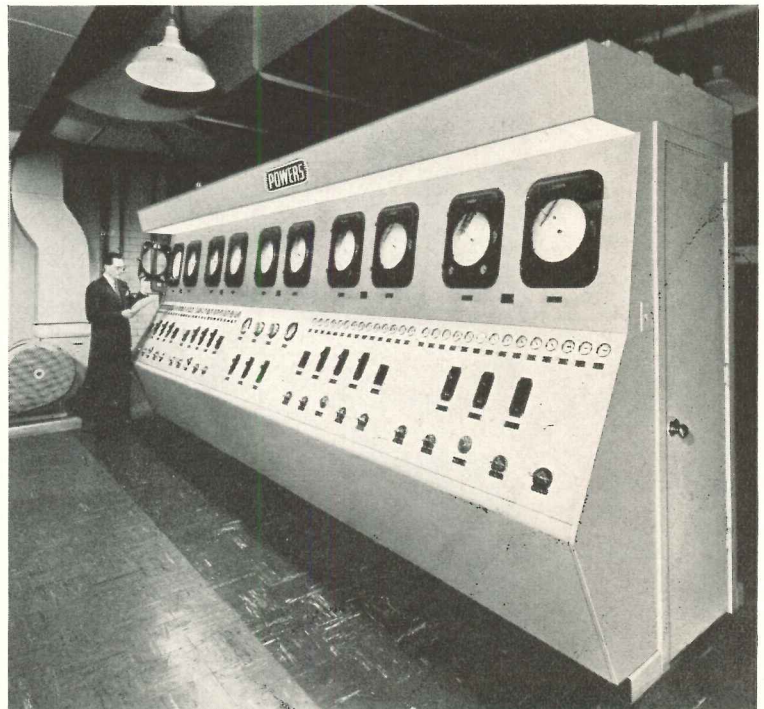
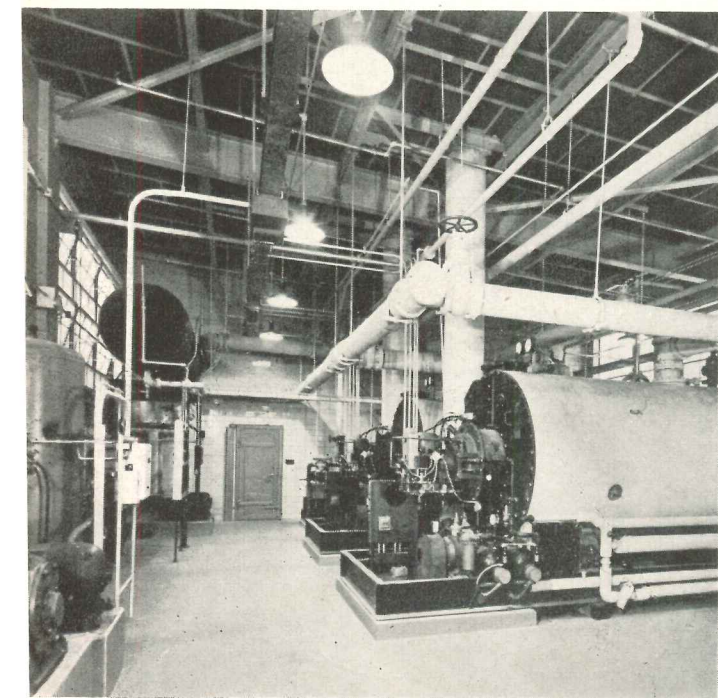

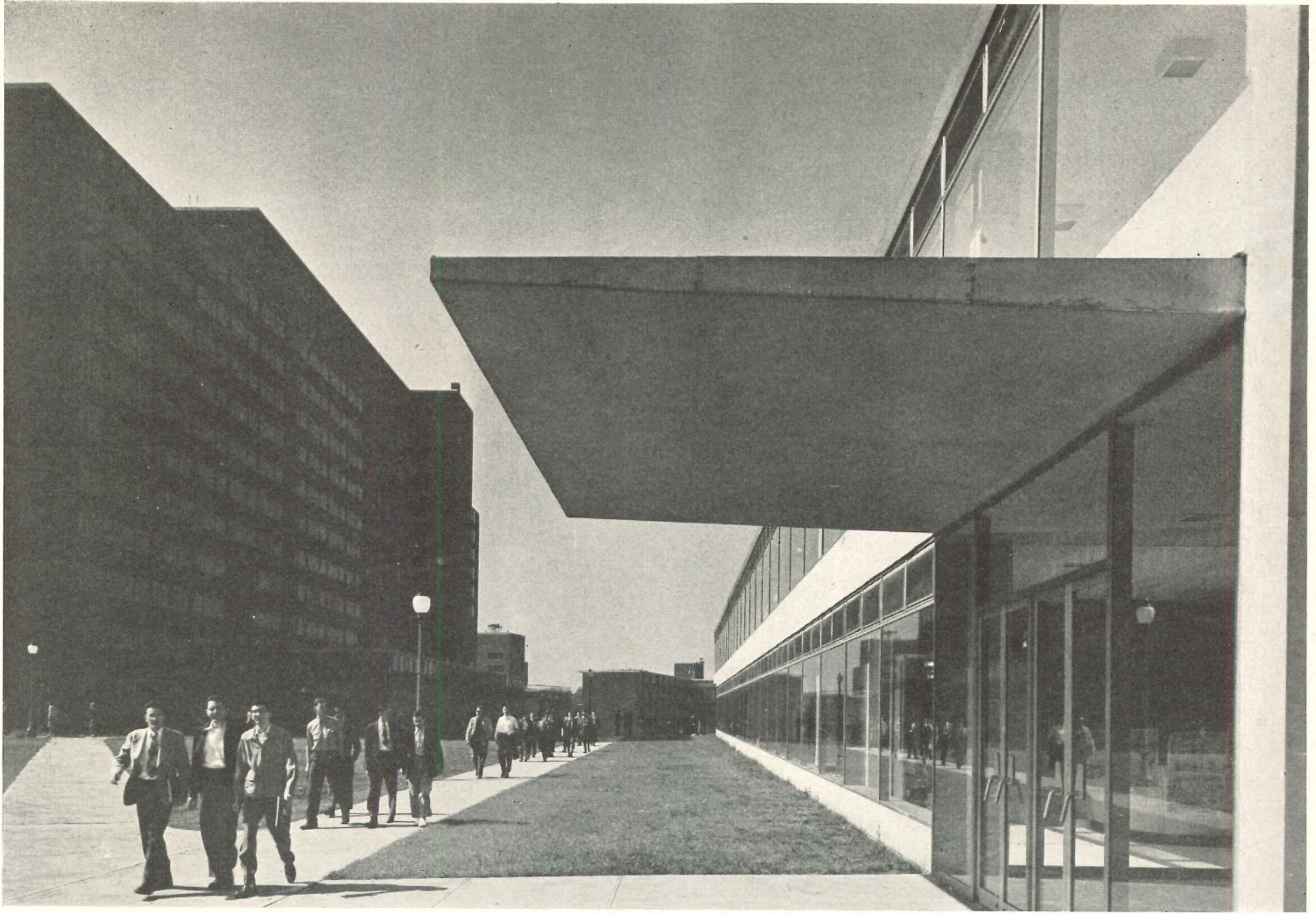

Torkel Korling

MEDICAL CENTER FOR OHIO STATE

Ohio State Health Center, Columbus, Ohio

Skidmore, Owings & Merrill, Architects

The Ohio State University

Dr. Howard L. Bevis,
President
Dr. Charles A. Doan,
Dean of the College of Medicine
Dr. Wendell D. Postle,
Dean of the College of Dentistry

Ohio State Department of Public Works

George B. Sowers,
Director

Ohio State Department of Health

Dr. John D. Porterfield,
Director

Ohio State Department of Public Welfare

Charles L. Sherwood,
Director

Skidmore, Owings & Merrill—Architects

N. A. Owings, Robert W. Cutler,
Partners in charge

Edward A. Merrill,
Project Manager

Andrew J. Brown,
Structural Engineer

Edward A. Salmon—Hospital Consultant

**Samuel R. Lewis and Associates—
Consulting Mechanical Engineers**

**Grove—Drake and Psaty—
General Contractors**

OHIO STATE HEALTH CENTER *Skidmore, Owings & Merrill*



Torkel Korling

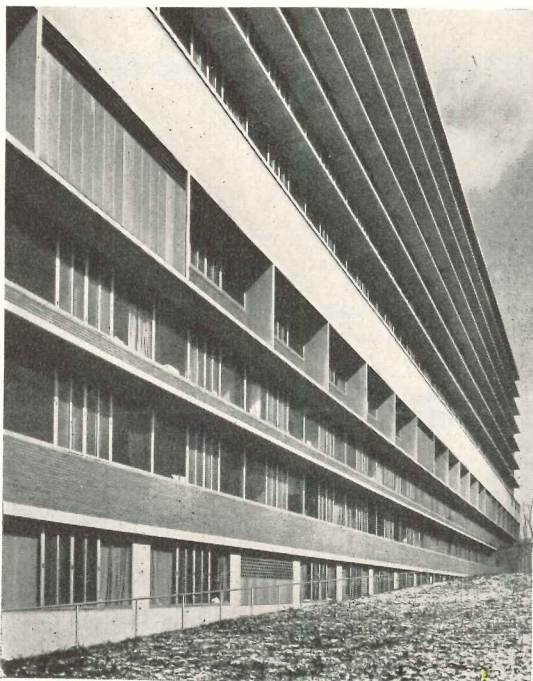

NOW THAT IT IS LARGELY COMPLETED the Ohio State Health Center is fulfilling its early promise as both an advanced concept of state-wide medical care and study and a design project of imposing dimensions. Medical concept and planning were described in detail in *ARCHITECTURAL RECORD*, Nov. 1948; in brief the Health Center represents the centering of Ohio's health programs at the University, so that facilities for care, teaching and research can be adequate for all interests, without duplication of either facilities or talents in small units.

Architecturally the buildings express the power of such an alignment of science, scholarship and financial means. The huge slices of buildings, long and slick and businesslike, suggest competent care rather than cozy comforting of the patient. One need not merely guess that a sense of competence is reassuring to patients — when a group of patients were first moved from the older

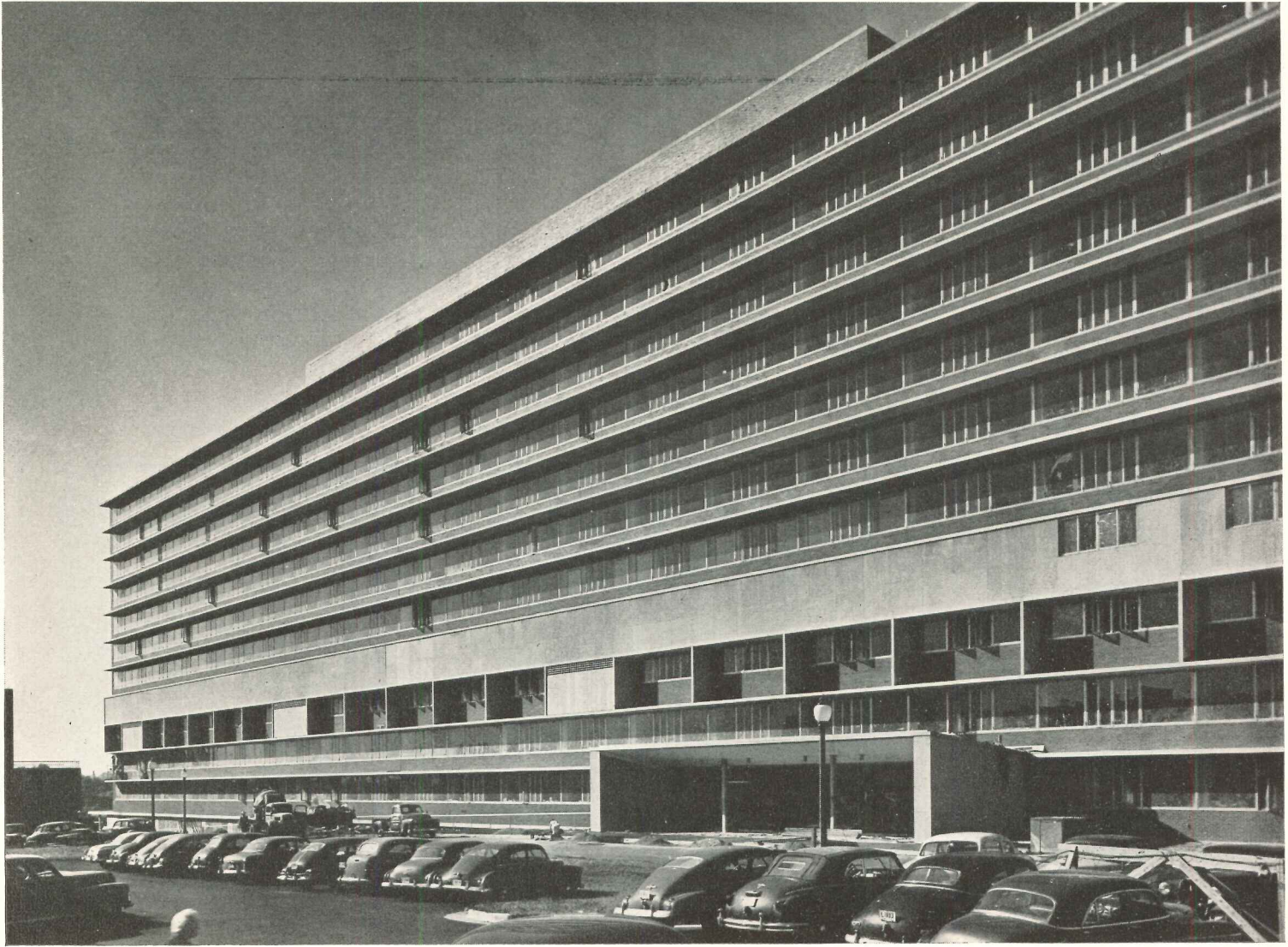

Torkel Korling

buildings to the new University Hospital (the largest building, above) they scarcely rang their call bells all day. This is not to say that a hasty look at a facade was sufficient to produce such a reaction by patients; the claim here is just that the buildings express the competence. And, no doubt, by expressing it, add strength to it.

The buildings are placed generally east and west, so that most patient rooms get the southern exposure. A few rooms face the north, as there are some patients for whom sunshine is undesirable. Width of buildings is determined by optimum dimensions for a nursing wing. The windowless story in the main building, with exterior wall flush with outer edge of sunshades, represents a widening of the floor for operating departments.

At the Health Center there has been some discussion of the amount of window glass on the southern exposure for patient rooms. It amounts merely to an academic



F. S. Lincoln

question about the merit of so much light for short-stay patients, especially in winter when sunlight enters the room, and when the views are a bit on the bleak side. In the summer, say the nurses, patients seem to be comforted by the views; it is suggested that this might be the reason for their not ringing the call bells, as previously mentioned.

Main building is a general hospital, nominally 600 beds, has fairly normal facilities for a large hospital, except that there is no outpatient department, this function remaining in the older building. Ground has been broken, however, for a fifth building in the group, to

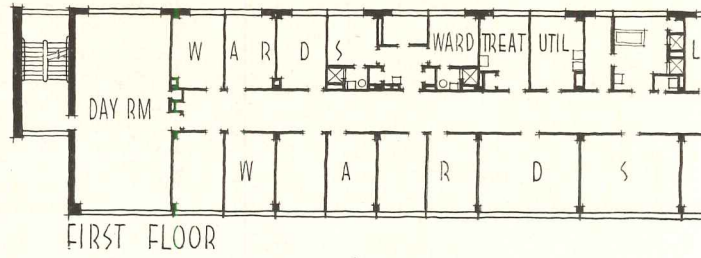

Receiving Hospital (mental patients) has two nursing units in a line. It has no need for extensive medical facilities; has only a small rear section for its treatment unit

Receiving Hospital ↓

University Clinic (under construction) ↓

College of Dentistry ↓

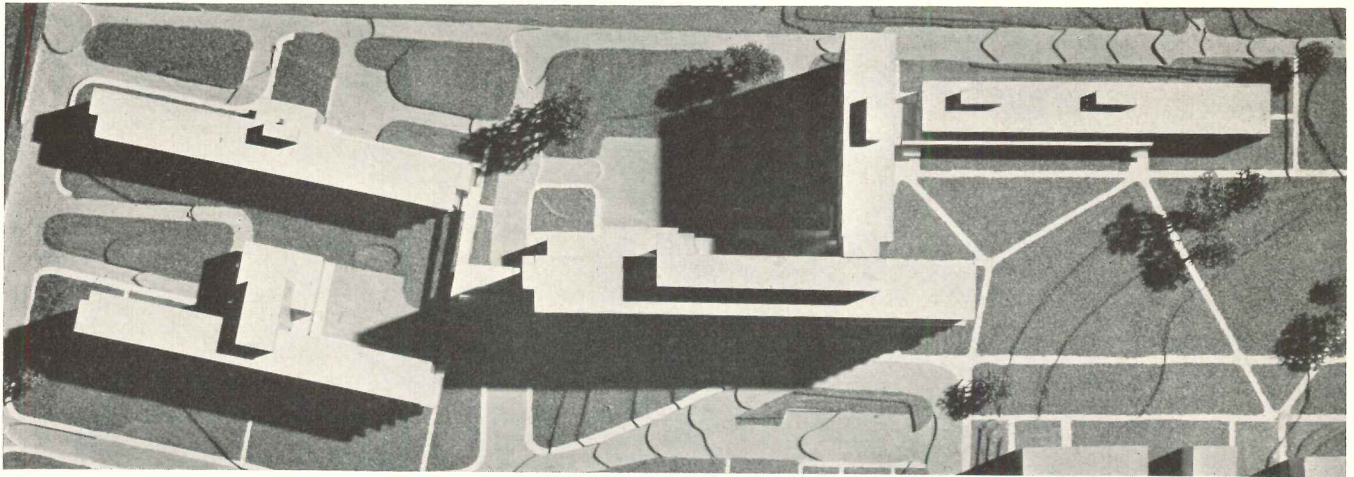

Tuberculosis Hospital ↑

University Hospital ↑

Tuberculosis Hospital also uses the long in-line scheme for nursing units, but has large rear extension for its laboratory and surgical facilities, as these procedures are largely special to a tuberculosis hospital

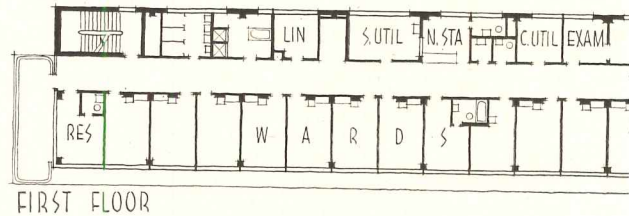

University Hospital (general) keeps the long narrow form, with three nursing units in line. One floor, not shown, is widened to line of sun visors to provide room for surgical and maternity departments, without windows

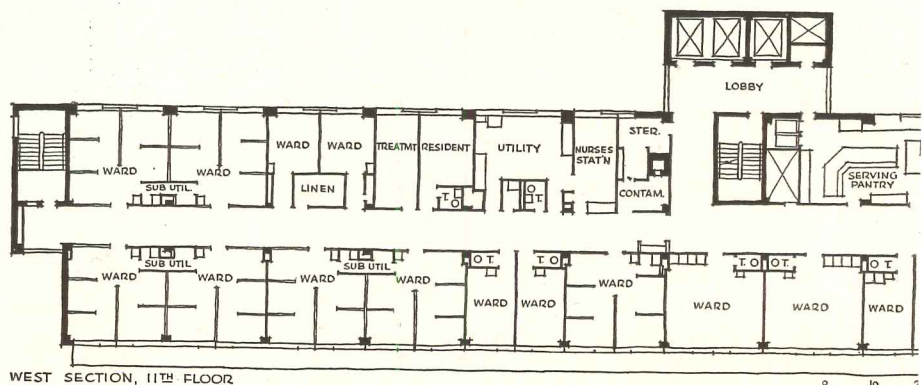

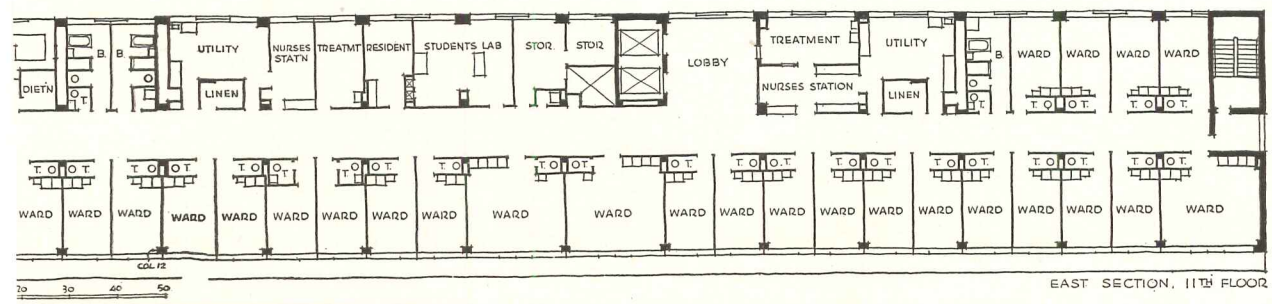
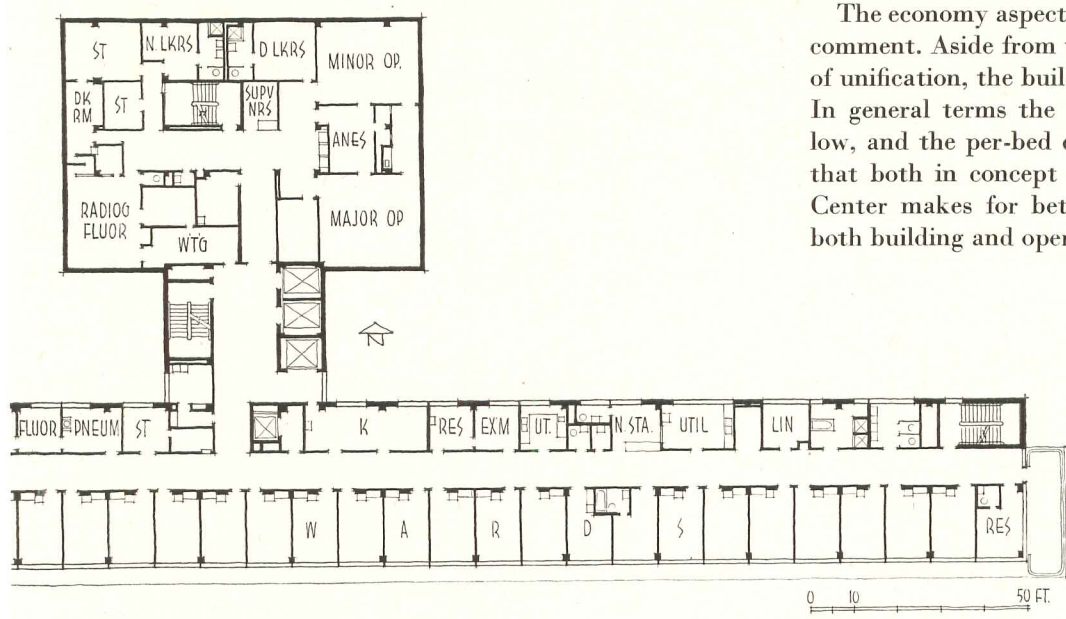
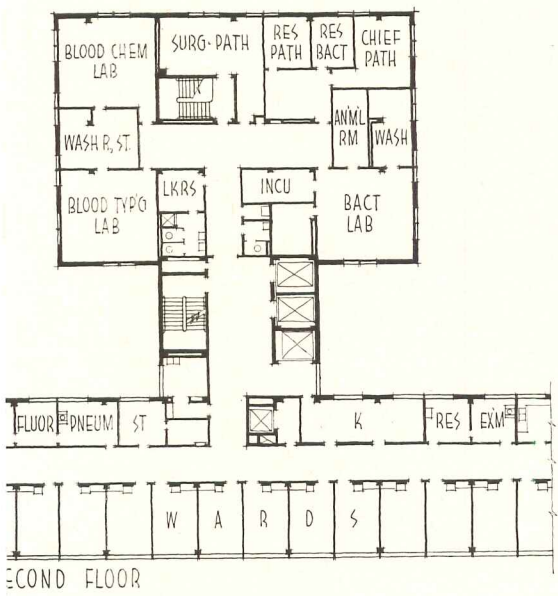
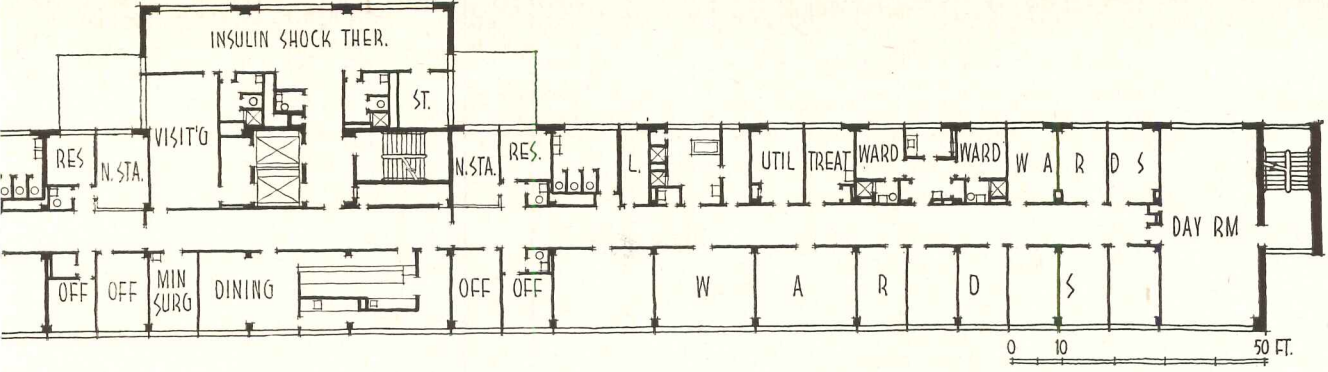

house outpatient department and research facilities. This will be a tie between the big hospital and the College of Dentistry Building. The main hospital is three nursing units long, which is to say that each nursing floor has three units of 30 beds each, arranged in a line, with three nursing stations.

Other buildings now complete are the College of Dentistry Building, the Tuberculosis Hospital and the Receiving Building, for mental patients. The latter two are under the State Department of Health, placed with the group for purposes already explained. The Receiving Building is especially well conceived in this respect; it is the intensive treatment unit for any newly committed mental patient in the state. He goes, not to some drab state institution with morbid associations, but merely to the Health Center at the University. The hope is that in a few months of intensive treatment he can be cured and discharged; if not, of course, he is transferred elsewhere for a more custodial care.

The economy aspect of the Health Center is worthy of comment. Aside from the basic economy of the concept of unification, the building scheme is generally efficient. In general terms the total building cubage per bed is low, and the per-bed cost economical, tending to show that both in concept and in planning the idea of the Center makes for better facilities and better care, in both building and operating expenditures.

OHIO STATE HEALTH CENTER *Skidmore, Owings & Merrill*

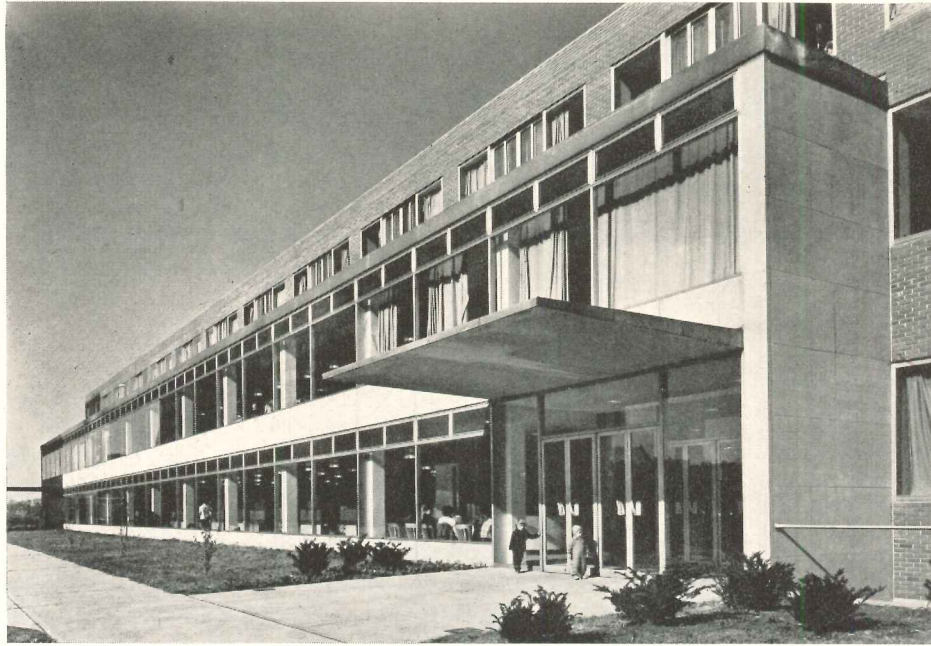

University Hospital at left; College of Dentistry, right and above. A building connecting these two is now under construction

Torkel Korling





General view of Tuberculosis Hospital

Tuberculosis Hospital at left; Receiving Hospital for mental patients in background

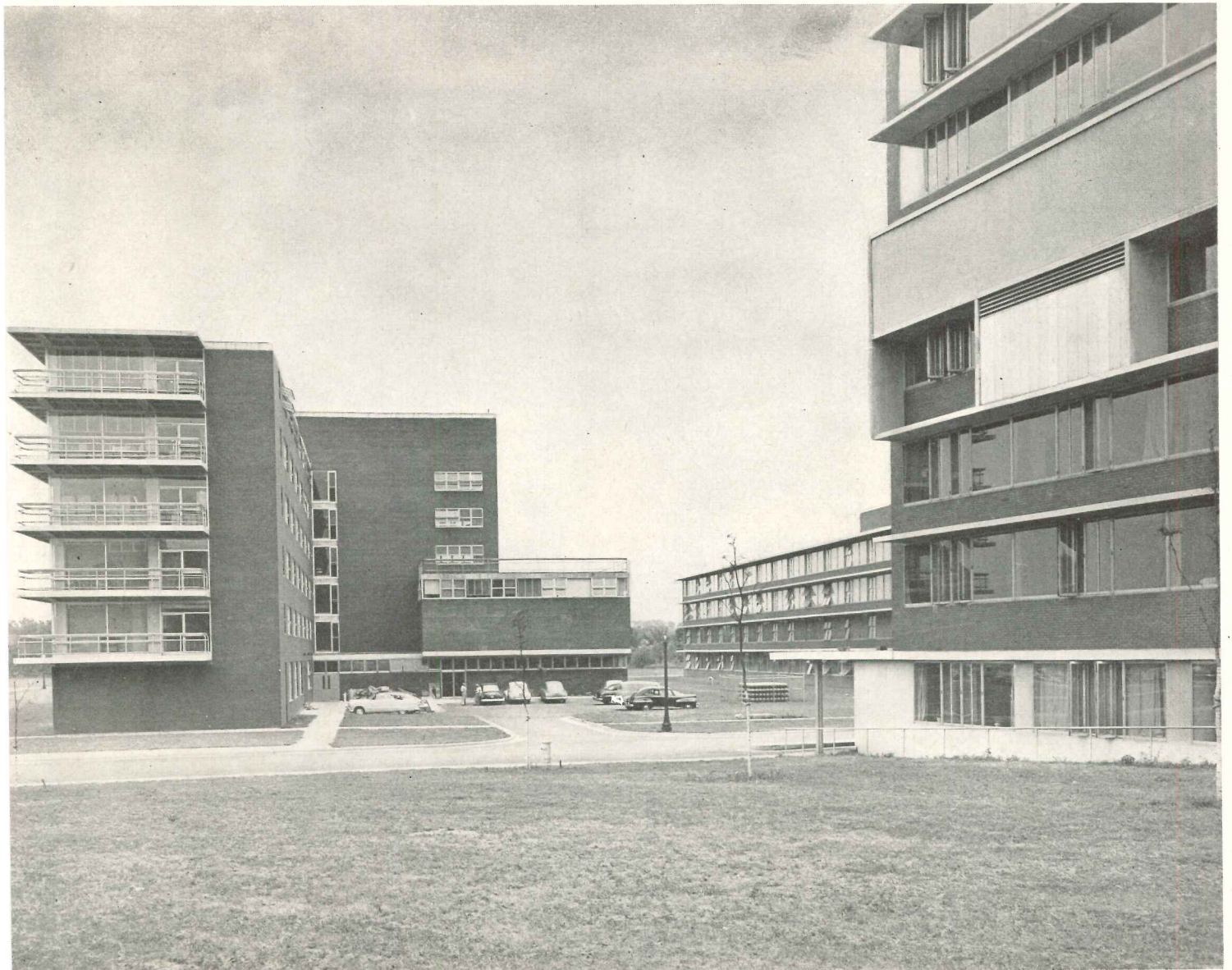

OHIO STATE HEALTH CENTER *Skidmore, Owings & Merrill*



Still unfurnished main lobby, University Hospital

Typical four-bed ward, University Hospital

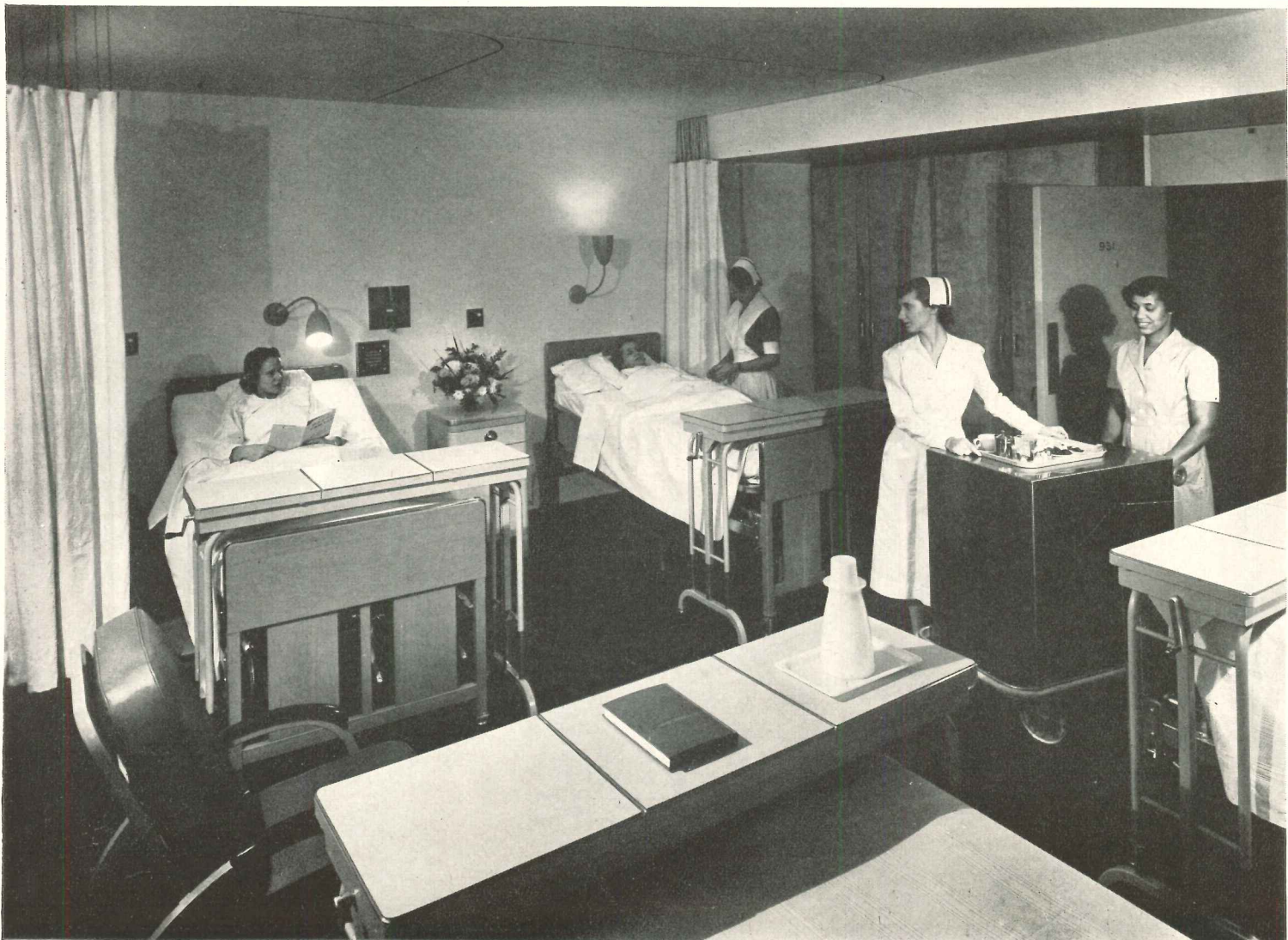



Reception room, Dental School



Admitting area, University Hospital

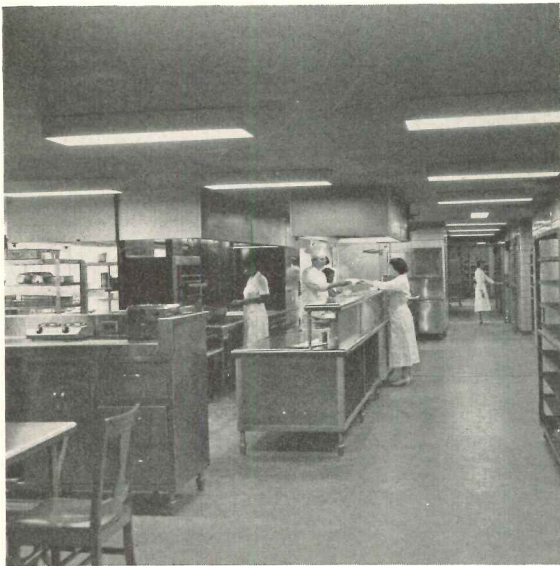

F. S. Lincoln

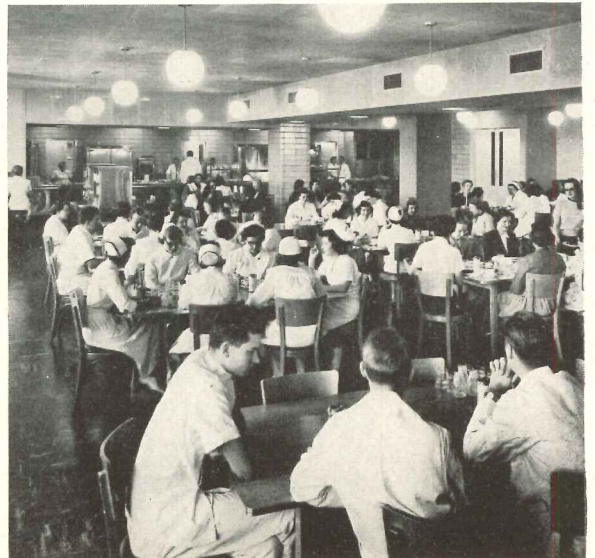

OHIO STATE HEALTH CENTER *Skidmore, Owings & Merrill*

These remarkable photographs of a hospital in use show, in the strip at the right: recuperation room in maternity ward; nursery corridor; a delivery in progress. Below: dental clinic where students and faculty work together. Opposite page: a major operating room as it is actually used

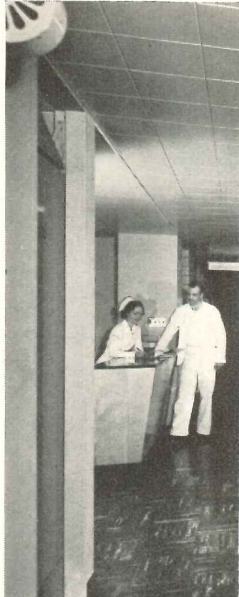
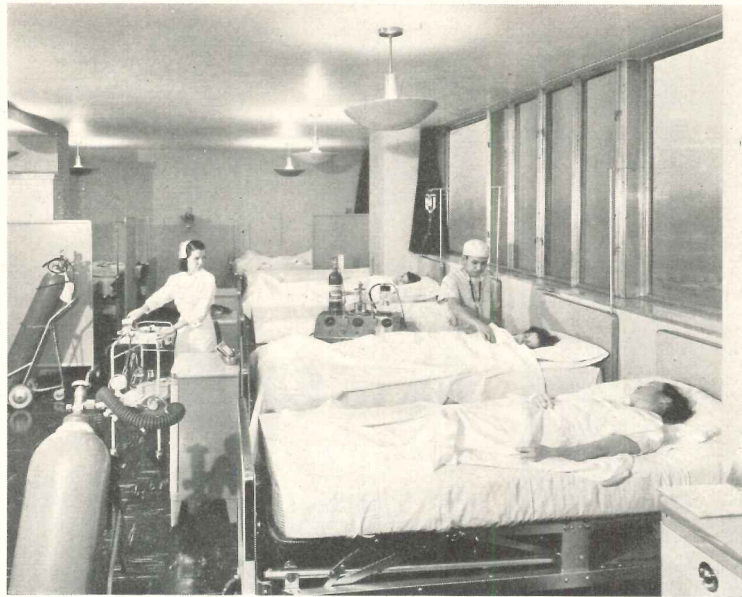

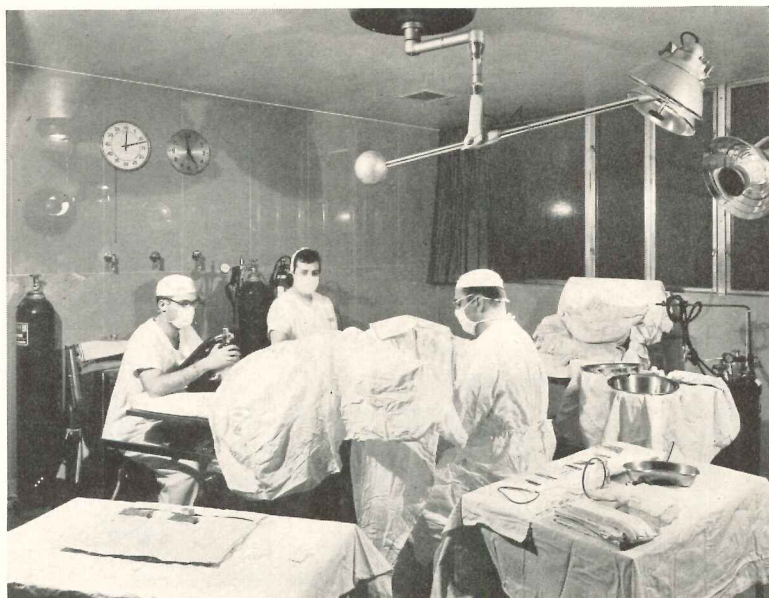

F. S. Lincoln



NAVAL AIR BASE IN NORTH AFRICA

Mackenzie, Bogert and White, Architects and Engineers

James C. Mackenzie, Project Architect

ARCHITECTS WORKING ON NAVY PROJECTS will find both considerable help awaiting them, in the form of schematics or definitives, and plenty of scope for normal design and planning techniques. In this case, a large naval air base in North Africa, the architects made use of definitive drawings for many types of buildings, drew their own plans for others. All of the basic schemes had to be modified both in construction and design for the semi-tropical climatic conditions and, of course, for the site plans developed. The site plan here, by the way, was not the least of the architects' assignment, and involved, besides normal planning problems, the integration of the new base with the original French constructions.

The architects made rather a point, with full blessings from the Navy, of giving attention to the architectural aspects of their work. The Navy is not known for throwing its money around for such nonsense as expensive monumentality, but within its budgets it considers appearance to be important.

The site here provided both a flat stretch for runways and taxi strips, and higher ground for administrative buildings, barracks, mess facilities, housing, ships stores, and so on. Low lying hills in the surrounding terrain gave plenty of room for glide angles. And the North African absence of trees served notice that wood construction was not to be considered.

Local materials were concrete, tile, stucco and terrazzo, and they were used as far as possible. All buildings were designed with reinforced concrete frames with terra cotta back fill and with reinforced floor and roof slabs, stuccoed over on the exterior, a type of construction with which the local Arab labor was familiar.

Climatic conditions demanded a good deal of attention. The sun is quite hot for a large part of the year, but winter months see heavy rainfall. Also cool evening breezes from the sea are an important factor in orientation. In the public type of buildings concrete or bamboo sunshades protect windows with southern exposure. For residential buildings an outside roll-up, slat-type awning, much used locally, gives protection against either sun or rain. Gravity or mechanical vents were frequently used to keep interiors cool.

Esthetics were worked out in terms of mass and fenestration rather than in special materials or detailing. Color was used rather freely, both in colored stucco and in brush coated finishes, to relieve the monotony of a large group of similar buildings.



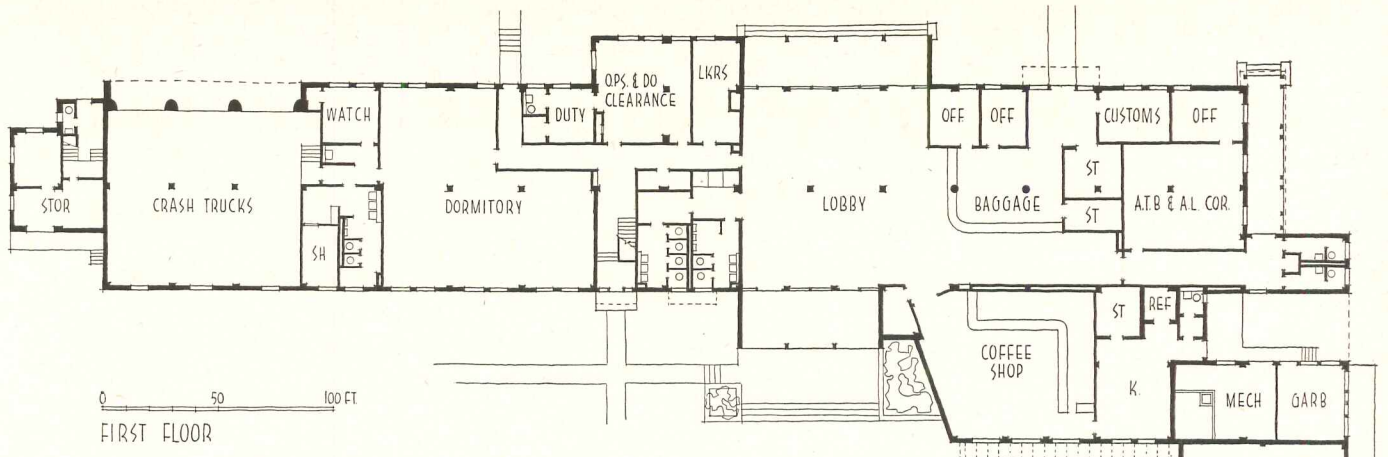

OPERATIONS BUILDING

At a large air base, the Operations Building becomes an air terminal for a city which has no railroads. Here are mail and air cargo departments, customs office, and a varied array of facilities for personnel, including a dormitory for transients. Here the control tower overlooks both the old French airstrip and the new runway system. The building also houses meteorological facilities

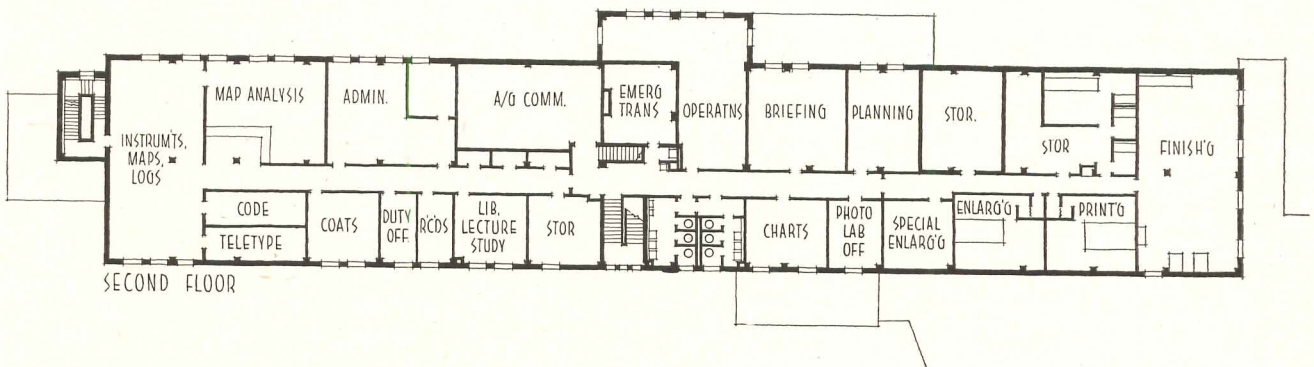
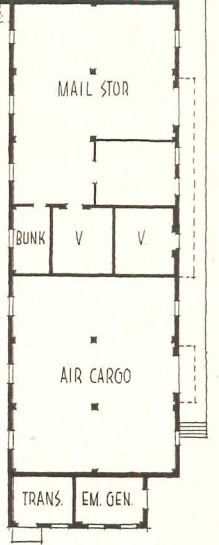

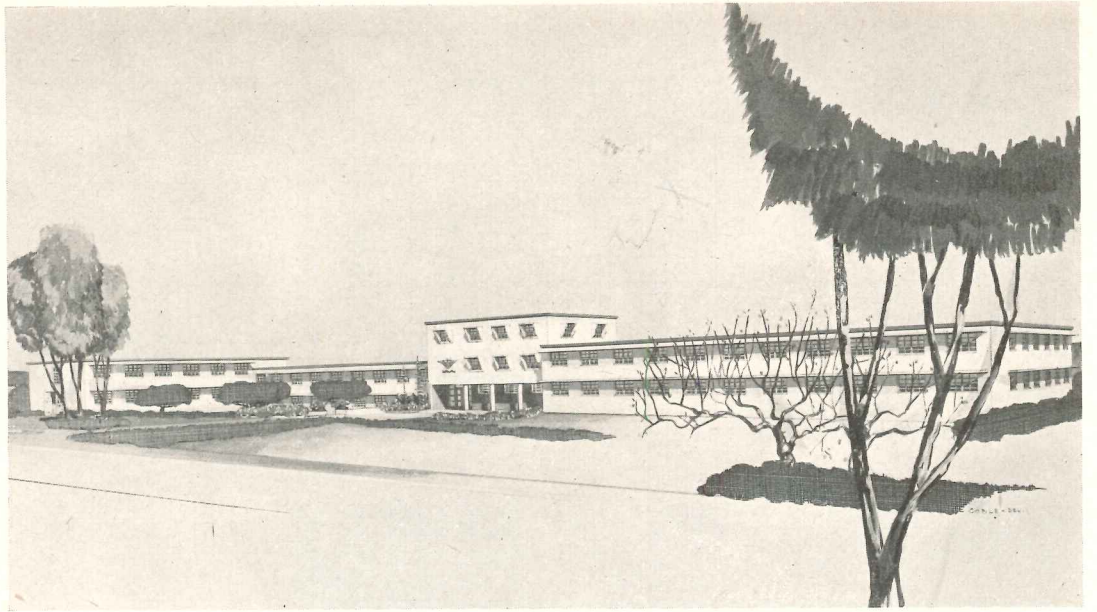

BACHELOR OFFICERS' QUARTERS

Being quite large, the B.O.Q. was given relief by off-setting wings slightly, adding a small third floor, and using natural grades for height variations. Concrete sunshades protect south windows, also add visual interest

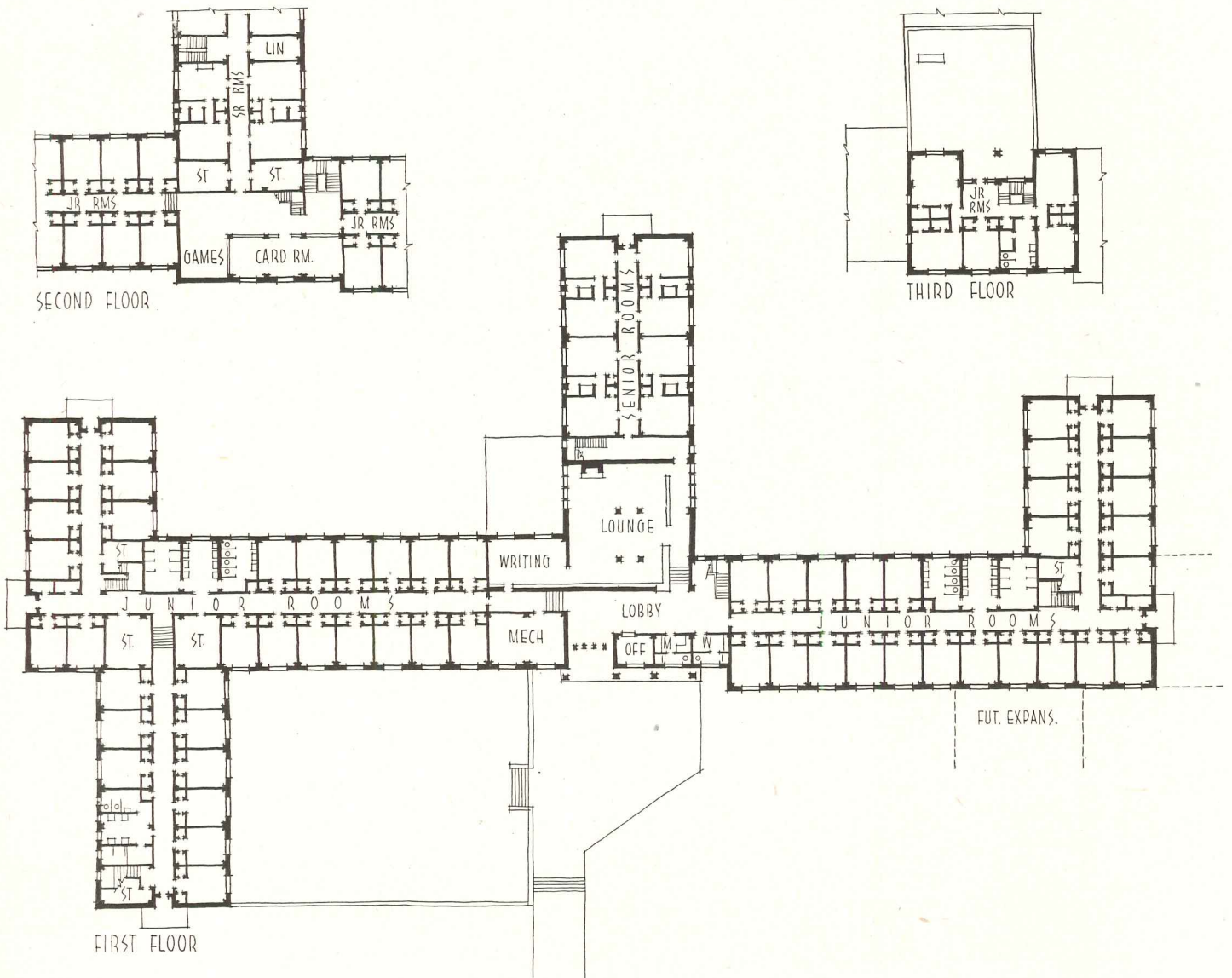

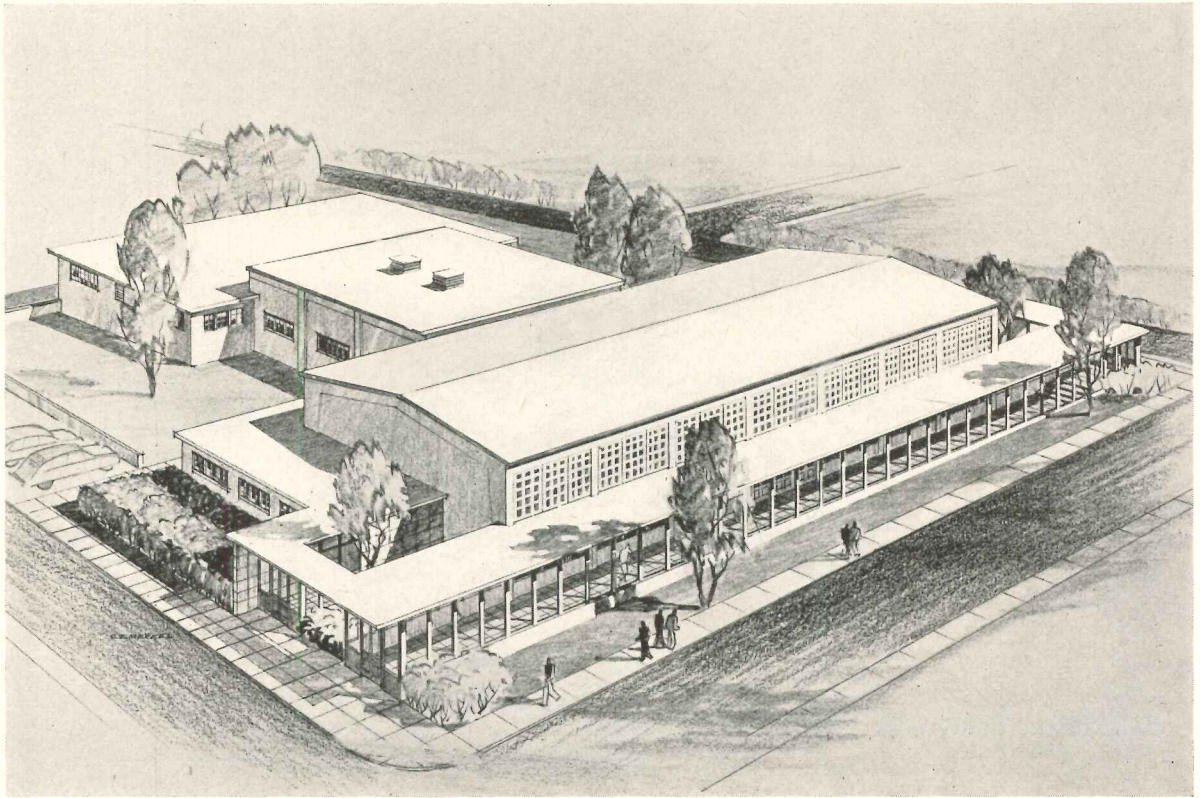

ENLISTED MEN'S MESS HALL

This mess hall, for 1,000 enlisted men, follows in general the navy schematic. An important addition is the long porch on the extreme side, to shelter the customary long queues of waiting men. The clerestory feature is a stock, local precast grille, protecting the glass as a sunshade, and adding a suggestion of local native architectural design.

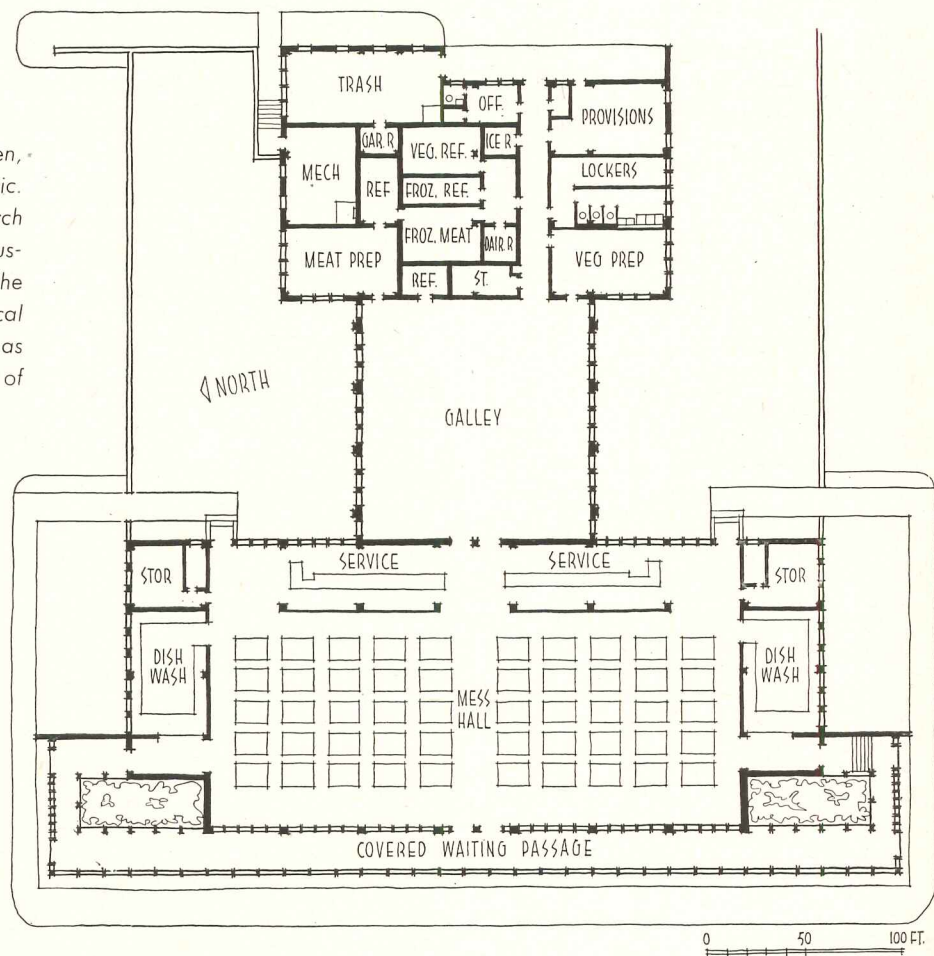
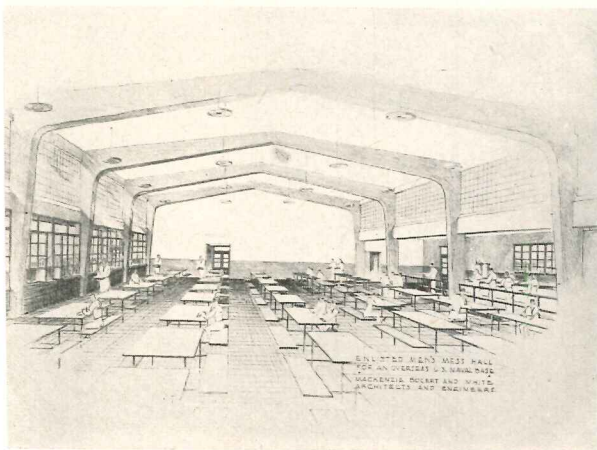

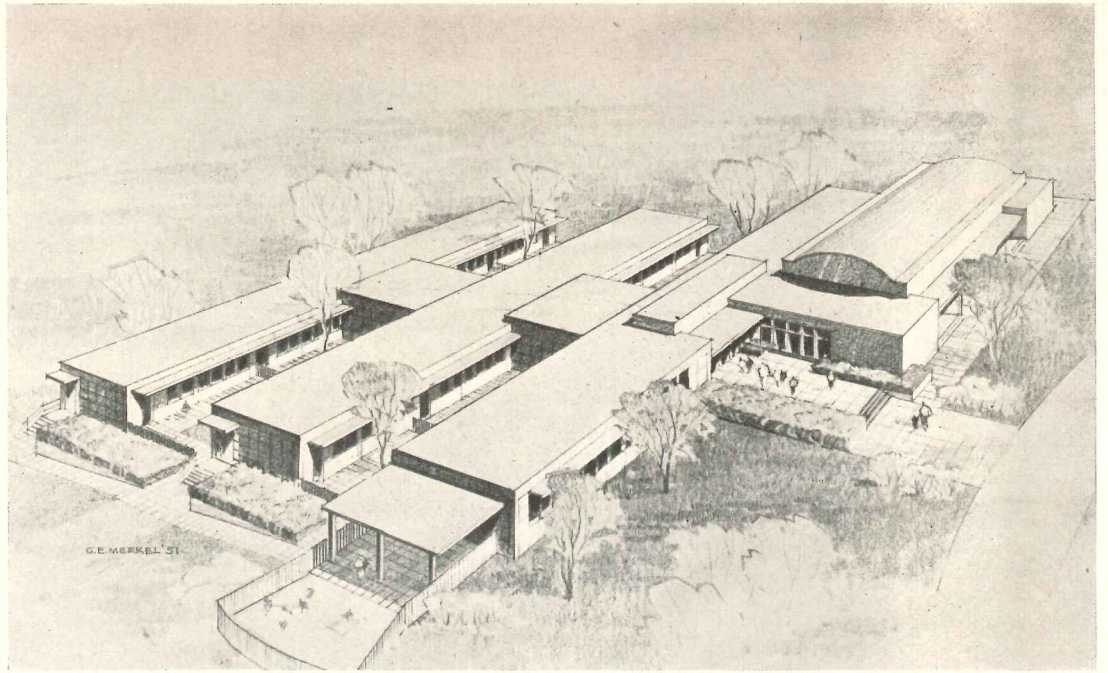

SCHOOL FOR 150 PUPILS

This looks like a modern elementary school, complete with finger plan and outdoor play area, and that's just what it is—for children of base personnel. It can be expanded in any direction, extending backbone or fingers

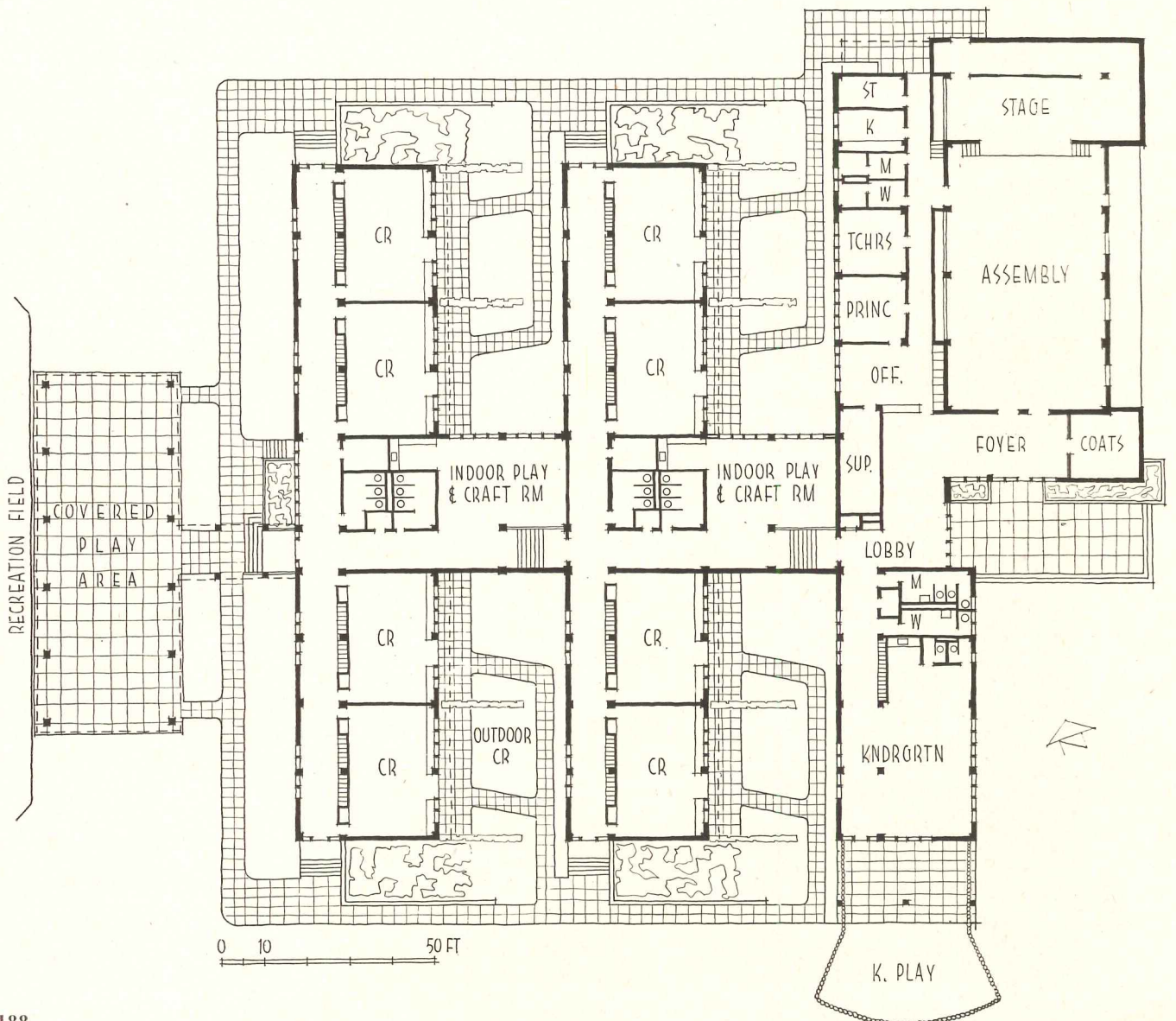

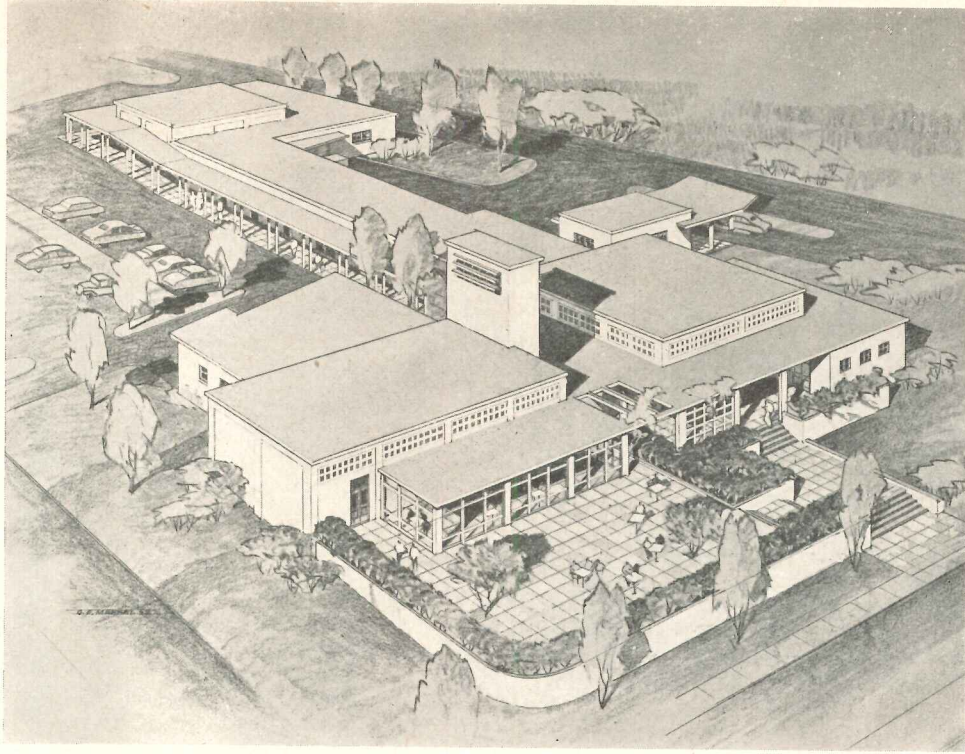

SHIP'S STORES FACILITIES

The Ship's Stores is the community shopping center for the base, for officers, men and housewives. Like other buildings it has the usual covered walks, there's hope some trees will grow for shade

88-BED DISPENSARY

Another important personnel facility is the dispensary, here located between barracks and housing. The grouping is interesting—four nursing wings in finger scheme, medical facilities around a court

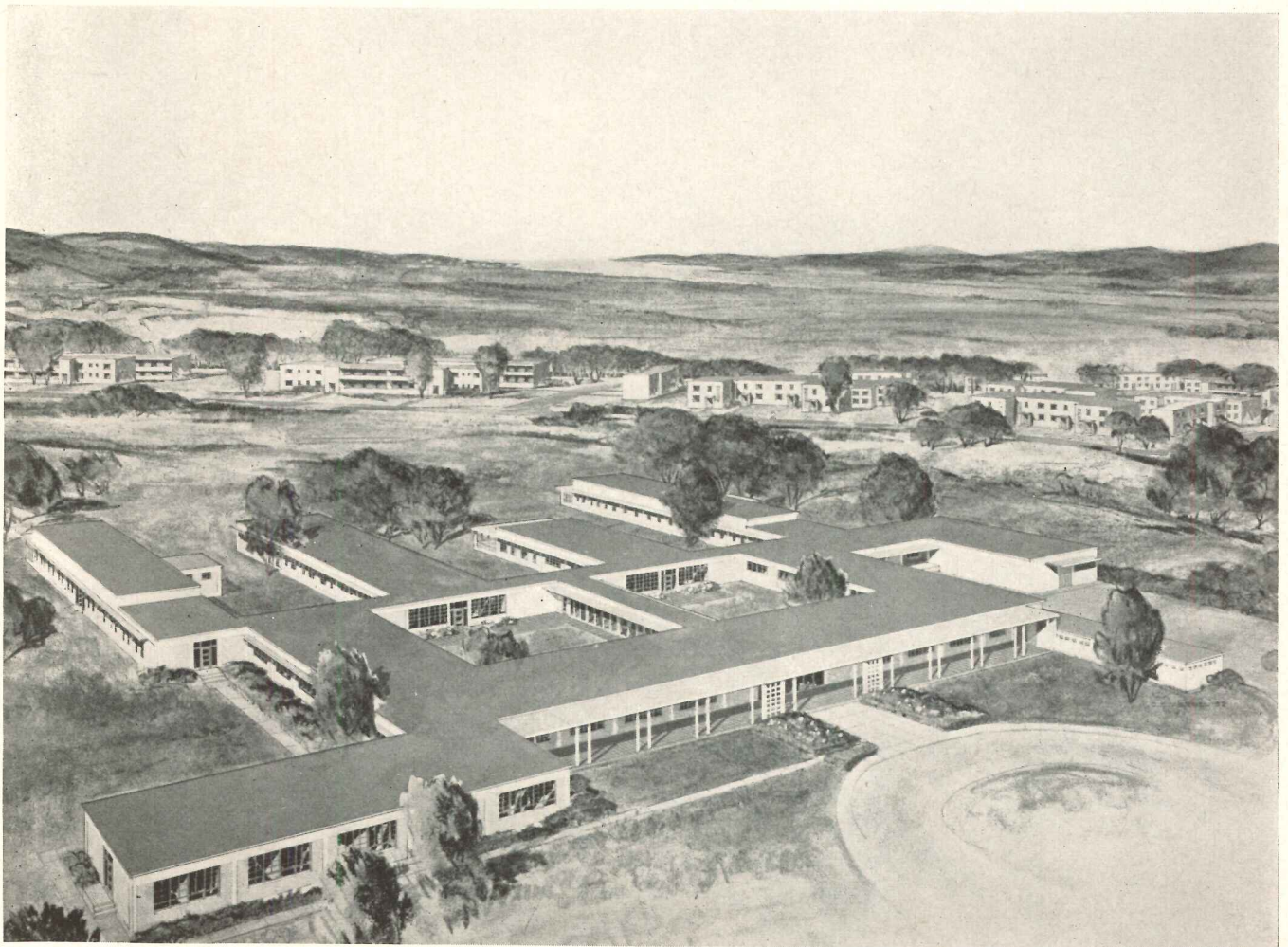

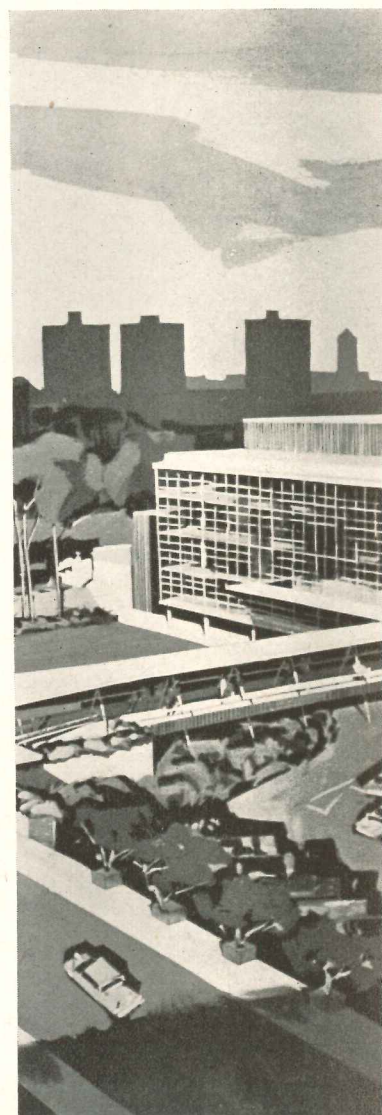
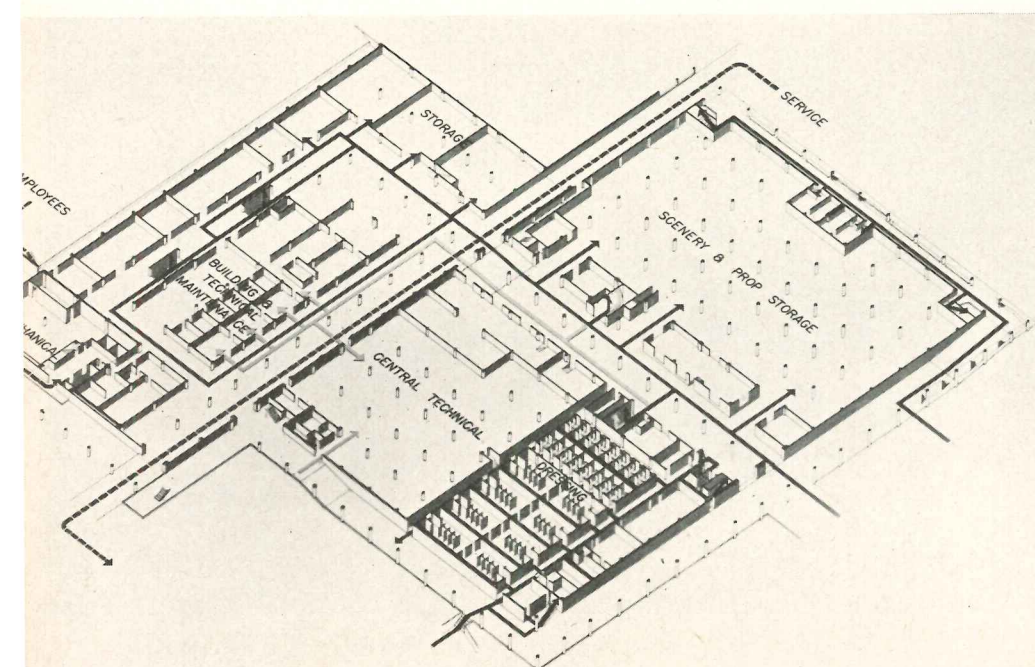
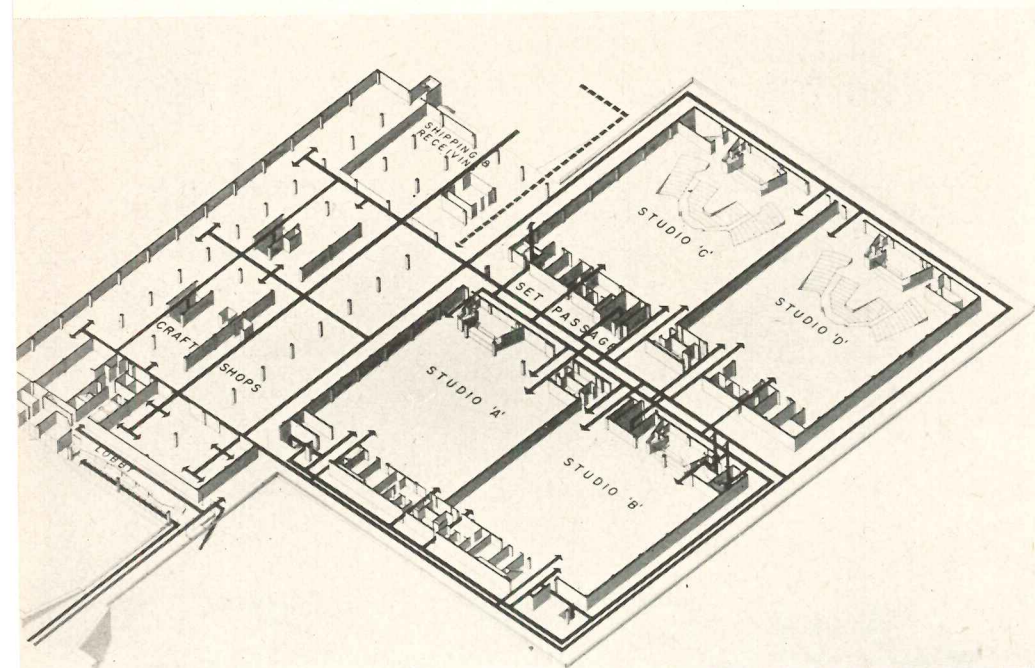
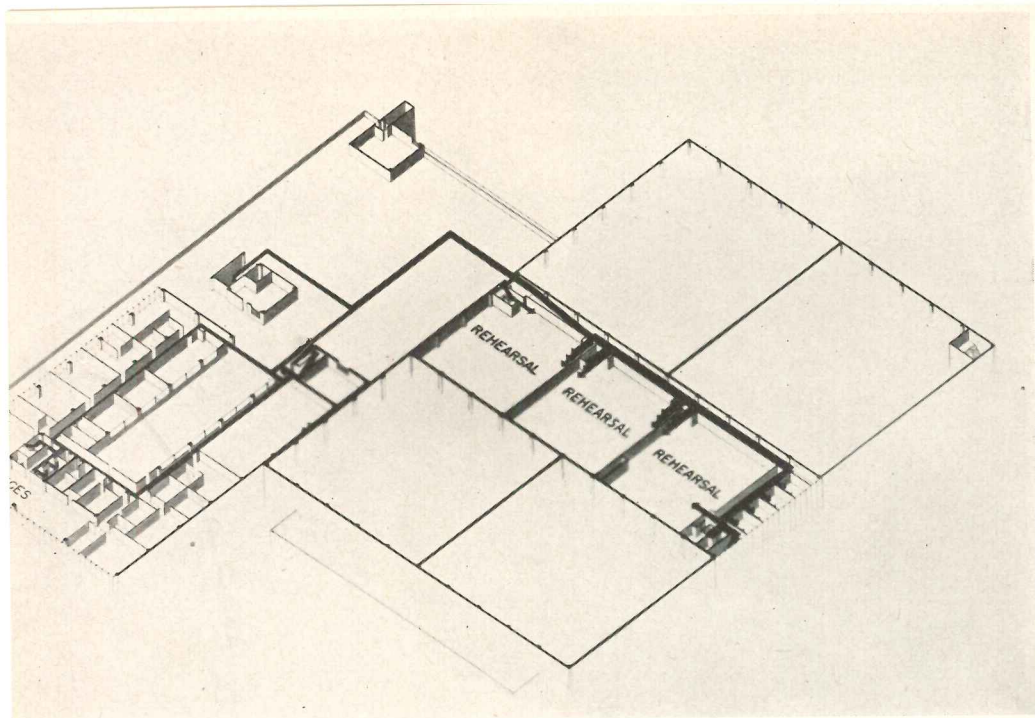

Plant is built around core of four studios on second floor, each containing 12,100 sq. ft. Ramps and extra-size elevators facilitate flow of stage sets and materials from shops to studios and back to storage

PREVIEW OF C.B.S. TELEVISION CITY

Pereira and Luckman, Architects

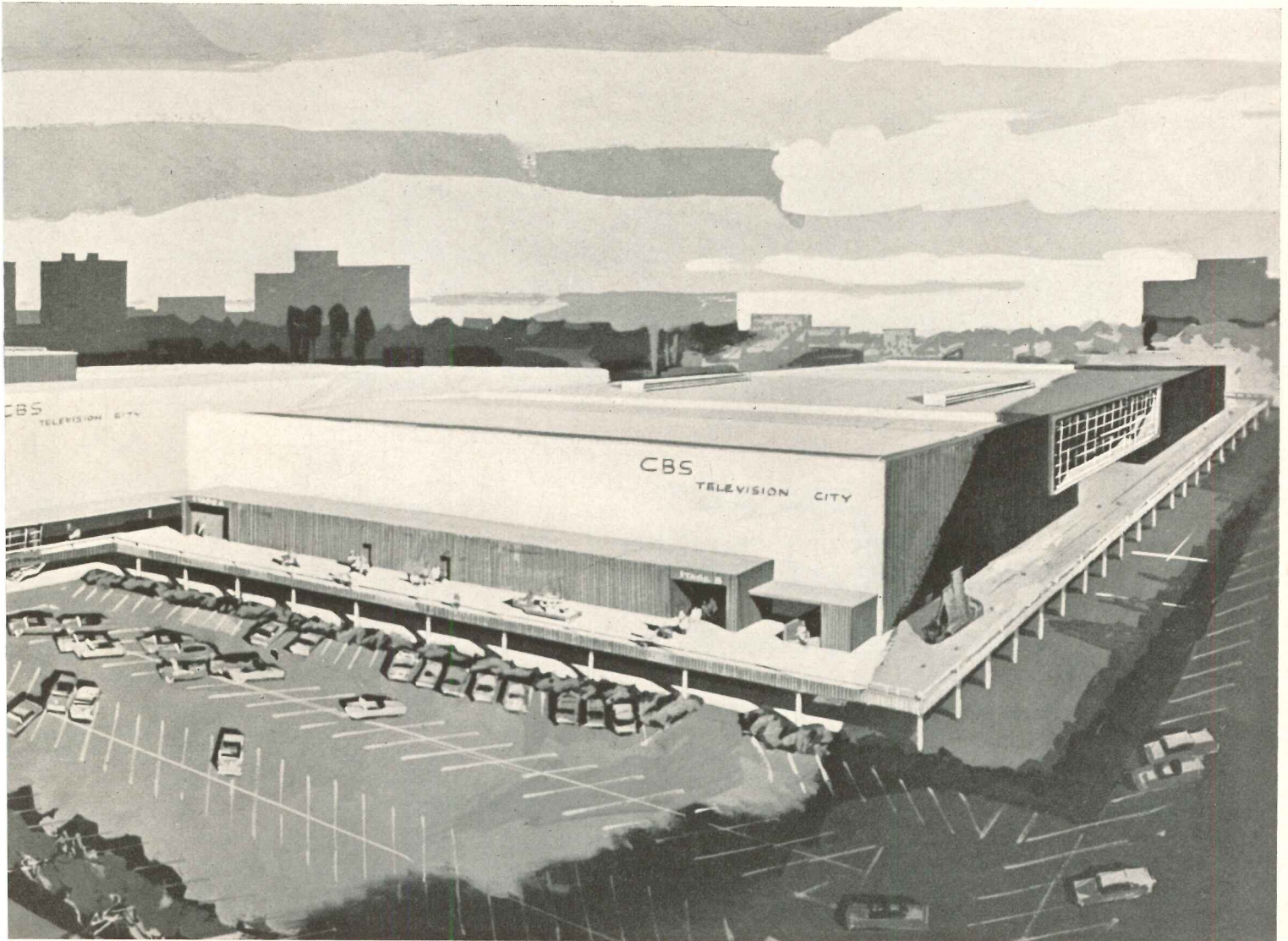

A FLEXIBLE, EXPANDABLE PLANT for TV production on a gigantic scale is the objective of the new C.B.S. Television City now rising on Gilmore Island, Los Angeles. The first unit is scheduled for completion in October, will house four huge studios, three rehearsal halls, carpenter shops and facilities for writers, directors, producers. Additional units, including a 13-story administration building, are to be added as TV expands. Exterior walls of a number of the first structures are built with hinged iron connections at supporting points, so they may be moved later. Walls separating many of the interior areas are movable so room sizes may be changed. Basic concept of the plan is a free flow of bulky sets and materials on a production-line basis. A grouping of long, relatively narrow buildings approximately 150 ft wide was selected, with a wide traffic platform encircling the studio area at second

floor level. The first unit in Television City is described by William Pereira as "an experimental workshop," since many facilities will be relocated, changed or expanded as experience in this growing field dictates.

Concrete platform extends around second floor, handles heavy traffic flow to and from studios. Initial plant covers 15 acres, will later be expanded to cover 25

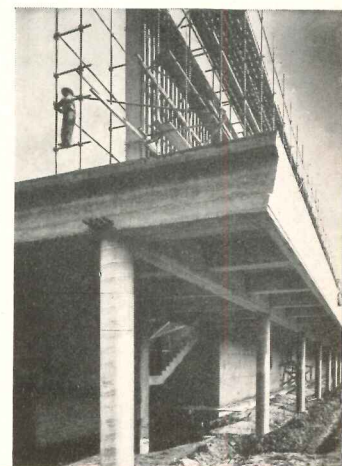

Ezra Stoller

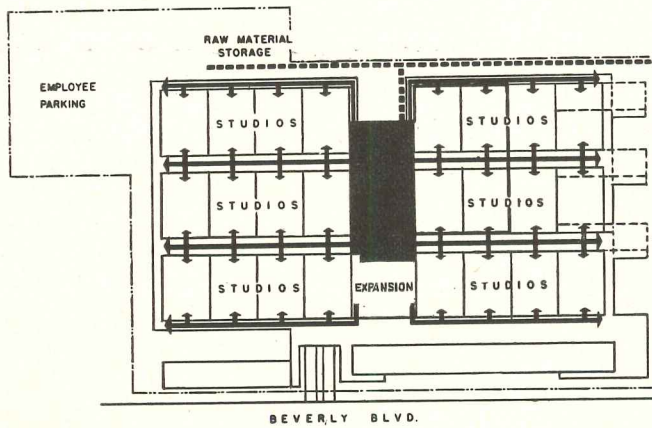
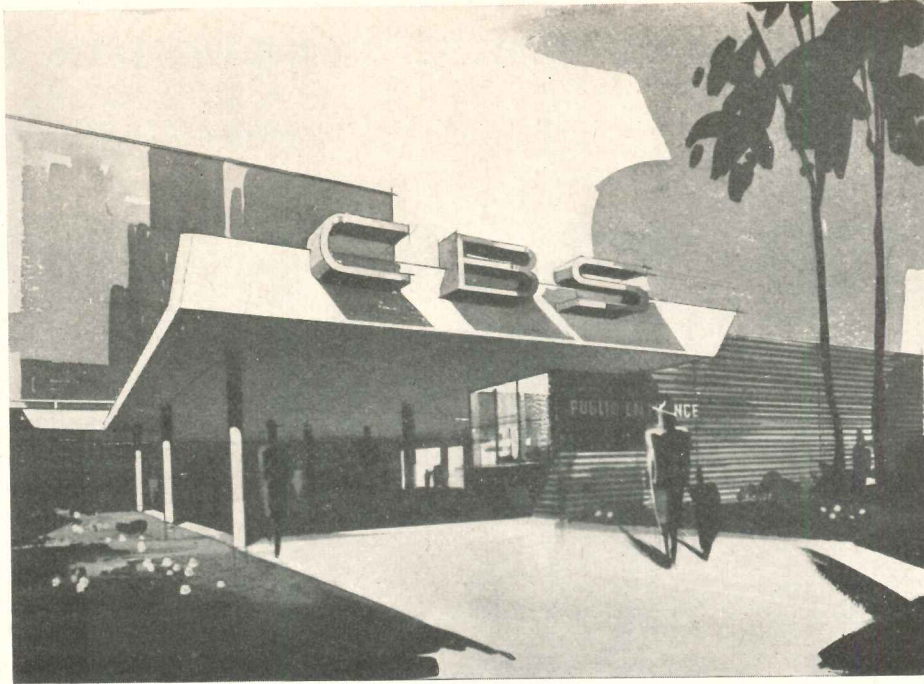

■ ■ SCENERY & PROPS

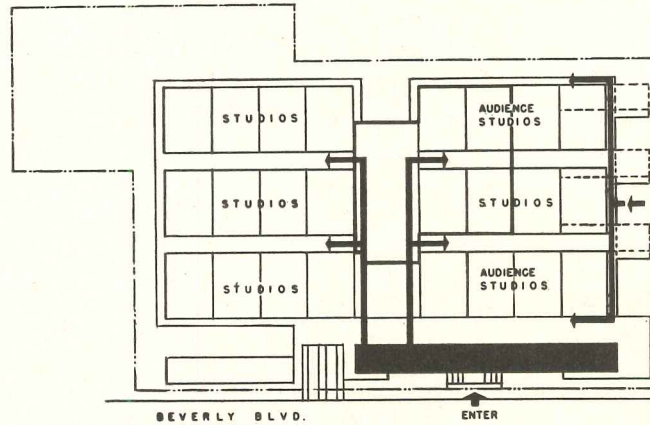

■ ■ ADMINISTRATION & PUBLIC

Flow diagrams were prepared to aid in charting TV production activities. Rehearsal hall (below) contains 4550 sq ft, has movable walls

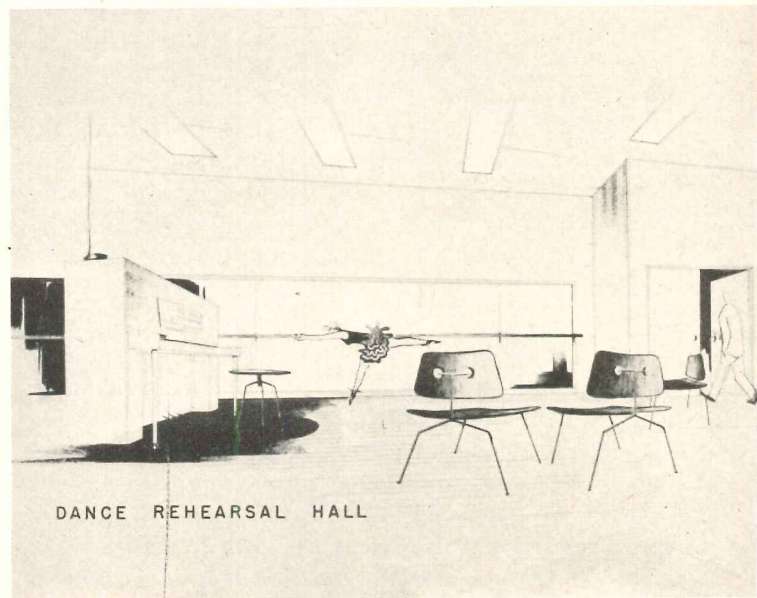
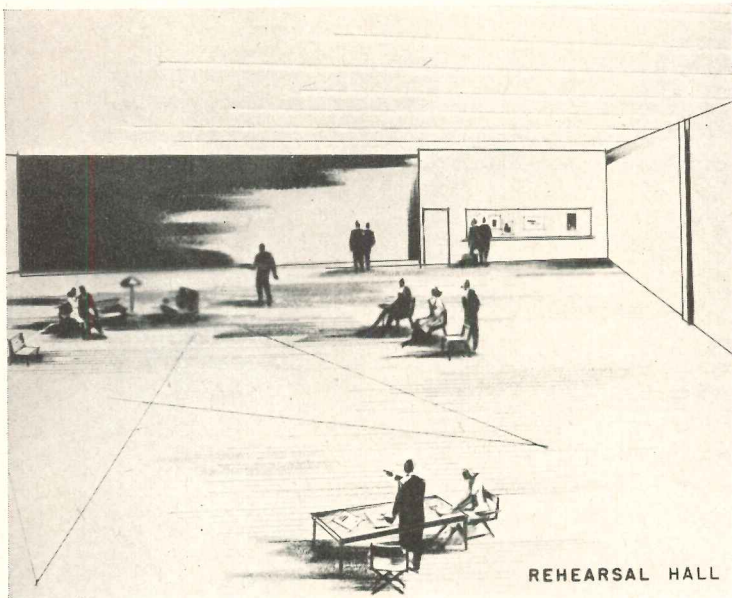

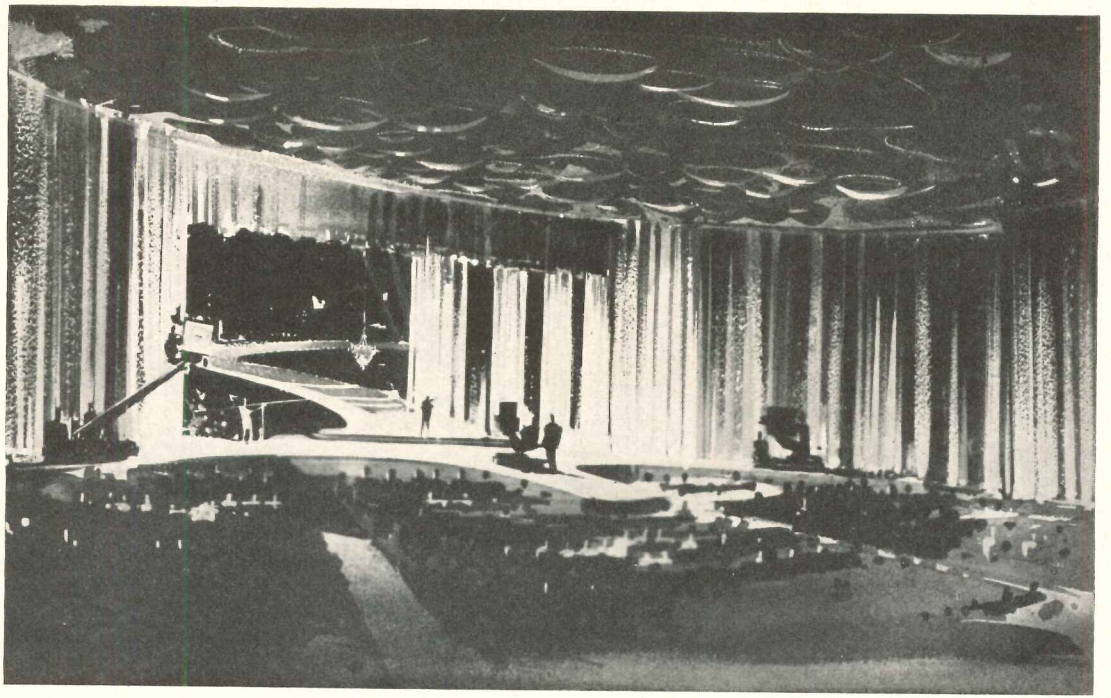
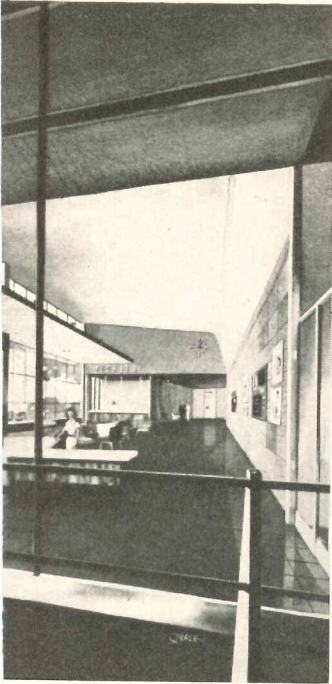

Size, shape and number of stages in TV studios can be altered to meet changing requirements and audience seating can be varied, or removed entirely. Electronic system controls complex stage lighting installation. Construction of the \$35 million plant started in December 1950

Photo by Ezra Stoller

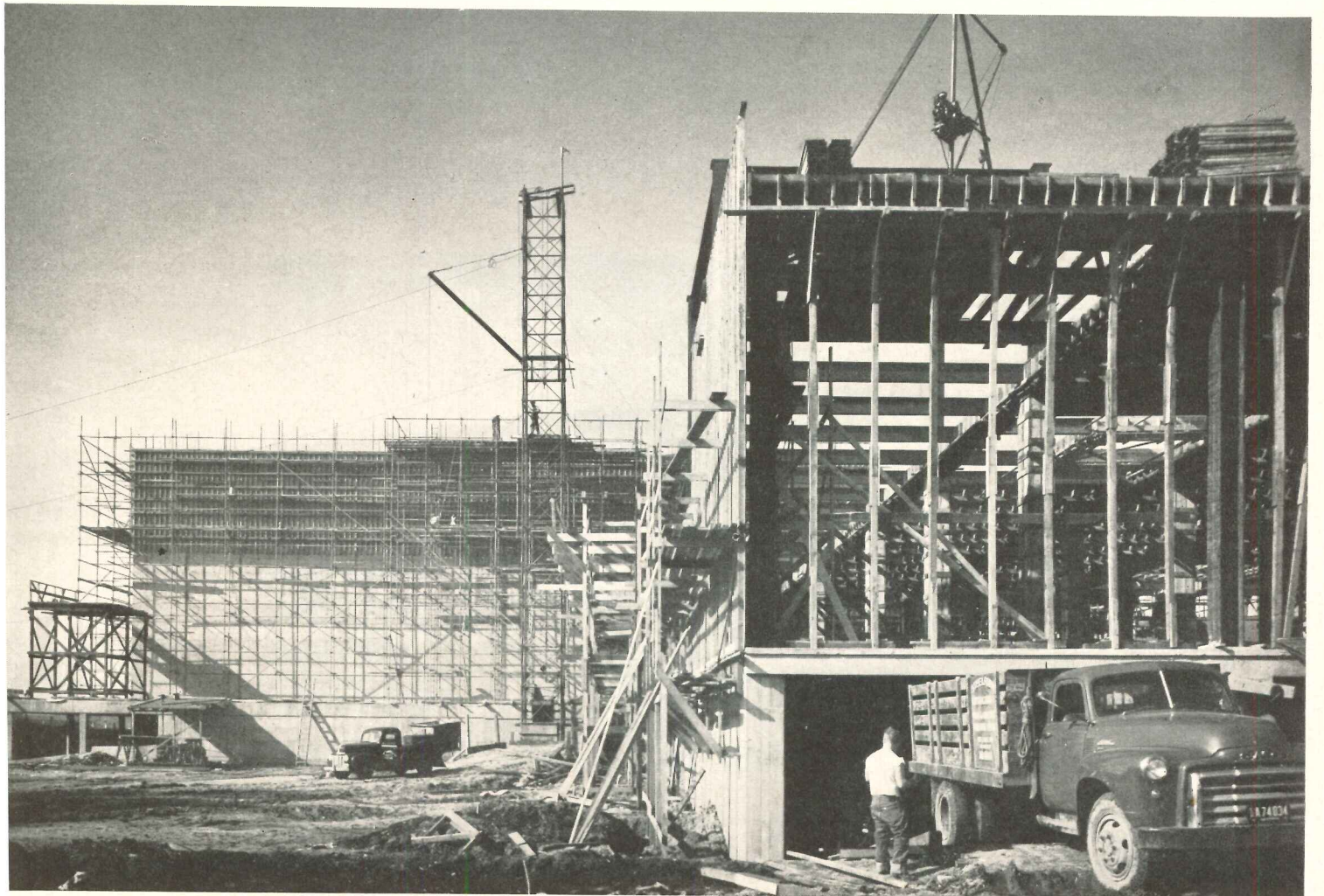

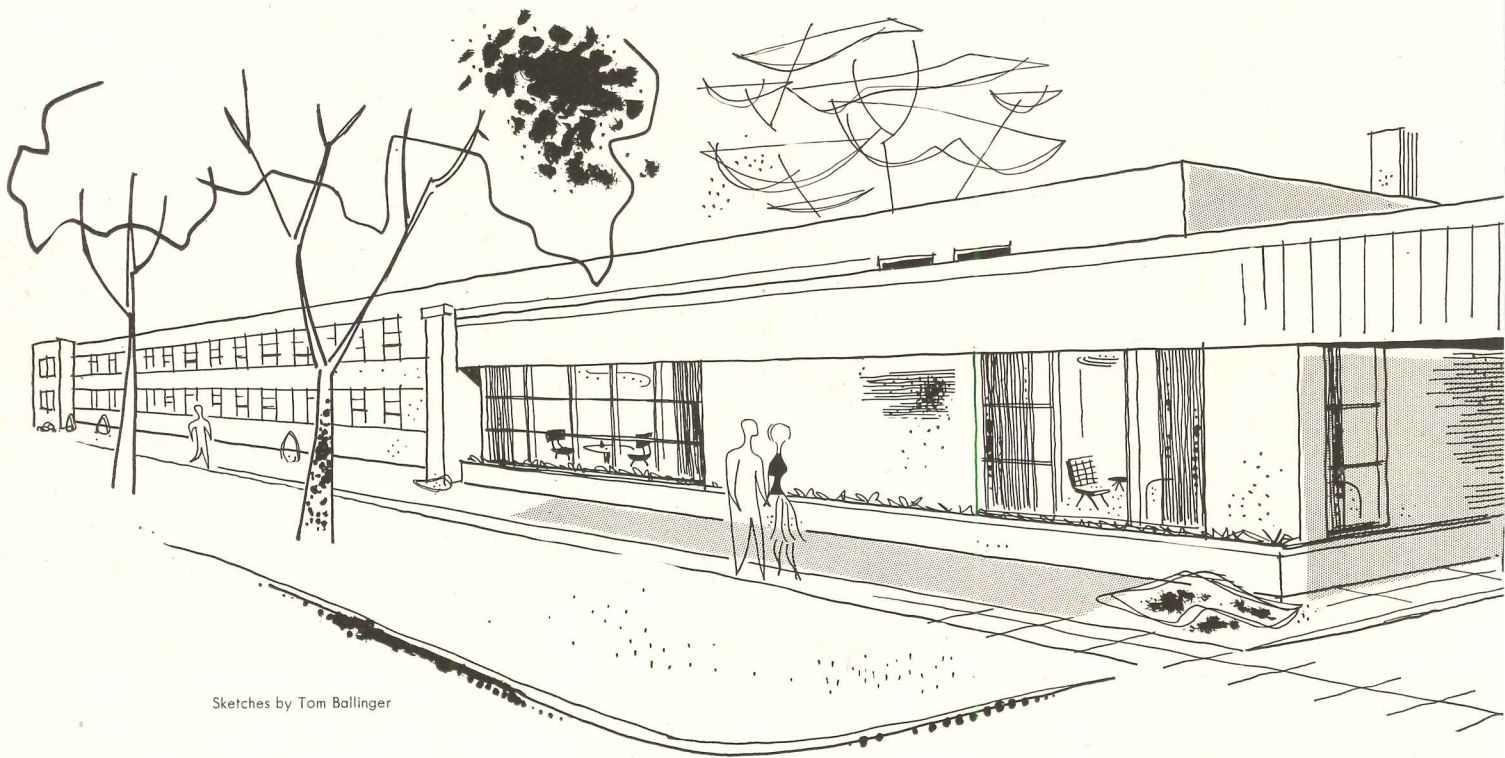

Sketches by Tom Ballinger

WISCONSIN HOTEL



Neatly designed Hotel Mead is planned for convenience of motorists, is run similar to motel

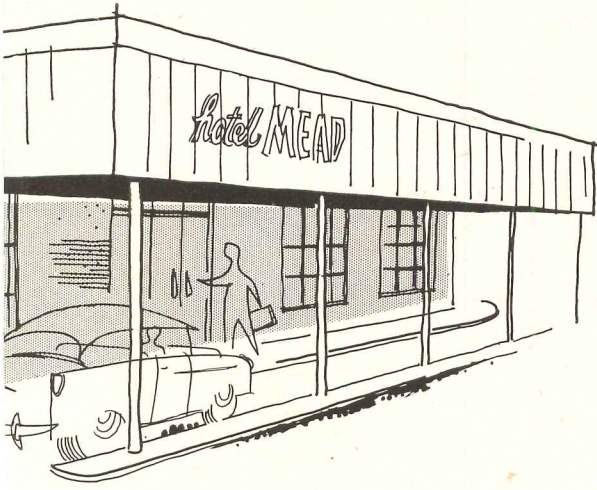

Hotel Mead, Wisconsin Rapids, Wis.

Donn Hougen, Architect

PROVIDES MOTEL FACILITIES

SINCE THE TOURIST COURT first made its appearance in outlying city areas, there has been a mounting concern among hotel planners and operators over the benefits that the courts, and the larger motels, offer automobile travelers: ample parking space, informality, no tipping. On the other hand, the downtown hotel still has certain advantages, especially for businessmen. The location is closer to business contacts, phone service is generally better, and meals and personal services are readily available if desired. Now we have a new concept, a "motelized hotel" which seeks to combine the features of both.

The new Mead Hotel was specifically designed to replace an older Wisconsin Rapids hotel, which is being torn down to make a place for a public park. Its "motelized" scheme was evolved after a survey of the area indicated that about 85 per cent of the hotel guests arrive by automobile. Throughout the project, the architect worked in close conjunction with the engineers and executives of the Consolidated Water Power and Paper Co., owners of the hotel.

The site chosen for the building is on one of the main highways running through the community, and is located a short distance from the actual downtown business area. The plot layout provides access from the principal street through a covered drive flanking the lobby; the building entrance is set well back from the street to cut down traffic hazards. The parking lot is at the rear with exits on a minor street.

The building itself was planned with two floors of guest rooms flanking a central corridor. Three entrances from the parking lot minimize the distance from car to room. Public rooms — dining room, bar and lobby — are grouped by the front office. The building is constructed of steel, concrete and masonry, and is radiant-heated by wrought iron coils in the first floor slab, copper coils in the second floor ceiling. All public areas are air conditioned, and corridors are pressurized by air conditioned units to provide a supply of filtered air to guest rooms. Acoustical plaster, carpeting, and painted cinder block corridor walls are used to cut down noise throughout the building.

HOTEL-MOTEL

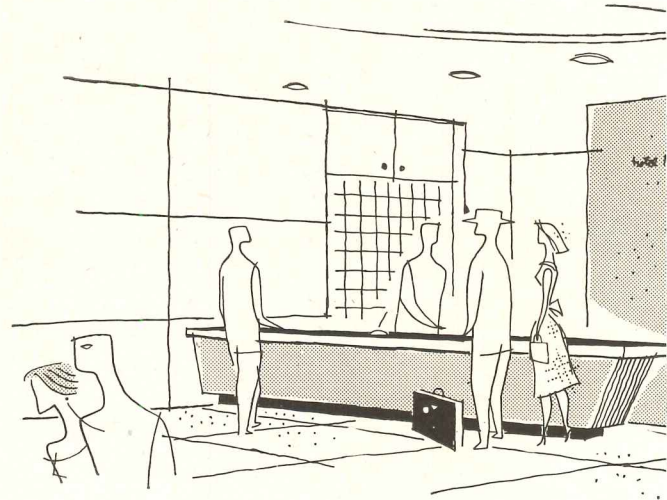
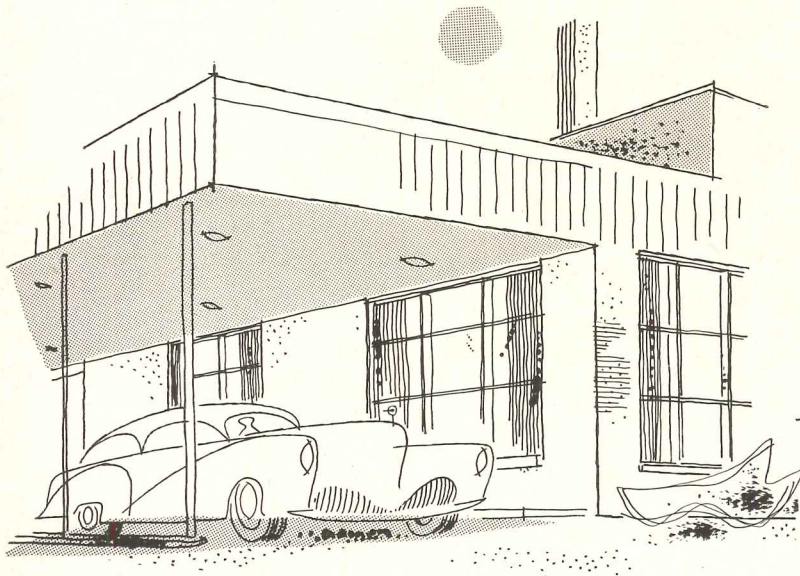

Circulation for hotel guests is carefully worked out. From main highway, guest drives under canopy to front entrance. Long drive is heated, shelters several cars. At front office, guest is assigned key, parking place by rear entrance nearest his room. Desk has 24 hour service. After parking, the guest carries own luggage to first or second floor room. Same key unlocks outside door and room. All 84 rooms have baths, outside exposure; interiors are simple, comfortable, have multi-purpose desk-dressers. Parking area exits on secondary street to rear; guest needn't return to lobby until he checks out

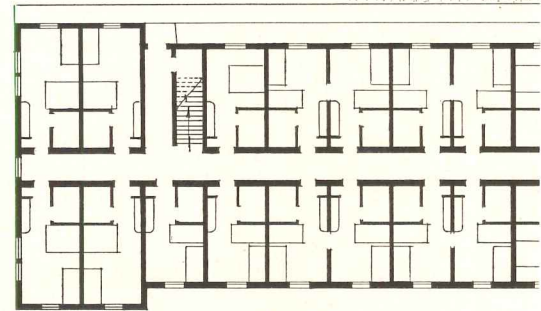
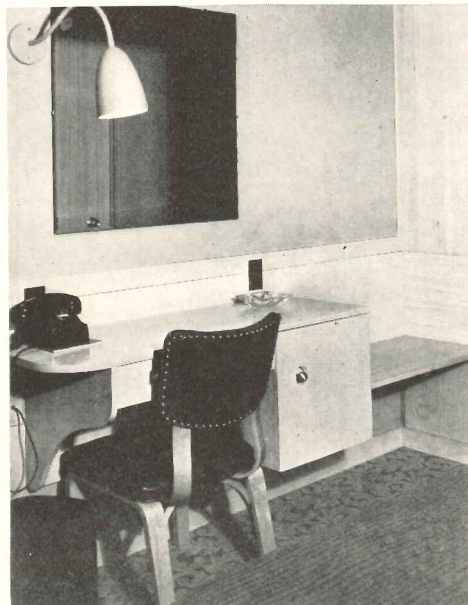

5 0 5 10 15 20 25 30 FT.

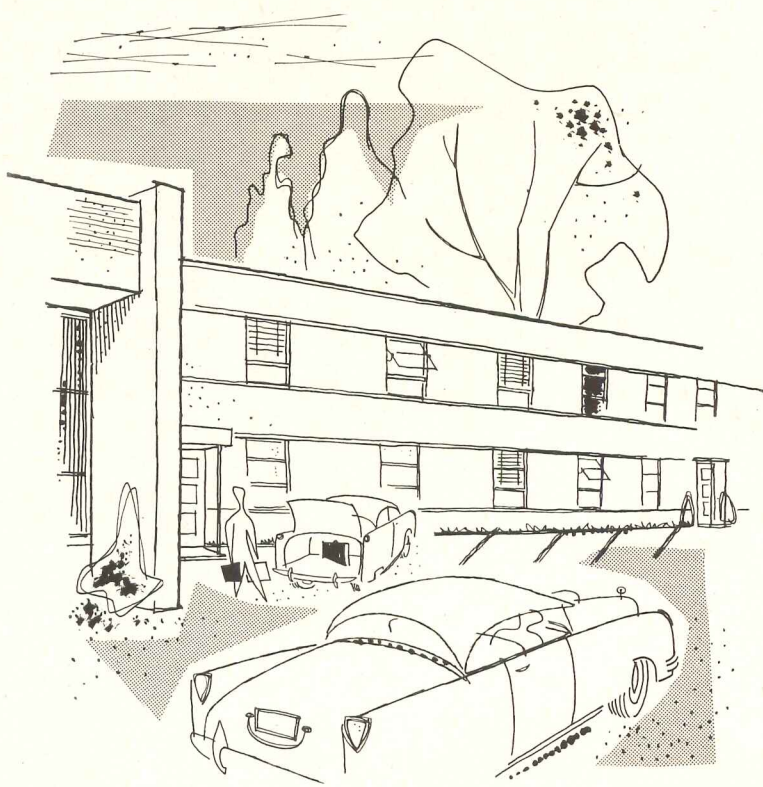
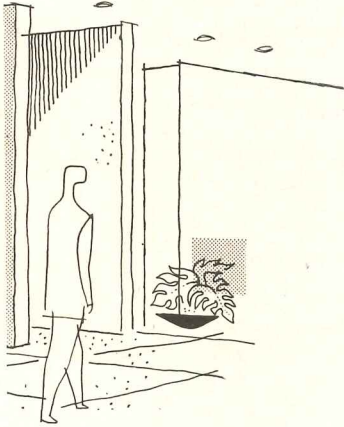

Second floor guestroom plan is identical to first (below), with manager's apartment at right. A basement is under lobby, dining and kitchen area, and houses heating system, food preparation and storage rooms, employees' lockers

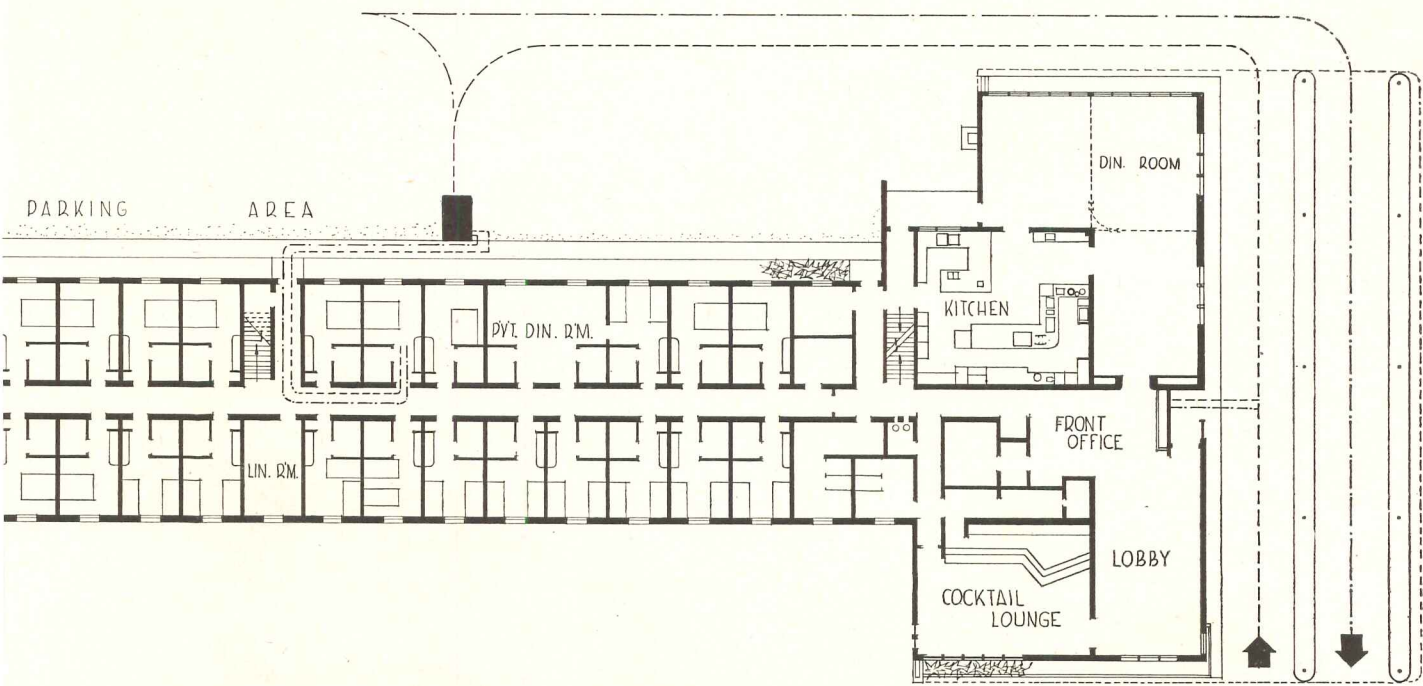

HOTEL-MOTEL

All public and service rooms are grouped at the entrance end of the building for easy supervision, and for convenient access by both hotel guests and community residents. Lobby, dining room and bar are all designed with numerous windows overlooking the quiet residential neighborhood. As in the guest rooms, interiors are kept simple, unobtrusive, comfortable. The dining room has an L-shaped plan and folding partitions, so that it can be divided in several ways to accommodate club and community groups as well as hotel guests. A small private dining room down the hall from the kitchen is planned for conversion into two extra guest rooms when needed. Plastic laminates are used extensively throughout the building to simplify upkeep. Such surfaces include counter, desk and table tops, bathroom walls, door surfaces, bed headboards and upholstery.

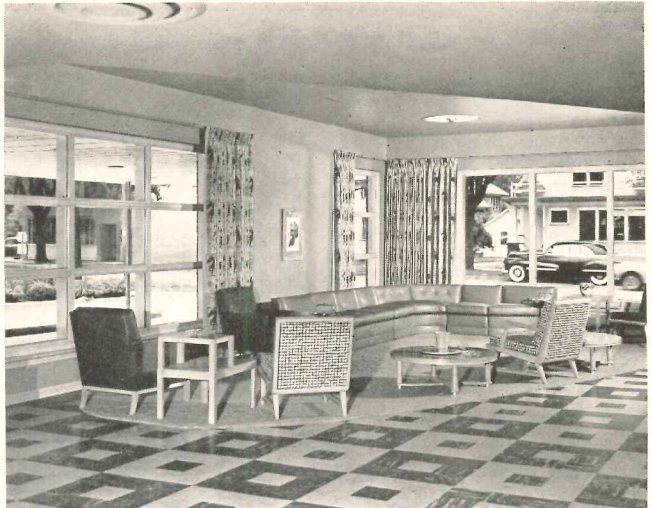

Sketches by Tom Ballinger

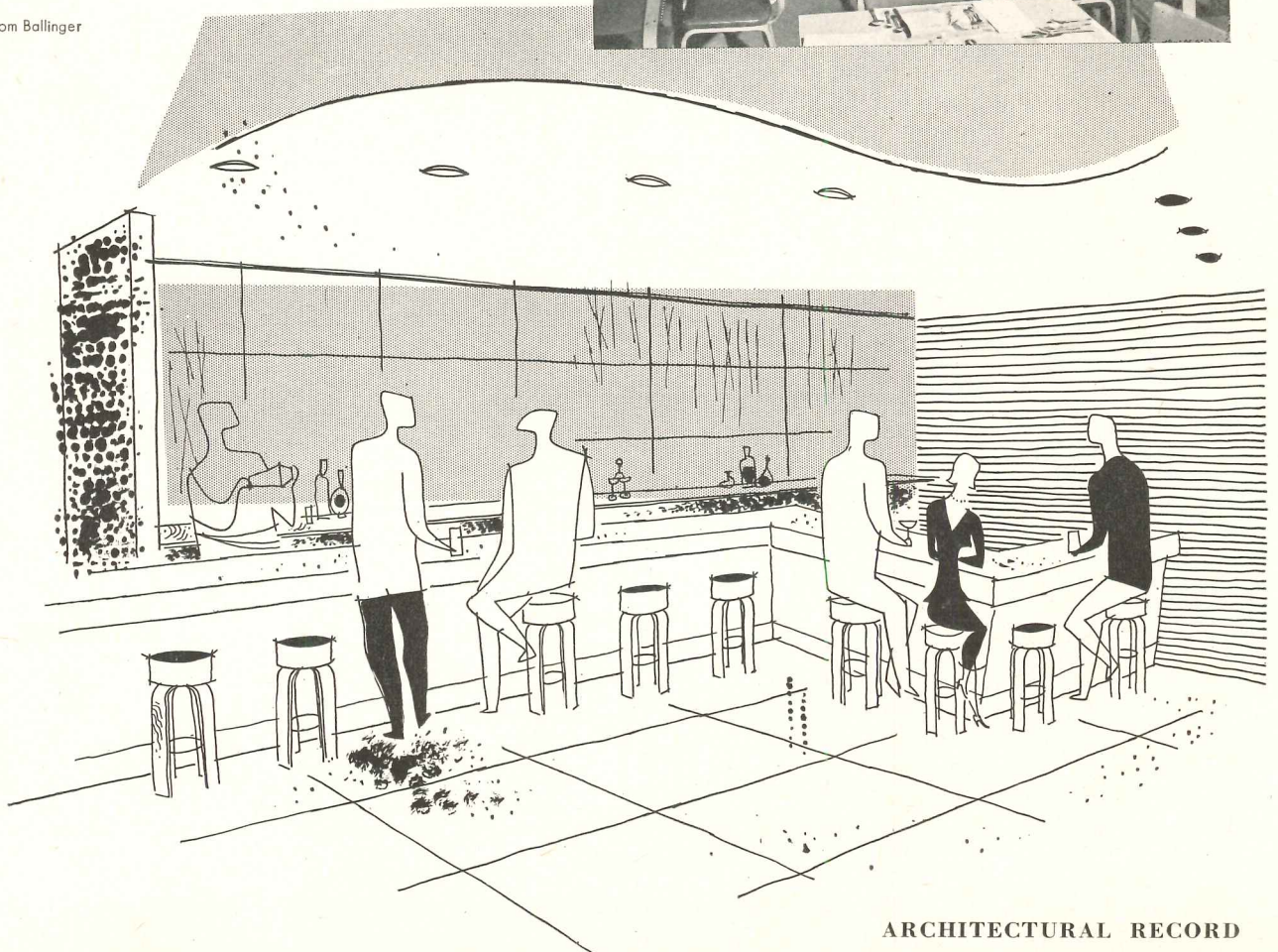

THE BIG NEWS IS THE BIRTH RATE

By Thomas S. Holden, President
F. W. Dodge Corporation

Twenty-one million new Americans will strain the nation's productive capacity and shelter facilities; will require factories, power developments, water supply, highways, houses, schools, churches, hospitals, shopping centers, parks, playgrounds. No visible let-up in construction demand in prospect.

1932 article laid basis for continuing population studies

POSTWAR BABIES are making their weight count in the American economy. Fastest moving item in Sears-Roebuck's sales last year was diapers. I am sure that statistics on sales of cowboy suits to five-year olds, if available, would make interesting reading. In the week of March 10, 1952, New York's biggest toy fair attracted ten thousand buyers come to place orders for Christmas trade. Readers of ARCHITECTURAL RECORD are thoroughly familiar with the primary and secondary school building boom that is going on all over the nation.

The United States baby crop broke all records in 1951. There were 3,900,000 new arrivals on the scene. That meant 75,000 new consumers every single week; or, if you prefer, 10,700 every day, 445 every hour, or 7.4 every minute. On arrival all were new prospects for everything the American economy has to offer.

Last year's baby total seems to be symptomatic of a trend, as is indicated in Chart I. A record number of marriages in 1946 (2,291,000) was followed by a record baby crop in 1947, almost as high as last year's figure.

In 1947, for the first time since 1915, the nation's birth rate was over 25 per thousand of population. There had been a marked downtrend in the birth rate from 1915 through 1933, then a moderate increase leading to the spectacular jump in 1947. Since 1947 the rate dropped off a little, but was again over 25 per thousand in 1951.

A striking fact concerning the 1951 baby total is that this all-time record number of births, which actually exceeded the 1947 total, followed a year (1950) in which total marriages were 27 per cent fewer than in the record marriage year 1946. It looks as if postwar parents are going in for larger families.

As might be expected, last year also broke all previous records for net population gain. Estimated net increase

was 2,650,000 persons: 3,900,000 babies plus 200,000 immigrants (of all ages) minus 1,450,000 persons of all ages who died in 1951. This net gain was rather more than the present total population of metropolitan Los Angeles. During each of the past five years the net gain in population has been more than 2½ millions.

POPULATION TRENDS

A quick review of census figures reveals striking stories of what has happened and what is happening with respect to U. S. population.

The 1920-1930 census decade showed a net gain of 17,611,000 persons, the largest increase recorded for

CHART I

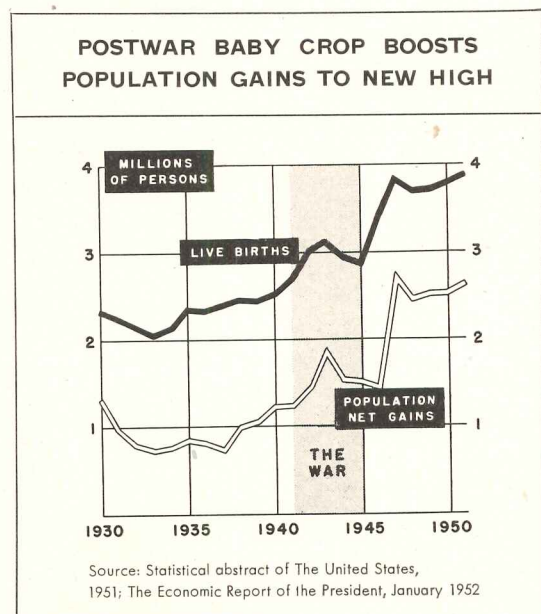

THE CONSTRUCTION OUTLOOK 1932 AND BEYOND

By THOMAS S. HOLDEN,
Vice President in Charge
of Statistics and Research,
F. W. Dodge Corporation

EFFECT OF REDUCED POPULATION GROWTH ON CONSTRUCTION DEMAND*

It has always been considered self-evident that building and engineering activities thrive best in growing communities, that population growth is an important factor in construction demand. That this has been true in the recent past is the conclusion arrived at by a thorough study and analysis of the construction and population statistics of 299 American cities for the census decade 1920-1930. In the case of 259 of these cities (omitting the largest) direct

Factual study of the demand and population conclusions:

1. If current population increase the past enable relative building has automatic tends to disappear.
2. Increased building development.
3. As population building the building sound engineering construction material.

The challenge upon the American show

THE BIG NEWS IS THE BIRTH RATE

any decade up to that time — a period of healthy growth.

In contrast, the net gain of the 1930's was only 9,047,000, smallest for any census period since the Civil War decade. This marked decline from the 1920's resulted from: (1) almost complete cessation of immigration; and (2) a continuously declining birth rate.

The amazing trend change of the 1940's resulted in a population gain for the decade of 19,575,000 persons, breaking all previous decade records and confounding all those predictions of a trend toward stable population that were so widely believed during the 1930's and early 1940's. It was a change of great significance to building.

HOW MANY PEOPLE IN 1960?

The sudden population upsurge in the late 1940's so surprised the experts that they are now rather reluctant to predict future trends.

The Bureau of the Census published in August 1950 some advance figures which it called "illustrative projections." They were carefully calculated figures based on varying assumptions as to birth, fertility, survival and mortality rates. These calculations produced three sets of yearly figures for future U. S. population totals, culminating in 1960 estimates as follows:

| | 1960 Population total | Increase over 1950 |
|---------------------------|-----------------------|--------------------|
| "Low series" | 161,679,000 | 10,297,000 |
| "Medium series" | 169,371,000 | 17,535,000 |
| "High series" | 180,276,000 | 28,220,000 |

These increase figures are to be compared with actual 1940-1950 increase of 19,575,000. Since the "low series" and the "medium series" both assume fairly rapid declines in the birth rate and since the actual 1951 birth total was even higher than the "high series" estimate for 1951 births, it seems reasonable to the present writer to anticipate a 1960 population total will be over the "medium series" figure though perhaps not up to the "high series" figure. That is to say that a net gain in the range of 20 to 23 million, as compared to the 1940-1950 actual gain of 19,575,000, may be a reasonable expectation. Even this would involve a moderate drop in the birth rate from the 1951 level, a trend that seems to be widely anticipated by the experts.

For the purposes of this article it will be assumed that the 1950-1960 net increase will be 14 per cent, or about 21,236,000 persons. Naturally, any considerable variations from this figure would tend to modify the conclusions which will be hereafter stated.

POPULATION STIMULATES CONSTRUCTION

Population growth is obviously a stimulator of construction demand in a dynamic society like ours. This proposition is quite strikingly illustrated in Chart II, which compares population net gains in the past three census decades with, first, numbers of new non-farm dwelling units and, second, with estimated overall construction volume. (Construction volume figures are all expressed in terms of 1939 construction costs, thus eliminating the effects of price changes from the comparisons.)

The 1930-1940 decade had only a little over half the number of new persons that were added in the previous decade; it had a 58 per cent decrease in number of new dwelling units and a 38 per cent decrease in total construction volume.

The 1940-1950 decade had a 116 per cent increase over the depression decade in number of new persons added to population; it had a 115 per cent increase in new non-farm dwelling units and a 33 per cent increase in total construction volume.

These comparisons illustrate an important relationship, although they do not, of course, provide any

CHART II

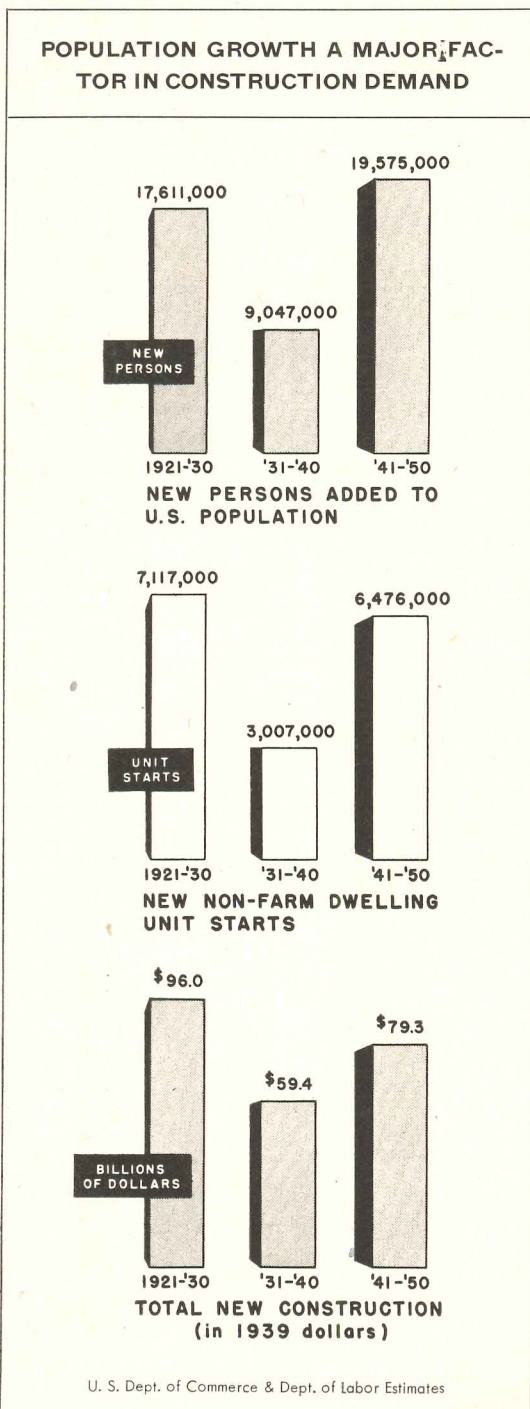

mathematical formula for measuring the relationship.

An effort was made to work out such a measurement by the present writer over twenty years ago. A statistical study compared 1920-1930 construction volumes of rapidly growing cities with those of slow-growing and retrogressive (population-wise) cities. The study was presented before an annual meeting of the American Statistical Association and was published in the January 1932 issue of ARCHITECTURAL RECORD.

The purpose of the study was to determine the probable effect, on construction volume in the 1930-1940 decade, of the reduced population growth then anticipated. Result of the study was an anticipated decline of 16 per cent in total construction and a 28 per cent decline in residential construction, as between the decade of the 1930's and the decade of the 1920's. These estimated declines purported to measure only the effect of the changed rate of population growth; they assumed that construction to accommodate the needs of new population would decline but that construction to fill the needs of existing population would continue at previous rates.

Actual declines were much more severe than indicated in these advance estimates; this may be attributed to the fact that the analysis undertook to measure only one bearish influence on construction trends for a period when there were actually a number of other bearish influences of major significance. The conditions of financial collapse certainly had a major effect on construction demand in the 1930 decade of low population growth; and World War II certainly limited the extent of construction industry revival in the 1940-1950 era of rising population trends.

This early study is here cited merely to show that for at least twenty years consideration of the growth factors in the American economy (of which population is a major one) has been given great weight in all F. W. Dodge Corporation's analyses of construction trends. Growth is the primary creator of construction demand.

BUILDING FOR POSTWAR BABIES

The immediate building program for wartime and postwar babies is a school building program which has already reached boom proportions and promises to continue at boom levels for quite a spell ahead.

Educational building volume in the 37 Eastern states rose from a subnormal 25,883,000 square feet of new floor space in 1946 to a record-breaking 72,345,000 square feet in 1948, and continued its rise to 110,554,000 square feet in 1950; the 1951 volume was only held down to 109,490,000 square feet by reason of material shortages and government controls. (Chart III.)

Continuing demand for added school facilities is indicated in Chart IV, showing an estimated increase of school-age population (ages 5-17) from 31.6 million in 1950 to 43.1 million in 1960. Just now the elementary schools are booming and they will continue to boom through 1958, perhaps longer if the birth rate holds up. The high school boom will definitely carry over beyond 1960 and then will come the turn of the colleges.

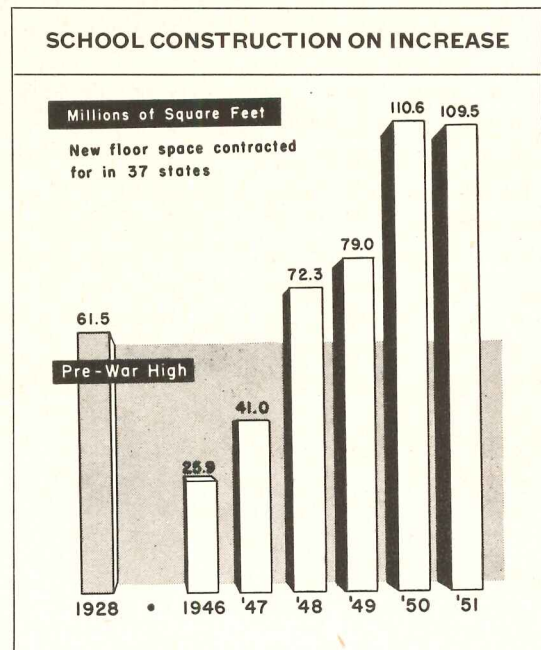

Translated into building demand, the estimated requirement for the entire country is 600,000 new rooms in elementary and secondary schools by the end of 1958. This is the estimate of Ray L. Harmon, Chief, School Housing Section, U. S. Office of Education. The figure includes growth requirements, backlog requirements and normal replacement requirements.

Babies do not immediately require new houses. But, as they grow a little older and acquire little brothers and sisters, their parents are very likely to build on additions or even move into bigger houses. With pros-

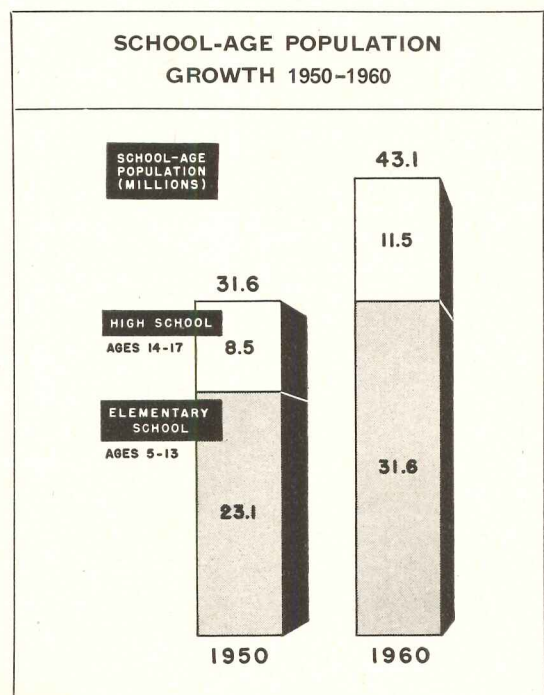

**TABLE I
CONSUMPTION EXPENDITURES**

| A. WHAT HAPPENED FROM 1940 TO 1950 | | | | |
|---|------------------------|---|------------------------|--|
| | 1940 Actual | 1950 (required for 1940 standard)* | 1950 Actual | 1940-1950 Improve- ment |
| Food..... | \$20.7 billions | \$ 50.3 billions | \$ 60.9 billions | \$10.6 billions |
| Clothing..... | 7.4 " | 15.7 " | 18.8 " | 3.1 " |
| Shelter**..... | 9.2 " | 13.2 " | 19.9 " | 6.7 " |
| All Other..... | 34.8 " | 62.8 " | 94.0 " | 31.2 " |
| Total..... | \$72.1 " | \$142.0 " | \$193.6 " | \$51.6 " |

** Consumption requirements for 1950 figured to take care of population and price increases.*

| B. WHAT MIGHT HAPPEN FROM 1950 TO 1960 | | | | |
|---|------------------------|------------------------------------|--|------------------|
| | 1950 Actual | Add 14% for more people | Suggested im- provement at 1/2 1940-1950 rate | TOTAL |
| Food..... | \$60.9 billions | \$ 8.5 billions | \$ 5.3 billions | \$ 74.7 billions |
| Clothing..... | 18.8 " | 2.6 " | 1.6 " | 23.0 " |
| Shelter**..... | 19.9 " | 2.8 " | 3.3 " | 26.0 " |
| All other..... | 94.0 " | 13.2 " | 15.6 " | 122.8 " |
| Total..... | \$193.6 " | \$27.1 " | \$25.8 " | \$246.5 " |

No estimate for changed price level between 1950 and 1960 is included in these figures.

The indicated improvement in the third column has no forecasting significance, but is merely a suggestion of what seems to be in the range of possibility.

**** Shelter expenditures include rent paid by tenant families plus estimated aggregate rental equivalent for home-owning families; these figures do not relate directly to capital cost of new housing.**

perity they will want the bigger houses to have more spacious rooms as well as more rooms and to be generally better than the two-bedroom G.I. houses the first babies came home to from the hospitals. During the period of declining marriage rate there may be declining numbers of new minimum houses, but there are likely to be increasing numbers of bigger and better houses.

Along with the schools and the bigger and better houses will come demands for community facilities of all kinds, public and private. Water supply and electric utilities will have to be expanded; neighborhood stores and drive-in shopping centers will increase, public health and recreation facilities, churches and parish houses and Sunday school rooms will be required: in fact, every type of facility for civilized living.

The postwar babies will not actively demand increased highway construction but their somewhat older brothers and sisters will. Population aged from 15 years up will increase from 110 millions in 1950 to 124 or 125 millions in 1960. In 1950, more than half the population aged 15 up had drivers' licenses: fifty-nine million of them drove 49 million motor vehicles. There

will thus almost certainly be some millions more licensed drivers and some millions more registered vehicles by 1960. There is already a tremendous backlog of needed road construction; the nation's highway system has nowhere near caught up with the 60 per cent increase in existing motor vehicles that took place between 1940 and 1950.

Increased motorization will require, in addition to more and better hard-surfaced highways and parkways and turnpikes, revamping of street patterns, off-street parking spaces and parking garages, as well as all the other structures required to serve America's licensed vehicles and drivers.

However, the real key to the realization of all these potential construction programs and to the potential prosperity of our rapidly growing economy will be the nature and extent of future expansion of the country's productive facilities.

It is obvious that a 14 per cent increase in population requires a concurrent increase of, roughly, 14 per cent in total output of goods and services, if the 1950 standard of living is to be maintained for the people who will be here in 1960. *(Continued on page 312)*

INDIVIDUAL APARTMENT HEATING FOR MULTI-STORY HOUSING

By Robert K. Thulman, Housing and Home Finance Agency, and
Robert L. Davison, Howard T. Fisher & Associates

ARCHITECTURAL RECORD REPORT No. 2 on Housing and Home Finance
Agency Research Project No. 1-T-99 with Illinois Institute of Technology *

REGARDLESS of what form housing may take, be it a huge slum clearance apartment building, a Greenbelt town consisting of a mixture of individual houses, row houses, and apartments, or a rural development of small farm houses, the fundamental heating problem is always the same. It is to provide heating equipment at a first cost consistent with the cost of the project, which, with reasonable care and attention, will maintain proper and acceptable comfort. And the operating and maintenance cost should be within the range of what the occupants of the project can afford.

This appears to be a simple problem, but when the heating engineer asks how much money he can spend, complications arise. From that time on, arguments, debates, and differences of opinion multiply with astonishing speed. When the heating engineer points out that excessive and poorly located glass areas make efficient and comfortable heating impossible, and that cheaply made windows will cause troublesome drafts, his remarks frequently fall on deaf ears. But when he translates window sizes, wall construction and infiltration factors into dollars and cents, the debatable points begin to clear up.

How Heating Design Progressed

Conventional practice in the design of heating systems for multi-family and especially multi-story projects has undergone radical change in the past fif-

teen years. There have been sweeping changes in architectural design, and changes in heating have followed changes in architecture.

The heating system for the typical six-story apartment house of the 'twenties was a one-pipe steam job of the all-on, all-off type. Hot water was not considered practical in tall buildings because the hydrostatic pressure mounted as stories were added and soon exceeded the design limits of the boiler. The room temperature was controlled by simply opening and closing windows when the system was "all on," and by hammering on the steam pipes when the system was "all off." Boilers and radiators were generously sized to avoid complaints.

When two- and three-story "garden type" apartments began to be built, hot water systems were a practical type to use. (Hydrostatic pressures were within the limits of low pressure boilers.) The chief advantage was the temperature control provided by modulating the hot water supply. A "one-pipe" hot water system could be installed at a cost not much more than that for steam.

The principle of modulating hot water, or even steam, was not new.

Modulation of steam had been proposed by some progressive manufacturers and had been used in a number of more elaborate projects where the higher cost of high-vacuum pumps and appurtenances could be justified. But for the lower cost garden apartment typical of the 'thirties, hot water was just as good as modulated steam and quite a bit cheaper.

Although hot water systems were restricted essentially to three-story jobs (when all equipment was located in the basement), the need for strict economy in the multi-story project required a tight control over the cost of heating, and the "open window" method of temperature control couldn't be tolerated. It was in this type of job that the newer developments in modulated steam and vapor systems were applicable. Simplified distribution piping and continuous down-feed radiation offset much of the cost of the differential pumps required to operate vapor systems at sub-atmospheric pressures.

Hot water systems are feasible in high buildings and have been used more recently simply by installing efficient heat exchangers in the upper levels. With

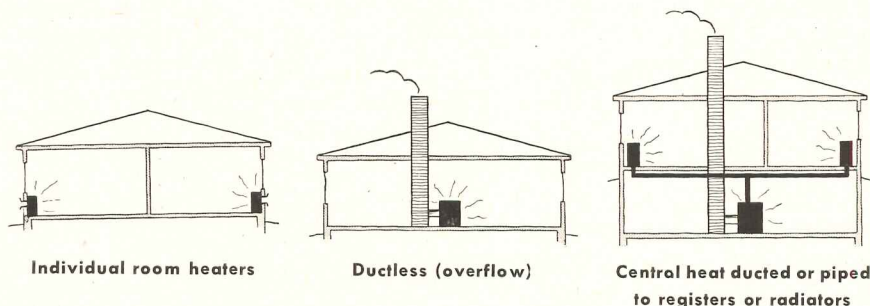

Three types of heating systems used in single-family houses which might be profitably adapted for use in multi-story apartments

* This article is based on a progress report on Housing and Home Finance Agency's Research Project No. 1-T-99 being conducted under contract by Illinois Institute of Technology, Prof. E. I. Fiesenheiser, Project Director, Howard T. Fisher & Associates, Inc., Architects and Industrial Designers, Subcontractor. The substance of this work is dedicated to the public. The accuracy of all statements or interpretations is solely the responsibility of the authors. Statements may be altered by further investigation before the project is completed.

INDIVIDUAL APARTMENT HEATING SYSTEMS

automatically fired boilers, it is also possible to locate the heat generating equipment in an intermediate story or on the roof.

"Overdesign" Can Make Central Systems Costly

The biggest hitch with central heating systems is that the equipment is expensive, but generally it is more durable, not susceptible to tenant "tinkering," and designed for a long term investment. Some costs are not always justifiable, as the heating system may be overdesigned: for example, controls are installed to translate the effect of wind and sunshine into temperature of the water, the design is too greatly refined, and materials are more durable than obsolescence requires.

There has been great improvement in automatic controls, especially those which modulate the temperature of the heating medium according to outside weather conditions. In fact, that improvement seems to have been carried to excess. Ideally, a control should limit the amount of heat delivered to the apartment to that required to maintain 70 F with the windows closed. The individual room radiators or convectors should be easily controllable by the tenant so that he can shut them off to cool an individual room, rather than open the window. The main point is that the central system *can be designed* to produce a satisfactory result in terms of both comfort and economy.

Designers of heating systems for apartments often are not familiar with the developments in heating for individual single-family houses. Some of the ideas now widely used for single-family house heating, and quite adaptable to apartment heating, are neglected for no better reason than that they may be considered too elementary. The need for exchange of ideas is apparent.

Some Pros and Cons of Individual Heating

The use of individual heating units, either as room heaters or small systems similar to those used in single-family dwellings and supplied with fuel at the tenant's expense, has been proposed from time to time for apartment heating. (There may be some confusion between "individual heating" and "individual metering." Although individual metering implies individual heating, it would be possible to have individual meters on a central steam or hot water system.)

The study which follows, based on an investigation made by the St. Louis Housing Authority, indicates potential savings from individual heating *without* individual metering. There is a difference of opinion as to whether individual metering would result in added savings and whether these savings are socially justified.

The proposed use of individual heating systems in high buildings is relatively novel. Their actual use requires a re-orientation of some ideas fairly basic to the apartment vs. single-family-house types of living.

One of the reasons why people live in apartments is the economic one which motivates people to try to reduce their expenses by sharing them with others, the cost of heating by a central system, for example. Given equal living space and equally heat-resistant construction, it is obviously cheaper to heat that space which is in direct contact with other similar spaces than if it is in a separate shell of its own. And, usually, it is cheaper per heat unit to buy fuel in the large quantities required for an apartment house than the small quantities for single-family houses.

With individual heating, each tenant has the responsibility to keep his own apartment warm and not "borrow" heat from his neighbor. This situation is avoided when heat is paid for as part of the rent. There is some advantage to knowing in advance what the monthly costs of shelter will be and to spread the cost of heating over 12 months instead of over just the heating season.

There is also the health angle to be considered. In low rent housing, there is a social responsibility in protecting the welfare of the tenant. If he has his own heater, he may economize on fuel to an extent detrimental to his family's health.

These points favor central heating; other points are its proved acceptability,

predictable behavior, known costs, and durability. The proponents of individual heating stress the lower initial cost and opportunities to eliminate heat waste as the principal advantages.

Study of Individual Heating in St. Louis

A comparative study of four types of heating made for the St. Louis Housing Authority indicated a 33 per cent saving in combined operating and carrying charges for heating and domestic hot water produced by individual systems, as compared with a central steam system (see breakdown of charges, p. 205).

In the St. Louis study, gas was selected as the fuel for individual systems, and gas and oil for the central system. The individual heating systems are assumed to provide the same amount of heat and comfort as is provided with the radiator system. The fuel cost for the individual system is assumed to be eight per cent less than the central system, due to the elimination of transmission losses between boiler and radiator.

The principal savings are due to reduced cost of equipment and installation as reflected in carrying charges. Reduced labor for operation accounts for about one-third of the saving. Savings estimated for St. Louis are on a system *not having individual gas meters*.

With individual meters, tenants will not waste hot water or heat. These savings are important, since heating frequently represents the largest single item of operating cost, and in subsidized housing may amount to 35 or 40 per cent of the rent charged. It is possible that this might be offset by gas rates higher than those for bulk purchase. Submetering, if permitted, might eliminate this objection.

Potentialities of Gas Heating

Gas as fuel is not economical in all locations, but the extension of pipe lines

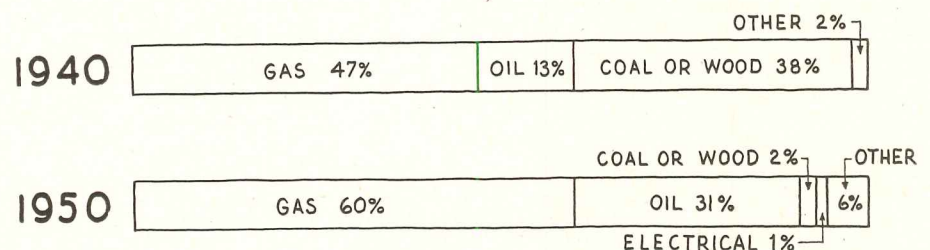

Types of fuel used for heating, classified as percentages of the total new homes built in 1940 and 1950. (Source: HHFA-RP-No. 129)

INITIAL COSTS \$671
(57% less than the central steam system)

| in dollars | |
|--|-----------------------|
| HEATING EQUIPMENT | 190.00 Gas Piping |
| | 245.00 Space Heaters |
| DOMESTIC HOT WATER EQUIPMENT | 80.00 Interior Piping |
| | 110.00 Water Heater |
| GAS LINES AND METERS | 31.00 |
| FLOOR SPACE FOR WATER HEATER | 15.00 |
| ANNUAL CARRYING CHARGES (33% less than the central steam system) | |
| 85.58 | |

Individual gas-fired heating units

Central steam system

INITIAL COSTS \$1571.04

| in dollars | |
|--------------------------------|---------------------------|
| INTERIOR PIPING AND RADIATORS | 935.00 Heating |
| | 100.13 Domestic Hot Water |
| EQUIPMENT AND DISTRIBUTION | 357.34 Heating |
| | 60.57 Domestic Hot Water |
| BOILER ROOM CONSTRUCTION | 100.00 |
| ANNUAL CARRYING CHARGES | |
| 128.95 | |

in dollars

| | | |
|--------------------------------------|---------------------------------|------------------------------|
| FUEL, SUPPLIES AND LABOR | 5.30 Labor | HEATING EQUIPMENT |
| | 42.10 Gas For Space Heater | |
| REPAIRS, MAINTENANCE AND REPLACEMENT | 8.60 Gas For Domestic Hot Water | DOMESTIC HOT WATER EQUIPMENT |
| | 4.57 Gas Piping | |
| | 13.25 Space Heaters | GAS LINES AND METERS |
| | 2.19 Interior Piping | |
| | 7.79 Water Heater | |
| 1.53 | FLOOR SPACE FOR WATER HEATER | |
| | | 0.25 |

in dollars

| | | |
|--------------------------------------|-------------------------|-------------------------------|
| FUEL, SUPPLIES AND LABOR | 21.22 Labor | INTERIOR PIPING AND RADIATORS |
| | 27.18 Oil | |
| | 26.30 Gas | |
| REPAIRS, MAINTENANCE AND REPLACEMENT | 1.44 Electricity | EQUIPMENT AND DISTRIBUTION |
| | 30.33 Heating | |
| | 3.99 Domestic Hot Water | |
| | 14.10 Heating | |
| | 2.66 Domestic Hot Water | |
| | 1.73 Boiler Room | |

Cost of heating and domestic water heating for high-rise apartments. Comparative analysis between a central steam system with gas-and-oil-fired boilers serving 400-500 dwelling units each, and a system of individual gas-fired units for each apartment. This study was made by George Hellmuth Associates, architects, John D. Falvey, consulting engineer for the St. Louis

Housing Authority. Out of four systems compared, the system with individual units was the first choice but had to be temporarily ruled out because gas was not available. The steam system analyzed in the cost breakdown above was the second choice. The system with individual units consists of separate heaters for each room, except kitchen and bath

INDIVIDUAL APARTMENT HEATING SYSTEMS

from natural gas regions, together with rises in cost of coal and oil, have resulted in a considerable increase in recent years in the use of gas for heating. The graph on page 204 shows the change from coal to gas from 1940 to 1950. Most of this increased use of gas has been in regions previously served largely by coal.

The increased use of insulation, together with the reduction in the size of single-family dwellings, has had an important effect on the type and size of heaters marketed and the fuel used; the size of heaters has decreased from a range of 120,000-70,000 Btu to 70,000-40,000 Btu. Heaters for apartments will drop these requirements to the 40,000-20,000 Btu bracket.

The reduction is possible because, with apartments above, below, and on both sides (except for corner apartments and the top floor), the surfaces through which heat is lost are reduced from six to two, and the large heat loss through the roof is eliminated.

With reduction in size and heat required per apartment, individual heating systems can be smaller, and fuel not practical previously may become the most economical to use.

It is obvious that all systems will not give the same degree of comfort, nor cost the same. The degree of refinement of the heating system should be related to the rental level of the particular project. When this factor is overlooked, the result is often a system too costly for a low rental project or one that lacks the refinements required by tenants in a higher rental project.

Four Heating Types

In this article we will consider four basically different types of individual heating. These are outlined here as applied to the typical apartment plan shown in ARCHITECTURAL RECORD, December 1951, page 138.

1: Single Overflow Heater per apartment. (The term "Overflow Heater" indicates one that heats more than one room by flow of warm air through open doors without the aid of ducts.) The logical location for a single heater system would be the center of the dwelling, or as close to it as possible. This heater can operate on gravity or fan for circulation. Bureau of Standards tests in a one-story bungalow indicated that although the use of the fan changed the pattern of heat distribution, there was not very much difference in comfort.

Because of the central location of the heater, a vertical vent will be most practical.

2: Separate Space Heaters located in each bedroom and living room under the windows and vented horizontally direct to the outside air. This gives a better distribution of heat than Type 1. A heater would not be needed in the kitchen because, normally, the heat from cooking would keep this room warm. It would be desirable, though, to have a register opening between living room and kitchen, possibly incorporating a fan so that heat may be supplied to the kitchen when necessary.

Since air leaves the apartment through a power vent in the bathroom, warm air from the apartment will be drawn to this room; in some cases, a radiator may be connected with the hot water supply for the bathroom.

3: Warm Air Duct System. This combines the merit of warm air discharge under the windows with the economy of one central heater. There are two principal ways in which the air can be dis-

Required size of space heaters has changed

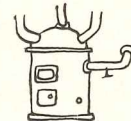
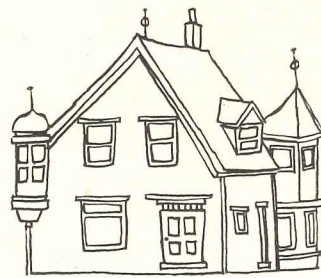

70-125 Btu

The old-fashioned house without insulation required a large-capacity furnace

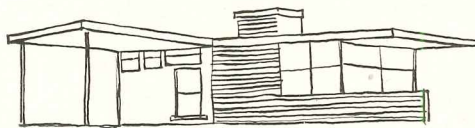

40-70 Btu

A modern well-insulated house does not require such large equipment

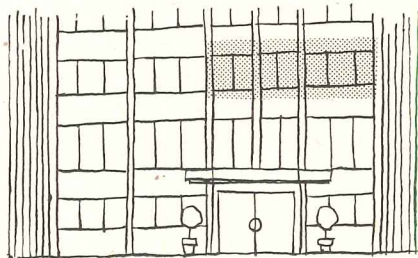

20-40 Btu

And a single apartment would require a still smaller unit

1. Single Overflow Heater

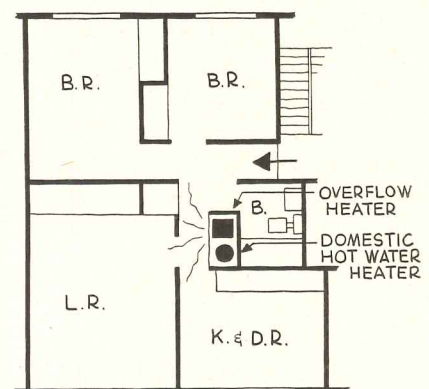

2. Separate Space Heater

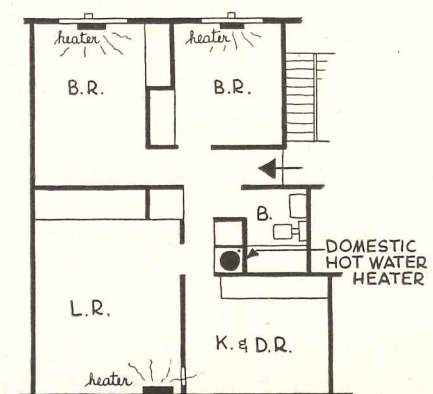

tributed: by gravity, with the heater located on the floor below the apartment to be heated; or by forced circulation, with the heater within the apartment to be heated and with registers at floor or ceiling level.

For maintenance of the gravity system, there must be access to the heating unit through the apartment below, but in a rental project, this should offer no serious difficulty. On the other hand, the forced system would have higher installation and maintenance costs.

The air can be heated by a separate hot air heater or by connecting a heat exchanger with the domestic hot water heater, which would perform the dual function of providing hot air and domestic hot water.

4: Radiators heated by Domestic Hot Water System. If the domestic hot water heater is to be the source of heat for the apartment, it may be more economical to place the heat exchangers right in the rooms in the form of hot water radiators and to run a pipe system to them, rather than to have a heat exchanger heating the air to be carried to the rooms by ducts. The decision will depend to some extent on the type of floor system used. If the floor system provides spaces within it which can be used as ducts, the central heat exchanger may be more economical, but if the floor and ceiling system is not suitable as a duct system, it may be more economical to use pipes and radiators.

When the hot water heater is used for this dual purpose, it is advisable to have a 40- or 45-gallon storage tank instead of the 30-gallon tank used for domestic hot water alone, and the capacity of the heater ought to be about 45,000 Btu/hr. The cost of this type of system should be lower than that of the individual domestic hot water heater plus a space heater. It is absolutely essential, if the domestic hot water heater is also used for space heating, that the tank and radiators be made of noncorroding materials. A galvanized tank will rust when used for heating as well as hot water because the water temperatures will frequently be higher than when used for domestic hot water only, and galvanizing is not likely to stand up. Where there are appreciable quantities of lime in the water, a central water treatment apparatus should be installed to eliminate the lime.

The design of the system and the selection of equipment should be such that the combined cost is less than that of a central plant supplying both heat

Two ways of heating air

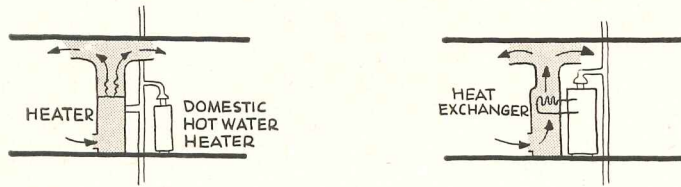

Space heater

Heat-exchanger with hot water coils from domestic water boiler

3. Warm Air Duct System

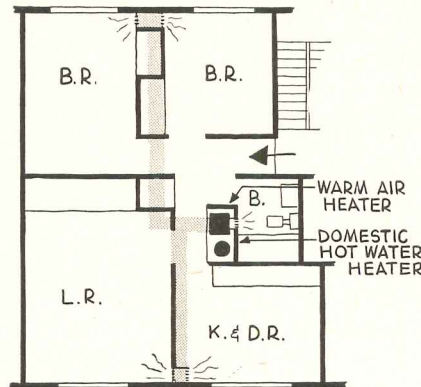

Three ways of distributing warm air

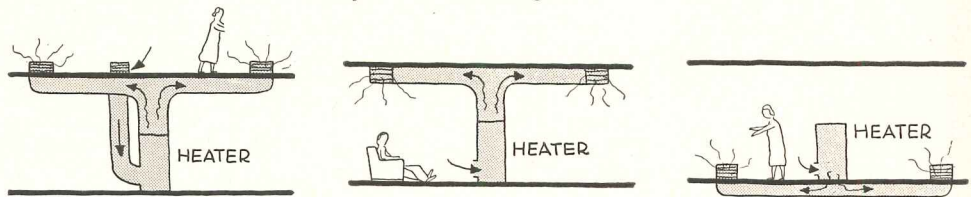

Gravity, heater below floor to be heated

Forced air, ducts at ceiling

Forced air, ducts under floor

Two types of hot water heating

4. Radiators

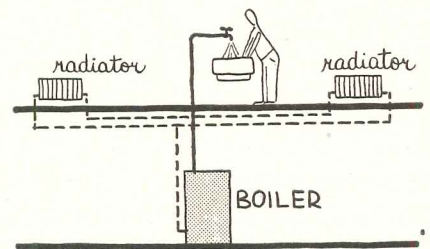
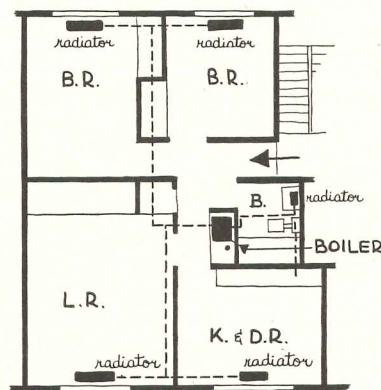

Gravity, boiler below floor to be heated

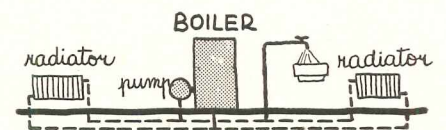

Forced, boiler within the apartment to be heated

INDIVIDUAL APARTMENT HEATING SYSTEMS

and hot water. Durability of equipment also has an effect on overall cost.

Labor Costs

Labor costs for operation will probably be quite a bit lower with individual heating plants. This is particularly true in certain localities where union regulations and codes require that licensed operators of certain qualifications be employed to run a central heating system, even though the system may be designed and installed so as to eliminate the need for most attention.

In Chicago, for example, the cost of such personnel would average \$5200 per man per year. Three men (for three shifts) will be required to service a central plant for 300 apartments. Labor costs will vary with local codes, type of fuel, type of heating equipment, and size of project. The estimated labor cost in St. Louis for operating and servicing a central heating plant supplying 400 apartments (see page 205) is estimated at \$21.22 per apartment per year. In Chicago, the labor cost for the same size project (assuming four men required) would be approximately \$52 per apartment. Such costs should not be considered a valid reason for shifting to individual heating systems. This is a matter for the local citizenry to deal with through changes in legislation, but, still, as long as such conditions exist, they cannot be ignored by the budget-minded housing executive.

Comfort Factors

Individually heated apartments can be more comfortable than those heated by a central system. There are several reasons why this may be so. With a central heating system, the hours that heat is supplied may not meet the time schedule of all families. If a central hot water radiator system with modulated controls is used, it will frequently be found that the system is not responsive to requirements of all rooms since there are bound to be variations in exposure to wind and sun.

The central heating system, though, has become such an established symbol of comfort and housing progress that a return to individual heating systems, although refined by modern technology, may be slow in receiving general acceptance. It is often argued that the performance of individual apartment heating systems is inferior to central systems. This is due to the association of individual heating systems with the single centrally located overflow heater, which, obviously, cannot give as good distribu-

tion of heat as a unit in each room.

If heating units — be they space heaters, registers or radiators — are provided in each room adjacent to the windows, there should be slight, if any, difference in the pattern of heat distribution, no matter if the units are activated by an individual or by a central plant. Since there is little difference in comfort — with the exception of the overflow heating system — the question then becomes one largely of economics.

Economics

The economy of individual systems has many aspects. The St. Louis cost analysis shows a lower cost for individual heating in comparison with central heating. This is due largely to lower carrying charges because of lower initial cost. In the St. Louis Housing Project, there is a central gas meter, and the same amount of heat per apartment has been figured as with the central plant.

The unit cost of gas to the tenant, even if the gas is purchased wholesale and submetered by the landlord, will necessarily be higher than with a central meter since there would have to be

carrying charges on the meters and additional bookkeeping and collection costs. Whether this higher unit cost will be counterbalanced by the opportunity for savings which the tenant has by reducing waste (and maybe comfort), is an open question that may depend on rate structure, climate, type of building, location of the apartment in the building, and consumer habits.

Another facet in the heating cost to the tenant, a psychological one, is the fact that tenants have come to expect heating supplied "free" by the landlord (included in the rent).

Comfort With Overflow Heaters

Where economy is paramount or climate is mild, overflow heaters may be found adequate for low-cost housing. With 48.2 per cent* of all homes in the United States heated with space heaters, there may be justification for the opinion that a comfort condition acceptable for those Americans who pay for their own homes should be high enough for those who live in subsidized housing.

* U. S. Bureau of Census — 1950 Census of Housing.

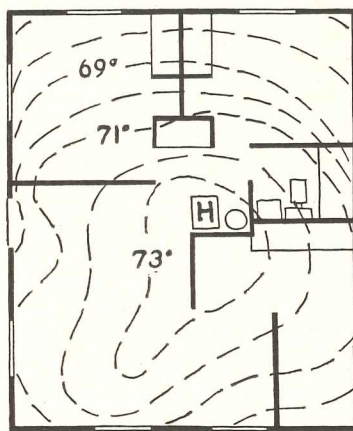

Heat distribution in a single-family house*

* From a study made in 1940-41 by I. M. Moriyama, under the direction of the Sub-Committee on the Hygiene of Housing, American Public Health Association

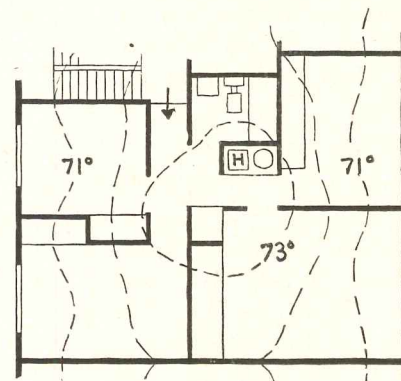
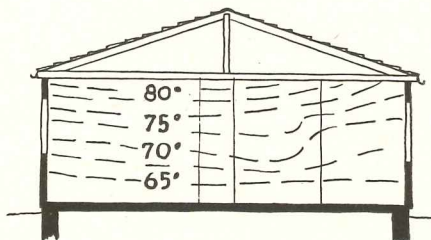

Assumed heat distribution in a multi-story apartment, 4 ft above the floor

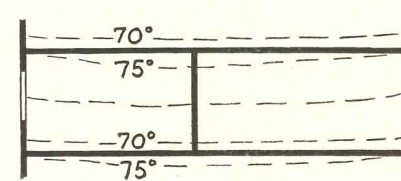

Heat distribution should be better in apartments than in single-family houses. In a single-family house, the greatest heat loss is through the roof. Also, overflow heaters in houses do not adequately eliminate cold floors. In an apartment, surrounded by other heated apartments, heat loss through the ceiling is largely eliminated, and the floors are warm

It can be argued that an overflow heater should give more comfortable heat distribution in an apartment than in a single-family dwelling of comparable size and floor plan.

While the exposure is less in an apartment dwelling unit than in a single-family residence, the windows which might occur in two walls of one room in a residence, may be combined in an apartment into one big window. This may cause a reverse circulation of air cooled by the glass, and set up uncomfortable air currents across the floor. The effectiveness of overflow heaters depends upon the compactness of the plan, the distance between interconnecting rooms, the total load to be handled in relation to the heat loss of the space in which the heater is located, and the heat losses of the individual rooms adjoining the heater room. In other words, the house or apartment must be small, compact, and of low heat loss.

The FHA, in specifying the conditions under which overflow heating is acceptable, limits the distance between the center of the heater outlet and the center of any room heated by the overflow heater to 18 ft, limits its use to dwellings having a calculated heat loss of 45,000 Btu or less, and prescribes not more than one doorway and one arched opening between the heater and the adjacent rooms.

Flues for Venting Gas-Fired Equipment

In the minds of most people, venting is still considered a serious obstacle to the use of individual heating in high-rise apartments. This is largely due to lack of information and experience on the vertical venting of individual gas equipment located on each floor. The American Gas Association, as a result of our research project, is conducting an investigation of this problem and expects to develop authoritative data for the design of individual and/or common vents.

The problem in tall buildings is not that of getting enough draft, but rather of preventing too much draft under certain conditions. Gas equipment operates on a very low negative chimney pressure, and since chimney draft varies with height, the average chimney temperature and the high stacks necessary in tall buildings are the most important problems. Assuming that the effect of excessive height can be overcome by lowering the gas temperatures, there is a serious problem of dealing with con-

densation, which, with fuel gas, occurs in the stack at temperatures of around 140 F.

One possible solution would be to design the vent as three independent vents, each three stories in height. The admittance of air at every third floor would prevent over-draft due to height of the building. This design is being considered by the American Gas Association as part of its study.

In buildings three or four stories in height, individual vents are often used. At first thought, one would assume that individual vents would take a great deal of space in a ten-story building, but since the individual aluminum vents need be only 4 in. in diameter, it is entirely possible to provide ten vents in a space 8 by 26 in., which is very little more space than required by a common vent. Since the vents can be constructed of .013 in. aluminum, the cost is nominal.

There is, however, a system suitable for immediate application, which has already been accepted by a number of building codes. This consists of a horizontal vent direct to the outside air for each individual heating unit. (This is the system that was intended for the St. Louis Housing Authority 7-story apartment. Also, the Los Angeles Housing Authority has plans for a 13-story building using this system.)

Availability of Fuels

A limiting factor in many communities at this time is the availability of gas for residential heating. The St. Louis Housing Authority would have used individual gas heaters if gas had been available. Availability is dependent on supply and storage. Since peak heating loads may be only for short periods during the heating season, the facilities for storage may be a more important factor than production capacity or pipe lines. This situation is being rapidly altered.

A project is under way in the Chicago area for storing gas in a natural underground dome of porous sandstone. This will have the effect of trebling the capacity to meet peak loads in this area.

One of the largest distributors of natural gas is putting in storage and pipe lines, which by 1955 will meet their anticipated residential demand.

However, considering the potential economies which research so far has demonstrated, it seems certain that the next few years will see a wide use in apartment houses of heating methods which were formerly considered practical only for single-family homes.

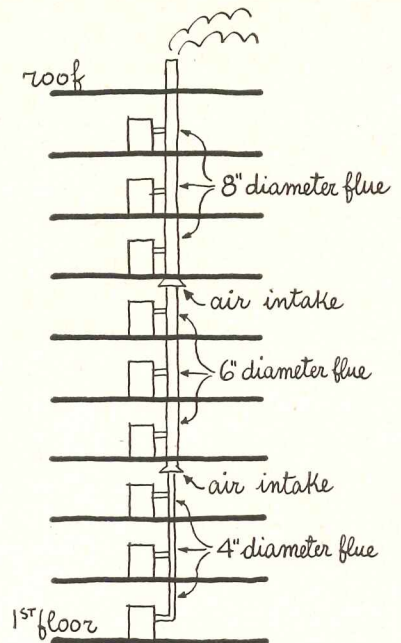

Common flue for gas space heaters in high-rise apartments. This is a proposed design with air intakes every third floor to prevent excessive draft

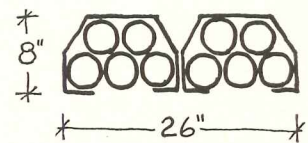

Individual flues can be easily nested to save space. Ten single 4-in. flues—sufficient for individual heaters in a ten-story building—occupy only 1.44 sq ft

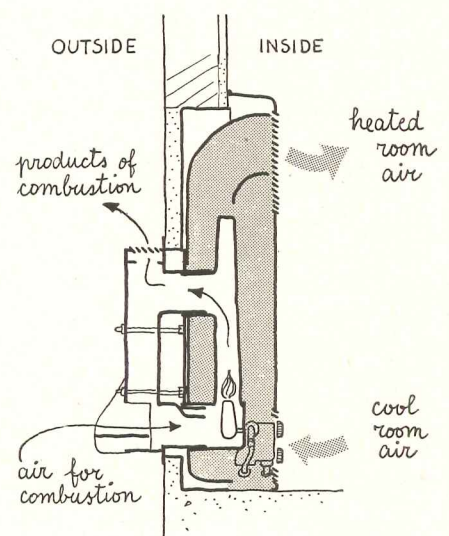

This individual gas room heater is vented directly through the outside wall



LIGHT AND COLOR IN ELEMENTARY SCHOOLS

By N. L. Engelhardt, Jr., of Engelhardt, Engelhardt and Leggett, Educational Consultants

CONSIDERABLE PROGRESS has been made in recent years in the lighting of elementary schools. Light is one element establishing the children's environment, and school planning today is concerned with the development of environment on equal terms with space and facilities. Ribbon windows, glass blocks, clerestory lighting, fluorescent lighting, color variations, and higher lighting intensities have all contributed to this progress.

The modern school program imposes a heavy burden on the eyes, not only in the extent and continuity of seeing, but also in the wide variation of task requirements. So it should be the aim of school planners to provide seeing conditions which will contribute most to the learning process and prevent harmful strain and fatigue.

Much work has been done in the attempt to determine optimum seeing conditions for school rooms. The emphasis has been on light intensities, reflection factors, brightness ratios, and color selection related to eye adaptability. How much light does the eye need to see? How much reflected light can the eye stand? What colors are most readily seen? Does inadequate light cause poor posture?

Unfortunately, some conclusions have been arrived at prematurely, without adequate research. Care should be taken to review carefully the character of research and the assumptions before accepting any "scientific" formulas.

Although many of the recommendations that prevail at the moment are based on analyses of physiological needs, there are those who feel that the psychological reactions are more important.

The visual comfort control of light source, intensity, and brightness contrast within reasonable limits appears to be valuable, but the adaptability of the human eye ranges far beyond the limits demanded in schoolwork.

Poor seeing, including lack of accommodation and definition, may be symptoms of individual difficulties requiring medical attention rather than alteration of the working environment. Poor seeing may also be caused by lack of interest. It has not been proved that, under reasonable conditions, lighting can correct poor posture or other physical defects, or cause any tremendous surge in the speed of learning.

Determining Factors of Light

With these points in mind, let us consider the following factors in the determination of satisfactory light and color:

1. Intensity of Illumination

The need is for different degrees of intensities with different tasks. The wide range of activities in elementary classrooms indicates the need for adjusting the lighting to correspond to the task. Examples: resting on the floor, reading, looking at motion pictures, playing games, building an airplane, studying plants, and acting in a play.

General illumination will be adequate if maintained at a reasonably low level, consistent with the principal tasks in the space. In elementary classrooms, 20 to 25 foot-candles are indicated. Localized light of higher intensity is desirable for such fine work as sewing. Science, shop, and art rooms should have somewhat higher intensities, especially if fine work is expected.

2. Brightness Contrasts

Contrasts of three to one should be sought in the field of vision — a purely empirical ratio which is difficult to achieve in all situations. This ratio offers much latitude in classroom design. If ceilings have a reflective value of 85 per cent, walls might range from 30 to 70 per cent. With floors at 30 per cent, wainscot could assume almost any reflective value consistent with appearance and ease of maintenance.

The task should be brighter than the background. For example, a light map would be easier to see against a dark wall than against a light wall. An object may become merely a silhouette against a bright window, but it will be easily distinguished in detail against a background darker than itself.

A dark wall is more restful to the eye than a bright one. When working at tasks requiring high intensity illumination, relief may be secured by glancing up at an area of dark wall. Bear this in mind when planning the color scheme.

Arrange bright surfaces and light sources above the eye in such a position that the eyebrows have a chance to function naturally as a blind.

3. Reflection Factors

Brightness of walls, ceilings, floors, and equipment is related to their reflection factors and intensities of illumination. Where adequate natural light is available, the reflection factors of walls are less important than when limited light must be regained as much as possible by wall reflection.

Bilateral and clerestory lighting offer wide opportunities in wall color treat-

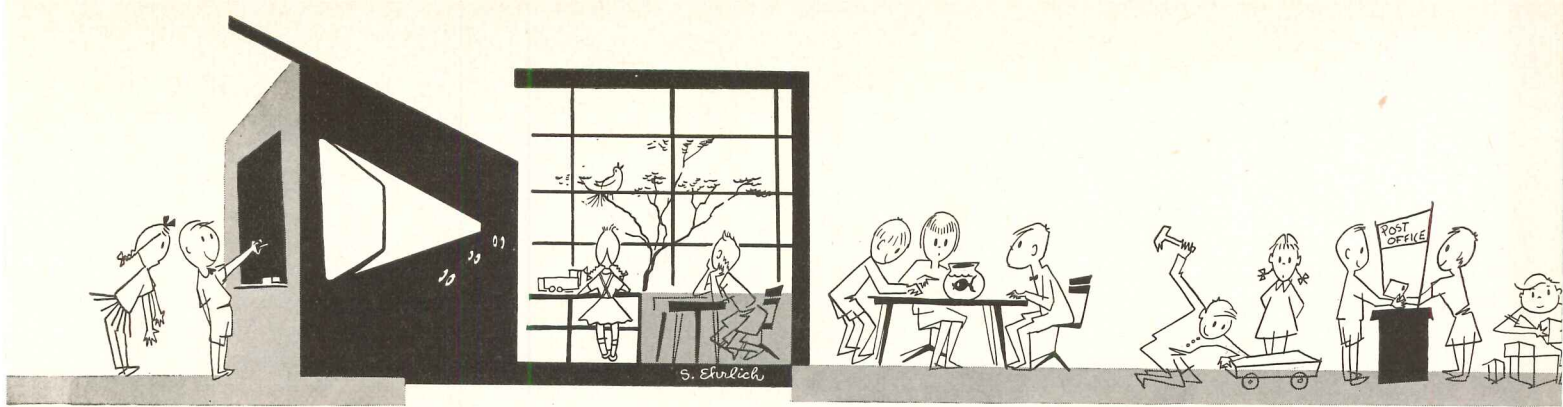

School activities vary widely, so the lighting must take into account each task rather than provide any overall standard of illumination

This article is a condensation of a chapter from the forthcoming book, **Planning Elementary School Buildings**, written by N. L. Engelhardt, Sr., N. L. Engelhardt, Jr., and Stanton Leggett and published by F. W. Dodge Corporation

ment. Lower ceiling heights in primary classrooms also make possible greater utilization of the ceiling as a major light source. The New York State Education Department has recently liberalized its regulations, taking cognizance of the potential of continuous artificial lighting and offering much freedom in design for natural lighting.

High intensity reflected light from walls may be overstimulating and irritating. Dark end walls, with a light wall under clerestory windows, would provide relief from continuous exposure to brightness.

What Lighting Must Do

As already mentioned, no single activity can be chosen to indicate lighting needs in a classroom. It also appears axiomatic that no single horizontal plane can be chosen as the one for satisfactory conditions of seeing. Criteria for light intensity or quality at desk top levels have only limited meaning. Adequate light is needed on tables, window or wall counters, floors, and walls too, since various activities demand that pupils may face in any direction.

The visual problems in a classroom, from a strictly educational viewpoint, include the following:

1. There should be ample light to carry on the varied tasks. In some cases, particular locations can be set aside for certain tasks. In others, a given activity may occur anywhere within the room.
2. The light should have a pleasing quality. This includes attention to effective colors and the elimination of annoying glare or brilliant sources of light.
3. Sunshine, at suitable times and

for certain tasks, is highly desirable. But, it should be controllable.

4. Opportunity for pupils to look out windows is imperative. There is no proof that the educational values of observing sky, land, water, or man-made structures outside the school should be abandoned for reasons of subjective classroom lighting "standards."

5. Low cost is important, both initially and in maintenance and operation.

6. Both natural and artificial light should be readily controlled by the teacher to meet changing conditions and needs during the school day.

7. Informal and pleasant conditions should be created. High intensity and uniform illumination may hinder the development of these conditions.

Standards of Foot-Candles

Many studies have been made in an attempt to arrive at standards for foot-candles of illumination in schools. It seems fair to state that, except in the most general terms, the results of the research are inconclusive.

An authoritative ophthalmological text

has this to say: "The pendulum has been swinging toward higher and higher standards of brightness for nearly all purposes. It seems to the author that it is swinging a little too far. It is true that daylight, out-of-doors, is often of a brightness of many thousand foot-candles; hence the eyes can stand extreme illumination. The point is that good results are possible with much less."*

Researchers Carmichael and Dearborn made a comprehensive review of the literature on light intensity for a study of visual fatigue.† They point out that "there is a striking difference of opinion between experts on this matter." As a result of their studies, they chose 16 foot-candles for experiments in reading as the "best generalization from the experimental evidence available."

Educational Activities Considered

In most of the research aiming to de-

* Conrad Berens, M.D., Editor: "The Eye and Its Diseases"; W. B. Saunders Co.; Philadelphia, Pennsylvania; 1949; p. 90.
 † L. Carmichael and W. F. Dearborn: "Reading and Visual Fatigue"; Houghton Mifflin Co.; New York; 1947.

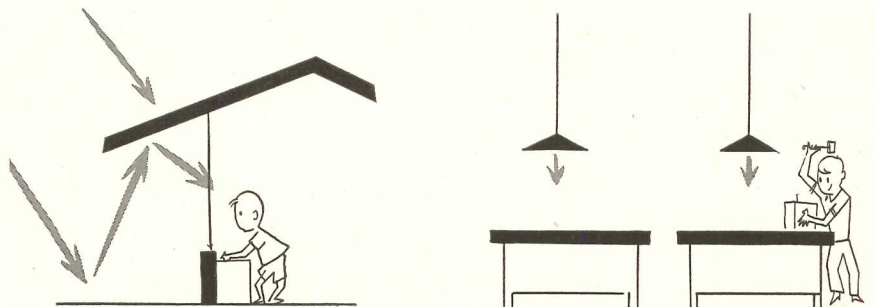

LIGHT AND COLOR IN ELEMENTARY SCHOOLS

termine standards of classroom illumination, there has been no discrimination between the specialized needs in elementary schools and the quite different needs of secondary or higher schools. There are, obviously, important differences in light requirements.

The early years of schooling generally do not make the demands for attention to detail or fine work common in the classrooms of secondary schools. Nor do elementary years have the long periods of application to a specific task that is to be found in the higher grades.

Research studies and personal observation in classrooms throughout the country offer no evidence to support the need for more than 25 foot-candles, providing optimum conditions are achieved in other respects. Furthermore, it seems unnecessary to provide 25 foot-candles everywhere in the room. Rather, a range of lighting might well be provided, utilizing a general lighting level of 15 to 20 foot-candles with localized lighting for more intense illumination at specific points.

There is no indication that high intensity, natural light, near the windows, is harmful. With children in early grades, it appears to be quite all right for them to work at certain tasks on the floor or tables with the sunlight streaming in through the windows, provided they are not required to make frequent adaptation to dark. In other words, contrasts should be reduced by a high level of illumination throughout. In playrooms, corridors, cloakrooms, and locker rooms, sunlight is much to be desired.

Effective means of controlling sunlight should be installed. Venetian blinds are quite acceptable, but are dirt catchers and require maintenance. Fixed outriggers are used, but do not offer the variability that is desired. Overhangs are helpful. Baffles and louvers have been tried, but are more expensive and generally less effective than blinds. Shades, pulling up and down from the

meeting rail or center of the window, are also satisfactory but less adaptable than Venetian blinds. Recent research, with a new acrylic fiber material, suggests rather exceptional improvement in light distribution by the use of shades. The shades may prove to be less expensive than Venetian blinds and nearly as satisfactory in this respect.

Directional glass block will diffuse and bend the light rays upward, thus preventing the direct sun rays from entering the rooms. It has been found, however, that under certain circumstances, it is necessary to install shades or blinds with the directional glass block to avoid glare or extreme brightness when the sun is shining on the window wall and to permit darkening for audio-visual purposes. Although glass block transmits less light than clear glass, it does direct more light to the far side of a standard classroom.

Those who advocate the elimination of sunlight in elementary schools would do well to pay heed to psychological aspects, as well as light intensities. This does not imply that glass block is not useful. There are many places in a school where glass block can be used effectively and to advantage, but careful analysis of its purpose is required in each instance. Satisfactory classroom conditions can be obtained with clear glass giving a close tie to the outdoors.

Brightness

The same difficulties are encountered with brightness as with intensity in attempting to lay down rules for optimum conditions. Empirical formulas are about all research has to offer at the moment. The adaptability of the eye to a wide range of conditions, the lack of evidence of fatigue within rational limits, and the indications of the importance of psychological reaction make difficult the acceptance of many recommendations that have become faddish lately. It may be that there is a tendency to go overboard in trying to develop a formula for an optimum static condition of lighting

when what we really need is a formula for variability to establish desirable divergence from a norm.

Another authority points out that: "Current in the lighting profession today is the theory that only an environment of uniform brightness is proper for safe and comfortable seeing.

"First of all, uniformity of brightness in an average interior is impossible of attainment, simply because it cannot be readily engineered. Secondly, no human sense — including vision — can respond consistently to fixed stimuli. Human sensations ebb and flow. . . . If overstimulation is troublesome, unrelieved monotony is hardly any better. Changes in the diameter of the pupil will take place even before an area of unvarying brightness. . . . Images on the retina, if held constant, will nonetheless fade in and out. Thus, if the lighting profession ever achieved its ideal of uniform brightness, it would have something definitely unnatural and disliked. Human eyes would be troubled rather than made content.

"Investigations clearly show that the eye may look *alternately* at moderately high brightness and low brightness without undue distress *if in each instance the major field of view is involved*. Trouble occurs chiefly when high and low brightnesses must be *concurrently*, rather than *alternately*, accepted. Hence, the theory of uniformity is not always valid, nor is there reason to accept it as some inviolable law of good seeing." **

Glare

Highly polished surfaces should be avoided since they produce specular reflection, which gives an image of the reflected object. Care in the design of light sources, the reduction of brightness contrasts, and the finishing of walls and equipment are essential in glare control.

(Continued on page 228)

** Faber Birren: "The Ophthalmic Aspects of Illumination, Brightness and Color." *Transactions American Academy of Ophthalmology and Otolaryngology*; New York, New York; May-June, 1948.

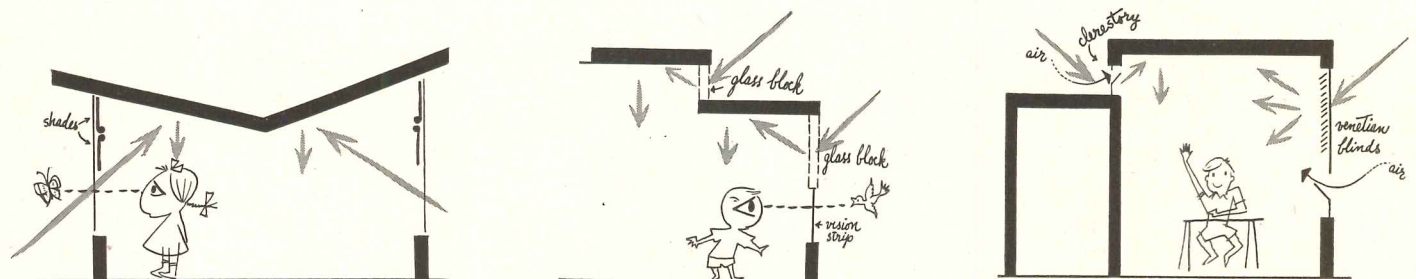

Light and sunshine should be controllable to give adequate illumination and to suit the different tasks throughout the day. Windows should allow the pupils to look outdoors, so they will not feel confined

ADVANCES IN ARTIFICIAL LIGHTING

Prize-winning installations at 4th International Lighting Exhibition vary from banks to museums and show trend toward more visual comfort by reduction of brightness contrasts.

By John O. Kraehenbuehl*

FROM May 6-9, the 4th International Lighting Exhibition and Conference was held in Cleveland, sponsored by the Industrial and Commercial Lighting Equipment Section of the National Electrical Manufacturers Association. A major feature of the exhibition this year and of two previous exhibitions in 1948 and 1950, was the display of award winning lighting installations. For the past three exhibitions, cash awards and certificates have been presented to members of the lighting and building industry, and to users of industrial and commercial lighting whose submitted designs were judged as being most outstanding during 1950-1951.

Entries Appraised

By looking back over the winners of the three competitions, it is possible to follow advances in lighting design and the thinking of the lighting industry and related fields, since the entries are representative of the best in industrial, school, office, store, and miscellaneous installations covering street, airport, flood, recreational, protective, and special problem lighting.

The general trend in design has been toward more comfortable lighting sys-

tems using recommended foot-candles for tasks, and toward reducing the brightness ratios in the field of vision.

Although the quality of entries has advanced markedly, indicating a growing consciousness of the requirements for better lighting and the availability of better designed equipment, the entries seem to be stereotyped, lacking in originality and imagination. Most designs still showed a predominance of high foot-candles with acceptable quality rather than good intensity with superior quality.

In the designs of former competitions, the tendency was to replace incandescent equipment with fluorescent, while in the recent contest early fluorescent installations were replaced by newer fluorescent designs and luminous and louverall ceilings. The ceiling as a lighting unit is now taking a prominent place in the superior lighting systems submitted. This type of lighting and the judicious use of supplementary lighting as a complement to a good general lighting are present in those installations which indicate the greatest originality.

The trend in the six year period has been from an emphasis on foot-candles to a consideration of brightness. It is not

an exception to have the entry include a complete study of the brightness pattern, with many entries approaching the recommended one-to-three ratio within the field of the visual task.

Yet, there seems to be a total lack of attention to economic aspects. The entries do not show that the final installation is the result of a study of several adequate systems of high quality illumination, with the final selection representing one which gives the client the largest number of lumen-hours for the dollar cost. Customer benefits are always expressed in terms of emotional pleasure derived from the new installation, rather than from the economic benefits of sound business practice.

Representative Installations

A few of the installations which received awards will be presented here. These representative installations are not necessarily the most outstanding, but were selected because they best demonstrate trends and practices.

The bank installation (Figs. 1 and 2) departs from the usual pattern of equipment and uses built-in lighting which considers the area and shape of the room

(Continued on page 232)

* Member of Merit Award Committee of 4th International Lighting Exhibition and Conference and professor of electrical engineering, U. of Illinois. Opinions expressed are those of the author, not necessarily those of the judges, nor of the National Electrical Manufacturers Assn.

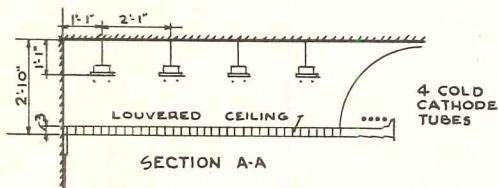

Bank lighting layout considers shape of room in combining indirect cove illumination with an egg-crate ceiling which has a higher intensity for work areas

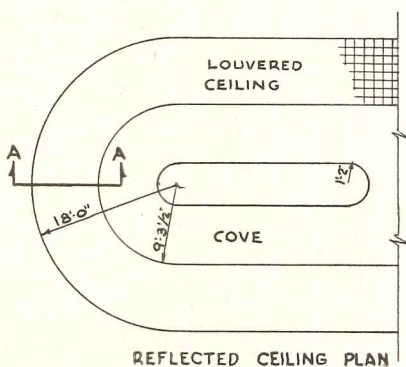

2



1

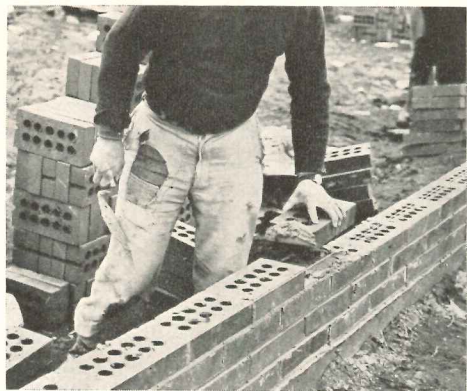
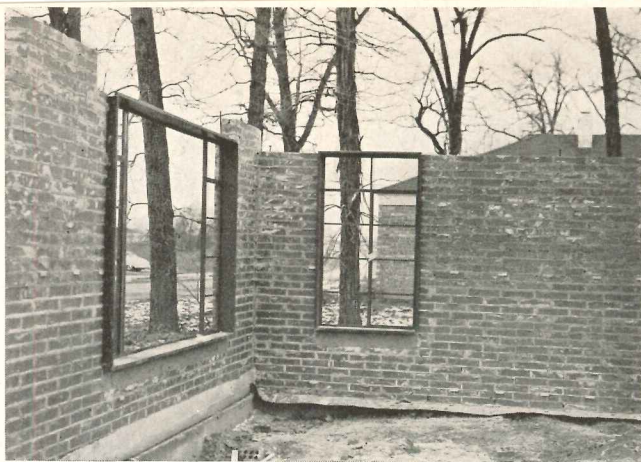

The SCR brick is designed to form complete wall with no backing other than finishing materials. Specially planned slots and coring reduce weight, simplify laying and installation of windows

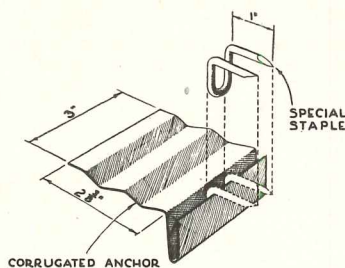
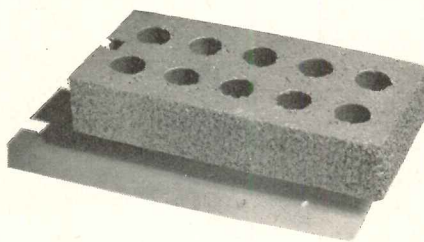

A special clip (left) reduces labor and costs in furring. Anchor is placed in mortar bed, staple driven in wood strip. Below: typical wall of new units

NEW WALL, ONE BRICK WIDE

THE cost of masonry construction is expected to be considerably reduced by a new masonry unit, the "SCR brick" recently developed by the Structural Clay Products Research Foundation. The brick has a number of features which are claimed to reduce the erected wall cost to that of quality frame construction. At present, the unit will be marketed to replace 8-in. wall construction in homes of one and one-and-a-half stories. However, approval is expected in the near future for its use in buildings of several stories.

In appearance and face size, the unit is the same as standard Norman brick, and is available in the usual range of burned clay colors. Its basic dimensions (see table below) provide modular sizes when laid with 1/2-in. mortar joints, and will turn corners nicely. Vertical coring was introduced to lighten the weight, facilitate proper laying and make it easier to handle. Holes also permit entrance of mortar which keys unit in place.

A jamb slot at one end of each brick facilitates the installation of metal windows when mounted directly in the wall without a wood surround. The unit is designed for use with 2 by 2 in. wood furring on which interior surface mate-

rials and insulation can be mounted. This provides an adequate cavity to prevent moisture penetration, reduces number of nailing plugs required.

It is reported that a mason can lay 450 of the bricks per day — the equivalent of 100 sq ft of wall. The unit has the full approval of the bricklayers union, and has obtained favorable comments from a number of architects, such as the following by Philip Will, Jr., of Perkins & Will, "This new product . . . should help to produce more space, better appearance and improve construction at lower cost, yet recognizes the realities of building codes and traditions which still govern the building industry."

Facts about SCR brick

- Size: 2 1/8 by 11 1/2 by 5 1/2 in.
 Weight: About 8 lbs.
 Features: 1. Symmetrical coring; 10 holes, 1 3/8 in. diam.
 2. Jamb slot in one end: 3/4 in. deep, 3/4 in. wide.
- Typical U factors (with 2 by 2 in. furring):
 1. 1/2 in. insulating board lath; 1/2 in. vermiculite plaster; 1 in. roll insulation12
 2. Metal lath; 3/4 in. gypsum plaster40

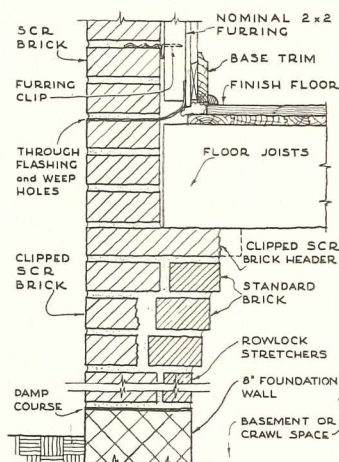
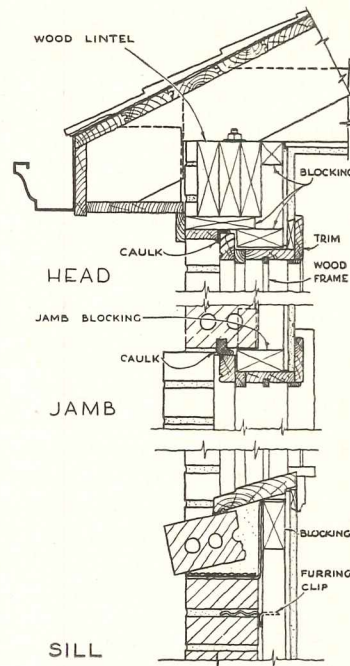

PRODUCTS for Better Building

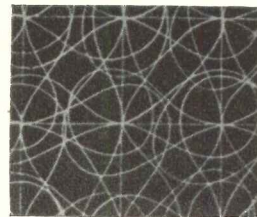
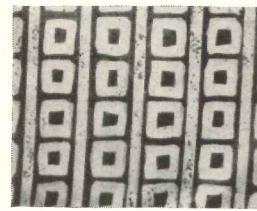
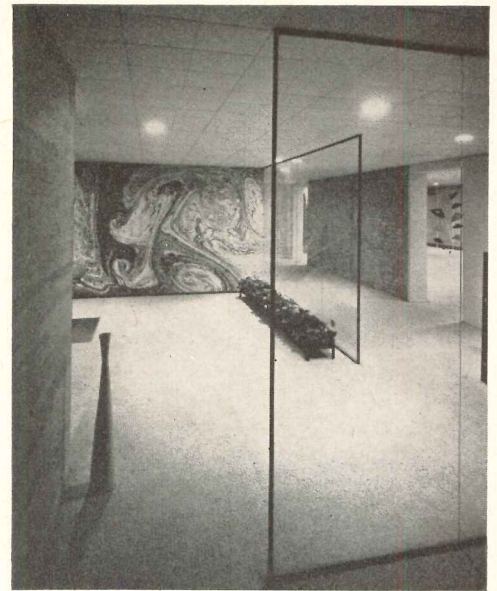
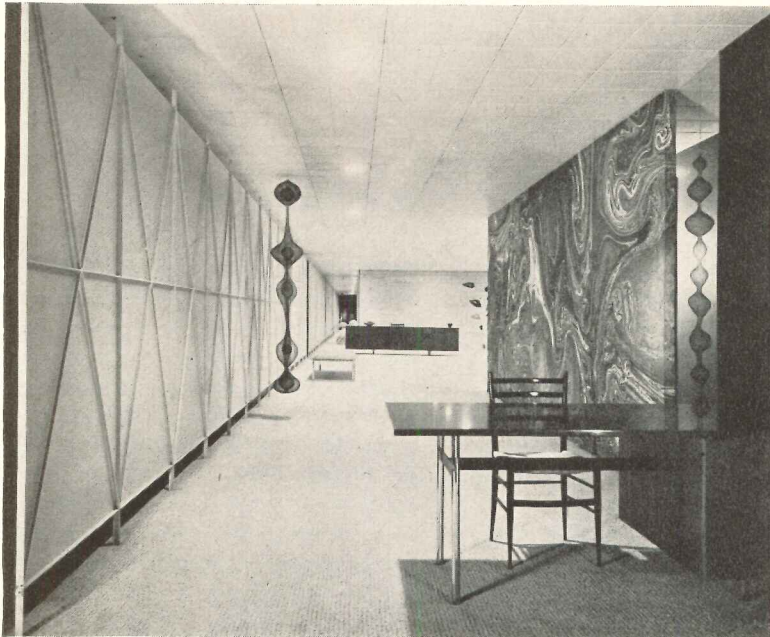

Entrance to new showroom (far left) reveals mural as background for displays (Similar rug design won A.I.D. Award). Main room (above) has great effect of spaciousness. Left: fibreglas fabrics, "Rugged Square" and "Fugue" (Good Design selection) possess translucent effect (below). Leather slung magazine rack (bottom) is typical of Laverne designs

SERVICE TO ARCHITECTS IN INTERIOR DESIGN PROBLEMS

Laverne Originals, source of many outstanding contemporary furnishings, including wallpaper, textiles, furniture and accessories, offers a special service to architects and interior designers in its "Architectural Research Unit." Working in an advisory and design capacity to assist the profession in problems of color, furniture and accessories, the group deals in both design and practical use — striving to provide intelligent solutions for individual needs and to bring about a greater cooperation between the architect, interior designer and design source. The firm's new showrooms are handsome examples of its work.

Constantly endeavoring to bring out new trends in the decorative line, Laverne has recently developed in its textile collection a new fibreglas material, which comes in a variety of handprints. This all-glass fabric is the result of the combined efforts of Laverne's Design unit and the Owens-Corning Fibreglas Research department. Possessing many qualities not found in the ordinary drapery material, it is completely fireproof, will help as insulation,

can be easily washed and requires no ironing.

Apart from the many wallpaper patterns — both individual and those coordinated with fabric — is the Marbalia Mural, an all-over, non-repetitive pattern in custom colors. Chosen by the New York Museum of Modern Art for the Good Design exhibit of 1952, the mural measures 21 ft long and 9 ft high.

Making effective use of leather, chrome-plated steel and Belgian marble, Laverne's furniture line combines simplicity with considerable elegance. Dining and occasional tables, benches, stools, and an interesting magazine rack are but few of the available items designed by the Architectural Research Unit.

Mr. Laverne is currently sponsoring a fellowship program on the recently acquired Tiffany Foundation property on Long Island, giving young designers a free reign to work out their individual ideas. Their work is carefully gone over at the end of a given time and many of the results are consequently produced in actuality. Laverne Originals, 160 E. 57th St., New York 22, N. Y.

(Continued on page 246)

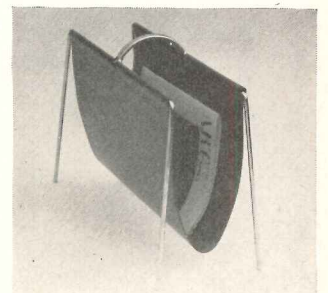
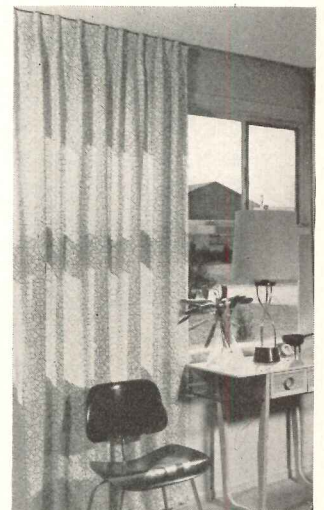

LITERATURE FOR THE OFFICE

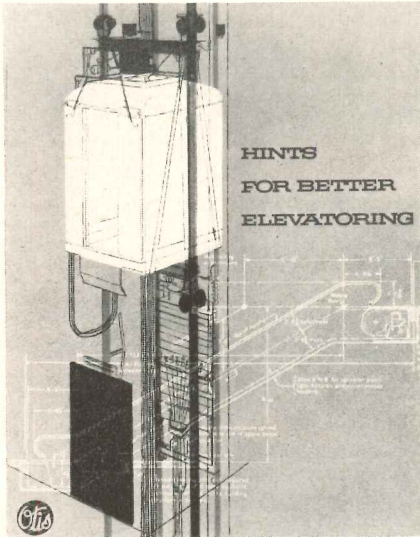

Booklet offers useful information relating to elevator system planning

Elevator Planning Guide

Hints for Better Elevating. Prepared primarily for students and for junior members of architectural and engineering staffs, this compact booklet outlines fundamentals of planning vertical transportation systems. Separate sections deal specifically with office buildings, retail stores, apartment houses, hospitals, transient hotels and industrial buildings. The booklet deals in each case with factors that must be considered in planning an elevator installation for the particular building type: building layout and structural requirements, elevator arrangement, operating systems and supervisory systems. Photographs, tables and schematic drawings are included, and recommended load capacities, platform sizes, hoistway sizes and door-opening dimensions are given. Information is also furnished concerning the planning of escalator installations. 28 pp., illus. Otis Elevator Co., 260 Eleventh Ave., New York 1, N. Y.*

* Other product information in Sweet's File, 1952.

Electrical Equipment

Fluorescent Ballast Tells Her Story. Brochure gives the progress of fluorescent lighting, concentrating mainly on the ballast — without which fluorescent lighting would be impossible. All of the functions of the ballast are thoroughly explained, and a description of what happens inside a fluorescent lamp is given, illustrating the uses of the electrodes, the gas and the phosphor coating. Brochure contains detailed drawings and sketches. 16 pp., illus.

Electric Power for Industry's Third and Biggest Expansion. Booklet tells how to get electric power for quick expansion — on time, at low cost, with a minimum of critical materials. The planning, ordering and installation of packaged power equipment is adequately discussed and illustrated with photographs and technical drawings. Contains information on how industry can obtain better protection against power shutdowns and secure safety for personnel. 23 pp., illus. General Electric Co., Schenectady 5, N. Y.*

Concrete and Cinder Block With Marble Facing

Marble Face Building Blocks for Interior and Exterior Uses. Catalog illustrates standard types, features and typical installations of the manufacturer's product, which was described in detail in PRODUCTS FOR BETTER BUILDING, p. 192, May 1951, ARCHITECTURAL RECORD. Specifications are included. 4 pp., illus. Marble Face Blocks, Inc., 565 Fifth Ave., New York 17, N. Y.*

Automatic Conveyor Systems

VMP Conveyors. Catalog describes and illustrates with sectional drawings the manufacturer's conveyor system for both vertical and horizontal travel. Typical recent installations are also illustrated. 4 pp., illus. Virginia Metal Products Corp., Product Information Dept., 60 Hudson St., New York, N. Y.*

Electrical Planning Data

Westinghouse Architects' and Engineers' Data Book, No. B-2161-E, 1952 Revised Edition. New edition of this well-known book includes information on new equipment and new methods of using equipment, as well as an entire new section on power distribution. Each piece of apparatus is thoroughly described with illustrations, charts and technical data. Application, features, selection, dimensions and specifications are included. The book is designed so that detailed information on almost any type of electrical equipment is readily accessible. 330 pp., illus. Westinghouse Electrical Corp., 306 4th Ave., Pittsburgh 30, Pa.*

Clay Tile Applications

Modern Industrial Washrooms, Cafeterias, Dispensaries, Kitchens; Booklet 300. Full-color photographs illustrate several model installations of clay tile and point up the advantages to be gained by employing the material. Suggested color combinations are also included, and a diagram showing desirable features in washroom planning is included. 20 pp., illus. American-Olean Tile Co., Lansdale, Pa.*

Axonometric Drawing Tools

Instrumaster Precision Tools. Circular illustrates a line of drawing tools for three-dimensional drawing, including isometric protractors, two-angle and ellipse stencils and hatching stencils. 4 pp., illus. John R. Cassell Co., Inc., 110 W. 42nd St., New York 18, N. Y.

Wrought Iron

Proof By Performance. Durability and corrosion-resistance of wrought iron in construction and piping is illustrated in this booklet with actual case histories of specific installations of the manufacturer's products. 8 pp., illus., A. M. Byers Co., Clark Bldg., Pittsburgh 22, Pa.*

(Continued on page 304)

PLANNING OCCUPATIONAL THERAPY DEPARTMENTS IN HOSPITALS: 1

By Alonzo W. Clark, A.I.A., with the collaboration of the American Occupational Therapy Association

The increasing recognition of occupational therapy as an integral part of the medical rehabilitation program has resulted in its becoming an increasingly important element of hospital planning. The following Time-Saver Standard sheets present a summary of the recommendations of the American Occupational Therapy Association on the planning of typical occupational therapy departments. These basic plans and discussions were developed to serve only as guides for designing similar units, and will not be universally applicable without some modification. This material was presented at length in the October, 1950, issue of *HOSPITALS, Journal of the American Hospital Association*. Reprints of this article, which contains extensive equipment and supply lists for planning storage are available from the American Occupational Therapy Association, 33 W. 42nd St., New York 36, N. Y.

BASIC SOLUTIONS for occupational therapy departments are largely dependent on the following factors:

1. **Number of patients to be treated.** On the basis of hospital surveys and committee recommendations, it was agreed that 30 per cent of hospital patients should normally be referred for occupational therapy. About 40 per cent of these would be treated in the clinic, and 60 per cent treated in their beds or on the wards. One occupational therapist in the clinic can generally accommodate about 15 patients in each of two daily sessions, one in the morning, one in the afternoon. This number will vary according to the type of patient—more psychiatric patients, fewer physically disabled patients.

2. **Floor space required by patients.** Approximately 54 to 61 sq ft per patient is recommended for the entire department, including clinic, office and storage. For the clinic alone, 42 to 47 sq ft per patient is suggested to allow for easy circulation and use of equipment. These figures are based on a study of the needs of a typical department.

3. **Types of treatment media to be used.** Some 70-odd activities are

used in occupational therapy departments throughout the country. Basic requirements for small units are as follows; these should be expanded for larger units:

1. *Bench work* — carpentry, plastics, metal work including painting and finishing of completed projects.
2. *Table work* — leather, blockprinting, fly-tying, sewing and art work.
3. *Loom work* — weaving, braiding.
4. *"Functional equipment"* (not an active classification) — bicycle jig saws and other adapted equipment for treatment of physical disabilities.

Storage facilities should provide for at least 3 months' supply, as many institutions order on a quarterly basis. All the above items must, of course, be adapted to suit a particular type and size of hospital.

4. **Location of the department in a hospital.** Daylighted space as close to patient areas as possible and readily accessible to toilet facilities is recommended. Proximity to the physical therapy department is advisable. Necessary facilities include running water, gas, and electric outlets; dust collectors for power woodworking tools are recommended.

THE SMALLER UNIT

For hospitals up to a 250-bed capacity, a basic plan was evolved as shown on Sheet 2. At the rate of referral cited, up to 30 patients should be accommodated. These could be cared for by one therapist, with a possible second therapist for ward service. On the basis of 15 patients per session at 54 sq ft per patient, the entire unit was allotted 813.75 sq ft. (17½ by 46½ ft). The clinic area, planned at 42 sq ft per patient, totals 638.75 sq ft (17½ by 36½ ft). The minimum basic activities were provided for with 20 work stations for flexibility in selection. Activities requiring bulky equipment such as printing and advanced ceramics were omitted. It was assumed that preparation and finishing could be done in the clinic or on a counter top in the storeroom. The following considerations were made for the three specific areas within the department:

1. **Clinic area:** The first obvious requirement is space for free circulation around the required equipment (see general list on Sheet 2). Space for parking at least 3 wheel chairs is also necessary. Double doors at shop entrance simplify moving equipment and supplies. Sliding doors for upper cabinets avoid interference with patients working at counter tops. No display case for finished articles was included as it was felt that this emphasized the product rather than therapeutic objectives.

2. **Storage area:** Space was provided for a mobile cart for servicing ward patients. A cabinet with work top was included for preparation and finishing work. It was assumed that only 8-ft lengths of lumber and plywood would be stored in this basic unit, and that other closets, rooms, etc. in various parts of the hospital could be used for "dead storage".

3. **Office area:** Space was provided for the usual office furnishings. A large glass panel in front of the desk facilitates control and supervision of the unit.

VARIATIONS FOR HOSPITAL TYPES

The basic plan is directly applicable to *psychiatric* and *general medical and surgical hospitals*. In the latter case, a bicycle jig saw is recommended in place of a drill press stand (a table model drill press could be used).

Tuberculosis hospitals require two minor changes: replacement of one floor loom and the braid-weaving frame with two industrial sewing machines.

Pediatric hospitals need the following changes: a plan adaptable to division into two parts—one for small children, one for adolescents. For equipment changes, see plan. Tables should adjust in height.

Physical disability hospitals can use the basic plan with a few variations in equipment. Although fewer patients can be treated per therapist, fewer will be able to come to the clinic for treatment; a second therapist will be needed for treatment in the wards.

NOW YOU CAN OFFER AT NEW LOW PRICES

NEW
LOW PRICES

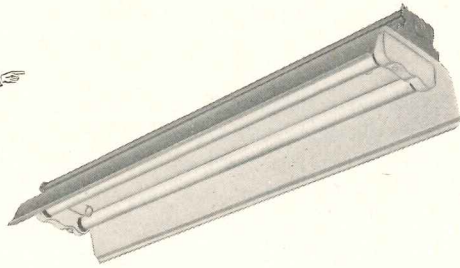

IMPROVED
PERFORMANCE



ALL-AROUND LIGHTING IMPROVEMENTS

LOW
MAINTENANCE COSTS

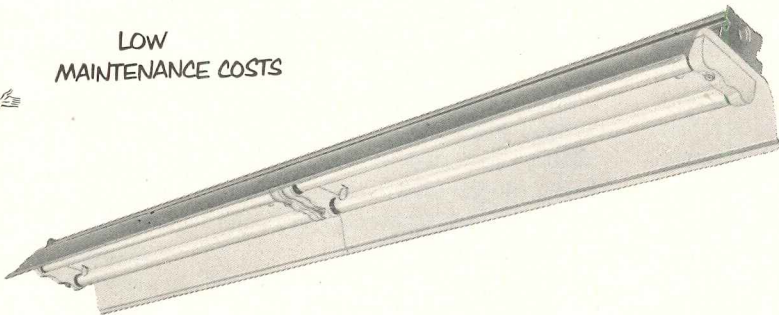

IMPROVED
DESIGN



with Sylvania's New Industrial Fixtures

Announcing 222 New Industrial Fluorescent Fixtures at an amazingly new low cost. All are engineered to meet every lighting need in any type plant for any level of illumination. Customers make additional savings since new design also cuts maintenance costs.

Reasons for Sylvania's flexibility and lower cost

Simplified designing is the basic reason for the success of this new line. With one skillfully engineered reflector and two top housings, Sylvania lighting experts have developed 6 interlocking "family" groups of 24 standard fixtures each. These, with optional variations, making up 222 different types, offer a variety and flexibility never before possible.

And, because this line requires comparatively few different parts, die costs and assembly costs are held way down. These savings are now passed along to you in lower prices.

You'll want all the facts about this splendid new fixture line. The coupon brings you new folder and data sheets for your file.

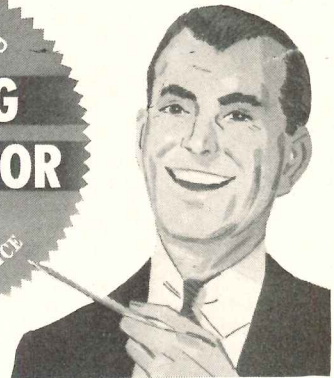
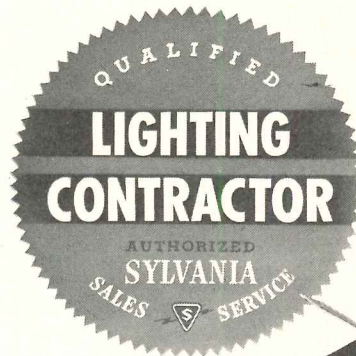

Expert interior designs need expert interpretations . . . so for your lighting requirements, see the man who displays this Qualified Lighting Contractor emblem.

MAIL THE COUPON NOW! ➔

SYLVANIA



FLUORESCENT TUBES, FIXTURES, SIGN TUBING, WIRING DEVICES; LIGHT BULBS; RADIO TUBES; TELEVISION PICTURE TUBES; ELECTRONIC PRODUCTS; ELECTRONIC TEST EQUIPMENT; PHOTOLAMPS; TELEVISION SETS

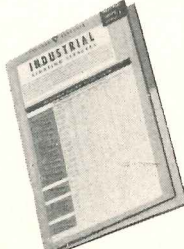

Sylvania Electric Products Inc.
Dept. L-1405, 1740 Broadway
New York 19, New York

Please send me illustrated folder and data sheets on the new line of Sylvania Industrial Fixtures.

Name

Street

City..... Zone..... State.....

PLANNING OCCUPATIONAL THERAPY DEPARTMENTS IN HOSPITALS: 2

By Alonzo W. Clark, A.I.A., with the collaboration of the American Occupational Therapy Association

Floor Plans For Typical Occupational Therapy Departments in Hospitals Up To 250 Bed Capacity

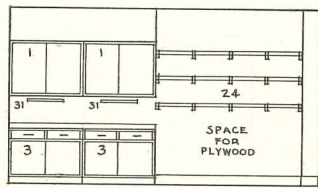

SECTION A-A

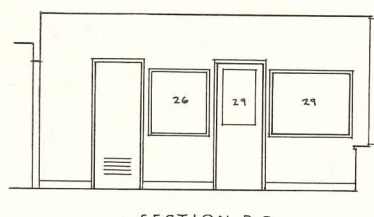

SECTION B-B

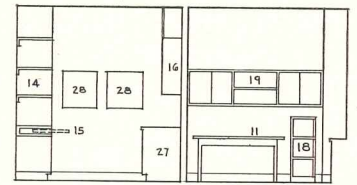

SECTION C-C

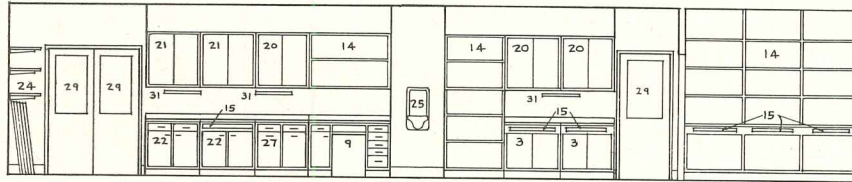

SECTION D-D

LEGEND

1. Shadow board cabinet
2. Electric tool grinder
3. Tool storage and work bench
4. 2-man bench
5. Electric jig saw
6. Drill press
7. Weave frame
8. Step stool
9. Stainless steel sink
10. Chair
11. Table—11A. Adjustable table
12. Floor loom
13. Warping board
14. Open shelving
15. Pull-out shelf
16. Storage cabinet
17. Bench for loom
18. File cabinet
19. Book shelf and cabinet
20. Tool cabinet
21. Paint cabinet
22. Finishing bench and cabinets
23. Electric hot plate
24. Lumber rack
25. Drinking fountain
26. Bulletin board
27. Storage bins and work bench
28. Table loom
29. Glass panel
30. Ironing board
31. Fluorescent light
32. Ward cart
33. Desk
34. Trash basket
35. Sand box
36. Play house
37. Circular table
38. Cut-out table—adjustable
39. Power lathe
40. Bicycle jig saw
41. Treadle sander
42. Accordion type folding door
43. Large kiln
44. Small kiln
45. Damp closet
46. Potters wheel
47. Imposing table
48. Type cabinet
49. Printing press
50. Electric circular saw
51. Typewriter table
52. Electric belt sander
53. Electric disc sander
54. Sewing machine

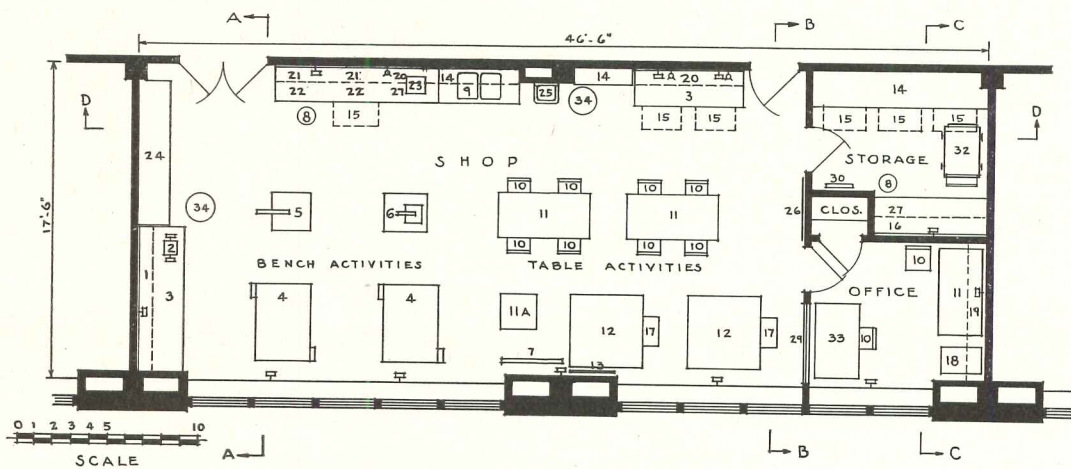

Basic plan for psychiatric, tuberculosis and general hospitals

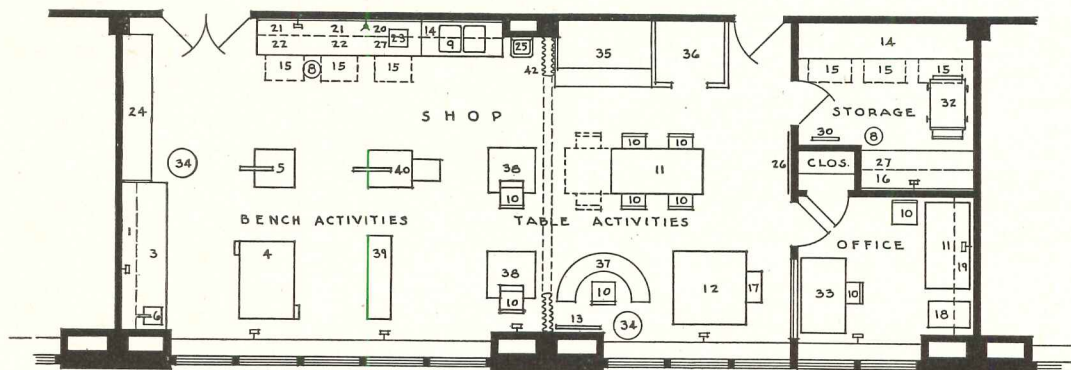

Plan adapted to physical disabilities hospitals

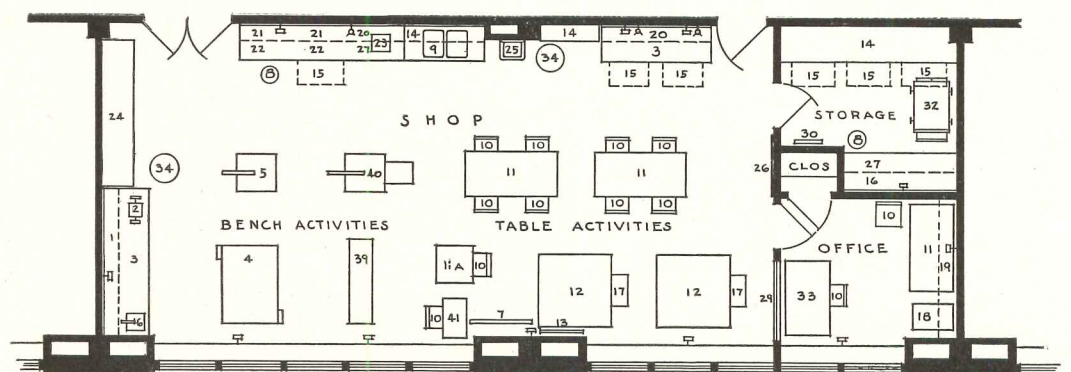

Plan adapted to pediatric hospitals

TIME SAVED STANDARDS

**the passing of time will only add
to the beauty and value of Westover
... and it's Buckingham Slate Roof**

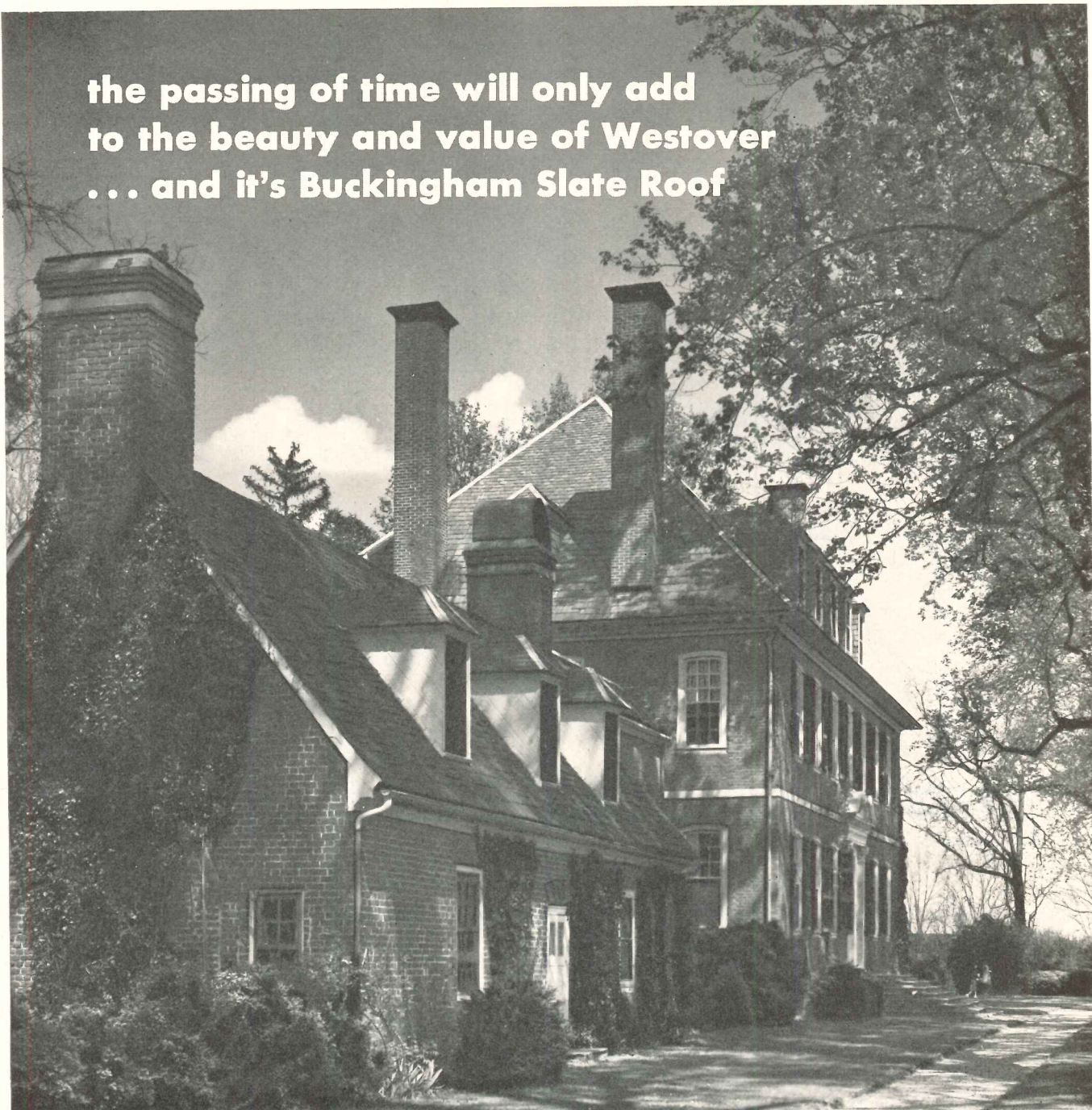

Westover: This historic Virginia Mansion is roofed for permanence and beauty with BUCKINGHAM-VIRGINIA SLATE. *Photo by Va. C. of C.*

For over five generations BUCKINGHAM slate has been selected as the best roofing material for many of the outstanding examples of architecture throughout America. No machine-made roofing product has ever surpassed the charm and permanence of this hand-crafted product of nature.

A BUCKINGHAM slate roof has many EXTRA-VALUE features . . . unfading color and lustre can be matched after any length of time, protection from elements for life of building, no costly repairs, no ultimate replacement, higher resale value, insurance and loan advantages, safe fire protection, lowest average absorption and highest resistance to acids of any slate in America.

Proven by 150 continuous years on the roof without fading or decay, BUCKINGHAM slate can be specified with confidence. Architects may select from a wide range of sizes and thicknesses, and prompt ship-

ments can be made from the ample stocks of our quarries at Arvon, Virginia.

Because of their insistence upon quality materials today, more architects than ever are giving their clients the benefit of this lifetime roof economy. See our catalog in Sweet's Architectural File, or write for samples and information.



**BUCKINGHAM-VIRGINIA
SLATE CORPORATION**
1103 E. MAIN ST. • RICHMOND, VA.

PLANNING OCCUPATIONAL THERAPY DEPARTMENTS IN HOSPITALS: 3

By Alonzo W. Clark, A.I.A., with the collaboration of the American Occupational Therapy Association

Floor Plans For Typical Occupational Therapy Departments in Hospitals Up To 500 Bed Capacity

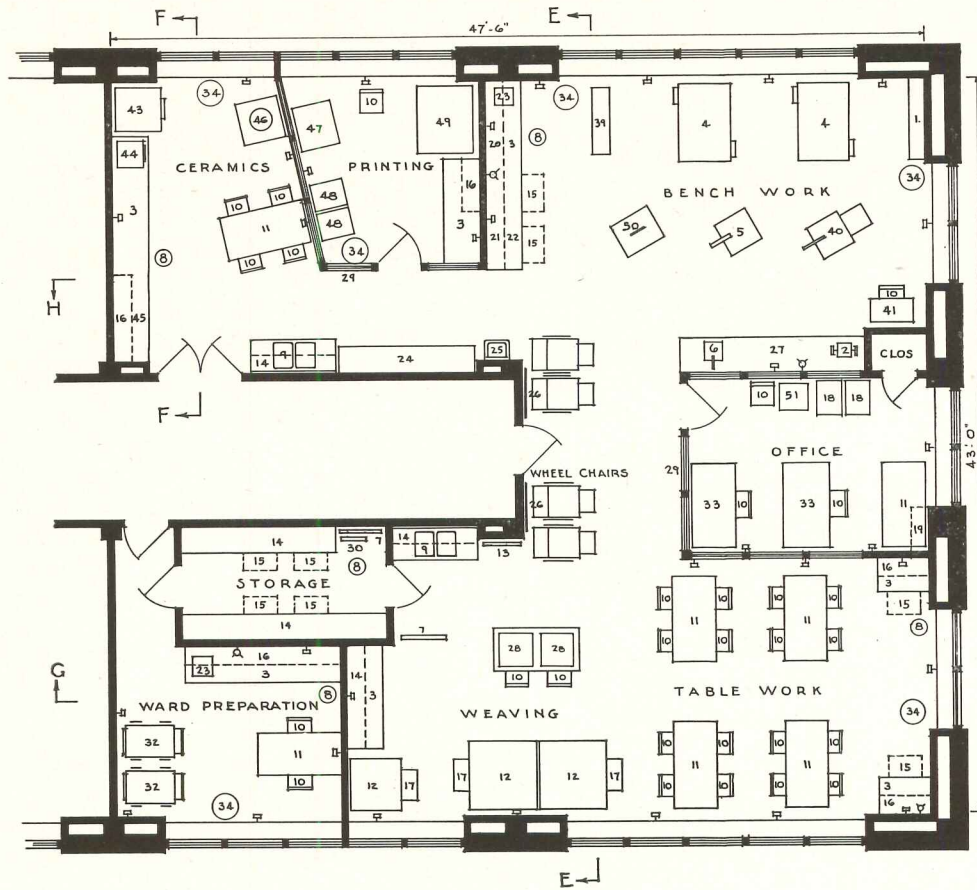

LEGEND

1. Shadow board cabinet
2. Electric tool grinder
3. Tool storage and work bench
4. 2-man bench
5. Electric jig saw
6. Drill press
7. Weave frame
8. Step stool
9. Stainless steel sink
10. Chair
11. Table—11A. Adjustable table
12. Floor loom
13. Warping board
14. Open shelving
15. Pull-out shelf
16. Storage cabinet
17. Bench for loom
18. File cabinet
19. Book shelf and cabinet
20. Tool cabinet
21. Paint cabinet
22. Finishing bench and cabinets
23. Electric hot plate
24. Lumber rack
25. Drinking fountain
26. Bulletin board
27. Storage bins and work bench
28. Table loom
29. Glass panel
30. Ironing board
31. Fluorescent light
32. Ward cart
33. Desk
34. Trash basket
35. Sand box
36. Play house
37. Circular table
38. Cut-out table—adjustable
39. Power lathe
40. Bicycle jig saw
41. Treadle sander
42. Accordion type folding door
43. Large kiln
44. Small kiln
45. Damp closet
46. Potters wheel
47. Imposing table
48. Type cabinet
49. Printing press
50. Electric circular saw
51. Typewriter table
52. Electric belt sander
53. Electric disc sander
54. Sewing machine

Plan for psychiatric, physical disability and general hospitals

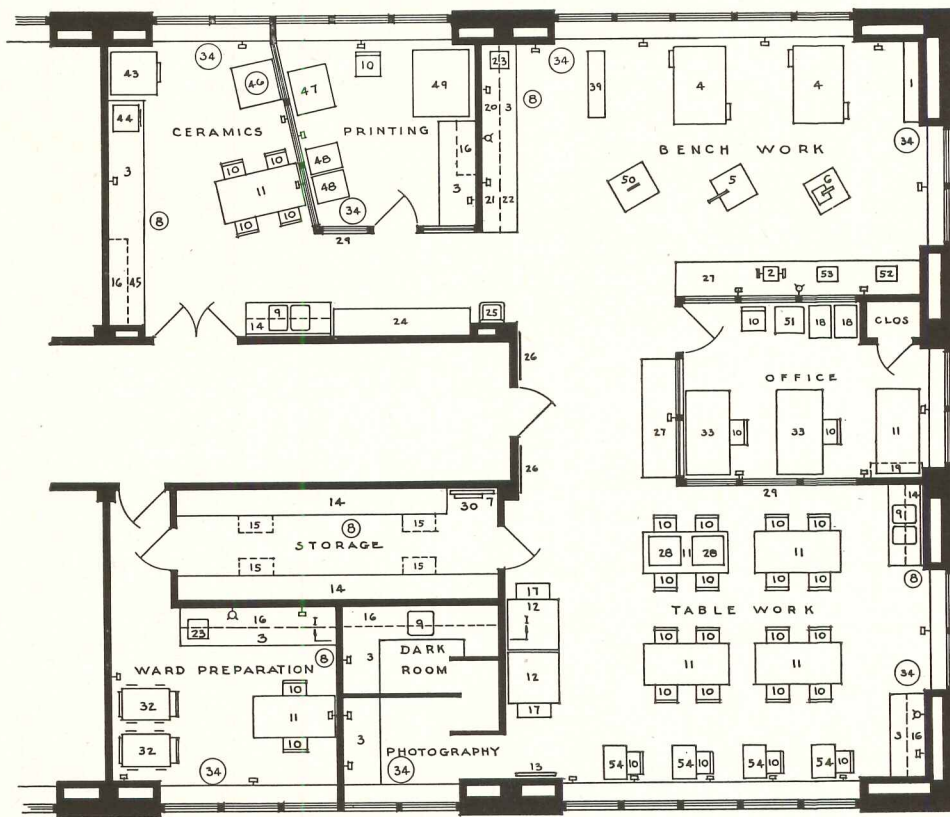

Plan adapted to tuberculosis hospitals 300 to 500 bed capacity

Architectural Engineering

marble

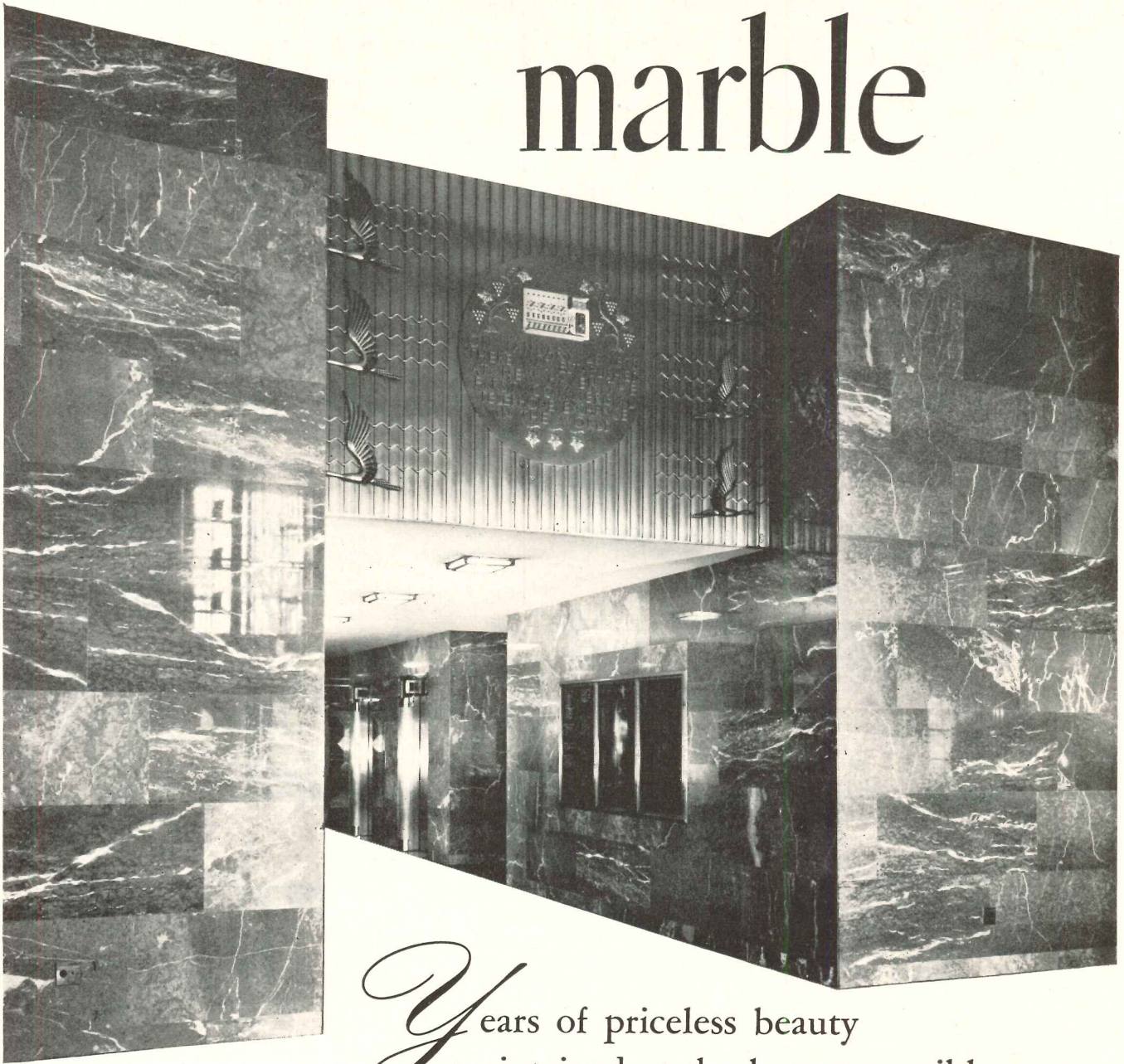

*Y*ears of priceless beauty
maintained at the lowest possible cost

Compare the cost of maintaining Marble with that for any other material. Add to this low-cost-maintenance factor the long years of beauty, prestige, and service which Marble provides. Can there be any better choice than Marble? *"There is no substitute for Marble."*

NEW ENGLAND TEL. & TEL. BUILDING,
NEW HAVEN, CONN.,
DOUGLAS ORR, ARCHITECT.

The Marble Institute of America protects your heritage in one of America's great industries. Each of its members is pledged to provide the finest materials, finished in America, by Americans, no matter what its source. You can depend on the integrity of your local M. I. A. member.

Literature available: M. I. A. membership list, Marble availability, Marble care, brochures on Marble in the Bank, the Home, the Hospital, Stores, *Write:*

MARBLE  NSTITUTE OF AMERICA, INC.

108 FORSTER AVENUE, MOUNT VERNON, NEW YORK

PLANNING OCCUPATIONAL THERAPY DEPARTMENTS IN HOSPITALS: 4

By Alonzo W. Clark, A.I.A., with the collaboration of the American Occupational Therapy Association

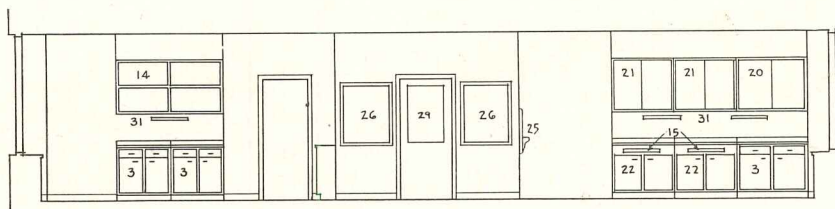

SECTION E-E

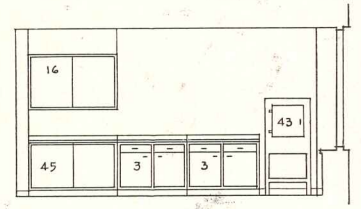

SECTION F-F

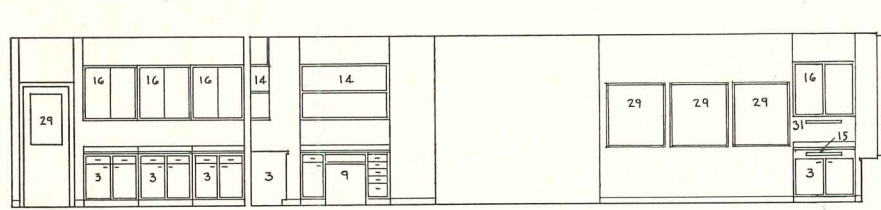

SECTION G-G

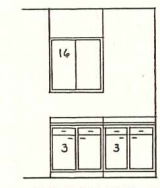

CABINET IN PRINTING ROOM

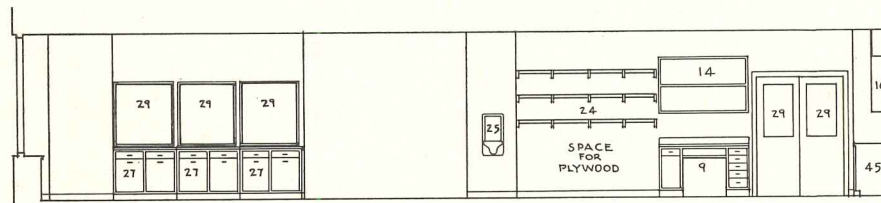

SECTION H-H

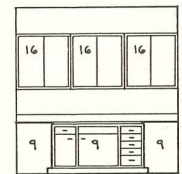

SECTION I-I

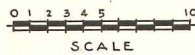

Room Sections for Typical Occupational Therapy Departments in Hospitals Up To 500 Bed Capacity (See Sheet 3 for Legend)

THE LARGER UNIT

A basic plan for a typical occupational therapy unit for large hospitals of approximately 500 beds is shown on Sheet 3. Again using the same basis for rate of patient referrals to the department (30 per cent of rated bed capacity), the large unit should accommodate 150 patients a day. The actual clinic load would be 60 patients (40 per cent of 150), or about 30 in each of two sessions.

The unit as presented was planned on the basis of 31 patients. Using 61 sq ft per person, the gross area allotted the entire unit is approximately 1,880 sq ft. Net area of the clinic is about 1,450 sq ft, or 47 sq ft per person.

This increased space per person over that allowed in the smaller unit is the result of adding two activities requiring bulky equipment and sepa-

rate rooms. These are ceramics and printing. It was also deemed essential to have a separate ward preparation room to serve the increased number of ward patients. To allow for a necessary dispersion factor, 10 extra work stations are provided in the clinic. The larger unit therefore contains the following sections:

1. Clinic, including weaving and table activities area, bench activities, printing unit, ceramics unit.
2. Office.
3. Storage.
4. Ward preparation area.

Three therapists plus three assistants could run clinic and wards.

Space requirements for the various activities were determined from the following estimate:

| Activity | % of Patients | No. of Patients |
|-----------------------------------|---------------|-----------------|
| Wood, plastics, metal | 22 | 7 |
| General crafts (table activities) | 64 | 19 |
| Ceramics | 9 | 3 |
| Printing | 5 | 2 |
| | 100 | 31 |

Variations for hospital types: the larger plan is suitable for general medical and surgical hospitals, psychiatric hospitals and, with minor changes in equipment, for hospitals treating physical disabilities. Several units might be used for very large psychiatric hospitals. Pediatric hospitals are seldom as large as 500 beds; if so more personnel are needed.

Tuberculosis hospitals require a number of variations as shown on the separate plan on Sheet 3. Separate recreational rooms and sterilization equipment might be needed.

Since the introduction of fluorescent lighting...

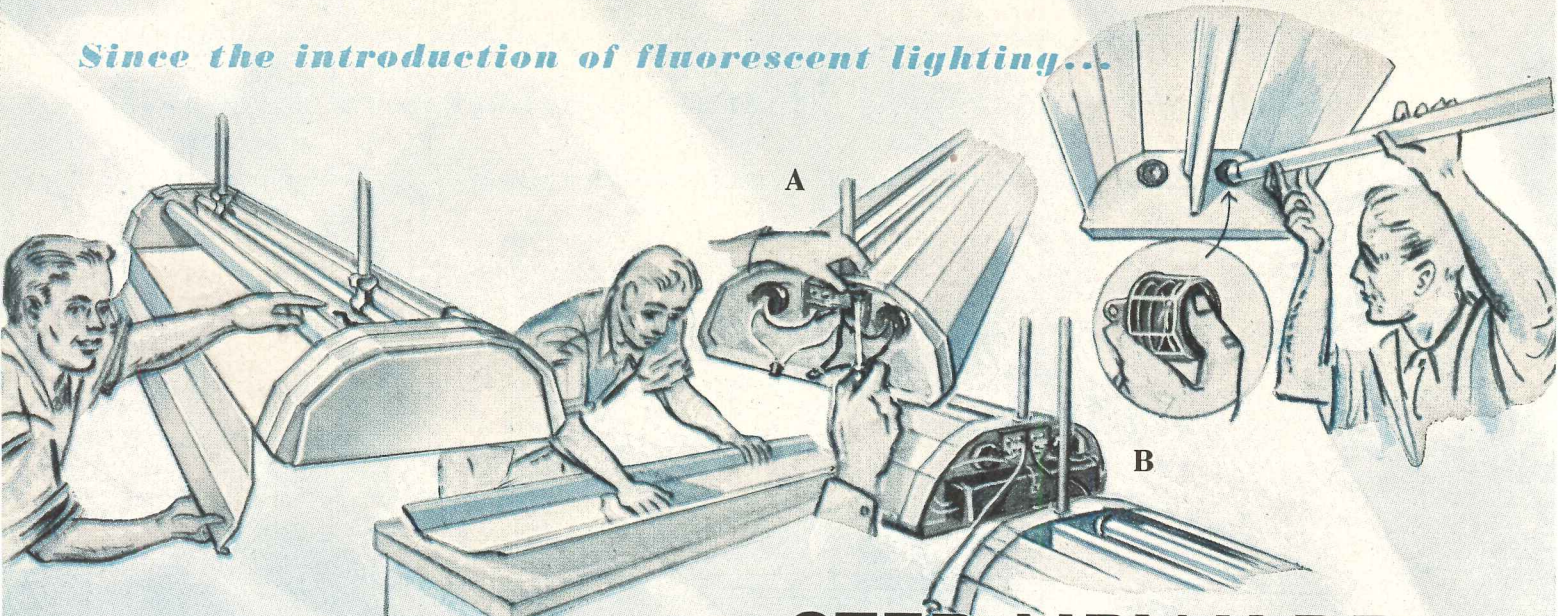

greatest **STEP UPWARD**
in industrial **SEEING COMFORT**
...new **BENJAMIN** *Task Master*

Shatters precedent with a completely new concept of lighting unit design!

Masters the brightness ratio problem by directing approx. $\frac{1}{4}$ of light upward!

Doubles...even triples...present standards for industrial seeing comfort!

Introduces new methods of installation and maintenance!

Yes, the new Benjamin "Task Master" is the greatest step UPWARD in industrial fluorescent lighting history. It's a step UPWARD to high lighting levels without the discomfort which can often accompany them... a step UPWARD to complete freedom from annoying ceiling contrast that may cause excessive brightness ratios. It's a step UPWARD to greater seeing comfort in Amer-

ica's work places! Moreover—"Task Master" represents a great step UPWARD in high-speed installation and trouble-free maintenance, as shown above. Get full details about this greatest step UPWARD in industrial seeing comfort... send for FREE "TASK MASTER" Data Bulletin, containing complete specifications. Write: Benjamin Electric Mfg. Co., Dept. Q-1, Des Plaines, Ill.

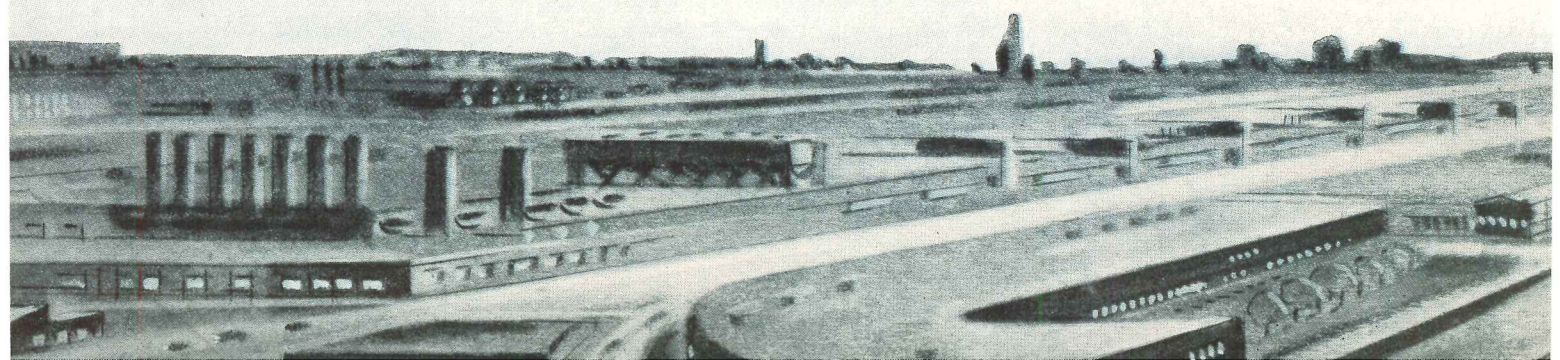

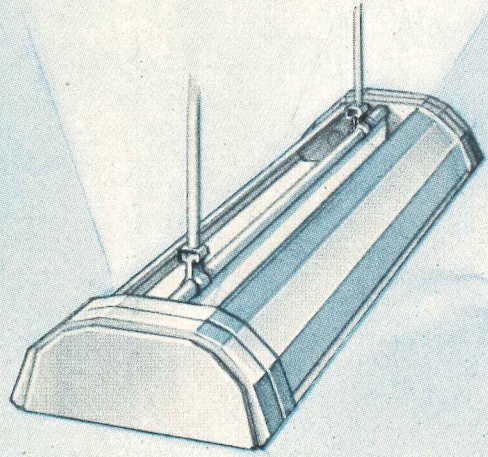
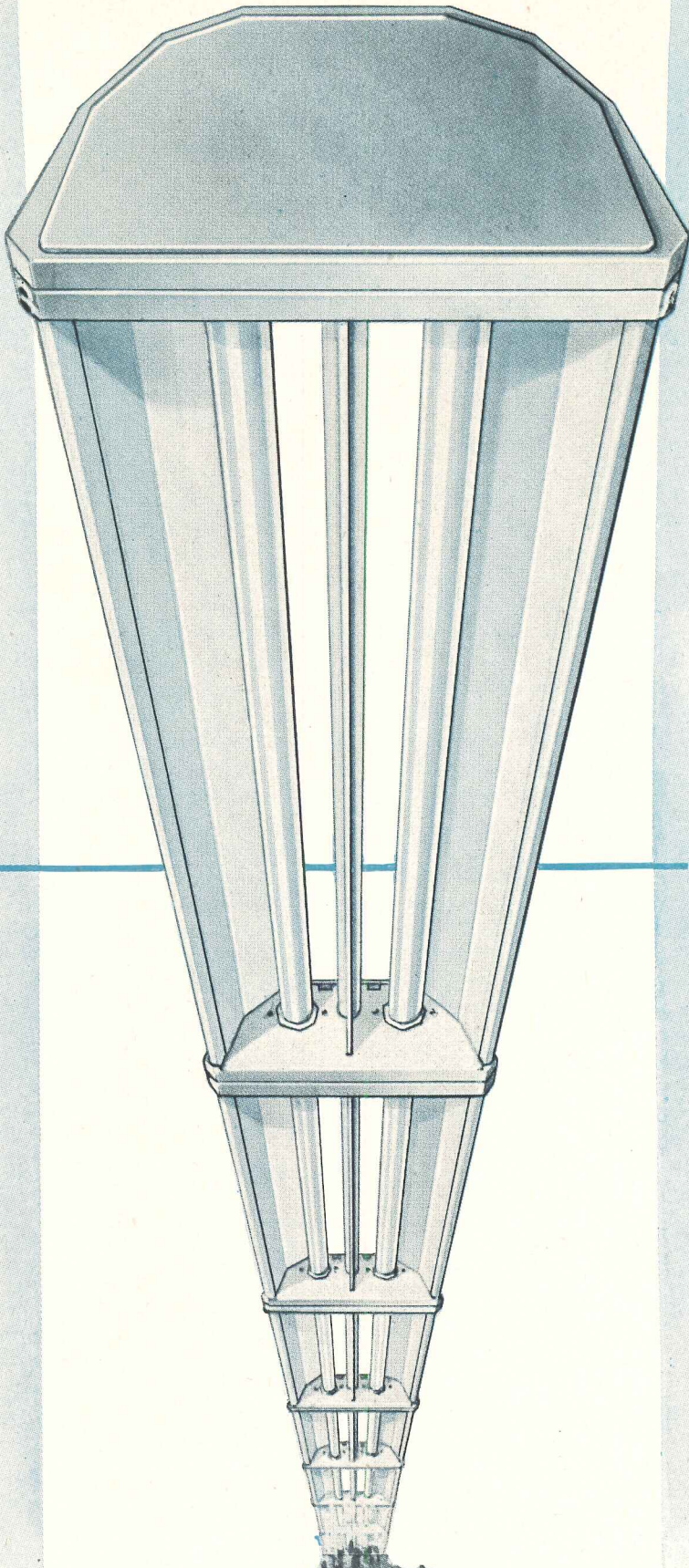

3 ways to mount: chain, conduit and sliding hanger suspension (illustrated).

UPWARD ILLUMINATION COMPONENT directs approximately $\frac{1}{4}$ of light towards the ceiling. In addition to providing more generous **UPWARD** flow of light, this unique construction reduces maintenance expense as it practically eliminates horizontal areas where dust and dirt can collect.

DETACHABLE REFLECTORS are hinged to facilitate easier, more thorough cleaning right on the fixture; or they may be quickly unhinged and replaced with reflectors which were previously cleaned at a bench. 2 simple spring-type clips lock or release each reflector . . . no tools needed.

PRE-WIRED . . . NO WIRE SPLICING . . . All Connections made to Terminal block. No need to run line wire through fixture. Furnished with branch circuit wiring already run through a combination spine support and lamp shield. (Shielding angle is 35°) Just connect line wires to terminals (see picture A above). For continuous line installations, simply connect "jumper" wires to opposite terminal blocks (see picture B).

BALLAST AND TERMINAL BLOCK are strategically located in easily-accessible end sections . . . out of the way for more streamlined appearance.

Of course, **EXCLUSIVE BENJAMIN "SPRINGLOX" LAMPHOLDERS** are standard equipment. They are acknowledged as embodying the most advanced lampholder features. Such as: rugged, all-metal construction and unique, patented spring design for "quick-in, quick-out" lamp maintenance.

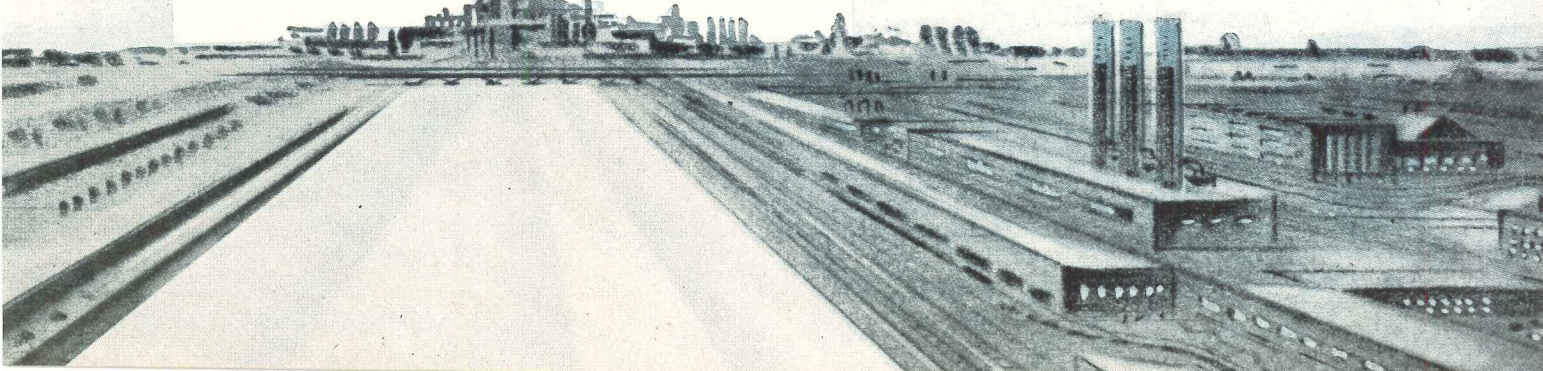

Color

There is every reason to consider the blending of colors as perhaps equal in importance to the more measurable light qualities of intensity and brightness. The environment in which a child works must, first of all, be inviting and pleasant. The ability of a normal individual to receive and understand what he is looking at is probably as much a matter of psychology as performance of the eye mechanism.

Low-contrast, high reflectance schemes, with their concomitant pastel shades, leave much to be desired from a decorative point of view and may actually not serve well the physiological and psychological needs of children.

Hue. Hue has been thought to have important psychological implications in school environment, largely due to color associations. Generally, the cool colors (green, blue, turquoise, and lavender) are restful and relaxing. The warm colors (red, orange, and yellow) are stimulating and exciting. The latter hues are also called advancing, since they are the ones most sharply focused by the eye, while the blues, greens and violets are receding; however, a brilliant green may "advance" in front of a dull red. There is a question as to how much psychological value any particular hue may have, in spite of all that has been said on the subject. The important thing is to achieve variety in their saturation and contrast in their use.

Still, the selection of hues for various school situations requires some consideration of the reactions and associations generally attributed to colors. Stimulating colors may be considered most useful in playrooms, lunchrooms, corridors, and entrances. When these hues are used in classrooms, they should probably be related carefully to the size of the area to

be covered and the particular result to be achieved.

The elementary classroom is becoming, more and more, a large laboratory with space provisions for a variety of activities. Color planning can do much to tie the laboratory functions together and yet allow the child to distinguish between the work areas.

The reading area calls for quiet hues, of a non-distracting quality. Areas for reading, music, art, and construction activities should utilize color for ready identification. The science space may possess qualities for the display of exhibits, small animals, fish and plants, to best advantage. The motion picture area should be designed to increase light absorption as much as possible.

There is little question that good illumination can be secured regardless of the hues. This, therefore, emphasizes the great latitude possible in choosing colors for elementary classrooms and the tremendous variety that may be employed to create an interesting environment. Children love color—big, bold, and bright. Soft, delicate, or grayish hues lack the cheerfulness and stimulation that appeal to them.

Corridors and stairways may be bright yellow, especially if poorly lighted naturally. A combination of dark purple stairwell and light treads makes the steps easy to see. Offices in soft green or blue-green are quite practical. And, of course, cool colors are desired on the sunny side.

Value. Value denotes the amount of light reflected from a color and is similar, therefore, to the term brightness as referred to lights. For example, blue may have many values ranging from light blue to dark blue.

The current tendency appears to be to weaken the colors by making them extremely light in value for the sake of greater reflectance. The desirability of

this trend is very questionable. It would seem more practical to vary the values from wall to wall, or area to area, if for no other reason than to provide a comfortable environment for each task.

Chroma. The strength of a color is known as chroma. It is a quality of brilliance. Some light blues, for example are more intense or brilliant than others. Also, within the spectrum, some hues are stronger in chroma than others. Red is the most intense color. Blue-green is a weaker color. A grayish blue-green would be extremely weak in comparison with a saturated red.

Intense colors require great skill in their use over large areas if they are to be universally pleasing. Accent given to small areas by the strong colors is frequently helpful if done in good taste.

Mass. What has been said about intense and weak colors would indicate that mass or area covered is an important consideration in color planning. Colors with high chroma should probably be confined to smaller areas in contrast with less intense colors.

Artificial Light and Color. Colors will vary in appearance with different types of artificial lights.

Here is what happens to a maroon under several artificial lighting conditions and different kinds of daylight:

| Type of Light | Cast of Maroon |
|---------------------|-------------------------------|
| Natural daylight | True maroon |
| Skylight alone | Bluish-violet cast |
| Sunlight alone | Brownish-orange |
| Incandescent | Light and bright |
| Fluorescent | |
| White | Brown cast, dull |
| Warmtone | Dark |
| Deluxe Warmtone | Bright, rich |
| Soft White | Red cast |
| Deluxe Cool White | Clear, vivid, slightly darker |
| Standard Cool White | Darkened, grayed |
| Daylight | Violet cast, dark |

In picking colors, it is important to view them under conditions of daylight with the proper exposure as well as under the artificial light which will be used.

Principally, schools need color, light, and a cheerful, open environment. There appears to be no formula by which this can be achieved. In fact, formulas and "perfection" may defeat the principal purpose by creating sterility of environment. Fundamentally, we desire an environment conducive to interest, stimulation, and growth of children. This is no mechanical task, but rather one of the greatest complexity.



A cheerful, open environment is needed in elementary schools, conducive to interest, stimulation and growth of children