

ARCHITECTURAL RECORD



SEPTEMBER 1952

RESEARCH LABORATORIES, SCHOOL OF MEDICINE, WASHINGTON UNIVERSITY, ST. LOUIS, MO.

Every Modern
Home Needs..

NUTONE

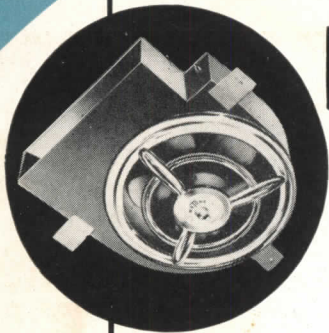

Fresh Clean Air

NUTONE VENTILATING FANS

For Kitchen, Bathroom, Recreation or Utility Rooms. 26 Wall and Ceiling Models. \$24.20 to \$38.50 list.

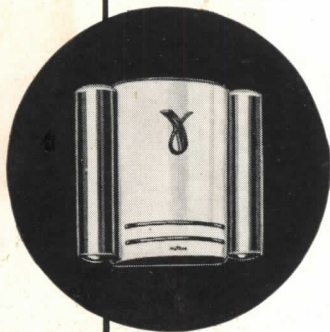

a "Cheerful Earful"

NUTONE DOOR CHIMES

For a friendly musical greeting at the door. 15 Models for Kitchen, Hall or Living Room. \$4.25 to \$82.75 list.

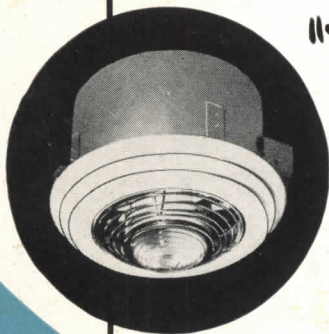

"Toasty Warm" Bathroom

NUTONE HEAT-A-LITE

The world's safest electric heater . . . built into the ceiling. No burns, no shocks. 8 Models. \$49.95 to \$67.95 list.



NUTONE

FREE

Complete details, literature, diagrams, specifications, installation data. Write NUTONE, INC., Dept. AR-16, Cincinnati 27, Ohio

ARCHITECTURAL RECORD



Copyright 1952 by F. W. DODGE CORPORATION, with all rights reserved • Publishing Director, Magazine Division, H. Judd Payne • Business Manager, Robert F. Marshall • EDITORS: Executive Editor, Joseph B. Mason; Managing Editor, Emerson Goble; Senior Associate Editor, Frank G. Lopez, A.I.A.; Associate Editor, James S.

Hornbeck; Associate Editor, Florence A. van Wyck; Associate Editor (Engineering), Robert E. Fischer; Associate Editor, Herbert L. Smith, Jr., A.I.A.; Western Editor, Elisabeth Kendall Thompson; Assistant Editor (News), Jeanne M. Davern; Contributing Editors, Ernest Mickel (Washington), John Caulfield Smith, M.R.A.I.C. (Canada); Editorial Assistants, Carl Scarenco, Enid Belding, Mary Lou Finnegan, Jeanne G. Whitbeck • DESIGN: Consultant, M. Peter Piening; Director, Alfred Petersen; Assistants, Joseph D'Amato, Donald Ervin; Drafting, Sigmond Ward • CONSULTANTS: Industry Relations Consultant, Thomas S. Holden; Statistical Consultant, Clyde Shute; Field Research Consultant, Clifford Dunnells, Jr.; Public Relations Consultant, Samuel C. Pace.

Architectural Record (combined with American Architect and Architecture) is published monthly by F. W. Dodge Corporation, 10 Ferry Street, Concord, N. H., with editorial and executive offices at 119 West 40th Street, New York 18, N. Y. Western editorial office, 2877 Shasta Road, Berkeley 8, Calif.

Chairman of the board, James McV. Breed; vice chairman of the board, Paul Abbott; president, Thomas S. Holden; vice president and treasurer, Howard Barringer; secretary, Sanford D. Stockton, Jr.; vice presidents: Irving W. Hadsell, Chauncey L. Williams, H. Judd Payne, T. Oliver Morgan; assistant secretaries: George W. Morgan, Jr., William C. Breed, Jr.; assistant vice presidents: Clyde Shute, Clifford G. Dunnells, Jr., Howard M. Thompson, Marc Wayne, Robert F. Marshall; assistant treasurers: Walter F. DeSalx, Edwin H. Freed, Irving B. Saffin; regional vice presidents: Carl S. Bennett, Ralph M. Hairston, Julius T. Little, Richard H. Ray.

Subscription rates: United States and possessions, Canada, Cuba, Mexico, Central and South America, and Spain, \$4.50 a year, \$7.50 for two years, \$9 for three years; elsewhere, \$6.50 a year, \$11.50 for two years, \$15 for three years. Single copy \$2. Circulation manager, Marshall T. Ginn.

Member of Audit Bureau of Circulations and Associated Business Publications. Architectural Record is indexed in Readers' Guide to Periodical Literature, Art Index, Industrial Arts Index and Engineering Index.

Every effort will be made to return material submitted for possible publication (if accompanied by stamped, addressed envelope), but the editors and the corporation will not be responsible for loss or damage.

Other Dodge services: Dodge Reports and Dodge Statistical Research Service, Sweet's Files, Home Owners' Catalogs, Chicago Construction News, Daily Pacific Builder, Denver Daily Journal, Real Estate Record & Builders' Guide.

Cover: Research Laboratories, School of Medicine, Washington University, St. Louis, Mo. Harris Armstrong, Architect; Hedrich-Blessing, Photographer

THE RECORD REPORTS	11
News from Washington. By Ernest Mickel	11, 38
News from Canada. By John Caulfield Smith	28
Construction Cost Indexes	42
REQUIRED READING	46
RESEARCH LABORATORIES, SCHOOL OF MEDICINE, WASHINGTON UNIVERSITY	109
St. Louis, Mo. Harris Armstrong, Architect	
THE END OF THE MODERN MOVEMENT IN ARCHITECTURE	115
By Osbert Lancaster	
HOUSTON'S LAW ENFORCEMENT CENTER	124
Police Administration, Corporation Courts & Jail Building, Houston, Tex. Kenneth Franzheim, Architect	
LANGLEY-BATH-CLEARWATER HIGH SCHOOL	130
Aiken, S. C. William G. Lyles, Bissett, Carlisle & Wolff, Architects	
CENTURY ELECTRIC COMPANY	136
St. Louis, Mo. Wm. B. Ittner, Inc., Architects & Engineers	
LOUISIANA WEEKEND HOUSE	139
Dr. and Mrs. Morris Shushan, Owners. Curtis & Davis, Architects	
CALIFORNIA BEACH HOUSE	142
Stinson Beach, Marin County, Calif. Mrs. Harry A. Yeazell, Owner. Francis Joseph McCarthy, Architect	
COUNTRY HOUSE ON LONG ISLAND	145
Residence for K. L. Rawson. Serge P. Petroff and Harvey P. Clarkson, Architects	
MISSISSIPPI HOUSE DESIGNED FOR HOSPITALITY	150
Mr. and Mrs. George Harrison, Owners. James T. Canizaro, Architect	
WAIKIKI BEACH SHOPS	153
Waikiki, Honolulu, Hawaii. Wimberly and Cook, Architects	
SUNSHINE SCHOOL FOR THE CEREBRAL PALSIED	156
Fresno, Calif. David H. Horn and M. D. Mortland, Architects; Clinton C. Ternstrom, Associate Architect	
DEPENDENT UNIT, RIVERSIDE COUNTY JUVENILE HALL	162
Arlington, Calif. Milton H. Caughey, Architect	
BUILDING TYPES STUDY NO. 190 . . . NAVY BUILDINGS	165
ARCHITECTURAL ENGINEERING	
TECHNICAL NEWS AND RESEARCH	
PLANTING THE SITE	197
By Maud Sargent, Landscape Architect	
TECHNICAL NEWS	204
Louvered Skylight, Ventilator Combined	204
Guide for A-Bomb Resistance of Buildings	205
PRODUCTS FOR BETTER BUILDING	207
LITERATURE FOR THE OFFICE	208
TIME-SAVER STANDARDS	193
Structural Forms — 5, 6, 7: Long Spans in Wood. By Seymour Howard, Architect	
Porcelain Enamel — 10: Sign Letters. Prepared by Harold Edelman, A.I.A.	
INDEX TO ADVERTISING	6

INDEX TO ADVERTISING

MANUFACTURERS' PRE-FILED CATALOG

Symbols "a", "b", and "e" indicate that catalogs of firms so marked are available in Sweet's Files as follows:

a—Sweet's File, Architectural, 1952
b—Sweet's File for Builders, 1952
e—Sweet's File, Engineering, 1952

a Accurate Metal Weatherstrip Co., Inc.	236	Globe Automatic Sprinkler Co.	32
ab Adam, Frank Electric Co.	233	a Goodrich, B. F. Co.	328
a Adams & Westlake Co.	209	a Goodyear Flooring Department	315
Aerofin Corporation	322	a Governor Corporation	361
a Aetna Steel Products Corp.	303	a Grant Pulley & Hardware Co.	368
Affiliated Gas Equipment	327	e Gregory Industries, Inc.	324
Air Devices, Inc.	378	a Guth, Edwin F. Company	370
Alan Wood Steel Company	296	a Haertel, W. J. & Company	294
a Alberer Stone Corp. of Virginia	359	a Hall-Mack Company	103
a Allan, W. D. Manufacturing Co.	343-378	Hamilton Manufacturing Company	357
b Alliance Ware, Inc.	382	Hart & Hegeman Division	375
Aloe, A. S. Co.	374	ae Hauserman, E. F. Co.	306
Alsynite Company of America	214	a Haws Drinking Faucet Co.	38
a Alumiline Corporation	349	ab Heatilator, Inc.	246
ab Aluminum Window Mfrs. Assoc.	40-41	a Heinemann Electric Company	352
a American Air Filter Company, Inc.	248-249	ae Harrick Manufacturing Co.	371
ab American Billrite Rubber Co.	292	a Herring-Hall-Marin Safe Company	69
ae American Blower Co.	337	Higgins Inc.	277
a American Brass Company	33	a Hilliard Sales Co.	34
ab American Hardware Corporation	220-221	a Hoffman Specialty Mfg. Corp.	265
American Pencil Company	367	a Holophane Co.	330
b American Radiator & Standard Sanitary Corp.	302	ab Homasote Company	266-267
ab American Welding & Mfg. Co.	354	a Horn Brothers Company	264
Ames Iron Works	357	ab Hunter-Douglas Corporation	298
ab Andersen Corporation	230-231	ab Hunter Fan & Ventilating Co., Inc.	380
a Anemostat Corporation of America	7	abe Ilg Electric Ventilating Co.	53
Architectural Record	286-287	a Imperial Brass Manufacturing Co.	16
ab Armstrong Cork Company	212	Infra Insulation, Inc.	15
Arrow-Hart & Hegeman Electric Co.	375	a Inland Steel Company	80-81
Art Metal Company	43	ab Insulte Division	242-243
abe Asbestone Corporation	95	Insulux Glass Block Division	305
a Auth Electric Company, Inc.	355	International Nickel Company, Inc., The	381
ae Barber-Colman Company	76-375	ab Jackson & Church Co.	343
ae Bayley, William Company	74	ae Johns-Manville	339
Benjamin Electric Mfg. Co.	55	Johnson, S. T. Co.	362
ab Bethlehem Steel Company	254	Kahstron	83
Bituminous Coal Institute	314	a Kawneer Company	250-251
Blank, Frederic & Company	331	ab Kenfile, Inc.	19
Books	292-316	a Kent-Moore Organization	347
Bostwick Steel Lath Company	54	ab Kewanee-Ross Corporation	240
a Bradley Washfountain Co.	320	Kewaunee Mfg. Co.	272
Briggs Manufacturing Co.	49	Keystone Steel & Wire Company	305
ae Brown Company	269	Kimble Glass Company	305
ab Bruce, E. L. Co.	373	Kinetic-Chemicals Division	98-99
Bryant Heater Division	327	ae Kinnet Manufacturing Company	364
a Bundy Tubing Company	57	a Knapp Brothers Mfg. Co.	345
Burnham Corporation	377	Koh-I-Noor Pencil Co., Inc.	345
ae Burt Manufacturing Co.	342	Kohler Co.	365
a Byers, A. M. Company	4	ab Kwikset Sales & Service Company	1
ab California Redwood Association	321	a LCN Closers, Inc.	89
a Cambridge Tile Mfg. Co.	247	LaSalle Products, Inc.	340
Canon Stoker Corporation	216	abe Libbey-Owens-Ford Glass Co.	279
ae Carrier Corporation	78-311	a Lighting Products Inc.	20-21
Case, W. A. & Son	288	Lincoln Electric Company	88
ab Case Steel Products Corporation	66-67	a Litecontrol Corporation	301
a Cedar Rapids Block Company	379	ab Louisville Cement Company	97
abe Celotex Corporation	104	ae Macomber, Incorporated	283
abe Certain-teed Products Corporation	91	a Mahon, R. C. Company	47-73
Certified Ballast Manufacturers	79	a Marble Institute of America	70
Cipco Corporation	378	Markel Electric Products, Inc.	340
Cleaver Advertisements	353	a Marlo Coil Company	334
ae Cleaver-Brooks Company	257	a Marmet Corporation	351
Combustion Equipment Division	370	a Masonite Corporation	62
a Concrete Reinforcing Steel Institute	335	McQuay, Inc.	85
a Congolux Nairn, Inc.	24-25	a Medart, Fred Products, Inc.	77
Connor, W. B. Engineering Corp.	345	a Mercoid Corporation	355
b Crane Co.	60	Midget-Louver, Inc.	365
abe Crawford Door Co.	371	a Miller Company	96
a Curtis Companies-Service Bureau	369	ae Mills Company	377
a Curtis Lighting Inc.	255	a Minneapolis-Honeywell Regulator Co.	222-223
a Curtis Refrigeration Machine Division	363	ab Minnesota & Ontario Paper Company	242-243
a Cutler Mail Chute Co.	341	a Minwax Company, Inc.	364
Deco Sales	83	ab Miracle Adhesive Corp.	356
a Detroit Steel Products Company	86-241	ae Mississippi Glass Company	291
ae Dicks-Pentlus Co.	343	ae Mitchell Manufacturing Company	362
ae Duro Corporation	226-227	e Midline Manufacturing Co.	39
DuPont, de Nemours, E. I. & Co.	98-99	a Moore, P. O. Inc.	369
a Duriron Company, Inc.	244	a Morgue, Inc.	84
a Duro-O-Wall Products	379	ab Mueller Brass Co.	361
Eagle Pencil Company	65	National Clay Pipe Manufacturers, Inc.	106
Eastman Kodak Company	218-219	ae National Electric Products Corp.	30-31
Edwards Company, Inc.	319	a National Gypsum Company	258
ab Elgay Manufacturing Co.	256	National Lock Co.	360
Employment Opportunities	353	National Plastic Products Company	326
Faber, A. W.-Castell Pencil Co., Inc.	372	a National Terrazzo & Mosaic Association	298
ae Facing Tile Institute	107	e Nelson, Herman Division	248-249
ae Federal Cement Tile Company	23	a Nelson Stud Welding	324
Federal Seaboard Terra Cotta Corp.	378	a Neo-Ray Products, Inc.	349
a Fenestra Building Products	86-241	a New Castle Products	37
ab Fiat Metal Manufacturing Co.	300	Norcor Manufacturing Company	373
a Fiske, J. W. Iron Works	361	Norris-Thermador Corporation	347
a Fitzgibbons Boiler Company	359	ae Nova Sales Co.	266-267
a Flexicore Co., Inc.	353	ab NuTone, Inc.	2nd Cover
abe Flynn, Michael Manufacturing Co.	10	Ohio Hydrate & Supply Co.	376
ab Follansbee Steel Corporation	267	a Owen, D. W. & Sons, Inc.	376
a Formica Company	362	a Otis Elevator Company	82
a Frick Co.	266	a Overy Manufacturing Co.	64
ae Frigidaire Division	238	abe Owens-Corning Fiberglass Corporation	293
Garden City Plating & Mfg. Co.	344	abe Owens-Illinois Glass Co.	305
ab Gate City Sash & Door Co.	346	Ozalid Division	276
General Aniline & Film Corp.	276	ab Paine Lumber Co., Ltd.	366
ae General Electric Co., Apparatus	68-71	a Penberthy Injector Co.	375
a General Electric Co., Const. Materials	270-289	a Pennsylvania Wire Glass Co.	353
ae General Electric Co., Home Bureau	262-263	Philippine Mahogany Association, Inc.	304
ae General Motors	238	ab Pittsburgh Plate Glass Company	102-237-295
a General Portland Cement Co.	290		
Georgia-Pacific Plywood Company	8-9		
Given Mfg. Co.	48		
a Glide Windows, Inc.	341		

NEW YORK—H. Judd Payne, Publishing Director; Robert F. Marshall, Business Manager; Tom Tredwell, Advertising Mgr.; Benton B. Orwig, Creative Service Manager; M. A. Murphy, Advertising Production Manager, 119 West 40th Street; BOSTON—Harry M. Horn, Jr., 855 Park Square Bldg.; CHICAGO—C. B. Riemersma, Robert T. Franden, David K. Bortz, 700 Merchandise Mart; CLEVELAND—John C. Jackson, Joseph F. Palmer, John W. Setzer, 321 Hanno Bldg.; DALLAS—Joe Sanders, 2909 Maple Ave.; LOS ANGELES—Bob Weinstein, 672 South Lafayette Park Place; PHILADELPHIA—Tom Tredwell, 1321 Arch St.; PORTLAND—Bob Weinstein, 1220 S. W. Stark St.; SAN FRANCISCO—Bob Weinstein, Howard Bldg., 209 Post St.

THE RECORD REPORTS

STEEL REPLACES COPPER AS BRAKE ON BUILDING

Strike Losses Prolong Steel Controls; Aluminum and Copper Eased Again

Latest news is that April 1 will bring revisions of NPA's basic construction orders which will more than equal the relaxations once planned for July 1 and stymied by the steel strike. The ban on recreation building, oldest of the building curbs, will be lifted; commercial construction will get the same treatment as industrial; self-authorization will be allowed for multi-family housing. Orders at the new level can be placed now for April 1 delivery.

SETTLEMENT of the 55-day steel strike with its estimated cost to steel production of 20 million tons was followed by both bad news and good for architects and builders.

As expected, steel controls were tightened; the effect of the strike was to postpone lifting of CMP restrictions on steel, perhaps by as much as six months. Defense Production Administrator Henry Fowler has estimated April 1, 1953 as the earliest date by which the steel supply can be expected to reach its pre-strike level. Under the strict priority system NPA established to assure access to the curtailed steel supply for military and defense-related projects, it seemed unlikely that many non-defense starts in the industrial and commercial categories would be possible before 1953.

The good news of relaxations in curbs on copper and aluminum came almost simultaneously with the tightening on steel. Self-authorization levels were nearly doubled, in some cases more than doubled, by the new amendments to CMP Regulation Six. Further, NPA lifted the ban on the use of copper and aluminum for drains, gutters, downspouts, store fronts and for decorative purposes. All copper and aluminum curbs were expected to go as soon as stockpiles of these metals were returned to the substantial levels of early this year.

TABLE III.—United States copper position 1950 and projected 1975

	[Thousand short tons]	
	1950*	1975
Consumption (actual)	1,730	¹ 2,500
Production:		
Mine	907	¹ 800
Secondary	475	¹ 700
	1,382	1,500
Imports (net)	448	² 1,000

*1950 consumption derived from data from American Bureau of Metal Statistics and U. S. Bureau of Mines. 1950 production and imports, Bureau of Mines.

¹ Projected.

² Required.

LONG VIEW ON COPPER: DESIGN ECONOMY RECOMMENDED

These charts from the report of the President's Materials Policy Commission show the pattern of production and consumption which lead the Commission to urge a technology of substitution to avoid future bottlenecks in copper supplies

TABLE IV.—Geographical pattern of free world copper production and consumption, 1950*

Region	Percent of total free world	
	Mine production	New copper consumption
United States	36	49
Other North America	14	4
South America	18	2
Total Western Hemisphere	68	55
Free Europe	4	37
Africa	23	1
Australia and New Zealand	1	2
Other Eastern Hemisphere	4	5
Total	100	100

*Based on data from the International Materials Conference.

TABLE V.—New copper position of the rest of the free world 1950 and projected 1975

	[Thousand short tons]	
	1950	1975
Consumption (new copper)	1,343	¹ 2,050
Net exports to United States	448	² 1,000
Mine production	1,608	² 3,050

¹ Projected.

² Required.

SOURCE: 1950 consumption and production based on International Materials Conference data. 1950 exports from U. S. import statistics, U. S. Bureau of Mines.



Right: architect's model of the whole scheme for Avenida Bolivar; tall buildings (center) are 28-story offices now under construction; bull ring (left foreground) is carryover from old Caracas. Above: helicopter view of first two completed buildings, highway entrance

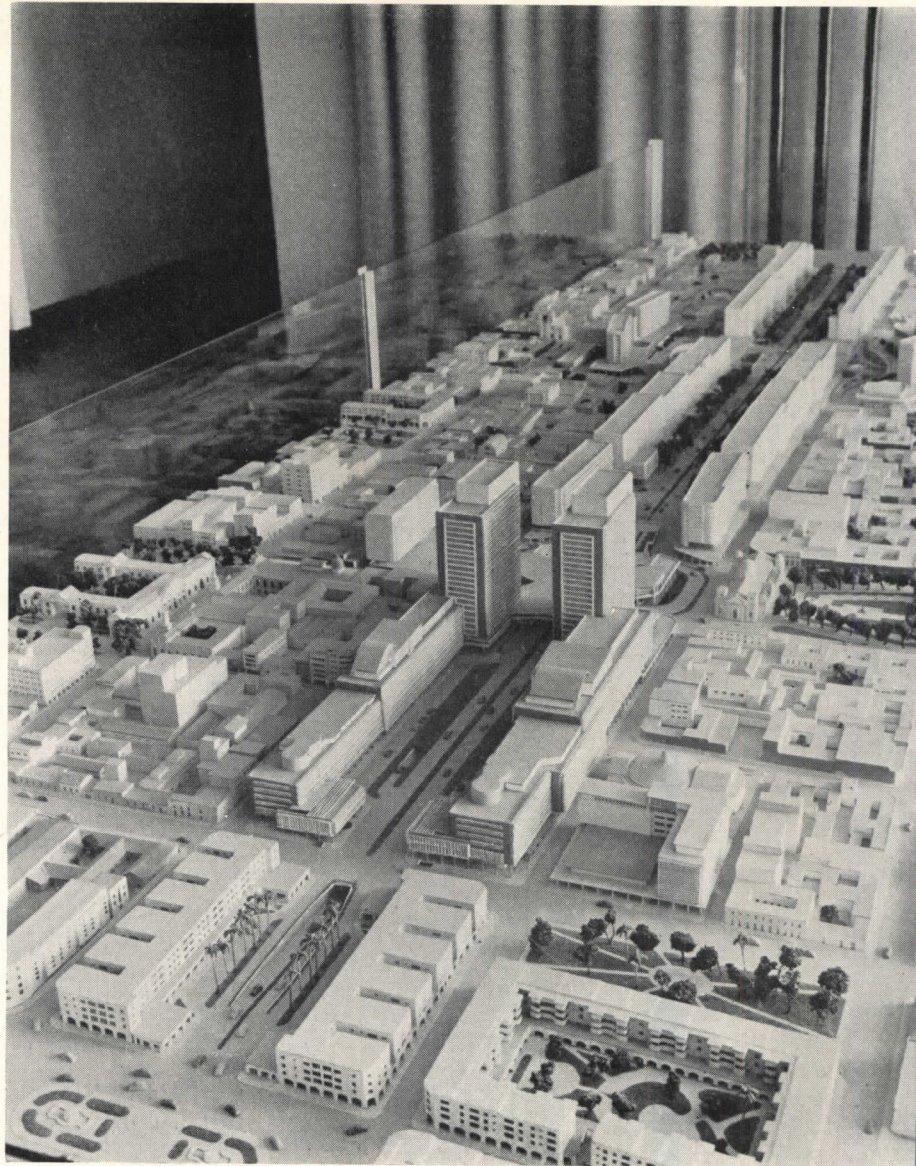

\$300 MILLION AVENIDA BOLIVAR MODELS NEW PLAN FOR

THE LONG-RANGE PLAN for redevelopment of Caracas has been launched with a mammoth initial project that is expected to serve as a model for all the subsequent reconstruction of the Venezuelan capital.

More than 400 buildings in the heart of the city have been torn down to make way for the \$300 million Avenida Bolivar, a mile-long eight-lane express highway with underground terminals for 600 buses and underground parking for nearly 1600 cars. Twenty-four new buildings — 12 on each side of the central thoroughfare — will provide office and living space, shops and restaurants.

Two eight-story office buildings, each planned for 1500 workers, have now been completed; two more office buildings, each 28 stories high and providing for 2000 workers, are under construction. The highway itself is completed, but multi-level auxiliary routes to pass beneath the 28-story buildings are still under construction.

The completed office buildings cover 300,000 sq ft of ground area. They are occupied by government offices and the headquarters of the project directors.

The new wealth from oil discoveries that will bring production to an estimated two million barrels a day in 1953

has been the catalyst in the revival and revision of a 15-year-old scheme to solve the acute problem of congestion in the 400-year-old city.

The original Avenida Bolivar plans were made by architects and city planners called in by the government in 1937, then blocked by property owners and "traditionalists;" in 1946, with conditions increasingly bad, the government made another attempt.

A National Urbanism Commission was created to study the problem; it revised the old plans and this time it was possible to rally support for them. In 1948 the *Compania Anonima Obras de*



Left: louvered façade of "North" building, one of two completed structures; both have second-floor terrace cafeterias, sheltered walks for pedestrians

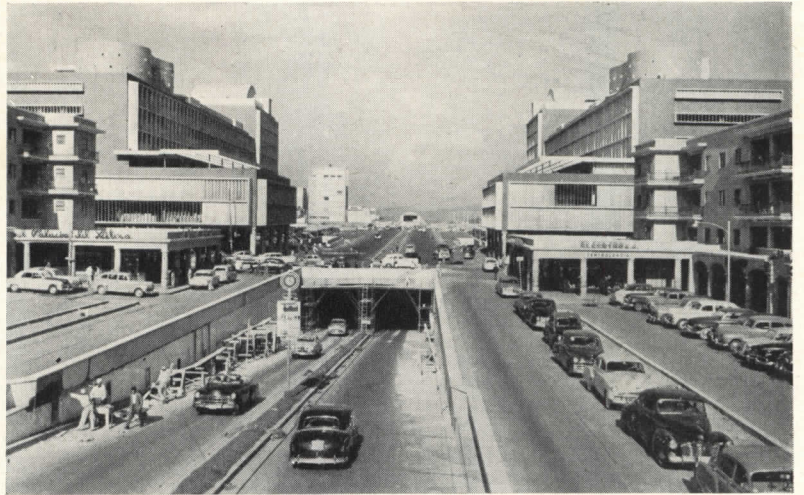

Above: view down mile-long highway showing underpass and (again) first two completed buildings. Left: constructing foundation for one of 28-story buildings (model photo below)

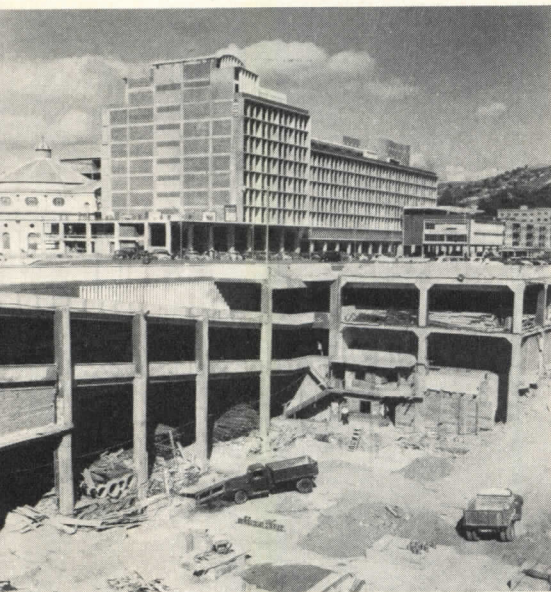

400-YEAR-OLD CARACAS

la Avenida Bolivar was organized with authority to condemn land and buildings to acquire needed space and to pay for these properties in government-backed bonds. The Avenida Bolivar company was set up with a capital of \$10 million, jointly owned by the Government *Banco Obrero*, the Venezuelan Development Corporation and Caracas.

Overall direction of the project is in the hands of Dr. Miguel A. Marquez Rivero, president of the Avenida Bolivar company. Dr. Carlos Dominquez is head architect and chief engineer; assistant architects are Dr. Carlos Raoul Villanueva and Maurice Rotival.

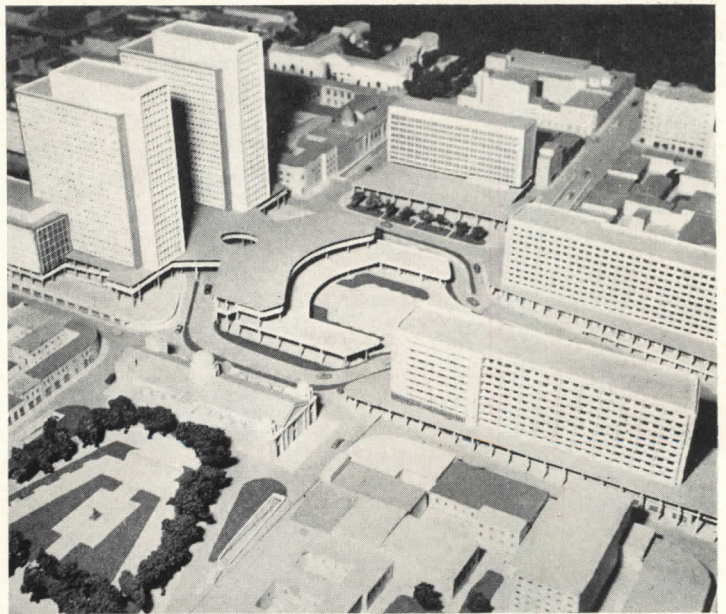

Above: section of the architect's model shows 28-story buildings now under construction; terraces will have outdoor dining rooms

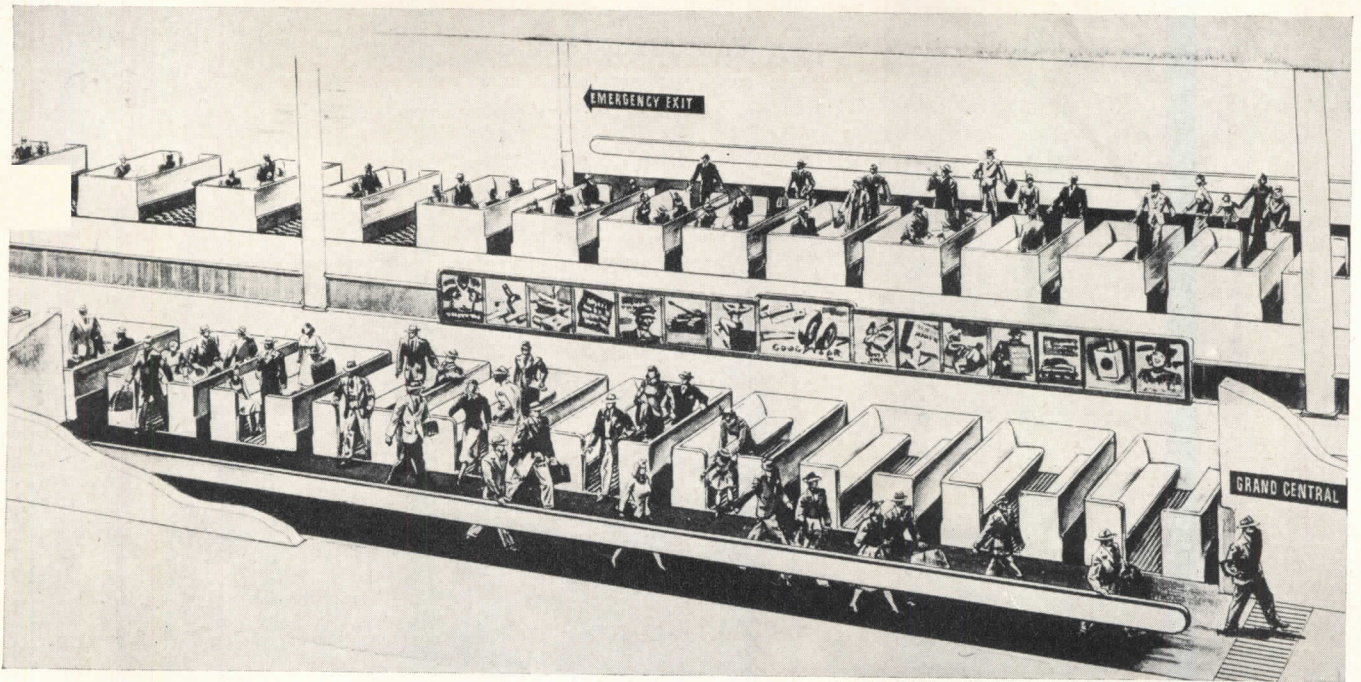

Sketch of proposed passenger conveyor belt system shows loading platform and synchronized belt with individual cars. Unloading belt is at rear

CONVEYOR BELT SYSTEM MAY REPLACE SUBWAY SHUTTLE

LAST MONTH in New York saw the announcement of a new engineering development which may have far-reaching consequences. The city's Board of Transportation has asked for \$3,800,000 to replace the 34-year-old half-mile subway shuttle between Times Square and Grand Central Terminal with a passenger conveyor system designed to accommodate 15,000 people an hour. Cost of the conveyor system itself was estimated at \$1,750,000, or about \$700 per sq ft. The remainder of the requested funds will be used for changes in existing tunnel.

Experiment and research have been conducted by the Goodyear Tire and Rubber Company, which, together with the Stephens-Adamson Manufacturing Company, has worked out engineering details. Briefly, the system is to work as follows:

At either end of the shuttle will be a 6 ft wide loading belt, traveling at the rate of $1\frac{1}{2}$ mph. Synchronized with this will be another belt carrying a continuous stream of small passenger cars with seats. Each car will seat 10 people and 25 cars will pass the loading platform

every minute. After leaving the loading point cars will be gradually speeded up to 15 mph over conveyor belts and banks of rubber-tired accelerating wheels. At the other end, they will be slowed again to $1\frac{1}{2}$ mph at a synchronized unloading platform. Then they will be turned around on a large wheel and sent in the opposite direction. The cars themselves will not be locked on the belts, but will be guided so that they will remain on the belts, without yawing. More specific details are not yet available, since patent arrangements are still in progress.

Below: N. Y. Transit Chief Sidney Bingham foresees use of belts as "moving sidewalks" for cross streets, stadium and airport exits, large market areas. Right: experimental Goodyear passenger belt

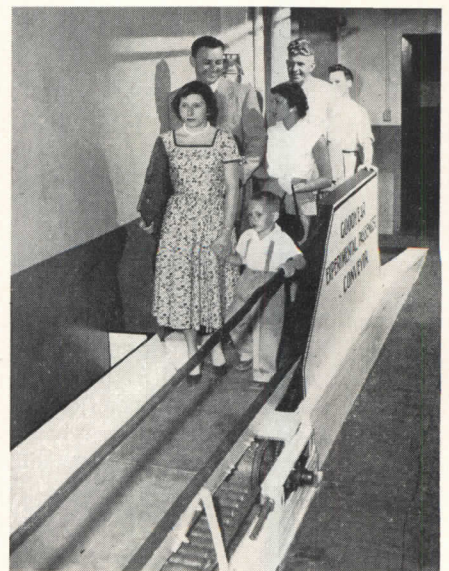
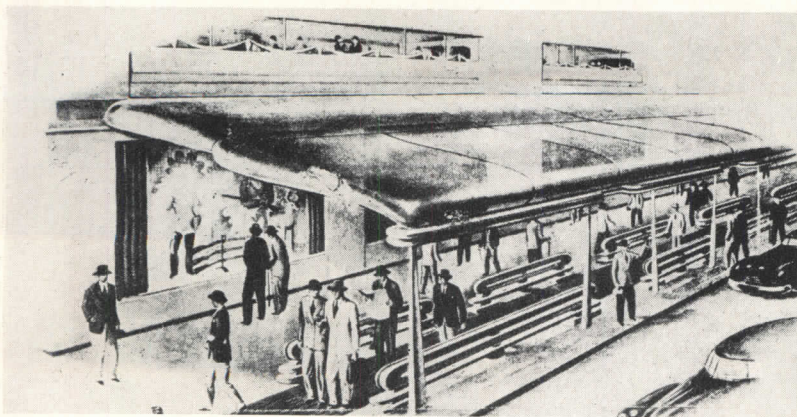

Ever Feel a "Draft" in a Warm, Closed Room?

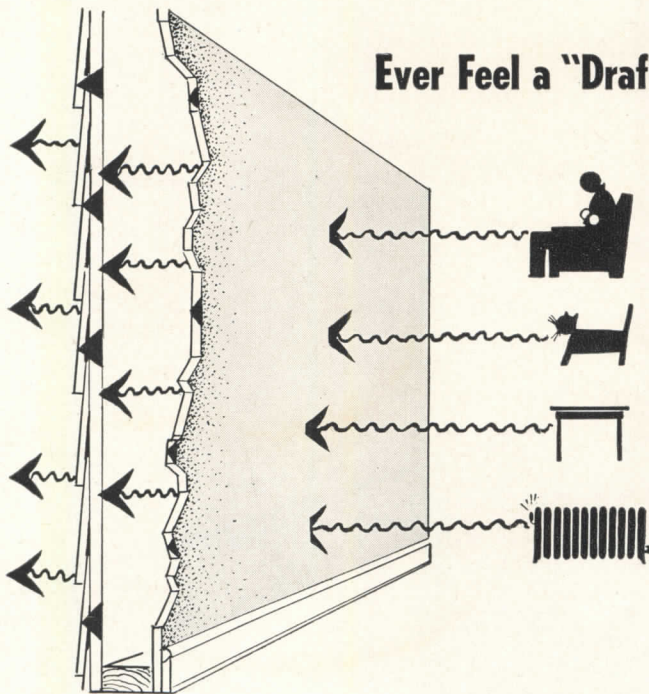

(RADIATION is the transmission of rays through space. Infra-red heat rays travel at the speed of light, are invisible, have no temperature, only energy. But when absorbed by a surface, they are transformed to HEAT. The surface of any object warmer than absolute zero – the Sun, You, Clothing, Wood, Plaster, an Iceberg, a Stove, a Chair, Paper, an Animal, will RADIATE to a colder surface.)

(CONDUCTION is the process by which warmth flows from a warmer object or particle by direct physical CONTACT, to a cooler one.)

People often complain of "drafts" in a room with air-tight walls and windows. Why? To a large extent because, by Nature's law, warmth *flows* to cold by RADIATION as well as by CONDUCTION. Cold walls, too, draw heat out of contacting air by conduction, causing a downward current of cold air.

The exposed skin of people and the outer surfaces of their clothing lose heat as infra red heat rays flow from them, at a 90% rate, to a cooler wall plaster surface, which absorbs the rays at a 93% rate and transforms them again to heat. If insulation is lacking or has packed down, most of this heat is transmitted by radiation to the colder outer wall at a 93% rate, absorbed, and then dissipated to the colder, outer air. Ordinary insulation in the wall space, or a solid wall, augments heat flow by direct conduction.

So people are uncomfortable, perhaps only in spots. More fuel is burned to obtain greater comfort. Unnecessarily high, less wholesome temperatures result.

Multiple sheets of accordion aluminum in the wall space would block convection and reflect back 97% of heat rays to re-heat the plaster by their absorption. With plaster sufficiently warm, no heat radiates from bodies to walls. There is no current of cold air on the surface of the wall. Comfort is maintained without unduly high temperatures or fuel costs.

In summer, the process is identical except for direction. Heat by radiation, conduction and convection is retarded by the multiple sheets of aluminum in the outer wall space. The interiors of rooms stay cooler. Their plaster surfaces are cooler than the body. So, by Nature's law that warm radiates to cold, some heat *leaves* the body for the colder wall surfaces, increasing body coolness and comfort.

The commercial form of multiple accordion aluminum is Infra Insulation, Types 6, 4, and 4 Jr.

INFRA THERMAL FACTORS. TYPE 6

Up-Heat C.089, R 11.23 = 4³/₅" dry rockwool
 Wall-Heat C.073, R 13.69 = 5⁵/₈" dry rockwool
 Down-Heat C.044, R 22.72 = 9" dry rockwool

This discussion is amplified in Schwartz's "Simplified Physics of Vapor and Thermal Insulation."

Infra Insulation, Inc., 525 Bway., N. Y. C. Dept. (R-9)
 Please send FREE "Simplified Physics of Vapor and Thermal Insulation."

Name _____

Firm _____

Address _____

Send Prices of Infra Insulations Send Sample

INFRA INSULATION, INC.
 525 Broadway, New York, N. Y.

Fine Flush Valves for Fine Buildings

For complete information on Watrous Flush Valves write for catalog No. 449-A.

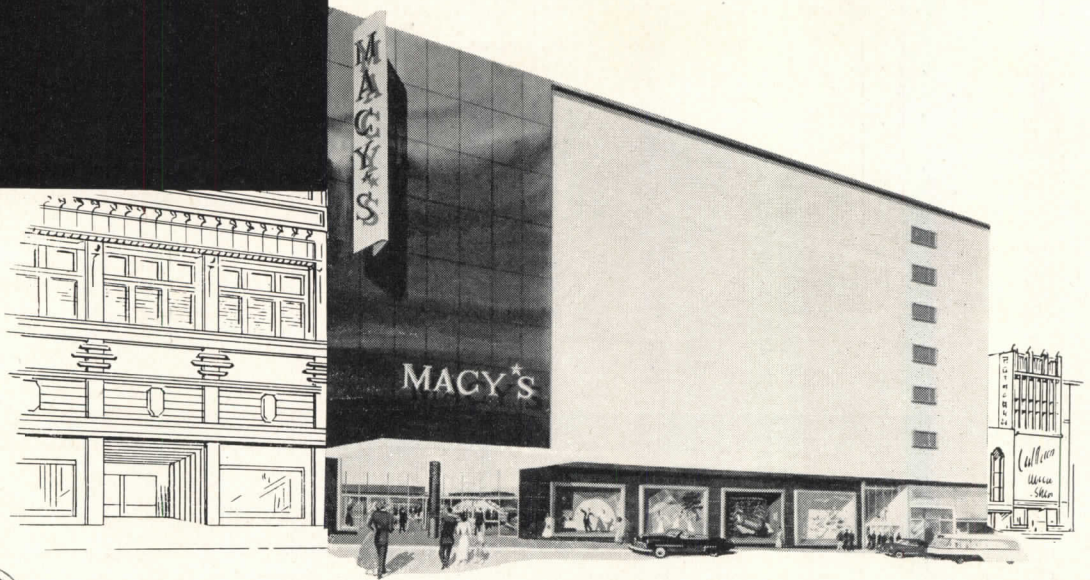

MACY'S, KANSAS CITY

One of the many fine buildings equipped with Watrous Flush Valves.

KIVETT & MYERS

Architects

WM. L. CASSELL

Mechanical Engineer

WINN-SENTER CONSTRUCTION CO.

General Contractors

EDW. W. LOCHMAN CO.

Plumbing Contractors

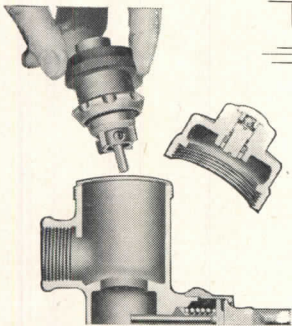

Among Watrous Fine Features

Single Step Servicing

Reduces maintenance time to an absolute minimum. Entire operating unit, including main seat washer, can be lifted out and replaced in a few seconds. No need to take valve off of line to service.

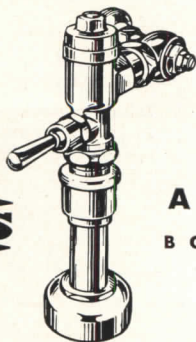

Watrous

ADJUSTABLE FLUSH VALVES
BOTH DIAPHRAGM AND PISTON TYPES

THE IMPERIAL BRASS MANUFACTURING COMPANY

1240 W. Harrison Street, Chicago 7, Illinois



A.I.A. TREKKERS AT NICE

Some of the members of the post-convention Architects' Trek to Europe June 28–August 1 snapped in a time exposure by David H. Horn of Fresno, Calif., at the Hotel Ruhl, Nice. Seated: Leon Chatelain Jr., Washington, D. C.; Mrs. Walter T. Rolfe, Houston; Alben Froberg, Oakland, Calif.; Mrs. Froberg; Mr. Rolfe; Paul Gerhardt Jr., Chicago; Mrs. Chatelain; Talmage C. Hughes, Detroit; George Bain Cummings, Binghamton, N. Y., Trek leader, and Mrs. Cummings; Hiram A. Salisbury, Houston; Paul L. Gaudreau, Baltimore. Standing: Mrs. R. V. Higginbotham, Dallas; Arthur Hooker, Muskegon, Mich.; Mrs. Thomas D. Broad, Dallas; Mrs. Hughes; Richard Walker, R.I.B.A., Trek director; W. Sargent Lewis, New Haven, Conn.; Miss Abigail Lewis, his daughter; and David Horn

GREAT CONVOCATION MARKS ENGINEERING CENTENNIAL

THE LARGEST CONVOCATION of engineers in history will assemble September 3–13 in Chicago for the Centennial of Engineering marking the 100th anniversary of the founding of the American Society of Civil Engineers.

Some 30,000 engineers representing every branch of the profession and 61 American and foreign societies are expected to take part in a program that will include 12 symposiums on basic aspects of engineering's impact on civilization; technical and other functions sponsored by more than 40 individual societies; engineering exhibits in the Museum of Science and Industry; and a dramatic stage production portraying significant developments in engineering.

Nearly 500 engineers from 20 nations in Europe, South America and Asia will attend the Centennial.

John O. Merrill, A.I.A., of Skidmore, Owings & Merrill, Architects & Engineers, and Walter C. Voss, A.I.A., of Massachusetts Institute of Technology, will deliver major addresses in the symposium on Structures and Construction. Other symposiums will deal with the role of the organized profession; education and training; food; tools; trans-

portation; mineral industries; chemical industries; communications; energy; health and human engineering; urbanization.

The American Institute of Architects, which will celebrate its own centennial in 1957, paid its tribute to the civil engineers with the special exhibit "Re-Union of Architecture and Engineering 1852–1952" at its 1952 convention.

LINE MAGAZINE SEEKS TO PROVIDE STUDENT FORUM

LINE MAGAZINE, the publication founded last year by architectural students for architectural students, is starting its second year with a determined crusade for more student contributors, more student editors and — a necessity for survival — more student subscribers.

Robert Laden of Cooper Union, who has succeeded Julian Sachs of Catholic University as editor-in-chief, emphasizes that the columns of the magazine are open to all architectural students. A staff of regional editors will attempt to keep the magazine in touch with schools of architecture throughout the country.

Three issues, the first in October, are offered for the subscription price of one dollar; architect subscribers are welcomed. The two issues published last year had a circulation of under 1000; a large increase is needed to make the magazine self-supporting. It carries no advertising.

Arthur Hald of Catholic University is business manager; David Dambowic of Cooper Union is art director.

Regional editors are: North Atlantic — Robert Laden, Cooper Union; New York State — A. Rothenberg, Rensselaer Polytechnic Institute; Middle Atlantic — A. Noel Alterman, Virginia Polytechnic Institute; Southeastern — Vince de Gutis, North Carolina State; Central States — Bayes Norton, Miami (Ohio) University; Upper Middle West — Roger Mohagen, North Dakota Agricultural College; Central Middle West — Manfred Wolfenstein, Kansas State; Southwestern — Jerry Kirkwood, Texas Institute of Technology. Editors for the California and Northwest regions were being sought.

— Drawn for the RECORD by Alan Dunn

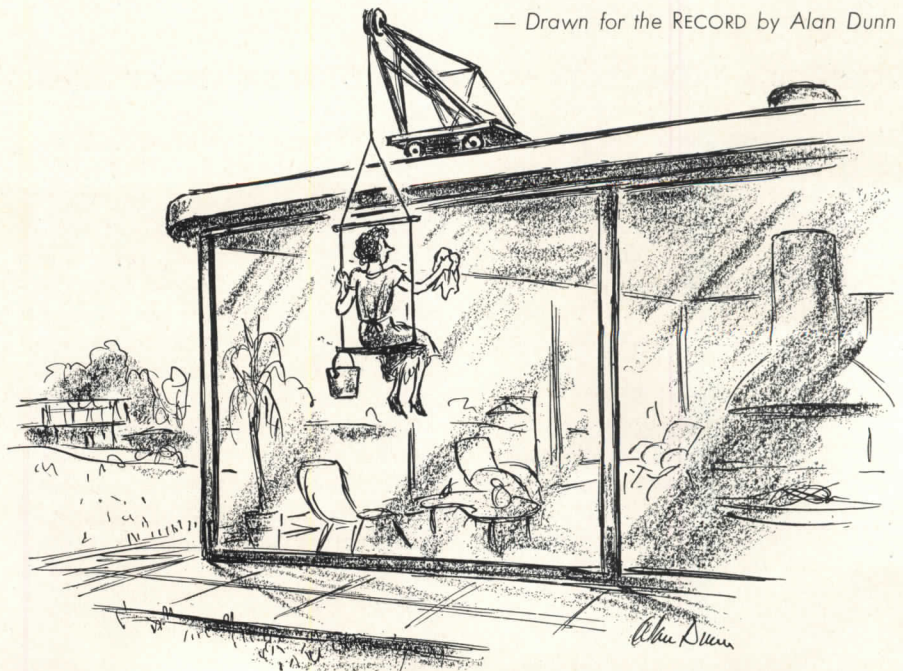

THE RECORD REPORTS

Far right: David Warsaw, Detroit Concrete Products Association president; Michigan Dean Wells Bennett; A.I.A. 2nd V.P. Norman Schlossman; C. Allen Harlan, president, Detroit Electric Co.; Mrs. G. Mennen Williams, wife of Michigan's governor; President Leo Bauer; right: Adrian Langius, Frank Lopez, Park Commissioner W. F. Doyle, A.I.A. Regional Director John Richards, President Ivan Kirlin of Kirlin Co., A.I.A. Secretary Clair W. Ditchy; and in foreground — Roger Allen

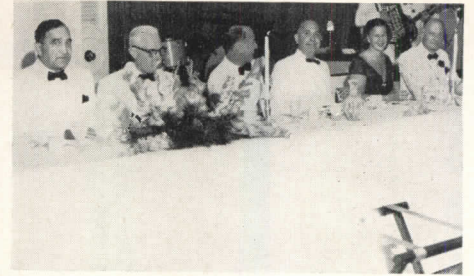

Above: Small House Competition First Prize Winner William P. Smith and Mrs. Smith. Below (foreground): Herbert L. Hawthorne, who won third prize, and Mrs. Hawthorne; the second prize winner, Donnally Palmer, and Mrs. Palmer



Above: Mrs. Ivan Kirlin; Leo Bauer; his sisters, the Misses Ann and Mary Bauer; Frank Lopez; Mrs. Robert Franden; Mrs. Lopez; Ivan Kirlin; Robert Franden



W. Stewart Woodfill, proprietor of the Grand Hotel, and guest, Jack Benny



Conference Chairman Ralph Knuth and one of his daughters

MICHIGAN ARCHITECTS MIX FUN AND BUSINESS AT MACKINAC

FUN AND FELLOWSHIP were the major theme of the ninth annual midsummer conference of the Michigan Society of Architects July 31-August 3 at the Grand Hotel on Mackinac Island. Ralph W. Knuth of Flint, conference chairman, had judiciously interspersed the serious business to add flavor to a four-day holiday.

Entries in the Small House Competition jointly sponsored by the Society and the Concrete Products Association of Detroit were on exhibition and prize-winners (see page 22) were announced at the closing banquet. The competition

drew 57 submissions from architects, architectural students and draftsmen in 39 Michigan towns.

Dr. Walter Cocking, editor of *The School Executive Magazine*, in one of two formal speeches on the conference program, said new concepts are needed for secondary schools — "let's dream a little," he urged. His own dream, he said, is the campus-type plan with a number of small buildings instead of a single building under one roof.

In his address at the banquet, Frank G. Lopez, senior associate editor of *ARCHITECTURAL RECORD*, suggested that

architects must be concerned with the layman's reaction to architecture both for the practical reason that *clients* are laymen and out of a broader concern with the position of architects and architecture in the culture of our times.

One of the memorable sidelights of the conference was the presentation by Lawrence Plym of the trophy case made as a gift to the society by the Kawneer Manufacturing Company to house the "Man of the Year" awards annually bestowed on one society member (this year Clair W. Ditchy) by the Portland Cement Association.

THE BOSS SAID
TO SPECIFY A GREASE-
PROOF FLOOR THAT
CAN BE PLANNED
WITH A COLORFUL
DESIGN.

WHY DON'T YOU
CHECK THE KENTILE
FLOORING CONTRACTOR. HIS
INFORMATION IS ALWAYS
THE VERY LATEST.



In a cafeteria like this, the Kentile Flooring Contractor would recommend SPECIAL (greaseproof) KENTILE because of its resistance to greases and oils; its colorful beauty and ease of maintenance.

The information the Kentile Flooring Contractor gives you is always accurate, up-to-date and complete

EVERYBODY knows that certain flooring materials are better than others for specific installations! But, not everybody realizes that it takes a trained and experienced Flooring Specialist to recommend the one floor that is exactly right ... the one floor that combines minimum expense with maximum wear ... eye appeal with

ease and economy of maintenance. The Kentile Flooring Contractor is such a man... qualified by years of training and experience to decide which of the countless products and materials available today are best for your needs. Be sure to call on him whenever you need his technical knowledge. No obligation, of course.

KENTILE • SPECIAL (Greaseproof) KENTILE • KENCORK • KENTILE RUBBER TILE

 **KENTILE INC.**

KENTILE, INC., 58 Second Avenue, Brooklyn 15, New York • 350 Fifth Avenue, New York 1, N. Y. • 705 Architects Building, 17th and Sansom Streets, Philadelphia 3, Pennsylvania • 1211 NBC Building, Cleveland 14, Ohio • 225 Moore Street, S.E., Atlanta 2, Georgia • 2020 Walnut Street, Kansas City 8, Missouri • 1440 11th Street, Denver 4, Colorado • 4532 South Kolin Avenue, Chicago 32, Illinois • 1113 Vine Street, Houston 1, Texas • 4501 Santa Fe Avenue, Los Angeles 58, California • 95 Market St., Oakland 4, Calif. • 452 Statler Building, Boston 16, Mass.

GREAT NEW ADVANCE IN

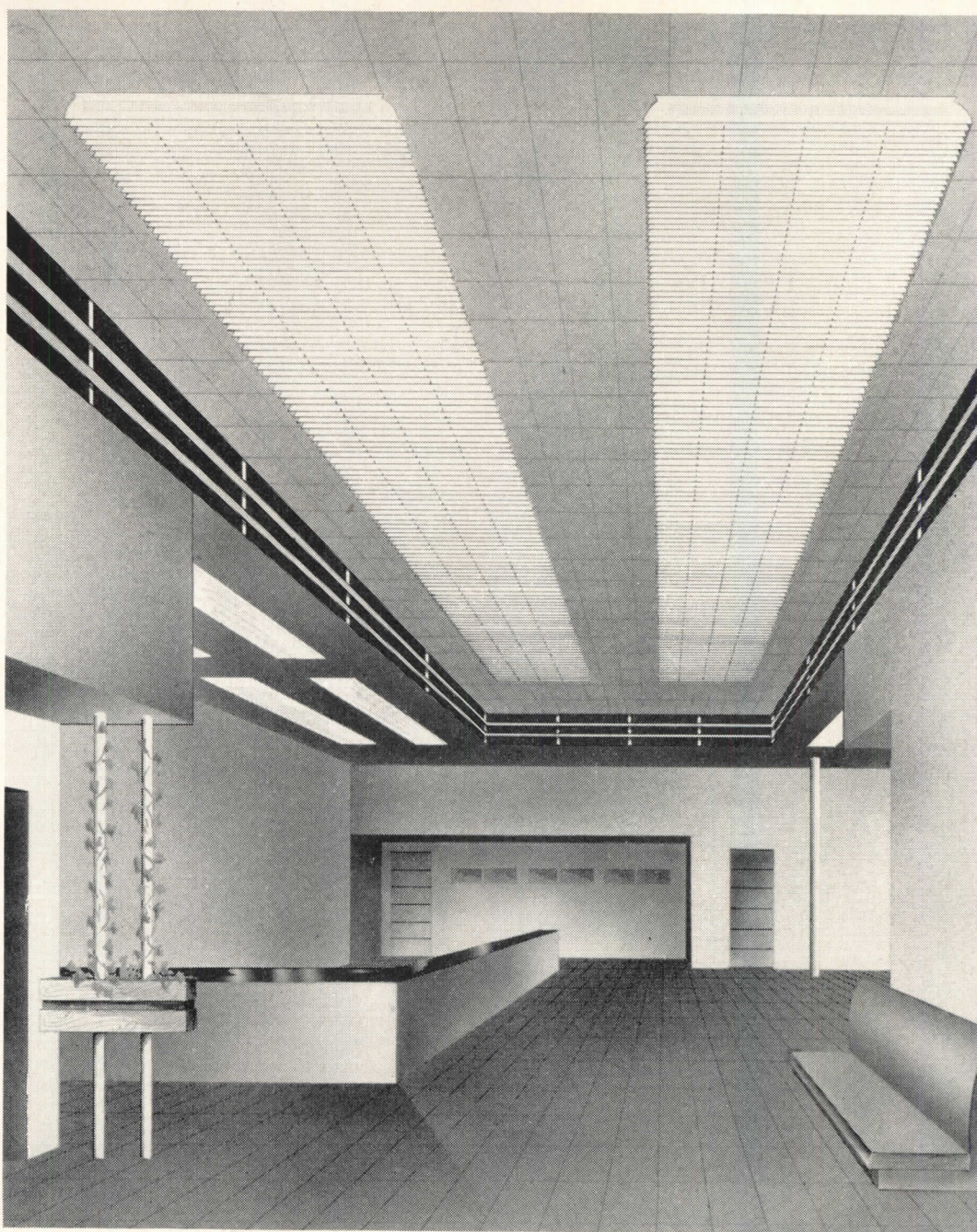
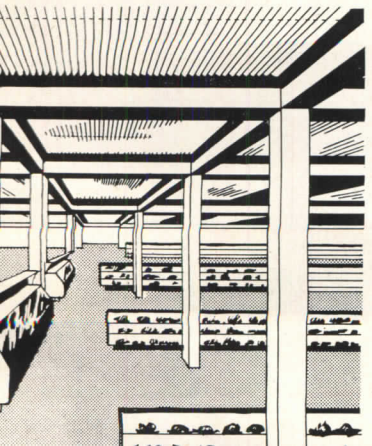
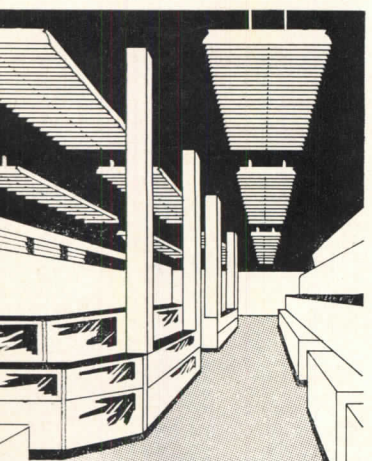
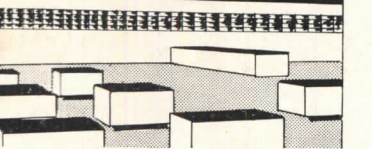
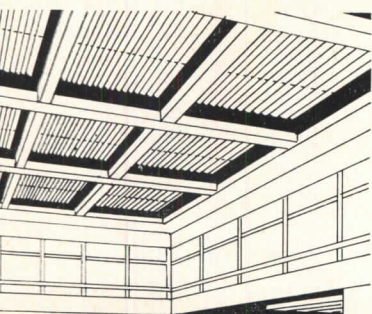
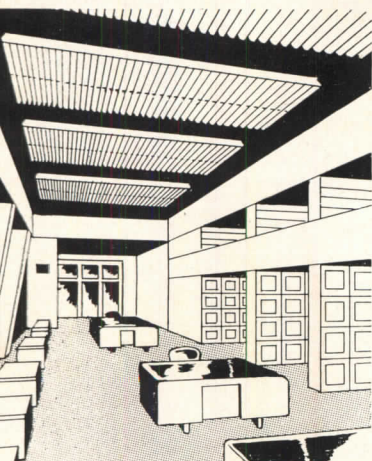

Note exclusive features of this new **(LPI)** invention

- (LPI)** Large area light source, very shallow, highly stylized.

(LPI) Priced comparably to standard width fixtures.

(LPI) Shipped completely assembled in one carton, ready to install, installation costs reduced to minimum.

(LPI) Each louver removed separately for jiffy-quick cleaning.

(LPI) Can be surface, suspension, or recess mounted.

(LPI) Fixtures can be joined endwise or side-
- wise, or both, for large interesting panels of light.

(LPI) As a louveral system AREALUX is completely *self-contained*, the first unit of its kind.

(LPI) Highly efficient when used individually or in various combinations.

(LPI) Perfect alignment is provided by ingenious hanger arrangement and accessories with AREALUX.

(LPI) Completely wired with E.T.L. and U.L. approved ballasts. U.L. approved and I.B.E.W. A.F.L. Union Label.

LARGE AREA LUMINAIRES

LPI

AREALUX

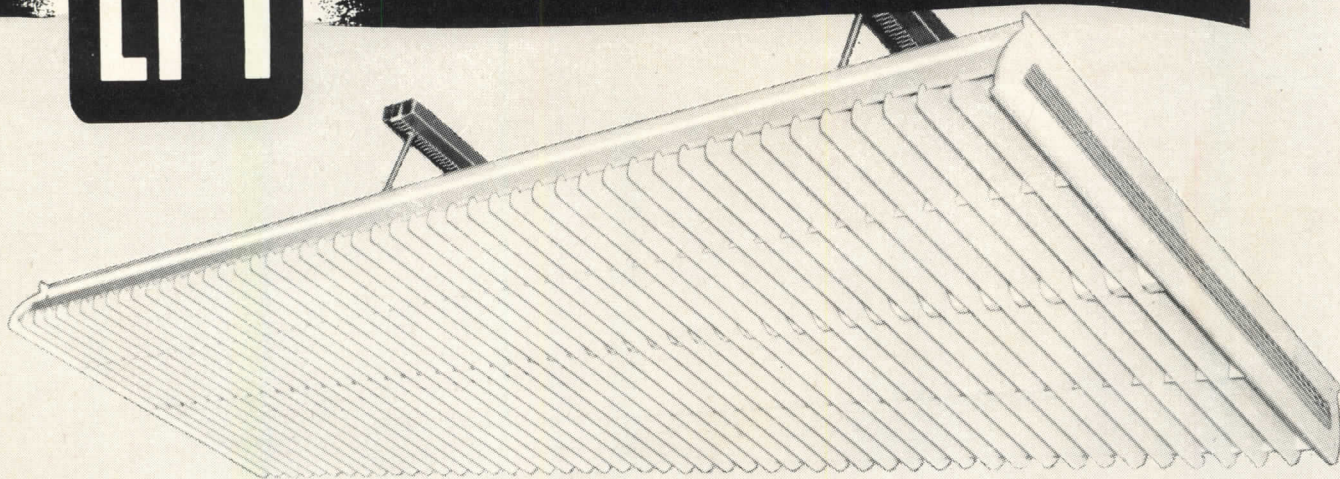

Architects and illuminating engineers, you know from your own experience, have found that in large, massive interiors or in high ceiling areas, older standard narrow fixtures are far from satisfactory.

The result is an ever-growing demand for panel, louverall, and grid lighting. Now, at last, LPI answers this demand with AREALUX—a new and original invention inspired by ideas submitted to us by a host of architects. LPI AREALUX is not only an exceptionally handsome fixture. By simulating with great fidelity the high qualities of natural daylight, it provides lighting that is ideal for working conditions in offices, stores and show rooms.

New LOW in cleaning costs

The AREALUX is 100% *cleanable*, as you will see in the two photographs below.

The panels, after being easily unhinged from the fixture, are then laid on the table face up, and then each louver comes out with fingertip pressure.

The now-famous LUV-R-LOX invention makes possible this new LOW in cleaning costs. Think of it! The time needed for cleaning the entire AREALUX fixture is only 5 to 10 minutes—about 1/10 the time and effort of an old-style fixture of equal size!

And you know how important it is to keep louver fixtures shining clean.

Soiled, dusty, grimy fixtures often deliver less than half their potential in foot candles.

Write for FREE Catalogue

LPI's new deluxe 60-page catalogue—"New Ideas in Fluorescent Lighting"—contains full information regarding the AREALUX, installation details, photometric data, assembly instructions, full description of technical features. Graphically illustrated with photographs and diagrams. Write on your letterhead for your FREE copy—*now*. Ask for Catalogue No. 50-A.

LIGHTING PRODUCTS, Inc.

HIGHLAND PARK
ILLINOIS

For information on other LPI fixtures, see our Catalogue in Sweet's File

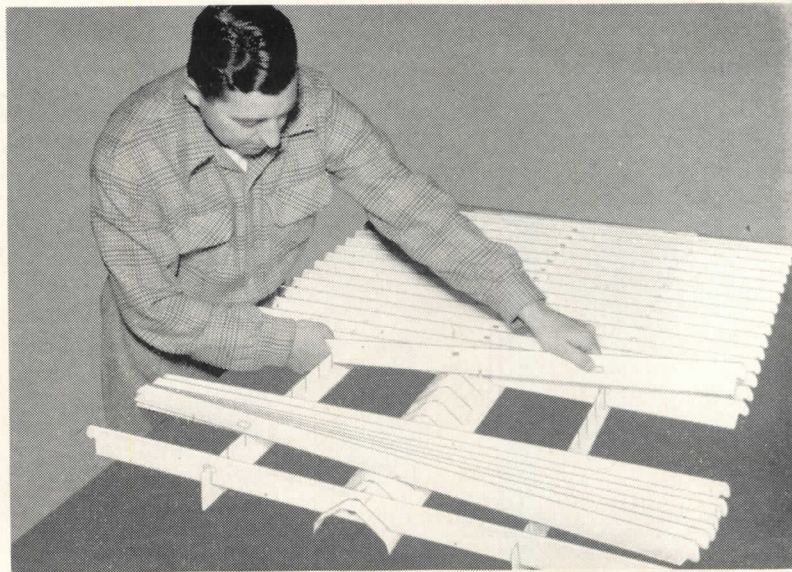
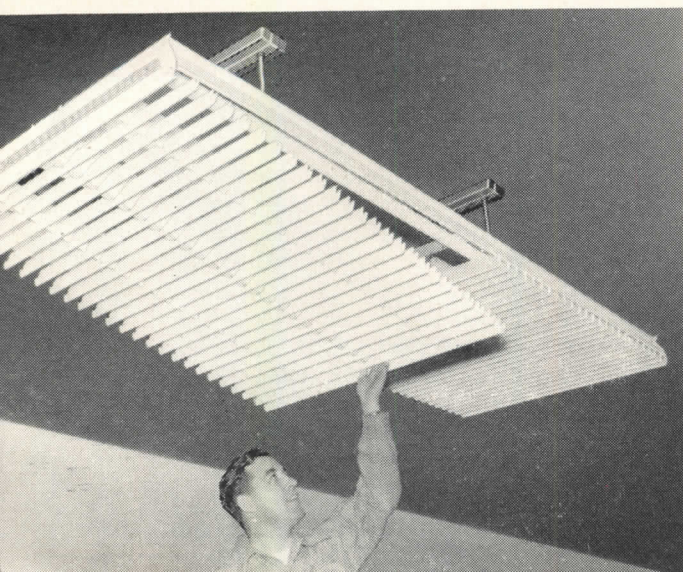

THE RECORD REPORTS

MICHIGAN (Continued): SMALL HOUSE AWARDS

Prizewinners in the Small House Competition co-sponsored by the Michigan Society of Architects and the Concrete Products Association of Detroit were announced at the Society's Mackinac meeting. The top three designs, shown on this page, and 10 mention winners begin a tour of Michigan cities this month

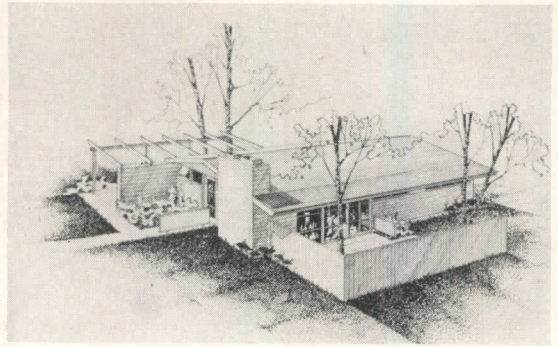

First prize of \$1000 went to William P. Smith Jr. of Willow Run Village, Mich., a draftsman. All three of the top prizes were awarded to draftsmen

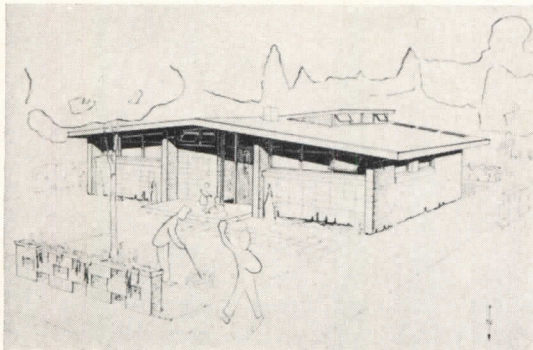

Donnally W. Palmer of Royal Oak, Mich., received the second prize of \$750. Entries had to be designed for concrete masonry construction

Third prize of \$500 was awarded to Herbert L. Hawthorne of Detroit for his entry. Ten mentions, \$100 each, went to Edward C. Bassett, R. C. Donkervoet, Joseph F. Dworski and Edward P. Elliott, Morris Jackson, W. K. Kagawa, J. R. Livingston, Douglas D. Loree, Robert J. Meacham, Avar Nagggar and Leonard S. Parker

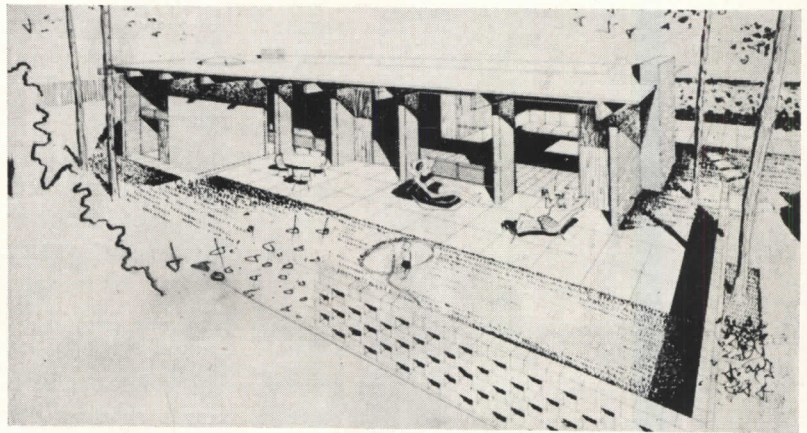

FIVE A.I.A. REGIONS PLAN OCTOBER SESSIONS

THE FIRST REGIONAL CONFERENCE ever held by the South Atlantic District of the American Institute of Architects leads off the fall and winter round of A.I.A. district sessions. The meeting, sponsored by the Georgia Chapter, is scheduled September 18-20 at Atlanta. "Schools in the Southeast" will be the theme of all the seminars.

Next month will bring five A.I.A. regional meetings and four conventions of state chapters.

The Northwest district will have a regional council meeting at Spokane; the other conferences will be full-dress regional gatherings with working seminars on a wide variety of subjects.

State meetings: Oct. 1-13 — Architects Society of Ohio, at Cincinnati; Oct. 2-4 — New York State Association of Architects, at Lake Placid; Oct. 9-11 — California Council of Architects, at Yosemite; Oct. 29-31 — Texas Society of Architects, at El Paso.

Scheduled regional conferences: Oct. 2-3 — Great Lakes District, at Cincinnati; Oct. 3-5 — Northwest District, at Spokane; Oct. 9-11 — Central States District, at Kansas City; Oct. 9-11 — Sierra Nevada District, at Yosemite; Oct. 24-25 — Gulf States District, at Montgomery, Ala.

The national A.I.A. Board of Directors will hold its semiannual meeting Oct. 26-28 at the Grand Hotel, Port Clear, Ala.

**THE GREAT
NAMES OF
THE COUNTRY
APPEAR
REGULARLY
ON REPEAT
ORDERS
for
FEDERAL
ROOFS!**



American Can Co., Milwaukee, Wis., with almost a half-million sq. ft. of Federal-Featherweight Precast Channel and Nailing Concrete Slabs. Architect: Turner Constr. Co., New York, N. Y. This is one of many American Can installations.

A Few of the Many Hundreds of Prominent Customers Who Have Repeatedly Bought Federal Roofs for Various Buildings

- FORD
- PACKARD
- CHRYSLER
- GENERAL MOTORS
- U. S. RUBBER
- B. F. GOODRICH
- DU PONT
- MONSANTO
- DOW CHEMICAL
- SOLVAY PROCESS
- BORDEN
- CARNATION
- COCA-COLA
- ALLIED MILLS
- QUAKER OATS
- KRAFT CHEESE
- GENERAL MILLS
- CORN PRODUCTS
- NATIONAL BISCUIT
- SEARS-ROEBUCK
- MONTGOMERY WARD

- SWIFT
- WILSON
- ARMOUR
- LIBBY-McNEILL
- JOHN MORRELL
- GEO. A. HORMEL
- U. S. ARMY
- U. S. NAVY
- U. S. ATOMIC
- PURE OIL
- SINCLAIR
- TEXAS CO.
- STANDARD OIL
- CITIES SERVICE
- SOCONY-VACUUM
- ATLANTIC REFINING
- BURLINGTON
- ROCK ISLAND
- PENNSYLVANIA
- NORTHWESTERN
- ILLINOIS CENTRAL
- PULLMAN COMPANY
- NEW YORK CENTRAL
- AMERICAN CAN
- CONTINENTAL CAN
- BAKELITE
- MASONITE
- JOHNS-MANVILLE
- ARMOUR LEATHER
- ARMSTRONG CORK
- MINNESOTA MINING
- CONSOLIDATED-VULTEE
- COLGATE-PALMOLIVE-PEET

- MEAD PAPER
- KIMBERLY-CLARK
- CONTAINER CORP.
- INTERNATIONAL PAPER
- DEERE
- J. I. CASE
- LINK-BELT
- ALLIS-CHALMERS
- FAIRBANKS-MORSE
- GENERAL ELECTRIC
- MINNEAPOLIS-MOLINE
- CATERPILLAR TRACTOR
- AMERICAN TEL. & TEL.
- COMMONWEALTH EDISON
- OKLAHOMA GAS & ELEC.
- NORTHERN STATES POWER
- INLAND STEEL
- BETHLEHEM STEEL
- ANACONDA COPPER
- HOMESTAKE MINING
- AMERICAN BRAKE SHOE
- REVERE COPPER & BRASS
- AMERICAN STEEL & WIRE
- CARNEGIE-ILLINOIS STEEL
- UNIVERSAL-ATLAS CEMENT
- AMERICAN STEEL FOUNDRIES
- YOUNGSTOWN SHEET & TUBE
- ILLINOIS TECH.
- UNIVERSITY OF ILLINOIS
- UNIVERSITY OF CHICAGO
- UNIVERSITY OF MICHIGAN
- UNIVERSITY OF WISCONSIN
- NORTHWESTERN UNIVERSITY

**FEDERAL-
Featherweight
STRUCTURAL
CONCRETE
PRECAST
ROOF SLABS**

"One good roof deserves another!" Hundreds of architects and business men have chosen Federal Roofs continually, on this basis. The first purchase may be a matter of faith, but all subsequent purchases are certainly the result of *actual performance*.

It is significant that so many nationally known buyers of both industrial and non-industrial roofs have so often placed repeat orders for more and more Federal Roofs.

Their roof records must be convincing . . . must show no indication of rot, rust or disintegration . . . no expense whatever for maintenance . . . long years of lasting strength and firesafety . . . the *overall low cost* which in the long run is the most important factor of all. CATALOG ON REQUEST.

MADE, LAID AND GUARANTEED BY
FEDERAL CEMENT TILE COMPANY

EXECUTIVE OFFICES: 608 SOUTH DEARBORN STREET • CHICAGO 5, ILL.

FOR OVER 45 YEARS

SALES OFFICES IN PRINCIPAL CITIES

Why the finest ship afloat uses

GOLD SEAL

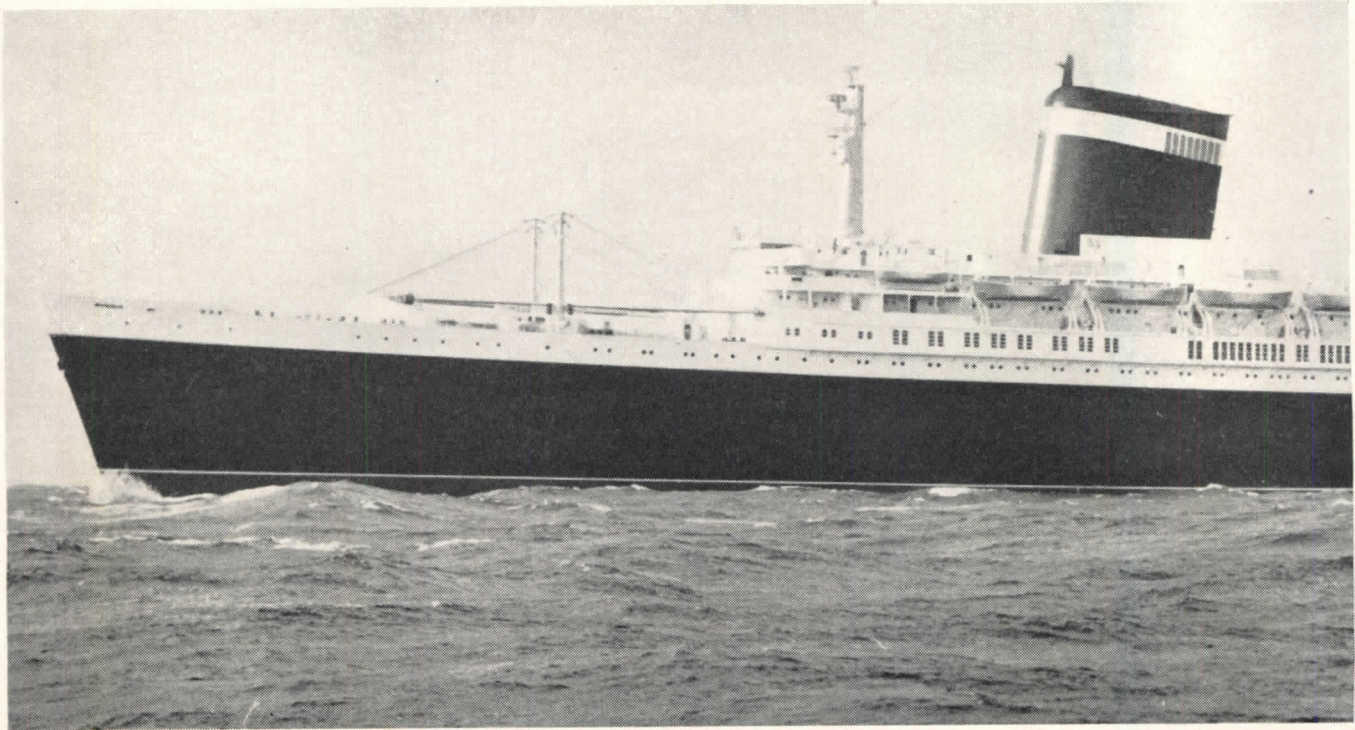

America's largest, fastest, finest passenger ship . . . the great 990-foot luxury superliner "United States" . . . built to the *safest* specifications in marine history. And every last square inch of linoleum aboard is by *Congoleum-Nairn!*

Gold Seal Nairn Static-Conductive Linoleum is used throughout her dispensaries and operating room because of its unusual property of *dissipating static electricity* which would otherwise present

an explosion hazard . . . because of its exceptional *durability* and *wear-resistance* . . . because of its *resilience* . . . because of its *slip-resistant surface* that's *sanitary* and *easy to maintain*.

And for the super-safe "United States" (where even chess-boards and chessmen are specially designed to be fireproof!) Gold Seal Nairn Marine Deck Covering was specified by Marine Architects Gibbs and Cox, because "Marine Deck" is the only

CONGOLEUM-NAIRN INC.

© KEARNY, N. J.

MAKERS OF GOLD SEAL GUARANTEED FLOOR COVERINGS



GOLD SEAL ASPHALT TILE

GOLD SEAL VINYL INLAIDS

GOLD SEAL NAIRN INLAID LINOLEUM

NAIRN LINOLEUM

America's new "Queen of the Seas" — the S.S. United States — holder of the trans-Atlantic speed record. Designed by Naval Architects Gibbs and Cox—built by Newport News Shipbuilding and Dry Dock Co. — **Gold Seal Nairn Linoleum** installed by the builder and Selby-Battersby Inc.

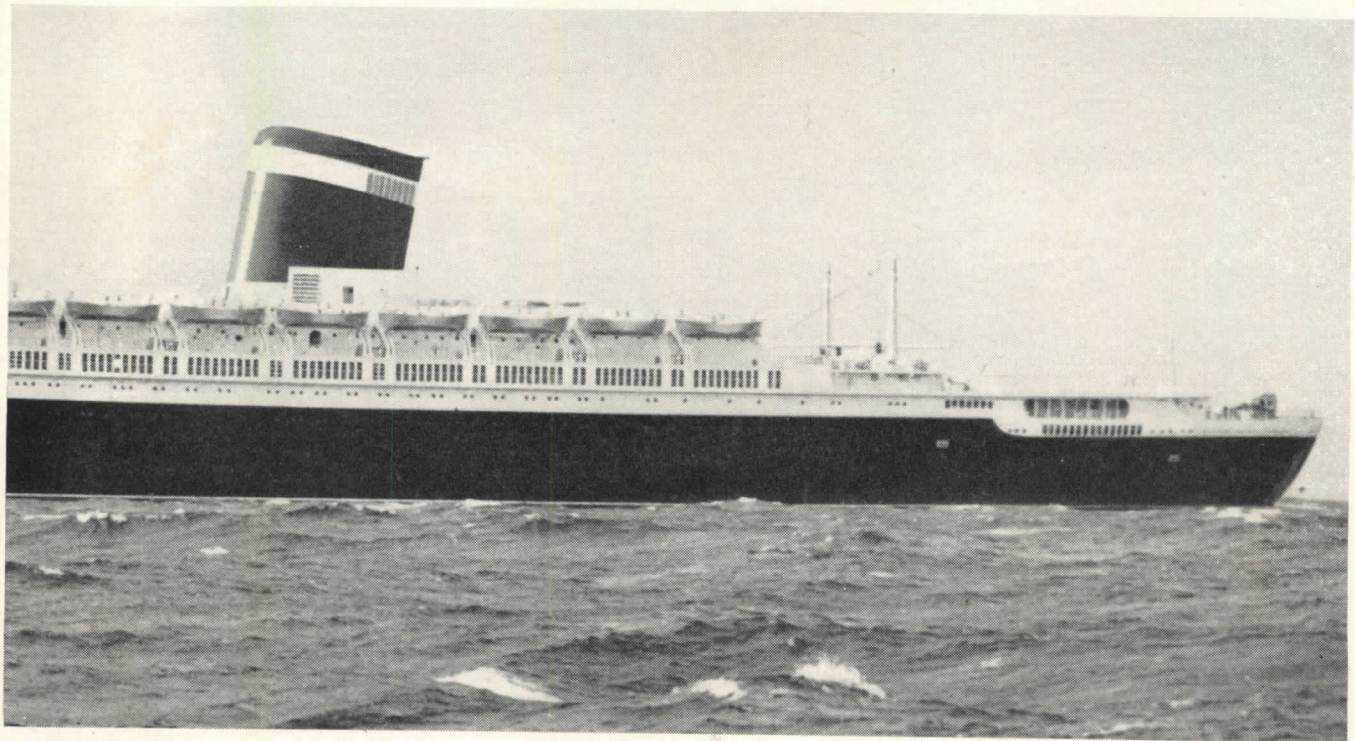

linoleum in the world that meets rigid U.S. Navy standards for true fire resistance and long wear . . . and delivers enduring beauty . . . genuine resilience . . . and easy maintenance.

Afloat . . . and ashore . . . Congoleum-Nairn has

the *right* answer to the toughest problems in floor covering. The entire line is backed by the famous Gold Seal guarantee: "Satisfaction or your money back" . . . *strongest money-back guarantee in the business!*

FREE: Complete information. Bring your file up to date. Mail coupon today!

Contract Sales Department
Congoleum-Nairn Inc.
Kearny, N. J.

Please send me your complete AIA file folder 23-J by return mail.

Name _____

Address _____

City _____ Zone _____ State _____

THE RECORD REPORTS

SARAH LAWRENCE BUILDS NEW FINE ARTS CENTER

NOW UNDER CONSTRUCTION on the campus of Sarah Lawrence College in Bronxville, N. Y., is a Student Arts Center building designed by Marcel Breuer. Although the structure will be primarily an arts laboratory and college center for 350 students and 65 faculty members, it is also intended to serve the surrounding Westchester community as a meeting place for college events and community functions. When completed, it will cost approximately \$500,000.

When the college, hard pressed for additional facilities, decided to build the center, it had a complicated set of requirements to offer the architect. "Every part of this program had to be designed for multiple use," Mr. Breuer has said: "Teaching *vs.* performance, social life *vs.* meditation, cost-dictated simplicity *vs.* multi-purpose complications."

Specifically, the building had to provide for an auditorium, theater, dance studio, student living room, snack bar, college store, music rooms and workshops.

The auditorium and stage are situated on the upper level of the building (see diagram, page 354). A roof terrace at the front leads into the auditorium on this level. Immediately below it is the area which accommodates the living room and snack bar.

On a slightly lower level behind this and just under the auditorium is the dance studio, flanked on either side by dressing rooms and quarters for music instruction and practice. Orchestra lift and sub-stage are at the rear, with space for mechanical equipment to one side.

The dance studio will accommodate 40 students, the living room 80 to 100 persons, and the snack bar will be equipped to serve 60 customers an hour. The front façade of the living room is completely glazed and leads onto an open flagstone terrace.

The 500-capacity auditorium-theater has removable alternate rows of seats which can be replaced with work tables or cabaret tables for forums, college dances and the like. Each seat is swiveled, to permit audiences to follow swift stage action.

An ingenious orchestra lift can be raised from ground level to conventional pit level, to floor level of the auditorium

(Continued on page 354)

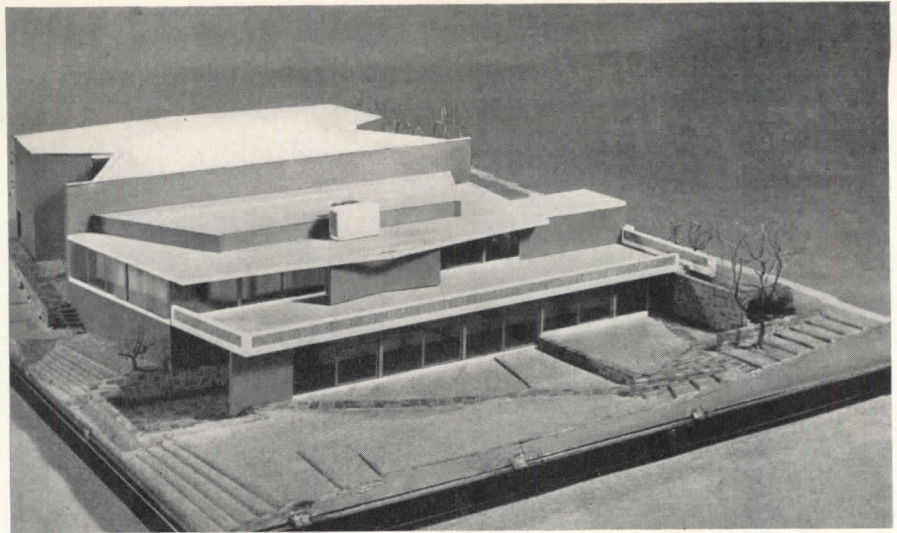

Above: view of model from front shows glass-walled living room, with terrace above. Auditorium and stage are at rear, upper level

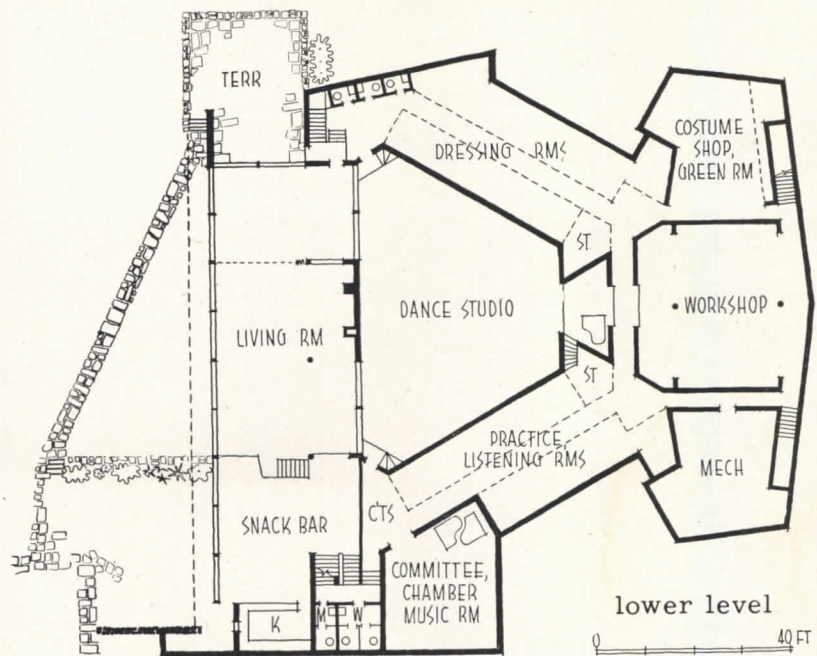

Plan, above, shows facilities on lower level. Dance studio and rooms at sides of building are below auditorium. Below, model from side

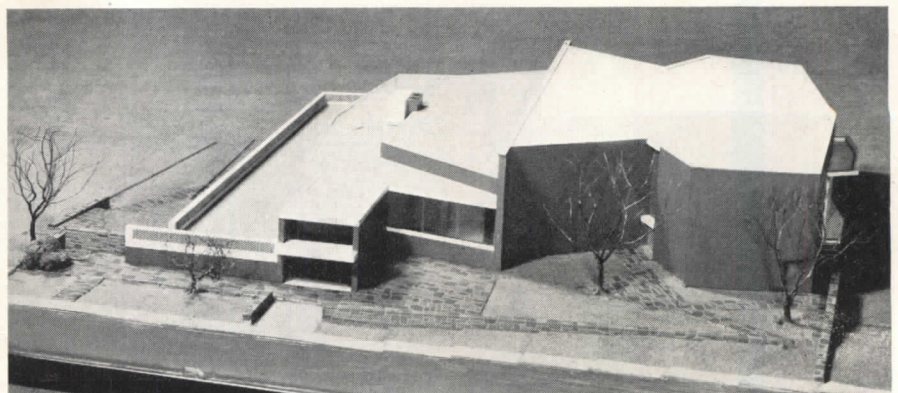

Here's Why

**LEADING ARCHITECTS
AND BUILDERS
USE AND RECOMMEND**

Sterling 600 SERIES **SLIDING DOOR HARDWARE**

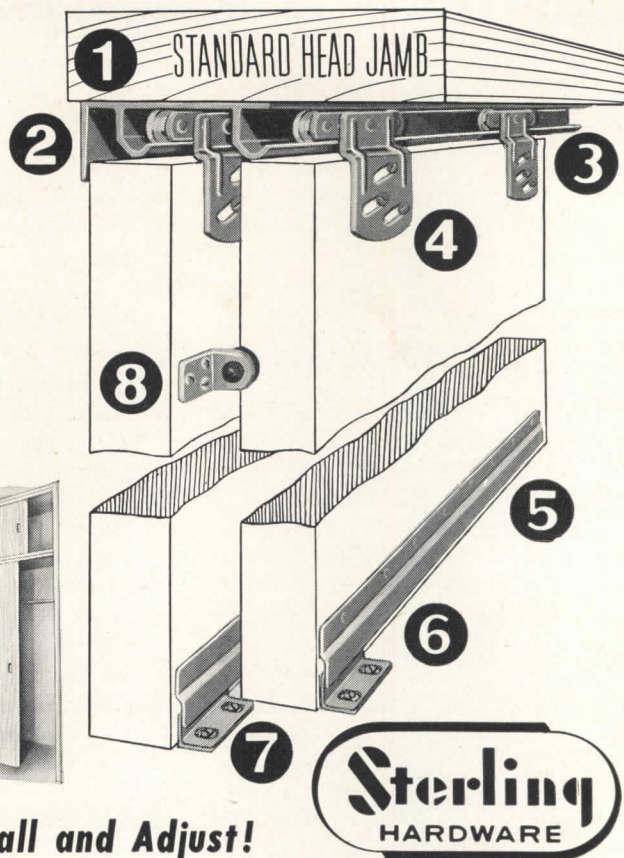
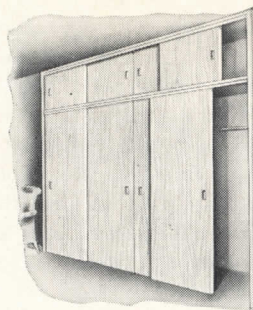

Saves Time! Saves Money! Easy to Install and Adjust!



- 1 USE STANDARD DOOR FRAME.** No special header construction needed. No grooving!
- 2 APRON CONCEALS HANGERS AND TRACK.** May be painted if desired. No extra trim necessary.
- 3 ONLY ONE INCH HEADROOM REQUIRED.** No need for extra headroom for hardware.
- 4 ADJUSTABLE HANGERS.** Slotted screw holes make it easy to plumb door with jamb.
- 5 GUIDE STRIPS** eliminate troublesome grooving of doors. Not visible from the outside.
- 6 DOOR GUIDES** can be installed after doors are hung. Slotted screw holes permit easy adjustment.
- 7 NO TRACK ON THE FLOOR** to catch dust and dirt ... floor is clear and clean at all times.
- 8 DOOR STOP** keeps flush pull on rear door always accessible. Fingers can't get pinched.

Write for Catalog on Sterling line of Sliding Door Hardware for wardrobes, pocket doors, side doors in home garages and other Sterling products.



Nationally Advertised

**IN ALL LEADING
MAGAZINES**

Read by **ARCHITECTS,
BUILDERS and
HOME BUYERS**



STERLING CASEMENT WINDOW HARDWARE

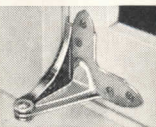

No. 190
EXTENSION
HINGES

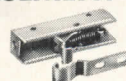

No. 165
PULL-TITE
CLOSER

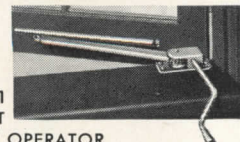

No. 61
CASEMENT
WINDOW OPERATOR

★ See our Catalog in SWEET'S Architectural File 18d/ST and Builders File 4e/ST

★ See our display at THE ARCHITECTS SAMPLES CORPORATION New York, New York

STERLING HARDWARE MANUFACTURING CO.

2345 WEST NELSON STREET, CHICAGO 18, ILLINOIS

NEWS FROM CANADA by John Caulfield Smith

TWO OFFICE BUILDINGS PLANNED FOR TORONTO

TWO LARGE OFFICE BUILDINGS scheduled to be constructed soon in Toronto will increase the city's available office space by approximately 325,000 sq ft.

One of them, a 15-story building designed by Earle L. Sheppard, architect, will be one of the city's largest office structures in terms of rentable floor space. This will amount to about 175,000 sq ft. To be known as the Exchange Building, it will front on the south side of Adelaide Street, between Yonge and Bay Streets. Indoor parking will be provided for tenants in a three-level parking garage below ground. The structure will be L-shaped and of steel frame construction. The exterior will be faced with stone. Cost is estimated at about \$3,000,000.

The second building, for which Page & Steele are architects, will be a 12-story structure and with its walls of glass will be the first building of its kind in Canada. It will be erected on the southeast corner of Richmond and York Streets, and will cost an estimated \$2,500,000. No name has yet been chosen for the building, which will also feature a three-tiered parking garage in the basement. It will provide 150,000 sq ft of floor space, and the ground floor will be rented to banks or stores. Construction will begin when steel restrictions are relaxed, and is expected to be completed within 18 months.

The provision for indoor parking facilities is an innovation in Toronto office structures. The Exchange Building was to have been the first in the city to include an indoor garage, but will now be sharing its honors.

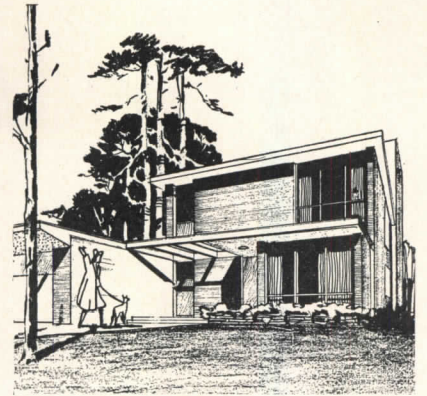

DESIGNED FOR PROMOTION

The house shown here was designed by Venchiarutti & Venchiarutti for use in a public relations project sponsored by the Ontario Association of Architects. An article pointing out the advantages of retaining architects to design residences was also prepared. The article, together with a mat of the drawing above, was sent to editors of newspapers in all Ontario communities of 20,000 or more population. Appearance, practical planning, higher resale value were stressed

(Canada News continued on page 32)

Ken Bell

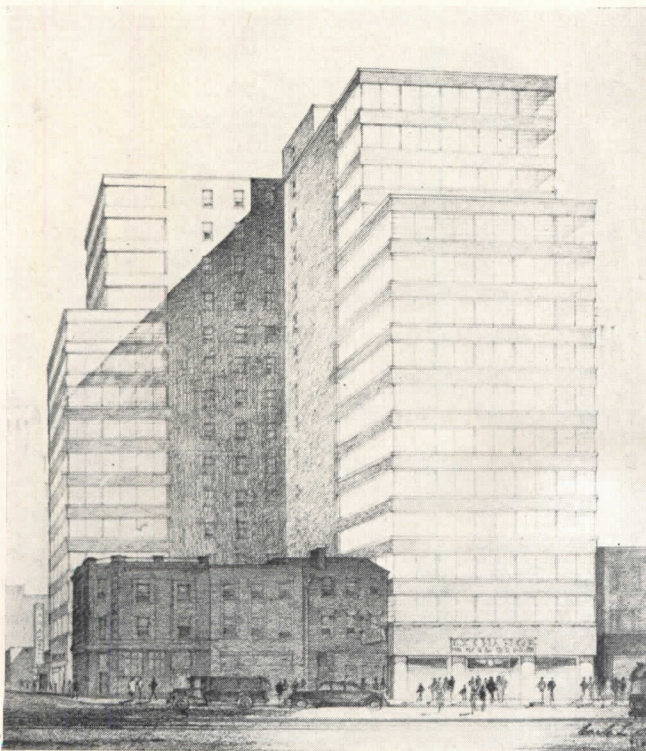

Fifteen-story Toronto office building will have indoor parking garage. Earle L. Sheppard, Architect

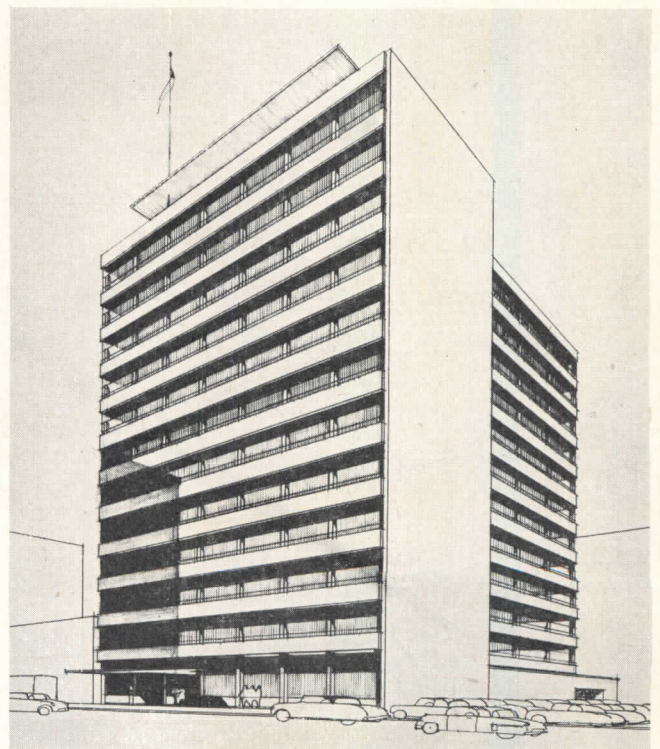

Canada's first glass-walled office building, to be built soon in Toronto. Page & Steele, Architects

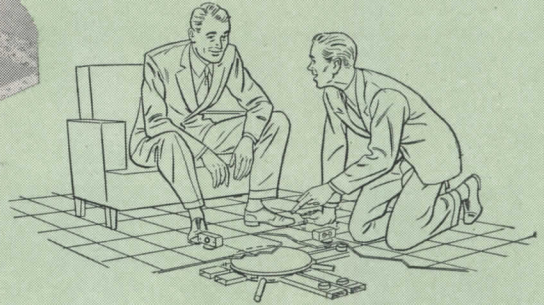
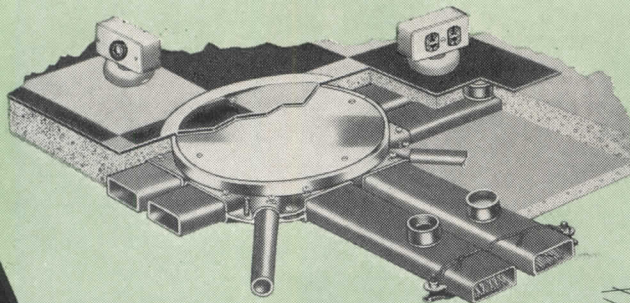

There are 100,000 electrical convenience outlets in the first three units of Pittsburgh's multi-million dollar Gateway Center, thanks to Nepcoduct! Nearly 38 miles of National Electric's all-steel underfloor electrical raceway supply power for lighting, business machines, telephone, buzzer and signal systems in these ultra-modern office buildings.

Nepcoduct provides the ultimate in electrical convenience—outlets *anywhere* they are needed. No matter how often office layouts and movable wall partitions are changed, Gateway tenants have easy access to power and communication *at the floor surface*. Outlets are already threaded, ready to use, just below the floor cover.

Nepcoduct fits any type of floor construction—ideal for new construction or wiring modernization of OFFICES, FACTORIES and COMMERCIAL BUILDINGS.

Nepcoduct is a *permanent* wiring system. Yet it provides all the flexibility and convenience of temporary wiring *for all time*—at a fraction of the cost required for extension, expansion and relocation of ordinary wiring systems.

Easy to lay out . . . easy to order . . . easy to maintain. Steel for permanence . . . grounded for safety! Listed by Underwriters' Laboratories, Inc. Write for catalog and complete details.

EVERYTHING IN WIRING POINTS TO

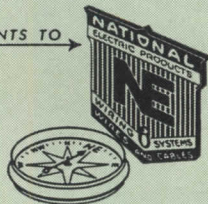

National Electric Products

3 Plants • 6 Warehouses • 42 Sales Offices

**National Electric Products Corp.
1327 Chamber of Commerce Bldg.
Pittsburgh 19, Pennsylvania**

Please send me the illustrated Nepcoduct catalog.

Name _____

Title _____

Company _____

Address _____

CANADA

(Continued from page 28)

Housing Leads July Contract Award List

July construction contract awards valued at \$139.4 million carried the total for the first seven months of 1952 slightly above the billion dollar mark, according to MacLean Building Reports Ltd.

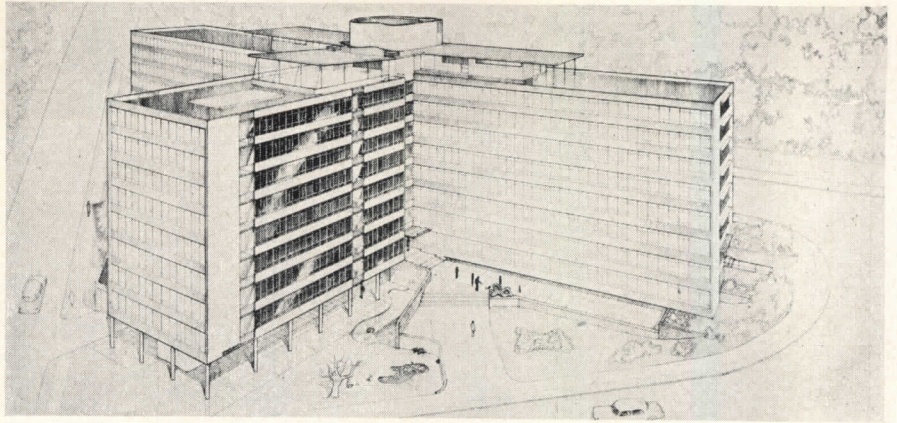

Graham Warrington

Hycroft Towers Apartments, Vancouver, B. C., are reported to be the largest in Canada. Of the 155 apartments, 25 are "double" luxury dwellings which may be subdivided, permitting increase to 180 apartments if necessitated by economic conditions. Architects are Semmens & Simpson, Vancouver

These figures, however, both for the month and for the year to date, are under last year's totals of \$362.8 million for July and \$1½ billion for the first seven months.

Housing led the field in the month's activities. In contrast with substantial drops in industrial and engineering construction, and also with a less drastic decline in commercial construction, residential building rose \$20.9 million over last year's figure to a total of \$64.7 million.

Commercial Drops

Commercial construction for July amounted to \$39.3 million, as compared with \$47.4 million for July 1951. Industrial construction figured for only \$11.5 million, down \$40.6 million from last year, and the \$23.9 million total for engineering work was off \$159.6 million from the previous figure.

Heading the list of big jobs for the month were a project of 147 houses at Edmonton; a \$1 million Toronto apartment; and housing developments in the Ontario centers of Ancaster, Levack, Dixie and Kitchener.

Other major items include a bridge, a dock and a grain elevator, all in Vancouver; a \$1 million sewage disposal plant in Oshawa; a \$2 million factory and 43 office buildings in Toronto; and a \$2.6 million airport in St. Johns, Nfld.

(Continued on page 34)

GLOBE SPRINKLERS

FIREMEN EVERY 10 FEET

SAVING MONEY...24 HOURS DAILY
 GLOBE Automatic Sprinklers stay on guard, day and night...always alert...discharging water *when and where FIRE starts*. GLOBE Sprinklers not only *discover and stop FIRE*, they also reduce overhead in the form of insurance costs.

GLOBE AUTOMATIC SPRINKLER CO.
 NEW YORK...CHICAGO...PHILADELPHIA
 Offices in nearly all principal cities

THEY PAY FOR THEMSELVES

where ANACONDA Bronze contributes enduring beauty:

Temple in Illinois

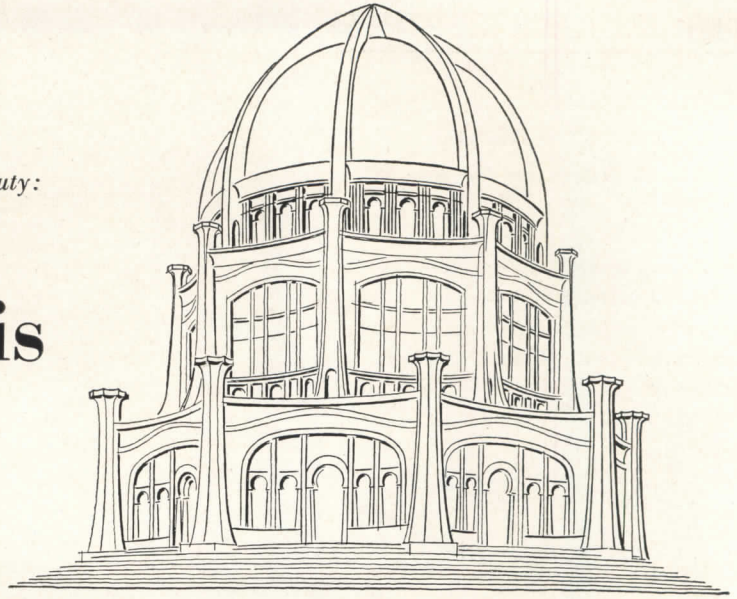

BAHÁ'Í HOUSE OF WORSHIP, Wilmette, Illinois. Louis J. Bourgeois, original architect for exterior. Shaw, Metz and Dolio, architect for interior. George A. Fuller Company, general contractor.

THIS IMPRESSIVE TEMPLE was started in 1920 by members of the Bahá'í faith to express Bahá'í teachings in progressive revelation and spiritual unity of East and West.

In the doors and windows of each of the nine sides of this Temple, the beauty of ANACONDA Architectural Bronze will outlast generations of worshippers. For no other metal surpasses bronze for monumental endurance, warmth or grace of effect. It is the oldest metal known to man — traditional in centuries of noteworthy architecture. Bronze creates the impression of stability and dignity so desirable in public, private and commercial buildings.

5203

Bronze doors and window frames in the Bahá'í Temple were fabricated by Waukegan Architectural, Inc. from extrusions and sheets. For information about ANACONDA Architectural Bronze, write The American Brass Company, Waterbury 20, Connecticut. In Canada: Anaconda American Brass Limited New Toronto, Ontario.

One of the nine entrances (right, exterior; below, interior). Original wood and steel frames were replaced with ANACONDA Bronze. First floor took ten tons.

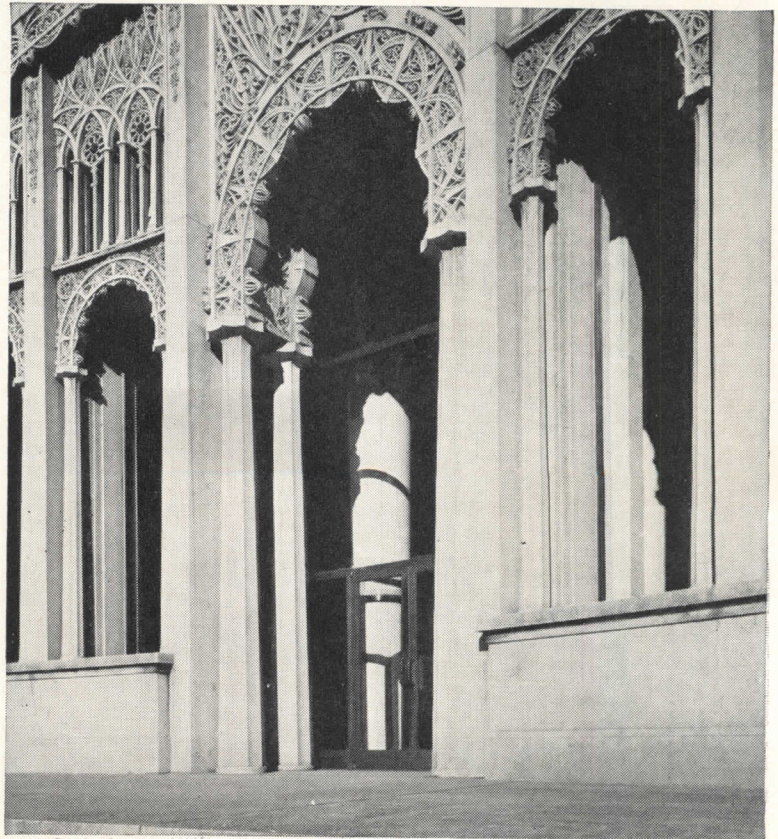

CANADA

(Continued from page 32)

Six Community Planning Fellowships Are Awarded

Six fellowships for postgraduate study in community planning during the academic year 1952-53 have been awarded.

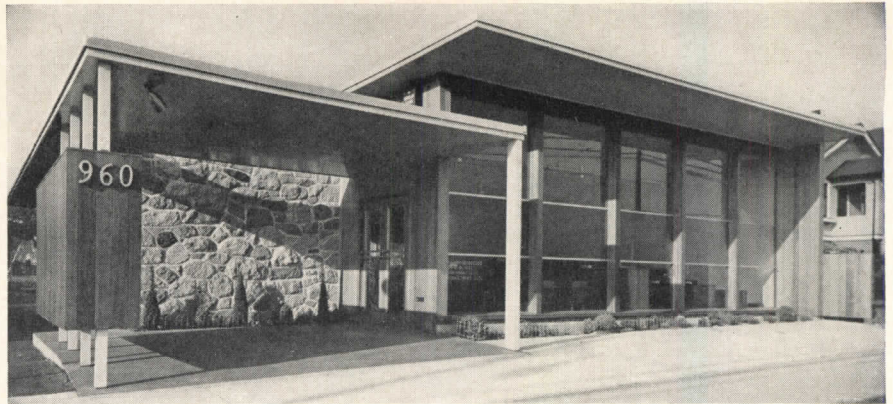

Graham Warrington

Columbia Securities Office Building, near Vancouver, B. C., houses an Automobile Finance Company. Located on a major highway, in a typical ribbon development with competing neon signs, it relies on simplicity of design for attention. Architect is Duncan McNab, Vancouver

A GOOD FLOOR deserves the BEST TREATMENT

Winona YMCA, Winona, Minn.
Architect: Bertram A. Weber,
Chicago, Ill.

Specify HILLYARD

Only a fraction of the initial investment of laying a good floor, is the cost of its protective treatment . . . so when you have chosen a good floor surface, it's sound economy to specify Hillyard floor seals, waxes and finishes . . . because Hillyard products are the result of "years-ahead" research—provide that "extra high quality" to guarantee effective performance on every type of floor.

Protect your floor investments—get the best—
Get Hillyard!

Why not give us a CALL TODAY!

We'll send along a Hillyard Maintaineer (floor expert) to give you "on job" advice, and help with any floor problem that may be troubling you. No charge for his services. AIA "specs" free on request.



... on your staff
not your payroll



St. Joseph, Missouri

Branches in Principal Cities

Winners of the prizes, offered by Central Mortgage & Housing Corp., are: F. Gerald Ridge, M.A., of Hamilton, Ont.; Earle A. Levin, B.Arch., of Winnipeg, Man.; M. B. M. Lawson, B.Sc., of Vancouver, B. C.; Zane Bakun, B.Sc., of Winnipeg, Man.; W. P. Paterson, B.A., B.S.W., of Vancouver, B. C.; Hugh Owen (diploma from Architectural Association of London), Toronto, Ont.

Mr. Lawson and Mr. Owen will do their postgraduate work at the University of Toronto. Mr. Ridge will study at McGill, Mr. Paterson and Mr. Levin at the University of British Columbia, and Mr. Bakun at the University of Manitoba.

The purpose of the fellowships, which are worth \$1200 each, is to aid students in receiving advanced training in community planning and allied fields which will enable them to enter practice either privately or in public service work. The funds are provided under Part V of the National Housing Act, which permits grants for housing research.

New Type of Concrete Trusses In First Canadian Appearance

Eight reinforced concrete Vierendeel trusses, the first of their kind in Canada, have been employed in the construction of a new bottling plant for John Labatt Ltd., London, Ont., brewers.

The trusses were used to span a 38-ft tank room and at the same time support a mezzanine floor and another floor with

(Continued on page 36)



DUKE UNIVERSITY CLASSROOM and ADMINISTRATION BUILDING, Durham, N. C.

Architects: Office of HORACE TRUMBAUER • WILLIAM O. FRANK • W. EDWARD FRANK, Philadelphia, Pa.

Consulting Engineer: WM. M. WALLACE II, Durham, N. C. • Heating Contractors: DURHAM PLUMBING & HEATING CO.

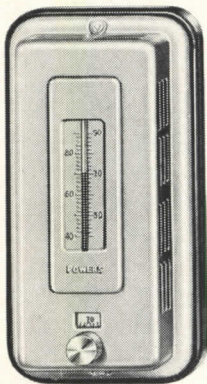

145 Powers Type D Thermostats used here with single knob limited temperature adjustment. When room is vacated for the day occupant turns dial to word "OFF". Note its simplicity and small size: H. 5 $\frac{5}{8}$ " , W. 2 $\frac{3}{8}$ " , Depth 2 $\frac{1}{8}$ " .

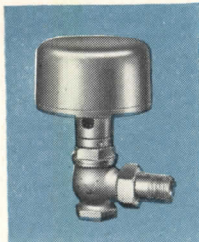

Powers Radiator Control Valve

In Prominent Universities —

POWERS **TEMPERATURE CONTROL**

is selected to provide the comfort and fuel economy which result from the elimination of overheated rooms.

In Duke University's beautiful new Classroom and Administration building the heating system will be automatically regulated by 145 Powers individual room thermostats controlling 236 radiator valves on convectors and direct radiation.

At Harvard, Massachusetts Institute of Technology and many other famous institutions Powers systems will be found giving dependable low-cost-maintenance-control after years of reliable service.

When problems of temperature and humidity control arise why not let POWERS work out the correct solution? Our more than 60 years of experience gained in all types of important buildings should be helpful to you. Phone or write our nearest office. There is no obligation.



Since 1891

(a93)

OFFICES IN
OVER 50 CITIES

THE POWERS REGULATOR COMPANY

SKOKIE
ILLINOIS

Structural Wood Framing Systems by Weyerhaeuser

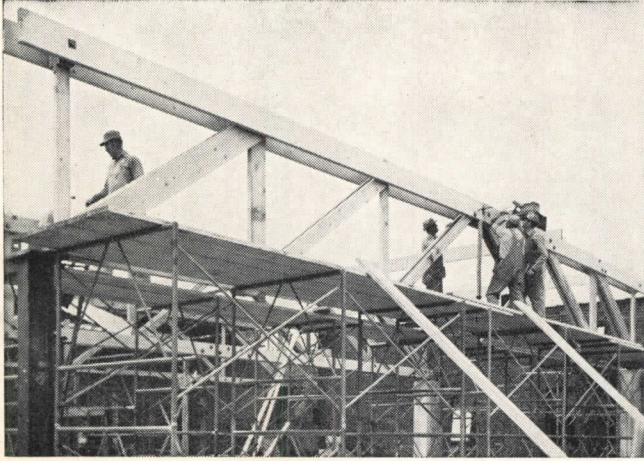

Engineering in lumber has developed a broad line of structural wood products, precision fabricated by Weyerhaeuser. A variety of types of roof trusses is offered: bowstring, flat top, tandem, and pitches, for post-free clear span buildings, 30 feet and wider . . . round top and pitched type trussed rafters . . . segmental arched rafters for 30 to 50 foot spans . . . buttressed arches for 50 to 100 foot spans . . . girders and other wood structural systems.

Fabricated from stress-graded Douglas Fir lumber, these products are delivered to the job site complete with hardware, ready for erection by local crews.

The catalog includes pertinent engineering and design data . . . Write nearest office for the catalog and other information.

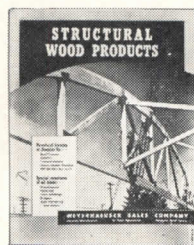

WRITE FOR
**FREE
CATALOG**

WEYERHAEUSER

SALES COMPANY

FABRICATING DEPARTMENT
SAINT PAUL 1, MINNESOTA
TACOMA, WASH. NEWARK, N. J.

THE RECORD REPORTS

CANADA

(Continued from page 34)

a heavy machinery load. The lack of diagonal members in the Vierendeel girder permitted a large amount of heating, plumbing, process piping and air conditioning ducts to be put through it.

Architects on the \$2 million project were Harley, Ellington & Day Inc., of Detroit and John M. Watt & Associates, London, Ont. Structural engineers were C. C. Parker & Associates, Hamilton, Ont.; general contractor was John Hayman & Sons Co. Ltd., London, Ont.

F. Forsythe Jr.

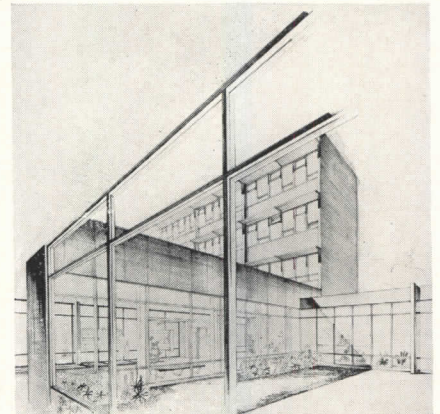

Thesis-project design of small hospital and chapel, above, won 1952 Pilkington Traveling Scholarship for Roger Morantville of McGill University. Given each year to a graduating student of a Canadian architectural school, it is worth \$1500 plus traveling expenses to and from England. Jury for this year's competition, shown below, included Toronto architects George Pokorny, J. C. Parkin and L. E. Shore



How to Build A Third Bedroom into A Two-Bedroom House

There's really nothing to it when you use "Modernfold" doors as *movable walls*. When you want to add length to your living room . . . fold "Modernfold" doors out of the way against the wall.

And when you want a private sitting room . . . another bedroom or guest room . . . just close the "Modernfold" door. This "Modernfold" freedom to control the size and number of rooms has been used to good advantage by builders all over the country.



Your ideas come to life . . . for life with "MODERNFOLD" doors

For every room division or door closure problem, there's a simple, economical, space-saving solution. That's "Modernfold," the original folding door.

Specifying "Modernfold" doors keeps clients happy. For these steel-framed, vinyl-covered doors can't be equaled *anywhere* for quality of design . . . for quality and strength of materials.

And because this line is *complete*, you're sure to save time and get exactly what you want when you specify better looking, easier operating, longer lasting "Modernfold" doors.

Sold and Serviced Nationally

NEW CASTLE PRODUCTS, NEW CASTLE, INDIANA

In Canada:

Modernfold Doors, 1315 Greene Avenue, Montreal

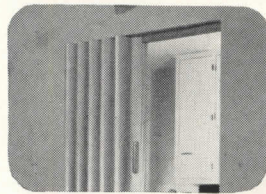

Better Looking

Fabric covering conceals all operating mechanism. No cornice needed. Adjustable trolleys keep doors hanging flush to jamb.

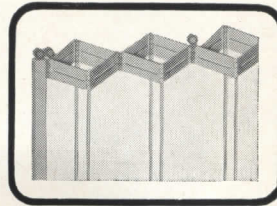

Longer Lasting

Balanced hinge construction both top and bottom. Trolleys attached at hinge intersections. No sidewise twist or pull possible.



Better Background

Over 100,000 "Modernfold" doors now in operation—a backlog of space engineering experience that's your guarantee of satisfaction.

YOU CAN'T GET MORE IN A FOLDING DOOR



COPYRIGHTED NEW CASTLE PRODUCTS 1952

New Castle Products
Box No. 816
New Castle, Indiana

Please send full details on "Modernfold" doors.

Name.....

Address.....

City.....County.....State.....

BRAB STARTS NEW PHASE OF CONSERVATION STUDY

DPA Contract Renewal Turns Efforts to Implementing Basic Recommendations

IMPLEMENTATION is the watchword in this second year of the Building Research Advisory Board's research on

conservation in building construction for the Defense Production Administration.

BRAB is now seeking ways to put into practice the findings of its first year's study, as presented to DPA June 30 in a rather monumental report including some 200 separate recommendations.

Two important approaches will be contacts with technical bodies on stand-

ards to enlist cooperation in translating the specific recommendations on standards into concrete action; and efforts to promote establishment of the Federal inter-agency mechanism urged by the BRAB report to encourage cooperation of government construction agencies on conservation matters.

Evaluation of the Report of the President's Materials Policy Commission as it relates to the problem of conservation in building may also be part of BRAB's project; and an attempt may be made to set up a set of principles to guide conservation in real emergencies.

BRAB Executive Director William Scheick indicated the Board would continue to consult the same advisory personnel and add some new ones for the second part of the study.

(Continued on page 288)

BRIGHT NEW STYLING

combines with

SEASONED LEADERSHIP

in bringing you the

HAWS 7G

Wherever Americans congregate... at work, at play... they recognize HAWS Drinking Fountains as an always dependable source of refreshing, sanitary drinking water. And have since 1909. This newest model in the complete HAWS line... beautifully achieved in highest quality vitreous china... is now available for your next specification.

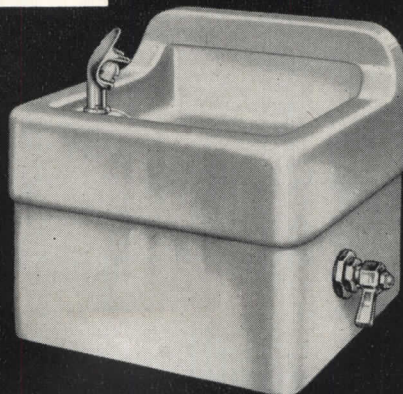

A detailed specification sheet of the HAWS Model No. 7G will be sent to you upon request. You'll want it in your file.

HAWS DRINKING FAUCET CO.
1443 FOURTH STREET • BERKELEY 10, CALIFORNIA



WALTER GREENE HEADS FHA

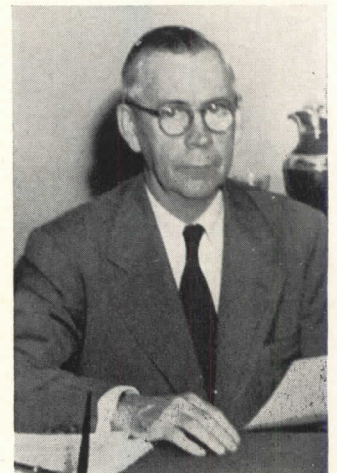

WALTER L. GREENE, the new commissioner of the Federal Housing Administration, has been with FHA since its inception in 1934, when he became administrative officer in the Birmingham, Ala., insuring office. He went to Washington in May 1937 as a supervisor in the Underwriting Division of FHA. In 1945 he was named zone commissioner in charge of 11 western states, Alaska and Hawaii. Since 1947 he has been deputy commissioner and chairman of the Finance Committee.

Commissioner Greene succeeds Franklin D. Richards, who resigned June 11 to open a brokerage office in Washington.

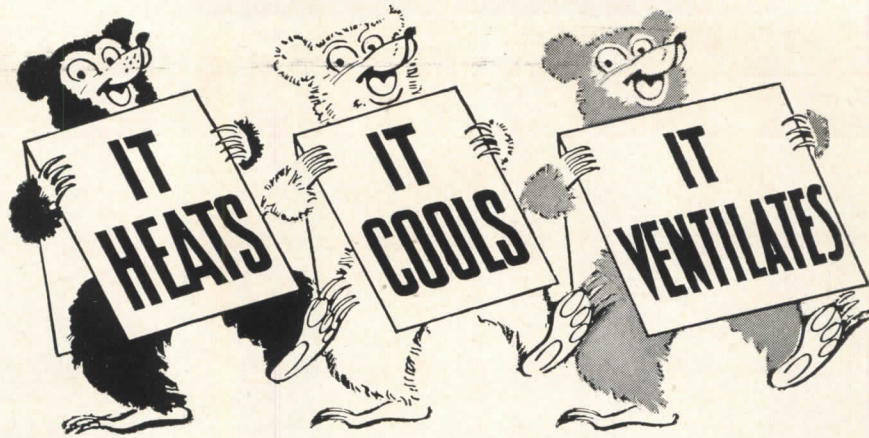

Yes, **Modine Cabinet Unit gives you ALL 3!**

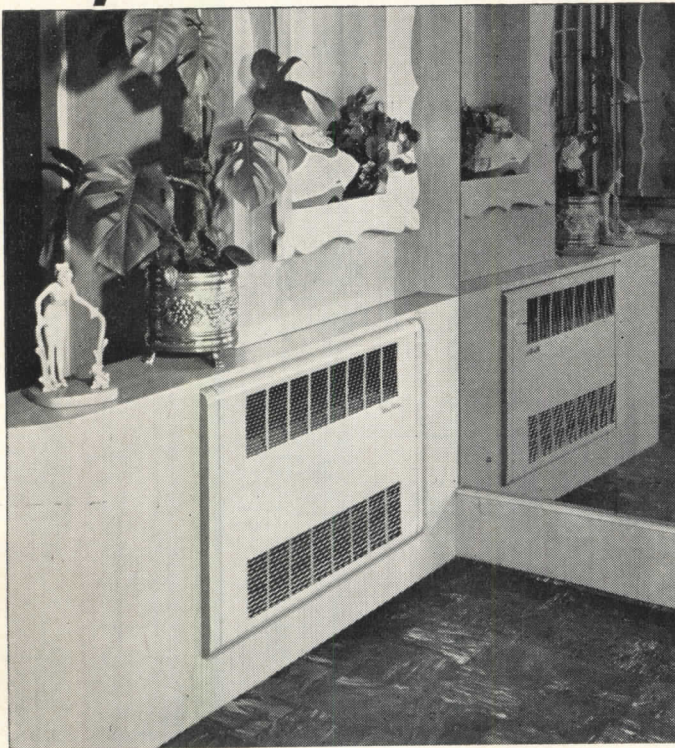

TYPE FF for heating only. Basic unit designed for exposed or recessed installation. Floor, wall or ceiling mounting.

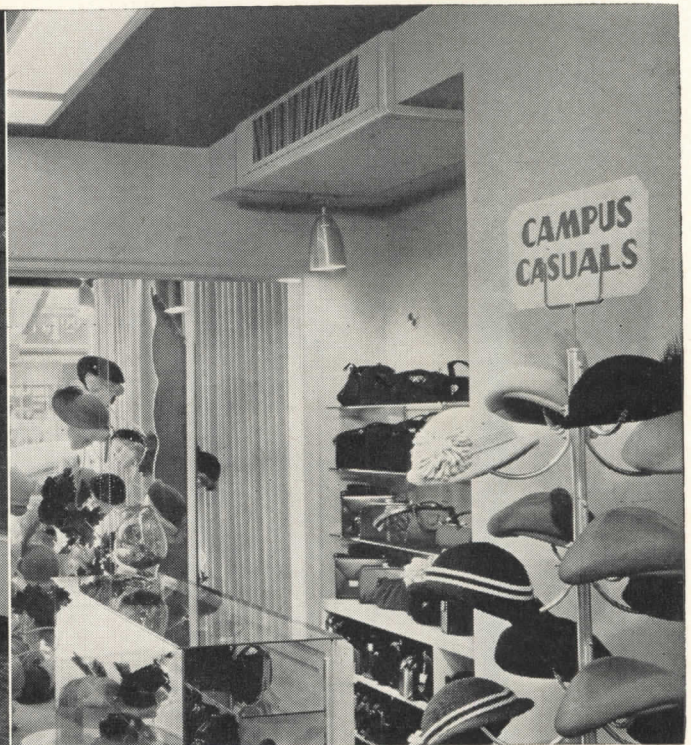

TYPE BT for heating, cooling (in floor-mounted position), ventilating, with or without ducts. Floor, wall or ceiling mounting.

IF you need economical equipment for heating, cooling and ventilating—and the expense of unit ventilators or air conditioners is not warranted—you'll find the perfect answer in Modine's newly expanded line of Cabinet Units.

Here, in a single unit, you can get quick, positive, quiet distribution of heated or cooled air . . . with or without ducts. Inexpensive accessories permit introduction, filtering, heating and distribution of fresh outside air for ventilation.

Whether it's new construction or modernization work—Modine Cabinet Units harmonize perfectly with any interior. You can choose from five different models—some for heating with steam or hot water only . . . others for heating plus cooling with chilled water.

Next time you have a heating application for commercial, institutional or public buildings—check Modine Cabinet Units. They're the low-cost answer to year 'round comfort.



Tear out coupon and mail today for your free copy of 28-page, profusely illustrated Bulletin 552. Or see your Modine representative listed in your classified phone book.

MODINE MFG. CO.
1510 DeKoven Ave., Racine, Wis.

Please send me immediately a free copy of 28-page Bulletin 552, "Modine Cabinet Units."

Name.....

Firm.....

Address.....

City..... Zn.... State.....

C-1166

Modine **CABINET UNITS**

Three welcome words...

"LOWEST MAINTENANCE COSTS"

HOSPITALS

Veterans Administration Hospital, Seattle, Wash.
Architects: U. S. Army, Corps of Engineers
Contractor: Sound Constr. & Engr. Co.

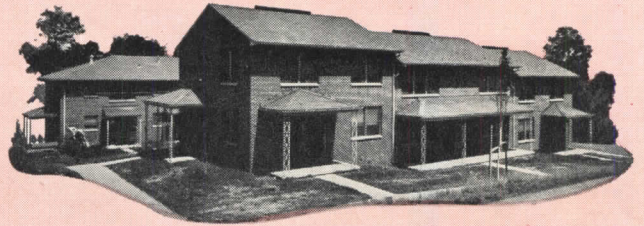
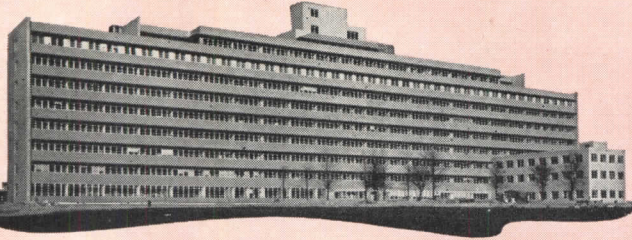

PUBLIC HOUSING

Unit in Public Housing Project—Ga. 78-1
East Point, Georgia
Architects: Abreu & Robeson
Contractor: Gilbert Beers

COMMERCIAL BUILDINGS

Chrysler Building East, New York, N. Y.
Architects: Reinhard, Hofmeister & Walquist
Contractor: Turner Construction Co.



APARTMENTS

Clairborne Towers, New Orleans, La.
Architects: Nowland Van Powell and
Henry A. Ehrensing
Contractor: Shelby Construction Co., Inc.



INDUSTRIAL BUILDINGS

Coca Cola Bottling Company, Columbus, Ohio
Architects: Tibbals, Crumley and Mussen
Contractor: R. W. Setterlin & Sons Co.

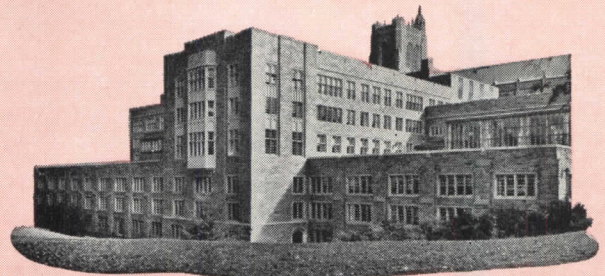
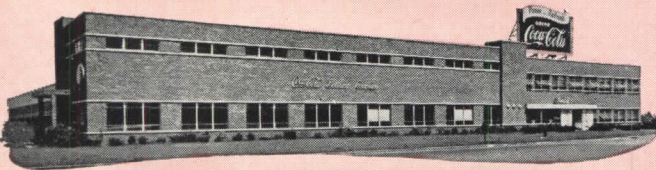

SCHOOLS

Firestone Memorial Library
Princeton University, Princeton, N. J.
Architects: R. B. O'Connor & W. J. Kilham, Jr.
Contractor: Turner Construction Co.



● ANY manufacturer whose windows meet the rigid A.W.M.A. specifications can qualify for this Quality Seal of Approval. Insist on the Seal when specifying or buying any aluminum windows.

FOR YOUR CLIENTS' PROTECTION INSIST ON THIS QUALITY SEAL

TESTED

For Quality Materials

TESTED

For Sound Construction

TESTED

For Strength of Sections

TESTED

For Low Air Infiltration

explain today's trend to

Quality Approved



ALUMINUM WINDOWS

When you plan a building, you want it to be beautiful, you want it to be useful; and if it is for investment purposes, you want it to earn the owner a profit. In all cases, you certainly want to stay within the appropriations set aside for it.

And most important, you want to keep the annual maintenance costs as low as possible. Quality-Approved Aluminum Windows will help you achieve all these objectives.

Check current costs for all types of good windows and you will find that Quality-Approved Aluminum Windows are in a competitive price range.

Figure maintenance costs over a 10, 20, or 50-year period and the savings from Quality-Approved Aluminum Windows add up to amazingly large amounts. In some buildings, they may be important enough to make the difference between a passable earning on the building investment and a really desirable cash return.

Equally important to architects, builders and owners is the fact that Quality-Approved Aluminum Windows are available for immediate delivery in an almost infinite variety of styles and sizes.

All are designed and engineered for long, trouble-free, low-cost service. They won't rust or rot; they never need painting. Practically the only maintenance is an occasional washing and wiping.

For detailed specifications covering Quality-Approved Aluminum Windows and names of "approved" manufacturers, consult Sweet's Section 17a/ALU, or write direct to Dept. AR-9.

*Aluminum Window
Manufacturers Association*

74 Trinity Place, New York 6, N. Y.

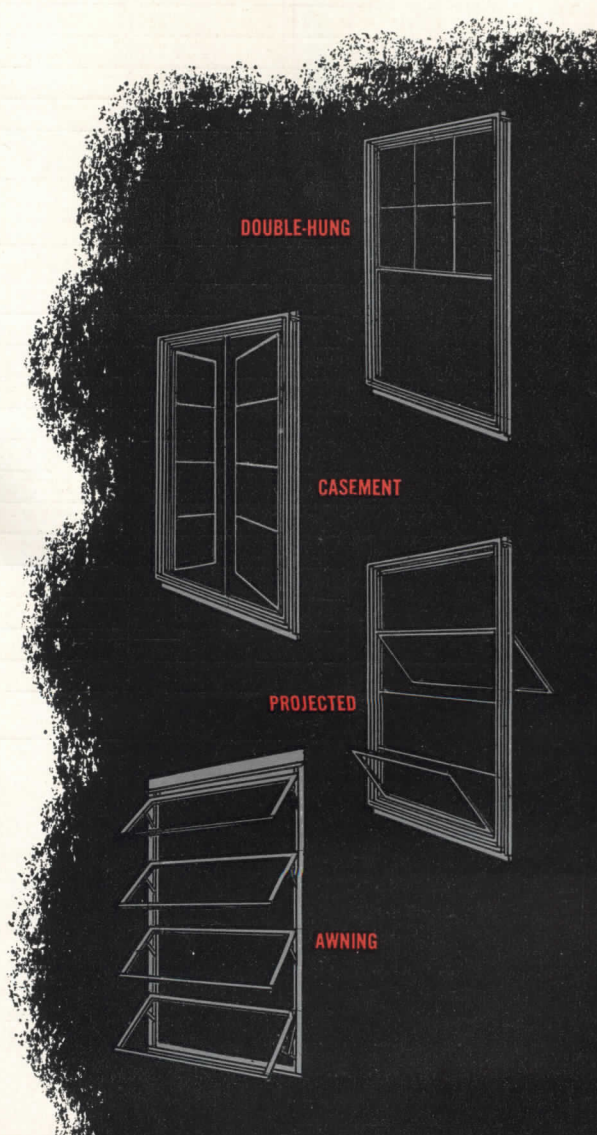

CONSTRUCTION COST INDEXES

Labor and Materials

United States average 1926-1929=100

Presented by Clyde Shute, manager, Statistical and Research Division, F. W. Dodge Corp., from data compiled by E. H. Boeckh & Assocs., Inc.

NEW YORK

ATLANTA

Period	Residential		Apts., Hotels Office Bldgs. Brick and Concr.	Commercial and Factory Bldgs. Brick and Concr.		Brick and Steel	Residential		Apts., Hotels Office Bldgs. Brick and Concr.	Commercial and Factory Bldgs. Brick and Concr.		Brick and Steel
	Brick	Frame		Brick and Concr.	Brick and Steel		Brick	Frame		Brick and Concr.	Brick and Steel	
1925	121.5	122.8	111.4	113.3	110.3		86.4	85.0	88.6	92.5	83.4	
1930	127.0	126.7	124.1	128.0	123.6		82.1	80.9	84.5	86.1	83.6	
1935	93.8	91.3	104.7	108.5	105.5		72.3	67.9	84.0	87.1	85.1	
1939	123.5	122.4	130.7	133.4	130.1		86.3	83.1	95.1	97.4	94.7	
1940	126.3	125.1	132.2	135.1	131.4		91.0	89.0	96.9	98.5	97.5	
1946	181.8	182.4	177.2	179.0	174.8		148.1	149.2	136.8	136.4	135.1	
1947	219.3	222.0	207.6	207.5	203.8		180.4	184.0	158.1	157.1	158.0	
1948	250.1	251.6	239.4	242.2	235.6		199.2	202.5	178.8	178.8	178.8	
1949	243.7	240.8	242.8	246.4	240.0		189.3	189.9	180.6	180.8	177.5	
1950	256.2	254.5	249.5	251.5	248.0		194.3	196.2	185.4	183.7	185.0	
1951	273.2	271.3	263.7	265.2	262.2		212.8	214.6	204.2	202.8	205.0	
Apr. 1952	277.2	273.7	269.9	274.0	270.1		217.8	220.1	210.5	207.7	211.1	
May 1952	277.5	274.0	270.1	273.5	270.0		218.1	220.3	211.3	208.6	212.5	
June 1952	277.5	274.0	270.1	273.5	270.0		217.7	219.9	210.8	208.2	212.1	
June 1952	124.7	123.9	106.7	105.0	107.5		152.3	164.6	121.7	113.8	124.0	
	% increase over 1939						% increase over 1939					

ST. LOUIS

SAN FRANCISCO

1925	118.6	118.4	116.3	118.1	114.4	91.0	86.5	99.5	102.1	98.0
1930	108.9	108.3	112.4	115.3	111.3	90.8	86.8	100.4	104.9	100.4
1935	95.1	90.1	104.1	108.3	105.4	89.5	84.5	96.4	103.7	99.7
1939	110.2	107.0	118.7	119.8	119.0	105.6	99.3	117.4	121.9	116.5
1940	112.6	110.1	119.3	120.3	119.4	106.4	101.2	116.3	120.1	115.5
1946	167.1	167.4	159.1	161.1	158.1	159.7	157.5	157.9	159.3	160.0
1947	202.4	203.8	183.9	184.2	184.0	193.1	191.6	183.7	186.8	186.9
1948	227.9	231.2	207.7	210.0	208.1	218.9	216.6	208.3	214.7	211.1
1949	221.4	220.7	212.8	215.7	213.6	213.0	207.1	214.0	219.8	216.1
1950	232.8	230.7	221.9	225.3	222.8	227.0	223.1	222.4	224.5	222.6
1951	252.0	248.3	238.5	240.9	239.0	245.2	240.4	239.6	243.1	243.1
Apr. 1952	258.9	253.2	247.5	253.5	246.2	248.0	242.8	242.2	245.0	245.5
May 1952	260.7	254.0	251.6	258.1	250.2	247.6	242.4	241.7	244.6	245.1
June 1952	260.7	254.0	252.2	258.6	251.5	252.9	247.8	247.2	251.0	251.0
June 1952	136.6	137.4	113.7	115.9	111.3	139.5	149.5	110.6	105.9	115.5
	% increase over 1939					% increase over 1939				

The index numbers shown are for combined material and labor costs. The indexes for each separate type of construction relate to the United States average for 1926-29 for that particular type — considered 100.

Cost comparisons, as percentage differences for any particular type of construction, are possible between localities, or periods of time within the same city, by dividing the difference between the two index numbers by one of them; i.e.:

index for city A = 110
 index for city B = 95
 (both indexes must be for the same type of construction).

Then: costs in A are approximately 16 per cent higher than in B.

$$\frac{110-95}{95} = 0.158$$

Conversely: costs in B are approximately 14 per cent lower than in A.

$$\frac{110-95}{110} = 0.136$$

Cost comparisons cannot be made between different types of construction because the index numbers for each type relate to a different U. S. average for 1926-29.

Material prices and wage rates used in the current indexes make no allowance for payments in excess of published list prices, thus indexes reflect minimum costs and not necessarily actual costs.

These index numbers will appear regularly on this page.

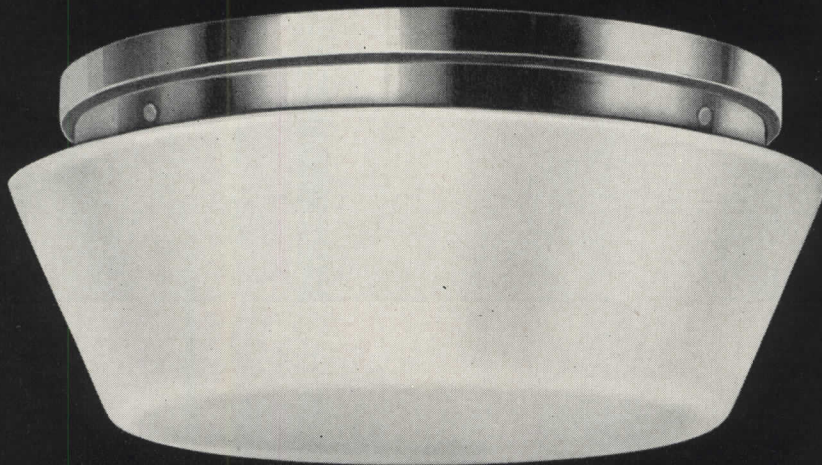

A new circular incandescent lighting form in close to the ceiling band units. Provides light to the ceiling with uniform surface brightness for visual efficiency.

Write
for
detailed
release sheets
on new
products

THE ART METAL COMPANY
CLEVELAND 3, OHIO

Manufacturers of Engineered Incandescent Lighting

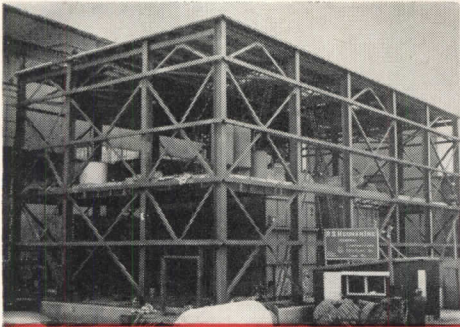

How long-lasting lightweight panels

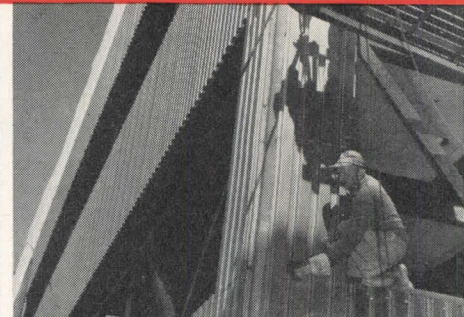
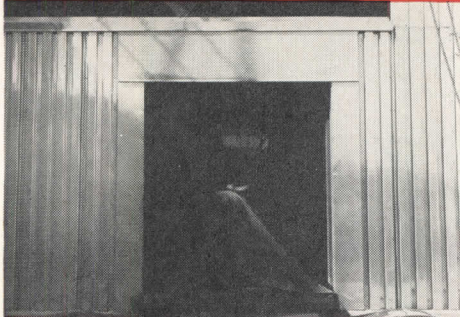

were used to completely enclose

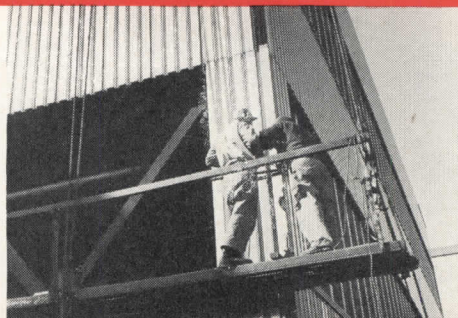
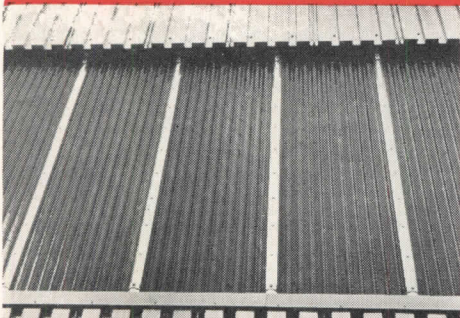

plant in eleven working days

STEP by step, these photographs show how U·S·S 17 (AISI type 430) Stainless Steel insulated building panels were installed on this addition to existing steam generating facilities at Olmsted Air Force Base, Middletown, Pa.

Only 11 working days were needed to bolt more than 7,000 square feet of panels to the structural framework. And that's only one of the advantages of this type of construction.

Panels of U·S·S 17 Stainless Steel give you a building with outstanding appearance, a minimum of maintenance and exceptionally long life. These benefits, plus the lightweight and low "U" value or heat transmission factor, make Stainless-paneled buildings the best answer to today's construction problems—especially since U·S·S 17 Stainless Steel is available without CMP tickets.

Get all the facts on this type of construction by mailing the coupon at the right.

**Job Superintendent
J. KALLEY says:**

"Our crew of eight men installed these panels at the rate of 600 square feet per day. Four to five men cleaned and drilled the panels, and three to four installed them on the building."



U N I T E D S T A T E S S T E E L

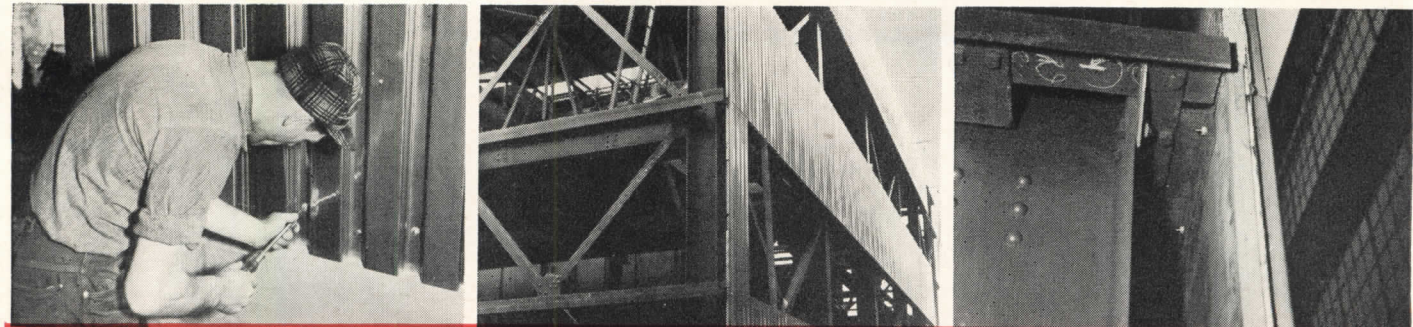

of U·S·S 17 (type 430) Stainless Steel

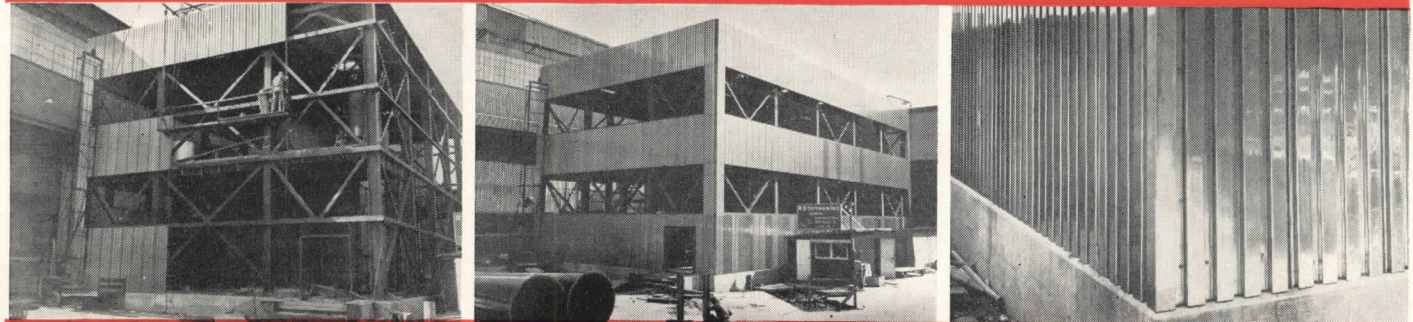

this 86½' x 46' steam generating

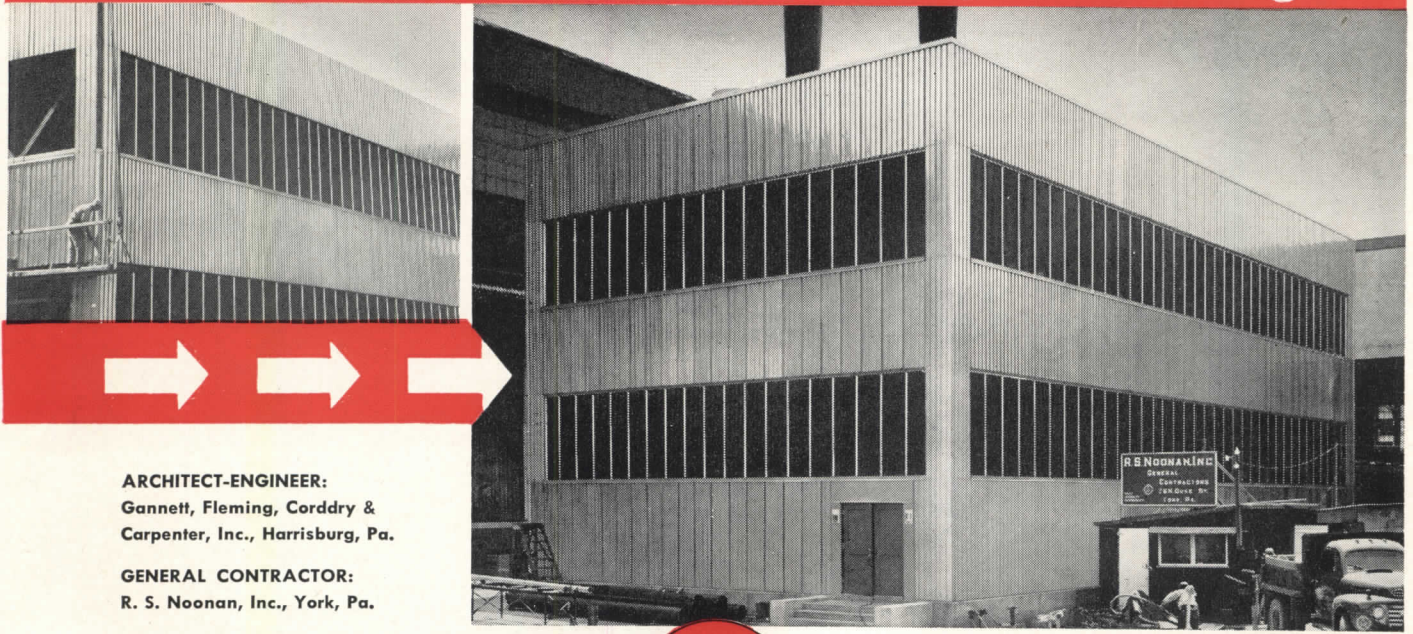

ARCHITECT-ENGINEER:
Gannett, Fleming, Corrdry & Carpenter, Inc., Harrisburg, Pa.

GENERAL CONTRACTOR:
R. S. Noonan, Inc., York, Pa.

WALLS are standard Stainless Steel panels fabricated and erected by H. H. Robertson Co., Pittsburgh, Pa.



UNITED STATES STEEL COMPANY, PITTSBURGH • AMERICAN STEEL & WIRE DIVISION, CLEVELAND
 COLUMBIA-GENEVA STEEL DIVISION, SAN FRANCISCO • NATIONAL TUBE DIVISION, PITTSBURGH
 TENNESSEE COAL & IRON DIVISION, FAIRFIELD, ALA.
 UNITED STATES STEEL SUPPLY DIVISION, WAREHOUSE DISTRIBUTORS
 UNITED STATES STEEL EXPORT COMPANY, NEW YORK

U·S·S STAINLESS STEEL

SHEETS • STRIP • PLATES • BARS • BILLETS • PIPE • TUBES • WIRE • SPECIAL SECTIONS

United States Steel Company
 Room 2805A, 525 William Penn Place
 Pittsburgh 30, Pa.

Please send me your booklet, "U·S·S 12, U·S·S 17 Stainless Steel Walls and Roofs for Industrial Buildings."

Please arrange to have fabricators of Stainless Steel wall panels send me literature on their particular type of construction.

NameTitle

Address

CityState

U N I T E D S T A T E S S T E E L

BUILDING MODERN FURNITURE

How to Build Modern Furniture. Volume II—Designs and Assembly. By Mario Dal Fabbro. F. W. Dodge Corporation (New York, N. Y.), 1952. 8½ by 11 in., 160 pp., illus. \$6.00.

REVIEWED BY MORRIS KETCHUM, JR., A.I.A.

This is a picture book. Straightforward instructions briefly point the way; drawings and models are the real text. The story starts with the home woodworker's tools and equipment. Brace and bit, plane and saw, clamps, marking devices, gauges, chisels, drills, workbenches and a completely equipped home workshop are analyzed as to form and function. The next section demonstrates the use of these tools: the right way to lay out full size drawings, to mark material for cutting, to saw, plane, chisel, glue, nail, sandpaper and finish woodwork. Basic furniture design in relationship to its use and to the size of the human body follows. This section shows standard measurements for nearly every type of furniture commonly used in the home. The final section, which makes up the greater part of the volume, gives complete instructions for building 60 different pieces of furniture. Perspectives, photo of scale models, elevations, "exploded" assembly drawings and text show how to apply the information and advice contained in the first part of the book. Everything looks easy but, as in any craft activity, time and tears must be added to the final formula. For those enthusiasts well equipped with talent, time and patience, the effort will be rewarding.

All this adds up to a superb guide for amateur woodworkers. They will no longer need to rely on those hackneyed handbooks which attempt to turn them — overnight and without the right tools — into bad copies of eighteenth century craftsmen. Too many eager amateurs have wasted their energy producing fake antiques. Thanks to Mario Dal Fabbro, their spare productive hours can now be spent in building simple, practical and handsome furniture appropriate to the tools at hand and to today's living. The

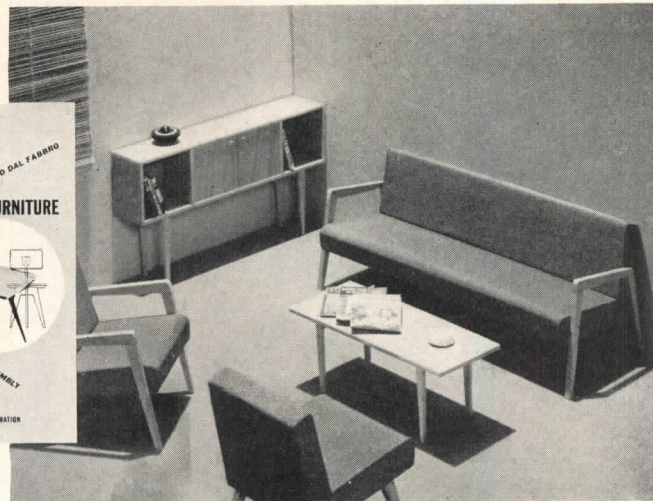
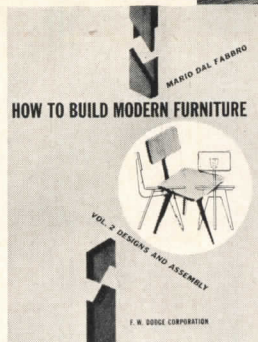

home workshop, in today's house, has left basement gloom for first floor light, air and sunshine. It is only fitting that its owner should also leave behind the insanities of amateur "basement borax" furniture.

Above and beyond this expert guidance for amateur craftsmen, "How To Build Modern Furniture" offers profes-

sional designers — cabinetmakers, interior designers, architects — an authoritative reference work. To be sure, the scope of reference is limited to a single material — wood. Many other materials used in the manufacture of furniture, including plastics and metals, which have been described in Volume I, are necessarily excluded from Volume II as

(Continued on page 48)

Typical page, below, gives details for coffee table shown in room setting above. From "How to Build Modern Furniture"

COFFEE TABLE

LIST OF MATERIALS.

A — 1 PIECE ¾" THICK AND 42" x 18".
B — 4 PIECES 1" THICK AND 14¼" x 2".
C — 1 PIECE 1" THICK AND 27" x 2". D — 2 PIECES 1" THICK AND 13" x 2". FOR GENERAL INSTRUCTIONS SEE PAGE 54. AFTER MATERIAL IS READY FOR ASSEMBLING PROCEED AS FOLLOWS:
JOIN (1) "B" WITH "D" (2) "D" WITH "C", (3) "A" WITH "C,D." NATURAL FINISH IS SUITABLE. SEE PAGE 14.

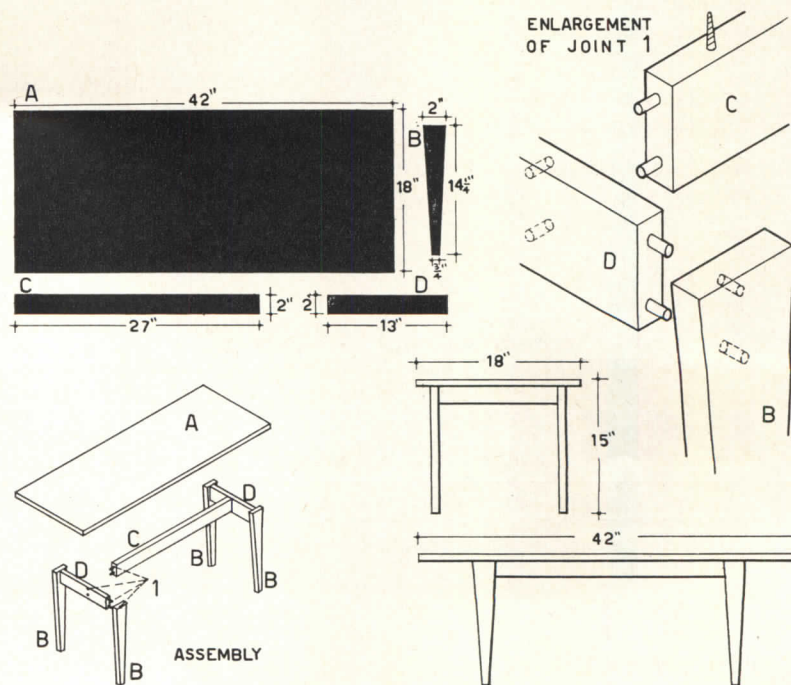
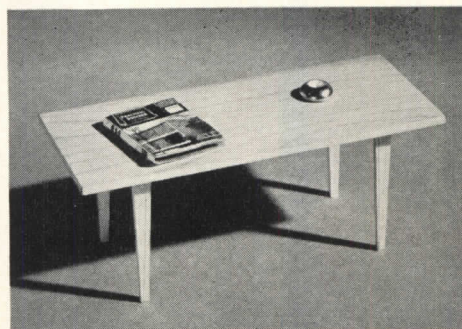

Midori Photographs

Rolling Steel

DOORS

Manually, Mechanically, or Power Operated

Illustrated below you see six Mahon Power Operated Rolling Steel Doors installed in the openings of a combination truck and rail shipping dock. The power operators are located inside with through-the-wall drives. A continuous hood over the roller shafts and operating mechanisms extends the entire length of the six truck openings. This is another typical installation where no other type of door would serve the purpose—because, the vertical roll-up action of a Rolling Steel Door eliminates overhead obstructions—occupies no usable space inside or outside the opening. All-metal construction provides permanence, greater security, and assures you a lifetime of trouble-free service. When you select Rolling Steel Doors, it will pay you to compare both specifications and price tags . . . you will find that the hot-dipped galvanized curtain slat material that goes into Mahon Rolling Steel Doors is chemically cleaned, phosphated and treated with a chromic acid solution to provide paint bond, and that the protective coating of synthetic enamel is baked on at 350° F. prior to roll-forming. This is just one of the extra value features of Mahon Rolling Steel Doors. See Sweet's Files for complete information including Specifications, or write for Catalog G-53.

THE R. C. MAHON COMPANY

Detroit 34, Michigan • Chicago 4, Illinois • Representatives in all Principal Cities

Manufacturers of Rolling Steel Doors, Grilles, and Automatic Closing Underwriters' Labeled Rolling Steel Doors and Fire Shutters; Insulated Metal Walls and Wall Panels; Steel Deck for Roofs, Partitions, and Permanent Concrete Floor Forms.

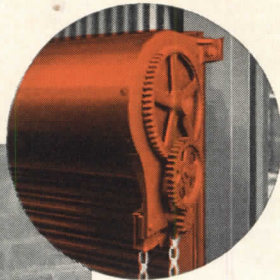

MAHON
CHAIN-GEAR
OPERATOR



MAHON STANDARD
POWER OPERATOR 920-P

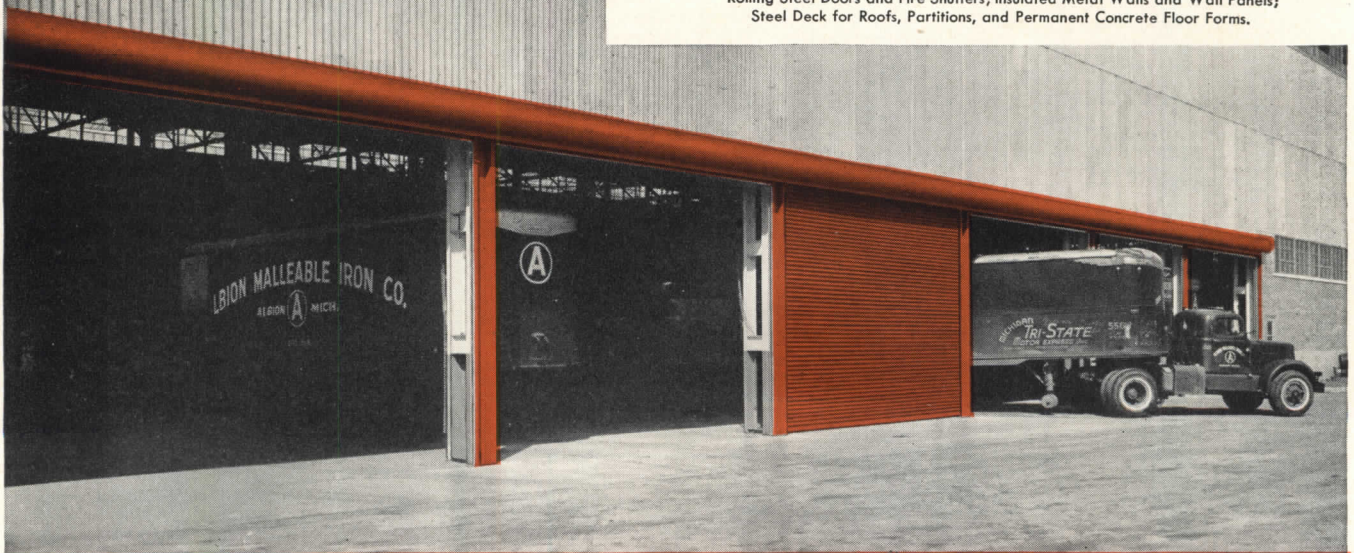

ROLLING STEEL DOORS, SHUTTERS AND GRILLES TO MEET EVERY REQUIREMENT

Six Mahon Power Operated Rolling Steel Doors 18'-7" x 14'-0" installed in a new building built by the Austin Company for the Albion Malleable Iron Works, Albion, Michigan. Another Mahon Power Operated Door 17'-0" x 22'-0" is installed in a railroad opening in the end of this enclosed loading dock.

MAHON



Assembly RM452 pre-rinses dishes, disposes garbage simultaneously—ahead of dishwasher. Equipped with "Silver-Gard" and pre-rinse.



Assembly RM352 is used at various centers where garbage occurs—in the dishwashing and vegetable center—and other centers of activity.

Garbage Problems Solved with WASTE KING COMMERCIAL PULVERATOR ASSEMBLIES!

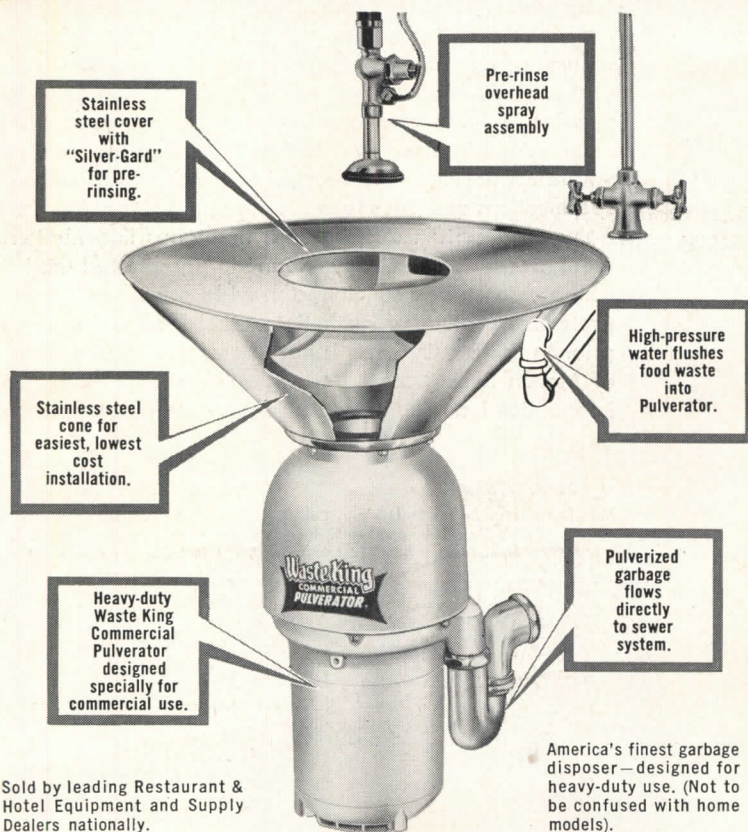

Sold by leading Restaurant & Hotel Equipment and Supply Dealers nationally.

ELIMINATE GARBAGE AT POINT OF ORIGIN! Complete Waste King Commercial Pulverator Assemblies designed to dispose of all garbage at the dishwashing area, cooks' table, rough vegetable and salad preparation center—other centers of activity where garbage occurs. Accumulation of garbage is eliminated.

PROVED AND ACCEPTED BY THE FOOD SERVING INDUSTRY. Thousands of Waste King Commercial Pulverators are being used daily in Restaurants, Hotels, Camps, Factory Commissaries and other food serving fields. Whether 100 or 100,000 meals a day are served—garbage costs are changed into profits with a Waste King Commercial Pulverator!

Remember! "Savings are as important to Profit as Sales"



A Product by Given Mfg. Co., Los Angeles, Calif.



Dept. A-9 Given Mfg. Co.
1250 Wilshire Blvd., Los Angeles 17, Calif.

Send full details on WASTE KING Commercial Pulverator Assemblies.

Send name of nearest restaurant and hotel equipment and supply dealer.

Firm Name _____

Address _____

City _____ State _____

Your Name _____ Title _____

REQUIRED READING

(Continued from page 46)

beyond the range of the home workshop. Also excluded, for the same reason, are examples of the superb craftsmanship, the fine woods and the creative fire of our top flight professionals. This is box-furniture, sturdy in scale, its members oversized against error, its whole technique rightly suited to simple skills and simple tools. In spite of this, or because of it, all the basic principles of good furniture design are neatly summarized for discerning eyes in its pages. Based on this, the professional can take off to more refined and complex objectives. Even more important, he can use this information as a sure guide for proportioning spaces, rooms and houses designed for contemporary living.

This volume is another important link in the chain which stretches between the Victorian revolt of William Morris and the contemporary craftsmanship of George Nagashima. With all proper respect to its publisher's intentions, it is to be hopefully desired that some day a popular edition may appear on every newsstand and drug store counter.

VOCABULARY FOR ARCHITECTS

Dictionary of Architecture, by Henry H. Saylor, F.A.I.A., John Wiley & Sons, New York, 1952. 4 by 6 1/2 in. 221 + 5 pp. \$4.50.

This pocket-sized book contains slightly over 4000 definitions and 16 plates of illustration. Pronunciation of difficult words is given in phonetic rather than diacritical form, while the pronunciation of obvious words is omitted. There is no cut-in thumb index, which might have added convenience to the volume's usefulness.

The proportion of historical to current terms is rather heavily weighted towards the former, but such a coverage is extremely rewarding to students and historians. Future editions might be made more comprehensive for the working architect by the addition of a wider range of contemporary expressions such as prestressed concrete, vinyl, split-level, etc. — terms which are everyday usage in the profession. The illustrations might also be updated to include a more extensive inclusion of *au courant* forms. Among the definitions are a few well known trade names while corresponding trade names of competing products have been omitted.

(Continued on page 376)

two bathrooms of BRIGGS *Beautyware*

IN COLOR

A MUST IN EVERY MODERN HOME!

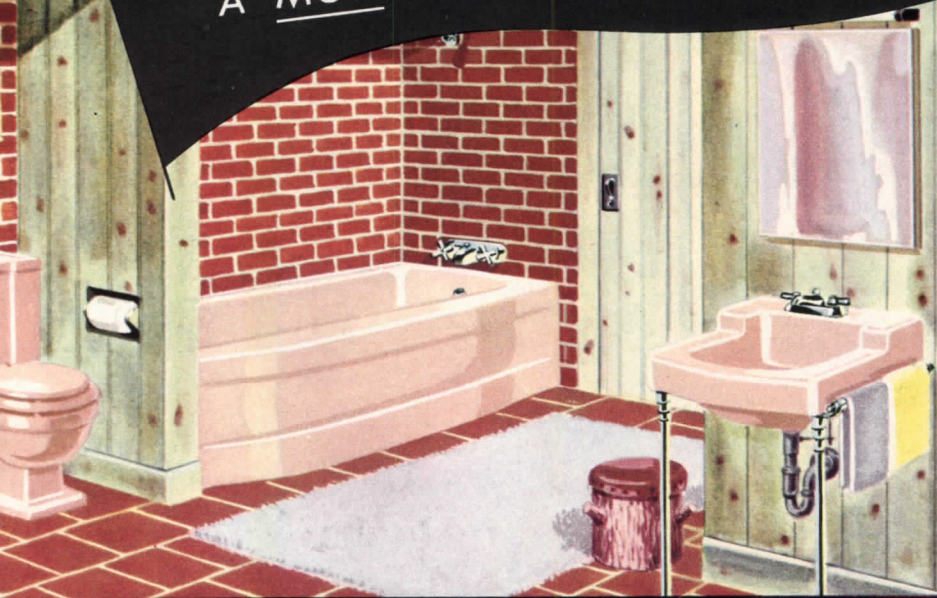

It's the big feature most wanted by today's smart home buyers

Offer your clients *two* bathrooms complete with gorgeous pastel Briggs Beautyware plumbing fixtures—and watch their eyes light up! Here's a luxury feature sure to help sell more homes—faster. Home buyers—even in the medium and low price brackets—know how it boosts convenience and increases resale value. They're especially pleased when they learn how little it adds to the monthly payments on the house.

Smart, new ultra-modern contours give Briggs Beautyware a top-quality look you can't miss. And the quality is built in! You'll find no finer plumbing fixtures anywhere than the acid-resistant porcelain enameled bathtubs and lavatories of rigid formed steel. There's a world of eye-appeal and lasting value, too, in the attractive vitreous china lavatories and water closets—as well as Briggs first-quality brass fittings.

When you draw up specifications, include *two bathrooms* of Briggs Beautyware—and design for better housing!

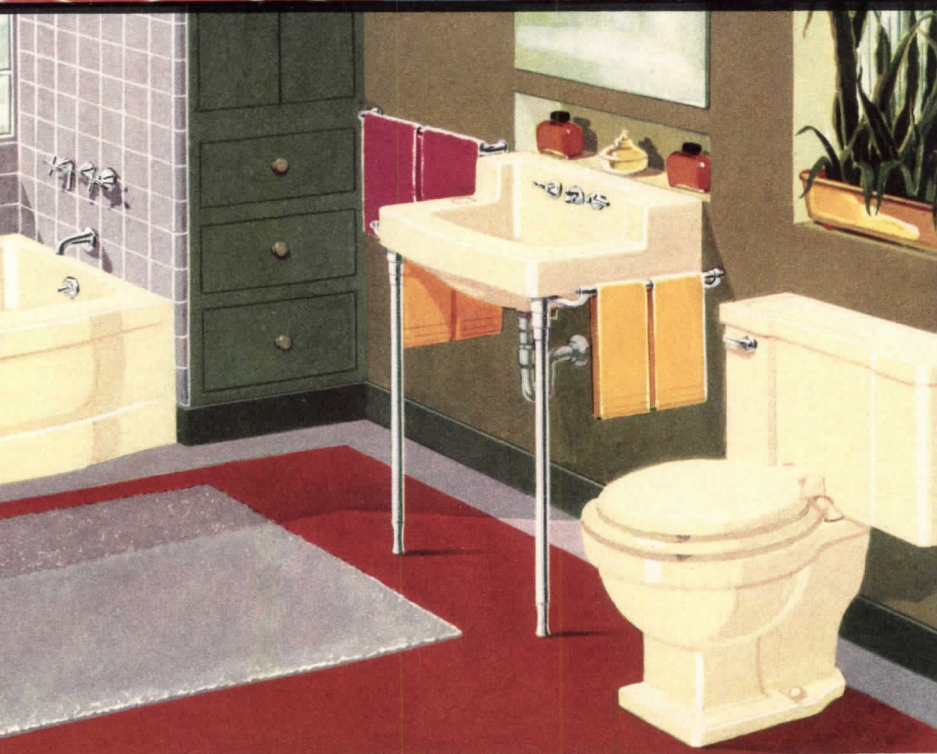

Here's extra distinction—a custom-built bathroom!

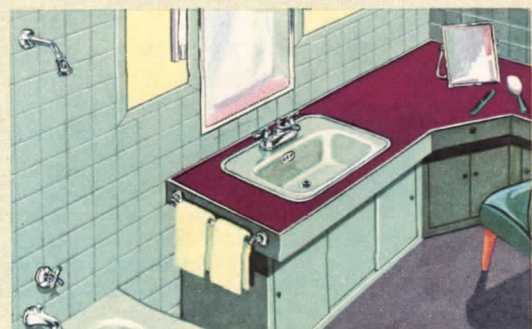

Briggs flat-rim lavatories provide a truly modern touch—the built-in treatment so popular with today's home buyers. Economical and easy to install, they offer endless opportunity for unusual bathroom designs.



Millions of home owners see these national ads! Magazine readers throughout America are seeing Briggs Beautyware in all the glory of its four famous decorator colors—Sky Blue, Sea Green, Sandstone and Ivory—in addition to sparkling white. This advertising works for you!

BRIGGS MANUFACTURING COMPANY • 3001 MILLER AVENUE • DETROIT 11, MICHIGAN

WIREMOLD ANNOUNCES PLUGMOLD 2000

**ONE Plugmold Raceway For THREE Wiring Services
Faster to Install, Easier to Install, Cheaper to Install**

PLUGMOLD 2000 has been tested in all types of construction

Proved best method yet devised for providing unlimited convenience outlets for homes, business, industry.

Here—for the first time!—is a single raceway for all 3 services! Plugmold 2000 is Wiremold's new, improved raceway base and cover assembly designed to accept Snapicoil with NEMA grounded receptacles, 2-wire "hot" Duplex receptacles, or 3-wire Duplex receptacles with one side switched and one side "hot".... For homes, office buildings, factories, stores—for new construction or the modernization of existing buildings—Plugmold 2000 has proved itself to be a far better, more modern way of providing more convenience outlets, more conveniently located. With Wiremold's famous Snapicoil pre-wired receptacles, Plugmold 2000 saves time and labor costs, because 3 simple steps complete any Plugmold 2000 installation.

PLUGMOLD 2000 is EASY to install!

Required lengths of Plugmold 2000 base are mounted in one continuous run. The proper Snapicoil pre-wired receptacles are quickly snapped into the raceway cover. Then the cover, with receptacles all inserted, is snapped into the base. A few simple fittings complete the job!

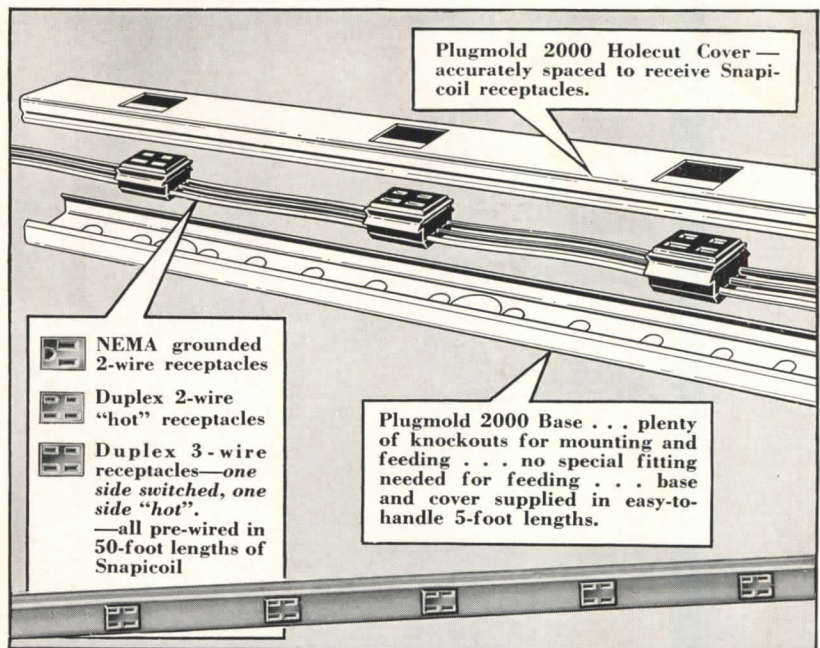

ARCHITECTS and BUILDERS WELCOME PLUGMOLD 2000

Whether you're building new homes, factories, office buildings, stores, a hotel, any other new building . . . or modernizing existing buildings, Plugmold 2000 enables you to provide unlimited convenience outlets. That makes a more desirable home or building! Plugmold 2000 is faster, easier, cheaper to install. It saves time and labor costs . . . no pre-engineering of the job is necessary, the installation is made in a continuous run, and cutting and fitting are reduced to a minimum.

Write today for new FREE PLUGMOLD 2000 Book!

Tells the whole Plugmold 2000 story! . . . shows the many applications of Plugmold 2000 . . . shows how easy it is to install, and how easy it is to specify and order Plugmold 2000 in units.

THE WIREMOLD COMPANY
HARTFORD 10, CONNECTICUT

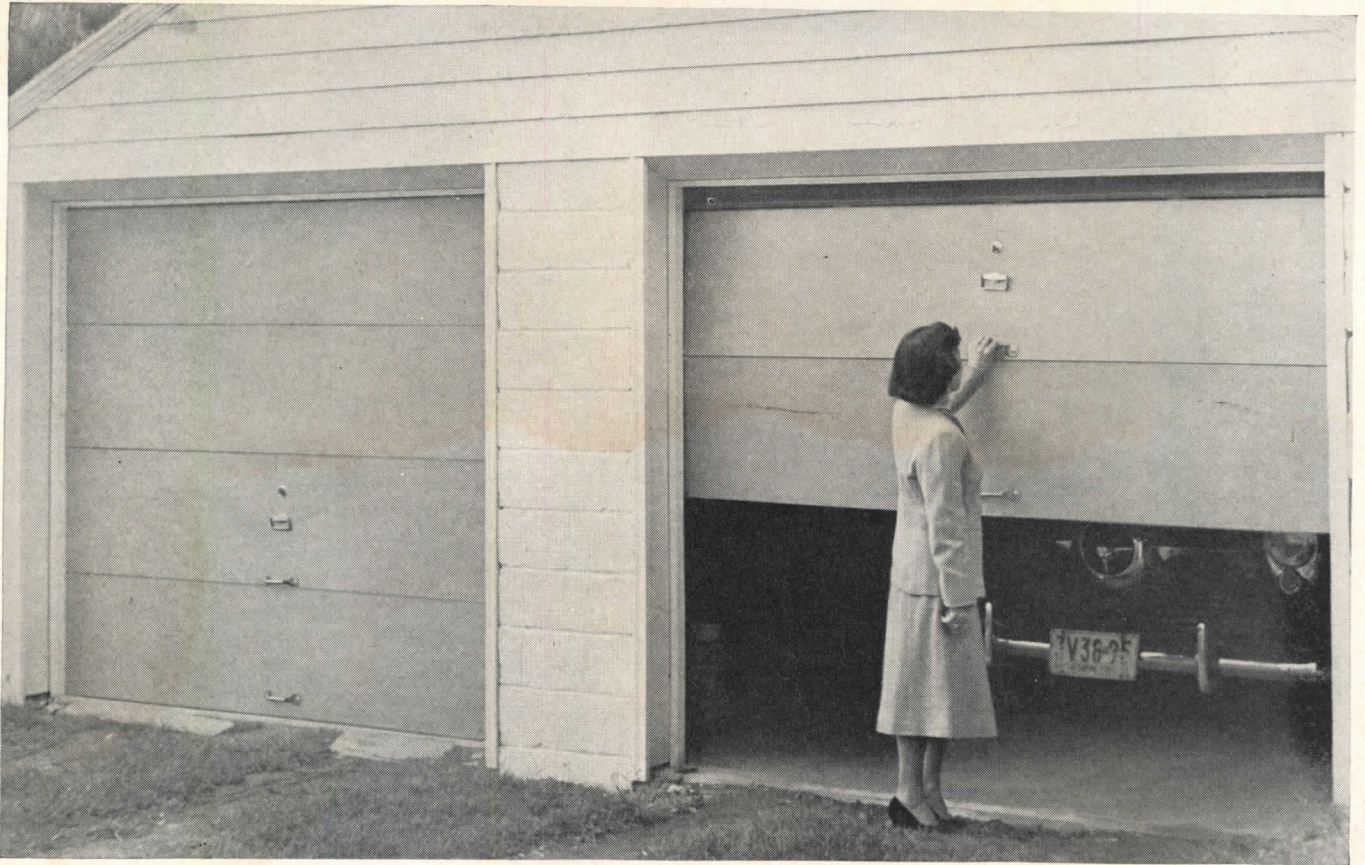

GPX . . . "OPEN SESAME" TO GARAGE DOOR SALES

GPX plastic-faced plywood brings a touch of magic to garages. Garage Doors of GPX lend custom-built quality that will make your customers stop, look . . . and buy! They have the polished beauty of a station wagon . . . and they stay that way permanently, without paint or varnish. It's a low-cost, profitable way to add a luxury feature.

Large, lightweight panels of GPX are easy to handle and fabricate—no special tools needed. Made from top-quality exterior Douglas Fir Plywood with solid cores, GPX is surfaced with phenolic resin plastic. Its armor-hard, satin-smooth plastic surface requires no finishing, remains impervious to weather extremes through the years without checking or cracking.

Available in four grades and five thicknesses, GPX is being used by hundreds of builders for built-in cabinets, sliding doors, wall paneling, exterior siding, soffits, etc. Bring your construction problems to Georgia-Pacific's staff of building experts. Call your G-P representative or write:



GEORGIA—PACIFIC PLYWOOD COMPANY

608-9A North Capitol Way, Olympia, Wash.

OFFICES OR WAREHOUSES IN: Augusta, Birmingham, Boston, Chicago, Cleveland, Columbia, Detroit, Houston, Lancaster, Los Angeles, Louisville, Memphis, Nashville, Newark, New Hyde Park, New Orleans, Olympia, Orlando, Philadelphia, Pittsburgh, Providence, Raleigh, Richmond, Savannah, Vineland.



Terminal Building,
International Airport,
Philadelphia, Pa.
Architects: Carroll,
Grisdale & Van Alen.
Consultants: Airways
Engineering Corp.
Plumbing Contractor:
L. E. Winter Co., Inc.
Plumbing Wholesaler:
C. J. Rainear & Co.
Consulting Engineer:
A. E. D'Ambly

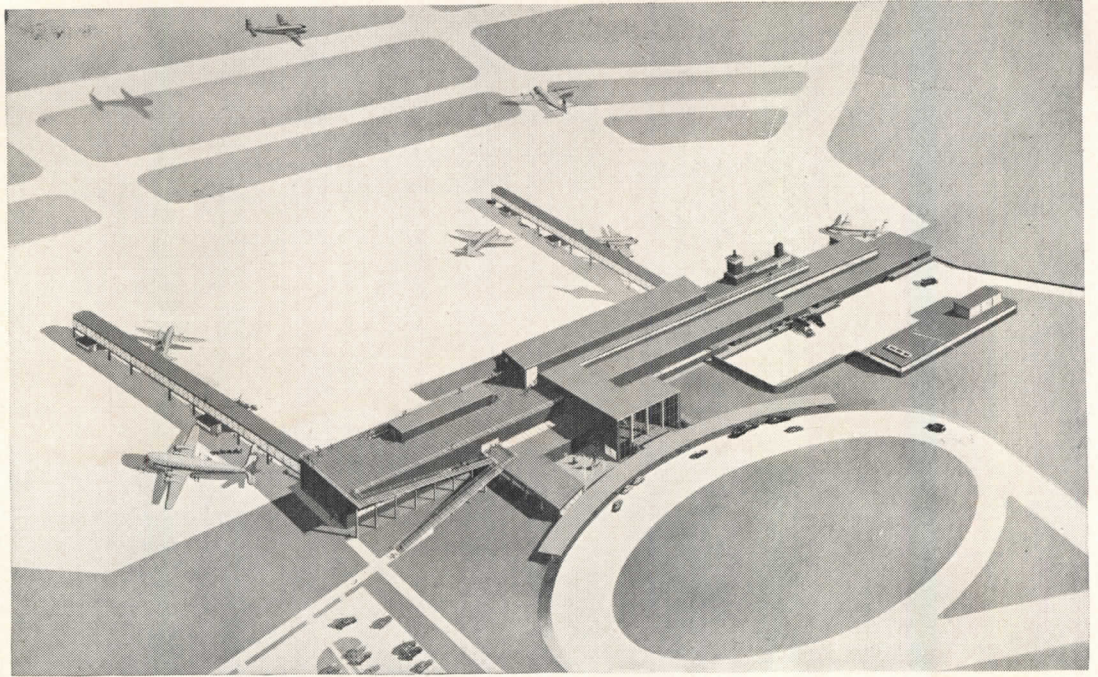

To Serve the Public Best . . .

SI-FLO FLUSH VALVES *Again are used*

Like many other prominent buildings, the ultra-modern terminal at Philadelphia's new International Airport uses Speakman Si-Flo Flush Valves in its washroom facilities.

Here are some of the facts that hundreds of Si-Flo installations prove:

Longer Service Life: because of construction features such as precision-machined, close-fitting parts . . . non-corrosive Monel working parts . . . brilliant plated finish of exceptional durability.

Silent Operation: Si-Flo only whispers . . . never shouts. It ends the annoying roar, rumble and hammer commonly associated with flush valves.

Sanitary Design: built-in back syphon preventer protects the water supply against contamination.

Faster Installation: adjustable connection between valve and stop cuts installation time by allowing quick, easy compensation for substandard roughing-in.

Only One Moving Part: a compact, easily replaced piston unit contains all working parts. Complete repair can be made in five minutes, just by renewing this inexpensive unit.

For further information, see your wholesale dealer in plumbing supplies—or write for your copy of our Catalog S-46.

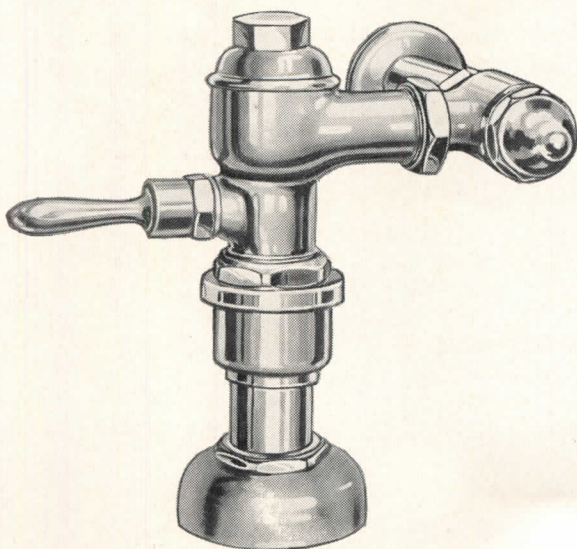

Si-Flo Flush Valves are giving faithful, trouble-free service in important buildings all over America. A wide choice of models is available to fit the requirements of any application.



In Our Eighty-third Year
SPEAKMAN

SHOWERS AND FIXTURES

SPEAKMAN COMPANY, WILMINGTON 99, DELAWARE

As maintenance-free as a propeller fan can be!

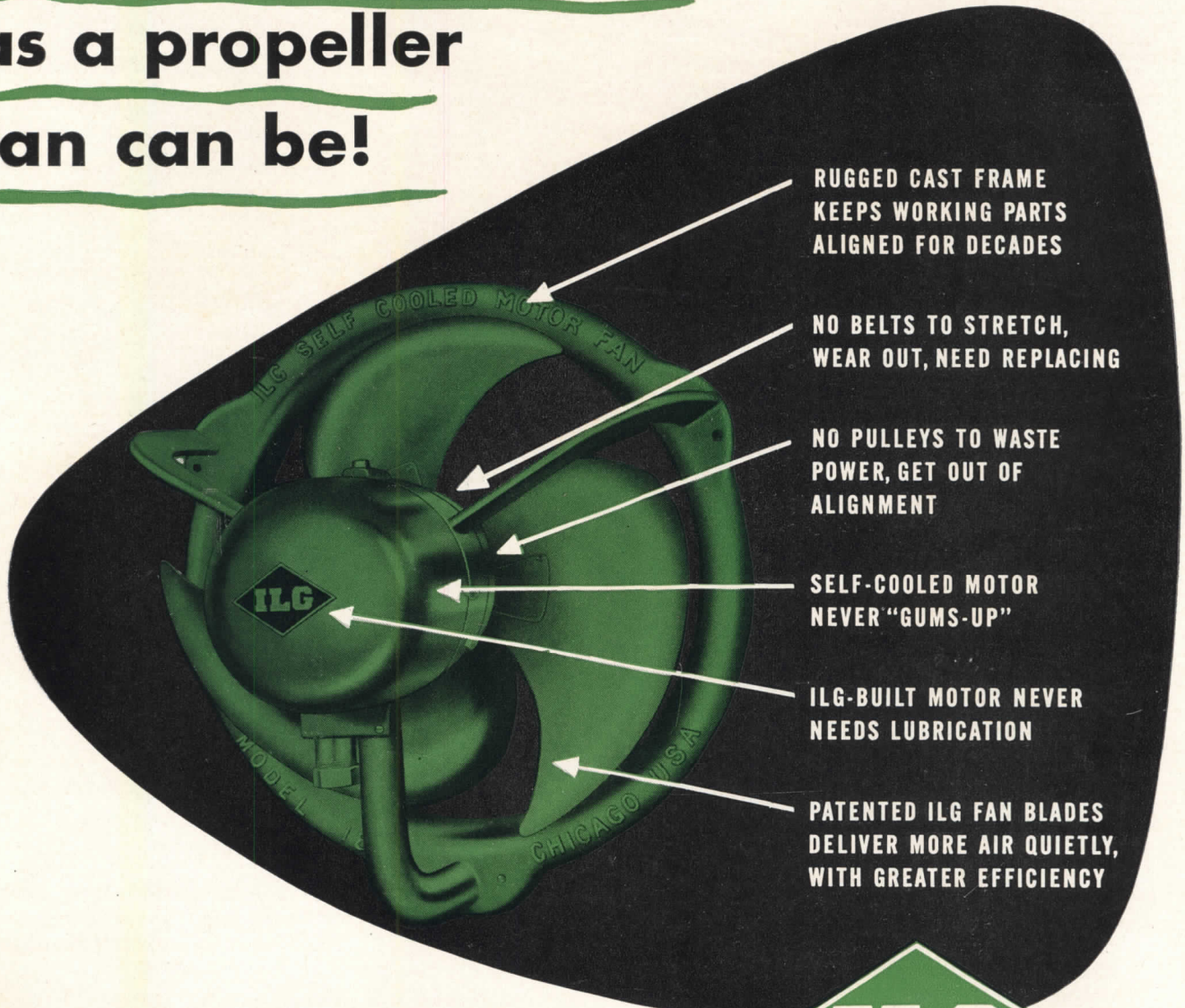

RUGGED CAST FRAME
KEEPS WORKING PARTS
ALIGNED FOR DECADES

NO BELTS TO STRETCH,
WEAR OUT, NEED REPLACING

NO PULLEYS TO WASTE
POWER, GET OUT OF
ALIGNMENT

SELF-COOLED MOTOR
NEVER "GUMS-UP"

ILG-BUILT MOTOR NEVER
NEEDS LUBRICATION

PATENTED ILG FAN BLADES
DELIVER MORE AIR QUIETLY,
WITH GREATER EFFICIENCY



ILG direct drive ends noise and trouble

• Here's the propeller fan that's practically maintenance-free over decades of service. Mounting of fan blade directly onto motor drive shaft, plus a rugged cast frame, keeps working parts in perfect alignment. Nothing can get out of order to cause objectionable noise, inefficient operation, or rapid wear. There are no belts to replace, no pulleys to adjust. The patented ILG-built motor has double-sealed, permanently lubricated ball bearings—and it's specifically designed with a self-cooling feature for exhaust fan duty. The motor stays clean, cools itself—no foul air reaches it to interrupt service, shorten its life. You get the *low operating cost* of an open-type motor with the *protection* of a fully-enclosed motor. Get complete data now on the fan you can install and forget. Send coupon or phone our nearby Branch Office (consult classified directory).

VENTILATION

ILG ELECTRIC VENTILATING CO.
2818 North Crawford Ave., Chicago 41, Ill.
Offices in more than 50 Principal Cities

Free! Engineering data bulletin 150 contains all essential data—sizes, capacities, dimensions, ratings. Send coupon now.

Send free bulletin 150.



Firm Name _____

Individual _____ Title _____

Address _____

City _____ State _____

FULTON SCHOOL

Located—7th and Fulton Street,
Aurora, Colo.

General Contractor—Platt Rogers, Inc.,
1530 W. 13th Ave., Denver, Colo.

Architects—Atchison and Kloverstrom,
1254 Monaco Parkway, Denver, Colo.

Plastering Contractor—Edwards and Milow,
4205 W. 53rd Ave., Denver, Colo.

Supplier of 4.5 Truss-Loop Lath—
Jones-Heartz Lime Company,
1475 West Colfax Ave.,
Denver, Colo.

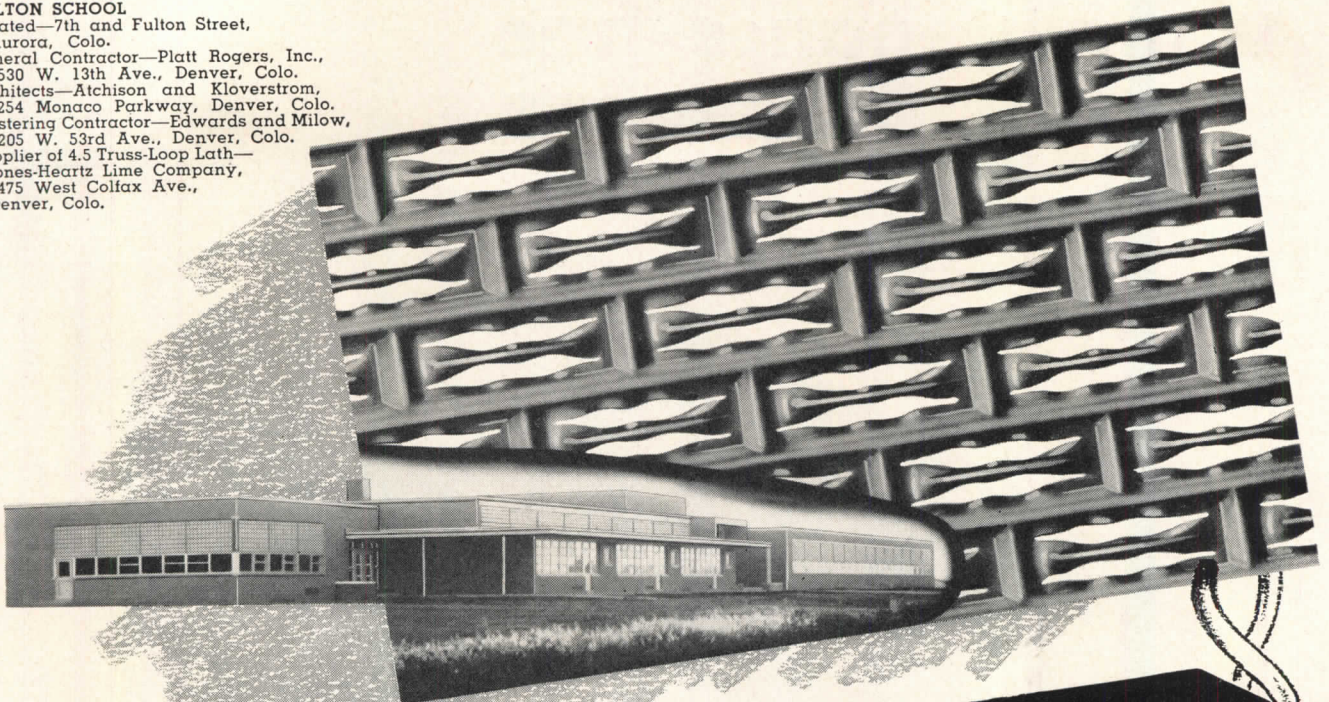

DON'T FORGET THESE 6 ADVANTAGES OF TRUSS-LOOP METAL LATH

Not to be confused with expanded metal lath, Truss-Loop is solid, perforated and formed of a copper alloy open hearth sheet of steel. Furnished in standard sizes 24" x 96" and 27" x 96" sheets, it weighs 4.5 lbs. per square yard. Extra stiffness comes from longitudinal ribs, transverse ribs and truss-like loops. This lath has been a favorite with many architects for more than 50 years.

1. SAVES LABOR. Its rigidity makes plaster stick on first application; each sheet can be easily handled by one man; no deflection in lath surface which would necessitate re-troweling.
2. SAVES YARDAGE. Nesting rib automati-

cally laps edge of each sheet, eliminating waste of overlapping.

3. SAVES FURRING STRIPS. Placing loops inward gives space for plaster key.
4. SAVES LUMBER AND CHANNELS. Its strength permits working wider centers—from 12 or 16-in. to 24-in.—requiring fewer channels, studs or joists—will not sag with mortar weight and is exceptionally rigid under the trowel.
5. SAVES PLASTER. Triple-bond plaster key grips all the mortar, allowing no waste.
6. SAVES TIME. Flat, non-giving surface makes for faster troweling; scratch and brown coats can be applied from same scaffold.

HE

Bostwick

105 HEATON AVE. • NILES, OHIO

STEEL LATH COMPANY



by all **QUALITY** standards...

BENJAMIN *"Magna-Flo"* Systems Excel!

that's why Overall Lighting Costs are LOWER!

Because Benjamin "Magna-Flo" Systems excel by every Quality Standard—lighting, electrical and constructional—they can provide high illumination levels at low overall lighting cost. Such cost involves more than the original price of the units. Overall lighting cost also includes the costs of installation, operation,

maintenance and replacement. Add them all up and see why you're ahead with "Magna-Flo" Systems (individual unit or continuous line)—because "Magna-Flo" excels by ALL QUALITY STANDARDS!

This chart gives some of the important reasons why:

**"MAGNA-FLO" CUTS
INSTALLATION COST**

wide variety of knockouts facilitate wire entrances into unit.
complete line of sliding hangers.
single, rugged channel coupling for continuous mounting.

**"MAGNA-FLO" CUTS
MAINTENANCE COST**

Porcelain Enamel reflecting surface is easy to keep clean with soap and water.
exclusive "Springlox" lampholders make possible "quick-in, quick-out" lamp maintenance.
Speedy, exclusive "Lok-Latch" reflector fasteners.

**"MAGNA-FLO" CUTS
OPERATION COST**

made for efficient utilization of high light output T12 Slimline lamps.
high power-factor ETL-approved ballasts for continuously-cool, efficient operation.
high reflection factor remains constant because genuine Porcelain Enameled reflector does not discolor or become dull with age.

**"MAGNA-FLO" CUTS
REPLACEMENT COST**

famous Benjamin "built-like-a-battle-ship" construction of heavy gauge steel.
rigid channels and reflectors withstand toughest industrial vibration.
96" reflectors are made in two sections, kept perfectly aligned by positive alignment clips.



FREE Bulletin AD-5705 brings you complete specifications on Benjamin "Magna-Flo" Lighting Systems—famous for "Task-Matched" Lighting Installations.
Benjamin Electric Mfg. Co., Dept. Q-1, Des Plaines, Ill.

*Easy, Low-Cost Solution To Every Architect's
Public Seating Problems*

Samson Folding Chairs

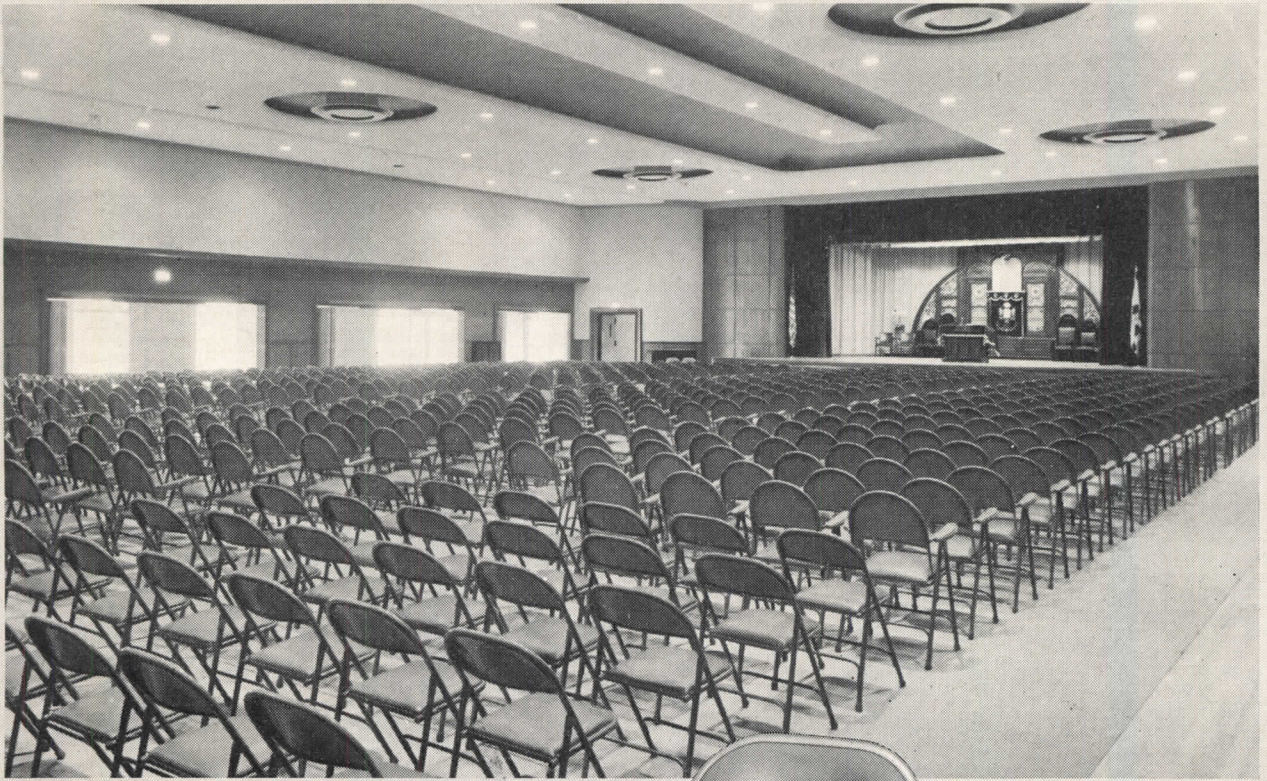

Congregation Beth Yeshurun, Houston

Handsome Appearance . . . Posture-Designed For Comfort . . . Ruggedly Built For Low Upkeep And Long Life!

ARCHITECTS everywhere are finding that Samson Folding Chairs allow quick, easy conversion of almost any room to a variety of uses—with complete seating comfort and at low cost.

Strong enough to stand on! Tubular-steel construction, cross-braced and electrically welded, means long life, low upkeep. (Gauge of steel meets U. S. Bureau of Standards specifications.)

Comfortable! Generously proportioned seats. Posture-curved backs. Noiseless, cushioned rubber feet.

Safe! Perfectly balanced—won't tip, tilt or wobble. Safety-guard seat hinge prevents finger injuries.

Easy handling! Samson Chairs open and fold as easily as a book. They stack compactly, conserve storage space.

Special low prices on quantity purchases. Ask your Samson distributor for quotation, or write us direct.



**Samson—
America's Number One
Public Seating Buy**

**Leading Users Of
Public Seating
Everywhere Choose
Samson Folding Chairs!**

Carl Schurz High School
Chicago, Illinois
Pan American World Airways
System
Claremont Hotel
Berkeley, California
Columbia Broadcasting
System, Studio 21
New York City
Veterans Memorial Building
Detroit, Michigan
Wanamaker's
Philadelphia, Pennsylvania
Dinner Key Auditorium
Miami, Florida
Harvard University
Cambridge, Massachusetts
Indiana State Teachers College
Terre Haute, Indiana

THERE'S A **Samson** FOLDING CHAIR FOR EVERY PUBLIC SEATING NEED

Shwayder Bros., Inc., Public Seating Div., Dept. J-8, Detroit 29, Michigan

ALSO MAKERS OF THE FAMOUS SAMSON FOLDAWAY FURNITURE FOR THE HOME AND SMART SAMSONITE LUGGAGE FOR TRAVEL

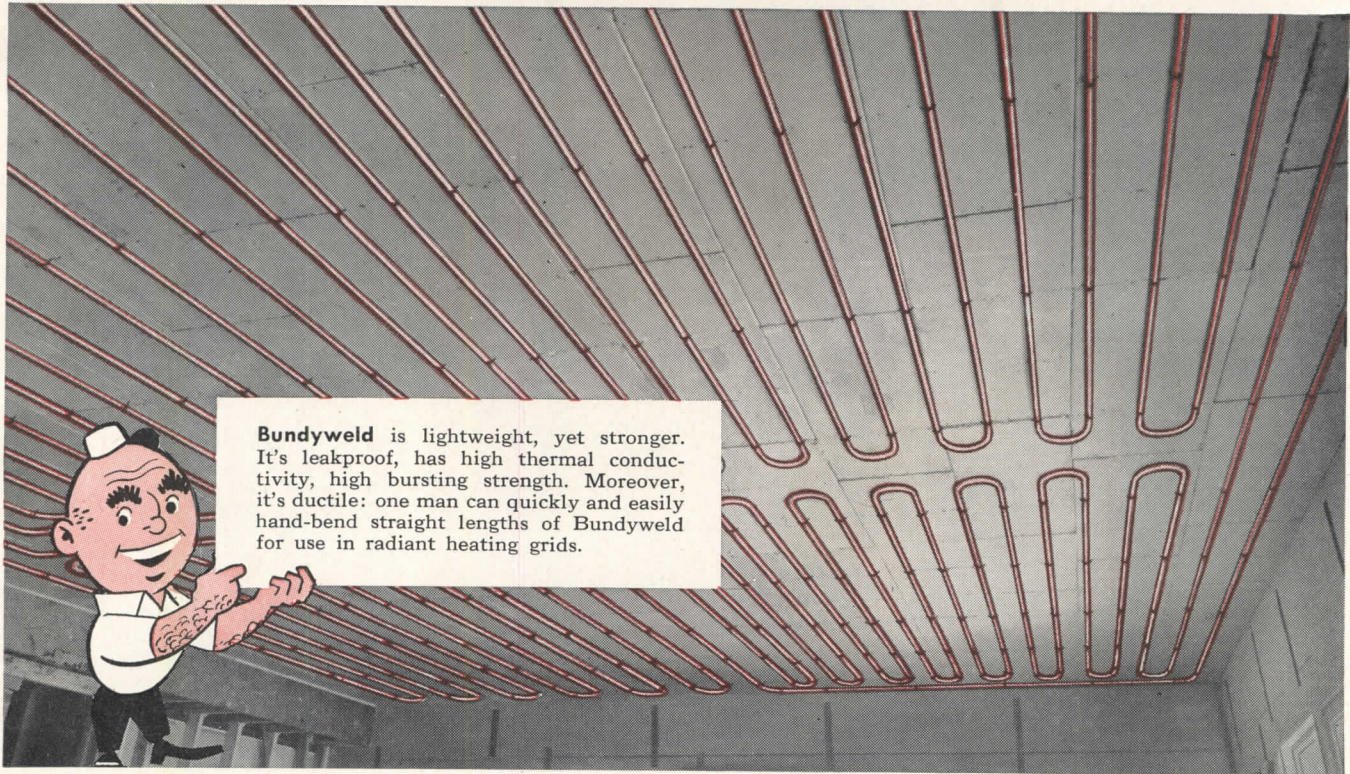

Bundyweld is lightweight, yet stronger. It's leakproof, has high thermal conductivity, high bursting strength. Moreover, it's ductile: one man can quickly and easily hand-bend straight lengths of Bundyweld for use in radiant heating grids.

Build new sales appeal into your houses with Bundyweld Ceiling Radiant Heating

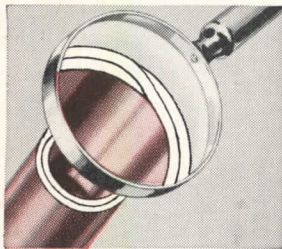

Key to Low Cost

Bundyweld is the only tubing double-walled from a single strip. It's steel, copper-coated inside and out. It gives finest radiant heating performance, with savings up to 50% on material costs and installation time.

Standard 20' or 24' lengths of Bundyweld are easily formed into coils in shop or on job site. Expanded ends (furnished when specified) are quickly soldered into leak-proof union. Joined, lightweight coils are easily mounted onto ceiling, quickly plastered over.

Think of telling a new-home prospect *his* house is free of sooty registers and radiators, free of heating drafts, free of the annoyance of streaked walls and ceilings.

Sound selling points? You bet they are, and that's only the beginning: houses built with Bundyweld Ceiling Radiant Heating offer air that's clean and fresh as spring, lower operating costs, and reduced housekeeping chores as well.

Beginning only recently, Bundy ads in *Better Homes & Gardens* and *American Home* have featured a coupon offering a free "Home Owner's

Guide to Bundyweld Ceiling Radiant Heating." Since the offer began, almost 20,000 have been sent out to prospective home buyers!

These people want to know more about today's most advanced, practical heating method; they want to know the names of builders and architects using it.

Put your houses squarely in the path of this quickly growing interest. Put your houses *years* ahead of competitive houses. Send the coupon below for details on Bundyweld Ceiling Radiant Heating and Bundyweld Tubing!

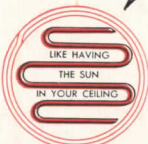

Bundyweld
Ceiling Radiant Heating

Radiant Heating Division
BUNDY TUBING COMPANY
Detroit 14, Michigan

Radiant Heating Division, Dept. AR-952
Bundy Tubing Company, Detroit 14, Michigan

- Send free 20-page nontechnical brochure explaining Bundyweld Ceiling Radiant Heating.
- Send Bundy technical radiant heating pamphlet.

Name _____ Title _____

Company _____

Address _____

City _____ Zone _____ State _____



RILCO CHURCH ARCHES

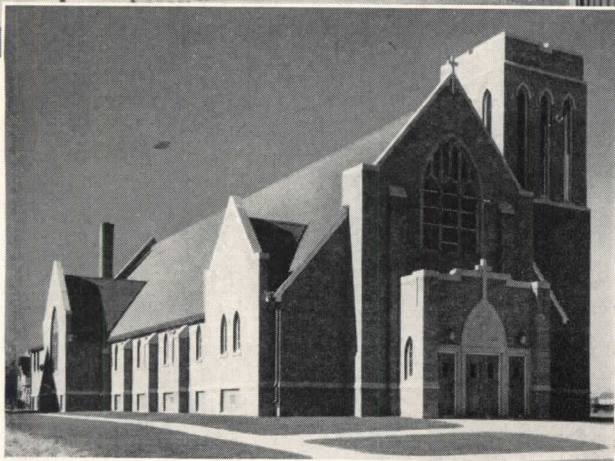

Rilco glued laminated arches offer important structural advantages and have a natural and distinctive beauty all their own as shown here in the Zion Lutheran Church, Buffalo Lake, Minn. Height of arch: 26'-6". Span: 43'. Architect: Ernest Schmidt, Mankato, Minn.

Decorative, Practical, Economical

HAVE you checked into the many advantages of Rilco custom designed and engineered church arches? Here is today's most practical answer to the special requirements of modern church construction. The distinctive beauty of wood laminations eliminates the necessity of expensive veneering and establishes a warm, friendly atmosphere. Arches, purlins and engineered hardware are delivered ready for fast, labor-saving erection. Your imagination is unrestricted when you design churches employing Rilco glued laminated wood arches. See our catalog in Sweet's or write for details. Our experienced engineering department and field representatives are eager to serve you.

RILCO

Laminated PRODUCTS, Inc.

2518 First National Bank Building • Saint Paul 1, Minnesota

Architectural Service

Copings, Gravel Stops and Facia

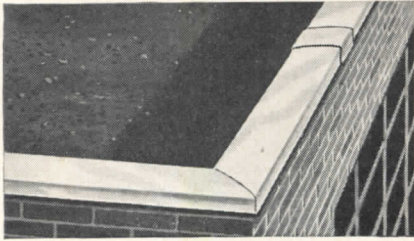

Aluminum copings, gravel stops and facia, whether employed separately or combined in an extruded design, serve a decorative as well as a functional purpose. Attractiveness, durability and freedom from destructive and disfiguring rust are a few of the advantages aluminum provides in this application. Standard copings and gravel stops, both with and without facia, are available in Reynolds Aluminum extruded shapes for most needs. Special designs can be made inexpensively, even for relatively small requirements.

Attractive Interior Railings

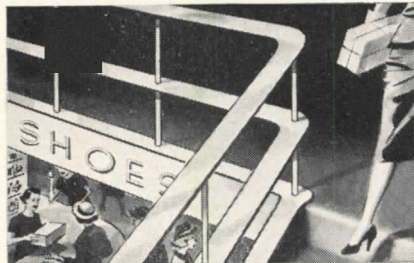

When a staircase is the point of focus, specify the rich, quiet tone of aluminum railings for stores, hotels and other commercial buildings. Aluminum is attractive but not distracting. It blends well with all color schemes, and when properly finished, is practically maintenance free. It designs well, too. Reynolds standard handrail and baluster sections permit a wide range of expression. And the flexibility of aluminum extrusions offers virtually unlimited design freedom on an economical basis.

Modern Fire Escapes



Protect the beauty of well designed buildings by specifying rustproof, rotproof, non-staining aluminum for fire escape construction. Strong, lightweight aluminum fire escapes never need painting and require practically no maintenance... save important money for the building owner especially in installations where corrosive industrial fumes are prevalent. Savings made possible by the lighter structural load and easier erection frequently offset the small added material cost. Write to Reynolds for details on these and any other architectural aluminum applications.

advertisement



Let Reynolds Architectural Service Help You Get the Most From Aluminum

Buildings that begin on your drafting board are sure to be *better* buildings if your plans include attractive, corrosion resistant, strong, lightweight aluminum . . . the modern metal that complements modern designs.

To get the maximum advantage of aluminum's design flexibility and other unique characteristics, make use of Reynolds Architectural Service. This service is available to aid you in solving special design problems. It's Reynolds way of saying: "Here's help toward getting the very most from aluminum."

Be sure to consider the benefits of standard aluminum products in your planning, too. A variety of aluminum windows, doors, hardware, light fixtures, awnings, insulation are made from Reynolds Aluminum by other manufacturers. These concerns have learned to rely on the high quality of Reynolds complete line of aluminum mill products—extruded shapes and tubing, structurals, sheet, wire, rod and bar. And remember—*aluminum is the only mass-produced metal that costs no more today than before World War II.*

For complete architectural aluminum information, call the Reynolds office listed under "Aluminum" in your classified directory or write direct.

FREE BOOKLET!

Send for your copy of Reynolds Architectural Folio today! A complete, up-to-date kit on architectural aluminum. In loose leaf form with drawings for direct tracing. Free when requested on business letterhead. Write to Reynolds Metals Company, 2572 So. Third St., Louisville 1, Ky.



REYNOLDS ALUMINUM

MODERN DESIGN HAS ALUMINUM IN MIND

Here's one room that YOU furnish!



THIS PLEASING BATHROOM is very economical. It is only 5' x 7'. Note the use of a simple perforated wallboard enclosure to hide cleaning equipment underneath the lavatory. As for fixtures, even Crane's low-priced lines feature clean, modern styling.

When you design a house, you may not choose the furniture your client puts in the living room or bedrooms, but you do have a big say when it comes to the bathrooms.

And today new ideas, materials and plumbing fixtures help you make bathrooms more attractive and useful than ever.

To help you get client approval for your new ideas and room arrangements, Crane has illustrated twenty-three new bathroom concepts and many

other practical ideas for utility rooms and kitchens, in the big Crane Sketchbook of Ideas.

If you wish, we can also provide practical suggestions for arrangements and decorations for any room in the book.

Ask your Crane Branch or Crane Wholesaler for details on this new Crane service to architects who specialize in designing homes.

COME TO CRANE FOR IDEAS

CRANE CO. GENERAL OFFICES: 836 SOUTH MICHIGAN AVE., CHICAGO 5
VALVES • FITTINGS • PIPE
PLUMBING AND HEATING



Equity Savings & Loan Company, Cleveland, Ohio. The main office and three private offices are lighted by Wakefield Ceilings, incorporating PLEXIGLAS diffusers. Architects: Dalton-Dalton Associates, Cleveland. Installed by Parker Electric Company, Cleveland. Wakefield Ceilings are produced by The F. W. Wakefield Brass Company, Vermilion, Ohio.

Lighting . . . Air Diffusion . . . Sound Control . . . Combined in a **Luminous Ceiling**

The Wakefield Ceiling shown above, with its corrugated PLEXIGLAS diffusing panels, combines three functions in a single installation.

- Mounted wall to wall beneath fluorescent tubes, the acrylic plastic panels provide high level, low brightness, evenly diffused illumination.
- Conditioned air from the space above the luminous ceiling is delivered into the room through the openings at the edges of the corrugated diffusers. The multiple openings insure an even distribution of air, with elimination of drafts on customers and employees.

- The simple framework for the PLEXIGLAS also supports acoustical baffles which absorb sounds from the work area.

This Wakefield method of combining air diffusion and sound control with the *best* in lighting—using PLEXIGLAS acrylic plastic—can reduce building construction and operation costs. In addition there is the advantage of duct-free, fixture-free appearance.

We will be glad to send you details about the installation shown above, and tell you how PLEXIGLAS may solve *your* lighting problem.

CHEMICALS  FOR INDUSTRY

**ROHM & HAAS
COMPANY**

WASHINGTON SQUARE, PHILADELPHIA 5, PA.

Representatives in principal foreign countries

Canadian Distributor: *Crystal Glass & Plastics, Ltd., 130 Queen's Quay at Jarvis Street, Toronto, Ontario, Canada.*

PLEXIGLAS is a trademark, Reg. U. S. Pat. Off. and other principal countries in the Western Hemisphere.

CONCRETE EVIDENCE

MASONITE CONCRETE FORM PRESWOOD
speeds work, cuts cost... 3 ways!



*Shortening Plant—Southern Cotton Oil Co.,
Memphis, Tenn.
Architect—Norton and Rice
General Contractor—S&W Construction Co., Inc.*

**Many
Applications:**

Bridges
Buildings
(all types)
Culverts
Dams
Docks
Piers
Grand Stands
Monuments
Sewers
Subways
Swimming pools
Tanks
Tunnels
Viaducts

- **REDUCES FINISHING COST**—Masonite Concrete Form Preswood® leaves a super-smooth finish, ready for paint . . . practically eliminates all costly hand-rubbing. This grainless, all-wood material produced the beautiful exterior surface on the building shown above.
- **CAN BE RE-USED—MANY TIMES**—Many contractors report using these tough hardboard panels as many as twenty times—with the same smooth results! 4' x 8' or 4' x 12' panels reduce the number of joints . . . confine moisture for complete, uniform hydration.
- **REDUCES MATERIALS COST**—Masonite Concrete Form Preswood eliminates the expense of dressed and matched lumber forms. This dense material will not split, splinter or crack . . . is easily worked with ordinary carpenter's tools . . . can be curved for arches or columns. You'll save time and money for your client when you specify Masonite Concrete Form Preswood.

For more information on Masonite Concrete Form Preswood, write:



MASONITE® CORPORATION
Dept. AR-9, Box 777, Chicago 90, Ill.

"Masonite" signifies that Masonite Corporation is the source of the product

BETTER HARDBOARDS FOR BETTER CONCRETE

3 LINES OF SAFETY SWITCHES *for* 3 DIFFERENT MARKETS

... one line can't do two or three jobs without compromising price and performance!

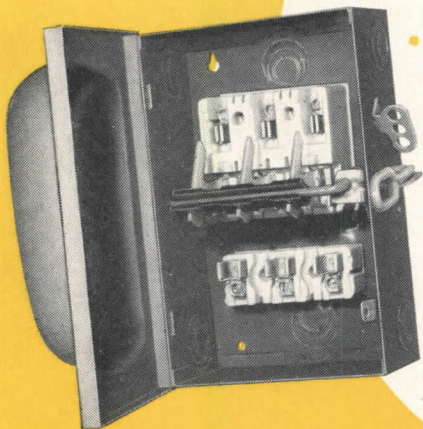

GENERAL PURPOSE

- 90,000 line designed for residential, commercial and other applications where price is limiting and the service factor is not great.

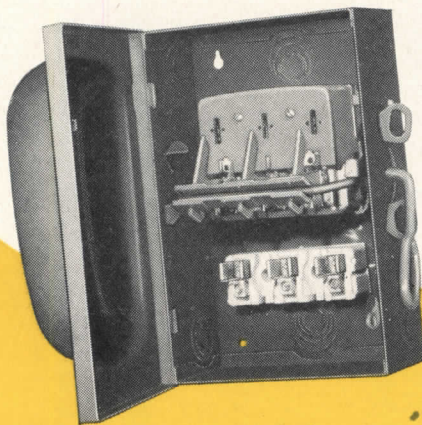

INDUSTRIAL

- 40,000 line designed for general industrial or institutional and commercial applications where the service factor is greater and price is an important consideration. MEETS BOTH GOVERNMENT AND NEMA SPECIFICATIONS FOR TYPE A SWITCHES.



HEAVY-DUTY INDUSTRIAL

- 80,000 and 50,000 line designed for mass production industries where price is secondary to continued performance under conditions of severe service and maximum safety. The 50,000 line is used where space is limited. BOTH ARE TYPE A but go far beyond those requirements.



UNIFORM STYLING

ASK YOUR ELECTRICAL DISTRIBUTOR FOR SQUARE D PRODUCTS

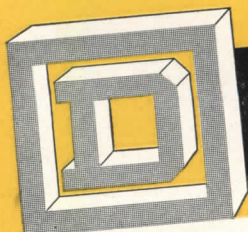

SQUARE D COMPANY

giant field house re-roofed by Overly

The University of Minnesota Field House, at Minneapolis, measures 444' long x 236' wide x 100' high. Its Overly-Goodwin Batten type aluminum roof, shown, is one of the biggest ever erected by Overly.

• *This replacement roof pays off by permanently eliminating leakage, maintenance, and the interior condensation problem. DESIGNERS: Harry L. Wilson and Dr. William F. Holman of the University's staff. Besides being watertight, the Overly-Goodwin Batten type roof lightens the roof load and lengthens the life of the building. This was an important consideration, because the structure was 22 years old when re-roofed.* • *For details on Overly patented construction, send for Catalog 8-B.*



OVERLY MANUFACTURING COMPANY
GREENSBURG, PA. (Phone Greensburg 154)

• Sales Representatives in All Principal Cities •

A turquoise blue print speaks for itself:

"TURQUOISE pencils and leads made with 100% 'Electronic' graphite sure make life easier for draftsmen. And as for us blue prints . . . we look snappier than ever before."

"Every line now stands out in clear contrast . . . sharp-edged and uniform."

"Every figure is plainly legible. Erasures come clean, and leave no 'ghosts'. I'm so easy to read that guess-work and mistakes are eliminated."

"No wonder I say . . . no wonder everyone is saying . . .

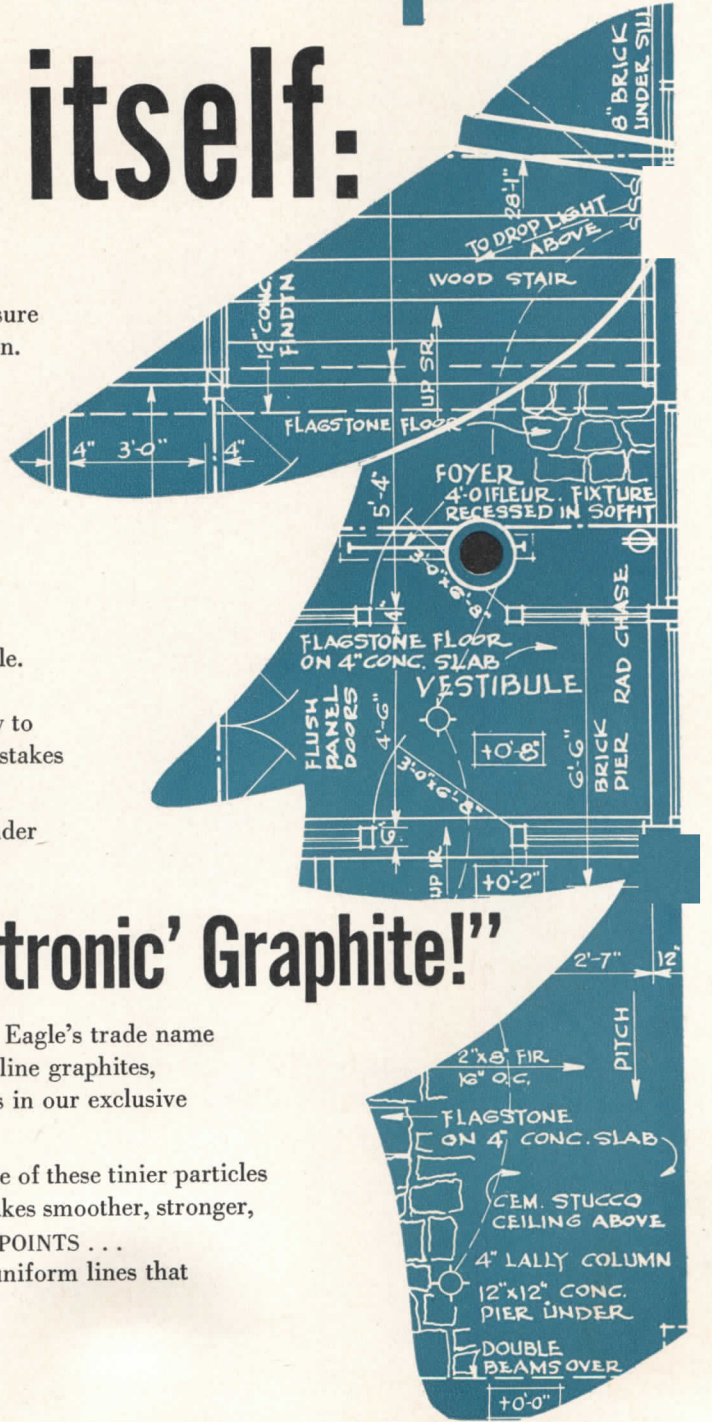

Hooray for 100% 'Electronic' Graphite!"

*'ELECTRONIC' GRAPHITE is Eagle's trade name for a blend of purest crystalline graphites, reduced to micronic fineness in our exclusive Attrition Mill.

By compacting millions more of these tinier particles into every inch of lead, it makes smoother, stronger, NON-CRUMBLING NEEDLE POINTS . . . and denser, sharper, more uniform lines that reproduce to perfection.

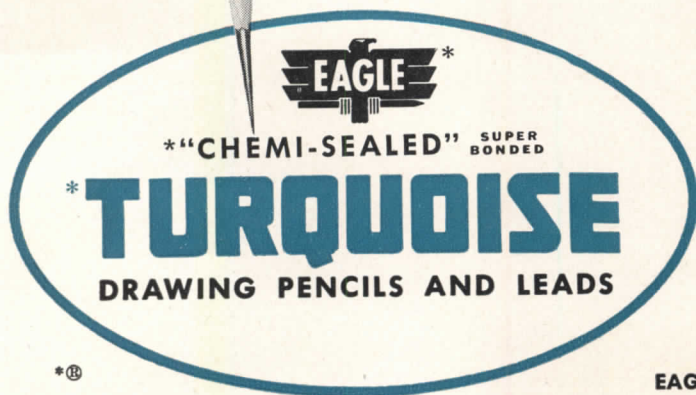

PROVE IT YOURSELF. Write us for a sample of the new TURQUOISE in any degree you desire.

EAGLE PENCIL COMPANY • NEW YORK • LONDON • TORONTO

Helping build America's might...

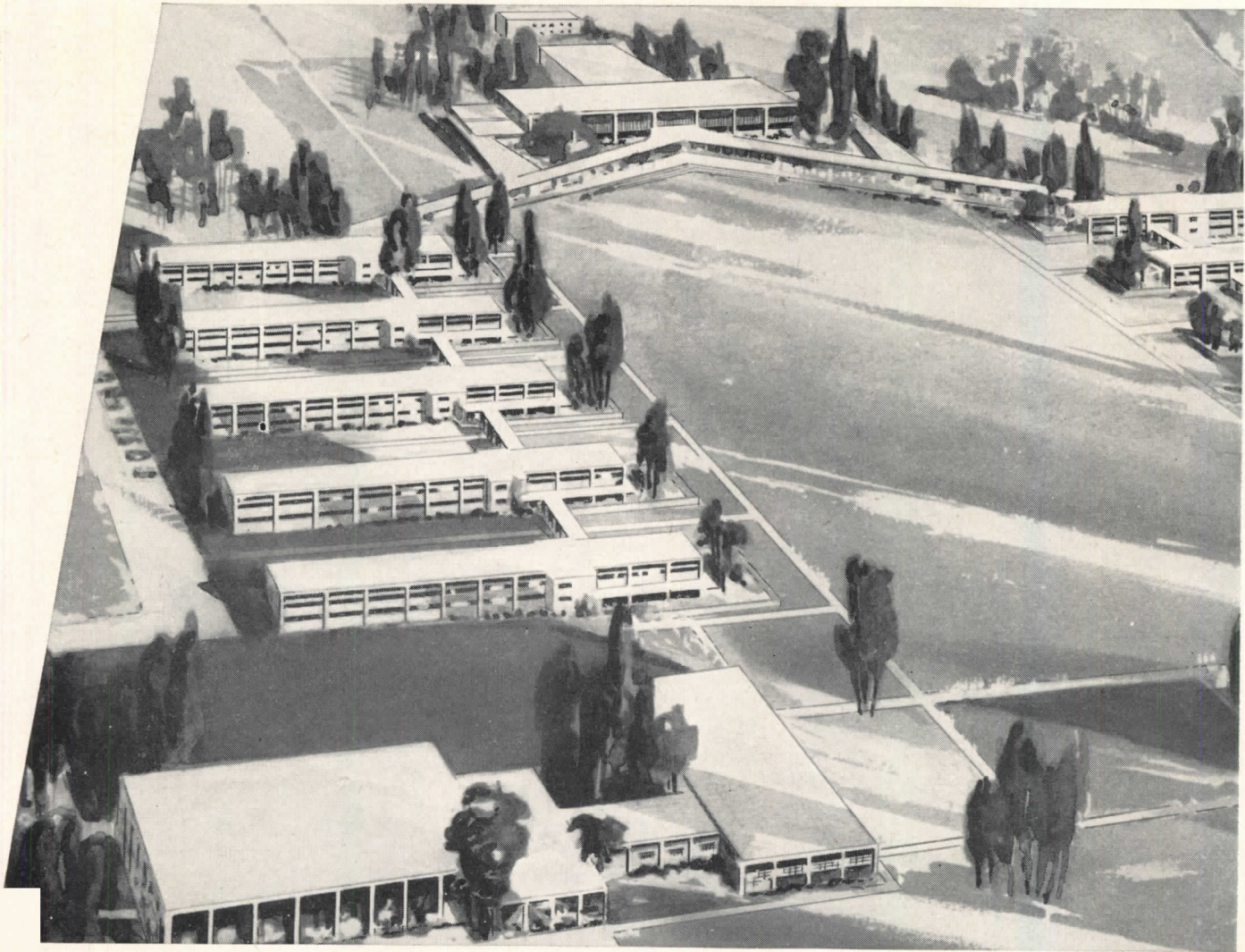

Across the nation the military bases of the Armed Forces are expanding... offering evidence of America's might. ... Aiding in this immense effort...Ceco Steel Products Corporation brings a one-source service to the military, speeding the all-important task... saving money, too... For Ceco's network of coast to coast plants means men and materials can be quickly brought to the area of need.

When concrete floor joist construction, steel windows and screens, reinforcing bars and accessories

were required for permanent buildings at Ft. Knox, Ky., Ceco's Birmingham office was on the job "on the double"... in addition, supplying materials and service at Ft. Campbell, Ky.

Halfway across the nation another Ceco office, Los Angeles, met the need with reinforcing steel, architectural projected windows and screens for Camp Pendleton, Calif... Ceco's Washington, D.C. office gets the call... at Ft. Eustis, Va., concrete joist construction, steel windows and screens meet the need...

CECO STEEL PRODUCTS CORPORATION

General Offices: 5601 West 26th St., Chicago 50, Illinois
Offices, warehouses and fabricating plants in principal cities

CECO ONE SOURCE SERVICE



CITED BY CECO FOR
EXCELLENCE
 in Design and Construction

**CECO
 STEEL**

and at Chanute Field, Illinois, apartment casements and metal screens are provided.

Then Ceco's Dallas office met job requirements at Sheppard Air Base, Wichita Falls, providing steel windows, steelforms, and reinforcing steel . . . while Omaha was serving the Offut Air Force Base with reinforcing steel, Meyer steelforms and welded wire fabric plus residence casements.

America's defense is speeded today because Ceco's one-source service is tailored to fit any job.

SUBSISTENCE BUILDING

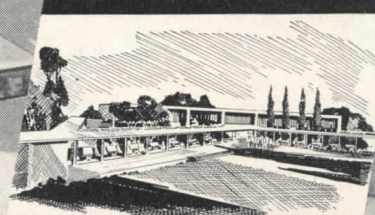

ADMINISTRATION BUILDING



RECREATION UNIT



BARRACKS



Here are those Ceco served in the nation-wide military expansion program.

Pereira & Luckman, Architects
 M. H. Golden Construction Co.
 Southeastern Construction Co.
 T. A. Loving & Co. • Doyle & Russell
 J. A. Jones Construction Co.
 Jonathan Woodner Co. • Echert-Fair Co.
 Jesse G. Dixon & Joe Ward
 Foster-Smetana Co.

In construction products **CECO ENGINEERING** makes the big difference

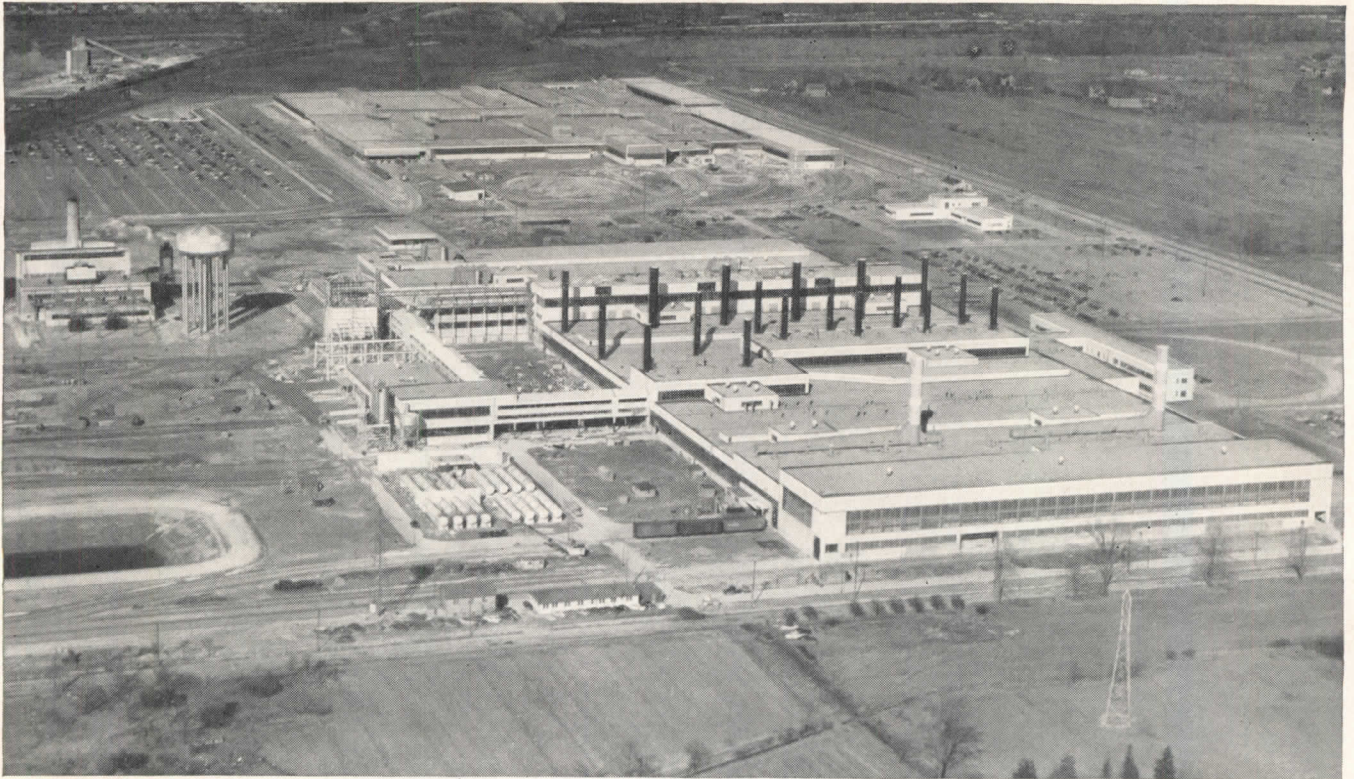

EASY TO SPECIFY AND INSTALL, G-E POWER DISTRIBUTION EQUIPMENT SERVES 1,000,000 SQ FT IN NEW ENGINE PLANT

"Packaged power" speeds Ford expansion

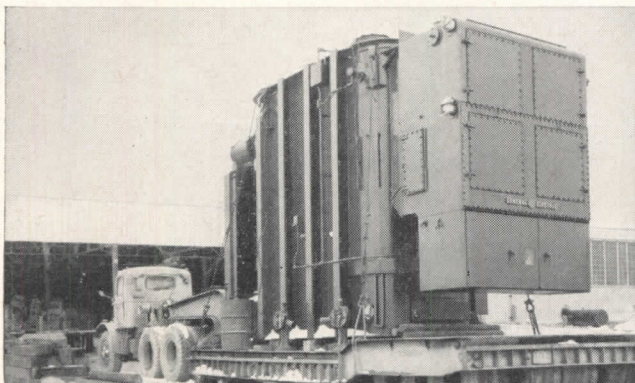

PRE-ENGINEERED to make system design easier, this 35,000-kva transformer is on its way to the plant substation. Use of two units increases dependability of power supply.

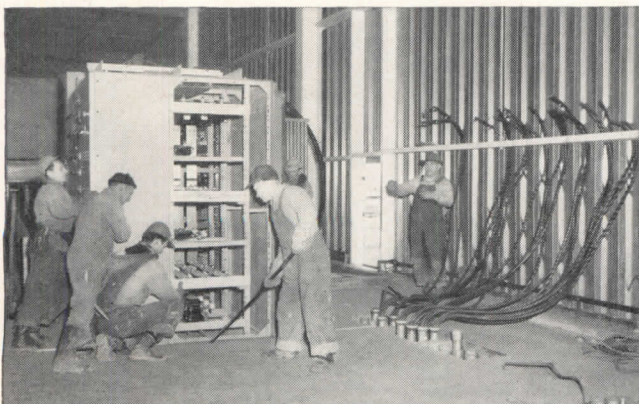

EQUIPMENT ARRIVES in unit form for fast installation, to conserve skilled manpower. Here, the switchgear section of a load-center unit substation is moved into position.

Pre-engineered components save months on design and installation of power system for new plant

Use of many automatic machines and processes in the new Ford Motor Co. engine plant near Cleveland means a heavy power demand. That made planning, selection, and installation of the power distribution system one of the most important phases of plant construction.

Ford, and Hatfield Electric Co. electrical contractors, saved months of engineering and installation time by selecting a power system made up of G-E equipment. Here's how: (1) co-ordinated systems are readily designed using pre-engineered G-E components, (2) "packaged" G-E equipment is quickly installed and connected, and (3) lost time involved in "piecemeal" systems is eliminated since we co-ordinate manufacture and shipment of system components.

You can save time and money on industrial plant electrification by specifying user-preferred G-E equipment. And our engineers are ready to assist in such planning and design. Besides power distribution, they'll help on outdoor lighting and electric drives for plant service systems. Contact your G-E Apparatus Sales Office early in the planning. General Electric Co., Schenectady 5, N. Y.

665-117B

**Engineered Electrical Systems
for Industrial Plants**

GENERAL  ELECTRIC

Herring • Hall • Marvin
presents

IMPORTANT IMPROVEMENTS in DRIVE-IN WINDOW DESIGN

Featuring an exclusive-type
Sliding Drawer Depository with
Push-Button Control

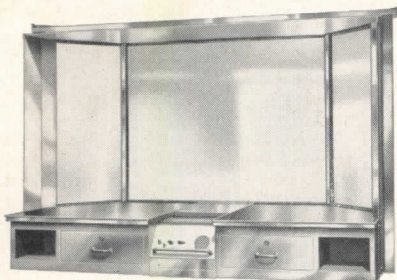

Inside view, showing work top with cash drawers and storage spaces.

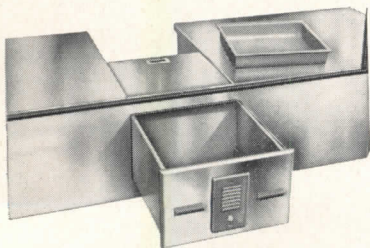

With stainless steel tray removed, the drawer will receive large bags or packages.

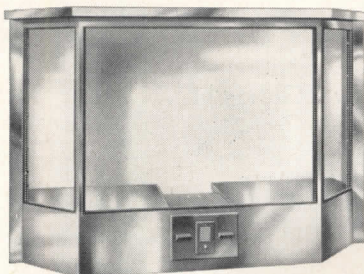

Outside view with drawer in closed position. Note clear vision afforded to both teller and customer.



The new window is available in three sizes: angular bay type, as shown in these photos—75" and 89" wide; flush type—42" wide.

Upon request, a trained H.H.M. specialist in protection equipment will call with detailed information.

THE TELLER presses a button and the depository drawer slides out smoothly, noiselessly. Travel of the drawer is flexible, to make it easily accessible from all types of cars. Another press of the button and the drawer returns to normal position, with its full contents at the teller's fingertips. The automatic operation impresses customers and speeds up transactions. The drawer opening is practically draft-proof.

OTHER IMPORTANT H-H-M FEATURES

- **IMPROVED SOUND SYSTEM.** Latest-type two-way communication between teller and customer.
- **TELLER CONTROL.** Drawer operation is by push-button control, thereby eliminating operator fatigue. No lid to raise to gain access to the drawer contents.
- **Removable stainless steel tray** is supplied in top of drawer for normal deposits. The tray is removed for receiving bags or packages.
- **CLEAR VISION.** Bullet-resistive glass extends down to the counter top, giving customer full view of all transactions, giving the teller full view of approaching vehicles.
- Two cash drawers and two open storage spaces in each unit.
- Vertical columns and exterior of entire assembly constructed of bullet-resistive glass and stainless steel.

Herring-Hall-Marvin Safe Co.
HAMILTON, OHIO

BUILDERS OF THE U.S. SILVER VAULTS AT WEST POINT, N. Y.

marble



*Y*ears of priceless beauty
maintained at the lowest possible cost

Compare the cost of maintaining Marble with that for any other material. Add to this low-cost-maintenance factor the long years of beauty, prestige, and service which Marble provides. Can there be any better choice than Marble? *"There is no substitute for Marble."*

NEW ENGLAND TEL. & TEL. BUILDING,
NEW HAVEN, CONN.,
DOUGLAS ORR, ARCHITECT.

The Marble Institute of America protects your heritage in one of America's great industries. Each of its members is pledged to provide the finest materials, finished in America, by Americans, no matter what its source. You can depend on the integrity of your local M.I.A. member.

Literature available: M.I.A. membership list, Marble availability, Marble care, brochures on Marble in the Bank, the Home, the Hospital, Stores, *Write:*

MARBLE  NSTITUTE OF AMERICA, INC.
108 FORSTER AVENUE, MOUNT VERNON, NEW YORK

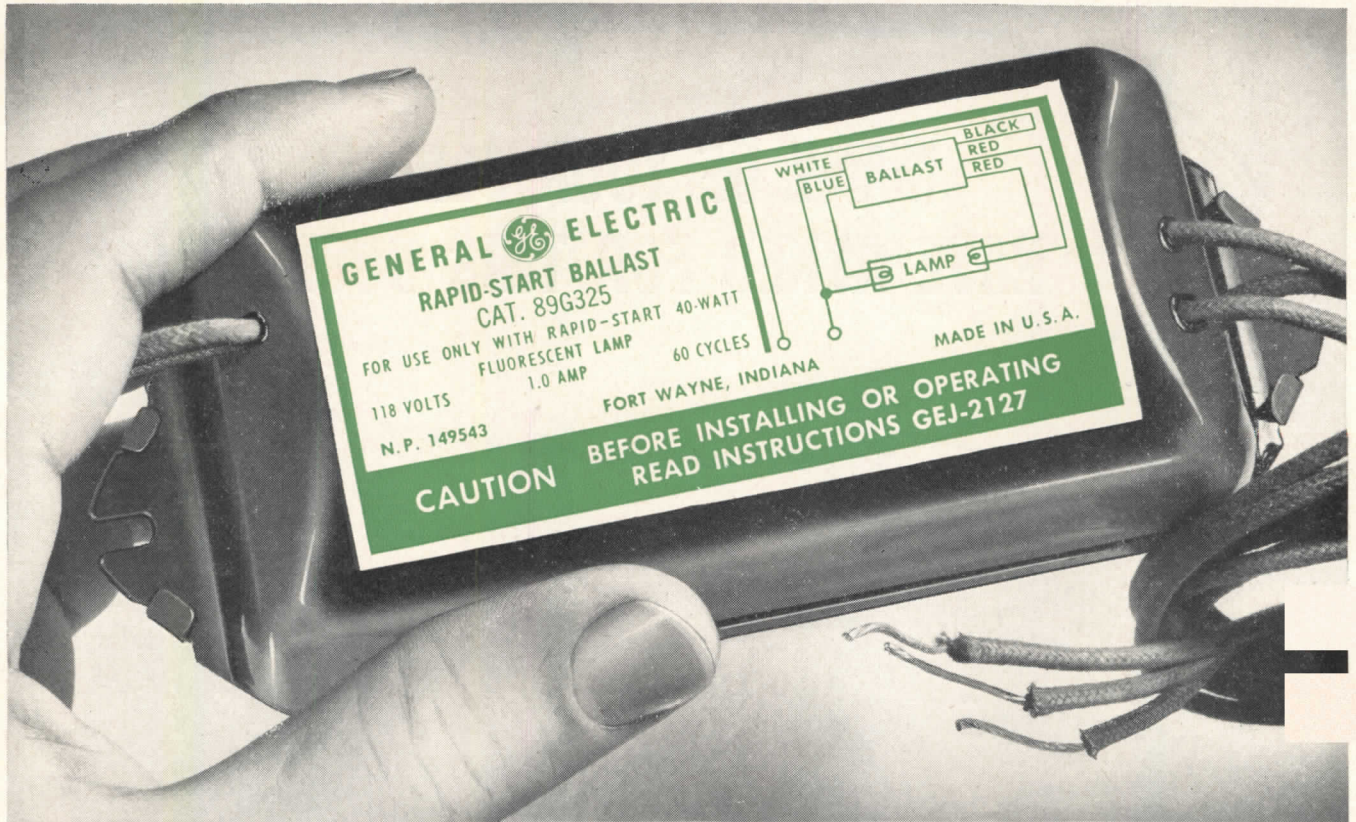

THE GREEN LABEL DISTINGUISHES NEW G-E 40-WATT RAPID-START BALLAST FROM OTHER G-E BALLASTS—NOTE SIMPLIFIED CIRCUIT

New G-E Lighting Development

40-watt RAPID-START system eliminates starters

General Electric—first to introduce fluorescent lighting in 1938—now brings you a starterless system giving full, rated lamp life. New, electrically matched 40-watt RAPID-START lamps and ballasts do away with bothersome blinking at end of lamp life, give you eye-easy, no-flicker starts at a touch of the switch!

Present “instant-start” 40-watt fluorescent is costly, uses a heavier ballast—present “switch-start” is complicated by auxiliary starters and wiring—new RAPID-START system features smaller, lighter ballasts at a lighting cost comparable to 40-watt switch-start lighting.

General Electric lamp and ballast engineers have again combined their efforts to bring you a revolutionary development in 40-watt fluorescent lighting—the volume market. For new installations or to modernize old installations—a sales plus your customers will want! Act today. Contact your nearest G-E Apparatus Sales Office, or write Section 412-102, for complete information. General Electric Co., Schenectady 5, N. Y.

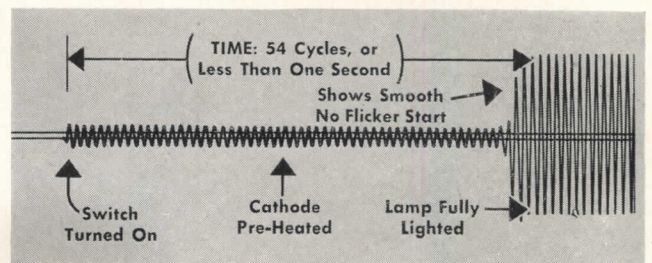

ENGINEER'S ANALYSIS of oscillograph readings shows fast, no-flicker pre-heated cathode action of new G-E Rapid-Start.

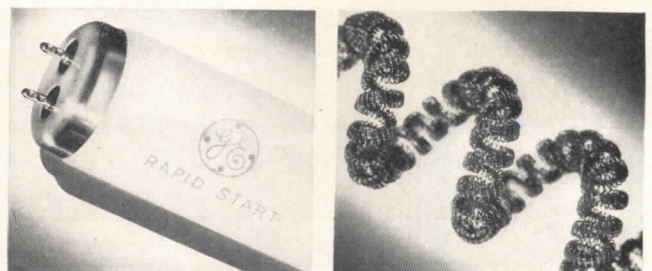

NEW G-E BIPIN LAMP, especially developed for fast, pre-heat starting, employs complex, triple-coiled cathode, right.

GENERAL  **ELECTRIC**

MANY OF YOUR CLIENTS HAVE ASKED FOR THIS BOOKLET

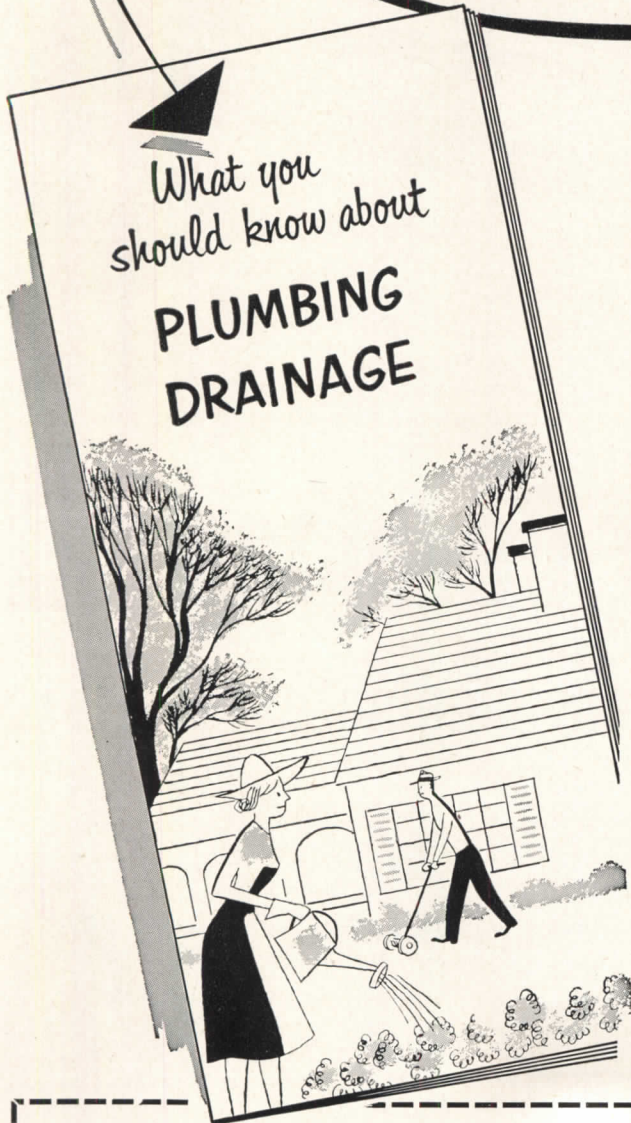

As a result of our advertising in the *Saturday Evening Post*, thousands of people have written us asking for the booklet at the left. They are people who own their homes or are planning to build. Some of them may be potential clients of yours.

Architects and plumbing contractors have also been asking us for "What you should know about plumbing drainage." They think it's a good idea to know what we are telling their clients and customers about **permanent Cast Iron Soil Pipe and Fittings**. Some of them have even requested the booklet in quantity, so that they could give it to prospects.

To get yourself a free copy, fill in the coupon and mail it to us. If you would like extra copies to give to prospective home builders, let us know how many you need.

CAST IRON SOIL PIPE INSTITUTE
Dept. A, Heurich Building, Washington 6, D. C.

Gentlemen:

Please send me _____ copies of your booklet "What you should know about plumbing drainage."

Name _____

Address _____

City _____ Zone _____ State _____

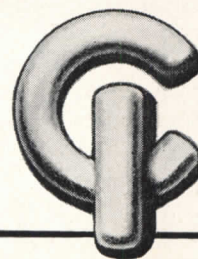
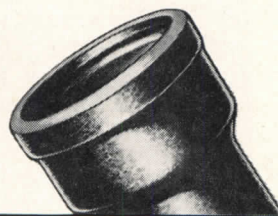

**CAST IRON
SOIL PIPE
INSTITUTE**

STEEL DECK

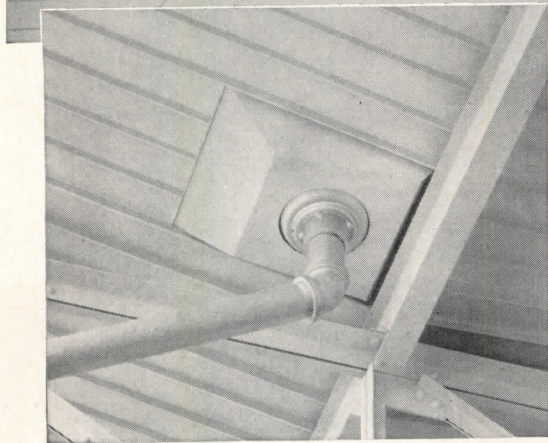
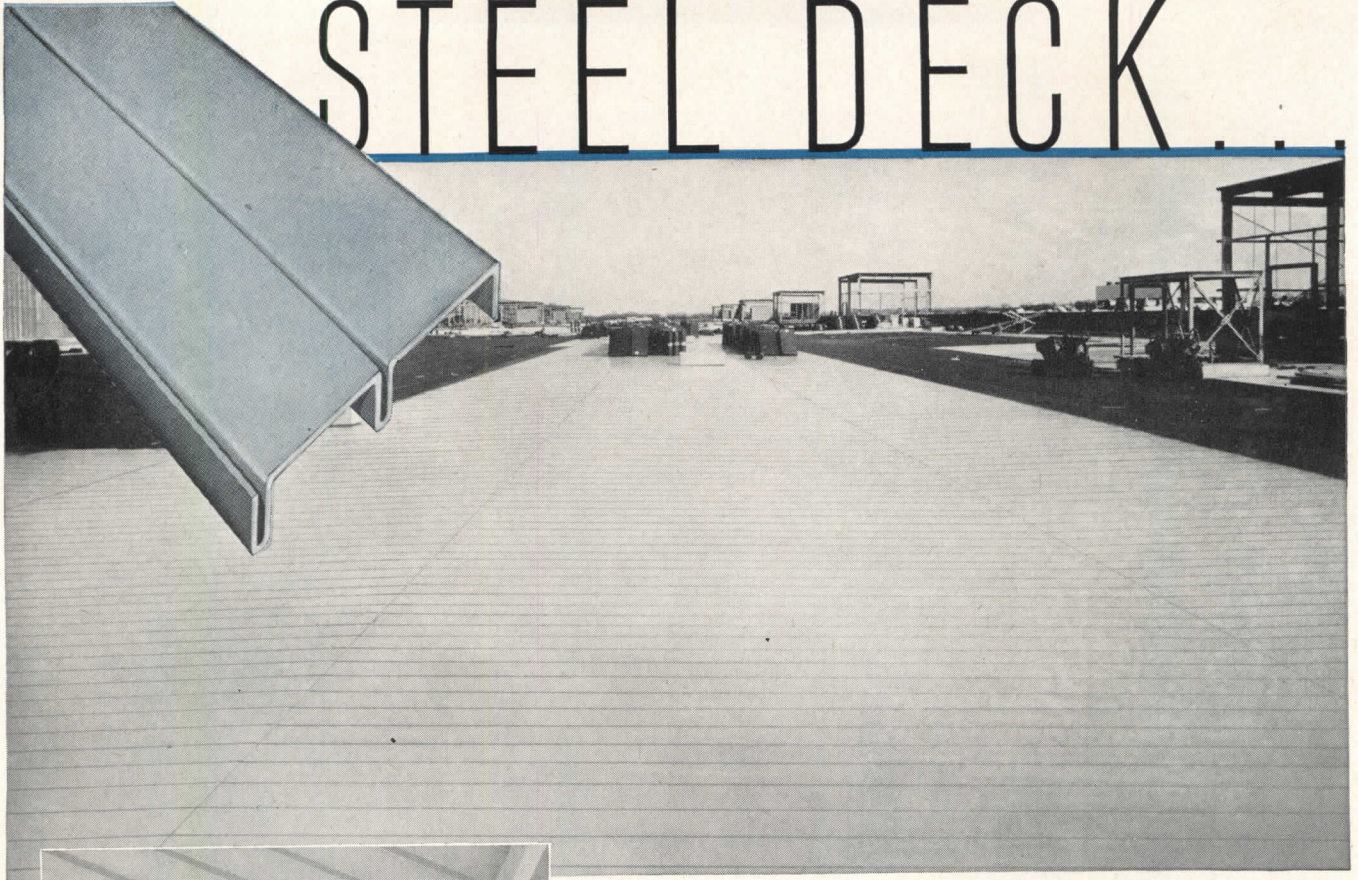

BUILT-UP SADDLES ELIMINATED

Built-up saddles are eliminated in Steel Deck Roofs. Purlins can be set to create valleys at sump locations in the drainage area. Steel Deck can be warped to conform. No additional deck plates are required—no cutting or fitting necessary.

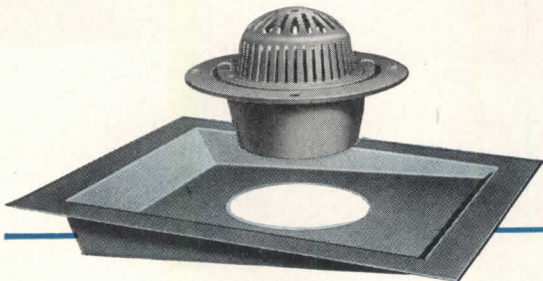

SUMP RECESSES and SUMPS

Mahon Roof Sump Recesses for use with Mahon Steel Deck can be furnished to fit any roof pitch. Mahon Cast Iron Sumps can also be furnished for 4", 5", and 6" conductors.

25 Acres of Mahon Steel Deck Protects New Industrial Plant!

When it comes to the selection of a permanent, firesafe roof for any type of industrial or commercial building, you will find that a Steel Deck Roof will cost less per square foot than any other type of construction with a comparable "U" Factor. Here are the facts: Steel Deck can be insulated to the exact degree to meet thermal requirements of the temperature range in any given locality—and, Steel Deck's light weight permits substantial savings in the supporting structure. Total dead load, including insulation and composition roofing material, is less than any other type of roof. Mahon Steel Deck is available in Galvanized or Enamel Coated Steel . . . it offers desirable features in both design and quality—for instance, the vertical-leg stiffening ribs of Mahon Steel Deck have no angular or horizontal surfaces where troublesome dust may accumulate. In the enameling process, the metal is chemically cleaned and phosphated to provide paint bond, and the protective coat of synthetic enamel is baked on at 350° F. prior to roll-forming. These are features worthy of your consideration. See Mahon's Insert in Sweet's Files for complete information, or write for Catalogs B-53-A and B.

T H E R . C . M A H O N C O M P A N Y

Detroit 34, Michigan • Chicago 4, Illinois • Representatives in all Principal Cities

Manufacturers of Steel Deck for Roofs, Partitions, Ceilings and Floors; Insulated Metal Walls of Aluminum, Stainless or Galvanized Steel; Insulated Metal Wall Panels; Rolling Steel Doors, Grilles, and Underwriters' Labeled Rolling Steel Doors and Fire Shutters.

M A H O N

Where the *other* services also count — it's always BAYLEY WINDOWS

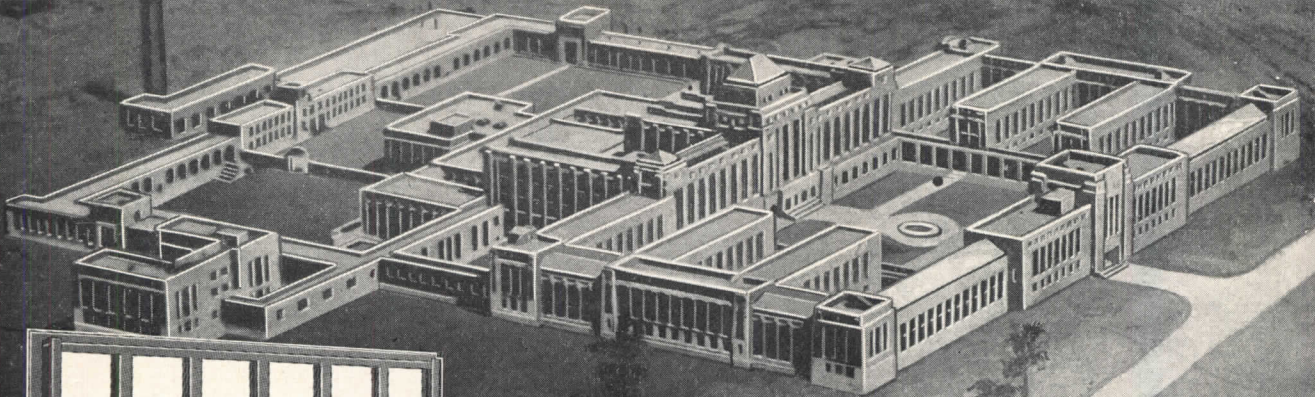

First U. S. Narcotic Farm, Lexington, Kentucky
U. S. Treasury Department, Archt., Washington, D. C.
Great Lakes Construction Co. Contr., Chicago, Ill.

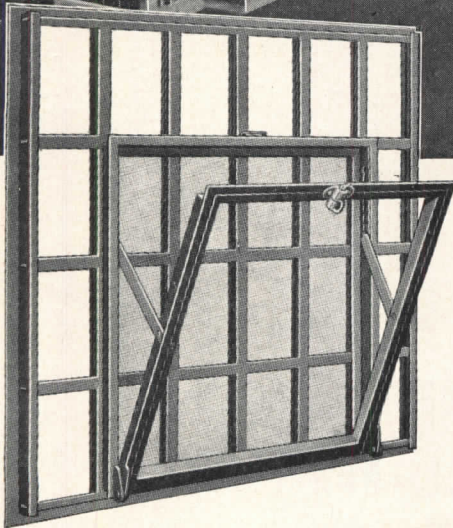

Highlights of the BAYLEY Guard Window System

- Job-proved for 25 years in all classes of penal structures.
- Guard of interlocked and welded super-bars of grades essential to various degrees of detention.
- Choice of ventilator location.
- Separate ventilator unit super-imposed on guard.
- Guards may be installed during rough construction — ventilators attached later.
- Prison-type hardware shop-attached for better fit and operation.
- Glazing and painting of ventilators may be done separately.
- Screens installed between guard and ventilator — deters tampering with guard.

Bayley *Super-Bar* Guard Windows *Especially Designed For All Classes Of Detention*

A fine quality product is only the first essential to a truly satisfactory relationship. Other phases of a supplier's services are equally important. Bayley's recognition — and years of actual demonstration — of this fact is the prime reason why discriminating designers from coast to coast so highly favor Bayley Windows.

To better serve — even the specialized types of structures — from the building's inception to its occupancy is exemplified in the Bayley Guard Window System, originated and developed by Bayley 25 years ago. Consulting, at that time, with penal authorities revealed a need for specialized, improved detention windows. Challenged with this problem, Bayley scientifically designed a window . . . building protection into it through the combining of detention guard, ventilator, and screen all in one unit. Without sacrifice of protection it provides inmates with more daylight and ventilation, and at the same time improves the building's appearance by eliminating the "prison look" to the occupants.

Since their introduction many thousands of Bayley Guard Windows have proved their worth — serving as mute testimony of Bayley's years of specialized window experience.

Regardless of window requirements, you too will find *extra values* in discussing your needs with Bayley. Write or phone.

See Bayley in Sweet's. Complete catalogs on aluminum windows, 17a/BA; steel windows, 17b/BAL; Saf-T-Gard Hospital Detention Window, 17b/BAY.

73 Years of
RELIABILITY

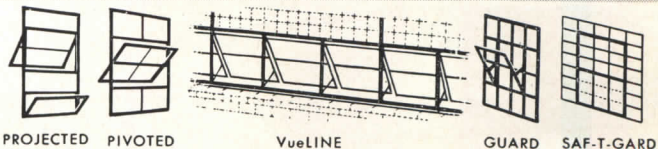

THE WILLIAM BAYLEY COMPANY

Springfield, Ohio

District Sales Offices:

Springfield

Chicago 2

New York 17

Washington 16

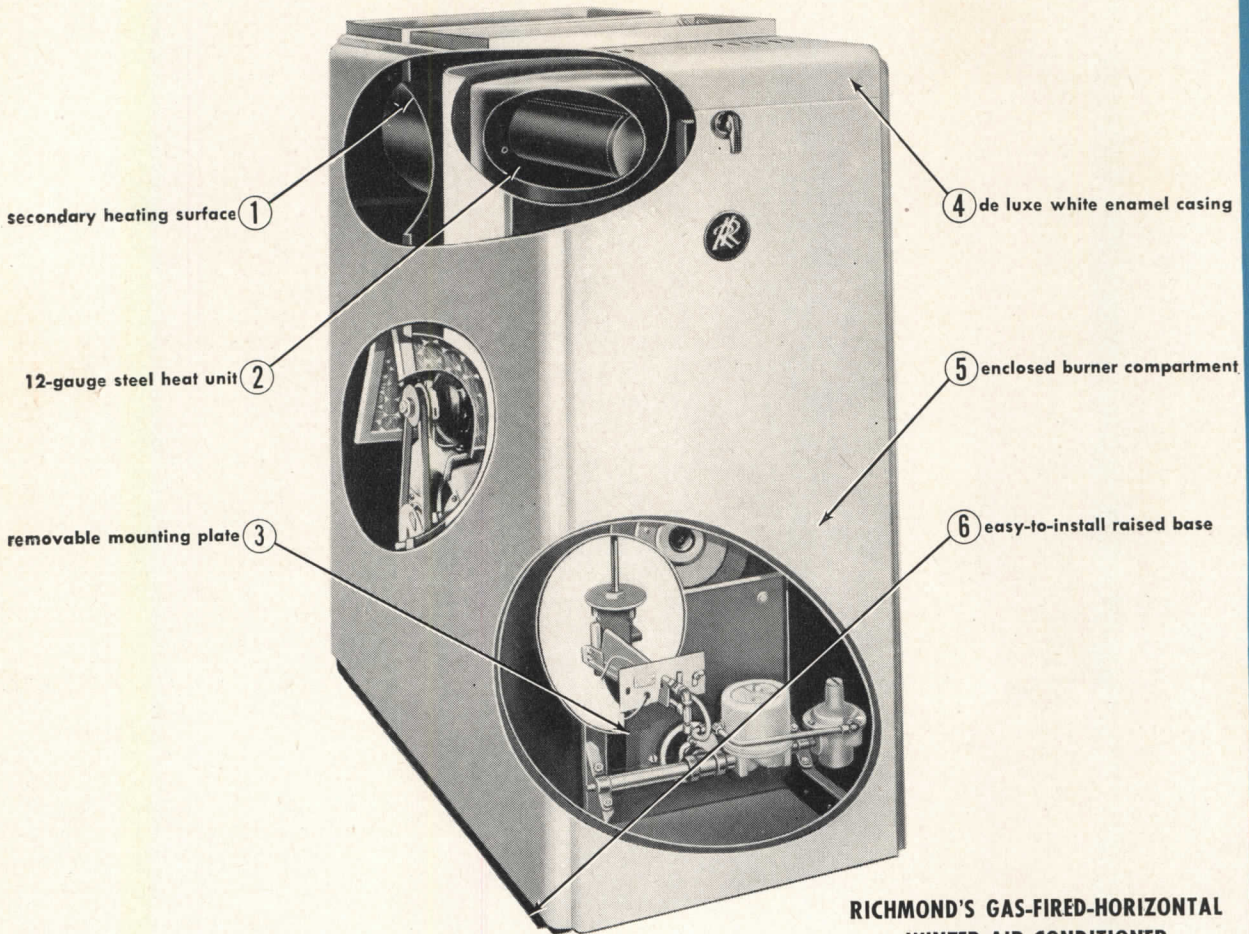

**RICHMOND'S GAS-FIRED-HORIZONTAL
WINTER AIR CONDITIONER**
type AS-12-G . . 90,000 btu/hr.
type AS-23-G . . 115,000 btu/hr.

6 features which make this the ideal heating unit!

With these fine features and with the full approval of the American Gas Association, these two quality Richmond units couldn't be more highly recom-

mended. They illustrate the usual high standards of Richmond efficiency—economy of installation, ease of service and dependability of performance.



RICHMOND

RICHMOND RADIATOR CO.—AFFILIATE OF REYNOLDS METALS CO.

See Your Wholesaler or Mail Coupon Today:

Richmond Radiator Company AR-9
19 East 47th Street, New York 17, New York
Please send me full information on the Richmond steel,
gas-fired winter air conditioners, AS12-G and AS23-G.

NAME.....
COMPANY.....
ADDRESS.....
CITY.....ZONE.....STATE.....

Barcol OVERdoors

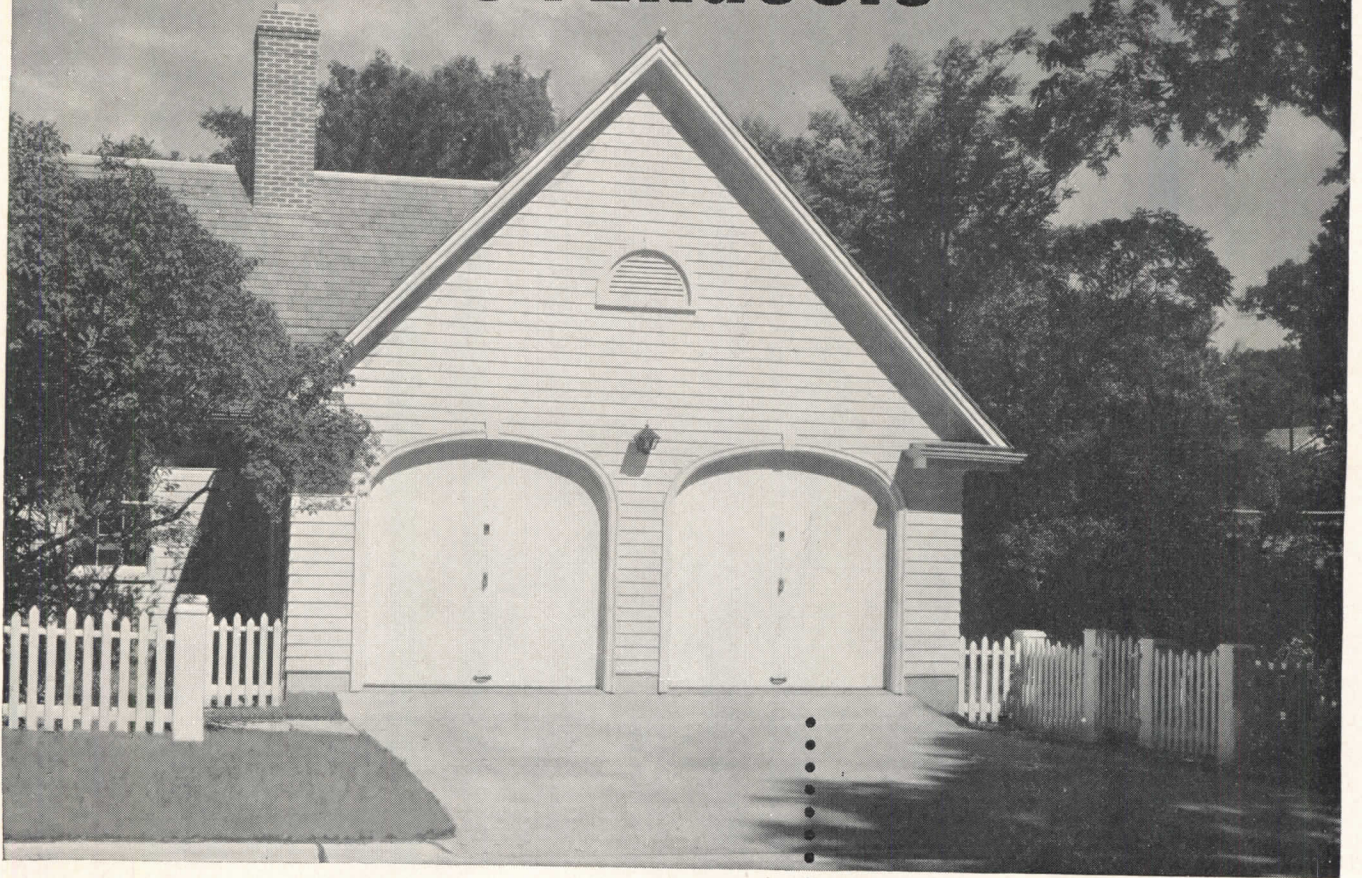

Attractive Appearance

When a midwestern architect set out to reproduce the charm of a traditional style, he got the results shown in the picture above. Aiding his efforts was the special design of the Barcol OVERdoor sections, with vertical grooves suggesting the boards in barn doors of a by-gone day. But back of this beautiful facing is solid, up-to-date mechanism that makes the Barcol OVERdoor "an *improved* overhead door" — a pleasure to own and use. We suggest you visit with your Barber-Colman representative on the subject of Barcol OVERdoors, electric door operators, and the Radio Control. He can give you full details and tell you the many advantages of these modern products, which are so useful toward improving the pleasure of good living.

PLUS

MECHANICAL FEATURES
THAT GIVE

EASY WORKING

NO STICKING

WEATHERTIGHT
CLOSING

LONG LIFE



FACTORY-TRAINED SALES AND SERVICE REPRESENTATIVES IN PRINCIPAL CITIES

BARBER - COLMAN COMPANY
102 MILL STREET, ROCKFORD, ILLINOIS

They're
Right
for any court!

Official Fan-Shaped 10-gauge 1-piece steel Backboard with channel reinforcement and exclusive "floating lugs" for easy replacement. (Official Fan-Shaped Herculite Backboard now being perfected. Ask for details).



MEDART

BASKETBALL BACKSTOPS

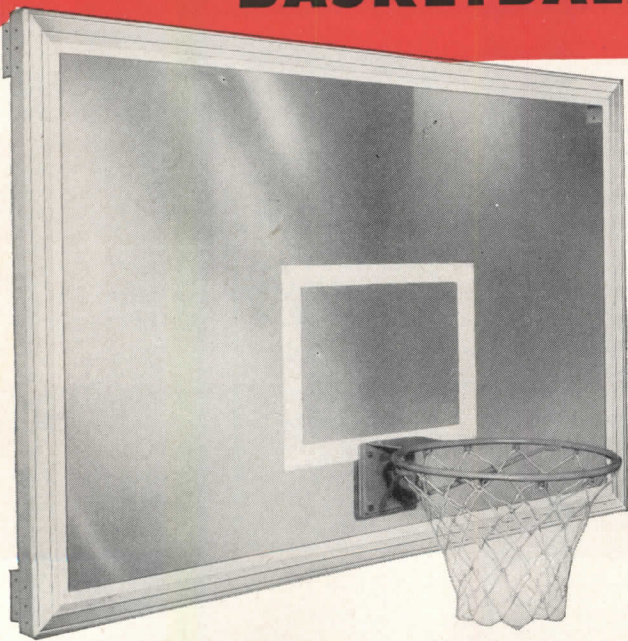

Official Rectangular Backboard of 1/2" Herculite glass with heavy aluminum frame. Official 1-piece heavy plywood Backboard also available.

The essential qualities of rigidity, rugged strength, durability and minimum vibration are built into every Basketball Backstop Medart makes. Whether of glass, wood or steel, they will never distort, buckle, splinter or wear.

But to insure the maintenance of these necessary attributes, Medart assumes responsibility far beyond that of simply supplying fine Backboards. From the time Medart Backstops become a part of the specifications, Medart engineers accept the task of analyzing structural conditions, playing requirements and other considerations—including budget—then help choose exactly the *RIGHT* Backstop for the building. Only through this combination of correct Backstop, "Tailored-To-The-Job" and properly erected, can a completely official and satisfactory installation be assured.

Insist upon Medart Basketball Backstops. Nearly 80 years of "know-how," acquired through the installation of thousands of backstops in all conceivable types of buildings throughout the world, is at your service.

Ask for *NEW* Catalog



FRED MEDART PRODUCTS, INC.

3540 DE KALB STREET
ST. LOUIS 18, MISSOURI



World's Only Complete Single Source For Gymnasium Equipment

Telescopic
Gym Seats

Lockers & Wire
Basket Shelving

Lockerobes
& Grade-Robes

Basketball
Backstops

Physical Fitness
Apparatus

Basketball & Football
Scoreboards

Physical Therapy
Equipment

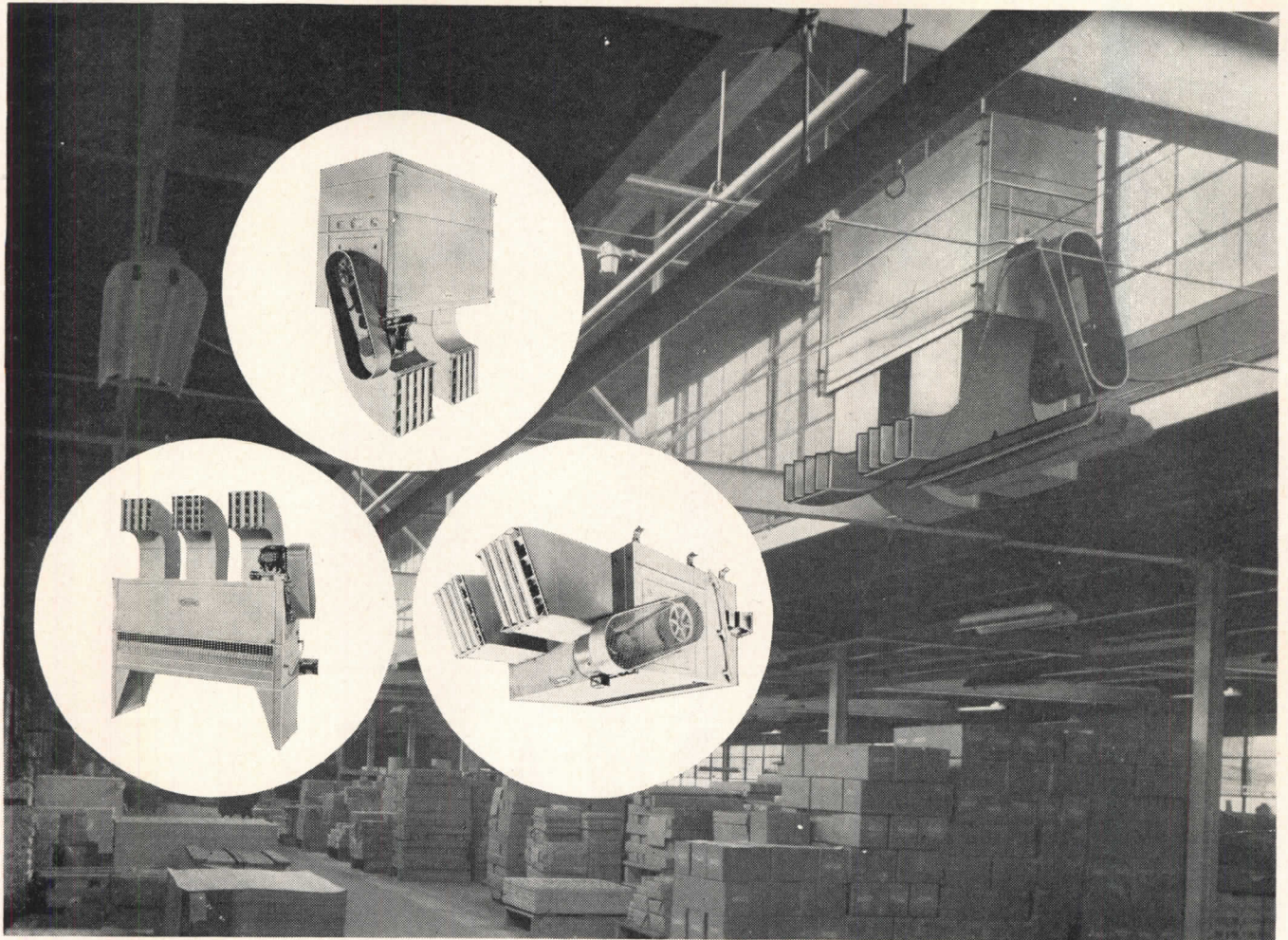

I. S. Berlin Press finds Carrier gives better heat for bigger buildings

It's the larger spaces that put heating units to a real test. That's why the I. S. Berlin Press, 3201 N. Kimball Ave., Chicago, relies on Carrier blower-type Heat Diffusers to heat their warehouse. Cold floors and drafty corners are never around in even the biggest warehouses, factories or garages when you specify Carrier Heat Diffusers for the job. They bring in fresh outside air, warm it quickly and evenly, and send it to every cranny of the building through multiple discharge outlets with adjustable louvers.

Famous Aero-fin coils for steam or hot water, as used in all Carrier Heat Diffusers, are available in either U-bend or Non-Freeze type. When Aero-fin Non-Freeze coils are used, there's no need to specify low-limit protective controls or to temper outside air, because these coils just *will not freeze*, even when handling 100% outside air at below-freezing temperature!

Another advantage: Carrier Heat Diffusers are of sectionalized construction, easily installed, and can be readily rearranged for floor, wall and ceiling mounting.

For steam or hot water, Carrier blower-type Heat Diffuser models 46P, Q, R are available in 6 sizes, to 2,390,000 Btu's per hr. at 2-lb. steam. Air-handling capacities to 31,000 cfm. There's more information in our catalog, "Carrier Heat Diffusers." And you'll find our free Industrial Heating Manual a valuable help. Write for both to Carrier Corporation, Syracuse, New York.



Air Conditioning • Refrigeration • Industrial Heating

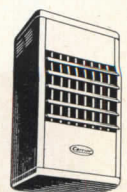
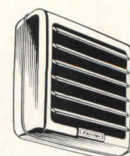
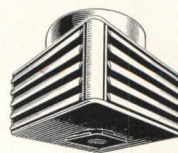

For smaller spaces, Carrier propeller-fan type Unit Heaters: Four-way Directed-flo vertical discharge model 46S (left), 7 sizes, 82,000 to 500,000 Btu's, for steam or hot water; horizontal discharge model 46U (center), 10 sizes, 21,000 to 200,000 Btu's, for steam or hot water; and gas-fired model 46T (right) and 46TD (duct type, not shown), 7 sizes, 70,000 to 230,000 Btu's, AGA-approved for all gases.

Architectural firm tells why it always specifies **CERTIFIED BALLASTS** for fluorescent lighting



Fulton, Krinsky & DeLaMotte, prominent Cleveland architectural firm specializing in schools, requests **CERTIFIED BALLASTS** in *all* fluorescent fixtures they specify.

Mr. Barton Quarm, their electrical engineer, says, "We always specify Certified Ballasts because we want trouble-free installations. Client satisfaction is assured by using Certified Ballasts."

More and more **CERTIFIED BALLASTS** are being specified and used because **CERTIFIED BALLASTS** assure—

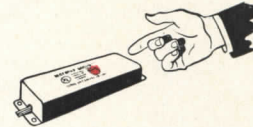

Full Lamp Life

Rated Light Output

Maximum Ballast Life

CERTIFIED BALLASTS are made to precise specifications, then tested by Electrical Testing Laboratories, Inc., which certifies they conform to these high standards.

Write for complete information on the types of **CERTIFIED BALLASTS** available from each participating manufacturer.

*Participation in the **CERTIFIED BALLAST** program is open to any manufacturer who complies with the requirements of **CERTIFIED BALLAST MANUFACTURERS**.*

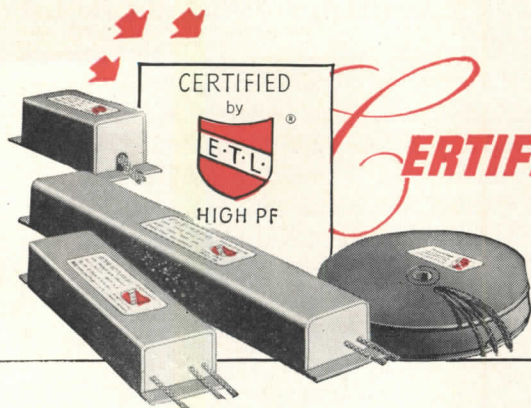

CERTIFIED BALLAST MANUFACTURERS

Makers of Certified Ballasts for Fluorescent Lighting

2116 KEITH BLDG., CLEVELAND 15, OHIO

CONSTRUCTIVE

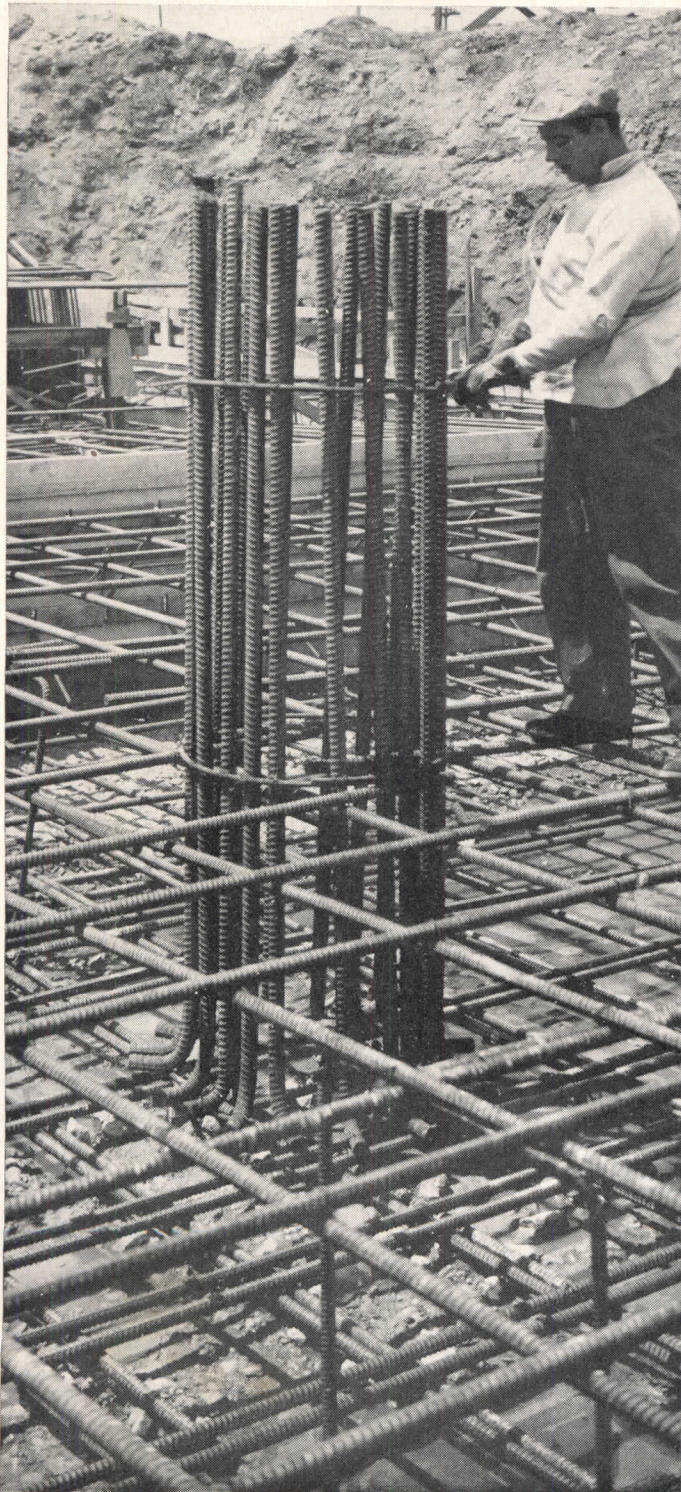

INLAND HI-BOND

The deep, reversed, double-helical ribs of Hi-Bond reinforcing bars provide a mechanical grip which gives maximum bond in concrete, thus permitting greater use of steel's potential strength in concrete construction. It also improves transfer of stresses, crack control and resistance to slip . . . advantages that will make possible higher design stresses and thereby lower construction costs. Hi-Bond meets standards set up by ASTM A 305.

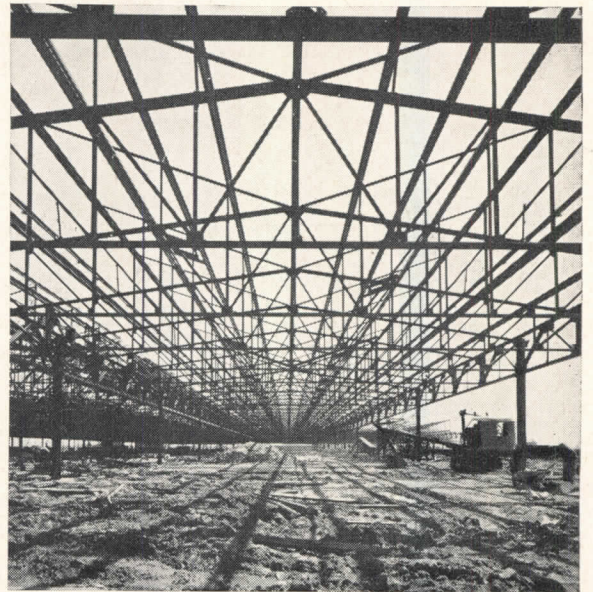

INLAND STRUCTURAL SHAPES AND PLATES

Inland's service on structurals and plates meets the most exacting requirements of today's construction and heavy equipment industries . . . in dependability of product and engineering cooperation with users. I-Beams, Angles, Channels and other standard structural sections, in a wide range of sizes, are rolled to all the standard specifications . . . also in Inland Copper-Alloy for increased resistance to atmosphere corrosion.



IDEAS



INLAND 4-WAY SAFETY PLATE

On scores of products, on new bridges, in new buildings—and for replacement, maintenance and repair—this scientifically designed steel floor plate, with its exclusive raised lug pattern, provides positive traction in every direction. Tough, durable, strong, it stands up under heavy loads and hard wear. It can be readily sheared, welded, punched, flame cut, and shaped. It has no pores, no cracks, absorbs no liquids and is easy to sweep. Comes in a wide variety of patterns and sizes. Write for Bulletin FI.

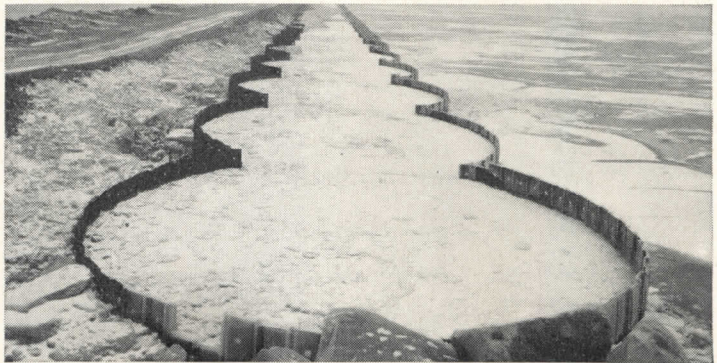

INLAND SHEET PILING

Taking the punishment of driving and pulling—being driven, pulled and re-driven as many as 15 times—Inland Sheet Piling has been used and depended on by piling contractors for more than 25 years. Made with highly efficient interlocks for water retention, it gives excellent service on single and double wall cofferdams, cellular breakwaters, jetties, docks, bulkheads and retaining walls. Rolled from a special analysis steel, with the strength, toughness and uniformity to withstand extreme and continued stresses. Available with all necessary sheet piling accessories. In Inland Copper-Alloy, at slight additional cost. And Inland sheet piling specialists with broad experience are available to help you on sheet piling problems. Write for Booklet SP2.

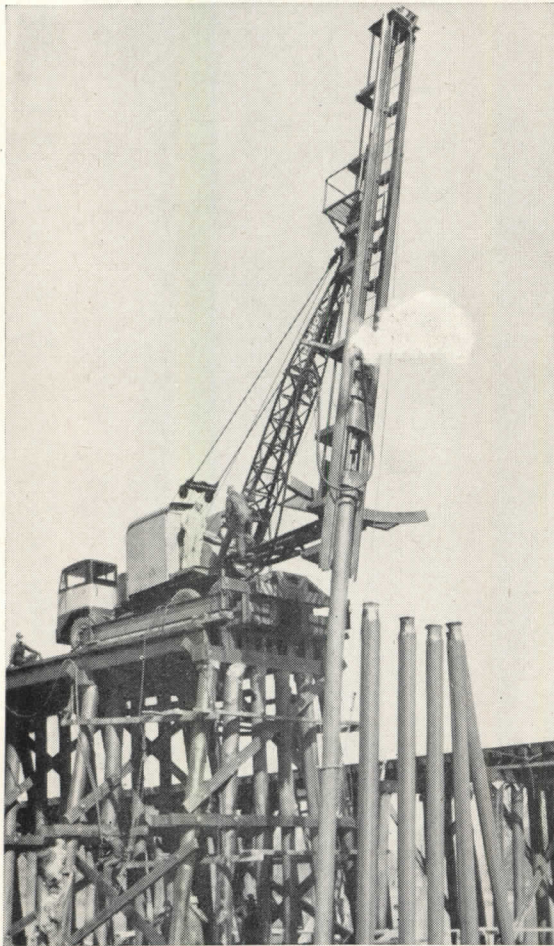

INLAND CREOSOTE OIL

For better, longer-lasting preservation of timbers and wood piling. Inland-owned-and-operated coal mines, coke ovens and tar distillation equipment assure quality control at every step in production of Inland Creosote Oil. Its low benzol insoluble content of about 0.1% (American Wood Preservers Association specifications permit 0.5%) gives clean, deep-penetrating, longer lasting preservation.

INLAND STEEL COMPANY

38 S. Dearborn Street, Chicago 3, Illinois

The tenants think it's wonderful

Self-service elevators for busy office buildings have been in successful operation for more than two years. These Otis AUTOTRONIC® elevators—without attendants—are now installed or on order in twenty cities from Boston to San Francisco.

AUTOTRONIC—without attendant—elevators may be operated either by passengers or by regular attendants in the cars, but passenger-operation has been more than satisfactory wherever it has been used. The tenants think it's wonderful.

Building management finds real advantages, too. Savings for each non-attended elevator average \$5,500 every year.

Why not look at an actual installation in a new or modernized building? Talk with the tenants and management. Ask any of our 266 offices for details. **Otis Elevator Company, 260 11th Avenue, New York 1, N. Y.**

**Better elevating
is the business of**



Passenger Elevators • Escalators • Freight Elevators • Electric Dumbwaiters • Modernization • Maintenance

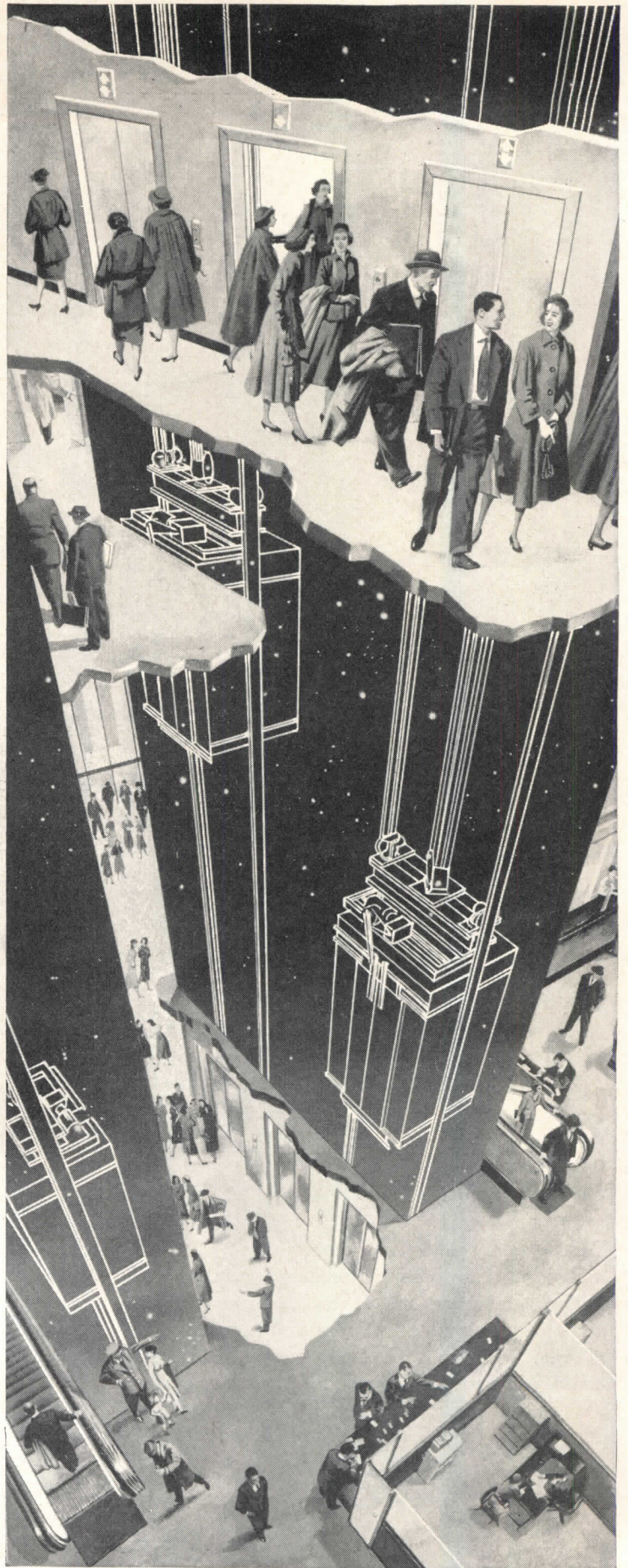



Above: Brown U., Main Dining Room, Providence, R. I. Architects: Perry, Shaw & Hepburn.
Pastel Green Kalistron covers wainscoting, Forest Green Kalistron on service doors.

UNBELIEVABLE DURABILITY

on our walls and doors...

That's the comment frequently heard about *Kalistron* installations. When walls, doors, columns or furniture are covered with Kalistron, they literally defy the wear and tear of "heavy duty" service. Years after installation, the Kalistron is still in excellent condition . . . unmarred, unscratched, with practically no sign of wear.

Kalistron is different because its color is fused to *underside* of clear sheet of wear-resistant Vinylite. Since nothing can touch this under-surface, Kalistron's beauty stays fresh and new-looking.

Kalistron cannot chip, crack or peel; minimizes maintenance costs. Cleans easily with a damp cloth. In 28 standard colors: special colors matched.

SEND COUPON BELOW for sample of Kalistron and nail-file. Test Kalistron yourself . . . prove its unbelievable durability.

Kalistron †
PAT. APPLIED FOR
 ← COLOR FUSED TO UNDERSIDE
 PLASTIC COVERING MATERIAL

U. S. Plywood Corp., Dept. F-8
 55 West 44th St., New York 36

Please send me FREE Nail-File Test (swatch of Kalistron plus actual nail-file) and folder "Facts About Kalistron."

NAME _____

ADDRESS _____

Distributed by: UNITED STATES PLYWOOD CORP., N. Y. C.
 and by: DECO SALES, 408 Freylinghuysen Ave., Newark, N. J.
 In Canada: PAUL COLLET & CO., LTD., MONTREAL

† TRADEMARK

Color fused to
 underside of
 transparent vinyl
 sheet . . . backed
 by flocking

MORGAN MAKES THE "Picture Door" FOR TODAY'S HOME



Morgan M-117 Tri-Panel Door in M-32 Entrance Frame

This is the
MORGAN TRI-PANEL
Door of Dimension

*with correctly proportioned panels creating
an ever changing "picture" of clean sharp
hi-lites and deep, soft shadows...*



MORGAN "Tri-Panel" DOORS are made in standard sizes for exterior and interior openings... designed to blend with every trend, and relieve the flat monotony of walls, ceilings, floors. Write Morgan for full details.

MORGAN COMPANY • OSHKOSH WISCONSIN

Doors • Entrances • Corner Cabinets • Kitchen Cabinets
Stairwork • Storage Walls • Mantels • Sash • Trim



Large area heating...

WITH OR WITHOUT
DUCT-WORK

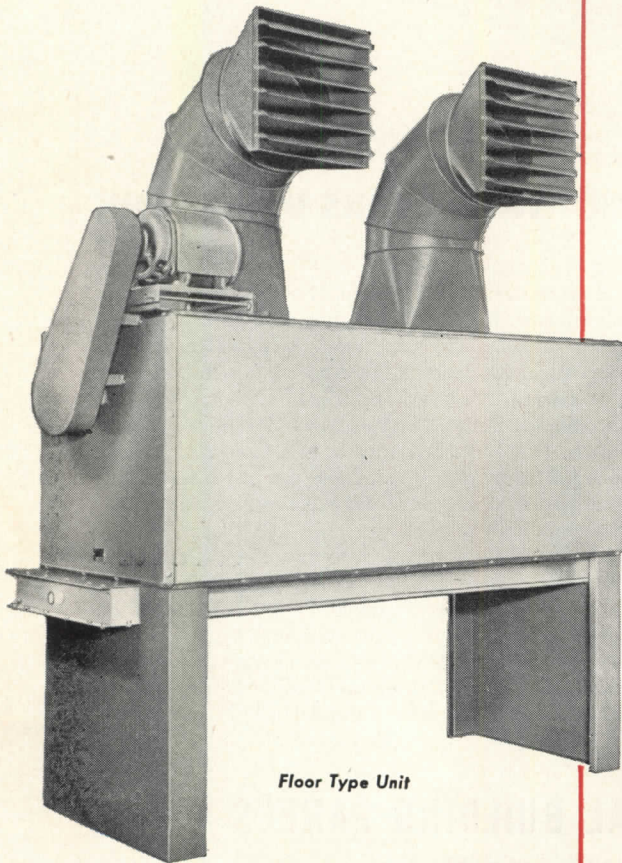

Floor Type Unit

McQuay INC.

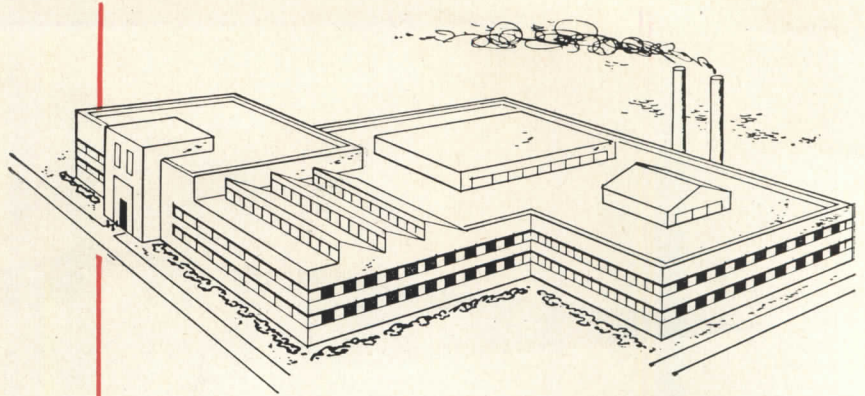

McQuay

BLOWER-TYPE

Unit Heaters

Where heat must be diffused over large open areas, as in warehouses, garages and industrial plants, the McQuay Blower-Type Unit Heater has a wide application. Available in floor, horizontal, vertical, wall and inverted styles in 8 sizes, up to 1,600,000 Btu. Only McQuay can give you famous Ripple-Fin coils—the construction feature that assures maximum heat transfer efficiency. Representatives in principal cities. Write McQuay Inc., 1605 Broadway Street N.E., Minneapolis 13, Minnesota.

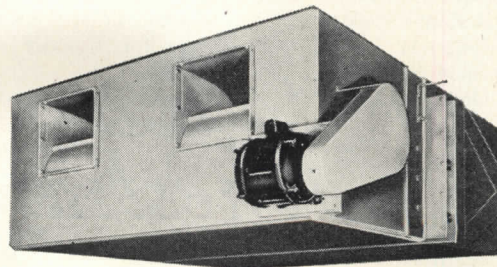

Horizontal Unit

HEATING
AIR CONDITIONING
REFRIGERATION



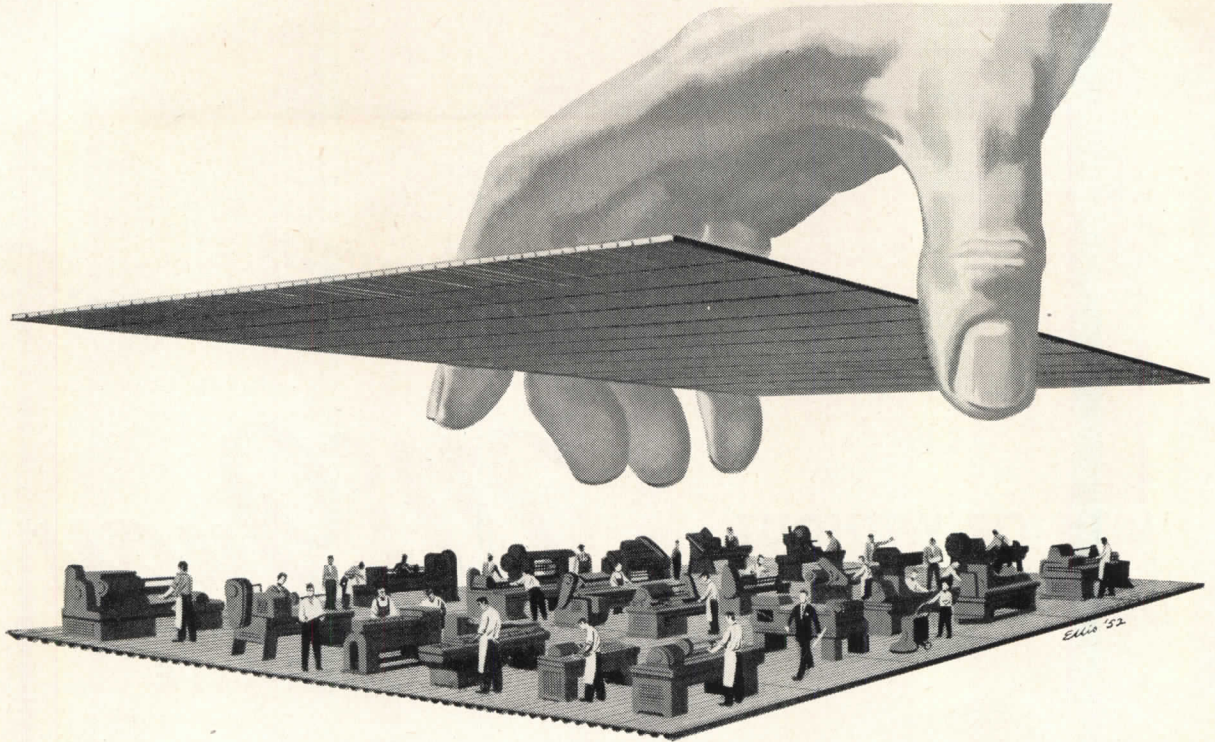

THIS ROOF IS A "SOUND BLOTTER" THAT SOAKS UP RED INK

NOISE IN YOUR PLANT IS A COSTLY WASTREL. It scrapes nerves red-raw . . . handcuffs production . . . causes accidents.

Industrial noise causes a reported \$4,000,000 a day loss in worker efficiency. And it has been the underlying cause of some pretty serious labor disputes.

Your answer to the problem is a wonderful new building idea: a combination acoustical-structural roof that costs as little as 75 cents per square foot . . . installed. In one compact unit you get: (1) Perforated light-gauge Holorib Steel Deck, which provides a smooth-finished metal-faced interior ceiling; (2) Sound absorbing element; (3) Efficient heat insulation; (4) Strong steel surface for support of finished roofing.

Holorib is lightweight. It saves you building time,

labor, materials and money. It's practically maintenance-free. But, if you want to, you can wash it or paint it time and time again without hurting its acoustical efficiency a bit. And it's noncombustible.

General Motors Technical Center, Warren, Michigan; Standard Press Steel Company, Jenkintown, Pa.; Simmons Saw & File Company, Fitchburg, Massachusetts . . . these are just a few of the companies taking advantage of this great Fenestra* development.

Write us for complete information—or have your architect write—and check on Fenestra floor panels and wall panels. Light-gauge Fenestra Metal Building Panels speed building and lessen the need for structural steel. Write Earle C. Hodges, Vice President, Detroit Steel Products Company, Dept. AR-10, 2252 East Grand Boulevard, Detroit 11, Michigan.

*Trademark

Fenestra METAL BUILDING PANELS

. . . engineered to cut the waste out of building

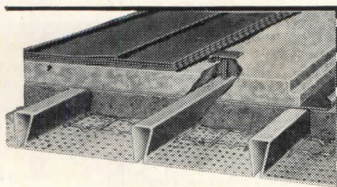

Acoustical Holorib for acoustical-structural roof. Width 18". Depth to 1½".

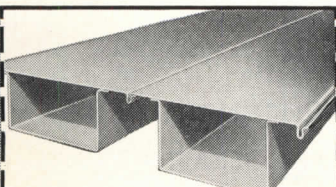

"D" Panels for floors, roofs, ceilings. Standard width 16". Depth 1½" to 7½".

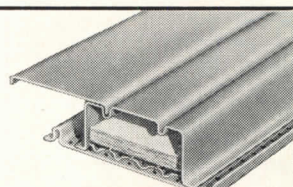

Acoustical "AD" Panels for ceiling-silencer-roof. Width 16". Depth up to 7½".

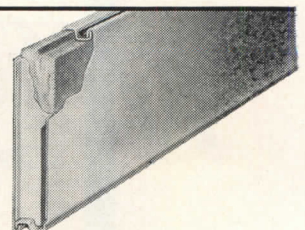

"C" Insulated Wall Panels. Width 16". Depth is 3".

New Drayton Arms Apartment uses Westinghouse Bus Duct throughout

Two, 1350-ampere, low-impedance bus duct risers carry power conveniently from basement to penthouse in this ultramodern, 198-suite apartment in Savannah, Georgia. Each riser is three phase, 4 wire and feeds half a floor at each level. Power take-offs are through circuit protective devices built into the duct.

Standardized duct sections co-ordinated perfectly with building plans, were quickly and easily installed. The contractor and owner are so pleased with the results that the contractor has selected and ordered similar Westinghouse Bus Duct for the new, 15-story Savannah Bank and Trust Building.

Check the four types of Westinghouse Bus Duct when planning power expansions or new jobs. Up to 5000 amperes it gives more power per pound of equipment than any other means of secondary power distribution. Types are available to handle all load conditions and service requirements.

Call your Westinghouse distributor for complete details or write for J-30106. Westinghouse Electric Corporation, P. O. Box 868, Pittsburgh 30, Pennsylvania. J-30106

BUS DUCT IS FLEXIBLE

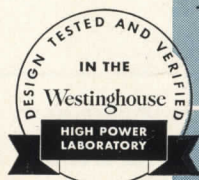

YOU CAN BE SURE...IF IT'S
Westinghouse

BUS DUCT



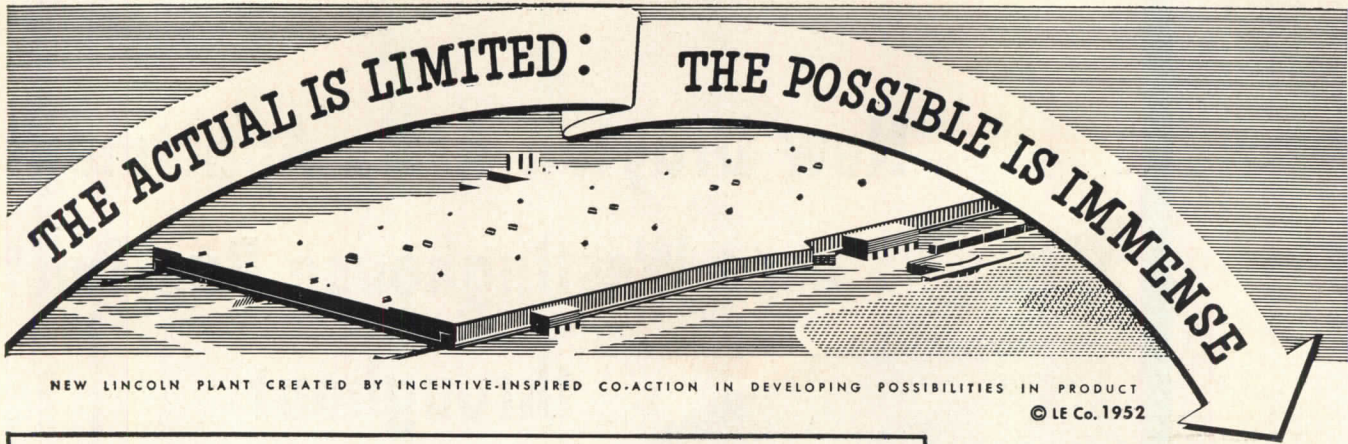

NEW LINCOLN PLANT CREATED BY INCENTIVE-INSPIRED CO-ACTION IN DEVELOPING POSSIBILITIES IN PRODUCT

© LE Co. 1952

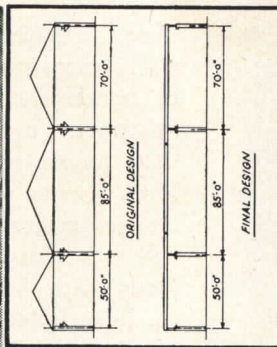
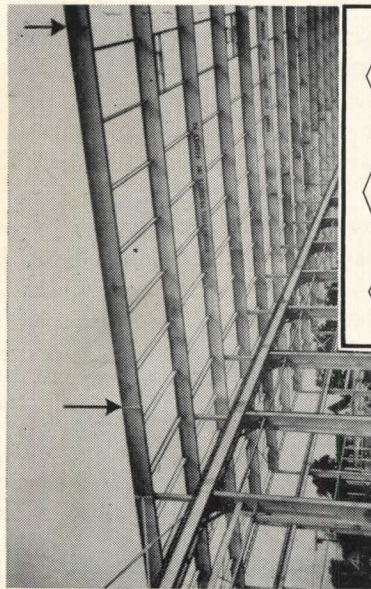

Fig. 3—Continuous Framing for the 85' bay with 30" girder beams attached to the cantilevers at various heights. Steel warehouse is for A. M. Castle Company. Architect: Lucius R. White Jr.; Fabricator and Erector: Reading Steel Products.

HOW TO DESIGN ARC WELDED STRUCTURES

Latest data on calculations, procedures and costs are found in the new 9th Edition Procedure Handbook of Arc Welding Design and Practice. Price only \$2.00 postpaid in U.S.A.; \$2.50 elsewhere.

**WELDED DESIGN COSTS 28% LESS
... CUTS STEEL REQUIREMENTS 21%**

By **Van Rensselaer P. Saxe**
Structural Engineer, Baltimore, Maryland

RIGID frame construction using welded design has saved 134 tons of steel and \$41,246 on this industrial warehouse. These figures represent a cost reduction of 28% with steel savings of 21% over riveted construction.

The original design contemplated pitched roof trusses over the entire roof area, ranging in depth according to the spans which were 50', 85' and 70'. However, to save on fabricating time a design was developed using continuous girders over columns so the entire roof girder structure could be developed using 30" depth beams of varying weights over the spans.

Of five bids submitted, the low bid was \$26 per ton less than the lowest bid on riveted construction. All steel was to be furnished by the owner except for angles and plates for the riveted design which were to be supplied by the bidder. The bid of the low fabricator for riveting was \$150 per ton with 40 additional tons of steel needed for connections. The welding fabricator's bid was only \$124 per ton including all welding rod and equipment.

**WELDED DESIGN
ALWAYS SAVES STEEL
AND LOWERS COST**

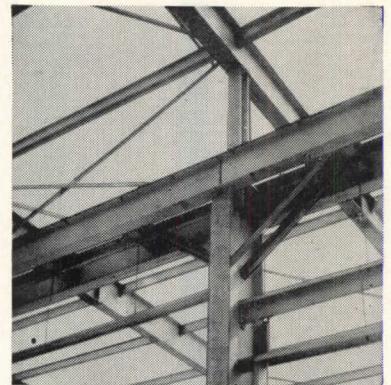

Fig. 1—Simpler Details Method for attaching crane girders to beam columns. Small stub column welded to top of W. F. beam supports roof girder construction.

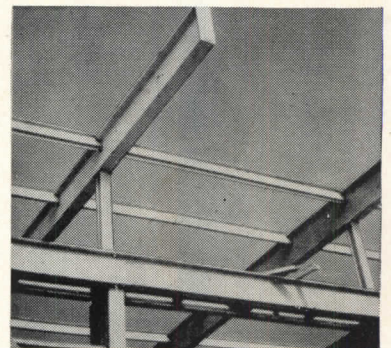

Fig. 2—Simpler Erection Cantilevered ends of roof girders project out from 50' and 70' bays and over the 85' bay are ready to receive the 30" girder to complete the 85' span.



Studies in Structural Arc Welding free on request. Designers and engineers write on your letterhead to Dept. 163,

THE LINCOLN ELECTRIC COMPANY

CLEVELAND 17, OHIO

THE WORLD'S LARGEST MANUFACTURER OF ARC WELDING EQUIPMENT



Ralph C. Flewelling & Walter L. Moody, Architects

MODERN DOOR CONTROL BY *LCN* • CLOSERS CONCEALED IN HEAD FRAME

CENTER STREET SCHOOL, EL SEGUNDO, CALIFORNIA

LCN CATALOG 11-E ON REQUEST OR SEE SWEET'S • LCN CLOSERS, INC., PRINCETON, ILLINOIS

here's a new product for you

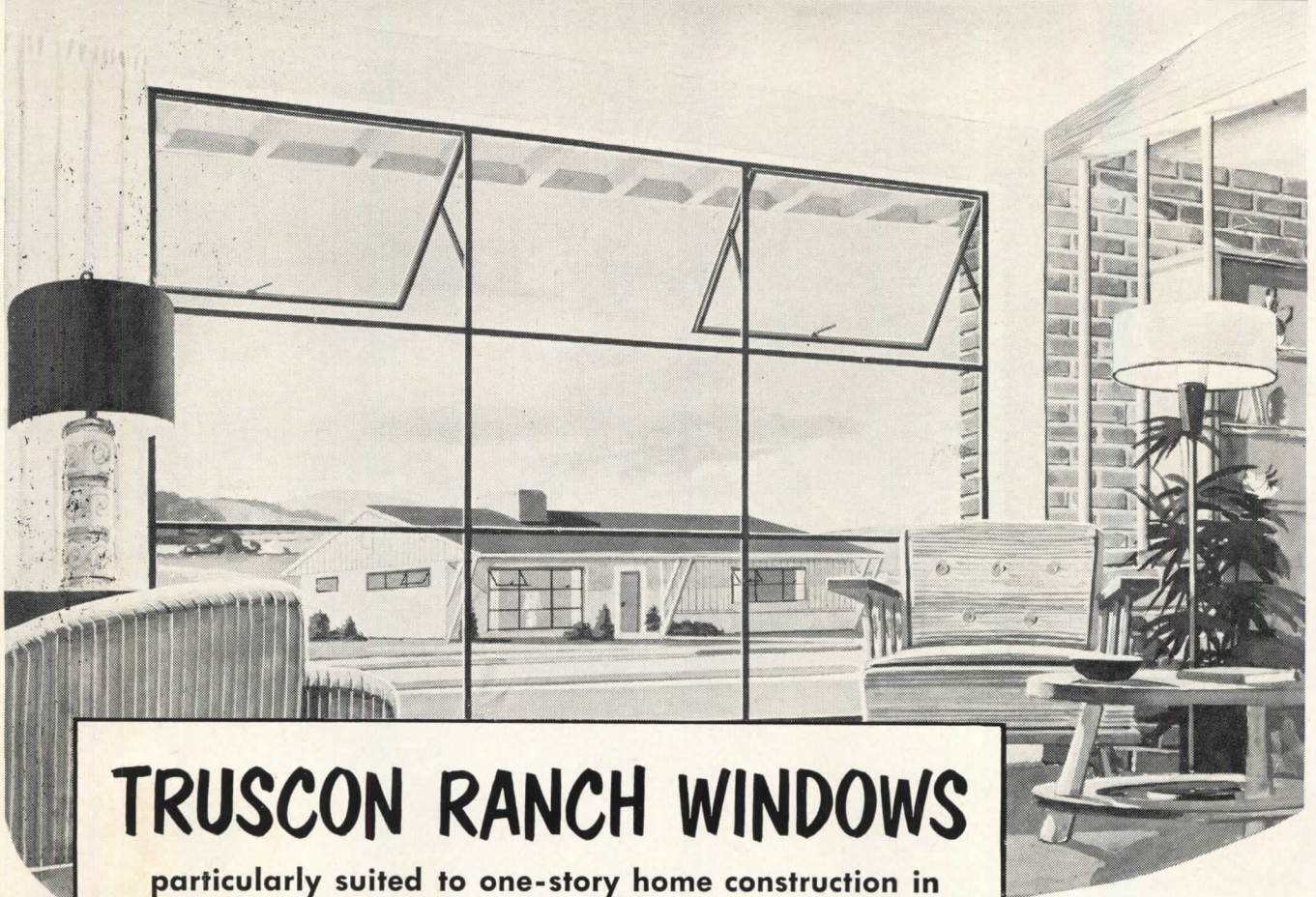

TRUSCON RANCH WINDOWS

particularly suited to one-story home construction in the widely-popular ranch house architectural style...

The Truscon Ranch Window offers new and attractive features not only for the favorite ranch-home design but also for enhancement of any residential unit following the modern trend.

Special Features—The Ranch Window in the larger sizes provides an attractive living-room picture window which, when viewed from the outside, tends to minimize the "wide open" effect characteristic of a large undivided glass area. The medium size units fit very conveniently into window openings for dining rooms, dens and libraries. In the smaller units, the windows are admirably suited for sleeping rooms.

Sturdy Design and Welded Construction—The window frames are constructed of specially rolled, extra heavy steel sections, one inch in depth. All joints and corners are securely welded.

Convenient Ventilation—Ventilators are of the awning type, hinged at the top to swing outwards at the bottom. The degree of opening is controlled by two adjustable sliding friction stays, one in each jamb and both completely concealed when the vent is in a closed position.

Available from Warehouse or Factory—Truscon Ranch Windows are available from key warehouse stocks. Screens, interior steel casings or exterior steel surrounds for all size units are also stocked. Consult your nearest Truscon District Office, local Truscon dealer, or write for further information.



TRUSCON® STEEL COMPANY
1062 ALBERT STREET • YOUNGSTOWN 1, OHIO
Subsidiary of Republic Steel Corporation

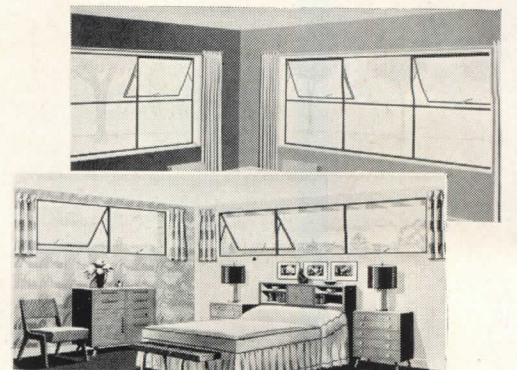
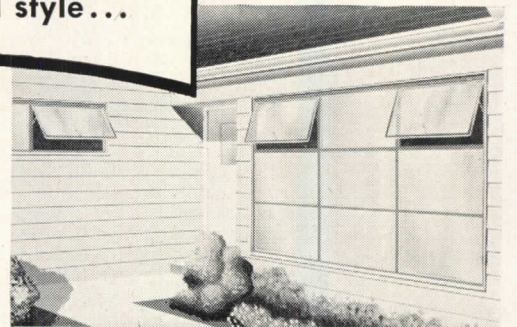

THE ANSWER MAN

Q: *I'm disgusted. I want to use a fireproof sheathing next time. Any suggestions?*

A: Certainly. Use one made of gypsum. Gypsum is rock—it cannot burn.

Q: *What's it covered with?*

A: A tough, heavy paper that's . . .

Q: *Hold it! I've heard about that cover. They say that it can't be stored outdoors.*

A: Outside storage on the job is no longer a problem. It was licked by modern research—like a lot of other old-time building material bugs. Today's gypsum sheathing is water-repellent—sheds water like a duck!

Q: *How about the wind resistance?*

A: Gypsum sheathing is tongued and grooved—locks together as tight as a drum.

Q: *Can it hold building paper satisfactorily?*

A: You won't even need building paper with it—unless a local building regulation requires it.

Q: *How about wastage?*

A: Little or none—because every cut-off piece, regardless of size, can be used. 1000 square feet of gypsum sheathing covers 1000 square feet of surface.

Q: *Fireproof, windproof, waterproof—I suppose you'll tell me it's ageproof.*

A: No, but I can show you letters from builders who have reported no deterioration or loss of strength of gypsum sheathing that was installed 25 years ago. And in the recent Topeka floods, gypsum sheathing was one of the few building materials that withstood devastation.

Q: *Now what about insulation?*

A: You'll get adequate insulation in most cases. Besides the amount provided by the gypsum sheathing itself, you must remember that you always use a finish too, like siding or shingles or brick. This combination, plus the air pocket between, provides good insulation.

Q: *What size does it come in?*

A: In the giant size—for large surface application—2' x 8', 1/2" thick. One man can handle a sheet with no trouble. It goes up fast, 16 square feet at a time; and easily—only 4 to 7 nails required; and it can be scored and snapped right on the studs.

Q: *Any other features?*

A: Gypsum sheathing won't warp, buckle or shrink. It defies dry rot, termites and other evils that vegetative building materials can't resist. You must remember that gypsum is not vegetable, but mineral. It's rock.

Q: *It's everything I've wanted. Is it economical?*

A: It's the least expensive sheathing on the market, as low as 50% less than other sidewall sheathing costs. This is a proved fact!

Q: *I'm sold. Where can I get it?*

A: Anywhere in America, because it's made throughout the country. And because it is manufactured under quality control, you'll never have the problem of various grades of gypsum sheathing. Every sheet is identical. Ask for it by this brand name—Weather-Shield Gypsum Sheathing, one of a great line of building materials produced by Certain-Teed Products Corporation, Ardmore, Pennsylvania.

(advertisement)



Office building of the new Lever Brothers plant, Los Angeles, California, reflects the trend of today's industrial design.

★ Six Westinghouse Power Centers, spotted in black, are the heart of the plant's electrical distribution system which provides reliable service under all conditions.

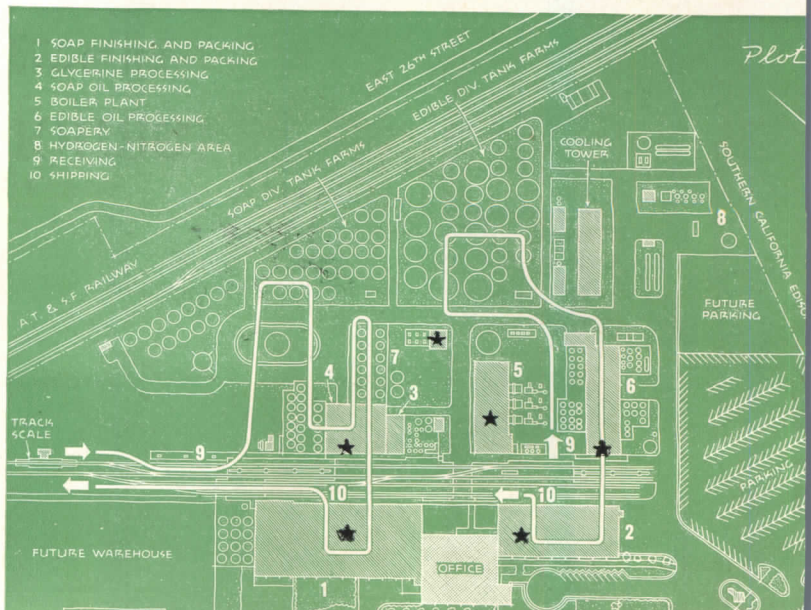

PLANNED POWER PAYS

They matched modern plant design with modern power distribution

This 25-million-dollar Lever Brothers plant incorporates the most modern advances in design, layout and construction methods. And its system for distributing electrical power is as modern as the plant—assuring uninterrupted service under all conditions.

The secondary network system was specified in the early planning days by Bechtel Corporation—the engineers and constructors—with Westinghouse assistance. It contains six interconnected power centers that maintain service even though an electrical disturbance may fault a primary line. Secondary faults are isolated quickly. The ultimate in reliable power is assured.

Early planning has also taken full advantage of the flexibility of factory-assembled Westinghouse Power Centers. These compact, standardized units save valuable space . . . minimize layout problems. Their dry-type transformers permit them to be located safely anywhere

in the plant. Additional units can be added easily, as loads and capacity increase.

CONSIDER THIS: A plant's distribution system is a vital design consideration. It must be planned at the blueprint stage . . . treated as an integral part of the building or expansion program. Today, the power needs of a modern plant require this kind of planning—coupled with completely co-ordinated equipment.

Westinghouse offers you assistance on *both* of these requirements . . . and backs them with years of experience, gained throughout all industry. You benefit by getting more freedom in design techniques . . . by providing your customer with the best system economically possible for *his* plant.

There is one best system of distributing electrical power for *every* plant. Let Westinghouse help you select it on your next job. Westinghouse Electric Corporation, P. O. Box 868, Pittsburgh 30, Pennsylvania. J-94955

Space problems were minimized with six of these compact Westinghouse ASL Dry-Type Network Power Centers. They are standardized, factory-assembled units . . . can be expanded easily as power needs grow.

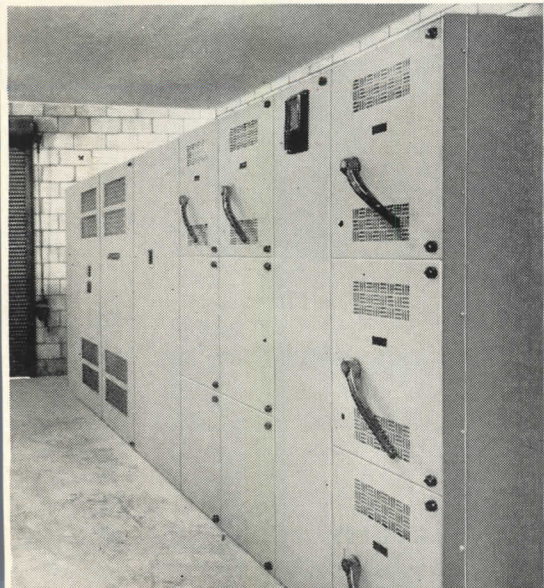

YOU CAN BE SURE...IF IT'S
Westinghouse

SYSTEM PLANNING



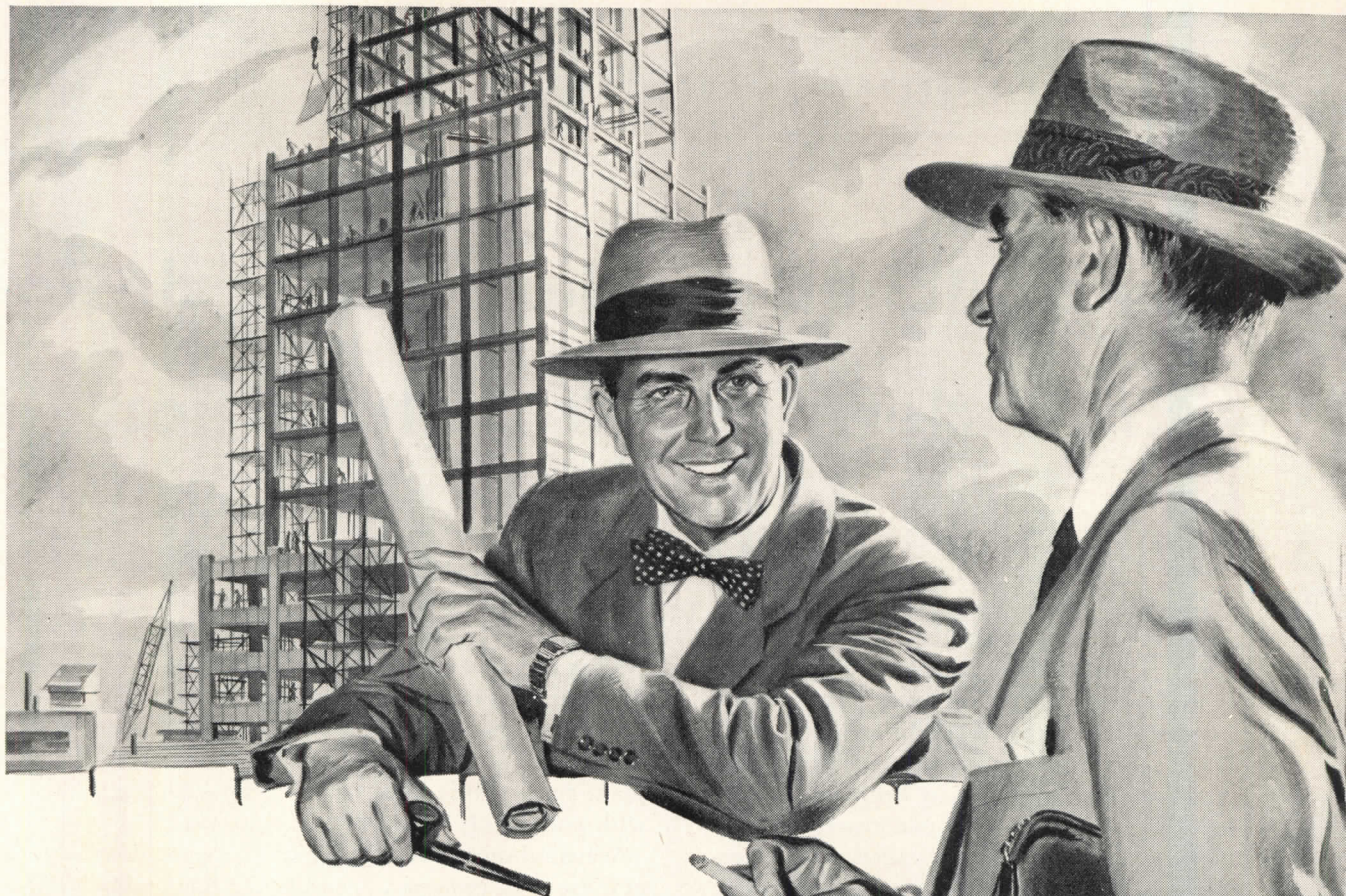

“John, this building of mine holds a

cost-cutting

Tip-Off

from ONE BUSINESSMAN TO ANOTHER”

“What is it?” asked John, a prominent appliance manufacturer.

The contractor answered, “Simply this: don’t take your fasteners for granted!”

“An RB&W man showed me how a switch in fasteners could help me make field connections much more economically.

“He suggested switching from rivets to high strength bolts. They cost more than rivets initially, but the assembled cost is much lower. My men work faster than with rivets. The building goes up faster.”

You, too, can find a cost-cutting lesson from this story, whether you’re in construction* or any other industry.

MORAL: Look to your fasteners for an often overlooked opportunity to reduce costs, and strengthen your competitive position. New in-

ventions, like RB&W’s SPIN-LOCK Screw, may prove more efficient than the fasteners you’re now using. Or you may save by the stepped-up production you get from using the finest fasteners . . . RB&W bolts, screws, nuts and rivets of uniform accuracy, dependability and physical properties.

Let RB&W help you make the most efficient use of fasteners on your assembly line. Address RB&W at Port Chester.

RB&W—The Complete Quality line. Plants: Port Chester, N. Y., Coraopolis, Pa., Rock Falls, Ill., Los Angeles, Calif. Additional sales offices: Philadelphia, Pittsburgh, Detroit, Chicago, Dallas, Oakland. Sales agents: Portland, Seattle. Distributors from coast to coast.

**RUSSELL, BURDSALL & WARD
BOLT AND NUT COMPANY**

*If you’re interested in construction, write RB&W at Port Chester for a free reprint of the recent article, “No More Riveting.”

RB & W 107 YEARS MAKING STRONG THE THINGS THAT MAKE AMERICA STRONG

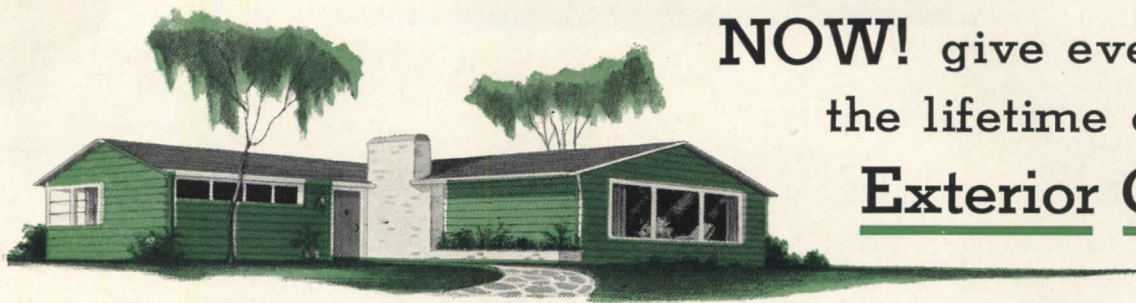

NOW! give every home
the lifetime charm of
Exterior Color

NEW —and styled for **tomorrow**

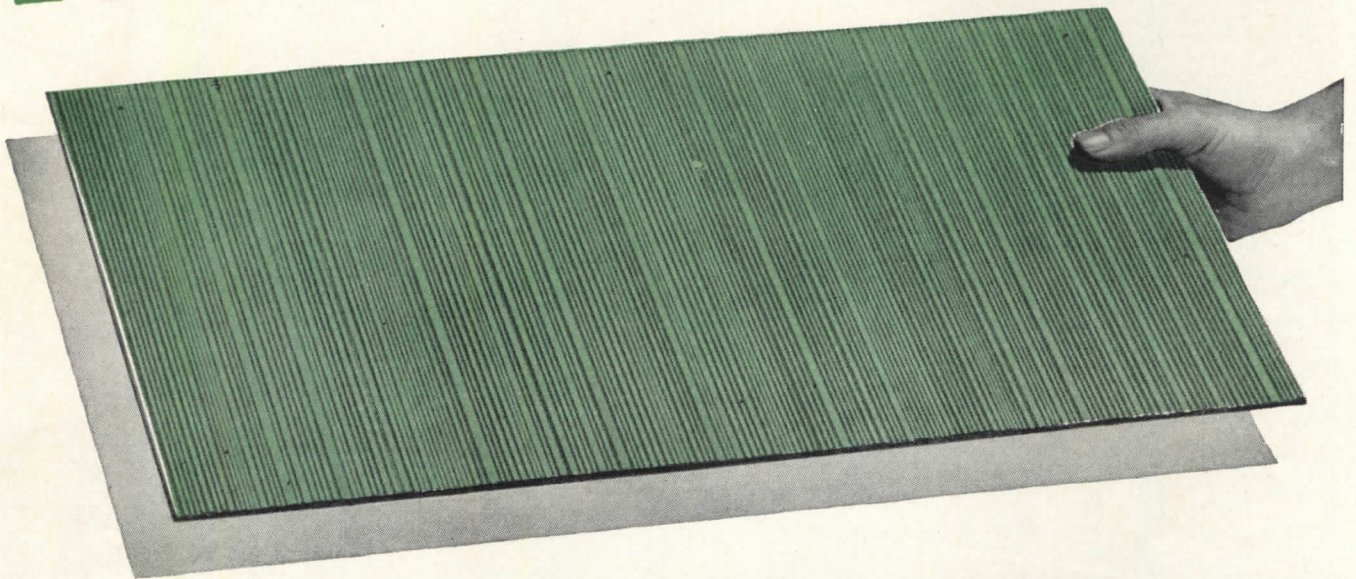

- ✓ **New deep-grain texture!**
- ✓ **New color harmony!**
- ✓ **Same lifetime durability!**
- ✓ **Same low price!**

CHROMA-TEX SIDING SHINGLES have a deep, natural-looking texture. Color is two-toned—dark in the valleys, light on the ridges—for a pleasing *new* kind of decorating effect that lends itself perfectly to modern color-planning ideas for exteriors. Like all Asbestone products, *Chroma-Tex* Siding Shingles are rock-like in their ruggedness—fireproof, weatherproof, rot-proof, termiteproof. Made of asbestos-cement, they need no painting, no preservative treatment, no maintenance of any kind.

- Put more color, more style, more **APPEAL** into every home you design.
- Give your clients the rich, textured effect of the costliest sidings on the market—for the same price as regular asbestos shingles.
- Use any of 5 appealing **CHROMA-TEX** colors to style every exterior with true "decorator harmony" from the ground up.

ASBESTONE

Chroma-Tex

SIDING SHINGLES

COLORS: Twilight Gray • Poplar Green • Pheasant Brown
Dusty Coral • Mellow Ivory

ASBESTONE CORPORATION
5386 Tchoupitoulas St., New Orleans 15, La.

Please send me samples and full information on NEW CHROMA-TEX Siding Shingles.

NAME _____
FIRM NAME _____
STREET & NO. _____
CITY _____ ZONE _____ STATE _____

ASBESTONE — Rugged as the rock it's made from

Roofing & Siding Shingles

Wallboard

Corrugated Roofing & Siding

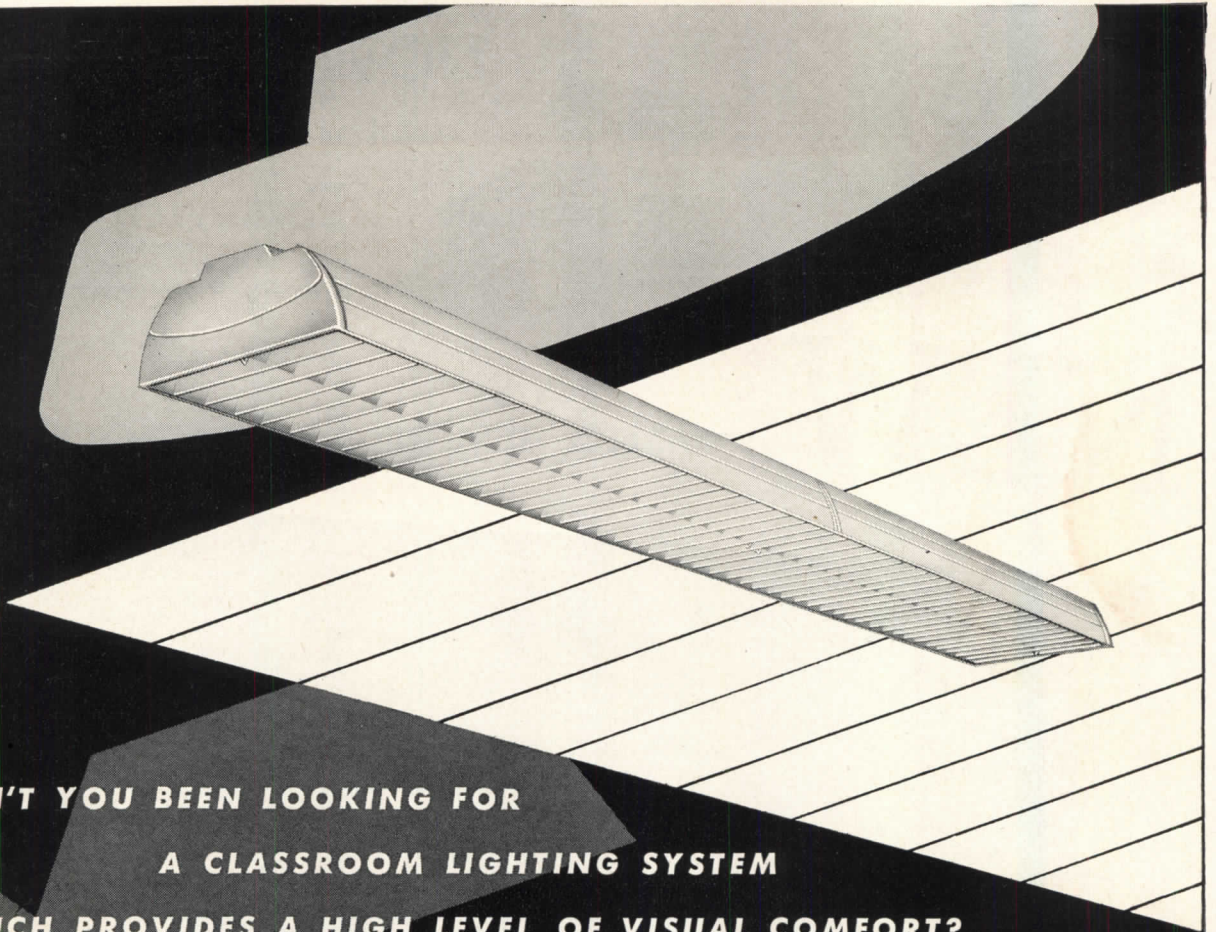

**HAVEN'T YOU BEEN LOOKING FOR
A CLASSROOM LIGHTING SYSTEM
WHICH PROVIDES A HIGH LEVEL OF VISUAL COMFORT?**

— BUT AT

L.O.C.

Drawing on 108 years' experience in manufacturing top quality lighting equipment, the Miller Company has developed, and proudly presents, the LEXINGTON.

SPECIFICALLY ENGINEERED — to meet your need for evenly-distributed, softly-diffused classroom lighting of high efficiency, and with extremely low brightness. Not only is first cost low, but so is its overall cost — the very important consideration — Low Overall Cost.

NOTE THESE FACTS ABOUT L. O. C.

INSTALLATION COST: LOW — simplified by sliding clamp hanger mounting.

MAINTENANCE COST: LOW — only one ladder position needed for relamping — only ETL Certified ballasts used.

LONG, USEFUL LIFE: assured by sturdy Miller **QUALITY** construction — rigid "T" cross-section channel — extremely strong louver assembly, with cross baffles and side rails of one-piece steel, interlocked with center baffle and end plates.

FINISH — 89% reflection factor. Hot sprayed high-bake white enamel over steel rust-protected by 5-stage Bonderite process.

IDEAL classroom lighting — at L. O. C.

WRITE FOR FULL DETAILS ABOUT MILLER LEXINGTON

It is the newest addition to Miller's complete line of luminaires — Fluorescent, Incandescent, and Mercury—which cover a wide range of industrial and commercial lighting requirements.

Miller field engineers and distributors are conveniently located for nation-wide service.

THE miller COMPANY MERIDEN, CONN.
SINCE 1844

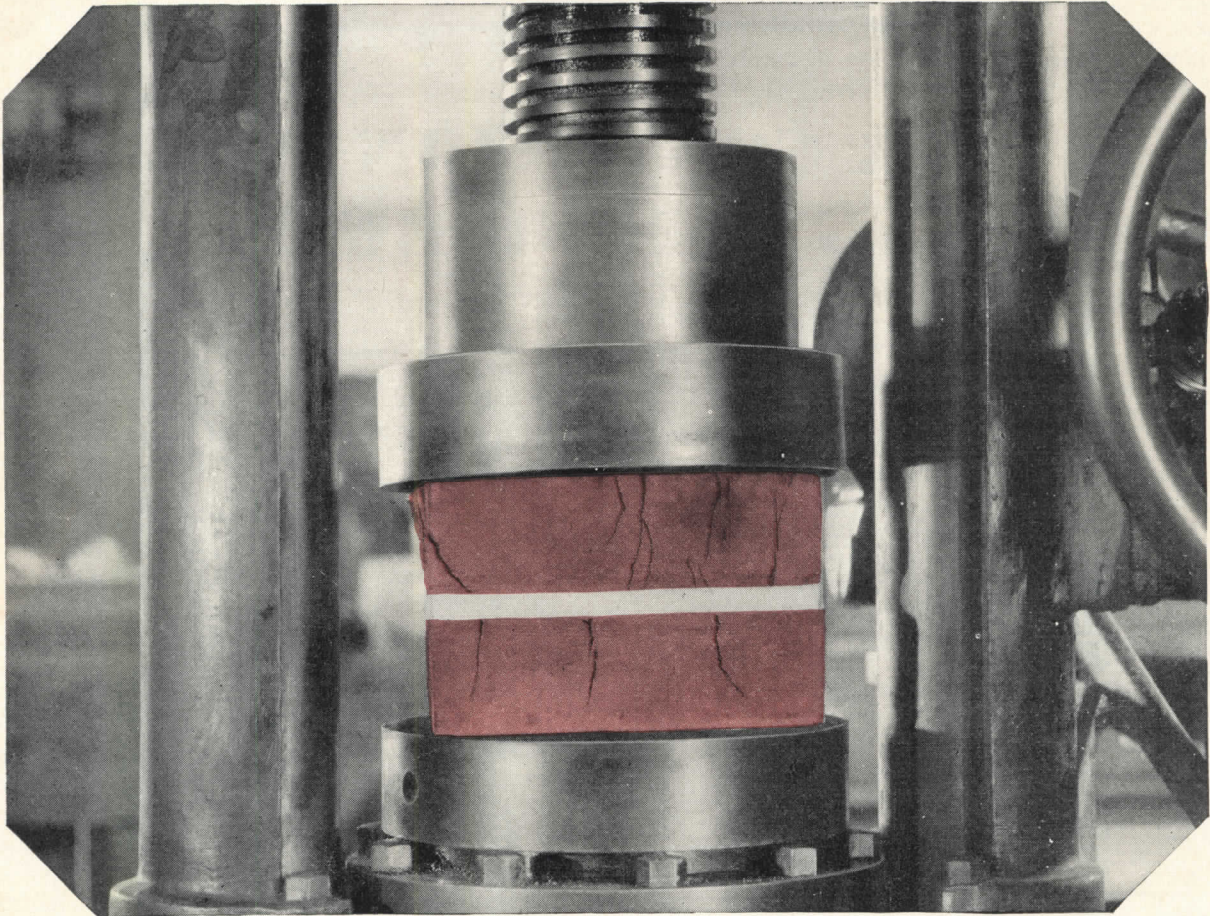

WHERE STRENGTH IS ESSENTIAL

The strength of a brick wall depends on three important factors: The strength of the brick, the strength of the mortar in the joint, and the strength of the *bond* between the two.

When Brixment mortar is tested in compression between two brick, at 28 days or later periods, the brick almost always fail before the mortar.

Brixment mortar assures a strong, durable bond because: (1) it hardens slowly enough to permit deeper penetration and more

thorough keying into the pores of the brick; (2) because it has high water-retaining capacity. . . This prevents the brick from sucking the water out of the mortar too fast and keeps the mortar from losing its fine plasticity when spread out on the wall. This permits a more complete bedding of the brick, and an increased area of contact between the brick and mortar. It assures a good bond above as well as below the mortar joint.

BRIXMENT



LOUISVILLE CEMENT COMPANY, Incorporated, LOUISVILLE, KY.

One of a series of papers prepared by leading authorities on air conditioning. The opinions and methods presented are those of the author and are not necessarily endorsed by the Du Pont Company. Reprints of this, and other articles in the series, may be had free upon request.

AIR CONDITIONING EXISTING OFFICE BUILDINGS

By WILLIAM P. HENSZEY, *Kimball & Henszey, Consulting Engineers, New York*



WILLIAM P. HENSZEY received his B.S. and M.S. degrees at Penn State, where he specialized in thermodynamics. Successful installation of his designs include government buildings in Egypt, cotton mills in India, cold-storage plants in South America and many

other interesting and diversified projects in this country and abroad. Since he became associated with Mr. Dwight D. Kimball, their firm has done considerable work in the air conditioning of existing buildings.

Office structures already built need not be without modern air conditioning. The installation of a satisfactory system may entail alterations, but such jobs are being undertaken daily to change obsolete, poorly ventilated buildings into comfortable, efficient business offices.

TYPES OF AIR CONDITIONING

Differences in construction, floor layouts, cubic measurements, exposures, and availability of water, steam, electrical and drainage facilities naturally affect design recommendations. Other factors include space requirements for ducts and equipment, sources of outside air, zoning, and the need to comply with city codes.

The following types of air conditioning installations are being used: *Window or console room air conditioners*—This type unit is completely self-contained. It is simply placed on or next to the window sill and plugged into a suitable sized electrical circuit. Air for room ventilation and refrigerant condensing is taken in through the window. Condensate, removed from the air passing through the unit, is thrown on the condenser coil where it vaporizes and is discharged into the outside atmosphere by the condenser fan. Unit sizes range from $\frac{1}{2}$ to $1\frac{1}{2}$ h.p.

Self-contained duct-type unit—Refrigerating and air-handling equipment, consisting of compressor, condenser, cooling and/or heating coils, filters, fan and controls, are combined in one cabinet. Refrigerant condensing is accomplished by city, well or cooling-tower water, usually at a rate approximating 3 GPM per ton of refrigeration. Certain manufacturers make units combining an evaporative condenser with the unit. Capacities range from two to twenty-five tons refrigerant effect.

Central Station "Built-up" Systems—Variations of this type of system are multiple. In general, they consist of a refrigeration compressor, condenser, cooling coils or washer, heating coil, filters, fan and controls all supplied separately and erected in the field.

Lately, the trend has been toward use of individual office under-window units supplied with hot or cold water from an apparatus room in the basement. Some manufacturers' units have a separate fan drive with direct outside air supply through the building wall. Another manufacturer has had great success piping relatively high-pressure, treated outside air to each under-window unit. This primary air acts as a motivating force to pull three times more secondary air over the cooling or heating coils and distributes the mixture into the room. Desired temperatures are maintained in both cases by a thermostatically controlled water-supply valve in unit.

Double-duct zoning-type fan-coil units, having cold and warm air duct supply to each zone or room, also fulfill the need for individual-office temperature control.

In all types of systems using ductwork to carry the air from cooling or heating units to the conditioned space, wider use is being made of higher duct air velocities and static pressure, with consequent savings in duct space requirements. Specially designed sound traps, plenum chambers and outlets have made this possible.

A ROOM AT A TIME

Single offices are best handled by small "packaged" window units or console models. Their installation gives the advantages of flexibility for tenant changes and progressive installation. First cost is low, and little building alteration is necessary. Room units, however, have small ventilation capacity. This is important in any season. Such units are often removed from the window and stored during the heating season. Some noise emanates from the unit, and cost of operation is fairly high when compared with so-called "built-up" systems.

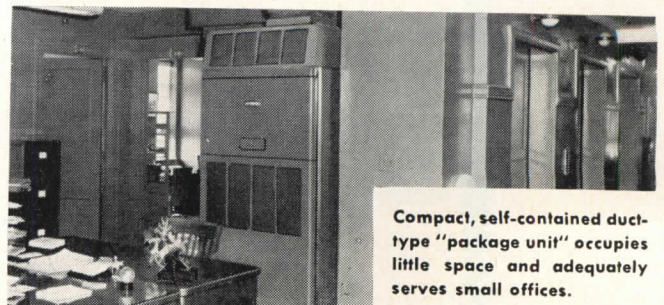

Compact, self-contained duct-type "package unit" occupies little space and adequately serves small offices.

GROUPS OF OFFICES

Groups of offices or complete floors of larger office buildings can be air conditioned most effectively by single or multiple self-contained duct-type systems located advantageously throughout the floor to be served.

Ducts, leading from units and suspended from ceilings, convey conditioned air into rooms. Hallways also serve as passage for return air to the units. In most cases, the existing heating system remains unchanged.

Some features of this type of air conditioning are:

1. Economy of operation during intermediate seasons when advantage can be taken of cool outside air.
2. Flexibility allowance for tenant changes.
3. Relatively low maintenance costs.
4. Winter ventilation as might be desired.
5. Humidification, if required.
6. Small enough in size so as not to require a licensed operating engineer demanded by many city codes.

The principal drawbacks include the possibility of low corridor ceilings, because of ductwork, and loss of rentable space used by equipment.



Attractive, modern offices of Henry Sears & Co., New York. Note arrangement of ceiling air diffusers of this central-station air conditioning system.

EVALUATING REQUIREMENTS

The following yardstick should be helpful in analyzing the average office building's air conditioning requirements. Figures are based on an average sensible heat factor of .91, 110 square feet of floor area per person, and 2.5 watts lighting load for each square foot of floor area.

For interior zones—1 cfm per sq. ft. floor area

For exterior zones—2 cfm per sq. ft. floor area

.35 tons of refrigeration per person

.0032 tons of refrigeration per sq. ft. floor area

In New York City and many other metropolitan centers, the price of installed equipment ranges from \$700 to \$1,100 per ton of refrigeration, or an average of \$2.00 to \$3.50 per square foot of floor area. The cost of remodeling an existing office building is normally more expensive than if air conditioning had been installed at the outset. This is principally due to cutting and patching, architectural changes, and costs incurred by disadvantageous equipment location.

New buildings of today, however, are designed to include air conditioning. True, for the older building, the need is there. But regardless of the age or type of structure, air conditioning is being successfully installed in many fine existing office buildings.

* * *

Popularity of air conditioning is steadily growing. Employees in every business office welcome it. In addition, management now recognizes the intrinsic value of this improvement. It increases employee efficiency and morale... promotes better health—reduces absenteeism.

In every business district there are dozens of existing office structures without air conditioning. Many of these, however, will be installing systems in the future. This paper has outlined in brief some of the types available and their suitability for different requirements.

When designing such installations you can further help by suggesting suitable types of equipment to meet individual needs. And when discussing air conditioning, be sure to cover the importance of selecting machines operated with "Freon" refrigerants. Explain that these refrigerants are safe... nonflammable, nonexplosive, virtually nontoxic and as pure as scientific methods of manufacture can produce. Explain that they are highly endorsed by architects and engineers... and widely used in office buildings everywhere. "Freon" refrigerants also meet all building-code requirements, and you can always recommend "Freon"-charged machines with full confidence that they will perform economically and efficiently. E. I. du Pont de Nemours & Co. (Inc.), "Kinetic" Chemicals Division, Wilmington 98, Del.

THE ENTIRE BUILDING

When modernization plans call for a system to completely air condition an entire existing building, a large central-station water-chilling plant is most often selected.

The large-capacity system usually has its refrigeration machinery located in the basement, cooling tower on the roof and fan-coil or air-washer units placed advantageously throughout the building. The location of these will depend upon zoning and other load requirements.

While the first cost of the large central-station plant may appear high, this type of system offers economy of operation and maintenance in multi-room buildings. The services of a licensed operating engineer may be stipulated by most city codes for systems of this size.

The method of conditioned air distribution and degree of temperature control depend to a considerable extent upon the physical characteristics of the building and the purchaser's air conditioning budget. Generally, unzoned duct-type systems with hall returns are least expensive, multiple-zoned systems next, and individually controlled under-window units in combination with separate interior-zone systems are the most expensive.

There is a wide and growing acceptance of types of air conditioning which allow temperature control in each office. Manufacturers have been quick to grasp this fact and are constantly improving the quality of their under-window-type units which give year-round comfort.



150th Anniversary

BETTER THINGS FOR BETTER LIVING... THROUGH CHEMISTRY

"FREON" SAFE REFRIGERANTS



"Freon" is Du Pont's registered trade-mark for its fluorinated hydrocarbon refrigerants

HOW TO ANTICIPATE PLANT EXPANSION

Q-PANELS

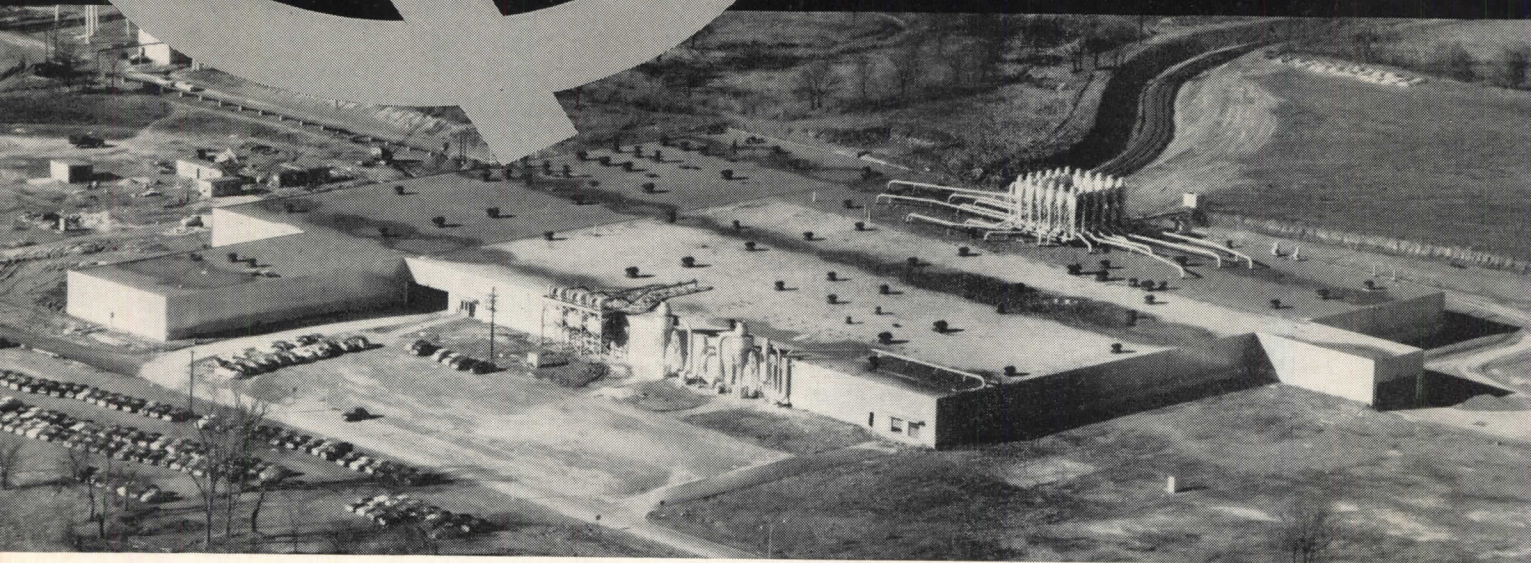

Air view of the FORMICA COMPANY'S building. Walls of Q-Panel were detached, moved forward and used again on the addition. A Q-Panel wall has the quality of a permanent wall but with the additional advantage of being removable to provide for plant expansion.



Close-up of the FORMICA plant shows the neat and attractive design formed by continuous Q-Panel fluted texture. Architects have achieved a great variety of design by combining Q-Panels with other materials for decorative effect.



From left to right—Mr. D. J. O'Connor, President of the FORMICA COMPANY, Mr. A. M. Kinney, President of A. M. Kinney, Inc., which designed the FORMICA plant and Mr. George H. Clark, Vice President in charge of engineering of the FORMICA COMPANY.

The FORMICA COMPANY built its new Cincinnati plant with Q-Panel walls, later removed the Q-Panels from two sides and re-used them on the addition. Note, in the air view, the older section has a lighter colored roof than the newer section.

ROBERTSON Q-PANELS can be taken down as easily as they can be erected—which is about nine minutes for a fifty-square-foot unit by a crew of only four men. Q-Panels provide you a good-looking wall, with erection and maintenance features that solve the peculiar construction problems which have arisen in the last ten years.

Q-Panels lend themselves to a great variety of designs. They are available in several fluted patterns. They require no maintenance, arrive at the site ready for erection either as a factory-assembled panel or a field-assembled panel. Do you have the details in your file?



Q-PANEL FACTS

MATERIALS—Metallic-coated Steel, Galbestos, stainless steel, aluminum on one or both sides.

SIZE—2'0" standard width. Lengths up to 25'0", depending on material used.

WEIGHT—Varies with metals selected but averages 4½ lbs. per square foot.

INSULATION VALUE—Superior to 12" of masonry with furred plaster. U-Factor—.14 B.T.U. in aluminum—.18 B.T.U. in steel.

STRENGTH—Great strength permits widest spacing of horizontal supports to meet the required wind load.

Write for Latest Catalog

Q-PANELS

H. H. ROBERTSON CO.

2404 Farmers Bank Building
Pittsburgh 22, Pennsylvania



Offices in ALL Principal Cities
in the U.S.A. and Canada

SCHLAGE CYLINDRICAL LOCKS...Time-Proven

Schlage Dependability—proven by
25 years service—makes Schlage Locks
leading choice for today's important buildings

PEACHTREE—SEVENTH BUILDING

EQUIPPED WITH SCHLAGE "NOVO" DESIGN LOCKS

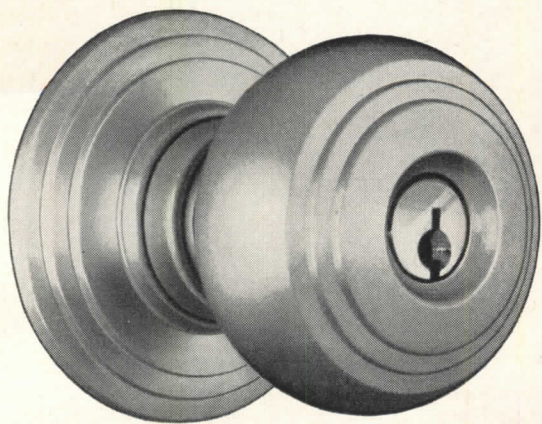

Peachtree—Seventh Building, Atlanta, Georgia
Architects, Alexander and Rothschild
Contractor, Charles R. Massell
Owner-Builder, Benjamin J. Massell

"The proved, low-cost maintenance record
of Schlage Locks was an important
factor in our final selection"—
Alexander and Rothschild, architects.

SCHLAGE®

THE *Time-Proven* CYLINDRICAL LOCK

SCHLAGE LOCK COMPANY
2201 Bayshore Boulevard, San Francisco, California
SCHLAGE LOCK COMPANY OF CANADA, LTD., VANCOUVER, B. C.

Carrara Glass

*... the quality wall material
that is famous for its
permanence, beauty,
adaptability*

● These properties have been proved in all kinds of interior and exterior applications. A rich, handsome veneer material, Carrara Glass has withstood the test of time. What is more, Carrara can be applied to store fronts and other building exteriors, without the need for structural changes.

As shown in the illustration here, Carrara Glass is particularly adaptable to the needs of the modern hospital. For being a true glass—homogeneous in structure and easy to keep clean and sanitary—it has high aseptic qualities. It may be installed in large sections, so there are fewer joint crevices to hold dirt and germs. And Carrara is impervious to weather, water, chemicals, grease and pencil marks. It is available in ten attractive colors to satisfy any decorative need.

You will find additional information on Carrara Glass in your Sweet's Catalog, Section 13e. Or, if you prefer, you may obtain complete data by writing to Pittsburgh Plate Glass Company, 2107 Grant Building, Pittsburgh 19, Pa.

Architects: Marlier, Wolfe & Johnstone, Pittsburgh, Pa.

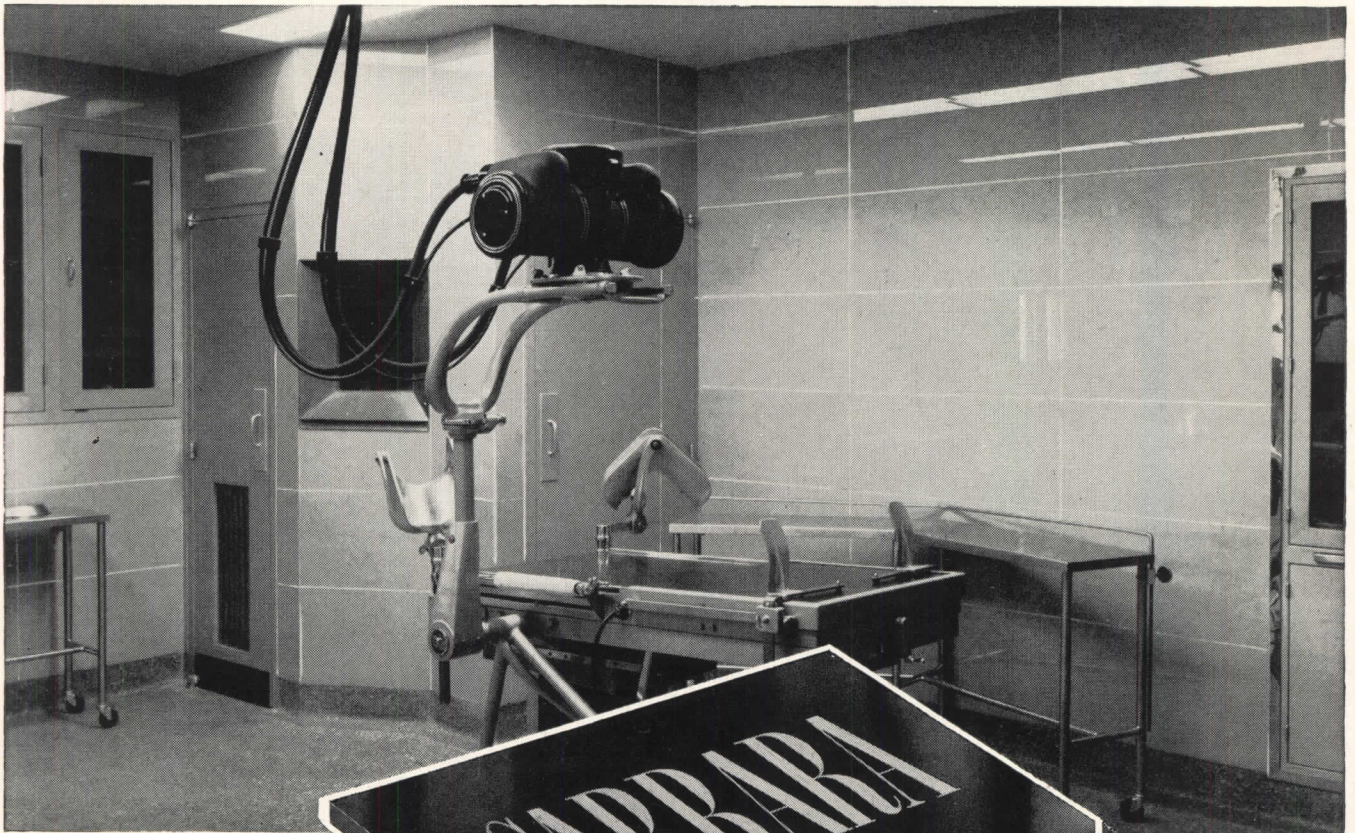

the quality

structural glass



PAINTS · GLASS · CHEMICALS · BRUSHES · PLASTICS

PITTSBURGH PLATE GLASS COMPANY

PERMANENCE

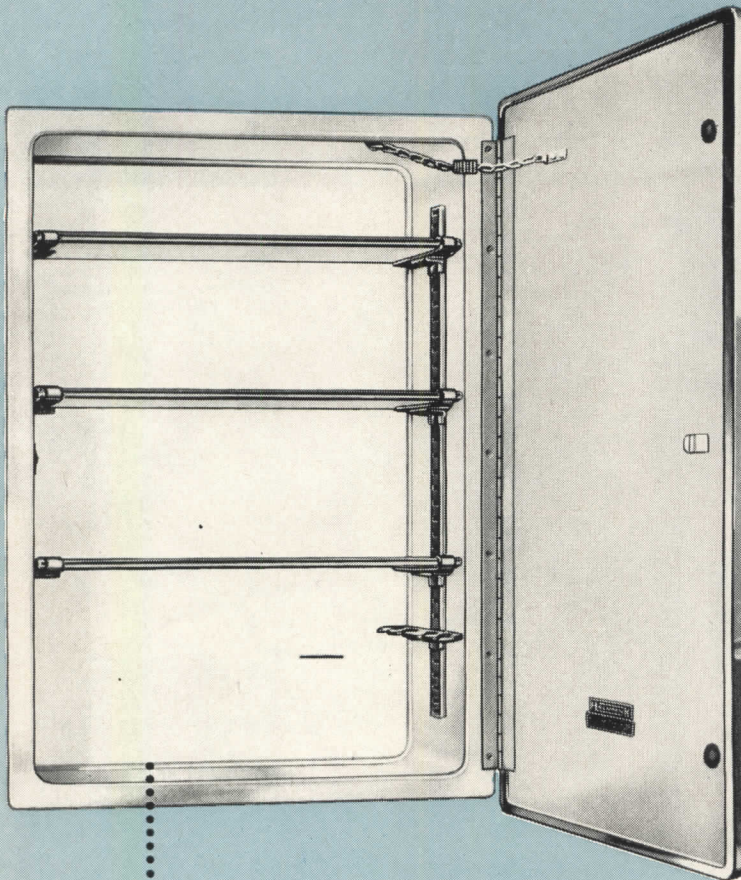

PERMANENCE is an important feature to consider in the selection of a bathroom cabinet when building or remodeling.

And it is the PERMANENCE of the interior finish that makes Hall-Mack bathroom cabinets the ideal choice for every bathroom.

Hall-Mack Porcelain Cabinets are drawn from a single sheet of iron and three coats of vitreous porcelain enamel are furnace-fused to the seamless interior. Better quality refrigerators, stoves, and lavatories are all finished in porcelain. Porcelain-on-iron is the most enduring and beautiful finish ever developed for bathroom cabinets—it's easy to clean...completely sanitary...it's a lifetime value!

The Porcelain-on-iron lifetime interiors give Hall-Mack cabinets a fresh, sparkling beauty that is ageless! This is but another example of Hall-Mack quality... another reason why Hall-Mack is the only answer to Quality Bathroom Cabinets. A Hall-Mack cabinet has every quality feature than can be desired in a fine bathroom unit. All trim is chrome plated... all mirrors are plate glass...and bulb edge glass shelves are fully adjustable. It blends perfectly with today's modern bathroom design!

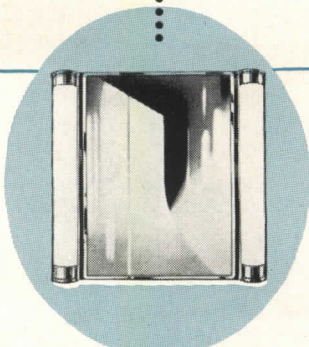

Mirror sizes 16 x 22 to 18 x 26...
Fluorescent or Lumiline lighting...
or without lighting

HALL-MACK COMPANY

1344 W. Washington Blvd., Los Angeles 7, California

7455 Exchange Ave., Chicago 49, Illinois



Sold by leading plumbing, tile and hardware dealers everywhere.

Announcing

an important roof insulation development...

NEW CELOTEX Channel-Seal

TRADE MARK

The roof insulation that gives an
EXTRA MARGIN OF SAFETY
against costly blisters or
separation of felt and insulation!

Here is new safety, new "insurance" against the hazard of roof damage due to the building up of high-pressure air "pockets" where insulation meets felt.

Celotex Channel-Seal Roof Insulation boards have bevels $\frac{7}{16}$ " high by $1\frac{1}{16}$ " wide on all bottom edges. When units are laid on the deck, these bevels form a network of broad, V-shaped, interconnecting channels extending over the roof area.

As higher pressures build up in some areas of the roof because of rising surface temperatures, they are relieved by air movement through the channels—thus

equalizing pressure and providing an EXTRA MARGIN OF SAFETY against blistering or separation of felt and insulation! (See diagram.)

New Celotex Channel-Seal Roof Insulation is made of an efficient low-density board with 0.33 conductance for nominal 1" thick material before coating and channeling. Asphalt coated on both sides and all edges, for complete moisture protection in storage and on the job. Comes in a range of thicknesses to meet the specific insulation requirements of each job.

Low in both initial and applied cost,

Celotex Channel-Seal Roof Insulation is light yet exceptionally strong, rigid, and tough. Resists damage from job handling. Quick, easy to apply. Smooth, coated surface assures positive bond to both roof deck and roofing felt.

What's more, it is the *only* roof insulation made of tough, strong, long Louisiana cane fibres—and protected by the patented Ferox® Process from dry rot and termite attack. Write today for complete technical data. The Celotex Corporation, Dept. AR-92, 120 South LaSalle Street, Chicago 3, Illinois.

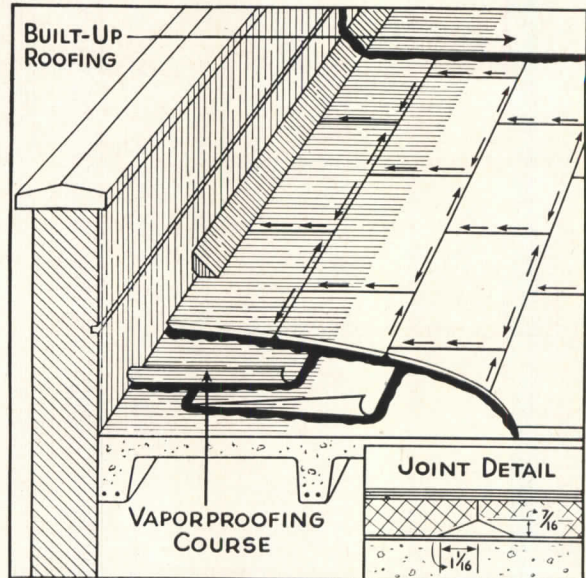

As the diagram shows, high-pressure air "pockets" cannot build up when you use new Celotex Channel-Seal Roof Insulation. Pressures due to temperature differences are constantly being equalized by the movement of air through the network of channels over the roof area.

For a Better Roof...Specify Genuine **CELOTEX**

REG. U. S. PAT. OFF.

ROOF INSULATION

THE CELOTEX CORPORATION, 120 S. LA SALLE STREET • CHICAGO 3, ILLINOIS

Silvray fluorescent units are **DOUBLE-ENGINEERED**

... for critical lighting requirements ... for easy, economical installation

The precise light control that distinguishes Silvray's silvered-bowl incandescent units is also found in this fine line of fluorescent luminaires. Designed specifically to meet the critical lighting requirements of schools, libraries, drafting rooms, offices, and commercial buildings, Silvray fluorescents provide glare-free diffused illumination of high intensity.

Silvray fluorescent units are available in a wide variety of styles to meet both decorative requirements and job economics. Every unit is engineered for easy installation — all parts precision die formed... identical dimensions for 2, 3, and 4 lamp units... simplified, accurate alignment and leveling methods, plus connections for continuous-row installations.

One of these will do your job

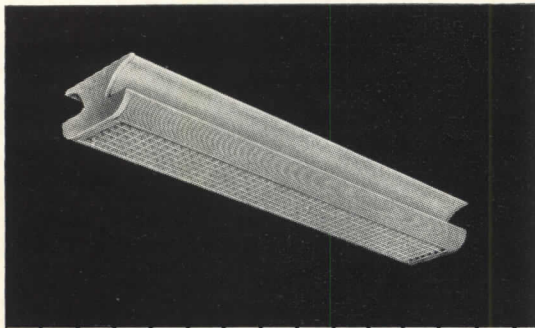

The 160 Line

Ceiling mounted units of the 160 Line give the impression of actually flowing into the ceiling. The curved side reflector distributes a portion of the light upward, eliminating bothersome brightness contrast usually associated with close-mounted ceiling fixtures. Made in models for both ceiling and suspension installation, these units feature a distinctive combination of slot-louvred side panels and eggcrate center section.

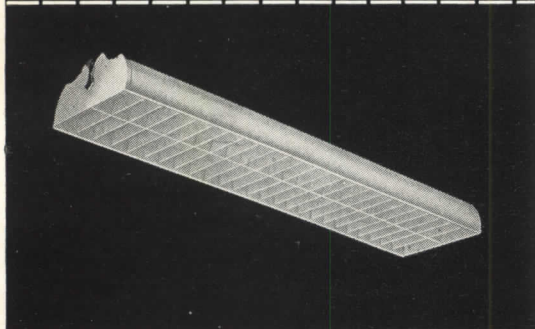

The 33 Line

An effective, reasonably-priced 48" unit suitable for offices and similar commercial lighting applications. 33 Line units are available in two and four lamp arrangements for either Bipin or Monopin lamps... can be ceiling mounted or suspended. 33 Line units for either 2 or 4 96" Slimline lamps are available in matching design.

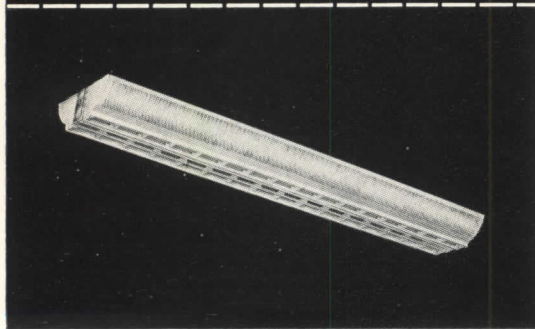

The 711 Line

Semi-indirect light distribution — 80% upward, 20% downward — mark the outstanding feature of this line. Designed for suspension *only*, these fixtures are available with 3 types of side panels: slot-louvred with diffusing plastic insert; slot-louvred; or opaque — provide brightness values from 1/2 candle per sq. in. to 2 candles.

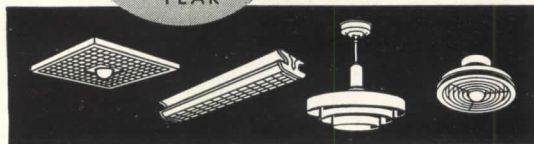

SILVRAY Lighting, Inc., 102 West Main St., Bound Brook, N. J.

Gentlemen:

Please send me complete information on Silvray Fluorescent lighting units.

Name _____

Firm _____ Title _____

Address _____

City _____ Zone _____ State _____

CLAY PIPE-ESSENTIAL * ECONOMICAL * EVERLASTING



Occupants of these duplex homes in the Marston Subdivision at West Point, Miss., will have the finest of sewerage facilities. Thousands of feet of Vitrified Clay Pipe are installed in the new sanitary sewerage system.

DEFENSE HOUSING AT WEST POINT, MISSISSIPPI,
Serviced **BY VITRIFIED CLAY PIPE SEWERAGE SYSTEM**

At West Point, defense activity at nearby Columbus Air Force Base and industrial expansion has made necessary new homes for defense workers. And wherever new dwellings are being constructed, you'll find Vitrified Clay Pipe on the job.

Clay Pipe is the *only* chemically-inert sewerage and drainage material. It's immune to acid attack, rust, decay, and all other forms of chemical decomposition. Its

performance has been proved—decade after decade—where performance really counts . . . *in the ground. It never wears out!*

NATIONAL CLAY PIPE MANUFACTURERS, INC.
 311 High Long Bldg., 5 E. Long St., Columbus 15, Ohio
 703 Ninth & Hill Bldg., Los Angeles 15, Calif.
 100 N. LaSalle St., Rm. 2100, Chicago 2, Ill.
 206 Connally Bldg., Atlanta 3, Ga.

C-652-2

HOW TO SELECT COLOR FOR BUILDING INTERIORS

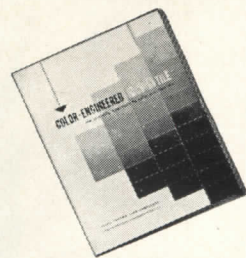

You will find real aid in color selection in our new book, "The Scientific Approach to Color Specification." It will help you make any room more useful. For your free copy, just drop a note to any Institute Member, or write us direct, Dept. AR-9.

LOOK FOR THIS SEAL



It is your assurance of highest quality Facing Tile. This seal is used only by members of the Facing Tile Institute...these "Good Names to Know."

BELDEN BRICK CO.
Canton, Ohio

CHARLESTON CLAY PRODUCTS CO.
Charleston 22, West Virginia

THE CLAYCRAFT CO.
Columbus 16, Ohio

HANLEY CO.
New York 17, New York

HOCKING VALLEY BRICK CO.
Columbus 15, Ohio

HYDRAULIC PRESS BRICK CO.
Indianapolis, Indiana

MAPLETON CLAY PRODUCTS CO.
Canton, Ohio

METROPOLITAN BRICK, INC.
Canton 2, Ohio

McNEES-KITTANNING CO.
Kittanning, Pennsylvania

NATIONAL FIREPROOFING CORP.
Pittsburgh 22, Pennsylvania

ROBINSON BRICK & TILE CO.
Denver 9, Colorado

STARK CERAMICS, INC.
Canton 1, Ohio

WEST VIRGINIA BRICK CO.
Charleston 24, West Virginia



Color links the wall to production

in "Color-engineered" Facing Tile

How can you make the wall a tool of production?

By giving careful attention to the selection of the *right* colors for industrial interiors.

You can do this, today, with "color-engineered" Facing Tile. You can select colors that help increase production by aiding eyesight, reducing fatigue and accidents and discouraging absenteeism. You can have colors that create psychologically-right interiors for employees, that encourage cleanliness and good housekeeping.

"Color-engineering" is the newest feature of Structural Clay Facing Tile —the rugged, load-bearing, steel-saving material that cuts construction and maintenance costs.

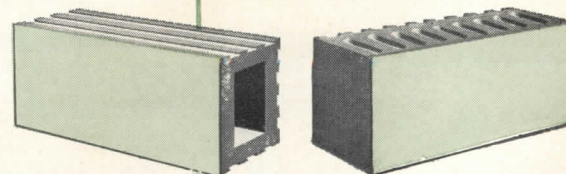

FACING TILE INSTITUTE

1520 18th Street, N. W., Washington 6, D. C.
1949 Grand Central Terminal, New York 17, N. Y.

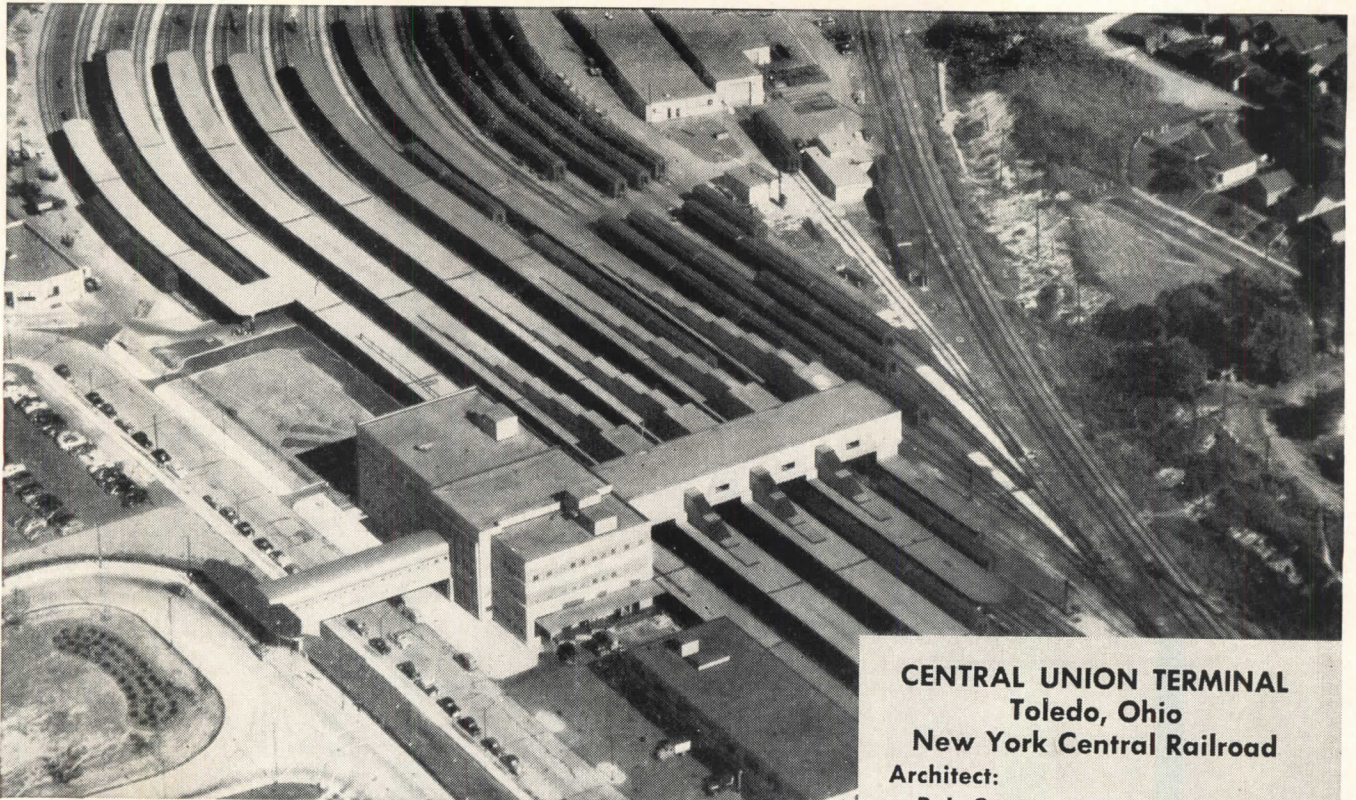

THIS *Roof* WILL MEET A MILLION TRAINS

Trains come in and trains go out at a rate of more than 100 every day at Toledo's modern new Central Union Terminal. Twenty years from now, the Ruberoid Built-Up roof, which covers the terminal and eight adjoining buildings, will still be meeting the trains. Architect R. L. Corsbie specified a Ruberoid Coal Tar Pitch and Tarrred Felt Roof with a 20-year bond.

300,000 Toledoans are justly proud of their new station. Passengers enjoy every comfort and convenience . . . mail and freight are handled speedily and efficiently. Ruberoid is also proud to have contributed to this project—the new showplace of a busy, progressive city.

In other cities from Portland, Maine, to El Paso, Texas, architects are finding the answers to their roofing problems in "Ruberoid Built-Up Roofs and Flashings". This 126-page book contains 37 different roofing specifications, including promenade, water-cooled and garden roofs. In addition you will find helpful construction details and flashing specifications. Write today for your copy of the 1952 edition. We will also send you a Ruberoid Built-Up Roof Selector, an automatic index to the roofing book. For further information see your Ruberoid roofer or Sweet's Architectural Catalog, Section 8A/RU. The Ruberoid Co., 500 Fifth Avenue, New York 36, N. Y.

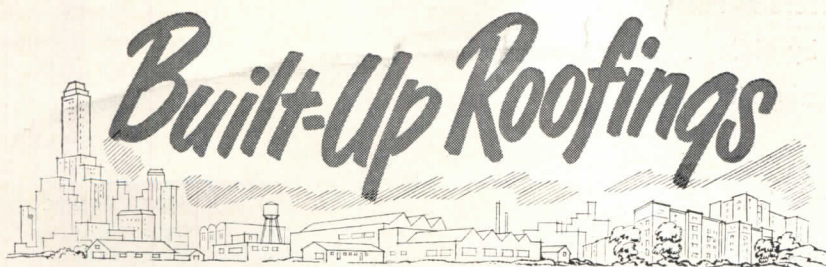

The **RUBEROID** Co.

ASPHALT AND ASBESTOS BUILDING MATERIALS

CENTRAL UNION TERMINAL Toledo, Ohio

New York Central Railroad

Architect:

R. L. CORSBIE, formerly N. Y. Central staff

General Contractor:

DUFFY CONSTRUCTION CORP.
NEW YORK AND CLEVELAND

Roofing Contractor:

WARNKE BROS. CO.
TOLEDO

RUBEROID RECOMMENDATION

A Typically Helpful Ruberoid Detail

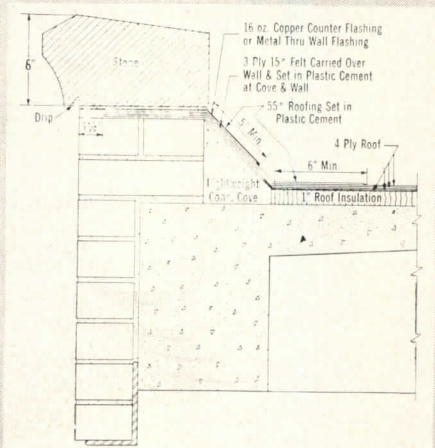

THE RIGHT ROOF FOR ANY JOB — FROM ONE SOURCE

Ruberoid makes every type of built-up roof — Smooth Surfaced Asbestos, Coal Tar Pitch with gravel or slag surfacing, and smooth or gravel-and-slag surfaced Asphalt . . . in specifications to meet any need. Ruberoid Approved Roofers are not prejudiced in favor of any one type. You are assured of centralized responsibility, smoother operation, uniform quality with Ruberoid built-up roofings.

RESEARCH LABORATORIES, SCHOOL OF MEDICINE,
WASHINGTON UNIVERSITY, ST. LOUIS, MISSOURI

Harris Armstrong, Architect

Ferriss & Hamig, Mechanical Engineers

Thomas D. Church, Landscape Architect

THE MEDICAL SCHOOL of Washington University was housed in two parallel four-story buildings 200 ft apart that were built during the first decade of the century. Traffic between the buildings traveled through a one-story corridor which formed the center bar of an "H" plan. The time wasted in descending to the ground floor to get from one building to the other dictated that the new laboratories building, in addition to its other functions, should serve as a continuous bridge at all levels and unite the two buildings into a complete, self-contained medical school.

Across the street from the medical school buildings is a large group of hospitals affiliated with Barnes

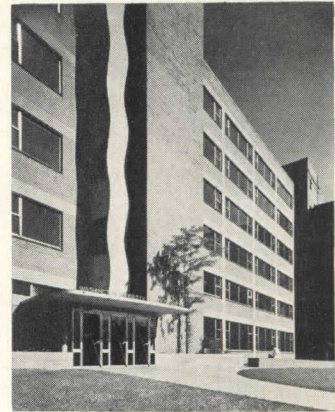

Hedrich-Blessing

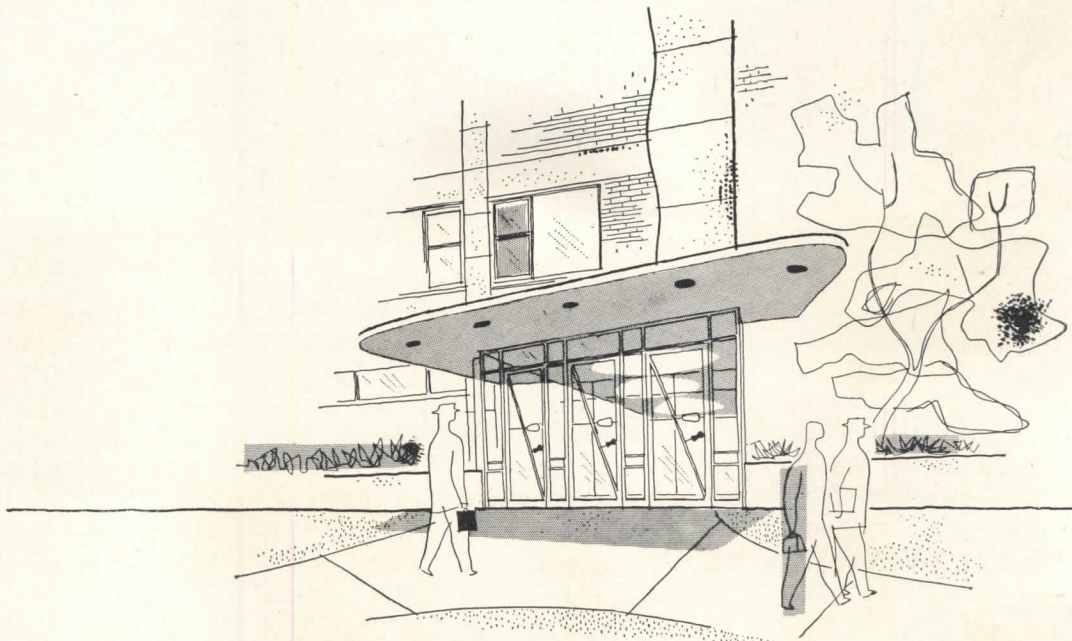

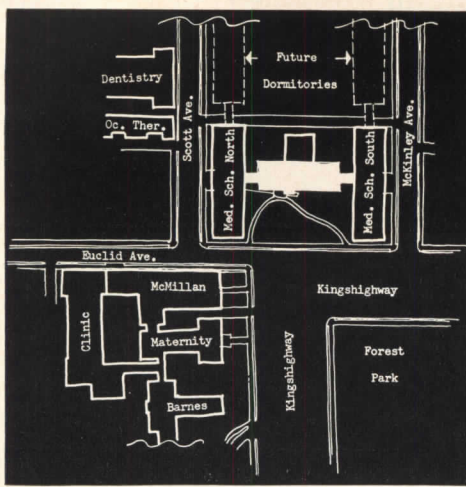

**RESEARCH LABORATORIES
WASHINGTON UNIVERSITY**

Left: site plan. Below: view from Kingshighway; this is the west façade. Facing page: glass-walled corridor

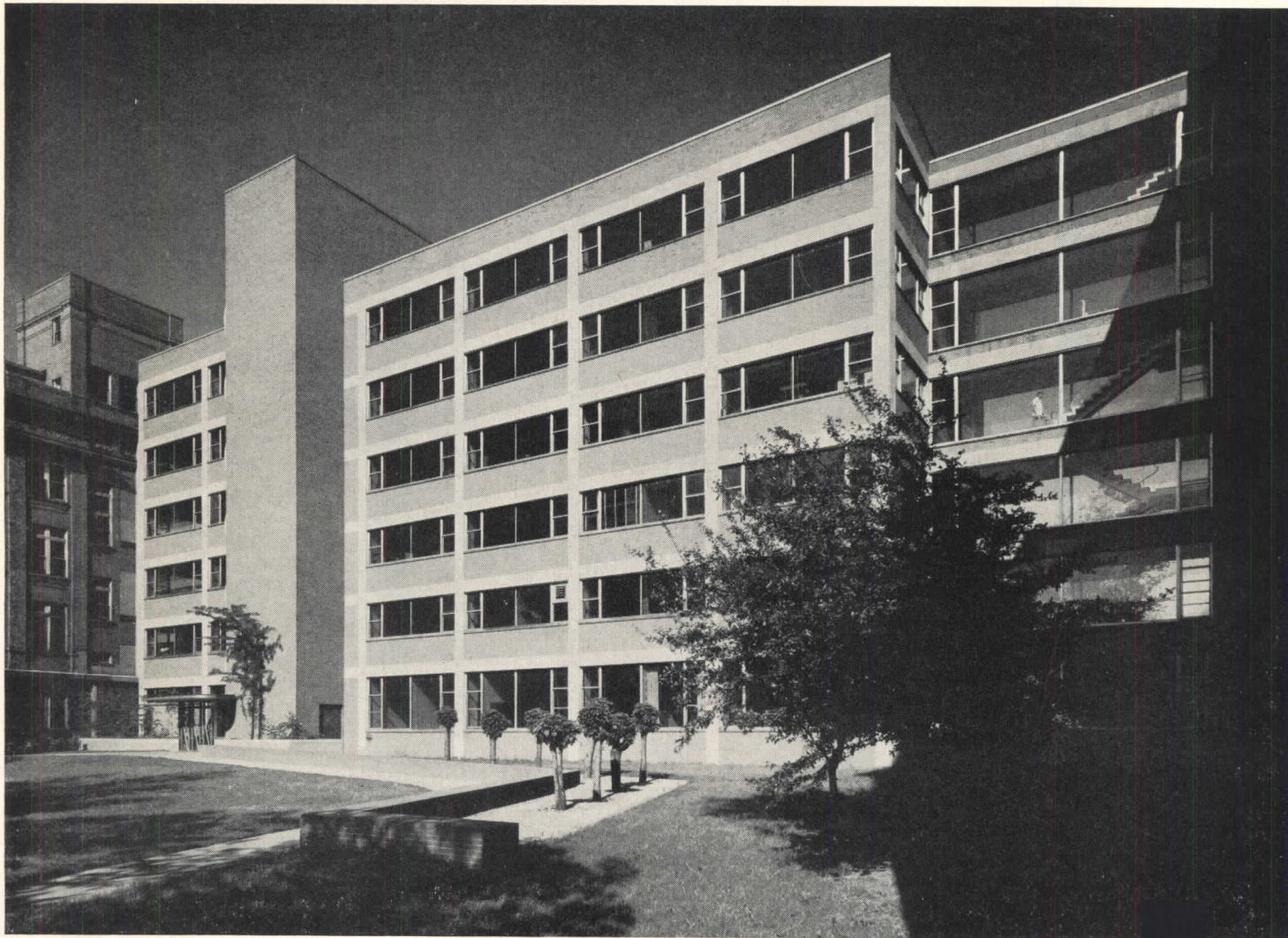

Hospital — Maternity, Childrens', Macmillan and Barnard as well as several other medical and research institutions.

Since the west-facing building was thus adopted for many compelling reasons, and since the west sun in St. Louis is formidable, utilities, elevators, stairs, etc. are located on this side and the windows are glazed with heat resistant glass. The bay depth on the east side is increased since this is the most desirable area.

The layout is strikingly similar to the typical long, narrow tower floor of many recent office buildings.

The old buildings had very high ceilings, which accounts for the various stairways that occur in the glass-enclosed connections between the new and old structures. The new building is of reinforced concrete with the structural frame protected by, yet expressed in, Indiana limestone. The panels are filled in with brick and aluminum-framed windows.

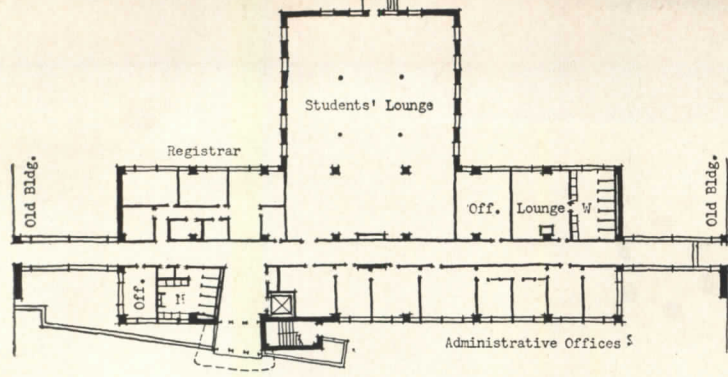

First floor

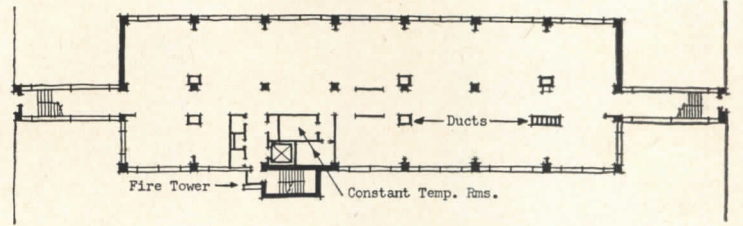

Typical floor

Hedrich-Blesing

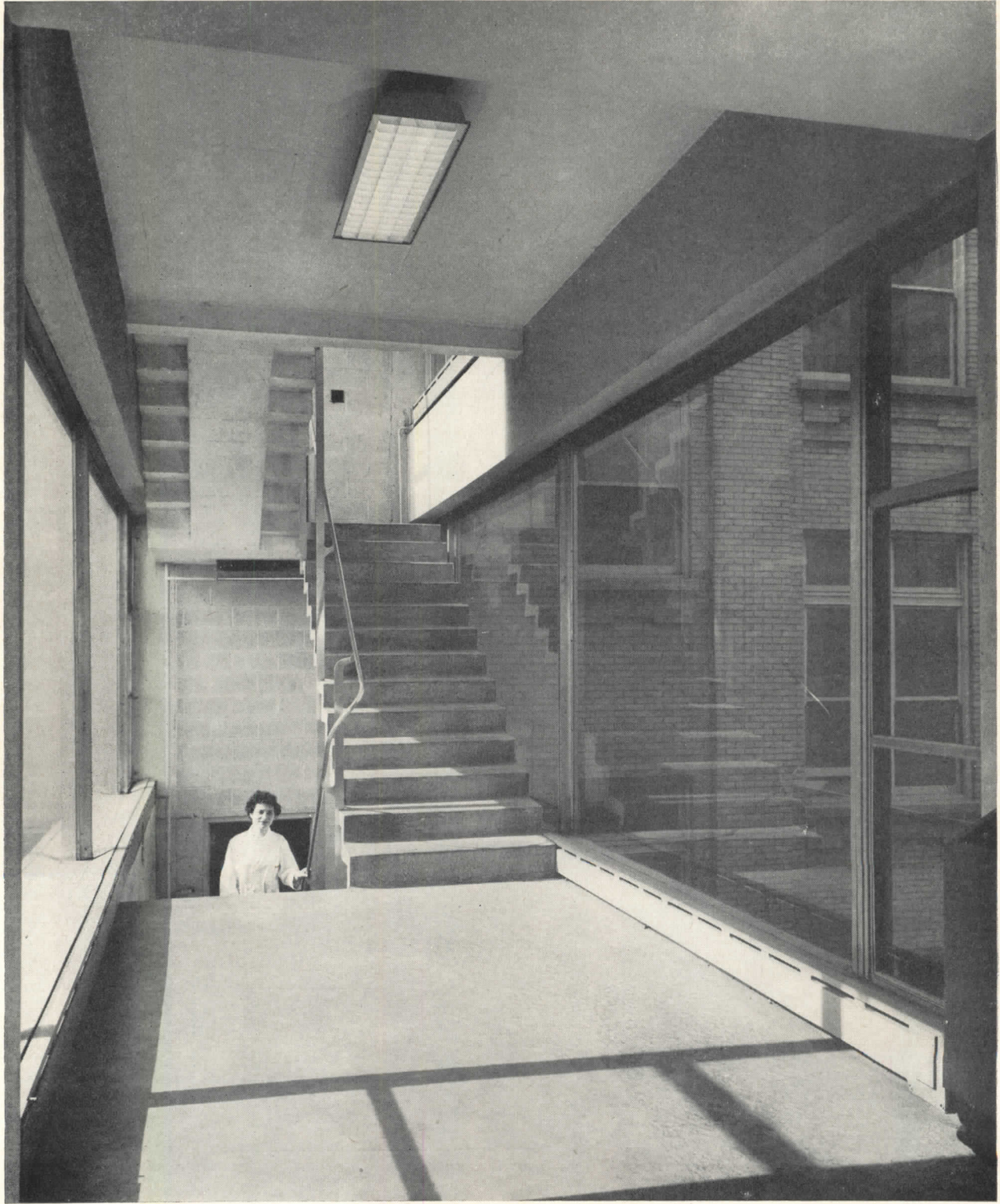

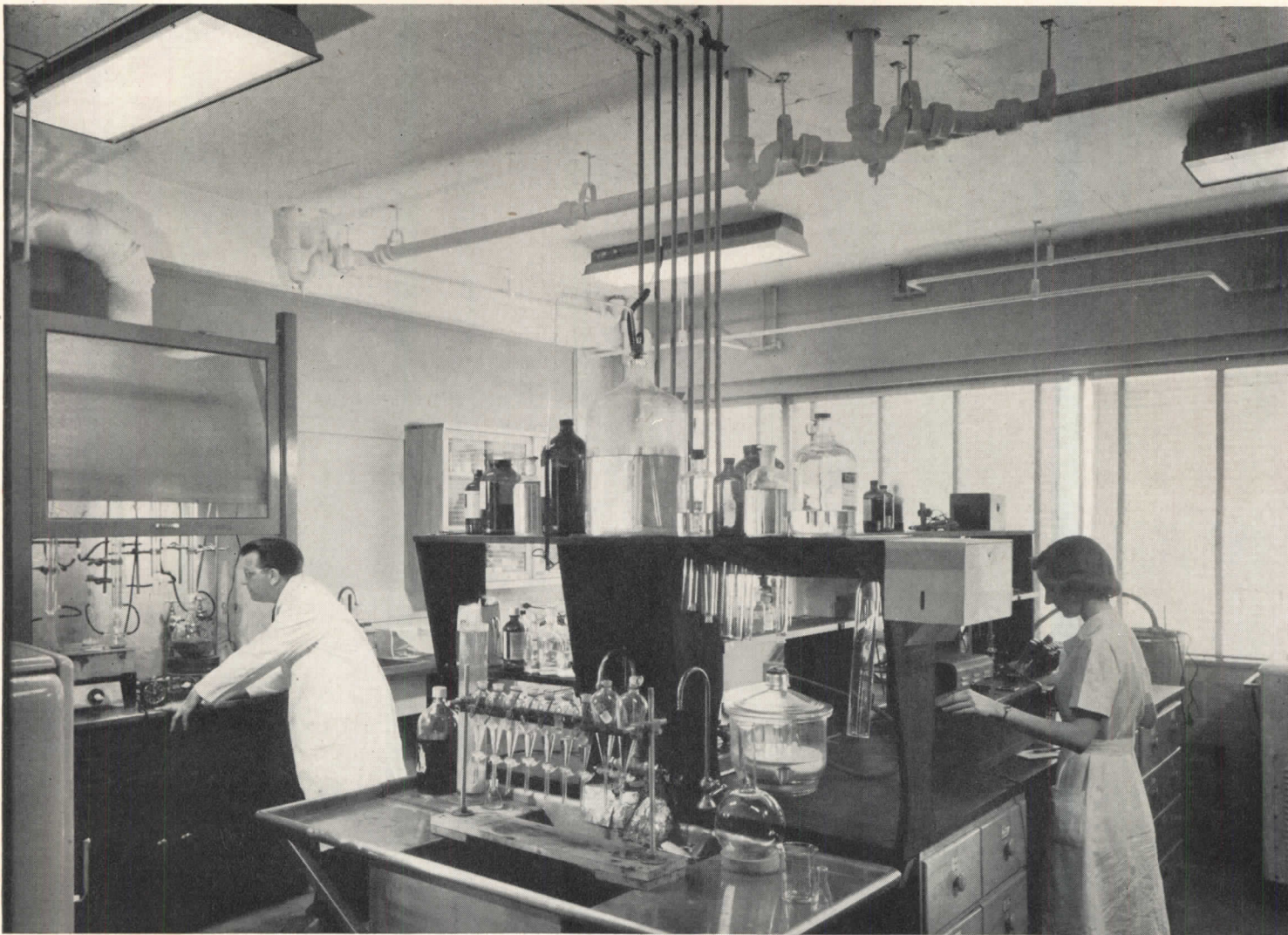

Typical laboratories, showing some of the possible arrangements of research equipment

Work areas may be divided by movable partitions into whatever size area is required for work

This section shows typical permanent construction before installation of movable partitions and equipment

Connecting glass bridge to present buildings at each floor level

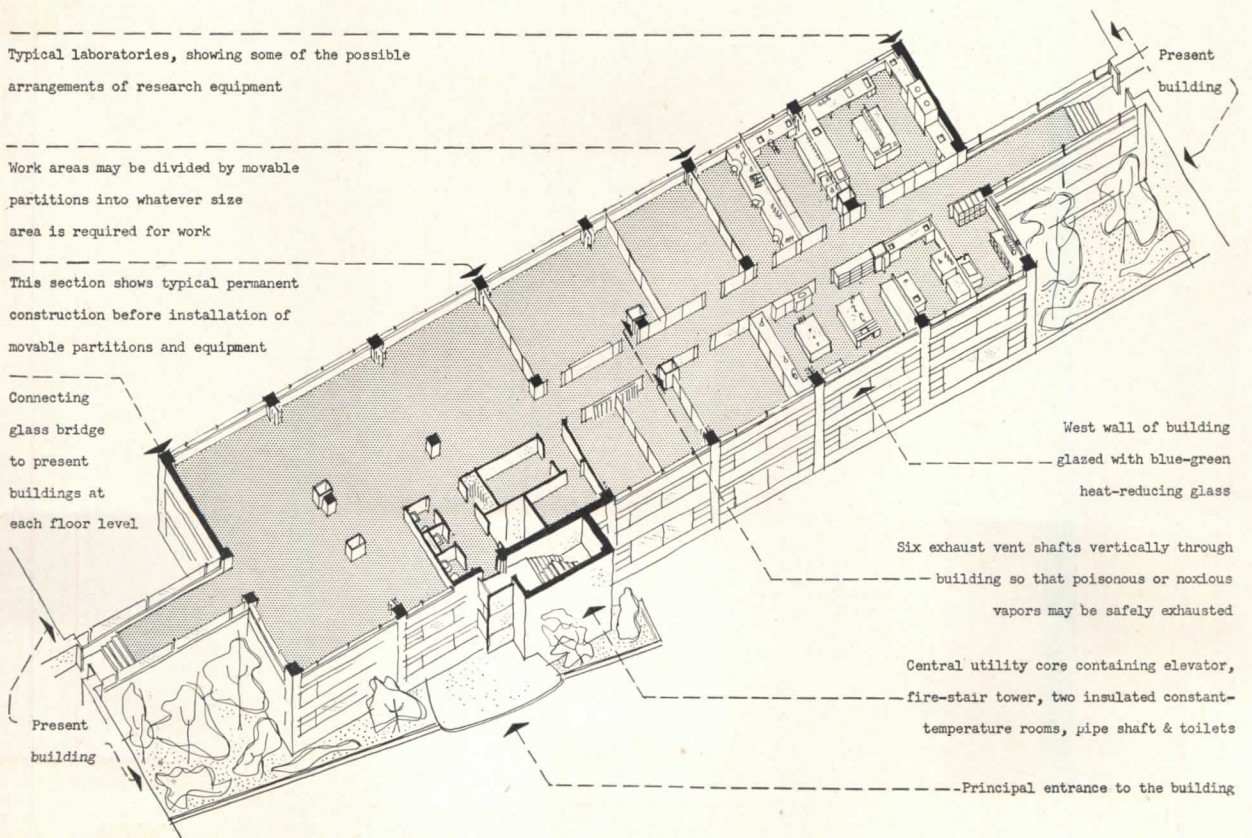

Present building

West wall of building glazed with blue-green heat-reducing glass

Six exhaust vent shafts vertically through building so that poisonous or noxious vapors may be safely exhausted

Central utility core containing elevator, fire-stair tower, two insulated constant-temperature rooms, pipe shaft & toilets

Principal entrance to the building

Present building

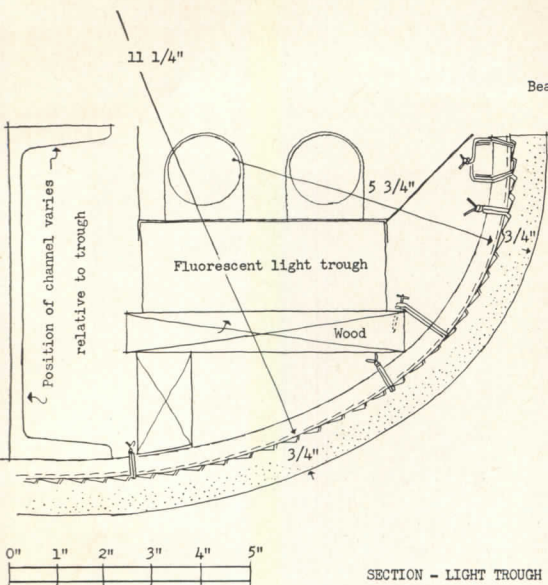

SECTION - LIGHT TROUGH

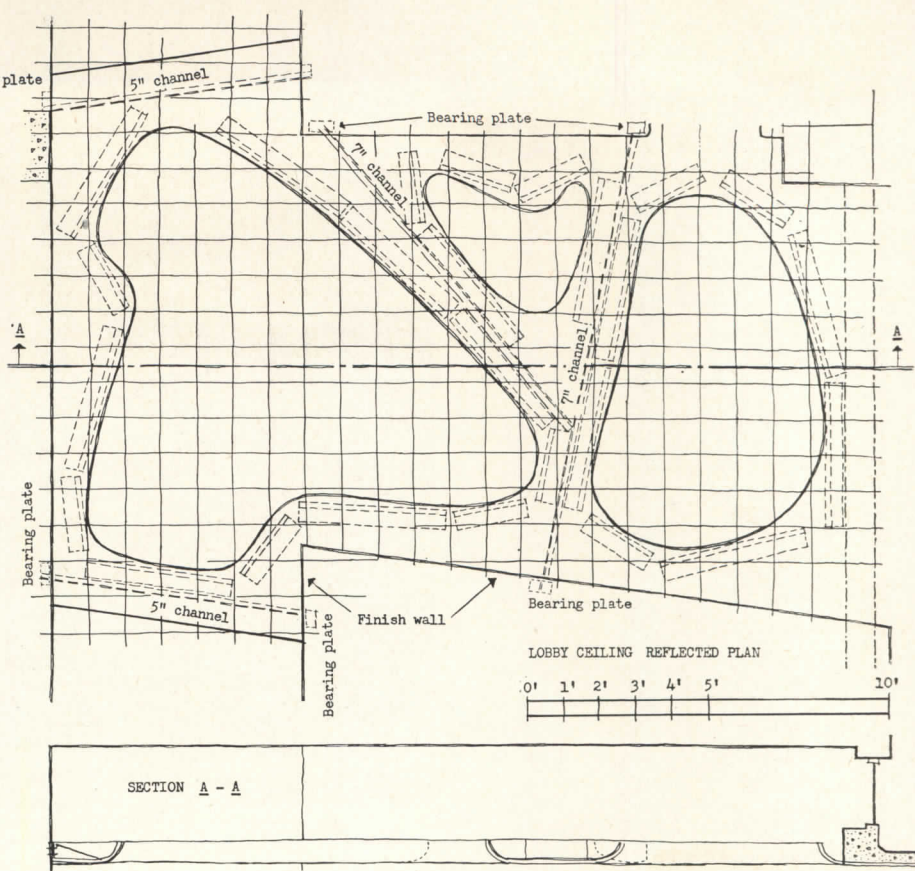

LOBBY CEILING REFLECTED PLAN

SECTION A - A

Hedrich-Blessing

RESEARCH LABORATORIES WASHINGTON UNIVERSITY

Since an inevitable result of research is change, it was early determined that as far as possible, partitions and equipment should be demountable and interchangeable. This led to standardized bays and locations for all services, which include hot and cold water, compressed air, vacuum, gas, steam, 110 and 220 v AC and 110 v DC current, exhaust duct connections. All services are exposed. Each floor has two constant-temperature rooms which may be warm, cool or cold. Several bays, equipped to handle atomic materials used in medical research, have independent ducts to dispose of wastes safely. Photo and details at right and above: sculptured ceiling in lobby was formed by lathers and plasterers from scale and full-size details



**RESEARCH LABORATORIES
WASHINGTON UNIVERSITY**



Hedrich-Blessing

Window-washing problems were solved by tracks permanently secured to window heads. Each track has two rolling carriers to which window-washer's harness is snapped, enabling washer to start at one operable sash and work across to the other. Below: landscaping of entrance court was designed by Thomas D. Church

All sketches by Tom Ballenger

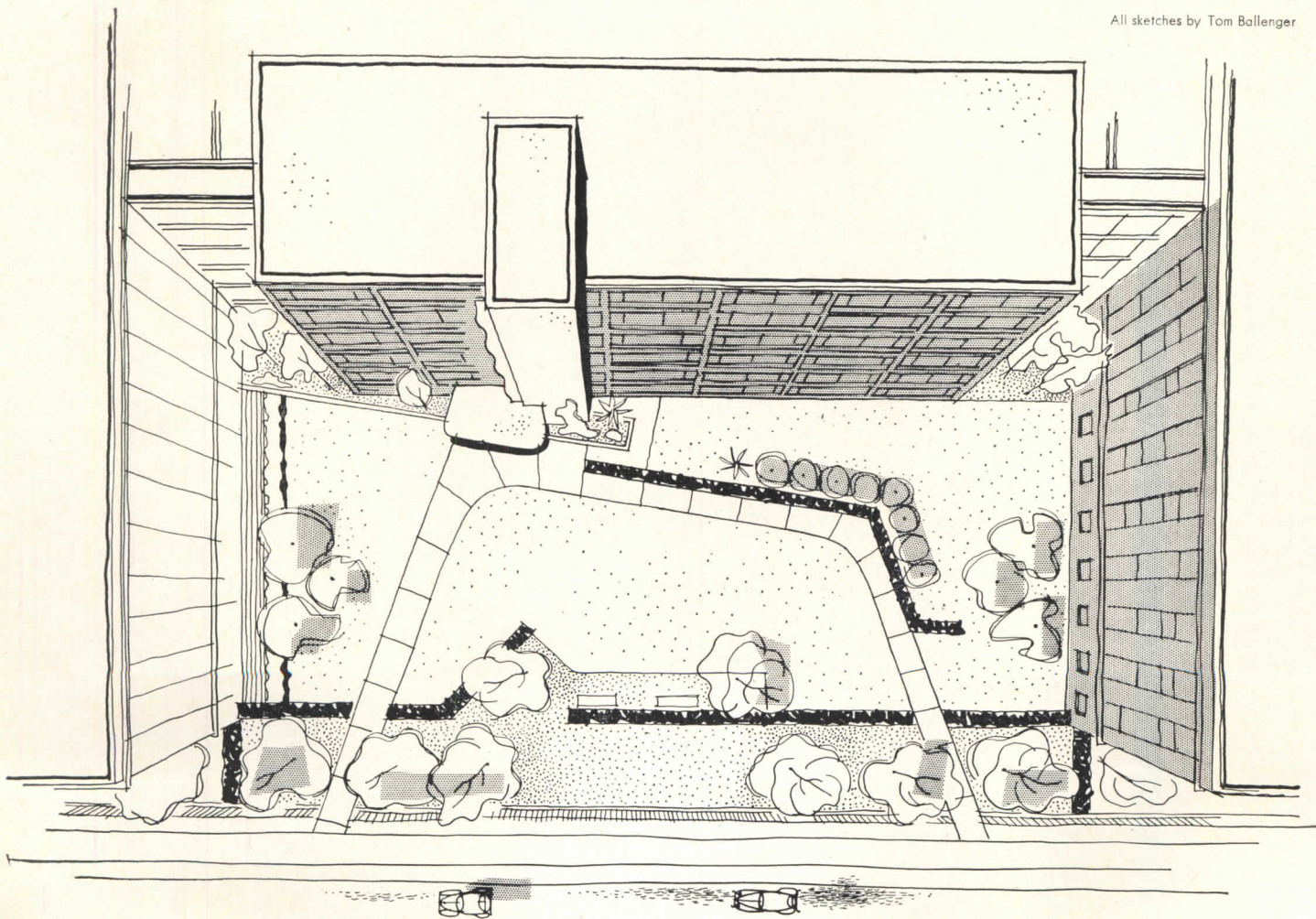

“... when we speak of the ‘modern woman’ . . .”

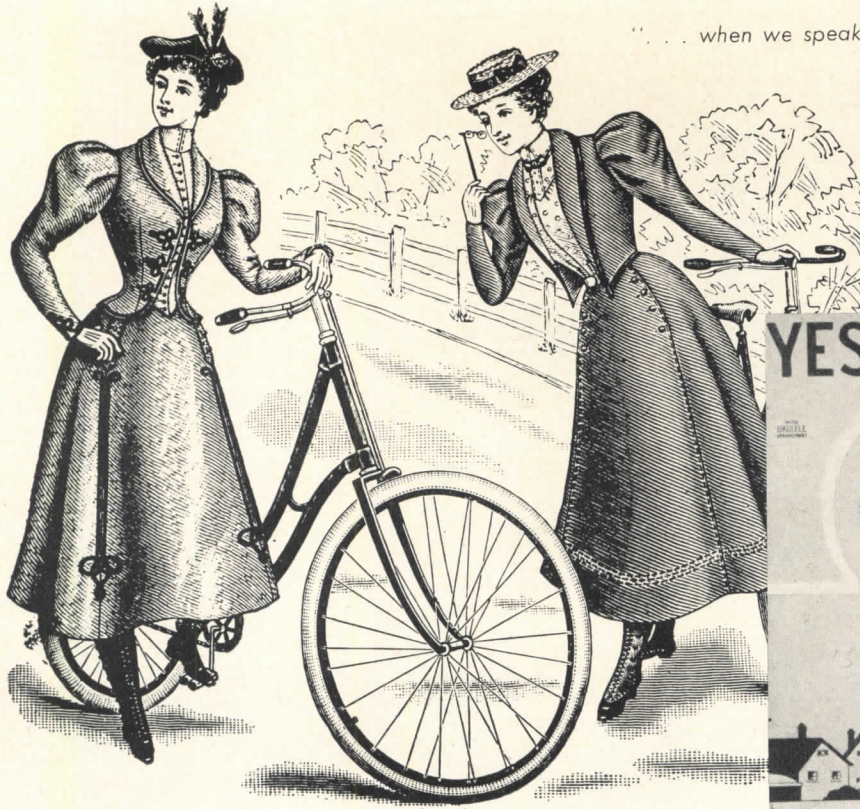

The Bettman Archive



Used by Permission of BOURNE, INC., New York

“THE END OF THE MODERN MOVEMENT IN ARCHITECTURE”*

By Osbert Lancaster

MODERN is probably one of the most ambiguous and certainly one of the most variously employed words in the English language. Unlike most adjectives, so far from defining or expanding the meaning of the noun to which it is attached, its own meaning is entirely governed by the word which follows it.

Thus when we speak of “the modern woman” we summon up a vision of some South Kensington Hedda Gabler, all shirt-waist and pince-nez, peddling madly round Battersea Park thinking about Mrs. Sidney Webb. If, on the other hand, we say “modern girl” this vision is replaced by a tubular siren showing acres of very shiny pink-silk stockings rhythmically jigging to the strains of “Yes, Sir, that’s my baby.” When employed in connection with art or architecture,

* Originally a BBC broadcast, the article is reprinted by permission from the *Listener*

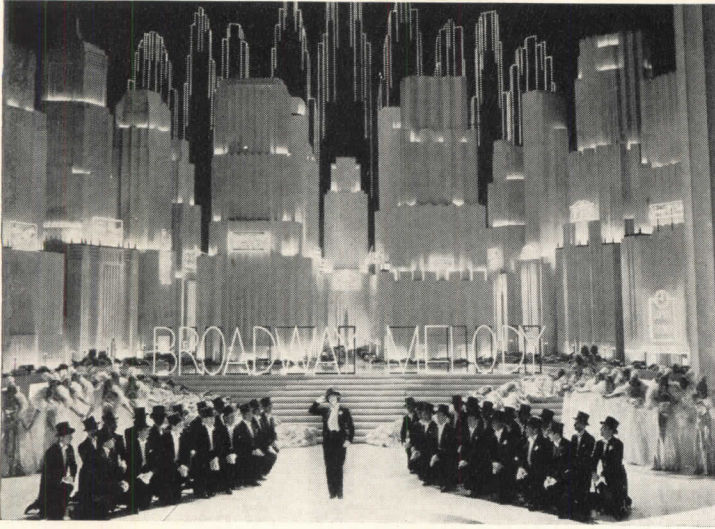

"... early Cubism by Metro-Goldwyn-Mayer ..."

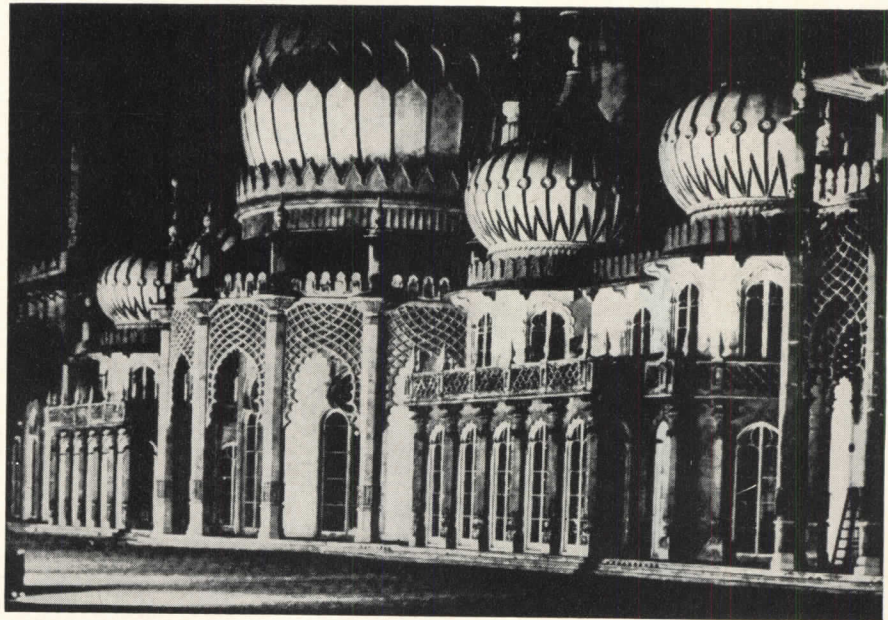
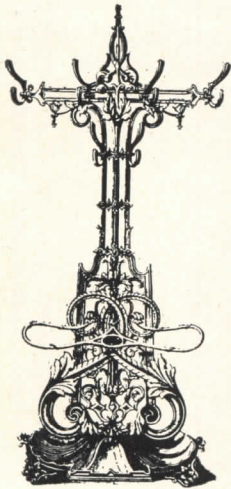

"... proclaimed the doctrine of salvation through decoration ..."

modern retains all its period flavour and may mean anything except contemporary. In ordinary usage the phrase "modern painting" is now practically confined to works produced in Paris between the emergence of Van Gogh and the coming of Surrealism; while "Modern Style," particularly if pronounced in a slight foreign accent, refers to those tendencies in design which flourished in Vienna and Munich at the turn of the century.

So overburdened has this unfortunate adjective become, that we have been forced to invent derivatives such as "modernistic," a term of contempt correctly

employed to describe a type of all too popular decoration out of early Cubism by Metro-Goldwyn-Mayer; or borrowing from abroad, to acclimatize a word such as *Modernismus* in an effort to distinguish English works which display a perhaps imperfect understanding of the principles enunciated at the Bauhaus. But to what precisely do we refer when we speak of the "Modern Movement"?

Thanks largely to the exhaustive researches of Mr. Morton Shand and Professor Pevsner, we know quite well when and how the modern movement started, and can follow the course of its early development. What,

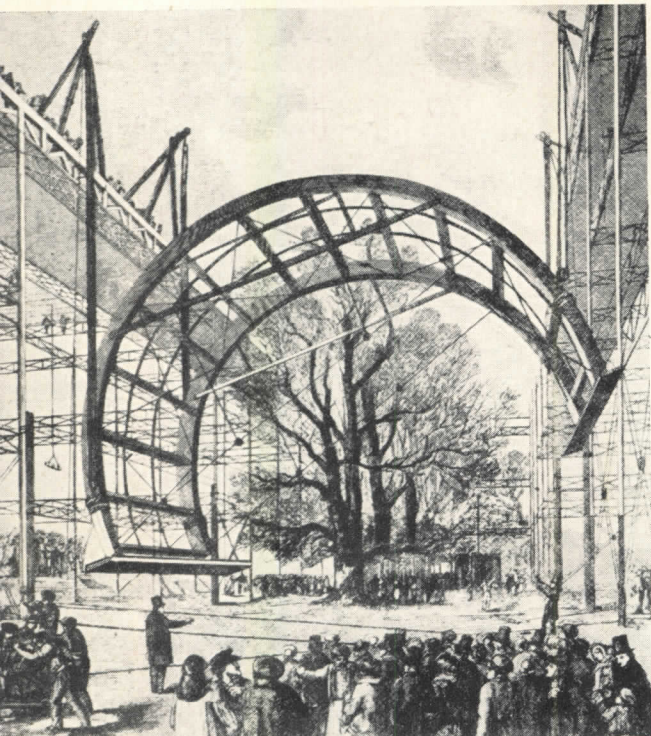

complete break with the past? Building the Crystal Palace



Courtesy: French Information Center, Inc.

"... romantic fun-and-games stage [of modern] ... Maxim's Restaurant"



"... the work of such men as Van de Velde . . ."

however, remains in doubt is exactly where we, and it, stand today. Does 1951 mark the final triumphant flowering, or just a further stage on the upward march, or the end of the whole thing and the beginning of something quite new? Is Mr. Hugh Casson, for example, an Alberti or a Bernini? The rest of my remarks here will be largely directed towards encouraging the last assumption.

It was generally proclaimed by the fathers of the modern movement that it represented a complete break with the past, and in so far as it was directed towards the abolition of "style," as generally understood, it

could not possibly be compared with any other historical architectural school. This contention, which is of course commonly made by all artistic pioneers at all periods, we will treat with the contempt it deserves, and draw what I hope may be a helpful parallel with the history of the Gothic Revival. I choose the Gothic Revival not in order deliberately to infuriate supporters of the Modern Movement, still less the rather smaller circle of Gothic Revivalists, but because not only has it a clearly defined beginning, middle and end, but thanks to Mr. Betjeman and Sir Kenneth Clark, its history is now generally familiar. And, moreover, the moment

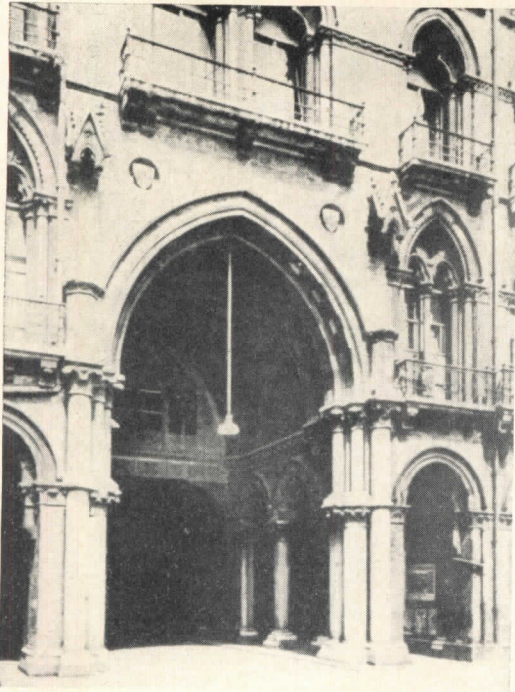

"... similarity between the rôles played by Sir Gilbert Scott and Le Corbusier, although perhaps less immediately striking, is none the less considerable . . . probably did more than any of their contemporaries not only to put their respective movements in the limelight, but keep them there." Above, St. Pancras Station, by Sir Gilbert Scott. Right, some drawings by Le Corbusier

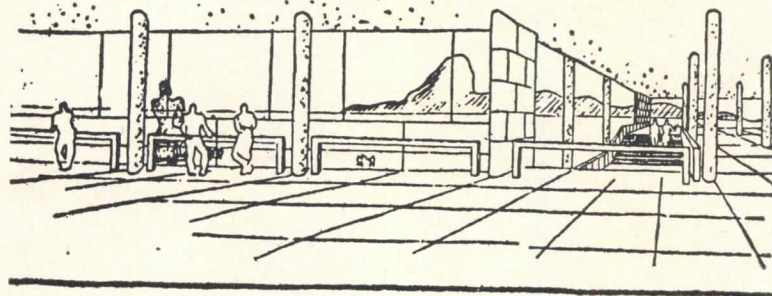

one begins to make the comparison one is immediately struck by some curious parallel.

Both movements started with what one may perhaps describe as a romantic fun-and-games stage, represented in the case of the Gothic Revival by Strawberry Hill and Fonthill, and in the case of the Modern Movement by such works as the interior of Maxim's Restaurant in Paris and Horta's house in the Rue de Turin. Then, after a short period of settling down, when the early exuberance had slightly diminished, represented in the one case by the Commissioners' Churches and in the other by the buildings of Voysey or Berlage, comes the doctrinaire period, all manifestos and witch-hunts. Pugin dismisses all the work of his contemporaries and predecessors as trivial, worthless, and based on a *complete misunderstanding* of the principles involved, and assisted by the Camden Society lays down the new law; Gropius and Loos do the same for Art Nouveau

and the Jugendstil and the work of such men as Van de Velde. And in both cases it is at this moment that the movement, hitherto purely architectural, tends to become involved in extra-curricular activities — in the one case tractarianism, in the other social planning. Then comes the high summer in both cases marked by the emergence of the twin-figures of the Prophet and Publicist.

Here, however, ensues a curious reversal of rôles, for in the one case the Prophet exerted his influence through the medium of words and in the other chiefly by practical example, but, nevertheless, the points in common between Ruskin and Frank Lloyd Wright are fundamental, the differences largely superficial. Both men, it seems to me, tower head and shoulders above all their fellows; the thoughts and outlook of both are deeply coloured by an evangelical background; and both, it must be admitted, exhibit aspects at which it is

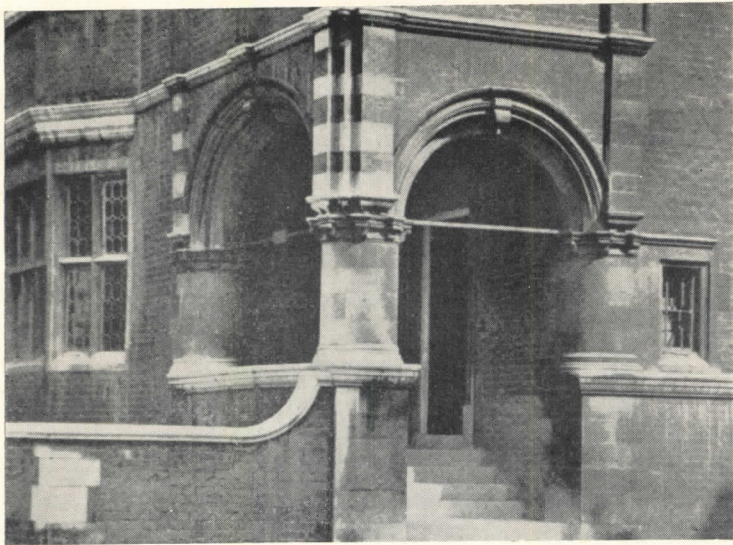

"... Norman Shaw's experiment ... provoked a storm of criticism ..."

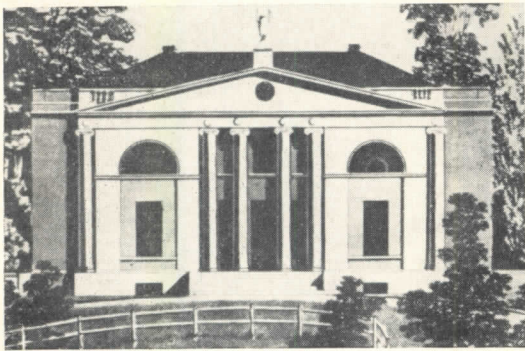

The Beilman Archive

"... soulless barrenness of late eighteenth century ..."

possible for trivial minds (which at some time or other includes most of us) to laugh. In the case of the publicists, the similarity between the rôles played by Sir Gilbert Scott and Le Corbusier, although perhaps less immediately striking, is none the less considerable. Sir Gilbert, it is true, built a great deal more than Le Corbusier and wrote a good deal less, but both men were in their own ways superb showmen and knew no equal in the handling of clients, and probably did more than any of their contemporaries not only to put their respective movements in the limelight, but keep them there.

To all intents and purposes the Gothic Revival was over by the 'seventies. Dozens more Gothic buildings were erected after that decade, but either they were largely hack work, or, if of merit, exhibited features which had little to do with nineteenth-century Gothicism and heralded a coming change. The event which

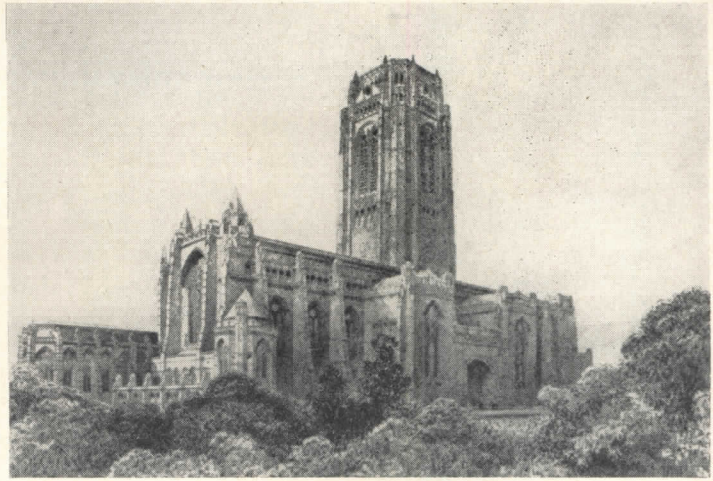

Copyright "The Builder". Courtesy: General Theological Seminary

"... that Gothic was the only style for churches."
Liverpool Cathedral; Sir Gilbert Scott

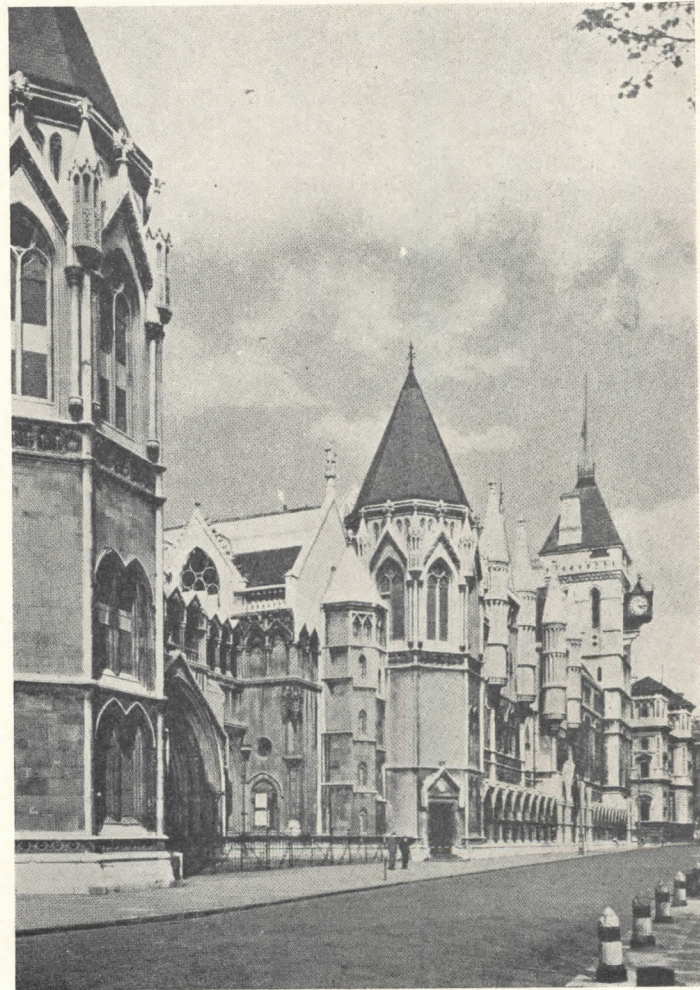

"... and in the history of the later Gothic Revival the office of G. E. Street played a rôle comparable to that of the Bauhaus in the Modern Movement"

may be held definitely to mark the end was Norman Shaw's experiment with Queen Anne; a deviation all the more important in that Shaw came from the Street stable, and in the history of the later Gothic Revival the office of G. E. Street played a rôle comparable to that of the Bauhaus in the Modern Movement. Shaw's heresy, of course, provoked a storm of criticism from the stern unbending Goths, and the curious thing is that the slight note of hysteria there detectable strangely resembles that which characterises the weighty condemnation in strong, if recently acquired, American accents delivered against that latter-day deviation from the Modern Movement known, for reasons that are not immediately obvious, as the New Empiricism.

But similarities in the course of the development of two movements are not themselves, even if convincing, sufficient to indicate that they will necessarily end at the same stage or in the same way. For that, it is necessary to examine rather more closely the fundamental doctrines on which each were based. There one is at once struck by a strange fact; it is not surprising that these should be totally different but it is curious that they should be so neatly antithetical.

At all times and in all places the rôle of the architect lies between that of the plumber and the sculptor; but seldom midway. If, like the majority of nineteenth-century architects, he is an aesthetic snob, he will get as close to the sculptor as he can; if, like most contemporary architects, he is an inverted snob, he will suck up to the plumber. Thus, roughly speaking, most of the Gothic Revivalists and of the Modern Movement boys are equidistant from the centre which makes their conflicting theories almost exactly complementary, and, in my view, equally suspect. The Victorian architect, reacting strongly against what to him, and almost all his contemporaries, was the soulless barrenness of late eighteenth-century and Regency architecture, proclaimed the doctrine of salvation through decoration. His immediate successors, not unnaturally surfeited with Early English capitals, terra-cotta enrichments, and neo-Baroque swags, pronounced decoration anathema and advocated the much-needed abolition of ornament and concentration on the beauty of form. However, what tended to get overlooked in the excitement was the fact that simplicity is not enough: that whereas an ill-designed building, or teapot, or page of type may be rendered unbearably vulgar by applied decoration, in its total absence it is revealed as devastatingly mean.

REVEALING FUNCTION THROUGH FORM

But apart from these theoretical over-simplifications the most striking fact in common between the two movements was their faults, totally dissimilar as were the products. Of these, one of the most important was an ineradicable tendency to give a general validity to theories that were by their very nature particular. Thus the Goths maintained, perfectly correctly given the liturgical requirements of the Catholic faith and the prevailing intellectual climate of their time, that Gothic

Painting by William A. Bougereau; courtesy, New York Public Library

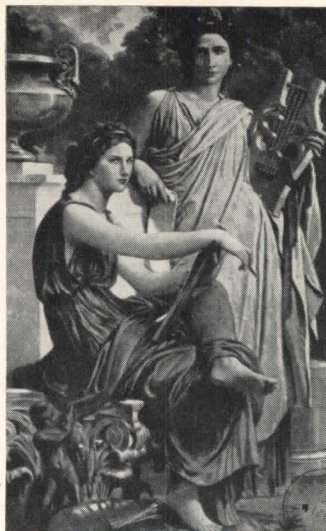

Naum Gabo: Column (space construction). The Museum of Modern Art

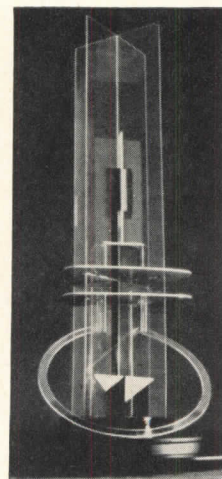

Henri Rousseau: The DREAM

"... le Douanier Rousseau . . . aimed at painting like Bougereau, but happily came nowhere near his avowed intention"

was the only style for churches. Where they went wildly wrong was to advance from this premise the untenable proposition that Gothic was the only style for railway stations. Similarly the Moderns were 100 per cent correct in maintaining that crenellations and lancets were out of place on power stations in which true beauty was to be obtained only by the revelation of function through form. When they went on to apply this theory to all architecture they were still perfectly justified on paper, but almost never in practice, for the very good reason that whereas the function of a factory, or a power station, or a hospital is exactly ascertainable, there exists a whole class of buildings, including domestic, where this is only partially true, and in all monumental architecture function can be defined only in the very vaguest terms.

It is in their varying reactions to this last awkward fact that the leaders of the Movement reveal the existence of a schism. If one may judge from the results



Dadaism rose and faded in 1920

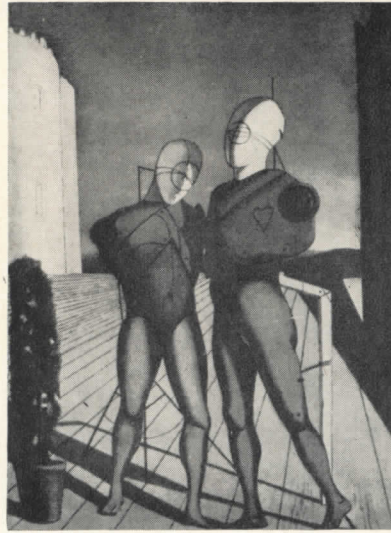

de Chirico: The Duo. The Museum of Modern Art



Picasso: Seated Woman. The Museum of Modern Art

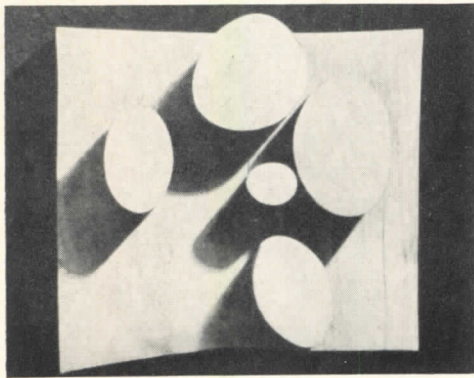

Hans Arp: Objects arranged according to the laws of chance

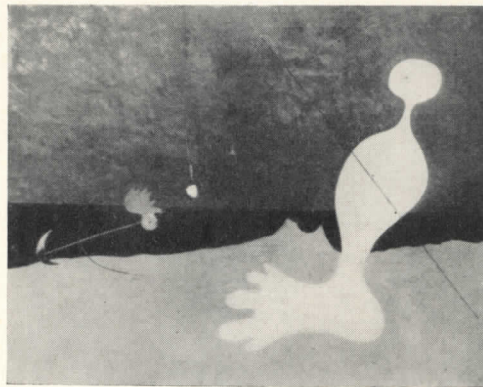

Joan Miro: Personage throwing stone at a bird
The Museum of Modern Art

"... abstract painting was not, as some might think, a blind alley but a necessary diversion . . ."

of the symposium on monumentality recently held by the ARCHITECTURAL REVIEW — which is not altogether easy, as the gift of clear literary expression seems, with the notable exceptions of Messrs. Summerson and Mumford, to be but grudgingly extended to modern architectural writers — the purists side-step the whole question by taking refuge in sociology and saying that the very idea of monumental architecture is ridiculous, uncontemporary, and not to be encouraged: an attitude which in view of the fact that a very large proportion of the building public, including both banking corporations and commissars alike, is still crazy for monuments, and whopping big ones, is not helpful. Far more praiseworthy is the reaction of those who admit the need and go gallantly ahead in an effort to meet it; even though, as at Coventry, that effort ends in almost total failure.

Let me say at once that this failure is not in my view to be laid at the door of Mr. Basil Spence. Rather is it

attributable to those responsible for organising the competition, who seemed to have but the vaguest idea of what they really wanted or what a cathedral is, an ignorance the more astonishing as the purpose and nature of a cathedral have so recently been admirably defined by the highest authority in the Archbishop of York's book on the Church of England. If they wanted a building which would combine the advantages of a glorified parish hall blown up to meet diocesan requirements with the popular appeal of a brand-new Odeon, they should have said so and not called it a cathedral. But to call in an architect trained in the functional tradition and not to have made it clear that in so far as cathedrals are concerned function is liturgy, and liturgy is function, was to invite disaster. In this bland denial of the very *tenets of the functional* faith the wheel has come full circle and Coventry Cathedral seems likely to be the St. Pancras railway station of the Modern Movement.

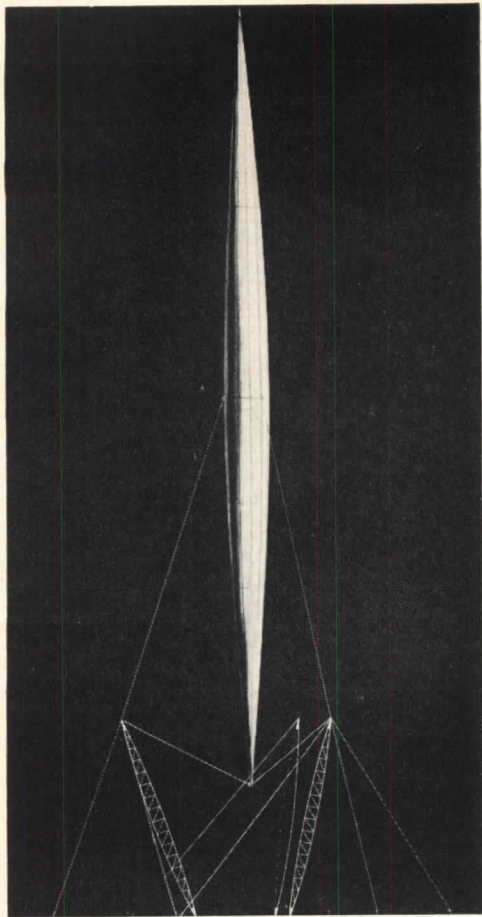

Courtesy: British Information Service

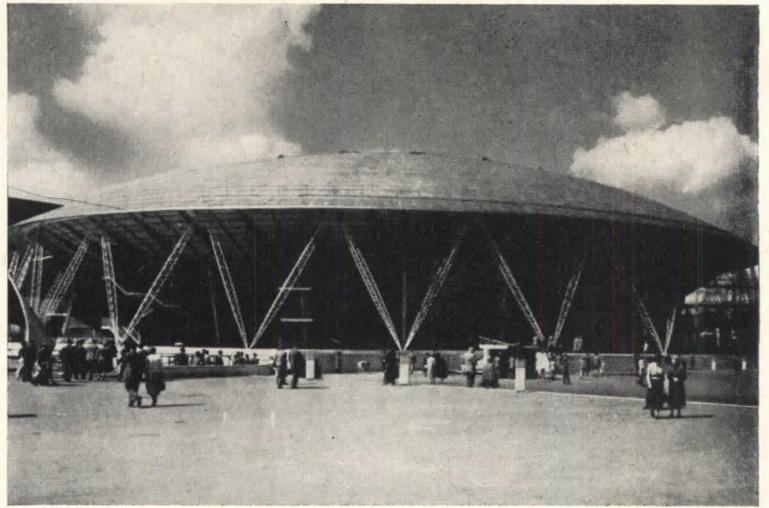

"Here [South Bank Exhibition] a hand-picked selection of the younger exponents of the Modern Movement were given a free hand to do what they liked without the necessity of making even a formal observance to theory"

MYSTIQUE OF THE MACHINE

But it is in their respective attitudes to the machine that both movements proved finally inadequate. The Goths invited disaster through fear, which so inhibited them that they were quite unable to take advantage of the mechanical revolution of their time, and finally led them into the cosy wilderness of arts and crafts. The attitude of their successors was more complicated. On the surface it was coloured by a mystique of the machine which found its earliest and dottiest expression in Marinetti and the Futurist manifesto and was later rationalised by such men as Professor Giedion. But underneath, deep down in the collective subconscious of the movement, there remained — inherited from William Morris who, it is important to remember, was a Janus figure standing exactly at the cross roads — a profound misgiving lest the price to be paid for all the manifest advantages to the consumer of "mechanisation taking command" prove disastrously high in terms of the spiritual well-being of the producer. However, further to expand this statement, with all its inevitable sociological implications, might well involve me in expressions of opinion to which in this tense pre-electoral atmosphere vile minds might attach a partisan significance.

Moreover to speak solely of failure is unjust and unhelpful, for the end of artistic movements is not commonly marked by failure but by the achievement of

unintended success, which provides a springboard for fresh leaps. An extreme example of what I have in mind, drawn from modern painting, is afforded by le Douanier Rousseau. He, as we know from his correspondence, aimed at painting like Bougereau but happily came nowhere near his avowed intention. But in the process he produced a number of masterpieces of a quite different kind. Without for one moment attributing to Hugh Casson and his colleagues a comparable degree of naïvety, the view that the Modern Movement has now reached its term is far more plausibly supported by the triumphs of the South Bank than by the inadequacies of Coventry.

Here a hand-picked selection of the younger exponents of the Modern Movement were given a free hand to do what they liked without the necessity of making even a formal observance to theory. Indeed, it would have been impossible for them to do so even had they so wished, for the purpose for which exhibition buildings must, one supposes, be fit, is to exhibit, and one of the most enjoyable things about the South Bank exhibition was that there was virtually nothing of the smallest interest to exhibit. Thus one could enjoy the wonderful Piranesi-like drama of the interior of the Dome of Discovery, without bothering one's head, any more than one suspects did Mr. Tubbs, as to whether this imposing arrangement of ramps and moving stair-

cases was in fact the best or most functional method of displaying all the pseudo-scientific bric-a-brac with which it appeared rather hurriedly to have been filled. Similarly in other pavilions, where the exhibits ranged in exotic fantasy from a row of cows being milked to a London omnibus, one was able undistracted to concentrate on the architectural qualities of the buildings themselves. As one did so one gradually became aware in many individual cases, but not all, and in the general effect of the whole ensemble, of something quite new — of a quickening wind stirring the grim, bare branches of modernism and a wind, moreover, that was certainly not blowing from the direction of Massachusetts.

THE NEW SPIRIT IN ARCHITECTURE

Is this new spirit — which I shall not attempt to define, for definition and analysis have been the curse of modern architecture — the first swallow of a new summer, or just a belated straggler from the old autumn of the picturesque, as certain of the more austere upholders of the international style would have us believe? It is at this stage quite impossible to say, but one thing is certain. If a really live and profitable movement is to develop from this beginning, then many of the most cherished illusions of the Modern Movement will have to go overboard: that frenzied rejection of the past, for instance, that ridiculous attitude of having absolutely no connection with the period next door, which has had such disastrous effects on architectural education. Then that inhibiting fear of the *cliché* must at all costs be overcome, and it must be realised that a good supply of sound, generally acceptable *clichés* is one of modern architecture's most urgent requirements; that whereas the success of eighteenth-century architecture, for example, as of eighteenth-century poetry, lay very largely in just this invention of *clichés*, that could safely be entrusted to local builders to exploit without becoming wearisome, the failure of the Modern Movement wholly to get clear of the coterie stage was in a very large measure due to the fact that the best they could produce in the way of *clichés* was a window that turned a corner and a couple of pavement lights. Above all, the modern architect must at all costs come down from his functional tower of reinforced ivory and realise that a public which has for years been asking for half-timbered bread is not going suddenly to be satisfied with a cantilevered stone.

If, in fact, we are witnessing a new departure, then it would be churlish to conclude without paying a tribute to the stern, if sometimes inhibiting, discipline which the Modern Movement imposed. If one thinks as I do that it always remained inextricably confused between ends and means, it nevertheless fulfilled an essential task. As with abstract painting it was not, as some might think, a blind alley but a necessary diversion, and those who passed through it are likely to have travelled considerably further than those who stuck to the main road.

Elizabeth Meigs Eidlitz photo

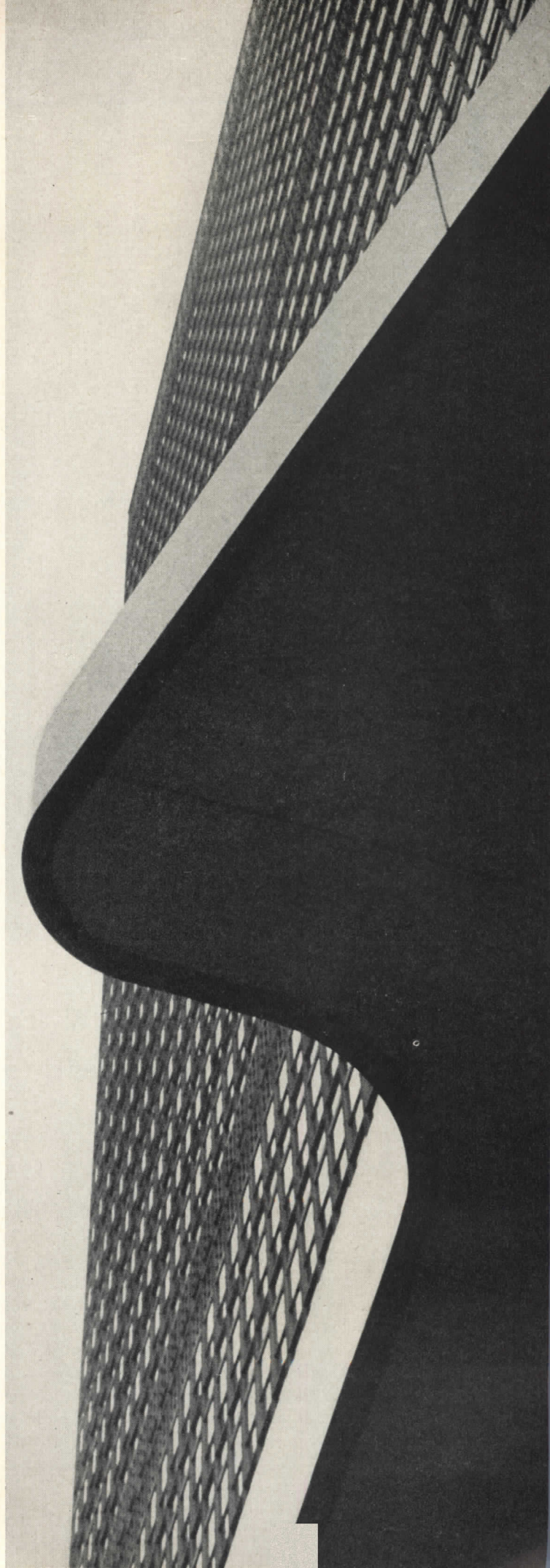

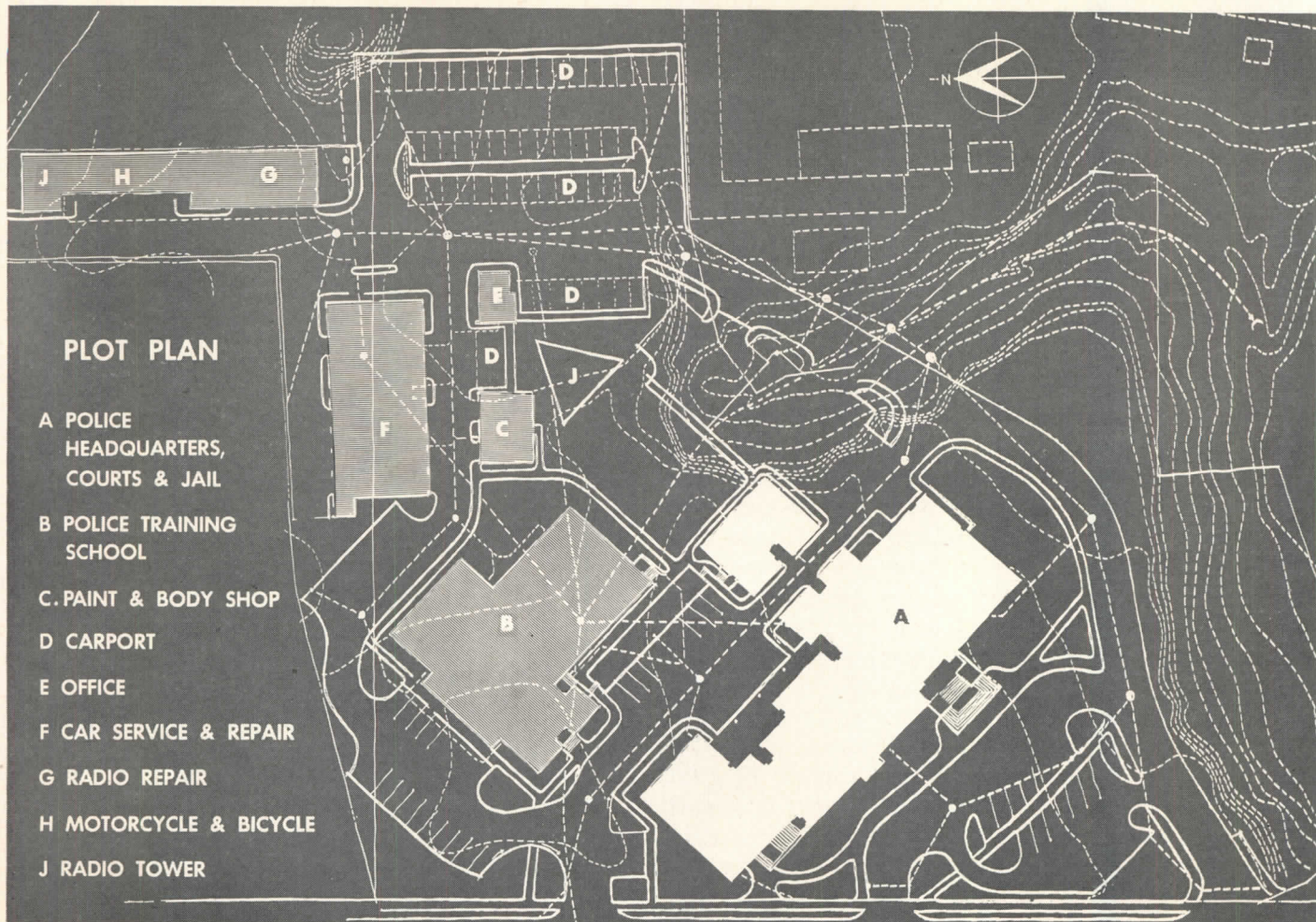

HOUSTON'S LAW ENFORCEMENT CENTER

*Police Administration, Corporation Courts & Jail Building
Houston, Tex. Kenneth Franzheim, Architect*

ON A 7½ ACRE PLOT FACING BUFFALO BAYOU, Houston has just completed a group of six buildings which will serve as a law enforcement center for the city. The main building (white in the plan above) houses the executive and administrative sections of the police department, three courtrooms, the city jail and a communications center for radio, telephone and television equipment. Ancillary buildings in the group contain the police training school and gymnasium, maintenance shops for mobile and radio equipment, storage garage.

The street façade of the six-story principal building provides entrances for public, judges, lawyers and police, while the jail and prisoner entrance is located at

the rear and reached by vehicle. These two segments of the building population are divided by separate stairs and elevators, brought together only as the workings of the law require. The jail function is divided into two main elements: reception and detention, which are at ground level — cell blocks on the fifth and sixth floors. This duality provides a means of isolating those arrested for minor illegalities from those with criminal tendencies or records. Only the latter reach the top floor cells, which are arranged to segregate prisoners into classes, especially as to age.

The exterior is of limestone and Texas granite. Windows, exterior doors and trim are aluminum.



Public entrance is through street façade (above) into lobby (below) from which one gains access to court-rooms, offices and elevators. Prisoners are brought by vehicle to opposite side of building (left) — are detained at this level until case can be classified

I. B. Lindenthal



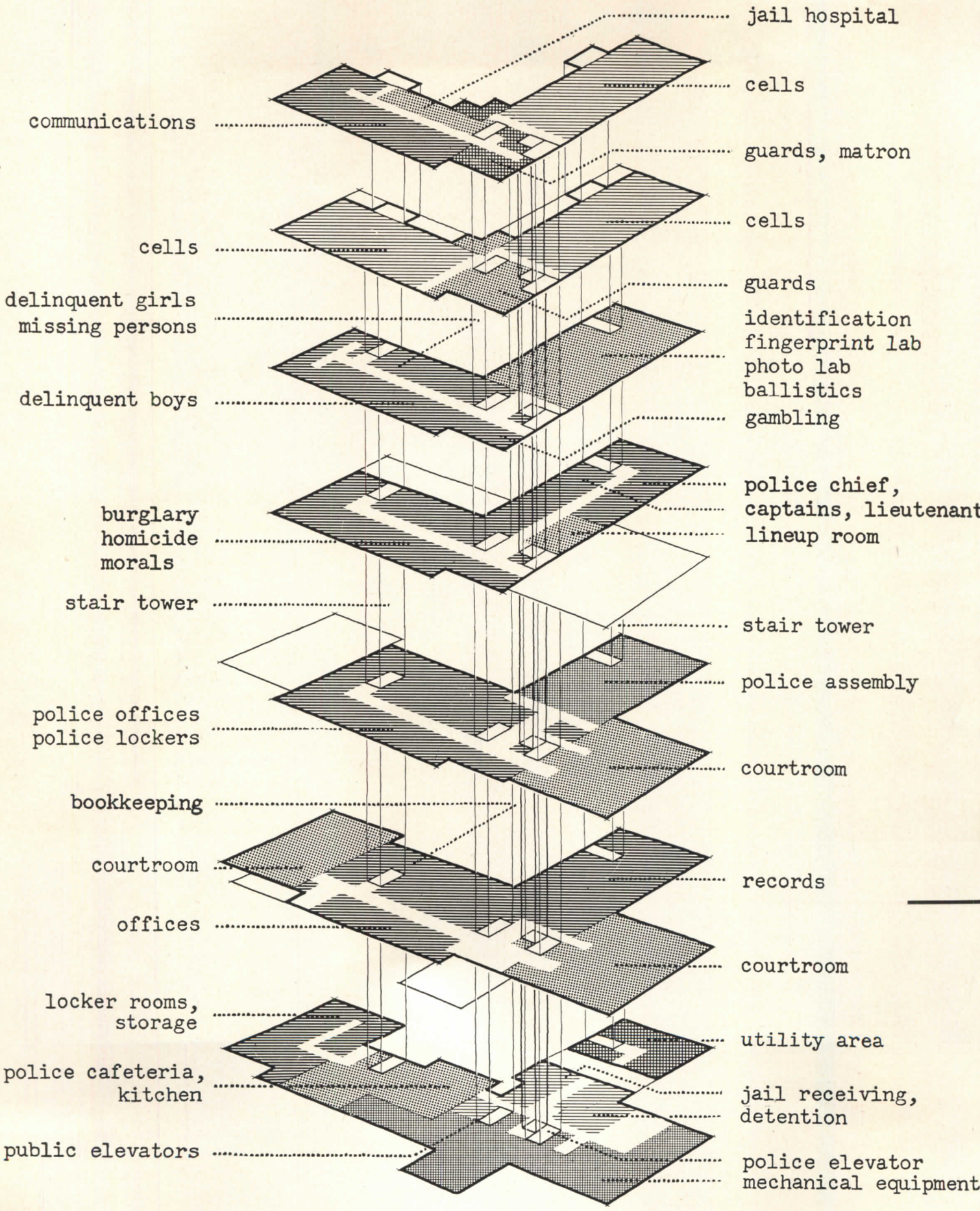



The three courtroom interiors (typical one shown at left) are treated in similar fashion. Police department offices (below, right and left) are air conditioned, pleasant, well lighted. Bottom photo shows 450 ft radio tower rising above building

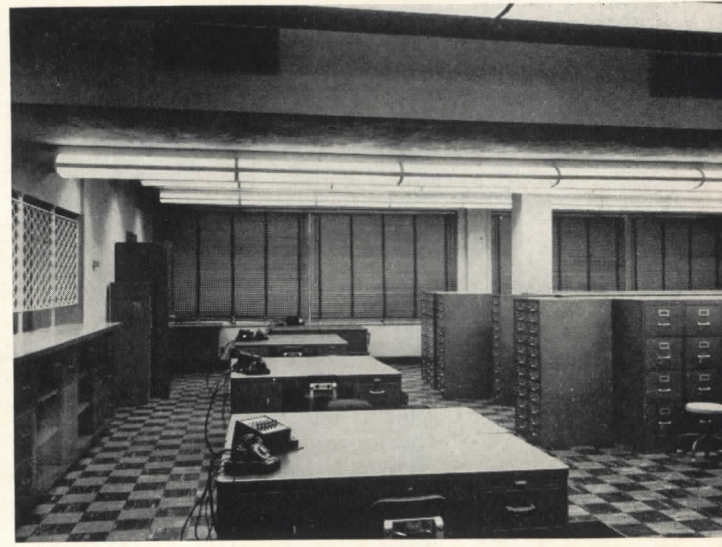
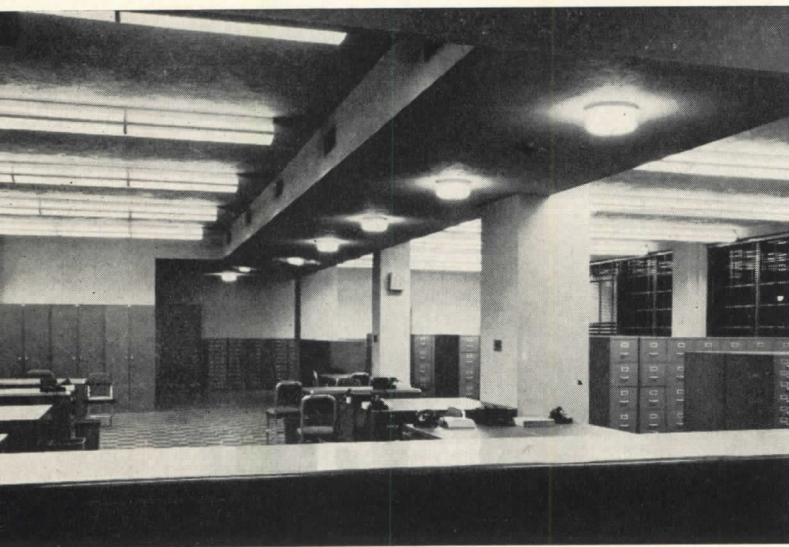

Perspective plans on opposite page show in diagrammatic form the seven floor levels that make up the building. Stairs and elevators are the vertical elements connecting the plans. Shown in their proper three dimensional relationship are the principal plan areas (courtrooms, cells, etc.) as well as the various departments within the police organization

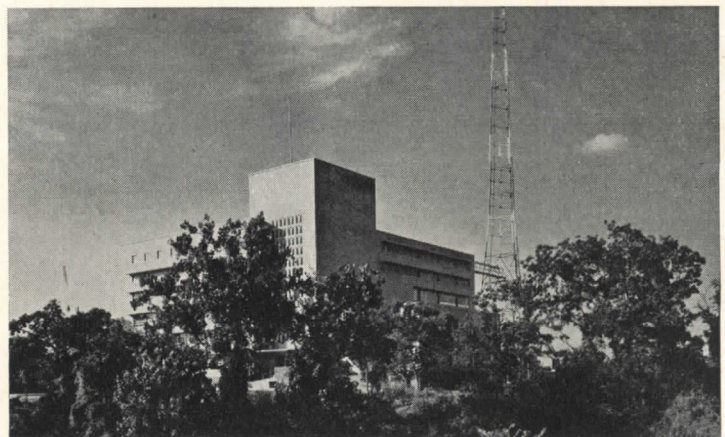

I. E. Lincenthal

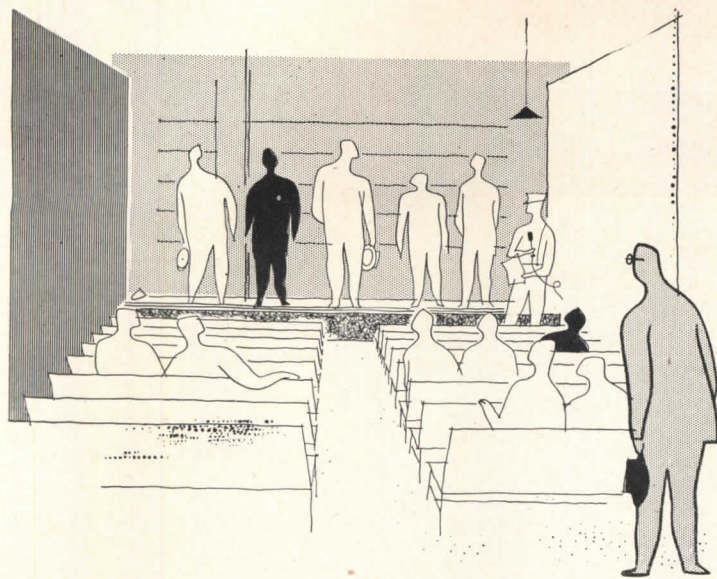

Drawing by Tom Ballenger

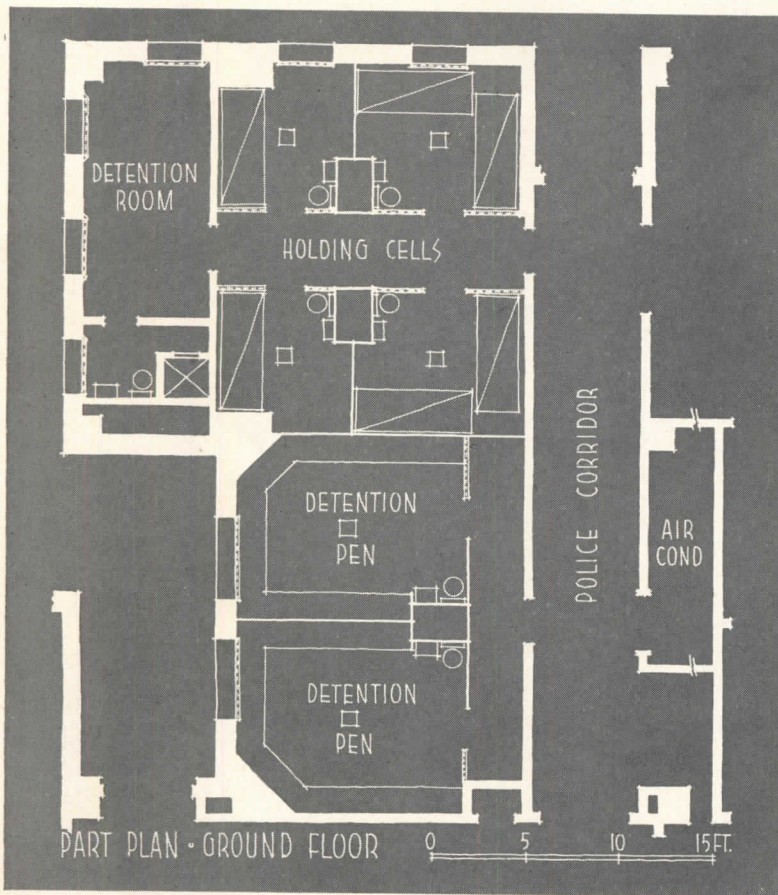

(Above) Police assembly room at second floor level — used for large gatherings of police and detectives for special briefings, etc. (Plan at left) Jail reception and detention area at ground floor level. Prisoners are held here to be screened and segregated into minor offender or criminal class. Only the latter are booked and put in a cell. (Plan below) Jail hospital at sixth floor level has facilities for both emergency and routine treatment of prisoners

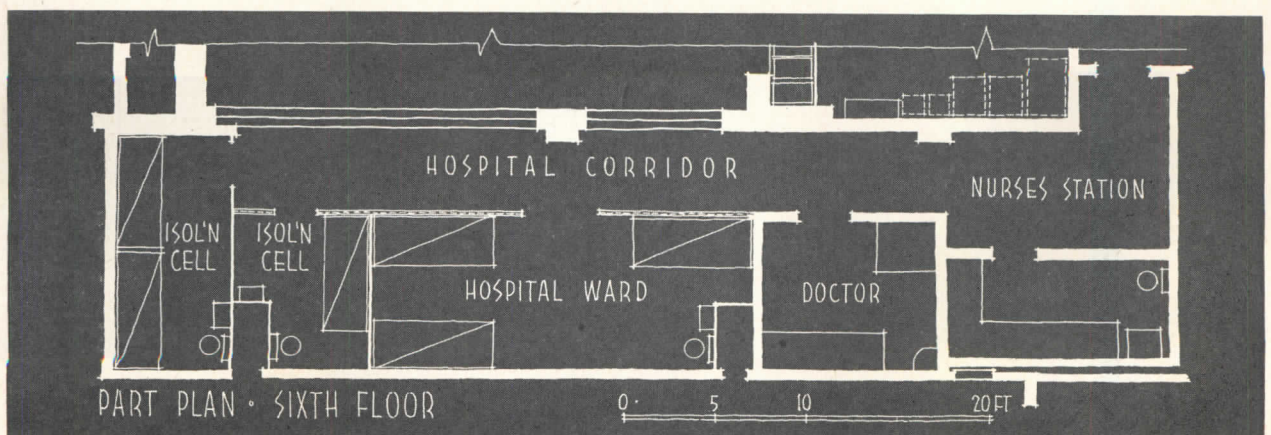

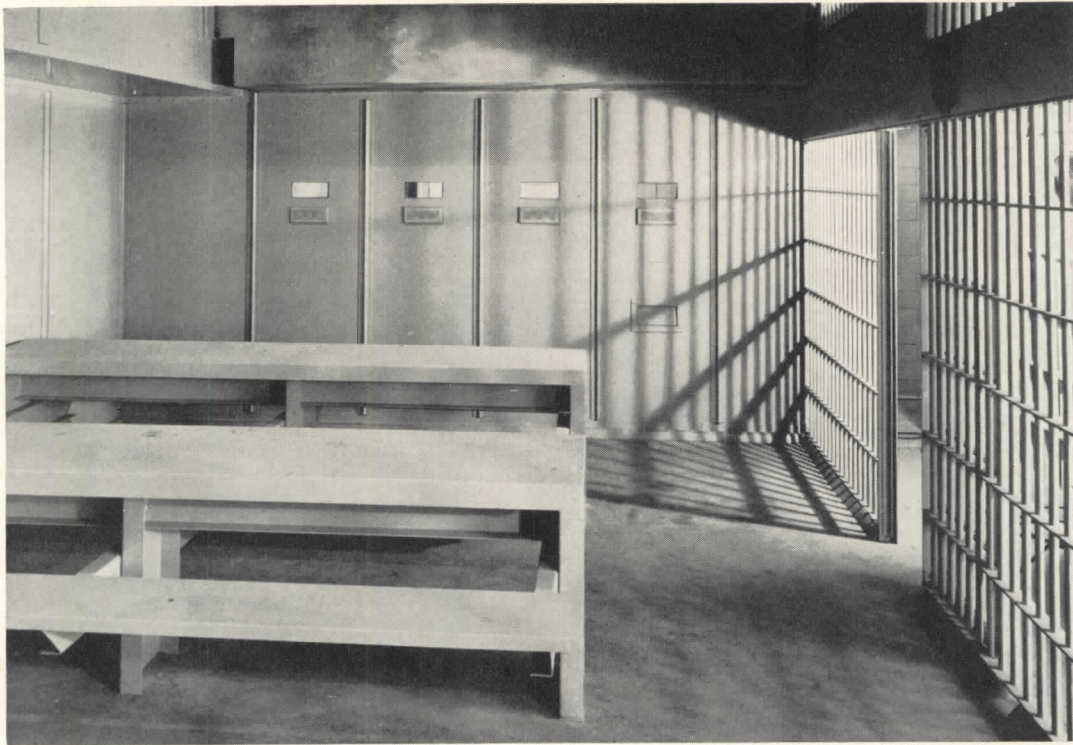

(Above) Cell block day room and dining area. Note wall apertures for seeing and talking to visitors. (Below, left) Typical cell contains bunks for four prisoners, lavatory and toilet. (Below, right) Prisoners' corridor is paralleled by guards' corridor, which separates cells from windows



I. B. Lindenthal

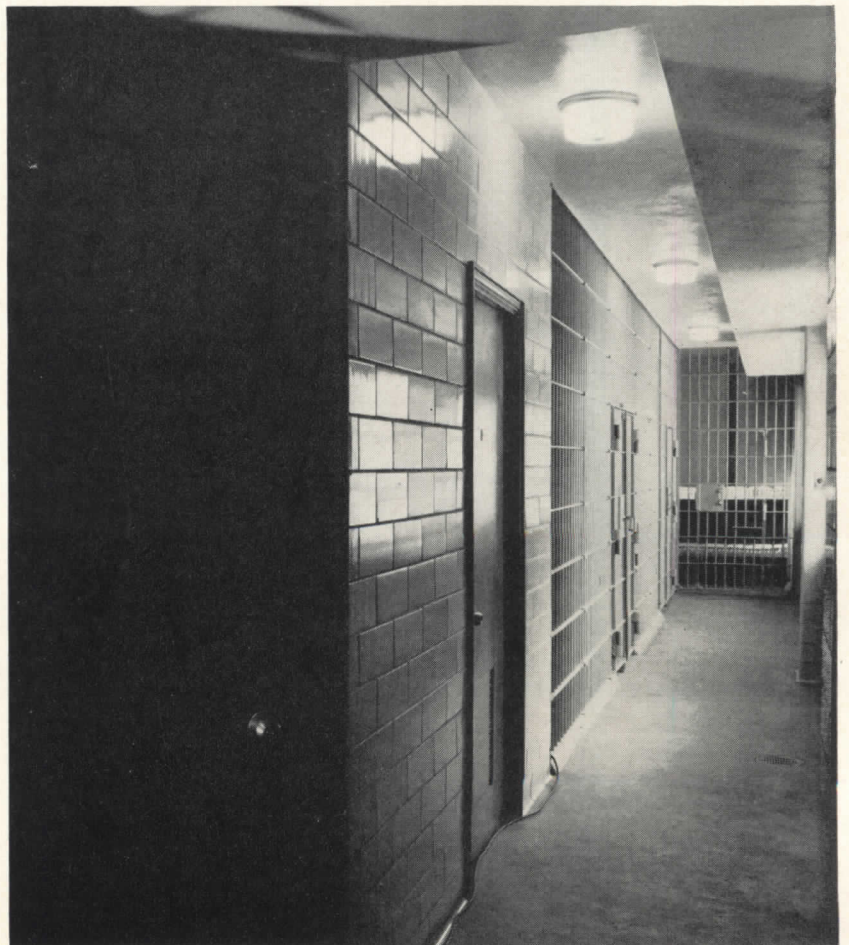

LANGLEY-BATH-CLEARWATER

William G. Lyles, Bissett

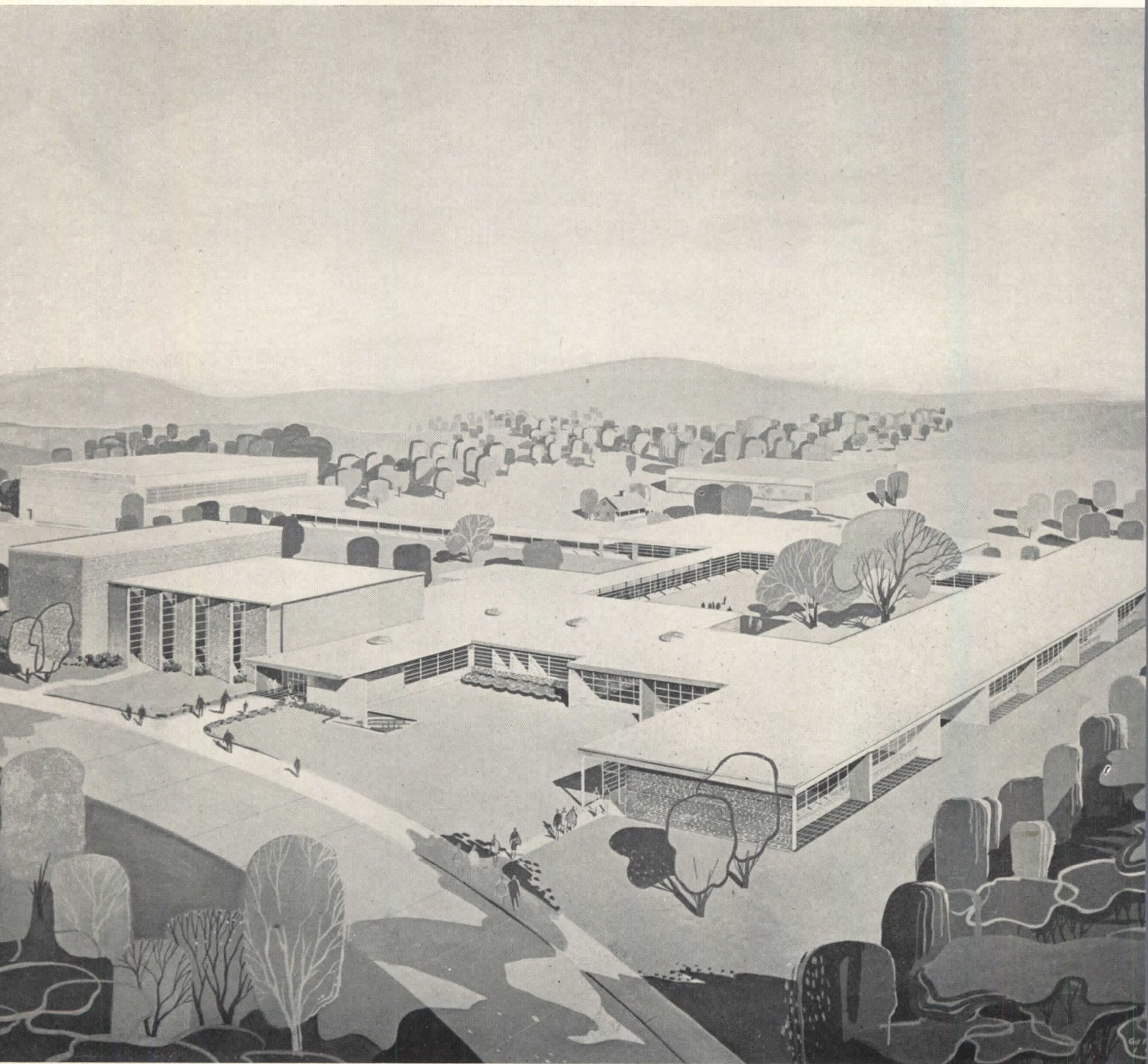

Classroom unit, right foreground, forms one side of a court around which other units are grouped. Gymnasium (far left) and shop (center background) are isolated

HIGH SCHOOL, AIKEN COUNTY, S.C.

Carlisle & Wolff, Architects; Engelhardt, Engelhardt & Leggett, Consultants

SELDOM ARE THE COMPLEX RELATIONSHIPS involved in school design as well resolved as they are here. The consultants and architects cooperated enthusiastically; the consolidated junior-senior high school is closely geared not only to the communities' adult needs but, more important, to the actual nature of the three mill towns it serves; the plan is a clear demonstration of the "core" curriculum which is emerging in secondary schools; the amenities of a campus scheme (domestic scale, clear definition of purpose, integration with site) are obtained, yet the close-coupled building units are organized to facilitate circulation; and construction is so rationalized that costs are extraordinarily low for this quality of work. The contract was awarded in January 1952, at a price of \$7.96 per sq ft.

It is a six-year high school — grades 7 through 12 — for 600 pupils, designed to provide a stimulating educational environment for pupils and to serve the community for meetings, recreation and social betterment. The variety of activities likely to take place in a school of this kind is hard to forecast, but the intent is to stir up and respond to real community needs. For instance, adults might experiment, in the home economics unit, with cloth from local mills for dressmaking and home decoration; or food habits might be studied through school gardens, diet and cooking courses or community canning projects.

In addition to present needs, the AEC H-bomb plant is in the county and, although the effect of increased population on this school is unpredictable, all of the 55-acre site was laid out as to eventual usage and the school plant was designed to be expandible to double its capacity.

Regarding curriculum: the school houses both junior and senior high school grades. The number of pupils in each may vary widely, and to duplicate specialized facilities would have been too costly, so the two are housed jointly. In the junior high program, one teacher has a class for the two or three "core" subjects (language, social studies, math, etc.); this provides a transition from elementary school experience to the more departmentalized senior high school program.

Laying out the units around a central court made it possible to use the court as an adjunct to both the cafeteria and the library; yet surrounding school rooms are

not affected by any noise this might cause since there is a corridor between to act as a buffer. Also, the rooms face outward to the pleasant countryside. Trees supplement wide eaves in keeping direct sunlight out of the rooms. Location of shop, gymnasium, auditorium and service areas, adjacent to the auditorium unit, was predicated on easy accessibility for adults and students, on segregation of noisy areas and on minimum extent of paved roadways.

Rooms are mostly 30 by 30 ft (except that home economics rooms are larger) for maximum flexibility. Partitions between them are load-bearing slag block, painted and extending beyond exterior walls. The standardized bays thus achieved are spanned by open web joists about 6 ft on centers; ceilings are combination acoustical and insulation board which serves as a form for the poured gypsum roof. Exterior window-walls run to the ceiling between joists and are made up of projected steel sash and mullions. Exterior corridor walls of glass are occasionally interrupted by sections of masonry to receive doors and to accommodate bulletin boards and tack strips. Walls between classrooms and corridors are prefabricated, of specially designed cabinets 3 ft high, with wood double-hung sash above.

Portion of the 55-acre site; entire area was studied and usages were defined for future expansion. The school won an award of merit at the American Association of School Administrators' Boston exhibition last spring

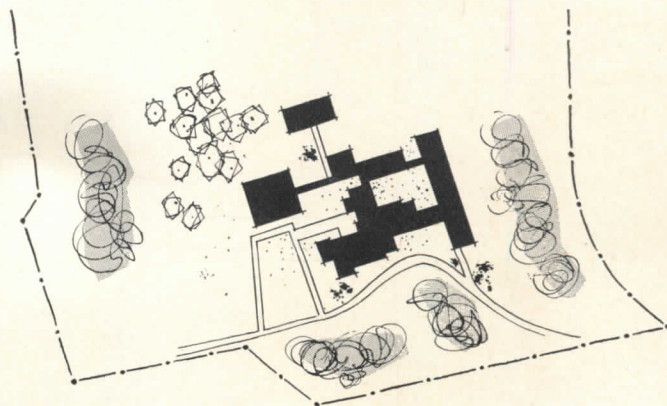

**AIKEN COUNTY
HIGH SCHOOL**

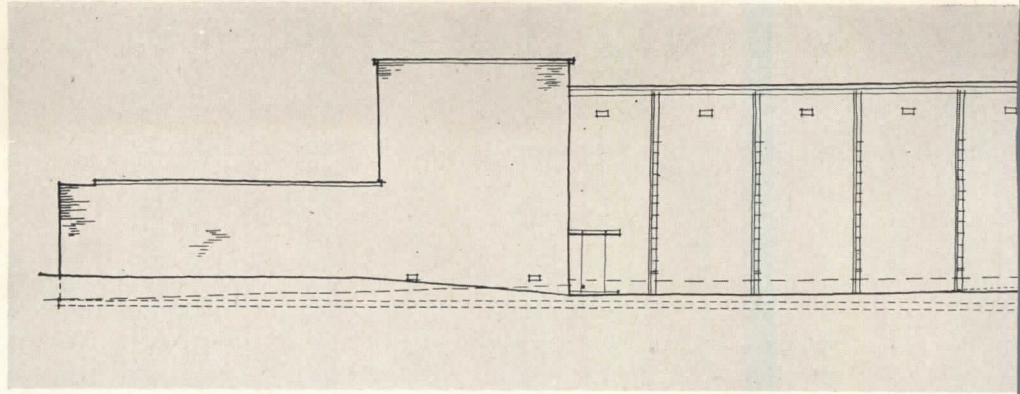

In plan, facilities are clearly organized; circulation between classroom unit and specialized departments or laboratories is simple and direct; noisy shop, gymnasium and auditorium are separated from quiet areas

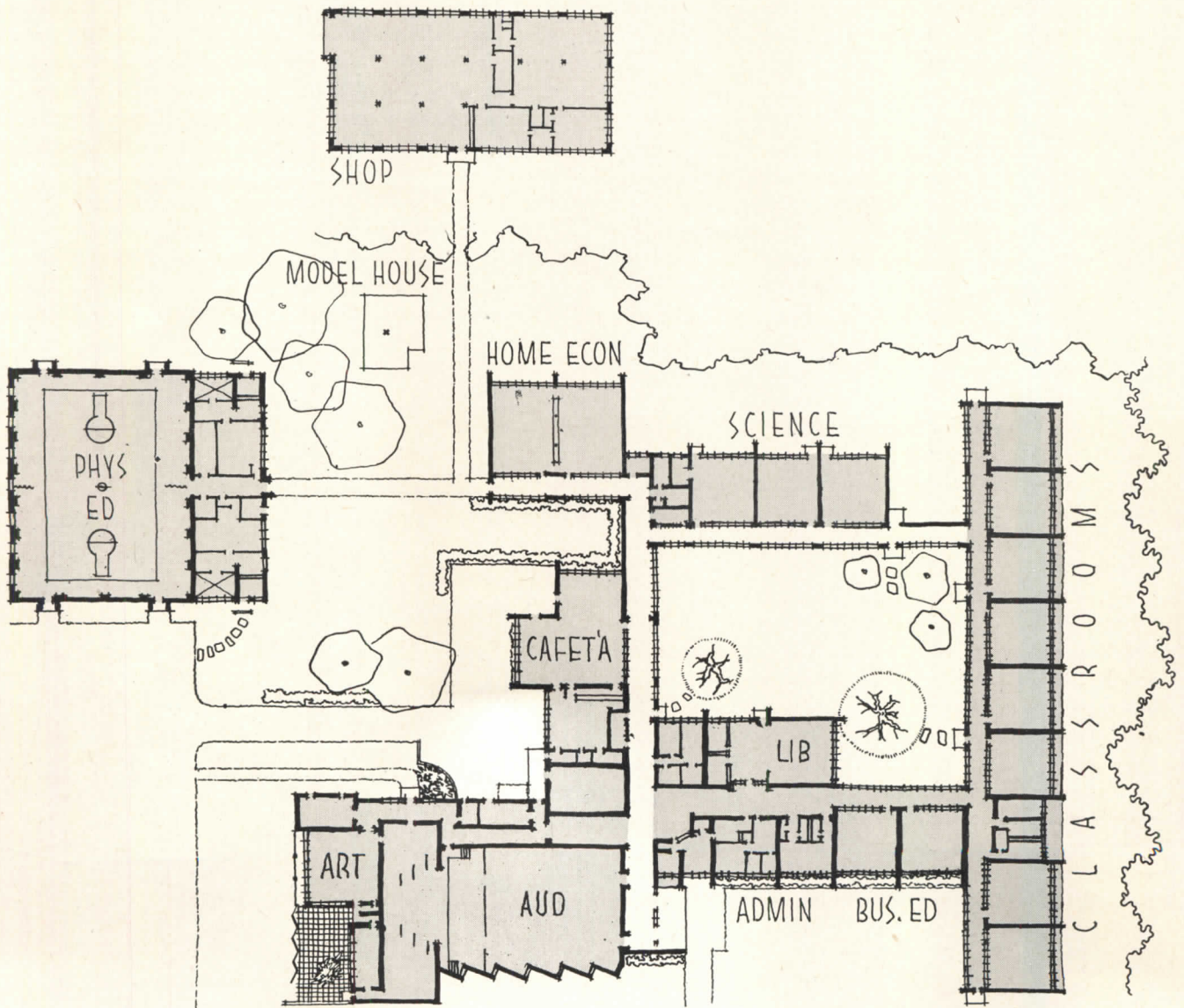

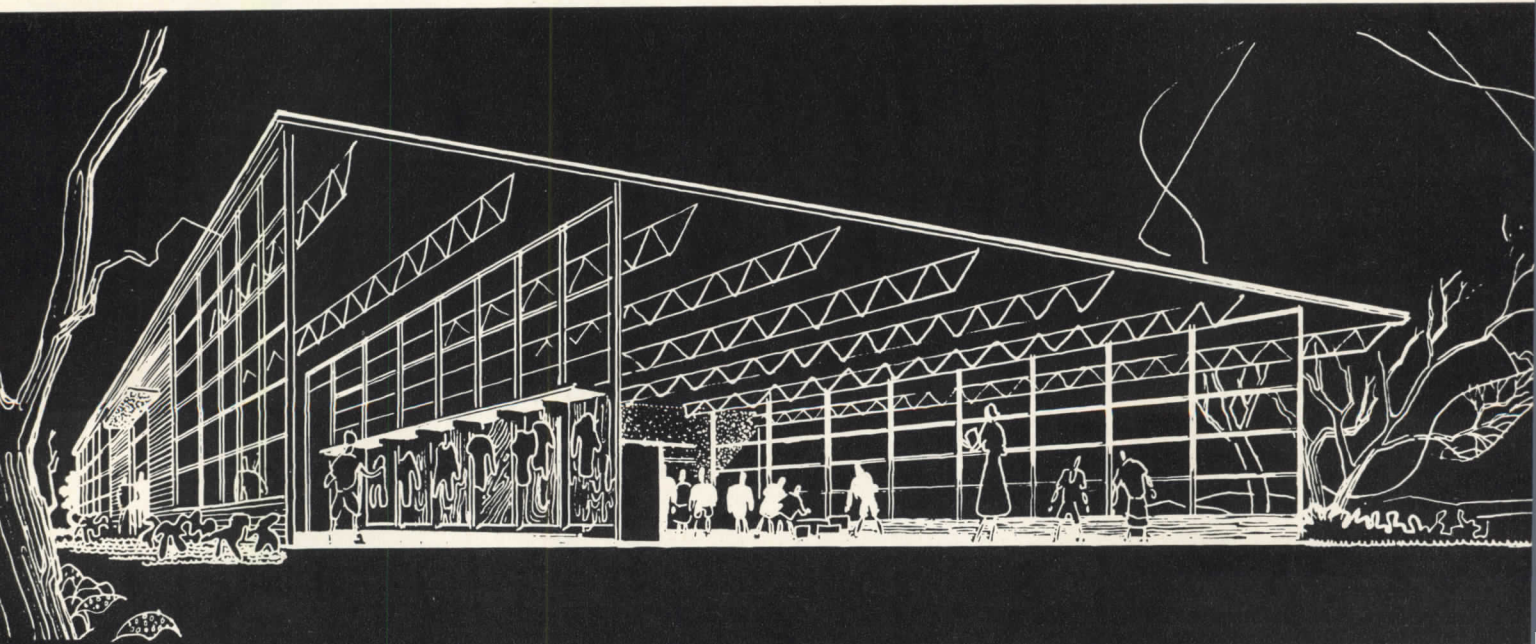
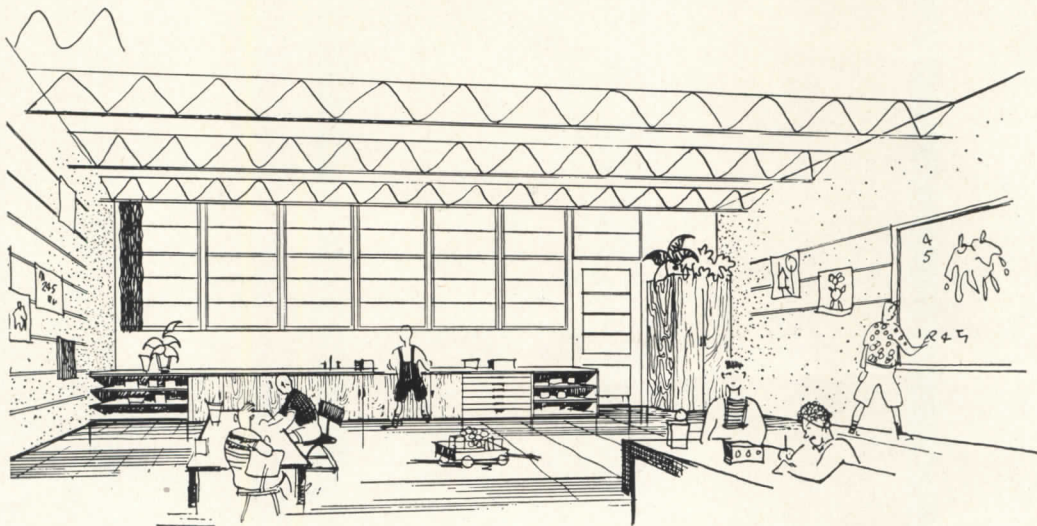
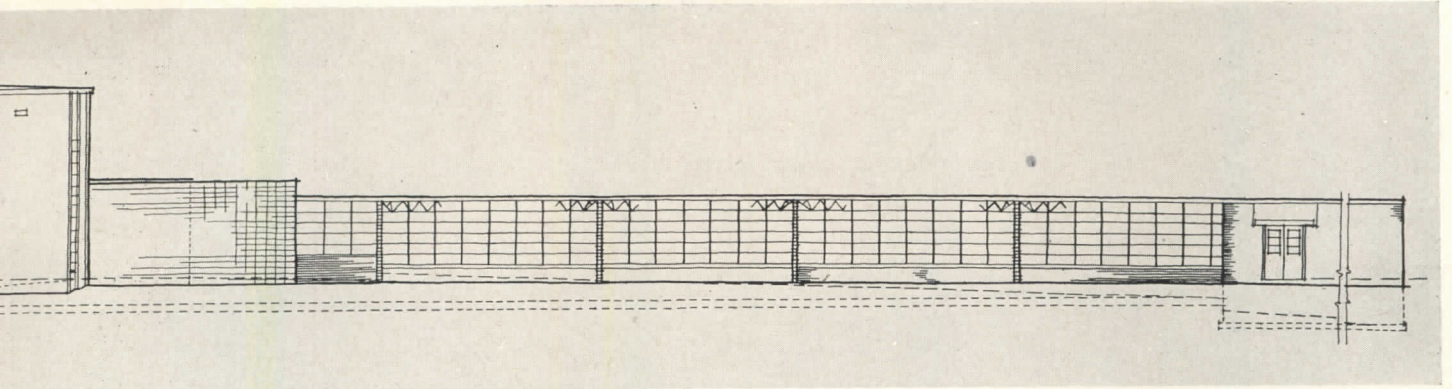

Perspective section through classroom wing, corridor at left

AIKEN COUNTY HIGH SCHOOL

There are two general science laboratories and one combination chemistry-physics-biology laboratory with adequate science material storage

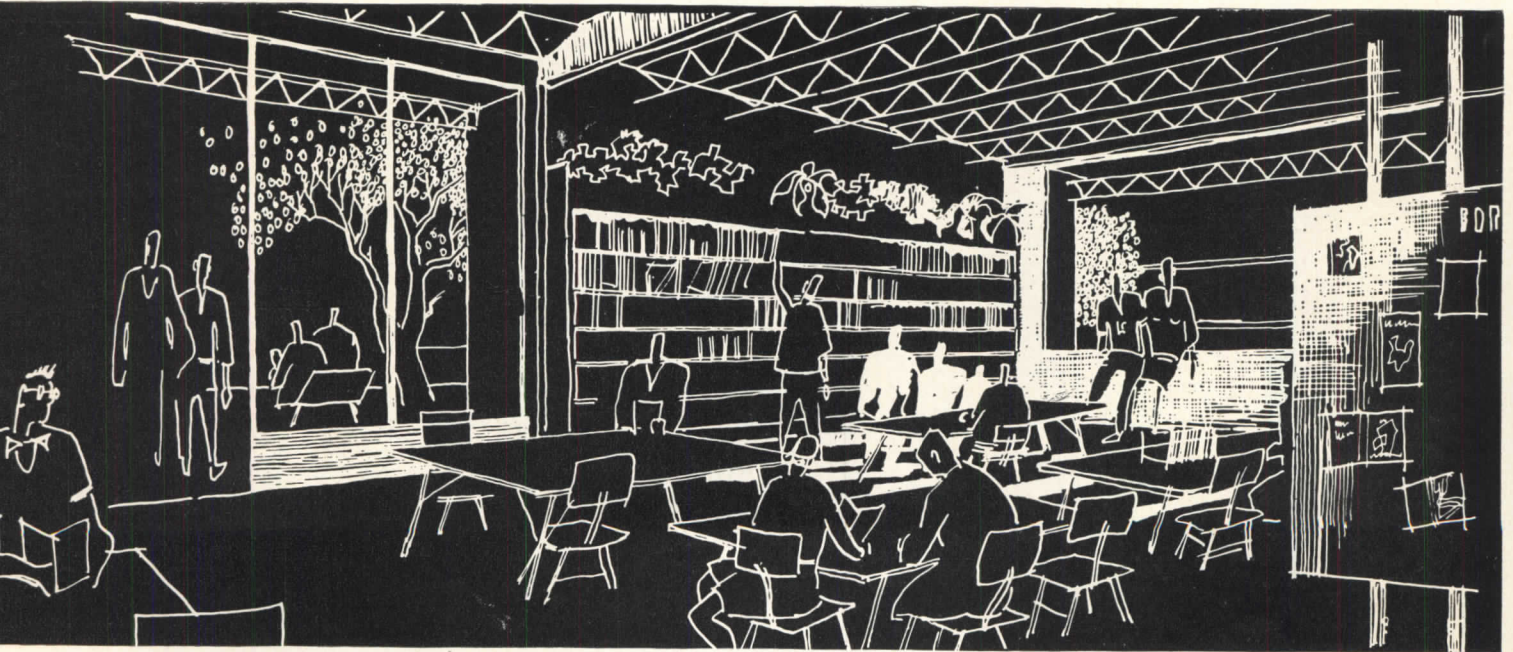
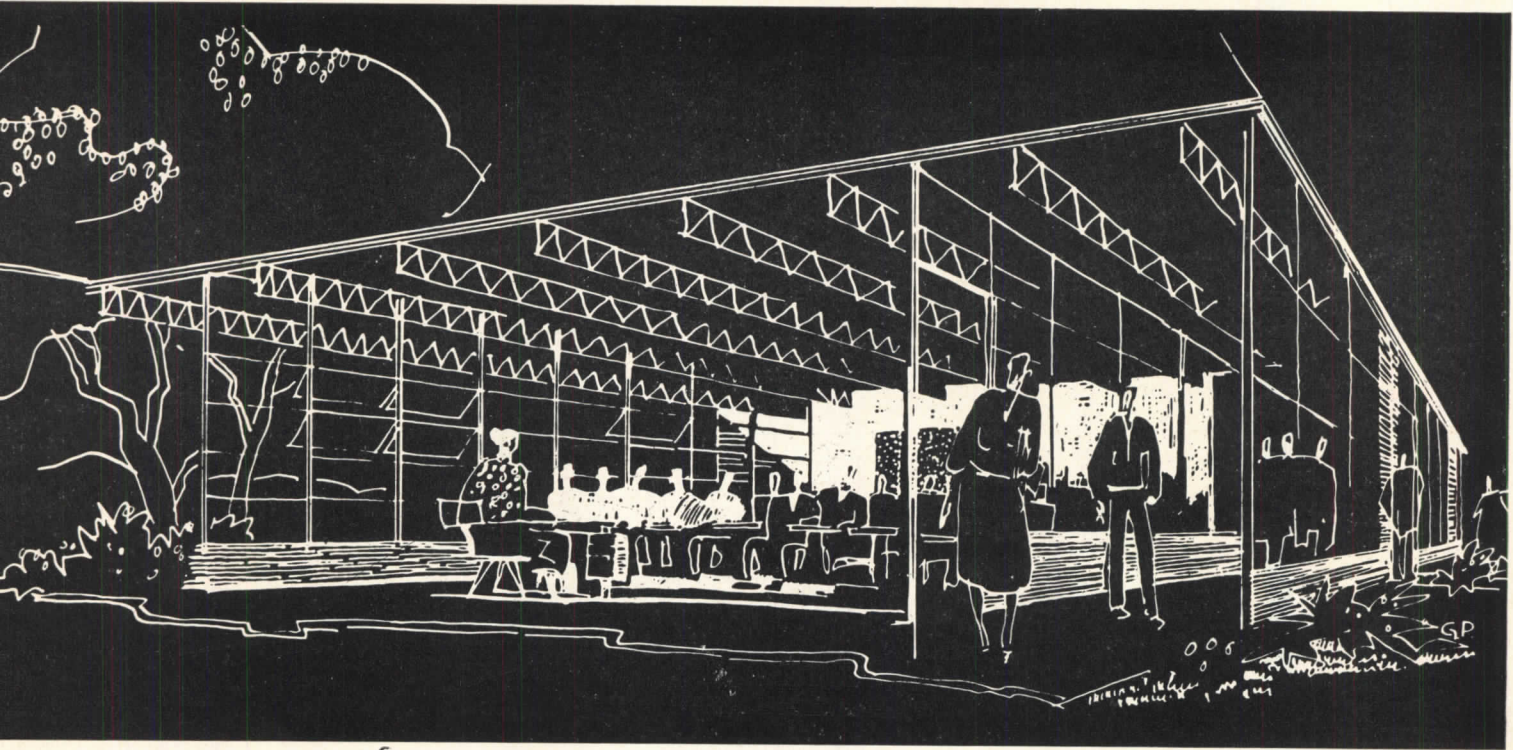

Library seats 75, has workroom for library and visual aids, a conference alcove for student use and connects directly to shaded outdoor area

Art classroom, at one end of auditorium unit, has its own outdoor area for working, exhibitions, etc. This also has ample storage space

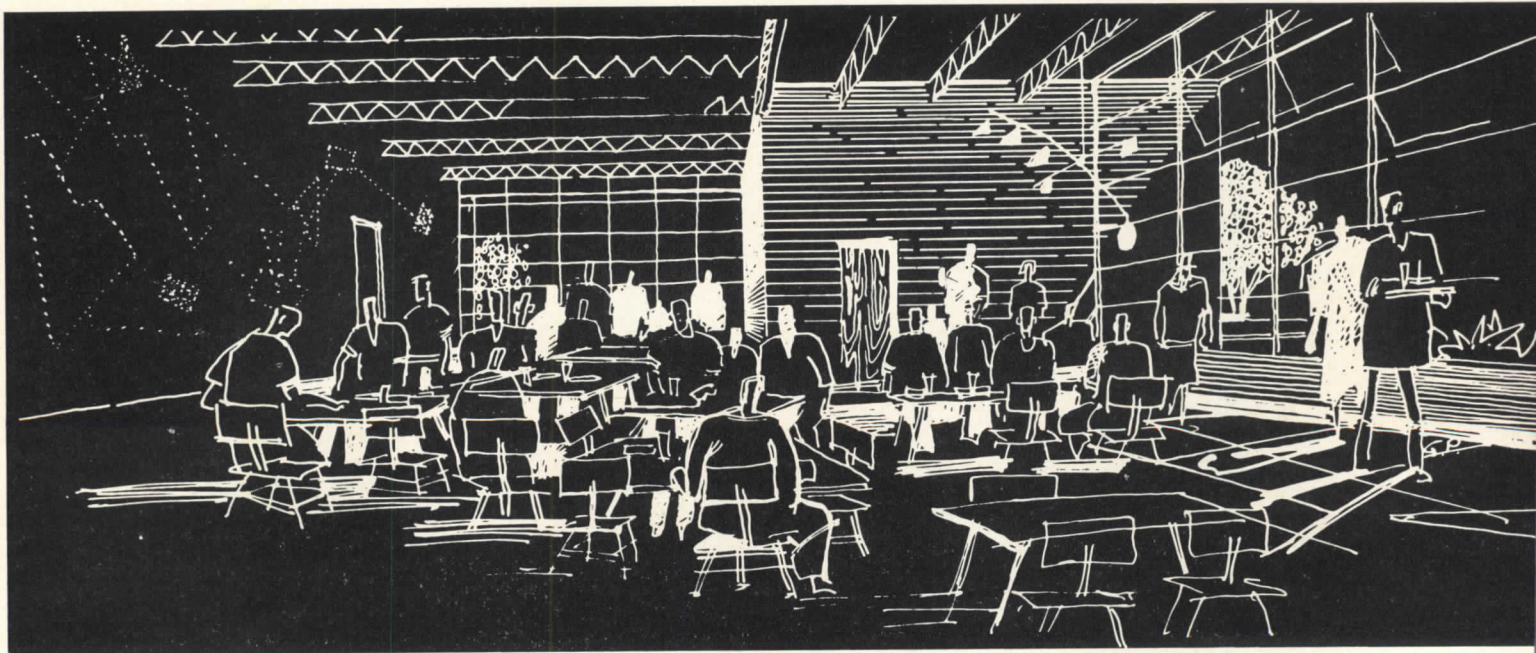
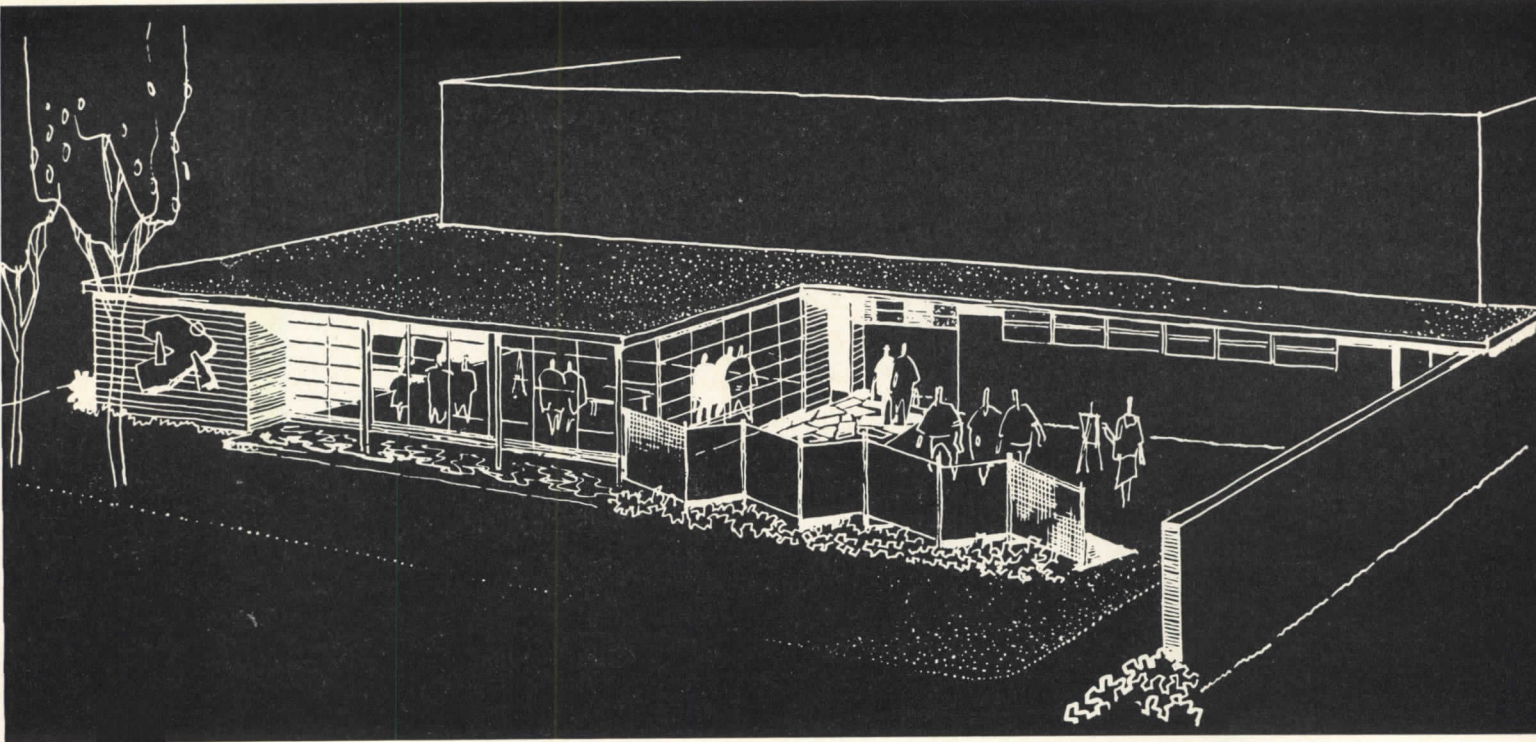

Cafeteria serves also as student social center, for group meetings, etc. Connected to outdoors, it is L-shaped rather than a barn-like large space





CENTURY ELECTRIC COMPANY, ST. LOUIS

Wm. B. Ittner, Inc., Architects & Engineers

THIS manufacturing plant faces the old Union Station across Aloe Memorial Plaza on St. Louis' Market Street. Focal point of the plaza is Carl Milles' fountain with its graceful figures and soft play of water. The juxtaposing of fountain and industrial plant sets up an interesting contrast between the lithe forms of the sculpture and the disciplined lines of the building.

The factory as we now see it was built in two stages: first a one-story plant designed to support seven more floors — three years later the present structure built about and above the original one. The lot was formerly a pond and presented problems in the design of the footings.

The program called for a large clear factory area for light manufacturing served by passenger and freight

elevators. Such a plant is suitable for multi-story construction in a downtown area since it presents no health hazards or public nuisance. The top five floors are at a common level throughout, but due to the loading dock and freight handling facilities on the side street, there is a stagger in level here which results in a building seven stories on the plaza and eight stories on the side street. Atop the roof is a large, glass enclosed all-purpose room suitable for worker-management meetings, film projection and recreation. This room opens to a terrace affording a pleasant view of the city.

Structure is a reinforced concrete frame with concrete rib tile floor construction. *The exterior is faced with terra cotta in dark green and cream color. Exterior trim is satin finish aluminum throughout.*

Horizontal sunshades on west façade (right) are 3 ft 6 in. concrete extensions of the floor slabs. Top surface is lead covered — bottom is concrete in coffered form. Vertical strip of glass block lights the main stair of the building.

Plan of typical floor (below) shows open area for light manufacturing. Shading indicates circulation and connection with existing building adjacent, owned by the same company

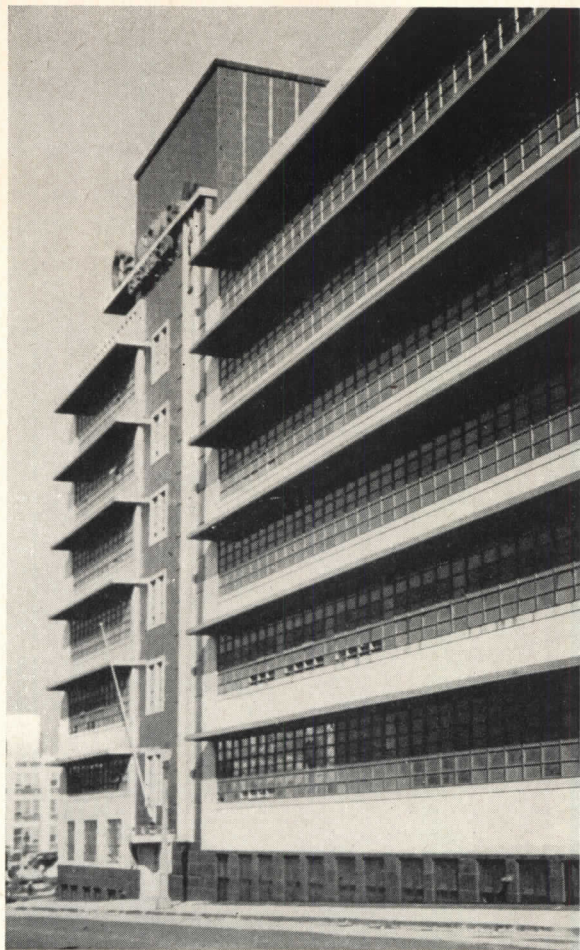

Lester C. Hoeckel

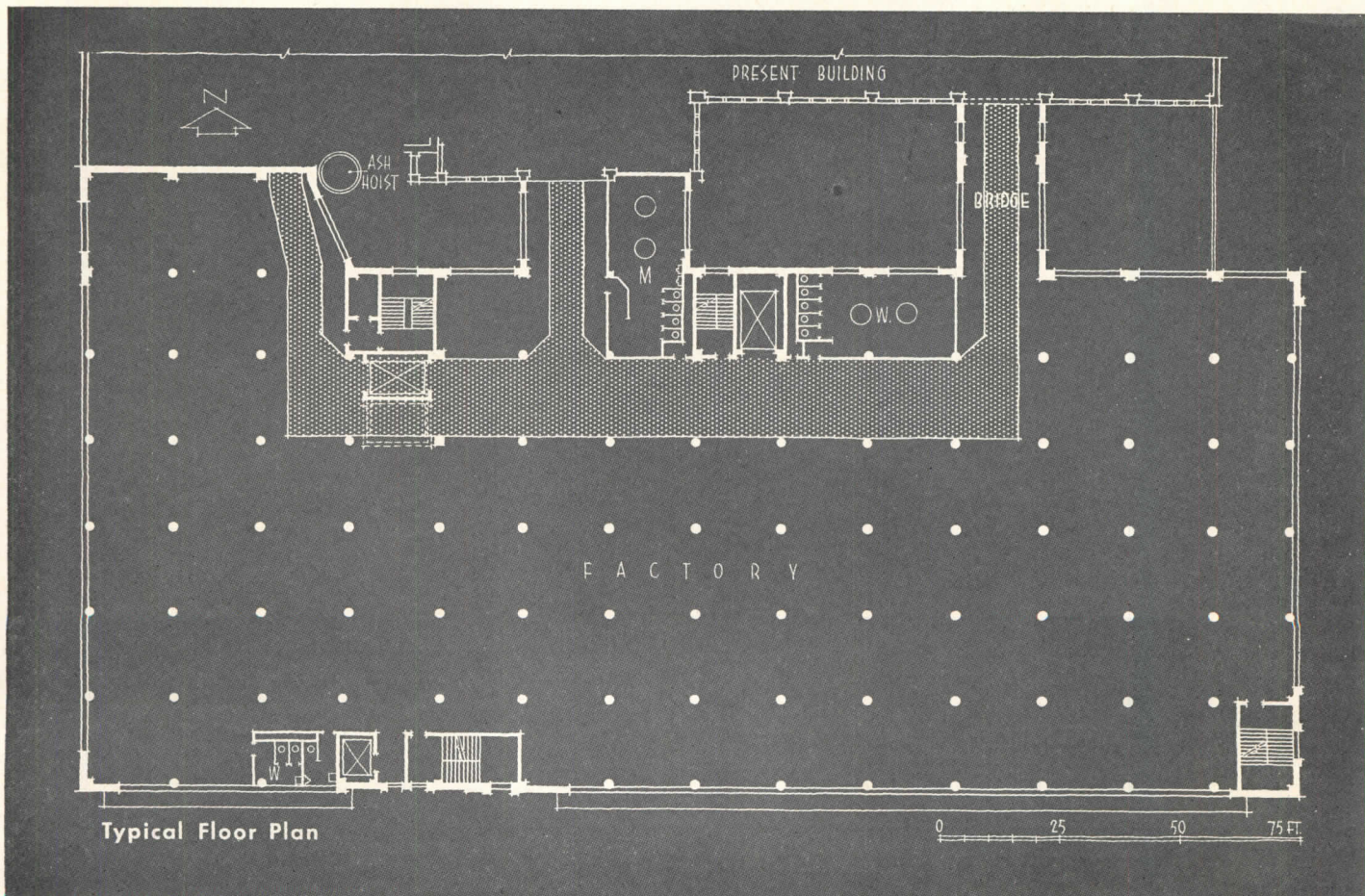



LOUISIANA WEEKEND HOUSE

Dr. and Mrs. Morris Shushan, Owners; Curtis & Davis, Architects

THE EXTREMELY ATMOSPHERIC SITE chosen for this weekend house in a northern suburb of New Orleans was a big factor in its final design. Careful orientation and a low roof pitch made it possible to preserve the

entire existing grove of beautiful old oaks. In keeping with its natural site, the house is constructed of wood frame, with the structure exposed where possible. Natural textures were used for all finishes.



Joseph W. Molitor

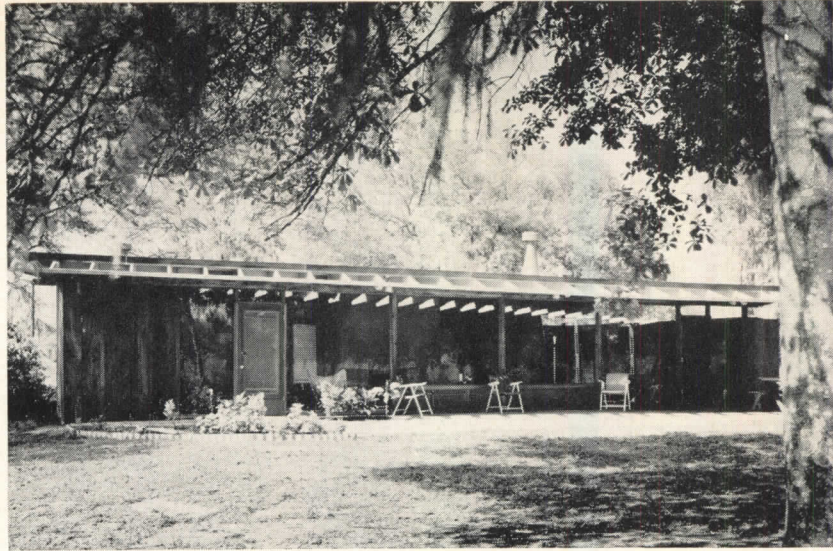

The openness of the plan and structure of the house is the result of the owner's request for as much spaciousness as possible in a limited area. The basic program called for one large room with a flexible arrangement and necessary facilities for entertaining. Although intended only for weekend use at present, the plan makes provision for the future addition of a bedroom by enclosing the covered terrace adjoining the bath. A mechanical room and insulated ducts are provided for future installation of air conditioning. Materials used include polished pecky cypress walls, flagstone floors, pine ceiling and glazed tile hearth.

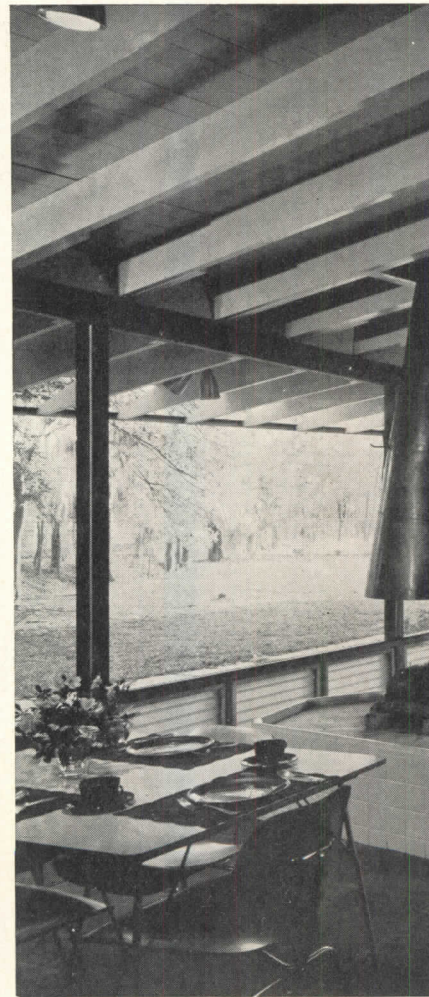
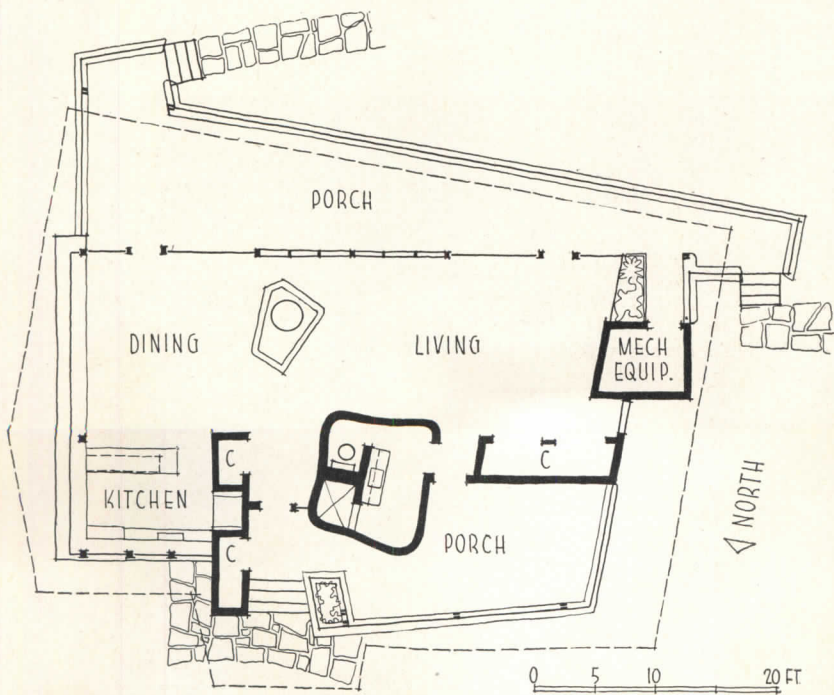

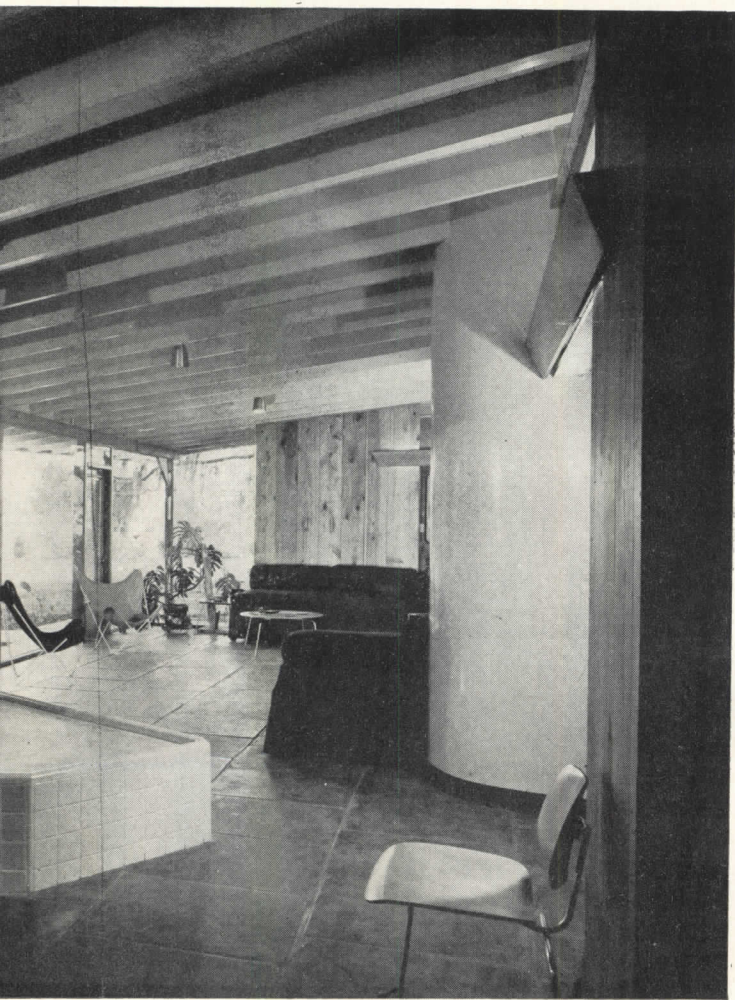
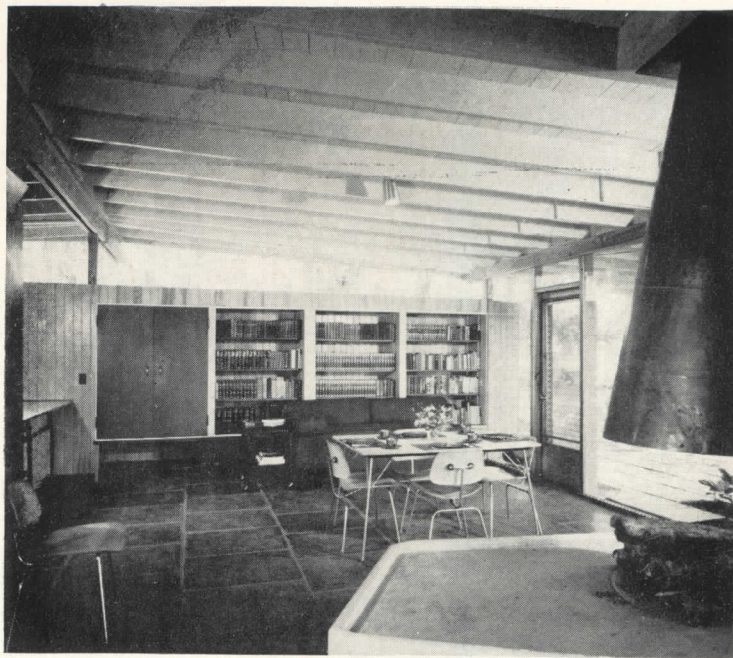
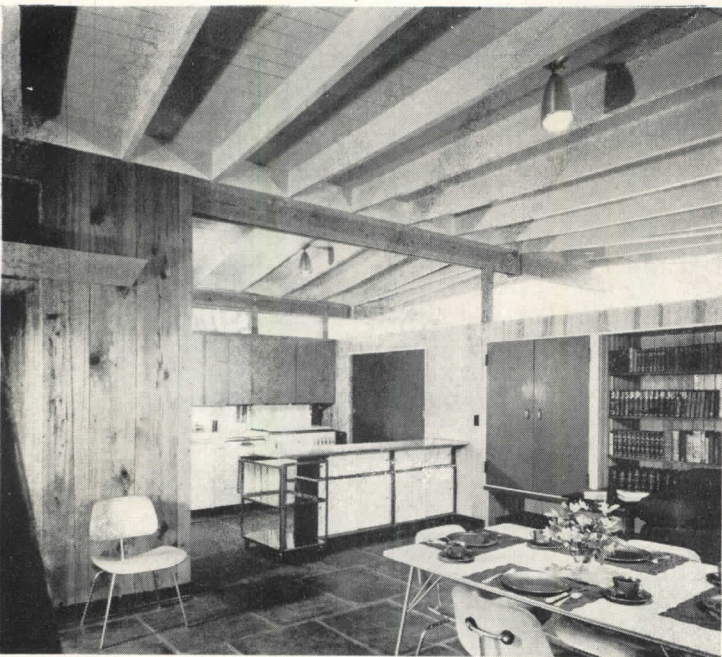

Fixed glazing in all rooms, except storage closets and bath, permits good views of oak grove, enlarges apparent area of house. Roof overhangs and trees shade glass; louvers on doors and below big windows give ventilation. The specially designed fireplace, shown in photo, left, and detail, below, has cone-shaped copper hood, raised hearth

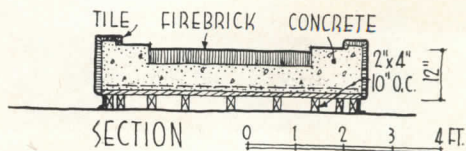
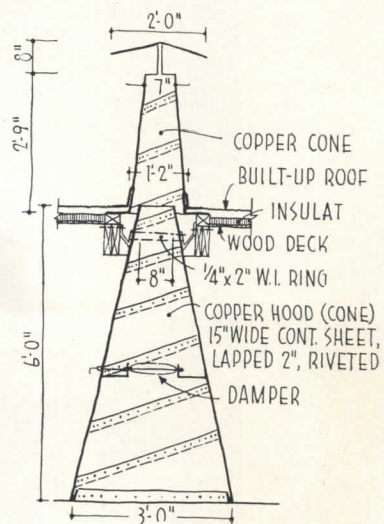

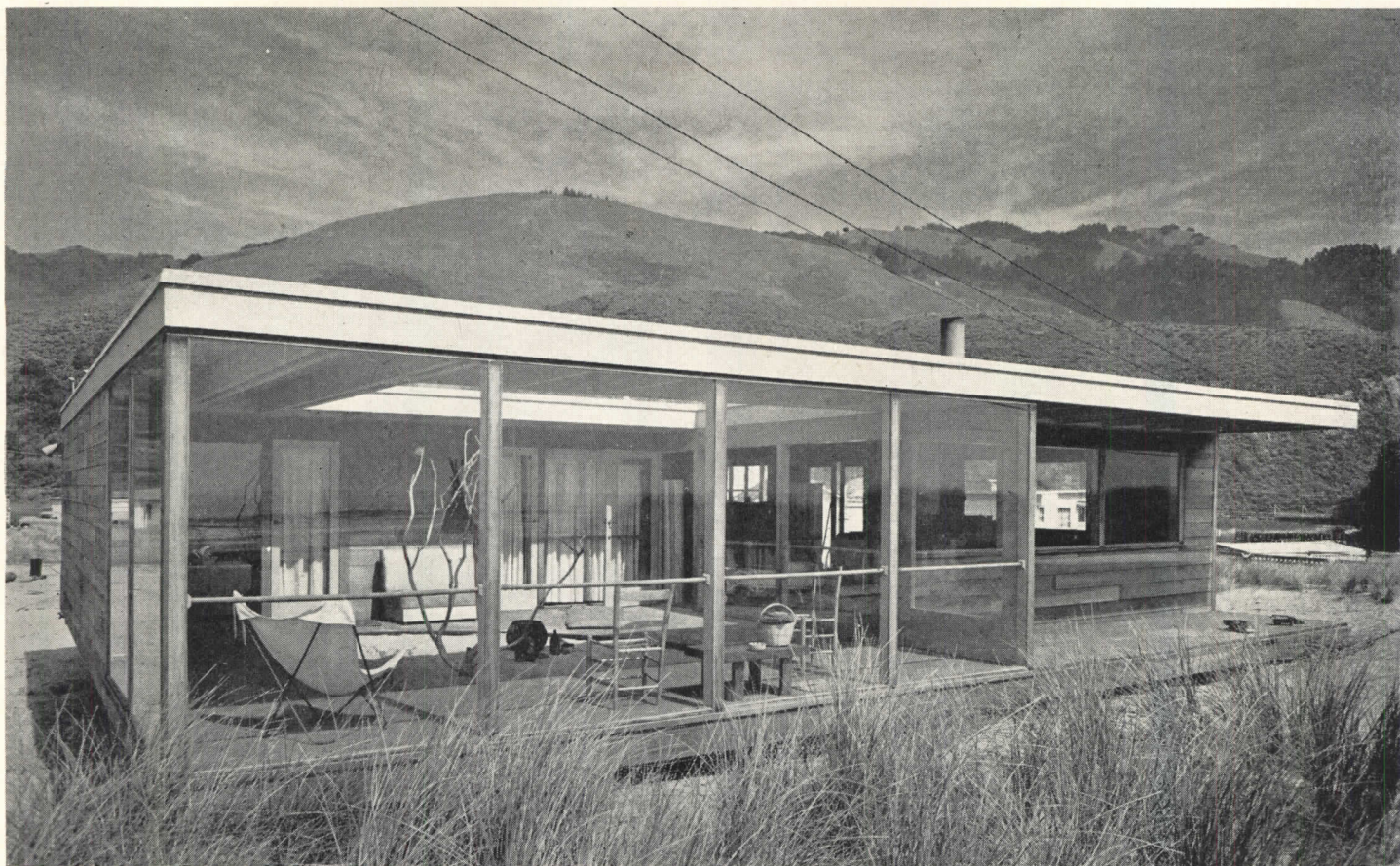

Roger Sturtevant

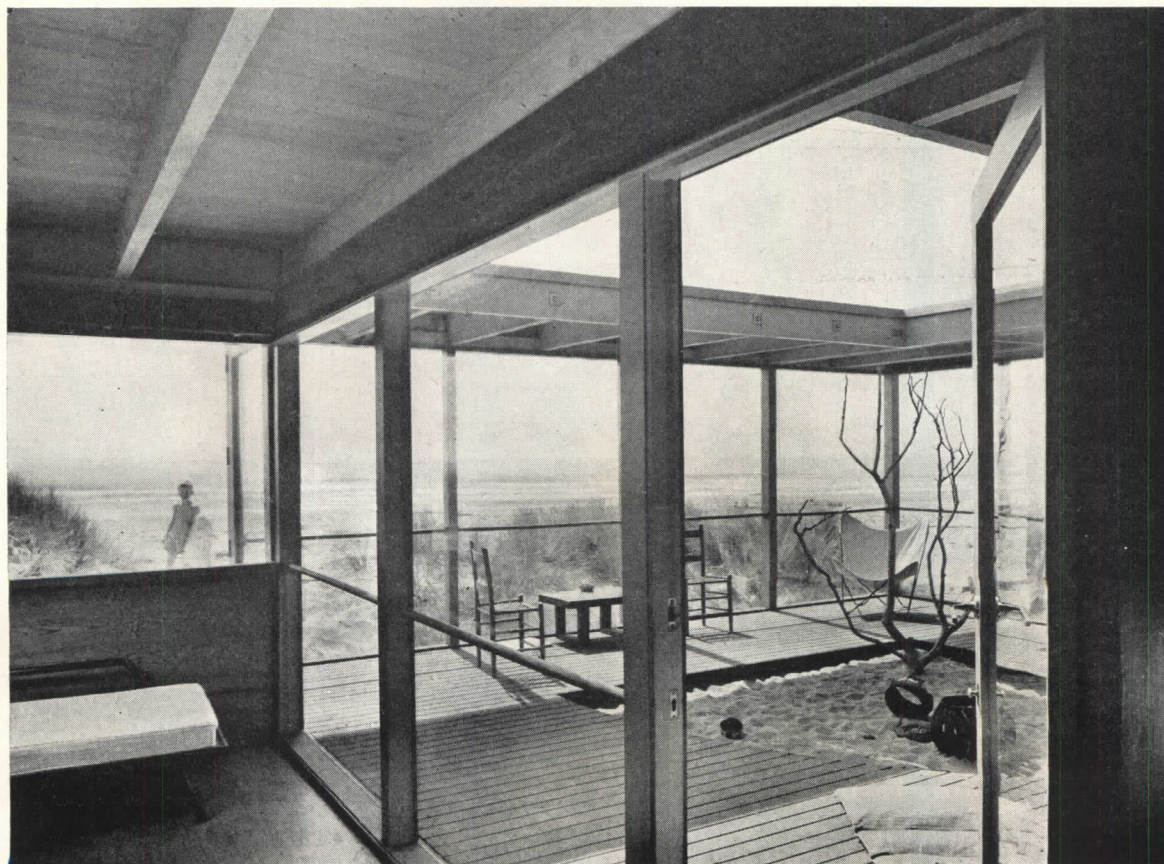

CALIFORNIA BEACH HOUSE

Stinson Beach, Marin County, Calif.

Mrs. Harry A. Yeazell, Owner

Francis Joseph McCarthy, Architect

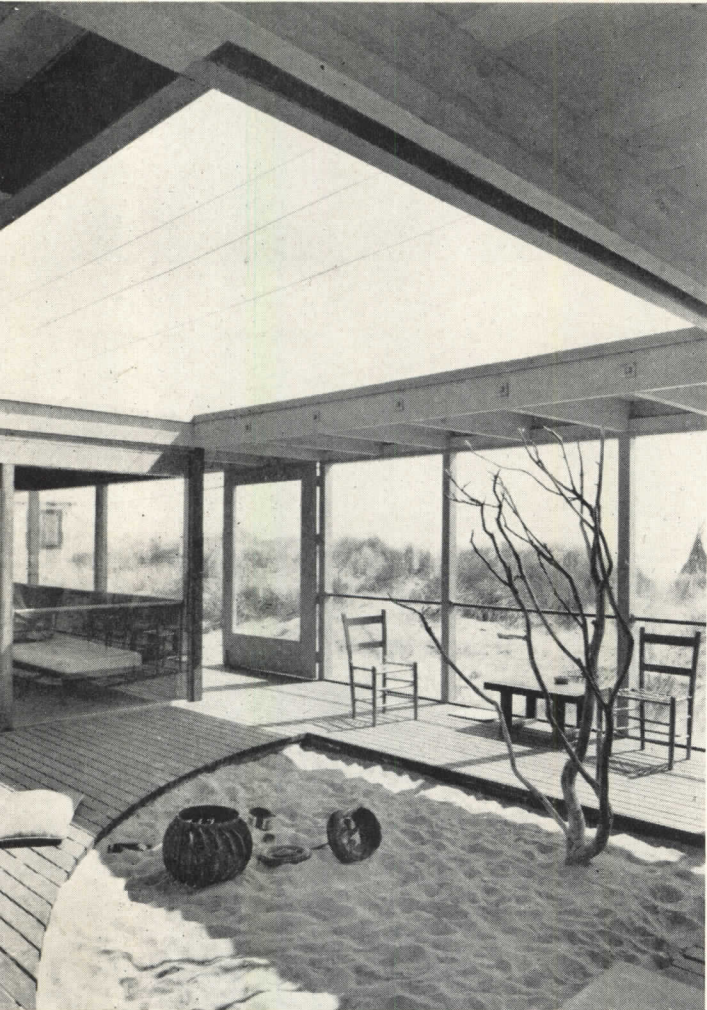

THIS simple, compact little house was designed for a grandmother who plans to rent it in the summer months to "inland vacationers". During the rest of the year, it will be used for weekend and winter vacations for herself, her children and grandchildren. The plan is basically one large all-purpose room, with two small bedrooms. Two daybeds in the living area double for sleeping. The glassed-in deck provides a sheltered place for sunbathing and for supervised play of the children. A small deck was provided outside the kitchen for outdoor meals.

The house is set on piles and girders several feet above the natural line of the sand dunes to avoid having to control the movement of the sand. Redwood was used for both interior and exterior walls, exposed ceiling beams and roof sheathing. The roof is tar and gravel. All interior floors are linoleum.

The partly open roof over the deck provides both sunny and shady areas for outdoor living. In winter, heat is provided by fireplace, portable electric heaters

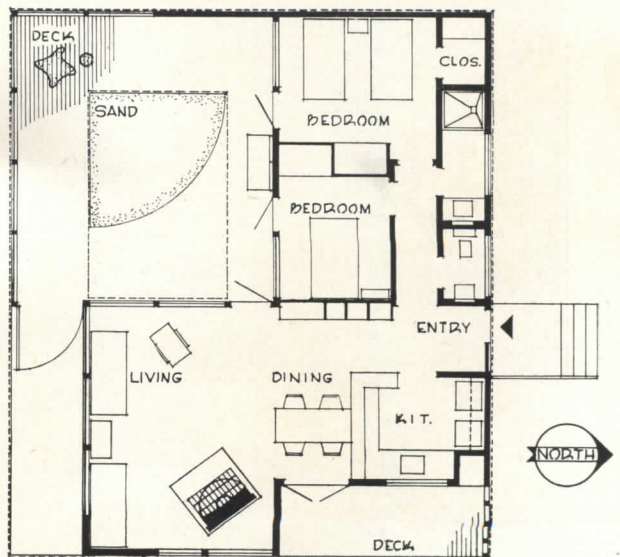
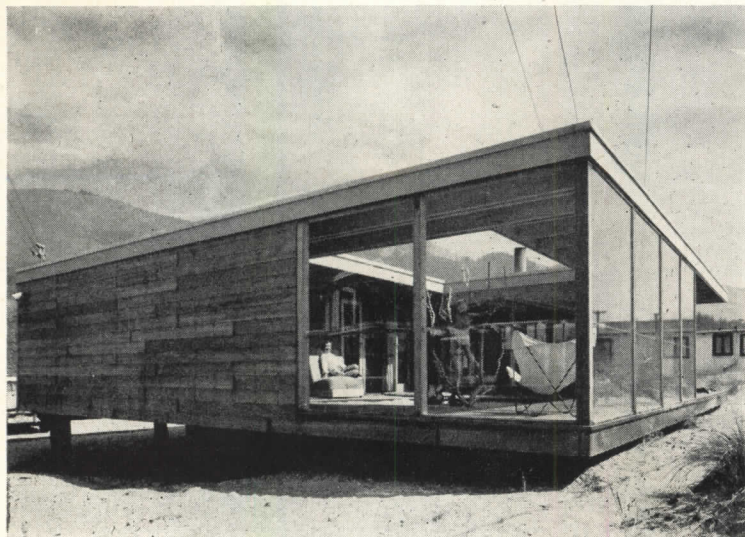

• PLAN •
SCALE 0 3 6 9 12



Roger Sturtevant

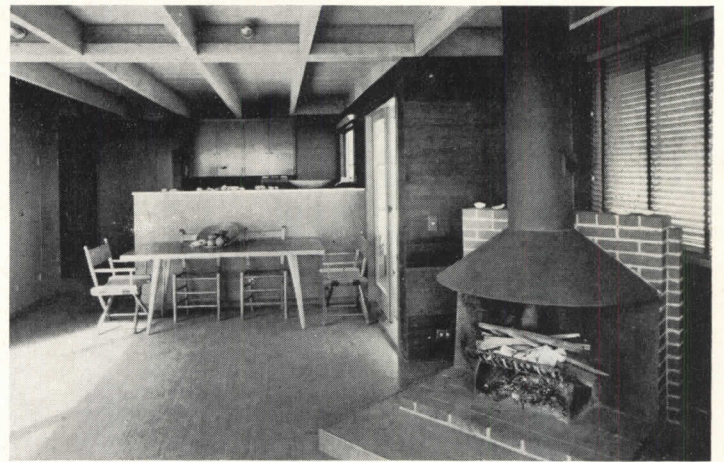
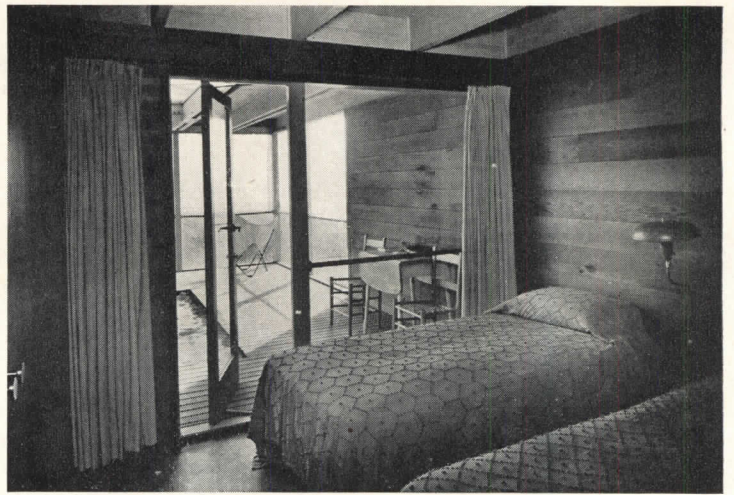

The plan and fenestration of the house were designed to give a sense of openness and good views across the dune grass to the sea, yet at the same time provide protection from winds and ocean glare

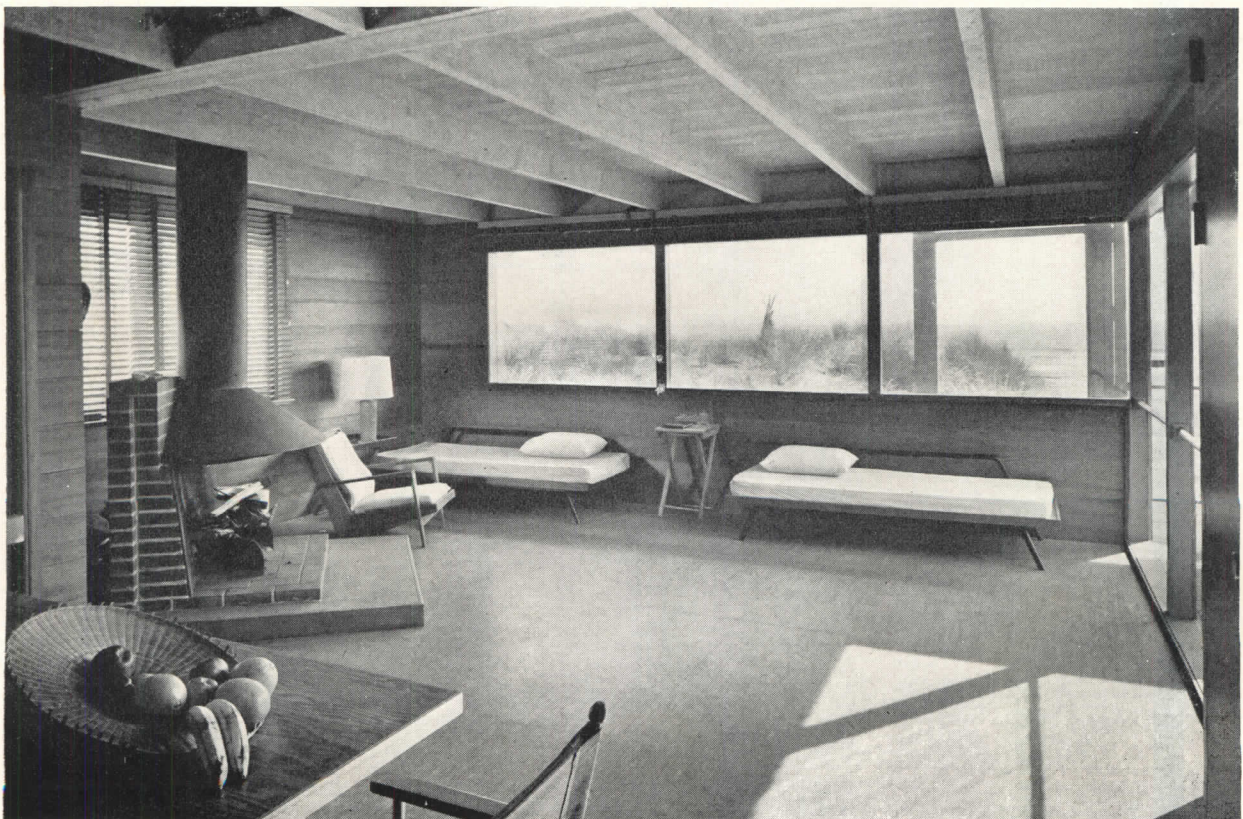



COUNTRY HOUSE ON LONG ISLAND

Residence for K. L. Rawson

Serge P. Petroff and Harvey P. Clarkson, Architects

THIS neatly designed country house, although intended for a somewhat more formal way of life than the two preceding houses as well as for year-round occupancy, still reflects much of the same spirit in its use of natural materials and open planning in its major living areas. Principal rooms are oriented to face the view afforded by the hilltop site and have exterior walls made mostly of glass. The front entrance of the house

is on the opposite side of the building and passes through a cloister-like patio formed by the guest room-library wing and the children's wing. This separation of sleeping quarters affords a great amount of privacy to each of the occupants. The patio itself may be opened out to the front lawn by raising a series of venetian blind panels in the enclosing wall. The house has natural-finished vertical siding, white trim.

Joseph W. Molitor

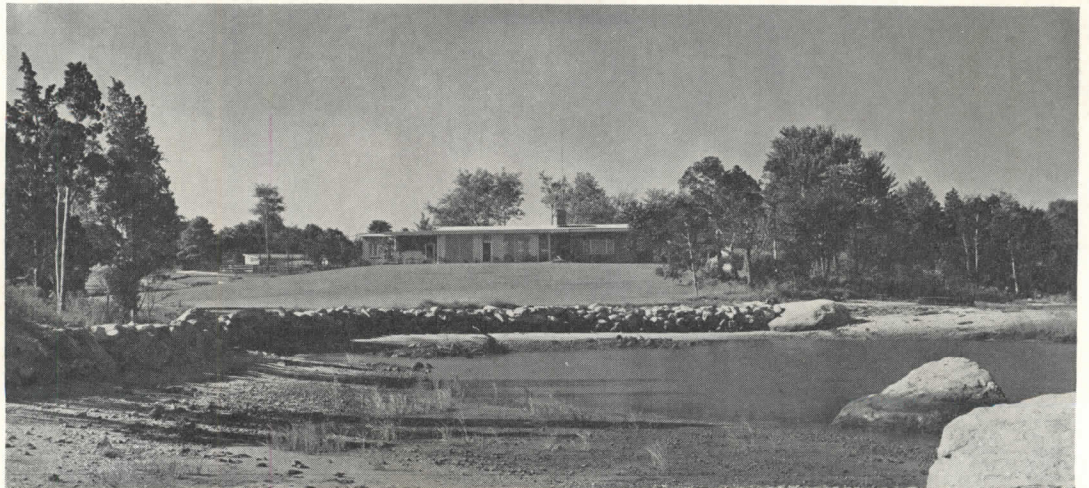

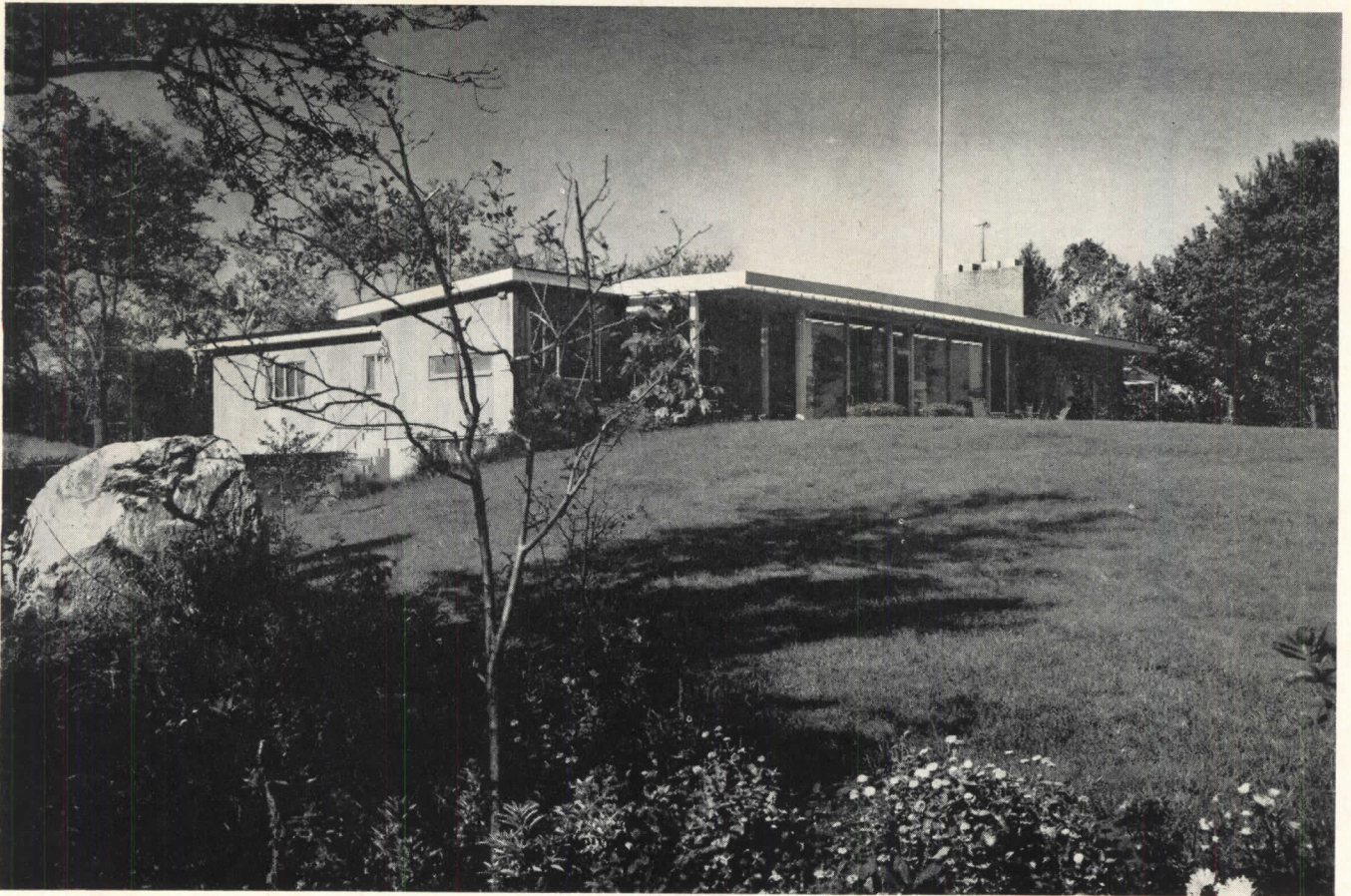

The U-shaped plan (below) has centralized living and service areas, flanked by three sleeping wings. Actual living space is extended by a sheltered terrace and a patio

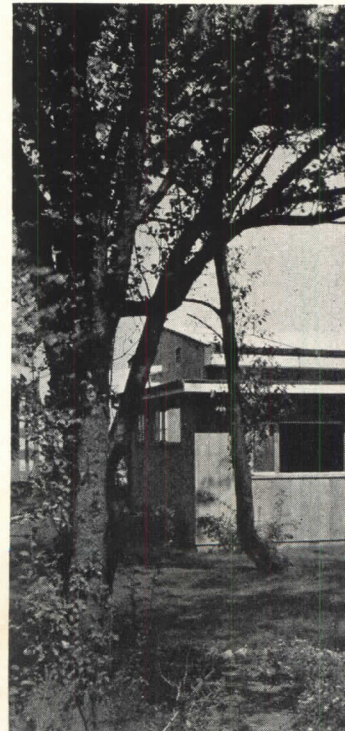
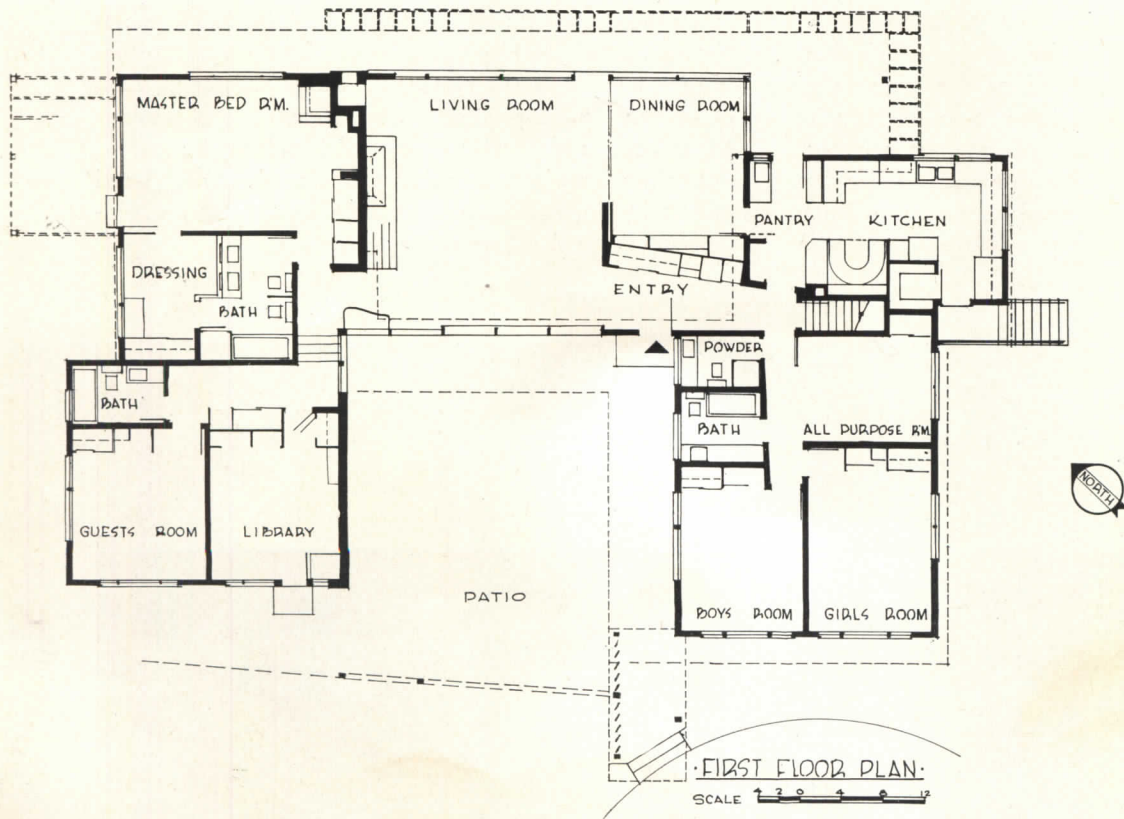

Joseph W. Molitor

Photos at far left and below, center show the north-east façade, with its covered terrace off the glass-walled living rooms. The kitchen also opens directly on the terrace to simplify service for outdoor dining

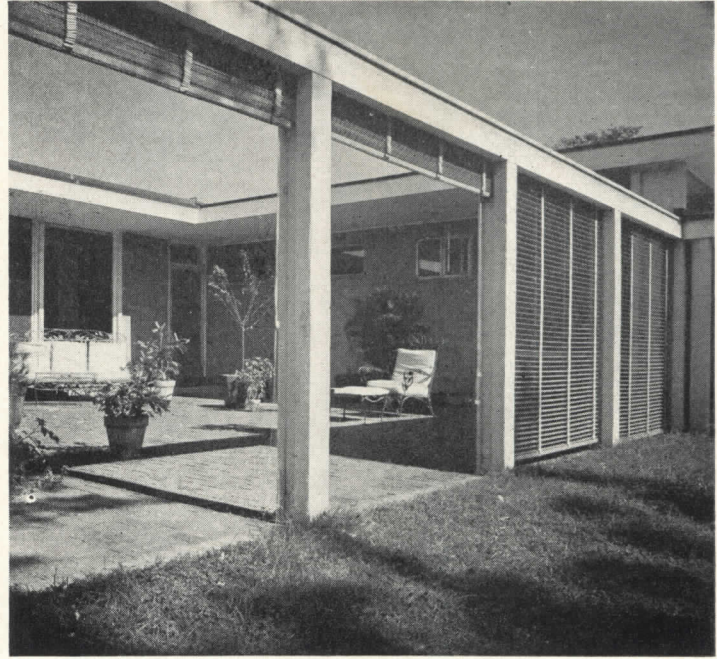

Privacy is gained for patio at front of house by venetian blinds hung on wood frame (above and below, left). Front entrance is shown directly below

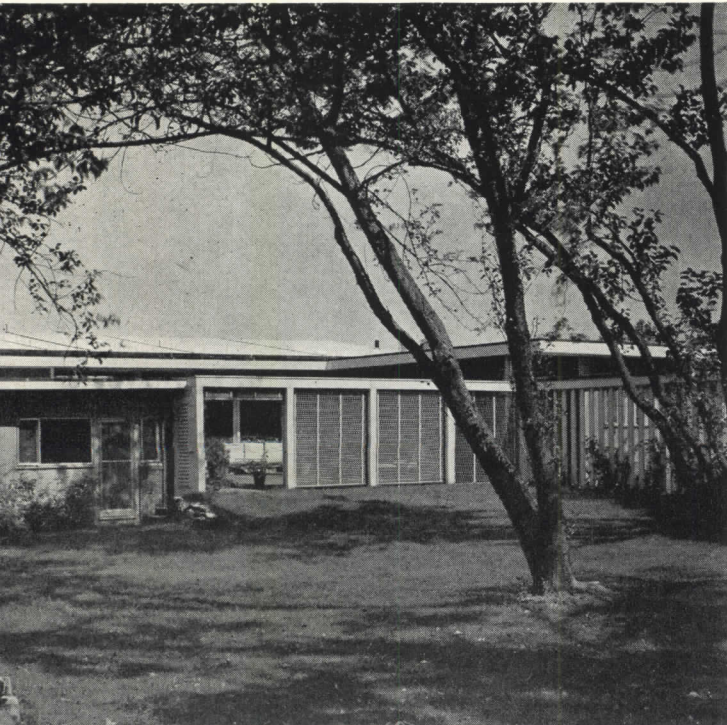



Joseph W. Molitor

The large living room (above) opens on both the terrace and the patio, is separated from dining area by folding partition. Study, guest room and master bedroom (below) open off corridor by fireplace wall





Well-equipped kitchen (right) opens directly to dining room and dining terrace, both of which are visible in the photo above

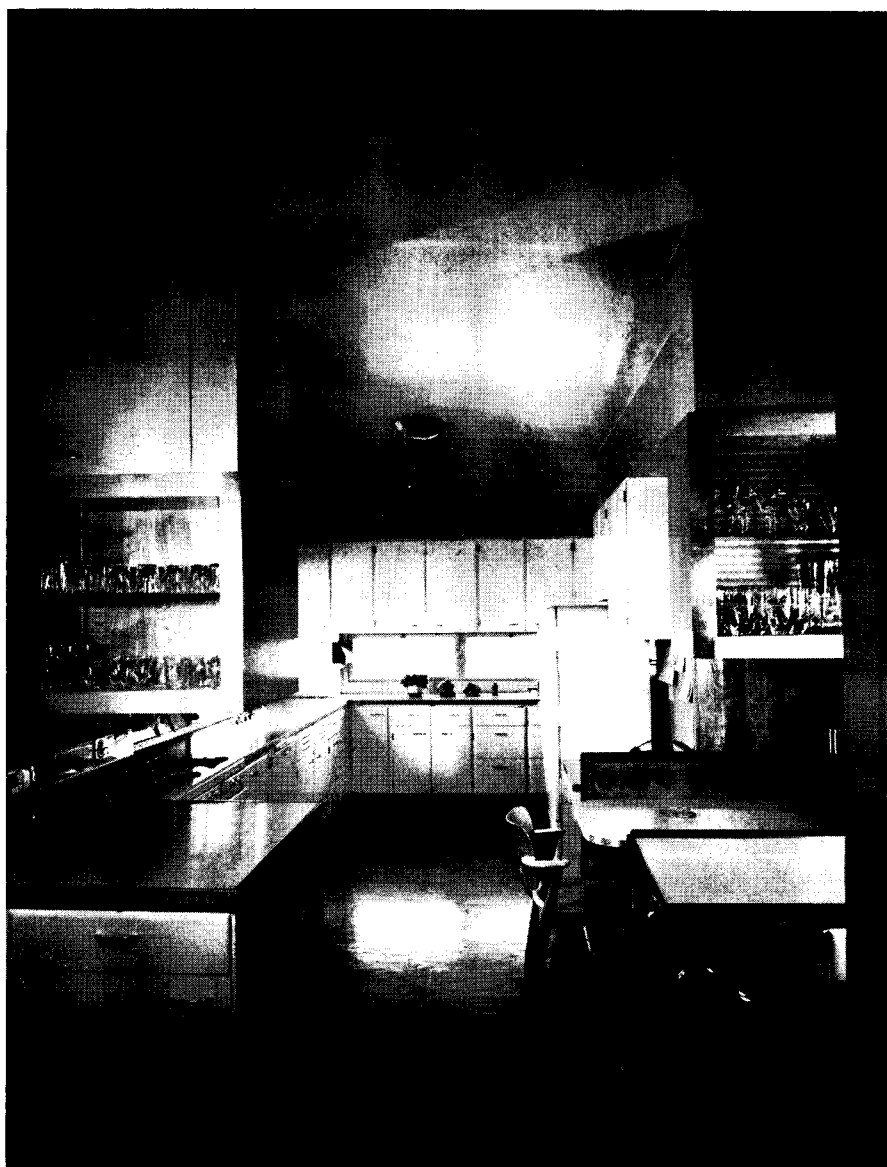

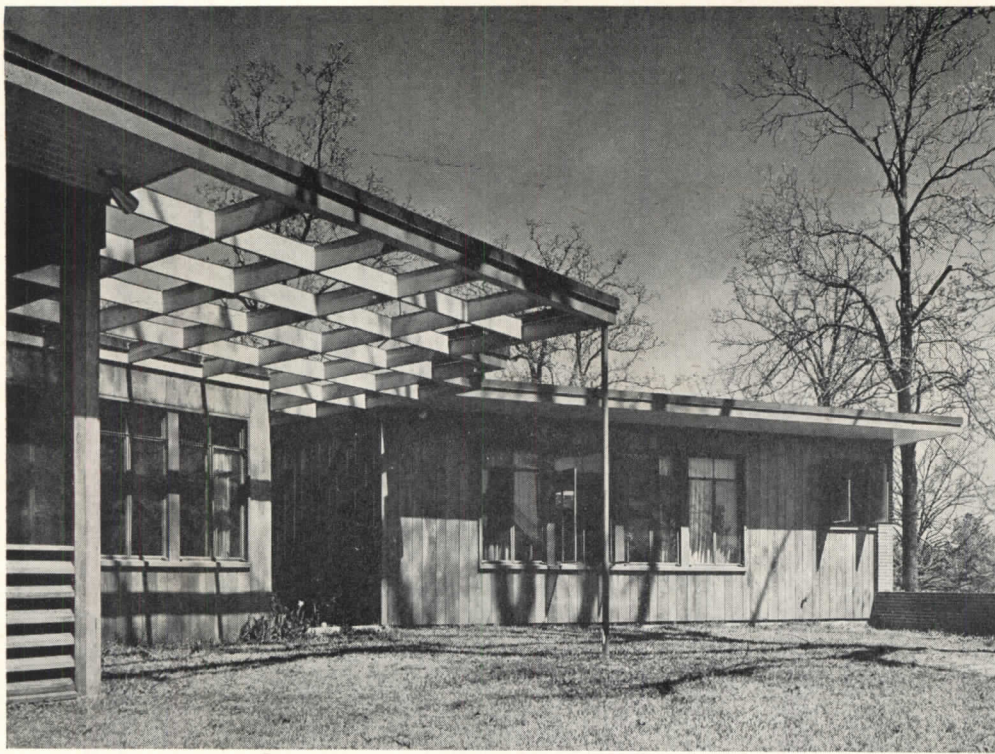

Joseph W. Molitor

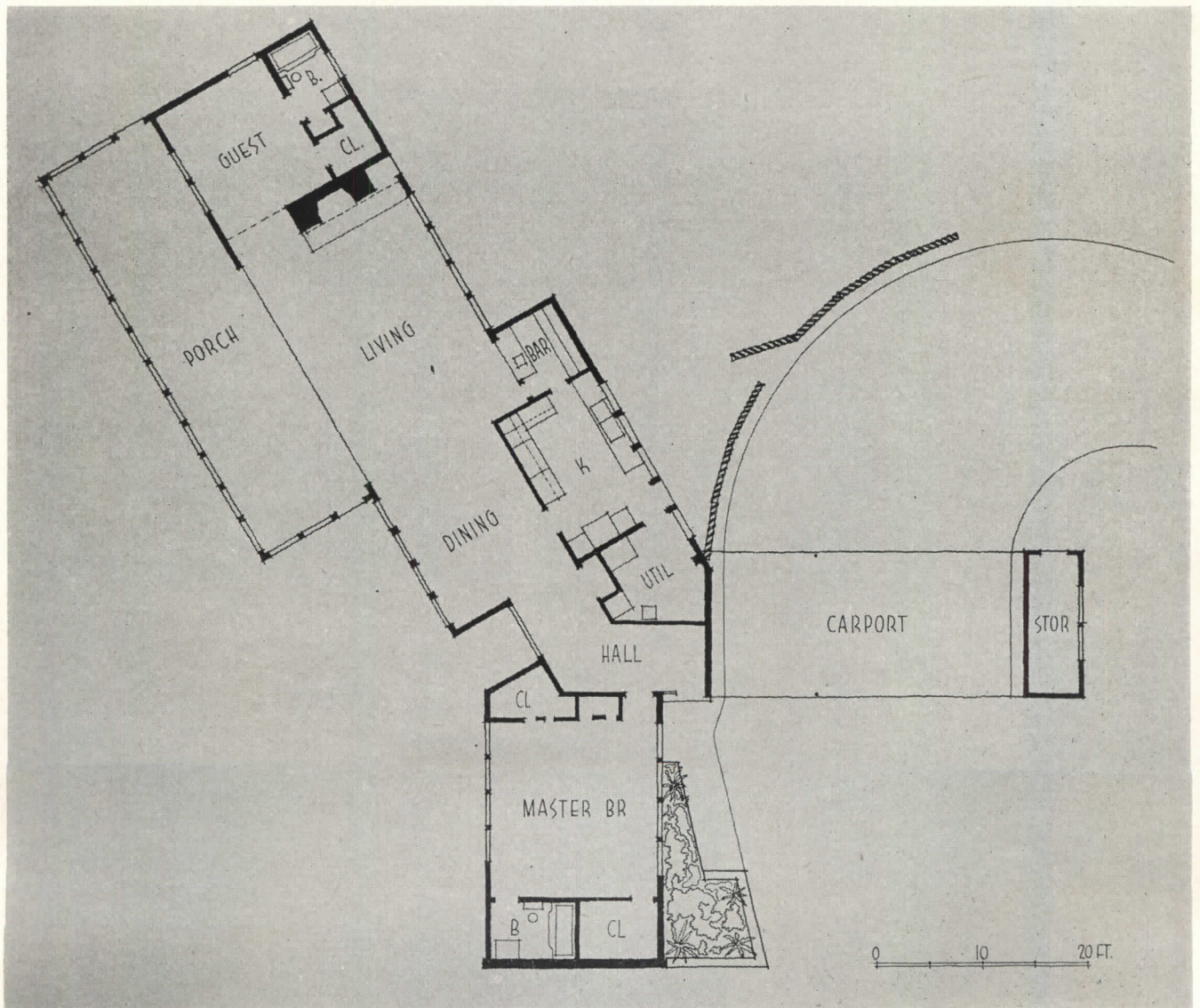

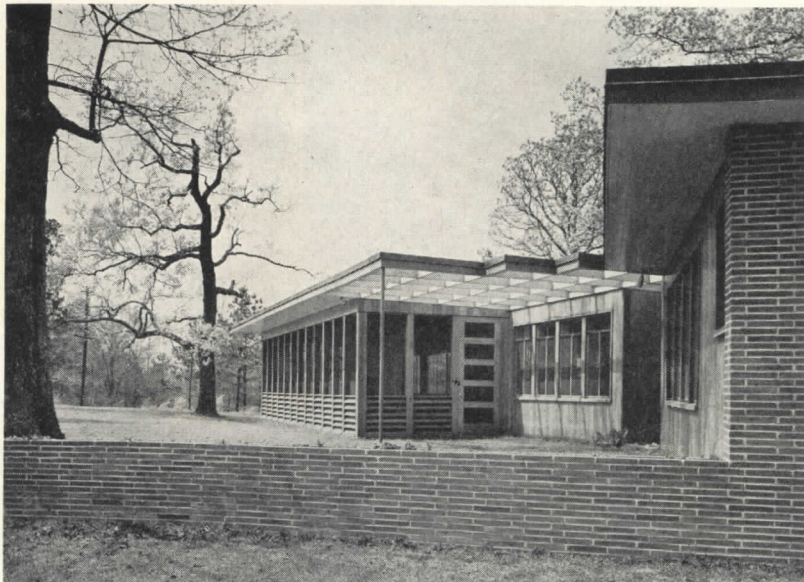

The house is oriented to eliminate glare of hot summer sun, has large screen porch on southeast

MISSISSIPPI HOUSE DESIGNED FOR HOSPITALITY

*Mr. and Mrs. George Harrison, Owners
James T. Canizaro, Architect*

SASSAFRAS SIDING, painted tidewater cypress trim, and a large screen porch combine to give a strong regional flavor to this Jackson, Miss. house. The natural finish siding is complemented by the use of a variety of colors for the trim: window trim is gray-green; open-square overhangs are a lighter green; overhang soffits are pale yellow; the roof is gray slag; and all the steel lally columns are a Chinese vermillion. The windowless

street façade and all garden walls are dark red roman brick, with recessed horizontal joints.

The plan of the house was arranged so that the living room, dining area, guest room and porch could be opened into a single area for entertaining. The bedroom-sitting room is separated from these rooms by the entrance hall. The entrance drive and carport were arranged to allow ample parking space for guests' cars.

Below, left: entrance drive, carport. Screen porch (below, right) has overhang, louvers to keep out rain

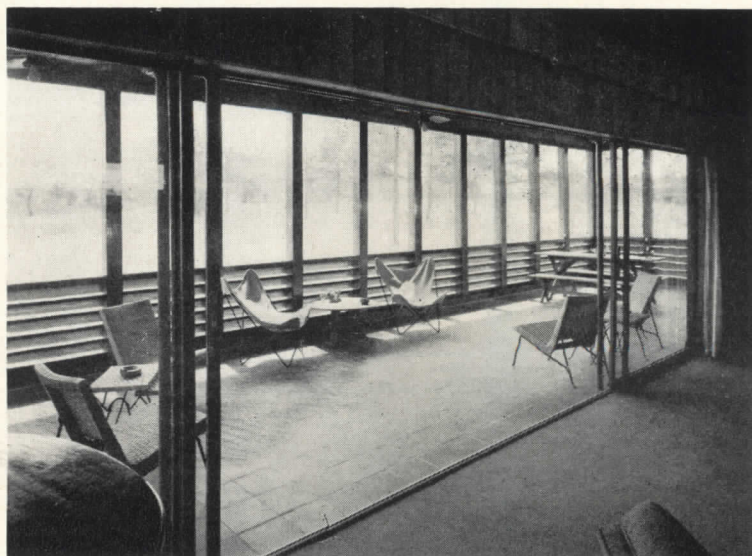
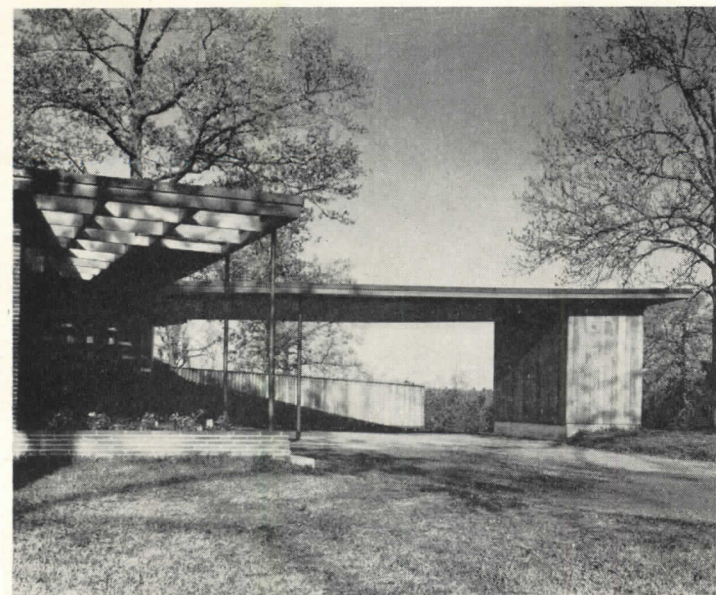

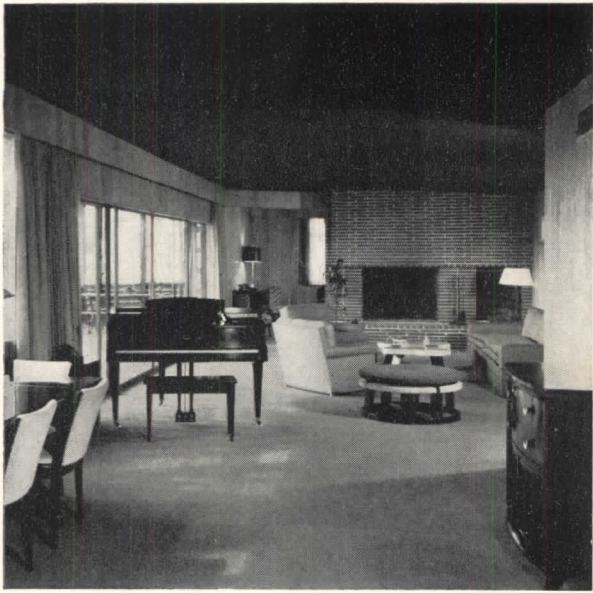

Interior walls of living room (above, left and below) and of entrance hall (above, right) are of natural finish ash. Ceilings are plaster, painted dark brown. Living room floors are wood covered with light green carpet; floors in the entry and on the screen porch are finished with quarry tile. The guest room can be separated from the living areas by a draw curtain

Joseph W. Molitor

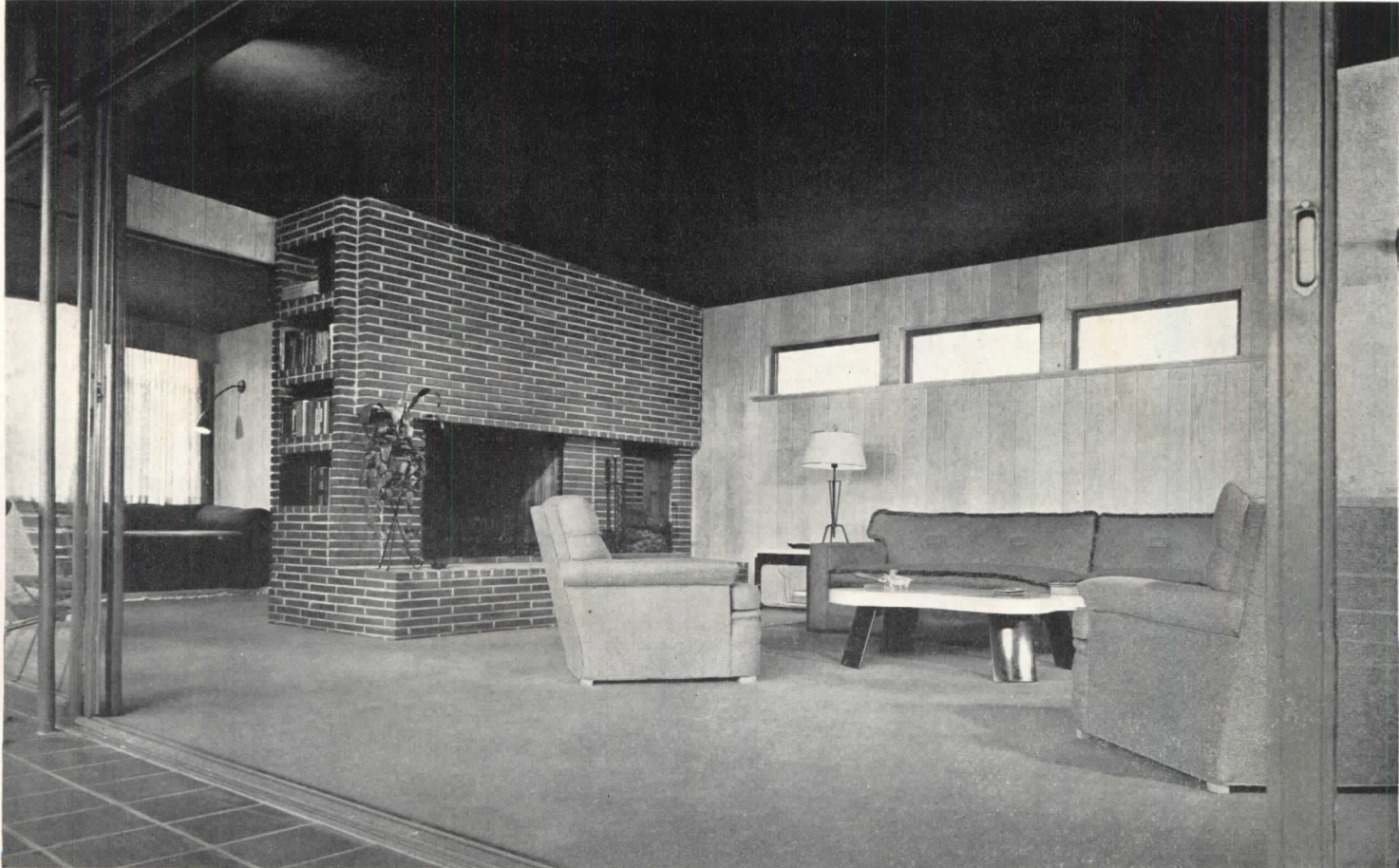

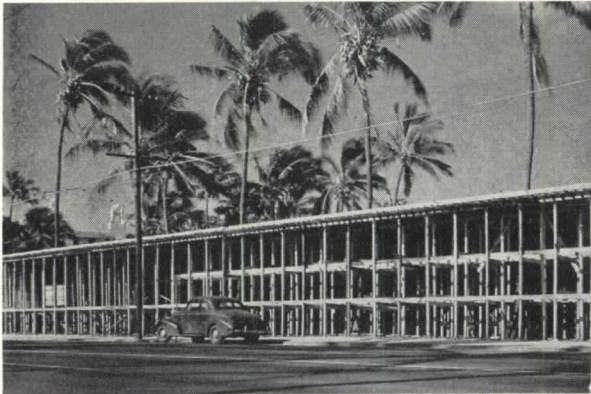
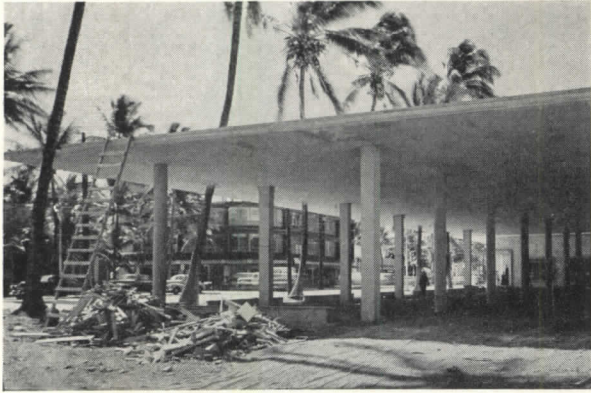

R. Wenkam



WAIKIKI BEACH SHOPS

Waikiki, Honolulu, Hawaii

Wimberly and Cook, Architects

COMPLETE SIMPLICITY in both plan and construction mark this new store building at Waikiki. When the project was started only two or three prospective tenants were interested, and maximum flexibility was called for to meet the needs of whatever tenants might eventually rent space. The site, on the grounds of the Royal Hawaiian Hotel, is 120 ft deep, with a 438-ft frontage on Kalakaua Avenue, one of Waikiki's main thoroughfares. Off-street parking was a must. Another requirement, stipulated in the property lease, was that the total height of the building be restricted to 30 ft.

To simplify financing, the building was designed as three identical units, each 136 ft long and 52 ft deep, which could be built one at a time, but which would

look like one continuous structure when completed. The three units also made it easier to follow the slight curve in the street and the slight drop in sidewalk elevation.

Each unit consists of six 22 ft 8 in. bays, suitable for use either singly or in combination. Ceilings are high enough to permit installation of mezzanines if desired. Flexibility is further stressed in the basic structure — a simple flat slab resting on three rows of seven columns each. Front walls are glass from floor to ceiling, rear walls concrete block, plastered. Dividing partitions are metal lath and plaster. A parking lot runs the full length of the building at the rear, reached by two 10-ft passages between units.

WAIKIKI BEACH SHOPS

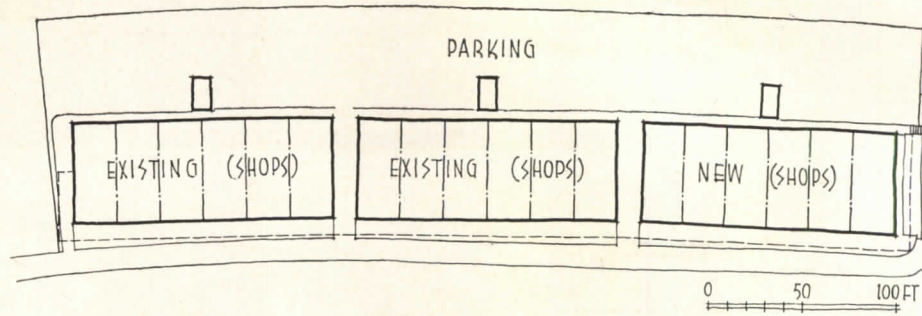

The three units are tied together chiefly by continuous concrete overhang. Tenants who leased space before building was finished had privilege of taking allowance for basic design to apply to cost of shop designed especially for their own requirements; McNerny's, in first building (above, right and opposite), had special front using a native sandstone

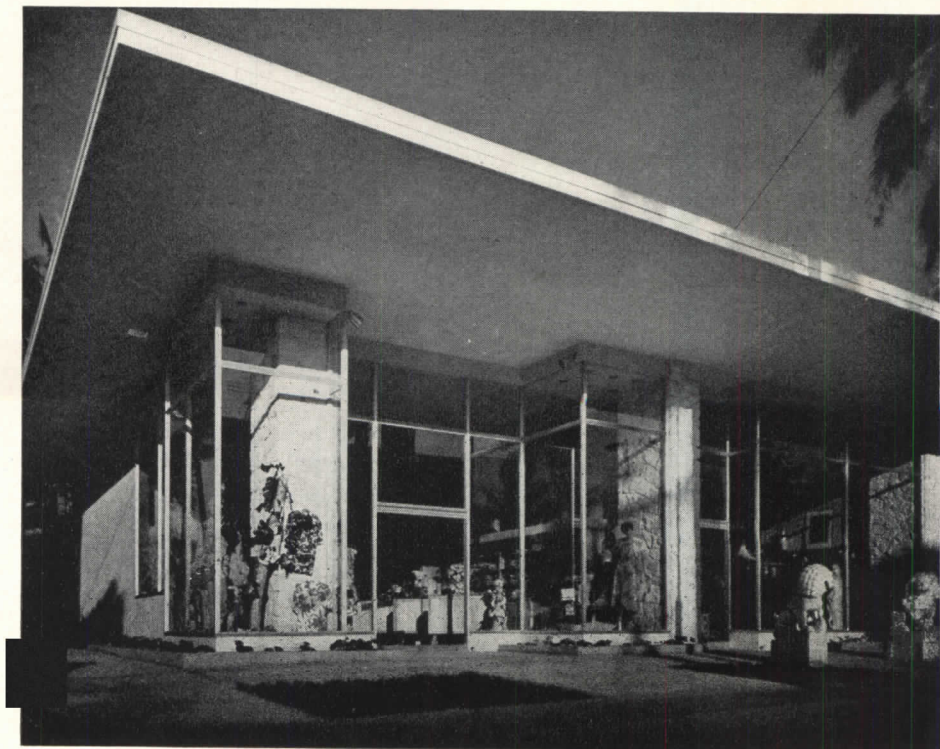

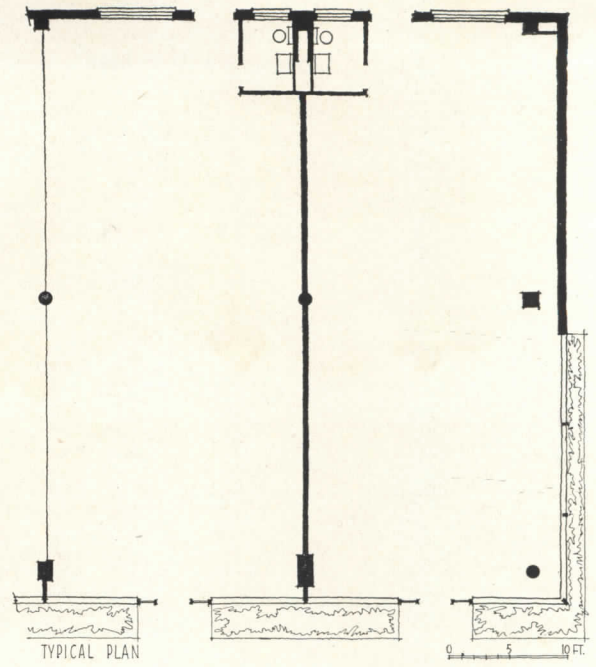

Above: typical interior and corner shops. In latter, street half of end walls is glass from floor to ceiling, rear half is concrete block, plastered

R. Wenkam



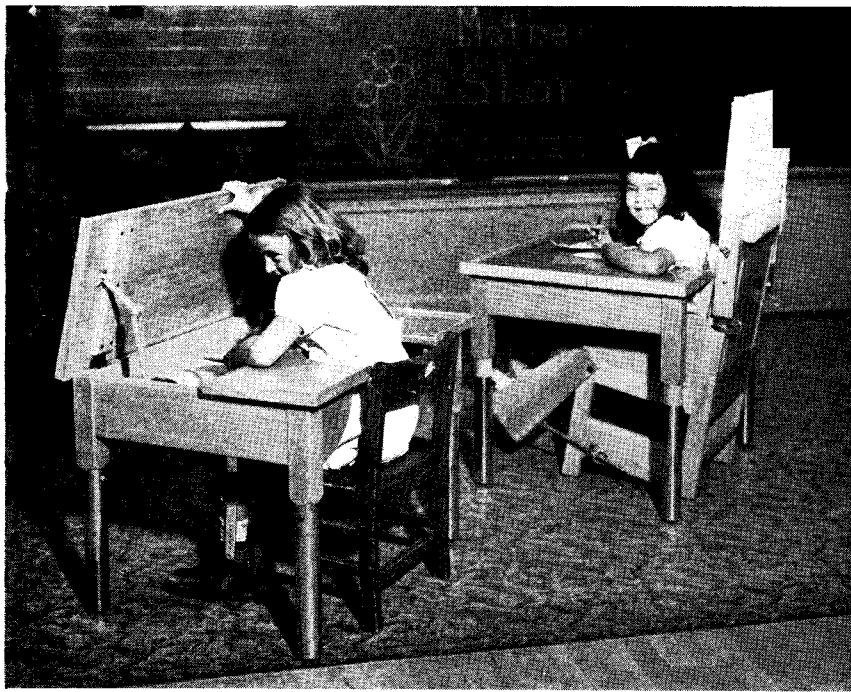

SUNSHINE SCHOOL FOR THE CEREBRAL PALSID

Fresno, Calif.

*David H. Horn and M. D. Mortland,
Architects*

*Clinton C. Ternstrom, Associate
Architect*

Home instruction or "borrowed" classrooms — makeshifts like the furniture above — were formerly the lot of Fresno County's cerebral palsied children. Now they have their own facilities — below and following pages — specially designed for them

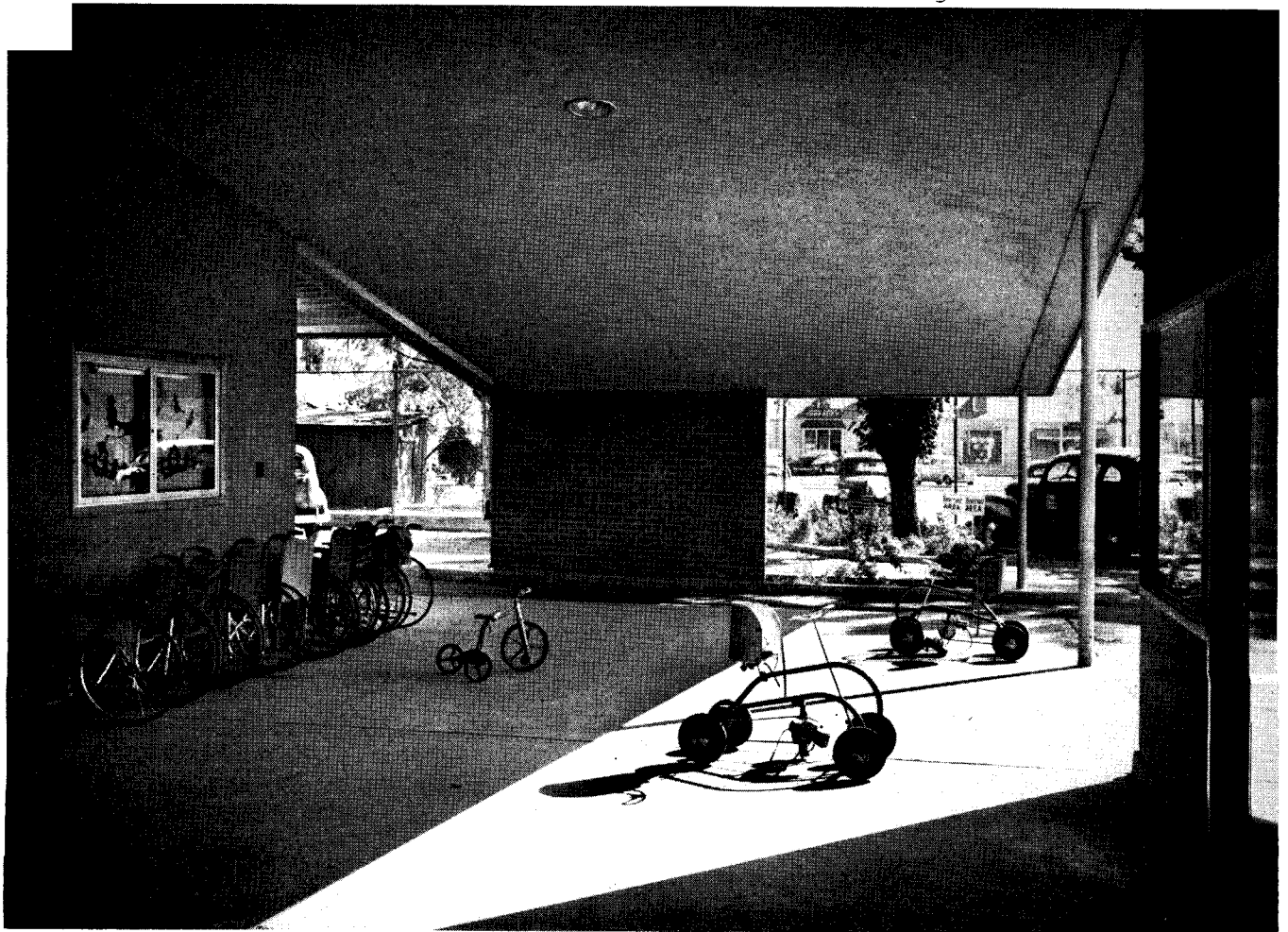

IT WAS ONLY FIVE YEARS AGO that the city of Fresno, Calif., started its program for cerebral palsied children. The first class was organized in April 1947 with eight children, one teacher and a part-time physical therapist, meeting in a single room in an elementary school. In 1948 larger quarters were assigned, ten more children were enrolled, and the staff was increased to two teachers, two physical therapists and two matrons. The amazing growth of the school made it obvious that the program deserved its own permanent home, and work was started in the fall of 1949 on a building especially designed to meet the needs of the

handicapped youngsters. Children and staff moved into the new Sunshine School in February 1950.

The architects of the new building had many a problem to solve before the plans were completed. After visiting and investigating all similar schools in central California, they drew up a long list of requirements:

1. *Space* — and plenty of it — for the special equipment, much of it on wheels, needed by the children as they move about.

2. *Only one level throughout*, with no stairs to impede the progress of the children, many of whom are dependent on wheel chairs or other wheeled vehicles.

(Text continued on page 159)

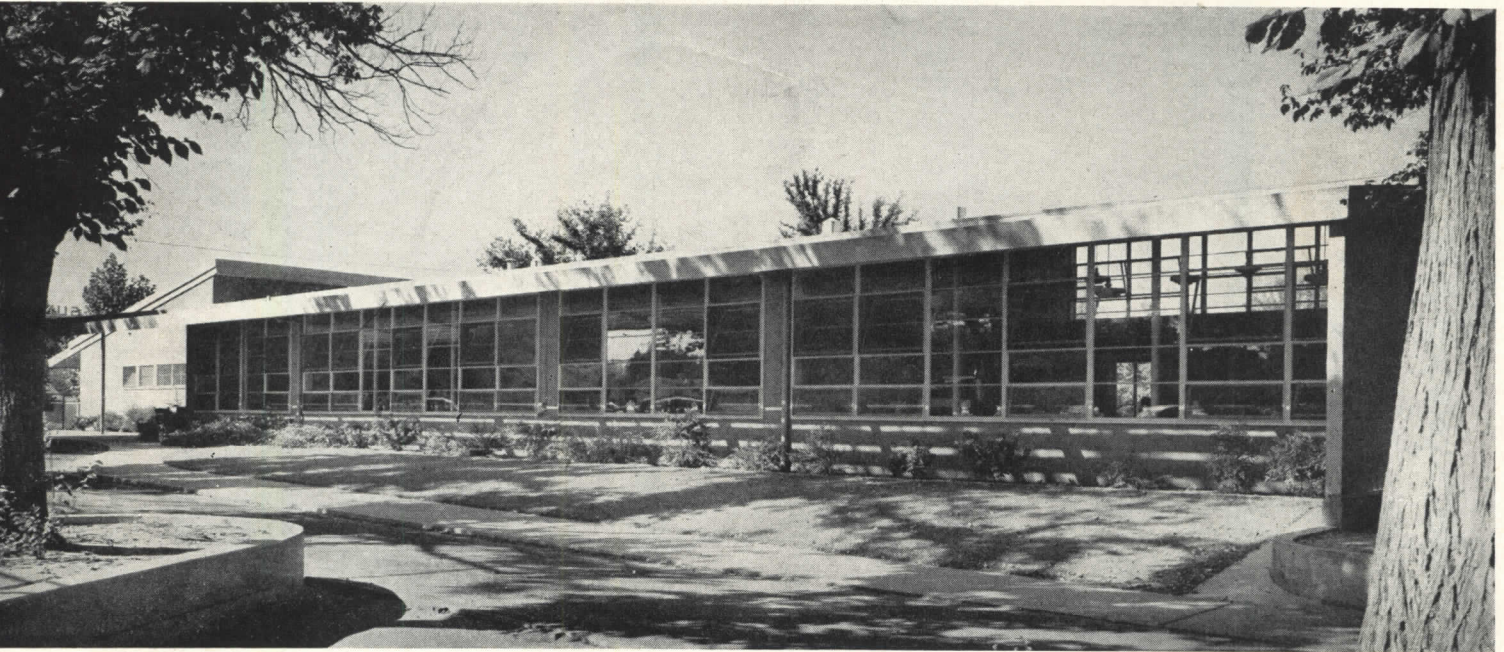

Julius Shulman

The entire building is at grade level to accommodate children in wheel chairs and other wheeled vehicles; even door saddles are eliminated. Opposite, covered entrance walk, wide enough for parking and manipulation of children's wheeled vehicles. Above: south classroom wing

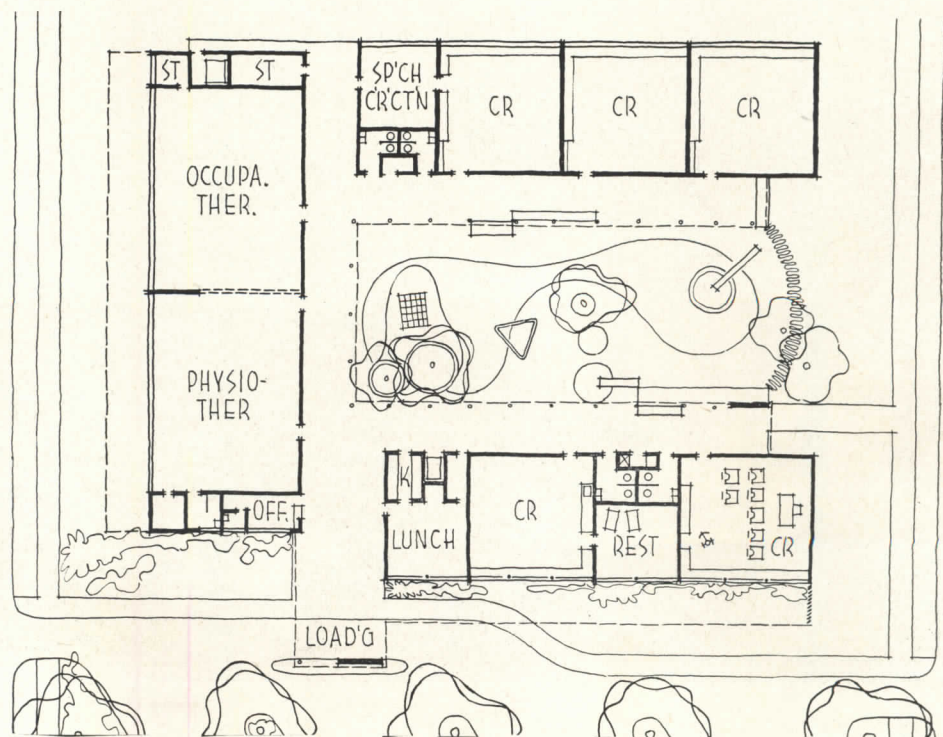

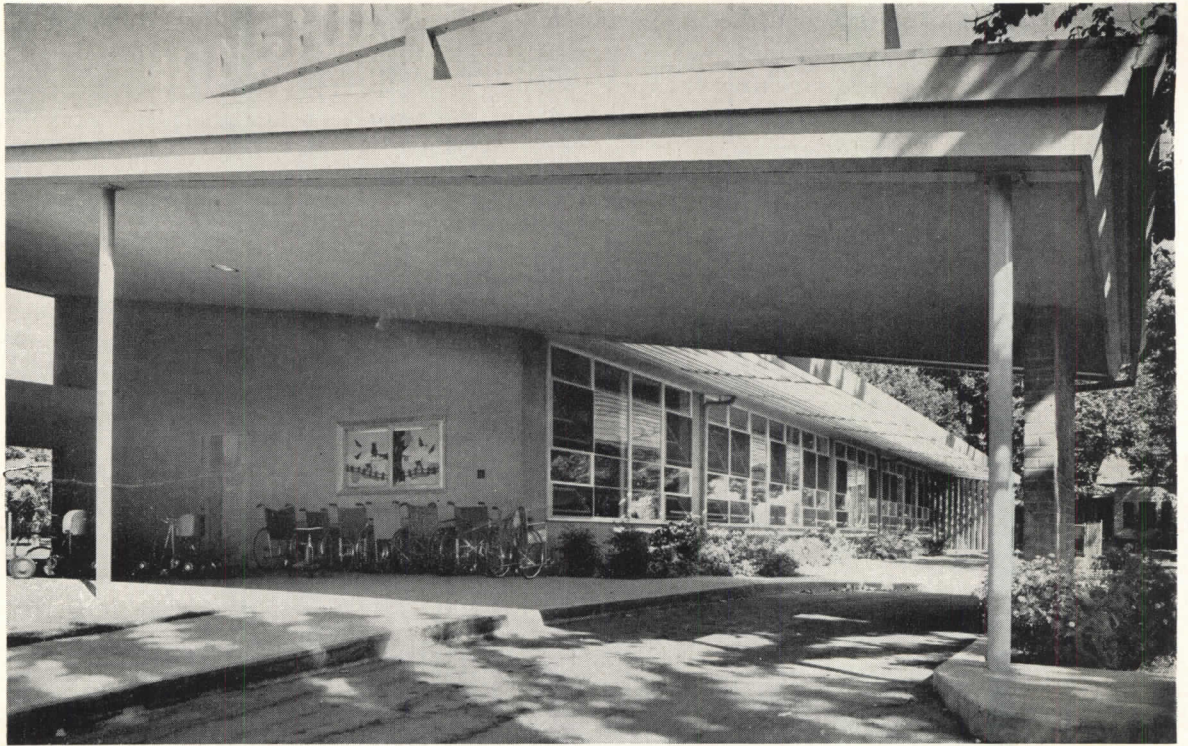

Above: entrance porch and south classroom wing, with entrance drive closely adjacent so children can get easily from cars to wheel chairs. Below: physical therapy includes training in walking and stair climbing

Julius Schulman



Despite limited budget, the school is a pleasant one visually. Large windows in classroom wings provide adequate light through most of the year; overhangs and louvers eliminate penetration of high sun

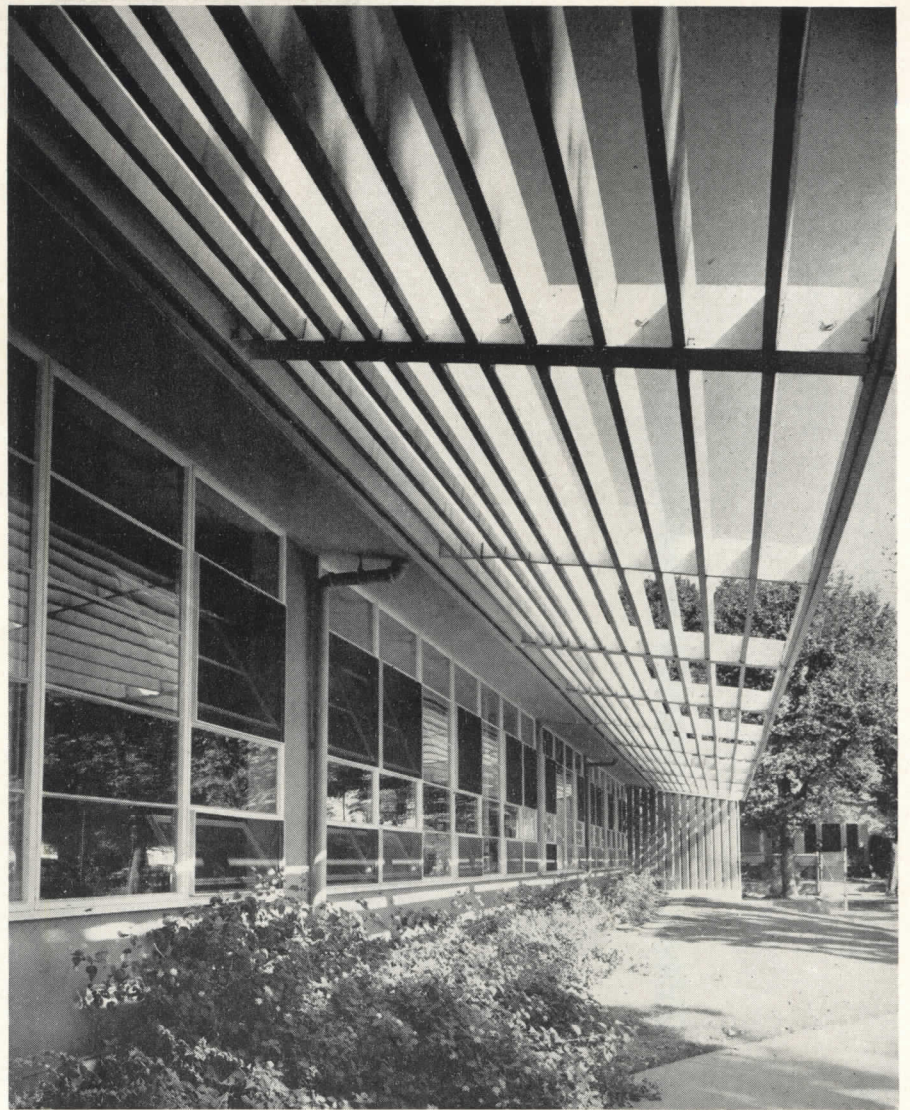

Julius Shulman



David H. Horn

3. *Special toilet room facilities*, including extra space around fixtures and vertical and horizontal bars adjacent to fixtures to aid children in self-care.

4. *Extra large doorways* to provide clearance for wheeled equipment (3 ft 6 in. was found to be adequate); large kickplates over the lower parts of all doors to protect them from equipment; metal door jambs.

5. *Open-fronted sinks and work counters* to permit access by students in wheel chairs.

6. *Large storage areas* to accommodate storage of specialized and constantly changing equipment.

7. *A protected play court.*

Instead of having an unusually large budget to meet all these special requirements, the architects were faced with very limited funds, and many compromises had to be made. Classrooms, for example, originally were to be about a third larger than the 1000 sq ft provided to accommodate each 15 pupils. Additional rooms for rest, speech correction and consultation had to be abandoned.

The building was made U-shaped, with classroom wings on north and south and therapy rooms on the

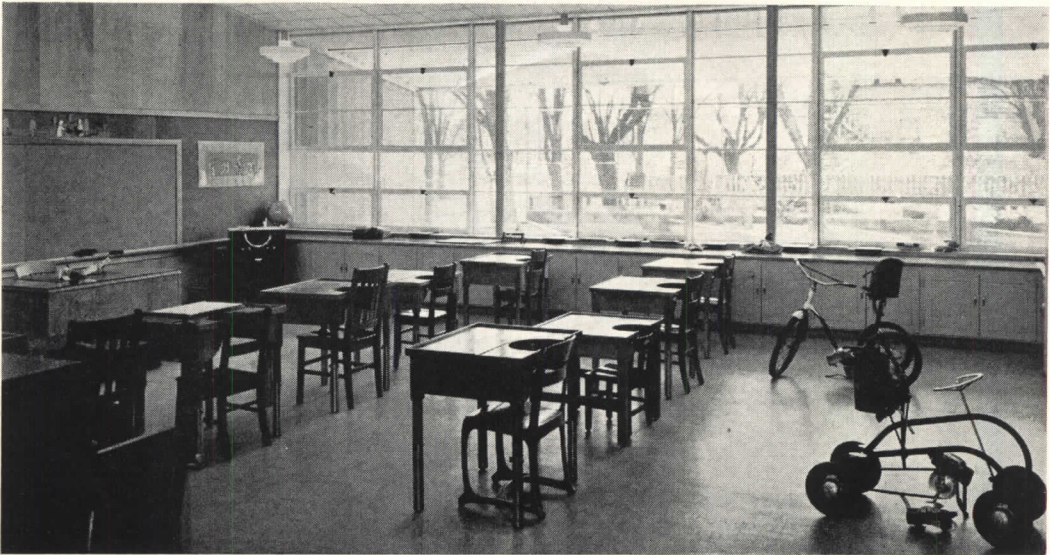
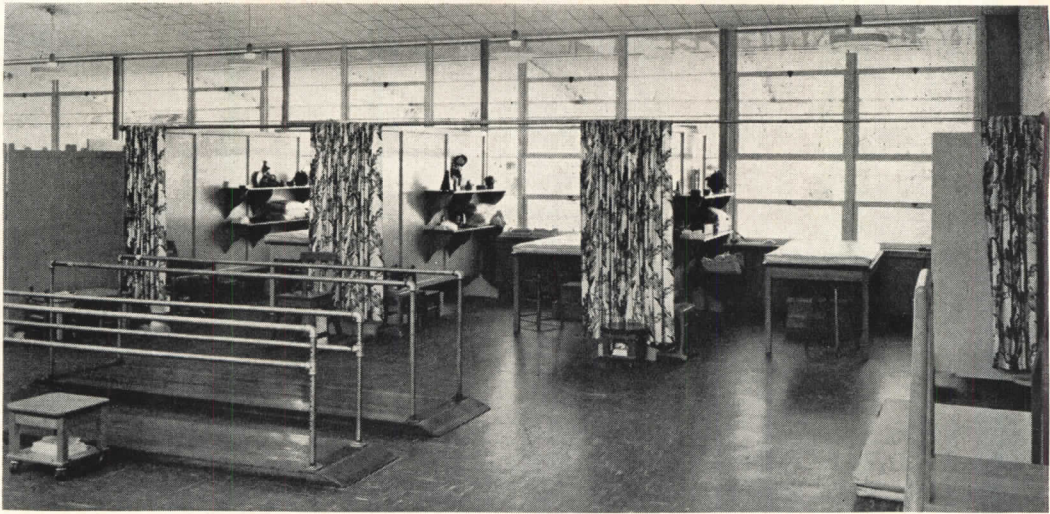

Claspill's Studio

Above: another view of physical therapy room, and a typical classroom. Desks are free-standing, easily shifted



David H. Horn

Above and right: play court is protected by building itself from occasional winds, sun and unwanted watchers



SUNSHINE SCHOOL

west to provide the protected play court requested by the administration. Both classroom wings have north light and corridors along the court. Louvers over windows on south and west walls eliminate direct sun, and obscure glass in the lower windows of the two therapy rooms prevent observation of activities from outside.

Original plans called for the corridors surrounding the court to be glass-enclosed but available funds would not stretch that far. As things turned out, the open corridors are much more satisfactory — they are more flexible, more pleasant in the warm San Joaquin Valley, and eliminate the expense of inevitable breakage by youngsters using wheel chairs.

The building is steel and wood, on reinforced concrete foundation. Exterior walls are stucco, interior walls are plywood, floors are concrete slab. Construction was in two stages: first, the south wing and physical therapy room, a total area of 6673 sq ft; and second, the north wing and occupational therapy room, a total area of 6855 sq ft. Costs were held to an average of \$11.25 per sq ft and \$0.85 per cu ft, excluding architects' fee; per pupil cost over 30-year period was \$110; per classroom cost was approximately \$11,810.



David H. Horn

Claspill's Studio

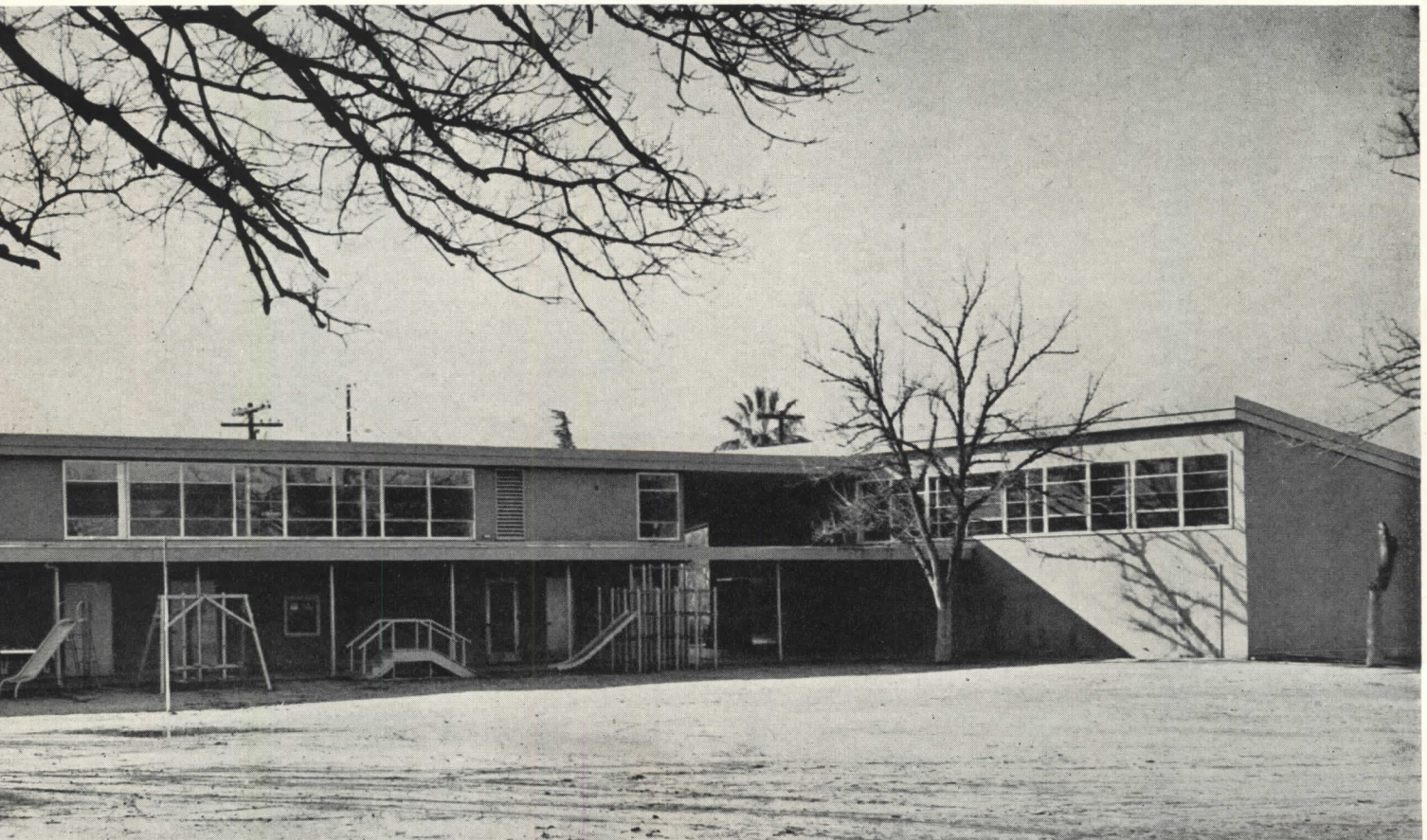

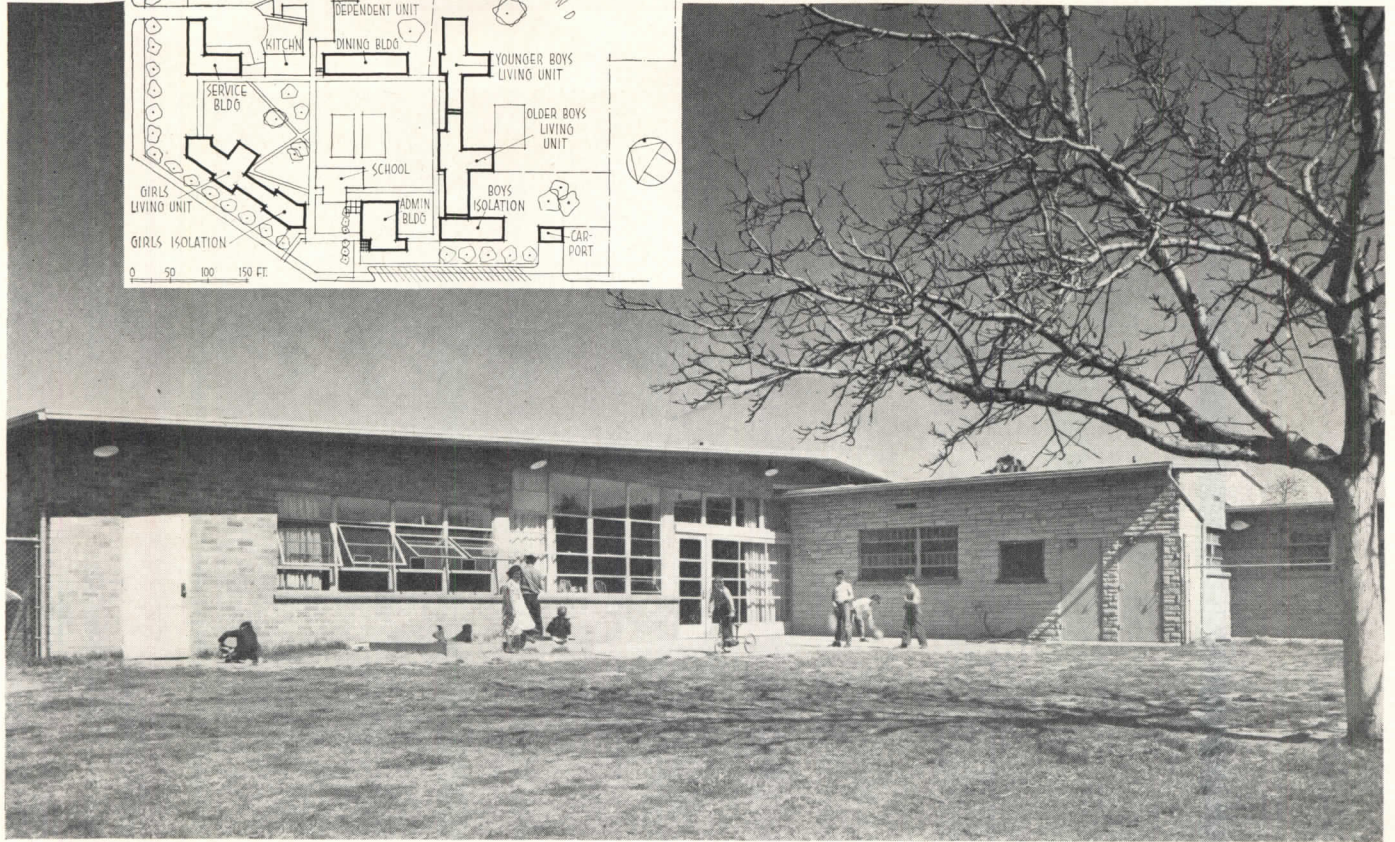
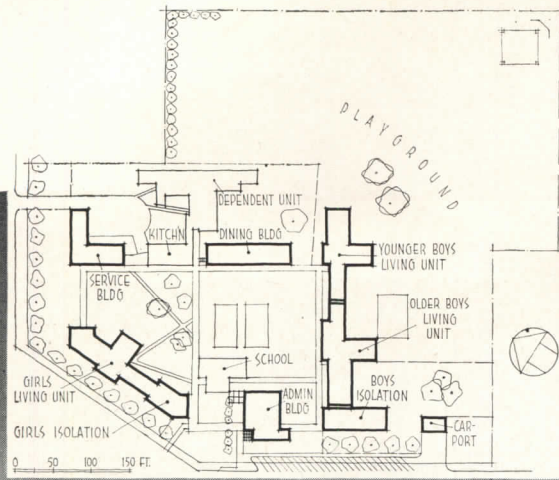

DEPENDENT UNIT, RIVERSIDE COUNTY JUVENILE HALL

Arlington, Calif.

Milton H. Caughey, Architect

ALL TOO OFTEN the child taken by court order from an undesirable home environment is placed in an institution which cares also for juvenile delinquents. That the two groups can be well segregated even so is proved by the plans of the Riverside County Juvenile Hall. The Dependent Unit, shown on these pages, is a completely separate building, with its own dining room and playground, but shares kitchen and administration facilities with the rest of the institution.

A homelike atmosphere, of course, is the chief consideration in the planning of both dependent and delinquent units. Flexibility is almost equally vital for both:

the population varies greatly in age, sex and number, and both sex and age segregation is necessary. Constant staff supervision and visual control of all areas is also essential in both departments.

A dependent unit, however, offers still further planning problems because it must provide for children ranging in age from one day to 18 years. At Riverside (see plan, page 164), there is an eight-bed nursery with its own kitchenette; boys' and girls' dormitories, at opposite ends of the building, have six beds each; there are also eight single rooms, three of which, directly behind the control desk, may be used for either boys or girls. A pantry, immediately inside the main entrance, is the connecting link between the institution's kitchen and the dependents' dining room.

The building has slab floors, reinforced brick walls and slab roof. Sash on the "security perimeter" are psychiatric type; sliding doors between activity and play areas are of safety glass, plumbing fixtures are tamper-proof and heating is by radiant panel (considered safest). Colors throughout are bright and gay, with each corridor door a different color.

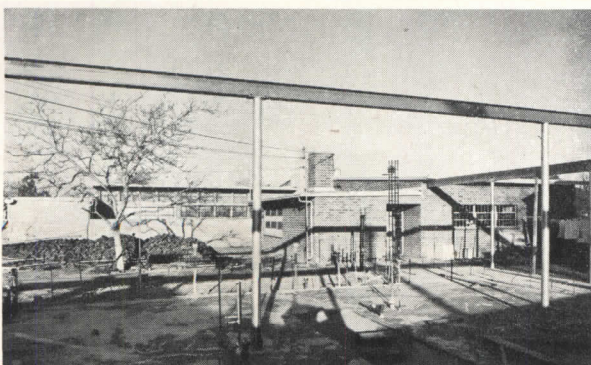

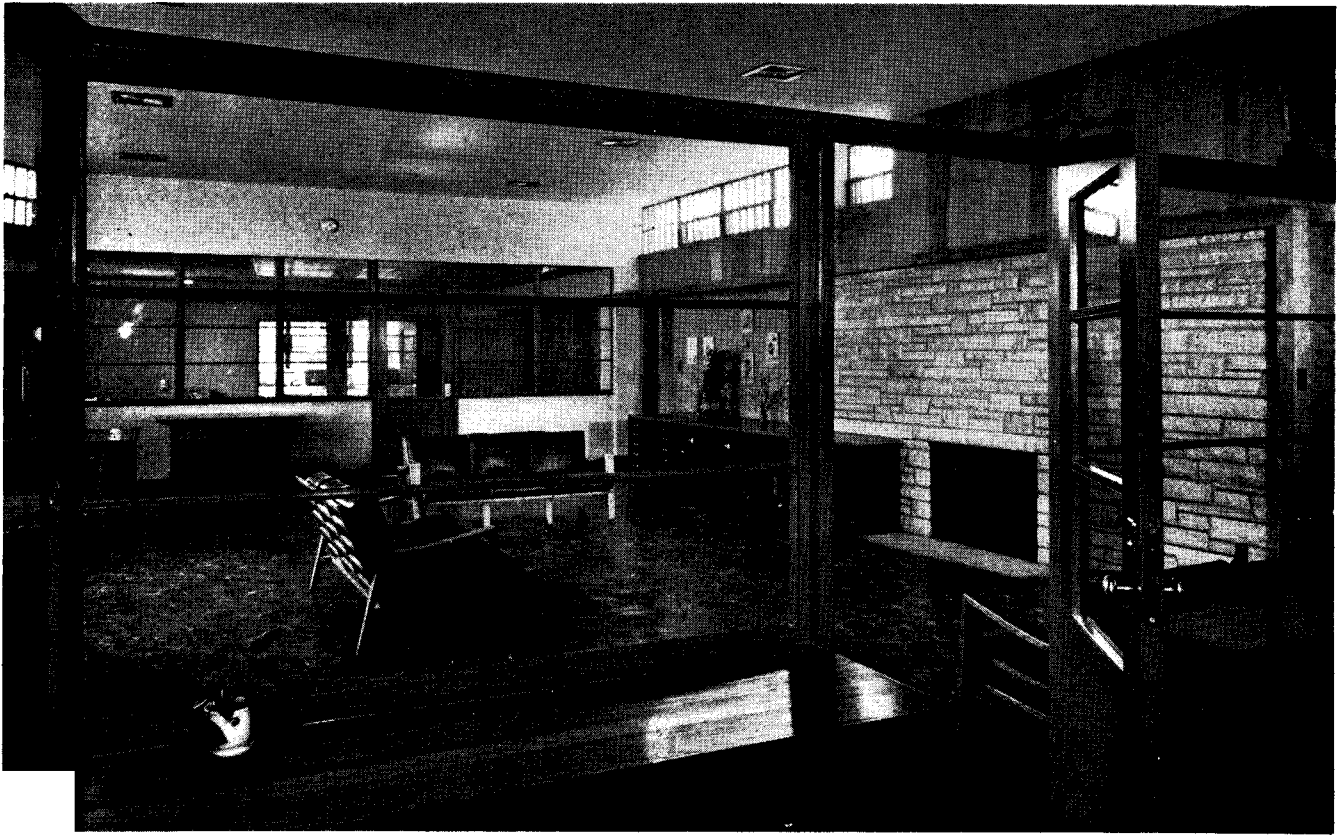

Julius Rosenberg

Use of stonework on both exterior and interior of the Dependent Unit was expensive, but emphasizes residential character of building. Play area (opposite, top) may eventually be closed off from delinquents' by solid wall to prevent visual contact. Supervisor can watch living room, dining room (behind glass partition in photo above) and all corridors without leaving desk



DEPENDENT UNIT

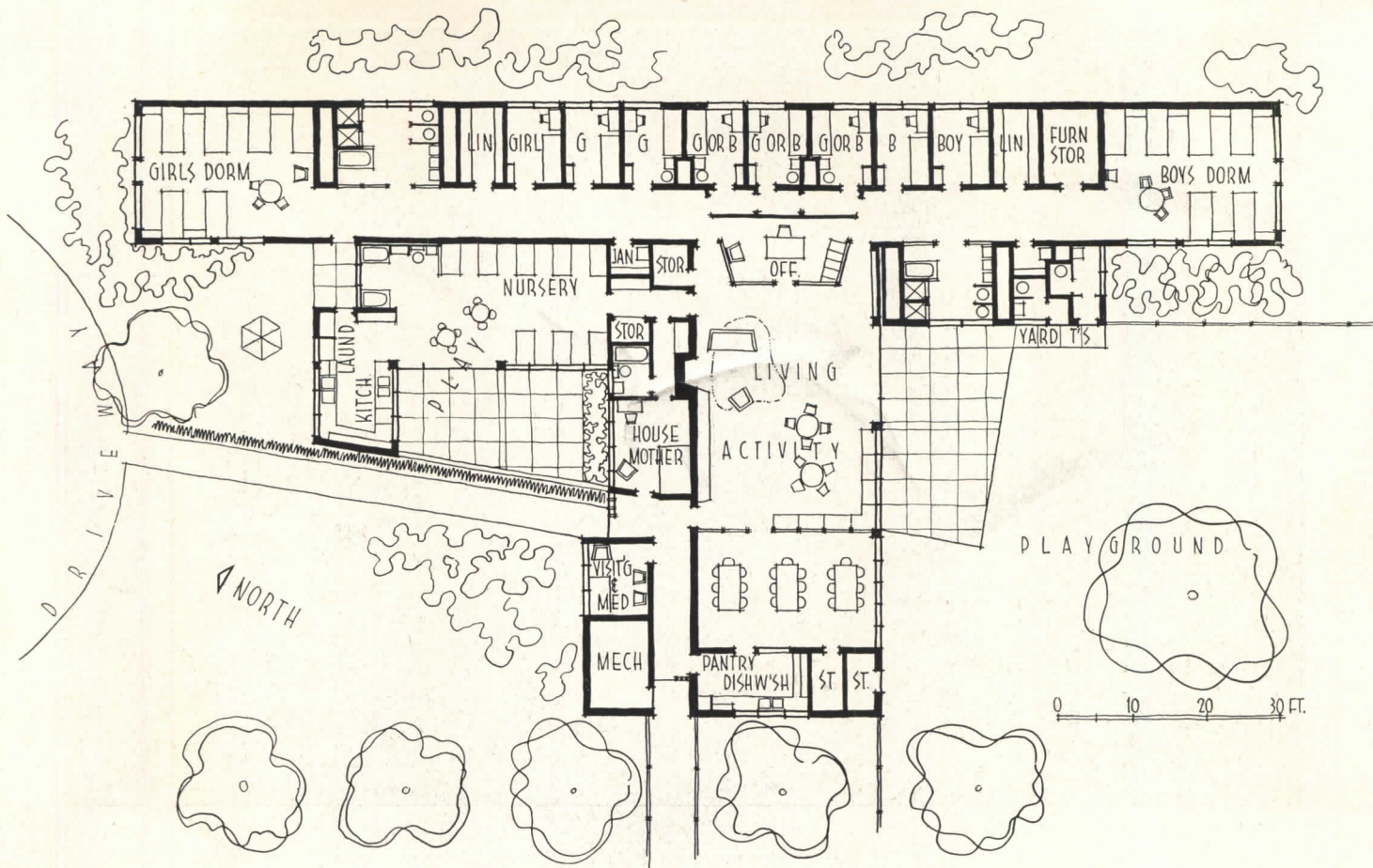

Dependent Unit has own driveway and entrance; three central single rooms provide locking facilities for unusually disturbed newcomers. Below: left, pantry, equipped for therapeutic dishwashing; right, nursery

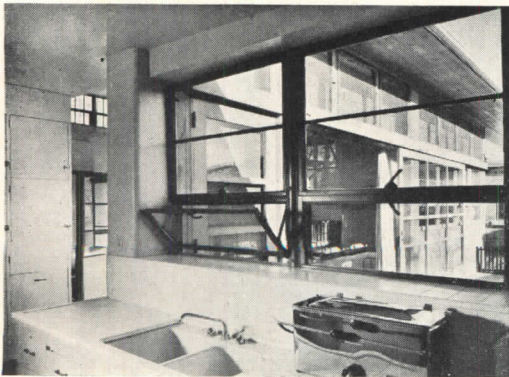

Julius Shulman

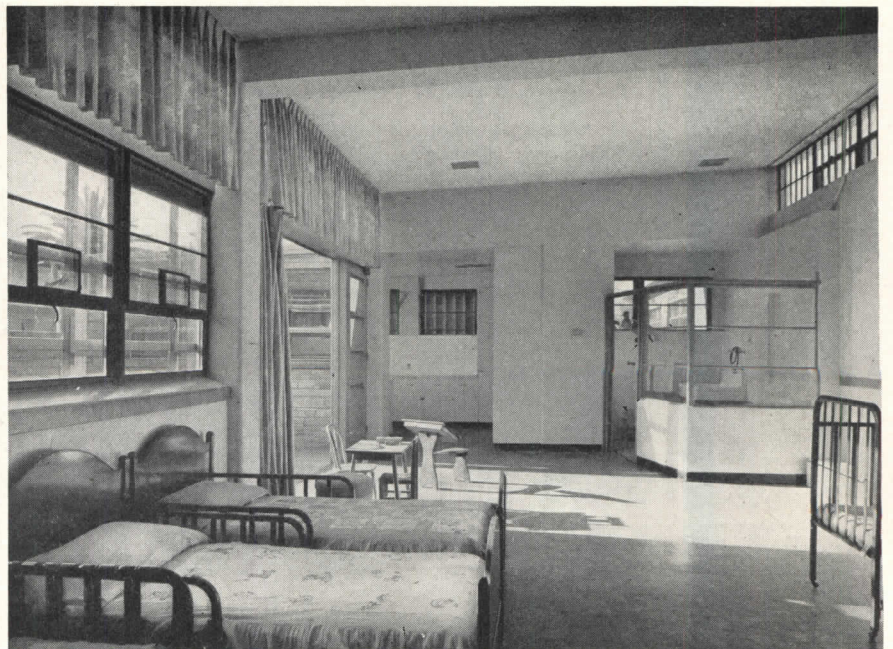

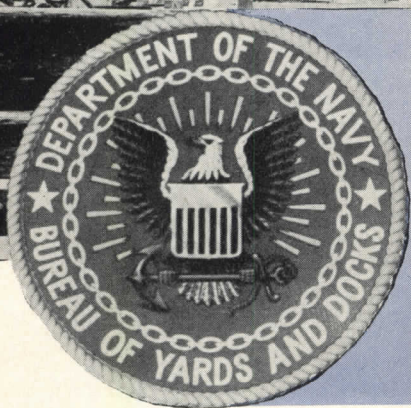
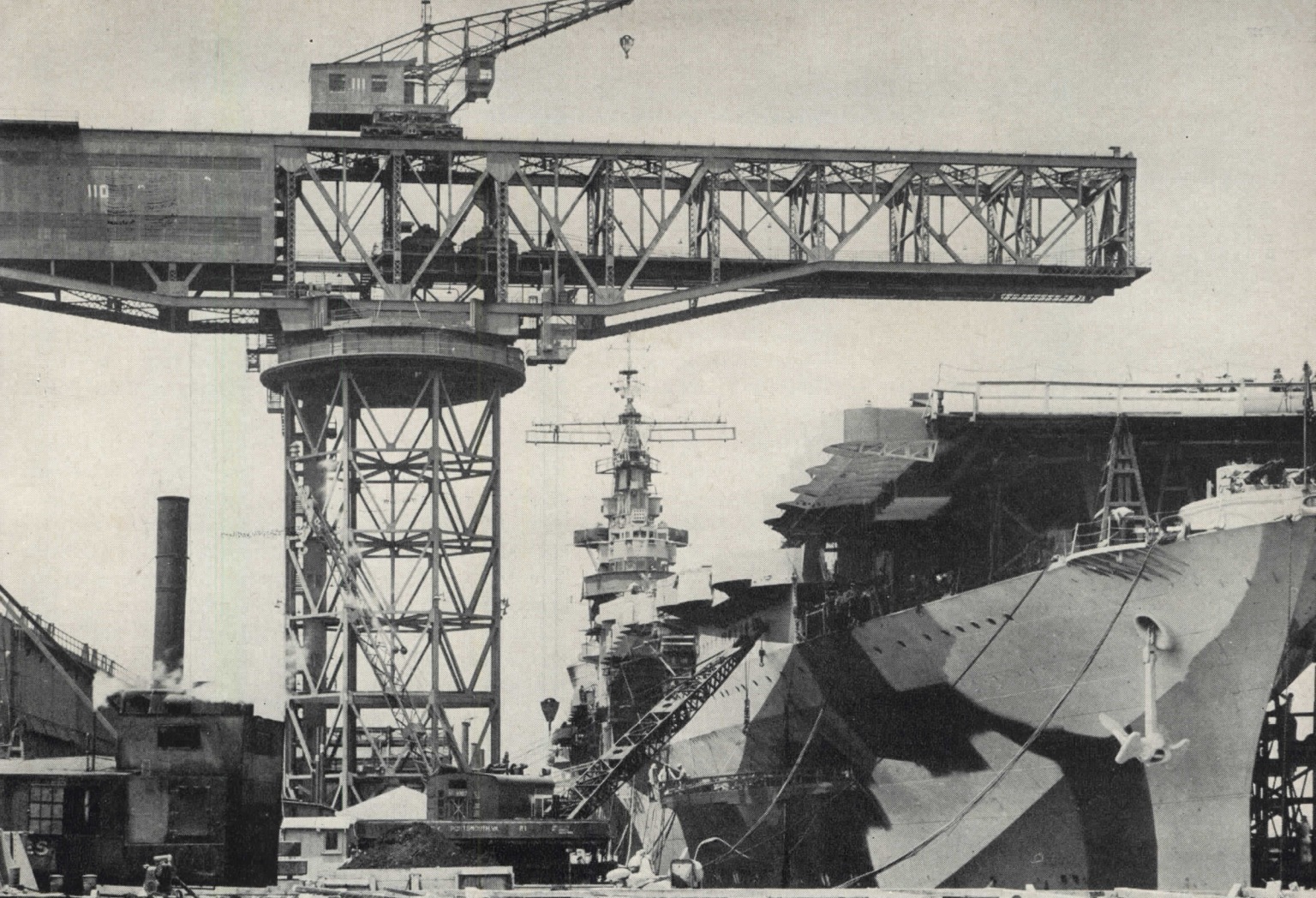

NAVY BUILDINGS

ARCHITECTURAL RECORD'S
BUILDING TYPES STUDY NUMBER 190

Bureau of Yards and Docks serves the Navy with an infinite variety of constructions on shore and at sea; maintains a staff of architects and engineers under the Civil Engineer Corps; but still has a considerable volume of work for private architects and engineers

VARIETY IS CHALLENGE IN NAVY BUILDINGS

FOR MORE THAN 150 YEARS the Navy has been growing with the country it protects, ever adding to its commitments, its technology, its personnel, its shore establishments. Now it must be prepared to fight literally anywhere in the world, and its building organization, the Bureau of Yards and Docks, must be ready to follow the fleet to any point on the globe, with facilities for building anything from a ship to a railroad.

Variety in the Bureau's building operations is probably the greatest challenge to its designers and to architects and engineers who undertake commissions for BuDocks. Probably no other building organization, even including other military establishments, has had to satisfy so many different requirements, for Navy work encompasses virtually all types of civilian and military buildings and then adds on top of those all varieties of more strictly naval operations. Housing, stores, churches, schools, hospitals, power plants, office buildings — the Navy builds them all. Railroads, highways, air fields, bridges, factories, warehouses — the Navy needs all those. Harbors, dry-docks, ship yards, munitions de-

pots — these are only a few. Almost \$10 billion went into naval bases in the last war.

Bureau of Yards and Docks is a complete building and operating organization. Its function is to design, build and maintain facilities for the fleet; being, or hiring, every functionary known to building. Its clients consist of all the other offices and bureaus of the Navy listed on the opposite page.

The Bureau of Yards and Docks is staffed by officers of the Civil Engineer Corps, and civilian personnel, all of whom are trained and experienced in some phase of architecture or engineering. This applies to both the central Washington headquarters and district offices. The headquarters staff is organized according to the chart herewith; the district offices are listed on page 173.

After the last world war the personnel of the Bureau was cut back, of course, to a permanent peacetime basis. It is still operating thus, though Korea has enlarged its work. Policy is to maintain its permanent organization and undertake such design activities as will keep this staff occupied and to control design policies and act as



BUREAU OF YARDS AND DOCKS ORGANIZATION CHART

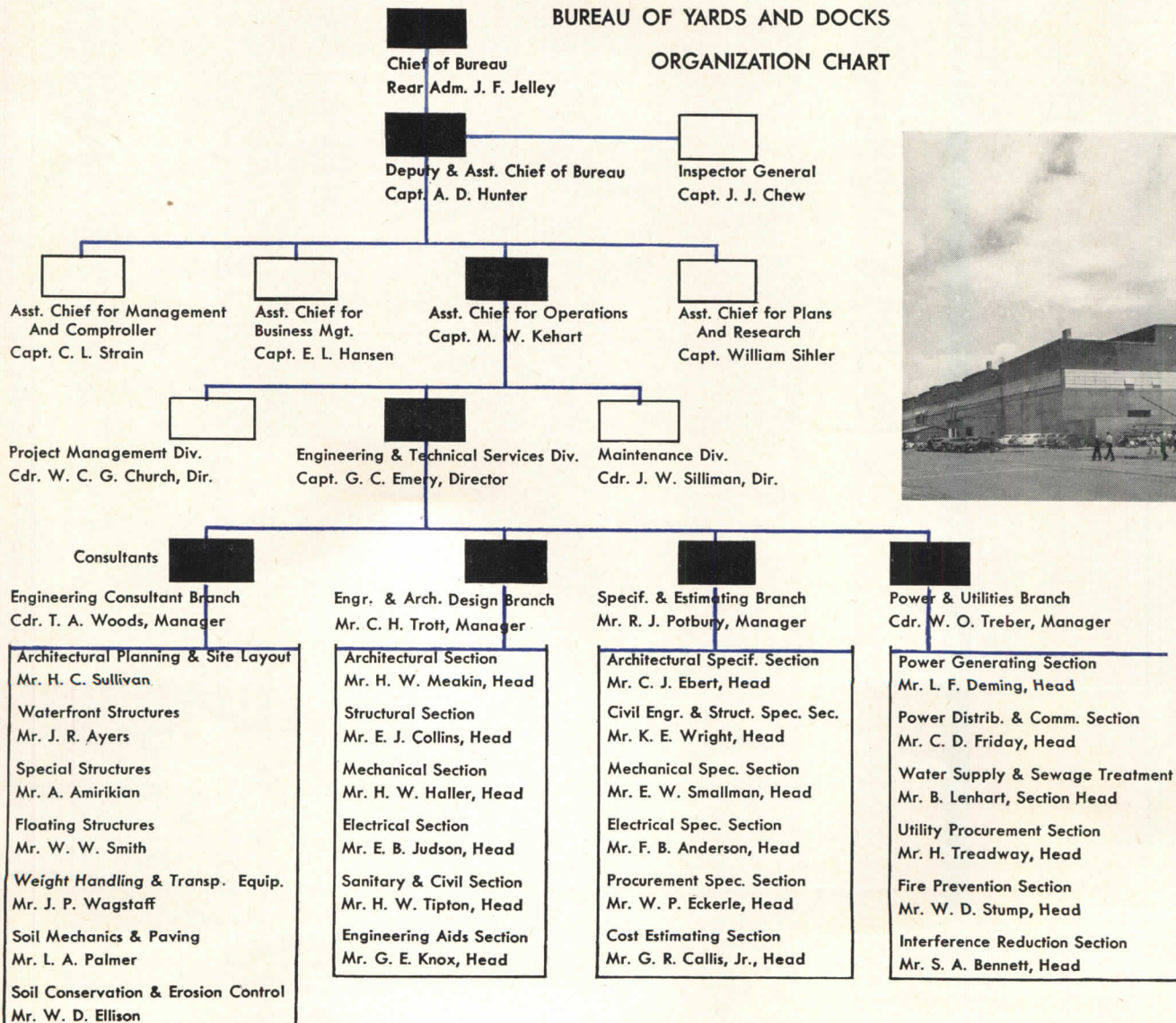

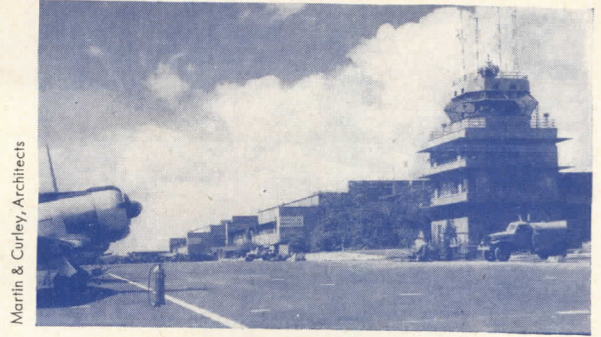

Martin & Curley, Architects

U. S. Marine Corps: chapel, Parris Island, S. C.

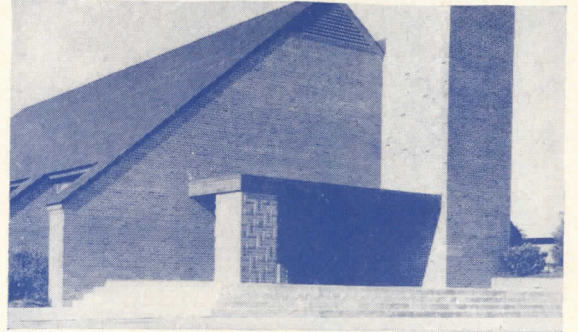

Bureau of Medicine and Surgery: Aiea Hospital, Pearl Harbor, Hawaii

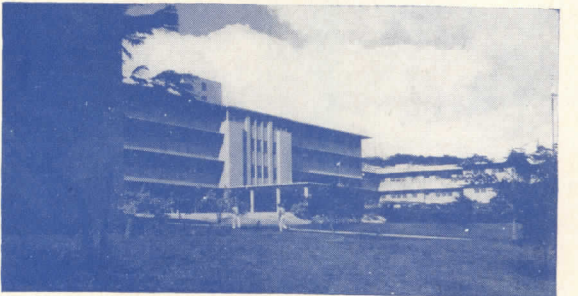

C. W. Dickey & Associates, Architects

Bureau of Ships: foundry, Mare Island, Calif.

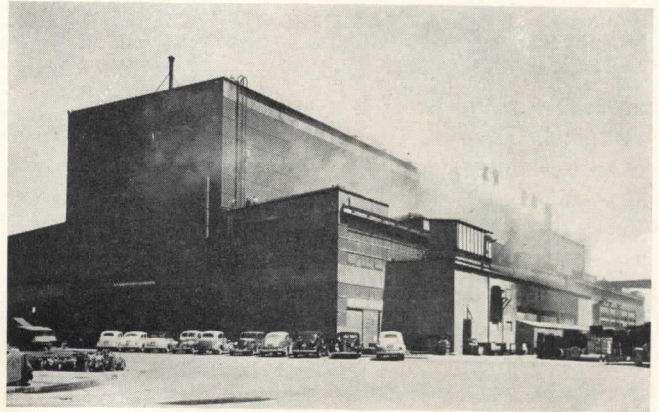

Office of the Chief of Naval Operations: master plan for U. S. Naval Academy, Annapolis, Md.



Bureau of Yards and Docks Annex, Washington, D. C. (above)



Allied Engineers, Architects

Bureau of Naval Personnel: auditorium-gym, San Pedro, Calif.

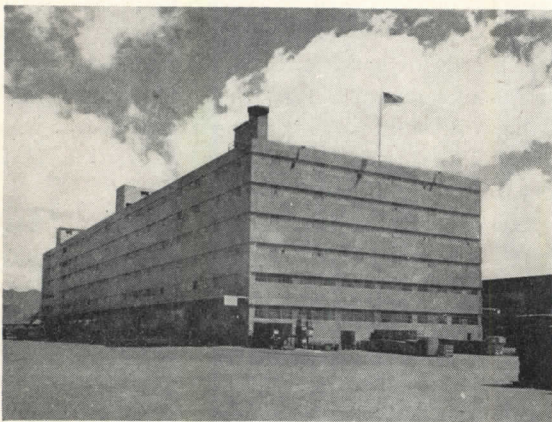

Bureau of Supplies and Accounts: shipping and receiving bldg., Pearl Harbor, Hawaii

Bureau of Ordnance: machine shop, Mare Island, Calif. (left)

consultants to the field on unusual and difficult projects, using private architects and engineers for any extra load. While during the war the BuDocks design staff, including both architects and engineers, was quite large, it was still unable to do more than a small proportion of the work the huge war program involved and concentrated mainly on specialized design and design policies. Now the situation is roughly the same — smaller staff, smaller work load, but a large proportion of the actual drawings for construction projects done by private architects and engineers.



NAVY BUILDINGS



RECENT CONGRESSIONAL EMPHASIS on economy in all military matters has given the Navy a special criterion for all construction work — austerity.

Architects and engineers with commissions for the Navy have always known that economy in design was a major requirement. But austerity is an extraordinarily harsh form of economy, and it is currently changing designs and construction. It is not merely a matter of leaving off ornamentation and doodads; austerity is cutting into space allowances, is paring down normal allotments for equipment and facilities, and generally imposing more rigid restrictions on everything from materials and finishes to whole parts.

BuDocks is, of course, still using all its know-how to produce sound construction while effecting economy in contract prices, for the Bureau must operate and maintain all its constructions. It is in effect its own building client in this respect, and so is fully conscious of the point at which first-cost economy brings excessive operating and maintenance costs. It is rather scrutinizing anew its more or less standard types of buildings to see wherein its normal practices might be made more austere.

The specific news in austerity is that the Bureau is cooperating with the Sub-committee on Military Construction of the Committee on Appropriations, House of Representatives, under the chairmanship of Congressman John J. Riley (South Carolina) in a scrutiny of its current building projects and its current planning in a search for all reasonable economies. All public works officers were alerted last spring, in fact were called to Washington for a three-day session on ways and means of effecting the specific economies considered to be practical. Beyond that, teams of CEC officers and Bureau consultants are visiting the district offices to check individual plans. The first two months of this effort yielded

direct savings of over a million dollars in current projects and contracts. This measure of savings is expected to continue, of course, as present blueprints progress into contracts.

Austerity scrutiny centers first on the more repetitive types of buildings — personnel facilities of all types from barracks and mess halls to hangars and warehouses. It is in these types of structures that the Bureau can be most effective in obtaining economies through setting standards of space and types of construction. The principle of economical construction can be applied to all of the Navy's hundreds of types of projects, even the most specialized, but the mandate of austerity applies most directly to repetitive types.

With everybody in America so conscious of mass psychology or morale, the standards of personnel buildings might be discussed at great length. In a recent interview Congressman Riley himself brought up the point. After pointing out that all concerned were alert to the morale factor, he expounded a principle quite close to one of the major tenets of modern design — human satisfaction with a building is not simply a function of its cost, or monumentality, but grows out of the architect's skillful integration of everything from functional suitability to the beauty of proportion and simplicity. If fixed standards seem restrictive in this respect, from the standpoint of service morale there is another reason for them: morale suffers from variations in facility standards in different bases and different services. That is a major reason for design "criteria," or "definitives," the principal purpose of which is to set some limits, both top and bottom, for comparative types of buildings.

It is important that standardization efforts in the austerity program are not intended to dictate too closely the selection of building materials or construction practices. It is well understood that throughout the



Pacific Island Engineers, Architects

Typical repetitive-type Navy buildings for enlisted men: Above, left — barracks, Adak, Alaska. Above — married men's quarters, Guam. Below, left — barracks, Jacksonville, Fla. Below, right — barracks, Guam



Albert Kahn Inc., Architects

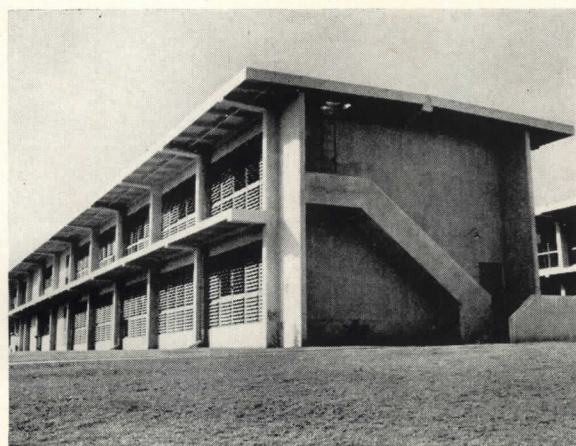

Pacific Island Engineers, Architects

country (the Navy in fact builds almost all over the world), there are wide local selections of materials, and methods as well. To force use of imported materials would be obviously expensive, and to push contractors into unfamiliar procedures would be equally silly. New ideas and techniques are always welcome, provided they do not impose such artificial strains on local building.

Austerity considerations can be quite complicated in

application to the wide variety of Navy work. Even in similar types of buildings the circumstances may differ depending on the relative permanence of the operation or its location on the globe. But BuDocks experts are giving it intensive concentration in all current operations, and will save money wherever possible without dilution of its reason for existence — to “serve the fleet” with all manner of land-based facilities.

MASTER PLANNING ANTICIPATES EXPANSION

OF ESPECIAL INTEREST TO ARCHITECTS and engineers is a current program of master planning of all permanent Navy bases. Each of the regular Navy establishments of all kinds is under careful study to develop a long-range plan on the recognized theory of master planning as it might apply to a city.

As applied to a Navy establishment, this theory has several special reasons and purposes. Preparedness is perhaps the outstanding one. The last was at least a two-ocean war for the Navy, and permanent and temporary establishments of many kinds were built under frightful pressure. Nobody can say where on the seven seas the Navy might next have to fight, and BuDocks might have to follow the fleet almost anywhere. But certain bases are predictable, and various degrees of expansion can be planned for, just as in a growing city.

Integration of thinking is another reason in the Navy. BuDocks, as already brought out, works for several bureaus of the Navy, each having its own interests and objectives at any given establishment. Yet each base is under an established command. And, of course, the planning staff at BuDocks must accommodate the interests of all these in setting a pattern for buildings and facilities.

Then, too, a Navy base might grow like a city —

slowly for some years then in an explosive burst.

So it is considered wise to have a master plan ready for any contingency, so that quick additions will not block logical development in the future; so that any Navy entity, asked suddenly to supply a certain facility, has a guide to immediate decisions.

In the Navy there are three types of planning involved. One is "strategic planning" in which military experts set up exact military missions. Second is "facility planning" which establishes the type and amount of facilities at each shore base to support the strategic plan. And, third, "site planning" — the normal architectural and engineering planning of the shore establishment.

Master planning of today encompasses the several types of construction previously outlined; peacetime, preparedness, wartime, mobilization, also postwar planning involving the conversion back to peacetime operation.

One step in the documentation of the planning study is a comprehensive manuscript, for the Bureau's manual, on planning, which will soon be published as part of the background material for architects, both in and out of the Bureau, who may have a part in the master planning of the Navy's establishments.



NAVY BUILDINGS

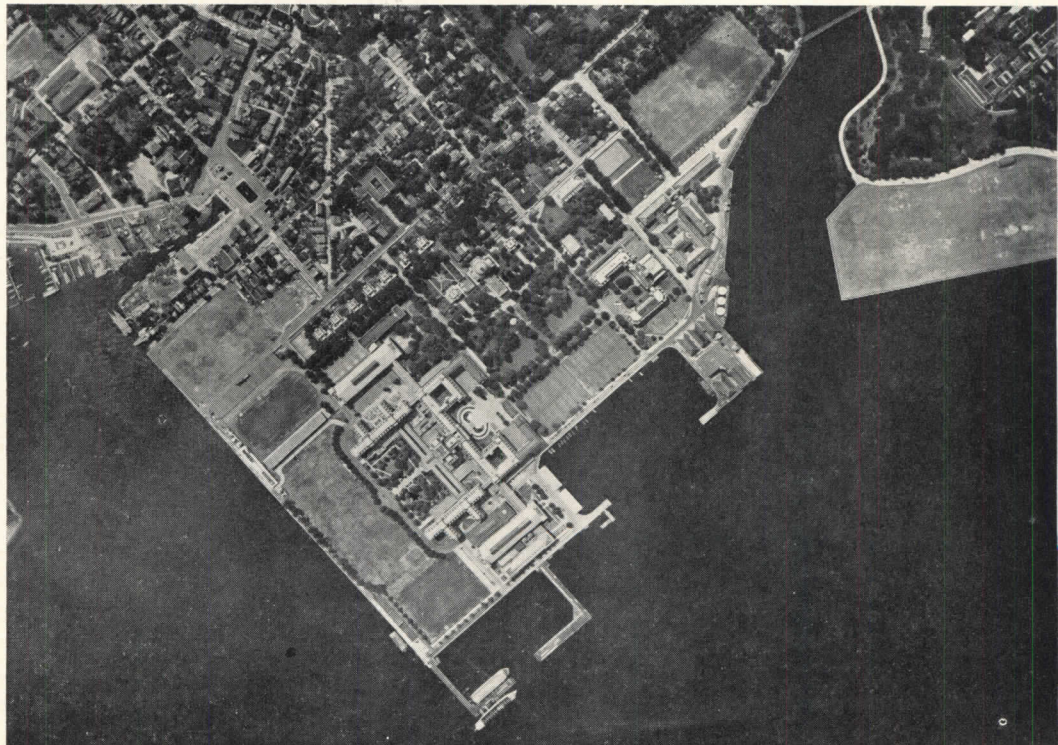

Above: air view of U. S. Naval Academy, Annapolis, Md., as it appears today

Navy Photos

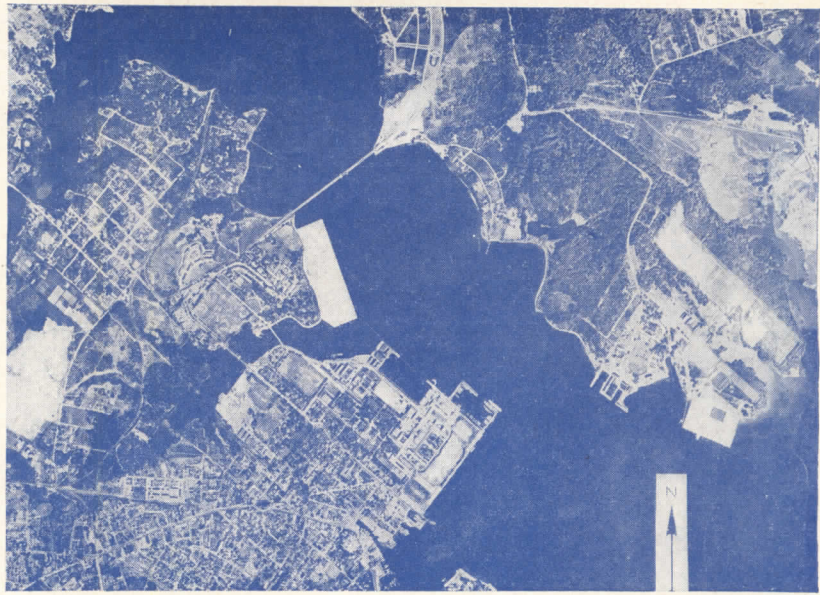

Typical of BuDocks' Master Planning Program is the study (below) for the proposed expansion of the Naval Academy and a related housing development across the river. A recent air view of the same area appears above



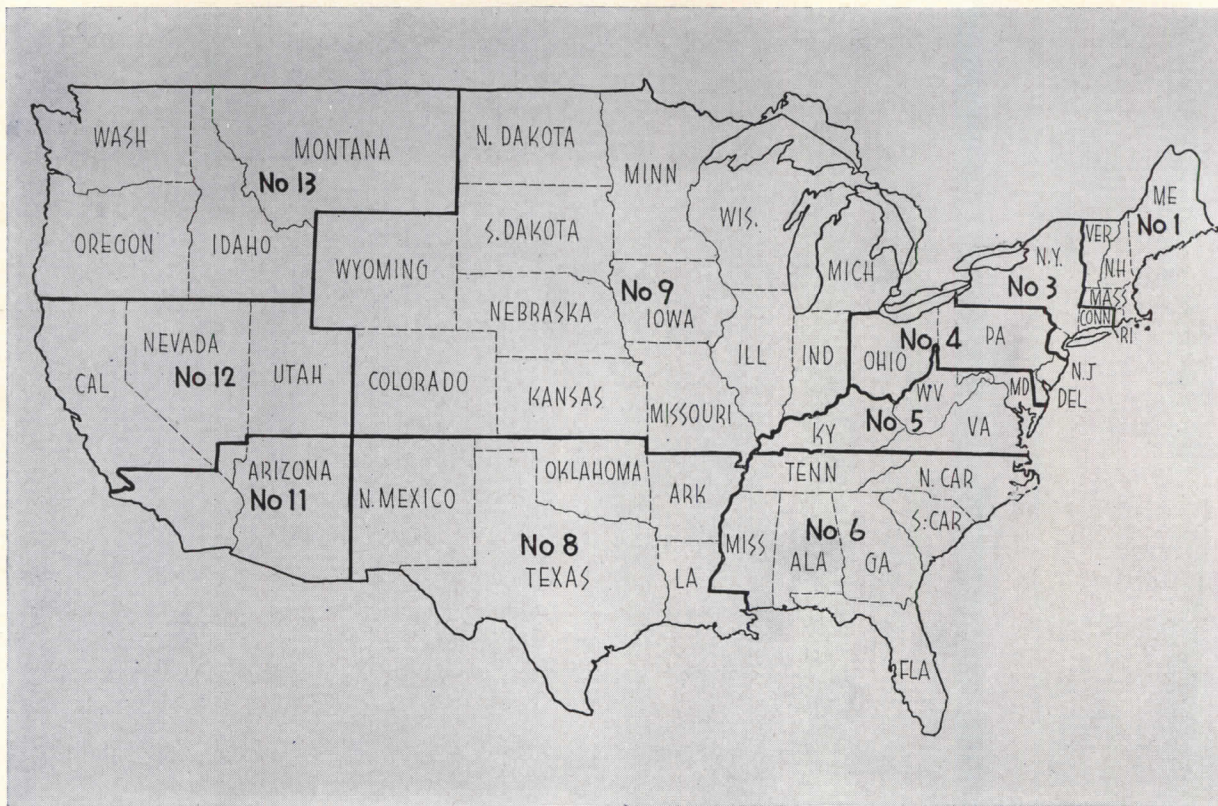
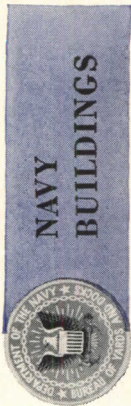

HOW TO FILE APPLICATIONS FOR NAVY WORK

EMPLOYMENT OF PRIVATE ARCHITECTS and engineers, "A-E's" in navy parlance, to augment the Bureau's design staff was resorted to considerably during the last war and postwar years. And BuDocks actively encourages architects and engineers to file their qualifications with District Public Works Officers, and possibly with Washington, so that contact can be quickly and intelligently established.

Almost any architect or engineer might find scope for his talents in the very diverse work of the Navy construction program. If he does not have, in his own office, sufficient range of design skills or staff for the required work he can effect combinations or associations which might qualify. Probably most established design offices are already familiar with the policies of the Bureau, and with the procedures, for they were in operation through the war years and since. But the Bureau still has personnel whose business it is to maintain liaison with private architects, engineers and associated groups, and to keep up-to-date records and brochures. For the Navy program is likely to continue active for some time to come. Moreover, in existing world conditions the Navy is keeping prepared for sudden bursts of construction activity should they be required. The Bureau wants to keep in touch with design talent for quick mobilization. Since there are something like 600 different categories of design and construc-

tion work, some highly specialized, the talent file assumes some importance.

Most design and construction contracts are given out by the district offices, and ordinarily architects and engineers need make no contact in Washington. If brochures are prepared, however, it is just as well to send a copy to Washington as well as to the district office. They are especially welcomed there if the design staff described includes some special know-how—experience in aerodynamics, for an example. Information on such individual experience is tabulated on I.B.M. cards for quick reference.

The Bureau has architectural and engineering staffs in Washington and in district offices; the present policy of economy, however, keeps these staffs relatively small, so that a great deal of design work has to be farmed out. The central staff is largely occupied with policy making, special design problems, standards, criteria, manuals and overall supervision.

As noted elsewhere in this study, the Navy is more than slightly allergic to the thought of "standard" plans. It does use them, in its "criteria" or "definitives," but the Bureau is keenly aware of the stultifying effect of arbitrary dictates when applied locally. It is also aware that good design is a precious quality. In short, it does not want to stifle initiative and creativeness in the work of its A-E's.

NAVAL DISTRICT PUBLIC WORKS OFFICES

NAVAL DISTRICT	LOCATION	NAVAL DISTRICT	LOCATION
1	495 Summer St., Boston, Mass.	11	1220 Pacific Highway, San Diego, Calif.
3	90 Church St., New York, N. Y.	12	San Bruno, Calif.
4	Naval Base, Philadelphia, Pa.	13	1611 W. Wheeler, Seattle, Wash.
5	Naval Base, Norfolk, Va.	14	Pearl Harbor, Hawaii
6	Naval Base, Charleston, S. C.	15	Balboa, Canal Zone
8	Bldg. 16, U.S. NB, New Orleans, La.	17	Kodiak, Alaska
9	NTC, Great Lakes, Ill.		
10	San Juan, Puerto Rico		

Locations of the various Naval District Public Work Offices listed above are centers BuDocks recommends architects to contact for work within the district. The chart at left gives boundaries of the districts in the U. S.; construction and design in theaters of war are done by SeaBees

As to contacting the Bureau, here are the official instructions:

"Construction contractors and architect-engineers should contact the District Public Works Office having jurisdiction over the areas in which they would like to work.

"Construction contractors or architect-engineers who are interested in performing work for the Bureau of Yards and Docks should provide information on their organization, background, and experience to each District Public Works Officer having jurisdiction over the areas in which they would like to work. The same information should be furnished to the Bureau of Yards and Docks, Navy Department, Washington 25, D. C. If there is a material change in these data, the submission of amended information from time to time would be advisable. The following will be of assistance in recording the qualifications of contractors:

"NAVDOCKS 382 — Architect-Engineer Firm Data

"NAVDOCKS 720 — Contractors' Data Brief

"These forms provide a convenient means of summarizing information concerning interested firms or individuals.

"If brochures are available, it is suggested that they be submitted also. It is not intended that contractors be required to incur the expense of preparing brochures as a condition to their receiving consideration; neither is it intended that the forms are required if the brochures

contain adequate information. Brochures, when available, are usually of mutual benefit.

"When joint ventures are formed as a means of securing large manpower and equipment potentials and of pooling the talents of contracting firms with special capabilities, information on such groups may be consolidated on the NavDocks form 720. If brochures on joint ventures are submitted, it is desirable that the record of each participant be shown separately . . ."

"Selections of architect-engineers for specific projects are generally made by the District Public Works Officer. For those cases which require approval of the Chief, Bureau of Yards and Docks, the recommendations of the District Public Works Officers are submitted prior to the final selection of the architect-engineer and the award of the contract.

"Contracts with architect-engineers will be negotiated contracts in every case because of the professional nature of the work. Selection of architect-engineers is subject to the following policy:

"Emphasis will be placed on selecting firms or individuals experienced in the design of the particular type of project involved, and having the ability to organize sufficient personnel to expedite the work. Where their qualifications are determined to be satisfactory, preference will be given to firms or individuals located in the same general geographical area as the project under consideration."

INDUSTRIAL BUILDINGS ARE BIG PART OF WORK

PERHAPS "INDUSTRIAL ARCHITECTURE," when applied to the Navy, most readily brings to mind its countless great waterfront structures — its enormous cranes, docks and piers. Even with the obvious importance of these facilities, they form only a portion of the Navy's industrial projects. The complete range includes shops, factories, mills, foundrys, warehouses — in short, all the vital facilities for equipping, repairing and supplying the land, sea and air wings of the Navy. True, in times of emergency it must rely heavily on civilian industry. In less critical times, however, it must preserve a degree of self-sufficiency for reasons of economy and preparedness.

BuDocks looks with pride at the industrial buildings it has constructed, a few of which are illustrated here. The Bureau has continuously sought to incorporate practical and economical new ideas and techniques in each of the projects, as well as to achieve good functional design. The planning has included the skills of specialists on new mass production methods, plant layout, safety and other aspects of factory design. Considerable attention has been paid to the personnel factor in addition to

operational and maintenance efficiency and economy. Light, space, ventilation, sanitation and the psychological appeal of color are all given much thought.

Although BuDocks produces some standardized types — the repetitive warehouses and storehouses — the less usual structures reflect a keen interest in structural developments and uses of new materials. In various instances it has employed large steel spans, reinforced concrete and welded rigid frames, precast concrete beams and arches, continuous frames, thin solid panels and curtain walls, large glass areas and many other types, and in each case to provide a particular advantage for a particular building.

Throughout its field of industrial architecture, BuDock's policy might be summed up by linking utility and economy with pleasing appearance and imaginative planning. It adheres to the philosophy that architectural effect is not necessarily obtained by the application of ornament, that a capable architect will produce the desired effect through suitable proportion, mass and composition, and by skillful handling of construction materials.

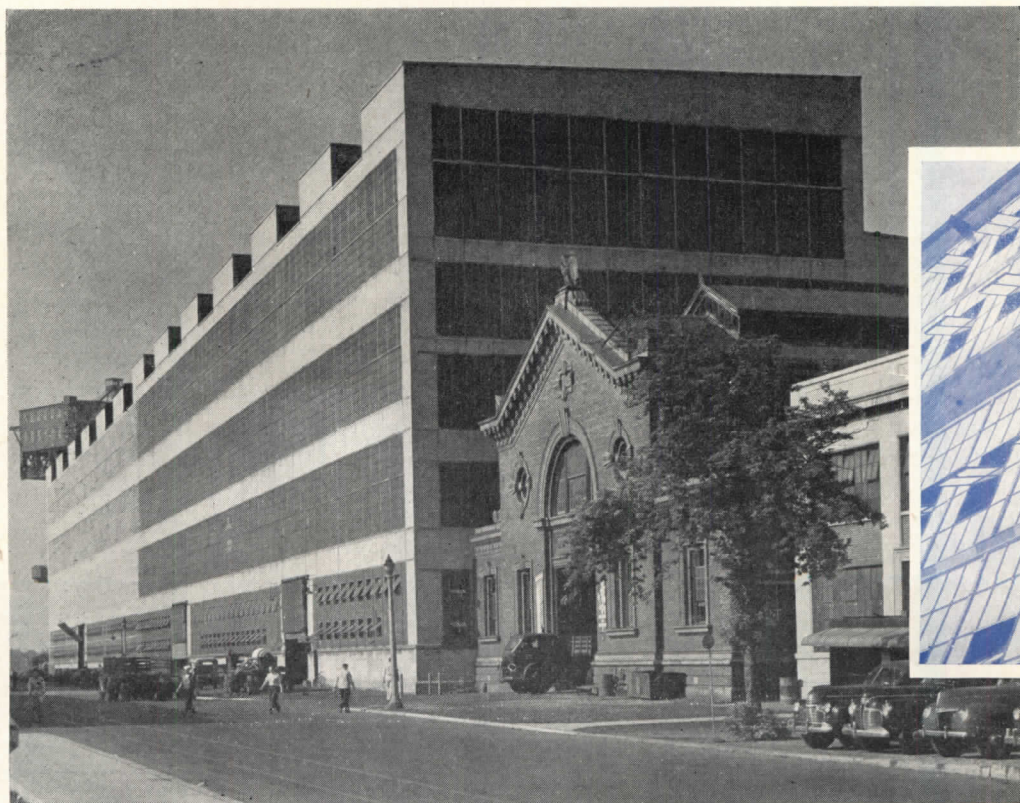



Above: electrical shop, Terminal Island, Calif., is example of concrete rigid frame construction. Right: machine shop, San Pedro, Calif., has thin curtain walls, large areas of corrugated wire glass. Below: warehouse at Naval Supply Depot, Bayonne, N. J., has repetitive roofs of thin shell concrete. Below, right: cold storage building, Oakland, Calif., is of reinforced concrete, has no windows, for easy temperature control

Robert & Schaefer Co., Architects

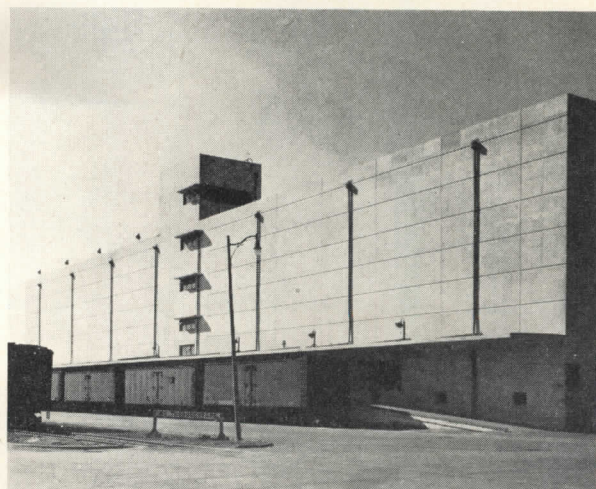
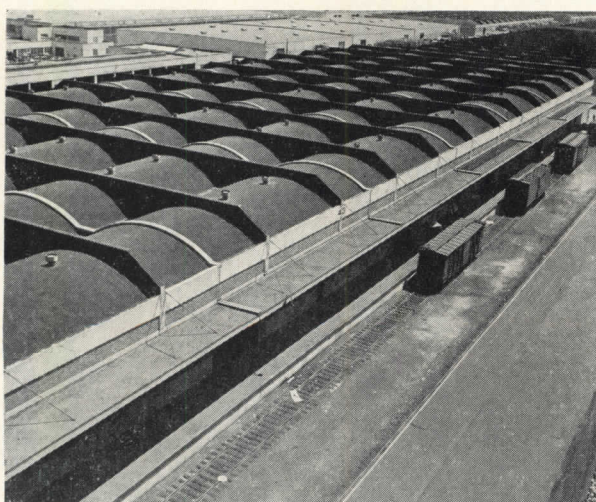

Far left: machine shop, Philadelphia, Pa., contrasts sharply with turn-of-century shop next to it. Inset photo, above left: fenestration detail of supply warehouse, Norfolk, Va.

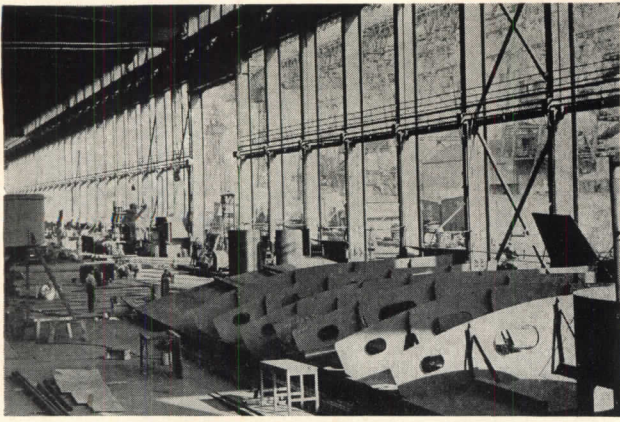

Left: interior of sub-assembly shop, Norfolk, Va.; one of the first welded steel structures done by the Navy. Below: foundry, Naval Shipyard, Philadelphia, Pa.; rigid frame structure frees interior space for convenient placement of machinery



**NAVY
BUILDINGS**

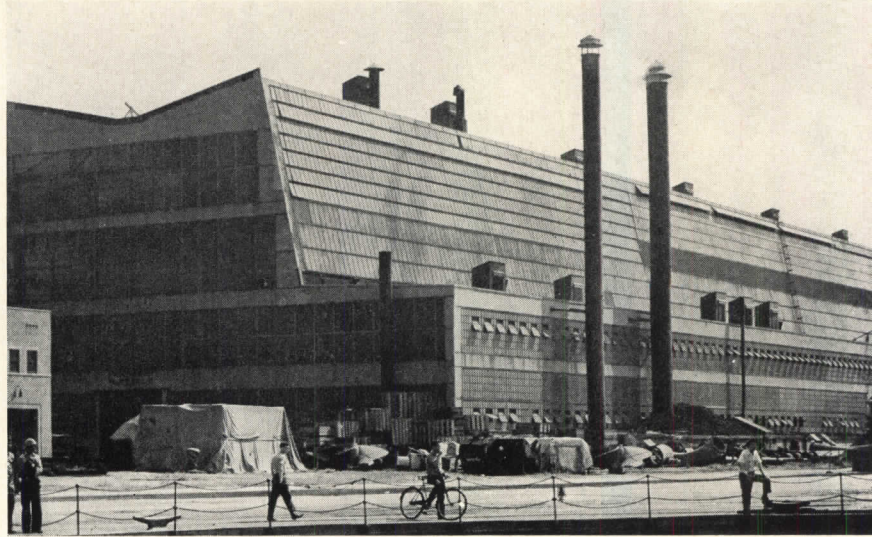

Below: lighter-than-air hangar, Weeksville, N. C.; two-hinged welded arches are among world's biggest

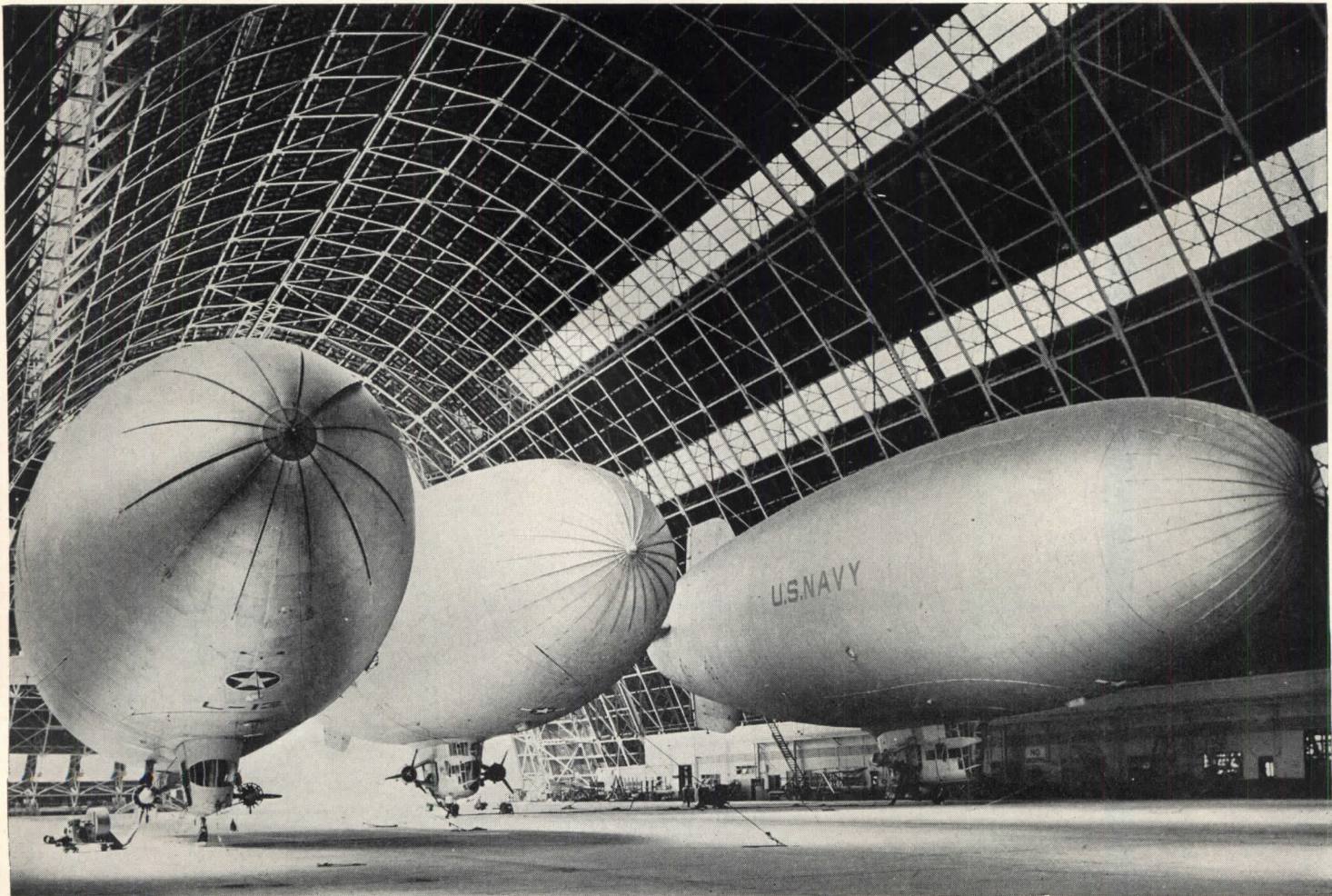



PAVILLION PLAN FAVORED FOR HOSPITALS

*U. S. Naval Hospital, St. Albans, N. Y.
York & Sawyer, Architects*



Photos: Sigurd Fischer

ONE OF THE LATEST OF THE NAVY HOSPITALS to be completed is this large group at St. Albans, N. Y., which illustrates official Navy thinking on the subject. The design stems from a pavillion type concept, with a central administration building, backed by a subsistence and recreation wing, and flanked by a series of projecting wings for the wards. The wards themselves are of the open type, with 28 beds each and centralized toilet facilities in a projecting bay. The pavillion type plan arrangement assures a double exposure for each of the wards.

The architects' design for the building simply reflects this plan disposition. Prime consideration was given to careful detailing and good construction in the building, and to the selection of durable and easy-to-maintain materials.

Other plan types for hospitals are under constant consideration. Decisions rest not only on new developments in hospital planning, but on special problems arising from the military point of view. Many areas where the Navy builds are subject to earthquake or typhoons. In possible combat areas, the target that a structure presents is of great concern. Factors such as these explain the continued use of the pavillion plan.



**NAVY
BUILDINGS**

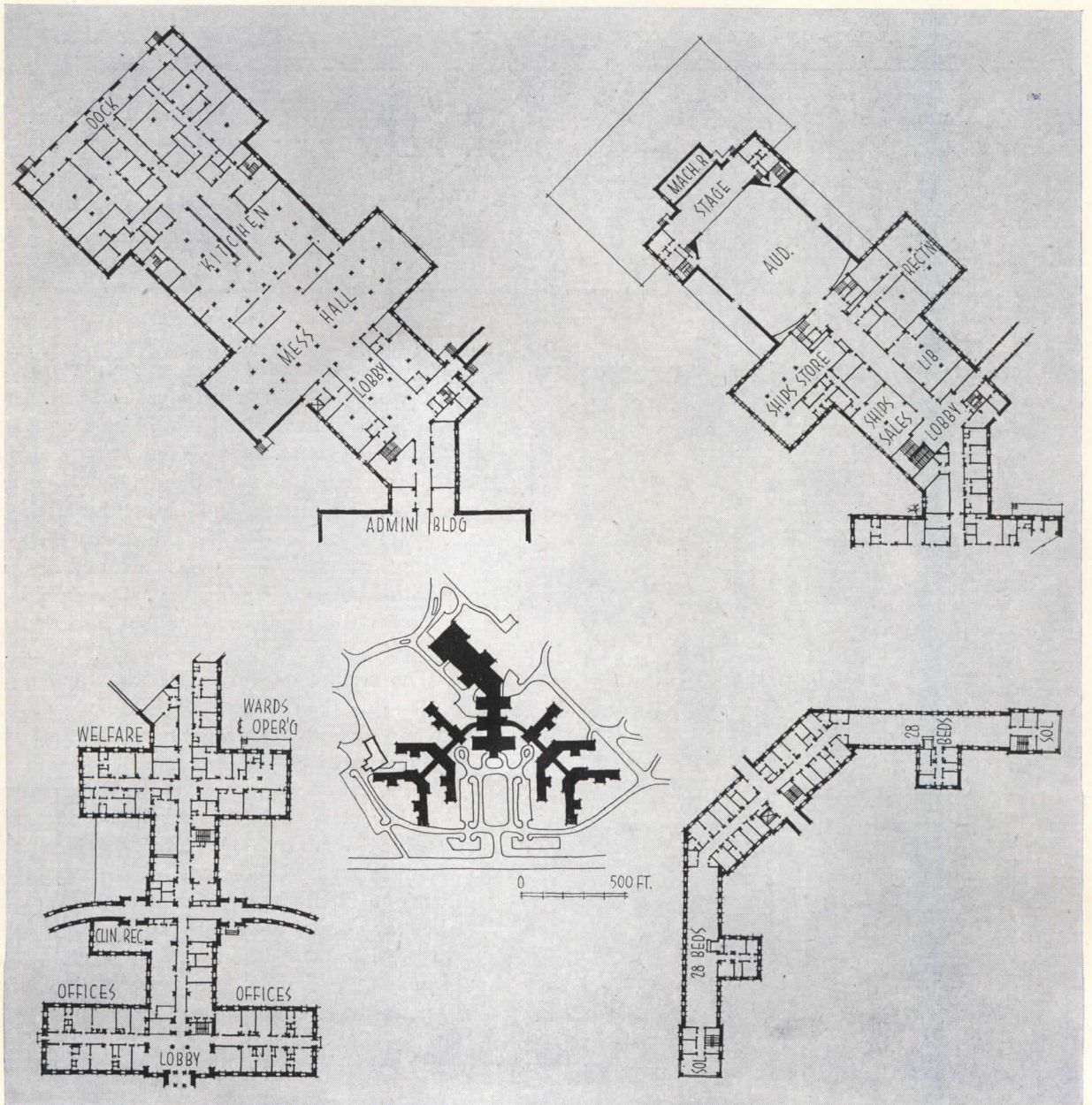

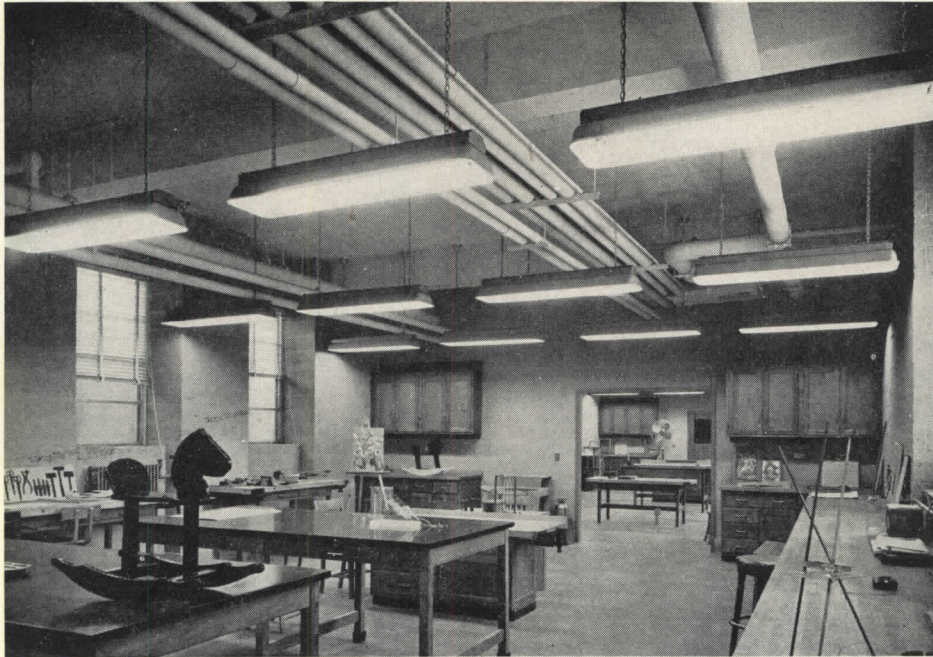
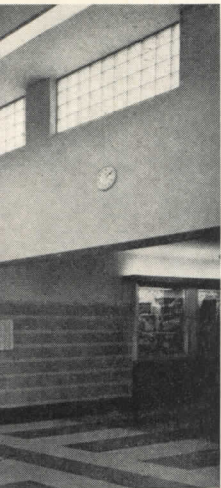
Below, left: key plan of hospital with details of central administration and subsistence building, typical nursing unit. Above, center: subsistence building lobby. Above: occupational therapy room. Below: typical open ward

Photos: Sigurd Fischer



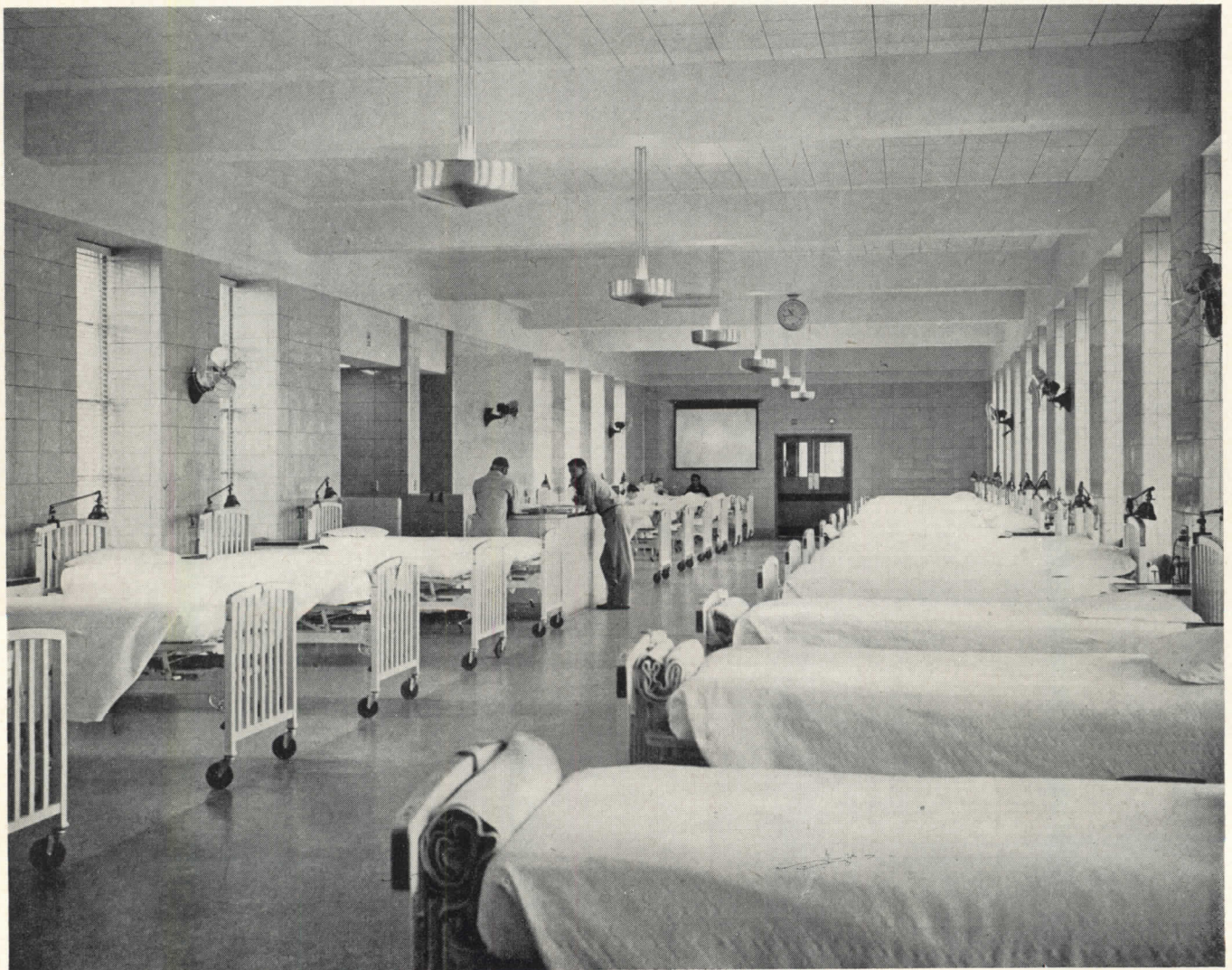

NAVY BUILDINGS

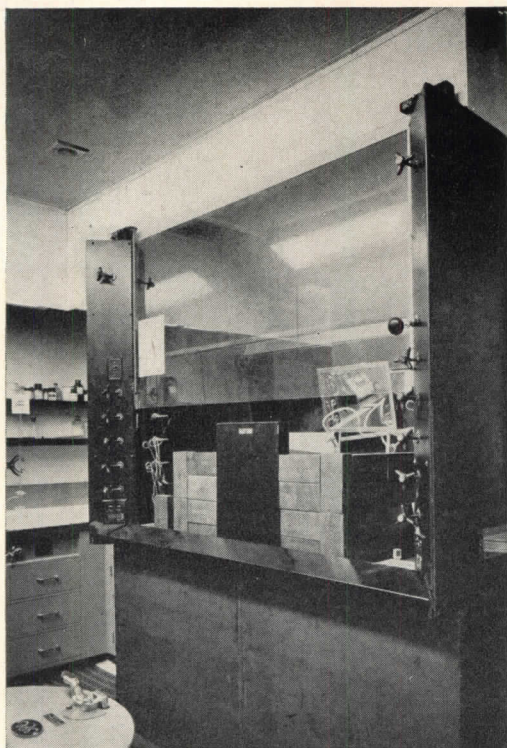

Photos: Sigurd Fischer

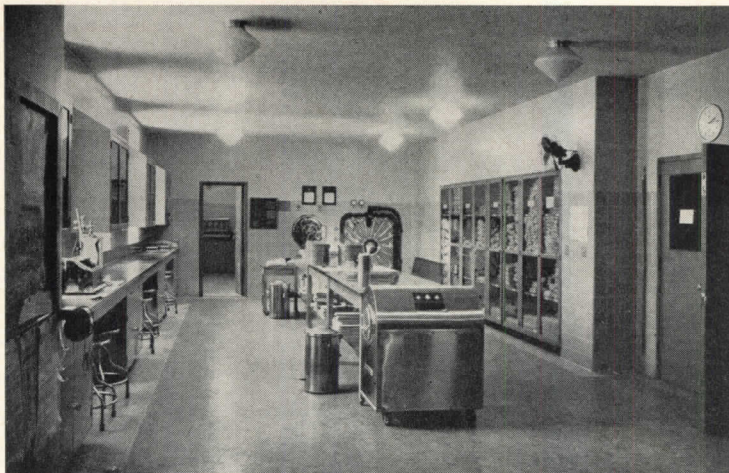

Specialized rooms in the St. Albans Hospital include: Left — radioisotope laboratory; above — sterilizing and supply room; below — typical operating room

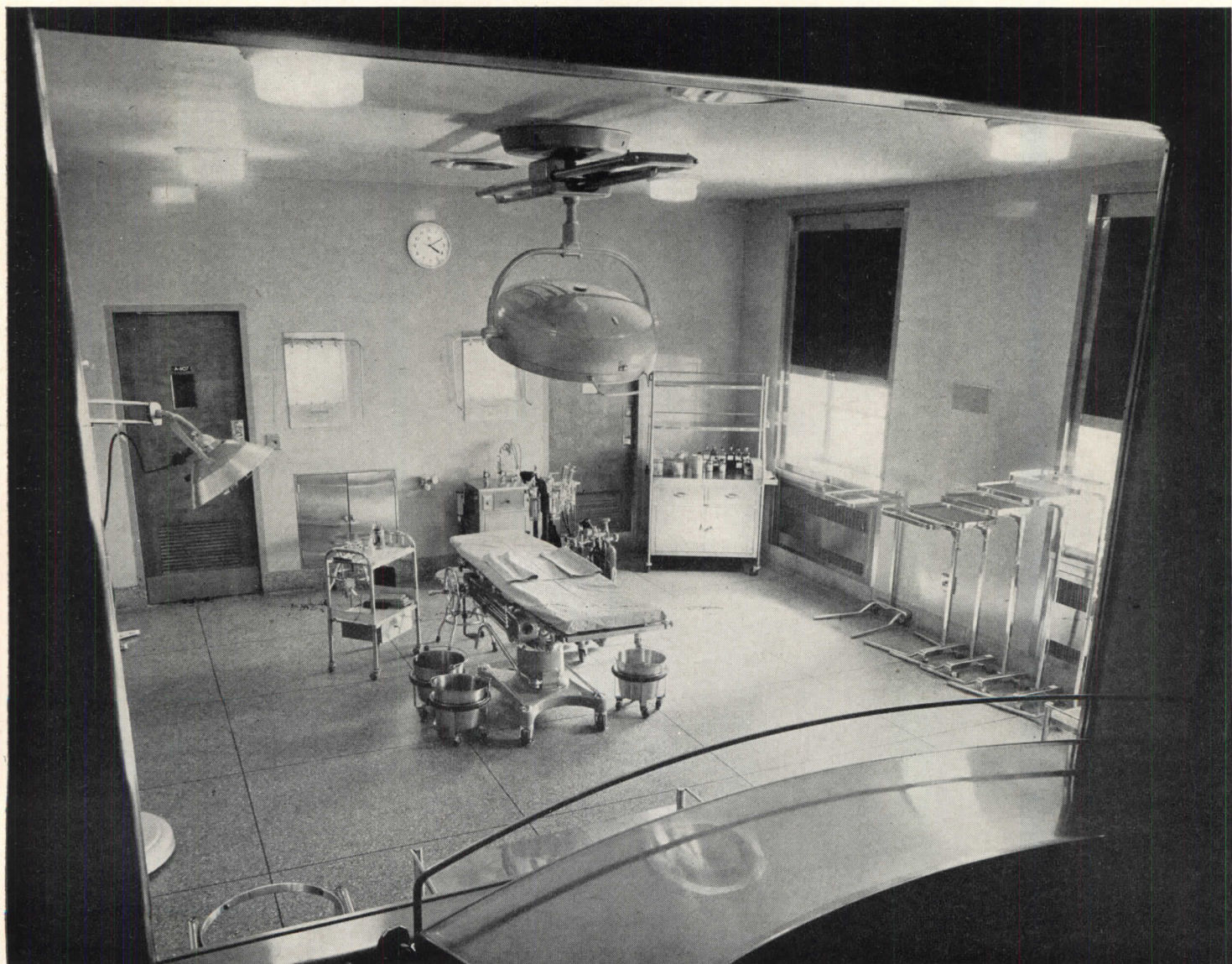

PERSONNEL SHELTERS FOR BLAST PROTECTION

AMONG THE MANY FACETS of the Navy's preparedness program is a project to develop a shelter which will assure a reasonable degree of personal safety for its occupants against atomic blast and radiation. BuDocks' basic research on blast-loading and structural deformation has led to the development of several types of ribbed thin-shell precast concrete shelters, three of which are presented on this and the following page. To provide economical and practical designs, it was considered necessary to utilize the full resistance of the critical structural members, just short of collapse. This

led to a sectional framing arrangement which would permit replacement of any parts which developed extensive cracking, spalling or local fractures from blast pressures. The use of sectional precast units also lends itself to either local or mass fabrication, and to stockpiling against an emergency. Similar, ribbed-shell panels could also be used to reinforce or form protective shells for existing buildings.

The three shelters shown here were designed to be covered with earth in immediate target areas, left exposed with ribs projecting inward in peripheral areas.

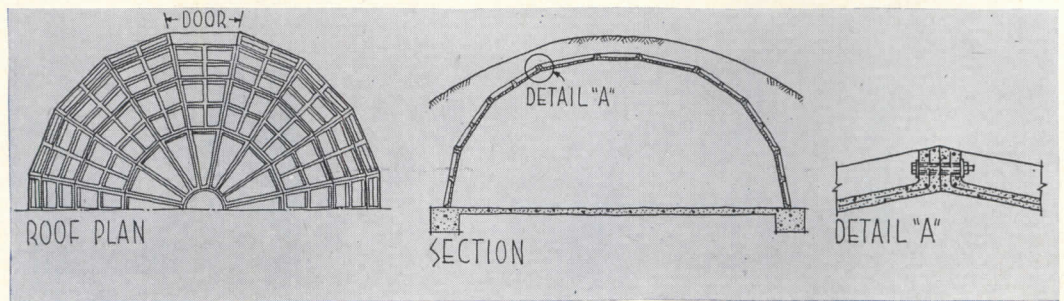

Ribbed-shell dome shelter has trapezoidal panels, bolted together in conical tiers, and circular crown

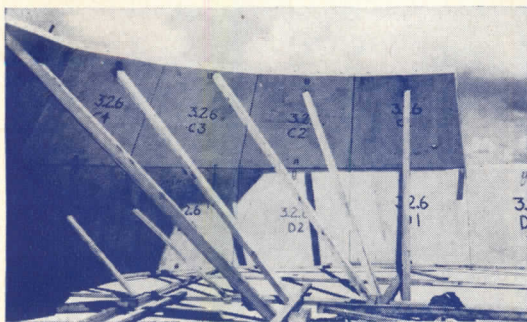
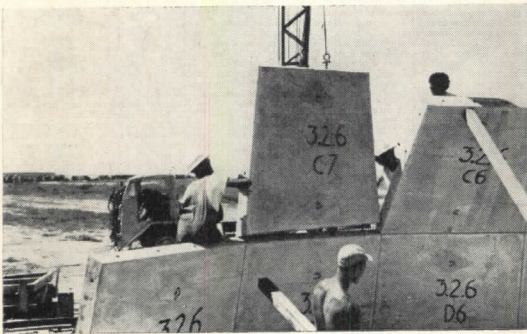

Easily erected panels are of like size in each tier. Units are bolted to precast or poured foundation

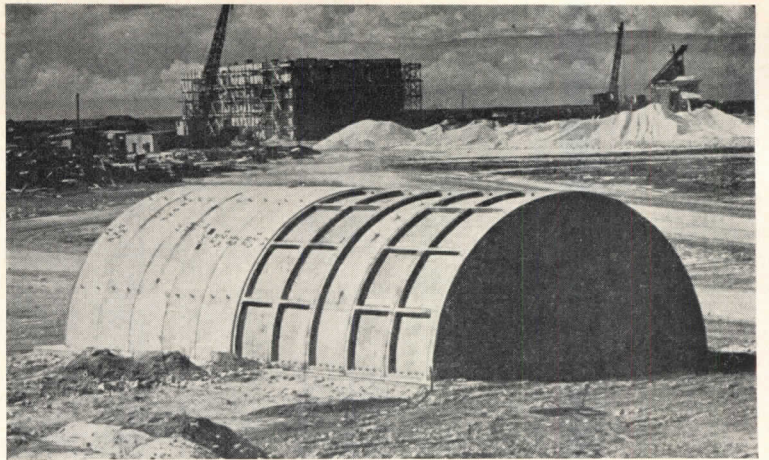
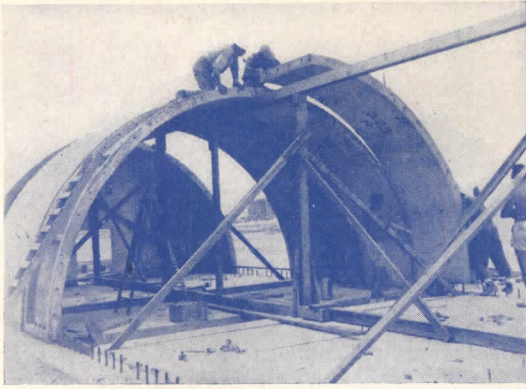

Ribbed-shell circular frame shelter (above) is concrete version of "Quonset" hut, has two-segment arch bolted at crown. Ends are flat ribbed panels

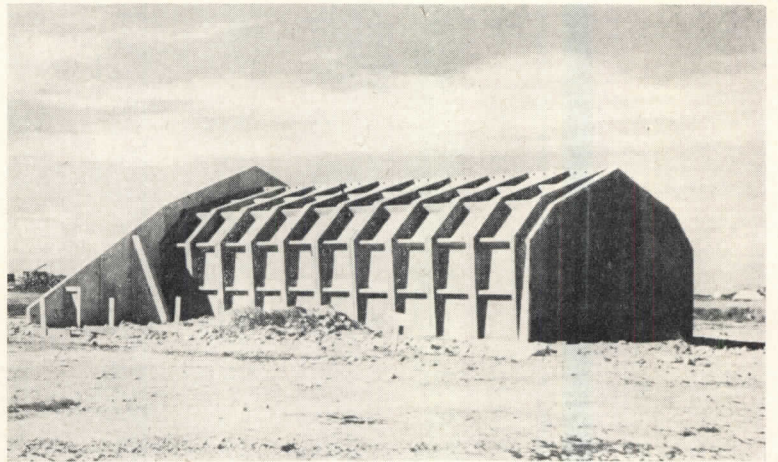
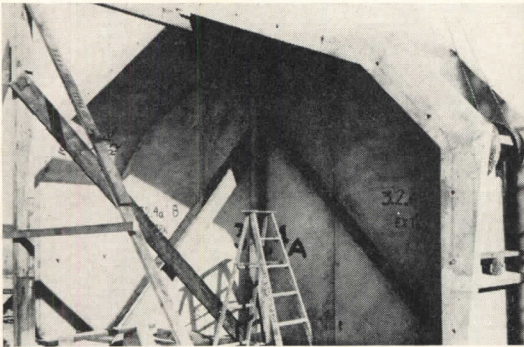
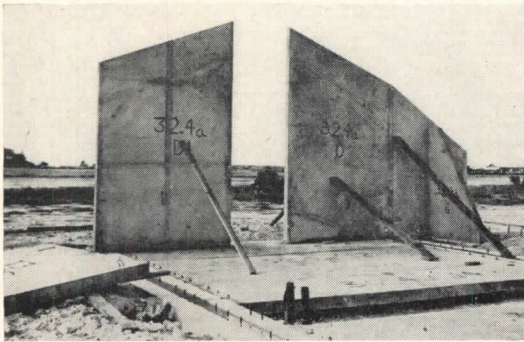

Gable frame shelter provides greater clearance, has deeper ribs to offset less favorable stress pattern

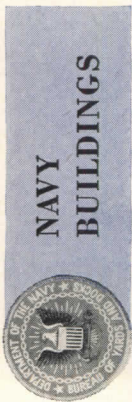
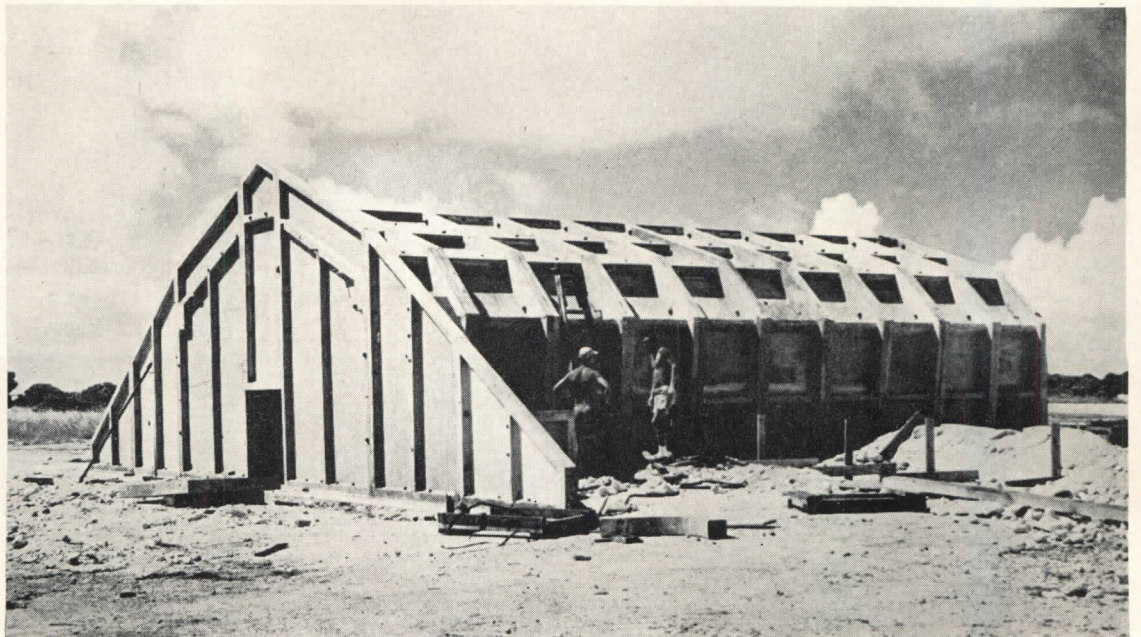



INYOKERN ORDNANCE RESEARCH LABORATORY

THIS NEW TYPE OF RESEARCH LABORATORY, designed for the Bureau of Ordnance, is typical of the special problems in both planning and site conditions that BuDocks handles. The trimly designed reinforced concrete structure is located in the midst of a desert at Inyokern, Calif. Optimum interior conditions were required for the scientific research programs; this was met by carefully designed air conditioning and dust- and

glare-control systems. The varying nature of the experiments also called for a maximum of plan flexibility. A rigid frame section (shown below, right) was adopted to free the laboratory wings of load-bearing columns and partitions. All piping and utilities are run in pipe tunnels below the floor. The lab wings flank a two-story office section and a large wing housing machine, carpentry and other shops.

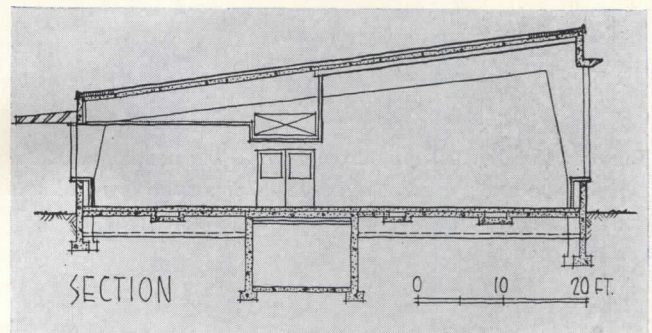
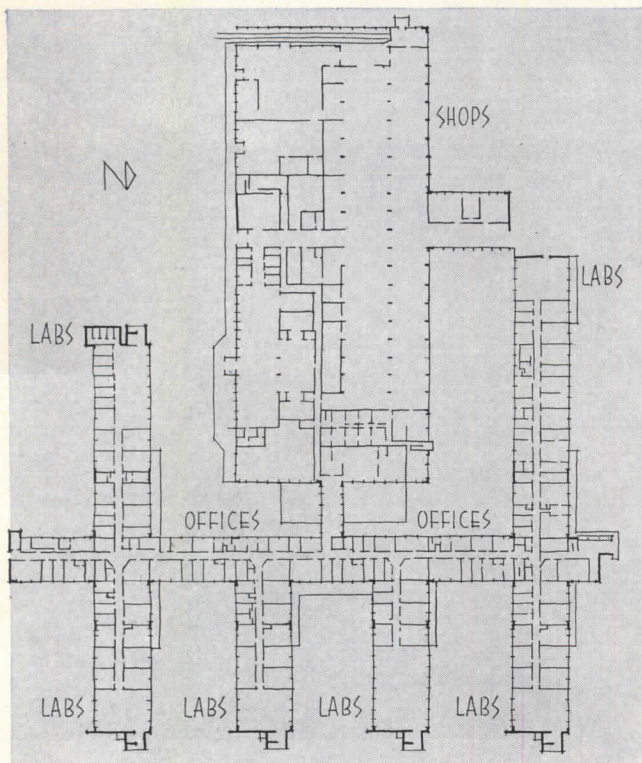

HUMAN CENTRIFUGE TEST BUILDING

THIS EXPERIMENTAL LABORATORY for the Bureaus of Aviation and Medicine and Surgery was planned specifically to house a powerful new centrifugal machine which subjects pilots to the extreme gravitational conditions encountered in high-speed aircraft. The centrifuge has a 50-ft arm attached to a motor capable of accelerating to 180 miles an hour in 7 seconds; a subject seated in an air tight gondola at the end of the arm can be rotated either forward or backward at the same time he is being whirled horizontally. A variety of instru-

ments record the subject's reactions. The plan and structure of the building were designed to accommodate the functions of the machine and its subsidiary laboratories and facilities, as well as to withstand the weight, stresses and strains it imposes.

A site was chosen at the U. S. Naval Air Development Center, Johnsville, Pa., where foundations could be built on solid rock to prevent excessive vibration. The building is built of reinforced concrete, with the roof supported on radial trusses.



The centrifuge (far right) around which the building was designed, can exert a force equal to 40 times the gravitational pull of the earth on a pilot seated in the gondola (closeup right)

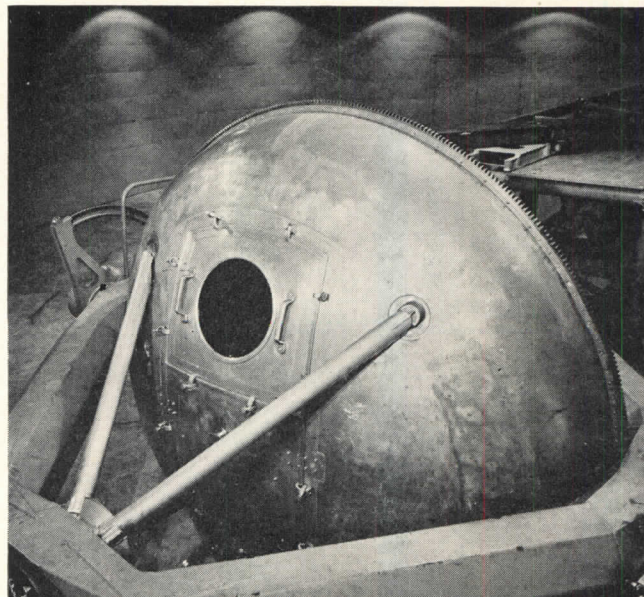
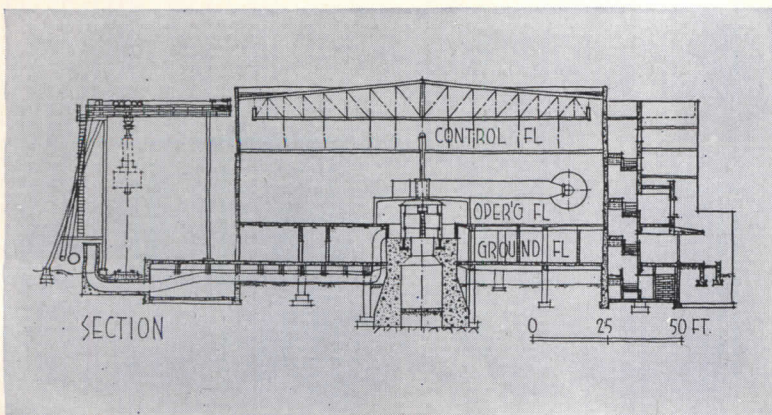

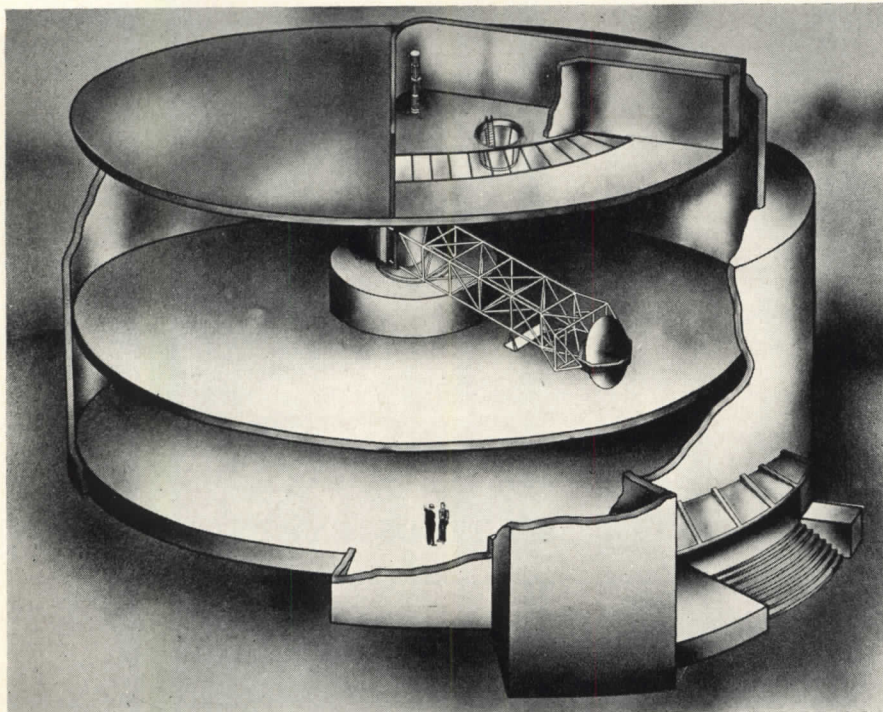
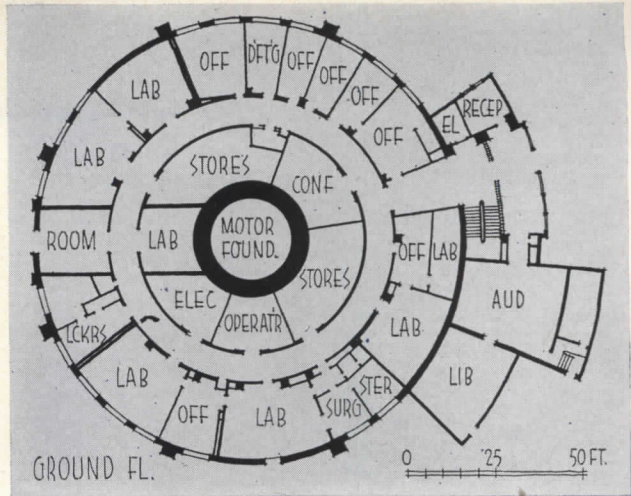
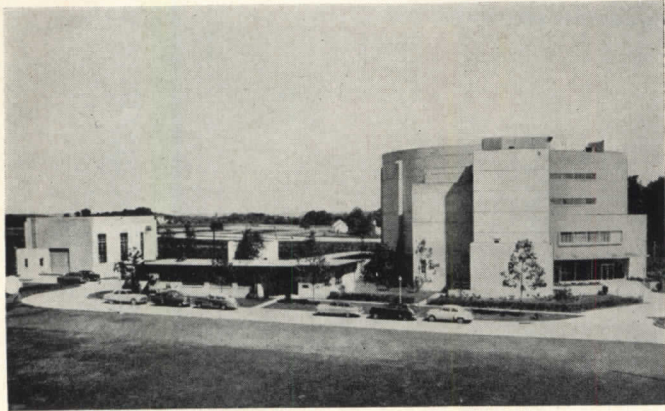

The first floor of the building (plan above) is allocated to the entrance lobby, offices, labs, an auditorium, shops, store rooms and a corridor for installing or removing the huge centrifuge motor. The second floor houses the centrifuge itself. The entire chamber is shielded with copper to eliminate electrical interferences with recording instruments. A mezzanine floor over the lobby and auditorium contains an emergency physiologists' room and a low pressure chamber. The top floor has the recording room, physiologists' space and a glass enclosed control blister which is suspended down into the centrifuge chamber

Equipment Designed By—Special Devices Center, Office of Naval Research and McKeirnan-Terry of Harrison, N. J.

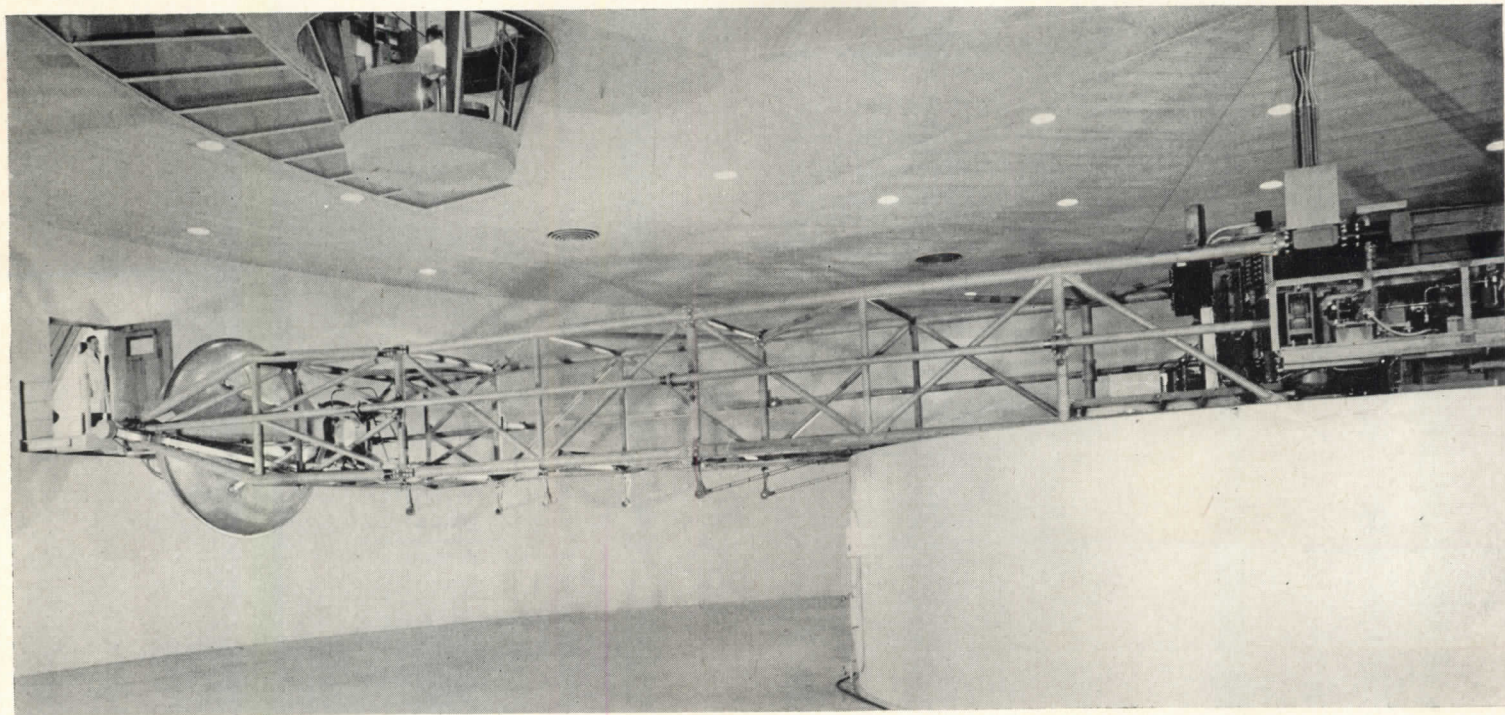

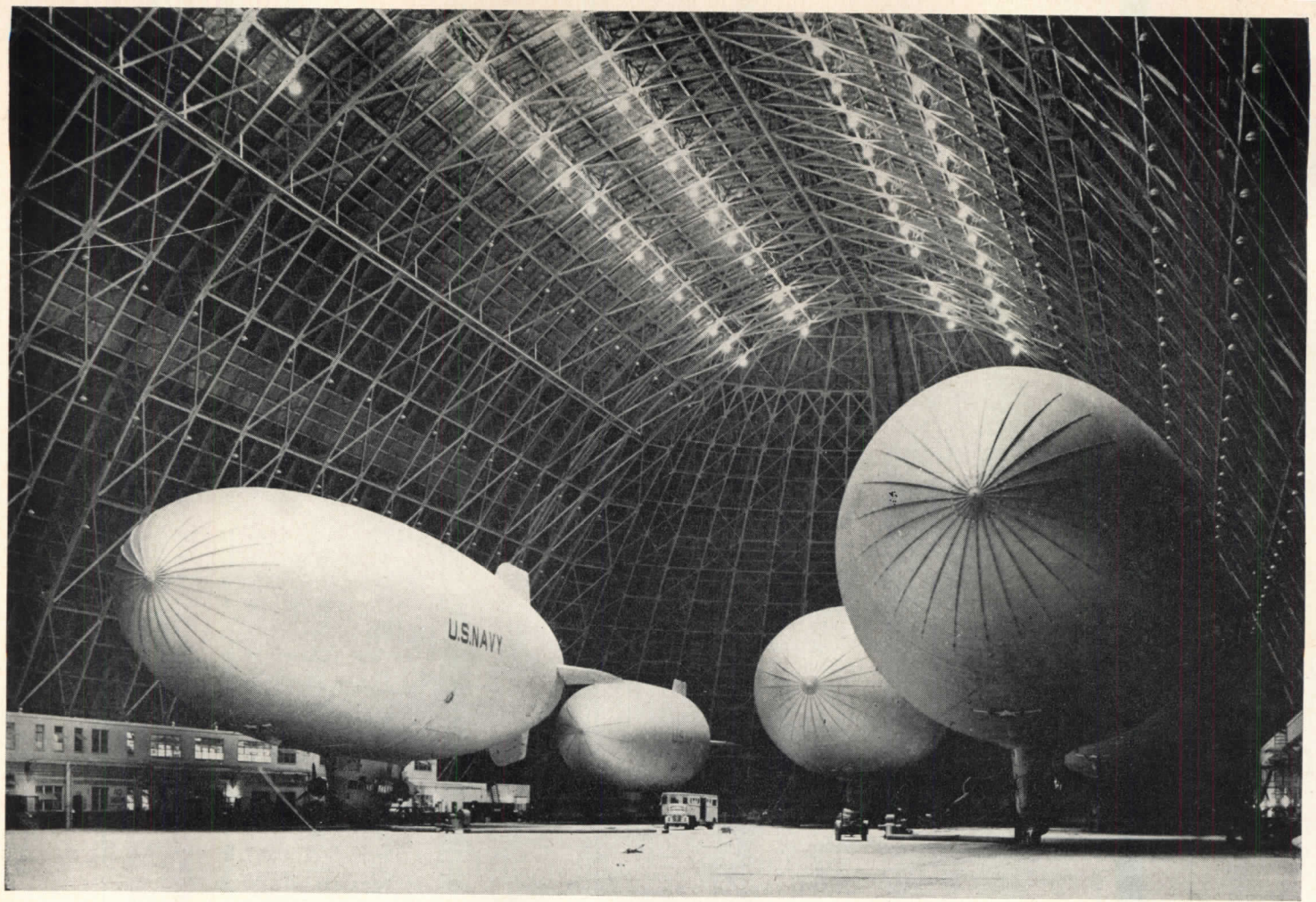

NAVY BUILDINGS

NAVY AIRFIELDS EXPAND FOR JETS

THE RAPID PROGRESS IN THE DESIGN of military aircraft during the postwar years has caused a tremendous spurt in the planning, design and construction of airfields to keep apace. The new jet planes and heavy bombers have heavier wheel loads, increased landing speeds, and rely heavily on instrument flying. These developments require longer, stronger and more durable runways than were necessary heretofore. As the Navy has practically changed over 100 per cent from reciprocating to jet engines, BuAir has set up a long range program for the development or conversion of appropriate

fields. Six master operational bases are now under construction, three on the East Coast — Oceana, Va., Cecil Field, Fla., Brunswick, Me. — and three on the West Coast — Whidbey Island, Wash., and Miramar and Moffit Field in California. These are to be supplemented by a series of auxiliary bases, some operational, and some industrial for maintenance and overhaul. In case of emergency, the auxiliary operational fields would in turn be converted to master bases with satellite fields. To keep up with the preparedness program, bases are being developed simultaneously in a three part program: first, runways and vital jet field storage facilities; next, hangars; and finally, the variety of buildings and facilities needed to complete the fields.

Although there can be no static rules to the planning of runways, due to the almost continuous modification of military aircraft, BuAir currently favors a flexible offset pattern. This wheel-spoke pattern (see diagram far left) eliminates taxiing, has control tower as center for all landings and take offs. Such a plan can be expanded by parallel dual runways. A typical airfield of this type is the Marine Corps Air Station at Cherry Point, N. C., shown at left superimposed on plans of three of the larger public airports.

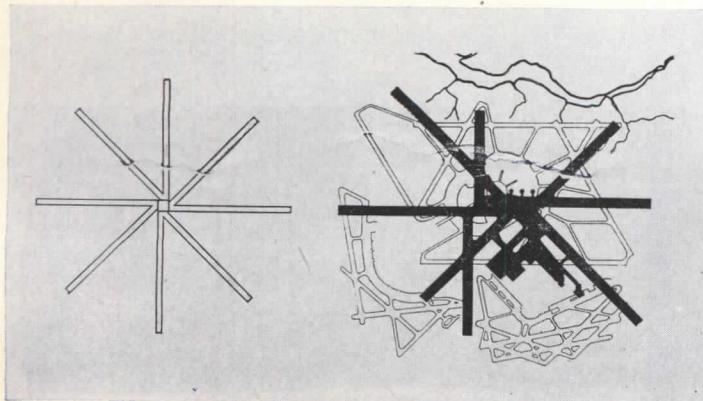

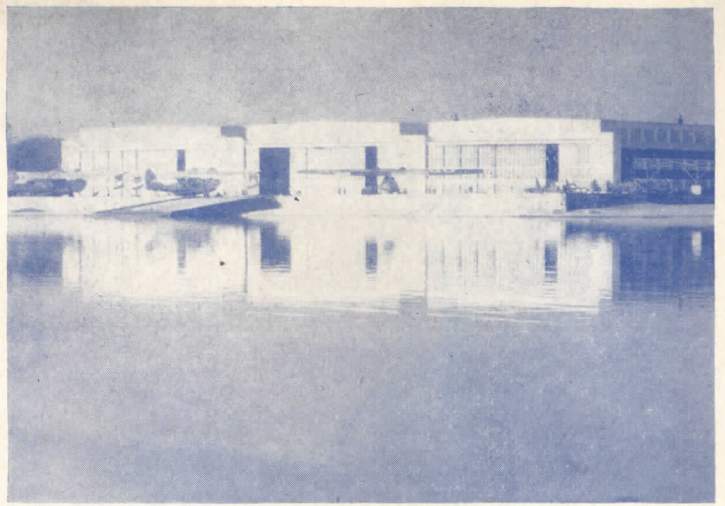
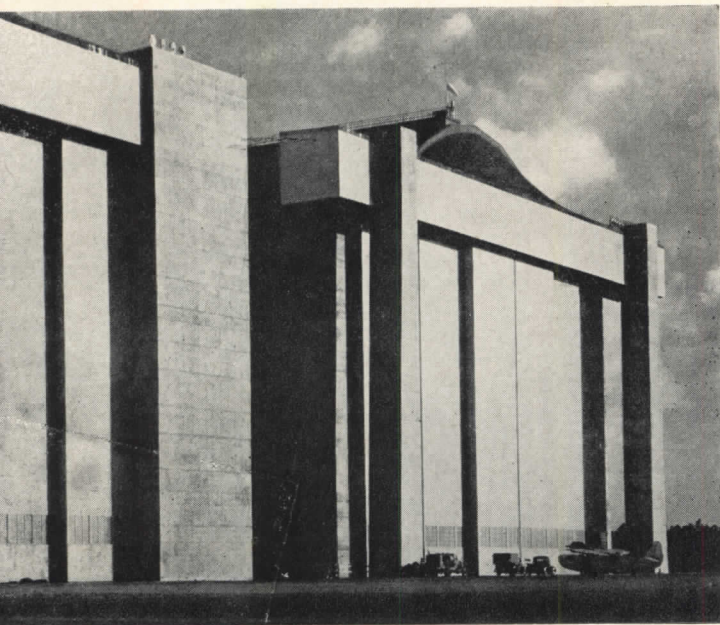

The Navy builds four categories of air facilities: lighter-than-air stations, seaplane bases, land-plane bases, and seaport and industrial air stations. Several typical examples are illustrated here. Far left: lighter-than-air hangar interior, Weeksville, N. C. Left: exteriors of similar hangars, Richmond, Fla. Above: Seaplane hangar, Pensacola, Fla. Below, left: Naval Air Station, Barber Point, Pearl Harbor, Hawaii. Below: nose hangars, Guam

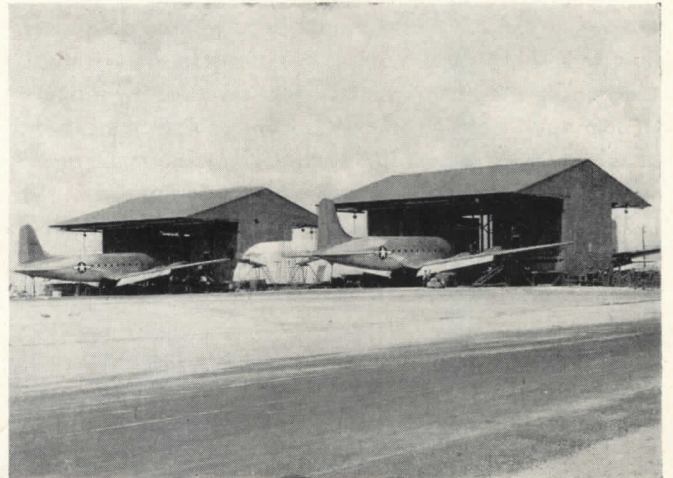
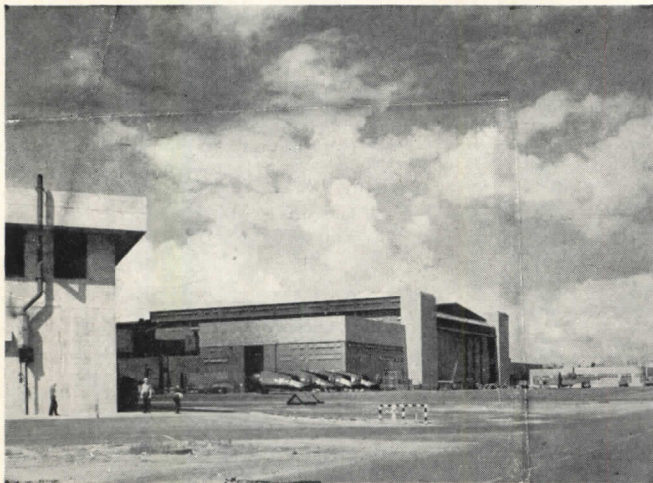

The photograph below shows a typical seaplane hangar at Jacksonville, Fla.

Albert Kahn Inc., Architect

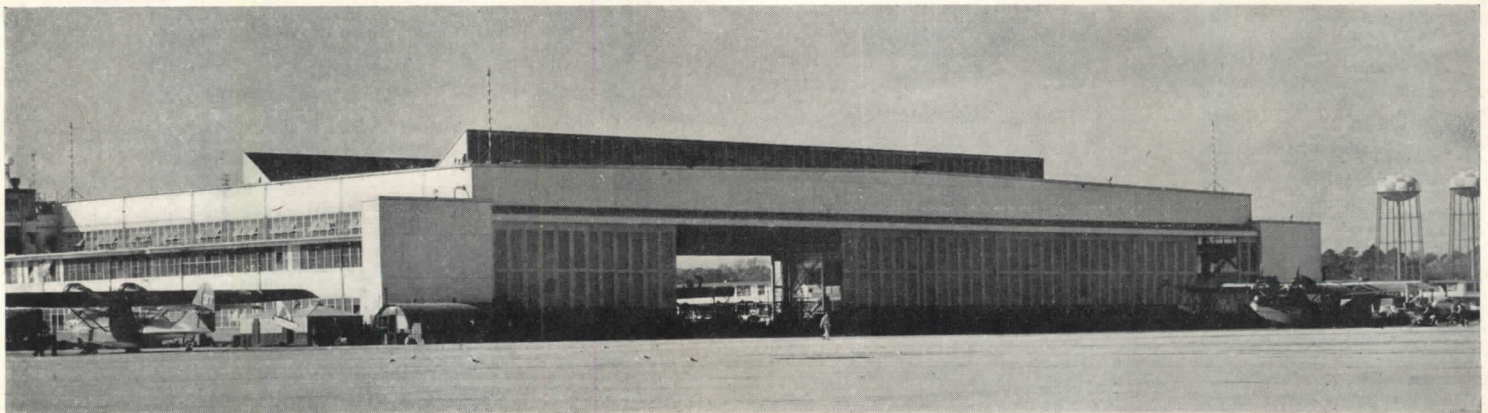

CRITERIA

DEFINITIVES

STANDARDS

ARCHITECTS AND ENGINEERS in the Bureau of Yards and Docks cringe slightly at any mention of "definitives," but they do have them for many types of buildings. They do not like the basic idea of "standard plans," and are always afraid that their work in "criteria" or "definitives" will be misunderstood, but they yield to the necessities of a huge operation with similar types of buildings erected in many places and many circumstances, and to the need for keeping these buildings comparable with similar ones at different bases, and comparable with similar types built by other military services.

Obviously, central headquarters must fix standard allowances for repetitive types of buildings like barracks, mess halls, storehouses, dispensaries. Many factors in design depend on top-level policies, or on requirements established at department level, as, for example, design of military hospitals. These matters are not to be left to individual inspirations, no matter how refreshing those might be. At BuDocks, however, there is full realization that any stated standard is likely to be inapplicable in some details to some given location, or might be "copied cold" when it ought to be changed.

But the definitives and criteria do prove useful in the field, for they state the Navy's wants in easily understood terms, and they serve as a check list reminder of many items which fresh inspiration might just overlook.

Standards at BuDocks include permanent, semi-permanent, emergency (built during the last war), and mobilization (definitives ready for a quick, new emergency program). Permanent is of course for continued use in permanent bases, with minimum maintenance expense. Semi-permanent differs very little from the first, but contemplates higher maintenance costs for continued use. Mobilization is the lowest standard, with smaller space allowance, fewer facilities, use of non-critical material and so on. The mobilization drawings envision a rapid building program of minimum buildings, with SeaBees buzzing about the world.

Currently, austerity is trimming allowances pretty much all along the line, as explained elsewhere.

It is understood, of course, that any prepared criteria apply only to standard, repetitive types of buildings. There could not possibly be any frozen or canned designs for a centrifuge building, a guided missile laboratory, a tropical harbor, a dirigible hangar, but these unique constructions are actually more typical of Navy design work than the ubiquitous barracks.



ENLISTED MEN'S

BARRACKS

Each of the military services has an explicit program to achieve a large degree of standardization and economy in its 1953 program for repetitive type buildings. In the barracks category, each is working toward a separate solution peculiarly adapted to its own requirements. The principal saving sought through these standard designs is the sizeable reduction of the gross area per man, without reducing each man's actual living space. The directions Navy thought is taking along these lines are illustrated in the two examples on the facing page. The rendering and top two plans show a two-story mobilization type barracks for enlisted men. This scheme was devised some time ago for emergency use. The bottom plan shows one of the floors of the most recently issued scheme for a permanent type enlisted men's barracks. This scheme has three stories, houses 172 men single bunked. It is sub-divided into three 48-bed dormitories for enlisted men and two 14-bed dormitories for Petty Officers or Non Commissioned Officers. Locker-height partitions divide rooms into cubicles of four bunks each. The scheme allots 72 sq ft per enlisted man, 82 sq ft per N.C.O. and an overall gross area of 125 sq ft per man, including service areas. Emergency double bunking must maintain 50 sq ft per man, net area.

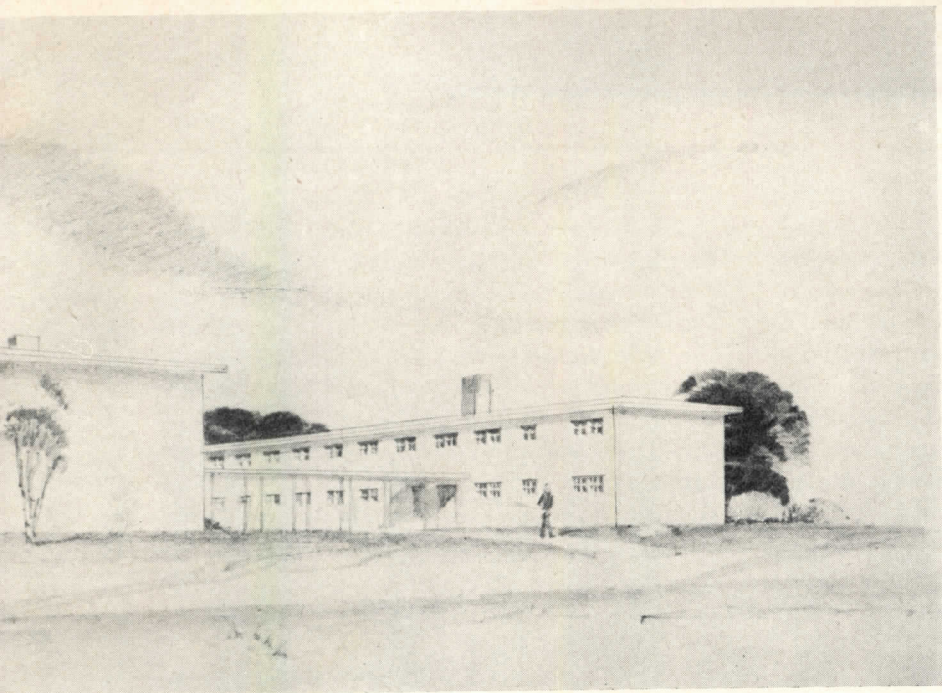

NAVY BUILDINGS

Mills & Pettitcord, Architects

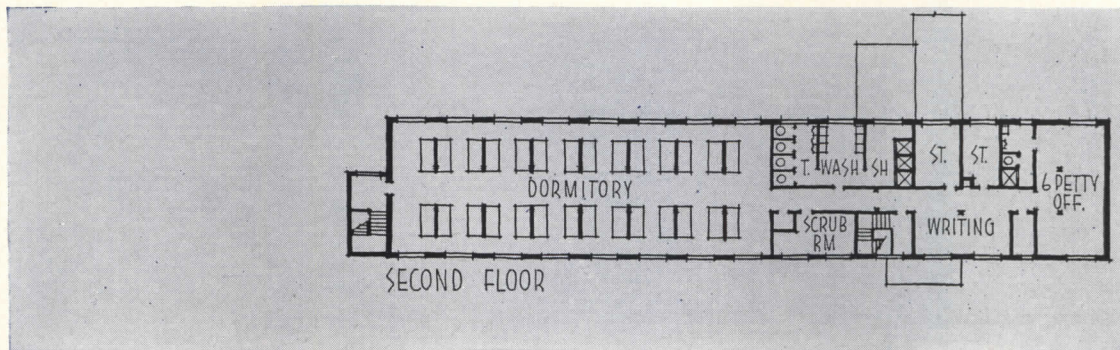

Mills & Pettitcord, Architects

Two-story mobilization type barracks (above, below)

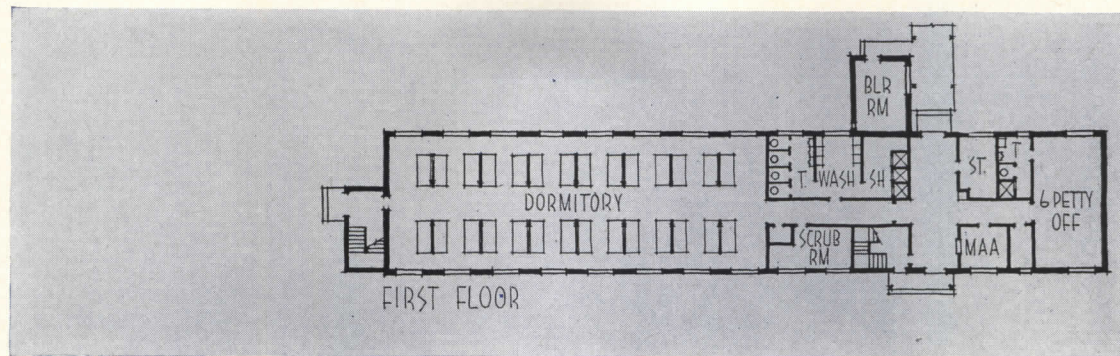

Three-story permanent type barracks, typical floor (below)

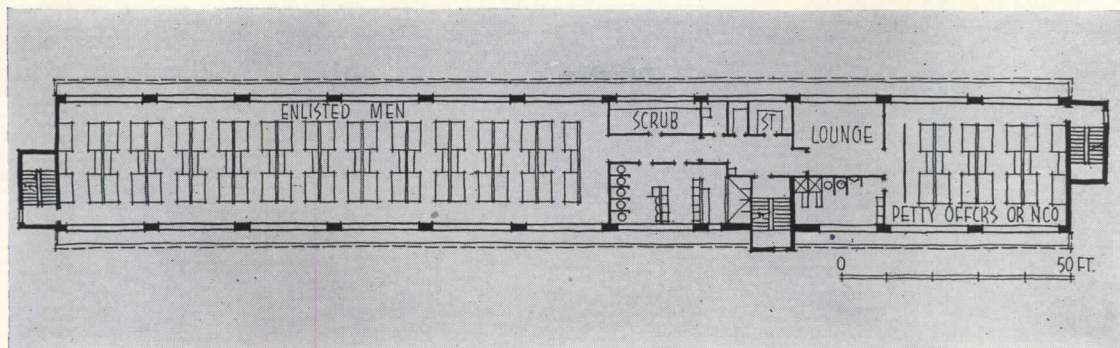



ONE-STORY GENERAL WAREHOUSES

THE GREAT QUANTITIES OF MATERIALS, foods and goods necessary to maintain a military operation place warehouses as one of the most vital of the repetitive building types. To permit a systematized method of operation and easy interchange of equipment, BuDocks has set up criteria and definitive drawings containing basic principles and design information for site selection, design and construction of a permanent standard warehouse of one story. This type is illustrated in plan and section at the bottom of the page.

The scheme is based on a compartment unit which may be used in multiples of, say, three or five, to form a complete warehouse. Particular attention is paid to the fire resistance of the structure and the combustibility of the goods to be stored. Each of the compartment units is separated by fire walls and has a floor area of approximately 40,000 sq ft.

BuDocks also has a small, single compartment mobilization type warehouse scheme on hand for use in an emergency period. This design is shown directly below.

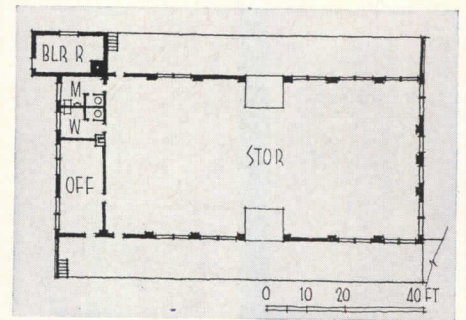
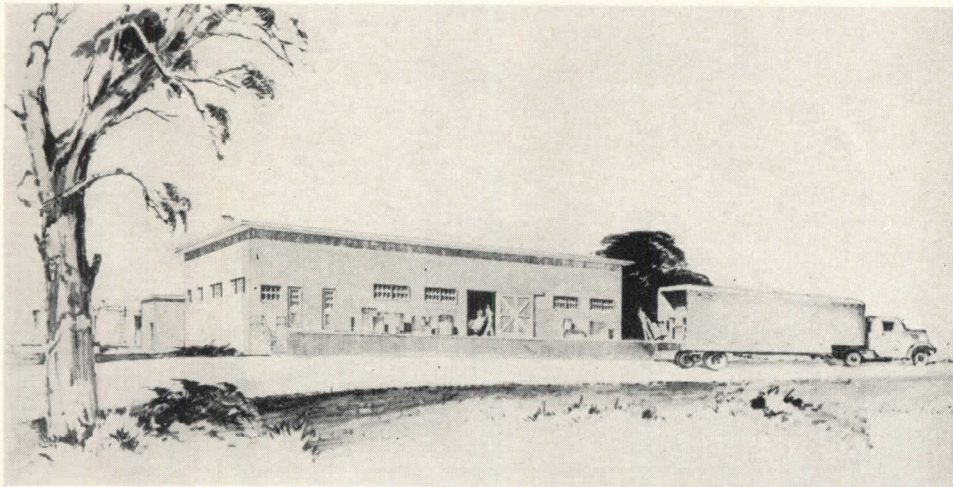

Mills & Petticord, Architects

Above: mobilization scheme for a small warehouse.
Below: three-compartment permanent warehouse

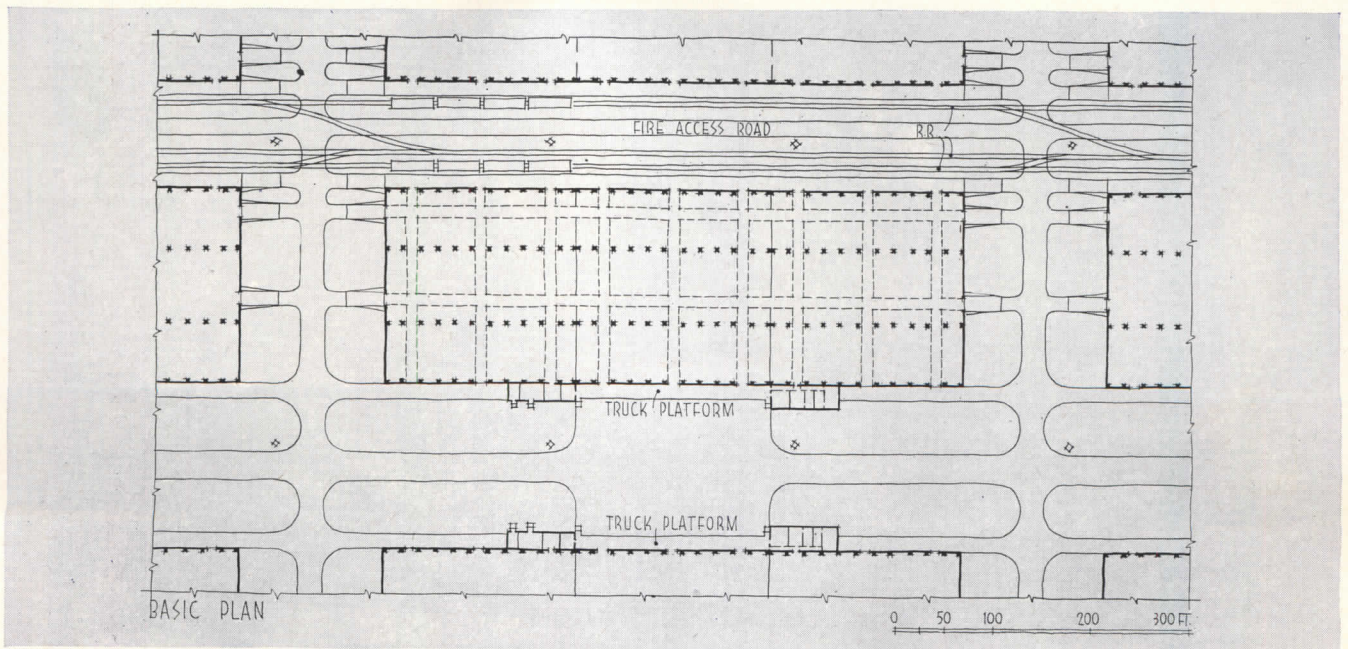

DISPENSARIES MOBILIZATION TYPE

TO SUPPLEMENT THE PERMANENT HOSPITAL FACILITIES in periods of emergency, BuDocks has a series of mobilization schemes for various size dispensaries. All the designs use the standard open type wards, with grouped washroom facilities. As in the permanent hospitals, the wards are ranged around a central unit housing offices, labs, clinics and operating rooms. The main difference in the various mobilization schemes for dispensaries is simply one of size, rather than any major change in plan organization.

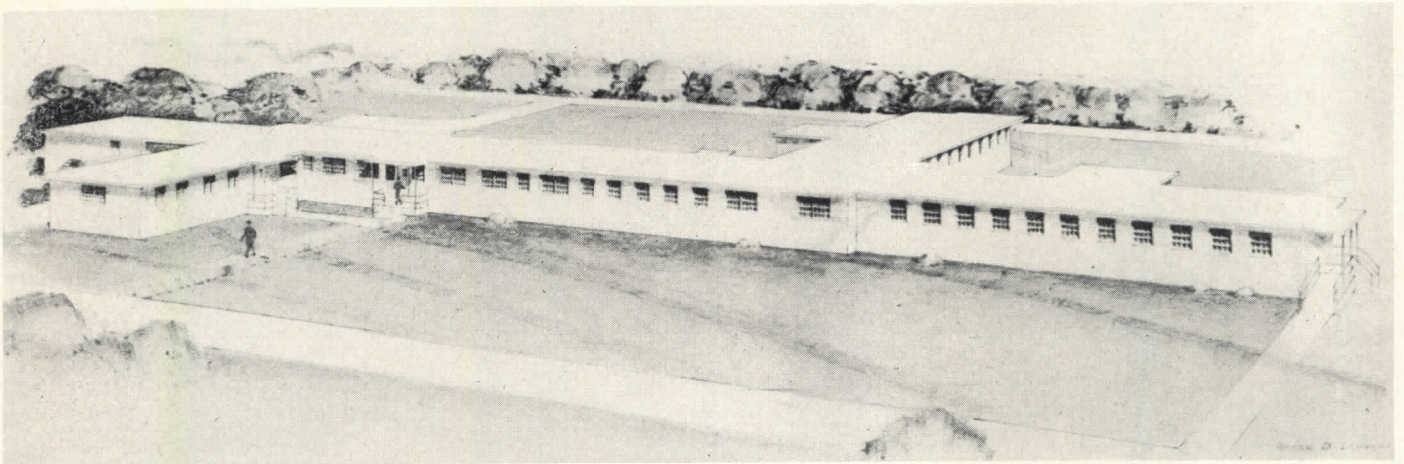

Mills & Petticord, Architects

A 50 bed dispensary is shown above and large plan below. The small plan in blue is a 10 bed unit

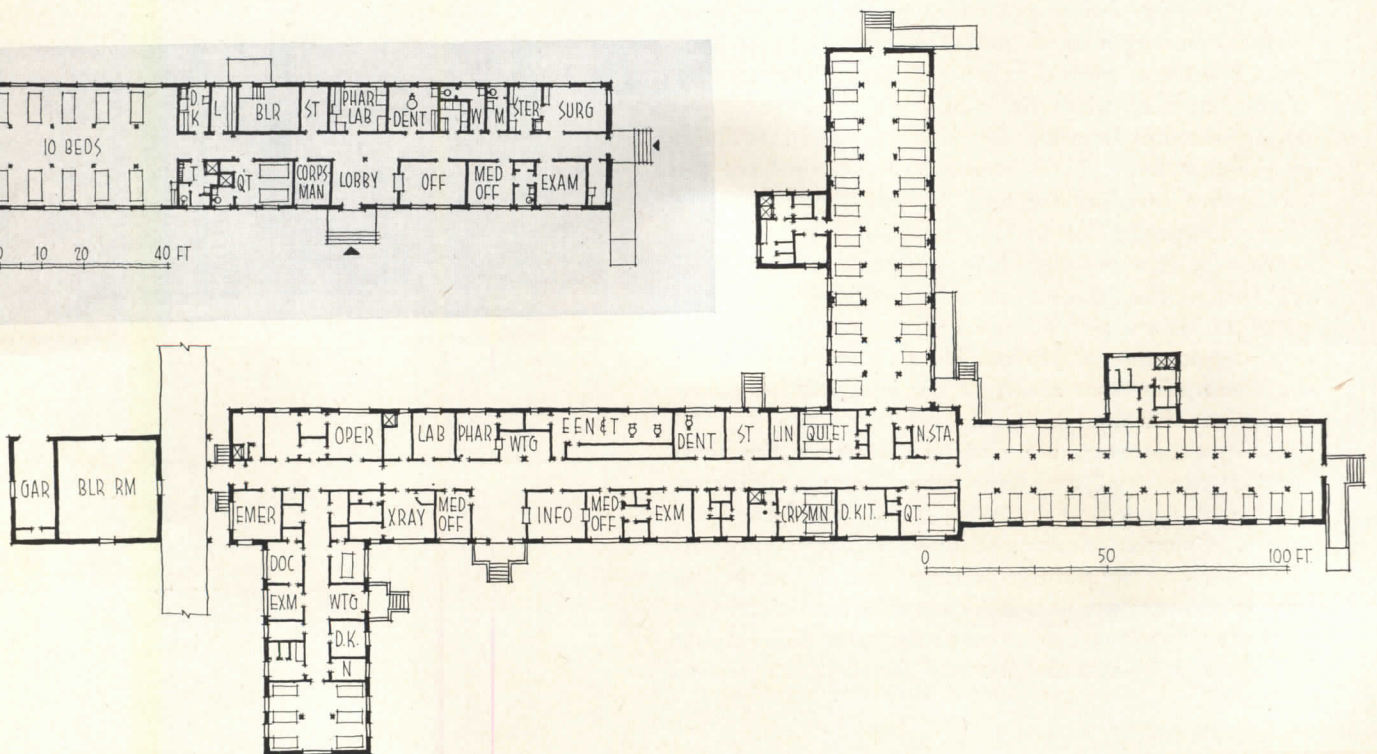
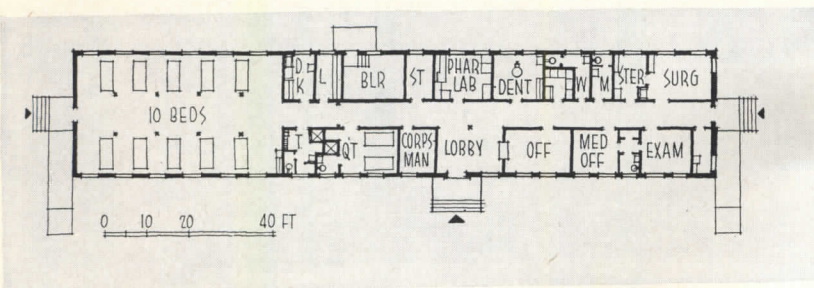

ENLISTED MEN'S SUBSISTENCE BUILDINGS

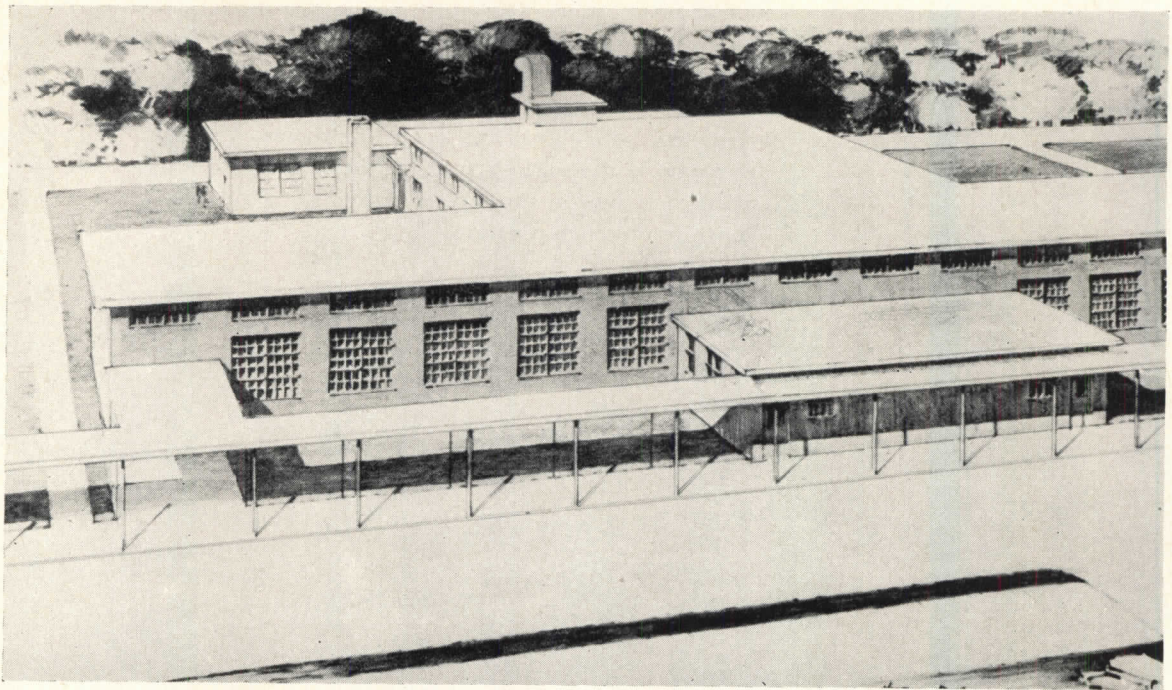
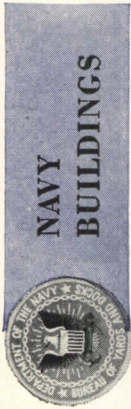

Mills & Peticord, Architects

MESS FACILITIES FOR NAVY and Marine enlisted personnel at Naval Shore Establishments have, in general, a standardized plan based on circulation patterns. The sizes and number of units at each base are directly dependent on the capacities of the barracks. For all bases except those of the Fleet Marine Force, one subsistence building is provided for each group of barracks having a total "normal capacity" up to 3300 men. The term "normal capacity" denotes the capacity of the barracks when single-bunked. "Emergency capacity" denotes capacity when double-bunked, or about 50 per cent more. Fleet Marine Force bases have one subsistence building for each barracks group with a "normal capacity" up to 1000 men.

Mess halls are designed for cafeteria service of 85 per cent of the "normal capacity" of the barracks in about an hour, and 85 per cent of the "emergency capacity" in about 1½ hours. These figures are based on the assumption that about 15 per cent will be absent for various reasons.

Galleys, however, are designed to serve the total "normal capacity," and have space for any additional equipment needed to serve the total "emergency capacity." Calculations are also based on time allowances of ten persons per minute passing through the serving line, 15 minutes per person for actual eating time. One cafeteria serving counter, one scullery for dishwashing and about 200 seats are provided for each 425 men to be served.

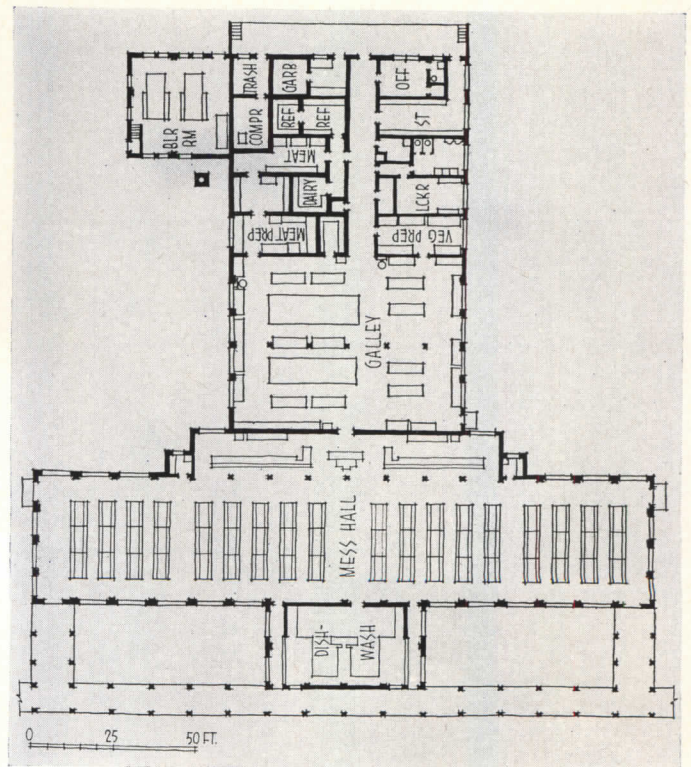

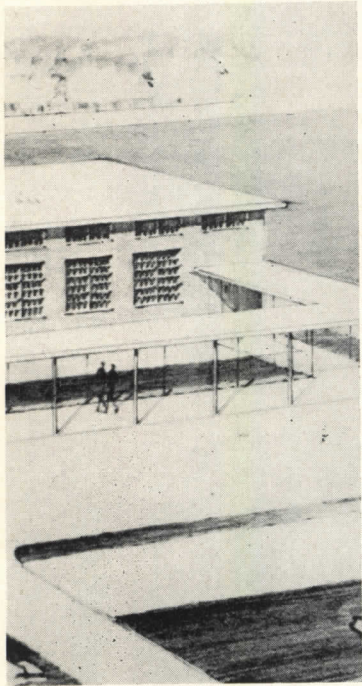
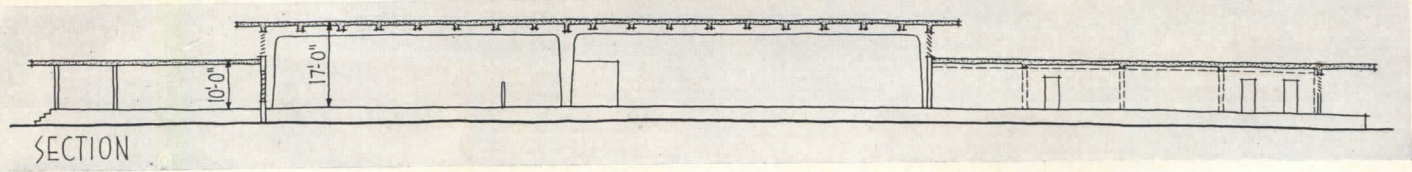

Navy standards follow the same general pattern for all types of subsistence buildings. The plan and rendering at left show the mobilization scheme for a unit to serve 1000 men at "normal capacity," 1550 men at "emergency capacity." The section and plan on this page show a permanent tropical type unit with a normal capacity of 2000, an emergency capacity of 3000. Buildings for northern zones are similar to tropical except for amount and type of fenestration, different roof design. Storage space in the permanent type is based on a one-week supply for "normal capacity," five-day supply for emergency. Type of equipment used depends on fuel available

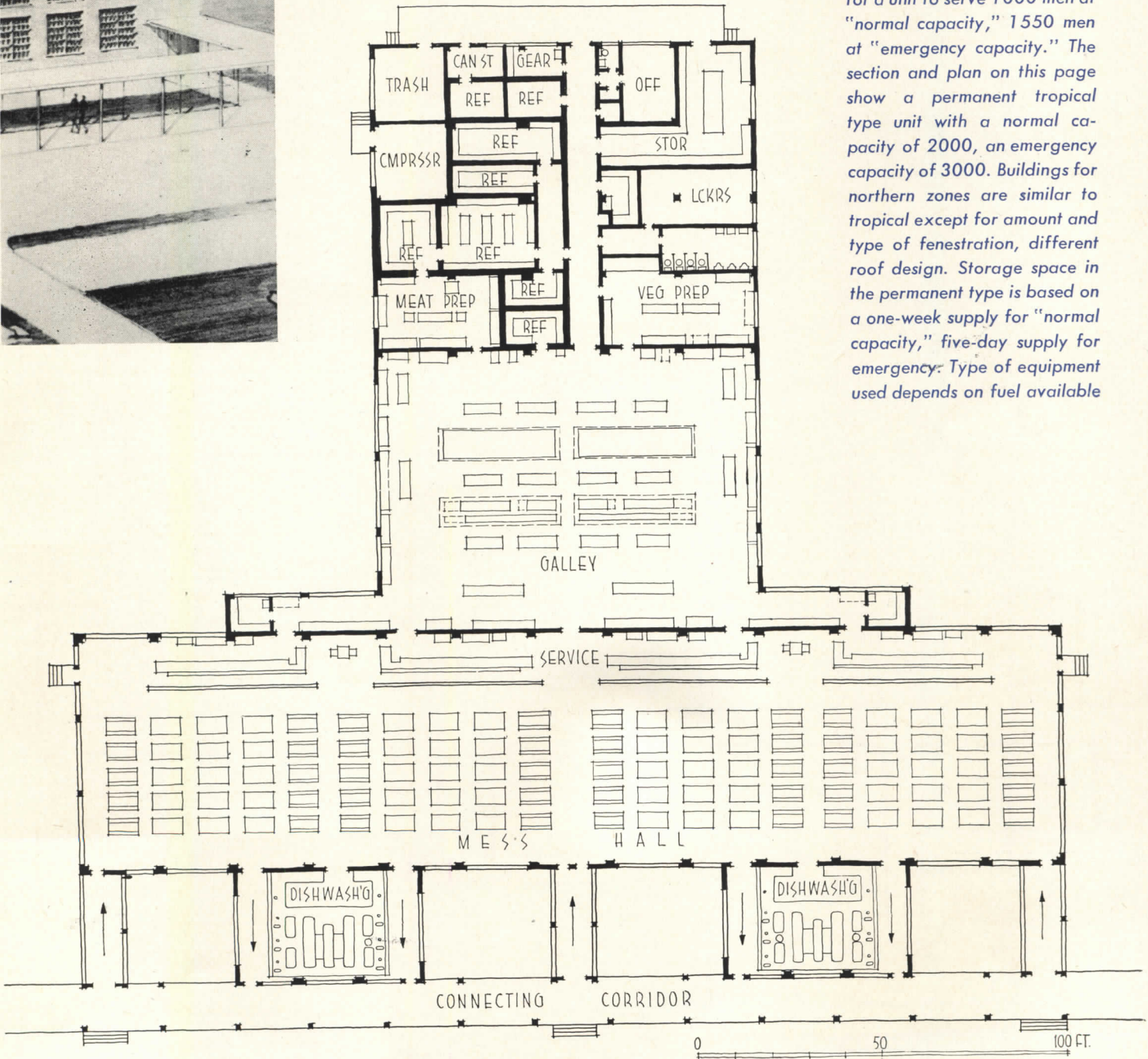

AIRFIELD CONTROL TOWER AND OPERATIONS BUILDINGS

THE RAPID EXPANSION OF THE AIRFIELD construction program, discussed previously, has greatly increased the importance of a standardized "criteria" for control towers and operations buildings. The traffic control tower itself is the nerve center of an air station. Within it are centralized facilities for giving taxiing instructions, takeoff clearances, approvals to deviate from prescribed traffic patterns and many other kinds of information on traffic, airfield conditions and weather.

The tower must be higher than any near-by structure that could limit or obstruct the operator's vision. Where the terrain is level, a height of 40 ft from the ground to the floor of the control room is considered the minimum.

The control tower is often constructed as part of the operations building for the sake of convenience to offices and facilities for aerology, operations, communications and Ground Control Intercept. In some instances, however, a separate tower is desirable.



NAVY BUILDINGS

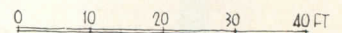
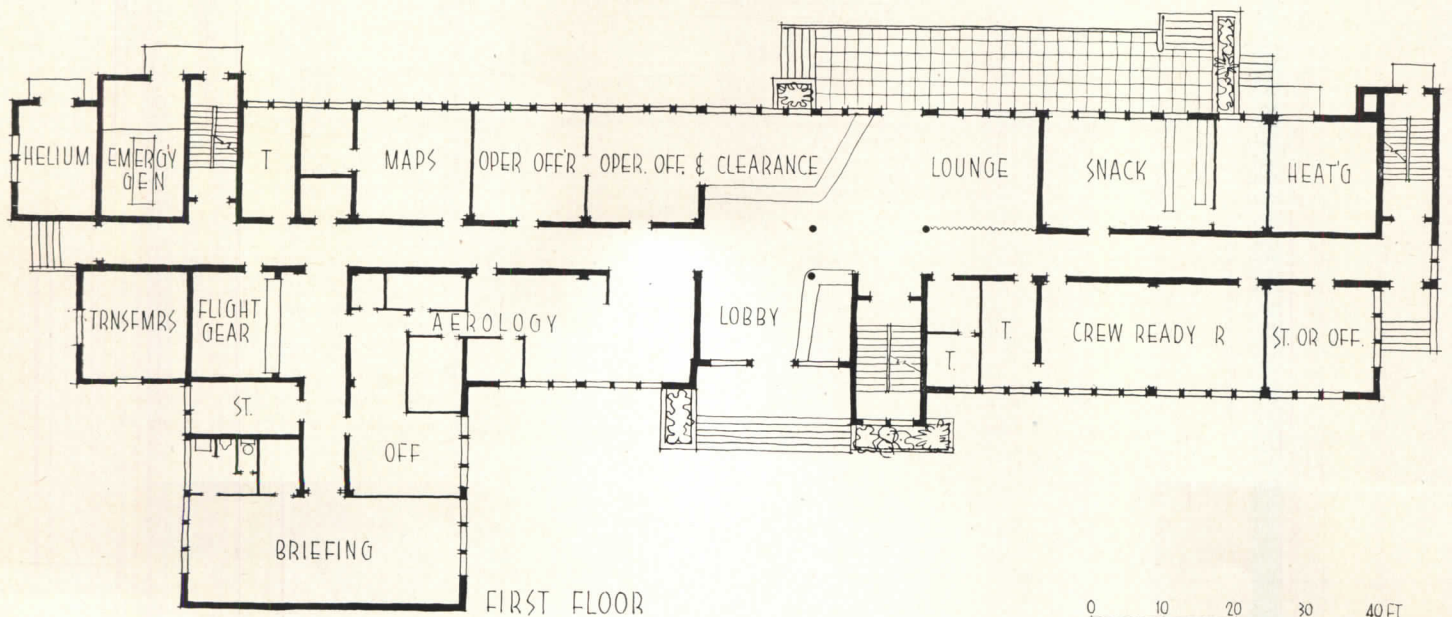
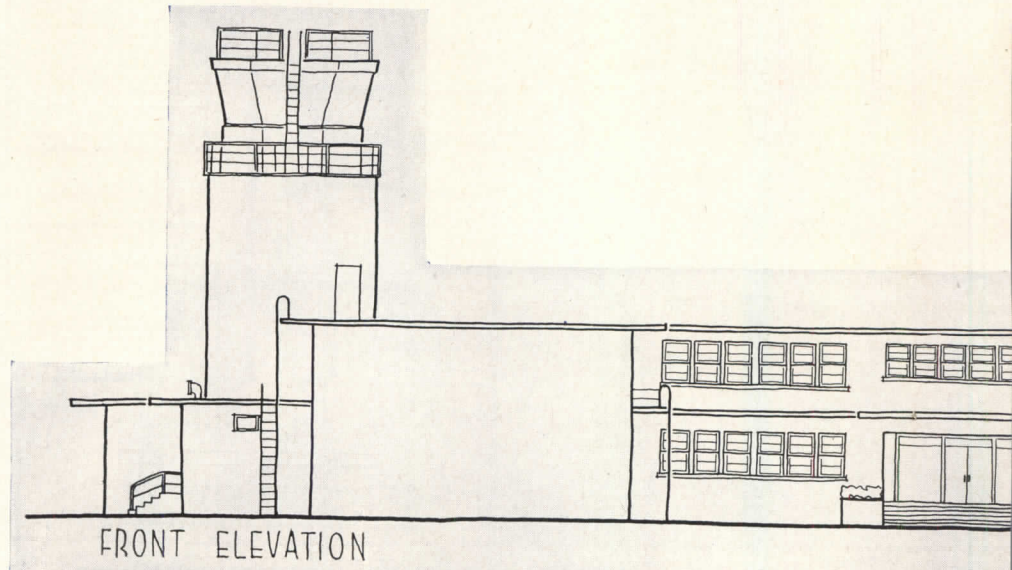

The sketch at top shows an elevation of a combined control tower and operations building as proposed by Navy Definitive Plans

Below: section through control tower which fits above emergency generator room on first floor plan. The two plans at right are typical floors in tower: electrical equipment room, control room

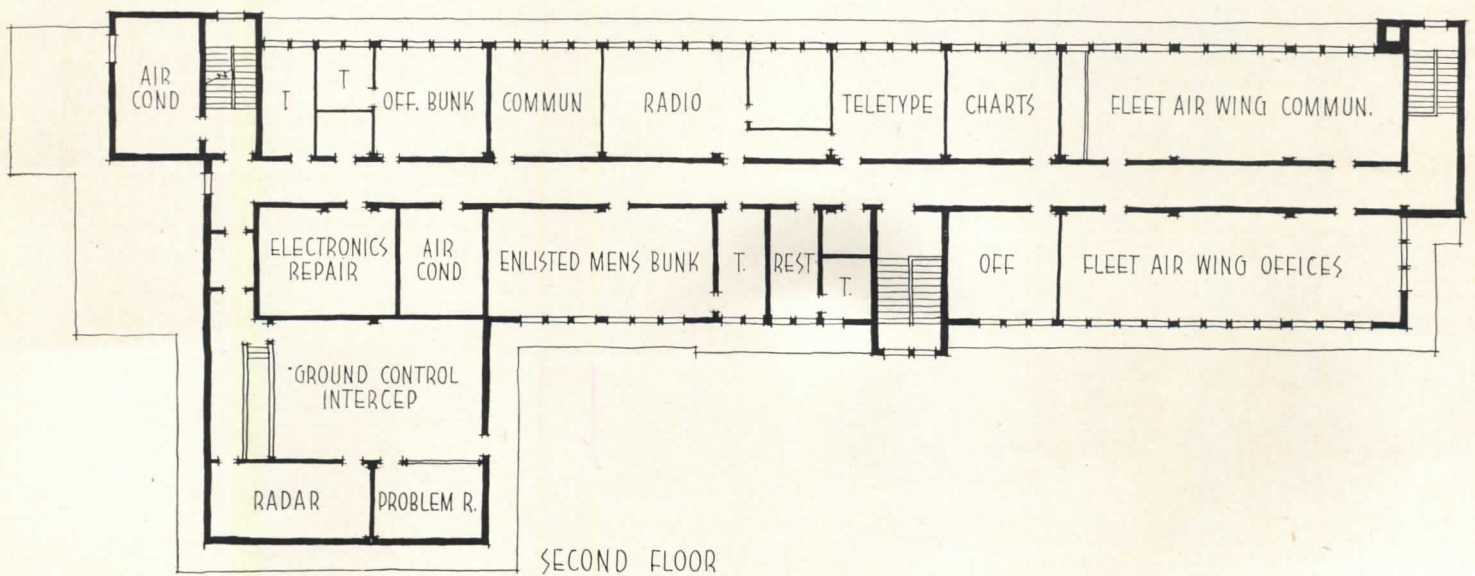
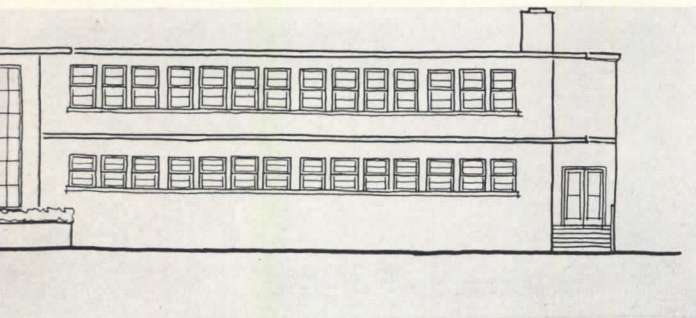
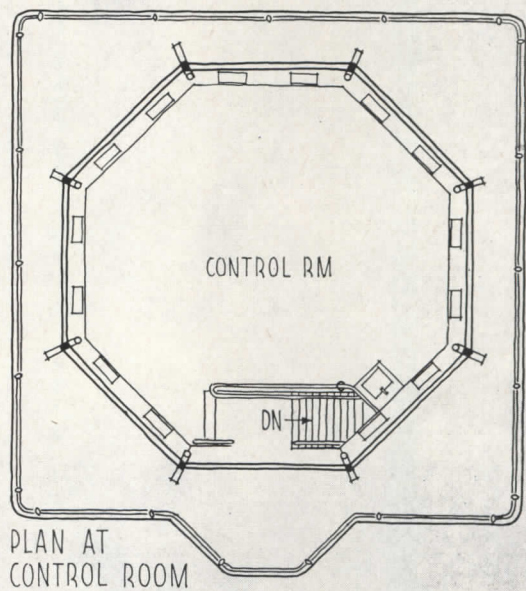
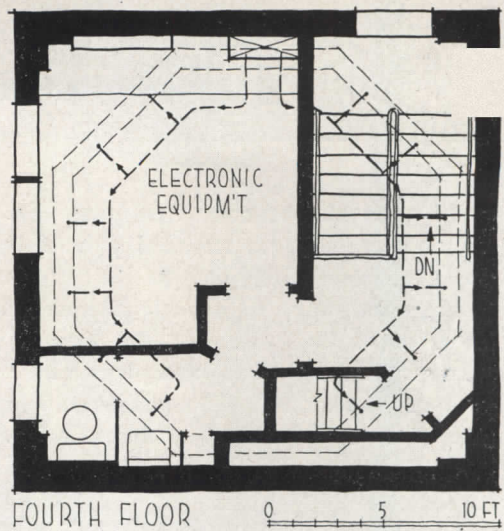
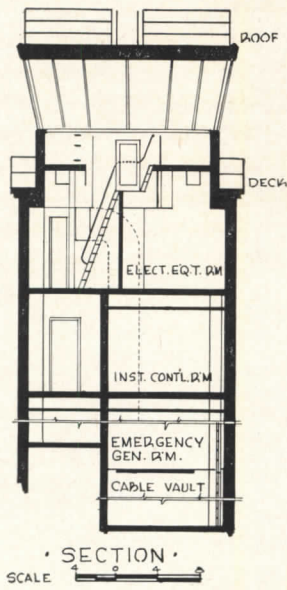

The floor plans at bottom of page show suggested layout for a permanent operations building, with rooms for crews, offices, repairs



BUDOCKS HAS BUILT MANY CHAPELS with fresh designs on Naval bases scattered over the globe. At present, the drive for economy has the Bureau Staff constantly seeking new ways to provide adequate buildings for lower cost.

In general, standardization plays a lesser role, except perhaps in plan and size, for permanent chapels. In case of a rapid build-up of bases, however, a direct,

simple mobilization scheme has been prepared to take care of personnel needs. The scheme is, of course, non-sectarian and makes provision for use by all faiths and denominations. The main chapel has a conventional plan, 594 seats. It is flanked by wings housing an 84-seat morning chapel and a 108-seat Sunday school. These wings could be added or deleted as budget, time and other conditions warranted.

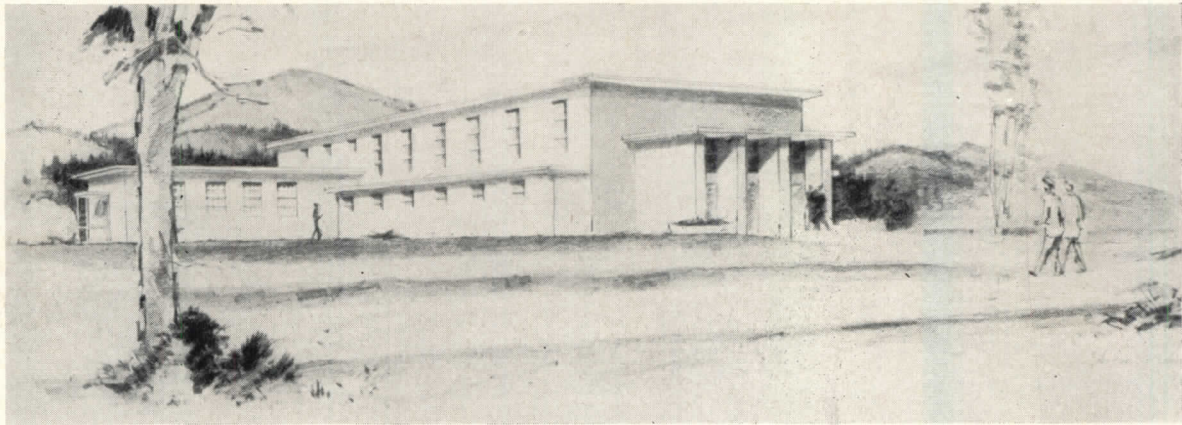

Mills & Petticord, Architects

The mobilization chapel scheme is shown in the rendering and plan at right

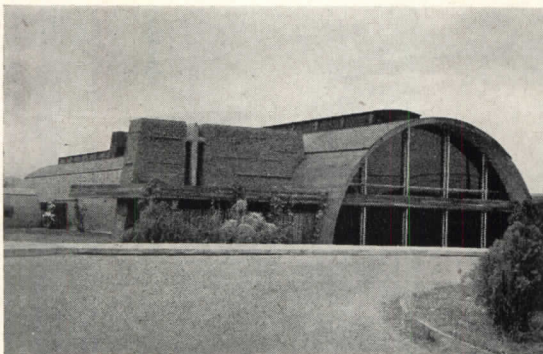

Bruce Golf, Architect

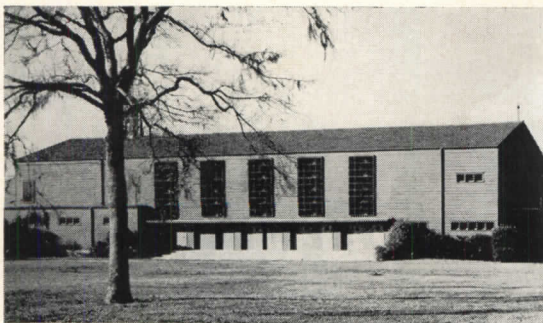

Robert Co. Inc., Architects

Above: two permanent chapels—top, chapel at Shoemaker, Calif. Bottom, Catholic chapel, Jacksonville, Fla.

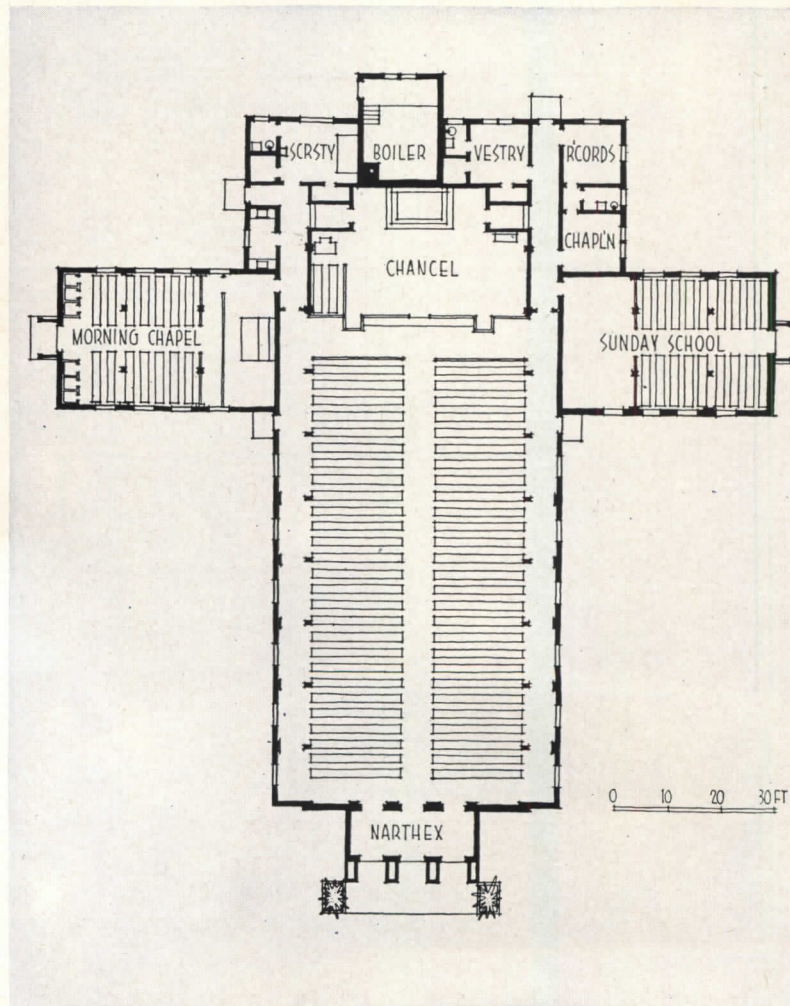

0 10 20 30 FT

PLANTING THE SITE

By Maud Sargent, Landscape Architect

This article deals with the more functional aspects of landscape architecture and was preceded by articles on site engineering including land drainage and building foundations. Here the author tells (1) which are the most desirable trees, shrubs and ground cover, (2) how they can be integrated with buildings and other construction, and (3) how to prepare the soil for them

PLANTING THE SITE should be regarded as an integral part of any project involving additions or alterations to the surface of the earth. It is not just a "dressing up" operation, but should be planned right along with the building.

There are practical as well as esthetic reasons for planting the site, although esthetic reasons are among the most practical.

PURPOSES OF PLANTING

Design Considerations

The design is three dimensional, and the main structure and the strongest elements of the design are trees. Shrubs form the fill-in material and may be used as color accents and emphasis. Lawn or ground cover forms the background.

Planting may be used to accent design; to build up emphasis to more important parts of the project; to bring out certain aspects and minimize others. This may be done by the use of various foliage and flower effects, and even fruit and colored bark in the winter season.

Accents and increased perspective can be obtained by the use of various foliage textures — the coarse catalpa (*Catalpa speciosa*) or Empress tree (*Paulownia tomentosa*) minimizing distance, and the fine textured honey locust (*Gleditsia triacanthos*) or tamarack (*Larix laricina*) giving an impression of greater distance. They can be used with carefully graded intermediate textures to create perspective. Color is also used to create conscious effects, changing with each season. See "Elements Used in Planting Design."

The building should look like it belongs to the site, and the site should blend with its surroundings. A landscape project cannot be enclosed in a frame; it cannot be seen in its entirety except in relation to its surroundings. Since the frame cannot be selected and the land-

scape beyond the project bounds cannot be controlled, the project itself must blend with its surroundings.

Not only must the exterior of the project be considered, but the view from the inside looking out is also important. Too often a large window looks out on a dismal aspect and the "landscaping" consists of an assortment of evergreen shrubs massed around the base of the building giving the impression that it is necessary to conceal the juncture of building and ground.

Practical Considerations

Conservation

1. Erosion Control. Since construction is not always completed at the proper time for planting, some quick growing cover crop should be planted to prevent erosion. Ground covers, grasses and low plants form good protection against erosion, and so do trees and shrubs, as they shade the ground and help to maintain a constant moisture content.

2. Air Conditioning. Vegetation is a natural agent for humidifying and purifying the air. On small projects this factor is negligible, in metropolitan planning it should be considered.

3. Maintenance of the Water Table. Planting is usually done around reservoirs to maintain the water table and protect the purity of the water.

Windbreak

1. The drifting of snow and the formation of ice may be discouraged by windbreaks.

2. Comfort and protection of buildings and plants may be improved by windbreaks. Shelterbelts in the great plains areas are a necessity. Windbreaks may consist of a single row of trees or shrubs or several rows of strategically located clumps of trees or shrubs. Deciduous and evergreen material can both

ELEMENTS USED IN PLANTING DESIGN

SHADE TREES

use: strong element in three dimensional design; shade; screen; windbreak.

EVERGREEN



oblong

white pine



conical

hemlock, fir

ELEMENTS USED IN PLANTING DESIGN

SHADE TREES



EVERGREEN
continued

columnar

red cedar

COLOR

dark

pitch pine

lighter

white pine

bluish

blue spruce

DECIDUOUS summer effect



round

maple, ash, linden



oblong

honey locust, tulip tree

be used, but, of course, evergreen plants give more year round protection.

Sturdy plants must be used such as red or white pine or hemlock among the evergreen trees; hornbeam beeches or pin oak among the deciduous trees; columnar junipers and arborvitae among the evergreen shrubs; and privet species, buckthorn and blackhaw among the deciduous shrubs.

Shade

Planting may be used very effectively to assist in keeping a building cool; it will make an appreciable difference in the temperature. A deciduous tree, of course, will not cast much shadow in the winter when the warmth of sun is desirable.

Screen

1. Undesirable views may be screened out by either a hedge or clumps of plants. Typical hedge plants are yew (evergreen) and privet (deciduous), but there are many other possibilities.

2. Service areas are usually screened from other parts of the project.

3. Noise and dust can be screened out to a considerable extent by planting (an important consideration in designing playgrounds).

4. Glare from lights can be eliminated in some places. In a divided lane highway or parkway, shrub planting in the center strip will cut down the glare of headlights.

5. Focus on certain points can be created by screening out distracting views.



Taconic State Park Comm.

Johh Gass photo

Natural landscaping helps separate opposing lanes of traffic on this parkway

Implement flow of traffic

1. Main roads or drives may be emphasized by tree planting. Curves in a road may be more clearly distinguishable from greater distance by planting trees on the outside of curves. Intersections and inside of curves must have a clear view.

2. Effective barriers can be made by planting shrubs. Dense growing or thorny ones will discourage unwanted short cuts by pedestrians.

3. "Slow" signs on a highway may be emphasized by trees which converge at that point.

SPECIAL PROBLEMS IN PLANTING DESIGN

Highway and Parkway Planting

Erosion prevention. Modern highways and parkways frequently have steep

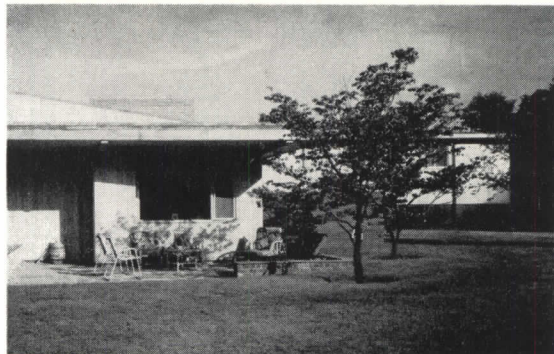

Ezra Stoller Photo

These trees, when grown, will provide welcome shade for the terrace and house. Albert Kennerly, Architect

banks of cut or fill to eliminate steep grades and sharp curves. Even when these banks are made at the angle of repose of the specific soil (a three to one slope generally) and if the underdrainage has been provided (See ARCHITECTURAL RECORD, July 1952, p. 155) there will be erosion unless the banks are planted with some sort of ground cover. Grass is sometimes satisfactory, only it requires mowing. Honeysuckle and Memorial Rose are two good ground covers for banks that require little maintenance.

Disease and pest free plants are required to keep maintenance budgets low. Long lived trees for permanent beauty are preferable, but since they are usu-



Standard Oil Co. (N. J.)

Strategically placed trees form visual barriers between the cloverleaf and the roads tangent to it

ally slower growing than the others, they are frequently interplanted with fast growing trees that can be removed later. Oaks, for example, are among the more permanent trees, and ash and poplar are among the quick growing. Trees native to the area are usually preferable.

Street Trees

The importance of street tree planting in cities is becoming more universally recognized. Curiously enough the larger cities seem to place more emphasis on street trees than the smaller ones which, although they may have more trees proportionally, are not always so assiduous in caring for them or in replacing them as it becomes necessary.

Shade. Trees reduce the heat reflected from paving and buildings, and they are just as useful in commercial as residential areas. The Chestnut Hill Shop-

ping Center Development Group in Philadelphia is now planting 64 Ginkgo trees in front of stores along Germantown Avenue.

Street noises. Trees will reduce noises. This has an appreciable effect on upper floors.

Specifications

1. Plants must be sturdy, long lived, free from diseases and pests. They must not have surface growing roots that will eventually lift up pavement (maple trees, for example) and they must not have roots that will get into sewers and clog them up (poplars and willows). Where planted in, or overhanging, pavement areas they must not have

flowers or fruit that will drop.

2. They should be planted 40 to 75 ft apart, at least 25 ft from an intersection and 10 ft from a fire hydrant, and at least 3 ft from the curb.

If they are planted in the sidewalk area they should have a rectangle of open earth around the trunk at least 6 by 7 ft. This may be covered by granite or concrete blocks laid with open joints so that the rain water can penetrate to the roots. Sometimes an iron grating is placed over the area to allow people to walk on it without packing the earth so hard that it becomes impervious to water.

Among the most satisfactory street trees are planes, red oaks, Ginkgos and silver lindens. Norway maples are one of the most commonly used street trees, but they have an uninteresting shape and all maples have surface-growing roots.

DECIDUOUS (Summer) *continued*



long oblong

white oak



columnar

lombardy poplar



vase shaped

American Elm

DECIDUOUS STRUCTURE

winter effect



dense twiggy

linden, pin oak

ELEMENTS USED IN PLANTING DESIGN

SHADE TREES

(winter)
continued



open
branched

white oak, American plane



ascending
branches

maple, ash



descending
branches

pin oak, pepperidge



horizontal
branches

white oak

DECIDUOUS	COLOR—SUMMER
light green	honey locust, larch
dark green	Norway maple
purplish (to be used sparingly)	purple beech
silvery	poplar (aspen)

	COLOR—FALL
red	maple, scarlet oak, sweet gum
yellow	tulip tree
brown	white oak

	TEXTURE—SUMMER
fine	honey locust, larch
coarse	catalpa, Empress tree

Parking Areas

Trees around the edge of the lot and in between rows of cars will be a welcome addition to any parking lot. Some protection is required to keep cars from bumping them; a raised curb is adequate if the trunk of the tree is 3 ft from the curb. The same considerations as for street trees must be used in selecting material and planting for parking areas.

Foundation Planting

A mass of shrubs should not be planted all around the base of the building. Although it may be desirable in the design to have a long continuous line, in general it is better to have groups of plants in the foundation planting and have spaces where the junction of building and ground is clearly visible so that the building appears to set solidly on the ground.

The size of the building and the site must be considered in the selection of plant material because the ultimate height and spread of the plants must be commensurate with the size of building and site. It is better to select mature plants than to crowd in too many young ones that may eventually grow too tall. A three-foot hemlock may look just right under the window when it is planted, but it is a forest tree and in five years it will cover the window entirely. Evergreen and deciduous material are both more effective when they are used together than when either one is used alone.

Playgrounds

An open area for active play is not the only requisite. Shaded areas for rest and relaxation are also part of the recreation needs. A planting barrier of trees and shrubs will reduce noise and make the playground more of an asset to the adjacent property owners.

Trees may also separate use areas in the playground and make an attractive design. Sturdy, long lived trees and shrubs should be used and ones without edible fruit on them.

Parks

In general, park plant material should be as for streets and playgrounds except that flowering and fruiting trees are desirable provided they are hardy and pest free and planted so as not to drop fruit on the pavement. Plants should be selected with regard to the park's size.

Private Homes

The primary consideration in planting design for private houses are:

1. Character of the surroundings.
2. Character of the site.
3. Character of the house.
4. Personal tastes and living habits of the occupants.
5. The amount of time the occupants are willing to spend on upkeep.

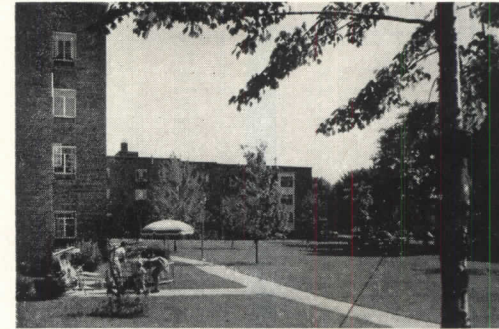

Sigurd Fischer photo

Apartment house planting requires simplicity of design and a sense of scale

6. Screening from neighbors may be desirable; or the more open feeling of a park, in which the open spaces of many neighbors merge, may be preferred.

7. Service area to be screened.

8. Human scale and livability.

Housing Projects

The neighborhood concept can be emphasized by planting design of the project as a whole. The whole is greater than the sum of its parts. Personal tastes of individuals generally are subordinated to give character to the whole project.

Apartment Houses

With the recent trend toward more land for the building, the planting becomes more important. Simplicity of design is essential.

The scale of the building must be considered in relation to the plants. Planting suitable for a low, one-story house would hardly be appropriate for a multi-story dwelling.

Planting may be used to direct the flow of traffic. Fences may be concealed or the hard lines softened by planting shrubs and vines.

Industrial Sites

The modern trend is toward larger

industrial sites and lower percentage of land coverage. This is partly due to the recognized need for off-street parking for employees and partly to a growing awareness that an industrial plant can be an attractive part of the community and can promote good public relations. Space around an industrial plant, if landscaped, can reduce noise considerably. It is an asset to have an attractive area where employees may eat and relax during the lunch hour.

FORMAL AND INFORMAL PLANTING DESIGN

The character of the project and its surroundings will determine whether it will be formal or informal. By formal design is meant the use of straight lines and geometrical patterns rather than axial symmetry.

In general the closer to the building or structure, the more formal will be the planting. The transition from the purely

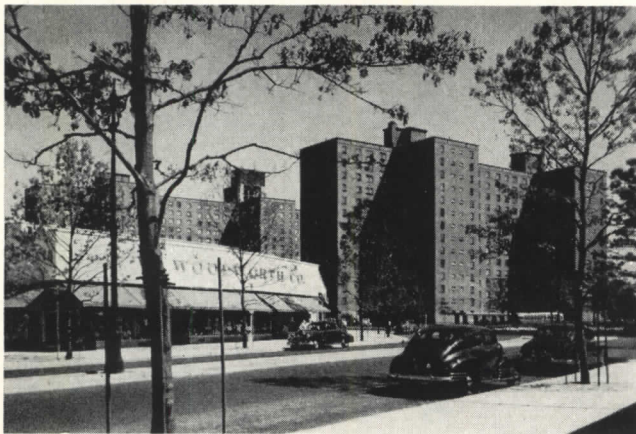

Sigurd Fischer photo

Trees are desirable in commercial as well as residential areas, cutting off heat radiated from paving and buildings. Fresh Meadows, N. Y. City. Voorhees, Walker, Foley and Smith

man-made structure to the purely natural landscape can be made by the planting design. Each designer will do it in a different way. The ultimate test is whether it looks as though it belonged there.

PREPARATION OF THE SITE FOR PLANTING

Fine grading

The ground first must be levelled off at 8 to 12 in. below the finished grade and smoothed, raked free of stones, roots, etc.

Topsoil

The topsoil is then spread and leveled off 2 in. above the finished grade to allow for compaction. The depth of topsoil occurring naturally varies considerably with the site. For planting operations 8 to 12 in. of topsoil are required for lawn or ground cover areas and tree pits and shrub beds are backfilled with topsoil.

Drainage

Usually the surface drainage will take care of the moisture in the soil if the minimum slope of a lawn area is 0.5 per cent. There may be some unusual conditions where it may be necessary to lay a tile drain field.

Tree pits

Tree pits should be at least 18 in. greater than the diameter of the roots of the tree and at least 1 ft deeper than the roots. The bottom of the tree pit should

be scarified to a depth of several inches to help the roots penetrate the subsoil. The turf removed from the top of the tree pit should be turned upside down in the bottom of the hole. The tree is then set at the same level as it was growing previously and the hole backfilled with topsoil.

Before the hole is completely filled, the earth must be settled in place with water. A saucer of earth slightly larger than the tree pit is made around the tree to hold the water. If the tree is planted on a slope the ground must be graded

SMALL FLOWERING TREES

use: accent and for variations in height.



upright

crabapple

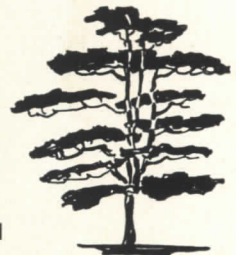

horizontal

dogwood

COLOR

	Flower
white	dogwood, sourwood
pink	flowering crab
red	carmine crab
yellow	golden chain tree

	Foliage and fruit—autumn
red foliage	dogwood
red fruit	dogwood, Sargent crab
yellow fruit	showy crabapple

SHRUBS

use: for fill-in design; accent; screen; erosion prevention; windbreak.

EVERGREEN



rounded

mountain laurel

ELEMENTS USED IN PLANTING DESIGN

SHRUBS *continued*



columnar
upright yew



procumbent
Waukegan juniper

EVERGREEN COLOR

Foliage

dark green	holly
lighter green	andromeda
grayish	juniper species

Flower

white	andromeda
pink	mountain laurel
red	rhododendron sp.

Fruit

red	holly, yew
black	inkberry

TEXTURE

coarse	rhododendron
fine	juniper

DECIDUOUS



vase
shaped
honeysuckle



rounded
spirea

around the tree to catch and hold water. This saucer should be left for a year before leveling off to grade.

Shrub beds

Shrubs are preferably planted in groups rather than as individual specimens. The whole shrub bed is excavated to a depth of 2 ft, the shrubs are set in place at the same level as they were growing before and the area is backfilled with topsoil, and settled with water.

Lawn areas

Ground limestone should be applied in the amount of 4000 lb per acre and commercial fertilizer (2-16-8). Lime should be applied at least a week before the fertilizer.

If seeding is done by hand it must be done in two directions to secure an even stand.

Grass must be pretty well grown be-

cedar posts with bark attached, about 2½ in. in diameter and 8 ft long sharpened at one end and driven at least 3 ft in the ground. The tree is guyed to these posts by No. 12 guage wire and the tree trunk is protected by short lengths of rubber hose. This kind of staking is the best for trees which are in a location where people might walk into the wires without seeing them. Otherwise it is best to stake the trees with three guys attached to 2 by 4's sharpened at one end and notched at the other and driven almost flush with the ground.

Pruning

After planting, most trees and shrubs should be pruned back so that the tops of the plants will not lose so much moisture until the roots are established. Trees may be pruned back about one third of the total branching system. All pruning cuts must be clean cuts and



Lighting combined with trees and shrubs comprise traffic islands at Bullock's, Pasadena, Calif. Welton Becket and Assoc., Architects and Engineers

fore it can withstand the hot sun. Lawn seed is usually made up of mixtures of several kinds of grass seed including Kentucky Blue Grass, Illahee Creeping Red Fescue, Rhode Island or Colonial Bent, Red Top and domestic rye grass. The rye grass, being annual, will germinate more quickly and give cover while the permanent grasses are maturing more slowly. Wild white clover is a good addition to a lawn. The amount of seeding is usually about 200 lb per acre.

Finishing Up

Staking the trees

All newly planted trees should be staked immediately after planting. Street trees are usually staked by two white

branches must be cut back to the next branch. Shrubs should also be cut back in the same manner and about the same amount.

Mulching shrubs

Newly planted trees and shrubs should be mulched by having an inch or two of humus spread over the tree pit or shrub bed. For ericacious plants, that is rhododendron, mountain laurel, highbush blueberry, etc., the mulch should be of oak leaf mold free of sticks and stones.

Feeding

1. Lime. Most plants thrive best in a fairly neutral soil but the decomposition of organic matter has a tendency to



New York City Park Dept.

Playground trees help to screen out noise and dust—can also separate use areas

build up the acidity of the soil and this must be counteracted by the addition of ground limestone. Different plants have different tolerances for acidity and should be planted in groups accordingly. For example, lilacs grow best in quite an alkaline soil and should not normally be associated with ericacious plants such as highbush blueberry which likes a pretty acid soil.

Some soils are more acid than others because of the nature of the particles which make up the mineral structure of the soil, or the basic rock strata which underlie it. In the eastern part of the United States, the soil has a tendency to become acid, and addition of lime at intervals is usually required.

In some parts of the country, however, the soil is so alkaline as to require neutralization before plants will grow. Lime, in addition to being one of the plant nutrients, has an effect on the texture of the soil. Strongly acid soil will pack down and become hard and almost impervious to water.

There are new chemicals on the market that help to condition the soil for favorable plant growth. They do not supply any plant nutrients, however, but make the soil more favorable for plant growth.

2. Manure (organic fertilizer). The advantage of manure over commercial fertilizers is that it supplies organic matter to the soil which helps to maintain the water content of the soil as well as to supply nutrients. The manure must be well rotted, more than nine months and less than two years old. Fresh manure is too strong and will injure the roots of plants with which it comes in contact.

Manure which is too old has lost much of the nutrient chemicals.

Green manure is a cover crop of alfalfa or rye grass which is turned into the soil while it is still green. This adds humus to the soil and nitrogen as the green plant disintegrates in the soil.

3. Commercial fertilizer. The main nutrient elements for plants are nitrogen, phosphorus and potash. In commercial fertilizers these elements are listed in that order and indicating amounts of each.

REQUIREMENTS FOR A GOOD PLANTING JOB

Material must be selected which is free from diseases, pests, abrasions and broken or poorly pruned branches. Some specimen trees and shrubs will have to be selected for their specific growing habits and shapes and will have to be oriented at the site for the best appearance.

Careful interpretation of plans. Sometimes in actual planting operation, in order to carry out the spirit of the design, it is necessary to deviate somewhat from the plans. For example, if it is desired to screen out a certain view it may be found to be more effective on the actual site to shift some of the plants one way or another.

Adequate maintenance is a very important factor in the appearance of a planting job in subsequent years. A planting job will rarely look its best immediately after the initial planting job is finished, and unless it is properly maintained it may never attain its maximum potentialities.

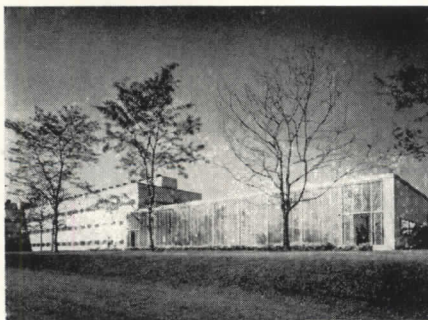

Hedrich-Blessing Studio

Landscaping furnishes pleasant atmosphere for grounds outside cafeteria at an industrial lab. Holabird & Root & Burgee

SHRUBS—DECIDUOUS

continued



broad spreading
dwarf Japanese quince



columnar

enkiathus

STRUCTURE

open	Siebold viburnum
dense twiggy	burning bush
thorny	barberries

COLOR

Flower

white	Japanese snowball
pink	deutzia
red	Japanese quince
yellow	hugonis rose, forsythia
blue	bluebeard

Foliage—summer

light green	hugonis rose
dark green	black haw
silvery	Russian olive
red	burning bush
yellow	witch hazel

Fruit

red	rugosa rose, honeysuckle
yellow	Japanese quince
blue	highbush blueberry
white	snowberry
silvery	bayberry

Twigs

red	red osier
yellow	yellow twig dogwood

VINES AND GROUND COVER use: carpet the ground; erosion prevention; screen or soften building or walls.

CARPETING MATERIALS

for shade	bugle plant, ivy
for sun	thyme, moss pink

LOW SHRUBBY GROUND COVER

for shade	yellow root
for sun	pachistima

GROUND COVER FOR DISTANCE

sumac species

VINES

clinging vines	ivy, trumpet vine
twisting vines	wisteria
	(need support)
trailing vines	memorial rose
	(cover slopes or low walls)

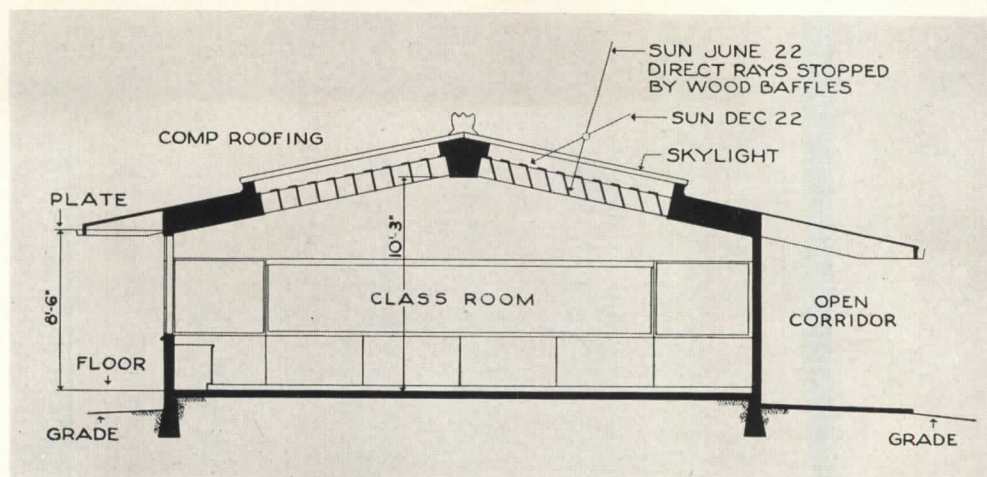

Double skylight eliminates necessity for high windows on side walls; also provides ventilation, solar heat

LOUVERED SKYLIGHT, VENTILATOR COMBINED

C. A. Caulkins Jr. and Associates, Architects, San Francisco and Santa Rosa, Calif.

QUITE A NUMBER of daylighting systems for schools have originated on the West Coast—encouraged to a great extent by the favorable climate. The new idea in skylights shown here, already in use in 17 schools and planned for several more, combines a louvered skylight with an adjustable ceiling ventilator; and curtains can be pulled over the skylight for audio-visual aids.

The skylight covers approximately 60 per cent of the ceiling, and the ventilator runs the full length of the classroom.

Light, Heat, Ventilation

A specially designed set of inverted, "L"-shaped louvers hang below the skylight which allow daylight to enter the room, but shut out the direct rays of the sun year 'round.

Problems of heating, cooling, ventilation, and audio-visual education are all involved in this skylight design.

A 10-in. space is provided between the heat-absorbing glass of the skylight and the louvers, so when the weather is warm, the heated air under the glass is sucked out through the ceiling ventilator by stack action; this creates a circulation of air throughout the classroom.

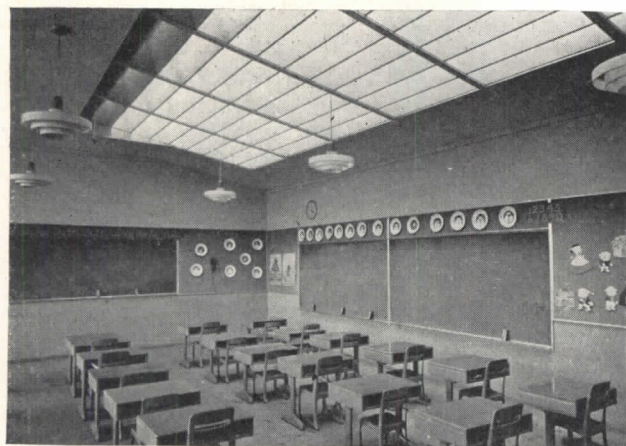

"L"-shaped louvers cut out direct rays of sun at all times, but still permit lots of daylight to get through. They can be darkened by means of curtains when audio-visual aids are being used

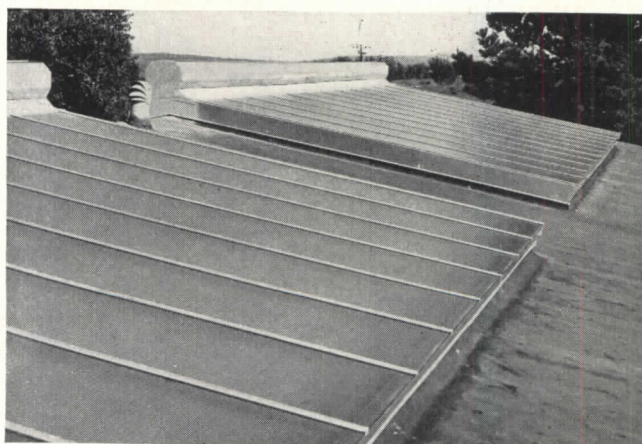

Adjustable, ceiling ventilator runs the length of the classroom. It pulls out the hot air under the skylight, induces room circulation, and can be closed as desired during the cooler weather

In cold weather, the ceiling ventilator can be closed as much as desired, and the room gets heat from solar radiation. Even though the sun may not be shining on a cold day, the architect says that many times there is enough solar heat to shut off the thermostat.

Darkening for audio-visual education is accomplished by means of curtains located between the skylight and the top of the louvers. The whole area can be darkened quickly, and there is still ample ventilation. According to the architect, the cost of shades is less than half that of curtains at conventional clerestory windows.

Louver Design

Before the double skylight was employed (see sketch) schools designed by Caulkins had high north windows, and top lighting was used to give more daylight to the far side of the room, providing a practically uniform level of illumination at the desk tops.

In order to keep out the glare of the sun, the architect experimented with various depths of louvers, but the louvers had to be so close together to eliminate the direct rays of the sun, that light penetration was insufficient.

Finally the architect experimented with louvers of various shapes and found that inverted "L"-shaped louvers did the trick. The dimension of the aperture at the top of the louver was the same as the distance between the original straight louvers. However, the distance between the "L"-shaped louvers was considerably greater, allowing a play of light between them.

Applications

After officials of the Eucalyptus School near Sebastopol, California were shown models and studies on the louvered skylight, they decided to incorporate it in their one-room building. Other officials were enthusiastic, and this top-lighting system was incorporated in 15 schools in rapid succession (see photos).

Next the architect decided to cut down the height of the north windows in his school designs and depend entirely on top lighting (see sketch). Two schools like this have been completed, and there are several more on the boards. With this design, the side walls were reduced in height from 11 ft to 8 ft 6 in. This cross section has about 25 per cent less volume than a flat-roofed school with 11-ft ceilings, and is said to reduce the cost more than enough to pay for the skylights.

GUIDE FOR A-BOMB RESISTANCE OF BUILDINGS

Civil Defense manual suggests methods to strengthen new buildings against blast

FOLLOWING CLOSELY two national conferences dealing with the problems of protecting buildings from atomic bombs is the publication of a new Civil Defense booklet, "An Interim Guide for the Design of Buildings Exposed to Atomic Blast."*

Intended primarily for architects and engineers, the booklet describes briefly the effects of atomic explosions on buildings; suggests methods of increasing the strength of new buildings; and points out hazards which should be considered in the design of shelter areas in buildings. Its prime purpose is to indicate the general nature of the problem resulting from an atomic explosion, and the steps to be taken until a more complete design manual is available.

According to the Federal Civil Defense Administration, resistance to atomic blast can be built into multi-story buildings for an average additional construction cost of only about three per cent. This figure has been backed up by cost data on two reinforced concrete frame buildings designed for both conventional loads and for

* Available from the Supt. of Documents, U.S. Govt. Printing Office, Washington 25, D.C., 15 cents.

recommended blast loads. Building "A" was an 11-story building, 158 by 190 ft. Building "B" was a 9-story structure of irregular floor plan with irregular wings. The increase in general construction cost for building "A" amounted to 2.2 per cent, and for building "B", 3.8 per cent.

Some indication of how buildings would withstand an atomic blast is given in the guide with a list of typical buildings in the order of their blast resistance (ranging from a high degree of resistance to practically none): (1) Reinforced-concrete and heavy steel-framed multi-story buildings, designed for wind or earthquake resistance; (2) Industrial buildings with continuous steel frames, rigidly connected and strongly braced in all directions; (3) Strongly braced wooden frame houses that are relatively low and wide; (4) Light, shed-type commercial and industrial buildings with long-span trusses and beams, light columns, and little lateral bracing and with large areas exposed to blast; (5) Masonry wall-bearing structures with ordinary floor, beam and column, or bearing partition construction; (6) Tall, light wood-frame buildings such as three-decker flats.

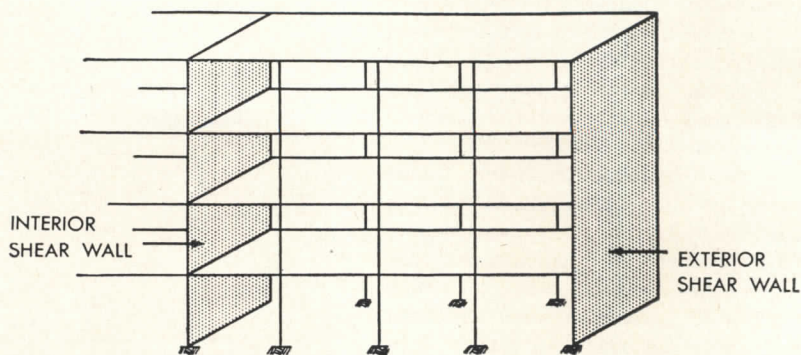

Shear walls, generally of reinforced concrete, are strongly recommended to supply resistance to lateral forces. They may contain openings for windows

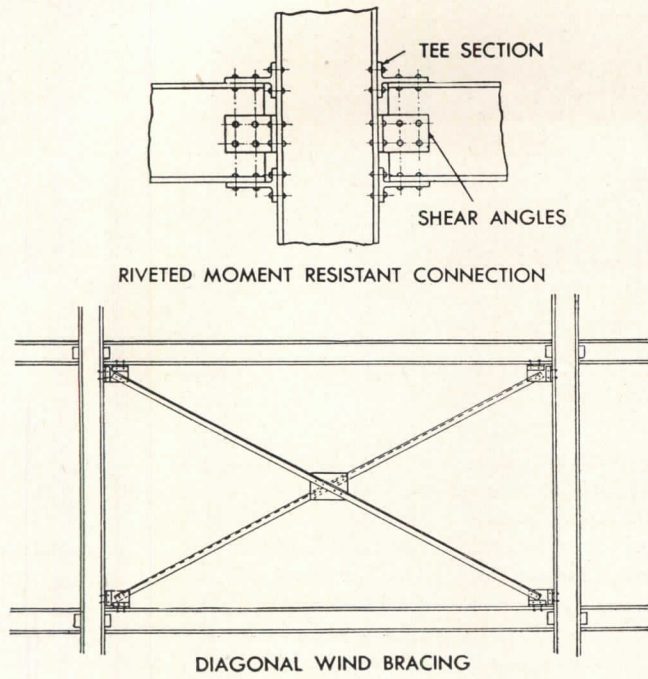

Moment-resistant connections and diagonal bracing supply resistance in steel frames, but concrete shear walls are better

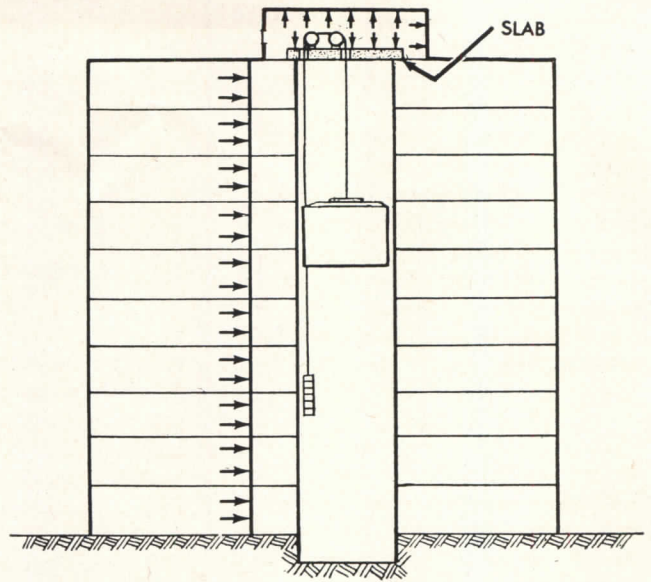

A resistant cover may be provided to reduce pressures within an elevator shaft and prevent damage to equipment within

It is not within the scope of this guide to provide a structural design procedure; however, a table of recommended live loads for blast resistance is given, and it is said that a design developed with these values will give reasonable probability of survival (partial damage) to structures at one-half mile or more from a 20 KT bomb. To explain the use of this table, there is an analysis of a hypothetical structure under static and dynamic loads showing the improvement in blast resistance that can be expected for various degrees of strengthening.

The guide notes that a number of Japanese buildings subjected to atomic-blast showed good resistance, the most satisfactory being built with what amounted to shear walls. A section of the booklet then tells where and how shear panels should be used for maximum effectiveness.

Preferred materials for walls and panels are either reinforced concrete that is well tied into the rest of the structure or lightweight, relatively fragile sheets such as gypsum or asbestos. A concrete wall strong enough to remain in place produces no fragments, may not require replacement, and is strong enough to strengthen the structure. Weak panels encourage breakage without exertion of large forces on the rest of the structure, and generally produce less dangerous fragments than do heavier walls.

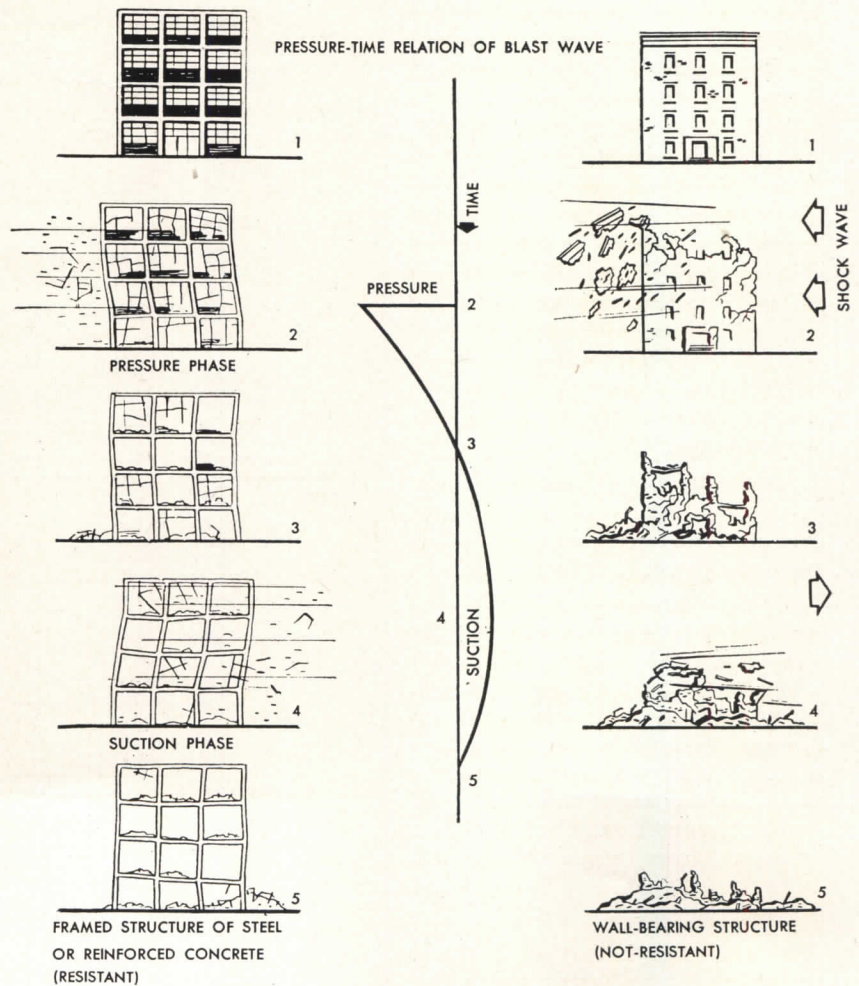

Above: relative resistance of two types of structures to atomic blast

PRODUCTS for Better Building

Metal-faced Panels for Curtain Wall Construction

With the increasing interest today in the use of prefabricated panels for curtain wall construction, many manufacturers have developed panels employing porcelain enamel and other facings in conjunction with a variety of core materials. Three of these are reviewed here:

- *Davidson "Vitrock"* panels are manufactured by a process in which a gypsum base is bonded to the porcelain enamel skin after enameling has been completed. This process is reported to successfully eliminate objectionable waviness and distortion in the finished panel, and the base material is said to furnish good insulating and sound deadening qualities. While the panel skins are held on magnetic holding blocks, a quick-setting, shrink proof gypsum base material is applied. Anchors welded to the inner face of the skin secure the Vitrock core to form a one-piece integral flat-surfaced unit. The panels are installed with stainless steel fastening clips and do not require any further structural reinforcement than the same panels without the Vitrock base would require. Available in almost any color or texture desired. Davidson Enamel Products, Inc., 1102 Kibby St., Lima, Ohio.

- *Seaporclad* panels are laminations of porcelain enameled steel to thermal and noise insulating cores. Kaylo, Marinite 23, Celotex, Honeycomb paper and other insulating materials are used for the cores. If so desired, the panels can be supplied with inside surfaces of Galvaneal, aluminum and other metals. Sizes of the panels range up to 4 by 10 ft with cores of varying thickness. Varied textures in any color can be obtained, affording a wide flexibility in design. Light weight of the panels is reported to speed assembly and erection of curtain walls and to effect considerable savings in structural steel framework. Seaporcel Metals, Inc., 28-20 Borden Ave., Long Island City 1, N. Y.

(Continued on page 220)

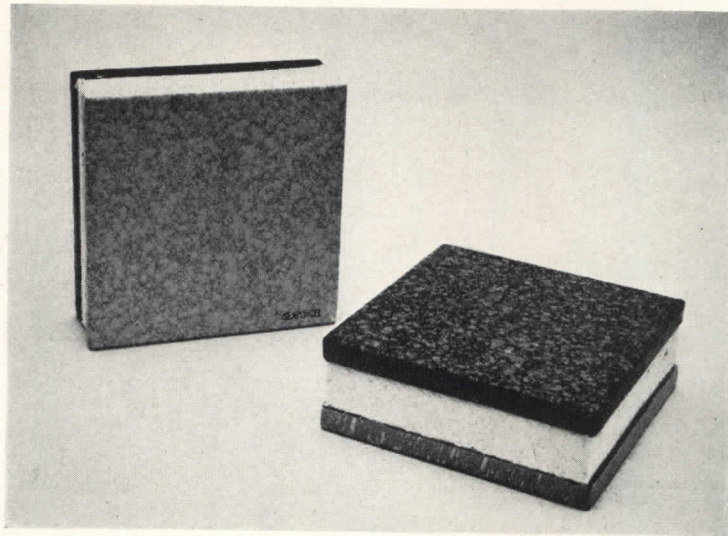

Seaporclad panels developed by Seaporcel have porcelain enamel outer face, thermal and noise insulating core. Sandwich type uses any of several metals for inner face

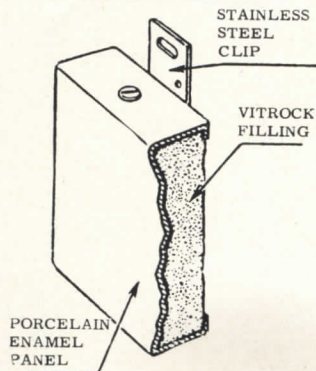

Davidson Vitrock panels, left, employ a gypsum base bonded to the porcelain enamel skin and secured with welded anchors

U. S. Plywood's Armorply panel, enlarged detail shown right, is available in a variety of facings and cores, is of sandwich-type construction

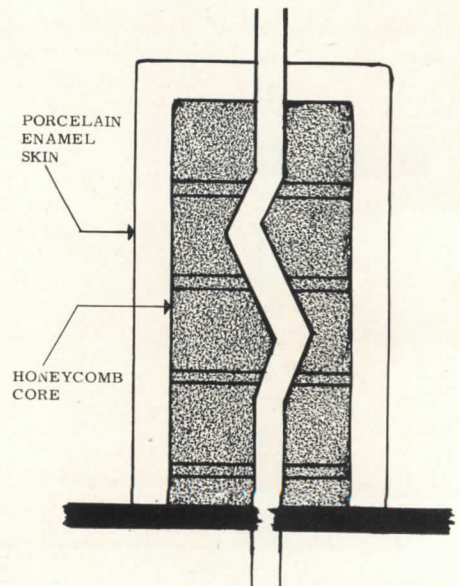

LITERATURE FOR THE OFFICE

SECTIONS THROUGH CLASSROOMS

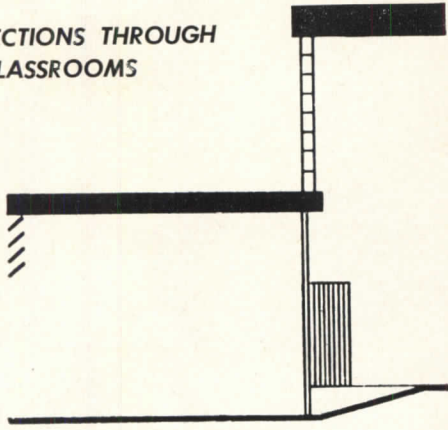

Glare control solution above uses outside corridor with louvers (left in drawing). Scheme at right employs a vision strip of fixed glass with fixed louvers for glare control, fixed louvers and sliding door for ventilation

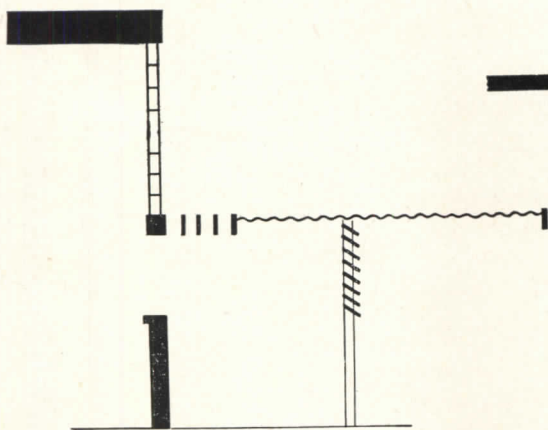
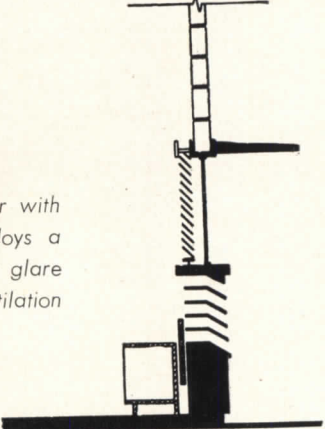

Scheme above utilizes a large outside canopy in combination with louvers. Sky is shielded at all times, and the canopy also serves as a covered passageway

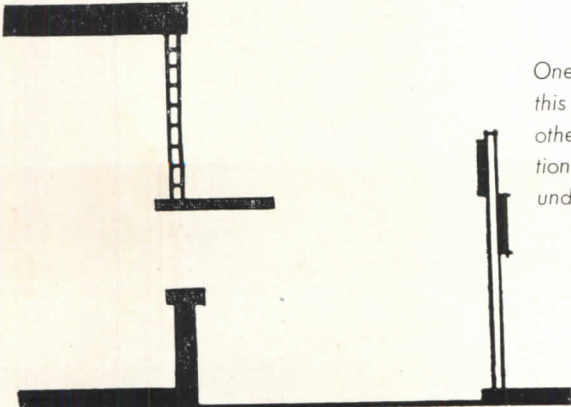

One of the simplest schemes, this uses screens of wood or other rigid materials. Ventilation is good, since air flows under the screen

Reducing Glare From Vision Strips

A Study of Vision Strips as Related to Glass Block Fenestration: A Project Conducted by the Texas Engineering Experiment Station in Cooperation with Kimble Glass Co. The second in a series, this report concerns a number of suggested solutions to daylight control problems encountered with vision strips employed in conjunction with glass block fenestration. The book suggests several projected schemes for providing proper vision, glare control and ventilation control where vision strips are used. These are classified in three categories of approach: through landscaping, through architecture and through manufactured products. In the first of these, methods of controlling glare and ventilation through the use of tree rows, rigid sky screens, play sheds between classroom wings, outside walls and vertical baffles are explored. Among the architectural schemes proposed are: outside corridors with louvers; projected glass block lighting panel; vision strip lowered to eye level of seated children; louvers suspended from a sun hood; a manufactured louver screen; screens of expanded metal; louvers in conjunction with a canopy; and fixed glass vision strip with separate venetian louvers for ventilation below and either fixed louvers or venetian blinds for sun control. The third approach is concerned with special transparent materials which might reduce sky brightness while permitting clear vision. In all, there are 14 schemes suggested, each analyzed in terms of both lighting and ventilation, and each illustrated with drawings, plans and sections. A section dealing with the results of brightness, visibility and color distortion tests of acrylic materials is included. 38 pp., illus. Kimble Glass Co., Subsidiary of Owens-Illinois Glass Co., Toledo 1, Ohio.*

Vertical Transportation

Westinghouse Vertical Transportation, 1952 Edition, B-4585. Booklet illustrates the manufacturer's line of elevators, (Continued on page 272)

*Other product information in Sweet's File, 1952.

~~Cross off
all window
maintenance
costs~~



with

Adlake

aluminum windows

Once they are installed, only the window-washer ever need touch ADLAKE Aluminum Windows! For they require no maintenance whatever, other than routine washing . . . and, in a few years, *they pay for themselves* through this economy!

Because their positive weather seal and finger-tip control are *built in*, they keep their dependable operation for the life of the building. Laboratory tests prove that after *one million* openings and closings, ADLAKE Windows still prevent air infiltration and operate as effortlessly as they did before the tests began.

Find out for yourself about ADLAKE's performance and economy. ADLAKE Representatives are in most major cities.



ONLY ADLAKE ALUMINUM WINDOWS
GIVE YOU ALL THESE "PLUS" FEATURES:

- Woven-Pile Weather Stripping and Exclusive Serrated Guides
- Minimum Air Infiltration • Finger-Tip Control
- No Warp, Rot, Rattle or Stick • Ease of Installation
- No Painting or Maintenance



THE

Adams & Westlake

COMPANY

Established 1857

ELKHART, INDIANA • New York • Chicago

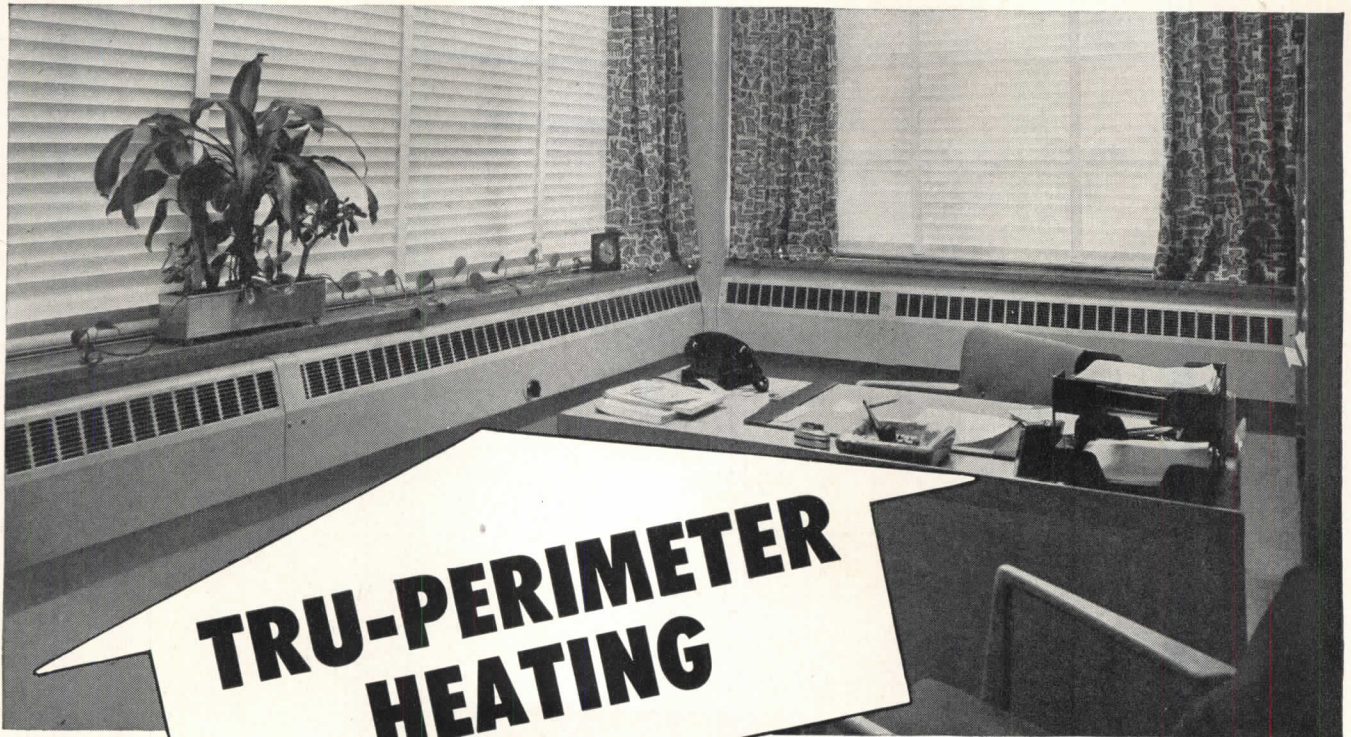

TRU-PERIMETER HEATING

Fully air-conditioned Physicians and Surgeons Building, Columbus, Ohio, uses Webster Walvector in perimeter heating to compensate for heat loss from large glass exposure

Webster Walvector, installed under the continuous windows and extending only about 3 inches from the wall, spreads the heat from wall to wall in the Physicians and Surgeons Building. A continuous flow of hot water is circulated, heated sufficiently to completely offset the effect of the cold glass, thereby assuring comfort *everywhere*.

Top heating efficiency is assured through the use of sturdy aluminum fins on copper

tubing, spaced for maximum effectiveness. Enclosures with integral grilles are sturdily built of amply heavy steel. Heating elements and enclosures are both mounted on a heavy gauge mounting angle, sealed against the wall with a continuous sponge rubber seal preventing any air flow in back of the mounting or enclosure.

The list of advantages of Webster Perimeter Heating with Webster Walvector is a long one.

Complete technical data on Webster Walvector is available in Bulletin B-1551 and the experience of the 60-year old Webster organization is yours to call upon. Get in touch with your Webster Representative or write us.

Address Dept. AR-9

WARREN WEBSTER & COMPANY
Camden 5, N. J. Representatives in Principal U. S. Cities
In Canada, Darling Brothers, Limited, Montreal

Webster
WALVECTOR
REG. U. S. PAT. OFF.
For Steam or Hot Water Heating

Physicians and Surgeons Building, Columbus, Ohio. Completed 1951, features Webster Walvector and complete air-conditioning. Architect: Tibbals, Crumley and Musson. Consulting Engineer: Robert S. Curl and Associates. Heating Contractor: The Huffman Wolfe Company.

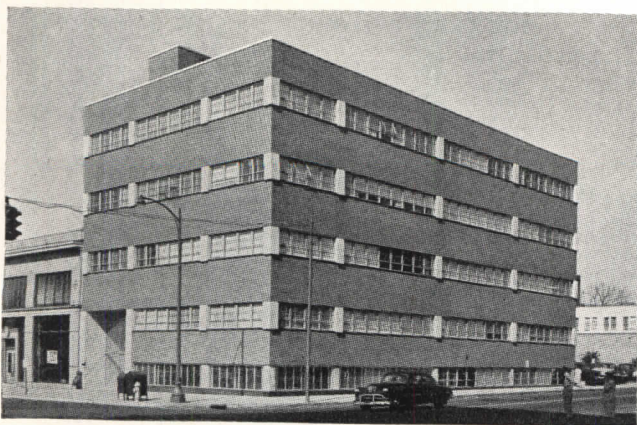

STRUCTURAL FORMS—5: Long Spans in Wood

By Seymour Howard, Architect, Instructor at Pratt Institute

GENERAL CONSIDERATIONS OF WOOD AS STRUCTURAL MATERIAL:

CHARACTERISTIC
Not homogeneous (orthotropic) (long cylindrical cells parallel to one axis)
Natural defects (cross-grain, spiral & diagonal; knots)
Decay hazard in exposed conditions
Swells or shrinks with changes in humidity
Although remaining elastic, under long-term (25 years or more) loads, a permanent sag or deflection takes place

CONSEQUENCE
Allowable stresses vary for pure tension & compression, tension & compression (extreme fiber) in bending, compression across grain, and also for shape of cross section ("Form factor"); depend on direction of stress with respect to direction of grain
Allowable stresses reduced to compensate theory of probability used in laminated sections permits higher stresses than for solid sections
Preservative treatments for permanent structures, with possible exception of reduced allowable stresses for temporary structures
Wood dried to expected service conditions of humidity before fabrication & assembly; for glued laminated sections, all laminations held to a 5% range of moisture content (e.g. 6% to 10% incl.)
Use double calculated dead loads or normal $E \div 2$ for figuring allowable deflection













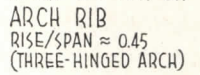



Note: These characteristics are listed as important differences between wood and the idealized, perfectly homogeneous and perfectly elastic material used in the mathematical analysis of strength of materials.

FIRE SAFETY

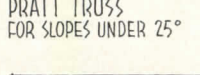
As is well known, heavy timber (6 in. nom, 5 in. min actual in least dimension) and plank construction is much better fire risk than thin sections and boarding. This fact gives glued laminated arches and frames some advantage over wood trusses and lamella arches. It also

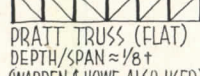
explains usual spacing of 8 ft for arches and frames, with 2 in. planking. (Next step is usually 16 to 20 ft spacing with purlins.) Small width (2 in. nom) arch rafters, spaced 24 in. o.c., with 1 in. boarding, are usually limited to farm structures and small warehouses.

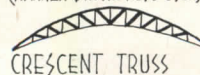
RECOMMENDED SPANS

TYPE OF STRUCTURAL UNIT	SPAN	SPACING	(Maxima in Parenthesis) TYPE OF STRUCTURAL UNIT	SPAN	SPACING
Joists	Up to 24 ft	16 to 24 in.		20 to 50 ft	24 in.
Sawn Beams	Up to 30 (40) ft	4 to 20 ft		20 to 60 (80) ft	24 in.
Glued Laminated Beams	Up to 60 (100) ft	4 to 20 ft		30 to 100 ft	2, 8 ft or 16 to 20 ft
 BOWSTRING TRUSS DEPTH/SPAN $\approx \frac{1}{4}$	40 to 150 ft (20 to 232 ft)	16 to 20 ft		20 to 100 ft (30 to 180 ft)	2, 4 to 8 ft or 16 to 20 ft
 LINK TRUSS BEST FOR SLOPES OVER 25°	40 to 60 ft (20 to 90 ft)	12 to 20 ft		30 to 100 ft (30 to 175 ft)	8 ft or 16 to 20 ft
 BELGIAN TRUSS	40 to 60 ft (20 to 90 ft)	12 to 20 ft			
 PRATT TRUSS FOR SLOPES UNDER 25°	40 to 120 ft (20 to 150 ft)	12 to 20 ft			
 PRATT TRUSS (FLAT) DEPTH/SPAN $\approx \frac{1}{8}$ † (WARREN & HOWE ALSO USED)	40 to 80 ft (20 to 160 ft)	16 to 20 ft			
 CRESCENT TRUSS	40 to 120 ft (25 to 165 ft)	—			
 LAMELLA ARCH RISE/SPAN: MIN $\frac{1}{8}$ USUAL $\frac{1}{6}$ TO $\frac{1}{4}$ MAX $\frac{1}{4}$ †					

Note: Glued laminated sections used in trusses for curved chords and heavily loaded straight chords and web members. Steel may be used for tension members. Glued laminated sections used for all arches and rigid frames, except that joist sections (2 by 8 to 2 by 12s) used for lamella arches.

Recommendations based on articles by Verne Ketchum (Chief Engineer, Timber Structures, Inc.) and "Architectural Construction" by Theodore Crane (Wiley, '47) and other sources.

* Some authorities recommend $\frac{1}{8}$ to $\frac{1}{4}$ for depth/span ratio.

† Some authorities recommend $\frac{1}{8}$ to $\frac{1}{10}$.

ACOUSTICAL MATERIALS AT WORK



Armstrong's Travertone was used in the attractive Bullock's Tea Room, as well as in the Employees' Dining Room.

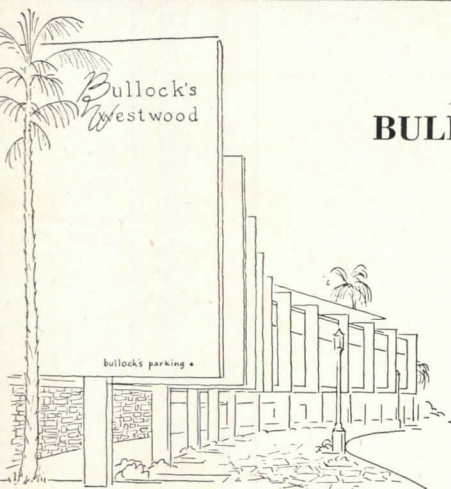

BULLOCK'S DEPARTMENT STORE, Westwood, California

The architect for this smartly styled branch of Bullock's considered many factors in choosing the acoustical materials. Acoustical efficiency, beauty, and fire-safety were important. Another factor was the need for a material well adapted to the mechanical suspension system to be used.

The architect met all these requirements with Armstrong's Travertone. A mineral wool tile, Travertone is completely incombustible. Its beautifully fissured surface blends well with this décor. It has high acoustical efficiency. Its strength and dimensional stability assure satisfactory performance when mechanically suspended. In addition, Armstrong's Travertone is ideally suited for installation with recessed lighting and ventilating fixtures.

Your Armstrong Contractor will be glad to give you full details on the complete line of Armstrong's Acoustical Materials. For the free booklet, "How to Select an Acoustical Material," write Armstrong Cork Company, 2409 Stevens Street, Lancaster, Pennsylvania.

Architect:

Welton Beckett and Associates

General Contractor:

C. L. Peck

Acoustical Contractor:

R. W. Downer Co.

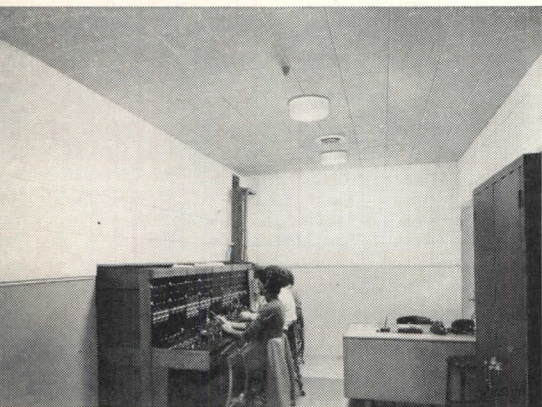

Ceilings and upper walls of the telephone switchboard room are sound conditioned with Armstrong's Cushiontone. Other office areas in Bullock's are also treated with this perforated wood fiber tile. Cushiontone raises efficiency and morale by absorbing irritating noise from telephones, typewriters, and other office machines.

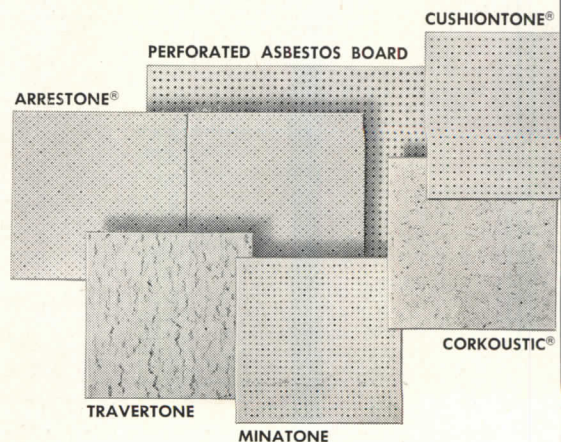

ARMSTRONG'S ACOUSTICAL MATERIALS

STRUCTURAL FORMS—6: Long Spans in Wood

By Seymour Howard, Architect, Instructor at Pratt Institute

GLUED LAMINATED WOOD—BASIC DATA

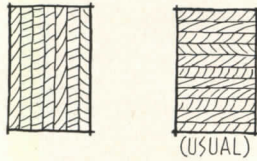

TYPICAL SECTIONS

Note that grain of all laminations is parallel to length of member (in plywood, grain directions of adjacent plies are at right angles)

Outer plies can be chosen for high strength and/or appearance

Lower-grade wood can be used for inner plies

Wood throughout section can be inspected before fabrication, unlike solid timbers, which may contain hidden defects

Wood throughout section can be seasoned uniformly, reducing chances of large checks and shakes often found in solid timbers

For service conditions involving low moisture contents, inspection and seasoning permit higher design stresses than for solid timbers

KINDS OF WOOD

SPECIES	USE
Douglas fir	General
Southern yellow pine	General
White oak	Ships
Sitka spruce	Aircraft

1. Other species may be used for special purposes of appearance or service

2. For exterior uses, plies may be brush or retort-pressure treated with creosote, creosote and oil, pentachlorophenol or suitable salts, before gluing

KINDS OF GLUE

INTERIOR USE (normal moisture not more than 15% in service conditions)

Water-resistant adhesives:

1. Casein Glue (Fed Spec C-G-456), water and mold resistant
2. Urea Resin Glue (Fed Spec C-G-496) — (not for service conditions above 150 F)

EXTERIOR USE (outdoors, underwater or service conditions causing greater than 15% moisture content [e.g. some textile industries])

Waterproof adhesives:

1. Phenol, Resorcinol and Melamine type resin glues, room and intermediate temperature setting, joint military specification Jan-A-397
2. Phenol, Resorcinol and Melamine type resin glues, high temperature setting, joint military spec Mil-A-5534

Notes: Chemists and manufacturers are still developing new adhesives; at present time water-resistant types are less expensive

END AND EDGE JOINTS IN LAMINATIONS

VERTICALLY LAMINATED BEAM

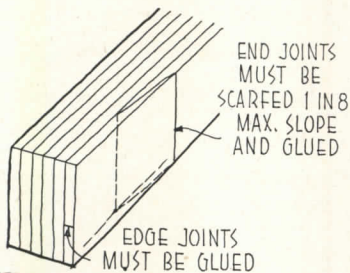

HORIZONTALLY LAMINATED SECTIONS

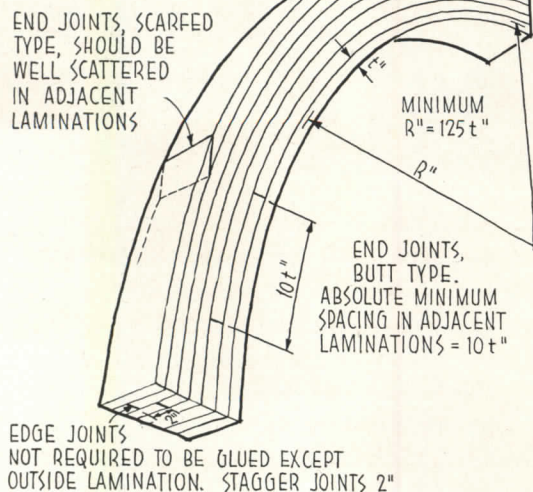

EXTREME SECTION

proportions recommended for curved members to prevent elastic instability

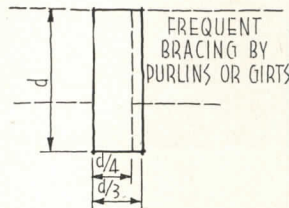

WIDTH OF LAMINATIONS	Nominal	3 in.	4 in.	5 in.	6 in.	8 in.	10 in.	12 in.	14 in.	16 in.
Actual	2 1/4 in.	3 1/4 in.	4 1/4 in.	5 1/4 in.	6 1/4 in.	7 in.	9 in.	11 in.	12 1/2 in.	14 1/2 in.

Actual Thickness	Minimum Radius of Curvature = 125 t in.
1/4 in.	2 ft—7 1/4 in.
3/16 in.	3 ft—3 1/16 in.
3/8 in.	3 ft—10 7/8 in.
1/2 in.	5 ft—2 1/2 in.
5/8 in.	6 ft—6 1/8 in.
3/4 in.	7 ft—9 3/4 in.
1 1/16 in.	13 ft—8 1/16 in.
1 1/2 in.	15 ft—7 1/2 in.
1 3/8 in.	16 ft—11 1/8 in.
2 in.	20 ft—10 in.

(Note: See National Design Specification of National Lumber Manufacturers' Association, and standard specs for structural glued laminated lumber of West Coast Lumbermen's Association and of Southern Pine Inspection Bureau for more detailed information.)

* Butt joints cannot transmit stress; design must take account of this.

STRUCTURAL FORMS—7: Long Spans in Wood

By Seymour Howard, Architect, Instructor at Pratt Institute

METHODS OF VARYING DEPTH OF SECTION

Methods 2, 3 or 4 normally used only if method 1 creates too large slope of grain

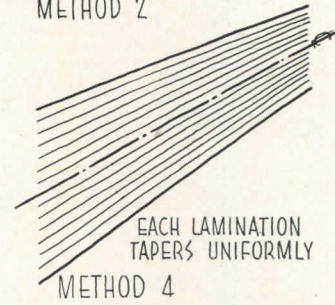
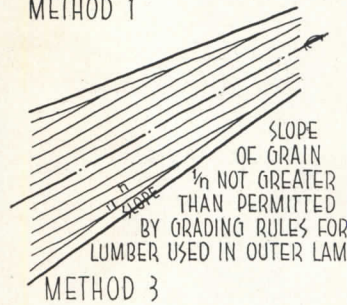
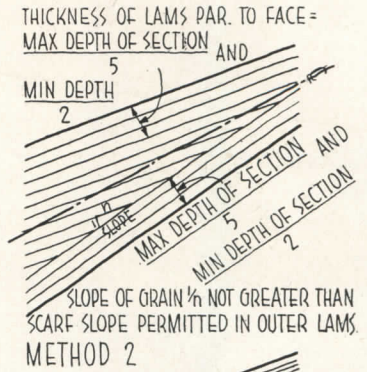
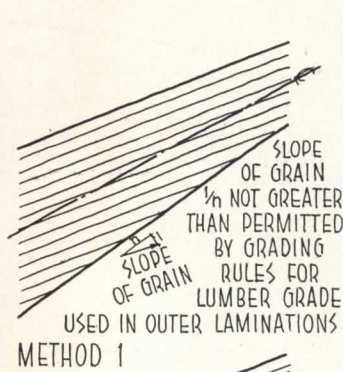

TYPICAL FASTENING DETAILS

Notes: • Special details should be developed for bases of frames and arches exposed to the weather to prevent water from lying around ends of members.
• Indoors as well as outdoors, ends of members should be painted

two coats or otherwise treated to reduce tendency to check.
• When more than one bolt is used (except parallel to long axis of wood) slotted holes should be used in jointing metal plate to permit movement caused by swelling or shrinking.

BASE DETAILS

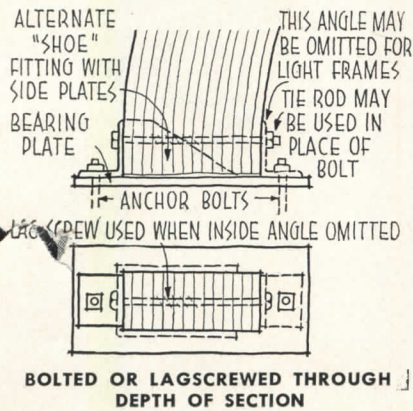

CROWN DETAILS

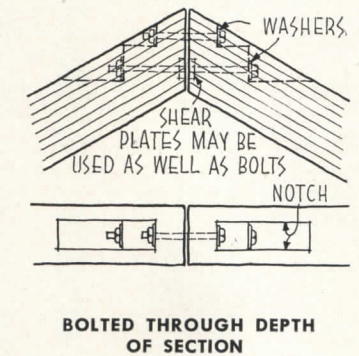

PURLING DETAILS

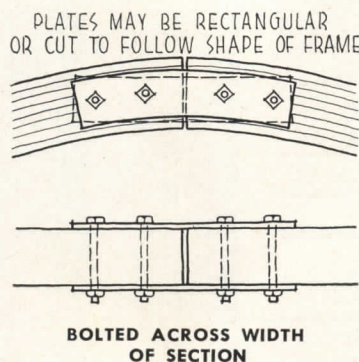
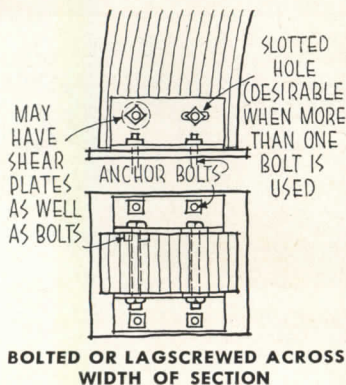
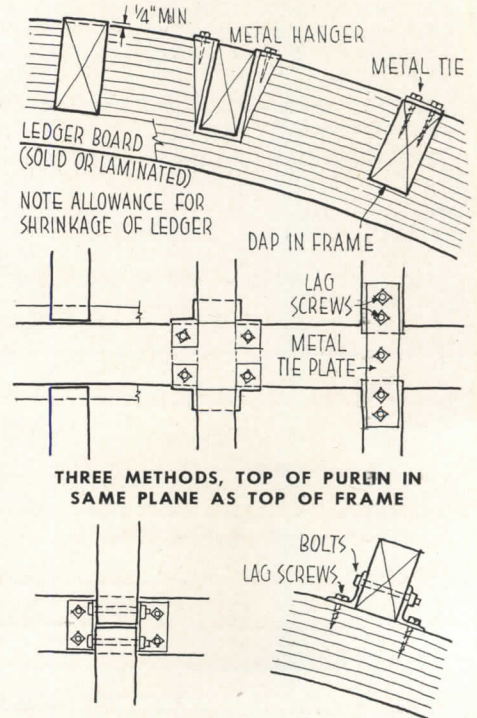

PURLIN RESTING ON TOP OF FRAME

Note: Purlins may be solid timbers or laminated.

CANTON

Flo-tubes
Trademark

**MODERN WAY TO
HANDLE COAL . .**

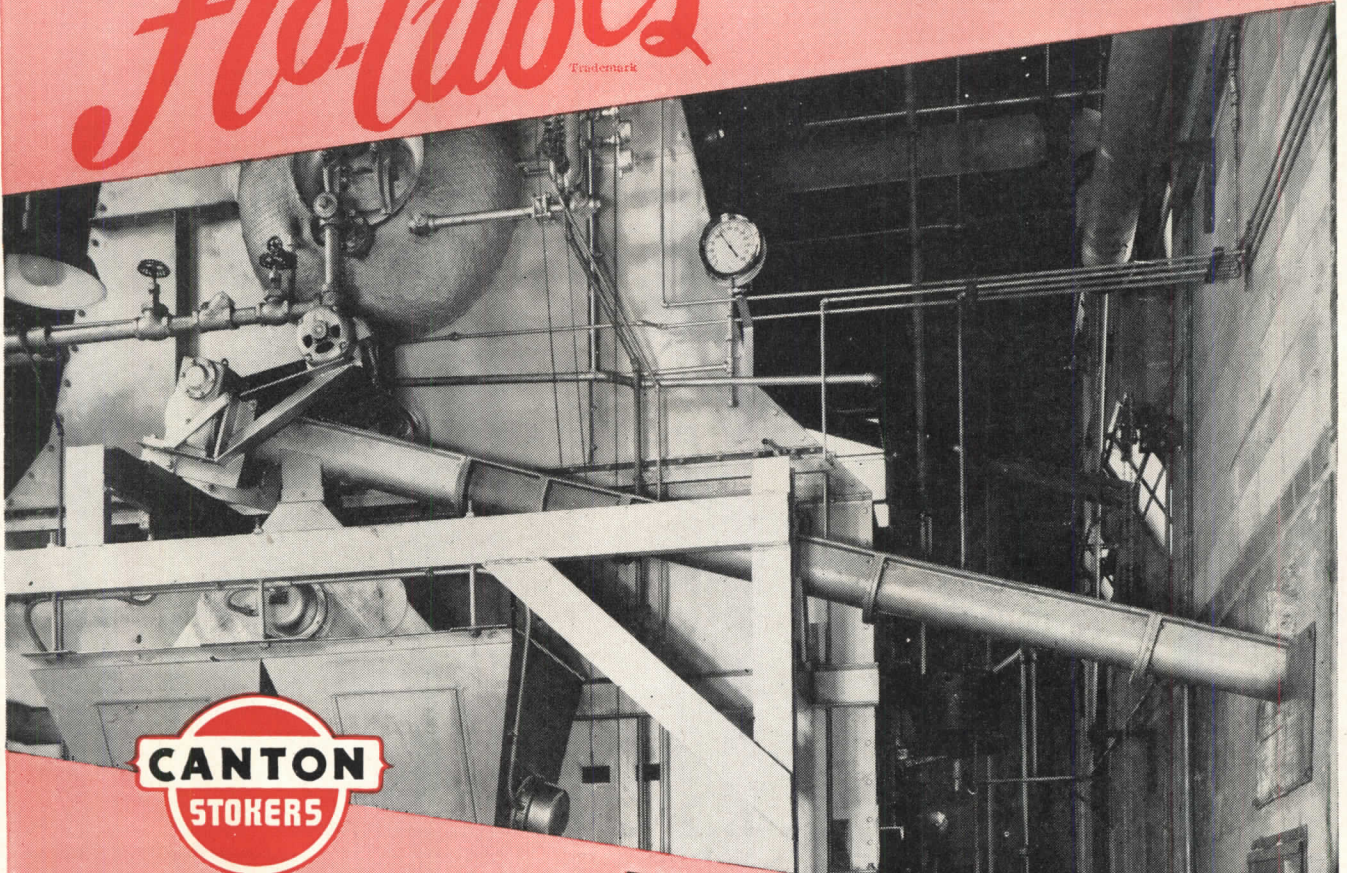

Feeding hoppers direct from pile or bin saves real money in time and man power . . . frees men for other duties, allows more efficient use of labor. Canton Flo-Tube installation above feeds from coal bin at right. Chute dividers are hand adjustable, hopper levels diaphragm controlled.

RIGHT photo—a horizontal application, using gate valves.

LOWER right photo—a reversed binfeed installation entering rear of boiler.

Canton Stoker Corporation — specialists in COAL FIRING, HANDLING, and CONTROL EQUIPMENT — invites you to contact their representatives in principal cities, or write direct.

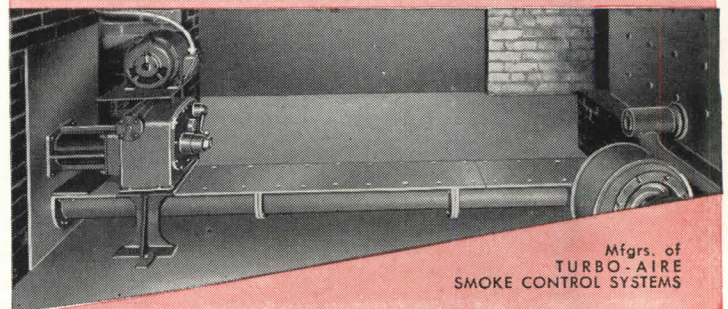
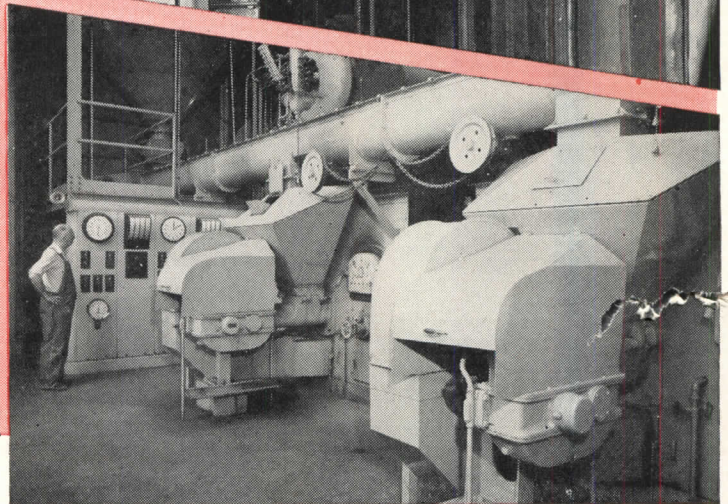

Mfgs. of
TURBO-AIRE
SMOKE CONTROL SYSTEMS

CANTON STOKER CORPORATION

2300 Andrew Place S. W. CANTON, OHIO

Send literature on: _____

Have a Canton Engineer interview us.

Name: _____

Company: _____

Address: _____

City: _____ State: _____

PORCELAIN ENAMEL-10: Sign Letters

Prepared by Harold Edelman, A.I.A.
 Instructor at Pratt Institute

6. Attachment Methods — attachment methods are usually designed to eliminate visible fastenings. They vary considerably among manufacturers, but the basic types are as follows:

a. Letters attached to wall panels before the latter are erected. Bolts are tack welded to back of letter, placed through slotted holes in the

wall panel and secured by nuts. Panel and letter are erected as one.

b. Letters attached to masonry or wall panels by means of clips fastened to the wall surface.

c. Letters are constructed with straps on the rear which have keyhole slots that drop over bolt heads projecting from the wall surface.

d. Curb boxes or raceways are used as a continuous support under the

letters which are secured to the curb by means of clip angles. Precautions must be taken not only for proper flashing but for bracing large letters against wind stresses.

Any of these methods may be used with a variety of spacers to project the letters from the wall surface. Chair mounts may be used to raise letters off the top of curb boxes, raceways and canopies.

Diagram C.

ATTACHMENT OF SIGN LETTERS

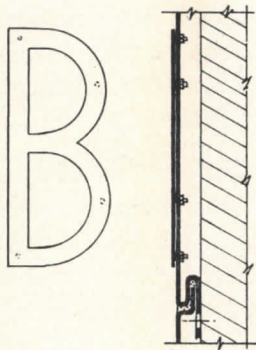

Flat letter attached as (paragraph 'a')

Raised letter attached as (paragraph 'b')

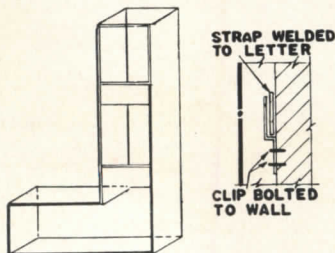
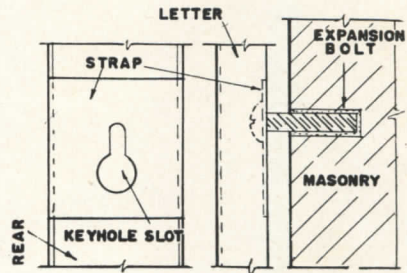

Raised letter attached as (paragraph 'c')



Cut drafting costs... Get better prints...

with Kodagraph Reproduction Materials...
created for use in your present equipment

DRAFTING COSTS go down when you use Kodagraph Reproduction Materials to protect valuable drawings from wear and tear... to reclaim old, soiled, faded originals... to revise or combine drawings... to copy prints.

And the legibility of your direct-process prints or blueprints goes *up* when you use Kodagraph reproductions of your drawings in print-making. For Kodagraph Materials are silver sensitized, photographic... have the ability to intensify weak detail... step up contrast... drop out stains, creases. And they pass on this improved quality to the final prints.

If you have a blueprint or direct-process machine or vacuum frame

You can produce *positive photographic intermediates directly* from your engineering drawings by



reproducing them on any one of four types of Kodagraph *Autopositive* Materials. To do the job—simply expose in your present equipment... and process in standard photographic solutions. No negative step. No darkroom handling—a fast, convenient room-light operation all the way.

- 1. Kodagraph Autopositive Paper Extra Thin**—the all-purpose intermediate material for *everyday* use—gives you intermediates on a durable, white paper base. *Intermediates* which will turn out crisp, clean blueprints and direct-process prints time after time... which will retain their line density and sharpness... and which will remain *photo-lasting* in the files.
- 2. Kodagraph Autopositive Paper Translucent...** has an exceptionally durable and translucent paper base... and a print-back speed which is 30% faster than regular Autopositive—an *important advantage in large-volume print production*.
- 3. Kodagraph Autopositive Film**—with its highly translucent Kodak safety film base—is especially valuable in reclaiming “hopelessly poor” tracings... and in reproducing extremely fine line detail. It is also widely used to reproduce catalog pages, etc., including half-tone illustrations.
- 4. Kodagraph Autopositive Cloth**—is recommended for producing the most durable prints (nearly exact in scale) from drawings in good condition. Its base is white fabric—tough, crease-resistant, highly translucent.

Kodagraph Repro-Negative Paper, which is processed in the same manner as the Autopositive Materials and with the same speed and convenience, enables you to produce positive intermediates directly from blueprints, Van Dykes, and other negative “originals.”