

# ARCHITECTURAL RECORD



JUNE 1955

EDUCATIONAL STUDY  
CREATING THE U.S.  
BUILDING

223

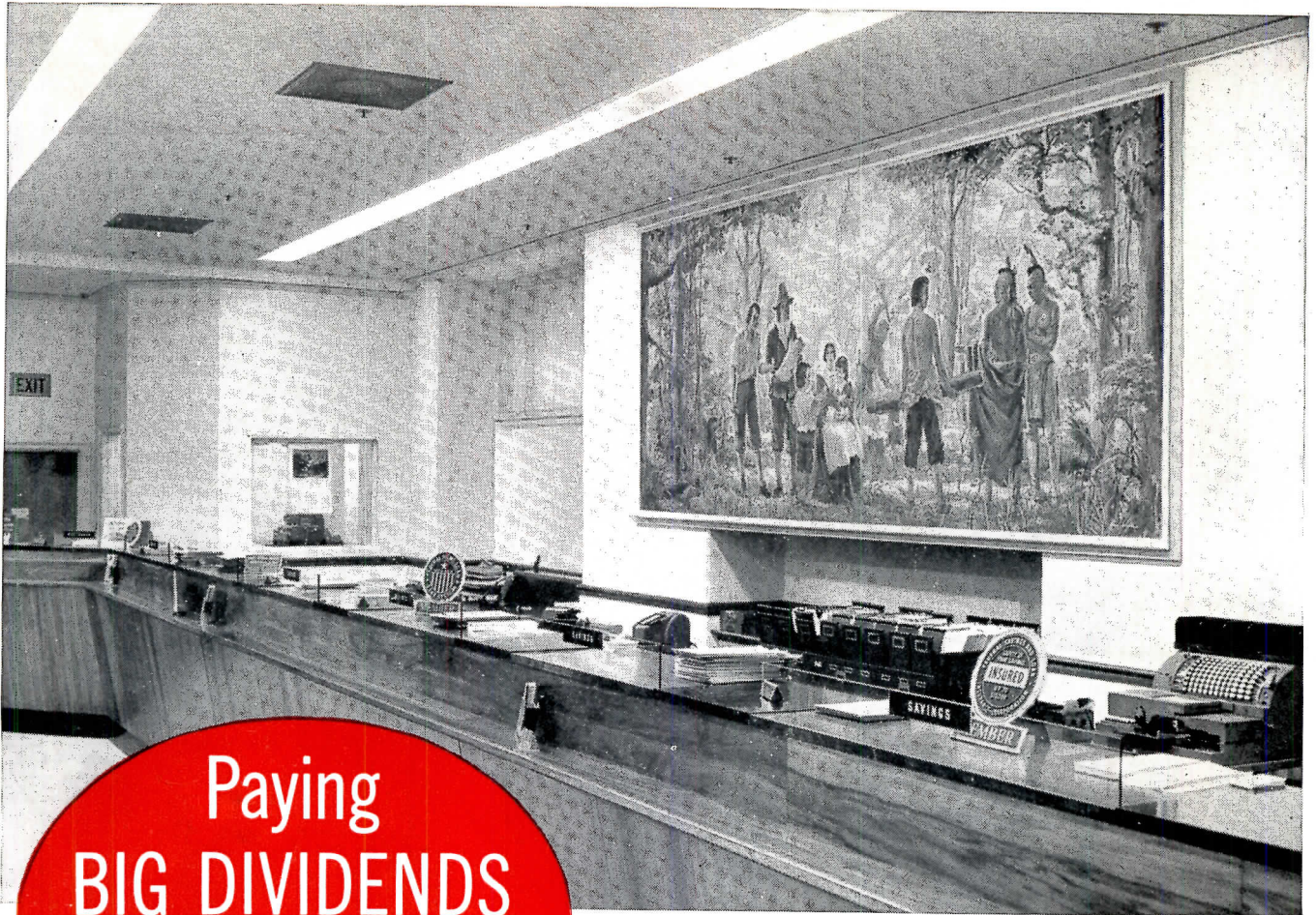

Paying  
BIG DIVIDENDS  
in Safety...



## GRINNELL SPRINKLERS



Practically out of sight, and surely out of mind for hundreds of daily patrons, Grinnell *flush-type* Ceiling Sprinklers provide inconspicuous protection against fire at the Roger Williams Savings and Loan Association in Providence, Rhode Island

There is an appropriateness in the choice of Grinnell. These new bank offices are designed to create an atmosphere of serenity and security—gently underlining the confidence this fine old New England institution inspires.

There is sound good sense, too, in the choice of Grinnell. Three-quarters of a century of fire protection engineering contributes to the proved reliability of Grinnell Automatic Fire Protection Systems. There is a Grinnell System for *every* fire hazard. Whether your next project is new building or remodeling, call on Grinnell while it's still in the planning stage. Or, write for literature on Grinnell Sprinklers. Grinnell Company, Inc., 269 West Exchange St., Providence, R. I.

# GRINNELL

PROTECTION AGAINST EVERY FIRE HAZARD



Manufacturing, Engineering, and Installation of Automatic Sprinklers Since 1878

ARCHITECTURAL RECORD (Vol. 117, No. 6, June, 1955) is published monthly by F. W. Dodge Corporation, 10 Ferry Street, Concord, N. H., with editorial and executive offices at 119 W. 40th St., New York 18, N. Y. \$5.50 per year; Foreign, \$20.00.

Entered as second-class matter at the Post Office, Concord, N. H., March 16, 1946, under the Act of March 3, 1879.

# ARCHITECTURAL RECORD

June 1955 Vol. 117 No. 6

Copyright 1955 by F. W. Dodge Corporation, with all rights reserved. ARCHITECTURAL RECORD (combined with AMERICAN ARCHITECT and ARCHITECTURE) is published monthly by F. W. Dodge Corporation, 10 Ferry Street, Concord, New Hampshire, with editorial and executive offices at 119 West 40th Street, New York 18, New York. Western editorial office, 2877 Shasta Road, Berkeley 8, California.

## STAFF OF ARCHITECTURAL RECORD



H. Judd Payne, *Publishing Director*; John Knox Shear, A.I.A., *Editor-in-Chief*; Robert F. Marshall, *General Manager*; Marshall T. Ginn, *Circulation Manager*. . . Emerson Goble, *Managing Editor*; Frank G. Lopez, A.I.A., *Senior Editor*; James S. Hornbeck, A.I.A., *Senior Associate Editor*; Elisabeth Kendall Thompson, *Senior Associate Editor and Western Section Editor (Berkeley, California, Office)*; Robert E. Fischer, *Associate Editor (Engineering)*; Florence A. van Wyck, *Associate Editor*; Jeanne M. Davern, *Associate Editor (News)*; Daniel M. Kelley, *Associate Editor (Engineering Assistant)*; Ernest Mickel, Dan Street (*Washington*), John Caulfield Smith, M.R.A.I.C. (*Canada*), *Contributing Editors*; Marjorie Blake, Grace M. Anderson, *Assistant Editors*; Ruth P. Watson, Helen E. Cook, *Editorial Assistants*; Eugene H. Hawley, Alfred Petersen, *Design*; Sigman-Ward, *Drafting Consultants*; Thomas S. Holden, *Industry Relations Consultant*; Clyde Shute, *Statistical Consultant*; George Cline Smith, *Economics Consultant*; Clifford Dunnells, Jr., *Field Research Consultant*; Samuel C. Pace, *Public Relations Consultant*.

## TABLE OF CONTENTS

### The Record Reports

Perspectives	9
1955 A.I.A. Honor Awards	10, 11
Meetings and Miscellany	15, 16
Views of Recent Periodicals; A.I.A. Chapter Publications	20
A Washington Report. <i>By Ernest Mickel</i>	24
News from Canada. <i>By John Caulfield Smith</i>	26
Washington Topics	38
Construction Cost Index	42
Required Reading	46
Current Trends in Construction	368



United States Air Force Academy, El Paso County, Colorado; Skidmore, Owings & Merrill, Architects  
Following page 172

### Chandigarh — A New Capital City

A second view of Chandigarh, the planned-from-scratch capital city of Punjab, India, as it actually is being built (an earlier view was expressed last year in ARCHITECTURAL RECORD by Lewis Mumford, in his article about Matthew Nowicki).

Chandigarh — A New Capital City. Article by Maxwell Fry 139

### Office Building Design for Export

Edificio Creole, Caracas, Venezuela; Lathrop Douglass, Architect 149

### Bucky Fuller and his Dome

A pictorial story of nearly three decades of work by the famous genius of geometry

Cycle of Evolution: The Work of R. Buckminster Fuller 155

### Library

American Memorial Library, Berlin, Germany; Gerhard Jobst, Willi Kreuer, Hartmut Willie, Fritz Bornemann, Architects 163

### House for the Double Life

The Wiley House, New Canaan, Conn.; Philip C. Johnson, Architect 167

COVER: "Aerial" view of projected housing neighborhoods for staff and support personnel, United States Air Force Academy. Photograph of model © Ezra Stoller

Continued on next page

## What Makes A Good School Building?

An article prepared in collaboration with the Subcommittee on "What Are Our School Building Needs?" of the committee for the White House Conference on Education. *By Frank G. Lopez, A.I.A.* 173

## Building Types Study Number 223 — Religious Buildings

Emphasizing the social, educational and recreational aspects of religion, and their effect on the new search for architectural form

<i>Introduction by John Knox Shear</i>	177
Grace Lutheran Church, Teaneck, N. J.; Paul Schweikher, Architect	178
"Seventy Thousand Churches in Ten Years." <i>By George Cline Smith</i>	181
Chapelwood Methodist Church, Houston, Texas; Hamilton Brown, Architect	182
"Characteristics of Today's Church School." <i>By C. Harry Atkinson</i>	185
K. T. I. Synagogue, Port Chester, N. Y.; Philip C. Johnson, Architect	186
Church of the Nativity, Honolulu, T. H.; Law & Wilson, Architects and Engineers	190
Interfaith Chapel for Texas A & M College, College Station, Texas; Bolton and Barnstone, Architects	194
Beth Israel Synagogue and School, Omaha, Neb.; Kivett and Myers, Architects	198
A Bibliography of Church Architecture	201
St. Peter's Lutheran Church, Norwalk, Conn.; Pedersen and Tilney, Architects	202
Church Art and Architecture Periodicals	205
First Baptist Church, Everett, Wash.; Durham, Anderson and Freed, Architects	206

## Architectural Engineering

Schools Can Be Made Blast Resistant. <i>By Ellery Husted and Boyd Anderson</i>	209
Heating, Air Conditioning and Plumbing (Part II) <i>By Nathan N. Wolpert</i>	215
Product Reports	217
Roundup	218
Office Literature	220
Time-Saver Standards — Thermal Insulation: 7; North American Building Stones, 17	223

## Index to Advertising

395

## OFFICERS OF THE F. W. DODGE CORPORATION

James McV. Breed, *Chairman of the Board*; Paul Abbott and Thomas S. Holden: *Vice Chairmen of the Board*; Howard Barringer, *President*; Irving W. Hadsell, Chauncey L. Williams: *Executive Vice Presidents*; Howard M. Thompson, *Vice President and Treasurer*; Julius T. Little, Robert F. Marshall, T. Oliver Morgan, H. Judd Payne: *Vice Presidents*; Carl S. Bennett, Clinton C. Bennett, Ralph M. Hairston, Roy J. Hard, O. O. Paulsell, Richard H. Ray, John M. Williams: *Regional Vice Presidents*; Edwin H. Freed, *Assistant Vice President and Comptroller*; George Cline Smith, *Assistant Vice President and Economist*; Walter F. DeSaix, Clifford G. Dunnells, Jr., Clyde Shute, Marc Wayne: *Assistant Vice Presidents*; Sanford D. Stockton, Jr., *Secretary*; William C. Breed, Jr., George W. Morgan, Jr.: *Assistant Secretaries*; Irving B. Satin, *Assistant Treasurer*.

## OTHER F. W. DODGE SERVICES:

Dodge Reports — Dodge Statistical Research Services — Sweet's Catalog Services — Dodge Books — Dodge Mailing Service — Chicago Construction News — Daily Pacific Builder — Denver Daily Journal — Real Estate Record & Builders' Guide.

Member of Audit Bureau of Circulations and Associated Business Publications. Architectural Record is indexed in Art Index, Industrial Arts Index and Engineering Index.

Every effort will be made to return material submitted for possible publication (if accompanied by stamped, addressed envelope), but the editors and the corporation will not be responsible for loss or damage.

Subscription rates in U. S., U. S. Possessions, and Canada: \$5.50 for one year, \$9.00 for two years, \$11.00 for three years. Elsewhere, subscriptions from those who by title are architects or engineers, \$6.50 for one year, \$11.50 for two years, \$15.00 for three years; subscriptions from all others outside U. S., U. S. Possessions and Canada, \$20.00 a year. Single copy price, \$2.00. Circulation Manager: Marshall T. Ginn. Change of Address: Subscribers are requested to furnish both old and new addresses, sending if possible the stencil impression from magazine wrapper. Allow four weeks for change.



# THE RECORD REPORTS

## P E R S P E C T I V E S

FAME IS THE SPUR: Only one architect has made the Hall of Fame, and he was Thomas Jefferson, elected and identified in New York University's now legendary collection in the open-air colonnade on its Bronx campus not as architect but as third U. S. president. This is election year for N.Y.U.'s "Hall of Fame for Great Americans," and as many as seven names may be added to the 83 selected in the series of elections held every five years since 1900. Nominees, who are proposed by the general public on ballots available on request to N.Y.U., must have been dead at least 25 years (until 1922, it was 10 years); final selections are made by an "electoral college" of American citizens representing all 48 states and substantial achievement in diverse fields. The visual arts altogether have produced only five of the 83 American heroes: and for two of them art was a secondary distinction — John James Audubon (1785–1851) is identified as "ornithologist and artist" and Samuel F. B. Morse (1791–1872) as "inventor of telegraph, artist." The others are Gilbert Charles Stuart (1755–1828), "portraitist"; Augustus Saint-Gaudens (1848–1907), sculptor; and James Abbott McNeil Whistler (1834–1903), "artist." The Hall has a single incumbent elected as an engineer — James Buchanan Eads (1820–1887). Architects can still say with the poet, "Fame is no plant that grows on mortal soil."

THE ARCHITECT AND THE STONE CARVER: At the Barnard College American Arts Festival, attended by student delegates from 35 colleges and universities, architecture was represented by Henry-Russell Hitchcock and Philip Johnson. Professor Hitchcock developed the theme that the work of three succeeding and overlapping generations of modern architects has created a "living tradition" of contemporary architecture. Mr. Johnson in his turn rejoiced that the present era has become "a golden age of architecture" because "we know where we are; we all use the same

grammar. . . . We've got a *style*." Explaining to his student listeners that this style had been most frequently referred to as the "International Style" from the 1932 book in which Hitchcock gave it for the first time a name and a formal code, Mr. Johnson said that the basic canons of contemporary architecture are still, as they were then, *the cage, order* ("but not axial") and *no applied ornament*. "We can't all be geniuses," he said, and the style in effect substitutes for genius by providing a ready-made vocabulary. "I am so glad I can now lean on Mies and Corbu, since I am weak; and to know that if my generation is good enough we may yet stand on their shoulders; but I'm glad there's a style to help us get there." In the same week came a comment on contemporary architecture from a less likely — though equally special — source. One of the ten stone carvers who are currently reproducing the intricate carving of an 1812 façade on a new facing for New York's historic City Hall was quoted by *The New York Times* in a story about the restoration. Said Frank Arno, 72, one of 18 remaining members of the New York Stone Carvers Union: "What they're building now is nothing! Just a plain box. Not a bit of carving!"

INDIVIDUALITY, not mechanization, will be the keynote of the successful restaurant of the future, the annual convention of the National Restaurant Association was told last month in Chicago. Dr. Ernest Dichter, president of the Institute for Motivational Research, of Croton-on-Hudson, N. Y., recommended the fullest use of contemporary design to create atmosphere and personality that will give the customer a feeling that "he has found something special, something with an 'air,' a character that he can tell his friends about." All the modernizing of restaurants which has been going on of recent years has too often, Doctor Dichter felt, produced "a glittering chrome, steel and ceramic sameness," and efficiency for

the restaurateur rather than the customer. "In other words, restaurants have become physically modern rather than psychologically and socially modern. There has been little thought given, for example, to the fact that some diners want speed — others want leisure. Some people eat alone — want a sense of privacy in doing so and not to be crowded into one table of long row of napkin-sized tables; others want the hustle and bustle of gaiety and activity. A really modern restaurant will be designed in the future to make full use of modern materials and technology, and yet to give the customer the particular psychological atmosphere he wants at the moment."

AT PRESS TIME comes word from Washington of the unexpected death on May 25 at the age of 55 of Marshall A. Shaffer, who had headed architectural and engineering phases of the U. S. Public Health Service hospital construction program since its inception in 1941. As chief of the Technical Services Branch of the USPHS Division of Hospital Facilities, Mr. Shaffer developed guides and criteria to assist architects throughout the country in the design of Federally-aided hospitals; the studies that came from his office have become, in fact, the prime references for any architect with a hospital design problem. It is doubtful if there has ever been a government official as widely known and as warmly admired by private architects. In the words of the citation which accompanied the American Institute of Architects' Edward C. Kemper Award, which Mr. Shaffer received in 1951, he "insured the conduct of the hospital building program of the U. S. Public Health Service in harmony with the highest ethical standards of the Institute and thus secured for the public the greatest benefit from the services rendered by its architects."

## THE RECORD REPORTS

---

### BUILDINGS IN THE NEWS



*JURY IN SESSION: Around the conference table at the Octagon, members of the 1955 Honor Awards jury (left to right) — Ernest Born, San Francisco; Eugene F. Kennedy Jr., F.A.I.A., Boston; Chairman Thomas F. Locraft, F.A.I.A., Washington, D. C.; Ludwig Mies van der Rohe, F.A.I.A., Chicago; J. Byers Hays, F.A.I.A., Cleveland*

## 1955 HONORS IN A.I.A. ANNUAL AWARDED TO 27

THE AMERICAN INSTITUTE OF ARCHITECTS' Seventh Annual Competition for Outstanding American Architecture brought First Honor Awards to five buildings (shown opposite) and Awards of Merit to 22 more (shown on pages 328 to 336). The jury (see cut above) said that the uniform quality of the work made its task of selection extremely difficult; and there were nearly 300 entries, the largest number ever submitted in an A.I.A. Honor Awards competition. There were no categories; "distinguished accomplishment in architecture" was the yardstick.

Architects of the winning buildings will be given certificates of award at the Awards Luncheon during the annual convention of the A.I.A. this month in Minneapolis. A specially designed stainless steel plaque also is furnished by the A.I.A. to be placed on each building receiving a First Honor Award. Panel

exhibits of the 27 winning buildings will be shown at the convention; afterwards, photo-lithographic reproductions will be made of each panel, and the complete printed sets will be available for showings by A.I.A. chapters, libraries and architectural schools and for exhibition in foreign countries.

The A.I.A.'s annual honor awards program was initiated in 1949 "to encourage the appreciation of excellence in architecture and to afford recognition of exceptional merit in recently completed buildings." The competition is open to any American architect for any building in the United States or abroad completed during the preceding five calendar years.

Altogether, in the seven competitions held so far, 22 buildings in 12 states and one foreign country have received First Honor Awards; 109 buildings in 24 states and one foreign country have received Awards of Merit. In a geographic

breakdown of award-winning buildings, California is way out in front, with seven of the 22 First Honor Awards and 51 of the 109 Awards of Merit. Nearest challenger is Texas, with three First Honor Awards and seven Awards of Merit. Michigan has two Firsts, and the others are distributed one each among Georgia, Iowa, Louisiana, Minnesota, New York, North Carolina, Oklahoma, Pennsylvania, Washington State — and Sweden. Of the remaining Awards of Merit, Illinois, Louisiana and Massachusetts have five each, Florida and Washington State four each, Colorado and Virginia three each, and Iowa, Indiana, Michigan, New York and Pennsylvania two each; and there has been a single award in each of nine states — Alabama, Arizona, Georgia, Minnesota, Nebraska, New Jersey, North Carolina, Ohio and Oklahoma — and Mexico. There are 24 states in which no building has yet received an award.

*(Awards of Merit, pages 328-336)*

### FIRST HONOR AWARDS, 1949-1954

#### 1949

First Honor Awards: Corona Del-Mar School, Corona Del-Mar, Cal. — Marsh, Smith and Powell, architects; residence, Dr. & Mrs. Alex J. Ker, Marin County, Cal. — Frederick L. Langhorst, architect.

#### 1950

First Honor Awards: Residence, H. C. Hvistendahl, San Diego, Cal. — A. Quincy Jones, Jr., architect; Davison-Paxon Company Store, Augusta, Ga. — Harold M. Heatley and Ketchum, Giná and Sharp, associated architects.

#### 1951

First Honor Awards: Clearwater County Memorial Hospital, Bagley, Minn. —

Thorshov & Cerny, architects; Coca Cola Bottling Plant, Houston, Tex. — Stone & Pitts, architects and engineers.

#### 1952

First Honor Awards: Lever House, New York City — Skidmore, Owings and Merrill, architects; William Beckett's Office, Los Angeles, Cal. — William S. Beckett, architect; Gaffney's Lake Wilderness, Maple Valley, Wash. — Young and Richardson, Carleton and Detlie, architects.

#### 1953

First Honor Awards: Engineering Staff Buildings, General Motors Technical Center, Warren, Mich. — Saarinen, Saarinen & Associates, architects, Smith Hinchman & Grylls, architects and engineers; North Carolina State Fair Pa-

vilion, Raleigh — Matthew Nowicki, designer, William Henley Deitrick, architect, Severud-Elstad-Kreuger, consulting engineers.

#### 1954

First Honor Awards: Moore Residence, Ojai, Cal. — Richard J. Neutra, architect, Dion Neutra, collaborator; Lan-kenau Hospital, Philadelphia, Pa. — Vincent G. Kling, architect; Fort Brown Memorial Civic Center, Brownsville, Tex. — John P. Wiltshire and J. Herschel Fisher, architects; Thomy Lafon School, New Orleans, La. — Curtis and Davis, architects; Norman High School, Norman, Okla. — Perkins and Will: Caudill, Rowlett, Scott and Associates, associated architects-engineers; Santa Monica City College, Santa Monica, Cal. — Marsh, Smith and Powell, architects.

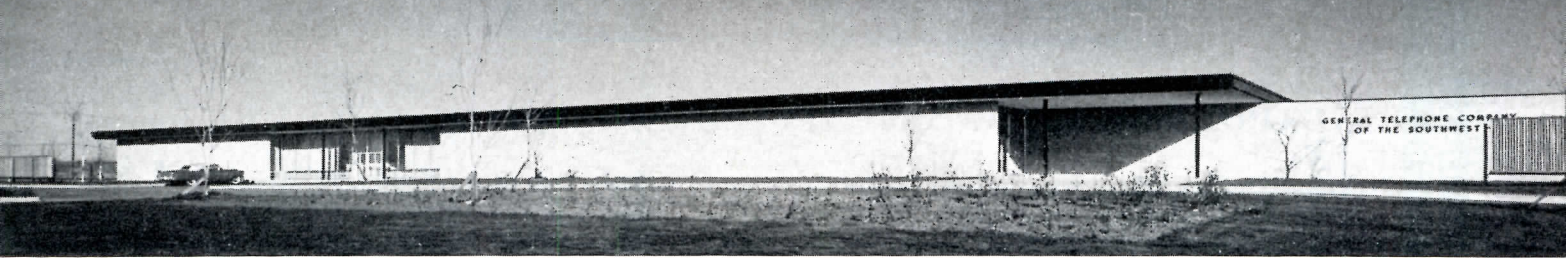

*FIRST HONOR AWARD: General Telephone Company of the Southwest, San Angelo, Tex.; architect, PACE associates —*

*Charles B. Genther, architect-in-charge; structural engineer, Frank J. Kornacker & Associates; builder, Evans & Taylor*

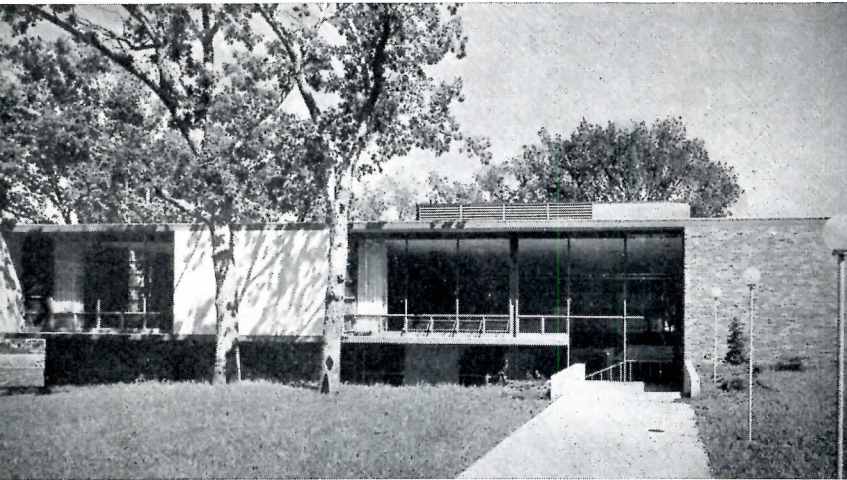

*FIRST HONOR AWARDS: (Left) Women's Dormitories and Dining Hall, Drake University, Des Moines, Ia.; architect, Eero Saarinen & Associates; structural engineer, Severud-Elstad-Krueger; builder, The Wertz Company Inc. (Right) Central Rest-*

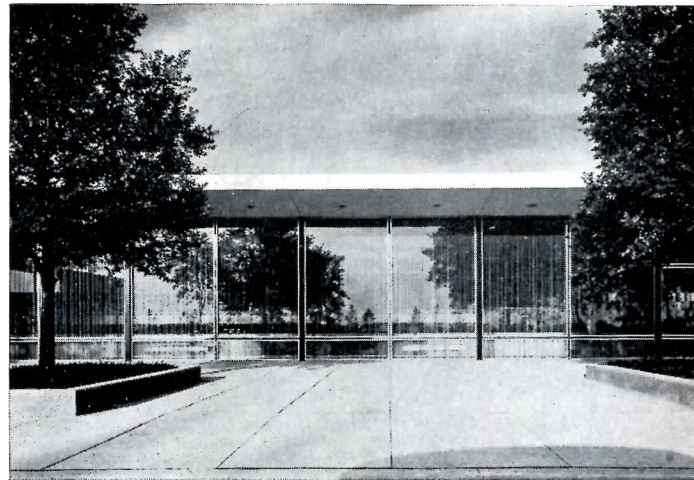

*aurant Building, General Motors Technical Center, Warren, Mich.; architect, Eero Saarinen & Associates; architect-engineers, Smith, Hinchman & Grylls Inc.; landscape architect, Thomas D. Church; associate architect, E. A. Eichstedt; builder, Bryant & Dewiler*



*FIRST HONOR AWARDS: (Above) North Hillsborough School, Hillsborough, Cal.; architect, Ernest J. Kump; general contractor, C. F. Parker. (Below) American Embassy, Stockholm,*

*Sweden; architects, Ralph Rapson and John van der Meulen; structural engineer, Sven Tyren; contractor, Ollie Engkvist & Nils Nessen*

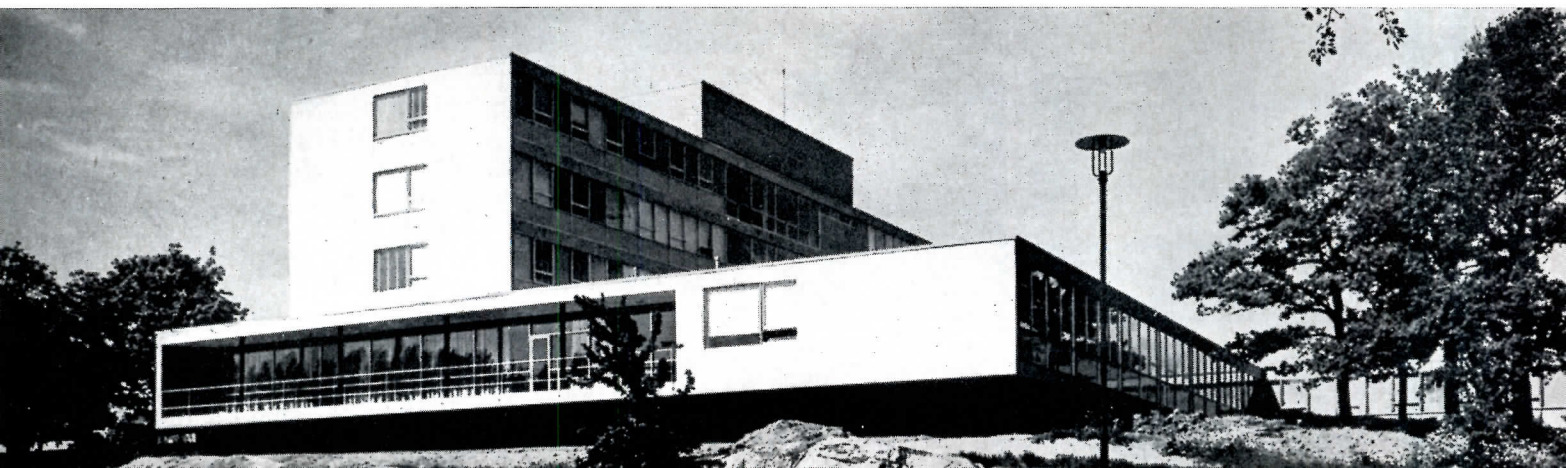

**MINNEAPOLIS 1955: COMMUNITY DESIGN IS A.I.A. THEME**

THE AMERICAN INSTITUTE of Architects holds its 87th annual convention this month in Minneapolis — June 21-24 at the Hotel Radisson. "Designing for the Community" is the convention theme; and in addition to the two major seminars relating to the theme, there will be seminars on client relationships and on regional and chapter problems. The three Minnesota chapters — Minneapolis, St. Paul and Duluth — are joint convention hosts, with G. Clair Armstrong of Minneapolis as chairman of the Host Committee.

Willem Dudok, distinguished Dutch architect and city planner, will receive the 1955 Gold Medal, the A.I.A.'s highest professional honor, in a ceremony at the annual banquet. Mr. Dudok, who made his first visit to the U. S. on an A.I.A.-sponsored speaking tour in the fall of 1953, will also make the convention's keynote address.

**Politics of Course**

All Institute offices and four regional directorships will be filled by balloting of delegates to the convention. President Clair W. Ditchy, F.A.I.A., of Detroit, now completing his second one-year

term, is not a candidate for reelection. Preconvention nominations, which closed May 12, produced this slate: for president — George Bain Cummings of Binghamton, N. Y. (national secretary for the past two years); for first vice president, Earl Heitschmidt of Los Angeles (the incumbent); for second vice president, Hugh Stubbins of Lexington, Mass., and John N. Richards of Toledo; for secretary, Ross Shumaker of Raleigh, N. C., and Edward L. Wilson of Fort Worth; for treasurer, Leon Chatelain Jr. of Washington, D. C. (the incumbent). Regional directors have been nominated as follows: New England, Austin Mather of Bridgeport, Conn.; New York, Matthew W. Del Gaudio of New York; Great Lakes, Brandt E. Hadley of Springfield, Ill.; and Rocky Mountain, Bradley D. Kidder of Santa Fe.

**This Year's Honors**

Investiture of new Fellows of the Institute, which traditionally takes place at the annual banquet, will have a special interest this year, because for the first time announcement of the selections will not be made in advance. The major

address at the banquet will be made by Clarence Stein, F.A.I.A., New York architect and city planner who gave U. S. city planning early fame with the pioneering U. S. planned community at Radburn, N. J.

Turpin C. Bannister, F.A.I.A., of Urbana, Ill., will receive the Edward C. Kemper Award for Service to the Institute for his work in the final editing of "The Architect at Mid-Century." The Danish architect Kay Fisker of Copenhagen will be made an Honorary Fellow; and honorary memberships are to be awarded to four (see below).

Other honors to be given at the convention are the Fine Arts Medal, highest honor the Institute can bestow in fine arts other than architecture, to Croatian sculptor Ivan Mestrovic, who is now teaching and working at Syracuse University; and the Craftsmanship Medal, to calligrapher John Howard Benson of Newport, R. I. An "Award of Recognition for Distinguished Achievement in Architecture or Other Planning" — a new award this year — will be made to the Kohler Foundation, Inc., for the restoration of Wade House, Greenbush Village, Wisc.



*A.I.A. GOLD MEDAL will be awarded this year to (left) Willem Marinus Dudok of Hilversum, The Netherlands, 70-year-old architect and city planner, a pioneer of the modern movement in Holland. Mr. Dudok is also the convention's keynote speaker. An American pioneer in city planning, (right) Architect Clarence Stein, F.A.I.A., of New York, will make the principal speech at the annual banquet*



*SEMINAR LEADERS at the two principal sessions developing the convention theme, "Designing for the Community," will be (right) Norman J. Schlossman, F.A.I.A., of Chicago, and Richard W. Perrin, A.I.A., executive director of the Milwaukee Housing Authority*



*TWO NEW HONORARY MEMBERS: (left) the poet and historian Carl Sandburg of Flat Rock, N. C., and James W. Follin of Washington, D. C., Commissioner of HHFA's Urban Renewal Administration. Others are George B. Melcher, Flour City Iron Works, Minneapolis; and C. D. Spragg of London, Secretary of the Royal Institute of British Architects*





**Sterling**  
HARDWARE

*Quality you can put your finger on . . .*

**NEW 883 POCKET DOOR PULL**

This new 3-in-1 Pocket Door Pull is another exclusive Sterling product. It takes the place of an edge pull and two flush pulls and requires only one simple cutout in door. It prevents pinched fingers by keeping door edge always accessible when door is in pocket. Available in all popular finishes. Be sure to use Sterling sliding door track, hangers and accessories wherever quality counts.

**STERLING HARDWARE MANUFACTURING COMPANY**  
2345 WEST NELSON STREET • CHICAGO 18, ILLINOIS

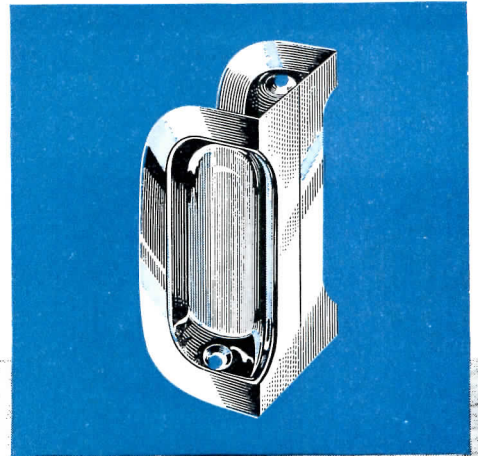

**Pocket Door Lock**  
For bathroom and bedroom doors where privacy is desired. Simple installation with standard boring jig.



**Pocket Door T-Frame**  
All steel T-Frame prevents warpage, makes pocket sturdier. Includes aluminum track, hangers and door guide.

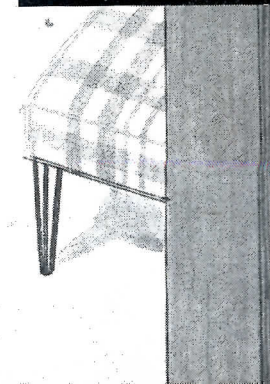

**STUDY WAYS OF RAISING \$750 MILLION FOR SCHOOLS**

EXAMINING the problem of paying for the 38,000 new classrooms Canada will need in the next ten years, a special research committee of the Canadian School Trustees Association has issued a report on "School Finance in Canada."

The problem involves raising \$750 million for new construction and an annual \$100 million for teachers' salaries. The three-way solution, as suggested by the trustees' committee, involves, first, greater assistance from municipal authorities through more uniform and equitable assessment on all property; the report points out the wide range in present tax rates from a low of two mills to a high of 84, and stresses

the substantial amounts of tax-exempt property in the various provinces. Second, the report advocates the replacement of the present numerous provincial grants with a single, larger basic grant. And third, it calls for federal assistance in the form of an annual grant; one third of this would be paid on a per pupil basis to all provinces, two thirds as an equalization grant to provinces with low tax paying ability.

**ARCHITECTS AS PLANNERS SUBJECT AT CONVENTION**

SPEAKING at the recent three-day annual convention of the Province of Quebec Association of Architects, Edouard Fiset, Quebec City architect and planner, declared that "architects must play

a major role in drawing up the master plan for urban centers and should try to regain the title of 'organizer of space.'" Mr. Fiset emphasized the necessity of establishing in the public and municipal mind that professional training has equipped architects to take the initiative in their communities as town or city planners. "We must always remember," he said, "that the architect is the first artisan of construction, that he must always remain there. The architect must participate more fully in the development of his environment. Above all, he must be a planner as well as a designer, and he must always think from the esthetic as well as the functional point of view."

*(Continued on page 30)*

**NEW BUILDING IN CANADA**

1. *Imperial Oil Company's projected engineering building, to be located at Sarnia, Ont., will be built of prefabricated "sandwiches" of colored porcelainized aluminum and foamed plastic and will be trimmed with aluminum; the cylindrical building attached to the main building is a 100-seat auditorium; John B. Parkin and Associates, Toronto, are the architects.* 2. *The \$2,900,000 Customs House in Vancouver was begun in 1953, and is now nearing completion; the architects are C.B.K. Van Norman & Associates, Vancouver.* 3. *The recently completed Guy Towers office building in Montreal, by architects Greenspoon, Freedlander & Dunne, has underground garage for 100 cars*

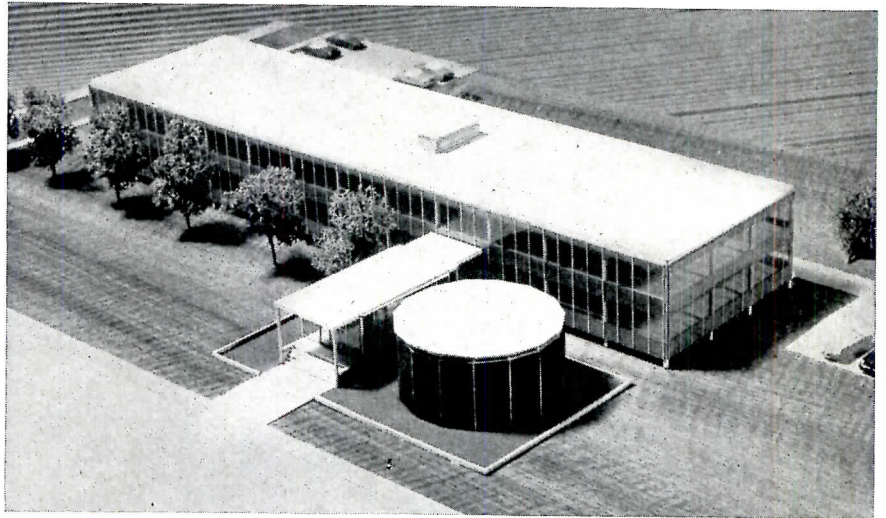

1

2

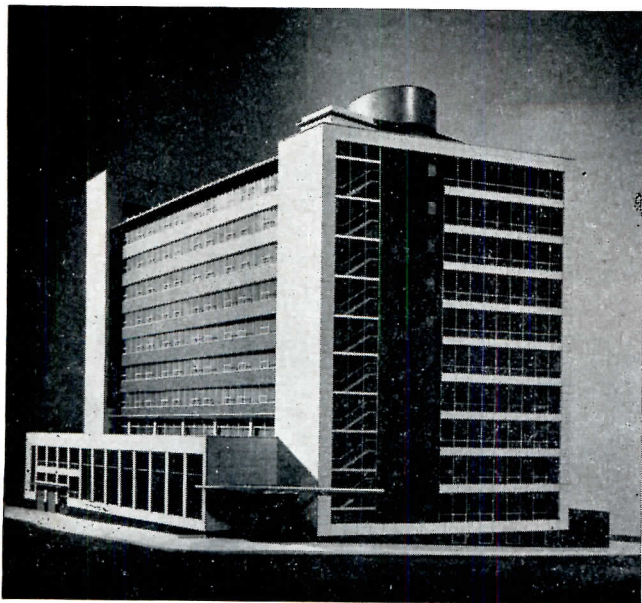

3



## WEYERHAEUSER PROVIDES DESIGNERS WITH A VARIETY OF LUMBER PRODUCTS

**PLYWOOD**—The Weyerhaeuser 4-Square plywood line now includes beautiful new Knotty Cedar and Knotty Pine, as well as Douglas Fir plywood.

**TREATED LUMBER**—Pressure-treating with Wolman salts\* extends the service life of lumber that is exposed to insects and decay. \*T.M.REG.

**SHINGLES**—The Weyerhaeuser 4-Square Kolorite line includes top quality Western Red Cedar shingles, shakes, and aristocratic hand-split shakes . . . natural finish or stained in 16 colors by the exclusive Kolorite process.

**SIDINGS**—All the basic patterns, in many Western species, including style leaders such as

bevel and bungalow, the new Rustic Red Cedar, and special vertical patterns.

**PANELINGS**—Standard patterns and special patterns, in a wide choice of species and grades . . . plus the plywoods listed above.

**UPPERS**—The Weyerhaeuser 4-Square line includes softwood floorings, moldings, stepping, finish items, etc., in Western species.

**GLUED-UP LUMBER**—Edge-glued lumber now includes sidings, stepping, and finish up to 30" wide, in various Western species.

**WEYERHAEUSER 4-SQUARE KILN-DRIED LUMBER** is produced

in a wide range of trade-marked items—in a variety of species, grades, and patterns. Thus it is possible for architects to specify in accordance with available local supplies.

Weyerhaeuser 4-Square Lumber is produced in many Western species, including Douglas Fir, West Coast Hemlock, Western Red Cedar, White Fir, Spruce, Idaho White Pine, Ponderosa Pine, and Western Larch.

Precision manufacture, kiln-drying, uniform grading, and careful handling and shipping add assurance that Weyerhaeuser 4-Square products will meet architects' specifications.

# Lumber



## Sales Company

MINNESOTA



# THE RECORD REPORTS NEWS FROM CANADA

(Continued from page 26)

## New Officers Elected

Delegates elected architect Edward J. Turcotte of Montreal to succeed Lucien Mainguy, Quebec City, as president of the association. Other election results: Henri Mercier, Montreal — first vice president; H. A. I. Valentine, Montreal — second vice president; Randolph C. Betts, Montreal — honorary secretary;

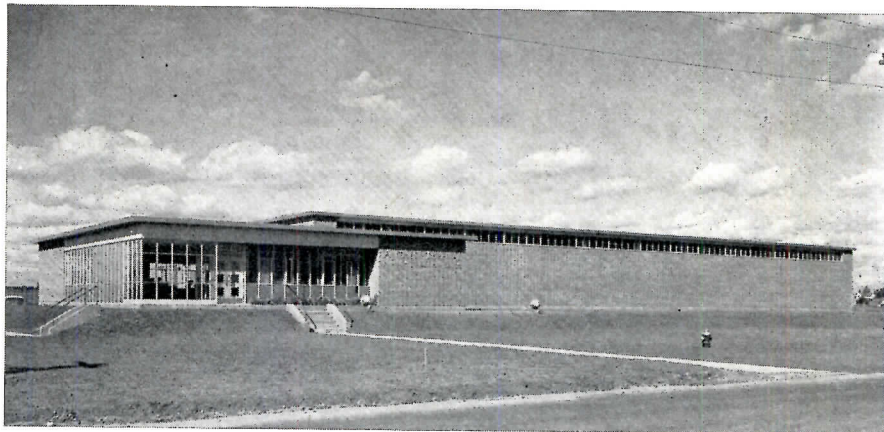

Ontario sales office and warehouse for Anthes-Imperial Company, Ltd., heating and plumbing equipment manufacturers, was designed by Toronto architects Marani & Morris

## Put America's most beautiful flooring in that new office building...

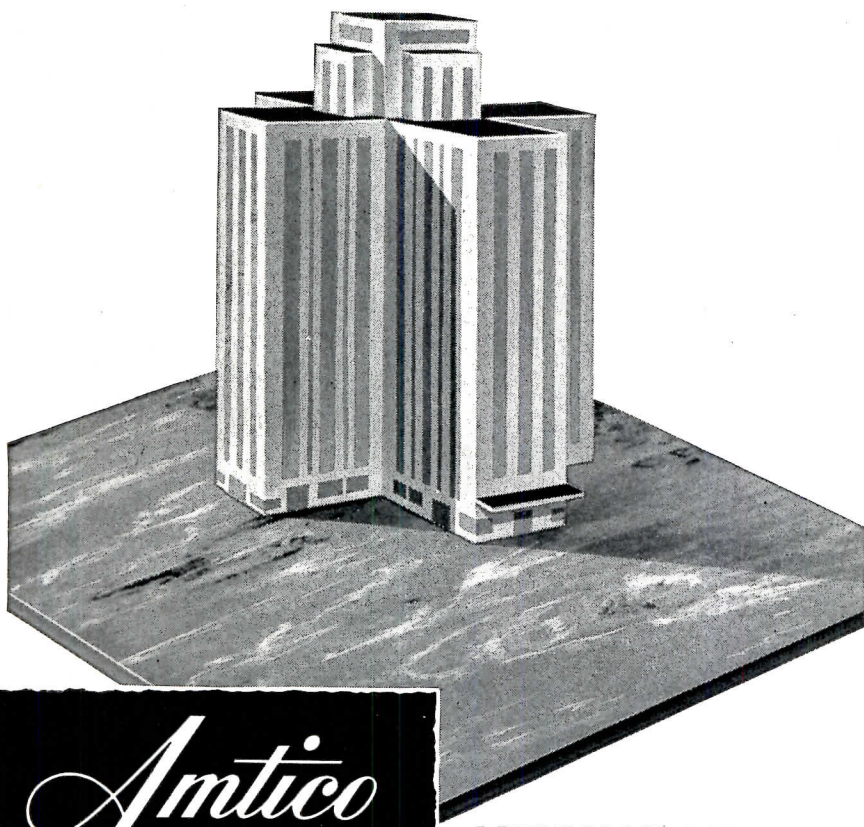

### AMERICAN BILTRITE

RUBBER COMPANY  
TRENTON 2, NEW JERSEY

In Canada—American Biltrite Rubber Co. (Canada) Ltd., Sherbrooke, Quebec

- Lifetime Economy
- Sound-Deadening
- Cushioned Resilience
- Easy Maintenance
- Luxurious Beauty
- Fire-Resistant

26 COLOR SAMPLE KIT . . . YOURS ON REQUEST



AMTICO, Dept. AR-3, Trenton 2, New Jersey

Gentlemen:

Please send me free box of 4" x 4" samples of Antico Flooring in standard 1/8" gauge and all 26 stock colors—also illustrated literature.

NAME.....

FIRM.....

ADDRESS.....

CITY..... STATE.....

(Please attach coupon to your business card or letterhead)

Gerard Venne, Quebec — honorary treasurer; George de Varennes, R. E. Bolton, F. J. Nobbs, C. David Goodman, Pierre Morency, S. A. Cyr, Arthur Lacoursiere, C. L. Douglas, Edouard Fiset, and Maurice Mainguy — members of the Council; John Bland, H. Ross Wiggs, P. C. Amos, Lucien Mainguy, E. J. Turcotte, Henri Mercier, R. E. Bolton, A. J. C. Paine (ex-officio) and Maurice Payette (ex-officio) — delegates to the Royal Architectural Institute of Canada. The executive secretary is Bernard M. Deschenes.

## C.C.A. ELECTS NEW HEAD AT QUEBEC CONVENTION

The Canadian Construction Association, at its recent convention in Quebec City, elected W. G. Malcom of Winnipeg to succeed Raymond Brunet, O.B.E., as president. Mr. Malcom is president and general manager of Malcom Construction Company Ltd.

A. Turner Bone of Montreal and Tullis N. Carter of Toronto were elected vice presidents.

Provincial vice presidents are: Newfoundland and Nova Scotia — S. W. Kennedy, Yarmouth, N. S.; New Brunswick and Prince Edward Island — R. L. Parsons, Moncton, N. B.; Quebec — W. Z. Marshall, Montreal; Ontario — L. J. B. Forbes, Toronto; Manitoba — E. J. W. Akins, Winnipeg; Saskatchewan — Allan Tubby, Saskatoon; Alberta — Charles A. Stollery, Calgary; British Columbia — M. L. Barr, Vancouver.

F. R. Murray of Montreal is honorary secretary, and D. L. Donaldson of Ottawa honorary treasurer.

(Continued on page 32)

# Contractors prove sanitary drainage systems of copper tubes and fittings cost less

\* Contractor "A" bid an "all copper" job for a housing development—water and drainage lines. His bid was 10% lower than others based on copper for water pipe only.

\* Contractor "B" was awarded a job. Before start owner changed specification to copper. Completed job cost \$19.01 less than original estimate.

\* Contractor "C", on his first copper drainage system, cut installation time 1/3, compared with similar size jobs using heavy wrought or cast piping.

*\*Names and addresses furnished on request.*

**Long lengths and light weight.** ANACONDA Copper Tubes for sanitary drainage systems come in standard 20' lengths. The light weight makes them easy to install and the 20' lengths save time and fittings when long runs are required. Light weight also permits more pre-assembly work at the shop. Even large units can be easily handled. A copper tube and fittings installation weighs about 1/4 as much as ferrous materials.

**Fast, easy-to-make joints.** Solder-type fittings save hours. No threading, no pouring and caulking of lead. No heavy, cumbersome equipment needed. The few tools and accessories used to install smaller diameter copper tube water lines are all you need.

**Saves carpentry and space.** You can install a 3" copper tube stack with fittings within a standard 4" width partition. There's no need to plan for wide plumbing walls or "build-outs." The trim copper tube and compact fittings give greater freedom of placement . . . reduce cutting of studs and joists.

Base your next bid on an "all-copper" job. Prove its economy to yourself and the builder. To get your free copy of "Copper Tube Drainage Systems" which gives information on tubes, fittings and their installation, fill in and mail the coupon. 5414 (Rev.)

**ANACONDA®**  
**COPPER TUBES**

Sold only through recognized distributors



**ONE MAN EASILY POSITIONS** this 3" prefabricated stack which fits in a standard 4" width partition. Anaconda offers you both Type M Tube and the new lighter-weight Copper Drainage Tube, Type DWV.

**FREE BOOKLET!**

The American Brass Company, Waterbury 20, Conn.  
(In Canada: Anaconda American Brass Ltd.,  
New Toronto, Ont.)

Send me free booklet, "Copper Tube Drainage Systems," which tells how I can cut costs with copper.

NAME .....

COMPANY .....

STREET .....

CITY.....ZONE.....STATE.....

## THE RECORD REPORTS NEWS FROM CANADA

(Continued from page 30)

### CMHC SEEKS NEW DESIGNS FOR REVISED PLAN BOOKS

The Central Mortgage & Housing Corporation has announced its plans to revise its plan books "Small House Designs," and is looking for architect-designed bungalows, split-level, two-story and one-and-a-half story houses.

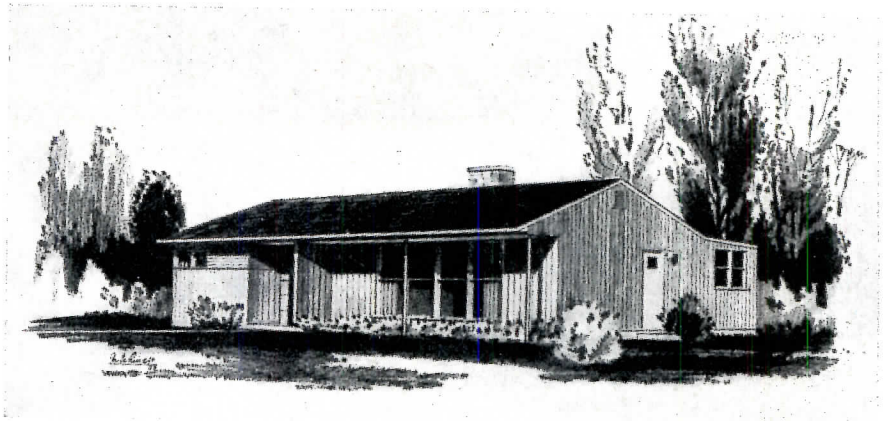

From CMHC's books "Small House Designs": center—a three-bedroom, one-and-a-half story house by architects Wilson & Newton, Toronto; top—a two-bedroom bungalow by architect S. Lloyd, Victoria, B. C.; bottom—a two-bedroom split-level house by architect, K. R. D. Pratt, St. Vital, Man.

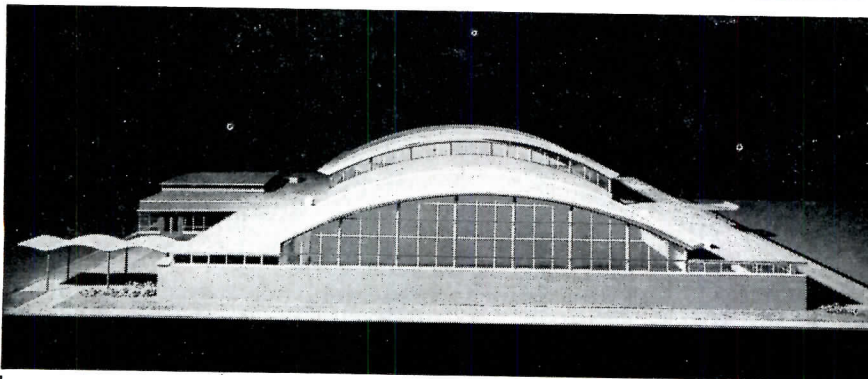

Edsel Ford Senior High School  
Architects and Engineers: Eberle M. Smith Associates  
Project Manager: Stewart S. Kissinger  
General Contractors: O. W. Burke Co.

## Hollow Metal at its best

This too is "HOLLOW METAL."

Once again, SUPERIOR FIREPROOF DOOR & SASH COMPANY, INC., has been chosen to furnish the "HOLLOW METAL" for an outstanding project.

This time, THE EDESEL FORD SENIOR HIGH SCHOOL.

Doors and frames constitute only a portion of "HOLLOW METAL." Arched openings as shown in the above view, 104 feet long, and multi-unit interior and exterior borrowed lite units are the mark of a true Hollow Metal Man.

"HOLLOW METAL" is the mark of a trade that has the ability to coordinate and fabricate many related sheet steel products.

It is not an afterthought of manufacturing a few more items. Rather it is the experience of having made these specific related products over a long period of time.

Thirty-five years of experience in manufacturing "HOLLOW METAL" has given us the ability to combine planning and production with economy into a service for the construction industry.

**Superior** FIREPROOF DOOR & SASH CO., INC.

EXECUTIVE OFFICES: 4175 PARK AVENUE, NEW YORK 57, N. Y. • PLANTS: NEW YORK AND SCRANTON, PA.

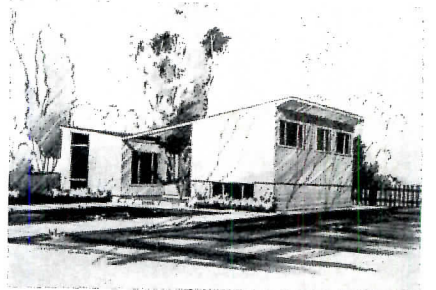
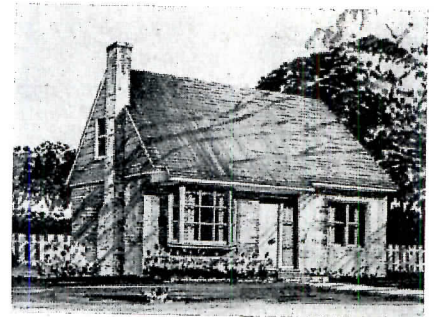

For designs accepted, the corporation offers two systems of remuneration: a flat and final fee of \$600 for a complete set of working drawings, or an initial fee of \$200 for the working drawings and a royalty of \$5 for each set of drawings sold. In both cases, the architect will retain the copyright to his design.

The current books, "Small House Designs; Two-Story and 1½-Story Houses" and "Small House Designs: Bungalows and Split-Level Houses," were published in November 1954.

### BRITISH FIRMS TAKE HOLD IN CANADIAN BUILDING

According to a recent survey by *The Financial Post*, British general contrac-

(Continued on page 36)

# A NEW CONCEPT IN AREA-LUME\* CEILINGS

## Combining Silvered Bowl and Fluorescent Lamps

### SKYCEIL FEATURES

- Permits combination of silvered bowl incandescent lamps and fluorescent lamps in any ratio or combination.
- Complete structural ceiling grid to support lighting elements and standard acoustical materials.
- Offers unlimited design possibilities from complete ceiling of light to tailor-made luminous panels surrounded by opaque acoustical areas.
- Conditions of building surfaces above the ceiling level does not affect the illumination.
- Accessories available for introduction of accent or special purpose lighting element.
- Will fit areas of any dimension.

### LIGHTING ADVANTAGES

#### EFFICIENCY:

Performance data under typical service conditions shows Skyceil combination system to be 30% to 40% more efficient than conventional luminous ceilings using fluorescent lamps alone. This increase in efficiency results from more efficient distribution and control of light by the Skylike silvered bowl fixture and from considerably lower depreciation losses.

#### MAINTENANCE:

Skylike units which comprise the basic lighting element are designed to be relamped from the floor using pole type lamp changers. The silvered bowl lamp carries its own sealed reflector and each relamping restores the unit to initial efficiencies. Occasional cleaning of the Skylike reflectors is easily accomplished.

#### COMFORT:

Skyceil offers a new comfort factor in lighting by eliminating the unpleasant contrast in brightness of lighted fixtures against adjacent unlighted ceiling backgrounds. Skyceil provides a complete structural framework for recessed fixtures in which the surrounding adjacent areas are softly luminous, eliminating all unpleasant brightness contrasts.

### SKYCEIL LIGHTING SERVICE

*This service offers actual plans whereby the Skyceil System can be installed economically to meet any structural or decorative requirement and also provide the desired illumination. Just send us details and ceiling plan—We'll do the rest. No obligations.*

### DESIGN POSSIBILITIES

Lighting elements may be varied to suit requirements. An infinite variety of silvered bowl incandescent and fluorescent combinations are possible to provide any range of lighting levels desired in any size area.

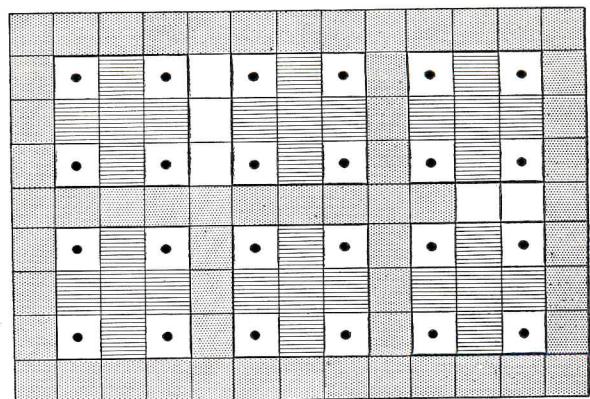
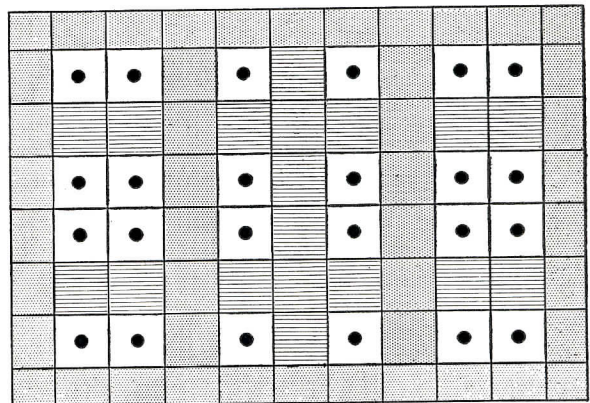
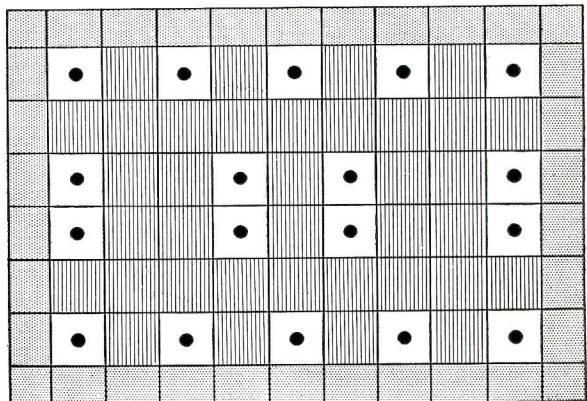

**SKYLIKE**  
 LIGHTING, INC.  
 A SILVRAY ASSOCIATED COMPANY  
 RKO BLDG. • RADIO CITY • NEW YORK

# THE RECORD REPORTS NEWS FROM CANADA

(Continued from page 32)

tors and builders, subjects of some discussion lately among their Canadian opposite numbers, consider themselves successful enough to want to continue competing for Canada's construction business.

Although few of the British firms managed to land Seaway contracts, the *Post* reports, most are counting on some of the work coming out of the Seaway construction — port development, industrial building and residential construction. And most of them have showed themselves able to take a good share of the general contracts; so successful that one British company previously engaged only in specialized contracting has recently extended its operations into the field of general contracting.

## NEWS NOTES

The University of Toronto will institute next fall a one-year course leading to a master's degree in town planning; this will replace a two-year course dropped last year because of lack of funds; candidates will need a bachelor's degree, and are eligible for the \$1200 annual fellowships awarded by Central Mortgage and Housing Corporation.

... The Central Mortgage and Housing Corporation will award 12 fellowships and three bursaries in the academic year 1955-56 to assist students of community planning and housing; information is available from CMHC. . . . "Best Apprentice of the Year" was sheet metal worker Terence E. Robb of Sault Ste. Marie, winner of the Ontario Association of Architects' Craftsmanship Award; the award was presented by Robert G. Calvert, O.A.A.'s public relations director.

Contracts Awarded: Comparative Figures\*  
(in \$ million)

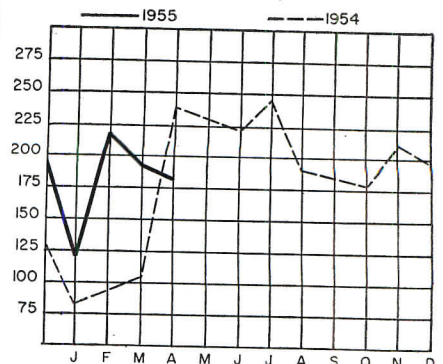

\* Compiled by the editor and staff of *The Building Reporter*, from information collected by MacLean Building Reports  
(More news on page 38)

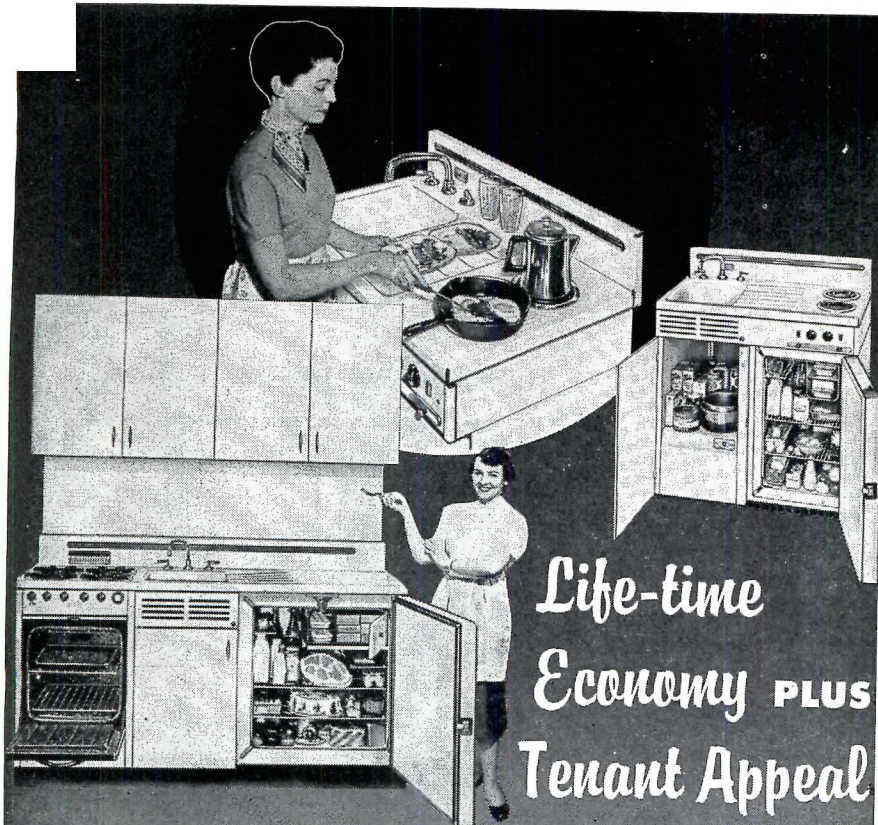

Life-time  
Economy PLUS  
Tenant Appeal

# DWYER KITCHENS

Four sizes . . . 39 to 69 inches wide. Gas or electric.

Enduring Quality Throughout . . . Refrigerator interiors are genuine vitreous porcelain on steel, never rust out and easy to keep fresh and clean. Work tops and fronts are porcelain. Never require repainting, dirt and grease wash off easily.

From hinge to tiny switch, every part of a Dwyer Kitchen has been designed and made for long, tough service.

For rarely needed service, every

mechanical part is accessible from the front . . . no need to disturb the kitchen assembly.

Made by Specialists . . . Dwyer Kitchens are engineered, manufactured in their entirety . . . and guaranteed by an organization which has specialized in compact kitchens for over a quarter century. They are easy to install . . . simple to service . . . last indefinitely.

Write for complete bulletins.

DWYER PRODUCTS CORPORATION Michigan City, Indiana

The new and beautiful DWYER 400

graces the room as a piece of smart furniture

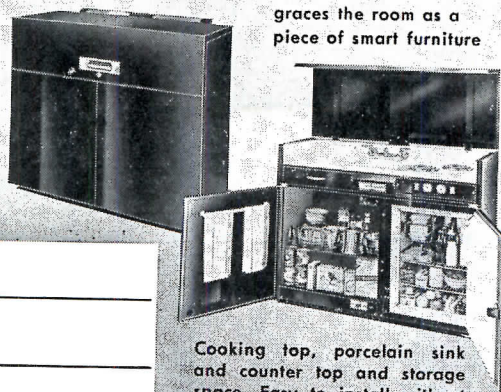

Cooking top, porcelain sink and counter top and storage space. Easy to install without costly remodeling. May be had without sink. Rich mahogany or blonde color. Ask for bulletin.

Mail Coupon  
for bulletin  
and  
complete  
information

Name \_\_\_\_\_

Address \_\_\_\_\_

Town \_\_\_\_\_ State \_\_\_\_\_

DWYER PRODUCTS CORPORATION  
Dept. F65, Michigan City, Indiana



# FILTERS

*New... All Aluminium... Lifelong*

Creates new design opportunities with (1) AMAZING HIGH DUST HOLDING CAPACITY . . . that slows down the clogging action of lint and dust . . . at the same time provides a DOUBLE MARGIN OF SAFETY for today's costly, and highly sensitive forced air equipment. (2) Allows highest efficiency of air handling equipment for a lifetime. (3) Gives SURE PROTECTION for a lifetime.

## **NEW . . . MORE FILTERING ACTION PER SQUARE INCH**

Precision stamped and angled openings of grid pact set up super high turbulence. Cause air to travel 3.5 times filter depth from inlet to outlet side . . . force it over 1.24 miles of burred, talon like edges in a 20" x 20" x 2" size filter.

## **NEW . . . MORE DUST CAPACITY PER SQUARE INCH**

Large precision cut openings on inlet side hold lint without stopping air flow. Minimize matting. Utilize filter depth. Give filter 200% greater dust holding capacity . . . without harmful resistance to air flow.

Put new performance, greater life into your air handling equipment with the COMPLETELY PRECISION MADE EVANS FILTER. Ask for prices, complete engineering data, and FREE ILLUSTRATED LITERATURE. Write today.

Blowup of Evans grid showing precision cut openings with thousands of burred talons for clutching and holding dirt.

## **NEW . . . MORE STRENGTH, RIGIDITY PER SQUARE INCH**

Frames made of extruded aluminum. Designed to hold true dimensions and alignment under heaviest stress . . . yet filters are so light and easy to carry that time and labor costs are cut to a minimum on every installation.

NOTE: The precision stamped grid pacts are so strong they will withstand an 1 and 1/8" stream of water under 65 lbs. pressure (at 300 gallons per minute).

## **NEW . . . CLEAN IN ORDINARY ROOM WITH TAP WATER**

No special facilities or costly cleaning equipment required. No dripping oil. No mess. Recoat an Evans filter simply by a light spray of filter fluid. Filter does not require dipping, immersion, or draining . . . nor standby filters.

Now a filter has been developed to give a performance ABOVE AND BEYOND ANY AVERAGE DEMAND . . . YET COST HAS BEEN HELD DOWN TO MAKE IT PRACTICAL FOR ANY INSTALLATION.

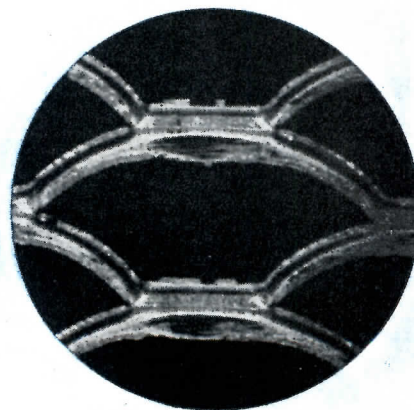

THE GEORGE EVANS CORPORATION MOLINE - ILLINOIS

Gentlemen: Please rush me complete free information on the new EVANS HIGH CAPACITY FILTER . . . THAT brings a revolutionary new concept to air filtering.

Name

Address

Company

City

State

## MUSEUMS WITHOUT WALLS\*

*Museums Without Walls* — a term Andre Malraux uses to designate history of art books — play a part in bridging the gulf between the layman and the artist (and the arts). All of the criticisms leveled at these books — lack of a sense of scale; the fallacy of color reproductions which lack true color and texture; the deception of the camera's angles — can be easily verified. Yet their value in bringing "the general public" in contact with the arts, and the best of the arts at that, cannot be denied. With the almost certain advent of color television within the price range of many, the broadcasting of art exhibitions into homes may soon become a common occurrence. These books would then serve not only as introductions to art but as guides to the TV tours.

*Masters of Modern Art*. Edited by Alfred H. Barr, Jr. The Museum of Modern Art (Distributed by Simon and Schuster, New York) 1954. 240 pp, illus. \$15.00.

WHEN one of the greatest museums in the world sets out to commemorate its twenty-fifth anniversary by, among other things, reproducing in a single volume a representative selection of its most valued treasures, it must be with the full realization that the result can be nothing short of perfect. And the result in this case, a Museum of Modern Art publication entitled *Masters of Modern Art*, can withstand the most critical examination and certainly lives up to the highest expectations.

*Masters of Modern Art*, which was edited by Alfred H. Barr, Jr., Director of the Museum collections, is a large (12-in. by 14-in.) and handsome book. It is attractively bound and beautifully designed, and the 356 plates (77 in color) with accompanying text are felicitously arranged in varied and very pleasing layouts. The book was printed in the Netherlands, and the reproductions, very particularly the color work, are excellent. All in all, the volume is a sheer visual delight.

Each of the Museum's four major departments is represented in the volume by a separate section, the first and largest of which is devoted to the painting, sculpture, drawing and print collections. The text matter is illuminating and interesting, and Mr. Barr writes about his subject with obvious enthusiasm. The reproductions selected for this section range chronologically over the last 75 years and even include works of younger artists of post-war Europe such as the 27-year-old Frenchman, Buffet, and recent American abstract artists such as Pollock and De Kooning.

William S. Leiberman, Curator of Prints; Edward Steichen, Director of Photography; Richard Griffith, Curator of the Film Library; and Philip C. Johnson, Director of Architecture and Design — all have made important contributions, each in his special field, to the completeness and thoroughness of *Masters of Modern Art*.

\* See *The Voices of Silence*. By Andre Malraux. Doubleday and Co., Inc. (Garden City, N. Y.) 1953. 661 pp, illus. \$25.

Though the sections devoted to photography and to the film library are, logically, considerably smaller than the first section, the very fact that they are included in this volume indicates the importance accorded these art forms by the Museum. As Edward Steichen points out, the Museum of Modern Art was the first museum to consider the value of photography as a visual art. And if, as stated in Richard Griffith's introduction to the section on the film library, "stills" cannot do justice to motion pictures, they at least can indicate something of the extent of the film collection. And the Museum's film collection is the largest in the world.

Philip Johnson, the Museum's authority on architecture and design, gives some idea of the range of that department's interest in his introduction by stating that "the plans of the Department had from the beginning (although it was called at first simply the 'Department of Architecture') involved the related arts which in scale extend all the way from teaspoons to town planning."

*Masters of Modern Art* testifies convincingly to the unique position enjoyed by the Museum of Modern Art. Produced with care and infinite good taste, "This picture-book," in the words of Alfred H. Barr, Jr., "is (at the very least) an invitation to see the originals!"

G. Assié

*Impressionism*. (2 volumes) By Jean Leymarie. Skira Inc. (381 Fourth Ave., New York) 1955. 120 pp, illus. \$4.95.

THE COLORFUL-SUN-DAPPLED REVOLUTION of Painting, known as Impressionism, is chronicled in these two volumes.

The revolutionists — Cézanne, Manet, Monet et al. — who fought with undisciplined brush and undiluted color are described as a group. Their influence on one another and the criticism of their contemporaries in literature and politics were as important to their development as were the settings of ateliers, woods, beaches and Japanese print shops.

(Continued on page 48)

# STEEL DECK

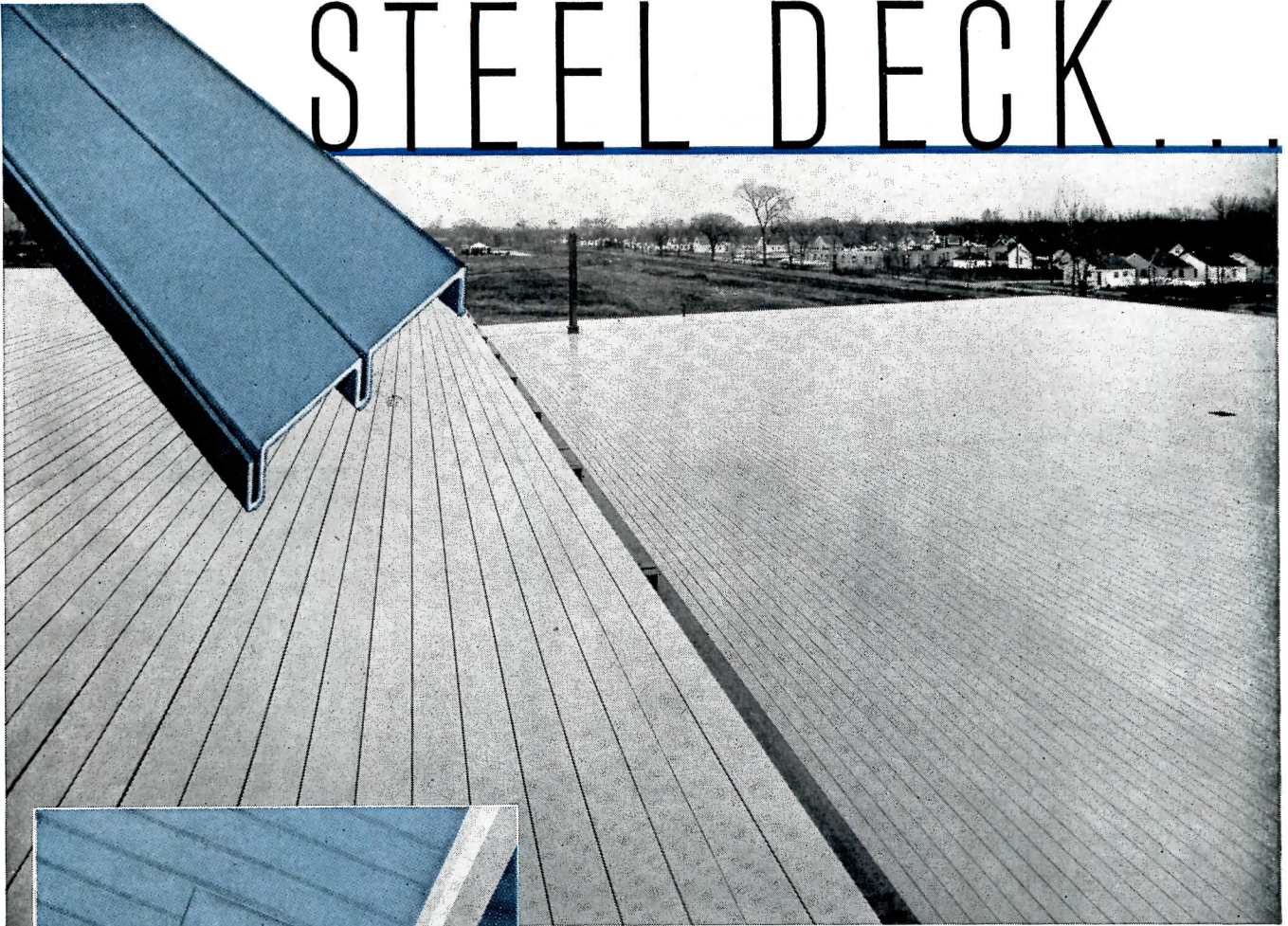

## BUILT-UP SADDLES ELIMINATED

Built-up saddles are eliminated in Steel Deck Roofs. Purlins can be set to create valleys at sump locations in the drainage area. Steel Deck can be warped to conform. No additional deck plates are required—no cutting, fitting or bending necessary.

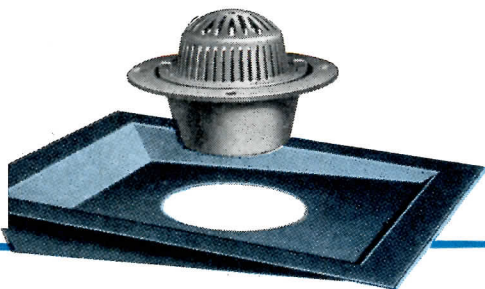

## SUMP RECESSES and SUMPS

Mahon Roof Sump Recesses for use with Mahon Steel Deck can be furnished to fit any roof pitch. Mahon Cast Iron Sumps can also be furnished for 4", 5", and 6" conductors.

## Light Weight Advantages Add Up to Multiple Savings in Building Dollars!

Steel Deck's light weight spreads dollar savings throughout the entire supporting structure. Steel Deck is basically the lightest deck material available, and it can be insulated to the exact degree to meet local requirements . . . total dead load of the completed Steel Deck Roof will prove to be less than any other type of construction in any given locality. New Mahon roof building methods, employing new type vapor seal, permits additional savings in over-all roof cost. Investigate these new developments in Steel Deck Roof Construction . . . you will find that Steel Deck now offers even greater advantages. Steel Deck is the MOST LOGICAL material to use because it COSTS LESS. It's MOST PRACTICAL because it's LIGHT WEIGHT, and it's SAFEST because it's STEEL. Mahon Steel Deck is available in Galvanized or Enamel Coated Steel . . . stiffening ribs are vertical—no angular or horizontal surfaces where troublesome dust may accumulate. Mahon Enamel Coated Steel Deck has a phosphate-bonded finish which is baked on at 350° F. prior to roll-forming. Check these features when you select a roof for your next building. See Sweet's Files, or write for Catalog B-55-A.

**T H E R . C . M A H O N C O M P A N Y**

Detroit 34, Michigan • Chicago 4, Illinois • Representatives in all Principal Cities

Manufacturers of Steel Deck for Roofs, Partitions, and Permanent Concrete Floor Forms; Insulated Metal Walls of Aluminum, Stainless or Galvanized Steel; Insulated Metal Wall Panels; Rolling Steel Doors, Grilles, and Automatic Underwriters' Labeled Rolling Steel Fire Doors and Fire Shutters.

# M A H O N

# NORTHWESTERN University

EVANSTON CAMPUS . . . CHICAGO CAMPUS

By using the Electro Silv-A-King "SKYLOUVER" in Chicago and the "20/20" fixture in their Evanston school, they were able to reduce maintenance costs and achieve an attractive uniformity in appearance regardless of location or mounting arrangement . . . and, at the same time, provide the correct level of comfortable, glare-free illumination for the various seeing tasks in every type of room.



**LECTURE ROOM - EVANSTON** Six rows of 4-ft. 2 light "20/20" units, single stem mounted on 4-ft. centers maintain 90 foot candles. Louvers are spaced equi-distant for more attractive appearance.

**LIBRARY - DOWNTOWN** This walnut paneled library seats 300 people. Ninety-six, thin 4-lamp "SKYLOUVER" units, with translucent styrene louvers, deliver 60 footcandles of "just like daylight" illumination.

Electro-Silv-A-King fixtures are also used in offices, laboratories, television studios, corridors, etc., in various buildings on both the Evanston and Chicago campuses.

Architects: Holabird, Root & Burgee, Chicago • Distributors: Revere Electric Supply, Chicago • Englewood Electrical Supply Co., Chicago • Contractors: Electrical Contractors, Chicago; Hubble Electric Co., Evanston.

## Electro Silv-A-King... for your school

Because the Electro-Silv-A-King line offers an unprecedented variety of fine quality fixtures now being used in many of the nation's outstanding schools. There is one that will meet your every requirement for performance, appearance and value.

Write today for your free Specification and Data Catalog illustrating and describing the complete line.



## Electro Silv-A-King Corporation

1535 S. Paulina St., Chicago 8, Illinois  
Spruce & Water Sts., Reading, Pennsylvania

DESIGNERS AND MANUFACTURERS OF THE FINEST IN LIGHTING

## REQUIRED READING

(Continued from page 46)

This makes interesting, accurate, almost intimate reading about a period as romantic (in a Bohemian way) as the paintings it produced. The text is profusely illustrated.

These two volumes on Impressionism are the latest in the Skira series, *The Taste of Our Time*, which up to this publication has dealt with the individual artists of the contemporary period. The books are small (6½ in. by 7 in.), well printed, inexpensive and very well written. This attractive presentation of "modern" art has induced many to read these books and "to use them as guides through the Museums."

### ART THROUGH THE AGES

*Fifty Centuries of Art.* By H. Francis Henry Taylor. Published for the Metropolitan Museum of Art by Harper & Brothers (New York) 1954. 184 pp, illus. \$5.00

*Fifty Centuries of Art* was written as a general survey on art "intended for that great multitude who claim to know nothing about art but 'know what they like.'" It is available at a price nearly everyone can afford.

Mr. Taylor has written an interesting summary of Eastern and Western art from early Egyptian to modern times to accompany the admittedly badly reproduced but well-selected works of art. The text is basic enough for a novice yet serves as a good refresher for those who are familiar with the subject.

### GRAPHIC ART

*Graphis Annual 54/55.* Edited by Walter Herdeg and Charles Bosner. Graphis Press. U. S. A. Distributors: Hastings House (New York) (Zurich) 1954. 208 pp, illus.

*International Poster Annual.* Edited by Arthur Niggle. Hastings House (New York) 1954. 171 pp, illus. \$10.95

*The Penrose Annual.* Edited by R. B. Fishenden. Visual Design Publications: Hastings House (New York) 1955. 129 pp, illus. \$8.50

The field of visual communications is well covered by periodicals and books. Although the amount of material presented is usually overwhelming, it nevertheless displays the vigor that is becoming almost universal in this art-form.

The leaders in this field are constantly striving to enlarge and enliven the scope which encompasses the designing of everything from placards and book jackets through packaging and motion picture cartoons to architectural lettering. They have at hand many new tools made possible by the advances in tech-

(Continued on page 364)

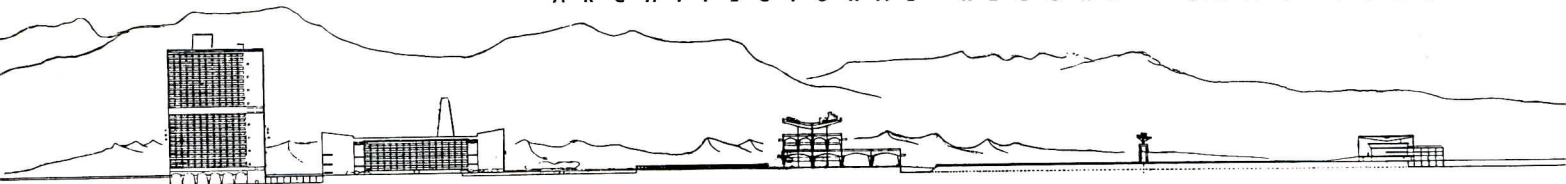

## CHANDIGARH—NEW CAPITAL CITY

by E. Maxwell Fry, C.B.E., F.R.I.B.A.

After preliminary designs for Chandigarh, new capital of the East Punjab in India, had been completed, the Indian government shifted from American architect-planners, Mayer & Whittlesey, to a European team: Maxwell Fry and his wife, Jane Drew; Le Corbusier and Pierre Jeanneret. Albert Mayer had headed the preliminary work, aided by — among others — Matthew Nowicki, whose proposals and tragic death en route from India to America were described in ARCHITECTURAL RECORD (Sept., 1954) by Lewis Mumford. Below, Fry describes what is actually being built. Of the Mayer plan Fry says: "Albert Mayer's pilot plan was a very fine job; but he, along with us all in the early discussions over the final plan, yielded to Le Corbusier's deeply based arguments and to the relentless pressure of his personality, and what went forward had his agreement too."

JUST AS A NEW HOUSE offers the opportunity of solving again the recurring problem of how a family shall live, and does in fact successively modify the living habits of succeeding generations, so the building of a new city on an open site raises the hope that the evils of city life — congestion, dislocation, incoherence, unsocialness, ugliness and boredom — will be replaced by an organisation responding more closely to human needs and aspirations.

To cure these evils in existing cities has involved costly techniques, and none more so than Le Corbusier's proposals embodied in his *Ville Radieuse* in which congestion is overcome by skyscraper concentrations of population, and dislocation by the carrying of fast-moving traffic on elevated highways leaving the ground free for pedestrian use.

Both these solutions are drawn from the heart of city congestion and both presuppose a high level of general wealth and industrial technique, because it is obvious that vertical circulation costs more than horizontal, and roads built up in the air are more expensive than roads on the ground.

At Chandigarh, a capital city built on flat ground for an impoverished Indian state, there existed neither the money nor the necessary technique to carry out such a solution, and the fact that the Chandigarh plan can be shown to meet the pressures of city life without destroy-

ing the delicate coherence of society, or degrading the pedestrian to the level of a hunted animal, is the measure of its contribution to planning.

What struck me in working alongside Le Corbusier — working with being next to impossible — is his capacity for using creatively the fruits of cool analysis. I believe this to be a rare gift that sets him completely apart.

The basis of the Chandigarh plan could be set to rest upon his simple analysis of road functions, which, having arrived at, he dramatised as the *seven V's* (from French *voie*). To show how simple they are I will list them as follows:

- V 1 — Inter-city, all-purposes highway, free from development
- V 2 — City distributive road, all purpose, separately tracked for fast, slow, cycle and pedestrian traffic, with development on outer slow-traffic frontages
- V 3 — Segregated fast-moving traffic road, without sidewalks or any frontage development
- V 4 — Slow-moving mixed traffic, main street shopping, business and parking
- V 5 — Residential slow-moving distributive road with minimum frontage development
- V 6 — House access road
- V 7 — Recreational or cycle road in parkway or open space

Having arrived at such a definition of function most people proceed to mix them up or at least fail to defend the function from impurity. But just as the essence of the *Ville Radieuse* is the exact employment of functions drawn from congested conditions and applied to the solution of congested conditions, so that of Chandigarh rests upon preserving intact the true functions of the seven V's.

The basis of the plan is a gridiron of V 3 (fast-moving traffic) roads intersecting at half a mile across and three quarters of a mile up the plan. These roads are 100 feet wide with a carriage way of 44 feet, tree lined borders, and NO FRONTAGE DEVELOPMENT. Traffic is interrupted therefore at half-mile and two-thirds-of-a-mile intervals



Jaqueline Tyrwhitt

## CHANDIGARH

only and is otherwise free to move at its own top legal speed.

The gridiron encloses areas known as sectors, of about 240 acres and housing up to 15,000 people; and what helps to safeguard the function of the V 3 roads is the fact that the sectors are planned *internally*, look *internally* for the varied activities of day to day life, and make contact with the surrounding fast traffic roads at specified points only. Thus a particular inhabitant, in order to reach, say, the Government Secretariat, would proceed by the roads V 6, V 5, V 4, V 3, V 2 if he went in his own car, or direct to a specified bus stop on a V 4 or V 3 road if he used public transport, or on a V 7 cycle track along an open space. In every case the route is defined and the function segregated.

Day-to-day life in the sector has two aspects. First, the life of activity, shopping, "rubbing shoulders" represented by the V 4 main street, or in India the Bazaar Street that runs irregularly across the sector and on the shady side only of which are placed the shops, local markets, offices, cinemas, etc., with plenty of shade trees and off-street parking space. Second is the leisure aspect of sport for youth, recreation in general, education and relaxation, represented by a band of open space running in the contrary direction, both of them continuing from sector to sector across the plan.

Thus in opposing directions that help to preserve function, but absolutely contiguous to the housing that fills up the space remaining, you have the two major elements of day-to-day life defined and provided for. The city then is built up of these day-to-day life sectors with the two opposing elements carried over, and such a plan could be placed on any flat land anywhere.

### What Sets Chandigarh Apart

What differentiates Chandigarh is that it is a capital city on a flat site immediately backed by high mountains, the Himalayas: and what gives it civic form is the *placing of the capitol group of buildings at the head*

of the plan against the mountains; the accentuation of the two major V 2 roads, with the city centre as opposed to the state centre to the right of the crossing; the creation of a city park along the line of a stream bed reinforcing the capitol approach road and opening to the left into a wider arm in which are situated the cultural buildings culminating in the University; and the confining of this accented plan within two dry river beds about 5 miles apart; and the line of foothills that stand before the great wall of Himalayas rising immediately to 5000 feet and continuing endlessly in either direction.

What is so interesting is to see the extent to which a rigid framework, following so austere a logic, can be animated by the varied stresses of its functional parts. To be able to step on the gas is a quality of motoring nearly suppressed in the modern city; but it is a good thing to be able to do so; hence the straight roads.

As life approaches the family orbit it may be more various and accidental, and within the sector this is not only possible but natural. Yet wherever you might be you are orientated by geometry of the simple road system and by the mountains.

The further accent given by tree planting will transform the present rather arid-looking urban landscape. The site is fertile agricultural land, and not desert as some enthusiastic Parisian correspondent suggested. A great variety of trees and shrubs will flourish, and from among them Le Corbusier has selected types which, whether on account of shape or the colour of their blossoms, will be used to identify the main roads, and to provide over-arching shade on the fast motor roads.

### The Capitol Buildings

The capitol group of buildings occupies 220 acres of land at the head of the plan, cut off by a canal and a boulevard from the nearest housing, but approached directly by the wide capitol approach road.

This is a very carefully adjusted asymmetrical siting of buildings carried to the limits of visual propinquity

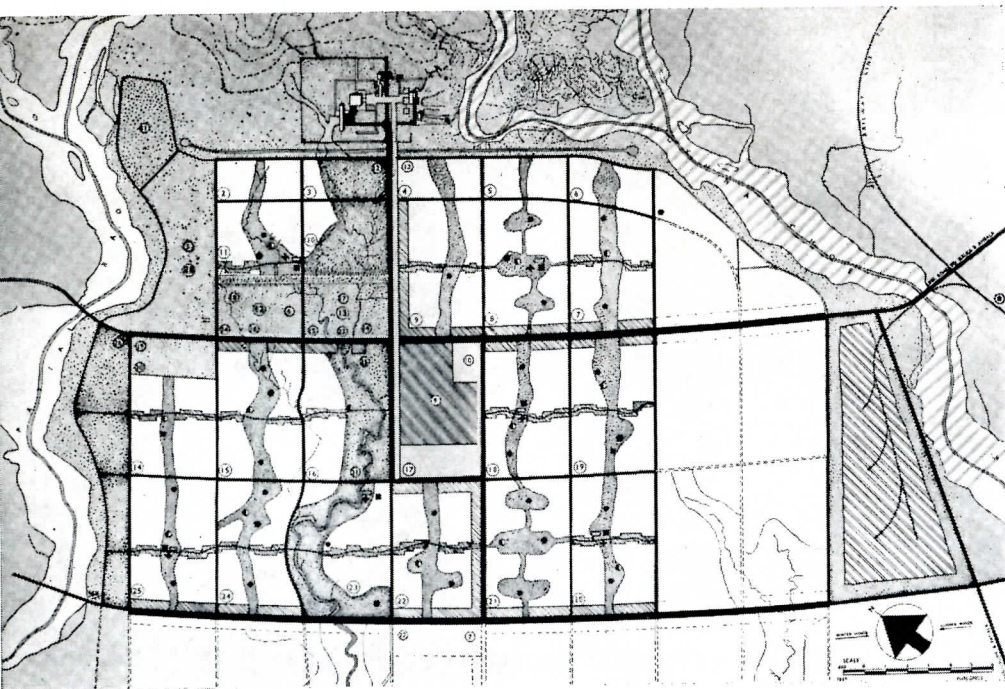

Set on flat land at the foot of the Himalayas, Chandigarh is being built to Le Corbusier's gridiron plan, with the grid of main thoroughfares enclosing sectors or super-blocks which differ somewhat in concept from those of the pilot plan. Capitol buildings are at top center of site plan; University at extreme upper left; business district and civic center in middle across central artery from park land in which are institutional and public buildings. Industrial area is shaded, at lower right. Additional commercial areas surround some sectors; each sector contains schools, market place, etc. General market lies southwest of developed area

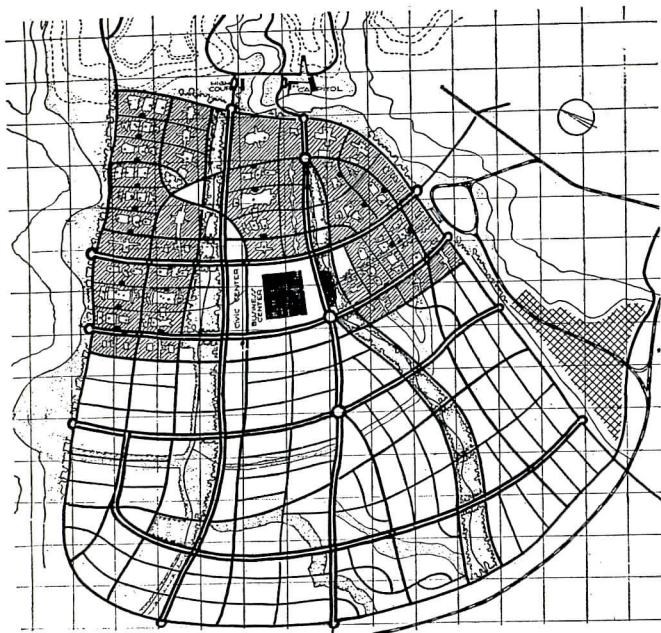

Above:  
Final plan of a  
portion of the city

Right:  
Typical sector (super-  
block), final plan

Left:  
Mayer & Whittlesey's  
pilot plan

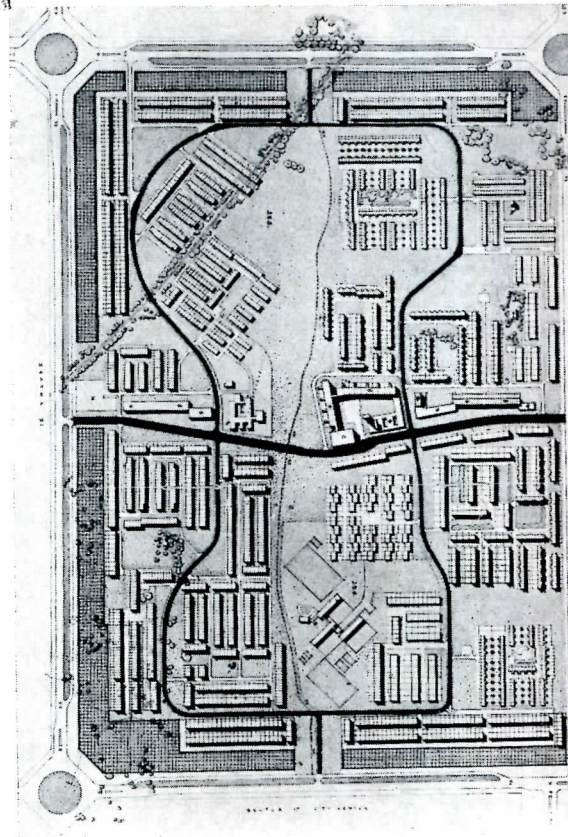

from "Journal, Royal Architectural Institute of Canada"

All drawings and site plans from "Le Corbusier 1946-1952", Girsberger, Zurich-Wittenborn, N. Y. except as noted

on a great layout of lawn and lagoon. The High Court and Assembly Buildings face each other across a broad pedestrian way; the Governor's Residence stands back towards the hills; the immense Secretariat, nine storeys in height and over 800 feet long, breaks the rectangle of the western corner, and the monument of the "open hand" provides subsidiary interest where it is needed.

In order to preserve the garden quality of the whole, approach roads to the buildings are in a cutting, helped to this end by the erosion of the city park stream bed that leads into the Secretariat; and the earth from these sunken roads Le Corbusier heaps into little artificial

hills, diversifying the landscape and emphasising the siting of the buildings.

These exhibit to a remarkable degree his luxuriant, fertile talent, narrowing the gap between sculpture and architecture by the free employment of expanded metal framework to produce effects independent of supporting structure, and in the case of the High Court reminiscent of quite another type of structure. The High Court Building, which when I last saw it gave every sign of becoming a noble monument, owes its particular form to Le Corbusier's reading of the problem of the tropical roof. Definition of the problem as, first, producing shade

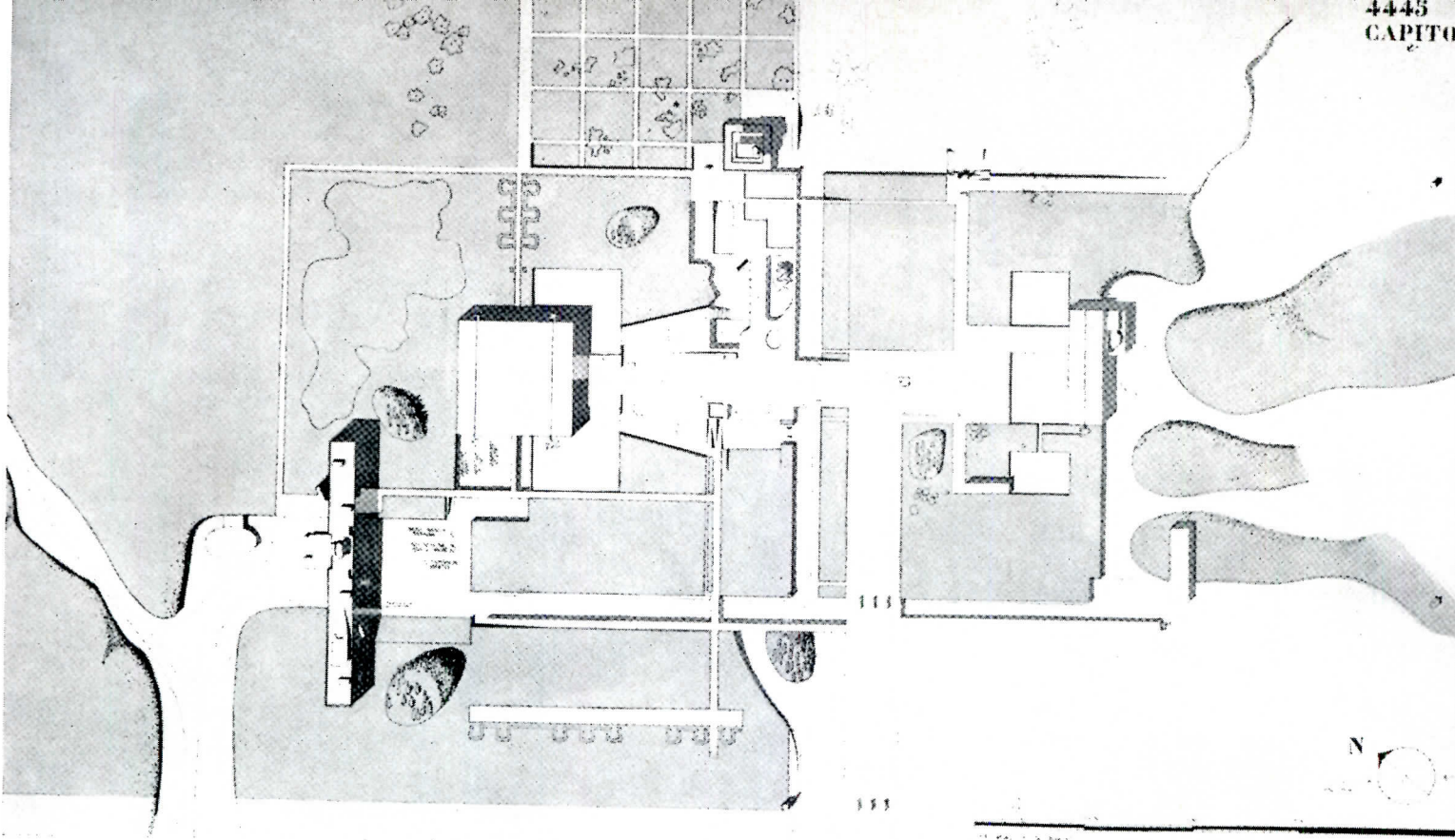

N. Y. Herald-Tribune

*Above, site plan, capitol buildings showing, far left, the Secretariat; center, Assembly Hall, square in plan; top, Government House; center right, High Court; right, below, Advocates Chamber. High Court, nearly completed, appears in photo at left as well as plan and sketch below*

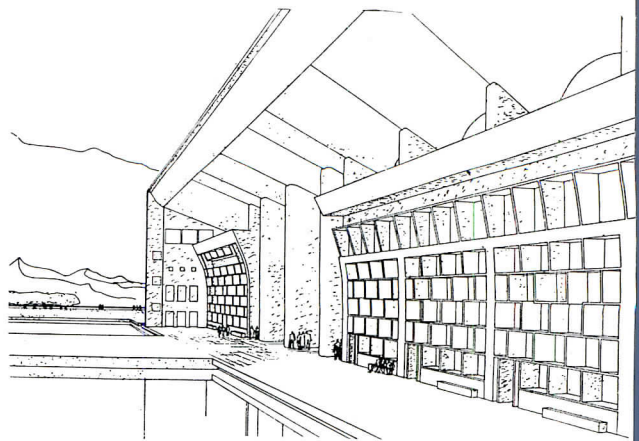
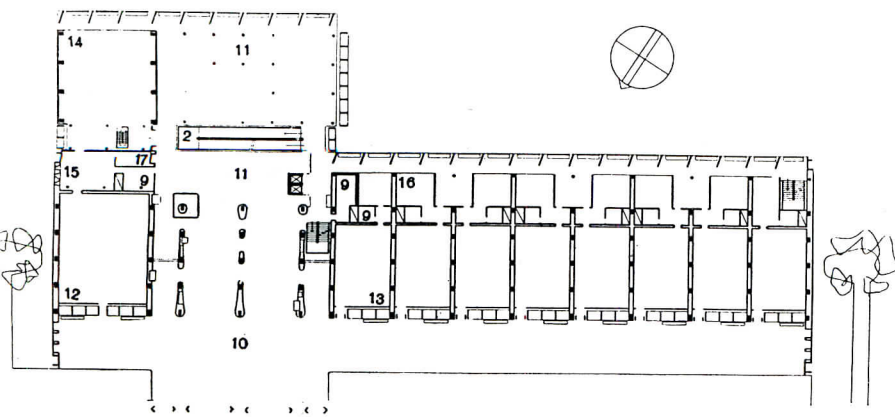

from "Journal, R.A.I.C."



temperature, and then protecting the interior, at once suggested the image of a parasol held over a building, and this lively image he translated into architecture in the form of a giant roof cantilevering over the court rooms and offices below in a series of vaults, resolutely contained by a massive wall at each end, from which great gargoyles spill the monsoon rains on to a tumble of rock in the lagoon 60 feet below.

I have little doubt that the result will justify the means, for within the frame of roof canopy and end walls, and despite a regular disposition of the court rooms and offices, there is a wealth of significant detail, responding to the conditions of climate and the uses of the building, and controlled by the *Modulor* system of proportion, with its creator behind it.

Of the other buildings it is perhaps early to speak, except to say that the Secretariat breaks from its rigid office grid to emphasise the quarters of the principal figures of state government, and to void its population of clerks down two ramps held away from the building face. The Assembly Building is the freest of these creations. Its canopy roof echoes the spirit of the High Court but the forms of the Government Chambers below are organic and unstructural. The delightful Governor's Residence is a return to a simpler medium, but with ravishing interplay of internal volumes leading to fairy-like roof gardens held in space; never was a lovelier little palace conceived.

Nothing is more difficult than establishing a city centre in advance of the pressures of business and shopping that are the reason for its existence. The space allotted for the purpose at Chandigarh is over 160 acres which, at the densities associated with a city centre, represents far more than the city could support for many years to come; but instead of leaving the heart or core to the last, this is to be developed from the beginning, leaving the outer parts as park.

Le Corbusier's city centre plan echoes the sector system but replaces the open space by large pedestrian shopping areas in the form of a cross widening at the centre to a large square on which are the city hall, post office and the first business premises.

Car traffic circulates in the rear and passes over on

fly-over bridges piercing the continuous facades, which are designed to a module that will allow of flexible adaptation to varying needs.

This description completes the work for which Le Corbusier was directly responsible and leaves the very great task of designing and building over 4000 permanent dwellings for all grades of government officials, and the social buildings such as schools, hospitals, health centres, etc., which were built concurrently with them.

### Houses and Housing

By far the most onerous task before the architects was the design of 13 categories of government houses, graded from the lowest costing only £244 (\$683.20) to the highest costing £4875 (\$1365.00) and excluding the house for the Chief Minister.

The accommodation asked for seldom matched the estimate, and most noticeably in the lowest grade, where a long suffering class of office messengers, drivers and the like pleaded for two rooms rather than one, and in which the critical item proved to revolve about the problem of whether or not an individual W.C. could be provided.

In fact on an area of 428 sq ft two rooms of about 100 sq ft each, a closed kitchen, a wash-room and a W.C. were provided by both M. Jeanneret and Jane Drew, together with a walled compound; and in the village group of 150-200 houses she planned for this type of house, Miss Drew was able to provide a central space, to close in the ends of her parallel pedestrian roads, provide linking end walls from block to block, along which electric supply cables were taken with a complete abolition of unsightly poles and therefore to plant trees in freedom — and all this at a cost of 0.9 per cent of the total.

Below this again, realising the existence of classes of sweepers and refugees uncatered for, she designed houses costing only £154 (\$431.20) in all, but with the essential amenities; and residential shops expandable into a courtyard of which 2000 were planned and about 600 built before she left in August 1954.

The low cost of this, and indeed of all housing, owes much to the cheapness of bricks at 30s (\$4.20) per

Jaqueline Tyrwhitt

*Chandigarh is essentially a government seat; the government buildings, all designed by Le Corbusier, stand on a raised plateau to the northeast, approached by a long civic avenue for the processions which are so much a part of Indian ceremonial. First building erected is the High Court of Justice, shown at right under construction and, on facing page, at the dedication this past spring*

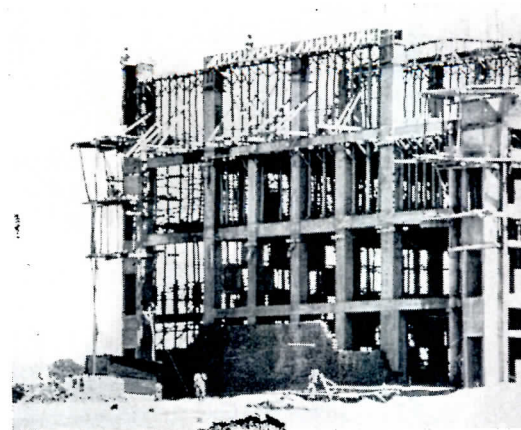
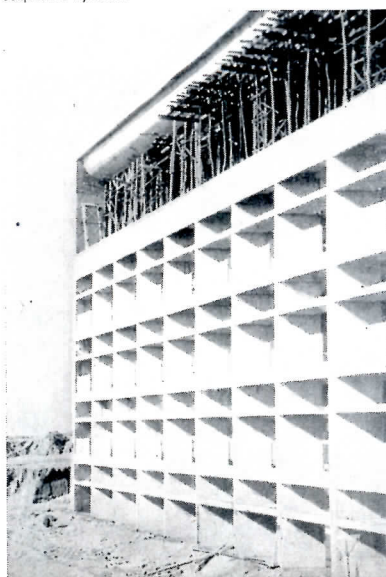

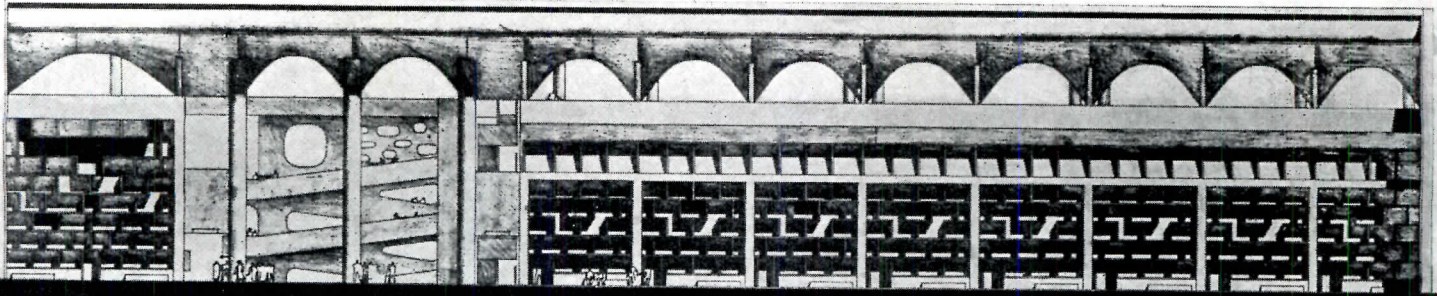

Jaqueline Tyrwhitt

## CHANDIGARH

thousand, made without any machinery on the periphery of the site; and to a labour force of men, women and children underpaid, unhoused, and uncared for, turning the heart by their beauty and cheerfulness under conditions as bad as could be imagined.

We had to contend with two imponderables: the habits and customs of a Hindoo population; and a climate that ranged from just above freezing point in the winter to 115 deg F before the breaking of the monsoon in June; that is to say with great rigours of dry heat, and all its accompanying dust storms and hot winds in the critical period before the rains; with high humidity and heat thereafter; but with, even at these times, the memory of a crisp and brilliant winter season to come. It is, as an old lady in Delhi remarked to me, not one climate, but six; and it took us a long time to recognise which season governed the others.

In meetings we had with typical groups of our new clients, drawn from the various grades, we learnt the intricacies of Hindoo religious observance in the domestic routine, the separation of sexes, castes and occupations; of customs of sleeping and relaxation brought about by climate; and in the first houses we designed, we gave them greater prominence than perhaps they deserved or the cost per square foot warranted.

For instance, it was impressed upon us that the normal woman preferred to cook at floor level, and for the four lowest grades of houses we designed accordingly. But in those above, mindful of the march of events and of cheap electricity to come, we designed a kitchen on the well studied lines that have lightened the labour of countless domestic workers in the Western world, and in due course listened to the reproaches of those who had been given exactly what we had been told they wanted.

Encouraged by this, we simplified the planning of houses thereafter and threw the additional space secured into the living-rooms and verandahs, preserving always the sleeping terrace on the roof with its *barsarti* into which the light *charpai* beds are withdrawn in the variable weather of the monsoon period.

With our band of open space in the sectors secured, we

planned closely in urban formation, using terraces freely and avoiding like the plague the amorphous garden-city character that has done so much to rob the new towns in England of a sufficiently contemporary character.

### Building Construction without Machines

The technique of house-building in Chandigarh relies nearly entirely on hand labour on the site. The only machines involved were lorries, an occasional concrete mixer, and some band-saws for rough carpentry. I personally came to rely more and more upon what bricks could do, and built sunbreakers, grilles and balustrades of brick, occasionally reinforced and very often plastered; and as time went on learnt to simplify, paying less attention to the needs of cross-ventilation, which in the critically hot period is of no avail, and more to the creation of cool interiors, as large as possible and as amply protected from the southwest sun as ingenuity and exiguous funds permitted; so that in the few of my house types that I felt really responded to the gruelling conditions there were few windows and small on the exposed fronts, and no openings of any size not protected by overhanging verandahs.

In Chandigarh the southwest aspect is above all vulnerable, but there is this critical period with temperatures up to 115 deg F, and high night temperatures, when everything is penetrated by heat above body temperature. Against this the only defence is to retreat behind massive walls or their equivalent, with every aperture closed and if possible sealed. Only certain ground floor rooms, set well into the building, are likely to be barely tolerable, and they must be secured or the house fails when it is most needed.

Starting from blank paper and an empty site the house building programme was completed in three years — over 20,000 people moving into permanent buildings — and the Government enabled to function in temporary quarters.

With this house building went schools, a health centre, hostel, a large Government Printing Press and a cinema. Of the educational buildings a Junior Secondary School of M. Jeanneret, a large High School by Jane Drew

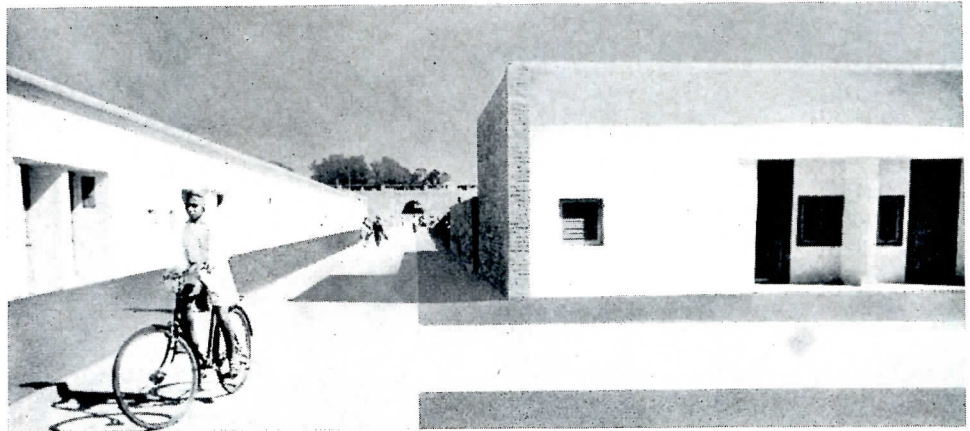
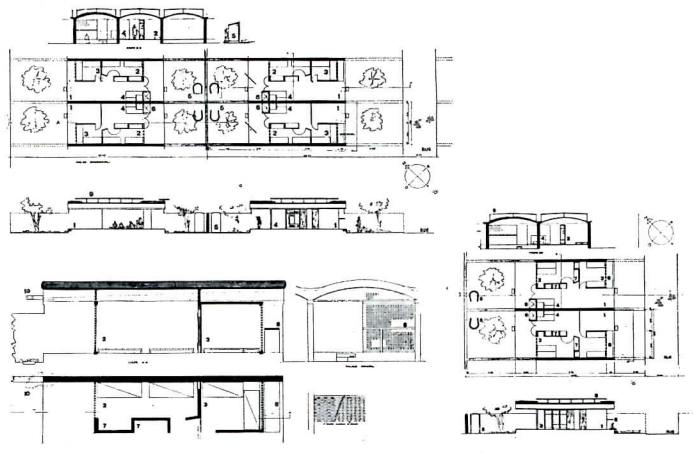
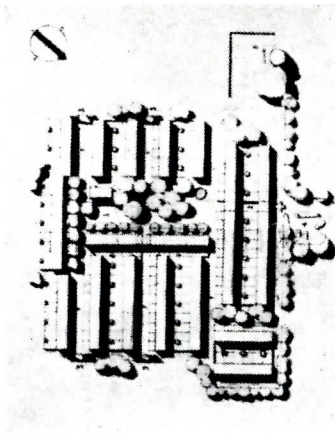

Housing types: group at top of page, dwellings designed by Le Corbusier and plan of a group in a typical sector. Center, types designed by Jane Drew, and typical construction techniques. Bottom, housing by Pierre Jeanneret

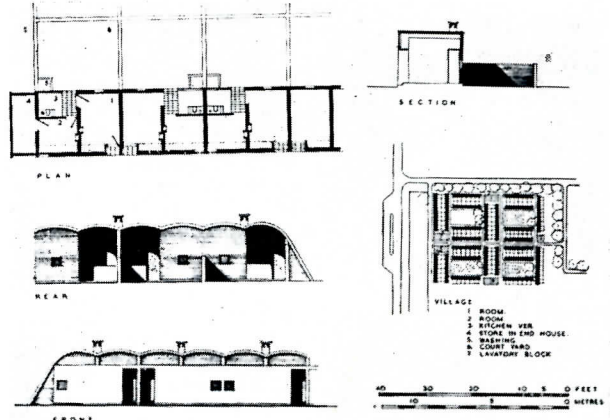

Jaqueline Tyrwhitt

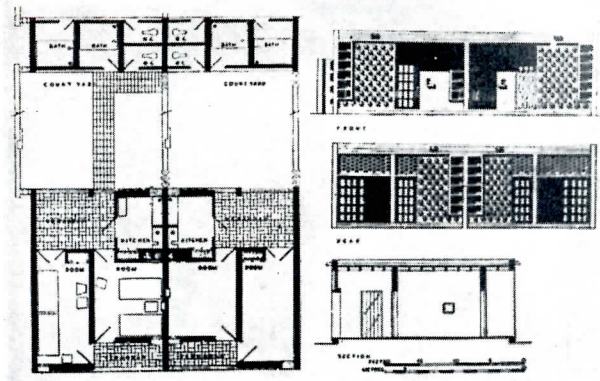

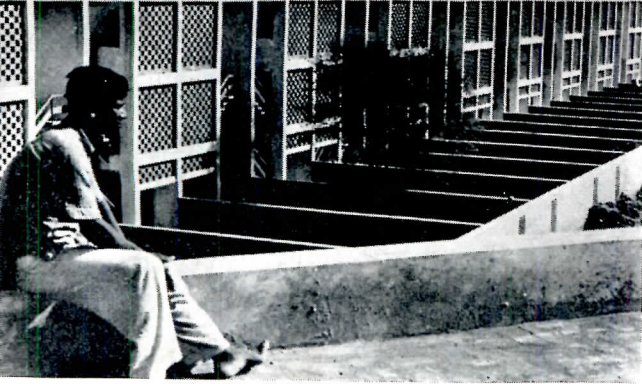

N. Y. Herald-Tribune

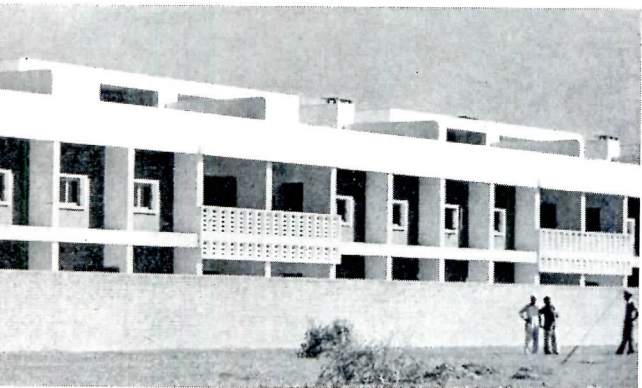

Jaqueline Tyrwhitt

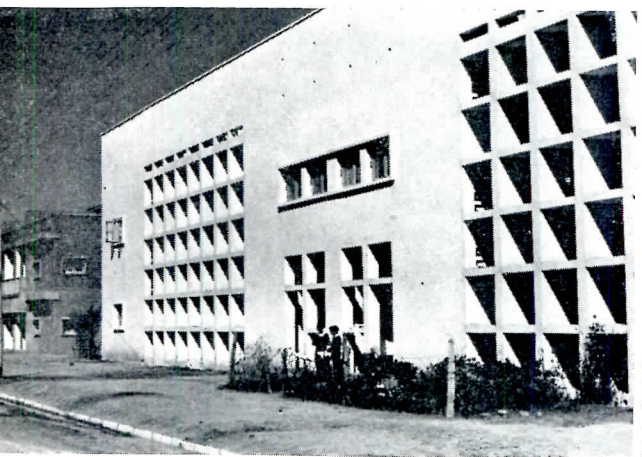

Shinde-Black Star



Jean Lyons-Black Star

*"... it was impressed upon us that women preferred to cook at floor level . . . we designed accordingly for the four lowest grades of housing . . . and in due course listened to the reproaches of those who had been given exactly what we had been told they wanted."*

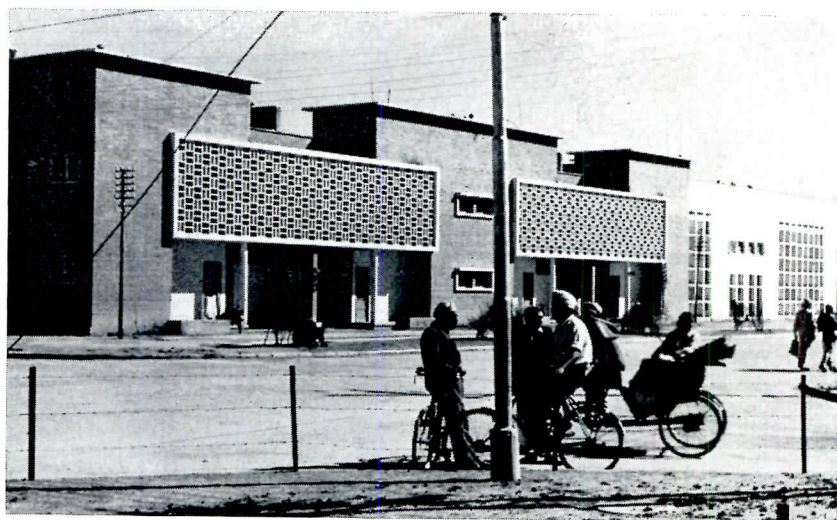

Shinde-Black Star

*Four photos above show types of housing for middle-income groups, a few of the ubiquitous bicycles, and use of masonry in various ways to protect against terrific sun. Below, housing for higher income groups; at left, a typical boundary wall*

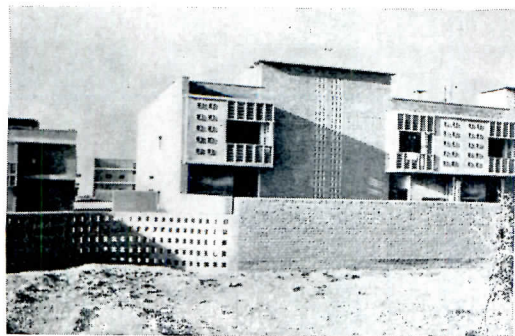

Tyrwhitt

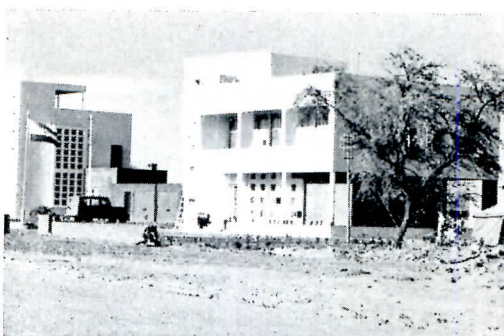

Tyrwhitt

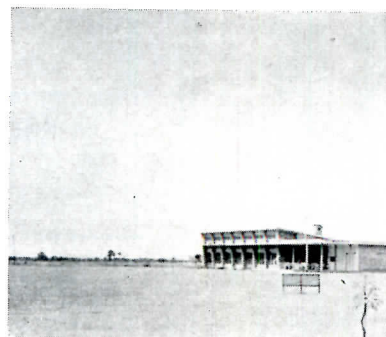

Tyrwhitt

and a college of Engineering by Mr. J. Chowdhury, the chief architect of the Public Works Department, were completed by the summer of 1954, together with some nursery schools, and a lovely health centre built very simply in plastered brick but more than normally well finished.

### Practical Legal Controls for Growth

In order to control growth we had also to frame bye-laws, to draft Acts for the control of advertisements, protection of trees, and control of the periphery; and because we were unwilling and unable to control the design of individual buildings erected by the public, we devised a system of sector planning sheets on which were shown graphically the building lines, permissible heights, buildable areas of plots, public open spaces, scheduled trees, and controlled boundary walls, with standard design for gates. Some frontages on important streets we controlled as to height, profile materials and set-backs, in order to protect to some extent the effects such streets would have when finally built. But further we did not wish to go, nor could go, without the aid of a large staff of inspectors in each of whom should burn an equal zeal for architecture; but in whom, despite appearances, and as we know somewhat to our cost in the West, a love of family and security quenches the immortal fire and replaces it with a care only for the letter of the law.

This work proved to be a great labour, but the public was grateful for the sure knowledge of what was and what was not possible, and it was as a system more responsive than the legal wording of building bye-laws, however necessary such things are.

The planning of the first project for 150,000 people takes place on 8919 acres of good flat agricultural land containing some 26 villages or hamlets, with future extension to a population of 500,000 secured by ordinance.

### Costs and Financing

The project contemplates a total expenditure of £12,886,385 (\$36,081,878.00) during its first phase, and of this more than half, i.e. £6,617,213 (\$18,528,196.40),

relates to the cost of development and of civic amenities; while the balance represents the cost of government building and water supply, with recoupable items bringing the gross expenditure to £13,417,154 (\$37,568,031.20).

Development costs are to be recovered from the sale of plots to the public, and taking into account rents paid for government buildings in the first phase, the net expenditure works out at £6,241,461 (\$17,476,090.80).

The cost at which land is sold to the public includes everything covered by the term "development costs" — land acquisition, roads and bridges, sewerage and drainage, electricity, dams across the river, landscaping, railway facilities, establishment charges, and a large item of civic works. This last includes as many as 35 educational and eight medical institutions in addition to six community centres, six swimming pools, a stadium, museum and art school, library, town hall and a number of administrative offices; and within the 35 educational buildings are large colleges for men and women, four high schools and a residential school, 11 junior secondary schools, 15 nursery schools, and a polytechnic and college of physical education.

The cost of land, loaded by everything that could be held to provide the social amenities of a modern welfare state, worked out at a value of 18s (\$2.52) per sq yd for small domestic plots grading down to 6s. 7d. (\$.92) per sq yd for the largest; at these prices land was sold by allotment with preference for displaced persons, to a waiting list far exceeding the number of plots that the overworked architects and town planners could make available at any one time. Similarly the industrial and commercial plots offered by public auction were eagerly taken up at prices nearly embarrassingly above the reserves set upon them in the estimate.

Thus the financing of nearly half of the total expenditure was advanced by the payment of the first of four annual instalments of 25 per cent of the plot values, in return for which purchasers could expect such amenities as had never before been offered to Indian citizens.

Conversely it became incumbent upon the architects to plan the city so as to realise the full value of these sales, and for the engineers and architects to keep within the already pruned estimates upon which these

*Typical of the semi-public and commercial buildings at Chandigarh: left, the hotel; center, public market; right, cinema*

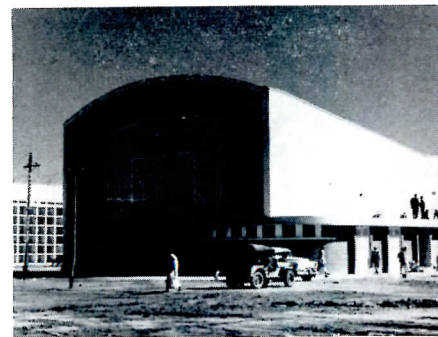
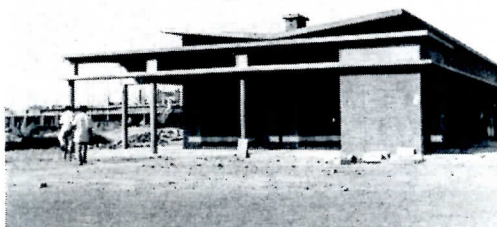
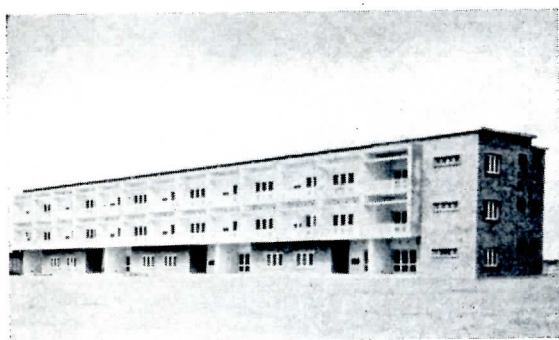

Jean Lyons-Black Star

Shinde-Black Star

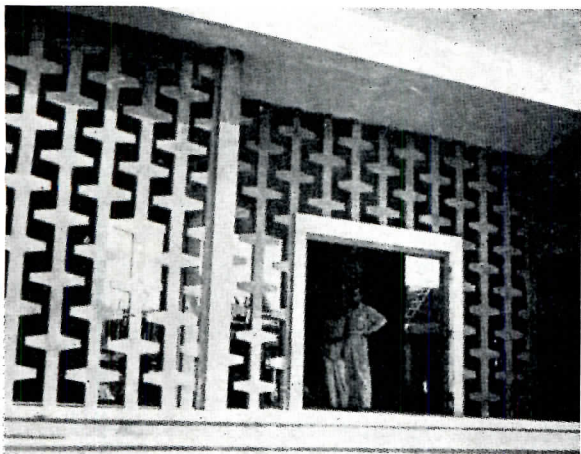
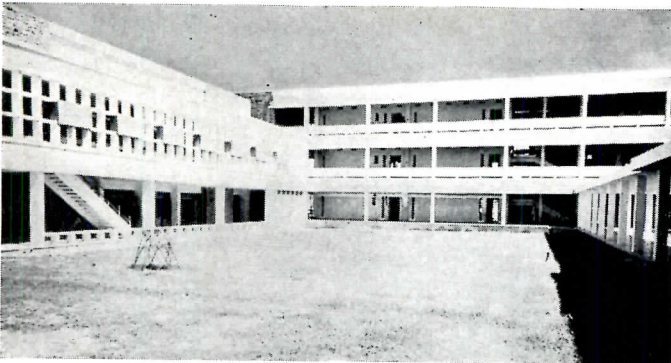
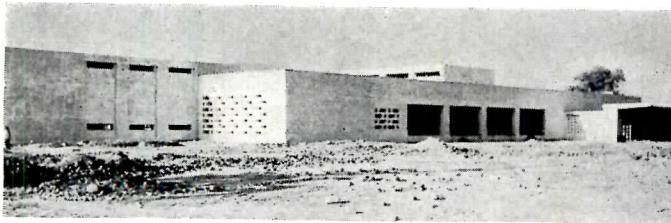

Jaqueline Tyrwhitt

*Above, health and school buildings: top, health clinic, one to each sector; center, secondary school designed by Jane Drew; bottom, entrance to school designed by Pierre Jeanneret. Below, Engineering College, by J. Chowdhury*

values depended, Chandigarh being on what might be called the "cash and carry" plan, with loans from the central and state Government, but only a comparatively small element of direct subsidy.

**A City at Once Frontier and Modern**

It is necessary to make clear to American readers that Chandigarh, though it is a first class town in so far as no house is without electricity, water and water-borne sanitation, is a frontier undertaking carried out with men, women, children, donkeys and camels in place of high overheads and lots of equipment. Apart from some trucks and a few concrete mixers, hardly a wheel turned. Materials were carried rather than hoisted; and everywhere it was the human hand instead of the machine.

Our all-Indian staff was enthusiastic but nearly entirely unqualified. They came to us from all over India, but largely they were fourth- and fifth-year boys from the Delhi School of Architecture who regarded the office as a finishing school. They proved that sustained enthusiasm is a substitute for experience because such people are serious and learn quickly; by their overflowing spirits they infected the whole undertaking, and compensated for many of the drawbacks of an antiquated Government system of working in which the architect normally occupies a subsidiary, irresponsible role.

We have done our three-year contract and Chandigarh goes on happily without us. I am writing this in Nigeria where changes no less spectacular are transforming another tropical way of life.

It seems but yesterday since P. N. Thapar, our one time administrator and Mr. P. L. Varma, our Chief Engineer, sat in our London flat trying to persuade us to leave Africa for a bit to take on this Indian adventure, and it was out of the difficulties of managing this that the chance came to bring in Le Corbusier, who thereafter dominated the scheme with his profound intelligence and courage.

As a friend of mine said on hearing of the decision: "You are likely to learn more from him than he from you, eh?" and that is how we all felt.

Shinde-Black Star

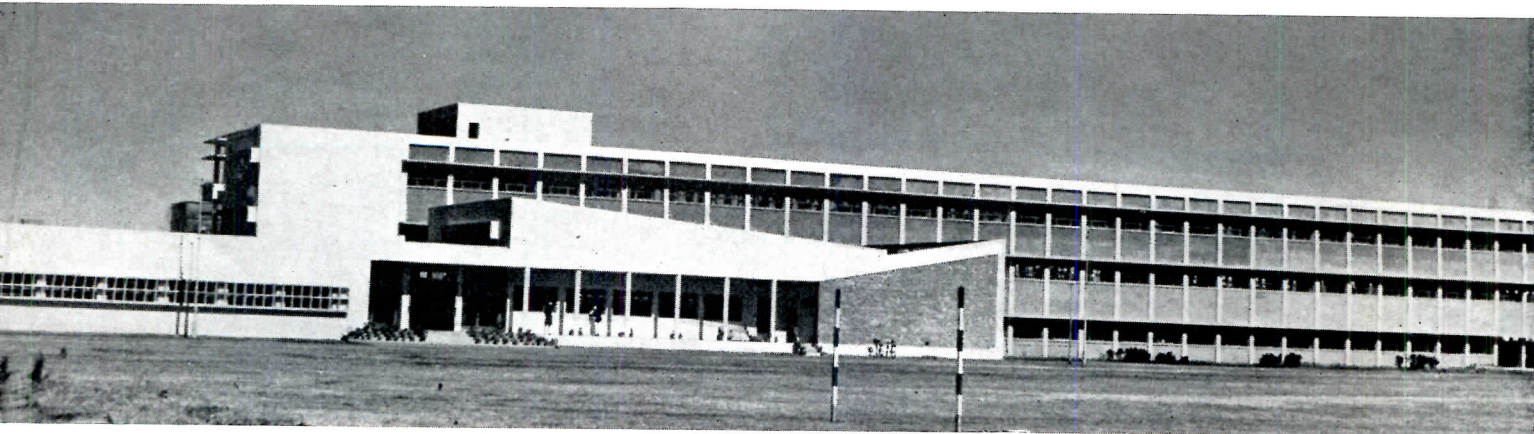

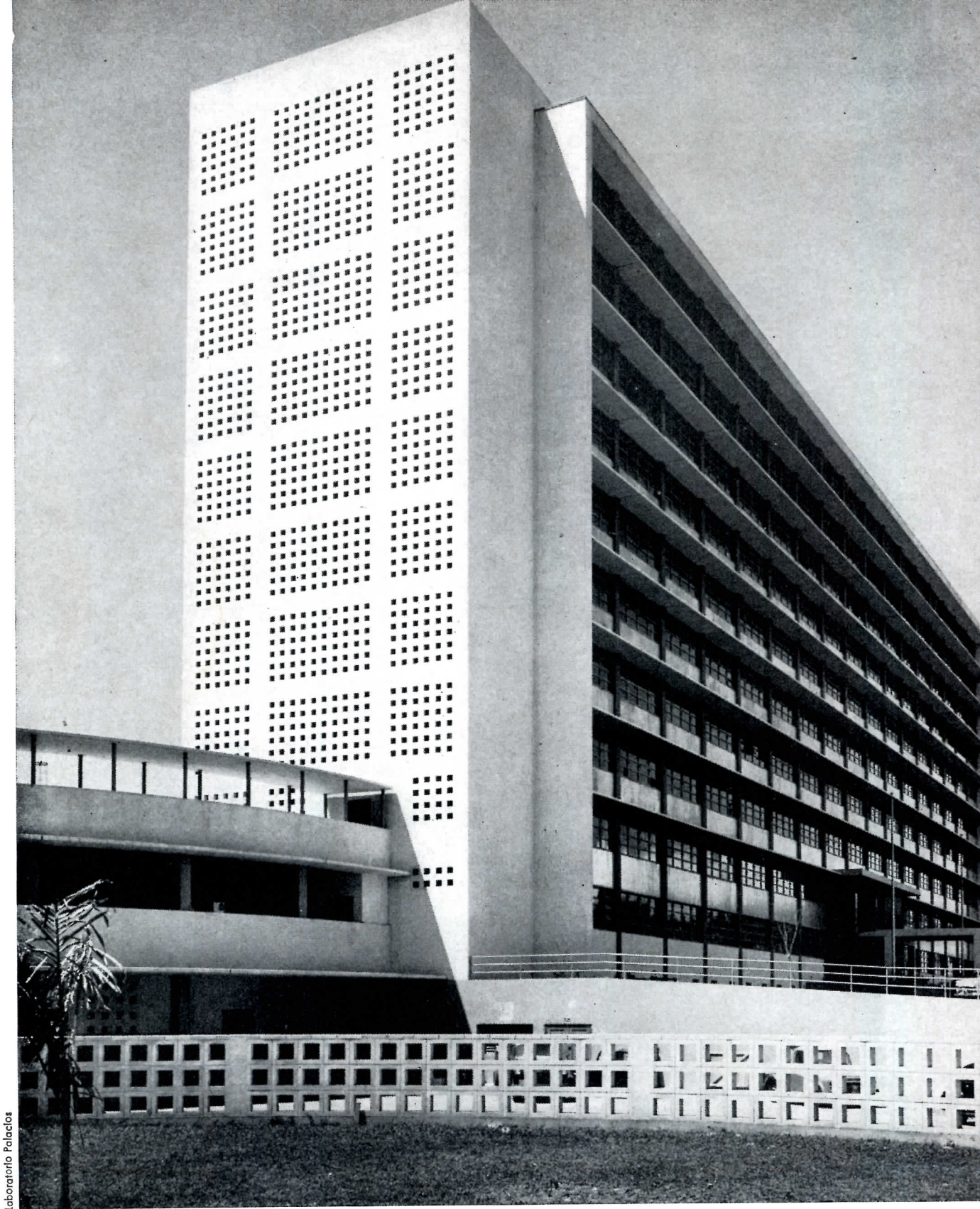

Laboratorio Palacios

## EDIFICIO CREOLE, CARACAS, VENEZUELA

*Office Building for Creole Petroleum Corporation*

*Lathrop Douglass, Architect*

*Severud-Elstad-Krueger, Structural Engineers*

*George F. Driscoll Company, Builders*

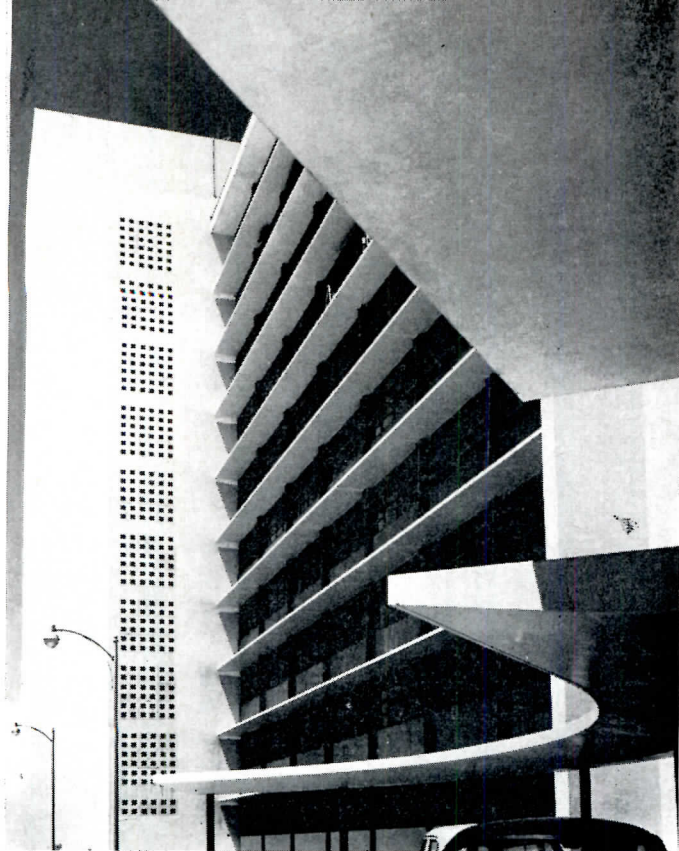

EDIFICIO CREOLE

THOUGH MANY exciting buildings have sprung up in the boom in Caracas since this building was designed (see ARCHITECTURAL RECORD, Jan., '49), and though many changes were made in the plans, the recently opened Edificio Creole is still a noteworthy example of North American design and construction techniques when exported to faraway places. Finding its architectural inspiration in logic and efficiency requirements, it demonstrates how fortunately such an approach can turn out.

While changes in the parti altered the total form of the main office building, its principal design determinants still hold: its slab form grew out of (1) climatic considerations, (2) a planned scheme of private offices and desk placing in large open areas, (3) space flexibility according to departmental integration, (4) direct circulation.

Climatic conditions are perhaps most interesting. The temperature as such is ideal; the building requires no heating or cooling. But the high tropical sun calls for positive measures. If a building traps the sun heat it can become intolerable. Moreover heavy rains make humidity a problem: ventilation is very necessary, and rooms for I.B.M. machines must be dehumidified. Also glare can be very annoying.

The slab form wrapped up these considerations quite neatly: with the long axis east and west, the building

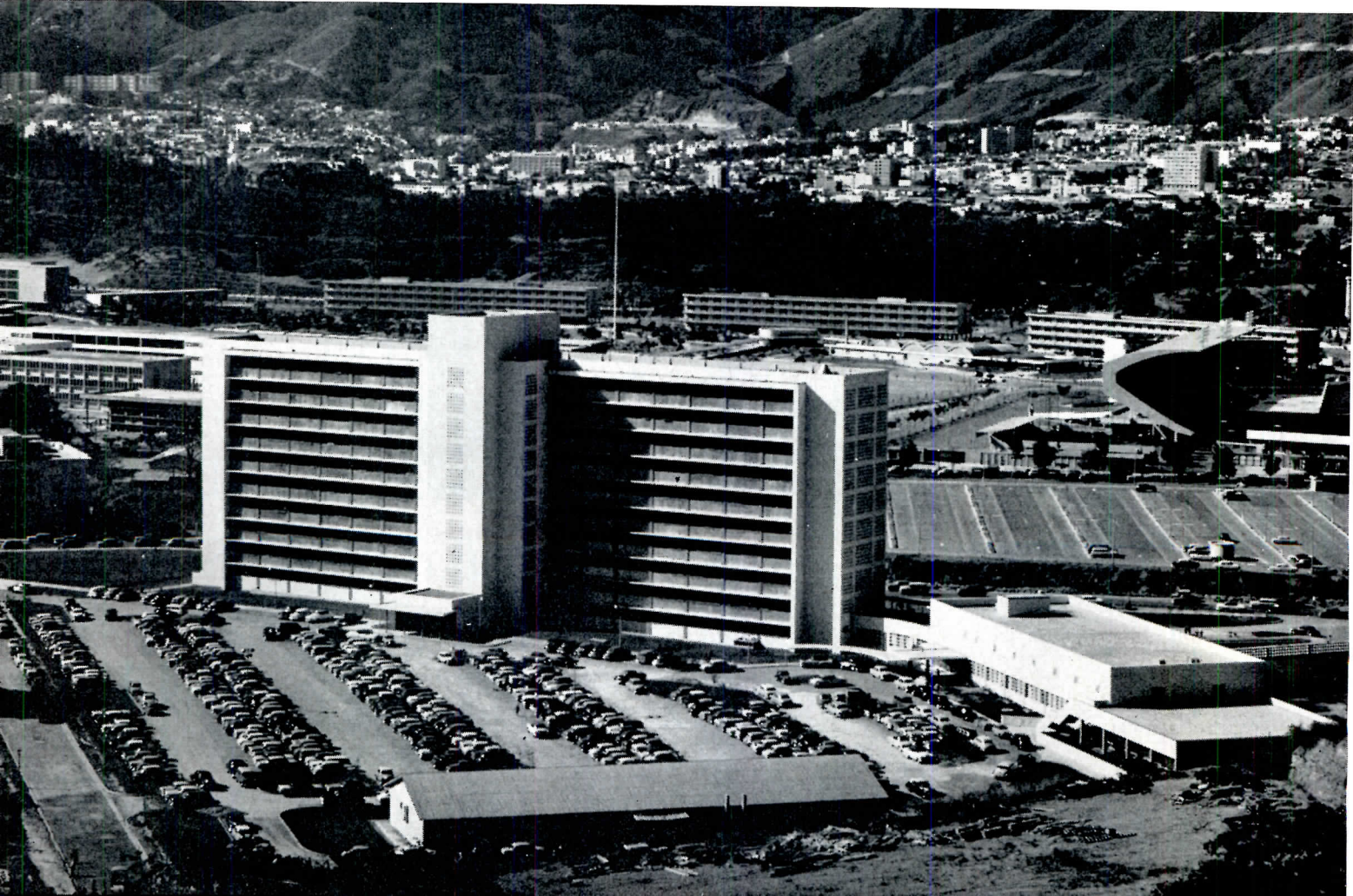



avoids the low east and west sun. These ends of the building are closed with stairs and toilets; all offices face north or south. The north and south exposures (both of which get sunlight) are easily protected by narrow sun visors, since the sun strikes these sides at very high angles. Also the long narrow form offers no surfaces for the glare of reflected sunlight. And the air circulation through such a building, with full-opening awning type windows, is at the maximum.

Heavy concrete walls at the ends of the building (the textured pattern comes from unglazed openings for ventilation) serve well for lateral earthquake bracing. Caracas is considered an earthquake zone although there have been no quakes for 100 years. The offset elevator stack with stairs at the center is also for earthquake bracing — there are heavy concrete walls here, offset for additional stiffness. Longitudinal earthquake braces at the columns are hidden in the spandrels; this necessity kept the columns from being placed completely outside the wall, as originally intended.

Principal changes to the scheme originally published were the omission of a wide two-story base shown in earlier renderings. This was planned as an enlarged air-conditioned section to house I.B.M. operations and deep file storage areas. In final plans these areas were included in the annex building, originally planned to house only cafeteria, medical and recreational facilities.

*Final plans kept the main building to ten typical stories, moved some special departments to the annex building. This two-story portion is angled off the east-west axis to take best advantage of change of grade, and to leave adequate space for parking lot and ball field. (University buildings in background)*

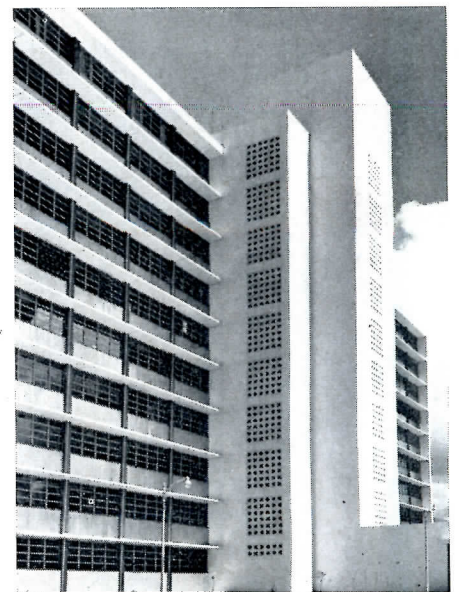
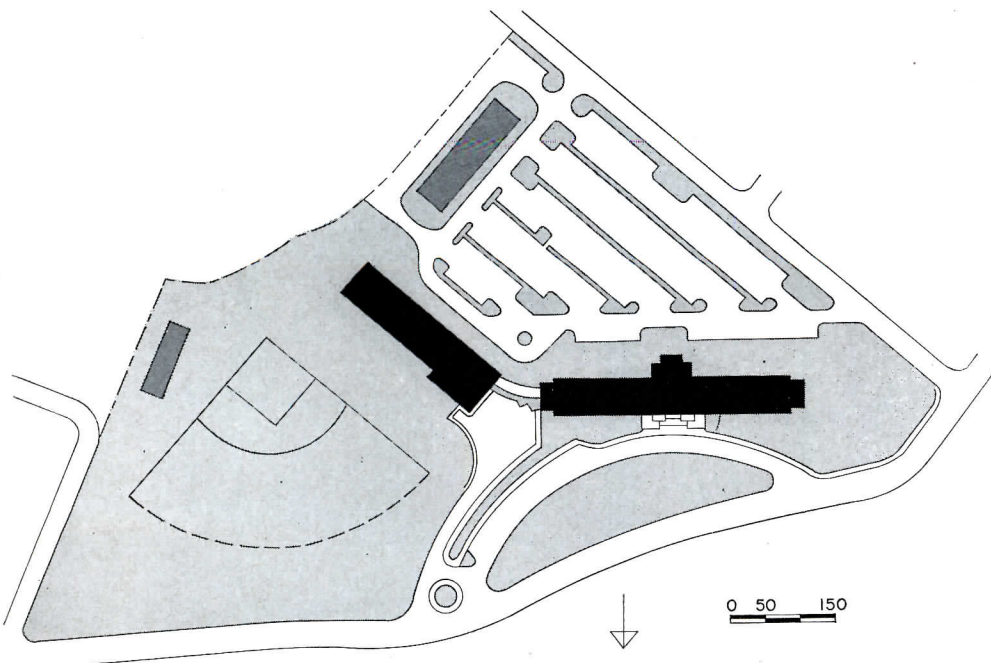
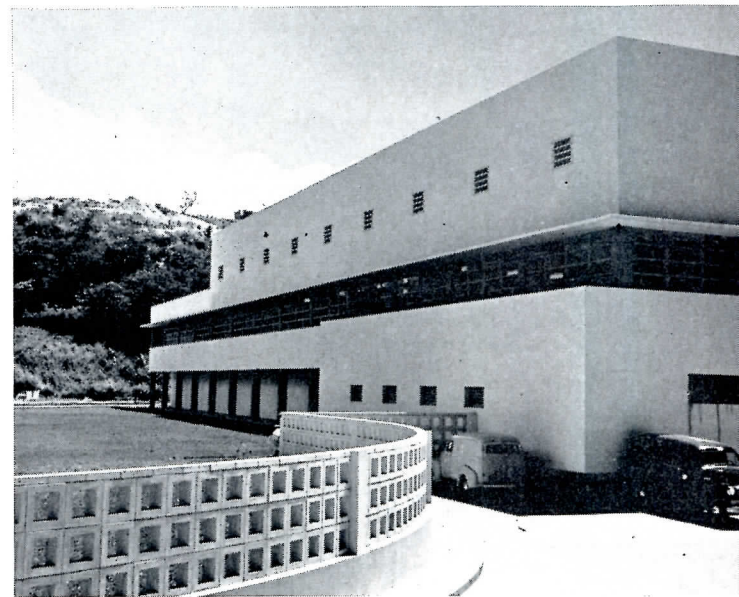
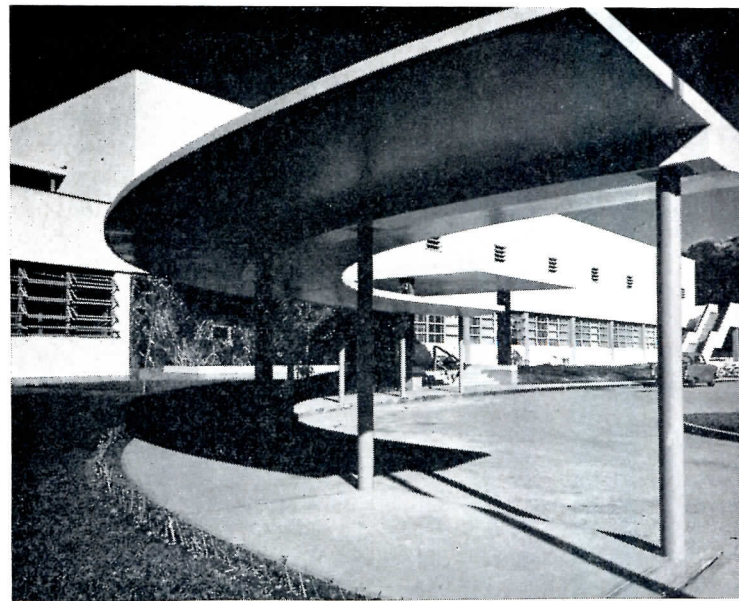

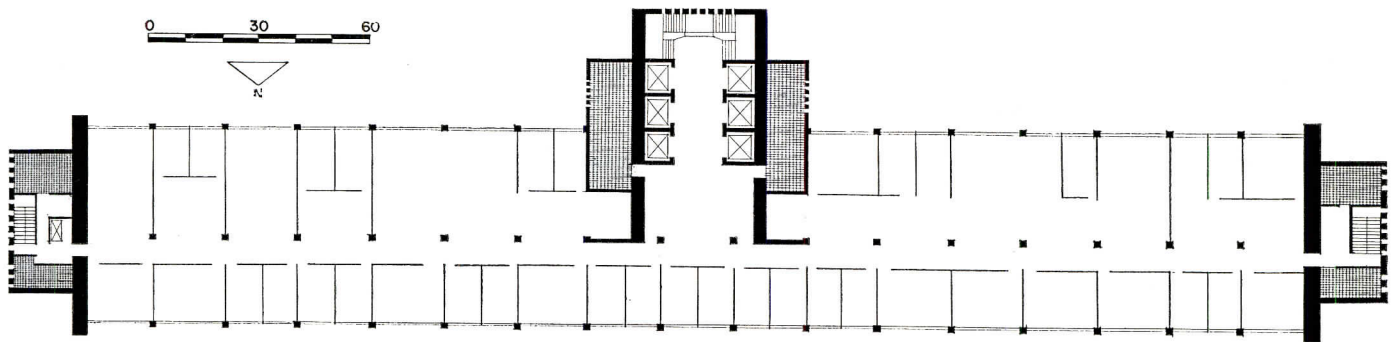

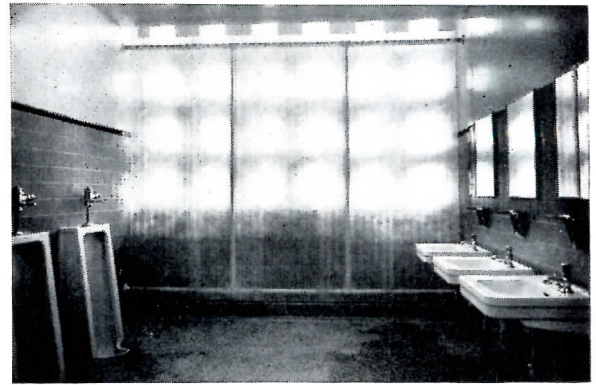
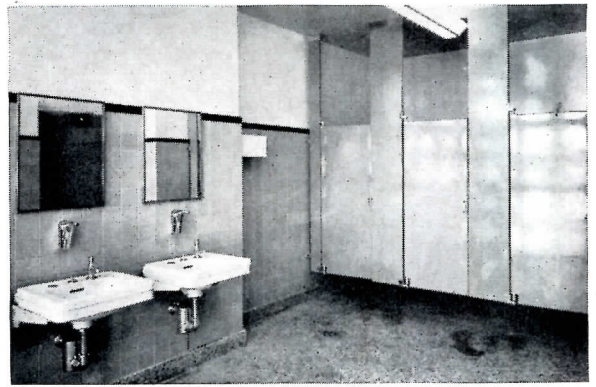
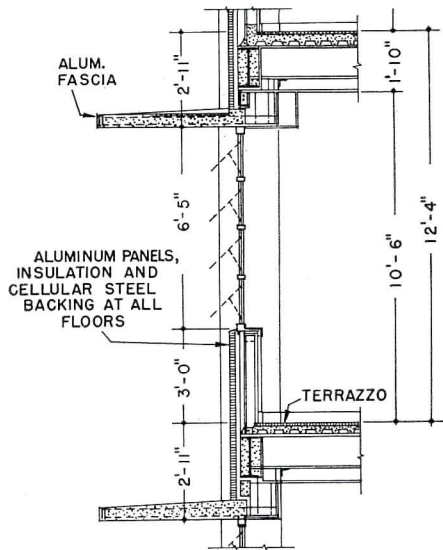

*Typical floor plan, opposite page, shows offset center columns placed for maximum space efficiency, with private offices on north side. Photograph below shows typical office space; sun visors prevent sun from reaching interior, full-opening windows permit maximum natural ventilation*



Laboratorio Palacios

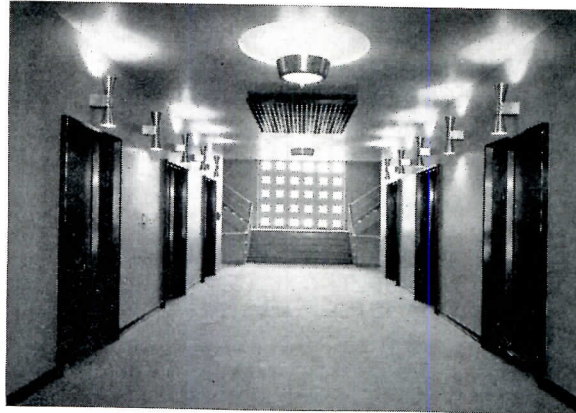

*The new office building meets a long-felt need for consolidation of many scattered Creole offices in makeshift quarters; the company has been looking forward for many years to the construction of this building. Executive office suite was decorated and furnished by Marshall Field & Co.: top, elevator lobby on executive floor (textured openings beyond lobby are unglazed for ventilation, done in precast concrete insets); right, board of directors' room, and, below, the president's office*



Inhabrentia Palacios

# CYCLE OF EVOLUTION

## THE WORK OF R. BUCKMINSTER FULLER

Manifestations of "Bucky" Fuller's theory of synergetic-energetic geometry appeared over 25 years ago. Today it has almost matured into a philosophy applicable to many contemporary phenomena; his structures are being proved by the military and the impact of his mind on students is widely felt. Below is his appraisal of the emerging architect and his work, followed by a pictorial review of his achievements.



1

1,000,000 B.C. — 1400 A.D.

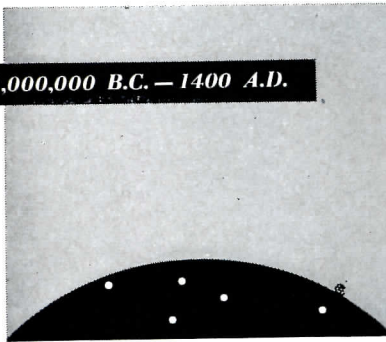

2

1400 — 1950

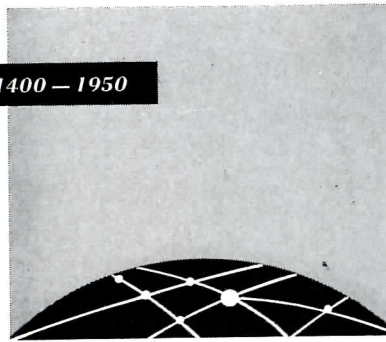

3

1950 — —



4



5

**I**N RESPECT to architecture, an utterly new chapter began 500 years ago — the Era of Commerce. During those 500 years the pattern of Man on Earth was transformed from an infrequent polka-dotting on an enormous sphere — (2) — to a network of lines encompassing a smaller sphere — (3).

The polka-dot pattern of all previous history ends abruptly at the time of Leonardo da Vinci when feudal architects had attained comprehensive authority to integrate their respective remote realms' resources — dearly, tentatively and meagerly won from the apriori, awesome pattern of Nature.

In the Era of Commerce which followed, the autonomous, ocean-borne, far-ranging tool-complex — called "ship" — broke asunder the comprehensive "across the board" functioning of the architect-engineer-inventor-artist-designer-military-strategist — as effectively coordinated in the homeport man.

However, the old architects' comprehensive overall planning prerogative, though seemingly abolished — and always invisible — was secretly retained by the supra-national masters of the world-around patterns of commerce who articulated their new master-architecture in discrete fractions through the visible functions of private and public servants of sovereign but sub-comprehensive world states, master-selected to govern trade, finance, statecraft, politics and armed protection of commerce and exploration.

Because high-seas piracy by competitors could best be countered with secrecy, the visionary, world-integrating dynamic architecture of the Era of Commerce was long obscure. It is now scrutable only because its historical primacy has been eclipsed.

The Era of Commerce knit its pattern of spherical surface lines to bi-Polar closure in 1910, and surprise-triggered another epocal transformation, during technical crises of World War One. An omni-directional, omni-frequency, broadcast, beamed, and trajectoried sky-ocean patterning now (almost invisibly) surrounds a *very small world* — (4).

This new pattern accelerated its ephemeralizations from: track to trackless, wire to wireless, pipe to pipeless — from a "Dead" norm of "at rest" to "quick", infra- and ultra-sensorial, reliable *norm* — of wave frequencies effective at 186,000 miles per second. The more it ephemeralized, the more it became permeative, perceptive, incisive and, inductively, omni-communicative. No longer were ships' captains absolute, autonomous commanders; they became intimately plugged-in executives of general authority. Master-architectural initiative shifted uninvited and irrevocably to democratic process authority.

The New Era Architecture is challenged to build for uniformly improving enjoyment of a unifying world; for an around-the-sphere and around-the-year emancipation of all individuals from the basic physical survival fears; from drudgery as muscle and nerve reflex machines.

Architects of the New Era must re-emerge as a fraternity of Leonardos.

There is one great difference, however: industrialization is a world-around objective integration of all the findings of all the exact sciences. To function successfully within it as free

1, paperboard dome, Triennale Exhibition, Milano 1954, won grand prize for U. S. A. 2, 3, 4, transformation of man's pattern on earth (see text). 5, Bucky Fuller

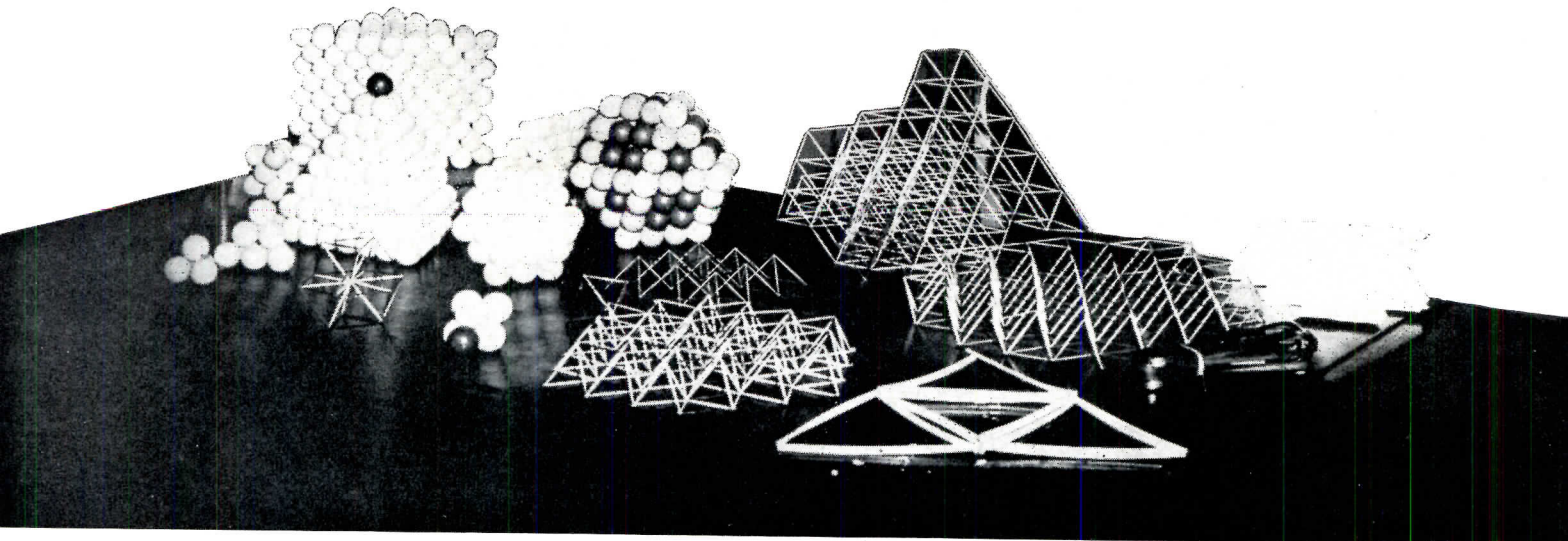

1

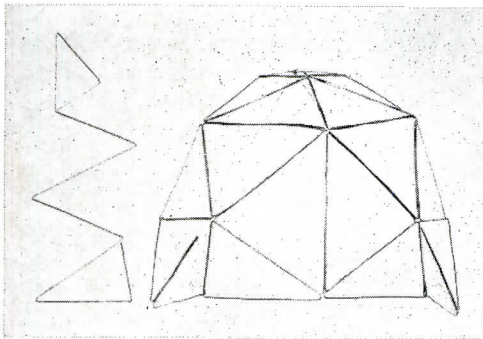

2

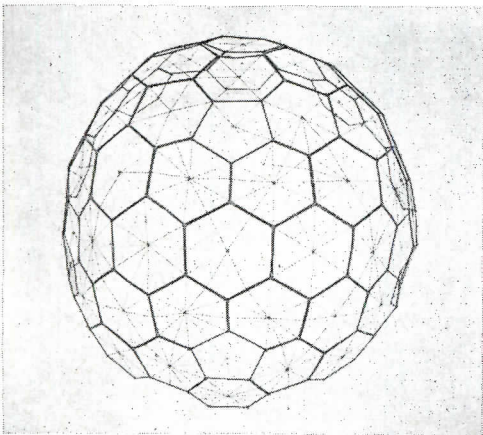

3

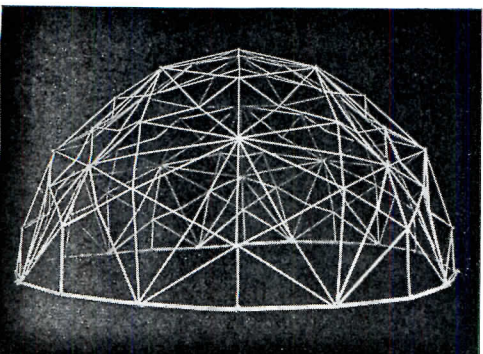

4

Shown here are a few of thousands of synergetic geometry models developed in the search for a comprehensive coordinate system which might integrate in one kinetic omninetwork all the separate, seemingly unique data of the sciences, the complex patterns of the animates, and the even greater complexities of interanimate behavior. 1, spheres packed into smallest possible volume and models depicting their common radii. 2, 3, 4, steps in development of geodesic structures. 5, "diamond turbotangent" used on first radome and on Triennale dome. 6, 7, sphere and mast formed of discontinuous compression, continuous tension members, in which Fuller, through his geometry, converted to man's use the fundamental principles kinetically structuring the macro cosmic and micro cosmic universe. Airocean world map (Fuller projection, patented) shows, without visible distortion, one world island in one world sea at bottom of the airocean.



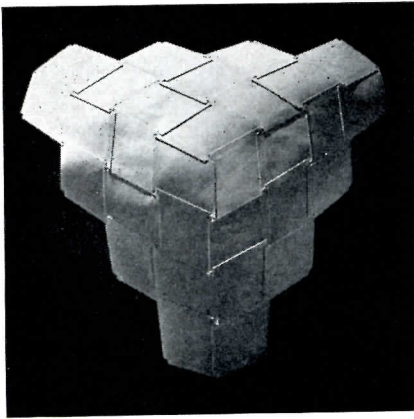

5

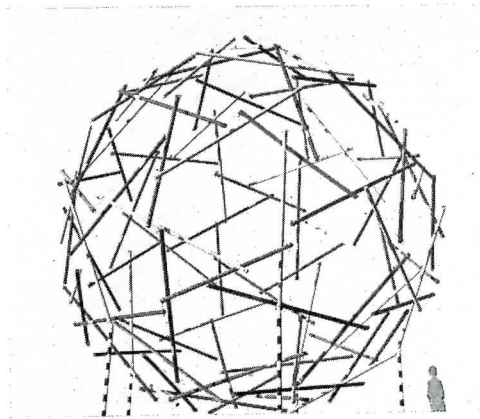

6

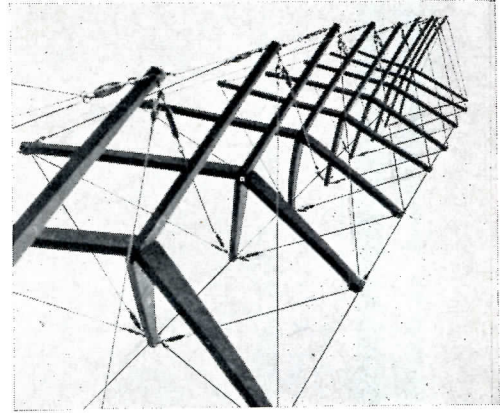

7

individuals, architects must first discover industrialization's inherently synergetic, regenerative augmentation. (Synergy: the pattern-behavior of aggregates unpredicted by their components.) Assuming *synergy* as elementary — architects will associate as an Initiating Body of search, research and objective design formulation — addressing themselves strictly to the generalized structures and process cases, as have the exact sciences — subjectively — and as have the naval and aeronautical architects — objectively — leaving to the lives that enjoy the new family of instruments the discovery, composure, and orchestration of an unfrozen music of architecture.

*R. Buckminster Fuller*

"How now my insulated friend  
 What calm composure can defend your rock  
 When tides you've never seen  
 Wash out the sands of what has been  
 And from your island's tallest tree  
 You watch advance what is to be —  
 The tidal wave devours the shore —  
 There are no islands any more."<sup>\*</sup>

<sup>\*</sup> Edna St. Vincent Millay, "Make Bright the Arrows", 1940, Harper & Brothers

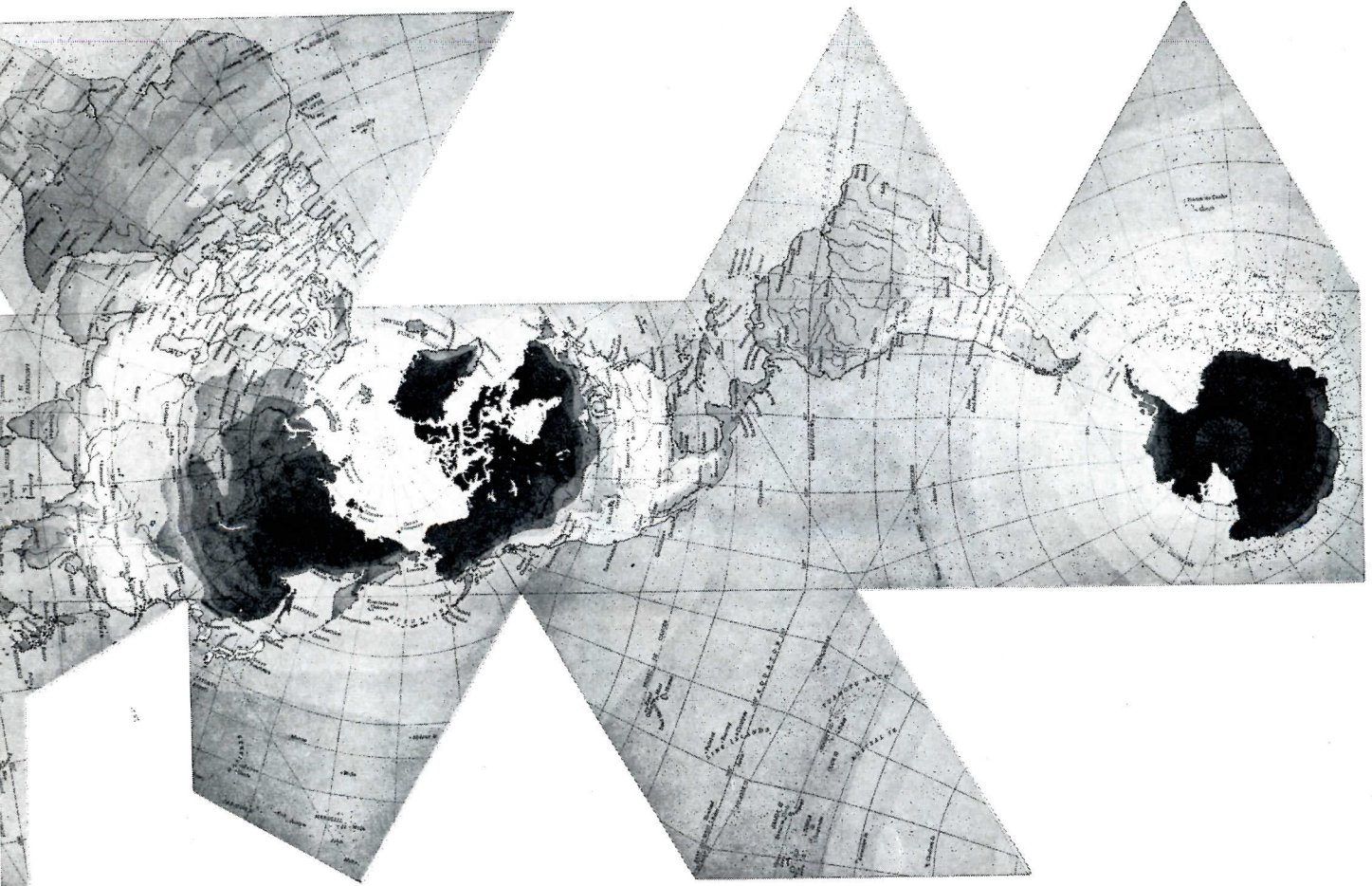

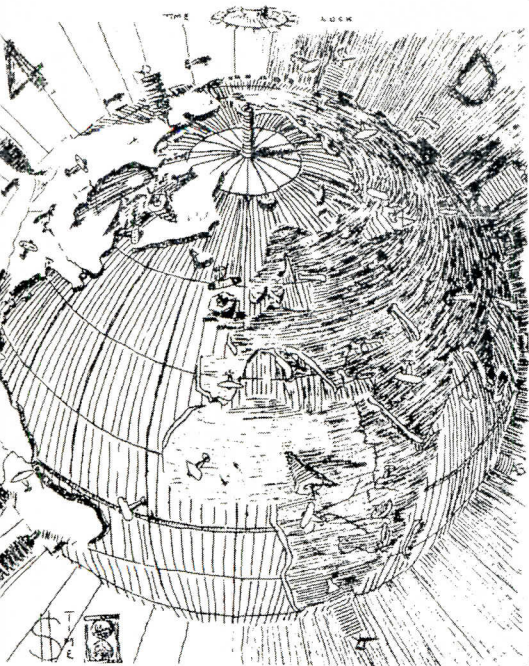

1

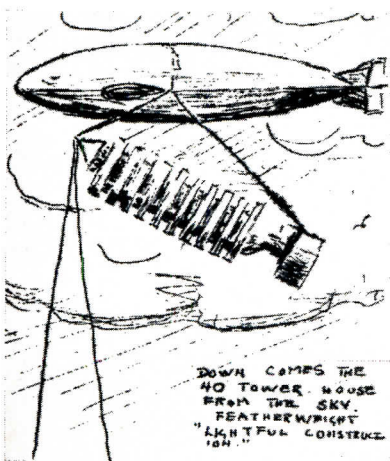

2

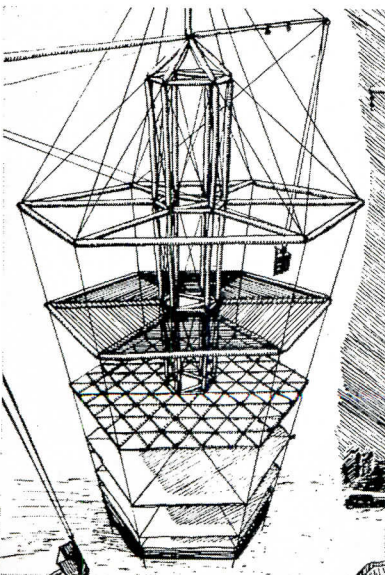

3

1, Fuller's 4th Dimensional Airocean world town plan (1927) showing theory of world-around air-delivery of principal structures. 2, Graf Zeppelin transporting one of the 10-story apartment houses which are shown in detail in figure 3. 4, the 6,000 lb Dymaxion House (1927) being assembled from the top down and hoisted aloft around a mast. 5, the Dymaxion 4D transport (1933), Fuller's principles applied to locomotion in an easily maneuvered front wheel drive vehicle. 6, Fuller House (1946), a shelter designed of parts so light and nestable they could be packed in an aluminum container (one standing alongside the assembled house in the photo) to be flown anywhere in the world and easily erected. Fuller also developed a "packaged" bathroom which could be mass produced and easily transported. 7, the "Skybreak" (1947) offered a new approach to shelter—a geodesic structure encompassing a large volume with one-third-hundredth the weight per cu ft of the equivalent in conventional dwelling. A similar structure developed in 1950 is being considered for the garden of the Museum of Modern Art in New York. 8, a quarter-century cycle nears completion: Fuller watches a Marine Corps helicopter air-lift a 30-ft dome during a 35 mph wind at Raliegh, N. C., headquarters of Geodesics, Inc. and Synergetics, Inc., two research and development corporations founded to further his work

4

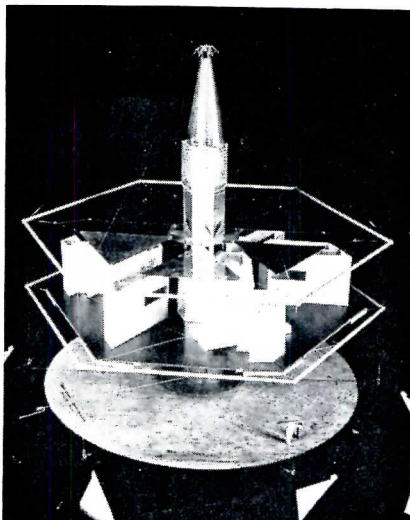

5





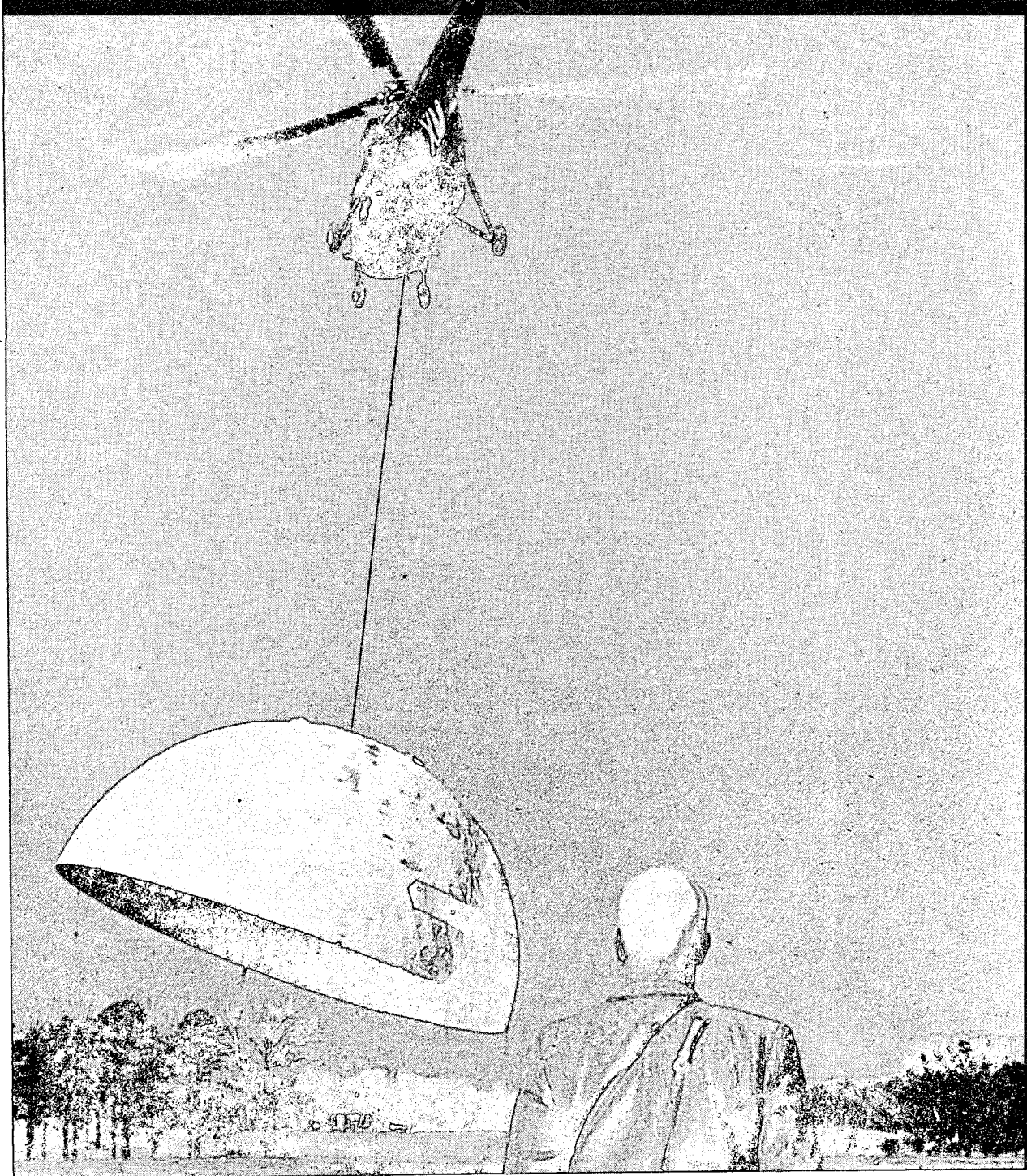

8

6

7

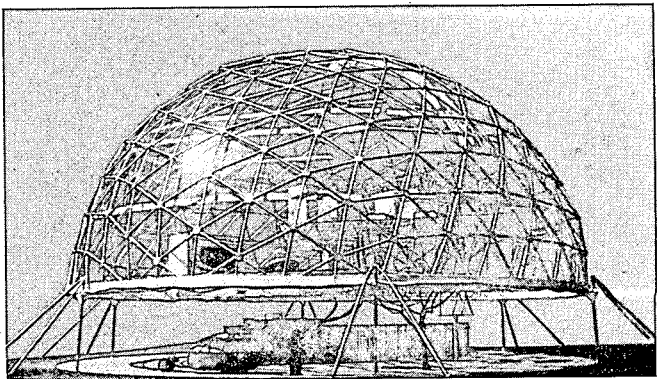
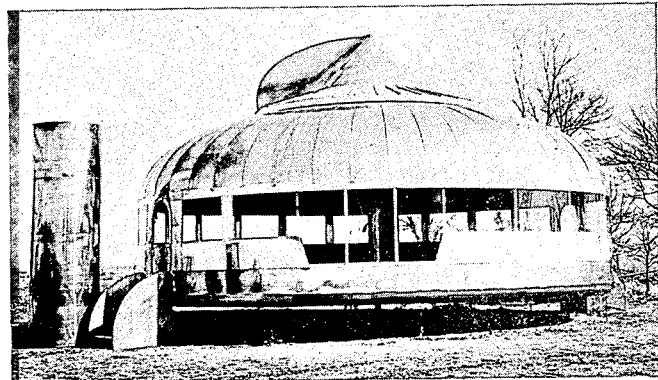

BUCKY FULLER: CURRENT APPLICATIONS



1, 2



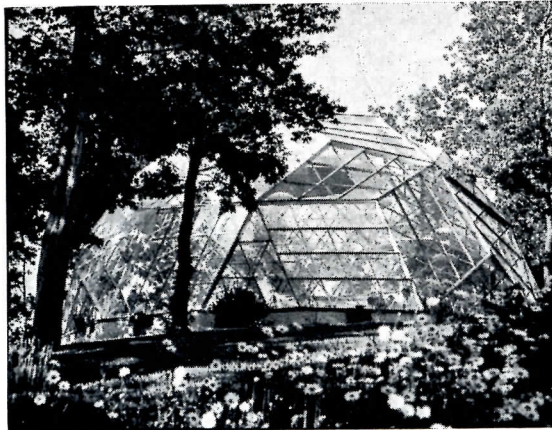

3

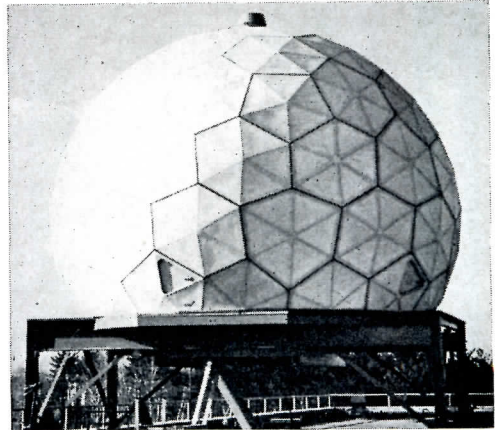

4

5



1, a 36-ft dome made of paperboard (1954), is one of two exhibited at the Triennale in Milan, Italy. This model was developed as a vacation house. Above it, 2, a helicopter air-delivering a 50-ft dome at 60 mph; on the ground this was used as a hangar for three planes at Quantico Marine Base, August, 1954. 3, dome covered with Mylar plastic was used as a restaurant by Architect Gunnar Peterson (1953) in Woods Hole, Mass. This structure withstood the full force of Hurricane Carol, whose destructive effect on conventional buildings was widely reported in the U. S. press. 4, a 31-ft polyester, glass-reinforced three-quarter sphere radome, designed and produced by Geodesics Inc., Cambridge, Mass. 5, the "Sky Eye" is a three-quarter sphere radio telescope developed in 1954, so light it will float in water on its own struts of Fiberglas-reinforced polyester resin

Charles Eames

## BUCKY FULLER AND THE STUDENT MIND



1

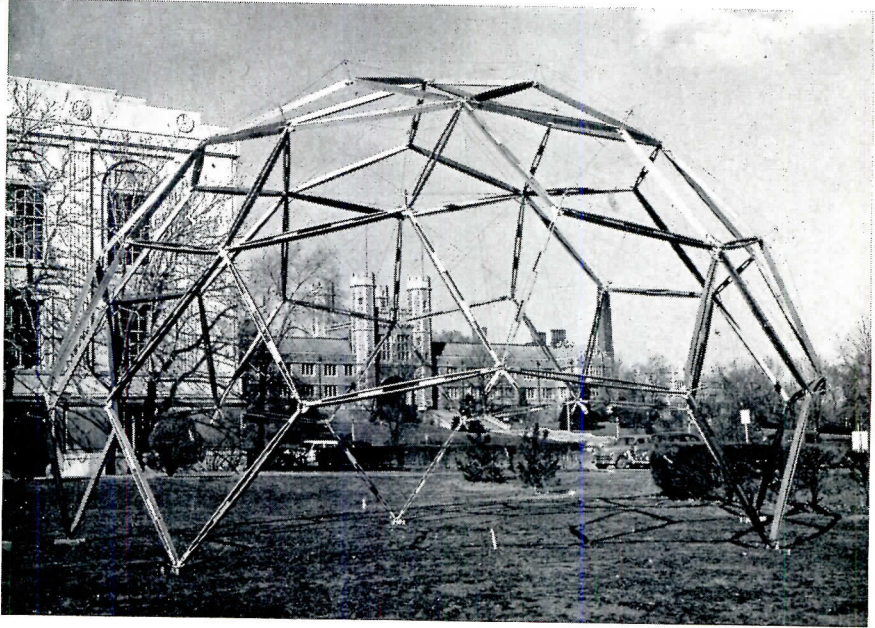

2

*Bucky Fuller's impact on college students is phenomenal; he has lectured, conducted seminars and inspired projects on campuses virtually all over the country. 1, University of Minnesota students assembling a 40-ft sphere of polyester-fiberglas struts fabricated by them in the school shop. Minnesota has prepared an exhibition of Fuller's work for display during the A.I.A. convention this month at Minneapolis. 2, a 42 ft, five-eighths sphere, designed to fold and unfold like an umbrella, fabricated by students at Washington University in St. Louis to be flown to the Helsingborg, Sweden, World Trade Fair as the "New Spirit of St. Louis." 3, Bucky lecturing before students at Princeton University*

3





# AMERICAN MEMORIAL LIBRARY

*Berlin, Germany*

## ARCHITECTS

*Gerhard Jobst, Willi Kreuer,  
Hartmut Wille, Fritz Bornemann*

## AMERICAN CONSULTANTS

*Francis Keally, Consulting Architect  
Charles M. Mohrhardt, Library Consultant*



Kessler



Foto-Gnilka

### BERLIN LIBRARY

**T**HIS NEW LIBRARY in West Berlin has more than lived up to expectations (see page 172 and AR, March '53). Of steel and concrete construction, it has a ribbed façade of square black slate panels alternating with windows of the same dimensions; off-white concrete ribs separate the two, and monotony is avoided by the mosaic pattern of the slabs, formed by small pieces of varying shades. Reading room is 273 ft long, unpartitioned except for glass wall enclosing children's room; ceiling slopes upward from inner to outer wall and has skylights along inner wall for maximum daylighting; flooring is rubber, ceiling is covered with sound-absorbing material.

Wolf Hejne (also photo p. 169)

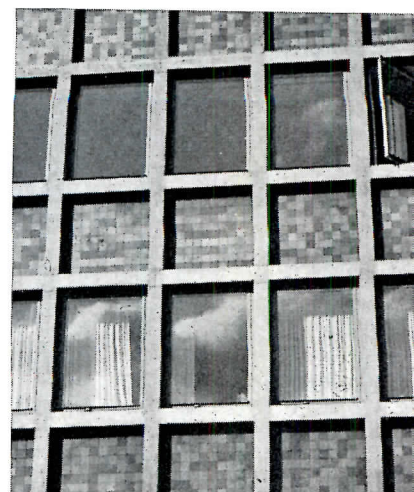

Upper floors are only 30 ft wide, assuring good daylighting for every room. Basement provides stack space for approximately 350,000 volumes, top two floors for another 170,000. Booklifts from basement were planned for either rearrangement or numerical increase; four are currently in operation, openings in reading room floor permit sixteen. Library school occupies half of fourth floor, includes classroom for 30 students

**SECOND TO SIXTH FLOORS**

- |                   |                                |
|-------------------|--------------------------------|
| 1. Typing         | 10. Photo Laboratory           |
| 2. Catalog Dept.  | 11. Stacks                     |
| 3. Accessions     | 12. Distributing, Checking     |
| 4. Offices        | 13. Printing                   |
| 5. Conference     | 14. Bookbinding                |
| 6. Local History  | A. Booklifts & Pneumatic Tubes |
| 7. Discussion     |                                |
| 8. Library School |                                |
| 9. Telephone      |                                |

**GROUND FLOOR**

- |                                  |                                |
|----------------------------------|--------------------------------|
| 1. Check Room                    | 12. Science, Law, etc.         |
| 2. Charge Desk                   | 13. Fine Arts, Theater         |
| 3. Return Desk                   | 14. Music                      |
| 4. Readers Registration          | 15. Record Player              |
| 5. Staff Work Room               | 16. Listening Booths           |
| 6. Terrace                       | 17. Piano Studio               |
| 7. Children's Library            | A. Booklifts & Pneumatic Tubes |
| 8. Fiction & Popular Non-fiction | B. Movable Desk with Booklift  |
| 9. General Reference             |                                |
| 10. Author Catalog               |                                |
| 11. Humanities                   |                                |

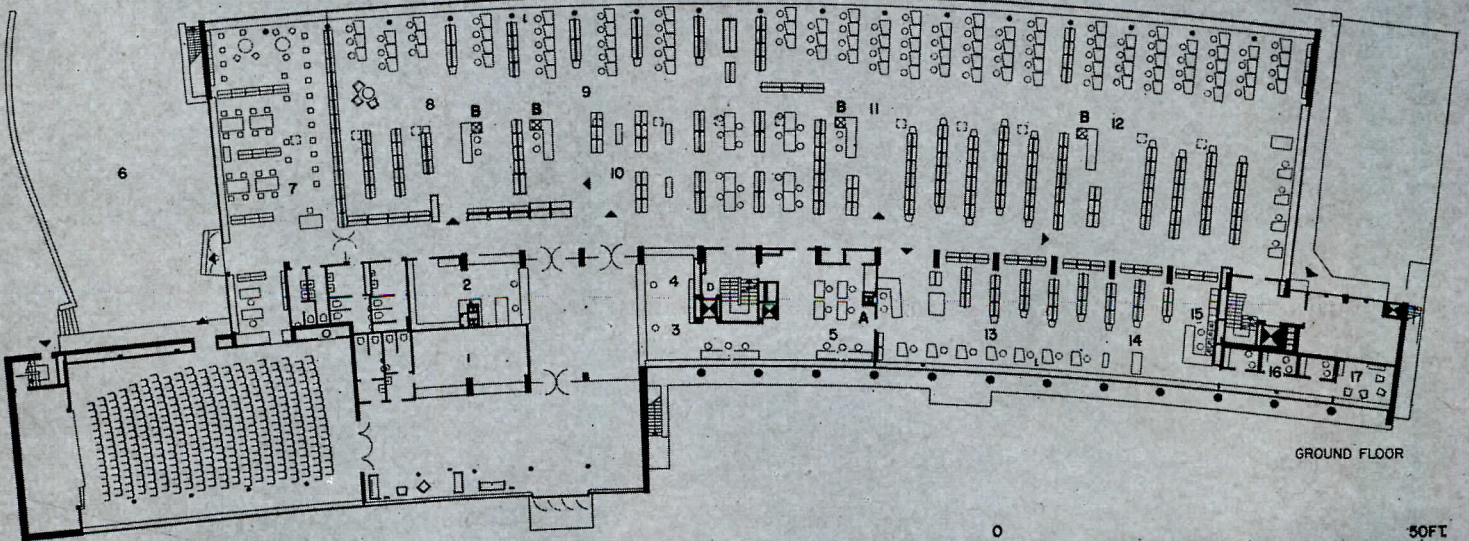
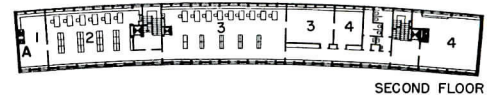
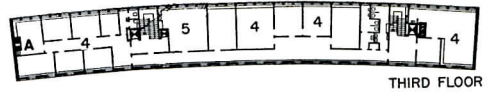
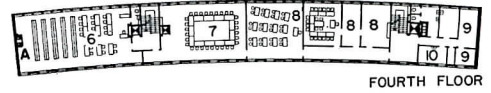
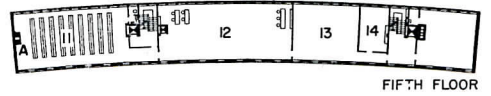

**BASEMENT**

- |                     |                                |
|---------------------|--------------------------------|
| 1. Stacks           | 9. Coal Cellar                 |
| 2. Air Conditioning | 10. Work Room                  |
| 3. Storeroom        | A. Booklifts & Pneumatic Tubes |
| 4. Dispensary       | B. Booklifts to Reading Room   |
| 5. Superintendent   |                                |
| 6. Janitor          |                                |
| 7. Mechanical       |                                |
| 8. Switchboard      |                                |

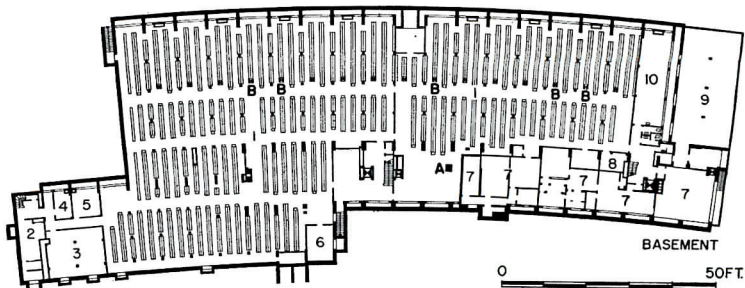

## BERLIN LIBRARY

*Library was built and equipped with funds granted by United States Government in recognition of West Berlin's gallant stand during blockade of 1948-49; memorial plaque at one end of entrance lobby quotes Thomas Jefferson on founding of University of Virginia: "This institution will be based on the illimitable freedom of the human mind. . . ." Main reading room is directly opposite entrance, reached through inner lobby with checkroom and control desks; auditorium entrance is at left. Auditorium seats 327, is fully equipped with stage, slide projector, tape recorder, etc. Library was opened in September '54; within its first two months it issued cards to 25,572 readers and circulated more than 117,000 books; its reading rooms are always crowded*



Kessler



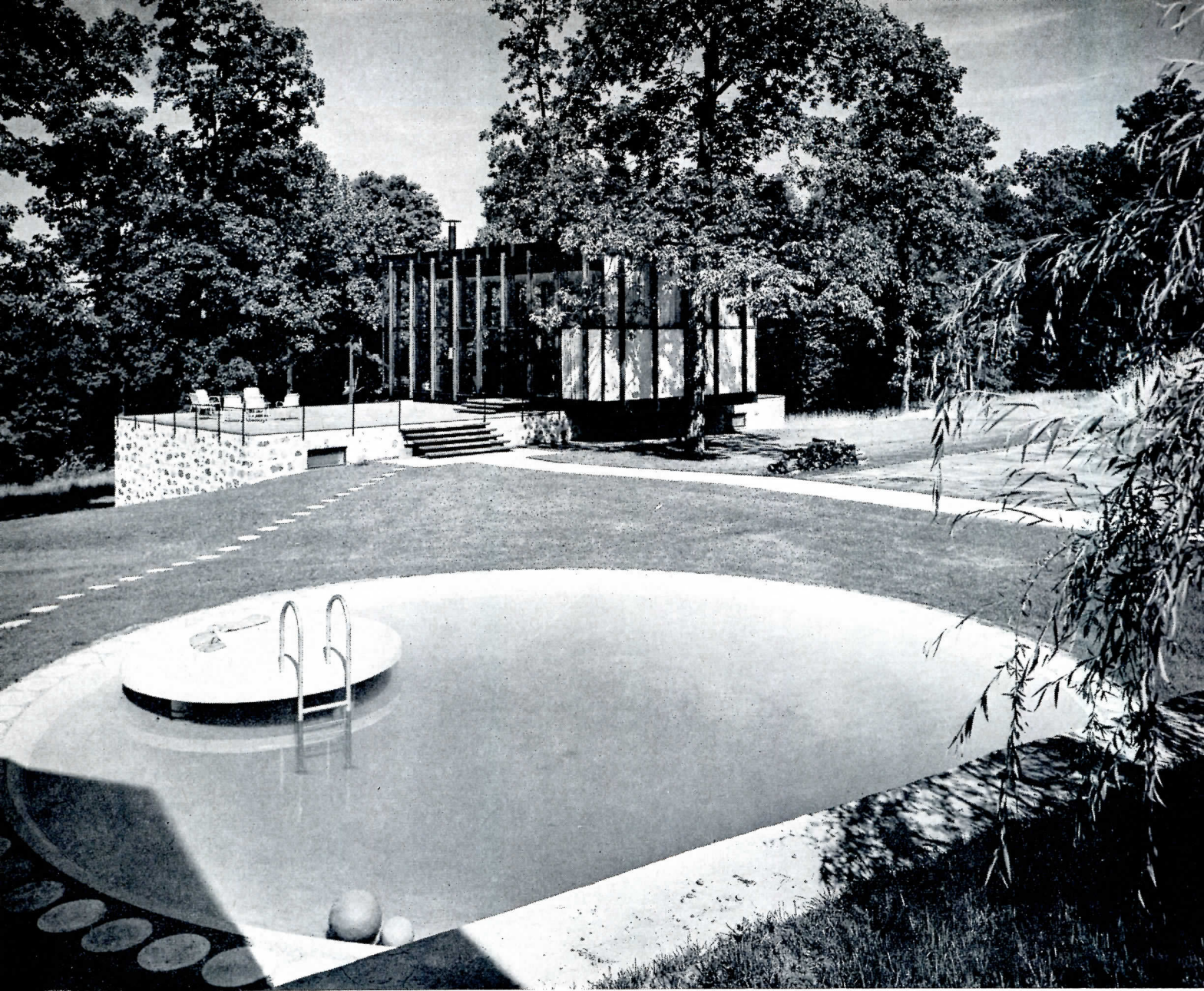

© Ezra Stoller

## A CLEAR-CUT EXPRESSION OF THE DOUBLE LIFE

*The Wiley House, New Canaan, Conn., Philip C. Johnson, Architect  
Richard Kelly, Lighting Consultant; John C. Smith,  
Contractor; Eipel Engineering, Structural Consultants*

**T**HERE HAVE BEEN many schemes to deal with the double character of typical family living; i.e., the every day business of rearing children, eating, relaxing and sleeping — and the apparently disparate activity of entertaining friends and guests as graciously as possible. Among others, there are: the “zoned plan,” the “family room,” the “parlor,” the “open plan,” etc. This particular design sharply separates the two functions; places a formal wood and glass pavilion (the parlor) atop the more casually arranged family element below. A throw-back to the Victorian, perhaps, but with the added element of a *second kitchen*; an idea the architect describes as “the key to the scheme — the trick that makes it work.”

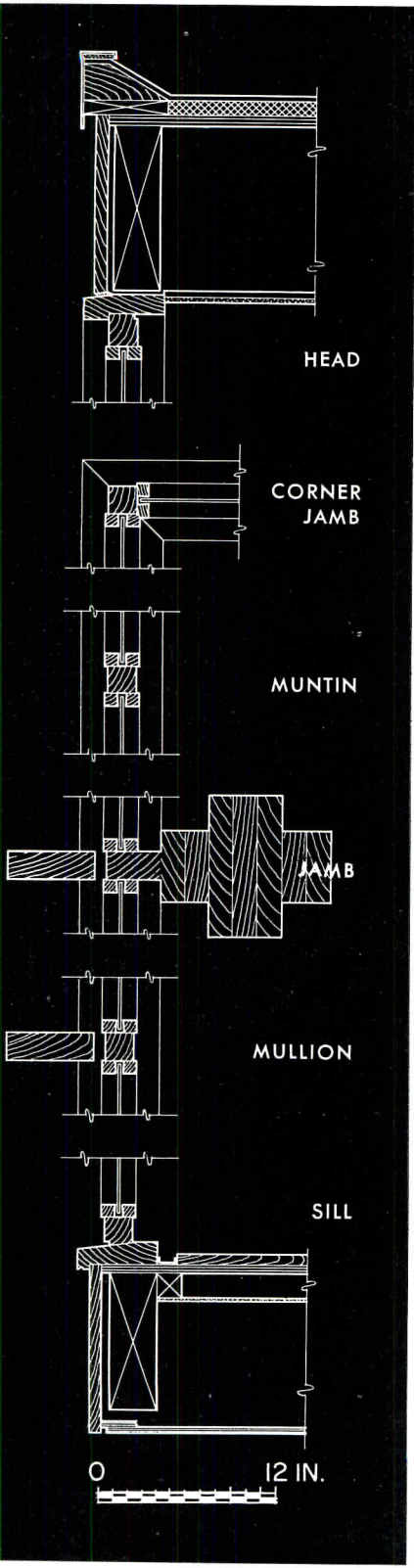
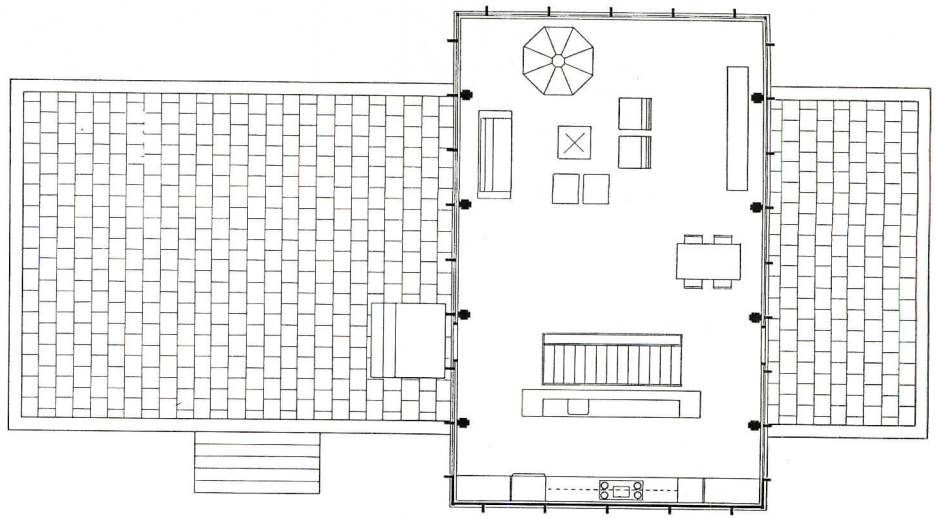

**Architect Philip C. Johnson says:**

“One more attempt to reconcile the (perhaps) irreconcilable: modern architectural purity and the requirements of living families. Why can't people learn to live in the windowless spheres of Ledoux or the pure glass prisms of Mies van der Rohe? No, they need a place for Junior to practice piano while mother plays bridge with her neighbors; they need a Victorian parlor where they meet only to entertain. What kind of form — I ask you — can an artist bring forth with these crowded commitments to consider?”

“One answer might be a retreat to the design of undifferentiated spaces — a series or a suite of rooms as in the 18th Century; some for sitting, some for sleeping, etc., but that hardly satisfies today; we still seem to want a bigger living room than sleeping room. We do not need to be as differentiated as the late 19th Century with its billiard room, drawing room, dining room, breakfast room, etc., but unfortunately, we cannot yet, *en famille* at least, sleep in the common area. Such a Utopia becomes a totally impracticable one.

“The Wiley house ‘solution’ of placing private functions below in a sort of podium to the 15 ft ceilinged public pavilion above gives the architect great freedom. The client can design downstairs as he pleases. Without injuring the proportions in the slightest, Mr. Wiley added six feet on the playroom during construction. The architect can design the pavilion above.

“The high glass pavilion is framed in laminated timber, and all the window frames are timber stained dark. The effect from inside — quite opposite to that

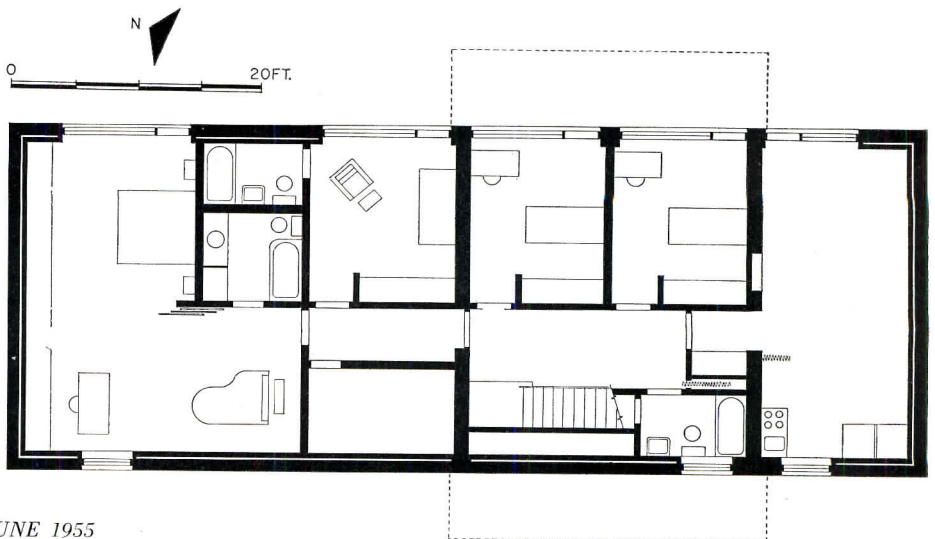





**Architect Philip C. Johnson (continued):**

of my glass house — is that of a cage. No indoor-outdoor nonsense. The 15 ft ceiling frees the view into the high hickories which surround the house and which at night make fantastic white tracteries against the black sky. Note: the fireplace — an experiment — draws well, but let readers beware of copying; too tricky.”



There was a conscious effort to conceal the elements resulting from mechanical, drainage and electrical systems. The flue was eliminated by locating the heating plant in an adjacent barn (which had to remain) and piping the hot water to a heat exchanger in the lower wing; vertical 2 by 2 aluminum tubes within certain mullions handle roof drainage and kitchen exhaust air.

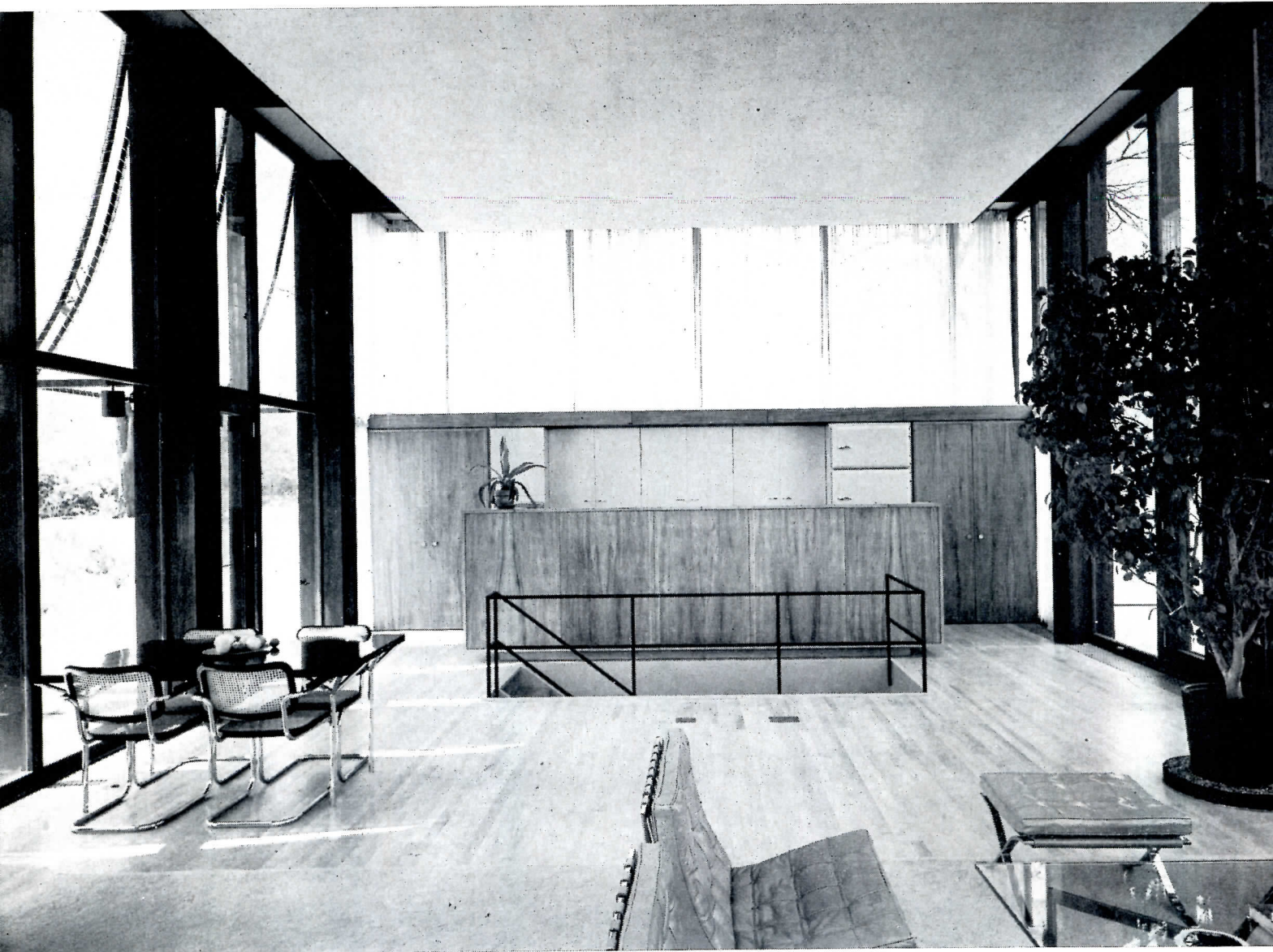

© Ezra Stoller

## THE WILEY HOUSE

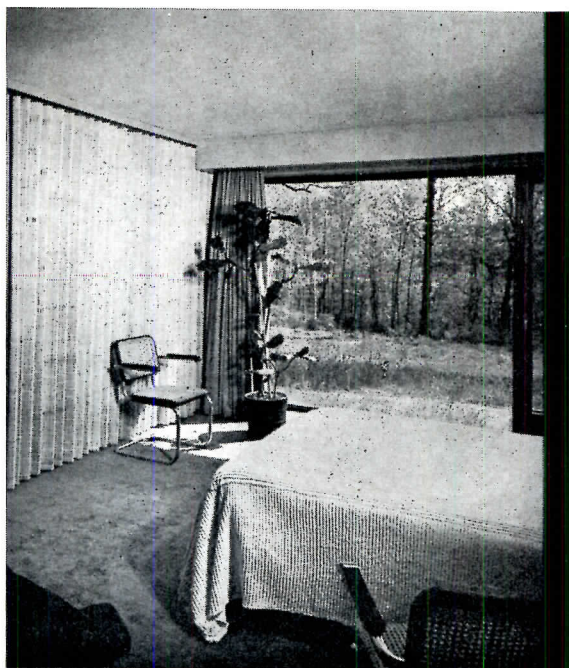

Above are two views of the master suite and a glimpse through the corridor toward the playroom and informal dining space. At this lower level, the floors are wall-to-wall carpeted; ceilings and walls are plaster; the wood sash are stained to match the upper floor wood; hardware is satin chrome.

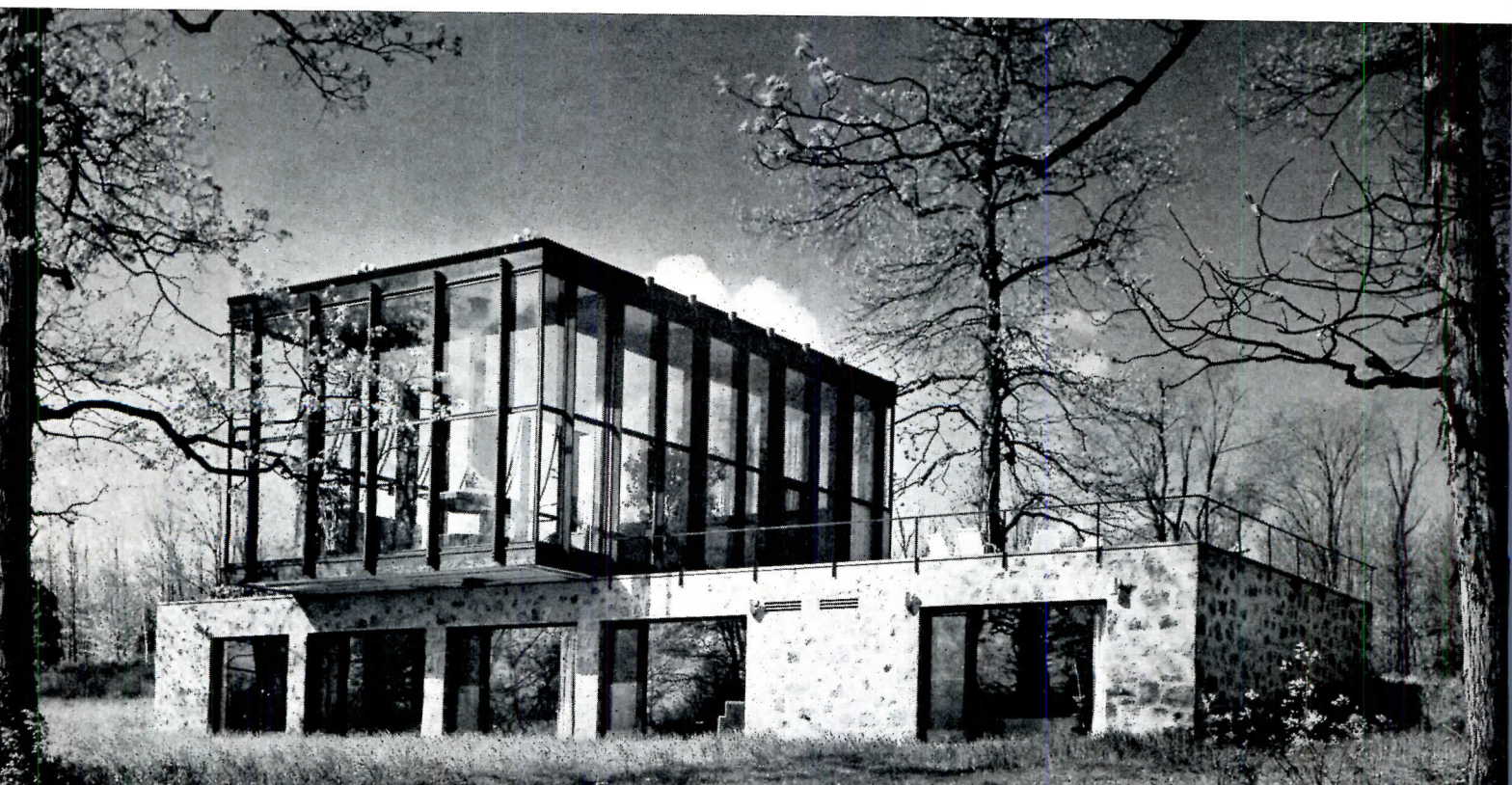

# UNITED STATES AIR FORCE ACADEMY

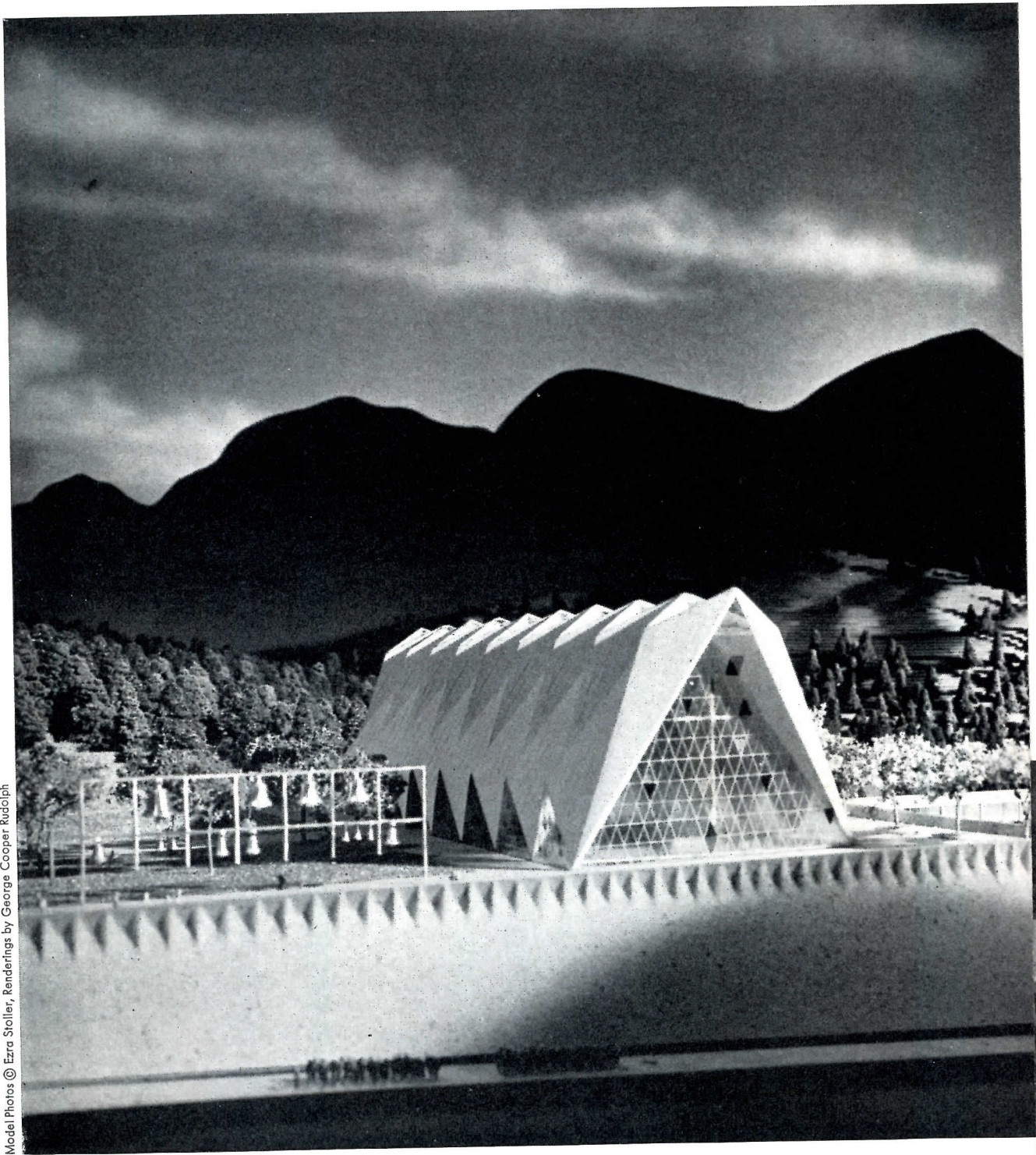

Model Photos © Ezra Stoller, Renderings by George Cooper Rudolph

**SKIDMORE, OWINGS & MERRILL, ARCHITECTS-ENGINEERS;**  
*Moran, Proctor, Mueser & Rutledge of New York, Robert & Company Associates of Atlanta, Syska & Hennessy of New York, Consulting Engineers*

**ARCHITECTURAL CONSULTANTS TO AIR FORCE SECRETARY**  
*Welton D. Becket, F.A.I.A., of Los Angeles; Dean Belluschi, F.A.I.A., of the School of Architecture and Planning of the Massachusetts Institute of Technology; and Eero Saarinen, F.A.I.A., of Bloomfield Hills, Michigan*

**DIRECTING OFFICERS AND AGENCIES — The Honorable**

UNITED STATES AIR FORCE ACADEMY

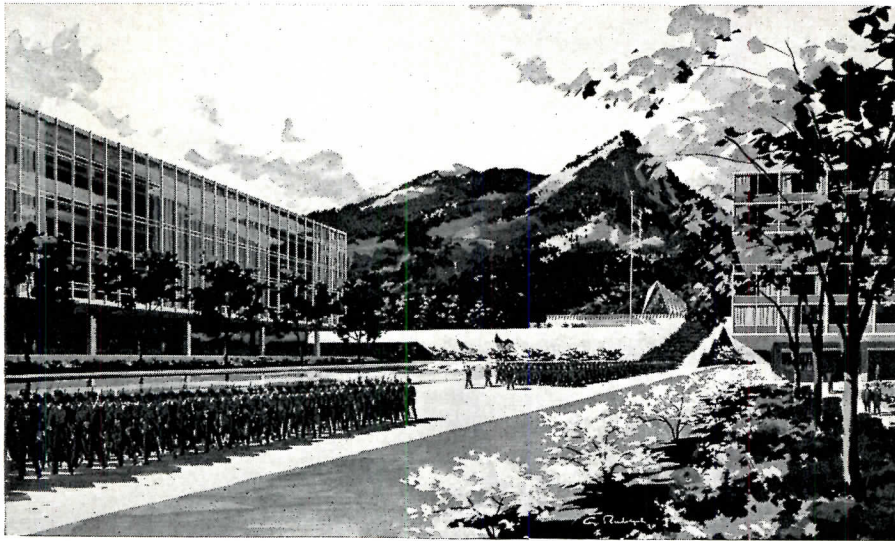

*Siting of cadet area gives Chapel a dominant location the architects liken to that of Mont St. Michel. Rendering at left suggests the series of plains that form the site — cadets march from Court of Honor, 50 ft below Chapel, across main campus, 25 ft below Court of Honor, past Cadet Quarters (end of easternmost unit visible at right) and down along pool bordering Library (at left), another 25 ft below the campus. Parade ground (see rendering bottom right) is still another 35 ft below. A series of terraces and broad, easy ramps will connect the various levels. Retaining wall below Chapel, and the others to be built all around the mesa site, will be of native stone*

*Design for Chapel, still under study, is proposed as counterpoint to discipline of other Academy buildings. As presently conceived, structure would be space frame of thin strips of aluminum filled in with narrow slabs of marble, giving the façade something of a mosaic affect; stained glass would be used not only at both ends and for side windows but for openings along ridge of roof. Entrances would be at sides, interior divided to provide 1650-seat Protestant Chapel and 600-seat Catholic Chapel on first floor, meeting room for Jewish services on level above. Social hall (at left in rendering) will have open galleries on all sides. Lowest of three levels will be mainly for cadet use*

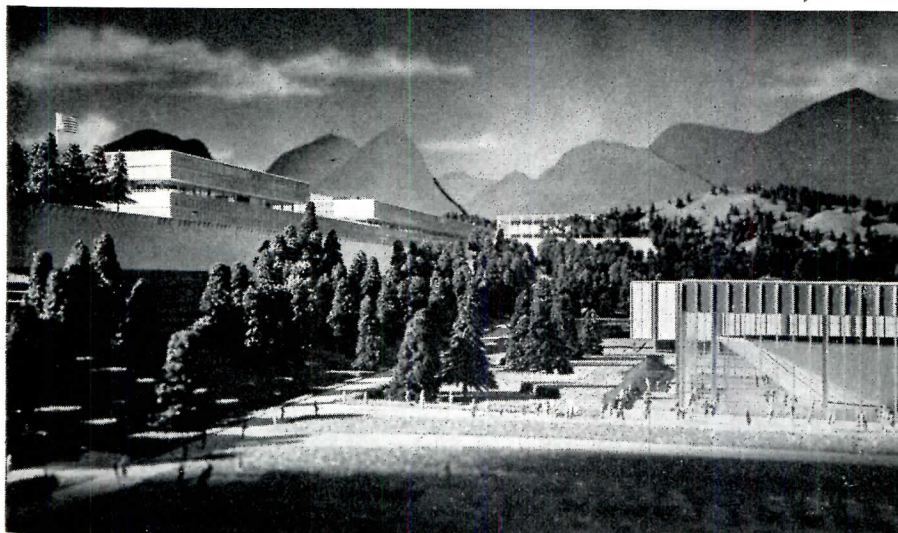
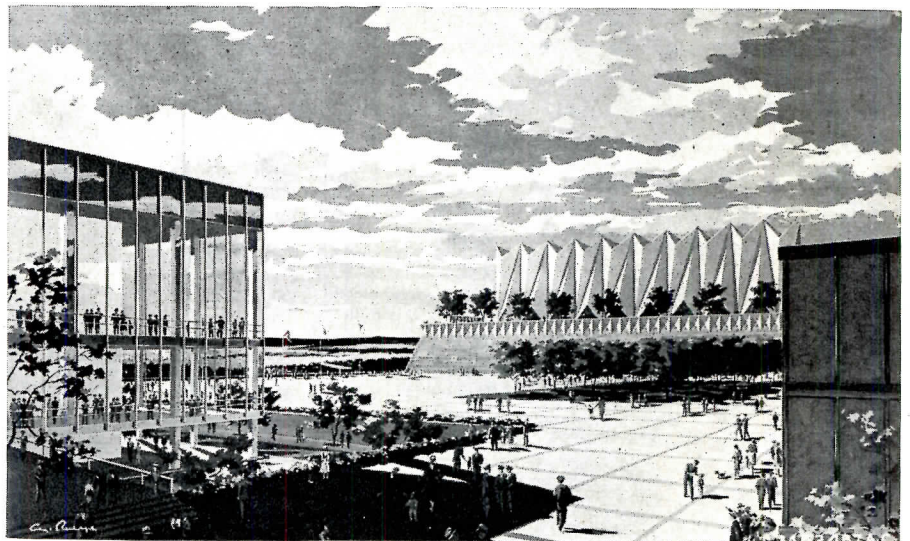

*Cadet Quarters are at left, above retaining wall, Basketball Arena lower right, in this view of model. Quarters, 1800 ft long, 250 ft wide, are planned to utilize a hillside site by providing two basic buildings, one above and one below an open arcade at main campus level. Design is based on projected organization of cadets into six groups of four squadrons each, will provide for squadron and group integrity by allowing for each group to be located around a quadrangle on two floors. Cadets will be assigned two to a room, with 300 sq ft allowed for each two men. Basketball arena is conceived as free standing concrete bowl to seat 7500 housed in square glass and steel structure 250 ft by 250 ft*



# WHAT MAKES A GOOD SCHOOL BUILDING?

by Frank G. Lopez, A.I.A., Senior Editor, *Architectural Record*

This article is published as a public service at the suggestion of, and in close collaboration with, the Subcommittee on "What Are Our School Building Needs?" of the Committee for the White House Conference on Education. It may be used by any of the several state and regional conferences on education as they may desire. It should be noted that the Committee for the White House Conference on Education has taken no position regarding Federal, State or local authority over school building expenditures, and that statements in the article on this subject are attributable to the author. The article has been reviewed by Professor W. R. Flesher, Consultant to the subcommittee on building needs, President of the National Council on Schoolhouse Construction and Head of the Division of Administration and Finance, Bureau of Educational Research, Ohio State University; and by the Committee on School Buildings of the American Institute of Architects.

## Is There One Ideal School Building?

School building requirements are rooted in local problems, and a good school is, among other things, one that leaves no local need unsatisfied. While education in all parts of America has the same goals, and although we strive to bring all our children to maturity with equally satisfactory opportunities to grow in experience and in capacity to reason, there are — thank goodness! — many ways to reach these ends. Such healthy differences of opinion and varying educational philosophies mean that while for each individual school there may be an ideal building, none can be called the ideal for all. Each locality or community or school district — often guided, it is true, by state or national organizations or departments yet nevertheless making its own decisions — delegates to its local board of education the job of formulating educational policies that suit its needs. Each board selects superintendents, principals and teachers to advise it, to administer the policies and to instruct, using the school building, its grounds and other facilities (that is, the school plant) as they do so.

## How Is a Good School Building Obtained?

The architect and the educator must work together to provide a good school plant, each recognizing the unique contribution of the other. The architect's function can be stated simply, though in practice it is highly complex. His is the responsibility for designing a building that will do for the community what the community needs done, in a manner and at a cost appropriate to the commu-

nity's situation, and for overseeing construction from start to finish.

Of the many factors which contribute to a good school plant, no one can be considered unimportant. Determining educational aims; selecting an architect; formulating needs in terms that can be translated into designs and so become the school's physical plant; selection of a site; development of the design to fit that site as well as the community's philosophy and pocket-book; determination of appropriate building materials, finishes and equipment; selecting teaching equipment of all kinds; purchase of operating supplies; making provision for maintaining the plant properly so the considerable investment of time, work and money is protected; selection and, if necessary, training of personnel — all interact so intimately that though their importance varies none can be neglected. Nor can good buildings alone guarantee a good school, though they facilitate its attainment greatly.

Suppose the custodian — or building engineer or janitor or whatever he may be called — does not understand complex modern mechanical equipment. He may cause an expensive, potentially valuable heating system to malfunction, if not to break down completely. Sometimes a site must be used even though it is far from ideal. The worst, however, can be imaginatively used — its faulty orientation turned to advantage by, possibly, reversing the normal position of a school's parts; a steep slope utilized by building in small units rather than one big mass, or by developing buildings part multi-story, part single story. This kind of study will be seen to have a positive bearing on building design.

Bridging the gap between existence of school building needs and the start of school building design, although it sounds simple, presents a serious problem. We have also spoken of it a couple of paragraphs back as: *formulating needs in terms that can be translated into designs*. An architect sums up this process in the one word *programming*, in which he includes the essence of a community's nature and its beliefs concerning education, much of what the educational specialist calls an educational specification, all that the school administrator requires in the way of spaces, rooms, corridors, etc., individually and in their numerous interrelationships, and everything each teacher needs so that each

The author, in addition to his position on the editorial staff of ARCHITECTURAL RECORD, is a member of the American Institute of Architects and of the American Association of School Administrators, a Department of the National Education Association. He gratefully acknowledges the large quantity of ideas and information derived from the work of the country's leading educators and architects; in particular, he thanks N. L. Engelhardt, Sr., educational consultant, for permission to incorporate in the article portions of a forthcoming book, "School Planners Handbook," by Engelhardt, Engelhardt and Leggett.

pupil may have the greatest opportunity to attain an education.

Stated thus, programming is hardly as simple a process as it may have seemed. Before an architect can provide a design, decisions are necessary, decisions as to what kind of school, for what age level, for how many pupils, to fit them to what degree for what kind of place in what kind of society. Is the school to be a stepping stone to higher levels of scholastic attainment? Conversely, is vocational or terminal education to be emphasized? Is the community a pioneering one, growing fast in response to social, economic or industrial needs? Is it relatively stable, and hence desirous of having a relatively conservative educational plant? How much will adults use the plant? The answers to these general questions are difficult to ascertain even within very broad limits of accuracy; yet they are judgments which have to be made with care, using all the bits of knowledge from all the sources of information — statistics, conversations, discussions, surveys formal or informal — that may be available. They directly affect the nature of school plants. From them are derived all the specific data which an architect needs if he is to produce blueprints and specifications from which a building can be built. Even more important, however, no school plant can hope to display those qualities of heart and soul, of attractiveness, of appeal, which foster pride in every member of the school community from grandparent to kindergartner, unless these judgments are soundly based and sympathetically interpreted. This is partly the community's responsibility, partly the educator's, and partly the architect's.

Ideally, it is true, the community and the educator, between them, furnish the architect with a program. Certainly, even if the architect formulates it (and he often does) the major share of responsibility for it remains the community's, while the responsibility for its execution is the architect's. The educator's responsibility is dual; he is the trusted mentor and the public servant, a professional whose guidance is essential during the programming process so that, when it is built, the school plant will function well and become both a satisfying tool for learning and a true source of pride and joy to the entire community.

### How Are Quality and Cost Measured?

Today more than ever the school board wants the most in working building for its hard-to-get dollars. The local tax rate and the good graces of neighbor-constituents are important; board members, too, pay their share of taxes and desire to live in harmony with their fellow citizens. At the same time they have also a mandate to spend, not too little, but just the right amount. It is all too easy to cheapen a school structure so much that maintenance costs will soar year by year, so that in perhaps five years or less a school plant either becomes so expensive to keep in habitable condition that additional school construction to keep pace with demands cannot be started; or maintenance is neglected and the buildings fall into serious disrepair.

There are respects other than structure alone in which

sound architectural quality merits consideration at least equal that given to economy. The students, the teaching and administrative staff, and the entire community are affected both as individuals and as groups, and in their relationships with each other. If this seems to place the buildings which make up a school plant on a pretty high architectural pedestal, consider how many people are affected in one way or another, for how many hours out of a year, by school buildings. What others have so intense, so personal an importance to so many?

Virtually every member of a community shares the school tax load. In most communities the school building program is the largest single expenditure of public funds. We are rightfully proud of school buildings that are soundly built, that serve their purposes well during their useful lifetime, and that satisfy esthetically. A school building has intrinsic importance, but its site should not be on a super highway because heavy traffic seriously limits its usefulness; again, many a well designed school built in an urban or rural slum has been known to raise its community's standards socially, commercially and physically.

There are many other reasons for community concern with school buildings. The prowess of local athletic teams, opportunities for combating juvenile delinquency, social opportunities for adults (organization meetings, parties, and the like), facilities for the local library, for adult education, even for municipal government — good schools often provide all of these. Inadequate design or poor construction can seriously interfere with the success of such activities. Just as we can not be honestly proud of a shoddy building, just as we should be as ashamed of architectural extravagance as we are of a gaudily overdressed woman, so even the most inexpert layman has a right to insist on even more than architectural adequacy.

Each community's character is different from its neighbors'. We classify communities as rural, suburban or urban, but within these general groups are endless variations and the number of variants is increasing. Industry is decentralizing; the rural school that once served an agricultural community now serves an industrial complex as well. The suburb may be just a dormitory whose adult males' interests are concentrated in a relatively distant city; it may have close ties to the metropolis it serves; it may have life and identity of its own strongly developed, with its "dormitory" aspects subordinated. It may be old, possessed of a strong tradition; rawly new; quiet; bustling; progressive; conservative — and it may be several of these at once. It may be a commercial center, a production center, an educational center, or merely a place where a group of people find it pleasant to live. Whatever its nature, it is probably in the process of growing and changing.

The school that is any good is a reflection of its community's character. In its curriculum, in its administration, and in the nature of its buildings, it mirrors the people and situations which have given it reality. If the community is falsely interpreted, if the people who make the decisions estimate faultily their own present and future condition and needs, if the archi-

tect's design reflects these needs poorly, the school will fail its purpose. A sound estimate, conversely, almost inevitably leads to a more than satisfactory school plant. It is difficult to make this kind of estimate; the best professional advice obtainable is very nearly mandatory. Difficult or not, the estimate and its effects will be operative for many years. The buildings, good or bad architecturally (which means educationally and as civic symbols, too) will stand as nearly perpetual reminders of correct or faulty estimates made now. Another sobering thought: the pupils now actually in school will later be paying the greatest share of the cost of schools we construct.

### **Does Building Quality Affect Staff Performance?**

Nor is mere adequacy sufficient for the task the school staff faces. The best of mechanical equipment may be partially wasted in a school building whose space organization is faulty; a sound plan and fine teaching equipment may have little value in a building whose roof leaks or whose rooms are badly lit or ventilated. It is usually as cheap, even in first cost, to build reasonably soundly though without extravagance, as to build poorly; for a good architect, it is as easy to design well as to plan poorly — and the effects on the teaching staff are immediately apparent.

A school that "feels good" to its teachers is one in which they want to teach. Often this good feeling can be induced or enhanced by encouraging teachers to share in the educational planning for a new building. There are innumerable instances like the situation in Westfield, Massachusetts, where the erection of one new school of high architectural quality resulted in teachers from all the other schools in the city requesting transfer to the new building. The new provided facilities soundly built, well proportioned and arranged ("planned") to meet the needs of the established teaching philosophy, equipped in an up-to-date fashion though hardly overfurnished, and esthetically pleasing in composition. In response, not only were teachers anxious to teach in it, but also the level of teaching quality substantially improved. A part of the answer to teacher shortages lies in providing architecturally good and educationally functional school houses. In the instance cited, a small problem was, it is true, created in the other Westfield schools; at the same time word got around, as it usually does, that the community was improving its facilities. Other new school construction is likely, and additions to the school staff have been somewhat easier to find.

### **How Does Architectural Quality Affect the Pupil?**

More than any item of equipment it contains, the school building itself is to the student an instrument for learning. This obvious prime function of the entire school system is occasionally obscured by preoccupation with practical school matters. Yet, what could be more practical than the demonstrable effects of structure, equipment, space organization and esthetics on the developing child, or on the adult who is using spare time to improve himself?

Building regulations require that the school structure be safe, that it protect its occupants; that much we take almost for granted. Less obvious is the need for privacy in certain educational pursuits, of maintaining satisfactorily small instructional groups, of providing so positively for traffic through the building that people follow the intended routes naturally. These are matters of convenience which good architecture affords; they ease the learning process, making many a modern school a pleasant daytime habitation rather than a source of "Monday morning stomach aches."

Closely allied are contributions to children's physical well-being that come with the well designed school. Ventilation and heating standards have been in effect for years; so have lighting standards, though these last are being thoroughly revised. Such standards have often unfortunately been arbitrary in concept and in enforcement; an inevitable reaction to carelessness in providing light, warmth and air at one time was the cause of their almost universal adoption. Enlightened educators and architects now believe that, as each school site differs, so each technical problem in school design requires individual solution. Orientation, elevation, trees, climate of the locale and the micro-climate of each site are taken into account in good design, with results directly benefiting each student. To consider just one of the many technological aspects: at the Mayo Clinic, investigations have led to the belief that a quarter of an individual's total physical energy is used in the simple task of *seeing*. Poor visual conditions increase the percentage. Such findings are supported also by research at the University of Michigan and at Tufts College. The practical value of correct lighting, natural and artificial, is apparent.

To consider further the same architectural element, light: the quality of a lighting installation is directly affected by the nature of the surfaces that surround a student in a classroom. Texture can cause light to be reflected specularly or to be diffused. Both change the effect of light sources on students. Intensity of color controls the amount of light a surface reflects, with effects of parallel importance. The positioning, area, intensity and relationship of light sources — fixtures, windows, etc. — to other elements of the interior are of at least equal importance in obtaining optimum ease of seeing. Of such considerations, also, are the esthetic characteristics of a classroom interior composed. Generally speaking, a rationally satisfying disposition of all the components of lighting (sources, textures, color and color intensities, and the interrelationships involved) will also be esthetically satisfactory.

Architectural quality thus depends on both the practical and the esthetic, if indeed one can separate the two; and the importance of esthetics to the learning process can not be over-emphasized. Should the pupil mature knowing nothing better than the poor average of things cultural, or even hating his student days for their ugly surroundings?

The words "scale" and "proportion" are often used in assessing buildings esthetically. In schools, we say the buildings are best when "child-scaled." This is a

source of confusion. To some, suitability for students means, perhaps, the coy use of decorations based on yesterday's nursery rhymes, in a manner that an old maid might gush over. But children are realistic animals; they recognize falsity immediately; for their own convenience they may agree with a superior authority as to the cuteness of nursery rhymes while their private opinions may be quite saltily the opposite. The practice of deception thus instituted can easily become self-deception; the child may grow up to believe the coy decoration is really something good. And because his small deceit of authority has once won him praise, is he being well educated to become an upright citizen?

### What Are Trends in School Plant Design?

Certain developments in educational theory are beginning to appear, particularly regarding secondary schools, and these are having marked effects on building design. There is an attempt to continue into higher grades the practice of focussing instructional guidance on the individual to a greater degree than has recently obtained. At the same time, efficiency of operation at this grade level is imperative; the secondary school plant is costly and complex, its teaching staff and its operation are expensive. There have been attempts at coordinating the study of groups of subjects, of continuing group activities into the secondary school. There is increasing recognition of the student as a human being. Quite recently a noted educator reported a number of requests from private industry for delaying the start of specialized education; potential employees more fully rounded in the basic general learnings are apparently coming into demand, with technical training put off until later.

These and other trends, some well defined and some tentative, are bound to be mirrored in tomorrow's school buildings. Some effects are visible today. One intermediate school in California (grades 7 and 8) has a large materials and information center where students do research and requisition books, electric ranges, ceramic kilns, etc., transporting them on small trucks to their home rooms, which are quite large and have extensive project areas and counter space. The finger-plan school, developed first in mild climates, has been succeeded in some places by small clusters of from two to six classrooms, for high schools as well as elementary, with the clusters connected sometimes by enclosed corridors, sometimes by mere paths. The monstrously huge high school of the 1920's is being built today as a group of separated buildings, to reintroduce warm human values into school architecture. These examples indicate, also, the trend toward larger acreage for school sites. On the other hand, the cold facts of economics and architectural virtuosity have at times combined to produce school buildings all under one vast roof, with many interior rooms skylighted and partitions largely of glass. Still others are built around pleasant courts.

A recent development in high school building design is the "school within a school," which is simply a group of small secondary schools, each for perhaps 250 to 400 students and each housing portions of all secondary

grades. The units are organized around central structures containing services, administrative and instructional areas which can serve the entire compound — offices, gymnasium, and the like. Such a plant can be designed now for construction piecemeal as need arises; future units can be changed as future curricula may demand; the student has a chance to become a force within his small unit which he might never attain in the larger whole. Examples of this type are being built now in Connecticut, Missouri, Maryland and other states.

### Can Change Be Accommodated Harmoniously?

The structure must accommodate the educational program for a long span of years. If it is to be built soundly enough to result in low maintenance and operating costs a building will last for decades. So the building should accommodate change; as architects and educators say, it should be flexibly planned. It must do more than function well today, with spaces properly interrelated and proportioned and connected; it must be capable of alteration at low cost, of expansion, or possibly of being contracted or put to another kind of use.

Built-in equipment, then, should be so designed and placed that changes will not impair its functioning; this applies to heating systems, ventilation, plumbing, water supply, electrical services and the like. Teaching equipment, much of it, is portable; fixed items such as sinks ought to be carefully located. In this area it is easy to spend undue sums of money. Today's building services are very complex and expensive. Is the building designed so they can be installed and, later, changed with minimum difficulty? Is each type of installation the simplest, most direct? Is each sufficient, in quantity and quality, to provide the appropriate degree of amenity? It is easy to be over-penurious, as easy as it is to be wasteful. All the while such an evaluation of a design is proceeding, esthetic judgments have been in the making. When the order and organization of parts satisfy logic — that is, when we are satisfied as to their propriety for a given situation — the question, "Is this beautiful?" is half answered. Not always do the results look familiar; if the unfamiliarity is unreasonable it is probably right to question the design on esthetic grounds. On the other hand, if what is unfamiliar is the result of a sound, rational ordering of parts and equipment, in response to the demands of the local educational program and conditioned by such local factors as site, climate and community characteristics, then even a radical building design should hardly be rejected simply because it is radical. Nor should the minute aspects of, for instance, local "atmosphere" or character carry undue weight. It is not necessary to imitate wood moldings of century-old houses in order to bring a school building into harmony with its surroundings. Sizes, colors, textures, kinds of materials, together with such intangibles as openness or closed-in qualities, friendliness or austerity, are much more reliable means to harmony with local fundamentals. A molding or pane of glass is hardly a true guide when the aim is a school plant that is to express a community's highest aspirations for its future.

# RELIGIOUS BUILDINGS

FOR THREE GENERATIONS the depressing effect of bad architecture has been visited upon the worshipers of America. Because our church buildings have seldom appealed to our total interests, they have failed to satisfy us. It must be acknowledged that churches share this failure with other building types, but because they are churches the failure seems more poignant.

Most of our buildings have failed because they have not been drawn from and do not express the whole range of man's needs and the experiences which are constantly reshaping those needs. Our buildings are, rather, the expression of our interest in certain fragments of experience, in selected stimuli. At best it is difficult to treat with the whole of any problem. Architects are not alone in their tendency to overlook the evidence of man's total experience in favor of working with those experiences and ideas which happen to be particularly stimulating at the moment. Dealing with parts of experience and parts of ideas is easier. Moreover, by changing periodically the particular set of motivations the illusion of progress may be achieved. It is easier to organize building form if one eliminates many of the considerations which should normally influence form.

Ralph Adams Cram wanted us to shut out of sight and out of mind all our experience since Gothic. Today's architects are little different from yesterday's. We are simply motivated by a different set of exclusive stimuli. It is a rare architect today who is able to resist the fascination of concentrating his interest on a favorite material, shape or system of construction. Too often it is a predominantly intellectual fascination and as such necessarily fatal for the total interests of the people.

For architecture is an art which is apprehended sensually. It is a spatial art whose point of departure is utility and in which vision is the triggering sense. When the spatial and visual solutions to our utilitarian problems can be solved in such a way as to appeal also to our minds, we may achieve an architecture

that will satisfy the spirit. But an architecture which tries to appeal to our minds without satisfying our senses or accommodating our activities can never be more than a partially utilitarian, highly personal kind of sculpture.

That is where we are today, but we need not remain there. We have still the opportunity to focus first on the spatial, then the structural; on the sensual before the rational. Surely our best interests are served through concentration on those things which have the most pertinence for man and hence — architecture.

In the design of churches the need for a direction of interests which can be shared with clergy, church officials and building committees is more than ever imperative today. Church membership is growing at a rate faster than the population. The buildings demanded by both new and expanding congregations must provide for the whole family throughout the entire week. A much larger proportion of the building budget must be used for educational, recreational and social facilities. New structural methods, new mechanical systems, and new equipment of all kinds must be employed in order to fit the budget and the program and to compete with the attractions of secular activities. Finally a growing interest in the historical meanings of our ways of worship and their relationship to the architecture and art of our churches is forcing the reexamination of the appropriateness of the spatial and visual organizations which we have inherited from the very recent past.

These are relatively new and tremendously challenging determinants. Architects can meet these challenges. If they will, we can look forward once again to a significant architecture. There are signs of it even now and when added to the handful of good churches of the past ten years, there is cause for encouragement. On the pages following there is apparent evidence of architects' concern for how people use buildings and how they respond to them.

*John Knox Shear*

# \* GRACE LUTHERAN CHURCH, TEANECK, N. J.

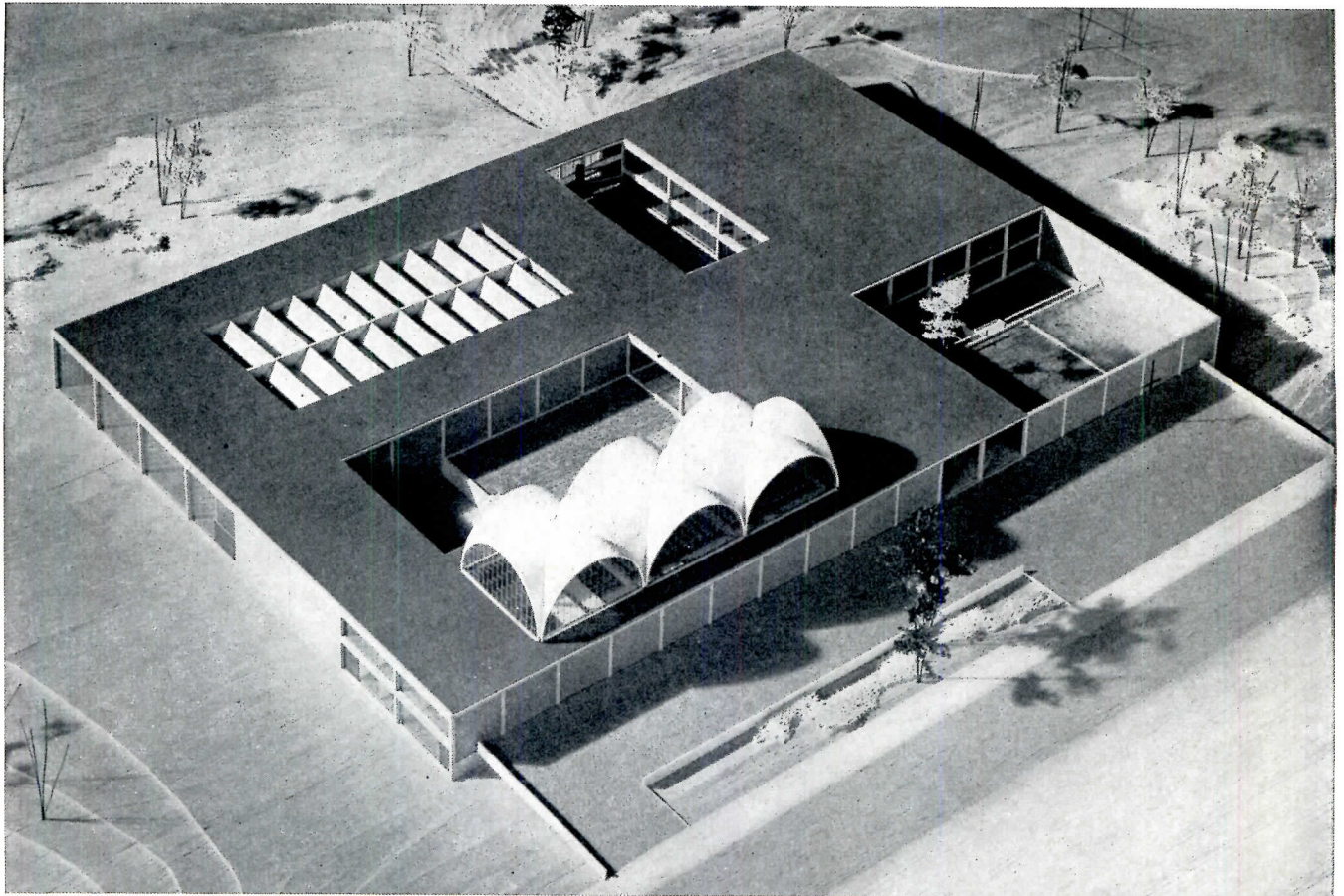

Howard Studio

*Paul Schweikher, Architect*

*\* Premiated in the 1955 Awards Program of the Church Architectural Guild of America*

IN THIS PROJECTED BUILDING, all of the problems normally attendant upon the integration of adjunct facilities with the sanctuary are not only present, but particularly insistent because of the necessity of providing for a fully-equipped parochial school plant. Here skillful handling of the courtyard is the great unifying device. An increasing number of architects are finding the use of the courtyard effective in church planning as well as in other building types. Proper organization of such sequestered outdoor rooms affords multiple values for all who use the church. As intermediate spaces arranged to prepare those entering the sanctuary from the street, their role is significant.

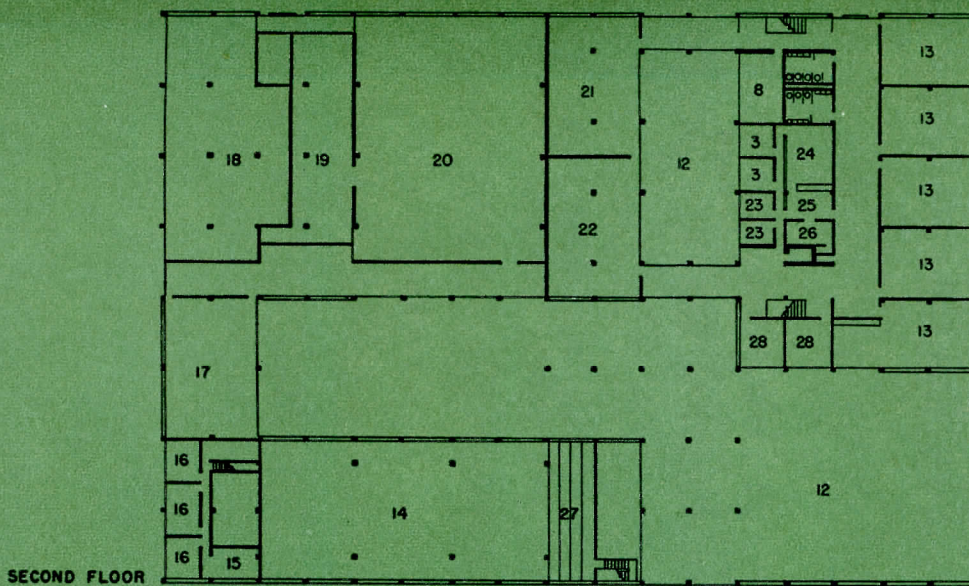

SECOND FLOOR

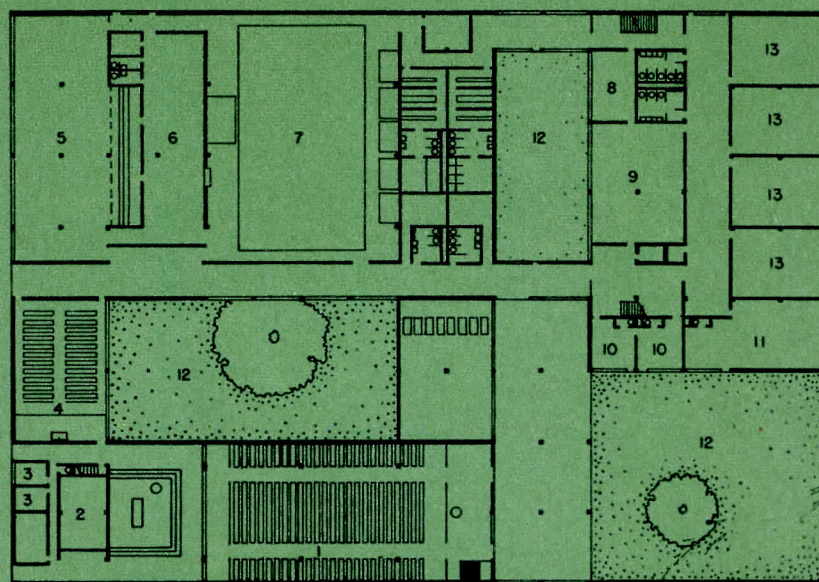

FIRST FLOOR

- 1 SANCTUARY
- 2 ORGAN
- 3 OFFICE
- 4 CHAPEL
- 5 CAFETERIA
- 6 KITCHEN
- 7 GYMNASIUM
- 8 FACULTY
- 9 LIBRARY
- 10 HANDICAPPED
- 11 KINDERGARTEN
- 12 COURTYARD
- 13 CLASSROOM
- 14 UPPER SANCTUARY
- 15 STORAGE
- 16 ROBBING
- 17 UPPER CHAPEL
- 18 UPPER CAFETERIA
- 19 UPPER KITCHEN
- 20 UPPER GYM
- 21 MANUAL TRAINING
- 22 DOMESTIC SCIENCE
- 23 AUXILIARY
- 24 GENERAL OFFICE
- 25 WAITING
- 26 HEALTH
- 27 BALCONY
- 28 ELECTIVE



In furnishing informal gathering spaces after services, they serve a time-honored and highly desirable activity. The spatial sensations and the resultant emotional situations that can be experienced in the juxtaposition of indoor and outdoor rooms, are particularly appealing in a building which to a degree must compete with secular attractions. Finally, there is a powerful appeal to the intellect for both architect and church member in the recognition that in the courtyard there is an expression of a long tradition in buildings generally, and churches particularly.

The grouping of all the elements within an enclosing wall and the use of the groin vault

forms, further emphasize a strong link with an historical tradition.

Grace Lutheran's Senior Pastor, Rev. Theodore W. Beiderwieden, reports that though unusual, the proposal has excited real enthusiasm in the congregation and among denominational leaders.

Construction on the seven-acre site will begin with the educational unit which is planned for 300 children with two special sections for the handicapped, whose difficulty with stairs dictated ramp circulation throughout the building. This special requirement made still more difficult the architect's job of achieving unity.

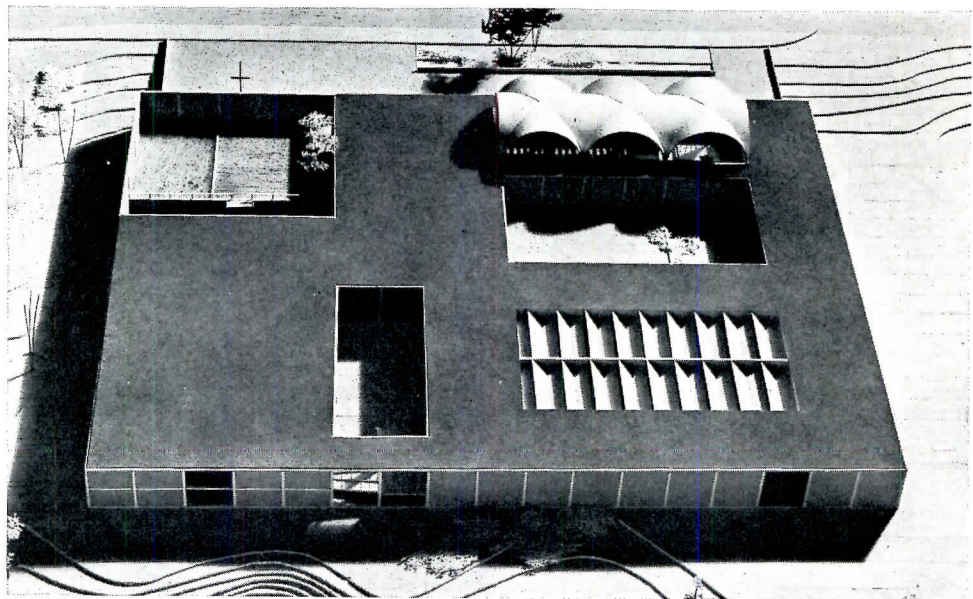
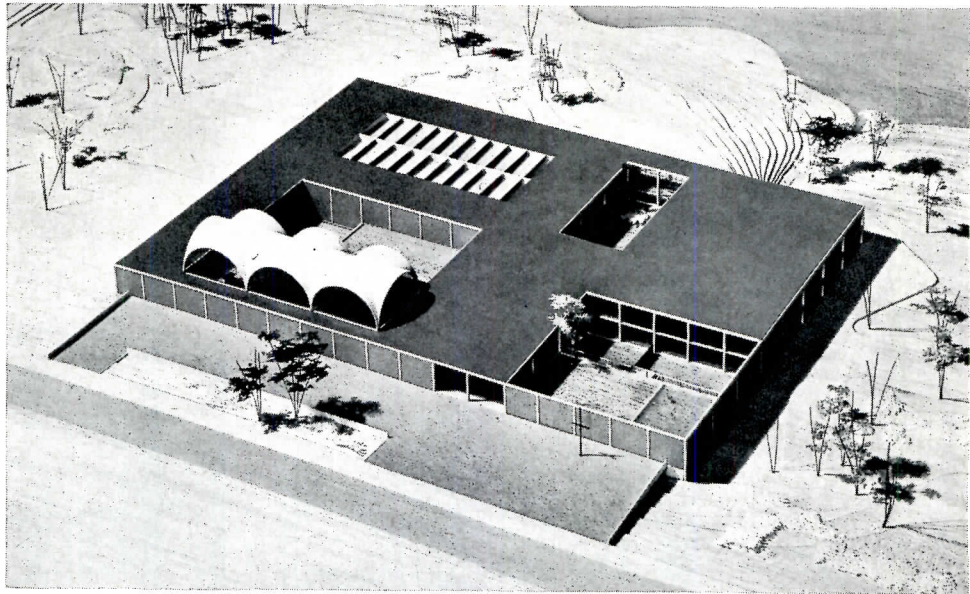

Howard Studio

FROM THE ARCHITECT: Mr. Earl P. Carlin of Schweikher's office reports: The structural system is to be an exposed concrete frame with curtain walls of masonry, glass or metal panels between columns.

One of Mr. Schweikher's purposes was to create a separate environment within the walls, not unlike the feeling of medieval monastic cloisters, hence the courtyards providing interior vistas. An additional advantage of this plan makes it possible, for reasons of economics, to build the structure in sections, with each unit complete within itself, eliminating the usual amputated look of partly finished construction work.

**Cost (Estimated): \$1,000,000**  
**Area: 52,000 sq ft**



# SEVENTY THOUSAND CHURCHES IN TEN YEARS

*By George Cline Smith, Assistant Vice President and Economist, F. W. Dodge Corporation*

**T**HE CURRENT UPSURGE of interest in religion is actually part of a long-term trend which has been expressed in rising membership of churches, both absolutely and in proportion to the population, through several decades. Other manifestations of this growing emphasis on church-going, which were noted in an article ("More Church Building Is Required to Keep Pace with Membership Growth") in last December's issue of ARCHITECTURAL RECORD, include a sharp increase in the number of members per church structure, indicating some tendency toward overcrowding, and a rise in church spending and building which seems to offer considerable room for further expansion to meet the demand of a growing, moving and more church-minded population.

The spiritual significance of this trend should be obvious. There is, as well, an economic side to the story of particular interest to architects and engineers.

The economic aspect of the situation boils down simply to this: it is reasonable to expect that in the coming ten years, some 70,000 churches and synagogues will be constructed or substantially altered at a total cost of nearly six billion dollars. In addition, there will be about 12,500 projects involving parish houses, Sunday schools and related buildings costing one and a quarter billion dollars. (Note: these estimates do not include parochial schools, which are classified as educational rather than religious buildings.)

This is considered to be a conservative estimate, in the light of past and present trends. It does make two important assumptions: first, that there will be no severe recession or depression during the period; and second, that there will be no major war. The estimate contemplates an average level of activity over the ten-year period somewhat below that of 1954 and considerably below the current rate

in early 1955. It is entirely possible, therefore, that the estimate may be on the low side, in view of our rapid population growth and movement, current prosperity and the increasing emphasis on church-going.

It has been estimated that somewhere in the neighborhood of 5000 architectural firms work regularly or occasionally in the church field. During the next decade, therefore, the average firm may expect to have about 14 church projects at about \$85,000 per job, and two or three other religious buildings at about \$100,000 each. This adds up to nearly a million and a half dollars' worth of work for the average firm in the church field, during the ten-year period.

These figures are based on contract awards reported by F. W. Dodge Corporation in the 37 eastern states, with an adjustment to take care of the estimated volume of building in the remaining 11 states. The average cost per job is calculated from 1954 reports, and the estimate assumes that there will be no substantial change in the value of the dollar.

Current activity in church construction is running at the highest rate in history. Contract awards for religious buildings in the 37 eastern states during the first three months of 1955 totalled \$128 million. That's an increase of 60 per cent above the previous first-quarter record set in 1951, and 61 per cent above the first quarter of last year.

The religious category in the first quarter of 1955 accounted for about 7 per cent of all non-residential building awards. This represents an enormous growth, not only in dollars but in share of the market, during the postwar period. In the corresponding quarter of 1946, the first postwar year, religious buildings totalled only \$17 million, and represented just 2 per cent of non-residential building.

The outlook for church building is bright. This is all to the good, because, in the words of Sir Thomas Browne, "They build not castles in the air who would build churches on earth; and though they leave no such structures here, may lay good foundations in Heaven."

# \* CHAPELWOOD METHODIST CHURCH, HOUSTON



F. W. Seiders

***Hamilton Brown, Architect  
Scheider Construction Co., General  
Contractor***

*\* Premiated in the 1955 Awards Program of  
the Church Architectural Guild of America*

THIS CHURCH is designed to seat 500; to furnish educational, social and recreational facilities for 200 at present, 500 ultimately; and to include a chapel for 100.

The sanctuary building and one-third of the classroom facilities have been constructed. Eventual plan includes two more of the courtyard centered classroom wings with covered passageways surrounding three sides of each court and interconnecting from court to court.

Particularly noteworthy is the fitness of the open courtyard units for a growing church where the budget permits building only one unit at a time. The overhangs of porch and passageways particularly suit the climate.

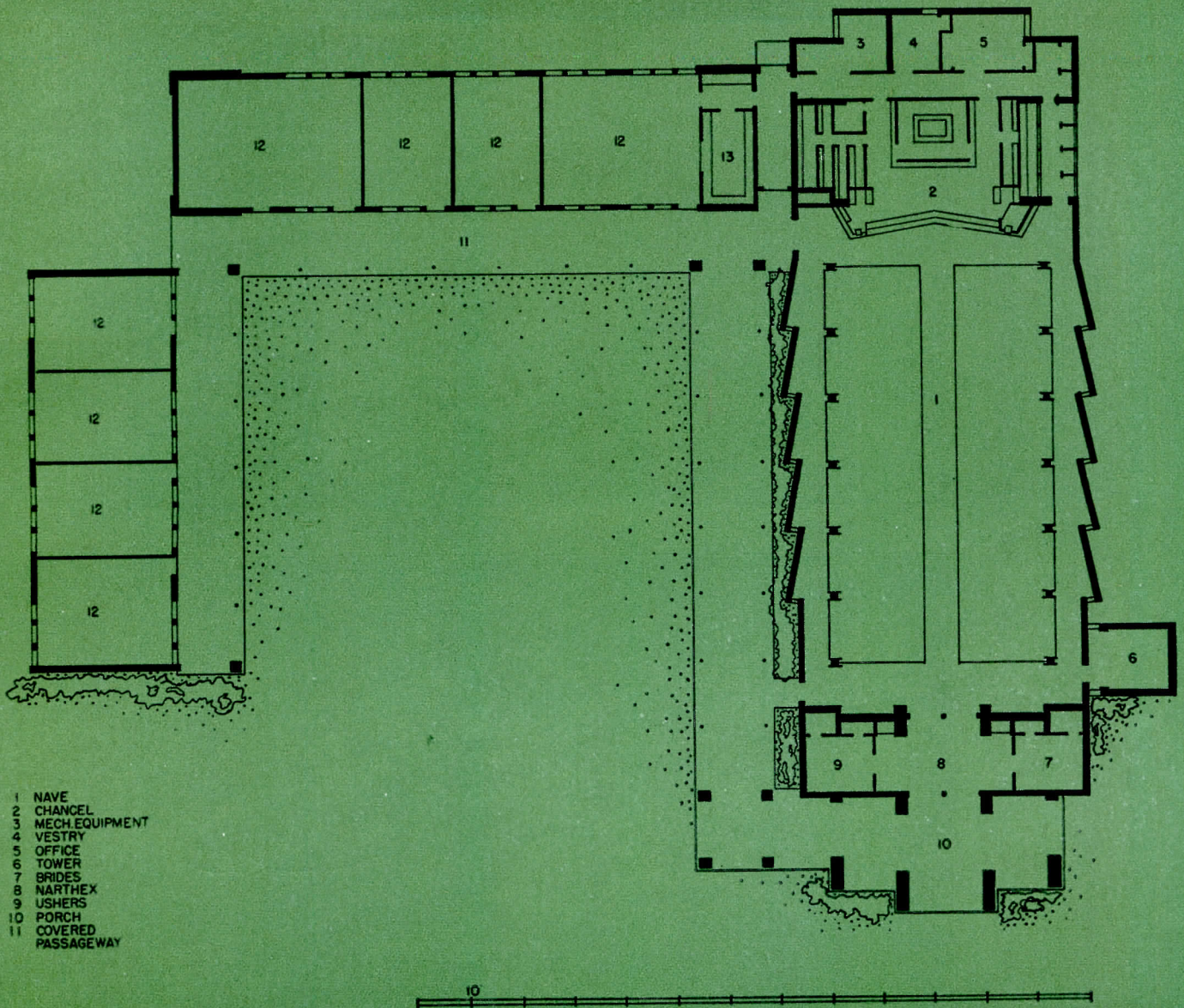

**FROM THE ARCHITECT:** This church serves a group of middle-income, young-to-middle-age people living an informal life in an attractive wooded area on the outskirts of the city of Houston.

Foremost in the mind of the architect was the thought that the environment created by the architecture must be closely related to the character of this particular congregation, as well as the form and content of the worship service desired by the congregation.

Emphasis is placed on the altar area of the chancel as the significant aspect of the worship service. Exterior light sources directed toward the altar area are arranged so that the original

source of light is not visible to the congregation when facing the altar. Interior lighting for night services has been designed to function in a similar manner.

The materials employed in the construction of the building are in the main used in their natural finish and lend, with their warmth, a character of informality.

The use of music has played an important part in the design of the building. Dramatic use of the choir may be employed through opening the ambulatory to the upper chancel sides and narthex to the upper nave, thus permitting processional music to carry into the sanctuary before the choir's entry.

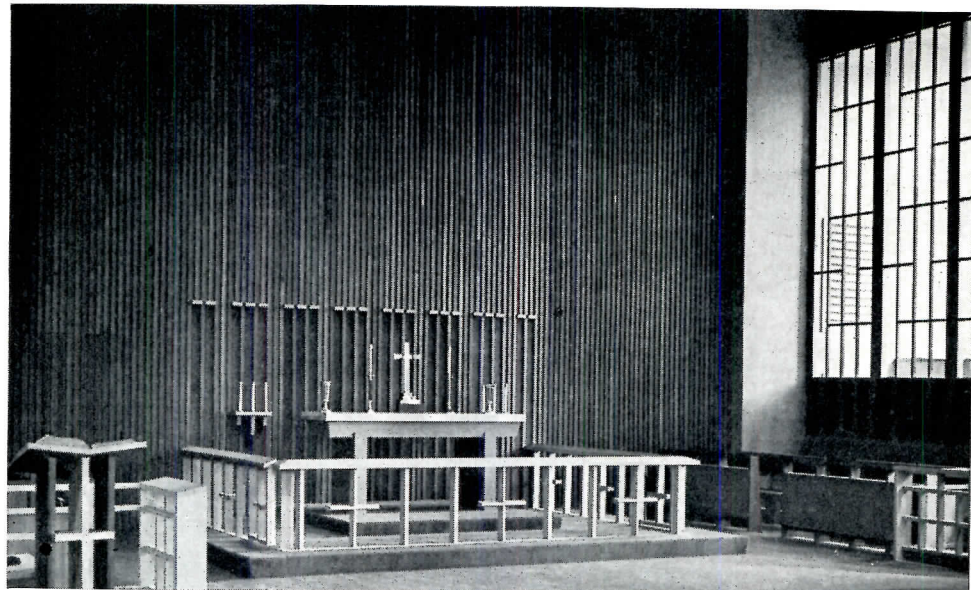
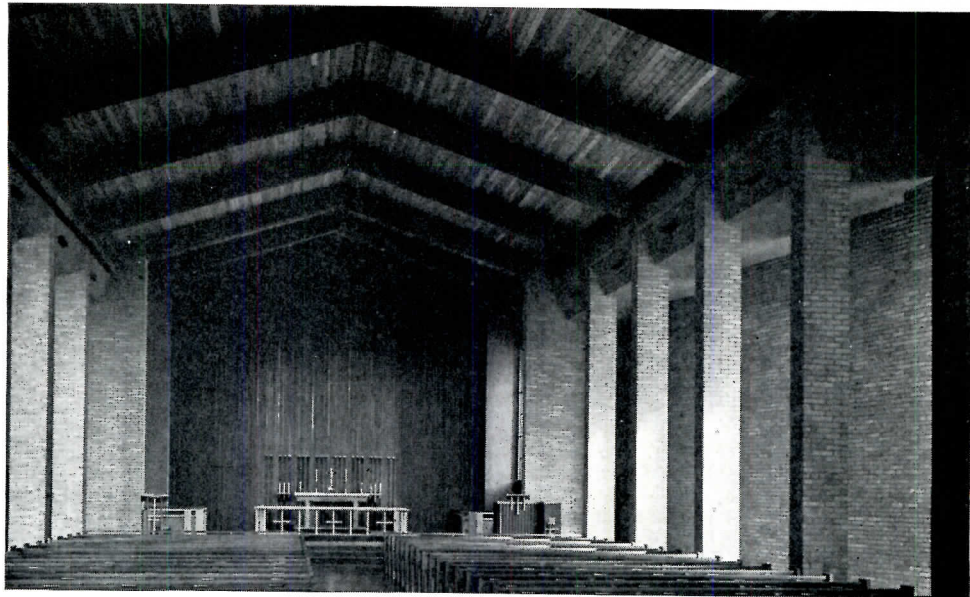

F. W. Seiders

*Nave framing is carried out with steel bents. Framing in the classroom wings uses wood trusses. Exterior walls of the church proper are of solid masonry; those of the classroom wings are brick veneer on wood frame. Interior walls of the church are handmade Mexican brick on the nave sides; perforated hardboard acoustical tile at the rear; and fabric-backed redwood staves at the rear of the chancel. Classroom interior walls are plywood. The roof is 4 in. tongue and groove cedar planking, built-up, gravel topped. Floor is cork tile in the nave; carpeting in chancel. Communion rail is in white birch.*

*Cost: \$187,174.62 (including pews and chancel furnishings; excluding land, landscaping, furniture and fees)*

*Area: 16,418 sq ft*

# CHARACTERISTICS OF TODAY'S CHURCH SCHOOL

*By C. Harry Atkinson, Executive Director, Bureau of Church Building, National Council of the Churches of Christ in the U. S. A.*

COMPARISON of a present day church building with that of yesterday reveals some striking changes. Adult worship once claimed practically all of every church building dollar. Today, a seven-day-a-week program of purposeful activities for all ages demands facilities running all the way from the babyfold and crib to craft rooms for elder citizens.

## *Planning for education*

Fifty cents of practically every church building dollar are now expended for educational purposes and for a variety of indoor and outdoor recreational and fellowship facilities. A present day church, when planning educational facilities, is giving far greater attention to the details. Rooms are being related definitely to the capacities and interests of each age group; are being planned in relation to each other, with a view to better administration and greater flexibility of use and space. Far more attention is being given to the philosophy of education and to the psychology of the pupils than heretofore, and as a result, the buildings are much more intimately related to the needs and interests of growing and developing persons.

## *Four basic questions*

The questions which the modern church school planner asks of the church school building are these:

Is it healthy, and safe, and comfortable?

Is it designed to further the learning program of children and adults?

Is the space so designed, and is the building so constructed as to permit greater flexibility in the use, and in the greater variety of activities so the educational pattern and the grouping of the children are not frozen?

More particularly, is the teaching space in which children live and work while within the church attractive?

## *Search for the spiritual*

These questions indicate that today's church buildings must be planned from the inside out and must be geared to human requirements; physical, psychological and spiritual. The complicated structure which makes up the modern church is beginning to show a new honesty, efficiency, and esthetic quality by which tangible expression is given of the functions of the church in modern materials and by means of modern methods of construction. The better work today carries with it intimations of the long spiritual heritage of the Christian Church.

## *Church School conference*

A recent three-day conference brought together for the first time architects from various sections of the country, nationally recognized religious educational specialists for each of the age level groups, and the church building executives of the churches comprising the Bureau of Church Building of the National Council of Churches. During this significant conference, certain standards for educational space and equipment for today's church edifice were arrived at. The following statement of the recommended requirements is a far cry from what was acceptable a few years ago.

## *Creative teaching*

Foremost in the thinking of this conference was a concept that teaching is a much more varied, democratic, and creative undertaking than that of imparting information to children and youth while seated about a table in a cramped classroom. Emphasis was placed upon ample space, especially for small children to permit greater freedom of movement, a variety of purposeful activities, and the avoidance of over-crowding — so detrimental to the physical and psychological well-being of children.

The following norm of standards were adopted both as to maximum pupil load per room, square footage of floor space per pupil, and as to general characteristics of spaces within the buildings.

*(Continued on page 189)*

\* K. T. I. SYNAGOGUE, PORT CHESTER, N. Y.

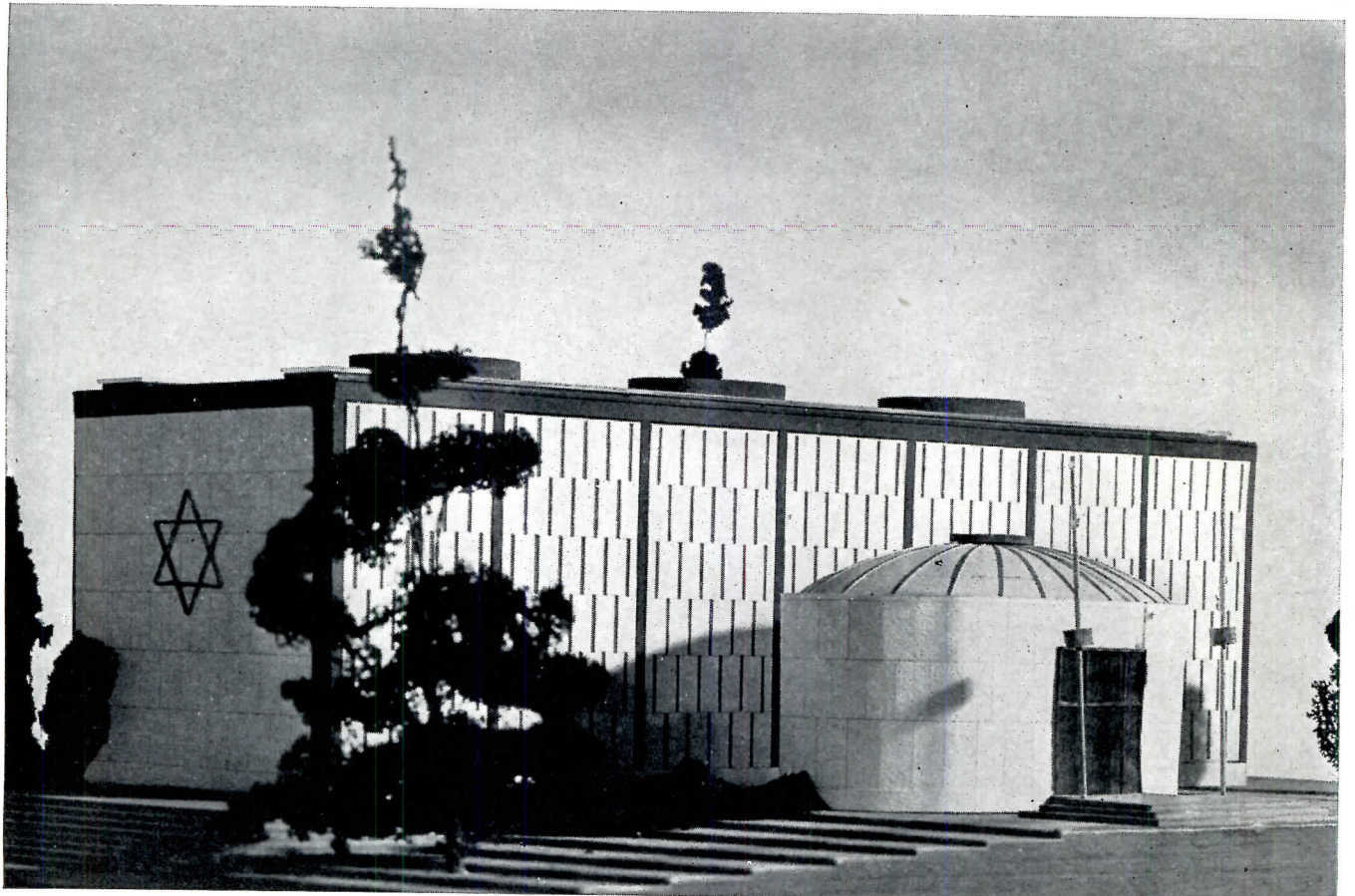

Emidio De Cusati

*Philip C. Johnson, Architect*  
*Marcello Mezzullo, Contractor*  
*Richard Kelly, Lighting Consultant*  
*John Johansen, Stained Glass Consultant*

\* *Kneses Tifereth Israel*

IN THIS SYNAGOGUE, whose sanctuary seats 300, it is necessary on certain occasions to accommodate more than 1000. The social hall can seat over 700 for services or 400 at dining tables. The daily prayer room seats 150.

The direct handling of this practical problem of flexibility in such a way as to make a virtue of the necessity is particularly noteworthy. The employment of the curvilinear entrance room as a space of preparation is unusual and effective. The ceiling treatment in the principal room, its height, and the pattern of stained glass slits are worthy of remark. Construction is planned for completion in October of this year.

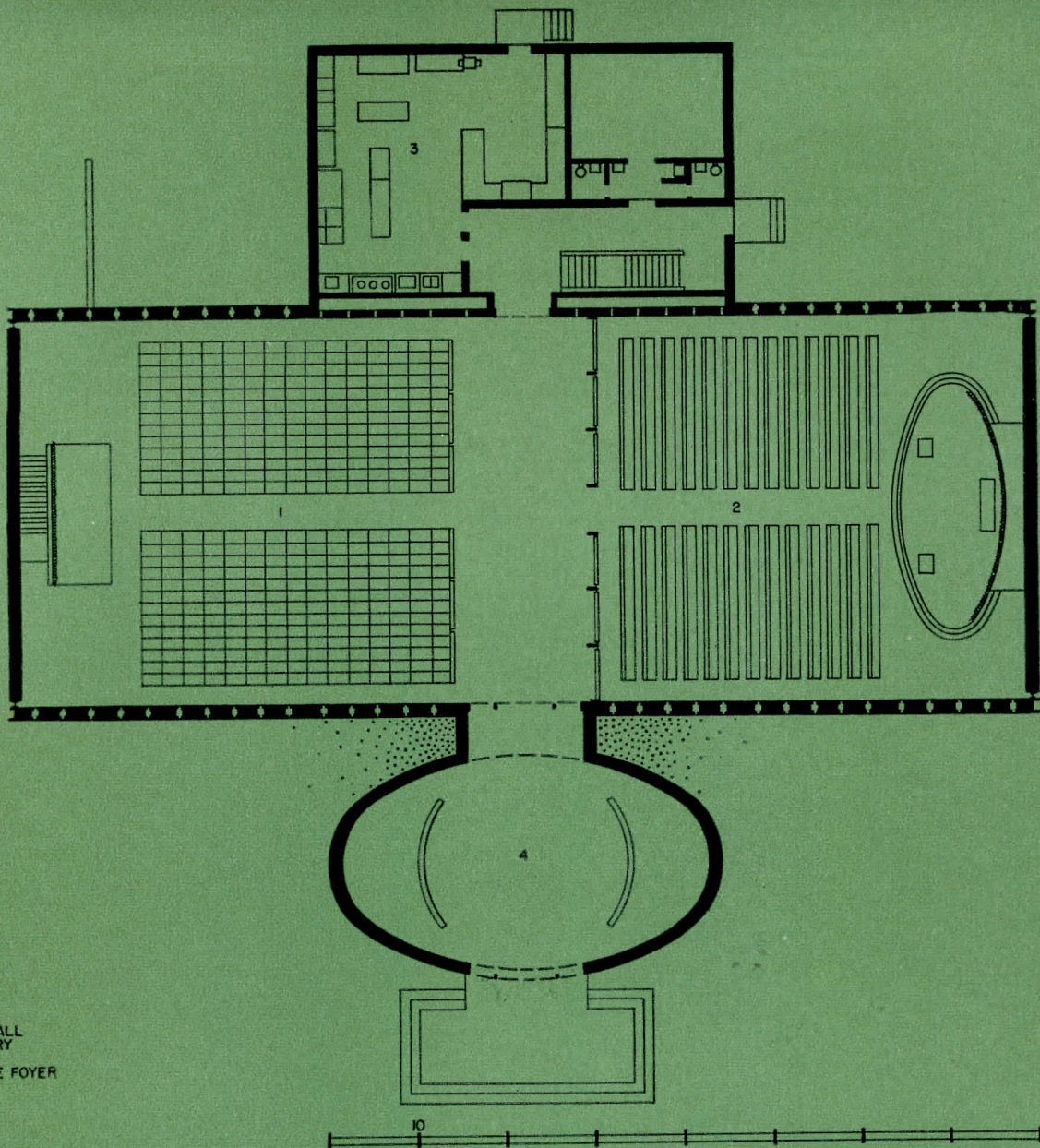

**FROM THE ARCHITECT:** The plan of KTI differs from most contemporary synagogues, in which the Temple is separated from the social hall by a complete wall, in that it is conceived of as one room 37 ft high with 8 ft partitions only between the part used as sanctuary and the part used as social hall. By this means the building looks its best on High Holidays when the maximum audience attends the services.

To introduce hieratic and professional effects the entrance foyer is constructed as a separate building oval in shape, thus preparing the visitor more than would the normal vestibule. In order to introduce more spiritual feel-

ing into what has been the rather cold style of architecture which we call modern, I have, besides designing ceilings higher than the usual synagogue, introduced vaulted "sails" of plaster which are intended to give a sense of containment to the space and also to act as light baffles for daylight and artificial lighting. The entrance pavilion has an oval dome to suggest the interior as well as to free the exterior pavilion as a shape set against the rectangularity of the main hall.

The exposed steel skeleton, however, still dominates the design. Only the infill is new: door size slabs of artificial stone separated by 8 in. by 7 ft lights of stained glass.

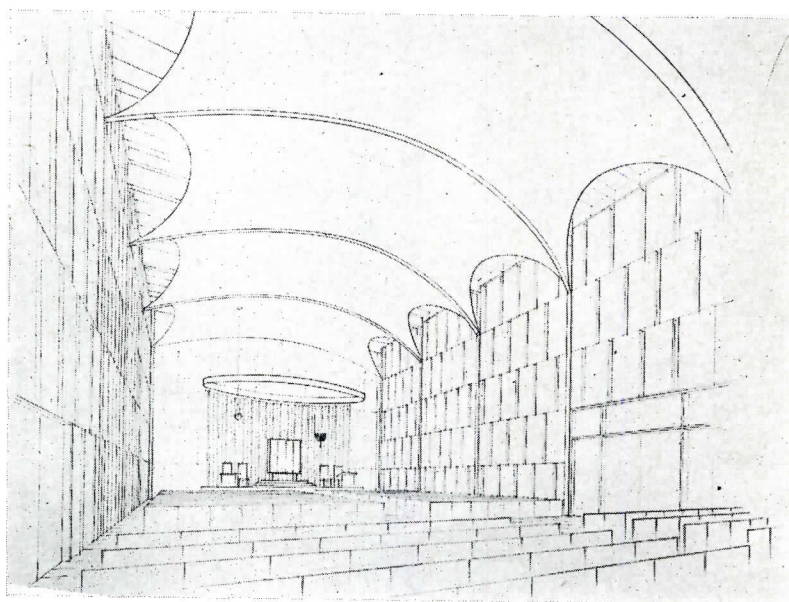
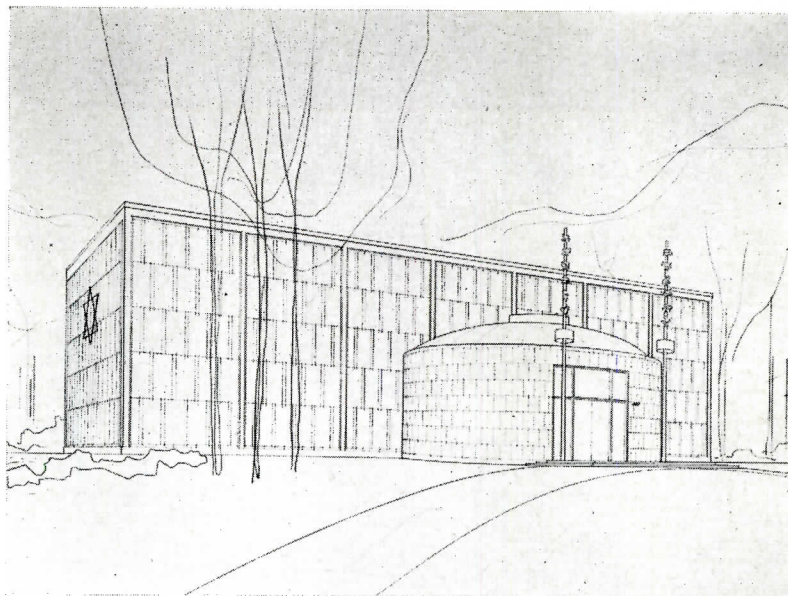

*Foundations of this building are in reinforced concrete; framing is entirely of steel in a carefully organized system permitting the exposure of the principal vertical members. Exterior walls of the synagogue consist of slabs of artificial stone 8 ft high arranged as infilling between the exposed steel columns. Interior walls are of plaster as are the curvilinear ceiling surfaces. Window openings are reduced to 7 in. slits and with their lights of stained glass spaced over the entire wall surface "should glow like a box of jewels" at night. It is expected that sculptural decoration will be added.*

**Cost: \$400,000**  
**Area: 15,000 sq ft**



# REQUIREMENTS FOR CHILDREN

## *Under three years*

The basic consideration for this age group was: how can the church best serve the family unit, both parents and children during their infancy and earliest years. Where the church assumes responsibility for children of two years and younger, the following standards should be strictly adhered to:

Floor surfaces should be easily cleaned and warm enough for small children to sit or play on them comfortably.

There should be a separate place for each 12 infants (not walking) or for eight toddlers. Separate rooms are desirable; separate space enclosed by dividers will serve.

There should be space to permit 3 ft between cribs for infants; toddlers should have at least 30 sq ft per child.

Toddlers should be provided with child's size toilet facilities, and a child's height wash basin for each eight pupils.

The size of the tables should be restricted to 24 in. by 30 in. by 18 in. in height for the nursery children, slightly higher for the kindergarten and primary departments.

Adjoining facilities should provide for heating and storing such food as may be required for small children.

While parents should not be permitted in the small children's rooms in the interest of sanitation, these rooms should be adjacent to and accessible to a reception area. It is recommended that a small room should be provided where a leader can take a small child who has become upset or ill to await the arrival of his parents in relative quiet.

It is important that a direct entrance from outside should be provided for the section of the building assigned to preschool children.

Windows should be of clear glass, and low — 24 to 30 in. above the floor in the nursery and kindergarten departments. It is not necessary to provide room for group activities other than those areas mentioned for children under three years of age.

## *Three year olds*

Here 35 sq ft per pupil is rated good. This permits space for moving about freely among the interest centers within the room which is so necessary for effective teaching of children of this age. Twenty to 30 sq ft per pupil is rated fair. Under 25 sq ft per pupil is rated poor.

It is recommended that not more than 15 children of this age should be in one classroom. Fifteen to 18 pupils is rated fair. More than 18 pupils, poor. Overcrowding often frightens small children who need individual attention.

## *Four and five year olds*

The same general standards recommended for three year old children obtain for children four and five years of age. No room for children of this age should be smaller than 15 ft by 20 ft, even if this makes necessary a temporary combination of two age groups within a given room. Dimension here is critical.

Rooms should generally be rectangular in shape with proportions of 3 to 4 or 4 to 5 ft. Wherever possible, the long dimension of each room should be on the outside wall to permit large window area. One wall should provide display space. Twenty pupils of this age group in a single room is rated good; 20 to 25 pupils fair; over 25 pupils poor.

Once children have attained elementary school age the church school pupil load is increased per room, and the square footage per pupil is slightly reduced.

Twenty to 30 sq ft per pupil is rated good; 20 to 25 sq ft fair; under 20 sq ft poor.

## *Six to twelve year olds*

Children in the grades of public school can be handled successfully in groups as large as 30.

Emphasis is placed upon the need to provide adequate storage space for every room.

There is a strong tendency away from the formal worship centers in the preschool and elementary children's classrooms. Today, all activities are carried on in a single room.

*(Continued on page 193)*

# \* CHURCH OF THE NATIVITY, HONOLULU, T. H.



*Law & Wilson, Architects and Engineers*  
*James J. Oberhausen, Electrical Engineer*

*Eugene Urbain, Mechanical Engineer*

*Harold Tanimura, Site Engineer*

*E. D. Phillips, Designer*

*Robert V. Davis, Furniture Designer*

*Richard R. Hadano, Contractor*

*\* Premiated in the 1955 Awards Program of the Church Architectural Guild of America*

THIS EPISCOPAL CHURCH provides seating for 380 in the sanctuary, 20 in the choir and 90 in a children's chapel. In addition, provision has been made for a Sunday school incorporating a day school for 160 pupils.

The organization of these facilities around the deep forecourt particularly urged bringing this building to the attention of architects who will recognize in the application of the ancient "atrium" element a rich source of appeal to the senses and the minds of those people who pass through it on their way to worship.

The walled courtyards on either side of the nave shut out the distractions of a nearby highway and complete the cloistered theme.

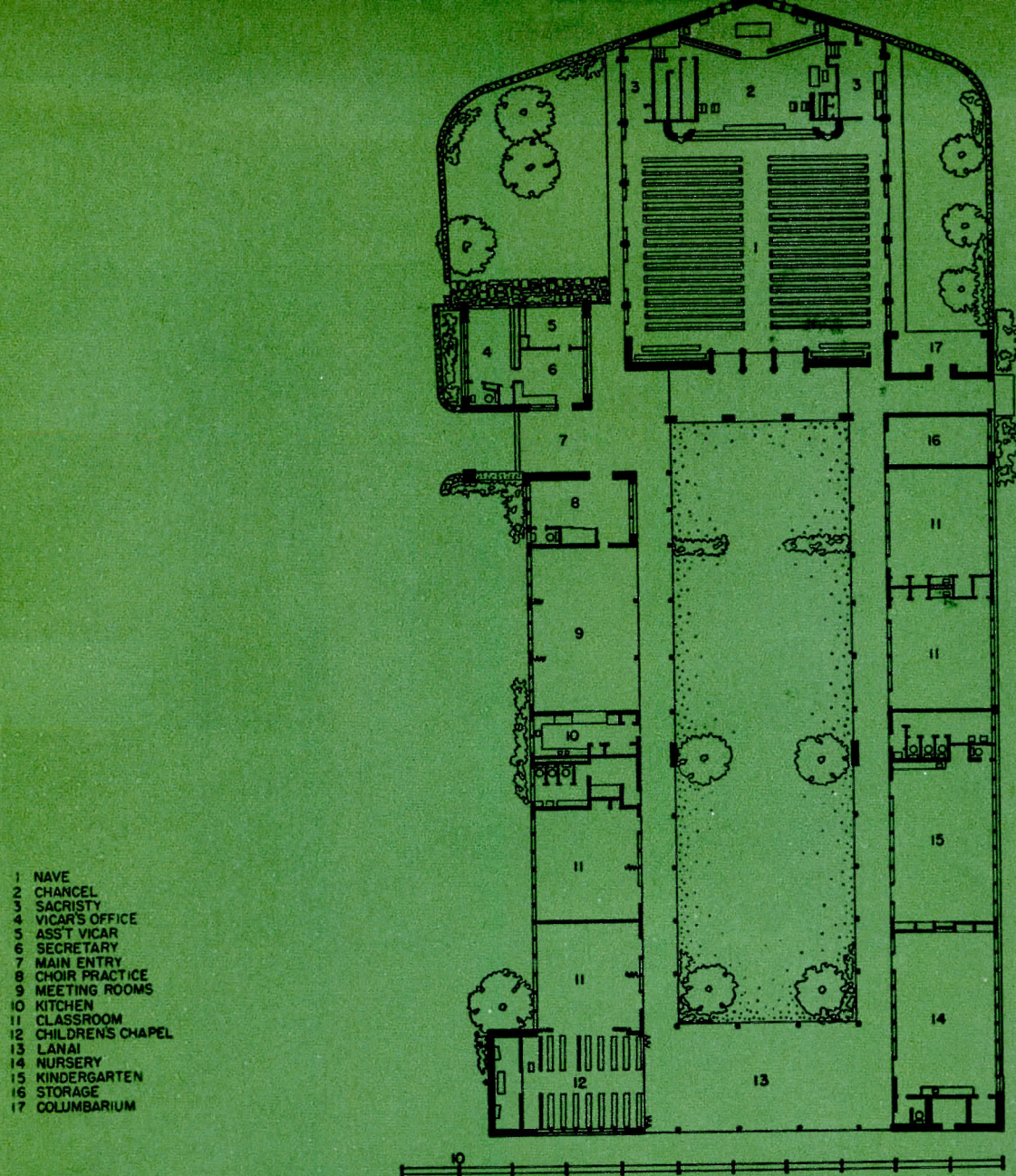

**FROM THE ARCHITECT:** The first small congregation of the Church of the Nativity had been meeting in a barn belonging to a local dairy, and it was perhaps this humble setting which led them to name their completed church after the Nativity of Christ.

In a four-stage operation, completely equipped day school rooms were built first, followed by partly completed Sunday school rooms and the children's chapel. This chapel served as the church for nearly three years. The day school had grown so that two classrooms were added, and last year the church was completed.

Much thought was given to ensuring that

the church should not be foreign to the land, that it should rise naturally from the soil and from the needs of its people. It is built of lava field stone gathered from neighboring hills. The pews, altar furniture, and panelling are made from the beautiful Hawaiian "koa" wood.

The distinguishing aspect of this church, aside from its adaptability to the Hawaiian scene, is its warm, family atmosphere. It was deliberately designed to draw children and parents together in their worship. The function of the courtyard in achieving this goal will be apparent. It is an integrating element of the strongest sort.

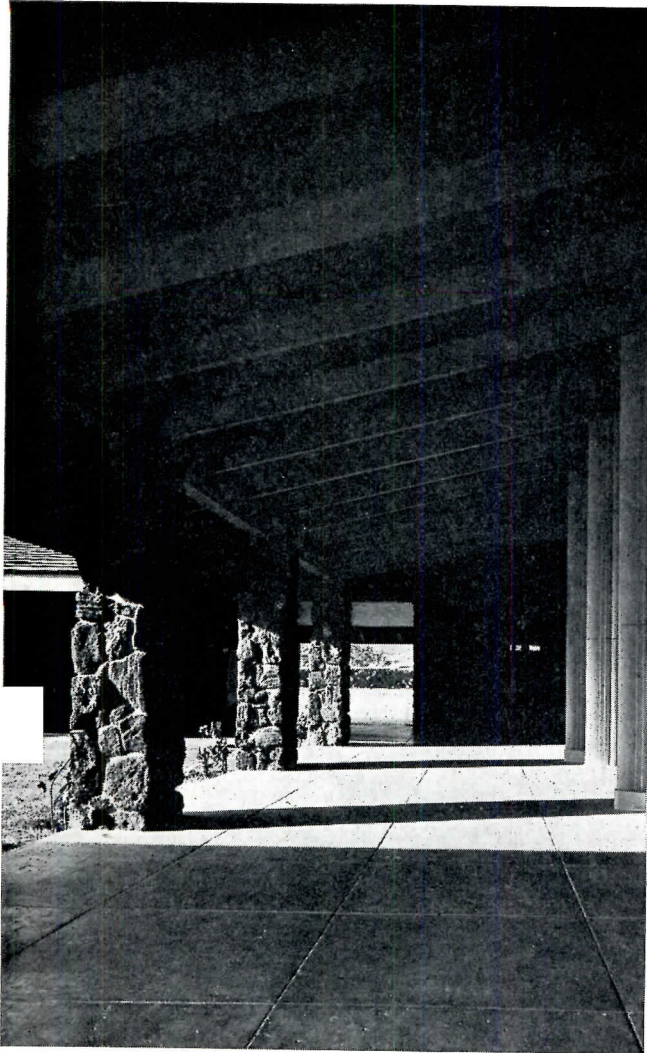

Williams

*Nave framing is laminated fir trusses. Exterior walls are of volcanic field stone gathered nearby. Interior walls are paneled in koa wood. The roof consists of 2 in. redwood sheathing covered with cedar shakes. Louvers are in redwood and glass jalousies are employed in the openings. Mullions, exterior cross, pulpit, lectern and altar rail are in cast stone. The lanai uses a coral aggregate simulating travertine. Pews are in koa wood. Altar and cross are in green marble.*

**Cost: \$196,533**  
**Area: 15,806 sq ft**

# REQUIREMENTS FOR YOUNG PEOPLE

Quite understandably the churches are spending a large share of their educational, recreational and social dollars on the age group 12 to 18; the junior and senior high school range. Appeal to these young people must be most carefully made in this stage of their development when steadying directions are difficult to achieve and maintain.

Provisions for youth activities in terms of space, equipment and particularly the character of the space are most critical matters. Here careful planning and good designs can often make the difference between maintaining the participation and enthusiasm of youth or losing them to completely outside interests.

## *Loads and spaces*

In the junior high and high school divisions, the recommended pupil load is 20 for junior high pupils and 25 for the senior high and older youth. Fifteen to 18 sq ft per pupil is considered good; 12 to 15 sq ft fair; and 10 to 12 sq ft poor. Here again, the provision of adequate floor space is deemed important to permit a greater variety of teaching procedures and a sense of freedom and livable conditions within a given room.

In some instances, pupils of this age will be provided with one room large enough to assemble the whole age group for such activities as they need to carry on as a unit. If this procedure is followed, there should be classrooms adjacent of the sizes mentioned where the classroom and more intimate study work can be carried on in smaller groups.

## *Extracurricular activities*

In many instances, these larger assembly rooms serve many purposes, and are often equipped with a small kitchenette which provides opportunity for sociable affairs and refreshments.

It is recommended that churches plan these rooms with a view not only to meeting the church school requirements, but also the extracurricular activities of young people.

In larger churches, snack bars and a rendezvous room where youth may gather for sociability under supervision, are much in evidence. Religious leaders find that young people will often discuss serious religious problems in these informal occasions, with the record player or television or radio going full blast. In fact, the informal gathering of people together within a church building is more and more becoming an important approach to a natural discussion of religious and personal problems.

## *Equipment and furnishings*

It is recommended that no matter what the numerical size of a class of young people is, the room should never be less than 12 ft by 15 ft in square footage. Here again, the whole concept of multiple use and flexibility of use is emphasized.

In youth departments, sturdy folding chairs which provide comfortable seating make possible a flexible arrangement and multiple use of space and equipment.

Chalk boards, maps of the roller type, plenty of cabinets for storing material, and carefully selected pictures with an appeal for youth are standard equipment for their rooms.

## *Reading and recreation*

Where the church budget will permit, a youth lounge with a fireplace is highly recommended for after church get-togethers and for discussion groups so much enjoyed by youth. Increasingly, a good church library with youth reference library is being installed in the modern church. Craft and game rooms in basement areas are important. The many clubs, Scout units, and other organizations of the church find increasing use for this kind of creative group activity.

While the trend is definitely away from gymnasiums and spaces for heavy athletic events, greater emphasis is being placed upon providing plenty of rooms of various sizes for the informal social gathering of small groups.

*(Continued on page 197)*

# INTERFAITH CHAPEL FOR TEXAS A & M COLLEGE

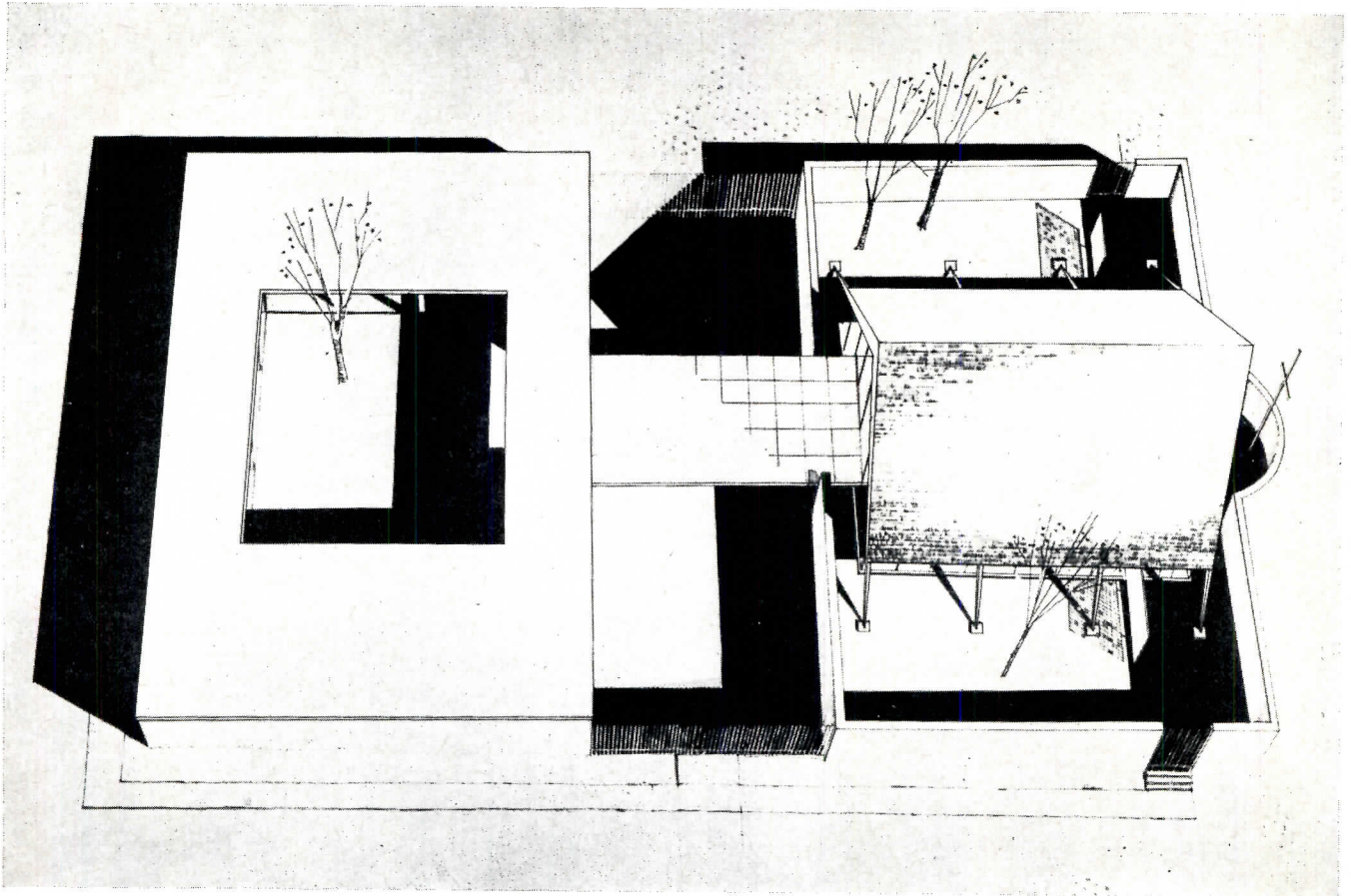

*Bolton and Barnstone, Architects*

THIS DESIGN for an inter-faith chapel was submitted in a competition open to former Texas A & M students. The program called for a chapel seating 200, and adjunct facilities consisting of rooms for administration, reception, library and conference, plus a garden accessible from the principal rooms.

The simple enclosing wall effectively expresses the meditative and worship functions of this building which was designed for a site on the busy Texas campus. The central outdoor meditation area is partially covered with a Plexiglas filled steel framework and paved with alternating rectangles of brick and marble chips and stones.

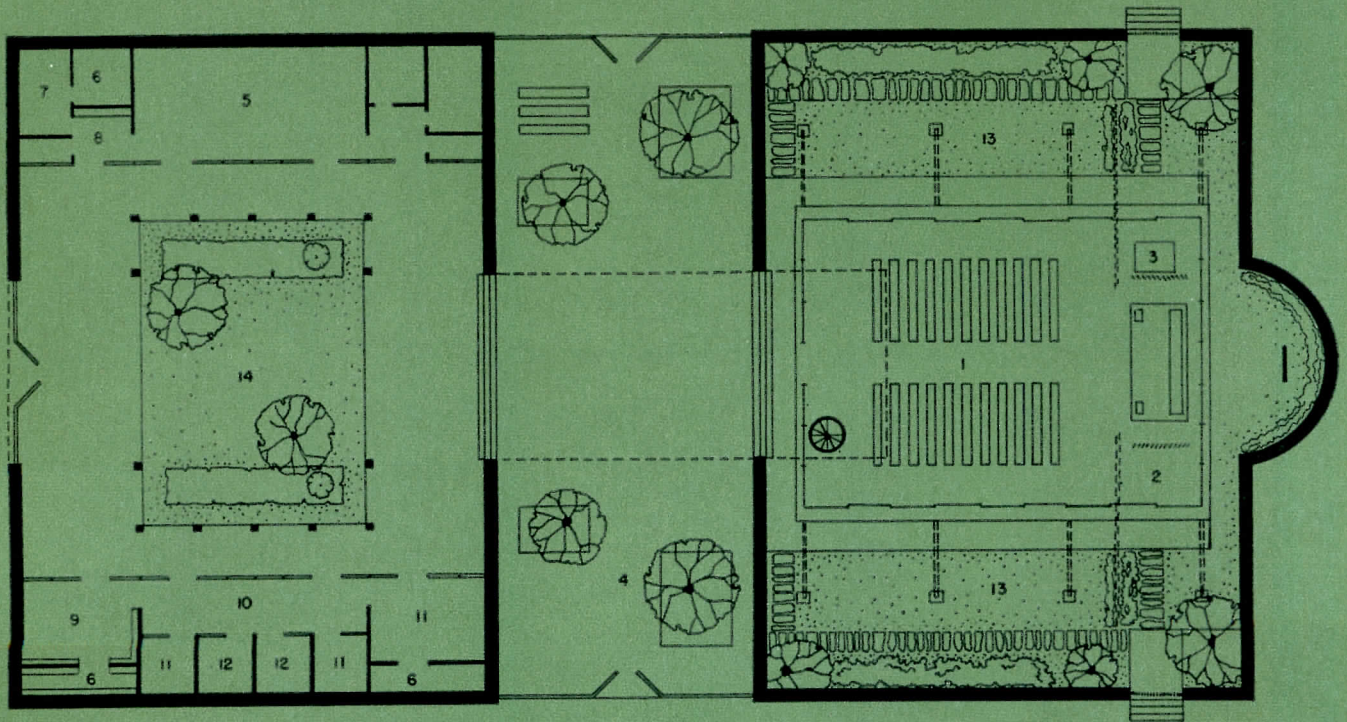

- 1 NAVE
- 2 ROBING RM.
- 3 ORGAN
- 4 OUTSIDE MEDITATION AREA
- 5 RECEPTION
- 6 STORAGE
- 7 MECH EQUIPMENT
- 8 KITCHEN
- 9 LIBRARY
- 10 WAITING-SECRETARY
- 11 CONFERENCE
- 12 OFFICE
- 13 GARDEN

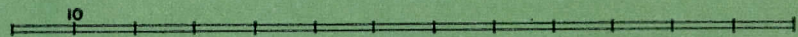

**FROM THE ARCHITECT:** In the near vicinity of the campus are churches of many denominations and faiths which provide religious services, educational facilities and fellowship to meet the choice of Christian and Jewish students. It is not intended that this Chapel shall provide the services furnished by those churches or supplant their importance in the community; but rather this shall be a place where men of all faiths shall find wholesome and inspirational environment for a moment of meditation and communion with God. Its purpose is to provide space for quiet meditation and discussion, a garden for beauty and enjoyment, an intimate and memorable

sanctuary for personal religious services, rites and ceremonies.

The gardens to either side of the nave are enclosed and made private by the brick walls and create a feeling of security and beauty. The choir loft is above on a projected balcony and may be used as auxiliary seating.

The court between the nave and the administrative area serves as circulation — as a place for occasional outside worship and as emphasis to the separate character of the Chapel and the administrative parts. Central to the entire design is the use of the garden courts. They provide the means of both extending and unifying the space visually.

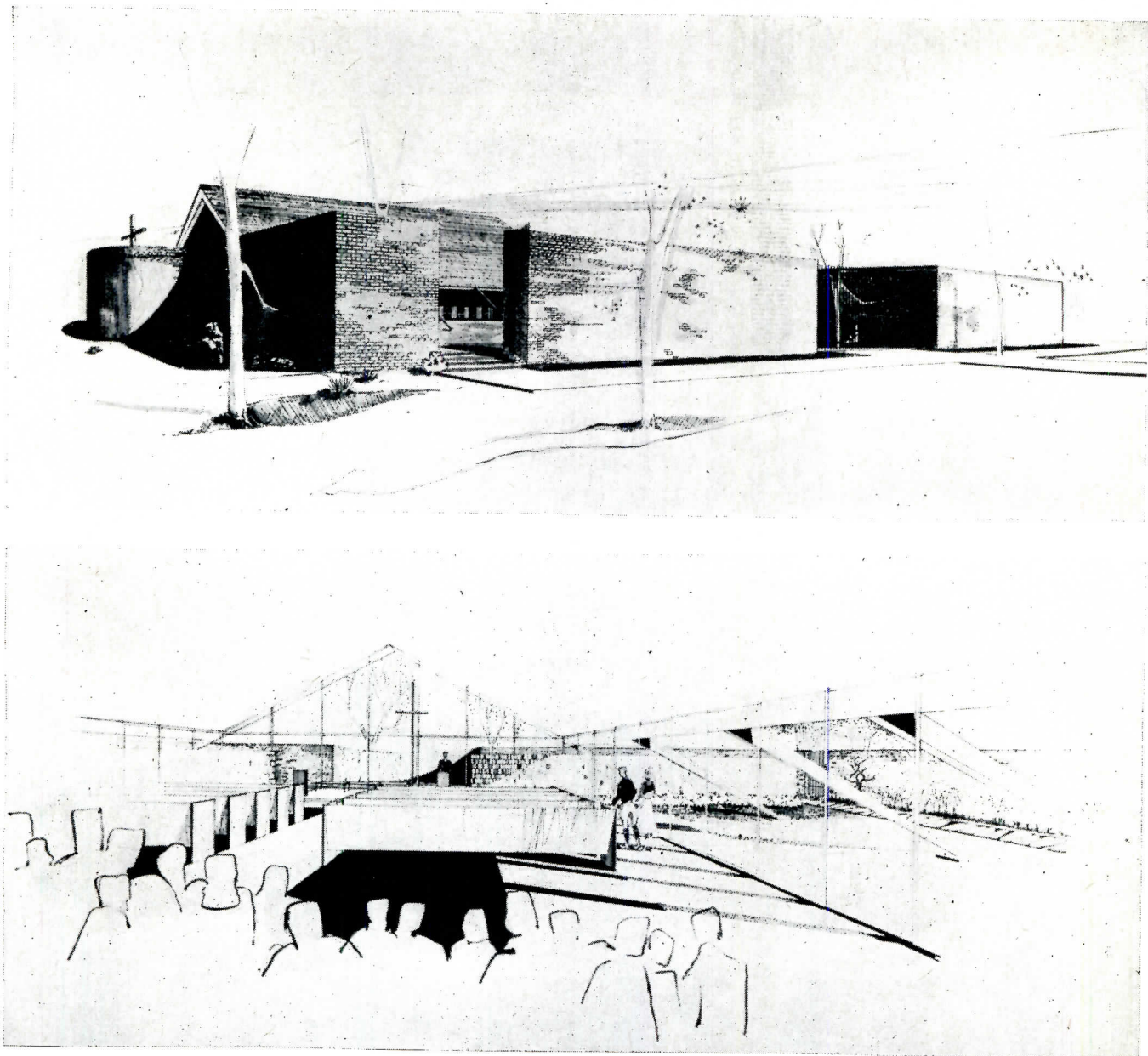

*Chapel roof framing is steel bents and purlins with steel joists in the administrative portion. Exterior walls of the chapel are glass on all four sides; cavity brick elsewhere in the building. Interior walls include sandblasted glass where facing the court. Roof of the chapel proposes wood decking and shingles; of the flat areas — 5 ply built-up roof. Ceiling is sound-absorbing plaster. Contemplated heating is through natural gas boiler, radiant system with copper tubing. Cooling is to be through 50 ton electrically operated plant with circulating lines to chilled water converters.*

**Cost (estimated): \$200,000**  
**Area: (Enclosed) 6,834 sq ft**  
**(Covered) 5,090 sq ft**  
**(Nave) 83,952 cu ft**  
**(Adm. Fac.) 45,920 cu ft**



# REQUIREMENTS FOR ADULTS

## *Loads and spaces*

The increasing number of elder citizens being added to our population each year, some 400,000 of them, presents a new challenge to the church to provide space, equipment, and opportunity for these older people to enjoy each other's company and to engage in creative activities suitable to their ages.

While youth can readily make use of the upper floors and buildings where it is necessary because of limited land use to erect such structures, adults should preferably be on floors which are close to grade and easily approached.

There is a noticeable tendency away from the very large adult classes running into memberships and attendance of 100 or more. Attempts are being made to organize adult work on the basis of interest groups and to keep the size of the groups to such numbers as will permit a more intimate friendship and a more general participation of the class in discussion.

Adult classrooms should be computed on the basis of 10 sq ft of floor space per pupil. This means that a class of 40 members will need approximately 400 sq ft of floor space or a room approximately 16 ft by 24 ft. For the reasons mentioned above, it is hoped that adult classes will not exceed from 40 to 50 members at the most.

## *Seating arrangements*

While adults usually are accustomed to sitting in formally arranged seatings, the tendency today is to make the adult classroom far less formal. Additional floor space and the careful selection of furniture permit a more homelike atmosphere in the adult classroom and the arrangement of seating in such a way as to give a sense of group participation rather than the lecture method of teaching.

A small kitchenette adjacent to adult classrooms makes it possible to use these rooms for small social occasions and for club or group meetings. In the design of this, flexibility of arrangement for maximum use is difficult but completely necessary for efficient use of the space.

## *Recreational requirements*

As with youth, craft activities are becoming increasingly popular among adults, and frequently create great interest in games or other forms of physical recreation. Men and women enjoy learning new skills or improving upon old ones, and in creating things which are both useful and beautiful. These classrooms can be equipped as elaborately as the interests of the adults demand, and as can be carried by the funds available. In some instances, ceramic kilns, power saws, knitting paraphernalia, sewing machines, leather tooling equipment, carpenter tools, and other related equipment are made available.

## *Dining provisions*

At least one large room should be arranged for the large banquets or dinners which should characterize the program of the modern church and for special dramatic or audio-visual programs as may from time to time be presented by the church. Here again, emphasis needs to be placed upon the fact that the new methods of lighting, heating and ventilating, and the new fabrics with which even an old building can be refurbished, make it unnecessary for any church to have a gloomy, unhealthy building, either from the standpoint of the room areas or the toilet facilities or the corridors and entrances.

## *Kitchen requirements*

From 10 to 12 sq ft per person is the requirement for a large dining or banquet hall. Kitchen facilities, which should be immediately adjacent, will require extra space. In the modern church, it is important that the kitchen be well planned by a competent architect or kitchen engineer, and that the many pieces of equipment which ease the labor of volunteer workers, should be installed. Today this equipment is available in price ranges suitable to the building budget of every church; the determination of equipment needs for kitchen, class and craft rooms should be among the very first acts of the architect as he begins the design of these facilities.

# BETH ISRAEL SYNAGOGUE AND SCHOOL, OMAHA

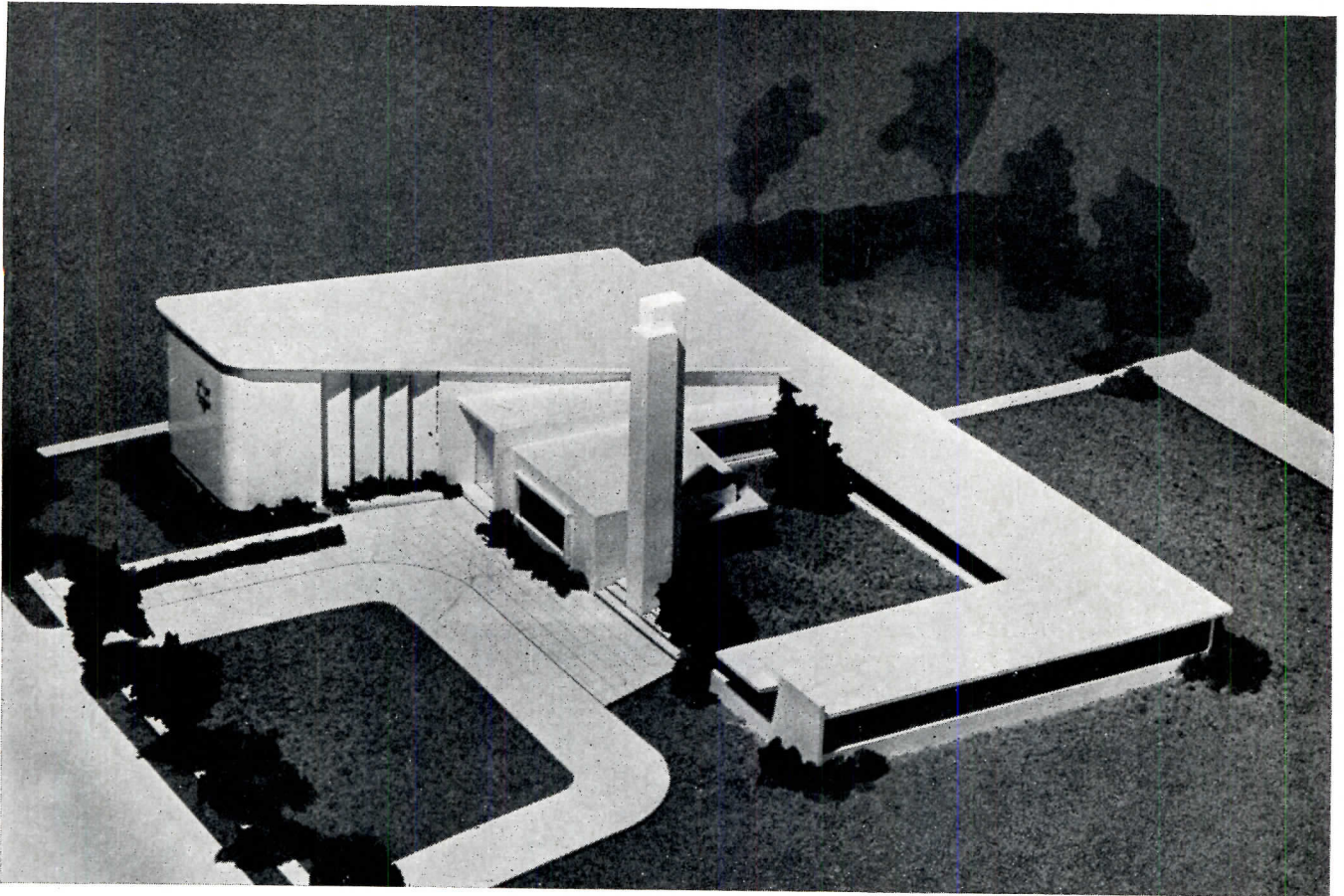

L. D. Jones

*Kivett and Myers, Architects*  
*Angus McCallum, Associate*  
*Steele, Sandham and Steele, Supervising Architects*  
*Pfuhl and Shideler, Structural Engineers*  
*W. L. Cassell, Mechanical Engineer*  
*Cooper Construction Co., General Contractor*  
*Miller Electric Co., Electrical Contractor*  
*Natkin Engineering Co., Plumbing and Heating Contractor*

PARTIALLY COMPLETED in 1953, and awarded the medal of the Kansas City Chapter of the A.I.A., this building seats over 650 in the sanctuary and an additional 800 in the congregational assembly hall which seats 400 at dining tables.

Here again is seen the use of the courtyard as an integral element in the design. Principal entrances to it may be made from either the driveway approach or from the main corridor which separates the assembly hall from the religious education unit.

The carefully organized plan provides for the great variety of use demanded by all religious buildings today.

- 1 CONGREGATIONAL HALL
- 2 SYNAGOGUE
- 3 ROSTRUM
- 4 STAGE
- 5 KITCHEN
- 6 STORAGE & UTILITY
- 7 FOYER
- 8 CANTOR
- 9 RABBI
- 10 OFFICE
- 11 CHAPEL
- 12 COURT
- 13 CLASSROOM

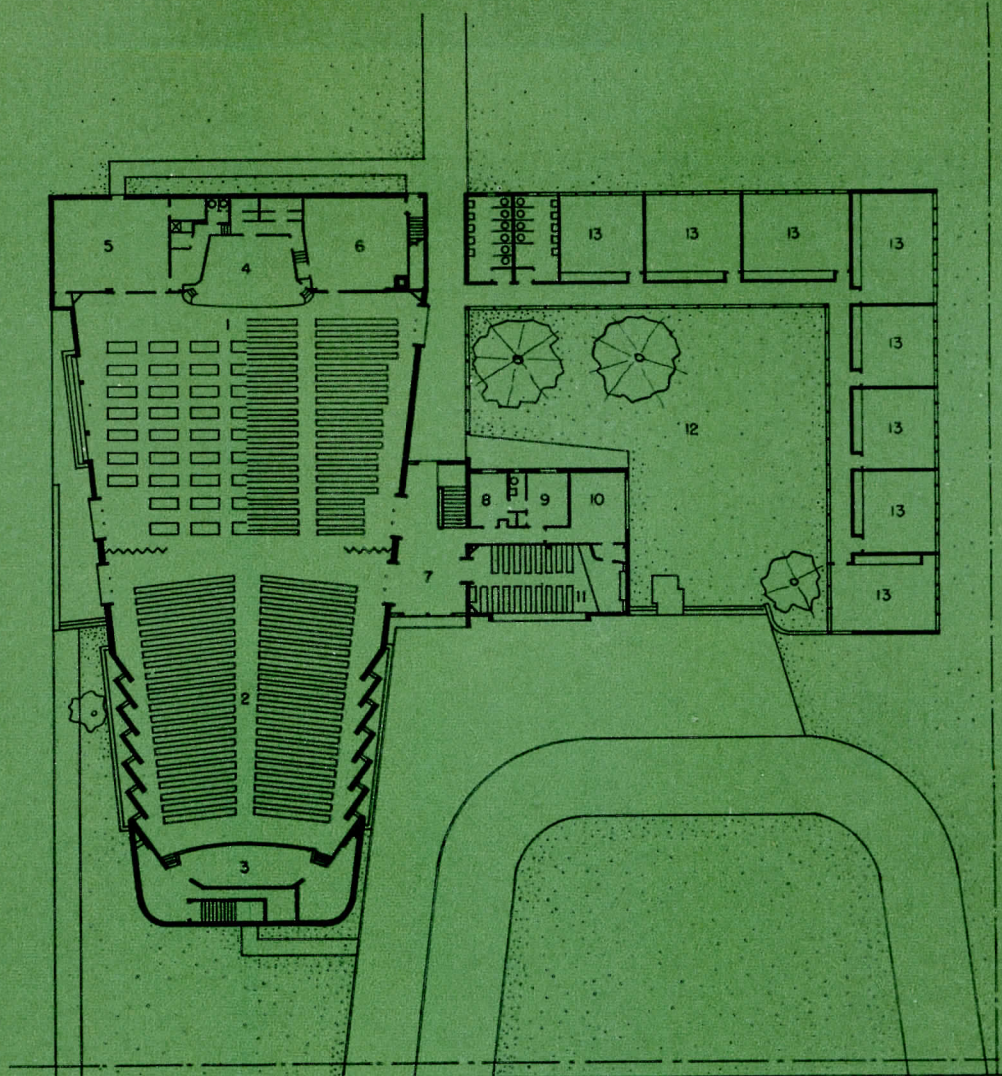

**FROM THE ARCHITECT:** Herewith some interpretation of the various symbols used in the Sanctuary: at the front of the auditorium, the two high walls on either side of the Ark covered with Stars of David, worked out in a three dimension pattern on a walnut background, are symbolic of the two tablets of the Ten Commandments, which are in turn joined, and partially covered by, a central curtain indicative of the curtain covering the Holy of Holies in the Temple. The curtain is golden, symbolic of the magnificent curtain that covered the Ark in the days of the Temple. Above the Ark is the high Menorah with seven branches, just as there was one in the ancient

days; it is symbolic of the creation of light and to the left is the Eternal Light, eternally reminding of the light that never failed in the Temple. One approaches the Ark by going up five stairs, these are symbolic of the five books of Moses; and the twelve windows and jutting walls are, of course, representative of the twelve tribes of Israel.

In Contemporary Jewish Houses of Worship a great effort is being made to make them uniquely American in form and spirit, and to establish a conscious and creative synagogue for our country. Architects will recognize that the design problems in synagogues today are in many ways unique.

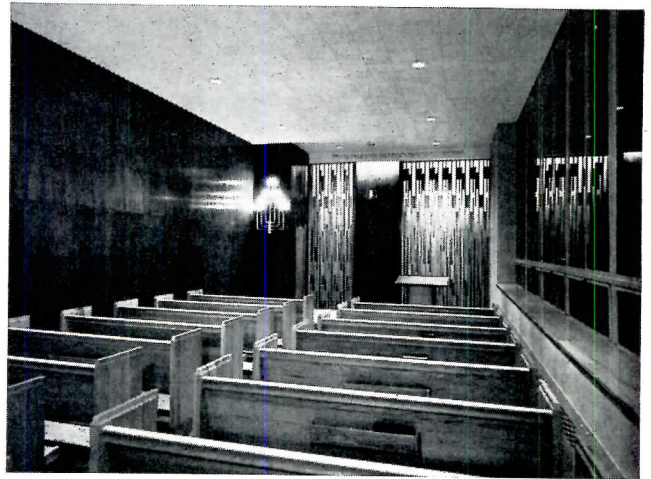
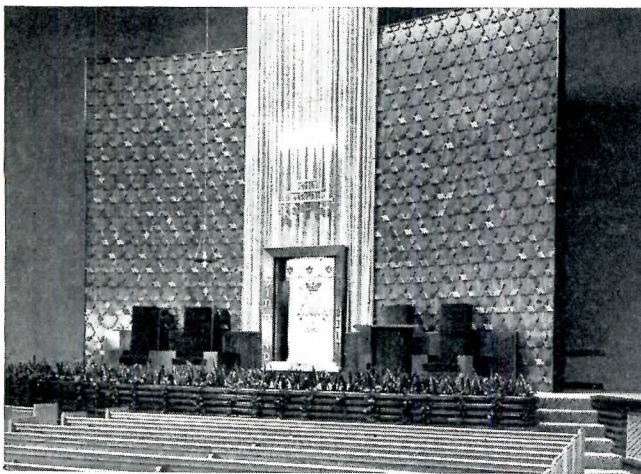
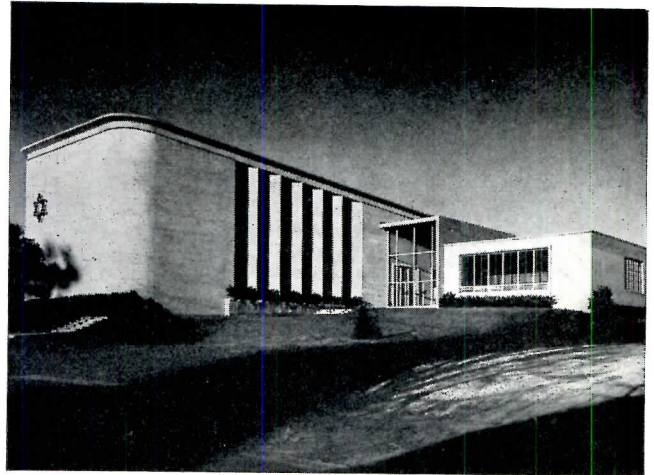
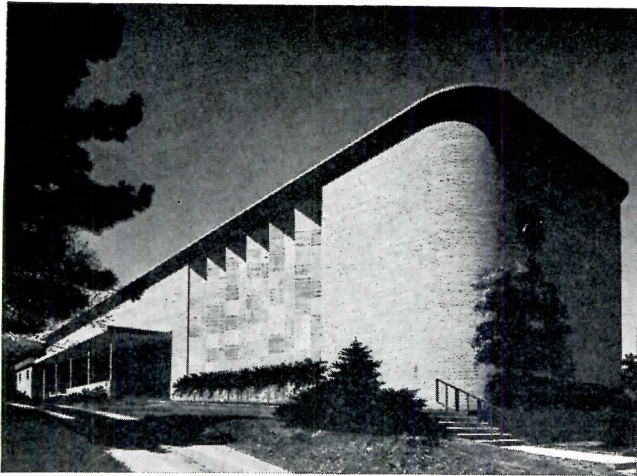

*Foundations here are reinforced concrete. Framing is steel. Exterior walls are light buff face brick and Indiana limestone with shot sawn finish. Interior walls are plaster. Partitions are masonry block. Roof is steel deck. The ceiling combines plaster and mineral type acoustical tiles; kitchen — metal pans. Floors are asphalt tile and terrazzo. Windows are steel frame. Exterior door is aluminum. Folding door partition between sanctuary and social hall is one of the largest of such installations.*

*Cost: \$418,000 (exclusive of religious school)  
Area: 20,957 sq ft*

# A BIBLIOGRAPHY OF CHURCH ARCHITECTURE

THE FOLLOWING BOOKS have been selected from the large literature of this subject in the interest of providing the active architect a simple, working list with the maximum pertinence for today's problems. Hence, most of these books have been published during the past ten years.

For their help in compiling this bibliography, ARCHITECTURAL RECORD is grateful to:

Marvin P. Halverson, Executive Director, Department of Worship and the Arts, National Council of the Churches of Christ in the U. S. A.

Prof. Herbert W. Johe, School of Architecture, University of Michigan

Maurice Lavanoux, Secretary, Liturgical Arts Society, Inc.

Rabbi Eugene Lipman, Director of Synagogue Activities, Union of American Hebrew Congregations

## *Protestant*

Addleshaw, G. W. O. and Etchells, F. ARCHITECTURAL SETTING OF ANGLICAN WORSHIP. Faber and Faber, London, 1948. An inquiry into the arrangements for public worship in the Church of England from the Reformation to the present day.

Briggs, Martin S. PURITAN ARCHITECTURE AND ITS FUTURE. Lutherwood Press, London and Redhill, 1946. Only 84 pages, about one half on the Puritan tradition and the remainder on the future.

Davies, John G. THE ORIGIN AND DEVELOPMENT OF EARLY CHRISTIAN CHURCH ARCHITECTURE. New York Philosophical, 1953.

Pfammatter, Ferdinand. BETONKIRCHEN (Modern European Concrete Churches). Zurich, 1948. Excellent illustrations.

Summerson, John. HEAVENLY MANSIONS. London, 1949. A collection of ten essays on architecture of which the first, an interpretation of the Gothic, is well worth reading.

Watkin, William Ward. PLANNING AND BUILDING THE MODERN CHURCH. F. W. Dodge Corporation, New York, 1951.

Whittick, Arnold. EUROPEAN ARCHITECTURE IN THE 20TH CENTURY (Vol. 2). Crosby Lockwood, London, 1953. Chapters 32, 33 and 34 include developments in Europe, principally in Germany and England, in the 1920's.

## *Catholic*

Anson, Peter. CHURCHES — THEIR PLAN AND FURNISHING. Bruce Publishing Co., St. Louis, Mo., 1948. Excellent reference work.

Msgr. Collins. THE CHURCH EDIFICE AND ITS APPOINTMENTS. Newman Press, Westminster, Md., 1946. This is something like a sacristan's manual but contains valuable data for draftsmen.

Ellard, Gerald, S.J. CHRISTIAN LIFE AND WORSHIP. Bruce Publishing Co., St. Louis, Mo., 1934.

Fortescue, Adrian. THE CEREMONIES OF THE ROMAN RITE DESCRIBED. Burns and Oates, London, 1934. Both books give the necessary background material for ceremonies, the Sacraments, etc.

Guardini, Romano. THE SPIRIT OF THE LITURGY. Sheed & Ward, New York, 1953. This book is the best introduction to the subject — short and to the point.

Maritain, Jacques. ART AND SCHOLASTICISM. Scribner's, New York, 2nd edition 1930, reprint 1954.

Maritain, Jacques. CREATIVE INTUITION. Pantheon Books, New York, 1954.

O'Connell, J. CHURCH BUILDING AND FURNISHING. THE CHURCH'S WAY. Burns, Oates, London, 1955. This book contains much matter already contained in several books listed above, but it is valuable for other matters as well.

Webb, Geoffrey. THE LITURGICAL ALTAR. Newman Press, Westminster, Md., 2nd edition, 1938. This is the standard book on the law and design of altars and their appurtenances. Webb was a stained glass painter but well versed in liturgical matters.

Pope Pius XII. Encyclical Letter MEDIATOR DEI (On the Sacred Liturgy). 1948. Chapters 187 to 196. These chapters, more particularly chapters 195 and 196, give the official directives of the Church relating to religious art — they provide the necessary atmosphere through which an architect can get the feel of what the Church teaches in these matters.

## *Jewish*

Braun, Isadore. JEWISH SCHOOL BUILDING MANUAL. Board of Jewish Education of Chicago, Chicago, 1954. Principles of planning.

Kayser, Stephen. JEWISH CEREMONIAL ART. Jewish Publishing Society, New York, 1955.

Kertzer, Morris. WHAT IS A JEW? World Publishing Co., 1953.

Loukomski, George. JEWISH ART IN EUROPEAN SYNAGOGUES. Hutchinson and Co., London and New York, 1947.

Reifenberg, A. ANCIENT HEBREW ARTS. Shoken, New York, 1950.

Steinberg, Rabbi Milton. BASIC JUDAISM. Harcourt, Brace, New York, 1951.

CONTEMPORARY DESIGN. Union of American Hebrew Congregations, New York, 1951.

## *General*

Thiry, Paul and Bennett, Richard M. and Kamphoefner, Henry L. CHURCHES AND TEMPLES. Reinhold, New York, 1953. A well illustrated account of the three groups.

# ST. PETER'S LUTHERAN CHURCH, NORWALK, CT.

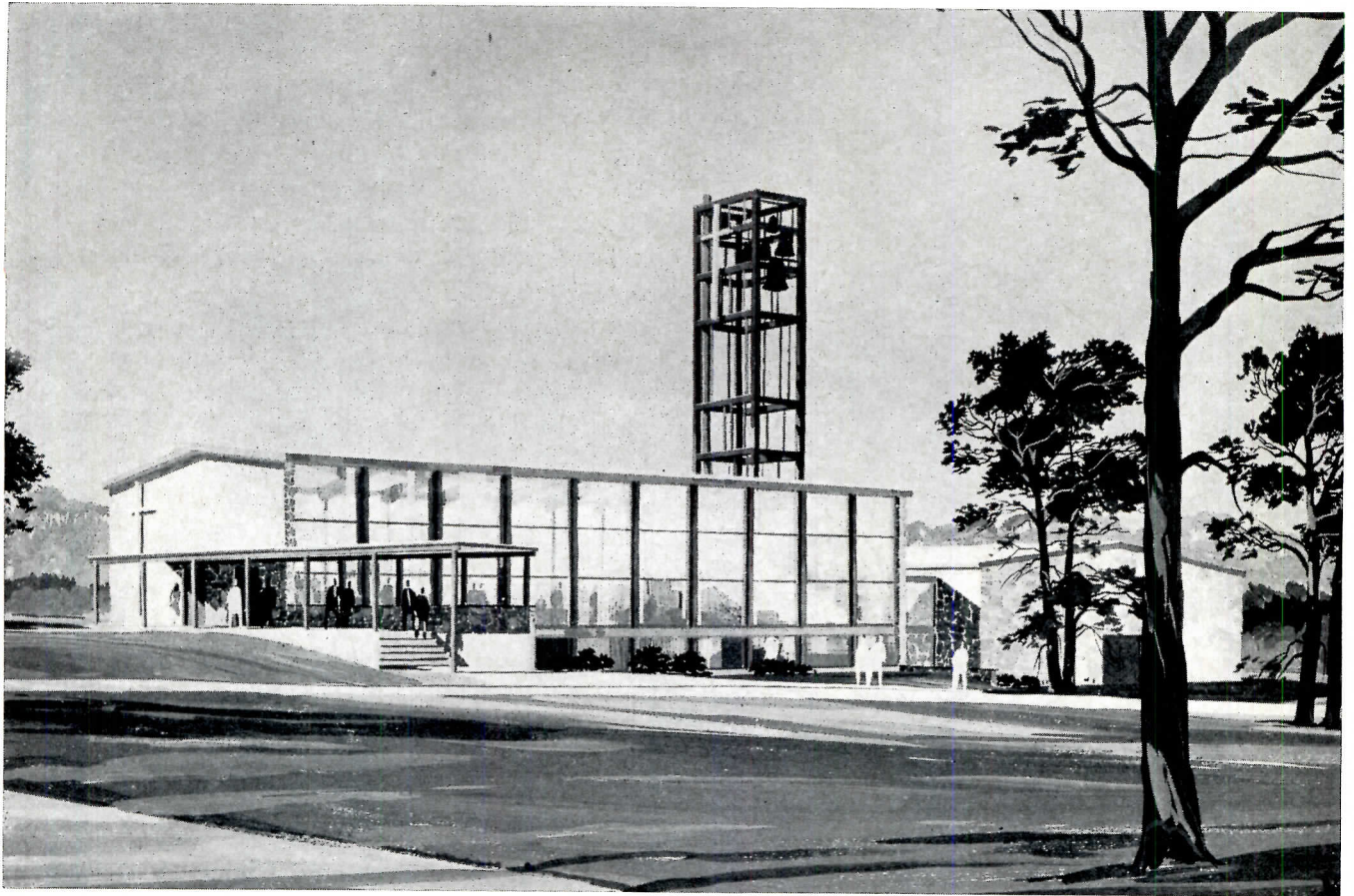

*Pedersen and Tilney, Architects*

THE PROGRAM for this building made these five major demands: a minimum of 300 seats in the nave and a maximum educational and parish activity area for the use of somewhat over 300 children from the neighborhood; a church which would conform properly to the established liturgical pattern of this Lutheran denomination; careful use of the irregularly contoured three-acre site in its pleasant suburban environment; a modern building of simple materials but without experimental forms; and a building of minimum cost. The chairman of the building committee is a merchant builder. The success of the architects in meeting these demands is evident here.

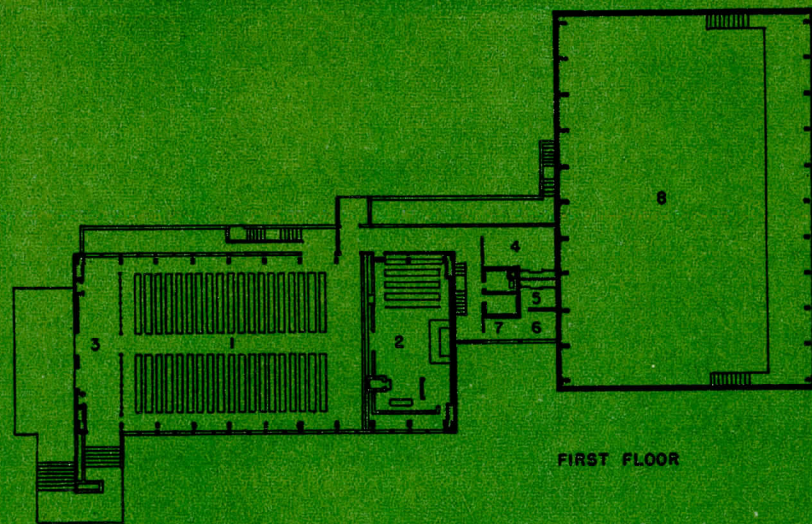

FIRST FLOOR

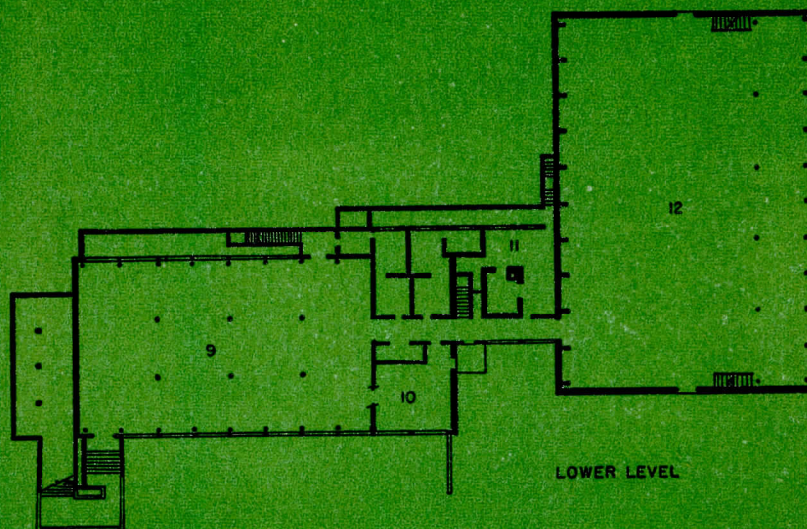

LOWER LEVEL

- 1 NAVE
- 2 SANCTUARY
- 3 NARTHEX
- 4 CHOIR
- 5 PASTOR'S ROBIN
- 6 OFFICE
- 7 RECEPTION
- 8 UPPER PART OF GYMNASIUM
- 9 ASSEMBLY
- 10 KITCHEN
- 11 BOILER RM.
- 12 GYMNASIUM



**FROM THE ARCHITECT:** The new church for St. Peter's Lutheran Congregation is strongly in the contemporary style characterized by the simple straightforward use of everyday materials — brick, redwood, glass and concrete — organized so they create a structure having the dignity and character required by a Lutheran church.

Use has been made of the natural contours of the site so three divisions of the building, the church proper, the fellowship building with gymnasium and the assembly hall, all receive the maximum of natural light and ventilation and so these elements of the church create a pleasing and harmonious composition. A sim-

ple open bell tower dominates the center of the building group.

The new church will be equipped with special lighting complementing the dramatic glass walls but will otherwise be plainly furnished. It will be fully air conditioned and will be provided with facilities such as kitchens and locker rooms for social and athletic gatherings.

(Editor's note: It is interesting to note that in this example — one of two in this study which do not employ the courtyard as an element — the site is pleasantly wooded, interestingly contoured and relatively quiet; in light of this there is no need for the court device.)

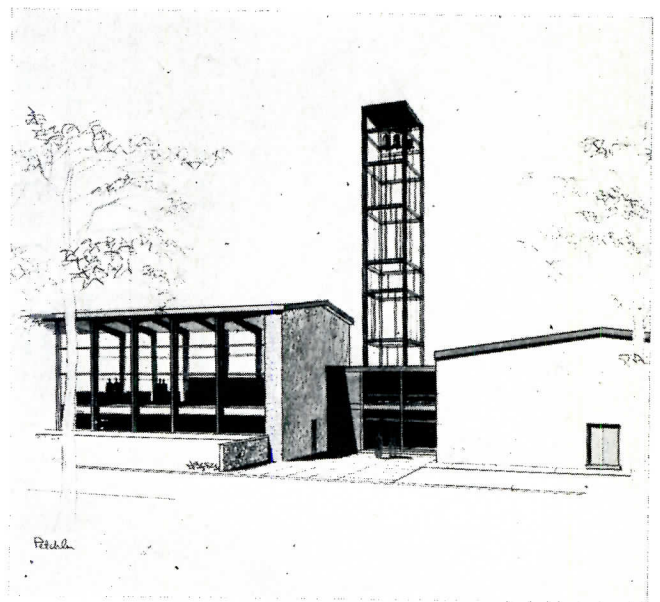
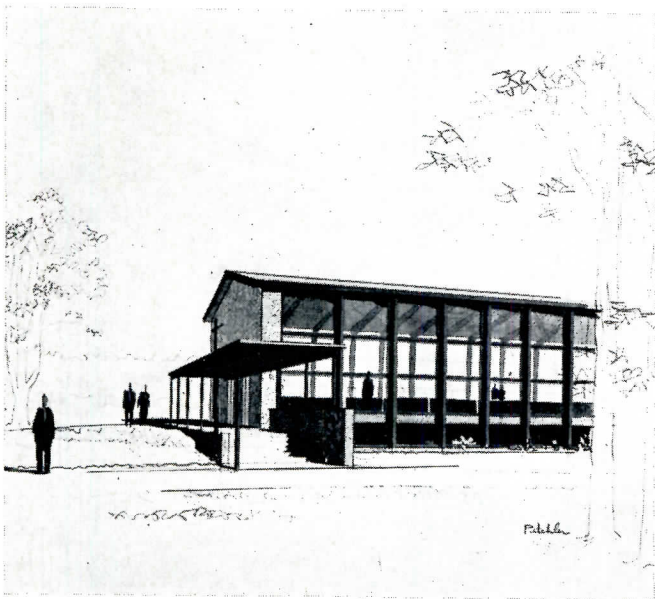
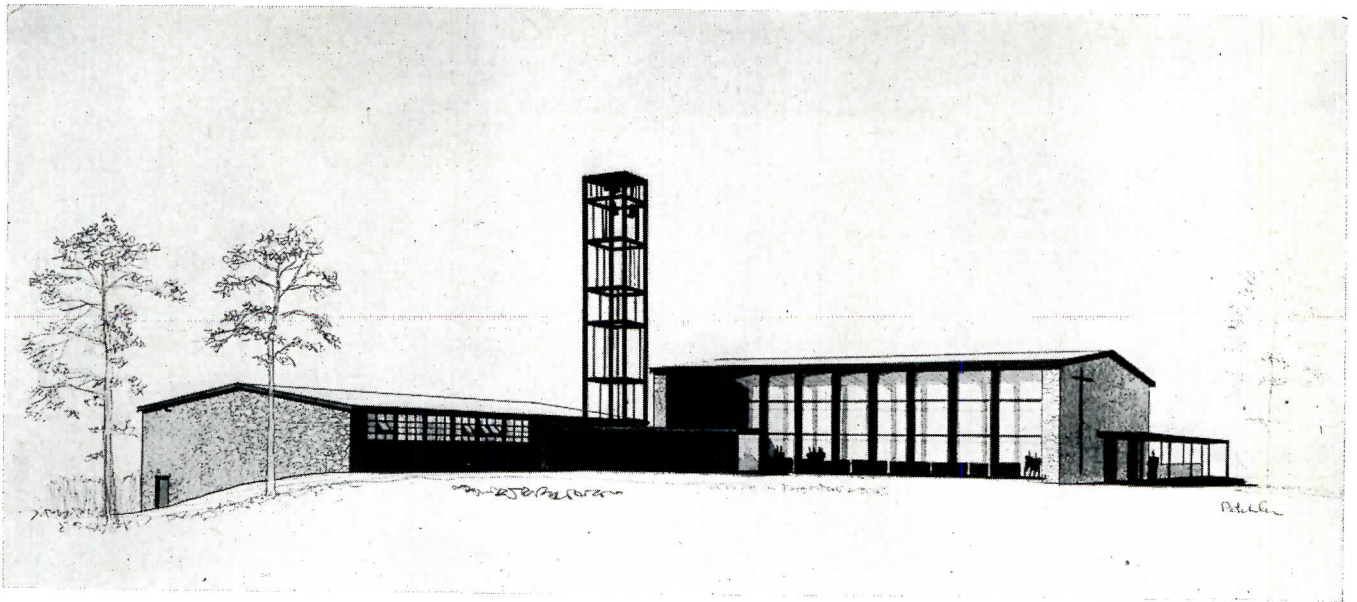

*Framing in this building employs laminated bents. Exterior walls of gymnasium and nave ends, originally intended to be in stone are presently proposed to be carried out in brick. Interior walls of the nave will be redwood siding. Roof will be 5-ply, built up, topped with white gravel. Floors in gymnasium will be hardwood; in the nave asphalt tile. Open tower will be in wood frame with poured concrete base. Narthex porch will be paved in flagstone. Narthex screen will be of plywood.*

**Cost (estimated): \$250,000**  
**Area: 21,500 sq ft**



# CHURCH ART AND ARCHITECTURE PERIODICALS

*Arte Christiana*. Published monthly by Scuola Beato Angelico, Viale S. Gimignano, 19, Milan. Current traditional design of Church regalia.

*Catholic Art Quarterly*. Published at Christmas, Easter, Pentecost and Michaelmas; official bulletin of the Catholic Art Association, 4380 Main Street, Buffalo 21, N. Y. Mainly secular.

*Catholic Building and Maintenance*. Published bimonthly by Joseph F. Wagner, Inc., 53 Park Place, New York 7, N. Y.

*Church Management*. Published monthly by Church Management, Inc., 1900 Euclid Avenue, Cleveland, Ohio. Special church building issues Jan., June, Oct. and Christmas.

*Church Property Administration*. Published bimonthly for the administrators of Catholic parishes and institutions by The Administrative Publishing Co., Inc., 20 W. Putnam Avenue, Greenwich, Conn.

*Das Münster* — Journal for Christian Art and Aesthetics. Published by Verlag Schnell & Steiner, Böhmerwaldplatz 10, Munich 27. Church art and architecture, historical and contemporary.

*L'Art d'Église* — A Review of Religious and Liturgical Arts. Published every three months by Abbaye de Saint-André, Brussels. (English translation.) Contemporary church architecture and ecclesiastical art.

*L'Art Sacré*. Published monthly by aux Editions du Cerf, 29, Blvd. Latour, Maubourg, Paris vii. Contemporary art and architecture.

Probably the best foreign periodical in this field.

*Liturgical Arts*. Published quarterly by Liturgical Arts Society, Inc., 7 East 42nd Street, New York 17, N. Y. (Roman Catholic)

*Protestant Church Administration & Equipment*. Published quarterly by the Christian Herald Association, Inc., 27 East 39th Street, New York 16, N. Y.

*Synagogue Service Bulletin*. Published bimonthly by Union of American Hebrew Congregations, 858 Fifth Avenue, New York, N. Y.

*Your Church*. Published quarterly by the Religious Publishing Co., 22-28 W. Putnam Avenue, Greenwich, Conn.

---

*Architectural Forum*

*Progressive Architecture*

ARCHITECTURAL RECORD

Religious Buildings — Building Types  
Study Number 223, June 1955

Religious Buildings — Building Types  
Study Number 217, December 1954

Religious Buildings — Building Types  
Study Number 205, December 1953

Religious Buildings — Building Types  
Study Number 177, August 1951

Religious Buildings — Building Types  
Study Number 156, December 1949

Religious Buildings — Building Types  
Study Number 138, June 1948

# \* FIRST BAPTIST CHURCH, EVERETT, WASH.



*Durham, Anderson and Freed,  
Architects*

*\* Premiated in the 1955 Awards Program of  
the Church Architectural Guild of America*

WITH AN EXTREMELY SMALL downtown lot, and a very low per capita budget, the architects of this building faced an unusually difficult problem of planning.

On a lot 120 ft by 194 ft, they were asked to provide sanctuary seats for 800; religious education facilities, including adults, for 800 to 950; dining facilities for 400; and a chapel for 100 or more persons.

The use of an entrance forecourt and rear and side courts provides an increased amount of light and vista as well as the means of unifying the many complex elements demanded in a large city church with a wide-ranging program of varied activities.

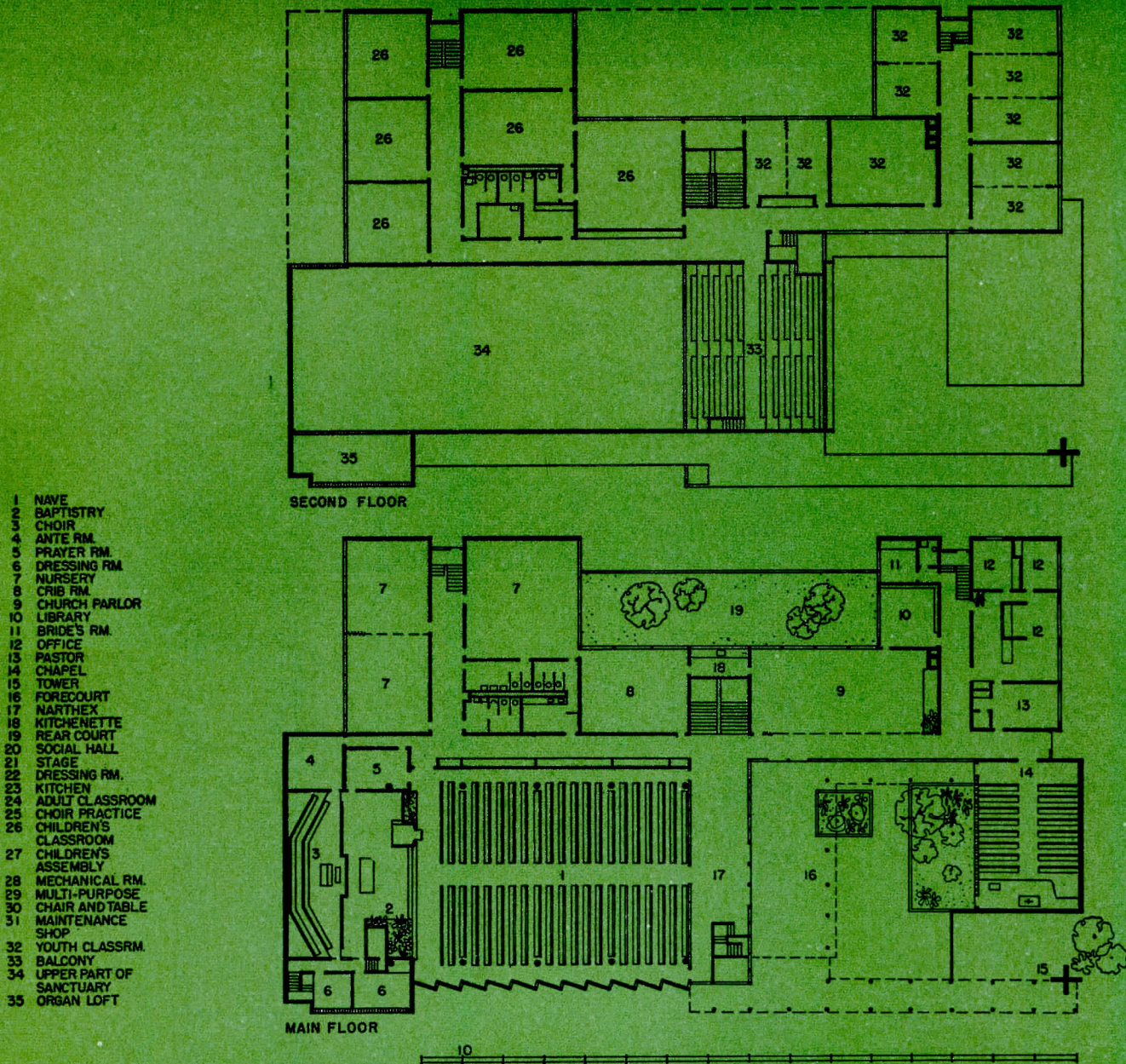

FROM THE ARCHITECT: The entrance to the church, chapel, and religious education spaces through the landscaped court creates, on a site lacking the appeal of a suburban tree-covered area, a composition pleasing in its relationship and interesting in its possibilities for texture, color and pattern.

Circulation on the main floor has been dramatized to connect the use of the chapel, church parlor and nave with the adjacent areas accommodating the administration offices and the space for the youngest children, in order that mothers will not have to leave this floor. The religious education space is organized into typical departmental areas. Large

classrooms are grouped around assembly areas for group worship with the purpose of alternating the use of worship and study space by separate groups. This church is unique in its development of adult classes which form an unusual percentage of the Sunday School attendance. Classroom areas have been kept as large and flexible as possible, well-lighted, and integrated with vertical circulation.

A multi-purpose area on the basement level is a compromise to find space for active play to meet those who wish to emphasize gymnasium activities. The social hall will be designed for multiple use, but it is not intended for gymnasium activity.

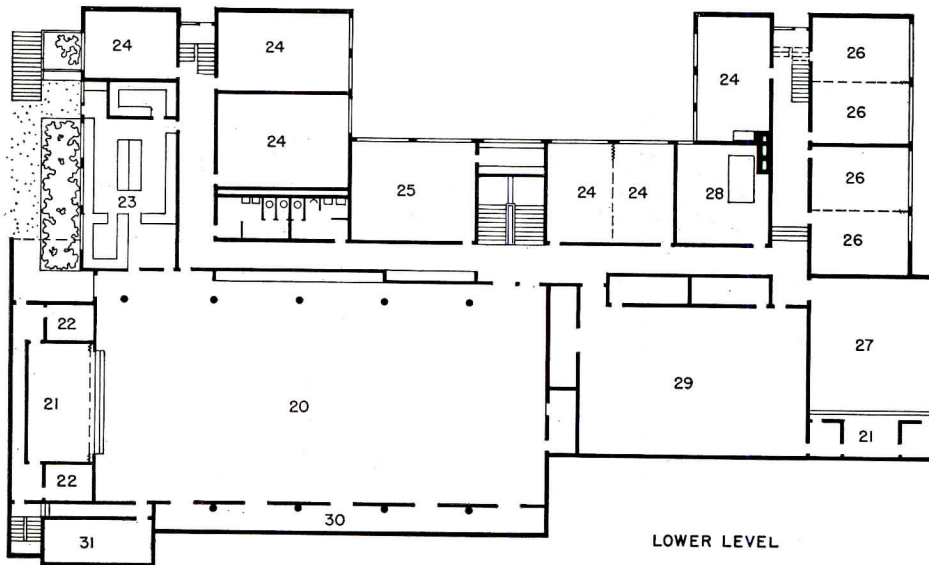
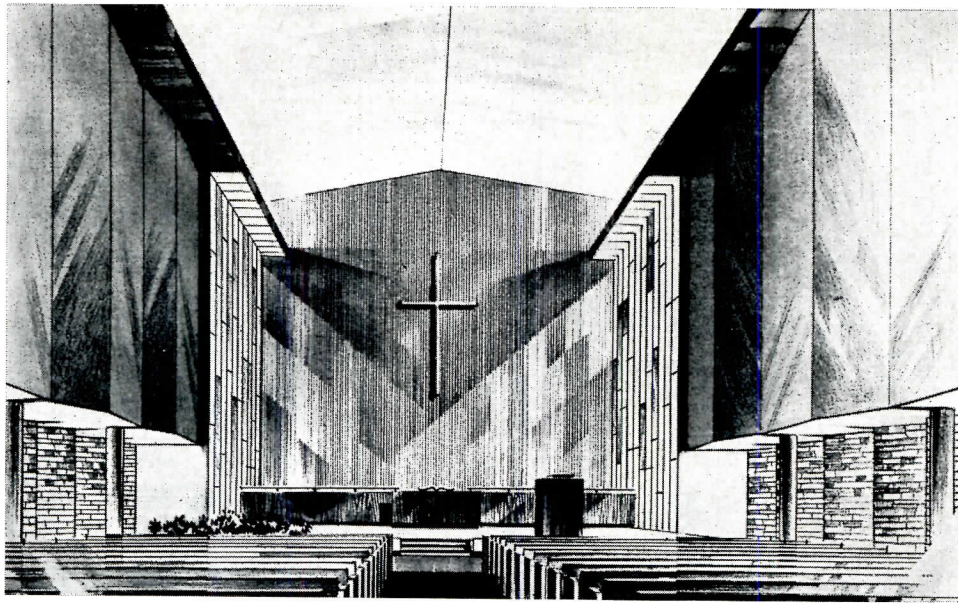

*Construction will be carried out in reinforced concrete using prestressed beams and slabs. Exterior walls will be faced with native stone and will result in a combination of exposed concrete, stone and glass. Interior walls will be plastered with large areas of sound-absorbing plaster. Partitions will be 2 in. plaster and the ceiling will be suspended. Floors will be finished in asphalt tile. Aluminum sash will be used for windows. Plastic sky domes are proposed in the garden court to illuminate multi-purpose room below. The heating system will be oil-fired, hot water with zone control.*

**Cost (estimated): \$563,000 (including furnishings, fees, sales tax)**  
**Area: 42,603 sq ft**

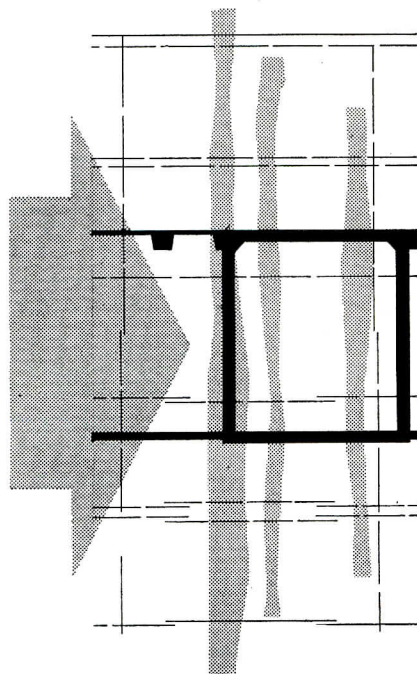

## SCHOOLS CAN BE MADE BLAST RESISTANT

By Boyd G. Anderson of Ammann & Whitney, Consulting Engineers,  
and Ellery Husted of Gugler, Kimball & Husted, Architects

CONTRARY to popular opinion, design for protection against atomic warfare is *not* a futile or hopeless undertaking. From the Japanese bombings in 1945 and from subsequent studies by civil defense officials, engineers and architects has come knowledge of types of construction and materials that can be used to provide life-saving protection against atomic blasts. The degree of protection will depend, of course, upon the distance of a structure from the blast and the size of the bomb. Of great importance is the fact that protection may be provided at distances which "scare" stories may have led people to believe will be areas of "complete devastation."

Among the key structures for which protection against attack is desired are the nation's school buildings. First, of course, protection is desired and needed for the children attending the school. Secondly, school buildings are considered of prime importance for emergency use *after* any possible future attack. The National Security Resources Board suggested during preliminary civil defense planning that all schools be commandeered for such emergency services as housing, first aid stations, hospitals and emergency feeding following attack.

### Experience from Japan

The effectiveness of certain types of construction offering maximum lateral stability as compared to conventional

wall-bearing structures is dramatically illustrated by the destruction at Hiroshima and Nagasaki. After the attack, reinforced concrete buildings in the cities stood like islands in a sea of rubble.

At Hiroshima University of Literature and Science, located 4200 ft from the blast, minor damage was done to the frame of the laboratory and classroom buildings, although fire severely damaged the contents. This building, of appreciably stronger construction than the average U. S. building, had a reinforced concrete frame with reinforced concrete roof, partitions, walls and floors.

Incredible as it may seem, the Honkawa Grammar School in Hiroshima remained standing although it was located only 1200 ft — about two city blocks! — from ground zero. The T bridge in the

upper photo on the following page was the aiming point for the atomic bombing on August 6, 1945. The Honkawa Grammar School is at far right-center. Three stories high with basement, it had a reinforced concrete roof and reinforced concrete floors and interior partitions. Though contents were completely destroyed and 15 per cent of the roof slabs were cracked, structural damage was limited to about one per cent of total floor area and superficial damage to six per cent. All finish, floors and trim were burned out, and sash and doors were blown out. However, as can be seen, the building survived. With a thorough clean-down and coverings for windows, it could serve as a shelter or provide hospital bed space.

Schools in Japan of lightweight con-

*Remains of Nagasaki Medical College. Concrete buildings remaining suffered various degrees of damage from blast and fire, but others of wood were completely destroyed*



struction roughly similar to United States schools collapsed at distances to 8500 ft from ground zero when subjected to a nominal bomb. The mortality rate was extremely high. The best of the Japanese schools, designed to resist earthquakes, survived at much closer distances. But of those that survived as structures, most failed as protective shelters. These schools were relatively strong structures compared with schools in this country.

**Blast-Resistant Features**

It is possible to provide blast resistance almost to ground zero — a point directly under the point of burst — of an A-bomb detonated in the air about a half mile up. It is possible but not economically feasible, save for a few very important buildings. However, it is quite practicable and within reasonable costs to provide a substantial degree of protection in buildings beyond a certain radius (see Fig. 1).

Three general improvements in construction can give new structures the lateral stability and other qualities necessary for effectiveness against atomic blast. These are:

(1) Connections capable of developing

all the strength available in columns and beams;

(2) Substitution of structural walls for curtain walls and light partitions; and

(3) Use of more massive walls to protect against radiation as well as blast.

To these should be added a fourth consideration: design and construction for fire resistance. Burned-out buildings in Hiroshima and Nagasaki demonstrated that improving the fire-resistance of a structure is almost as important as increasing its strength. Thermal flash concurrent with explosion of an atomic bomb can cause combustible materials to literally burst into flames. For example, black cotton "black-out" curtains were ignited two-thirds of a mile from air zero — the exact point of burst of the bomb. Directly radiated heat from a nuclear weapon can also ignite and quickly char unprotected wood surfaces near the blast. Even where structures survive the initial blast and extreme temperatures of the bomb explosion, they will unquestionably be called upon to resist local fires of many natures. In many instances in Hiroshima and Nagasaki, observers found it difficult to determine whether collapse was due to

blast or to weakening of the structure by prolonged exposure to fire.

**Many Schools Vulnerable**

Most people are unaware of the vulnerability of the average American school (or for that matter, of most other buildings) to bomb blast, earthquake and high winds. They judge by appearance only. Many schools, new as well as old, particularly those of wall-bearing construction, are vulnerable to all the effects of atomic weapons — blast, fire, flash, radiation, splintering glass, flying debris — and many are equally vulnerable to natural disasters.

**Two General Approaches**

A view of complete helplessness against A-bomb or H-bomb attack should not be accepted. Many new schools, following housing trends, are being built on the outskirts of big metropolitan centers. What might be considered minimum protective measures for such schools may be surprisingly effective, since they will generally be at sufficient distance from the main target areas to make it unlikely that they will be exposed to the most intense blast pressures. The im-

*Top: aiming point for the A-bomb drop at Hiroshima was the T-bridge. Honkawa Grammar School (right-center) only 1200 ft away still stands. Bottom: concrete structure at Hiroshima University, 4200 ft from ground zero, suffered only minor damage*

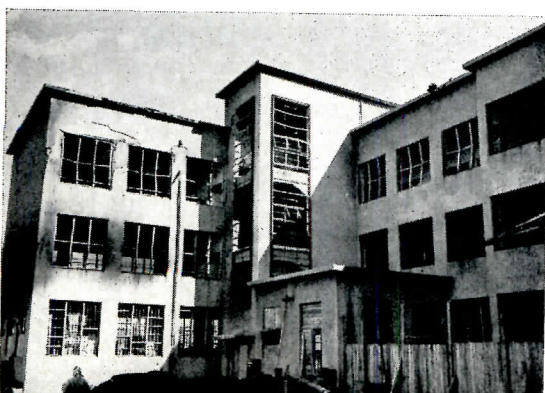
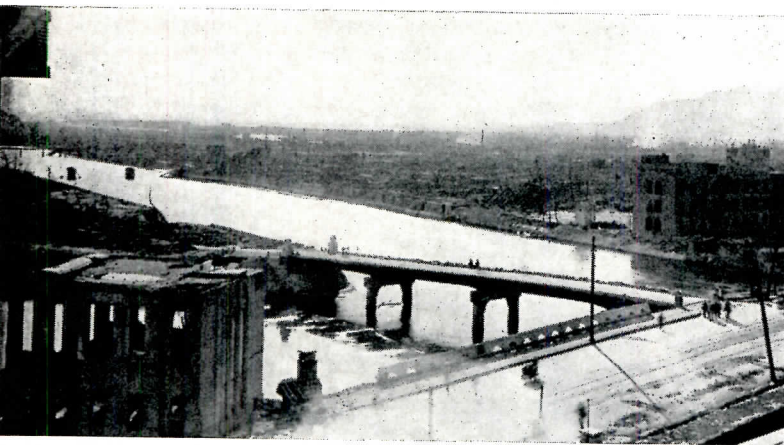

*Graph shows increase in cost for blast protection in multi-story structures as they are closer to assumed ground zero. Rings show that more buildings in outer area can be protected for a given increase. Costs would be even less for schools*

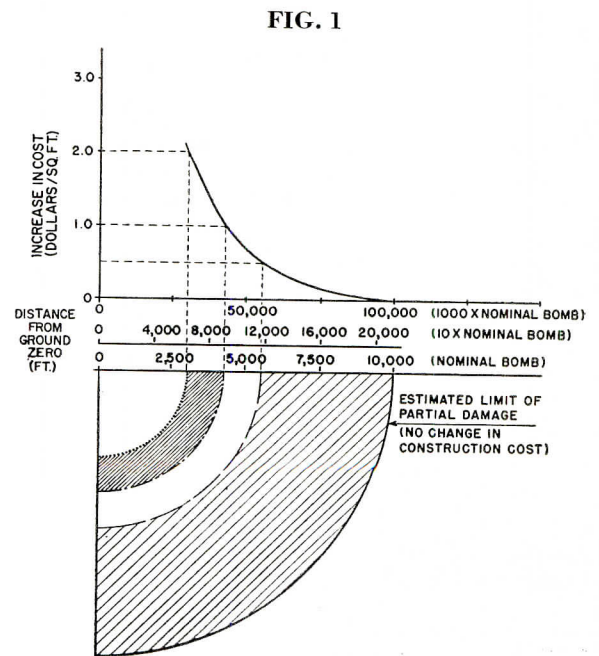

**FIG. 1**

portant thing is that this knowledge be put to work now, while there is still time.

There are two general approaches to the problem of building blast-resistant school buildings. Both assume that there will be sufficient warning of attack to get students out of classrooms (which are areas of special danger due to windows) and into shelter areas.

The first approach is to provide protection only in certain sections within the buildings, such as the corridors and basement. These sections would be so constructed as to provide protection despite collapse and damage to other portions of the structure.

The second approach is to provide special shelter areas, and in addition to improve the entire structure in an attempt to limit structural damage to any part of the school to reasonable amounts. This approach, by improving the whole building, would seek to keep the structure usable after attack, first for emergency purposes and later perhaps for reconversion to school use.

Since no two schools are alike nor necessarily need to be arranged alike to obtain the desired protection features, only simple elements such as classroom units, corridors and special rooms are used in the ensuing discussion on blast-resistant school buildings.

### Special Shelter Areas

A shelter area in the basement has a number of advantages in adaptability and radiation protection. It should be covered with a reinforced concrete floor of sufficient thickness to resist the blast pressure, and weight of falling debris and to provide adequate resistance against radiation. Typical framing and reinforcement for basement shelters are shown in Fig. 10. The space should preferably be free of gas, steam and water pipes, free-standing lockers, suspended fixtures and combustible materials.

At least two exits should be provided. A floor area of 6 sq ft should be allowed per person. Ventilation need not be elaborate. Area windows with sash that can be quickly opened or removed may suffice both for ventilation and for alternate escape exits. Earth outside the basement walls will effectively shield occupants from direct radiation.

Where the shelter is a corridor, the roof and walls must be designed to resist blast pressure and withstand wracking and overturning. Corridor walls may be reinforced concrete or reinforced masonry. Roof and floor slabs should be reinforced concrete.

FIG. 2

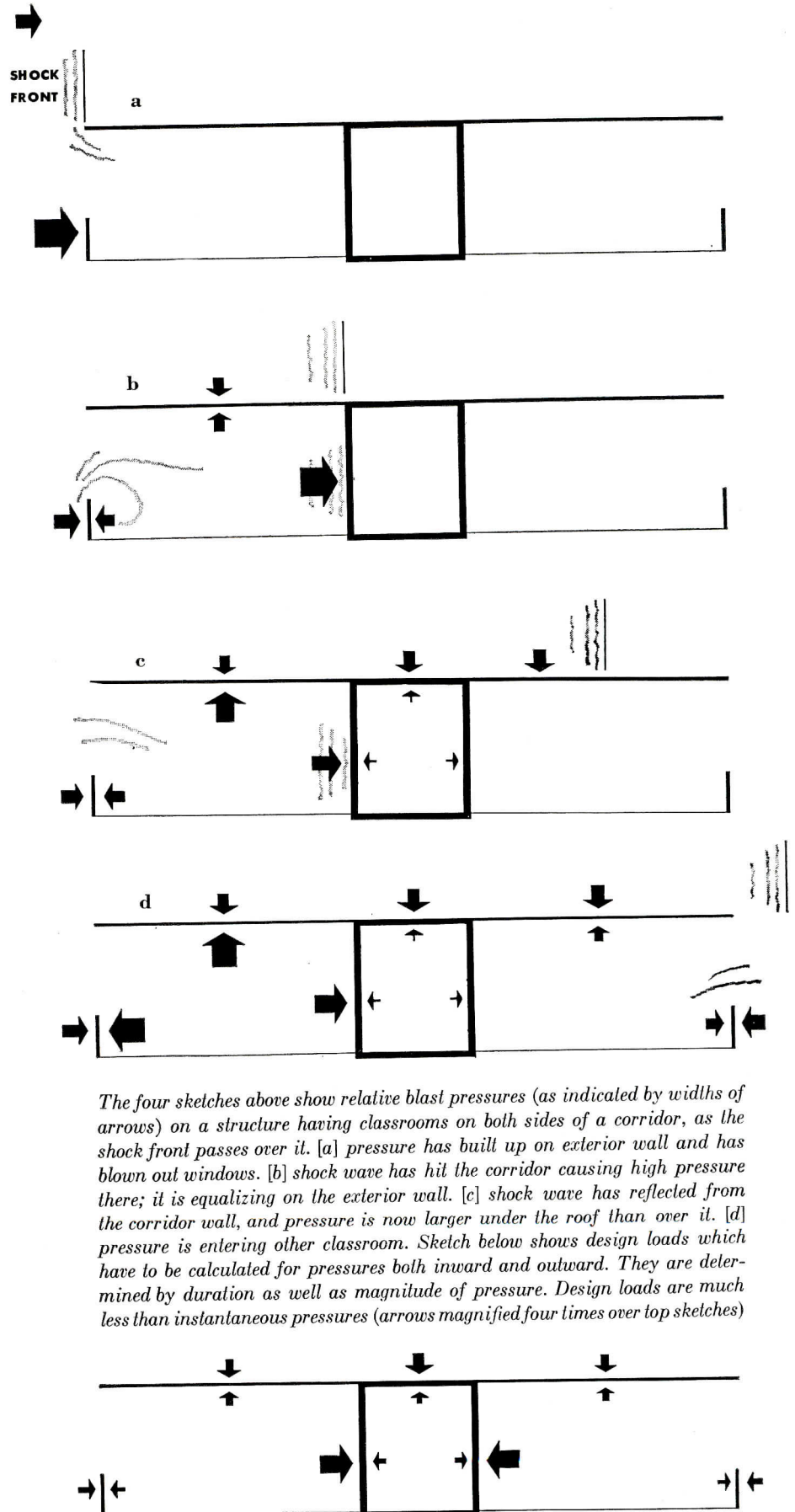

The four sketches above show relative blast pressures (as indicated by widths of arrows) on a structure having classrooms on both sides of a corridor, as the shock front passes over it. [a] pressure has built up on exterior wall and has blown out windows. [b] shock wave has hit the corridor causing high pressure there; it is equalizing on the exterior wall. [c] shock wave has reflected from the corridor wall, and pressure is now larger under the roof than over it. [d] pressure is entering other classroom. Sketch below shows design loads which have to be calculated for pressures both inward and outward. They are determined by duration as well as magnitude of pressure. Design loads are much less than instantaneous pressures (arrows magnified four times over top sketches)

## CORRIDOR-CLASSROOM DESIGNS FOR BLAST RESISTANCE

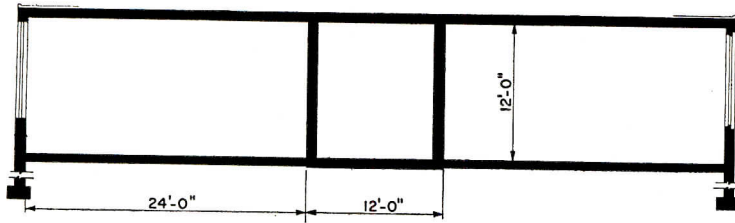

FIG. 3 Poured-in-place classroom and corridor sections

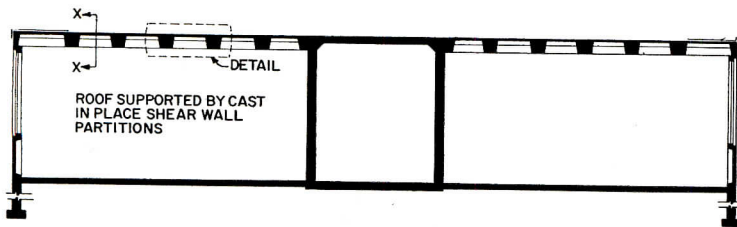

FIG. 4 Precast roof, poured-in-place corridor

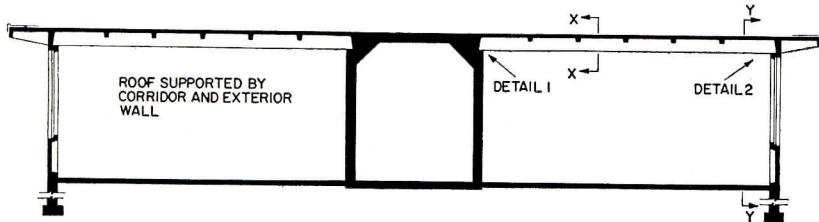
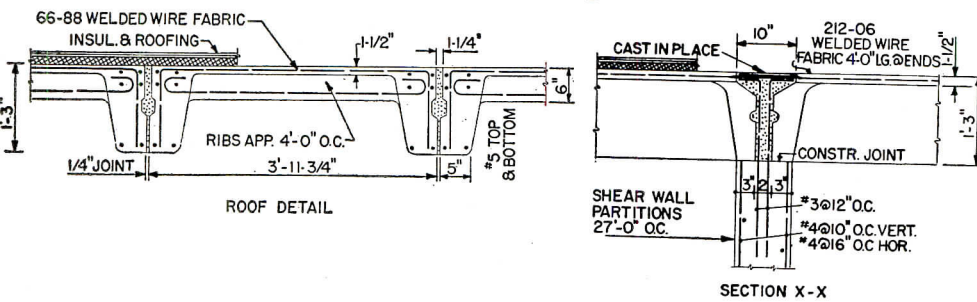
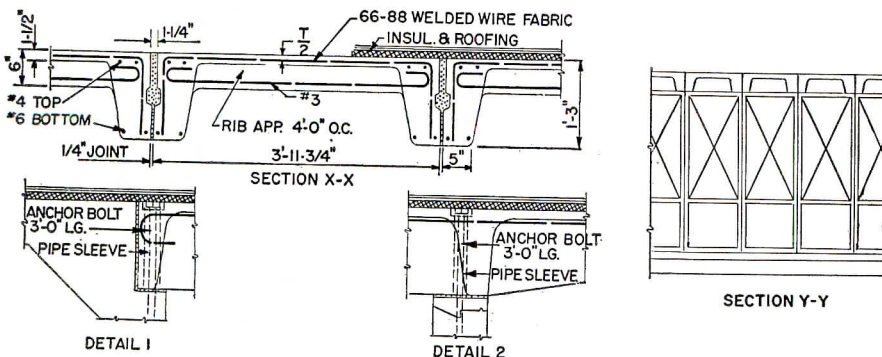

FIG. 5 Precast roof and exterior walls, poured-in-place corridor



The two designs shown for the corridor unit in Figs. 6 and 7 are intended to resist blast pressure at distances of from 2000 to 5000 ft for a nominal bomb, 4300 to 10,800 ft for a ten-fold bomb, and 20,000 to 50,000 ft for a thousand-fold bomb.

Earlier it was pointed out that blast resistance could be obtained through judicious use of materials at little or no additional cost over less durable construction. As an example, consider the cost of providing blast resistance in a reinforced concrete corridor cell, as described. This cost would be averaged over a 58-ft width, consisting of a 10-ft wide corridor with a 24-ft wide classroom on each side. The cost might be from \$0.50 psf less to \$0.50 psf more than a conventional wall-bearing type of construction.

A blast-resistant corridor with shear walls serving as partitions between classrooms is shown in Fig. 4. These shear walls resist lateral movement through strength in shear and act to prevent side sway of the corridor walls. In this way, vertical bending moments in the corridor walls are reduced. All potential missiles, particularly objects containing glass, should be eliminated from corridors if they are to serve as shelters. Doors should be latched open when the shelter is to be used. Incombustible draperies over the opening would protect occupants from flash burn. (Blast-resistant doors could replace both.) In fact, illustrations appearing in the booklet "Effects of Atomic Weapons" show that a cloth baseball cap worn by a Japanese civilian was enough to protect the top of his head and brow against flash heat, while his lower face received burns. Incombustible draperies alone, however, might permit entrance of sound into rooms during normal use.

Lighting fixtures should be either recessed, or firmly fixed to the ceiling as near flush as possible. They should be provided with a plastic face or cover.

### Improving the Whole Structure

Improving the whole structure, in addition to certain sections to be used as bomb shelter areas, would render the school usable after attack, for emergency purposes and later for reconversion to school use.

If a central blast-resistant core is provided, then saving the remainder of the classroom wall and roof framing is greatly simplified. A corridor built as described to act as a bomb-shelter is strong enough to provide the rigid frame



action necessary — the needed lateral resistance. This means that the members outside the core unit — the outer classroom roof and wall — need resist the blast only as simple beams; they do not have to possess lateral stability. To prevent collapse by bending, it is necessary to provide only local bending and shear strength.

While the corridor unit will be exposed virtually to the same total lateral pressure regardless of the size of window openings in the classroom walls, the local bending strength required by the exterior walls can be greatly reduced by an increase in the window area. The net pressure acting on the exterior walls and roof is lessened where large window openings in these walls permit the blast to enter and counteract the external blast pressures. Any type of framing adequately designed to resist the unbalanced pressure loads will suit this purpose. However, the stronger and more massive roof systems should be selected. Reinforced concrete slabs, supported by reinforced masonry partition walls and by concrete columns, provide a tough blast-resistant classroom framing that can be designed readily for any degree of resistance. If large windows are used, little strength beyond that for vertical loads would be required.

Door and window glass would undoubtedly be blown in, hung ceilings would fall, loose or weakly-attached equipment would be blown about, and in general the area would not be suitable for shelter against blast or radiation. However, after removing debris and covering the window openings, these areas could function for post-attack use. To reduce missiles and damage, the window sash should be firmly anchored.

### Precasting

Still another way of improving the blast resistance of new school buildings is to take advantage of the economy of precast reinforced concrete construction for walls, floors and roofs. This means of providing blast resistance may be used in either or both of the general approaches listed above, i.e., in providing over-all or partial protection.

Schools that are relatively simple in plan lend themselves well to modular design. Adapting precast elements to modular construction makes it possible to take advantage of "mass production" construction methods, employing a minimum number of panel types repetitively. Panels can be cast in a plant or on the site and then tilted or lifted into

place. Procedures for casting such slabs are well-established. The panels, depending upon insulation requirements, may be either "ribbed" or "sandwich" type — a smooth exterior surface perhaps being best. Along with its proven low cost, precast construction also offers excellent blast resistance when properly designed and detailed to insure adequate interaction between component elements; careful attention must be paid to anchorages and to continuity. In order to take full advantage of the economy of precasting, building plans should be standardized as far as practicable and a modular system adopted.

Unquestionably, in areas and on projects where modular precast construction is feasible, good protection against atomic blast can be obtained at savings in initial cost.

A precast concrete panel roof may be supported either by a rigid frame corridor unit and exterior walls or by cast-in-place stiff shear walls. Another possibility is to use precast units also for the partition walls. Figure 5 shows both the exterior walls and roof units precast and connected to a central corridor which is cast in place. This arrangement, where the partitions between classrooms are not depended on for carrying roof loads, would permit greater flexibility in room arrangement.

### Auditoriums and Gymnasiums

Most schools will have one or more long-span areas, a gymnasium, for example. In small schools a single multipurpose room may also serve as lunch room and auditorium. Auditoriums and gymnasiums are particularly vulnerable to blast, since they ordinarily are built with high, un-reinforced load-bearing walls or slender columns, and the roof is frequently supported by light roof members, weakly connected to the supporting wall structure.

It is more difficult to provide blast resistance in these areas, but they are so potentially useful in emergencies that every attempt should be made to make them safe.

The two primary difficulties in providing the desired resistance in such areas are: (1) to carry the intense local pressures on the long roof and wall spans, and (2) to provide the relatively high degree of lateral stability needed to prevent collapse.

It appears impractical to enclose high-ceilinged auditorium or gymnasium areas with blast-tight walls and roofs. For example, a roof structure alone for an

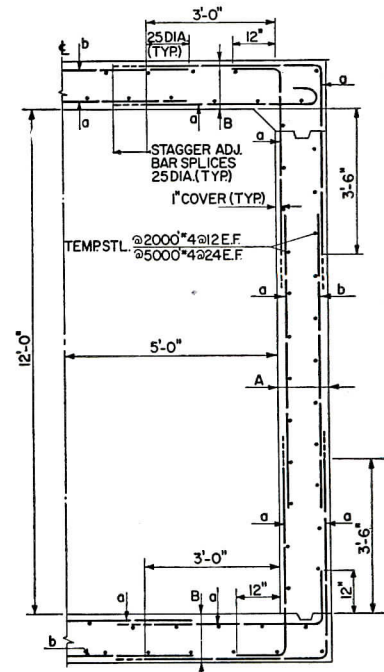

FIG. 6

A	8 in.
B	8 in.
a	# @ 43 1/2 in
b	#4 @ 7 in.

### CORRIDOR DETAILS

*Above: reinforcing pattern for a rigid frame corridor. Below: reinforcing for a rigid frame braced laterally by shear walls. Designs are for 5000 ft from ground zero with a 20 kilo-ton atomic bomb*

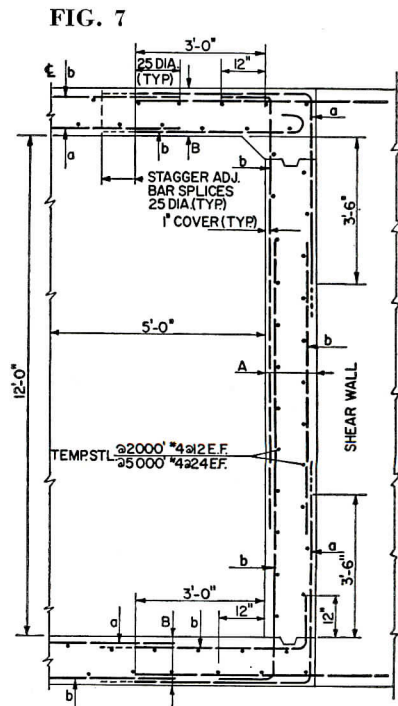
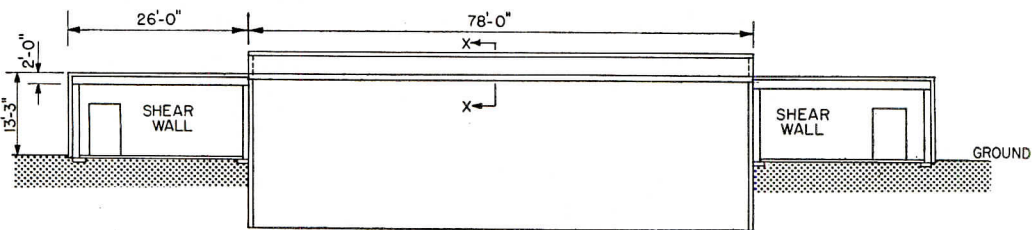
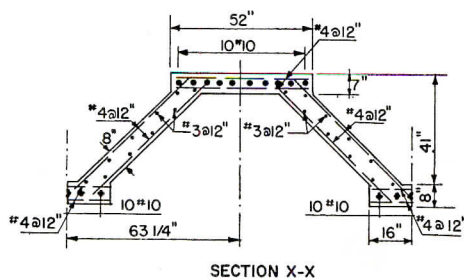

FIG. 7

A	8 in.
B	8 in.
a	#4 @ 5 in.
b	#4 @ 10 in.



**FIG. 8** Long-span structures are difficult to make blast resistant. Setting part of the building below ground and flanking it with classrooms partitioned by shear walls helps



**FIG. 9** A corrugated long-span roof has strength to resist unbalanced roof loads and to transmit lateral loads from side walls to shear walls

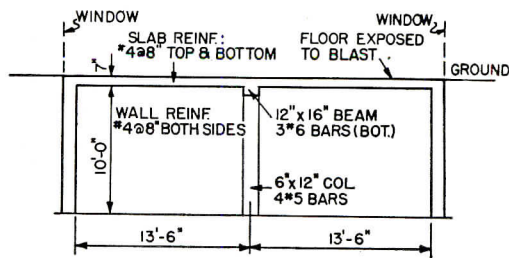

Framing and reinforcing is given for a basement sheller which could go directly under the classroom-corridor wings shown previously **FIG. 10**

80-ft span designed to resist the full pressure of the "small" nominal bomb at 5000 ft would cost close to \$5 per square foot. For a 100-ft span the cost would be approximately \$7 per square foot.

For shorter spans it may be advantageous to depress part of the building below the surface of the protecting earth. The example shown in Fig. 8 indicates a possible arrangement of this type that would strengthen the gymnasium walls. In this example, the surrounding earth and flanking rooms screen and reduce the effects of the blast pressure on the gymnasium walls and help to support the building. By strategically locating the interior partitions of rooms flanking the gymnasiums and giving them sufficient strength to act as shear walls, the weaknesses in the long side walls of the gym are counteracted. The partition walls dividing these rooms brace the long walls of the gymnasium and act as buttresses or counterforks to transmit the loads into the foundation.

Windows of the gymnasium are located high above the floor, just below the roof line. This high location assures some radiation and thermal heat protection to lagging occupants. The corrugated hipped roof as shown in Fig. 9 not only provides the strength necessary to carry the unbalanced roof loads, but also acts as a horizontal girder to transmit the lateral reactions to the shear walls (see Fig. 8 at top of page).

For longer roof spans it may be more advantageous to place the structure above ground and to use as much window area as possible to reduce the unbalanced pressure on the roof. (Windows will blow out immediately, letting pressure enter the building.) However, in the latter case the portion of wall area should be provided as shear wall, to carry the lateral forces to the foundation.

Because of the glass areas and the relative weakness as compared to corridor and basement shelter areas, the gymnasium cannot be recommended for shelter use. It can, however, be designed to withstand appreciable blast loads and remain intact for post-attack use at distances much closer to ground zero than would be possible in customary designs.

Special rooms like shops, project areas and cafeterias in which spans are over 30 ft may be considered in the same category as gymnasiums.

#### Cost-Distance Ratios

Figure 1 is based on studies of the cost of providing blast resistance for multi-story apartment buildings. It can also be used to estimate the cost of reducing the area of destruction of such buildings when they are subjected to forces caused by bombs of various sizes. The chart has been included because it presents graphically some idea of the cost of providing construction which will limit damage to any part of a school

building within reasonable amounts.

The cost of protecting certain limited areas in school buildings — providing "bomb shelter" corridors and basement — and at the same time reducing the damage in the remainder of the school, will be considerably less than the cost of providing blast resistance for multi-story buildings.

Actually, the building frame — the basic factor in providing maximum blast resistance — is a relatively small item in the total cost of a structure. The cost of a reinforced concrete frame built to provide a high degree of blast resistance would be competitively reasonable.

Experience has shown that construction as described above is most effective in withstanding not only A-bombs but also fire, earthquakes and tornadoes as well. For example, one of the early reinforced concrete structures on the West Coast — the Leland Stanford Jr. Museum at Palo Alto, Calif. — came through the 1906 earthquake with but minor damage.

A blast-resistant school of concrete need not be stereotyped or unattractive — the architect still has freedom in arrangement and appearance.

This statement bears repeating: our children's schools can be made far safer against atomic blast, fire, earthquake, hurricanes and tornadoes with little, and in certain cases, no extra cost. In an era of school construction this is a fact that should not be overlooked.

# HEATING, AIR CONDITIONING AND PLUMBING

By Nathan N. Wolpert, Associate Editor, Air Conditioning, Heating and Ventilating

*This concludes a review of trends and new developments over the last two years in equipment and systems. Part 1 appeared in the March issue and covered fuels, heating and cooling. Part 2 deals with ventilation, insulation, pipes and ducts, controls and plumbing.*

## FILTERS

Filters are necessary not only to prevent large smudge areas around air outlets and to halt the discharge of dirt particles into rooms, but to filter out pollen and dust.

For the home, there is a ceiling suspended electrostatic air cleaner placed in the main return air duct of a forced warm air heating system. It is said to remove about 90 per cent of all airborne dust and pollen and is effective against tobacco smoke. The only electrical requirement is a connection to a 115-volt a-c power line. A standard unit handles from 1000 to 1200 cfm although for larger homes there is a model for 2000 to 2400 cfm. Units clean both recirculated and fresh air.

One of the family of electrostatic filters has a simple push button method of spray washing with the filters remaining completely in place. Accumulated dust on the electronic collector plate is

flushed away by hot water from needle spray nozzles. The header with its sprays moves across the face of the filter and at the end of the run it reverses automatically. After the washing step, the same header applies an adhesive oil on the cleaved collector plate surface. This oil binds the dirt particles to the plate and acts as a solvent for the washing operation. Powerpacks and control units are located outside the unit.

One washable filter utilizes the static electricity characteristic of polyethylene film. When air is forced through the filter, it takes on an additional electrostatic charge which attracts dust particles. The filter is cleaned by being rinsed in clear water. It is 1-in. thick and comes in 4 sizes and various models.

For use in commercial and industrial air conditioning and ventilating systems, there is an automatic self-cleaning air filter of fiberglass. Filtering medium is a continuous length of fiberglass material that is supplied in rolls of about 70 lineal ft. This roll is mounted at the top of the filter casing and is transported on a continuous screen that rotates over top and bottom circuits, down the face of the filter and is re-rolled at the bottom, after collecting its dust load. A pressure switch, sensi-

tive to the pressure differential across the filter curtain, actuates a drive motor that rotates the screen and feeds an amount of clean media for the filter curtain. The filter is made in vertical sections 3, 4 and 5 ft wide and in heights from 5 to 15 ft. One drive mechanism will operate from 3 to 6 sections, depending on height.

## VENTILATION

The roof ventilator is favored as an inexpensive means for removing heat from a house to provide some cooling in summer, particularly at night. An attic ventilator for a sloping roofed house has an air opening of 120 sq in. and is low in height to provide an inconspicuous appearance on the roof. It is designed to fit shingled roofs on any pitch. The ventilator is flanged, baffled and screened and is watertight. It is made in galvanized steel, aluminum and copper.

A three-speed fan for homes and small commercial installations is mounted on an outside wall or roof and is connected to interior grilles in the walls or ceiling. Standard 7-in. round ducts lead from the grille inside the building to the fan. Motor and fan are outside the grease-

*Flexible tubing in this suspended ceiling provides 40-degree turns for every 10 ft of the duct run*

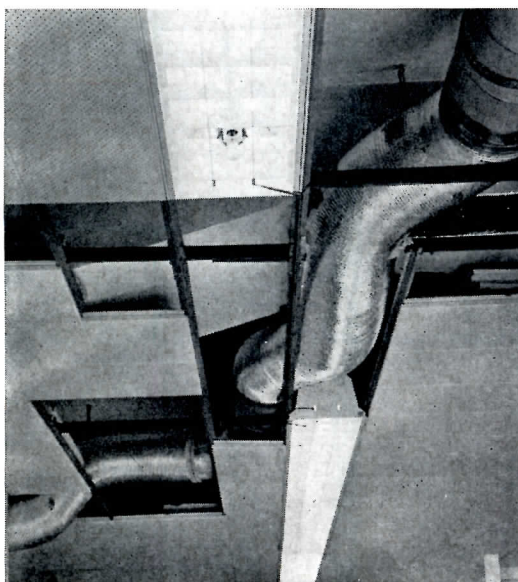

Flexible Tubing Corp.

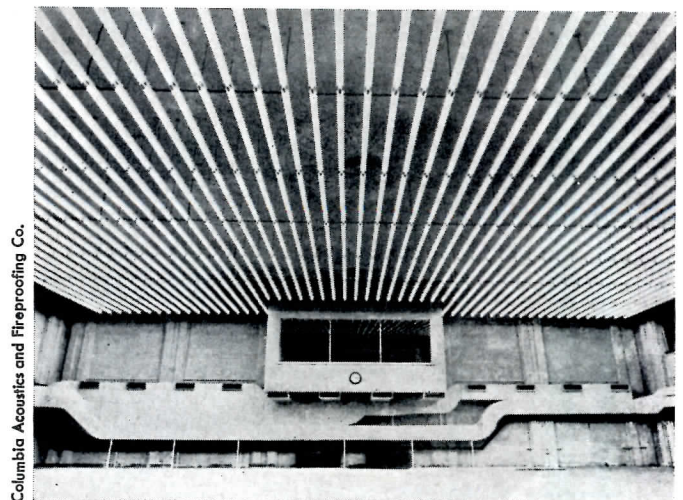

Columbia Acoustics and Fireproofing Co.

*Sprayed on mineral wool serves as sound insulation in this TV studio; it also can be used for insulating against heat*

laden air stream to reduce maintenance.

To cut down on fan noise, there is a galvanized steel or aluminum sound trap to fit inside a duct. It is available in 11 standard sizes and in three types for various sound conditions.

A complete prepackaged perimeter duct system for a 6-room house can be ordered by specifying one of four kits. Packaged system includes everything needed for a 6-room house — registers, return air duct material and plenum chamber. Sets come for 4½ and 6-in. individual round type systems; 4½ and 6-inch extended plenum systems with sidewall or floor diffusers.

### INSULATION

A one-piece, molded glass fiber pipe covering can easily be spread at the seam so as to snap over the pipe and then return to its original shape. It will not break, powder or crumble or bend out of shape.

A special blend of mineral wool fibers is applied to ceiling and walls by a spray gun method for building interiors. It can be applied to any clean rigid surface such as metal, plaster, wood, wire lath.

A double glazed insulating window is said to be particularly desirable for air conditioning and refrigeration applications. The window consists of 2 layers of ⅛ in. glass with ⅜ in. air space between. Under average conditions, the heat transfer is reduced to one-half that for single glazed windows. It is available in sizes up to 50 by 62 in.

For a vapor barrier there is a liquid plastic which is sprayed on a surface to provide a rubber-like sheeting 20 to 40

mils thick. The spray, which comes in several colors, can also be used as a corrosion resistant flashing and lining for air conditioning ducts.

An insulating mat, reinforced with parallel strands of glass yarn and coated with waterproof asphalt material can be used as a vapor barrier under basement-less buildings, weather sealing for above ground insulated pipe and exposed ducts. It can also be used as a lining for swimming pools. It is flexible and will not rot. It can be cut with a knife and sealed with a rapid-sealing asphaltic cement.

### PIPE AND DUCTS

Plastic pipe is coming into use and offers a number of advantages; however, one must have an understanding of the various types available and know the limitations of each and how it should be used. This pipe has been used for outdoor skating rinks, snow melting installations, radiant heating, lawn sprinkling systems and gas and water services to houses.

There are various methods for joining plastic pipe, from the use of a cement or adhesive to metal fittings. Brass fittings are available that have teeth which grip the pipe. Fittings are easily removed and can be used again. A sleeve is slipped over the pipe and there is a tapered adapter or coupling inside. As the sleeve is tightened, teeth grip the pipe inside and out. Fittings come in sizes from ½ to 2 in.

For use in new buildings, and particularly suitable for existing buildings, is a flexible tube that can be used for air conditioning and ventilating systems. A continuous galvanized steel spring is

covered with a permanently bonded 3-ply laminate of fiberglass fabric sandwiched between two layers of aluminum sheeting. In installation, the tube can be worked around existing obstructions. It comes in diameters of 2 to 10 in. and in 12 ft lengths.

### CONTROLS

Today almost everything in the fields covered by this article is automatically controlled, from the thermostat which controls the operation of heating systems to the television unit which transmits gage readings from a remote point to a viewing monitor. There are controls to insure proper operating cycles and devices which serve as safety measures.

A self-powered control system for gas burners requires no electric power connection, and is no larger than a matchbox. A very small amount of gas is introduced through minute holes spaced relatively far apart to permit a sufficient amount of secondary air to mix with the gas for complete combustion. Electric power, supplied by a thermopile, ranges from 500 to 800 mv depending on the temperature of the surrounding air, and the type and pressure of the gas being used. The same pilot that heats the thermopile ignites the main burner. One orifice is used for natural, mixed and manufactured gas. A readily interchangeable orifice is used for LP gas.

A safety control is available for pressurized oil burners to prevent excess oil flow should the fan fail to operate. The control is mechanical and requires no electrical connection. Air pressure against a diaphragm actuates the device,

*(Continued on page 230)*

*Electronic air cleaner is washed automatically by motorized nozzle. Adhesive is then reapplied*



Westinghouse Electric Corp

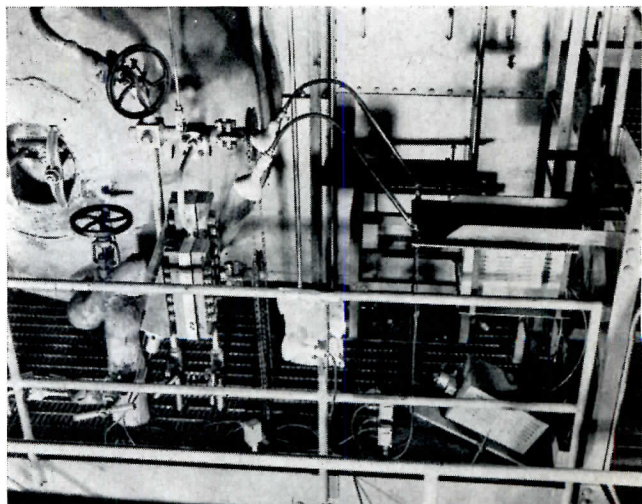

*Closed-circuit television makes possible remote readings of boiler gages in a central location. Camera is at lower right*

Yarnell-Waring Co.

**THERMAL INSULATION — 10: U Factors**

By Laurence Shuman, Consulting Engineer

**U Factors for Frame Ceilings**



Ceiling Type	Insulation	Season	Ceiling Finish							
			A	B	C	D	E	F	G	H
Open joists. No insulation above	1	Winter	.80	.78	.75	.70	.69	.39	.37	.24
		Summer	.53	.52	.51	.49	.48	.31	.30	.21
Insulation on joists. No insulation on ceiling	2 (on ceiling)	Winter	.20	.20	.20	.20	.19	.16	.16	.13
		Summer	.18	.18	.18	.17	.17	.15	.14	.12
Insulation on joists. No insulation on ceiling	3 (on ceiling)	Winter	.12	.12	.11	.11	.11	.10	.10	.09
		Summer	.11	.11	.11	.11	.11	.09	.09	.08
Insulation on joists. No insulation on ceiling	4 (on ceiling)	Winter	.07	.07	.07	.07	.07	.06	.06	.06
		Summer	.07	.07	.07	.07	.06	.06	.06	.05
Insulation on joists. No insulation on ceiling	5 (at top to form 1 air space)	Winter	.28	.28	.27	.27	.27	.20	.20	.15
		Summer	.08	.08	.08	.08	.08	.08	.07	.07
Insulation on joists. No insulation on ceiling	6 (to form 2 air spaces)	Winter	.17	.17	.17	.16	.16	.14	.13	.11
		Summer	.05	.05	.05	.05	.05	.05	.05	.04
Insulation on joists. No insulation on ceiling	7 (to form 3 air spaces)	Winter	.12	.12	.12	.12	.12	.10	.10	.09
		Summer	.04	.04	.04	.04	.04	.04	.04	.04
Insulation on joists. No insulation on ceiling	8	Winter	.19	.19	.19	.19	.19	.15	.15	.12
		Summer	.17	.17	.17	.16	.16	.14	.14	.11

**Legend:**

- A Metal lath and plaster
- B 3/8" gypsum board, plain or decorated
- C 1/4" plywood
- D Wood lath and plaster
- E 3/8" gypsum lath and plaster

**Ceiling Finishes**

- F 1/2" insulation board
- G 1/2" insulation board
- H 1" insulation board and plaster

**Insulation**

- 1 None
- 2 1" flexible
- 3 2" flexible
- 4 3 3/8" flexible
- 5 Aluminum foil, 1 sheet
- 6 Aluminum foil, 2 sheets
- 7 Aluminum foil, 3 sheets
- 8 1" insulation board

Ceiling Type	Insulation	Season	Ceiling Finish							
			A	B	C	D	E	F	G	H
1" (25/32) subfloor (Yellow Pine) on joists	1	Winter	.32	.32	.31	.30	.30	.22	.22	.16
		Summer	.26	.26	.26	.25	.25	.20	.19	.15
1" (25/32) subfloor (Yellow Pine) on joists	2 (on ceiling)	Winter	.14	.14	.14	.14	.14	.12	.12	.10
		Summer	.13	.13	.13	.13	.13	.11	.11	.10
1" (25/32) subfloor (Yellow Pine) on joists	3 (on ceiling)	Winter	.09	.09	.09	.09	.09	.08	.08	.07
		Summer	.09	.09	.09	.09	.09	.08	.08	.07
1" (25/32) subfloor (Yellow Pine) on joists	4 (on ceiling)	Winter	.06	.06	.06	.06	.06	.05	.05	.05
		Summer	.06	.06	.05	.05	.05	.05	.05	.05
1" (25/32) subfloor (Yellow Pine) on joists	5 (on top face of ceiling)	Winter	.23	.23	.23	.22	.22	.17	.17	.13
		Summer	.09	.09	.09	.09	.09	.08	.08	.07
1" (25/32) subfloor (Yellow Pine) on joists	5 (to form 2 air spaces)	Winter	.15	.15	.15	.15	.15	.12	.12	.10
		Summer	.05	.05	.05	.05	.05	.05	.05	.05
1" (25/32) subfloor (Yellow Pine) on joists	6 (to form 3 air spaces)	Winter	.11	.11	.11	.11	.11	.10	.09	.08
		Summer	.04	.04	.04	.04	.04	.03	.03	.03

**U Factors for Flat Roofs**



Roof Deck	Ceiling Finish	Season	Insulation on Roof Deck							
			A	B	C	D	E	F	G	H
Metal roof deck	1	Winter	1.04	.43	.27	.24	.15	.25	.18	.14
		Summer	.78	.37	.25	.22	.15	.23	.17	.13
Metal roof deck	2	Winter	.46	.28	.20	.16	.13	.19	.15	.12
		Summer	.41	.26	.19	.15	.12	.18	.14	.11
Metal roof deck	3	Winter	.29	.21	.16	.13	.11	.15	.12	.10
		Summer	.28	.20	.15	.13	.11	.15	.12	.10
Metal roof deck	4	Winter	.17	.14	.11	.10	.10	.11	.09	.08
		Summer	.16	.13	.11	.10	.09	.11	.09	.08
Metal roof deck	5	Winter	.10	.09	.08	.07	.07	.08	.07	.06
		Summer	.10	.09	.08	.07	.07	.08	.07	.06
Metal roof deck	6	Winter	.06	.06	.05	.05	.05	.05	.05	.05
		Summer	.06	.06	.05	.05	.05	.05	.05	.05

**Legend:**

- A None
- B 1/2" insulation board
- C 1" insulation board
- D 1 1/2" insulation board

**Insulation on Roof Deck**

- E 2" insulation board
- F 1" corkboard
- G 1 1/2" corkboard
- H 2" corkboard

**Ceiling Finishes**

- 1 None
- 2 3/8" gypsum board or plaster
- 3 1/2" insulation board
- 4 3/8" gypsum board and 1" flexible insulation over ceiling
- 5 3/8" gypsum board and 2" flexible insulation over ceiling
- 6 3/8" gypsum board and 3 3/8" flexible insulation over ceiling

Roof Deck	Ceiling Finish	Season	Insulation on Roof Deck							
			A	B	C	D	E	F	G	H
Concrete roof deck 2" thick	1	Winter	.89	.40	.26	.19	.15	.23	.17	.14
		Summer	.70	.35	.23	.18	.14	.22	.16	.13
Concrete roof deck 2" thick	2	Winter	.43	.27	.20	.15	.13	.18	.14	.12
		Summer	.39	.25	.18	.15	.12	.17	.14	.11
Concrete roof deck 2" thick	3	Winter	.28	.20	.16	.13	.11	.15	.12	.10
		Summer	.26	.19	.15	.12	.11	.14	.12	.10
Concrete roof deck 2" thick	4	Winter	.16	.13	.11	.10	.09	.11	.09	.08
		Summer	.16	.13	.11	.10	.08	.11	.09	.08
Concrete roof deck 2" thick	5	Winter	.10	.09	.08	.07	.06	.08	.07	.06
		Summer	.10	.09	.08	.07	.06	.08	.07	.06
Concrete roof deck 2" thick	6	Winter	.06	.06	.05	.05	.05	.05	.05	.05
		Summer	.06	.06	.05	.05	.05	.05	.05	.05

**Our 101st Year  
of Successful  
Manufacturing Experience**

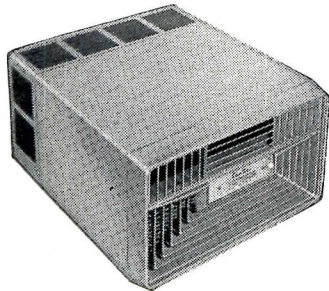

NEW Attractive Window Units up to 1½ tons for commercial and residential use

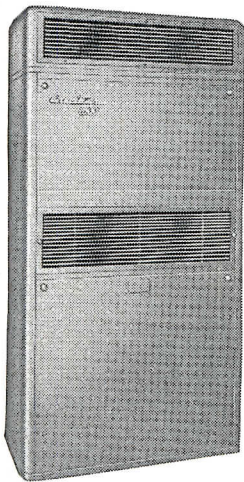

Package Units—2, 3, 5, 7½ and 10 tons. Choice of Open or Semi-hermetic Compressors... and 15 ton packaged central type units.

# *Curtis*

## AIR CONDITIONING

**Units Are Your Assurance of Client Satisfaction**

The Curtis line is precision-built to assure a long life of trouble-free service. You can specify Curtis air conditioning equipment with the assurance that it will never let you down.

- ✓ Installation is fast and easy.
- ✓ Maintenance costs are low.
- ✓ Priced to meet competition.
- ✓ Smooth, quiet operation.
- ✓ A Curtis Unit for every job—  
a complete range of sizes and types.

See Curtis data in Sweets Catalog File, and write for your free copy of NEW Curtis Architects' Air Conditioning Manual.

## **RESIDENTIAL... INDUSTRIAL... COMMERCIAL**

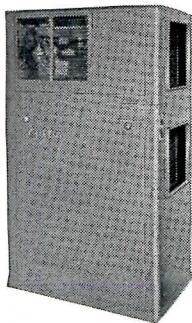

Residential Cooling and Heating Units

Also manufacturers of compressors and hoists for industrial uses and compressors, lifts and car washers for the automotive service industry.

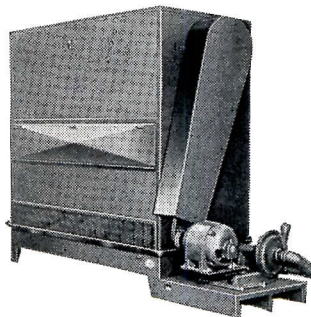

Air handling units, cooling towers, and evaporative condensers

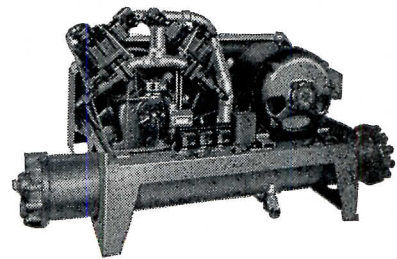

Water Cooled Condensing Units—through 80 tons

# *Curtis*

**REFRIGERATING MACHINE DIVISION**  
of Curtis Manufacturing Company  
1986 Kienlen Avenue, St. Louis 20, Missouri

THERMAL INSULATION — 11: U Factors for Flat Roofs

By Laurence Shuman, Consulting Engineer

Legend:

- Insulation on Roof Deck**
- A None
  - B 1/2" insulation board
  - C 1" insulation board
  - D 1 1/2" insulation board
  - E 2" insulation board
  - F 1" corkboard
  - G 1 1/2" corkboard
  - H 2" corkboard

Ceiling Finishes

- 1 None
- 2 3/8" gypsum board or plaster
- 3 1/2" insulation board
- 4 3/8" gypsum board and 1" flexible insulation over ceiling
- 5 3/8" gypsum board and 2" flexible insulation over ceiling
- 6 3/8" gypsum board and 3 3/8" flexible insulation over ceiling



Roof Deck	Ceiling Finish	Season	Insulation on Roof Deck								Roof Deck	Ceiling Finish	Season	Insulation on Roof Deck																																		
			A	B	C	D	E	F	G	H				A	B	C	D	E	F	G	H																											
Concrete roof deck 4" thick 	1	Winter	.78	.37	.25	.18	.15	.23	.17	.13	Wood roof deck 2" thick 	1	Winter	.34	.23	.18	.14	.12	.17	.13	.11	Summer	.31	.22	.17	.13	.11	.16	.13	.11																		
		Summer	.63	.33	.23	.17	.14	.21	.16	.13			Summer	.25	.18	.15	.12	.10	.14	.11	.10		Summer	.23	.17	.14	.12	.10	.13	.11	.09																	
	2	Winter	.41	.26	.19	.15	.12	.18	.14	.11		3	Winter	.19	.15	.12	.11	.09	.12	.10	.09	Summer	.18	.14	.12	.10	.09	.11	.10	.08	Summer	.13	.11	.09	.08	.07	.09	.08	.07									
		Summer	.36	.24	.18	.14	.12	.17	.13	.11			Summer	.12	.11	.09	.08	.07	.09	.08	.07		Summer	.09	.08	.07	.06	.06	.07	.06		.06																
	3	Winter	.27	.19	.15	.13	.11	.15	.12	.10		4	Winter	.09	.08	.07	.06	.06	.07	.06	.06	Summer	.09	.08	.07	.06	.06	.07	.06	.06	Summer	.06	.05	.05	.05	.05	.05	.05	.05									
		Summer	.25	.19	.15	.12	.10	.14	.11	.10			Summer	.06	.05	.05	.05	.05	.05	.05	.05		Summer	.06	.05	.05	.05	.05	.05	.05		.05																
4	Winter	.16	.13	.11	.10	.08	.11	.09	.08	5	Winter	.09	.08	.07	.06	.06	.07	.06	.06	Summer	.09	.08	.07	.06	.06	.07	.06	.06	Summer	.06	.05	.05	.05	.05	.05	.05	.05											
	Summer	.16	.13	.11	.09	.08	.10	.09	.08		Summer	.06	.05	.05	.05	.05	.05	.05	.05		Summer	.06	.05	.05	.05	.05	.05	.05		.05																		
5	Winter	.10	.09	.08	.07	.06	.08	.07	.06	6	Winter	.06	.05	.05	.05	.05	.05	.05	.05	Summer	.06	.05	.05	.05	.05	.05	.05	.05	Summer	.06	.05	.05	.05	.05	.05	.05	.05											
	Summer	.10	.09	.08	.07	.06	.08	.07	.06		Summer	.06	.05	.05	.05	.05	.05	.05	.05		Summer	.06	.05	.05	.05	.05	.05	.05		.05																		
Concrete roof deck 6" thick 	1	Winter	.70	.35	.24	.18	.14	.22	.16	.13	Wood roof deck 3" thick 	1	Winter	.26	.19	.15	.12	.11	.14	.12	.10	Summer	.24	.18	.14	.12	.10	.14	.11	.10	Winter	.20	.15	.13	.11	.09	.12	.10	.09	Summer	.18	.15	.12	.10	.09	.12	.10	.09
		Summer	.57	.32	.22	.17	.13	.17	.16	.12			Summer	.15	.12	.11	.09	.08	.10	.09	.08		Summer	.15	.12	.11	.09	.08	.10	.09		.08																
	2	Winter	.38	.25	.19	.15	.12	.17	.14	.11		3	Winter	.16	.13	.11	.10	.08	.11	.09	.08	Summer	.11	.10	.09	.08	.07	.08	.07	.07	Summer	.11	.10	.09	.08	.07	.08	.07	.07									
		Summer	.34	.23	.17	.14	.12	.16	.13	.11			Summer	.15	.12	.11	.10	.08	.10	.09	.08		Summer	.11	.10	.09	.08	.07	.08	.07		.07																
	3	Winter	.26	.19	.15	.12	.11	.14	.12	.10		4	Winter	.08	.07	.06	.06	.06	.07	.06	.05	Summer	.08	.07	.06	.06	.05	.06	.06	.05	Summer	.08	.07	.06	.06	.05	.06	.06	.05									
		Summer	.24	.18	.14	.12	.10	.14	.11	.10			Summer	.10	.09	.08	.07	.06	.07	.06	.06		Summer	.08	.07	.06	.06	.05	.06	.06		.05																
4	Winter	.16	.13	.11	.10	.08	.10	.09	.08	5	Winter	.08	.07	.06	.06	.06	.07	.06	.05	Summer	.08	.07	.06	.06	.05	.06	.06	.05	Summer	.05	.05	.05	.04	.04	.05	.04	.04											
	Summer	.15	.12	.11	.10	.08	.10	.09	.08		Summer	.10	.09	.08	.07	.06	.07	.06	.06		Summer	.05	.05	.05	.04	.04	.05	.04		.04																		
5	Winter	.10	.09	.08	.07	.06	.07	.06	.06	6	Winter	.05	.05	.05	.04	.04	.05	.04	.04	Summer	.05	.05	.05	.04	.04	.05	.04	.04	Summer	.05	.05	.05	.04	.04	.05	.04	.04											
	Summer	.10	.09	.08	.07	.06	.07	.06	.06		Summer	.06	.05	.05	.05	.05	.05	.05	.05		Summer	.06	.05	.05	.05	.05	.05	.05		.05																		
Wood roof deck 1" thick 	1	Winter	.52	.30	.21	.16	.13	.20	.15	.12	Gypsum fiber concrete roof deck 2 1/2" thick 	1	Winter	.39	.26	.19	.15	.12	.18	.14	.11	Summer	.35	.24	.18	.14	.12	.17	.13	.11	Winter	.27	.20	.15	.13	.11	.15	.12	.10	Summer	.25	.18	.14	.12	.10	.14	.11	.10
		Summer	.44	.27	.20	.16	.13	.19	.14	.12			Summer	.20	.16	.13	.11	.09	.12	.10	.09		Summer	.19	.15	.12	.11	.09	.12	.10		.09																
	2	Winter	.32	.22	.17	.14	.11	.16	.13	.11		3	Winter	.13	.11	.10	.09	.08	.09	.08	.07	Summer	.13	.11	.10	.09	.08	.09	.08	.07	Summer	.13	.11	.10	.09	.08	.09	.08	.07									
		Summer	.29	.21	.16	.13	.11	.15	.12	.10			Summer	.09	.08	.07	.06	.06	.07	.06	.06		Summer	.09	.08	.07	.06	.06	.07	.06		.06																
	3	Winter	.23	.17	.14	.12	.10	.13	.11	.09		4	Winter	.09	.08	.07	.06	.06	.07	.06	.06	Summer	.09	.08	.07	.06	.06	.07	.06	.06	Summer	.06	.05	.05	.05	.05	.05	.05	.05									
		Summer	.22	.17	.13	.11	.10	.13	.11	.09			Summer	.09	.08	.07	.06	.06	.07	.06	.06		Summer	.06	.05	.05	.05	.05	.05	.05		.05																
4	Winter	.14	.12	.10	.09	.08	.10	.09	.08	5	Winter	.09	.08	.07	.06	.06	.07	.06	.06	Summer	.09	.08	.07	.06	.06	.07	.06	.06	Summer	.06	.05	.05	.05	.05	.05	.05	.05											
	Summer	.14	.12	.10	.09	.08	.10	.09	.08		Summer	.09	.08	.07	.06	.06	.07	.06	.06		Summer	.06	.05	.05	.05	.05	.05	.05		.05																		
5	Winter	.09	.08	.07	.06	.06	.07	.06	.06	6	Winter	.06	.05	.05	.05	.05	.05	.05	.05	Summer	.06	.05	.05	.05	.05	.05	.05	.05	Summer	.06	.05	.05	.05	.05	.05	.05	.05											
	Summer	.09	.08	.07	.06	.06	.07	.06	.06		Summer	.06	.05	.05	.05	.05	.05	.05	.05		Summer	.06	.05	.05	.05	.05	.05	.05		.05																		
Wood roof deck 1 1/2" thick 	1	Winter	.41	.26	.19	.15	.13	.18	.14	.12	Gypsum fiber concrete roof deck 3 1/2" thick 	1	Winter	.32	.28	.20	.16	.12	.16	.13	.11	Summer	.29	.26	.19	.15	.11	.15	.12	.10	Winter	.23	.17	.14	.12	.10	.13	.11	.09	Summer	.21	.16	.13	.11	.10	.13	.11	.09
		Summer	.36	.24	.18	.14	.12	.17	.13	.11			Summer	.20	.16	.13	.11	.09	.12	.10	.09		Summer	.18	.14	.13	.10	.09	.11	.10		.08																
	2	Winter	.28	.20	.16	.13	.11	.15	.12	.10		3	Winter	.17	.14	.12	.10	.09	.11	.09	.08	Summer	.17	.14	.12	.10	.09	.11	.09	.08	Summer	.12	.10	.09	.08	.07	.09	.08	.07									
		Summer	.25	.19	.15	.12	.10	.14	.12	.10			Summer	.12	.10	.09	.08	.07	.09	.08	.07		Summer	.12	.10	.09	.08	.07	.09	.08		.07																
	3	Winter	.20	.16	.13	.11	.10	.12	.10	.09		4	Winter	.08	.08	.07	.06	.06	.07	.06	.06	Summer	.08	.08	.07	.06	.06	.07	.06	.06	Summer	.08	.08	.07	.06	.06	.07	.06	.06									
		Summer	.19	.15	.13	.11	.09	.12	.10	.09			Summer	.08	.08	.07	.06	.06	.07	.06	.06		Summer	.08	.08	.07	.06	.06	.07	.06		.06																
4	Winter	.14	.11	.10	.09	.08	.09	.08	.07	5	Winter	.08	.08	.07	.06	.06	.07	.06	.06	Summer	.08	.08	.07	.06	.06	.07	.06	.06	Summer	.06	.05	.05	.05	.05	.05	.05	.05											
	Summer	.13	.11	.10	.09	.08	.09	.08	.07		Summer	.08	.08	.07	.06	.06	.07	.06	.06		Summer	.06	.05	.05	.05	.05	.05	.05		.05																		
5	Winter	.09	.08	.07	.06	.06	.07	.06	.06	6	Winter	.06	.05	.05	.05	.05	.05	.05	.05	Summer	.06	.05	.05	.05	.05	.05	.05	.05	Summer	.06	.05	.05	.05	.05	.05	.05	.05											
	Summer	.09	.08	.07	.06	.06	.07	.06	.06		Summer	.06	.05	.05	.05	.05	.05	.05	.05		Summer	.06	.05	.05	.05	.05	.05	.05		.05																		

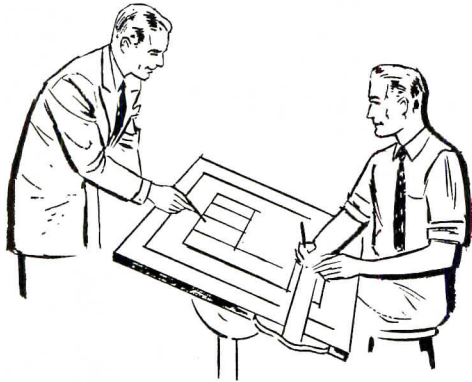

for dimensional stability,  
strength, light weight and  
life-time service always specify . . .

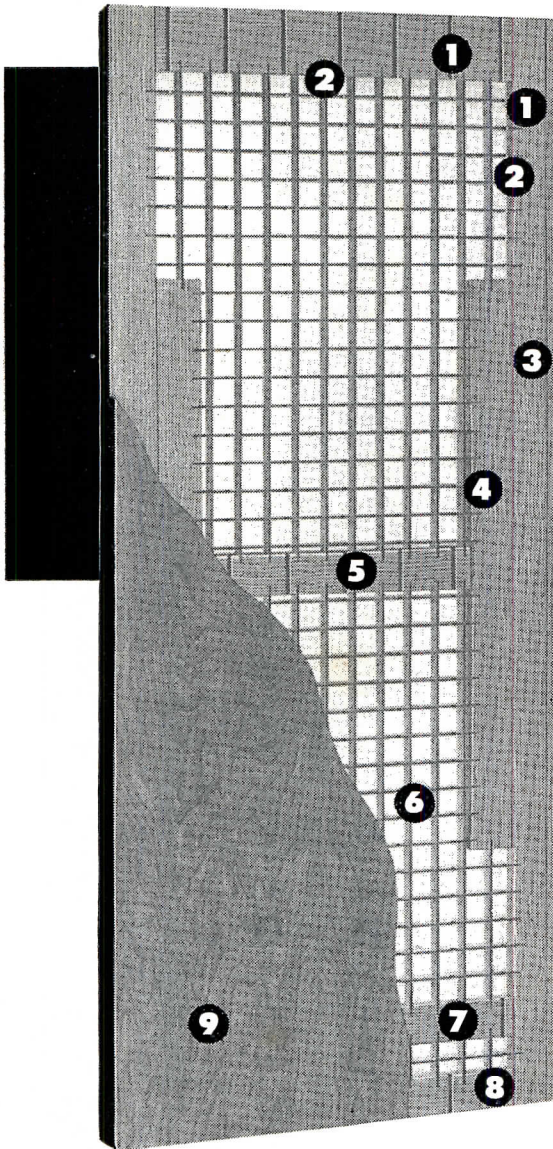

**PAINÉ**  
**REZO**  
T. M. REGISTERED

**INSTITUTIONAL**  
all-wood grid core  
**FLUSH DOORS**

*America's Finest*

**Only REZO offers all these features:**

- 1** One rail is 5" wide and can be used as either top or bottom of the door. Stiles are 3" (nom.).
- 2** All-wood gridwork is locked into the stiles and rails for greater strength.
- 3** Matching vertical edge strips can be furnished and finish not less than 1/2" wide after trimming.
- 4** Lock area is 6 3/4" wide and 21" from either end and varies in length proportionate to door height.
- 5** 3" rail for special hardware is 41" from bottom of door to top of rail unless otherwise specified.
- 6** Heavy duty 2" x 2" air cell all-wood gridwork interlocked for strength and durability.
- 7** 3" rail for kick plate located 10" from bottom of door to top of rail unless otherwise specified.
- 8** Vent grooves in top and bottom rails help keep moisture content in balance — prevent warpage.
- 9** Hand-matched hardwood face veneers, 3 ply, of any commercial species. Sanded to cabinetmaker's finish.

Cost? Less expensive than solid core doors — and better! For full details, see Sweet's Catalog or write:



Light Weight — easy,  
one man installation

Resists Abuse — for  
life-time service

Convenient — easy  
to open and close

**PAINÉ**  
**LUMBER COMPANY, LTD.**  
ESTABLISHED 1853 • OSHKOSH, WIS.



## NORTH AMERICAN BUILDING STONES—17

Presented through the cooperation of the International Cut Stone Contractors' and Quarrymen's Association

## INDEX OF BUILDING STONES — (To be concluded in later issue)

**73 COLORADO BERTHOUD VARIEGATED**

**Company Name:** Colorado Stone Co.  
**Quarry Location:** Near Berthoud, Col. (Mail address: Longmont, Col.)  
**Geological Designation:** Quartzitic Sandstone  
**Texture:** Very fine-grained, closely cemented, fine texture  
**Color:** Light pink with stripes, bands and swirls of complementary darker colors  
**Weight:** 156 to 162 pcf  
**Furnished As:** Dimensional, Splitface, Ledge-stone, Flagging. Heights—1" to 3"; 1" to 6"; ¾" to 2"; 6" to 11". Lengths—12" to 12'  
**Surface Coverage:** Splitface—40 to 44 sq ft per ton. Flagging—120 to 140 sq ft per ton

**74 COLORADO LOVELAND BUFF**

**Company Name:** Colorado Stone Co.  
**Quarry Location:** Near Loveland, Col. (Mail address: Longmont, Col.)  
**Geological Designation:** Quartzitic Sandstone  
**Texture:** Smooth, even medium grain; stratified to dense  
**Color:** Light buff with dark or light horizontal lines; off-white with buff and brown stripes and bands; gray-white, gray-white with blue-gray and buff horizontal lines, stripes and colorations  
**Weight:** 150 pcf  
**Furnished As:** Splitface, Ledge-stone. Heights—1" to 3"; 1" to 6"; ¾" to 2"; 6" to 11". Lengths—12" to 12'  
**Surface Coverage:** Splitface—40 to 45 sq ft per ton  
**Other Comments:** This stone is from the Lyons Ledge-stone formation

**75 COLORADO LYONS RED**

**Company Name:** Colorado Stone Co.  
**Quarry Location:** Noland and Beech Hill, near Lyons, Col. (Mail address: Longmont, Col.)  
**Geological Designation:** Quartzitic Sandstone  
**Texture:** Even-grained, smooth stratified to hard dense  
**Color:** Red, pink, rose; red or pink with white stripe, brown and glazed tan on natural seam faces (one side of small percentage of splitface strips); blue, brown, tan on natural strata surfaces  
**Weight:** 150 pcf  
**Furnished As:** Dimensional, Splitface, Ledge-stone, Flagging. Heights—1" to 3"; 1" to 6"; ¾" to 2"; 6" to 11". Lengths—12" to 12'  
**Surface Coverage:** Splitface—40 to 45 sq ft per ton. Flagging—120 to 150 sq ft per ton  
**Other Comments:** This stone is from the Lyons Ledge-stone formation

**76 ETOWAH PINK GEORGIA MARBLE**

**Company Name:** The Georgia Marble Company  
**Quarry Location:** Tate, Ga.  
**Geological Designation:** Marble

**Texture:** Large sparkling crystals

**Color:** Pale pink to rose with greenish-black random veining  
**Chemical Composition:** Calcium carbonate—98.2%; magnesium silicate—1.03%; silica—0.48%; alumina—0.09%; oxide of iron—0.04%; moisture—0.16%  
**Physical Tests:** Specific gravity—2.71%; absorption of moisture—0.08%; abrasive hardness—13.4%; carbonic acid test—slight roughening but no granulation  
**Strength:** Crushing strength—13,590 psi. Crushing strength unaffected by freezing and thawing 30 times  
**Furnished As:** Splitface. Heights—¾", 2¼", 5". Lengths—3' average, 5' max., 1' min.  
**Surface Coverage:** 40 sq ft per ton—one-third 2¼" thick, two-thirds 5" thick ashlar veneer (more when higher proportions of low risers are used)  
**Other Facts:** Veining is extremely irregular, runs in all directions.

**77 FLAGSTONE**

**Company Name:** Palos Verdes Stone Dept., Great Lakes Carbon Corp.  
**Quarry Location:** Rolling Hills, Calif. (Mail address: 612 Flower St., Los Angeles, Calif.)  
**Geological Designation:** Silicified limestone and chert  
**Texture:** Medium coarse  
**Color:** Off-white and off-gray  
**Furnished As:** Splitface. Heights—1"–3". Lengths—12"–48"  
**Surface Coverage:** 30–50 sq ft per ton

**78 LYONS REDSTONE, LITTLE THOMPSON COLOR STONE**

**Company Name:** Brown Stone Quarries  
**Quarry Location:** Lyons and Little Thompson Canyon, Col.  
**Geological Designation:** Quartzitic Sandstone  
**Color:** Pink, red candy stick red stripe, pink-white blend  
**Weight:** 160 pcf  
**Furnished As:** Splitface, Ledge-stone. Heights—¾" to 5". Lengths—14" to 40", 4" width  
**Surface Coverage:** Approx. 40 sq ft per ton 4" veneer

**79 MOSSBACK**

**Company Name:** Palos Verdes Stone Dept., Great Lakes Carbon Corp.  
**Quarry Location:** Rolling Hills, Calif. (Mail address: 612 Flower St., Los Angeles, Calif.)  
**Geological Designation:** Silicified limestone and chert  
**Texture:** Coarse  
**Color:** Light gray variegated with moss  
**Furnished As:** Ledge-stone. Heights—2"–8". Lengths—6"–24"  
**Surface Coverage:** 30–50 sq ft per ton

**NOW...**  
the greatest  
drain  
development  
in years!

# Josam SUPER-FLO

VIEW OF SECTION OF TOP OF Josam SUPER-FLO DRAIN showing perimeter slots in addition to center slots.

VIEW OF SECTION OF TOP OF STANDARD DRAIN showing slots only in the center of drain top.

● Through Josam pioneering, a great new advancement in drains is presented to the industry. A comparison of features quickly shows why Josam SUPER-FLO drains will be preferred over conventional drains.

## GREATER FLOW

Josam SUPER-FLO Floor Drains are designed with perimeter slots in the grate which increase the free drainage area of the top and permit greater flow into the drain. In SUPER-FLO Floor Drains, waste water enters the drain at the very edge of the drain top instead of flowing over the wide rim of conventional drains before it reaches the grate openings. Because of this, water friction loss in Josam SUPER-FLO Drains is greatly reduced, and the flow rate (GPM) into the drain is greater than the flow rate in standard drains of the same or larger size top.

## SAVINGS IN COST

Because of the increased flow rate in Josam SUPER-FLO Drains a smaller top size Josam SUPER-FLO Floor Drain can be installed to service the same drainage condition as a larger top size standard floor drain.

Therefore, you benefit not only from savings in the cost of the drain itself but in additional savings because of the number of drains to be installed. No other floor drain offers these exclusive features and advantages.

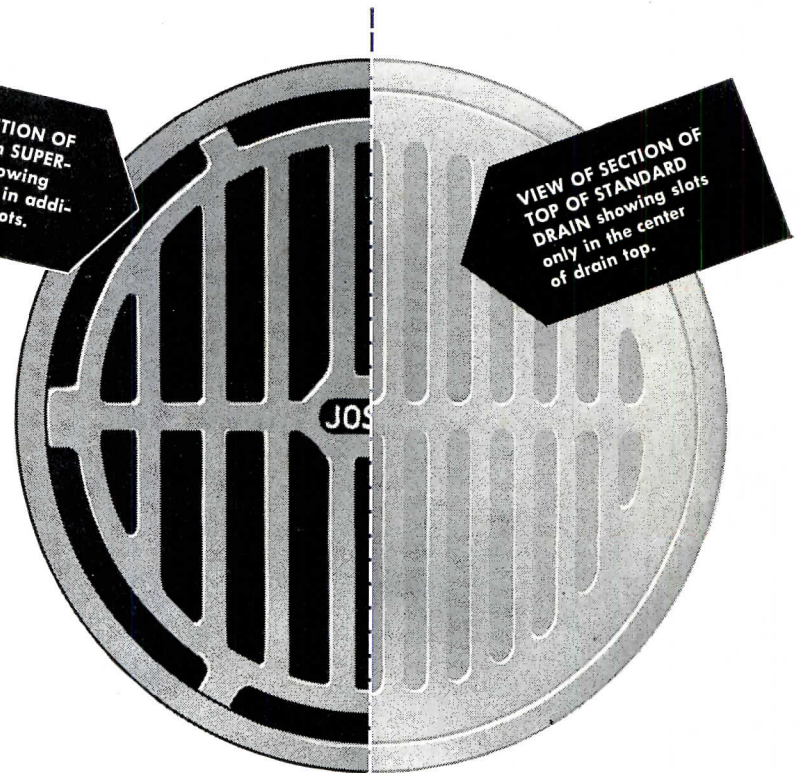

Josam SUPER-FLO Drain with 7" top

STANDARD DRAIN with 9" top



gives the same or greater flow rate and can be used instead of a

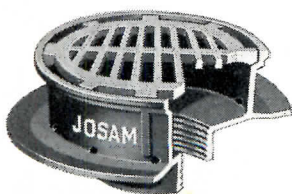
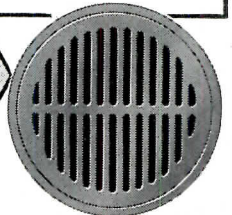

JOSAM SUPER-FLO FLOOR DRAIN with 7", 9" or 13" round top having a free drainage area of 17, 27 and 61 sq. in. respectively, and 2" to 6" threaded bottom outlet.

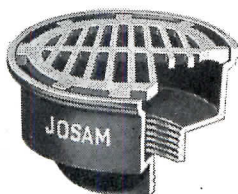

JOSAM SUPER-FLO AREA DRAIN with 7" or 9" round top having a free drainage area of 17 and 27 sq. in. respectively, and 2", 3" or 4" threaded bottom outlet.

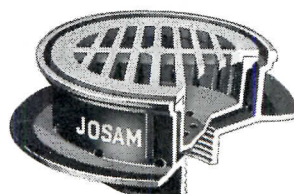

JOSAM SUPER-FLO NON-CLOG TRIPLE DRAINAGE FLOOR DRAIN with removable sediment bucket which supports grate, 7", 9" or 13" round top having a free drainage area of 11, 16 and 29 sq. in. respectively, and 2" to 6" threaded bottom outlet.

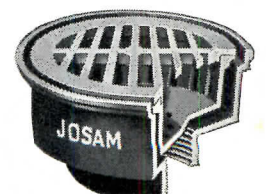

JOSAM SUPER-FLO NON-CLOG AREA DRAIN with removable sediment bucket which supports grate, 7" or 9" round top having a free drainage area of 11 and 16 sq. in. respectively, and 2", 3" or 4" threaded bottom outlet.

SEND COUPON FOR COMPLETE INFORMATION ON FEATURES, MATERIALS AND FINISHES