

# ARCHITECTURAL RECORD

FEBRUARY 1957

BUILDING TYPES STUDY 243 : INDUSTRIAL

# AT GIMBELS

*in the Southgate  
Shopping Center...*

*unobtrusive,  
dependable*

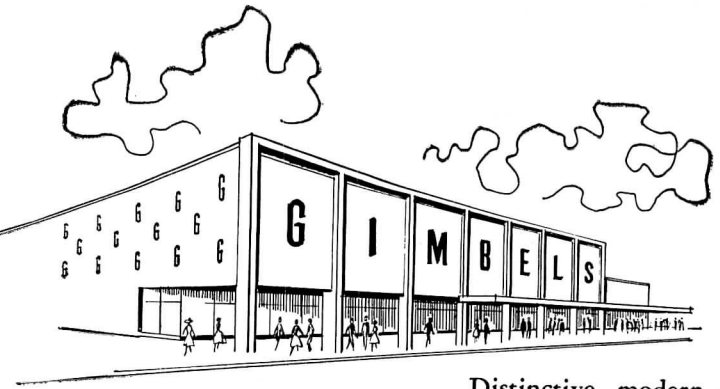

# GRINNELL SPRINKLERS

*Architects: GRASSOLD-JOHNSON ASSOCIATES  
WELTON BECKET & ASSOCIATES*



Distinctive, modern design, inside and out, plus effective store planning make Gimbel's Southgate an attractive addition to Milwaukee's first suburban shopping center. The spacious, uncluttered interior was designed for shopping ease and comfort . . . as well as to make the most effective use of merchandising areas.

The Grinnell Sprinkler System, specified by the architects at the planning stage, also has been made a functional part of interiors. Notice particularly how the Grinnell Ceiling-Type Sprinklers are almost invisible; extend but a scant inch and a quarter from the ceiling — not marring the interior decor. The end-result is an unobtrusive, smartly planned fire protection system that fits so well into the store design. Yet, should fire strike, Grinnell Sprinklers stand ready to operate quickly — effectively, day or night, to stop fire at its source.

Call in a Grinnell Fire Protection Engineer when you design your next project. He can advise you on the best system to suit your requirements. There is a Grinnell System for every type of fire hazard. Write for literature. Grinnell Company, Inc., 269 West Exchange Street, Providence, Rhode Island.

# GRINNELL

PROTECTION AGAINST EVERY FIRE HAZARD

— Manufacturing, Engineering, and Installation of Fire Protection Systems Since 1870 —



# THE RECORD REPORTS

## P E R S P E C T I V E S

**INAUGURAL FOOTNOTE:** The grandstand from which President Eisenhower reviewed the Inaugural Parade which helped to launch his second term in office last month was not — though it might have been — the design of Ernest L. Daly, winner of this year's edition of the Inaugural grandstand design competition which has become a tradition in the Washington-Metropolitan Chapter of the A.I.A. Chapter President Grosvenor Chapman reports that the competition was held as usual, Mr. Daly's design was selected as the winner, and Inaugural Chairman Robert Fleming duly apprised; but before the existence of the new design had even been mentioned to the President, *he* had disposed of the grandstand question by asking what was wrong with the other one? — so the 1953 competition winner by Robert A. Weppner Jr. had a reprise.

**ANOTHER PART OF THE FOREST:** To nobody's surprise, the talk about Frank Lloyd Wright's Mile High Illinois proposal goes on apace even if construction doesn't, and there are views (AR, Jan. 1957, page 9) and views — for example, the A.I.A. Chicago Chapter monthly *Bulletin*, devoting a page to the project, with such comments as these: "Architecture was front page news, and its greatest publicist had done another superb drawing in superlatives that even modified would still be awe inspiring, and inspiring to all and aspiring to anything. That this particular building is at all practical or possible is much less the point than that we have a man in our profession who dares, who cares and does, and is so able to say so much in his work and with his words both. . . . The bold statement in work and words are his, uncompromised, uncompromising. We need someone prodding us to keep us from just plodding along, building out of prosperity instead of into posterity. . . ."

**THE BEST WE CAN DO AS ARCHITECTS,** Maxwell Fry told an Architectural League of New York luncheon meeting in his honor last month, "is to make good buildings; but after that we must make town planning a much more important part of architectural practice." Mr. Fry, who was here from England for an eight-weeks stint as a visiting critic at Harvard's Graduate School of Design, talked about some of the things he had learned from his work in "this tropical world" (of India, of West Africa) where growing nationalism and growing industrialization and a trend toward socialism make the context in which architectural problems must be approached. In particular, Mr. Fry remarked the tendency of industrialization as the great moving force in these developing parts of the world to destroy old ways and old values to the detriment of local cultures and too frequently to the inadvertent substitution of materialism. In this situation, Mr. Fry observed, architects have become "people to whom has been given a responsibility for converting such materialistic trends into something of both human and spiritual value."

**THE PATRONS OF ARCHITECTURE:** "Shall we not have our own bishops and princes?" asked Joseph Hudnut at the convocation on "The Next Fifty Years" which marked the fiftieth anniversary of the University of Michigan's College of Architecture and Design. "Clearly," he answered himself, "our bishops and princes are the great corporations who, for good or evil, have taken the mistress art under their somewhat ambivalent protection. I mean of course the manufacturers of steel and oil and motor cars; the huge department stores; the banks; and — with a different emphasis — the boards, committees and other agencies of govern-

ment that build hospitals, schools and universities on an heroic scale. Together these sum up the will of our epoch and represent its grandeur. The House of Seagram, the Prudential Life Insurance Company, the Chase National Bank are building themselves in skyscrapers and in so doing they 'set forth in plastic terms the energies of our era.' Because they have need of that expression they will understand and cherish modern architecture. I do not mean that creatures so alive and ready to go places will forever chart their programs of building within the reasonable and disciplined tradition of modernism. On the contrary I think we may expect some very surprising exploitations of industrial technology and invention. Corporations have to think a great deal about the important but often nebulous form of diplomacy they call *public relations*; and this diplomacy includes advertisement and promotion. Skyscrapers are created, like millinery, to be talked about; like mink and diamonds they announce the status and wealth of those they clothe; and they must be in the fashion. Our new architecture therefore may some day melt into a steel-and-glass baroque. And since a baroque architecture cannot live without the decorative arts these too will free themselves from their present imprisonment and flower anew in an uninhibited humanism. The arts, as we know, change together. They change in echelon, poetry and painting one step ahead of architecture. Nor should I call such a baroque a disaster. I need no further sanction for my faith in corporations than the recent buildings of the Technical Center near Detroit, or the new buildings of the Illinois Institute of Technology and the New Campus of the University of Michigan. Such noble *simplicities* renew our faith in ourselves and our time."

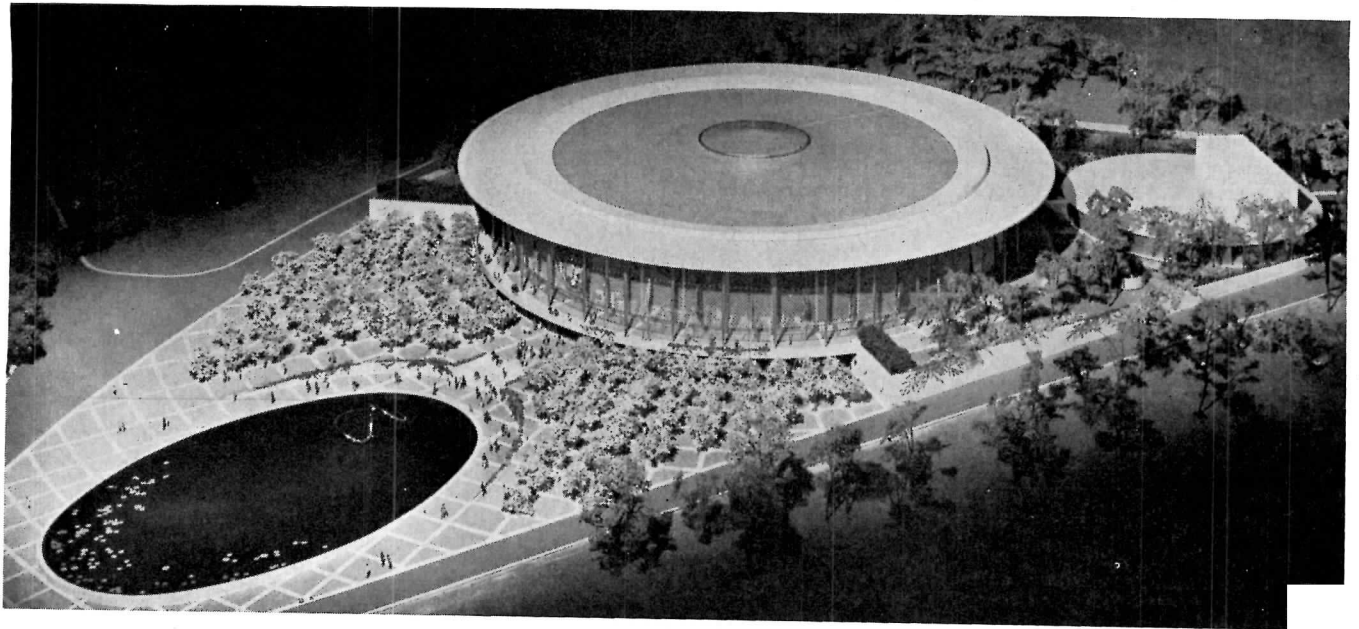

LIGHT, STRONG AND FREE:

**BICYCLE WHEEL ON COLUMNS SPANS 300 FT TO ENGINEER  
A CRYSTAL AND GOLD PAVILION FOR U. S. AT BRUSSELS**

Edward D. Stone's design for the U. S. building at the Brussels World's Fair 1958 will set in the shallow natural amphitheater of an irregularly-shaped site a translucent and shimmering building with spectacular interior spaces made possible by a structural system adapted from that of the roof of the Roman Coliseum. The design has now had all the necessary approvals from official sources, and construction is expected to get under way this month or next.

The structure will be both extremely light and extremely strong. Two concentric rings of steel columns 12 in. in diameter will support a roof constructed like a bicycle wheel, with an outer compression ring of reinforced concrete connected to an inner metal ring 60 ft in diameter and 24 ft deep by two layers of high tension steel cables 2¼ in. thick, for a clear span of 300 ft: one of the largest circular buildings of all time. The structure of the Coliseum (larger, but elliptical) lacked the inner drum. The roof structure of the Brussels building will carry "almost no load" except the live load imposed by the elements.

An outer covering of translucent plastic will rest on the upper roof cables; a ceiling of metal mesh, continually luminous either with natural or artificial light, will be suspended below. Honeycomb walls of transparent or

translucent plastic cells will be hung free from the outer rim of the roof structure between the rings of columns. All the exposed structural members will be sheathed in gold-anodized aluminum or gold leaf.

The U. S. site in Brussels adjoins those of the Soviet Union, Bulgaria and the Vatican. Its development has been carefully designed to provide for the U. S. building a setting of park, gardens and — facing the main entrance — a great plaza dominated by an elliptical pool. Near the main entrance it is planned to have an outdoor cafe serving traditional American food specialties.

The main building itself is a two-level exhibition pavilion measuring 381 ft in its widest dimension and 95 ft in its highest, with a "water garden" 150 ft in diameter as its center. This interior garden, framed with existing willow trees, will have sculpture and fountains.

The ground floor, in effect scooped out of the natural bowl of the site, will provide a 60-ft-wide strip of apisdal exhibition space around the water garden. Various services and general offices are grouped around the perimeter. Ceiling height here will be just over 12 ft for contrast with the great and lofty space above.

The upper level is 50 ft from floor to

ceiling; the plan again is a 60-ft-wide strip overlooking the water garden in its center; but here the translucent walls are all the enclosure of the perimeter, and a strip of sliding glass doors also opens the whole circumference — for two thirds of the way offering direct access to park and garden (at grade), for the other third to a balcony overlooking the entrance plaza and lagoon.

The smaller unit adjoining the pavilion contains a theater below ground level; above is the U. S. Commissioner's Pavilion, where distinguished visitors will be received. Howard S. Cullman, New York businessman and honorary chairman of the Port of New York Authority, is U. S. Commissioner-General to Brussels World's Fair 1958.

The Brussels project is the second instance of a State Department request to the American Institute of Architects for advice and assistance in selection of an architect and programming of a U. S. architectural project abroad. Mr. Stone was selected as architect of the Brussels project by an A.I.A. advisory committee consisting of Earl T. Heidschmidt of Los Angeles, the then (Spring 1956) A.I.A. first vice president; A.I.A. past president Clair W. Ditchy of Detroit; Edgar Williams of New York; Richard Koch of New Orleans, and Roy Larson of Philadelphia.

**TWELVE FIRST HONOR AWARDS GIVEN AT SEVENTH ANNUAL A.I.A. GULF STATES CONFERENCE**

The most recent Honor Awards Competition of the Gulf States Region of the American Institute of Architects, held in conjunction with the seventh annual regional conference last Fall at Chattanooga, attracted more than fifty submissions and produced a total of 19 premiated buildings.

The report of the Jury of Award headed by Clinton H. Cowgill, F.A.I.A., of Washington, D. C., paid tribute to the "general high quality" of the submissions and to the effective presentation techniques of most of them. It also contained the following critical comments:

"One of the most common difficulties was an apparently exaggerated interest in details, leading to failures to attain unity. In some designs diverse

elements, forms and materials were combined with wild abandon. Some of the drawings submitted did not adequately illustrate the thoughts of their designers. Plot plans lacked indication of points of the compass, wind direction, consideration of view, or the kind and direction of access or circulation. In some cases the boards were so crowded with drawings and photographs as to be confusing. In others the displays appeared empty; and in a few the scale was too small to be legible even with trifocals." Members of the jury besides Mr. Cowgill were Buford L. Pickens, A.I.A., of Washington University, St. Louis, and (architect and sculptor) Julian H. Harris, A.I.A., of Atlanta.

In addition to the twelve First Honor Awards, all of which are shown on this

and the next page, Awards of Merit were given as follows: A. L. Aydelott and Associates, Memphis — Carter County Health Center, Elizabethton, Tenn.; Baumann and Baumann, Knoxville — University of Tennessee Memorial Research Center and Hospital, Knoxville; Barber and McMurry, Knoxville — West Knoxville Branch for Hamilton National Bank; Office of Walk C. Jones Jr., Memphis — DeSoto County Jail, Hernando, Miss.; Yandell Johnson, Little Rock — National Old Line Insurance Company Building, Little Rock; William B. Wiener and Associates, Shreveport — Uptown Commercial Center, Shreveport; A. Hays Town, Baton Rouge — Union Federal Savings and Loan Association Office Building, Baton Rouge.



1, 2

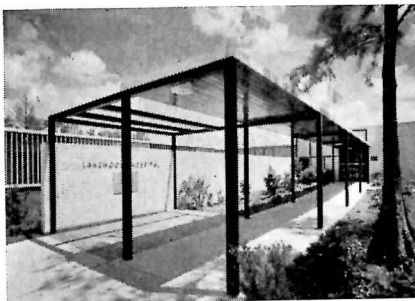

3, 4

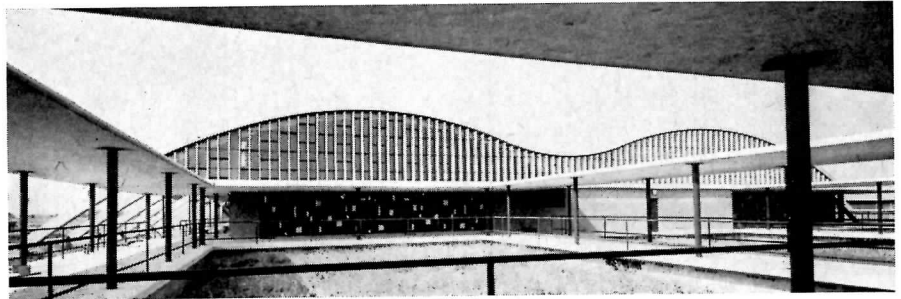

Photos by Earl Saunders

*Above: four award winners by Curtis and Davis of New Orleans. 1. Arthur Q. Davis Residence and 2. John T. Upton*

*Residence, New Orleans. 3. Lakewood Hospital, Morgan City, La. 4. Louisiana State Penitentiary, Angola, La. Below:*

*two by Erhart, Eichenbaum and Rauch in Little Rock. Left, the firm's own offices. Right, Horace Mann High School*

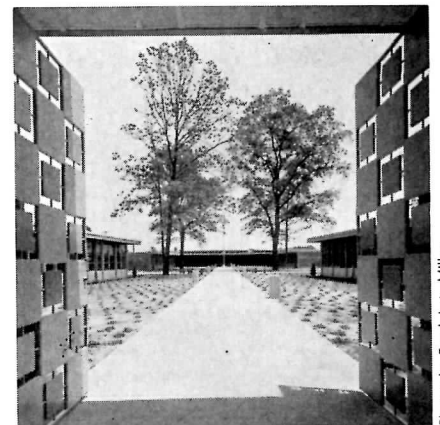

Photos by Frank Lotz Miller

(Continued on page 12)

*(Continued from page 11)*



*Above: Clinic for Dr. J. L. Wishik and Dr. H. J. Goldstein, Montgomery, Ala.; Donald L. Horton and Martin K. Johnson and Albert L. Williams Jr., Associated Architects. Below: 1. Gretna Methodist Church, Gretna, La.;*

*Lawrence, Saunders and Colongue, Architects. 2. Henry C. Beck Building, Shreveport, La.; Neild-Somdal Associates, Architects. 3. Tennessee Valley Branch Bank, Knoxville; Painter, Weeks and McCarty, Architects. 4. Sales and*

*Warehouse Building for Evans Electric Supply Inc., Lafayette, La.; H. J. Lagroue, Architect. 5. Cafeteria Building, Southeastern Louisiana College, Hammond, La.; Desmond and Davis, Architects*

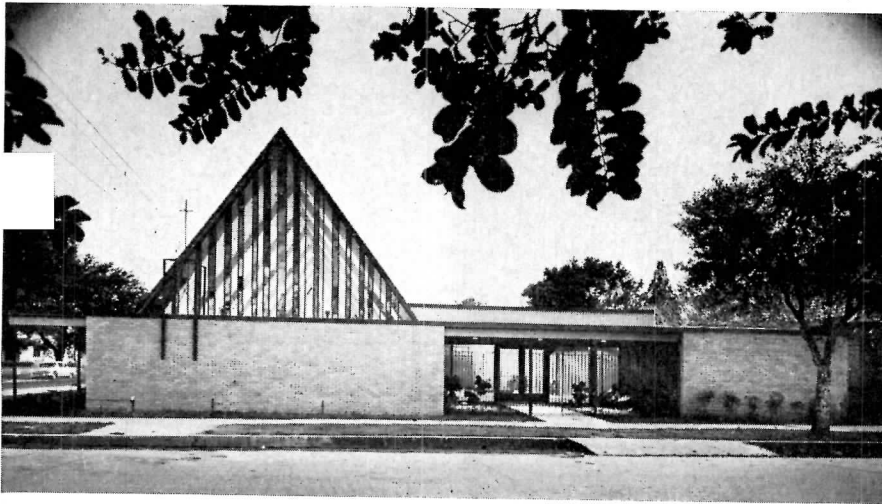

1, 2  
 Frank Lotz Miller



Thurman C. Smith

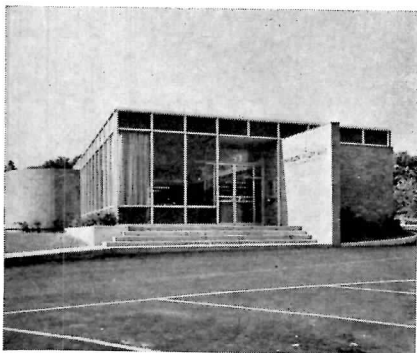

3, 4

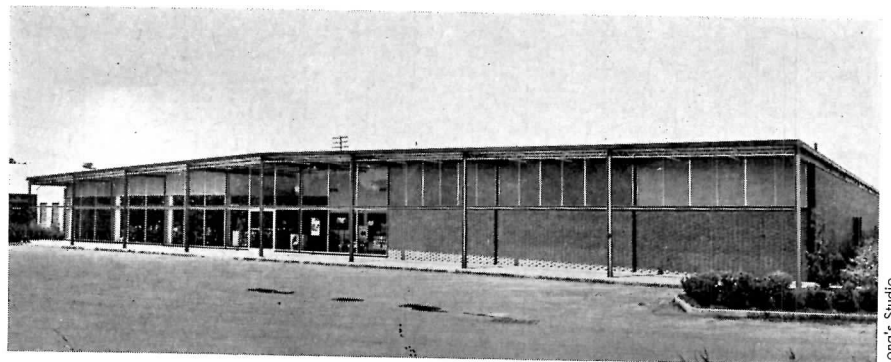

Long's Studio

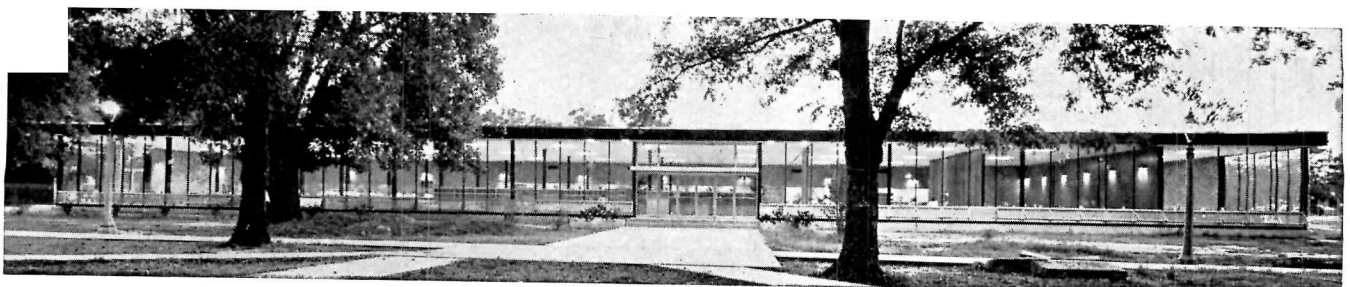

5

Frank Lotz Miller

*(More news on page 16)*

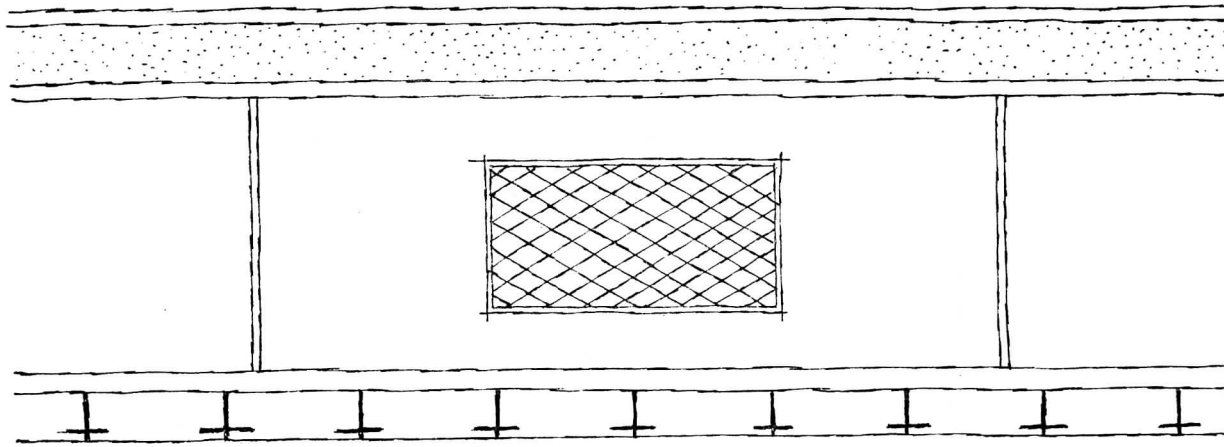

**Fig. 1**  
Flat roof construction requires adequate ventilation regardless of the amount of air space between the suspended acoustical ceiling and the roof deck.

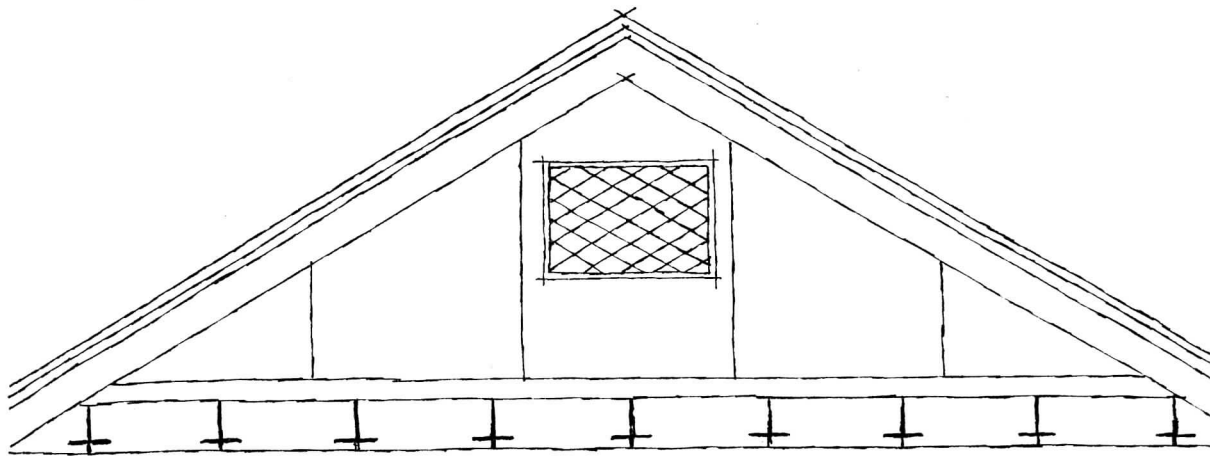

**Fig. 2**  
With gabled roofs, it is important that at least one-half of the ventilated area between the suspended acoustical ceiling and the roof be in the upper portion of the air space.

## a suspended acoustical ceiling?

plies to gabled roof construction (Fig. 2). However, where the pitch is greater than 2/12, at least one-half of the vent area shall be in the upper part of the air space, as close to the peak of the roof as practical.

Your Armstrong Acoustical Contractor can give you full data on proper ventilation methods for acoustical ceilings. An expert in his field and familiar with all types of sound-conditioning problems, he can also help you select just the right material for any noise control need.

For free booklet, "Armstrong Acoustical Materials," containing interesting information on the latest sound-conditioning materials and methods, write direct to Armstrong Cork Company, 4202 Rock Street, Lancaster, Pennsylvania.

### **Armstrong** ACOUSTICAL CEILINGS

Cushiontone® • Travertone\* • Arrestone®

Minatone® • Corkoustic® • Crestone®

(Continued from page 12)



1, 2, 3

**DESIGN IN HARDWOODS AWARDS** for 1956 went to 36 entries in four classifications in the annual competition sponsored by the Fine Hardwoods Association. Among the "Architectural Installations" winners, awards "for highest honors" went to (1) mahogany bookshelves on mahogany plywood walls — Bertrand Goldberg Associates; and (2) restaurant walls of Philippine hardwood overlaid with birch battens — Marshall W. Perrow; Honorable Mentions included (3) lobby and lounges of Minneapolis Athletic Club (teak plywood and cherry paneling) — Lang & Raugland; (4) living room wall with radio-phonograph and book shelves in birch plywood — George Fred Keck and William Keck; (5) organ screen (bleached walnut) in Christian Science church — Maynard Lyndon; (6) and (7) beach house of stressed skin Philippine hardwood (featuring a cantilevered "flying room") — Bertrand Goldberg Associates. Noguchi had two "Production Furniture" winners, both designs for Knoll Associates: (8) rocking stools in solid teak or walnut (Honorable Mention); and (9) — with Lewis Butler — round walnut and maple dining table (award "for highest honors"). Edward J. Wormley won other award "for highest honors" in "Production Furniture" with (10) tile inlaid walnut pentagonal table. In the "Custom Furniture" category, Pipsan Saarinen Swanson's room divider (11) of white oak plywood won Honorable Mention. "Miscellaneous" award "for highest honors" went to (12) church pew of combed grain oak or figured veneers — B. W. H. Hendrickson & A. C. Hoven for American Sealing

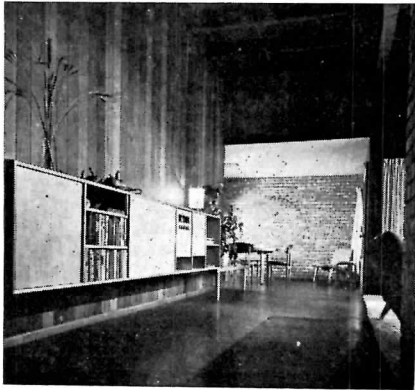
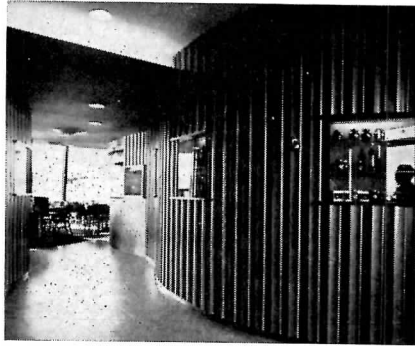

Hedrich-Blessing  
4



5



6

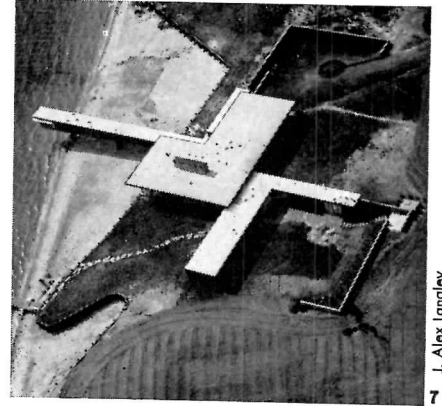

J. Alex Langley  
7

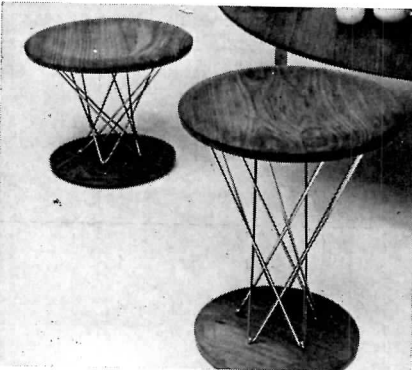

8



9

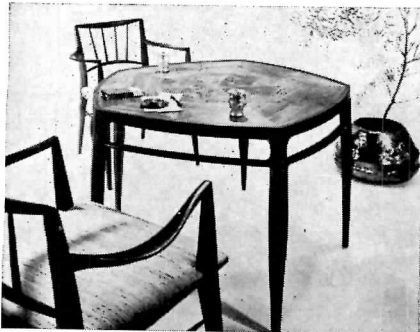

10, 11, 12

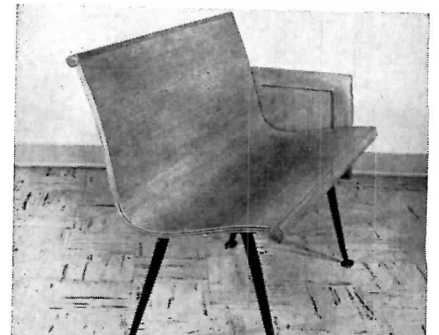
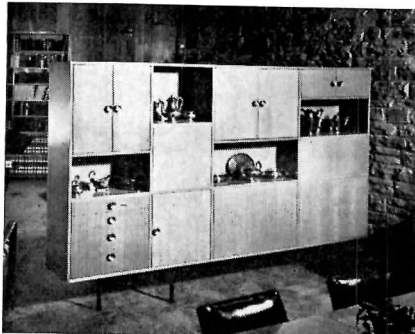

(More news on page 17)



ARCHITECTS OF AMERICA will be honored in the issue of a three-cent stamp (facsimile at right) to be placed on sale for the first time in New York on February 23, the centennial of the founding in that

city of the American Institute of Architects. The stamp, which will measure .84 by 1.44 in., color to be announced, was designed by Robert J. Schultz, A.I.A., of South Bend, Ind., competition winner



LOUIS SKIDMORE NAMED TO RECEIVE 1957 A.I.A. GOLD MEDAL

Centennial Gold Medal, Special Award This Year, Goes to Ralph Walker — President Eisenhower Invited to Address Centennial Celebration Convention

Major honors to be awarded at the Centennial Celebration Convention of the American Institute of Architects May 13-17 in Washington, D. C., were made known last month; and it was also announced that President Dwight D. Eisenhower was among the distinguished personages invited to address the convention.

The Gold Medal of the A.I.A., highest honor in the gift of the profession, will be given this year to Louis Skidmore, F.A.I.A., of New York, founder of the architectural firm of Skidmore, Owings and Merrill. The Gold Medal, which is given only when the A.I.A. Board of Directors can unanimously agree on the recipient, has been awarded 22 times since its establishment in 1907, eight times to foreign architects. It is officially described as "the highest honor the Institute can bestow," and is awarded "in recognition of most distinguished service to the profession of architecture or to the Institute." Previous American recipients have been: Charles Follen McKim (1909), George B. Post (1911), Bertram Grosvenor Goodhue (1925), Howard Van Doren Shaw (1927), Mil-

ton Bennett Medary (1929), Paul Philippe Cret (1938), Louis Henry Sullivan (1944 — posthumous), Eliel Saarinen (1947), Charles Donagh Maginnis (1948), Frank Lloyd Wright (1949), Bernard Ralph Maybeck (1951), William Adams Delano (1953), Clarence Stein (1956).

Ralph T. Walker, F.A.I.A., of the New York architectural firm of Voorhees Walker Smith and Smith, Institute past president (1949-51) and tireless servitor, will receive the Centennial Gold Medal, a special award established this Centennial year to recognize exceptional service to the Institute.

Other major awards:

The *Fine Arts Medal*, "the highest honor the Institute can bestow in the fine arts other than architecture," to painter Mark Tobey of Seattle.

The *Craftsmanship Medal*, "the highest honor the Institute can bestow for craftsmanship in the industrial arts," to Charles Eames of Venice, Cal.

The *Edward C. Kemper Award*, "made each year to the A.I.A. member who has made significant contributions to the Institute and the profession," to

David C. Baer of Houston.

*Citation of Honor* to an organization "in recognition of excellence or achievement," to the Foreign Buildings Operation of the U. S. Department of State.

*Citation of Honor* to an individual "in recognition of excellence of achievement," to sculptor Milton Horn of Chicago.

*Honorary Fellowships* to Pier Luigi Nervi of Italy and Christiano das Neves, dean of MacKenzie School of Architecture, São Paulo, Brazil.

*Honorary Membership* to J. Winfield Rankin of Washington, D. C., A.I.A. Administrative Secretary.

The A.I.A.'s Centennial Celebration will pick up momentum this month, with the actual anniversary of the founding of the A.I.A. on February 23 scheduled for celebration at numerous chapter events around the country. In New York, A.I.A. President Leon Chatelain Jr. will unveil a commemorative plaque at 111 Broadway, site of the original meeting of the founders; the week of February 17-23 is to be "Architects Week" and for that week Times Square will become "Architects Square."



GOLD MEDAL, A.I.A.'s traditional "highest honor," to Louis Skidmore



CENTENNIAL GOLD MEDAL, a special award this year, to Ralph Walker



CRAFTSMANSHIP MEDAL, another traditional award, to Charles Eames (More news on page 21)



# COMPACT • CONVENIENT • Hotpoint Customline

Women lose their hearts to this handsome, modern combination of the very finest pushbutton appliances and colored cabinets—under *one* gleaming stainless steel countertop.

In modern styling—in compact work-saving efficiency—in superb performance—nothing equals the sales appeal of a 1957 Hotpoint Modular Kitchen!

Compact and efficient, Hotpoint Modular Kitchens are designed for fast, low-cost installation without tricky hook-ups. They save floor space—“enlarge” your kitchen—and give you greater freedom in kitchen planning! They’re the dramatic, economical solution to a small kitchen—the glamor highlight of a big luxury kitchen!

Capitalize on the most modern advances in the appliance industry—be the first builder in your community to offer Hotpoint Modular Kitchens—they’ll be the talk of the town!

## 9 FEET OF GLEAMING PUSHBUTTON LUXURY—

*In one unit—a complete meal preparation and clean-up center*

- Automatic Super Oven with Rota-Grill Rotisserie.
- 4 Calrod® Surface Cooking Units, including raisable automatic unit under deep-well cooker.
- Automatically-controlled Plug-In Griddle.
- De luxe pushbutton Dishwasher.
- Disposall® Food Waste Disposer (optional).
- One-piece, stainless-steel countertop and sink with Wonderflo single-control faucet.
- Pushbutton controls and appliance outlets.
- Roomy storage cabinets and drawers.

Look to **Hotpoint** for the finest...first!



*Skip this page...  
If you're not interested  
in the finest vinyl flooring*

*Decorators—Virginia Chappell, Robert Henry of VR Interiors*

*If you are looking for the ultimate in fine flooring, then by all means Amtico Vinyl Flooring is the answer.*

First of all . . . **BEAUTY!** Amtico Vinyl Flooring comes in over 100 exciting colors and designs. In fact, Amtico Vinyl Flooring has won fashion group awards for its outstanding design qualities. You'll find a marvelous selection to help you create striking effects for any decor.

Secondly, there's **EASY CARE!** Amtico Vinyl Flooring needs *less care* than any other flooring. Its gleaming lustre never, never fades. Dirt can be simply damp-mopped

away. Colors stay bright and beautiful for the lifetime of the floor.

And finally, there's outstanding **QUALITY!** Resilient and durable, Amtico Vinyl Flooring (rated Number One by leading consumer research organizations) is built to take it. It's *all vinyl* . . . colors go through and through its entire thickness . . . assuring you of a flooring that will provide a long lifetime of beauty.

Mail the coupon for colorful information and **FREE** samples.

*None but the finest from Amtico*



Also makers of:

**AMTICO RUBBER FLOORING**  
The luxury leader among rubber floorings.

**AMTICO PLASTEX RUBBER FLOORING**  
First choice for beauty on a budget.

**AMERICAN BILTRITE  
RUBBER COMPANY**

Amtico, Dept. AR-1, Trenton 2, N.J.  
Please send me illustrated literature and free set of samples:

AMTICO VINYL FLOORING

AMTICO RUBBER AND PLASTEX RUBBER FLOORING

Name \_\_\_\_\_

Address \_\_\_\_\_

City \_\_\_\_\_ Zone \_\_\_\_\_ State \_\_\_\_\_

# THE RECORD REPORTS

## MEETINGS AND MISCELLANY

(Continued from page 24)

### A.I.A. PUTS ARCHITECTURAL PHOTOGRAPHERS ON PARADE

Six award-winners and 26 other photographs selected by an A.I.A.-appointed jury went on view January 23 in the A.I.A. gallery, 1741 New York Avenue, N.W., Washington, D. C., as the Second Exhibition of Architectural Photography sponsored by the American Institute of

Architects, with the cooperation of the Architectural Photographers Association. The exhibit will tour under the auspices of the Smithsonian Institution's Traveling Exhibition Service after the current showing at the Octagon ends February 27.

The jury consisted of one professional photographer, Volkmar Wentzel, of the National Geographic Society; one architect, Leon Brown, head of the Department of Architecture at Howard University; and one editor, William A. Reedy, of *Applied Photography*, *Commercial Camera*, and *Bulletin for the Graphic Arts* of Eastman Kodak.

Purpose of the exhibition and the competition is "to recognize and encourage outstanding work in the field of architectural photography."

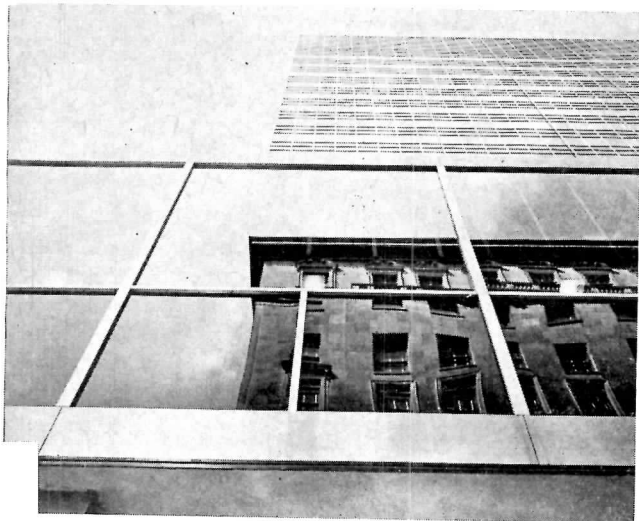

1, 2

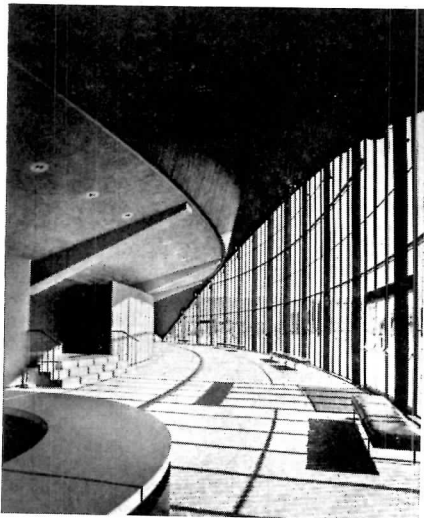
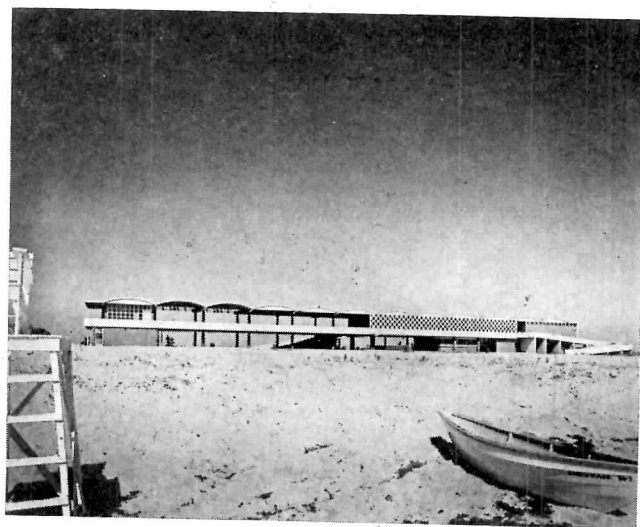

4, 5, 6



3

**FIRST PRIZE** went to S. C. Valastro for his photograph (1) of Lever House, New York City (Skidmore, Owings and Merrill, Architects). **SECOND PRIZE** — Joseph W. Molitor for his photograph (2) of Salisbury Bath House, Salisbury Beach, Mass. (Coletti Brothers, Architects). **THIRD PRIZE** was tied between Gabriel Benzur's photograph (3) of Georgia Institute of Technology, Atlanta (Aeck Associates, Architects), and Joseph W. Molitor's photograph (4) of the Auditorium at Massachusetts Institute of Technology, Cambridge, Mass. (Eero Saarinen and Associates, Architects). In

addition, two Honorable Mentions were given, one to S. C. Valastro for his photograph (5) of the Mile High Center, Denver (I. M. Pei, Architect) and the other to Mason Paulak for his photograph (6) of the Michigan Racing Association Grandstand, Livonia, Mich. (Giffels and Vallet, Inc., and L. Rossetti, Architects and Engineers). The prizewinners and 26 other photographs selected by the same jury will be circulated by the Traveling Exhibition Service of the Smithsonian later on. Applications for bookings of the show may be made through Mrs. John A. Pope, Chief of the Traveling Exhibition Service

(More news on page 32)

# Line window suits building plans!

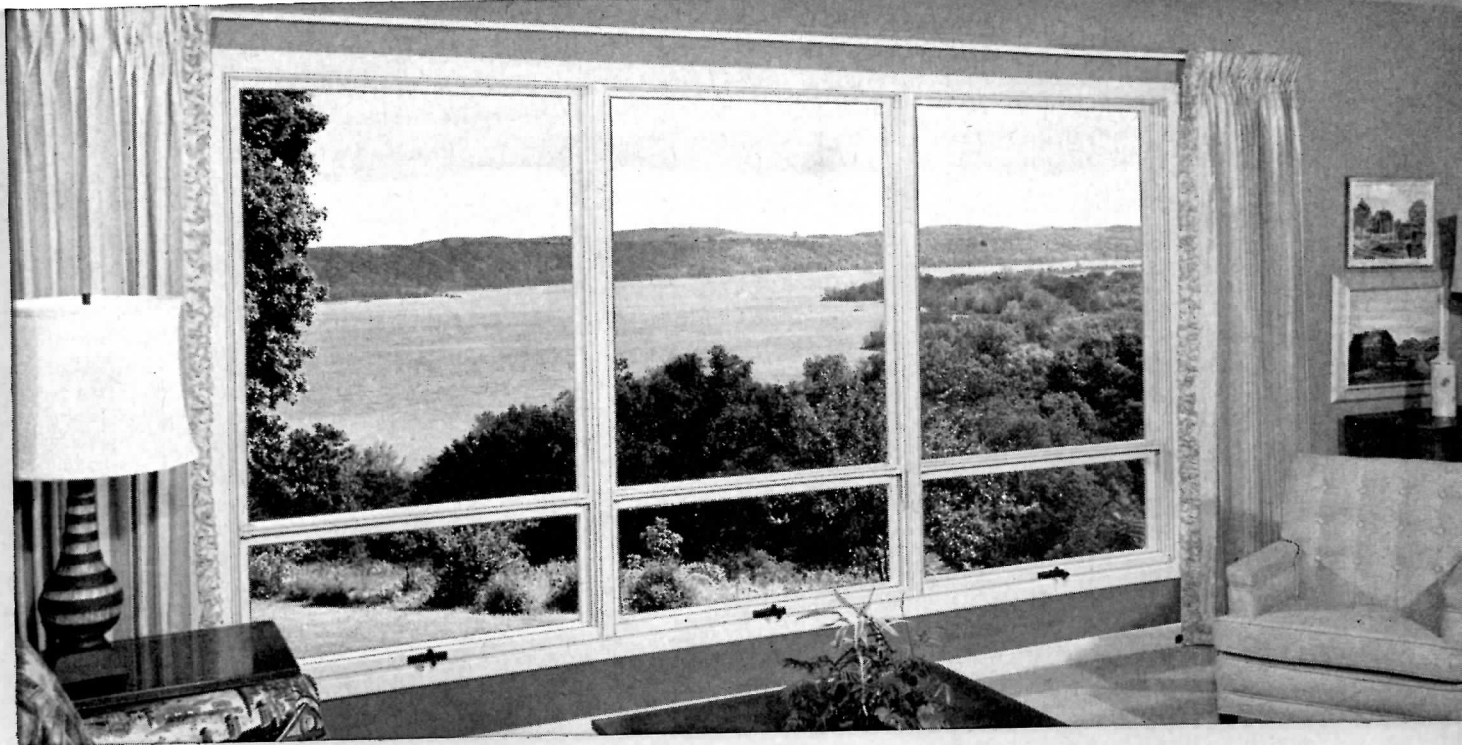

**Ideal for living rooms.** Tall and handsome 5'10" high Beauty-Line Windows combine to form glamour Andersen WINDOWALLS so popular in modern family living. Narrow meeting rails are located to give minimum interference with vision in sitting or standing position. Three choices of hardware. Standard Lock, Bar-Lock for low-cost underscreen operation and Roto-Lock (shown on windows above) which also works under screen and pulls sash corners in snug and tight.

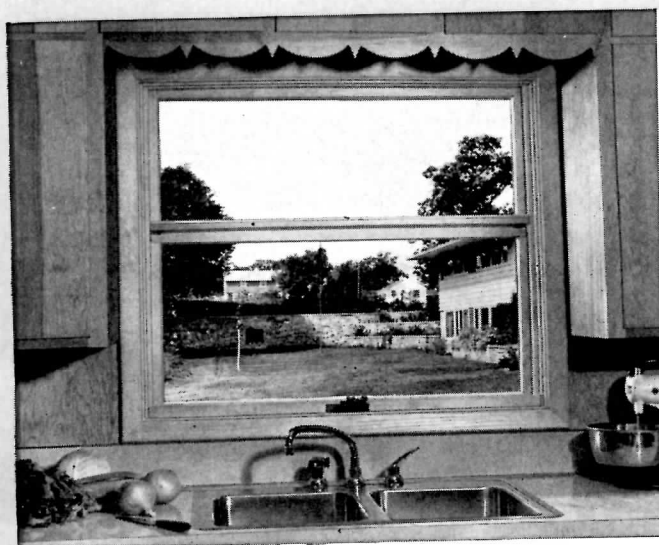

**Ideal for kitchens.** Short 3'3" height of Beauty-Line makes perfect kitchen window for use over kitchen sink or counter. Also serves as excellent privacy window when specified for bedrooms.



**Ideal for dining rooms.** Medium 4'7" height of Beauty-Line is useful in dining areas . . . and all through the house. This view shows Andersen Bar-Lock Operator, one of three operating hardware options.

## PUBLIC WORKS PLANNING: AN INDICTMENT AND A CHALLENGE

The developing program of public works coordination in the Federal government carries with it a great deal of meaning for the architect and engineer. This endeavor, now a year and a half old, does not deal with complete working drawings for public works projects, but it does attempt to aid states and local communities in defining their needs, setting up priorities, estimating costs, and getting into long-range planning programs. The architect and engineer logically should be a part of the long-range projections, and he has an essential role in the estimating work.

Assistant to the President Maj. Gen. John S. Bragdon, as the Administration's Coordinator of Public Works Planning, is welcoming the participation of architects and feels that they can serve an essential role in the development of city and state programs even before the time of detailed plan preparation. In consulting capacities they can help guide the lower governmental jurisdictions and point the way toward the desired integration of their public works schedules with those of other communities.

In his first progress report to the President since his appointment in August 1955, General Bragdon emphasized the enormity of the job still to be done. "Public works planning in its present state," he said, "is a sprawling monster with many heads and arms reaching haphazardly into every phase of our everyday life. It is administered by some 40 agencies of the Federal government together with over 100,000 lower governmental jurisdictions. As a rule, neither heads nor arms of all concerned act with reference to each other unless constrained to do so." His report stressed that "if the objectives of sound planning are achieved, the average citizen would secure his most needed public improvements first. He would get them at less cost. His public official would avoid the waste of wrongly chosen sites, duplication, unbalanced development and pressure of expediency."

In accepting this recent report from General Bragdon on 15 months of activity, President Eisenhower made it clear that he wanted the work continued and expanded. In a letter commenting on

accomplishments of the office, the President wrote:

"In our country where the Constitution recognizes the proper sphere of state government and where the independent functioning of our local governments is retained and fostered, it is especially necessary that truly comprehensive planning be accomplished at and by all levels and that it be oriented with reference to intergovernmental relationships in order to secure sound, integrated development. This will be helpful in assuring and preserving the proper division of responsibility among levels of government."

Declaring that the Federal government should take the lead in developing effective coordination of public works planning, the President urged General Bragdon to develop procedures for "early recognition and identification of problems and policy issues that may arise in this field, and continue the formulation of lines of action for their resolution."

At the same time, the President concurred with General Bragdon's belief that Executive departments and agencies of the Federal government should "intensify their planning efforts," and that states and local governments should be persuaded to increase their public works planning.

Mr. Eisenhower's letter concluded: "You have my continued interest and support in the efforts to move forward more rapidly toward the attainment of the objective of strengthening the nationwide public works planning."

General Bragdon proposes that as a new approach to comprehensive and coordinated planning, states would be urged to establish planning units which would keep governors and state legislatures informed as to how proposed state public works programs would fit in with Federal public works activities. Cities would be encouraged to create comprehensive planning units which would keep mayors and city councils apprised of how their construction programs would meet the requirements of the cities' expansion over the next 15 or 20 years.

If this proposal can be carried out as now projected, governors, mayors, the

### PUBLIC WORKS ADVISORY COMMITTEES

#### Federal

- Gen. John S. Bragdon, Special Assistant to the President — Chairman
- Robert E. Merriam, Assistant to the Director, Bureau of the Budget
- Dr. Leo Grebler, Council of Economic Advisors
- Walter Williams, Under Secretary, Department of Commerce
- Ervin L. Peterson, Assistant Secretary, Department of Agriculture
- F. S. Bryant, Assistant Secretary for Property and Installations, Department of Defense
- George H. Roderick, Assistant Secretary, Department of the Army
- Frederick Stueck, Commissioner, Federal Power Commission
- Fred G. Aandahl, Assistant Secretary, Department of the Interior
- Willis D. Gradison Jr., Assistant to the Secretary, Department of Health, Education and Welfare
- John C. Hazeltine, Commissioner, Community Facilities Administration, Housing and Home Finance Agency
- Fred S. Poorman, Deputy Commissioner, Public Buildings Service, General Services Administration
- Floyd D. Peterson, Public Works Planning Unit — Secretary

#### State-Local

- Gen. John S. Bragdon, Special Assistant to the President — Chairman
- Robert E. Merriam, Assistant to the Director, Bureau of the Budget
- Walter Williams, Under Secretary, Department of Commerce
- Willis D. Gradison Jr., Assistant to the Secretary, Department of Health, Education and Welfare
- John C. Hazeltine, Commissioner, Community Facilities Administration, Housing and Home Finance Agency
- Dr. Frederick L. Bird, Director, Municipal Research, Dun & Bradstreet, New York
- Carl H. Chatters, City Comptroller, Chicago
- Dewitt C. Greet, State Highway Engineer of Texas, Austin
- Kenneth K. King, Public Works Director, Phoenix, Ariz.
- Donald R. Larson, University of Miami, Coral Gables, Fla.
- Schuyler Lowe, Director, Department of General Administration, Washington, D. C.
- Frank C. Moore, President, Government Affairs Foundation, New York
- John M. Peirce, Director of Finance, State of California, Sacramento
- Francis A. Pitkin, Bureau of Community Development, Pennsylvania Department of Commerce, Harrisburg
- Austin J. Tobin, Executive Director, Port of New York Authority, New York
- Jean L. Vincenz, Director, Public Works, San Diego, Cal.

executive heads of all communities and their legislatures, councils or governing boards would receive data from their planning organizations which would help

(Continued on page 352)

# Von Duprin®

FIRE AND PANIC EXIT DEVICES

"THE SAFE WAY OUT"

On schools, churches, hospitals . . . *wherever* people congregate . . . you can depend on Von Duprin exit devices to protect lives.

Choose from a complete line. Select the *right* installation for *any* opening . . . for

normal or rugged, demanding service.

Specify Von Duprin! Your Von Duprin "Exit Specialist" will be glad to help you plan the best exit for your needs. If you don't know his name, write direct to factory.

VON DUPRIN DIVISION • VONNEGUT HARDWARE CO. • INDIANAPOLIS, INDIANA

## Dependable Devices in Every Price Class!

For the top combination of economy, quality and dependability, specify the Von Duprin 88 series of rim, mortise and vertical rod devices.

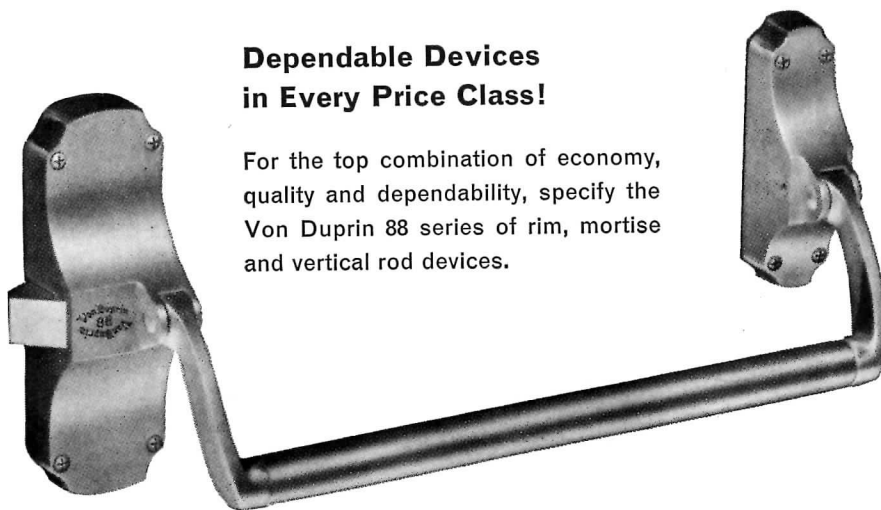

**SCHOOLS, CHURCHES, HOSPITALS,  
WHEREVER PEOPLE CONGREGATE**



**MORE BRITISH FUNDS SEEN IN CANADIAN CONSTRUCTION**

An increase in the amount spent by Britain on Canadian construction and industrial investment is looked for in 1957. Source of this information is the British Board of Trade, which points out that in 1955-56 British firms did £87.2 million worth of building overseas. Investment in the dollar area amounted to £19 million, most of that sum being spent in Canada.

Among recent examples of British construction investment in Canada, is the Toronto project, "City Park Apartments," shown at right. Among upcoming projects already announced are the multi-million-dollar development at Meadowvale, near Streetsville, Ont., to be built by Richard Costain Ltd., Britain's third largest construction firm, in association with Dolphin Development Company; the Suez Canal Company's participation in a proposed \$250 million satellite town in suburban Montreal; and industrial and commercial development of Vancouver's Annacis Island (AR, Dec. 1956, page 36) by Grosvenor Estates Ltd., the Duke of Westminster's company.

Other disclosures of British capital investment plans are expected shortly when details are approved by the Bank of England.

**HOUSING DROP IN 1957 EXPECTED BY INDUSTRY**

A sizeable drop in residential construction in 1957 is anticipated by industry leaders, largely because of the unattractive return—five and a half per cent—on National Housing Act mortgages compared with other investments. Completions, it is said, may fall to 110,000, compared with an estimated 130,000 in 1956.

The National House Builders Association is pressing the Federal Government for action it recommends to alleviate the situation. The organization calls for clarification of official policy as regards the effect of short-term credit control on long-term housing production; establishment of a market to deal in NHA mortgages; and quicker publication of house building statistics.

**B. C. ARCHITECTS REPORT MEMBERSHIP AT NEW HIGH**

A total of 196 architects now are members of the Architectural Institute of

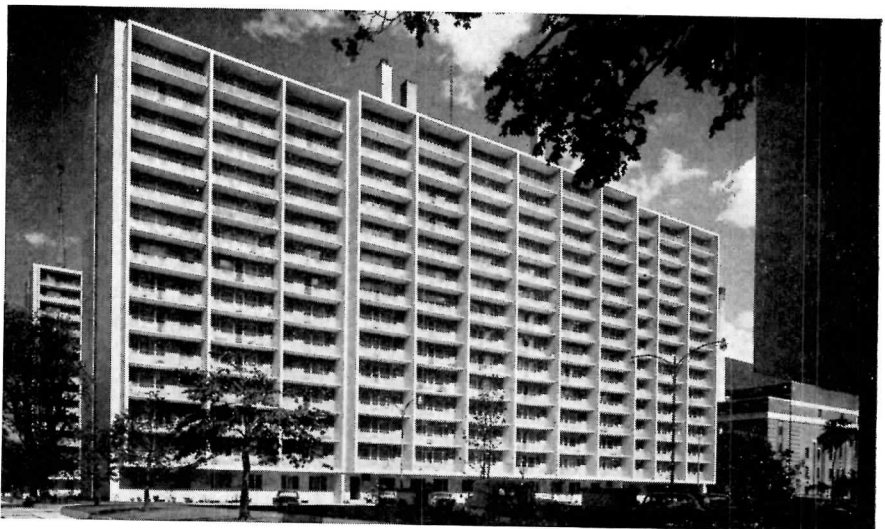

Max Fleet

*CITY PARK APARTMENTS in Toronto (above) are British investment in Canada; Peter Caspari was the architect. Below: architects Page & Steele of Toronto have designed these apartment buildings for one of the most beautiful sites in Ottawa, surrounded by magnificent trees and with views in every direction. Each of the 300 suites will have a balcony. Frame will be reinforced concrete flat plate construction; all apartments will be fully air conditioned. Parking is provided for every tenant*

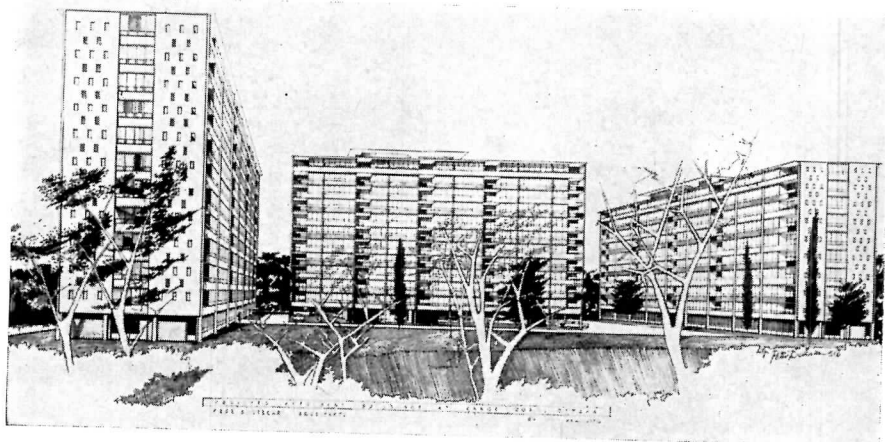

British Columbia, retiring president John L. Davies reported at the 37th annual meeting of the Institute, held at the Hotel Georgia in Vancouver December 7-8. There was a net gain of 11 members during the year.

Succeeding Mr. Davies as president is Clive D. Campbell, Deputy Minister of Public Works for British Columbia and chief government architect. In his inaugural address, the new president expressed confidence in the continued growth of the province and pleasure that, as indicated by the increase in membership, the profession is keeping pace with this progress. Other officers elected at the meeting were: W. G. Leithead, vice president; Warnett Ken-

nedy, registrar; and F. Murray Polson, honorary treasurer. Kenneth McKinley was also elected to the Institute's executive council, on which John L. Davies, C. E. Pratt and R. W. Siddall will continue for another year. Professor Fred Lasserre is government representative on the council. R. B. Deacon continues as executive secretary.

Three special committees were set up at the meeting; these are to deal with public relations, architectural firm names and the structure of professional fees. Speakers included Douglas Brown, Vancouver barrister, and city alderman George Cunningham.

The 1957 annual meeting will be held at the Empress Hotel in Victoria.

*(Continued on page 40)*





**What women want** in a built-in refrigerator-freezer are all the convenience features the best free-standing refrigerator offers. And they're all here in this 13 cu. ft. Westinghouse Horizontal Built-In. Special Meat, Butter and Egg Storage . . . a New Tilt-down Showcase Crisper . . . 120-lb. Zero-Degree Freezer—all at easy reach-in level.



**The same deluxe features** are in this Westinghouse Vertical Built-In. Less than a yard wide! New Stoop-Saver Design keeps foods used most often up top. 13 cu. ft.; 155-lb. zero-degree Freezer.

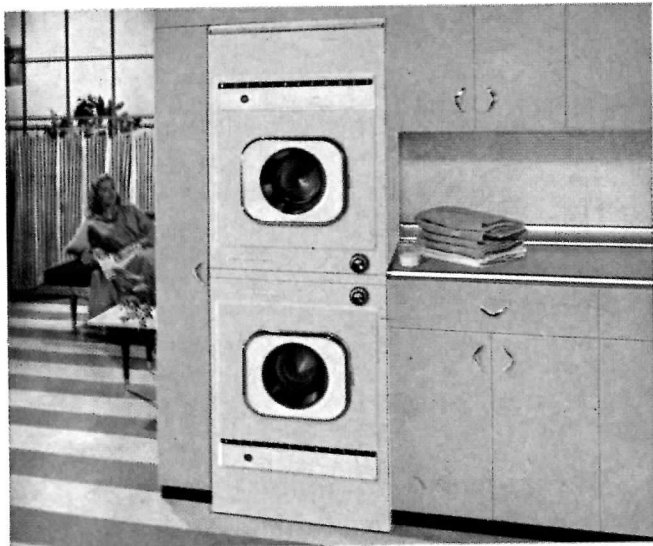

**Complete Home Laundry in 25 Inches!** That's the Westinghouse Space-Mates. Separate Laundromat and Dryer install vertically—both do a full 8-lb. load. There's no need to add an extra laundry room—Space-Mates will install anywhere there's 25" . . .



**Or you can build-in** the same units side-by-side—under a counter or even in a wall at waist level. Installation's simple with easy-to-hook-up plumbing and venting connections. Available in 5 Confection Colors. It's the builder's answer to a low-cost complete home laundry!



**Most flexible built-in range line** in the business. You can combine ovens and platforms anyway your prospect likes . . . it's a personal touch that helps you sell. Shown: Giant 24" interior-width oven; separate 2-unit platforms with remote controls.



**Another arrangement is 17" oven** with 4-unit surface platform. Platform controls come flush-mounted . . . oven has clock and timer. Line offers choice of 5 Confection Colors, Antique Copper and Brushed Chrome. You can be sure . . . if it's Westinghouse.

# THE RECORD REPORTS

## NEWS FROM CANADA

(Continued from page 40)

observed, that Canada's money supply is only slightly higher than a year ago.

Another opinion was advanced by A. C. Ashford, president of the Toronto-Dominion Bank. He warned that alertness of the Government to deflationary trends which might develop was of prime importance. Coming months, he

said, may prove to be a real test for monetary management.

### NEWS NOTES

**Candiac**, a city of 50,000, would be built on a 2500-acre site on the south bank of the St. Lawrence across from Montreal under an "integrated development" scheme proposed by a French syndicate in which the Suez Canal Company is reported to be one of the biggest backers. . . . **Tallest building in Saskatchewan** will be a 14-story "skyscraper" to be built in Regina for

the Saskatchewan Power Corporation at an estimated cost of \$4 million. Architect is Joseph Pettick of Regina. . . . **Winnipeg Builders Exchange** opened its new office building December 5; architects were Waisman & Ross of Winnipeg. . . . **The National Building Code**, after a two-year test period, appears to be winning almost universal acceptance by municipal authorities, subject, of course, to adjustment for local conditions, according to a survey made by *The Financial Post*. The *Post* thought that within five years the Code would be quite generally effective. . . . **André Blouin**, Montreal architect, has just been appointed Canadian representative of the French monthly *l'Architecture d'Aujourd'hui*. . . . The **Association of Professional Engineers of British Columbia** has elected as its new president W. O. Richmond, head of the Department of Mechanical Engineering of the University of British Columbia. . . . The **Alberta Association of Architects** has named W. W. Butchart chairman of its Architects-Engineers Liaison Committee. . . . **Robert F. Legget**, director of the National Research Council's Division of Building Research and an Honorary Fellow of the R.A.I.C., has been made a Fellow of the Royal Society of Canada. . . . **Ontario Association of Architects**, through its Committee on Public Relations, is supplying the material for "Ask Your Architect," a new question-and-answer feature appearing on the Saturday realty page of *The Telegram*, a Toronto evening daily. . . . **Office Notes** — *Balharrie, Helmer & Morin* is the new name of the Ottawa architectural firm known as *Abra &*

(Continued on page 46)

## Wood Beauty ARCHITECTURAL HARDWARE



Get this latest bulletin—see the colored illustrations of our newest Wood Beauties.

These are custom built to complement distinguished architecture and appointments. Your choice of selected hardwoods or Stratawood and metals, make design combinations that are almost endless. Metal parts are available in Aluminum, Brass, Bronze and Stainless Steel.

Architects desiring to design their own will receive complete production cooperation from us.

Write us for your copy of this beautiful 8 page bulletin



2200 COLE ST.  
ST. LOUIS 6, MO.

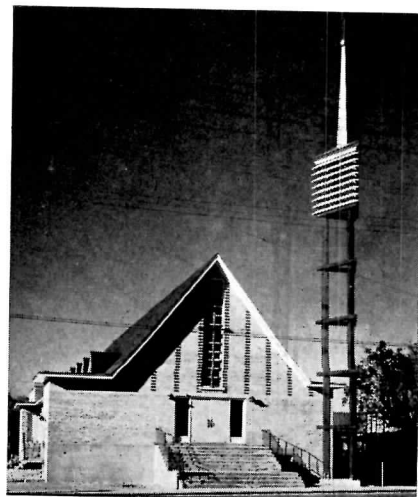

Studio Alain

OTTAWA — Our Lady of the Angels Church, designed by Quebec architect René Richard of Hull



STUDENT UNION BUILDING, OHIO STATE UNIVERSITY. • ARCHITECTS: BELLMAN, GILLETTE & RICHARDS, TOLEDO, OHIO

## Timeless Terrazzo, Contemporary Classic

RECREATION ROOM  
WITH SHUFFLEBOARD

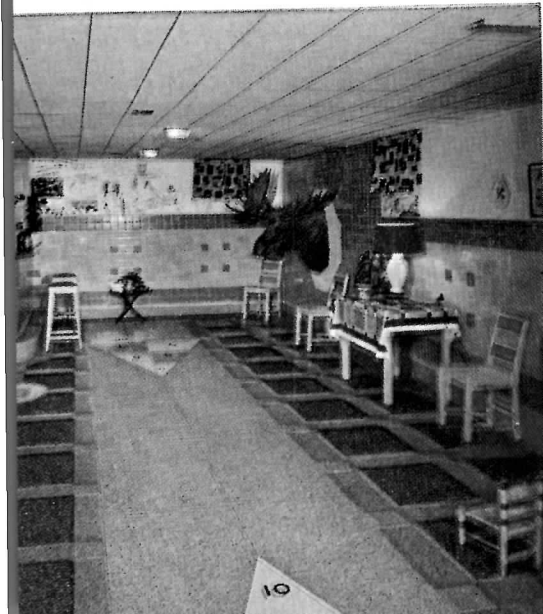

**D**URABLE enough to serve for years without end as the floor for a Student Union building . . . adaptable enough to reproduce the colorful pattern of a shuffleboard in a private home! That's timeless Terrazzo, the contemporary classic.

No pattern is too difficult, no task too demanding, for Terrazzo. Initial cost is more than offset by absence of repair or replacement cost. The smooth, joint-

less surface cleans readily, is easy to walk on and less slippery than a waxed surface.

Specify any design you wish, in virtually any combination of colors—Terrazzo, marble-hard and concrete-durable, is versatile as your imagination. Free AIA Kit upon request to the National Terrazzo and Mosaic Association, 711 Fourteenth St., N.W., Washington 5, D. C. Catalogued in Sweet's.

THE NATIONAL TERRAZZO AND MOSAIC ASSOCIATION

404 SHERATON BUILDING, 711 14TH ST., N. W.

WASHINGTON 5, D. C.

**MORE CONSTRUCTION MONEY IN PROPOSED 1958 BUDGET**

President Eisenhower's new budget for fiscal 1958, submitted to Congress at mid-January, points the way toward an increase in many Federal construction and aid-to-construction programs.

The larger expenditure increments proposed by the President for the year starting July 1 included military public

works as a whole, and civil functions of the Army's Corps of Engineers. The former would increase from estimates of \$2037.1 million in the current year to \$2323.5 million in fiscal 1958, with the Navy and the Air Force showing increases, the Army a decrease. Civil works expenditures, for such projects as flood control, navigation, and multi-purpose projects with power would go from \$456,300,000 to \$515,065,680.

The President's new school construction aid program, in effect compressing the five-year program defeated last year into four years, was reflected in his request for new authorization of \$451 million. He would like to spend \$185 million of this during the 1958 fiscal period.

The new budget sought an increase of almost \$15 million in Hill-Burton grant expenditures for public hospitals and in health research facilities. The figure would mount from \$38,410,000 in fiscal 1957 to \$52,747,500 in fiscal 1958.

An estimated expenditure increase from \$25.5 million in 1957 to \$33.7 million in 1958 is budgeted for the Architect of the Capitol.

Expenditures for advance planning of public works, a practice strongly endorsed by the President, were estimated for 1958 at \$39 million, including \$11 million for the Corps of Engineers and Bureau of Reclamation to carry on planning of some 85 projects already authorized. Planning will be underway next fiscal year on buildings for the Smithsonian Institution, the National Bureau of Standards, various Federal hospitals and other buildings.

The construction of State Department buildings abroad will remain at about the same level during the next fiscal year.

The President said he would send up a supplemental 1957 request for \$10 million for sites and expenses in Public Buildings Service's lease-purchase contract program. This would permit "some advancement in acquiring sites, contracting for plans, and other expenses," according to the budget wording.

Under the lease-purchase program to date, 144 projects involving construction costs of \$602 million had been approved. PBS has indicated it intends to send another \$200 million worth of projects to Capitol Hill for approval by Congressional committees at this session of Congress, and about \$100 million next session, bringing the program total close to \$1 billion.

In his State of the Union message, delivered in person on January 10, the President had urged the Congress to give high priority to his school construction proposals, which were to be submitted in a later message. Also in the State of the Union message was a reaffirmation of Mr. Eisenhower's "partnership" principle regarding water resources development.

(Continued on page 356)

**BRUNER INDUSTRIAL WATER SOFTENERS**



ARE FREQUENTLY

*Specified*

BY

LEADING ARCHITECTS

FOR IMPORTANT

INSTALLATIONS!

STATLER HILTON HOTEL, Dallas, Texas  
 Architect: William B. Tabler, New York, N. Y.  
 Consulting Engineers: Jaros, Baum and Bolles, New York, N. Y.  
 Plumbing Contractor: Brown and Olds Plumbing Co., Dallas, Texas

Many institutional, commercial and industrial buildings in all 48 states and seven foreign countries are serviced by Bruner water softeners and filters. Equipment is available from stock for most installations. Uses range from small laundries and schools to huge hospitals and atomic energy plants. Bruner is proud of its customer service — famous for product quality.

We solicit your inquiry.

**BRUNER CORPORATION**  
 America's most complete line of quality water softeners and filters  
 Executive Offices: 4763 N. 32nd St., Milwaukee 9, Wis.  
 Plants: Milwaukee, Wisconsin, and Santa Barbara, California  
 Sales and Engineering Offices in all principal cities.

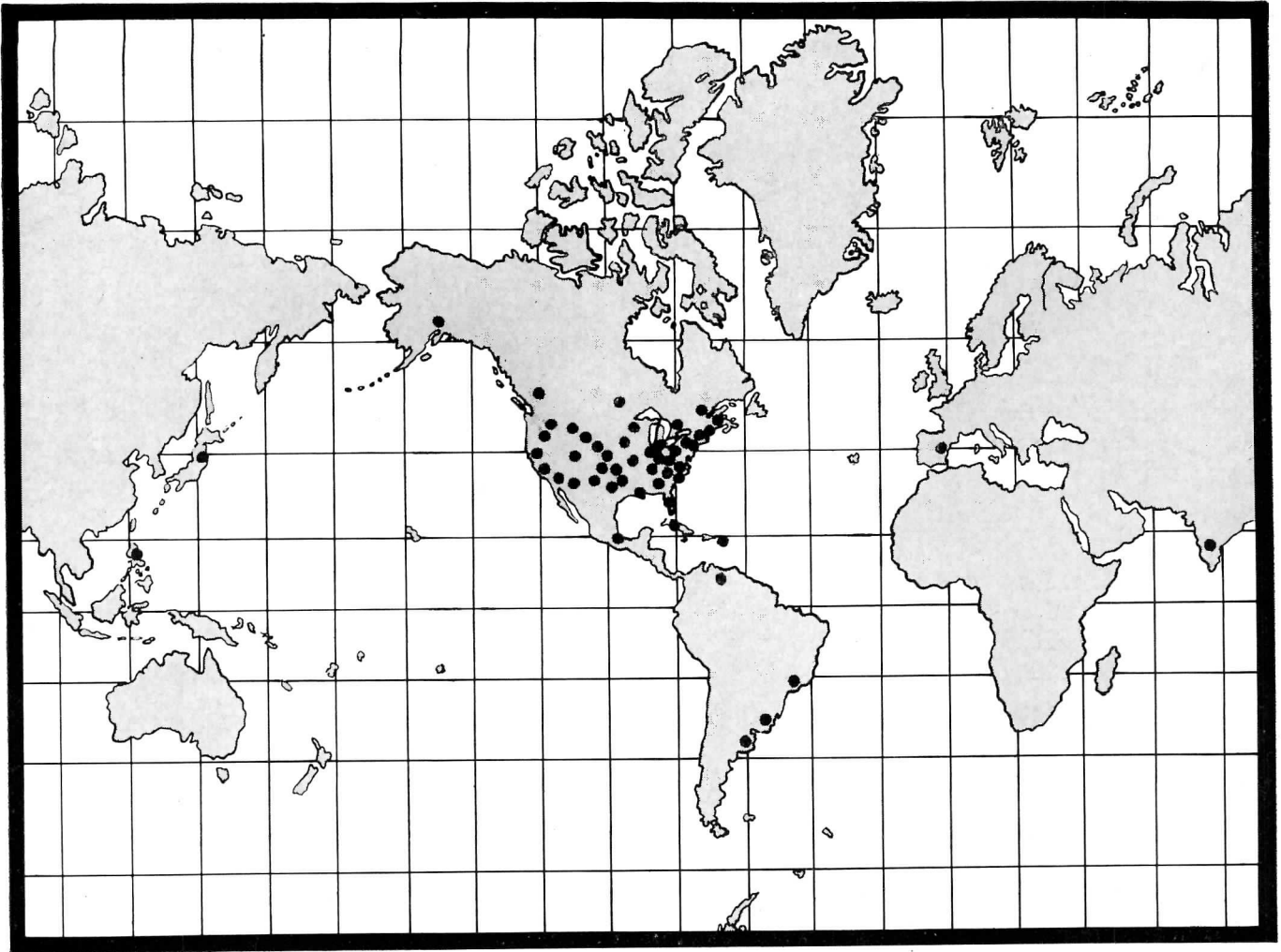

# *Ric-wil* offers **WORLD WIDE** Service for Prefabricated Piping Systems

Over 75 field offices, both national and international are at your disposal on any project dealing with prefabricated piping systems. These field representatives offer on the spot assistance in planning, delivering and installing underground or overhead piping. A Ric-wil representative will be glad to discuss plans involving steam, hot water or oil distribution lines . . . and he represents the world's largest supplier of prefabricated piping systems.

For the name of your nearest representative or the catalog covering the Ric-wil line, call or write the home office.

*Quality Piping Systems . . .  
. . . of Exceptionally High Thermal Efficiency*  
SINCE 1910

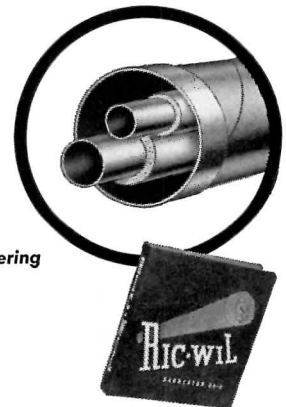

**PREFABRICATED INSULATED PIPING SYSTEMS**

**BARBERTON, OHIO**

IN CANADA: THE **RIC-WIL** COMPANY OF CANADA LIMITED

# THE RECORD REPORTS: CONSTRUCTION COST INDEXES

Labor and Materials

U. S. average 1926-1929 = 100

Presented by Clyde Shute, manager, Statistical and Research Division, F. W. Dodge Corp., from data compiled by E. H. Boeckh & Assocs., Inc.

## NEW YORK

## ATLANTA

Period	Residential		Apts., Hotels Office Bldgs. Brick and Concr.	Commercial and Factory Bldgs. Brick and Concr.		Brick and Steel	Residential		Apts., Hotels Office Bldgs. Brick and Concr.	Commercial and Factory Bldgs. Brick and Concr.		Brick and Steel
	Brick	Frame		Brick	Frame		Brick	Frame				
1930	127.0	126.7	124.1	128.0	123.6		82.1	80.9	84.5	86.1	83.6	
1935	93.8	91.3	104.7	108.5	105.5		72.3	67.9	84.0	87.1	85.1	
1939	123.5	122.4	130.7	133.4	130.1		86.3	83.1	95.1	97.4	94.7	
1946	181.8	182.4	177.2	179.0	174.8		148.1	149.2	136.8	136.4	135.1	
1947	219.3	222.0	207.6	207.5	203.8		180.4	184.0	158.1	157.1	158.0	
1948	250.1	251.6	239.4	242.2	235.6		199.2	202.5	178.8	178.8	178.8	
1949	243.7	240.8	242.8	246.4	240.0		189.3	189.9	180.6	180.8	177.5	
1950	256.2	254.5	249.5	251.5	248.0		194.3	196.2	185.4	183.7	185.0	
1951	273.2	271.3	263.7	265.2	262.2		212.8	214.6	204.2	202.8	205.0	
1952	278.2	274.8	271.9	274.9	271.8		218.8	221.0	212.8	210.1	214.3	
1953	281.3	277.2	281.0	286.0	282.0		223.3	224.6	221.3	221.8	223.0	
1954	285.0	278.2	293.0	300.6	295.4		219.6	219.1	223.5	225.2	225.4	
1955	293.1	286.0	300.0	308.3	302.4		225.3	225.1	229.0	231.5	231.8	
Sept. 1956	313.2	304.1	324.0	334.3	329.2		239.7	238.0	245.8	248.2	252.9	
Oct. 1956	313.0	303.8	324.1	334.7	329.2		239.7	238.0	245.8	248.2	252.9	
Nov. 1956	313.2	304.0	324.4	334.9	329.4		239.8	238.1	245.5	248.1	250.8	
Nov. 1956	% increase over 1939			% increase over 1939			% increase over 1939			% increase over 1939		
	153.6	148.4	148.2	151.0	153.2		177.9	186.5	158.1	154.7	164.8	

## ST. LOUIS

## SAN FRANCISCO

1930	108.9	108.3	112.4	115.3	111.3	90.8	86.8	100.4	104.9	100.4	
1935	95.1	90.1	104.1	108.3	105.4	89.5	84.5	96.4	103.7	99.7	
1939	110.2	107.0	118.7	119.8	119.0	105.6	99.3	117.4	121.9	116.5	
1946	167.1	167.4	159.1	161.1	158.1	159.7	157.5	157.9	159.3	160.0	
1947	202.4	203.8	183.9	184.2	184.0	193.1	191.6	183.7	186.8	186.9	
1948	227.9	231.2	207.7	210.0	208.1	218.9	216.6	208.3	214.7	211.1	
1949	221.4	220.7	212.8	215.7	213.6	213.0	207.1	214.0	219.8	216.1	
1950	232.8	230.7	221.9	225.3	222.8	227.0	223.1	222.4	224.5	222.6	
1951	252.0	248.3	238.5	240.9	239.0	245.2	240.4	239.6	243.1	243.1	
1952	259.1	253.2	249.7	255.0	249.6	250.2	245.0	245.6	248.7	249.6	
1953	263.4	256.4	259.0	267.6	259.2	255.2	257.2	256.6	261.0	259.7	
1954	266.6	260.2	263.7	273.3	266.2	257.4	249.2	264.1	272.5	267.2	
1955	273.3	266.5	272.2	281.3	276.5	268.0	259.6	275.0	284.4	279.6	
Sept. 1956	289.1	280.5	289.2	300.4	296.3	280.8	271.6	293.1	302.3	300.8	
Oct. 1956	289.1	280.5	289.2	300.4	296.3	281.0	271.8	293.4	302.5	301.0	
Nov. 1956	289.3	280.7	289.5	300.6	296.5	282.6	272.8	295.8	306.8	302.9	
Nov. 1956	% increase over 1939			% increase over 1939			% increase over 1939			% increase over 1939	
	162.5	162.3	143.9	150.9	149.2	167.6	174.7	152.0	151.7	160.0	

Cost comparisons, as percentage differences for any particular type of construction, are possible between localities, or periods of time within the same city, by dividing the difference between the two index numbers by one of them; i.e.:  
 index for city A = 110  
 index for city B = 95  
 (both indexes must be for the same type of construction).

Then: costs in A are approximately 16 per cent higher than in B.

$$\frac{110-95}{95} = 0.158$$

Conversely: costs in B are approximately 14 per cent lower than in A.

$$\frac{110-95}{110} = 0.136$$

Cost comparisons cannot be made between different types of construction because the index numbers for each type relate to a different U. S. average for 1926-29.

Material prices and wage rates used in the current indexes make no allowance for payments in excess of published list prices, thus indexes reflect minimum costs and not necessarily actual costs.



## Betty Furness invites you to "Time" Westinghouse Elevator Operation

### One "Do-it-Yourself" Stop Watch Test Is Worth Ten Thousand Words.

You can't describe superior elevator performance, you've got to *experience* it. That's why we're rolling out the red carpet to you who are planning new heavy traffic buildings—or thinking about modernizing old ones. A simple stop watch test verifies these new standards set by Westinghouse for more economical and more efficient elevating:

- ... Better floor-to-floor time-saving
- ... Elimination of all unnecessary door open time
- ... Maximum speed with smoothness and comfort

Yes, we invite you to test all operational phases of Westinghouse automated (operatorless) elevator systems. Call our nearest office today to arrange for a stop watch demonstration and also learn how you save up to \$7000 per car per *year* with operatorless elevators—and learn more about the remarkable components which allow elevators to think for themselves:

1. Selectomatic for master supervisory control
2. Synchro-Glide for accurate, smooth, soft landings
3. Traffic Sentinel® for safe, courteous, yet time-saving passenger handling
4. Automatic Traffic Pattern for Traffic Controlled Elevating
5. Shuntless Relays and Electric-Driven Selectors for reliable operation

**AUTOMATED**

**Westinghouse Elevators  
AND ELECTRIC STAIRWAYS**

**YOU CAN BE SURE...IF IT'S Westinghouse**

*Karnak, Temple of Amon. The great hall of pillars of Kings Sethos I and Rameses II, seen from below*

## EGYPT: 3000 YEARS OF ART AND ARCHITECTURE

*Egypt: Architecture, Sculpture, Painting.* By Kurt Lange and Max Hirmer. Phaidon (London) 1956. Distributed by Garden City Books, N. Y. 362 pp. Illus.

FOR NEARLY 3000 YEARS the heartbeat of human development pulsed through ancient Egypt. Modern man, in quest of the same spiritual and esthetic satisfactions the Egyptians were seeking, turns with awe and delight to the artistic products of this ancient civilization. At once the reflection of an unfamiliar and rather exotic way of life peculiar to that nation, the art and architecture of Egypt also expresses universal aspirations to which man of all ages continues to respond. However, the response is not always affirmative. Attitudes toward ancient Egypt seem to waver between under- and over-valuation. One man may believe the Nile civilization, as evidenced by its art and architecture, achieved the ultimate in human aims. Another may think the Egyptians held a persistent complacency toward the progress of thought, never freeing themselves from archaic attitudes toward religion and despotism. A sober analysis of Egypt's artistic accomplishments with relation to

*(Continued on page 66)*





Daylight Research House, Ann Arbor, Michigan. Architect: Harris Armstrong, A. I. A., Kirkwood, Missouri. Decorator: Marian Quinlan, Chicago, Illinois



**SEE HOW THESE NATURAL WOOD** PELLA FOLDING DOORS harmonize with the walls, floor, ceiling, and furnishings of this room. And PELLA DOORS contribute to over-all excellence of room design, too—you can close for privacy, open to create attractive spaciousness. Handsome veneers of birch, pine, oak and Philippine Mahogany are available. Easy-to-install, doors are factory assembled, and come complete with all hardware.

## WOOD FOLDING DOORS

**ROLSCREEN COMPANY**  
Dept. 1-21, Pella, Iowa  
Please send literature featuring PELLA  
WOOD FOLDING DOORS.



FIRM NAME \_\_\_\_\_

ADDRESS \_\_\_\_\_

CITY \_\_\_\_\_

ZONE \_\_\_\_\_

STATE \_\_\_\_\_

ATTENTION MR. \_\_\_\_\_

TEL. NO. \_\_\_\_\_

Keeping industry bright with **ABolite**

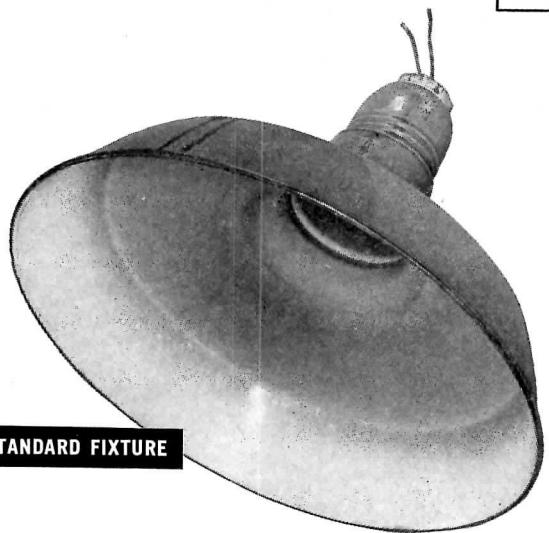

**STANDARD FIXTURE**

**6-MONTH TEST RESULTS**

The photographs show two reflectors after 6 months of side-by-side use in the core department of the James B. Clow and Sons plant, Coshocton, Ohio. Note the heavy deposit of dirt and grime on the non-vented unit, drastically reducing its illuminating value. The Abolite slotted-neck reflector shows minimum dirt deposit; lighting efficiency remains high.

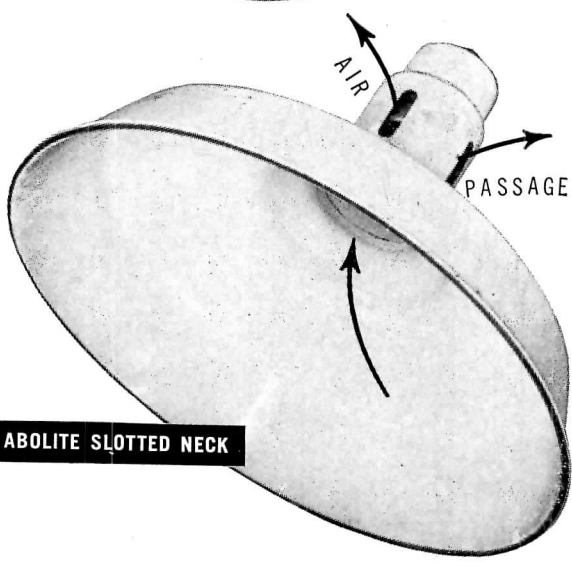

**ABOLITE SLOTTED NECK**

**Self-cleaning Abolite fixture gives 30% more light, longer lamp life**

The slotted-neck reflector design, by Abolite, greatly increases lighting efficiency and lamp life, cuts maintenance costs way down. Air circulation through the ventilator slots keeps dust and grime on the move. Lamp and reflector stay clean nearly twice as long, give 30% more illumination. Lamp operating temperature is reduced 40%. Make sure you get all these advantages—at no extra cost—by specifying Abolite. For full details on Abolite's complete line of lighting fixtures, write *ABolite Lighting Division, The Jones Metal Products Co., West Lafayette, Ohio.*

**ABOLITE** LIGHTING



**REQUIRED READING**

(Continued from page 62)

religious political, and economic influences is presented by Kurt Lange and Dr. Max Hirmer in their co-authored book, *Egypt: Architecture, Sculpture, Painting.*

In a 40-page introductory text, the authors draw an historical outline of the Egyptian civilization, discussing the way of life, the religious beliefs, and the organization of the State. Ancient works of art are placed in proper perspective to these variable influences. Thus new vistas of understanding are made available to both the student and the layman interested in Egyptian art.

As the introduction to this book espouses, everything Egyptian, wherever it may be, has its own atmosphere around it, and the only way to uncover the reality of the image with which these men mastered the incomprehensible and the feasible is to adapt oneself to their sphere, to *feel* like an Egyptian. This comes from understanding their way of life. Extracting Egyptian art from its proper and natural orbit and dissecting it for purposes of analysis is like testing a fish out of water to see how it swims. That does not mean Egyptian art and architecture is void of universal expression, but rather that we must become familiar with the *mode* of expression before we can fully appreciate the universal implications. This new volume by Lange and Hirmer helps us do that.

Those who criticize ancient Egyptian religious beliefs — upon which much of its art and architecture was founded — as stagnant, despotic, and full of materialistic fantasies, will do well to note from the introductory pages that more than a thousand years before similar ideas became prevalent in neighbouring countries, Egypt harbored a religious conviction that our fate in the world to come depends on our moral behaviour in this life, which we shall have to justify before the throne of God.

Following the introductory text is a 244-page section of illustrations, exquisite in content, composition, and reproduction. The aim of the illustrations, as Dr. Hirmer mentions in the Foreword, is to give an idea of the landscape in which the buildings were erected over a period of 3000 years, and an idea of the buildings themselves and their component parts. The reader, he contends, can then deduce the details from the living whole, rather than to guess from details what the whole may

(Continued on page 380)

THE CURRENT WORK OF  
PAUL RUDOLPH

FEBRUARY 1957 ARCHITECTURAL RECORD

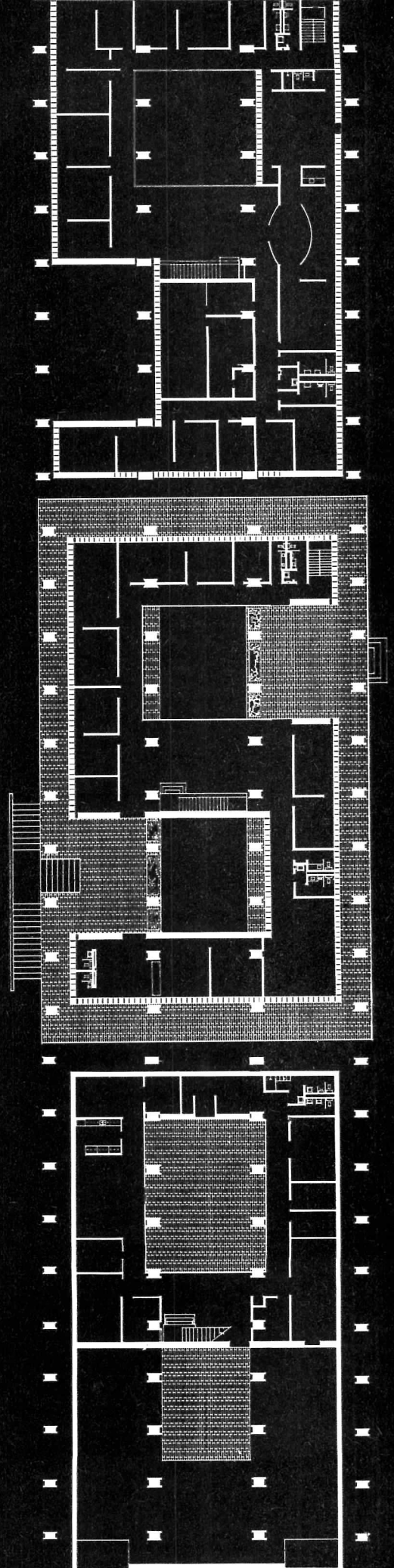

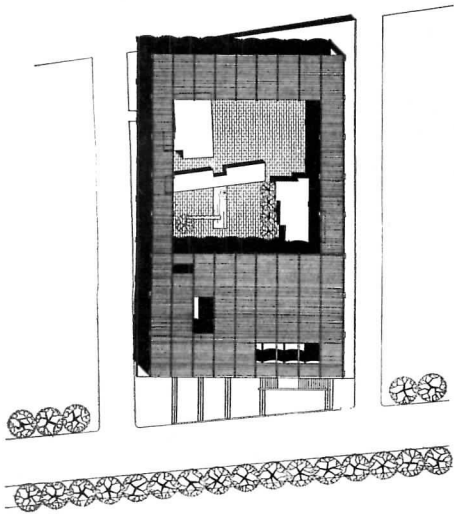

## THE UNITED STATES EMBASSY FOR JORDAN

**I**N THE HARSH, hot daylight of Jordan where the maintenance of mechanical cooling equipment is difficult, this building finds a natural answer in the ancient Arabian double tent. Here a vaulted parasol of close-spaced concrete ribs echoes a common regional form and expresses its independence of the lower watertight roof which it shelters. All piers and walls employ the local technique of pouring concrete into 5-in.-thick forms of native

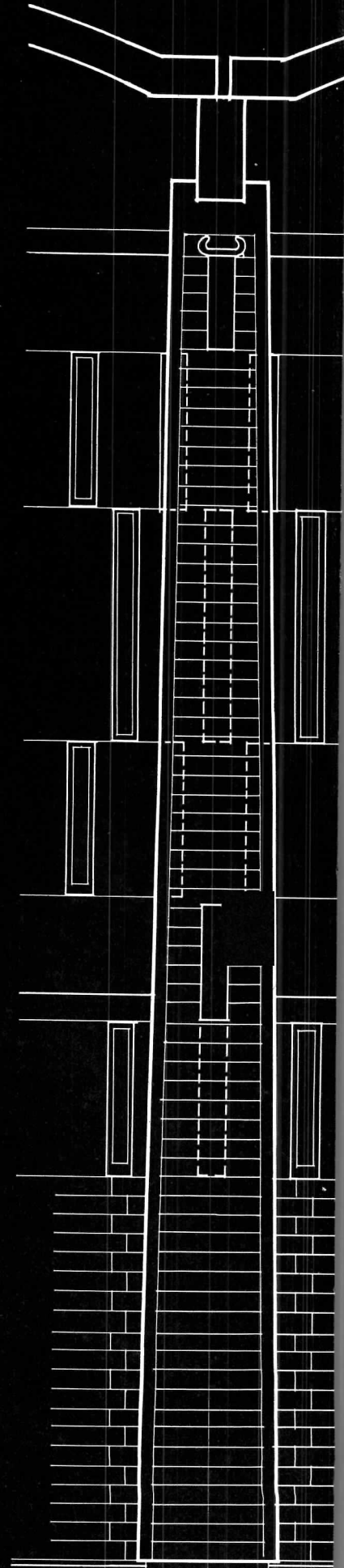
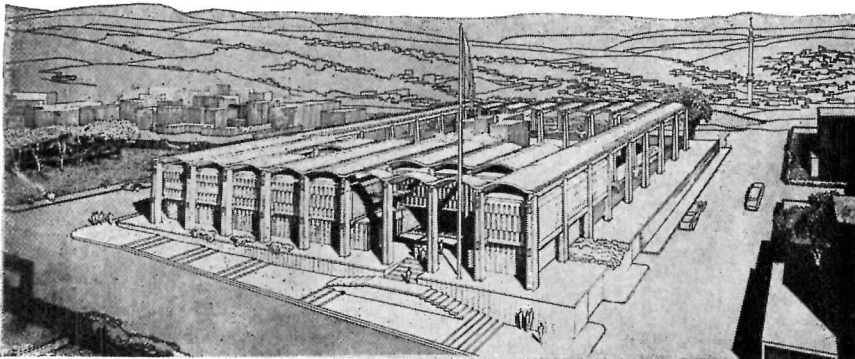

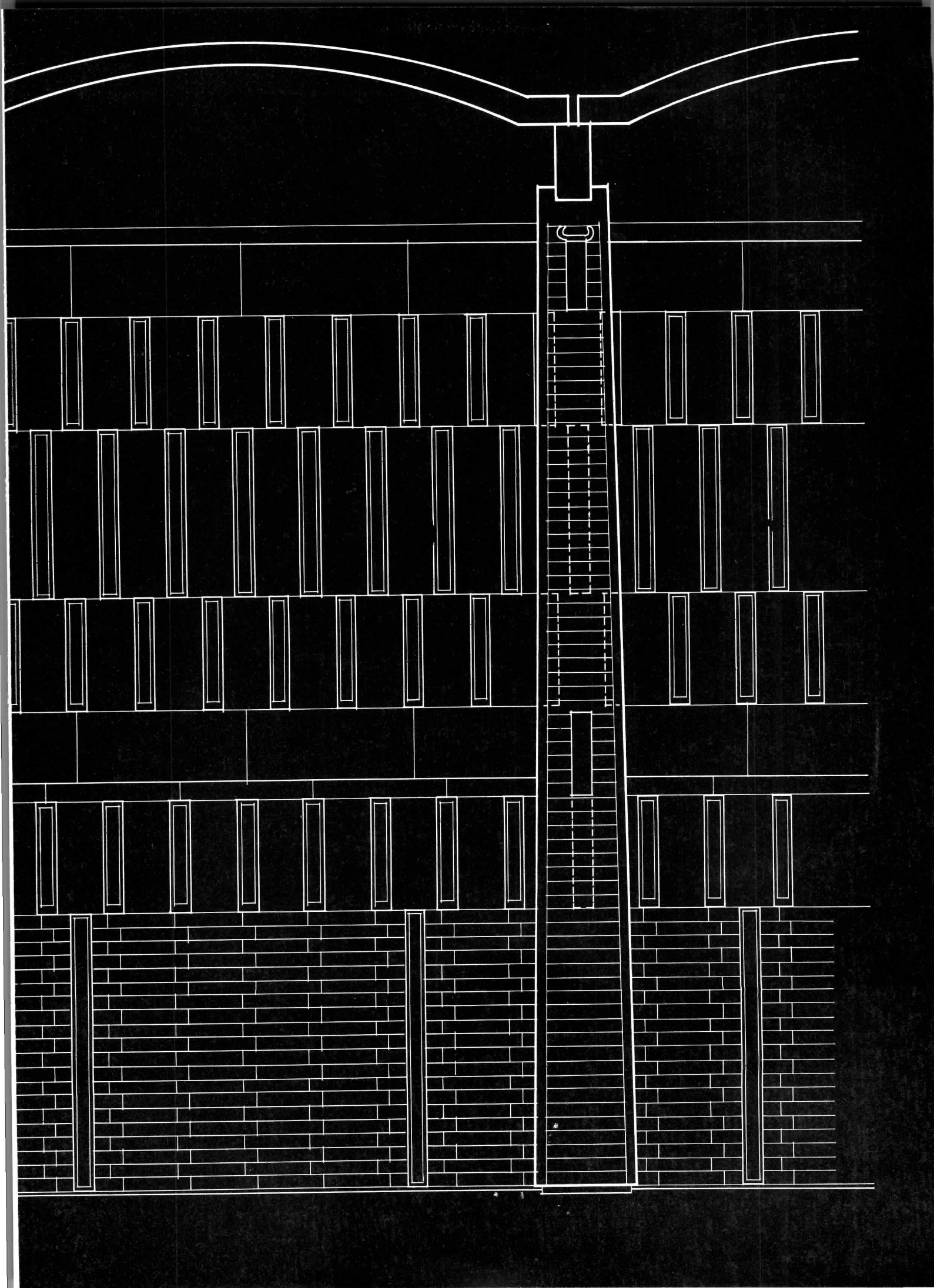

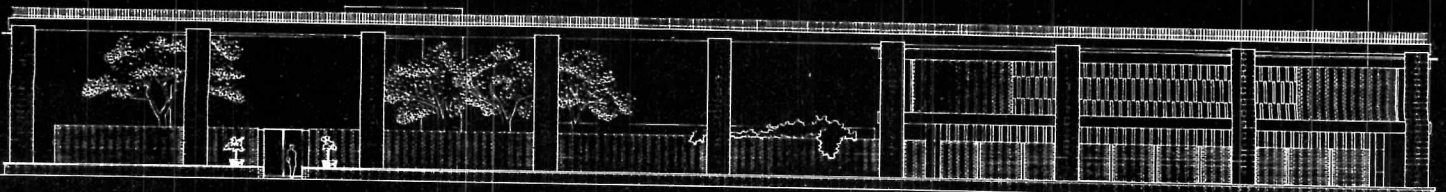
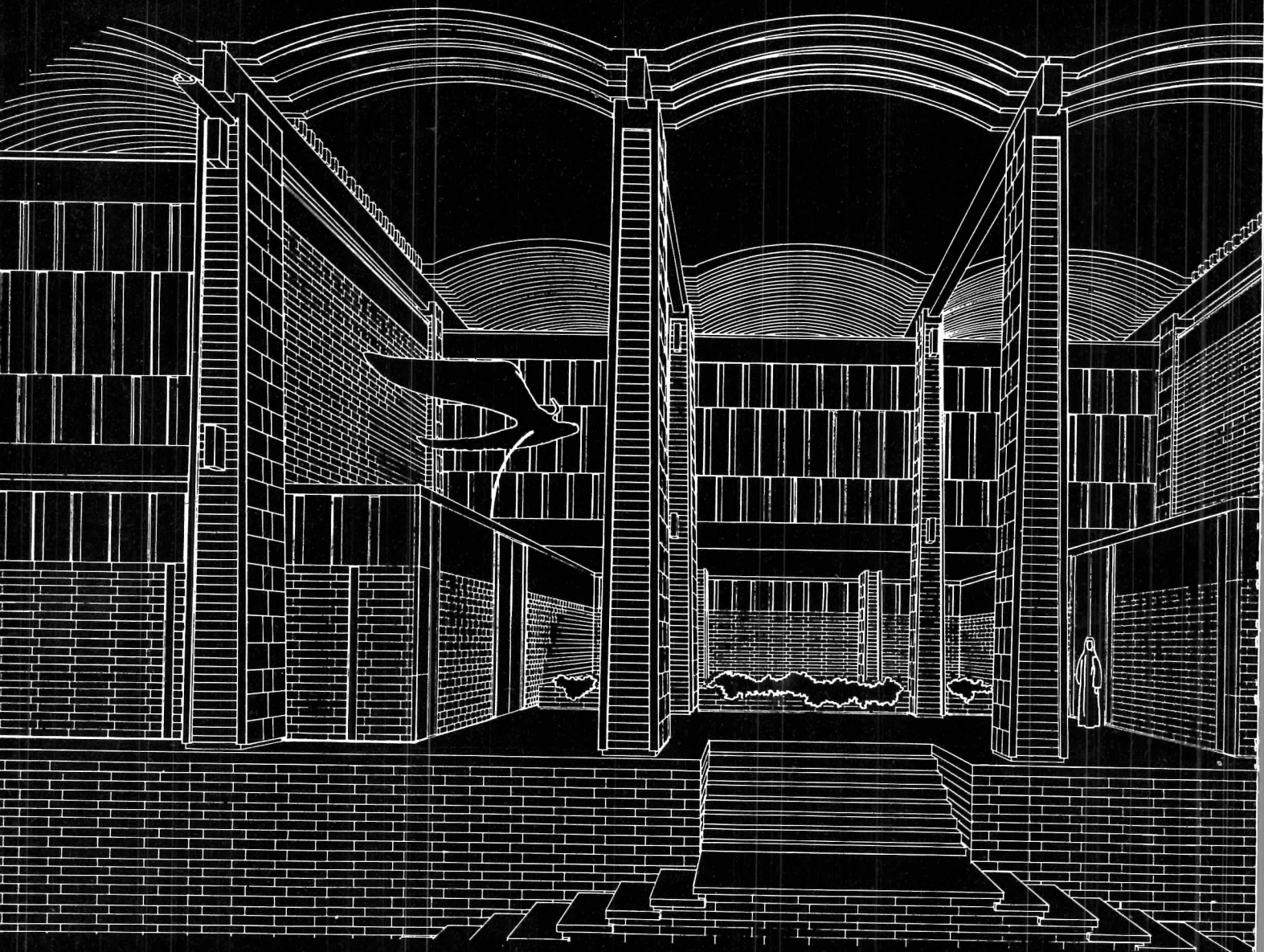

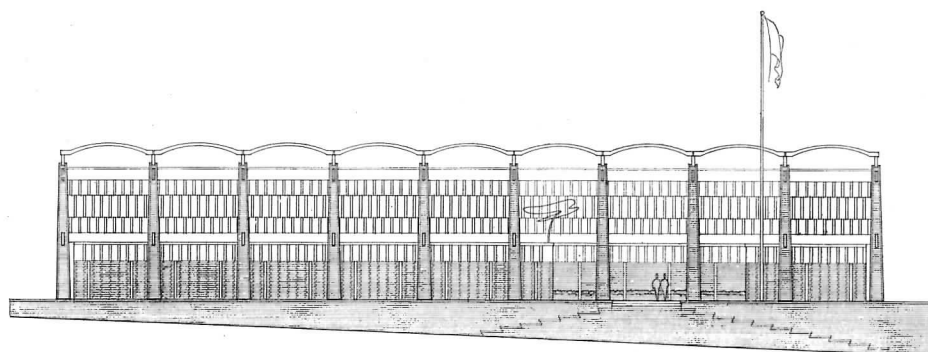
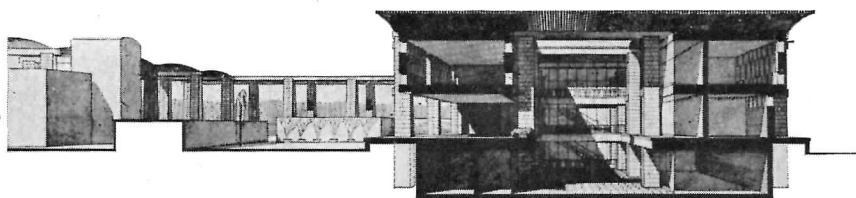
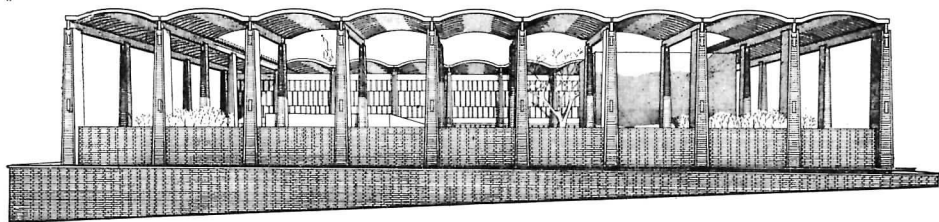
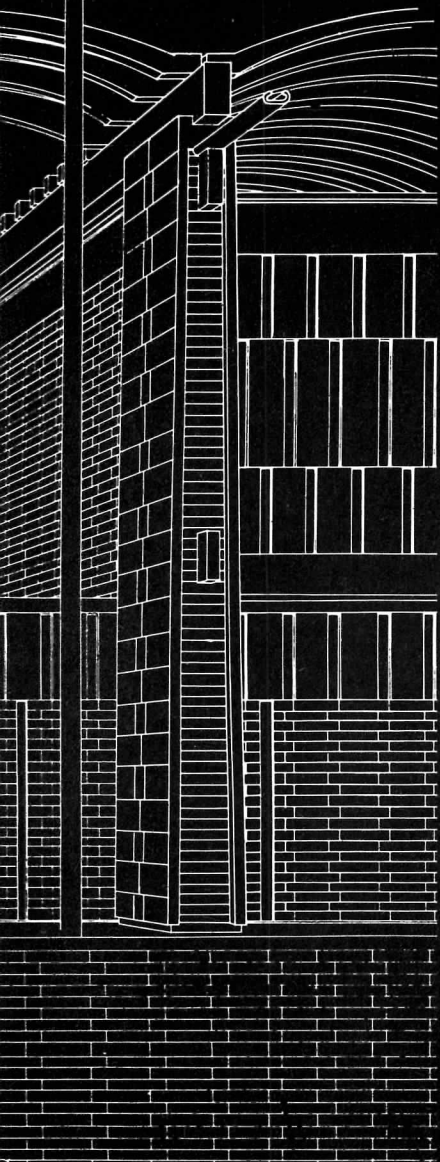

limestone which, as the finish material, relates the building clearly to the surrounding city. Under the great shade roof the several units are broken into small masses in scale with nearby buildings, and this kind of response to local tradition is seen, too, in the customary independence of first- and second-floor plans, the use of the compound wall, and the inviting spatial sequences of the courtyard — in which the existing residence of the Ambassador will remain. *Sasaki & Novak, Landscape Architects; Seelye, Stevenson & Knecht, Structural Engineers; Ebaugh & Gothe, Mechanical Engineers.*

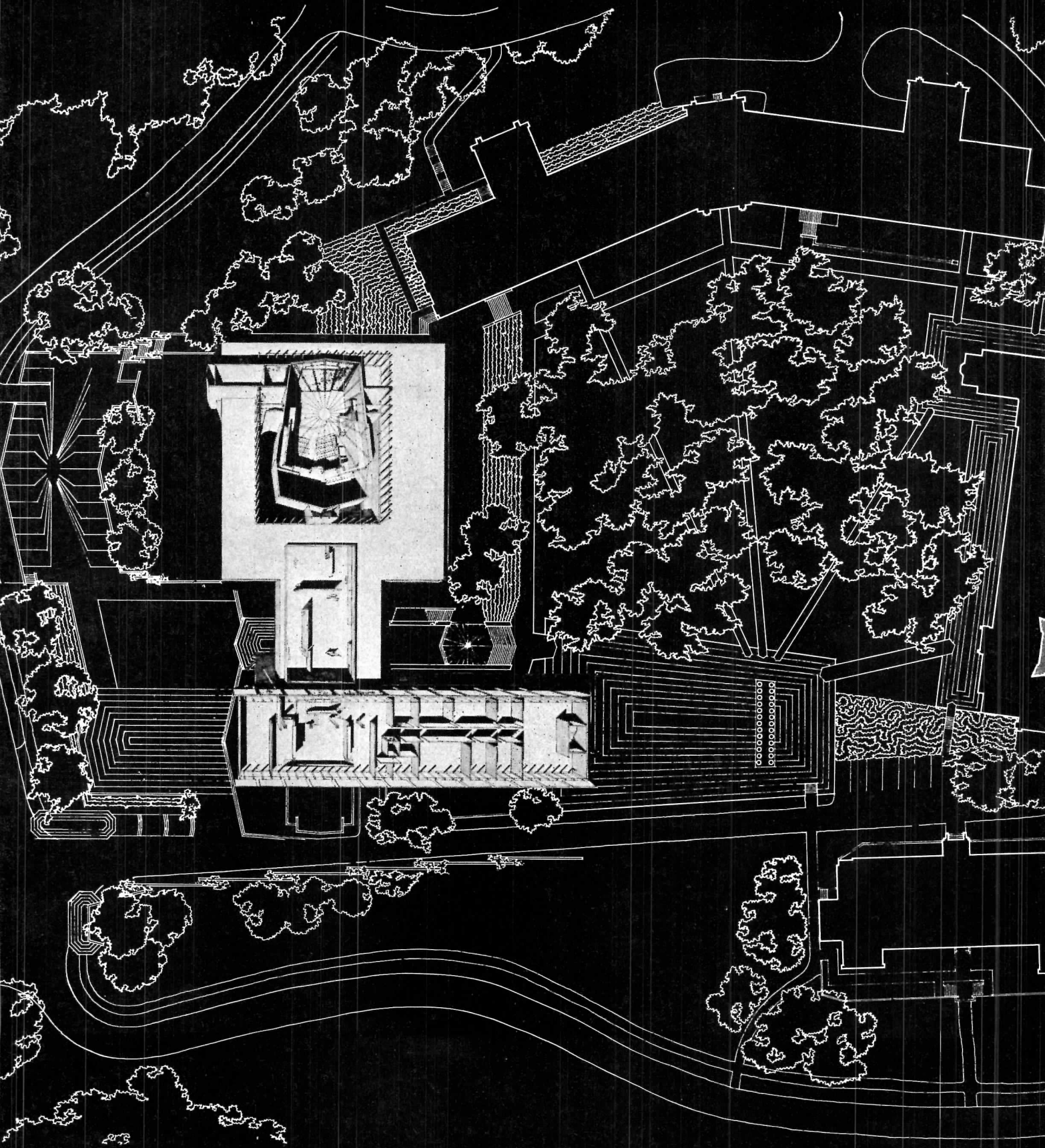



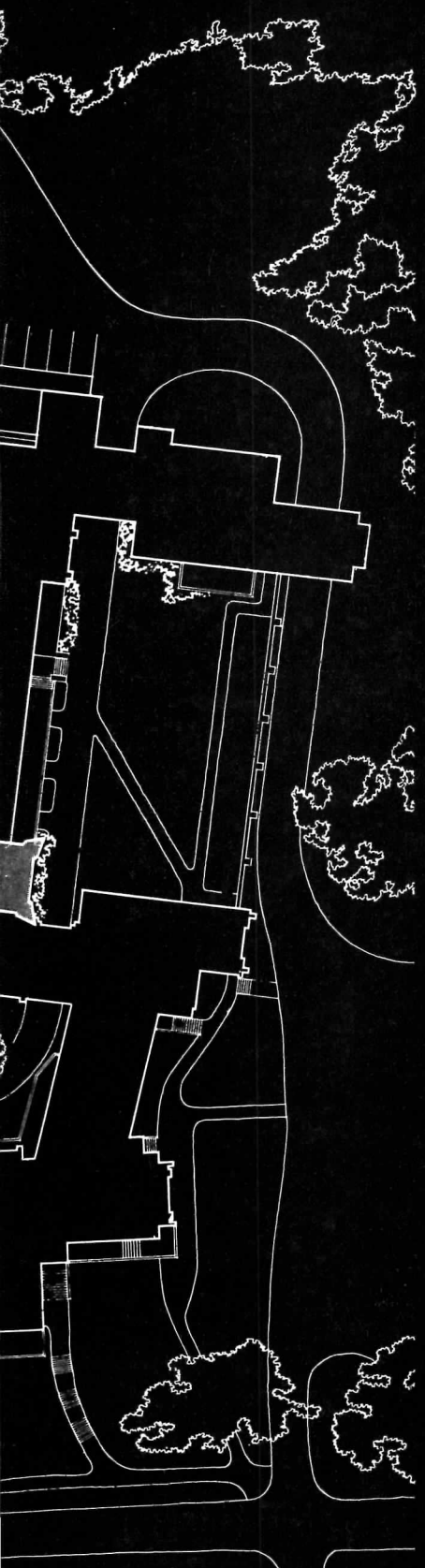

## THE MARY COOPER JEWETT ARTS CENTER

THIS Wellesley building for creative art activities is a clear example of sensitive response to environmental relationships and a careful exercise in plan organization. Music and drama functions are located in the square unit and consist of a classroom and auditorium core standing free in a clerestory-lighted covered courtyard surrounded by ground-floor practice and listening rooms and second-floor library and offices. A bridged lobby

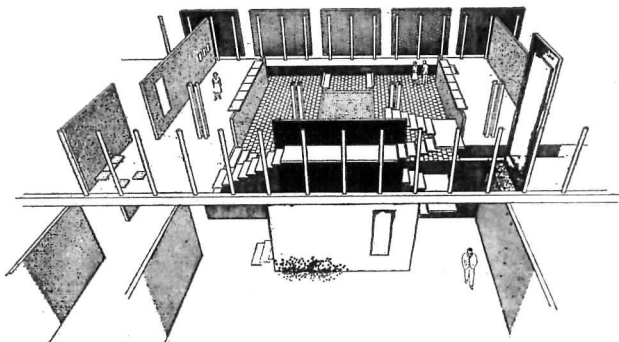

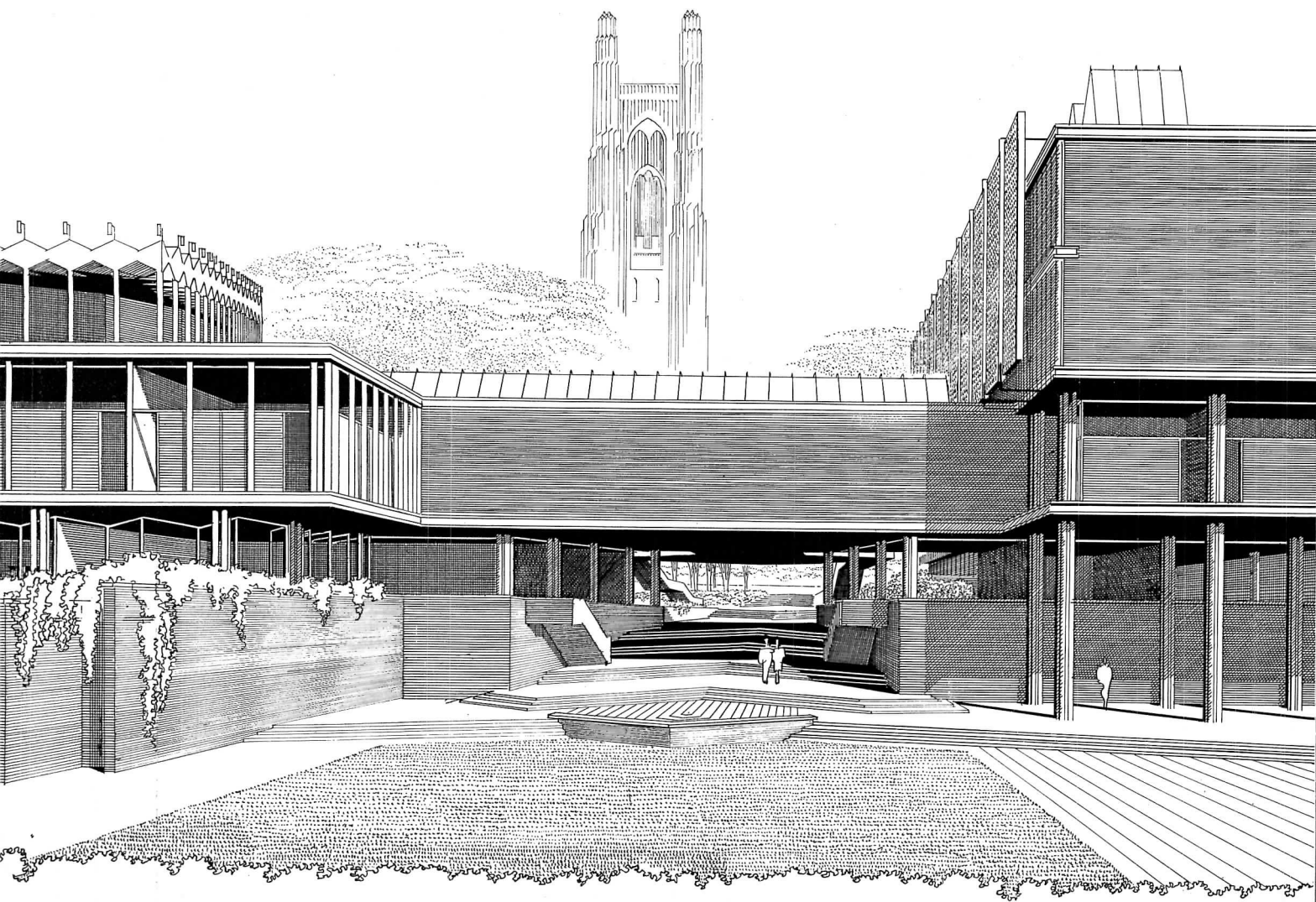

and exhibit gallery connect this unit to the long art building which stacks classrooms, library and offices, study rooms, and studios in four levels. Visual integration with the existing hilltop cluster of brick and limestone Collegiate Gothic buildings grows from the location of the building; from its dimensional characteristics (the 15-ft. module, repeated vertical measures, and a close similarity between new cluster columns and existing mullions all afford a harmony of scale); from the prism-like skylights and undulating facia which extend the elaborate silhouettes; and from its color. *Paul Rudolph, Architect; Anderson, Beckwith & Haible, Associated Architects; David Johnson, Job Captain; Sasaki & Novak, Landscape Architects; Goldberg, Le Messurier Associates, Structural Engineers; Stressenger, Adams, Maguire & Reidy, Mechanical and Electrical Engineers; Boll, Beranek & Newman, Acoustical Consultants; George A. Fuller Co., Contractor.*



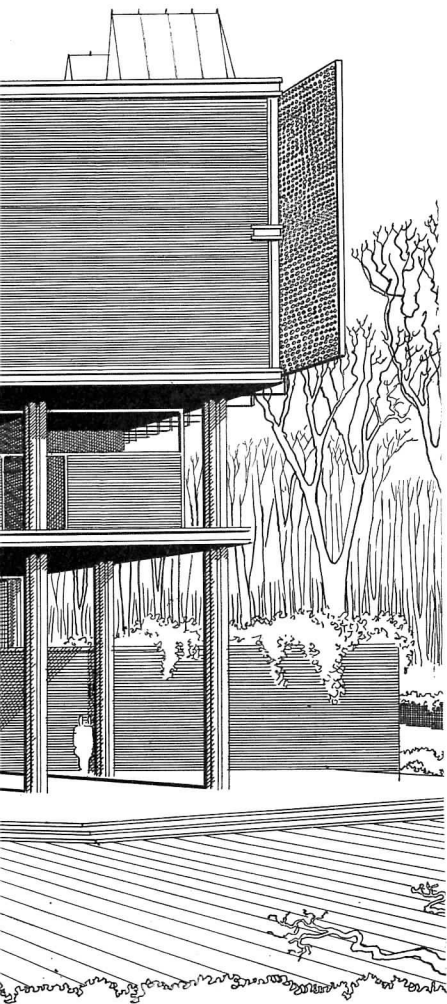

Mock-up porcelain enamel screen, Fred Stone photo

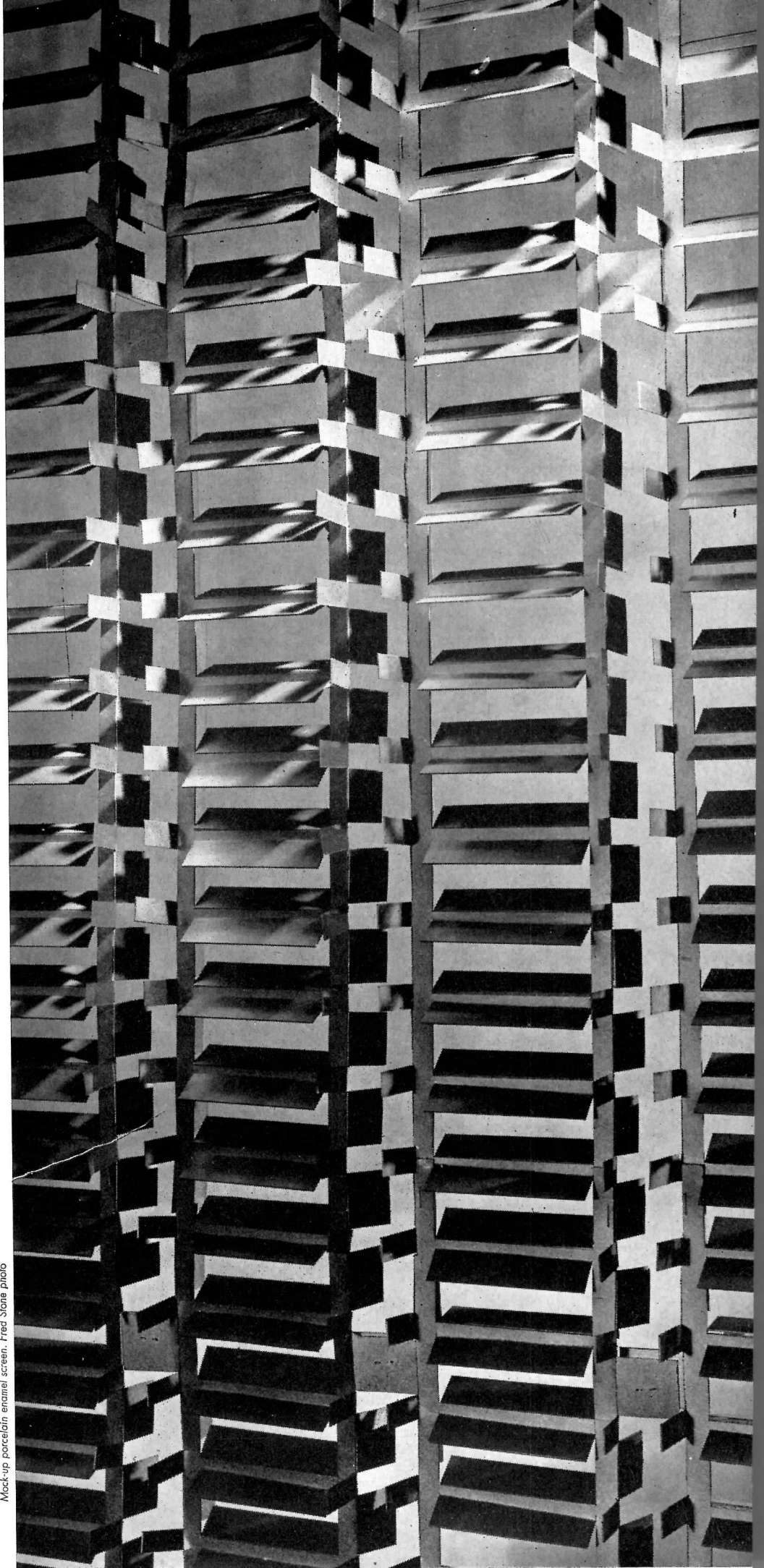

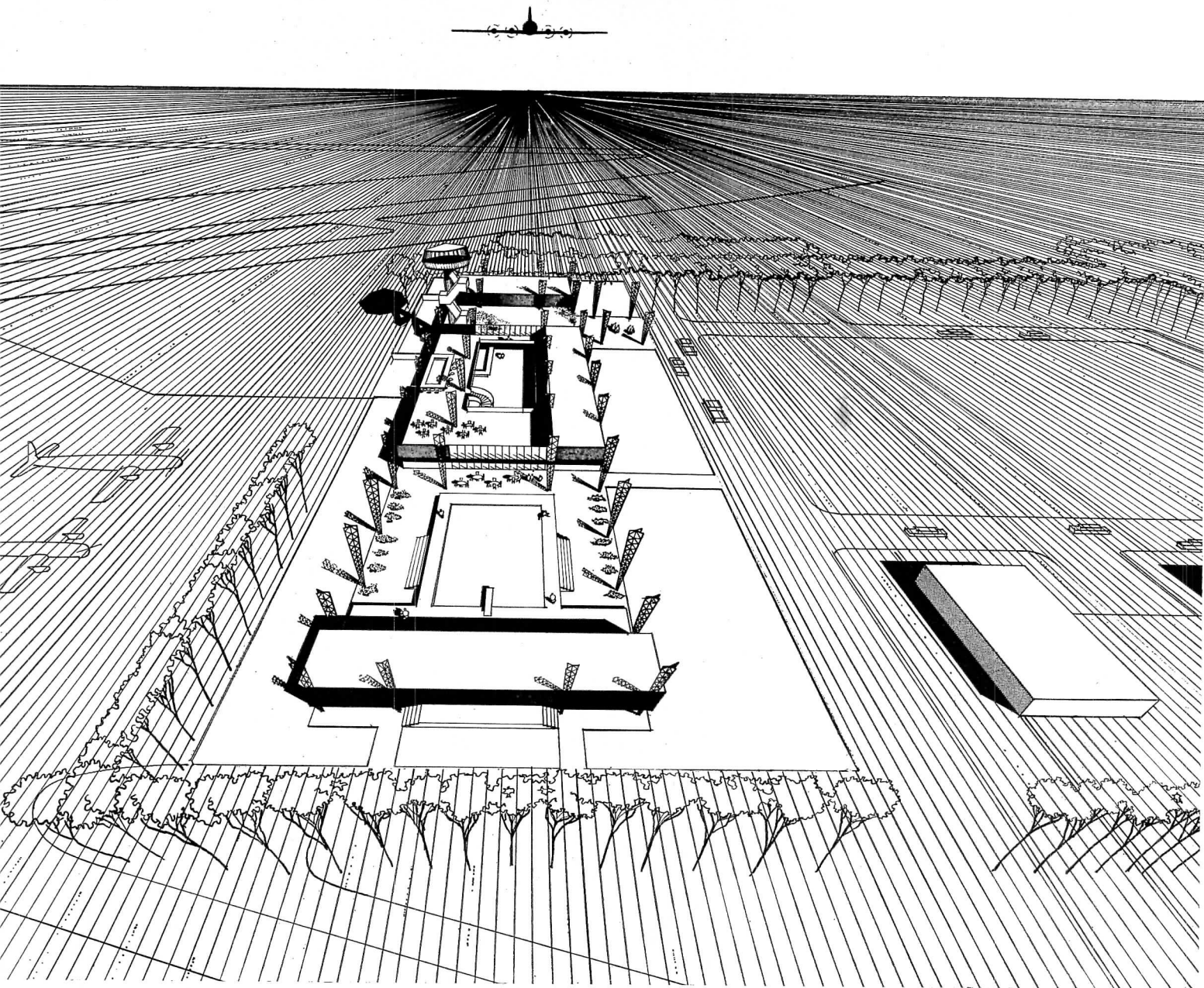

## THE SARASOTA-BRADENTON MUNICIPAL AIRPORT TERMINAL BUILDING

**I**N A TOURISM ECONOMY it was deemed important to provide overnight, eating, swimming, and private-plane facilities. Built by the Air Force during the last war, the palm-lined approach terminates in a grass forecourt to the building which has been conceived as a single great pavilion uninterrupted even by the open-web steel structural system. The two roof levels are supported variously by the upper and lower chords of the trusses. The qualities of lightness and precision felt appropriate to an airport have been sought throughout. *Paul Rudolph, Eliot C. Fletcher, John M. Crowell, Associated Architects; Charles T. Healy and Associates, Mechanical Engineers; George L. Jerome, John M. Crowell, Structural Designers.*

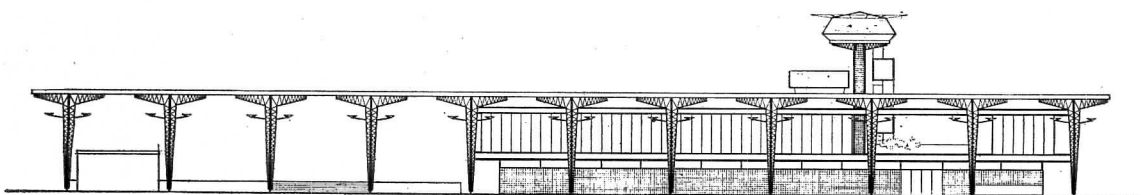

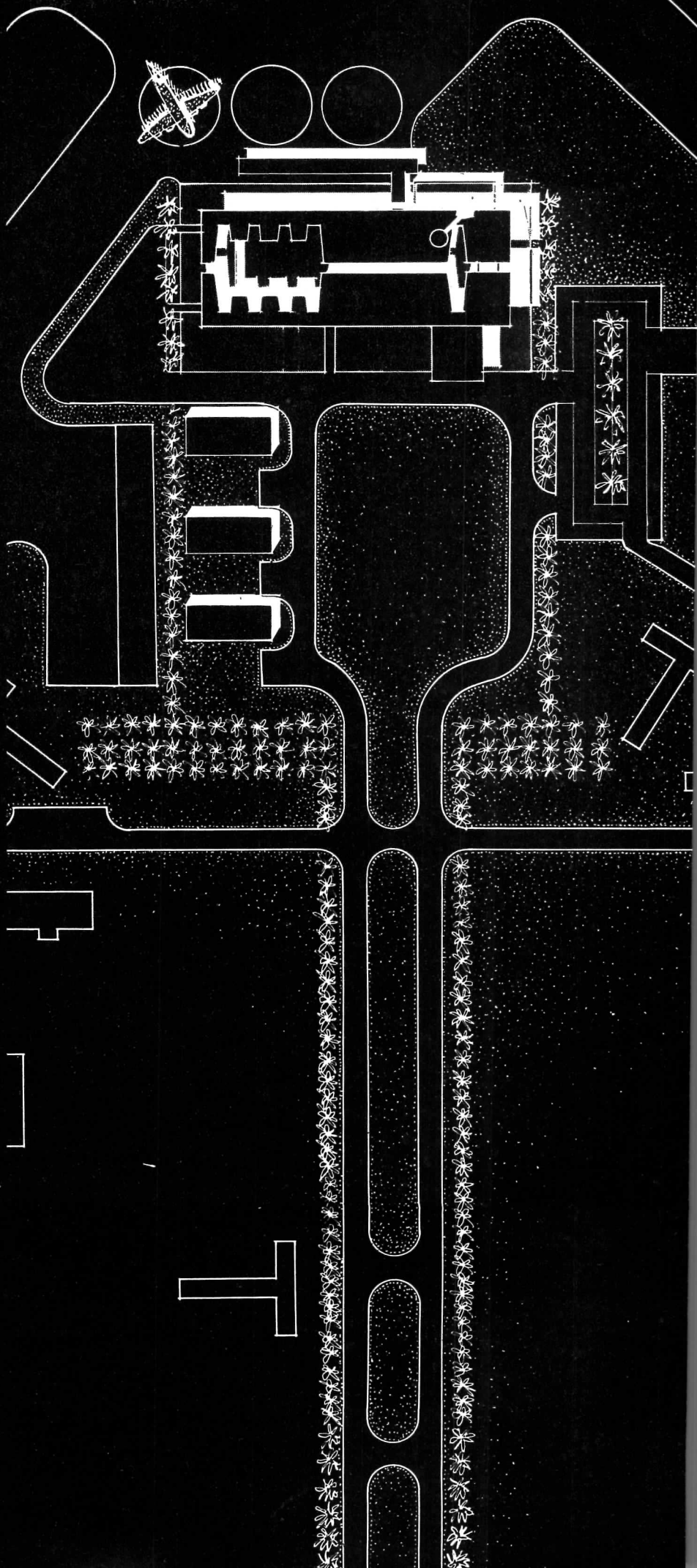
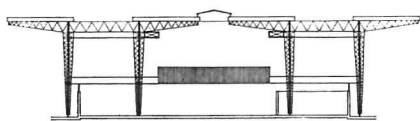
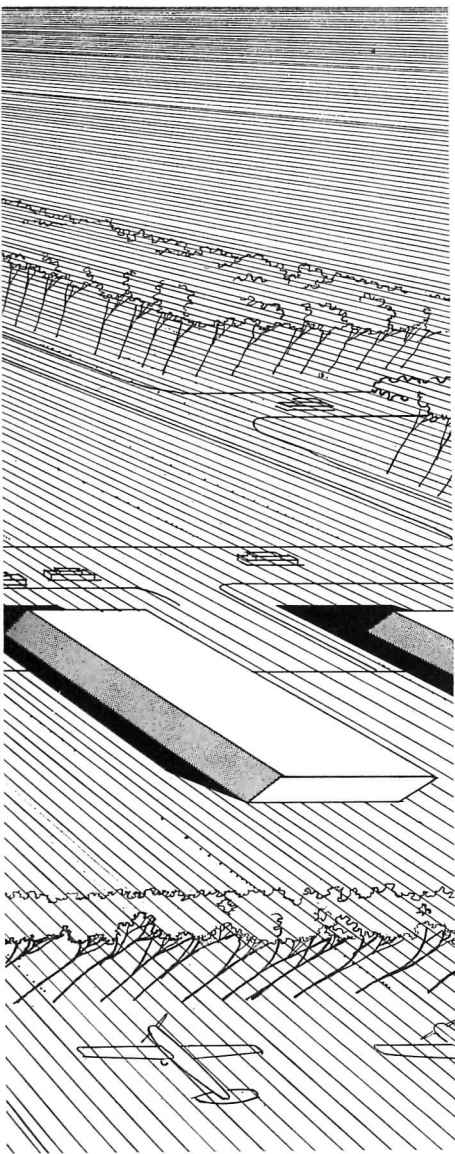

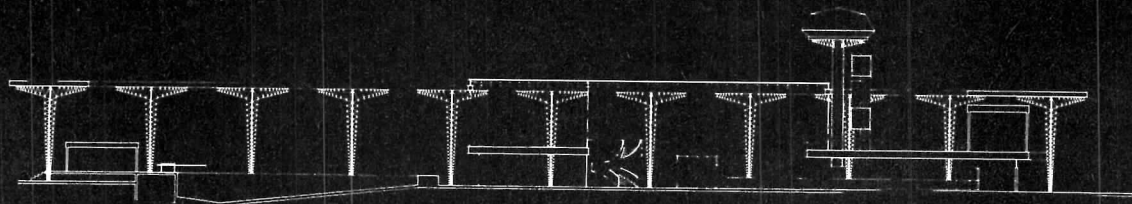
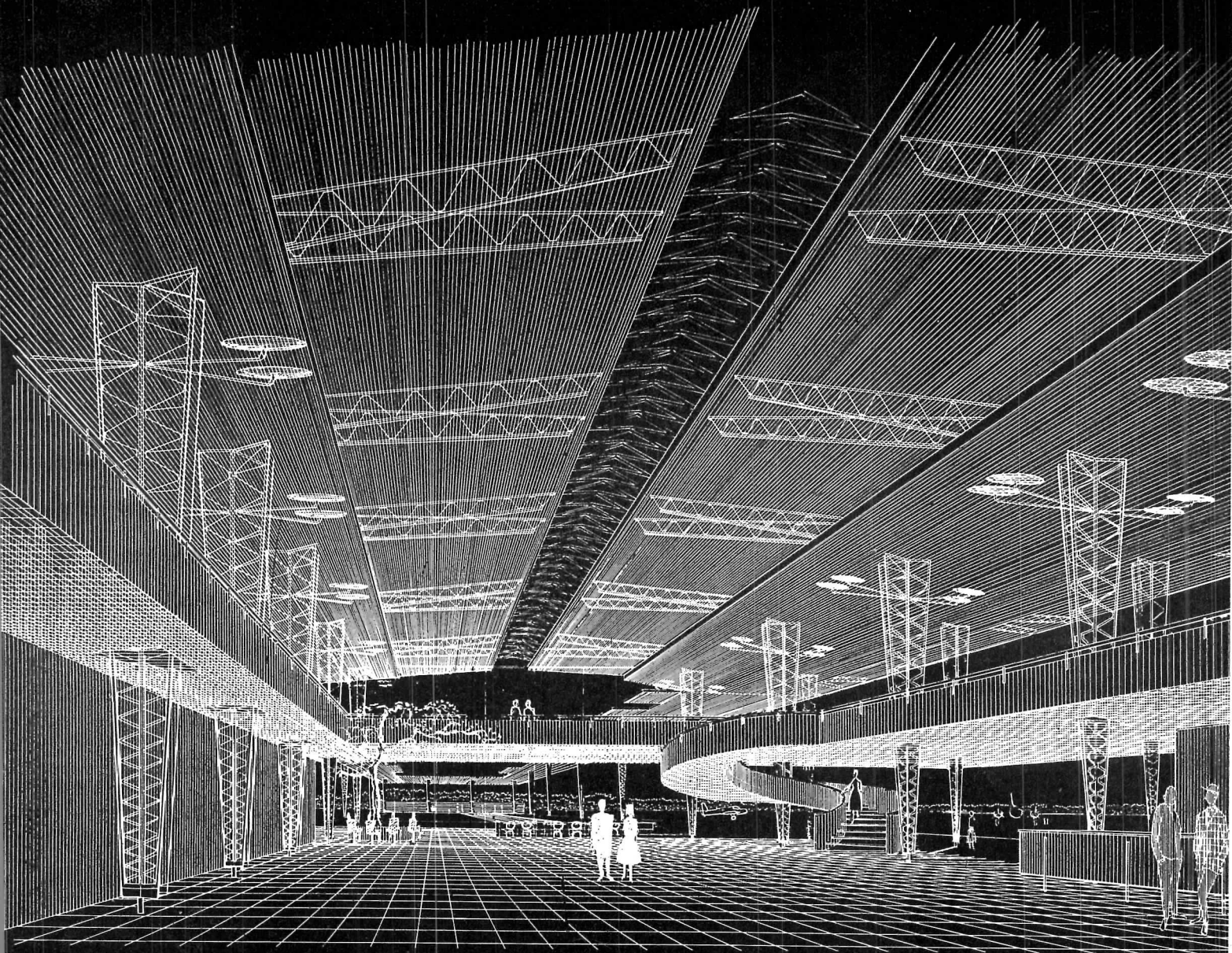

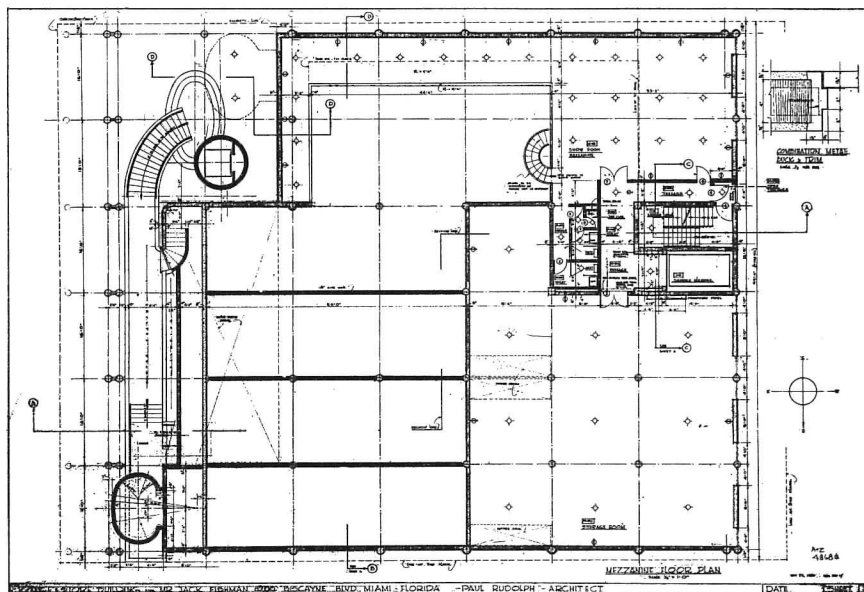
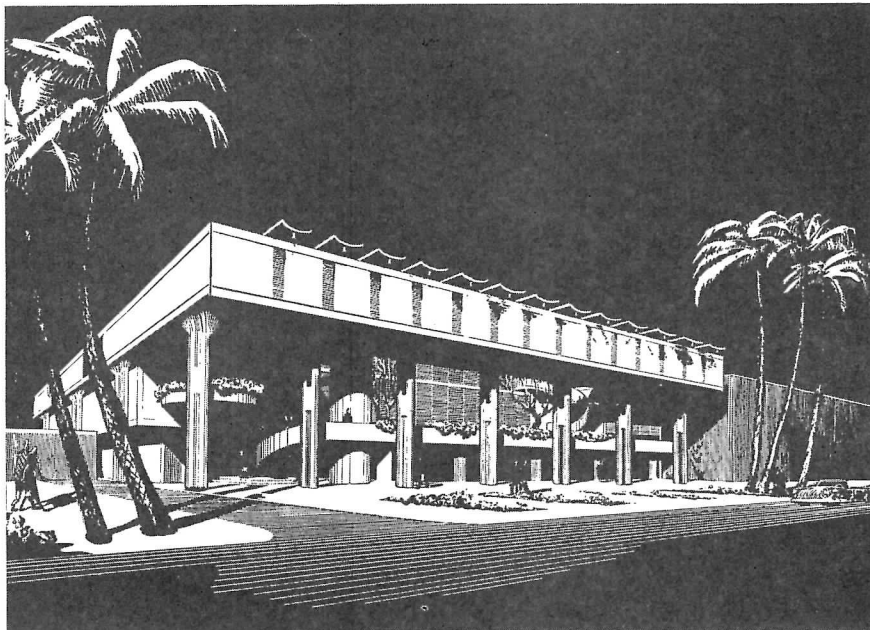
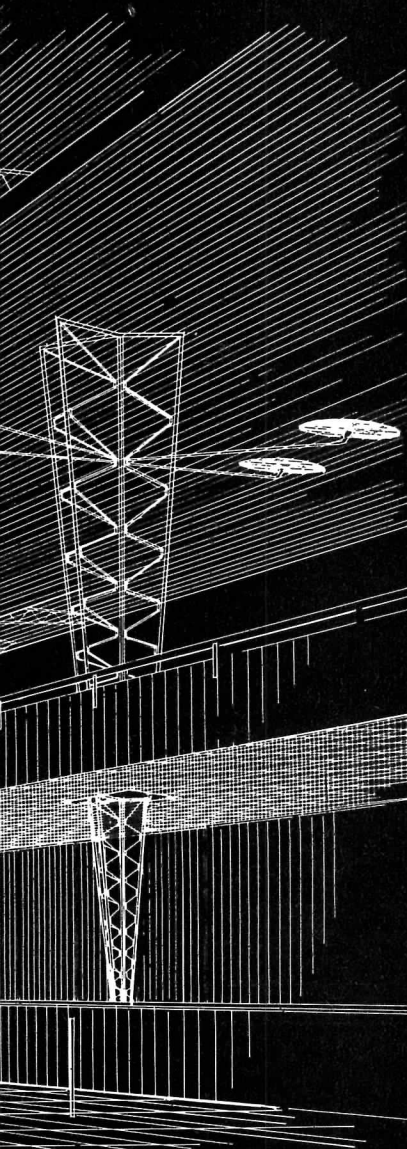

## THE BRAMLETT COMPANY BUILDING, MIAMI

AROUND A SECOND-FLOOR PATIO open to the sky the exhibition spaces of this hotel and restaurant kitchen-equipment manufacturer are organized so as to use the space for both exhibition and circulation. A free-standing, circular elevator, "bridged" to the various levels, including a mezzanine, rises from the ground-floor store area. Plastic use of reinforced concrete was a prime design motivation. *Obler and Clark, Structural Engineers.*

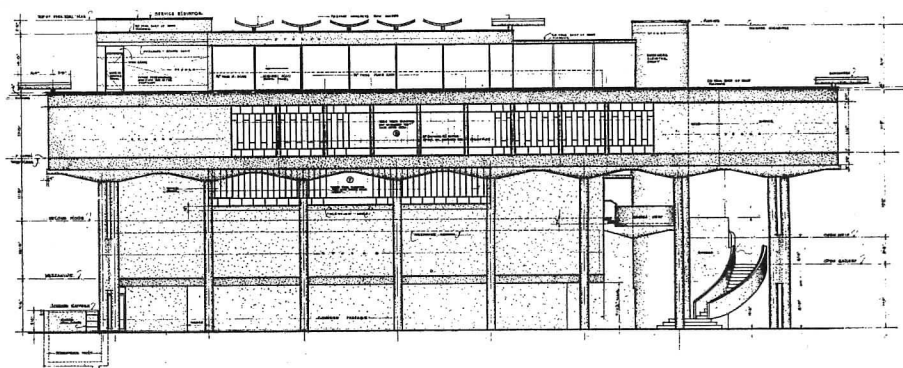

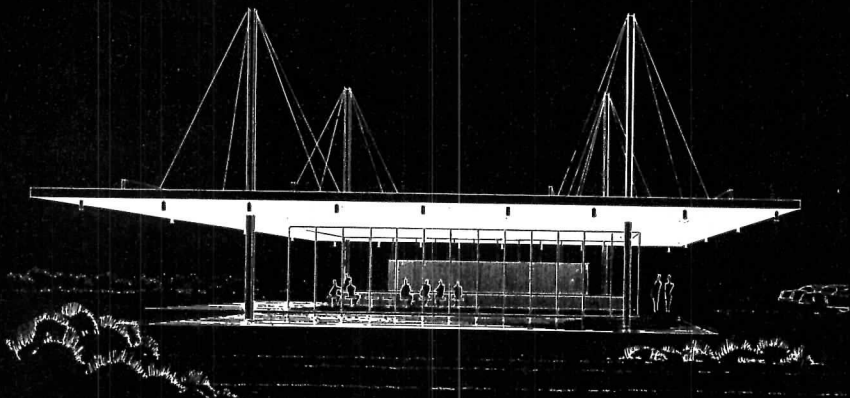

STAND FOR DOUGHNUTS, TAMPA, FLORIDA

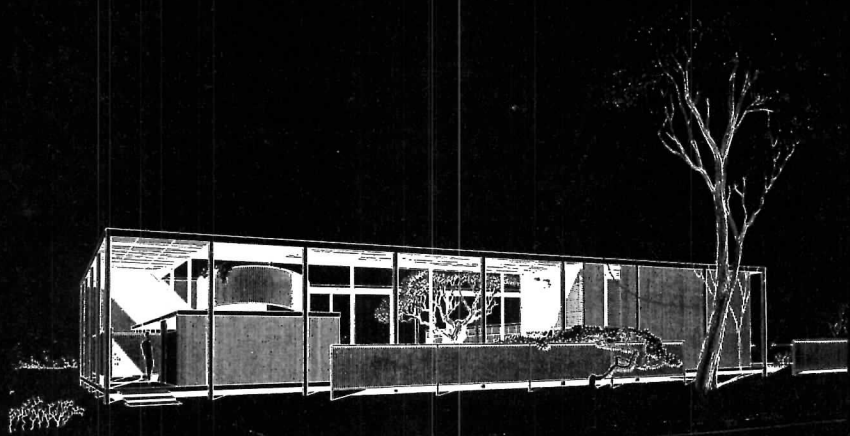

APARTMENT HOUSE, SARASOTA, FLORIDA

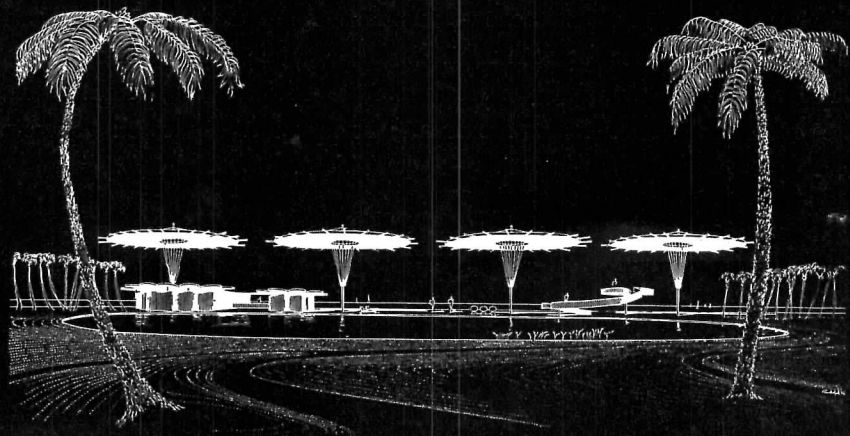

PUBLIC BEACH DEVELOPMENT, SIESTA KEY, FLORIDA

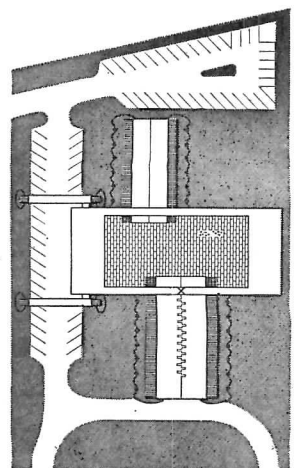
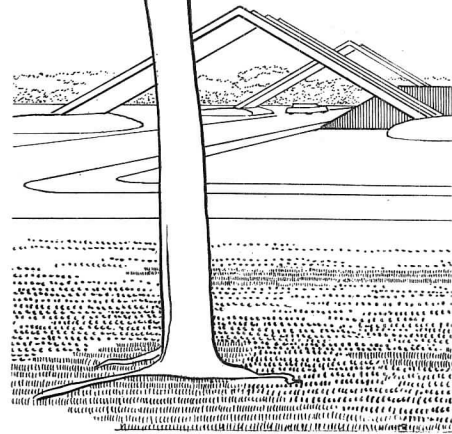
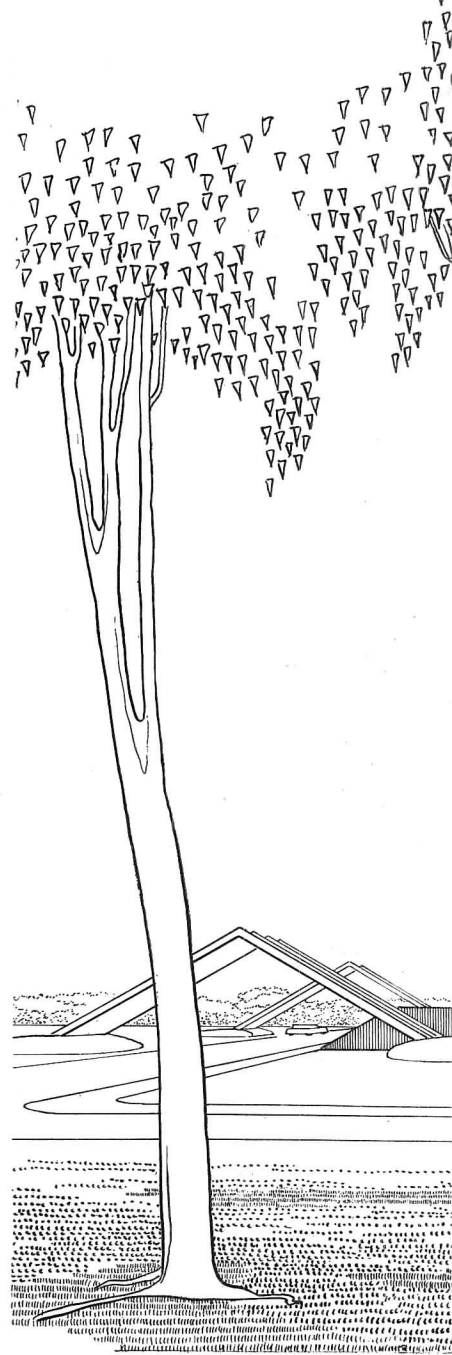



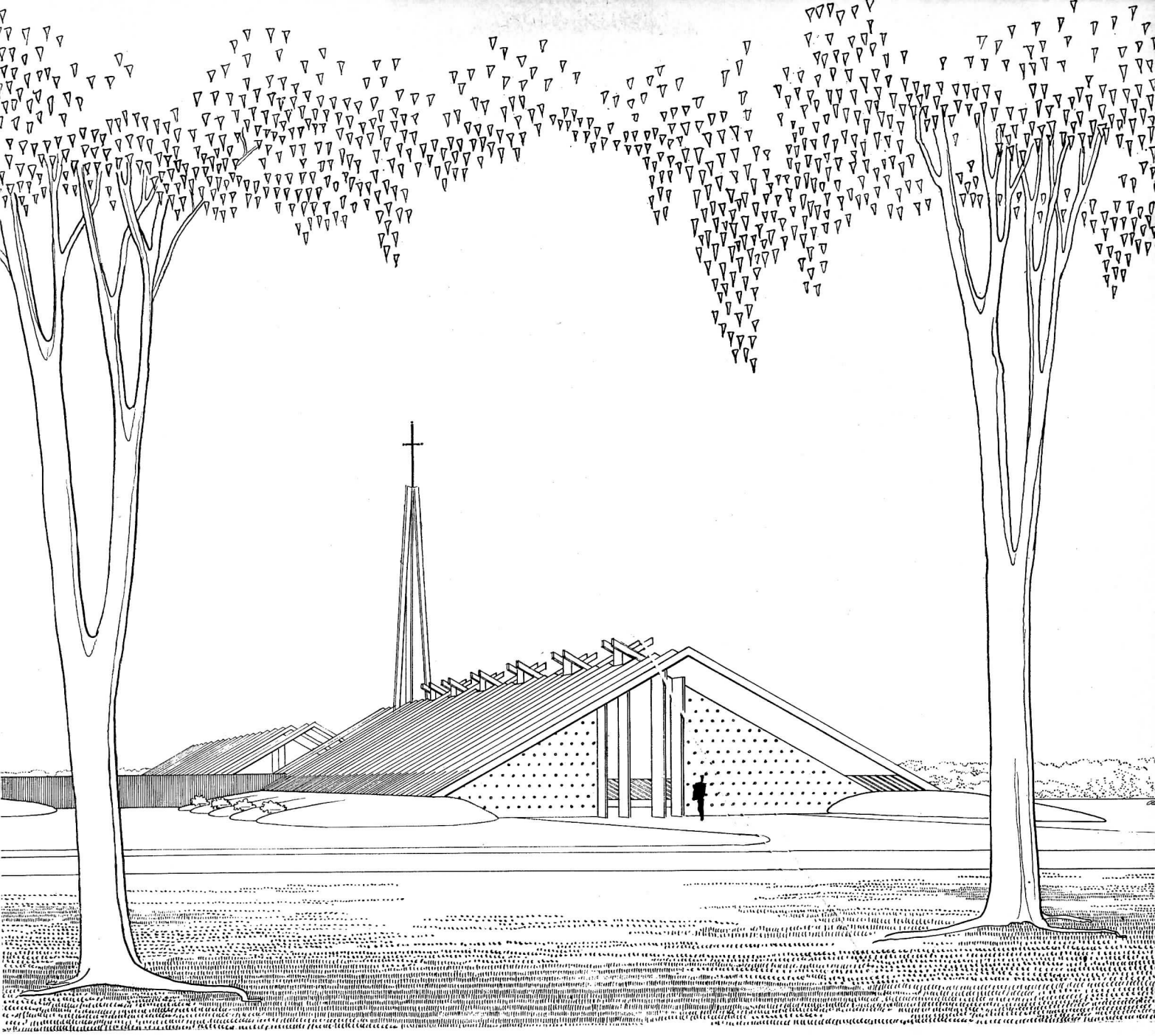

## ST. BONIFACE EPISCOPAL CHURCH, SIESTA KEY, SARASOTA, FLORIDA

FOR A REMOTE SITE on Florida's west coast this parish specified a pitched roof in reinforced concrete. The ribs of the inverted precast double-T roof slabs are extended beyond the continuous glass sidewalls and received by parallel 30-in.-high mounds of earth. Fern beds between mounds and glass will be partially screened by the ribs and along with them will act to filter the light. A series of clerestories between the ridge-line extension of the ribs will introduce colored light into an interior featuring an alternately red and purple banded ceiling and walls of shell-encrusted concrete tiles. An off-white stucco exterior will carry spaced ceramic tiles. The parish house unit will be completed in a subsequent stage.

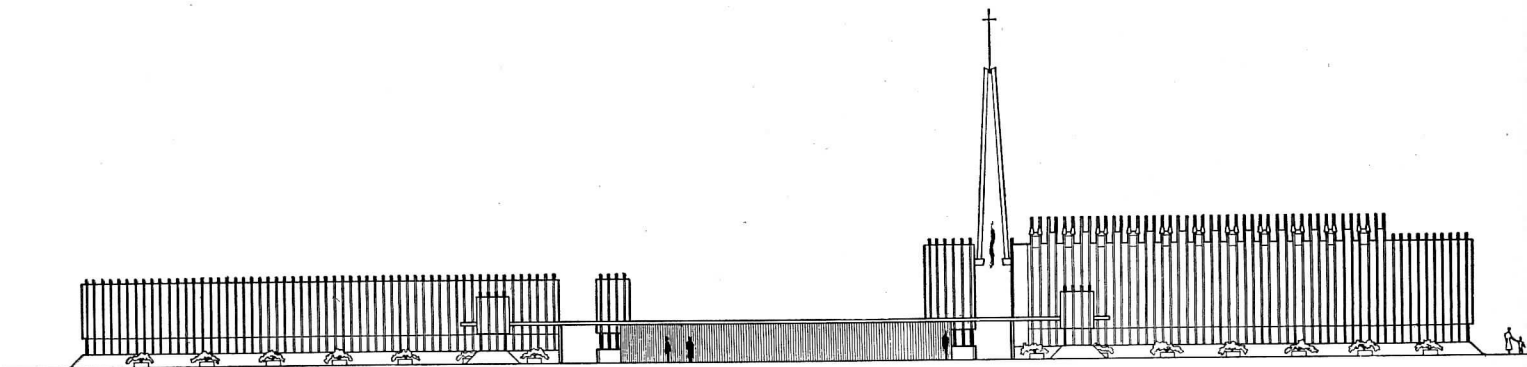

TO THOSE WHO ARE FAMILIAR with the previous work of Paul Rudolph — and there must be few young architects anywhere who have been more published in the last ten years — it will be evident that in the recent expansion of his practice he has been able to realize still more fully the characteristics which marked the architecture of his houses. The new work — although still in project form — promises a considerable ability to appeal to the mind and stimulate the senses without sacrifice of significant utility.

On the basis of his houses alone it might sometimes have been difficult to detect that his respect for the utilitarian needs of his clients equalled his concern for other functions. Since any house program is an acutely individual matter, the degree of its satisfaction cannot easily be judged by those not privy to the specific way of life and range of values. But in the non-residential design on these pages it is apparent that Paul Rudolph is no more grandly oblivious to the specific uses of a building than he is intimidated by them. For too many architects the itemized requirements of a program become immediately the itemized excuses for mediocrity. For others the requirements seem never to have been itemized. For Paul Rudolph it appears that there are few demands in a building program not germane to his search for an architecture which can satisfy man at the several levels of his appreciation.

But while accepting and answering the unique instructions of a specific program, this architecture is not limited by them. It is an architecture which goes on to concern itself as well with those relationships of size and shape and surface which can speak directly to the senses. It possesses, almost always, that studied intricacy of parts within a frame of comprehensible unity which renders it at once rich *and* simple: Rich through the elaborate profiles and abundant surfaces which achieve both fine scale and plastic spaces; simple through the discipline of strong, overall shapes and the insistent regularity of its principal structural parts.

Finally, these very sources of sensory satisfaction can be accepted — at the level of intellectual appreciation — as appropriate to the time and place and purpose of the buildings. This architecture seems to welcome the products of technology — both its materials and methods — and when it is in Jordan it is equally sensitive to the level of building means there. It recognizes, too, the genius of those places where it is to stand. These buildings are alive to the determining role of climate and wind and sun and in consequence can develop out of the natural as well as the man-made environment a high degree of individual character. A character which is evolved from the buildings' purposes as well. The refreshing absence of a stereotype in these projects bears significant witness to concern for harmony between form and functions, whether these be read at literal levels or in terms of symbols well known and much needed. Perhaps it is in this last that the architecture of Paul Rudolph suggests its greatest strength. For it addresses the tension inherent in our attraction to the new and the equal pull to the known. It deals with the new and is not bizarre. It deals with the known and is not banal. It promises a provocative resolution of both the new and the known.

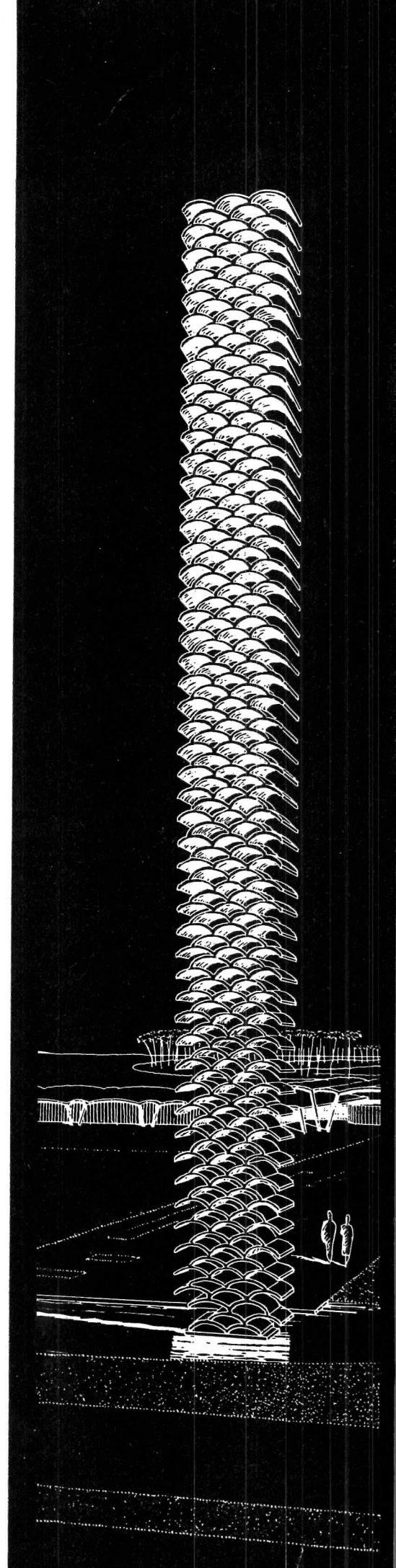

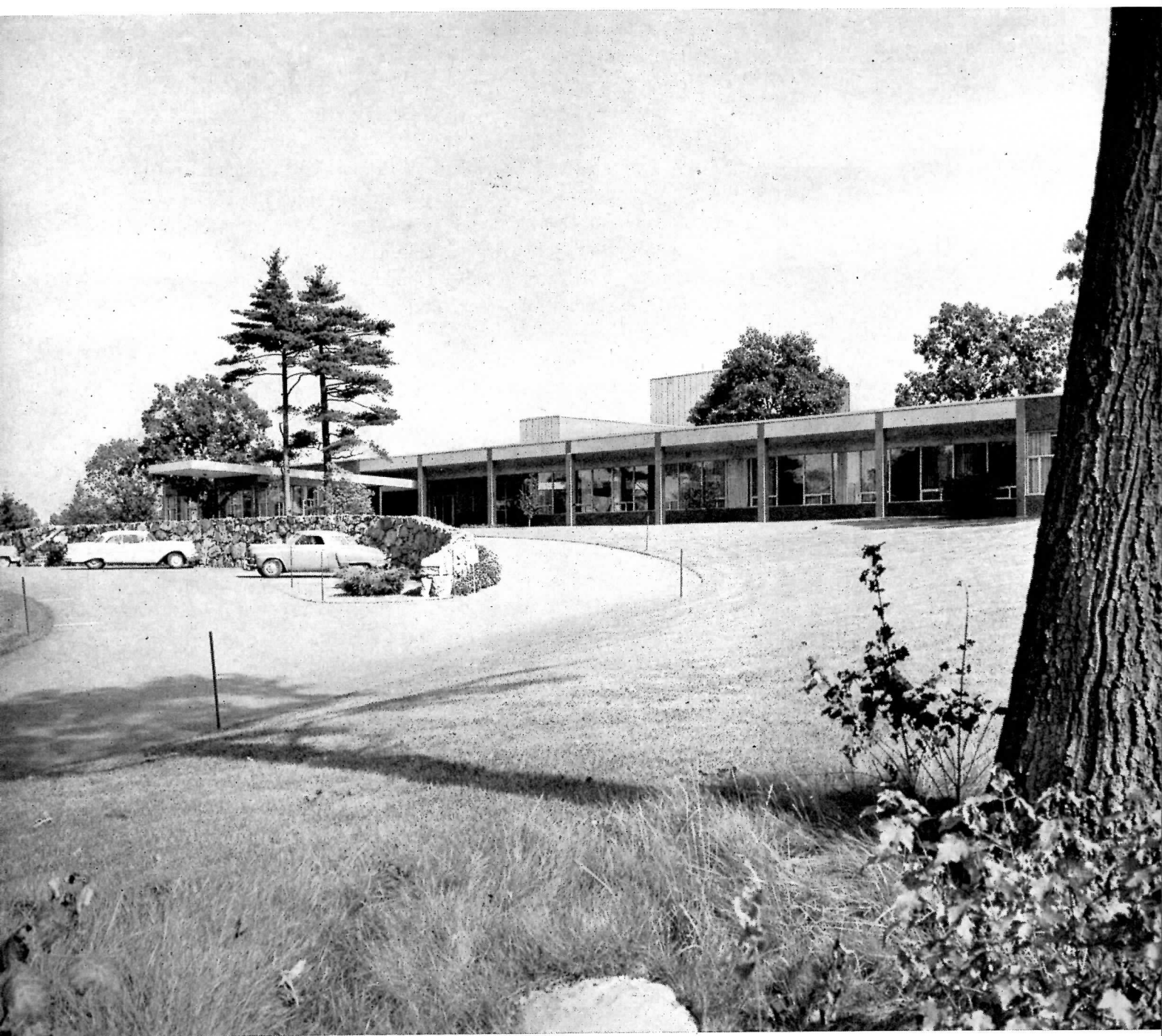

## OFFICE BUILDING NEAR WALTHAM, MASS.

*Middlesex Mutual Building Trust, Owners. Architects: Anderson, Beckwith & Haible. Engineers: Structural, Cleverdon, Varney & Pike; Electrical, E. P. Mahard; Plumbing, J. M. McCusker Assoc.; Mechanical, Delbrook Ventilating Co.; Acoustical, Bolt Beranek & Newman. Landscape: Kelsey-Highlands Nursery*

**MIDDLESEX MUTUAL  
OFFICE BUILDING**

**T**HE DOUBLE CLIENT for this suburban office building was two insurance companies which have much in common, including sharing the work of certain departments such as management, financial, personnel and service. Both companies have many branches and district offices here and abroad; the Waltham building houses both their home and branch offices. It was the expressed desire of the client to achieve a significant advance in office building design, to provide an attractive atmosphere and an environment which would still be ahead of the times 25 years hence — a building pleasing to see, comfortable and restful to work in, highly efficient for conducting business.

Company operation did not depend in either case on a Boston business address, so an 84-acre site was acquired on the belt highway, Route 128, which encircles Boston at some distance in the country. The building overlooks a large reservoir from its hilly setting in an area carefully zoned for limited commercial use under an effective ordinance which limits type of occupancy, restricts building coverage to 20 per cent of the land, requires one quarter of the site to be landscaped and sets maximum height of structure at two stories or 35 ft.

The natural landscape has been guarded and turned to advantage; many existing trees and shrubs were included in the overall concept; and such refinements as depressing the parking space for executives' and visitors' automobiles, in front of the building, were added in developing the site.

*Lawrence Lowry*



*Air view shows multi-floor organization around central court. Above, reception lobby; right, main entrance*

*Photo opposite page, Louis Reens*

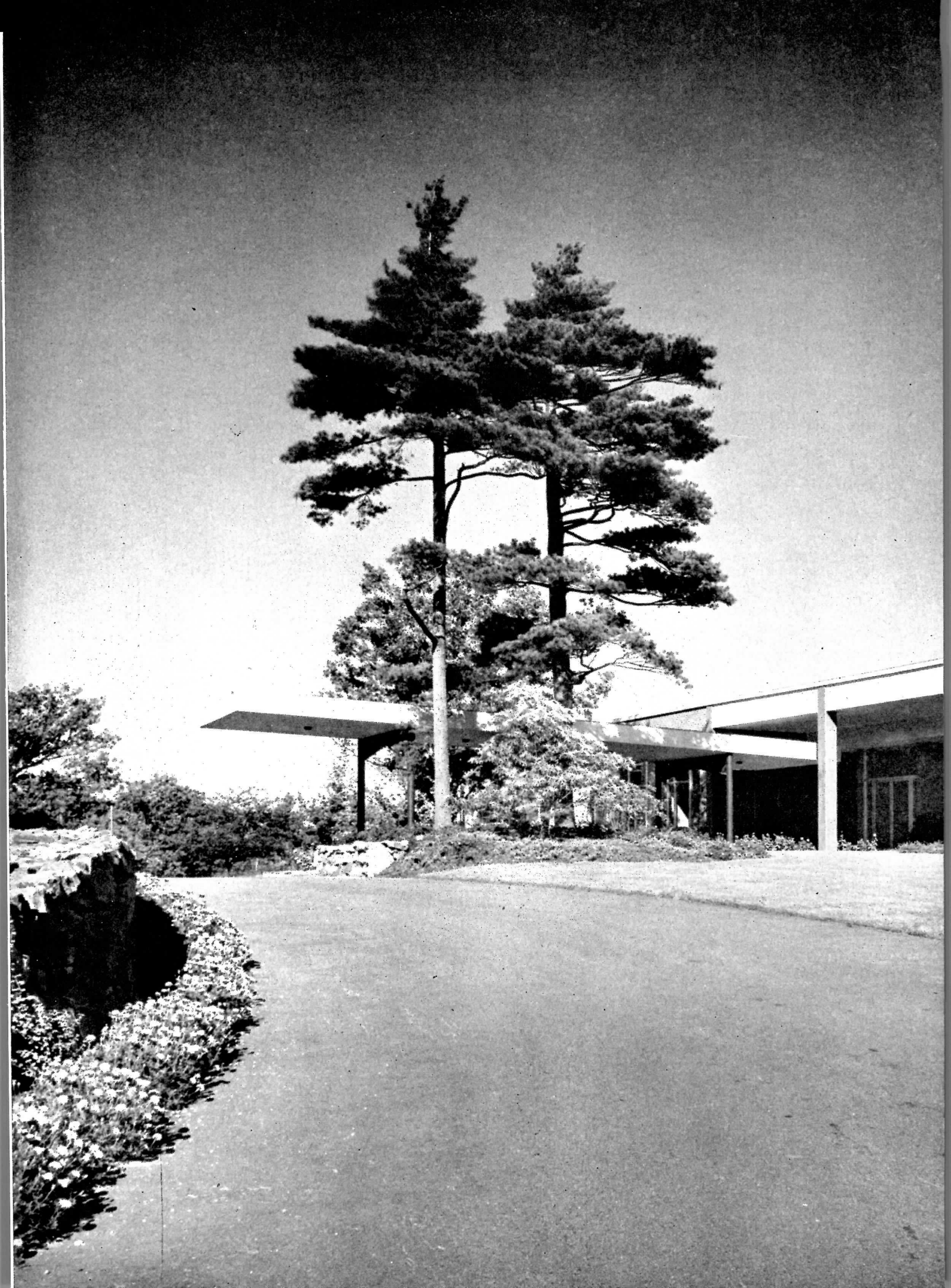

**MIDDLESEX MUTUAL  
OFFICE BUILDING**

*Ramps connect the two working levels with cafeteria level, have handled well the circulation of numbers of people at lunch and closing hours*

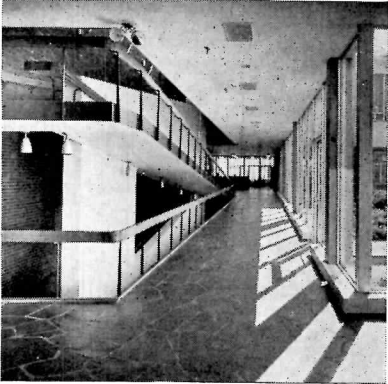
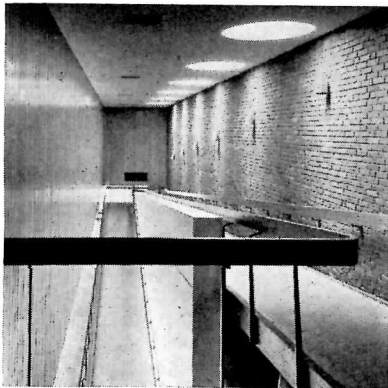

Louis Reens

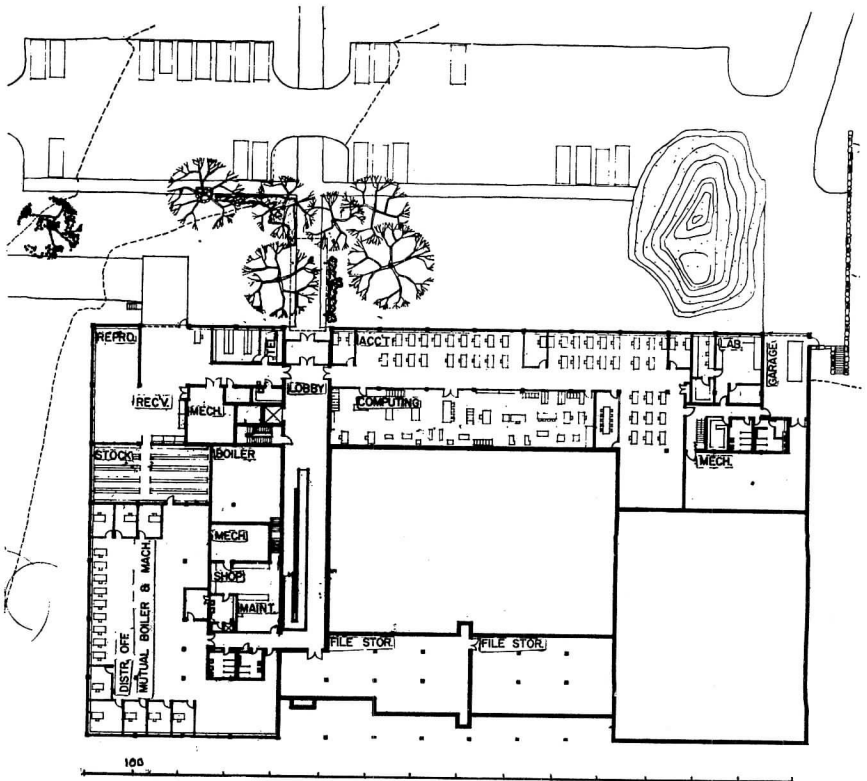
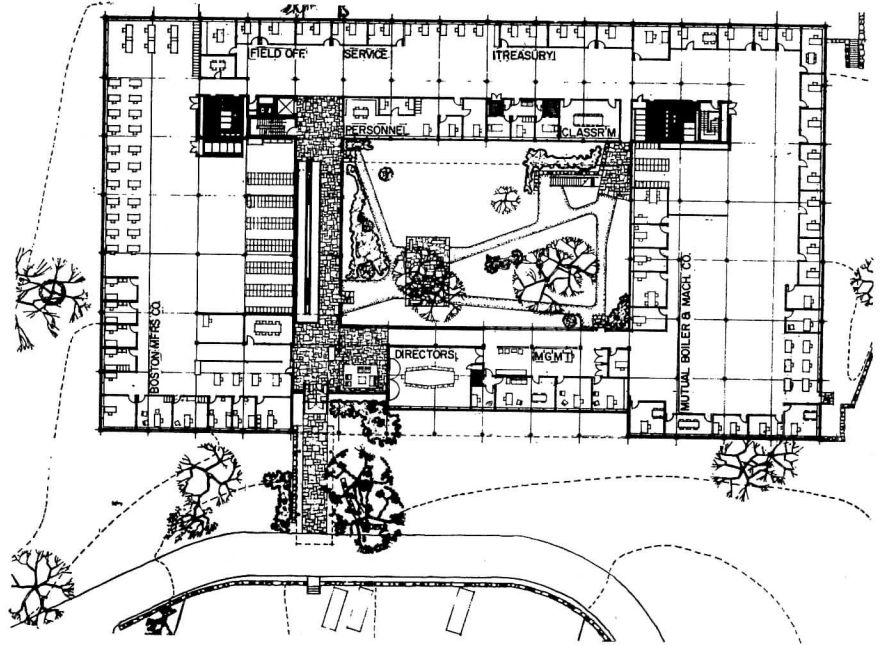
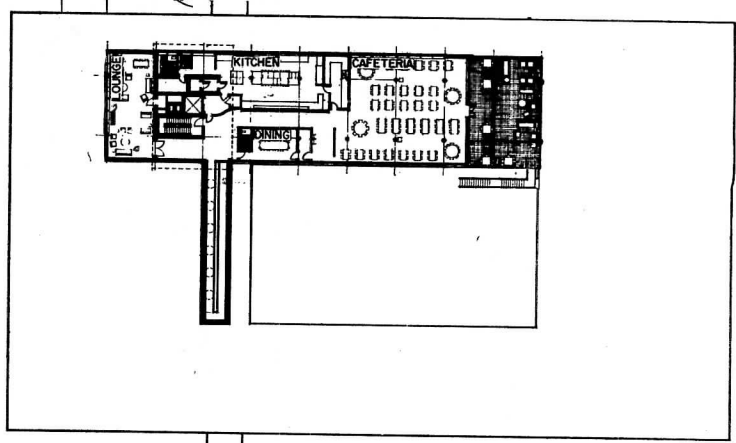

The two clients for whom the building was designed are the Boston Manufacturers Insurance Company and the Mutual Boiler and Machinery Insurance Company, both old and respected businesses which have had common management for some years. In building design a 5 ft. module was used, with movable partitions, sprinkler system, underfloor ducts, lighting and air outlets accordingly located — a fact which proved valuable within only a few months after occupancy, when office changes became necessary. Structure has steel frame, metal spandrels, aluminum sash, cellular steel upper floors.



MIDDLESEX MUTUAL  
OFFICE BUILDING

*Penthouse cafeteria and lounge  
were included for benefit of em-  
ployees, many of whom come  
from Waltham or Boston*



Louis Reems

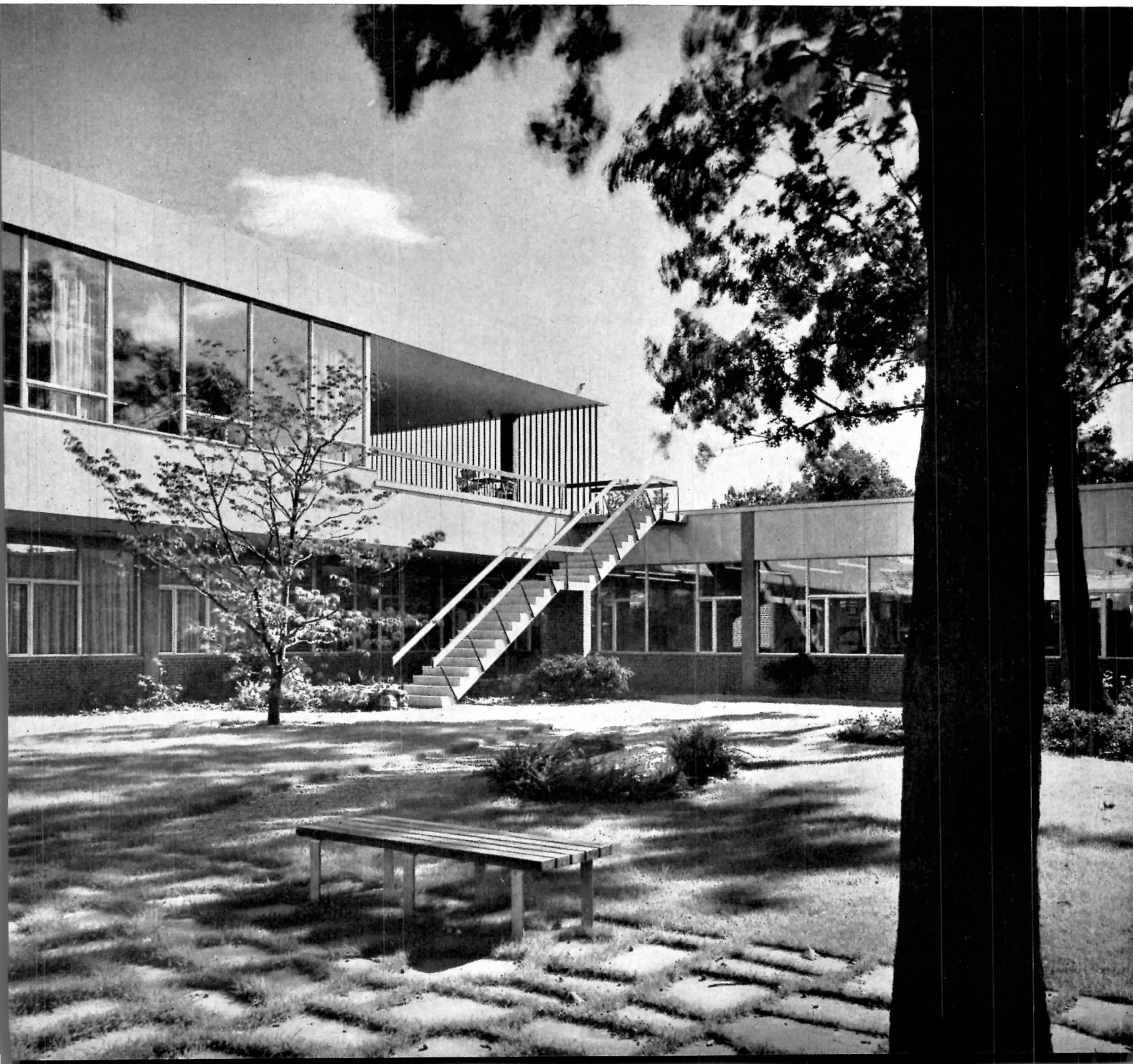





Hedrich-Blessing

## A RESIDENCE OF EXCEPTIONAL DISTINCTION

*Lake Bluff, Illinois*

*George Fred Keck  
William Keck  
Architects*

*Alfred Caldwell  
Landscape Architect*

*As the photo above so strongly indicates, this is a house of quality and individuality. Its pleasing contrast of glass and brick, its adaptation to site and view, and its well-zoned plan are almost incidental to its fine detailing and many unusual features. It is a house which deserves close study.*

**T**HE HOUSE IS SITUATED at the top of a bluff on the west shore of Lake Michigan, a few miles south of Waukegan. On the one side a long, tree-lined drive connects it with the main road; on the other a deep ravine separates it from the water's edge. The easterly view was the only site problem.

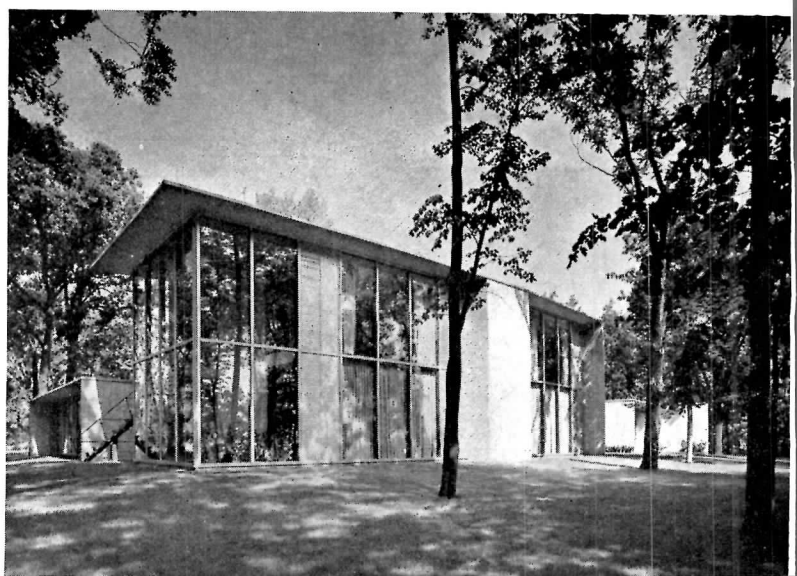
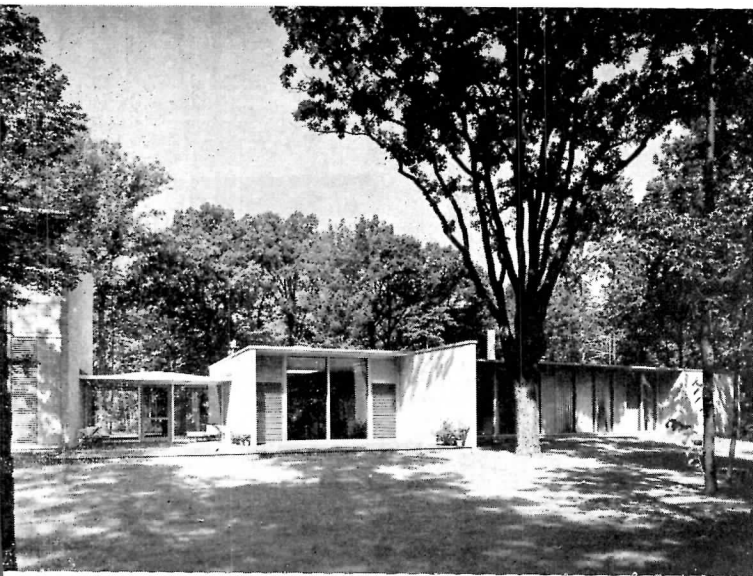
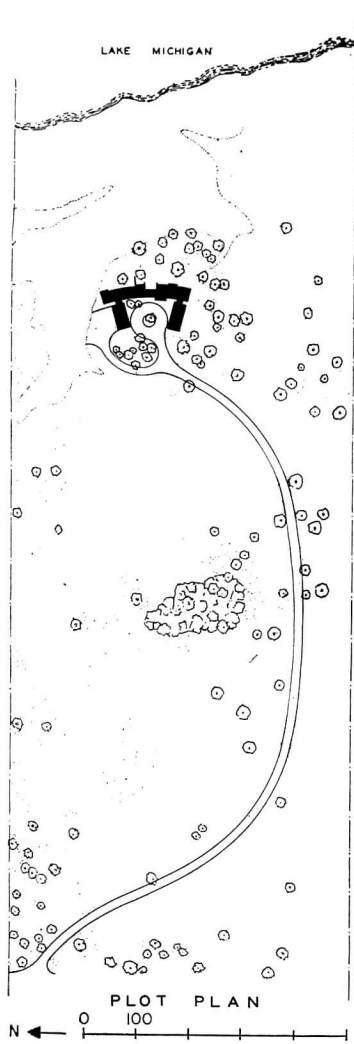



*Hedrich-Blessing*



The house was placed at the maximum height of the property not only for the lake view but also because here the land was level and well-wooded. A curved plan (radius 300) was chosen to fit the location: all main rooms thus can enjoy the view without being troubled by the sun from the south.

Construction is fireproof: exterior walls are brick, bone-white in color, laid double stretcher and header throughout; all exterior trim is aluminum, with aluminum adjustable shutters operating from the inside; large glass areas are all double-glazed and sealed, and further thermal insulation is provided by a special sprayed-on preparation.

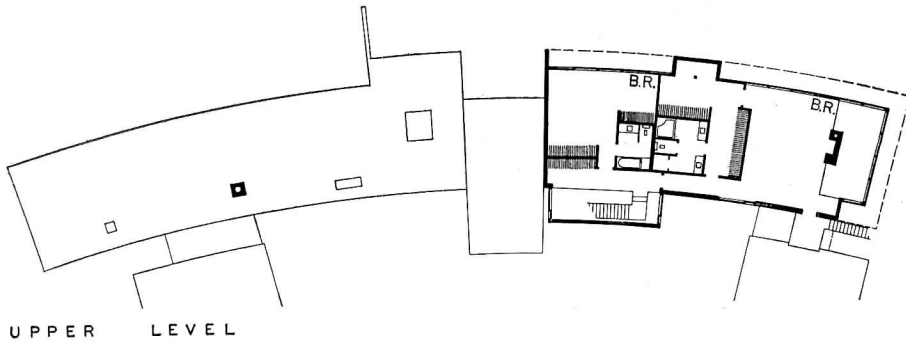

UPPER LEVEL

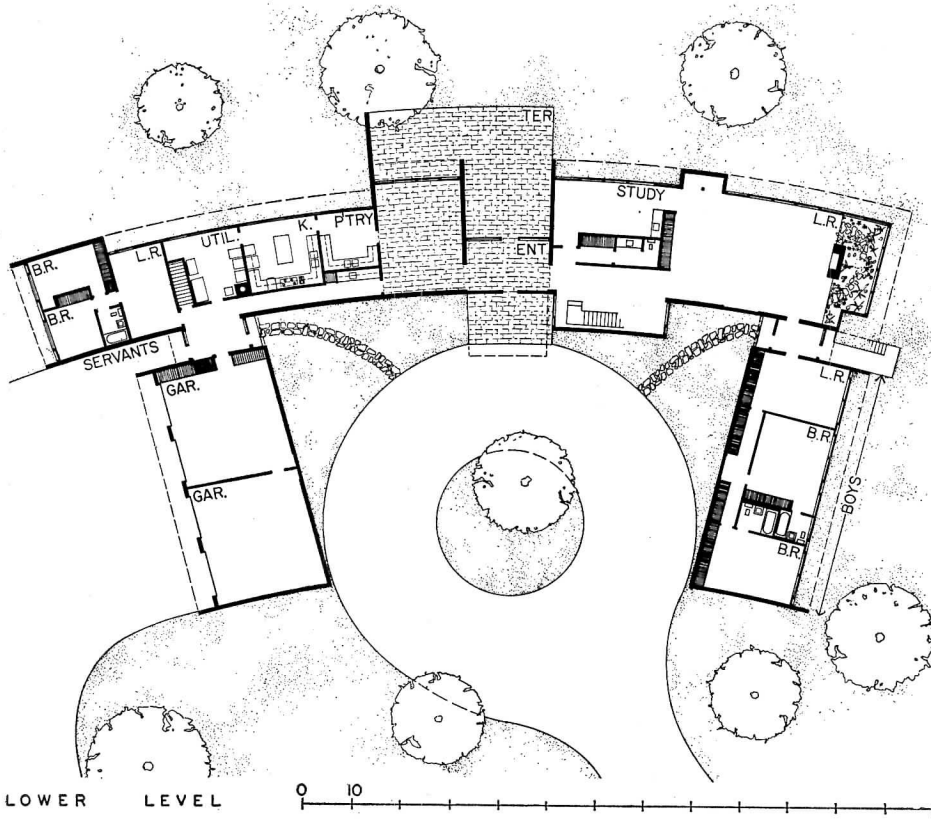

LOWER LEVEL

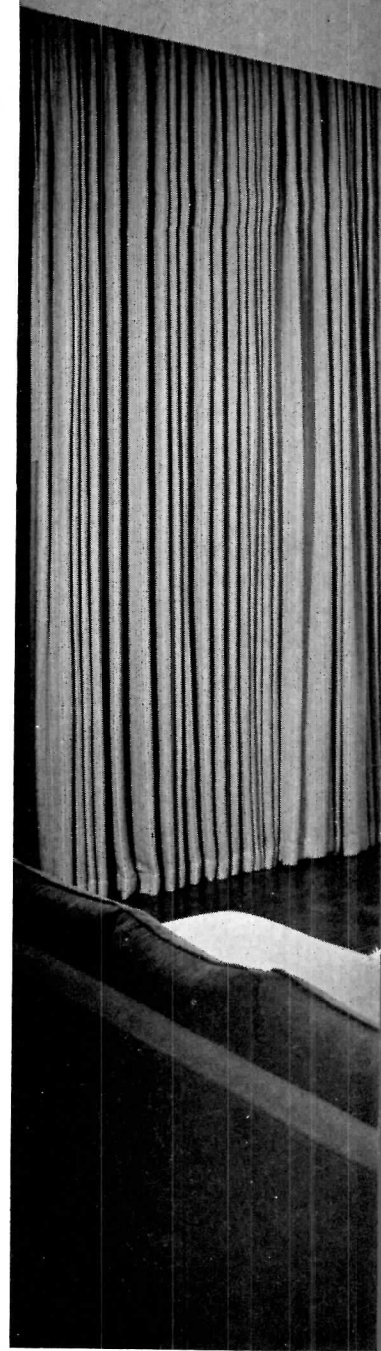



*Hedrich-Blessing*



Plan-wise the house is perfectly zoned: a central entrance hall is flanked by the kitchen and servants' wing on one side and the main living area on the other; the master bedroom suite is over the living room, sharing its view of the lake and the two-storied planting area; the boys' bedrooms and living room occupy a virtually separate wing with direct access from the driveway and garage.

Floors in the living room, study and stair hall are of white oak parquet; dining room floor is black slate. Wall finishes are plaster, painted or covered with grass cloth. The fireplace wall is marble with soapstone trim.

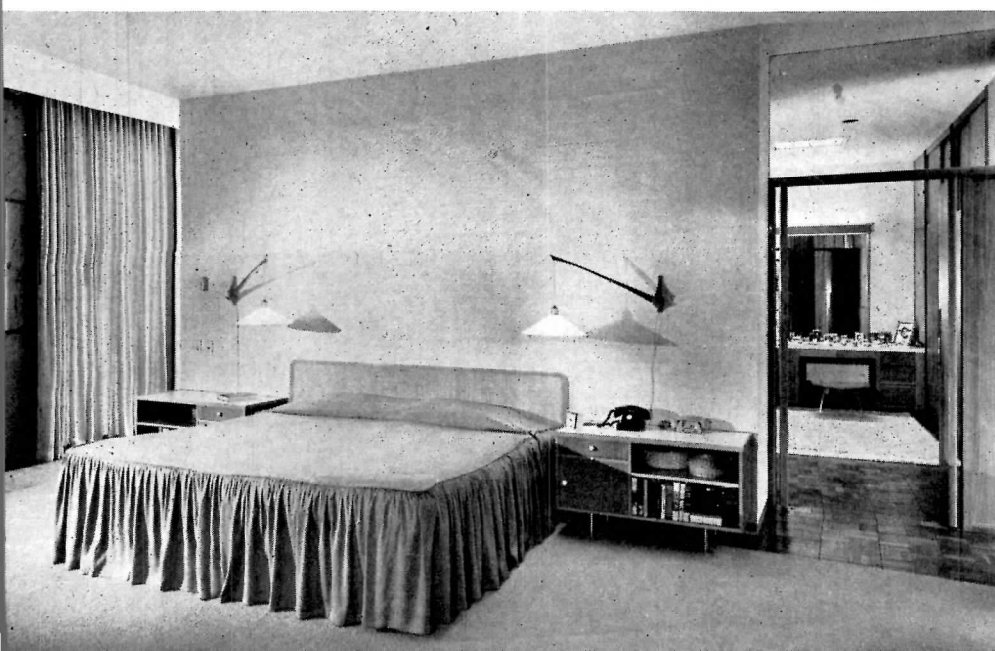
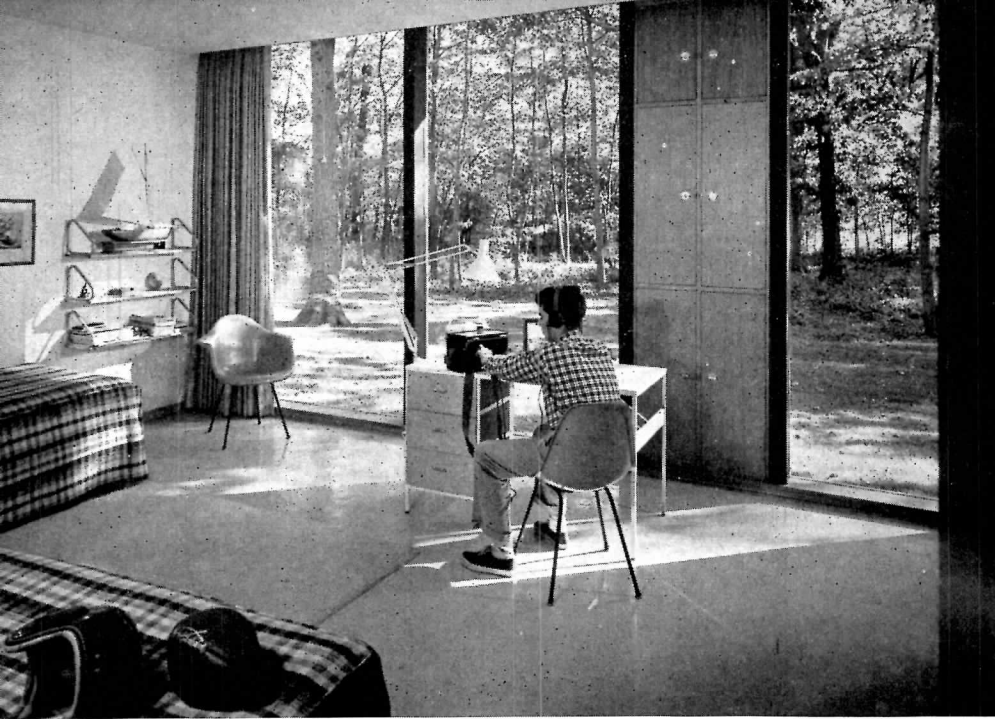

*The boys' suite (top two photos) consists of two bedrooms and a central living room with built-in TV and storage areas. Flooring is plastic. Ventilating doors, used throughout the house, are shown closed in photo of boys' bedroom and partially open in master bedroom at left. Built-in cabinets and doors are all rift white oak in natural finish. Heating is radiant hot water in floors and ceiling coils*



## THE DESIGN OF PERSIAN GARDENS

By DONALD WILBER

ABOUT THE YEAR 1300 when Marco Polo passed through Tabriz on his way to China he noted that the Persian town was girt round with charming gardens, and before the end of that same century Hafiz, the lyric poet of Shiraz, was exclaiming:

*"Oh! Bring thy couch where countless roses  
The garden's gay retreat discloses;  
There in the shade of waving boughs recline  
Breathing rich odors, quaffing ruby wine!"*

And the roses still bloom around his garden tomb (Figure 1).

In the early 15th century the great Tamerlane rested from his conquests in the gardens of his capital, Samarkand. A chain of these orchards and gardens was strewn around the town, and he was wont to move from one to another of them, holding court upon a throne placed under an awning of the costliest carpets, or taking his private ease in a pavilion hung with bright silks and gold brocades. The deep delight in life in the open persisted, and in the early 17th century, after Shah Abbas had established his reign at Isfahan, a traveler from far-off London had this to say:

"For thirtie days continually, the King made the Feast in a great Garden of more than two miles compasse, under Tents, pitched by certain small courses of running water, like divers Rivers, where every man that would come, was placed according to his degree, either under one or other Tent, provided for abundantly with Meats, Fruit and Wine, drinking as they would, some largely, some moderately, without compulsion. A Royaltie and Splendour which I have not seen nor shall see again but by the same King."

For centuries such gardens endured, and early in this one an American architect was drawn to them: the

young Bertram Goodhue has left us his essay, "Of Persian Gardens," illustrated by eight masterful pen-and-ink sketches of the gardens at Shiraz. The design and character of these gardens had a definite message for Goodhue; have they any such meaning for us? Certainly, and a more precise one, for in these very recent years as our summer living moves out of doors we need to know how the Persians developed the handling of water, shade, and shelter in a unique fashion.

It is important to look at Persian gardens right away, for many of the fine old ones are threatened with extinction. As the towns spread out the gardens are cut up and give way to apartment houses; thus, the vast Qasr-i-Qajar just north of Tehran has entirely disappeared. In addition, Western features such as formal flower beds and expanses of lawn appear with increasing frequency. However, the conditions under which Persian gardens reached their finest expression remain unchanged.

Iran spreads over an area as large as the eastern United States, and its upland valleys which rise 5000 feet and more receive only a dozen inches of rain a year, none from April until November. Throughout most of the country field crops must be irrigated, and all gardens must have their perennial water supply. Water comes from springs, from mountain streams, and from a unique system of exploitation called the *qanat*. In this system advantage is taken of the fact that the winter snow on the ranges melts and seeps down to establish a water table at the base of the abrupt mountains. A mother well is driven into this water table and from this point a slightly inclined tunnel is dug in the direction of the village or town requiring water; a series of vertical shafts provides air to the diggers and a means of disposing of the debris. Carrying flowing water throughout the year, the tunnel emerges on the surface uphill from the village, and its precious burden is led into open channels which flow through gardens,

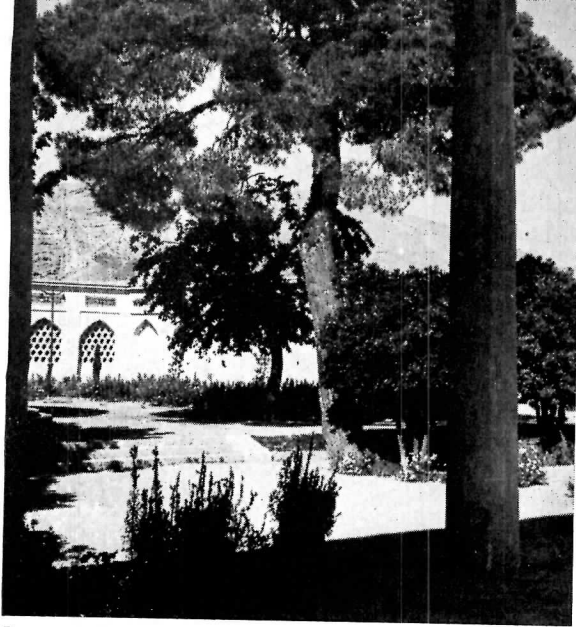

1

## THE DESIGN OF PERSIAN GARDENS

turn mills, line the village lanes, and spread over the fields of grain on the lower slopes.

Water gives the garden life, and the long water axis — a standard design feature — emphasizes its role. Dense foliage shades the water, and high mud-brick walls shut out the arid landscape. Moisture, shade, and coolness — the garden furnishes just those things which are most prized in a denuded, arid, burning land.

Royal gardens display all the characteristic Persian features; some featured palaces at which the court remained in residence for months at a time, while others were scattered along the main highways, always in readiness when the cortege of the ruler passed that way. Traveling or at home, royalty and commoners spent a very large part of their time in gardens, and the most important single fact about Persian gardens is that they were to be lived in rather than walked through.

The Qasr-i-Qajar, or Castle of the Qajars, was built on a slope above Tehran before 1800, and the restored plan has been compiled from the sketches and descriptions of a number of European travelers (*Figure 2*). The castle stepped down the hill in a series of terraces, with the topmost rectangle housing the royal harem. From these terraces the vista was across a great pool and over many acres of cultivated orchard and woodland. At the center and on the long axis was a pavilion of marble, brick, and painted plaster (*Figure 3*). By the middle of the 19th century the garden had begun to fall into ruin — as the sketch shows — and today the structure on the hillside is an irregular mound of bricks.

In contrast with Tehran, Isfahan proudly displays a royal garden pavilion in excellent condition. The Chehel Sutun, or Forty Pillars, was built shortly after 1600 as an element in the imperial city commanded by Shah Abbas. Nearby, a vast public square, faience-clad mosques, and a monumental entranceway

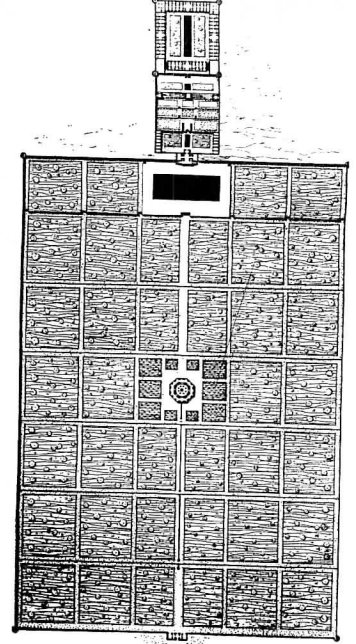

2

to the palace and garden area survive in all their early splendor. The plan arrangement of the garden is typical, except for the fact that there are two competing water axes (*Figure 4*). The plan of the pavilion itself (today the archeological museum of Isfahan) reflects its functions — smaller rooms for private living and reception, and one vast, lofty hall for nightly entertainment. Most masterly is the manner in which free space is gradually reduced and contained through successively smaller areas each less open than the one before it. On many pleasant mornings when Shah Abbas sat in audience on a bed-throne placed in the niche behind the porch, his view passed over pools and fountains to the soaring minarets and domes of the Imperial Mosque, the Masjid-i-Shah, constructed at his order (*Figure 5*).

Gardens which featured an artificial lake are found throughout Iran and were made possible by the existence of copious hillside springs. Quite typical is the Shah Gol, or Royal Pond, situated near Tabriz and in existence at least as early as 1785 (*Figure 6*). From the terraces the view takes in the octagonal pavilion and across the lake, which appears almost to be suspended above the barren landscape; again an abundance of water challenges the aridity of nature (*Figure 7*). Certainly this type of garden was in vogue in Iran long before the examples of known date, and it was this design form that influenced the renowned gardens of Kashmir and Lahore in India.

Private landowners were apt to create less formal plans in the midst of their orchards and their money-crop forests of poplars. This is the case at Fakhra-bad, near Tabriz, where the axial water channel flows through pools of varying size and shape to plunge into a huge, deep-set pool hemmed around with enormous plane trees (*Figure 8*). A modern house, without character, has replaced an earlier pavilion.

Typical of the town house and garden is the old



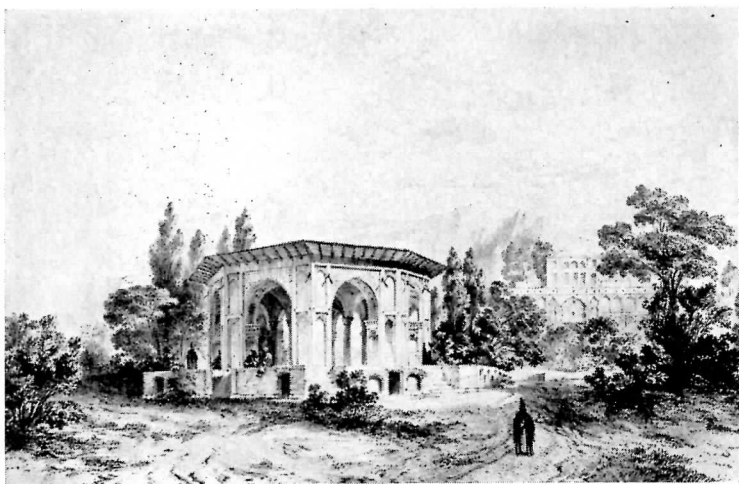

3

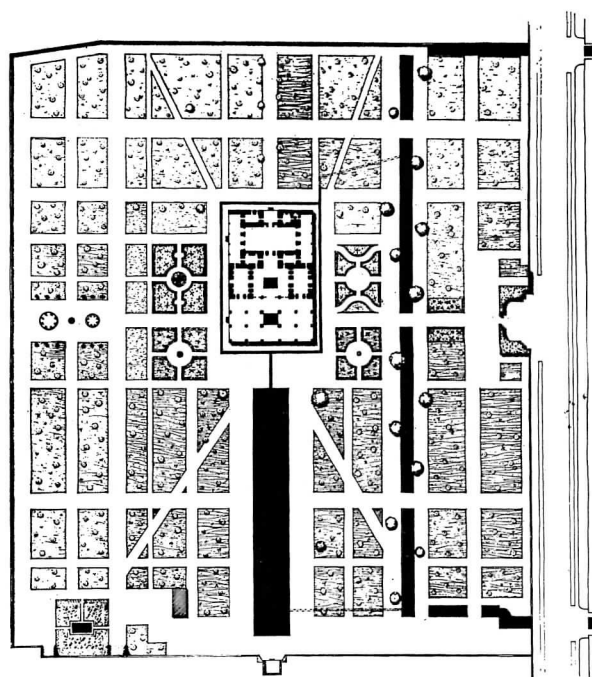

4

5

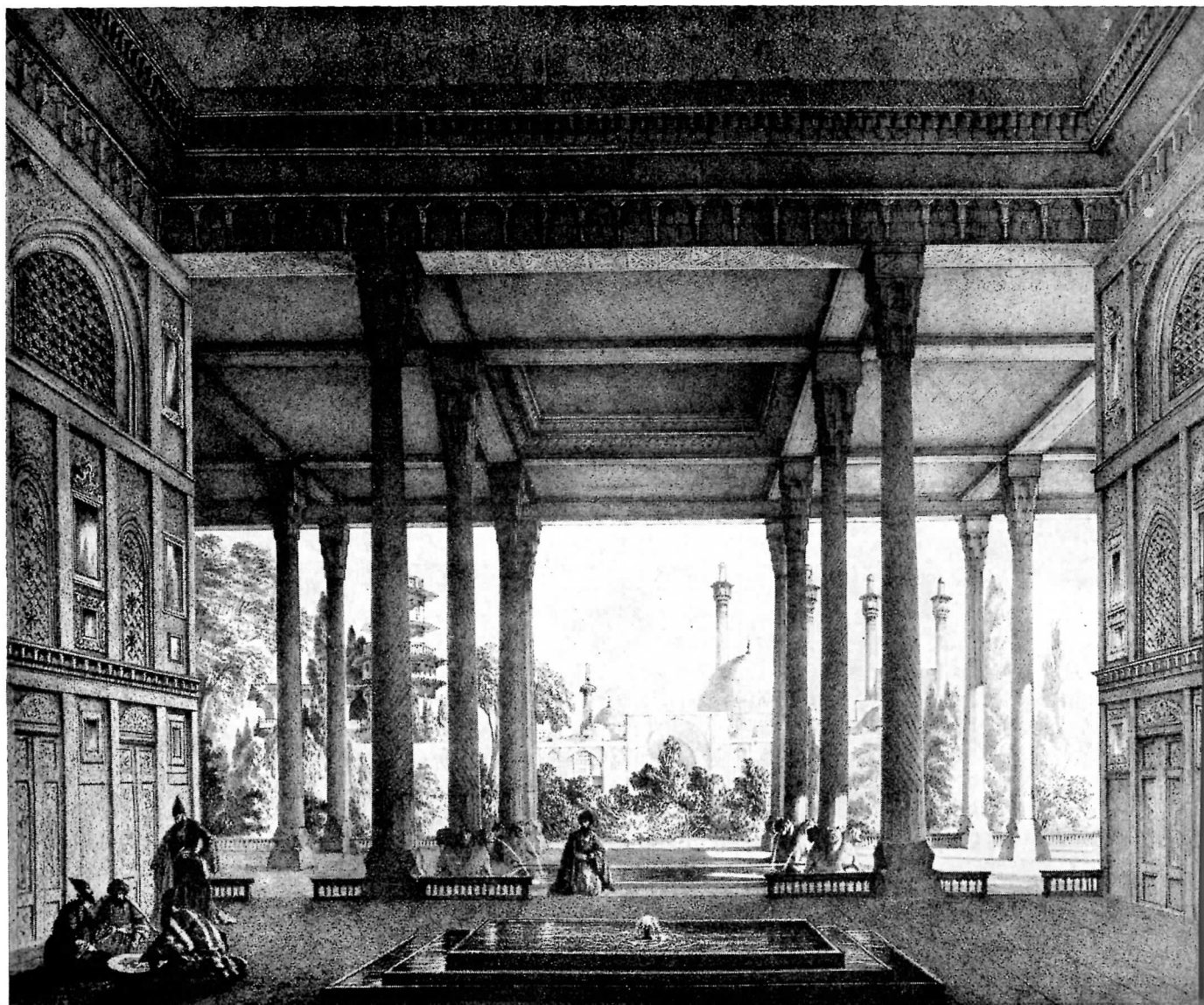

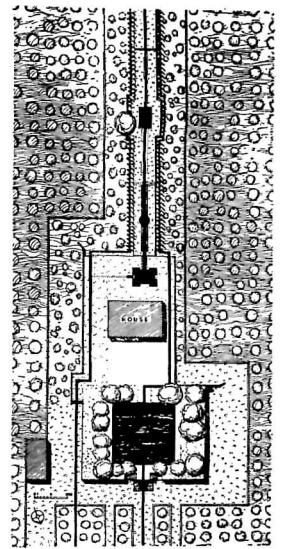
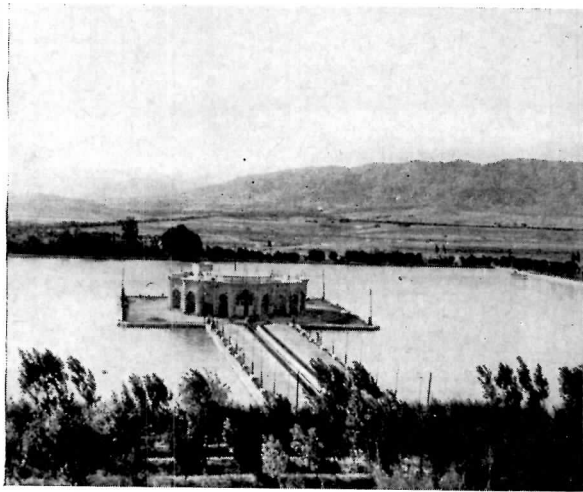
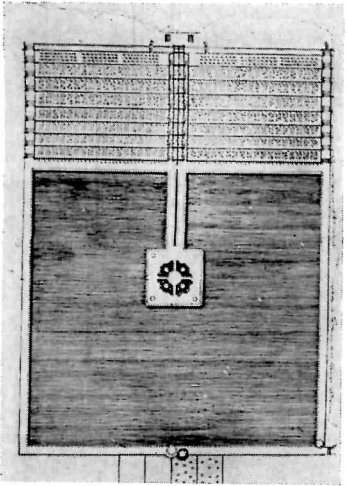

## THE DESIGN OF PERSIAN GARDENS

Divan Khaneh at Shiraz (*Figure 9*). Every feature reflects long-established usage: the right-angle turns in the entranceway to give privacy; the high lateral walls; the location of servants' quarters and kitchen flanking the entrance; the elevation of the principal rooms above the level of court and pool; and the orientation of these rooms toward the south. The longitudinal axis may be marked by a water channel or by a flower-bordered path, while the side areas display cypresses, fruit trees, and pomegranate bushes. Decorative panels in carved stone or glazed tile accentuate selected areas; in the Divan Khaneh the niche masking the entrance depicts servants offering the produce of the garden (*Figure 10*).

All older houses and pavilions display a series of rooms facing south and elevated from a few steps to a full story above the level of the pool. A fine example at Shiraz is the Bagh-i-Aram, shown in a 50-year-old photograph (*Figure 11*). From the central porch the view is prolonged for several hundred yards down a water alley flanked by great cypresses, while from the room behind the porch the view is up and into the hills beyond. The lower level offers another characteristic feature—a water-cooled summer room. The main water channel of the garden flows directly through the room, in and out of a bubbling pool with its playing fountain.

Another variant of this general type is represented by the Golestan palace at Tehran, shown in a drawing made about one hundred years ago (*Figure 12*). The architectural arrangement was admirably suited to the climate of Iran: in the heat of summer there was always shade within the deep central porch, and the great awning could be stretched forward so that it projected over part of the pool itself. In the winter the low, bright sun flooded into a kind of a heat trap—often the walls were lined with mirrors—and one could sit there in comfort on the chilliest days.

While the plans and photographs mentioned above have illustrated the principal design elements, it is necessary to concentrate on the details in order to isolate features that lend themselves to modern adaptation. Emphasis has been placed upon the consistent interest in contrasting the order and clarity of straight channels, tended pathways, and narrow beds of flowers against a jungle-like background of bushes and trees. In the larger gardens it is easy to wander a few yards from the pavilion and be lost in a growth far denser than nature unaided could produce. Indeed, it was just this contrast that led the Persians to compare their gardens with Paradise itself. In the words of one of their poets:

*"This playing fountain like the hand of the Shah  
Fills earth and sky with a shower of pearls.  
I asked, 'Is this the life-giving water?'  
And the answer came, 'Yes.'  
I asked, 'Is this garden Paradise?'  
And wisdom replied, 'Certainly.'"*

The very qualities of water are exploited to the full. Channels are commonly lined with blue enameled tiles and so pitched that the water gushes merrily along or tumbles down inclined slides at changes in garden level. Pools are shaped in almost infinite variety and may display a single fountain or be crowded with jets fed by lead pipes so that the jets can be made to play in different combinations (*Figure 13*). At night candles sheltered in crystal globes were launched on the surface, while during the day the arrival of guests might be marked by scattering rose petals on the water to spell out words of welcome. Most ingenious and most interesting for modern adaptation is the manner in which the pools extend without apparent edges, as in a contemporary garden at Tehran (photo on page 189). This pool is constructed so that its stone slab sides rise

9

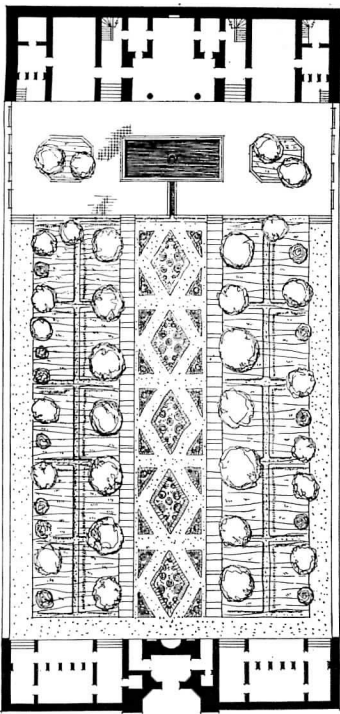

10



11



12

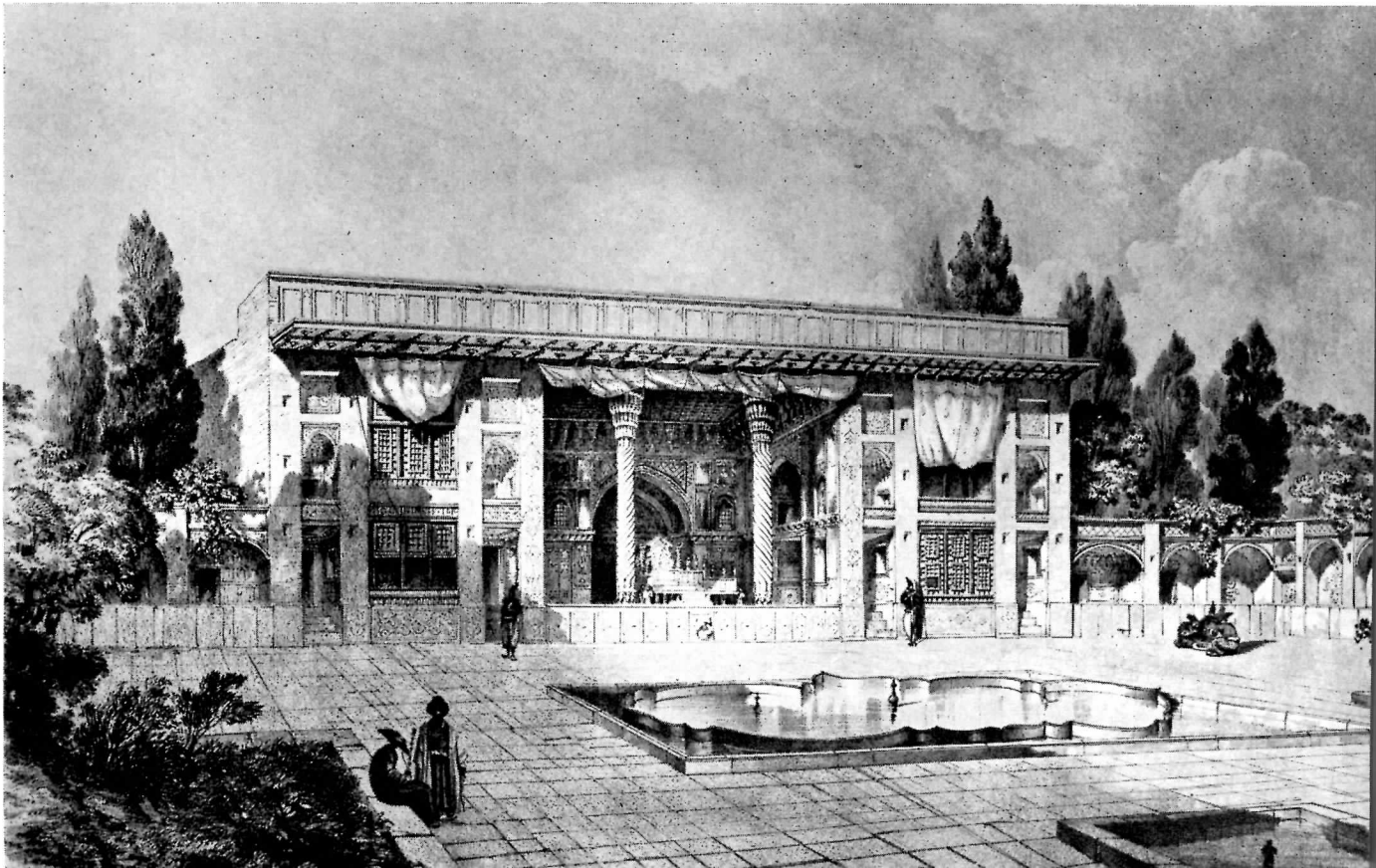

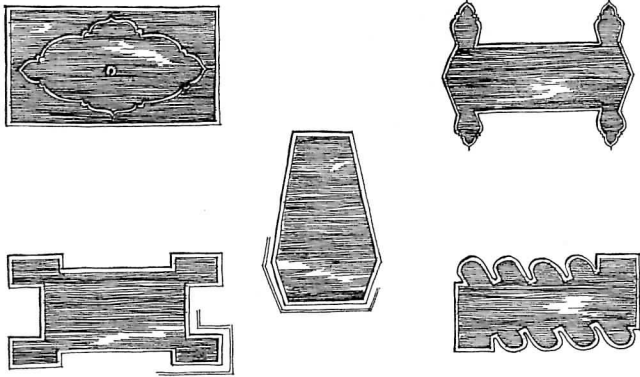

13

### THE DESIGN OF PERSIAN GARDENS

about a foot above the surrounding ground level while around these sides is an overflow gutter about a foot wide but only a few inches deep. As the pool is fed the water flows over every side; the eye is deceived and the scale of the pool seems vastly larger. Such a pool set under a domed pavilion in the royal garden of Fin, near Kashan, expresses the very essence of gushing, icy water (*Figure 14*), and at Tabbas, an oasis set in the midst of the desolate wastes of southeastern Iran, the pool of Paradise is ringed by both evergreens and palms (*Figure 15*). On a more modest scale, every Persian house has its own courtyard or garden pool, and if limitations of space are severe, the pool and its background area are bordered with potted flowers.

Among the many attractive features of the Persian gardens, only a few have been singled out in these few paragraphs. The fact that the gardens were meant to be lived in rather than walked through; the contrast between the formal axis and the background of wild foliage; the garden pavilion, decorated with color as bright as the very flowers; and the inexhaustible skill with which water was handled and emphasized. Flowers, used in a massed display, play a less vital role in garden design, although nearly all those common to our gardens appear in Iran. Indeed, the tulip, iris, and rose have been grown in Iran for many centuries and were introduced into Europe only in comparatively recent times. Renowned above all in the Persian garden is the rose, informally scattered about under the trees or massed in great bowers; all the great poets of the country sang in praise of the rose.

To the Persian the garden meant relief from inclement nature, a place of retreat from daily burdens and cares, and a foretaste of the pleasures of Paradise. These designs and features, resulting from centuries of development, are still unknown in the West and do offer a fresh approach to nature and fertile sources for atmosphere and appropriate detail.

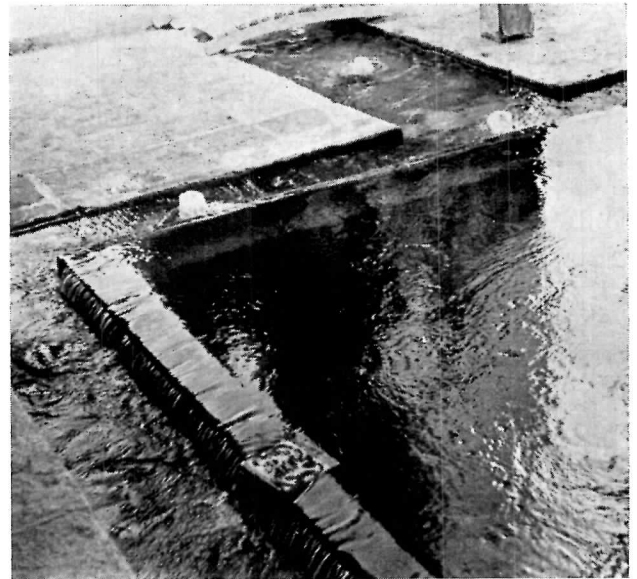

14



15

# AN OPEN PLACE AT THE HEART OF A CITY

*Mitchell & Ritchey, Architects*

*Simonds & Simonds, Landscape Architects*

PERHAPS NO AMERICAN CITY has ever so much needed and, latterly, so much deserved a garden at its heart. This bright mosaic of water and terrazzo and green growth is giving back to the people of Pittsburgh something of their long-lost hill and river heritage.

Here is the light and open, the cool and almost quiet space so often urged by planners and so seldom reclaimed from downtown congestion. Here, too, is a foreground for the buildings that surround the Square: for the new Alcoa Building; for the buildings on east and west whose axial symmetries have so long awaited this vista; and, most appropriately, for the Mellon Bank and the U. S. Steel Building. For it was through the grants of three Mellon family foundations, as well

as the auspices of an enlightened city administration, that the 1.37-acre park and its six-level underground parking garage were realized.

Eighteen hundred cars a day crawl in under the slightly inclined floor of the park. Twentieth-century beetles burrowing under a twentieth-century garden. The drop in the street elevations from east to west which allows insertion of a row of shops under the western edge of the park also leaves the garden elevated on all but its eastern side. Thus, unlike the most familiar plazas of Europe, it is a place lifted up, and through this it gains just that sense of removal so desirable for those seeking quiet instead of shortcuts. Mellon Square Park is a notable achievement for all concerned.

*From the hotel on its eastern side the entire park is revealed as a place of skillfully organized textures and volumes*

*Joseph Malitor*



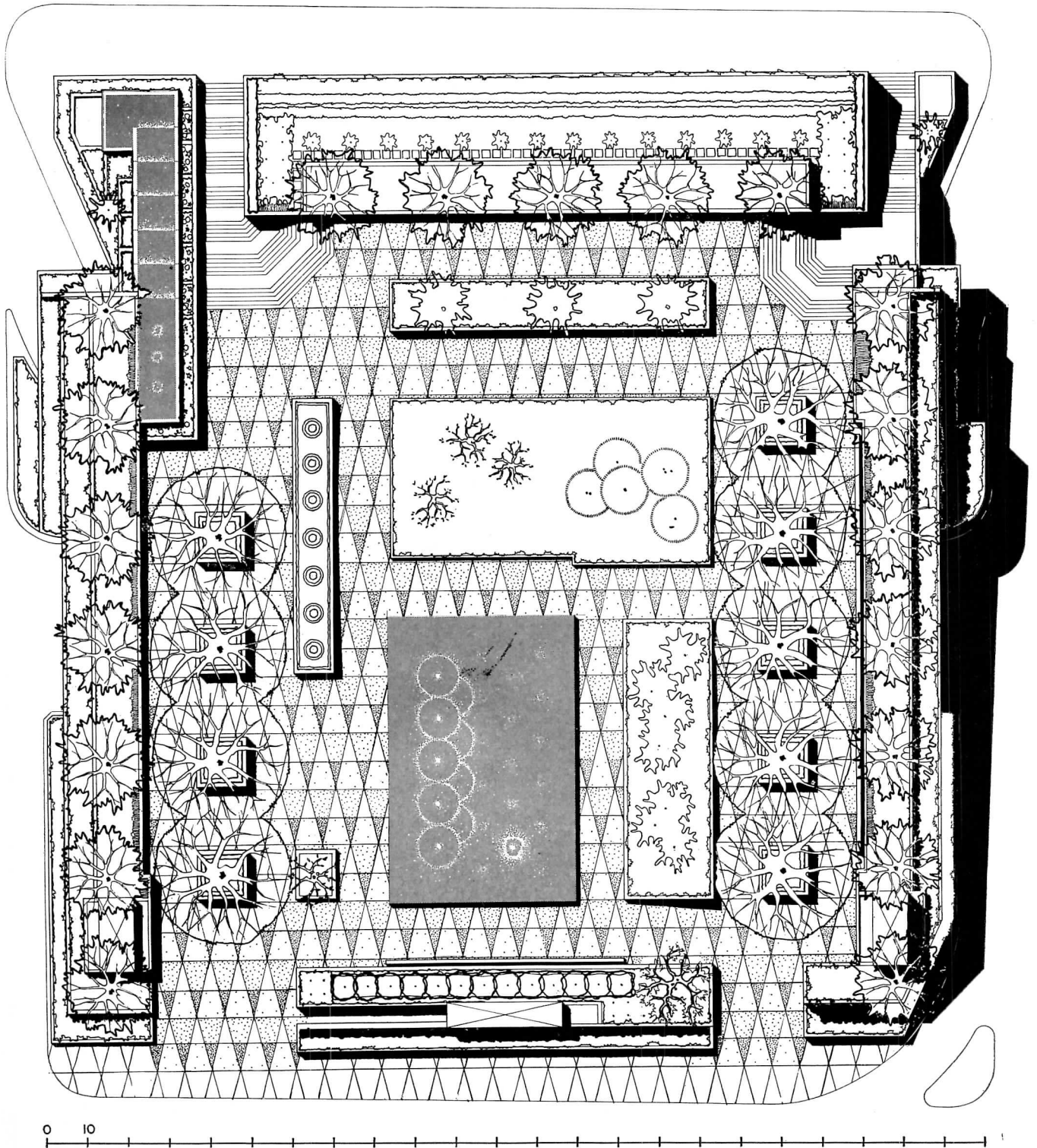



*Elevation of the park is greatest along its western side where the approach up the steps is eased by the cascading waters*



*Looking north, the polished gray granite walls of the "hanging garden" are a strong base for the Alcoa Building at the right*

Joseph W. Molitor



*Triangular pattern in the terrazzo paving symbolizes Pittsburgh's famed "Golden Triangle" which lies largely to the west*

## MELLON SQUARE

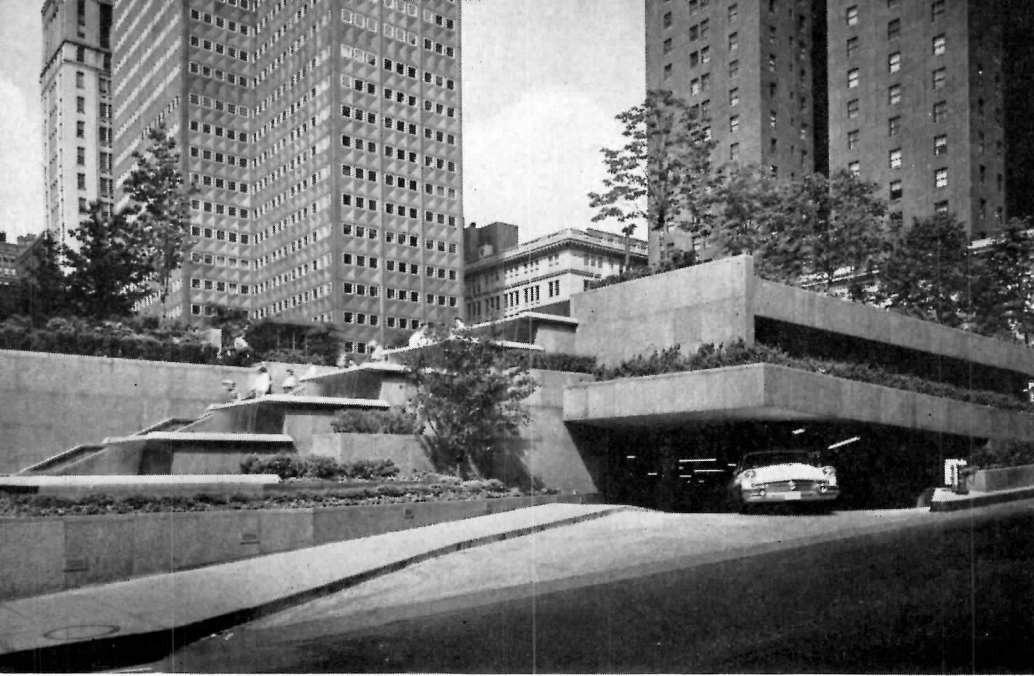

*Linden, Sweetgum, Honeylocust, Magnolia, and Boxwood are among the many varieties of trees and shrubs which have been used*

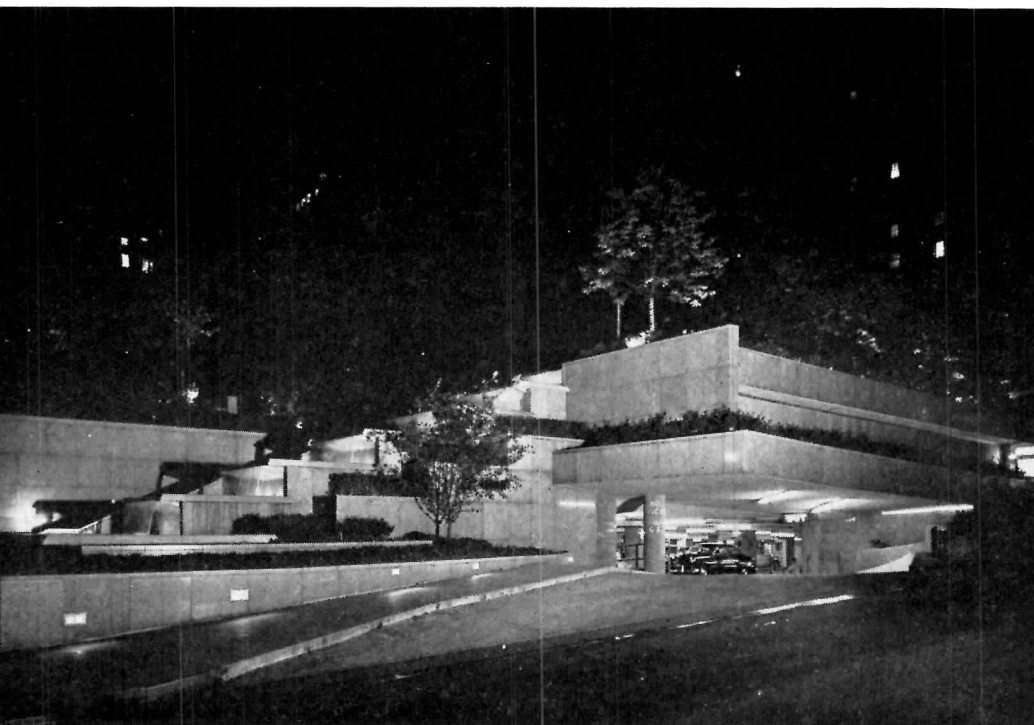

*At night the water, paved surfaces, and foliage are expressively lighted with soft blue (mercury vapor) spotlights*



Joseph W. Molitor

*In the large fountain pool are nine-foot, 3000-pound bronze basins; all gratings are aluminum; shops are at left*



CARSON PIRIE SCOTT STORE, Chicago  
 Louis Sullivan  
 ROCKEFELLER CENTER BUILDINGS, New York  
 Reinhard & Hofmeister; Corbett, Harrison  
 & MacMurray; Hood & Foulhoux  
 LEVER HOUSE, New York  
 Skidmore, Owings & Merrill  
 TRINITY CHURCH, Boston  
 H. H. Richardson  
 PHILADELPHIA SAVINGS FUND SOCIETY  
 BUILDING, Philadelphia  
 Howe & Lescaze  
 GENERAL MOTORS TECHNICAL CENTER, Detroit  
 Saarinen & Saarinen  
 LAKE SHORE DRIVE APARTMENTS, Chicago  
 Mies van der Rohe  
 S. C. JOHNSON & SON, INC., ADMIN. BLDG., Racine  
 Frank Lloyd Wright  
 MONADNOCK BLOCK, Chicago  
 Burnham & Root  
 DAILY NEWS BUILDING, New York  
 Hood & Howells  
 TVA NORRIS DAM & POWER HOUSE, Tennessee  
 Roland Wank, Architect-in-charge  
 BOSTON PUBLIC LIBRARY, Boston  
 McKim, Mead & White  
 STOCK PAVILION, Raleigh  
 Nowicki & Deitrick  
 CHRISTIAN SCIENCE CHURCH, Berkeley  
 Bernard Maybeck  
 WOOLWORTH BUILDING, New York  
 Cass Gilbert  
 CROW ISLAND SCHOOL, Illinois  
 Saarinen & Saarinen,  
 with Perkins, Wheeler & Will  
 MANUFACTURERS TRUST BUILDING, New York  
 Skidmore, Owings & Merrill  
 UNITY CHURCH, Oak Park  
 Frank Lloyd Wright  
 NEBRASKA STATE CAPITOL, Lincoln  
 Bertram G. Goodhue  
 S. C. JOHNSON & SON, INC., LABORATORY, Racine  
 Frank Lloyd Wright  
 UNITED NATIONS SECRETARIAT, New York  
 Wallace K. Harrison & Consultants  
 LINCOLN MEMORIAL, Washington  
 Henry Bacon  
 M.I.T. AUDITORIUM, Cambridge  
 Eero Saarinen  
 EQUITABLE BUILDING, Portland  
 Pietro Belluschi  
 ALLEGHENY COUNTY BUILDINGS, Pittsburgh  
 H. H. Richardson  
 UNIVERSITY CLUB, New York  
 McKim, Mead & White  
 CRANBROOK SCHOOLS, Michigan  
 Eilii Saarinen  
 MINERALS & METALS RESEARCH BLDG., I.I.T., Chicago  
 Mies van der Rohe  
 ALCOA BUILDING, Pittsburgh  
 Harrison & Abramovitz  
 MUSEUM OF MODERN ART, New York  
 Goodwin & Stone  
 PENNSYLVANIA STATION, New York  
 McKim, Mead & White  
 EXPERIMENTAL SCHOOL, Los Angeles  
 Richard Neutra  
 DODGE TRUCK PLANT, Detroit  
 Albert Kahn  
 100 MEMORIAL DRIVE APARTMENTS, Cambridge  
 Kennedy, Koch, DeMars, Rapson & Brown  
 CENTRAL LUTHERAN CHURCH, Portland  
 Pietro Belluschi

**HOUSES**  
 F. C. ROBIE, Chicago  
 Frank Lloyd Wright  
 E. J. KAUFMANN, Pennsylvania  
 Frank Lloyd Wright  
 TALIESIN WEST, Arizona  
 Frank Lloyd Wright  
 HENRY VILLARD, New York  
 McKim, Mead & White  
 WATTS SHERMAN, Newport  
 H. H. Richardson  
 AVERY COONLEY, Illinois  
 Frank Lloyd Wright  
 W. W. WILLITTS, Illinois  
 Frank Lloyd Wright  
 D. B. GAMBLE, Pasadena  
 Greene and Greene  
 PHILIP JOHNSON, New Canaan  
 Philip Johnson  
 WALKER GUEST HOUSE, Florida  
 Paul Rudolph  
 ELLEN SCRIPPS, La Jolla  
 Irving Gill  
 WESTON HAVENS, Berkeley  
 Harwell Hamilton Harris  
 LOVELL "HEALTH HOUSE", Los Angeles  
 Richard Neutra  
 EDITH FARNSWORTH, Chicago  
 Mies van der Rohe

## ONE HUNDRED YEARS OF SIGNIFICANT BUILDING

### 9: HOUSES SINCE 1907

ELEVEN OF THE FOURTEEN HOUSES nominated by ARCHITECTURAL RECORD'S panel have been built in the past fifty years and are presented herewith. The three built before 1907 were published in the fifth installment of this series and included the first of the five houses with which Frank Lloyd Wright dominates the residential selections.

His Robie and Kaufmann houses, built a generation apart in time and in form, are nevertheless tied for first place in the voting on houses and his Taliesin West is placed second. The beautiful Avery Coonley house, voted fifth among all houses, is third among those since 1907.

Interestingly Wright is not represented by any house built since 1941. In that fifteen year period only examples by Johnson, van der Rohe, and Rudolph were nominated frequently enough to be listed.

Often several houses by one man were voted without any single house gaining enough votes to qualify. Since the total work of one man may well have significance beyond any single work of another the natural shortcomings of this kind of polling are revealed.

In this connection it must be noted here that several houses of Schindler, Gropius and Breuer, Wurster, the Kecks, and Belluschi were nominated more than once though none as often as those on the following pages.

Of those architects represented here many — it may be felt — are not represented by their best work. Neutra may serve as an illustrative case in point. If this is true the explanation certainly lies in the fact that the panel has recognized that often an earlier essay is more significant in terms of its impact than some later, more matured and refined, example. In any event these are the architects, if not always the particular houses, who have most influenced the vigorous and imaginative design of houses in America today.

*F. C. Robie House, Chicago, 1909, Frank Lloyd Wright.  
(Tied for first)*

“The Robie house created at the domestic level something new to the eyes of 1909 Chicago, supplanting the symmetrical classicism of the day by an asymmetrical monumentality. In the structurally expressive use of piers, wall planes, and strips of windows all clustered about a central chimney, one senses an unusual coherence of planning. Visually this produced a bold interplay of forms with strong horizontals at different levels, originating in but leading away from the dominant vertical. The fenestration represented a radically new concept, with its almost continuous light source interrupted only by structural piers and amply shaded by wide eaves; the logical outgrowth of a harsher climate to which the conventional New England window had never been properly suited. One senses Wright’s complete mastery in this house of that low-lying, horizontal type of dwelling which he had originated and named the ‘Prairie House.’”

*Alan Burnham*

“The Robie house is the culmination of Wright’s ‘Prairie Style,’ and a milestone in the history of modern architecture because of its organically flowing space in which rooms are no longer conceived of as boxes. Because it still contains so much

of the furniture originally designed for it, the house can still display to an unusual degree the great architect’s original conception of it.”

*Donald D. Egbert*

“The slender, extended Robie house has long been thought of as a masterwork of Wright’s ‘Prairie Style,’ but few have realized the exceptional tribute it received in being wittily paraphrased by a leading younger architect forty years after its erection. Was the paraphrase conscious? It is successful. Compare if you will the first house Marcel Breuer built for his family at New Canaan to the Robie. In both the main floor is lifted above grade. In both cantilevered ends project. In both an off-center stairwell winds around a chimney mass, emerging into the full expanse of the main living area. In both this vertical feature divides living from dining. In both the chimney breast is opened through to free the flow of space and view along the principal axis of organization. In both the long window stretch is sheltered by an overhang. And both are most pleasant experiences. It is a theme for a house that shouldn’t stop with two architects, now that its versatility is established.”

*Edgar Kaufmann*

Hedrich-Blessing

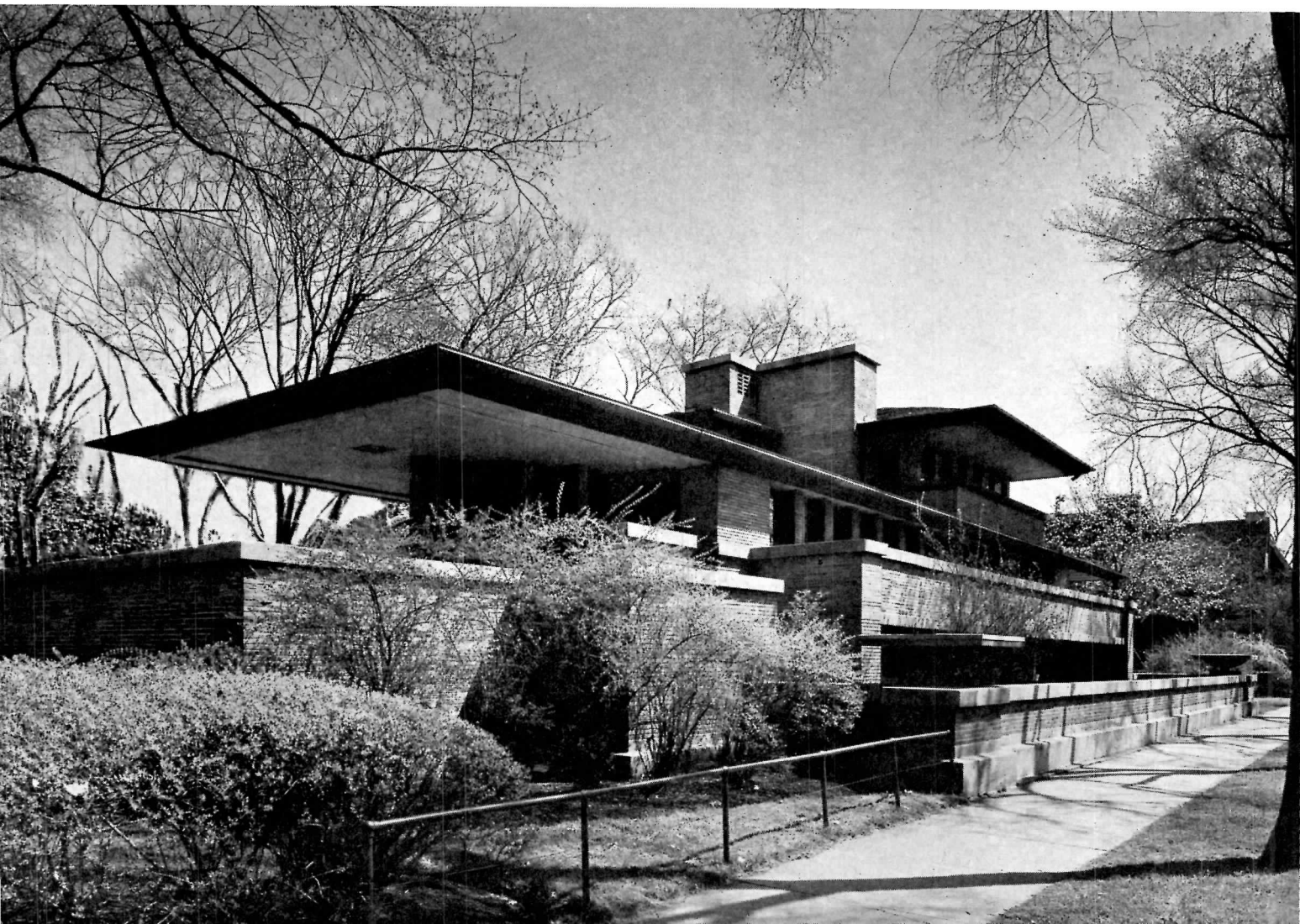



Hedrich-Blessing

*E. J. Kaufmann House, Bear Run, Pennsylvania, 1936,  
Frank Lloyd Wright. (Tied for first)*

"The same skill in adjusting a house to its environment that is shown in the Coonley house received quite a different expression in the famous Kaufmann house that overhangs a little waterfall in Pennsylvania, and there is in it the same conscious command of axes, of views, and the same skillful balance. Yet, if the expression of the Chicago house is that of a rather urban elegance, the expression of the Kaufmann house

is one of extreme sophistication completely at home in the most primitive surroundings. The great gray rocks, leading to the rough stone chimneys and end walls, enframe the long suave white horizontals with stunning effect, and the large spaces within open to the outside in ways that make the interior as well as the exterior integral with its Allegheny mountain site."

*Talbot F. Hamlin*

*“Taliesin West,” Phoenix, 1937 to date, Frank Lloyd Wright. (Second)*

“To make a visit to Wright’s caravansary in the Phoenix desert is an experience in color, light, and time. The reds, oranges, and grays of the desert stone heaped into the battered walls; the natural colors of the exposed roof trusses; the tawny textiles and rugs; most of all the dusty greens of the gardens: all seem a part of the duns of the desert distances which surround it. Within the great rooms, such as the drafting room or the recreational ‘Garden Room,’ one shelters from

the harsh outdoor sunlight, and yet through the canvas roofs it is transmuted into an ambient light of indescribable softness. Most of all, the building is an experience in time: the approach terraces, the steps, the long walk under the pergola, the penetration into the heart of the building itself: all these form a subtle sequence of varied spaces, scales, and shapes, opening and closing and opening again to give an unwonted sense of freedom. Perhaps never since the baroque period has the element of time been used so skillfully in realizing the enchantment of an intricate work of art.”

*Hugh Morrison*

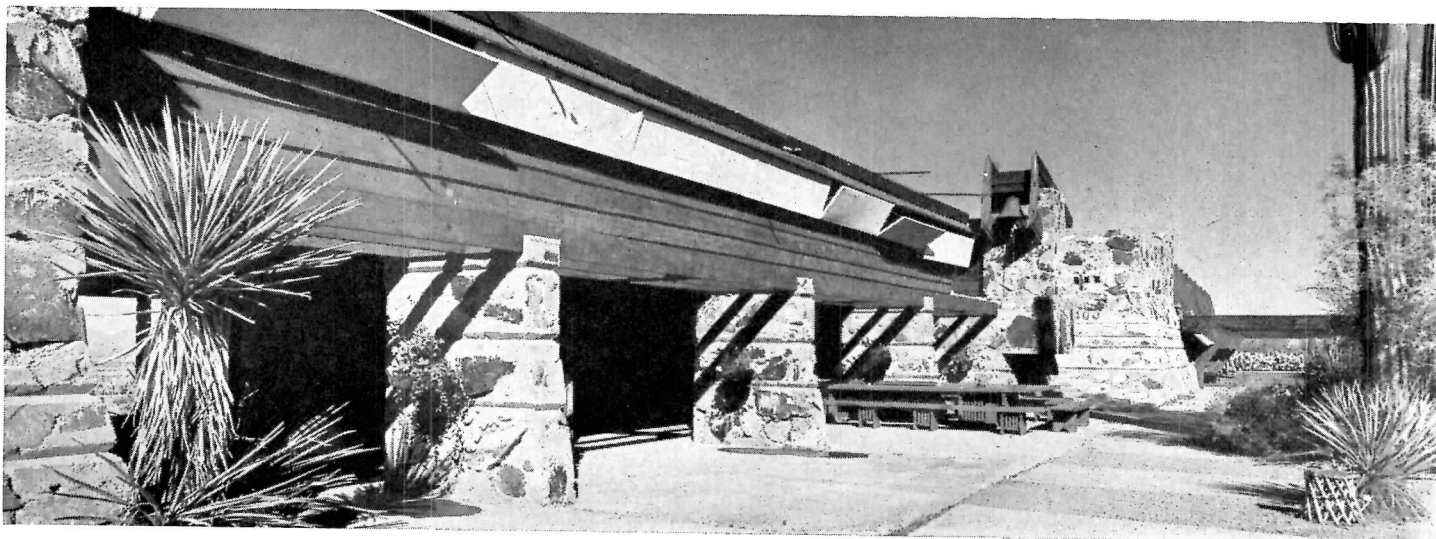

© Ezra Stoller

*Avery Coonley House, Riverside, Illinois, 1908, Frank Lloyd Wright. (Tied for fifth)*

“Henry-Russell Hitchcock has remarked that, though Wright considers himself a romantic, actually he is also one of the greatest classic planners America has ever had. The Coonley house is superb evidence of this fact. It has the richness of an Italian villa and the same unity of architecture, terracing, and garden; yet the whole is also completely American, completely of its date, and without a trace of imported style.”

*Talbot F. Hamlin*

“The Coonley house is at the top of the curve of Wright’s residential work, and a high point in the total spectrum. The Willitts house, as a summation and as progenitor of many later houses, is surpassed in architectural quality and significance by the Coonley house, which is a departure from earlier types of plans and more functional in recognition of living requirements. Its richer and more complex spatial geometry and the use of permanent color decoration forecast later developments in Wright’s designs for other types of buildings.

*Walter A. Taylor*

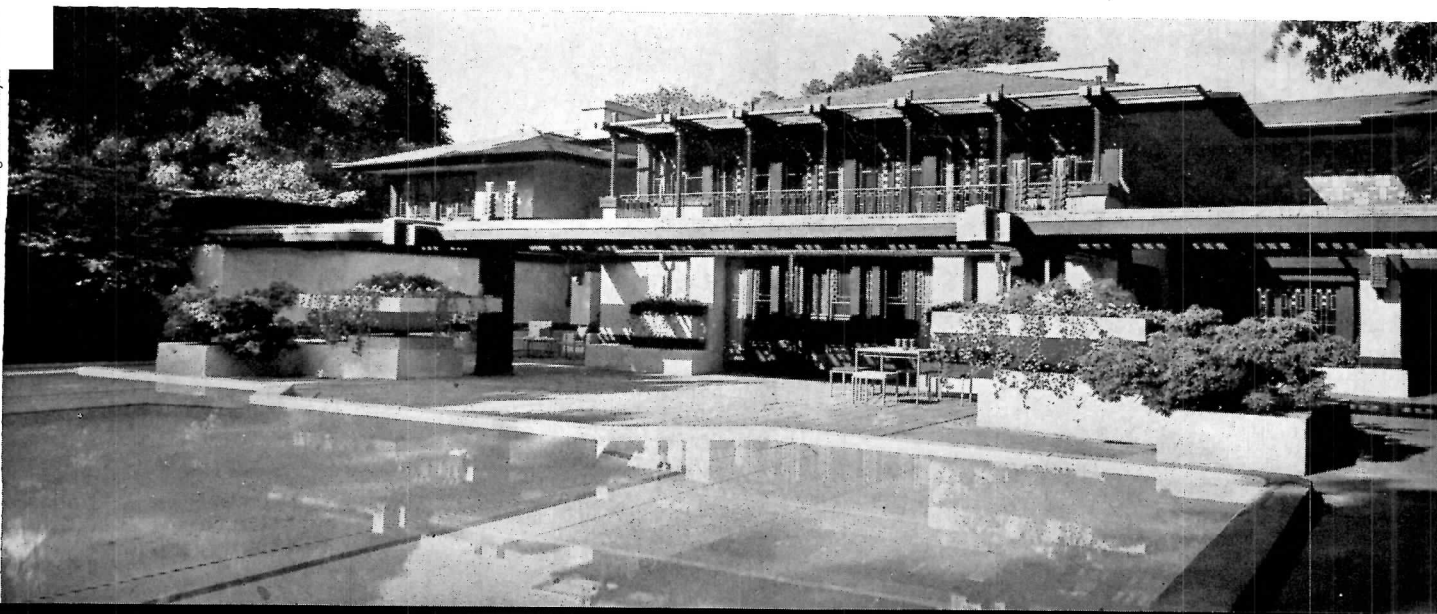

(Courtesy of House Beautiful Magazine) Maynard Parker



Julius Schulman

***D. R. Gamble House, Pasadena, 1908, Greene and Greene (Sixth)***

“The Gamble house is the meeting ground of the eastern shingle style, the Orient, two extraordinary architects, and a sensitive industrialist. It shows a mastery of the structural and expressive potentialities of wood architecture seldom sur-

passed in our time. William Morris would have loved the house for its design and craftsmanship. Every chair, rug, fixture, and window was conceived by Charles Greene to fit the unique quality of the materials (lots of teak) and the architecture. Here survives the lofty spirit of that paragon of American architectural magazines, *The Craftsman*.”

***James S. Ackerman***



© Ezra Stoller

***Philip Johnson House, New Canaan, 1950, Philip Johnson. (Seventh)***

“In architectural history there has usually been a ‘royal pavilion’ in every age — a structure for living quite above and beyond the norm, yet of enormous influence. Philip Johnson’s house is such a structure in our day.

For America’s millions imprisoned by municipal walls, this pavilion enclosed by nature is a deeply appealing, if apparently impractical, dream. Amidst the inevitable clutter of daily living, the stark simplicities of this house and its

furnishings spell serenity. Out of the ugliness of misused new techniques and materials, here is one example which is strangely beautiful. Surely no piece of domestic architecture of the current decade has had so wide an influence.

Philip Johnson, one of the first to write about the International Style, has here contributed to its actual development. To the basic concepts of Mies van der Rohe he has added elegance, at last removing the long taint of Bauhaus machine oil. Steel, glass, and masonry have been united with a new and classic severity, miraculously related both to the age of the jet and to the age of Pericles.” ***Leslie Cheek, Jr.***

*Walker Guest House, Sanibel Island, Florida, 1953, Paul Rudolph. (Eighth)*

“This small structure may well stand as typical of the residential work which has captured the interest of architects everywhere. In a sense it almost sums up the principal characteristics of Paul Rudolph’s contribution to date: its fine, spare frame is carefully scaled; the total structure — in plan or profile — presents a simple, retainable image; its voids

and solids produce a rich play of light and shadow and a great sense of volume; all its parts are expressed with clarity and with great simplicity; it possesses the gift of near weightlessness so appropriate for a structure of small wooden members; its moving flaps permit a flexibility in use and in appearance; and withal one gets the sense that while it is manifestly a product of its place and time, it is nevertheless an architecture developed out of disciplines and concerns which transcend the local and the immediate.”

*John Knox Shear*

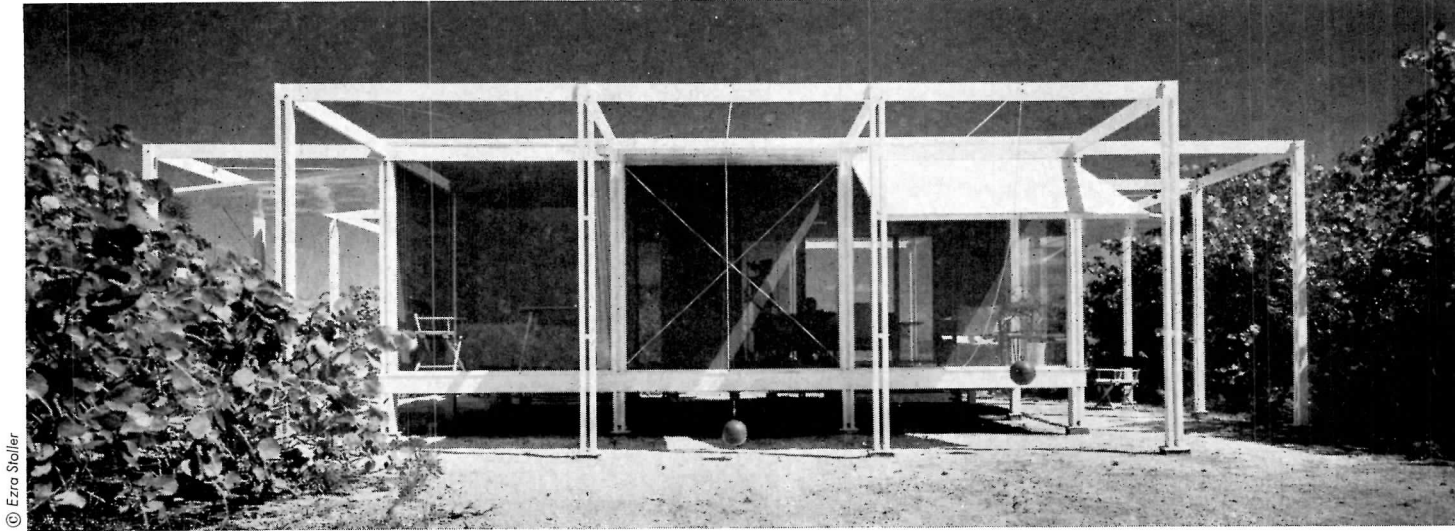

© Ezre Stoller

*Ellen Scripps House, La Jolla, 1917, Irving Gill. (Tied for ninth)*

“Irving Gill is one of the unsung pioneers of modern architecture, and one of the most isolated. During the second decade of the century he produced in the San Diego region buildings of an amazing modernity. Smooth-skinned, geometric, with large sheets of plate glass and strip-windows, they are the antithesis of the baroque fantasies of Maybeck or the inspired

carpentry of the Greene brothers, his leading California contemporaries. Indeed they seem entirely apart from the Richardson-Sullivan-Wright mainstream of American modernism. If his remote ancestor was Claude-Nicolas Ledoux in the 1790’s, his most obvious descendant is the European ‘International Style’ of the twenties and thirties. With a style of ruthless elegance, Gill seems a sort of early Corbusier anchored to the ground.”

*Hugh Morrison*



Julius Shulman

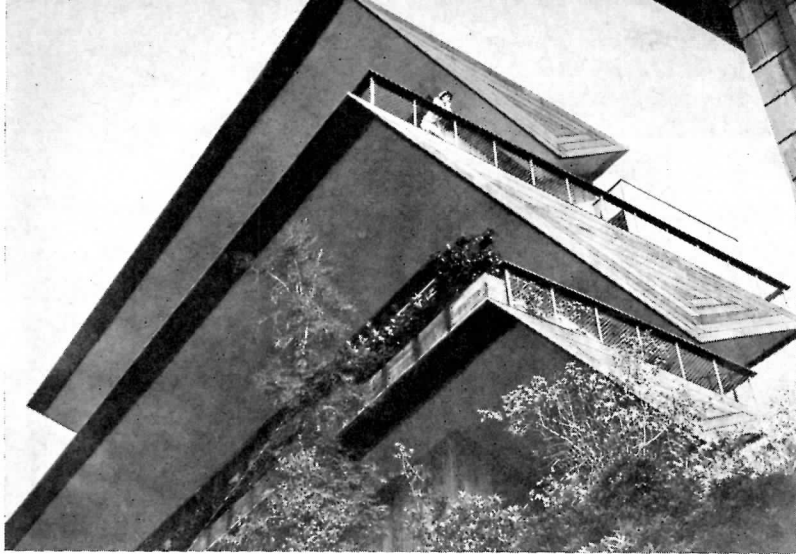

Roger Sturtevant

*Weston Havens House, Berkeley, 1940, Harwell Hamilton Harris. (Tied for ninth)*

“Like the Kaufmann house, the Weston Havens house is an outstanding example of a house designed for a special, unusual, and difficult site. Here the entire concept was based on the view over San Francisco Bay to the distant Marin County hills and the equal necessity of getting into a house on a

steep western slope as much morning sunlight as possible. These requirements, interpreted poetically as well as practically, have resulted in a house full of unexpected beauties, flooded with light from unexpected sources, and yet always, as it were, calling to its inhabitants to come to the western windows to look out over the superb distances.”

*Talbot F. Hamlin*

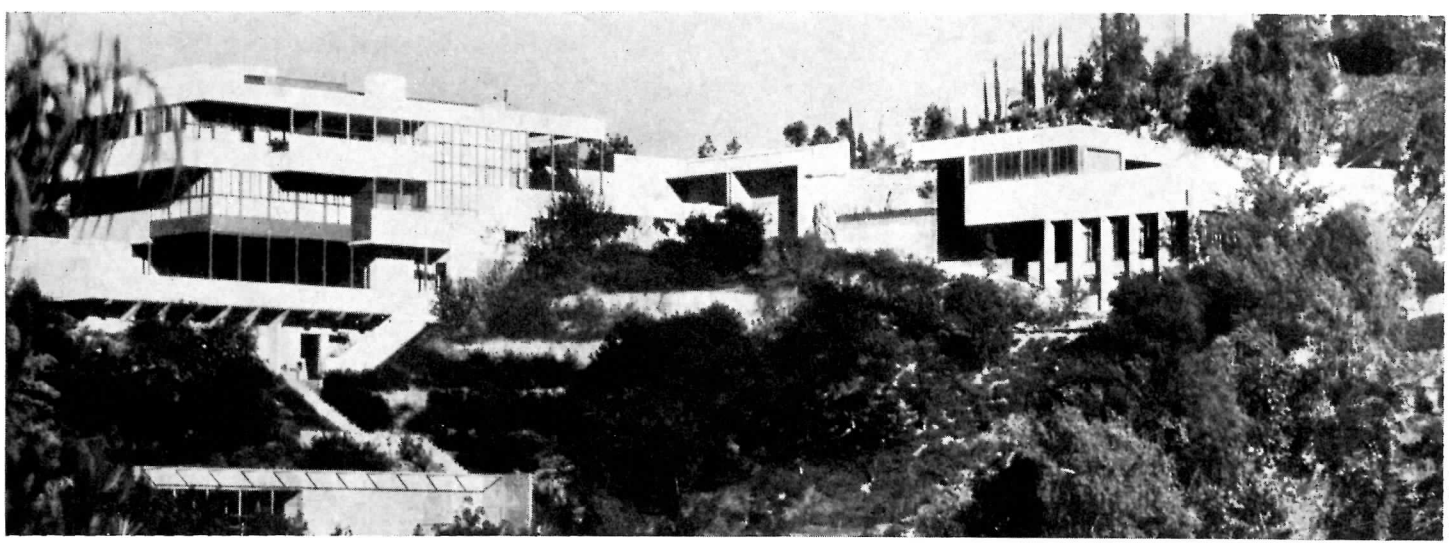

Johannes Shulman

*Lovell "Health House," Los Angeles, 1927, Richard Neutra. (Tied for ninth)*

“Combining in an original way the rational clarity of form of the International Style with a Wrightian sensitivity for the natural site, Richard Neutra here produced a house that was much ahead of its time, not only in the United States but in the whole world.”

*Donald D. Egbert*

“Sited on the hillside, this house demonstrated before any other the native ‘open plan’ successfully wedded to the modular steel skeleton. It is a brilliant and prophetic milestone showing both the practical and the esthetic advantage of the curtain-panel wall in residential design.”

*Buford L. Pickens*

## ONE HUNDRED YEARS OF SIGNIFICANT BUILDING

### *Edith Farnsworth House, Chicago, 1951, Mies van der Rohe. (Tenth)*

“The house for Dr. Farnsworth is for America the house of the century. Its significance is at least two-fold: In defining for others, if not for Mies, the direction of his thinking, and in the influence that it has had on the work of others — an influence already apparent before its own construction was begun.

The house is austere and it is beautiful. If, as a house, it disdains the paraphernalia of comfort and convenience, it

does this so compellingly that any house less disdainful is tawdry by comparison.

The structure is exact and finished rather than urbane. Its superiority is in the preciseness of detail and proportion. The polish of steel, stone, and plaster emphasizes the precision, not the surface. Similarly, the whiteness unifies and clarifies, transforming a rural house into a pavilion — into a temple.”

*Paul Schweikher*

Hedrich-Blessing

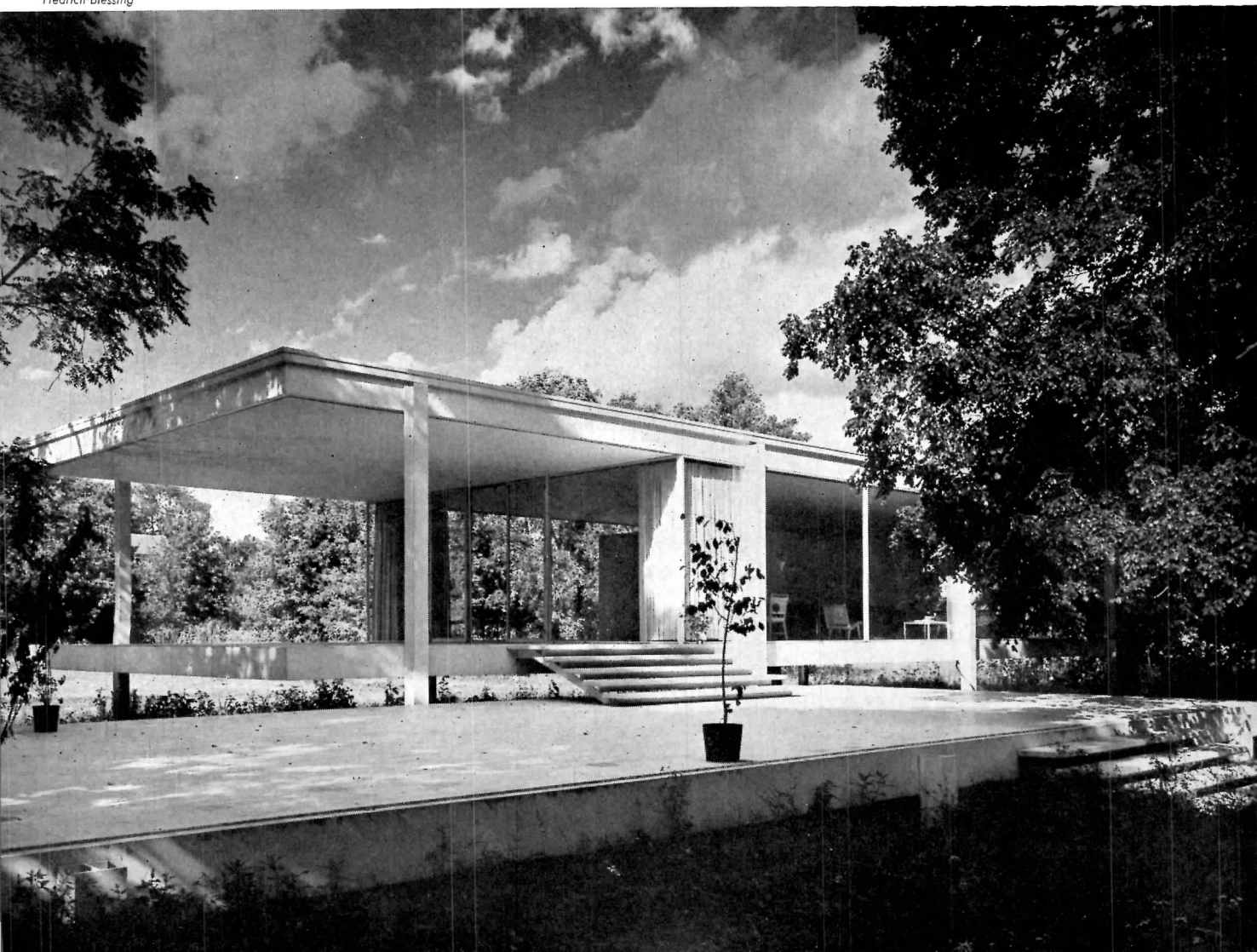



INDUSTRIAL PRODUCTION ROARS ON at a pace that is forever astonishing. So also does the production of facilities for production. Industrial production is always breaking into new ground — new technological exploitation, new geographical areas, new sales markets, always with new impact on our lives and habits of thought.

In architectural areas, this industrial rat race produces some interesting reactions. Perhaps the most obvious one is that more and more architects are working, in one way or another, for industry. There are always new needs, in new places, for new purposes. More clients for more architects.

It seems more significant, however, that architectural thinking seems to be penetrating into new ground. A lumber yard (page 214), a steel yard (page 208), a truck terminal (page 224). Prosperity certainly is one reason. But one likes to think there is a deeper meaning here, an extension of appreciation for the architect's contribution to the job to be done, whether that is selling, manufacturing, shipping, or anything else. Whatever the reason, it is good to see an ever closer relationship between architects and the world of industry and commerce.

It is, of course, the basic reason-for-being of contemporary architecture that it seeks attunement with modern times, modern techniques and needs. If, as has frequently been remarked, modern architecture is most convincing in industrial buildings, small wonder, for technology was at least its uncle. Its crisp, clean character is expressive of industrial order and efficiency.

While noting this happy rapport, however, one sees complications. The well known confusion over just what is to be expressed is not to be avoided even here. In many instances the promotional demands on the building draw the client toward some pretty fancy notions; some small industrial buildings look like Alan Dunn's cartoon drawings of hot-dog stands (page 21). Sometimes the employees are given more consideration than the customers (page 228), and this is reflected in design.

All of the buildings in this study exhibit a great deal of thoughtful attention to space outside; there is some, in the first place, and it is carefully developed.

All by way of saying again that buildings are for people as well as for processes, and so is their architecture. This age old fact seems to be freshly discovered in manufacturing circles, or at least in ever widening circles.

It is more than ever true that every architectural office, large or small, can find opportunity in this field, to whatever extent it is prepared to serve.

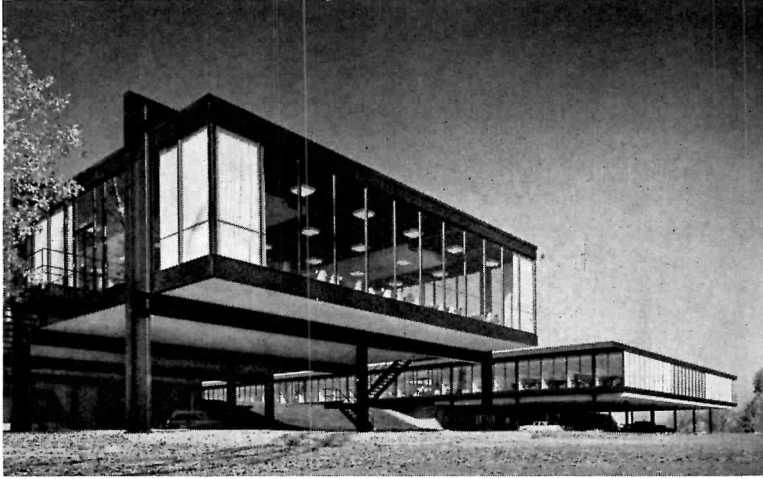

## NEW VALUES IN OFFICES

*Three-Unit General Offices for Kimberly-Clark Corporation  
Neenah-Menasha, Wisconsin*

*Skidmore, Owings and Merrill, Architects and Engineers*

IF IT IS TRUE that industry generally has a new appreciation of the contributions of the architect, one reason might be the quality of executive office buildings that have appeared in recent years. Architects have made good use of the freedom from restrictions of downtown sites. They have done surprising things to older concepts of office buildings; have put new meaning in the phrase "amenity values."

These new "general and executive offices" for a large paper manufacturing concern are a group of three buildings: one of two stories on stilts for the executive offices; a large unit of one story and basement for general offices, and a cafeteria building. They are located at the main plant in the Neenah-Menasha community of northern Wisconsin, at the edge of a small lake. They were designed for an ultimate population of 900.

The decision for three units came from the program: executive offices mean, of course, private offices for executives with the usual implications about isolation from noisier operations, entertainment of visitors, and so on, suggesting a building with mostly peripheral locations and shallow dimensions. General offices here suggested larger open spaces for pool operations and office machine work. The executive unit is the "North Building," the two-story one on stilts. At the lowest level the only enclosed space is the visitor lobby; the rest becomes covered parking for executives and visitors. The general offices have the South Building, which is 500 ft long and 150 wide, with two interior courts to give light and scale to the large office areas.

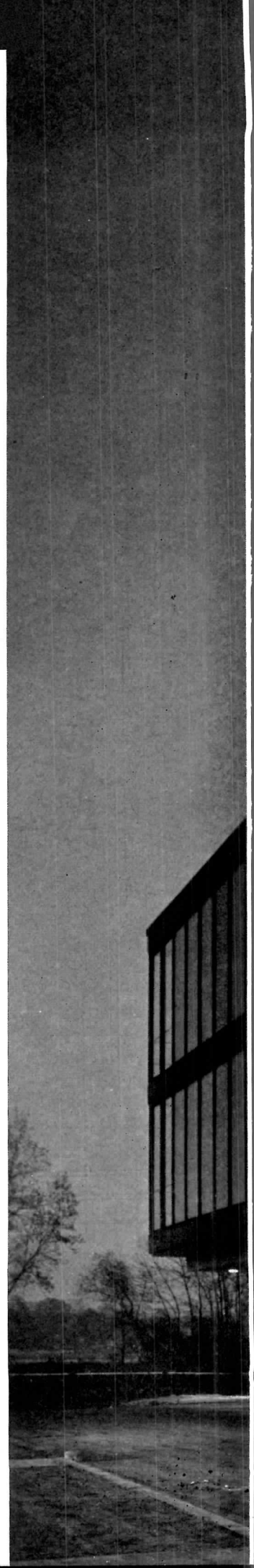



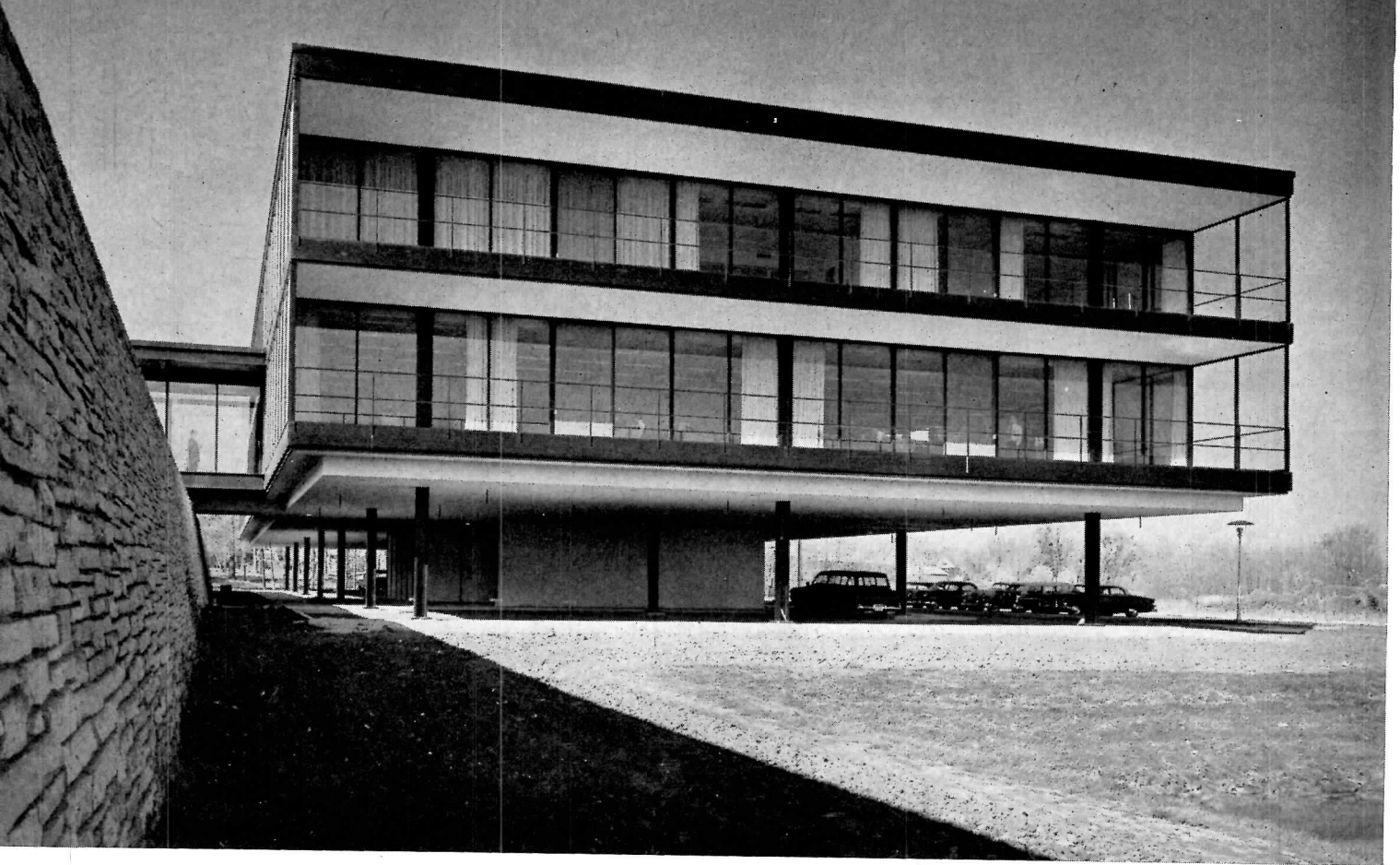

If the photographs seem to suggest that the architects were indulging in some whimsy in arranging levels of the three buildings, it would be more accurate to say that they turned to advantage the conditions of the site. The land sloped rather awkwardly in places, particularly where they wanted the office workers' parking lot. Some of the site had been filled with paper-making waste, which had to be scooped out before the land was suitable for building. Part of the low portion was made into a cooling pond-reflecting pool. Actually a great deal more earth moving proved necessary than was originally contemplated. But the result seems a happy one: the strictly visual dividends seem good and there were some on the functional side as well. There is a nice separation developing between cafeteria, parking lot, general office and executive and visitor parking. Buildings are, of course, connected for bad weather; the two office buildings by a covered passage above ground, the connection to the cafeteria being a tunnel.



Bill Hedrich, Hedrich-Blessing

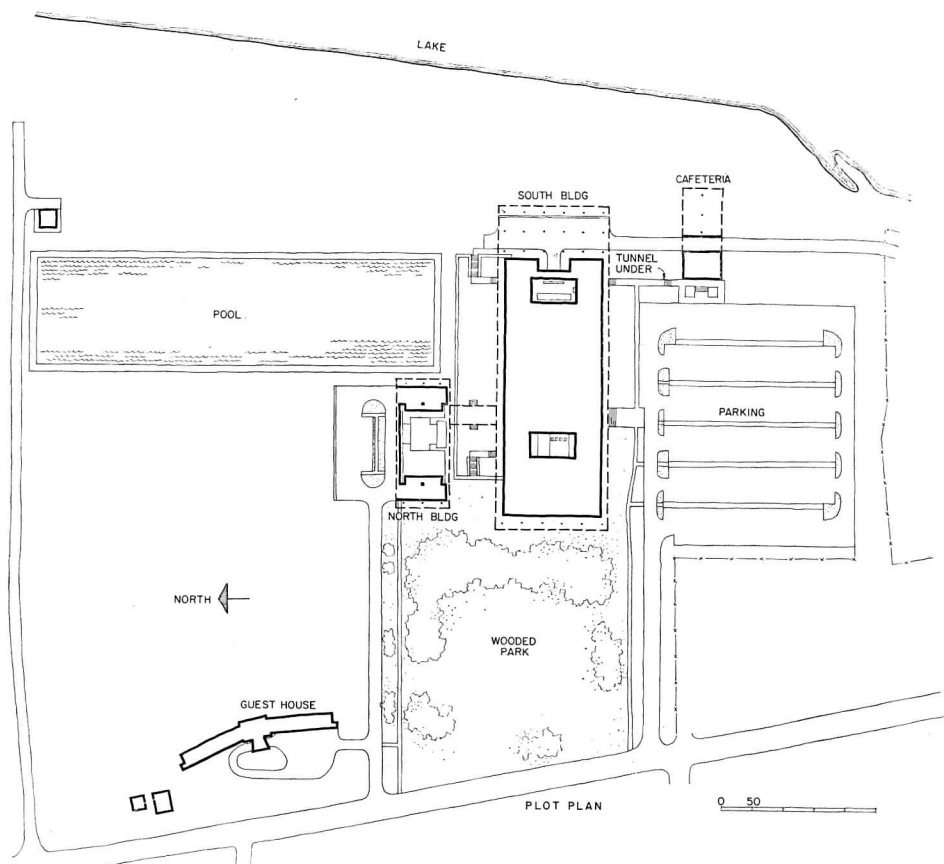

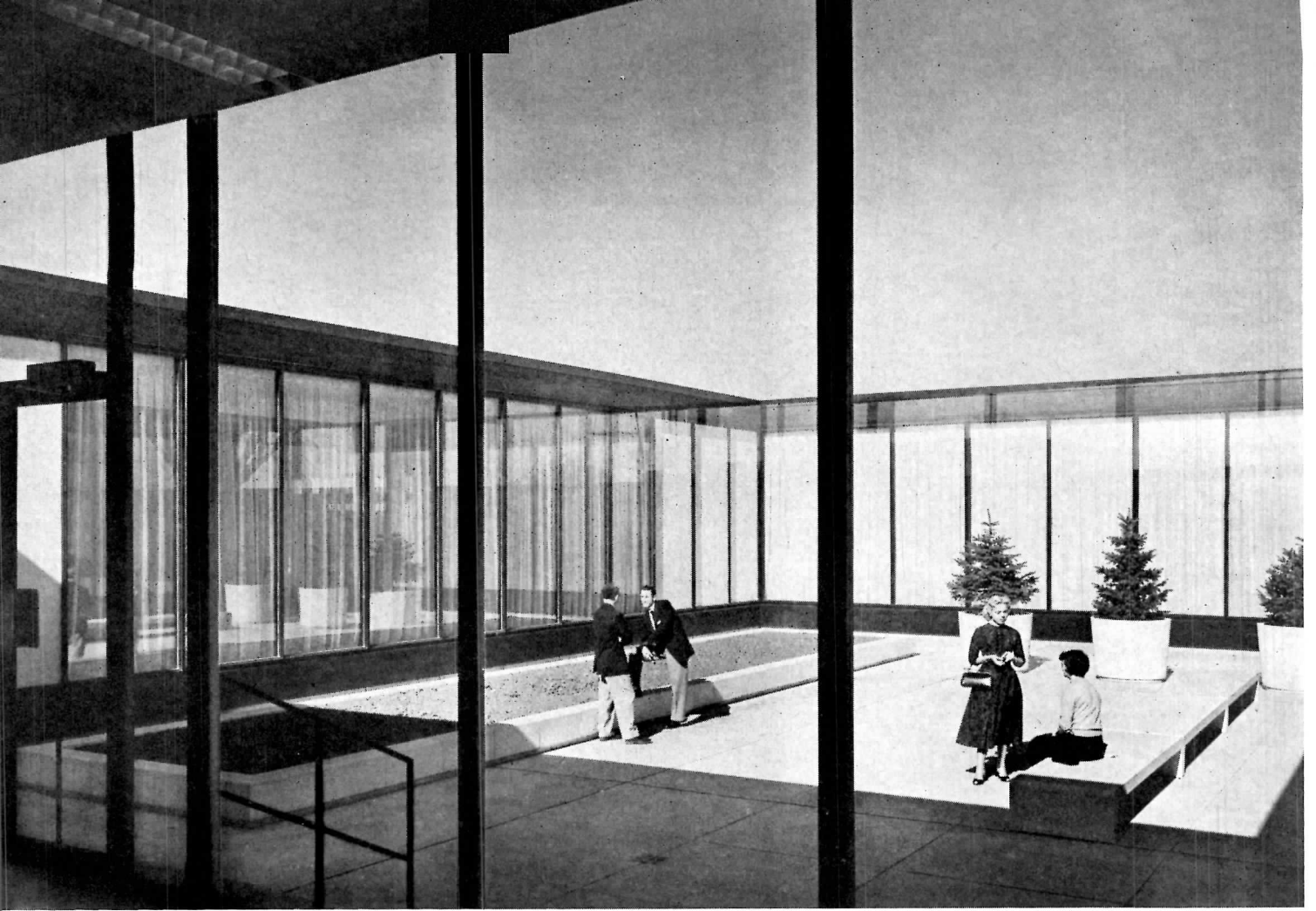

Architecturally the three buildings maintain the same order of vertical panels of precast concrete or glass in 5-ft modules. The buildings are of exposed steel frame, which is painted black. The cafeteria was conceived as a clear space facing the lake, a space 60 by 10 ft; this is the building with the exterior steel bents. The two office buildings are steel grids consisting of 12-in.-wide flanges 10 ft on center in each direction in a 30 by 30 ft bay cantilevered 10 ft in all directions. The buildings keep to the 5-ft module, expressed in all the elements such as lights and air conditioning diffusers. Panels are of 3-in. precast concrete; these are interchangeable with glass in the wall system. Generally the module is expressed with black painted mullions; some cafeteria walls use the concrete panels merely buttered together. An important dividend of the framing system and the arrangement of levels is protection against snow, and against its blinding reflections.

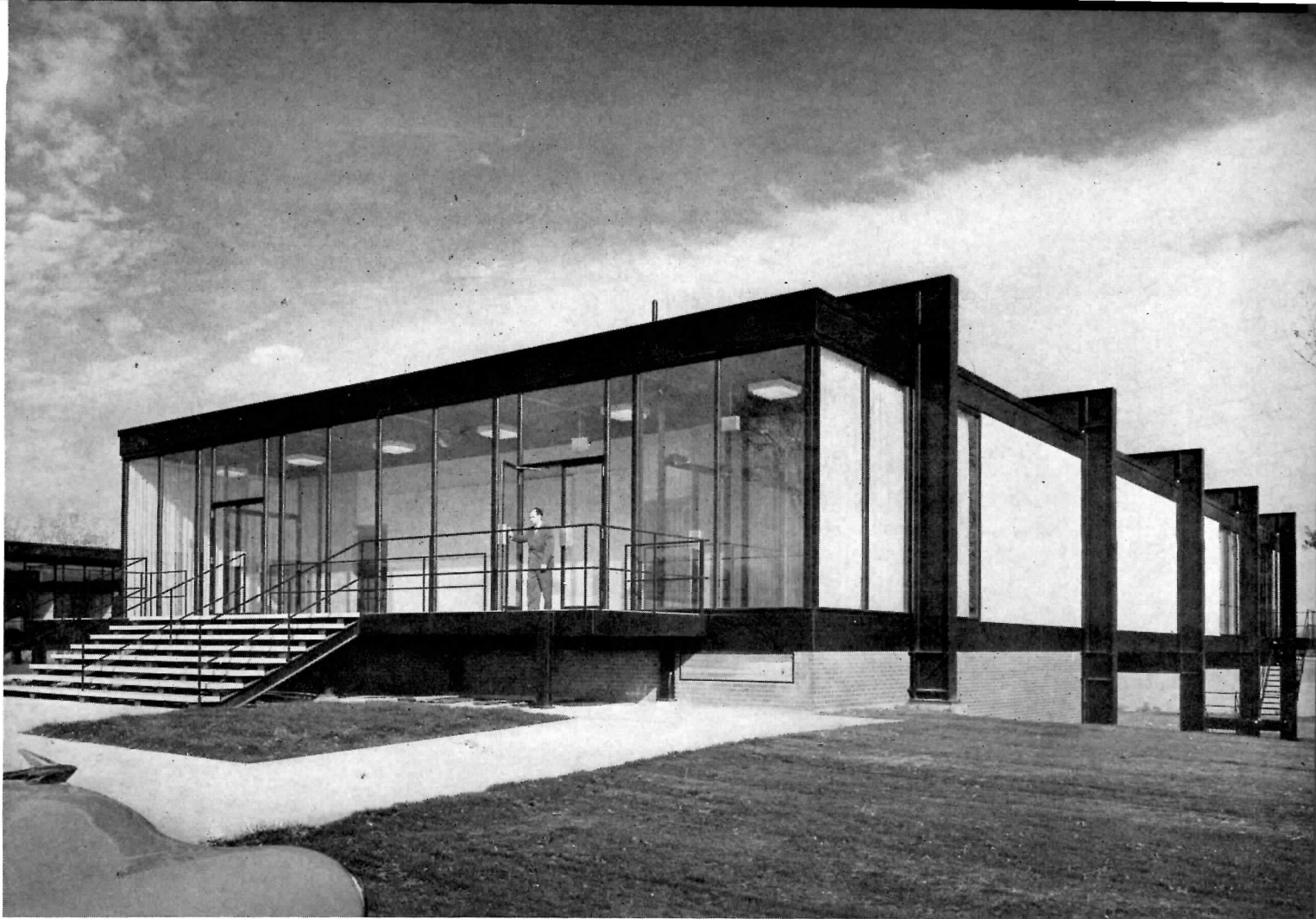

Bill Hedrich, Hedrich-Blessing

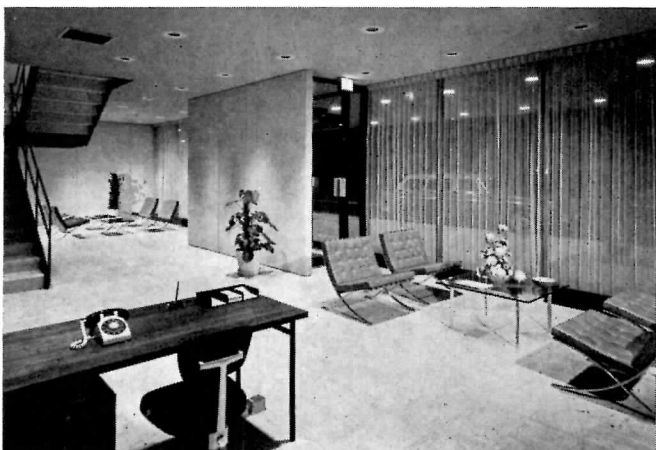



## MODERN LUMBER YARD

*Offices, Warehouse and Factory for  
The R. Laidlaw Lumber Co., Ltd., Weston, Ontario  
Pentland & Baker, Architects*

*The Rankin Company, Ltd., Industrial Engineers; Wallace Car-  
ruthers & Associates, Structural Engineers; Leah, Koyabashi &  
Associates, Mechanical and Electrical Engineers; Donington-  
Grubb & Stensson, Landscape Architects*

IT IS NOT EXACTLY CUSTOMARY for a lumber yard to feel the need for the services of architects but it might be a good idea, as witness what happened in this instance. The power of the photograph herewith might suggest that the architects' efforts focused on designing a handsome office building, but that isn't true — the architects were just as heavily involved in functional aspects of the whole operation. They were responsible not only for arriving at the relationships between processes, but, together with the client's staff, for arriving at the individual process layouts of each department, and for preparing the process flow sheets in all manufacturing operations.

The new plant (it is a factory, not just a "yard") was a from-scratch assignment. The establishment began in 1871 and its buildings had just sort of accumulated ever since. Its problems had accumulated also, problems of loading, trucking, materials handling, processing, not forgetting disposing of the shavings. A new location was indicated, and a completely new plant. Hence the long and intensive study that ensued. Architects and clients visited some 50 of the most progressive manufacturing lumber yards.

It is fitting to report that the architects evidently became intensely interested in the study, for their reports about the buildings deal almost exclusively with matters of materials handling, mill-work and manufacturing process layouts, fire protection, costs, and so on. And, oh yes, the owners did want the buildings, especially the offices, to do credit to the products sold.

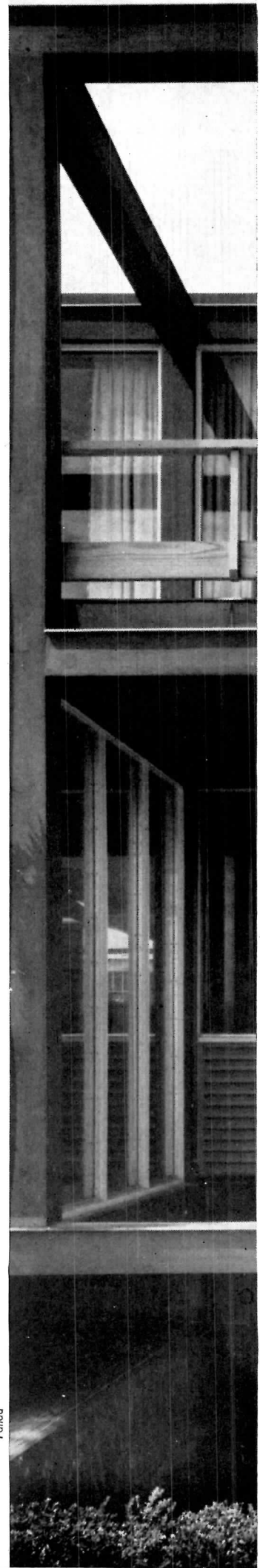

Panda







As for matters of appearance, "it was the owner's wish [to use the architects' words] that the plant be economical in cost and contemporary in design, emphasizing the potential uses of wood, both as a finish and as a structure. The entire plant was to be a showroom of those products sold and manufactured by the company, but at the same time no special matching or selection of materials other than those readily obtainable from stock was permitted."

The result is architecturally and philosophically interesting. The clean, disciplined rectangles and the stark exposed framing of this design are those that today one associates more naturally with metal construction. Here it is executed in wood and timber. Surely this is not a twist, for the wood looks perfectly natural in this use. Can it be that this is a full-circle story, returning wood to an earlier dignity?



Hugh Robertson—Panda

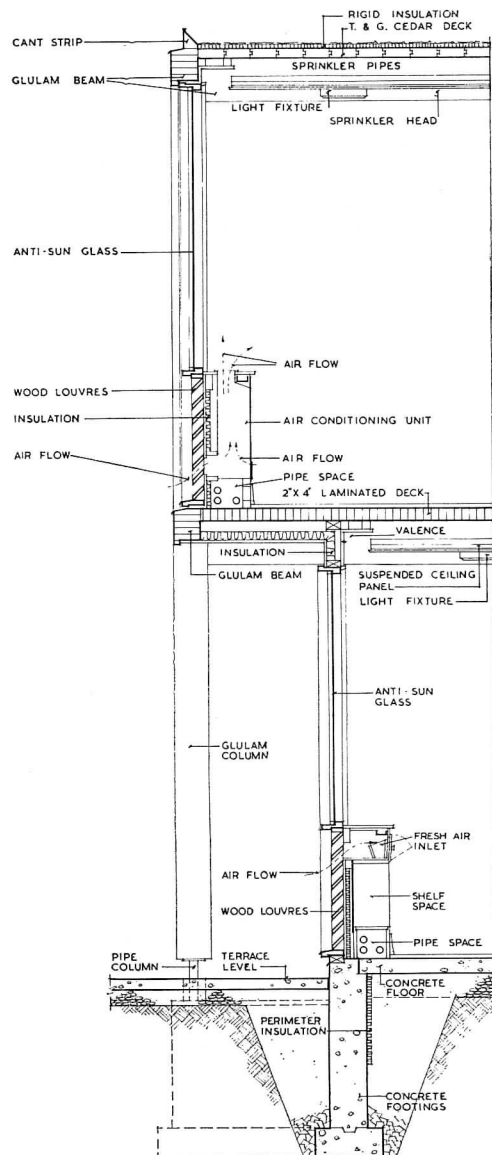
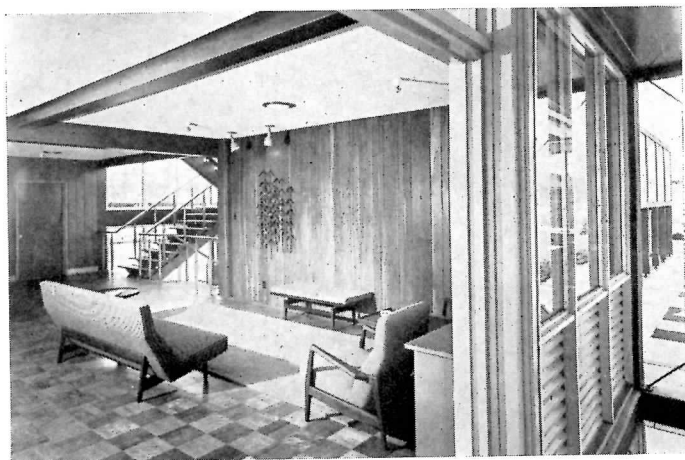



Exterior walls of all warehouses and storage building, planing mill and millwork factory, are 3-in. tongue and groove Western Canadian Cedar, as are some exterior walls of the office building. Structural framework throughout is glue-laminated beam and post, excepting for clerestory in the planing mill and millwork factory, which are wood trusses. Roof decking is the same 3-in. Cedar, with some insulation in office and manufacturing buildings, with bonded felt and gravel covering. Finished floors in office building are hardwood or wood block over mill sub-flooring. The office building is air conditioned, and all windows are fixed with opening louvers which have been built into the cabinets containing heating and air conditioning units under windows.



Eric Trussler, KenBell Photography Ltd.

Panda Photography

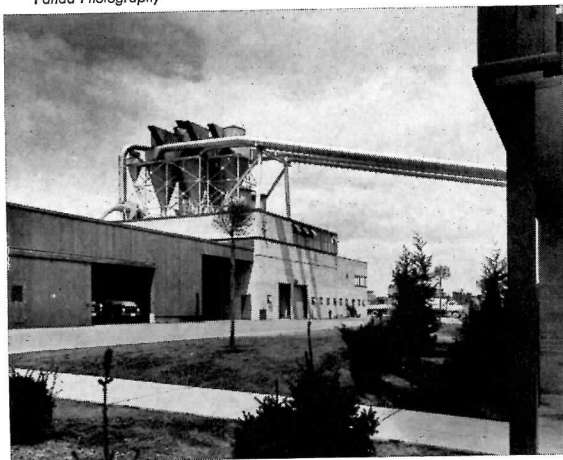

Hugh Robertson A.R.P.S.—Panda





## STEEL EXHIBIT PROJECT

*Office Building for Bethlehem Pacific Coast Steel Corp.  
Torrance, California*

*Albert C. Martin & Associates, Architects and Engineers*

*Chancy M. Lott, Project Architect in Charge*

*Arnold Dutton, Landscape Architect*

IF AN ARCHITECT can make a sizable contribution to a lumber yard (page 214), how about a steel fabricating yard? Here the story develops a bit differently, if it does arrive at roughly the same point. Here it was the architect who suggested that the building might serve to demonstrate new and untried uses for the product sold, in this case steel. The client quickly enthused, and pleasure was had by all in the ensuing collaboration.

"This is the first building of its type," says the architect, "to have the structural steel supporting frames exposed. Weatherproofing and placement of the curtain wall played an important part in the design. Wherever there is angle bracing on the exterior, fluted paneling is carried immediately behind it for best effect. This fluted paneling continues inside; in fact, if the building were turned inside out the appearance of the walls would not differ radically (except that certain interior panels are special).

"The roof of the structure is built up over steel decking; the second floor slab is poured onto steel decking, and doors, partitions and paneling all are of steel. No wood is used.

"With the completion of the building, an analysis of costs clearly indicated that steel can be as economical as it is structurally and esthetically effective. It was possible to keep within the \$15.00 per square foot cost limitation, yet apply steel in many heretofore unthought of applications." Such was the architects' enthusiasm for an interesting assignment.

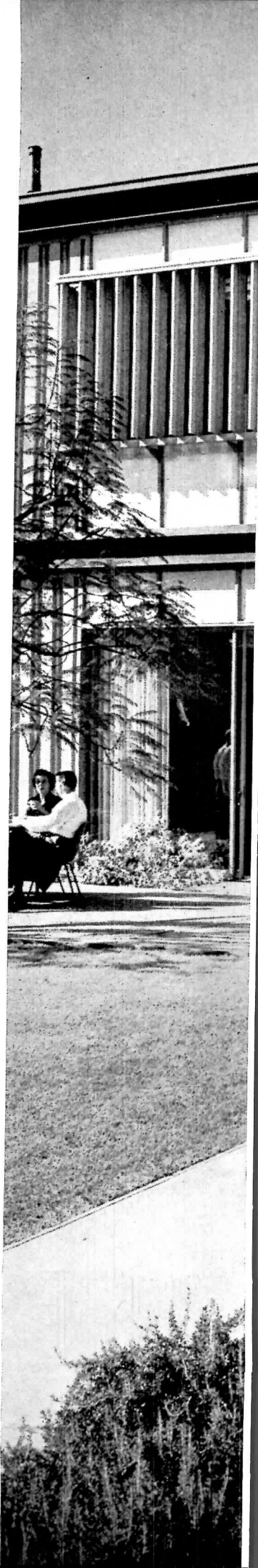





The architect comments also that the use of color is closely related to the steel industry. He began with the red lead effect of steel which he used for the X bracings. As background for the vivid red a variety of grays was used, with light gray behind the cross bracing, charcoal in columns and beams, pale gray on the porcelain enamel. The exterior grays are carried through to the interior, and new colors — yellows, greens, tans, corals — are added. The desire was to achieve a pleasant background that would best meet functional aspects of color use.





Julius Shulman

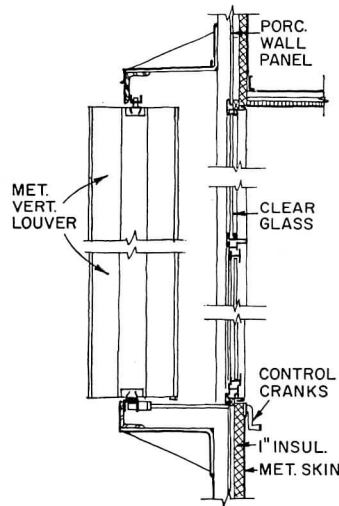
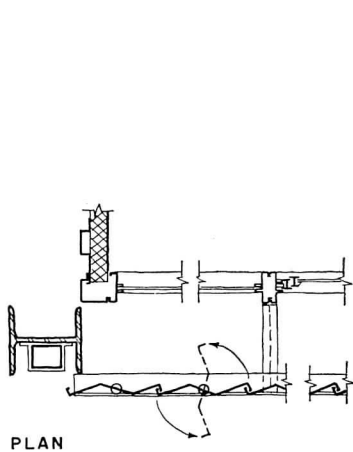
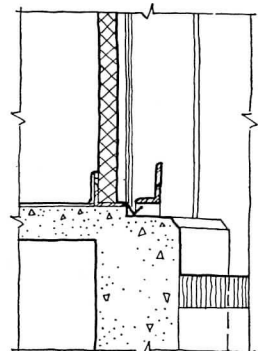
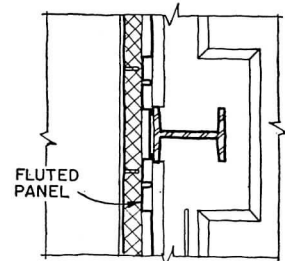
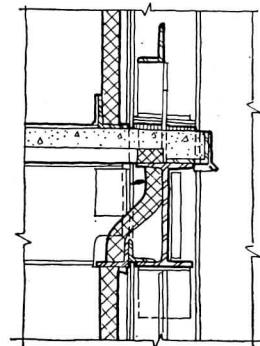
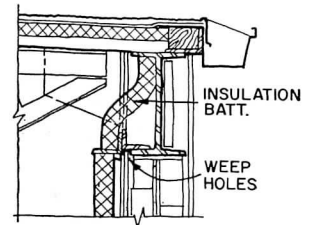

SECTION

FLUTED WALL DETAILS



## LARGEST TRUCK TERMINAL

*Pacific Intermountain Express Company Terminal  
Los Angeles, California*

*Albert C. Martin and Associates, Architects and Engineers  
Chancy M. Lott, Project Architect in Charge*

ONE OF THE NEWLY IMPORTANT TYPES of buildings in the industrial field is the truck terminal, which has changed from a Topsy-like shed to a huge and scientifically arranged docking facility. This new one handles 2,000,000 pounds of freight each day, has 700 employees. It represents the consolidation of activities of three older terminals in the Los Angeles area, and reaches a new height in size and comprehensiveness of facilities. So it becomes an interesting assignment for architects.

Facilities include a two-story, split-level office building, measuring 110 by 88 ft, completely air conditioned and landscaped; a 705-ft dock with 32 dock bays and 30 double truck bays on each side, capable of landing and unloading 144 trailers at a time; shop area 251 by 272 ft, to handle virtually all types of truck maintenance. The shop unit houses test facilities and engineering staff for study of new and better transportation facilities. The dock area and its handling equipment has been intently studied, for here, of course, the relative efficiency of freight handling is the determinant of profit or loss. A 1400-ft underfloor-cable conveyor system pulls hundreds of carts transferring freight; the operation is controlled by an intercom system and a system of pneumatic tubes.

Designwise, the architects have followed the idea of using materials and colors that identify the client and the business. The P I E trucks and trailers, moving throughout the western states, are recognized through aluminum panels and through a distinctive red color in signs and on equipment. So aluminum is used for panels of the main building and gate house; the red appears in porcelain enamel panels.

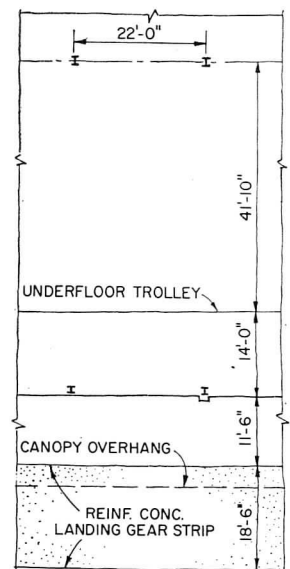
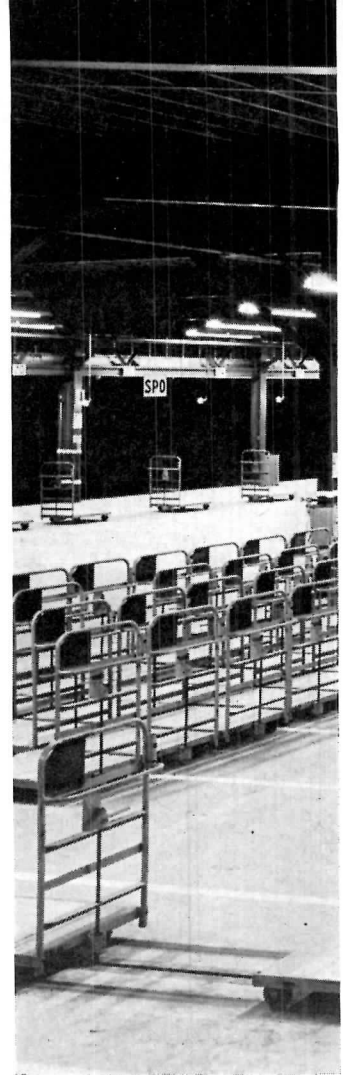

TYPICAL BAY

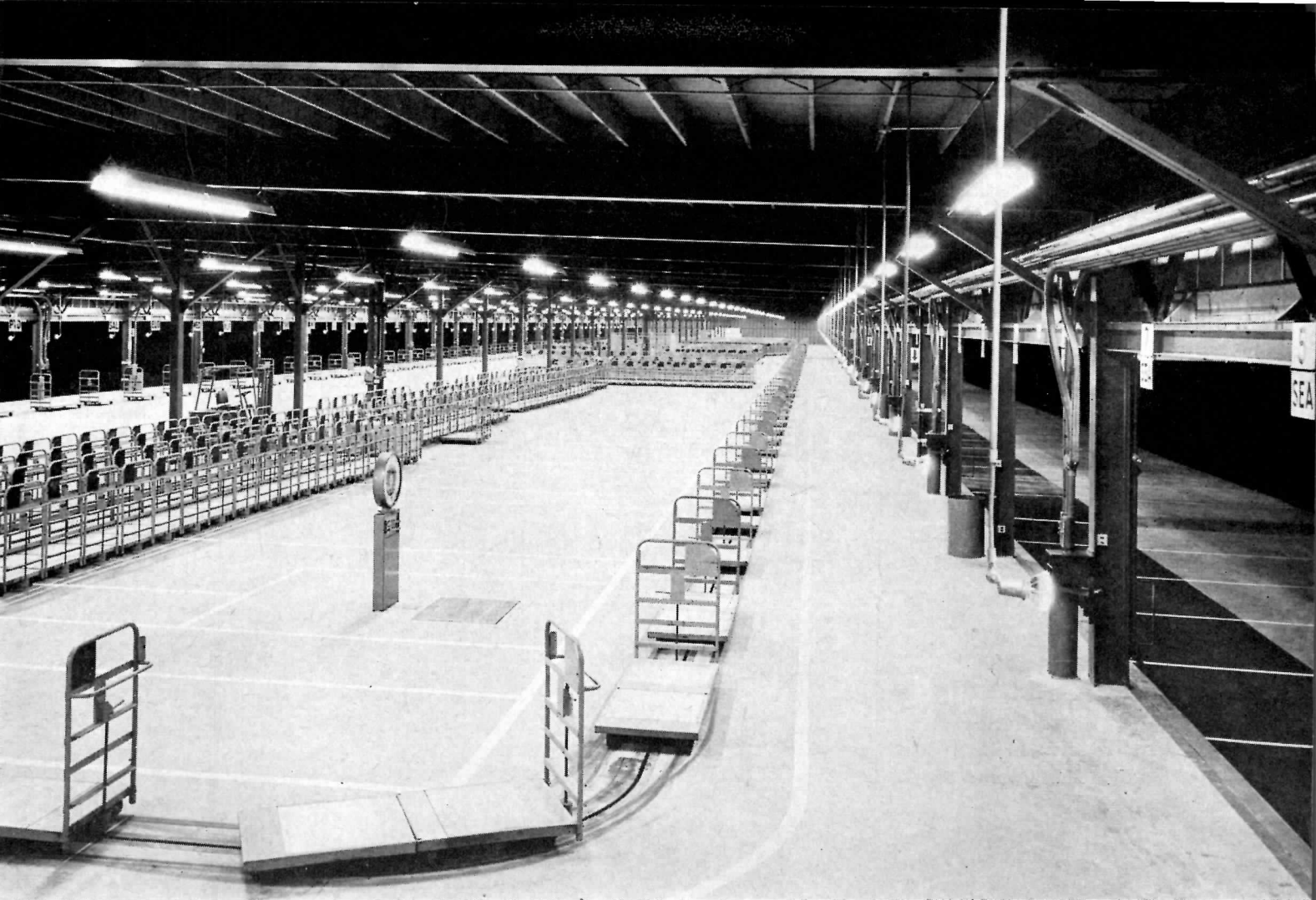

Cal—Pictures

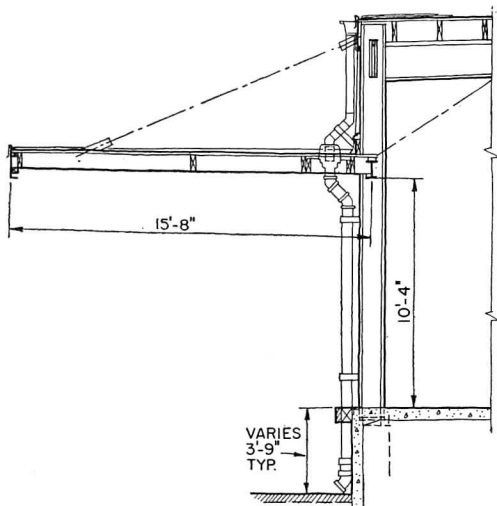

TYPICAL WALL SECTION



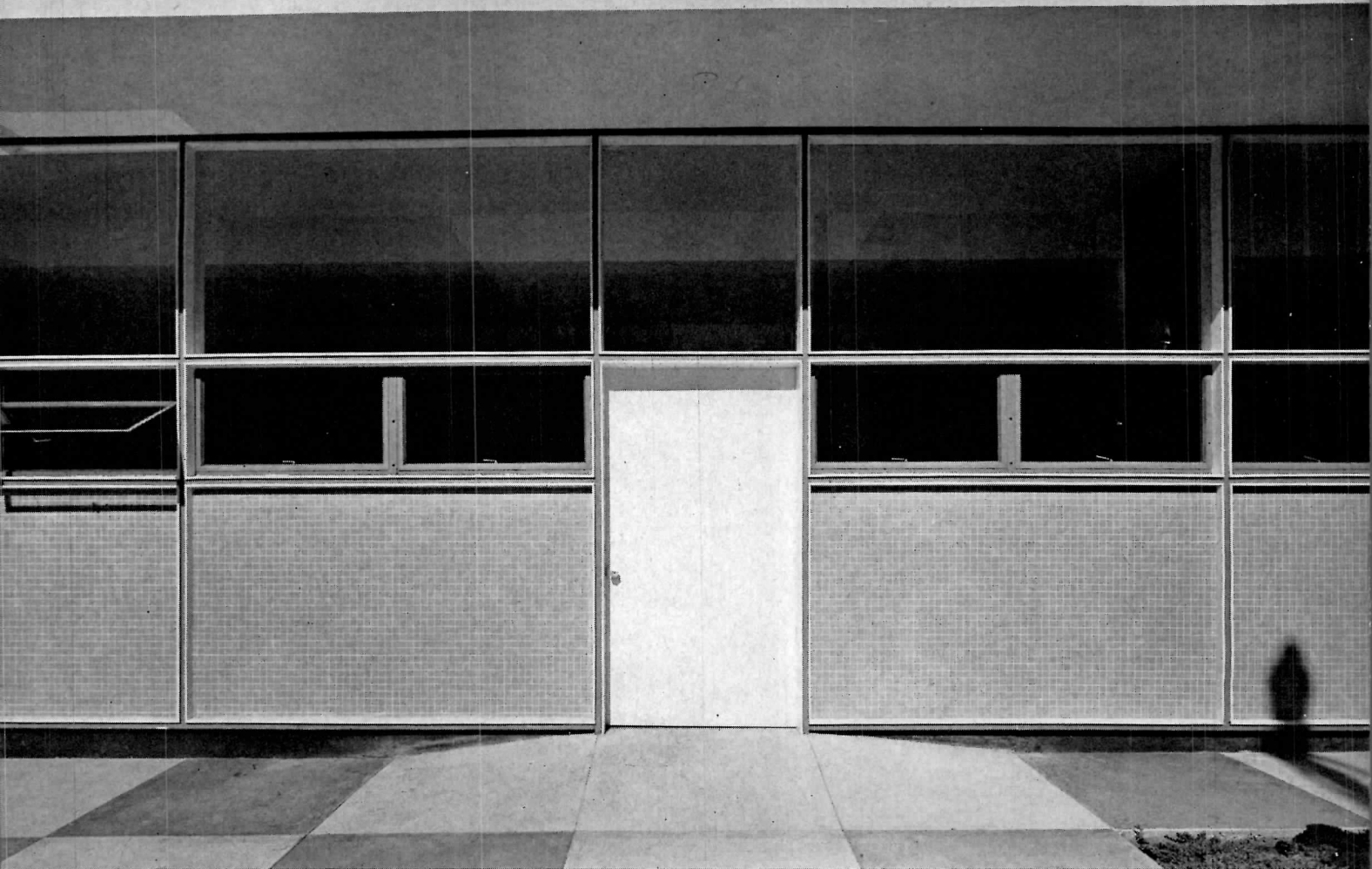

## BABY FORMULA FACTORY

*Baby Formula Company*

*San Francisco, California*

*Falk & Booth, Architects and Engineers*

A DYNAMIC ECONOMY, they tell us, is always developing new products; then sooner or later new buildings are needed for their manufacture. It must be so; this little building is convincing testimony. Started ten years ago with two part-time workers, this baby formula business now has its own building, complete with battery of sterilizers, conveyor system, running full blast 24 hours a day. What it means in architectural requirements: walls that could be steam cleaned, sterilized; a plant that need never be closed down for "repainting"; attractive clean appearance. This building is of load-bearing concrete block exterior walls, spanned by steel beams, non-load-bearing partitions. Wood ceiling joists and hung ceilings. Front is of unglazed ceramic tile panels set in wood frame, glare-reducing glass.



Roger Sturtevant

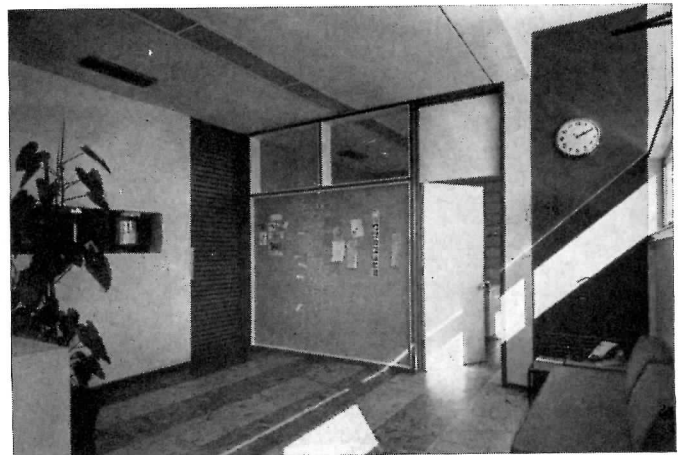
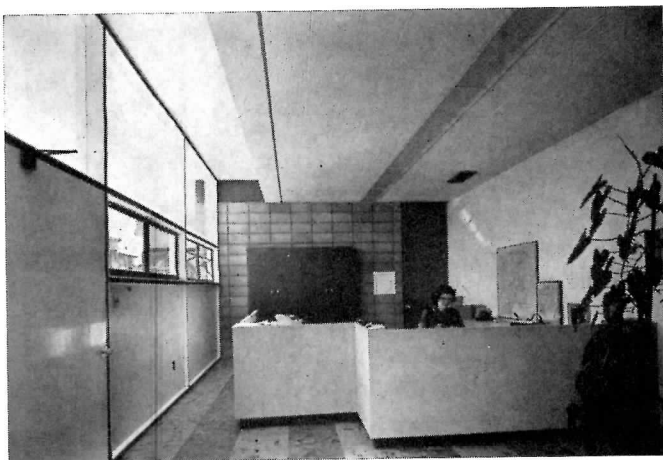



## EMPLOYEES COME FIRST

*Factory and Offices for Oregon Saw Chain Company  
Portland, Oregon*

*Van Evera Bailey, Architect*

*Robert E. Kremers, Structural Engineer; J. Donald Kroeker & Associates, Mechanical Engineers; Fritz Klawa, Electrical Engineer; Chandler Fairbank, Landscape Architect*

THIS FACTORY FOR SAW CHAINS follows progressive thought in many respects. Perhaps most notable is the evident consideration for workers. The two pictures above show the employees' entrance, not the visitors' entrance, and the employees' lobby, the stairs leading to the cafeteria. For another thing, it follows the idea of locating the plant out in generally residential surroundings, with pleasant outlook and freedom from traffic congestion. The architect comments that he worked especially to achieve the lowest insurance rate, and managed that not-easy feat. Lowest rate was important in a factory doing much heat treatment. Observers comment that this is one tilt-up wall job that looks like an architect designed it; both wall panels and columns are precast concrete, set in place with cranes. Otherwise the building is of mill construction, with Bailey's special laminated roof construction.

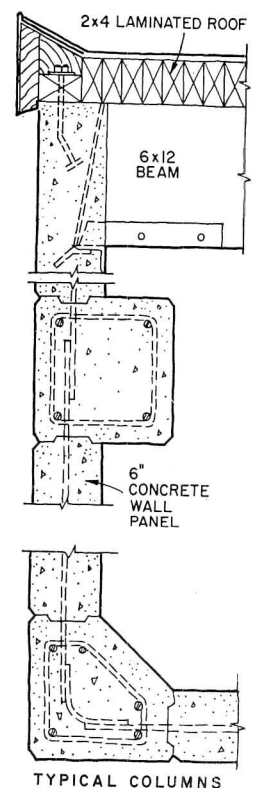
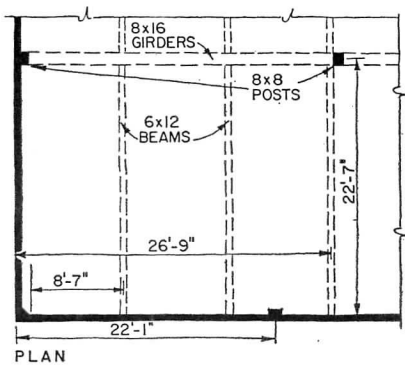



Photo-Art Commercial Studios





## CONVERTIBLE DESIGN

*Research Laboratories for Ramo-Wooldridge Corporation*

*Los Angeles, California*

*Eugene Kinn Choy, Architect*

*Eugene D. Birnbaum, Structural Engineer; Frank Lehnnan Smith, Civil Engineer; Ernest R. Dexter, Mechanical Engineer; Parr and Jones, Electrical Engineers; A. J. F. Clement, Technical Adviser; Eckbo, Royston and Williams, Landscape Architects*

A RESEARCH-ORIENTED ELECTRONICS development concern, this company has grown with phenomenal speed; in fact it has grown so fast it has scared itself. This record affected the planning of its laboratory complex. The project started at one end of what is now a row of four buildings, with the conversion of an existing warehouse for office and laboratory use. Soon the company acquired adjoining acreage and three new buildings were started. These were to follow generally warehouse construction, so that they might be sold for other purposes should the fears be justified. The buildings have the height (14 ft in the clear), the construction (concrete panel tilt-up), and the more elaborate fronts of small factory buildings, though they are used only for electrical design cubicles and shop work in connection with the research.





*Julius Shulman*

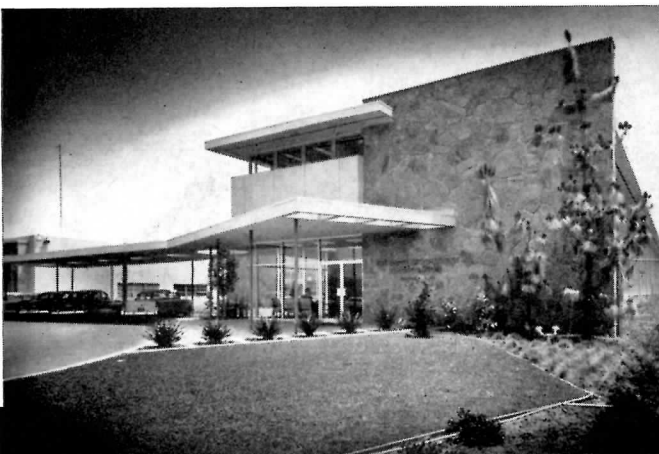

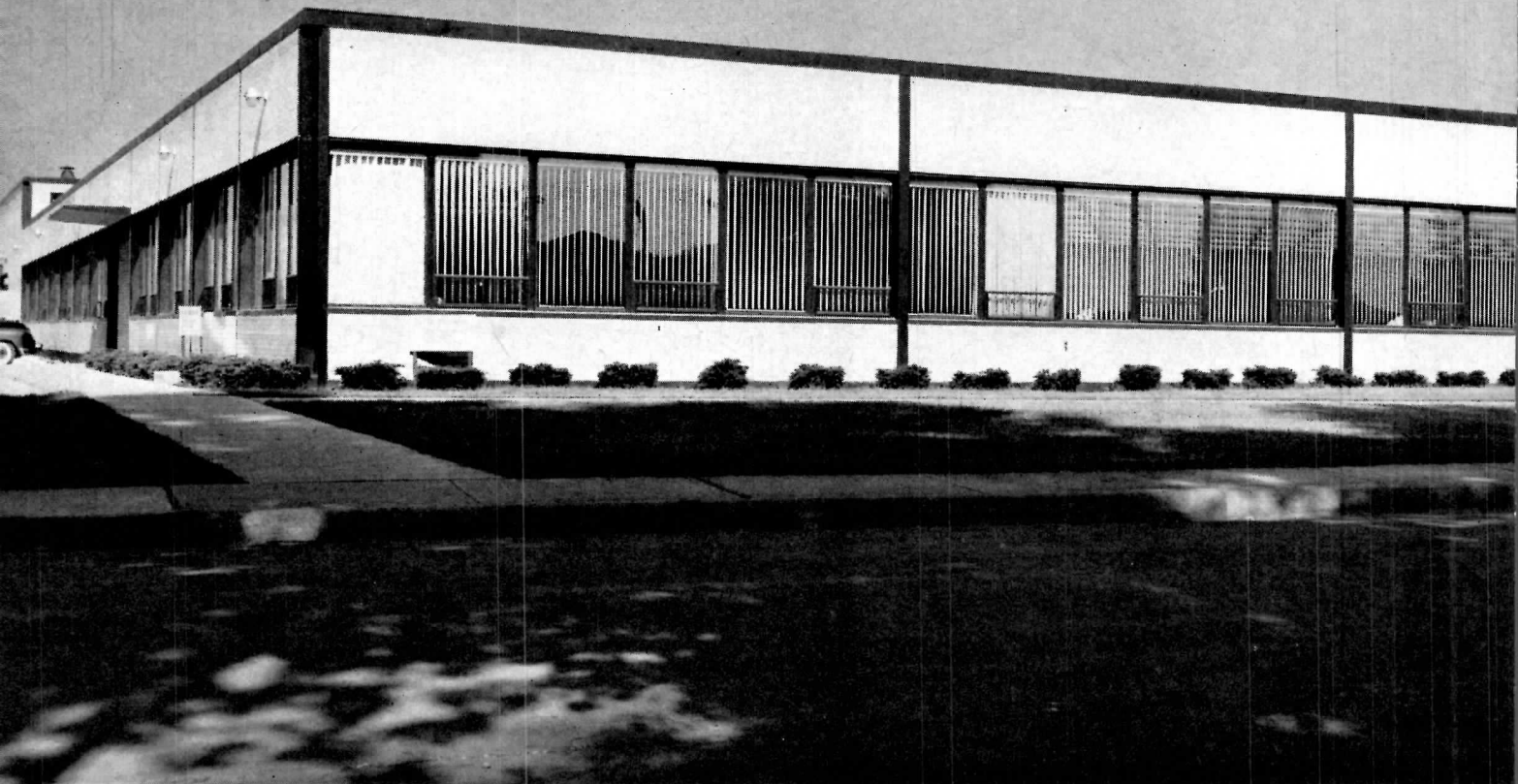

## PLANT FOR ELECTRONICS

*Shure Brothers, Inc.*

*Evanston, Illinois*

*A. Epstein and Sons, Architects and Engineers*

**P**RESUMABLY THIS CLEAN little manufacturing and office building could have been built for any of the light industries, but it seems peculiarly fitting that it is actually for a manufacturer of electronic components. Elements of the building are small and their use is clear and precise. It seems a fitting expression for a precise and definitely modern industry. The building is enclosed with brick walls, using face brick on three sides. Clear height is approximately 12 ft to the under side of the steel framing. Column spacing is 25 by 40 ft. The floor is 6-in. reinforced concrete, with hard steel troweled surface treated with liquid hardener. Windows are of projected steel sash, glazed with clear and obscure glass. Interior partitions are of concrete block, painted in finished areas.



Hube Henry, Hedrich-Blessing





Julius Shulman

## LOW COST WAREHOUSE

*West Coast Headquarters Building, American Greetings Corporation  
Los Angeles, California  
Kenneth N. Lind, Architect*

A FAIRLY TYPICAL NEED, especially on the West Coast, is buildings to warehouse products for area distribution. The warehouse portion must be built at absolutely minimal cost since handling costs are always under close scrutiny; especially for a low-unit-cost product like greeting cards; yet part of the building must have enough impressive quality to serve as area offices. Low cost was achieved here with concrete tilt-up construction. The interior of the building is exposed concrete; office areas are gray with oyster white, pale ice green and a darker gray green. The exterior is white and gray with accents of yellow at the facias of the office portion.

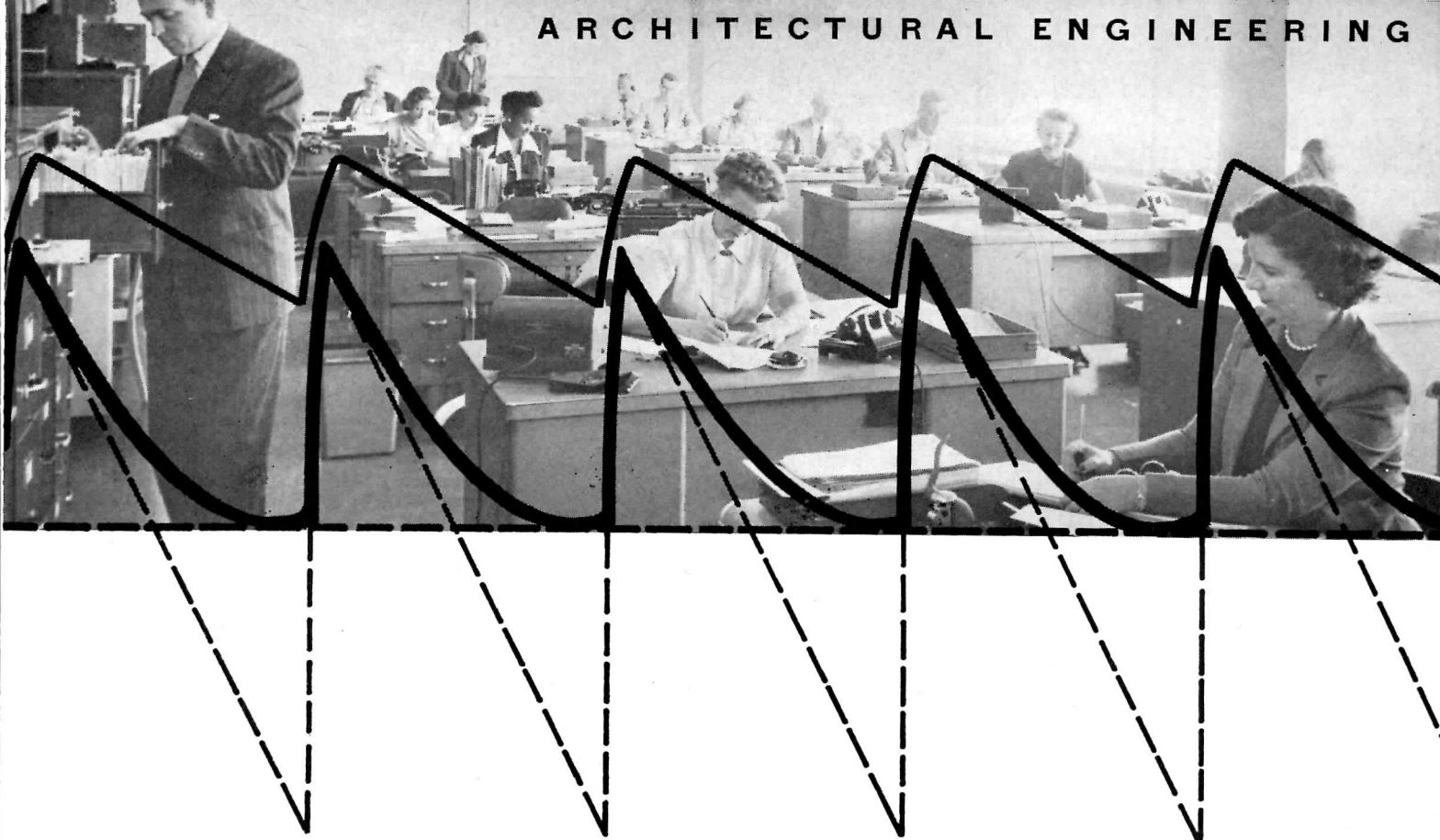

## A GUIDE TO OFFICE ACOUSTICS

HOWARD C. HARDY

Consultant in Acoustics, Chicago, Illinois

WE ALREADY HAVE PASSED through two eras representing different approaches to the acoustic treatment of offices. Two generations ago, in the "Paleozoic" (very primitive) era, nothing at all was done about it. Of course, there were then probably fewer sources of noise, possibly less crowding, and perhaps more leisure in what was almost a completely masculine environment. In contrast to the ornate inner sancti of some of the banking and industrial tycoons, there was little comfort in the average worker's environment.

In the late twenties and early thirties ("Mesozoic" or let's-try-a-few-things era) the use of acoustical tile on the ceiling was found to give very beneficial results, and within a decade its use had become almost universal. The biggest impetus to the use of acoustical tile was the standardization of the square foot modular unit which was found to be the

most convenient size that could be stuck up on an uneven plaster ceiling and present a satisfactorily level appearance.

The acoustic material industry has done a splendid job in engineering its products. Such developments as consistent absorptive properties, industry-wide consistency of measurements, fine workmanship in application, strong adherence, good light reflectance, low maintenance cost, and good flame resistance have been satisfactorily accomplished. Often the products have been considered a cure-all for *all* acoustic problems. Too often today we hear the complaint of the office manager, "I do not know why we should have a problem, we've got an acoustical ceiling."

We are now entering what might be called the modern era — a period of prodigious office construction and re-vamping of old offices. Drastic changes

are being made in office architecture and the methods of office operation, for example:

- A great increase in the spaces provided with air conditioning.
- Use of more heavy office machines and computing equipment.
- The elimination, to a great extent, of partition walls.
- Choice of new decorative and lighting schemes.

In connection with these trends seldom has much thought been given to what the results *will sound like*, although everyone of the changes mentioned has serious acoustical ramifications. In fact, there have been quite a few mistakes or omissions in acoustical design.

Not all of the changes have been in the wrong direction. Use of air conditioning closes the windows to outside noise; drapes and horticulture may

## A GUIDE TO OFFICE ACOUSTICS

make a more pleasant acoustical as well as visual environment. We are introducing so many new noise problems, however, that it behooves us to open our designers' ears to the new changes before they become too difficult to remedy. Another point, and a sore one among some of the new schools of architecture and design, has been the restriction on ceiling surfaces caused by the conventional square foot modular design of most acoustical treatments.

### What Makes an Environment Sound Right?

The human ear will always be the court of last resort in judging the ultimate acoustical acceptance of a particular environment. The criterion of whether an office "sounds right" depends on many factors, but four are most important:

1. The sound should appear "natural." Man's ears were developed biologically to operate outdoors. Living indoors is a rather new thing in our evolutionary chain of development. The outdoor sounds usually are of low level and the direction from which they come is easily discerned. These characteristics are usually preserved in home and

school, but the situation deteriorates as the individual is exposed to poor sound environment of offices and factories.

2. A person should be able to hear telephone conversations easily and to converse with persons in the immediate vicinity.

3. He should not be annoyed by conversation of others at a distance.

4. There should be no unusual or distracting sounds, especially if it appears they are unnecessary or controllable.

It should be obvious that acoustical design can never be reduced to single numbers any more than architectural design or personnel management can, but there are a few good rules in this branch of human engineering which have evolved from experience.

### How Much Noise is Acceptable?

In order to draw a rating scheme for office noise, it is necessary to use a subjective scale rather than a physical one. For that reason, measurements of decibels on a sound level meter are of very little significance. Personnel will accept many more decibels at low frequencies (hums, thuds, etc.) than at high frequencies (hisses, screeches, etc.)



Telephone conversation should be easy

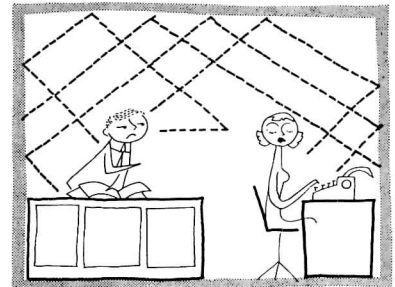

Sound should appear "natural"  
(Too many reflections jumble sound)

### LOUDNESS OF VARIOUS HUMAN ENVIRONMENTS

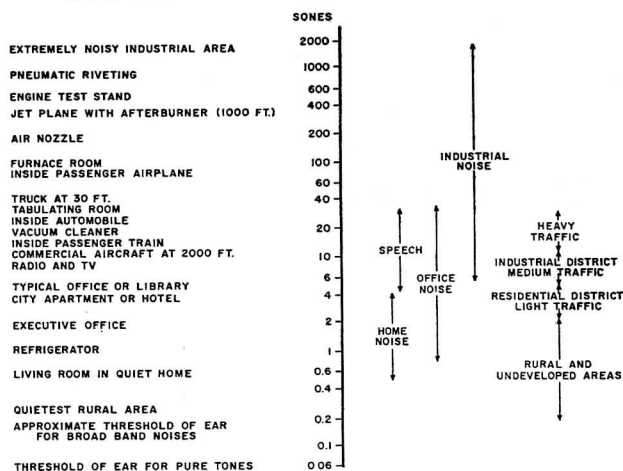

The acoustical engineer first measures the noise in frequency bands an octave wide (an octave is a frequency range of two to one) and then computes the loudness from these data. The unit of loudness is a sone, which is approximately the sound of an average refrigerator in a kitchen. The loudness of various human environments in sones is given in the chart opposite. Offices range between 0.5 and 40 sones.

In the chart the subjective rating of offices is correlated with the number of sones. Below one sone is very quiet. Around 10 sones would be considered rather noisy, and above 50 sones would probably be considered intolerable for an office. Some noisy office machines today give sounds as high as 40 sones.

When the level rises above 30 sones, it is practically impossible to carry on conversation except by shouting in the ear. Conversation over the phone or with a person nearby is difficult if the noise is above 10 sones. When the loudness is only two sones, conversation is very easy and relaxed.

From practical experience and good office usage, it is recommended that executive offices not exceed two sones and general offices eight sones. A practical maximum for areas where there are heavy office machines — such as tabulators, card punches, and computing

### LOUDNESS RATINGS FOR OFFICE SPACE

TOTAL LOUDNESS (SONES)	CONDITIONS FOR CONVERSATION	RECOMMENDED USE
EXTREMELY NOISY	50	
VERY NOISY	25	PRACTICALLY IMPOSSIBLE
NOISY	10	DIFFICULT
SLIGHTLY NOISY	5	
QUIET	2	EASY
VERY QUIET	1	

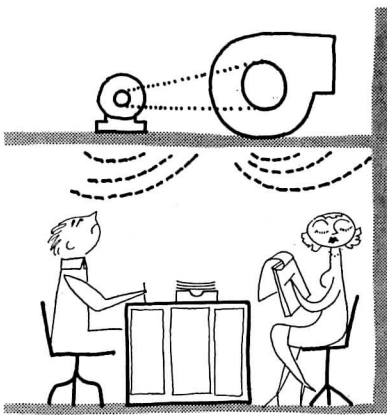

*There should be no unusual or distracting sounds*



*Distant conversation should not be disturbing*

equipment — would be about 20 sones.

It should be remarked that noise, when it is *steady* and not too high in level can be beneficial rather than harmful. A person will become so used to a steady low frequency background noise, such as outside traffic, an office fan, or ventilation noise, that he will no longer be conscious of it. This noise will tend to mask out the transient sounds such as typewriters and telephone conversations and conferences being held some distance away. For this reason, people will often complain more about the office noise when the fans are off than when they are on. If, however, the background noise becomes so high that telephone conversation and small conferences are difficult to conduct, then noise complaints will be registered again.

This narrow margin between the beneficial and nuisance levels of background noise, especially in the large open offices, is the reason why there is such a wide range of human reaction to spaces which at first observation appear to be very much the same. Efficiency of acoustical material can make a real difference which will be discussed below.

The architect should beware of the "too quiet" executive office if he wants to avoid trouble. A typical example is that of an executive who

announced he wanted extreme quiet in his new office suite. As a result, the contractor spared no expense — put in rugs, drapes, fine acoustical ceiling, thirty feet of acoustical lining on all branches of the air conditioning ducts, and double windows to remove traffic noise. He finally obtained an extremely low background with a loudness of 0.2 sone, which was even quieter than remote rural areas.

Unfortunately, with this low background, conversation at a very low, but clearly understandable level could be heard through the office doors, and the privacy of the inner sanctum was not secured. Minute rumbles from walking and other activity overhead could be heard.

The cure in this case was to use a slightly heavier door, and, without letting the executive be aware of it, to remove the acoustical duct lining so that a small amount of noise was brought into the room.

#### Things to Look Out For

Below is a check list for the architect which, if not exhaustive, still should be helpful as a reminder. Nearly everyone can add other items from his own experience. Remember, however, that the importance of the items will depend on the circumstances:

- a. Noise from mechanical equipment:
  1. Heating and air conditioning
  2. Plumbing
  3. Floor excitation from above
  4. Elevators and escalators
  5. Pneumatic tubes
- b. Outdoor noise and vibration
- c. Improper architectural arrangements
- d. Unusual focusing of sound
- e. Sound transmission through doors.

Air conditioning noise makes up a good share of the complaints in office buildings recently completed. Cooling towers are often placed directly over the top executive's office. The mechanical equipment is often located too close to other areas in which quiet is desired. Noise is transmitted down the ducts. The good acoustic design of such a system has a negative parallel to the design of the air distribution. With a certain amount of noise power available from the system, the amount distributed to each branch point should be computed and abatement measures taken, if necessary. In addition, regeneration of noise may occur at the regulators, grilles, and air diffusers.

Plumbing and heating noise control consists principally of proper isolation

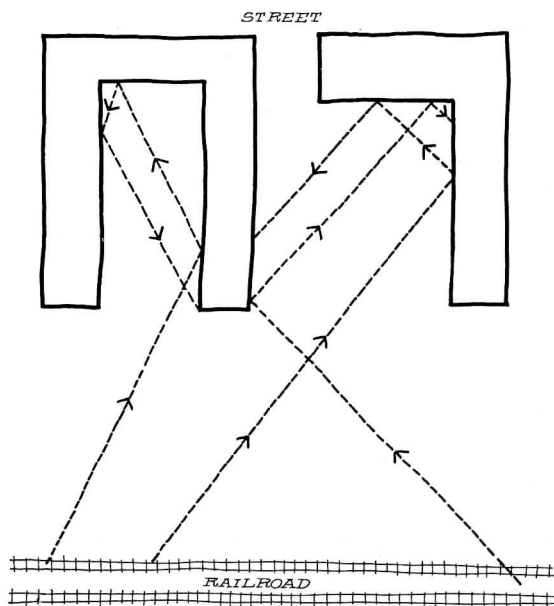

*Fig. 1. An L- or U-shaped building may cause unforeseen focusing of sound around parts of the building*

of the pipe-conducted vibration from the building structure itself. In a few cases, proper attention must be given to isolating the furnace from surrounding areas.

Floor and wall excitation from elevators, escalators, pneumatic tubes, etc. can be often avoided by having a structure sufficiently stiff and free of large spans. The structure carrying an excitation type of loading should be as near as possible to supporting columns.

This is somewhat true of overhead noises. Where heavy mechanical equipment is anticipated, sufficient stiffness and mass should be provided in the supporting structure. Avoid application of forces to the center of large spans. Also vibration isolating material will be ineffective if the floor is easily put into vibration.

A few of the improper architectural arrangements are the following:

1. Open windows near large outside sources such as trains or truck routes.
2. U- or L-section plans which may focus outside noises towards particular parts of the building. See Fig. 1.
3. Thin roofs where there is intense air traffic noise.

4. Internal arrangement of office doors so that there is ready transmission of noise from one office to another either directly or by easy reflection. See Figs. 2 and 3.
5. Arrangement of corridors so that heavy personnel traffic exists at undesired places.
6. Putting a multiple switchboard in an open area causing disturbance both for the operator and the poor harassed office neighbor.

The designer also should be aware that there can be trouble due to unusual focusing problems. One such case occurred in a brand new office: the personnel manager had a northeast corner office, the receptionist the southwest corner. The personnel manager maintained an open door policy and did not like to shut the door during conferences. Conversation in his office could not be heard outside, but unfortunately it was directed into the opposite corner which acted like a parabolic reflector focusing the information to the receptionist who happened to have her ears at the right spot. Naturally, there was quite a leak of information of personal importance. The solution: put a heavy drape on the wall behind the personnel manager's chair.

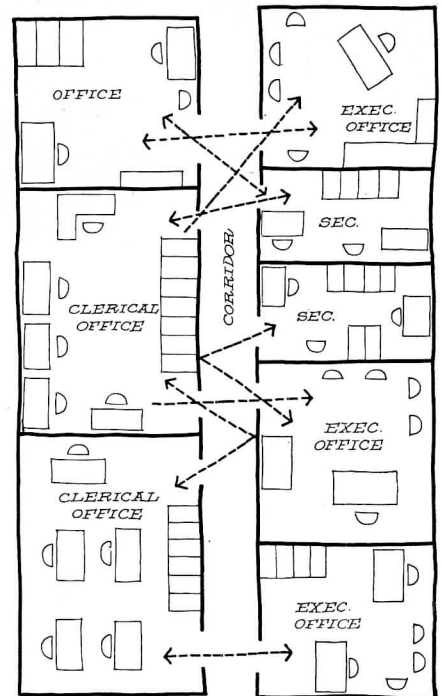

Fig. 2. A faulty arrangement of offices along a corridor. The presence of many doors at one point makes noise transmission likely, and it also causes traffic concentration in these areas

To be avoided are cylindrically concave walls which, unless precautions are taken, cause even more focusing than corners, resulting sometimes in very peculiar acoustic effects.

One of the largest sources of complaints is the sound transmission through doors. The architect should ask himself whether the door is to be an acoustical as well as a visual barrier. If so, lightweight wood doors, accordion doors and air circulation vents in the door should not be avoided. There are ways of obtaining acoustical privacy without doors — using short corridors for isolation — but these must be designed with complete knowledge of the outside environment and the intended use.

**What an Acoustical Ceiling Does**

It might be a good idea at this point to recognize what an acoustical treatment on the ceiling accomplishes. In most cases it is the chief absorber of sound in the room, other absorption being contributed to a minor extent by the walls and furniture, and to a greater extent by rugs and drapes, if they are present.

Take the example of a 12- by 20-ft office in which there are on the average two or three persons. Without an acoustic ceiling, the absorption would be of the order of 100 sabins (one square foot

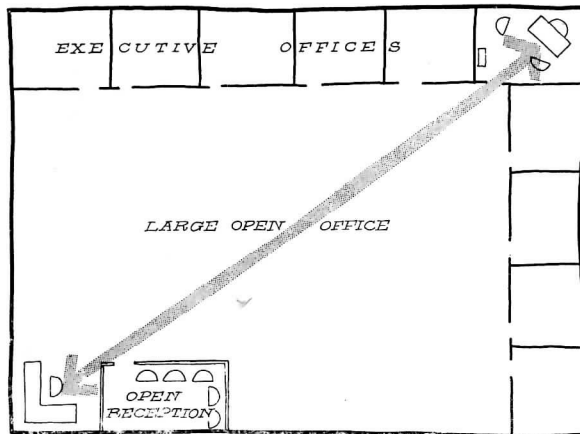

Fig. 4. Example of focusing of conversational sound from an office across an open space to a reception area



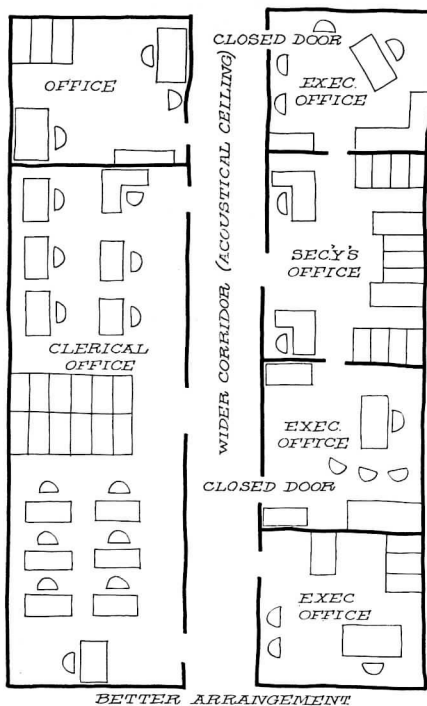

Fig. 3. The wider corridor covered with an acoustical ceiling isolates the office entrances. Two partitions have been eliminated. Executive offices are better isolated from the outside

of 100 per cent absorption equals one sabin.) With an acoustical ceiling, the absorption might be increased to 270 sabins. This would reduce a steady noise by 4.3 db. If rugs and drapes were used in addition, the total absorption might be 400 sabins, and the total steady noise reduction would be 6.0 db.

However, this does not adequately describe the effect because most acoustic disturbances in offices — telephone conversations, typewriters, etc. — are not steady sounds. Both speech and typewriter sounds consist of impulses with a rate of repetition of about 5 pulses per second. These impulses are bouncing around the room striking about 50 room surfaces per second; that is, in the order of ten reflections between impulses exist in the size of room given above. The absorbing material has therefore a good chance to reduce the sound between impacts. See Fig. 5.

For the example given, the sound would decay about 10 db between impacts without an acoustic lining; about 27 db with acoustic lining and about 40 db with the addition of rugs and drapes. Of course, the steady state noise might be only 15–20 db below the noise of the typewriter and the chief advantage of the material is that it causes the sound to decay more rapidly with fewer reflections.

From a subjective point of view, because of the gaps between the noise impulses, the acoustical material may have a subjective effect of 10–15 db, instead of the 4 to 6 db it has for steady noises. The lesson to be learned here is that acoustical materials are more effective on impulse sounds than on steady noises.

The discussion given above applies also generally to large open offices except that in addition there is an attenuation of the sound as it propagates through the office. This attenuation is not as great as would occur if there were full partitions, but it can be adequate in a large number of cases, if well designed. The two most important parameters are height of ceiling and the acoustical absorption coefficient. The higher the ceiling and the higher the percentage of absorption, the greater the drop with distance. Fig. 6 illustrates the drop with distance in a large office room of the sound from a single steady noise source.

The drop off with distance can be increased considerably for the higher frequency sounds, such as speech and typewriters, if partial partitions are used. The reason is that the sound normally reflected from the floor and from the desk and other office equipment and spread through the room is now ul-

timately reflected upward and has more chance of being absorbed in the ceiling treatment. The effectiveness of the treatment will depend on the partition height and approaches the effect of a full partition at about 0.8 the ceiling height.

Even a 5-ft partition has an advantage over no partition, if the noise sources are from conversation of seated persons and other sources at table height, such as typewriters. The drop off with distance of the sound in offices with 5-ft partitions is given in Fig. 6. In some cases it can exceed the drop with distance measured outdoors. Again the upper boundary is for low ceiling and low absorption. The lower boundary is for high ceilings and high absorption.

Sometimes the partial enclosure can be placed around the noisy machine rather than around the listener. In the worst cases complete enclosure is the only remedy. The advice of the machine manufacturer or an acoustic consultant should be sought in these cases.

The most important frequencies for absorption in offices are those concerned with speech and those which are chiefly radiated by office machines. These are the frequencies above 250 cps. Most commercial acoustical materials are designed to cover this. However, if acoustical absorption is also provided at low frequencies, the room will sound less

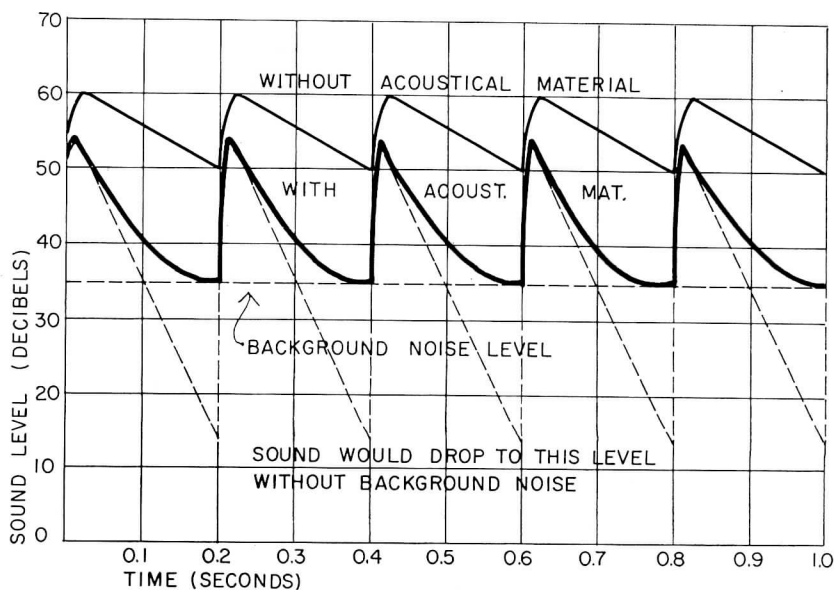

Fig. 5. A good acoustical ceiling reduces noise by causing sound to decay between impacts. Through the "picket fence" sounds can be heard more easily

boomy and a little more comfortable. Generally, suspended treatments have much higher low frequency absorption than those treatments which are adhesively bonded. This is because the air space behind the facing allows the long wave length sound (250 cps has a 4.6 ft wave length) to penetrate into the material.

**Future Trends**

An attempt to get away from the appearance of the conventional acoustical ceiling has been to use plastic translucent surfaces. Although these allow the low frequencies to pass through and be absorbed, they are good reflectors to high frequencies, which is the wrong direction for good acoustic performance. One way of providing sound absorption is through the use of acoustical baffles.

In an office the ceiling is the largest single surface the designer has to work with. Observation of men and women at work indicates that few of them ever look at the ceiling. However, its appearance cannot clash with the other elements of the design and it must supply other functions, one of the most impor-

tant of which is lighting.

One of the trends in ceiling acoustics which can be predicted, therefore, is toward more choices of treatment. Undoubtedly, many designers will make more use of suspended treatments since they provide means of hiding plumbing and air conditioning. The white monolithic appearance of certain treatments such as acoustical plaster and some of the newer mineral tiles appeals to some designers. Combination of function of lighting, heating, and ventilation with acoustic absorption has been done and very probably more new ideas will arise.

One of the most important trends is in the field of air conditioning systems using high velocity air. The saving in space makes these systems very attractive, but they are a potential source of noise. Not only is there high noise at the source, but it is generated down the line due to the turbulence in the ducts, in the turns, or near the outlets. Not only will these problems have to be solved by the air conditioning manufacturer, but they will require more diligence by the architect in planning for them in future building construction.

The advent of the computing machine in accounting, data processing, and customer contacts (subscription service, billing, mail order), may change our office layouts drastically. So far it is doubtful if the architect has met the challenge of designing a building which will best fit the new office technology. When this happens, an important part of the design should be how such a place will sound.

Finally, there is one other trend which it appears will change our approach to office design. This involves fitting the office to the operation and not the operation to the shape of the building. In a few office designs, this has been done and has been very helpful in improving office traffic. Efficiency in office traffic may improve or increase noise depending on the location of the noise sources. It is, therefore, important not to lose in office efficiency by an improper noise environment what is gained by more convenient layout.

The chief problem in the future, however, will be to take all those desired environmental properties of sound, lighting, air conditioning, fire control, office traffic, and make them consistent with good performance and good appearance. We all will be busy.

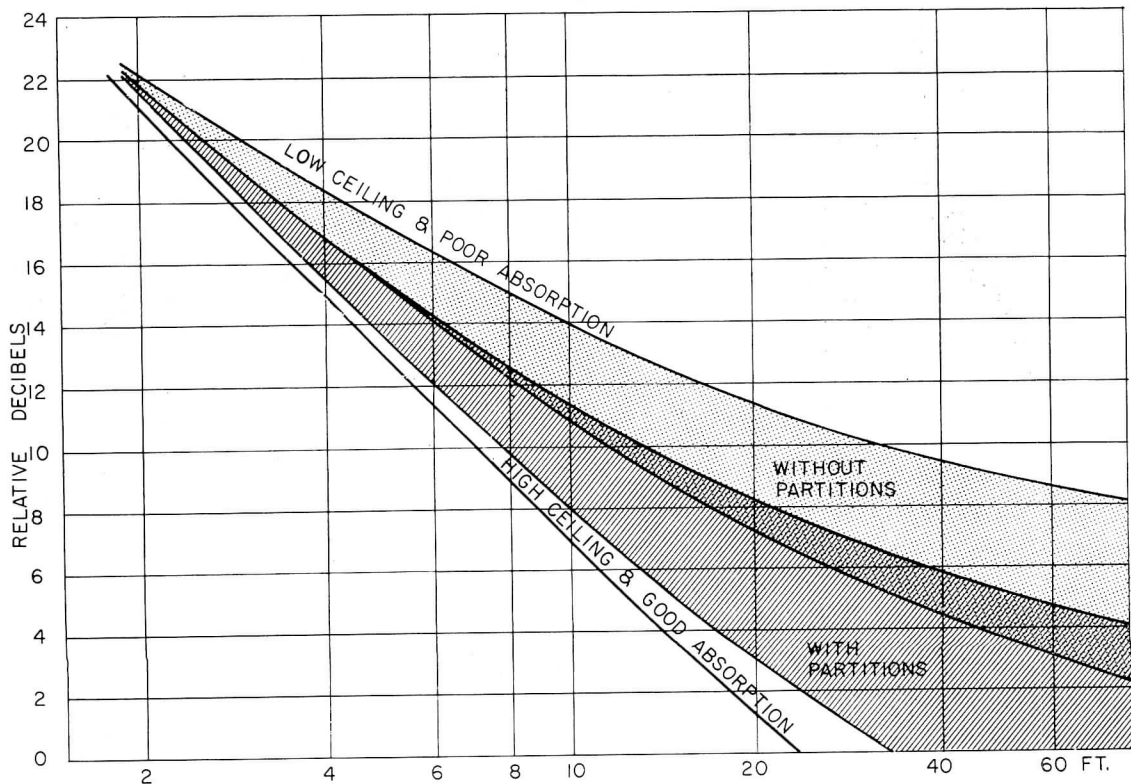
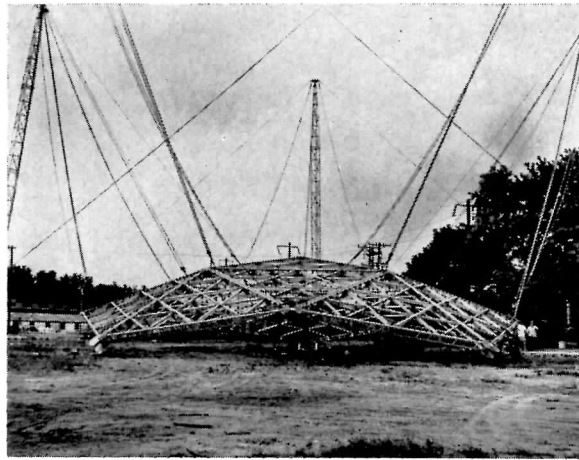
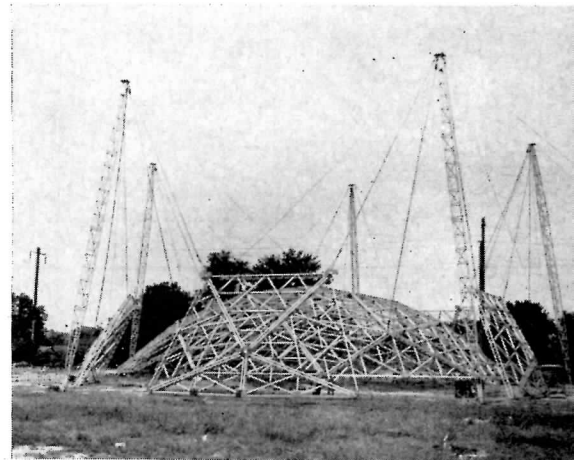

Fig. 6. How sound drops with distance in a large open office with different acoustical treatments. The upper shaded area is without office partitions; the lower shaded area is with 5-ft partitions



*The top ring of five triangles and the second ring are lifted 3 ft off the ground with ginpoles to permit addition of next ring*



*Final lift will sit the top assemblies on the ground assemblies, shown ready for moving under the sections when they are lifted*

## LARGEST BUCKY FULLER DOME

### PERMITS SPEEDY ERECTION OF PORTABLE AIRCRAFT HANGAR

ANOTHER BUCKY FULLER DOME has been created — this one the largest ever, 117 ft wide at the base. With a basic structure of non-corrosive aluminum alloy and a skin of fiberglass-reinforced plastic, the huge clear-span dome was erected by the Washington Aluminum Company in Baltimore for the U. S. Marine Corps as a portable aircraft hangar and/or repair shop.

The major advantages claimed for the dome are its portability, short erection time, strength and minimum maintenance. The completed dome weighs less than 52,000 lb and can be broken down into packages of no more than 100 lb each for shipping. Erection time is two and a half days with thirty men working.

The dome is designed to withstand winds of 150 mph and a 20 psf overload plus the weight of a jet fighter suspended from the dome shell itself at a number of points.

Key to the speedy erection of the dome is a system of color and number codes which serve to identify the elements of the nine basic triangle types which make up the dome. Struts and

clips are keyed by numbers to trusses; and trusses, struts and clips are keyed by color to the triangle to which they belong. The hubplates which join the major triangles are colored in segments to indicate the sequence of assembly of the triangles. With this key the dome can be erected without reference to a blueprint of any sort.

The dome is actually raised by means of five aluminum ginpoles in three separate lifts. The first five "black" triangles are assembled on the ground and lifted first. The next two rings of triangles are attached to the hubplates as specified and lifted second. The third lift raises three rings of triangles high enough off the ground to sit on top of the ground ring assemblies, including the aircraft doors. The complete dome of 80 triangles is never lifted at one time, although the load is within the safety limits of the ginpoles.

The plastic panels, which are attached to the struts with anchor nuts, are formed like shallow pyramids, weigh about 13 lb each and measure 4 ft per leg. The number used to cover the entire 46-ft-high dome is 1112.

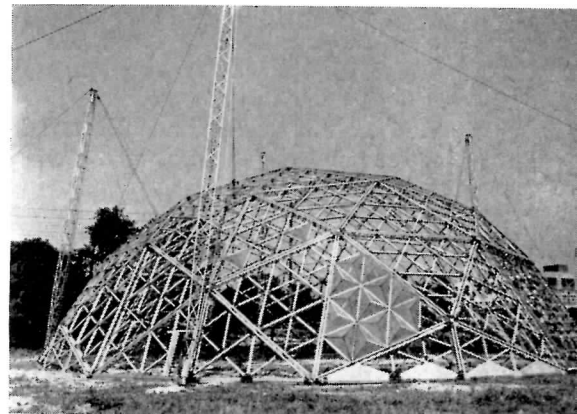

*Some of the pyramid-shaped plastic panels are shown in place*

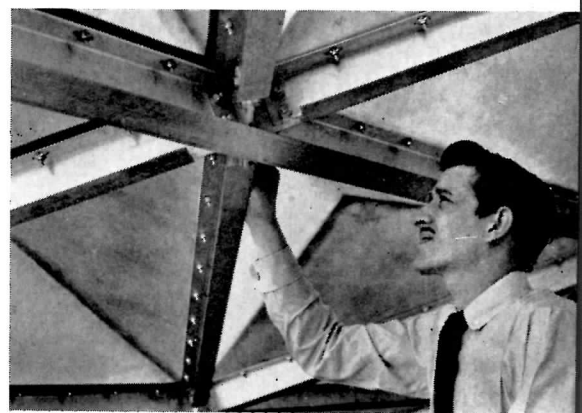

*Plastic pans are attached to struts with anchor nuts. Connections between struts are by means of nuts and bolts*

## MODEL TESTS PREDICT NATURAL VENTILATION

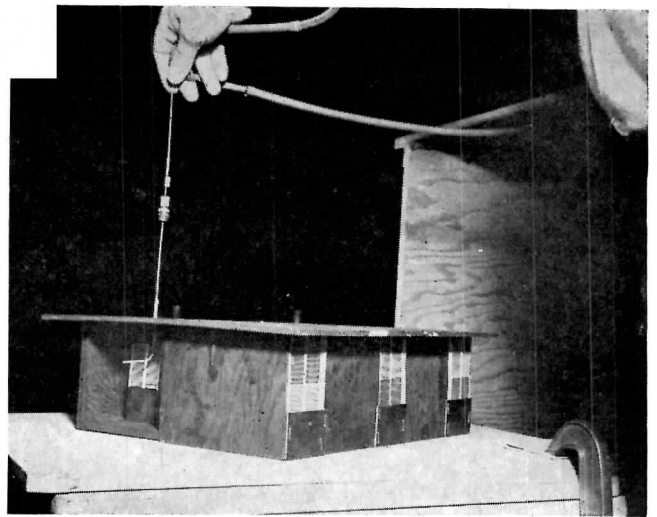

RECENT EXPERIMENTS in natural ventilation at the Columbia University School of Architecture have produced a method which gives a fairly close approximation to the wind velocities in and around a structure. Although previous investigations have shown that smoke passing over a model in an air chamber will give a valid approximation of the air flow pattern to be expected in a structure, there has been no reliable means of determining wind velocities about the building to supplement this visual representation. By making some modifications in the conventional procedure, graduate student Dan Branch was able to gather quantitative data on air pressures within a test model which permit accurate correlation with the average velocity of prevailing breezes at a proposed site. The tests were run in a wind tunnel at slightly higher air speeds than are usual for the air flow chamber tests, and gauges were used to measure air pressures in inches of water. It was found that measurements of the wind pressure

at various points of a model and the free stream velocity pressure in the wind tunnel could be used to predict the actual velocity at corresponding points on a proposed structure by applying the general relationship:

$$V_i = V_p \sqrt{\Delta p_n / \Delta p_w}$$

where  $V_i$  is the velocity at any point on the actual structure,  $\Delta p_n$  is the pressure at the same point on the model,  $\Delta p_w$  is the free wind velocity pressure in the tunnel, and  $V_p$  is the prevailing wind velocity at the site. A curve plotted for the appropriate value of  $V_p$  will yield the corresponding values of  $V_i$  for any combination of measured test pressures, enabling the designer to quickly determine the quantitative effects of variations in design and orientation on wind behavior, and to use this information in conjunction with a visual study of the air flow patterns for a reliable forecast of the efficiency of a proposed building in utilizing available breezes.

Pressure gauges inserted in a model during wind tunnel tests as above yield measurements which can be used to predetermine actual air velocities in the completed structure. Comparative air pressures as measured at various points on a typical floor plan are shown below.

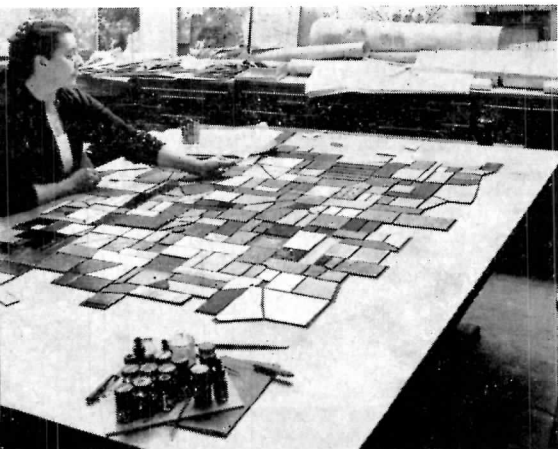
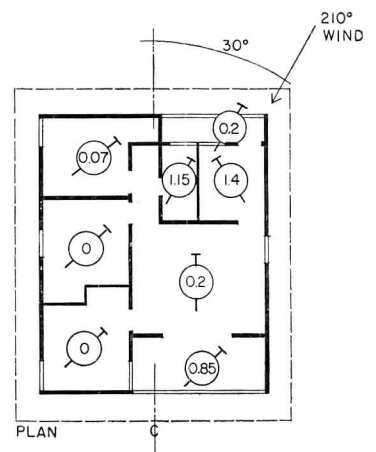

Forecast designer Ilonka Karasz envisions aluminum foil as an entirely new decorative material. Best-known for her *New Yorker* covers, she is also a leader in the field of wallpaper and fabric design.

## RESEARCH PROGRAM "FORECASTS" FUTURE

In a unique research program aptly dubbed "*Forecast*," the Aluminum Company of America has commissioned well-known designers to create their impressions of tomorrow's home under the directive, "Think in Aluminum." The program, which was centered in the home and family to avoid the limitations of a strict industrial approach, includes projects designed to uncover new uses of aluminum in home planning and building, household furnishings, textiles and even children's toys.

Although the participating artists have not been limited to problems of immediate production, it is hoped that

their work will lend impetus to original design in aluminum, thus helping to pave the way for future product development.

In one of the earliest *Forecast* projects Ilonka Karasz, commissioned to explore the possibilities of aluminum wall coverings, conceived of the heat-radiating aluminum foil wall as a decorative feature in tomorrow's home. The result, shown here, is a mosaic of foil-covered plywood shapes in a variety of colors and textures assembled against a radiant-heating panel of heavy gage gun-metal aluminum foil.

(More Roundup on page 254)

## USEFUL CURVES AND CURVED SURFACES: 16 — Remarks on Surfaces, Cont'd

By SEYMOUR HOWARD *Assistant Professor, Pratt Institute, Architect associated with Huson Jackson and Harold Edelman*

**Reflection.** Analysis of the reflective properties of surfaces can always be made by knowing the point source of energy (heat, light, sound) and the tangent plane at all points on the surface. Rays can be drawn to each point on the surface and the reflected ray found by the law: angle of reflection equals angle of incidence. It is more revealing to find the image of the source on the opposite side of the surface and then, using this as a center, to draw concentric circles or rays. In general a concave surface will concentrate rays, a convex surface will scatter them.

**Structural.** In general a curved surface will carry the external forces acting on it by direct stresses only, provided the supports can furnish the required vertical and horizontal reactions and provided the boundaries or edges are properly stiffened. Bending stresses may be set up near the boundaries, near the supports and at points of application of concentrated loads. Bending stresses

may be set up where the curvature of the surface changes rapidly and especially at "knuckles" or sharp ridges. These bending stresses can be taken care of by thickening the shell or adding stiffening rings or ribs to the shell.

A surface of double curvature will be stiffer and deform less under load than one of single curvature, but generally it will be more expensive to calculate and to construct. While any imaginable three-dimensional surface can be drawn and built, whether it is susceptible to simple mathematical analysis or not, the description of a surface by relatively simple equations enables the engineer to make a more accurate estimate of the stresses to be expected. The mathematical surface should be taken at the centerline of the thickness of the shell or skin.

The usual procedure is first to analyze the so-called membrane stresses. These are all direct stresses and are found by analyzing

a typical region of the surface on the assumption that it has no boundaries. The disturbances set up by the existence of boundaries are taken care of by separate calculations. So-called line loads are applied to the edges. The stresses set up by these are added to the membrane stresses and the net stress calculated. (This is similar to the methods of analyzing continuous frames.)

As in the case of all statically indeterminate structures, curved shells (or stressed skin constructions generally) must be drawn accurately and completely dimensioned before they can be calculated. It is essential that the preliminary guess of shape and dimension be made on the basis of the maximum amount of experience, since the loads to be carried may consist largely of the weight of the structure itself. Simple, rough calculation methods should be used in the early stages until the lightest, thinnest and stiffest combination is found. Then more detailed calculations can be made.

	SINGLE CURVATURE DEVELOPABLE	DOUBLE CURVATURE NOT DEVELOPABLE				
		Negative Curvature (Saddle-Shaped)			Positive Curvature (Cup-Shaped)	
		Ruled Singly	Ruled Doubly (Only Two Exist)	Unruled	All Unruled	
<b>RULINGS</b>	All Ruled Singly	Ruled Singly	Ruled Doubly (Only Two Exist)	Unruled	All Unruled	
<b>NAMES of Some Surfaces</b>	Cones; Cylinders; Tangential Developables of Space Curves	Conoids; Right Circular Helicoid	Hyperbolic Paraboloid	Hyperboloid of One Sheet	Hyperboloid of Two Sheets; Elliptic Paraboloid; Catenoid; Pseudosphere; Inner Half of Torus; Parts of Unduloids; General Helicoid	Sphere; Spheroid; Ellipsoid; Outer Half of Torus; Parts of Unduloids
<b>SURFACES OF REVOLUTION</b>	Cone and Circular Cylinder Only	None	None	May Be	May Be	May Be
<b>MINIMAL SURFACES</b> Mean Curvature = 0 Gaussian Curvature Always Negative	None	May Be (Right Circular Helicoid)	May Be, When Rulings Are At Right Angles	None	May Be. Usually Fall in This Group	None
<b>MEAN CURVATURE</b> $\frac{1}{2} \left( \frac{1}{R_1} + \frac{1}{R_2} \right)$	+	+, 0, -	+, 0, -	+, 0, -	+, 0, -	+. Sphere Is Only Surface (Without a Boundary) of Constant Positive Mean Curvature
<b>GAUSSIAN CURVATURE</b> $\frac{1}{R_1 R_2}$	0	-	-	-	-. A few Surfaces Such as Pseudosphere Exist With Constant Negative Curvature	+. Sphere Is Only Surface (Without a Boundary) of Constant Positive Curvature



## Hospital interiors inspire confidence thru color and cleanliness

Providing patients and staff with cheerful hospital interiors is no problem when you specify Architectural Terra Cotta . . . so vast is the range of colors and textures available. Utmost cleanliness is assured. Maintenance consists only of simple soap-and-water washings. Everything considered—from versatility to washability, from beauty to the budget, time-proved Architectural Terra Cotta helps you solve most design problems. For exteriors as well as interiors, sculpture or plain surfaces, it is custom-designed to your precise specifications.

**PROVIDENCE HOSPITAL**  
 WASHINGTON, D. C.  
**Faulkner, Kingsbury & Stenhouse—Architects**  
**Charles H. Tompkins Co.—Builders**  
*Main lobby, diagnostic clinic lobby and waiting area are glazed Architectural Terra Cotta peach multichrome units 18" x 33" x 2".*



**FEDERAL SEABOARD  
 TERRA COTTA CORPORATION**

10 East 40th Street, New York 16, N. Y.  
 PLANT AT PERTH AMBOY, NEW JERSEY

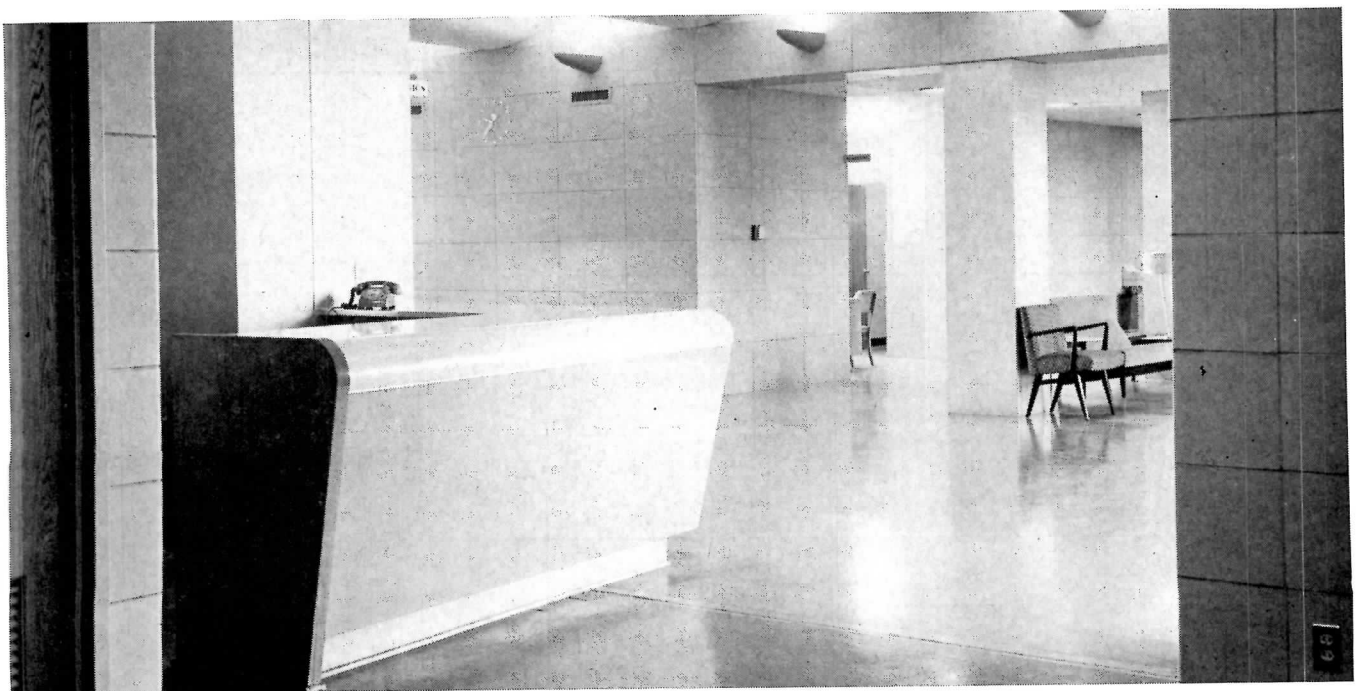

USEFUL CURVES AND CURVED SURFACES: 17 — Cylinders and Prisms

By SEYMOUR HOWARD Assistant Professor, Pratt Institute, Architect associated with Huson Jackson and Harold Edelman

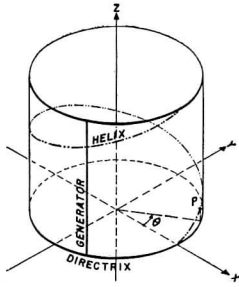

A cylinder is generated by a straight line element (the generator or generatrix) which moves along a plane curve (the directrix) parallel to an axis which is not in the plane of the curve. When the axis makes a right angle with the plane of the curve, the surface is called a right cylinder. For design purposes we can always arrange the cylinder to be right.

Any curve can be used for the directrix. If a conic is used, the cylinders are quadric surfaces and all sections are also conics. Only quadric cylinders are shown here, but other forms such as a catenary cylinder may be preferable for structural reasons.

The right circular cylinder is the surface  $x^2 + y^2 = r^2; z = z$

or, in cylindrical coordinates:  $r = r, z = z$

$x = r \cos \phi; y = r \sin \phi; z = z$

[The elliptical cylinder, not shown, would have similar equations derived from those of the ellipse, (see sheet 4 on curves).]

The geodesics on the right circular cylinder are all circular helices and the most useful form of their equation is:

$$x = r \cos \phi; y = r \sin \phi; z = k \phi$$

where  $k = \frac{2\pi r}{h}$  and  $h =$  pitch of helix or distance traveled in one revolution. The angle  $\phi$  which the helix makes with any generating element  $= \arctan \frac{2\pi r}{h}$ . Length of geodesic  $= \frac{z}{\cos \phi}$  and for one revolution  $= \sqrt{(2\pi r)^2 + h^2}$

The projection of the circular helix on the  $xz$  or  $yz$  planes (i.e. "side elevation") is always a sine curve (see sheet 12 on curves).

The lamellas or elements of a lamella roof (see Time-Saver Standards, 3rd edition, F. W. Dodge Corp., p. 106) trace helices on the surface of a cylindrical roof. The drawing of the parabolic cylinder explains this.

Any section of a circular cylinder is an ellipse. The foci of the ellipse are the projections on the section plane of the centers of the spheres tangent to the cylinder and to the plane. They are also the points of tangency of these spheres and the section plane. The directrix of the ellipse is the intersection of the section plane with the plane of the circle of tangency of the sphere.

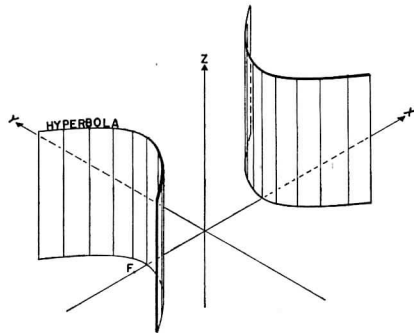
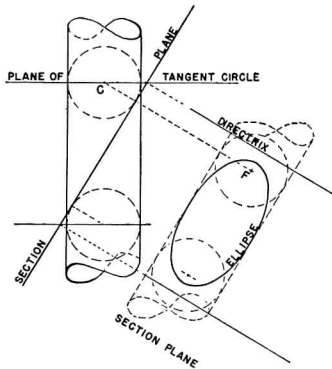

The hyperbolic cylinder is the surface

$$\frac{x^2}{a^2} - \frac{y^2}{b^2} = 1; z = z$$

All sections are conics and are most easily drawn by projecting a few points and using Pascal's method (see Time-Saver Standards, 3rd edition, p. 25).

The parabolic cylinder (coordinates as shown) is the surface

$$x^2 = -2py; z = z$$

Sections are all conics and are drawn as

described for the hyperbolic cylinder.

The parabolic cylinder is shown in orthogonal projection with lines of equal arc length drawn on the surface. To find the geodesics, the developed surface is drawn showing these same lines. Then any system of straight lines drawn on this developed surface is a system of geodesics. They can then be projected back on the  $yz$  plane.

This method of drawing geodesics can be used for any developable surface. In the case of cylinders the geodesics are all helices or portions of helices. (See sheet 18 for possible regular patterns.)

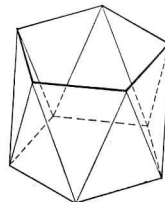
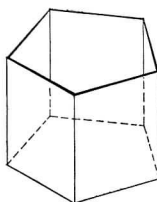
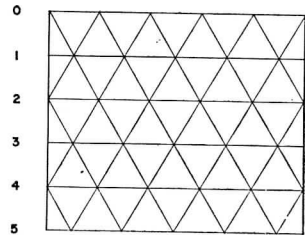
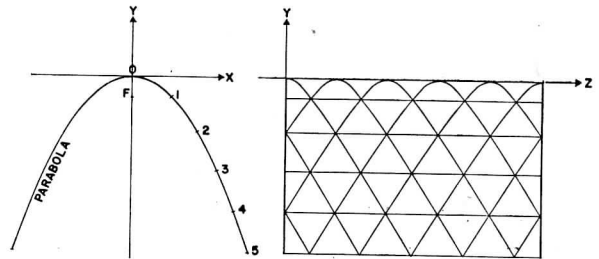

Prisms or anti-prisms offer convenient approximations to cylinders or may be chosen for their own shape. Any regular polygon can be used for the two bases; for the anti-prisms the two bases are twisted so that the vertices of one are above the mid points of the sides of the other.

(For areas, surfaces and volumes of cylinders, prisms and anti-prisms see Time-Saver Standards, 3rd edition, p. 25.)

*richer-looking . . . longer-wearing* **TOLEX**<sup>®</sup>  
*supported vinyl . . . reinforced with fiber glass*



*. . . the favorite of*



TOLEX, fiber glass reinforced vinyl covering material on Holcomb & Hoke's fine line of FOLDOORS, assures you of finest quality. Tolex is more durable . . . withstands years of normal flexing and folding without cracking or peeling. Tolex is more beautiful . . . offers dozens of truly authentic patterns and

effects in a wide range of smart decorator colors, all easily kept clean with an occasional swish of a damp cloth. And remember, Tolex is fire resistant, an important feature in the institutional field.

When specifying folding doors and partitions, be sure they are covered in TOLEX.



**THE GENERAL TIRE & RUBBER COMPANY**  
 TEXTILEATHER DIVISION • TOLEDO 3, OHIO



USEFUL CURVES AND CURVED SURFACES: 18— Polygon Patterns

By SEYMOUR HOWARD Assistant Professor, Pratt Institute, Architect associated with Huson Jackson and Harold Edelman

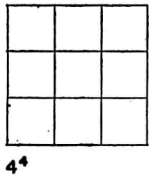

4<sup>4</sup>

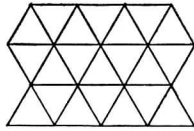

3<sup>6</sup>

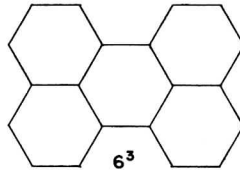

6<sup>3</sup>

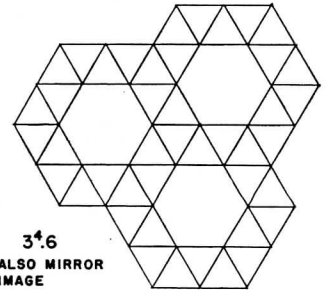

3<sup>4</sup>.6  
ALSO MIRROR  
IMAGE

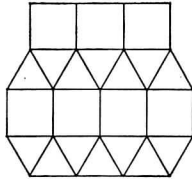

3<sup>3</sup>.4<sup>2</sup>

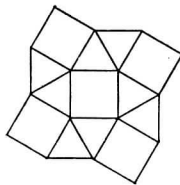

3<sup>2</sup>.4.3.4

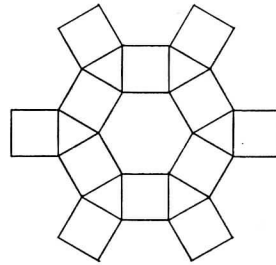

3.4.6.4

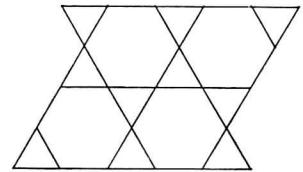

3.6.3.6

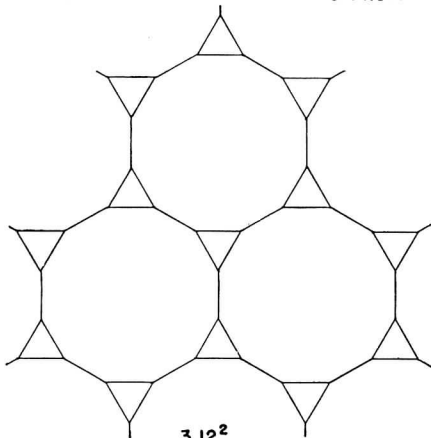

3.12<sup>2</sup>

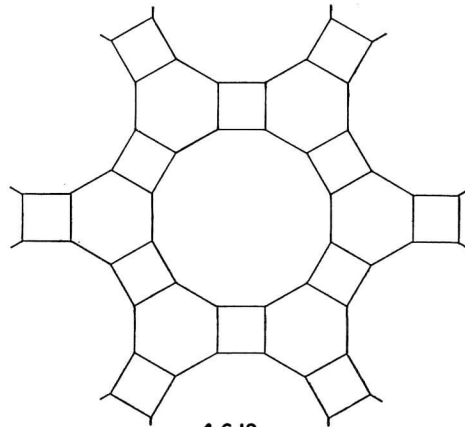

4.6.12

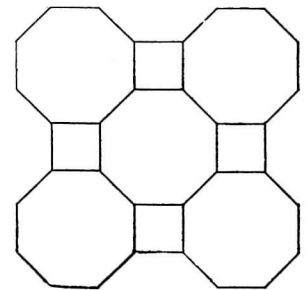

4.8<sup>2</sup>

REGULAR AND SEMI-REGULAR PATTERNS

The division of a plane into regular polygons is often necessary for structural or decorative reasons. There are only three regular tessellations (patterns) in which all the polygons are regular but not identical; all the sides are of equal length. One of the semi-regular tessellations has two forms which are mirror-images of each other. All vertices are congruent. The notation is based on the

vertex figure of each tessellation. The polygons are listed by the number of sides as they are found in sequence around a vertex. These tessellations are related not only to the plane but to every surface which is developable and which can therefore be drawn without distortion on a plane. The sides of the polygons will, of course, all be geodesics. Not every tessellation can be used

for every surface; it will be necessary to experiment to find which will fit and which will be most suited to the structural or esthetic purpose. Any polygon used structurally must be held rigid, either by division into triangles or by provision of a continuous membrane.

Reference—"Mathematical Models" by Cundy and Rollett

REFERENCES FOR COMPLETE SERIES

1. *Practical Geometry* by David Allen Low, Longmans Green, 1912.
2. *Mechanical Engineers' Handbook* by Lionel S. Marks — section "Mathematics" by E. V. Huntington (McGraw Hill, 1941).
3. *The Mathematics of Engineering* by Ralph E. Root (Bailliere, Tindall and Cox, 1927).
4. *Elements of the Differential and Integral Calculus* by Granville, Smith and Longley (Ginn 1941).
5. *Geometry and the Imagination* by D. Hilbert and S. Cohn-Vossen (Chelsea, 1952).
6. *Mathematical Models* by H. Martyn Cundy and A. R. Rollett (Oxford 1951).

# Come visit us at the Exposition!

See the American Blower exhibit, Booths 22 and 26 at the Heating & Air Conditioning Exposition, International Amphitheatre, Chicago, Illinois, Feb. 25-Mar. 1. Get all the facts on what's new in the complete American Blower line!

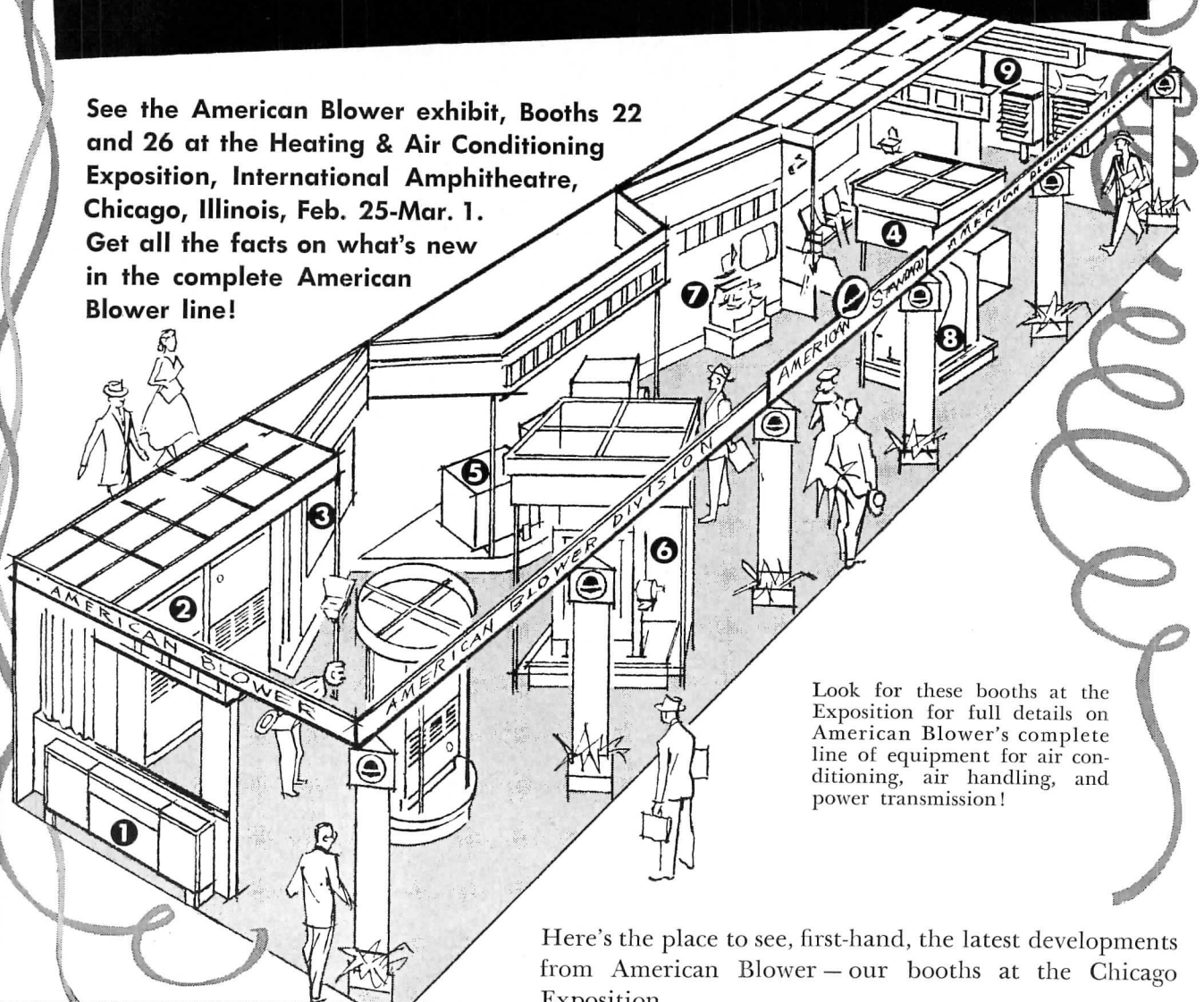

Look for these booths at the Exposition for full details on American Blower's complete line of equipment for air conditioning, air handling, and power transmission!

## Here are some of the things you'll see!

- ① Unit Conditioners—designed to provide year-round air conditioning on an individual-room basis.
- ② American Blower Packaged Air Conditioners—modern styling, engineered for industrial and commercial applications.
- ③ Tonrac\* centrifugal refrigeration machines that maintain chilled-water temperature regardless of load.
- ④ Ventura Fans—propeller fans, with streamlined inlets, for general ventilation in commercial applications.
- ⑤ Air-Conditioning Units—components for central station air-conditioning systems.
- ⑥ Sirocco High-Pressure Fans, for high-velocity direct air-conditioning systems and industrial applications.
- ⑦ GYROL® Fluid Drives for smooth power and adjustable-speed control in a wide variety of industrial applications.
- ⑧ Utility Sets—self-contained fan units for general supply or exhaust where duct work is required.
- ⑨ Unit Heaters—horizontal and vertical models for use with steam or hot water, plus gas-fired heaters.

\*Trademark

Here's the place to see, first-hand, the latest developments from American Blower—our booths at the Chicago Exposition.

You'll find a display on Tonrac, our new centrifugal refrigeration machine that installs on a single level. You'll see our completely new line of comfort-engineered packaged air conditioners, the latest Gyrol Fluid Drive, high-pressure fan, utility set, unit heater, and much, much more.

And there'll be motion pictures, moving displays, fact-filled literature—everything to make your visit interesting and informative. So make a note now to stop by! American Blower Division of American-Standard, Detroit 32, Michigan. In Canada: Canadian Sirocco products.

## AMERICAN BLOWER

Division of AMERICAN-Standard





**POOR SUBSTITUTE**

**FOR GOOD LIGHTING**

The green eye shade . . . it used to be standard equipment for the skilled machinist, toolmaker and precision assembler. It was his sole defense against the painful glare conditions found throughout industry until a very few years ago . . . and still found in an alarming number of plants even today.

Wonderful things happen when the need for the green eye shade is eliminated by modern lighting planned to give good "seeing"—for greater efficiency, accuracy and comfort. Case after case proves that production goes up, rejects go down, absenteeism and industrial accidents are greatly reduced.

Quality industrial lighting . . . and re-lighting . . . very quickly pays for itself. May we demonstrate the facts? Call in your electrical contractor and your Miller representative!

**MILLER RLM INDUSTRIALS**

Miller industrials, "Crown" and "Imperial", meet and exceed the newest standards for quality plant lighting. They provide greater light output, increased upward light, better shielding, more efficient reflection factors. Improved structural details mean longer life, lower maintenance and quicker installation. Write for bulletin.



*Better Lighting  
for a Brighter America*

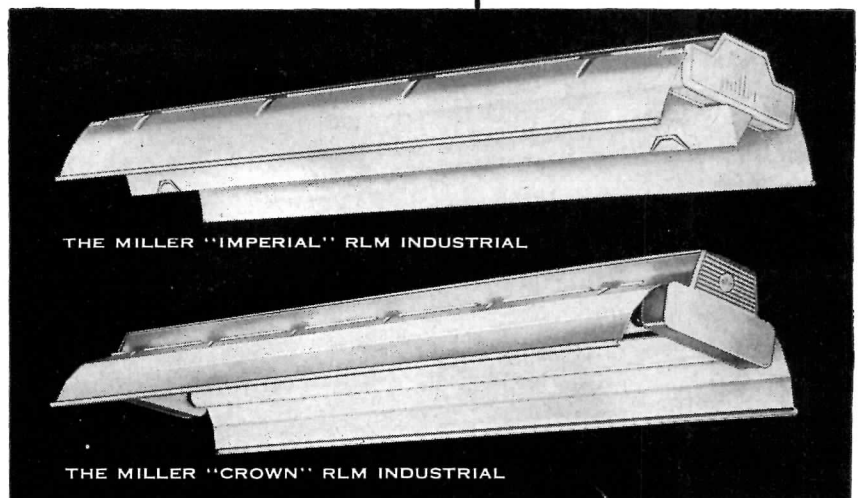

THE MILLER COMPANY • GENERAL OFFICES: MERIDEN, CONN. • FACTORIES: UTICA, OHIO and MERIDEN, CONN. • IN CANADA: CURTIS LIGHTING OF CANADA LTD., TORONTO

(Continued from page 242)

**CORNELL STUDENTS PLAN  
"PERFECT" PLANT COMMUNITY**



A group of graduate students in city and regional planning at Cornell University recently joined forces with municipal and corporation interests to plan a "perfect" living environment around IBM's new Airborne Computer Laboratories near Owego, N. Y. At the invitation of the International Business Machines Corporation, the students undertook as a class project the preparation of detailed plans for a community of some 5,000 persons, including expected employees, their families and the business and professional people who will provide secondary services to the community. Detailed engineering and social data were furnished by IBM, and close collaboration with company officials as well as with interested citizens of Owego brought the group into direct contact with the problems of the new community, enabling them to work realistically.



**Masonry Wall Fire Test**

An 8-in. lightweight concrete masonry wall has passed a standard ASTM 4-hr fire test at the University of California. Professor Raymond E. Davis, an au-

thority on building materials, concluded from the tests that the Rocklite lightweight concrete masonry wall could resist the passage of flame and heat for a period of 4 hr and could resist the action of a standard hose stream after the fire.

The Rocklite wall, just 8 in. thick, was built to conform to the minimum requirements of the Los Angeles Building Code for concrete block construction. Reinforcing steel was placed 24 in. on centers, and the cores were filled with  $\frac{9}{16}$ -in. Rocklite coated expanded shale aggregate to serve as insulation. Although temperatures on the exposed

side of the 14- by 11-ft wall reached 2000 F, the maximum average temperature rise on the unexposed side was only 166 F, appreciably lower than the maximum permissible average temperature rise of 250 F. The maximum temperature rise at any one point was only 191 F, much lower than the permissible rise of 325 F. The fire test was followed immediately with the standard hose stream test using water pressure of 45 psi. By all standards the heated wall resisted both the force and the severe thermal shock of the water stream.

(More Roundup on page 258)

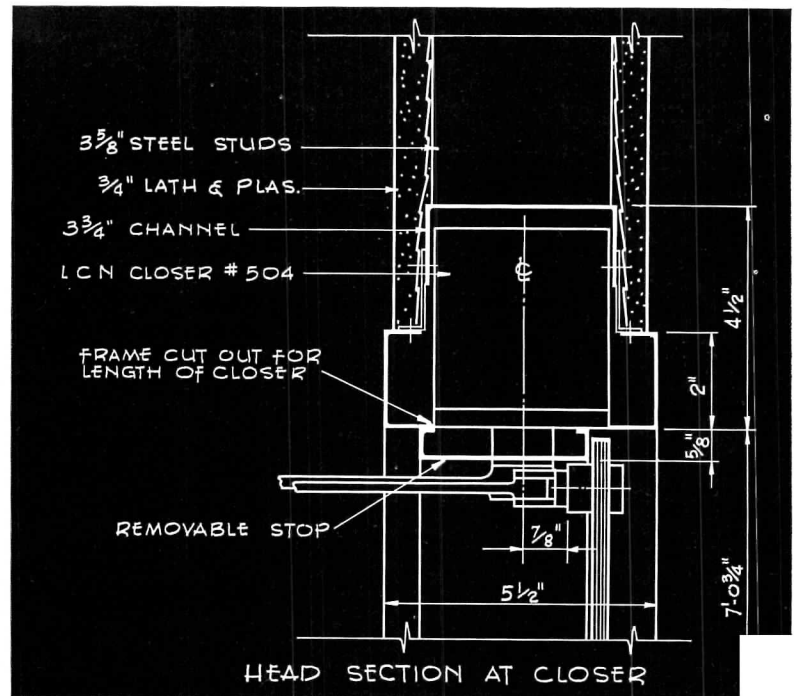

**CONSTRUCTION DETAILS**

for LCN Overhead Concealed Door Closer Installation  
Shown on Opposite Page

*The LCN Series 500 Closer's Main Points:*

1. Efficient, full rack-and-pinion, two-speed control of the door
2. Mechanism entirely concealed; arm visible on inside of an out-swinging door
3. Hydraulic back-check prevents door's being thrown open violently to damage door, walls, etc.
4. Double lever arm provides maximum power to overcome wind and drafts
5. Arm may be hold-open type, 90° to 140° or 140° to 180°

Complete Catalog on Request—No Obligation  
or See Sweet's 1957, Sec. 18e/La

**LCN CLOSERS, INC., PRINCETON, ILLINOIS**

# do your drawings do justice to your designs?

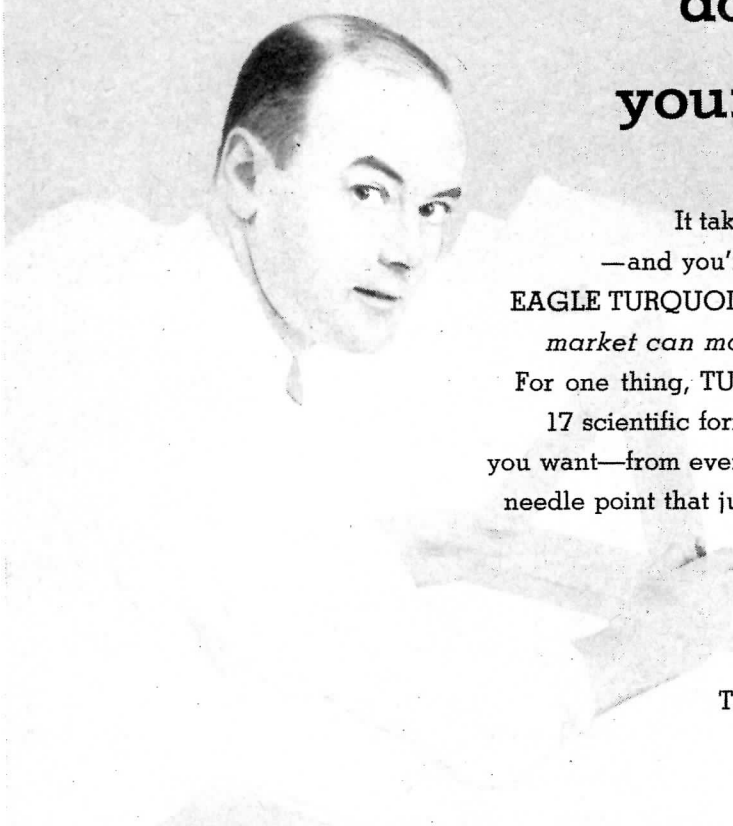

It takes a sharp drawing to sell a sharp idea  
—and you're halfway there when you pick up an  
**EAGLE TURQUOISE** drawing pencil. *No pencil on the  
market can match TURQUOISE for reproduction!*

For one thing, TURQUOISE is tops for uniform grading.

17 scientific formulas guarantee exactly the blackness  
you want—from every pencil, every time! You get a strong  
needle point that just won't crumble—and stays sharp for

line after long line of unchanging  
width. You can't beat it for smooth-

ness, either—thanks to Eagle's

exclusive <sup>®</sup>“Electronic” graphite.

TURQUOISE makes your drawings look  
sharp—and you, too!



• TURQUOISE DRAWING PENCILS: With 100% <sup>®</sup>“Electronic” graphite. 17 grades, 6B through 9H.



• TURQUOISE CLEANTEX ERASER:  
Super-soft, non-abrasive rubber.

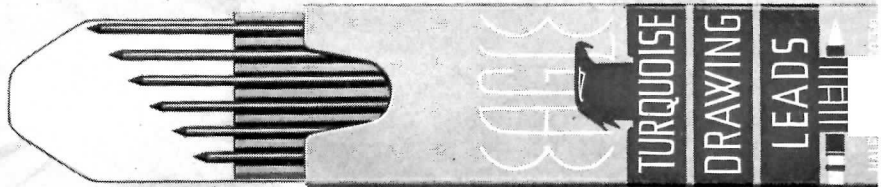

• TURQUOISE DRAWING LEADS: Fit any standard holder. Grades 5B through 9H.



• TURQUOISE LEAD HOLDERS: Hold any grade of Turquoise lead—so firmly that lead cannot be pressed back.

## EAGLE <sup>®</sup> TURQUOISE

PENCILS,  
LEADS AND  
HOLDERS

*are the largest-selling in the United States!*

EAGLE PENCIL COMPANY • NEW YORK • LONDON • TORONTO • MEXICO • SYDNEY • BOGOTA

RESIDENCE FEATURES  
PORCELAIN ENAMEL

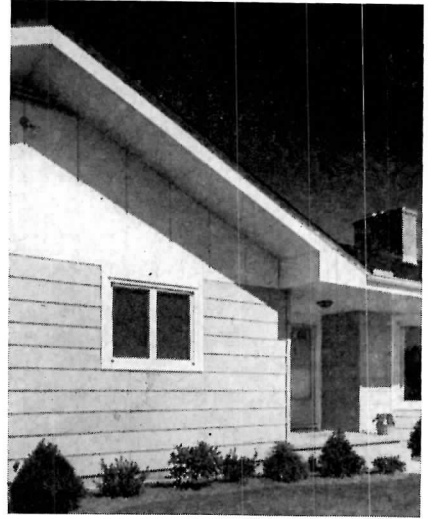

A house built for the vice-president of The Erie Enameling Company in Erie, Pennsylvania, uses porcelain enamel where wood is conventionally used, including the lap siding, gable and planking, trim, soffits, and door and window frames. The exterior walls are of standard frame construction with plaster board and plaster inside and 3/4 in. sheathing outside to which porcelain panels are fastened with stainless steel lugs. Special square sections permit smooth joining at the corners. The finished wall has a U factor of below .10, and requires no maintenance. On the interior of the house, porcelain is used for kitchen wall surfaces and counter tops, while the bathrooms are finished completely with pan and lug porcelain enamel panels.

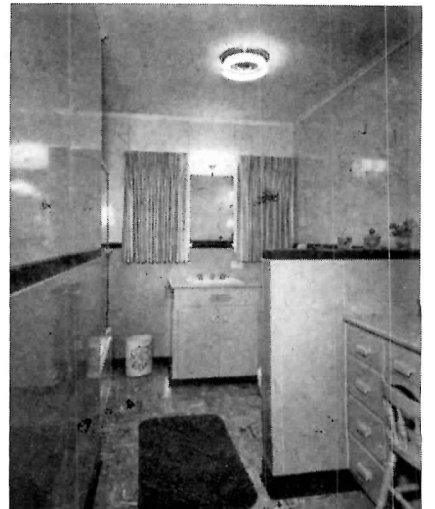

(More Roundup on page 262)

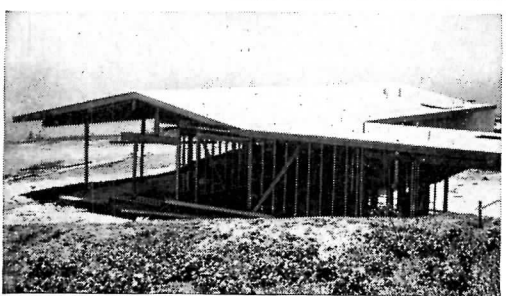

California contractor estimates:

**Time and labor costs cut 75%  
with the Remington Stud Driver**

Out on the California coast, "Research House" has taken shape. It's an experimental house sponsored by Associated Architectural Publications and the latest tools have been used to build it—such as the Remington Stud Driver.

Contractor Bert Pickney says, "The Stud Driver cuts time and labor costs around 75% in anchoring beam supports, partition sills and furring to concrete. It took us only half a day to install the sills—a 2-day job with bolts. No pre-drilling

is necessary, and sills are set tight! I certainly recommend the Stud Driver to any contractor!"

**YOU CAN SPEED ALL STUD FASTENINGS**—light, medium and heavy-duty—with the Remington Stud Driver. It sets both 1/4" and 3/8" diameter studs in steel or concrete—up to 6 studs a minute either size. The tool is cartridge-powered, portable, ready to work *anywhere*. Forty styles and lengths of Remington Studs to choose from. Get full details by mailing coupon.

**Remington**



**STUD  
DRIVER**

Industrial Sales Division, Dept. AR-2  
Remington Arms Company, Inc.  
Bridgeport 2, Conn.

Please send me your free booklet which shows how I can speed the job and save with the Stud Driver.

Name \_\_\_\_\_ Position \_\_\_\_\_

Firm \_\_\_\_\_

Address \_\_\_\_\_

City \_\_\_\_\_ State \_\_\_\_\_





COPR. 1957—O.D.C.

## DOOR OPENING WITH THE "OVERHEAD DOOR"

The "OVERHEAD DOOR" has enjoyed and appreciated the confidence of architects for more than three and a half decades. The requirements we meet, year after year, add up to a certainty of quality installation and service . . . by exclusively dedicated craftsmen.

The Overhead Door Corporation produces The "OVERHEAD DOOR" in sizes to fit all standard door openings . . . and is glad to cooperate

on unusual size doors. America's pioneer and leader in upward-acting garage doors, the Overhead Door Corporation offers a complete line of doors—commercial and residential—with or without electric and Ultronic operators.

OVERHEAD DOOR CORPORATION, Hartford City, Ind.

MANUFACTURING DIVISIONS: *Hillside, N. J.* • *Nashua, N.H.*

• *Cortland, N.Y.* • *Lewistown, Pa.* • *Oklahoma City, Okla.*

• *Dallas, Texas* • *Portland, Ore.*

FOR 36 YEARS...

*Architects have specified*



*more than any other brand!*

**BUILT-IN BLAST RESISTANCE FOR CLAY MASONRY WALLS**

A simulated nuclear explosion was recently set off in an effort to determine the resistance of various types of masonry construction to blasts from atomic and hydrogen bombs. Conducted for the Structural Clay Products Research Foundation of Illinois Institute of Technology, the study showed that structural clay masonry walls can be designed to withstand explosions, tornadoes, earthquakes and other lateral forces without appreciably increasing construction costs. The explosion, which was set off within an eight-sided structure in an abandoned surface mining area near Coal City, Illinois, was designed to approximate forces at 4,600 ft from the center of the blast in "Operation Cue," a nuclear test in which different types of structures were exposed to atomic explosions. The charge, 45 lb of an explosive similar to TNT, was tied to a post in the center of the test structure,  $\frac{3}{4}$  of it above the center point of the wall panels. Seven of the 10 ft square panels were of structural clay masonry, varied as to thickness and reinforcement in order to determine their comparative resistance to the explosion. The single exception was a control wall of 8 in. vertically reinforced concrete block constructed with built-in bottom, pinned top, and two sides free in the same manner as the wall which withstood an atomic explosion in Operation Cue. It was felt that damage to this panel would indicate blast effects at least equal to those imposed on the buildings in the actual atomic test. Half of the walls were built into their vertical supports and spanned horizontally; the rest were spanned vertically, being built-in at the base and pinned at the top as in conventional construction. Four high-speed cameras placed around the structure recorded the effects of the blast. At the conclusion of the test, it was found that the control wall and an 8 in. wall constructed of face brick with a concrete block back-up had been completely demolished. The all clay masonry walls including the  $5\frac{1}{2}$  in. SCR brick panel remained structurally sound, indicating that properly designed clay masonry construction has a "built-in" resistance to lateral forces.

(More Roundup on page 266)

**3 quality lines, completely weatherproofed, make Miller sliding glass doors ideal**

**1 Aluminum "250 Series" for single glazing only.**

Snap-on glazing mold accommodates  $\frac{3}{4}$ " plate or crystal. Fully Alumilited finish. "Magic-touch" hardware with Lucite pull.

**2 Aluminum "1000 Series" for interchangeable single and dual glazing.**

Converts from  $\frac{3}{4}$ " plate to 1" insulating glass (or reverse) anytime without disturbing framing installation. Fully Alumilited finish. Full-grip hardware.

**3 The Steel Series for single or dual glazing.**

Made from heavy gauge Bonderized steel. Full-grip hardware with Lucite pull.

**Miller SLIDING GLASS DOORS**

Frank B. Miller Mfg. Co., Inc.  
3216 Valhalla Dr., Burbank, Calif.

Write for catalogs. See your Distributor.

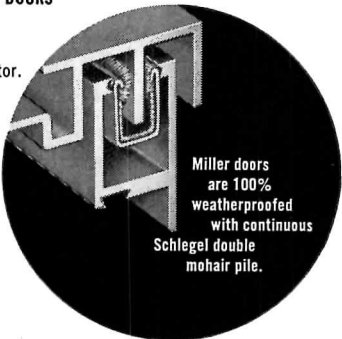
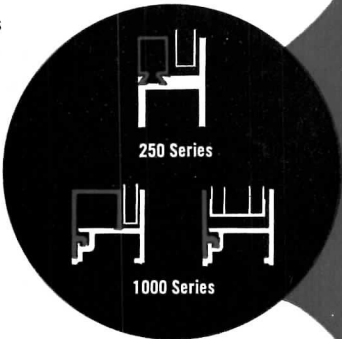

Miller doors are 100% weatherproofed with continuous Schlegel double mohair pile.



# SUNTROL...

*color... function*

Subtle green Suntrol adds the design expression of color to glass block fenestration. A sealed-in fibrous green screen, shown in the exploded view at the left, produces a pleasing accent tone on panel exteriors . . . a soft, cool glow inside.

Functionally, Suntrol keeps out more heat and glare than other types of glass.

A modular product, Suntrol is available in two sizes—8" and 12"—and in three types—light-directing, light-diffusing, and toplighting.

Specified for color, or for function, or both, subtle green Suntrol offers the architect a versatile material for forecast designing. Suntrol is an exclusive PC product.

For details, write Pittsburgh Corning Corporation, Dept. C-27, One Gateway Center, Pittsburgh 22, Pa. In Canada: 57 Bloor Street West, Toronto, Ontario.

## PC Suntrol\* Glass Blocks

\*T.M. Reg. applied for



® Also manufacturers of FOAMGLAS® insulation

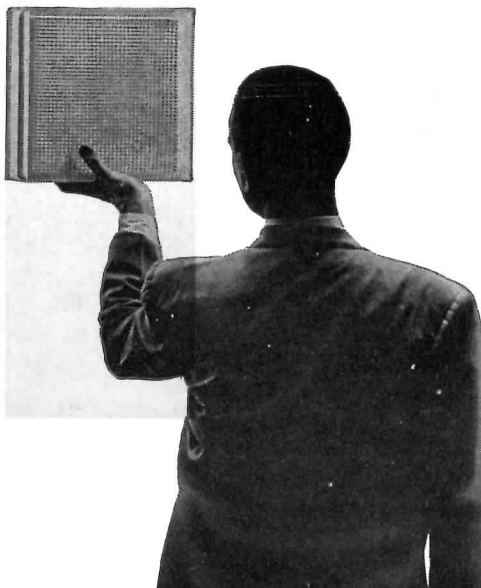

Cuts costs as much as 3 - 0%...

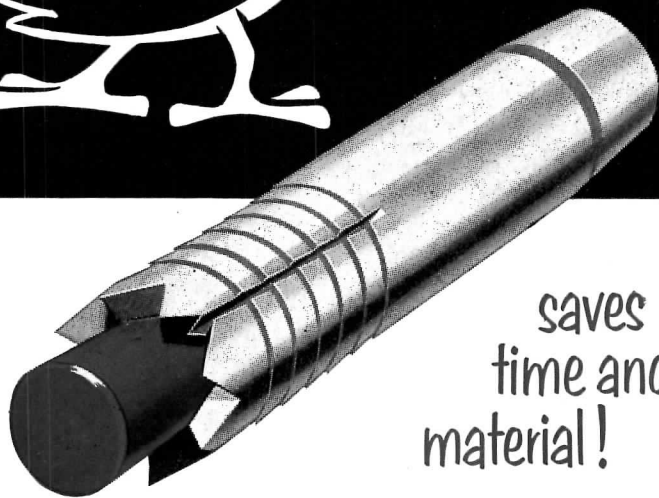
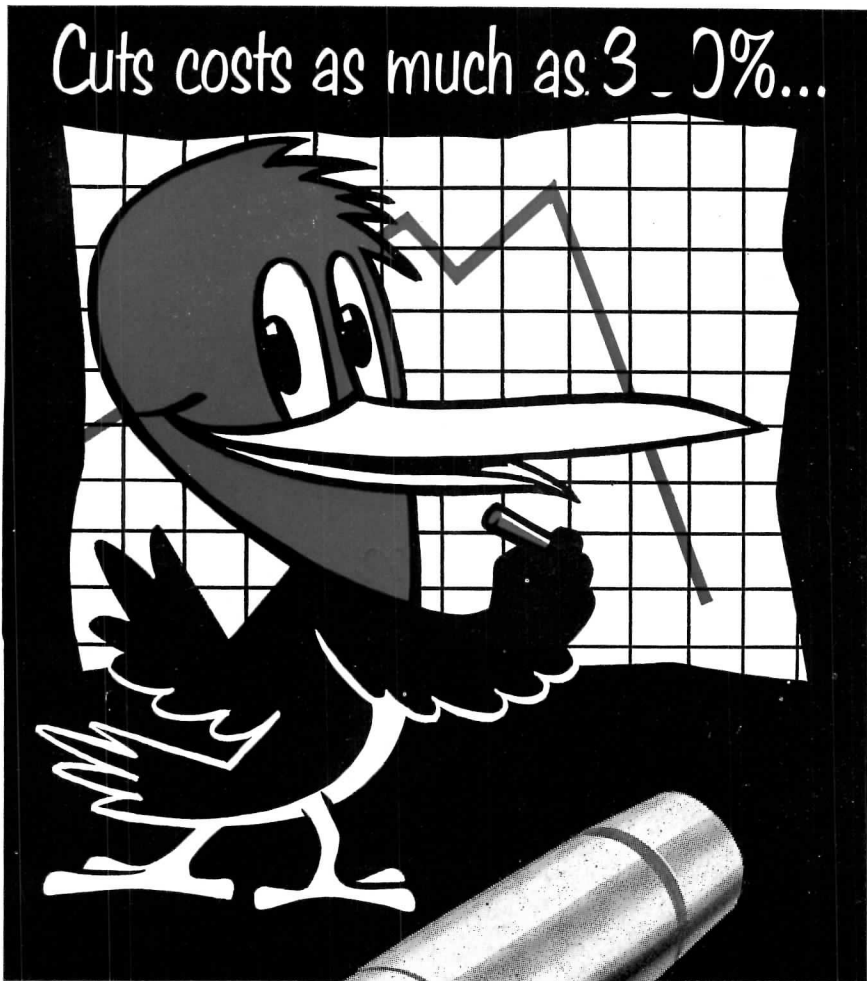

saves  
time and  
material!

Less expensive installed than any other method of fastening to concrete, because every RED HEAD drills its own hole! No expensive explosive charges or drills needed. Once it's in, the concrete itself must fail before it comes out. Can't pull out, rust out, melt out or vibrate loose because of full dove-tail expansion. Easy to install, by hand or impact hammer. Write today for your catalog and free sample... Demonstration at job site can be arranged.

**PHILLIPS®**  
**RED HEAD**



CONCRETE FASTENERS  
the original since 1916  
PHILLIPS DRILL COMPANY, MICHIGAN CITY 3, INDIANA

TECHNICAL ROUNDUP

STEEL FRAME SOLUTION TO FOUNDATION PROBLEMS

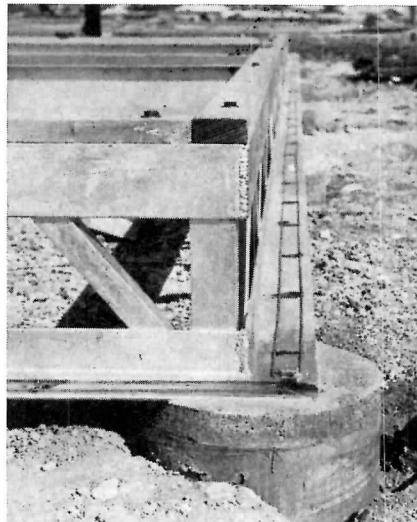

To answer the shifting soil problem that perennially plagues foundation-builders, Paul F. Watson of the Watson Foundation Company, Inc., has employed a steel foundation floating on concrete piers for his 2300 sq ft residence in Fort Worth, Texas. The specially constructed piers are anchored on solid bed rock well below the water table to avoid the cracking often caused by soil expansion and contraction accompanying variations in ground moisture content. Sonotube casings on the piers prevent their bonding with unstable upper ground strata. The rigid steel frame is bolted to the piers and spans them without intermediate supports. Exterior masonry walls — including a fireplace — rest on a steel apron of the foundation, keeping the structure entirely above the ground level. It was found that the use of steel resulted in time-saving ease of fabrication, and eliminated over 120,000 lb of concrete.

New Air Conditioning Standards

Standards and test codes for air moving and conditioning equipment were adopted by the Air Moving and Conditioning Association, trade association of the industry at its annual meeting. The new standards, which conform as nearly as possible with those previously published and accepted by the industry, cover commercial and residential fans, steam and hot water unit heaters, dehumidifying air washers, central air conditioning units, and power roof ventilators.

(More Roundup on page 270)



**LIGHT ENGINEERING IS SIGHT ENGINEERING**

**AT  
GUTH**

one of the many results:

**GRATELITE\***

Louver-Diffuser



**THE EDWIN F. GUTH COMPANY**

**ST. LOUIS 3, MISSOURI**

**TRUSTED** name in lighting since 1902

\*® U. S. Pat. No. 2,745,001  
Canadian Patent Pending

• A good chair is like a good wife...if you choose with care, it will look after your comfort and aid you in your work for a long time to come



## Cramer CHAIRS ARE GOOD CHAIRS

Scientifically planned to aid YOU in your work . . . designed to support you comfortably whether you're chewing your pencil or bent over hard at work . . . engineered from the quality materials YOU would recommend, with independently adjustable seat, back and footring to conform to your physique . . . and with removable, replaceable covers in a wide range of fabrics and colors to match YOUR decorating plan.



*Pictured, Cramer Hi-Model 4D-22T with forward-tilt seat; others available. All are low-gravity balanced for safe use on casters if desired.*

### LIKE MORE INFORMATION?

Cramer Posture Chair Co., Inc., Dept. AR27  
1205 Charlotte, Kansas City 6, Mo.  
Please send me complete facts on the  
Cramer Hi-Model chairs designed for  
working architects and engineers.

Name \_\_\_\_\_

Firm \_\_\_\_\_

Address \_\_\_\_\_

## TECHNICAL ROUNDUP

### REVERSE FLOW FIREPLACE FEATURES HORIZONTAL FLUE



A prefabricated fireplace unit installed directly in the center of a canted glass window-wall employs the idea of a forced draft horizontal flue which may in many cases allow increased freedom in locating fireplaces. Custom-engineered by Bennett-Ireland, Inc., for the North Carolina home of architect Edward Lowenstein, the reverse flow fireplace consists of a firebox and smoke chest with the smoke drawn down through an underground flue and out to a remote vent. A  $\frac{1}{16}$  hp draft fan located in a special fan pit at the base of the chimney is connected with the fireplace unit by a 15 ft duct of standard 13 by 18 in. flue tile. The fireplace itself is of welded construction with a stainless steel outer shell and a carbon steel inner shell. Sandwiched between the shells are the alternating layers of one inch rock wool and aluminum foil that insulate the unit. Since a portion of the glass wall bears on the fireplace, the insulation was designed to prevent excessive expansion as well as to contain heat for safety. Heat tests indicated that the outer shell remained safe to the touch even when the inner shell reached temperatures of 750° F.



## WHAT KIND OF A BUYER ARE YOU?

### If you buy air filters on PRICE



consider this: FAR-AIR filters save over 'cheap brands' to pay for your original filter investment several times. You get reasonable first cost, and lower maintenance costs.

### If you buy air filters on PERFORMANCE



consider this: FAR-AIR filters efficiently handle more air with less pressure loss. The FAR-AIR line gives the most practical solution for your dust problem.

### If you buy air filters on QUALITY

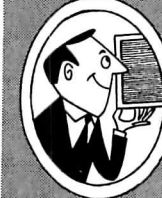

consider this: FAR-AIR filters are built up to a standard, not down to a price. There is no compromise on quality or workmanship. Compare!

### If you are from "MISSOURI"



consider this: Actual tests on your filter bank under your operating conditions, will prove to your satisfaction that FAR-AIR filters give better performance and save you money.

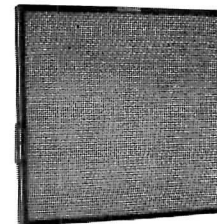

So, no matter how you buy, you'll find it good business to buy FAR-AIR products because they will do a better job at a lower cost. Write us for details.

# FARR

COMPANY

LOS ANGELES • NEW YORK • CHICAGO • NEW ORLEANS

Manufacturing Licensees:

Farr Company Mfg. Ltd., Montreal, Canada  
The Clyde Engineering Co. Pty. Ltd., Sidney,  
Australia • Intermit Ltd., Birmingham, England

Originators of FAR-AIR Certified Filter Service

# food for thought:

## EXTREMELY MOISTURE RESISTANT

1.5% Absorp. by Vol. 24 Hrs. Total Immersion

## INCOMBUSTIBLE

Flame Spread — 20.5

## FASTER LAYING

More Daily Roof Area Covered: 24" x 36" Size,  
Cuts Cleanly, Easily

## PERMANENT

Of Mineral Composition — No Fungus, Rot or Decay

## LIGHT WEIGHT

Only 9 Oz. Per Board Ft.

## FIRM, RIGID

Compression Resistance 174.8 PSI

## DIMENSIONALLY STABLE

Does Not Grow, Shrink, Curl.

Linear Change at 100% RH at 10 days: + 1/5th of 1%

# FESCO BOARD

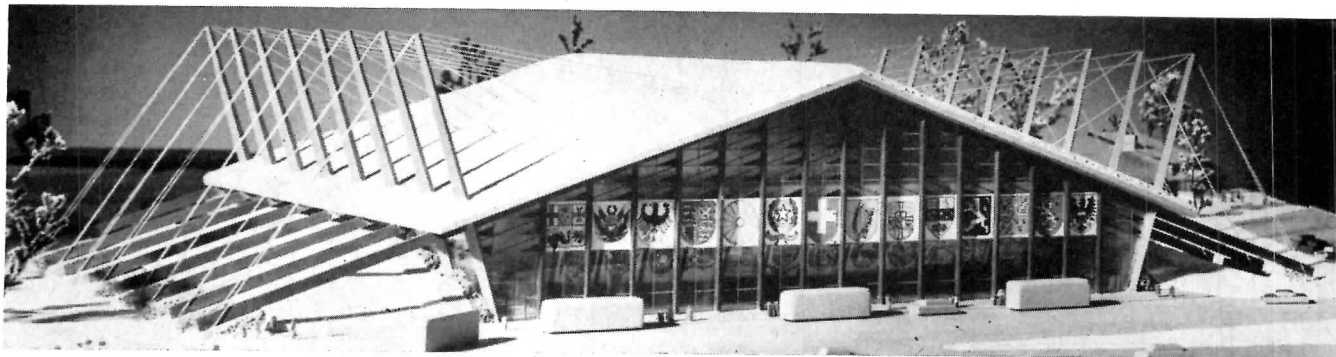

Enclosed ice arena with roof structure calculated to resist very heavy snow loads is key feature of Squaw Valley Olympic development; below, athletes' village at lower right



...in **COLOR** ...in **FIBERGLAS**  
...by **HAWS**

**A bright new idea in drinking fountains!** Model 10Y combines HAWS famous sanitation features with amazing lightweight toughness of Fiberglas plastic...the modern strength material.

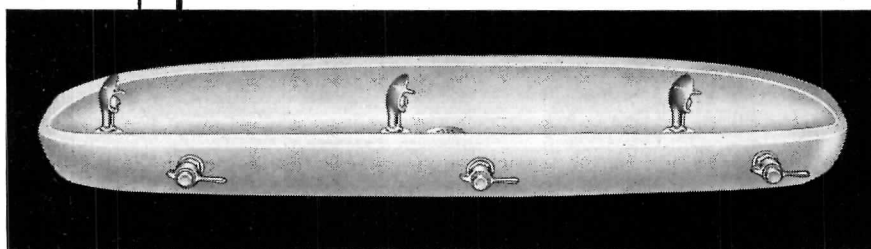

Model 10Y

**In color!** Choose from five decorator colors and white, permanently bonded to receptors to assure lasting vitality. Fiberglas strength foils vandalism, too! Color appeal and ruggedness make this model ideal for school use.

**Write today for details...**

and ask for your free copy of the 1957 HAWS Catalog...72 pages, with hundreds of design ideas for drinking facilities.



**HAWS DRINKING FAUCET CO.**  
1443 FOURTH STREET (Since 1909) BERKELEY 10, CALIFORNIA

**OUT OF THE WILDERNESS:  
A WINTER OLYMPICS AREA**

Preliminary proposals for development of the 1960 Winter Olympic Games Site in Squaw Valley near California's famed Lake Tahoe have been presented to and approved by the Olympic authorities.

The problem faced by Corlett and Spackman, Kitchen and Hunt, Architects Associated, was unique: to turn a virtually trackless and undeveloped wilderness sometimes buried under 20 ft of snow into the first site in Olympic history for the staging of all Winter Games in one centralized area.

Athletic facilities to be built include two ski jumps, speed skating rink, three hockey rinks which double as figure skating rinks, a bobsled run, downhill and slalom ski course and cross-country course. Among the supporting facilities will be an Athletes' Village which, again for the first time in the history of the Winter Games, will house all 1200 participating athletes and their coaches and trainers in one secluded area.

Most important of the individual structures to be erected will be the enclosed ice arena which will house the opening and closing ceremonies of the Games, figure skating and ice hockey events.

(Continued on page 338)

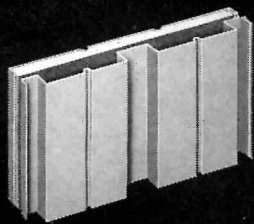

**NEW Fenestra Type "FA" Wall Panel** — Designed for simple, fast field assembly. Distinctive exterior design with deeply revealed fluting. Exterior — galvanized steel or grained aluminum (porcelain enamel optional). Interior — galvanized steel. Width 24". Lengths to 31'. Depth 3".

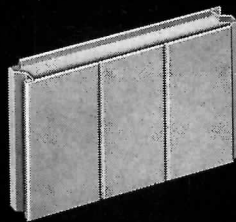

**NEW Fenestra Type "C" Wall Panel** — Smooth flush surface. Factory assembled. For use either horizontally or vertically in walls or partitions. Grained aluminum or galvanized steel. Width 24". Lengths to 14'. Depth 3".

## NEW Fenestra\* Insulated Wall Panels

# CUT PLANT CONSTRUCTION COSTS!

To meet your demand for better looking, more efficient, lower cost wall panels for curtain wall construction, Fenestra introduces two new insulated metal wall panel products. Based on more than a quarter century of experience in the design and erection of this type of construction, these new Fenestra Insulated Metal Wall Panels give you many important advantages for industrial, commercial and other types of buildings.

*Fast, easy erection*—Lightweight, large area Fenestra Wall Panels are quickly attached by welding or bolting. Your buildings can be enclosed in days rather than weeks. This saves labor costs and gives the owner quick occupancy and a faster return on his investment. New Fenestra Type "FA" Panels are designed for field assembly for extra economy.

*Distinctive appearance*—New Fenestra Type "FA" and Type "C" Panels give the designer a choice of exterior appearance. The "FA" Panel provides a dramatic, deeply revealed fluted surface to create bold shadow lines that give distinctive beauty to any façade. The "C" Panel gives you a smooth flush surface and may be installed vertically or horizontally. Either panel is available in galvanized steel or a new grain-textured aluminum that hides scratch marks and reduces maintenance. There are also many exciting design possibilities in colorful field

painting or in porcelain enamel finishes on aluminum.

*High insulating value*—Fenestra Metal Wall Panels provide insulating values better than a 16" masonry wall furred and plastered. U-factors range from .08 to .19 depending on panel type. Two-pound-density glass fiber insulation with excellent nonsettling properties is used. Since the panels are only 3" deep, this efficient insulation value means extra floor space for your buildings within the same foundation area.

*Structural steel savings*—Due to the lightweight construction possible with Fenestra Insulated Wall Panels, important savings are possible in the structural steel framework and foundation of your buildings.

*Low-cost expansion*—When the panels are attached by bolts, your building can be quickly expanded. The panels are removed, the addition erected and the panels reinstalled with minimum time and cost. Fenestra Wall Panels have been re-used as many as three times in plant expansion programs.

The New Fenestra Wall Panel catalog gives you complete details and design data on Fenestra Type "FA" and Type "C" Insulated Metal Wall Panels. Mail the coupon, below, for your FREE copy or call your local Fenestra representative—listed in the yellow pages.

\*Trademark

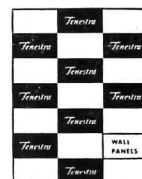

# Fenestra

INCORPORATED  
INSULATED METAL WALL PANELS

Your Single Source of Supply for  
BUILDING PANELS • DOORS • WINDOWS

*Fenestra Incorporated*  
2252 East Grand Boulevard, Dept. AR-2  
Detroit 11, Michigan

Please send me FREE copy of New Fenestra Wall Panel Catalog.

NAME \_\_\_\_\_

FIRM \_\_\_\_\_

ADDRESS \_\_\_\_\_

CITY \_\_\_\_\_ STATE \_\_\_\_\_

(Continued from page 334)

The 300-ft clear-span roof shelter of the arena rises at a 4-in-12 pitch to a height at the ridge of 90 ft above the skating rink. The arena is enclosed on three sides, completely open on the fourth to the warming sun from the south, with a view of the speed skating rink and the ski jumps beyond.

The roof structure, which must be capable of supporting very heavy snow

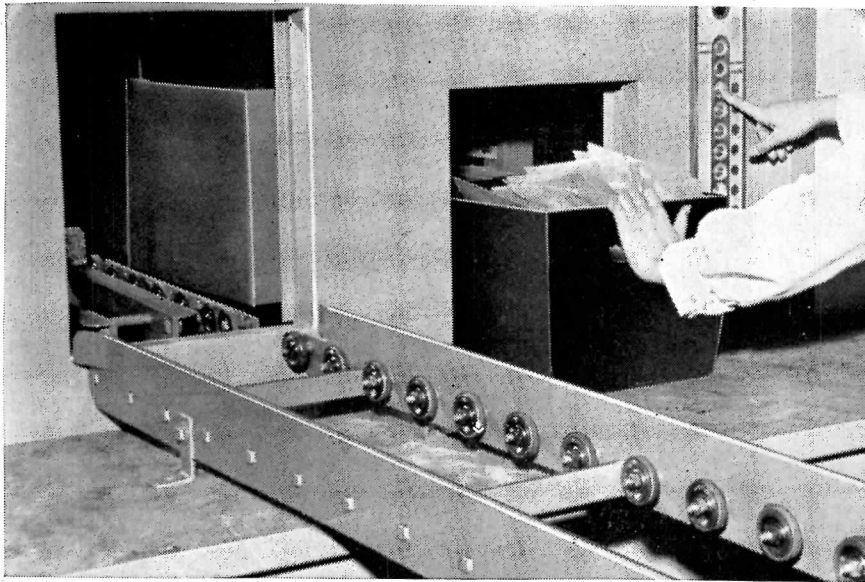
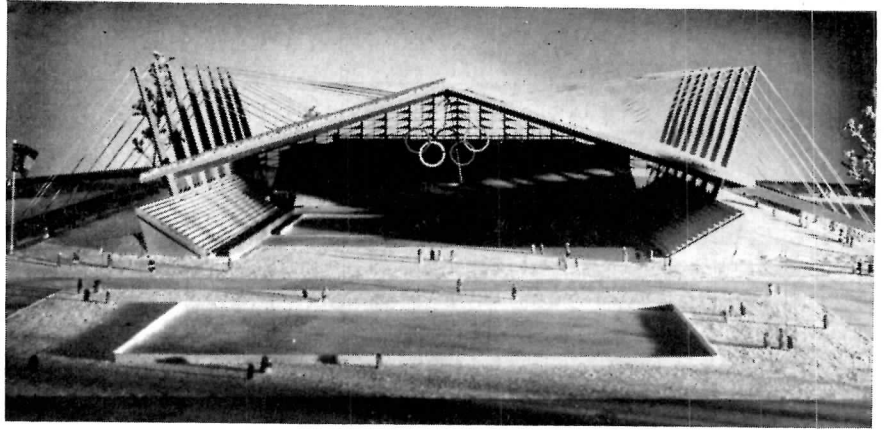

## RECORDLIFT speeds important papers floor-to-floor automatically

*If you have an office building job on the board — read this*

HERE'S the perfect answer to inter-floor handling problems in modern multi-story buildings. This STANDARD conveying system can distribute tons of mail, supplies and business papers every day—quickly and safely.

RECORDLIFT convenience and speed permit the uninterrupted coordination of related departments, regardless of their location. Containers can be sent to any floor in just a few minutes. And because of its simplicity and push-button control, the RECORDLIFT can be easily operated by anyone.

For complete details on cur-

rent RECORDLIFT installations, contact STANDARD CONVEYOR COMPANY, General Office: North St. Paul 9, Minnesota. Sales and Service in Principal Cities.

For details, see the Standard Engineer listed in your phone book or write for Bulletin S-150-00. Address Dept. AA-1.



loads, consists of a cellular steel deck spanning about 12 ft, rolled steel beam purlins spanning 33 ft, and the main supporting frames at 33-ft centers, spanning 300 ft. The main supporting frames consist of tapered columns built up from steel plates, tapered steel box girders, and inclined cable tension members. Each half of the main frame acts independently, in somewhat the manner of a guy derrick, with the roof girder functioning as the boom, the column as the mast and the inclined cables as the guys. Cable anchorages are provided by deadmen of concrete and masonry, with the roof girders extended resisting the horizontal thrust.

Reverse cycle refrigeration, preliminary analysis has indicated, can be used economically to melt the snow, reduce condensation and partially heat the entire building. For economical distribution of the heated air, the roof deck is used to carry it for melting the snow and preventing condensation; areas under the bleachers are used to carry the main air, partly warming the seats and permitting such ducts to be concealed.

H. J. Brunner and John M. Sardis are structural engineers for the project; Vandament and Darmsted, and John Gayner, mechanical engineers; Punnett-Pares and Hutchison, consulting engineers; Office of Clyde C. Kennedy, sanitary engineers; Eckbo, Royston and Williams, landscape architects; Anne Knorr, delineator.



(More news on page 342)