



MACMILLAN BLOEDEL BUILDING: A NEW SKYSCRAPER FOR VANCOUVER, B.C.
THE OAKLAND MUSEUM BY KEVIN ROCHE JOHN DINKELOO AND ASSOCIATES
AIR CONDITIONING: HOW TO DEFINE AND CONTROL QUALITY
BUILDING TYPES STUDY: OPERATION BREAKTHROUGH
FULL CONTENTS ON PAGES 4 AND 5

ARCHITECTURAL RECORD

APRIL 1970 **4** A McGRAW-HILL PUBLICATION TWO DOLLARS PER COPY

Devoe announces a line of colors you can stick with.

Now that we've re-formulated our entire color system to jibe with the fashions and fabrics of the seventies—we've made specifying our colors easier, too.

The new Devoe color index book is cross-referenced to a bound set of color chips with self adhesive backs. You don't have to paper clip chips anymore, or tape them or staple them. Just peel them off the page and stick them to your specs.

Ask your Devoe man about the Colors of the Seventies—available in all paint finishes, from flat to gloss, for any job. Produced with high-hide bases for improved coverage and greater performance.

See your Devoe man.
Devoe Paint, Division of
Celanese Coatings Co.,
224 East Broadway, Louis-
ville, Kentucky 40202.

For more data, circle 2 on inquiry card



First with the fashion paint colors of the 70's

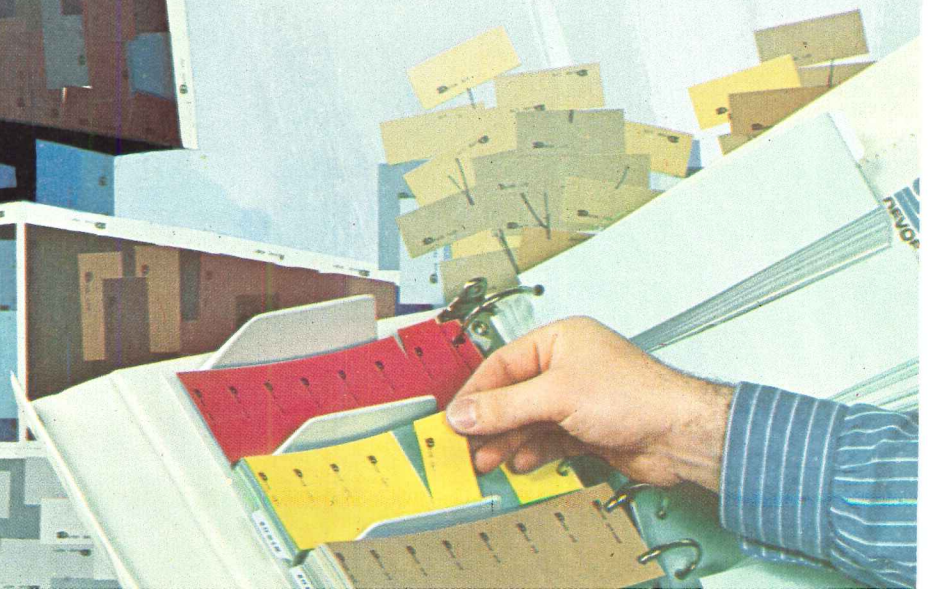

Specify laboratory table tops of corrosion resistant Durcolam

This tough, epoxy-based laminate can be mounted on practically any supporting material. Only one-eighth of an inch thick, it is light in weight, easy to handle, easy to fabricate and available in sheet sizes up to 63" x 96". Highly versatile, convenient means of renewing old, corroded tops. Durcolam is also an inexpensive, convenient means of renewing old, corroded reagent shelves, and many other applications demanding high resistance to corrosion. Send for complete details in Bulletin PF/8.

THE DUPIRON COMPANY, INC., DAYTON, OHIO



For more data, circle 3 on inquiry card



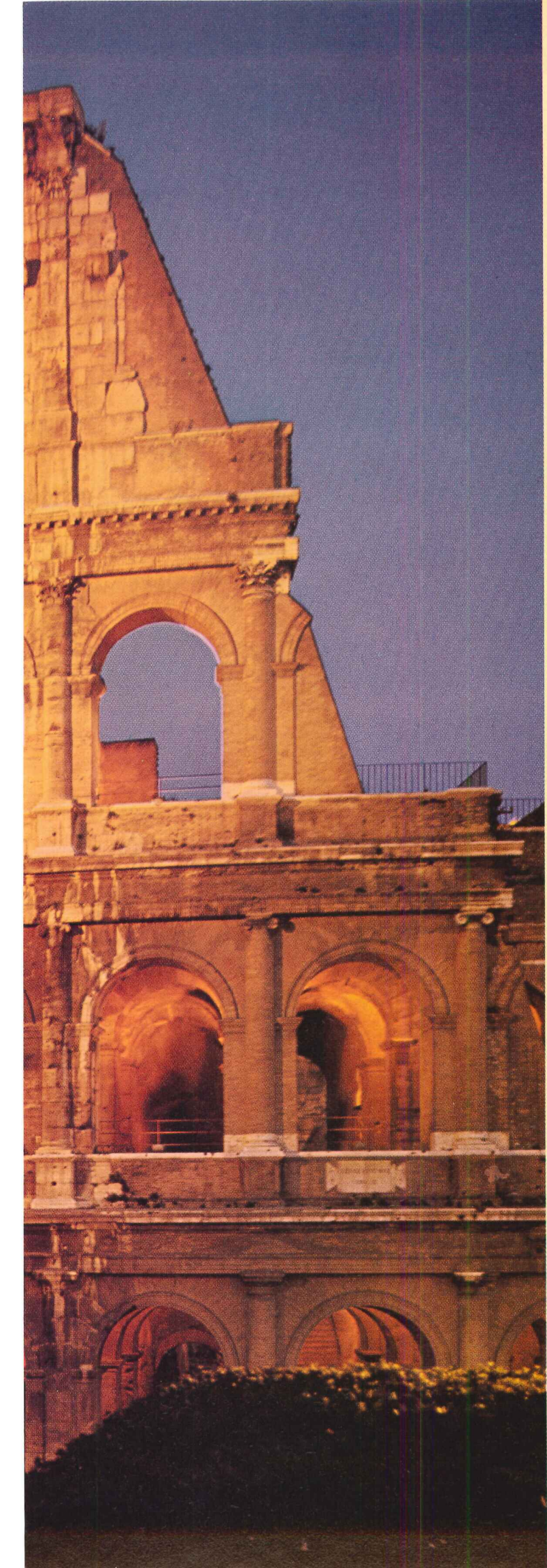

You don't build 'em like they used to.

You're not building for the ages. Space needs change faster today, materials cost more. You can't raid a neighboring empire for captive labor.

You need new building techniques for modern building needs. That's where Keene comes in, with Speed-Steel™ nailable structural steel that enables you to frame a three-story building in less than a week. Modular interior systems that let you redesign building interiors... walls, ceilings and lighting... without damaging a single component. Instant-access ceiling systems, movable partitions, lightweight metal doors.

Why has Keene put together a capability for making so many advanced building products? We want to be there when you build them like you're going to.

KEENE
CORPORATION

We've just begun to grow.

Can Keene innovations in building products and techniques help you? Let's find out. For details on Speed-Steel, movable partitions and metal doors, write to our Metal Construction Products Division, Parkersburg, West Va. 26101. For instant-access ceilings—Sound Control Division, Princeton Service Center, U.S. Route 1, Princeton, N.J. 08540. For interior systems—Interior Systems Division, Route 206 Center, Princeton, N.J. 08540.

For more data, circle 4 on inquiry card



Cover: MacMillan Bloedel Building,
Vancouver, British Columbia
Architects: Erickson/Massey and Francis Donaldson
Photographer: © Ezra Stoller (ESTO)

- 9 EDITORIAL
Beauty and the Beatles, or, Why can't Johnny see?

- 10 PERSPECTIVES

THE RECORD REPORTS

- 35 NEWS IN BRIEF
- 36 NEWS REPORTS
- 42 BUILDINGS IN THE NEWS
- 96 OFFICE NOTES
- 111 LETTERS

**ARCHITECTURAL
BUSINESS**

- 81 GUIDELINES FOR EARLY PLANNING ESTIMATES
- 85 BUILDING ACTIVITY: CURRENT TRENDS IN CONSTRUCTION
Construction vs. inflation: part 3, materials
- 90 INDEXES AND INDICATORS

FEATURES

- 115 THE OAKLAND MUSEUM

Designed by Kevin Roche John Dinkeloo and Associates, the Oakland Museum appears to be a terraced park rather than a building. Appearance to the contrary, it is more than a handsome public park: it is a huge \$10-million complex consisting of interrelated museums tucked under terraces and opening onto gardens, and is widely acknowledged as a major architectural achievement.

- 123 THE MACMILLAN BLOEDEL BUILDING

The young firm of Erickson/Massey of Vancouver, British Columbia has designed a distinguished 28-story reinforced concrete office building for Canada's largest forest products company to reflect the owners' desire for a distinctive and handsome, but matter-of-fact and economical, building.



Chalmer Alexander

129 BOOK REVIEWS

Thomas Jefferson, Architect, by Fiske Kimball. Reviewed by Paul F. Norton.
Arcology: The City in the Image of Man, by Paolo Soleri.
New Directions in American Architecture, by Robert A. M. Stern.

131 A LUMINOUS SHOWCASE FOR OFFICE FURNITURE

Warren Platner's new showroom for Steelcase in Chicago's Merchandise Mart provides an elegant and artfully simple space which dramatizes objects and images in an unorthodox but highly effective manner.

**BUILDING TYPES
STUDY 408**



137 OPERATION BREAKTHROUGH

This major government program has created a booming interest in industrialized housing techniques, and for complex reasons large corporations have been contending for selection as Breakthrough developers. Importantly, and happily, most of the consortiums include experienced architects in the development work. This Building Types Study will describe the 22 industrialized building systems which HUD has picked as winners, and examine the significance of Breakthrough for the housing industry as a whole.

**ARCHITECTURAL
ENGINEERING**

153 SPECIAL REPORT: THE SYSTEMS APPROACH TO AIR CONDITIONING

Part 4 is concerned with that somewhat elusive factor known as "quality." Quality is affected not just by the equipment that is used, but by the way systems are installed, and, moreover, by the competence of people involved in the links in the chain from owner through design specification, installation and operation.

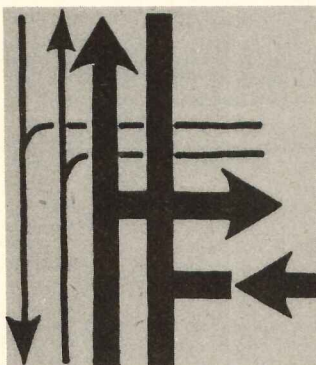

165 PRODUCTS REPORTS

224 OFFICE LITERATURE

252 ADVERTISING INDEX

254 CLASSIFIED ADVERTISEMENTS

255 READER SERVICE INQUIRY CARD

ARCHITECTURAL RECORD, April 1970, Vol. 147, No. 4. Published monthly, except May, when semi-monthly by McGraw-Hill, Inc., 330 West 42nd Street, New York, New York 10036. CORPORATE OFFICERS: Shelton Fisher, President and Chief Executive Officer; John L. McGraw, Chairman; John J. Cooke, Vice President and Secretary; Gordon W. McKinley, Vice President and Treasurer. SUBSCRIPTION RATE: for individuals in the fields served \$6.60 per year in U.S., U.S. possessions and Canada; single copies \$2.00; further details on page 6. THIS ISSUE is published in national and separate editions. Additional pages of separate edition numbered or allowed for as follows: Western Section 32-1 through 32-8. PUBLICATION OFFICE: 1500 Eckington Place, N.E., Washington, D.C. 20002. Second-class postage paid at Washington, D.C. and at additional mailing offices. POSTMASTER: Please send form 3579 to Fulfillment Manager, ARCHITECTURAL RECORD, P.O. Box 430, Hightstown, N.J. 08520.

ARCHITECTURAL RECORD STAFF

EDITOR

WALTER F. WAGNER, JR., A.I.A.

MANAGING EDITOR

HERBERT L. SMITH, JR., A.I.A.

SENIOR EDITORS

ROBERT E. FISCHER
WILLIAM B. FOXHALL
MILDRED F. SCHMERTZ, A.I.A.
ELISABETH KENDALL THOMPSON, F.A.I.A.

WASHINGTON EDITOR

ERNEST MICKEL

ASSOCIATE EDITOR

ROBERT JENSEN, A.I.A.

ASSISTANT EDITORS

ANNE LUISE BUERGER
JONATHAN HALE
DONALD-DAVID LOGAN
NANCY LOU MOORE
ANNETTE K. NETBURN

DESIGN

ALEX H. STILLANO, Director
ALBERTO BUCCHIANERI, Associate
JUDY GEIER, Assistant
SIGMAN-WARD, Illustration
JAN WHITE, Consultant

EDITORIAL CONSULTANTS

EDWARD LARRABEE BARNES, F.A.I.A.
ROBERT F. HASTINGS, F.A.I.A.
PAUL RUDOLPH, A.I.A.

INDUSTRY CONSULTANTS

GEORGE A. CHRISTIE, JR., Economics
WILLIAM H. EDGERTON, Building Costs

McGRAW-HILL WORLD NEWS

ARTHUR MOORE, Director
DOMESTIC NEWS BUREAUS—Atlanta,
Chicago, Cleveland, Dallas, Detroit,
Los Angeles, Pittsburgh, San Francisco,
Seattle, Washington, D. C.
INTERNATIONAL NEWS BUREAUS—Bonn,
Brussels, Hong Kong, London, Mexico City,
Milan, Moscow, Paris, Rio de Janeiro, Tokyo

PUBLISHER

BLAKE HUGHES

SALES MANAGER

LOUIS F. KUTSCHER

CIRCULATION MANAGER

HUGH S. DONLAN

COMING IN THE RECORD

A SHOWCASE FOR "DESIGN RESEARCH"

Architect Benjamin Thompson's new building in Cambridge, Massachusetts for his own store, "Design Research"—to be featured in May—is a glass showcase for the display of dresses, fabrics, furniture and objects that depends greatly on the color and life inside as a major part of the architectural design.

BUILDING TYPES STUDY: PLACES FOR PEOPLE TO PLAY

Recreation facilities continue to be a major need and open space use a major concern. The May Building Types Study will examine the means for accomplishing these apparently paradoxical aims. Among buildings to be included will be three simple camps for day use, a clubhouse building and a horticultural hall for a state fair. An article by William Penn Mott, Director of Parks and Recreation for the State of California, will describe plans and programs of our most populous state for handling 40 million visitors a year in its state parks.



McGraw-Hill



ARCHITECTURAL RECORD (combined with AMERICAN ARCHITECT, ARCHITECTURE and WESTERN ARCHITECT AND ENGINEER), April 1970, Vol. 147, No. 4. Title ® reg. in U.S. Patent Office © copyright 1970 by McGraw-Hill, Inc. All rights reserved including the right to reproduce the contents of this publication either in whole or in part. Quotations on bulk reprints of articles available on request. Indexed in Reader's Guide to Periodical Literature, Art Index, Applied Science & Technology Index, Engineering Index, and the Architectural Index. Architectural Record is a McGraw-Hill publication, published monthly, except May, when semi-monthly, by McGraw-Hill Publications, a division of McGraw-Hill, Inc., 330 West 42nd Street, New York, New York 10036. James H. McGraw (1860-1948), Founder.

EXECUTIVE, EDITORIAL, CIRCULATION AND ADVERTISING OFFICES: 330 West 42nd Street, New York, New York 10036. Western Editorial Office: 255 California Street, San Francisco, California 94111. PUBLICATION OFFICE: 1500 Eckington Place, N.E., Washington, D.C. 20002; second-class postage paid at Washington, D.C.

OFFICERS OF McGRAW-HILL PUBLICATIONS COMPANY: Joseph H. Allen, president; John R. Emery, J. Elton Tuohig, senior vice presidents; George H. Reppert, group vice president; vice presidents: John R. Callahan, editorial; William P. Giglio, administration; John M. Holden, marketing; David G. Jensen, manufacturing; Jerome D. Luntz, planning & development; Robert M. Wilhelmy, finance. Director of circulation: Ralph Blackburn.

OFFICERS OF THE CORPORATION: Shelton Fisher, president and chief executive officer; John L. McGraw, chairman; Donald C. McGraw, chairman, executive committee; Robert E. Slaughter, executive vice president; Frederick A. Stahl, chairman, finance committee; Daniel F. Crowley, Donald C. McGraw, Jr., Bayard E. Sawyer, senior vice presidents; John J. Cooke, senior vice president and secretary; Gordon W. McKinley, vice president and treasurer.

Every effort will be made to return material submitted for possible publication (if accompanied by stamped, addressed envelope), but the editors and the corporation will not be responsible for loss or damage.

SUBSCRIPTIONS: Available only by paid subscription. Publisher reserves the right to refuse non-qualified subscriptions. Subscriptions solicited only from architects and engineers. Position, firm connection, and type of firm must be indicated on subscription orders forwarded to Fulfillment Manager, Architectural Record, P.O. Box 430, Hightstown, New Jersey 08520. Subscription prices: U.S., Possessions and Canada: \$6.60 per year; other countries, to those who by title are architects and engineers, \$15.00 per year. Subscription from all others outside U.S., U.S. Possessions and Canada, \$24 per year. Subscription includes 12 monthly issues and Mid-May "Record Houses" issue.

SUBSCRIBERS: Address change of address notice, correspondence regarding subscription service or subscription orders to Fulfillment Manager, Architectural Record, P.O. Box 430, Hightstown, New Jersey 08520. Change of address notices should be sent promptly; provide old as well as new address; include zip code or postal zone number if any. If possible, attach address label from recent issue. Please allow one month for change of address to become effective.

UNCONDITIONAL GUARANTEE: The publisher, upon written request, agrees to refund the part of the subscription price applying to the remaining unfilled portion of the subscription if service is unsatisfactory. OTHER McGRAW-HILL SERVICES TO THE BUILDING AND CONSTRUCTION INDUSTRY: College and University Business—Construction Methods and Equipment—Daily Construction Reports (Los Angeles)—Dodge Building Costs Services—Dodge Construction News (Chicago, Denver, San Francisco)—Dodge Construction Statistics—Dodge Reports—Dodge Spec-Fax—Engineering News-Record—Hospital Purchasing File—House & Home—House & Home Planners' Digest—Management Control Service—Modern Hospital—Modern Nursing Home—Nation's Schools—Sweet's Construction Catalog Systems—Sweet's Canadian Construction Catalogue Services—Sweet's information and Library Centers—Sweet's Microfilm Systems.



If you didn't notice
the air conditioning,
we made our point.

Another great ceiling. This one
in Ohio's Newark City Hall.

Architects: Blum & Harden.

Air conditioning: All-air,
Carrier Moduline® system.

Basic component: The Moduline air
terminal. 12" x 48". Flush-mounted.
Interconnectable plenum.

Automatic controls regulate flow
of air (15-180 cfm) through
linear slots which in turn diffuse
air so it hugs ceiling,
mixes evenly with room air.

Design advantages: Inconspicuous.
Draftless. Sensitive to any
temperature change in immediate
area. Eliminates wall thermostats
and wiring. Allows complete
flexibility in arrangement of units,
future altering of interior space.

Client advantages: Unequaled
climatecontrol throughout building.
Low initial and operating costs.

Applications: Office buildings,
department stores, schools,
hospitals, any multi-room building.

Moduline design data: write
Carrier Air Conditioning Company,
Dept. A, Syracuse, New York 13201.



We keep on inventing air conditioning

Mexican Sand.



Kohler's new cool/hot color captures Mexico's artistry...romance. ¡Viva!

Viva Kohler's latest move to help you promote the idea of a bath as dramatic as any room in the house. Mexican Sand. It's cool/hot. A rich, vibrant tan that's whatever you make it. Accessorize with brilliant red and purple notes. Or sunny splashes of orange and yellow. Or muted earth tones. All are simpatico with Mexican Sand. Kohler captures its magic in a complete line of fixtures. Sell customers on the installation possibilities and stretch-out ease of a 6-ft. Caribbean bath tub, with safety grip bars

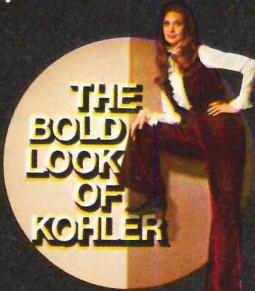

and Safeguard® bottom. Show them Kohler's shampoo center and baby bath, bidet and the smart new water closet. Go bold with a lavatory in Espresso or any of four other accent colors. Set off everything with unique Alterna fittings...Kohler's newest. Four contrasting, changeable accent-inserts for each handle are a perfect decorator touch. Sell the return of artistry to the bath...helped by Mexican Sand and all Kohler's Bold Look fixtures and colors. ¡Elegante!

Kohler Co., Kohler, Wisconsin 53044

For more data, circle 6 on inquiry card

Beauty and the Beatles or, Why can't Johnny see?

Wouldn't it be something if the children and young people—say from kindergarten through high school—were as concerned about quality of design in their environment as they are about the latest doings of the Beatles?

I've got a 12-year-old girl (if you'll pardon a personal note) who can tell you Paul McCartney's mother's maiden name. She also, at the public expense of at least two school hours per week, has learned to play the flute very well. She is also required by public policy to spend several school hours a week drawing pictures, making collages, and dabbling in paper and flour paste in the name of "Art." But never, despite the fact that she is getting an impressive education in an impressively-managed and suburbanly-financed public school, has anyone ever talked to her about architecture—about the quality of the design of the environment in which, for example, she attends school for six-and-a-half hours a day, 180 days a year.

The point is simple, of course: 1) We can and should (and must) teach the rudiments of quality in the environment that we all must share, and 2) Creating this awareness of quality in environment in children's still-open minds is really pretty easy—if we can only feed them ideas about quality of design and environment as effectively as we feed them ideas about set theory and computer language. And if there's time to teach the flute, there's time to teach something about form and grace in architecture.

Some real attempts are, of course, being made to develop this awareness of quality design and environment in the schools. The A.I.A. has been involved since 1966, when it set up the task force which in 1969

became a full-fledged committee (Committee on Public Education). Projects designed to stimulate interest in this kind of environmental education have also been undertaken by many state and local chapters, and by individual architects.

For example: the Philadelphia chapter has helped develop a broad program to be incorporated in the program of the upper six grades of the public schools, designed "to prepare students for their future responsibilities as citizens and clients."

The Northern California chapter has developed a curriculum and some teaching materials for grades K-6 to "enrich existing social studies." Explains Betty Thompson, RECORD senior editor in San Francisco who has been active in this chapter program since 1966 as well as in the national A.I.A. committee: "The method we are using requires that the child evolve his own bases for judgment out of the 'learning experiences' which form the major part of the material in preparation. The teacher, however, is provided background material for her own handling of the content of the lessons. The lessons are in effect an enrichment of what is already required in the social studies curricula, and do not constitute a new or additional course. They amplify what is suggested but rarely documented in teacher manuals. Since the material is being prepared by persons whose training, experience and daily work are in the design of the environment, this aspect of the content is accurate (which cannot be said of most school materials which touch on architecture and urban design) and, we dare to think, imaginative enough to interest not only the children but the teacher as well."

There have been other projects of varying scope in over a dozen other chapters.

There have been personal efforts. Just one example: architect Donald Gibbs of Long Beach, California, proposed to the district curriculum supervisor a review of existing textbooks to determine what, if any, material they contained on architecture and the visual environment. A cursory survey revealed (surprise!) very little and very poor content in those areas. And the school district then appointed, at Gibbs' suggestion, a committee of architects, landscape architects, and planners to do a careful review and advise on texts before their purchase.

Some curriculum materials have been developed as part of these projects. Other material is in development by CEMREL (Central Midwestern Regional Education Laboratory) for an experimental K-12 "environmental studies program" to be tested in Missouri; by architect Richard Hatch as a result of an ARCH program of "Urban Action; Planning for Change" in Harlem and other New York City schools; and by some corporations in the educational field.

These and other programs will be detailed in a new Guidebook on Environmental Awareness to be published by the A.I.A. Committee on Public Education.

But what is needed is more: more programs, more curriculum material, more involvement by teachers and by professionals working together. For as Betty Thompson points out: "Alas, the educator knows all about method but little about the environment—and has the strangest ideas about it when he thinks he does know about it. The architect (and others in the design fields) know about the environment but little about writing in the educational method."

With the right effort by teaching and design professionals working together, in today's climate of environmental concern, it seems likely we can make students as involved with the quality of design as they are, say, with the latest doings of the Beatles. Wanna try? —Walter F. Wagner, Jr.

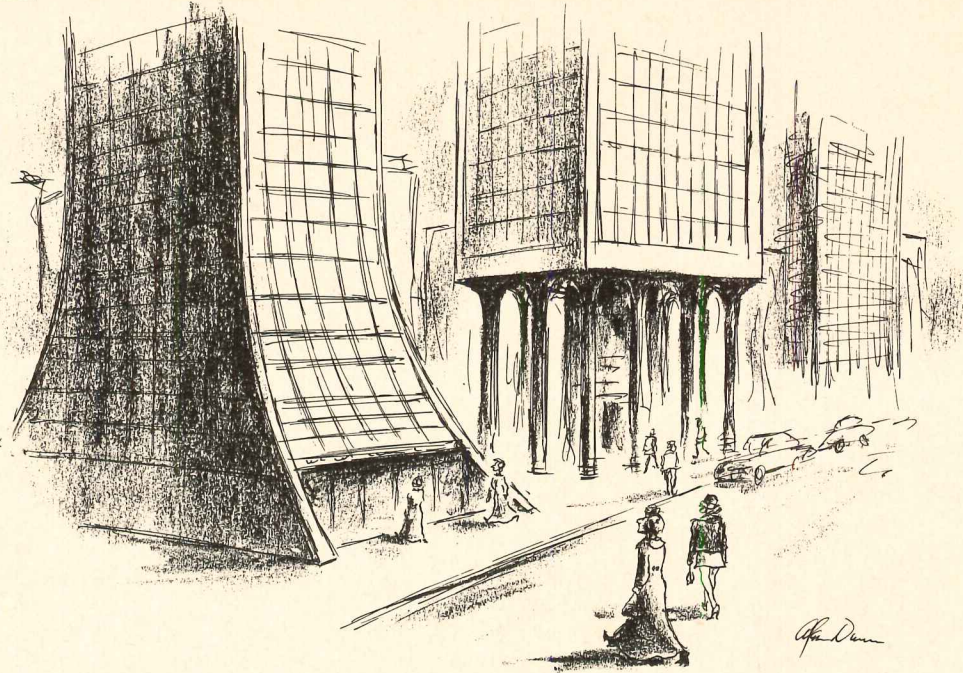

Postscripts on education and environment

Postscript No. 1: A new kind of joint action towards more and more effective teaching of design and environmental values was begun just a few months ago at the Octagon. A Consortium on Environmental Awareness and Public Education, attended by spokesmen for 25 private organizations and Federal agencies, agreed to consider "joint action in classroom instruction, testimony before government bodies, and information to the public."

Some quotable quotes:

By George Arnstein of the National Academy of Sciences: "What we all share is a feeling things are going badly. If we don't move now, we may not get another chance to help shape growing public concern over quality of the U.S. habitat."

By Mrs. Alice Cummings of the Association of Classroom Teachers: "Teachers are worried about the lack of concern by schools in presenting environmental problems to students. We want to get our 900,000 members excited about the potential in such instruction."

By Paul B. Mott, Jr. of the Urban Design and Development Corporation, an A.I.A. affiliate: "Students, consumers, and politicians are increasingly voicing determination to improve the quality of life in the U.S., and professionals must organize to see that this energy is not wasted."

Postscript No. 2. Two of our sister McGraw-Hill publications—*Nation's Schools* and *College & University Business*—are making a very special effort to reach school administrators with information on this need. Writes Daniel M. Kelley, their publisher: "Ever since President Nixon's State of the Union address, the subject of environmental control has been covered exhaustively. . . . Ultimately, after the initial furor subsides somewhat, it will be left to our schools and

colleges to provide a proper continuing education on this very essential subject. Most of you know about the 'environmental teach-in'—to be called 'Earth Day'—scheduled for April 22 in education institutions across the country. Students and faculty will be making demands at that time, some rational and some not so rational, about the future course of their curriculum as it relates to the environment. . . . To provide some direction at this critical time, the April issues of *Nation's Schools* and *College & University Business*, which will reach the desks of education administrators just prior to Earth Day, will devote a major part of their editorial content to the subject of our changing environment and its effects on education."

Postscript No. 3. Guess who (hint: not the architects) is holding a series of eight evening programs of adult education on "Criticism and Imperative Needs," "Environmental planning," "Pollution," "Transportation," "Structures," "Education and Public Policy." With such speakers as Ian McHarg, Larry Halprin, David Brower, Alan Voorhees, Gerald McCue. The meetings—"with attendance limited to 390"—are being held in Oakland and presented jointly by the San Francisco Section of the American Society of Civil Engineers, and the Structural Engineers Association of Northern California. Again, hooray for the engineers.

On the necessity for excellence . . ."

"For man to take full advantage of modern technology he must raise his standards of knowledge and performance."

That quote, by crusty Vice Admiral Hyman Rickover before a Congressional committee, is from a statement on naval procurement. But what he went on to say is worth thought by all design and building

professionals in these days of "new technology" and "new systems" in building:

"Utmost care must be taken in design, manufacture, installation and operation. No carelessness can be tolerated anywhere in the entire chain—or the result may prove disastrous. Every person involved must constantly bear in mind that he personally is responsible for the entire ultimate result. Advertisements and statements claiming that the particular organization has an effective so-called zero defects program should be recognized for what they are—motherhood and propaganda statements. These are the sort of words administrators, who have little or no technical competence or experience, love to use. They tend to delude the workers and the customers as well as those who make the claims. In this way they detract from meaningful effort. It should be a mandatory requirement that every administrator be made responsible for personally directing in detail one of his projects. This would immediately show him the human and material pitfalls involved. He would not be able to sit at a desk issuing orders and reading reports without understanding their real meaning. The only way to obtain the kind of quality that is essential today is for each person involved to understand what he is doing and to recognize the consequences of failure."

How about a monument to bad judgment?"

The Friends of the Earth, the San Francisco-started conservation organization, has proposed that San Francisco Embarcadero Freeway, on which construction was halted by public indignation, be left standing as "a concrete reminder of our profound environmental crisis . . . and the inability of the old technological solutions to cope with the numerous problems raised by urban development a colossal monument to bad planning and bad architecture." —W.W.

**The next four pages
contain ideas
which could change
the design approach
to entrances
and windows
for many years
to come.**

Kawneer introduces a new system of aluminum entrance coordinates ... Entara

**Now you can design entrance areas
as individual and memorable as your
buildings.**

For the first time you aren't confined
to stereotyped entrance styles.

Entara is a system of aluminum
extrusions, sub-assemblies, parts,
pieces and hardware. Variants in stiles,
rails, plankings, glazing options.
Related in appearance and in function
to achieve a wide selection of
interchangeable design elements
for an almost limitless variety of
entrance configurations.

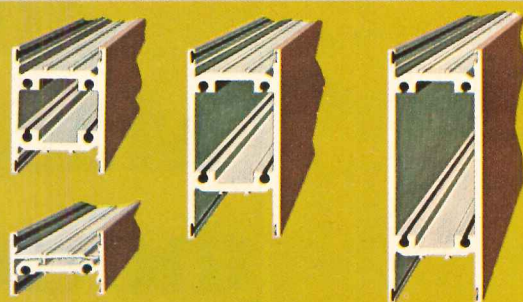

MIX or MATCH BASIC SHAPES

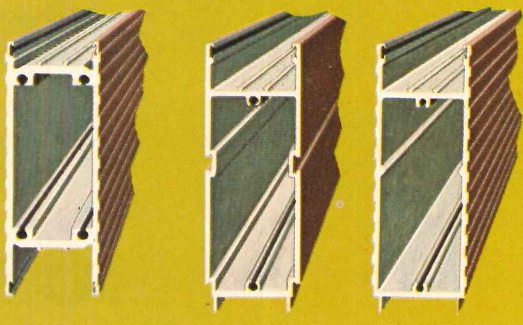

To put it another way . . . Entara is
a system of entrance coordinates.
Door coordinates—Frame coordinates
—Hardware coordinates. New form,
dimension, plane, texture, color. New
push-pull hardware, created as part
of the system, can be varied to
meet your design individuality.

The multiple components of the
Kawneer/Entara system give you
optimum design freedom. For full
information, see your Kawneer
representative or contact Kawneer
Product Information, 1105 N. Front St.,
Niles, Michigan 49120.

Entara is a trademark of Kawneer/AMAX.

For more data, circle 7 on inquiry card



DEPARTMENT OF INTERIOR

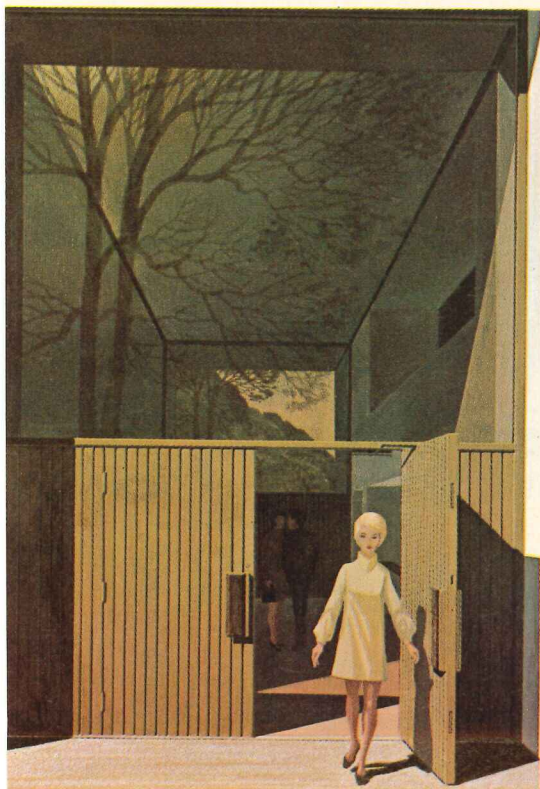
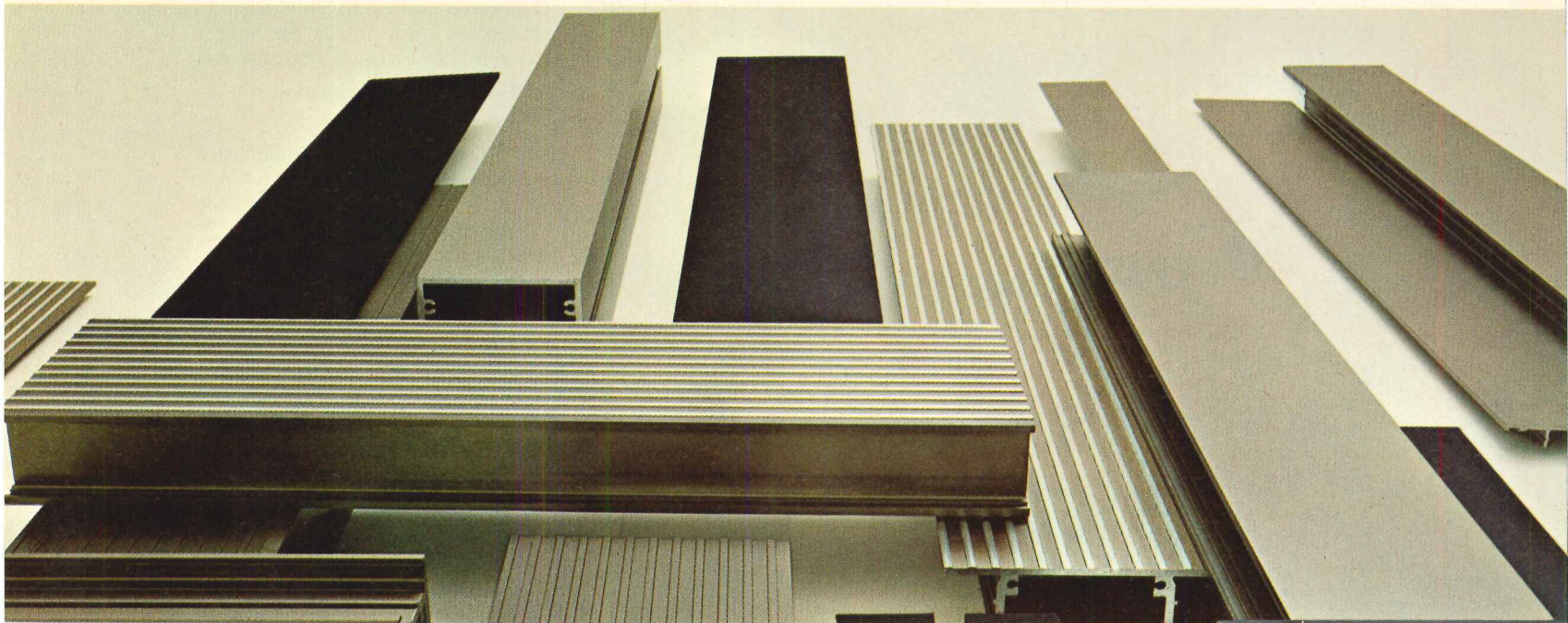
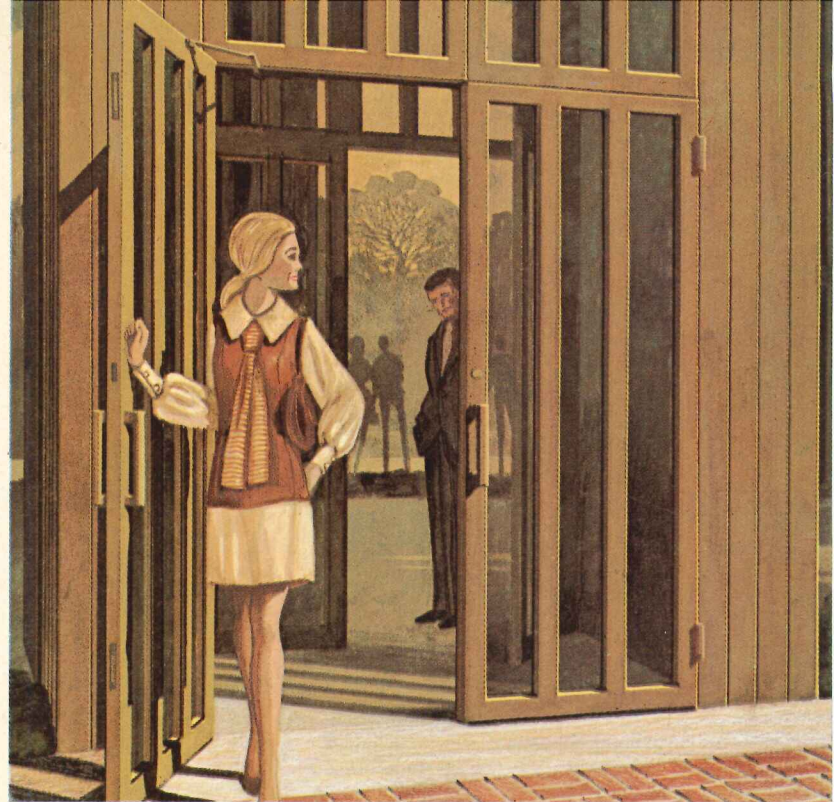

Kawneer has just re-invented the window ...Ventrow

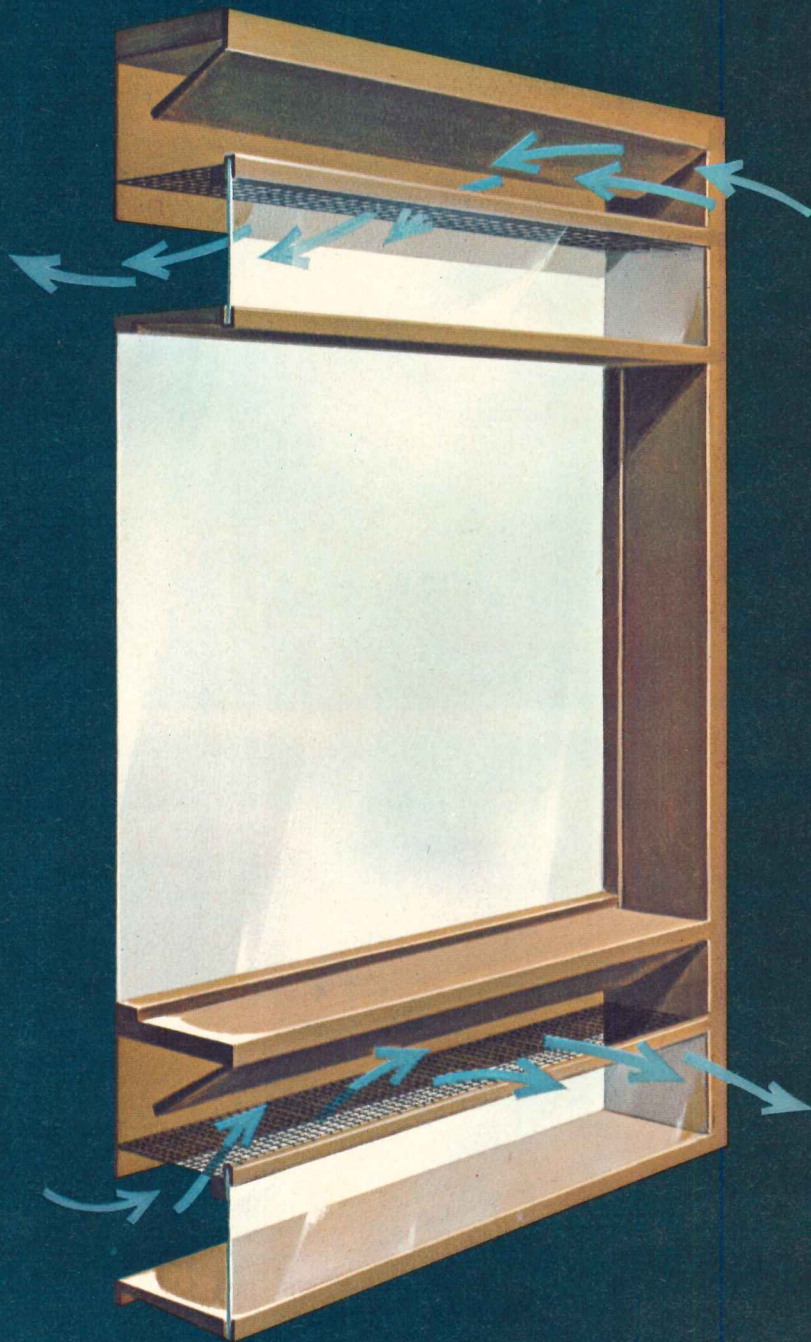

From the exterior, open or closed, Kawneer Ventrow appearance doesn't change. No operating hardware. No protrusions. Invisible, hidden screen. It's burglarproof, fall-out-of-proof and throw-things-out-of-proof to maintain a building's security . . . eliminate all worry about leaving windows unlocked or open.

Kawneer Ventrow is the aluminum window that delivers fixed window performance, yet ventilates in a unique way. It is designed to be left open, even during driving winds, rain or snow. Without leaking. Without gusts. Without drafts. Air movement, using natural air circulation principles, is always controlled and even. An easy pull shuts vent tight. In fact, the harder the wind blows, the tighter the seal.

Natural selective ventilation is always possible!

Get full details on the Permanodic® maintenance-free aluminum window you have to see to believe —Kawneer Ventrow. Write Kawneer Product Information, 1105 N. Front St., Niles, Michigan 49120.



Warren Packaging, Ltd.
Scarborough, Ontario

Architect: Brian T. E. Atkins M.R.A.I.C.
Toronto, Ontario

General Contractor: Kannakko Construction, Ltd.
Scarborough, Ontario

THE KAWNEER CONCEPT:
Attention to detail

KAWNEER
ARCHITECTURAL PRODUCTS

AMAX
ALUMINUM

Kawneer Company, Inc., a Subsidiary of American Metal Climax, Inc.
Niles, Michigan • Richmond, California • Atlanta, Georgia • Bloomsburg,
Penn. • Harrisonburg, Va. • Kawneer Company Canada, Ltd., Toronto

VENTROW IS A TRADEMARK OF KAWNEER/AMAX. PATENT APPLIED FOR.

For more data, circle 7 on inquiry card





You'll be surprised how fast **VIP-260** service is.

Stay on your toes.

With the new Otis VIP-260 system,
you'll be at your floor before you know it.

Because a computer controls and
coordinates every movement the elevator
makes. Starts and stops are swifter and smoother
than ever. Our fast, gentle arrivals could
catch you offguard.

The system's electronic brain also saves
waiting time. It responds instantly to changing
situations. Actually anticipates calls.

VIP-260 is the most advanced elevating
system ever devised. Our engineers spent
years on it.

To save you a few moments every day.

Otis[®]
The Elevator Company

Bigelow wool carpets help make architectural innovations possible.

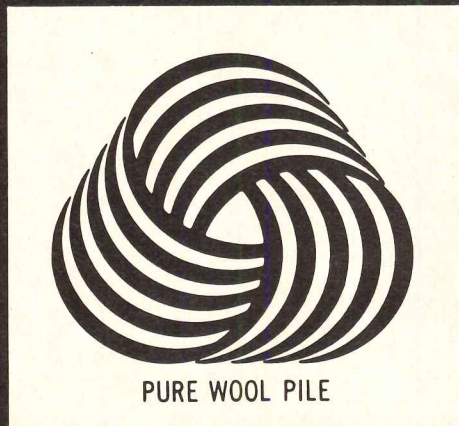

The woolmark is
your assurance of quality-
tested carpet made of
pure wool pile.

What other kind of carpet could be so naturally resilient, so long-wearing, so soil-resistant, so luxurious? That's why architects, designers and other specifiers are innovating with Bigelow wool carpets—for schools, hospitals, and public buildings of every kind.

Whenever you build or renovate, plan around a Bigelow wool carpet. Its Woolmark label is the sign of the world's finest wool.

People who have everything always walk on wool.

Bigelow 
RUGS & CARPETS SINCE 1825



Handsome Gropoint® in Adriatic Moresque, Bigelow Approved 100% Wool Face.

The school that could never be built before.

Bigelow carpets help make architectural innovations possible.

Walls can be lighter, thinner than architects ever thought possible. Yet rooms stay remarkably quieter and warmer. Heat is conserved. Glare is considerably reduced. And when you choose Bigelow school carpeting, you can save substantially over the cost of maintenance of hard-surface floors.



Whenever you specify

Bigelow, you get a vast engineering, design, and research staff in the bargain. Plus highly skilled Bigelow field specialists. All their new ideas are at your command—whether you're building or renovating a school, hospital, church, office, or store.

Our 57 trend-setting patents are proof that Bigelow is the carpet to innovate

with. We offer a wide collection of time-proven grades. And a limitless variety of special designs, patterns, and colors. (If your specifications call for it, we'll even custom-make the right carpet for you.)

To achieve spectacular design innovations, do your planning from the floor up. The first step is to call the first name in the contract carpeting field: Bigelow.

People who know...buy **Bigelow** 
RUGS & CARPETS SINCE 1825

For more data, circle 8 on inquiry card

If you're looking for a wall that resists fire

a wall that has earned a one-hour fire rating and meets flame spread requirements.

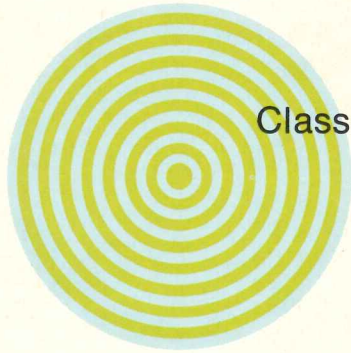

sound

a wall with a Sound Transmission Class of 45 or even greater on other tested assemblies.

scuffs

a wall that takes almost anything and wipes clean with a damp cloth.

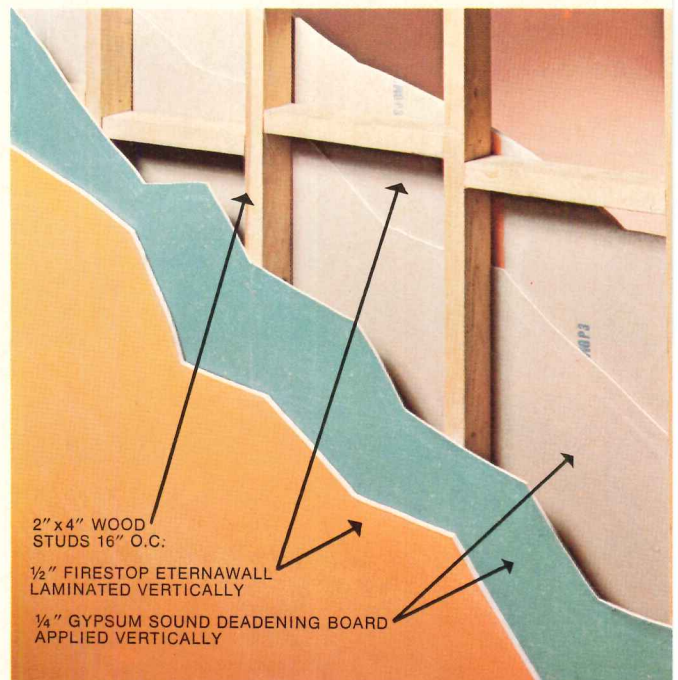
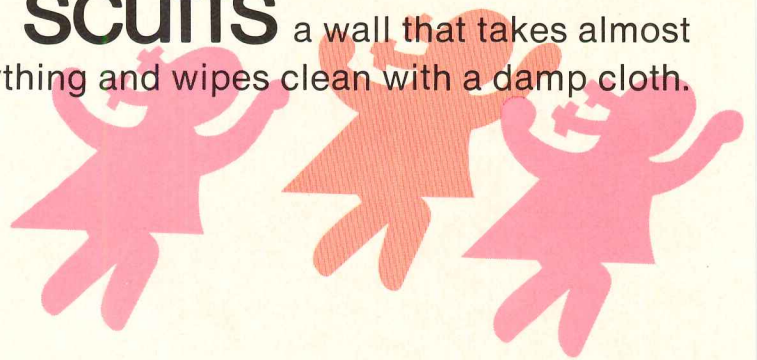

U.L. DESIGN 30 STC 45



looks good a wall that comes in
a great number of colors, textures and patterns.

and costs less

a wall that eliminates the need for batten
strips and costs less than any comparable system.

we've got the system! It's Georgia-Pacific's Firestop®

Eternawall™ vinyl surfaced gypsum wallboard
laminated directly to ¼" Incombustible Gypsum
Sound Deadening Board.

The vinyl covering is tough. Colorfast.
Abrasion resistant. And beautiful.

Installation? Fast! Drywall contractors can
hang it just like regular wallboard.

Also available with Fiberglass insulation,
giving an STC of 50 on wood studs and an
STC of 54 on steel studs.

Call your G-P Distribution Center for details.
Or, write for free brochure on sound control:
Department GDI-370, Georgia-Pacific
Corporation, Portland, Oregon 97207.

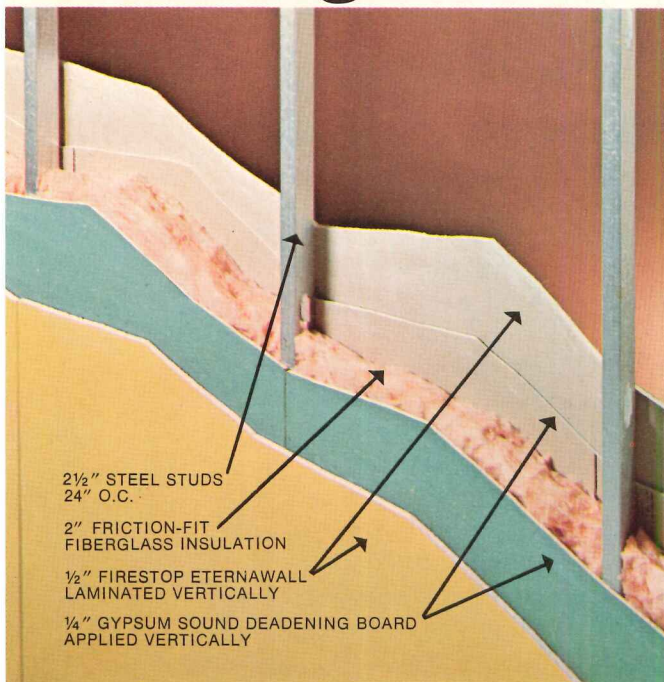

2½" STEEL STUDS
24" O.C.

2" FRICTION-FIT
FIBERGLASS INSULATION

½" FIRESTOP ETERNAWALL
LAMINATED VERTICALLY

¼" GYPSUM SOUND DEADENING BOARD
APPLIED VERTICALLY

U.L. DESIGN 32 STC 50



For more data, circle 9 on inquiry card

Crime is on the way out

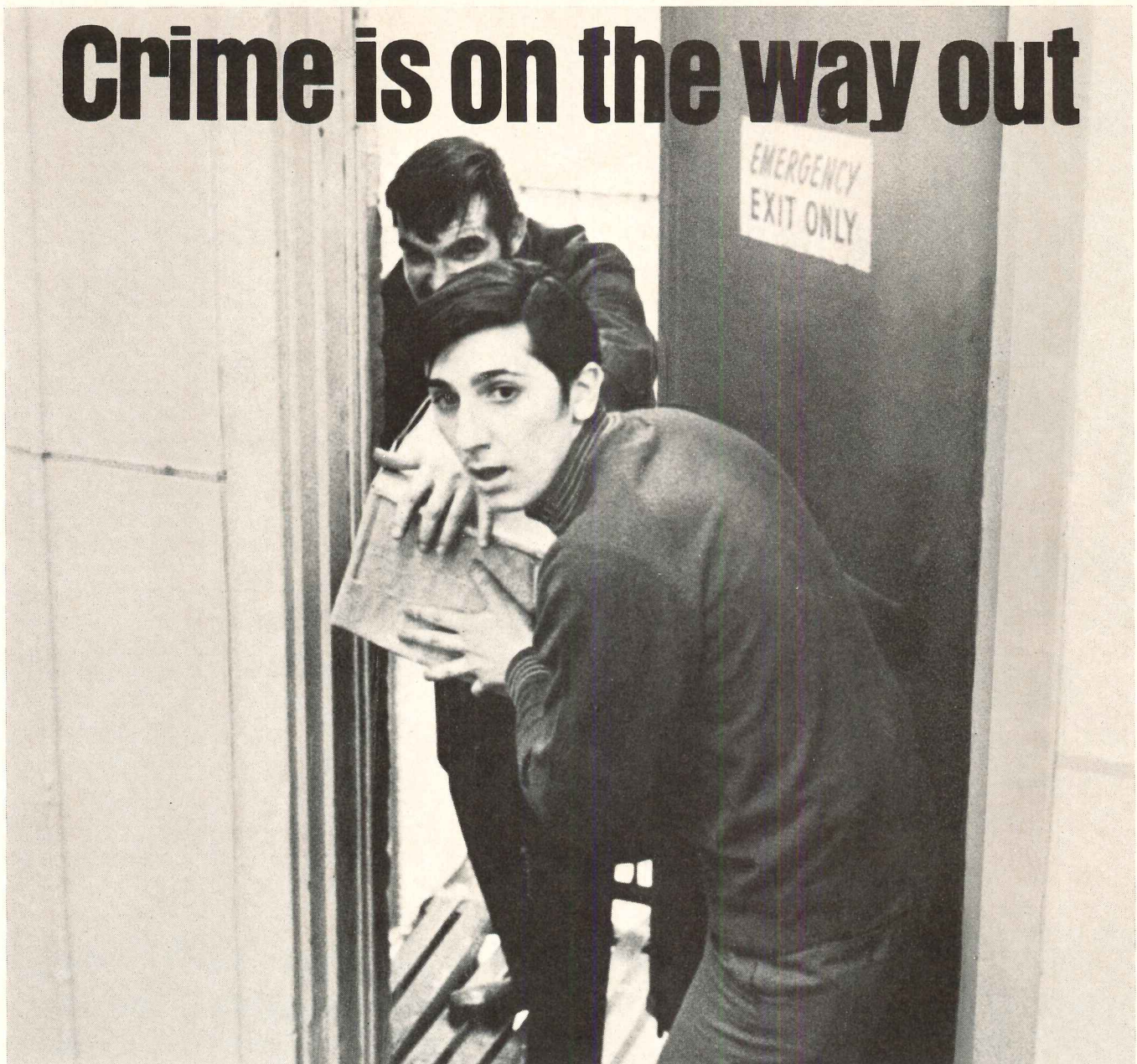

-when you protect doorways with Detex exit and entry control systems

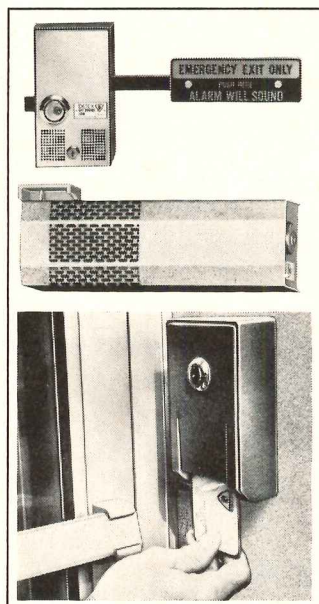

Unless entries and exits are protected against unauthorized use, profits could go right out the door. But theft, pilferage, shoplifting, industrial espionage and even armed robbery can often be effectively prevented with the proper Detex Security System—as many criminals have already discovered. A trained Detex security expert can help select the proper system for you:

Detex Exit Alarm—Self-contained door alarm permits authorized personnel to use a doorway freely but sounds alarm whenever the door is opened by anyone else.

Detex Exit Control Lock—Similar to the Detex Exit Alarm, with the addition of deadbolt latching. Permits exits to be locked, yet still available for emergency or panic use.

Detex Entry Control (DENTCO) System—Uses secretly coded plastic cards instead of conventional key cylinders to prevent illicit use of doorways. Write or call for free literature today.



Detex Corporation

Dept. AR-4 53 Park Place, N.Y., N.Y. 10007 Tel. (212) 732-6450

For more data, circle 10 on inquiry card

LENNOX PRESENTS

Office comfort with affordable tenant control

Growing demands for individualized office comfort—plus spiraling costs and expensive money—all have combined to create a new “specification” for many buildings: heating/air conditioning systems with affordable tenant control. Tall order? Yes—but a Lennox modular system can provide the necessary flexibility for true tenant control of individual environments. And Lennox does it with cost-saving affordability.

continued overleaf . . .



The Garden City Office Building—Long Island's largest—is being built in Carle Place, near Mineola. The five-story, 289,000-sq. ft. area will have individual comfort zones, regulated by tenant control of Lennox heating and air conditioning. Architect: Theodore E. Bindrim, A.I.A. Engineers: S. M. Limoggio Associates. Owner-Builder: Garden City Plaza Corporation.

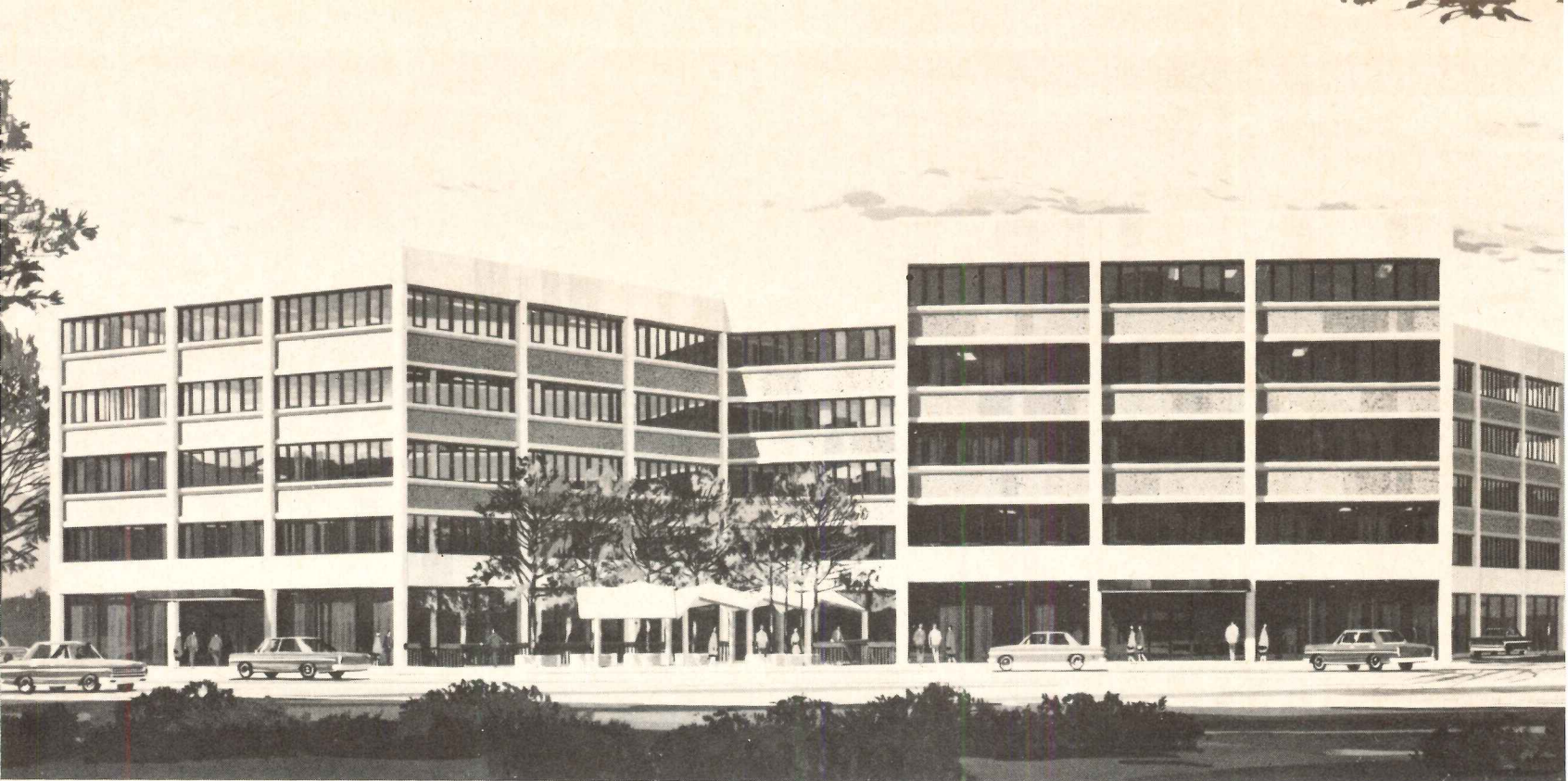

Long Island's new Garden City Office Building has Lennox modular heating and air conditioning because, according to Tom Pepitone, president of the owner company, "We need tenant (zone) control. With a central system, this would have cost two or three times as much. One supplier—Lennox—provided all equipment needed." On the roof: Direct Multizone System (DMS) and single-zone combination gas heating/electric cooling units, and single-package air conditioning. In the basement: indoor DMS and blower-coil units with POWER SAVER™ for ventilation.

Continued . . .

affordability in office comfort

Consider the benefits in tenant control of individual environments, and practical owner cost—both achieved without design restriction. It's done with Lennox modular systems. Here's the widest equipment choice, too, to fit *your* building's design: any type and size—in single-zone, multizone, combination units, remote, indoor and out, thru-the-wall, rooftop and ground. For any fuel. Lennox designs for predictable installation costs. Minimal on-site labor is assured by flash-in mounting frames, and equipment which is factory-assembled and -wired, including controls. No costly standby overcapacity needed.

These four Wellesley, Massachusetts multi-tenant office buildings have more in common than their geography and handsome, modern design. All have tenant system gas heating and electric air conditioning—ducted, individually-controlled comfort zones. And it comes from their rooftops . . . from the dual-duct systems of modular Lennox DMS combination units hidden there. Architects: Donaldson Ray McMullin Associates, Job Captain John C. Staniunas; Builder and Developer: G. Arnold Haynes, Inc.; Heating-Air Conditioning Contractor: Hampden Heating and Air Conditioning Company, Inc.

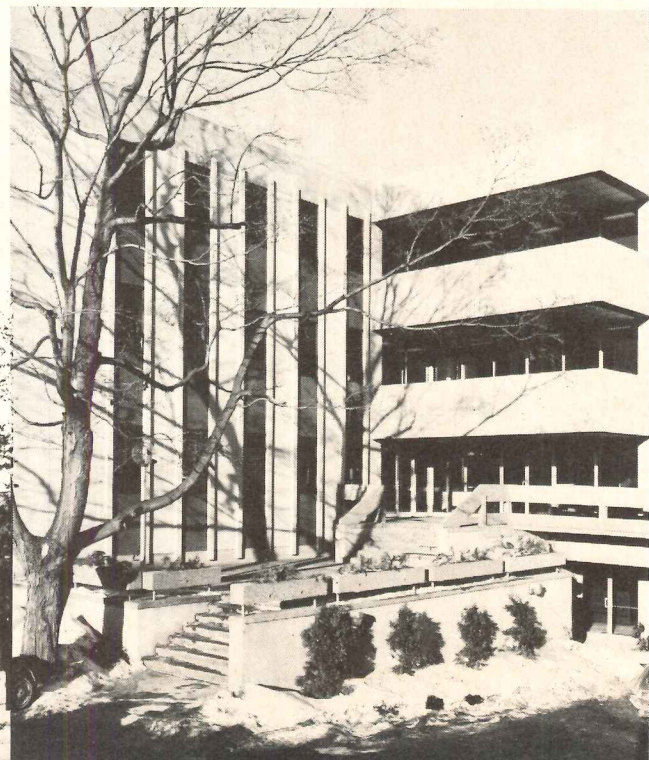

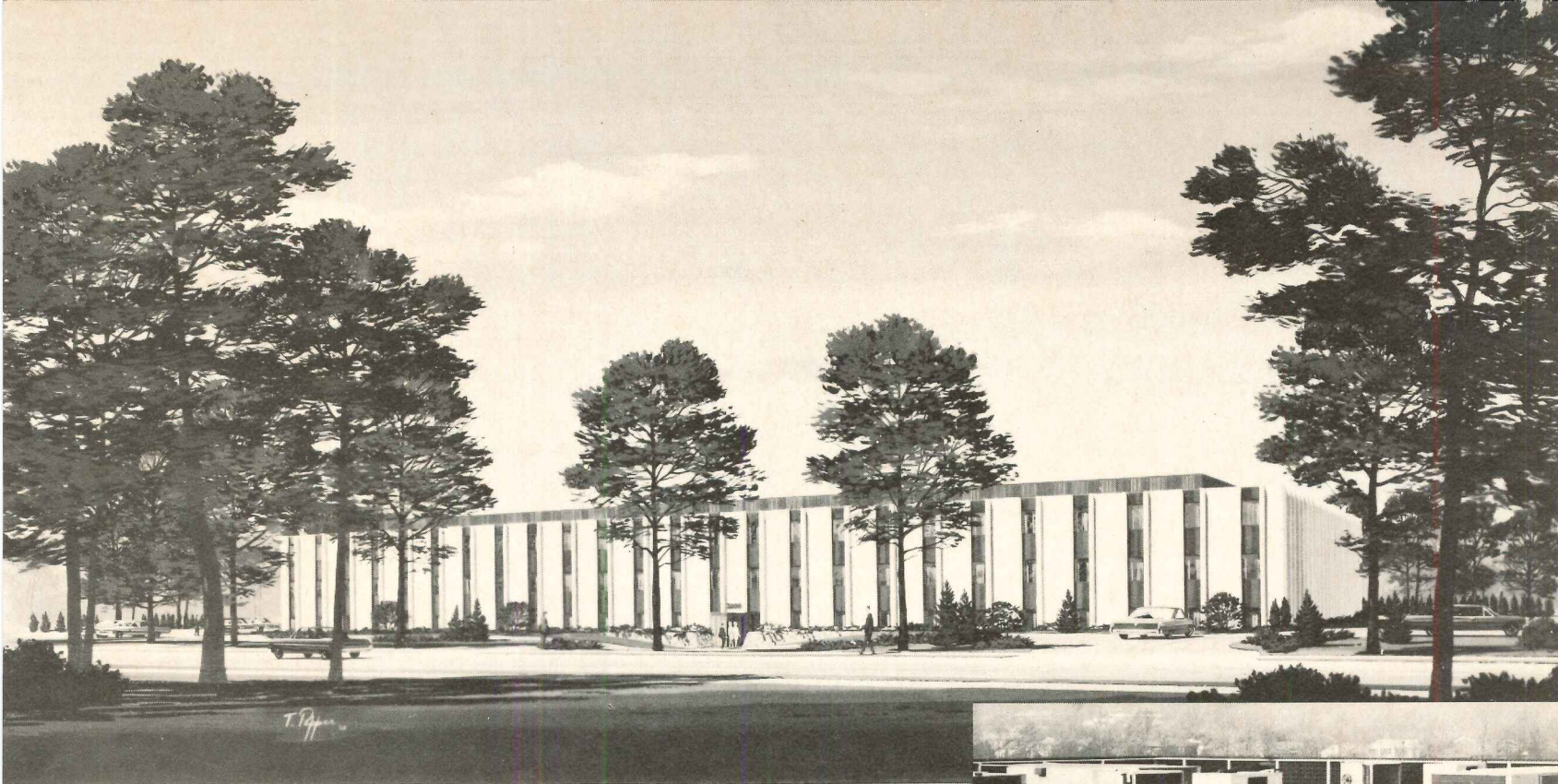

T. Papp

Tenant comfort control lends added appeal to "2000 Marcus Avenue," new 100,000-sq. ft. Lake Success (L.I.) office building, leased by Unicard Division, Chase Manhattan Bank. Says J. Louis Lazarus, president of Elan Associates, owners, "Lennox rooftop units are ideal for zoned heating and cooling in a three-story building like this. No consideration was given to a central system, due to its considerably higher costs and inflexibility." Architects: DeNigris & Maier. Engineers: Benjamin Silberstein Associates. Builder-Owner: Elan Associates. General Contractor: Louron Construction Corp. Heating-Air Conditioning: Con-Air Corp.

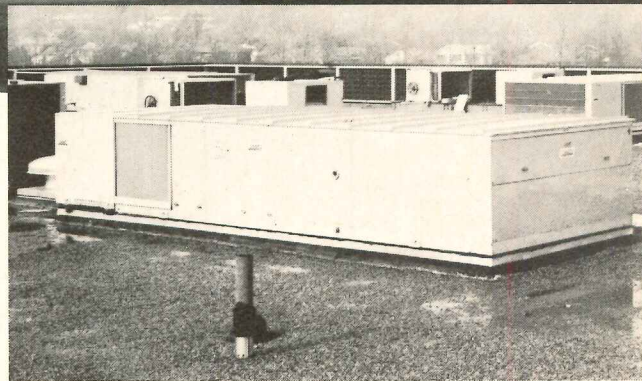

Owning costs are predictable, too—with equipment quality-built for long, reliable service, low maintenance. Extended component warranties. Long-term service contracts available. *And Lennox single-source responsibility.* Lennox ducted modular systems are designed for progressive occupancy, fast-starting pay-out. And they won't let a whole building down at once. If something does fail, it's back in service fast, with fewer tenants inconvenienced. To top it off, low-profile Lennox equipment hides easily and its light weight allows non-load-bearing walls. Think about that, too, next time you plan.

LENNOX

AIR CONDITIONING • HEATING

For details, see Sweet's 29a/Le—or write Lennox Industries Inc.,
801 S. 12th Avenue, Marshalltown, Iowa 50158.

For more data, circle 11 on inquiry card





COLOR TINT CONTROLLED With MEDUSA WHITE...



Bright new addition to the changing Cleveland skyline will require a total of 2,140 buff colored precast units. Medusa White Portland Cement with an umber pigment was specified to assure positive, uniform color control.

Shipped to Cleveland—three panels to a truck—precast units measure 11' x 15'10½", having a light exposed aggregate finish with even color throughout.

White cement is the most carefully color controlled portland cement produced to assure constant uniformity in the finished concrete product.

Precast units of Medusa White are moldable to the architect's creativity, easy to install, weather tight, fire safe, and require minimum maintenance. Write Medusa Portland Cement Company, P. O. Box 5668, Cleveland, Ohio 44101.

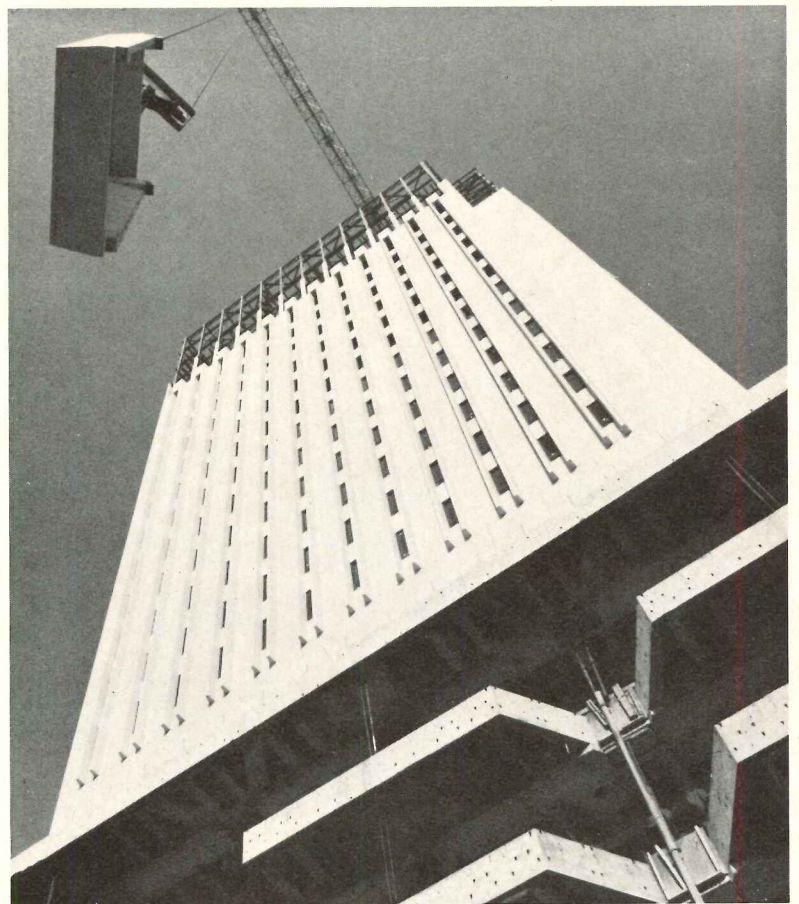

CLEVELAND STATE UNIVERSITY (Library & Faculty Tower) Cleveland. General Contractors: (Joint Venture) Blount Brothers, Construction Company of Birmingham; William Passalacqua Builders, Cleveland. Precast Producer: Marietta Concrete Company, Marietta, Ohio.

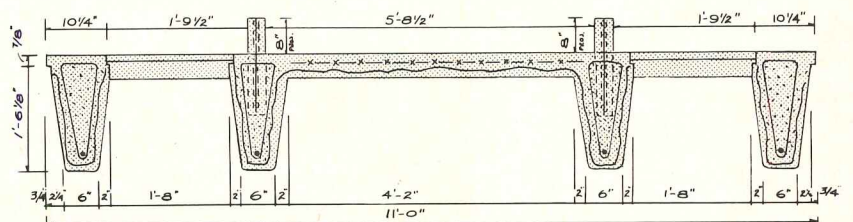
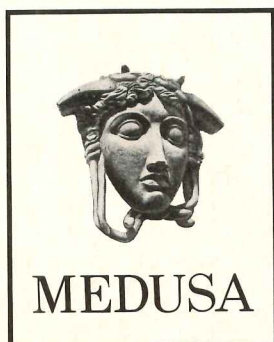

For more data, circle 12 on inquiry card

Put sound in its place.



Beautifully.



You can take technical performance for granted when you specify Celotex ceiling products and systems. NRC's to .90. Designs for 1, 2, and 3 hour time-rated assemblies. Products to meet every budget, every code requirement. Even a panel with 0-0-0 Fire Hazard Classification.

But there's another property of Celotex ceilings that can't be measured in the testing laboratory: their intrinsic, unmatched beauty—a quality you can see and compare. The exquisite texturing of natural fissured

Celotone® tiles, ranging from a delicate, non-directional travertine effect to bold, deep fissuring. The unique texture of glazed total ceramic ceilings. Reveal-edge panels that accentuate the recessed grid. Modern Vari-Tec* luminaire systems. And many more.

Your Acousti-Celotex contractor/distributor will welcome your call for specifications, samples and estimates.

*Trademark



THE CELOTEX CORPORATION
Tampa, Florida 33607
Subsidiary of Jim Walter Corporation

For more data, circle 13 on inquiry card



At Mississippi Power Company PPG Performance Glass looks great, keeps people comfortable, and saves money. Even after a hurricane.

PPG Performance Glass enabled the designers of Mississippi Power Company's "electric light showcase" to achieve exactly the esthetic character they desired . . . both in color and reflectivity . . . and open up their building's view of the beautiful gulf coast. More than they thought possible.

Many factors affected the selection of *Solarban® Twindow®* Units besides the good looks and the good view, however. *Solarban* Units significantly reduced the complexity and operating cost of the HVAC System. They contributed to total environmental comfort for the building's occupants. And they offered adequate strength levels so important in this tropical storm belt.

The building's "heat of light" system incorporates simultaneous control of air temperature, humidity, cleanliness, and distribution.

Under summertime conditions, the reflective *Solarban* Units assist this environmental control by turning back much of the solar radiant energy rather than permitting it to become a load on the cooling system.

Even on chilly winter days, enough heat is produced by the lighting alone to require some cooling of the room air (with outdoor temperatures down to 40 F) before reintroduction. The same low-emissivity reflective coating on the *Solarban Twindow* Units (normal insulating glass constructions with a 1/2" air space) enables them to perform like triple glazing in reducing conducted heat loss. No chilly downdrafts, no condensation.

And no supplementary perimeter heating devices are required.

As John Borum, Consulting Mechanical Engineer, said: "The premium cost of this glass could be justified not on an air or tonnage savings necessarily . . . although there was that . . . but, more importantly, on the reduced sophistication of the mechanical system required. If you don't have a great swinging load, the system is more stabilized and can be designed more simply. With *Solarban Twindow* Units, we're dealing with

a glass with a U-Factor that's actually the same as the wall."

Put all these environmental control factors, and the visual comfort advantages of a 20% Visible Transmittance rating, to work for your clients. Contact a PPG Architectural Representative for technical assistance, or write: PPG INDUSTRIES, One Gateway Center, Pittsburgh, Pennsylvania 15222.

Architect: Curtis & Davis, New Orleans-New York
Associate Architect and Structural Engineer:
Milton B. E. Hill, Gulfport
Mechanical Engineer: Lazenby & Borum, Atlanta

PPG is Chemicals, Minerals, Fiber Glass, Paints and Glass. So far.



Mississippi Power Company's seven-story concrete and glass general office building in Gulfport withstood Hurricane Camille's 200-mph winds and storm tides with only minor damage to the 24,000 square feet of glass.

PPG
INDUSTRIES

For more data, circle 14 on inquiry card

For more data, circle 15 on inquiry card

**An airport should set a traveler's emotions into flight
before he's airborne.
As the architect, you chose concrete.
The result: A design exactly as you conceived it, thanks
to Fiberglas*-reinforced plastic construction forms.
Strong, versatile Fiberglas, the new basic material.**

Illustration: Houston Intercontinental Airport Terminal Building.
Design Features: Coffered ceilings and compound shapes of concrete.
Architects: Golemon & Rolfe and Pierce, Goodwin & Flanagan, Houston, Texas.
Let Fiberglas-reinforced plastic construction forms increase your design
freedom. Write: A. R. Meeks, Owens-Corning Fiberglas Corp., Fiberglas Tower,
Toledo, Ohio 43601. *O.-C. F.Reg. T.M. for the glass fiber reinforcements used in the construction forms.

OWENS/CORNING
FIBERGLAS
TRADEMARK ®

Owens-Corning is Fiberglas



Whatever your underfloor raceway requirements, **we have what you need**

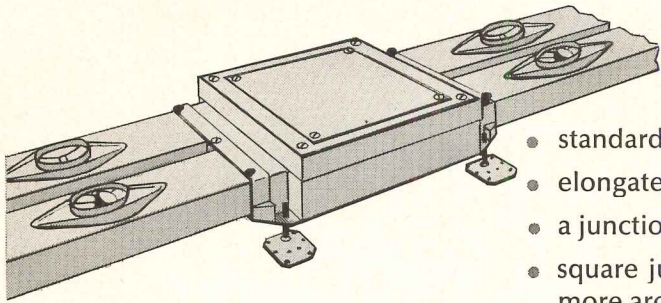

UNDERFLOOR DUCT

All underfloor duct systems are not alike. Square D gives you these extra advantages:

- standard duct lengths of 5, 6, 10 and 12 feet
- elongated inserts that simplify fishing and pulling
- a junction box that can be adjusted easily after the concrete is set
- square junction box tops for easier tile and carpet installation—more architecturally pleasing
- tile trims that are part of the box itself, eliminating extra pieces and parts
- feet on all leveling legs (both boxes and support) for nailing and fastening to forms, pans and rough slabs

HEADER DUCT

Square D offers real flexibility in design with two types of Header Duct:

separate access units

- units can be installed on cells on any centers desired
- interconnect between units with blank header duct
- compensates for irregularities in cell centering during construction

attached access units

- access units factory-installed on duct on predetermined centers
- lengths available up to 12 feet

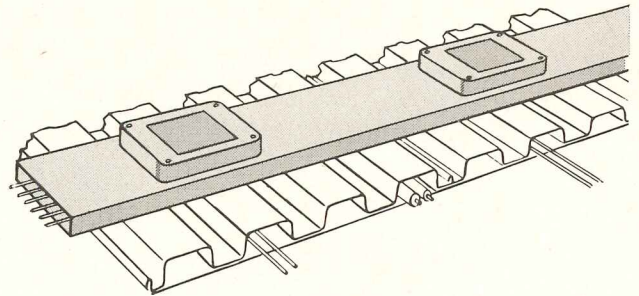

standard with both types of header duct

- after-set inserts that require no special tools to install
- square access unit tops for easier tile and carpet installation

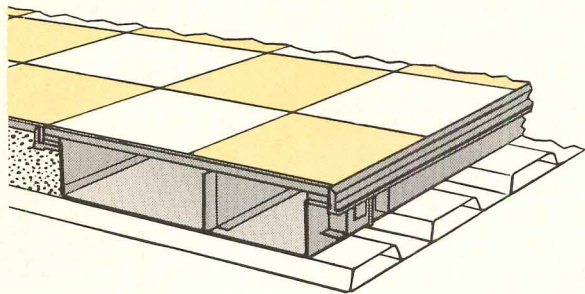

TRENCH DUCT

You get better trench duct from Square D. We give you:

- cover plates and trim assemblies that are supported by the concrete. Once installed, they won't move
- tile trims that can be installed without removing cover plates

Expert Application and Installation Help



We will make an installation drawing for any job, large or small, at no charge. We have a staff of qualified layout men who will make recommended layouts on very short notice. Our product specialists are available to travel anywhere to help—not to mention more than 400 local field men. So bring your underfloor duct problems to Square D. We're in business to help you.

*For detailed information, contact your Square D distributor or field office
Or write Square D Company, Dept. SA, Lexington, Kentucky 40505*



SQUARE D COMPANY

Wherever Electricity is Distributed and Controlled



Joan Gregory in 12F is sleeping beautifully.

Of course she is.

She knows the people responsible for her apartment have done everything possible to make her safe and secure.

For a start (it's a big one), they've put a Jamb-Gard® alarm on the door.

Very simple. Easy to install. Solid. Handsome. *And effective.*

At night, before Joan goes to bed, she turns Jamb-Gard on with her key. If the door is opened, the alarm goes off.

Loudly. Otherwise, Joan gets on with her sleep.

When leaving, she turns Jamb-Gard on and closes the door. Should an intruder intrude in her absence, the alarm alerts the neighbors and—no doubt—scares off the intruder.

What could be simpler?

Jamb-Gard is 12 inches of elegant metal. In two standard finishes: anodized aluminum and gold.

(Special finishes on request.) Jamb-Gard is battery operated, solid state circuitry—and only 1 $\frac{3}{4}$ " wide.

Plan for it on any metal door jamb.

But plan now. Jamb-Gard must be flush mounted; you'll be doing the right thing aesthetically—and protectively.

And you'll be helping the Joan Gregory's of this world get their rest. Think about it.

Jamb-Gard by



Continental
Instruments Corporation

3327 Royal Ave., Oceanside, N. Y. 11572

U.S. (NO. 3,410,245) AND FOREIGN PATENTS.

For more data, circle 20 on inquiry card

News in brief

The freeze has thawed on about \$1.5 billion of construction money provided by the Federal grant-in-aid program and state and local governments. The 75 per cent Federal cutback remains in effect, but it will end this summer if economic trends follow projections. However, it will take more than a year to bring Federal construction up to pre-cutback levels.

There was evidence of a thawing of military construction funds last month. For the first time since the "big freeze" several months ago, the Bureau of the Budget told Defense it could use \$61.3 million immediately for building family housing.

The A.I.A. will decide how to handle the controversial ethics question when the board meets this month. Relations with clients, information disclosure, advertising, securing of commissions, and contracting are at issue.

The housing systems, the sites, and the site designers have now been picked for Operation Breakthrough. HUD Secretary Romney announced twenty-two proposals as "winners" in the Federal government's program to break the housing crisis by industrializing our techniques for building, and these systems will be tested and erected as prototypes beginning in July of this year. The systems, all capable of mass production, range from existing prefabricated suburban housing now in production to rather innovative concrete and fiberglass modules which would be stacked at the building site. Four of the winners are precast concrete panel systems imported from Europe. Architects have been widely involved in Operation Breakthrough: nine of the eleven site designers are architectural firms, and all but four of the twenty-two winners have architectural firms as members of their proposing consortium. (See page 137 for a summary of the proposals and an evaluation of Breakthrough as a whole.)

A \$1,000,000 scholarship fund to help minorities become architects will be financed by the Ford Foundation and the American Institute of Architects. Each will pay half. The A.I.A. will conduct a search for candidates, with the assistance of local chapters, A.I.A. Community Design Centers, the Urban League, and other groups. Students will receive scholarships leading to a first professional degree in architecture.

HUD will give priority treatment in all areas to communities that waive building codes to accommodate HUD-approved housing systems in an effort to make sure Operation Breakthrough goes beyond the prototype stage.

Many historic sites face extinction unless Congress adequately funds the National Historic Preservation Act, according to the A.I.A. The A.I.A. points out Congress has appropriated about one-twentieth of the \$32,000,000 it voted in 1966 for a four-year period. Last year, \$82,500 in matching funds was divided among 25 states and Puerto Rico for preservation. (It cost the A.I.A. \$350,000 to restore its 1798 Octagon House in Washington, D.C.)

Architect Kevin Roche has been elected to the National Institute of Arts and Letters, the most prestigious U.S. honor society of the arts. Mr. Roche, who came to the U.S. from his native Dublin in 1950 when he was 28, worked for Eero Saarinen before forming his own practice with John Dinkeloo.

Harvard University has guaranteed minority employment in two recent construction contracts, the first of their kind, the University believes. The two contracts, which total \$5 million, contain detailed, specific "manning tables" for each of the crafts and each phase of the work, leading to a projected 19 to 23 per cent minority employment rate. Firms with the most open hiring practices got the jobs. Clifford Alexander Jr., former chairman of the U.S. Equal Employment Opportunity Commission, led the Harvard group that negotiated the contracts. The action was largely the result of pressure from black students at Harvard.

Israeli new town on ancient site receives Reynolds award

A new town on the site of the Biblical city of Beersheba has received the second R. S. Reynolds Memorial Award for Community Architecture. The first went to Cumbernauld in Scotland in 1967. Beersheba now has a population of 70,000 and is planned for 250,000 in thirty years. The Israeli Ministry of Housing made the over-all plan, but private architects were called in to do individual buildings. A national competition was held for the multi-use Town Center building (right), which contains stores, offices and apartments. Planners had to integrate the new Town Center and high-density residential sections with the old town. Jury members were Daniel Schwartzman, F.A.I.A., George T. Rockrise, F.A.I.A., and Jules Gregory, F.A.I.A.

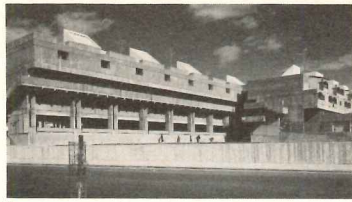

1



2



3

1) Town Center, by Carmi and Associates; 2) prefab apartment tower, by Garmann and Lofenfeld; 3) Immigrant Hostel, by Yaski and Alexandroni; 4) Bus Terminal, by Yaski and Alexandroni with Shani and Rozanski



4

Ran Erde photos

New lumber sizes at issue

For more than seven years, the lumber interests of this country have been seeking a suitable compromise of their positions on board sizes to effect a satisfactory revision of the softwood lumber standards of 1953. After considerable blood-letting on the part of rules writing, producing and marketing groups a version now has been run through the industry "acceptor list" by the U. S. Department of Commerce and, presumably, is to take effect September 1.

But this so-called final version was to have been made effective March 1 of this year. At the last minute the American Lumber Standards Committee notified interested parties that the effective date had been pushed back six months "to provide an orderly transition from Simplified Practice Recommendation 16-53 to Product Standard 20-70," the revised wording.

Meanwhile, however, a new board of review established by the revision will be empowered to receive and act upon regional grading rules prior to the September 1 date.

Involved in this hocus-pocus exercise stretching over so many years have been a number of factors. Dimensions of green versus dry softwood lumber were at the heart of arguments; span tables, stress values, methods of canvassing industry opinion (the acceptor list), and what the change might do to housing costs were points of disagreement—and still are. Modules of elasticity values and Federal Housing Administration's attitudes toward them have been important.

Architects and engineers have been interested observers of this long fight to change basic measurements of softwood lumber through the voluntary industry standards process. But by virtue of their technical interests they have not been on the firing line.

The fuss culminated in full-fledged Congressional hearings in March when a select subcommittee on small business of the House of Representatives took a look at not only lumber standards revisions but also the whole subject of voluntary industry standards.

News continued on page 40

Louis Kahn to receive New York A.I.A. award

The New York Chapter of the American Institute of Architects will give Louis I. Kahn, F.A.I.A., its Medal of Honor at a preview of the Metropolitan Museum of Art's major exhibit, "The Rise of an American Architecture" May 4. Mr. Kahn, who is 69, is the author of a new book brought out by Rice University, *Louis I. Kahn: Talks With Students*, a small, elegant paperback in blank verse filled with the familiar Kahn cleverness, simplicity, and optimism: "I believe that if you just hand it over to the architects, everything will be fine."

Open space marks development

Village Greens, the largest single-family home community in New York City (2000 houses), will be built on Staten Island as townhouses grouped around wooded green spaces. Architect Norman Jaffe has planned the project to keep out all through-roads and separate pedestrian and auto traffic. According to Mr. Jaffe, the clustering of houses will make it possible to preserve the land's natural con-

tours and save trees, providing 35 acres of green space within the 160-acre tract. Village Greens will consist of nine "villages" of 225 town houses.



Robert F. Marshall, former RECORD publisher, retires

Robert F. Marshall, Vice President—Administration, of the McGraw-Hill Publications Company, retired April 1, after a long, distinguished career always closely associated with ARCHITECTURAL RECORD. He joined F. W. Dodge (now McGraw-Hill Information Systems Company) in 1935; transferred to RECORD in 1941, and subsequently served as promotional manager, advertising sales manager and publisher. In 1963 he was named Group Vice President of McGraw-Hill Publications Company and assumed his present post in 1969.

St. Louis architecture students build Seguin sculpture

Students at the School of Architecture of Washington University in St. Louis have built a large sculpture designed by Olivier Seguin. They cast the concrete and welded the Cor-Ten steel for its five vertical elements during Mr. Seguin's two-months as visiting artist at the School of Architecture.

Mr. Seguin is French, but lives in Mexico City, where he built a huge sculpture for the Olympics in 1968.



Reese Williams photos

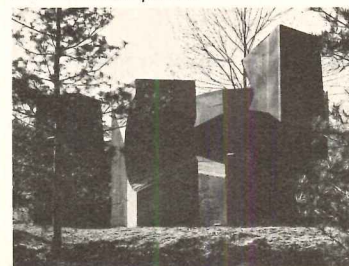

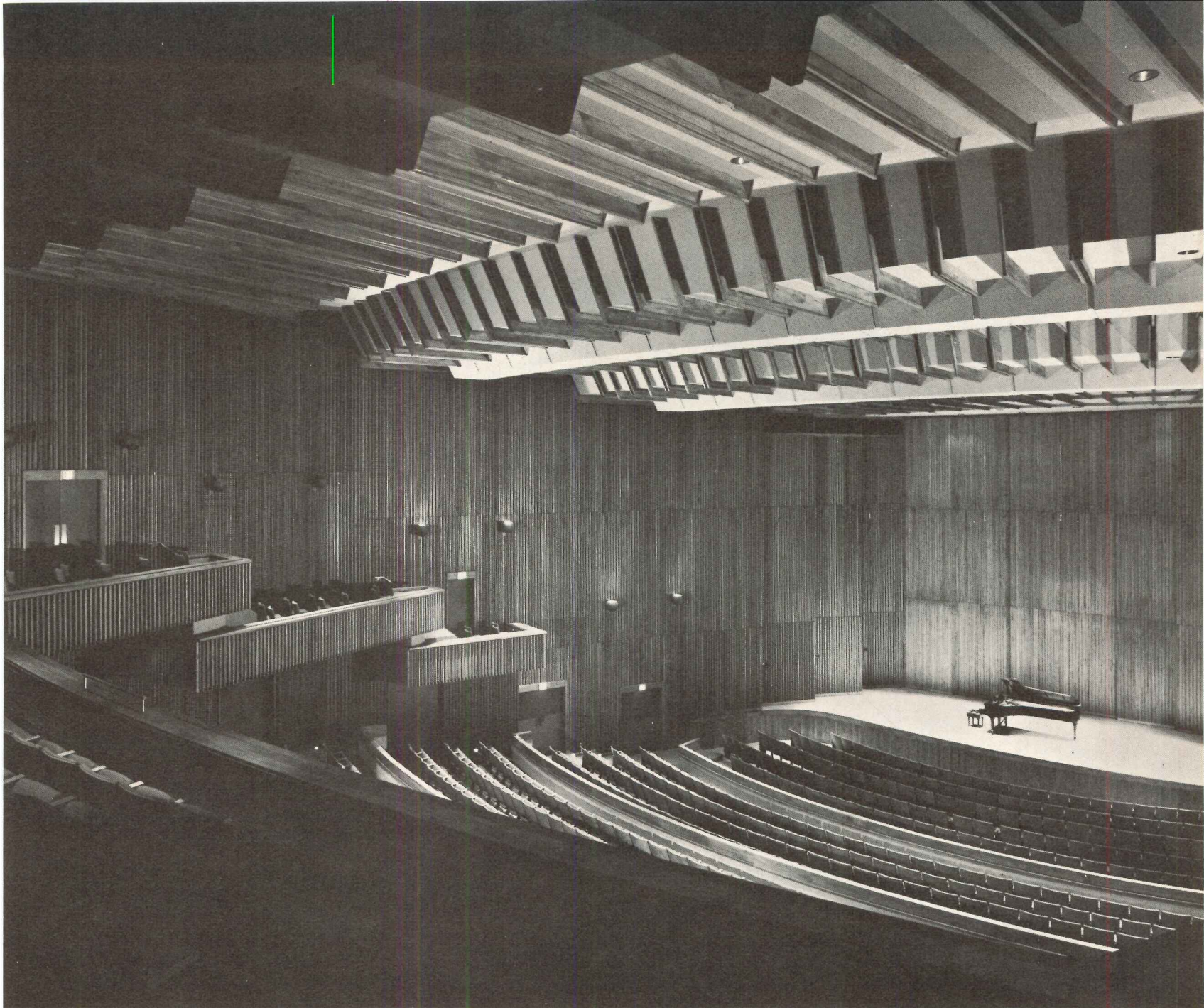

Alice Tully Hall, The Juilliard School

Dover delivers

orchestra lifts for the three performing halls of The Juilliard School

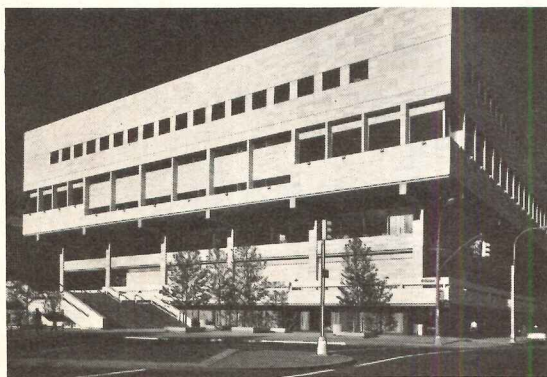

THE JULLIARD SCHOOL, New York, N.Y. Architect: Pietro Belluschi—Eduardo Catalano and Helge Westerman, associated architects; Frederick Taylor, Robert Brannen, Joseph V. Morog and Austris Vitols, project architects. General Contractor: Walsh Construction Company. Dover Oildraulic orchestra lifts installed by Burlington Elevators, Inc., subsidiary of Dover Corporation.

With the recent opening of The Juilliard School in Lincoln Center, Dover completes the largest and most elaborate project involving stage lifts ever conceived.

Each of the three performing halls of The Juilliard School has an Oildraulic® orchestra lift designed, built and installed by Dover. The largest has a curved platform measuring 14 by 61 feet, and a lifting capacity of 33,000 lbs. While primarily for optimum positioning of orchestras, the lifts also provide for extensions of the stages for theatrical performances.

Elsewhere in Lincoln Center, Dover installed an elaborate sys-

tem of seven 8 by 60 foot lifts in the Metropolitan Opera House. These operate in conjunction with scenery and orchestra lifts to provide an ultimate degree of flexibility in operatic staging.

Dover is the nation's most experienced builder of stage lifts. Write for literature. Dover Corporation, Elevator Division, Dept. A-4, P. O. Box 2177, Memphis, Tenn. 38102.



the elevator innovators

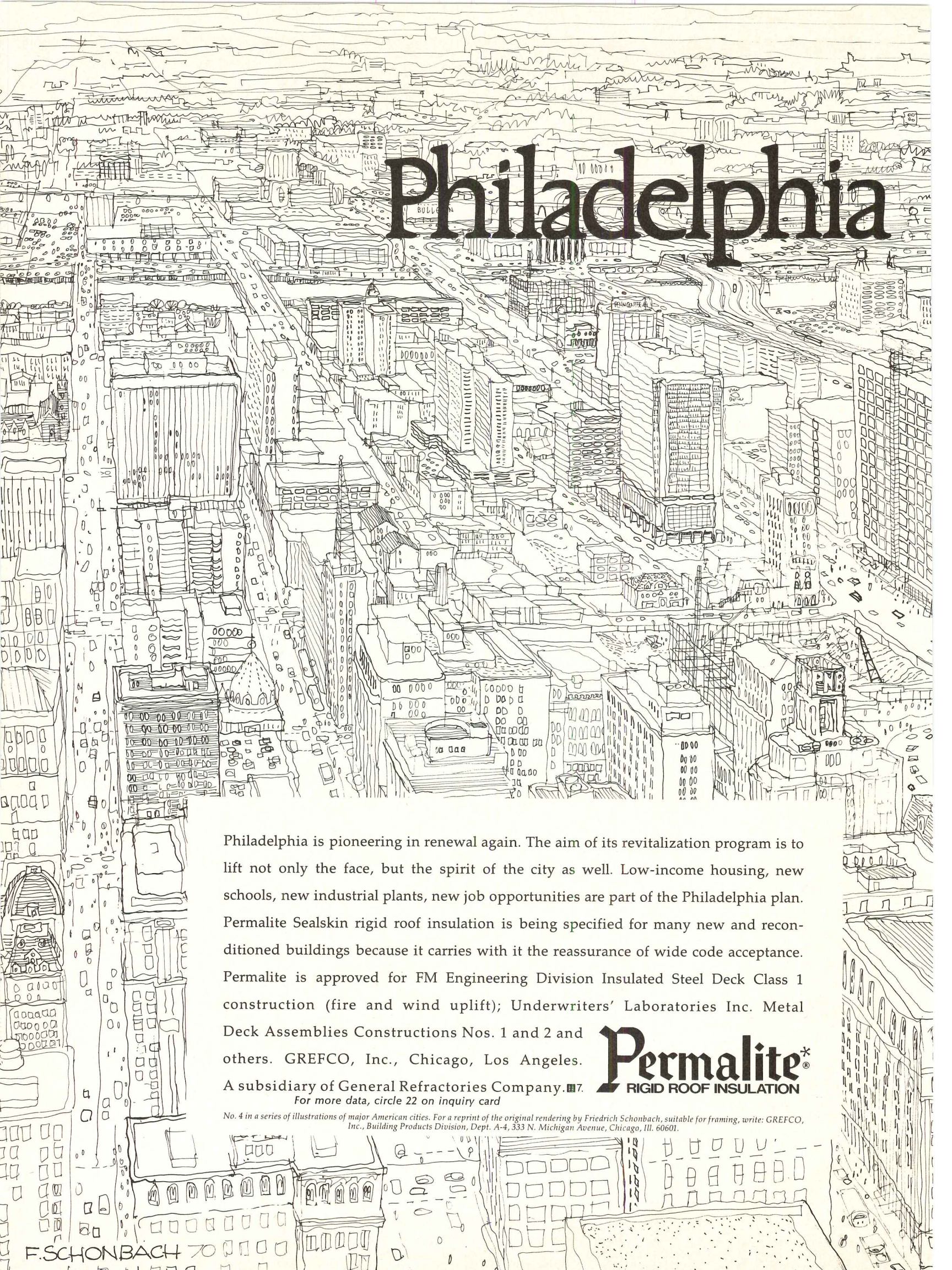

Philadelphia

Philadelphia is pioneering in renewal again. The aim of its revitalization program is to lift not only the face, but the spirit of the city as well. Low-income housing, new schools, new industrial plants, new job opportunities are part of the Philadelphia plan. Permalite Sealskin rigid roof insulation is being specified for many new and reconditioned buildings because it carries with it the reassurance of wide code acceptance. Permalite is approved for FM Engineering Division Insulated Steel Deck Class 1 construction (fire and wind uplift); Underwriters' Laboratories Inc. Metal Deck Assemblies Constructions Nos. 1 and 2 and others. GREFCO, Inc., Chicago, Los Angeles.

A subsidiary of General Refractories Company. ■ 7

For more data, circle 22 on inquiry card

Permalite^{*}
RIGID ROOF INSULATION

No. 4 in a series of illustrations of major American cities. For a reprint of the original rendering by Friedrich Schonbach, suitable for framing, write: GREFCO, Inc., Building Products Division, Dept. A-4, 333 N. Michigan Avenue, Chicago, Ill. 60601.



revitalizes renewal.
Permalite® helps.

Masterpieces of two Sullivan students: one is destroyed, one saved

Irving Gill and Frank Lloyd Wright both learned their art at Louis Sullivan's feet. At the beginning of this century, they designed two monuments of residential architecture which were to have perilous existences.

Dodge disaster

Early one recent Monday morning, in the pouring rain, Irving Gill's Los Angeles Dodge House (1916) was demolished, ending a long struggle to preserve it. Three days before, its owners, Riviera Management Corp., had told Ray Girvigian, California State Preservation Coordinator for the A.I.A., that they had no plans to demolish it. A Citizens

Committee for the Dodge House and a lawsuit had failed to get the house any official protection. Far from it: the Los Angeles High School District condemned the house and evicted its occupants in 1939, later changed its mind about tearing it down, and eventually auctioned it off at a 1000 per cent profit.



L. A. Times, courtesy National

New life for the Martin house

Darwin Martin was responsible for the construction of four Frank Lloyd Wright buildings in

Buffalo, including the Larkin Building (demolished in 1950). His own house (1904) is a clear predecessor of the Robie House, with its combination of grandeur, peacefulness, three-dimensionality, and excitement, and with an even greater richness of materials and colors. Its structure is steel, concrete and brick.



New York Times by Wm. Aller

When Martin Meyerson, president of the State University of New York at Buffalo (March, page 36) persuaded the University to buy the house for the presidential residence a few years ago, it had been divided into three apartments and an office and the out-buildings, stable and conservatory had been destroyed. However, the house was in good condition,

and architect Edgar Tafel of New York, a former Wright student, began the work of "revitalization"—not, says Mrs. Meyerson, just reproduction. Much of the original Wright furniture was relocated with the help of Mr. Martin's two children, who also described the original color scheme, which has been generally lightened, while keeping to Wrightian earth colors. A grant will be necessary to continue the restoration.

The three other remaining Wright buildings in Buffalo have come into the hands of University faculty.

The Martin restoration and the Meyerson presence have stabilized and brought new life into what had been an aging neighborhood.

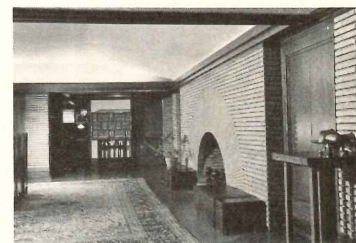

Marvin Rand, for H.A.B.S.

First HUD-assisted new town springs up

Jonathan, Minn., a town of about 45,000, is taking shape twenty miles outside Minneapolis. The new community, which will include housing (both high-rise and single family), industry, recreation, and a college, is the first to be built under HUD's New Communities Program, which can guarantee up to \$50,000,000 for a project. Architect for Jonathan is Benjamin H. Cunningham, A.I.A. The plan emphasizes preservation of natural features, use of air-rights in single-structure (for protection from severe winters) town center and reliance on prefab houses. The units shown below sell for \$6,000 to \$10,000.

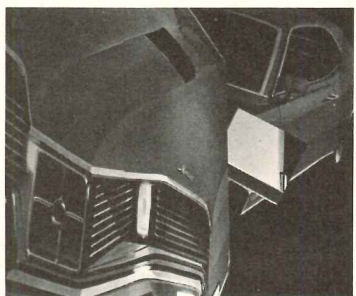

Arkansas exhibit stresses environment

"Architecture and 3-D space should celebrate man's presence," "The auto is a Trojan horse," "Give a damn," say the captions of an exhibition in Little Rock's Arkansas Art Center, designed by Charles Witsell of The Cromwell Firm and Mike Moose of Environmental Design, Inc. The show's sponsors are the Arkansas Chapter of the A.I.A., the Junior League of Little Rock, and the Art Center, and it consists largely of diagrams and large painted panels (above).

Other notes on the condition of Earth:

Secretary of Transportation Volpe reiterated to the

Reuss Committee (March, page 36) his promise that "no commercial supersonic aircraft will be allowed to fly over populated areas at boom-producing speeds." Some, including Representative Reuss (D.-Wis.), interpreted this to mean they would not fly over land, but Friends of the Earth (February, page 36) went ahead with its plans to publish a full-page anti-SST advertisement in *The New York Times* saying "we had better come up with alternatives to endless technological expansion, considering that we live on a planet of fixed size."

The California Council of the A.I.A. announced it would seek national action to promote establishment of a Santa Barbara Channel National Marine Sanctuary to stop "exploitation of our natural scenic resources on California's coastline." Meanwhile, oil covered beaches in Florida and Louisiana.

Salvaged glass can now be converted into building bricks, insulation and pavement additives, according to the U.S. Bureau of Mines, which has de-

veloped technology for these uses, as well as means of magnetically separating glass and metal fractions from incinerator residue.

Bills to facilitate bringing lawsuits against environmental hazards, toughen penalties for polluters, help small businesses reduce pollution, and introduce regular weather bureau-type reporting of air and water pollution were introduced in Congress last month.

New York City which has the nation's (world's?) worst air pollution (even worse than L.A., according to H.E.W. figures) announced its air is measurably cleaner than last year. Breathing easier? The emphysema death rate in the city has increased 500 per cent since 1960, according to the New York Tuberculosis and Health Association.

Governors in 28 metropolitan regions have a year to implement new Federal clean air standards. The National Air Pollution Control Administration set the deadline, standards and control methods.

APRIL 22 IS EARTH DAY

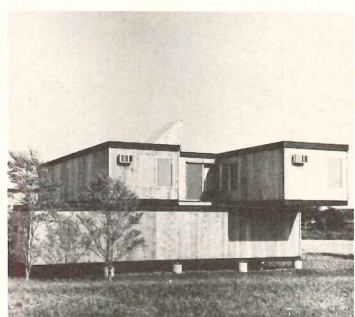

Community Design Center conference meets at Howard University

It's not architecture, it's politics. That was the message at the A.I.A.-sponsored meeting in Washington for 250 architects, students, planners, engineers, and neighborhood leaders, at which leaders from design centers around the country participated. Anger and despair often came to the surface as C.D.C. leaders told of their experiences. Some major successes were described, as in Cambridge, Mass., where Urban Planning Aid has successfully (so far) prevented construction of a super-highway through a low-income neighborhood, and in New York City, where ARCH (February, p. 41) helped force Mayor Lindsay to put a black and a Puerto Rican on the Planning Commission. But for every (usually small) success, there were reports of years of bitter fighting against an apathetic, obstinate, often-hostile "establishment."

Architects were not omitted from that establishment; and despite the national A.I.A. support, many C.D.C. leaders at the

meeting were pessimistic about the depth of the profession's commitment. The Cleveland Design Center found one of its biggest problems was "getting the local A.I.A. to function," although it needed its approval to qualify for government money. A leader of the Real Great Society Urban Design Group (New York City) described a battle with a prominent architect who objected to community suggestions on a school design "because they would limit his self-expression." Many at the meeting urged that architects donate their time along Legal Aid Society lines.

The Community Design Centers clearly aren't going to give up or go away, despite their failures and their bitterness, and hope to be "a healthy thorn in the side of the architectural profession." But again and again during the conference, C.D.C. leaders emphasized their belief that only political power will get their programs built.

One encouraging note: While "poor" and "black" may be nearly synonymous in this country, most Community De-

sign Center staffs contain many whites; and no one at the meeting expressed cynicism about their commitment.

Vanishing historic engineering works recorded

American ingenuity has been famous since Franklin invented the lightning rod, but much of that inventiveness has brought about rapid obsolescence, neglect, and loss of many monuments, small and large. To record what remains, the National Park Service, the American Society of Civil Engineers and the Library of Congress have established the Historic American Engineering Record.

That record is being made with the help of the National Trust for Historic Preservation and the Smithsonian Institution, along with local groups in survey areas. The first survey covered the Troy, New York area, once a great center of transportation and iron production. Six structures were measured and drawn and numerous others photographed.

This year, H.A.E.R. will cover 180 miles of the Baltimore

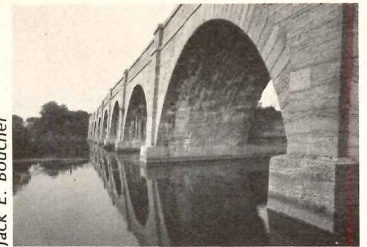

Jack E. Boucher

Erie Canal aquaduct ruins, Fort Hunter, N.Y.

Cast iron bridge, circa 1860, near Albany, N.Y.



Jack E. Boucher

and Ohio Railroad, bridges, in Pittsburgh, sites in Virginia, a canal in New Jersey, and, possibly, structures in Pennsylvania and Montana.

Soleri and Guimard are subjects of two major exhibits

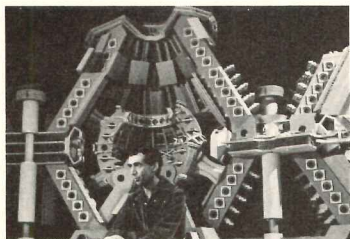

Arcology stirs up a storm

Most of the Corcoran Gallery in Washington, D.C. is given over (through April 6) to the urban visions of Paolo Soleri (above), who has coined the word "arcology" (architecture plus ecology) to describe his mega-structure cities, drawings and models of which fill the Corcoran (right). The exhibit has been very heavily attended and well-covered by the national press, not only because of the magnificence of the huge models, 80-foot drawings, and elegant ink renderings, made by Mr. Soleri and his co-workers, but also for the city idea it presents.

A population of several million could be concentrated in an arcology a mile high and a few miles in diameter, unburdening the land from the spread of cities which, Mr. Soleri believes, will inevitably destroy life unless it is stopped. The inhabitants of arcological "miniaturized" cities the size of Mount Washington would "find stimulation in the closeness of contact within the structure and in the openness of the land out-

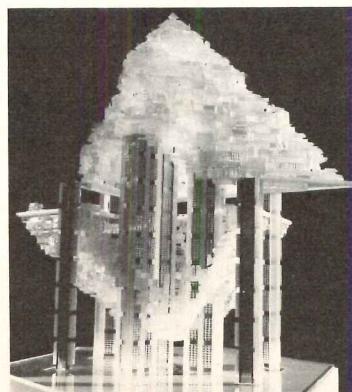

side." While the examples in the exhibit are emphatically schematic, they are not unbuildable, according to Mr. Soleri.

Until now, Mr. Soleri has lived in relative obscurity in Arizona, not far from Scottsdale, where he worked for Frank Lloyd Wright for two years. He was known only among critics and his students and followers. But the co-sponsorship of his show by the Prudential Company of America and HUD and the publication of his new book, *The City in the Image of Man*, by the M.I.T. Press (page 129), indicate arcology is, to some minds at least, an idea whose time has come. A well-known critic advises: "He is the prophet in the desert and we have not been listening". Praise, however, has not been universal. Another equally well-known critic writes, "The answer is not to despoil man's humanity as well [as the earth] by making him bring up his children in Babylonian stone piles and or to remove him further from contact with nature."

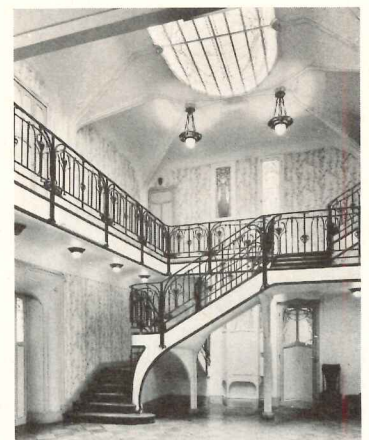

Art Nouveau

The Museum of Modern Art in New York City has put together a show of about 200 items by Hector Guimard (1867-1942), "France's most original and important Art Nouveau architect and designer," which illustrate Guimard's interest in "molding his entire environment" (above). Much of the work shown was uncovered in research done for the exhibit. The show will run until May 10; then it will travel to San Francisco, Toronto and Paris.

Detroit A.I.A. Chapter announces annual Honor Awards

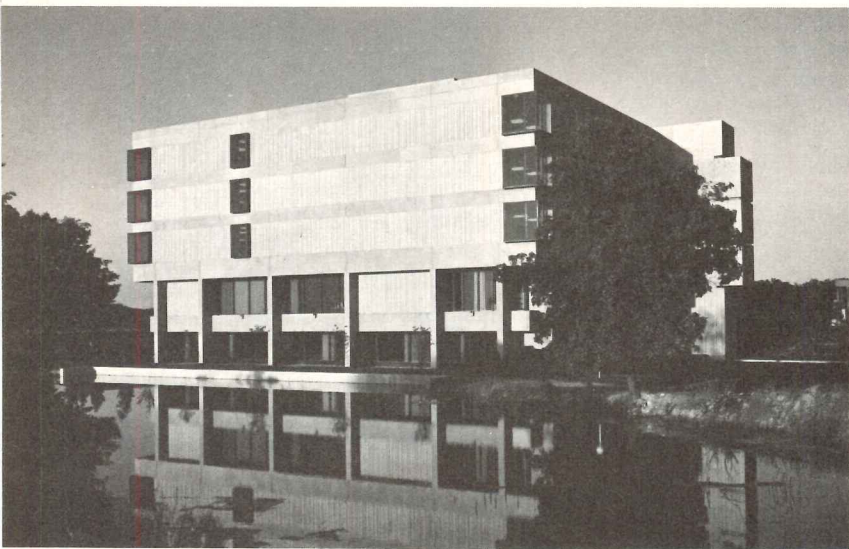

Zumberge Library at Grand Valley State College (Allendale, Michigan) and **Lecture Hall Center** (right) at the Stony Brook campus of the State University of New York, both by William Kessler and Associates, Inc., architects, were among projects by

three Detroit firms to receive Honor Awards. Albert Kahn Associates, Inc. was honored for its Chevrolet-Saginaw Foundries Administrative Office Building (Saginaw, Michigan), and Tarapata-MacMahon-Paulsen Associates, Inc. received an

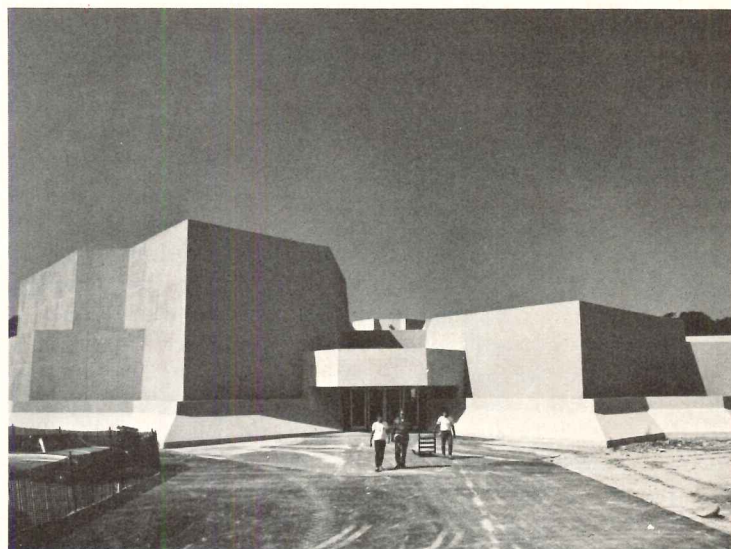

award for its Campus Center, Residence Hall, and Parking Deck for the General Motors Institute (Flint, Michigan). The Zumberge Library, designed for a capacity of 850 student stations, emphasizes ease of circulation, informality, and unity

with the rest of the campus. The Lecture Hall Center comprises ten halls for 60 to 600, for a total capacity of 2,000 students of all disciplines. Its sculptural appearance belies an efficient plan, reflecting the various needs of the ten halls.

New York State Association of Architects announces honors

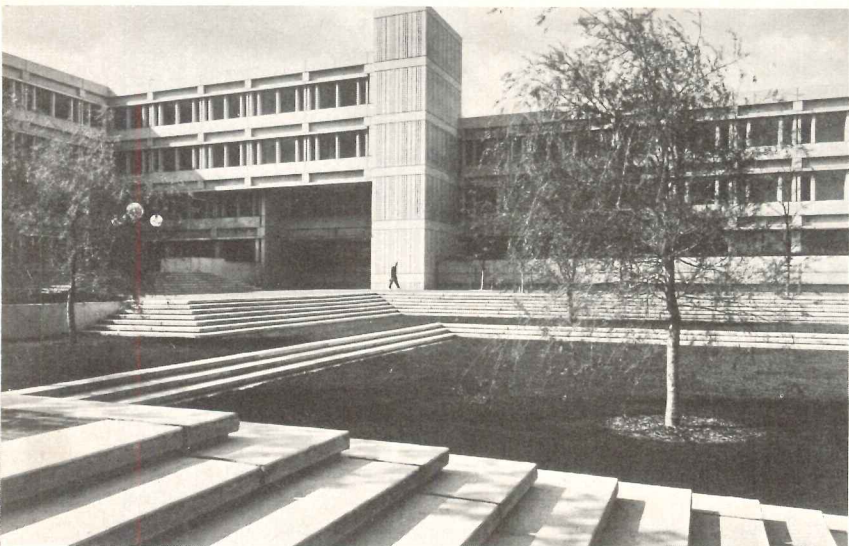

David Hirsch

Earth and Space Sciences Building at Stony Brook, New York, by Gruzen and Partners (New York City), and the Jewish Child Care Association's **Residential Treatment Facility** for emotionally maladjusted youth (right) in New York City, by Horace Ginsbern, A.I.A. (New York City)

were among five projects to receive Certificates of Merit. The Earth and Space Sciences Building stresses "encouragement of interrelationships between faculty and students, graduates and undergraduates, instructors and researchers." The Treatment Facility is designed to



Gil Amiaga

provide a "home-like" quality with sleeping facilities for 40 children and 8 staff members, also provision for future vertical expansion. Other Certificates of Merit went to Gray Taylor, A.I.A. and SMS Partnership (Stamford, Conn.) for the Hudson River Museum Public Branch Li-

brary in Yonkers, N.Y.; William S. Downing, Jr., A.I.A. of Ithaca, N.Y., for the Edlund Division, Monarch Tool Company, Cortland, N.Y.; and Leonard Feldman, A.I.A., of White Plains, N.Y. for his design of the Helmut Jacoby Town House, New York City.

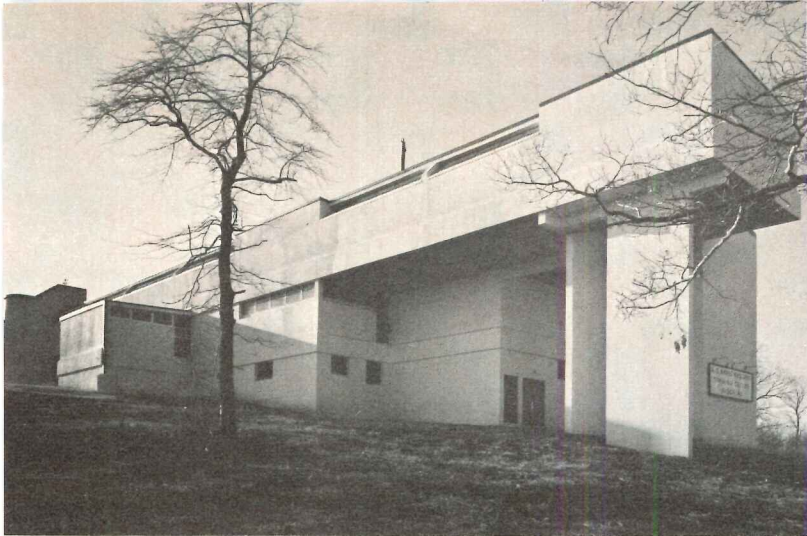

Naval Reserve Training Center, Scranton/Wilkes-Barre, Pa., Von Storch and Burkavage, architects, Clark's Summit, Pa., was the first building reviewed by a panel of distinguished architects under a

new Navy program. "Use areas," arranged for maximum convenience to related functions, are externally expressed at a scale comprehensible to cars passing on a nearby highway.

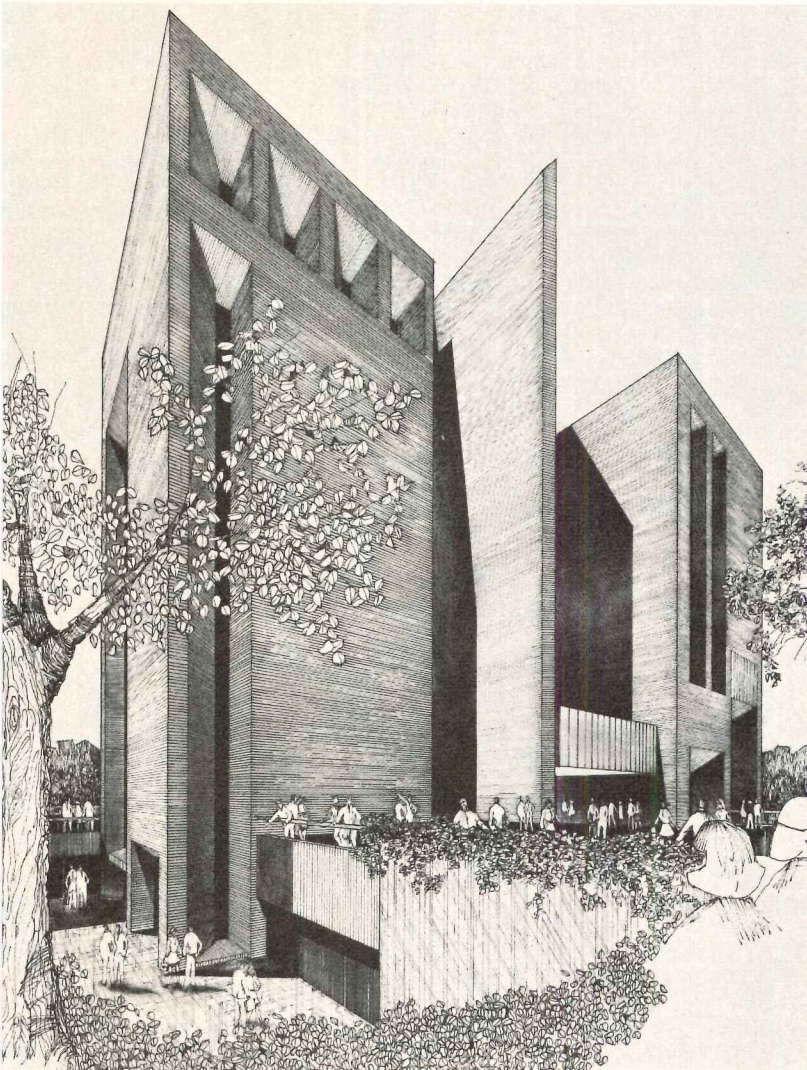

Library-Learning Center at the Green Bay campus of the University of Wisconsin, by Daverman Associates, Inc. of Grand Rapids, Michigan, Cal Lane project architect, is to be made of concrete with brick veneer. The first stage will form the hub of the new campus, and will be directly linked to the University's four colleges.

Minneapolis Clinic of Psychiatry and Neurology, by Hammel Green and Abramson, Inc., of St. Paul, received the First Honor Award of the second national medical clinics awards program of the A.I.A. and the American Association of Medical Clinics. It was chosen for its combination of practicality and non-institutional character.

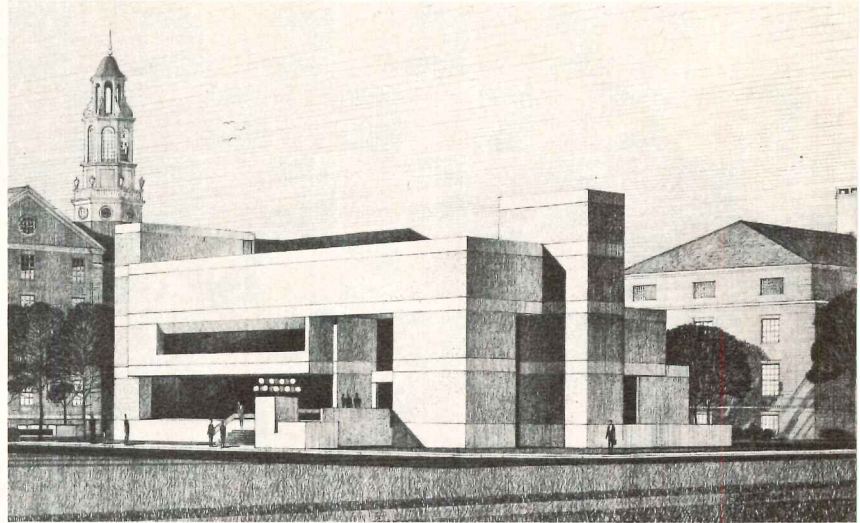

Harvard Business Review Building at the Harvard Graduate School of Business Administration, Boston, Mass., by Kubitz and Pepi Architects, Inc. (Wellesley, Mass.) con-

tains such diverse users as the *Business Review*, a college store, and a U.S. post office. It is made of poured concrete and planned with future expansion in mind.

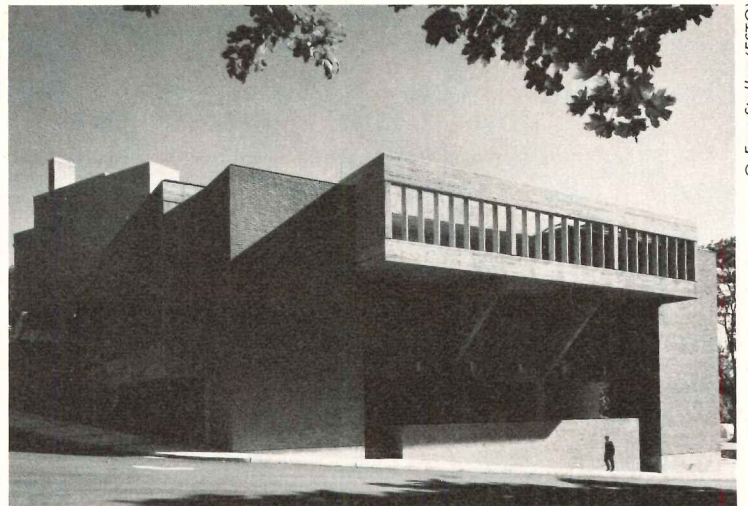

© Ezra Stoller (ESTO)

Greenwich Library addition, The SMS Partnership, architects (Stamford, Conn.) houses 100,000 books in open stacks and a 370-seat auditorium. Easy auto accessibility was

important, as well as provision for expansion and ease of maintenance. The architects designed much of the casework and graphics and selected furnishings and colors.

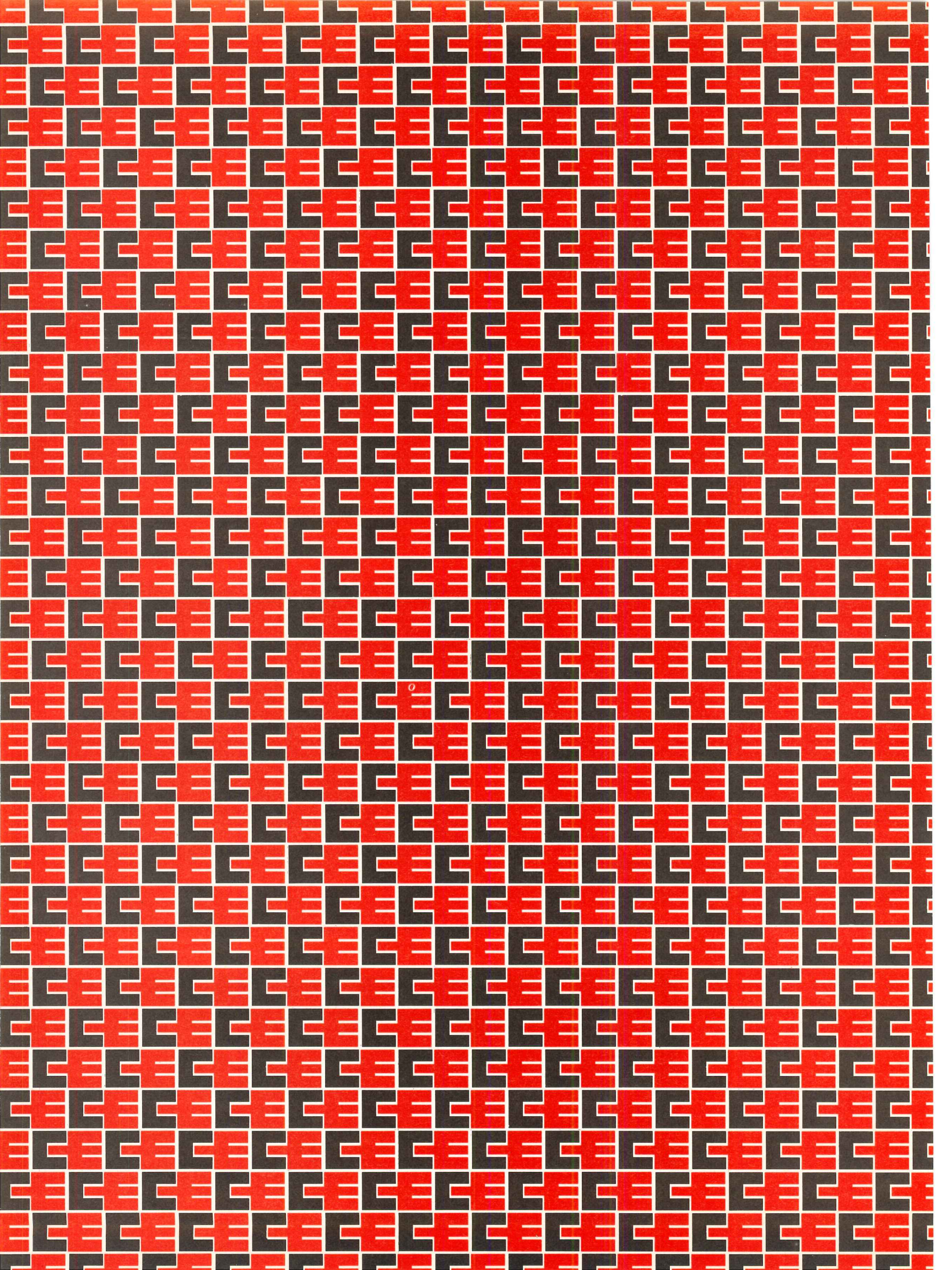

**We interrupt our
ad programs to
introduce our new
corporate symbol.**



(Mississippi Glass Company and the Hordis Group)

Patterned, wired, tempered, and insulated glass products.



Steam generation equipment; pollution-free incineration systems; and chemical recovery units.

Uninterrupted, of course, is our ability to meet the most exacting design and product specifications of architects and engineers engaged in residential, commercial, industrial, institutional and governmental building.

C-E is the new corporate symbol for Combustion Engineering and its congeneric operations. Corporate Headquarters: Combustion Engineering, Inc., 277 Park Avenue, New York, New York 10017.

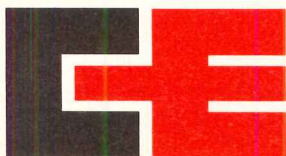

Announcing

EE GLASS

A new entity in glass manufacturing and fabricating has been formed. Its name . . . CE Glass.

It links Mississippi Glass Company, a leading U. S. producer of rolled, figured and wired glass and polished wired glass since 1874, with the Hordis Group of companies*, a major supplier of tempered glass, insulating glass and spandrel panels since 1951. Both are wholly-owned subsidiaries of Combustion Engineering, Inc.

As CE Glass, we offer architects a much greater range of high-performance glass products that expand selections for the designers' needs in today's architectural innovations.

Our centralized research and development provides architects with an authoritative source for answers on glass adaptability and performance in varied environments and on approved techniques for both usual and unusual

applications. This service is available through 10 CE Glass sales offices located from coast to coast: Pennsauken, N. J.; Stone Mountain (Atlanta), Ga.; Tampa, Fla.; Miami, Fla.; Lancaster, Ohio; Itasca (Chicago), Ill.; St. Louis, Mo.; Houston, Texas; Long Beach, Calif.; Fullerton, Calif.

CE GLASS PRODUCTS

ARM-R-CLAD® tempered glass

ARM-R-BRITE® fully tempered ceramic enameled spandrel and spandrel insulated panels

CERAMALITE® heat strengthened ceramic enameled spandrel and spandrel insulated panels

POLARPANE® insulating glass units

POLARPANE® sound control units

POLARPANE® sun control units

MISCO® wired glass and polished wired glass

MISSISSIPPI® patterned glass

PROFILITE® channel-shaped structural glass

For further information or details on specific products, please contact the office nearest you, or write CE Glass, 825 Hylton Road, Pennsauken, N. J. 08110 or call 609-662-0400.

*Polarpane Corp.; Texas Tempered Glass Co.; Hordis Bros., Inc.; Hordis Bros. of Florida, Inc.; Hordis Bros. of California, Inc.

The logo for CE Glass features the letters 'CE' in a bold, black, sans-serif font. The 'C' and 'E' are connected at the top. To the right of 'CE', the word 'GLASS' is written in a smaller, bold, black, sans-serif font.

**First Complete
H. I. D. Line...
in a SINGLE
CATALOG**



Round Recess. For Mercury, Lucalox and Metal Halide lamps. Flush or Regress Trim, 2 x 2 Lay-In Pan; Open, Louvered or Wire Guard bottoms. Also Light-Multiplier types.

ALL ARE LISTED BY
UNDERWRITERS' LABORATORIES, INC.

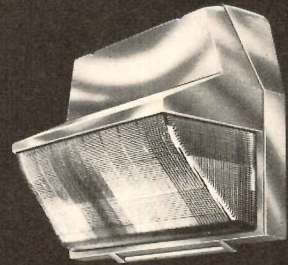

Outdoor Brackets. Big PRISMACKET wall-flood. For Mercury, Lucalox and Metal Halide lamps. Cast aluminum body and frame. Guard available. Also, dusk-to-dawn controls. Fully enclosed Ballasts.

Guth has invested 7 exciting years in high-intensity discharge (H.I.D.) fixture developments. New, proprietary prismatic lenses, accurately Hydroformed reflectors, cast aluminum housings and Alzak finishing by Guth—in Guth's own plant.

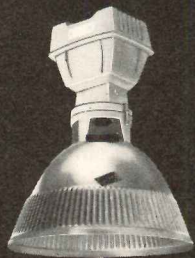

Industrial Luminaires. For Mercury, Lucalox and Metal Halide lamps. Single or Twin High-bays. Open or enclosed; louvers or wire guard. Integral ballasts.



Send for this catalog presenting the largest Line for the H. I. D. lamps.



THE EDWIN F. GUTH COMPANY
2615 Washington Blvd.
Box 7079
St. Louis, Missouri 63177

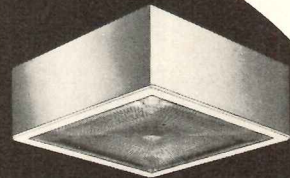

SLD Squares. For Mercury, Lucalox and Metal Halide lamps. Recessed or Surface. All feature Guth's exciting new (Patented) "Square Light Distribution" prismatic lenses.

For more data, circle 24 on inquiry card

LEASE A CARPET SYSTEM

AND SAVE.

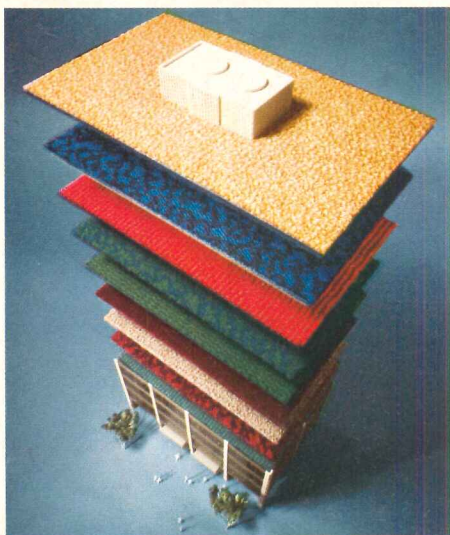

Have all the benefits of a completely carpeted building without using capital funds... through leasing.

Commercial Carpet Corp.—world's largest carpet systems manufacturer—introduces Showplace, the program that provides a leased carpet system *plus* complete building maintenance.

The money your carpet system saves on janitorial maintenance will substantially pay for the lease cost. And you'll speed up and increase your cash flow.

We can show you how the system can fund the lease cost in as little as five years. Then, maintenance savings continue to mount. For years after.

The Showplace program could only be developed by CCC because *only* CCC has the system and carpets that make the maintenance savings possible.

The system includes an analysis of your functional and financial requirements; selection of the right carpet; guaranteed installation by CCC-certified experts; a preventive maintenance program. Service is assured

through CCC's nationwide single-source responsibility.

We have the heavy-duty products that fit the system: anti-static, anti-soil carpets featuring DuPont's Antron II nylon. In fact, certain lines are on the GSA Schedule.

It really doesn't pay to wait for the benefits of a carpet system. And you don't have to. You can have lower maintenance costs, plus the comfort, morale, quiet and safety of the system now.

Send in the coupon for a Showplace brochure today or look us up in the Yellow Pages.

CCC Commercial Carpet Corporation 10 W. 33rd St., New York, N.Y. 10001, Dept. AR-4	
Attention: Mr. Walter Brooks	
<input type="checkbox"/> Please have your representative call on me.	
<input type="checkbox"/> Please send Showplace brochure.	
Name	_____
Title	_____ Phone _____
Organization	_____
Address	_____
City	_____
State	_____ Zip _____

For more data, circle 25 on inquiry card

For more data, circle 26 on inquiry card

The old whiteprinter hop



BRUNING: A SINGLE GRAPHIC SOURCE

is now a simple one step.



You remember the routine. Four quick steps to the paper storage cabinet. Then back. Several pivots and dips as the original and copy paper are collated. Adjusted. Readjusted. And finally, fed into the machine.

The whiteprinter hop is out. The new step is the one step. That's all it takes to operate the new Bruning 850.

The operator simply slides originals into the machine.

There's no handling of copy paper because the paper is stored inside the machine on two rolls. The 850 selects the proper paper size (either A, B or C). Cuts the copy paper to the exact length of the original. And produces perfect copies.

So at the end of the day, your operator is working with early morning efficiency. And you can expect an increase of from 50 to 100% in your whiteprint production.

It's easy to learn more about our easy-to-operate whiteprinter. Just write to Market Development Department, 1800 West Central Road, Mt. Prospect, Illinois 60056. Or call your Bruning representative for a demonstration.

For everything graphic, think Bruning. Your one source of supply for the smallest instruments as well as the largest whiteprinters. And all the rules, scales, curves and supplies in between. A single graphic source for draftsmen, designers, engineers and architects.

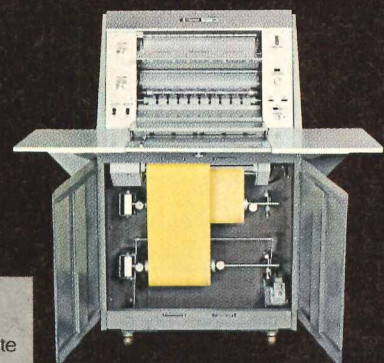

BRUNING

.....helping people communicate



build a colorscape that lasts

With panels color coated to defy every punishment the elements can offer. And stay beautiful after years of exposure to wind, snow, hail and rain.

Only the best of the color coatings—long-lasting finishes containing Kynar 500®—are good enough to protect your next metal-walled building.

You can choose from dozens of colors, ranging from bright pastels to subdued bronzes. And match your color, exactly, panel after panel.

Coatings made with our fluorocarbon

resin, Kynar 500, are as durable as they are impressive. They resist chemicals, corrosive atmospheres and mortar stains; won't crack or craze; and take abrasion in stride. In fact, accelerated tests by Pennwalt project 30 years of maintenance-free life.

Banish the dull and ordinary. Build a colorscape, with finishes containing Kynar 500. Contact Pennwalt Corporation, Plastics Department, 3 Penn Center, Philadelphia, Pa. 19102. Tel: 215-LO 4-4700.

*Kynar 500 is Pennwalt's registered trademark for its vinylidene fluoride resin.

1. RCA Graphic Systems Division Plant, Dayton, N.J.
Architect: Vincent G. Kling and Associates, Architects, Philadelphia, Pa.
Finish: DeSoto Fluoropon®.
Panels: Elwin G. Smith & Co., Inc.

2. United Air Lines Hangar, Minneapolis, Minn.
Architect: Miller-Whitehead-Dunwiddie, Inc., Bloomington, Minn.
Finish: DeSoto Fluoropon®.
Panels: The Binkley Company.

1. RCA Graphic Systems Division Plant, Dayton, N.J.



2. United Airlines Hangar, Minneapolis, Minn.



and lasts.

Make your base specification **KYNAR 500®**

 **PENNWALT**
ARCHITECTURAL COATINGS

DVC

For more data, circle 27 on inquiry card

**Rule: All buildings must be
the same color.**

Drab. Dull. Deadly. Studies in
solid monotony.

Well if that's what you're
content with—if you'll settle for the
orthodox, the ordinary—turn the
page and stay in your gray world.
We're working for a brighter one.

To the most efficient window-
covering ever known, we've added a
spectrum of hues you may never
have known existed.

Orange blinds, red blinds, yellow
blinds, green blinds. Blinds in dozens
of different standard colors or any
special color you name.

Blinds that look like linen;
blinds that resemble wood. Blinds
so brilliant they demand attention;
blinds so slim they seem to disappear.

Blinds tinted one color on one

side (to blend with exteriors) and another on the other (to contrast with interiors). Or the other way around.

We've stopped at nothing.
So you can start fresh.

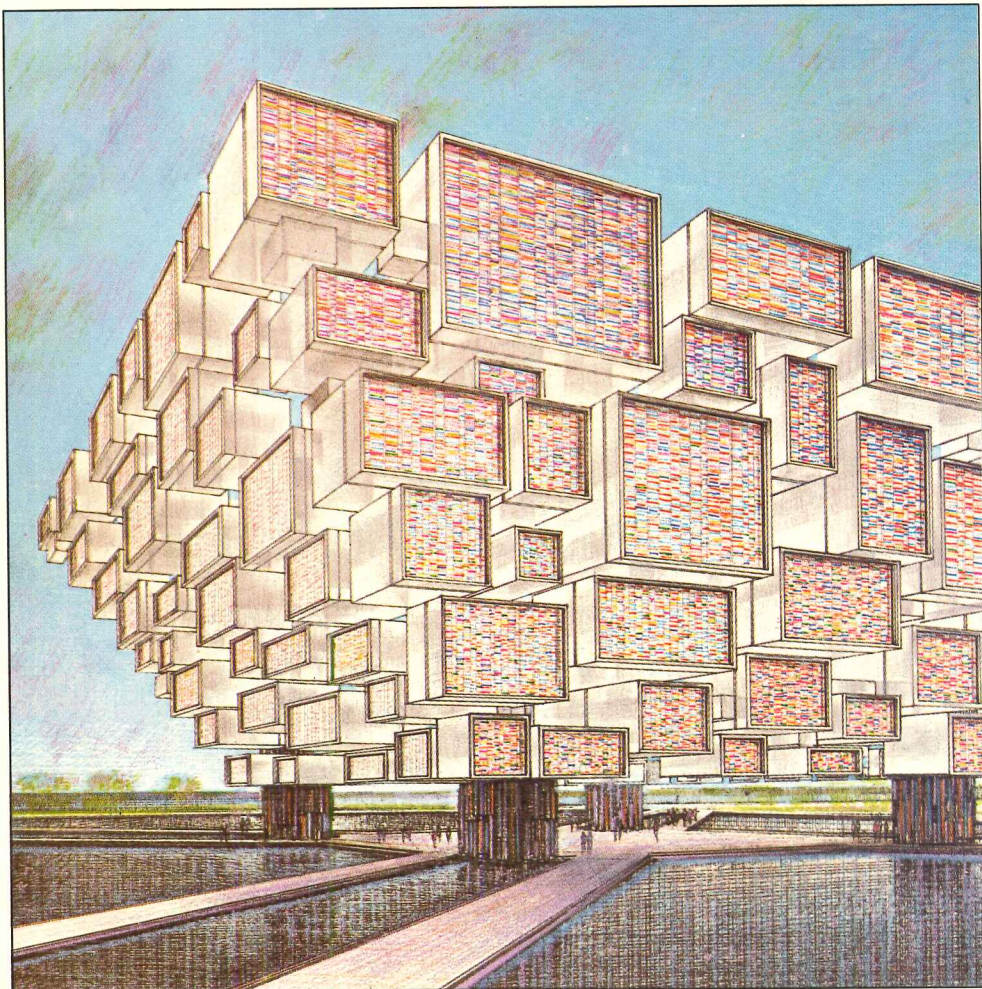

Levolor Blinds. For architects who break the rules.

ARCHITECT ARA DERDERIAN USED CONVENTIONAL LEVOLOR BLINDS IN AN UNCONVENTIONAL WAY. HE USED DIFFERENT COLORED SLATS, IN AN ALTERNATING PATTERN, TO CREATE THE SHIMMERING EFFECT HE WANTED. □ TELL US ABOUT YOUR CURRENT PROJECT. WHILE THERE'S STILL TIME TO DO IT THE WAY YOU WANT IT. □ LEVOLOR LORENTZEN INC., 720 MONROE STREET, HOBOKEN, NEW JERSEY 07030.

For more data, circle 28 on inquiry card



RALSTON PURINA COMPANY
CHECKERBOARD PLAZA TOWER OFFICE, ST. LOUIS.
Architect: Hellmuth Obata & Kassabaum, Inc.
Contractor: J. S. Alberici Construction Company, Inc.

NEW DESIGN FREEDOM!

A-E System Delivers Air and Electricity THROUGH THE FLOOR SLAB

Ugly, bulky ducts, piping and other obstacles to design freedom need no longer stand in your way. Granco's A-E (Air-Electric) Floor System puts all mechanical and electrical services into a slender sandwich floor slab. Air, telephone, power and signal distribution are artfully concealed. Now you can incorporate waffle ceilings. Design floor-to-ceiling windows. Select exterior skin designs formerly denied. Or make the basic structure a strong design element and expose it openly. Use luminous ceilings, balconies, overhangs and comfort-conditioning systems to their fullest esthetic and functional capabilities.

A-E Floor gives you new freedom to create and to innovate. *It's the only system compatible with both concrete and steel frame construction.* It's the only system that gives you such scope for expressing your most advanced architectural concepts. Send for our new A-E Floor Systems brochure. This 24-page, award-winning booklet shows how A-E Floor brings new versatility and freedom to architectural design. Granco Steel Products Company, 6506 North Broadway, St. Louis, Missouri 63147. A subsidiary of Granite City Steel Company.

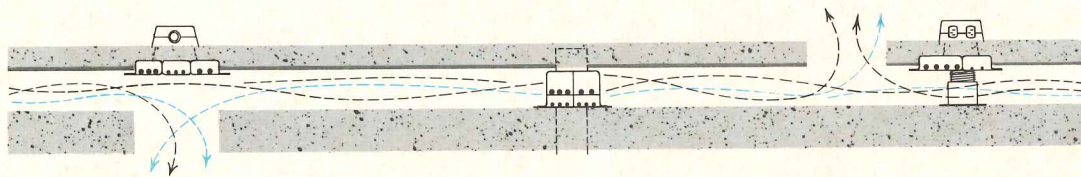

IMAGINATION IN STEEL

For more data, circle 29 on inquiry card

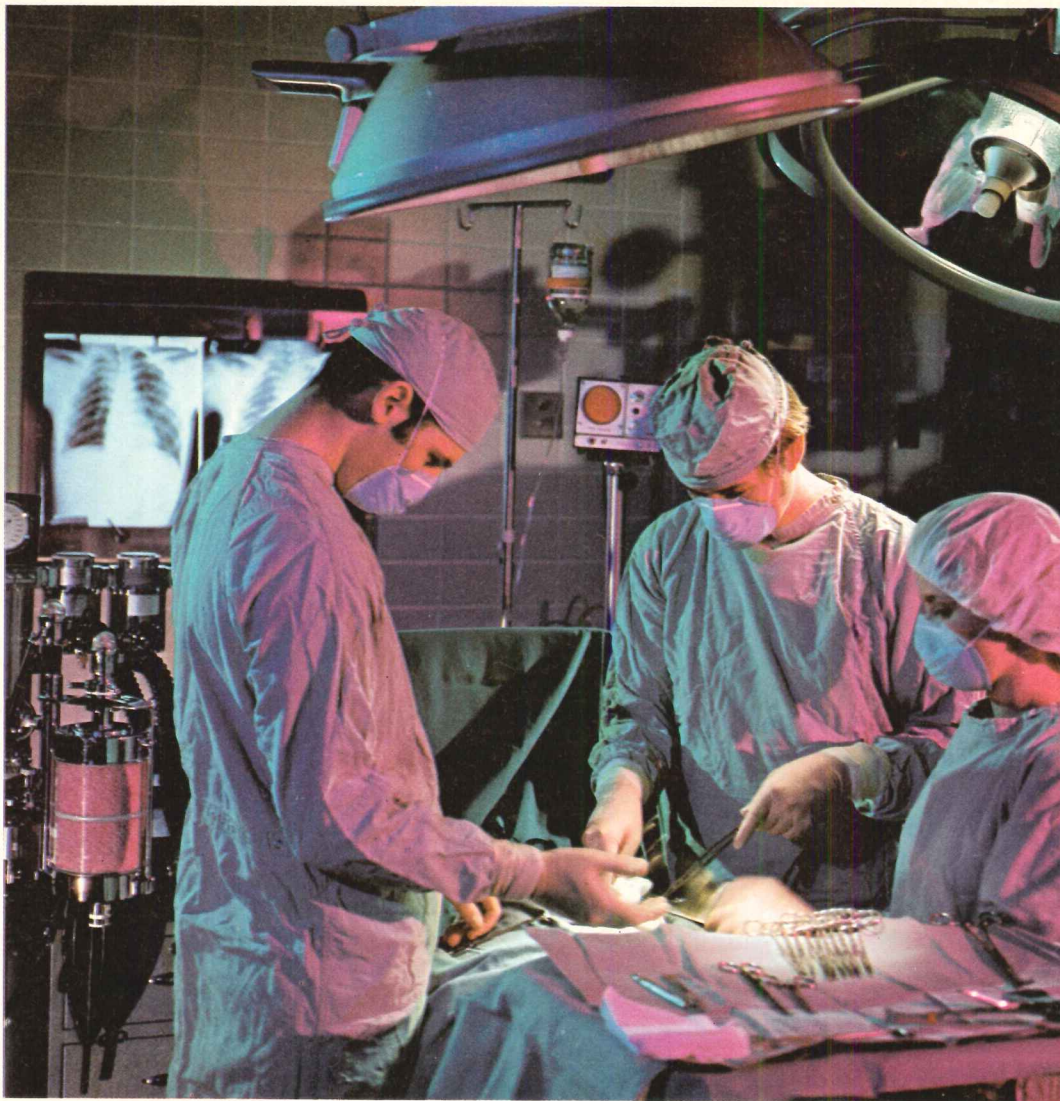

Introducing the gas powered operating room.

The switch to Gas Total Energy is on.

That's right. The electricity to power the overhead lights, the electrocardiograph and the other physical status monitoring equipment in this operating room comes from a natural gas total energy system. Not from a distant power station.

Why gas total energy? Because the people who design, build and operate hospitals know a gas total energy system is one sure way to provide maximum

reliability of energy service. And at annual cost savings unheard of 10 years ago.

Gas total energy systems generate electricity and utilize recovered heat on the site where the energy is going to be used. This means not only ultra-dependable electric power for lighting and motors but also in the operating room where continuity of service is really important. And, heat recovered from the natural gas prime movers additionally provides energy for heating, water heating, air conditioning, laundry and sterilization. The

natural gas supply, which is the sole source of energy, is also available for food preparation and other applications. Total energy systems operate at maximum efficiency, need little maintenance and act as their own standby power supply.

Sold on gas total energy? If not, you soon will be. For complete details contact your gas company, or Bob McChane, Northern Natural Gas Company, 2223 Dodge Street, Omaha, Nebraska 68102.



Home Office: Omaha, Nebraska

For more data, circle 30 on inquiry card

Bright idea



Beautiful way to brighten washrooms and cut costs: new, polyester fiberglass-reinforced Bradglas Washfountains. The smart-looking, colorful, new Washfountain materials add a touch of drama to any washroom. They weigh up to 80% less than precast stone, yet have a strength-to-weight ratio approaching that of steel. The smooth, non-porous bowls and panels are highly resistant to abrasion, acid, and corrosion. And will not chip, peel, or flake. Vandalproof Washfountains serve up to eight people with just one set of plumbing connections, reducing installation costs as much as 80%. Washfountains also save about 25% on both floor and wall space. And because they're foot-operated, they're more sanitary than ordinary washfixtures. Circular and semi-circular 54" diameter models are available in your choice of decorator colors. For details, see your Bradley washroom systems specialist. And write for literature. Bradley Washfountain Co., 9109 Fountain Boulevard, Menomonee Falls, Wisconsin 53051.

from Bradley!

Leader in Washroom Fixtures and Accessories



For more data, circle 31 on inquiry card



American Airlines Terminal Building, Washington National
Airport. Architect: Giuliani Associates, Washington, D. C.
Precast concrete panels: Tecfab, Inc., Beltsville, Md.
Stainless steel frames: Habgood Co., Philadelphia, Pa.

Introducing stainless concrete.

No concrete curtain wall was ever improved by brown or green streaks of metallic corrosion.

Giuliani Associates' design for American Airlines solves this problem

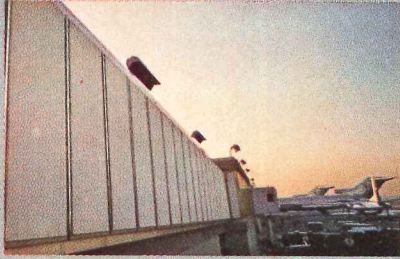

by combining the best features of precast concrete and nickel stainless steel. Architect and client can be

confident that the wall will be free of corrosion streaks for the life of the building.

The 4 $\frac{1}{8}$ -inch thick panels were custom-made by leaving .063-inch thick Type 304 stainless forms in place as the concrete hardened. The forms thus became framing members, and were polished just before erection.

Stainless adds strength to the concrete, while withstanding the multiple corrosive attacks of jet engine exhaust fumes, general urban air pollutants and particularly the caustic environment of concrete.

Stainless shines as a beautiful partner with masonry. It won't pit in a

caustic environment. It never dribbles corrosion streaks down light-colored surfaces. And the high strength of stainless lets you design with thinner members, lighter gauges.

Our architectural fact sheet has all kinds of ideas for designing with stainless. For your copy, write to The International Nickel Company, Inc., 67 Wall Street, New York, N.Y. 10005.

INTERNATIONAL NICKEL

For more data, circle 32 on inquiry card



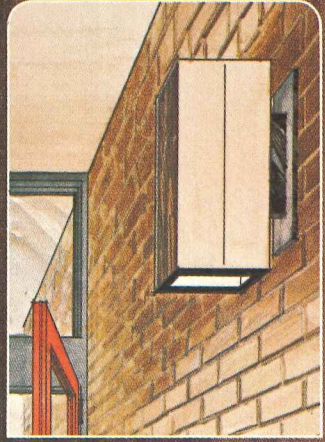

COMMUNITY HOSPITAL

Light is to find you by. Light is to know you by. Light is a cordial hand after dark.

You're welcome here. Come in out of the night.

That's what light should say, and we say the light should fit.

Here it's our Concept series. Up high on gracefully canted poles for large areas. Down low for walks. Crisp and contemporary when that's your design. Coordinated with our fixtures to finish the effect. Like up-down luminaires to light an entry or wall-mount fixtures to point the way.

We've got more. Large and small. Traditional and contemporary. To fit your building design.

May we show you? Just circle the reader service card. Call us. Or call your nearby Crouse-Hinds agent. He'll do the analyzing, costing and comparing, with an assist from our home office computer.

Crouse-Hinds Company,
Outdoor Lighting Dept.,
Syracuse, N. Y. 13201.

CROUSE-HINDS

CROUSE-HINDS

We bid you
good light



PARKING →



THE SECRET OF THE MASTERS

is in every can of PRATT & LAMBERT PAINT



SUPERB REPRINT of this Master Painting on excellent quality paper, size 19 x 24 inches, may be had by sending \$1.00 to Department M2, Pratt & Lambert, Box 22, Buffalo, N.Y. 14240.

For more data, circle 34 on inquiry card

Add solid comfort on the spot.

Ceraglo. The trouble- free, solid state heater.

Our new infra-red spot heater is as versatile as aspirin. It brings quick comfort to chilly workshops and utility rooms. To farm buildings and garages. To loading docks, guard shacks, in-plant cold spots.

But Ceraglo cures a lot more than the chills. It ends your installation

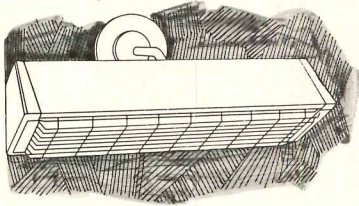

headaches and relieves maintenance troubles. The secret ingredient is a totally new heating element.



A 3M discovery. It lets this 1500-watt unit operate safely and efficiently on 120 volts. Allows simple, direct mounting with standard junction box, wiring and switches. Ceraglo's heating element is a strong, solid state

ceramic designed for a long, healthy life. With no fragile internal filament or resistance wires to break or burn out. Operates in any position.

We've engineered other comforts, too. Like compact size. Choice of mounts for wall or ceiling. And a tough acrylic finish that guards against rust and corrosion indoors or out. Contact your local electrical distributor for full details.

We build Ceraglo to put heat where your customers want it. And to take the heat off of you.

3M. We make it hard to go wrong.

3M
COMPANY

For more data, circle 35 on inquiry card

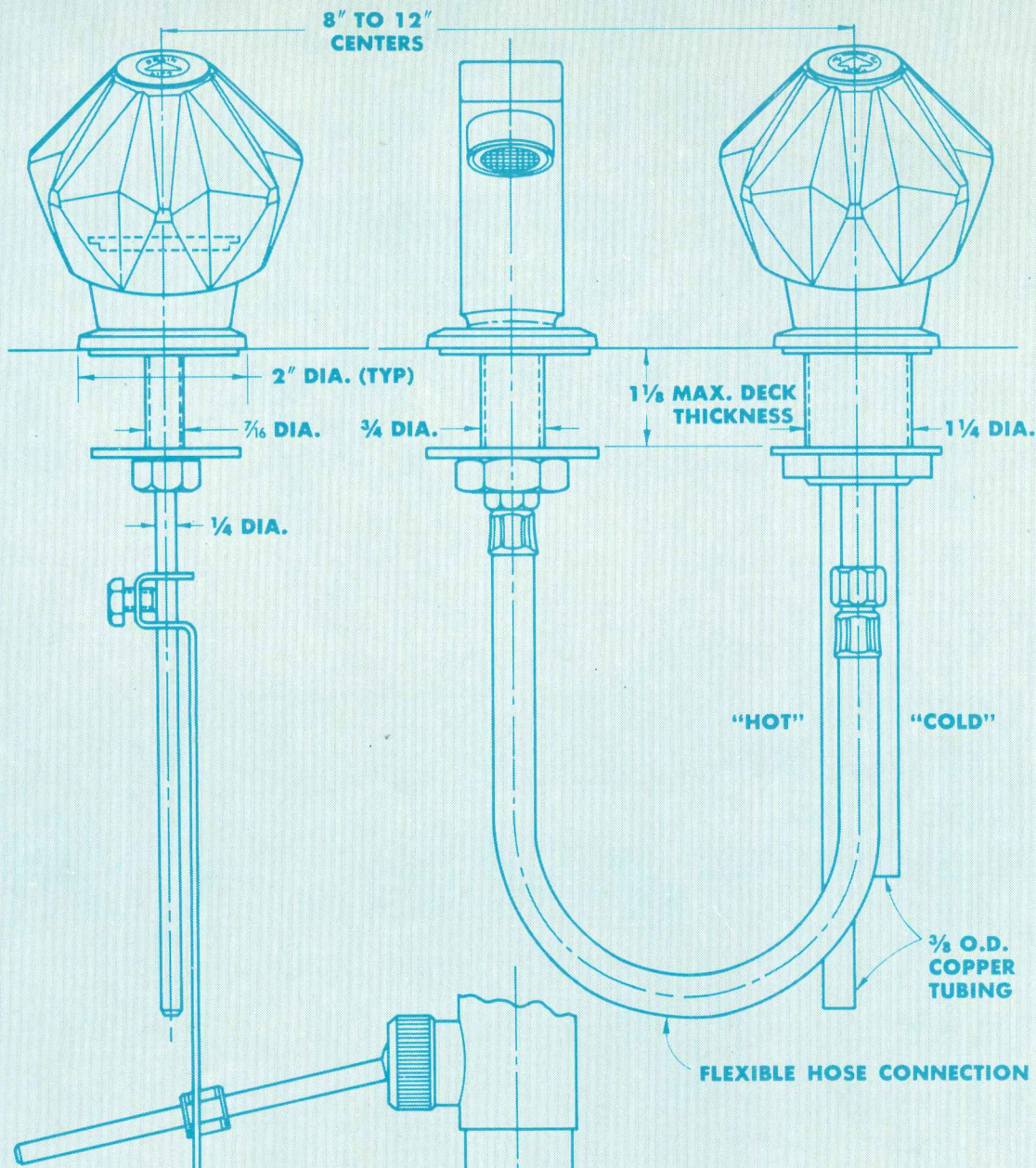

The new Delta Fjord two-handled single handle valve is so easy to install, you could almost do it single handed.

What more could a profit-minded businessman ask for?

We've designed the Delta Fjord with a flexible attachment for easy installation. And you can spread our widespread anywhere from 6 to 16 inches. Making the Delta Fjord versatile enough to fit virtually any lavatory.

But don't ignore our new valve's looks. We've designed the Delta Fjord with today's fashion-con-

scious housewife in mind. In decorator finishes of chrome, brushed chrome, bright gold or satin gold. In models for the tub, shower and lavatory.

And we haven't forgotten our original concept of one moving part for maintenance-free service. What could be better? A faucet housewives will be crying to have installed . . . and not sobbing to you about return calls for adjustments.

DELTA

Div. of Masco Corp., Greensburg, Ind.
In Canada:
Delta Faucet of Canada, Ltd.,
Rexdale, Ontario

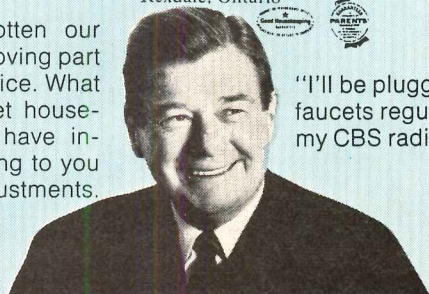
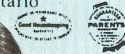

"I'll be plugging Delta faucets regularly on my CBS radio show."

For more data, circle 36 on inquiry card



Series 8100

Architectural simplicity is enriched with the warmth of tone and texture. Char Bronze, Mirror Chrome . . . walnut, rosewood, teak . . . mix the finishes as you will to complement the crispness of this design. The options are yours; so are the opportunities.

alma

See this and other Alma Series in our showrooms in High Point and Chicago (Space 1140, Merchandise Mart). You may consult our catalogs in Sweet's Interior Design File or write Alma Desk Company, Dept. AR-02, Box 271, High Point, N. C. 27261.

New choice of, profit-maker window systems-- only from Caradco.

**Our standard
Caradco
C-100 window.
Unusually smart,
because it's
easier to remove,
yet stays airtight.**

Compare, then think how impressed your customers will be. The sash lifts out with little effort, then snaps back, airtight. No other window can match the airtight Caradco. Not with our exclusive stainless steel weatherstripping. It grips with spring tightness, yet never sticks. You virtually eliminate costly call-backs and reduce on-site labor costs. What's more, it's factory-primed. Specify the complete Caradco package—grille, storm panels and screens—and see how sales grow—how much better your profits are. Write for details.

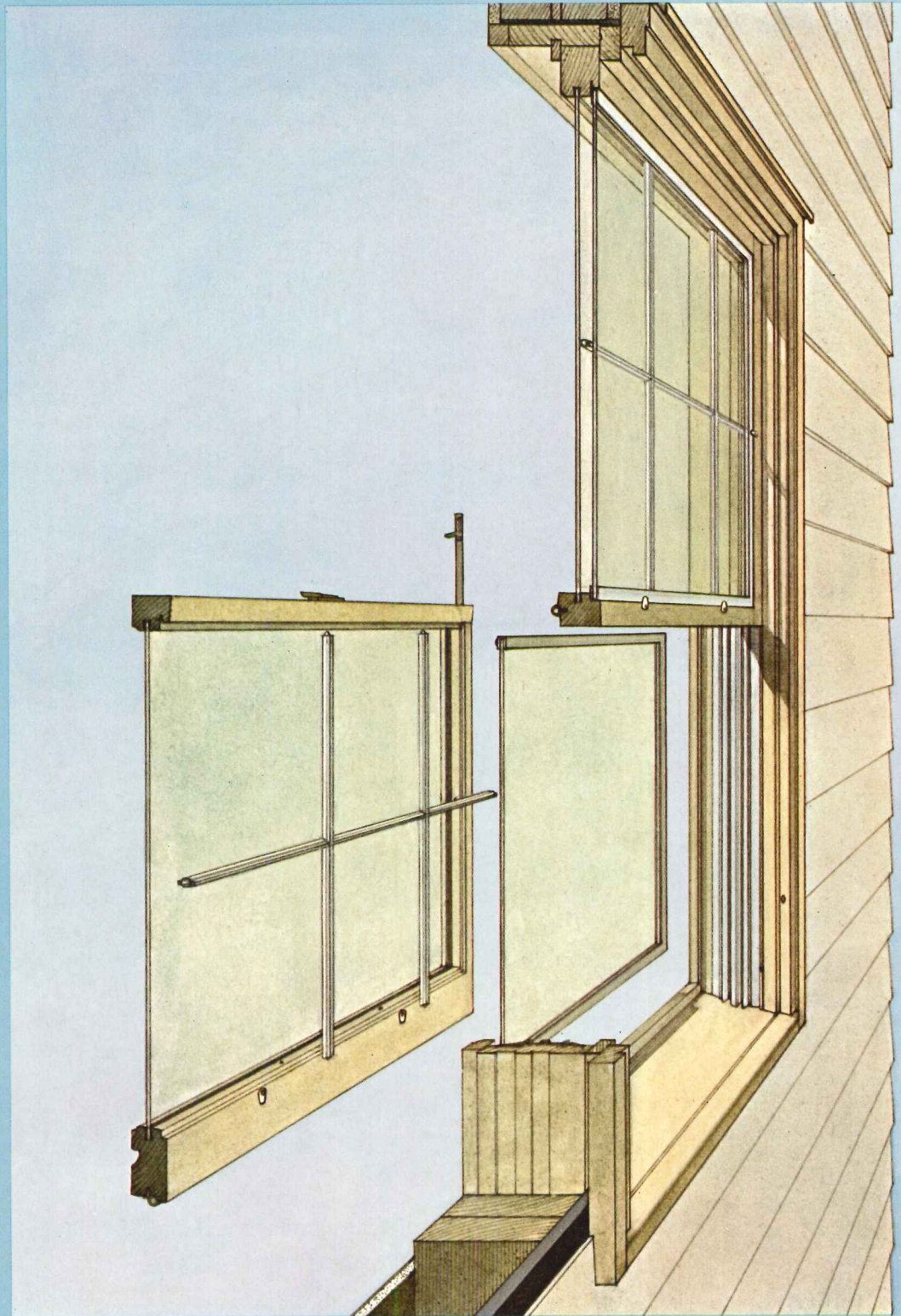

**Our new
PF C-100 model,
pre-finished
outside and in.**

We know you won't miss the painting and clean-up expense. We know, too, that you'll be happy to make a lasting good impression on your customers. So let's talk specific advantages: our new Pre-Finished C-100 window is finished inside and out. The frame is vinyl-clad for permanent, care-free protection. Never needs painting. The sash is protected on the outside by a 4-step finish that outlasts conventional finishes two or three times. Inside, a wood-toned stabilizer resists water and soil. You refinish only to change color and you can use either stain or paint. Want more? Our windows are easiest to remove, yet snap back, airtight. The more you compare, the more you'll want Caradco wood windows.

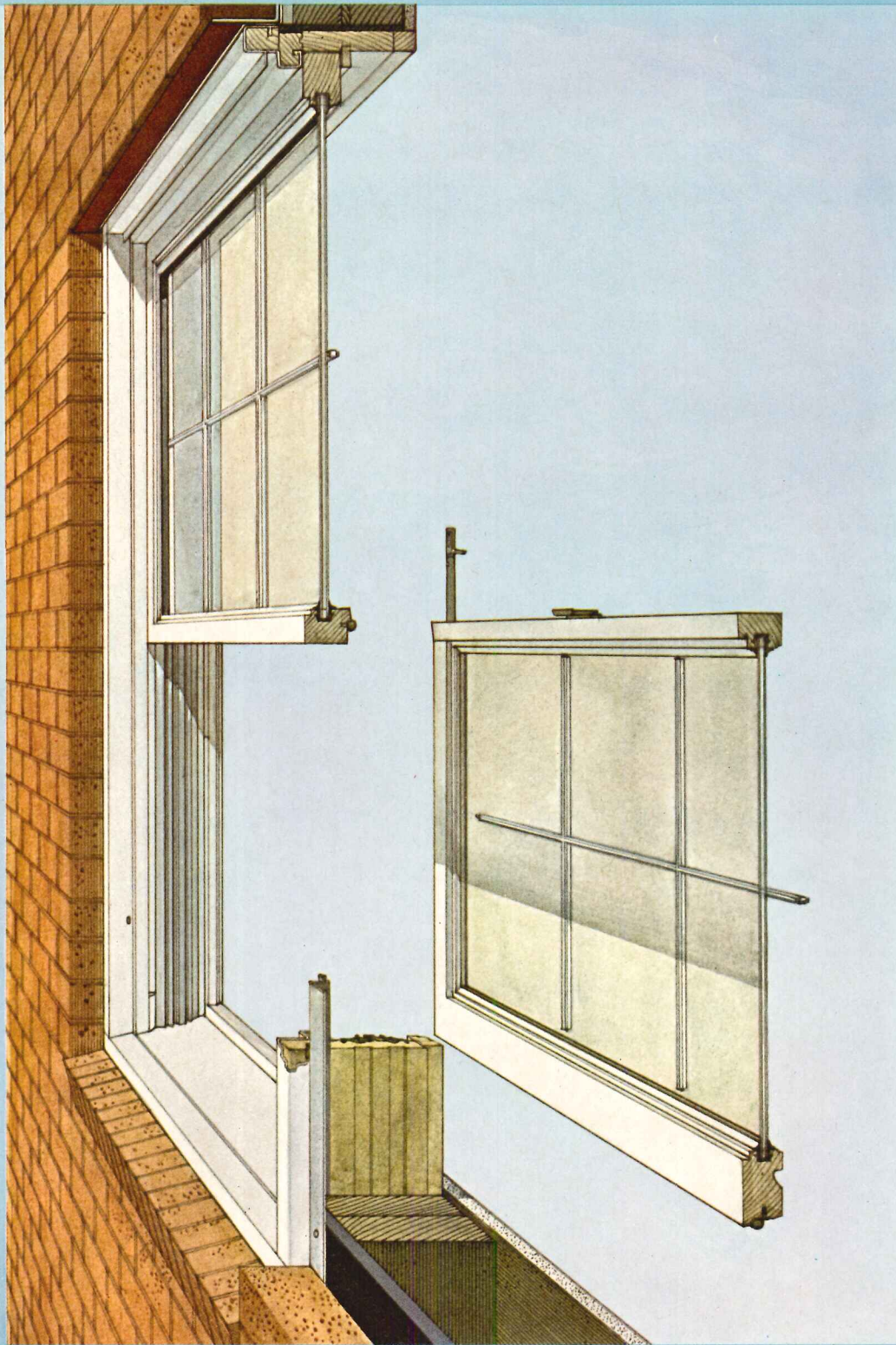

CARADCO

SCOVILL

Dubuque, Iowa 52001
Eastern Assembly Plant, Pemberton, New Jersey
Ohio Assembly Plant, Columbus, Ohio

For more data, circle 37 on inquiry card

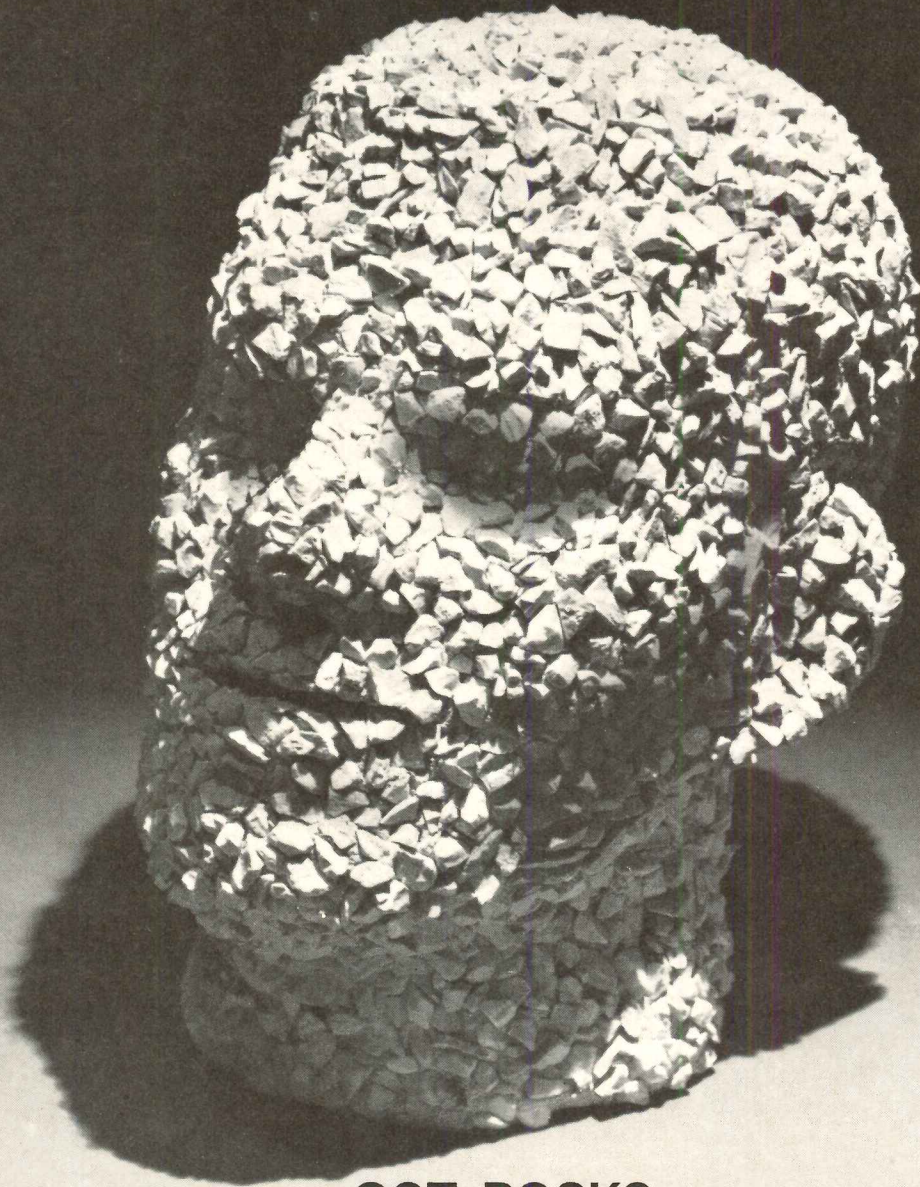

GOT ROCKS IN YOUR HEAD?

To put it another way, do you have exposed aggregate in mind for exterior or interior walls?

Tuff-Lite® is an excellent epoxy-based matrix to use for exposed-aggregate walls.

Because it has held larger rocks (and more of them) for a longer time than any other epoxy matrix!

And because its holding power has been proven in temperature cycles of -40°F. to +135°F. for periods of up to eight consecutive years.

Write for specs on Tuff-Lite Epoxy-Based Wall Matrix. And we can also give you specs on our complete line of epoxy floor systems: Tweed-Tex® Epoxy/Ceramic-Granule, Tuff-Lite Epoxy Terrazzo (both conventional and conductive), and Heavy-Duty Epoxy Floor Topping.

Refer to Sweet's Architectural File Numbers 11g/Fu, 11o/Fu and Industrial File Number 10e/Fu.



HB FULLER COMPANY

CONSTRUCTION DIVISION

2400 Kasota Avenue, St. Paul, Minnesota 55108 Dept. 34342

For more data, circle 38 on inquiry card

WOODSCAPE^{*} LIGHTING...INSPIRATION

for a dramatic lighting system, combining standards of wood with 15 Line luminaires of cast aluminum. Whether you specify straight or curved laminated standards, the strong rectangular form of this fixture adds enduring character and visual stimulation to any environment . . . city mall, shopping plaza or rugged countryside. It embodies mcPhilben's unique unitized cast aluminum construction, enclosed and gasketed for weathertight performance. Housing and pole adaptor have a triple ground, satin black anodized finish, with an additional black enamel protective coating. Light control elements include molded symmetric and asymmetric lenses and a white glass diffuser. 15 Line Woodscape lighting . . . an inspiration of lasting beauty!

*
Trademark of Weyerhaeuser Company

mcPhilben Lighting



mcPHILBEN LIGHTING
EMERSON ELECTRIC CO.

270 LONG ISLAND EXPRESSWAY/MEVILLE, N. Y. 11746
CANADA: 2275 MIDLAND AVE., SCARBOROUGH, ONTARIO



Modi-File is a partition.

A wall.



**A piece
of furniture.**



We almost forgot. It's also a file.

It just doesn't look like one (we even eliminated the handles). That's why you can stack MODI-FILES[®] as a free-standing partition. Or line them up against a wall. Or disguise them as executive suite cabinets.

But deep inside, MODI-FILE is all file. Because of a unique hinge suspension that gives it more filing space for its depth than any other lateral file. In letter and legal sizes, 30 and 36 inch widths. With a complete selection of accessories (even a wardrobe unit). At your Art Metal dealer.



ART METAL
JAMESTOWN NY
© 1969 ART METAL, JAMESTOWN, N. Y.

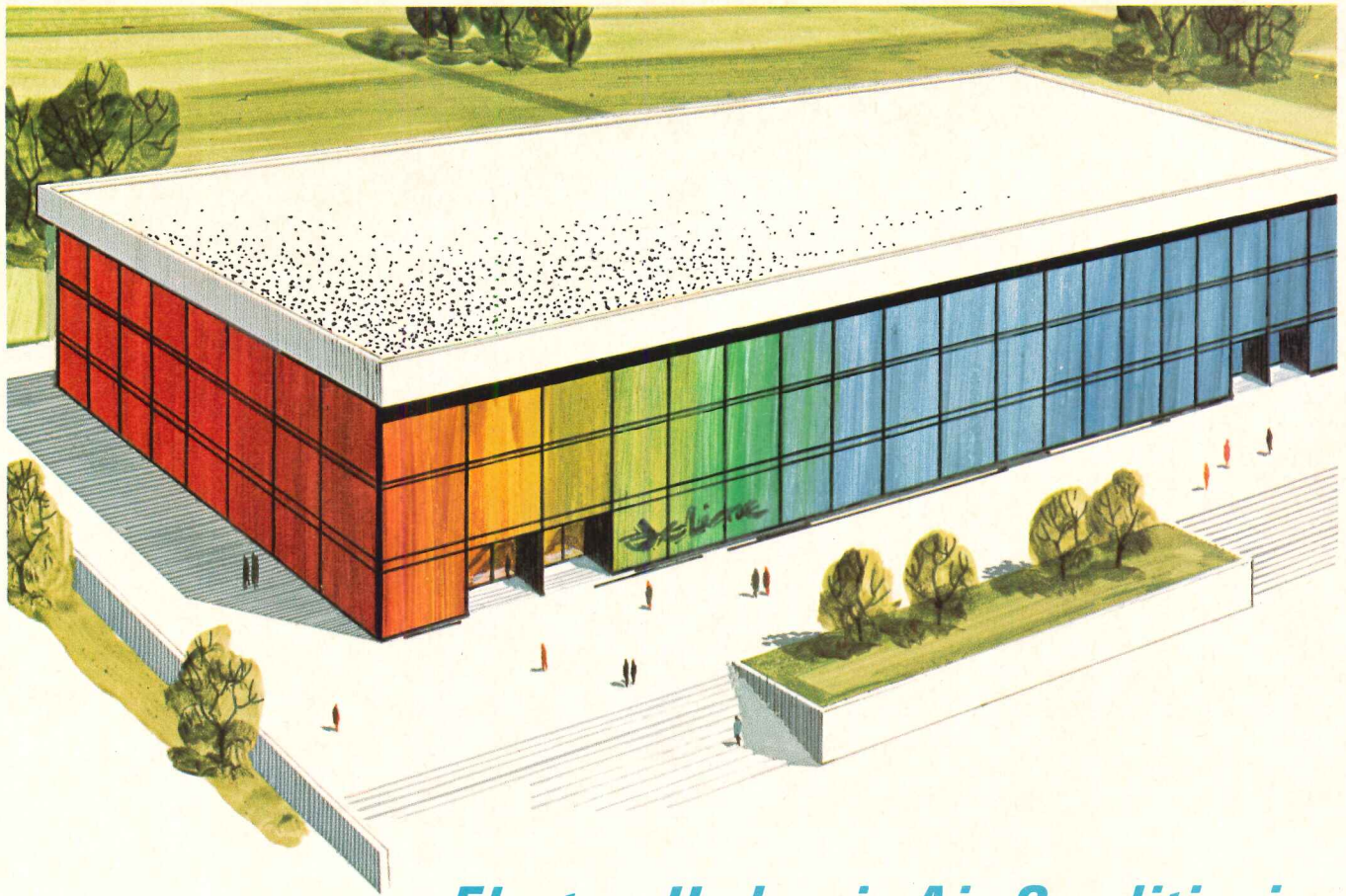

***Electro-Hydronic Air Conditioning
operates for less than most
conventional systems
available today.***

Bold statement? Probably. But here are some cost study figures you can examine to decide whether it's justified.

Medical Building — Monthly cost for heating and cooling averaged less than 1 cent per square foot for a two-story building (33,400 sq. ft.) in Casper, Wyoming. This severe winter exceeded 7800 degree days with temperatures as low as 31° below zero.

Office Building — Monthly operating cost for heating and cooling was under 1.1 cents per square foot for a ten-story building (69,000 sq. ft.) in Los Angeles, California.

Apartment Building — Monthly energy cost for heating and cooling fifteen two-bedroom suites, and six apartments (23,400 sq. ft.) was just over 0.3 cents per square foot for a three-story building in Los Angeles, California. A nearly identical cost was realized in another Los Angeles apartment, a high rise building about 25 times larger.

Motel — Monthly energy cost for heating and cooling averaged less than 1.3 cents per square foot (30,000 sq. ft.) for a motel near Washington, D.C.

There are more studies like these available to support that bold statement.

Maybe your next job — new or renovation — will be a candidate.

Electro-Hydronic systems also install for less than typical dual duct or four-pipe systems. Contact your local American-Standard Sales Representative for more information or write to:

Working with air to keep people comfortable.



COMMERCIAL AIR CONDITIONING DIV.
1300 Federal Blvd., Carteret, N.J. 07008.

For more data, circle 5 on inquiry card

**From the radical
and the daring
comes the
revolutionary.**

They're here to revolutionize treatment of walls and ceilings. To give interiors a radically different look. To break traditional paneling barriers.

Element I™ from U.S. Plywood. Five exclusive concepts in which veneers of a wide variety of wood species are used as they've never been used before.

Panels of mismatched or random-matched veneers. Panels which retain the rough natural textural beauty of wood. Panels joined in new ways with plastic or built-in reveals. Panels or battens that are available in many widths to vary surface treatment.

For a breakthrough in the use of wood for interior design, U.S. Plywood's Element I includes:

Butcherbloc™—a paneling of dramatic impact inspired by the counter of the neighborhood



butcher shop. Cedar veneers are laid end-to-end in vertical rows to reproduce the handsome look of heavy board inlay. Veneers are random length, in a variety of natural color tones and grainings. The overall effect is solid and audacious—in keeping with the paneling's namesake.

Collage™—choice wood veneers of birch, elm, oak, walnut, pecan, teak and rosewood are overlapped in random arrangements across each panel face to form a syncopated pattern of wood grains and color shadings. Veneers vary in length and width, texturing the surface of each panel in bold three-dimensional relief. A special bonding process has been devised to retain this unique and strikingly beautiful sculptured appearance.

Ionic®—a matchless architectural paneling in which smooth wood veneers alternate with "black olive" vertical reveals of plastic. This arrangement creates a pattern of classic simplicity. The effect is reminiscent of the slender, fluted columns of ancient Greece. A masterpiece of graceful paneling.

Palisade™ batten & trim—an unconventional decorating material in which veneers of De-

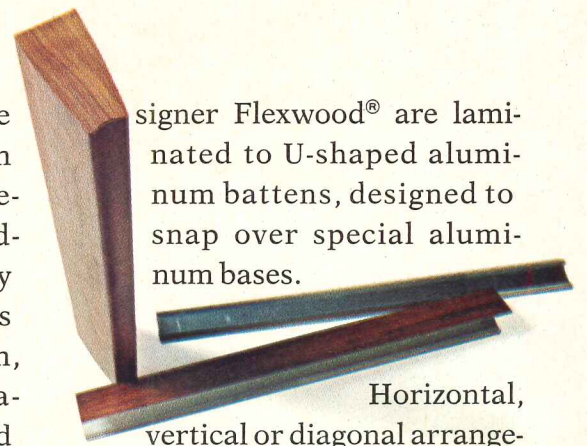

Horizontal, vertical or diagonal arrangements produce a limitless range of arresting visual effects. A novel, versatile, unique decorating material.

Concept 32™—a stark, beautifully basic interior paneling in which natural grain patterns of walnut, ash, teak and rosewood swirl unfettered across 32-inch wide panel faces, accented by charcoal black or deep chestnut



brown reveals. Faces are mismatched and flush. The look is modern, symmetrical, fundamental.

Element I. Because of its radical departure from tradition, it may be the

kind of wholly different wall or ceiling treatment you've always wanted to specify, but one that you have never been able to obtain until now.

So why not get more complete information about Element I? The Architectural Service Representative at your nearest U.S. Plywood office can supply all the details you'll need to make use of these innovative wall coverings. Or, if you'd prefer, simply write to U.S. Plywood, 777 Third Ave., N.Y., N.Y. 10017.

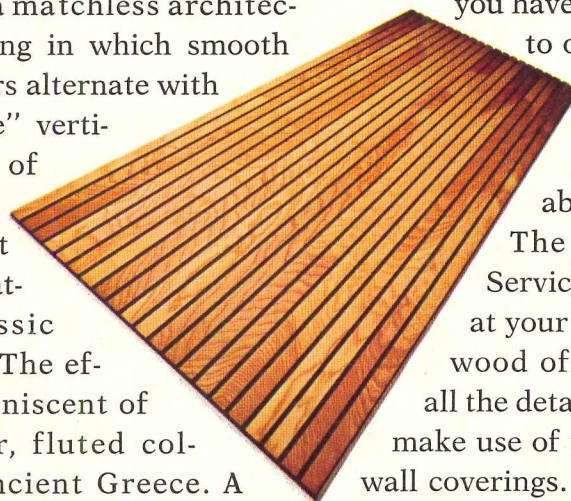

U.S. Plywood

A Division of U.S. Plywood-Champion Papers Inc.
777 Third Avenue, New York, New York 10017

For more data, circle 41 on inquiry card



Building: Abraham A. Ribicoff Apartments, New Britain, Connecticut. Architects: Kane, Fairchild, Farrell, White & Rallis, Hartford, Connecticut. Joseph E. Kane, Architect-in-Charge.



A nice warm story about growing old... with Andersen Windows.

One day, a Hartford architect was commissioned to design a high-rise apartment for the elderly.

Naturally, he wanted to make it a warm and comfortable place. As homey as possible.

So he did.

Outside, he planted trees to look at. Colorful benches to sit on. Cheery lights to sparkle at night.

Inside, to keep things warm and cozy, he specified electric heat. And he also insisted that the windows be Andersen Perma-Shield® with insulating glass.

He knew, from experience, that these windows would seal out nasty cold-weather drafts. (If there's one thing old people hate, it's feeling chilly!)

He also knew that our Perma-Shield Casements would let in lots of light—to read and sew by. Lots of fresh air, too. (They provide top to bottom ventilation.)

Finally, and perhaps most important of all, he knew these windows were not only beautiful, but practical. They wouldn't need storm windows. And their vinyl exteriors wouldn't need paint!

So, that's our story . . . of how an architect helped make some older people warm and comfortable—with the help of Andersen Windows.

Why not write an Andersen Window story of your own? For all the material you'll need, consult your Sweet's Catalogue, call your Andersen dealer or distributor. Or drop us a line.

Andersen Windows™ 
Window beauty is Andersen. Andersen Corp., Bayport, Minnesota 55003



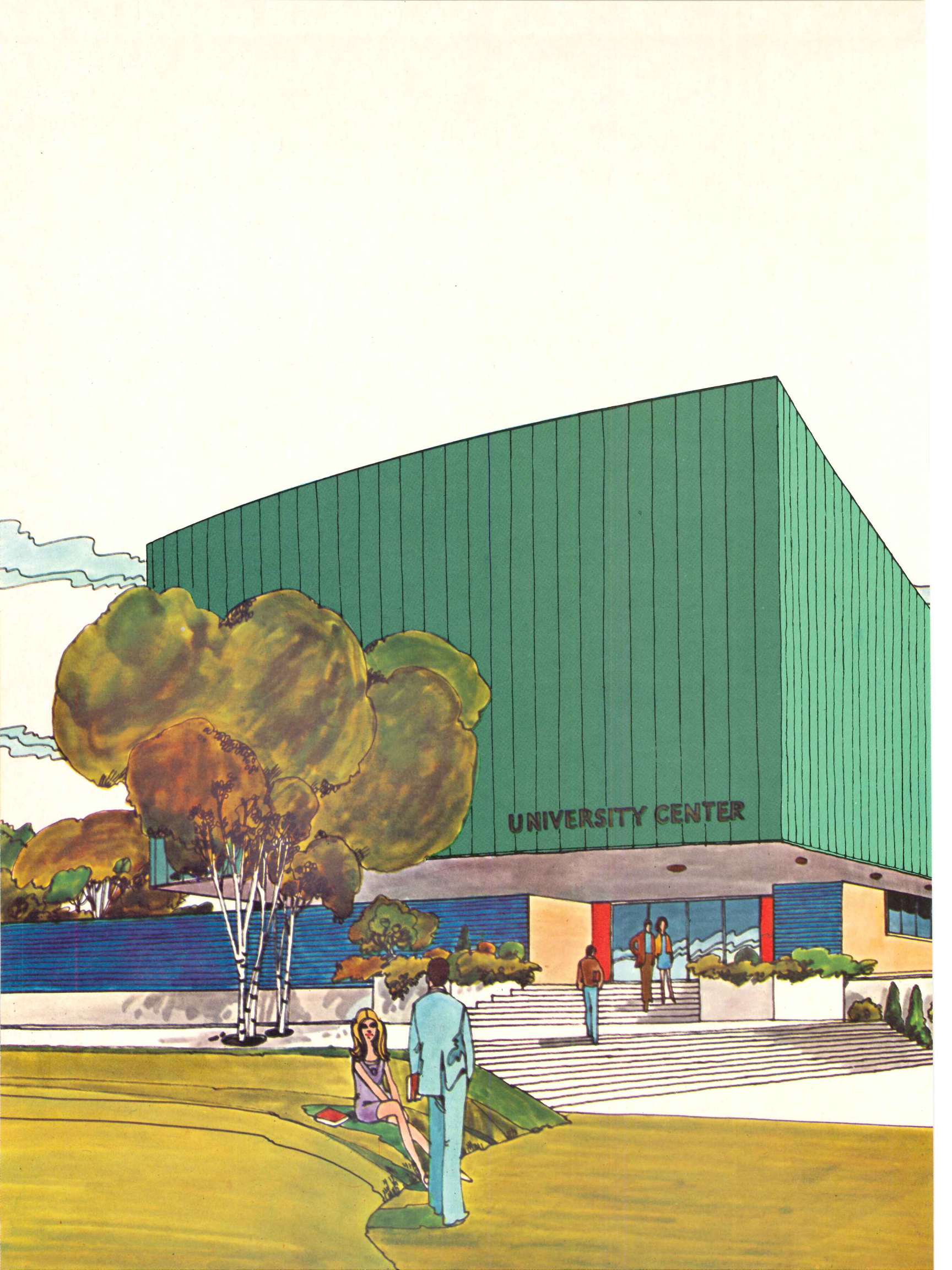

UNIVERSITY CENTER

PPG Coating Technology adds value to factory-finished metal

NEW DURANAR™ 200 **low-cost, long-life fluoropolymer finish** **lengthens the future of metal buildings**

Now you can specify an exterior finish for metal buildings combining the rich beauty, long life and low maintenance of a fluoropolymer coating—at about *half* the cost you'd expect.

New DURANAR 200 chemical coating makes the difference. This unique modified fluorocarbon enamel, a product of PPG research, offers excellent resistance to ultraviolet degradation. Actual field results

prove that DURANAR 200 colors retain original lustre and appearance longer than even the finest siliconized finishes. The low cost makes DURANAR 200 coating a most attractive finish for any structure.

Add value to your next building with new DURANAR 200 coatings, our fastest-growing line. Put them to work for you now as a factory-applied finish on steel

and aluminum panels and trim. You can choose from a selected range of architectural colors to enhance the beauty of all types of buildings. See Sweet's Architectural File. Or contact your architect, coil coater, panel manufacturer or PPG INDUSTRIES, Inc., Dept. 16W, One Gateway Center, Pittsburgh, Pa. 15222.

**PPG is Chemicals, Minerals,
Fiber Glass, Paints and Glass. So far.**

For more data, circle 42 on inquiry card

Coil
Coatings 
INDUSTRIES

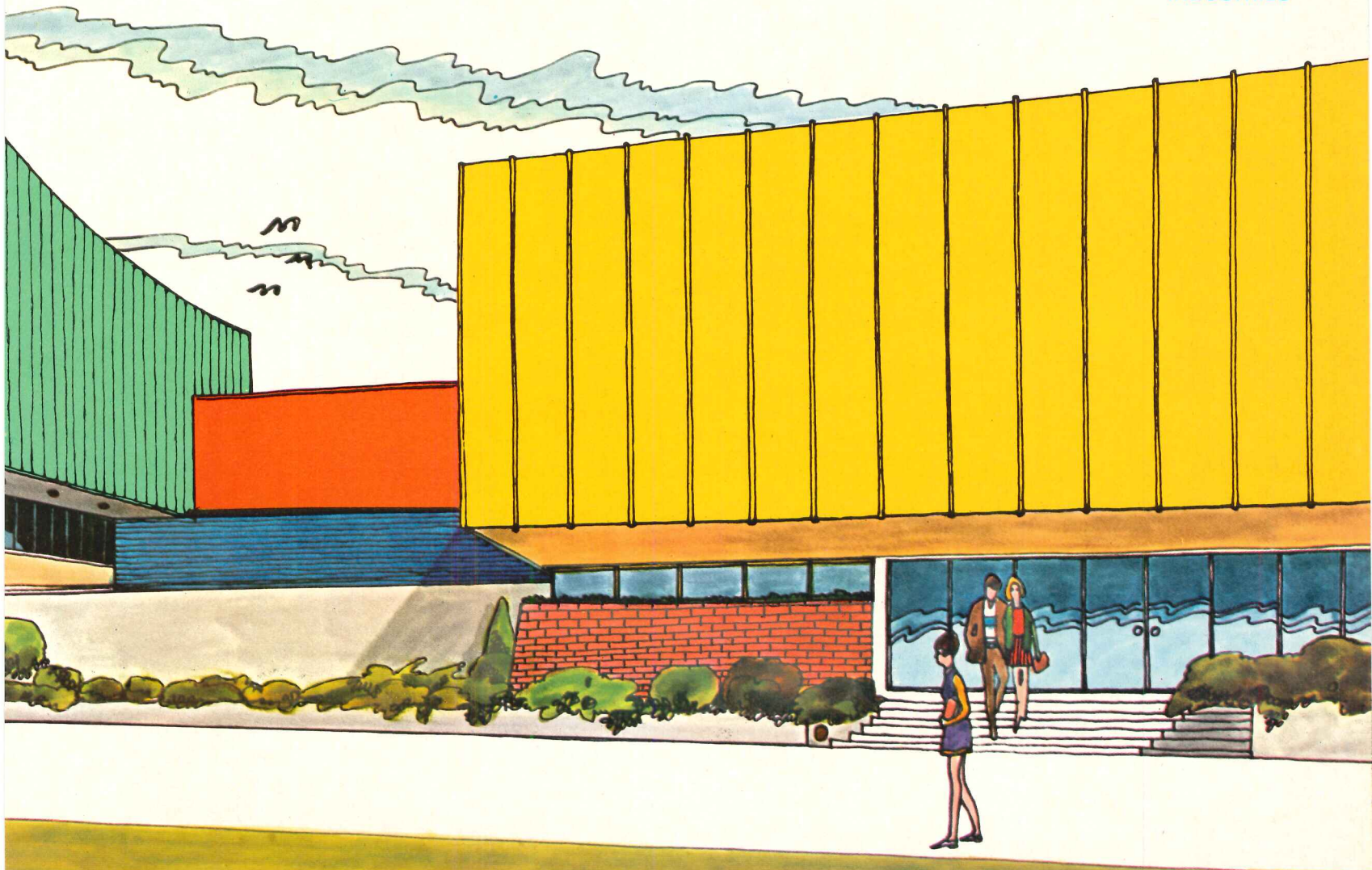



The Best Recommendation an Industry Leader can offer!



Reliable performance for 75 years is the best recommendation for a Supplier's product quality, reliability of service and financial responsibility that a Building Designer can be given. And, this is especially meaningful when applied to the originator and pioneer — and still the Industry's Leader — of the interlocking slat Rolling Door.

Kinneer has met the constant challenge of a competitive industry with many design and construction refinements along with the modifications to keep pace with the newest, present-day closure and barricade requirements. And, this alertness to changing needs is never relaxed! Even to this day, however, the original basic principle of Rolling Door operation, developed by Kinneer, has never been excelled for operational efficiency, space savings, durability and maintenance economy.

By specifying Kinneer Rolling Service and Fire Doors, Grilles, Counter Shutters and Power Operators, you are assured of a time-tested product backed by a nationwide installation and service organization. Kinneer Corporation, Columbus, Ohio 43216.



Guidelines for early planning estimates

By Bradford Perkins, McKee-Berger-Mansueto Inc., Construction Consultants

The relationship of building complexity to construction cost, while obviously positive, has been one of the most difficult functions to quantify in terms of both budget estimates for clients and fee structures for architects.

A recent study of estimated building costs for the City University of New York sought to develop guidelines based on data gained in prior planning estimates involving some \$316 million in construction for six other metropolitan New York colleges. While the whole study would be more particular than useful, one section of it, a checklist of trade-related elements arranged in order of complexity, reprinted below, may be a useful outline for others whose costing resources can adapt the method for other building types and locations.

By relating each project to the listed elements and a set of current square-foot costs, it is possible to increase greatly the sensitivity of advance estimates. Further, this approach offers an itemized scrutiny of design options related to cost control as well as a

realistic basis for fee negotiation.

Prior to using the checklist, the estimator needs certain documents and information in hand: the owner's program regarding quality and substance of his needs; the architectural program of net and gross space allocation; advance drawings showing general configuration and physical scope of the project; qualitative information about foundation problems, structural and mechanical systems, basic materials and finishes and any site or schedule problems that may affect costs.

The procedure is successively to refine an approximate over-all estimate based on rational square-foot costs through discussion and detailed evaluation of the trade-related items below. Confirmation of the "complexity-related" approach developed in an analysis of university buildings by type which showed that each of seven types was represented at all three levels of complexity with surprisingly uniform brackets of square-foot costs: "simple" in the low \$30's; "average" in the upper \$30's; "above

normal" between \$40 and \$50. The logical overlap of an "above normal" gym with a "simple" lab further confirms the complexity approach.

The following table shows the range of trade-related values applied in the New York project:

	Simple	Average	Above normal
Structural*	\$ 4.50	\$ 6.00	\$ 7.00
Architectural treatment*	15.00	19.00	22.00
Plumbing	1.00	1.50	2.00
Plumbing w/labs	3.50	4.50	6.00
HVAC	5.75	7.00	8.50
Electrical	2.75	3.50	4.50

* In New York State, these items comprise "general construction," one of four basic contracts. See scope of each in checklist below.

Note that a mixture of complexity categories occurs in almost all projects. Further, users are reminded that these figures are for a particular time and place and must be adjusted for any other use. Also, the following list is adaptable and is shown to demonstrate a method, not to limit applicable cost considerations.

STRUCTURAL

Simple

Unclassified earth excavation, minimal elevation deviations.
 Stockpiling of excavated material on site.
 Balanced cut and fill.
 Uniform spread footings.
 Continuous wall footings, non-stepped.
 Concrete block or poured concrete foundation walls.
 Concrete slab on grade.
 Minimal interior foundation wall requirements.
 Simple bay size layout.
 Masonry load-bearing walls.
 Exposed steel frame, spray-on or masonry fire-protected. Bar joist framing with poured concrete plank decking.
 Generally simple shaped building, easily framed.

Average

(25 to 45 per cent higher in cost than "simple" construction)
 Unclassified earth excavation, some variance of grade elevations.
 Stockpiling of excavated materials on site.
 Balanced cut and fill.
 Spread footings generally uniform

dimensions with some oddities.

Continuous wall footings, with stepped requirements.
 Poured concrete foundation walls.
 Concrete slab on grade.
 Some interior foundation wall requirements.
 Usually uniform bay size layouts for structural system, including variances for special conditions.
 Reinforced concrete frame and arches.
 Structural steel frame, masonry or spray-on fire protection.
 Simple-use precast concrete or architectural cast concrete members for structural purposes.
 Generally more complicated building shape with breaks, corners, cantilever requirements requiring an experienced contractor.

Above normal

(Over 45 per cent higher in cost than "simple" construction)
 Classified earth excavation such as hardpan, clay, boulders, rocks, etc.
 Great variations in grade.
 Dewatering problems.
 Required bracing, shoring, etc.
 Unbalanced cut and fill resulting in need of borrowed material.
 Foundation complications requiring spread footings of varying sizes

and shapes; special foundations, such as piles.

Grade beam requirements more often than typical, continuous wall footings and foundation walls.
 Structural slab not on grade.
 Interior requirements for foundation walls and footings.
 Varying bay sizes.
 Complicated reinforcing concrete frame and slab; structural steel frame encased in concrete fireproofing.
 Involved precast concrete or architectural concrete details.
 Generally complicated shaped structure requiring unique structural design solutions or considerations requiring high-caliber contractor.
 Design for future expansion.

ARCHITECTURAL TREATMENT

Simple

Simple shaped building with minimal architectural features.
 Exterior brick or block with stock window shapes, some stone work or precast trim, low ratio of windows.
 Unplastered block or drywall partitions in most areas.
 Resilient tile floors, V.A.T., predominantly used.
 Painted exposed ceilings in most areas.
 Hung ceilings in corridors and of-

fices.

Flat roofs with parapets.
 Simple waterproofing requirements.
 Vitreous spray or cement enamel in lieu of ceramic tile, minimal use of vitreous materials except for floors in wet areas.
 Simple program requirements.
 Low ratio of interior work.
 Hollow metal doors and bucks at normal heights.
 Simple stair exiting, and fire protection requirements.
 Minimum provision for future flexibility.
 Minimum circulation space, double loaded corridors.

Average

(20 to 40 per cent higher in cost than "simple" treatment)
 More complex shaped building expressing architectural features.
 Exterior glass brick, architectural concrete, larger ratio of windows, special size windows, moderate use of stone work.
 Unplastered block partitions utilizing expressive bonds. Use of more expensive interior finishes, especially in public areas.
 Resilient tile floors, V.A.T., predominantly used, some use of carpet-

ing or other more costly finishes.

Greater requirement for hung ceilings, simple suspension system and economic use of acoustical tile.

Flat roofs with some setbacks on different levels.

More complex waterproofing requirements.

Greater use of vitreous materials on walls and floors in wet areas.

More complex program requirements, modular design.

Greater density of interior work.

Solid wood doors and metal bucks; heights may vary according to need and location.

Greater fire protection and exiting requirements.

Modest provisions for flexibility.

More circulation space requirements.

Greater need for mechanical equipment space.

Modest use of varied materials for interior finishes.

Above normal

(Over 40 per cent higher in cost than "simple" treatment)

Complex shaped building requiring architectural treatments such as plazas, stilt designs, overhangs, setbacks, multi-levels, etc.

Exterior walls expressing and accentuating architectural esthetics predominantly utilizing stonework, precast or architectural concrete units, special window shapes and details, high ratio of glass work, greater use of metal alloys for trim and decorative purposes.

Plastered interior partitions, greater use of vinyl wall coverings, and glazed ceramic or vitreous finishes on walls.

Greater use of vinyl tile floors and architecturally expressive finishes.

Greater use of hung ceilings in most areas.

Multi-level roofs, setbacks, penthouses, promenade decks, etc.

Costly damp-and-waterproofing requirements.

Ceramic tile or glazed block used on floors and walls in wet areas.

Complex program requirements for multi-purpose occupancy.

High density requirements for interior work; single loaded corridors.

Expensive fire protection requirements, large exiting needs.

Large circulation and public areas.

Large need for mechanical equipment space.

Expensive vertical and horizontal transportation equipment.

Large degree of flexibility inherent in layout and design to accommodate future changes and requirements for mechanical and electrical trades.

PLUMBING

Simple

Gravity type sanitary and storm system using extra heavy cast iron pipe and fittings.

Domestic hot and return water systems utilizing submerged tankless coils in boiler.

Gas distribution for gas unit heaters, rooftop cooling and heating units and boilers.

Austere fixtures.

Economical toilet layouts, i.e., typical in-line facilities.

Fire standpipe system, if required.

Insulation for mains, risers, water lines and horizontal storm drains in finished areas.

Average

(Includes "simple" category plus the following items resulting in more than 40 per cent higher cost than for simple systems.)

Sump and ejector pump systems.
Hot water generator.
Domestic water pressure system.
Emergency generator—gas connections.
Standard fixtures.
Kitchen work.
Tempered water for showers.

Above normal

(Includes "simple" and "average" categories, plus the following) which will add 90 per cent or more to "simple" costs.

Galvanized steel or wrought iron above grade for sanitary and storm systems.

Foundation drainage if required.
Preheater for domestic hot water.
Water treatment if required.
Gas piping for laboratories.
Acid-neutralizing system for labs.
Exotic gas systems for labs.
Emergency showers and eye wash.
De-ionized and distilled water systems for labs.
Heavy kitchen work—i.e., slurry systems with extractors and pulpers.
Air compressors, vacuum pumps, distillers.
Fire pump and jockey pump.
Insulation of all domestic water piping and all horizontal storm piping.
Luxury fixtures.

HVAC

Simple

Low pressure, one pipe steam system.
Two pipe circulating hot water system.

Ventilation only, of interior areas (toilets).

Self-contained, low pressure heating and air conditioning systems, all air.

Forced air heat only.
Self-contained boiler rooms.

Insulation of piping and supply duct work.

Electric automatic temperature control system.

Average

(Includes "simple" category plus the following which will add 20 to 40 per cent to cost.)

Central station heating and air conditioning (single zone).

Multi-zone heating and air conditioning systems with reheat coils.

Fan coil perimeter system, two or four pipe.

Unit ventilator system, two or four pipe.

Kitchen and "simple" laboratory exhaust.

Mechanical equipment rooms, including converters, chillers.

Acoustic lining.

Automatic sprinkler system (fire prevention).

Pneumatic controls, electric-electronic controls.

Above normal

(Can include "simple" and "average" categories, plus the following which will tend to increase costs more than

40 per cent above costs for "simple" systems.)

Dual duct system with mixing boxes, or terminal reheats.

Induction system.

Fume hood exhaust.

Dust collection system.

Thermal wheel heat exchange.

Run-around heat reclamation.

High pressure steam, with PRV stations.

Radiant ceilings and floors.

Air-light distribution systems.

Heat pumps.

Glycol and/or brine systems.

Steam humidification.

Snow removal systems.

Water treatment systems.

Boiler feed system.

CO₂ fire prevention system.

Remote power plant installation.

Central station, computerized monitoring for automatic temperature controls.

Sound attenuation systems.

Design requirements for future expansion.

Design for a high degree of flexibility.

ELECTRICAL

Simple

One main distribution panel (wall mounted) serving simple 120/208V.

Feeders: runs feeding one or more panels at a time.

Lighting fixtures: fluorescent fixtures mainly in continuous rows. Few incandescent fixtures.

Branch circuit work: use of one light switch per average room, receptacles used sparingly.

Motor work: individually mounted starters furnished by others.

Fire alarm system: master control board with stations and gongs at stairs and exits. Non-coded, non-zoned.

Sound system: master amplifiers with microphone and page common to all speakers.

Clock: inexpensive clock with cord plugged into outlet on wall.

Emergency lighting: wall mounted battery units with headlamps.

Emergency lighting: wall mounted battery units with headlamps.

Average

(Items resulting in 20 to 50 percent higher cost than "simple" systems.)

Service and panels: one main distribution board (free standing) serving light and power panels. Simple 120/208V service.

Feeders: runs feeding one or more panels at a time.

Lighting fixtures: fluorescent fixtures mainly in continuous rows. Few incandescent fixtures. Specialty lighting where necessary plus some architectural lighting for esthetic purposes.

Branch circuit work. Two or more light switches for each major room controlling different rows of fixtures. Use of three-way switching. More generous employment of receptacles—both duplex and special.

Motor work: motor control center furnished by electrical contractor.

Fire alarm system: master control board with stations and gongs at stairs and exits plus zoning and coding of fire signal. Use of some heat and smoke detectors.

Sound system: master amplifiers with microphone and page common to all speakers.

Clock and program system: master control cabinet plus devices in

major rooms and halls.

Television system: antennas, amplifier and receiving outlets throughout building.

Emergency lighting system: use of emergency generator and automatic transfer switch feeding one emergency panel.

Laboratory work. wiremold raceway with receptacles on laboratory walls.

Above normal

(Items resulting in more than 50 per cent higher cost than "simple" systems.)

Service and panels. 480/277V service into building, one or more free standing main distribution boards, 480/120-208V transformers, sub-distribution panels, light and power panels.

Feeders: multiple sets of feeders between main distribution boards, and from main distribution boards to sub-distribution panels. Single feeder runs from sub-distribution panels to light and power panels. Possible use of bus duct for main feeders.

Lighting fixtures: fluorescent fixtures mainly in continuous rows. Few incandescent fixtures. Specialty lighting where necessary plus some architectural lighting for esthetic purposes. Dimming effects and luminous ceiling areas. High intensity lighting for special areas.

Branch circuit work: two or more light switches per major room controlling different rows of fixtures. Use of three-way switching. More generous employment of receptacles—both duplex and special.

Motor work: motor control centers plus intricate interlocking and control devices, fan shutdown coupled with fire alarm system.

Fire alarm system: coded and supervised fire alarm system plus complete smoke detection, heat detection and sprinkler alarm systems. Fan shutdown facilities coupled to motor control centers.

Sound system: master system plus sub-systems in other facilities interconnected for selective paging.

Clock and program system: master control cabinet plus devices in major rooms and halls.

Television system: antennas, amplifiers and receiving outlets throughout building plus program originating and sending facilities. Possible television studio.

Emergency lighting system: emergency generator plus complete system of feeders and panels to all areas.

Public telephone system: complete system of feeder conduits, terminal cabinets and outlets.

Stage lighting and dimming: theatrical stage lighting with complete dimming facilities.

Intercom telephone system: automatic exchange plus handsets.

Laboratory work: special lab panels with contactors, wiremold raceway with multi-voltage receptacles, lab bench wiring, explosion proof areas.

Surveillance and security system: All exterior and stair doors, plus door to special rooms, wired to central security console. Possible closed circuit television hookup included.

Design for future expansion.
Design characteristics reflecting high degree of flexibility.

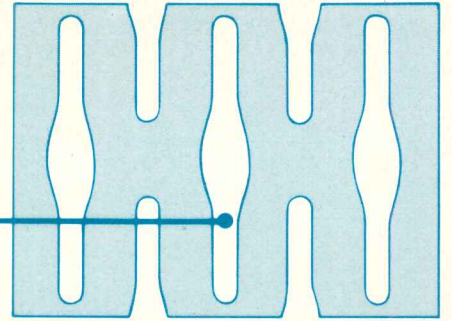
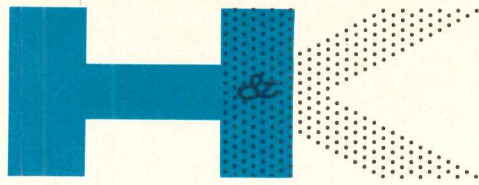

POSI-LOCK METAL DISPLAY PANELS

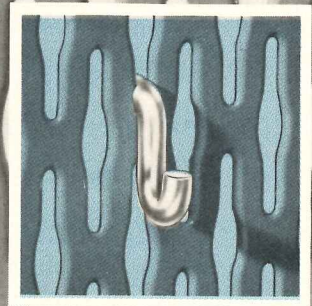
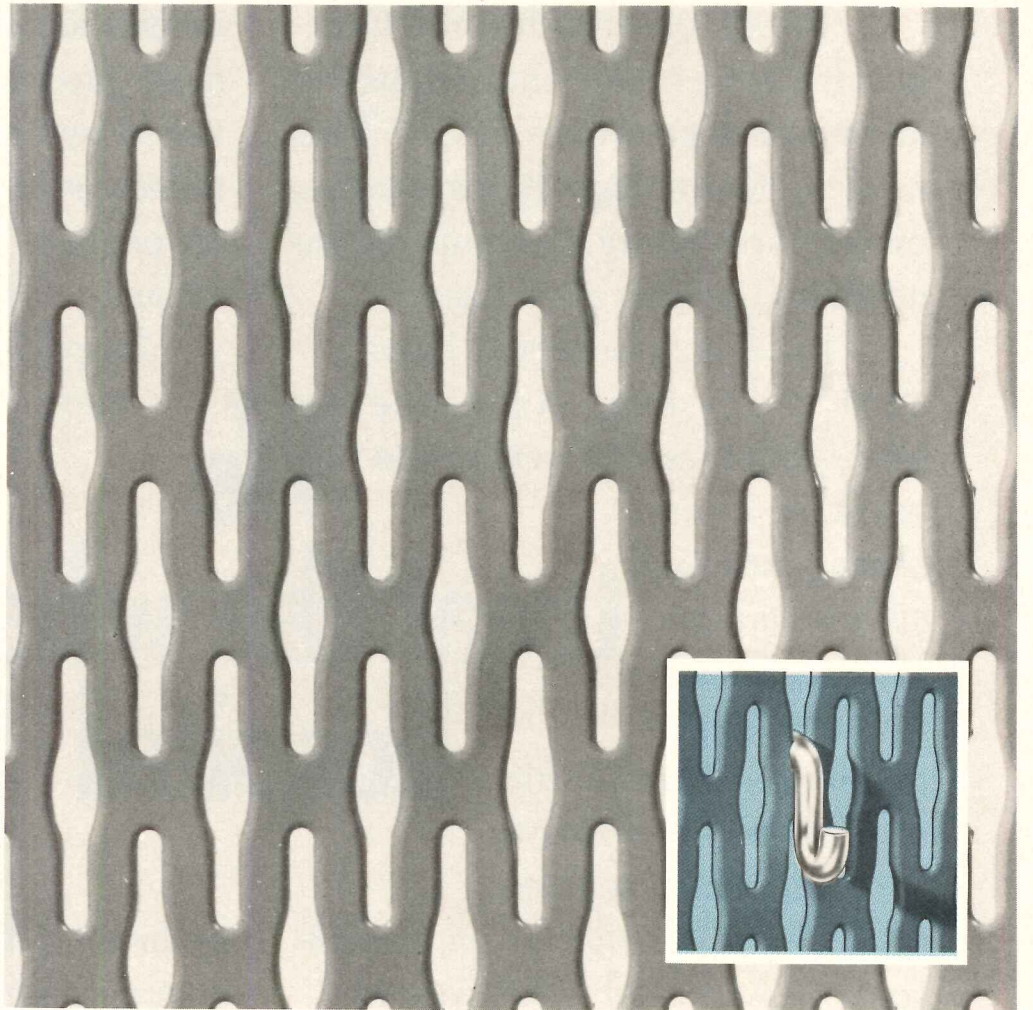
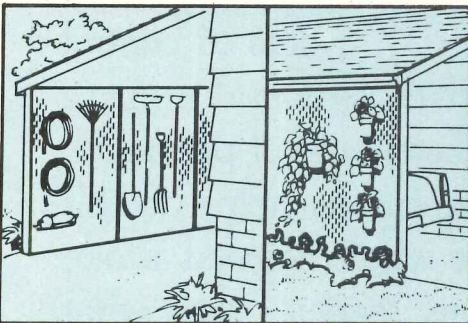
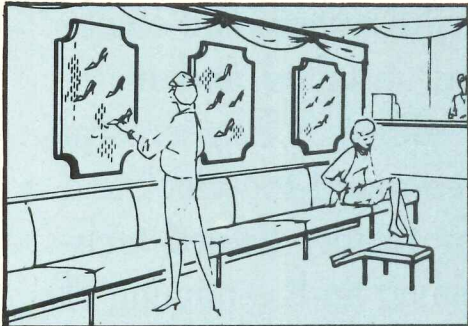

MAIN ILLUSTRATION ACTUAL SIZE

DESIGN PATENT NO. 189402

Here is a refreshing departure from the commonplace—a display panel with a distinctive pattern, featuring eye-catching beauty as well as versatile utility. H & K POSI-LOCK metal display panels are light . . . bright . . . strong . . . colorful. They lend a decorative touch, while providing useful display space. Write for catalog sheet including complete information on available metals, colors and sizes.

HARRINGTON & KING PERFORATING CO., INC.

5624 FILLMORE ST., CHICAGO, ILL. 60644 / 90 PARK AVE., N.Y., N.Y. 10016

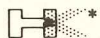

... since 1883, the symbol of quality, service and dependability in the perforating industry.

*TRADEMARK

For more data, circle 44 on inquiry card

When you call Executone, you get a diagnosis that covers every part of the hospital.

We do it with Hospital Communications Programming, better known as Executone HCP. This modern technology helps analyze present and future communications needs for hospitals of all sizes.

HCP goes far beyond basic nurse call systems. It puts the newest advances in electronics to work in every nursing area and all hospital service departments. Fully integrated communications could include administrative intercom, doctors' register, pocket page, security alarm, patient-controlled TV, and sound systems.

Executone HCP gets hospital people working together better, and at the same time improves the quality of service to patients. No other organization is as well qualified as

Executone to administer HCP:

- One manufacturer assuming full responsibility for all hospital communications.
- All systems and equipment produced, installed and maintained by one source.
- Expert local service provided round-the-clock and on premises by factory-trained technicians.
- Training and re-training of hospital personnel by communications experts.

We treat the whole hospital

Whether your client is interested in modernization, expansion or new construction, he wants to control costs and make more efficient use of personnel.

Executone helps do this by treating the whole hospital as one communications scene. That's what HCP is all about.

Call one of our specialists for a consultation, or write us today for a free portfolio on hospital communications. ***Executone***

Executone, Inc., Dept. S-5, 29-10 Thomson Ave., Long Island City, N.Y. 11101. In Canada: 331 Bartlett Ave., Toronto.

CURRENT TRENDS IN CONSTRUCTION

Robert M. Young
Senior Economist
McGraw-Hill Information Systems Company

Construction vs. inflation: Part 3, materials

Building materials hold the price line surprisingly well despite recent surges

In previous articles in this column, we have examined the general nature of inflation in the construction industry and the effects of wage trends and labor productivity on building costs. This month we'll look at the other major component of direct construction costs—building materials. These can influence final costs in three ways: the price trends of the materials themselves; the replacement of one material by another; and the substitution of materials for labor.

The table of materials price trends shows that building materials as a group contributed practically nothing to inflation in the first half of the Sixties. The combined index rose at a rate of less than one tenth of one per cent a year through 1965. Since manufacturing hourly wages rose three per cent a year (and wages in the building materials industries averaged close to the median for all industry), it can be assumed that productivity gains in building materials manufacture matched or exceeded those for the economy as a whole.

Beginning in 1965, this situation began to change—slowly, at first, then much more rapidly as the decade came to a close. Building materials prices rose at an annual

rate of 2.1 per cent between 1965 and 1967. This was a little higher than the rise in total wholesale prices and intermediate goods, but still below the gain in final goods costs. A number of building materials were still posting declines in prices, but some that had fallen or remained stable in the early part of the decade began to pick up sharply. Plumbing and heating equipment and concrete products prices reversed earlier declines as inventories were cut back following the housing slump of 1966.

In 1968, building materials prices jumped 5.6 per cent—more than twice the rate for all wholesale prices and intermediate materials, and almost twice that of final goods. This was followed by a six per cent rise in 1969, bringing the rate of increase in construction product prices in the past two years up to the total rise during the previous twelve years.

This sudden, sharp rise in building materials prices was a combination of a number of factors. First, the general inflationary trend in the economy made itself felt in the form of higher factory wage rates and raw materials prices. Secondly, the sharp drop in housing in 1966, followed by a boom in commercial construction in the past two years upset the normal capacity-demand relationships of many building products manufacturers, and prices were adjusted to

restore balance (and to yield profits, which had been much lower than those in most other industries for several years). Finally, a good bit of the over-all price rise since 1967 has been concentrated in lumber, millwork and plywood, where unusual shortages at the source forced prices up over 30 per cent.

Designers and builders have been able to reduce many materials costs by substituting less expensive products for those with higher absolute costs or rising price trends. Thus, output of vinyl floor coverings has tripled in the past decade, while usage of hardwood flooring has been cut in half. Wooden doors, window frames and sash are being challenged by metal and plastic components. Concrete panels have found increasing markets in place of both wood and metal for many uses. By and large, those products made of readily available raw materials, easily transported and capable of further technological improvement, have shown the stablest price patterns and offered the best opportunities for savings.

The greatest potential for cost savings in construction probably lies in substituting materials for labor—in effect, adding an additional step at the factory and eliminating one at the building site. The increasing emphasis being placed on off-site manufacture of larger building modules and components suggests that the application of mass production techniques to construction provides one of the most likely ways of curbing long-run inflationary tendencies (zoning regulations and union rules permitting).

TRENDS IN WHOLESALE PRICES AND WAGES DURING THE SIXTIES
(Average annual per cent change)

	1960-1965	1965-1967	1967-1968	1968-1969	1960-1969
All commodities	0.4	1.7	2.5	3.9	1.3
Intermediate materials ¹	0.2	1.6	2.3	3.5	1.1
Final goods	0.4	2.2	2.9	4.0	1.5
Building materials	0.1	2.1	5.6	6.0	1.8
Lumber	0.4	3.3	17.4	12.1	4.0
Millwork	0.6	2.1	5.4	11.6	2.7
Plywood	-0.9	-1.7	15.6	7.8	1.4
Structural steel	0.6	2.0	1.8	5.9	1.6
Plumbing fixtures	0.0	3.5	3.3	2.7	1.6
Heating equipment	-1.4	0.5	2.4	2.6	-0.1
Concrete products	-0.1	1.9	2.6	3.7	1.0
Gypsum products	0.4	-0.5	2.6	0.9	0.5
Paint	0.9	1.8	4.8	3.9	1.9
Wire, nails	-0.1	-3.5	0.2	7.3	-0.1
Asphalt roofing	0.3	1.2	4.8	0.6	1.0
Vinyl floor covering	-0.1	-3.0	6.0	-5.4	-0.7
Hourly wages					
Manufacturing	3.0	4.1	6.4	6.0	3.9
Construction workers	3.7	5.4	7.0	8.2	5.0

¹ i.e., goods used at a later stage of production

CORRECTION

Figures in the following table were disarranged in printing of this page in the March issue

F.W. DODGE SUMMARY OF CONSTRUCTION CONTRACT VALUES

	Millions of dollars		
	1968	1969	% Change
Stores & warehouses	3,968	4,367	+10
Office buildings	3,677	5,357	+46
Manufacturing	3,768	3,887	+3
Educational	5,347	5,480	+2
Hospital and health	2,114	2,780	+31
Public	1,112	1,141	+3
Religious	778	669	-14
Amusement	954	1,100	+15
Miscellaneous nonresident	795	886	+11
Apartment buildings	6,551	7,627	+16
Hotels, motels, dormitories	1,492	1,525	+2
Total	30,556	34,819	+14
One- and two-family houses	16,795	16,067	-4
Nonbuilding construction	14,381	16,539	+15
Total construction	61,732	67,425	+9

Elkay refrigerated water coolers fit today's creative design ideas for every type of building. Easily replaceable decorative panels of laminated vinyl in nine colors and two in baked enamel are offered at no extra cost and for immediate delivery. A unique cascade design, anti-splash basin with built-in, vandal proof drain teams up with a hooded stream projector and separate control button. The complete water cooler line includes Elkay innovated corner models, floor models and wall models, in regular and compact sizes. Three sizes of fully recessed and two capacities in semi-recessed coolers complete the line. Parts interchangeability and standardization are part of the Elkay concept in improved water coolers.

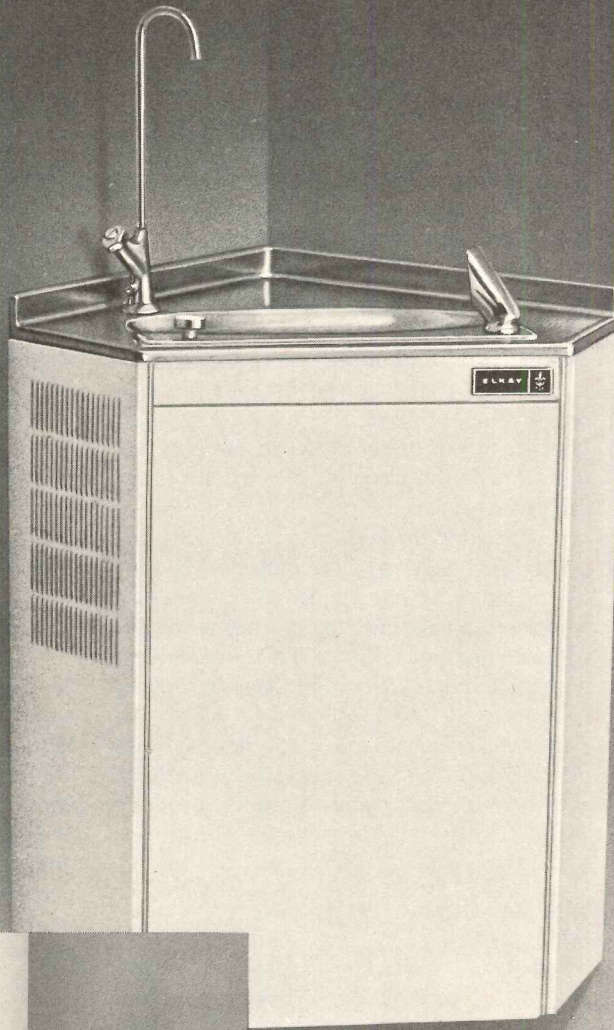

Ingenious corner model permits full utilization of space—eliminates corridor traffic problems. Meets "Hill-Burton" program requirements.

see our catalog in Sweet's 

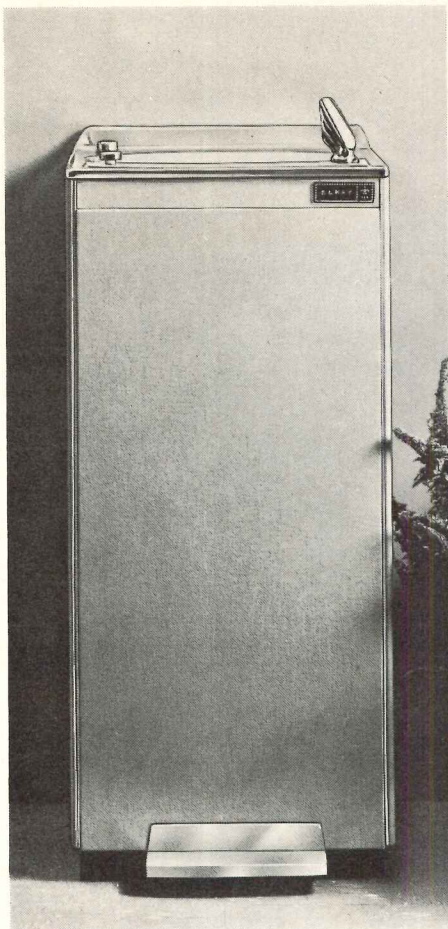

Floor models in 5 capacities. An attached child's size is available for side-by-side installation. Hot and cold water supply optional except on Model EF 4.

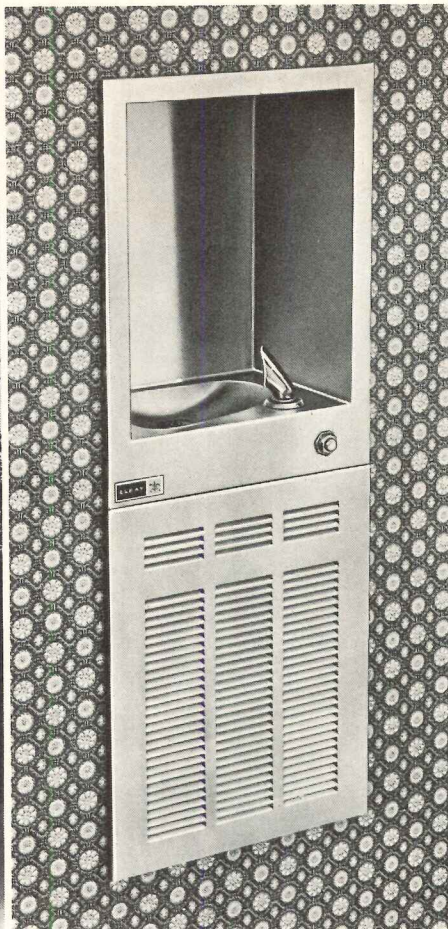

3 styles of fully recessed coolers in 8 and 12 gallon capacities created by Elkay comply with "Hill-Burton" program requirements.



Regular and compact sizes in wall mounted coolers are available. Combination two level cooler. Attached child sizes are also in the complete line of coolers. Hot and cold feature available on all models.



Made in two capacities. Both of the Elkay semi-recessed water coolers take the same rough-in dimensions and incorporate the famous cascade basin.

from the
ELKAY[®]
family of firsts



Hooded stream projector — a mark of Elkay innovation. When you see this Elkay product you are sure of sanitation and properly designed flow for drinking.



For complete information write for Catalog No. DFC-4 or call Customer Service Dept., Area Code 312-681-1880. ELKAY MANUFACTURING COMPANY, 2700 S. Seventeenth Ave., Broadview, Ill. 60153

For more data, circle 46 on inquiry card



Shhh.

American Plywood Association quietly announces the no-squeak floor for commercial buildings.

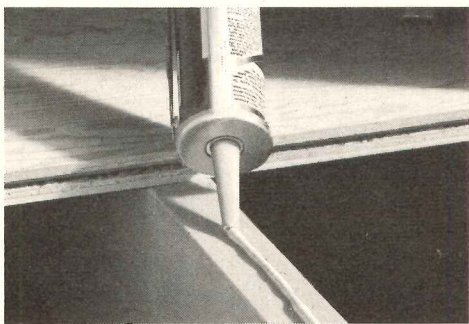

The APA Glued Floor System began in the home.

Now it's being specified for townhouses, apartments, schools, and all kinds of commercial buildings.

The system consists, simply, of glue-nailing a single layer of tongue and groove plywood to wood joists.

Floor and joists are fused into a T-beam unit. The entire floor is stiffer, and joist size can often be reduced.

Properly constructed, the system can eliminate squeaks because the glue rather than nails carries the stress. That keeps floors quiet.

Other advantages:

No nail pops.

No callbacks.

Single-layer construction.

Longer spans with the same size joist.

All-weather application capabilities.

Reduced nailing schedule (by 25 percent).

Less deflection.

Big savings in labor and materials.

Quite a set of claims? Yes.

But we've got the facts, figures and APA test results to back them up. New how-to photos. Diagrams. Span tables and charts. Case histories. DFPA plywood grade-use guides. Glue recommendations and supplier lists. Send coupon. (Lab report 118 on structural and adhesive tests available on request.)

The no-squeak floor is just one more example of the dozens of timesaving, efficient building systems developed by American Plywood Association. You can depend

on it. Just as you can depend on the DFPA grade-trademark on plywood. That means it meets the rigid standards of the oldest quality-testing program in the forest products industry. American Plywood Association.

**American Plywood Association, Dept. CM
Tacoma, Washington 98401**

Can you really keep floors from squeaking? Prove it. Please send me all the facts.

Name _____

Title _____

Firm _____

Address _____

City _____

State _____ Zip _____

(USA only)

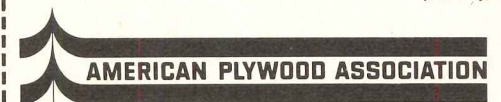

Plywood quality-tested by the Division For Product Approval.

AR-040

WHAT'S BEHIND COST TRENDS

Although recently negotiated wage increases for construction labor will average 15 per cent per year over the next two or three years for most trades, the prevention of future increases of similar scope would not "contain the rabid inflationary malaise now infecting the industry," according to Gerald McKee of McKee-Berger-Mansueto Inc. In a recent talk to C.S.I., McKee pointed out that wage increases thus far can account for only about half the rate of construction cost increase, especially in the East where rates of 12 to 15 per cent per year are responsibly quoted. The remainder, he said, can be traced to the preponderance of demand over supply. Trade union policy in general supports the status quo in which two-thirds of all labor input to a building is performed on site. But this requirement, says McKee, "equally suits the purposes of contractors and subcontractors, local material suppliers and, in many cases, even the design professionals." Labor's role as an impediment to change and growth, then, is "symptomatic of a more pervasive disorder rather than its cause."

Building cost indexes

The information presented in the tables indicates trends of building construction costs in 35 leading cities and their suburban areas (within a 25-mile radius). Information is included on past and present costs, and future costs can be projected by analysis of cost trends.

The indexes are computed on a basis of 40 per cent labor rate and 60 per cent materials price. Wage rates for nine skilled trades, together with common labor, and prices of four basic building materials are included in the index for each listed city.

Differences in costs between two cities can be compared by dividing the cost differential figure of one city by that of a second.

APRIL 1970				
Metropolitan area	Cost differential	Current Index		% change year ago res. & non-res.
		residential	non-res.	
1941 average for each city = 100.00				
U.S. Average	8.5	302.3	322.0	+ 7.77
Atlanta	7.5	381.9	405.1	+ 9.65
Baltimore	7.6	309.8	329.5	+ 3.78
Birmingham	7.2	286.2	307.7	+ 5.05
Boston	8.4	217.9	304.7	+ 7.90
Buffalo	9.2	334.4	356.2	+ 9.01
Chicago	8.8	349.5	367.6	+ 6.28
Cincinnati	9.0	317.5	337.4	+ 7.25
Cleveland	9.8	343.5	365.1	+ 7.24
Columbus, Ohio	9.0	323.2	344.3	+ 7.17
Dallas	7.7	303.6	313.5	+ 7.93
Denver	8.3	326.9	347.5	+ 8.19
Detroit	9.5	342.4	359.5	+ 8.56
Houston	8.1	295.7	314.9	+11.18
Indianapolis	8.8	287.0	305.7	+ 6.43
Kansas City, Mo.	8.3	289.1	306.0	+ 7.25
Los Angeles	8.3	323.9	354.4	+ 6.88
Louisville, Ky.	8.1	298.6	318.0	+ 8.60
Memphis	7.6	289.2	308.0	+ 5.60
Miami	8.6	326.4	342.6	+ 9.09
Milwaukee	9.2	356.9	380.1	+ 8.27
Minneapolis	8.9	325.2	345.7	+ 9.84
Newark	8.9	297.8	317.2	+ 7.79
New Orleans	7.9	292.3	309.7	+ 6.82
New York	10.0	334.2	359.5	+ 7.93
Philadelphia	8.6	317.0	332.9	+ 7.84
Phoenix	8.2	167.8	178.7	+ 6.66
Pittsburgh	9.1	301.7	320.7	+ 6.52
St. Louis	9.2	320.8	340.0	+ 9.11
San Antonio	8.1	121.8	129.7	+ 7.67
San Diego	8.2	122.2	130.1	+ 7.64
San Francisco	8.9	425.8	465.9	+ 9.44
Seattle	8.6	299.0	334.2	+ 9.75
Washington, D.C.	7.9	277.6	295.7	+ 8.21

Cost differentials compare current local costs, not indexes.

HISTORICAL BUILDING COST INDEXES—AVERAGE OF ALL BUILDING TYPES, 21 CITIES																
Metropolitan area								1969 (Quarterly)				1970 (Quarterly)				
	1962	1963	1964	1965	1966	1967	1968	1st	2nd	3rd	4th	1st	2nd	3rd	4th	
	Atlanta	298.2	305.7	313.7	321.5	329.8	335.7	353.1	364.2	365.9	382.8	384.0	399.9			
Baltimore	271.8	275.5	280.6	285.7	290.9	295.8	308.7	311.4	313.0	321.8	322.8	323.7				
Birmingham	250.0	256.3	260.9	265.6	270.7	274.7	284.3	288.4	289.9	302.4	303.4	303.5				
Boston	239.8	244.1	252.1	257.8	262.0	265.7	277.1	278.2	279.6	294.0	295.0	300.5				
Chicago	292.0	301.0	306.6	311.7	320.4	328.4	339.5	340.4	342.1	354.9	356.1	362.2				
Cincinnati	258.8	263.9	269.5	274.0	278.3	288.2	302.6	309.8	311.5	324.8	325.8	332.8				
Cleveland	268.5	275.8	283.0	292.3	300.7	303.7	331.5	334.9	336.7	357.1	358.3	359.7				
Dallas	246.9	253.0	256.4	260.8	266.9	270.4	281.7	287.2	288.7	307.6	308.6	310.4				
Denver	274.9	282.5	287.3	294.0	297.5	305.1	312.5	317.9	318.5	337.9	339.0	343.4				
Detroit	265.9	272.2	277.7	284.7	296.9	301.2	316.4	326.8	328.5	351.8	352.9	355.2				
Kansas City	240.1	247.8	250.5	256.4	261.0	264.3	278.0	281.0	282.3	294.5	295.5	301.8				
Los Angeles	276.3	282.5	288.2	297.1	302.7	310.1	320.1	323.7	325.4	343.0	344.1	346.4				
Miami	260.3	269.3	274.4	277.5	284.0	286.1	305.3	309.6	311.2	328.3	329.3	338.2				
Minneapolis	269.0	275.3	282.4	285.0	289.4	300.2	309.4	310.6	312.2	330.1	331.2	341.6				
New Orleans	245.1	248.3	249.9	256.3	259.8	267.6	274.2	285.5	287.1	296.6	297.5	305.4				
New York	276.0	282.3	289.4	297.1	304.0	313.6	321.4	324.9	326.6	343.4	344.5	351.1				
Philadelphia	265.2	271.2	275.2	280.8	286.6	293.7	301.7	304.6	306.2	320.0	321.0	328.9				
Pittsburgh	251.8	258.2	263.8	267.0	271.7	275.0	293.8	297.0	298.6	310.0	311.0	316.9				
St. Louis	255.4	263.4	272.1	280.9	288.3	293.2	304.4	306.8	308.3	323.7	324.7	335.2				
San Francisco	343.3	352.4	365.4	368.6	386.0	390.8	402.9	415.6	417.5	439.9	441.1	455.4				
Seattle	252.5	260.6	266.6	268.9	275.0	283.5	292.2	296.1	297.5	316.8	317.8	325.4				

Costs in a given city for a certain period may be compared with costs in another period by dividing one index into the other; if the index for a city for one period (200.0) divided by the index for a second period (150.0) equals 133%, the costs in

the one period are 33% higher than the costs in the other. Also, second period costs are 75% of those in the first period (150.0 ÷ 200.0 = 75%) or they are 25% lower in the second period.

BILCO SCUTTLES: EASY WAY TO THE ROOF

cover literally "floats open" on
compression spring operators

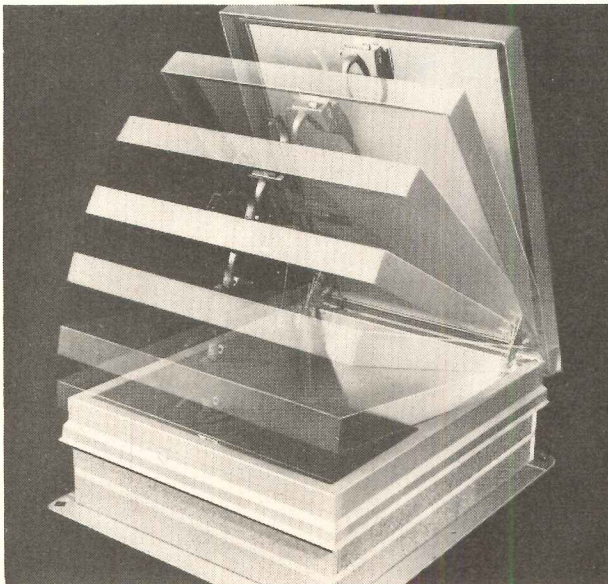
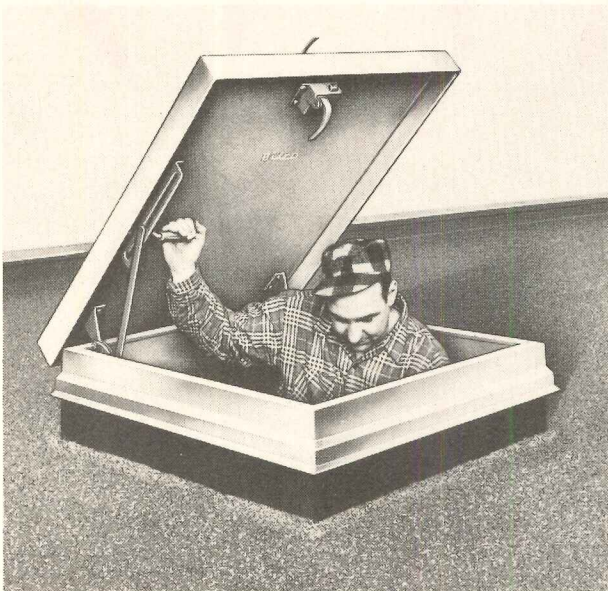

The Bilco construction "floats" Scuttle covers upward on compression spring operators and automatically locks the cover in open position. A conveniently located handle releases the lock, giving the operator the safety of one hand on the ladder and effortless control of the cover to its closed and latched position. Bilco scuttles come in a wide range of sizes and styles to meet every requirement.

Write for complete information



AMERICA'S FINEST
ROOF SCUTTLES

THE BILCO COMPANY Dept. AR-24, New Haven, Conn. 06505

For more data, circle 48 on inquiry card

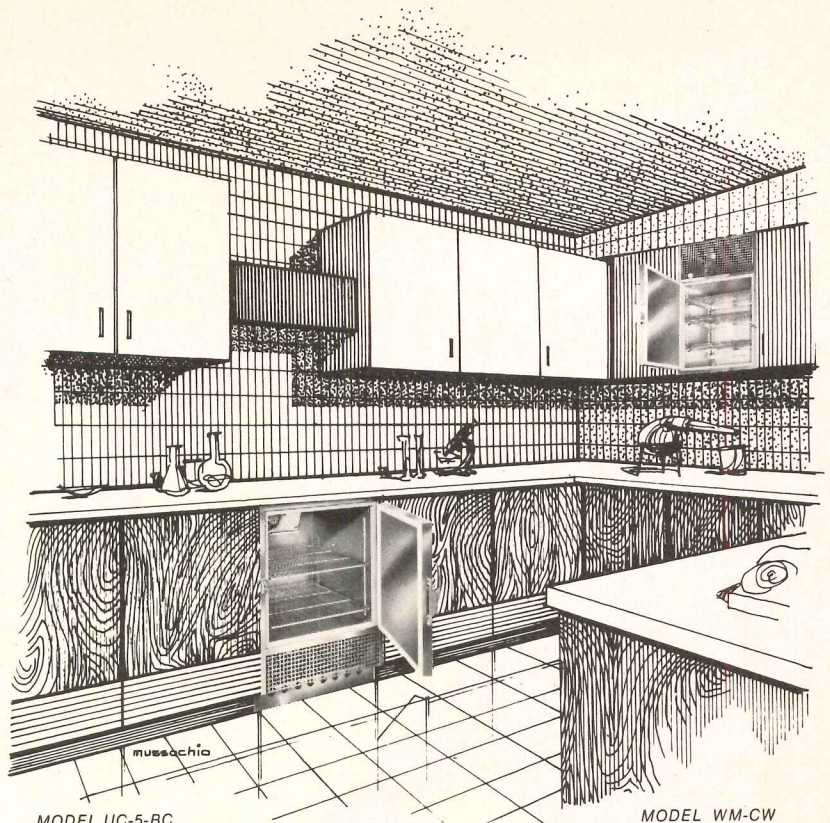

MODEL UC-5-BC

MODEL WM-CW

INTEGRATED DESIGN IN EYE-LEVEL AND UNDER-COUNTER REFRIGERATORS

Designed to fit flush with adjacent cabinet work in stainless steel or custom finished to your specifications, these space saving refrigerators provide a clean, uninterrupted line of design. The thin-wall construction incorporates polyurethane insulation and an air-tight neoprene thermo-break door seal. The undercounter models have outside dimensions of 24" x 24" x 34½" and a capacity of 5.4 cubic feet. The single door wall mounted models come in four sizes 18" W. x 13" D. x 30" H. with 1.5 cubic foot capacity up to the 4.3 model with dimensions of 24" W. x 18" D. x 36" H. Also available are double door models with capacity of up to 9.6 cubic feet.



MODEL UC-5

- Gleaming stainless steel interiors.
- Explosion-safe and total explosion-proof construction, optional.
- Removable front grille through which all fittings and controls can be easily serviced without moving refrigerator.
- Dished interior bottom to protect floors from spilled products.
- Automatic and semi-automatic defrost system with built-in condensate evaporator and accumulator. Eliminates need for floor drain.



MODEL UC-5-CW

MODEL UC-5-CW

Cold wall type cooling system with automatic push button defrost. No freezing compartment. Explosion-safe and total explosion-proof construction available on this model only.

MODEL UC-5-BC

(illustrated above)

Blower type cooling system with automatic off cycle defrosting. No freezing compartment.

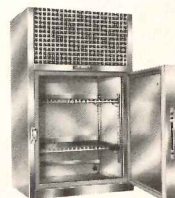

MODEL WM-CW

MODEL UC-5

Two-tray ice cuber cooling system and semi-automatic defrost.

MODEL WM-CW

(illustrated above)

Cold wall type cooling system with push button defrost.

NOTE: Jewett also makes a line of freezers with the same dimensions and features listed above.

THE JEWETT REFRIGERATOR CO., INC.
2 LETCHWORTH STREET
BUFFALO, NEW YORK, 14213

MANUFACTURERS
OF REFRIGERATORS
OF EVERY TYPE
FOR INSTITUTIONS
Since 1849

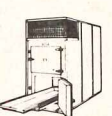

For more data, circle 49 on inquiry card

A large, stylized white sunburst graphic is centered on a solid orange background. The sunburst has a circular center with numerous pointed rays extending outwards, some of which are curved. The text is positioned in the middle of the sunburst's central area.

How to throw 50% of the sun out of the window.

**PPG Feneshield®
fabrics:
the environmental-
control
drapery system.**

With scientifically rated FENESHIELD fiber glass drapery fabrics and a clear glass window, you can bounce up to 50% of the solar heat right out of the room before it can affect interior temperature. Combine these fabrics with a high-performance glass like PPG SOLARBAN® TWINDOW®, and you can eliminate up to 85%. People sitting near the window remain comfortable, because there is little reradiation from FENESHIELD fabrics. Natural light filters through. Air conditioning systems carry less load.

The FENESHIELD fabric rating system helps you choose fabrics

scientifically to reduce glare, modify or enhance a view and improve interior sound control. Your building will retain the clean lines of your original design concept. In addition, FENESHIELD fabrics cost less to maintain than other shading devices.

For documentation and additional data, read our book about FENESHIELD fabrics. Mail coupon.

*PPG makes the yarns only,
not the fabric.*

PPG INDUSTRIES, Fiber Glass
Division, One Gateway Center,
Pittsburgh, Pa. 15222.

PPG is Chemicals, Minerals, Fiber Glass, Paints and Glass. So far.

Dept. 113, PPG INDUSTRIES, Fiber Glass Division
One Gateway Center, Pittsburgh, Pennsylvania 15222

I'd like to know more about PPG FENESHIELD fabrics.

- Please send me your booklet.
 Please send me names of authorized FENESHIELD fabric representatives.

Name _____ Title _____

Company _____

Street _____

City _____ State _____ Zip _____

Fiber Glass



INDUSTRIES

Since

HOPE'S STEEL WINDOWS

1818

STEEL WINDOWS HAVE THE STRENGTH AND RIGIDITY THAT NO OTHER WINDOW CAN MATCH

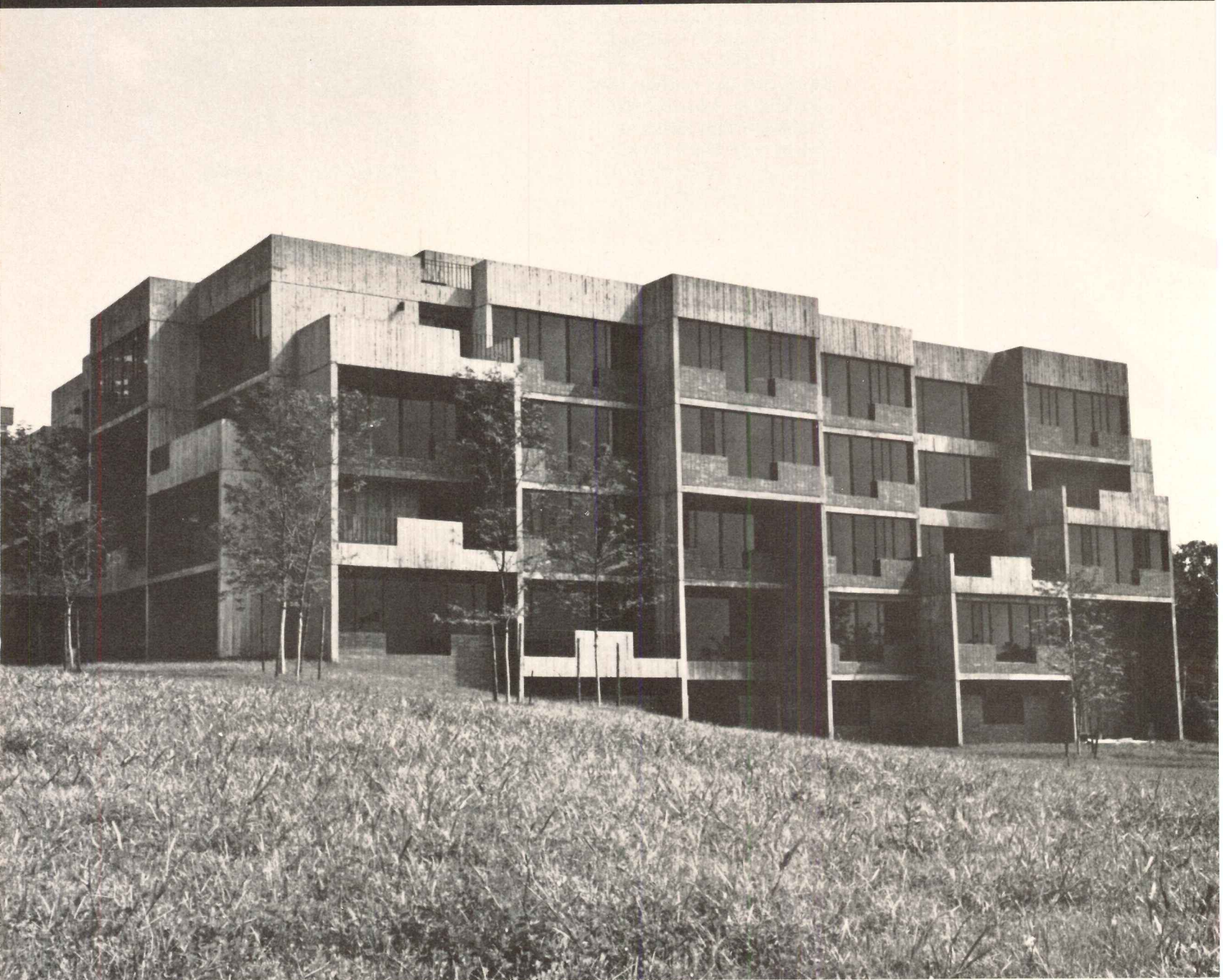

HEBREW HOME FOR THE AGED

RIVERDALE, N. Y.

GRUZEN AND PARTNERS, *Architects*

VALRIDGE CONSTRUCTION CORP., *Builders*

In designing this modern building for senior citizens, the architects' goals were beauty, comfort and cheerful environment. To assist in achieving these goals, a substantial number of heavy intermediate steel windows were furnished to the architects' specifications and installed by Hope's own workmen. These custom-built windows, important elements in the over-all design, contribute much to the success and efficiency for which the structure has won recognition.

HOPE'S WINDOWS, *Jamestown, N. Y.*

THE FINEST BUILDINGS THROUGHOUT THE WORLD ARE FITTED WITH HOPE'S WINDOWS

A DIVISION OF ROBLIN HOPE'S INDUSTRIES, INC.

INNOVATIVE FLEXIBILITY with R-W operable walls

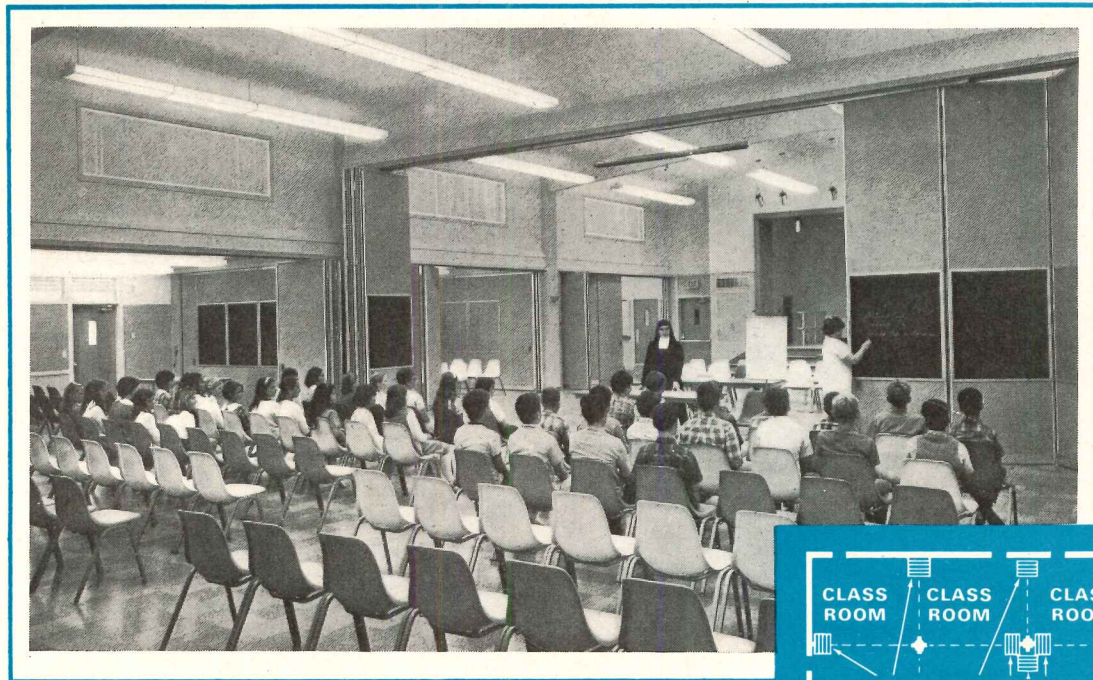

R-W OPERABLE WALLS OFFER THE FLEXIBILITY TO MAKE ANY LARGE ROOM SERVE A MULTI-PURPOSE FUNCTION

When a special situation arises on your next job and a standard operable wall just won't fit, try the INNOVATIVE FLEXIBILITY of Richards-Wilcox. The high quality construction of standard R-W units frequently allows simple modifications to custom-fit a special requirement.

The other factors that can offer you an easy solution to your room division problems are the INNOVATIVE DESIGN of R-W sales engineers and factory staff. What may be a special, or nearly impossible problem for you, can well be nothing more than a problem these INNOVATORS have already solved. They've had years and years of experience in providing operable walls for almost every kind of location . . . classrooms, auditoriums, meeting rooms, study halls, cafeterias, stages, laboratories, gymnasiums, swimming pools . . . you name it.

So the next time you have a tricky job, take advantage of the basic INNOVATIVE FLEXIBILITY of R-W operable walls and the INNOVATIVE DESIGN service offered by R-W Sales Engineers. Send for Bulletin A600 . . . Room Functional Flexibility.

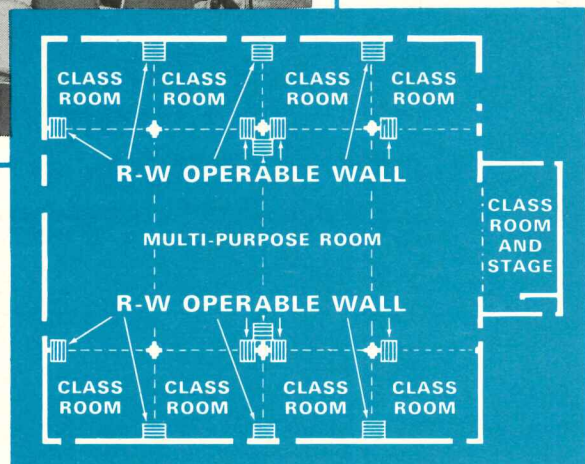

R-W Operable Walls within and all around the main Multi-Purpose Room of Our Lady of Grace School, Castro Valley, California.

Offering the ultimate in flexibility, the Multi-Purpose Room is used as an auditorium, gymnasium, and for lectures. Eight satellite classrooms open into the Multi-Purpose Room for added flexibility.

The Operable Walls not only open up or close off the rooms, but mount blackboards and corkboards for added usage.

OPERABLE WALLS FEATURE:

- SOUND CONTROL ■ LOW OVERALL COST ■ MINIMUM MAINTENANCE
- SPECIFIED APPEARANCE ■ EASY OPERATION ■ QUALITY CONSTRUCTION

ARCHITECT:

Wahamaki & Corey
Hayward, California



Richards-Wilcox

MANUFACTURING COMPANY
116 THIRD STREET • AURORA, ILL. 60507

One of the White Consolidated Industries



For more data, circle 51 on inquiry card

NEW FIRMS, FIRM CHANGES

The Denver architectural firm of **Anderson Barker Rinker** has appointed two associate architects, **Richard A. Lehman** and **Dana C. Rickli**.

Ronald W. Backhus has been named an associate with **Fitch Larocca Carington Jones, Architects—Planners** of Chicago.

Armand Bartos and Associates, Architects, New York City, have recently appointed **Martin Price** as partner and **Augusto Morpurgo** and **Robert Rhodes** as associates.

Burton W. Berger has announced the admission of **Robert D. Ascione** as a partner of the firm of **Berger and Caltabiano** for the continuing practice of architecture, city planning and urban design under the firm name of **Berger Caltabiano and Ascione**. The firm is newly located at 170 Fifth Avenue, New York City.

The partnership of **Berger/Spiers Architects—Engineers** has announced the admittance of **Richard D. Parsons, A.I.A., Architect** as a general partner and the merger of their firm with **Porr, Loddengaard & Parsons, Architects—Planners**. The address of the new firm, **Berger/Parsons/Spiers** is P.O. Box 3742, Harrisburg, Pa.

Harold E. Wagoner, F.A.I.A. and Associates has announced the advancement of **Angel B. Chorno, R.A.** to associate.

Bernard M. Deschler, A.I.A. has recently announced the formation of his architectural firm, **Bernard M. Deschler Associates, Architects**, 53 East 34th Street, New York City.

Architect Carroll R. Dove is now an associate in the firm of **Segreti & Stillwell, Architects/Planners**, Washington, D.C.

Carol Lynne Freyer has been named director of interior design for the Miami firm of **Ferendino/Grafton/Pancoast/Architects**.

Parsons, Brinckerhoff, Quade & Douglas, New York City-based engineering, architectural and planning firm announced that **Henry L. Michel** and **Perry D. Lord** have been admitted to the partnership. **Paul H. Gilbert** has been named an associate.

Ginocchio, Cromwell, Carter & Neyland has announced the continuation of the practice of architecture and engineering under the name **Cromwell, Neyland, Truemper, Millett & Gatchell**. The firm has offices in Little Rock, El Dorado and Forrest City, Arkansas.

Wallace B. Berger, A.I.A., Barnard A. Fischer, C.S.I., Irving L. Levett, Paul Silver, A.I.A. and Murray Sput, A.I.A. have been named associate partners of the New York and New Jersey architectural, planning and engineering firm, **Gruzen & Partners**. Promoted to the position of associate were **Harold E. Ehrenberg** and **Paul Willen, A.I.A.**

Formation of **Innerspace Design, Inc.**, a professional service organization specializing in interior space planning and design

continued on p. 242



IN 1828 ARCHITECTS HAD NO REASON TO CONSIDER HELIPORTS

Because, in 1828, Vittorio Sarti's helicopter was strictly a flying machine. There were no urban traffic snarls or airports far from city business districts. Today, the business use of helicopters is a growing reality. New twin-engine helicopters will eliminate flight restrictions over cities. If you are designing city centers, industrial plants, major building complexes and hospitals, now is the time to plan for heliports and helistops. It costs substantially less to include a heliport in your original plans than to add one later.

Free Heliport Design Kit

Send for Bell's free heliport brochure, plus an official FAA Heliport Design Guide. Simply fill out the information below and mail to:

Dept. 391K _____, Bell Helicopter Company, Fort Worth, Texas 76101.

Name _____ Title _____

Firm _____

Address _____

City _____ State _____ Zip _____

Remarks: _____



BELL HELICOPTER

FORT WORTH, TEXAS 76101 • A **textron** COMPANY

For more data, circle 52 on inquiry card

For more data, circle 53 on inquiry card

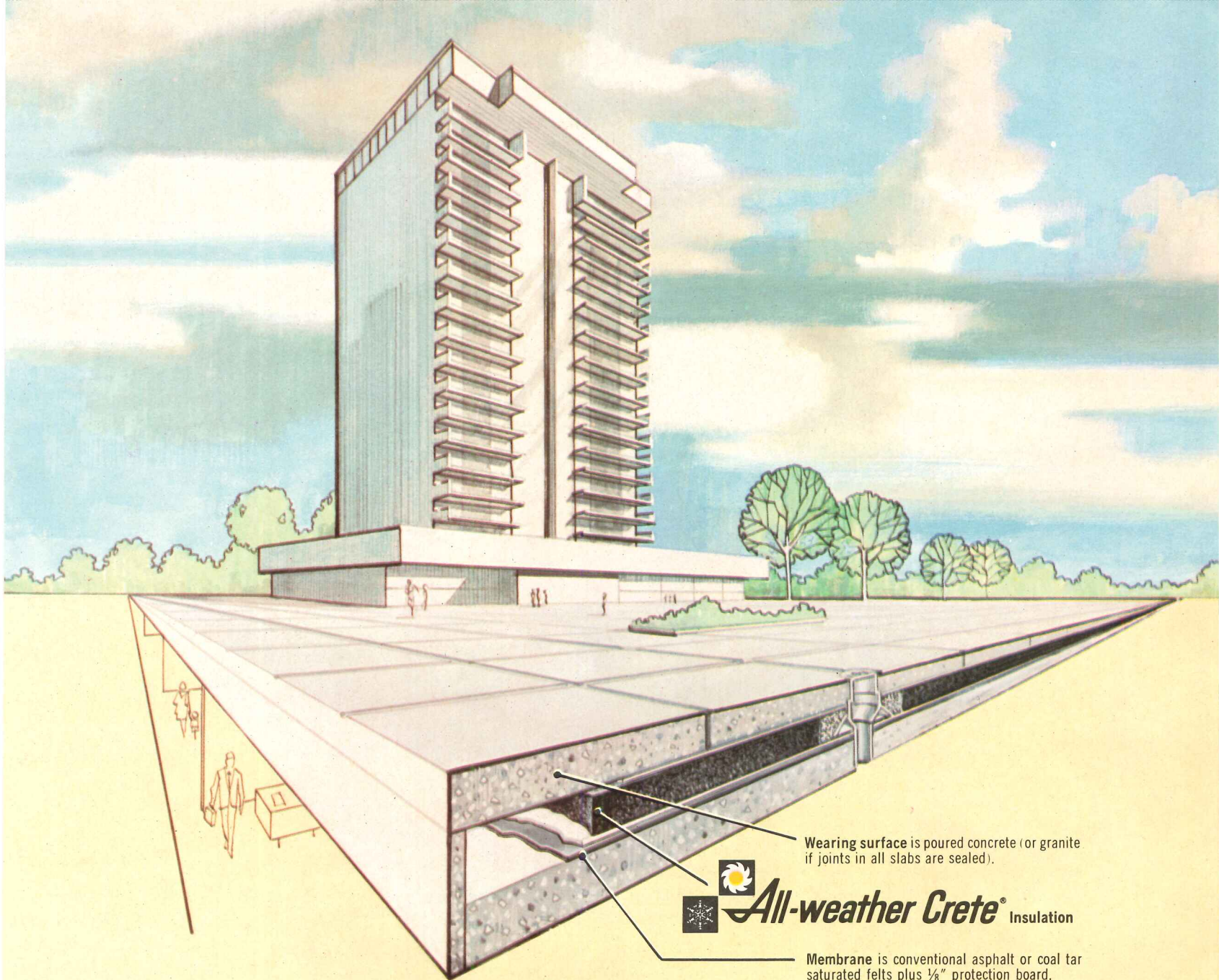

Wearing surface is poured concrete (or granite if joints in all slabs are sealed).

All-weather Crete[®] Insulation

Membrane is conventional asphalt or coal tar saturated felts plus 1/8" protection board.

plaza two

Another proven plaza design utilizing All-weather Crete insulation. Each of eight designs has been developed to solve a specific problem and fit individual building requirements. Plaza "Two" provides an extremely efficient system for use over concrete structural slabs which are sloped to the drains.

These systems are being used today by leading architects throughout the nation. Why? Because no other type of insulation offers so many advantages in plaza construction. Heavy density All-weather Crete acts as an insulating cushion to protect the waterproof membrane, thus solving a failure problem often encountered in other systems. The K factor is .46; it has excellent load bearing capabilities and can be sloped or applied level. There are other advantages too.

Check out "Plaza One"—Two—Three—all Eight! Write for a full color brochure complete with diagrams and specifications. (You may want to design "AWC Plaza Nine" yourself.)



SILBRICO
CORPORATION

6300 RIVER ROAD • HODGKINS, ILLINOIS 60525 • (312) 735-3322

For more data, circle 59 on inquiry card

There's something to be said for timeless beauty, and Cee Jay is saying it

The sands will never run out on Corry Jamestown's new 2500 Series office chairs. You look at them and you see an enduring simplicity of line.

So immediately they sidestep a problem for you. You remove the pitfalls of fad. Fad. That tempting rascal who makes things look great for a while, then lets you down.

Resolve the matter with the number 2500. Unmistakably contemporary, unshakeably elegant. Taste and beauty. Always.

Oh yes. 2500 Series chairs sit well. Corry Jamestown has an exclusive knack for making chairs totally compatible with the human anatomy. Plus a dedication to quality construction that assures performance as enduring as the style.

Cee Jay, our favorite steno, is bursting to give you all the details on the full 2500 Series line. Swivel, pedestal and side chairs. Plus her own favorite, the 2523 Steno Chair.

Write to her, care of Corry Jamestown, for the new 2500 Series Chair Catalog. Better yet, see for yourself. Check the Yellow Pages for your local Corry Jamestown Dealers, and call or visit him.

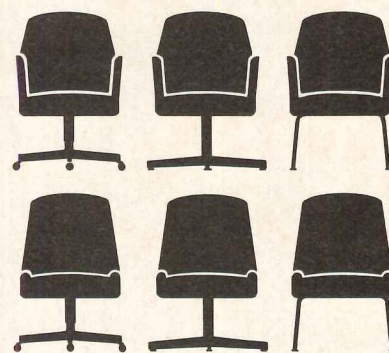

SINGER
BUSINESS FURNITURE
Corry Jamestown

A Subsidiary of The Singer Company
Corry, Pennsylvania 16407

For more data, circle 50 on inquiry card



we're
good
for
what
ails you



Alexander Smith Carpeting vs. Big Business.

Falling ashtrays. Leaky pens. Purses that dump every conceivable kind of make-up. That's the kind of life a commercial carpet has to lead in the world of big business. It isn't easy unless the carpet is Commentator II by Alexander Smith. Commentator II is made of new Anso[®] nylon. The fiber that fights back. Anso is engineered to resist soiling. It's



got beauty, color, and texture you'd never expect from a commercial carpet. Yet it wears so well, Allied Chemical guarantees it for five years.* Even if your business isn't big, you ought to know more about new Anso. Write: National Contract Sales Manager, Alexander Smith Carpets, 57 Lyon St., Amsterdam, New York 12010.



THE VERSATILE FIBER THAT'S MADE TO FIGHT BACK.

*This carpet is guaranteed by the Fibers Division of Allied Chemical Corporation. If it is properly installed and maintained and the surface pile in any given area wears more than 10% within 5 years, it will be replaced at our expense. The guarantee does not cover tears, burns, pulls, cuts, or damage due to improper cleaning agents or methods.

For more data, circle 54 on inquiry card

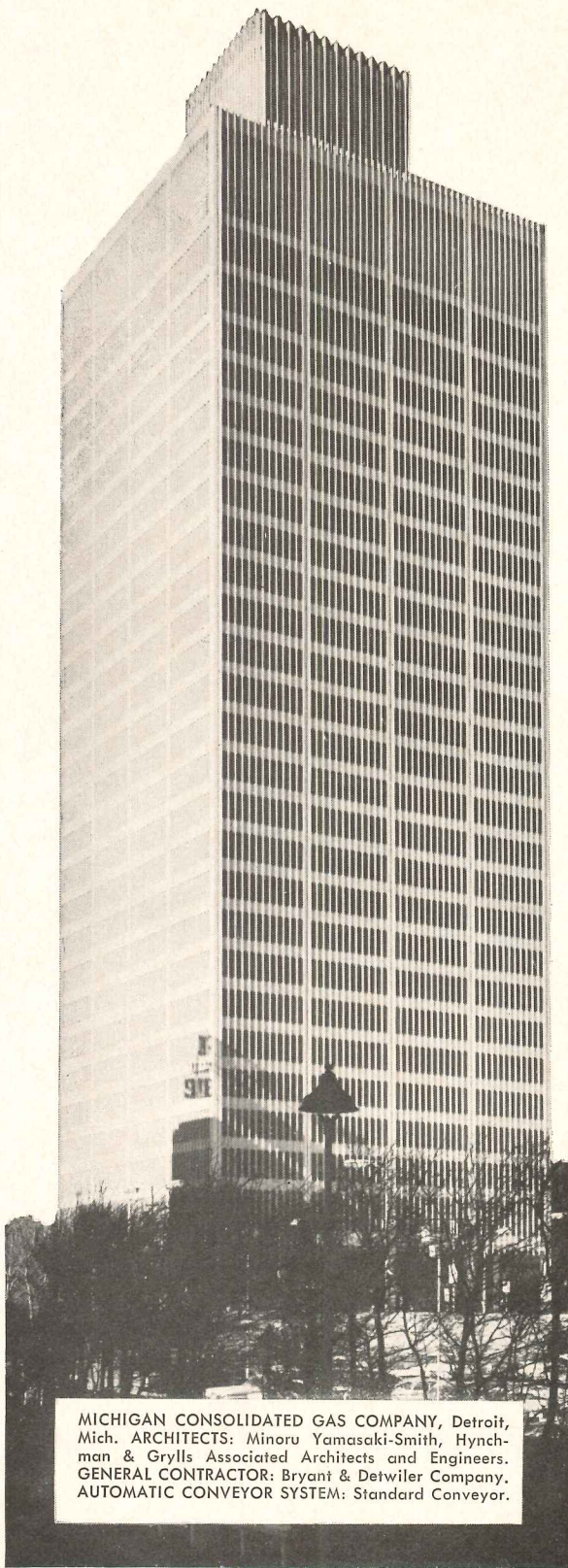

MICHIGAN CONSOLIDATED GAS COMPANY, Detroit, Mich. ARCHITECTS: Minoru Yamasaki-Smith, Hynchman & Grylls Associated Architects and Engineers. GENERAL CONTRACTOR: Bryant & Detwiler Company. AUTOMATIC CONVEYOR SYSTEM: Standard Conveyor.



Mail room clerk sends basket to designated floor simply by pushing a button. Each tote box carries up to 32 lbs. of payload... the conveyor accepts up to 12 loads a minute.



At proper floor, the box is automatically shunted off vertical conveyor. "Magnetic memory" control system has no moving parts, levers, or between-station wiring... nothing to wear out.

New Michigan Consolidated Gas Co. Building features

28-story Recordlift mail conveying system

A recent publication from the U. S. Post Office Department recommends that "in the large office building the owner and his architect should assure that proper consideration has been given to the mail collection and delivery needs of tenants." It suggests further that the use of vertical tray conveyors is "most effective."

An outstanding supplier of this type of high-speed mail distribution equipment is STANDARD CONVEYOR COMPANY... and STANDARD's *Recordlift* system in Detroit's new 28-story Consolidated Gas Company Building is an outstanding recent installation.

Mail can be sent from any floor to any other floor on the system in a matter of minutes—simply by pushing the proper address button. During rush hours, the *Recordlift* can deliver 384 lbs. of mail a minute to or from the mail room.

A complete *Recordlift Data File* can prove most useful in designing your next multi-story building. *Request one today.*

Other typical Standard Conveyor Recordlift Installations

- Kaiser Center Office Building
Oakland, California
- Western Electric Co., New York, N.Y.
- Atlantic Coast Line Railroad Company
Jacksonville, Florida
- Ontario Hospital Services Commission
Toronto, Ontario, Canada
- Bank of America Service Center Bldg.
San Francisco, California
- Bankers Life Company
Des Moines, Iowa
- State of Oregon, Salem, Oregon
- First National Bank
Minneapolis, Minn.
- Lincoln National Life Insurance Co.
Fort Wayne, Indiana
- Time-Life Building, New York, N.Y.
- Mutual Service Insurance Company
St. Paul, Minnesota
- State of Texas Employment Comm.
Austin, Texas
- Ohio Oil Company, Findlay, Ohio
- California State Teachers Association
Burlingame, California
- Los Angeles County Hospital
Los Angeles, California
- Zurich Insurance Co., Chicago, Illinois
- Seattle First National Bank
Seattle, Washington
- Public Library Division
City of Minneapolis, Minnesota

LISTED IN SWEET'S—SECT. 24d/ST • SALES AND SERVICE IN OVER 40 CITIES—SEE YOUR YELLOW PAGES



**Standard
Conveyor
COMPANY**

312-D Second St., North St. Paul, Minn. 55109

Automatic Pneumatic Tube Systems • Recordlift Systems
• Mechanized Dish Handling Systems • Escavator Continuous Vertical Conveyors • Custom Engineered Conveyor Systems • Sorting Systems, Automatic and Semi-Automatic • Heavy-Duty Conveyors for Industrial Plants, Factories, Special Applications • Pre-Engineered Hand-drive Conveyors and Components • Pallet Stackers and Dispensers • Case Unstackers • Spiral Chutes

For more data, circle 55 on inquiry card



Put a Bally Prefab Walk-In Cooler /Freezer in the kitchen. The name of the game is speed-feed for a hungry generation on wheels. They put it away—steaks, shakes, fish and fries—you name it. It all starts with dependable Bally prefab storage. Erect any size or shape quickly and easily from standard metal clad panels. Write for 32-page book and urethane sample.

There's an
evolution in the
kitchen



Bally Case and Cooler, Inc., Bally, Pa. 19503
AR-4

© 1970, ALL RIGHTS RESERVED.

120,000 sq.ft. of free-access Weberfloor...

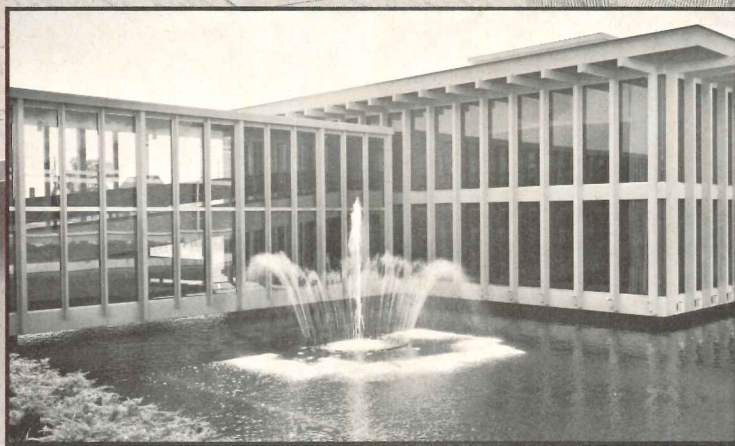
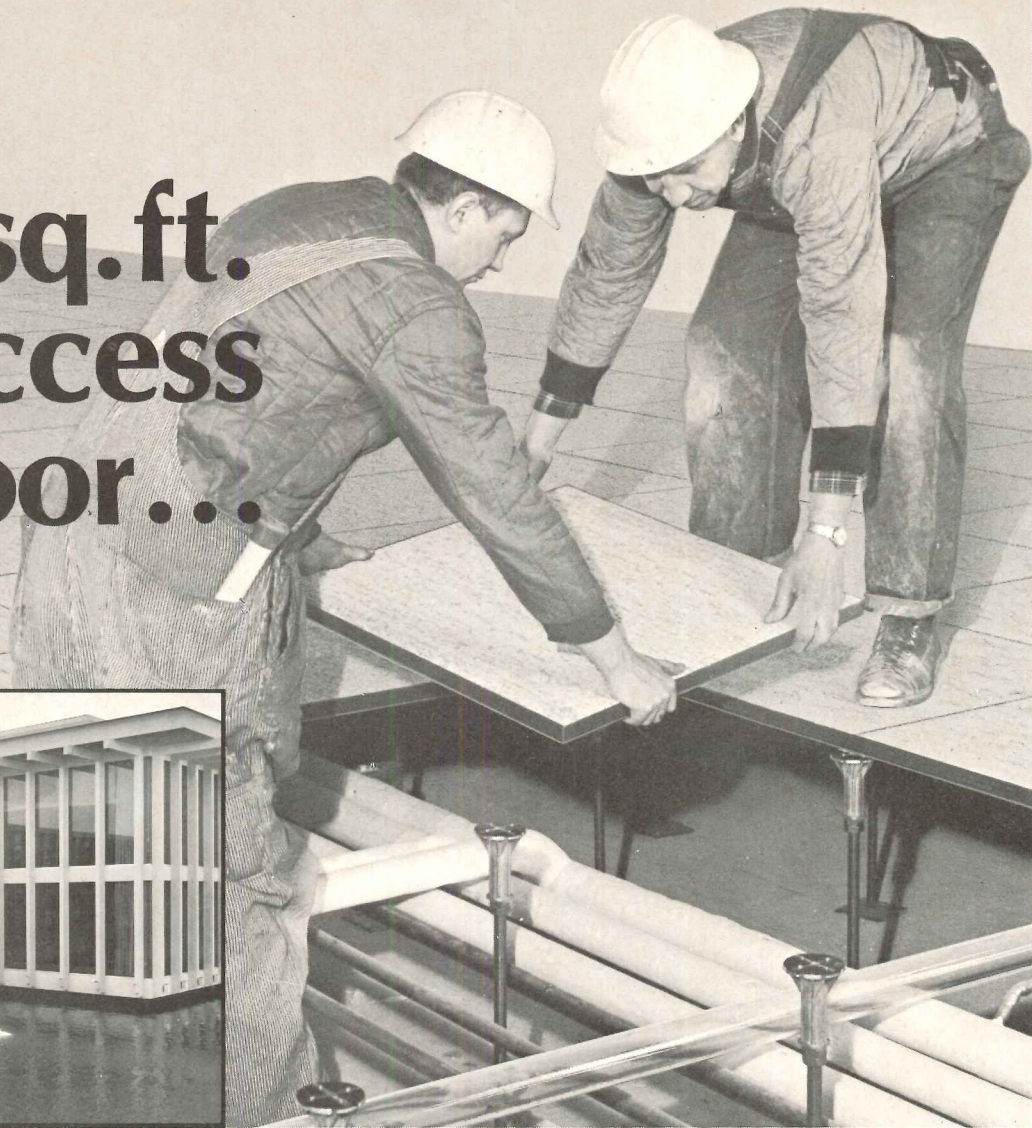

speeds construction of Administrative & Research Center

Globe-Union, Inc. of Milwaukee gave architect Charles W. Harper of Harper-Drake Associates two demanding goals for its new administrative engineering and research complex. First, a 10-month completion deadline requiring steel erection in less than 30 days. Second, complete flexibility in building design to accommodate constantly changing services of all kinds.

With Weber's access flooring, electrical and communication lines, the special plumbing required for laboratories, heating and ventilating ducts and mechanicals of all kinds could be installed after the floor slabs were poured. These utilities were designed while the building shells were being completed. Once the buildings were closed in, installers of the various services were able to work faster and more accurately under comfortable indoor conditions.

With unrestricted access to all services under the Weberfloor, Globe-Union has the flexibility it needed for modifying or re-locating these utilities at any time. Offices and laboratories can be rearranged without tearing up expensive flooring and without the expensive mess of drilling through concrete to conventional raceways.

With savings in electrical, plumbing and mechanical services deducted, Globe-Union's finished Weberfloor, about half of it carpeted, netted out to approximately \$1 per square foot.

Write for free booklet, giving many other advantages of Weberfloor in general construction. Please contact Weber Architectural Products, Division of Walter Kidde & Company, Inc., 1340 Monroe N.W., Grand Rapids, Michigan.

For more data, circle 57 on inquiry card

THE AQUADOME RECREATION CENTER
Architect—Aycock & Neville, Decatur, Alabama
Recreation Planner & Consultant—Charles M. Craves, Atlanta, Georgia

This is IBG DOMESYSTEM. IBG also designs, manufactures and builds IBG SKYLYTE and IBG BARRELVault glazed structural systems and IBG SUN/FUN pool enclosures. See our catalog 22a/lc in Sweet's. / IBG, P. O. Box 147 Deerfield, Illinois 60015. Phone 312 634-3131. / IBG OF CANADA, LTD., 90 Bartlett Road, Beamsville, Ontario, Phone 416 563-8276.

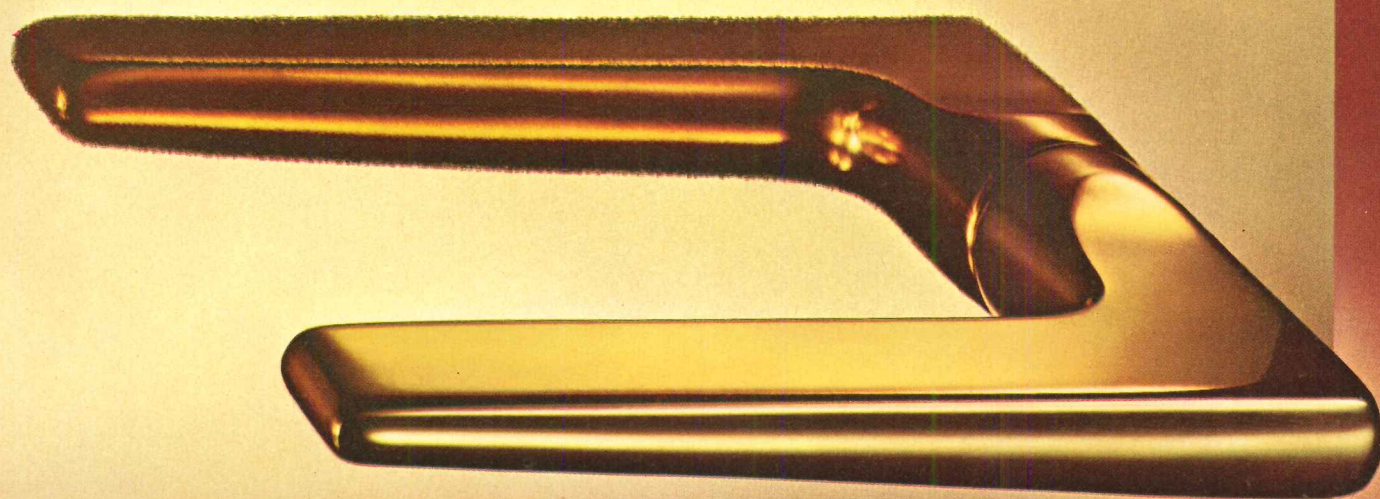

 **SARGENT**[®]

*A complete line of advanced architectural hardware, including the Sargent Maximum Security System
New Haven, Connecticut • Ontario, Canada*

Carpets are cheaper than floors.

Did you ever think of putting carpets in your school? It doesn't sound logical, does it? Kids running up and down the halls all day. All the wear and tear. Can carpets take it?

They can take it better than your floors can.

Just take a look at your floors. They're probably scuffed and scratched and boring looking. And just keeping them that way costs you a lot of money. Because you have to pay to have somebody sweep them, wash them, wax them and then to take off the wax and put it back on again.

We make Stevens-Gulistan carpet. And that's another story. Because these days our school carpets are cheaper than school floors. All you have to do to our carpet is have somebody

vacuum it at night and shampoo it maybe once a year.

That's our kind of carpet. It's made of Anso* nylon and comes in two styles. With cushion attached *or* without self-cushioning. Both are specifically tested to withstand the wear and tear a student can dish out.

A lot of schools have our carpets already. So

do hospitals, churches, apartment houses, hotels and more places you can think of. If you know a school that needs carpets, call Stevens-Gulistan Carpet collect, in New York at 212 679-1220, Extension A1.

Stevens-Gulistan, a division of J. P. Stevens & Co., Inc., 295 Fifth Avenue, New York, N. Y. 10016.

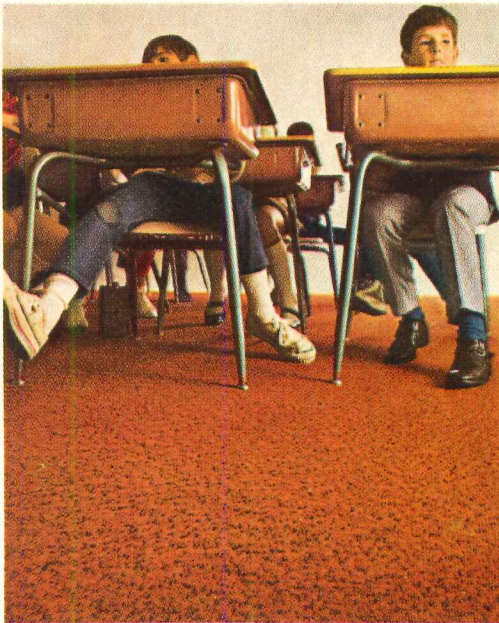

Stevens-Gulistan
Our carpets take care of themselves.

*TM Allied Chemical Corp., for its nylon fiber.

For more data, circle 60 on inquiry card



Nine times out of ten, MONO fills the sealant gap.

When it can't, he can.



We know you'd like an all-purpose trouble-free construction joint sealant. □ So would we. But right now, MONO's as close as we can come . . . and it won't do everything, any more than any other types and brands we've tested. □ Sure, MONO's good and works so well under the kind of adverse conditions (dust and moisture) that are common to the job site, that we suspect many construction people actually look on it as an all-purpose sealant. □ But actually Tremco's business isn't based on selling *any* all-purpose sealant. Instead we're a single-purpose company. We're The Water Stoppers and we want to give you leakproof security in every joint on the job. □ So we make not one, but fourteen other sealants besides MONO, like a very good polysulfide (Lasto-Meric), a highly-regarded preformed tape (440) as well as a dozen others with special purposes. □ The only all-purpose item in our catalog is the Tremco Representative. He has been thoroughly trained to provide you the proper sealant for each application and is ready to give job-site assistance before, during and after each project. □ Why not give him a call next time you run into the sealant gap? He'll get you across every time. □ The Tremco Manufacturing Company, Cleveland, Ohio 44104; Toronto 17, Ont.

TREMCO
The water stoppers

For more data, circle 61 on inquiry card



In corporate headquarters offices of Heublein, Inc., in Hartford, Conn., tiles fit snugly in the Accesso Concealed Suspension System to form a smooth, almost seamless ceiling.



Every tile is an instant-access panel

with the new Keene Accesso™ Concealed Suspension System for acoustical tiles and pans.

Tilt any tile up and lift it out. With the Keene Accesso system, that's all you do for instant access to overhead systems anywhere in a building. With no need to interrupt office routine. No searching for special access panels. No special tools to strong-arm tiles down.

Accesso is the most convenient ceiling system ever. What's more, Accesso members aren't locked permanently, so you're not locked into the building module. You're free to locate, and relocate, lighting fixtures and air-handling devices wherever you like. And because the Accesso system—exclusively—can also be used to suspend metal-pan ceilings in high-humidity areas, you can specify just one ceiling system for the whole building.

You can use any standard tile in the Accesso system, with no special machining. But for looks to match convenience, specify beautifully fissured Styltone or other acoustical tiles from Keene. For full details, write Keene Corporation, Sound Control Division, Princeton Service Center, U.S. Route 1, Princeton, New Jersey 08540.

KEENE
CORPORATION

SOUND CONTROL DIVISION

We've just begun to grow.

For more data, circle 62 on inquiry card



Automation with
a 3-year payoff!
We've been doing
it for 19 years.

That spans the era of building automation, pioneered by Honeywell in 1951.

And with each installation — college complex, hospital, skyscraper, industrial plant — Honeywell continues a restless reach for the ultimate in building automation.

Next: *Your* building? Look what your client gets. One-man operation . . . complete pay-off in 3 years or less from savings in manpower alone. A customized system built from standardized, off-the-shelf modules. Add-on capability to grow as the building grows.

On-time delivery, installation, check-out. Supporting services, personnel training, maintenance programs, too.

So call in a Honeywell specialist early in the planning stages of your building. Or send for our Building Automation Planning Guide: Honeywell, Commercial Division, G2118, Minneapolis, Minn. 55408

Reaching for the
perfect building...

Honeywell

LETTERS

Mr. Mayer for publication

We have followed with keen interest the segments of the series by Mr. Albert Mayer in which he so forcefully sets forth his alternatives to the present trends in city planning. You can well appreciate that we in the electric utility industry are vitally concerned. Will you please advise whether this treatise is going to be available as a separate publication.

Elwyn L. Jordan
Construction Coordinator
Metropolitan Edison Company
Reading, Pennsylvania

Mr. Mayer does plan to enlarge on this series for a book, but I am afraid its publication is some time off. You might be interested in his earlier book published by McGraw-Hill, "The Urgent Future." —WW

New York State Health Facilities

On behalf of the Corporation, I wish to express my gratitude for the exceptionally clear and comprehensive article about our work in the January issue. We are a relatively young organization, but thanks to the driving imagination of our executive director, Milton Musicus, and the hard work and uncommon ability of my predecessor, Dan Sullivan, we were able to get the best environments that limited money can buy for the state's mentally and physically ill.

The names of the deserving architects who are really responsible for the day-to-day success of the program, my Development Administrators are: Sidney Delson, Frank Eliseo, G. Darcy Gibson, Frank Jacobi, Edward La Mura, Donald Levy, Sanford Malter, Anthony Mancini, Andrew Mitropoulos, Mildred Popkin, David Sanders, Charles Scalera and Julius Twyne.

Roy Harlow, A.I.A.
Director of Development
State of New York
Health and Mental Hygiene
Facilities Improvement Corporation

Non-architects the world over

"The making of non-architects," an article by Sibyl Moholy-Nagy is very relevant to present-day students' lives in every department of architecture throughout the world. What she discussed is very true down to details, even in India. U.S. students flock to Canada, Europe and the Arizona desert whereas we flock to the U.S., Canada, Europe—for that matter, even Kuwait. This article makes it clear that the lives of the students of architecture worldwide is akin and alike and it is nothing but utter frustration.

Mrs. Moholy-Nagy's article is commendable. It discusses every case except that of the faculty members with nil practical experience whatsoever, who settle in the department till time for their pensions, making real non-architects out of us.

M.V. Babji Rao
Fourth-year student
Department of Architecture
I.I.T. Kharagpur, India

◆ For more data, circle 63 on inquiry card

For more data, circle 64 on inquiry card ◆



It's a cold fact: CORDLEY COOLERS HELP ARCHITECTS, BUILDING OWNERS and MAINTENANCE MEN ALIKE!

ARCHITECTS: Put a Cordley in an alcove. Or on walls you can't build into. Or in busy spots where lots of people gather. Rich cabinet colors, patterned vinyls. Low-height accessory fountains for children, too.

OWNERS: Cordley coolers keep service costs low. Deep-drawn basin and stream-breaker keep any excess water from splashing on walls, floors or clothing. Users enjoy a refreshing and healthful cold drink.

MAINTENANCE MEN: Wall-hung coolers mount flush-to-wall and off the floor. Stainless steel top is crevice-free. Both floor-cleaning and cooler-cleaning are easier and faster. Sanitary, squirt-free bubbler.



DISPENSER DIVISION CORDLEY PRODUCTS

799 ROOSEVELT RD., BUILDING NO. 4, SUITE 20
GLEN ELLYN, ILLINOIS 60137

Consult Sweets Architectural File or write for complete catalog.

Sparkling all-stainless steel cabinet available. Sanitary appearance. Ideal for hospitals, laboratories, schools, etc.

Modern, easy-to-remove cabinet gives the serviceman 3-sided access to compactly designed refrigerating unit.

Strainer lifts out with simple standard tool. Drain can be cleaned completely without removing the cooler top.



Landmark is stamina in lighting

Landmark Recta-Flood is designed for endurance and stamina. Weatherproof cast-aluminum housing, finned to disperse heat. Heat and shock resistant tempered glass lens. It's the smallest integral ballast floodlight of its type on the market. Bathes buildings, parking areas, shopping centers, and industrial sites in bright, even light. Variable beam patterns with easily adjustable three-position lamp socket. Mercury or metallic vapor to 1000 watts. Contact your electrical distributor or write for catalog.

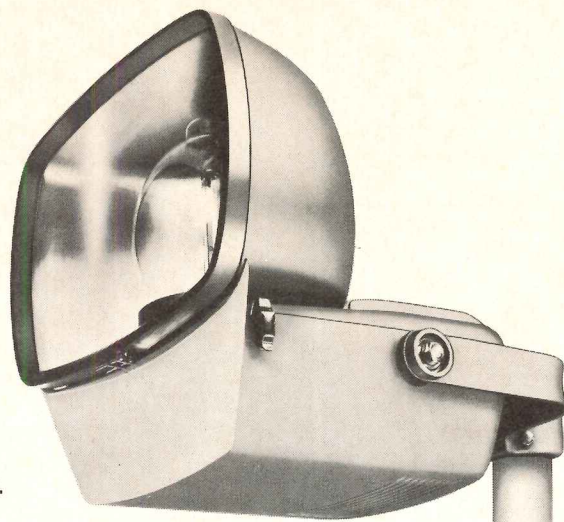

For more data, circle 65 on inquiry card



LANDMARK LIGHTING
Southaven, Mississippi 38671

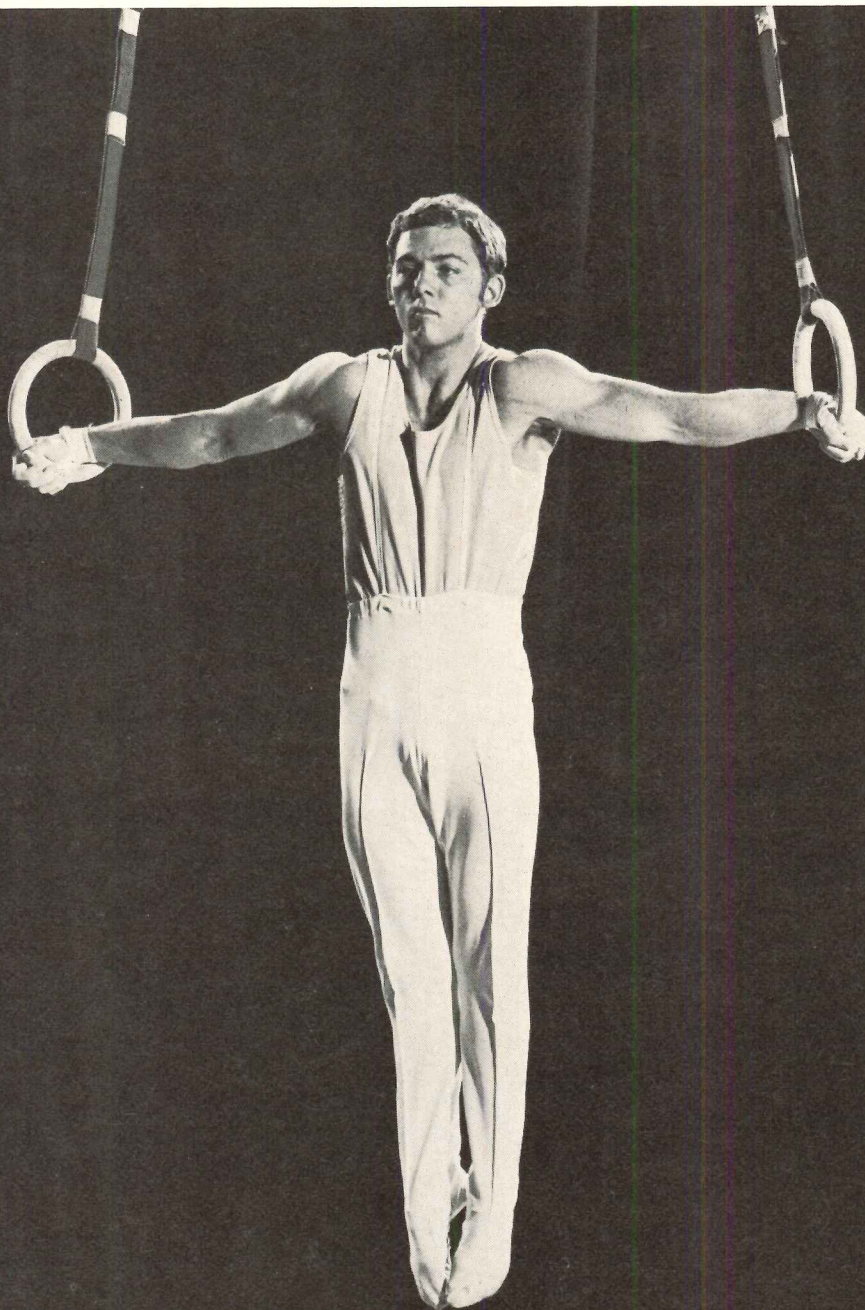

urethane foam insulation passes blowtorch fire test for hospital wall use

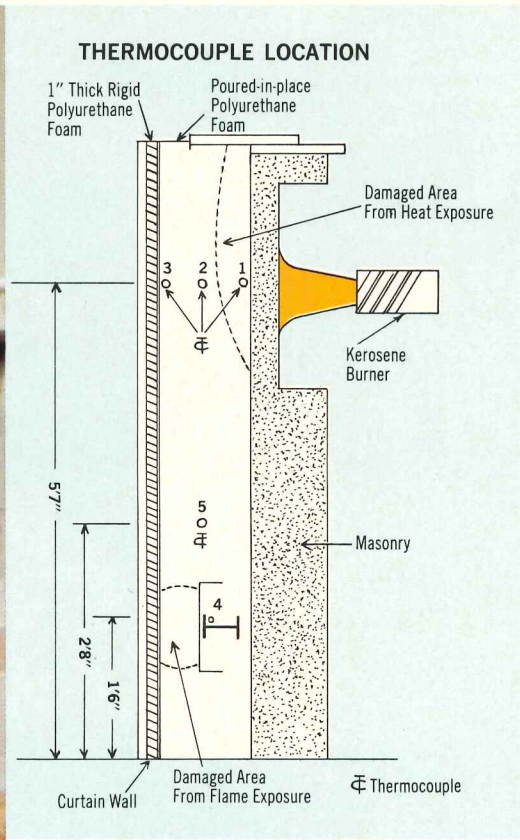

"Rigid poured-in-place polyurethane, when placed in the wall assembly, does not of itself add a significant fire hazard to the building."

This was the conclusion drawn from a series of field and laboratory tests conducted by Factory Mutual Research Corp., recently, to measure flammability factors and toxicity of thermal decomposition products of rigid urethane foam.

For the tests, a wall section was built to duplicate structural features of an existing hospital building. The tests were made for Charles A. Maguire Associates, Providence, R. I., engineers-architects for the project.

The tests evaluated the effects of extreme heat and direct flames (@ 2000°F) on urethane foam insulation in cavity walls, and the possible toxicity of gases released from the urethane during foaming or by excessive heat or fire. Both the flammability and toxicity hazards were found to be negligible.

The urethane foam system used was supplied by Diamond Shamrock Chemical Co., based on a Mobay polymeric isocyanate. Copies of the complete Factory Mutual report (FMRC 18829), plus additional abstracts and other relevant data, are available from: **MOBAY CHEMICAL COMPANY, AR-40, PITTSBURGH, PA. 15205**

S Check Sweet's Architectural Catalog File 8a/Mb for typical specs on urethane foam insulation.

engineering
plastics
and
chemicals

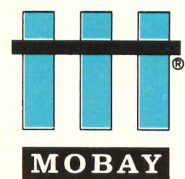

For more data, circle 66 on inquiry card



Steelcase: More office without more floor space.

Flexible Steelcase office furniture lets you build *up*, instead of out. Helps you give people more privacy, more storage, more working surfaces . . . without moving walls or increasing floor space. Next time you want to do a lot with a little, say the word: Steelcase. Steelcase Inc., Grand Rapids, Mich.; Los Angeles, Calif.; Steelcase Canada Ltd., Ont.

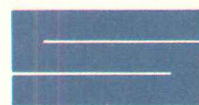

Showrooms & Offices: New York
 Chicago • Grand Rapids • San Francisco
 Philadelphia • Boston • Cleveland • Dallas
 St. Louis • Atlanta • Detroit • Los Angeles
 Portland, Ore. • Toronto • Montreal

STEELCASE

For more data, circle 67 on inquiry card

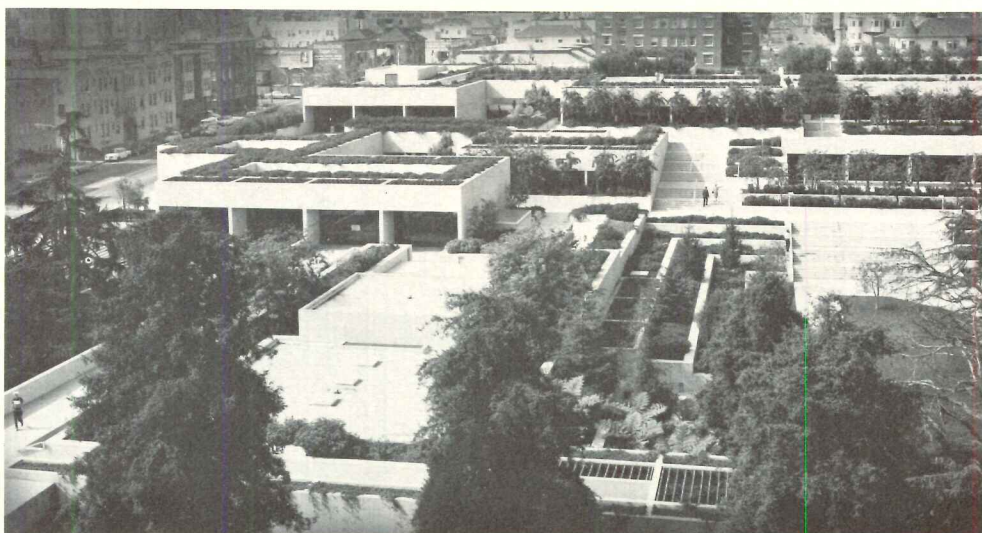
*Chalmer Alexander photos*

THE OAKLAND MUSEUM

The city of Oakland, California now boasts a regional museum much of which has been constructed underground. Designed by Kevin Roche John Dinkeloo and Associates on a four-block site which slopes downward toward an inland tidal lake, it appears to be a terraced park rather than a building. Appearance to the contrary, the Oakland Museum is more than a handsome new public park. It is a huge \$10-million complex consisting of three interrelated museums tucked under terraces and opening onto gardens, the latter designed by landscape architect Dan Kiley.

At the outset the city's program called for three separate structures to house the collections of Oakland's art, history and natural science museums. Architect Kevin Roche was convinced from the beginning that these three collections belonged together in one place. After careful analysis of Oakland's actual and potential urban design structure (page 122) Roche also decided that an urban park was urgently needed on the site as the first link in a chain of integrated work and leisure facilities designed to give order and coherence to the city. Since Roche believes that museums and parks belong together, the solution then became obvious to him—a three-part underground terraced structure with a park on top. The result as built has been widely acknowledged as an architectural triumph for Roche, but it also stands as strong evidence of his power of persuasion. He didn't give the city of Oakland what it originally asked for. He convinced the city to want and build what it really needed.

—Mildred F. Schmertz

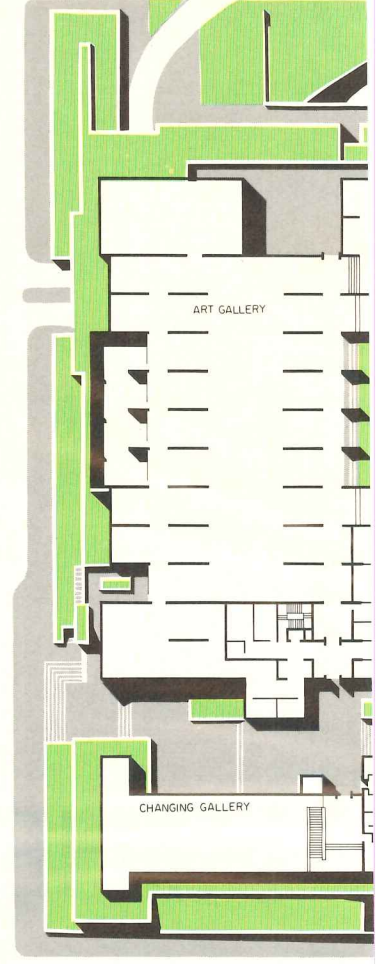

Plan at park level

Plan of art museum and environs





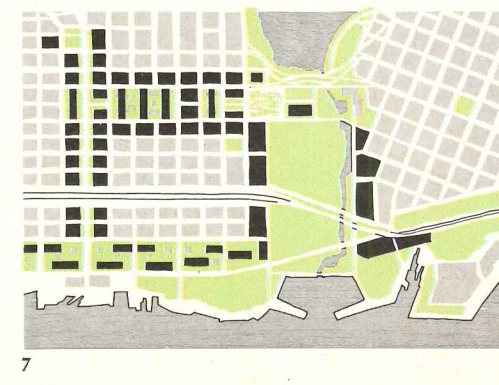
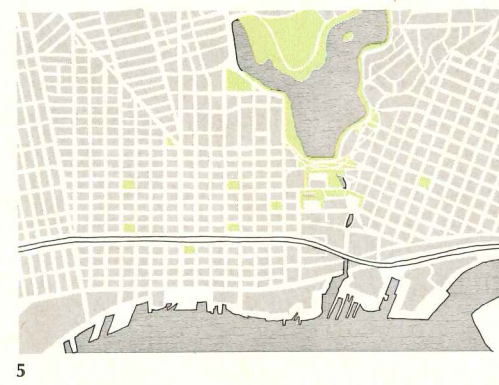
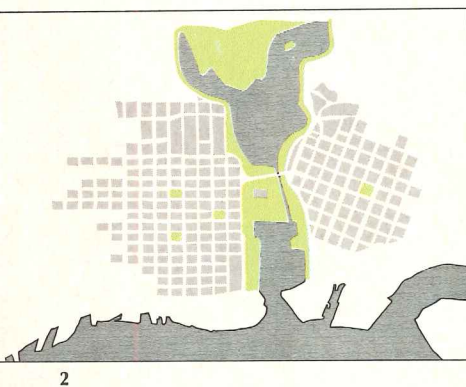
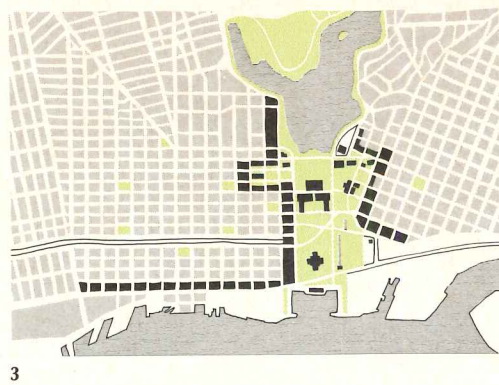
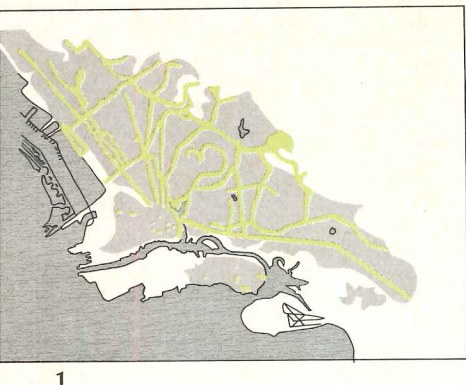

1. A park system for Oakland in a city plan report prepared in 1915 by Werner Hagemann, one of the great city planners of the time. It was based on recommendations made by Frederick Law Olmsted in 1868 and again by Charles Mulford Robinson in 1906. It proposed that a series of parks be developed along the natural creeks and canyons which would form green arteries into the heart of the city. On axis with the entry into the harbor, an island park was proposed—both to screen the industrial development in this area and also to provide a space for water sports and regattas. Unfortunately these plans were never carried out. The heart of the proposal for Oakland was the Lake Merritt Park and the Connection to the East Bay.

2. A closer look at the Lake Merritt Park and the East Bay connection. Hagemann proposed that the main north-south axis not be obstructed by buildings placed across, as the new civic auditorium (white rectangle) had unfortunately been, but rather that the axis should be emphasized by buildings placed parallel to it, thus preserving the free continuity of water and park.

3. Plan for a civic center developed in 1930 by the Alameda County Society of Architects, based on Hagemann's recommendations. It creates a formal park right down to the estuary to be bordered by public buildings. Two proposed buildings make a formal composition to the south of the civic auditorium. On the north side the plan follows Dr. Hagemann's suggestion for a plaza with fountains projecting into Lake Merritt. On the west side of this plaza the plan indicates a group of civic buildings around a mall. The first of these, the county court house, was built at this time. Roche believes this to have been an excellent plan. "While it may have been unrealistic about traffic," he acknowledges, "this was certainly excusable in 1930; had this plan been followed, Oakland would truly have one of the most magnificent centers in the country today." Unfortunately this scheme was forgotten during the war years through industrial development along the waterfront.

4. The 1947 master plan, an outgrowth of a civic center study begun in 1944, reflects a 1935 zoning ordinance which designated the waterfront for industrial use. The plan reflects the fact that the center of population had begun to move to the south and east and the belief that a civic center should not be located in a central business district because of land cost and the constrictions it places on expansion. The plan argues, therefore, that the

civic center should spread across the park, tying the east and west together. It eliminates the rest of the proposed park and thereby destroys the estuary connection. The plan also indicates an elaborate intersection of roads, now built in a somewhat altered form. Roche criticizes this plan (fortunately never implemented) for closing the estuary connection, "an idea so logical that it has been re-occurring for over 50 years;" for isolating the cultural part of the civic center from pedestrian access and from the lake; for compounding the road network; for creating dead public space and for lacking visual unity and apparent connection to the city.

5. The Lake Merritt area in 1961 when Roche's studies for the Oakland Museum began. The 1947 plan had become obsolete, a site had been picked for the Museum which was inconsistent with that or any other earlier plan and the Nimitz Freeway had radically altered the traffic pattern of the area. It was apparent that at this stage Oakland had neither a civic center nor a plan for one which could be realized. So Roche began by taking a broader look at the whole city.

6. An analysis of the Lake Merritt area in the context of Oakland in 1961, which was still a city ringed by mountains revolving around a natural focal point—Lake Merritt—and facing an estuary and bay. Much of the land bordering the estuary, and now given over to junkyards, is publicly owned and can be reclaimed as park. Five distinct centers had developed by 1961. Bordering the northwest finger of Lake Merritt is a cluster of office buildings known as Kaiser Center. To the southeast is the courthouse area near the city auditorium, almost due west is the city hall and to the south near the harbor breakwall is Jack London Square, a highly successful development bordering the central business district.

7. Roche's proposal showing the elements which constitute the city tied together to form the city. His unifying means would be wide park-lined boulevards and avenues with a mix of commercial, cultural and private buildings. The excitement generated by shops, hotels, museums and theaters would give life to the green open spaces and to the public and private office buildings located within or under them. The Oakland Museum, which doubles as terraced green space, is really the first segment of Roche's grand plan based in part on the work of Hagemann. Roche believes that to have built a large building on the site would have been wrong for the city, architecturally and humanistically.

The local environment—as actually accomplished and hopefully envisioned—shaped Roche's plans for the Oakland Museum. "If the city is to have a sense of order," says Roche, "a building must be part of an over-all composition. It must dominate or be subservient to its local environment. Visual responsibility goes far beyond the limits of a site."

The architects made an extensive study of the Oakland area, not as a comprehensive report nor as a proposal for a city plan, but for their own use as part of a preliminary investigation in the orderly process of designing the Museum. The ultimate development (7) shows the Oakland Museum as constructed but includes a proposal for the entire area which Roche believes is deserving of serious consideration by the people of Oakland.

THE OAKLAND MUSEUM, Oakland, California. Architects: Kevin Roche John Dinkeloo and Associates—Philip Kinsella, associate on job; engineers: Severud Associates (structural); Alexander Boome (mechanical and electrical); landscape architect: Dan Kiley; contractor: B & R Construction Company.

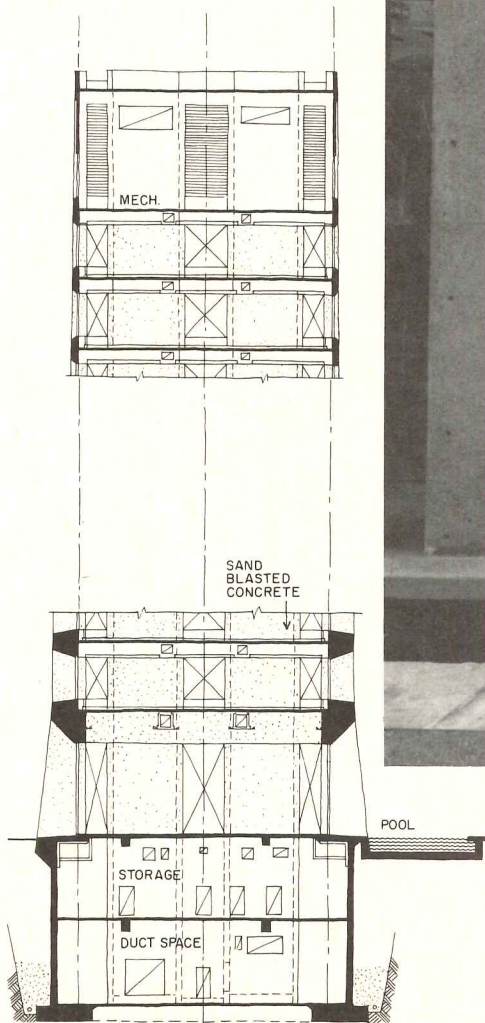

Columns and spandrels of exterior tower walls taper from 4 feet 6 inches at second floor level (with an additional taper at the base) to 12 inches at top. There are no interior columns: in each tower, the main beams, I-shaped and spaced 10 ft. o.c., span 42 feet clear. The 28-story building is of reinforced concrete throughout, sandblasted both inside and out.

A BUILDING IN THE DORIC TRADITION

The new MacMillan Bloedel building in Vancouver, British Columbia, is the latest—and finest—building of the young firm of Erickson/Massey, whose principals gained international fame a few years ago with their winning design for Simon Fraser University. This new office building, their first tall building—urbane, well suited to its location and well sited in the downtown part of the city, and much the reflection of itself which the client wanted—almost did not come into being.

MacMillan Bloedel Limited, Canada's largest forest products company, had con-

sidered a number of proposals for a headquarters building. Finally, unhappy with the then latest, (a package deal for a typical core-plan building with a precast curtain wall) they first asked Erickson/Massey to improve, then to restudy their entire program and suggest—in two months—an equally economical but architecturally distinctive solution. In the specified time the architects produced a design for the building based on one pervading concept, simplicity: outside, giving expression to the "vigor, directness and strength" which the architects found characteristic of their

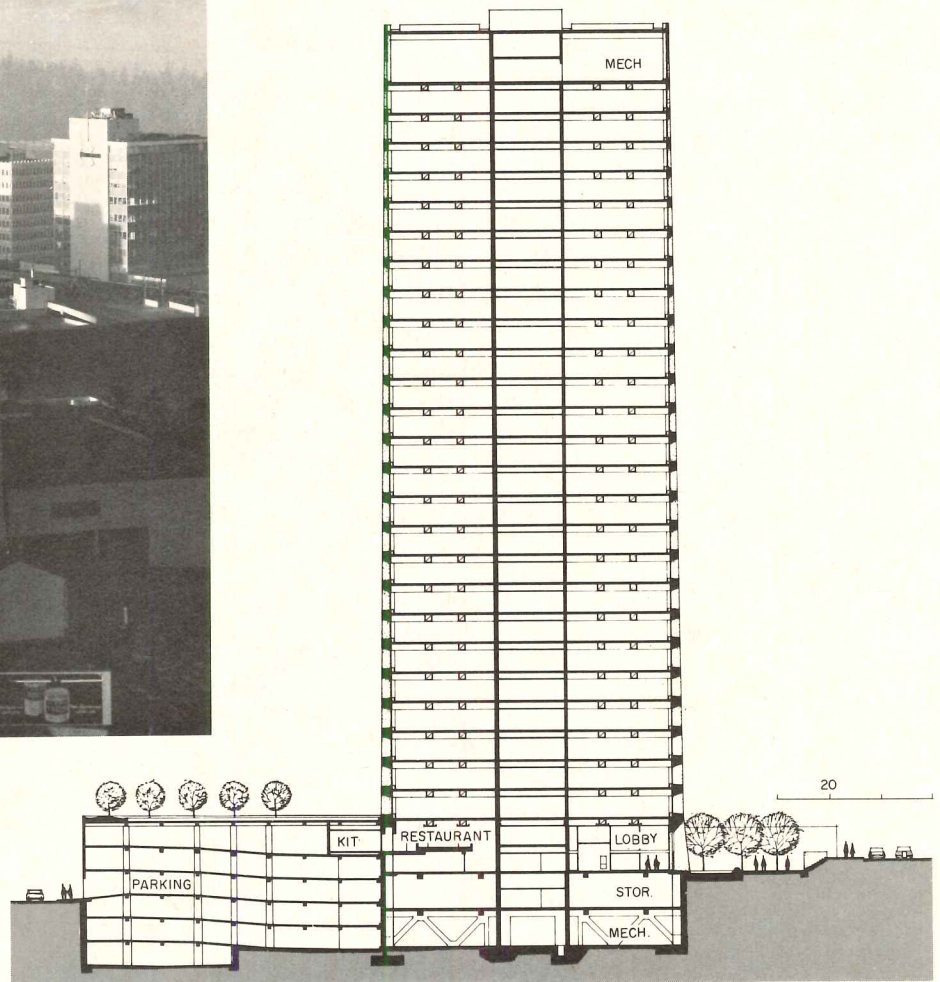
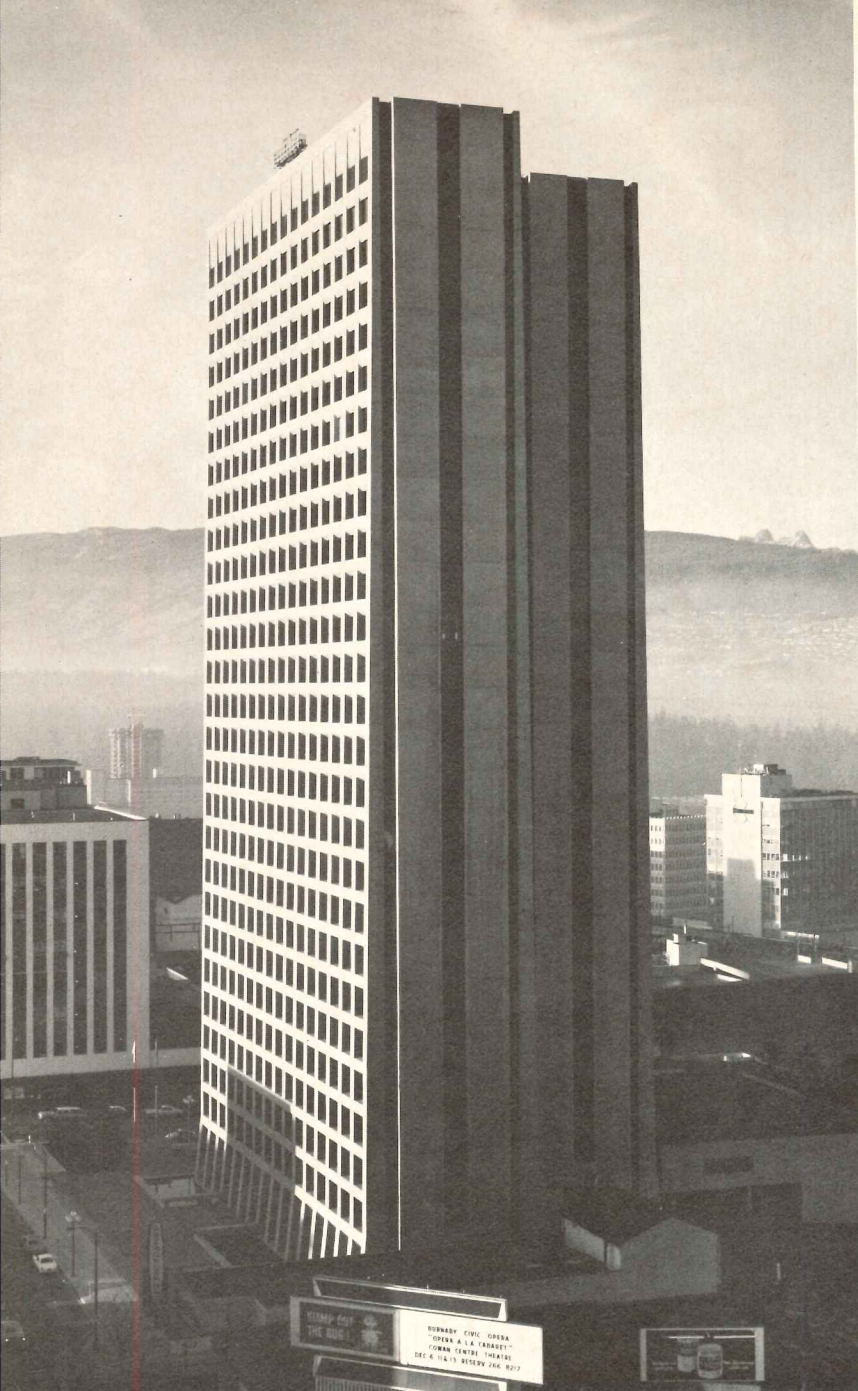

ERICKSON/MASSEY'S MACMILLAN BLOEDEL BUILDING IN VANCOUVER IS STARK AND SIMPLE BUT NEITHER PLAIN NOR BARE

clients' company; and inside, reducing the usual office clutter by minimizing the number of elements needed for good function.

This elegant leanness is best described in Arthur Erickson's own words: "a Doric building in its starkness and simplicity." This is nowhere more evident than in the exterior wall surface, the most important feature of the building. Its concrete, unrelieved except for the square opening of the deep-set windows, reads as it was poured, says Erickson, "because the total surface is big enough for the irregularities to act as a patina to the concrete." The size of the openings was carefully calculated to let the wall act as a wall, not as a system

of spandrels and columns (which is the structural solution) and to permit the use of one sheet of glass, unbroken by mullion or muntin, in each opening. The effect is, to quote Erickson again, "of glass jammed into the concrete directly to bring out the extreme contradiction of character of each. All detail was avoided in achieving an uncompromising junction between glass and concrete—void and solid."

The over-all form of the building is uncluttered, too, both towers and central core being of the same height. The offset of the two towers from each other and from the core breaks the volume, heightens the interest and increases the access to natural

Floodlighting at night dramatically emphasizes the "contradiction of void and solid" and the concrete nature of the building. The sunken plaza along the building front affords a view of the venerable Hotel Vancouver and a picturesque contrast in architectural style and statement. The building is entered across a walkway between two reflecting pools. A 240-car garage at rear has direct access to lobby, arcade shops and mezzanine restaurant. The central core separates the twin towers and, with their exterior walls, provides the main vertical structural support for the building.

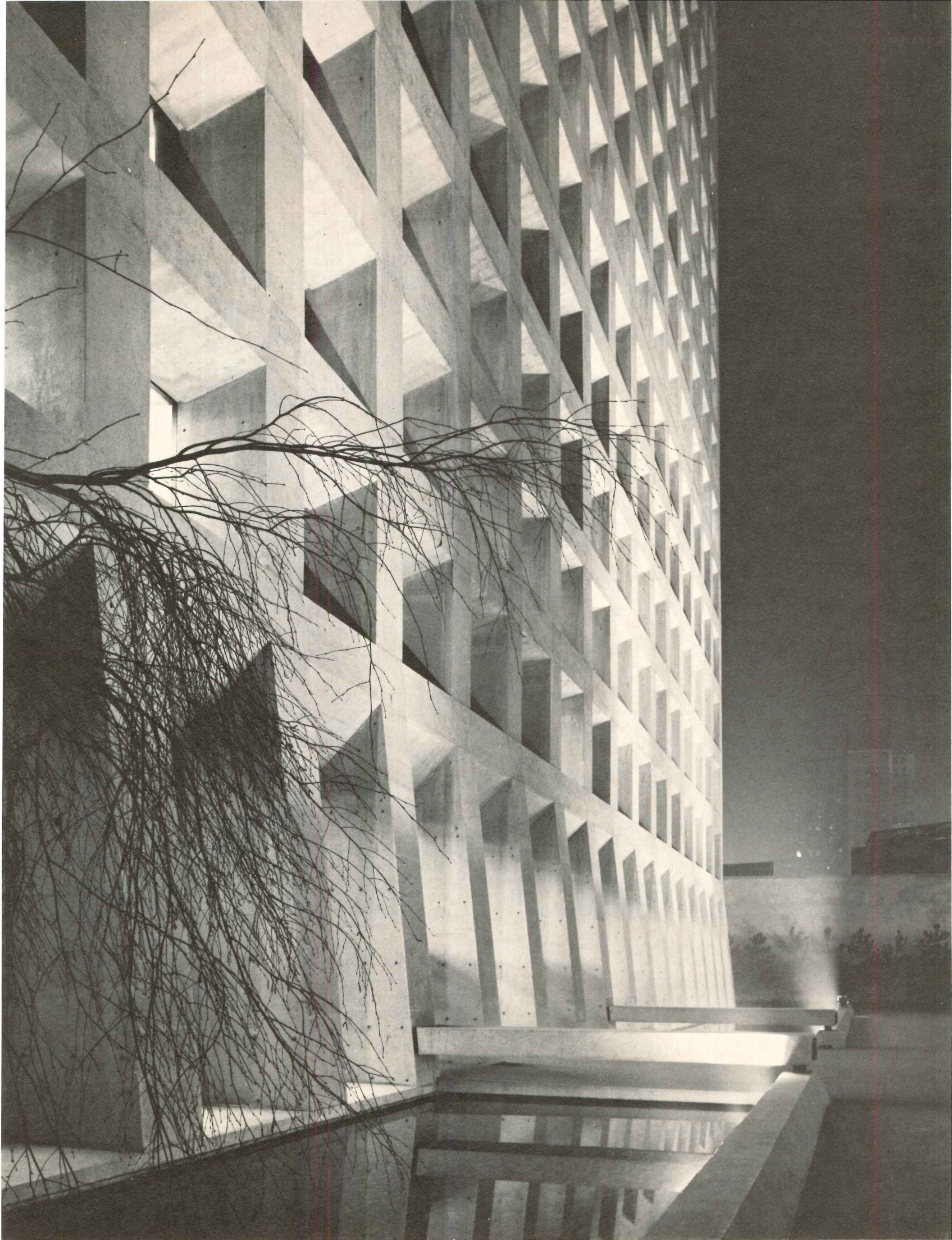



ELEGANCE OF INTERIORS AND ABSENCE OF CLUTTER DISGUISE ECONOMY OF BUILDING SOLUTION

light and view for the office areas—design objectives from the beginning—and allows the width of each tower to be determined by the best subdivision for perimeter offices (many were required) with a central corridor for circulation and, on some floors, for secretarial stations. The structural solution derived from this: a clear span of 42 feet, bearing wall to bearing wall in each tower. The mass of the walls at the base and the solidity of the core offer effective wind resistance.

The interior expression of the same principle of simplicity that governs the exterior, and is as important in assessing this building's significance, results in exceptional spaciousness because of a unique ceiling

structure which integrates electrical and mechanical services with the structural grid, eliminates hung ceilings, permits a standard-height partition throughout and effectively reduces the usual clutter of office interiors.

MACMILLAN BLOEDEL BUILDING, Vancouver, British Columbia. Owner: *MacMillan Bloedel, Ltd.* Architects: *Erickson/Massey and Francis Donaldson*—*Arthur Erickson, partner-in-charge of design; James Strasman, project architect for Erickson/Massey; Procter Lemare, project architect, production, for Francis Donaldson;* structural engineer: *Otto Safir;* mechanical, electrical engineers: *Reid Crowther & Partners, Ltd.;* soils engineers: *R. A. Spence, Ltd.;* special lighting consultants: *Bolt, Beranek & Newman, Inc.;* graphics consultant: *Lester Beall & Associates;* contractor: *Laing Construction & Equipment, Ltd.*



The ceiling grid—structural beams crossed by air-conditioning ducts—is left exposed, economically providing unusual spaciousness for office areas: under beams, height is 8 feet 8 inches; between beams, 11 feet. In the coffer thus produced, 7 feet square, a single light fixture is sus-

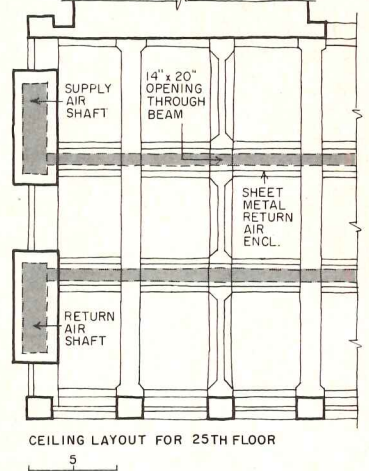

ended at a height which makes it unnoticeable beyond the second in a row; this is augmented by indirect light from each side of the ducts. One fourth the usual number of fixtures results in low-contrast, glare-free, desk-level light. Secretarial desks are designed to fit the storage wall (see section, bottom), and match it in color and wood. Floors are carpeted.

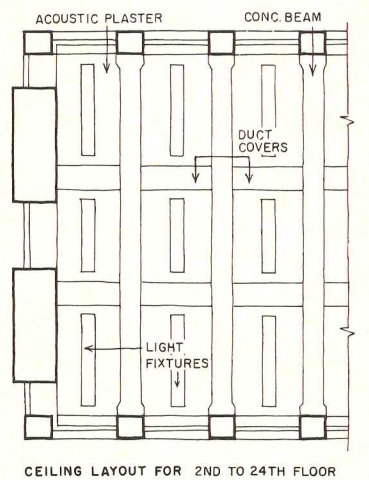

The architects designed all company interiors and selected most of the furnishings. Interior walls are natural concrete, sandblasted, except along corridors where storage walls, finished in oak or in walnut, are used. The lobby (across page), 40 by 40 feet, appears larger because of its 15-foot windows and 21-foot ceiling, similar to ceilings throughout the building. The lighting—natural by day, indirect by night—and the felicitous handling of the reception area furnishings make this lobby exceptional for its warm and human quality and for its pleasant scale. Walls are concrete.

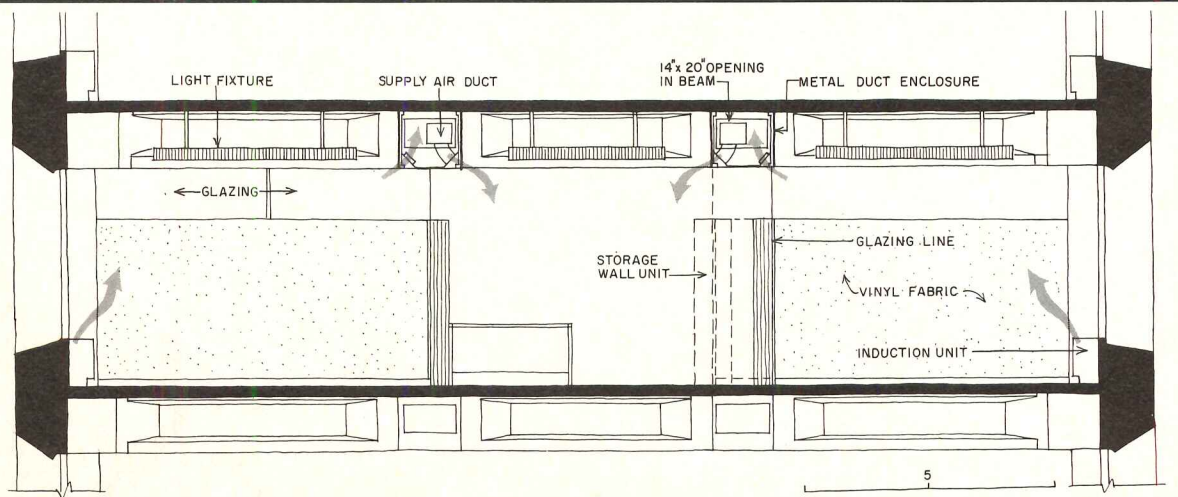

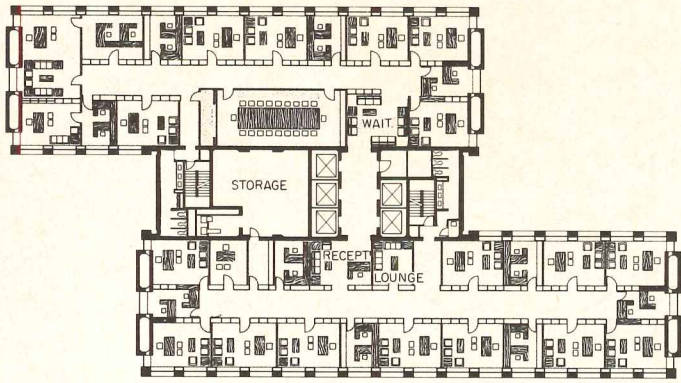

25 TH FLOOR

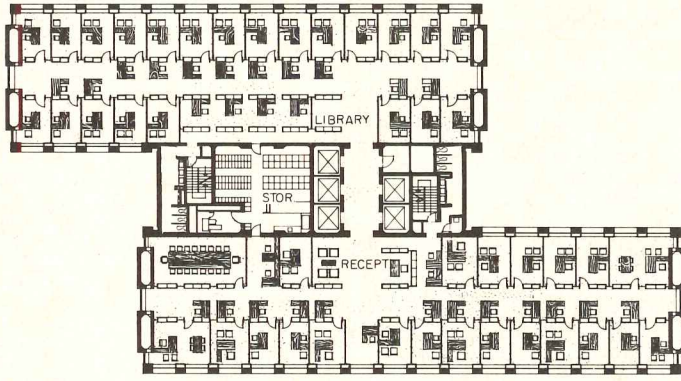

TYPICAL FLOOR

10

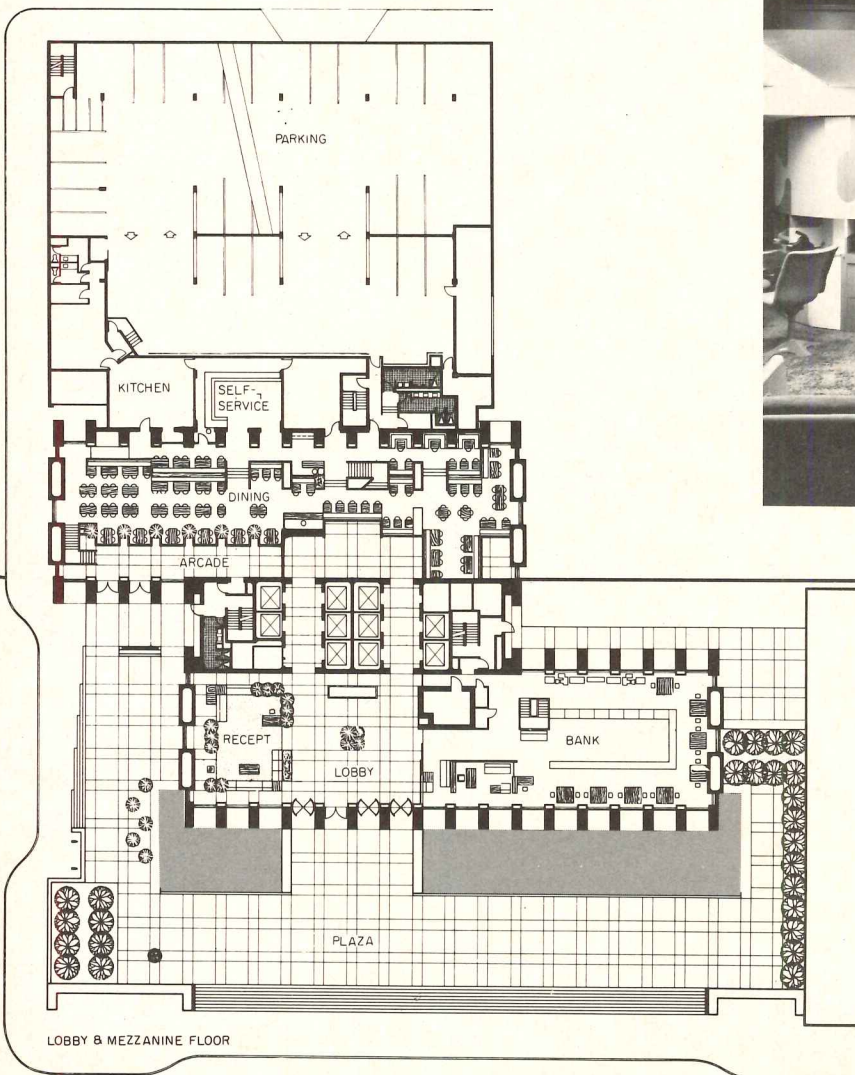

LOBBY & MEZZANINE FLOOR

The shopping arcade (top), originally designed as a one-story space, was altered after construction had been completed to accommodate a mezzanine floor for a restaurant and bar. Access to the arcade is from the lobby (via elevator lobby) and from the side street, across the sunken plaza. Of the small commercial areas, International Travel was designed by James Strasman of Erickson/Massey. Its area, though small, is exciting, due to the conjunction of colors (green, blue, yellow, red-brown), many lights and mirrors, which together produce the effect on the visitor of being inside a kaleidoscope.

STANDING AT THE HEAD OF HIS PROFESSION

THOMAS JEFFERSON, ARCHITECT, by Fiske Kimball

Da Capo Press, New York, 1968, with a new introduction by Frederick D. Nichols. 348 pp., illus., hard cover, \$80.00

Reviewed by Paul F. Norton. Dr. Norton is Chairman of the Department of Art at the University of Massachusetts. His research has dealt mainly with English and American architecture of the 18th and 19th century.

Today Fiske Kimball's scholarly study of Jefferson's architecture (first published in 1916) may still be called excellent, and although as F. D. Nichols points out, new drawings have come to light, and further documents have proved a few of his conclusions incorrect, there is little to criticize after fifty years. This cannot be said of most of the writing on architecture before the First World War.

Any work excellent as this is needs reprinting as it becomes difficult to obtain; and we should be most grateful to the Da Capo Press for undertaking its publication. The first edition was very limited and had become almost impossible to buy.

Since the new edition of Kimball's book is not an exact replica of the old, one may wish to know what changes were made. The size of the book is reduced considerably (and the weight cut by two pounds), but it maintains exactly the same dimensions for the printing and illustrations. A third introduction (W. C. Ford and Kimball each wrote one) is added by F. D. Nichols, and a page of bibliographical notes. New photographs were taken of each drawing and slightly more legible numbers

in black replace the obscure white.

The introduction by Nichols, the only important addition, is informative about Kimball the indefatigable scholar and Kimball the great director of the Philadelphia Museum of Art. Although Nichols has mainly praise for Kimball, he finds him in error a few times and takes him a little to task for not emphasizing the "highly personal quality" of Monticello. He points out too that Morris's *Select Architecture* (1755) is a book Jefferson owned, but which Kimball did not consult (it was not available to him). The importance of Morris's book is that its plates explain the origin of several of Jefferson's drawings. In this regard Nichols might have mentioned that Clay Lancaster first pointed out the relationship between Jefferson's drawings and the plates in Morris (*Journal of the Society of Architectural Historians*, Vol. 10, No. 1, March 1951, pp. 3-10). Of the four extensive quotations in his introduction Nichols gives no hint as to the published source of any.

That the Jefferson drawings have survived so well must be owing to careful preservation. But, in spite of all effort, the new photographs reveal the disappearance of many little pieces during the last fifty years. Almost all the drawings have, since 1916, received pen and ink numbers corresponding to those Kimball uses in this book. There are better ways of identifying drawings than by defacing the original. Although the black printed numbers replacing the former white ones are easier to see, they tend to detract from the appearance of the drawings, particularly where they mingle with the designs. Would it not have been

better to number the drawings beneath each, or in the margins? In this way both the Kimball and Nichols numbers could have appeared and made identification far easier. On comparing the drawings in the two editions it is clear that each edition has some drawings reproduced better than the other. Drawing number 176, in the new edition, is upside down.

Perhaps it is not so clear how this book can be of interest to a practicing architect. There is little apparent relation between the style of 1800 and the 1970's. And yet, the book is a mine of information for understanding how the architectural profession was carried on in Jefferson's time; it gives much insight into Jefferson's often inspired solutions to architectural problems; and it shows us with what sincerity he attempted to raise the level of architecture in America partially by his own talents, but even more as an example to others. Jefferson, the first man to recognize the importance of introducing the profession of architecture to America, was instrumental in bringing architects, as well as architectural taste, to this country. He hired professional men when they arrived from Europe for the building of national monuments. He assisted young men to become architects of the future. Jefferson stands then, in a sense, at the head of the profession as we know it in America today. The line of descent is clear as each generation from Latrobe, to Mills, to Town and Davis, and Upjohn, to Richardson, Sullivan and Wright, strove for perfection in its art and continued to maintain the high esthetic standard first introduced by Jefferson.

ARCOLOGICAL VISIONS FROM THE DESERT

ARCOLOGY: THE CITY IN THE IMAGE OF MAN, by Paolo Soleri.

The MIT Press, 1969, illus., \$25.00

Paolo Soleri has produced a deceptively beautiful book. It describes "arcologies," great structures for containing millions of people and their activities, designed to keep urban sprawl from despoiling the earth (see also page 41).

The Soleri city is not three-dimensional, but multi-layered. Frank Lloyd

Wright's "Living City," to which Soleri adherents have compared it, is single-layered (old fashioned?), but three-dimensional in its architecture and its physical contact with the earth. Mr. Soleri's arcology is probably technically feasible. It is Wright's spread-out, land-conscious way of living that is "impractical," but a true departure from our super-mechanical cities and society.

Paolo Soleri is a mystic. Arcologies are mystical-mechanical artificial worlds whose inhabitants peek out from a mile up at the

vast stretch of vacant land separating them from the next towering arcology. Arcologies are designed as if the world did not exist, as if man were superfluous, as if he weren't a part of the earth, but (grandly) a part of "the universe", floating in a mental outer space with nothing but ideas and images to live in.

The beautiful images in Mr. Soleri's book have their own power, but they were not designed for human life.

—J.H.

ADDITIONAL BOOKS

NEW DIRECTIONS IN AMERICAN ARCHITECTURE, by Robert A. M. Stern. This is one of eight books by the same publisher identifying "new directions" in the architecture of major nations or regions. Each book has its own author, who is usually involved in the architectural transformations about which he writes. Robert Stern has served as an editor of *Perspecta*, has written for various journals, and is an architect with the New York City Housing and Development Administration.

In a brief initial classification, Stern divides modern architects into "first generation, second generation and third generation designers," not classified by age, but by "philosophical stance." He then develops two broad approaches to architecture which in his view dominate current thinking—the inclusive and the exclusive approach—and places the architects he discusses in one of these two camps: Paul Rudolph, Kevin Roche and Philip Johnson are second generation and "exclusive" designers; Robert Venturi, Romaldo Giurgola and Charles Moore are third generation and "inclusive" designers.

All this is as simplistic in the book as it appears to be here. Stern is restricted by his classifications, feeling that he must make every building and architect he discusses either inclusive or exclusive, either second generation or third generation, or what is worse, either good or bad: the inclusive designers are "good"; the exclusive designers are "bad." He leaves us with a good idea of his gut reactions to a building (everyone is entitled to have them), and we might be able to appreciate the bare outlines of his theoretical position—the scaffolding of his classification system—as a thing that must have taken months to erect. But it is threatened with collapse by every architect stuffed within it. Stern's position allows little discussion of the exceptions to his rules; we get no feeling for the one-of-a-kind complexities that separate one architect from another, as Venturi is separated from Moore, for instance, though Stern puts them in one big bag, as they appear to be, superficially. True, it is more convenient to create one or two clear forms for everything, but architects are not that way right now; in his own terms, Stern has taken a very exclusive, second generation position. —R. J.

George Braziller, New York, 116 pp., ill., \$5.95

PAINTING, PHOTOGRAPHY, FILM, by Laszlo Moholy-Nagy. This is a translation of volume eight in the original Bauhaus series. To the list of topics contained in the title, a fourth—book design—may be added, inasmuch as the publisher has adhered closely to the typography and make-up devised for the original edition. Few authors have contributed so many seminal ideas to modern art theory as this one.

The MIT Press, Cambridge, Mass., 110 pp., ill., \$7.95

THE CHICAGO SCHOOL OF ARCHITECTURE, A History of Commercial and Public Building in the Chicago Area, 1875-1925, by Carl W. Condit. A new printing of the 1964 publication, which was in turn a revised and greatly enlarged edition of the author's *The Rise of the Skyscraper* (1952). There would seem to be a correlation between the disappearance of Chicago buildings (the Stock Exchange being the latest to be threatened) and the continuing popularity of this book.

The University of Chicago Press, 238 pp., ill. \$8.95

THE ARCHITECTURE OF CHARLES BULFINCH, by Harold Kirker. A definitive, for the most part non-critical, chronological catalogue of the architect's work. Each listing is accompanied by illustrations and a brief, but very informative essay. These are supplemented by biographical and bibliographical material and other appendices. Bulfinch's astringent, Adamesque architecture is clean and cool to the eye, while warm to the spirit; the buildings in this book will appeal to many besides scholars of the early Republican period.

Harvard University Press, Cambridge, 398 pp., ill., \$11.95

URBAN STRUCTURE, edited by David Lewis. Like the same editor's *Pedestrian in the City*, this is a valuable contribution to the literature of urbanology. The twenty-three contributors are usually architects, and English; most of the articles have been written especially for the book, on two themes: population and technology.

John Wiley & Sons, Inc., New York, 283 pp., ill., \$18.50

THE DESTRUCTION OF LOWER MANHATTAN, by Danny Lyon. As the phoenix rises from the ashes, so also may a work of art arise out of decay, death and often senseless destruction. Such is the author's photographic documentation of the wholesale demolition of Manhattan's oldest and most historic area. Lyon's photographs are especially effective, even hauntingly so, when interiors are depicted, where something of the lives of the former occupants seems to linger, long after the lights and the landings are gone, to the bitter end.

The Macmillan Co., New York, 75 photographs and random text, \$12.95

ARCHITECTURE IN NORTHERN GHANA, A Study of Forms and Functions, by Labelle Prussin. A study of village pattern and household architecture of six tribes. A wide range of architectural styles and structural features within this selected group demonstrates the creative character of these Ghanaian tribesmen and display for us, in photographs and architectural renderings, the shapes that life takes on. From the foreword by Walter Goldschmidt.

University of California Press, Berkeley and Los Angeles, 120 pp., ill. \$8.95

ZONED AMERICAN, by Seymour I. Toll. A critical presentation of the historical development of zoning legislation in the U.S. Mr. Toll, who studied city planning at Yale while taking a degree in law, has since been active in Philadelphia planning groups. By virtue of his broad-based cultural approach to his subject, he demonstrates the profound effect of zoning legislation on the environment.

Grossman Publishers, Inc., New York, 370 pp., ill., \$13.95

MEANING IN ARCHITECTURE, edited by Charles Jencks & George Baird. A series of essays related to semiology—the theory of signs as the fundamental science of human communication—discussing the degree to which such issues relate to architecture. The authors of the essays are usually English, Charles Jencks is one of our better new architectural critics, and everyone has a fine time arguing his particular theory.

George Braziller, New York, 285 pp., ill., \$15.00

ART IN A MACHINE AGE, A Critique of Contemporary Life through the Medium of Architecture, by Maxwell Fry. As his subtitle reveals, the noted English architect has taken as his subject not only the whole field of architecture, but civilization as well. He is up to the task. His insights and opinions, which have as their focus what the author feels is the over-technologization of our society, the mistaking of a means for an end, while seldom those in vogue, are all the more well worth considering. Intertwined with this presentation is an inside picture of Fry's professional past: a pioneer of the modern movement in Britain, in partnership with Gropius in 1934-36, and his association with Corbusier on Chandigarh.

Barnes and Noble Inc., New York, 184 pp., ill., \$8.00

CRAIG ELLWOOD, by Esther McCoy. In the words of the Introduction, Ellwood "set out to take the raw materials available in modern industry, and the new techniques, and to turn these . . . into the most elegant, the most refined idiom that he could develop." The collection of buildings that follows, mainly residences, shows that with not a little help from the Japanese, Neutra, and Mies he succeeded.

Walker and Company, New York, 156 pp., ill., \$15.00

THE INDUSTRIAL REVOLUTION RUNS AWAY, by Frank Lloyd Wright. The architect's revised edition of *The Disappearing City* (1932), in which he announced his "Broadacre City." Actually two books in one, this spiffy, slip-cased limited edition carries on the left-hand pages facsimile reproductions of Wright's copy of the original title, with changes and addenda in his own hand; the facing pages show the revised, printed text. Hopefully, the latter will be published in a less expensive form.

Horizon Press, New York, 187 pp., \$40.00

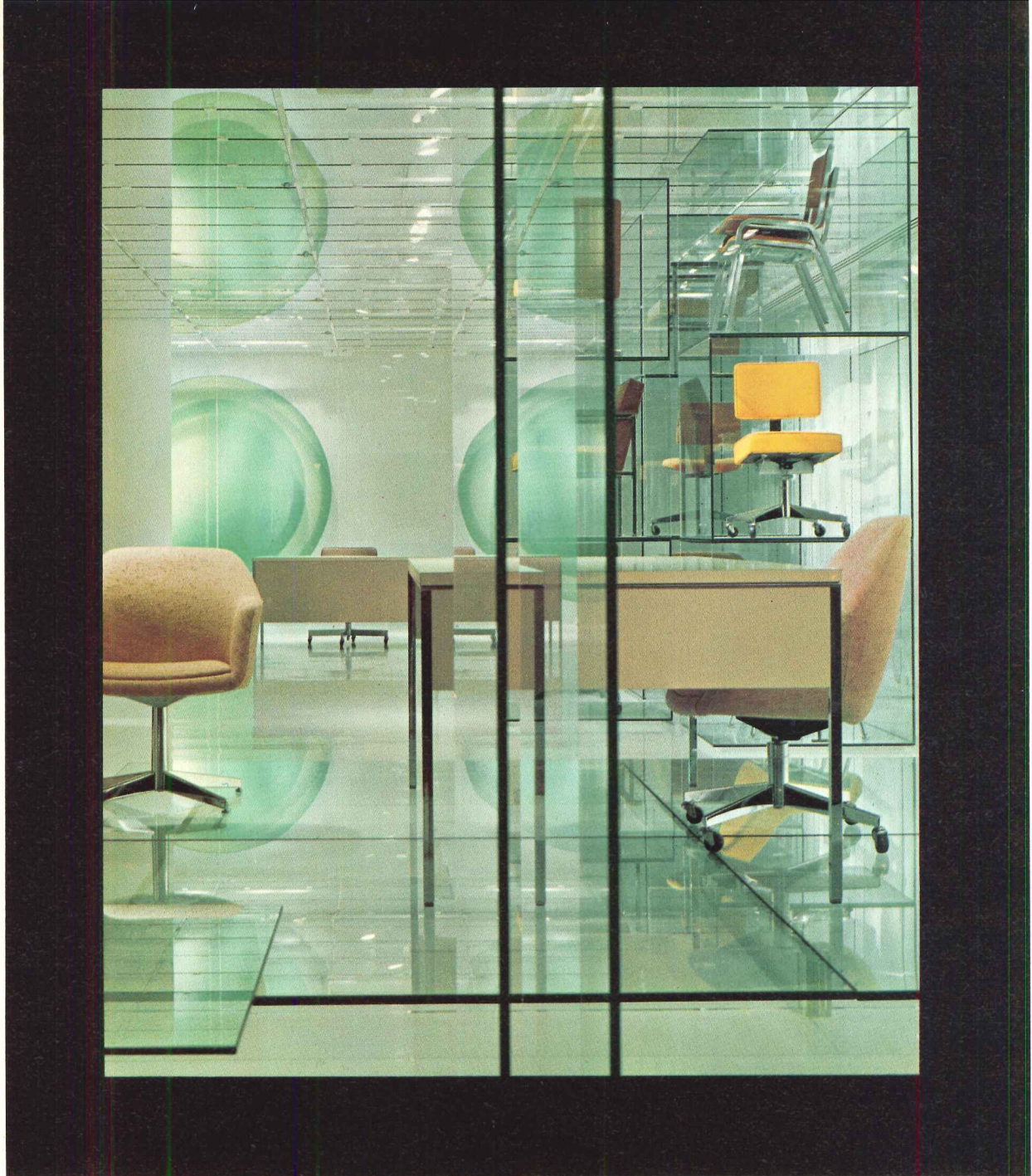

photos © Ezra Stoller (ESTO)

OBJECTS AND IMAGES: A LUMINOUS NEW SHOWCASE FOR OFFICE FURNITURE

Warren Platner designs
an elegant new space for Steelcase in Chicago

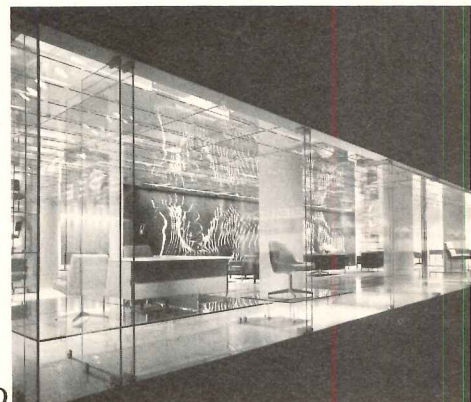



DESIGN OF INTERIORS

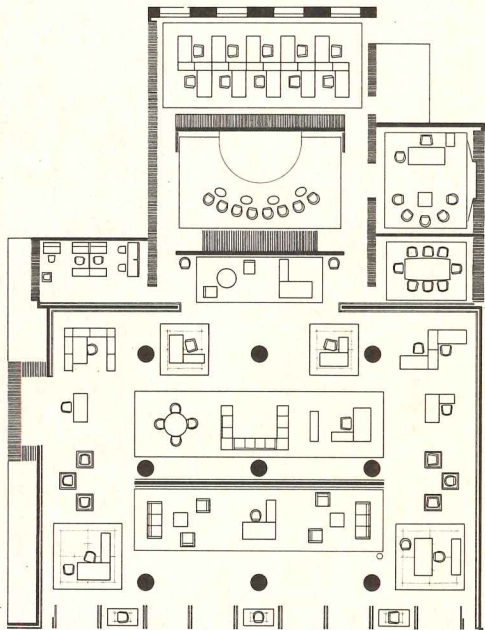



SHIMMERING, SUBTLE REFLECTIONS EXTEND THE REAL SPACE and add considerable glamor and effectiveness to the Steelcase products displayed in the new exhibit in Chicago's Merchandise Mart.

Warren Platner has created a real traffic-stopper in the big, busy showroom center by minimizing the usual "room setting" techniques and creating a deceptively simple, reflecting space which enhances both the furniture on exhibit and the visiting customers. Almost all surfaces in the basically loft-like space were coated white—vinyl floors, painted plaster walls and structural ceilings. A sparkling glass shell has been created within this room for the major display and exhibit area. Countless glass doors line the corridor facade and the walls; all doors are operable (and placed a few inches out from the walls) to

assure easy cleaning and maximum sparkle, and to permit a changing series of graphics behind.

Horizontal glass panels are suspended below the ceiling, which is fitted with an adjustable track system of spot and floodlights; within the room, islands and cases of glass delineate display groupings. The end effect is an eye-catching glitter which dematerializes the confining spaces provides an endless series of subtle reflections of everything in the room. Color and accent are provided by the furniture displayed, by the sparingly used graphics, and by people walking through. All the graphics are changeable, and intended to be changed. In this initial installation, the translucent images on the side walls are all x-rays of Steelcase construction de-

tails, and the big black and white mural represents body motion and implications for posture and comfort. The hatched areas shown on the plan at left are floor-to-ceiling walls of the company's line of files and cabinets, handsomely arranged into Mondrian-like compositions. Thus, apart from a very few leather paneled walls toward the back, all wall surfaces are products or their reflections.

STEELCASE SHOWROOM, Chicago, Illinois. Architects: Warren Platner—project associates, Mark Morgaridge, Robert Brauer, Paul Sargent, Lawrence Kilbourn, Lee Ahlstrom; mechanical engineer: John L. Altieri; graphics: Vance Jonson and Joel Margulies, Unimark International; contractor: E. H. Marhoefer, Jr. Co.



DESIGN OF INTERIORS





THE PRECISE LINE OF THE PRODUCTS IS ECHOED in the precision of the over-all showroom design. All the lights and electrical work are neatly placed above the horizontal glass panels and fixed to the ceiling. Spaces above, as well as below, the glass are airconditioned to reduce the heat load. The glass itself is considerably thinner (quarter-inch) than normally used in this country, reducing costs and weight. The panels rest on simple rotating clips suspended on a standard metal strut system; the corners of the glass were cut out where needed for sprinklers.

All the display devices are demountable and portable; there is a storeroom to one side of the main display area for those items not in current use. The glass display islands may be walked on.

A smooth transition is made

between the "glassiness" of the exhibition space (the back portion of which is shown here) and the more compact, efficient work and conference rooms beyond, by creating an open alcove with a dropped plaster ceiling and backed by a brightly-lighted wall of warm-toned leather. Sympathetic colors (browns, beiges, yellows, orange) are used for upholstery and accent colors in the office areas. Corridors to either side are lined with displays of files and cabinets to further help the transition from purely exhibit to functional areas.

Explaining why—except in the real, working offices—there has been no attempt to create "office settings" in the showroom, Warren Platner comments that "it was our intent to create an exhibition space where the products shown are

seen for what they are—objects of quality and utility—not to be confused with arbitrary decisions as to what one designer might think an office should look like. In other words, we put the products in the context of a showcase (and hence 'exhibition space' is a much better description than 'showroom' which conjures visions of model rooms with their confusing image of what to do with a product). We wanted a very light space, a luminous one, so you could see everything clearly—and of course the reflecting glass furthers that too."

The very simplicity of the project (which, characteristically, was achieved only by a long and painstaking design process) gives it an extraordinarily strong and fresh sophistication that should make it a high point in the Mart.



DESIGN OF INTERIORS



CONFERENCE AND OFFICE AREAS are all located behind the exhibit spaces, and are reached via corridors lined with files and cabinets (photo, left). Similar banks of cabinets form one wall in the regional manager's office (top photo), with folding triptych panels for client presentations in the center; the panels can be closed until needed, and the space is also fitted with a white roller shade silk-screened with a bright orange-colored tree for a graphic accent as shown. An adjoining space (above) has two sliding walls to open it up, and is fitted as a presentation room for multiple-projector films, conferences and sales meetings. The films can be shown effectively with the sliding doors entirely open so that it becomes part of the exhibition space, to be seen by all clients and visitors.

OPERATION BREAKTHROUGH

THE SYSTEMS, THE SITES AND THE DESIGNERS ARE CHOSEN. THE QUESTION NOW:
ON WHAT STANDARDS SHOULD THE PROGRAM BE JUDGED?

Operation Breakthrough has a clearly worded goal, and it is a good place to begin a discussion of its progress so far. As stated in its request for proposal the Breakthrough goal is "... the establishment of self-sustaining mechanisms for rapid volume production of marketable housing at progressively lower costs for people of all income levels, with particular emphasis on those groups and individuals which have had difficulty in obtaining satisfactory housing in the past."

There are two phrases here that touch on areas of some confusion, and these should be cleared up, for Breakthrough officials have been a little hesitant in establishing the scope of their program, and therefore the standards on which they want it evaluated.

First, Breakthrough is not a scheme to significantly or quickly reduce the cost of housing construction. Second, what housing it provides will be for all income levels, not just low-income. Whether it's toasters, houses, or cars, there always has been an assumption that mass production quickly reduces costs. Breakthrough officials, in the beginning, implied that their program could reduce housing construction costs quickly, and they have used the term "low-cost housing" rather freely in their speeches. But when pressed, and in all of the written releases from HUD, it is never said that Breakthrough can significantly reduce the present cost of construction. They do say it can gradually reduce the present cost of construction, if industrialization becomes widespread and that it will, if successful, keep costs from rising as quickly as they have in the past. On the low-income issue, Romney believes there would be a public stigma attached to Breakthrough housing if it were designed and erected for that group alone. Each Breakthrough site will contain low, middle, and high-income housing.

HUD's two-part program to meet the above-stated goal is now well advanced, with the selection of twenty-two consortium proposals as "winners," ready for prototype testing and construction. The housing systems of these Type A winners, which are discussed and illustrated on the following pages, will be financed and constructed on eleven sites throughout the country,

beginning in July of this year. (The first part of Breakthrough also calls for the selection of several Type B proposals for further development—Type B being housing schemes not yet ready for prototype construction—but this selection has not yet been made.) Breakthrough has also picked eleven "site planners"—all but two of which are architectural firms—to help coordinate the placement of the housing on the sites. Construction of these 22 proposals on the eleven sites will provide, all told, 2,000 new units.

The first part of Breakthrough has generated a lot of hope and activity, yet if Breakthrough stops at 2,000 units it will have been a failure regardless, or perhaps because, of the hope it has created. Thus the second part of Operation Breakthrough—HUD's attempt to "aggregate" a housing market for its demonstration systems—is crucial. HUD hopes to identify sites around the country which could be used for housing, classify these sites on a regional basis for better information breakdowns for potential developers, apply Federal incentives for variances if local codes or zoning seems to make a site or a system unusable, and give priority treatment to Federal funding of sewer, street and water contracts so that the site may be developed quickly. A site would be assembled and developed by a local "sponsor," which could be state urban development corporations, state or city housing authorities, private developers of any size that seek a profit, or private non-profit agencies. HUD has no plans to purchase and develop sites themselves, and they will not financially aid their 22 winners or anyone else in creating factories and beginning assembly line production. In other words, there is lots of logistical support, and a willingness to attempt change in any way that seems hopeful, but there is little money. HUD has \$15 million it is using to reimburse proposal costs for the winners and is asking for an additional \$35 million to help pay for the testing and erection of prototypes.

Operation Breakthrough could effectively change several existing and improvable parts of the housing industry. For example: **Labor.** It is potentially very useful in dealing with the labor short-

age in housing construction. The industry now is dependent on skilled labor—carpenters, plumbers, electricians. They are in short supply, and this has in some areas slowed the production of housing. Breakthrough—if it works—will transfer part of the labor base of the housing industry from skilled to unskilled workers. The labor unions show signs of going along with such a transition. In some jurisdictions, for example, a man nailing wall sections together on the line need not be called a carpenter and paid carpenter's wages; he may be called an "assembler"—a new classification—and be paid the rate for assemblers, which is less than a carpenter because he is employed year-round, not just when the weather is good. The housing industry would have had to do something about its labor shortage with or without Breakthrough, but Breakthrough provides a large, very necessary impetus.

Materials. Operation Breakthrough has stimulated needed basic research into new materials for housing, or at least more efficient ways of using old materials. We have a limited supply of lumber in this country (indeed, in the world); wood has been cheap because it has always been plentiful, but it is not cheap any more. Breakthrough has produced ways of using materials other than wood so that they can be successfully sold, and, through its testing program, its evaluations, and finally its stamp of approval, will provide some basis for acceptance by local building departments and local builders of structural systems and finishes they have never seen before.

Codes and zoning. Building codes should provide the public and a buyer with a safe house and an acceptable standard of value, but they are sometimes used today as devices to protect union jobs, methods, and traditional materials. Zoning laws are sometimes a last useful weapon against commercial exploitation, but sometimes they help create de facto segregation. Breakthrough could help strengthen the good parts of existing codes and zoning laws and eliminate the bad parts, if HUD officials apply the leverage they are capable of applying on Breakthrough sites. Restrictive local codes will be effectively attacked if Breakthrough housing which violates them is nonetheless erected and if the municipality then erects more housing because HUD has given them priority treatment on funding programs. On zoning, Breakthrough housing will be for all income levels, and each site will include all income levels. HUD has insisted there can be no racial restrictions to their housing, and all of the proposing consortiums have had to prove that they will hire without discrimination.

The main problem with Breakthrough is money: there is none. Lack of money is the reason for the housing crisis in the first place, and it is difficult to see how the crisis will be alleviated without it. We have a housing crisis because 1) most builders cannot afford to create new housing—apartments or detached residences—for low- and middle-income people; they cannot make a profit. And 2) we have a crisis because many people cannot find the kind of housing they expect to be available at a price they can pay. This, of course, is simply two different ways of stating the same problem.

Operation Breakthrough has no provisions for subsidizing or in some way lessening the cost of interest on loans for builders—whether the builder is a highly industrialized consortium or a neighborhood contractor—or subsidizing the cost of direct construction. Breakthrough has no provisions for reducing the amount of interest a prospective homeowner must pay for a mortgage loan, nor for subsidizing the amount of rent an apartment dweller must pay. HUD does have existing programs—221d3,235,236 and 78 others at last count—which have been available since at least the 1968 Act to aid builders, owners and renters—but the crucial programs are miserably funded and mired in red tape. An argument can be made—and it is true to a degree—that if exist-

ing builder, owner, and renter subsidy programs were funded so that everyone who wanted to use them could do so, and if a few new ones were created, the housing crisis would soon be ended, and people would be relatively happy with their choices of housing and costs, all within the existing system—without aggregating one market, without industrializing one building system.

Romney has been publicly vocal in his insistence that the housing industry needs money; he has deplored the government's lack of financial commitment and recognizes the desperateness of the problem. But he has been ineffective in the Cabinet and in Congress, where it counts; the main fault lies outside HUD, in the commitment of our leaders and in our much-debated national priorities. If there were legitimate signs that the real power in the administration wanted to fund housing adequately, and had a commitment toward that end, there would be less criticism of Operation Breakthrough.

In one sense Breakthrough should be judged on a different set of terms. It should not be denounced for failing to provide direct funding subsidies when it never was set up to do that, when there are other programs within the mother agency which were created specifically for funding purposes, and which it would be redundant for Breakthrough to preempt or otherwise reorganize when there is no money anyway. But HUD has always made it appear that they are putting all of their eggs in the Breakthrough basket; that it is their chosen great hope for reversing the housing crisis and that Breakthrough—standing alone—can do it.

Breakthrough turns out to be a rather sophisticated Federal program of friendly persuasion; it relies on its ability to convince, rather than equal ability to alter through direct use of power. It pushes gently but firmly; it certainly does not revolutionize. Breakthrough has tried to convince the unions of the inevitability of its directions, not bowl them over, and it seems to be succeeding. It will probably provide new opportunities for local developers, even small ones. It certainly does not try to usurp local or state governmental agencies; it wants more of them, it wants community control. Some local builders are threatened (if all they do is build houses, not develop land) but the Levitts and National Homes have been threatening them long before Breakthrough.

Some of the winning consortiums appear to believe (and perhaps this is why they are involved) that for the nation to get the amount of housing it needs, and for which Congress has called, HUD will eventually have to fund Breakthrough as N.A.S.A. funds the space program: by direct purchase of products—in this case housing—as they come off the assembly line. Their hope: "defense contract" kind of funding and profit. But it appears that money will flow through existing funding agencies in HUD, thereby spreading throughout the diversified and local building industry; these existing funding programs are by no means profitless, but it takes a large amount of experience and hustle to take advantage of them.

Operation Breakthrough is an experiment, in the end; it is a developing program feeling its way and this is why everyone is willing to (and feels he should) criticize it and offer free advice; it is still possible to alter the format into more effective channels and strengthen the good points and face the flaws. Operation Breakthrough can be seen as a well-conceived beginning, a success up to now, and a necessary second front for greater efficiency in housing production—to supplement a still-to-be-realized first front of funding for housing. But, again, Breakthrough is wholly inadequate without funding, and if money for the housing industry is not to come directly through Breakthrough, but through existing funding agencies in HUD, then HUD must acknowledge that Breakthrough cannot reverse the housing crisis by itself. Breakthrough must soon establish the standards on which it wants to be judged.

—Robert Jensen

Several of the Breakthrough proposals are traditional in design and approach— one guarantee of production and salability

Operation Breakthrough was conceived as a program which could do something about the housing crisis soon, and in that context the selection of firms such as Scholz Homes and Boise-Cascade as winners makes sense. These groups are ready to go with high volume production right now; their manufacturing plants are already in operation. Another way such groups can be characterized, and their proposals can be seen as similar, is their decision to go with "conventional" elevations and exteriors. The exterior motifs on all of the eight proposals on this and the following page are proven and marketable—pitched roofs, clapboard siding, panelled doors, shingles, shuttered windows, and private balconies abound on the single-family houses and garden apartments. The high-rise apartments are the balconied, double loaded corridor types we have all come to recognize. These, of course, could be the most successful of the Operation Breakthrough proposals because they make no demands on the public to change their "taste" in housing.

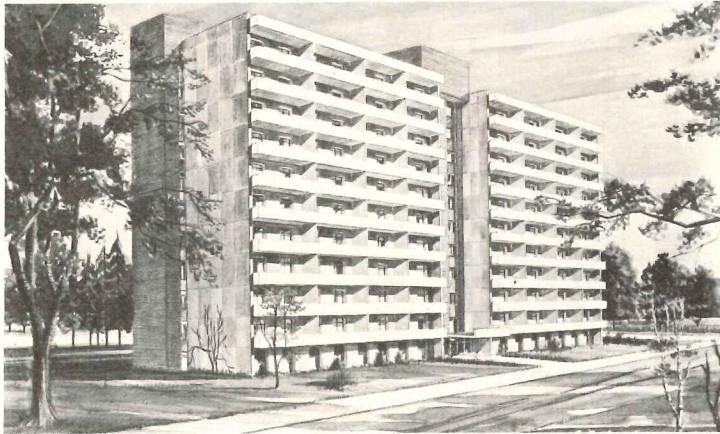

1

Stirling Homex Corporation. Stirling Homex has an existing single-family and low-rise housing system already in production which was proposed for Breakthrough. It is a wood-framed modular system of boxes, three or four together forming a dwelling unit. They can be stacked for low-rise apartments, and the look is strictly conventional, geared for suburban development sales. In addition to this, they have created an entirely new high-rise building system of steel framing and concrete panels, which will also be a Breakthrough prototype. Stirling Homex seems to be relying on its in-house management and financing expertise, and is one of two winners that list no other organizations as consortium partners.

Other consortium members: None.

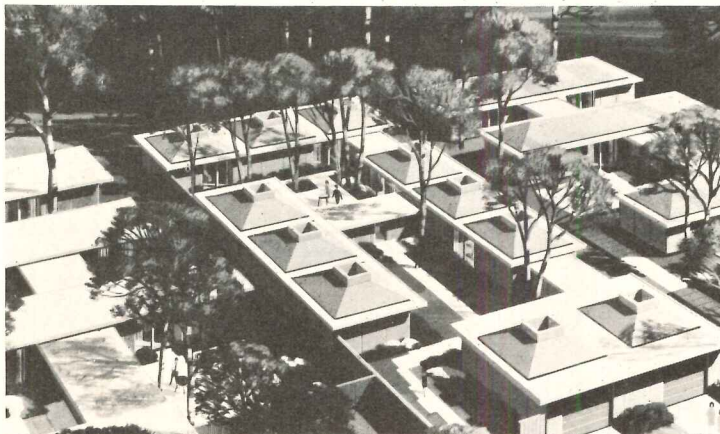

3

Republic Steel Corporation. Steel is the principal structural material in this system; it is formed into components to provide a variety of detached, single-family residences for low- and moderate-income occupancy. The system permits relatively high density single-family arrangements with privacy, and so is probably more appropriate for an in-city site than "detached residence" makes it sound. Kitchen-bathroom units are preassembled and set in place.

Consortium members: Republic Steel Corporation, Youngstown, Ohio; Bob Schmitt Homes, Inc., Strongsville, Ohio; The Tappan Company, Mansfield, Ohio; American Standard, Inc., Louisville, Ky.; Climatrol Industries, Inc., Milwaukee; Emerson Electric Company, St. Louis.

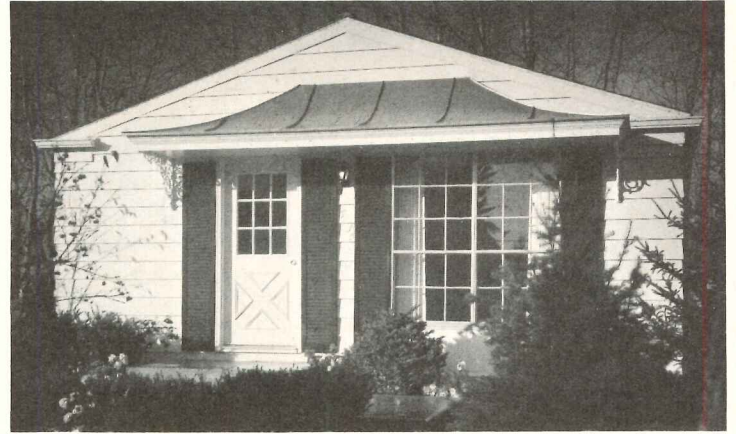

2

Scholz Homes, Incorporated. Scholz submitted, and won with, a straight extension of their existing factory-built homes; they can be either single family detached or two-story row housing. Visually they are "colonial", or "ranch" or "dutch" or some other eclectic motif. Scholz has been most successful in the \$30,000 and higher housing market for suburbanites, but it also makes a low-cost model, above. The primary structural material is wood, and each modular unit is a completed part, to be set in place by a crane. Their proposal uses plant capacity now existing, with more plants contemplated to meet higher volume for an aggregated market.

Consortium members: Scholz Homes, Inc., Toledo, Ohio; Stiles-Hatton, Inc., Grand Rapids, Mich.



4

Boise-Cascade. This is already the largest company in the housing and construction field, with mobile homes, lumber companies, and real estate. They have an existing production capacity of 1,000 dwelling units per week, and made a complete "product line" proposal to Breakthrough to develop any of its shelter types on a site, and to mix them. Comprehensive financing plans are a part of their proposal, with both wood and steel as the basic construction material.

Consortium members: Dalton-Dalton-Little, Cleveland; Frank Hall Assoc., New York; Computer Applications, Inc., New York; National Building Agency, London; David Crane Assoc., Arch., Philadelphia; Brevard Engineering, Cocoa Beach, Fla.; MIT-Urban Systems Laboratory, Cambridge, Mass.

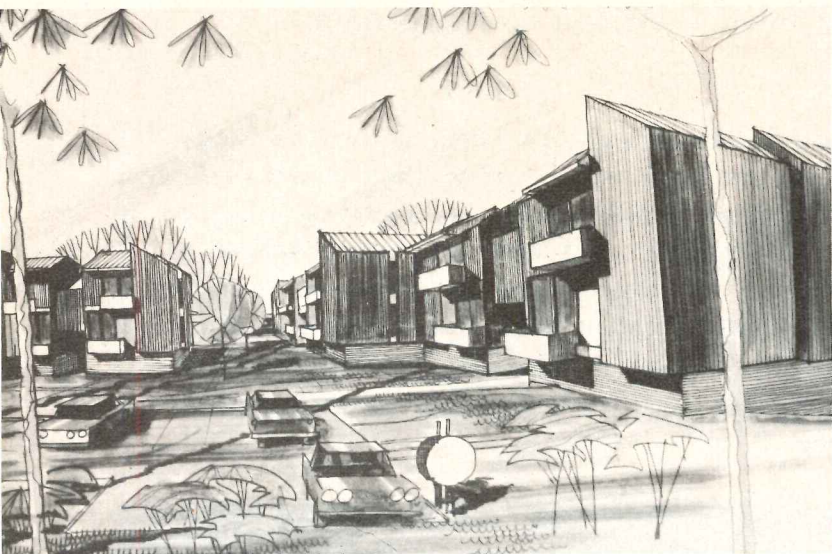

5

Aluminum Company of America (Alcoa). Alcoa submitted some fourteen separate proposals to Breakthrough, from high-rise, core-city schemes to detached single family houses. The proposals for which they received HUD's approval were their townhouses and multi-family, walk-up garden apartments. These are constructed from factory-built, three-dimensional modular service cores that serve two living units. A panel system encloses the main living spaces, and the drop-in cores contain kitchens, bathrooms, stairway, utilities, heating, and some closet space. Alcoa uses a variety of conventional materials, with the possibility of extruded aluminum exterior siding.

Consortium Members: Aluminum Company of America, Pittsburgh; *Urban Design Associates, archts.*, Pittsburgh; Ryan Homes, Pittsburgh; Urban Systems Research and Engineering, Inc., Boston; *The Perkins and Will Partnership, archts.*, Chicago; *Collins and Kronstadt, archts.*, Silver Spring, Md.; Slayter Associates, Inc., Elkhart, Ind.; Andrew T. Kostanecki, Inc., New Canaan, Conn.; Rohr Corp., Chula Vista, Calif.; Sectional Structures, Inc., Oswego, N.Y.; Tappan Co., Mansfield, Ohio; Bryant Air Conditioning Co., Indianapolis, Ind.

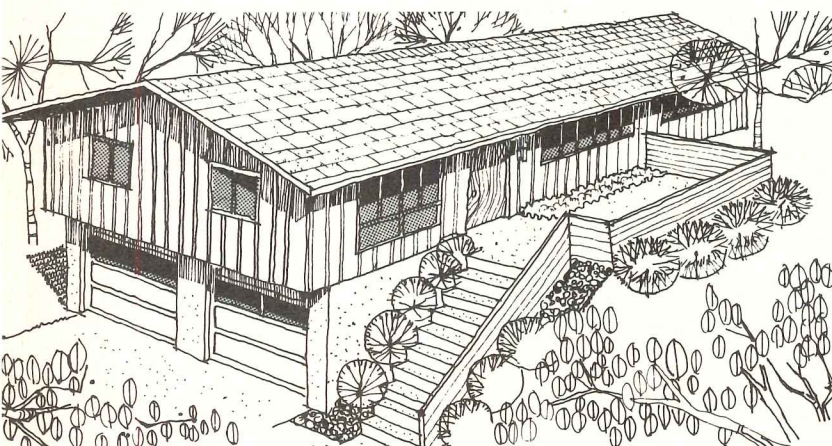

6

Home Building Corporation. This is the "little guy" of the Breakthrough winners. The firm has been producing standard developer housing in the Missouri area for 30 years, but on a small scale compared to others in the field. They listed no other members besides themselves within their proposing consortium, leaving them devoid of additional sources of financing (such as combination with a large corporation or insurance firm might provide), and they have no architectural firm with them. Their construction system utilizes factory-built modular units, 12 feet wide for highway transportation; the structural system is wood, but alternate materials can be used as costs dictate. The factory production system is designed to provide flexibility in design, to permit the customer to choose features he finds preferable. They have developed a new home-, land-lease plan as part of their Breakthrough financing.

Other consortium members: None.

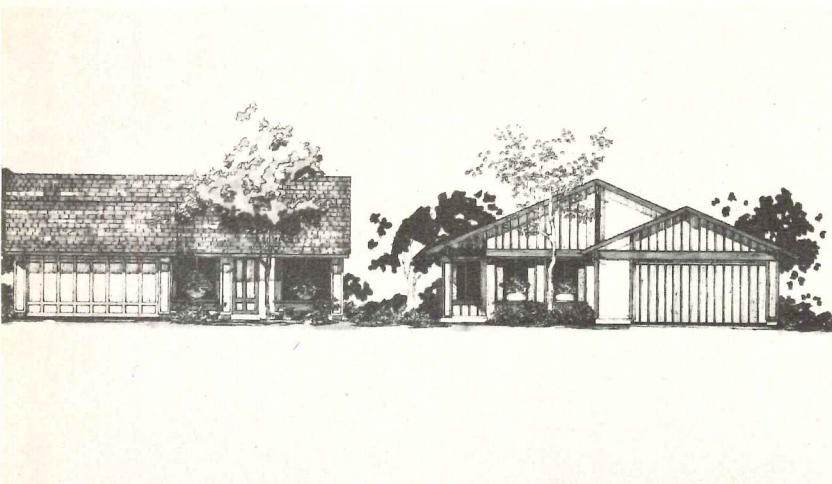

7

Christiana Western Structures, Inc. The parent corporation of this firm has been involved in large-scale real estate development for a long time. Christiana Western already produces "low-cost" housing in volume, and they now have a plant capable of producing 6,000 housing units a year. The firm utilizes a system of shop-fabricated, wood frame panels for walls, partitions, carports, and garages. Both interior and exterior finish materials are shop-applied. A kind of polyester resin finish coat, reinforced with fibrous glass, has been developed as an interior and exterior wall surface in lieu of paint. This finish, applied to a full length plywood wall base, allows the fabrication of a complete wall panel of any length without a joint. The CWS system works for single family detached dwellings as well as for multi-family, low-rise structures, and is used extensively in southern California.

Consortium members: Christiana Western Structures, Inc., Los Angeles; *B. A. Berkus Associates, archts.*, Los Angeles; Mutual Ownership Dev. Foundation, San Francisco.

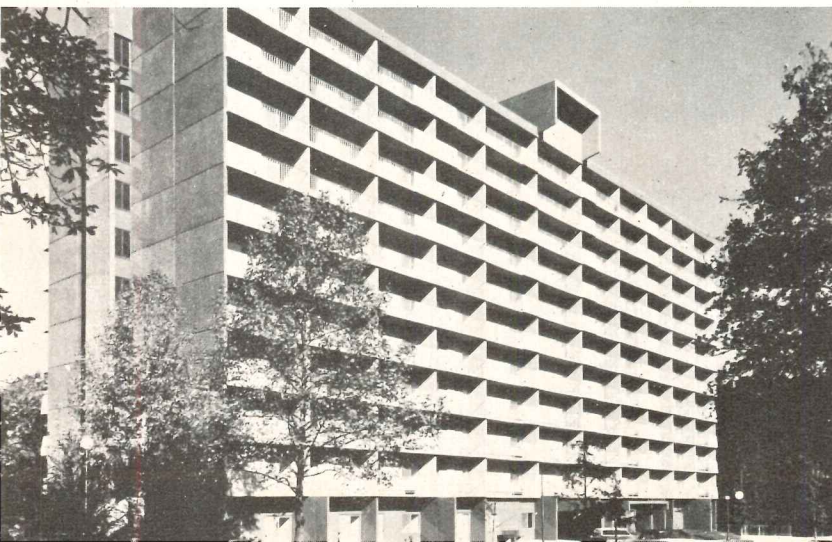

8

Forest City Enterprises, Inc. This consortium has developed a precast concrete system using both floors and panels; it has been used already in modified form in two projects, one of them the Saferstein Towers in Akron, Ohio, shown at left. The precast system is also suitable for single family detached housing and townhouses. Prefabricated wood framing, designed and manufactured by Forest City, is used for infill exterior walls, all interior partitions, and the roof. The concrete components can be manufactured at a central factory or may be cast on site; surfaces are ready to receive paint, vinyl wall covering or other suitable finish. The wooden front and rear walls provide a variety of facades through the use of wood or aluminum siding, cedar shakes, brick veneer or any other exterior treatment.

Consortium members: Forest City Enterprises, Inc., Cleveland; Forest City Materials Co., Kent, Ohio; Thomas J. Dillon & Co., Inc., Akron, Ohio; Top Roc Precast Corp., Hudson, Ohio; *Barbitta-James & Assoc., Archts.*, Akron, Ohio.

The majority of Breakthrough proposals are "innovative," at least compared with what is being produced on the new-housing market

The testing and erection of prototypes, which is the next step in Breakthrough, is intended as an evaluation of the systems, to see if they work as well as their proposers claim. If they don't HUD will find out, and supposedly prospective buyers will find out, so the most thorough analysis of the drawings and claims of the proposers has yet to take place. The Keene Corp. Consortium, with its Townland system, is the only group that has directed its effort totally toward the problems of the core-city, high-density site. If you want to guess which system will succeed first, bet on Levitt. Rouse-Wates and Module Communities Inc. have proven systems and are best geared to take quick advantage of new Federal funds through existing sources, when that funding starts: they are ready to sell aggressively, and are big enough. Ball Brothers and TRW Systems, who have most of their previous experience in defense work and aerospace, emphasize revolutionary new panels or ways of making boxes, which is only about one sixteenth of the problem. Of the 22 winners, all but four have architects within their consortiums.

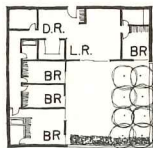
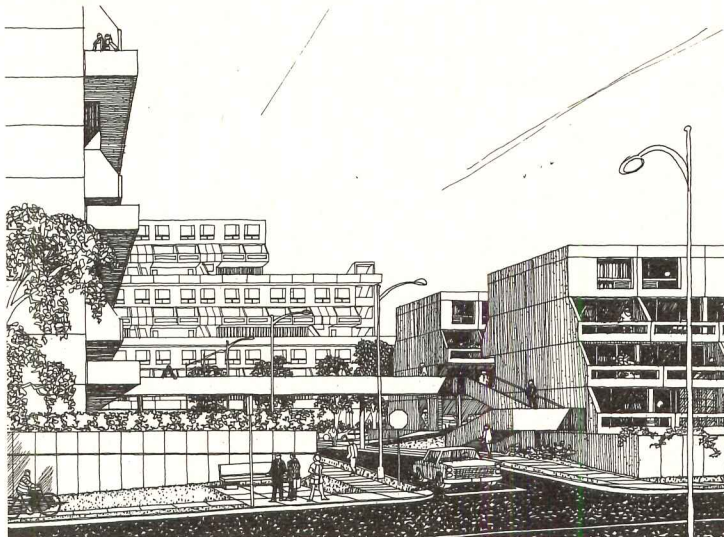

ATRIUM HOUSE

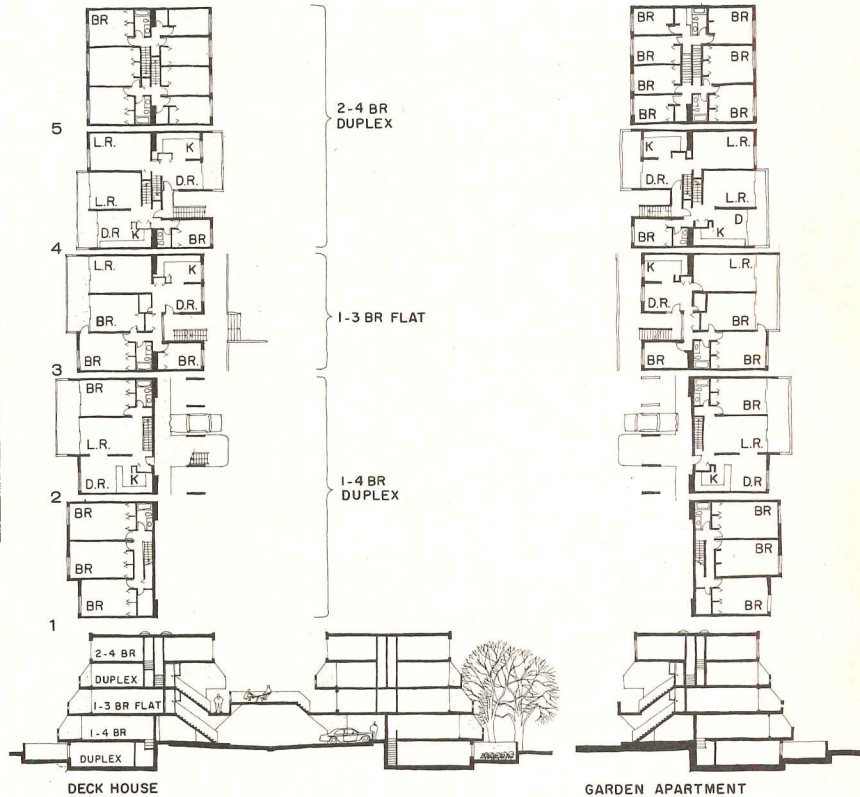

9

Henry C. Beck Company. This consortium is headed by an Atlanta general contracting firm, and its technical proposal is the Balency precast concrete system, used extensively since 1949 in several European countries and Israel. The Balency system has been adapted for the American market; it utilizes factory-produced concrete floor and wall panels, which are assembled on site into all types of housing. An atrium single-family detached house, a deck house concept, a garden apartment design, and a high-rise scheme are illustrated here, all produced from the same concrete panel elements. The system is particularly appropriate for high-density locations, with the deck areas providing private open space areas for occupants. As illustrated in the rendering above, either balconies or broader "garden decks" can be generated, with overhead circulation ramps "leapfrogging" from tower to tower, if necessary. The Beck proposal includes special training for residents of an area the buildings are to be erected in, so that they may help build the housing and participate economically.

Consortium members: Balency-MBM-US Corporation, New York; William R. Morris, New York; Henry C. Beck Company, Atlanta; Raymond D. Nasher Company, Dallas; Borg Warner Corp., Chicago; R. G. Greene Development Company, Atlantic City; Keyes, Lethbridge and Condon, archts., Washington, D.C.; Sulton and Campbell, archts., Washington, D.C.

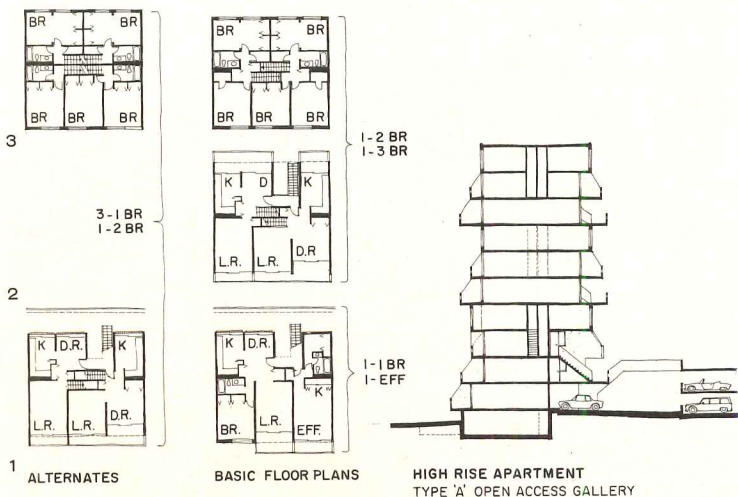

Descon/Concordia. This Canadian consortium submitted one of the two or three best sets of graphic information on their system that have come out of Breakthrough, as this page illustrates. The structural system is a series of factory produced reinforced concrete panels, which are capable of producing all types of housing with the exception of single family detached units. The panels may be prestressed, post-tensioned, or simply reinforced, depending on the availability of local resources. Casting may be done on the site, if necessary, and there is a technique for using "dry" mechanical joints between parts in adverse weather conditions. The Descon/Concordia system has its own interior partitioning panels too, with built-in raceways for electrical connections, and its own system of exterior wall units, prefinished, with heating and air conditioning systems incorporated in them. This makes the system totally coordinated and complete, but also more complex than most. Other concrete panel systems prefer to use on-site labor, standard materials, and accepted finishes for partitions and some outside walls, for flexibility and "salability." Descon Management Corporation has had prior construction experience in a variety of residential developments, principally the 1,000-acre Nun's Island project in Montreal.

Consortium members: Descon Management Corp. Limited, Montreal; Concordia Management Limited, Montreal; *Philip David Bobrow, Arch.*, Montreal; Gamze, Korobkin & Dolphin Associates, Chicago; Professor Colin H. Davidson, Montreal; Seymour Glouberman, Prof. of Philosophy, Montreal; *Neal Mitchell & Associates, Archts.*, Cambridge, Mass.; Kenneth Mabuchi, Washington, D.C.; Paul Spindell, System Analyst, New York; *Michael Brill, Arch.-Researcher*, Buffalo; *George E. Buchanan, Arch.*, Bradford, Conn.

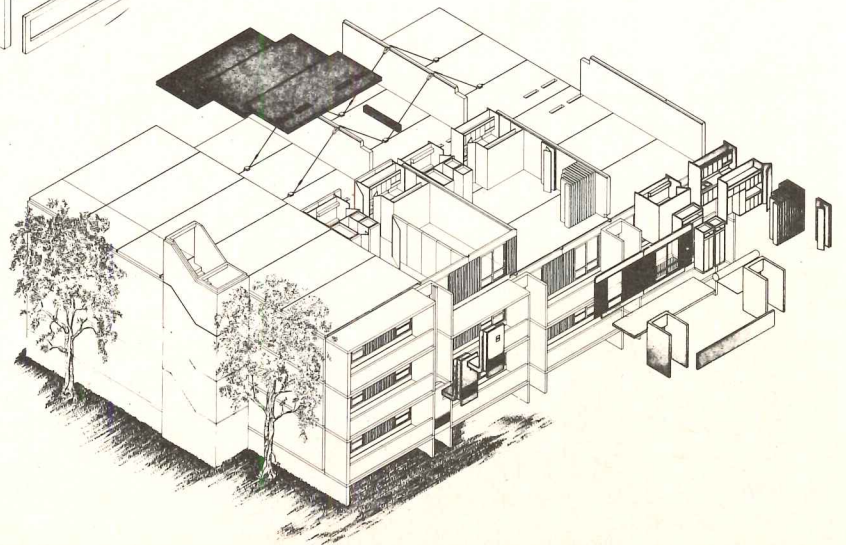
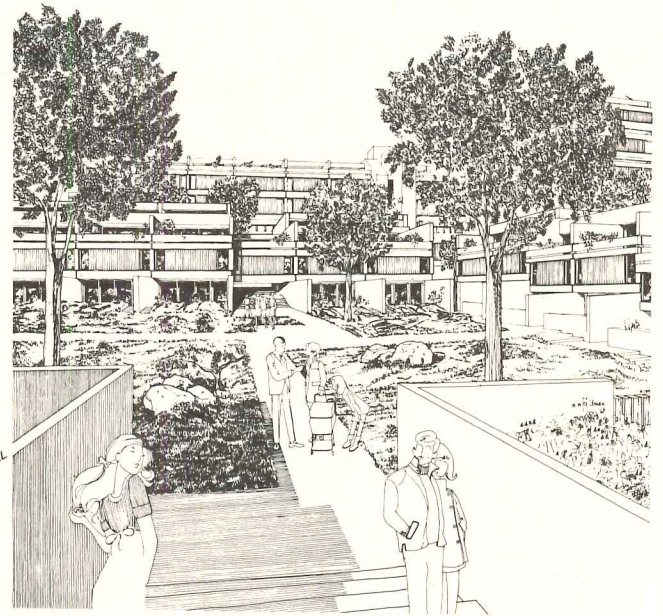
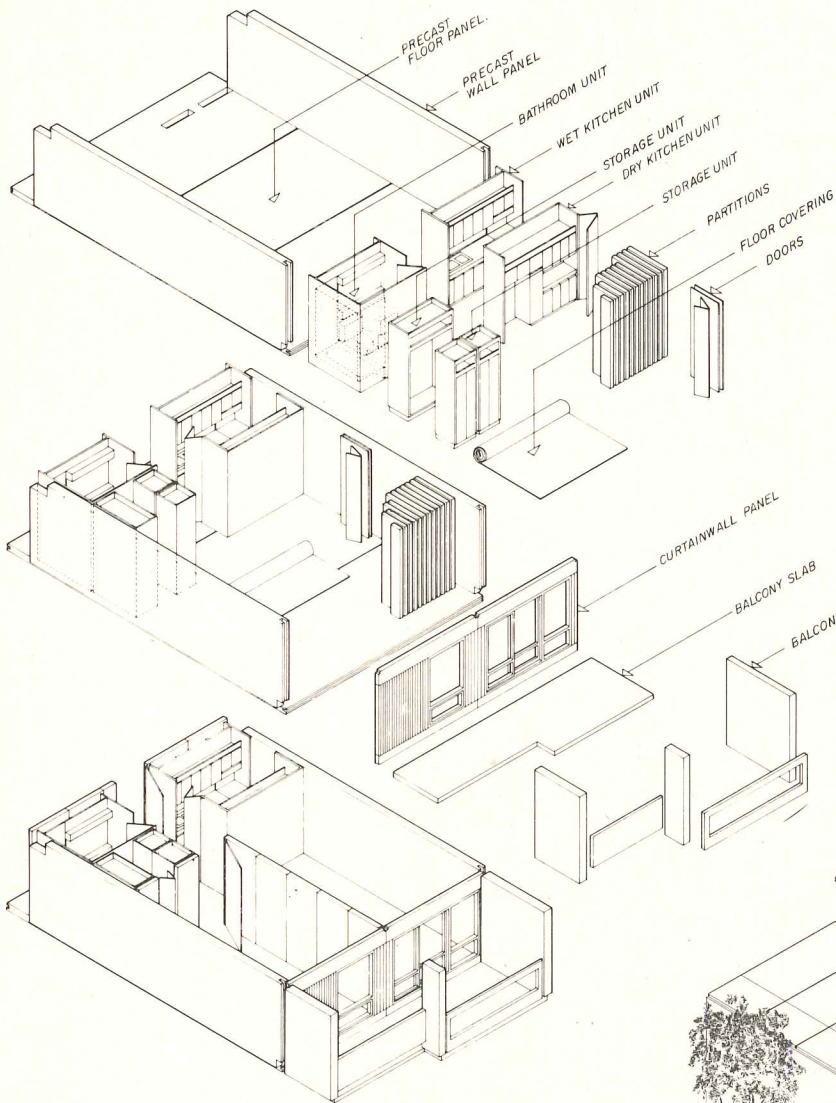
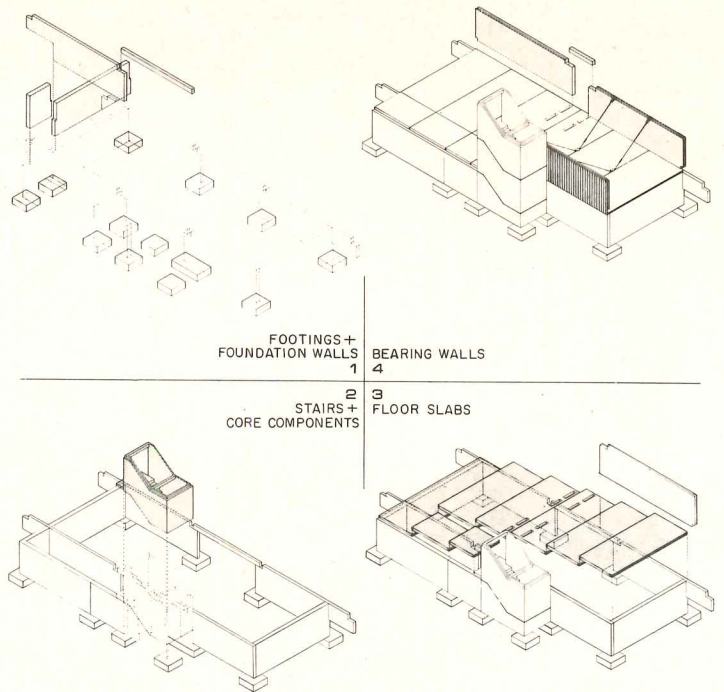

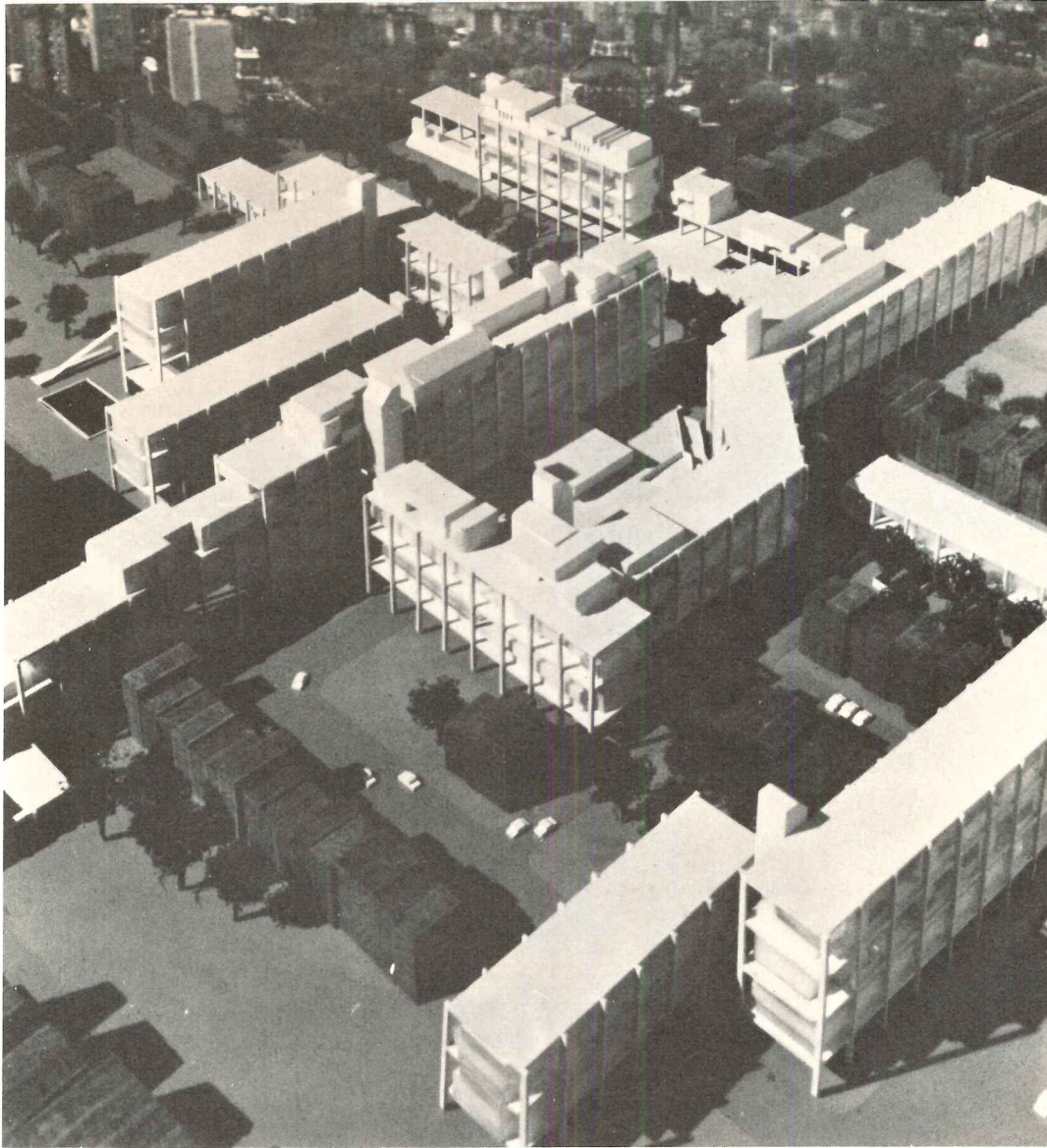

OPERATION BREAKTHROUGH

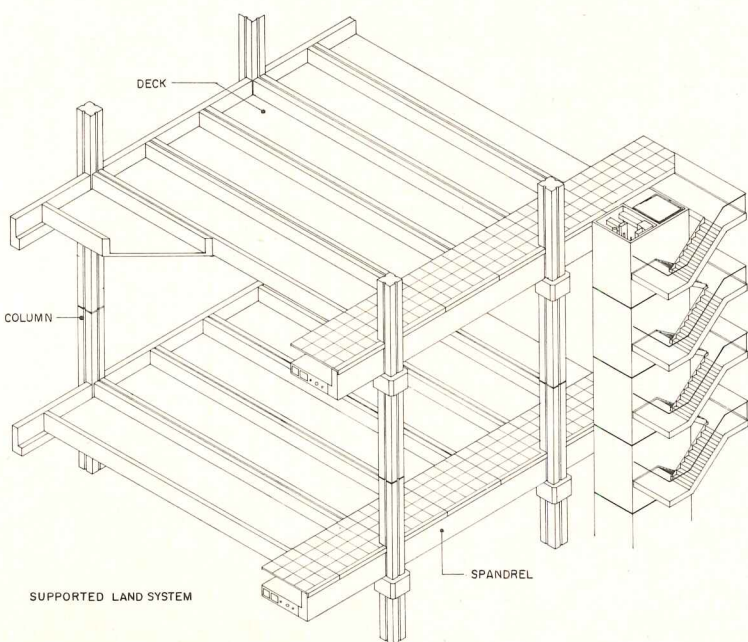
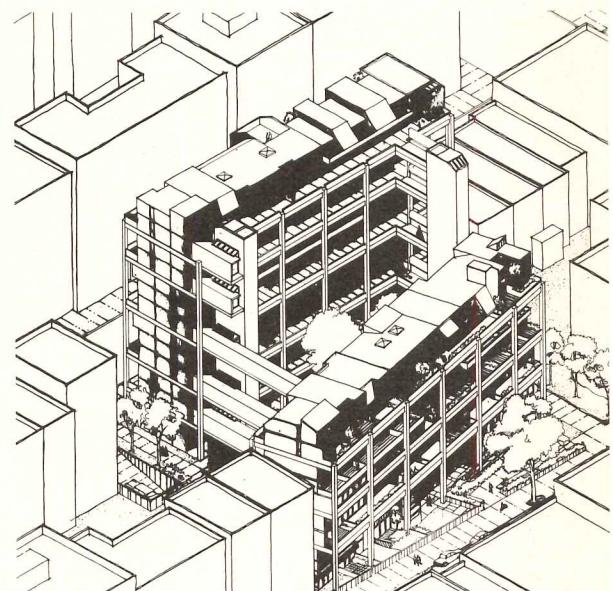
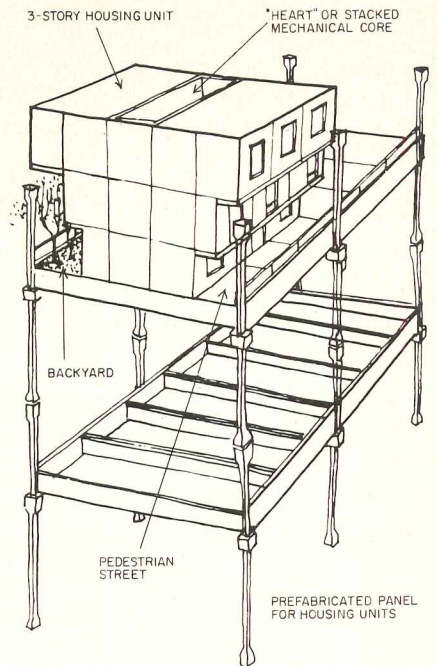

11

Keene Corporation. Keene is a major manufacturer of building materials, and heads a consortium formed to market the Townland Housing System. This system has been developed specifically for Operation Breakthrough; it emphasizes life in the city more than most of the others do, and its proposal has been directed toward bettering the environment in high-density urban areas. The Townland system stresses the life style of its occupants, and provides for the creation of "synthetic land", elevated pedestrian "streets", and earth-filled back yards on the concrete platforms. In most cases, dwelling units would be created by a wide variety of materials and finishes already commercial available, along with lightweight prefabricated core units holding kitchens, bathrooms, etc. These dwelling units would be placed within the main precast structural frame and columns in a variety of ways, allowing for individual expression and even construction. Platforms could be wide apart to accommodate the building of three story housing units between platforms, as in the sketch above. The Townland system allows rapid construction, and by utilizing air rights over existing housing, could be put up on already occupied land with a minimum of dislocation of present tenants.

Consortium members: Keene Corporation, New York; Warner, Burns, Toan, Lunde, archts., New York; Grumman Corporation, Bethpage, New York, Node 4 Associates, Inc., Brooklyn, New York; Formigli Corp., Philadelphia; Alvin E. Gershen Assoc. Inc., Trenton, N.J.; 3H Building Corp.; Robert Hughes Associates, Ltd., Montreal; Lennox Industries, Inc., Marshalltown, Iowa; Portland Cement Assoc., Skokie, Ill.; Ryan Incorporated, Janesville, Wis.; Wickes Corp., Saginaw, Mich.

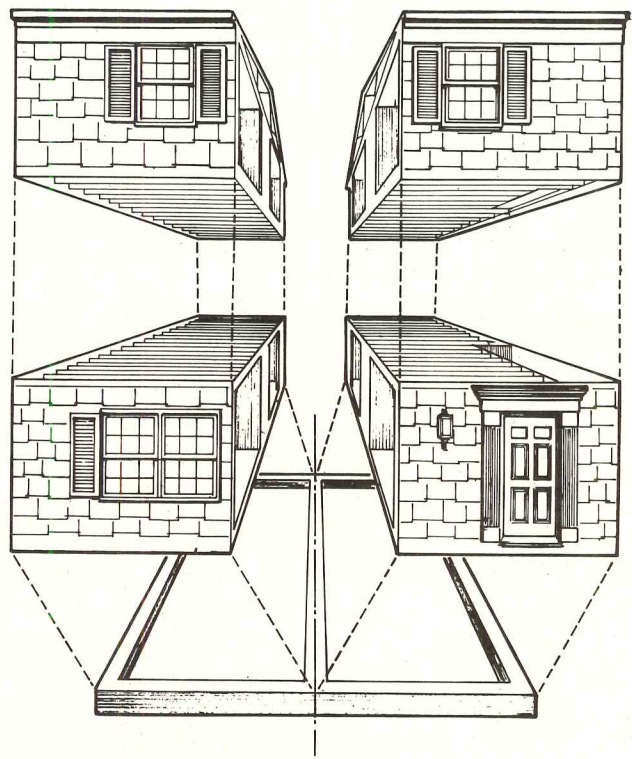
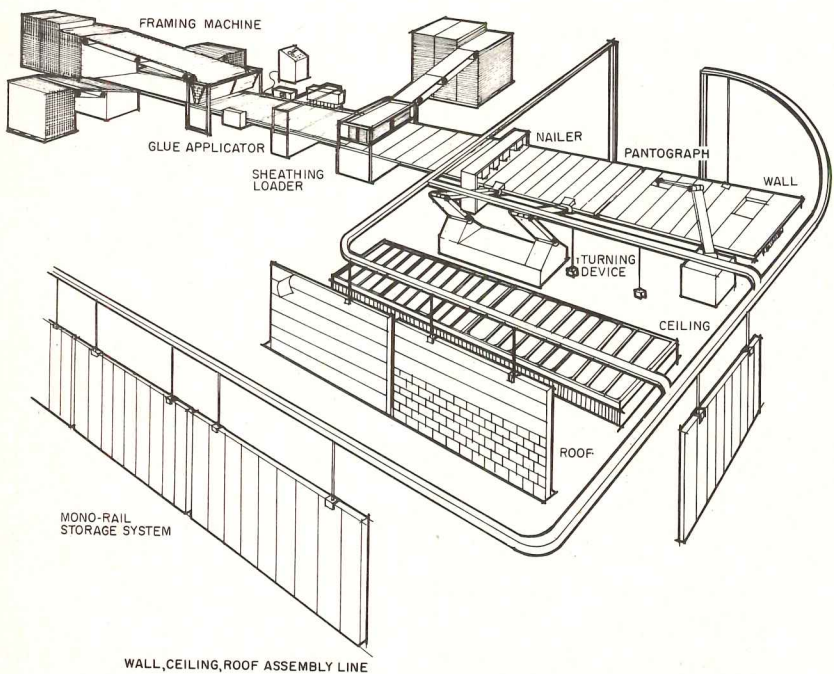
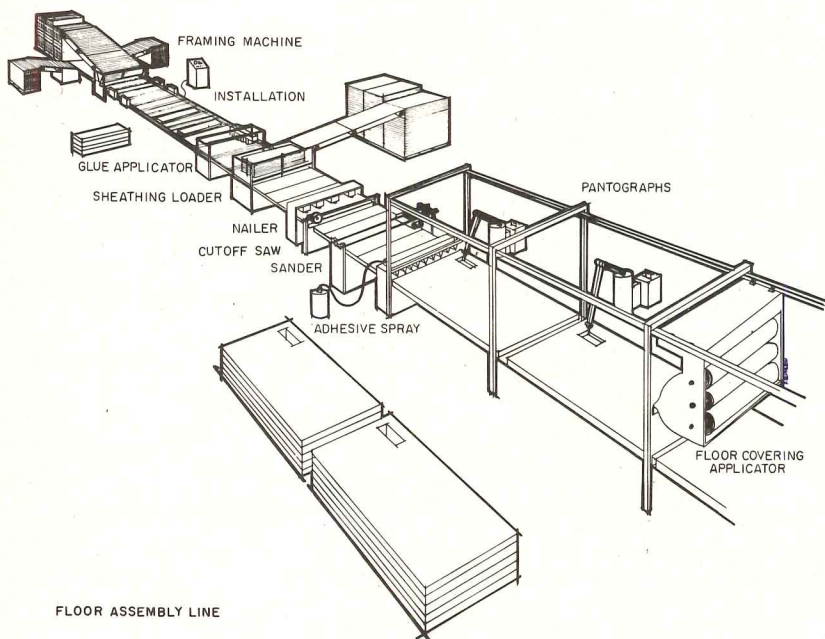

12

Levitt Technology. Levitt will produce housing that looks very much like the site-built units which have been so successful for the firm, except that it will be produced by assembly line techniques. Townhouses, low-rise and high-rise apartments are possible within the new module system. They have created an assembly line system for floor panels (above) and for wall panels (left) and these form three dimensional modular boxes which are arranged at the site into dwelling units. Levitt's factory homes are created from two basic modular types: "wet" modules which would include baths, kitchens, and heating and air-conditioning equipment; and "dry" modules, which are the living spaces divided by the interior partitioning, door, and closet system. The modules do not include fixed elements for the facade, rather they provide a structural frame that allows a variety of exterior parts and materials to be used interchangeably. These include slide-out elements such as projecting windows, balconies, closets, skylights and foyers; fold-out elements such as pitched roofs, balconies and porches, and add-on elements such as entrances, porches, decks, screen walls, balconies, parapets, and awnings.

Consortium members; Levitt Tech. Corp., Lake Success, N.Y.; B. A. Berkus Assoc., Inc., archts., Los Angeles; The Stanley Works, New Britain, Conn.; Auerbach Corp., Philadelphia; Dunham-Buch, Inc.; West Hartford, Conn.; Hamilton-Howe, Inc., Los Angeles; Simpson Timber Co., Seattle.



13

Shelley System. Shelley has developed a precast concrete module with floors, walls, and roof fixed as they come out of the factory. These modules are used as "building blocks" to create an apartment structure. They are stacked in a staggered pattern, as shown here, which resembles a checkerboard of solids and voids in elevation, the voids being approximately as large as a full module. There is no frame into which these boxes are placed; the one below supports the one above it, and the alternate solid-and-void pattern means there is no duplication of floors and walls in the completed structure. The voids are closed in on each end and partitioned as required to provide the living spaces of each dwelling unit. The overlapping edges of the modules provide chases for utilities, and post-tensioning of the boxes provides rigidity in the completed frame, clamping the boxes together. A typical building can be erected with conventional equipment up to 22 stories. The modules are finished when set in place; interior partitions, doors, windows, mechanical and electrical equipment and floors may be installed either at a temporary plant set up at the building site or in a permanent plant built for manufacturing the concrete shell and all its parts.

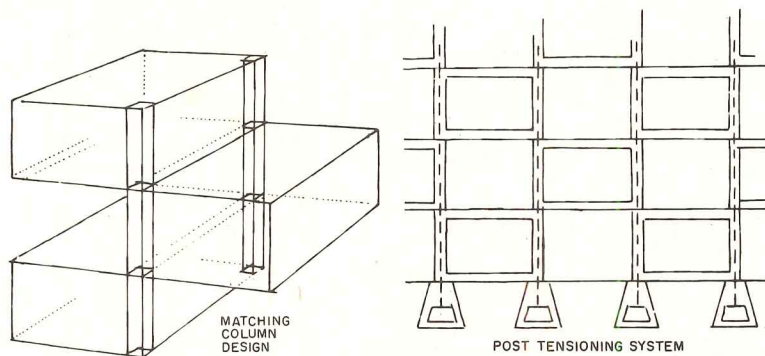

Consortium members: Shelley Systems, Inc., San Juan, Puerto Rico; Banco Popular de Puerto Rico, San Juan; Hampton Development Corp., San Juan; Caribilt Const. Corporation, San Juan; Shelga Corp., San Juan; Carlos Alvarado, Hsg. Mgmt. Cons., San Juan; U.S. Home & Development Corp., Freehold, N.J.; Dr. H. R. Stanton, Worcester, Mass.; Dr. N. P. Loomba, New York; H. R. H. Construction Corp., New York; Urban Systems Research & Eng., Inc., Boston; Robert Phillips (Charter Mortgage Co.), Miami; Dr. August Komendant, Philadelphia; Dr. S. K. Schiff, Chicago.



14

Material Systems Corporation. From the pictures at left, this might seem like the most conservative architectural proposal of the twenty-two, but it is in some ways the most revolutionary. The basis of this consortium's proposal is a new material—"a fiber-reinforced resin and filler"—which was developed over the last ten years as a product of United States aerospace research, and which has never before been used in housing. The resin is applied in molds in an on-site factory to produce fabricated structural and decorative panels and other building elements which are then assembled into the final house. In the picture below, workers are applying the resin to the molds which were used to produce the house above, on an Indian reservation in southern California. The house is made mostly of resin: the roof was formed to look like Spanish tile, the walls to look like adobe brick, corner piers and structure to look like concrete, and the front door to look like antique Spanish wood. Demonstrated, then: the composite resin material permits an almost unlimited choice of final appearance in exterior parts, depending only upon available designs. The material is said to be permanently colored and maintenance free. Tests on the houses completed to date indicate excellent thermal insulation properties and satisfactory structural strengths. The system would ultimately rely on controlled manufacturing processes, and largely unskilled labor.

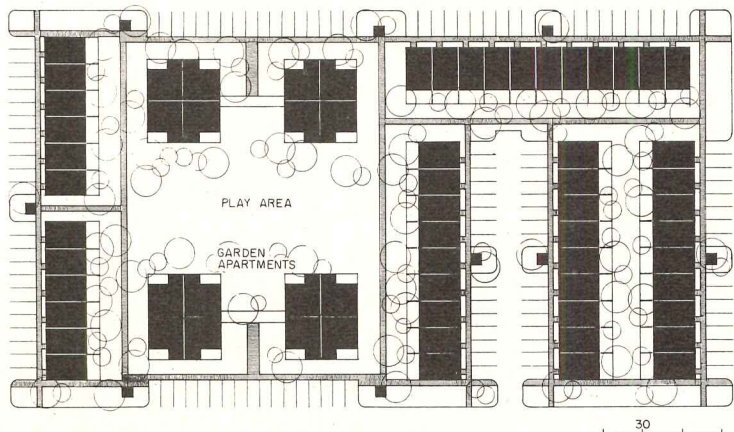

Consortium members: Material Systems Corporation, Washington, D.C.; U.S. Material Systems Limited, San Diego; U.S. Financial, San Diego, Skidmore, Owings & Merrill, archts., Chicago.



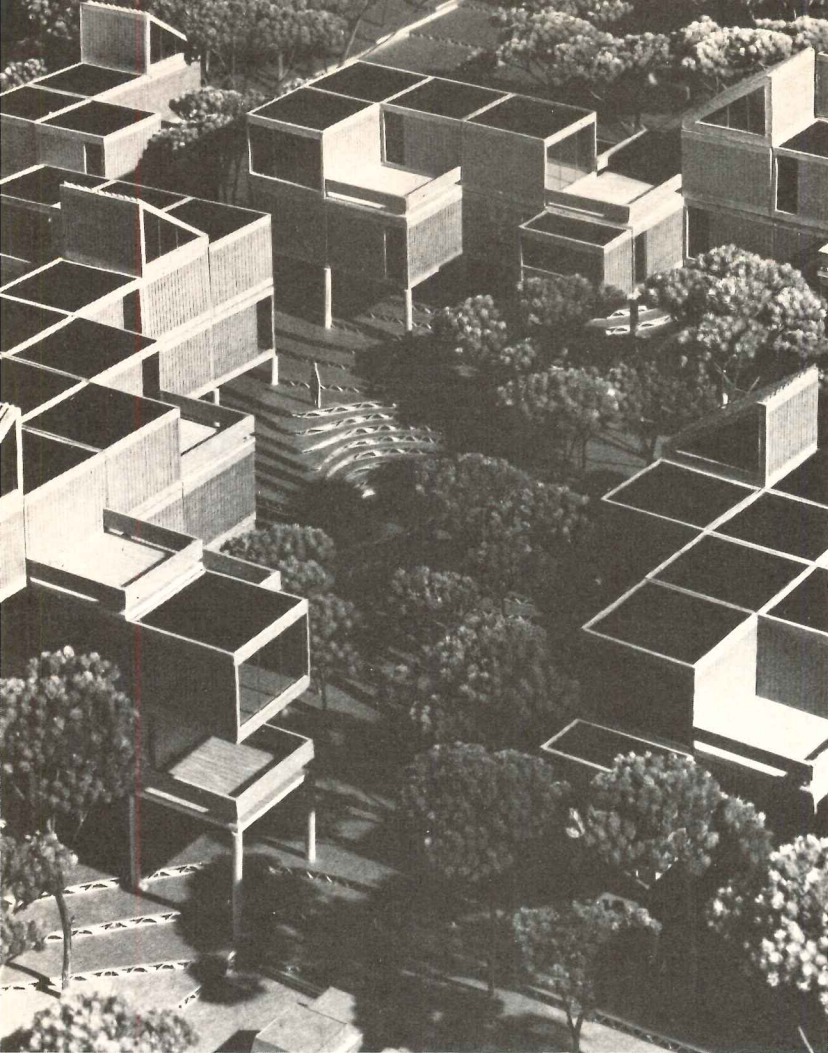

FACTORY FABRICATION

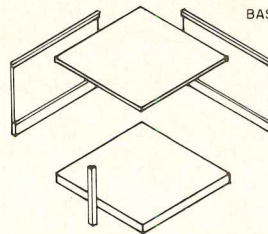

BASIC COMPONENTS

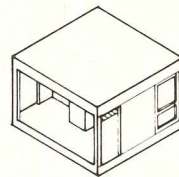
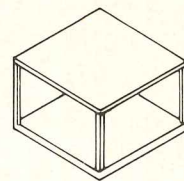

12 MODULE TYPES

SHIPPED TO SITE

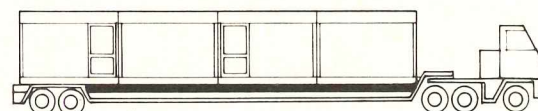

ASSEMBLED AND INTERCONNECTED

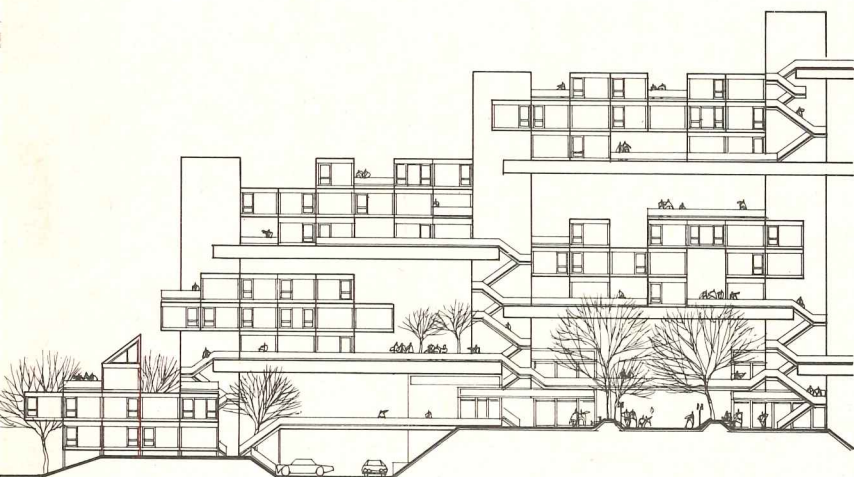
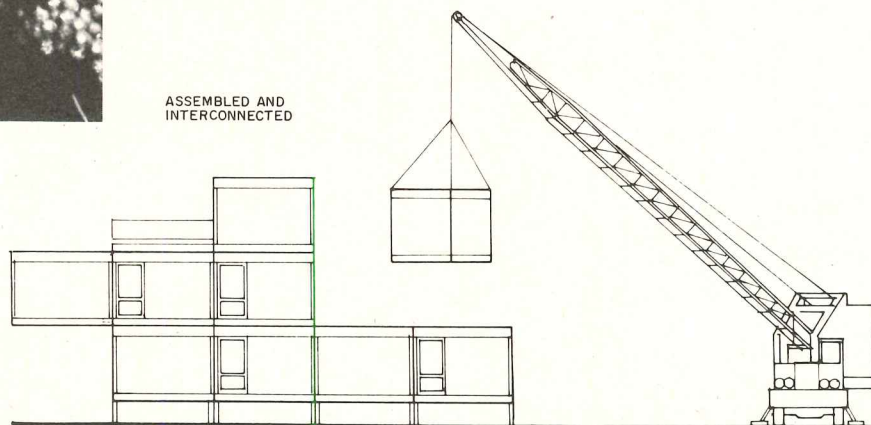

15

Pemtom, Incorporated. This firm proposes a factory-produced volumetric module it calls Unimod, based on stressed-skin plywood. Panels are held together by polymer bond which causes the panel to act as a single structural unit in resisting loads. The system contains the framing material, sheathing, and interior finishing materials in a single unit, reducing the weight considerably. The flat plywood stressed-skin panel is efficient and easy to handle and suitable for roofs, floors and walls. The panels are placed together at the factory into 12 basic module types (plus variations), shipped to the site over the highway or by rail like mobile homes, and erected at the site by stacking them as shown in the series of drawings above. The units can be stacked three high before intermediate structural support becomes necessary, and may be cantilevered the full width of a unit. Rooms can be made of various sizes by combining and dividing modules, and using "room extenders"—half size modules available as an accessory. In production the system would include a choice of interior and exterior finishes, furniture packages, structural accessories such as decks, and modules to change a flat roof to a pitched roof. Pemtom's Living System and their Unimod structures may be used for infill housing on scattered lots, as well as in planned subdivisions.

Consortium members: Pemtom, Inc., Bloomington, Minn.; *InterDesign, Inc.*, archts., Minneapolis; Lorimer, Chiodo & Associates, Minneapolis; 3M Company, St. Paul; Jacus & Amble Engineering, Minneapolis; Community Involvement and Development Associates, Inc., Minneapolis.

National Homes. National Homes is one of the largest home-builders in the country, but it has developed an entirely new stackable high-rise system for its Breakthrough proposals. Its fourteen-foot wide modules (right) form townhouses, garden apartments and high-rise buildings. The modules can be stacked to a height of six floors, although the high-rise buildings will need a separate structural frame for support, as shown below. The system is designed for flexibility in floor plans through the use of three basic modules: the living module, the utility core and the bedroom module. Each incorporates the architectural and structural elements necessary for its function in the dwelling unit. The modules are trucked to the building site where they are combined horizontally and vertically to form complete buildings. The major mechanical innovation of this proposal is the use of a vacuum sewage system developed and first used in Sweden more than ten years ago. Principal advantages are that it sharply reduces water supply needs for families and can substantially reduce initial plumbing costs, especially in large developments.

Consortium members: National Homes Corp., Lafayette, Inc.; Edward Durell Stone & Assoc., archts., New York; Edward D. Stone, Jr. & Assoc., archts., Ft. Lauderdale, Fla.; Semer, White & Jacobsen, Washington, D.C.; Praeger-Kavanagh-Waterbury, New York; Antini Associates, New York; Computer Applications, Inc., New York.

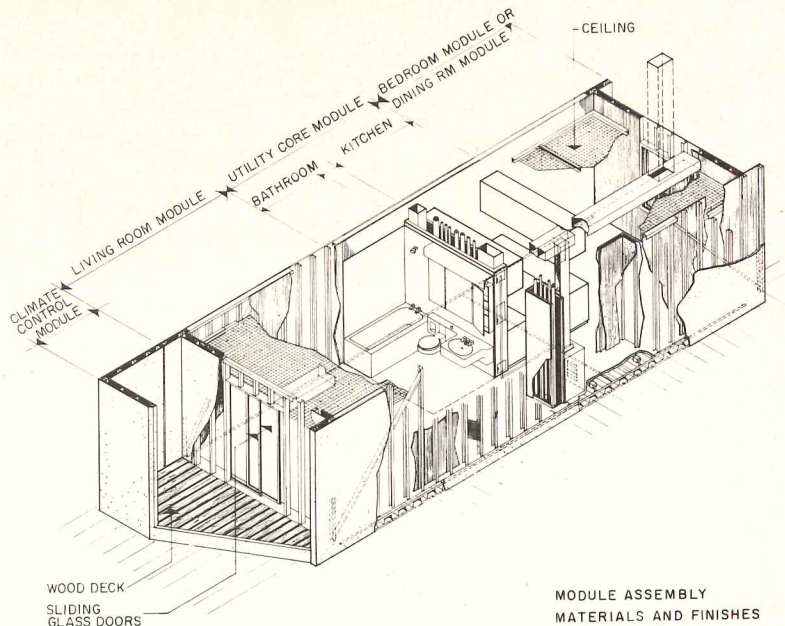

MODULE ASSEMBLY MATERIALS AND FINISHES

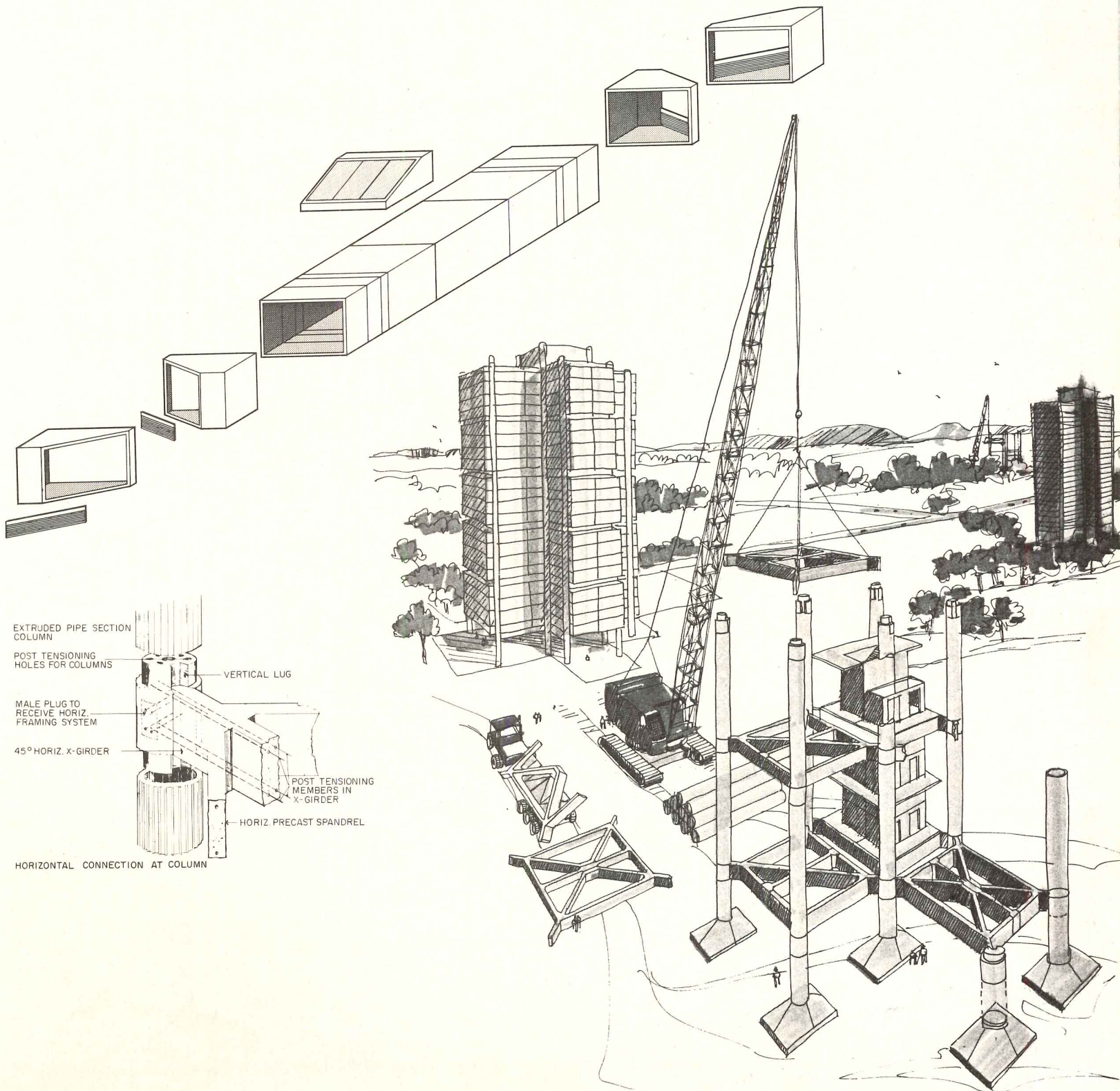

Module Communities Incorporated. Through Industrialized Building Systems Inc., this consortium has the American rights to the European developed Tracoba precast concrete building system, and that is the basis of their Breakthrough proposals. The photographs on this page show various panel shapes and application techniques on actual construction sites, and a typical slab-wall connection joint from the Tracoba system, below. The engineering has been adapted for American usage; it incorporates on-site or near-site factories producing panels and slabs for use in single family dwellings, townhouses, garden or high-rise apartments. Two factories are now being constructed in the United States, and there is an apartment building based on the Tracoba system which will soon be under construction in Yonkers, New York. The sponsors are committed to provide housing other than Breakthrough, and will work throughout the U. S. as investor-developers, or in joint venture with others, they will provide technical assistance to community groups on a franchised basis, or franchise to local contractor-developers.

Consortium members: Module Communities, Inc. (M.C.I.), Yonkers; Celanese Corp., New York; American Standard, Inc., New York; Industrialized Bldg. Systems, Inc., New York; Paul Weidlinger, New York; Consentini Assoc., New York; U.S. Trust Co., New York; Skidmore, Owings & Merrill, archts., New York; Hudson Institute, New York; The National Urban League, New York; Institute for Urban Environment Columbia University, New York; Urban Action & Experimentation Program (UAEP), Columbia Univ., New York; Architects' Renewal Committee in Harlem, archts., New York; Association of United Contractors of Am., New York; F. D. Rich Co., Stamford, Conn.; Royall, Koegel & Wells, Washington, D.C.

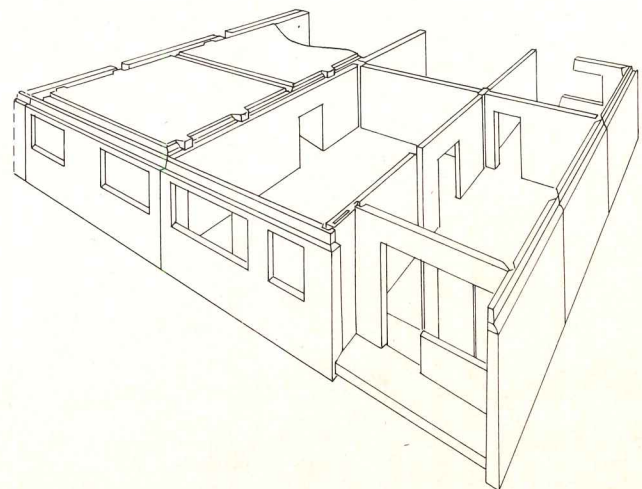
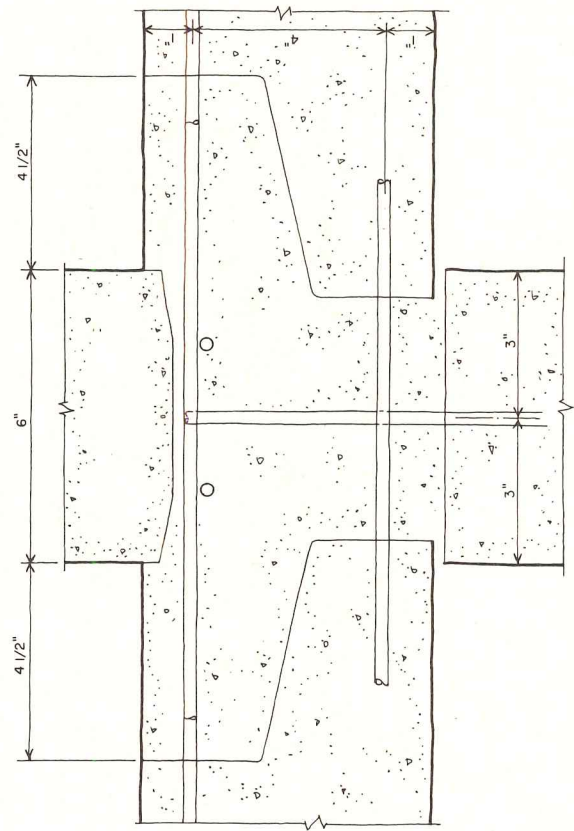
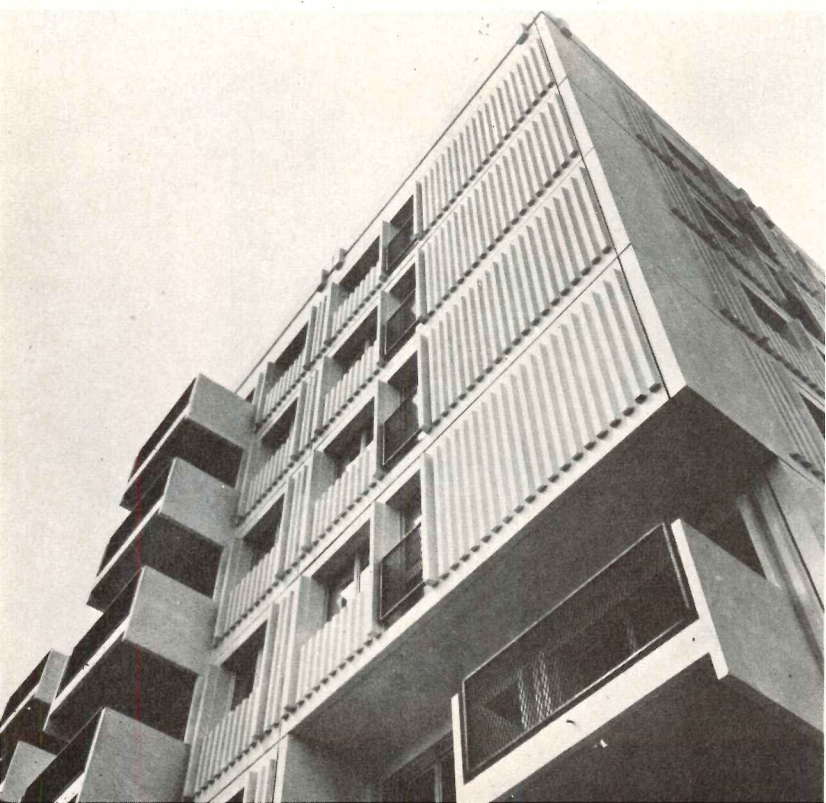
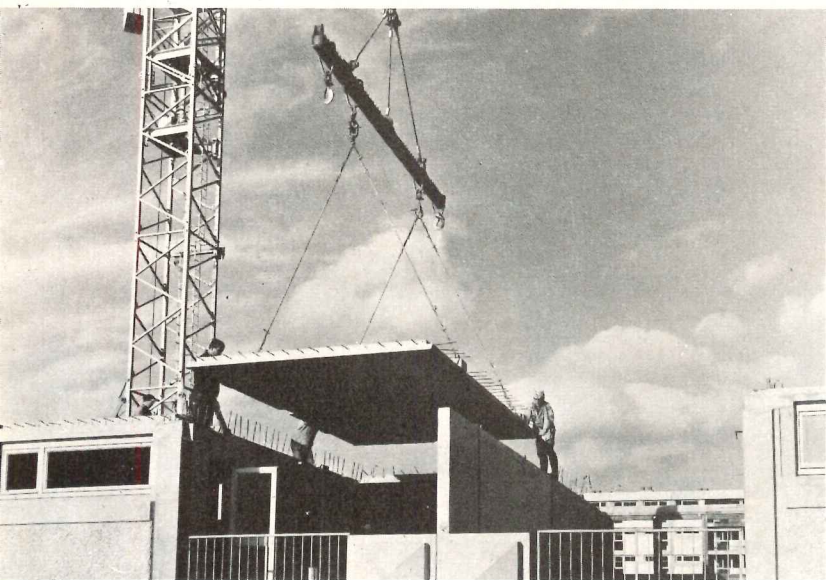
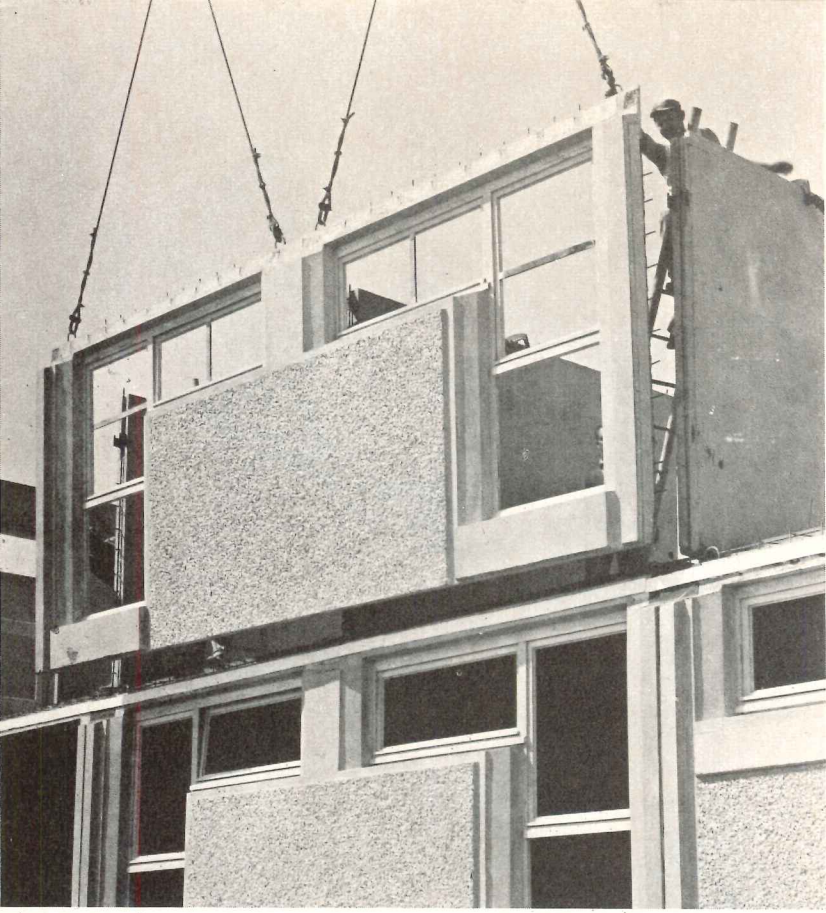

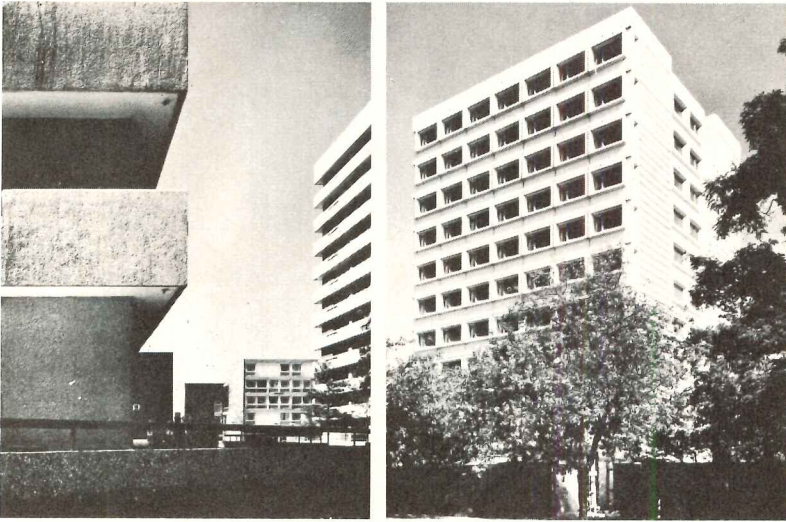

18

Rouse-Wates. The Wates precast concrete building system has been used extensively in England to produce residential structures of all kinds, as shown in these photographs. It is the basis for this consortium's Breakthrough proposal, along with the Rouse Corporation's extensive experience with residential development in this country. The Rouse-Wates system employs on-site, factory-produced concrete panels; story-high pre-cast concrete wall panels are joined with room-size precast concrete floor panels at the site, to create low or high-rise structures. Wall panels have exterior surfaces completely finished in a variety of architectural treatments and are installed fully glazed and insulated, ready for interior painting and decoration. An in-system elevator is part of the development package, with prefabricated entrance units, car units, shaft wiring, and machine room unit.

Consortium members: Rouse Development Co. of the Rouse Co., Columbia, Md.; Wates Systems, Inc. (USE) of Wates Ltd. (London, England).

19

Ball Brothers Research Corporation. The Ball system uses a foamed plastic core structural panel as the basis of its housing system. The composite panel is fabricated from a 4-foot by 8-foot sheet of hardboard, and a 4-foot by 8-foot sheet of asbestos board as the outside skin over a polyurethane foam core. The two skins are held in place prior to foaming with an aluminum extrusion which becomes a part of the edge of the panel and a component of the panel locking system. After the foam is poured between the panels the exterior surface is covered with an $\frac{1}{8}$ " coat of epoxy matrix and stone aggregate. Interior surfaces may be prefinished with either paint, wallpaper, or prefinished panels. A central core containing the heating unit, bathrooms, and kitchen is prefabricated and delivered to the site as a complete unit. Single family dwellings, low-rise apartments, and possibly high-rise apartments can be erected from the Ball Brothers system.

Consortium members: Ball Brothers Research Corporation, Boulder, Colo.; Borg Warner Corp., Chicago; Building Officials Conference of Am., Inc., Chicago; Elliott H. Brenner, archt., Lafayette, Ind.; Leo E. Zickler, Indianapolis; American Fletcher Mortgage Co., Indianapolis; Oxford Development Corp., Indianapolis; Tectron, Inc., Indianapolis; Floyd E. Burroughs & Associates, Indianapolis; Ball Corp., Muncie; Bradley & Bradley, Architects, Fort Wayne; Ewing Miller & Associates, Terre Haute; Applied Decision Systems, Inc., Cambridge, Mass.; Bolt, Beranek & Newman, Inc., Cambridge, Mass.; The Foundation for Cooperative Housing, Washington, D.C.; Blyth & Co., Inc., New York; The National Urban League, New York.

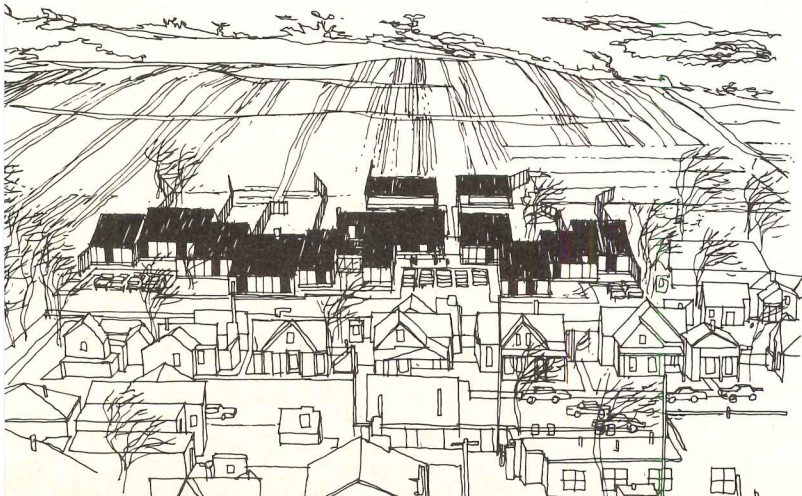
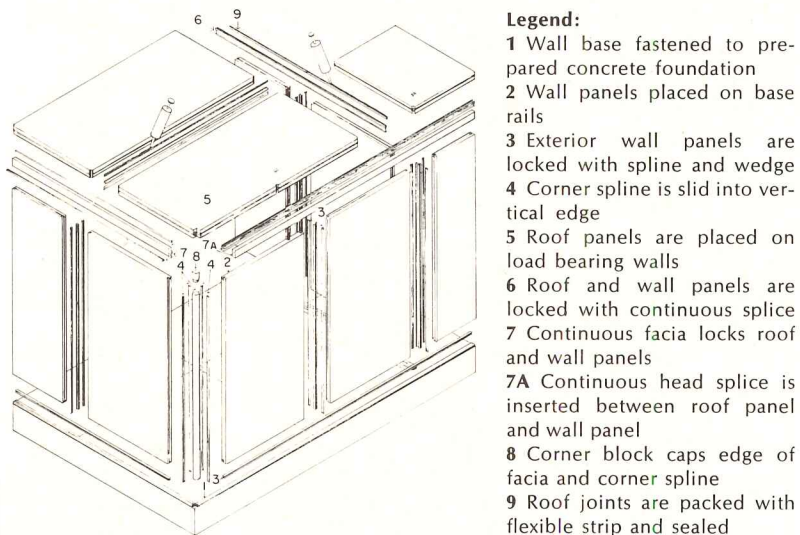

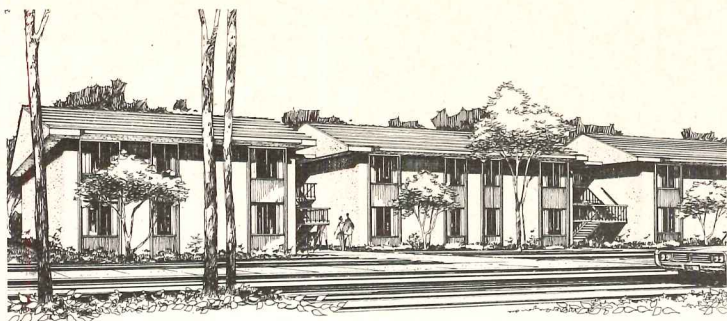

20

General Electric Company. For several years, G-E has been developing a factory produced housing system for the Department of Defense, to be used at George Air Force Base, and they have relied heavily on the experience from this program for their Operation Breakthrough proposals. G-E proposes to manufacture major subassemblies for townhouse and apartment units, which would be supplied to local builder/developers who would erect the dwelling units, using the corporation as technical support. They will pick a builder/developer to create the first prototype housing for Breakthrough, rather than develop the site themselves. The system is primarily directed toward single-family detached housing and multi-family row housing, rather than high-rise. The building systems consists of rigid floor panels of honeycomb core with stressed plywood skins that serve as a pallet for the house subassembly and transportation to the site. Interior walls and ceilings are finished with plaster that has been precast in full wall and ceiling lengths at the factory, as in the photo above, (it shows a roof with cast-in-place plaster on it being lowered onto the walls). Walls and ceilings are thus joint free.

Consortium members: General Electric Company, Philadelphia; Hugh Gibbs and Donald Gibbs, archts., Long Beach, Calif.; Leon Julius, archt., Washington, D.C.; Candeub, Fleissig & Associates, Newark; FCH Services, Inc., Stamford, Conn.

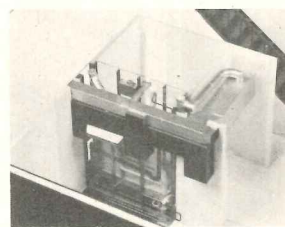
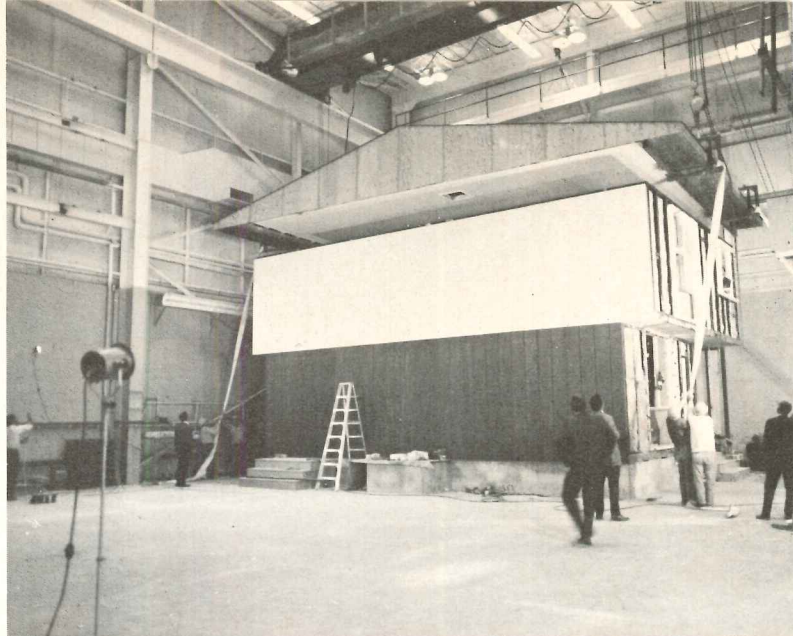

Utility chase

Cast plaster wall

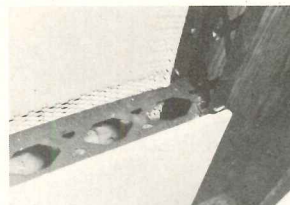

Honeycomb floor

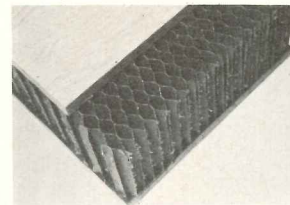

21

Hercules, Incorporated. The Hercules wood-framed modules shown below are already in production, with the large variety of shapes delivered to the site by truck, and placed together. This system is proposed for Breakthrough sites requiring single-family attached, detached, and low-rise dwelling units. High-rise applications are to incorporate metal module frames and panels around which light-weight concrete will be poured. The metal module frames and panels will serve the dual purpose of providing formwork and reinforcing for the concrete. Steep and irregular terrain is accommodated by placing both building systems on stilts.

Consortium members: Hercules, Inc., Wilmington, Del.; Modular Structures, Inc., Bethesda, Md.; Armstrong & Salomonsky, Arch., Richmond, Va.; Harlan, Betke & Myers, Inc., New York; University of Utah, Salt Lake City.

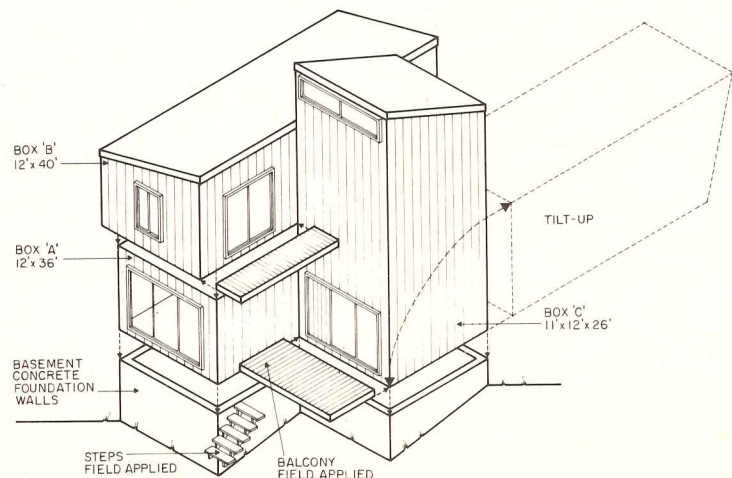
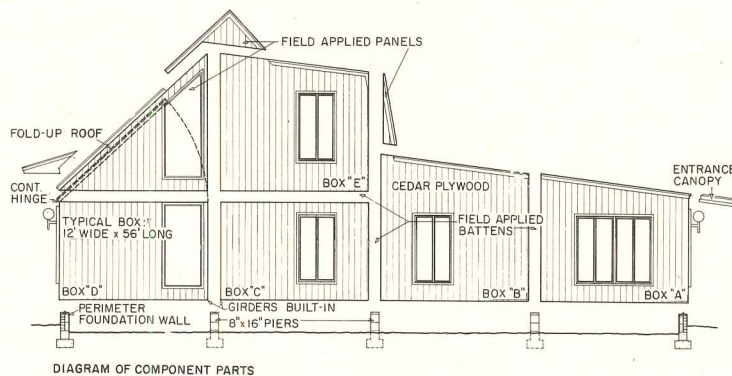

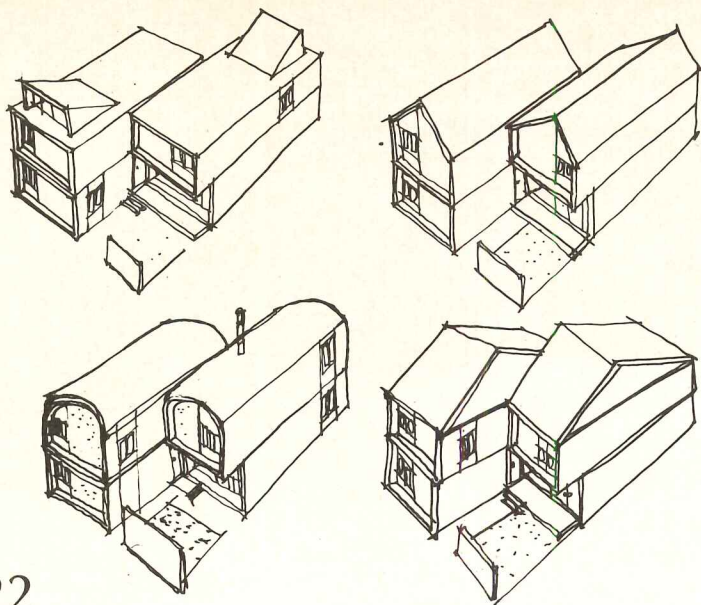

22

TRW Systems Group. TRW will manufacture mandrel-wrapped, fiber-shell modules for use in single-family residences, townhouses, low-rise apartments, and, eventually, in high-rise construction. The production system involves an off-site factory for manufacturing panels and small shapes plus a relocatable on-site factory which will produce room sized modules on a mandrel capable of assuming many different configurations. The wall of a typical TRW module is made of a honeycombed paper core, illustrated at right, which is "wrapped" with resin on the large mandrel assemblies, shown above. The mandrel can wrap a whole module at once, and the module can be any one of many shapes: triangular, oval, or rectangular with pitched round or flat roofs. Panels only are shipped to the site and wrapped in the mandrel, so that the dimensions of the modular unit are not restricted by the size of the largest box which can be shipped over the road. Many exterior and interior finishes are possible; stucco, wood panelling, vinyl, sheet rock, or any other substance which adheres to the adhesive used in wrapping.

Consortium members: TRW Systems Group, Redondo Beach, Calif.; Bldg. Systems Development, Inc., San Francisco; Kaufman & Broad, Inc., Los Angeles; Mid-City Developers, Inc., Washington, D.C.

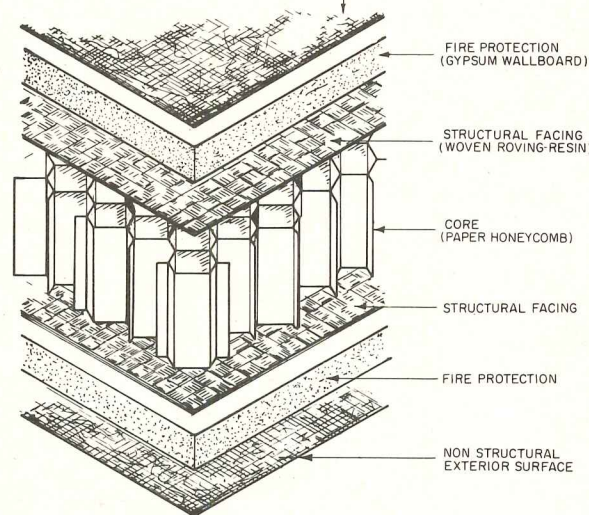
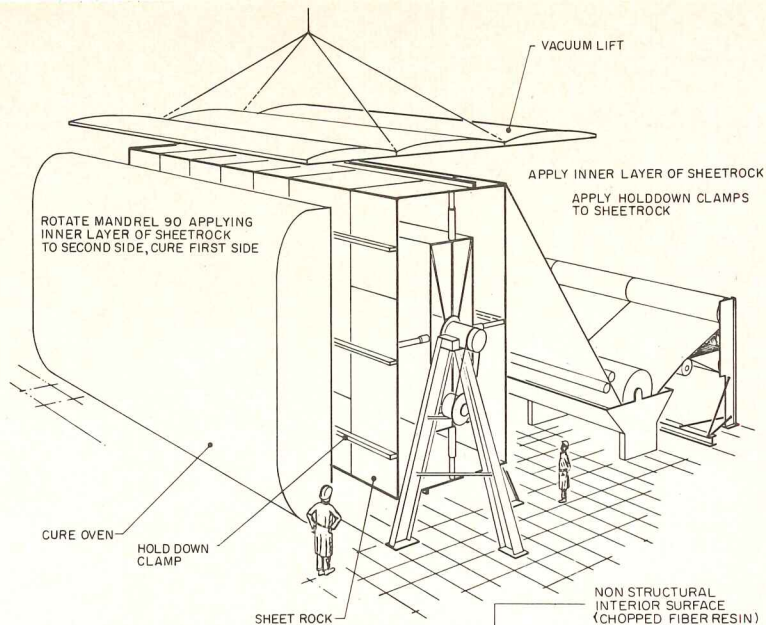

BREAKTHROUGH SITES AND "SITE PLANNERS"

HUD has completed the assignment of their "site planners," all but two of which are architects, to the eleven sites, as listed below. It is essential that there be no discrimination in the rental or sale of housing on these sites, and HUD seems committed to this. There will be two or three different systems on each site and this could create a nearly impossible planning problem, unless systems visually or sociologically incompatible with each other are kept apart.

Wilmington, Del. This rolling, wooded, suburban site is located about five miles from downtown Wilmington. The site is 100 acres, which is part of the State-owned Ferris School for Boys. RTKL, Inc., Architects, Planners, Baltimore, Md.

Houston, Texas. The site consists of 15 acres in Harris County, about three miles outside the city limits in the Clear Lake area. Caudill Rowlett Scott, Architects, Planners, Engineers, Houston, Texas

Indianapolis, Ind. Site is on the periphery of the city near the Indianapolis Speedway. The tract of up to approximately 80 acres is a part of the former State Mental Health Farm, now owned by Marion County. Skidmore, Owings, Merrill, Architects, Engineers, Washington, D.C.

Jersey City, N.J. This 6½ acre inner-city site is one block from Journal Square, the heart of the downtown area. This site, in the St. John's urban renewal area, has a view of downtown Manhattan, which is 20 minutes away by rapid transit. David A. Crane—Architects, Planners, Philadelphia

Kalamazoo, Mich. This site of approximately 30 acres is located on a plateau overlooking a lake in Spring Valley Park in Kalamazoo. Perkins and Will, Architects, Planners, Engineers, Chicago, Illinois

Seattle, Wash. The selected area is a combination consisting of about two acres in the Yesler-Atlantic Neighborhood Improvement Project in the downtown section of Seattle, and a plot of approximately 30 acres in King County.

Building Systems Development, Architects, Planners, San Francisco

King County, Washington.

Eckbo, Dean, Austin and Williams, Landscape Architects, Planners, San Francisco, California

Macon, Ga. This 50-acre site is presently an attractive pine-wooded estate with a six-acre lake located on Chambers Road, four miles from Central Macon, in a rapidly developing area of Macon.

Reynolds, Smith and Hills, Architects, Engineers, Planners, Jacksonville, Florida

Memphis, Tenn. This site of approximately 10 acres is located in the Court Avenue urban renewal area in downtown Memphis, near the University of Tennessee Medical Center.

Miller, Wilhry and Brooks, Landscape Architects, Engineers, Louisville, Kentucky

Sacramento, Calif. This site of up to 60 acres occupies the eastern portion of the old California State Fairgrounds located at 57th and Broadway about four miles southwest of downtown Sacramento.

Wurster, Bernardi and Emmons, Inc., Architects, San Francisco, Calif.

St. Louis, Mo. This prototype site occupies two neighboring parcels of 7.6 acres and 7.9 acres in the Mill Creek urban renewal area in downtown St. Louis.

Hellmuth, Obata and Kassabaum, Inc., Architects, St. Louis, Mo.

Many excellent proposals didn't get picked as winners, and several of them will probably continue to develop their systems

Such corporate giants as Westinghouse and U.S. Steel failed to get selected for Breakthrough prototypes; Westinghouse particularly has been deeply involved in housing through its Urban Systems Development Corporation, and will continue to take full advantage of government funding programs for low and middle income housing. U.S. Steel has developed a steel module framing and erection system in conjunction with a Walt Disney hotel project in Florida, and could convert this into housing without much revision. It is impossible to tell how much new technology will come out of HUD's Type B program; it has not been evaluated yet by HUD and few people have seen the proposals. It is beginning to look like the Type B's are being neglected in favor of the more visible Type A program, and this would be too bad. There is a place for visionary, even unbuildable proposals for housing, because they tend to extend our conceptions of what is possible in city life, thereby extending, in time, what we really do.

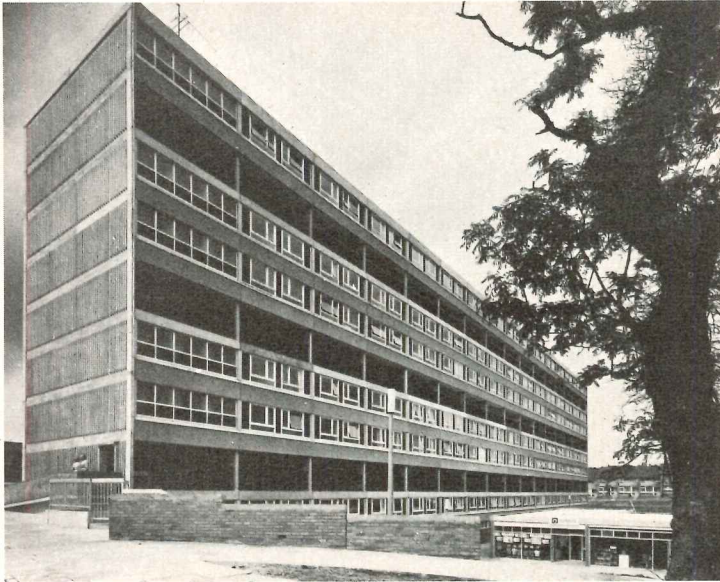

Sectra America. This is the only consortium of the 37 semifinalists which is headed by a group of architects and although it was not selected as a winner, the system will continue to be developed without HUD backing. The Sectra System is a proven European industrialized technique, handsome, and one of the most efficient in higher-density core city sites. Further, the Sectra America proposals to HUD recognized that the most pervasive and fundamental problems in housing are in the realm of management, institutional commitment and human relations; they are not primarily technical or material. The firm of Ecodesign, headed by three Boston architects, were leaders of the consortium team of two large contracting firms. Sectra is a concrete system, with the usual precast floors and walls, involving a movable formwork and curing frame which can be used on site.

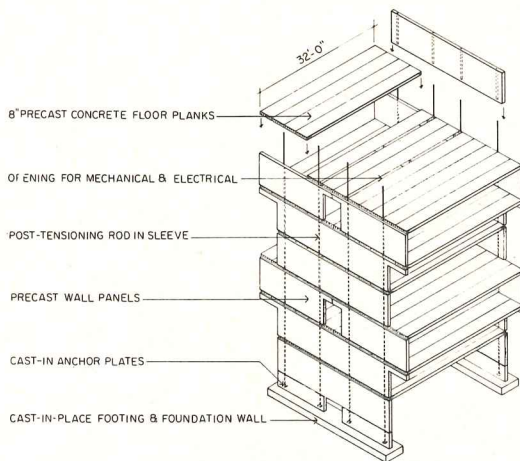

Omniform Incorporated. This consortium based its technical proposal on the Sepp Firnkas Structural System, which has been proven on more than 2,000 housing units already constructed in the United States, and it is a system with very flexible architectural applications—it has been used for housing and as the basis for an office building design (by Paul Rudolph) now under construction in Dallas. Sepp Firnkas was the engineer working with Carl Koch for several years; Koch's Techcrete system was also a Breakthrough proposal that came near to winning but didn't, and Techcrete is very similar to the Firnkas system. Further, the Development Corporation of America, another consortium which did not win, proposed a structural system of precast concrete slabs and walls relying on much of the same technical experience and previously built housing which lead to the Koch and Firnkas proposals. It is curious that none of these three systems have been given further support by HUD, for they represent innovative thinking on the creation of factory-built housing, and are based upon work that has been under test for the last years.

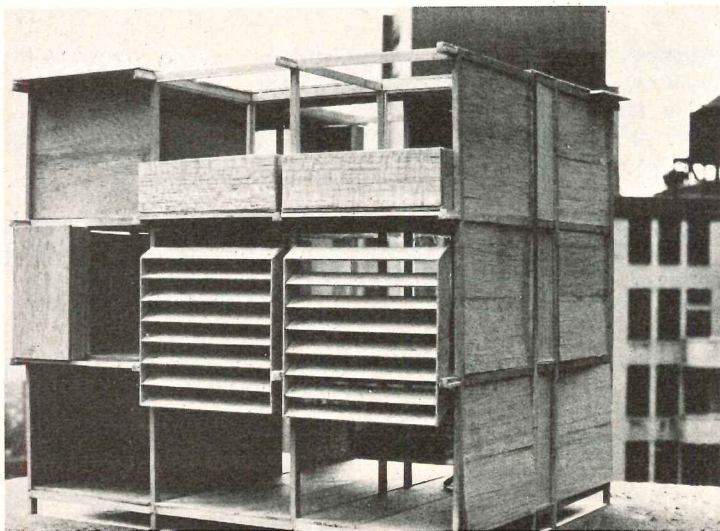

Mid-City Developers, Inc. This consortium has been asked by HUD to contribute its "management expertise" to Operation Breakthrough, but it was not one of the 22 winners. Its structural system is based upon the framing system developed by Neil Mitchell Associates of Boston. The system has been under development for about six years, there are construction demonstration units completed in Austin, Texas and Lancaster, Pennsylvania, and it can be developed into very handsome architectural configurations, as in the illustration at left, proposed for a development in Israel. An early version of the Mitchell system has already been tested by National Bureau of Standards when code restrictions threatened to stop construction in Detroit. The Mitchell system is a post and beam concrete technique, with infill slabs for floors and walls, rather than the usual structural precast slabs. A large amount of field construction and casting is possible, if labor sources and locations make this more feasible than using a factory.

What the systems approach means to air conditioning Part 4

by Robert E. Fischer, senior editor, and F. J. Walsh, consulting engineer

Experienced architects and engineers know what constitutes good design and construction quality. Unfortunately, this knowledge is not transmitted sufficiently to owners in terms they understand. Owners, through their staffs, have yardsticks for evaluating the quality of completed HVAC systems. Architects and engineers know what alternates are possible within the range of quality levels they feel the

owner wants. But more tangible, agreed-upon yardsticks—quantified where possible—should be developed. The owner needs to be better informed about the implications of the quality of: 1) architectural and engineering design services, 2) construction management services, and 3) physical construction. While these are difficult to define and explain, they are the key to over-all quality.

The term quality applied to building systems, sub-systems and materials can only be measured in relative terms. Whatever degree of quality the owner has in mind needs to be defined in fairly great detail if there is to be common understanding among designer, manufacturer and installer. Obviously the most meaningful indications of quality will emanate from the most knowledgeable owners. Furthermore, there can be a number of levels of quality, and different owners will decide what level they want based upon a balance of appropriateness, reliability, maintainability, first cost, operating cost, etc.

The most knowledgeable owner is the one who has adequate technical staff on the same level as the architects and engineers he retains. Also, the knowledgeable owner is the one who is able to indicate in physical terms what he wants and what his usage and space requirements are so that this information can be communicated to his consultants. If we rate the owner in quality terms, quality could be equated with knowledgeability.

The quality chain is comprised of the owner, the designer and the contractor

It is particularly important that the owner be able to define what services he wants from his architectural and engineering consultants, and for this to be possible they must advise him what their services are in terms of: staff organizations and levels of competence used, preliminary planning, reports, budget evaluations, comparative evaluations, quality and completeness of engineering drawings, detailing of how

elements fit together physically, and scope of construction management services.

Perhaps the organizations best able to evaluate quality and scope of professional services are those which have an architectural-engineering staff and do a certain amount of design and construction supervision, inspection and construction management. Unfortunately, these organizations are confined principally to the heavy-industrial field with only a few counterparts in the commercial and institutional areas. An example of an exception would be the building construction and maintenance staff of a large metropolitan hospital requiring large and complicated mechanical and electrical systems. Such staffs often are more particular in what they call for in professional services because of the critical as-

pects of maintainability, access to equipment, and the necessity of provisions for change. They also may ask for more services related to inspection because of the complexity and criticality of the installation. Beyond this, such owners realize that they need to prequalify the contractors doing the installation to assure they get what they call for.

The next link in the chain of quality involves architectural and engineering services and how they are defined. Much of the time, the scope and detail of architectural and engineering services are not spelled out as completely as they should be. Thus, the range of services, and hence quality, that might be provided for the same type job can vary widely.

Architects and engineers have had

CHANGING BALANCES IN EVALUATING QUALITY

Changing technology and changing industry influences complicate the problem of defining, controlling and securing desirable quality levels at least cost. Knowledgeable decision-making by the owner and by architects and engineers requires more clear-cut standards relating to materials, equipment, system performance, A/E services, construction engineering and construction management services.

Slow Response
Consultant's own judgment, research and verification of actual experience

Quick Response
Evaluation or approval by governmental or quasi-governmental groups

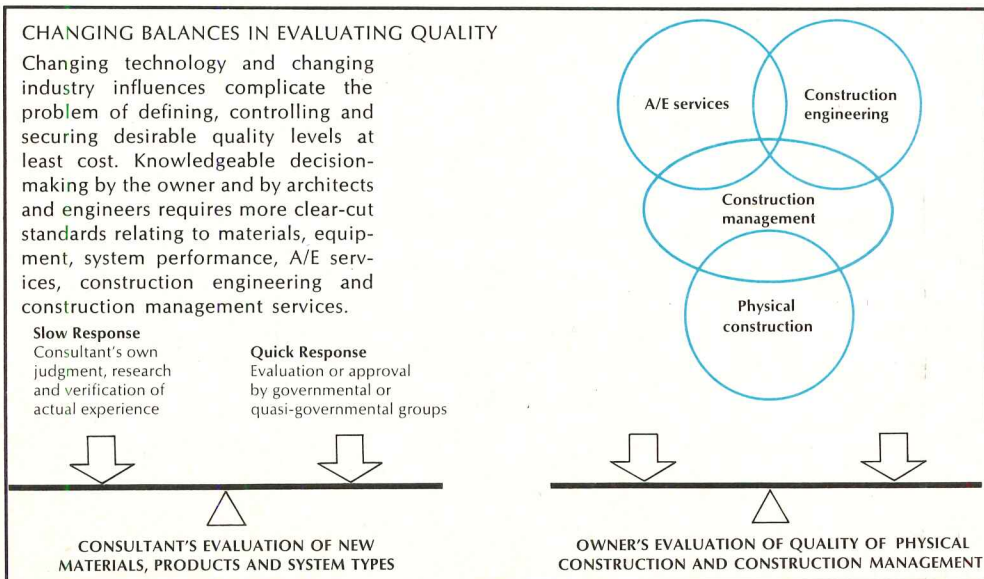

**DIRECT ARCHITECT- AND ENGINEER-GUIDED
DESIGN AND CONSTRUCTION**

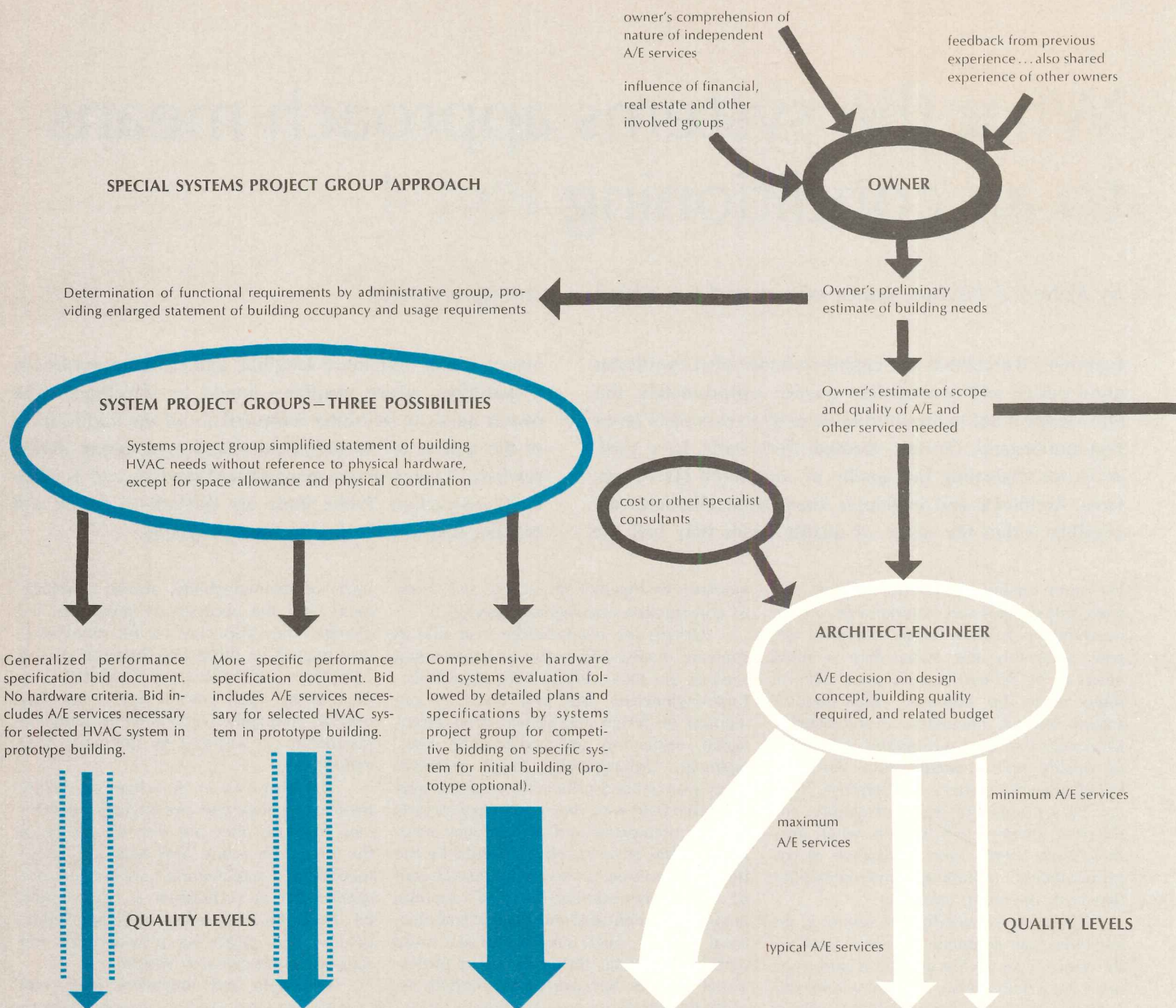

- 1. PHYSICAL CONSTRUCTION**
May be preceded by mock-up construction for acceptance testing.
 - 2. CONSTRUCTION MANAGEMENT SERVICES**
Includes: a) acceptance tests, b) all phases of putting system into operation, c) evaluation of operation.
 - 3. SPECIFIC SUPPLEMENTARY CONSTRUCTION MANAGEMENT SERVICES OTHER THAN BY CONTRACTOR**
Owner designates specific services to be provided by A/E, specialist consultants, or owner's staff. Reason: 1) insures better quality, 2) supplements services either not available from or not satisfactorily done by contractor.
- Effective control depends upon detailed specific guidelines, inspection, test, and measurement.*
- Management services can implement design, but not effectively supplement it.*



MULTIPLE BUILDINGS

The key to system quality is quality of design and construction management services plus construction by quality contractors.

PACKAGE OR TURN-KEY APPROACH

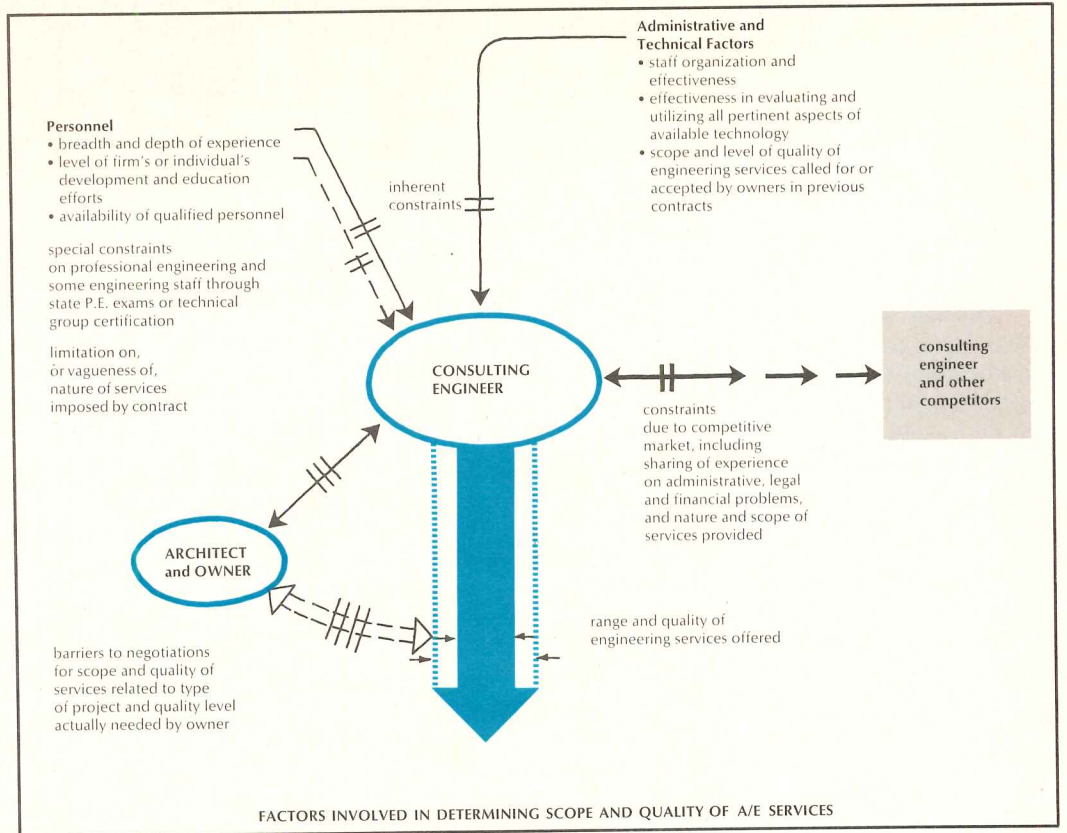
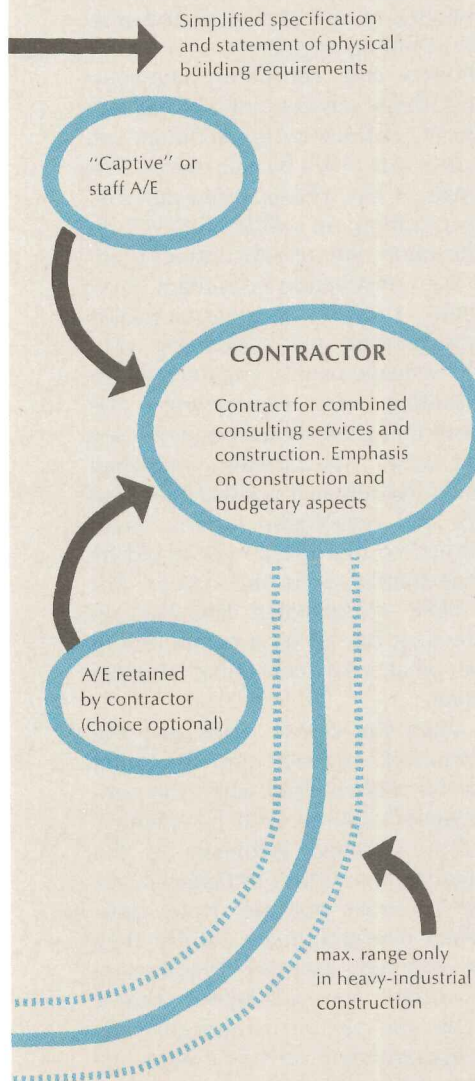

Quality of an air-conditioning installation depends upon a number of factors that link up like a chain. Quality can be achieved only with detailed criteria for each element.

Quality is bound to be highly variable when: 1) criteria are too vague, 2) performance specifications are too open, 3) design input is weak, limited in scope, or overly

restricted in responsibility.

"Quality" will vary with building types and with owners' motivations. Owners and designers of critical facilities such as hospitals should seek higher quality than those of speculative office buildings. Experience in the latter area does not yield expertise in the former. Construction consultants and owners often ignore this.

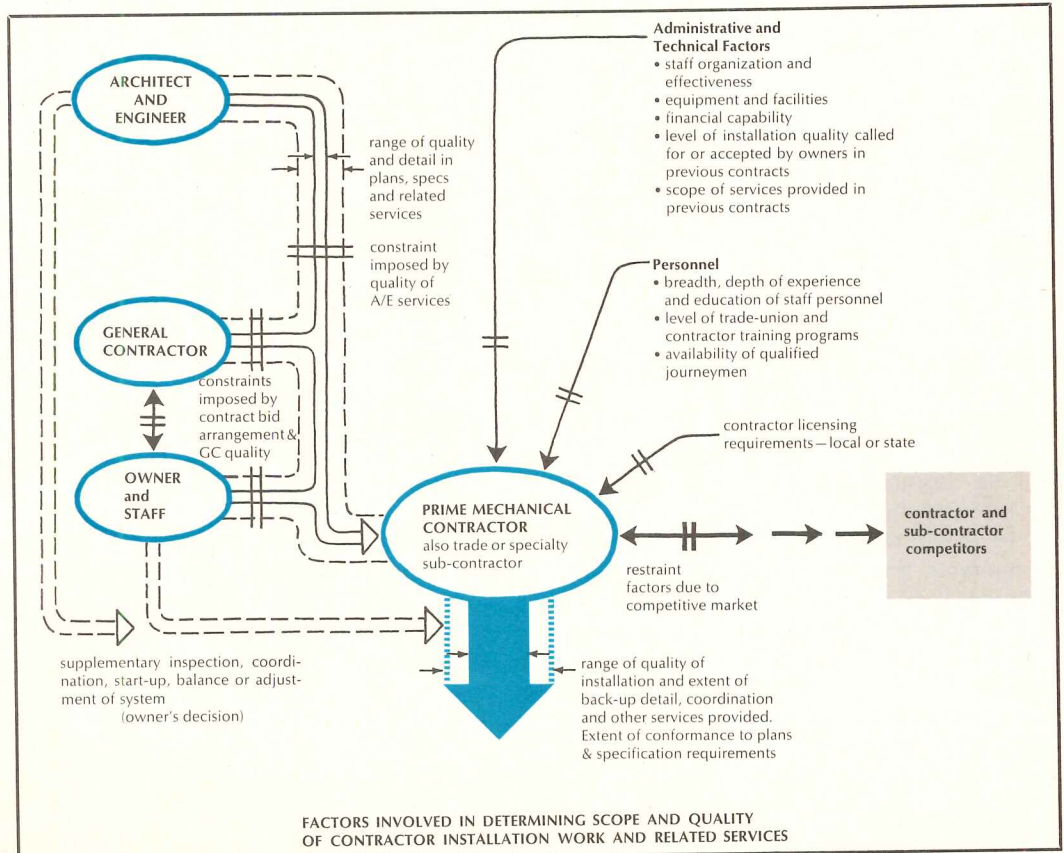

to direct an inordinate amount of attention recently to liability problems related to deficiencies in construction and functioning, and third-party claims arising from various hazards. So thus it is today they "inspect" and "observe," rather than "supervise." "Supervision" is probably a term that never should have been used, for the reason that supervision implies monitoring contractor's personnel as they are doing a job. The terminology was not good. When the economy was less competitive this did not matter much. But today, there is even less "inspection."

On top of this, architects and engineers have not really defined what the qualifications should be of the construction superintendents in the various trades. While not all qualifications need be fully spelled out, and while consideration must be given to what quality of personnel is available, nonetheless sufficient qualification can be required—in effect indirectly prequalifying the contractor as far as personnel are concerned.

In any consulting firm, the technical base is derived from the experience that individuals have brought with them from previous firms. Consulting engineers find it increasingly difficult to acquire and keep current all the pertinent information on various phases of design, construction and operating and maintenance technology. Owners are not really able to evaluate the quality of technology used by a particular firm. The conceptual engineering that goes into design is not reflected without detailed study of the plans and specifications, although degree of detail and completeness is, and this is easier to evaluate. With standard approaches to design (for example, some types of school heating and ventilating) conceptual thinking is at a minimum. But the upgrading of standard design, changing to a different type of system, calls for quality of engineering conceptual ability.

While consulting engineers may develop standards for design, indicating that certain systems should be selected for certain applications and design be done in a certain way, frequently references are not identified adequately, and their relevance not periodically reviewed. The quality rating of a given engineering firm thus should include an evaluation of the currentness and adequacy of scope of its technical information. The main purpose of these standards is to minimize errors and to expedite the flow of work. Unfortunately consulting engineers seem reluctant to share this information, considering the standards to be in the realm of "trade secrets." This contradicts the concept of a profession wherein there should be voluntary uniform acceptance of standards and procedures.

Sharing of information among professionals occurs mainly in areas of administrative problems rather than technical. There ought to be more interchange relating to quality levels, design features, types of installations and how satisfactory they are, field inspection problems, etc.

The quality of services the engineer can provide is governed to a large extent by the quality of his personnel. Consulting engineers in the building field complain that they have difficulty these days attracting competent people. Perhaps one of the reasons for this is that the consulting engineering profession has not spelled out in detail the qualifications for personnel at different staff levels. There is a lack of consensus among these consultants as to what education, experience and other qualifications are required for different phases of work whether it be calculations, design and drafting, detailing, or evaluation of controls, job start-up, etc., tied in with building type, and type and size of system. Furthermore architects and owners do not ask consulting engineers how they plan to staff each job because they have not set up criteria themselves.

The range of quality and detail of work done by various engineering consultants varies widely, and this will always be true to some extent. But it would seem that quality of work cannot be upgraded without the consultants establishing qualifications for different levels of work. There is a lack of consistency today from consulting firm to consulting firm in the way personnel are elevated to different levels of responsibility. Admittedly this is difficult to achieve, particularly with today's emphasis on production and time schedules, but unless standards are established, the marketplace will determine the quality it will buy. With personnel standards established, however, the more particular owners will use the more particular engineers, and the profession, over-all, should benefit.

A third link in the quality chain is the actual physical construction or putting together of the elements, whether it be in the shop or on the job—fitting together of pipe or setting a piece of equipment. Architects and engineers need not tell the contractors how this work should be done. With application of coatings, finishes or insulation, on the other hand, the engineer could insist on methods of application to insure proper quality. For example, with painting of exterior surfaces he might want to require steps such as sandblasting and even the type of equipment to be used, and allowable weather or ambient conditions.

Setting the qualifications for design and construction services

In terms of architectural and engineering services, there are not, for the most part, licensing exams that serve as a qualification function in specialty areas. However, certification or screening may be possible through technical or professional society examinations, supplementing state licensing. Strangely enough, state registration boards do not usually allow as experience time spent in construction engineering and management with contractors. The point is that engineering is concerned not only with engineering related to design before instal-

lation but with what happens during and after it.

The consulting engineer does perform certain construction management functions during system construction, however, whether this be inspection and reporting on a minimal basis of what he has seen, more detailed observation, or even conducting performance and acceptance tests of portions of the systems. The services may extend to involvement in balancing, testing and adjustment, or actually supplementing plans with detailed drawings to assist the contractor in installation. More and more, general contractors and others are offering broad-scope construction consulting services which emphasize cutting time of construction and control of budgeting cost factors combined with an "acceptable" level of quality. The construction consultant, generally speaking, is not bound by the same restrictions, such as ethics and qualifications as certified by state screening, as are architects and professional consulting engineers.

Architects and consulting engineers know what these services entail. They can be specifically defined by the architect and engineer, but not really by the owner. The professionals, if they chose, could put construction consulting on a different level, retaining the same type of subcontractor advice that the construction consultant does. They could provide cost-versus-quality evaluations terming this consulting construction "management" engineering or cost consulting cost engineering. This would mean that professional engineers are doing the work, not directly concerned with supervising physical construction, and reasonable and meaningful criteria could be established so that the service could be made understandable to the owner. For example PEPP (Professional Engineers in Private Practice) has set up a committee to determine what cost consulting services should entail.

Too often the owner reads into the vaguely worded contract the maximum service for his money. Even when the consulting engineer's liaison with his client is through fully qualified engineers in the client's organization, others in financial and managerial positions may be overly optimistic. When disappointment results, they blame the consulting engineer. The practice of hazily-worded contracts allows others to come into the picture to perform construction management services, undercutting the consulting engineering.

How control of the construction process is achieved

Decisions as to sequence of operations, equipment and tools used in the construction process will be made by the general contractor. Too often the contractor's attitude is that the architect and engineer should not have any part in suggesting changes. But the architect and engineer should give thought in their plans and specifications to the possibility of one op-

eration interfering with another. The sequence should not be allowed if: 1) it does not provide sufficient time for submittal of shop drawings from the subcontractors and study for approval, 2) it does not provide enough time for certain tests that are to be witnessed by architect or engineer, 3) certain work is covered up before inspection can be done (example: insulation put on piping before the piping can be tested for tightness or insulation applied to ductwork that will be concealed by ceilings or chases). If performance tests are required on certain portions of the system these will have to be considered in the sequence of operations. Also in the picture are inspections by governmental and insurance representatives.

It is important to note that architects and engineers cannot properly evaluate the contractor's schedule unless they understand how the work will be done.

More frequently today, architects' and engineers' plans are, because of competitive reasons, less complete than heretofore. If a contractor is given schematic drawings and is asked to provide installation drawings, there may or may not be space and coordination problems. Perhaps not if the building is of fairly standard design with standard equipment and system arrangements, and if the contractor has the right personnel. But still, problems may arise with provisions for access and maintenance.

Knowledgeable owners who spell out additional services they want from architects and consulting engineers beyond those ordinarily required also often retain specialty mechanical and electrical contractors for cost consultation.

The one who is closest to the mechanical and electrical trades is the consulting engineer. But if he is to provide consulting construction management and/or cost engineering services, he first of all has to define what his basic services encompass with regard to system engineering. The trouble is that today these are not made altogether clear to the owner. He will have to explain his services in clearer and more comprehensive terms to owners if he is to convince them that he can undertake consulting construction management engineering as well. The unchallengeable advantage to the owner of obtaining these services from the consulting engineer or architect-engineer is that these professionals who also are continually engaged in design have a continuing base for making judgments. The deficiency of any construction consultant who does not practice consulting engineering is that he does not understand design.

What criteria do owners use in evaluating the performance of architectural and engineering services? Implicit, of course, is that buildings and their systems satisfy their intended purposes. But owners are especially concerned with two other criteria: 1) how well design completion schedules are adhered to, and 2) how detailed and well presented evaluations and records are. In respect to drawings and specifications, the

owner is influenced more by volume and draftsmanship than content. Further, owners evaluate consulting engineers on whether or not shop drawings are approved fast enough to allow contractors to proceed on schedule. Conflicts can arise, and jobs delayed interminably, if shop drawings are not presented in proper form to the consultant by the contractor. The consultant has to prove to the owner that his work is moving as fast as can reasonably be done. The time factor can readily be measured by the owner; not so the competence of the consultant's staff nor whether the proper amount of work is being done by the proper people. Thus consultants, in order to protect themselves, will want to urge prequalification of contractors wherever possible. Building trades unions have not established sufficient categories of specialty journeymen consistent with changes in equipment and system technology. Neither have they established adequate training programs or personnel screening procedures, either independently or in conjunction with contractors or manufacturers efforts in necessary areas.

Consultants' problems in making product and system evaluation

If quality levels are to be pinned down more precisely, the consulting engineers must define ranges of quality in the physical installation—a piece-by-piece quality-level evaluation. The terms, a "Cadillac" system or a "Ford" system are meaningless. An example of this type of characterization might be a fan-coil system in an apartment building relying on infiltration for ventilation versus a fan-coil system with ventilation air. The fact of the matter is that with the basic fan-coil system itself there are big differences in cost and quality—for example, in a seemingly simple matter of the way the condensate drains are handled.

Architects and engineers obviously will have more incentive to consider a wide range of quality levels if the client is paying a reasonable fee. But why make specifications and planning more complex to save the owner money when it results in a cut in fee that is marginal to start with?

There always has to be a certain amount of safety factor in what the engineer specifies because he does not always

Definitions

Quality—is a series of characteristics that can be defined in relative terms. It can be used to describe the value content of professional or management services involved in building construction, or the value of the physical construction itself. The latter would be measured in terms of wearability, dynamic performance or various physical attributes which sometimes can be tested in terms of prescribed numerical standards.

Construction—job-site erection and/or assembly; also application of contractor shop or field-fabricated or factory-produced system or sub-system elements or finish materials.

Construction engineering—in the broadest sense includes: 1) Detailed interpretation and evaluation of plans and specifications produced by A/E services. Provision of such services to the extent sufficient to keep up with current system design technology. 2) Detailed knowledge of construction practices and related basic construction management. 3) Detailed knowledge of supplementary construction management practice including cost evaluation and budgeting. 4) Detailed knowledge of system operation and maintenance technology and costs.

Basic construction management—all services by trade or specialty subcontractors relating to: 1) supervision of supplying and installing all elements of the physical installation, 2) simple functional tests and functional start-up, etc.

Supplementary construction management—all services not required to be performed by trade or specialty subcontractors, such as: 1) inspection, measuring or recording of acceptance test data, 2) coordination and overall scheduling, functions, 3) operational start-up, balance test and adjustment of systems, etc.

Specifying Quality A/E Services

Definition of services and statement of A/E firm responsibilities may be of limited comprehensiveness in standard contract agreements developed by consultant organizations. Basis for this is legal advice regarding professional responsibility hazards and restrictions of liability insurers, which the consultants must accept in order to receive insurance coverage. Insurance consultants necessarily base their restrictions on worst risks. This necessarily reflects experience with consultants whose quality is less than average.

Quality and completeness of A/E services (once a firm has been selected) involves consideration of the following:

1. Defining project staffing criteria relating to level of engineering involved and personnel qualifications essential to each area of work.
2. Engineering reference data and design criteria to be used by consultant.
3. Depth of analysis, amount of detail, and format of agreed upon preliminary engineering reports and plans prior to final design decisions.
4. Exact manner of establishing budget construction estimates.
5. Exact amount of detail and coordination required for working drawings and specifications.
6. Selection and prequalification of possible general contractors and all subcontractors.
7. Detailed discussion and agreement on construction schedule and arrangements for optimum use of A/E firms' supplementary construction management services, based insofar as possible on this schedule and a careful evaluation of quality level of contractors being asked to bid.
8. Detailed discussion and agreement of post-construction A/E services relating to optimizing HVAC system operation and assistance to owner in establishing and optimizing operating and maintenance provisions.

While system quality stems from the quality of design services, it depends also upon quality of fabrication and erection.

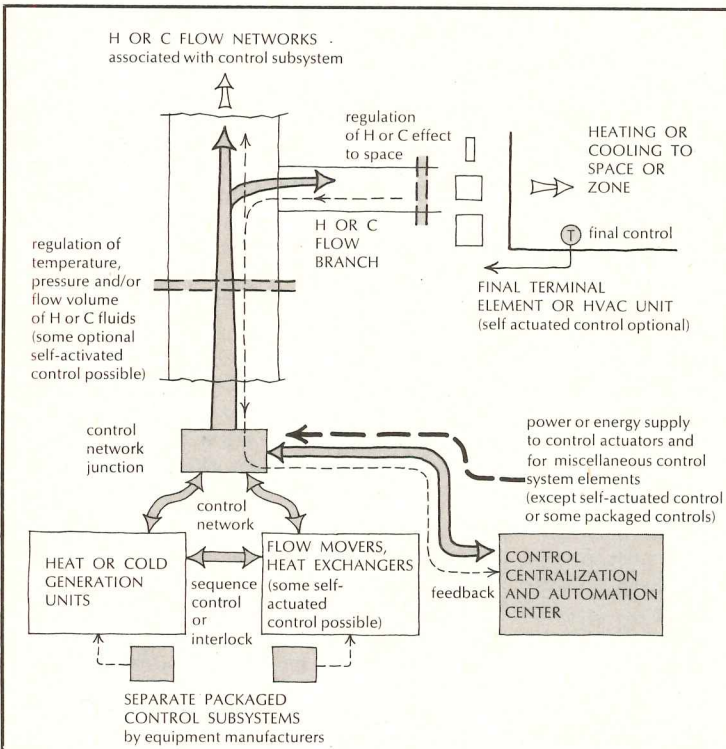
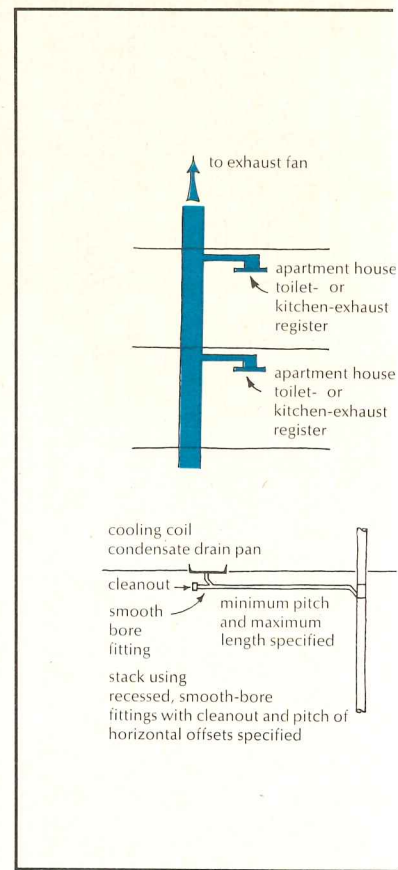
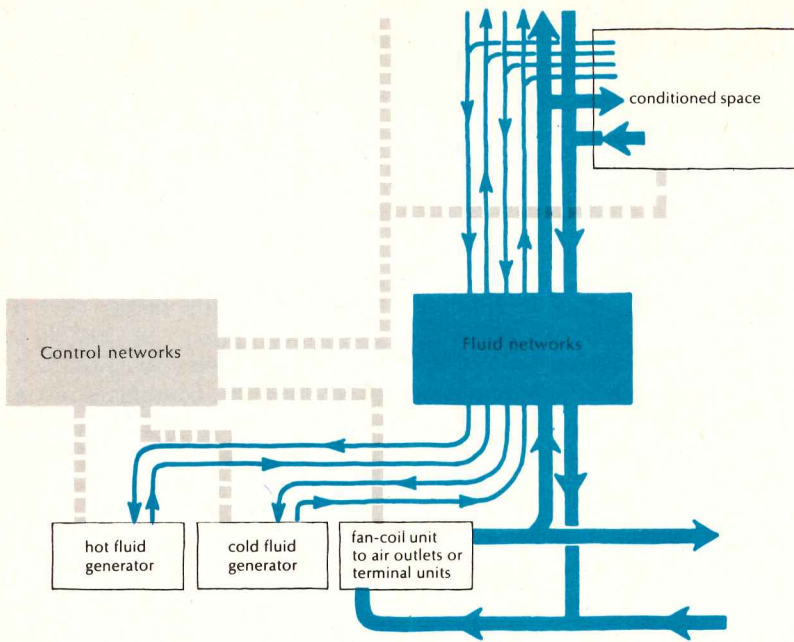

AUTOMATIC TEMPERATURE CONTROL NETWORK

With built-up (custom) automatic-temperature-control systems, there usually is little difference in quality between the equivalent control system devices of one manufacturer and another. Therefore, the consulting engineer need not necessarily know the exact quality or performance capability of each device. The consultant should specify the catalog number for reference where he does not fully specify design of the item.

The complete inclusion of all the various essential control-signal-network auxiliary devices required to make the control system elements

function is a specialty area of engineering outside the expertise of the consulting engineer. Usual performance-specification-type buying allows each control system bidder to offer an equivalent performance-type system.

The consulting engineer still has the difficult task of analyzing and thinking through the coordinated operation and functioning of both systems.

Packaged control sub-systems do require careful analysis and evaluation of internal control components because of big variations in quality and performance of such components.

THE AIR FLOW NETWORK

The airflow network is expensive and consumes considerable space. Obvious cost savings can result from dual use of building spaces or enclosures. Example: fan room or ceiling space used as plenum. Such applications, however, reduce the effectiveness of over-all system quality control.

Dissatisfaction with system air balancing, based on vague specifications, has led to specifications calling for work to be done by prequalified specialty contractors.

Many departures from optimum or good construction are possible in the duct system, both as to shop fabrication practice and details, and field

installation.

Aside from difficulties with noise and vibration, the biggest problems are those of system balance-ability and duct tightness. Because low pressure duct systems are typically enclosed before the fan system is started, reliance on quality of contractor installation is the only real assurance of basic system capability. (High-pressure ductwork has all joints tightly sealed, and is leakage tested in sections with a test blower. No equivalent test has yet been devised for low pressure systems because joint designs allow a fair amount of leakage.)

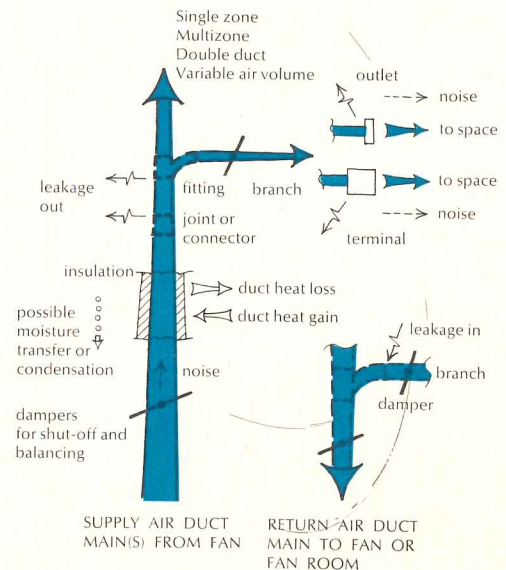

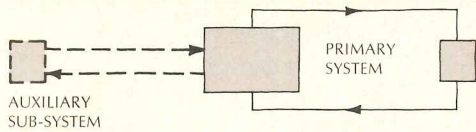

AUXILIARY SUB-SYSTEMS

These sub-systems are essential to over-all HVAC functioning. Typically, they require expertise in a specialty area of engineering and/or installation practices, and it is essential to utilize quality specialty subcontractors. Systems: water treatment systems; fuel-oil-burning systems, including fuel oil piping and storage, combustion control; custom, built-up refrigeration piping systems; etc.

CODES AND PERFORMANCE STANDARDS IN HVAC SYSTEMS

Ventilation systems essential to health, as shown, require certified test of performance in some cities. On the other hand, condensate drainage requirements for fan-coil-unit systems would readily be determined if they were included under plumbing code requirements, but they are not. Many systems installed are not even minimal because this area of design has been neglected.

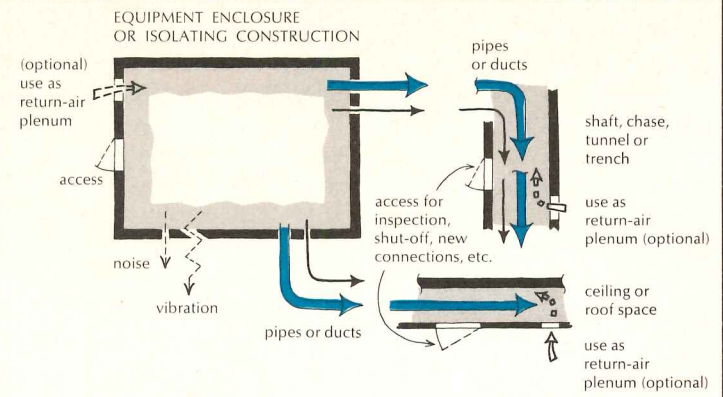

EQUIPMENT AND FLOW NETWORK ENCLOSURES OR ISOLATION

The HVAC system design engineer has difficulty finding proper physical location for equipment and flow networks and in coordinating space requirements with the architect's design. He also needs to consider safety factors related to fire protection, particularly with regard to the air network and heat generating equipment.

Equipment rooms and ceiling spaces used as air plenums form part of the HVAC flow network, and put control of air tightness and insulation into another trade, reducing the effectiveness of controlling over-all HVAC system results.

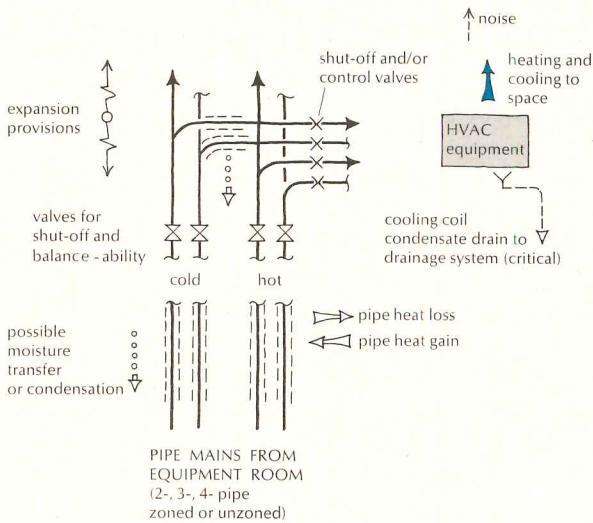

LIQUID (OR VAPOR) FLOW NETWORKS

Piping flow networks generally do not allow as much quality reduction in fabrication or field installation as their air-duct counterparts. Space requirements are considerably less and, particularly in congested areas, actual pipe locations may be considerably different from those shown on engineers' plans. Design for balanceability, system shut-off and accessibility are essential, and must be fully detailed by the consulting engineer.

Insulation of chilled-water piping mains and branches is expensive, so it is here that the largest quality reductions are made. Thermal losses, how-

ever, usually will not be high enough to adversely affect system capacity or cooling to terminal units. The worst effect is corrosion of pipe and fittings from the outside and dripping of condensation from horizontal runs of pipe through ceiling construction.

Installation quality also is affected by final decisions of the contractor on provisions for pipe anchoring and expansion and contraction, which often are not covered by engineers' drawings or contractors' shop drawings. Mistakes can lead to gradual opening or failure of pipe joints or excessive stress on equipment.

SUPPORT AND ISOLATION OF EQUIPMENT. FLOW NETWORK CONNECTIONS

Minimizing noise and vibration that might arise from mounting equipment on floor, roof or on walls requires coordination with architect and structural engineer. Custom analysis at reasonable cost often is not available.

The matter of adequate and satisfactory equipment mounting cannot be separated from the requirement that flow connections to and from pumps and fans be as close to ideal as possible.

Quality here means accessibility, maintainability and optimum equipment support and connection, yielding minimum maintenance cost and maximum equipment life and reliability.

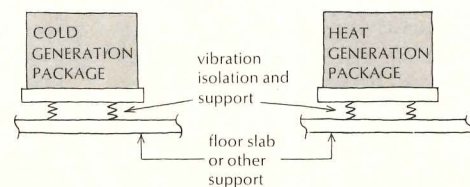
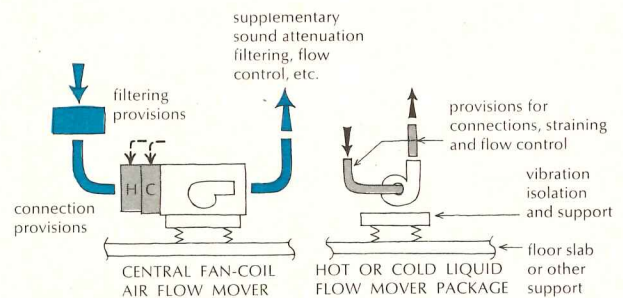
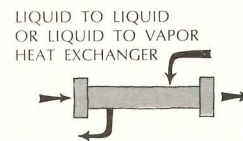

know what the competitive situation will be with regard to bidders. Inasmuch as materials and equipment are not always installed the way they have been specified, the engineer may be reluctant to use atypical or new materials or installation methods if he has no idea what quality contractor will be doing the work.

The previous article discussed quality of equipment and products in terms of criticality of various features as they relate to application. The concern here, however, is with the services provided—design, construction management, construction itself, and further with the hooking up of the equipment and products into a complete system within a building. If criteria are being set up to define quality, some reference is needed for measurement—certain standards, acceptance criteria, performance test criteria, etc.

A properly staffed and organized systems project group can start from fresh in setting standards and tests to be followed by subsequent users of the systems and components that are developed. Such systems groups could make it clear exactly what quality level they want, through their specifications and testing and modification of the initial systems; guidelines could be developed for others to follow.

Architects and consulting engineers find themselves being beseeched to use new materials, equipment and system approaches to help reduce costs. They want to avail themselves and their clients of the new things, but before they use them in advance of longer term field experience they would like to have some evaluation by a responsible official organization such as standards or code group. They themselves do not have the time, the money or the resources to conduct such quick evaluations.

The implications of speeding up product and system evaluation

What type of organizations provide materials evaluation guidance? Mainly they are governmental or quasi-governmental groups.* Basically they perform a screening function by setting up test procedures and devising or recommending test equipment. They take on no legal responsibility. Tests are run on samples, mock-ups or

“mini-modules”, according to certain procedures, and these either pass or fail. Ordinarily neither certification nor warranty is provided. Further, these tests are usually minimums and do not give real indications of long-term reliability. In some areas accelerated tests may be used for exposure to weather, but these usually apply to building materials such as roofing, sealants, paint and the like. Hardly any of the organizations have tests and test procedures that apply to a total system.

Seemingly, a hallmark of systems project groups—implied by their performance specifications—is the search for new approaches, and hence new materials and equipment. The main thing new in HVAC to come out of these projects is modified approaches to handling ductwork—new materials, or omitting it altogether by building it into the structure. Some of these solutions do not have universal application, however, because of certain code restrictions covering how the structure and fireproofing of the structure relates to the air-conditioning system—in effect establishing a certain quality level regarding safety.

The HVAC design engineer needs to become more involved with safety aspects because many new systems are not only coordinated, but, rather, integrated with the structure.

Architects and engineers have been pushed to assimilate new approaches faster because of the new developments emanating from system project groups. Reason is that reliance on their own judgment alone is not enough, since acceptance by the systems project group amounts to a prestigious, if conditional, “stamp of approval.” Of course architects and engineers would expect the manufacturers to take on a maximum amount of product liability. The question then arises whether these manufacturers can take the financial responsibility and have the proper staff back-up and technical know-how in order to instill confidence in non-systems project group specifiers adopt-

* Examples: Underwriters' Laboratories, Air Conditioning and Refrigeration Institute, National Electrical Manufacturers' Association, National Fire Protection Association, A.S.T.M., Factory Mutual Insurance Fire Insurance Companies, FHA.

ing the approach. If this aspect is not thoroughly evaluated by the architect and engineer, quality can possibly degrade. The fact, alone, that a “system” passes a given test—wherein only prequalified consultants, manufacturers and contractors are used and all phases carefully monitored—is only partial evidence of quality because tests cannot relate to long-term application in the competitive marketplace.

Conscientious architects and engineers should check back on installations to see how systems and equipment have performed and lasted. Beyond this they should examine the work of others and discuss withstandability, reliability and adequacy with contractors, manufacturers and others. This way they can evaluate whether their standards for specifying materials and equipment for different quality levels are current. Also manufacturers can be asked about the effect on quality of departures from optimum installation procedures and conditions. At least manufacturers could indicate under what circumstances trouble definitely will occur. Keeping a record of good jobs and bad jobs is part of a quality manufacturer's field back-up service. They could also give some guidelines in departing from optimum or best quality.

An index of quality is how well the system performs dynamically. First, the system is designed to perform in a coordinated, integrated way. Then, once installed, the question is whether the system was put in as called for in plans and specifications and whether it performs as anticipated. But none of this matters unless the system performs so that the owner is satisfied—the real criterion of success.

The initial performance of a system should stay pretty much the same throughout its life, except for a slight loss in efficiency as it gets older. How the system stands up depends upon how well it is maintained, and this, in turn depends upon having provisions for access and easy maintainability.

Inasmuch as a tremendous amount of instrumentation would be necessary to enable thorough evaluations of dynamic performance of many HVAC systems, evaluations in a practical sense have to be somewhat loose. Basically the owner wants 1) satisfactory temperatures throughout the various spaces, 2) absence of drafts, 3) good ventilation (absence of odors) and filtration (absence of dirt), 4) a system simple and easy to maintain, 5) economy of operation.

Owners looking for long-life, and hence quality, installations in the commercial and institutional fields want their consulting engineers to inform them of options in various degrees of quality. Most often, cost-cutting originates with the contractor because he is concerned with bidding the job and doing it at the lowest possible cost. The more competitive the market, and the less prequalification of contractors, the more ways the contractor finds of cutting by reducing quality of workmanship and materials, or even by redesign.

Quality control requires commonly-understood standards

Any approach to quality control, to be effective, should consist of an interrelated system of standards. These should cover tests and/or evaluation procedures that tie in with the owner's over-all planning, A/E design, building construction and the owner's operation and maintenance.

Existing mandatory codes and legal restrictions form only a minimum bottom limit for quality. Actual working standards are always developed by the A/E and owner to supplement these. Sharing of information is inadequate which hampers industry understanding.

Realistic and uniform quality standards for judging the efforts of the owner's staff, the A/E

or the contractor do not exist as such. But it is possible to identify variances in today's performance that can be used to further communication and understanding.

Functioning organizations in design and construction find it difficult to change because they adapt to meet the market, and are locked into a particular quality level of performance. Owners must recognize that working to a wide spread of quality levels is a managerial impossibility.

Many owners such as some hospitals, housing foundations, high-quality chains, and systems-project-oriented owners are seeking for a better balance between quality and cost.



Hallmark

by **DAY-BRITE**

A unique luminaire that establishes
a dramatically new standard
of excellence in surface lighting.

TURN PAGE 



Hallmark

..... is more than a new fixture. It is a creative concept in prismatic lens processing... in chassis design. It achieves for the first time a nonfixture, "in limbo" look which doesn't detract from interior designs. Gone are the traditional opaque ends. In their place is an exclusive one-piece injection molded prismatic lens that provides luminous ends as well as sides. A splay around the entire chassis permits uplighting, completely dispelling fixture shadow. And with unique corner "fins", Hallmark retains a crisp, square look when viewed from any angle.

HALLMARK... architecturally correct, highly efficient... with as many applications as your mind can conjure. See it. Then draw your conclusions.



DAY-BRITE LIGHTING DIVISION
EMERSON ELECTRIC CO.
5411 BULWER
ST. LOUIS, MISSOURI 63147

For more data, circle 68 on inquiry card

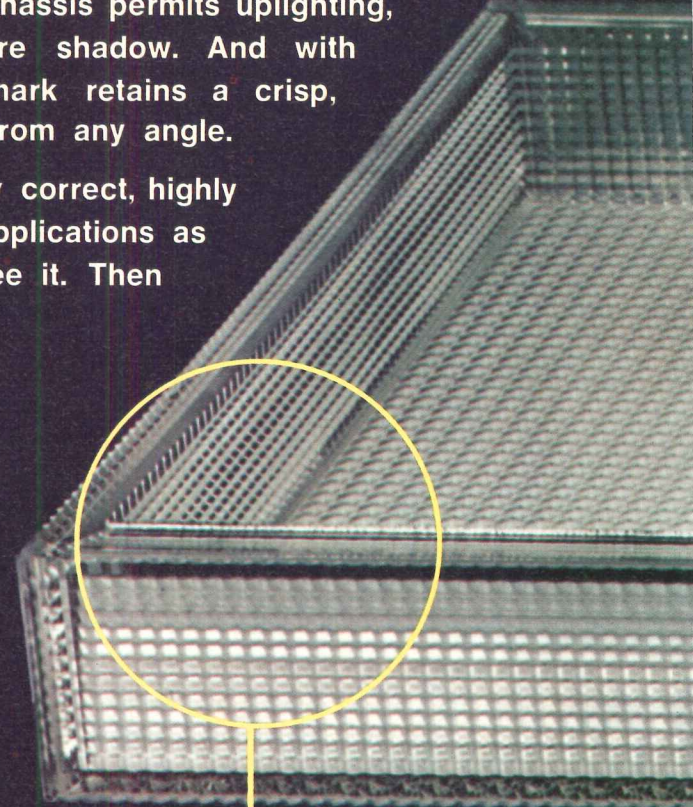

LENS — Hallmark's high efficiency low brightness prismatic lens is the first to have a return edge around its entire periphery. Of virgin Acrylic, it is injection molded in one piece by a totally new process... transmits light from all four sides.

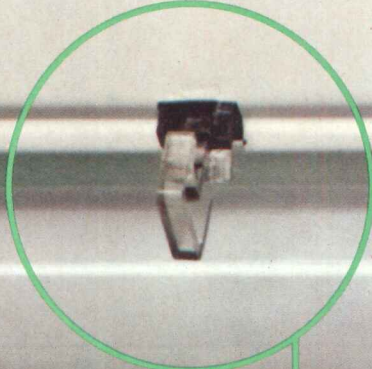

LATCHES—Enclosure is hinged on both sides for easy access in cleaning and servicing, and remains captive when in fully open position. Positive-lock, invisible mechanical latches will not let lens get out of alignment.

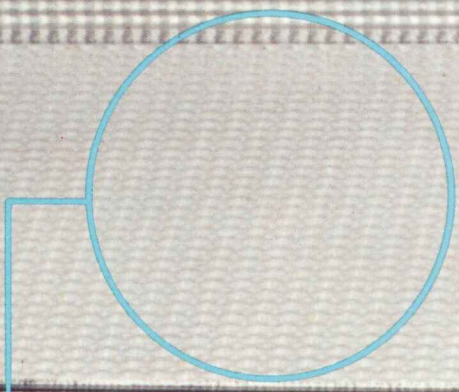

SPECS—Hallmark is a slim 3" deep, 12" wide in the 2-lamp model... 16½" wide in the 4-lamp. It comes in 4' and 8' lengths, for use singly or in tandem, surface or suspended. Metal splay is available in baked white enamel finish, or matte black.

CHASSIS—Hallmark eliminates the traditional "pocket" to achieve uplighting. Instead, entire chassis fits flush-to-ceiling, angles inward to permit uplighting around entire fixture. Unique corner "fins" offset splay to retain a clean, vertical corner line when viewed from any angle.



**Sandstrom has a
basement sealer guarantee
that holds water.**

The guarantee is the reason their basement sealers stand out on a crowded shelf in a paint store.

It directly states: "When applied according to directions on a properly prepared surface, except when leaks are due to cracking on the surface itself, is guaranteed to provide a water-proofing coating for three (3) years from date of sale, or we will refund the cost of the paint if you send proof of purchase to Sandstrom Products Company, Port Byron, Illinois 61275."

They can offer that kind of guarantee because

their sealers stop moisture as much as five times better than other kinds.

That's a powerful selling edge to have over your competition. And our PLIOLITE® Resins helped them get it.

These tough synthetic compounds do more than just coat masonry. They actually plug the holes in concrete, brick and cinder block. Form a flat, nonporous shield that stops seepage from rain or ground water.

They come in a variety of colors. Go on easily by a variety of methods: brush, roller or spray.

And the first coat is the last almost any surface needs.

Don't you need an advantage like this in today's competitive markets? Talk with us. We're a market-oriented company, with a reputation for turning a chemical breakthrough into a selling edge.

Call Bill Smith, Product Manager, at 216-794-4867, or write Goodyear Chemicals Data Center, Dept. P-84, P.O. Box 9115, Akron, Ohio 44305.

PLIOLITE—

T.M. The Goodyear Tire & Rubber Company, Akron, Ohio

Get your selling edge from Goodyear Chemicals

For more data, circle 69 on inquiry card

For more information circle selected item numbers on Readers Service Inquiry Card, pages 255-256

Architects design individual aluminum entrances with the new Entara Entrance System

The *Entara System* of 125 different extrusions provides 9000 separate parts from which the designer can achieve "truly custom, individual entrances in aluminum." A group of 20 design coordinates provides shapes, sizes, colors and finishes for not just a door itself, or even a door and entrance frame, but for the whole facade of the building (lower left photo).

According to A. J. MacKersie, the company's product marketing manager, "*Entara* is not a door, not a frame, not a line of entrances; there are no standard units and no stock entrances. The entrance *has to be designed* from the system of extrusions, sub-assemblies, parts and hardware." The designer can develop doors ranging from fully opaque to any degree of glazing required. And, besides the coordinates provided in the *Entara System*, he can incorporate panels of other materials—cast, carved, painted, embossed or printed.

Photo top left shows a cross section of the entrance system. Below right is an entrance that incorporates cast aluminum inserts into the door leaf. ■ Kawneer Company, Niles, Mich.

Circle 300 on inquiry card

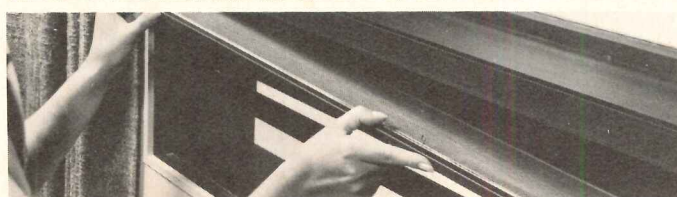
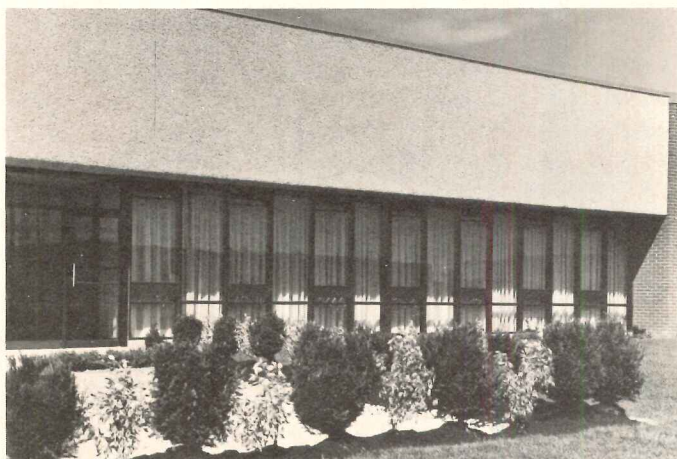
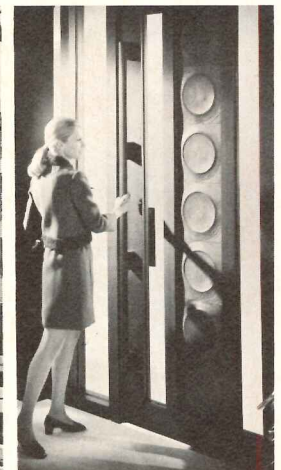
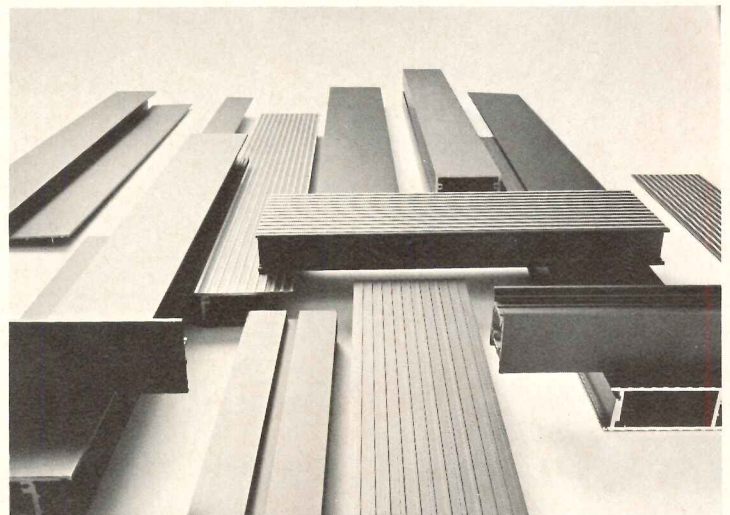
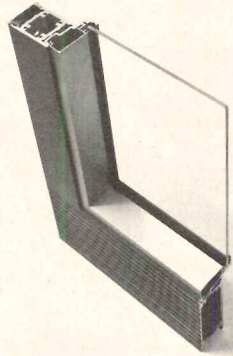

A window that looks the same whether open or closed provides ventilation without leaks or drafts

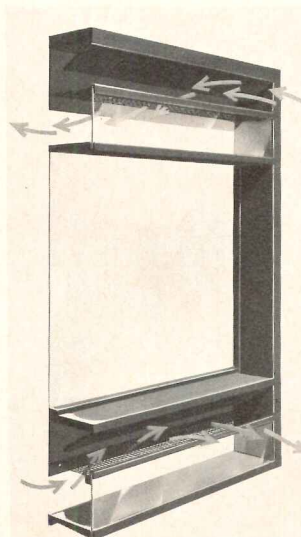

The *Ventro Window* is designed to provide ventilation, even in rainstorms with 110 mph wind conditions, without interfering with the design of the building. The window has no operating hardware, no projections inside or outside and no visual indication that the window is actually open. A simple baffled space provides the ventilation without leaks, drafts or bugs.

The *Ventro* frame is 5 in. in depth; the ventilation units are in the top and bottom. Photo bottom left shows the screen that keeps out bugs. Photo top left is a test installation. The window is recommended for such installations as schools and hospitals.

■ Kawneer Company, Niles, Mich.

Circle 301 on inquiry card

more products on page 170



WHICH WOULD YOU CHOOSE TO REDUCE OUTSIDE NOISE?

By using Soundtropicane® 40 you combine the sound isolation effectiveness of a 6" concrete block wall with the beauty and strength of laminated glass. Ordinary plate glass is about 1/10 as effective as equivalent thickness Soundtropicane® in isolating acoustical energy, less than half as effective in isolating noise.

Soundtropicane® is available with STC ratings of 36, 40 and 43. It can be made to control heat and glare by incorporating any of three pleasing bronze shades in 10%, 28%, or 55% light transmission, using any thickness of glass desired.

Discover it for yourself. Consult Sweet's File catalog 4a/De or write Dearborn today for a free copy of the Glas-Wich catalog.



DEARBORN GLASS COMPANY

6600 S. Harlem Avenue
Argo, Illinois 60501

For more data, circle 70 on inquiry card

SOUNDTROPICANE® INSTALLED IN NEW O'HARE OFFICE PLAZA

Architect: Morton Z. Levine and Associates, Inc.
Leasing & Managing Agents: Nardi and Podolski
Contractors: Inland-Robbins Construction, Inc.

Soundtropicane® is the ideal glass for installations, close to large metropolitan airports, where excessive noise is a negative environmental factor. The location of the new O'Hare Office Plaza required a glass that would effectively reduce the noise of jets on take-offs and landings, and be strong enough to withstand shattering due to jet vibrations. Soundtropicane® filled all the requirements.

Dearborn is also the manufacturer of Tru-Site non-glare glass and variant forms of glass for industry and architecture.



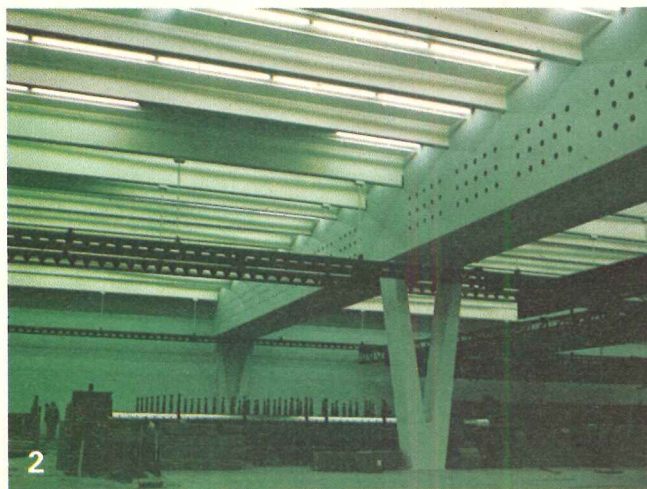

ARCHITECTS: (1) J. ALFRED HAMME & ASSOCIATES; (2) HARRY PAYNE & ASSOCIATES;
 (3) ALEXANDER KEAY & ASSOCIATES; (4) J. ALFRED HAMME & ASSOCIATES;
 (5) PIERSON, MILLER, WARE & ASSOCIATES

PRESTRESSED CONCRETE

brings the wide-open spaces inside!

When your design calls for a broad sweep of column-free floor space, prestressed concrete gives you the long span muscle you need. Without premium cost. Ceilings have a clean, modern appearance because mechanical and electrical systems can be channeled between the stems of well proportioned structural members, providing easy access.

Get in touch with your nearest PCI producer member for complete information on how prestressed concrete can give you more design freedom in your next project. His experience can help you most in the earliest stage of planning.

Professional membership in PCI can be of value to you in many ways. Send for membership information.

PRESTRESSED CONCRETE INSTITUTE  PCI

ARCHITECTURAL STRUCTURAL

205 West Wacker Drive, Chicago, Illinois 60606



For more data, circle 71 on inquiry card

We challenge any other drapery fiber to pass this test.

1. Fire-safe
2. Won't rot, shrink or sag
3. Resists soil
4. Easy to maintain
5. Resists fading
6. Long lasting

Glass fiber is the only commercial drapery fiber that can pass all six performance tests at left. The Consumer Testing Laboratories of Boston just proved it. Modacrylic can't pass. Neither can modacrylic blends, rayon/cotton or any other cotton-blend.

The test showed that Fiberglas* glass yarn is inherently *fire-safe*. No other fiber can make that claim. Some other fibers had flame-retardant finishes, but they burned. Smoked. And fumed. Fiberglas fiber can not.

Fiberglas fabric *won't rot, shrink or sag*. It's inorganic. So it is dimensionally stable, by nature.

Fiberglas draperies *resist soil*. Dirt can't sink in as readily.

And they're *easy to maintain*, too. You can wash Fiberglas draperies on

the premises. No expensive, time-consuming dry cleaning needed.

Draperies of Fiberglas also *resist fading* better than others...even when they're hung in direct sunlight.

All of which means that Fiberglas draperies *last longer* than others.

If you'd like to know more, write: Owens-Corning Fiberglas, Architectural Fabrics, 717 Fifth Avenue, New York, N.Y. 10022. We'll even send you the complete Consumer Testing Laboratories Report on Fiberglas performance.

But, if you didn't like the way Fiberglas draperies look, you wouldn't care how well they perform. So this is how they look. Beautiful.

 FIRE-SAFE FABRICS

 OWENS/CORNING
FIBERGLAS
TRADEMARK ®

*T.M. REG. OWENS-CORNING FIBERGLAS CORPORATION.

Owens-Corning is Fiberglas



For more data, circle 72 on inquiry card



The number is Corbin 4726

Your number for security. Corbin exit devices operate at a finger's touch. Dependable, safe and whisper-quiet. This is only one of many designs. It displays the style, quality and security built into the complete Corbin line of door closers, locksets and exit devices.

Your Corbin distributor can furnish you with complete data on this design, or write P. & F. Corbin, Division of Emhart Corporation, Berlin, Connecticut 06037. In Canada—Corbin Lock Division.



For more data, circle 73 on inquiry card

continued from page 165

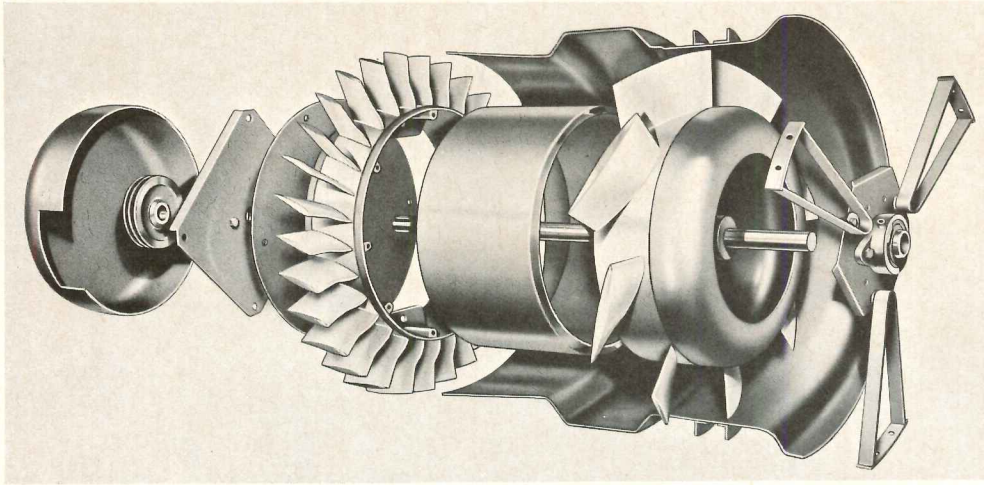

COMPACT FAN / The Compact Model Q Fan "is substantially smaller and quieter than others of comparable capacity." Capacities range from 1,000 to 43,000 cfm. They are AMCA Certified and are available for Class I, II or III operation. The Model Q may be installed vertically or horizontally and is recommended for both supply and exhaust air-conditioning applications. ■ The Trane Company, La Crosse, Wis.

Circle 302 on inquiry card

MATTHEWS' METAL LETTERS

provide the creative finishing touch.

Matthews' custom metal letters combine distinctive identification with almost limitless creative possibilities. Cast letters in bronze, or aluminum are available in many finishes, styles, and sizes. Fabricated letters in stainless steel and aluminum add beauty to function. Custom trademarks, cast tablets, etched plaques, name plates and sculptured symbology are also available. Send today for free catalog, illustrating Matthews' complete Identification-In-Metal capabilities.

See us in Sweet's Interior Design, File A-6

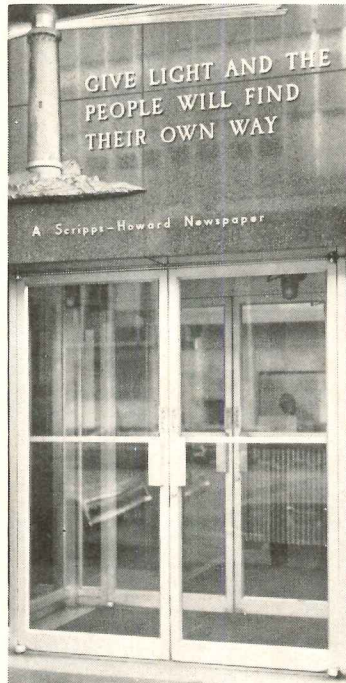
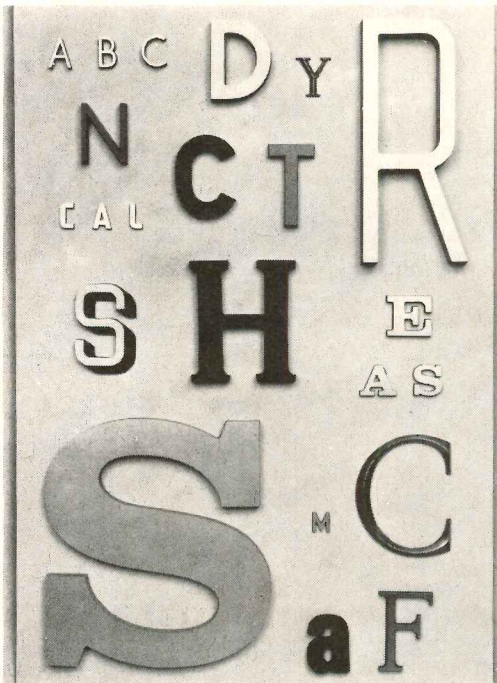

Memorial Bronze/H. W. Knight & Son
Divisions of **JAS. H. MATTHEWS & CO.**

1315 W. Liberty Ave., Pittsburgh, Pennsylvania 15226

PLANTS IN PITTSBURGH, PENNSYLVANIA; SEARCY, ARKANSAS; MILTON, ONTARIO; SUN CITY, CALIFORNIA; SENECA FALLS, NEW YORK; EL MONTE, CALIFORNIA.

For more data, circle 74 on inquiry card

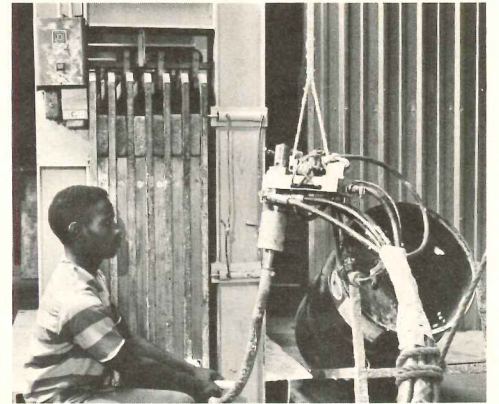

FOAMED-IN-PLACE DOOR INSULATION / Workman in the picture is frothing *Expand-foam* urethane insulation (a product of Armstrong Cork Company) through a hole in one of the steel doors held in a hydraulically controlled jig. Advantages are said to be high insulation value, a solid core that gives exceptional strength and prevention of hollow or metallic sounds. ■ Dittco Products, Inc., Monroe, La.

Circle 303 on inquiry card

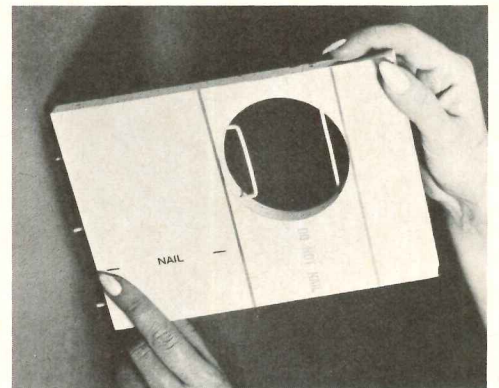

RADIANT HEAT PANELS / *Panelectric*, a prefabricated, single-layer, radiant heat ceiling is made of gypsum board 5/8 in. thick in which an insulated resistance cable is embedded. The system operates on 240 volts with a surface temperature of 100°F. Each panel is a separate heating unit with an output ranging from 245 to 720 watts depending upon size. Non-heating panels are used around fixtures, etc. Normal dry wall application procedures are used, and panels can be painted or papered. ■ National Gypsum Company, Buffalo.

Circle 304 on inquiry card

more products on page 176



Timely beauty by Lyon says you care!

Crisp, clean Lyon design says a lot about you and your awareness! Notice those filing cabinets. You won't find a seam, unsightly weld, or machine mark on the front, back or sides. A sleek, one-piece wrap-around shell does the job—beautifully. Drawers open full length, with whisper-smooth ball-bearing suspension. Finger-tip latches are concealed. These cabinets are the perfect complement to the Lyon desk, which features quieter double-wall construction muffled by honeycomb filler, the personalized comfort of flexible modular design. And wait'll you try the handy "lock-in-top" that controls *all* desk drawers! It all says you care. So see your Lyon dealer. He cares too!

Showrooms: New York, Los Angeles, Boston, Aurora, Ill.



Show how much you care—write today!

Lyon Metal Products, Inc.
451 Monroe Ave., Aurora, Ill.

- I'd like the name of my nearest dealer
 Send my free copy of your full color brochure

Name _____

Address _____

City _____ State _____ Zip _____

For more data, circle 75 on inquiry card



The "OVERHEAD DOOR" . . . when you want a garage door

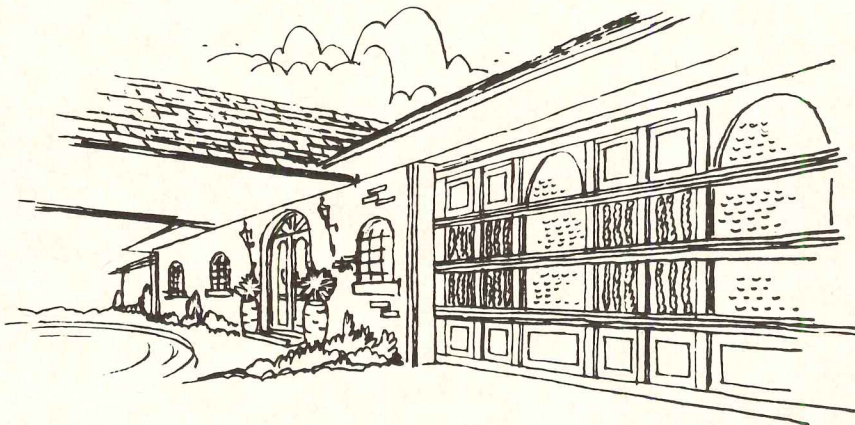

Ideally, a garage door should reflect the architectural design of the house. If it disrupts or deviates from the design, the overall beauty of the house is seriously diminished.

We build doors that complement home designs, not disrupt them.

The "OVERHEAD DOOR" can

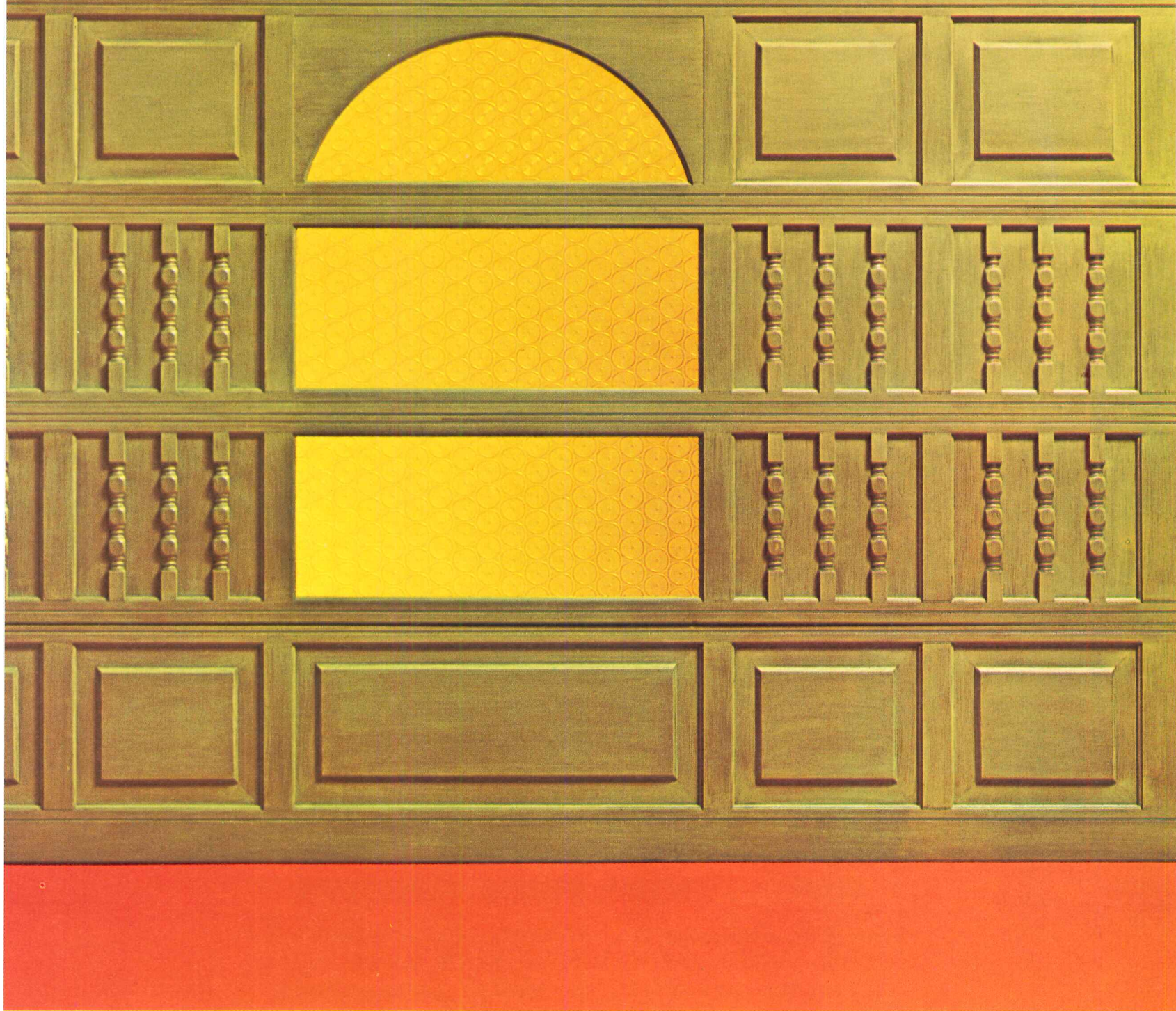

that's truly a part of the home.

look any way you want it to look. Imposing or unobtrusive. Dynamic or serene. Colorful or quiet. It just depends on how you want the house to look.

We also market electric operators to go with our doors. Fingertip garage door control provides unprecedented

convenience to homeowners. Particularly when you consider that the garage door is the largest moving part of the house.

If you want a garage door that doesn't look like a garage door, see your nearby Overhead Door distributor. He's only minutes away if you live in America.



OVERHEAD DOOR CORPORATION
General Offices: Dallas, Texas 75240
Manufacturers of The "OVERHEAD DOOR" and
electric operators for residential and commercial buildings

For more data, circle 76 on inquiry card



TERNE . . . FORM, COLOR, FUNCTION

From a functional standpoint, Terne metal has a durability measured in generations rather than years, and its inherent affinity for both form and color permits any visual roof area to become a significant component in design. These characteristics are probably sufficient in themselves to explain Terne's increasingly important role in contemporary architecture, but they are further enhanced by relatively moderate cost.

FOLLANSBEE

FOLLANSBEE STEEL CORPORATION • FOLLANSBEE, WEST VIRGINIA

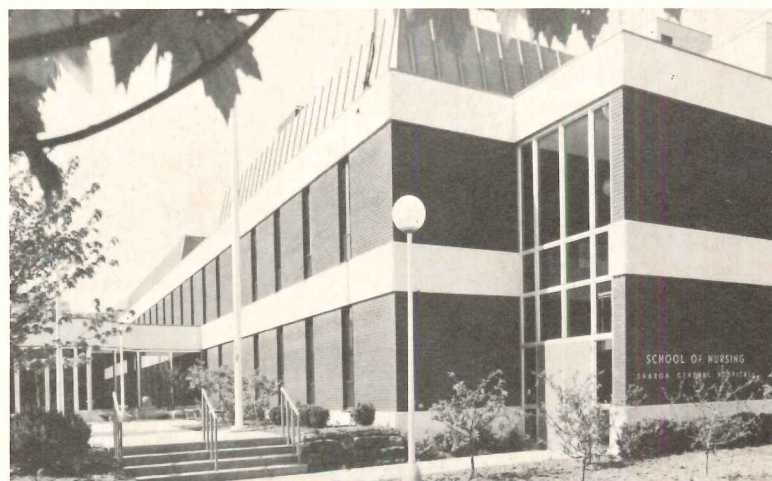

School of Nursing
and Morrison Hall,
Sharon General Hospital,
Sharon, Pa.
Architect:
Brooks & Redfoot,
Sharon, Pa.
Sheet Metal Contractor:
The Woodward Company,
Warren, Ohio
Photographs: Frank S. Pavliga

For more data, circle 77 on inquiry card

Fall in Love with a Castelli/Krueger 106?

Designed by G. C. Piretti
 Produced by Castelli
 Assembled and solely distributed by
 Krueger Metal Products, Inc.



1. The basic model 106 chair



2. Upright stacking on storage dollies.

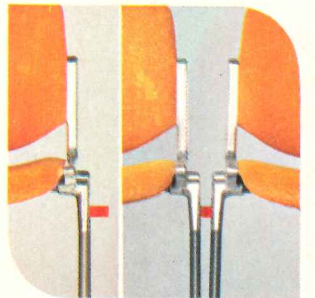

3. Ganging in rows with inter-locking nylon pins



4. Tip-away Tablet Arm permits easy stacking



5. Detachable book rack and ashtrays



6. Single or double armrests—that also stack

7. Wood finishes in Beech, Walnut or Rosewood



Everybody does! It's really groovy.

Unbelievable but true. The Castelli/Krueger 106 with its 7 concepts drastically reduces your investment in seating versatility. And, its trim European styling and beauty, coupled with extra wide, contour shaped seating comfort really turns you on. Much more than a chair, the Castelli/Krueger 106 is really a system, as illustrated at right. Bear up to a designers real love for the exciting and dramatic choice of finishes, too: Warm satin-finished molded plywoods in Beech, Walnut or Rosewood for the more subtle interior... or perk up a dull setting with 8 choice colors of luxurious fabric or 6 colors of business-like vinyl plastics. That's another thing that's so groovy about this chair. We've a special new catalog that gives the complete story. *Write for a copy, on your letterhead, please.* It's real groovy.

KRUEGER
 METAL PRODUCTS, INC. • GREEN BAY, WISCONSIN • 54306

Showrooms: NEW YORK: 20 E. 46th Street • CHICAGO: 1184 Merchandise Mart • Indianapolis • Dallas • Houston • Los Angeles

For more data, circle 78 on inquiry card

continued from page 170

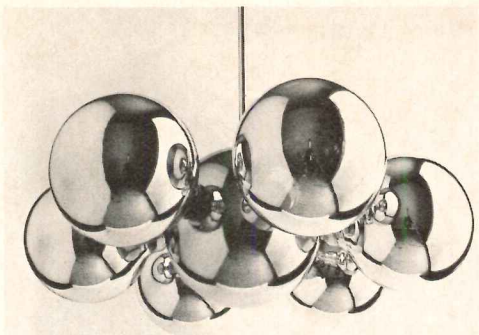
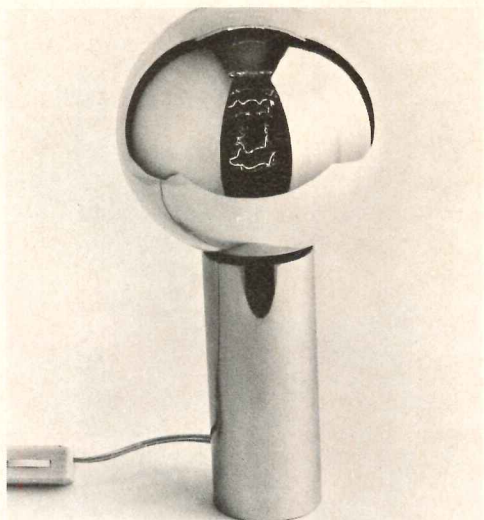

DECORATIVE LIGHT BULB / The *Tovibulb* is an incandescent electric light bulb that is designed as a strong decorative element. When the bulb is off, it looks like a solid sphere of highly polished metal that reflects

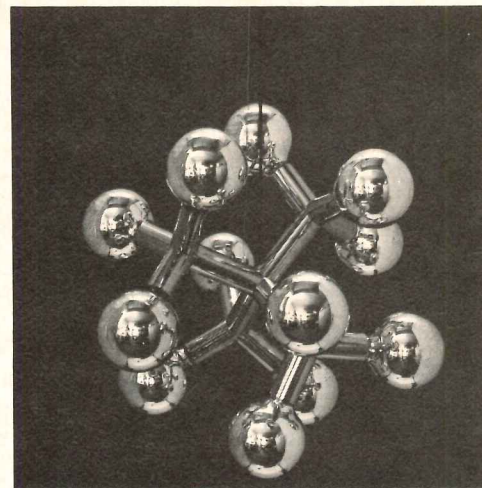

the images around it. When it is on, the filament is visible and casts reflections about the room. Two or more bulbs used together produce an infinite number of reflections and re-reflections. The bulb is also used outdoors, causing the sun's light to fall in patterns on walls and other surfaces. A dimmer may be used not only to control the amount of light, but also the visual effect of the filament and its reflections. Several companies are designing fixtures especially for the *Tovibulb*, but it can be used in traditional fixtures and fits any household socket. ■ Tovi and Perkins, Inc., New York City.

Circle 305 on inquiry card

Our 46th year

ADJUSTABLE HEAD & JAMB EQUIPMENT

LIGHT, SOUND AND DRAFT PROOF PROTECTION FOR METAL OR WOOD DOORS

#555

the most complete and authoritative guide for—

- WEATHER STRIPPING
- SOUND PROOFING
- LIGHT PROOFING
- THRESHOLDS

Zero's 1970 Catalog shows many new products, contains 177 full size drawings.

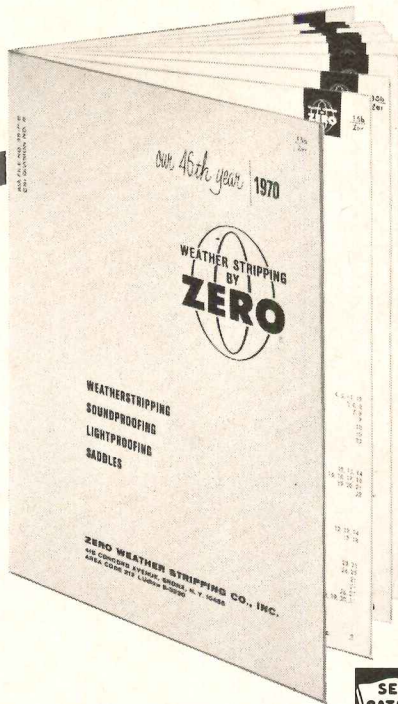

Write today for your copy

ZERO WEATHER STRIPPING CO., INC.

Our 46th year of service to architects

415 Concord Avenue, Bronx, New York 10455 • (212) LU 5-3230



For more data, circle 79 on inquiry card



WRIST WATCH COMPUTER / The *Pertograph* extends the personal usefulness of PERT (Program Evaluation & Review Technique) and CPM (Critical Path Method), Navy-developed management planning techniques previously considered possible only with large electronic computers. The watch not only indicates today's precise time and date, but contains circular dials designed to allow one instantly to compute all future times, milestone event dates, etc. for any PERT Program. The watch can be programmed to solve earliest and latest dates to find the "critical path" of any program plan. The watch, which is manufactured and guaranteed by Longines-Wittnauer Watch Co., Inc., sells for \$100. ■ Halcomb Associates, Sunnyvale, Calif.

Circle 306 on inquiry card

more products on page 190



We make a lot of different ceilings
to do a lot of different things.
This one's thing is flexibility.

Three air-delivery systems, three air-return systems, and—by interchanging vaulted modules and flat panels—an unlimited number of lighting arrangements. This is the kind of flexibility the Armstrong C-60/30 Luminaire Ceiling System delivers. The kind of flexibility that also gives superior sound control, UL-rated fire protection, sprinkler head and parti-

tion adaptability. The kind of flexibility that has led to the development of a complete series of Armstrong Luminaire Ceiling Systems. An Armstrong representative is in the best position to tell you more about Luminaire and the wide range of Armstrong Ceiling Systems. For his name and a copy of our folio, write: Armstrong, 4204 Rock St., Lancaster, Pa. 17604.

Armstrong / CEILING
SYSTEMS
THAT WORK

Scotwall Saved 500 Man Hours Here!

It took a five man crew 14 working days to set the 220 marble-faced Scotwall spandrel panels on the National Bank of Westchester. That's about half the time it would have taken to install the much heavier conventional panels.



Laszlo Papp and Associates, architects; R. C. Daly, construction consultant; Alexander-Jennings Construction Co., general contractor; Consolidated Stone Setters, setting contractor.

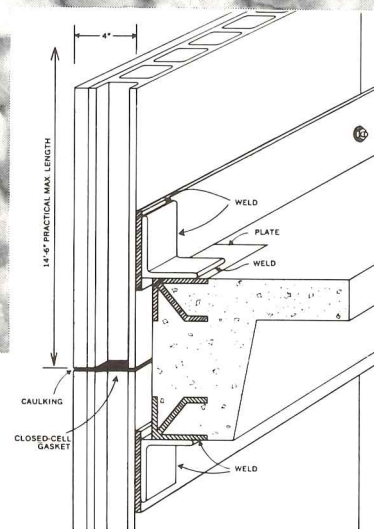
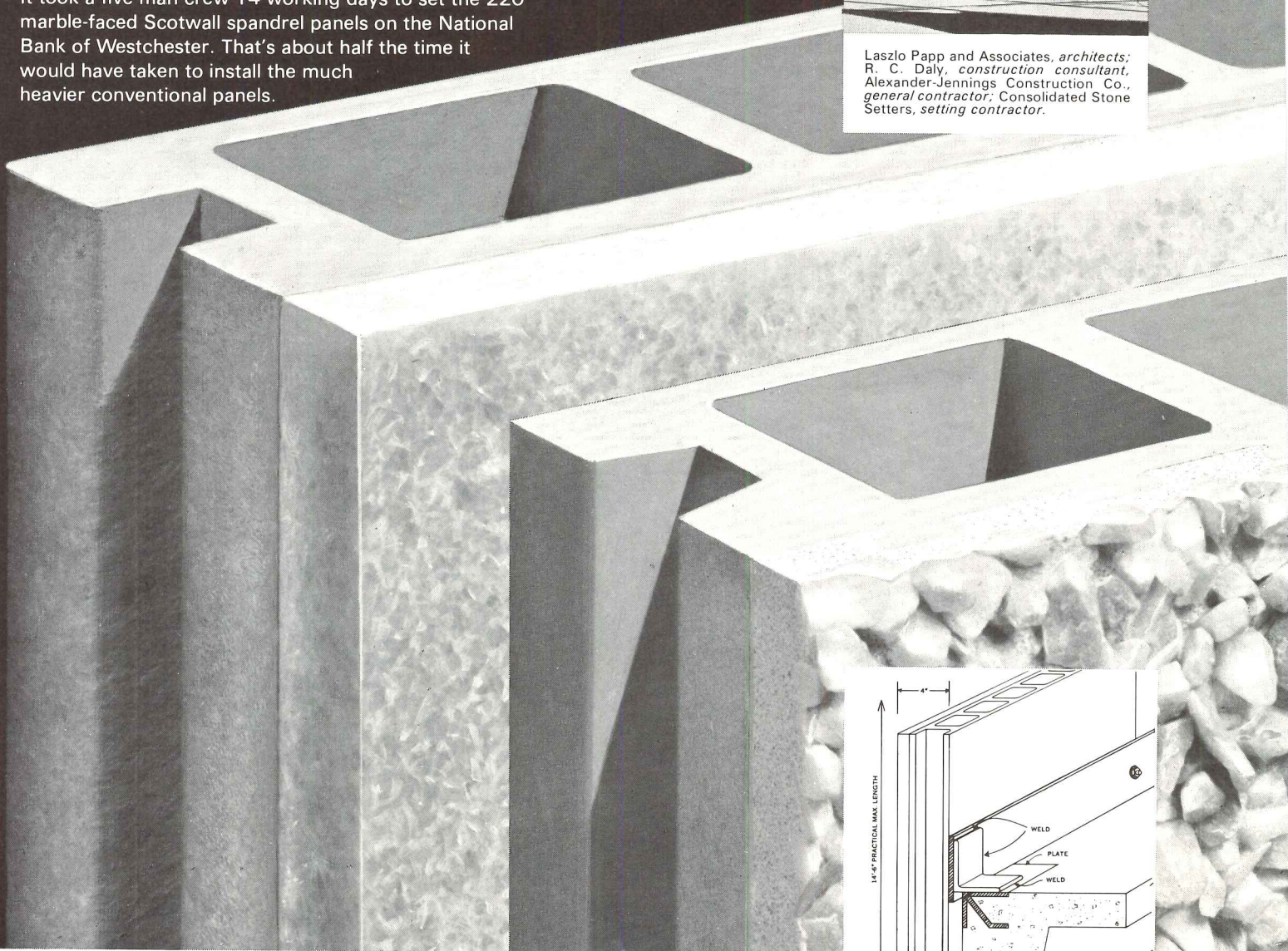

Scotwall panels have an asbestos-cement substrate faced with 7/8" marble or aggregate. The marble-faced panels weigh only 25 pounds per square foot and aggregate-face even less. They go up quickly with small crews and light equipment. Scotwall's combination of strength, stability and light weight permits a much lighter supporting structure and far greater design freedom.

The new Scotwall Panel System will give your buildings the beauty of marble or aggregate cladding for an in-place cost below that of many less desirable materials. Let us show you.

WRITE FOR YOUR COPY OF THE NEW SCOTWALL BROCHURE



Georgia Marble Company

11 PRYOR STREET, S.W., ATLANTA, GEORGIA 30303
A subsidiary of Jim Walter Corporation

COAST-TO-COAST CONSULTING SERVICE—Our engineers stand ready to assist you any time anywhere on any project involving marble or limestone. A phone call will put one of our men across the desk from you in a matter of hours. Phone 404/688-2861.



For more data, circle 80 on inquiry card

For more data, circle 81 on inquiry card

**Unatap uses its head
to get your hands
hygienically clean.**



**And saves hot water
in the process.**

Unatap was scientifically designed to wash hands with a hygienic spray of water. A spray that is steady, concentrated. Yet Unatap does something else—it conserves water. In one test, it actually reduced hot water usage by 60%.

Unatap is a single tap which mixes hot and cold water and delivers a constant spray at the temperature you select. Result: more efficient hand washing. No waste of hot water.

Unatap is operated with the flick of a wrist. Its single control knob permits the user to operate the faucet and set the temperature simultaneously.

Don't leave the faucets to chance. Make a point of specifying Unatap. Made by Richard Fife, Inc. The company that's made a big business out of controlling water beautifully.

**Also specify Rada thermostatic mixing valves—
another way to control water beautifully.**

Richard Fife, Inc.

1140 Broadway, New York, N.Y. 10001
Phone: (212) 683-0745

For more data, circle 82 on inquiry card

**Sheald^{*}
brings
noise
levels
down
to a
hush.**

*1/64" of Sheald and noise stays
where it belongs.*

Sheald makes a great plenum barrier or ceiling blanket. Because it doesn't absorb noise like other acoustic materials: Sheald stops it! Sheald continuous cast lead sheet is the ideal material for sound and moisture control, used by itself or laminated to other construction materials. And, it's the easiest to install, the lightest, thinnest and the most effective!

Sheald is readily available across the U.S. and complete information is quickly available. Just use the coupon below, or circle the number on the reader service card.

* Trademark of Cominco Ltd.

Sheald 



SEE OUR
CATALOG IN
SWEET'S
14b/CL

**Cominco Ltd.
New Metal Product Sales
630 Dorchester Blvd. West
Montreal 101, Quebec**

Please send me

- Information on noise control and other architectural applications of Sheald
- A sample swatch of Sheald
- Name of U.S. distributor in my area

Name _____

Firm _____

Address _____

City _____

State _____

Zip _____

For more data, circle 83 on inquiry card

**Wide-Lite* designed Spectra
to be good looking light.
But we never thought all
of Mexico City would notice.**

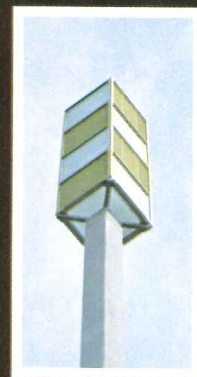

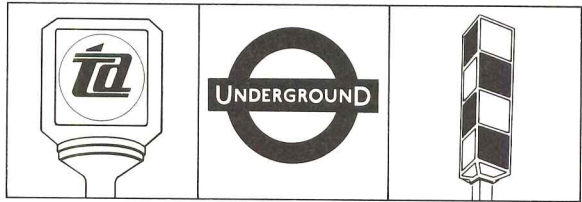

This means "Subway" in New York City. This means "Subway" in London. This means "Subway" in Mexico City.

In a city famed for beauty, Spectra by Wide-Lite is well on its way to becoming a landmark. Why?

Because Spectra luminaires have been chosen to light the stations of Mexico City's new subway. Their distinctive, geometric design now illuminates entrances of "El Metro" for all the city to see.

On the opposite page is Insurgentes station at the heart of the city. Here four Spectra I area lights are mounted on 40-foot poles about the rim of the spacious promenade. Each "Wide-Lite" fixture houses four 1000 watt Deluxe White lamps. Because light is projected from opposite sides of the four cubes in a double overlap pattern, each Spectra I produces more than an acre of remarkably uniform illumination at Insurgentes.

But, after all, Spectra is better than good looking. It's also good lighting.

Other stations on Mexico City's rapid transit line utilize one or more Spectra area lights. They illuminate some of the most dramatic architecture in the Americas. They compliment by their own good design.

You should see Mexico City's "El Metro". When you're there, just look for Spectra by Wide-Lite. All of Mexico City does.

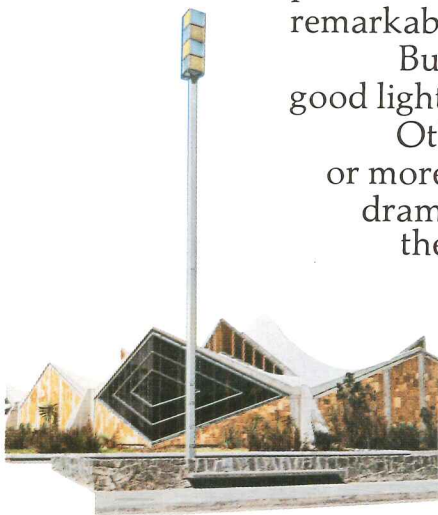

The San Lazaro station by architect Félix Candela. Spectra I area lights by Wide-Lite. These luminaires are available in 400 and 1000 watt models in any combination of embossed glass and extruded aluminum panels with matching poles. There is also a "2-cube" Spectra area light available for parking lots and other outdoor lighting jobs.



Directional signs for Mexico City's new subway were inspired by Spectra design form. Notice the handsome similarity here at Candelaria station.

Only four Spectra area lights produce this noticeably smooth level of illumination on the Insurgentes station promenade.



The Spectra series for Mercury Vapor, Metal Halide, and High Pressure Sodium lamps also includes:

				
SPECTRA II 100 to 1000 watt post-top and roadway luminaires	SPECTRA III 100 to 1000 watt floodlights	SPECTRA IV 175 to 250 watt wall washers	SPECTRA V 100 to 1000 watt indoor luminaires	SPECTRA VI 400 to 1000 watt pendant indoor luminaires

WideLite®

P. O. Box 191, Dept. A R-4/70-1009,
Houston, Texas 77001
Also manufactured in Australia, Belgium,
Canada, Mexico and Great Britain.
A Division of Esquire, Inc.
*Trademark of Wide-Lite Corporation

TALL BRONZED and HANDSOME

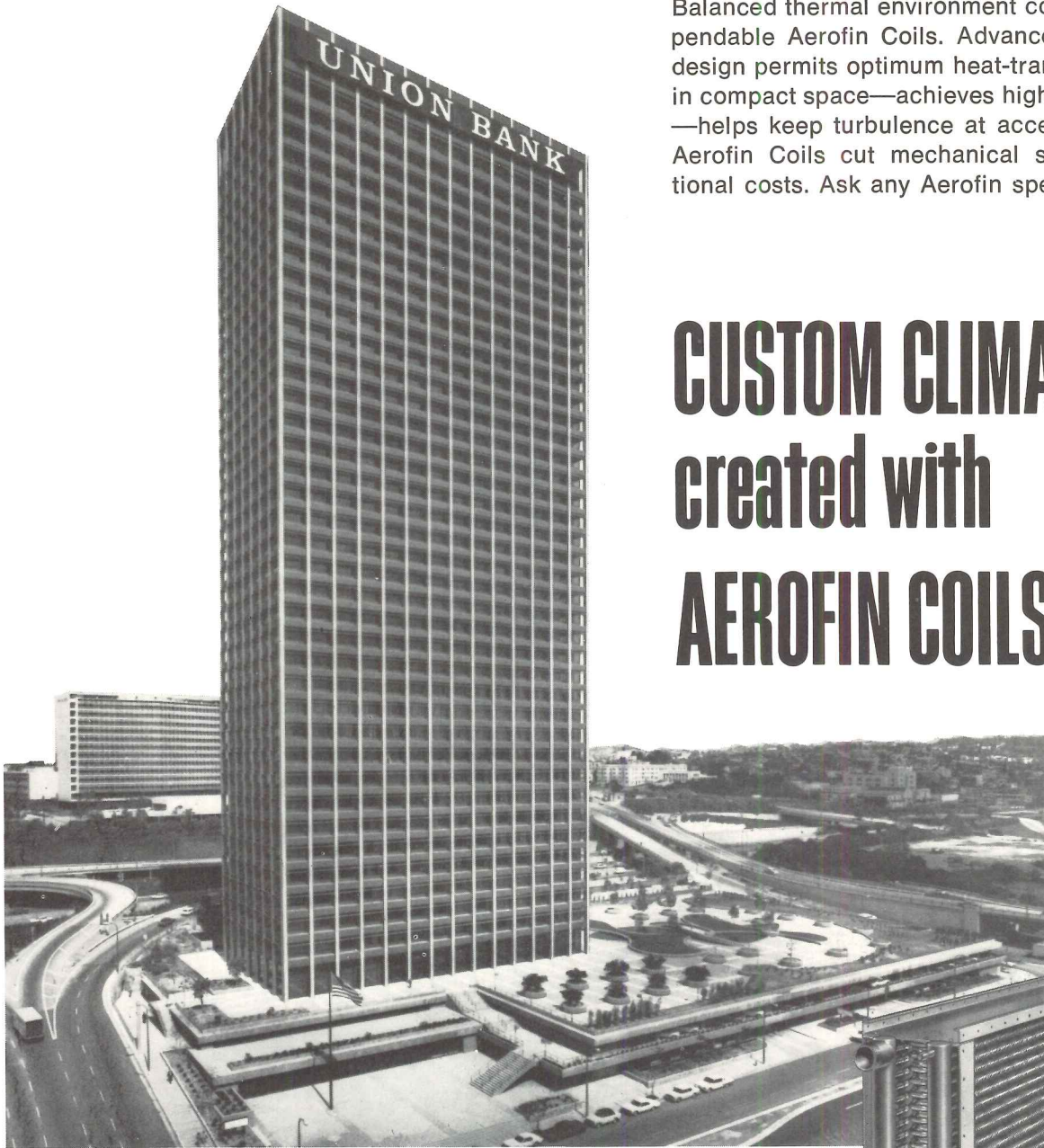

Union Bank, one of Los Angeles' tallest office buildings stands on a three-acre park, adjacent to the Harbor Freeway. It also anchors the \$500 million Bunker Hill project. Recessed bronzed-tinted windows under overhanging floors control solar heat.

Balanced thermal environment comes from dependable AeroFin Coils. Advanced smooth-fin design permits optimum heat-transfer capacity in compact space—achieves high air velocities—helps keep turbulence at acceptable levels. AeroFin Coils cut mechanical system operational costs. Ask any AeroFin specifier.

CUSTOM CLIMATE created with AEROFIN COILS

Architects: Harrison and Abramovitz, New York □
Associated Architects: Albert C. Martin and Associates, Los Angeles □ *General Contractor:* Turner Construction Company □ *Consulting Engineers:* Jaros, Baum & Bolles □ *Air Conditioning:* Western Air Refrigeration, Inc., Compton, Cal. □ *Owner:* Connecticut General Life Insurance Co., Hartford, Connecticut □ *Co-Developers:* Galbreath-Ruffin Corporation, New York.

Type C
used for cooling and heating.
Also Type CH coils used for heating.

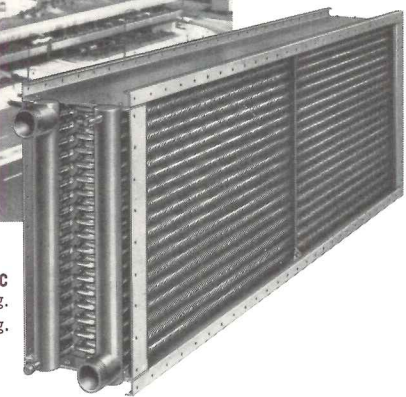

AEROFIN

CORPORATION • LYNCHBURG, VIRGINIA 24505

AeroFin is sold only by manufacturers of fan system apparatus. List on request.

AEROFIN OFFICES: Atlanta • Boston • Chicago • Cleveland • Dallas • New York • Philadelphia • San Francisco • Toronto • Montreal
AEROFIN CORPORATION (CANADA) LTD., Gananoque, Ontario



The New England Center for Continuing Education

Durham, New Hampshire

Designed by William L. Pereira Associates
Planning · Architecture · Engineering

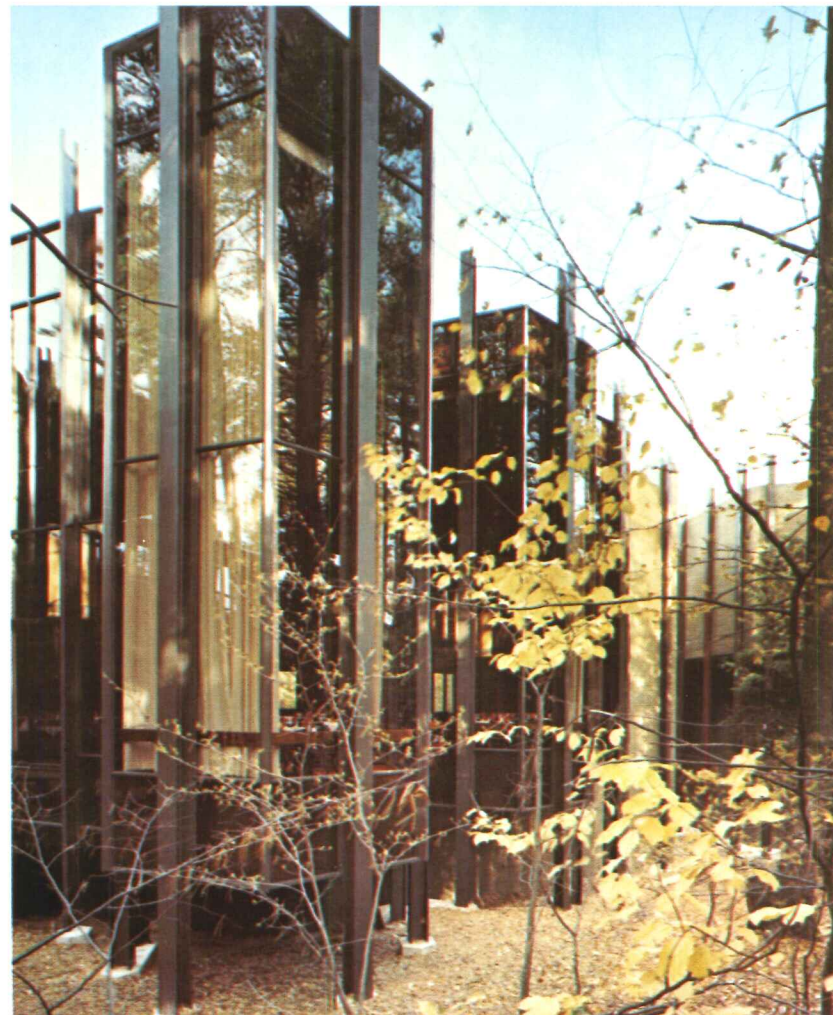

The New England Center for Continuing Education

is designed for continuing study by resident adults within a university environment. It is sponsored and supported by all six New England state universities.

The first phase of construction, completed in fall, 1969, represents an investment of \$3.7 million, provided by private, Federal, state, and local contributions, and substantial grants from the Kellogg Foundation.

The Center is located on 8½ wooded acres adjoining the University of New Hampshire campus. The primary structures now in service include a residential tower accommodating some 82 guests, and the Learning Center, which houses seminar rooms, an auditorium, audio-visual facilities, and dining areas. Future construction will provide two more residential towers, additions to the Learning Center, and a magnificent pavilion for social activities.



Viewed from the University of New Hampshire campus, the 8-story residential tower is a dramatic architectural statement . . .



. . . but, within the Center, the building blends into the trees, its reflective surfaces and dark-painted steel columns echoing the rhythms of nature.

Discussion nooks are provided on every residential floor in the tower.



(Plot plan) Completed structures are shown in solid color. Others are planned for later phases of development.

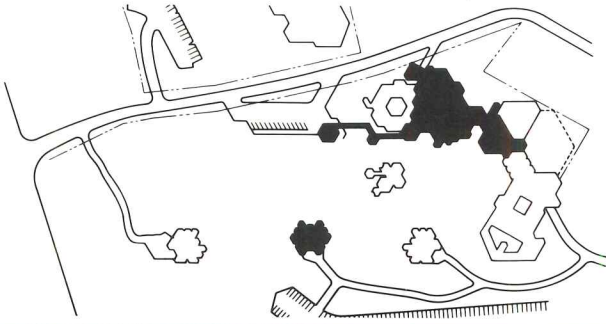

The dining area in the Learning Center is "papered with the view."



A spacious gallery within the Learning Center can accommodate large groups of conferees, while niches and alcoves overlooking the dining area encourage more intimate conversations. There is direct flow between the gallery and seminar rooms of various sizes at left.





A steel bridge provides access to the Learning Center from the arrival area.



Visual delights abound throughout the Center. Above, a promenade at the entrance level of the residential tower; right, a stairway in the Learning Center.

The New England Center is completely steel-framed, with painted exterior columns setting off exterior surfaces of glazed brick and dark, reflective glass.

If you would like to have a more detailed description of the structural design, please ask for "Structural Design News—1969," Booklet 2594. It is available from the nearest Bethlehem sales office or by writing Manager of Advertising, Bethlehem Steel Corporation, Bethlehem, PA 18016.

BETHLEHEM STEEL



Architect: William L. Pereira Associates; structural engineers: LeMessurier Associates, Inc.; mechanical/electrical engineers: Rollins King and McKone; civil engineer: Grant Davis; first phase general contractor: Davison Construction Co., Inc.; first phase steel fabricator and erector: Augusta Iron Works.





New concept for special-care facilities — a home-like atmosphere.

(Haws drinking fountains were specified because they look better... and they last.)

The Las Trampas School for the Mentally Retarded features extensive use of maintenance-saving materials—redwood siding, copper flashings and downspouts, and concrete shakes on the mansard roof for long wear and fire resistance.

Up-to-date facilities are embodied within a home-like atmosphere. The 2½-acre campus in Lafayette, California, includes four buildings on different site levels, which harmonize with the country setting.

First impressions are important. As you approach Las Trampas the feeling is one of welcome, of progress and happiness. First impressions are important with Haws fountains, too. The new Model 3120 square pedestal design is rugged, handsome, and built to last. For details write **Haws Drinking Faucet Company, 1441 Fourth Street, Berkeley, California 94710.**

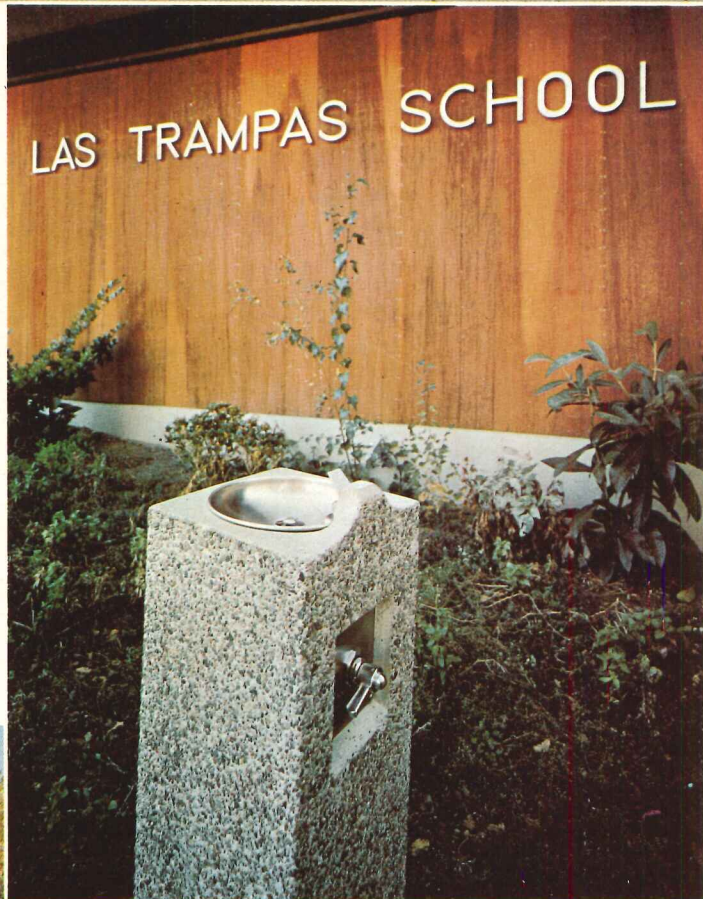

Architects:
Perata and Sylvester A.I.A., Lafayette, California

For more data, circle 85 on inquiry card





DON'T LET YOUR ROOF TURN INTO A POND.

**SPECIFY
TAPERED
FOAMGLAS[®]
INSULATION**

Tapered FOAMGLAS automatically slopes a flat deck for positive drainage. The roofer simply places factory-tapered FOAMGLAS and roofs over immediately. An added advantage: single-contractor responsibility.

FOAMGLAS is completely waterproof, strong and dimensionally stable, so it's an excellent base for built-up roofing. It's guaranteed. For further information, contact Pittsburgh Corning Corporation, Dept. AR-40, One Gateway Center, Pittsburgh, Pa. 15222.

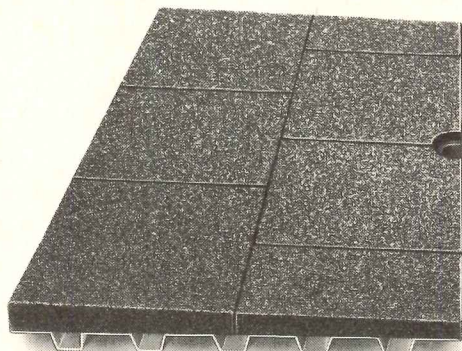

For more data, circle 95 on inquiry card

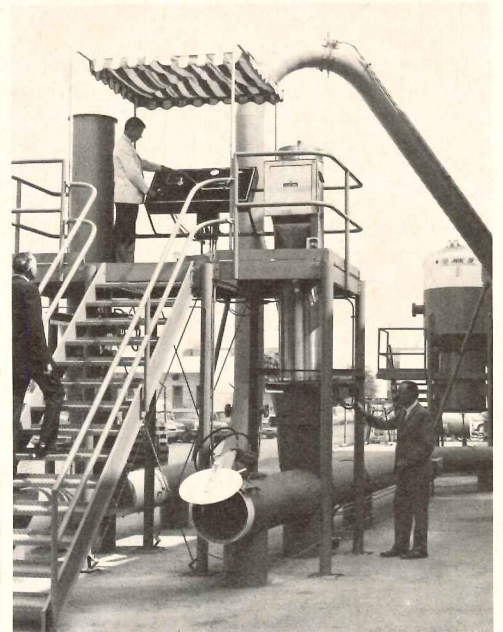

PNEUMATIC TUBE TRASH DISPOSAL / Trash placed in a tube will be drawn to a central collection point through pneumatic tubes by a 60-mph air stream. A Federal grant will pay for a portion of the system which will be used in a New York City apartment complex being operated by The United Housing Foundation. Said Richard D. Vaughan, Director of the Bureau of Solid Waste Management, U.S. Department of Health, Education and Welfare, "The introduction of a pneumatic transport system in this country could revolutionize refuse collection for high-rise multi-building complexes." In addition to saving labor, the pneumatic transport system can reduce air pollution, as well as odors, littered basements and cans of exposed garbage. A dual version of the system to handle both trash and solid linen is being installed in the Martin Luther King Memorial Hospital in the Watts section of Los Angeles. ■ Aerojet-General Corporation, El Monte, Cal.

Circle 307 on inquiry card

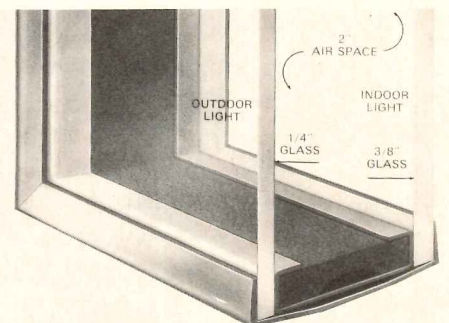

ACOUSTICAL WINDOW / This double-glazed window is designed to be used primarily for airport buildings, hospitals and other places where noise reduction is important. The air space between the panes is 2 in. and 4 in., and noise reduction is 39 and 45 decibels. The window also provides light and heat control by use of tinted glass. ■ PPG Industries, Pittsburgh.

Circle 308 on inquiry card

more products on page 198



Globe Union, Inc.—Glendale, Wis.—Reception Area
Charles Harper and Assoc., Architects

Sears

Contract
Sales
Division

total
interior
space
planning

Sears Contract Sales Division offers a complete service of interior work . . . from the initial concept of design to the creation of custom furnishings. The happy result is a "total concept" of interior decoration that is integral to the whole architectural intent.

Let us explain how we can put this "total concept" to work for you. Mail the coupon for your *free* Contract Furnishings catalog, or ask to have a Contract Representative contact you.

**Sears, Roebuck and Co., Department AR4
3609 W. Arthington Street, Chicago, Ill. 60607**

- Send free Contract Furnishings Catalog
- Have Contract Representative contact me

Name _____

Company _____

Address _____

City _____ State _____ Zip _____

AR4

Your Plans Are Never Complete Until They Specify Protection

If your plans do not provide for total protection . . . go back to the drawing board! No building is finished or functional unless you have specified full protection against fire and burglary, and have provided for supplementary communications and sound systems.

By planning for total security and sound systems in the initial stages, you guard against costly construction adjustments if the need for any of these systems has been overlooked.

We know you are aware of fire regulations. You should also recognize that the

need for security systems today is equally important.

ADT protection consultants will work with you in the planning stages. They will assist you in integrating total, custom-built protection and sound systems into your building.

And with ADT you get the entire protection package. ADT designs, manufactures, installs and maintains its own systems. ADT service keeps them in top operating condition.

Progressive architects with a sense of security plan with ADT . . . the protection professionals. For information and literature, see Yellow Pages or write.

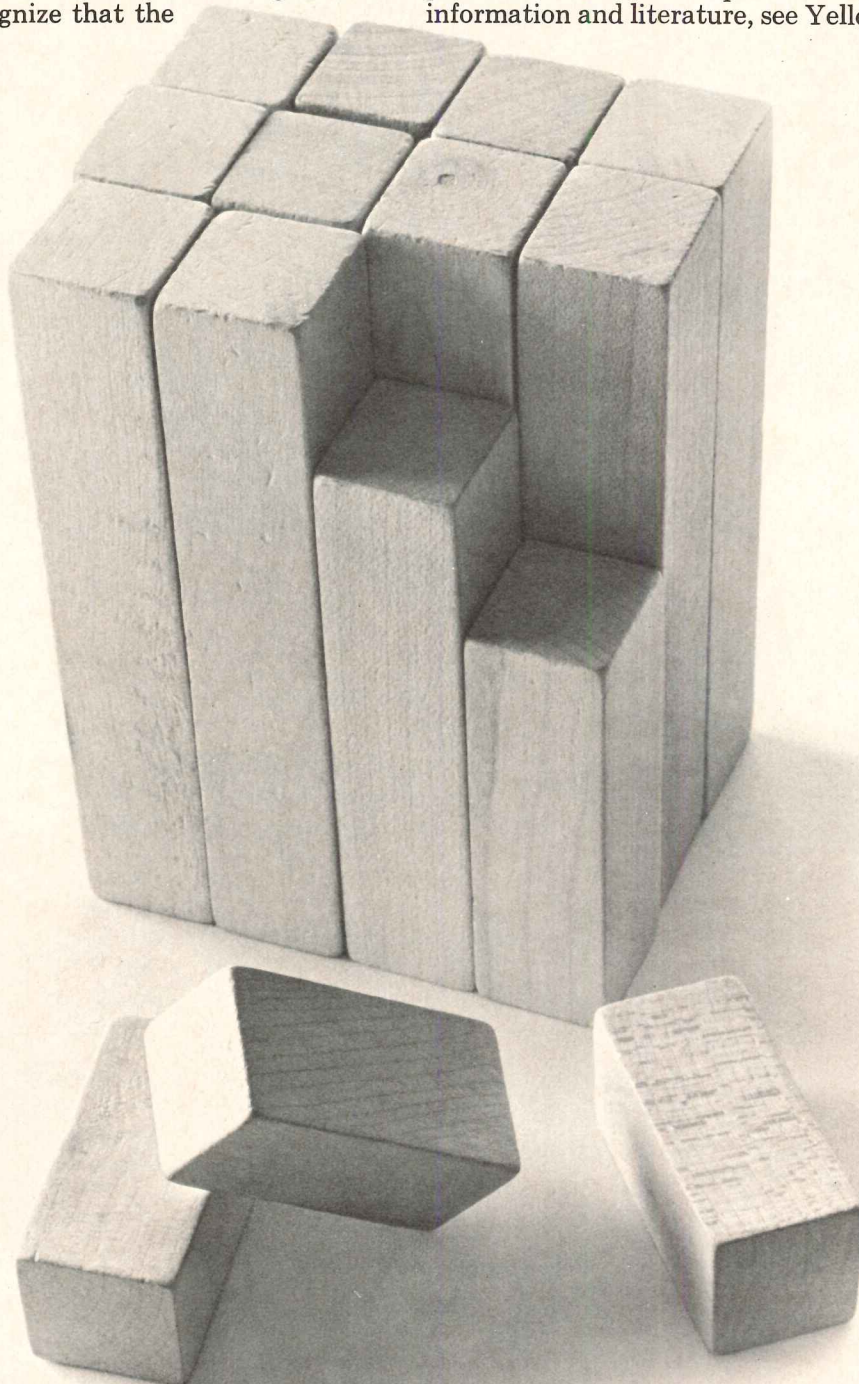

ADT[®]

An International Organization 155 Sixth Ave., New York, N.Y. 10013

For more data, circle 88 on inquiry card

It's about time.

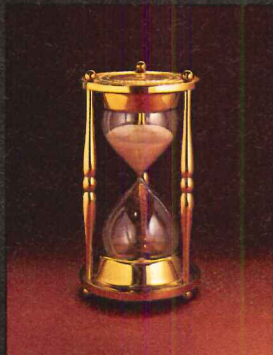

Span-Deck's story is about time . . . like in "time is money." And in Span-Deck's story, we mean lots of money.

We're talking about "time costs" that have become so important, such as . . .

- . . . interest on construction loans
- . . . uncompleted-job site vs. income producing property
- . . . supervision and overhead hours
- . . . architect's inspections and phone time
- . . . weather and labor hazards
- . . . fluctuating material costs

Span-Deck minimizes time costs . . . for while a job-site is being prepared, structural elements can be plant-produced off-site. Span-Deck floors and roofs erect at 10,000 to 20,000 square feet per day, wall panels at 5000 square feet per day. This is the kind of speed that has cut "time costs" in half.

The Span-Deck story is also about design flexibility, fire-safety, acoustics, low span-depth ratio, dimensional accuracy, nationwide availability and the finest, most precise, prestressed concrete, hollow-cored decking unit (requires no topping) made in the United States, Canada or England.

If *your* time is valuable, it's about time for Span-Deck.

For the complete Span-Deck story and the name of the producer nearest you, contact: Span-Deck, Incorporated,
P. O. Box 99, Franklin, Tennessee 37064.

For more data, circle 89 on inquiry card

span deck®

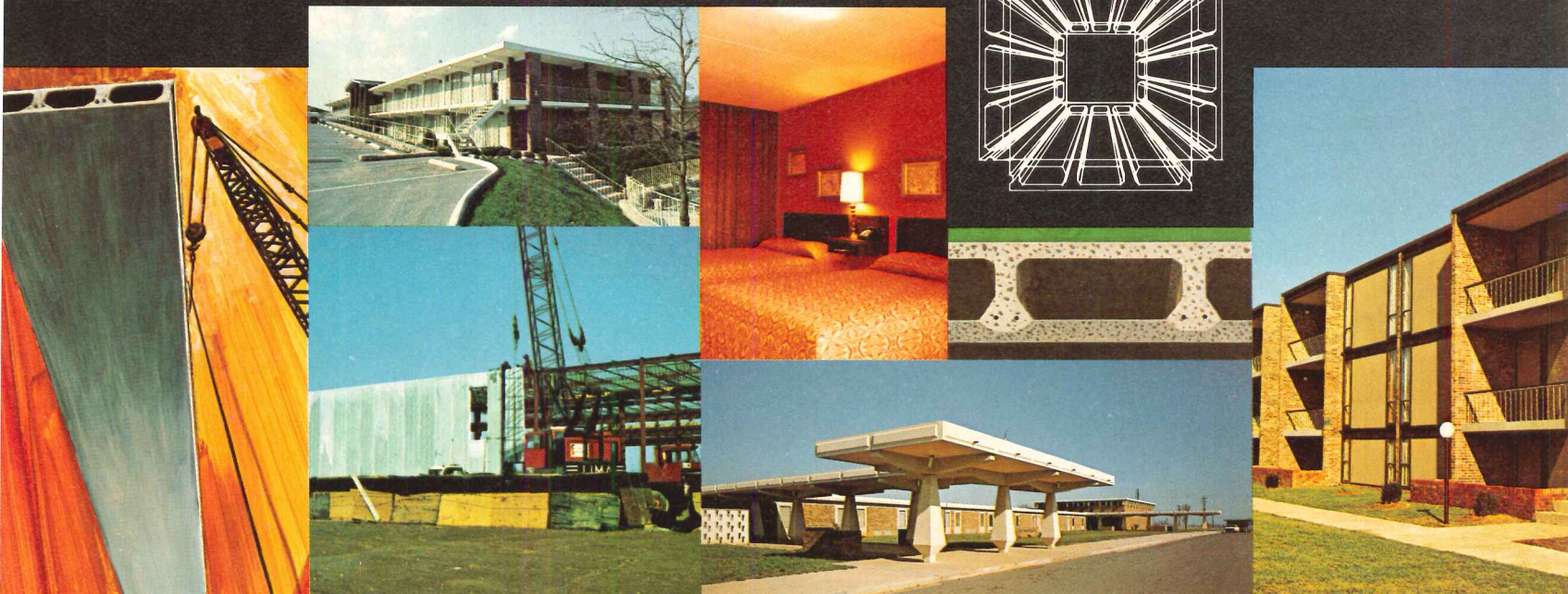
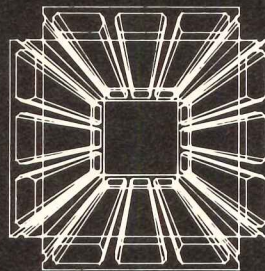

HILLYARD

FLOOR TREATMENTS

Used in America's Newest,
Most Modern Buildings



*Onan, Division of Studebaker Corp.
Minneapolis, Minnesota
Designers-Engineers: Walter Kidde Constructors, Inc.
of New York City*

Hillyard floor seals, waxes and cleaners were chosen for use in the huge new \$15 million plant occupied early in 1969 by Onan Division of Studebaker Corporation, one of the world's leading builders of electric power plants, air cooled engines, separate generators and automatic controls.

The Onan complex consists of a one-story manufacturing building with 456,200 square feet of floor space; a one-story engineering building with a floor area of 57,640 square feet; and a three-story office building with a total of 85,000 square feet.

HILLYARD SPECIFICATIONS MANUAL

Write for your copy today. There's a Spec File for the treatment of every type floor. Spec-Data sheets are also included. Each file will be kept up to date for you in a three ring binder.

Also ask, at no obligation, for the services of a Hillyard architectural consultant. He's trained to recommend proper, approved treatments for the floors you specify, and also to supervise application at the job site.



HILLYARD FLOOR TREATMENTS

ST. JOSEPH, MISSOURI U.S.A.
Totowa, N.J. San Jose, Calif.
Minneapolis, Minn. Dallas, Tex.
Boston, Mass.

IN CANADA: Calgary, Alberta
London, Ontario



SINCE 1907

*The most widely recommended and
approved treatments for every surface*

For more data, circle 90 on inquiry card



Fiberglass

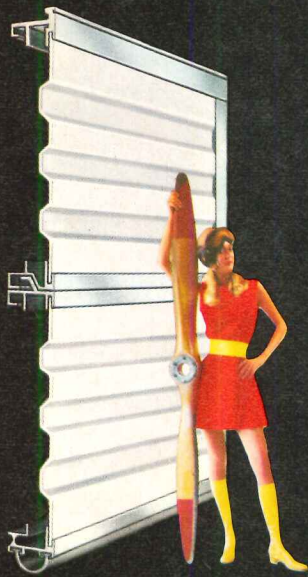

Aircraft hangar



Service station



Flush wood



Panelled wood



Flush steel



Ribbed steel

7 garage doors to make your job easier... only from Raynor

Choose your material . . . wood, fiberglass, steel, aluminum. Pick your style . . . industrial, commercial, residential. Then check with Raynor, because only Raynor builds them all. For all architectural styles. And they're all backed by the finest guarantees in the industry. Plus design advantages like customized hardware to match the installation. Extra-heavy tracks. Custom-wound springs. Service and replacement ad-



vantages like "forever" parts lists recorded on data film. Expert engineering consultation in the field and from the factory. The complete range of accessories — lights; special panels; windows; electric openers and controls for all doors; headroom hardware. Name your garage door problem and Raynor will solve it. You can depend on that. Raynor Manufacturing Company, Dixon, Illinois 61021.



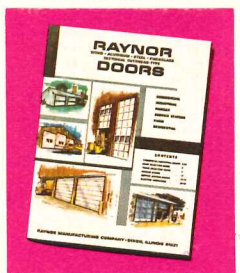

Send for literature

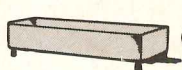

RAYNOR[™]

The Brand You Can Depend On

For more data, circle 91 on inquiry card

Doesn't anybody make refrigeration equipment with all-copper tubing  and an Automatic Defrost-Vaporizer  and heater wire strips and triple-seal gasketing   and 5 standard finishes  and self-supporting insulation  and adjustable legs?

Nor-Lake does. With a full range of components and options, the only thing we won't change is the quality.

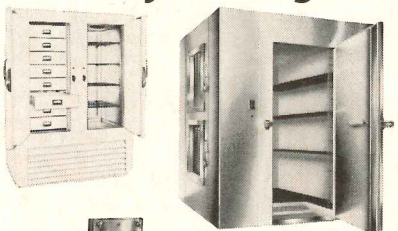

NOR-LAKE INC.
Second and Elm, Hudson, Wisconsin 54016
Phone: 715 386 2323 Dept. 3161

*Pride is contagious
at Nor-Lake*

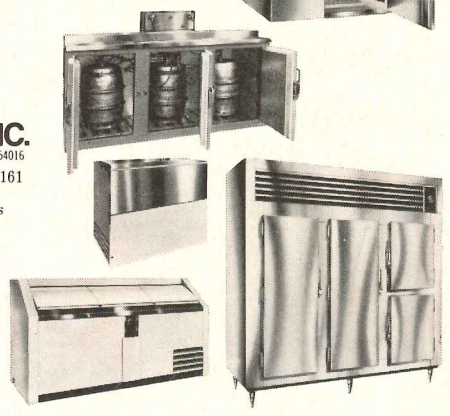

Over 270 models—all designed to NSF configurations.
Sweets File 23a/No.

What else should I know about Nor-Lake Refrigeration equipment?

Name: _____

Address: _____

City: _____ State: _____ Zip: _____

I need Refrigeration Equipment for _____

For more data, circle 92 on inquiry card

Massey put it together.

A new chair with a one-piece moulded plastic back. The Polaris chair. Massey put a lot of thought into the Polaris chair. To make it just right.

They put it together with a one-piece back. Because it's stronger. Looks better. Because they could eliminate ugly seams and exposed screws that snag clothing. And because there's no fold to catch dust and candy wrappers.

They put it together with 2" of foam on the back and a foam cushion over springs on the seat. Because they knew it would sit better. Be more comfortable. Hour after hour.

They put it together of moulded plastic. To keep its beauty for a lifetime. To keep it from getting scratched and marred in heavy day to day traffic.

They put it together to give you a chair that can meet the public. Over and over again. Put it together yourself. If it adds up. Write Massey and get together with their new Polaris chair.



Massey
seating co.
NASHVILLE, TENNESSEE 37208

For more data, circle 93 on inquiry card

**I WANT
YOU**

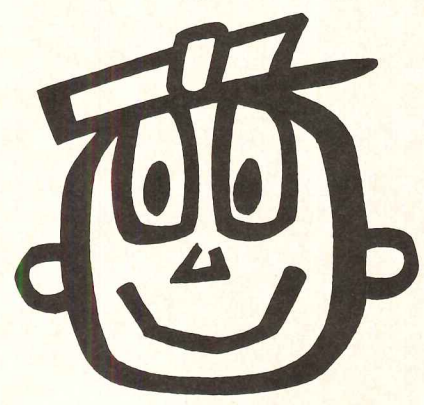

**TO USE
ZIP CODE**

So that you can have faster,
more efficient mail service.

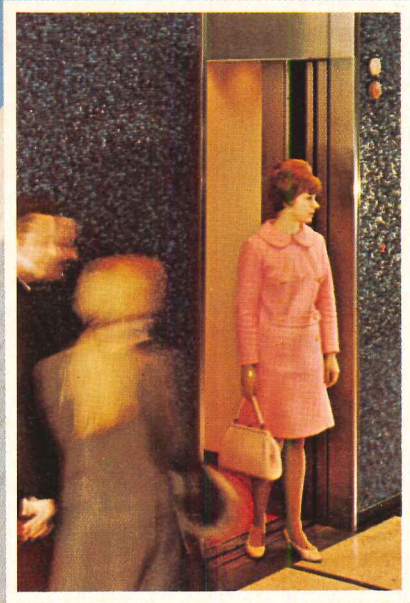

Haughton 1090 versus the other elevator control systems:

No contest.

Consider the facts, proven in leading buildings coast-to-coast.

A given number of elevators under our new 1090 computerized elevator control system can move more people with speed and comfort than any other contemporary system you can specify.

There are ample reasons why this is so. Things like new concepts in solid state components. An incredibly efficient computerized *brain* that actually anticipates calls. Electronic demand response modules. And a whole lot more.

If superior elevator service for

new buildings or modernization projects is important to you, get the full story about our new 1090 computerized elevator system.

Ask your Haughton representative to call at your convenience. Or, write us.

HAUGHTON
ELEVATOR COMPANY 
DIVISION OF RELIANCE ELECTRIC COMPANY
P.O. BOX 780 • TOLEDO, OHIO 43601

For more data, circle 94 on inquiry card

continued from page 190

NICE and COLD

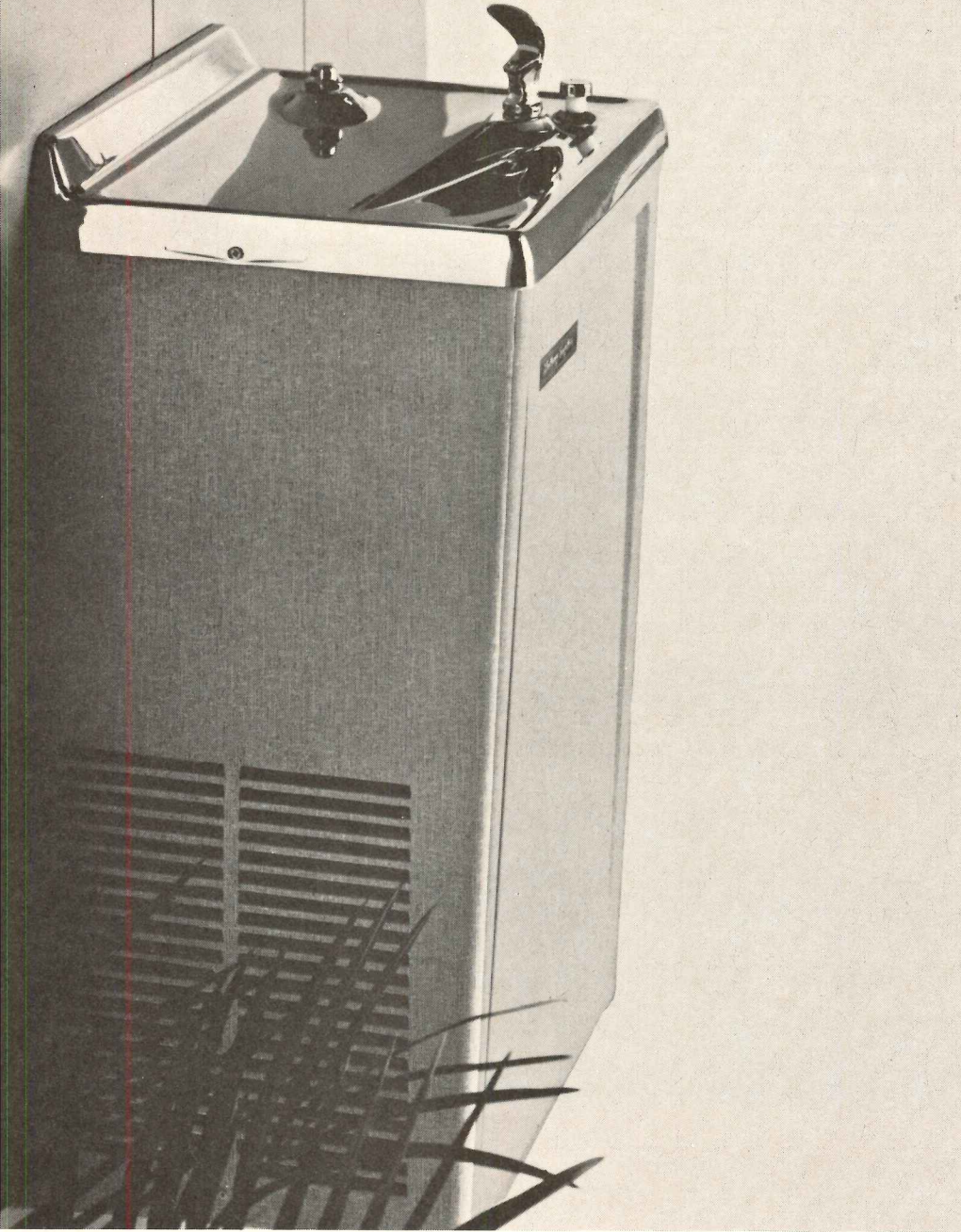

WM SERIES Wall-Mounted Coolers

4 Capacities — 8.0, 14.0, 16.0, and 19.0 G.P.H. of 50° water.

Cabinets — Vinyl-clad steel, silver spice, and mocha brown; also stainless steel, and gray baked-on enamel.

Can be Factory Equipped with — 60-cup hot water dispenser • bi-level fountain for juvenile service • water-cooled condensers • water filter.

SW SERIES — Mini-Coolers — measuring just 20½" top to bottom — in 8.0 and 13.5 G.P.H. capacities.

Write for Catalog and specifications.

THE HALSEY W. TAYLOR COMPANY
1560 Thomas Road, Warren, Ohio 44481
SUBSIDIARY • KING-SEELEY **KST** THERMOS CO.



For more data, circle 86 on inquiry card

ANTI-STATIC YARN / Zefstat, an aluminum fiber coated with polymer, is being used to produce an anti-static carpet yarn. Carpets made with Zefstat are guaranteed non-static for the life of the carpet. The aluminum fiber cannot be seen and can be used with any carpet construction. No special backing is necessary. ■ Dow Badische, New York City.

Circle 309 on inquiry card

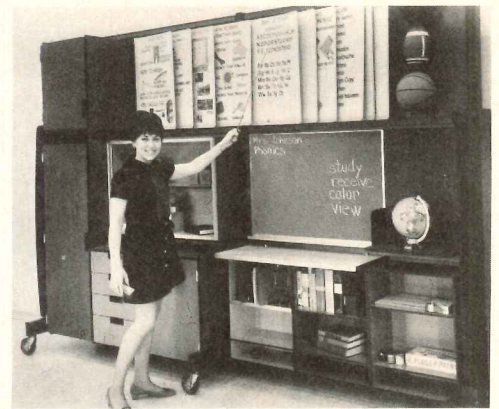

RE-USABLE LEARNING PANELS / The VUE (Visual Unified Environment) line consists of storage and display units that are wall-mounted to keep basic materials and supplies in full view of students at all times. The panels are lightweight and can be re-used by simple re-arranging. Color-coordinated components of the system include closed and open storage cabinets, mobile walls, chalk, tack and peg boards, counters and shelves. ■ American Seating, Grand Rapids, Mich.

Circle 310 on inquiry card

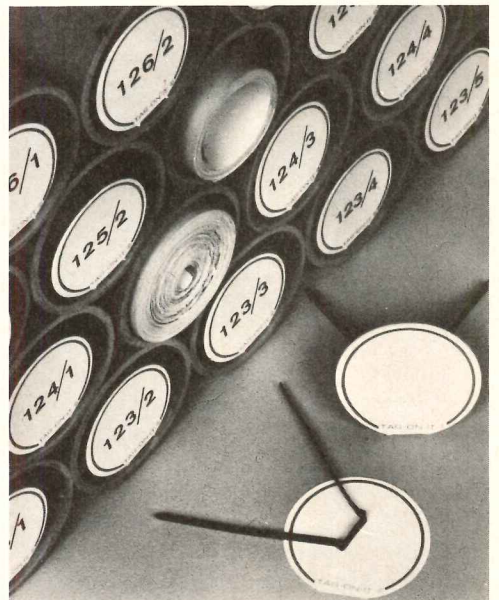

IDENTIFICATION DISCS / These flat cardboard discs, which can be marked or typed on, adhere to a double metal prong that can be inserted into any rolled material. They come in various sizes in kits of 50 discs and 30 prongs for \$9.50. ■ Guy Voyce Assoc., New York City.

Circle 311 on inquiry card

more products on page 202

SPEAKMAN

Anystream®

SHOWER HEADS



S-2252

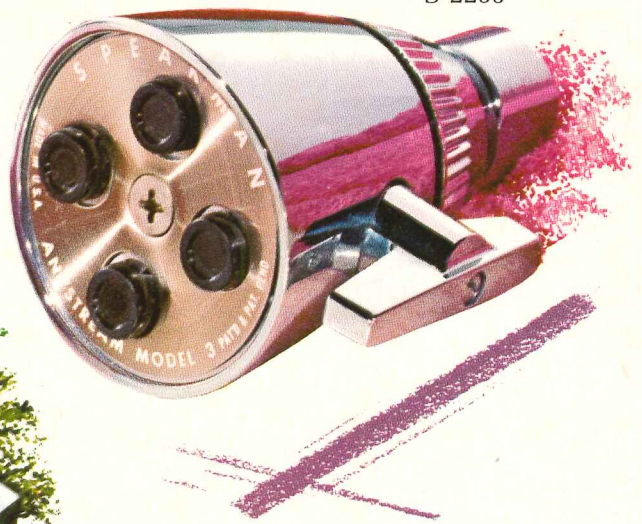

S-2253

You are looking at the world's most popular shower heads. In addition to distinctive styling and flawless workmanship, they offer design advantages found only in Anystream.

Even at low pressure, a solid spray pattern without center hollows or voids.

Adjustable through a full spectrum of spray patterns from needle to flood.

Non-stick, deposit-resistant Lexan* plungers to practically eliminate maintenance.

Each shower head available with AUTOFLO, Speakman's patented water-saver.

Selection includes swivel ball-joint, wall-type and vandal-proof models.

Speakman Anystream: An eloquent expression of your ideas.

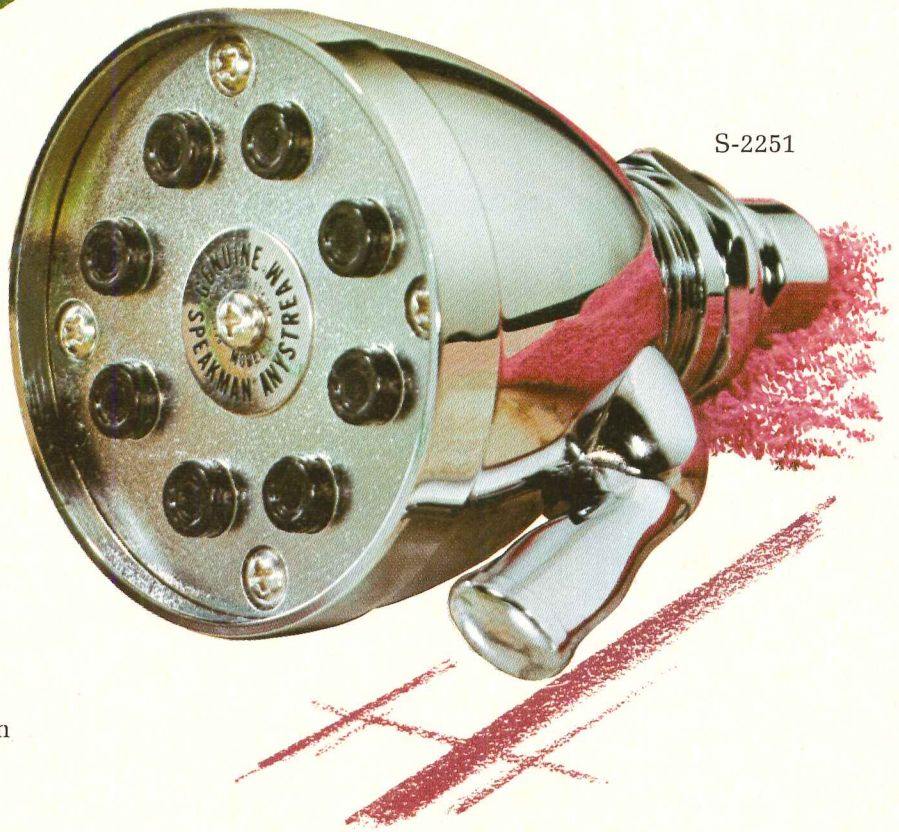

S-2251

*TM General Electric Co.



SPEAKMAN® COMPANY • Wilmington, Delaware 19899 • In Canada—Cuthbert-Speakman, Quebec

For more data, circle 96 on inquiry card



TESTING.

There's an idea floating around the construction industry. It has to do with microfilming information. Like catalog pages. It's not a new idea. In fact, we at Sweet's have already spent five years and over one million dollars working on it. And we're still working on it, because it still needs work.

Several companies have announced that they have stopped working and started selling. They haven't announced that they still have problems. Which can become your problems. Like cost. Like locating information. Like browsing and comparing. Like queuing up at the reader/printer. Like color.

For the record, we'd like to announce that we have a microfilm library, too. Sweet's Architectural Microfilm Library—only it's not *just* microfilm. Together with Sweet's Architectural Catalog File, which you all know and use, it forms a complete system combining the advantages of printed and filmed data. In total, over 120,000 pages of product information.

Our new system will be rigorously tested this year in 300 architectural offices. And only when it has passed these tests and we are satisfied that it is the best system available will we sell it.

By best, we mean the most

efficient, trouble-free, economical information retrieval system in the market. Like you'd expect from Sweet's.

So, if you're interested in microfilm and are somewhat confused about all the blue-sky claims and promises being made by various companies, join the club. And get un-confused—we have some down-to-earth facts for you on this whole microfilm subject. Just send your name and address to: Architectural Microfilm Library, Sweet's Construction Division, McGraw-Hill Information Systems Company, 330 West 42nd Street, New York, New York, 10036

An aerial photograph of a city skyline, likely New York City, taken from a high angle. The city is illuminated by the warm, golden light of a setting or rising sun, with the sky transitioning from a deep blue to a bright orange near the horizon. The water in the foreground is dark and reflects the city lights and the sky. The overall mood is dramatic and emphasizes the verticality of the city.

Without Westinghouse Elevators, Electric Stairways and Electric Walks, millions of people couldn't go up.

Did you ever stop to think what a city would look like without vertical transportation?

All over the country, Westinghouse Elevators make skyscrapers more efficient. In New York, they serve Rockefeller Center, CBS and the Pan Am Building. In Chicago, the Civic Center, and the First National Bank Building. In Dallas, One Main Place. In San Francisco, the Embarcadero Center. In Los Angeles, Crocker Citizens Plaza.

Westinghouse Electric Stairways help keep a city moving. In Grand Central Station four of them carry 250,000 people a day. For the Bay Area Rapid Transit System in San Francisco, 96 units are now being installed. And they serve people in stadiums, shopping centers and office buildings.

Westinghouse Electric Walks will make shopping easier in five new J. B. Hunter Department Stores. An Electric Walk at the new Burlington House in N. Y. C. will move people on an exciting journey through the world of textiles. Walks are going into airports. And soon, they'll even be used by people visiting a zoo.

Westinghouse not only helps make cities possible; we also do our best to make them efficient and enjoyable. Westinghouse Elevator Division, 150 Pacific Avenue, Jersey City, N. J. 07304. In Canada: Canadian Westinghouse Co., Ltd., Elevator Division, Etobicoke, Ontario.



You can be sure...if it's Westinghouse

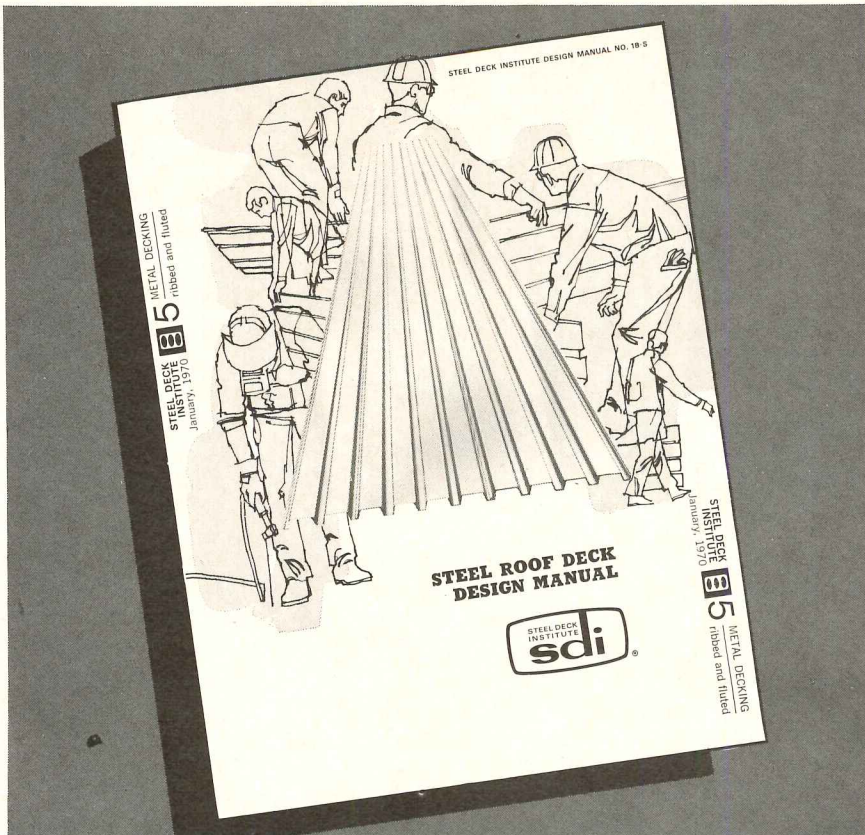

1970 DESIGN MANUAL FOR STEEL ROOF DECK...

New 12 page design manual contains standard load tables, complete list of fire ratings... latest revision of the Basic Design Specifications and SDI Code of Recommended Standard Practice... and suggested Architects Specifications.

For the first time, information on Site Storage, Erection and Accessories is included... the 1970 Manual will serve as a reliable reference for your future roof designs.

STEEL DECK INSTITUTE



Airtherm Manufacturing Co. • Armco Steel Corp. • Bowman Building Products Div., Cyclops Corp. • The Ceco Corp. • Epic Metals Corp. • The Goldsmith Metal Lath Co. • Granco Steel Products Co. • Inland-Ryerson Construction Products Co. • Macomber, Inc. • The R. C. Mahon Co. • Merco Manufacturing, Inc. • Republic Steel Corp. Mfg. Div. • H. H. Robertson Co. • Roll Form Products, Inc. • Rosewall Industries, Inc. • United Steel Deck, Inc. • Wheeling Corrugating Co.

For free copy fill in coupon and clip to your letterhead

STEEL DECK INSTITUTE, 9836 W. Roosevelt Rd., Westchester, Ill. 60153

Please send me the 1970 Steel Roof Deck Design Manual

NAME _____

TITLE _____

For more data, circle 98 on inquiry card

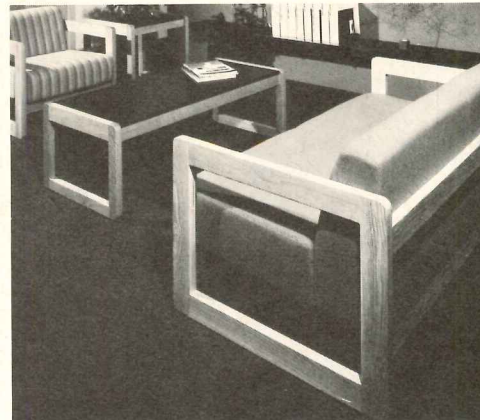

FURNITURE SERIES / Use of exposed structural elements unites the furniture in the *Linear Oak Series*. Most of the nine seating units and four tables use a sled base. The furniture is adaptable to many different needs, and is compact without sacrificing strength. ■ Harter Corp., Sturgis, Mich.

Circle 312 on inquiry card

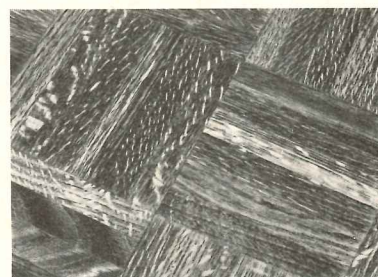

IMPREGNATED WOOD / *Gammapar* floor parquets are made of wood impregnated with liquid plastic that is solidified through a nuclear-energy process. Floors are suitable for areas subjected to heavy foot traffic and abuse. They are highly resistant to moisture and require only light buffing to maintain. The parquets come in a variety of colors and wood tones. ■ The American Novawood Corporation, Lynchburg, Va.

Circle 313 on inquiry card

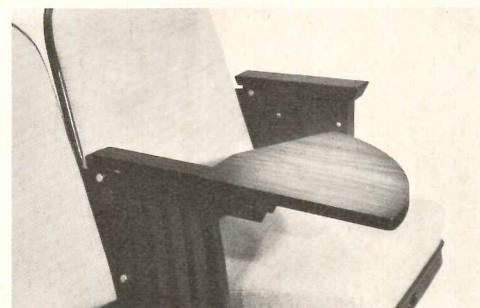

NEW TABLET ARM / This new arm uses a gravity-operated swing swivel instead of an exposed support bar and eliminates the problem of snagged hosiery as well as providing more knee room. The company claims that there is no loss of strength due to lack of a support bar, and that the new arm will support a load of 800 lbs at its center. ■ Irwin Seating Co., Grand Rapids, Mich.

Circle 314 on inquiry card

more products on page 220

**One
manufacturer certifies that you
get every watt of standby power
you pay for. Each system must
earn its Performance Certification
from an independent testing
authority. It's great comfort
when people are betting their
lives on our product.**

No.1 is the One



Onan[®]

1400 73RD AVENUE N.E., MINNEAPOLIS, MINNESOTA 55432
OUR 50TH YEAR BUILDING GENERATORS AND ENGINES

For more data, circle 100 on inquiry card

If it's worth protecting... it's worth Anchor.

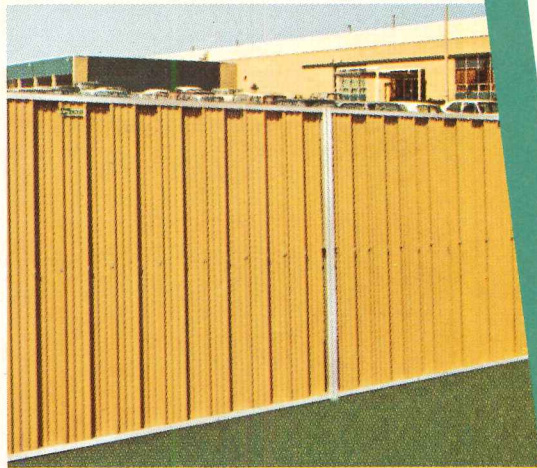

FREE BOOKLET

Free 16-page color booklet on exciting new dimensions in industrial fencing. Mail to Anchor Fence, Dept. C-04, 6500 Eastern Ave., Baltimore, Md. 21224.

Name _____ Title _____

Firm _____

Street _____

City _____ State _____ Zip _____

Anchor Fence, a division of Anchor Post Products, Inc.
Plants in Baltimore, Houston, Los Angeles; 48 branch offices.

Anchor "Permafused"® Chain Link with corrosion-resistant aluminum framework, fabric of handsome, rugged Woodland Green vinyl thermofused to steel. Ideal where requirements are strength, minimum upkeep, attractive appearance. Also available: fabrics in steel or aluminum, framework in galvanized or vinyl-coated steel.

TOP: Anchor Privacy Board-on-Board conceals, protects, adds beauty — with minimum upkeep. All-aluminum, in choice of 5 baked-on enamel colors.

BOTTOM: Aluminum strips locked into chain link make Anchor Weave® screening fence. Gives you strong protection plus privacy, choice of 8 baked-on enamel colors.

For more data, circle 101 on inquiry card

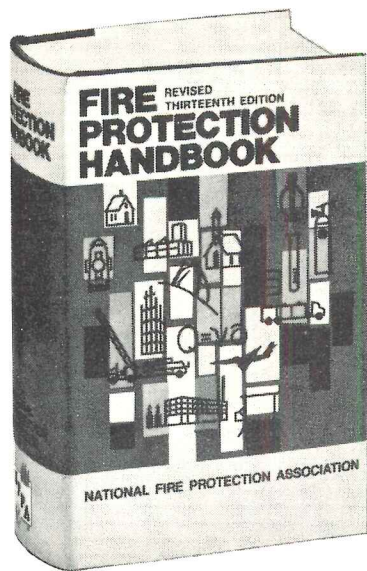

The "bible" of fire protection. Just issued 13th Edition gives a progressive understanding of fire and its control while being a logical encyclopedia on sound fire protection engineering. Published by NFPA — worldwide, the leading authority on fire. 2,128 pages. \$22.50 per copy, f.o.b. Boston. Postage prepaid when check accompanies order. Write Dept. D7.

National Fire Protection Association
60 Batterymarch St., Boston, Mass. 02110
Telephone (617) 482-8755

For more data, circle 102 on inquiry card

**STC
40
in
WOOD**



PANELFOLD WOOD FOLDING DOORS AND PARTITIONS, 1090 East 17th Street, Hialeah, Fla.
S SWEET'S ARCHITECTURAL FILES 13b AND 17i

For more data, circle 103 on inquiry card

Mount Airy Granite the New Look in Plaza Flagging

More and more architects recognize there's something special about Mount Airy Granite with its distinctive features, limitless design possibilities, durability and maintenance-free characteristics. Below, Mount Airy Granite forms the white field of Syracuse Plaza over underground parking garage. Similar plaza work, using the unmatched beauty of Mount Airy Granite, was used over an underground garage for the John F. Kennedy Plaza, Philadelphia and Monroe County Civic Center Plaza in Rochester. For complete details write today.

NORTH CAROLINA GRANITE CORPORATION
Mount Airy, North Carolina 27030



Syracuse Plaza, Syracuse, N.Y. Architect: Gordon Schopfer Associates. General Contractor: Stateway Builders, Inc., and William C. Pahl Construction Co., Inc. Stone Contractor: The Ryan, O'Brien Stone Co., Inc. Fabricated by: J. D. Sargent Granite Co. from Mount Airy Granite.

For more data, circle 104 on inquiry card

For more data, circle 105 on inquiry card ▶

Flat walls



Dimension V: Patent Pending

This is Dimension V™ paneling

are out!



OAK

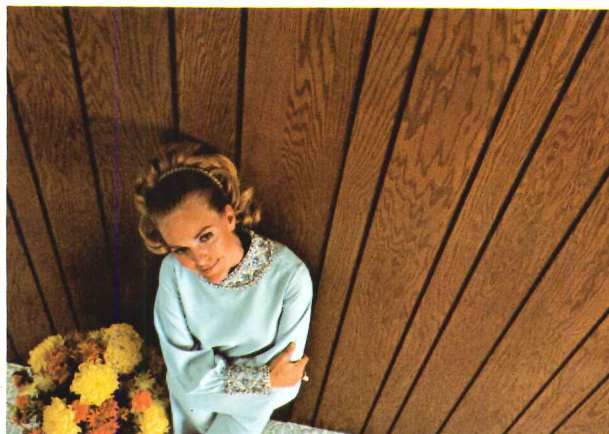
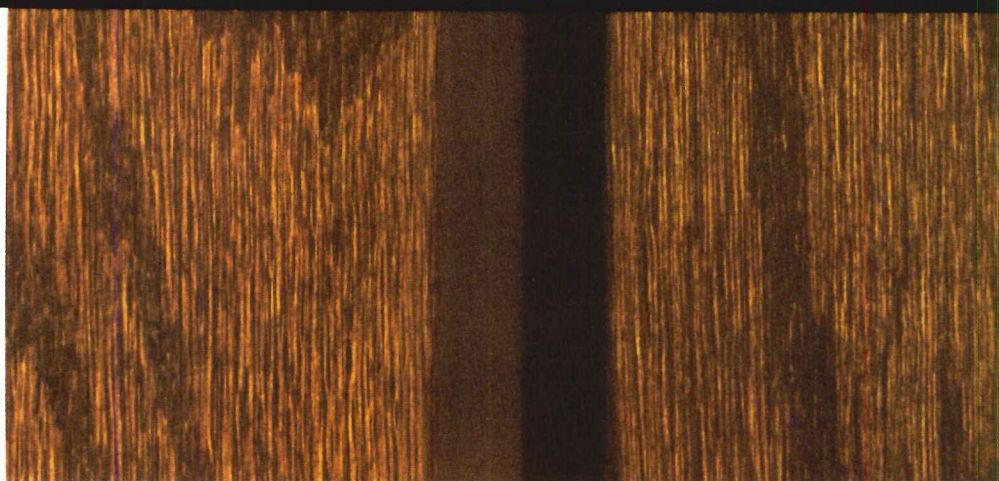

Announcing the beginning of the end for flat walls! Introducing Dimension V paneling with the deeper, wider grooves—deeper and wider than any other paneling.

Dimension V is unique, distinctive, elegant. Use it in any private or commercial building. You'll get effects never before possible with paneling. It gives a mood that is at once masculine and delicately beautiful.

Dimension V is available in oak, walnut, birch, and Brasilia®. Today, talk to your G-P representative about Dimension V. Then use it anywhere you want to get the look of the 70's!



GEORGIA-PACIFIC
THE GROWTH COMPANY
PORTLAND, OREGON 97207

KSH-17—The lighting panel that does everything!

FACT SHEET PROVES IT!

BEAUTY Bold, modern design with $\frac{3}{8}$ " square prisms gives your lighting a new contemporary look.

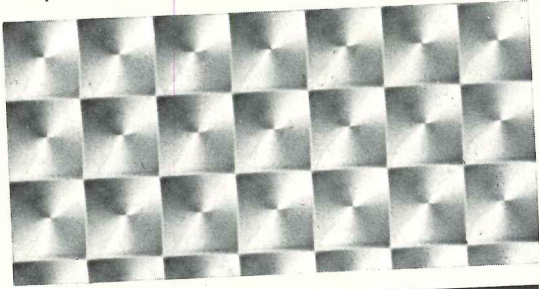

STABILITY .240" thickness in KSH quality acrylic. No sag even in the widest panels.

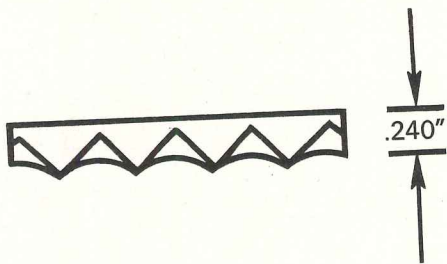

SIZES (you name it).

1 x 2	1 x 4	2 x 4
2 x 2	3 x 3	4 x 4

COLORS To give you the exact effect you want.



Dark Silvertint

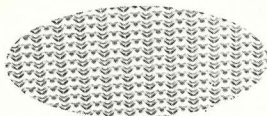

Clear



Silvertint

GLARE CONTROL KSH-17 panels are designed for both reflected and direct glare. Compare with any other type!

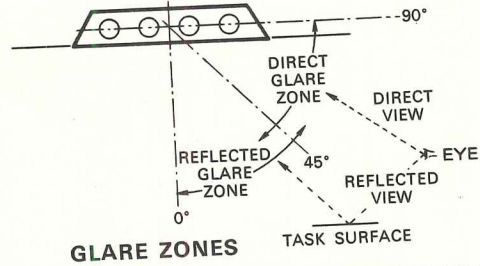

VISUAL COMFORT RATINGS Silvertint and dark silvertint give you a VCP from 85 to 96 (well over the minimum 70). Also meet the scissors curve for 4 lamps in a 2 x 4 fixture.

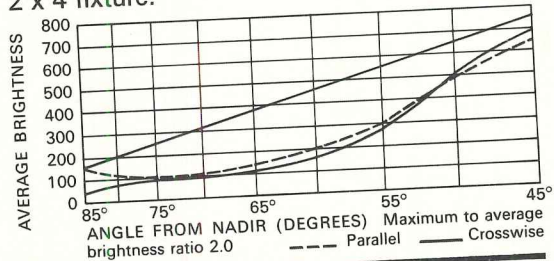

NO SHOW All KSH-17 prismatic panels have excellent lamphiding power... similar to that of an opal panel.

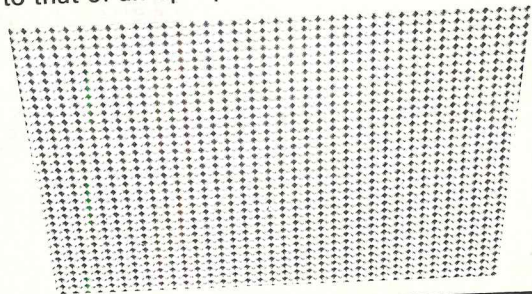

THE SECRET KSH-17 is a composite panel... with a thin sheet of acrylic on top of a high-quality KSH prismatic panel. Sealed to keep it moisture-proof. A unique KSH idea!

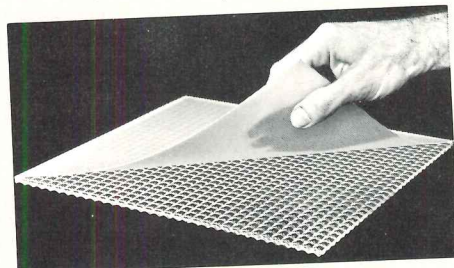

WRITE FOR BROCHURE K1 520 **KLITE**[®]
K-S-H, Inc., 10091 Manchester Road, St. Louis, Missouri 63122

For more data, circle 106 on inquiry card

◆ For more data, circle 105 on inquiry card

Have you seen our big electric power line?

Now there are seven Allis-Chalmers Diesel Electric Systems to see for standby or continuous power. Starting with the 35-KW DES-35. And ranging on up to 45, 60, 90, 125, 200, 250-KW models.

All designed for easy paralleling of two or more units for unlimited KW capacity. And offering unmatched dependability as a source of electric power.

Voltage response is three to four times faster than with any others! Quick voltage recovery, high momentary KVA. And voltage regulation accuracy from no load to full load—only plus or minus $\pm 1\%$!

Fast frequency response time with minimum transient dip. In most cases 3 to 5% regulation from no load to full load is obtained with a simple mechanical governor. Steady state regulation of $\pm .25\%$ is standard.

All these systems are powered by high-torque, fuel-saver Allis-Chalmers diesels in a compatible, compact match of engine, generator and controls. With parts and service responsibility from one source. Allis-Chalmers.

And backed by one of the most generous warranties in the industry. Two years or 3,600 hours of operation as standby power—one year or 3,600 hours of operation on continuous duty! Ask your Allis-Chalmers Engine Dealer about it. Refer to Sweet's Architectural File Number 30d/ALL. Or send the coupon.

Free book on Selection, Planning, Installation of Diesel Electric Systems is yours for the asking. Just tell us where to send it.
Mail to: **ALLIS-CHALMERS Engine Division**,
P.O. Box 563, Harvey, Ill. 60426



NAME _____

TITLE _____

COMPANY _____

ADDRESS _____

CITY _____

STATE _____ ZIP _____

AR-20

For more data, circle 107 on inquiry card

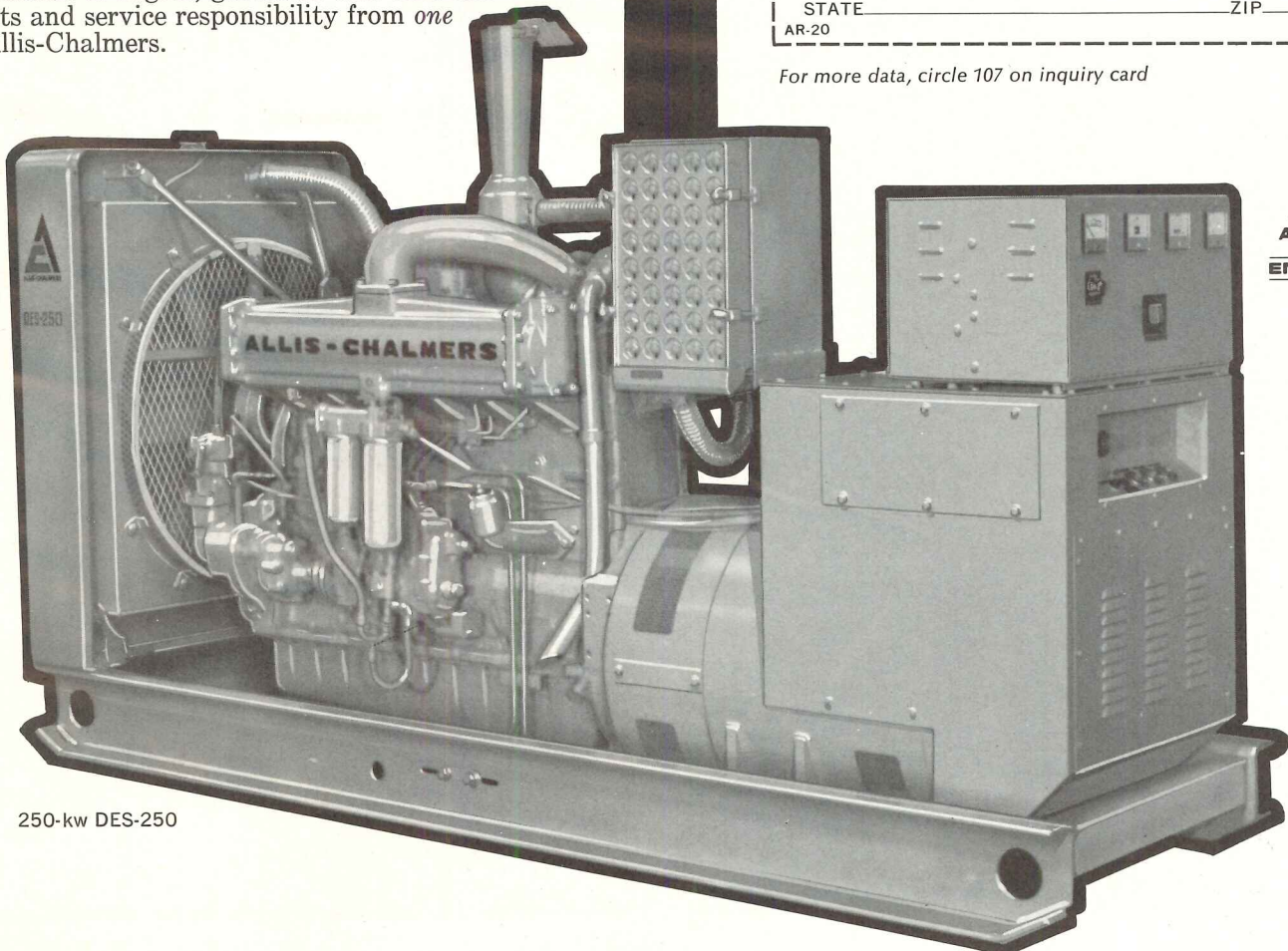

250-kw DES-250



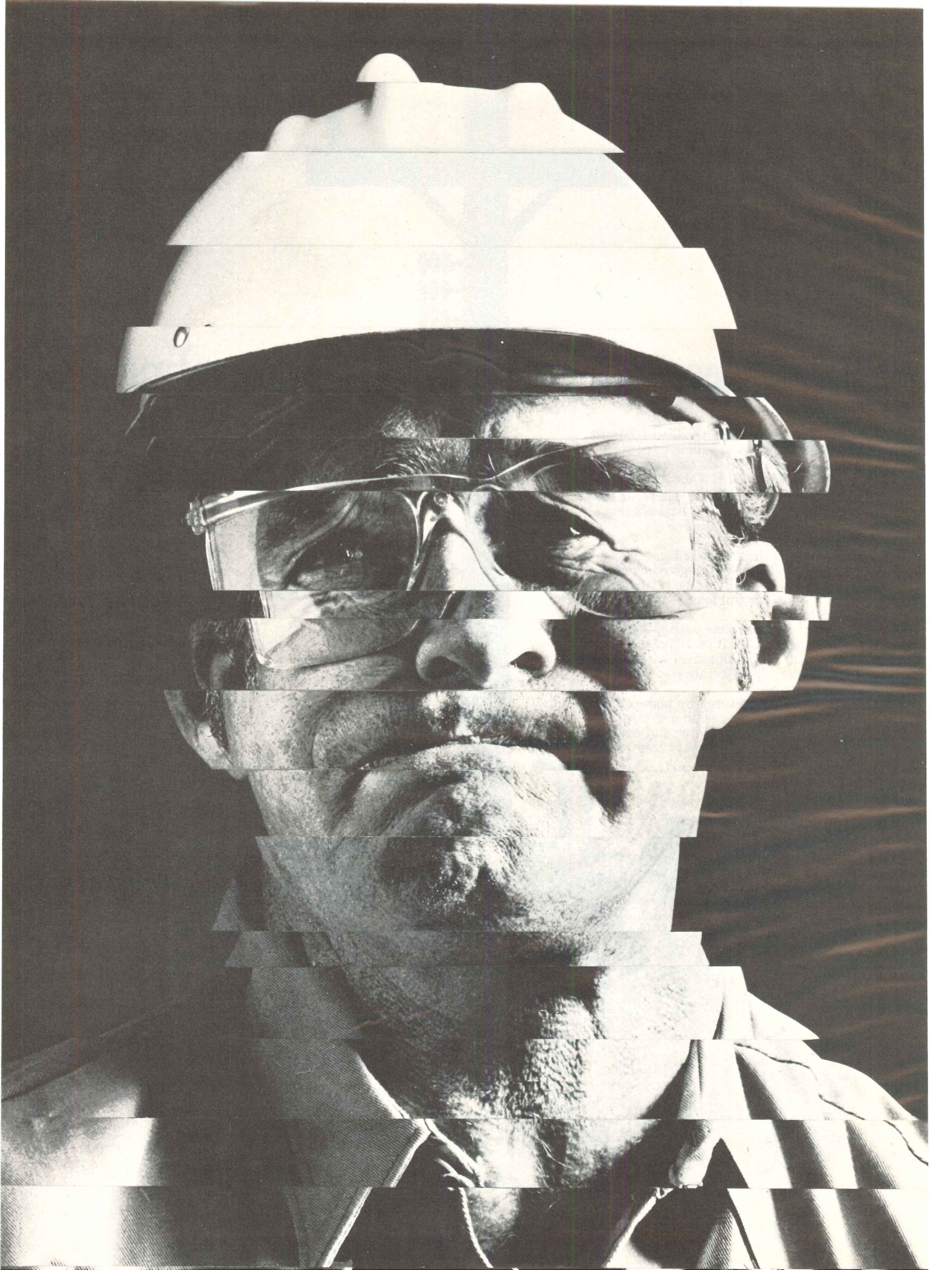

Industrial Noise Pollution.

How to combat it with Inryco[™] Acoustideck[®]

Sound control now federal law.

Industrial noise pollution has always been a problem. It has contributed to worker discontent. It has been the cause of increased numbers of disability claims, which in turn, have caused higher insurance costs.

Now this serious problem has become critical. Critical enough to spawn legislation like the Walsh-Healey Public Contracts Act. Now a company who expects to get a government contract of \$10,000 or more must agree to keep in-plant noise at specified decibel levels. This can be accomplished by: (1) reducing the noise level at the machine itself; isolating noisy equipment; or baffling it by absorption barriers; (2) lowering the noise level with acoustical treatment of the building; (3) or by providing ear protection devices.

Combating noise with Acoustideck.

The added cost of making a new building structure acoustically efficient can be as low as a fraction of 1% of total construction cost. In turn this can help lower the cost of other noise reduction measures. Inryco Acoustideck not only acts as a structural steel deck but also serves as a sound absorbing ceiling. Its performance has been proven in the field and in the laboratory by more extensive testing than any other acoustical steel roof deck system. It is also available in the widest variety of profiles on the market. The same characteristics are found in structural elements of Inryco Acoustifloor[™] for multi-storied buildings and Acoustiwall[™] Insulated Wall Panels.

Send for booklets. (Fig. 4) Catalog 23-3 highlights key points on sound legislation, provides complete NRC ratings for Inryco Acoustideck. Catalog 23-1 gives a comprehensive view of Inryco Roof Systems. For copies contact your Inland-Ryerson sales engineer or write to Inland-Ryerson Construction Products Company, Dept. D, 4033 West Burnham Street, Milwaukee, Wisconsin 53215.

We solve other roof design problems as well.

Cable hung roof deck spans 360 feet (Fig. 1). The concave roof structure consists of a double layer of cables. The top layer is covered by Inryco roof deck and the bottom layer with Inryco Acoustideck. Inland-Ryerson designed a welding method to attach the deck to the cables. The Acoustideck was installed from the top, eliminating special scaffolding.

Folding Plate Design uses Inryco roof deck (Fig. 2). Acoustideck serves as an acoustical ceiling as well as a structural roof deck in a vaulted design for a high school library. Inland-Ryerson engineers came up with an economical steel folded plate design that helped the architect achieve excellent acoustical characteristics.

All-steel hyperbolic paraboloid roof used on hangars for giant 747 jets (Fig. 3). The engineering firm commissioned to design these huge hangars turned to Inland-Ryerson. A new product evolved—a high strength roof deck that becomes part of the structure itself, bearing part of the stresses instead of merely acting as an enclosure.

Lock design of long span Inryco H Deck ends gap problems. As part of a continuing program of new product development Inland-Ryerson has produced a new side joint that locks panels together along their entire length. No need for mid-span welds or clips. Also available on H-Acoustideck.

Match the roof to your design. Design freedom is the keynote of Inryco steel roof decks, standard and acoustical. They are available in more profiles, cover a wider range of spans than any other. Ultimate design freedom is the result.

If you like, Inland-Ryerson will assist you in the design of individual projects, similar to the ones shown here, and help in the application as well.



Fig. 1

SALT PALACE
(SALT LAKE COUNTY
CIVIC AUDITORIUM)

Architect:
Bonneville Architects
Consulting Engineers:
Zetlin, De Simone,
Chaplin & Assoc.



Fig. 2

J. F. KENNEDY
JUNIOR HIGH SCHOOL,
SALT LAKE CITY

Architect:
William Rowe Smith
Structural Engineers:
Hughes and Page.

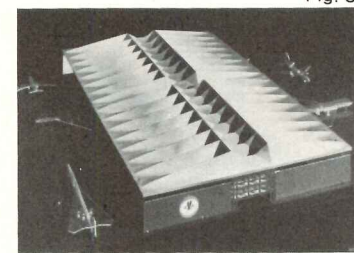

Fig. 3

AMERICAN AIRLINES HANGARS
SAN FRANCISCO AND
LOS ANGELES

Architect:
Conklin & Rossant.
Consulting Engineers:
Zetlin, De Simone,
Chaplin & Assoc.



Fig. 4

Two informative booklets
on roof system design,
are available on request.

INLAND RYERSON

A member of the  steel family



FRITZ HANSEN
979 Third Avenue
New York 10022

Is there a special way to view Arne Jacobsen's "Swan" chair? Not really. The "Swan" is exciting and

different from every point of view. One of the most versatile chairs ever designed in Denmark. In fabric, leather or vinelle. With Aluminum or teak base. See more of the FH furniture in our catalog.

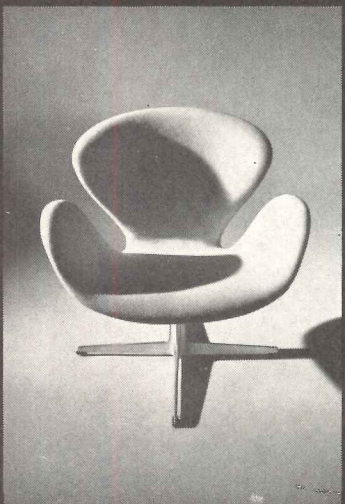
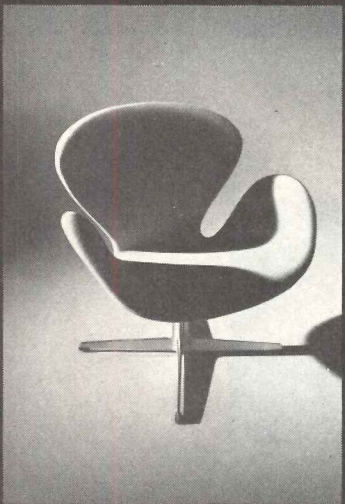
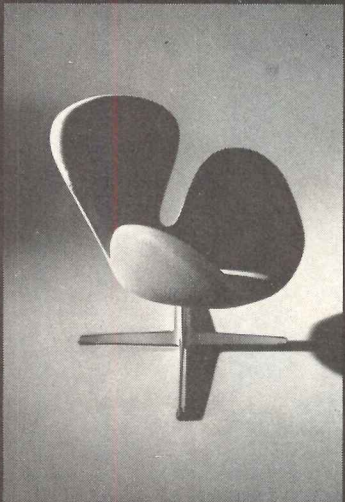
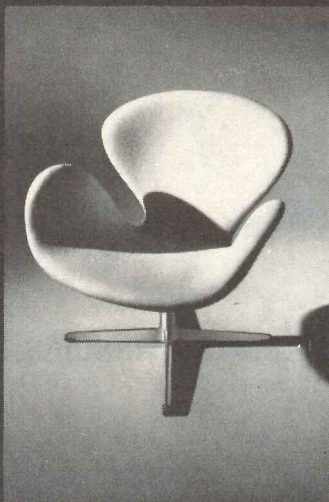

Spectra-Glaze®

**GLAZED CONCRETE
BLOCK ...**



**THE
INHERENT
ECONOMIES
OF BLOCK ...**

**COMBINED WITH THE PERFORMANCE
OF GLAZE ...**

- Loadbearing units eliminate expense of back-up wall
- Thru-wall units in 4", 6", 8", 10" & 12" thicknesses
- Fire rating of block construction: 1, 2 or 4 hr.
- Re-inforced or non-reinforced walls
- Excellent sound loss and insulation
- Modular dimensions

© Reg. U.S. Pat. Off., Can. & other countries by
THE BURNS & RUSSELL CO., Box 6063 (R), Baltimore, Md. 21231

© Cataloged
in SWEET'S



(Scored and Design faces also available ...
Local delivery, world-wide)

For more data, circle 110 on inquiry card

STOP! **BEFORE YOU SPECIFY A FREIGHT ELEVATOR**

*Moto-Flow does the
job for "peanuts"*

Need a freight elevator? Specify the M-B MOTO FLOW Conveyor and save your client thousands of dollars. A MOTO FLOW is the lowest cost solution to handling palletized or bulky loads between floors and to and from mezzanines. Approved for installation in old or new buildings; classified as freight conveyor; available with automatic loading and unloading features.

① **PUSH BUTTON OPERATION;** operator does not ride platform.

② **CAPACITIES UP TO 6000 LBS.;** four models.

③ **FULLY SELF-SUPPORTING** no shaft needed.

④ **FAIL-SAFE FEATURES** to stop and hold load in any emergency.

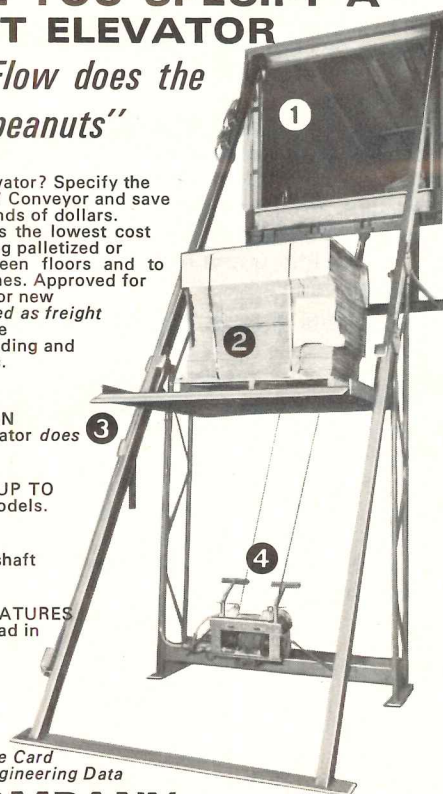

Mail Reader Service Card
For Catalog and Engineering Data

M-B COMPANY

NEW HOLSTEIN, WIS. 53061 • Phone: (414) 898-4261

270

For more data, circle 111 on inquiry card

◆ For more data, circle 109 on inquiry card



Oakland-Alameda County Coliseum Complex Arena Building Architects/Engineers: Skidmore, Owings & Merrill, San Francisco

Glass-walled sports arena weatherproofed with Neoprene.

A bright new addition to the rapidly expanding San Francisco-Oakland Bay area is the Oakland-Alameda County Coliseum Complex, with its adjoining stadium, indoor sports arena and exhibit hall.

Striking feature of the Arena building is its 70-foot-high window wall sealed with structural gaskets of Du Pont Neoprene. It took nearly 10 miles of the preformed sealing strips to weatherproof the expansive glass facade.

Architects Skidmore, Owings & Merrill specified Neoprene gasketing for two primary reasons—neat appearance and long-term dependability.

Gaskets made of Du Pont Neoprene keep a tight grip between frame members and glazing, year after year. The gaskets stay resilient . . . adjust to normal building movements . . . withstand exposure to sun, rain, heat, cold, ozone and corrosives. And Neoprene won't propagate fire. It is inherently flame resistant.

Du Pont makes Neoprene, not gaskets.
 For data sheets on building seals, write:
 Du Pont Company, Room 7994, Wilmington, DE 19898.

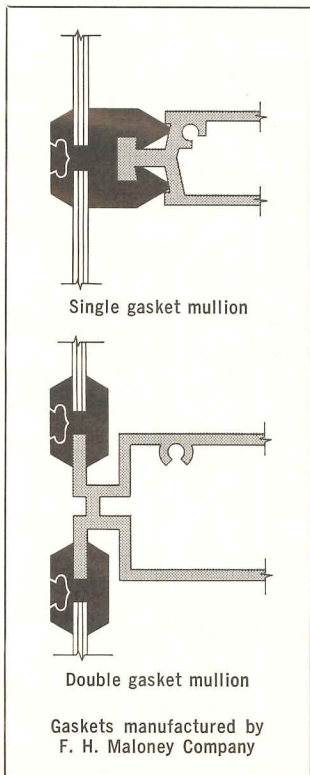

For more data, circle 143 on inquiry card

Vanguard model ventilator
illustrated

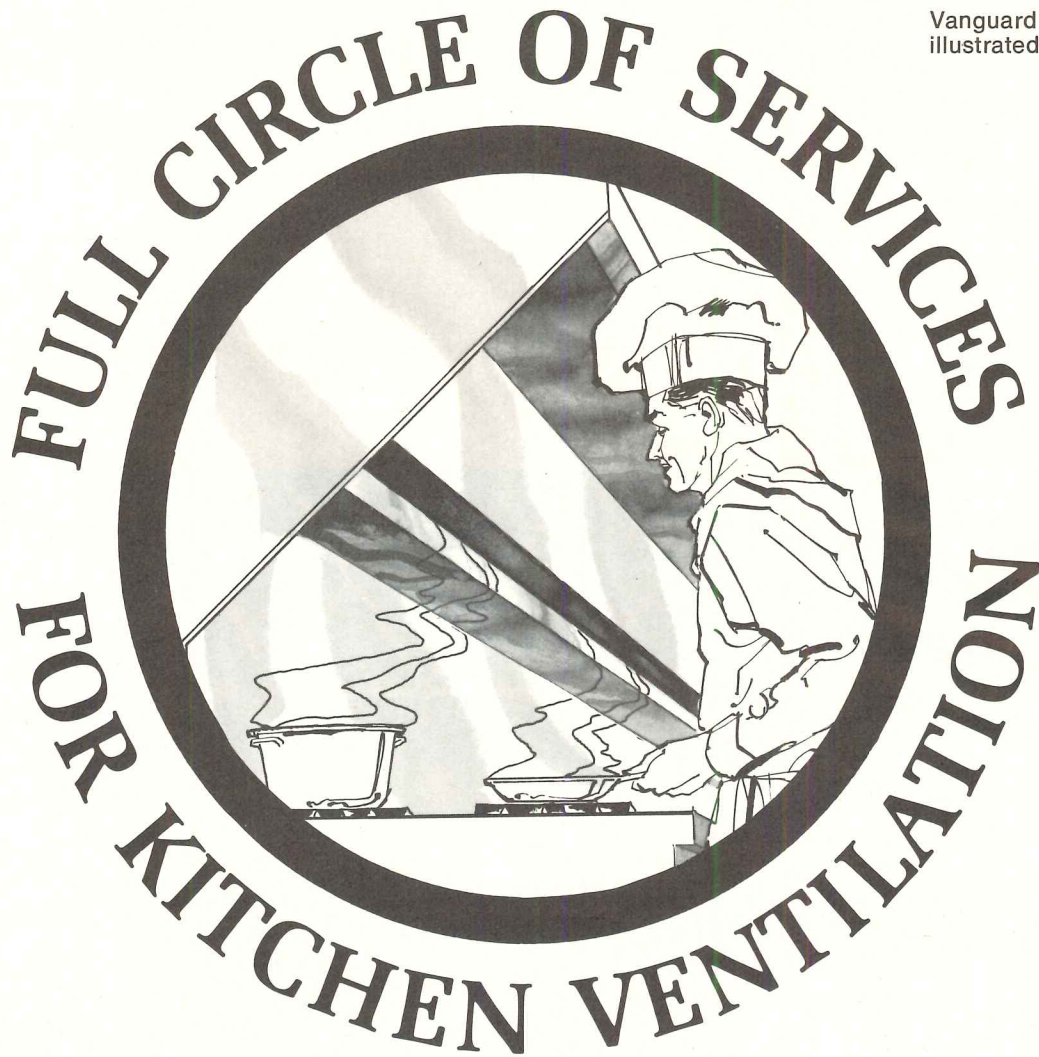

Mass feeding, drive-in-carryout operations, and fine restaurants . . . all get maximum benefit with Cockle ventilators.

Here's why. Specialized engineering to assure proper and economical ventilation for the cooking equipment in your layout and to meet tightening local and national codes. Meet-your-budget capability from our full line spanning basic equipment to advanced systems with patented grease extraction (up to 99+% constant), built-in wash, built-in fire protection. Complete range of convenience options. Centralized quality control in manufacturing. The kind of attention to detail that makes your order the only one in our plant. Write for our descriptive brochure and technical specifications.

VANGUARD MODEL NO.



Cockle

VENTILATOR COMPANY, INC.
1200 S. WILLIS AVE., WHEELING, ILL. 60090

Cockle quality commercial kitchen ventilators are installed in fine restaurants everywhere, fast food chains, in-plant feeding for major industrials, air line flight kitchens, colleges and universities throughout the nation, military facilities, hospitals, department stores. Specific locations on request.

ENGINEERING • DRAWINGS • FABRICATION / COMPLETE SERVICES IN KITCHEN VENTILATION

For more data, circle 148 on inquiry card

CMC* 1100

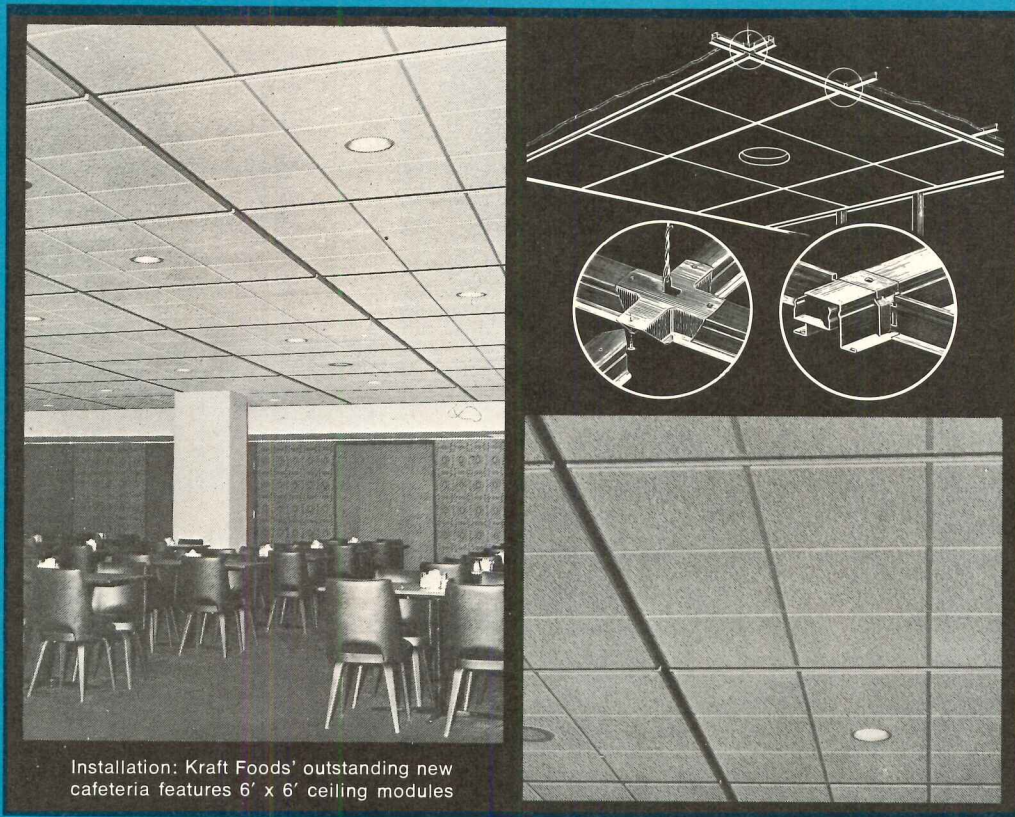

MODULAR GRID CEILING SYSTEM Solves installation and remodeling problems simply

The CMC 1100 Modular Grid Ceiling System permits easy installation or relocation of lighting fixtures, air diffusers or wall partitions.

You can reposition a light fixture, air unit or even a partition without marring or replacing the ceiling or sacrificing load requirements. To stabilize a repositioned wall partition system, standard 1 $\frac{5}{8}$ " steel studs are solidly retained in the specially-designed recessed channel runners, permitting secure partition anchoring to the ceiling—*without screws, bolts or mounting clamps*. You save considerably on time and materials.

Within CMC 1100 System modules, all types of ceiling tiles and acoustical or translucent lay-in panels can be installed by use of concealed or exposed cross-tees in any direction. This flexibility permits the use of many different types of lighting fixtures and air diffusers. Tiles or panels are easy to remove for access to the overhead plenum area.

CMC 1100 channel runners can be produced to any length for meeting nearly any job situation or module requirement. To achieve distinctive aesthetic effects, black, walnut grain or aluminum paint finish inserts may be snapped into the channel runner recesses.

Two-hour fire-rated assembly approval will be available in 1970.

See for yourself the superior strength and design advantages of the CMC 1100 System. Write for information.

Project: Kraft Foods, Chicago; Architect Designer: Howard A. Tonsager, Kraft Foods; Acoustical Contractor: Fisher, Albright & Masters Inc., Chicago, Ill.

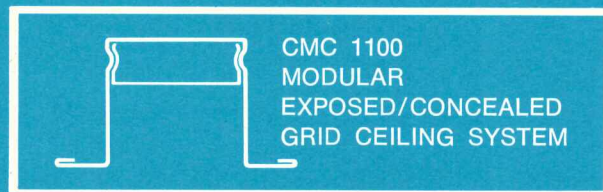

***CHICAGO METALLIC CORPORATION**

4849 South Austin Avenue
Chicago, Illinois 60638



CHICAGO METALLIC CEILINGS, INC., 4720 District Boulevard, Los Angeles (Vernon), California 90058

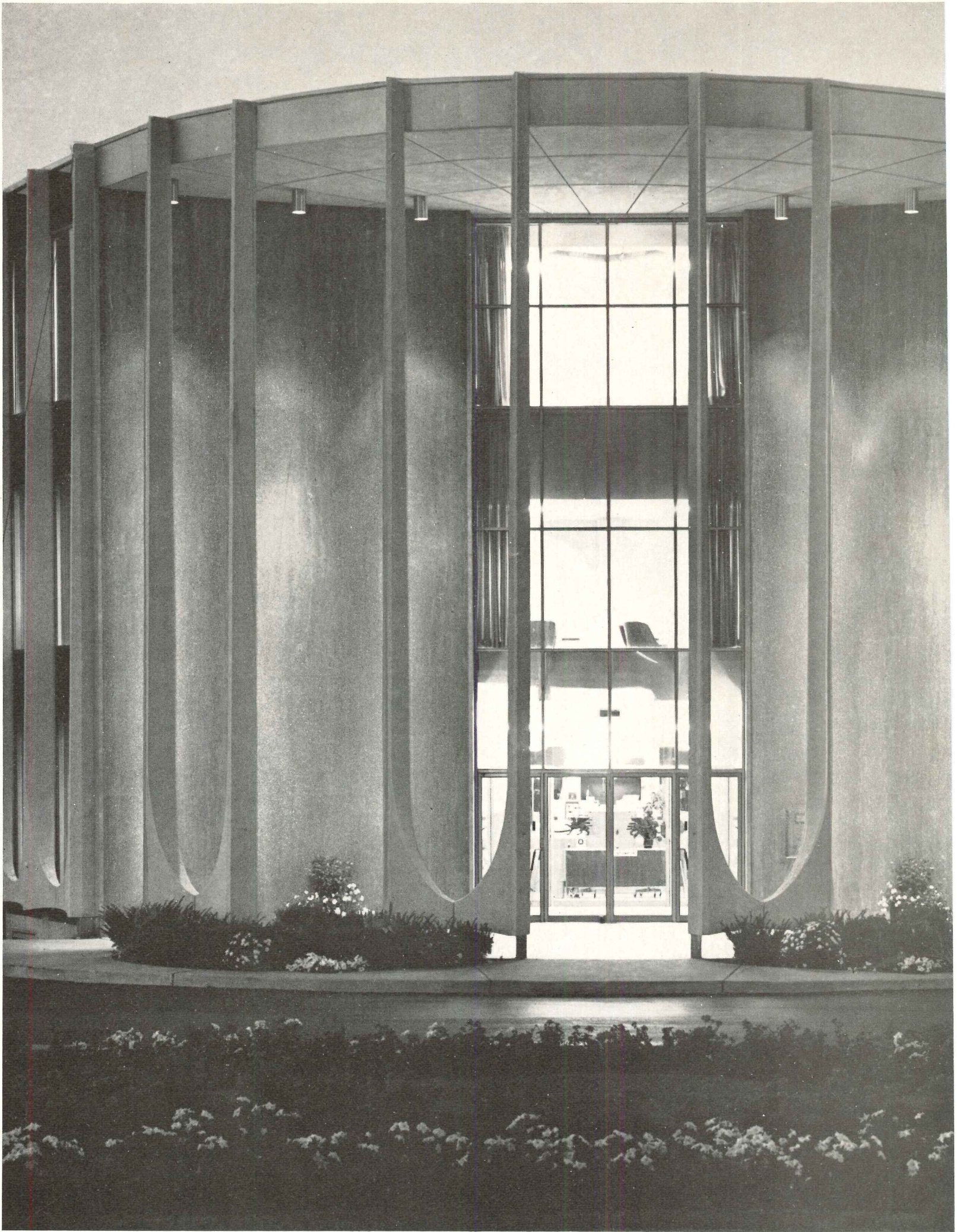

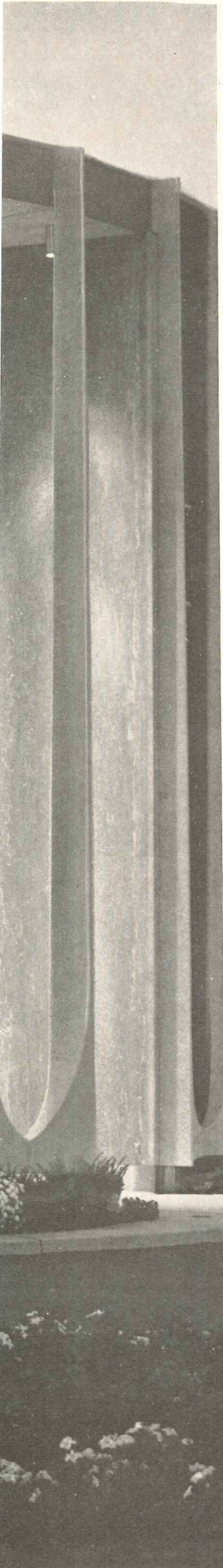

Architect John A. Benya must love All-Electric design. It gave him the freedom to design a heart-shaped bank.

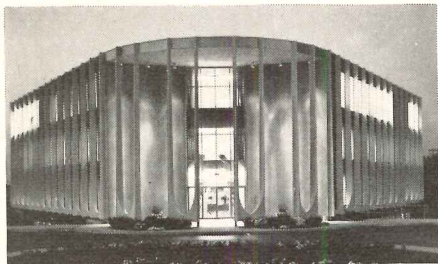

John A. Benya won't build anything unless it's All-Electric—the most flexible approach to total environmental control.

The people at the Creve Coeur Bank in Creve Coeur, Missouri, bought this concept when they asked him to design a new bank. Now the town of Creve Coeur (French for broken heart) has an All-Electric bank in the shape of a heart. Two years ago Mr. Benya used the freedom of All-Electric design to build a football-shaped bank.

For the Creve Coeur Bank,

Mr. Benya used electric baseboard units plus supplemental heating units in the environmental control system. This system allows the bank to heat one area while cooling another. The system is totally flexible and it gives the freedom to expand the building when necessary.

Electric heat is clean. And there's no loss of energy because the source of heat is right in the room. So you don't lose heat transporting it down the line.

With these advantages, you can understand why so many commercial buildings are going All-Electric. Talk to your electric utility company today.



Live Better Electrically

Edison Electric Institute, 750 Third Ave., New York, N.Y. 10017

For more data, circle 113 on inquiry card

While the Xerox 1860 darkens the lines,
a beautiful print, he can go on to the next



cleans up the paste-up marks and makes problem.



Skilled draftsmen should use their skills making new drawings. Instead of renewing old ones.

And that's where the Xerox 1860 Printer comes in.

In many cases, it takes the 1860 just one quick run-through to make fuzzy, faded lines become crisp and black. And darkened backgrounds become white and clean.

Or, if just a portion of the original needs changing, use the 1860 to make a same-size print of the original. Re-draw the particular portion. Paste it on the print. Run that through the 1860 again. And—bingo!—there's the new drawing.

(Another convenience feature: the optional Roll Paper Feeder-Cutter. It holds 2,000 feet of roll paper stock which is automatically fed and cut into lengths anywhere from 12 inches to 72 inches.)

The 1860 also reduces prints. With six printing selections—100%, 95%, 75%, 62%, 50% and 45% of original size—it takes originals up to 36" wide, up to an 1/8" thick and any length.

All this on ordinary untreated paper, translucent intermediates or offset master stock.

For more refreshing information about the 1860, please write to Dept. EP Xerox Square, Rochester, N.Y. 14603.

And we'll have a product specialist call on you.

For more data, circle 114 on inquiry card

XEROX

What's the One Word That Means Chalkboard Quality, Performance and Durability In Any Language?...

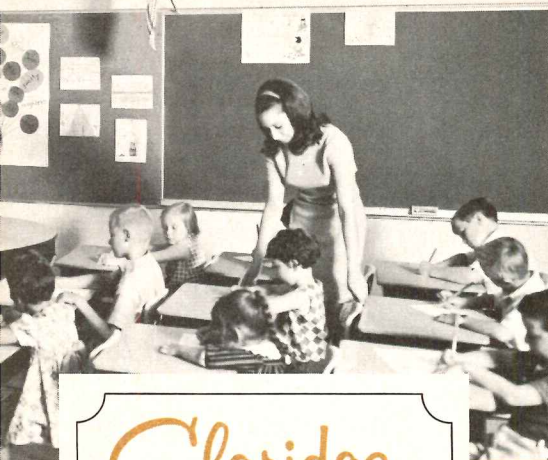

Claridge

Over two thousand schools of higher learning throughout the free world use Claridge chalkboards. So do countless numbers of elementary and high schools.

There's a reason, of course, for the remarkable acceptance which Claridge products have gained.

It's very simply this: Claridge makes the finest chalkboards and related equipment available anywhere. To assure product excellence, Claridge maintains rigid quality control over every step of manufacture. And Claridge research provides products that meet the ever-changing needs of modern education.

Through its industry leadership, experience and innovation, Claridge can serve you in many ways:

For instance, if you need help in selecting the most practical chalkboard for any given installation, ask Claridge. Since Claridge makes every type of chalkboard, the advice you get will be completely unbiased.

And only Claridge extrudes and anodizes aluminum chalkboard trim in a new, modern plant devoted expressly to these operations. Thus, trim quality can be fully controlled, and chalkboards and trim can be color-coordinated to add new dimension and beauty to classrooms.

Claridge also offers a new concept in movable walls and space dividers that permit greater classroom flexibility. In addition, Claridge provides horizontal or vertical sliding chalkboards for lecture rooms.

All these items and many more are fully described and illustrated in Catalog 70 in Sweet's Section 37a, 1970 edition.



Special Claridge School Architect's Manual shows samples of various chalkboards, bulletin boards and trim. It's yours for the asking. Just drop us a line on your stationery.

CLARIDGE PRODUCTS AND EQUIPMENT, INC.

HARRISON, ARKANSAS 72601
PHONE: AC 501/365-5415

PRODUCT REPORTS

continued from page 202

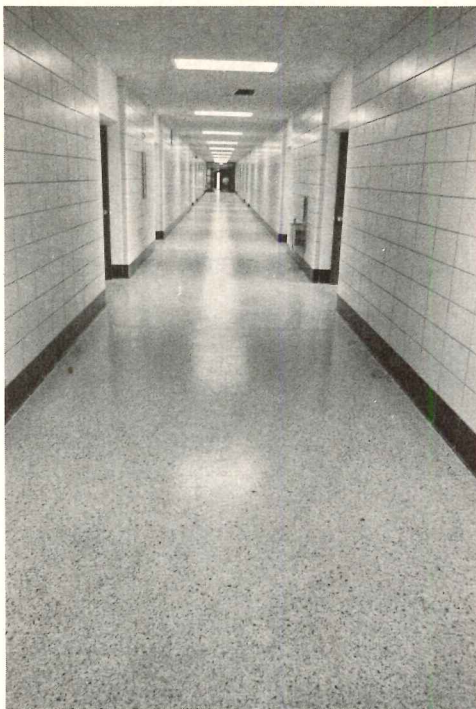

POURED SEAMLESS FLOORS / *Florock* is essentially a three step process in which the base coat is poured out, rolled and scattered with chips while still wet. When dry, a liquid polymeric glaze is applied, sanded and re-applied several times. *Florock* floors are said to be easy to clean, weather resistant, not subject to yellowing, durable and able to maintain their luster for years. ■ Crawford Laboratories, Chicago.

Circle 315 on inquiry card

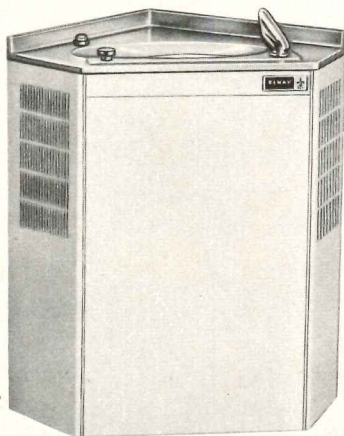

CORNER WATER COOLER / This wall-mounted cooler is one of many new models presented by the company, previously known for its stainless steel sinks, but now making a full-scale entry into the water cooler market. The unit shown is recommended for heretofore unusable corner space and should find special application in hospitals, schools, nursing homes and institutions. It has removable panels with a choice of 11 colors or stainless steel in a variety of textures and finishes. ■ Elkay Manufacturing Company, Broadview, Ill.

Circle 316 on inquiry card

FREE!

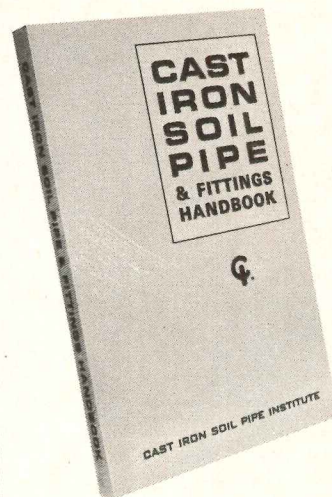

This valuable new book is yours for the asking!

CAST IRON SOIL PIPE & FITTINGS HANDBOOK

A comprehensive, authoritative textbook, fully illustrated, complete with statistical tables, calculations and charts, giving abbreviations, definitions and recommended symbols.

Invaluable if you design, estimate or install plumbing systems.

To receive your free copy, address a request on your company letterhead to:

CAST IRON SOIL PIPE INSTITUTE
2029 - K Street, N.W.
Washington, D.C. 20006

ALLOW 4 WEEKS FOR DELIVERY

Copper clad steel mansard — bargain buy for new farmers market.

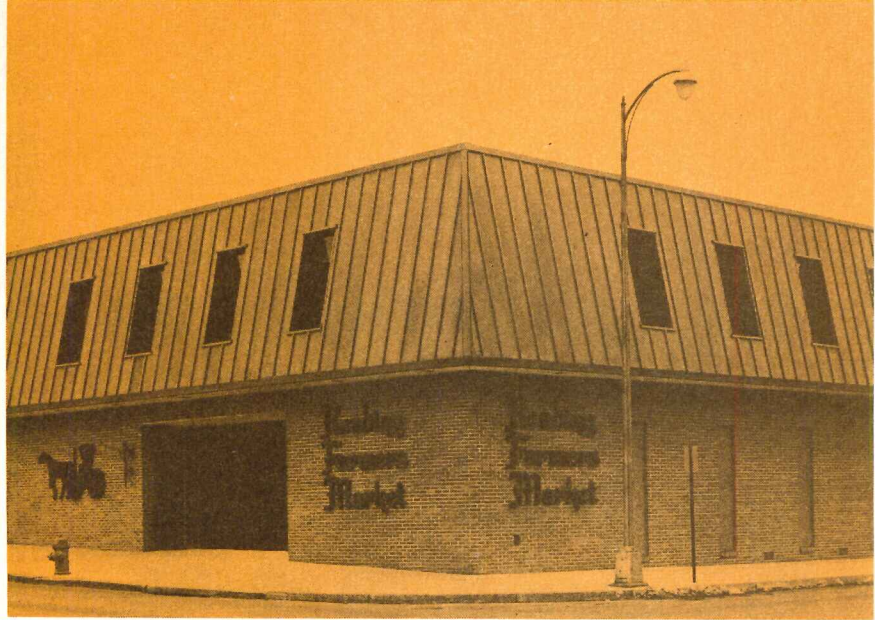

Solid copper's beauty, warmth and durability, plus the strength of stainless steel at 25% less cost than solid copper. That's why the new Farmers Market in Reading, Pa. is topped with Ti-Guard* copper clad stainless steel. This unique multimetal of solid copper metallurgically bonded to both sides of Type 409 stainless steel not only looks like solid copper, but also outperforms it. Fully annealed, Ti-Guard cuts and forms like ordinary sheet metals, solders as easily as solid copper, and it is weldable.

Textured Ti-Guard panels precut to 13' x 20" were specified by architect Wilbur Latshaw for this distinctive mansard roof. And because Ti-Guard is lighter than copper, installation was easier even with these large panels. The embossed stucco pattern, plus Ti-Guard's low thermal expansion, eliminates "oil canning" common in most sheet metals. Like solid copper, Ti-Guard weathers uniformly to a soft brown patina which is enhanced in this roof by the embossed surface.

Ti-Guard is widely used for fascia, wall panels, roofing, flashing, rain drainage, and all general sheet metal work. It's supplied through a nationwide network of quality sheet metal and roofing distributors. Ask your local distributor for details, or write: TI Building Materials, 34 Forest St., Attleboro, Mass. 02703.



TEXAS INSTRUMENTS
INCORPORATED

For more data, circle 116 on inquiry card

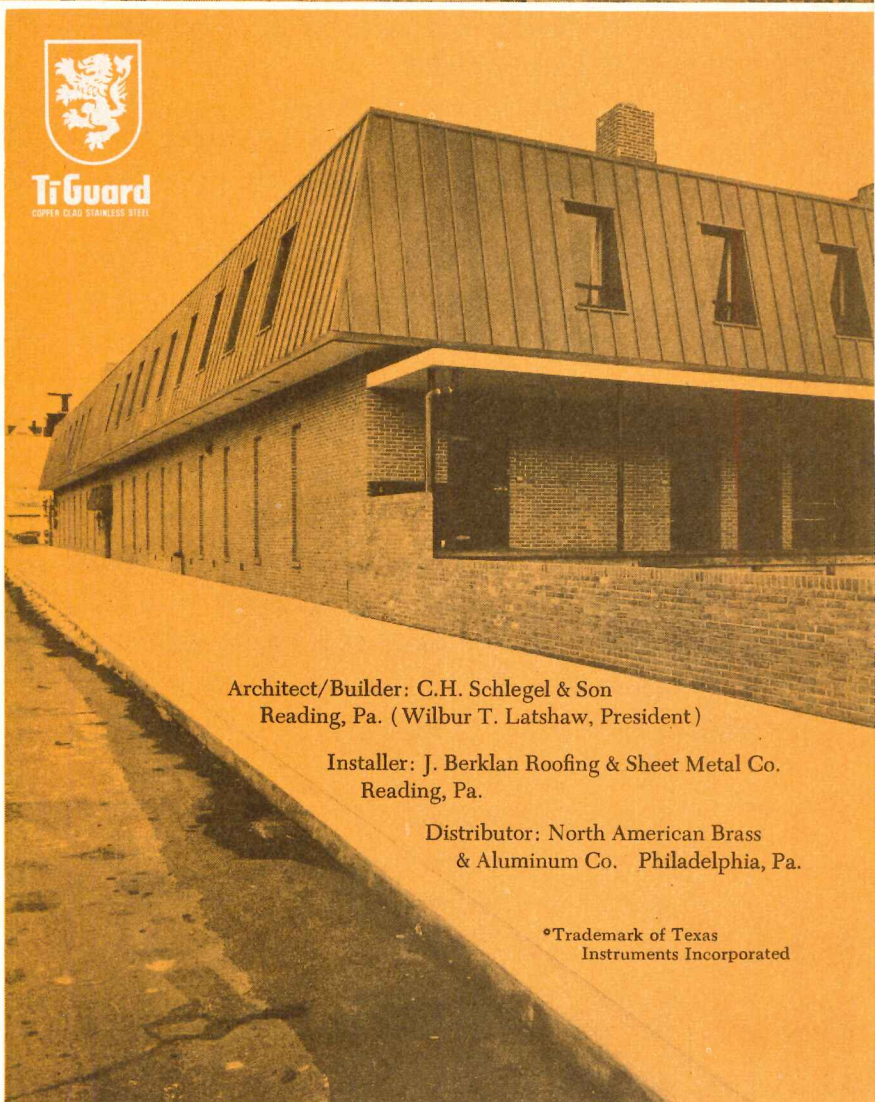

Architect/Builder: C.H. Schlegel & Son
Reading, Pa. (Wilbur T. Latshaw, President)

Installer: J. Berklan Roofing & Sheet Metal Co.
Reading, Pa.

Distributor: North American Brass
& Aluminum Co. Philadelphia, Pa.

*Trademark of Texas
Instruments Incorporated

NEW DRYWALL PARTITIONS FROM U.S.G.

SERIES "4"

- Simplified design
- Easier layout
- One throat size for door frames
- Lightweight
- Floor space savings
- Simplified material stocking
- Reduced material cost

This new USG® Metal Stud Drywall Partition System, with a constant 4-inch out-to-out dimension, provides all the fire and sound ratings commonly required. For all non-load bearing interior walls, you simply specify SERIES "4" in varied stud widths with single or multiple layers of ½-inch SHEETROCK® SW FIRECODE® "C" Gypsum Wallboard, plus 1½-inch THERMAFIBER® Sound Attenuation Blankets. Walls will stay virtually free of joint imperfections. Varied-size openings in studs provide chaseways.

Ask your U.S.G. Architect Service man for details, or write us at 101 S. Wacker Dr., Chicago, Ill. 60606, Dept. AR-04.

*Reg. U.S. Pat. Off. U.S. Patent No. 3,435,582 for SHEETROCK SW

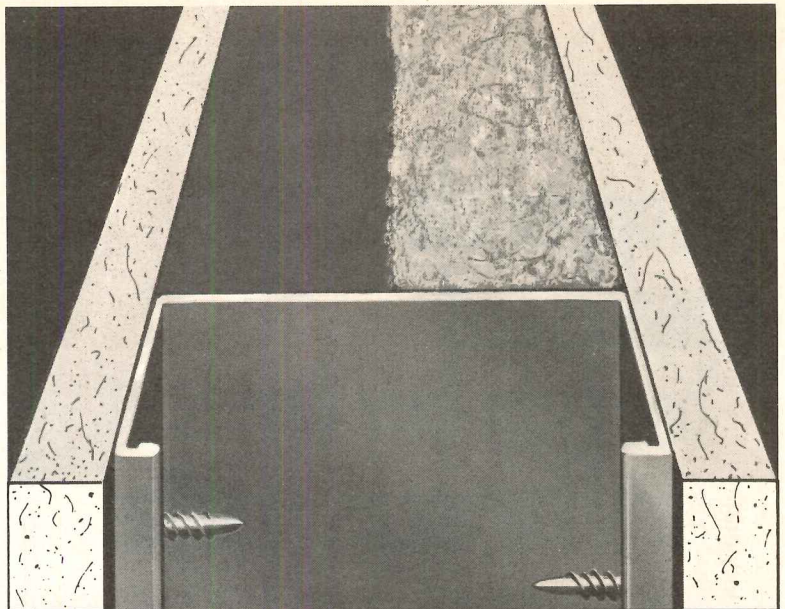

4-in. over-all with 3-in. metal stud; single-layer construction with ½-in. SHEETROCK® SW FIRECODE® "C" Gypsum Wallboard screw-attached each side; 1½-in. THERMAFIBER® Sound Attenuation Blanket in cavity. 1-hr. fire rating, 43 STC.

ONE 4" THICKNESS DIMENSION
YOU CAN SPECIFY 3 WAYS
FOR ALL REQUIREMENTS.

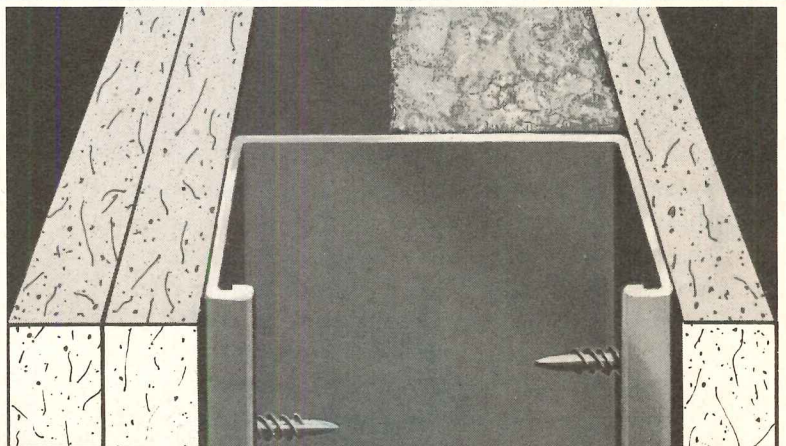

4-in. over-all with 2½-in. metal stud; unbalanced construction with single-layer ½-in. SHEETROCK SW FIRECODE "C" Wallboard screw-attached one side, two layers other side; 1½-in. THERMAFIBER Insulation in cavity. 1-hr. fire rating, 49 STC.

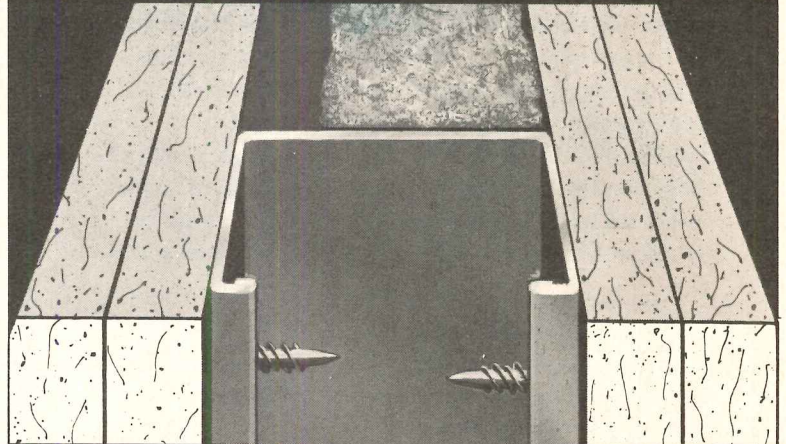

4-in. over-all with 2-in. metal stud; double-layer construction with two layers ½-in. SHEETROCK SW FIRECODE "C" Wallboard screw-attached both sides; 1½-in. THERMAFIBER Insulation in cavity. 2-hr. fire rating, 52 STC.

UNITED STATES GYPSUM

For more data, circle 117 on inquiry card

Something has gone out of carpet. You won't miss it.



No static-shock with Zefstat anti-static yarn.

Introducing the changed carpet. It looks the same. It feels the same. With one major difference. No static-shock. The enlightened new performance is the work of Zefstat anti-static yarn, the latest product from Dow Badische Company.

Zefstat does not affect the aesthetics of the carpet. On the contrary, it adds to cleanability and ease of maintenance by holding down electrostatic attraction of dust and dirt.

At this moment, quality mills are working with Zefstat. One

of them is Bigelow, offering a line of impressive carpet in a new Dow Badische yarn called Zefran® CR-4 (blend of 68% Zefran acrylic, 29% nylon, 3% Zefstat). Samples shown, from Bigelow's anti-static "Durotred" line. Available in 10 colors, 12' widths.

Make the informed choice. Ask for Zefstat in your next carpet. Call or write Dow Badische Company, 350 Fifth Avenue, New York, N.Y. 10001 (212) 244-6000.

ZEFSTAT™
ZEFSTAT ANTI-STATIC YARN

Carpet with anti-static Zefstat, new from Bigelow.



Zefstat™, Zefran®, are trademarks of Dow Badische Company.

For more data, circle 118 on inquiry card

Coming soon:

Weath·R·Proof

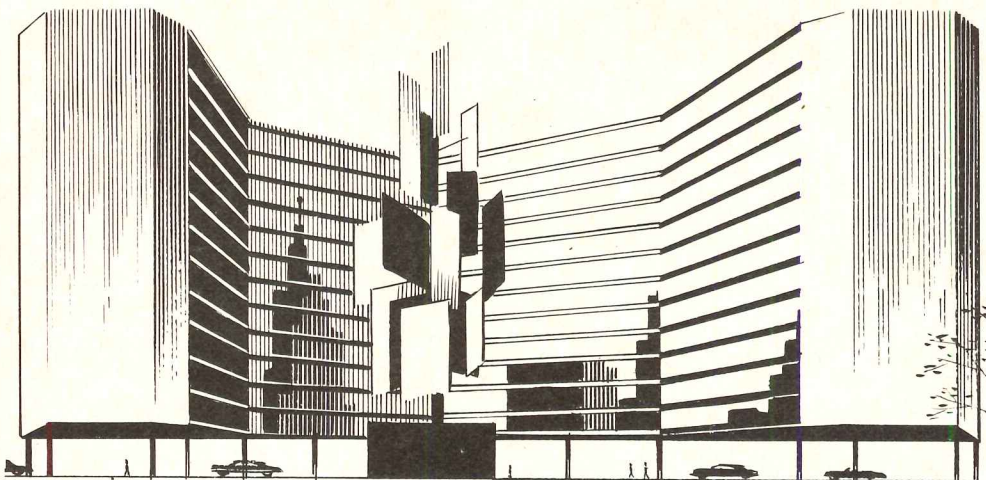

A New Name in Insulating Glass

A New Product in the insulating glass field, Weath-R-Proof has been under extensive research, development and testing by Thermoproof Glass Company since 1965.

A 20 Year Warranty stands behind each Weath-R-Proof unit . . . an expression of our confidence in a product manufactured with innovative techniques and the finest materials.

An Established Company in the insulating glass field, Thermoproof Glass Company is large enough to handle monumental glazing jobs . . . small enough to be personal.



Thermoproof Glass Company—4815 Cabot Avenue—Detroit, Mich. 48210
Subsidiary of Shatterproof Glass Corporation

For more data, circle 119 on inquiry card

OFFICE LITERATURE

For more information circle selected item numbers on Reader Service Inquiry Card, pages 255-256.

PVC PIPING / A 64-page, hardcover volume entitled "PVC Engineering Data Book" is described as a general guide for specifying, designing and installing PVC piping systems. The book covers many topics related to the piping, including principal applications, pertinent portions of standards set by the U.S. Department of Commerce and temperature and pressure variations. Cost is \$5. Write direct. ■ Borg-Warner Pipe and Products, 1524 Crystal Avenue, Kansas City, Mo. 64126.

STEEL DOORS AND FRAMES / A 16-page booklet features a door with precured expanded foam core, leather-like-exterior textured steel doors, galvanized doors, extra-heavy-duty doors and other related doors. ■ Amweld Building Products, Niles, Ohio.*
Circle 400 on inquiry card

STAGE SYSTEMS / Eight-page booklet explains that, "In any new building intended for the performing arts . . . design concepts must provide the means to set up and perform stage productions quickly and economically." The booklet presents a variety of stage machinery and equipment systems aimed at that purpose. ■ Peter Albrecht Corporation, Milwaukee.
Circle 401 on inquiry card

WALL SYSTEMS / Three booklets cover a complete line of movable wall systems and the Videne wall paneling system. Also included is information on available finishes and colors, sound core, raceways, wiring and hardware. ■ Modern Partitions, Inc., Holland, Mich.
Circle 402 on inquiry card

LIGHTING / A 24-page color booklet entitled "Creative Architectural Lighting" shows examples of architectural lighting created for some new and some existing interiors. Job notes accompanying each installation serve as guides in providing an understanding of each project, and show the broad possibilities with which architects, engineers and clients have to work. ■ BMD&R Lighting, Division of Sterner Lighting, Inc., Minneapolis.
Circle 403 on inquiry card

BUILDING PROBLEMS / "Ten Costly Mistakes to Avoid before You Build" is a 24-page booklet documented by case histories from building owners who have encountered the problems and solved them. Subjects include planning, expansion, heating and cooling bills, and seven more. ■ Stran-Steel Corporation, Houston.*
Circle 404 on inquiry card

* Additional product information in Sweet's Architectural File

more literature on page 236

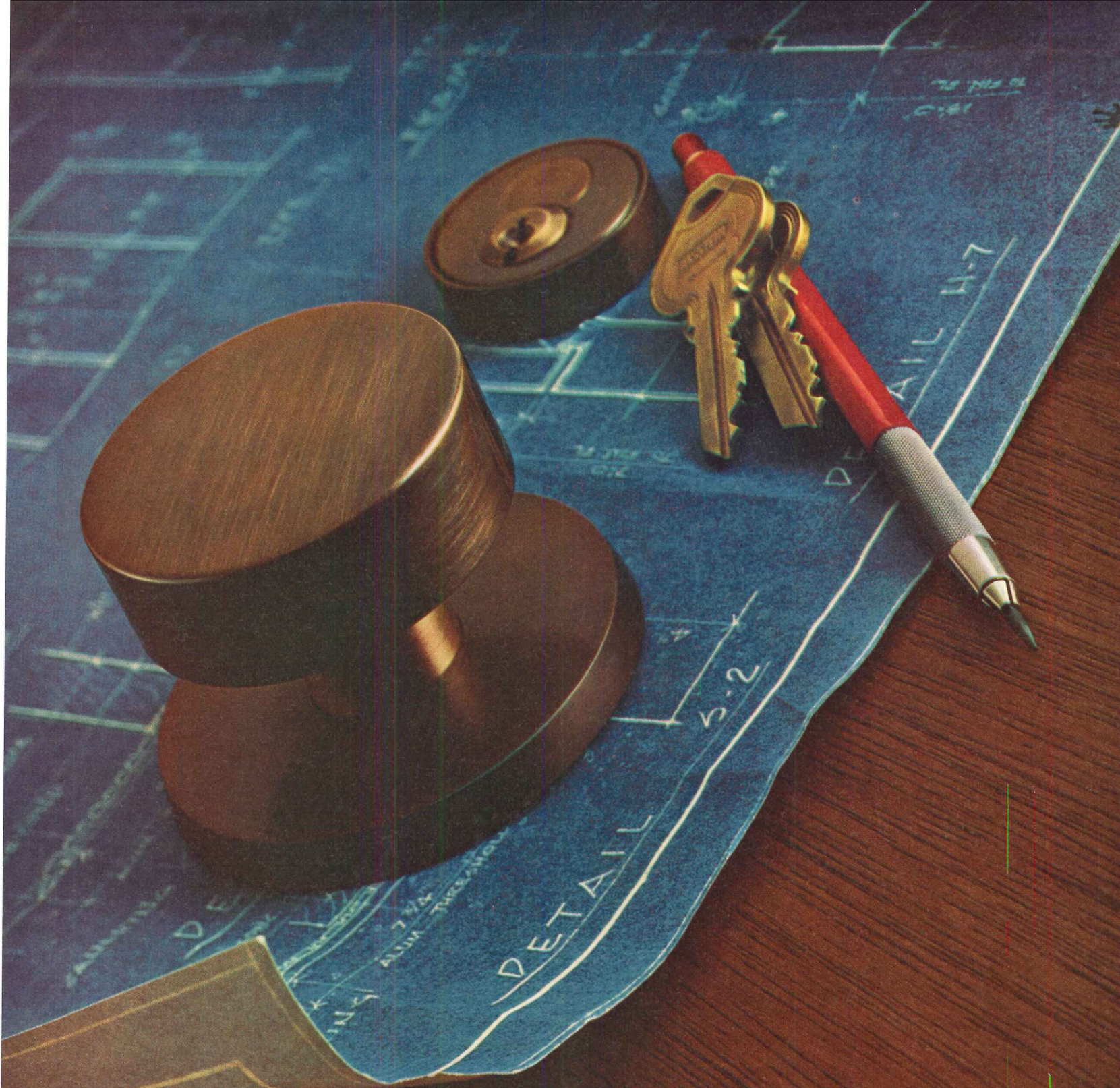

à la mod

Dominant design accents the modern mood.

Simple cylinder core substitution
for fast, foolproof relocking.

Tune in on today.

Unmistakably Russwin.

Russwin, Berlin, Connecticut 06037.

In Canada — Russwin,
Division of International Hardware.



Carson Design

For more data, circle 120 on inquiry card

CHIARO I & II

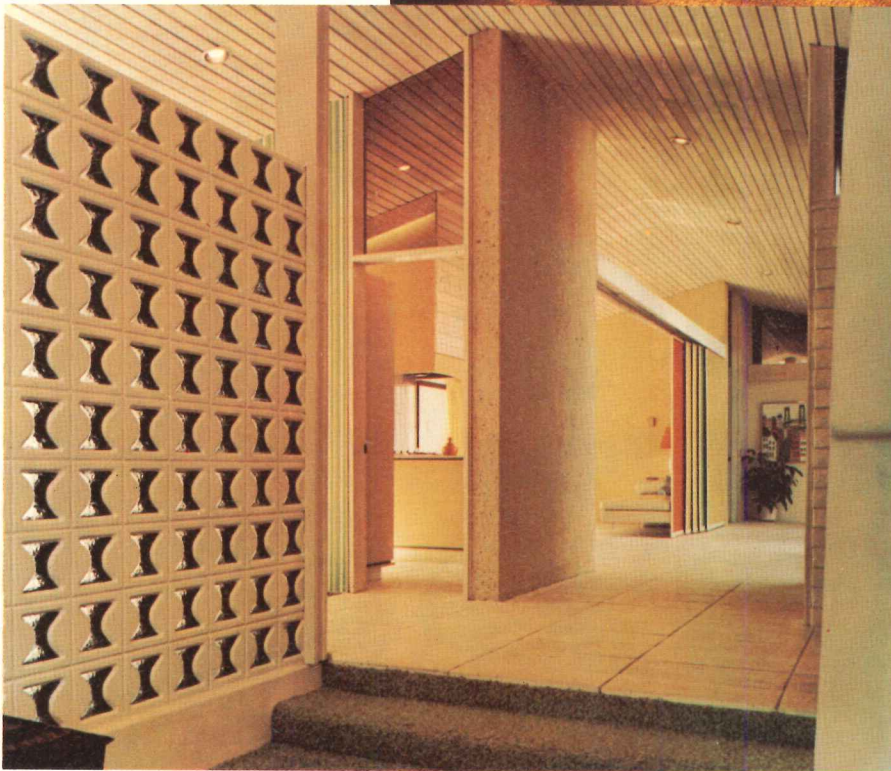
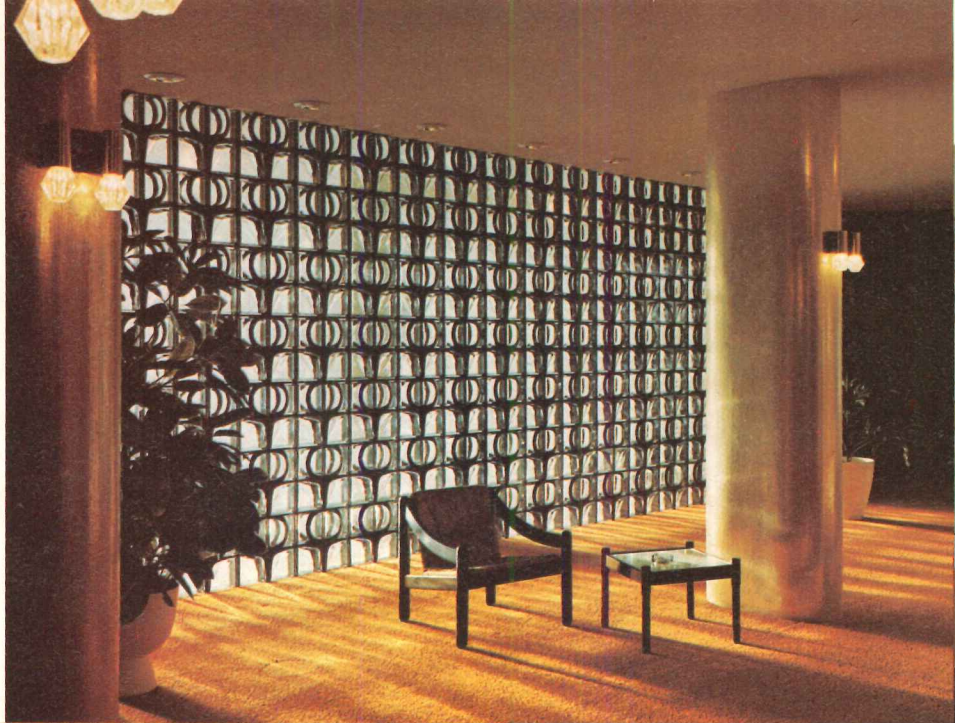

INTAGLIO II

PITTSBURGH
pc[®]
CORNING

***Imagination
has changed the
face of glass.***

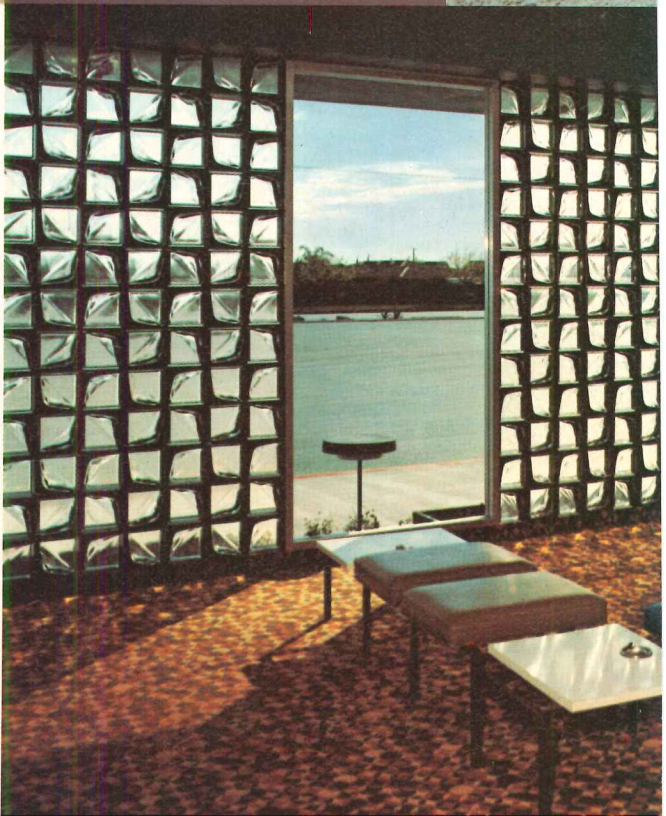

CHIARO II



CHIARO I & II



INTAGLIO III

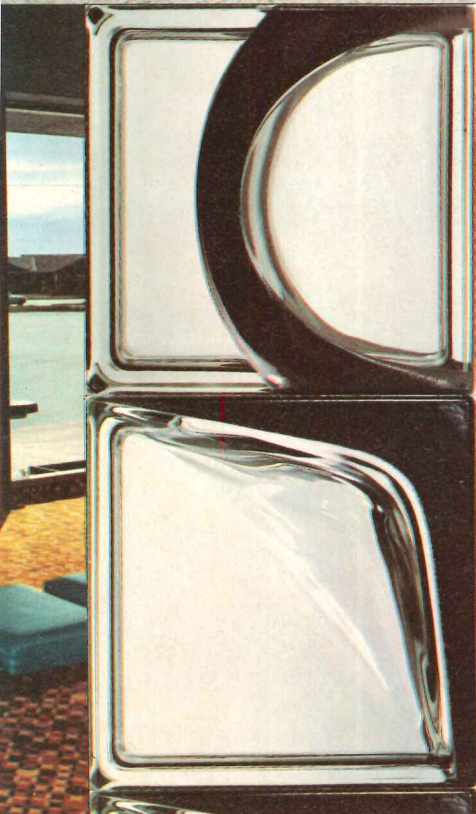

The world is viewed through glass.
The face of the earth can be changed with
imagination . . . and the environment aesthetically altered.
Imagination has changed the face of glass.

Architects can now work with a totally new
contemporary line of glass products. Building units
with sculptured relief surfaces that open up new
dimensions in creativity and architectural expression.

In a variety of striking surfaces, glass block can
produce lighting effects ranging from a gem-like
sparkle in bright sunlight to contrasting silhouettes
under artificial illumination. They're insulating, too.

Find out more about today's glass block, and some
interesting ways architects, like yourself, are using
them. Write Pittsburgh Corning Corp., Dept. AR-40G
One Gateway Center, Pittsburgh, Pa. 15222.

For more data, circle 121 on inquiry card



Self-adhesive

Tar bucket waterproofing is dead. Suddenly rubber sheeting and sprayed-on waterproofing methods are as old-fashioned as tarpaper.

The new way to waterproof concrete is Bituthene. Bituthene combines two of the best-known waterproofing materials — polyethylene and rubberized asphalt. One's been around for 20 years, the other for 30. But only Grace had the idea of putting them together in one factory-controlled, self-adhesive membrane.

You simply roll Bituthene out on any horizontal or vertical concrete or masonry surface and the job is done. Unlike rubber sheeting, Bituthene needs no tricky tapes — seams are self-sealing. If accidentally punctured, Bituthene heals itself and fits smoothly, easily around drains and other contours.

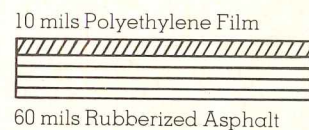

Bituthene's uniform thickness eliminates "puddling" and inadequate



Bituthene[®] is born.

coverage on high spots, common faults of sprayed-on waterproofing. It can withstand a 75-foot head of water; won't rot, mildew or harden; is unaffected by acids, alkalis, concrete and soil chemicals and has a water vapor transmission rate of practically zero.

Bituthene can be applied for substantially less than the cost of rubber membrane systems and sprayed-on waterproofing.

Millions of square feet of Bituthene have been used in major jobs in England, the U.S. and Canada—without a leak!

No wonder we'll guarantee it in

writing for five years whenever requested for specific construction projects.

For complete specs, write us on your letterhead. W.R. Grace & Co., Construction Products Division, 62 Whittemore Ave., Cambridge, Mass. 02140.



Just say Grace

For more data, circle 122 on inquiry card

Now! An industrial fiberglass door that won't blister, peel, or fade.

The Reason: DuPont Tedlar

A new option for Crawford's white Marvel-Lucent industrial fiberglass doors. The incredible exterior surface of DuPont Tedlar.

Not an ordinary finish, but an incredibly tough polyvinyl fluoride film that has none of the failings of finishes that are sprayed or rolled on. A special laminating process permanently fuses Tedlar to the fiberglass panel.

Tedlar cannot be harmed in normal use. The toughest stains wipe right off. The strongest industrial cleaning agents will not harm it. Virtually impervious to any atmosphere.

Color stays bright Clear. Translucent.

Fresh and new-looking long after ordinary fiberglass panels have faded and lost their light-transmitting ability.

And that's only part of the story.

Even without the amazing Tedlar surface, this door is still the best industrial/commercial fiberglass door money can buy.

Complete details from your local Crawford distributor. He can also tell you about other Crawford innovations that will help you precisely match every uprising door you specify to the job it must do. He's listed in the Yellow Pages under "Doors." Call him. Or write to us.

**Crawford Door, 4270 High Street
Ecorse, Michigan 48229
Division of The Celotex Corporation**

For more data, circle 123 on inquiry card



Crawford Marvel-Lucent Fiberglass Door

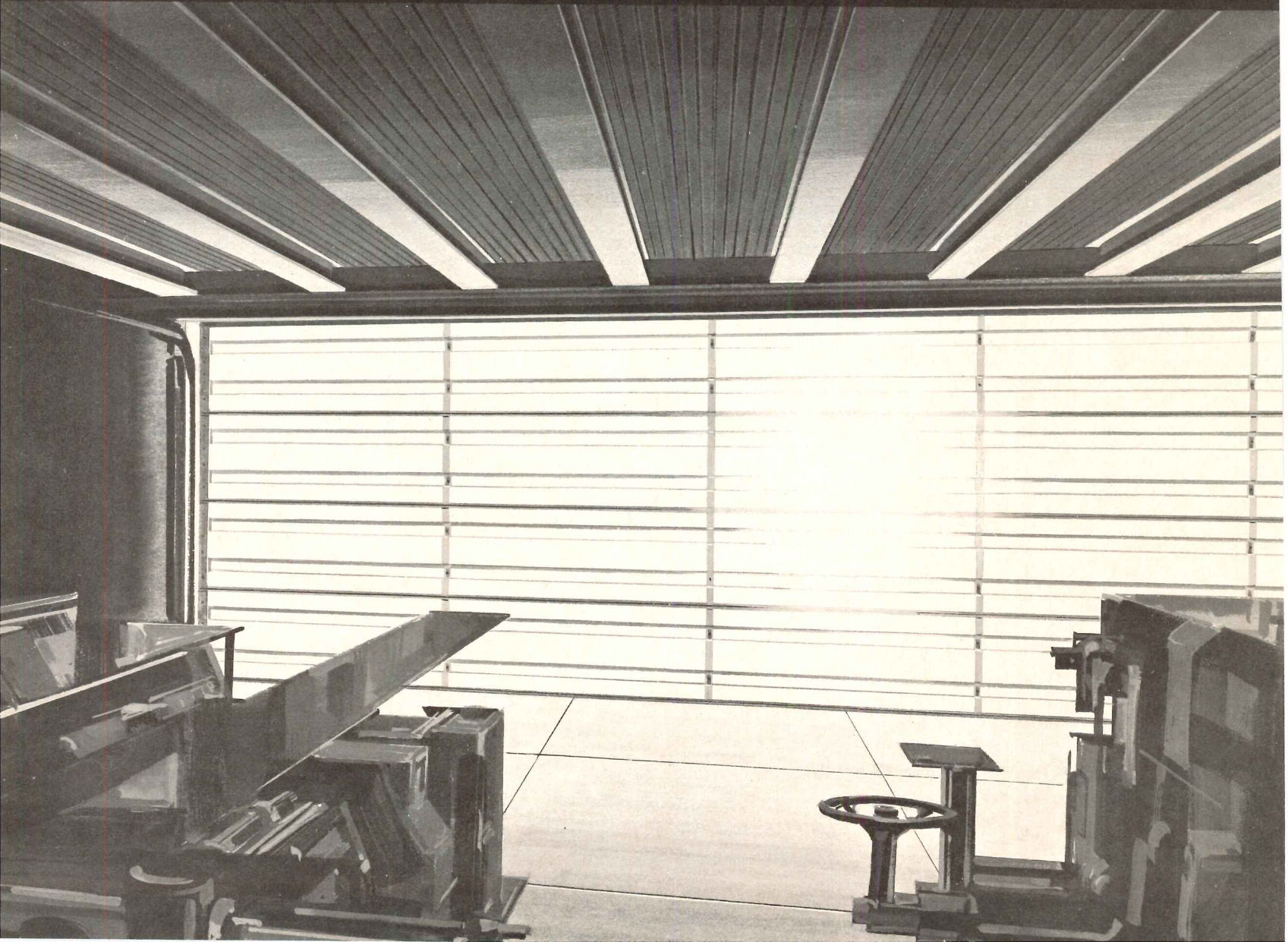

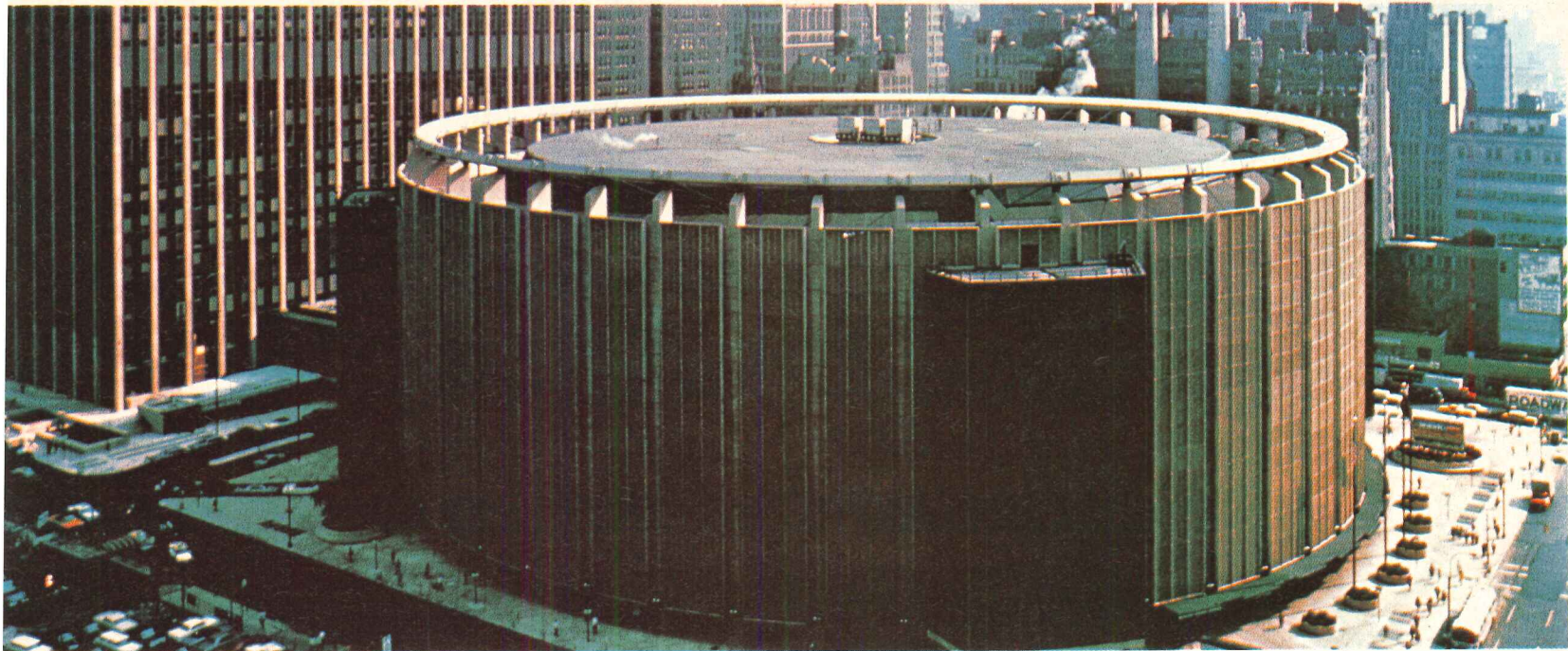

Madison Square Garden Center ARCHITECTS: Charles Luckman Associates

Architects are accepting the invitation to High-“T” — TITANALLOY — the alloy of good taste and substance. Job-captains and specifications writers, too, appreciate its four-squaredness that seems to match the design, the construction, the permanence, the practical-cost considerations of their most critical building assignments.

In every ounce, this zinc-titanium-copper alloy couples a designer's leverage with an engineer's conscience for “what's right.” In every pound, TITANALLOY presents a cost, less than many metals which serve with far less distinction on the job.

This utterly corrosion-resistant alloy has no peer for roof, flashing, valley, gravel-stop or thru-wall applications. Forms easily and solders in the shop or roof-site.

Both time and the elements are kind to TITANALLOY, which weathers to a delicately-distinctive even-dark-grey patina consonant with all architectural styles. Won't streak or stain adjoining materials and requires no maintenance after installation. Superior to aluminum and galvanized sheet under extreme corrosive coastal atmospheres.

High on the architectural “spec-writer's” list, TITANALLOY is available to meet pressing building schedules. To become more fully acquainted, phone us for an Architect's File of data and samples or check in the pages of SWEET's under 21g mat.



MATTHIESSEN & HEGELER ZINC COMPANY

Main Office
LaSalle, Ill., Phone: 815/223-8600
New York Office
233 Broadway, Rm. 4015, Phone: 212/267-6542

HIGH “T” IN THE GARDEN

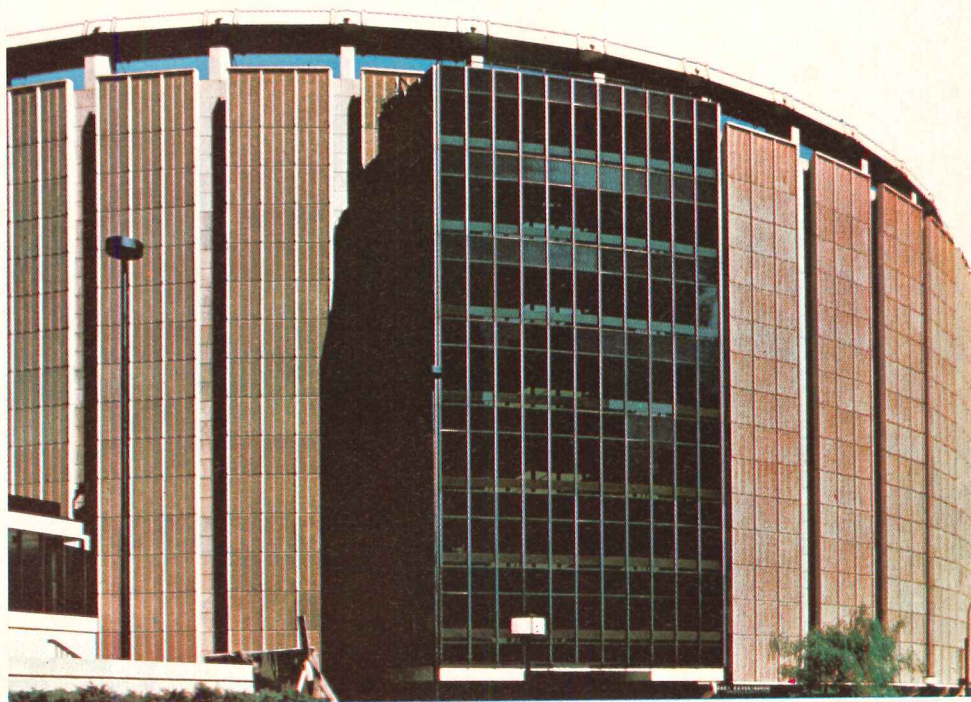

TITANALLOY THE ARCHITECT'S METAL

For more data, circle 124 on inquiry card

American-Standard has what your clients want:

Excitement



**New Marble/China Fixtures...
Better Than Real Marble!**

This is new. *And* different. *And* very profitable for you. These new Marble/China fixtures give your clients all the classic beauty and custom appearance of real marble. Yet they have the practical advantage of a hard-as-glass, vitreous china surface. A surface that's impervious to stains, extremely durable, and wipes clean and sanitary instantly.



Marble/China
Ultra® Lavatory

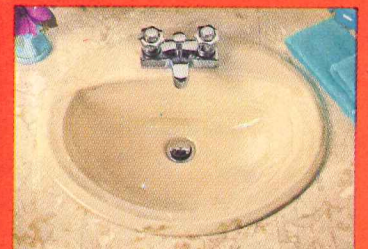

Marble/China
Aqualyn® Lavatory



Marble/China
Elongated Cadet® Toilet

Each American-Standard Marble/China fixture is "one of a kind." Just like natural marble, the pattern is never the same twice. And the beige-brown veining goes all the way through. It's not just surface coloring.

New Marble/China harmonizes with any decor, any fixture color... especially new high-fashion "Bone." Adds an important luxury look to every powder room and bath. Three popular fixtures available: Ultra® Lavatory, Aqualyn® Lavatory, and Elongated Cadet® Toilet. All attractively priced, too.

...Plus!

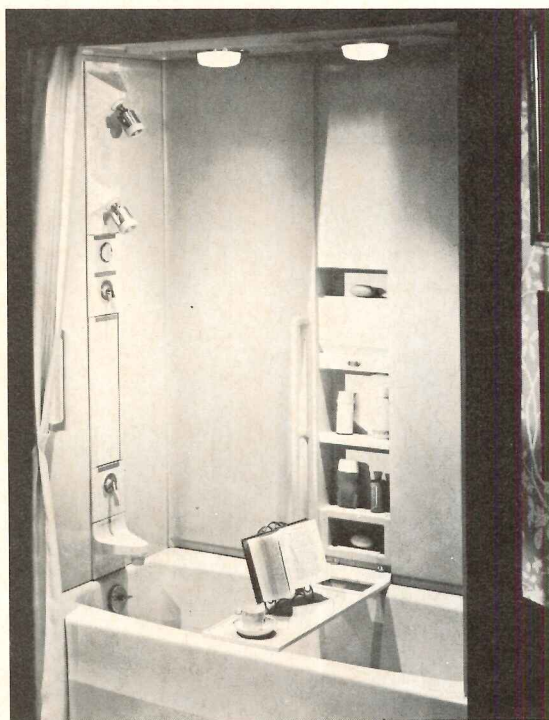

Spectra 70* "The Everything Bath" No other bath gives your clients so many built-in conveniences and safety features. Fiberglass reinforced Tri-Wall* has built-in storage, fold-away table and seating, high and low soap dishes, two safety grab bars and optional lighted ceiling unit. Exclusive Shower Tower* column features dual Stereo* Shower Heads, Hide-Away* Rinsing Spray, and a pressure balancing valve that prevents sudden spurts of too-hot or too-cold water. And the new Spectra 70 bathtub has a head rest rim, contour back and Stan-Sure® slip-resistant bottom.



The UltraBath* This has got to be the most advanced bathing and showering center available today. It's every woman's dream of bathing luxury come true. The wide-oval bathing pool is lavishly spacious. Has a totally relaxing whirlpool attachment, too. Console* Panel has an array of automatic controls to fill the pool, pre-select water temperature, time the whirlpool bath. Exclusive Shower Tower* column features high and low Stereo* Shower Heads and a Hide-Away* rinsing spray.

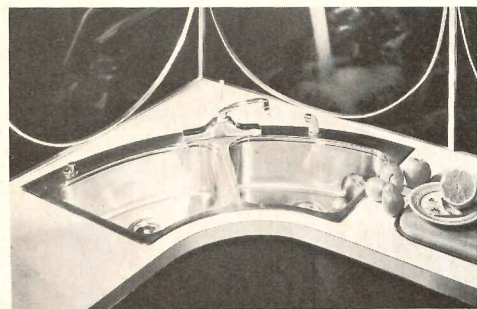

New Corner Concept® Stainless Steel Sink This is the kitchen sink that saves space... and saves steps... beautifully. This unique stainless steel sink is designed to tuck neatly into kitchen corners in one swooping curve. Perfect for compact kitchens. And it's self-rimming for easy installation. The convenient single lever sink fitting with hand spray completes this exclusive sink center.

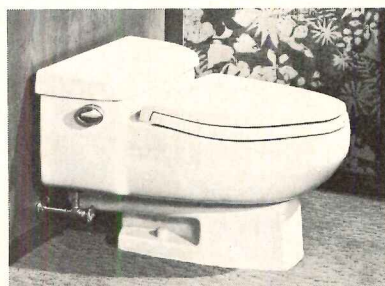

Luxor/Vent-Away® Toilet One glance and your clients know. *This* is what a modern toilet should look like! The tank is built so low it's almost out of sight. And the sleek, sculptured lines add a luxury look to any bathroom. The Luxor also features whisper-quiet flushing plus the very popular Vent-Away self-ventilating feature that keeps bathrooms fresh always.

For more details on any of these advanced products, see your American-Standard representative or write us.

AMERICAN STANDARD
PLUMBING & HEATING GROUP

40 W. 40th St., New York, N.Y. 10018

*Trademark of American-Standard ©American-Standard 1970

For more data, circle 125 on inquiry card

Fairfax Hospital, Falls Church, Va.
Architect and Structural Engineers: Metcalf and Associates, Washington, D. C.
Mechanical and Electrical Engineers: Henry Adams, Inc., Baltimore, Md.



Waukesha power protects the circuits that must not quit

Three Waukesha Diesel Enginators® Provide Standby Power at Fairfax Hospital

Fairfax Hospital is a maze of vital electrical circuits. These circuits must function without interruption in operating rooms, intensive care wards and other areas where life may virtually hang by a wire. There will be no interruption. Three Waukesha standby electric sets will see to that.

One Waukesha Enginator provides 500 KW standby power in the central powerhouse. Two others, rated at 350 KW each, divide the responsi-

bility for critical circuits throughout the hospital. One stands ready to keep elevators, vacuum pumps, air compressors, heating and ventilating systems running. The other quickly restores light and power to operating rooms, refrigeration lab units, blood banks, intensive care and recovery wards.

Hospital designers realize you can't correct a slip-up with an apology. That's why they measure standby equipment by only one yardstick — complete reliability. Your Waukesha distributor will be glad to show you why Enginators thrive on this type of measure. Call him. Also ask for Bulletin 5008.

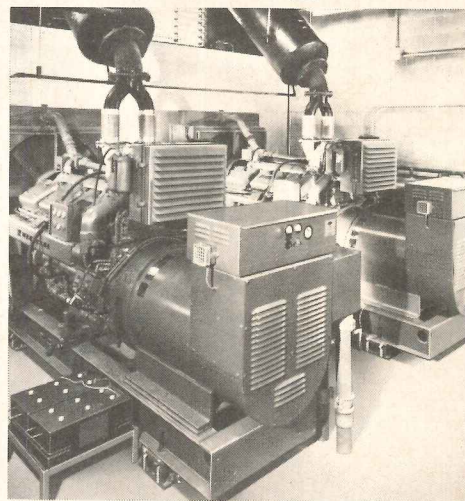

Ridgewood, N.J. 07451

WAUKESHA
MOTOR COMPANY

WAUKESHA, WISCONSIN 53186

Tulsa, Okla. 74107

Downey, Calif. 90240

Anchorage, Alaska 99502

© A BANGOR PUNTA COMPANY

Look for the **THONET** mark...
your assurance of quality that lasts.



THONET
ONE PARK AVENUE, NEW YORK, N. Y. 10016
THE BEST KNOWN NAME IN CONTRACT FURNITURE SINCE 1830

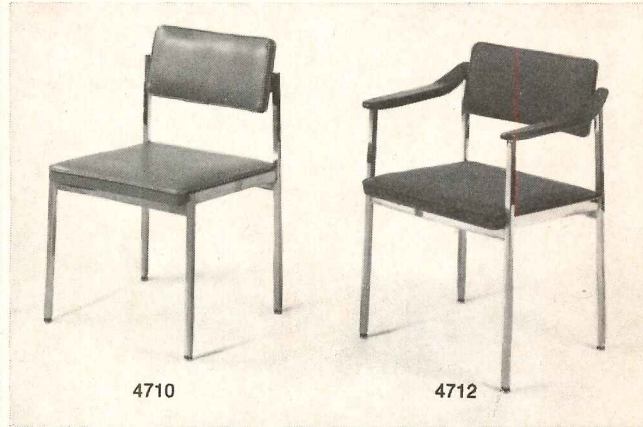

4710

4712



2087

2077



2815

2814



8808

8809



1294

1289

Contract furniture buyers have long known that choosing a chair or lounge or any other item of furniture for use in a public place is never just a matter of esthetics. Along with eye-appeal and functional styling—and equally important—is the question of ruggedness. Will the piece still be in good shape after several years of

constant exposure to the stresses and strains of a crowded restaurant or college dormitory, a busy waiting room or hotel lobby? When in doubt, look for the THONET mark. It's your assurance of durability that's literally engineered into every product we make. Extra mileage, we call it. Uncompromising insistence on top-grade materials is the

secret, plus our 139-year tradition of craftsmanship. With Thonet, beauty is more than skin deep. Come see for yourself at Thonet, your one best source for every kind of contract furniture. Showrooms: New York, Chicago, Los Angeles, San Francisco, Dallas, Miami, and Atlanta.

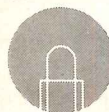

THONET THE BEST KNOWN NAME IN CONTRACT FURNITURE

THONET INDUSTRIES, INC., at the "Top of One Park," One Park Avenue, New York, N. Y. 10016
Telephone: (212) 683-1230

For more data, circle 127 on inquiry card

continued from page 224

INTERIOR SYSTEMS / The 1970 Interior Products Catalog presents a systems concept of building that divides design and construction into four subsystems. The 66-page catalog shows candidates for two of these subsystems: integrated ceilings and space division. ■ Conwed Corporation, St. Paul.

Circle 405 on inquiry card

CARPET / Two booklets present studies on sound and costs. "Sound Conditioning with Carpet" tells of tests made in order to give acoustical consultants, architects and designers new parameters with which to work in advising commercial and residential carpet buyers. The booklet tells who made the tests and where, which tests were made and the results. "Cutting Costs With Carpet" treats its subject in a like manner. ■ The Carpet and Rug Institute, Dalton, Ga.*

Circle 406 on inquiry card

LAB FURNITURE / A comprehensive 86-page catalog includes color photos and complete detailed information on the company's laboratory equipment and apparatus, including new color-coordinated laboratory hoods. ■ Labconco Corporation, Kansas City, Mo.

Circle 407 on inquiry card

POWERED LOADING DOCKS / A pocket folder explains how to select the right dock for any application. ■ Autoquip Corporation, Chicago.*

Circle 408 on inquiry card

DAMPER MANUAL / A 60-page technical handbook explains airflow theory and damper application for commercial, industrial and institutional air-conditioning systems. The manual discusses conventional and low-leakage designs, the theory of feedback control, flow equations and damper construction. ■ Honeywell's Commercial Division, Minneapolis.

Circle 409 on inquiry card

FLOORING / The 1970 edition of the firm's resilient flooring products shows all colors and patterns. The 16 pages also include general information on sizes, gauges, uses, installation, light reflectance values and brief specifications. ■ Azrock Floor Products, San Antonio, Tex.*

Circle 410 on inquiry card

SAFETY GLASS AND SAFETY CODES. "Safety Glass and Safety Codes" is a 12-page brochure containing the FHA "Minimum Property Standards for Glass," with excerpts from three influential codifying bodies' manuals. ■ American Saint Gobain Corporation, Kingsport, Tenn.*

Circle 411 on inquiry card

* Additional product information in Sweet's Architectural File

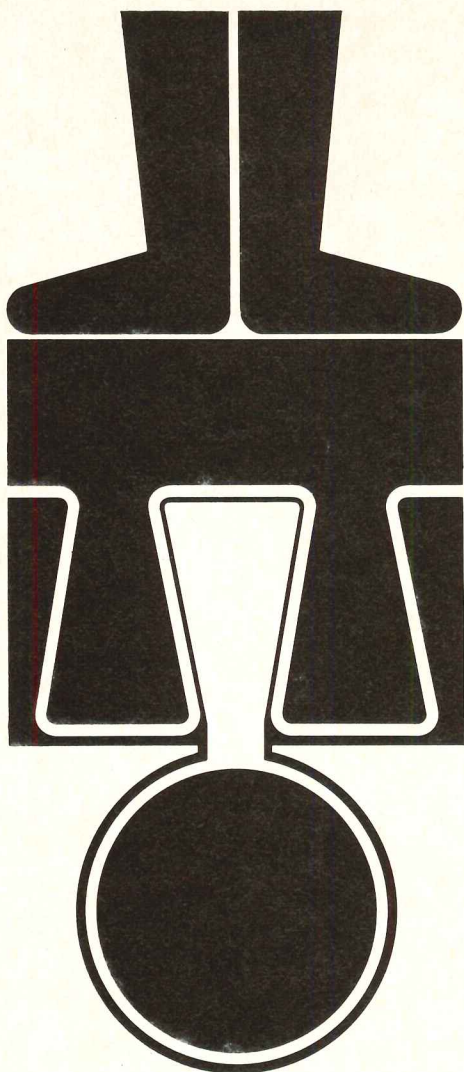

PIPE TUNNELS OF THE WORLD, UNITE

... with EPICORE, the revolutionary composite floor system. Supports the people above. Suspends the pipes below. Does both in spans up to 12 feet without joists or beams. The strength is in its size and shape. Two inches deep. Triangular. Forms a permanent alliance with concrete. For the pipes, there's the EPICORE clip that hangs on until they need to be changed. Plumbers cheer. People cheer. You will too. For EPICORE, from

EPIC
METALS CORPORATION
1844 Ardmore Blvd.
Pittsburgh,
Pennsylvania 15221.
(412) 242-8343.

EPIC
METALS CORPORATION
1844 Ardmore Blvd.
Pittsburgh,
Pennsylvania 15221.
(412) 242-8343.

For more data, circle 128 on inquiry card

First the
HA3-1/2" x 3-1/2"
for 1-3/8"
doors... Now

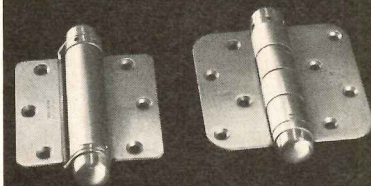

Bommer brings
you the 4" x 4"
POWER HINGE
for 1-3/4" doors.

Now, thanks to a unique new spring hinge design, you can use a POWER HINGE in the same cut-out used by 4" x 4" butt hinges on 1 3/4" doors. Pivot point lines up with butt hinges in case you use only one. Can be used in existing as well as new installations. Hinge is reversible for right or left hand doors and has adjustable spring power to control closing speed. No mortising necessary either when replacing butt hinges — a screwdriver is the only tool needed to install the POWER HINGE. Ideal for doors between kitchen and garage, for air conditioned rooms, for motel, office and apartment doors. Great for furnace room doors too. The economical Bommer HA4" x 4" closes doors smoothly and keeps them closed. In addition, Bommer gives a ten year guarantee. That's how tough this hinge is. Ask your hardware supplier about the new Bommer HA4" x 4" ... latest addition to the fine Bommer family of spring hinges. Or write Bommer directly for complete information.



SALES OFFICES AND WAREHOUSES:
263 Classon Ave., Brooklyn, N. Y. 11205; 180 N. Wacker Dr., Chicago, Ill. 60606; 2257 S. Atlantic Blvd., Box 6732, Los Angeles, Calif. 90022

For more data, circle 129 on inquiry card

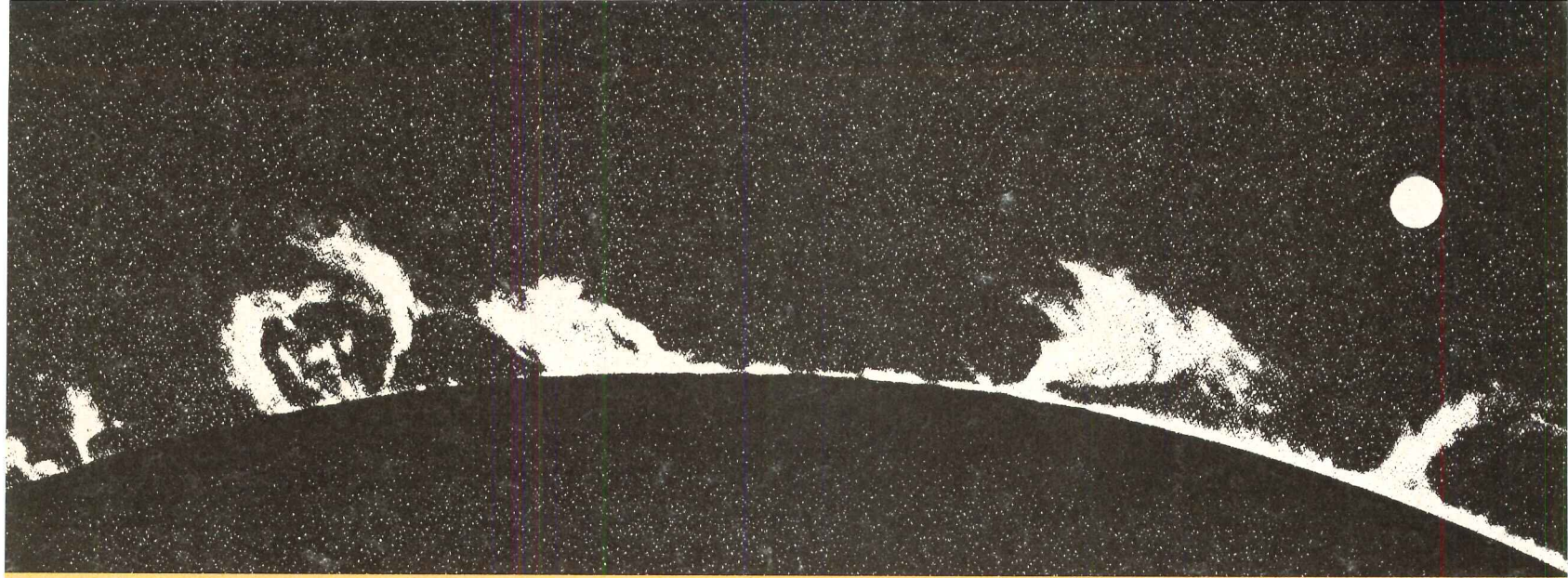

Outside heat raises inside cooling costs. Zonolite can help reduce the problem at its foundation.

Look into Grace-Zonolite® Masonry Fill Insulation. It's incredible stuff. To put it another way, it's a lightweight, free-flowing, water-repellent, vermin-proof, rot-proof, fire-proof, sound-deadening, inorganic, granular vermiculite!

Year after year, it can deliver savings in cooling and heating dollars that far exceed the initial cost of the fill.

Other virtues? Yep. Zonolite® Masonry Fill Insulation reduces sound transmission 20% to 31%. It increases a 2-hour fire rating to 4. It pours in at the rate of 28 square feet per minute. It's acceptable in FHA-financed housing.

Want all the details, test data, specifications, and such? Say the word!

"U" VALUES—concrete block walls

Wall Thickness, Inches	Type of Block	Block Only	
		Uninsulated	Insulated
6	Lightweight	.40	.26
	Heavyweight	.33	.17
8	Lightweight	.53	.36
	Heavyweight	.33	.12
12	Lightweight	.46	.25
	Heavyweight		

ZONOLITE

W. R. GRACE & CO.
62 Whittemore Avenue
Cambridge, Mass. 02140

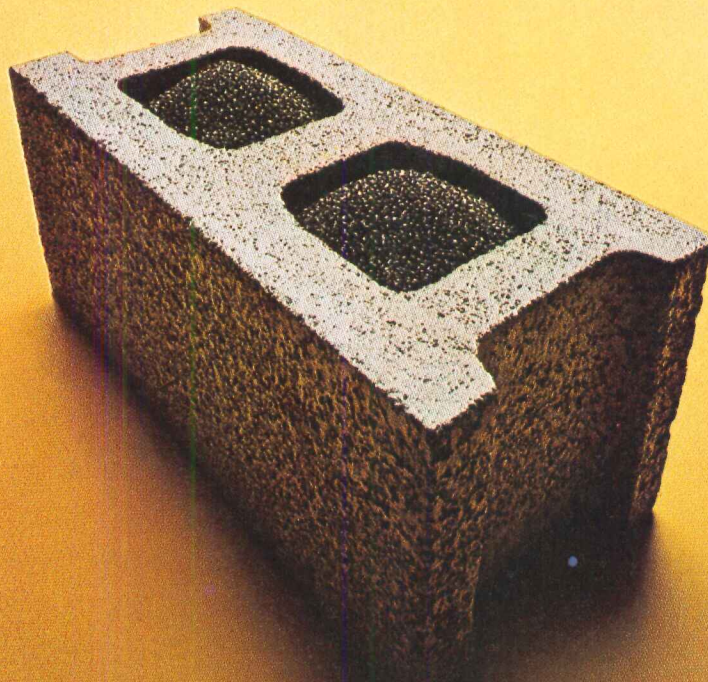

Just say Grace.

Quality: An open-and-shut case.



School lockers — you get out of them what you put into them.

Republic Steel lockers give you total quality. For dependable operation, good looks, the utmost in life expectancy.

Heavy-gauge steel construction. Handles that are kick-proof. Rubber silencers riveted to the frame hooks, and 19 decorator colors to choose from.

Not that these are extras. They're standard equipment. They're what happens when sound construction and fine engineering come together. In single or double tier lockers with standard or full louvers. Two person, box type, you name it.

Case closed. Manufacturing Division, Republic Steel Corporation, Youngstown, Ohio 44505.



Republicsteel
Manufacturing Division

For more data, circle 131 on inquiry card

The broad range of PRC products for the construction industry makes it possible for the architect or contractor to select exactly the right sealant or coating system for any construction requirement. It is possible to use a performance-proven PRC product from the very top of a high-rise construction project right down to waterproofing and coating sublevel parking areas.

No longer is it necessary to seek out one supplier for the sealants, another supplier for the

One Source Complete Waterproofing Package

Sealants / Coatings / Adhesives

deck coating systems and still another for membrane coatings. All the requirements can be satisfied by one or more of the broad range of PRC products.

A PRC Technical Service representative in your area is ready to assist you right from the beginning in the selection of the proper product.

A complete new construction catalog detailing the excellent properties of all these products is available on request to the company.

From Rooftop Heliport To Sublevel Parking Areas There Is A PRC Construction Product To Fit The Need!

Parking Decks
Malls
Fountains
Curtain Wall Panels
Glazing
Expansion & Contraction Joints
Flashing
Walkways
Concrete, Metal and
Wood Decks
Ramps

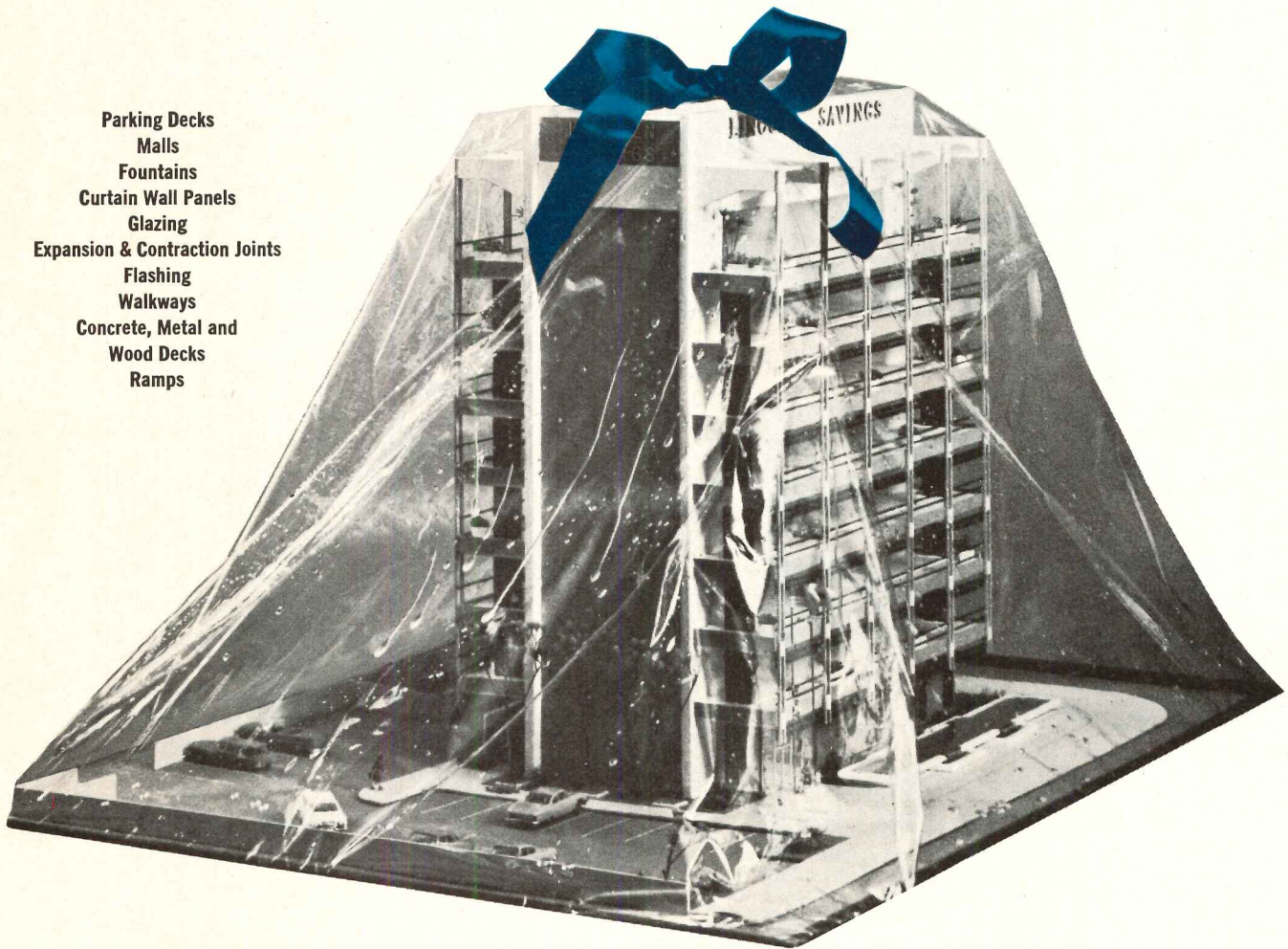

PRODUCTS RESEARCH AND CHEMICAL CORPORATION

Corporate Offices & Western Manufacturing Division, 2919 Empire Avenue, Burbank, Calif. 91504 • (213) 849-3992
Eastern Sales & Manufacturing Division, 410 Jersey Avenue, Gloucester City, New Jersey 08030 • (609) 456-5700
Manufacturing and Sales Facilities Maintained in Ontario, Canada

For more data, circle 132 on inquiry card



BAPTISTRIES, SPIRES, LIGHTING by *Wiedemann*

BAPTISTRIES Originator of the fiberglass baptistry . . . and leading baptistry specialist. Over 150 shapes and sizes of baptistries available.

SPIRES In unit-molded fiberglass for extra strength and durability.

LIGHTING In five styles to complement any style of architecture. Available in natural aluminum or anodized in gold, brass or coppertone.

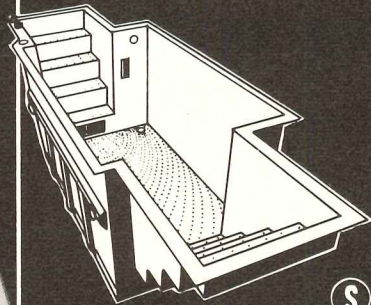

Write for free information kit. See Sweet's Architectural File.

Wiedemann Industries, Inc.

Box 672, Muscatine, Iowa 52761 Ph.: 319-263-6642

For more data, circle 133 on inquiry card

MODERN DOCK DESIGN HINGES ON...

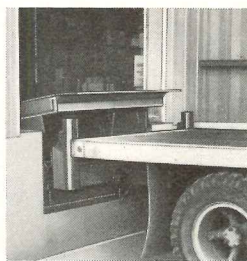
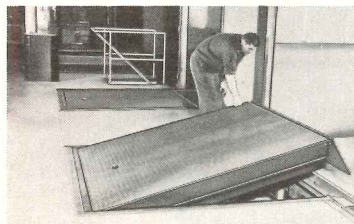

FULLY AUTOMATIC

SEMI-AUTOMATIC

RITE-HITE MECHANICAL DOCK LEVELERS

The widest choice of styles and models to meet your exact dockside requirements. Choose from: Fully-automatic truck actuated, semi-automatic flush return, torsion bar walk down, vertical stored for bi-level docks, and edge-of-dock add-on dock levelers. Also fully mechanical railcar ramps, truck bumpers, and total dock safety kits with wheel chocks.

FREE

Send today for your 8-page dock design catalog



**RITE
HITE
CORPORATION**

6005 S. Pennsylvania Ave.
Cudahy, Wisconsin 53110

IN CANADA: Matthew Moody Ltd.
251 St. Louis Street
Terre Bonne, P.Q., Canada

See Us At Booth 1664, Plant Engineering & Maintenance Show

For more data, circle 134 on inquiry card



"I'm sorry, but Mr. Morgan is no longer with us."

He left the company. For good. Like 25,000 other valuable employees who lost their lives last year in auto accidents.

Which has prompted a lot of businesses to set up the National Safety Council's Defensive Driving Course. A course that utilizes tested concepts and techniques of defensive driving that can dramatically reduce traffic accidents among your employees.

Western Electric has already trained hundreds of its employees how to drive and survive. So have other employee-conscious businesses like National Cash Register. Oklahoma Gas and Electric. And the Hartford Insurance Group.

You, too, will find it very profitable to set up your own Defensive Driving Course for your employees.

Because the best way to keep your workers working is to keep your workers alive.

Send for the survival course.

Special Projects—Public Information
National Safety Council
825 Third Avenue,
New York, N. Y. 10022



advertising contributed
for the public good.

Please mail me full details on the Defensive Driving Program.

Name _____

Title _____

Firm Name _____

Address _____

City _____

State _____ Zip _____

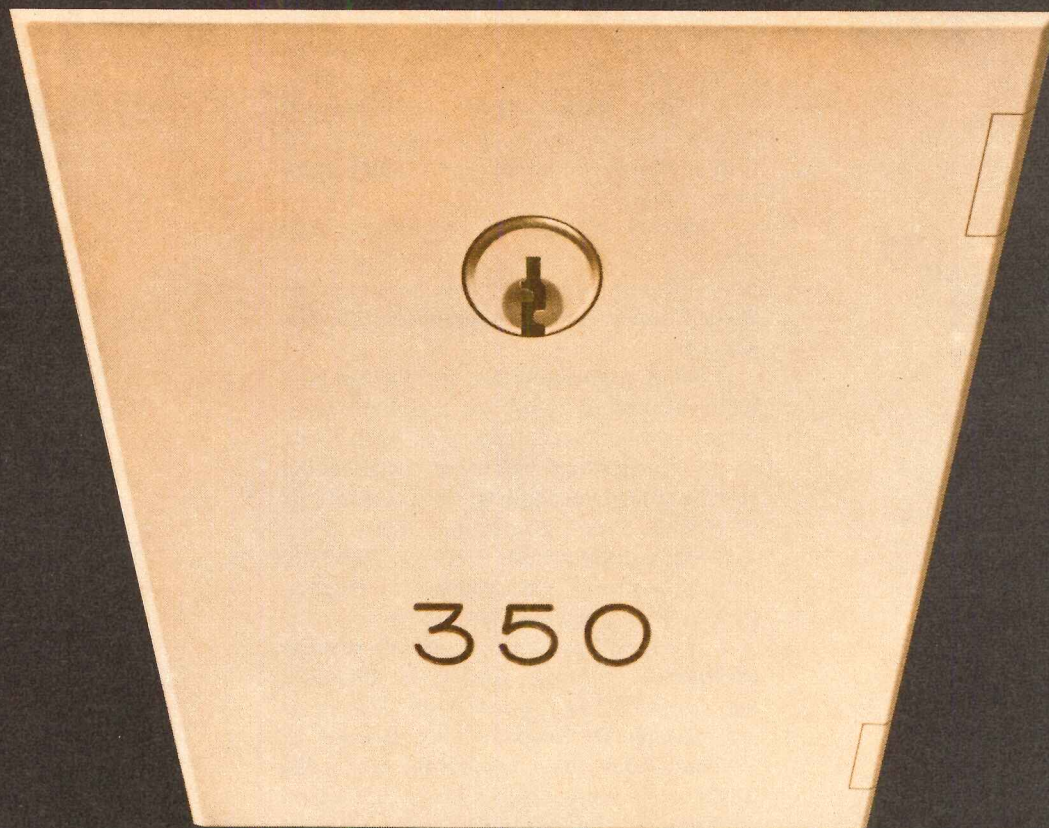

neater nester

**New, flush, Custom Design letter boxes by
Wood Products Division nest beautifully.**

Build smooth, gleaming, virtually unbroken banks of receptacles.

Provide tight security too.

Solid cast bronze or cast aluminum doors

... flush fronts ... flush hinges ... 5-pin tumbler latch bolts.

**Meet U.S. Post Office Department regulations for apartment buildings
or wherever letter boxes are carrier-serviced.**

**A model for rear loading ... another with
Slim Master® doors for front loading.**

Complete layout service available without cost.



WOOD PRODUCTS
DIVISION OF EMHART CORPORATION
BERLIN, CONNECTICUT 06037

For more data, circle 135 on inquiry card

continued from page 96

The "or" in "or equal" usually ends up in . . . "inferior"

Those two words—"or equal"—in your specifications section can lead to considerable disappointment in a finished project. Particularly in vinyl wallcoverings. A moment of inattention, a persuasive salesman, a rash attempt to save a few dollars and you agree to a substitute for Vicrtex. Sometimes, the substitution is even made without your knowledge.

There's only one way to guarantee that you get superior stain-resistant finishes, attractive textures, unique patterns and lustrous colors of Vicrtex vinyl wallcoverings. By tight specs and double-checking along the way.



*If you know enough
about vinyl wallcoverings
to specify VICRTEX,
make sure you get Vicrtex.*

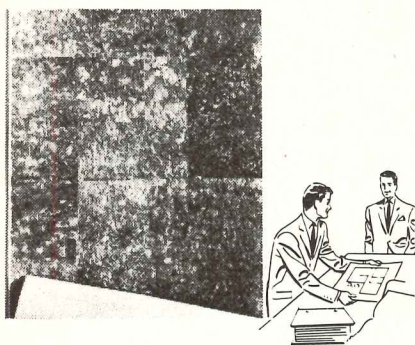

Write today for our helpful booklet: "A Practical Guide to Specification, Selection and Use of Vinyl Wallcoverings."

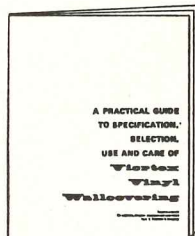

L E CARPENTER
AND COMPANY  A DAYCO
COMPANY

964 Third Avenue, New York 10022
(212) 355-3080

has recently been announced. The new company is a subsidiary of **Gruen Associates**, New York City-based architectural, planning and engineering firm. President is **R. L. Baumfeld**. **Clarence Wescott** and **Gene Nelson** have been named vice presidents.

Frank Cardile, **John Foti**, **Charles Hyun**, **Richard Kliemt**, **Martin Raab** and **Alvin Squire** have been made associates with the firm **Haines Lundberg & Waeher**, New York.

Eugene Patrick Holden and **Velpeau E. Hawes** have been named associates in the firm of **Harrell + Hamilton, Architects Planners**, Dallas.

Hawley & Peterson, Architects, Palo Alto, California, has announced the appointment of three architects as associates: **Brian Cooper**, **Takao Nishiura** and **Charles Ross, Jr.**

Hill & Associates, Inc. and **Fenton Hollander/Architect** announce that their combined architectural practice is now being carried out through **Hill Miller Friedlaender Hollander, Inc./Architects**. Offices continue at 16 Eliot Street, Cambridge, Mass.

Mackie & Kamrath, Houston architects have announced that **Vincent B. Hughes, Jr.** is now an associate member of the firm.

The new partnership, **Weiss Whelan Edelbaum Webster, Architects Planners**, has recently been announced. Principals are: **Joseph D. Weiss A.I.A.**; **Donald V. Whelan, A.I.A.**; **Saul Edelbaum, A.I.A.**; **Ida B. Webster, A.I.A.** Offices are at 527 Madison Avenue, New York City.

Architects **Wilmsen, Endicott, Greene & Associates** have announced the addition of **James V. Bernhard, A.I.A.** to their partnership and the firm name change to **Wilmsen, Endicott, Greene, Bernhard & Associates**. Offices are at 863 Thirteenth Avenue East, Eugene & 803 International Building, Portland.

Honolulu architect **Thomas Wells** has announced the reorganization and expansion of his firm under the name of **Thomas Wells and Associates, Architects**. **David W. Curtis** has joined the firm as a principal; also associated are **Remo Patri** and **Norman Lacayo**.

ADDENDA

In the February 1970 issue, page 132, the designers within the John Andrews office of Belconnen Town Center, Australia, were incorrectly listed. The design group should have read, "John Andrews, Peter Courtney, Roger duToit and Henry Shefter." Also, the Andrews office is not setting up a branch of the firm in Australia, as was reported on page 146 of the same issue.

Architects for the City Hall for Santa Rosa, California (January 1970, pages 102-103) are correctly "DeBrer Bell and Heglund," not "Jacques DeBrer and Richard Heglund" as published.

RECORD IMPRESSIONS

A new service offering reprints, reports and back issues.

RECORD HOUSES OF 1968

RECORD HOUSES OF 1969

Did you miss these important issues of RECORD HOUSES? If so, there is a limited supply available.

1968—\$2.00 per copy
1969—\$3.25 per copy

Fill in the coupon below and return with your check or money order.

Record Impressions
ARCHITECTURAL RECORD
330 West 42nd Street
New York, New York 10036
Att: Joseph R. Wunk

No. of copies

Please send me:

- RECORD HOUSES of 1968—
@ \$2.00 per copy
- RECORD HOUSES of 1969—
@ \$3.25 per copy

Enclosed is my check

Money order

for \$ _____

NAME _____

FIRM _____

ADDRESS _____

CITY/STATE _____

ZIP _____



“We want you to make us the world’s biggest rug.”

That’s what the Nassif people asked us for their new 10-story block-square building in Washington.

Of course what we installed isn’t really a “rug.” It’s 128,000 square yards of Antron® nylon carpet which went into the building that houses the entire U.S. Department of Transportation.

Aldon won this record contract in competition with just about every other major carpet manufacturer in the country.

Because what Nassif wanted from us wasn’t just our fine Aldon carpet.

Nassif wanted our Aldon Carpet System.

The famous System that takes over the entire job.

We have top engineers and technicians on our staff who will supply you with a detailed program of your total operation. From specifying the right carpet according to traffic-and-use areas, right on through installation and maintenance. All of it planned to save you miles and miles of money every inch of the way.

But the full story is too big to be told here. So we’ve prepared a brand new booklet. Send for it.

The Aldon Carpet System features Antron® nylon and 501* nylon. *DuPont certification mark.

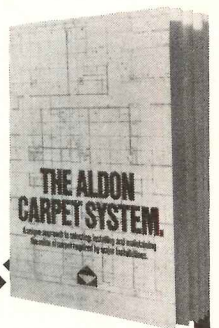

Aldon
THE INNOVATORS

V. P., Commercial Carpets
Aldon Industries Inc.
295 Fifth Avenue
New York, N. Y. 10016

Please send me your booklet,
“The Aldon Carpet System”.

AR4

NAME _____

TITLE _____

COMPANY NAME _____

ADDRESS _____

CITY _____ STATE _____ ZIP _____

For more data, circle 137 on inquiry card

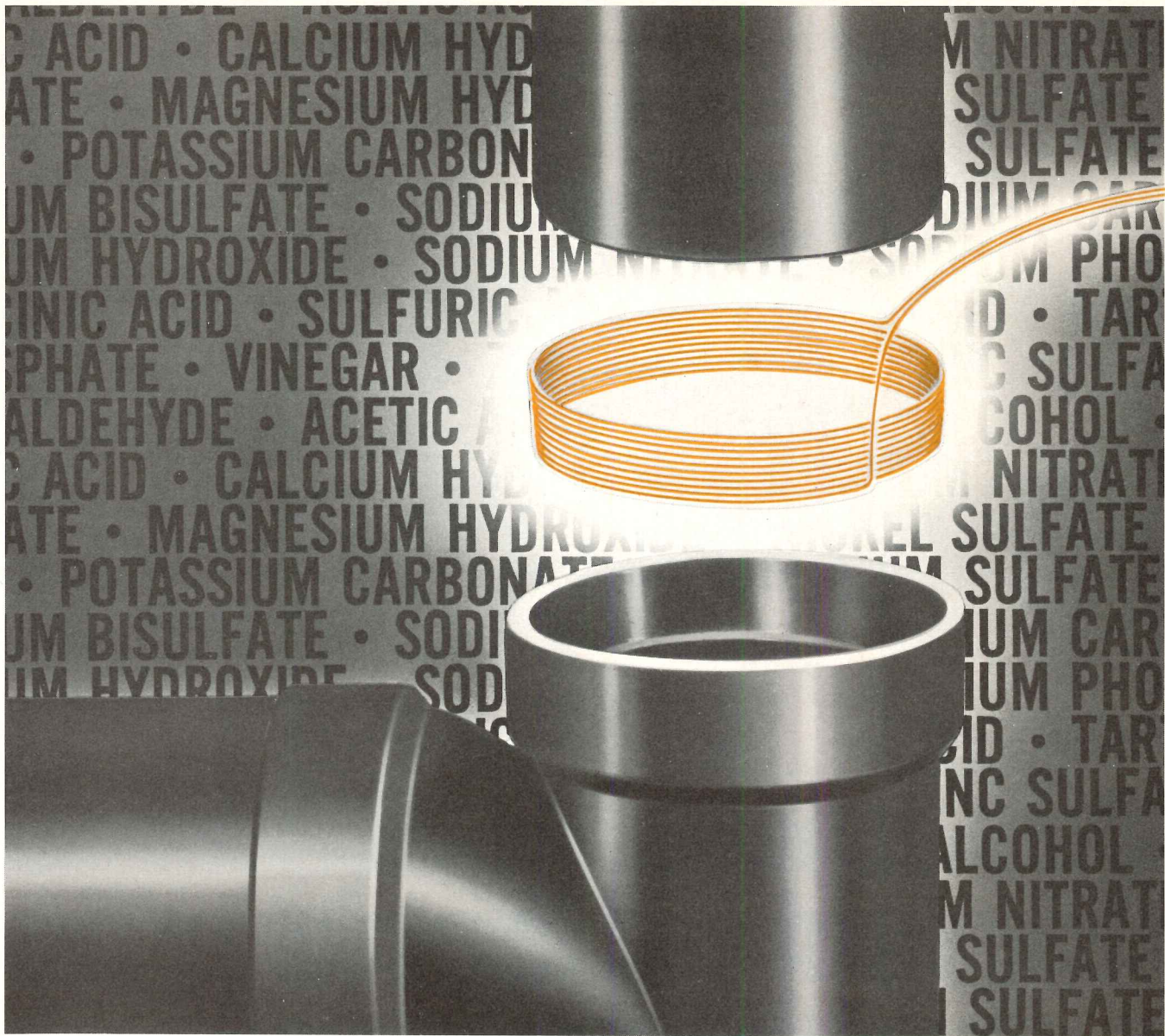

0202



Polypropylene fittings and pipe for chemical wastes quickly joined with electrical fusion process.

HOT under the collar

A full circle of heat—precisely regulated, precisely applied—seals the joints in GSR® Fuseal® acid drain-waste-vent systems. The patented Fuseal process offers the only simple, practical way to take advantage of the superior corrosion resistance of polypropylene. Installation time and cost are minimized, and strong, leakproof joints are assured.

The GSR polypropylene pipe and fittings are made for each other—and for the exclusive Fuseal process. The hot collar—a simple resistance coil imbedded in polypropylene—slips over the end of the pipe before insertion into the socket. The collar is connected to the Fuseal power unit, the timer is set, and in 90 seconds the interface between pipe and socket is fused into a homogeneous, leakproof unit. If later adjustments are required, the joint can be reheated and swung to the new position.

Specify the simplest, most practical, most economical acid drainage system with the modern GSR Fuseal process. Write today for full information and ask for your copy of the new GSR polypropylene acid resistance chart. R & G SLOANE MANUFACTURING COMPANY, INC.

7606 N. Clybourn Ave., Sun Valley, Calif. 91352

GSR® FUSEAL® JOINT FUSION PROCESS

PLANT, WAREHOUSE AND SALES OFFICE: 6100 Hillcrest Dr., Cleveland, Ohio 44125 • Tel. (216) 524-8600
 WAREHOUSE AND SALES OFFICES: 3126 Brinkerhoff Road, Kansas City, Kan. 66115 • Tel. (913) 371-0412 □ 1669 Litton Dr., Stone Mountain, Ga. 30083 • Tel. (404) 939-6644
 The GSR FUSEAL bonding process is covered by U.S. Patent No. 3,094,452 and Canadian Patent No. 668,419; Fuseal Power Unit, U.S. Patent No. 3,465,126; Fuseal Coil, U.S. Patent No. 3,378,672.

For more data, circle 138 on inquiry card

SOUND CONTROL IS NO PROBLEM HERE



The interior design of 3M Company's new multiple-purpose office building in St. Paul called for office partition flexibility and mobility. Sound transmission is an inherent problem with this kind of partition design. It was easily controlled with the use of lead.

Since the building is designed to house administrative, marketing, sales, purchasing and other personnel, there was a plan to build office partitions that would be easily relocatable as need might dictate. Partition design, in turn, called for a soundproofing system that would prevent noise pollution from office to office or from noise-producing workrooms located in the building.

Lead plenum barriers' renowned ability to block

sound and their ease of installation, especially around difficult piping, duct and conduit areas, dictated their use. 67,700 square feet of lead sheeting were used to soundproof the building. In addition, the company's own Scotch Brand lead foil tape was used to seal the joints and seams.

Solve your noise problems with lead: metallic sheet, leaded plastics, bulk damping compounds, and other lead products. For more information on the use of lead for the attenuation of airborne noise and a copy of "Acoustical Plenum Barriers and How To Install Them," write Lead Industries Association, Inc., Dept. LL4, 292 Madison Avenue, New York, New York 10017.

 **Lead Industries Association, Inc.**

For more data, circle 139 on inquiry card

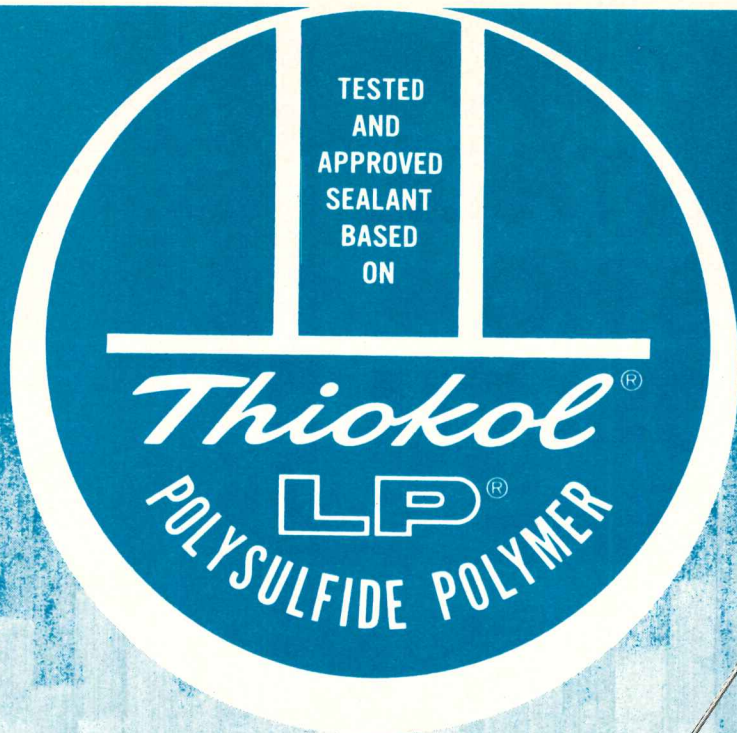

The Seal of Security ON GUARD!

Tested and Approved Sealants based on Thiokol LP® polysulfide polymer for steel-grip bonding—Rubbery flexibility—Highest resistance to weather, wear and aging. Total waterproofing . . . on a long term basis.

These are the qualifications of products wearing the Thiokol Seal of Security. The "Seal" symbolizes a standard of performance excellence for joint sealants maintained through a program of testing of production runs and "on-job" sampling of sealants based on Thiokol LP® Polymers.

The FIRST and only full service, quality assurance program in the sealant industry. The Seal of Security is awarded to only Thiokol LP® Polysulfide Polymer based compounds meeting all the product standards established by Thiokol. Compounds must maintain these high performance standards throughout the continuing program of testing OR forfeit the seal.

Thiokol
CHEMICALS

Need more facts or a special viewing of Thiokol's new film "ON GUARD"? Write Thiokol. Touché.

THIOKOL CHEMICAL CORPORATION □ CHEMICAL DIVISION
780 N. CLINTON AVENUE, TRENTON, N.J. 08607

Allied Chemical Tower, N.Y.C. Architect: Haines Lundberg & Waehler, N.Y.C. Two-part LP® polysulfide based sealant in all joints of marble panels.



For more data, circle 140 on inquiry card



the system

the long span roof and floor structural system with the built-in economies.

You can see some of those economics at a glance . . . the wide, nailable wood chords for direct attachment of plywood as a roof deck and for low cost ceiling materials. Those open webs save money, too, providing room for fast and easy installation of ductwork, wiring and plumbing.

Take a second look and you'll realize that TRUS JOISTS are light weight, fast to erect and because of that light weight require less costly footings, foundations and bearing walls.

What the picture doesn't show are the various TJ shapes, from parallel to pitched, tapered, curved and crescent, all economical and all custom engineered to your design. Need long spans? To 150 feet? You'll get delivery three weeks after you approve shop drawings.

TRUS JOISTS bear equally well on steel, masonry or frame construction. They have been used in thousands of schools, shopping centers, apartments and commercial buildings of every type over the past ten years.

Add up the advantages . . . the savings and you'll more than likely want more information, perhaps a complete design manual or free cost estimate.

Just call or write

Trus Joist
®

9777 Chinden Blvd.

Boise, Idaho 83702

Plants in: ■ ARIZONA ■ CALIFORNIA ■ IDAHO ■ IOWA ■ OHIO ■ OREGON ■ CANADA (Alberta)

For more data, circle 141 on inquiry card



We've Raised The Standards Of Civilization

Autoquip Corporation comes to the aid of the Empire with the Porta Contact Platform Lift. There are times when you'll feel it's the eighth wonder of the world: Where would civilization be if we couldn't solve problems that are impossible with conventional lifting devices?

For example, when you're faced with a low dock or an excessively steep angle of inclination, the Porta Contact Platform Lift raises to the exact truck height to permit simple movement of goods in and out.

When there are no docks . . . a situation familiar in warehouse and chain store trailer unloading . . . the Porta-Contact raises from a ground installation, allowing the operator to move the goods from the truck to the platform. The platform is then lowered with the operator and goods, saving many manhours of labor.

When you're faced with severely heavy or awkward loads, the Porta-Contact can be used as a universal platform lift, loading from the floor to trucks at different levels.

In solving your particular materials-handling problem, be grateful for one of the greatest inventions since the birds, the bees, and the Italians . . .

The Autoquip Porta-Contact Platform Lift.

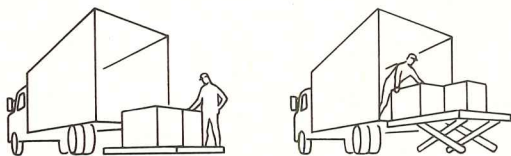

Write for description, literature and price.

Autoquip CORPORATION

1140 S. WASHTENAW AVE./CHICAGO, ILL. 60612

For more data, circle 144 on inquiry card

Beyond Comparison...

SCHEMENAUER MULTIZONE-ROOFTOP UNITS

Investigate the Benchmark II, the problem-solving heating, cooling and ventilating unit from Schemenauer. You'll see how our progressive engineering has solved the problems first posed by multizone-rooftop systems. For example, our low-silhouette unit is really weather-tight, utilizing a one-piece fiberglass top and enameled aluminum side panels. There's no exposed steel to rust. When it comes to maintenance and installation, you'll find beauty combined with practicality. For instance, access to all areas of the Benchmark II is simplified because of post and panel construction which eliminates hundreds of screws. Two compressors, centrally located for even weight distribution, operate in a dual refrigeration circuit to conserve power loads and give

you maximum performance at minimum operating costs. During the normally humid cooling season, the Benchmark II provides dehumidification of *all* air to the building. Advanced Schemenauer technology has eliminated problem areas inherent in most rooftop units. Water leaks, high humidity levels, and extensive operating costs and maintenance worries are now a thing of the past. For this new age of building design, rooftop units are the answer . . . and the Benchmark II is the leader. Why not call your nearest Schemenauer Products representative today for complete details? Or write Modine Manufacturing Company, 1510 De Koven Avenue, Racine, Wisconsin 53401.

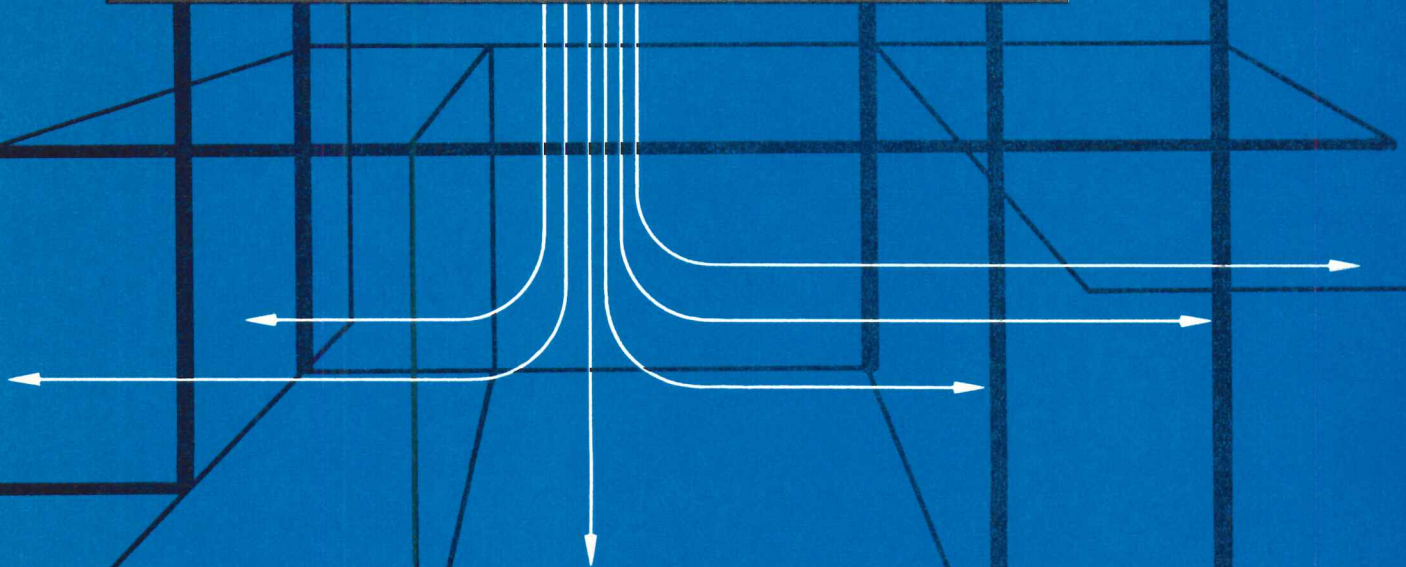
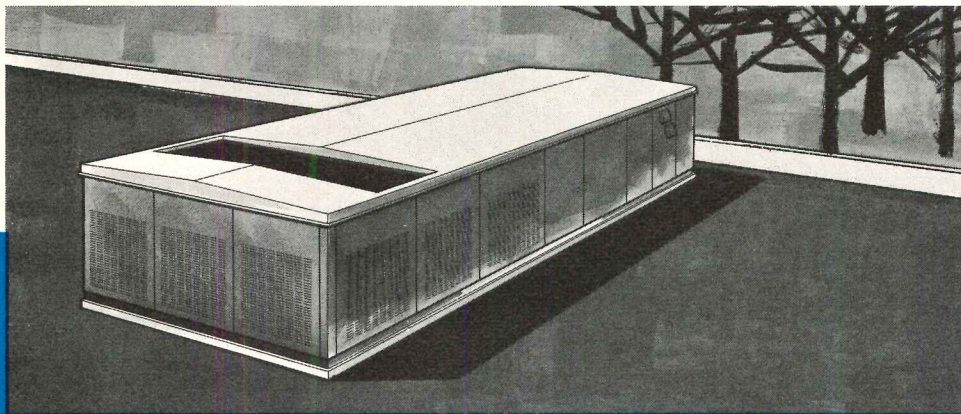

SCHEMENAUER PRODUCTS



MODINE

For more data, circle 142 on inquiry card

A mouse has already been saved from leukemia. Help us save a man.

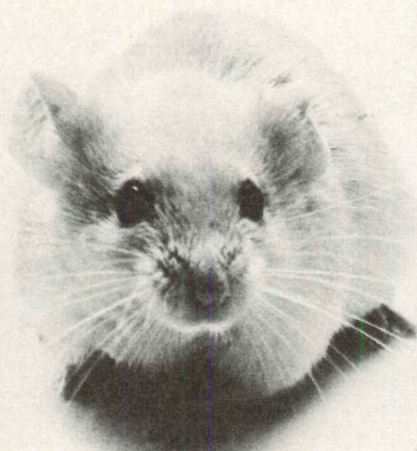

For years, you've been giving people with leukemia your sympathy. But sympathy can't cure leukemia. Money can. Give us enough of that, and maybe we'll be able to do for a man what has already been done for a mouse.

American Cancer Society 

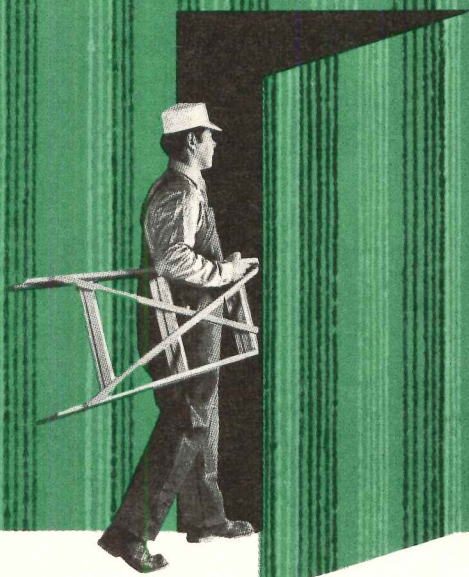

WALLCRAFT* is sending Du Pont nylon right up the wall.

The finest denier continuous filament nylon ever produced for tufting opens exciting new interior design opportunities.

Du Pont 760 denier nylon** is being put to a new use: wall covering. Called "Softwall," the tufted material made by Wallcraft* resists scuffing and scratching, is easily maintained and acoustically advantageous.

This particular fine denier yarn allows Wallcraft* to exploit an almost unlimited potential of color and design. "Softwall"

is being initially offered in color-coordinated solids, tweeds and stripes.

Available in 4-foot widths, "Softwall" is designed for direct application or pre-paneled surfaces... wherever a combination of good looks, low maintenance and sound-absorption is desired.

For more information, contact Du Pont, 308 East Lancaster Ave., Wynnewood, Pennsylvania, or your local Wallcraft* distributor.

*Wallcraft is a Division of E. T. Barwick Industries, Inc.

**Du Pont makes fibers, not tufted wall covering.



Better things for better living... through chemistry

For more data, circle 149 on inquiry card

ADVERTISING INDEX

Pre-filed catalogs of the manufacturers listed below are available in the 1970 Sweet's Catalog File as follows.

- A Architectural File (green)
- I Industrial Construction File (blue)
- L Light Construction File (yellow)
- D Interior Design File (black)

A

- Aerofin Corp. 184
- Aldon Industries 243
- A-D Allied Chemical Corp., Fibers Div. ... 101
- A-I Allis-Chalmers Mfg. Co.210A
- D Alma Desk Company 67
- American District Telegraph Co. 192
- A-I-L American Plywood Association88-89
- American Standard, Applied Air Conditioning Department 73
- American Standard, Commercial Products Department232-233
- A-I Anchor Post Products, Inc. 204
- A-L Andersen Corp.76-77
- A-I-L-D Armstrong Cork Co. 177
- D Art Metal, Inc. 72
- A Autoquip Corp. 248
- A-L Azrock Floor Products3rd cover

B

- A Bally Case & Cooler, Inc. 103
- Bell Helicopter 96
- Bethlehem Steel Corp.185 to 188
- A Bigelow-Sanford Carpet Co.18-19
- A-I-L Bilco Company 91
- A Bommer Spring Hinge 236
- A-I Bradley Washfountain Co. 59
- Charles Bruning Co.50-51
- A-I Burns & Russell Co.210D

C

- A-L Caradco Division of Scovill Mfg. Co. ..68-69
- A-I Carpenter & Co., L. E. 242
- A-I-L Carrier Air Conditioning Co. 7
- Cast Iron Soil Pipe Institute 220
- Celanese Fibers Marketing Company2nd cover
- A-I Celotex Corp.28-29
- A-I Chicago Metallic Company 215
- A-I Claridge Products & Equipment, Inc. ... 220
- Cockle Ventilator Co., Inc. 210F
- A-I Combustion Engineering Inc.44-45
- A Cominco Ltd. 181
- Commercial Carpet Corporation 49
- Continental Instruments Corp. 34
- A-I-D Conwed Corp.209-210
- Corbin, P&F, Div. Emhart Corp.169
- D Corry Jamestown Div. 100
- A Crawford Door Company 230
- A Crouse-Hinds Company62-63

D

- Day-Brite Lighting Div. of Emerson Electric161 to 163
- A Dearborn Glass Company 166
- A-L Delta Faucet Company 66
- A Detex Corp. 22
- A Dover Corp., Elevator Div. 37
- D Dow Badische Co. 223
- A-I DuPont de Nemours & Co., Inc. Neophrene210E
- I-D DuPont de Nemours & Co., Inc., E.I.-Textile Fibers 251
- A-I Duriron Co., Inc. 1

E

- A-I Eaton, Yale & Towne-Cordley 111
- Edison Electric Institute216-217
- A-L Elkay Mfg. Company86-87
- A-I-L-D Epic Metals Corp. 236
- Executone, Inc. 84

F

- Fife, Inc., Richard 181
- A Follansbee Steel Corp. 174
- D Fritz Hansen Inc.210D
- A-I Fuller Co., H. B. 70

G

- A-D Georgia Marble Co. 178
- A-I-L-D Georgia-Pacific Corporation ..20-21, 206-207
- Goodyear Tire & Rubber Co. 164
- A-I-L W. R. Grace & Co., Construction Products Division228-229
- A-I Granco Steel Products Co.56-57
- A-I GREFCO, Inc., Building Products Div. 38-39
- Guth Co., Edwin F. 48

H

- Hardwick & Magee Co.97-98
- A Harrington & King Perforating Co. Inc. . 83
- A Haughton Elevator Company 197
- A-D Haws Drinking Faucet Company 189
- A-I Hillyard Chemical Co. 194
- Honeywell 110
- A Hope's Windows, Inc. 94

I

- A Ickes-Braun Glasshouses Inc. 105
- A-I Inland-Ryerson Construction Products Co.210B-210C
- International Nickel Co., Inc.60-61

J

- A The Jewett Refrigerator Co., Inc. 91

K

- A Kawneer Co.11 to 15
- A-I Keene Corp. 2-3
- D Keene Corporation, Sound Control Division 109
- A-I Kinnear Corp. 80
- A-I Kohler Company 8
- A-D Krueger Metal Products Co. 175
- K-S-H, Inc. 208

L

- A Landmark Lighting Div., American Electric Mfg. Corp. 112
- Latco Products32-8
- A-I-D Lead Industries Assn., Inc. 245
- A-L Lennox Industries, Inc.23 to 25
- A-D Levolor Lorentzen, Inc.54-55
- A-I-L-D Libbey-Owens-Ford Co.211 to 214
- A-D Lyon Metal Products, Inc. 171

M

- Massey Seating Co. 196
- D Matthews & Co., J. H. 170
- A Matthiessen & Hegeler Zinc Co. 231
- M-B Company210D
- A McPhibben Lighting Div., Emerson Electric Co., Inc. 71
- Medusa Portland Cement Co.26-27
- A-I 3M Company 65
- A-I-L Mississippi Glass Co.46-47
- A Mobay Chemical Company 113

N

- National Fire Protection Association .. 205
- A Nor-Lake, Inc. 196
- A North Carolina Granite Corporation ... 205
- Northern Natural Gas Company 58

O

- A-I Onan Div., Studebaker Corp. 203
- A Otis Elevator Co.16-17
- A-I Overhead Door Corp.172-173
- A-I Owens-Corning Fiberglas' Corp.32, 168

P

- A Panelfold Doors, Inc. 205
- Payne Company32-1
- A-L Pella Rolscreen Co.179-180
- A-I Pennwalt Corp.52-53
- A-I-L Pittsburgh Corning Corp.226-227
- A-I-L Pittsburgh Corning Corp.-Foamglass 190
- A-I PPG INDUSTRIES, INC.-Coatings & Resin Div.78-79
- A-I-L PPG INDUSTRIES, INC.-Fiberglass Division92-93
- A-I-L PPG INDUSTRIES, INC.-Glass Division 30-31
- Pratt & Lambert, Inc. 64
- A-I Prestressed Concrete Institute 167
- A Products Research & Chemical Corp. .. 239

R

- A-I Raynor Mfg. Co. 195
- A-I Republic Steel Corp. 238
- A-I Richards-Wilcox Mfg. Co. 95
- I Rite Hite Corporation 240
- RUSSWIN, Div. Emhart Corp. 225

S

- A Sargent & Company 106
- Schemenauer Mfg. Co. 249
- Sears, Roebuck & Co. 191
- A Silbrico Corp. 99
- A-I Sloan Valve Company4th cover
- Sloane Mfg. Div., R. & G., Susquehanna Corp. 244
- Southern California & Southern Counties Gas Cos.32-6-32-7
- A-I Span-Deck Mfg. Assn. 193
- Speakman Company 199
- Square D Company 33
- A Standard Conveyor Co. 102
- Steelcase Inc. 114
- A Steel Deck Institute 202
- Stevens & Company, Inc., J. P. 107
- Sweet's Catalog Service200, 253

T

- A-I Taylor Co., The Halsey W. 198
- A Texas Instruments Inc. 221
- A Thermoproof Glass Co. 224
- A-I Thiokol Chemical Corp. 246
- A Thonet American Chair Company 235
- A-I 3M Company 65
- Trus Joist Corp. 247

U

- A-I-D United States Gypsum Co. 222
- A-L U.S. Plywood Corp.74-75
- A-L Uvalde Rock Asphalt Co.3rd cover

W

- A Waukesha Motor Company 234
- A Weber Showcase & Fixture Co. 104
- A-D Westinghouse Electric Corp. 201
- Wide-Lite Corporation182-183
- A Wiedemann Industries Inc. 240
- Wood Products Div. of Emhart 241

X

- XEROX CORP.218-219

Z

- A-I Zero Weather Stripping Co., Inc. 176
- A-I-L Zonolite Division 237

ARCHITECTURAL RECORD

McGraw-Hill, Inc., 330 West 42nd Street,
New York, New York 10036
Advertising Sales Mgr.: Louis F. Kutscher (212) 971-2838
Eastern Sales Mgr.: Donald T. Lock (212) 971-3583
Central Sales Mgr.: Robert G. Kliesch (215) 568-6161
Production Mgr.: Joseph R. Wunk (212) 971-2793
Marketing Services Mgr.: Elizabeth Hayman
(212) 971-2858
Classified Advertising: (212) 971-2557

District Offices:

- | | |
|---------------------|--|
| Atlanta 30309 | Edward G. Graves
1375 Peachtree St., N.E., (404) 892-2868 |
| Boston 02116 | Ted Roscoe
607 Boylston St., (617) 262-1160 |
| Chicago 60611 | Robert T. Franden
Edward R. Novak
645 N. Michigan Ave., (312) 664-5800 |
| Cleveland 44113 | Willis W. Ingersoll
55 Public Square, (216) 781-7000 |
| Dallas 75201 | Angus A. Macaulay
1800 Republic National Bank Tower, (214) 747-9721 |
| Denver 80202 | Douglas J. Carthew
1700 Broadway, (303) 266-3863 |
| Detroit 48226 | 2600 Penobscot Bldg., (313) 962-1793 |
| Houston 77002 | Angus A. Macaulay
2270 Humble Building (713) 224-8381 |
| Los Angeles 90017 | Robert L. Clark
1125 W. Sixth St., (213) 482-5450 |
| New York 10036 | Donald T. Lock,
Douglas S. Markhouse
Ted Roscoe
500 Fifth Ave. (212) 971-3583 |
| Philadelphia 19103 | Robert G. Kliesch
George T. Broskey
6 Penn Center Plaza, (215) 568-6161 |
| Pittsburgh 15222 | Edward C. Weil
4 Gateway Center, (412) 391-1314 |
| St. Louis 63105 | Richard Grater
7751 Carondelet Ave., (314) 725-7285 |
| San Francisco 94111 | Robert L. Clark
255 California St., (415) 362-4600 |

**WE
MUST BE DOING
SOMETHING RIGHT.**

YOU REFERRED TO SWEET'S
55,000,000 TIMES LAST YEAR —
5,000,000 MORE REFERRALS
THAN 1968.

**THANKS FOR YOUR GROWING
VOTE OF CONFIDENCE.**

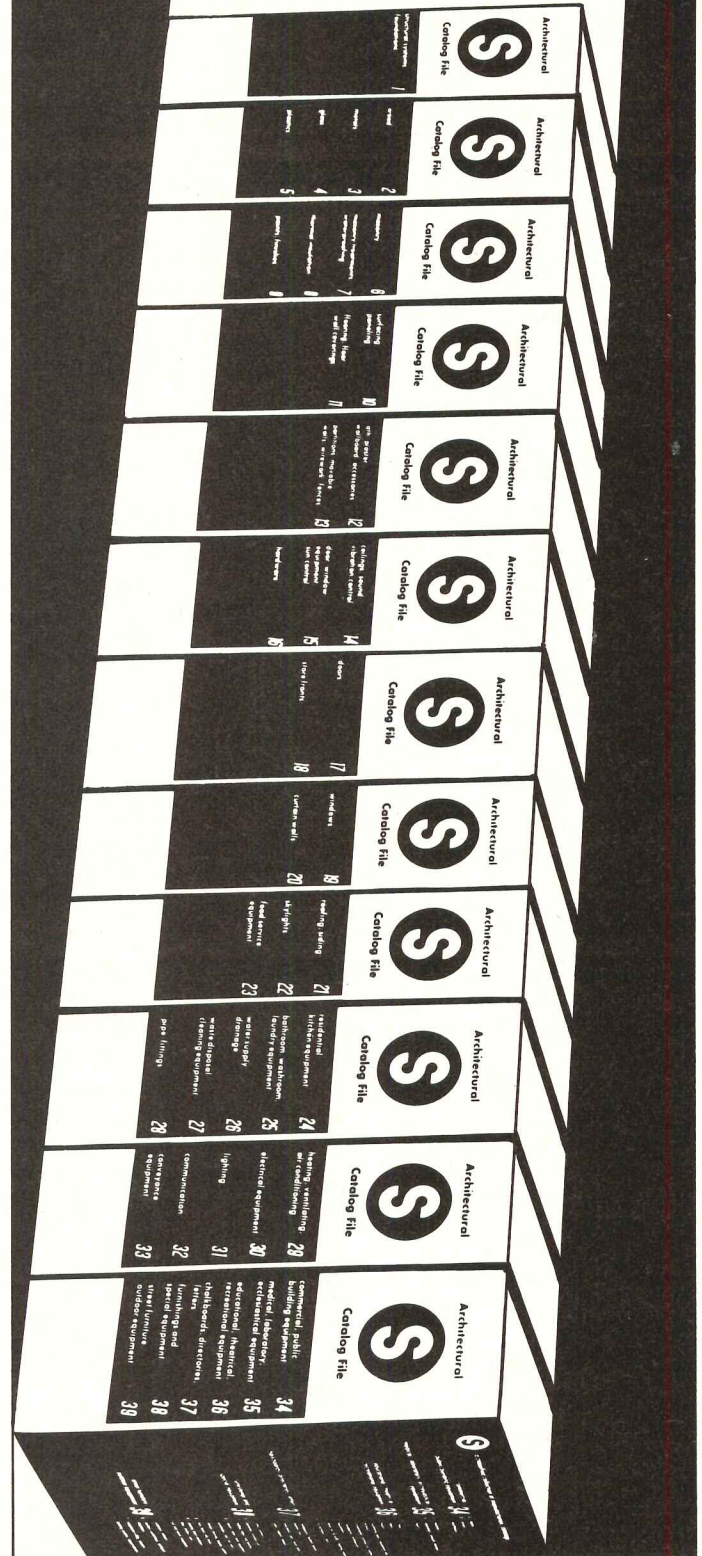

Sweet's Construction Catalog Services
McGraw-Hill Information Systems Company
330 West 42nd St., New York, N. Y. 10036

CLASSIFIED SECTION

EMPLOYMENT

BUILDING DESIGN

Career opportunity available for either a Graduate Architect or Architectural Engineer. Other engineering degrees acceptable with experience. Applicant should have a minimum of four years experience in the building design field. Salary open. Advancement opportunities in keeping with the established history of solid growth.

Consumers Power Company is a progressive natural gas and electric utility servicing the lower peninsula of Michigan. The assignment would be at the General Offices, with an excellent geographical location in Michigan's water-winter recreation land. Plant interview expense and relocation of household goods will be completely reimbursed.

Call collect or send resume to R. E. Wallace, University Relations, Area Code 517, 788-1350.

Consumers Power Company

212 W. Michigan Avenue
Jackson, Michigan 49201

An Equal Opportunity Employer

POSITIONS VACANT

Architectural Teachers—Requirements: Masters degree in architecture and six years of architectural practice of which at least two years included interaction with computer applications related to completed building projects. Teach in a two year computer oriented architectural technology program. Location 28 miles northwest of Chicago, Illinois. Contact Chairman, Division of Engineering, William Rainey Harper College, Algonquin and Roselle Roads, Palatine, Illinois 60067.

Project Architect—Expanding Architectural/Engineering firm has opening for "talented" Project Designers and Draftsmen. Located in Western New York and maintaining a regional practice through the states of New York, Pennsylvania, Vermont, New Hampshire and Connecticut, this firm can provide exciting challenges to architects orientated to the design of medical, educational, commercial and industrial facilities. License and/or degree helpful, but not mandatory. Please send confidential resume including salary requirements to: Mr. Franklin D. Guidone, AIA, Director of Design, THE CANNON PARTNERSHIP, 2637 Main Street, Niagara Falls, New York 14305

ADDRESS BOX NO. REPLIES TO: Box No.
Classified Adv. Dept. of Architectural Record
Send to office nearest you.
NEW YORK, N.Y. 10036: P.O. Box 12
CHICAGO, ILL. 60611: 645 N. Michigan Ave.
SAN FRANCISCO, Cal. 94111: 255 California St.

REGISTERED ARCHITECT

For diversified projects. Minimum of 5 years' experience in commercial and industrial work. Liberal Benefits Program.

Write in confidence to the Personnel Department, or call (615) 336-2261, Ext. 276.

RUST
THE RUST ENGINEERING CO.
DIVISION OF LITTON INDUSTRIES

P. O. Box 222
Calhoun, Tennessee 37309

An Equal Opportunity Employer

ARCHITECTS—Dynamic East Coast Client Currently seeks several experienced Architects. Positions are in Design, Production, Fabrication, coordination areas. Salaries from \$16,000 to \$23,000. Candidates should have Degree plus a minimum of 3 years experience in Modular housing, Pre fab. housing or Hi-Rise structures. For more information contact in complete confidence Ronald Williams, EVERETT KELLEY ASSOC. 121 S. Broad St. 20th fl. Philadelphia. Pa. 19107

Top Architectural Designer—Design position available to a registered Architect with a minimum of 8 yrs. comprehensive experience. Position includes directing design teams for varied projects at a large firm located in the Mid-Atlantic Region. Work includes high rise office buildings, commercial and industrial buildings, schools, hospitals and laboratories. Excellent compensation, benefit plans, and growth potential are available. Location permits year around fishing, hunting, golfing, swimming and skiing. Submit confidential resume of experience and earnings to P-1235, Architectural Record.

POSITIONS WANTED

Partnership of two young architects seeks association with architect anticipating retirement. Both partners are ambitious, determined and highly energetic with 4 to 5 years experience in a wide range of architectural projects. Recent work includes research and development of industrialized building systems. PW-9934, Architectural Record.

PROFESSIONAL SERVICES

CONSTRUCTION COST CONTROL, INC.
Consulting Engineers
Construction Management • Preliminary Estimates
Working Drawing Estimates • CPM Scheduling
6355 N. Broadway Chicago, Ill. 60626
312-338-6060

Classified Section Non-Display Order Form

This section is designed to provide our readers with a convenient national marketplace where they can solve their professional and personal needs in the same publication to which they look for latest news and developments in their fields.

To place a non-display advertisement, fill out this form, attach it to a separate sheet containing your advertising copy, and mail it to:

ARCHITECTURAL RECORD / P.O. BOX
12
NEW YORK, N.Y. / 10036

Please insert the attached advertisement under:

- Employment Opportunities
- Business Opportunities
- Selling Opportunities
- Financial Opportunities
- Professional Services

Rates: \$3 per line, minimum insertion ten lines, six words to a line, box number counts as one additional line.

NAME _____

ADDRESS _____

CITY _____

STATE _____

ZIP _____

Payment Enclosed \$ Bill me

Use Name & Address Use Box No.

Advertisement to appear time(s)

Signature _____

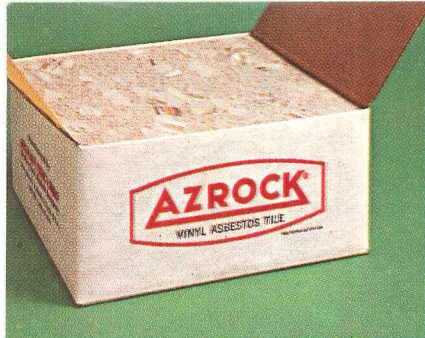

Carton Full of Miracles
Azrock Vinyl Asbestos Tile.
It's what's happening
in hospital flooring.



The creative styling of Azrock's vinyl asbestos tile is effectively demonstrated in the scores of outstanding Azrock installations in U. S. hospitals. Azrock floors are ideally suited to the specialized requirements posed by heavy foot and wheel traffic, tracked-in dirt, spilled foods and medications. Azrock makes more than 120 imaginative colors and styles in vinyl asbestos tile . . . makes it easy to plan custom floor design from room to room, from floor to floor. Put Azrock's "Carton Full of Miracles" to work on your next hospital project.

specify **AZROCK**® with confidence

Consult Sweet's File or write for samples. Azrock Floor Products Division, 521A Frost Building, San Antonio, Texas 78205.

For more data, circle 145 on inquiry card



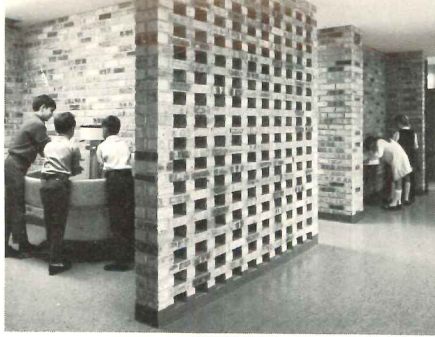

**Twin suburban schools
"made to order"
for Pre-teen education**



ARCHITECTS, *O'Donnell Wickland Pigozzi, Architects, Inc.* • MECHANICAL ENGINEERS, *William T. Brookman & Associates*
PLUMBING CONTRACTOR, *Di Pietro Plumbing Corp.* • PLUMBING WHOLESALE, *Miller Supply Company* • FIXTURE MANUFACTURER, *American Standard*

Two new elementary schools, serving pupils from kindergarten through sixth grade, now offer the utmost in modern learning facilities in Chicago's suburban Deerfield. Named Briarwood and Cadwell, the two schools have identical "core" facilities that include an all-purpose room, center for instructional materials, facilities for pupil-personnel services and offices. Two classroom wings, each with a distinctive look, project from the central core.

Briarwood School (shown) accommodates 375 pupils with 11 classrooms and two kindergarten rooms. The Cadwell School accommodates 400 pupils with 12 classrooms and two kindergarten rooms. Future expansion to 20 classrooms is possible at both Briarwood and Cadwell.

The buildings are steel frame, cavity wall construction, slab on grade, with a gypsum roof deck. Main exterior material is brick which carries inside and combines with painted concrete block partitions in the classrooms. All fixtures and facilities were carefully chosen on the basis of esthetic and practical considerations. Thus all sanitary fixtures, closet bowls, urinals and service sinks are equipped with Sloan Quiet Flush II Flush Valves, selected for their acknowledged quality, quietness, dependability and low maintenance costs. Sloan flush valves are recognized as a mark of excellence in any building. To be sure your new building has this same Sloan quality your architect-engineer should specify and insist on Sloan Quiet Flush II Flush Valves.

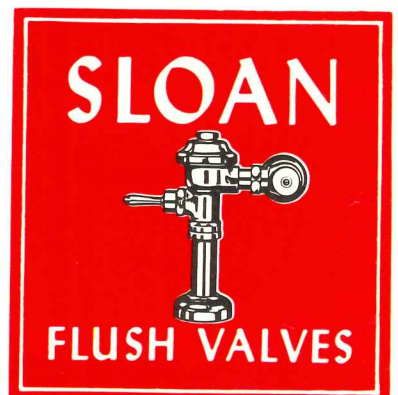
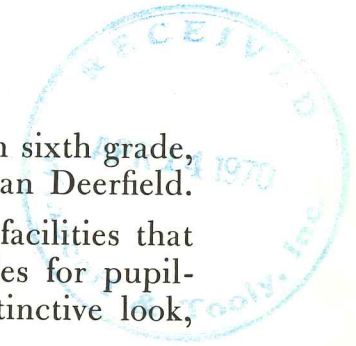

SLOAN VALVE COMPANY • 4300 WEST LAKE STREET • CHICAGO, ILLINOIS 60624
For more data, circle 146 on inquiry card