



NEW HAMPSHIRE COLLEGE IN MANCHESTER BY HUYGENS AND TAPPÉ

CROWN CENTER: EXPERIMENT IN PRIVATE RENEWAL OF THE CITY

THE NEW CHINA: A SOCIETY—AND ITS ARCHITECTURE—IN TRANSITION

BUILDING TYPES STUDY: A RETURN TO HUMAN SCALE IN CAMPUS DESIGN

ARCHITECTURAL ENGINEERING: CONCRETE FORMING TECHNIQUES FOR HIGH-RISE HOUSING

FULL CONTENTS ON PAGES 4 AND 5

# ARCHITECTURAL RECORD

OCTOBER 1973

10

A MCGRAW-HILL PUBLICATION THREE DOLLARS PER COPY







# A floor that's practical, quiet, and comfortable can also be beautiful. Quiet Zone™ proves it.



What's so practical about Quiet Zone?

A heavy-duty wear layer of Vinyl Corlon® stands up to heavy-duty traffic. We've even reinforced it with a tough layer of glass-fiber-reinforced vinyl to resist impact damage. And virtually non-porous vinyl has excellent stain resistance. Spills wipe right up. That's what's so practical about Quiet Zone.

What's so quiet and comfortable about Quiet Zone? Look at the inset picture. A 125-mil-thick backing of foam vinyl helps to muffle the sounds of footsteps and falling objects. It makes standing and walking more comfortable. But it isn't *too* soft, either. Seams stay sealed, and moveable furniture moves easily on it.

OK, fine. Now what's so beautiful about it?

Quiet Zone's new Grand Central design blends nicely into practically any decor. It is richly textured and comes in an appealing selection of colors. What's more, it helps disguise seams, subfloor irregularities, dirt, and traffic marks. That's the beauty of Quiet Zone.

Quiet Zone. So soft and quiet you wouldn't think it's vinyl. So tough and long wearing you know it has to be.

FROM THE  INDOOR WORLD® OF

## Armstrong

For more data, circle 1 on inquiry card

For more information on Quiet Zone, write Armstrong, 304 Rock Street, Lancaster, Pa. 17604.

NAME \_\_\_\_\_

COMPANY \_\_\_\_\_

ADDRESS \_\_\_\_\_

CITY \_\_\_\_\_ STATE \_\_\_\_\_ ZIP \_\_\_\_\_

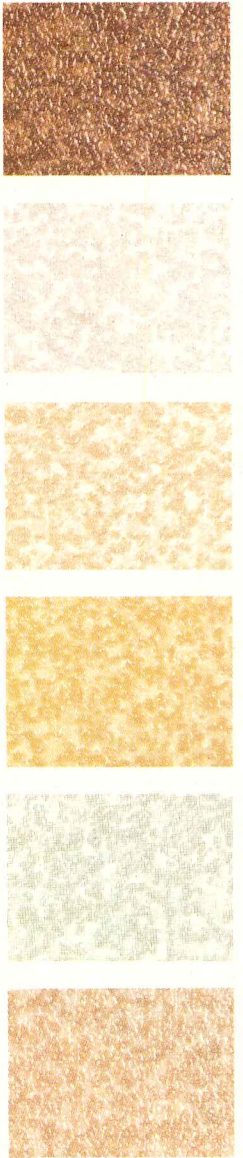



**What makes these  
ceiling systems  
right for this job?**

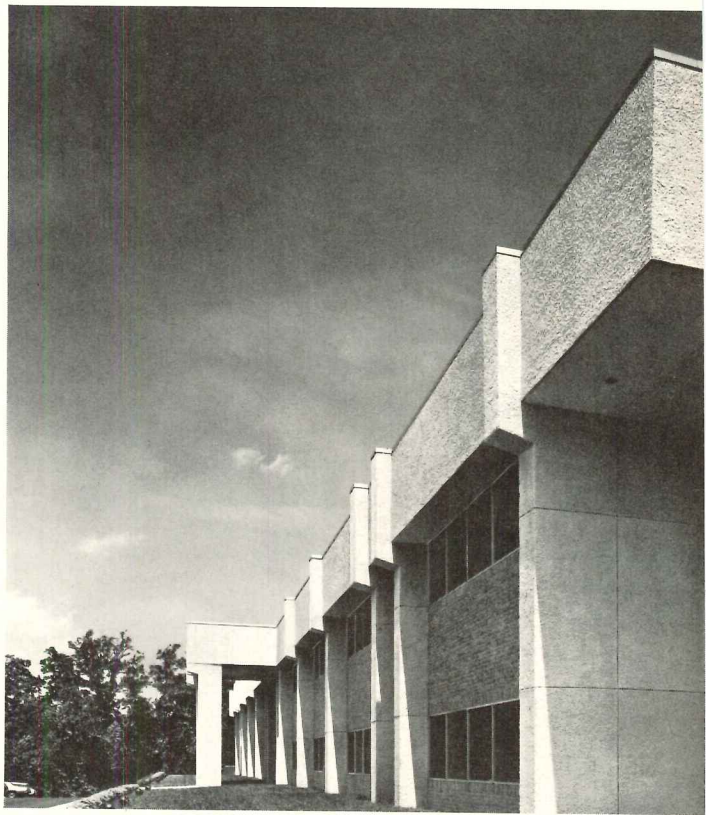



# The way they bring high-quality lighting and noise quieting to a precision manufacturing operation.

Top-notch working conditions were high on the list of facility requirements when Vega Precision Laboratories built their new plant for design and manufacture of radar-related products. An imaginative use of Armstrong Luminaire Ceiling Systems met stringent lighting and noise-reduction specifications.

For the design, engineering, production, and assembly areas, footcandles of 125 and 160 are maintained, depending on the illumination requirement of the space. The ceiling system is Armstrong C-60/30 Luminaire, chosen for its design flexibility and high-quality, efficient lighting.

With this ceiling system there's no sacrifice in sound absorption. The panels in the coffered units provide a noise-reduction coefficient equal to that of the flat 60" x 30" modules.

The dramatic C-60/60 Luminaire System, with 2' x 2' recessed troffers and a border of Armstrong Travertone™ tile (Sanserra design) added design interest in the auditorium and stairwells.

For more information about Armstrong Ceiling Systems and how they work, write today to Armstrong, 4210 Rock Street, Lancaster, Pa. 17604, or call your Armstrong representative. In Canada, write Armstrong Cork Canada, P.O. Box 919, Montreal 101, Quebec.

OWNER: Vega Precision Laboratories Incorporated, Vienna, Virginia  
ARCHITECTS: Barkley-Pierce Associates, Falls Church, Virginia  
GENERAL CONTRACTOR: Edsall Corporation, Springfield, Virginia  
MECHANICAL CONTRACTOR: Calvert-Jones Co., Inc., Arlington, Virginia  
ELECTRICAL CONTRACTOR: Bee and H Electrical Co., Fairfax, Virginia  
CEILING SYSTEMS CONTRACTOR: Southern Floors and Acoustics, Inc., Merrifield, Virginia

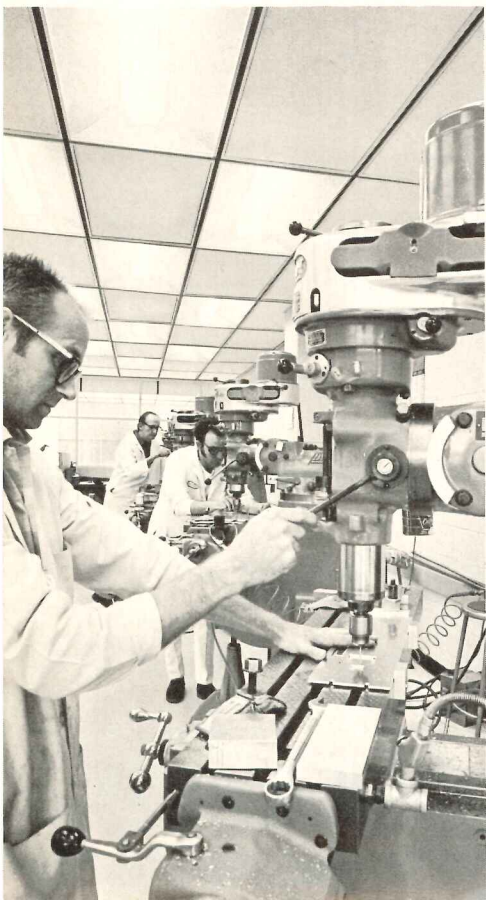





Cover: New Hampshire College  
Manchester, New Hampshire  
Architects: Huygens and Tappé  
Photographer: Julius Shulman

EDITOR

WALTER F. WAGNER, JR., AIA

MANAGING EDITOR

HERBERT L. SMITH, JR., AIA

SENIOR EDITORS

ROBERT E. FISCHER  
WILLIAM B. FOXHALL  
MILDRED F. SCHMERTZ, AIA  
ELISABETH KENDALL THOMPSON, FAIA

WASHINGTON EDITOR

ERNEST MICKEL, Hon. AIA

ASSOCIATE EDITORS

BARCLAY F. GORDON  
CHARLES E. HAMLIN

ASSISTANT EDITORS

GERALD ALLEN  
CHARLES K. HOYT, AIA  
ANNETTE K. NETBURN

DESIGN

ALEX H. STILLANO, Director  
ALBERTO BUCCHIANERI, Associate  
ANNA-MARIA EGGER, Assistant  
MURIEL CUTTRELL, Illustration  
J. DYCK FLEDDERUS, Illustration  
JAN WHITE, Consultant

EDITORIAL CONSULTANTS

EDWARD LARRABEE BARNES, FAIA  
JONATHAN BARNETT, AIA, Urban design  
GEORGE A. CHRISTIE, JR., Economics  
ROBERT F. HASTINGS, FAIA  
PAUL RUDOLPH, FAIA  
DAVID STEWART, Foreign architecture  
*L'Architecture d'Aujourd'hui*, Paris

McGRAW-HILL WORLD NEWS

WALTER A. STANBURY, Director  
10 domestic and 8  
international news bureaus:  
Bonn, Brussels, Buenos Aires,  
London, Milan, Moscow, Paris,  
Tokyo.

SALES MANAGER

LOUIS F. KUTSCHER

CIRCULATION MANAGER

HUGH S. DONLAN

PUBLISHER

BLAKE HUGHES

**THE RECORD REPORTS**

**9 Editorial**

Architectural education:  
time out for reexamination

**33 News in brief**

Short items of major national  
interest as well as  
upcoming meetings and events.

**34 News reports**

Filmmakers rediscover 1100-year old  
Maya temple. Cities in  
Europe and United States act to stem  
growing traffic problems.  
Two-billion dollar "floating city"  
planned for Newark, New Jersey.  
Israeli Olympians memorial sports  
complex proposed for Haifa, Israel.

**39 Buildings in the news**

Aluminum building products design  
winners. One Market Plaza,  
San Francisco. Harrison Shore  
House Condominiums, Harrison Township,  
Michigan. Harbor Point condominium,  
Chicago. Agora Place des Sciences  
(below), Louvain, Belgium



Atelier de Genval

**43 Required reading**

**47 Letters**

**257 Office Notes**

**ARCHITECTURAL BUSINESS**

**65 Let's make sense of FHA fees  
and processing**

A report to HUD by a task force  
of the National Center for Housing  
Management, Inc. takes a look at  
what's wrong with Federal and  
FHA procedures that inhibit the  
participation of architects in  
subsidized or FHA-insured projects.

**67 Construction management**

Bradford Perkins reviews the various  
divisions of work and the contractual  
relations in A/E-CM relationships  
that are gradually gaining definition  
even in the sensitive areas of  
fees and A/E.selection.

**71 Building cost indexes**

John Farley, senior editor of  
Dodge Building Cost Services sees  
costs resuming a steep climb.

**73 Housing: after the freeze—what?**

Why was there a nine-month silence  
between the freeze on old Federal housing  
programs and any announcement of new  
proposals? Jim Carlson relates a few  
speculative comments to what has  
really been happening.



ARCHITECTURAL RECORD (Combined with AMERICAN ARCHITECT, ARCHITECTURE and WESTERN ARCHITECT AND ENGINEER)

October 1973, Vol. 154 No. 4. Title® reg. in U.S. Patent Office copyright® 1973 by McGraw-Hill, Inc. All rights reserved. Copyright not claimed on front cover and editorial four-color separations. Indexed in Reader's Guide to Periodical Literature, Art Index, Applied Science and Technology Index, Engineering Index, and The Architectural Index. Published monthly except May and October when semi-monthly, by McGraw-Hill, Inc.

Quotations on reprints of articles available. Every possible effort will be made to return material submitted for possible publication (if accompanied by stamped, addressed envelope), but the editors and the corporation will not be responsible for loss or damage.

EXECUTIVE, EDITORIAL, CIRCULATION AND ADVERTISING OFFICES: 1221 Avenue of the Americas, New York, N.Y. 10020. Other Editorial Offices: 425 Battery Street, San Francisco, Cal. 94111; 1249 National Press Building, Washington, D.C. 20004.

PUBLICATION OFFICE: 1221 Avenue of the Americas, New York, New York 10020. Second class postage paid at New York, New York 10001 and at additional mailing offices.

OFFICERS OF McGRAW-HILL PUBLICATIONS COMPANY: John R. Emery, president; J. Elton Tuohig, executive president-administration; David J. McGrath, group publisher-vice president; senior vice presidents: Ralph Blackburn, circulation; John B. Høglund, controller; David G. Jensen, manufacturing; Gordon L. Jones, marketing; Jerome D. Luntz, planning & development, Walter A. Stanbury, editorial.



**FEATURES**

**113 Private enterprise generates urban growth at Crown Center**

Except for the residential structures and the shopping center, phase one of Crown Center—Kansas City's so-called "model community" financed and built by Hallmark Cards, Inc.—is now complete. Master planned by Edward Larrabee Barnes, who also designed the office complex, Crown Center also features a remarkable hotel by Harry Weese and Associates.

**127 Architecture in the People's Republic of China**

In a society in transition, architecture will also be in transition, and so it is in China today. Once deeply influenced by Soviet architects and engineers, China is showing interest in what other countries are doing in design. With the universities open again after five years' closure because of the cultural revolution, schools of architecture will soon begin to turn out a new generation of architects.

**135 MGIC Headquarters: new focal point for Milwaukee**

An image-creating building, intentionally limited in size, is big on monumental scale, quality design, and in playing a key role of downtown stabilization.

**141 Beach house-retreat**

Designed and built by Travers/Johnston, the beach house is used as an office retreat. It is located in Salishan, Oregon, on the end lot of a spit of land commanding a magnificent view.

**BUILDING TYPES STUDY 453**

**145 Campus Buildings**

After a decade of unparalleled growth, followed by a period of belt tightening, campuses are building again, perhaps more cautiously. University planners are finding new ways of dealing with rising enrollments and costs and are more reluctant than before to accept building designs that are inhumanly scaled, crudely massed or contemptuous of emerging campus lifestyles.

**148 Rockefeller Hall, Harvard University Cambridge, Massachusetts**

Edward Larrabee Barnes, architects

**150 University of California Campus Santa Cruz, California**

Hugh Stubbins & Associates, architects

**154 Faculty Housing, Radcliffe College, Cambridge, Massachusetts**

Ronald Gourley/Carleton R. Richmond, Jr., architects

**156 New Hampshire College Manchester, New Hampshire**

Huygens and Tappé, architects



Julius Shulman

**158 Monterey Peninsula College Monterey, California**

Edward Larrabee Barnes, architects

**ARCHITECTURAL ENGINEERING**

**161 New concrete forming techniques tried for multi-story housing**

On-site construction methods have been somewhat overshadowed by the attention given to factory-produced concrete. But contractors have been looking into new methods for speeding up the construction of site-fabricated structures, while providing a high quality of concrete finish for interior surfaces and walls.

The approaches of three contractors on three different types of apartment structures are discussed and illustrated in this article.



**173 Product Reports**

**175 Office Literature**

**177 Building Components**

**211 Personal Business**

**244 Record Impressions**

**256 Classified Advertising**

**258 Advertising Index**

**261 Reader Service Inquiry Card**

CORPORATION OFFICERS: Shelton Fisher, president; Wallace F. Traendly, group president—McGraw-Hill Publications Company and McGraw-Hill Information Systems Company; John J. Cooke, senior vice president and secretary; Ralph S. Webb, treasurer. SUBSCRIPTIONS: Subscriptions solicited only from architects and engineers. Position, firm connection, and type of firm must be indicated on subscription orders; CHANGE OF ADDRESS or subscription service letters should be forwarded to Fulfillment Manager, ARCHITECTURAL RECORD, P.O. Box 430, Hightstown, N.J. 08520. Provide old and new addresses, zip code or postal zone number. If possible, attach issue address label. Annual subscription prices: U.S., U.S. possessions and Canada: \$9.00 for architects, engineers and other individuals in the fields served, all others \$20.00. Other countries: \$25.00 to architects, engineers; others \$35.00. Single copies \$3.00.

GUARANTEE: Publisher agrees to refund that part of subscription price applying to unfilled part of subscription if service is unsatisfactory. ASSOCIATED SERVICES/McGraw-Hill Information Systems Co.: Sweet's Catalog Files (Architectural, Light Construction, Interior Design, Industrial Construction, Plant Engineering, Canadian Construction), Dodge Building Cost Services, Dodge Reports and Bulletins, Dodge/SCAN Microfilm Systems, Dodge Management Control Service, Dodge Construction Statistics, Dodge regional construction newspapers (Chicago, Denver, Los Angeles, San Francisco). THIS ISSUE is published in national and separate editions. Additional pages of separate edition numbered or allowed for as follows: Western Section 32-1 through 32-8. POSTMASTER: Please send form 3579 to Fulfillment Manager, ARCHITECTURAL RECORD, P.O. Box 430, Hightstown, N.J. 08520.





# Knoll International

745 Fifth Avenue, New York 10022





**Andrew Ivar Morrison and Bruce R. Hannah design for Knoll**

Their new series of office chairs not only combines an original supporting armrest with soft, replaceable upholstery but also swivels, tilts, glides and brings comfort to the working environment.

Knoll International designs for the way you work.



*For more data, circle 3 on inquiry card*







## Anywhere – on any map Notifier Multiplex simplifies security monitoring

**For Example: Abbott Laboratories** in Chicago uses Notifier's CMX-4000 Multiplex System to monitor security and fire protection throughout their office, manufacturing and warehouse complex. Only unconditioned voice/data grade lines were required to link stations several miles from the Command Console. Low-cost transmission lines...simple installation

and expansion... minimal standby power... these are only a few of the reasons why Notifier Multiplex Systems are part of the security plan in hospitals, schools, industry, mobile home parks and high rise developments.

To find out how a CMX-4000 can pay for itself, write today or phone 402-434-0211 and ask for Multiplex Planning Department.

Systematic Security from  
 **NOTIFIER®**

Dept. AR, 3700 North 56th Street • Lincoln, Nebraska 68504   
 A subsidiary of Emhart Corporation

For more data, circle 4 on inquiry card



## Architectural education: time out for reexamination

Beginning July 1, the National Architectural Accrediting Board has had in effect a one-year moratorium on all accreditation visits to schools of architecture.

Even with a few exceptions in cases of hardship—for example, some new schools or schools with short-term accreditation—this is a dramatic and drastic action for NAAB to take. And it is taking it on the recommendation of the Five Presidents\* Special Task Force on Education as part of its thorough-going examination of the architectural education process—which process students, educators, and practitioners alike agree needs careful study.

Students' dissatisfaction with education was of course a key element of the student unrest of the late 60s, and the voice of architectural students, which began being heard loudly and effectively on social issues at the Chicago convention in the person of then-ASC president Taylor Culver has continued—more moderately in tone and more broadly in scope—under ASC presidents Joseph Siff and Fay DeAvignon.

And from the practitioner side of education, a great deal of concern over the schools and the training provided future architects has been voiced, with some urgency implanted by the advent of the new professional exam and licensing procedure, which most architects feel puts a heavier-than-before responsibility on the schools.

In a recent interview John Amundson, Eugene, Oregon architect and this year's NAAB president told us that: "During the moratorium year, our board is going to re-examine all the criteria for accreditation, in part because of the new responsibilities of the schools under the new examination procedure (which, for example, does not test a candidate directly on structures), but mainly to make sure the student is getting the education he needs and deserves."

### **The NAAB study is intended to go right back to basics . . .**

. . . to the purposes and intents of accreditation. In its paper "Concepts for Restructuring," NAAB suggests that it needs to consider the purpose of accreditation, the growth of the accrediting program within architecture . . . and its growth within other professional schools, the accreditation processes in higher education generally, the purposes of other accrediting organizations (such as the U.S. Office

of Education of HEW, The Brookings Institute, and The Academy for Education Development).

It intends to question, among many other things: Should accreditation be reevaluated every five years, or one year, or when administrations change, or when programs change? Should data be evaluated only within a school, schools within specific regions, schools throughout the country; or by type of school program? Should NAAB adopt an accreditation program involving goals for progressive upgrading of architectural education on a specific time table? Should member schools be required to create educational development plans for specific periods of time—say five years? Should annual reports require evaluations of how each school has met its planning goals?

Further, NAAB is asking itself, and the other involved professional organizations, whether it should "promulgate and use more specific educational standards in evaluating schools? Should these be based upon a flexible performance criteria emphasizing effort, commitment and resources allocation? Should these performance criteria be based upon educational curriculum common among all schools? At present (to wildly over-simplify) NAAB evaluates schools on the basis of goals set by the schools—and there is no formal evaluation of these goals.

### **These are questions that cut right to the core of what the schools are like . . .**

. . . what they teach, and how they teach it—in the face of undoubted differences in financing, (especially endowment), in location, in quality of student that has been attracted (or that can get in) and in support of the architecture school by university. They are also questions that cannot be asked (or answered) by NAAB alone—and that of course is the reason for this study being undertaken in conjunction with an advisory panel appointed by AIA, NCARB, ACSA, and ASC/AIA.

John Amundson says that his hopes for this study year include "establishing criteria for the performance of the staff, of the student, and of the institution in support of the architecture school." Amundson is sure that NAAB should not attempt to specify course curriculum—a matter that is the province of a school or its administrators. "We should not say that you must have a course in structures, but we probably should say that the student must be taught structures, whether in a special course or as

\*Presidents of AIA, NCARB, NAAB, ACSA, and ASC/AIA



part of a design course.

"We hope for performance criteria that the schools can understand—a clear document that says 'Here is the way we want you to submit a program to us, and here are the criteria we'll judge on . . .'"

"We want the schools to evaluate their goals, and make those goals clear to the students—so that they can evaluate whether that is what they want from the school."

### The lack of standard information troubles not just NAAB, but the students

In its section of a report to the Five Presidents, the ASC says: "The type of information presently accessible to both active and prospective students of architecture is limited; but perhaps more seriously, it is not entirely useful. The information normally provided in departmental catalogs is not adequate to get an understanding of an individual school.

"The information provided . . . must allow for the curriculum or school to stand on its own individualism, and at the same time it must be in accord with some sort of common level of student understanding. So much of the student's architectural education goes beyond mere facts and descriptions of curricula and faculty that broader information is necessary for the student to make a wise decision regarding a school of architecture. . . ."

The students want tough answers to tough questions. Again, from the ASC report: "Much of the 'laundry list' information regarding a school—for example, the number of students, faculty, square footage—is easily derived from ACSA or directly from the school. But it must be reordered into new, student-recognizable forms. For example, in the terms of the professional language of architectural education, a school's library may be described in terms of the number of volumes, of slides, of domestic and foreign subscriptions, and the square footage. To the student considering the use of that library, different questions come to mind: what hours the library is open, is it a comfortable place in which to work, are the volumes current, how accessible and how good is the slide collection?"

### And so the most thorough study of architectural education for a long time is underway

The Five Presidents Special Task Force on education has these broad goals:

- "To collect and analyze the concerns and suggestions of the profession about its school and internship programs, and to deliver the results of this effort to the Five Presidents with the Task Force recommendation (with the purpose of) . . ."
- "The establishment of the most efficient system for producing architects who in turn can best serve the needs of society."

And surely those are worthy goals. Three cheers for the dedicated architects serving in this effort as representatives of NCARB, AIA, NAAB, ACSA and as private resource consultants, and to the students from ASC who themselves are well into the educational process, but whose ideas may serve well generations of students behind them, and in turn the profession.

—Walter F. Wagner Jr.

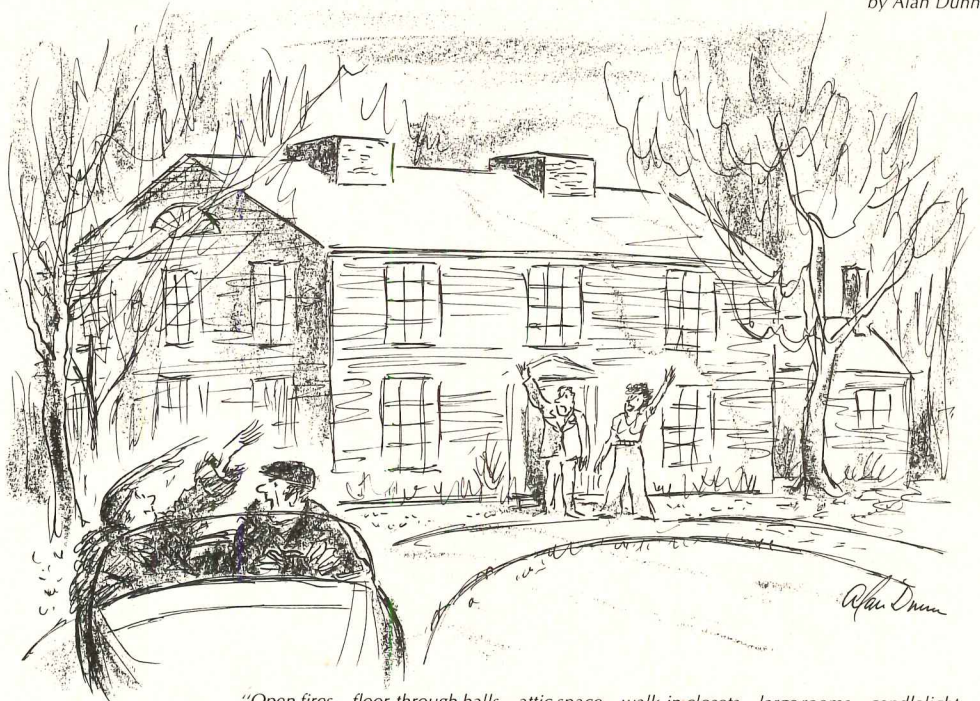

"Open fires—floor-through halls—attic space—walk-in closets—large rooms—candlelight—  
Talk about being nouveau!"

### P.S. to the study of education: the new exam takes hold

When the new exam set forth by the NCARB was first presented to the various state boards, there developed some concern over whether the multiple-choice examination, with its entirely new (less mechanics, more tactics) content, would be broadly accepted by the states.

As the date for the first professional exam approaches (December 1973), the picture is clear: the new examination has been accepted by the sovereign states to an astonishing degree—a tribute to the NCARB staff and especially E. G. Hamilton, who was the prime force behind the new examination and who spent countless days travelling the country and explaining the new exam and its implications.

NCARB has just published the results of a survey of its 55 boards (the 50 states plus the District of Columbia, Puerto Rico, Canal Zone, Virgin Islands and Guam). All but the Virgin Islands responded, so that is a base of 54 replies:

- 47 of 54 boards indicated that their state had implemented the new Equivalency Examination in June and would implement the Professional Examination in December 1973. Of the remainder, Rhode Island, New Jersey, Illinois, Minnesota, Missouri and Idaho expect to begin giving the new exams in 1974. District of Columbia is uncertain. Massachusetts, listed in the yes column, might have to delay implementation, but expects the 1973 start.
- Perhaps the key question (the question that indicates whether the state boards are indeed accepting graduation from an accredited school of architecture as proof of competence in the required disciplines) is this: "Will your state require holders of accredited architectural degrees to take both the Equivalency and Professional Examinations for registration? Illinois did not answer, but of the remaining 53, 42 indicated that the college degree was

acceptable, 11 are requiring graduates to take the equivalency exam. Ohio is requiring "for the time being" that candidates exempt from the equivalency exam take a design exam in addition to the professional exam.

### Community development: the AIA keeps the heat on in Washington

The AIA is keeping up (and hooray) the lobbying for human- and community-oriented development with Federal programs.

For one thing, Arch Rogers (on behalf of the AIA) recommended to the Senate subcommittee on housing and urban affairs that Congress adopt, for use when the moratorium valve is reopened by the Administration, a comprehensive approach to building and rebuilding cities—by consolidating Federal grants, by guaranteeing a constant supply of Federal funds, and by including incentives for large-scale development.

Mr. Rogers used the report of the National Policy Task Force which he chaired as the basis for his recommendations; and told the subcommittee that "basic changes are needed in the ground rules that now shape communities."

Also last month, Bob Nash, past vice-president of the AIA, made some specific suggestions to the committee on Labor, Health, Education, and Welfare: He recommended (as a spokesman for AIA) that \$4 million be appropriated within the OEO budget to provide financial aid for Community Design Centers to "furnish design and planning assistance to persons in urban and rural poverty areas." (His proposal: supplying an average of \$60,000 annually to 50 CDCs already existing, six expanded rural design centers at \$100,000 each, and ten new centers at \$40,000 each.)

These two pieces of news prompt me, once again, to say hooray to the AIA for continuing this kind of political activism that not long ago would have seemed impossible. —W.W.



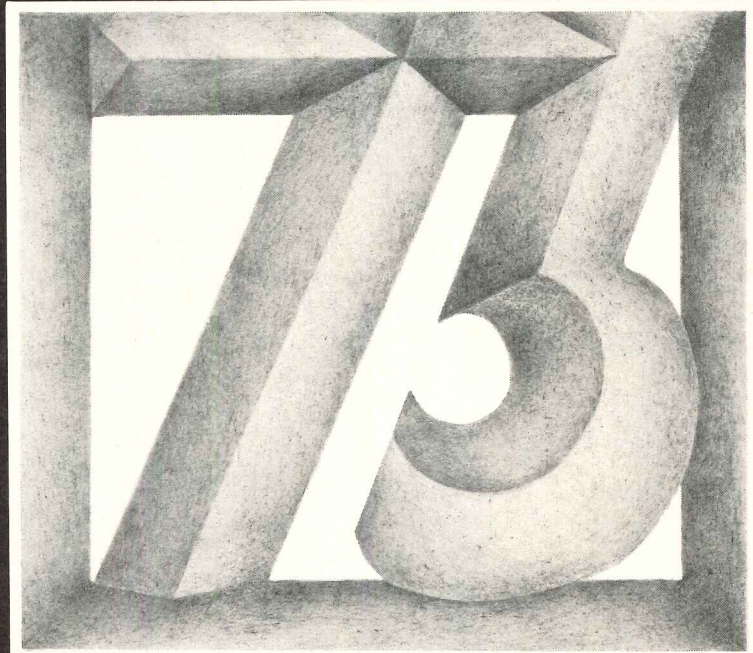

**ANNOUNCING THE  
WINNERS OF THE  
ARCHITECTURAL  
AWARDS. 1973**



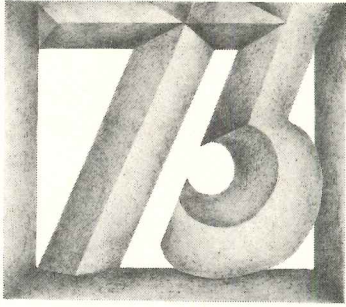

## AWARD WINNING ENTRIES AND COMMENTS BY THE JURY.

The eminent jurists selected by the Board of Directors of the American Institute of Architects for the 1973 Red Cedar Shingle & Handsplit Shake Bureau/A.I.A. Architectural Awards Program have selected the winners from some 250 entries submitted by architects from the United States and Canada.

The five, First Award and 16 Merit Award winners have been selected to honor design excellence and significant functional or aesthetic uses of red cedar shingles or shakes.

Awards in five categories—Residential Multi-Family, Vacation Homes, Residential Single Family, Commercial/Institutional and Interior Design—were presented at the Bureau's Annual Meeting. No awards were given in the categories of Remodeling/Restoration, Special Design and Industrial Housing.

For more data, circle 5 on inquiry card

## JURY.

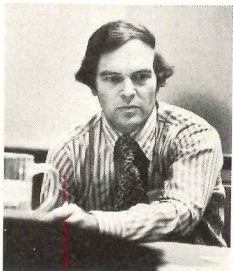

**Clovis Heimsath,  
A.I.A., Houston, Texas**

A specialist in creating environments for special conditions, his award-winning work includes the unique recreational facilities for the Manned Spacecraft Center, a Connecticut country club and a planned unit development in Louisiana. Mr. Heimsath is a member of the National A.I.A. Housing Committee and holds degrees from Yale University, Yale School of Architecture and attended the University of Rome as a Fullbright Scholar.

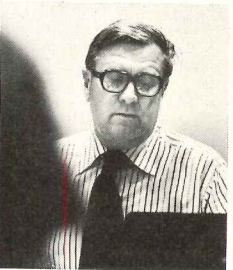

**Richard Foster,  
A.I.A., Greenwich, Connecticut**

Richard Foster brought a broad spectrum of architectural design concepts to the 1973 jury. The New York State Theatre at Lincoln Center, the Biology Tower at Yale University, the State Pavilion at the New York World's Fair and other such diverse projects as the Montauk Golf and Racquet Club and several buildings for New York University. He is a graduate of Carnegie Institute of Technology and Pratt Institute.



**Saul Zaik,  
F.A.I.A., Portland, Oregon**

Efficient houses in the woods, at the coast and in the mountains have become Saul Zaik's trademark in distinctive Northwest design. And his designs in the residential field have been strongly marked by their use of wood. Mr. Zaik received his academic training at the University of Oregon Architecture School and he is a member of the College of Fellows of the American Institute of Architects.

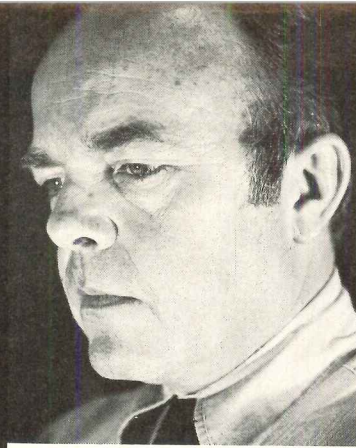

### RESIDENTIAL MULTI-FAMILY, FIRST AWARD

**John Hackler and Company**

One Commercial National  
Bank Building  
Peoria, Illinois 61604  
Pierson Hills, Peoria

**Comments:** Excellent human scale—The village quality relates well for site and people users—Variety of form and intermixing of one and two stories exemplary.

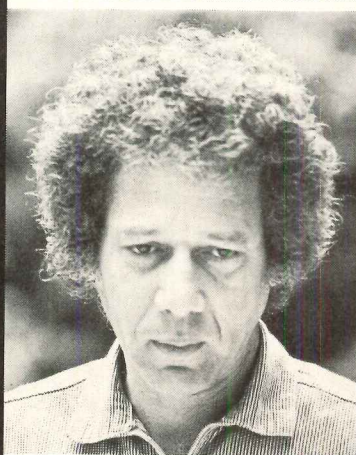

### RESIDENTIAL MULTI-FAMILY, FIRST AWARD

**Leonard Veitzer, AIA**

3625 Fifth Avenue  
San Diego, California 92103  
Collwood Townhouse Apartments,  
San Diego

**Comments:** Precise planning creating an intricate variety of elegant outdoor public and private living spaces—Units are well planned in terms of access locations and relationships to achieve interest and variety.



### VACATION HOMES, FIRST AWARD

**Walz and MacLeod, Architects**

50 Green Street  
San Francisco, California 94111  
Willard S. Johnston Residence,  
Seascape—Muir Beach

**Comments:** Sensitive application of shingle detailing—Restraining respect for magnificent site—Interior spaces relaxed and innovative.

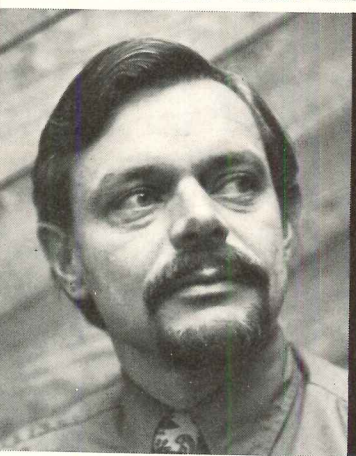

### VACATION HOMES, FIRST AWARD

**Roland/Miller Associates**

666 Seventh Street  
Santa Rosa, California 95404  
Clarence Hall House,  
The Sea Ranch

**Comments:** Meticulous care in detailing and execution. Jury noted excellent craftsmanship displayed and compliments to builder—Reflects study of exterior spatial qualities which result in a strong unified composition.

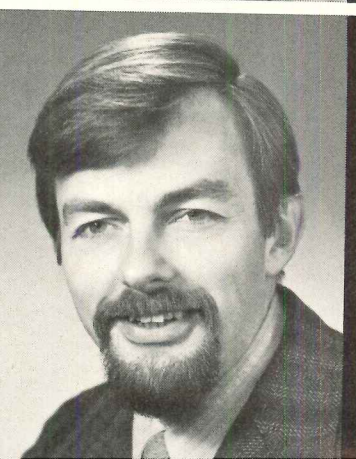

### RESIDENTIAL SINGLE-FAMILY, FIRST AWARD

**Gary L. Michael AIA,**

Architects & Planners  
430 S.W. Morrison Street  
Portland, Oregon 97204

Jan Zach Residence & Studio,  
Elmira, Oregon

**Comments:** Innovative, strong, sculptural statement—Details consistent with straightforward techniques.



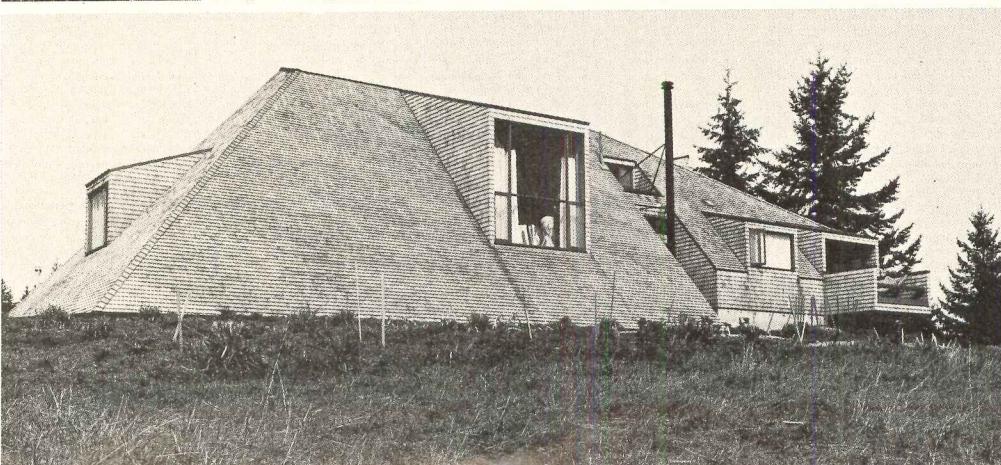
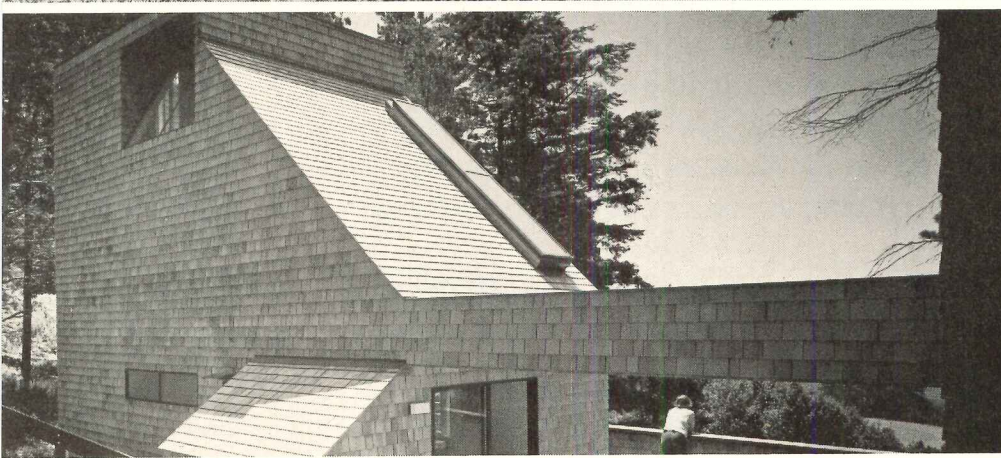
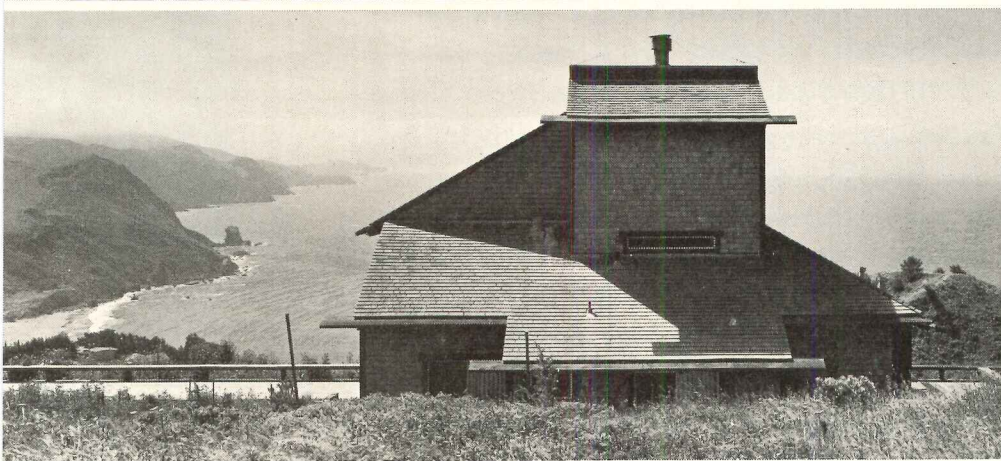
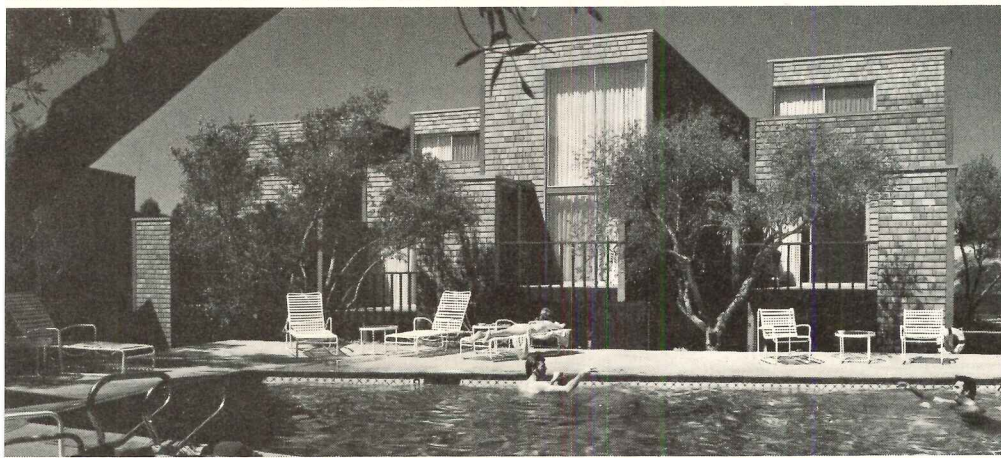
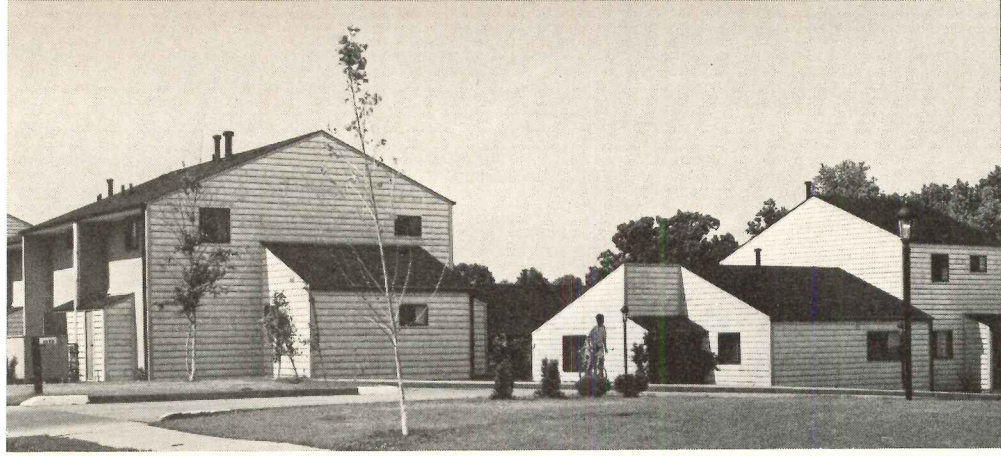

## MERIT AWARD WINNING ENTRIES.

### RESIDENTIAL MULTI-FAMILY

**Bissell/August Associates**

359 San Miguel Drive  
Newport Beach, California 92660  
Sixty-01, Redmond, Washington

**Bulkley, Sazevich and Associates**

1154 Clement Street  
San Francisco, California 94118  
Friendship Village, San Francisco

**William Kessler and Associates, Inc.**

18000 Mack Avenue  
Grosse Pointe, Michigan 48224  
Wayne Public Housing, Wayne, Michigan

### VACATION HOMES

**Rodney Wright**

4643 North Clark Street  
Chicago, Illinois 60640  
Hawkweed Farm, Osseo, Wisconsin

**Venturi and Rauch**

(with the assistance of **Terry Vaughn**,  
Project Architect Christopher Holland)  
333 South 16th Street  
Philadelphia, Pennsylvania 19102  
Trubek and Wislocki Houses, Nantucket Island

### RESIDENTIAL SINGLE-FAMILY

**Alfredo De Vido**

4 West 58th Street  
New York, New York 10019  
Michel House, Southold, New York

**Bahri & Associates**

1015 Park Street  
Peekskill, New York 10566  
Y. S. Bahri Residence, Putnam Valley, N.Y.

**Bull/Field/Volkman/Stockwell AIA**

350 Pacific Avenue  
San Francisco, California 94111  
Residence

### COMMERCIAL/INSTITUTIONAL

**Calvin/Gorasht Architects**

303 East Pine Street  
Seattle, Washington 98122  
Lake Wilderness Park, Maple Valley

**Boyle Engineering Corporation**

John P. Barbarino AIA, Project Architect  
412 South Lyon Street  
Santa Ana, California 92702  
San Diego Zoo Skyfari Cable Lift, San Diego

**Peter Hemingway Architect**

11810 Kingsway Avenue  
Edmonton, Alberta, Canada  
Central Pentecostal Tabernacle, Edmonton

**Aotani & Oka Architects, Inc.**

225 Queen Street  
Suite 400  
Honolulu, Hawaii 96813  
Inter-Island Terminal, Ke-ahole, Kailua

**Robinson and Mills**

45 Ecker Street  
San Francisco, California 94105  
Borel's Restaurant, San Mateo

**Russell Gibson von Dohlen**

80 South Main Street  
West Hartford, Connecticut 06107  
Church of St. Peter Claver, West Hartford

**Anderson Notter Associates, Inc.**

10 Thacher Street  
Boston, Massachusetts 02113  
Brocton Art Center-Fuller Memorial, Brocton

### INTERIOR

**Oda/McCarty, Architects**

P.O. Box 5, Hilo, Hawaii 96720  
Harrell McCarty Residence, Hilo

### REMODELING/RESTORATION, SPECIAL DESIGN & INDUSTRIAL HOUSING

No awards were given in these  
categories for 1973.



# Before you settle for ordinary solutions to out-of-the-ordinary building problems, call in **Keene—the architectural specialists.**

Keene doesn't compete with all the companies that make bulk quantities of staple building products. Instead, we offer you a variety of specialty building products for your unusual architectural applications. Consider lighting. Although Keene is a major multi-line manufacturer of commercial fixtures, we're also flexible enough to meet your special lighting needs. We can provide many "showcase" lighting fixtures for prestige areas, including wall- and ceiling-mounted units that illuminate evenly, softly, enhancing room decor. We can even work closely with you to design and fabricate custom lighting for special areas such as lobbies and auditoriums.

Keene movable partitions offer you an unlimited choice of material and color combinations—from natural cork to handsome walnut and teak vinyls. We make many specialized acoustical products, such as mineral fiber Sonosorbers to reduce noise levels in auditoriums and swimming pools. And if you're involved in low-rise architecture, perhaps a garden apartment or nursing home, Keene's Rapidwall lightweight framing system goes up faster and costs less than conventional wood or cinder block construction.

You already know Keene as the Interiors People, providing individual interior products as well as complete systems. Now think of us as the people to call on for a wide range of special architectural solutions. For details, please circle the appropriate Reader Service numbers below.

**KEENE**  
CORPORATION

345 Park Avenue, N.Y., N.Y. 10022

**We've just begun to grow.**

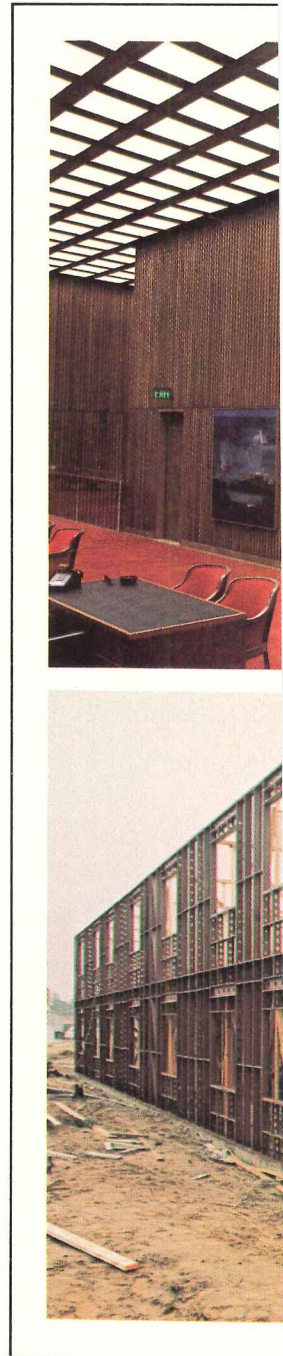

*Spec 100 ceiling systems* 50. *Rapidwall framing* 51. *Movable partitions* 52. *Custom lighting* 61. *Sonosorbers* 53.



*Sechrist custom lighting specialists worked closely with architect-engineers, Skidmore, Owings & Merrill, to fabricate a unique lighted ceiling system for the Bank of Washington Plaza, Tacoma, Washington.*

*Keene partitions are available in many distinctive materials, colors and textures to match the decor and function of any interior area.*



*Rapidwall lightweight steel framing panels are a labor saving, cost saving alternative to wood and masonry for exterior framing.*

*A specialized Keene interior system: new Spec 100 ceiling systems incorporate lighting, acoustics and air distribution in a self-contained unit.*



# ECO, today's answer to tomorrow's security problems.

Unobtrusive. Economical. Reliable. Simple to install. Hager's Electronic Control of Openings (ECO) offers a unique, new concept in building security and traffic control. ECO's patented electronic contact and switch hinge now makes it possible to lock, unlock and monitor openings electrically from one central security station. Only slight modification to standard A.N.S.I. door and frame preparation is required. Installation is simple. Electrical contractors can easily incorporate ECO into the building's wiring system. For more information, call your architectural hardware consultant or mail this coupon today.

**eco**  
electronic  
control of  
openings

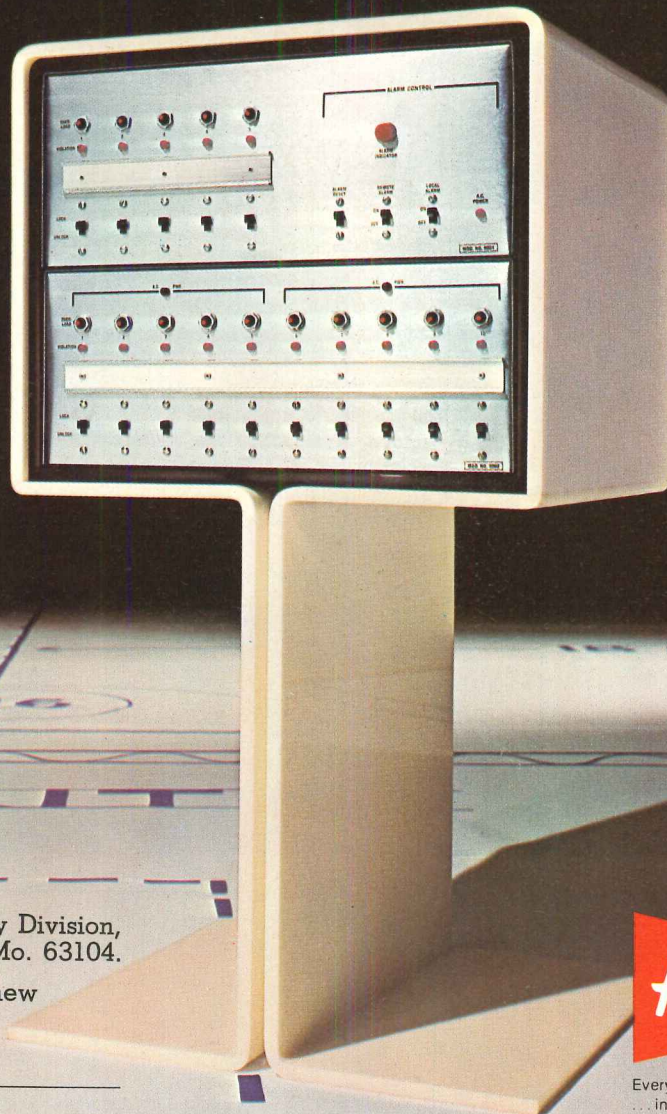

Mail to: Clarence King, FCSI, President—ECO Security Division,  
Hager Hinge Company, 139 Victor Street, St. Louis, Mo. 63104.

Please send me more complete information on Hager's new  
ECO security system.

Name \_\_\_\_\_

Company \_\_\_\_\_ Phone \_\_\_\_\_

Address \_\_\_\_\_

City \_\_\_\_\_ State \_\_\_\_\_ Zip \_\_\_\_\_

For more data, circle 6 on inquiry card



Everything hinges on Hager  
... including security.



We can't speak for the chicken. As for the egg-crate louver, we're certain: It was born in 1948.

We were there. Moreover, we've been there for every major development in louvers ever since. Non-yellowing acrylic louvers. 45° and 55° shielding for low brightness. Special-size louvers — 3' x 3', 3' x 4' and 2½' x 5 ft. No company has done as much to extend the uses of this universally specified lighting diffuser.

And no lighting diffuser has ever improved on the louver for positive

light control, easy cleaning, and free air circulation for longer lamp life.

Every size of every louver in our line is available in stock for immediate delivery. Because when we considered service, there was no question about which came first.

You do.



AMERICAN LOUVER COMPANY  
SKOKIE, ILLINOIS 60076 (312) 966-0300  
For more data, circle 7 on inquiry card

**Which  
came first—  
the chicken or  
the egg-crate louver?**

SEND FOR NEW BULLETINS #101 and #102



# SIMMONS. 10-month, turnkey package. O'Hare International Tower Hotel.



Interior design: Norman de Haan, A.I.D., Norman de Haan Associates, Inc.  
Architect: C. F. Murphy Associates

Only Simmons could put together a package deal like this one—from conception to installation in just 10 months.

In April of 1972, Norman de Haan Associates, Inc., were brought in by Madison Square Garden Corporation to create the interiors of the new O'Hare International Tower Hotel. When plans were finished, in an incredibly short 8 weeks, all guestroom furnishings had been custom designed.

Simmons made them all. Delivered them on time. And worked out a tight installation timetable that allowed the hotel to open in February of 1973, just 10 months from project start.

The Tower presented unusual problems that demanded unusual custom solutions. Noise level was a big one. Simmons helped to solve it with sound-absorbent draperies from Bloomcraft. Carpeting has thick padding as part of the sound-control measures. And all furnishings meet the new flammability standards.

The 981 guestrooms have five carpet colors and six alternate Bloomcraft bedspread and drapery schemes, a tricky record-keeping challenge that Simmons handled without a hitch.

The unusual shape of the building, plus the need for a given number of rooms, made each room relatively small. Headboards with attached lights from Raymor/Richards, Morgenthau that also serve as bedside tables maximize the floorspace. Beds are on easily maintained plinth bases that conserve space. And all bedding is Beautyrest by Simmons.

Thonet created the sleek guestroom case goods. The handsome chairs are by Simmons Living Room Division. Both custom-designed by Norman de Haan, A.I.D. Much of the seating in public areas is from Selig and Thonet.

The lobby is rather long and narrow with glass walls on two sides. Mr. de Haan visually stretched the area with low profile Thonet fiberglass chairs and a Simmons geometric carpet spread throughout the entire area.

In addition there are 63 conference rooms, 18 meeting/banquet rooms, a mezzanine and seven restaurants. Furnished and accessorized for the most part with Simmons products.

The entire interior installation was coordinated by Simmons. It was done in vertical thirds as each section of the hotel was completed, making warehousing, delivery and scheduling of installation operations critical.

Remarkably, it all came together on time. And, Simmons can tailor a complete turnkey package for you.

With all the Simmons resources at your command, you save time as well as make pricing, coordination and installation immensely simpler.

Call Bob Costello, General Manager, Simmons Contract. (312) 644-4060. For a package plan par excellence.



**SIMMONS COMPANY** Domestic Divisions and Affiliates: Living Room • Contract • Juvenile Products • Hausted • Thonet • Greeff • Bloomcraft • Katzenbach & Warren • Raymor/Richards, Morgenthau • Moreddi • Selig • Artisan House • Debu/Flair • American Acceptance • Corinthian Casket • York-Hoover • Elgin Metal Casket □ International Operations: Simmons Limited, Canada • Simmons de Argentina, S.A.I.C. • Simmons Bedding Co., Pty. Ltd. and V.S. Wright & Sons, Pty. Ltd., Australia • Sleepzee Limited and Warner & Sons Limited, England • Cie. Continentale Simmons, S.A., France • Cia. Italiana Simmons • Simmons Japan Limited • Compañia Simmons, S.A. de C.V., Mexico • Simmons, Inc., Puerto Rico • Simmons de Venezuela C.A., Venezuela.

For more data, circle 8 on inquiry card







---

# **"THE REAL BEAUTY LIES IN THE REDUCTION**

---





# OF VARI-TRAN<sup>®</sup> OF COOLING COSTS."



NEAL HOUGHTON, PROPERTY PLANNING  
AND DEVELOPMENT MANAGER,  
VALLEY NATIONAL BANK, PHOENIX, ARIZONA.

In Phoenix, the "Valley of the Sun," solar heat gain can be a stifling problem. With a mean year-round temperature of 70° and an average high in July of 105°, buildings are often planned with more concern for avoiding the heat than enjoying the view.

Valley Center takes advantage of magnificent desert and mountain vistas without the normal glare problems. In fact, the silvery-hued Vari-Tran reduces glare by up to 86%.

"The reduction in air conditioning needs and supportive mechanical equipment increases the amount of rentable floor space in Valley Center, as well as lowering costs," according to Houghton.

Heating costs are also diminished, because the Vari-Tran is utilized in Thermopane<sup>®</sup> insulating units.

If your next building could use this kind of beauty and energy-saving practicability, we'd be glad to help. For more information on Thermopane insulating units with Vari-Tran coated glass, write for our brochure, "Reach for a Rainbow," Dept. R-1073, Libbey-Owens-Ford Company, 811 Madison Avenue, Toledo, Ohio 43695.



Owner: The Valley National Bank Building, Inc. • Project Consultants and Leasing Agents: Cushman and Wakefield, Los Angeles. • Architects and Engineers: Welton Becket and Associates. • Contractor: Henry C. Beck Co., Phoenix. • Curtainwall Contractor: Cupples Products Div., H. H. Robertson Company, St. Louis, Mo. • Glazing Contractor: Gateway Glass Div., H. H. Robertson Company, St. Louis, Mo.

# LOE

For more data, circle 9 on inquiry card





# Cor-Ten Steel: The next best thing to nature.

Standing on 20 rolling acres on the outskirts of Madison, Wisconsin, is a new building that could have been designed by Nature herself. It fits perfectly into the environment—yet establishes its own character and dignity on the rural scene.

The Farm Bureau Building, which houses the Rural Insurance Companies, the Wisconsin Farm Bureau and several smaller offices, is a beautiful example of how USS COR-TEN Steel blends with other materials and helps the total structure harmonize with its natural surroundings.

The \$4½ million, 143,580 square-foot building has a USS ULTIMET Steel Curtainwall System and utilizes materials that are easy to maintain:

USS COR-TEN steel, brick and solar glass.

For practical and aesthetic reasons, COR-TEN was a natural choice. It doesn't have to be painted—so it saves maintenance costs. If it ever gets scratched, the surface oxide heals itself! And that rich, russet color actually deepens and becomes more strikingly beautiful as it gets older.

Inside this unique building . . . even more surprises. A fully enclosed atrium, complete with shrubs and trees that reach upwards for four stories, take up about 10% of the interior space. Steel on the interior of the atrium is pre-weathered COR-TEN steel.

The Farm Bureau Build-

ing is another example of the intelligent use of a remarkable steel: USS COR-TEN. It represents the most imaginative expression of contemporary architecture—with due respect for what Nature built first!

For more information, contact a USS Construction Marketing Representative through the nearest USS sales office or write: United States Steel, 600 Grant Street, Pittsburgh, Pa. 15230.

*Owner:* The Rural Insurance Companies, Madison, Wisconsin  
*Architects:* Peters & Martinsons, Madison, Wisconsin  
*General Contractor:* J. H. Findorff & Son, Inc., Madison, Wisconsin  
*USS COR-TEN Fabricator:* Reinke-Schomann, Inc., Milwaukee, Wisconsin.  
USS, COR-TEN and ULTIMET are registered trademarks



## Cor-Ten Steel

For more data, circle 29 on inquiry card







GRANGE HALL  
136  
1898

— THE HOME OF —  
WETHERSFIELD GRANGE  
NO. 114  
MEETINGS, 2<sup>ND</sup> & 4<sup>TH</sup> TUESDAYS  
AT 8 P. M.







Built 75 years ago at a total cost of \$5,000, Wethersfield, Connecticut's Grange Hall is still a focal point of community action in this historic Connecticut River town. And the mortise lock is the same Sargent hardware specified in the building's original plans.

**Consider the doors  
equipped with  
Sargent hardware.**

**Still proud doors.  
Still proud hardware.**



 **SARGENT®**  
First in quality since 1864.

Sargent & Company • New Haven, Connecticut 06509 •  
In Canada, Sargent & Company (Canada) Ltd.

For more data, circle 10 on inquiry card



# telelift<sup>®</sup> is number



## and mosler makes it.

...and has been making it for years. Number one, not just because we were first with a new concept in materials handling, but because we proved to over one hundred and sixty owners of **Telelift** that their confidence in us is not misplaced.

### Mosler

An American-Standard Company

**Telelift** didn't happen over night. It happened because **Mosler** is proud of its reputation for high quality equipment. We couldn't persuade ourselves to introduce an unproven system to people who rely on us for the best.

Only after years of development, engineering, experience and testing are we able to offer the reliable, flexible, proven system **Telelift** is today.

We didn't make **Telelift** Number 1, the confidence of our customers did. Talk with us. We'll show you why **Telelift is going to stay number one.**

MOSLER/AIRMATIC SYSTEMS DIVISION,  
415 PATERSON HAMBURG TURNPIKE, WAYNE, NEW JERSEY 07470

TELEPHONE: (201) 278-6300

*For more data, circle 11 on inquiry card*



A man wearing a plaid shirt and an orange hard hat is working in a nursery. He is holding a pine sapling with its roots exposed. In the background, there are several other pine saplings in pots, and a large, curved structure, possibly a tunnel or a covered walkway, is visible. The sky is blue with some clouds.

# Farmers plant for the fall. We plant for the 21st century.

Plant and harvest. Farmers have been doing it for centuries. Most sow in the spring, reap in the fall.

Potlatch people are farmers, too—tree farmers. But our crop interval is much longer. So long, in fact, that many people have never thought of timber as a crop.

But wood *is* a renewable resource. Potlatch people provide for ample future harvests by practicing careful forest management on 1,300,000 acres of timber lands owned by the company. We exercise the same kind of care and concern on our forests that any good farmer lavishes on his crops and land.

In Idaho, Potlatch foresters are leading the research effort in control of the pine bark beetle. In Minnesota, where natural seeding can't always be depended upon to quickly renew the forests, we plant an average of 1,000,000 trees annually.

Today there are healthy new forests growing on Potlatch land in the cedar, pine and fir country of Idaho, the aspen and northern pine stands of Minnesota, and the southern pine and hardwood regions of Arkansas.

While these forests are maturing, they are usually open to the public for recreation. Then, after 40, 50 or even 80 years, we harvest our crop. That's a long time to wait for return on investment, but Potlatch people believe good forest management is good sense and good business—both for today's shareholders and for future generations who will benefit tomorrow from the harvest of the trees we're planting today.

*Good forest management is good for wildlife, too. Write for our Idaho Wildlife brochure.*

***Potlatch People Mean Business***

## Potlatch

Potlatch Corporation  
P. O. Box 3591  
San Francisco, California 94119

*For more data, circle 12 on inquiry card*

Tree planting  
in Minnesota.





## We helped turn the



Tennis has been moving indoors out of the cold, the wet, the wind, the sun and the night.

But there's still a stumbling block—the lighting. Light shining down on the players gets in their eyes and makes it hard to see the ball.

The Square Lake Racquet Club in Bloomfield Hills, Michigan, solved this problem with uplighting instead

of downlighting.

They use 142 Sylvania Metalarc lamps in an indirect lighting system, giving them uniform, glare-free illumination all over their courts.

Thousand-watt Metalarc high-intensity lamps emit a light nearly five times stronger than incandescent lamps of the same wattage. Which means it takes fewer lamps





## lighting business upside-down.

and less electricity to light up a court.

The lamps have an average rated life of 10,000 hours. They last about ten times longer than 1000-watt incandescents.

And they're color-balanced to produce a natural effect. It's like bringing the outdoors indoors.

The lamps have been used for

years for direct lighting of stores, factories, ball parks, car lots and parking lots.

Now more and more tennis courts are using Metalarc lamps in fixtures pointed up to the ceiling.

Whole new illumination systems have been developed to take advantage of the Metalarc's good points.

So thanks to a lamp with a lot on the ball, things are looking up in the lighting business.

*For details, call your GTE Sylvania representative or local distributor (in the Yellow Pages under Lighting) —or write to Sylvania Lighting Center, Danvers, Mass. 01923.*

**GTE SYLVANIA**



# A roof contract has to be strong to protect you for ten years.

Whether it's a Philip Carey or Barrett Inspection & Service Contract, what you're getting, in writing, is the assurance that Celotex will back up specific built-up roofing systems and services. With pre-installation planning, periodic inspections during and after installation, and the finest roofing materials.

That's a pretty strong promise. But we know we can keep it. That's why we give it to you in writing.

## **Celotex**

a **JIM WALTER** company

For an actual copy of the Celotex Inspection & Service Contract and all the details of the program, see your Celotex BUR Approved Roofer, or Celotex field representative, write us direct, or consult Sweet's Architectural Files. The Celotex Corporation, Tampa, Florida 33622

*For more data, circle 14 on inquiry card*



# The copper "life safety" fire sprinkler system makes this landmark hotel one of the nation's safest.



Tucson's Pioneer International Hotel was recently remodeled to become the nation's first with copper "life safety" sprinkler protection in every room.

The system's emphasis is on prompt detection and suppression of fires in compartmented structures using small quantities of water. Because of the system's superiority, costly structural alternates were not necessary.

Copper tube ends the need for oversizing to compensate for pipe corrosion buildup. Copper tubes stay clean inside and also handle the pressures reliably.

Easy joining by soldering and small size make copper tube perfect for snaking tube around obstructions when remodeling existing buildings.

Payoff: installed cost low enough to extend sprinkler protection to all rooms in hotels, high-rise office buildings, nursing homes, hospitals and motels.

Count on copper for ideas to make any existing compartmented building safer. New ones, too.

Copper Development Association Inc.  
405 Lexington Avenue, New York, N.Y. 10017

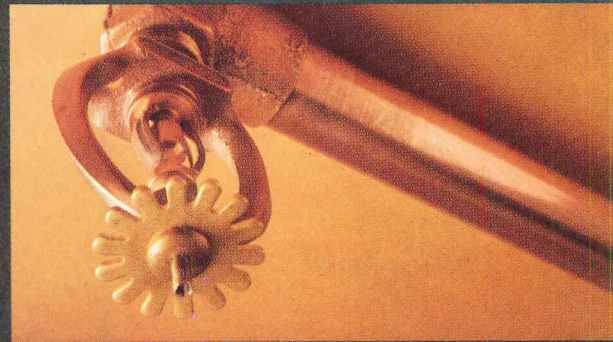

**COUNT ON COPPER**



# DON'T PLAY WITH FIRE.

## CCC's New Naturalweave spongebonded carpet has a Class "A" Flamespread rating.

If you're looking at carpet for an office building and it doesn't have a Class "A" flamespread rating—25 or less in the Steiner Tunnel Test—you may be playing with fire. The danger of fire always exists, that's why fire safety standards are becoming more and more stringent. At CCC, we know all about fire safety. We've become experts, because we've installed millions of yards of carpet in offices, hospitals, schools and stores.

Since fire safety is a major concern to us, we've just introduced a fire-retardant, spongebonded carpet with a Class "A" flamespread rating. We call it NATURALWEAVE FLAMEGARD and it meets *all* governmental flamespread standards.

NATURALWEAVE FLAMEGARD is an addition to our heavy duty Densylon Carpet series. It has a five-year wear guarantee and is made of tightly-twisted, densely-packed ANSO nylon bonded to B. F. GOODRICH fire-retardant sponge rubber cushioning. This built-in cushion extends the carpet's wear-life by one-third compared to carpet without padding. It's

guaranteed not to lose resiliency, enhances the carpet's appearance retention, reduces leg fatigue and increases floor safety. Among its other benefits, NATURALWEAVE contains a static control system, is easy to clean and keep clean, and helps cut maintenance costs.

But you get more than just superior carpet from CCC. We're the largest manufacturer of commercial and institutional carpet systems in the country. With CCC, you get SINGLE SOURCE RESPONSIBILITY for every aspect of your carpet projects anywhere in the country, starting with product selection and guaranteed installation through a comprehensive maintenance program that gives you maximum carpet wear-life at minimum life cycle cost. We even know how to effectively integrate carpet with subfloor access systems and can show you how it's done with trench headerducts and handhole covers.

For more information, just fill out the coupon below. CCC's NATURALWEAVE FLAMEGARD...THE SPONGEBONDED CARPET WITH A CLASS "A" RATING.

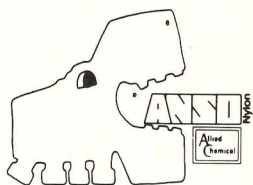

**Not just carpet,  
but complete  
carpet systems.**

Chicago:  
Merchandise Mart (312) 321-0803  
Los Angeles:  
8899 Beverly Blvd. (213) 274-8171

For more data, circle 16 on inquiry card



**Disappointment over the President's housing message last month is strong with U. S. mayors** and the National League of Cities. They applauded the partial lifting of the housing freeze, however, but said in a statement, "after nine months of extensive study and a nine-month freeze on housing programs for low income families, the nation's cities deserve a more comprehensive, unified housing proposal than was presented." For more details, see page 36.

**The Justice Department will not let down in its fight against what it terms illegal price fixing in professional services.** Thomas E. Kauper, assistant Attorney General recently said the Justice Department will continue to assign a significant amount of its resources to architectural, engineering, real estate, brokerage and similar services. Last year the AIA signed a consent decree, agreeing to remove from its Standards of Professional Practice a prohibition against submitting price quotations for architectural services. Recently the Justice Department was given another 60 days to prepare its case against the National Society of Professional Engineers, charging the organization with an anti-trust violation.

**James F. Shivler, Jr., past NSPE president, will head a study of unethical activity by engineers** involved in public works contracts. The special task force will make recommendations for actions to eliminate unethical or illegal activities, issuing a report by the end of this year. (See item on illegal practices statement, next page).

**Six American architects have been invited to be the U. S. representation at the 15th Triennale in Milan,** currently running. Peter Eisenman, Michael Graves, John Hejduk, Richard Meier, Charles Gwathmey and Robert Seigel were invited largely on the basis of their work which is said to represent a significant direction in American architecture. The Triennale is an international exhibition of architecture, industrial design and decorative arts which occurs every three years. This is the 50th anniversary of the event.

**AIA and RIBA have agreed to jointly publish *Architectural Research and Teaching*,** formerly published by RIBA alone. The hope is that this merger will make the best of British, European and American research available to architects on both continents. Inquiries about the publication and about submitting research papers should be addressed to Don Conway, AIA, 1735 New York Avenue, N. W., Washington, D. C. 20006.

**The 17th annual convention of the Society of American Registered Architects will be November 16, 17 and 18,** at the Fairmont Hotel in San Francisco. The program will cover continuing education, opportunities for government contracts and how to produce contract documents efficiently and economically. For further information on the convention, contact Samuel E. Hart, 8417 Beverly Boulevard, Los Angeles, California 90048.

**The Anthony G. Adinolfi Memorial Court, State University of New York at Purchase will be dedicated this month,** on October 13. Containing a fountain and a large single oak, the court is being established on the new performing arts campus in tribute to the late Dr. Adinolfi, general manager of the State University Construction Fund. Under his leadership, architectural excellence was brought to New York State's expanding university system, one of the nation's largest single public clients in the 1960's.

**Deadline for entering the National Plywood Design Awards program is January 31, 1974.** To be eligible, all projects must have been completed after January 1, 1970 and before the deadline. Cash awards plus citations will be presented in the AIA sponsored program conducted by the American Plywood Association. For an official entry form and complete rules, write to: American Plywood Association, 1119 A Street, Tacoma, Washington 98401.

**November 1, 1973 to April 1, 1974 is the period for a design competition for a neighborhood health care center.** The competition, sponsored by the National Institute of Architectural Education with the help of the New York Chapter, AIA, offers a \$1500 first prize and is open to all persons in the architectural field under 35 years of age. Entrants will be judged in May, 1974. For further information, contact Byron Bell, National Institute of Architectural Education, 20 West 40th Street, New York, New York 10018.

**William W. Wurster, founder of the College of Environmental Design, University of California, has died.** Mr Wurster died September 19 at the age of 77, at his home in Berkeley, California. He was a leading architect in San Francisco and former dean of architecture and planning at MIT. His firm, Wurster, Bernardi & Emmons is noted for projects such as San Francisco's Ghirardelli Square, Golden Gateway complex and the Bank of America headquarters. A Fellow of the American Institute of Architects, Mr. Wurster received the gold medal in 1969.

**Giovanni M. Cosco, architect, planner, theoretician and teacher of architecture died in June of this year,** in an auto accident. Mr. Cosco gained international recognition as a member of the team that was runner-up for first prize in the international competition for the Beaubourg Cultural Center in Paris in 1971. Born in Italy, he had practiced and taught architecture in Philadelphia since 1968, and was readying for publication a book in which his main goal was to solve what he saw as the dilemma between the increasing encroachment of technology on design and the widening application of technology to design.



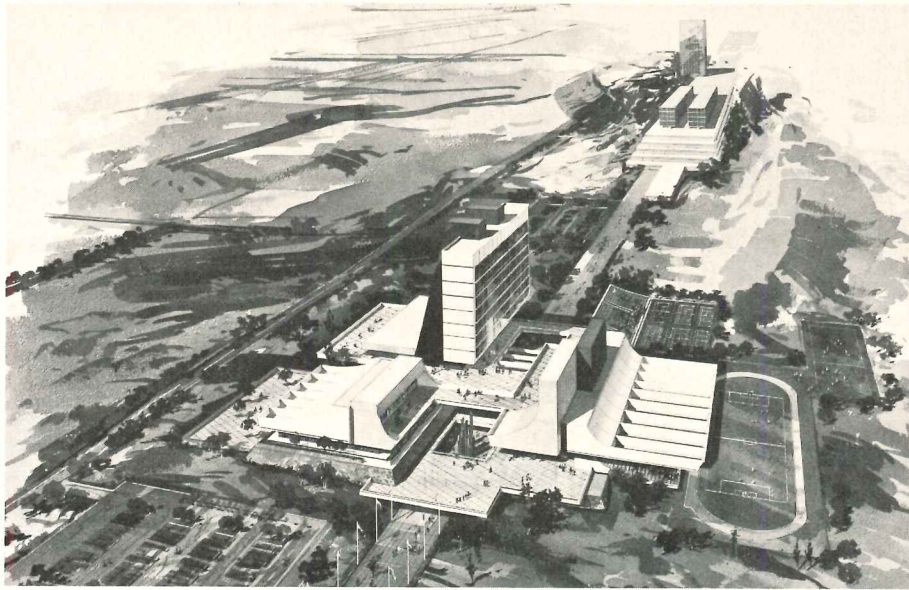

### Sports complex to be built in Israel as Olympic memorial

Sponsored by The American Friends of The University of Haifa and endorsed by national personages from all walks of life, a Sports Complex is planned to be built on the crest of Mount Carmel, Haifa, Israel.

In memoriam to the eleven Israeli Olympians slain on September 5, 1972, during the Games of the 20th Olympiad, the center will be an integral part of the University of Haifa.

The project was launched at a New York City inaugural dinner held September 12.

Among the participants were Bowie K. Kuhn, National Baseball Commissioner, and U.S. Senators Hubert H. Humphrey, Henry M. Jackson and John Tunney. Guest of honor was Mark Spitz.

Conceived as a living tribute to the Olympic ideals and their personification of the brotherhood of man, the Memorial will be built in increments to include indoor athletic centers, outdoor stadia and an administration tower.

Master planning and archi-

tectural design are under the direction of Maxwell Starkman & Associates.

The promenade linking the Sports Complex to the University of Haifa passes under an elevated plaza which serves as a cohesive common ground from which all athletic activities will fan out.

Architectural focus of the Sports Complex will be, central in the plaza, the Well of Tribute, from which will rise 11 pylons of forged metal, symbolic of the fallen eleven.

### Floating city to be constructed over portion of Newark, New Jersey

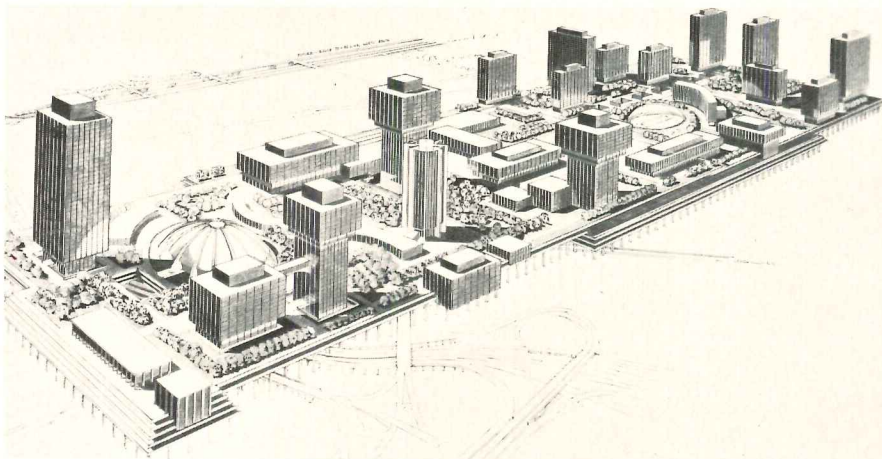

A recently announced concept for the revitalization of the City of Newark calls for a \$2.5-billion "Floating City," to be constructed over the top of an existing section of the city—utilizing that area's air rights—between Newark International Airport and the downtown business district.

The concept for "Gateway 2000" was conceived and planned by Porter and Ripa Associates.

Parking will be provided on three levels beneath the city. There will be no vehicular traffic on the main level. Mobil-

ity within the complex will be either on foot or via a personal rapid transit (PRT) system which will provide fast transportation throughout the new city area, which will be approximately a mile-and-a-half long and a third-mile wide.

Chairman of the Gateway 2000 Board will be Louis C. Ripa and those corporations which will participate in the actual development of the complex through the construction of office buildings, hotels, apartment houses, etc., will become members of the Gateway 2000 Corporation.

It was pointed out that more than half of the area of the planned Floating City is presently free of any dwelling or business property. In the remainder there are also many vacant lots and vacant buildings as well as numerous dwellings which are badly deteriorated. Those holding the air rights will either be able to sell them to the corporation outright, or, if they prefer, trade them for shares in the corporation and shares in its profits.

Completion of the entire project is planned in phases over a period of 20 years.

### Unprofessional conduct denounced by seven groups

In a strongly worded statement issued last month by seven design profession organizations, architects, engineers and planners re-emphasized their "responsibility to discipline members for unprofessional conduct."

The statement was issued in the wake of recent allegations of improper, or patently illegal conduct by design professionals

seeking contracts for public work. It was signed by the presidents of the AIA, NSPE, ASLA, CEC, ASCE, AIP and ASCP, and strongly supports legislation for limitation and full public disclosure of all political contributions, and recommended enactment of laws that would make improper conduct grounds for suspension of licenses.

### Filmmakers rediscover Maya temple, lost since 1912

On May 7, 1973, an expedition led by film makers under contract to a New York public television station rediscovered Temple B, archetype of the Rio Bec style of classic Mayan architecture. Missing for 61 years in the southeastern jungles of Mexico's Yucatan region, the temple was located by freelance film makers Hugh and Suzanne Johnston during the course of shooting "The Mystery of the Maya," a documentary they are producing to air nationally over the Public Broadcasting Service early in 1974.

Temple B was originally discovered in 1912 by Harvard's R. E. Merwin and Clarence L. Hay. The photographs Merwin brought back of the 1100-year-old structure attested to its excellent condition and the archaeology world soon recognized the building to be one of the finest extant examples of the Rio Bec style. In 1935, a plaster model (top) of the temple, based on Merwin's notes and photographs, was made and copies are on exhibit

at institutions throughout the world.

However, from 1912 until its rediscovery in May, Temple B had been an elusive treasure.

The Johnstons were initially unsuccessful in their search for the temple; their first foray in 1972 was a failure. After returning to the United States, the film makers studied Merwin's original field notes and thesis and developed a more precise idea of the temple's location. It took them only two days during their 1973 expedition to find what they sought.

What they found (below) was a Temple B that had deteriorated only slightly since Merwin took his pictures. After the chicleiro's machetes cut the jungle growth away from the building's walls, Gillett Griffin, curator of Pre-Columbian Art at Princeton said: "In Mayan architecture, it ranks with the temple of the Sun at Paleque, Building 22 at Copan or the Governor's Palace at Uxmal. It would compare with any great piece of architecture in the world."





## Italian cities experimenting in eliminating cars, traffic downtown

Milan, which like many other old European cities was not exactly laid out with the automobile in mind, for the last two and a half months has returned to that primal state—well, almost—in its innermost part. Starting May 1, the Milan city administration banned most automobile traffic in an area of about 113 acres, comprising about one fifth of Milan's historic center around the Duomo, Milan's gingerbread dome and including some of the city's most elegant shopping streets. The exceptions are taxis, some bus lines, cars of core-city residents with provable off-street parking space and delivery vehicles allowed through at certain hours.

The results look encouraging, although nobody is really prepared to make a hard and fast judgment. Vittorio Carnemolla, head of Milan City Planning and development office, thinks the city's ambience has definitely improved. The Piazza in front of the Duomo now features occasional entertainment as part of an effort to stimulate people to come downtown and street life seems to be somewhat gayer.

Milan's city planners have plans all mapped out to shut down other adjacent sections southwest and southeast of that first section, with another 116 acres or so, but a current crisis of Milan's city government and the chance of a change in adminis-

trations has made the date of the changeover uncertain.

Rome, meanwhile, which traffic jam connoisseurs rate as Europe's most advanced in terms of urban bedlam, also is planning to shut down large chunks of its inner city to most pass-through traffic, with the first of seven sections closed August. That area comprises about 54 acres.

Pisa, which earlier had banned traffic from the Piazza Dei Miracoli, site of the leaning tower and the city's 11th-century cathedral, extended the ban to cover most of the city's historic center to make the city's historic sights more accessible to pedestrians, mostly tourists of course.



## Controversy continues over future of Piccadilly

Few historic sites have had such an architectural battering as Piccadilly Circus, the entertainment hub of London. Since 1958, when the then London County Council announced a desire to improve the Circus, there have been a series of schemes calling for everything from remodeling nearly all of existing buildings to constructing highrise hotels and a 435-foot tower.

While planners have bickered over design, Piccadilly has been allowed to become a series of decaying buildings, tatty streets, and overcrowded pavements with excessive traffic fumes, noise and derelict sites.

The most recent effort on the part of the Westminster City Council to change Piccadilly resulted in a major furor from architectural conservationists who claimed that historic buildings were being destroyed. That plan, presented by the Council in May, 1972 called for an intensive redevelopment which replaced aged buildings with high-rise hotels and office blocks plus an upper level pedestrian deck, widened roads, and an amphitheater surrounding the statue of Eros. In addition, a favorite building, the Criterion Theatre, was to have been demolished. The public outcry against the Council's plan resulted in a new inquiry. Objectors wanted a limit on building height, and more street level pedestrian area with a minimum of emphasis on traffic.

A working party set up by Westminster Council has since presented four alternatives and issued a set of guidelines which should be followed no matter which alternative was chosen.

These roughly state that the character and vitality of Piccadilly should not be changed but

a greater emphasis placed on preservation and restoration of what already exists. No new building will be over 100 ft high, equal to the present highest structure, nor will the Victorian tiled Criterion Theatre or the Regency styled Lilly-whites sporting goods store fall to the demolition ball.

In conflict between traffic and pedestrians, the traffic has lost. In any new scheme, the traffic increase will be only 10 per cent, not 50 per cent as originally planned. And, some streets, instead of being widened for vehicles will be sealed off and used as pedestrian concourses . . . the pedestrian deck has been completely eliminated in favor of improvement for pedestrian facilities at ground and subway levels.

But planners will still have their problems. Piccadilly is plainly overcrowded. An estimated 36,000 people walk through the Circus each hour and over 5000 vehicles enter from one of the five main roads.

Of the four options presented by the council last year option number three seemed closest to the philosophy for redevelopment: greater preservation of historic buildings, desire to conserve the character, less concessions to traffic and a demand for more human scale buildings.

This option was reshaped by the Council and a draft brief was made public on July 26.

Basically, it calls for a rearrangement of the traffic pattern to merge all traffic passing through the circus on the north side of Eros. The roadway between the Criterion Theatre on the south side and Eros would then be closed and paved over creating a new, large pedestrian area. Option three also includes a remodeling of the London Pa-

(continued next page)

## Energy and the environment document released by Federal government

The Council on Environmental Quality has published a 58-page document on energy and the environment as related to electric power which purports first-time documentation of trade-offs to be considered in the application of various energy systems.

The report emphasizes that energy conservation is one of the best ways to reduce environmental impacts. But it points out that all electric energy systems are inherently inefficient, noting that from 75 to 90 per cent of the energy resource in the ground

never makes it to the consumer. We often use electricity, C.E.Q. maintains, when direct use of a fossil fuel—such as in home heating—can be over twice as efficient.

Aiming to aid decision-makers in future choices, the report is said to present a technique for projecting the environmental consequences of various alternative mixes of energy systems. Particularly, the findings are expected to be useful to Federal agencies in meeting standards of the Environmental Policy Act.

The Council begins its analysis with emphasis on the dramatically increased use of electricity: over the past decade electricity consumption has grown at a seven per cent annual rate, double the growth rate of all other energy uses. By 2000, it is likely that over 40 per cent of all energy will be used to produce electricity. Meanwhile, population growth is only 1.5 per cent a year.

(You can order the booklet from the U.S. Government Printing Office, Washington, D.C. 20402).

## Visionary plan of Atlanta sees auto ban, more parks and night life

What will Atlanta be like in the year 2000?

At the core, an 18-hour-a-day activity center, without an automobile in sight; a 525-acre park with interconnected greenways; people movers; more and better housing where now there is little; multi-level living which takes off from the now famous

Underground Atlanta and extends interconnectors on four different levels.

This is the concept of Atlanta architects and planners Finch, Alexander, Barnes, Rothschild, and Paschal.

"This will be such an exciting, human place people will move back into town, and stop

sprawling over all the landscape," says Cecil Alexander.

The plan sees Atlanta's core, essentially neglected in the city's dramatic 14-year thrust forward, as a dynamic, architecturally exciting city-within-the-city. This area, the historic founding stone of this Southeastern city, is the financial district, the home of giant Rich's, and the Atlanta newspapers, Georgia State University, and of Underground Atlanta. It is also the government area, but it has been a core which dies every day after 5:00 p.m.

The city's time has come, according to Alexander, and architects have an opportunity and an obligation to bring together now all the diverse, creative, exciting ideas which we have been trying in parts of cities. He sees malls and people movers, better housing, and more parks, less pollution and more sunlight, all in one grand plan relating every aspect of urban life to every other.

The FABRAP plan is one developed for an Atlanta magazine issue on Atlanta's future.

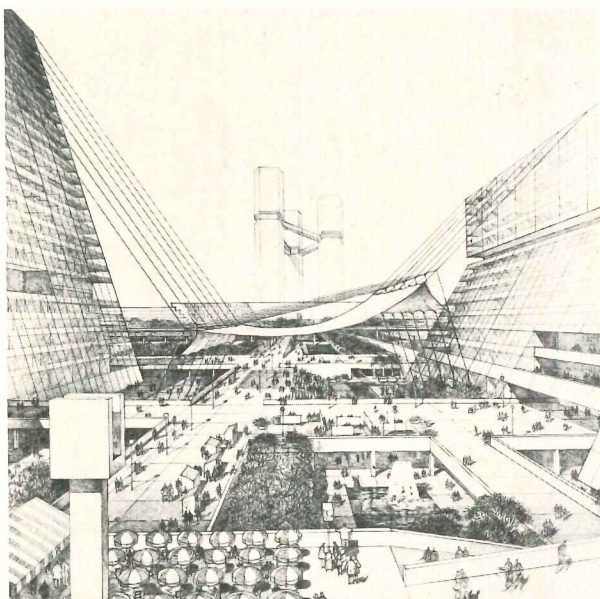



*Continued from page 35*

evilion, a large theatre, which could be turned into restaurants, exhibition space and an information center. One of the main features of this option is a vast enlargement of the underground subway ticket hall to contain new pedestrian walkways and shopping areas.

The committee is now working out exactly how many buildings will be remodeled and redeveloped. The total Piccadilly area is only 10.3 acres; half would be renewed.

The site is divided into three areas. The north side of Piccadilly is called Monico, the east is Trocadero and the area south of Eros is Criterion.

In option three, redevelopment is confined to the front portion of the Monico site, the western part of the Trocadero site and the whole of Shaftsbury Avenue. Reconstruction of individual buildings would be carried out piecemeal but in accordance with general height requirements.

Under this option, traffic is in a U-shaped road pattern which merges all traffic passing through the Circus on the northern side of Eros. This re-arrangement takes traffic out of the center of the circus and makes possible the construction of much more pedestrian area.

In all, the planning is expected to take another two years. With a long-range timetable of at least 10 years before all construction is complete. Cost is estimated at 40 million pounds sterling.

However, the new plan will not be the final word. After the Westminster City Council and the public have accepted, it must go to the Greater London Council and finally the Secretary of State for the Environment. With this in mind, planners are wise to opt for the least change.

**British architects ousting free-lancers**

A new code of professional employment from the Royal Institute of British Architects will contain two clauses that prohibit the hiring of temporary architectural staffers.

The code, approved in August by the RIBA council, is aimed at stamping out the professional free lance architect.

The reason for this move is a growing trend in Great Britain for architectural and allied staff to quit permanent employment and join an agency where they receive short term, fill-in, work. Often, temporary workers make twice the salary of permanent employees. A "temp" may

work side by side with a more senior permanent man doing similar work but the temporary will receive almost double the salary.

The salary situation is exacerbated by the freeze which aims to keep wage hikes for permanent employees to eight per cent. While a man working for a placement agency can get an increase on each new job because each is negotiated individually and is not subject to the freeze policy.

It is estimated that the recruiting of temporary architectural staff has increased by 100 per cent in the last two years. The number employed in London alone is over 1,000.

Objections to the use of professional free lancers are that they disrupt established salary structures and breed discontent. And, the free lancers' lack of involvement means they can quit in the middle of a project.

Maurice McCarthy, chairman of RIBA's salaried architects working group, who drew up the code, says that the temporary architects commitment to the client is often in question and that permanent staffers must supervise him more closely.

He adds that many architectural firms use temporaries as an excuse for bad personnel

planning. The surge of work in the last year has caught many employers unprepared. Not many were certain of the long-term possibilities of work and the idea of taking on temporary staff who could be unloaded without embarrassment, was attractive.

In addition, several architects have realized the tax advantages of being self-employed and have opted to do agency rather than permanent work.

There will be many firms who are loath to lose the ability to hire temporary staff but the RIBA seems determined to nip the movement in the bud.

The new code could become effective early next year.

**Denver votes new transit program**

Voters in Denver have okayed a \$1.56 billion public transportation system depending heavily on a personal rapid transit such as those currently being tested by the Federal government.

Denver's master plan calls for expanding the bus line and later supplementing it with almost 100 miles of fixed connecting lines using the personal rapid transit cars, relatively small vehicles carrying six to 12

passengers and controlled by computers; the cars would circulate through the system, stopping on call at stations.

The proposed elevated, grade-level and underground system is smaller and less expensive than conventional urban subways, but Denver's 98 miles would cost an estimated \$1.5 billion. Construction is planned to start in 1976, with completion in 1983.

**Reactions negative on new housing message**

The President's lengthy message to Congress on the nation's housing ills and how to solve them did not live up to expectations according to the bulk of reactions flowing from Congress and the private sector.

With the shelter industry strangulating for lack of mortgage money and with the Federally subsidized programs still shrinking, it had been hoped in many quarters that the Administration would propose bolder moves to restructure the Federal programs and get at the job sooner than is indicated in the 14-page document sent to Capitol Hill.

Sen. John J. Sparkman (D-Ala.), whose housing subcommittee will study the proposals in early October hearings, said

Bollards have always been little more than light markers... now Moldcast has produced the Bollard Pericline, a broad distribution light source which is virtually free of glare. Designed for effective ground illumination even when spaced up to 45 feet apart, Bollard Periclines provide a glare-free environment as soft and comfortable as a living room. The tiny alternative to tall lighting poles, in round and square shapes. From Moldcast, only Moldcast!

Preview some of Moldcast's other Night Time Environments

Write for literature and specifications

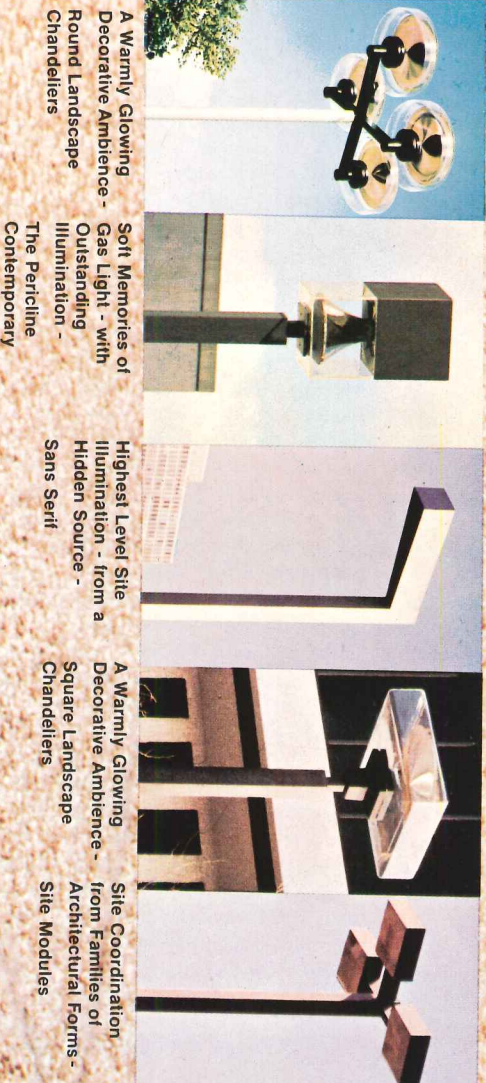

A Warmly Glowing Decorative Ambience - Round Landscape Chandeliers

Soft Memories of Gas Light - With Outstanding Illumination - The Pericline Contemporary

Highest Level Site Illumination - from a Hidden Source - Sans Serif

A Warmly Glowing Decorative Ambience - Square Landscape Chandeliers

Site Coordination from Families of Architectural Forms - Site Modules

The Night Time Environment People

**MOLDCAST**

Manufacturing

164 Delancy Street, Newark, N. J. 07105  
In Canada: Varco Industries Ltd., Montreal 379

For more data, circle 31 on inquiry card



he was disappointed with the announcement of the President's plans for "improving" housing programs. Like many others commenting on the long-awaited plan, he expressed concern that the housing allowances portion of the message and those sections dealing with other "corrective measures" would require such a long period for activation. Mr. Nixon, in the document, and his HUD Secretary, James T. Lynn in his briefings, indicated that many of the measures would not be operative before late next year or early in 1975.

Rep. Henry S. Reuss (D-Wis.), member of the Housing subcommittee, used considerably stronger language: "We were told almost a year ago that the Administration would produce its bold new program for low- and moderate-income housing by September, 1973. Now the mountain has labored, and brought forth not a mouse, but the promise of a mouse by 1975. . . . For the low and moderate income American, already hopelessly priced out of the housing market, this is cruel news."

And Sen. William Proxmire (D-Wis.), who as chairman of the appropriations subcommittee largely controls the flow of HUD funds, called the propos-

als a great disappointment, adding: "For all practical purposes the present housing moratorium will continue for another two and a half years. Then, after 1976, they are proposing housing allowance programs ultimately costing from \$8 billion to \$11 billion a year, the effect of which . . . will merely bid up the price of existing housing."

Commenting further that the announcement was "mostly sound and fury signifying nothing," the Wisconsin legislator predicted Congress and the public would be most reluctant to support "such a costly and potentially ineffective program."

It was not all criticism, by any means. Warmly welcomed was the President's assurance that he was, by executive action:

1. Authorizing the Federal Home Loan Bank Board to provide savings and loan associations with another \$2.5 billion in loan authorization to make "forward commitments," thereby increasing the incentive for S&Ls to finance housing construction. This involves a FHLBB promise to loan money needed by the institutions at a future date to cover commitments made currently.

2. Directing HUD to reinstitute the tandem plan under

which the Government National Mortgage Assn. will provide money for FHA-insured mortgages at rates below market levels. Up to \$3 billion in such loans for new housing only will be so financed. It was estimated this would bring tens of thousands of new homebuyers into the market.

Congressional approval will be required for these other proposals:

—A tax credit of up to 3.5 per cent on interest earned by financial institutions investing a certain amount of their portfolios in residential mortgages. The tax credit benefits would increase in proportion to the amount invested in housing loans. When at least 70 per cent is so invested, the credit on interest those mortgages earn would be 3.5 per cent, yielding, at current levels, an added one-half of one per cent.

—FHA insurance of larger housing loans on a low downpayment basis for both single- and multi-family dwellings.

—Permit buyers to pay market-level interest rates and still be eligible for Federal insurance thus eliminating added charges, or "points" which presently raise the price of the house and the size of downpayment.

—Gear the level of repayments to expected changes in

family income. Make life-of-loan payments flexible to reflect increasing family incomes—low in early years and increasing in later years. It's believed this would enable families to remain in their original homes instead of making frequent moves as incomes increase.

—Develop more private mortgage insurance concerns by permitting them to purchase inexpensive Federal reinsurance. Such insurance, according to the White House, would provide added protection to the mortgage owner and speed acceptance of such private mortgage insurance, especially in secondary markets.

Details of the plans will be spelled out further in proposed legislation which HUD officials said would be submitted to Congress soon. There were no estimates on what the proposals would cost.

The housing allowance plan as a substitute for so-called subsidized housing, much ballyhooed in earlier phases of the HUD study of housing approaches, was mentioned last week as something that must be tried with a pilot test and applied in future years if its value is proven. The President told Congress that of the policy alternatives available in this area of providing housing for the low-

income family, direct cash assistance appeared to be "the most promising way" to provide decent shelter. He described it as, in the long run, the most equitable and least expensive way of achieving the decent housing goal.

Acknowledging that such an approach might develop disadvantages now unknown, the Chief Executive said he would explore the situation with Congress before moving ahead. First priority would be for the elderly poor. The plan is now being tested in 10 cities and Congress is asked for authority for HUD to take additional steps in testing the cash assistance approach. The proposal calls for the Federal government to pay the difference between cost of housing on the private market and a determined percentage of earnings that a family can afford to pay for housing. (This normally has been considered to be around 25 per cent.)

Assuming a Congressional go-ahead for the cash allowance program, its first application would not come before the fiscal 1976 budget which goes to Congress in January of 1975 and covers the year starting July 1, 1976. It's this delay that gave rise to so much criticism last month.

—Ernest Mickel

## Meet 42 inches of Site Lighting Revolution





# Dover® Stage Lifts. Rising star in the theater.

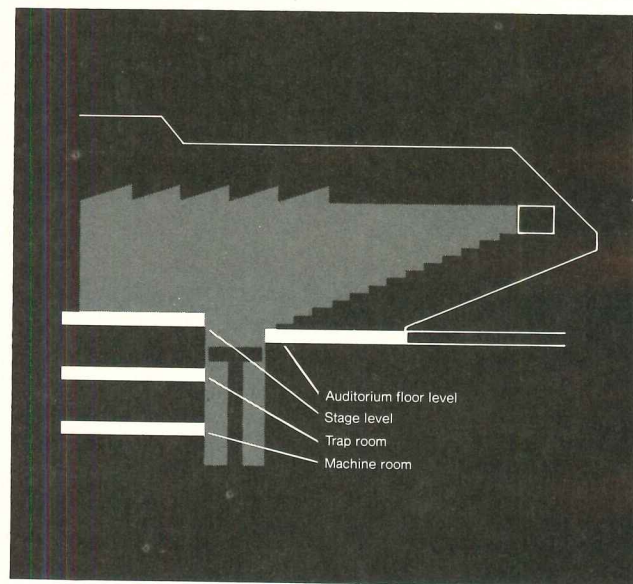
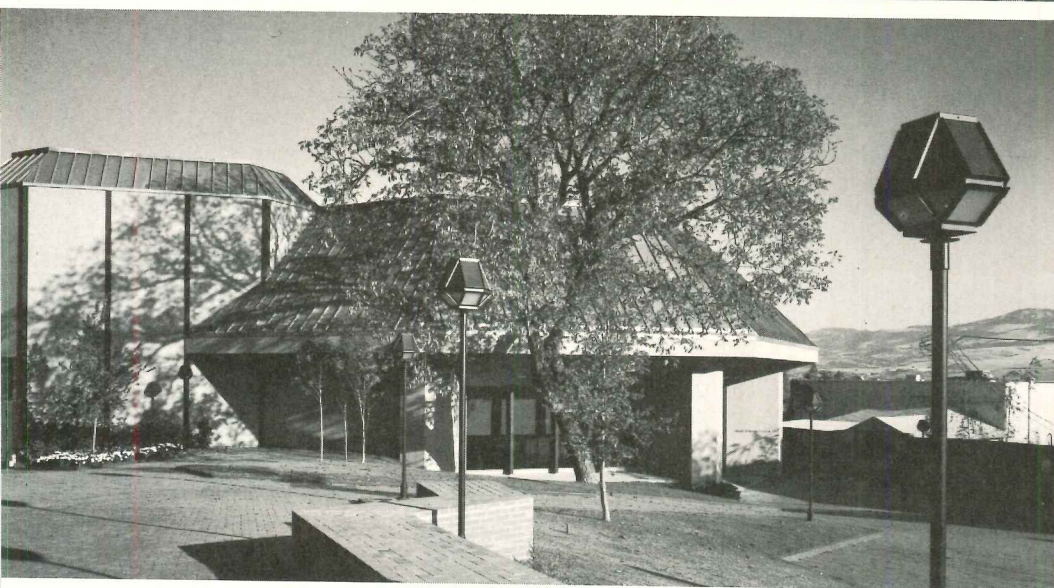
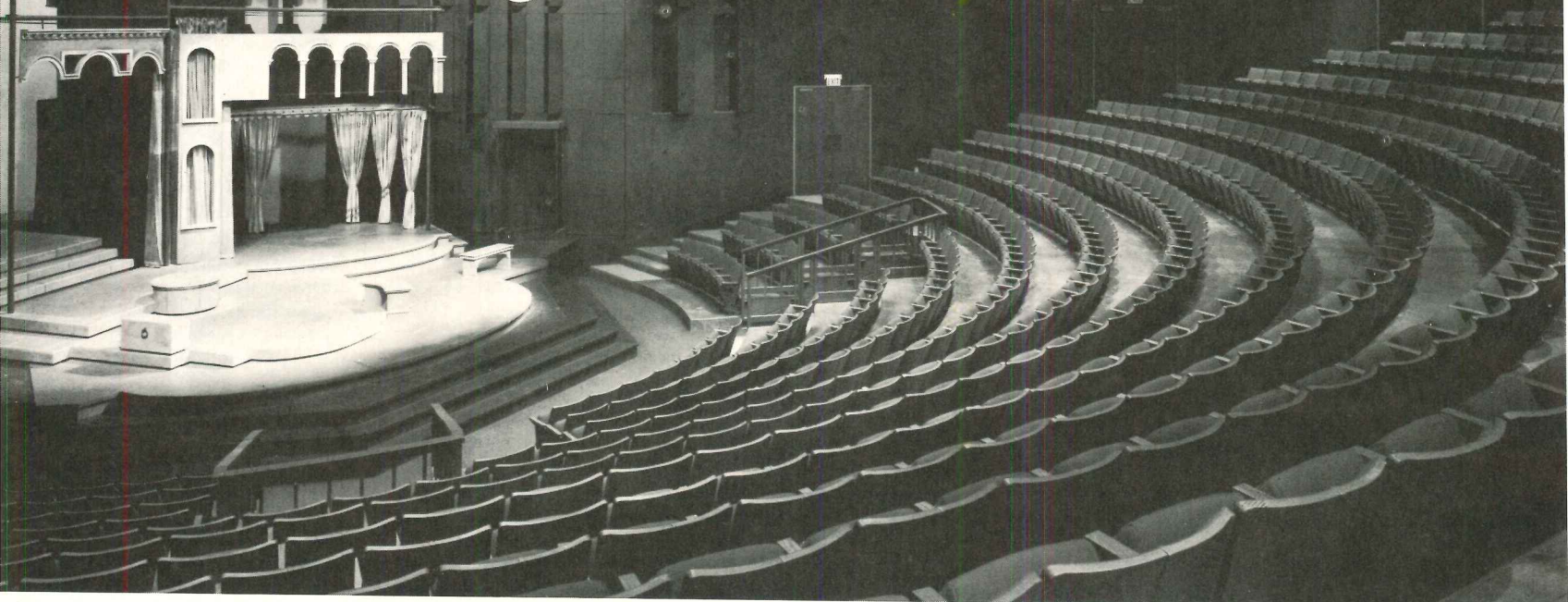

A good actor must adapt himself to a wide variety of roles and styles of interpretation. So must a good stage.

The designers of the Oregon Shakespearean Festival's Angus Bowmer Theater, Ashland, Oregon, recognized this and utilized a Dover Stage Lift as the heart of their new 600-seat playhouse.

This 28' x 8'6" lift is truly a versatile performer. It travels 21' and serves four levels: machine room, trap room, auditorium floor, and stage. In various positions it becomes part of the stage, part of the auditorium, and an easy way to move heavy, awkward scenery between floors.

Dover Lifts can be found in the Metropolitan Opera House and the Juilliard School, New York; in Harvard's Loeb Drama Center, the Santa Fe Opera House, and the Stardust Hotel, Las Vegas.

The same Dover skill that designed and built these lifts can be applied to your stage lift project, regardless of size or special requirements.

For more information, see our catalog in Sweet's Files, or write Dover Corporation, Elevator Division, Dept. A-10, P. O. Box 2177, Memphis, Tenn. 38101. In Canada: Dover/Turnbull.

OREGON SHAKESPEAREAN FESTIVAL ASSOCIATION, Ashland, Ore.  
Architects: Kirk, Wallace, McKinley, A.I.A. & Associates, Seattle, Wash.  
Theater Consultants: Landry, Hunt & Bogan, Palo Alto, Calif.  
General Contractor: Robert D. Morrow, Inc., Salem, Ore.  
Stage Lift installed by Dover Elevator Co., Oakland, Calif.

**DOVER**  
**Stage Lifts**

For more data, circle 22 on inquiry card



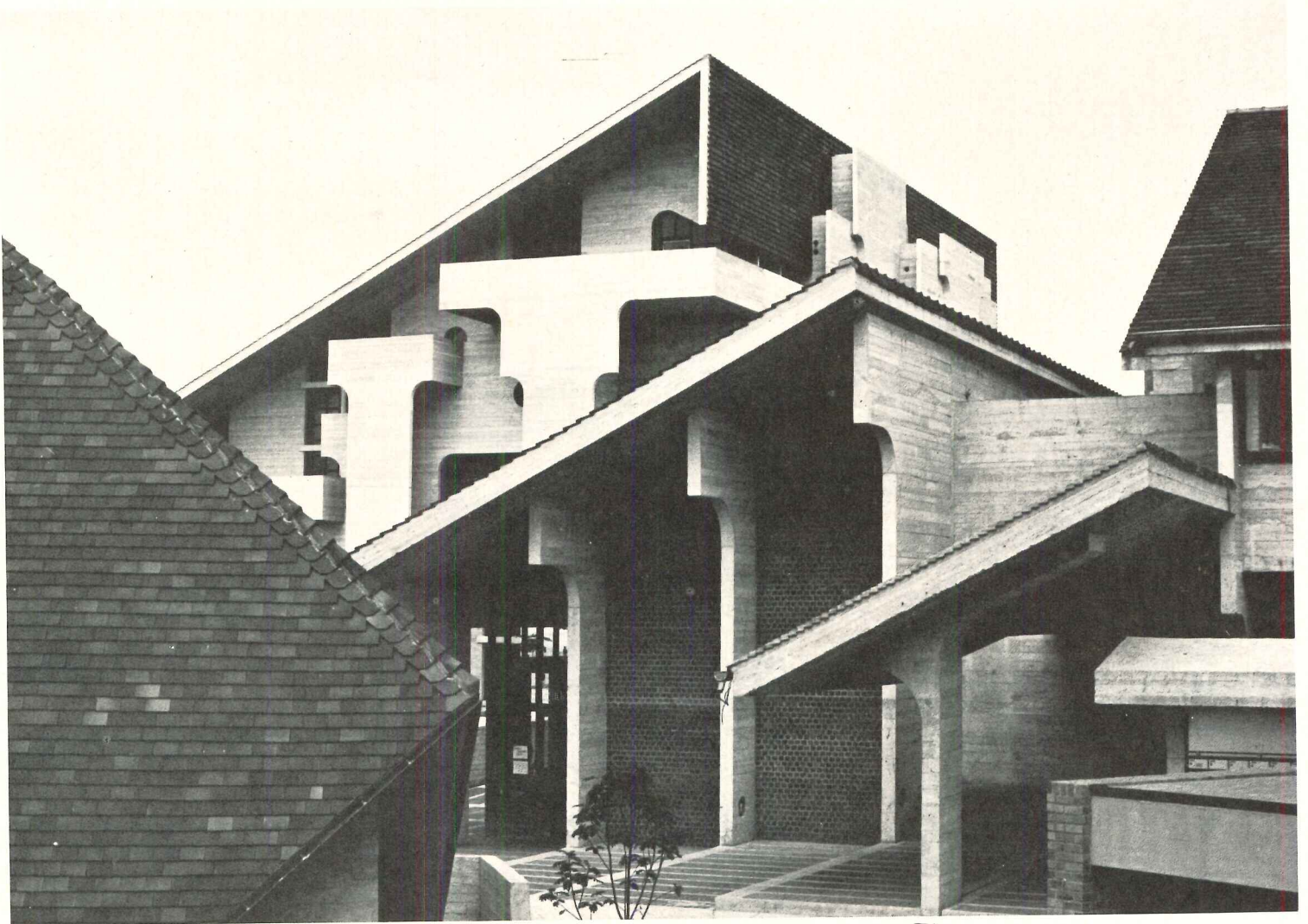

**Reshaping the university in Louvain, Belgium**

One of the most well known universities in Europe, the Catholic University of Louvain, is being doubled with the birth of Louvain-la-Neuve, a French speaking university similar to the Flemish speaking old university. In searching for the design, the architects at the Atelier de Genval wanted to capture the "impromptu, the charm, the Medieval architectural heritage" of the area. Derivative of the huge farm buildings nearby, with their big roofs, the resulting design is an agora with a large scientific library (shown), restaurants, auditorium, seminar areas and administrative section grouped around the square, with parking underneath. The entire project is of concrete using white cement.

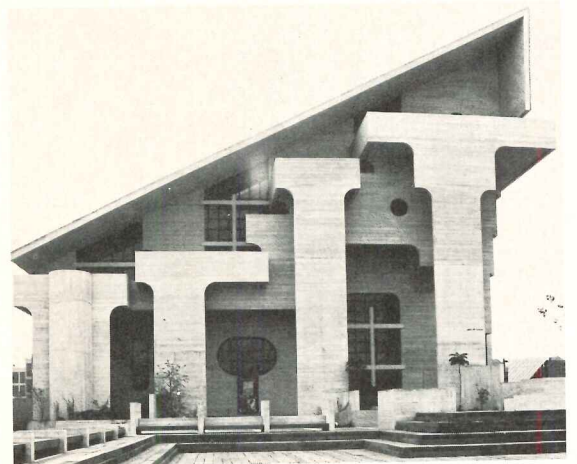
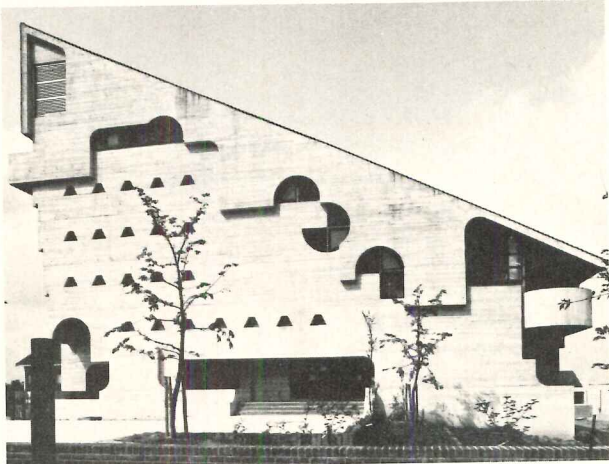
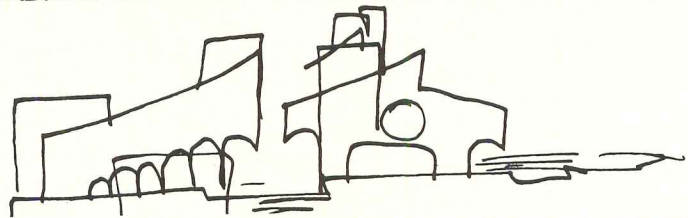



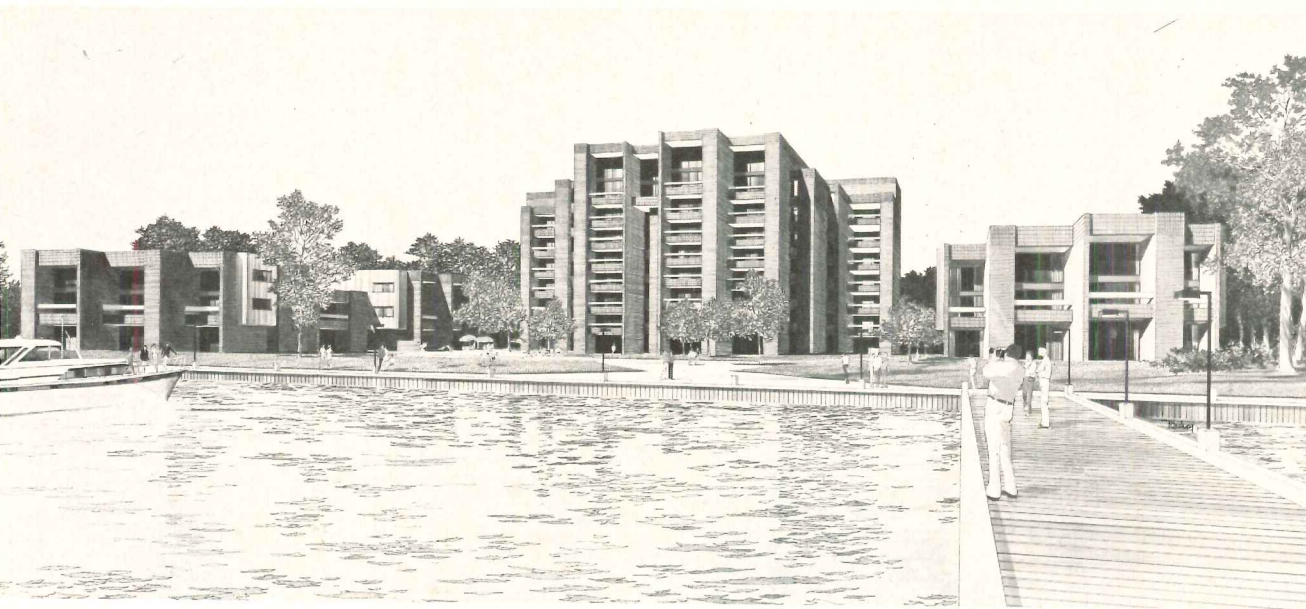

### Lakefront condominium restricts height

Although zoning would allow architects Rossetti Associates to build without height limitations, they chose to develop this residential community in Harrison Township, Michigan in keeping with the surrounding single-family unit community. Being built at a cost of \$2.4 million, the 64-unit condominium includes a 9-story midrise unit with brick/block bearing wall and precast concrete floor construction. The garden units are wood construction with brick and vertical wood siding. The complex is three separate buildings arranged in a U-shape with the open side facing Lake St. Clair and swimming pool.

### First of six Chicago condominiums

Located on Chicago's lakefront, the first building in a six-building condominium complex is under construction, part of the 83-acre Illinois Center development. The 54-story building shown will rise from a plaza and contain 742 apartments, 14 to a floor, selling in the \$30,900 to \$127,000 price range. Architects are Solomon, Cordwell, Buenz & Associates.

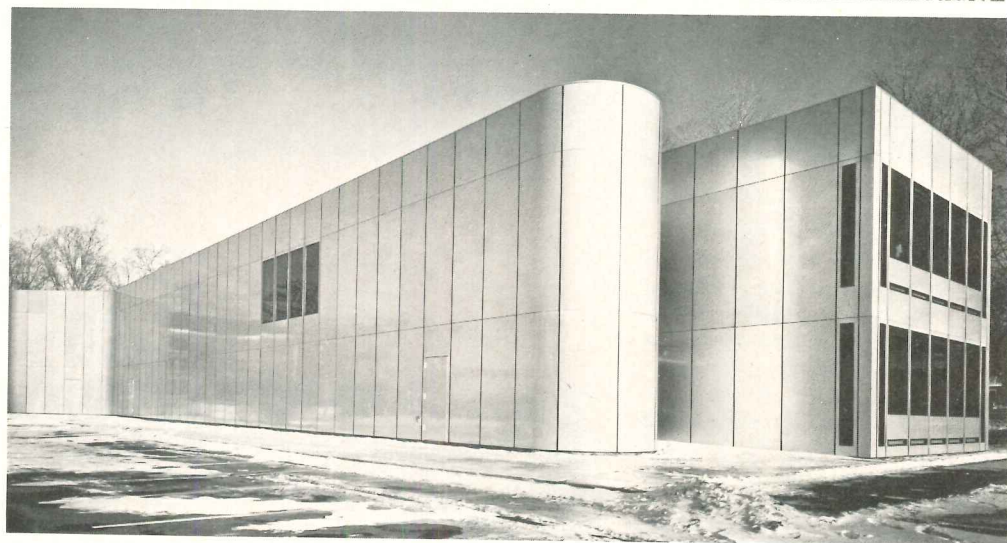
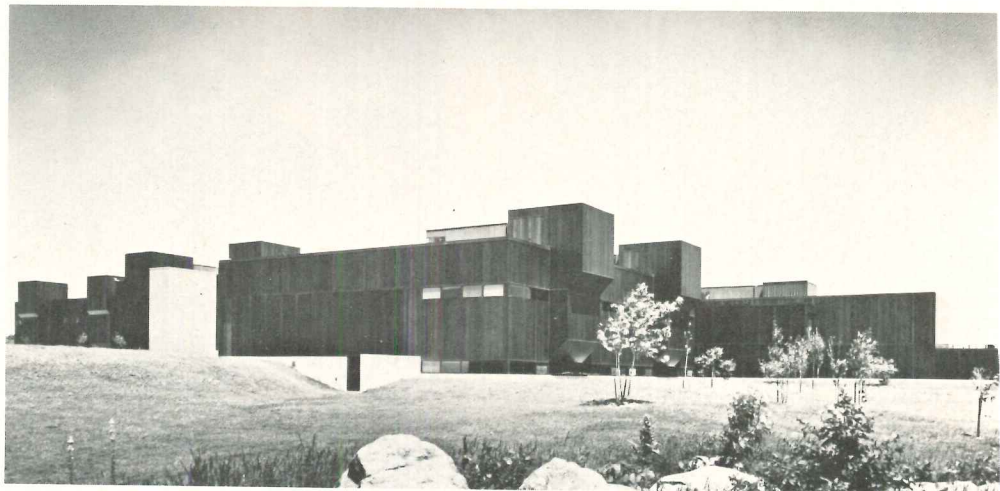
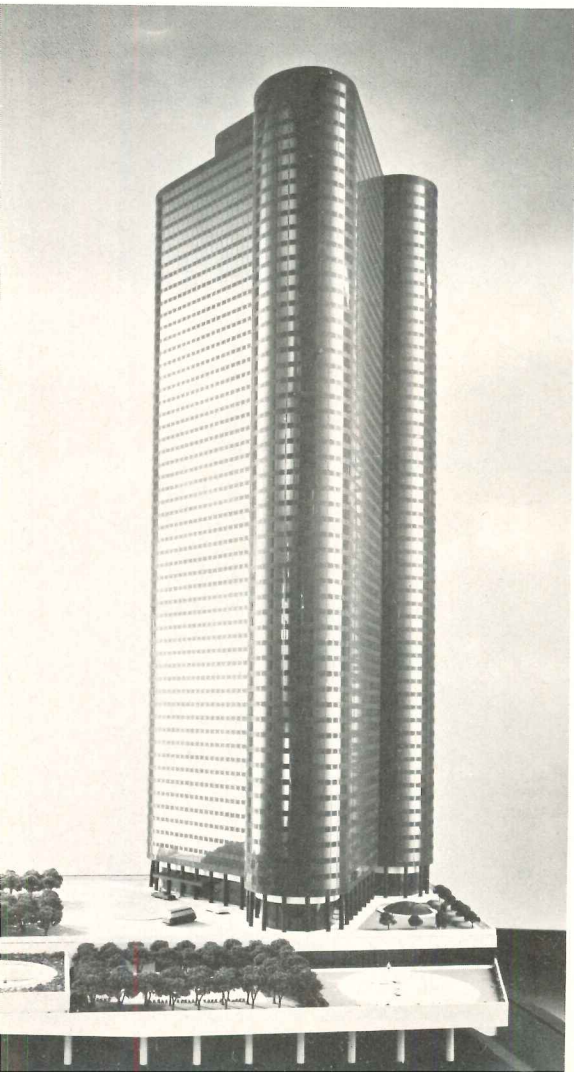

### Finalists announced in Aluminum Building Products Design Competition

Three finalists in each of two categories of the first Aluminum Building Products Design Competition have been chosen, with winners to be announced this month in Seattle, Washington, at the annual meeting of the Architectural Aluminum Manufacturers Association. Shown are two of the finalists in the

new construction category. Top is the Sir Sandord Fleming College in Peterborough, Ontario by R. J. Thom & Associates; bottom photo is the Middletown State Hospital in Middletown, New York by Prentice and Chan Ohlhausen. The third finalist in this category is the IBM computer operations headquarters

in Sterling Forest, New York by Gunnar Birkerts & Associates. Finalists in the remodeling category are: Bache Building, Binghamton, New York by Norman J. Davies; Goodyear office in Akron, Ohio by Hoag Wismar Henderson Associates; and the offices of architects Smith, Hinchman & Grylls in Detroit.



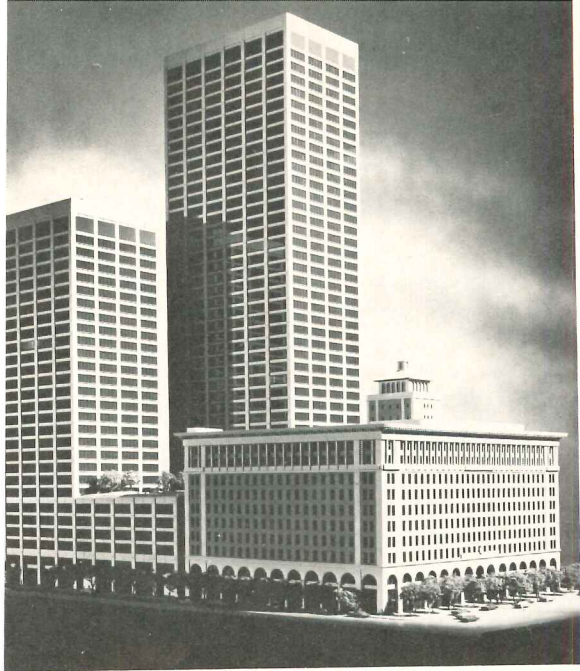

### Complex will preserve San Francisco view

View corridor protection for California and Pine Streets was one of the prime considerations in the design of One Market Plaza, a major commercial center in the Embarcadero section of San Francisco. The city's Planning Commission unanimously approved the project two years ago, no doubt because the design by Welton Becket and Associates retains the existing Southern Pacific Building, thus preserving one of the truly great views in San Francisco—from Nob Hill down California Street. Two office towers, 28 and 43 stories, will be constructed, while the 55-year-old 11-story headquarters will be modernized.



### Herbert F. Johnson Art Center designed by I. M. Pei for Cornell University

This recently completed edifice on the Ithaca, New York campus of Cornell University is the gift of patron of art and architecture Herbert F. Johnson of the family who commissioned Frank Lloyd Wright to build the Johnson Wax Company administration building in Racine, Wisconsin. The Johnson Art Center by I. M. Pei is the architect's work alone and has been described as impressive architectural sculpture. Its most prominent feature is an open space at the third floor level, a sculpture terrace with a view of Lake Cayuga. Around this loggia are three elements—a subterranean entrance and temporary exhibit space; a tower housing offices and library; and the massive canopy housing the main galleries.



### Sicilian hotel opened in Taormina

This hotel recently opened on the east coast of Sicily, built on steeply inclined terrain overlooking the sea. The land slopes at about 45 degrees near the ancient port of Taormina. The hotel is a series of cells, sixty of which have a living room, bedroom and bath. Each room has an intimate private balcony. The main entrance is at the top level, and parking is some distance. The architects are Alberto Gatti and Diambra de Sanctis.





## ***New sculptured white-on-white ceiling looks extravagant...but isn't.***

It's the latest addition to our economy group of textured AURATONE® acoustical ceilings. This new Terress pattern features micro-perforations on a richly embossed ultra-white field. Gives such extra-value features as good sound absorption, a fire rating of incombustible, and Class A light reflectance. A super-tough plastic coating that resists dirt and stains — makes washing quicker and easier, is available at optional cost. Get all the specifics from your U.S.G. representative. Or write to us at 101 S. Wacker Drive, Chicago, Illinois 60606, Dept. AR-103.

*For more data, circle 23 on inquiry card*

### ***New AURATONE® Terress ceiling panels.***



**UNITED STATES GYPSUM**   
BUILDING AMERICA



# Hi-Density mobile shelving increases filing capacity by 100% and more.

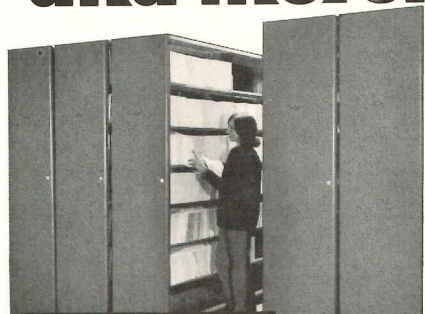

for files, computer tapes,

films, drugs

A single, mobile access aisle is why Hi-Density shelves hold twice as much as conventional shelves and four times as much as drawer files. Frees floor space—saves filing and retrieval time. Features include smooth floors (no above-the-floor rails), modular design, steel divider type shelves, choice of decorator colors. Available electrically powered or manual. For information on a better way to file, write: Automated Storage Systems, Drawer E, Red Bank, N.J. 07701, or call (201) 542-5000.

## Automated Storage Systems

DIVISION OF ESTEY CORPORATION

For more data, circle 24 on inquiry card

### A Building is a Quiet Revolution

MODERN MOVEMENTS IN ARCHITECTURE, by Charles Jencks; Doubleday Anchor Books, Garden City, New York, 1973, paperback, 432 pages, illus., \$4.95.

Charles Jencks's new book *Modern Movements in Architecture* is a densely packed, amply illustrated critique of 20th century architecture. If you can cope with language and style that is often complex and sometimes obscure, you will be rewarded with a very stimulating set of stories.

Each chapter deals with a major figure or movement of the century in a different and interesting way. But unifying the book is criticism of various modern movements—not only in formal terms, but also in terms of how each of them relates to issues of political and artistic freedom and social equality, and how each has been part of a supposed revolution in architecture and politics.

A major part of the book, then, is a sad story of failure: failure of the noble intentions and ideals of the 20's gone awry, or compromised or proven inadequate; of the "Modern Masters" who sold out to the Fascists, to the *Zeitgeist*, to the myth of their own para-divine reputations; of the next generation of Johnsons, Saarinens and Stones who have been unable to see their work aspiring to social and moral values beyond those which supported their careers and places in history, and whose most "successful" work has most certainly not been the stuff of revolution, but instead, according to Jencks, has served to provide corporations with images of crushing banality and caution; of architectural historians (from Hitchcock and Pevsner to Scully and Rowe) who in a century theoretically open and pluralist continue to peddle the idea of one inevitable line of architectural development with the implication of a determined future, instead of supporting several live traditions as alternate futures (as indeed Jencks does in his first chapter, describing six alternate modern movements).

On the other hand, though, Jencks is unabashedly full of praise for the successes of the century—the extraordinarily fine buildings of Le Corbusier, Alvar Aalto, Aldo van Eyck and James Stirling. He regards them as successful because they are multivalent, so full of meanings and imaginative relationships of form that they are subject to the same multiple interpretations which characterize great buildings throughout history. Jencks doesn't just praise; he gives generous examples of how buildings can act rhetorically and symbolically.

Between these extremes of success and failure, Jencks discusses an astonishing array of architects, projects and movements. Included are some of the best discussions yet of postwar American and British architecture and important urban design projects from around the world. Jencks's intellectual stance (his desire to be pluralist and inclusive) serve him and the reader well.

The flaws in the book start to show when you begin to wonder about those people and movements not included. What about Schindler, Norman Bel Geddes, Bertram Goodhue, Raymond Hood, Oud, Lescaze,

Lapidus, the architects of the Chrysler Building, or the Boots Factory or the classic McDonald's? None of these fit Jenck's expanded but still quite narrow conceptual framework. There are probably limits to pluralism and inclusiveness because it is just as bad to support every viewpoint as to support only one. But I think Jenck's omissions are symptoms of a greater flaw. For all his attempts to break out of it, he is still operating well within the theoretical limits of the early Modern Movement, and he seems stuck with a viewpoint on art and revolution and politics which is notoriously old-fashioned, naively romantic, full of *déjàvu*.

The Postscript, called "Architecture and Revolution," suggests that because "architecture concretizes the public realm" and because "that public realm is both politically repressive and socially anachronistic, the expressive nature of architecture is thrown into doubt," and what is needed is a simultaneous revolution in political, social and architectural forms. Shades of 1917! It seems incredible that Jenck can propose the Russian revolution and Constructivism as a model, while ignoring how quickly that revolution slid into repression and classicism, and without offering a shred of evidence that a new revolution elsewhere would be any different. But I am even more amazed that anyone would still persist in linking art and politics at all.

Art (and I believe architecture) can almost always be revolutionary to the degree that it deals with change. Politics, and political systems, almost always (and luckily) deal with stasis. What Jenck seems not to see is that political revolution comes by upheaval and momentous occasions, and then is endorsed by established architectural forms (as in Russia, or indeed here at home in our own Revolution).

By contrast, architectural revolution continually comes sneaking quietly in the back door, building by building, to change our view of our world and ourselves. Jenck's Postscript seems to stand in glaring contrast to the early parts of his book, where he prefers to believe, as much as I do, in the extraordinary powers of a good building, large or small. It is the tension between his wish to see architecture as a partner of political revolution and the contrasting power of an individual building quietly to revolutionize our vision which is central to Jenck's book—and which makes for exciting, if difficult, reading.

—Richard Oliver  
Mr. Oliver, currently practicing in New York, has taught at the University of Texas and UCLA.

### Also Received

TIME-SAVER STANDARDS FOR BUILDING TYPES, edited by Joseph De Chiara and John Hancock Callender; McGraw-Hill, New York, 1973, 1065 pages, illus., \$27.50.

An outgrowth and extension of the well-known *Time-Saver Standards*, this new work complements that reference book and contains greatly expanded treatments of such materials that were drawn from it. The emphasis is on basic planning and functional considerations for particular building types, and the presentation is mainly graphic and practical. Architects, plan-



REQUIRED READING *continued*

ners and students, faced with the design of an unfamiliar building type, can use the book for initial programming and schematic design, and, later, for more detailed design development. In all, the book examines ten major building types: Residential, Educational, Cultural, Health, Religious, Governmental and Public, Commercial, Transportation, Industrial, Recreational and Entertainment, and Miscellaneous (farm buildings, greenhouses, riding schools, kennels, etc.).

ART AND ARCHITECTURE IN ITALY: 1600 to 1750, by Rudolf Wittkower; Penguin Books, Baltimore, 1973, 485 pages, illus., \$35.00.

A part of the Pelican History of Art Series, this is a third revised edition of the late Professor Wittkower's detailed study, which was first published in 1958.

EARLY ILLUSTRATIONS AND VIEWS OF AMERICAN ARCHITECTURE, edited by Edmund V. Gillon Jr.; Dover Publications, New York, 1971, 295 pages, illus., \$6.95.

A collection of 742 line cuts from printed sources dating between 1839 and the early 20th century. The buildings are from 249 cities in 27 states and the District of Columbia, and they range in date from the early 17th to the late 19th centuries.

HISTORIC BUILDINGS OF OHIO, by Walter C. Kidney, with a preface by James C. Massey; Ober Park Associates, Pittsburgh, 1972, 130 pages, illus., \$20.00.

HISTORIC BUILDINGS OF WASHINGTON, D.C., by Diane Maddox, with a foreword by Arthur Cotton Moore; Ober Park Associates, Pittsburgh, 1973, 191 pages, illus., \$17.50.

THE ARCHITECTURE OF CARSON CITY, NEVADA, by S. Allen Chambers Jr.; Historic American Buildings Survey, Washington, 1973, 194 pages, illus., paperback.

*Historic Buildings of Ohio and Historic Buildings of Washington, D.C.* are the first two in a new series of volumes "Historic Buildings of America" based on extensive documents compiled by the Historic American Buildings Survey and stored in the Library of Congress. The publishers plan to release two or three new volumes each year, and their contents will be gathered on a state and regional basis.

*The Architecture of Carson City, Nevada*, is a part of HABS's own series "Selections from the Historic American Buildings Survey," begun in 1966. HABS, which this year celebrates its 40th anniversary, has also published a number of other documents, as well as a bewildering multiplicity of catalogues of the collection itself. Those wishing to be initiated into HABS's mysteries—and who may need drawings or photographs of a particular building—may write for a Publications List from the Historic American Buildings Survey, Office of Archeology and Historic Preservation, National Park Service, Department of the Interior, Washington, D.C. 20240.

The Museum of Texas Tech University, Lubbock, Texas  
Associated architects: Stiles, Roberts & Messersmith  
McMurtry & Craig, Lubbock, Texas

## DOORWAY NOTES . . .

HERE TALL, GLAZED, EXTERIOR DOORS ARE CONTROLLED BY LCN 4110 SERIES SMOOTHIE® HEAVY DUTY DOOR CLOSERS.

FULL HYDRAULIC CONTROL OF OPENING AND CLOSING SWINGS.

PERFORMANCE UNDER HEAVY TRAFFIC, WIND AND WEATHER.

ADJUSTABLE SPRING POWER AND OPTIONAL HOLD-OPEN ARM.

LCN AFFORDS THE WIDEST CHOICE OF CLOSERS. CATALOG ON REQUEST. SWEET'S, SEC. 8.

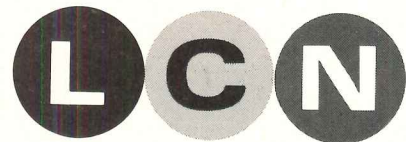
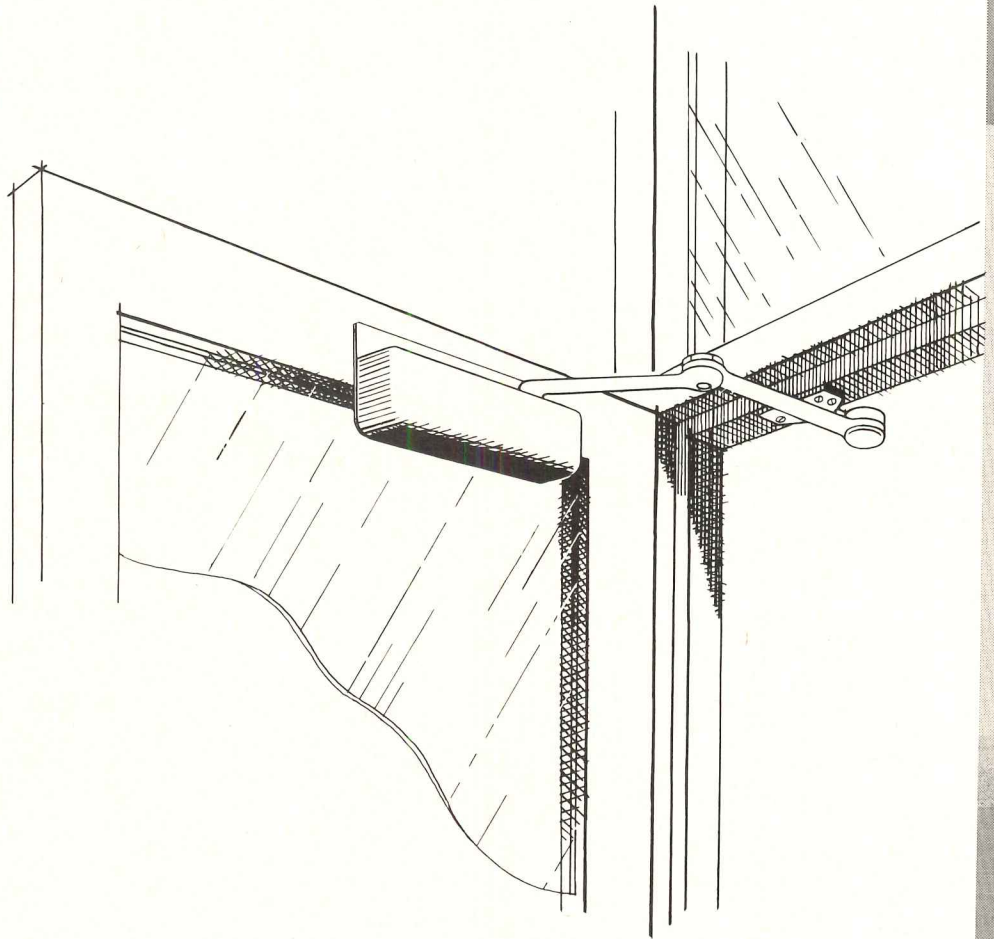

LCN CLOSERS, Princeton, Illinois 61356



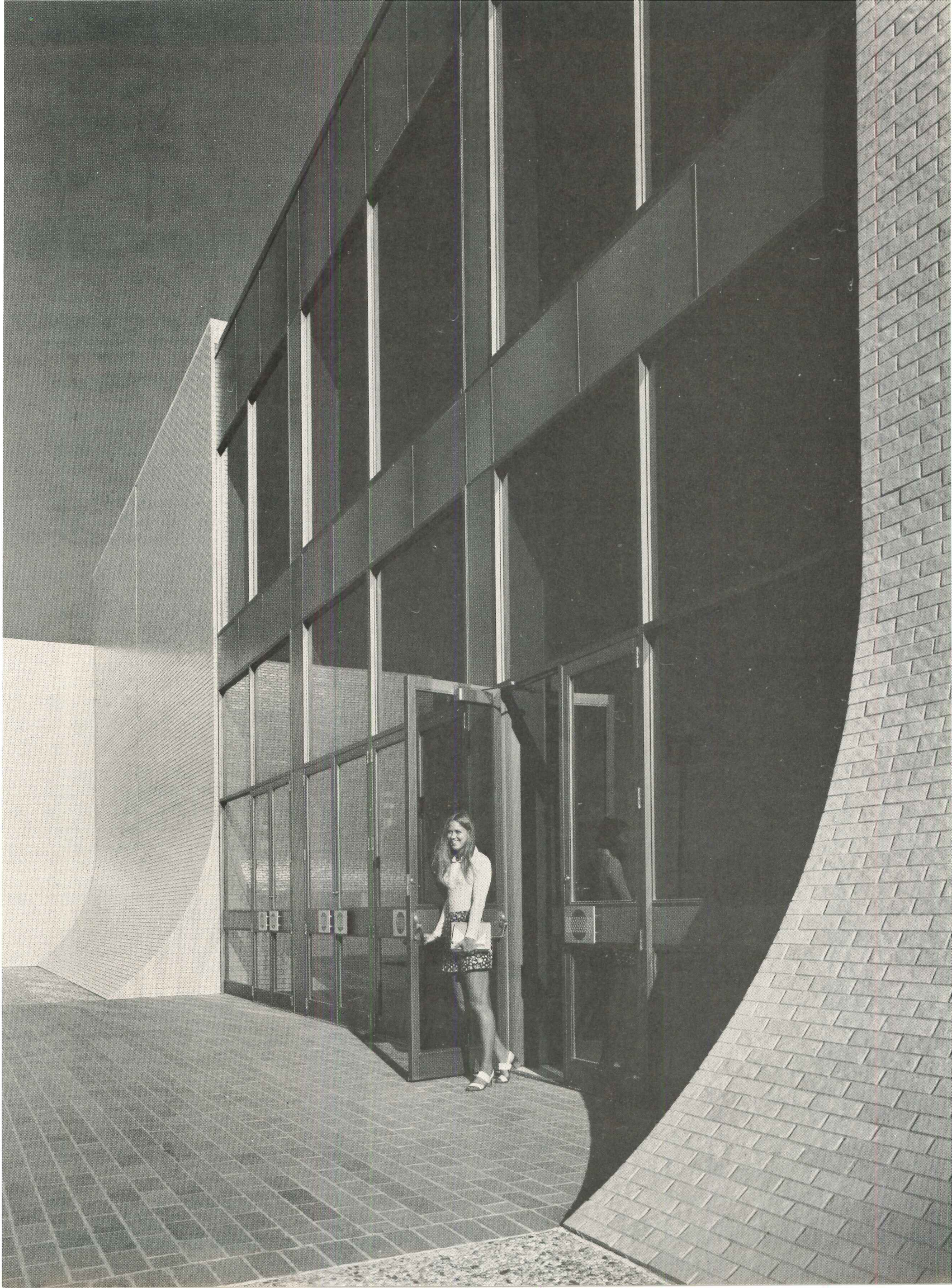



# The new Weldwood Collection. Suddenly, anything else seems out of date.



Introducing The Weldwood Collection™ from U.S. Plywood. Quite simply, the finest group of prefinished panels available anywhere in the world.

The Weldwood Collection. A paneling created exclusively for those once-in-a-lifetime opportunities when nothing less than the finest in quality is acceptable. Where superb hardwoods are crafted into face veneers worthy of the term "heirloom".

The Weldwood Collection features veneers of hickory, teak and walnut. Just these are given a formal planked effect, with slender eighth-inch-wide grooves spaced two or four inches on center. Some are medium and dark shaded. Others light-toned for a contemporary feeling.

Three more fine woods – walnut, oak and cherry – are highlighted like fine furniture with normal random spacing and eighth-inch grooves. We also have retained the very best panels from our Charter® and Deluxe groups: Charter pecan and Gothic oak.

See this limited edition, now at your U.S. Plywood Branch Office.

**U.S. Plywood**

777 Third Avenue, New York, N.Y. 10017

*For more data, circle 26 on inquiry card*



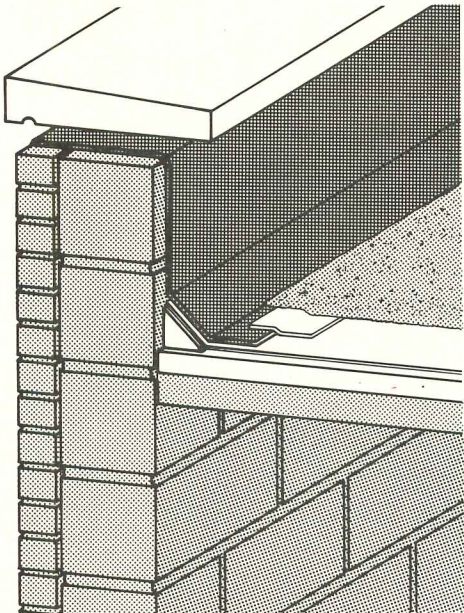

## Flexseal. The name tells you why this vinyl flashing is so good.

We didn't name our vinyl flashing by tossing a coin.

We named it Flexseal™ because we know the job it is designed to do.

**Flex.** The ability to expand and contract to compensate for roof movement.

**Seal.** The ability to maintain watertightness over the years that a building settles. Without cracking, splitting or drying out.

Flexseal. A vinyl flashing that over the last ten years has meant fewer call backs for roofers. Less maintenance. And increased life.

And Flexseal vinyl flashing is just one of several vinyl products from B.F. Goodrich for moisture and thermal protection.

BFG also makes vinyl expansion joint covers, in sheet and extruded form. Waterstops and membrane waterproofing. Through-wall flashing. Masonry control joints.

They're all modern, job-proven products that live up to the promise of their name.

For a free 24-page booklet on all the Flexseal vinyl systems, write the B.F. Goodrich General Products Company, Dept. 0445, Akron, Ohio, 44318.

**B.F. Goodrich**

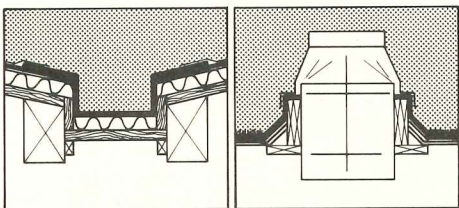

For more data, circle 27 on inquiry card

Your article "The Courts at Clinton" in the August issue is one of the most intriguing to have crossed your pages in a long time.

It is moving to observe man's fundamental urge to build regardless of circumstances.

The prison authorities are to be commended for having tolerated the courts despite recent penal philosophy. As a private citizen, one cannot help but wonder whether the tragedy of Attica might have been averted with a tradition like Clinton's.

You have uncovered architecture which surpasses in poignancy all the contemporary forms of art I can think of. There are social lessons to be learned at Clinton. The article is a treasure trove, reminiscent of Rudolfsky's "Architecture without Architects."

Janko Rasic

Janko Rasic Associates Architects

I am very late indeed in writing this letter of congratulations to you for your efforts in this year's RECORD HOUSES. The overall quality of design displayed in the magazine to me surpasses the already high standards established by this annual publication. All of the houses were real buildings that can survive mumps, measles, chicken pox and the onslaught of popular taste. It is difficult, at least for me, to find buildings today that are house houses but not trendy things dotting the landscape.

The photographs, layout and copy, covering the Schwaikert house in Salisbury, Connecticut, particularly pleased my office and self. As you know I have always considered being included in this publication the singularly most important recognition any architect can receive who considers his work to be serious in domestic architecture. I look forward to entering the lists once more in 1974.

Congratulations are also in line for the tough and important piece on Stores and Shops in the August issue. The collection of shops (which included my two invisible ones in the Lincoln Memorial and the Renwick Gallery) showed a variety in scope expressing at once elegance, charm and a sound merchandising sense.

The reproduction of Lautman's photographs of both the Lincoln Memorial and Renwick Gallery are stunning. The Record always has the best reproduction in the biz!

Again, congratulations to you and the staff of the Record.

Hugh Jacobsen, FAIA

### Errata

I would like to note that our work at Clinton owes a great deal specifically to Frank Eliseo and Andy Metropulos of the New York Health and Mental Hygiene Facilities Improvement Corporation.

Further, most of the quotes in Barclay Gordon's excellent article came from the work of Ronald Roizen, a sociologist, whose consulting work for us has been invaluable on a number of projects.

Herbert McLaughlin  
Kaplan and McLaughlin

Just  
15 minutes reading  
could save you  
hundreds of hours,  
thousands of dollars  
in design/drafting.

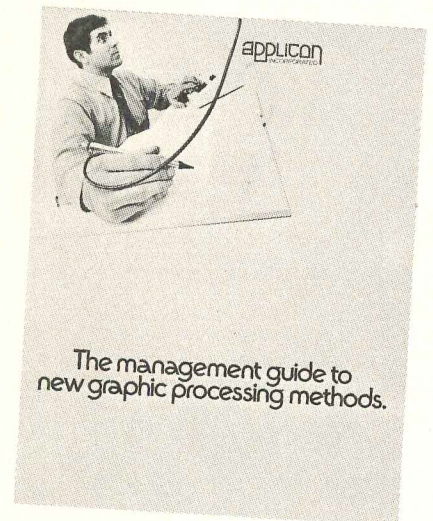

The Management Guide to Graphic Processing Methods describes how designers/draftsmen utilize the Applicon Graphic System to realize dramatic cost and time savings.

The AGS 700 handles input, storage, manipulation and output of drawn lines fed into a minicomputer. Comes ready-to-use. Available with a wide range of standard options. Integrates with your current drafting and production methods.

For free guide, send reader service card or mail coupon.

APPLICON, INCORPORATED		AR-1
154 Middlesex Turnpike		
Burlington, Mass. 01803		
Please send Applicon Graphics Processing Guide directly to:		
NAME	_____	
TITLE	_____	
COMPANY	_____	
STREET	_____	
CITY	_____	
STATE	ZIP	_____

**APPLICON**  
INCORPORATED

For more data, circle 28 on inquiry card



*In senior citizens housing*

# Conventional, steel-framed high-rise apartment "beats" HUD guidelines by \$100,000.

Generally speaking, Pariseau Apartments in Manchester, New Hampshire, is a plain, ordinary apartment building. The high-rise residential home provides low-rent housing for the elderly. Its construction was federally funded under The Housing and Urban Development program.

What makes the structure distinctive is the fact that it was built within the budget. None of the construction principals could think of another HUD structure in their area with a similar budget record. They lauded the fact that the building was constructed using conventional contracting methods as opposed to the more common "turnkey" method.

## **\$100,000 within HUD guidelines**

Said the architect, "all the others were 'turnkey' projects. This was one of the first HUD high-rise projects to be handled by a conventional contracting method that comes well within the budget. We estimate that we stayed within the HUD guidelines by more than \$100,000. We accepted a challenge" he said, "and decided on the most economical, practical design."

The Housing Authority home for the elderly is part of a larger \$3.5-million development known as the Flatiron Urban Renewal Project located on 21.6 acres in Manchester. Pariseau Apartments occupies 1.7 acres in the project. The structure incorporates 100 apartments surrounding a central core flanked by two stairways. There are 58 efficiency (studio-type) apartments in the building, 41 one-bedroom apartments, and 1 two-bedroom unit.

The 11-story structure measures 76 by 79 ft. Floor to floor heights are as follows: ground floor—12 ft; floors 2



Owner: Manchester Housing Authority; architect: Isaak, Moyer, Walsh & Dudley; structural engineer: Albert Goldberg & Associates, Inc.; fabricator: Lyons Iron Works, Inc.; erector: Concrete Erectors, Inc.; general contractor: Davison Construction Company, Inc.

through 11—9 ft, 8 in.; floor to ceiling height is typically 8 ft. The structure encompasses 61,548 sq ft. Overall costs are \$2 million, but the basic construction costs are \$1,787,800, about \$29.00 per sq ft.

Explains housing director Paul Lamie, "HUD allowed prototype costs, and we came within the limitations. These limitations varied per unit. This is a good basic building with no frills."



Steel framework required approximately 310 tons of structural steel—all Bethlehem, and all ASTM A36. A single crane erected the framework operating from one side of the building. Typical columns in the framing system are W16 members ranging from 96 to 31 plf. Three- and 4-story columns were used. The long columns helped speed the overall project. Their use meant that lower floors could be turned over faster to the other building trades.

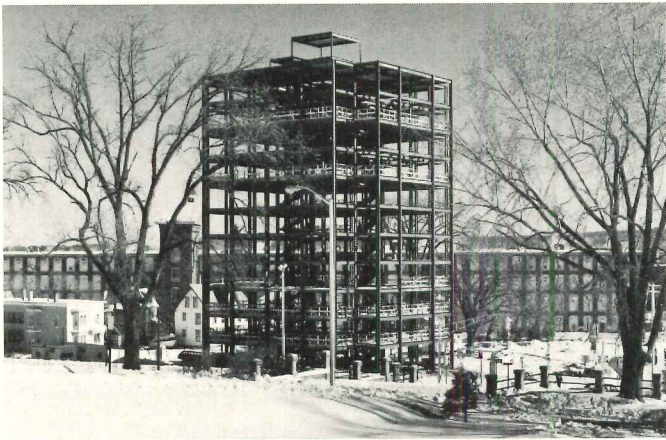

On a typical floor, girders are W14 sections; tie beams and spandrels are W12 and W14 members. An additional 75 tons of open web steel joists and some 60,000 sq ft of permanent steel forms are included in the building. The 28 gage steel centering, 9/16-in. deep, is used to support the 2-1/2-in. reinforced concrete floor slab. Design live loads are 40 psf for the floors and roof; dead loads are 60 psf.

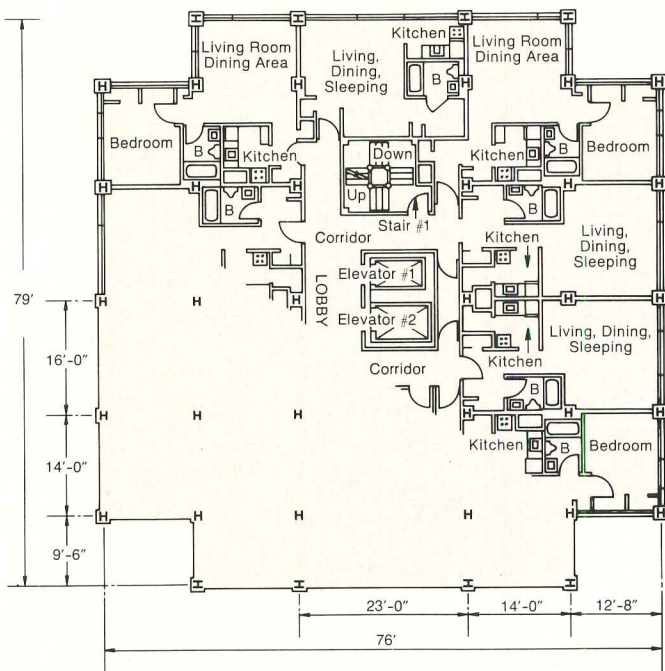

The structure incorporates 100 apartments surrounding a central core flanked by two stairways. There are 58 efficiency (studio-type) apartments in the building, 41 one-bedroom apartments, and 1 two-bedroom unit.

### Conventional contracting favored over "turnkey"

The apartment building is designed as a rigid frame in both directions and primarily incorporates end-plate moment connections. No vertical bracing is used in the framework. In the opinion of the fabricator, "It's an economical structure—easy to fabricate and erect, with few alignment problems. With the use of end-plate, high-strength (ASTM A325) field-bolted connections, we gained economies over welded column connections.

"In a project like this everyone knows exactly what the costs are," he added. "We can compare 'apples and apples' as opposed to the 'turnkey' type of project where it's conceivable that some costly items may be present which are not essential."

The steel framework required approximately 310 tons of structural steel—all Bethlehem, and all ASTM A36. An additional 75 tons of open web steel joists and some 60,000 sq ft of permanent forms are included in the building. During construction, 28 gage steel centering, 9/16-in. deep, was used as a permanent form for the 2 1/2 in. reinforced concrete floor slab.

Although the framing system looks relatively simple, it required a good deal of analysis to evaluate theoretical seismic and wind forces, especially in relation to the end connections of the framework and subsequent transmittal of forces to tied spread footings. "The construction site is near the Laurentian Fault," commented the structural engineer, "so the structure is designed for Zone 2 Siesmic conditions. The foundation required ties so we used spread footings tied together with reinforced concrete tie beams."

### Benefits of steel framing praised

The housing director noted that about 80 per cent of his elderly tenants live on social security payments. Rents for public housing are limited to 25 per cent of individuals' incomes. "And that isn't much," commented Lamie. "Lack of funding is a critical problem. In projects like ours, steel framing benefits can provide a meaningful contribution to economy. The time factor is important. Because steel frames go up faster than alternate framing systems, a housing authority can look forward to earlier occupancy."

The Manchester Housing Authority operates 1,396 units including 916 for the elderly and 480 for family and general occupancy. Perhaps steel framing can provide economies for your next construction project. Call your local Bethlehem sales engineer, or write: Bethlehem Steel Corporation, Bethlehem, Pa 18016.

**Bethlehem** 



# Tectum: decorative, insulating,

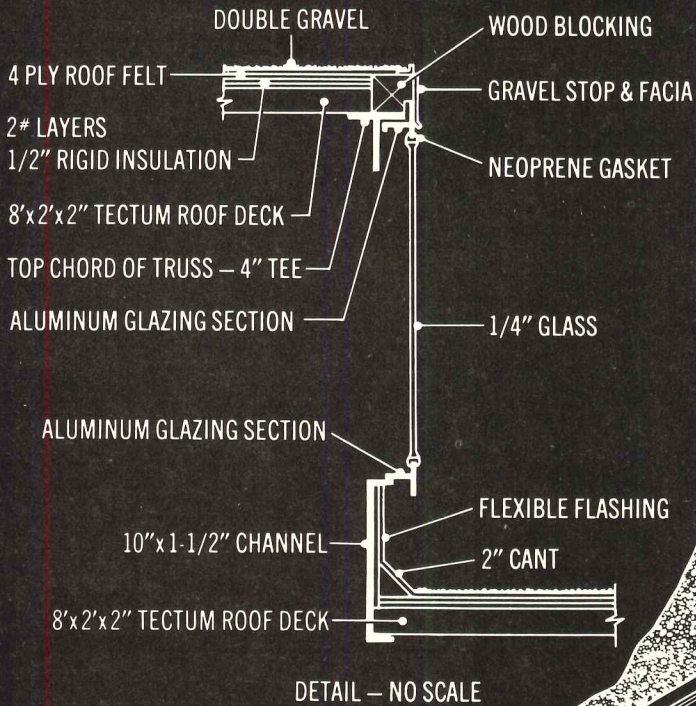

At Gund Hall, Harvard's Graduate School of Design, Tectum was used as a structural roof deck and exposed ceiling in this unique and distinctive canopy of glass and steel. Toronto architect John Andrews specified 2" thick Tectum to span the translucent roof truss enclosures and develop a thin profile for the stepped roof section. The detail shows how this section was constructed. In the open central studio space under the canopy, Tectum's sound absorption is an important factor. Its NRC is in the .50-.60 range.

SEE DETAIL ABOVE

8'x2'x2" TECTUM PLANKS

10"x1-1/2" CHANNEL

#218 BULB TEES 24" O.C.



# structural, acoustical, non-combustible.

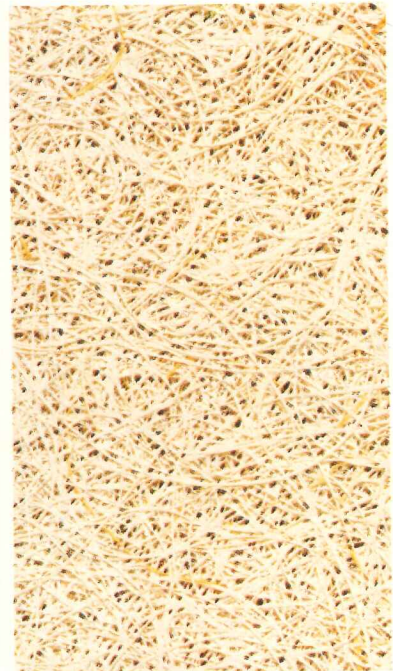
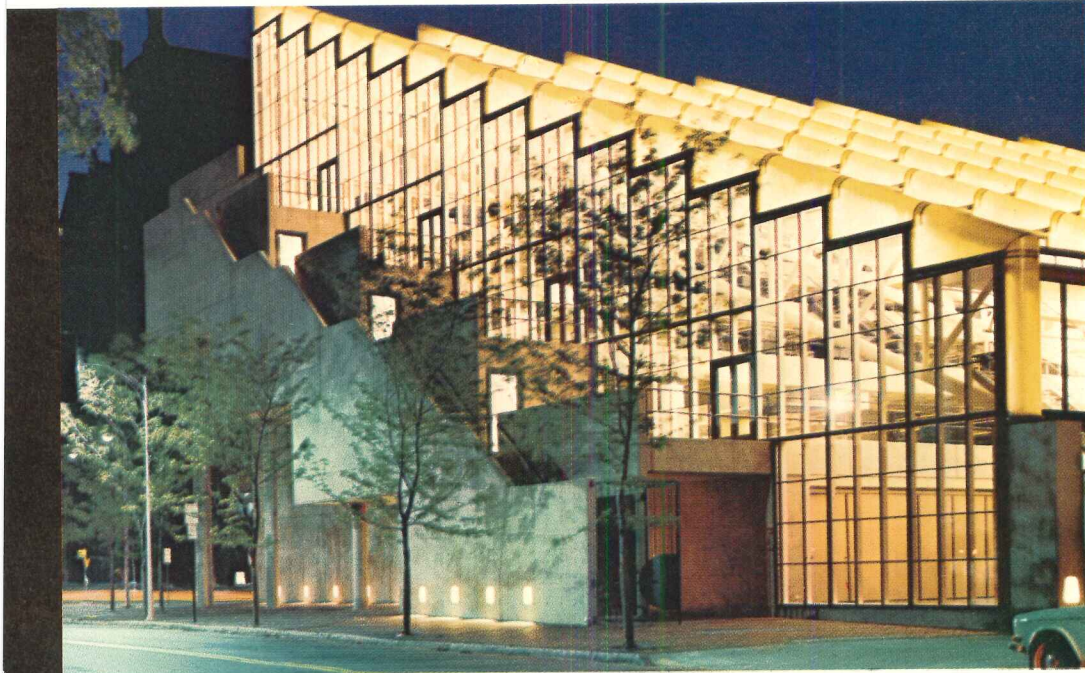

Gund Hall Graduate School of Design, Harvard University, Cambridge, Mass.  
Architects: John Andrews, Edward R. Baldwin and John Simpson, Toronto.  
Structural Engineers: Le Messurier Associates, Boston.  
Tectum Contractor: Bay State Structural Specialties, Boston.

Texture is the thing about Tectum, but not the only thing.

There's no end to the ways you can be constructive with Tectum Roof Deck. Look at the way it was used in Gund Hall, shown at left. As a structural material, Tectum gives the roof a thin, efficient section, and demonstrates impressive insulating values as well. In the two-inch thickness, resistance to heat transmission is 3.50. With its Noise Reduction Coefficient in the .50-.60 range, it soaks up sound. And with its rugged finish, Tectum looks good exposed.

The reason Tectum is so constructive is because of the way it's put together. An exclusive inorganic binder bonds long wood fibers into a compact sheet under heat and pressure. Like wood, it's easy to cut, shape and install. Unlike wood, it's rated noncombustible and Tectum has been given an uplift rating of Class 90.

## Long Span Tectum Roof Deck

Tectum is also available in Long Span

Tectum. This adaptation allows even greater areas of the exposed Tectum surface to remain unbroken by purlins. Tongue and groove edge of Long Span Tectum is designed for galvanized 16-gauge steel channels. These channels permit spans of up to 6' for 3", 5' for 2½", and 4' for 2" thick Long Span Tectum.

Like other Tectum Roof Deck, Long Span Tectum has factory-applied asphalt felt membrane, and is applicable to flat or pitched roofs with steel, wood or concrete framing.

So, for a good-looking way to cut roofing costs, why not cut down on the number of materials you use? With Tectum, or Long Span Tectum.

For more information, write Gold Bond Building Products, Division of National Gypsum Company, Dept. AR-103T, Buffalo, New York 14225.

TRANSLUCENT  
FIBERGLASS  
ENCLOSURE  
(SKYLIGHT)

TOP CHORD  
OF TRUSS  
12" DIAMETER  
PIPE 24' 0" O.C.









# terr a z z o



## *the excitement of texture.*

Add excitement outdoors to building entries, plazas, terraces, swimming pools. Beautify downtown sidewalks, malls, public transportation areas and platforms. Attractively. Safely. All with Rustic Terrazzo—the carefree enhancer. □ Add adventurous accents on any and all surfaces, horizontal and vertical. With subtle blends of texture and color, or striking contrasts. Combinations of materials and color as infinite as your imagination. Outdoors—and indoors—Rustic Terrazzo adds more than beauty. Its attractive texture means surefooted safety for sure, everywhere it's used underfoot. □ If it's been a long time since you talked to a terrazzo contractor, you may have been missing a lot. The ancient art has been changing, and there's more to terrazzo today as a design material than meets the eye. Circle the number for a copy of our colorful brochure. For technical assistance, or a copy of new Terrazzo Design Data, containing 125 true-color terrazzo reproductions, contact Derrick Hardy, Executive Secretary, Terrazzo, 716 Church Street, Alexandria, Virginia 22314. (703) 836-6765.



# Bring your ideas to light

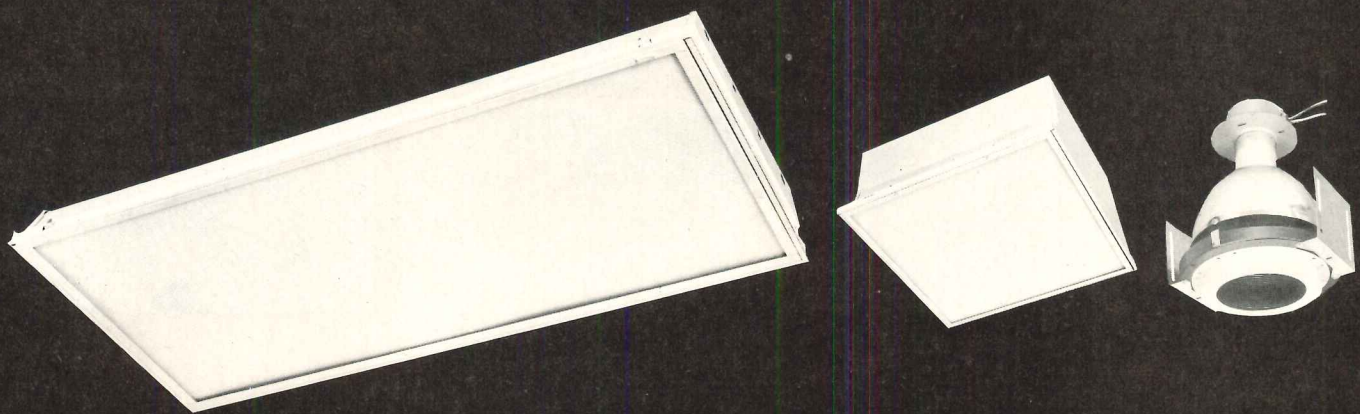

from plain...

Run the spectrum of your ideas.

Then bring them all to light from one source.

When the plans call for lighting fixtures, call on Litecraft. With incandescent, fluorescent and H.I.D. fixtures in every popular shape, finish and type . . . from stylish surface-mounted models to functional recessed styles.

For your grand design, Luminous Ceilings offers that extra plus in design assistance. And we offer the means to make it all work . . . from basic design panels to decorative ceilings to dazzling total environmental ceiling systems.

Litecraft. Luminous Ceilings. Two names to remember. One source to rely on.

From idea . . . to reality.

Litecraft/Luminous Ceilings Company, P.O. Box 22601, Tampa, Florida 33622





to fancy

 **Litecraft**

 **Luminous  
Ceilings**

Bringing your ideas to light

a **JIM**  **Walter** company

*For more data, circle 32 on inquiry card*









## PPG's Total Vision System™ in the new AIA Headquarters gives you an unobstructed view of 1799.

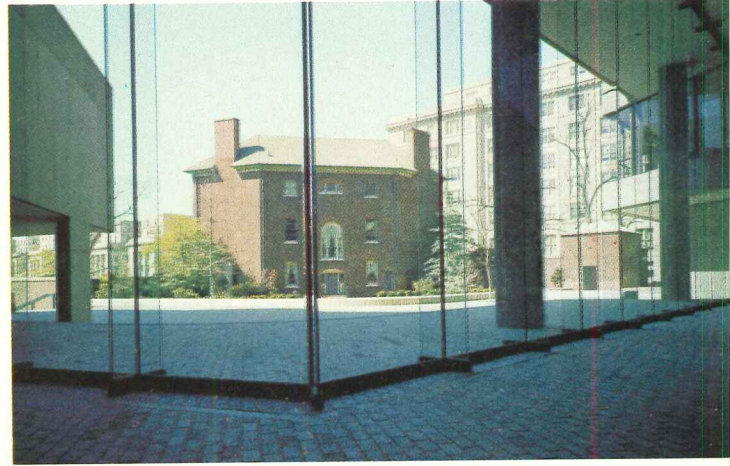

The new AIA Headquarters Building shares the site of its historical counterpart, The Octagon House, to make a contrasting but complementing architectural statement.

Focal point of the new structure: a two-story Total Vision System by PPG in the center of the plan.

This totally transparent section integrates reception area, a grand staircase, and second-floor social gallery without seeming like an enclosure.

It also unites indoors and outdoors. The brick-paved lobby suddenly becomes the brick-paved terrace and Octagon House garden—creating a magnificent open feeling.

With no obtrusive metal.

You see, the major supporting elements in a Total Vision System are  $\frac{3}{4}$ -inch clear annealed float glass mullions. Unobtrusive aluminum sections frame the system at head, jambs, and sill. When installed, these sections, along with the black structural adhesive, seem to disappear.

Total Vision Systems are available as a single-source construction package from PPG. Complete information on glass recommendations, installation techniques, glazing details, test results, and other data is contained in the TVS™ Data Folder. Contact your PPG Architectural Representative or write PPG Industries, Inc., Technical Services Department, One Gateway Center, Pittsburgh, Pa. 15222.

**PPG: a Concern for the Future**

Owner: The American Institute of Architects  
Architect: The Architects Collaborative, Cambridge, Mass.





PACIFIC OCEAN

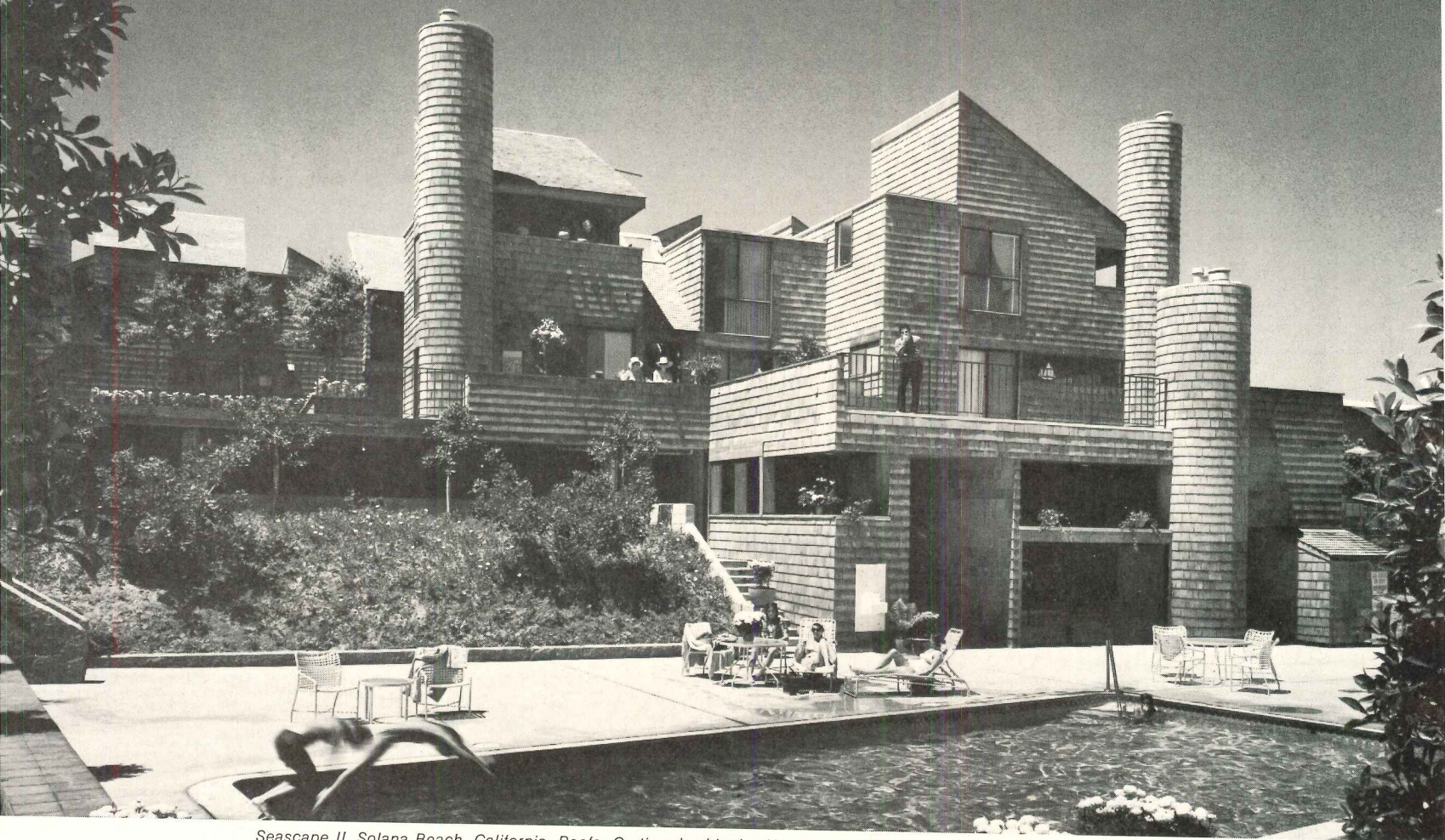
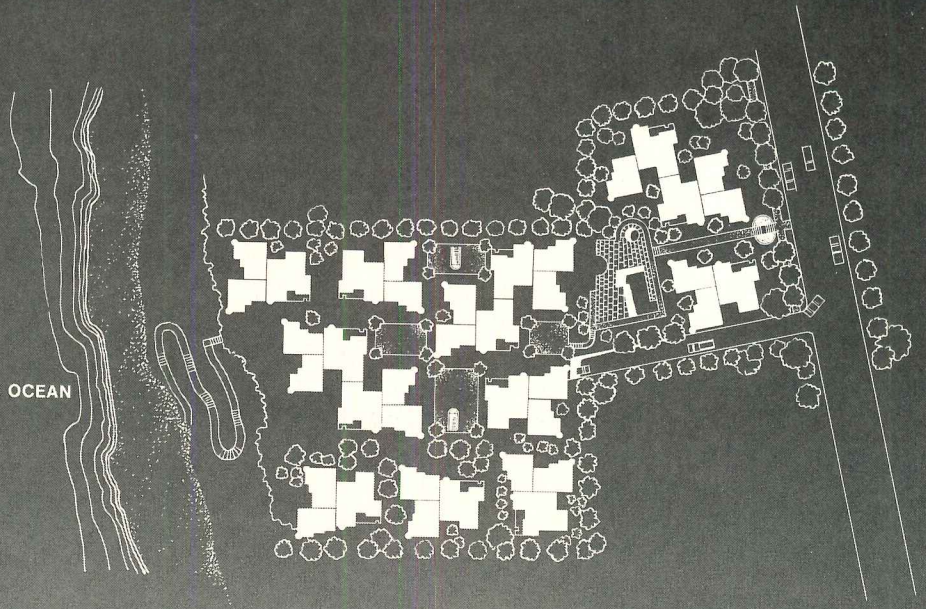

*Seascape II, Solana Beach, California. Roofs: Certigrade shingles No. 1 Grade, 24" Royals. Walls: Certigrade shingles No. 1 Grade, 16" Fivex. Architects: Oxley & Landau.*

## At a California condominium, beauty takes many forms.

Circular, angular and rectilinear forms create a sculptured look for this fifty-unit seaside condominium near San Diego.

Richly textured red cedar shingles give natural expression to the novel design. They establish a single identity for the community of diverse structures and shapes.

Their quality appeals to residents and to local planners as well.

Equally important, red cedar shingles are durable. They weather beautifully, even in harsh marine air. Their look of warmth and elegance lasts for decades with virtually no upkeep.

And they'll withstand hurricane winds.

For details and our specification guide on Certigrade shingles and Certi-Split handsplit shakes, write us at 5510 White Building, Seattle, Washington 98101. In Canada, write 1055 West Hastings St., Vancouver 1, B.C.



**Red Cedar Shingle & Handsplit Shake Bureau**

One of a series presented by members of the American Wood Council.

For more data, circle 34 on inquiry card



# TEST PROVES: NO NYLON FIBER HIDES SOIL BETTER THAN ENKALURE II.

The truth is out about soil-hiding nylon commercial carpet fiber.

Enkalure® II is as good as the best.

It's been tested and proven by the independent testing laboratory, Nationwide Consumer Testing Institute. They placed carpets made of the leading nylon fibers in one of the most heavily traffic'd airports in the country.

And when the results came in, Enkalure II's soil-hiding ability proved to be every bit as good as the best-known soil-hiding nylon.

The reason is that, unlike conventional nylon fibers, Enkalure II bulked continuous filament nylon and staple fiber have no deep grooves to trap and hold dirt. Also, its special construction causes light actually

to bounce off the fiber in every direction. So the color looks clean, even when the carpet is dirty.

Anyone installing Enkalure II has our guarantee that it will not wear more than an average of 10% in five years, or we'll replace it.

If you have the kind of floor that takes a lot of traffic as well as a lot of dirt, you would do very well to put down carpeting made of Enkalure II soil-hiding nylon.

In fact, now we know you can't do any better.

For specific carpet information and a 14-page report of the test results, contact American Enka

530 5th Avenue, N.Y., N.Y.  
10036. (212) 661-6600.

**ENKALURE II.  
THE OTHER LEADING  
SOIL-HIDING NYLON.  
ENKA**

*For more data, circle 35 on inquiry card*

ENKALURE® II IS A REG. T. M. FOR SOIL-HIDING, MULTIGLOBAL NYLON FIBER MANUFACTURED BY AMERICAN ENKA CO., ENKA, N.C., A PART OF ALZONIA INC. ENKALURE II IS LICENSED FOR USE IN CARPET MANUFACTURED ACCORDING TO QUALITY SPECIFICATIONS SET BY ENKA











**SHADOWFORM<sup>®</sup> By KAWNEER** **AMAX**

The Shell Canada Limited Oakville Research Center, winner of the Massey Medal for outstanding achievement in architecture, features the Kawneer Aluminum Hardcolor Finished Facing—SHADOWFORM.

Architects & Engineers: Shore & Moffat and Partners

For more data, circle 36 on inquiry card



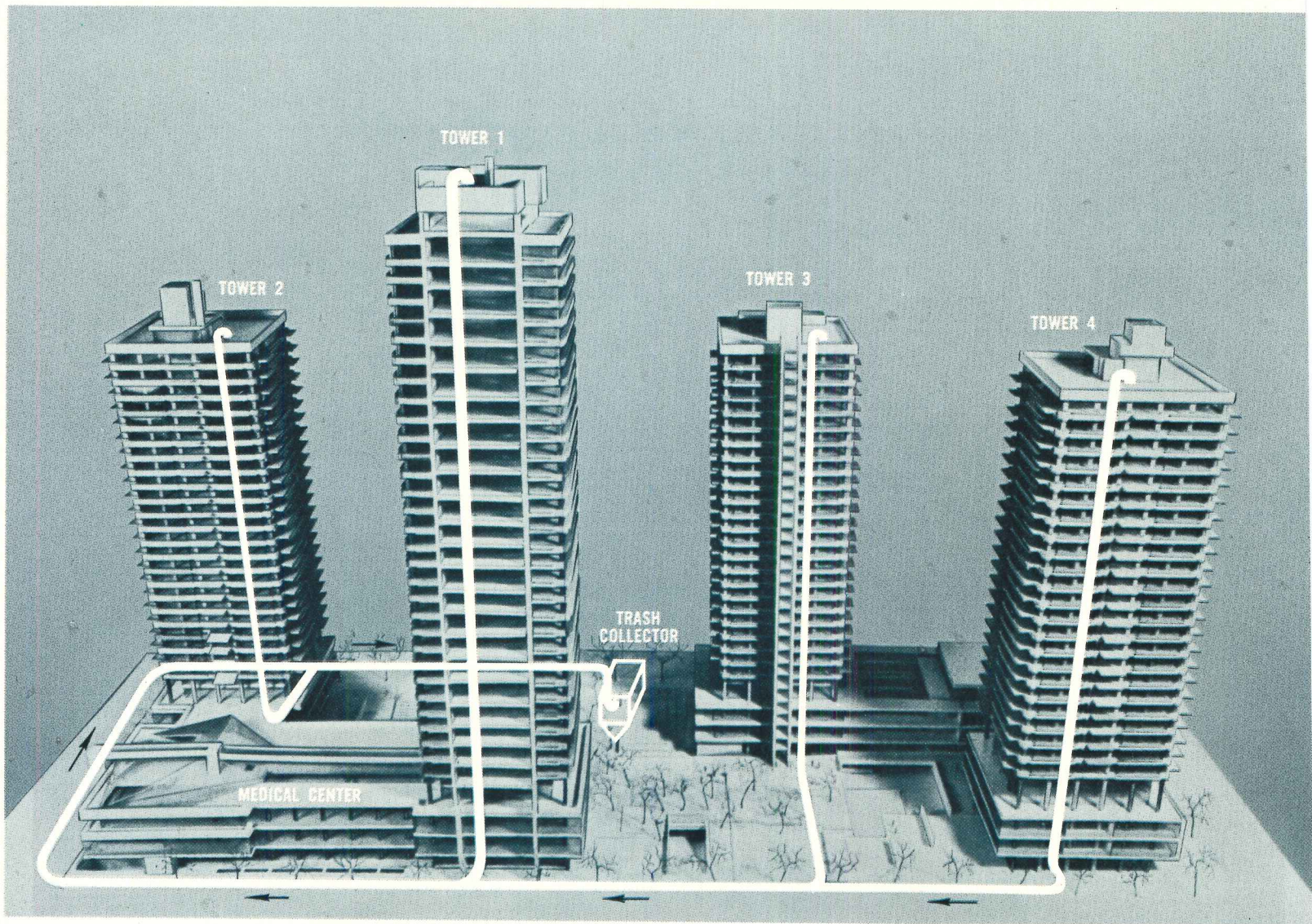

## This is how one pressure group operates to keep Harlem clean.

The pressure we're talking about is the negative pressure exerted by the vacuum principle of ECI's Air-Flyte pneumatic waste disposal conveying system.

It was the kind of pressure the East Harlem Tennant Council and their architects, Silverman & Cika needed to protect the environment of their highrise project.

They wanted to make sure that the garbage cans, the odors and most importantly the vermin and the rodents that can ruin a project of this size, were completely eliminated.

Four towers housing 656 families, a day care center, a job training facility, children's playhouses, an amphitheater and stores can produce a lot of trash.

The initial estimate was 7,500 pounds a day. The planners turned to an ECI Air-Flyte pneumatic conveying system using a negative pressure vacuum system to remove it, cleanly and effectively.

The system consists of conventional gravity trash chutes, specially designed sizing and receiving hoppers, an ECI Air-Flyte pneumatic conveying system and a waste holding area, containing two large compactors with 35 yard roll-off containers.

Waste is placed in the gravity trash chutes, or directly into receiving hoppers in the commercial and service areas.

The system automatically sizes and transports the waste to the central collection system via the Air-Flyte conveying system. The Air-Flyte system uses a negative pressure vacuum principle to

carry the waste at a mile-a-minute, in any direction, up, down, diagonally, around corners—over any required distance.

Once the waste is placed in a trash chute or hopper it's never touched again. Because the system is completely enclosed, odors, vermin and rodents are eliminated.

The Air-Flyte system works efficiently to keep the environment clean, in Harlem or anywhere else. Ask your ECI representative for the whole story on Air-Flyte trash collection systems.



**ECI Air-Flyte Corp.**

Subsidiary of Eastern Cyclone Industries, Inc.  
15 Daniel Road • Fairfield, N. J. 07006

Regional Sales Offices:  
BOSTON • CHICAGO • LOS ANGELES  
ATLANTA • DALLAS

For more data, circle 37 on inquiry card



A man with a prosthetic left arm is working at a drafting table. He is wearing a patterned shirt and a dark tie. He is looking intently at a set of blueprints on the table. His prosthetic arm is a dark, metallic, segmented limb. The drafting table is illuminated by a desk lamp, and various drafting tools like a ruler and a compass are visible on the table. The background is dark, suggesting an office or workshop environment.

## Thinking elevators? Escalators? Look around.

Don't stop at the first or second name you think of. Think of Armor.

We've been in vertical transportation more than 40 years. And right now we're growing faster than ever.

Especially in high-rise construction. With super-fast, super-smooth elevator systems. Sophisticated controls. Plus the sleekest new escalators around. And in low and medium rise buildings calling for tough, dependable geared or hydraulic elevators.

Armor covers them all. And delivers important bonuses too. Like eager, comprehensive design help from pit to penthouse. The finest engineering in the field. Contract maintenance programs tailored precisely to building needs. And more.

When you think of vertical transportation, think beyond the ordinary. Think Armor.

Armor Elevator Company, Inc., Louisville, Ky. 40214.  
Armor Elevator Canada Limited, Pickering, Ontario.

**Armor**

A Subsidiary of **ASmith** Corporation



# INTRODUCING THE ONE-WORD UNDERLAY SPEC: OMALON.

There's a simpler way to write a carpet underlay spec than writing a manual.

Simply say Omalon.

Omalon Patented Process\* Carpet Foundation.

It's a spec in itself. A new standard. Here's why:

First off, Omalon reduces noise levels dramatically. It set a new standard in recent independent laboratory tests.

Omalon resists odor, moisture, mildew, vermin and alkali.

It can be installed everywhere cushion can't be. Above grade. On grade. Below grade.

Or on any kind of floor. Wood. Tile. Cement. You name it. It's lightweight. Easy to handle. Cuts easily. Seams perfectly. Lays flat.

So now you don't have to resort to specifying "no-pad" installations because ordinary underlay won't perform.

Why?

That's simple, too.

Because Omalon isn't ordinary underlay.

Omalon is carpet foundation.

The only Patented Process\* Carpet Foundation. Which is why Omalon provides you with such superiority.

There's a complete line of four Omalon Contract Carpet Foundation systems.

The latest is Omalon System C-4. C-4 is the ultimate contract pad where firmness and luxury are paramount.

And of course, Omalon meets

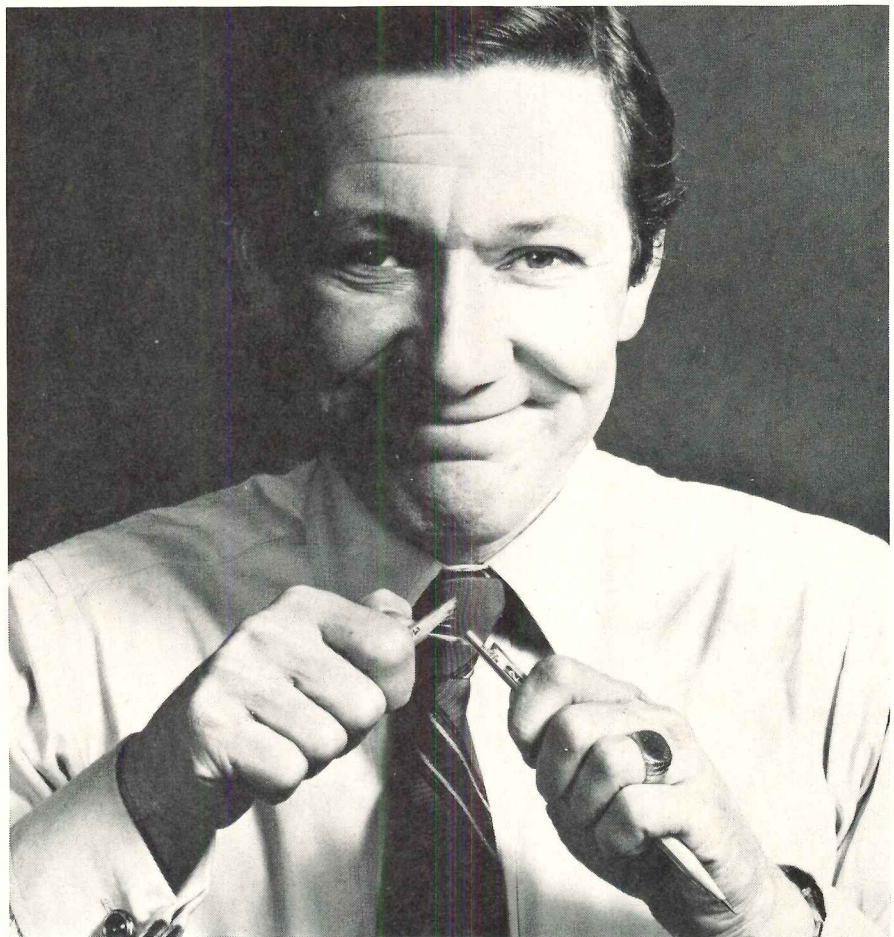

all technical standards presently in use by the floor covering industry such as the Pill Test (DOC FF 1-70) and Hill-Burton requirements measured by the Steiner Tunnel Test (ASTM E-84) and has received its own Materials Release, F.H.A. MR 681-a.

In short, there isn't any kind

of installation which Omalon can't satisfy completely.

For full information and specs on Omalon Contract Carpet Foundation, see Sweet's Architectural and Interior Design files, or write Olin Corporation, Consumer Products, Dept. AR-10, 120 Long Ridge Road, Stamford, Conn. 06904. Or call 203-356-2450.

**omalon**<sup>®</sup>  
PATENTED PROCESS CARPET FOUNDATION  
BY **olin**



Omalon is a registered trademark of Olin Corporation. \*Produced under patented process, Olin U.S. Patent No. 3506600.

For more data, circle 39 on inquiry card



## Let's make sense of FHA fees and processing

"Many of the best architects in the country will not design FHA-insured and subsidized multi-family projects either because they feel that the maximum FHA fees are too low or because of the difficulties involved in working through detailed governmental design reviews."

This statement appears in Volume III of a voluminous report to the Housing and Urban Development Department prepared by a task force of the National Center for Housing Management, Inc. For six months this task force directed its attention to improving the operation of Federally insured or financed housing programs, and now has fed its recommendations into a growing number being laid before HUD as the Department decides what to do about restructuring housing programs.

Lewis Davis, partner of Davis, Brody & Associates, New York, served as a member of the Advisory Council.

The report concluded that if HUD is going to produce well designed and architecturally sound projects, it must be willing to work with architects in a fashion that more closely approximates practice in the conventional sector.

Separate volumes of the NCHM report treat single-family housing and public housing. The main thrusts of the documents run to recommendations on processing requirements to expedite construction and improve quality—in short, once more, untangling red tape.

The NCHM is a non-governmental institution established in April of last year to provide objective and independent leadership in housing management and training.

### The NCHM report favors fees based on per-unit cost

The Center recommends that HUD base its architectural fees for multifamily housing on per-unit cost, possibly including it in the builder-sponsor profit and risk allowance. The present method is based on per cent of cost and on a sliding scale.

Each regional office of HUD, the Center believes, should establish standard per-unit architectural fees based on comparable conventionally financed projects in the area. Under a per-unit fee that would taper off with increases in the number of units in the project, the architect would (which makes sense) receive the same benefit from designing a minimum-cost compared to a higher-budget building.

The report also favors mandatory use of the so-called San Francisco plan, under which known, reliable and experienced architects would be able to forego HUD architectural re-

views at the pre-construction period. It advocates giving private designers the option of seeking a pre-construction review of specific design issues with an architectural board established within each regional office.

On this point the document adds:

"At the time of cost certification, architects would certify that the project was designed to meet the objectives of FHA's Minimum Property Standards. If it were determined that these standards had not been met, Housing Ownership Management Entities (HOMEs—i.e. turnkey consortia per se) should not be refused permanent Federal financing. In most cases, HUD should instead not allow the architect at fault to participate in any future HUD housing programs."

### Another recommendation: fewer inspections during construction

HUD now requires that sponsors hire independent construction inspectors, whose work is then reviewed by FHA architects. "Inspectors inspecting inspectors is obviously time-consuming and to no apparent purpose," the NCHM report commented. "Since the design architects have an interest in ensuring that their design is being carried out faithfully, they should be permitted to contract for their own inspection services and include them as a part of their fee negotiated with the HOME. HUD, on the other hand, should certify independent inspecting architects (or require the use of in-house HUD architects for that purpose) to protect the project from a construction quality standpoint."

HUD also was advised to allow participation by identity-of-interest (i.e., equity-holding) architects. Such a relation between a HOME or builder and an architect may be of value, the report held, because of the necessity to fit architectural design closely to construction possibilities and minimum property standards. HUD was told it should accept these relationships openly and assume that they will exist in regard to many projects.

Despite the many recent attacks on the Department, the Center feels that in general the quality of FHA-insured multifamily housing is superior to the quality of most comparably priced, conventionally financed housing. Troublesome as Minimum Property Standards may be to work with, and difficult as the inspection and cost certification rules of FHA are, the end result is that the tenant generally obtains a better product, the report says.

Recognizing that many communities have

their own local property standards differing from the national agency's, and because it generally favors turning more authority for program operation over to state and local bodies, the task force considered recommending a waiver of Federal standards in those particular areas. It did not do so, however, on grounds 1) that the one uniform standard guarantees a consistent nationwide quality standard, and 2) that relying on a single standard opens more options for simplifying processing and accelerating FHA application and review.

### Mobile home makers support safety standards

The Mobile Home Manufacturers Association has supported, almost wholly, new legislation aimed at some level of Federal supervision over the safety of these residential units.

Criticism of an alleged lack of safety features in mobile homes has been mounting with the recent tornado and flood disasters resulting in what some consider to be excessive damage to this type of shelter. A Senate housing and urban affairs subcommittee has held hearings on three bills in this area.

Testifying for MHMA, the Trailer Coach Association, Anaheim, California, and the Southeastern Manufactured Housing Institute, Atlanta, Georgia, John M. Martin, MHMA president, said that the organizations would not propose Federal control but that if Federal regulation is to be mandated by Congress, they feel minimal requirements should be included. The several mobile home safety measures so far introduced have made no "particularly compelling case establishing the need for Federal mobile home safety standards," he said.

From the viewpoint of the associations, a valid part of the proposed law is that calling for reciprocity among the states for mobiles and an inspection uniformity far beyond that so far developed through state legislation. (Presently 36 states have adopted ANSI mobile home standard A 119.1)

While S. 1348, one of the bills under consideration, would apply to "single wides" only, Martin proposed a broader definition which he said would effectively separate the mobile home industry from the recreational vehicle producers, yet clearly define mobiles. His proposal: "'Mobile Home' means a structure, transportable in one or more sections, which exceeds eight body feet in width, equipped with running gear, and designed to be used as a dwelling when connected to the required utilities."

—Ernest Mickel





Phipps Plaza Shopping Mall, Atlanta

## This floor has been stomped, trampled, wheeled over and ice-creamed on for 5 years. But it wears and looks like it's only been tip-toed on.

You know what a shopping mall is like. Thousands of people and kids running, kicking, dropping and dragging things.

And all the poor floor has to look forward to is more and more of the same.

That's why a floor like this should have a floor covering like our Powerbond Pile Vinyl. Just as you see pictured above, Powerbond stands up to abuse. Without scuffing, unraveling, pitting or rippling.

Powerbond is the best possible fused combination of hard and soft surface floor covering. It's soft, yet it has vinyl's durability. Not only for shopping mall floors, but for school, hospital, office building and department store floors. Anywhere you need the permanence of vinyl.

Powerbond has other things going for it besides longevity: color, warmth, comfort, texture, insulation, sound-absorbency. And class. Yet Powerbond Pile

Vinyl is many times stronger than rubber and other backings.

And unlike hard-surface vinyl, maintenance costs are low. No waxing, no stripping ever. The pile is so dense that most soils can just be vacuumed or sponged off.

But perhaps the real power behind our Powerbond is our guarantee.

We guarantee against excessive surface wear (more than 15% reduction in weight of pile surface) for 7 years. Or we'll replace the affected area.

So if you have floors that need what Powerbond can give them, call (212) 371-4455 or write Dept. AR-10, Collins & Aikman Commercial Floor Systems, 919 Third Avenue, New York, N.Y. 10022.

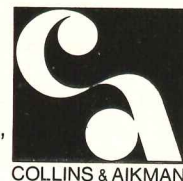

## Collins & Aikman makes the Powerbond® Pile Vinyl that makes things happen.



## A/E-CM relations: approaching a modus vivendi?

*Bradford Perkins of McKee-Berger-Mansueto, Inc., whose popular series on professional firm management was written last year in his role as vice-president of the D'Orsey Hurst division of MBM, now turns his attention to some of the sensitive and controversial areas of architect-construction management relations including contracts, liability, fees and the architect/engineer selection process.*

From the beginning of the growth of construction management as an accepted and desired professional service, a persistent question has been "How does the CM role affect the architect/engineer?" The urgency of this question varies considerably from project to project and from group to group within a project, but in spite of the growing industry experience it remains one of the more troublesome aspects of this rapidly expanding service.

As construction managers, MBM is currently working in virtually every one of the several possible organizational relationships with architect/engineers (separate-but-equal, partner, consultant-to, and extension-of-owner-staff). It has been possible for us to analyze the impact of CM in the major areas of A/E concern: contracts, liability, relations with the owner, fees and A/E selection.

If the architect/engineer is using one of the standard AIA owner-architect agreements, there is very little contractual overlap with the typical CM agreement. In fact, one of the major reasons for the current popularity of CM is the impression (ignoring whether or not it is a justified impression) that the typical agreement of architect with owner omits some of the services most desired by owners. Detailed cost estimates and analyses, detailed scheduling, full-time on-site management (or even representation), coordination of multiple prime contracts, and other key services are either ex-

cluded from consideration by such architect-owner contracts altogether or separated for marginal attention by identifying them as "extra services."

In fact, the better CM agreements—such as the standard GSA contract—supplement rather than overlap or confuse the typical architect/engineer role. This can be seen by a brief review of the major elements of the CM agreement:

- 1) *Cost management*—estimates, cost analysis, special value-engineering studies, etc.
- 2) *Scheduling*—usually by CPM for pre- and post-construction phases as well as construction phase.
- 3) *Design review*—to identify potential construction and/or coordination problems.
- 4) *Bid packaging*.
- 5) *On-site management*—to provide supervision, inspection, administration.

While some of the above services clearly reinforce or support the usual A/E functions, there is no dilution of, or basis for reducing the scope of any of the basic A/E contract services. In most cases, the architect/engineer is supposed to prepare his own "statement of probable construction cost." This serves as a check on the CM's estimates and vice versa. The A/E still must assure that the construction product accords with the design; he still must interpret the contract documents; review shop drawings, etc.; and the A/E still acts as the owner's agent in all matters relating to the quality of design. In practice, the areas of confusion or overlap between A/E and CM services are limited to certain aspects of contract administration. But these are the same types of overlap that occur when the owner provides an on-site representative, or imposes an established program of administrative procedures—and even here the overlap usually works to the benefit of the A/E.

Indeed, some CMs have been complaining that a lot of time-consuming administrative services otherwise provided by the A/E (though not necessarily spelled out in his agreement) are being shifted to the CM. These relate primarily to document flow and include final checking and coordination of the documents; preliminary processing of shop drawings; preparation of bid packages and bidding documentation; on-site communications and change order analysis and processing. In addition, responsibilities for field engineering and continued on-site inspection are being assigned to the CM. Many of these tasks must be performed by the firm most involved at the job-site or in the bidding process whether or not it is clearly part of that firm's contract. In most cases, this snow means the CM is taking the primary responsibility.

One point that should be remembered here is that the notion of "basic services" is a surrender of clarity to convenience. There is no such thing as a typical job, and the service definitions in standard contracts—good as those contracts may otherwise be—are a lazy man's approach. Every job has different requirements and every combination of owner, A/E and CM has different capabilities. Therefore, for a successful contractual relationship, the project professionals should work out a clear definition of each group's function and responsibility in as much detail as possible before the contracts are executed. Standard agreements make good boiler plate, but a clear service definition makes up the boiler's working parts.

### There should be no overlap in professional liability

Because of the minimal overlap with the typical contractual definition of the A/E's role, there should be little change or overlap in liability on most projects. This can be illustrated

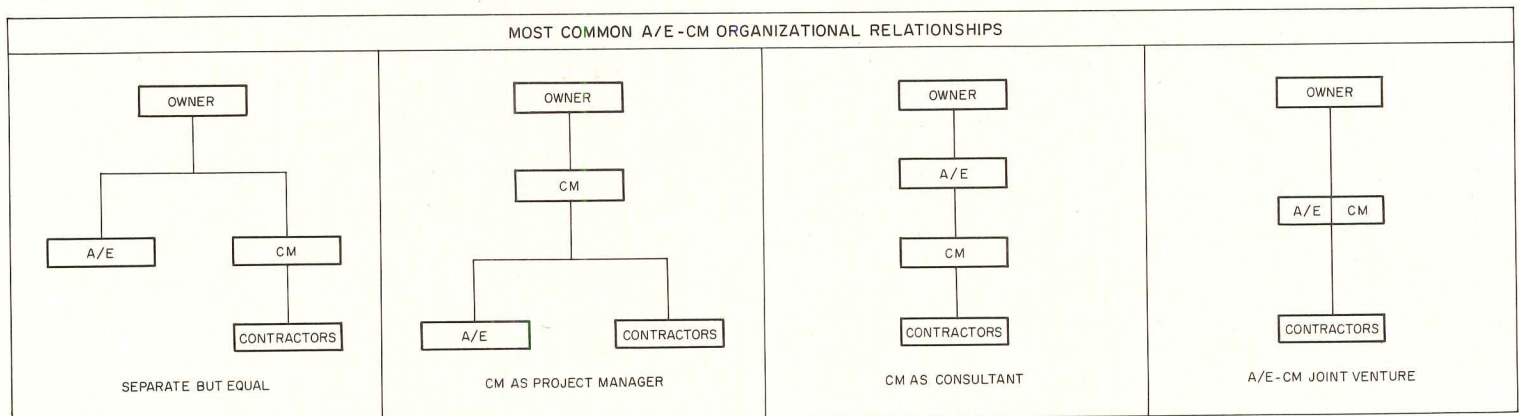



by the standard liability language used in many of our contracts.

A. The services which shall be performed by MBM pursuant to the provisions of this Agreement shall not constitute MBM an architect, engineer or contractor nor impose upon MBM any obligation to assume, render to, or perform on behalf of the client any responsibilities, duties, services or activities which would otherwise be assumed or rendered by any architect, engineer or contractor employed on the Project except for the provisions of this Agreement, nor impose upon MBM any liability with respect thereto.

B. Nothing contained herein shall be construed to impose upon MBM any liability with respect to the performance of the services referred to in the section on "Inspection," and the responsibility and liability for performing the construction work for the Project in accordance with the contract documents and assuring and certifying such performance shall continue to be solely that of the contractor, architect or engineer performing such services or doing such work in accordance with the contract documents to which such services or work relate.

What this means is that the A/E is still the A/E, the contractors are still the contractors, and the CM does not pre-empt any of their classic responsibilities nor assume any of their normal liabilities. This clause should not be thought to imply that the CM has no defined responsibility or liability exposure. He does, of course, but these are limited to his own services, as spelled out in his own contract.

On some jobs—in particular those where the service responsibilities of the CM, A/E and other team members overlap or are poorly defined—the liability issue will probably become troublesome. The practice of CM is quite new and thus there is too little experience and virtually no case law to permit analysis of the full potential of this problem.

It should be remembered, of course, that the root causes of many of the disputes and claims plaguing the design professions are inadequate management controls regarding project costs, schedule and contract administration. This dispute may be based legally on some supposed specific lapse in contract performance, but all too often the real cause is an owner's dissatisfaction with the over-all management of the project, with its failure to achieve its time/cost goals. Since CM is aimed at reducing this dissatisfaction it may end up helping reduce the liability problems of the entire construction industry.

#### **The CM presence should improve A/E relationship with the owner**

Contract obligations and liability limitations do not in themselves define an owner-designer relationship. There remain the concerns of mutual respect and the regard of both parties for both design freedom and fiscal responsibility. These provide the sinews and substance of a good working partnership. The emergence of the CM has had a significant impact on the A/E's relationship with the owner in several ways—some positive and, unfortunately, some negative.

The negative aspects have resulted largely from the elements of the CM service which often force him into hard review of A/E decisions in his role as cost manager and problem

spotter. This is true even where the CM is a subsidiary of an A/E firm. Tactful staff and A/E-CM cooperation can minimize this problem, but it cannot eliminate it. Owners expect the CM to "ride herd" on costs and other construction issues. Few design professionals enjoy being second-guessed or guided by the CM, and conflict can easily arise.

Some conflict can be healthy, of course, and the independent perspective of the construction manager is at the core of the CM service. This is one of the major arguments advanced by proponents of separation between A/E and CM service firms.

Over-all, however, the net impact of CM services on the A/E-owner relationship has probably been positive. Good CM services have tended to mitigate some of the problems that strain communications understanding. By reducing the A/E's involvement in functions which many design professionals do not want to perform, the CM concept may eventually create a more effective and happier A/E-client relationship. The price, however, is a redefinition of the A/E's role as the "prime project professional," for now he has a partner who will probably have equal influence with the owner; albeit in the harsher world of cost and schedule where the A/E may welcome such a partner. Fair payment for extra design work will usually get swifter approval from a school board, for example, if the CM can attest to its reasonableness and advise as to the norms of the profession in such matters.

#### **What to think about in discussions of fees**

All of the above points serve as a preamble to an area of primary concern to both the A/E and owner—the impact of CM service on the A/E's fee. Since all professional fees should be related to the extent, quality and cost of providing them, obviously their evaluation can be found only in an analysis of the services that must be provided. There are other considerations as well, however, and every A/E should note them before he agrees to a fee for a project which will employ a CM.

1) While many of the CM's services should make the A/E's life easier, this help usually occurs in areas of effort which the A/E should have been (but typically has not been) receiving additional compensation in the past.

2) Typical of such an area are services related to contract administration, paper flow and management information. On the one hand, the A/E may be able to reduce his responsibility for the basic paper flow; on the other hand, he will be required to play his role in the increased tempo of management controls which a CM generally employs. The additional reporting and information required from the A/E for such efforts as design phase CPM schedules can have major benefits but they also have associated costs.

3) Yet, if the CM is a good manager and/or if the project is phased or otherwise accelerated, there are major cost savings for the A/E. Among the major causes of the low profits frequently associated with A/E practice are the stops and starts, delays, redesigns and other problems that frustrate or extend the A/E's effort. On many projects in our experience, the

A/E effort has been unusually profitable because owner decisions have been expedited, the owner-review delays have been minimized, and the design phase duration, relieved of endless alternates, is compressed to a minimum. The result is a situation where the A/E professionals can budget their efforts and keep within the budget.

4) Beware of the guaranteed maximum price contract. This is not construction management, for as soon as the GMP goes on the "CM" becomes a general contractor—not an owner's agent. When this happens, the A/E can no longer assume that he has a partner to share or reduce his workload.

5) Of course, the A/E should always try to avoid accepting a fee based on a percentage of the actual construction costs. In such cases, the CM, by attempting to reduce project costs, will by working indirectly to reduce the A/E's fee. This can lead to a strained relationship between the two, even though most A/E firms have had to face that conflict of interest by themselves in the past.

Considering all of the above factors, most A/E's and owners should assume that the presence of a CM furnishes no reason in itself, for an increase or decrease in A/E fees. Fees for "basic" A/E services should apply even if the engagement of a CM is not contemplated until after the A/E-owner agreement is signed. This is a matter we are always questioned about and our answer is consistent: The CM may save the A/E some administrative costs, but these savings should be reserved for application to the demands of a more vigorously managed and tightly controlled project with consequent profit to the owner in terms of over-all cost.

#### **A/E selection and the future**

To date, the CM has rarely been called on for advice in the selection of the A/E because the CM is often selected at the same time as or after the A/E. This is subject to change, however, as owners are more often engaging architects, construction managers and other consultants for feasibility studies, programming and other pre-design work in more and more areas of owner concern.

One has to remember that the rapid rise in the use of separated services called construction management can be viewed as a symptom of "consumer revolution." GSA and other owners—rather than construction industry producers—have taken the lead in the development and definition of CM because they needed more effective means of delivery of large, complex projects than had been available through public bidding of single contracts for each project.

Construction management, however, is only one part of the response to this demand for improved project delivery. A still vaguely defined idea now emerging is one of total project management—the concept of a single, unified project venture with all of the required capabilities working toward a common set of objectives. Leadership of that future venture is probably one of the greatest challenges facing both the A/E and CM today.

—Bradford Perkins



# RENAISSANCE™

## The new, antique look in paneling.

Introducing Renaissance™ hardwood plywood wall paneling from Georgia-Pacific. It comes in six warm shades of real hardwood face veneer, each flecked and shadowed. With a finish that looks handrubbed. Renaissance paneling. A new old-fashioned look, at old-fashioned prices.

Renaissance comes in 4' x 8' x 1/4" panels. And it's available with a Class III flame spread rating. For more information, just contact your G-P representative.

**Georgia-Pacific**

The Growth Company

Portland, Oregon 97204

For more data, circle 41 on inquiry card







# Waterproof coatings based on Pliolite get people across new bridges faster.

Unlike most waterproofing paints, high-build coatings based on Goodyear Pliolite® resin don't delay bridge construction because they can be applied to damp or dry masonry surfaces in almost any kind of weather.

In fact, when applied to green concrete, they act as curing agents—allowing the concrete to cure to its full structural strength.

And coatings based on Pliolite seal concrete so effectively that water can't penetrate. So it can't freeze and expand, causing cracking and spalling.

In addition, high-build surfacing materials based on Pliolite cover minor surface imperfections, eliminating costly hand finishing. And they meet the specifications of Mississippi State Special Provision No. 9078046.

So if your job is to waterproof and protect masonry surfaces, either interior or exterior, high-build coatings based on Pliolite resin can help you do it better. For more information, and a list of manufacturers, write Bill Smith at Goodyear Chemicals, Dept. 7142, Box 9115, Akron, Ohio 44305.

**GOODYEAR**  
CHEMICALS



**Costs resume steep climb as materials and labor both gain**

Construction costs across the nation rose an average of 12.5 per cent for the year ending September 30, 1973. On a comparative basis, the cost of construction labor and materials for the year ending September 30, 1972 increased 5.9 per cent.

A contributing factor in the 12-month climb was an average of 15.8 per cent rise in the building materials cost and the supporting factor of moderating rise in wage rates—7.5 per cent for building trades craftsmen. In comparison, a year ago, the period ending October 1972, showed a 6.9 per cent hike in craftsmen's wages.

Cost gains over the 12-month period were generally highest in the Pacific Coast 13.1 per cent, while the Metropolitan New York/New Jersey region (usually the leader in cost increases) experienced a gain of 12.4 per cent. This was even below the average increase for the Eastern U.S. which was 12.6 per cent. Another interesting factor worth watching is the large gains experienced in the South. In the six-month period ending September 30, 1973, the Southeastern and South Central states saw construction costs soar 7.2 per cent—far outstripping its closest competitor, the Pacific Coast, by 0.6 per cent. This was due primarily to the fact that material prices in the South showed the largest increase (9.0 per cent) of any section of the country.

—John H. Farley, senior editor  
Dodge Building Cost Services

INDEXES: October 1973		Current Indexes				% change last 12 months
Metropolitan area	Cost differential	non-res.	residential	masonry	steel	
U.S. Average	8.1	437.2	410.5	427.8	417.6	+12.06
Atlanta	7.5	550.9	519.3	539.0	527.2	+ 9.61
Baltimore	8.1	483.0	454.1	470.9	457.6	+13.30
Birmingham	7.3	406.7	378.2	392.4	388.0	+12.45
Boston	8.8	442.9	418.5	436.7	425.9	+11.20
Buffalo	8.7	476.0	447.0	468.1	454.6	+10.74
Chicago	8.4	515.2	489.8	496.7	490.5	+14.66
Cincinnati	8.5	467.9	440.2	454.8	443.8	+12.78
Cleveland	8.7	468.1	440.4	457.2	446.8	+ 7.83
Columbus, Ohio	7.9	451.2	423.6	438.9	429.9	+ 9.83
Dallas	7.5	439.8	425.8	429.2	420.9	+13.09
Denver	7.9	465.5	437.9	457.5	443.4	+11.16
Detroit	9.5	506.0	482.0	508.9	489.3	+15.87
Houston	7.0	395.4	371.3	384.8	378.4	+ 7.32
Indianapolis	7.5	395.9	371.7	386.7	378.5	+ 9.18
Kansas City	7.9	410.5	387.8	401.1	390.8	+10.78
Los Angeles	8.4	514.8	470.5	499.7	488.8	+18.99
Louisville	7.4	435.1	408.6	424.6	415.5	+11.90
Memphis	7.7	432.1	405.7	414.9	409.2	+17.18
Miami	7.7	452.0	430.6	438.2	429.3	+10.23
Milwaukee	7.9	477.4	448.2	467.4	453.7	+ 8.77
Minneapolis	8.5	460.6	433.3	452.4	442.2	+10.65
Newark	8.4	418.3	392.7	410.7	402.8	+10.13
New Orleans	7.3	425.4	401.5	419.1	409.4	+13.96
New York	10.0	495.9	461.1	483.8	471.3	+14.90
Philadelphia	9.0	489.9	466.7	485.3	472.1	+15.84
Phoenix (1947 = 100)	7.7	249.7	234.4	241.6	237.5	+12.53
Pittsburgh	8.5	428.5	403.1	423.4	410.4	+11.80
St. Louis	8.4	449.4	424.1	442.0	431.9	+10.55
San Antonio (1960 = 100)	6.9	159.3	149.5	154.0	150.9	+ 6.52
San Diego (1960 = 100)	8.0	179.5	168.5	175.5	171.9	+18.02
San Francisco	9.2	645.8	590.3	639.4	620.1	+12.85
Seattle	8.4	434.8	389.1	429.9	413.9	+14.46
Washington, D.C.	7.5	405.1	380.3	392.9	384.4	+ 8.81

Cost differentials compare current local costs, not indexes.

Tables compiled by Dodge Building Cost Services, McGraw-Hill Information Systems Company

Metropolitan area	HISTORICAL BUILDING COST INDEXES—AVERAGE OF ALL NON-RESIDENTIAL BUILDING TYPES, 21 CITIES										1941 average for each city = 100.00							
											1972 (Quarterly)				1973 (Quarterly)			
	1963	1964	1965	1966	1967	1968	1969	1970	1971		1st	2nd	3rd	4th	1st	2nd	3rd	4th
Atlanta	306.7	313.7	321.5	329.8	335.7	353.1	384.0	422.4	459.2		472.5	473.7	496.1	497.7	516.4	518.0	543.8	
Baltimore	275.5	280.6	285.7	280.9	295.8	308.7	322.8	348.8	381.7		388.1	389.3	418.8	420.4	441.8	443.6	474.5	
Birmingham	256.3	260.9	265.9	270.7	274.7	284.3	303.4	309.3	331.6		340.4	341.6	356.7	358.3	371.7	373.2	401.1	
Boston	244.1	252.1	257.8	262.0	265.7	277.1	295.0	328.6	362.0		377.3	378.5	392.8	394.4	414.0	415.6	436.8	
Chicago	301.0	306.6	311.7	320.4	328.4	339.5	356.1	386.1	418.8		422.8	424.0	442.7	444.3	465.3	466.9	507.6	
Cincinnati	263.9	269.5	274.0	278.3	288.2	302.6	325.8	348.5	386.1		399.9	401.1	400.1	410.7	430.4	432.0	461.4	
Cleveland	275.8	283.0	292.3	300.7	303.7	331.5	358.3	380.1	415.6		415.2	416.4	427.7	429.3	436.7	438.3	461.2	
Dallas	253.0	256.4	260.8	266.9	270.4	281.7	308.6	327.1	357.9		364.9	366.1	385.0	386.6	407.3	408.9	435.4	
Denver	282.5	287.3	294.0	297.5	305.1	312.5	339.0	368.1	392.9		398.3	399.5	413.8	415.4	429.5	431.1	460.0	
Detroit	272.2	277.7	284.7	296.9	301.2	316.4	352.9	377.4	409.7		416.9	418.1	431.5	433.1	463.4	465.0	500.0	
Kansas City	247.8	250.5	256.4	261.0	264.3	278.0	295.5	315.3	344.7		348.7	349.9	365.4	367.0	387.7	389.3	404.8	
Los Angeles	282.5	288.2	297.1	302.7	310.1	320.1	344.1	361.9	400.9		407.8	409.0	422.9	424.5	453.3	454.9	503.2	
Miami	269.3	274.4	277.5	284.0	286.1	305.3	329.3	353.2	384.7		391.5	392.7	404.8	406.4	419.0	420.6	446.2	
Minneapolis	275.3	282.4	285.0	289.4	300.2	309.4	331.2	361.1	417.1		401.7	402.9	411.3	412.9	430.6	432.2	455.1	
New Orleans	284.3	240.9	256.3	259.8	267.6	274.2	297.5	318.9	341.8		350.9	352.1	368.1	369.7	382.1	383.7	419.5	
New York	282.3	289.4	297.1	304.0	313.6	321.4	344.5	366.0	395.6		406.5	407.7	421.5	423.1	453.5	455.1	484.3	
Philadelphia	271.2	275.2	280.8	286.6	293.7	301.7	321.0	346.5	374.9		394.2	395.4	417.9	419.5	459.3	460.9	484.1	
Pittsburgh	258.2	263.8	267.0	271.1	275.0	293.8	311.0	327.2	362.1		364.5	365.7	378.7	380.3	406.3	407.9	423.4	
St. Louis	263.4	272.1	280.9	288.3	293.2	304.4	324.7	344.4	375.5		385.5	386.7	400.9	402.5	427.8	429.4	443.2	
San Francisco	352.4	365.4	368.6	386.0	390.8	402.9	441.1	465.1	512.3		535.3	536.5	559.4	561.0	606.4	608.0	631.3	
Seattle	260.6	266.6	268.9	275.0	283.5	292.2	317.8	341.8	358.4		363.0	364.5	369.9	371.5	388.4	390.0	423.4	

Costs in a given city for a certain period may be compared with costs in another period by dividing one index into the other; if the index for a city for one period (200.0) divided by the index for a second period (150.0) equals 133%, the costs in the one period are 33% higher than the costs in the other. Also, second period costs are 75% of those in the first period (150.0 ÷ 200.0 = 75%) or they are 25% lower in the second period.



# the J & J Differences!

"The Commercial Specialists"

the DESIGN MANUAL



the SPECIFIER

THE BIG DIFFERENCE: J & J makes only COMMERCIAL Carpeting, and we have independent test results to prove these carpets meet the most stringent performance standards. These results are available to you in the new J & J "Design Manual". J & J wants you to know! DIFFERENCE NUMBER TWO: The Manual contains samples of carpet in selected weights and densities for all commercial installations. DIFFERENCE NUMBER THREE: The manual contains the "Specifier" which gives you the facts so that you can determine what carpet to use and where... what weights... and what density to accommodate light, medium, or heavy traffic requirements. DIFFERENCE NUMBER FOUR: J & J uses only premium fibers for the contract market, such as Monsanto's Acrilan 2000+. Add up the J & J Differences... the answer is OUTSTANDING COMMERCIAL CARPET.

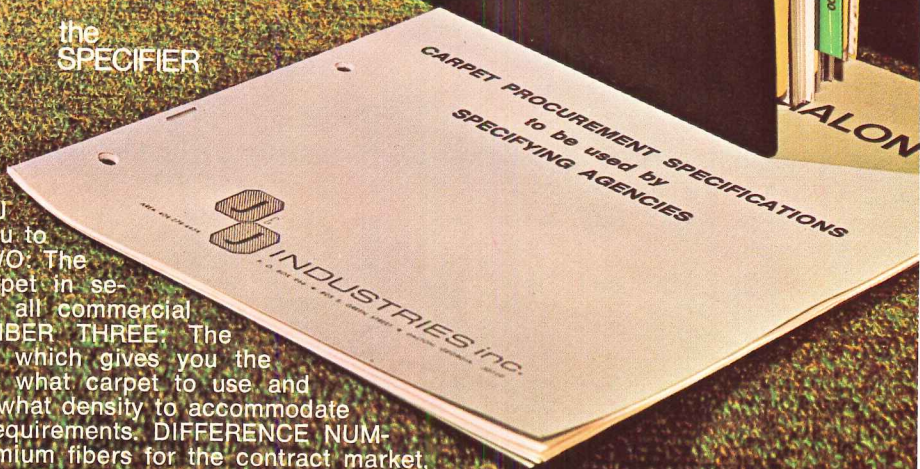

**J & J INDUSTRIES, Inc.**

(404) 278-4454 • P. O. BOX 966 • DALTON, GEORGIA 30720

For more data, circle 43 on inquiry card



## Housing: after the freeze?

Whether the nine-month period between the freeze on the old Federal housing programs and the presentation of the Administration's new housing proposal was a deliberate attempt to symbolize the act of creation, or an inadvertent coincidence, need not concern us directly. It is interesting to speculate, though, on why it *did* take that long. And, in this respect, it's possible to formulate two extreme positions: a) The problems with the old programs were so massive, that the combined efforts of Federal housing experts were hard put to correct them—a situation that, if true, does not reflect kindly on the volumes of testimony and commission reports (some, years in the making) on which the landmark Housing and Urban Development Act of 1968 was based. Or, b) the Administration, preoccupied with other problems, not the least of which was Watergate, had "Housing Act reform" pretty low on the list of priorities.

### The Administration is concerned with establishing need and cutting waste

President Nixon did say in his State of the Union address, that, "one of my highest domestic priorities this year will be the development of new policies that will provide aid to genuinely needy families and eliminate waste." And, it's pretty clear from the Fifth Annual Housing Goal Report, released in August, that he felt the current housing program, both, wasteful, and not always providing aid to "genuinely needy families."

Here's how the Report views the old programs: "To achieve the high levels of subsidized production, financing techniques were devised which in a real sense "mortgage the future" by committing the Federal Government and future generations of taxpayers over possibly as long as the next 40 years to bear costs now estimated for HUD and USDA programs at between \$65 billion and \$85 billion—even if not a single new unit were to be added in the last half of the goal decade. Additional costs are borne by the taxpayer due to the various tax incentives designed to encourage the construction and rehabilitation of these housing units for low- and moderate-income families."

### Few of the needy really get the help proposed

In addition, "It has been clear for some time that all too frequently the neediest have not been the primary beneficiaries of *some* of the programs. The programs also do not treat all

families equitably since only a modest proportion of the families eligible for subsidies—that is, whose incomes qualify them according to the law to receive housing assistance—actually receive them."

And, while, for the first half of the housing goal decade, total housing production is exceeding the target for those years, "subsidized rehabilitated units are falling behind target levels for FY's 1969-73, with actual rehabilitation amounting to 199,620 units, or 60 per cent of the target volume." And, in the new construction area, "subsidized housing units constructed (excluding rehabilitation) reached nearly 1.6 million units—about 72 per cent of the target set. . . ."

You've got to infer from this that if the subsidized programs were meeting their goals, the estimated future costs of these programs would be in the neighborhood of \$85 to \$115 billion, not the \$65 to \$85 billion estimated in the report quoted above.

Part of what's at issue here, though, is not that the provisions of the 1968 Housing Act were necessarily wrong, or massive miscalculations, but rather, that there's been a change in the criteria by which the old housing program is being judged. The 1968 Housing Act was formulated during a period when total housing production was in the 1.4 to 1.5 million unit range (and that includes mobile homes). A prime goal of the 1968 Act was to get housing *built*, period. And, although subsidized housing did not hit the targeted amounts expected of it, an awful lot *did* get built. Nobody said that this could be done cheaply. Cost was not the significant criterion at the time.

### The industry's capacity to produce doesn't guarantee livable housing for everyone

Here, in the second half of 1973, after the private sector's ability to produce housing has exceeded all expectations, we not only *can* afford to evaluate subsidized housing with a more critical eye, but we should.

But, a reevaluation done with the recent triumphs of the private sector so fresh in mind, has within it the dangers of overreaction. There's no doubt that the private sector has met or exceeded the volume targets set out for it in the Housing Goal Reports, but, this does not necessarily guarantee that the ultimate goal of all this, the realization of a decent house for every family to actually live in, is also being achieved. The proposals to give the needy family a direct allowance to enable it to go and

find its own housing, can't presume, first of all, that private industry is going to automatically put the home where the needy family wants it. The whole concept is still based on this whole questionable concept of the "trickle-down" effect. The theory is that the needy get what's left after the more fortunate have moved on to better housing. Since everyone ends up with a better home, the theory goes, everyone is better off.

### The trickle-down theory doesn't square with the problem of abandoned neighborhoods

There are two very basic problems with this theory: First, if a neighborhood is no longer considered a good place in which to live the condition of its housing is irrelevant. If the home is not conventionally located in an area of gainful employment, or if it is rampant with social ills like crime and drug addiction, you're not really doing anyone a favor by giving him an allowance so that he can move into the neighborhood. (After all, the previous occupant left it for a reason too, didn't he?)

Secondly, this method has very real economic costs attached to it that are not completely evident at first. Current estimates of housing removed from the inventory or abandoned range between 700,000 and 750,000 a year. This compares with a 450,000 average for the decade of the 1950's. It would be nice if this upsurge in removals were all in the form of dilapidated housing. Unfortunately, though, this does not appear to be the case.

Much of this accelerated removal rate represents sound housing or housing in need of minor repair, that has become abandoned. The housing did not deteriorate, it was the neighborhood that deteriorated. And, the point is, that anyone with a housing allowance is not going to go into a deteriorating neighborhood if he can help it, so that neighborhood is going to continue to go down hill—probably at an accelerated rate. That neighborhood needs something to turn it around *first*. Some initial rebuilding or redevelopment to make it attractive as a rental or home ownership market again. The private housing industry is not geared to provide this initial burst of incentive—that has to come from the public sector. The cost of not providing this, of course, is the needless waste of sound housing. And for a nation that is finally coming to realize that its resources are not unlimited, that it can't simply tear down and rebuild at will, this is a real cost.

James E. Carlson, Manager, Economic Research  
McGraw-Hill Information Systems Company



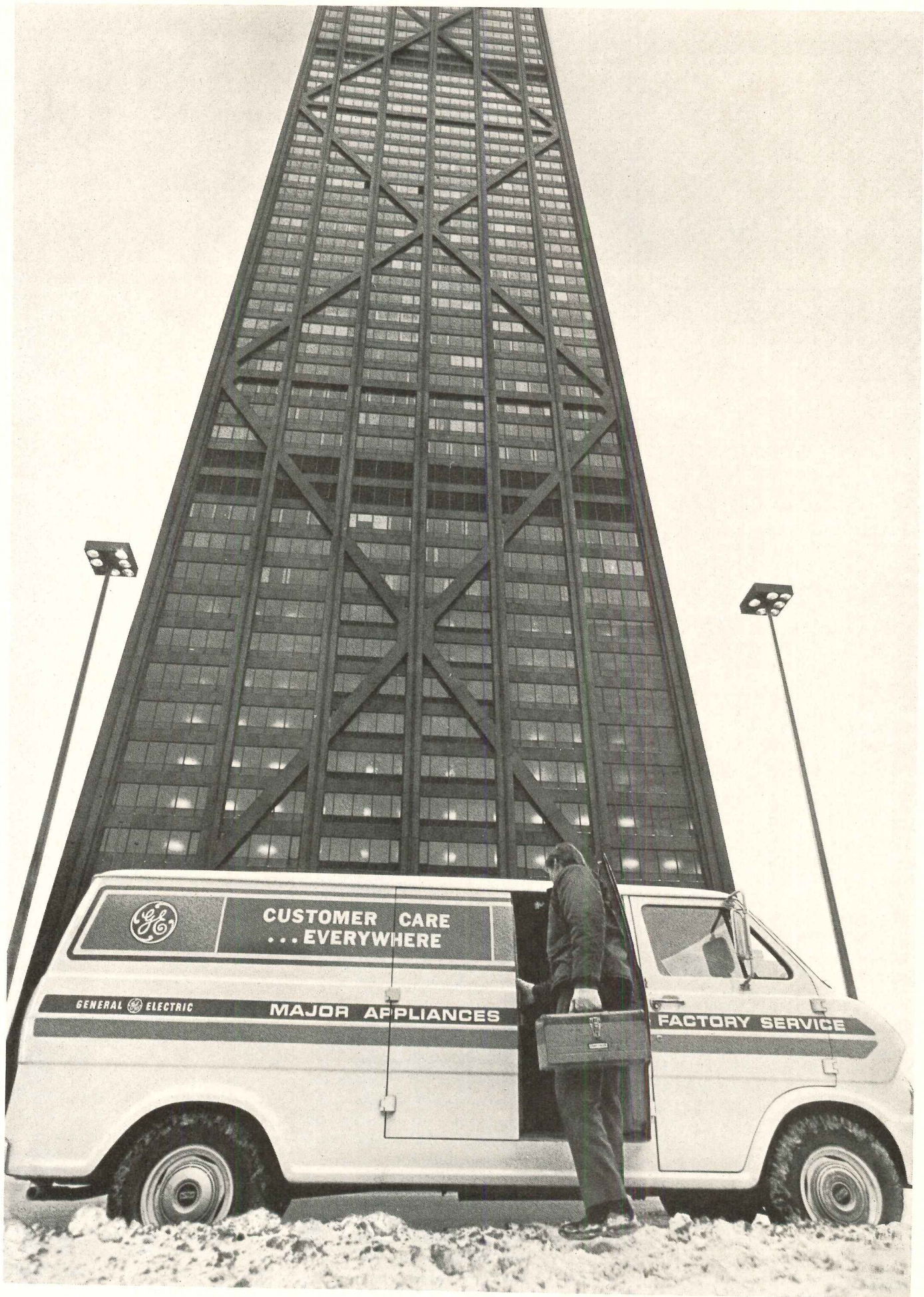



# Job site service.

## Your clients get it when you specify General Electric Zoneline™ air conditioners.

When you specify packaged terminal air conditioners to your clients, it's a major investment for them.

So if anything should go wrong later on, we believe they're entitled to have repairs made promptly and expertly. And if it's at all possible, repairs should be made right at the job site.

This is exactly what happens with General Electric's Customer Care... Service Everywhere.™ Which means that wherever your project is in the continental U.S.A., there'll be a qualified GE serviceman nearby.



GE has a network of Factory Service Centers in 100 major cities plus 5,000 franchised servicers throughout the country.

Our service trucks and experienced servicemen can take care of most problems right at the site. Should a major component such as the compressor be involved, however, we remove it, repair it, replace it, and, during the warranty period we pay for it. GE Zoneline Air Conditioners carry a one year parts and service-labor repair warranty against failure due to manufacturing defects with an additional four year parts and service-labor repair warranty on the sealed refrigerating system.

So when you specify packaged terminal air conditioners, remember General Electric provides what you want—factory authorized job site service, everywhere in the continental U.S.A.

For more information call your GE Contract Sales Representative or write to: Air Conditioning Contract Products Operation, General Electric Company, Building 53, Louisville, Kentucky 40225.

**GENERAL**  **ELECTRIC**

*For more data, circle 44 on inquiry card*



# There's a Wilsonwall Paneling System for every interior.

## System 610

A Class 1A fire hazard classification panel system, featuring acrylic coated extruded aluminum moldings.



## System 110

For an unusual esthetic effect, the laminated plastic reveal strip accents the panel.

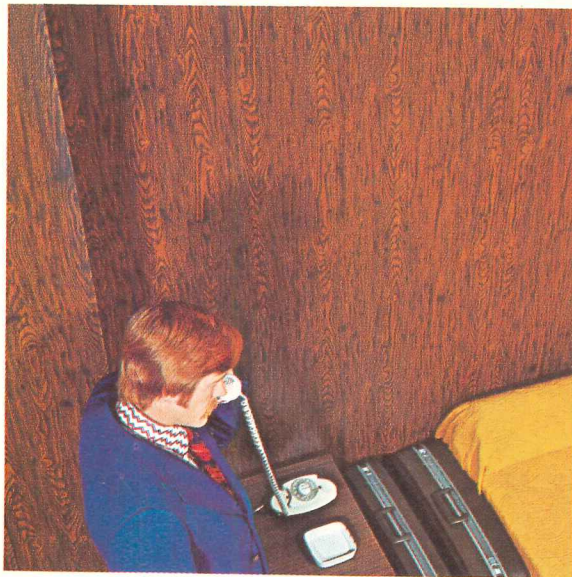

Smooth fitting V-Groove joints give the appearance of a continuous wall . . . utilizing a hidden extruded aluminum molding system.



Featuring a standard V-Groove joint system . . . allows continuity of woodgrain where desired.

## System 310

## System 210

For the fastest and best service in the industry, contact the Wilson Art Architectural Design Representative nearest you today.

- Atlanta 404-377-0731
- Chicago 312-437-1500
- Denver 303-388-3686
- Los Angeles 213-723-8961
- Miami 305-822-5140
- New Jersey 609-662-4747
- New York 212-933-1035
- San Francisco 415-782-6055
- Seattle 206-228-1300
- Temple, Texas 817-778-2711



**WILSONWALL®**  
PANELING



These four distinctive systems, available in over 150 Wilson Art laminated-plastic woodgrains and solids, offer you total design control. Wilsonwall is low in initial and ultimate cost, high in installation and maintenance benefits. The beautiful, durable answer — whatever the application. Specify Wilsonwall for a very practical combination of esthetic and economic benefits.

#### Wilsonwall System 610 Specifications

Panels:  
**thickness:** nominal 7/16"  
**surfacing:** 1/32" Wilson Art fire retardant laminate (LD1-1971), Velvet finish, all Wilson Art woodgrains and solid colors  
**core:** 3/8" mineral composition  
**back:** .020" fire retardant backing sheet  
**sizes:** 47½" x 96" and 47½" x 120" (other sizes quoted on request)  
**moldings:** extruded aluminum (hidden base moldings, mill finish; face moldings, acrylic coated, standard in Lt. Bronze, Dk. Bronze, Brown and Black)

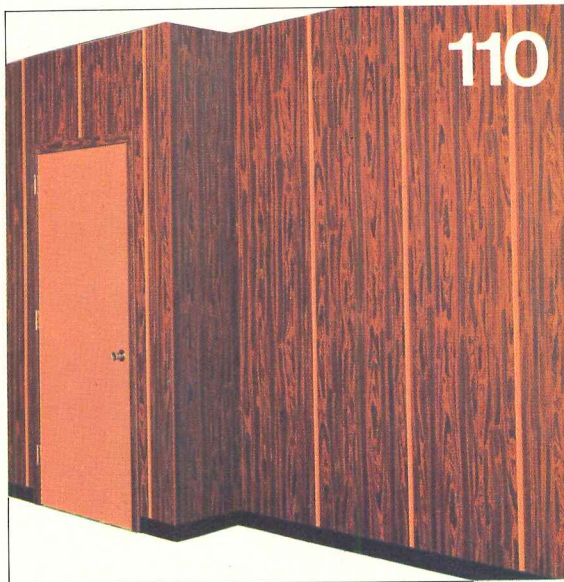
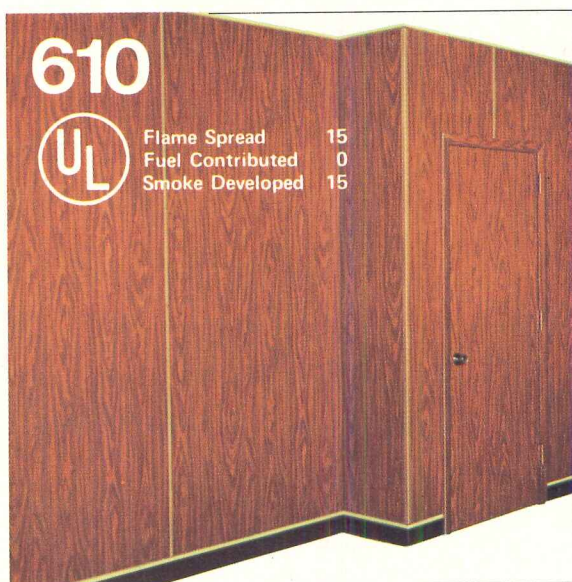

#### Wilsonwall System 110 Specifications

Panels: **thickness:** nominal 7/16" **surfacing:** 1/32" Wilson Art laminate (LD1-1971), Velvet finish, all Wilson Art woodgrains and solid colors  
**core:** 3/8" particleboard (CS-236-66)

**back:** .020" backing sheet  
**sizes:** 15½" and 24" widths; 96" and 120" lengths (other sizes quoted on request)  
**reveal strips:** 1/16" thick Wilson Art laminate; 1/2", 3/4" and 1" widths; 96" and 120" lengths  
**NOTE:** Upon request, panels meeting Class I or Class II fire hazard classification depending upon specific code requirements.

#### Wilsonwall System 310 Specifications

Panels:  
**thickness:** nominal 7/16"  
**surfacing:** 1/32" Wilson Art laminate (LD1-1971), Velvet finish, all Wilson Art woodgrains and solid colors  
**core:** 3/8" particleboard (CS-236-66)  
**back:** .020" backing sheet  
**sizes:** 48" widths; 96" and 120" lengths (other sizes quoted on request)  
**moldings:** extruded aluminum, mill finish  
**NOTE:** Upon request, panels meeting Class I or Class II fire hazard classification depending upon specific code requirements.



#### Wilsonwall System 210 Specifications

Panels:  
**thickness:** nominal 7/16"  
**surfacing:** 1/32" Wilson Art laminate (LD1-1971), Velvet finish, all Wilson Art woodgrains and solid colors  
**core:** 3/8" particleboard (CS-236-66)  
**back:** .020" backing sheet  
**sizes:** 15½" and 24" widths; 96" and 120" lengths (other sizes quoted on request)  
**sizes:** 15½" and 24" widths; 96" and 120" lengths (other sizes quoted on request)  
**NOTE:** Upon request, panels meeting Class I or Class II fire hazard classification depending upon specific code requirements.

All Wilsonwall Panels feature



RALPH WILSON PLASTICS COMPANY TEMPLE, TEXAS

DART INDUSTRIES INC

For more data, circle 45 on inquiry card



# Light is a lot of details,



Custom fixtures, like the Directionaire Street/Sign light, add form to function, 'round the clock.



Only light the land you own. Profile™ light's reflector design provides excellent cutoff and delivers predictable rectangles of even illumination, to build yourself an outdoor sales floor.



Cladding options come as you need them. The Ultra-Lite™ family matches motifs in wood, metal, vinyl, colors.



For large areas, SCL series luminaires keep the light on the ground, not in your neighbor's eyes. Its high efficiency gets the most light to the need, economically.

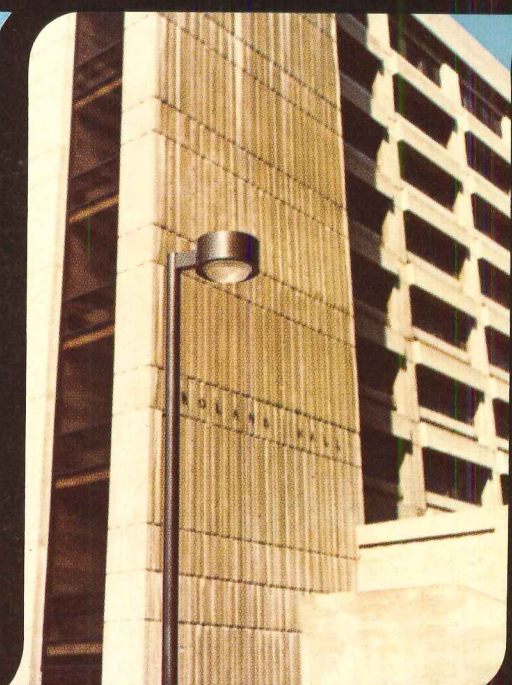

This architecturally styled small-area and walkway luminaire (Model RSL) can provide symmetric and asymmetric light distribution to meet a variety of site lighting requirements.

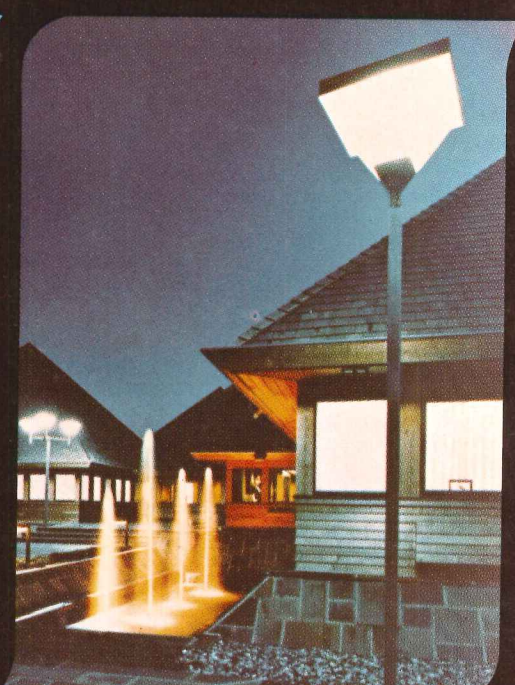

Courtyards take on a soft glow, as do walkways and small parking areas, with the PTL-A post tops. They're available with up to four luminaires per pole.



# done right.



Up/Down accent lights can help you write an after-dark signature that arouses interest, discourages trouble. And they look good by day, too.



Custom designed fixtures, such as this twin 400-watt luminaire with single housing, can meet the most demanding requirements—photometrically and aesthetically.

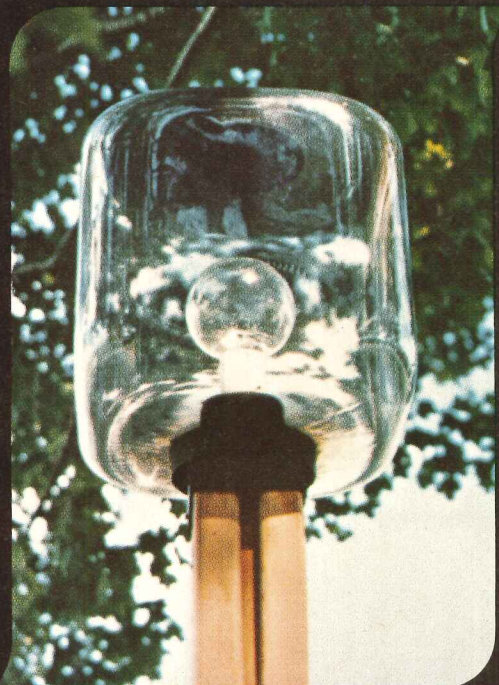

This acrylic cube, Type CAC, is one of dozens of fresh ideas from our post-top line.



You can light an acre with a single large Sky-Cube™ fixture; other Sky-Cube models come small enough to highlight a plaza or brighten a walkway.

And making those details work is really a matter of finding the right blend of art and technology to fit a particular need. At the same time considering your neighbors, local ordinances, and your pocketbook.

We're here to help.

We're your Light House. A nationwide team of lighting specialists. Ready with a complete line of fixtures and poles. Ready to talk over any detail, including custom ideas you may have in mind.

We work directly with architects, developers, engineers, contractors to keep aesthetic and economic options open. We do it best if you call us early in the design stages.

Get your details done right. See us first. And early. Crouse-Hinds Company, Lighting Products Division, Syracuse, N.Y. 13201.

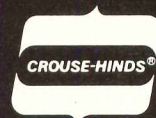

**CROUSE-HINDS**

# Your Light House is Crouse-Hinds.

For more data, circle 46 on inquiry card



# Cook Field

YONKERS, N.Y.





# An award-winning structure in the 1972 Architectural Awards of Excellence Competition, American Institute of Steel Construction

"A playful sculpturesque shelter in a park is bordered by a very logical use of steel hexagonal umbrellas to produce an interesting and imaginative lighting arrangement. The inverted umbrella creates a lovely counterpoint"—Jurors' Comments.

A series of weathering steel, hexagonal umbrellas make up this unusual shelter, one of two such facilities in a large urban park. The design of the individual components is one that is both compatible with and accentuates the shape, scale, and feeling of the wooded area. The shelter covers 5,000 square feet to provide a focal point for separate group picnics.

The umbrellas are fabricated of 1/4-inch thick welded plates. Weathering Steel was selected because it is virtually indestructible, maintenance free, and inexpensive. Bethlehem Steel supplied the Mayari R Weathering Steel plates used in this award-winning structure.

# Bethlehem



#### Jury of Awards

S. SCOTT FEREBEE, JR., FAIA  
First Vice President  
The American Institute of Architects  
President, Ferebee, Walters & Associates  
Charlotte, North Carolina

VINCENT G. KLING, FAIA  
Managing Partner, Vincent G. Kling & Partners  
Philadelphia, Pennsylvania

JOHN O. MERRILL, JR., AIA  
Partner, Skidmore, Owings & Merrill  
San Francisco, California

LEO PLOFKER  
Partner, The Office of James Ruderman  
New York, New York

MARIO G. SALVADORI, F. ASCE  
Chairman, Division of Architectural Technology  
School of Architecture, Columbia University  
New York, New York



Owner: City of Yonkers, New York  
Architect: Joseph Roth & Associates, Yonkers, New York  
Structural Engineer: Zoldos/Silman, New York, New York  
General Contractor: Yonkers Contracting Company, Inc., Yonkers, New York  
Steel Fabricator: United Iron Inc., Mount Vernon, New York, and Eastern Tank Fabricators, Inc., Manhasset, New York





# Don't overdraw. Use these Kodak shortcuts:

---

The snappy restoration shortcut.

---

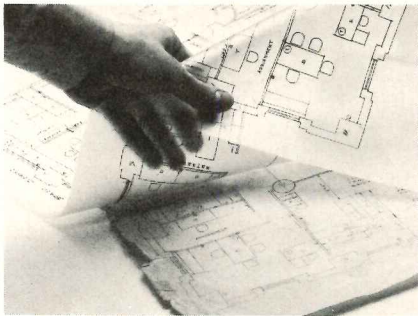

Why waste time retracing your old, battered drawings? Restore them by making sharp, clean photographic reproductions on Kodagraph film. Weak lines come back strong and clear. Stains virtually disappear. And instead of gray lines on yellow, you'll have snappy, contrasty, black-on-white prints.

---

The drop-of-water shortcut.

---

Why retrace the whole design for a few revisions? Just

order a second original on Kodagraph wash-off film. Then use a drop of water and erase unwanted details.

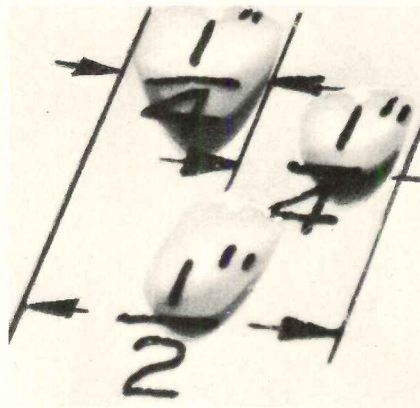

Draw your design revisions on the film and you're done.

---

The multiplication shortcut.

---

Why draw the same detail over and over? Kodagraph film will do the job for you. That way you draw the detail just once. Make as many photoreproductions as you need. Cut them out, paste them down, and make a

Kodagraph film print of the paste-up.

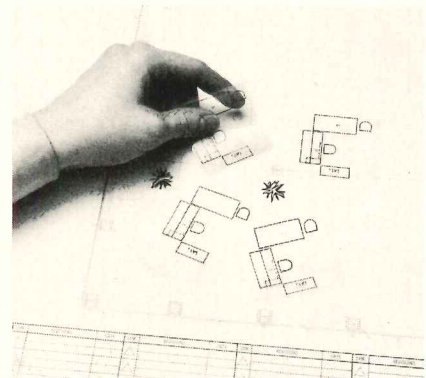

Now you have a superb second original for subsequent printmaking.

---

Get the facts from Kodak.

---

Drop us a line for more facts on how you can reduce drafting time and save money too, with Kodagraph films and papers. Eastman Kodak Company, Business Systems Markets Division, Dept. DP-893, Rochester, N.Y. 14650.

**Kodak products for drawing reproduction.**



For more data, circle 47 on inquiry card



# Bright idea



**Beautiful Washfountains that hold up beautifully.** Bradglas® Washfountains . . . colorful like nature. Brick red. Desert yellow. Surf green. White marble. Driftwood beige. With clean, contemporary lines to fit today's commercial, industrial and school buildings. Durable like steel. Smooth, non-porous. Resistant to abrasion, acid and corrosion. Won't swell, shrink or warp. Won't chip, peel or flake. Vandal-proof and fire-safe, too. Reinforced polyester is tough . . . yet light for easy installation . . . 80% lighter than precast

stone. Bradglas Washfountains cut installation costs because they serve up to 8 people with one set of connections. Save on wall and floor space. Can be installed anywhere . . . washrooms, halls, alcoves. More sanitary than lavatories because they're foot-operated. In 54" and 36" circular and semi-circular models. See your Bradley washroom systems specialist. And write for latest literature. Or call (414) 251-6000. Telex 2-6751. Bradley Corporation, 9107 Fountain Boulevard, Menomonee Falls, Wis. 53051.

# from Bradley!

Leader in Washroom Fixtures and Accessories

For more data, circle 48 on inquiry card





# A VANDAL'S GUIDE TO TODAY'S LIGHTING MATERIALS.



## GLASS.

Thick and heavy. But a breeze to break. Often mounted high to deter you but stones or snowballs can reach it. Sometimes enclosed in wire cages. Ugly to look at, still easy to break. Just try small rocks or BBs. Drives maintenance men batty. Disrupts lighting budgets. CAUTION: Shattering fragments are dangerous.

## PLASTIC.

Also known as acrylic, styrene or butyrate. Not as fragile as glass. But even impact grades break, crack, chip, shatter. Still keeps people in the dark, maintenance men on the move. May become an even weaker target with exposure to the elements. Cold can cause hazing. Lacks UL self-extinguishing ratings. Frequently seen distorted by heat. CAUTION: Since it breaks, it can hurt.





## NEW LEXAN<sup>®</sup> 303. RESIN

Don't waste your time. It's virtually indestructible. Many times tougher at sub-zero temperatures than plastics at room temperature. Seen with all types of light sources, all shapes and sizes, indoors or out. Responsible for slashing replacement costs. So rarely seen with maintenance men. Has UL recognition. Look for it soon in high-pressure sodium and mercury vapor luminaires. **CAUTION: Flying objects tend to ricochet.**

For a list of manufacturers and a sample of unbreakable LEXAN resin, write Sect. 194R1, Plastics Department, General Electric Company, One Plastics Avenue, Pittsfield, Mass. 01201.

World Leader in Engineering Plastics  
LEXAN<sup>®</sup> NORYL<sup>®</sup> GENAL<sup>®</sup> PHENOLICS VALOX<sup>®</sup>

GENERAL  ELECTRIC

*For more data, circle 49 on inquiry card*



# If granite is just for 40-story buildings, why didn't someone tell McDonald's, Powers, CNA, Bank of America, New York City, Houston and Cincinnati.

Some people get the impression that granite is strictly for big jobs. So to clear up that matter, we'd like you to meet a number of architects and owners who don't deal in impressions. They deal in facts. And when they got all of the facts on granite, they incorporated granite into their thinking.

Granite is being used on a lot of smaller jobs these days. And for some very good reasons. The natural beauty of polished granite resists weather, stains and all types of traffic the way no other building material can. It won't fade or deteriorate. It requires virtually no maintenance. And it comes in a wide spectrum of colors.

How expensive is granite? Talk to our Customer Service Department about that. Tell them what you want to do. They'll tell you how it can be done, step by step. And likely as not, you'll find that granite fits into your plans on a cost-in-place basis. Refer to Sweets Catalog No. 4.1/Co. Or call us. (612) 685-3621.

*For more data, circle 54 on inquiry card*

Granite  
can color  
your thinking.

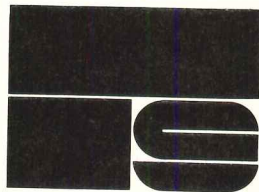

Cold Spring Granite Company  
Cold Spring, Minnesota



FOUNTAIN SQUARE PLAZA



McDONALD'S PLAZA



Fountain Square Plaza, Cincinnati  
Architect: RTKL Associates, Inc.

McDonald's Plaza, Oak Brook, Illinois  
Architect: Salvatore J. Balsamo & Associates, Inc.

Powers Northtown, Minneapolis  
Architect: Ralph B. Shimer, AIA Architect

Greenacre Park, New York City  
Architect: Sasaki, Dawson, DeMay Associates, Inc.

Consulting Architect: Goldstone, Dearborn & Hinz

Planetarium, Houston Museum of Natural Science  
Architect: Pierce, Goodwin & Flanagan Architects

CNA Building, Los Angeles  
Architect: Langdon & Wilson  
Landscape Architect: Emmet L. Wemple, ASLA

Bank of America Domestic Branch, San Francisco  
Architects: Wurster, Bernardi & Emmons, Inc., Skidmore, Owings & Merrill



BANK OF AMERICA DOMESTIC BRANCH



CNA BUILDING



PLANETARIUM, HOUSTON MUSEUM OF NATURAL SCIENCE



POWERS NORTHTOWN



GREENACRE PARK



About 4,000 gallons worth! To seal the joints of pre-cast masonry sections and thousands of glass walls and windows in the new Transamerica Pyramid soaring 48 stories above the streets of San Francisco.

These LP polysulfide base sealants will provide lasting protection against sun, wind and rain. Assure unbroken adhesion and flexibility despite temperature extremes and structural movement. We're sure of it because they bear the famous Thiokol Seal of Security.

To merit the Seal, sealants must meet

**LP<sup>®</sup> polysulfide  
base sealants  
used  
all the way up.**

exacting standards. And always be subject to laboratory testing to see that they maintain those standards. No approved sealant has ever failed on the job.

LP polysulfide polymers are just a few of the many products made by our Chemical Division. For aircraft, automobiles, buses, trucks and trains. For joint and window sealants, insulating glass. For gaskets, seals, printing rollers, hose and industrial tires.

Would you like more information? Write Thiokol Chemical Corporation, Chemical Division, Trenton, N.J. 08607.

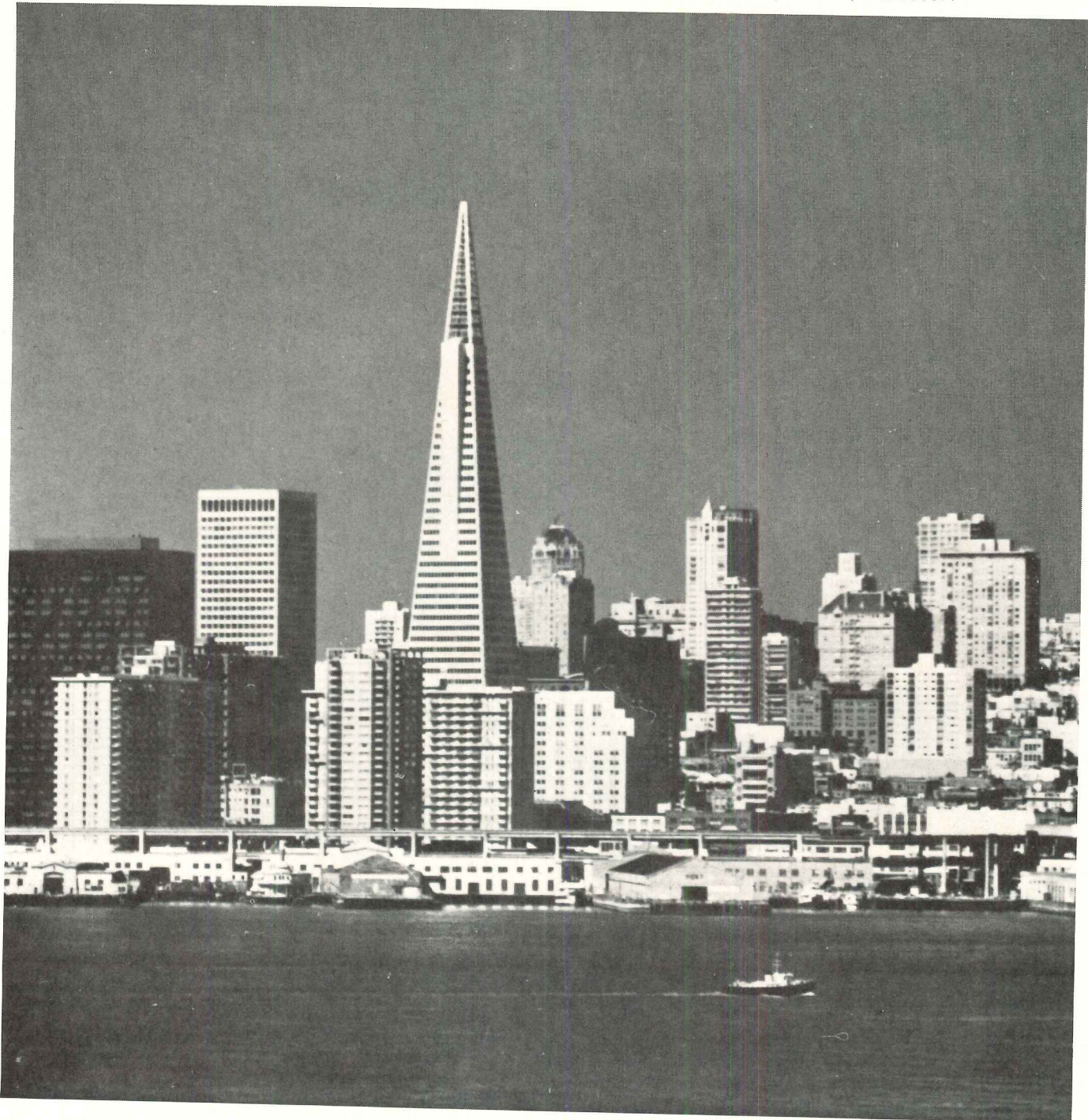

# Thiokol

*Specialty Polymers • Off-The-Road Vehicles • Synthetic Fibers • Sprayers • Propulsion • Human Development  
Friction Materials and Laminates • Pyrotechnics • Closures • Rubber and Rubber Chemicals • Medical Electronics Equipment*

*For more data, circle 55 on inquiry card*



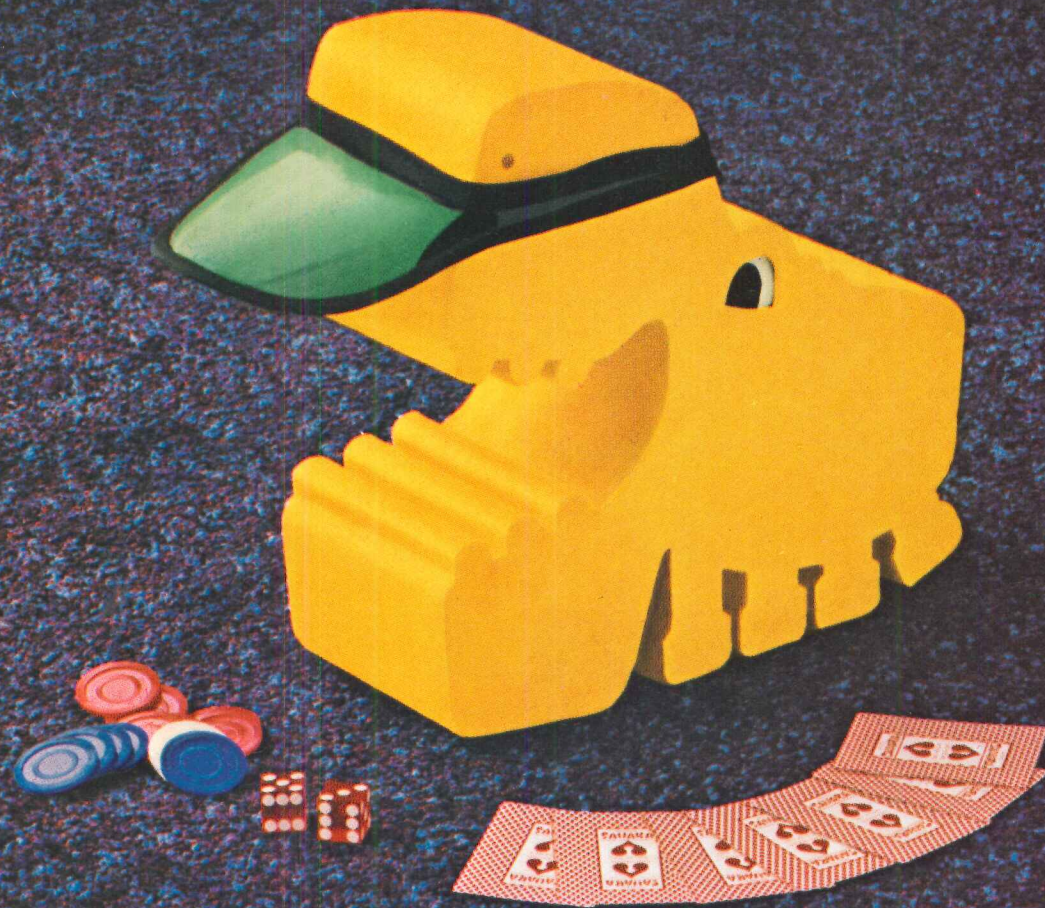

# Anso<sup>®</sup> nylon's five year carpet guarantee. It puts the odds on your side.

When it comes to carpet, the Sahara Hotel in Las Vegas doesn't believe in gambling.

So they put their money on "Years Ahead," by Berven of California. And got Guaranteeth—the guarantee with teeth. Allied Chemical's assurance that any carpet made of either ANSO nylon, or ANSO-X anti-static nylon, will not wear more than 10% in 5 years, or we'll replace it, installation included.

Now when you specify "Years Ahead," you will get the benefits of ANSO-X, the most advanced anti-static system on the market. The anti-static protection is built right

into the fiber. That means uniform protection over the entire carpet and it means permanent anti-static protection that's guaranteed for the life of the carpet.

So when you're looking for carpet, look for the label with the little animal who symbolizes Allied Chemical's Guaranteeth—the strongest carpet fiber guarantee that you can get. For your free copy of our contract carpet manual, write to: Allied Chemical, Home Furnishings Merchandising, Dept. AR, 1 Times Sq., N.Y. 10036. (212) 736-7000, ext. 7766.



## Guaranteeth. The guarantee with teeth.

Hotel Sahara, Las Vegas.

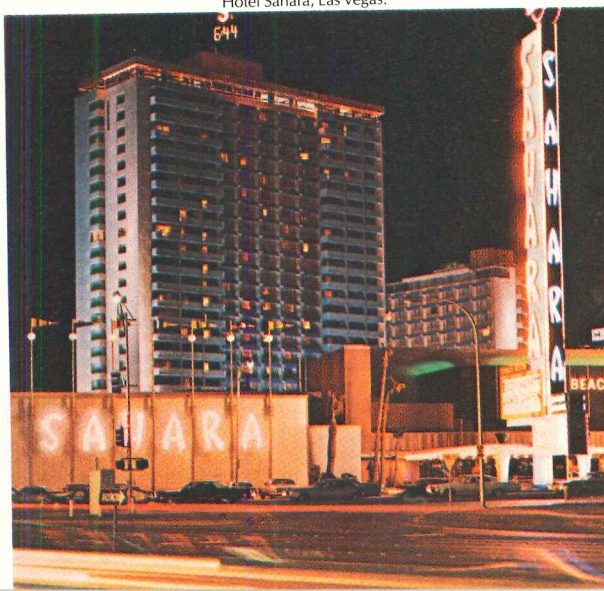

For more data, circle 56 on inquiry card



Architect: Phillip Johnson & John Burgee, Architects  
Contractor: Pigott Construction International, Ltd.

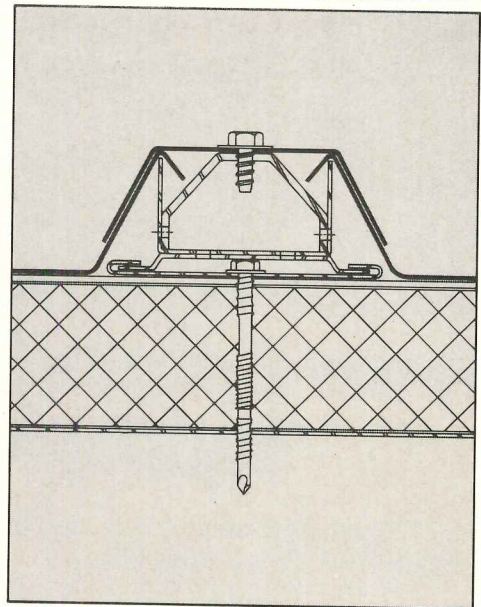
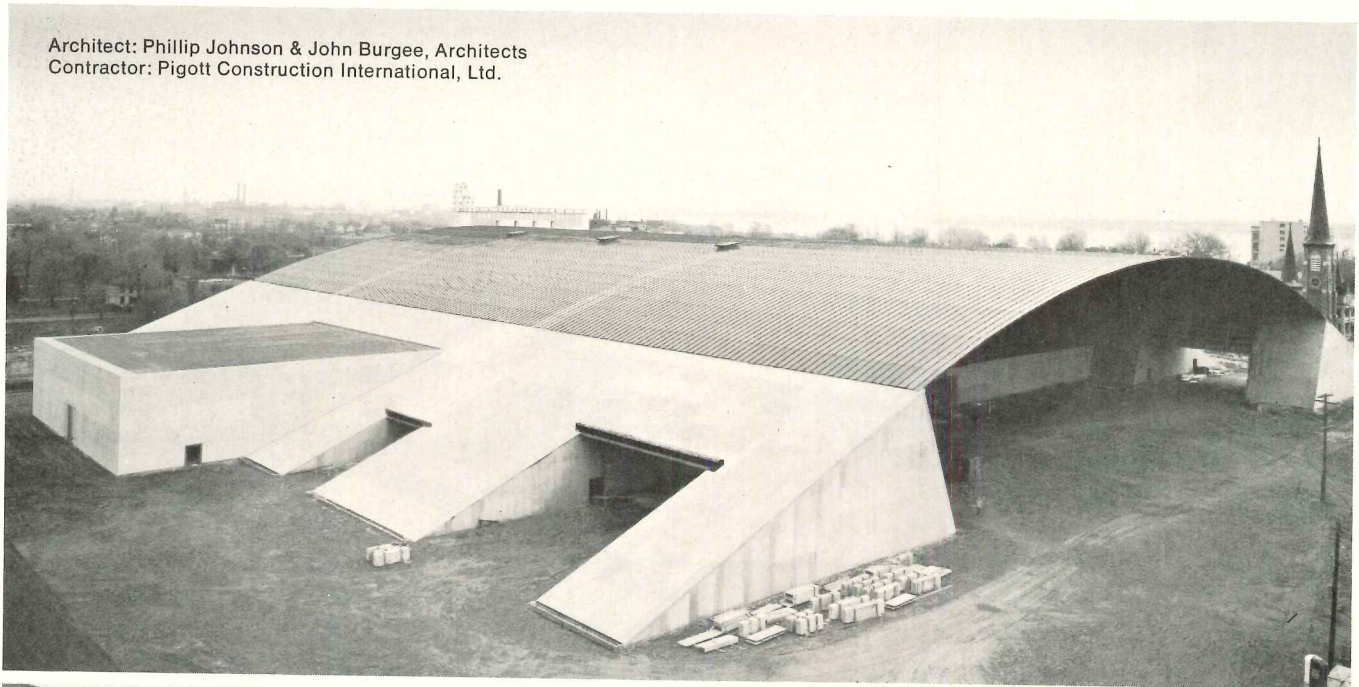

## Overly makes the metal roofs that others don't.

No building's too big for an Overly metal roof. This one, recently installed on the Niagara Convention Center, Buffalo, N. Y., covers 4.3 acres, and it is only one example of the kind of work we do.

Overly metal roofs have a unique joint system that expands and contracts both longitudinally and laterally during temperature

changes. Sheets are interlocked, so water can't seep in. Our systems are backed by a 20-year guarantee against leaking and a warranty against defects in workmanship. Overly roofs are available in aluminum, copper, stainless, or weathering steel.

We offer expert design assistance, erection capabilities, or complete prefabrication for erection by your crews. Unusual roof shapes are never a problem at Overly. For more information on Overly's capabilities, write Overly Manufacturing Company, Architectural Metals Division, 574 West Otterman St., Greensburg, Pa. 15601.

**overly**  
MANUFACTURING CO.  
DOES WHAT OTHERS DON'T

For more data, circle 57 on inquiry card



**Bally Walk-Ins  
belong where  
food must  
be right  
and ready  
for the daily  
pupil parade**



Bally Walk-In Coolers and Freezers belong everywhere mass feeding takes place. They can be assembled in any size for indoor or outdoor use from standard panels insulated with four inches of foamed-in-place urethane, UL 25 low flame spread rated and Factory Mutual research approved. Choice of stainless steel, aluminum or galvanized. Easy to enlarge . . . easy to relocate. Refrigeration systems from 35°F. cooling to minus

40°F. freezing. Subject to fast depreciation and investment tax credit. (Ask your accountant.) Write for 28-page book and urethane sample. **Bally Case & Cooler, Inc., Bally, Penna. 19503.** ADDRESS ALL CORRESPONDENCE TO DEPT. AR-10



© 1973. ALL RIGHTS RESERVED.

For more data, circle 58 on inquiry card



A.

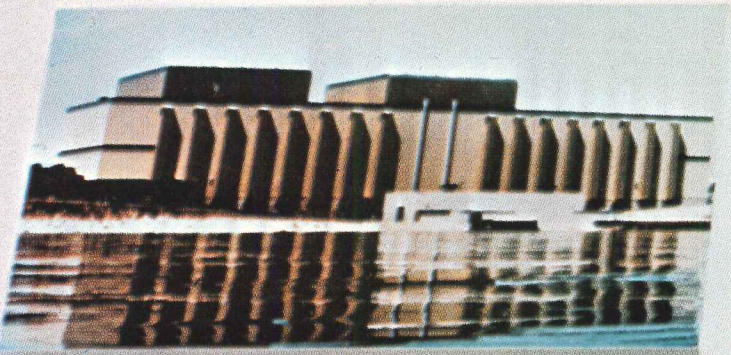

B.

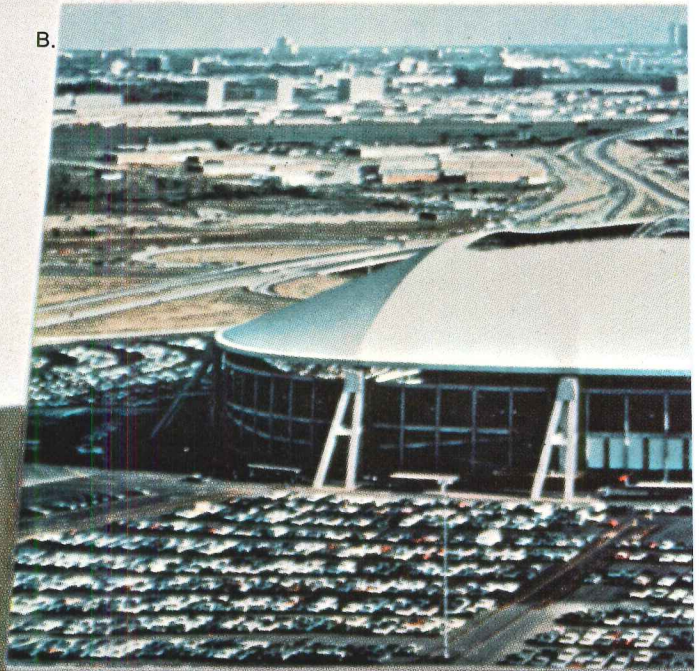

E.



G.



D.





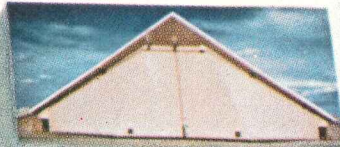
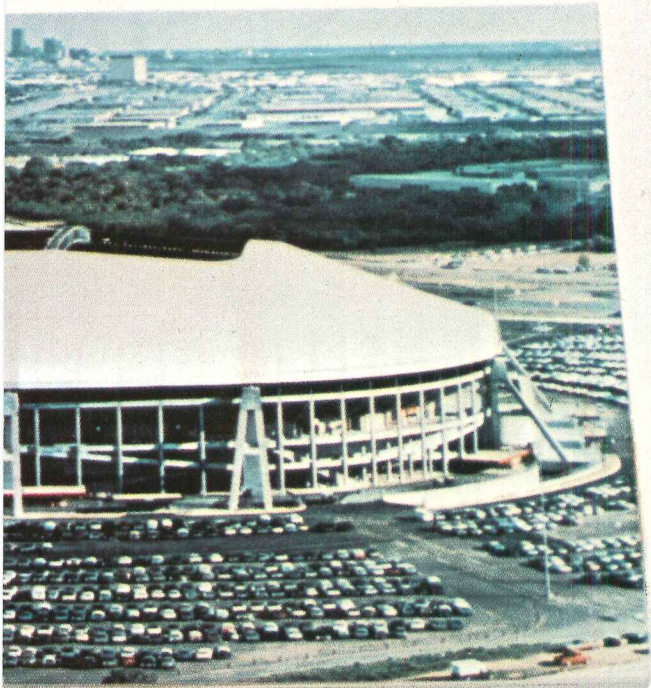

C.

# KYNAR<sup>®</sup> City... without limits.

KYNAR 500\*-based finishes are at home in any city, in any country, in any kind of climate. From the seasonal extremes of Washington, D.C. to the baking, blistering heat in the heart of Texas, to the industrial environment of Los Angeles, finishes based on KYNAR 500 can take it all.

On metal curtain walls, louvers, window frames, trim and shingles, finishes based on KYNAR 500 resist chalking, chipping, cracking and fading long after other finishes have become eyesores.

For complete test data and technical details contact Page Murray, Plastics Dept., Pennwalt Corporation, Three Parkway, Philadelphia, Pa. 19102. (215) 587-7513

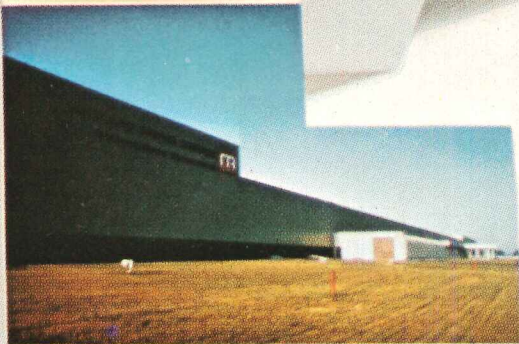

F.

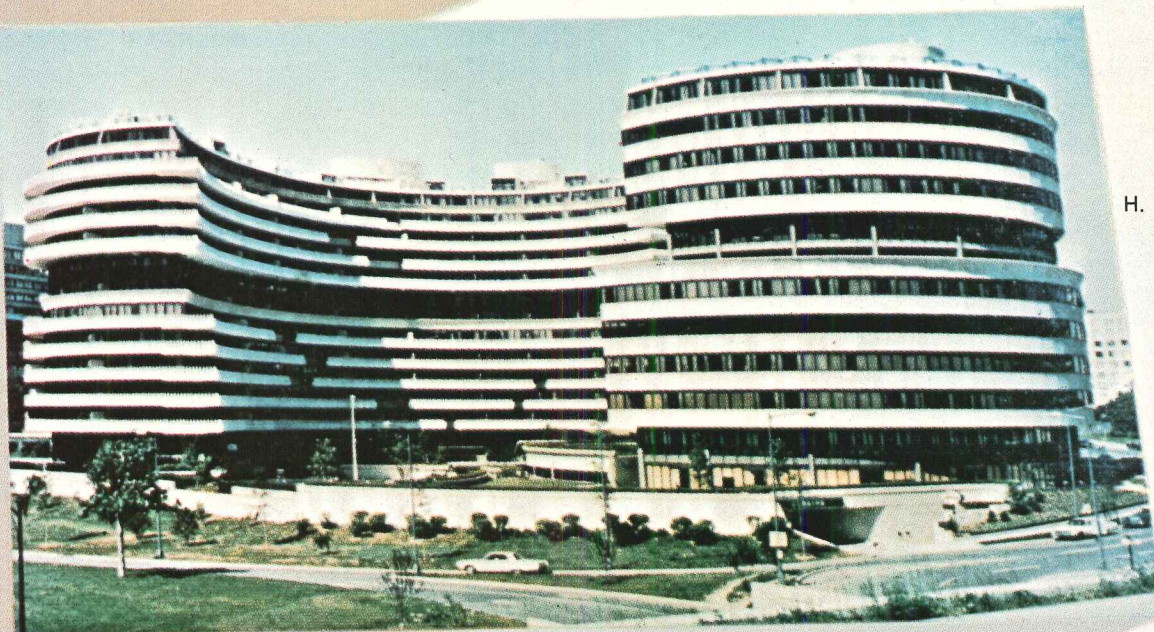

H.

**PENNWALT**  
ARCHITECTURAL COATINGS

- A. Point Beach Nuclear Plant  
Two Creeks, Wisconsin
- B. Texas Stadium  
Irving, Texas
- C. United Airlines Hangar  
Minneapolis, Minnesota
- D. Zenith National  
Insurance Building  
Los Angeles, California
- E. VA Hospital  
Gainesville, Florida
- F. Midland-Ross Warehouse  
Maumee, Ohio
- G. Bailey Plaza Shopping Mall  
Jackson, Mississippi
- H. The Watergate Development  
Stage IV  
Washington, D.C.



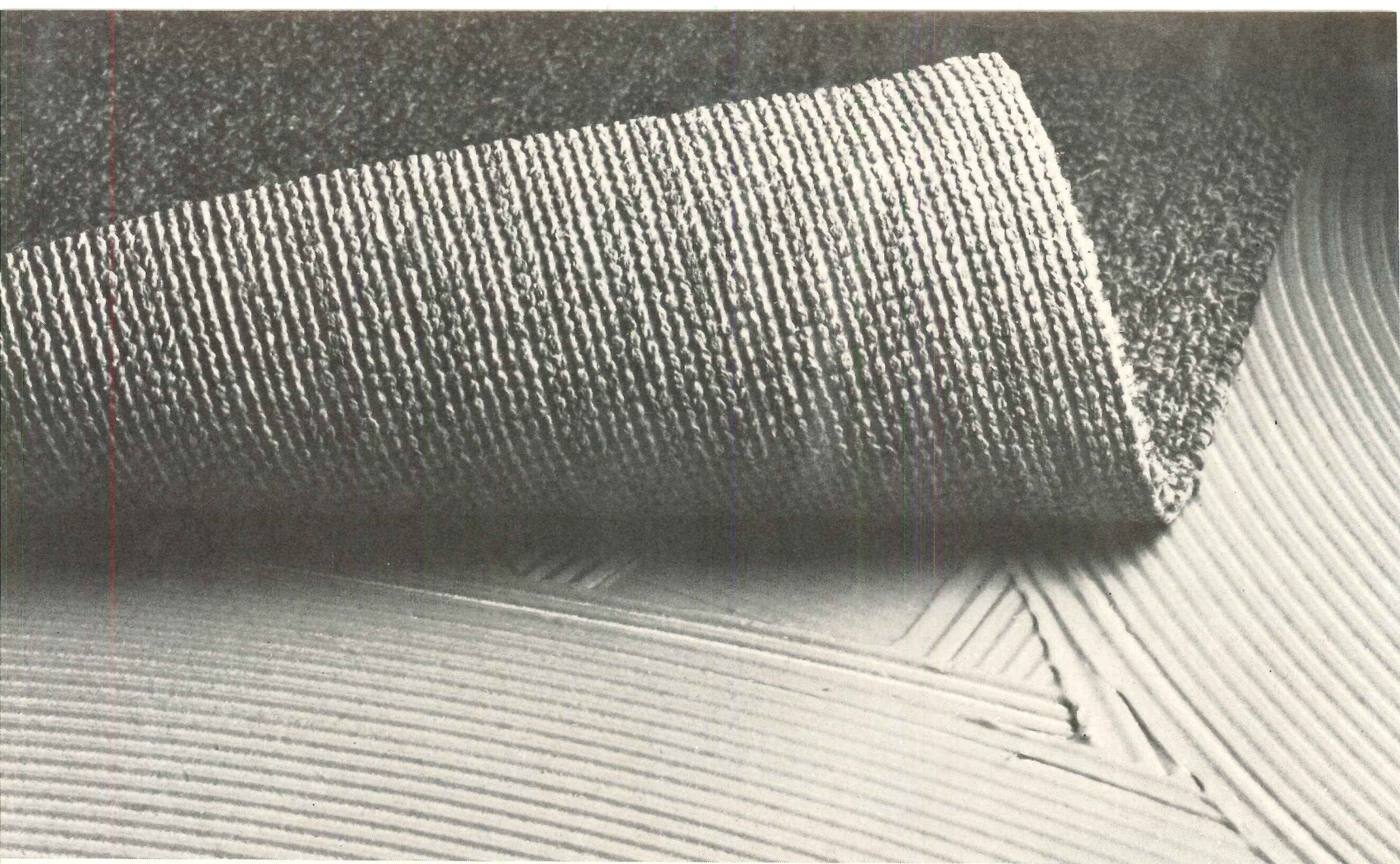

# Hard-surface floors don't have to be hard.

Hard-wearing floors can be soft. Quiet. Safe. Easier to maintain. With carpet that has pile yarn tufted into unitary backing of Typar\* spunbonded polypropylene and directly glued down.

This is carpet with no secondary backing—just one, tough unitary backing of “Typar” that acts like a common bond between carpet pile and floor.

When properly glued down, there's little danger of

delamination from stresses and wet cleanings. No secondary backing for heels and wheels to loosen.

“Typar” won't fray or ravel at the edge. Seams stay tight and virtually invisible. No matter how you twist it, “Typar” keeps its shape. Patterns can be repeated in the longest corridors.

Unlike natural fibers, “Typar” resists rotting, swelling or shrinking when wet. Can be used below grade. And unitary carpet is usually more economical than carpet with secondary backing.

Specify the warmth and beauty of carpet in places you always thought had to be hard. For more hard facts write: Du Pont, Carpet Fibers, Centre Road Bldg., Rm. AR 2, Wilmington, Del. 19898, Attn: Unitary Specialist.

\*Du Pont registered trademark.  
Du Pont makes carpet backing, not carpet.



Carpet of Antron® nylon with unitary back of “Typar” installed in Tabb High School, York County, Va.

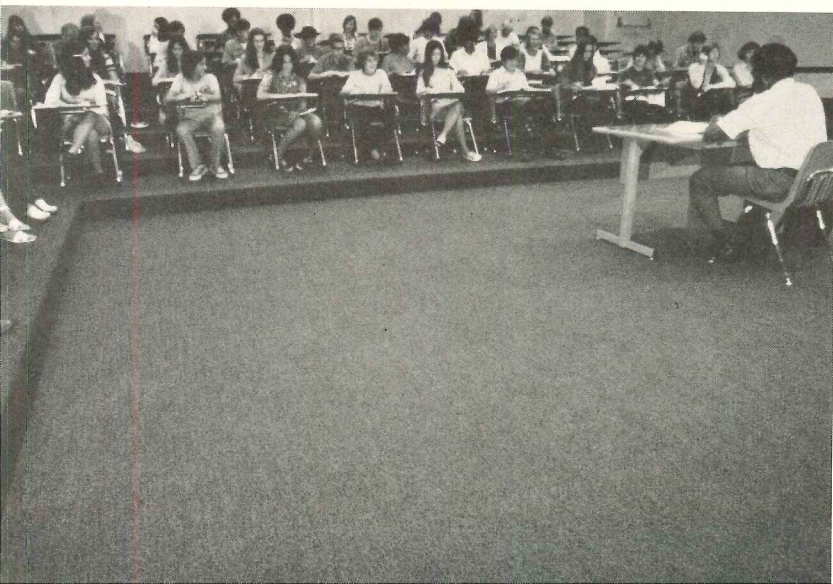

*For more data, circle 60 on inquiry card*

## TYPAR® for unitary carpets you glue down.



# It makes you look good, too.

We put beauty, elegance and reliable operation into the Delta faucet.

We left the washer out. And all the problems worn washers cause.

That's why when you specify Delta, you are specifying one of the most efficient, trouble-free faucets made.

One of the safest, too. Because of the Delta pressure balance bath valve.

When flushed toilets or clotheswashers suddenly decrease the pressure on water lines, the valve automatically compensates to maintain the same hot or cold water mix.

So the shower temperature stays constant. And no one gets scalded or hurt.

There are Delta washerless faucets for kitchens and bathrooms. For sinks and showers. Both single-handle and double-handle models. In beautiful new decorator designs.

They're styled to look good and to work better. And to make the specifier look as good as they do.

*For illustrated literature, write Delta Faucet Company, A Division of Masco Corporation, Greensburg, Indiana 47240, and Rexdale, Ontario.*

## Delta Faucets.

**Washerless. To work as good as they look.**

*For more data, circle 62 on inquiry card*





# Ask a roofer about slope. He'll tell you about Tapered Foamglas<sup>®</sup> insulation.

PITTSBURGH  
**pc**  
CORNING

The next time you seek a roofing contractor's experience, ask him about Tapered Foamglas Insulation as a base for the built-up roofing membrane.

He'll tell you Tapered Foamglas Insulation isn't the cheapest product on the roofing market. But the cheaper products don't have 20 year guarantees, either — a guarantee that Tapered Foamglas Insulation will remain waterproof and incombustible and will retain its full insulating efficiency, dimensional stability and compressive strength. And the lightweight pre-cut, pre-sloped blocks insure a perfect slope.

Tapered Foamglas Insulation also provides one contractor responsibility from built-up roofing to the membrane.

After you've talked with the roofing contractor, we'd like to tell you more. Contact our nearest representative or write Pittsburgh Corning Corporation, Dept. AR 103, 800 Presque Isle Drive, Pgh., Pa. 15239.

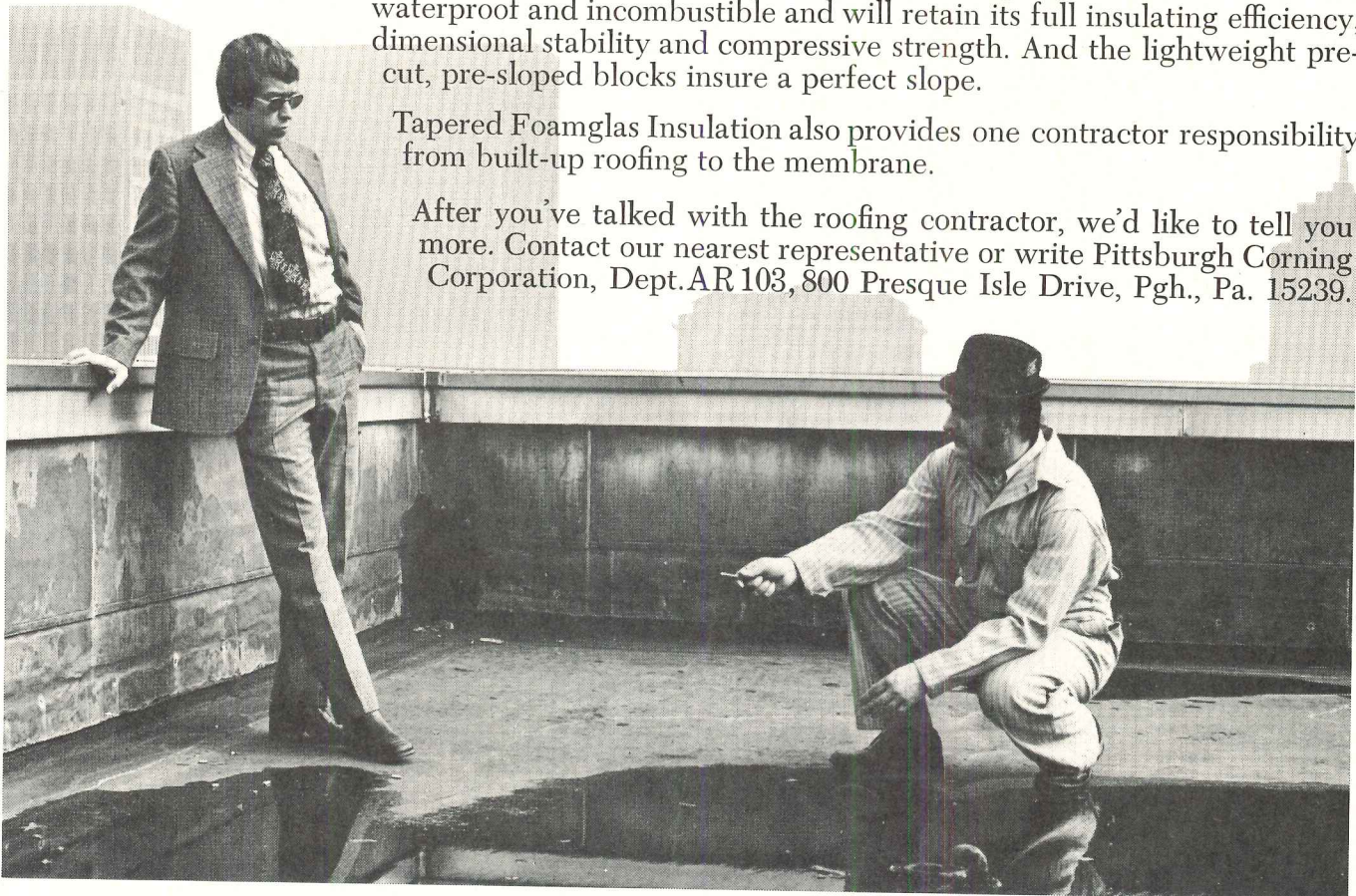

*For more data, circle 63 on inquiry card*



**A basic form  
inspires  
a timeless design. The Body Chair.**



We started with the human body. Comfort first—a unique seat recess, dual-density foam cushioning, and soft, resilient arms. Then solidity and durability from unitized, dual-shell construction. Beauty takes care of itself, in clean, functional lines that won't date when architectural styles change. The Body Chair: an integrated collection of executive, guest, clerical, and secretarial chairs. All in colors and upholsteries to fit any decor. Ask your GF branch or dealer for our new 16-page catalog. Or write to us. GF Business Equipment, Inc., Youngstown, Ohio 44501.



*For more data, circle 64 on inquiry card*



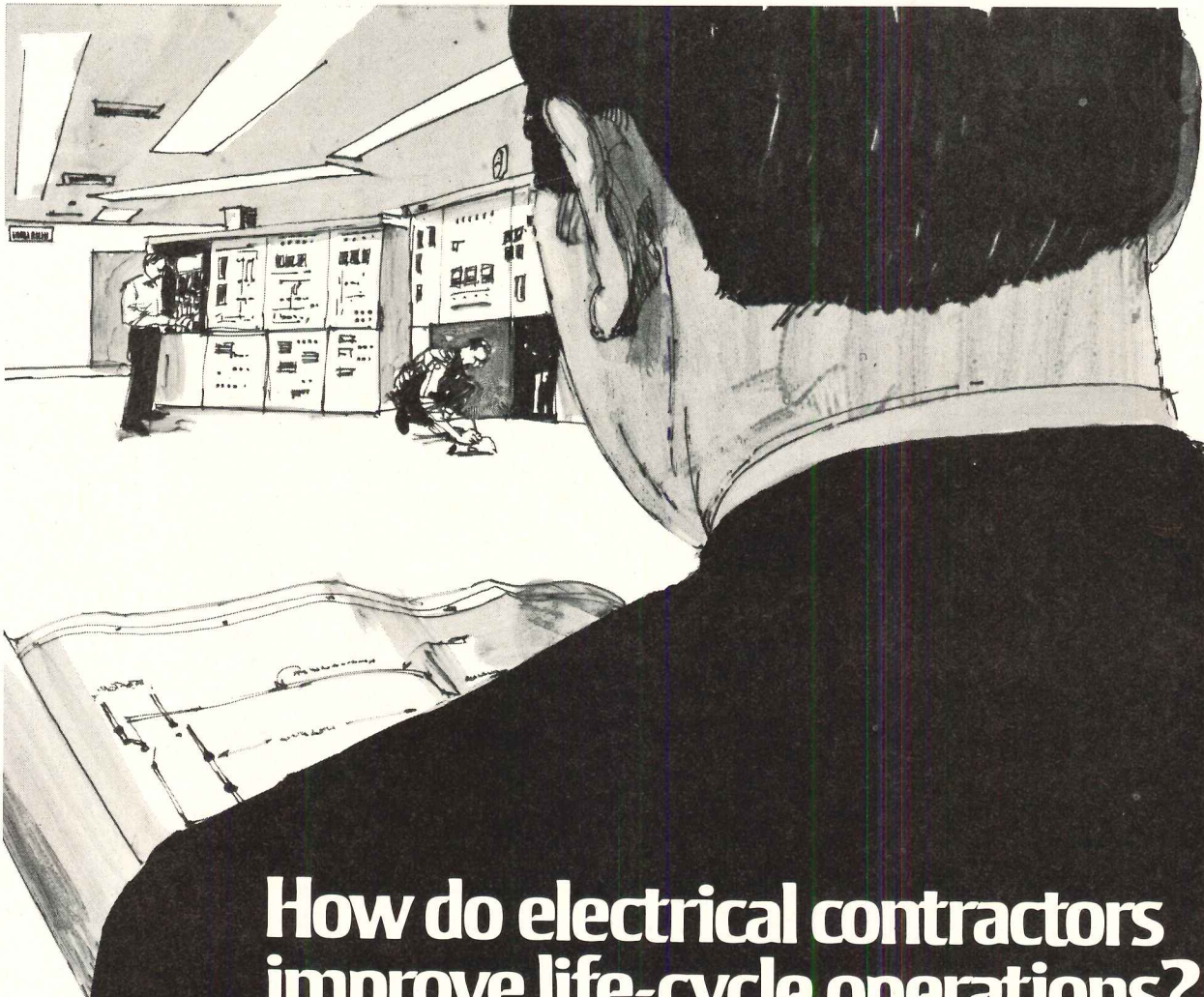

## How do electrical contractors improve life-cycle operations?

### NECA study reveals opinions of design professionals.

In a study commissioned by the National Electrical Contractors Association (NECA), the problem of life-cycle building operation and maintenance was considered. Solution?

The majority of participants agreed: the full benefit of complex and sophisticated electrical systems can only be realized when regularly maintained by professional electrical contractors. Reasons? As members of the building team, electrical contractors possess specialized

knowledge and electrical applications experience. They understand the benefits of electricity and the potential operational difficulties that can arise . . . even in expertly designed buildings. They know that the best way to solve operations and maintenance problems is to correct them before trouble results.

If you can't afford electrical downtime, or a full-time work force for preventive maintenance, you can't afford not to select a professional electrical contractor. Remember him . . . for maximum maintenance at minimum cost.



National Electrical  
Contractors Association, Inc.  
Washington, D.C. 20014

**If electricity makes it possible, electrical contractors make it practical.**



# "FreeSpace" for Your Clients

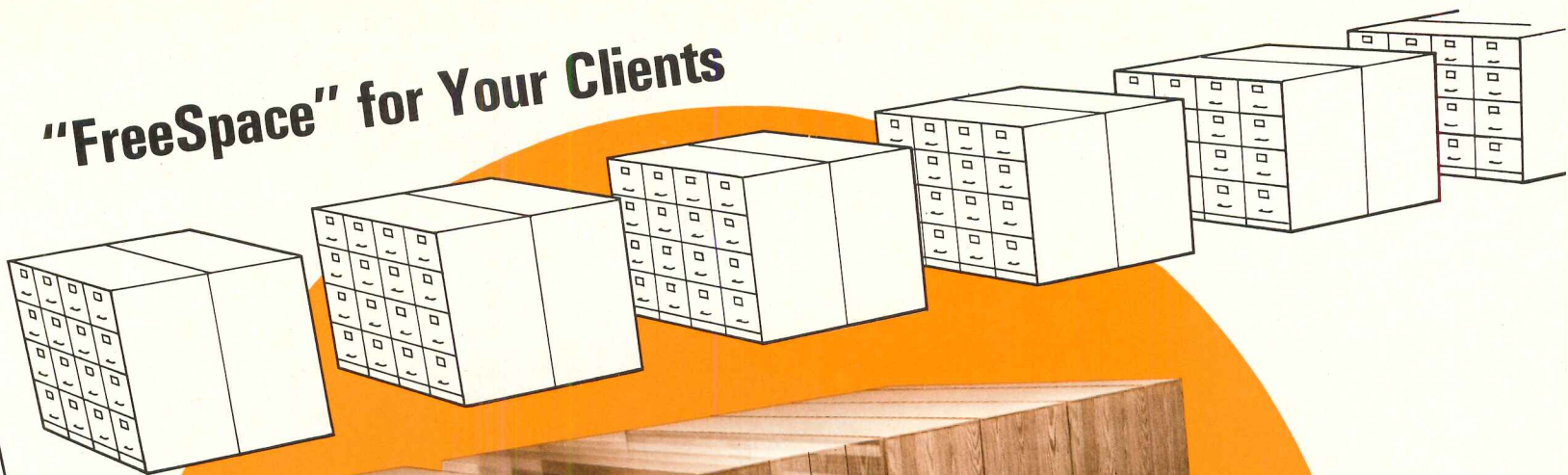

## Put all their files in one fourth the area

### With Lundia FULLSPACE® Mobile Filing and Storage Systems

Now you can "free" valuable floor space. It's a matter of record. In business firms nationwide, Lundia FULLSPACE systems are saving space, retrieval time and money.

FULLSPACE occupies about one quarter the floor space of drawer files of equal capacity. Suppose your drawer files and aisles occupy 400 sq. ft. FULLSPACE of equal capacity saves space for other purposes by requiring only 100 sq. ft., or you can put four times the filing and storage in existing space.

Swedish-designed Lundia FULLSPACE mobile wood shelving has no equal... for efficient management of general files, records, computer tapes, printout forms, ledgers, books, stationery, supplies of all kinds, and even parts inventory.

When you select FULLSPACE for centralizing records-keeping and storage, you really have something working for you. Ask how FULLSPACE can pay for itself. Have a Lundia representative survey your requirements, present a free layout, and provide a cost estimate.

Your installation date will be met. That's in the record, too.

CALL FRANK BROWN COLLECT  
**217-423-3451**

OR WRITE TODAY FOR COMPLETE DETAILS

**LUNDIA**  
The World's Record Holders

LUNDIA, MYERS INDUSTRIES, INC. DECATUR, ILLINOIS 62525

For more data, circle 65 on inquiry card



# Fred Munder, one of the east coast's leading roofing and sheet metal contractors, talks about DUROFLASH:



"Ever since we started in business in 1895, we've been keeping up with the latest product innovations.



Such as DUROFLASH®, Republic Steel's stainless roofing and flashing material. We've been using it since it was introduced a little over six years ago.



We used it here as flashing.

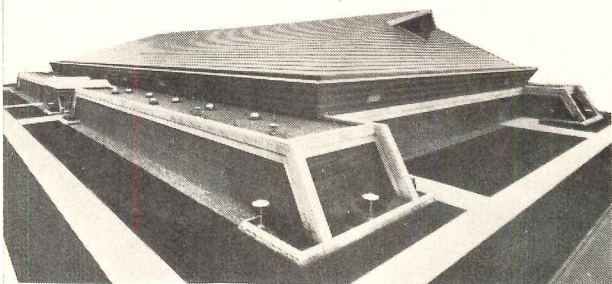

And it has been used as a complete roof system on many other structures. To the great satisfaction of architects and builders . . . and roofers.



No springback. Duroflash is dead soft. You can form it by hand if you want.



No change in color. Less fluctuation in price. And it lasts a lifetime.

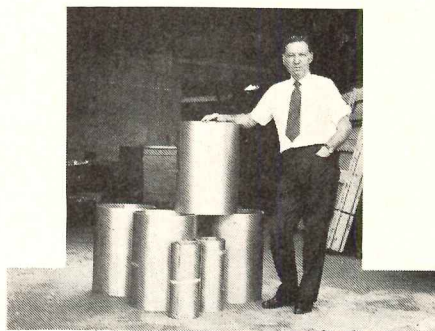

You can get Duroflash in sheet form or in convenient 100 pound coils from most distributors.



And it's backed by America's leading producer of stainless steel . . . which, to me, means consistent quality and service after the sale.



And Republic makes all kinds of data available." (Write Republic Steel, Cleveland OH 44101 for Information Kit and the name of your nearest distributor.)

**"Take it from me, DUROFLASH is a good deal."**

Fred Munder is president of A. Munder & Son, New York N Y

## Republicsteel

For more data, circle 66 on inquiry card





Dannon® bet all its berries on Crusader's carpet of Herculon®...



and really cleaned up.

Crusader calls it "Rebound". You'll call it the best carpet news in years. Made with pile of 2600-denier HERCULON\* olefin fiber, this handsome level-loop original fears neither man nor yogurt.

The stain resistance of HERCULON, coupled with uncommon resistance to abrasion and fading, gives you the ideal carpet for any commercial installation.

Dannon cleaned up on Crusader's "Rebound". So will you.

For detailed information on HERCULON see Sweet's  Light Construction, Architectural and Interior Design files. Or, write Fibers Merchandising, Dept. 301, Hercules Incorporated, Wilmington, Delaware 19899 for free 24 page booklet.



\*Hercules registered trademark.

Specify carpet of stain resistant Herculon®

For more data, circle 67 on inquiry card





Because  
manufacturers  
care about safety





they want UL  
to fire-test  
the complete  
floor and  
ceiling system.

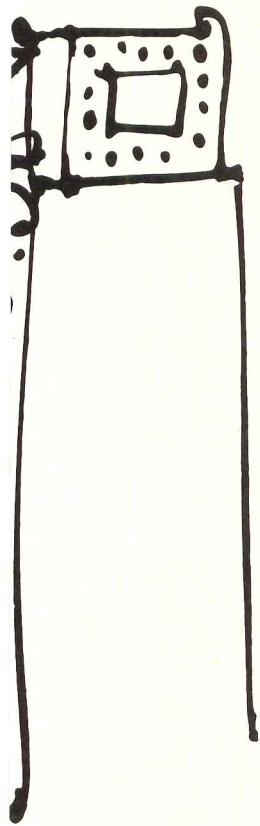

Comprehensive systems testing doesn't come cheap or easy. But manufacturers so value the unbiased verdict of a UL test that they willingly submit their systems to our untender mercies.

Everyone benefits. The manufacturer gains an independent, third-party evaluation of his system so he can offer it with confidence. Jurisdictional authorities and inspectors, architects, insurance underwriters, builders and consumers benefit because UL's findings and Classification ratings are published in UL's **Fire Resistance Index**.

A system has to be good to succeed under the rigors of UL testing. For instance, in the test caricatured here, just the preparation alone for the test can take a week or more. Our engineers used a furnace simulating a room with four brick walls and a network of gas burners within this structure. Then building tradesmen constructed the floor and ceiling system, including the pouring of the concrete floor. This floor-ceiling assembly was lowered onto this "room." Weights simulating maximum floor loads were installed. The test itself was over in a matter of hours, specifically the number of hours at which the system will be rated. Because the test was successful, you can read the results in UL's **Fire Resistance Index**.

Systems testing is one of many ways we work with building materials manufacturers. In the past decade, manufacturers have doubled their work submittals to UL, indicating their increased concern for public safety.

**Underwriters Laboratories, Inc.**  
An independent laboratory testing for public safety.  
Chicago and Northbrook, Ill., Melville, N.Y., Santa Clara, Cal., Tampa, Fla.

For more data, circle 68 on inquiry card



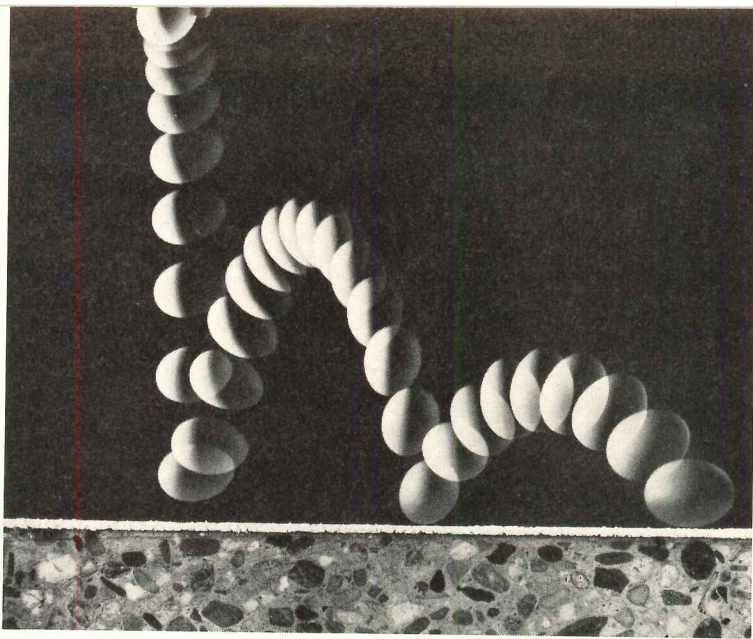

Stroboscopic photograph shows bounce of a fresh egg dropped from 20 inches onto concrete cushioned by 0.30 inch commercial style pneumacel.

Du Pont polyester pneumacel\* is a first. It is a cushion like nothing you've ever experienced.

Even an egg dropped on it bounces. Yet the heaviest traffic doesn't bottom.

This is because pneumacel cushion contains billions of closed cells. Each cell is pneumatic—pressurized with an inert inflatant and air. The result is a springiness that cannot be fully compressed.

# This bounce introduces a from Du Pont. And a unique

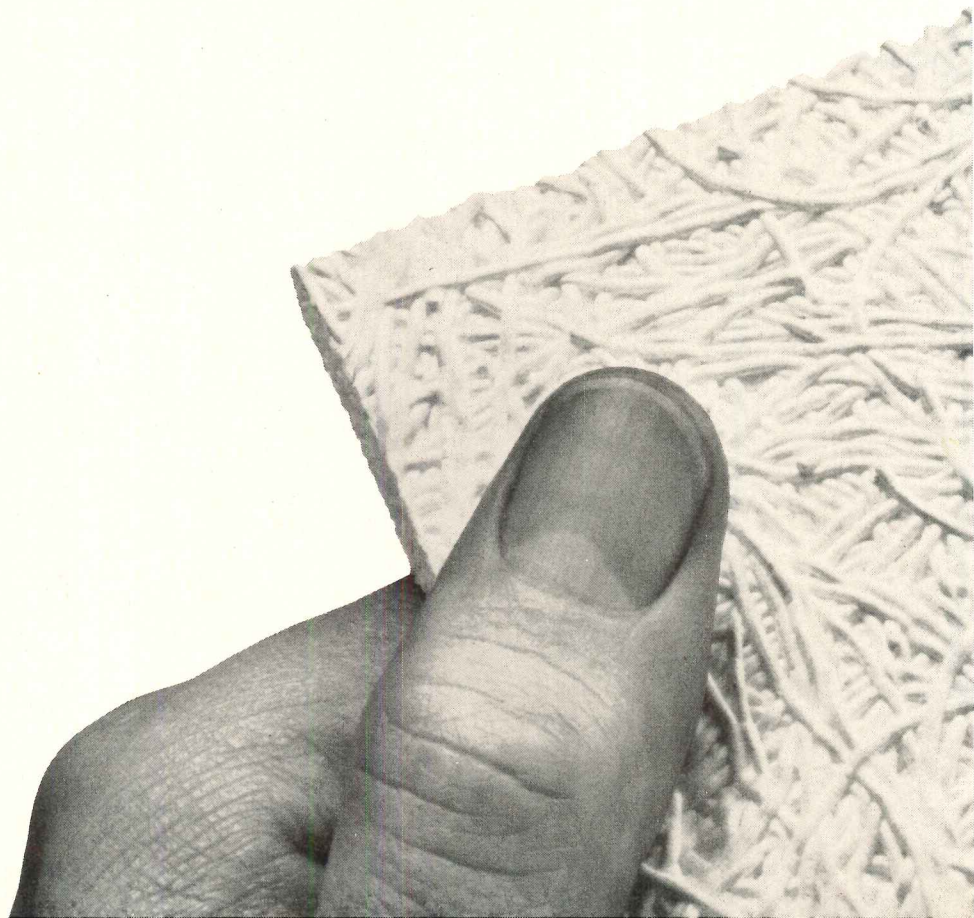

\*Pneumacel is the generic term for pneumatic cellular polymeric cushioning material.



The ideal carpet cushion

Pneumacel is the first cushion to combine maximum carpet protection and maximum luxury.

By spreading the load and not bottoming out, it extends carpet life.

At the same time, according to consumer panels, it gives carpeting a most luxurious underfoot feel.

And it retains its resiliency even after years of heavy traffic.

Of special interest to architects

Pneumacel doesn't absorb water. It can be used above or below grade. Indoors or out.

And pneumacel won't rot or degrade.

It meets or exceeds recognized industry and Federal standards for fire retardancy and smoke generation.

Acoustically, pneumacel gives the design advantage of outstanding impact-noise reduction. It is a significantly better thermal insulator than competitive cushion. And it can be used on any finished or unfinished floor.

Samples and complete technical information available on request. Write Du Pont, Textile Fibers Dept., Wilmington, DE 19898.

*For more data, circle 69 on inquiry card*



# new form of matter carpet saver.



**DuPont  
Pneumacel\*  
Carpet Cushion**



# It would be a shame to get called back because the drapery track won't perform. Instead, specify Contrack.

Heavy-duty anodized natural aluminum finish—blend perfectly with the window casings.

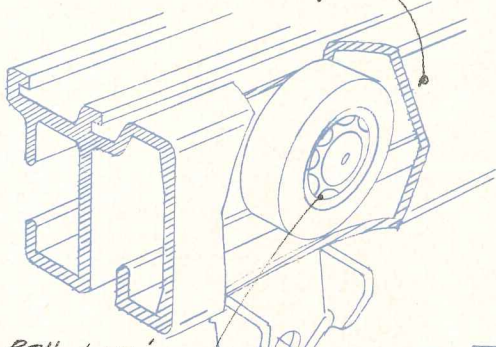

Ball-bearing carrier w/ large cross-section minimizes friction drag. Smooth rolling. No jamming. Quiet, long life. Bumper carrier pendant design makes overriding, jamming impossible (Big point!)

Graber Contrack 9-804 cord traverse track.

Ball-bearing rollers in masters too—good load distribution. Tough nylon outer race construction.

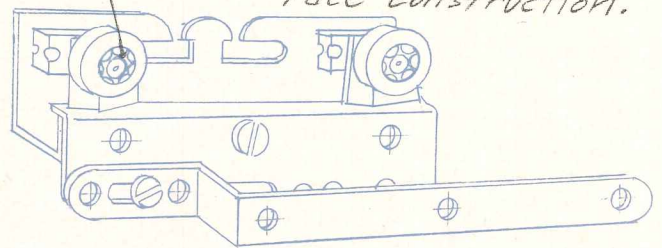

Cords in separate back channel. Good! Less wear. Carriers in track positioned to stack drapes close, even, keep headings erect.

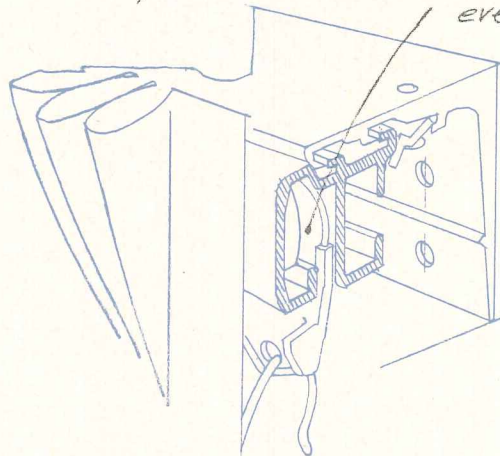

Will set up to solve our problem with the pentagonal bay windows—draw left, right, in multiples. Track can be angled and curved right down to 12" radius.

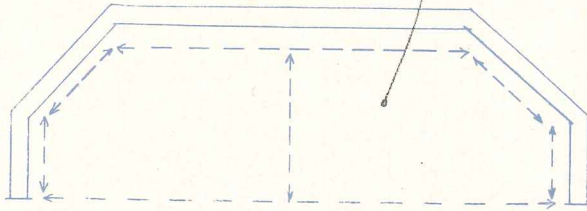

Great maintenance feature carriers can be added and removed through special gate in pulley housing.

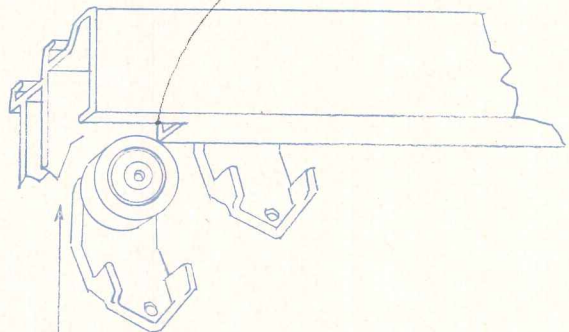

Three points of support for extra strength. Five projections from 3/4" to 5" plus a ceiling mount—handy for board room floor-to-ceiling windows.

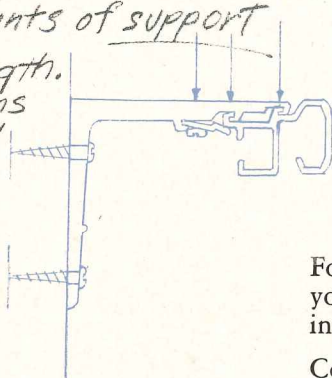

For full information on why Graber Contrack is your safest choice for performance, see our pages in your Sweets' Architectural File.

Contrack—a full line of hand and cord traverse commercial drapery hardware from

**Graber™**  
the window fashion people

A CONSOLIDATED FOODS COMPANY • RESPONSIVE TO CONSUMER NEEDS

Middleton, Wis. (608) 836-1011 • ™ Trademark of the Graber Co. • © COPYRIGHT GRABER CO. 1973

For more data, circle 70 on inquiry card





*Why steel joists  
were the  
right answer  
to this  
building need*



## SEVEN PINES...WHERE STEEL JOISTS SAVED CONSTRUCTION HOURS AND DOLLARS

On a steeply wooded bank in Glenwood, New York, with a commanding view of the Hudson River and Palisades, rise the handsome Seven Pines Apartments. Designed largely to answer the needs of middle income tenants, the 300-unit tower was designed by Gruzen & Partners, Architects-Planners-Engineers, New York City and Newark, N. J., for the New York State Urban Development Corporation. The building is diamond shaped, with large balconies at each corner and smaller balconies on the sides, and is set at an angle to provide most apartments with views of the river.

Open web steel joists were used extensively throughout the tower. The architects state, "Our use of open web steel joists was recommended by the sponsor/builder and specified by the engineer. Because of this, we saved time and money, but more important ended up with a satisfactory alternative to solid reinforced concrete.

"The open web steel joists support corrugated decking (for a three-inch concrete-slab floor) which was pre-punched to match upward projections of the webs. Crimped sheet metal wedges were used to lock the decking to the joists.

"This composite system offered the necessary bracing strength, avoided the need for extensive welding, and virtually became monolithic. We expect to be using it more often in the future."

Learn more about the benefits of open web steel joists. Send coupon today.



Mail to: **STEEL JOIST INSTITUTE**  
7th Floor, 2001 Jefferson Davis Hwy.  
Arlington, Va. 22202

Please send me your new copy of Specifications and Load Tables for Open Web, Longspan and Deep Longspan Steel Joists.

NAME \_\_\_\_\_

TITLE \_\_\_\_\_

FIRM \_\_\_\_\_

ADDRESS \_\_\_\_\_

CITY \_\_\_\_\_ STATE \_\_\_\_\_ ZIP CODE \_\_\_\_\_

73-004

For more data, circle 71 on inquiry card



# SWITCHES

Why the Eagle TOUCH-A-MATIC® Switch is the safest, most dependable choice for your electrical specifications.



Cat. No. 1240

**How it works:**

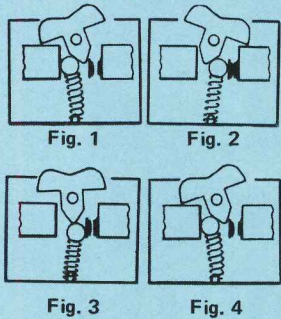

Fig. 1, switch in "off" position (contacts open). As switch lever is rotated, actuating ball compresses the coil spring, but ball must pass pivot point of lever before it can close the contact. As it passes the pivot point it has maximum momentum and closes the contact points positively and rapidly. All independent of hand action (Fig. 2.). As the switch lever is rotated in the opposite direction, Fig. 3, the ball is depressed and slowly releases some spring tension on the contact arm, permitting the contact points to open enough to break the arc slowly. Then as the ball passes the pivot point it completes the cycle (Fig.4.).

The Eagle Heavy Duty Touch-A-Matic Switch operates on a completely different principle than the generally used cam-action switch. This principle is specifically designed for AC use.

Touch-A-Matic is a ball bearing and spring patented principle that assures a fast make and a slow break, (which is independent of hand action); so that arcing is prevented. This means a safer switch action — and less erosion of the contacts, so that the switch lasts longer. In fact, the rigid overload and endurance testing program which Eagle Touch-A-Matic switches must pass is equivalent to turning the switch on and off twice a day at full load for 40 years.

Eagle Touch-A-Matic Switches have both screw and E-Z WIRE® pressure terminals, which permit faster installation at lower cost. Touch-A-Matics are Specification Grade, UL listed and meet Federal Specifications and OSHA standards. Available in Single Pole, 3-way, Double Pole, 4-way; 15 and 20 Amp, 120-277V AC only (½ HP, 120V AC), in brown and ivory; and white in some styles. Lifetime Guarantee. For more information on Touch-A-Matics and the complete line of Eagle wiring devices, send today for a copy of our catalog.



Eagle Electric Mfg. Co., Inc., Long Island City, N.Y. 11101  
In Canada: Eagle Electric of Canada Ltd., Ontario

For more data, circle 72 on inquiry card



## HOUSE OF TEAK

The most comprehensive inventory in America

From around the world, bold inventories of kiln dried hardwood lumber and veneer—ranging from domestic Ash to exotic Zebrawood.

CHESTER B. STEM, INCORPORATED  
GRANT LINE ROAD, NEW ALBANY, INDIANA



The guide spec that opened countless doors to carpet

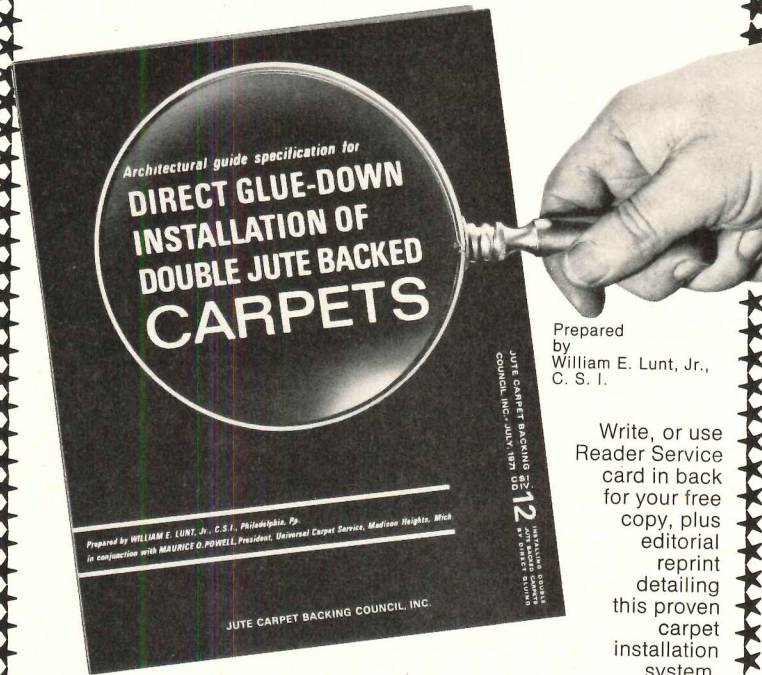

Prepared by William E. Lunt, Jr., C. S. I.

Write, or use Reader Service card in back for your free copy, plus editorial reprint detailing this proven carpet installation system.

**JUTE** CARPET BACKING COUNCIL, INC.  
25 Broadway • New York, NY 10004



For more data, circle 73 on inquiry card





## Meet Yale® monolock. Strong. Solid. Simple.

It's the pre-assembled lockset that's quicker and even easier to install than mortise or cylindrical locksets.

All it takes is one notch cut out of the door. Yale monolock slips in. Attaches more securely with the added strength of anchor screws.

Then it cleanly covers all screw fasteners to look smart as well as resist tampering.

Yet, Yale monolock is easier to service. Can be rekeyed without removing the lockset from the door.

It's the bold and beautiful lockset that can mean easier and more profitable completion of contract work. With more enthusiastic customer satisfaction.

Yale monolock comes in eight different knob styles and two lever handles. To find out just how beautiful they are, send for our brochure A-33. Ask your Yale representative or write to: Eaton Corporation, Yale Marketing Dept., P.O. Box 25288, Charlotte, North Carolina 28212.

**EAT•N**  
**Security Products  
& Systems**

*For more data, circle 74 on inquiry card*



# Crown Center is a city within a city..





## ...and U.S. Steel is involved.

It will take 10 years to finish and cost all of \$200,000,000! That's Hallmark's Crown Center — spreading over 85 acres in Kansas City. A new hotel has just opened. Hi-rise apartments and town houses are under way. Shopping centers, theaters, fine restaurants, a skating rink — they're all part of a unique enterprise that promises to make Kansas City an even greater place to live and work in.

Already completed and in full operation are the five 7-story Crown Center Office Buildings. The new buildings set a stunning pattern for things to come and are a beautiful example of what is happening in Kansas City. They also highlight our involvement in the project, because many tons of our steel and cement have already gone into Crown Center.

Kansas City's great development plan includes the new International Airport, Penn Valley Community College and the new Hallmark Distribution Center — third largest structure in the world. All these major projects used our steel and cement.

Of course, U.S. Steel is much more than a supplier of materials. We have people right here in Kansas City to help planners, architects and engineers make the best use of steel. We also help clear new design concepts through Code Committees. And we offer a unique Computer Analysis Service for buildings — to help evaluate steel against other structural systems. Just a few of the ways we can make a valuable contribution to building projects.

*Big things are happening in Kansas City... and we're involved.*

**United States Steel**   
TRADEMARK

*Architects:* Edward Larrabee Barnes, Harry Weese, The Architects Collaborative, Marshall & Brown.  
*Fabricator/Erector:* Havens Steel Co., Kansas City, Mo. Southwest Ornamental Iron Co., Bonner Springs, Kansas. Kansas City Structural Steel Co., Kansas City, Kansas.

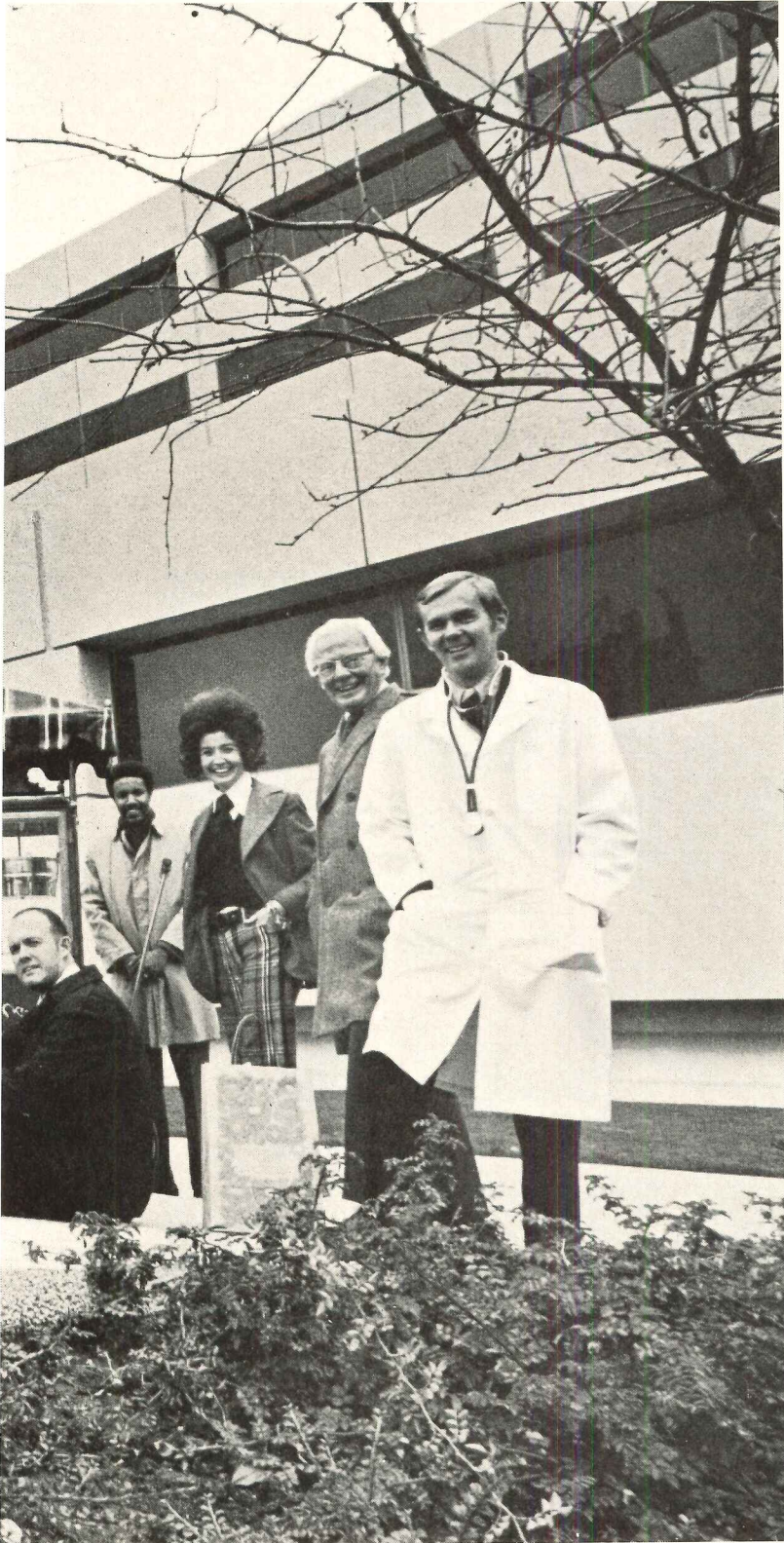



**Steelcase Mobiles:  
Helping your employees be  
more productive.**

Using the Mobiles office furniture approach, you give each person as much privacy, storage and work surface as he or she needs. For example, in the accounting department below, rollout workshelves accommodate machines, cabinets contain binders, vertical service modules on the desks help to organize invoices and other vital business documents.

In an adjoining area, pictured at right, company salesmen who are in the office just a few hours a week have sufficient work surface, storage, display space and semi-privacy in a minimum of square footage.

In each case, precise needs are met. With Mobiles, Steelcase's name for creative mobile assemblies of lateral files, movable walls and desks.

For details contact your local Steelcase dealer. He's listed in the Yellow Pages. Or, please write to



Steelcase Inc., Department G,  
Grand Rapids, Michigan 49501.

**Steelcase**



*For more data, circle 75 on inquiry card*



# CROWN CENTER

ARCHITECTURAL RECORD OCTOBER 1973

Urban renewal for a Kansas City grey area—privately financed, without Federal subsidy, by a manufacturer of greeting cards

Five minutes southward by car from downtown Kansas City is the headquarters of Hallmark Cards, Inc., the world's largest manufacturer of sentimental little messages in print. Here writers concoct heartwarming phrases and poems, and 500 artists create the pictures to go with them. By appealing to the better side of human nature, founder and chairman Joyce W. Hall, 82, and his son, company president Donald J. Hall, 45, have built a business with current annual sales of \$350 million and estimated annual profits of \$25 million. One of the decreasing number of large U.S. companies still in private ownership, Hallmark belongs to the Hall family with a moderate number of shares available to employees. Since Hallmark is not publically held, the Halls are not responsible to outside stockholders. They can literally invest their profits as they please in ways in which no publically owned corporation would dare. The Halls are spending \$400 million developing real estate adjacent to and surrounding the Hallmark plant. The project (named Crown Center because a crown is Hallmark's symbol) comprises 23 square blocks and includes office buildings, a bank, a shopping center with 65 stores, apartment buildings and town houses, a 730 room hotel and a motel. This huge venture will not be completed until ten years from now. As conceived it will take twice as long to become profitable as other real estate developments of comparable size. The Halls have long been quietly philanthropic and community minded, and are known for their support of the arts including architecture and design. Crown Center is their way of getting it all together and Kansas City benefits. —Mildred F. Schmertz



At the top of the photo is the Kansas City Municipal Airport. The towers adjacent, on the opposite side of the Missouri River, belong to the downtown center. Superimposed upon this aerial photo is a model photograph of the way Crown Center will look when it is complete, 10 years from now. The principal architects for Crown Center are Edward Larabee Barnes, Harry Weese and Associates and Norman Fletcher of TAC.



## Crown Center: The master plan by Edward Larrabee Barnes called for a large volume of initial construction to create an impact in a decaying area

Economic studies began in 1958, and land use analysis commenced in 1961. The principal land use planners were Victor Gruen Associates. In 1967, Edward Larrabee Barnes was named coordinating architect and master planner responsible for giving form to the project.

The Hallmark plant exists in a grey area. Although it is adjacent to a large park and a major medical center, the over-all urban context is one of characterless and non-descript low-rise buildings. (See photo overleaf.) To create an urban center within this worn and aging metropolitan fabric called for a bold initial statement—sufficient construction at the beginning to create what Barnes calls a “critical mass.” To develop public interest and bring tenants to Crown Center, Barnes advised the Halls to start construction of a 626,300 square foot office complex distributed in a five-unit medium-rise structure with continuous horizontal space. He also recommended that the first phase of construction include in sequence the terraced lawns and plaza, the hotel, the shopping center and finally the housing. All of the first phase, except for the housing which has not yet begun, is complete.

Barnes believes that, generally speaking, high-rise buildings belong in the inner urban or downtown core, but that medium-rise is appropriate for what he terms the “middle ground” where Crown Center is located. This rationale controlled his design for the horizontal office block (top left rear in the photo right) which follows the contours of the site and of the curved street. The V-shaped hotel by Harry Weese and Associates (lower right foreground in photo right) breaks the medium-rise scale which Barnes originally intended to achieve.

Barnes’ master plan closes and builds over a then existing north-south street to create the terraced lawns and plaza, but allows the other north-south artery to remain. The plaza is set at the level of this street as can be seen in the photograph (right). The street itself is bridged by a shopping arcade.

Parked cars will not be part of the ambience at Crown Center. Hallmark employees park on the roof of their plant (as the photo at right indicates) and all other visitors and workers will park their cars underground.

Crown Center’s rapid growth would appear to be the result of three factors—plenty of front money by an unusually patient developer, a realistically phased master plan and a lack of significant opposition on racial or ethnic grounds. Crown Center will displace a total of 19 families, all of whom are being rehoused by Hallmark. It is bringing thousands of new jobs to the Kansas City area (the hotel alone has provided 1,000 new opportunities for employment) and is providing a strong impetus for the regrowth of the nearby downtown area.

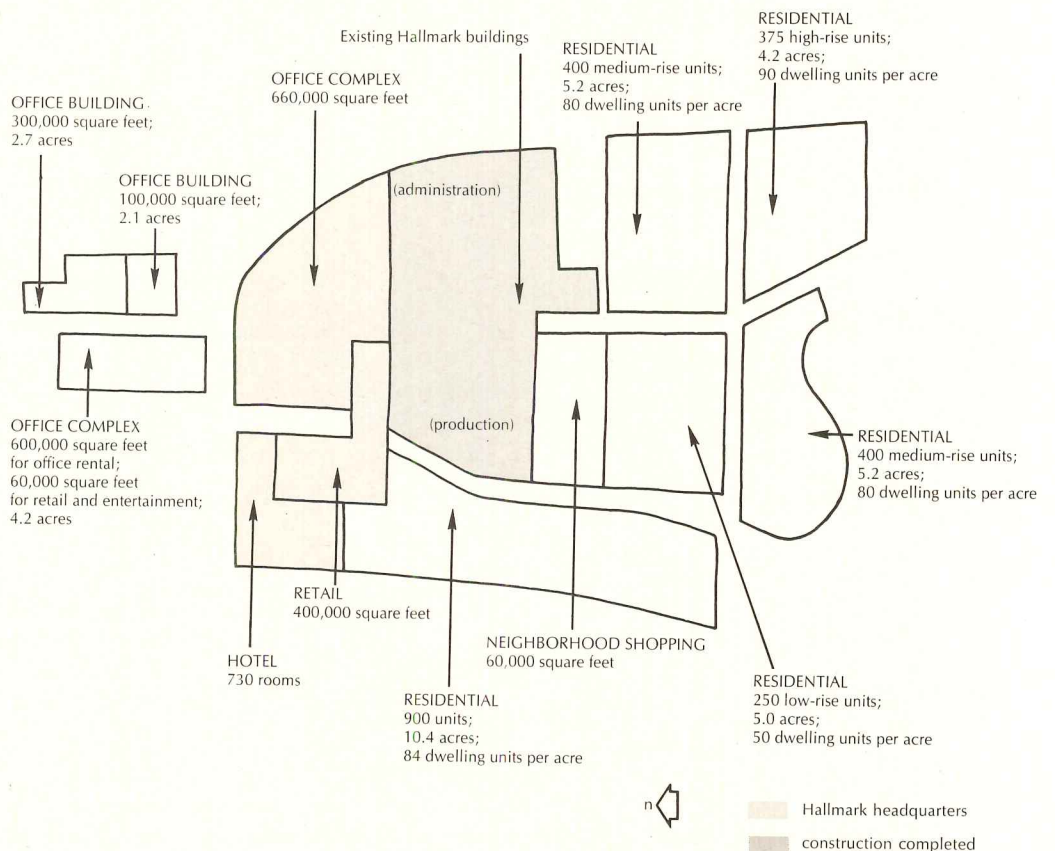
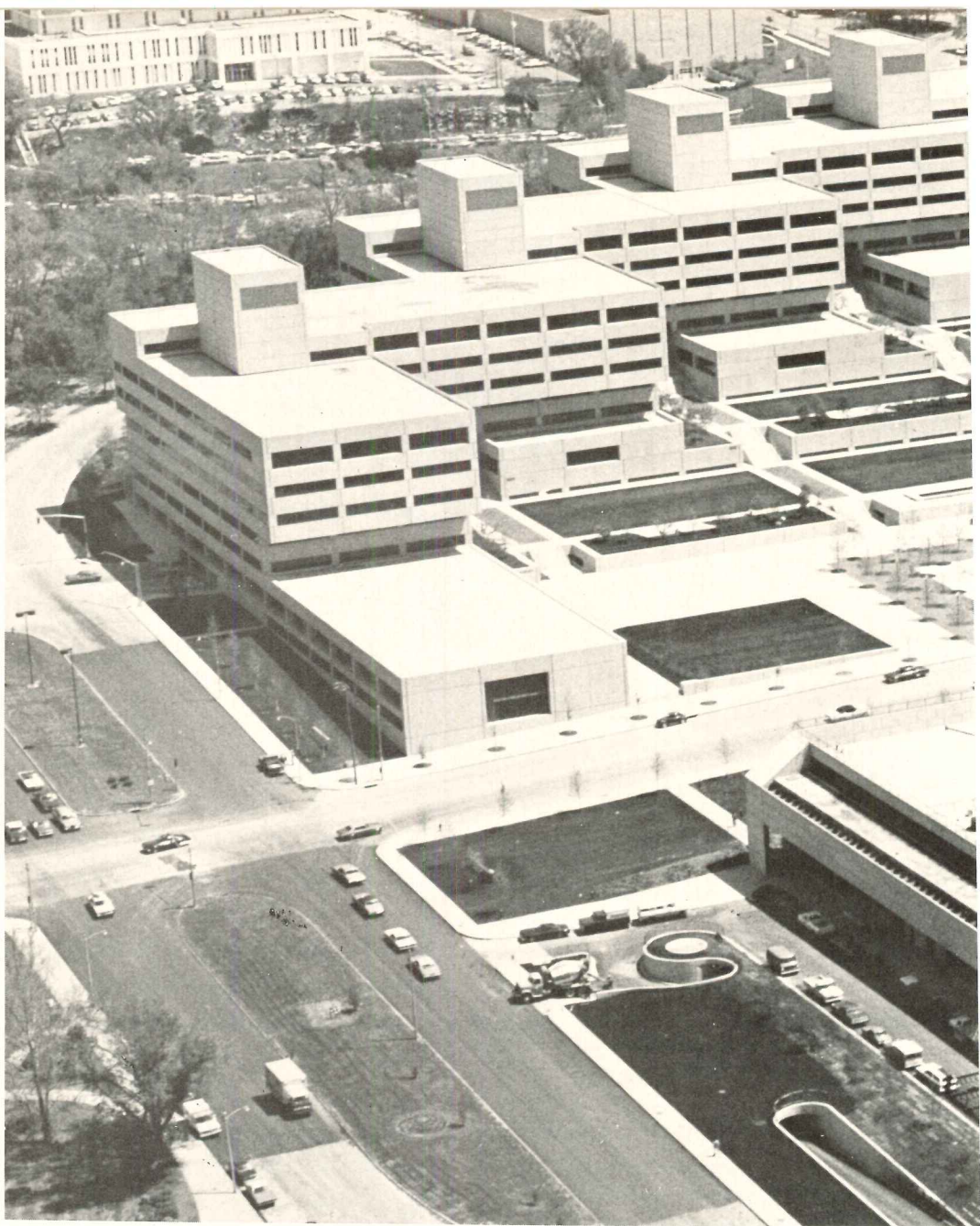





The photograph above shows the conjunction of the new development with the Hallmark plant. Almost all of the completed construction of phase one can be seen. Obscured from view by the hotel is the shopping center which will have a rooftop restaurant by Warren Platner and shops by Francois Dallegrè and Joseph Baker and other leading architects and interior designers. The projected housing will be built along the same outcropping as the hotel. This first residential block at Crown Center will have 450 apartments including two condominium buildings. The second phase of construction, scheduled to be completed in 1977 will give Crown Center additional apartments and a second retail complex to serve them. The third phase, finished by 1980, will provide still more apartments and office space. The final phase, to be completed in 1983, includes a 100-unit motel and more apartments. Eventually 8,000 people will live in Crown Center.

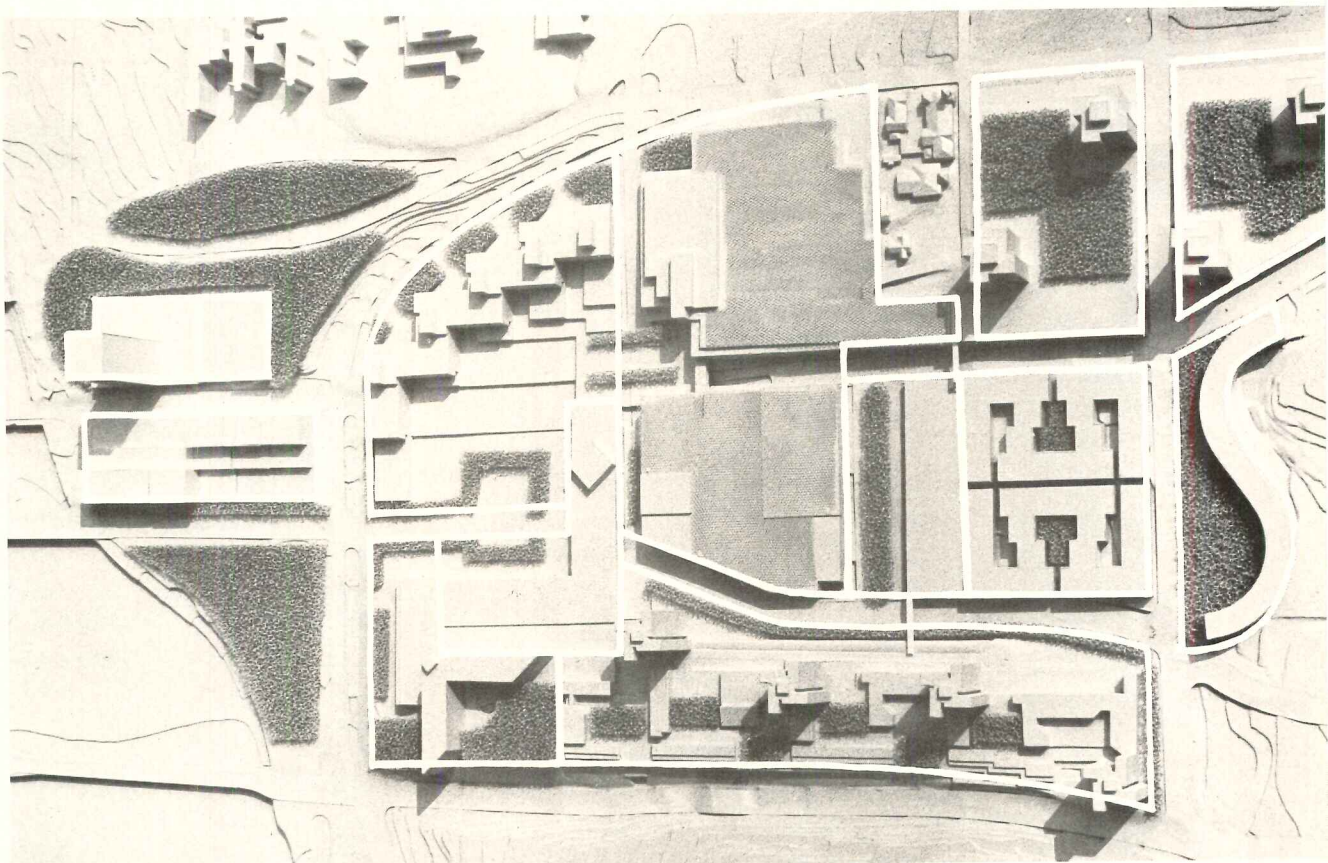



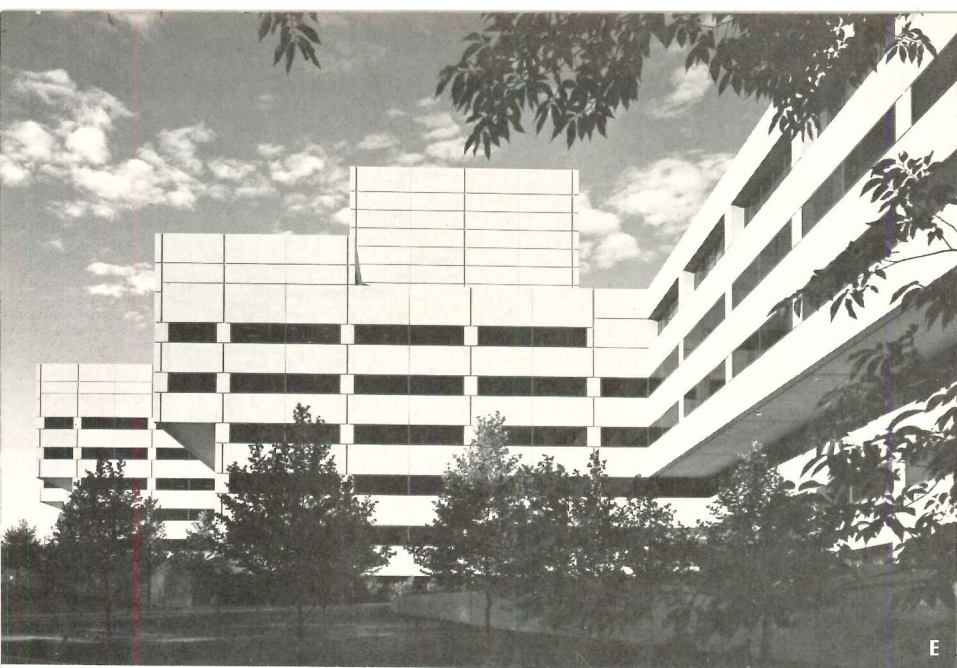

E



B

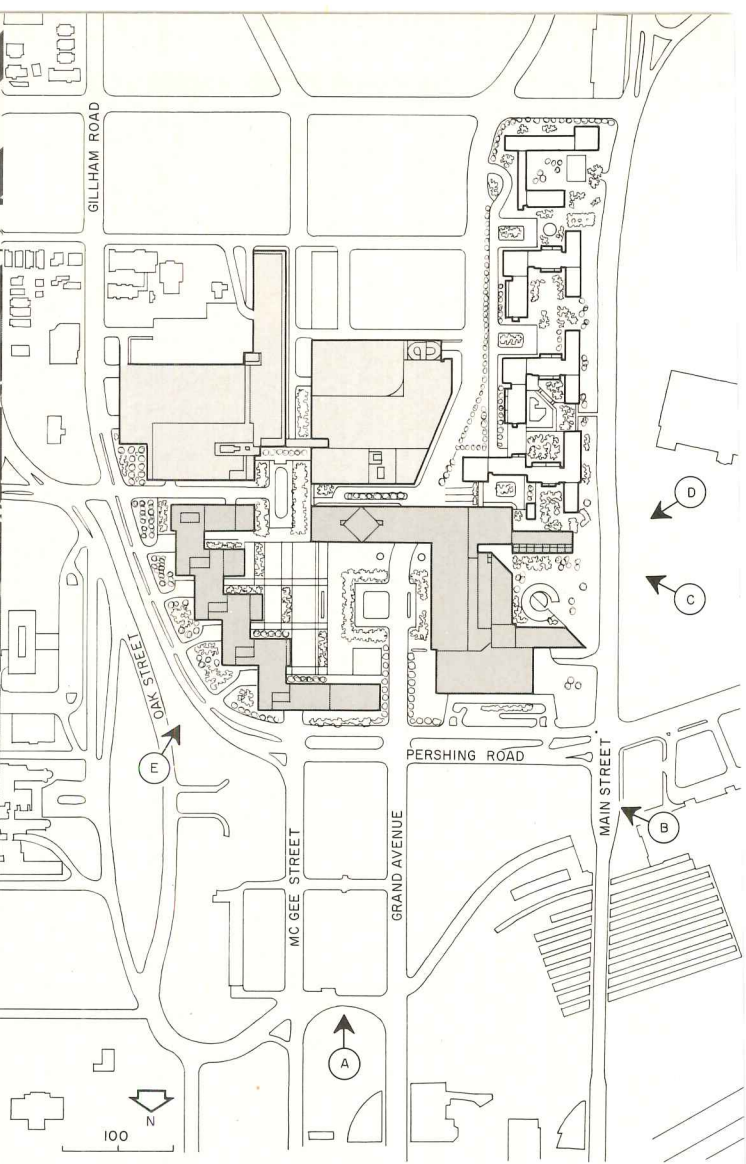

The construction photo (A) was made before the hotel was completed and the shopping center underway. It shows the proximity of the plaza to the four-lane street. As the site plan (bottom left) indicates, this is not a major artery and should not have too much traffic. Photos (B) (D) and (E) show the over-all scale of the center. The model photograph (C) shows the first phase of apartment construction to begin late this year. The apartments are by TAC.

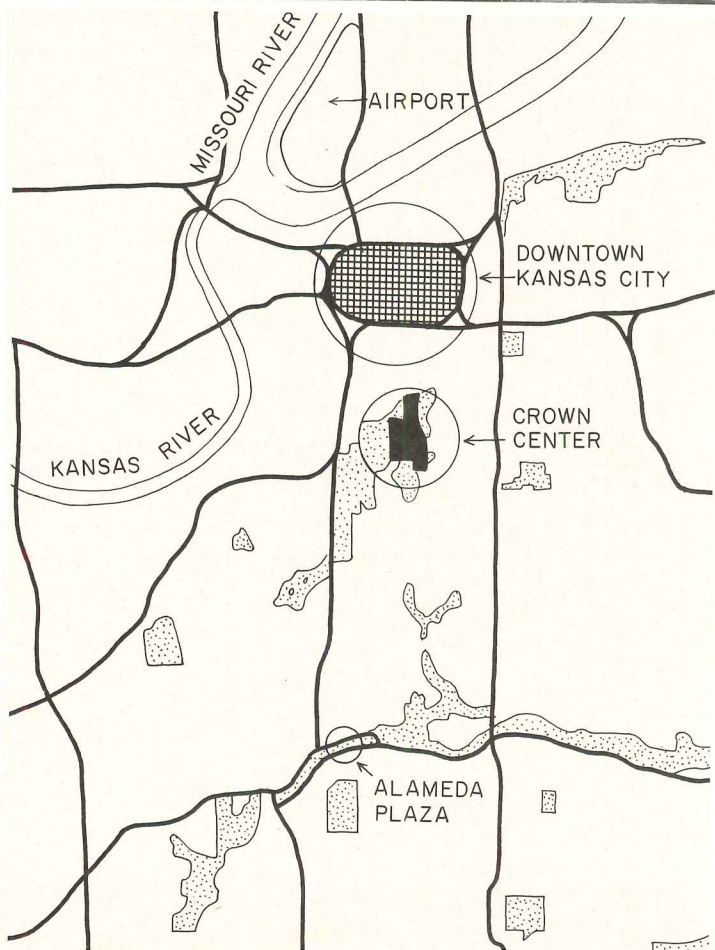

A







Conventional site planning wisdom applied to public plazas, calls for separation of pedestrian and vehicular traffic movement. For many planners a plaza is simply not a plaza if it has a four lane street running through it at the same level. At the very least, conventional wisdom insists that a plaza be shielded from traffic by raising or depressing the street. Master planner Barnes argues that plazas which are too well separated from vehicular traffic don't work. They tend to be underused by pedestrians and therefore shops don't thrive. When Crown Center's L-shaped shopping wing is completed, workers in the office complex and the Hallmark plant can enter it from their sides of the plaza. This shopping arcade will serve as a bridge linking both sides of the street. Perhaps very few pedestrians will actually cross the street on their way to the shopping center and hotel. Both the shopping center and the hotel have excellent vehicular access.

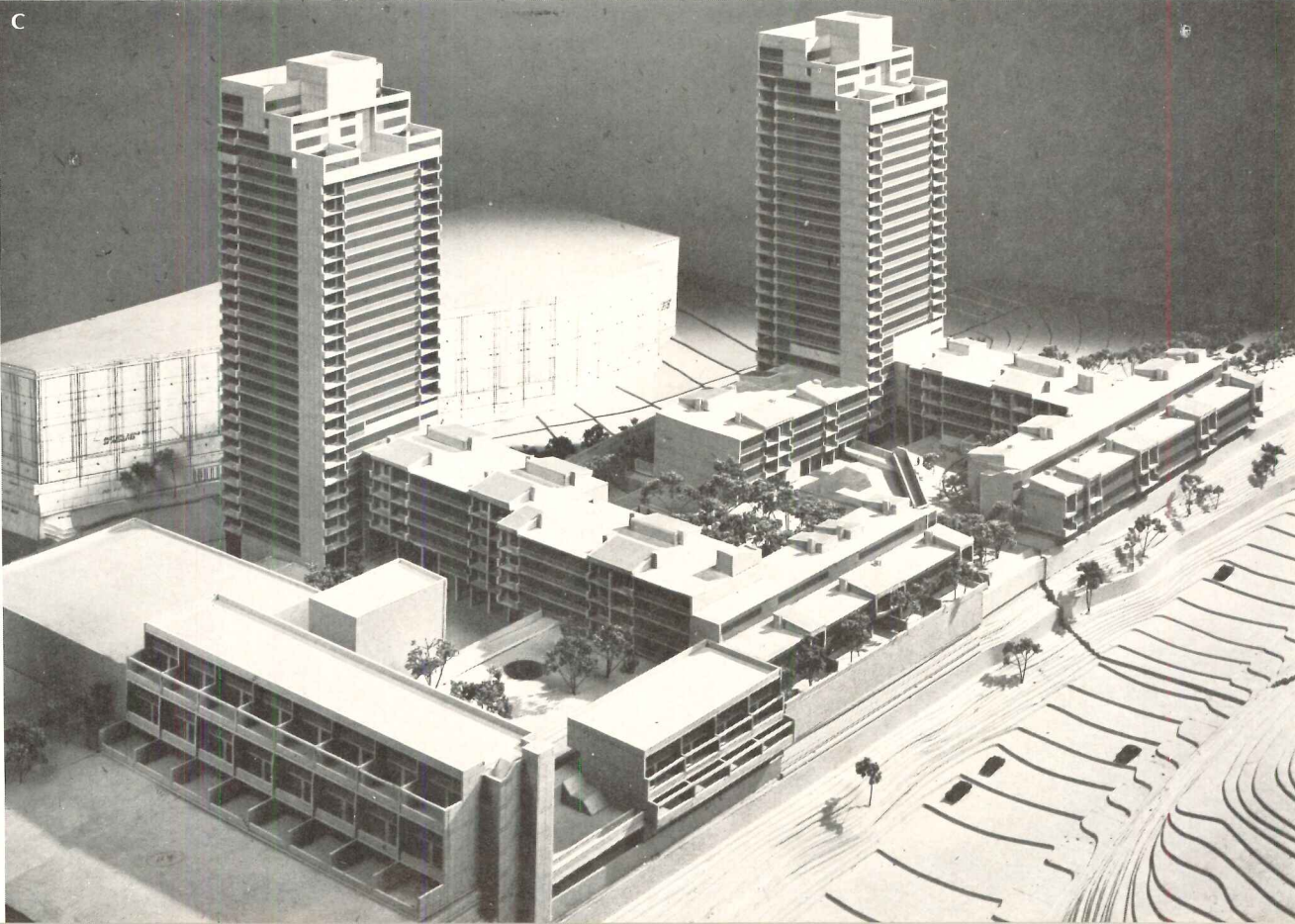



## Crown Center: A hotel by Harry Weese obeys, yet transcends the design formulas of an international hotel chain

The 730-room Crown Center Hotel is perched upon a limestone outcrop on the western edge of the Crown Center development. Its elements are superbly organized around the rockface and part of the rock itself is exposed indoors. Master planner Barnes and Harry Weese, the architect who designed the hotel, originally wanted it to be a horizontal structure following the contours of the rock. Thus both sides of the square would have been controlled by the concept of medium-rise massing implicit in Barnes' office complex and his master plan.

Western International Hotels, the firm operating the hotel, has such a hotel in its chain—the beautifully designed medium-rise Camino Real in Mexico City. This operator's experience with horizontal as opposed to vertical circulation has not been entirely satisfactory, however, since hotel guests and staff appear to prefer quick elevator rides coupled with short walks, to slow hikes with or without baggage or food carts through long corridors.

After Western International shot down Weese's various medium-rise schemes, both he and Barnes had to accept the fact that medium-rise Crown Center was to have at least one tower. (The laws of economics and practicality will bring more towers later on. The high- and low-rise apartment complex was first conceived as a series of horizontal terraces.)

Once Weese began to design the kind of tower-podium structure which hotel operators favor, within the constraints of the rock outcrop, he was on his way to the creation of a remarkable building. The five-story high podium element literally backs into the rock. Here are the spaces which typically form the guest room tower base—lobby, shops, ballroom, restaurants, kitchens and service areas, with extensive garage space adjacent and below. The V-shaped 14-story tower begins at the top of the rock, approximately 70 feet above the level of the surrounding streets. What is splendid about the architecture of this hotel is the spatial transition from the lobby through the indoor rock garden to the outdoor garden, swimming pool and roof terraces shown in the plot plan (right). From the street (opposite page), the massing is spectacular.

CROWN CENTER HOTEL, Kansas City, Mo. Owner: *Crown Center Redevelopment Corporation*. Architect: *Harry Weese and Associates*. Associated architects: *Marshall and Brown*. Project managers: *Concordia Management Services—project manager: W. M. Flanagan, hotel coordinator: E. A. Balys*. Engineers: *Jack Gillum and Associates* (structural); *TEC* (mechanical/electrical); *R. C. Coffeen & Associates* (acoustical); *Dónald Bliss* (lighting). Consultants: *PBNL Architects, Inc.* (interior design); *Landscape Associates* (landscape architecture); *Harper and George* (graphics). General contractor: *Eldridge & Son Construction Co., Inc.*

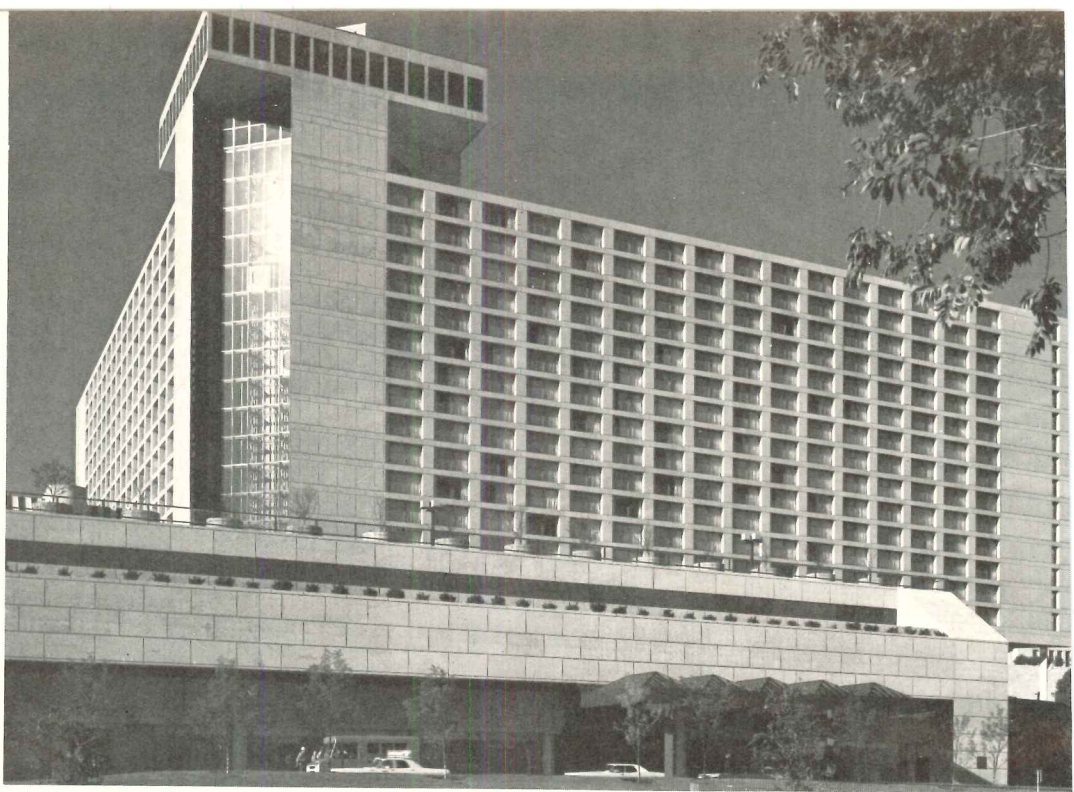

At the corner of the guest room tower is a glass walled elevator shaft, a design device which must delight more guests than it terrifies, judging from the frequency with which it now appears in luxury hotels. At the top of the shaft is a restaurant with a panoramic view, another essential of the modern hotel. The north face of the guest room tower is set back behind the podium. The podium roof contains tennis courts, a putting green and badminton and shuffleboard facilities. The steel and glass canopy (left) shelters the principal entrance. At the rear of this photo is Union Station. Should rail travel revive, the hotel will benefit.

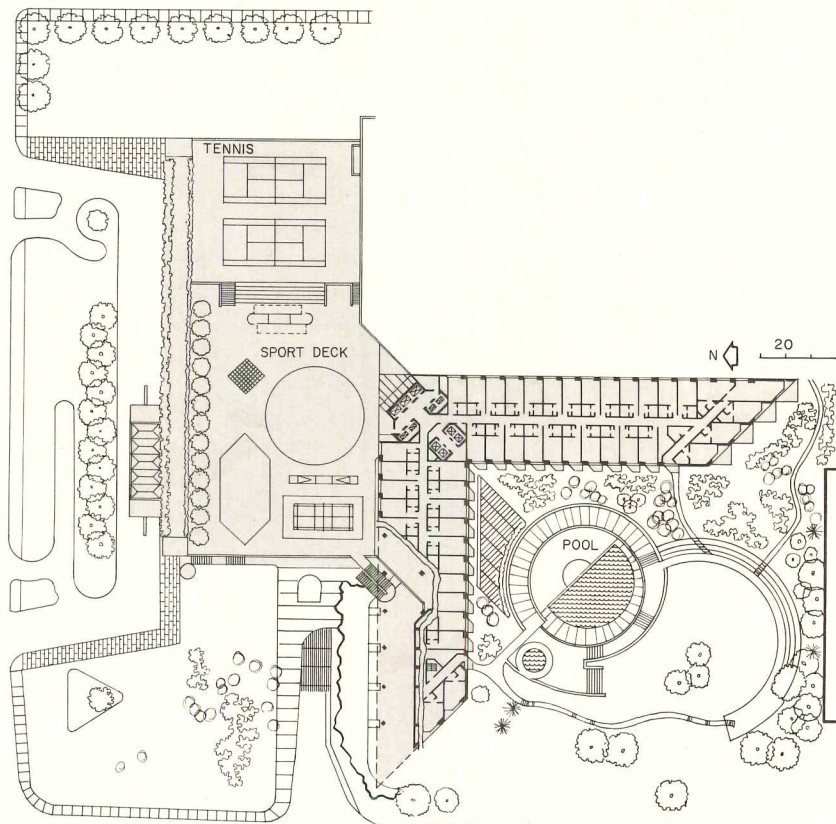







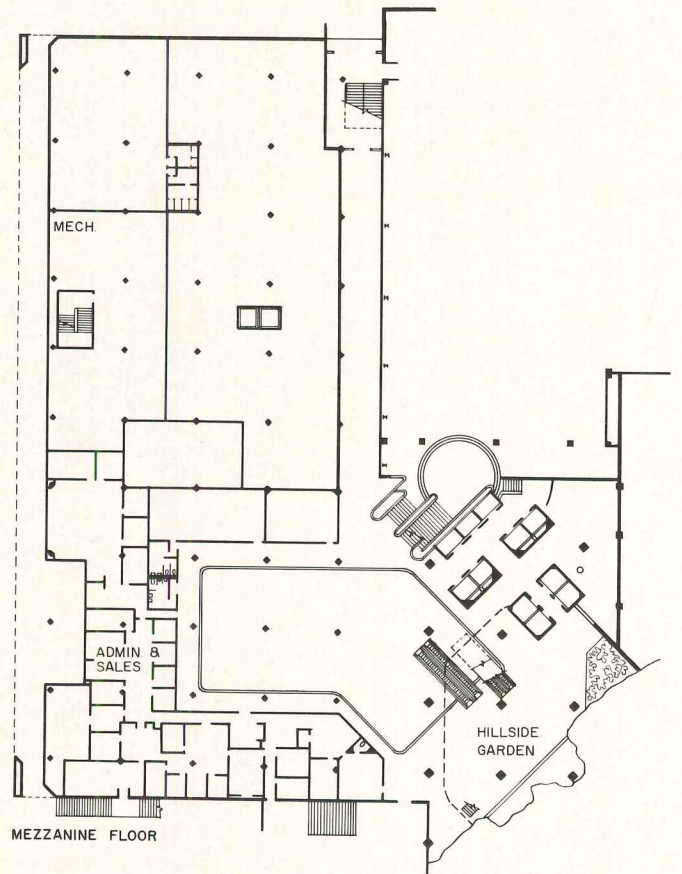
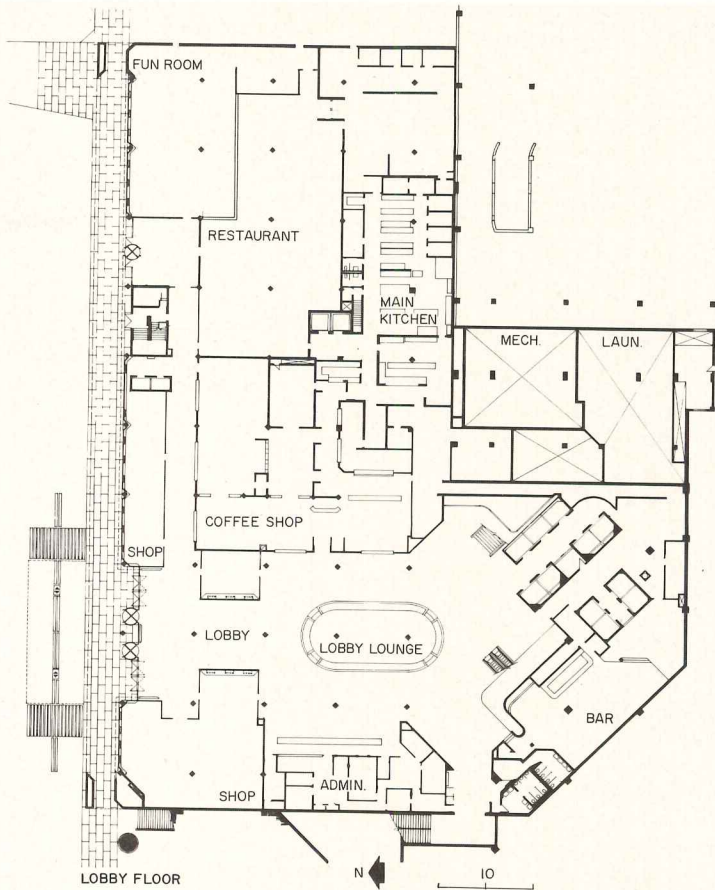
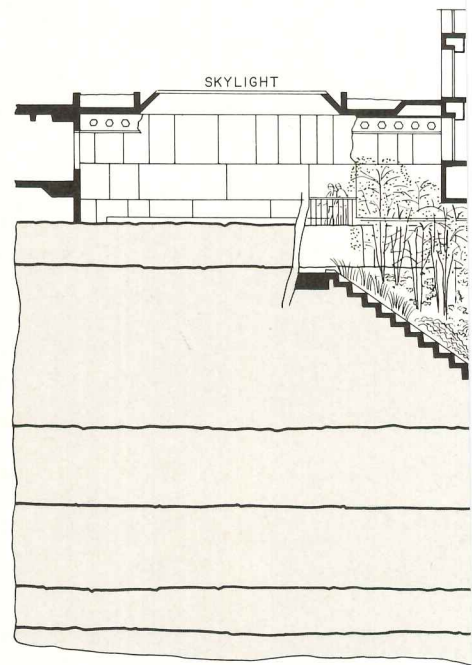
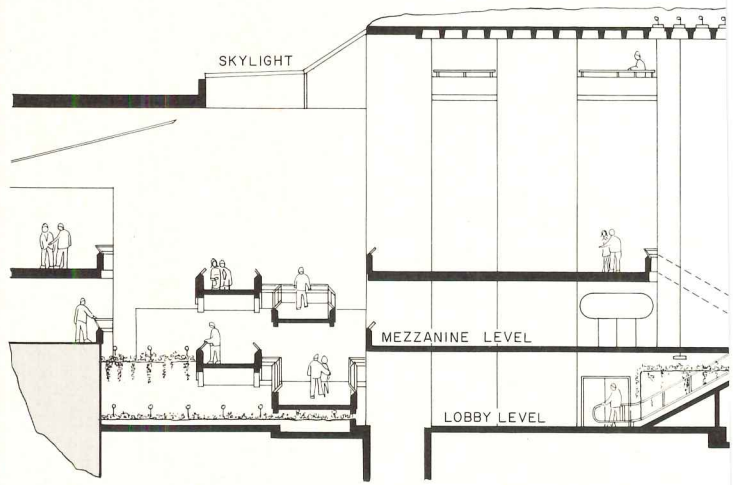
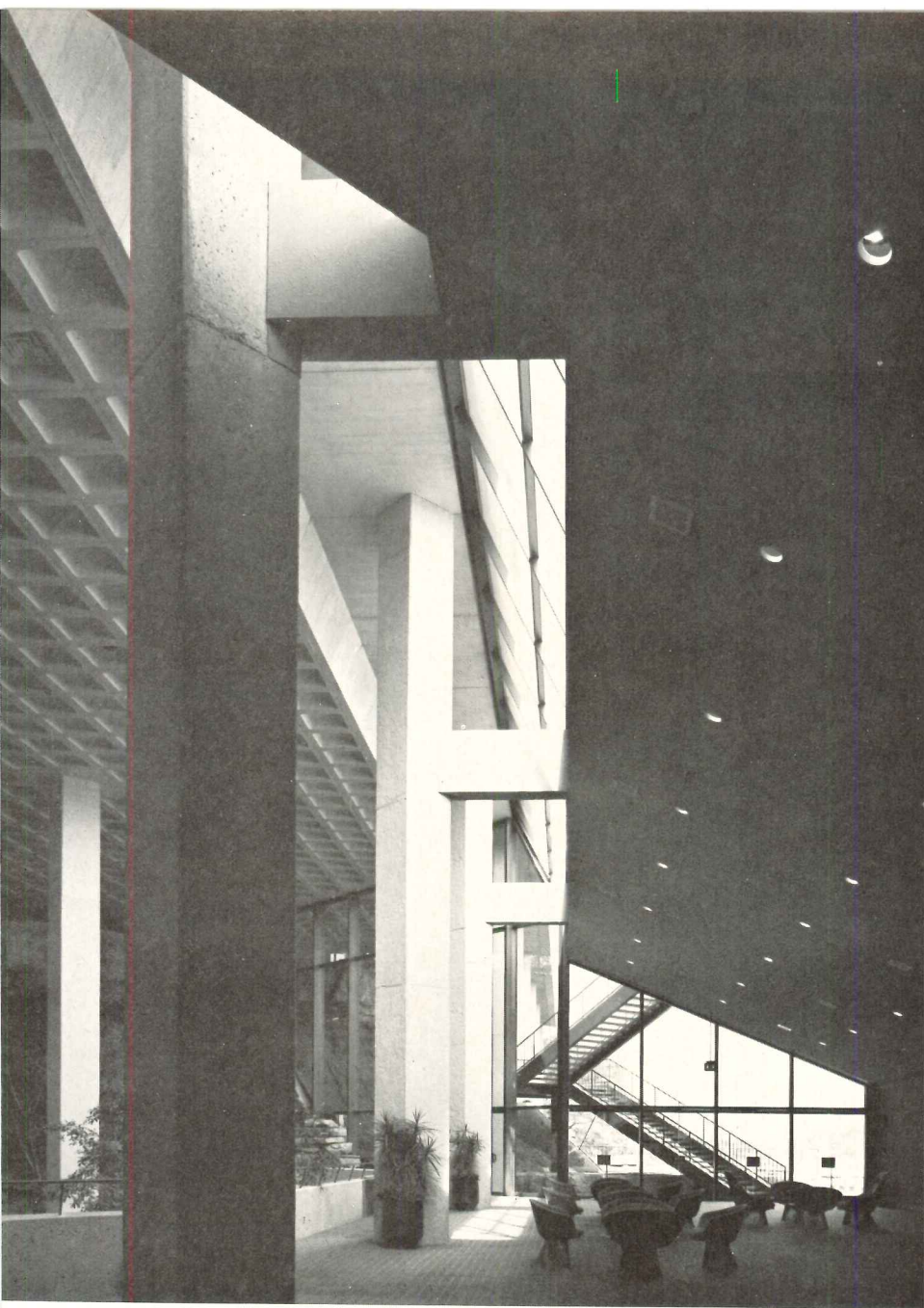



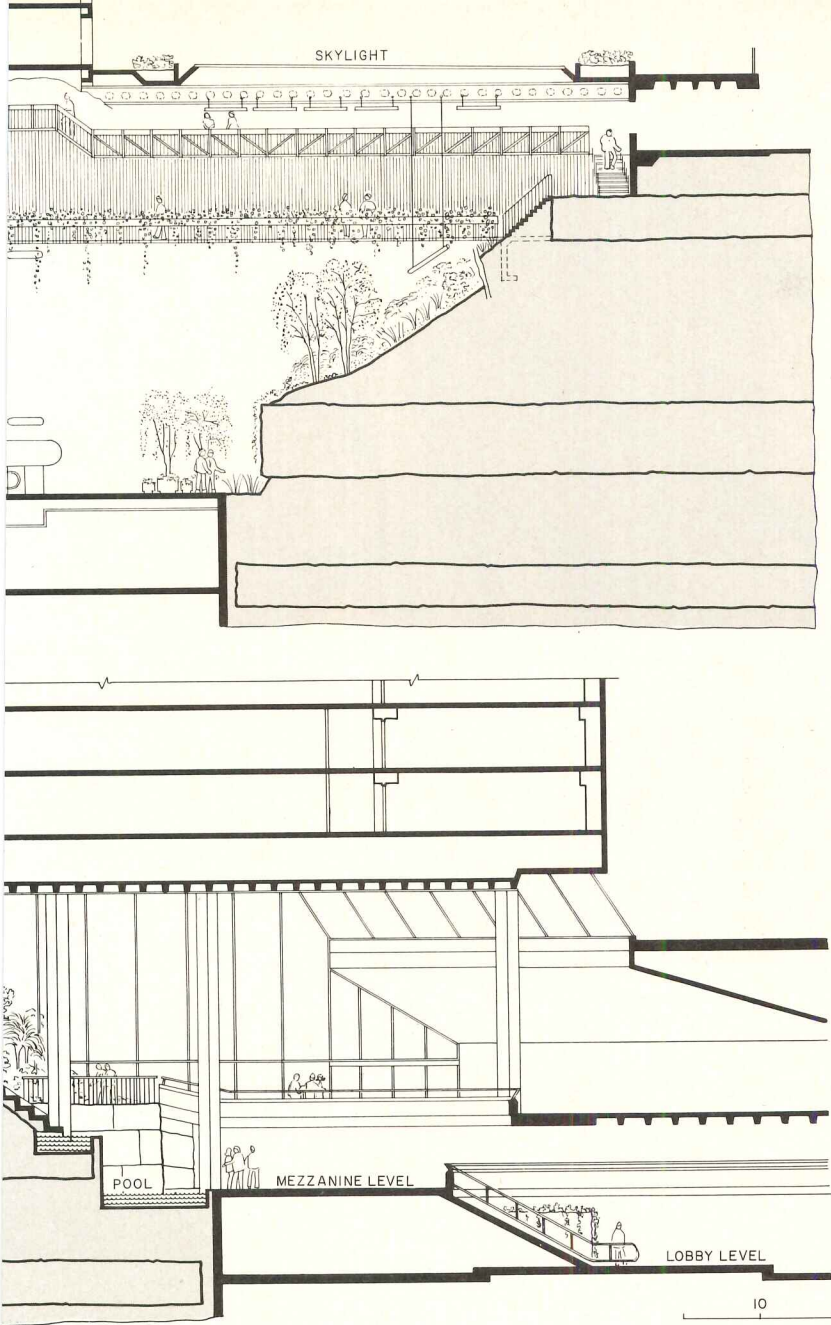

The indoor rock garden and waterfall (above) can be seen at the rear of the lobby seating photo (below), and in the sections (left) and is adjacent to the general lobby (opposite page). Guests may take a winding stair through the garden and emerge at an upstairs cocktail lounge which overlooks this splendid conservatory, or cross a bridge spanning the cascades which leads either to the outdoor pool or the sports deck. Robert L. Shaheen of Landscape Associates constructed the garden and selected the plant materials.

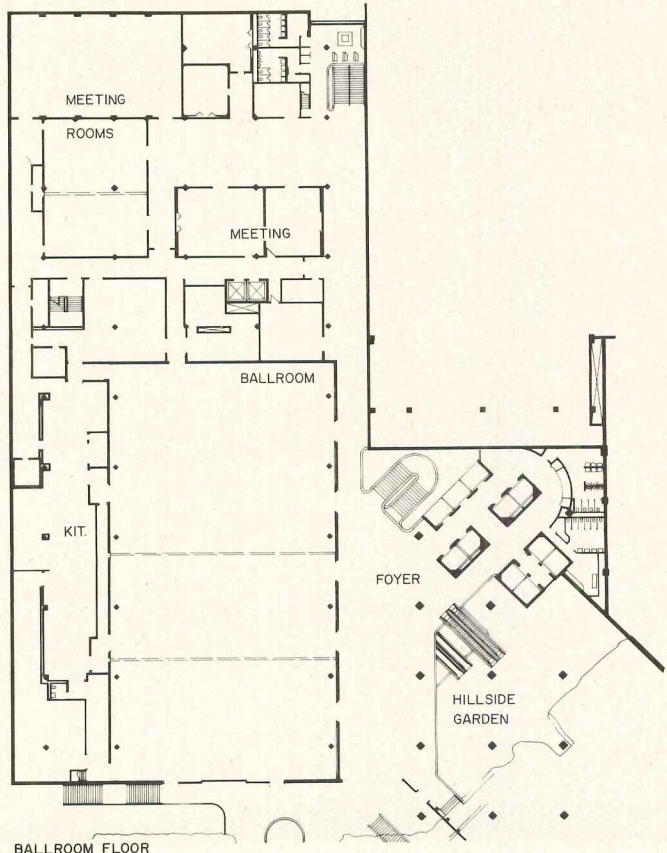







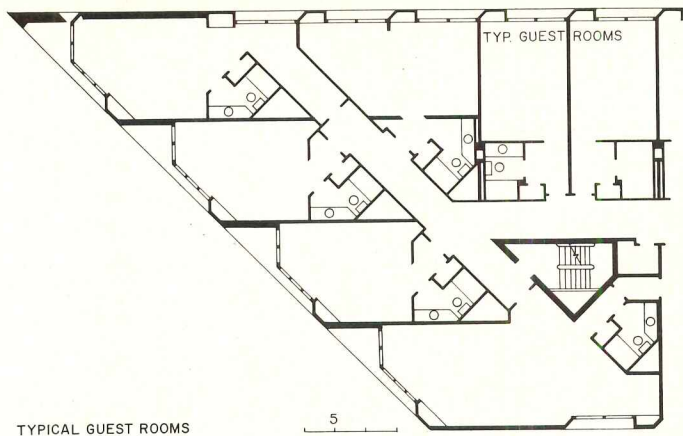

TYPICAL GUEST ROOMS

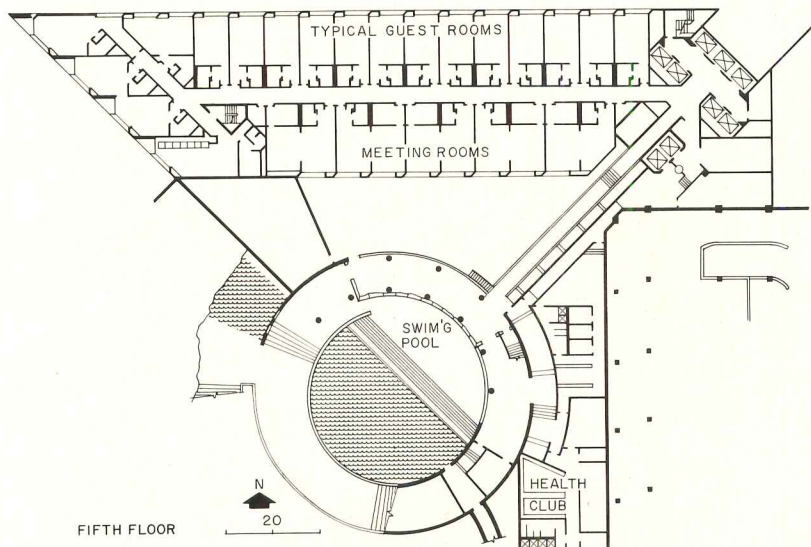

FIFTH FLOOR

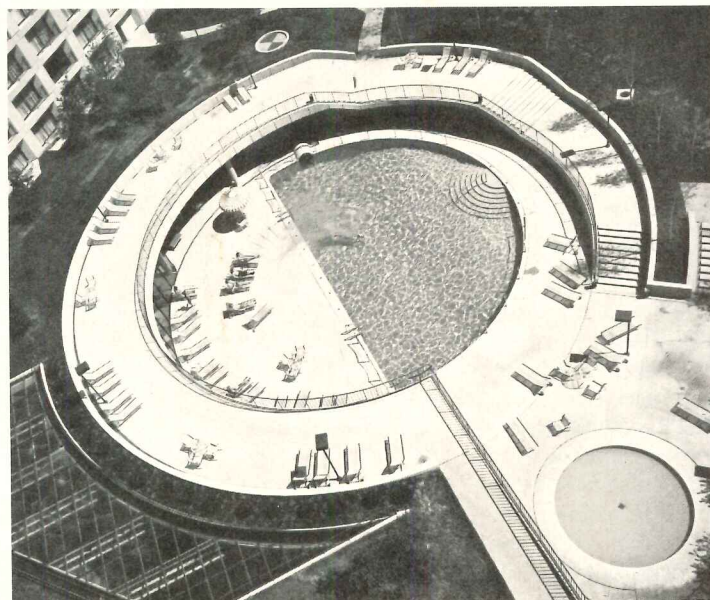
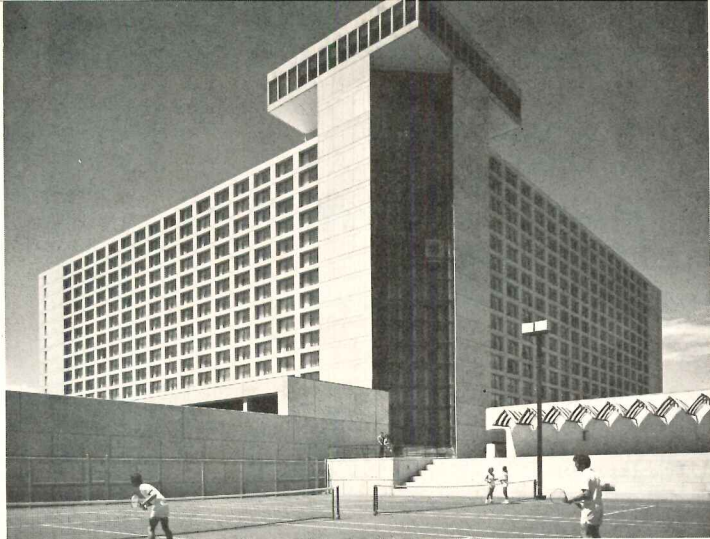

The sports facilities form an in-town resort which for elegance of arrangement—in the purely architectural sense of the phrase—is unmatched by any U.S. luxury hotel. The pool and its outdoor garden are sheltered by the two wings of the tower. The top of the indoor garden is circumscribed by the pool. The circular pool terraces are the principal means of transition between the indoor and the outdoor gardens. Ingenious circulation networks, including a marvelous bridge, separate swimmers, sports deck users, visitors and service.

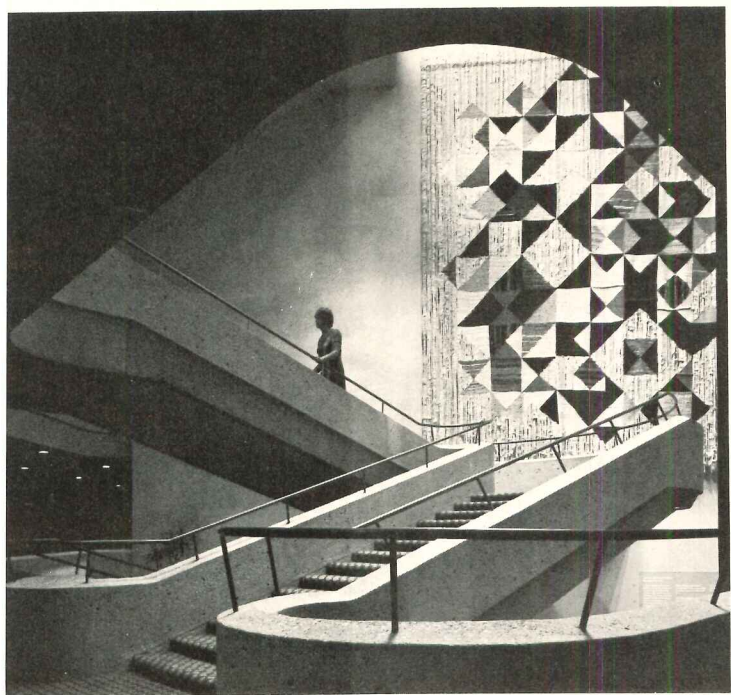

The tapestry (left and above) is made of undyed wools and mineral rocks in a diamond pattern which deliberately echoes Weese's use of the 45-degree angle as his geometric basis for the design of the hotel. Designed by Helen Anselevicius, it faces the glassed-in elevators which appear beyond the main staircase (right). The stair connects the main lobby with the ballroom floor.

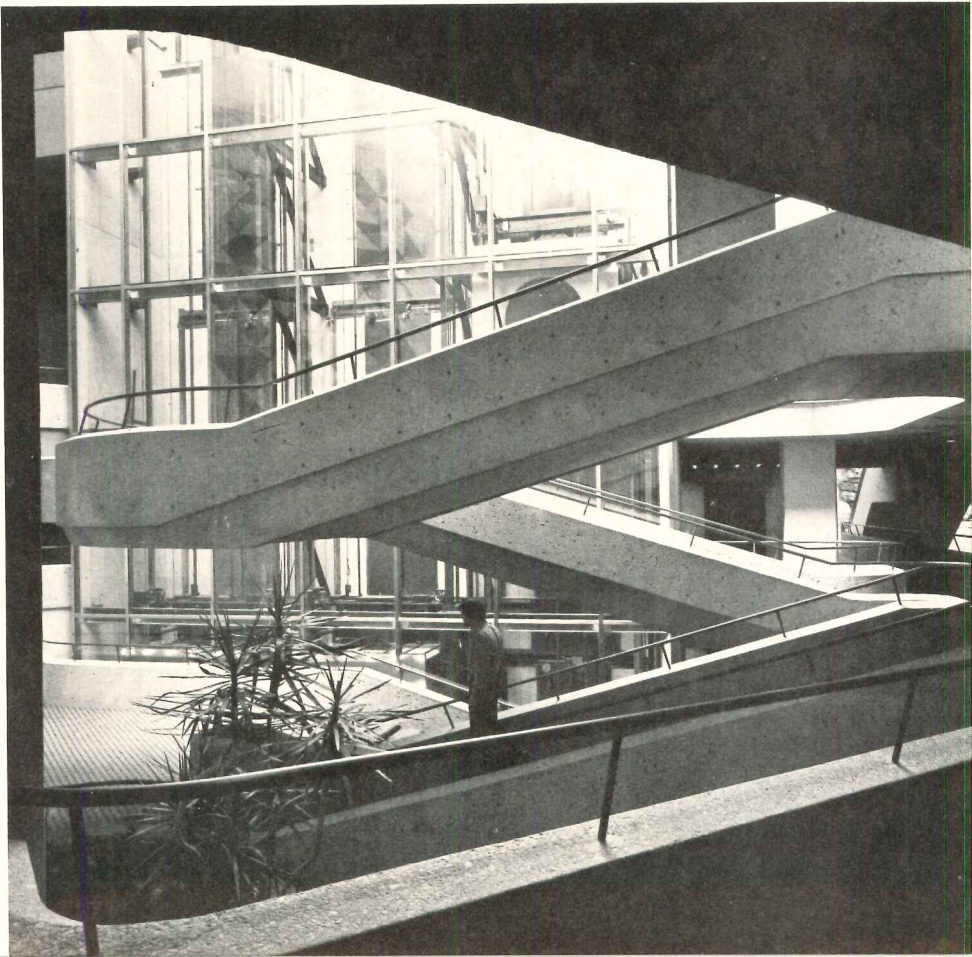



## Crown Center: Five medium-rise office buildings by Edward Larrabee Barnes are linked together to form a single complex

The first building group to be completed at Crown Center was the office complex. The public plaza followed, then the hotel. This fall the shopping center, known at Hallmark as the "retail entertainment center," will open its doors. At the end of the year, work will begin on the first group of apartments by TAC.

As Hallmark's initial gesture in its long-range development plan for Crown Center, the design of the office complex was extremely important. These buildings had to make an impact on the grey area surrounding the Hallmark plant. They were to symbolize and prefigure the quality of the architectural environment to come. It was essential that this office space please prospective tenants with its own intrinsic amenity, enticing them to sign leases and move in. All that Crown Center promises and has accomplished would never have begun had the office complex failed to attract tenants. Fortunately it has, due in large part to the quality of its architecture.

The buildings are each only seven stories high. The office workers, therefore, are physically close to the office plaza and its life. Although the structures are linked on alternate floors, each has its own entrance contributing to separateness and identity. The buildings step down the slope as do the terraced lawns they overlook. The quiet restraint of their architectural expression makes them an appropriate background for all the public activity which Hallmark hopes to generate in the plaza.

The plan configuration (right), provides flexible rentable square footage and office arrangements. The individual buildings range from 80,000 to 157,000 total square feet, with whole floors ranging from 8,600 to 28,000 square feet. Taken together, all five buildings comprise 626,300 square feet. Large 30-foot clear spans and five-foot modules contribute to the flexibility.

Underneath the offices is a six level 934,000 square foot garage with 2,300 reserved spaces for tenants. Maximum security prevails in the garage and office spaces through the use of television monitoring, special lighting and a uniformed security force. The combined garages underneath the office complex and the hotel provide a total of 7,000 parking spaces.

CROWN CENTER OFFICE COMPLEX, Kansas City, Missouri. Owner: *Crown Center Redevelopment Corporation*. Architects: *Edward Larrabee Barnes, FAIA—associates: John M. Y. Lee, Edward Z. Jacobsen*. Associated architects: *Marshall & Brown—partner-in-charge: Jack E. Lakey*. Engineers: *Marshall & Brown* (structural); *Joseph R. Loring & Associates* (mechanical/electrical). Consultants: *Don Bliss Architectural Lighting Consultant* (lighting); *Peter G. Rolland & Associates* (landscape); *Harper & George, Inc.* (graphics). General contractor: *Eldridge Construction Company*.

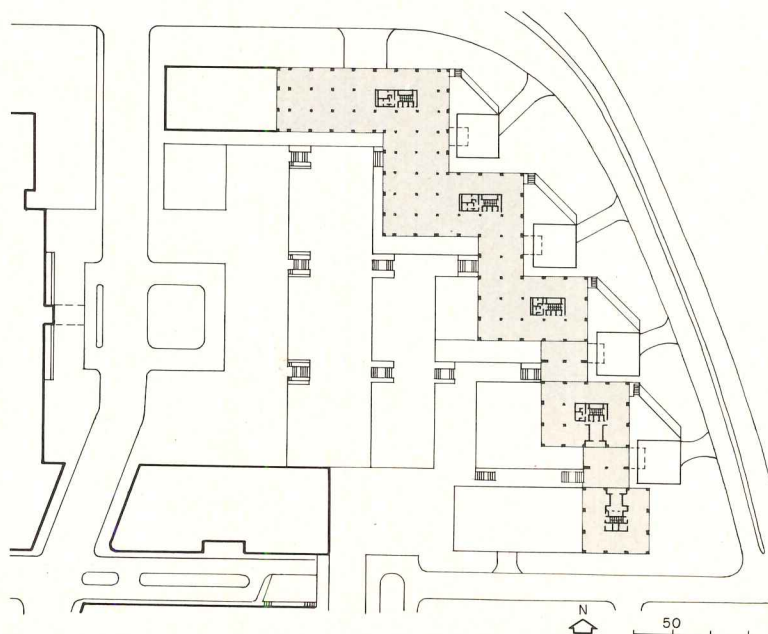
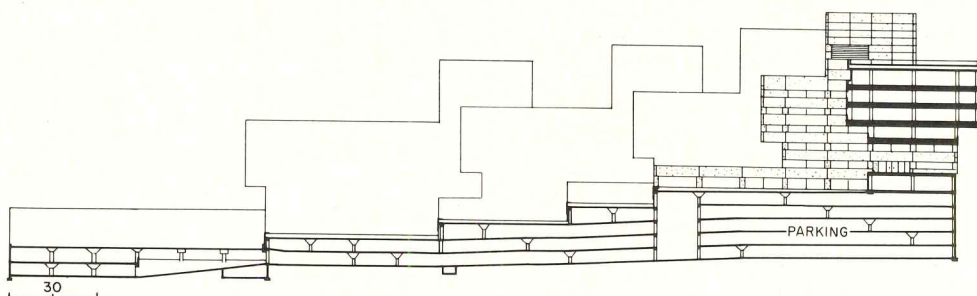
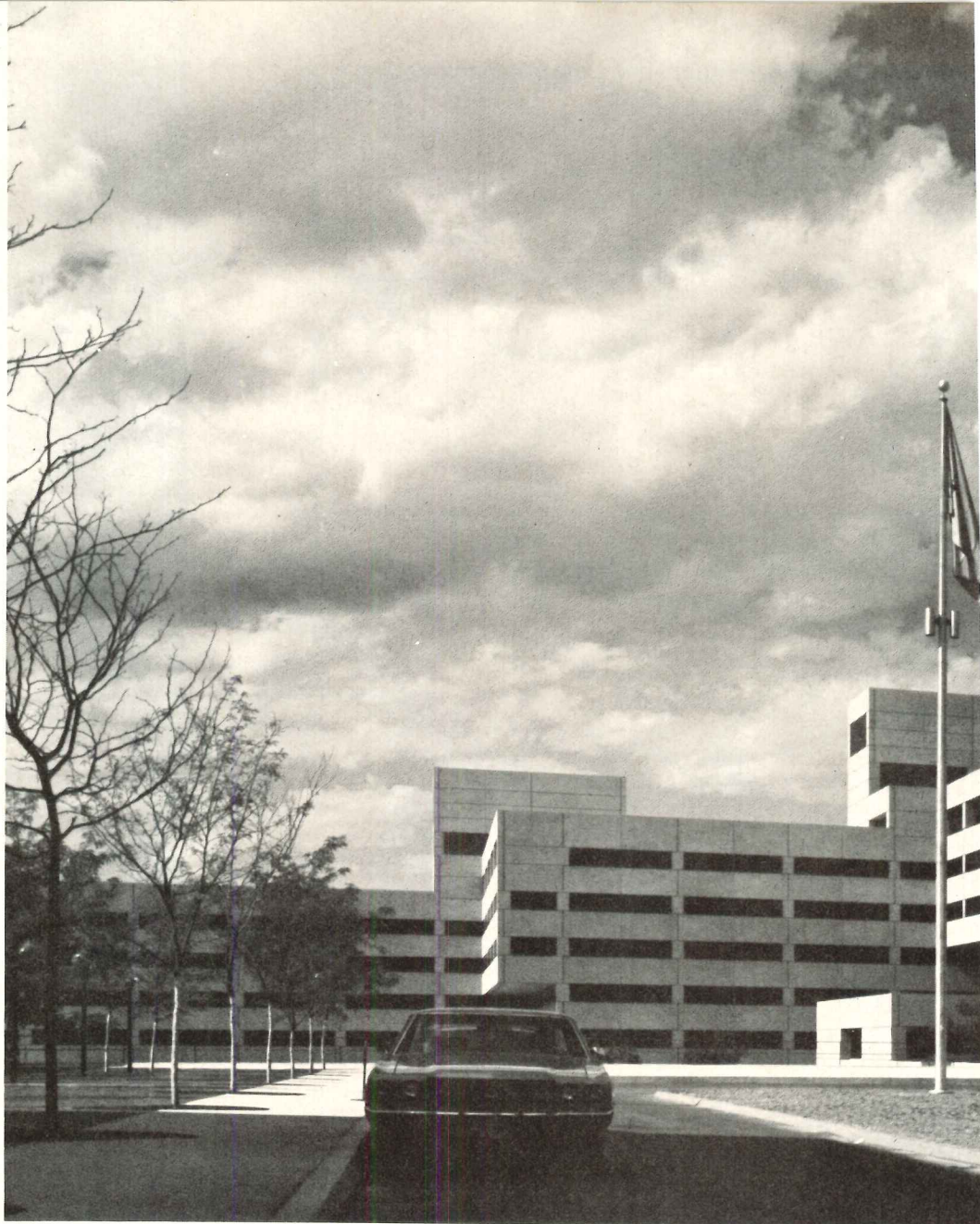





The fountain, designed by architect Barnes, is composed of 49 water jets, placed seven feet apart under special gratings. Water heights from each jet can be adjusted to any point between zero and 25 feet. This individual jet regulation permits the creation of such two-dimensional water patterns as a triangle, circle or square, as well as three-dimensional pyramids or cubes of water suspended within the whole. The 2,000 square foot fountain floor is paved with flat cobblestones and surrounded by a 23-foot apron of granite blocks. Below each water jet is a 300-watt colored light which automatically turns on at dusk, forming colored patterns within the flowing water. When the fountain is turned off, the cobblestoned floor and surrounding apron area become part of the larger plaza. An almost imperceptible incline allows for drainage and recycling back to the 8,000 gallon tank located in a nearby underground garage. The water flows at the rate of 3,500 gallons per minute.







The proportions of window to spandrel, and the modular organization of the precast panels have the elegance for which Barnes is famous. The proportions are equally handsome from within. The continuous bands of window glass range up to 750 linear feet per floor.

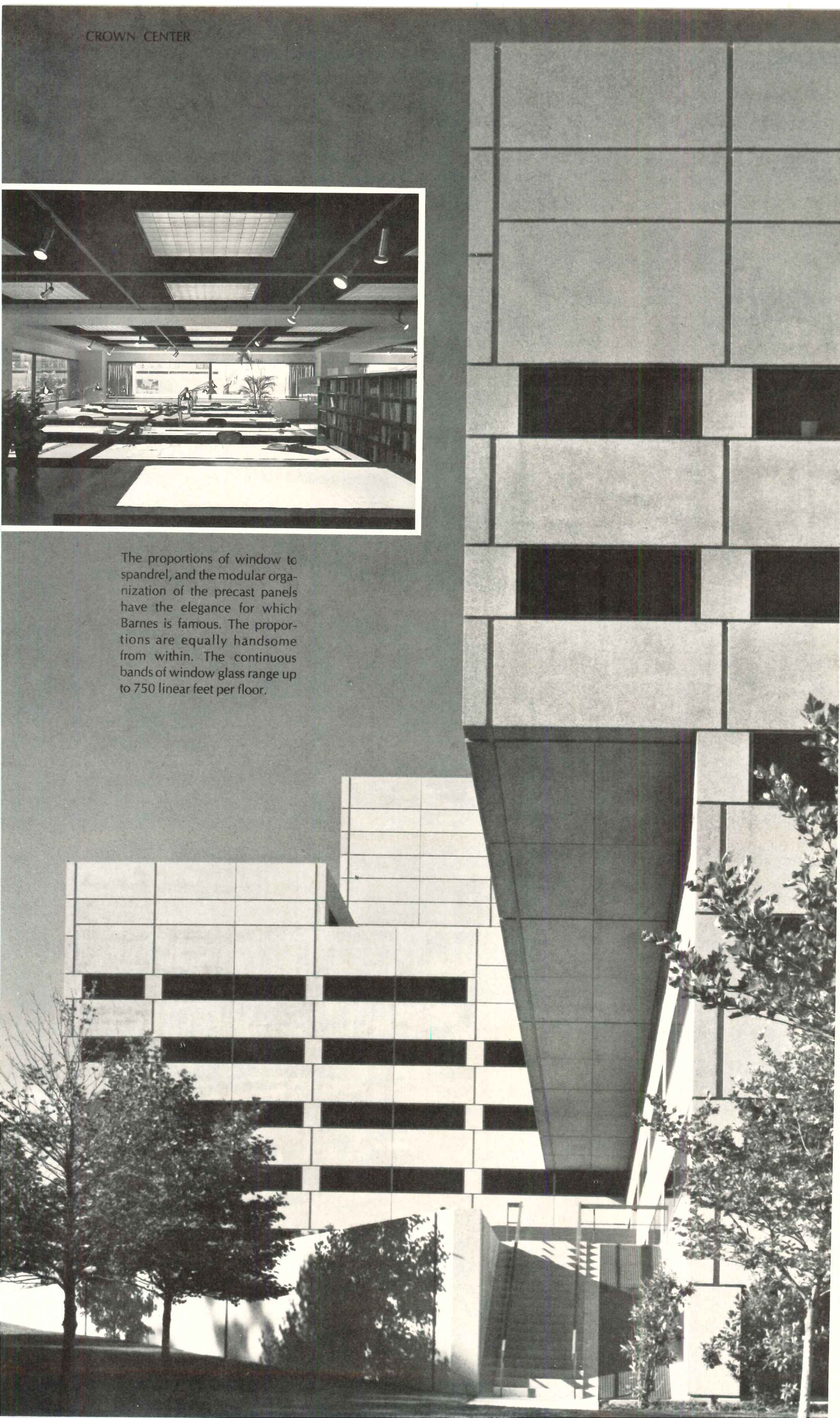



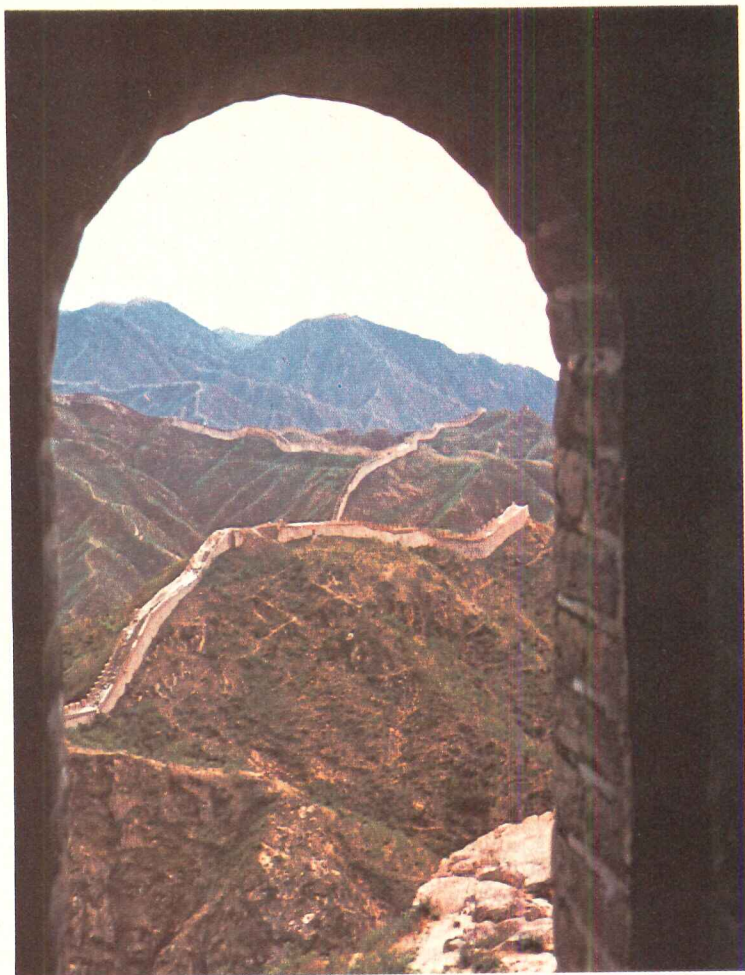

Joseph T.A. Lee photos

# THE NEW CHINA

China today—new nation, old land: What is it like? What are its cities like? What does its architecture express as the People's Republic of China nears the end of its first quarter-century of existence? To find out, *Architectural Record* asked two recent visitors, an architect and a newsman, to describe what they saw. Both were first-time visitors to China. Architect Joseph T. A. Lee of Ann Arbor, Michigan, Canada-born naturalized American of Chinese parentage, spent four weeks in China as a member of a group of professors and visited Canton, Shanghai, Changsha (and Shaoshan, Mao Tse-Tung's birthplace), Hangchow and Peking. Michael Mealey, Chief of the Tokyo bureau of McGraw-Hill's World News, went to the Canton Trade Fair and visited factories and communes in Canton and Kwantung province. Professor Lee's photographs (above) of the Great Wall of China, begun 3d century B.C., and of the Industrial Exhibition Hall in Shanghai, built since 1949 to display current models of machines, need no words to point out contrasts inevitable in a society—and an architecture—in transition. —*Elisabeth Kendall Thompson*



As more and more people visit and report their impressions of the People's Republic of China, some of the mystery and inscrutableness of this country, until so recently off-limits to Americans, is being dispelled. But the new China is still a paradox—an old, old country yet a brand new nation; the oldest civilization and the newest political system; a society in evolution from a revolution while it is still in revolution. Less than 25 years ago it was a war-torn country, mired in social vicissitude, political corruption, human misery, poverty, drugs, famine, and crime. Today—at an awful cost for some—there is peace. And the social system—at the price of acceptance by the people of an almost total loss of the individualism and freedom so precious to us—has eliminated extreme poverty and drugs, and has made famine unlikely. There is, whatever the price, a clearly apparent feeling of security, well being and national pride. Although in its early days the People's Republic asked for and got help from its Soviet neighbor, China based its form of Marxian political philosophy, and its method on ideas which are essentially Chinese, using basic Chinese traditions of family and community relationships, thus continuing a "communism"—a belief that the welfare of the group takes precedent over individual benefit—which has existed throughout her history. What is happening in China today is a unique experiment. Like most experiments, it has a record of errors as well as of accomplishment, and it recognizes that much remains to be done. What is important to remember is that the new China is an evolving society and that because it replaces a minimum of public and social concern its people are seemingly willing and eager to work for success. An impression recurrently brought back by those who have visited China in recent months.

Joseph T. A. Lee went to China as the architect member of a group of educators and scientists from various parts of the United States, all of whom are natives of China except Professor Lee, who was born in Canada. Like the others, Professor Lee is a naturalized citizen, and like them, speaks Chinese. His impressions of the landscape and of the people on his four-week visit are vivid and enthusiastic:

"I was impressed with the beauty of the countryside, lush and green in the humid south where rice paddies on contoured hillsides and in flat plains are common, and golden brown in the wheat country of the north. Since I was on the coast side of the mountains during most of my travels, the mountains formed a backdrop for most of the rural scenery I saw. Land is so intensively used for agriculture that it was cultivated right up to the edge of the road. A country-wide program of reforestation has not only filled once-barren hillsides



1



2

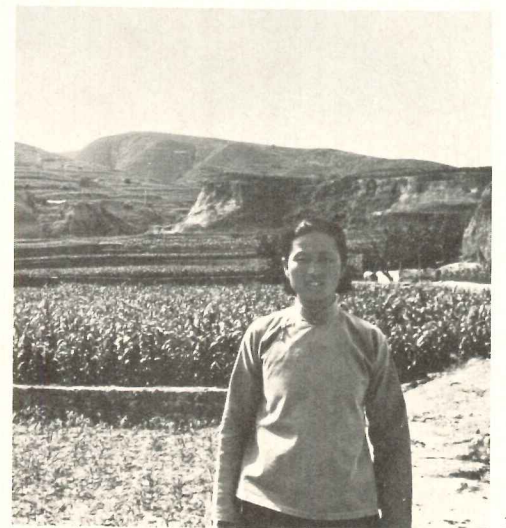

3

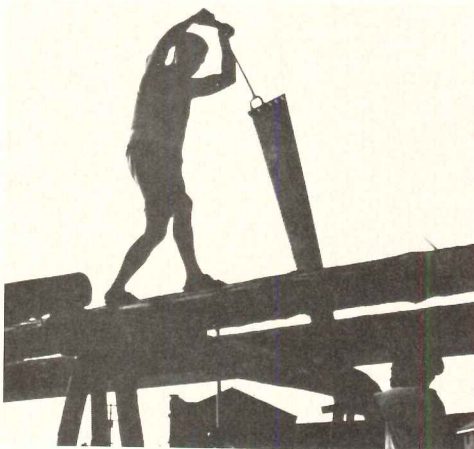

4

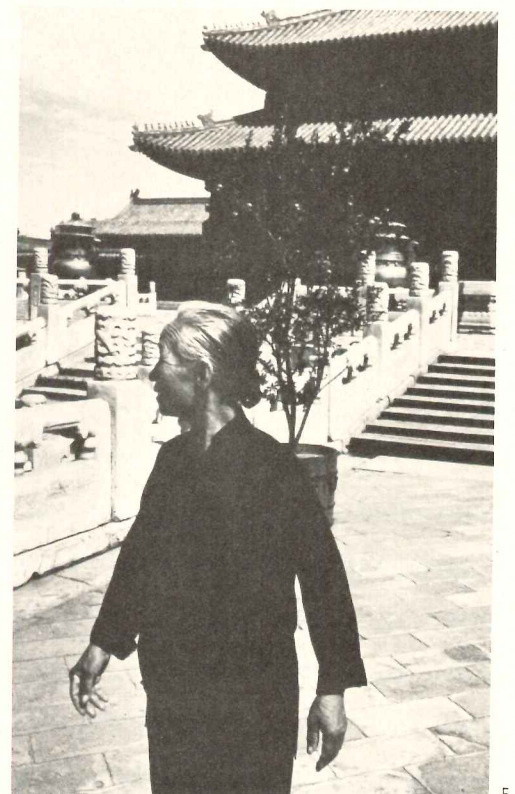

5

1. Gate of Heavenly Peace, Tien an Men Square, Peking
2. Bicyclist with a load of baskets near Canton
3. Commune member in field, Tachai, Shansi Province
4. Lifting logs from Manchuria for new construction, Tachai Commune
5. One of many visitors to imperial palaces in Forbidden City, Peking
6. Contoured rice paddies and reforested hillsides, south China
7. Harvest beside road near Canton, Kwantung Province
8. Return from early Market, West Lake, Hangchow
9. The Temple of Heaven, Peking
10. Carrying stone for dam construction, Tachai Commune
11. School boys playing cards, Peking



All photos Joseph T.A. Lee



6



7



8



9

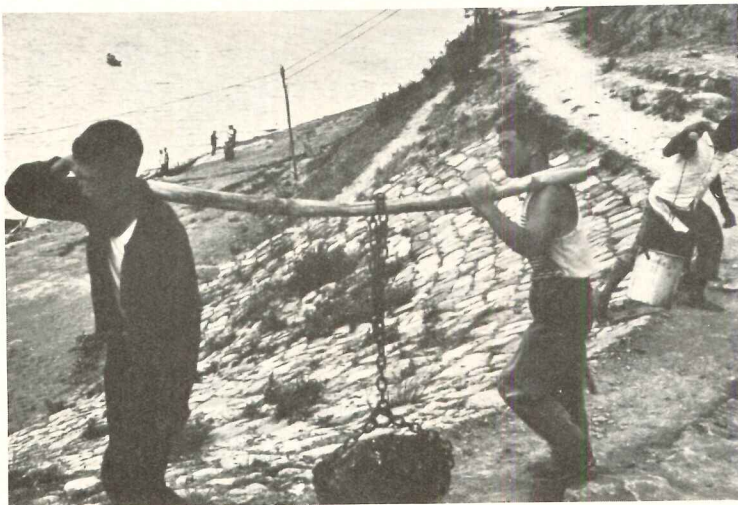

10



11

China's countryside is beautiful, with lush green rice paddies in the south, wheat fields in the north. A national reforestation program, to conserve moisture and to reduce the erosion and flooding, has filled once-barren hillsides with trees and lined roads and streets with trees. The intent was practical, but the result is beauty. The people seem happy, confident and selfless in concern for group, not individual welfare.



with new trees, but has lined every road and railroad right-of-way that we saw with from one to three rows of trees on each side (on some of Peking's streets there are as many as 10 rows on each side). This is not a beautification program but one of important practicality, aimed at conservation of moisture and reducing the erosion and flooding which have been China's bane for centuries. But there is no denying that the omnipresence of trees in the countryside and in the cities—for the program has included city streets—adds beauty to the scene and gives shade in summer.

"The countryside has its unbelievable contrasts—more, I thought, than I had seen in any other ancient country: water buffalo plodding in fields crossed by electric power lines; people in the landscape wherever I went, not as here where one sees no people for miles; paved roads where bicycles were the only vehicular traffic; dams, irrigation ditches and reservoirs built by the hands and feet of human beings, not by machines, and construction materials carried to the site, stone by stone, suspended from bamboo poles. Brick are made by hand and baked in sunken ovens in an age-old way. Tractors work the fields of some communes, in others oxen are the only additional help for people.

"The people were wonderful. Everywhere I went I found the same happy, content, confident, amazingly selfless and self-sufficient people, a contrast of extraordinary dimensions to those who knew the pre-1949 China in which the mass of the war-weary people were poverty-stricken, disease-ridden, oppressed by taxation and often by corrupt landlords, hopeless. The revolution removed the wealthy, the entrenched officeholders, the intellectuals ruthlessly, but it has certainly given the mass of the Chinese people what they never had before—housing, food, clothing and, most of all, a sense of security. And they have responded with total acceptance of the new system, reinforced by their traditional Chinese values: everyone appears to put the good of the group above individual gain—indeed, to ignore completely the possibility of individual gain; there seems to be no greed nor envy (perhaps a uniformity of living conditions helps in this, but one cannot be sure it is only this); everyone seems content to work at whatever they are assigned. The explanations seem easy, when one sees the smiling faces, but the factors which influence these new social conditions are many and cannot be ignored: the influence of the still-unexplained Cultural Revolution; the contrast of present and past social conditions; the universal education of the young in one system and the dominance of one personality in education as well as in politics; the dire alternatives to conformity of thought.

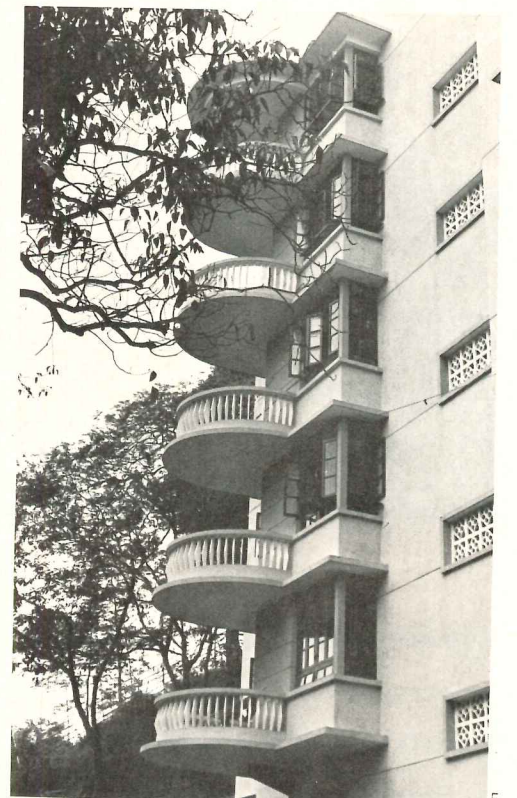

1. People's Department Store, Canton, Kwantung Province
2. Apartment building in older section of Canton
3. Factory workers' housing, Canton
4. Balconies on apartment buildings, older section of Canton
5. Semi-circular balconies, new apartment building, Canton
6. High-rise office building and park, downtown, Canton
- 7, 8. Tree-lined pedestrian and cycle ways, Canton



All photos by Michael Mealey



6

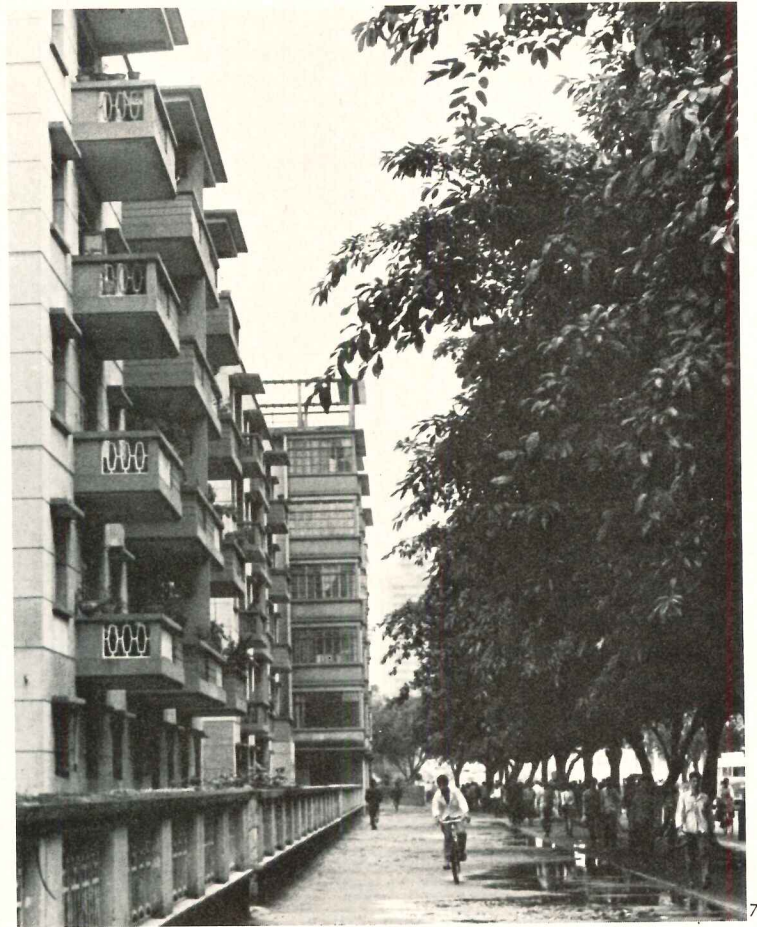

7



8

Canton is a city of tree-lined streets and well-kept parks, with tall office buildings in its business district and residential areas with many blocks of four- to five-story apartment buildings. Although Soviet influence was strong in the early post-revolution years, recent buildings show a definite trend away from that approach. Housing is government-owned and -designed: there are no private architects.



"Notwithstanding, the people have, as they always have had, a fundamental outlook, uniquely Chinese, on life and they set examples in many ways which we would benefit from studying. Their attitude toward group responsibility, for instance, is 'Why should I not do this?', rather than—as we are apt to say—'Why should I?', and 'Everyone will benefit from this; not 'What's in it for me?'

"Impressed as I was with the character and attitude of the people, I was disappointed and dismayed by the post-1949 buildings I saw in the large cities of Canton, Shanghai and Peking. The Soviet influence on Chinese construction and technology was strong in the early days of the revolutionary government and the architectural expression of the Moscow school was a natural result. In the cities I visited, the buildings which house government functions are all of this pompous, sterile, drab style. Best known of these (through news media coverage of President Nixon's visit to China) is a vast, dull facility for large gatherings known as the Great Hall of the People, in Peking's Tien an Men Square (their analogy to Moscow's Red Square). But there are many other buildings, not so large but similar in aspect, architecturally and otherwise. Some newer buildings show signs of getting away from the Soviet influence—for the most part, apartment buildings; but a few such are government structures of recent construction.

"On the other hand, it is impossible not to take delight in the classic Chinese monuments in Peking and Hangchow, not only for their architectural splendor and beauty, but for what they express of the essence of two distinctly Chinese philosophies: Confucianism in the magnificent formalism of the Imperial City in Peking, Taoism in the naturalness and clarity of Hangchow's tranquil villas, temples and gardens. In the last of these, I finally found the roots of East Asian architecture for which I had looked elsewhere in the Far East and not found.

"Visible and notable is the human scale of the traditional Chinese dwellings which still prevail in villages and are found even in the largest cities, despite the intrusion of a larger scale in the characterless five-story apartment buildings which do, however, provide the security of good, sound, housing for millions of people.

What keeps these acres of housing from being completely scaleless and characterless are the broad streets, the balconies which give both variety and modulation to the facades, and the lovely trees on each side of the street. Michael Mealey, McGraw-Hill's newsmen in Tokyo, reports on the newer apartment buildings he saw on a week-long visit to Canton and the Trade Fair, and on the apparent change that is in the air for architectural design:

"The newest buildings that I saw in

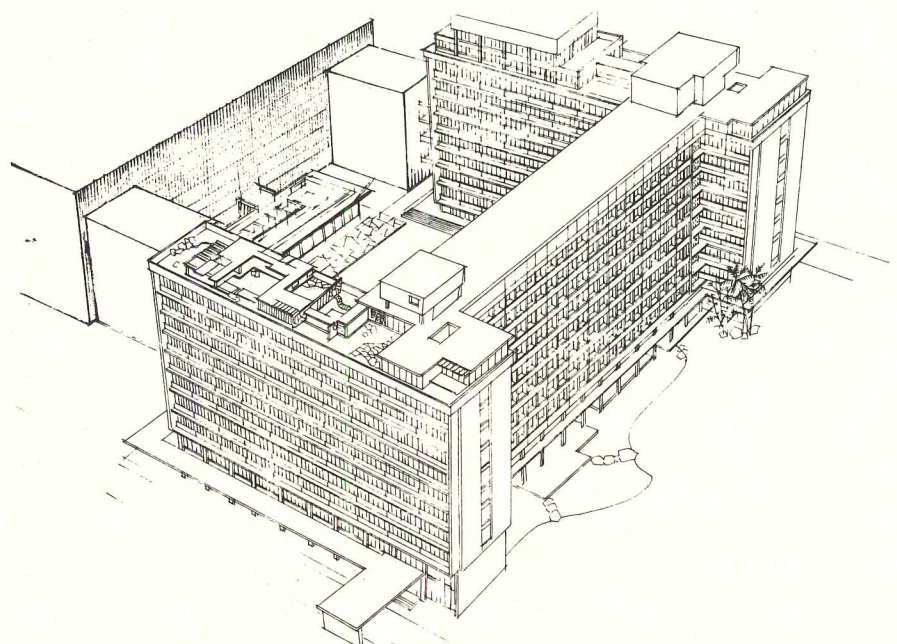
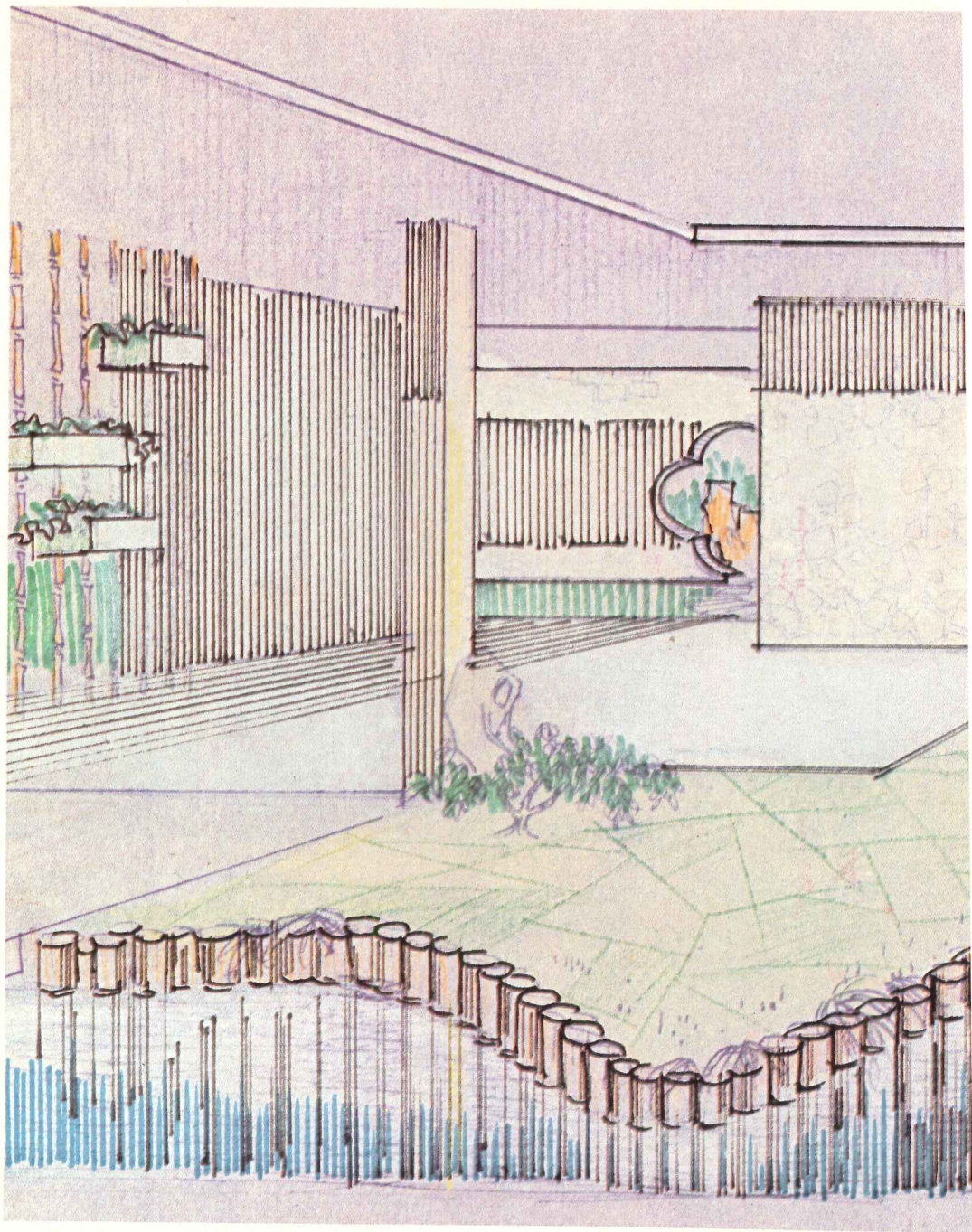



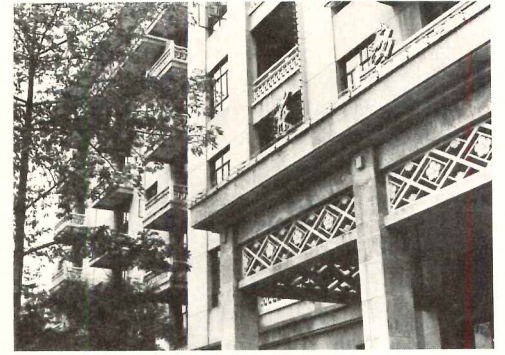
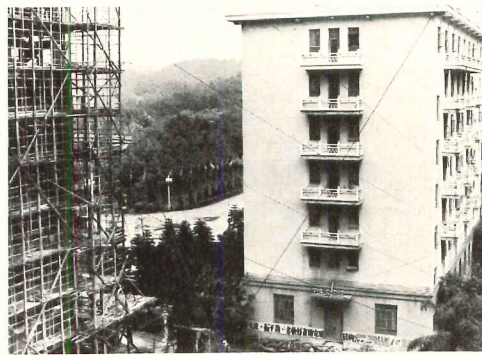
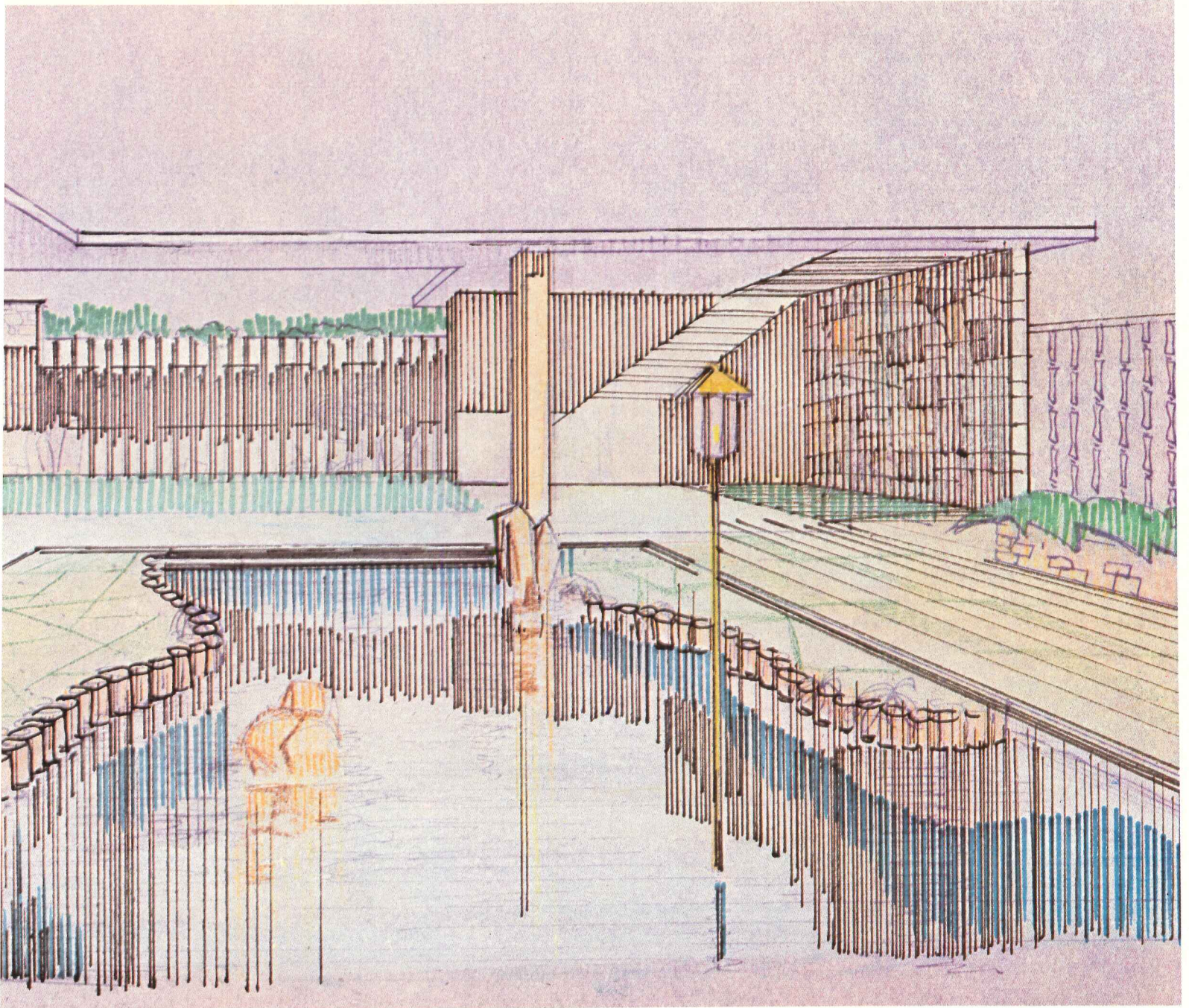

Michael Mealey photos

The addition to the Tung Fang Hotel in Canton—larger, more elaborate and more Western in style and appointments than the existing hotel it enlarges—suggests that China's architects, in turning to foreign models, are as yet unaware that to achieve a high order of art and architecture, the contemporary expression must derive from indigenous sources, based in culture, history and tradition, and in freedoms not now theirs.



Canton indicate that Chinese architects are genuinely interested in designing buildings which are both more attractive (than the Soviet-influenced design of the '50s) and more up-to-date technologically. The fact that a team of Chinese architects was recently sent to Hong Kong to study what new buildings there are like is a further and even more important indication of this trend.

"The addition to the Tung Fang Hotel in Canton, currently under construction, is a good example of what is happening in China. This 11-story addition is a far cry from the existing hotel, an undistinguished and dull-looking eight-story building built some years ago. The new building has a U-shaped plan and is open and spacious with a handsome landscaped court and a large pool, reminiscent of Western resort hotels. Its design is, in effect, a combination of what is presently known in China of Western architecture and what was already known of it. Two wings of the 766-room addition will be 11 stories high; the center wing will be 12 stories.

"China has an increasing need for modern hotel facilities and is building these on what would seem a modest scale in the United States, but one which was unheard of in the People's Republic.

"Construction of apartment buildings in the cities, where they are still much needed, continues, and as part of the total volume of construction is helping to increase the variety of made-in-China building materials and products. Among these are plastics, acoustic tile and toilets. In outward appearance the newest apartment buildings are different from those of the Fifties, particularly in the use of a different form for the balcony that is so important to comfort through China's long hot summers. The most recent designs show semi-circular balconies, unprecedented in China."

Between 1966 and 1969 China went through a period of violence—the Cultural Revolution—the full impact of which is still not known. One visible result was the closing of the universities. When they reopened in 1970, with less than full enrollment, admission was not by examination but on recommendation for "ideological fitness" by the peasants and workers with whom a candidate had been living and working. In the fall of 1972, however, there were indications that the system was undergoing further change and that admission and promotion will once again be by examination. Now at least two universities, Tsinghua in Peking and Tung Chi in Shanghai, have announced organization of architectural departments. Tsinghua's department had been in operation for two months at the time of Professor Lee's visit; Tung Chi was developing its curriculum by the process known as Mao's "Route of the Masses," which Professor Lee describes:

"The Curriculum Committee—

made up of the department head, workers, propaganda team members, teachers of courses such as design, construction, technological sciences and the arts—first agrees on a curriculum; then consults with architectural departments from other universities; and then submits it for approval to the Educational Section of the Revolutionary Committee—students, faculty and cadres administrators).

"Architecture lends itself better, perhaps, to the approved educational method of combining work and education than would some other studies, as the tentative four year curriculum indicates. During the first six to eight months, the student is developing 'consciousness and awareness of architecture' and, by participating in a job, he is also getting a basic knowledge of materials, structures, reading of working drawings and simple surveying along with some political science, foreign language, math and physical education. In the next three years he progresses from design of small buildings (usually housing) to design of such large buildings as group housing, theaters, hospitals, factories and multi-story (four-five floors) buildings, with several months' participation in construction of one of the buildings. Political science, Chinese history (usually since 1840, with no mention of earlier history or culture) are continued, and acoustics, thermo-dynamics, heating and ventilation, methods of construction, building economics and relation of design to construction are added. A half-year graduate design problem completes the four-year course. Tung Chi expects to have 500-600 students in architecture and city planning."

To have achieved so much generally in so short a period has left no time for development of the arts. In any case, the arts, like all of society in present-day China, must "serve the masses." The arts today—literature, theater, graphic arts, music—are all directed toward assisting in the revolution, educating in terms that are comprehensible to the masses, not toward amusing, entertaining or giving insight to the intangibles of life. Techniques of unique Chinese methods—cloisonné, painting on silk, jade grinding—are being transmitted by old masters but, says Professor Lee, the taste which governs what is done today has relevance to world markets rather than to the spirit, tradition or long cultural history of China.

"Perhaps," says Professor Lee, "as the people of China come to realize the beauty of their classic buildings, many of which were previously inaccessible to them, they will find the essence of their own nature and their time, and will be able to express this in an art and architecture that is not borrowed or imitated, but is their own distinctive and individual statement of man's universal search for meaning and beauty."



Joseph T.A. Lee photos

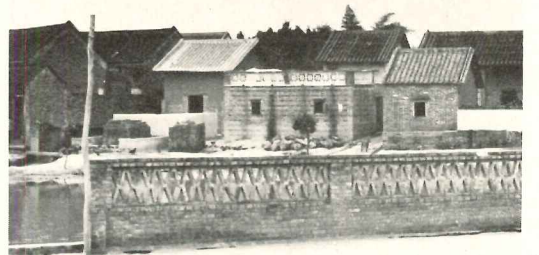

1 & 2. Rainbow Commune, near Shanghai: housing for workers and peasants  
3. Shin Hua Commune near Canton: housing under construction  
4. Administration office (two story section), Shin Hua Commune



# MGIC HEADQUARTERS: NEW FOCAL POINT FOR MILWAUKEE

The decision by the MGIC Investment Corporation to build on its downtown location represents a substantial new commitment to the future health of Milwaukee, Wisconsin. It is not a big building—53,000 square feet—but it establishes a very high quality standard, and, with an adjacent 10-story rental building, it plays a pivotal role in Milwaukee's emerging center city renewal. The two buildings form the MGIC Plaza development, to which a hotel will be added.

The building—designed by the Chicago office of Skidmore, Owings & Merrill and by Warren Platner—is clearly an image-creator. Scarcely 15 years old, MGIC is among the top 100 U.S. corporations, in terms of capital stock, and controls a far-reaching network of operations. Visible solidity was a program requirement. And, in an intentional contrast with the insurance-company image of vast bureaucracy, MGIC is structured with relatively few persons of broad role and to keep things that way, floor space is limited.

Even so, the company has expanded support services into four floors of the rental building.

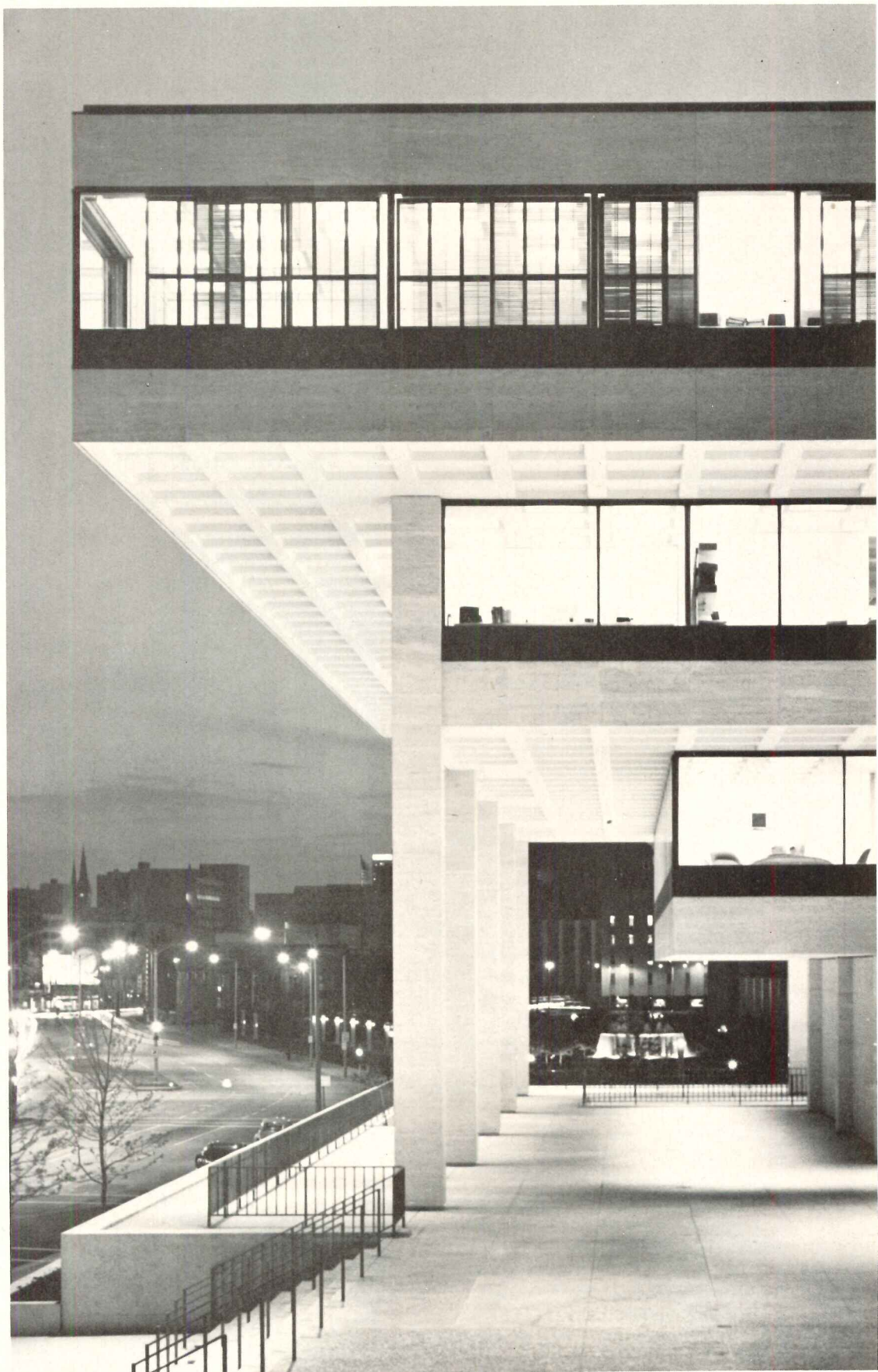

Ezra Stoller © ESTO photos



Explaining the design approach by the architects, Louis Skidmore, Jr. says: "The clients thought about a new headquarters long before they made the decision to proceed. They had had a long time to think about the particulars, and they wanted things right. The operations would be weighted at the top—working executives with minimum support personnel—and the finished building literally reflects this organization with the inverted pyramid configuration." No commercial facilities would occupy the ground floor, and only a small lobby was required at the pyramid apex. The projecting upper floors give something of the monumental image created by the cornices of older such buildings being rapidly ripped down. The desired air of solidity is further emphasized by building placement on the podium of a parking garage. Skidmore noted control of solar heat gain as a tangible asset of setbacks.

This project saw an unusually happy division of design responsibility. The interiors were done by architect Warren Platner, but his input did not begin on a finished building while the other architects were packing up their drawings. As noted earlier, SOM established the structure (poured concrete), the unusual massing, the travertine cladding and the exteriors' crisp detailing. From that point there was a give-and-take with Platner having real responsibility for everything within the enclosed shell including mechanical and electrical systems. And his work clearly establishes the desired image begun with the exterior.

And how do SOM and Platner feel about the results of their two-year marriage? Both describe it as unusually happy, but then the partners are both architects with mutual appreciation.

MGIC Plaza has a broader meaning for Milwaukee's general citizen. Max Karl, MGIC president, spoke with pride of his buildings' relation to the handsome, venerable City Hall (photo right), and it is sure that this new development will reinforce that older building's continued existence. A performing arts center by Harry Weese stands to the east and a new city park to the north of the 10-story rental building (right in plan, opposite page). Such visible confidence in a "downtown" should become self-perpetuating and is certainly commendable.

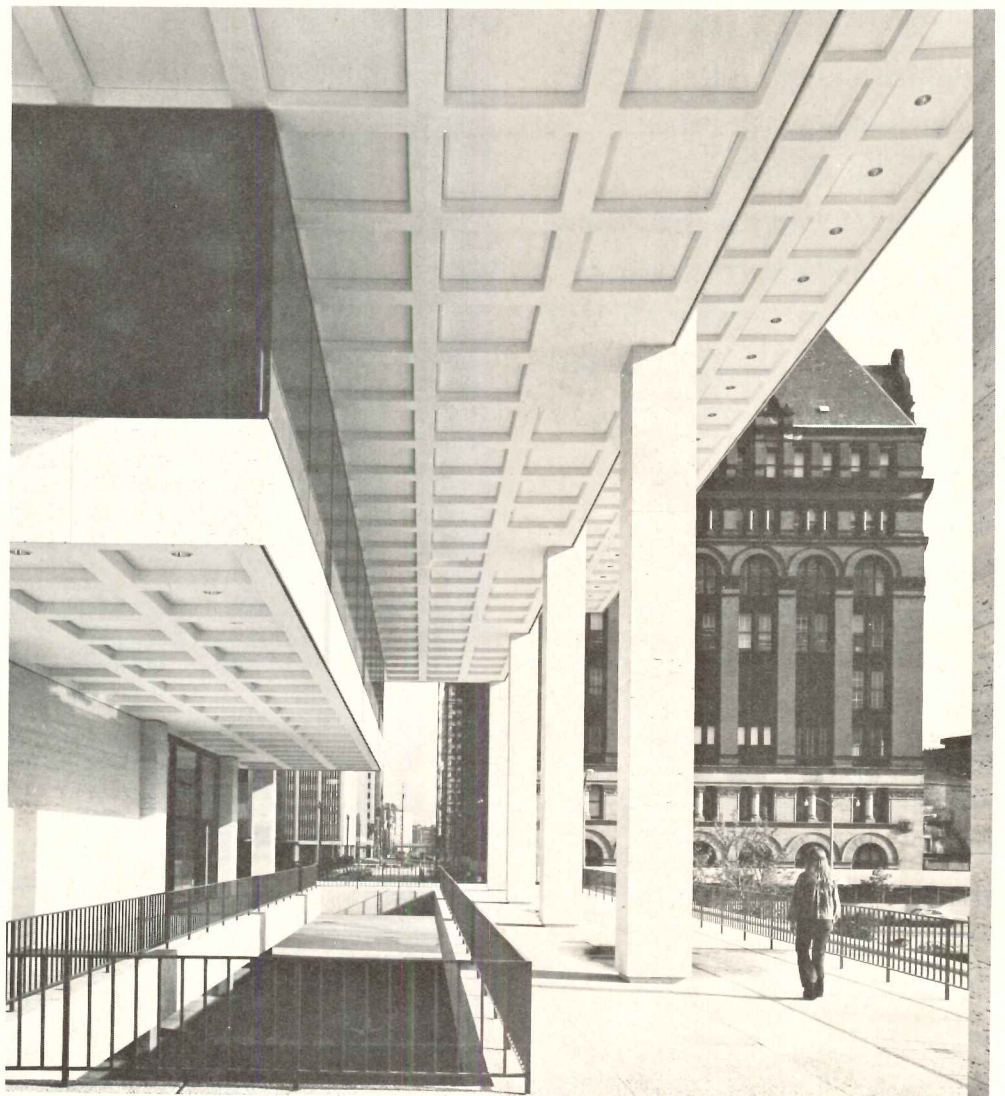
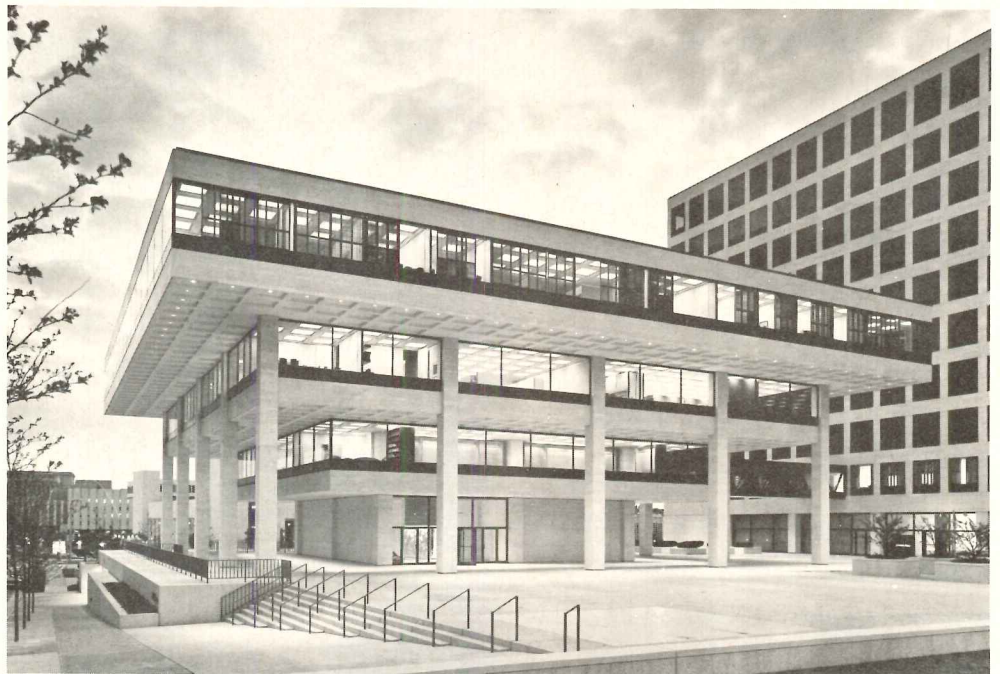



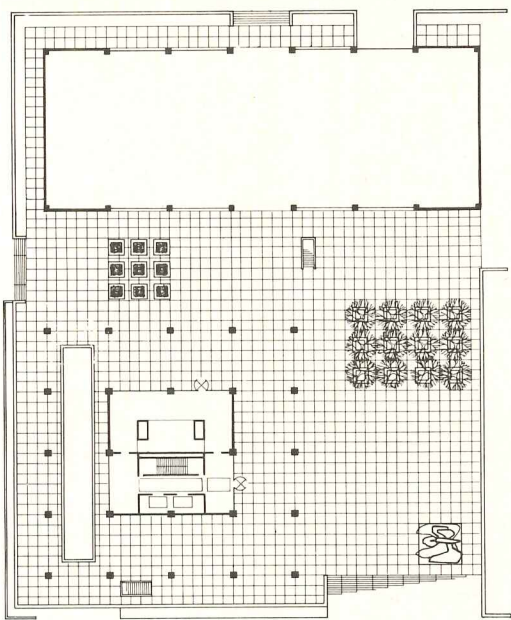

PLAZA LEVEL

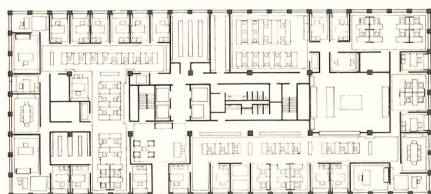

THIRD FLOOR LEVEL

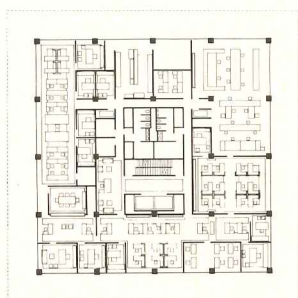

SECOND FLOOR LEVEL

MGIC is still a "shirt sleeves" organization despite appearances. The projecting upper floor results from a "top heavy" working executive force, as well as a desire to establish visual solidity. One expression of this solidity is the 20-foot piece of solid chiseled granite in the ground floor elevator lobby (seen in place above and reflected in the polished bronze alloy metal directory and ceiling, opposite). The connected 10-story rental building can be seen (photo opposite page, above right).

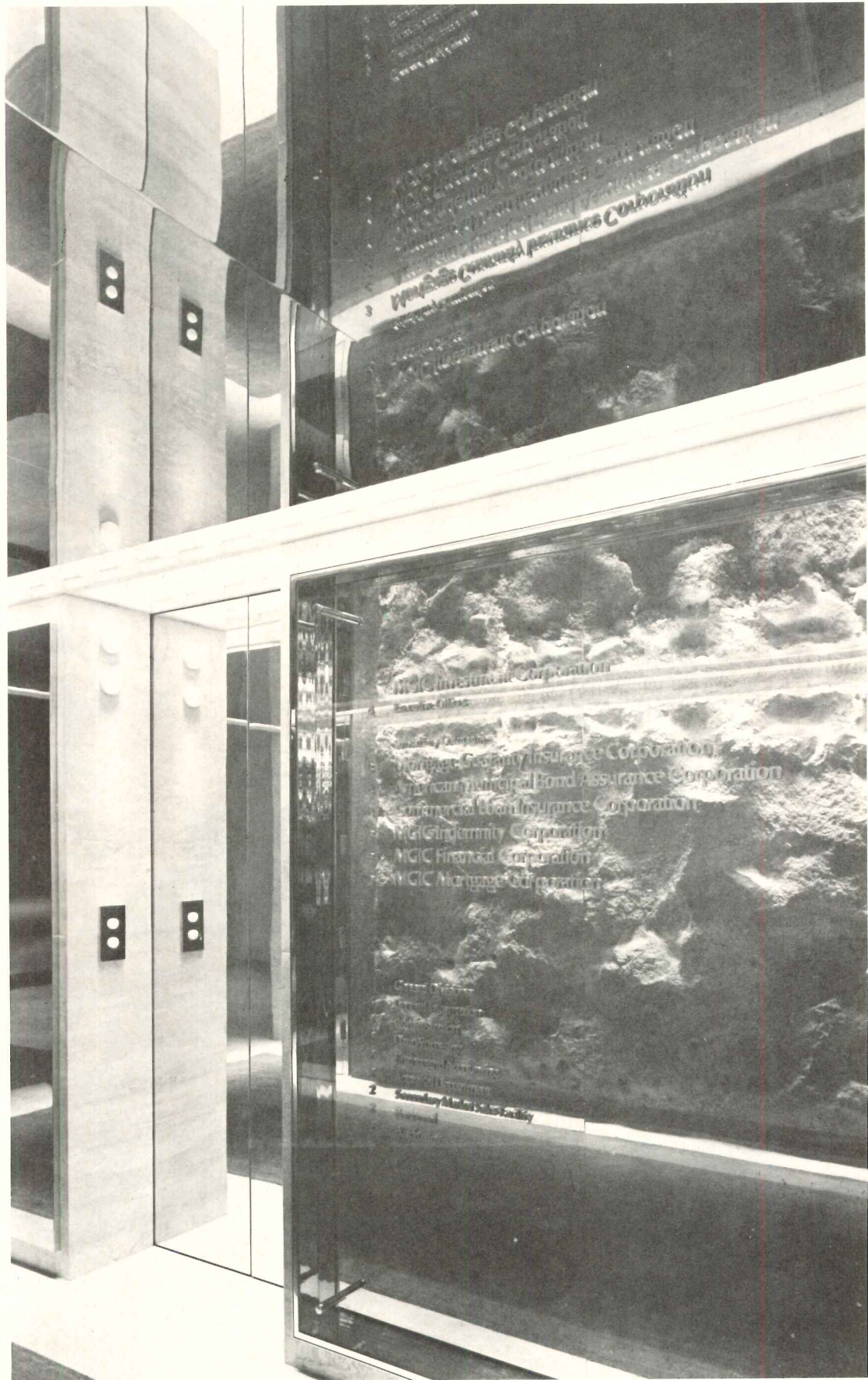
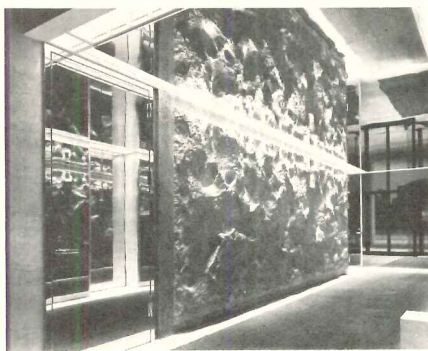





The building contains no "grand" spaces, in the current two- and three-story sense, and the interior effect relies heavily on custom detailing and axial views within a uniform floor height. The receptionist stations are the first progressional element seen on leaving the elevator at upper floors. The dramatic effect of two of these can be seen on the opposite page. Fabric hangings by Sheila Hicks are employed for visual focus behind the stations and in a series of axially aligned conference rooms (center left). In keeping with the operational importance of each employee, there is an equalization of facility standards from the president's office (above) to open work stations (bottom, left). The exposed concrete pan ceilings contain light fixtures with a special grid to avoid glare at the edges. Partitions are plaster, with painted steel edging, and surfaces in work areas are covered with linen on sound absorbent felt. Custom hardware includes oversize hinges for visual emphasis. Much of the cabinet work and the louvered shutters on the top are white oak. Thick wool carpeting is recessed into vinyl flooring on fill. Interior columns are covered in travertine. Cabinet faces are leather and counter tops are granite. There is an astounding array of materials, and order is maintained by a subdued color scheme and by panelization of surfaces. One cause for user complaint is the common one in such schemes—lack of privacy in open work stations. The users seem—after an initial adjustment phase—otherwise delighted.

MGIC INVESTMENT CORPORATION, *MGIC Plaza, Milwaukee, Wisconsin*. Architects and engineers for building structures and plaza: *Skidmore, Owings & Merrill, Chicago*—design partner: *Bruce Graham*; partner-in-charge: *William Dunlap*; project manager: *Louis Skidmore, Jr.*; coordinating architect: *Arthur Muschenheim*; structural engineer: *Srinivasa Iyengar*. Architects for MGIC interiors: *Warren Platner Associates*—associates of *Warren Platner* for this project: *Mark Morgaridge, William Smith, David Connell, Robert Brauer, Allan Stadler, Lee Ahlstrom*. Supervising architects: *Fitzhugh Scott*—architect-in-charge: *George Troller*. Lighting consultant: *Claude Engle*. Landscape architects: *Sasaki, Dawson, De-May*. General contractors: *Inland-Robbins Construction*. Owners of MGIC Plaza: *MGIC Plaza Venture (MGIC Investment Corp. and Urban Investment and Development Co.)* Owners of MGIC headquarters: *MGIC Investment Corp.*



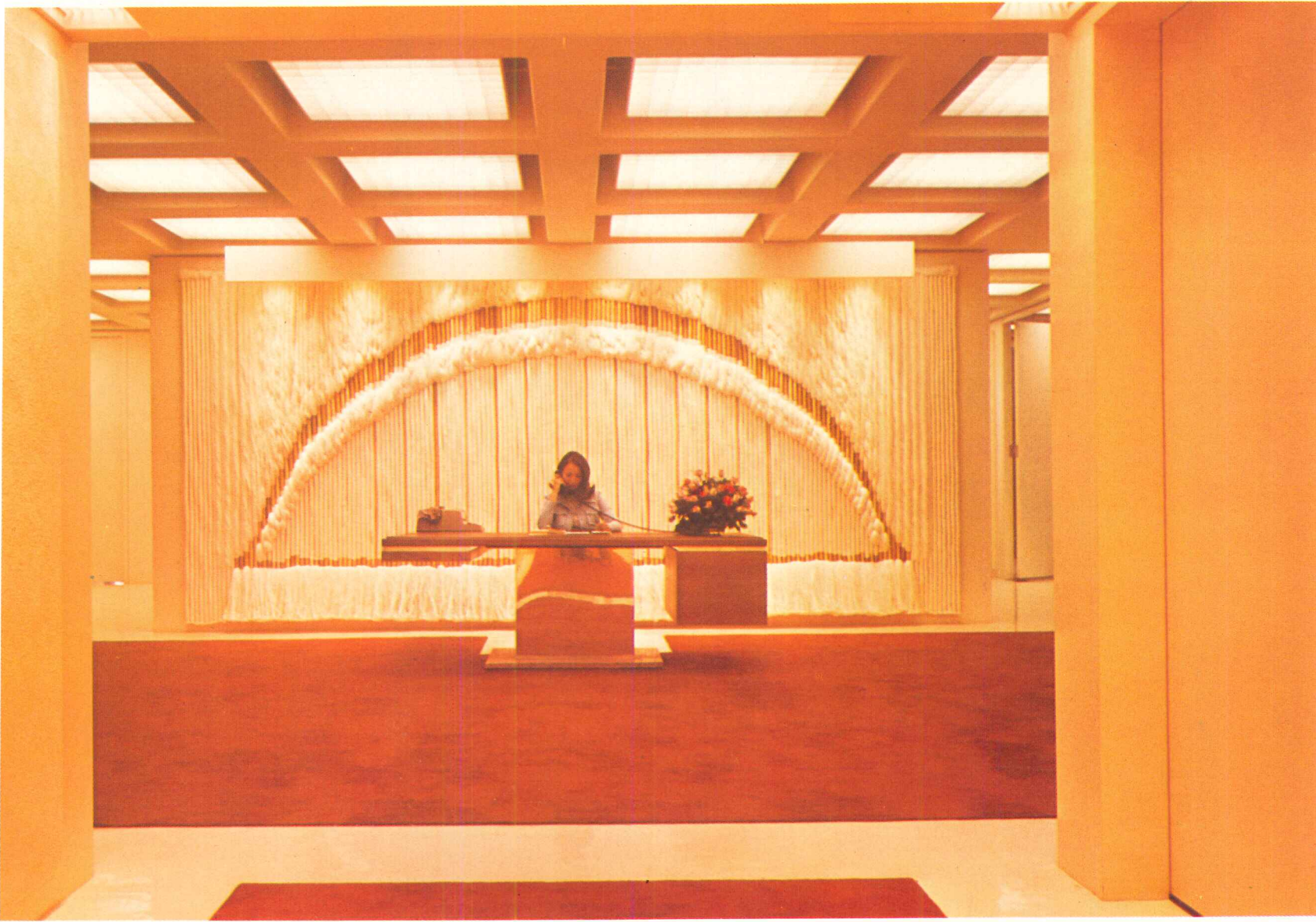

*A multitude of rich materials, special detailing and furniture, and dramatic axial views enforce the client's desired image within the confines of the uniform-height, exposed concrete ceilings. The president's office and an open work station (both opposite) show the same attention to quality and detailing.*

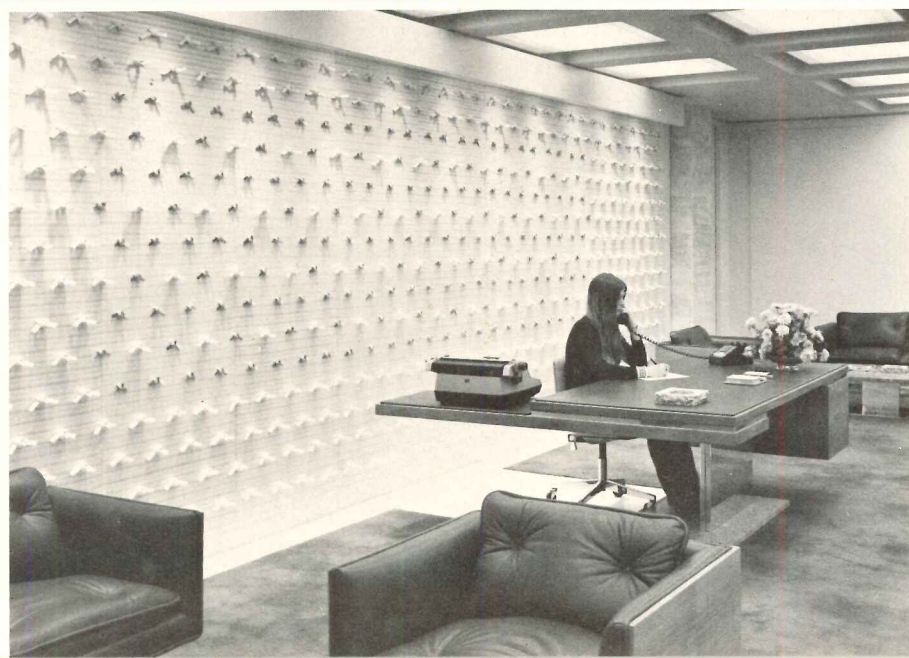
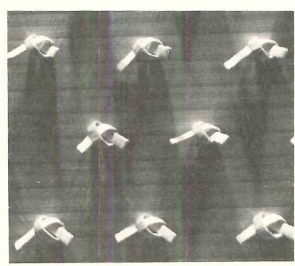





*MGIC's concern for its employees is exemplified in the cafeteria and even the required couch (it's velvet!) in the ladies room. The exposed concrete ceiling with special light diffusers and recessed carpet detailing can be seen in the cafeteria. Much of the furniture is of Platner's own design and is due to go into commercial production shortly. While this was clearly a premium job, great attention was paid to efficient job management. For example, Platner sublet most trades directly—resulting in considerable savings.*

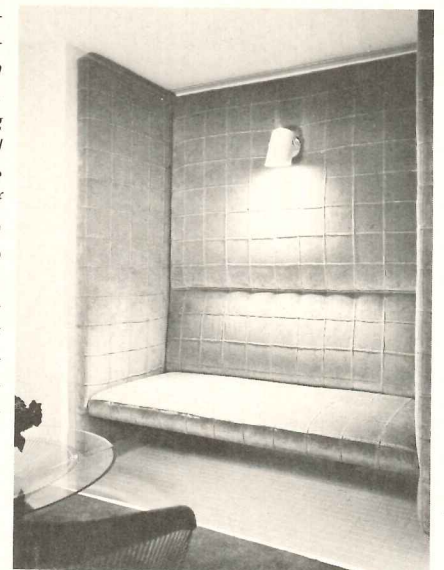



# BEACH HOUSE-RETREAT IN OREGON FOR ARCHITECTS' OFFICE



Edmund Y. Lee photos

On the central Oregon coast at Salishan a beach house complex, designed by and for the architectural office of Travers/Johnston as a retreat, has been successfully created as "another world . . . a world I wish we could share with all," says Stephen Johnston. As a tribute to the delightful character of the retreat, it has been in almost constant use by the architects and employees and their families, clients and friends.

Located on the end lot of a spit of land separating Siletz Bay from the Pacific Ocean,

the site has a commanding and uninterrupted 270 degree view of water. After the idea of a retreat was decided upon, the office staff was asked for suggestions with the final design concept being derived from many "bull sessions." The two major requirements were that it must be a retreat which would allow places for solitude as well as group gatherings, and that it accommodate several families at the same time. This need for a variety of spaces spurred the idea of an octagonal lodge and three hexagonal bedroom units (or modules), grouped in





a circle to create a central courtyard onto which all doors open. The focal point of the courtyard is a sunken area where guests can sit around an open fire-pit. Two decks on the ocean side provide space for sunning. A basement under one module ("Bay" on plan) serves as boat shed, laundry and storage area.

At the angles of each unit are fins extending outward. This element of the design is a strong exterior feature, visually unifying the buildings and serving as a partial windscreen against the strong and almost constant winds.

The exterior is of resawn cedar with a roof of cedar shingles. To capture the magnificent views of land and water and to allow as much light as possible to enter on the foggy and stormy days that are so much a part of the Northwest coast's weather, glass doors and many large windows are used. Glass partitions between units also serve as additional wind-screens and open up views to the courtyard. The largest of the modules, the lodge, provides such necessary community facilities as kitchen, eating and lounging areas. Smooth cedar

is used on interior walls, resawn hemlock on the ceiling. The communal character of the project is emphasized by the fact that the whole complex was not only designed but built by the architects and their staff.—J.N.

BEACH HOUSE-RETREAT, Salishan, Gledon Beach, Oregon. Architects: *Travers/Johnston*. Engineers: *MacKenzie Engineering Inc.* (structural), *Hugh L. Langton & Associates* (electrical), *McCinnis Engineering Inc.* (mechanical). Interiors: *Travers/Johnston*. Landscape architect: *William Teufel*. Contractor: *Trajon Corporation*.



An exhilarating site for a retreat, the Salishan Spit is sand dunes stabilized by pines, grasses and logs swept onto the beaches. Comprising 2000 sq ft, the retreat does not intrude on the area. The only landscaping needed was to reestablish native grasses and pines surrounding the complex.

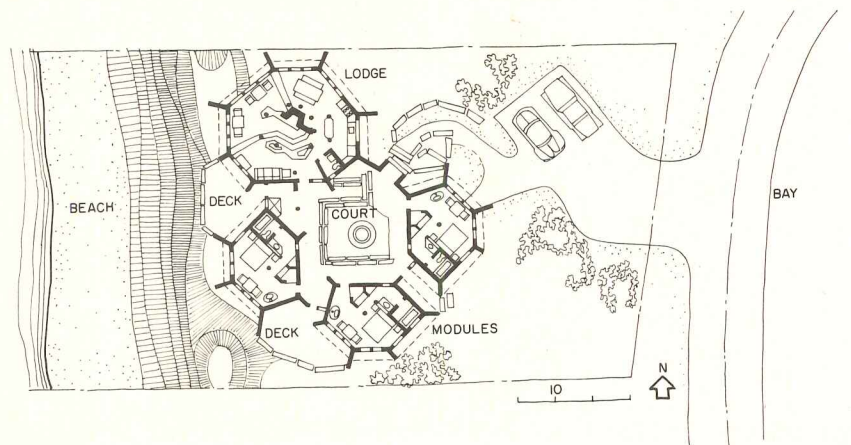
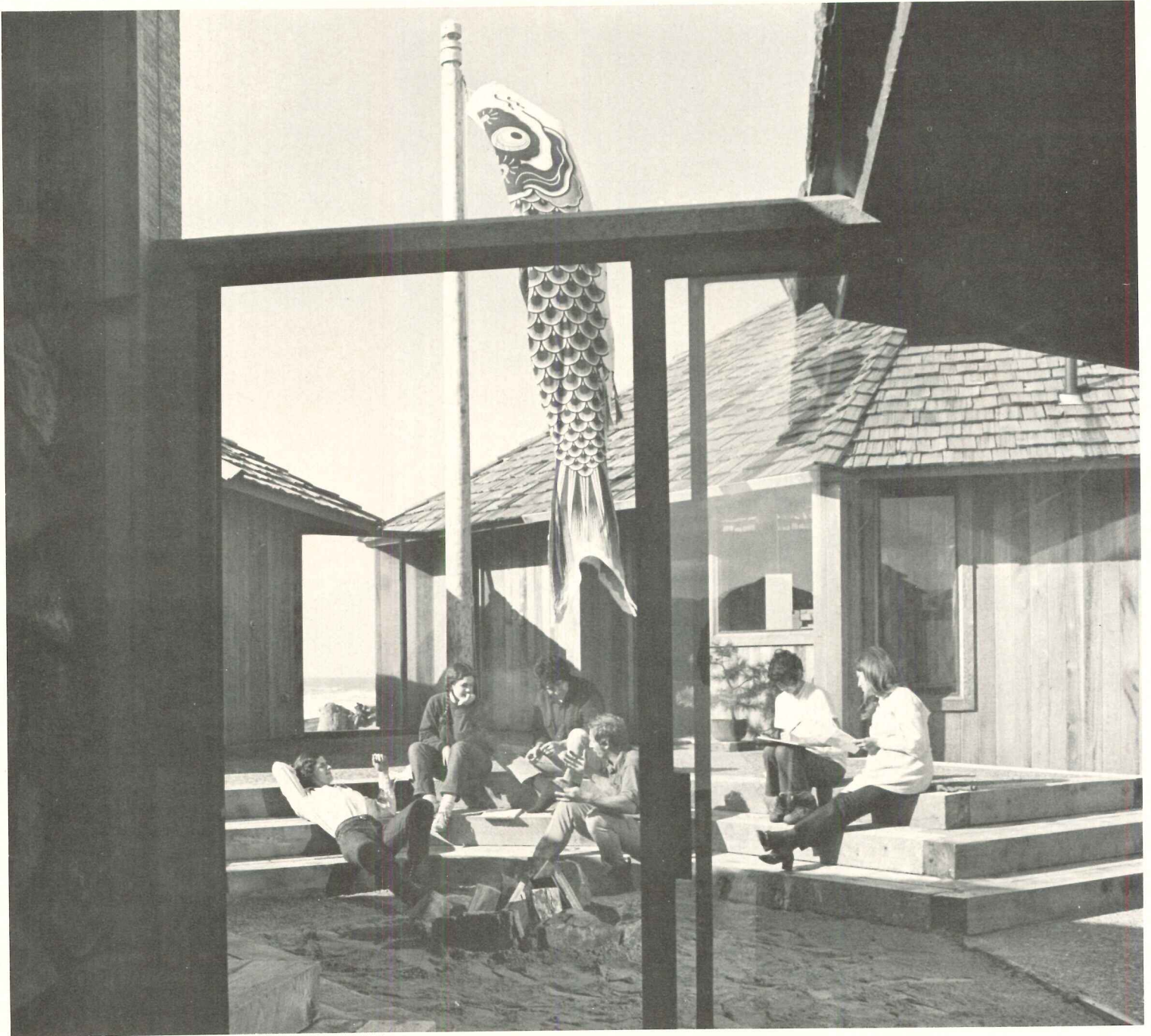



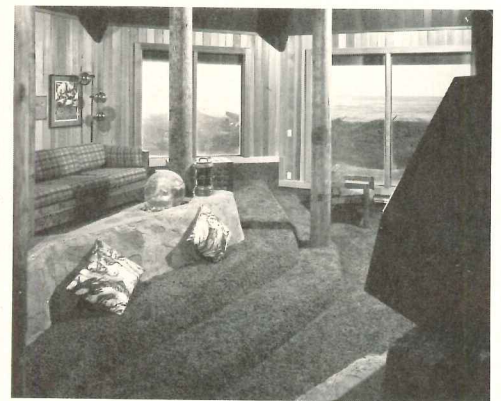
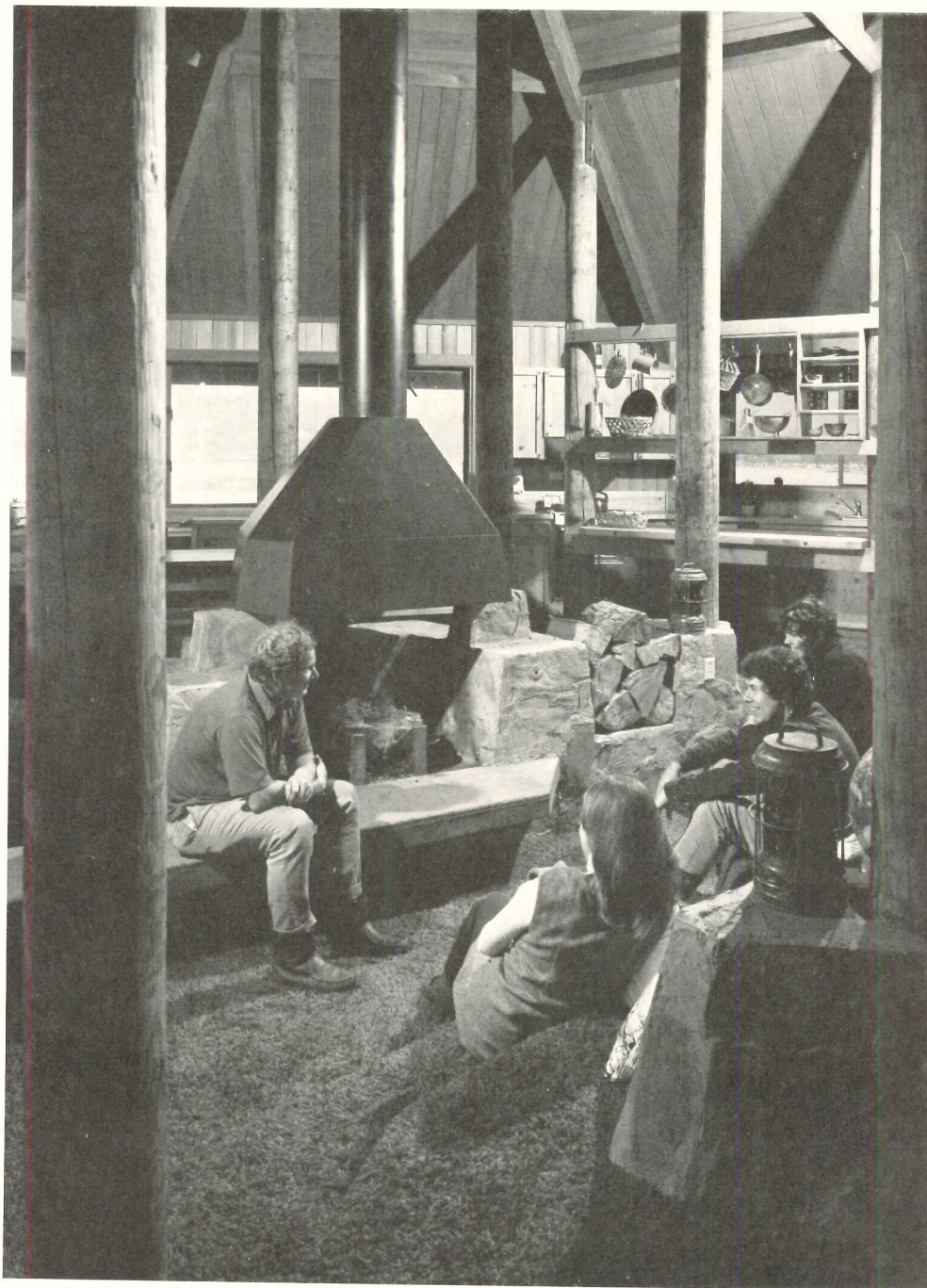

The lodge (left), as the center for most group activities, has the only kitchen, dining and lounge areas. Changes in floor level, expressed in carpet-covered concrete steps, form seating around the fire-pit and contribute to the informality of the room. The bedroom modules are identical. Two modules have views of dunes and one has an ocean view.

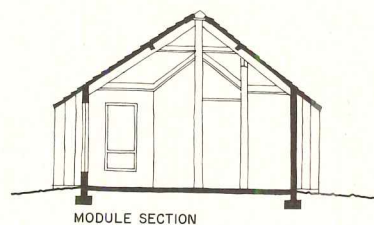
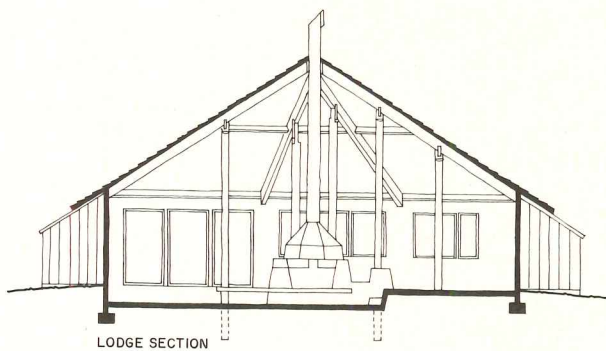
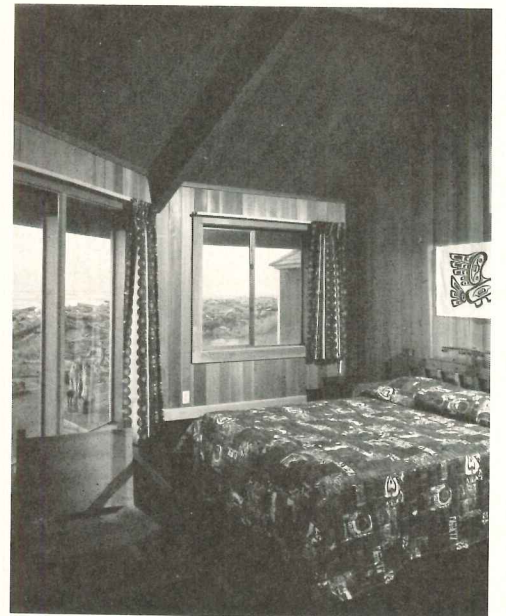



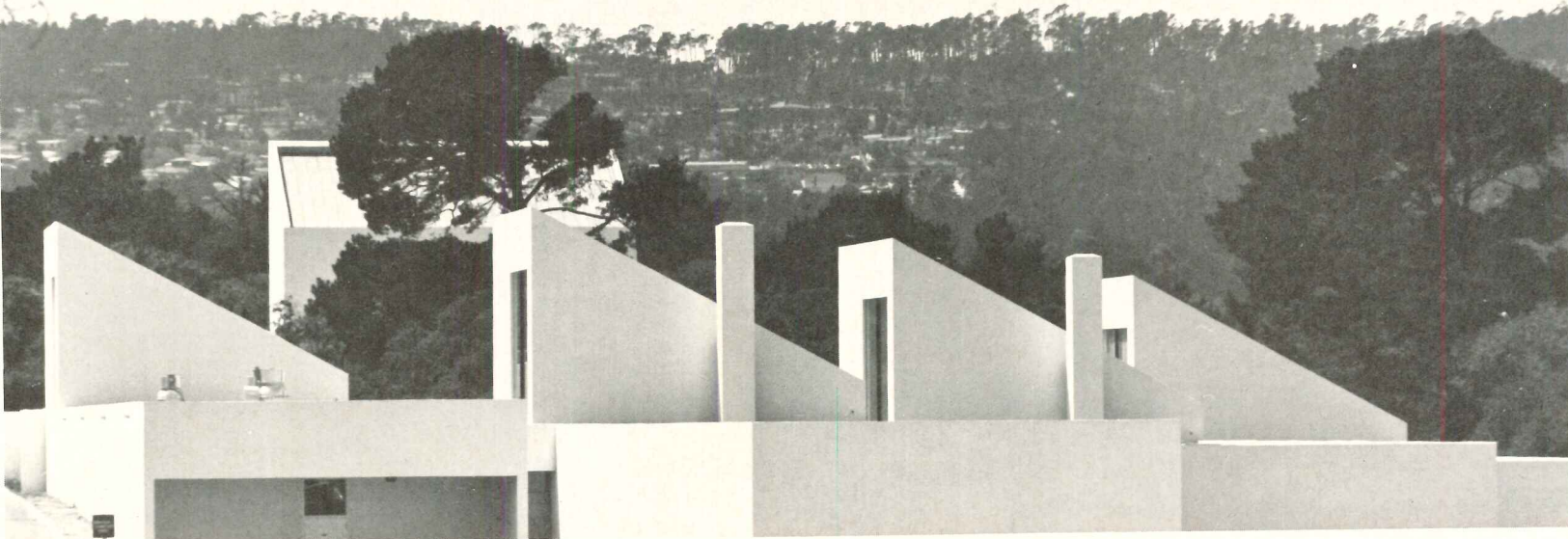

Monterey Peninsula College by Edward Larrabee Barnes

## CAMPUS DESIGN: A NEW FOCUS ON PEOPLE

Because college and university campuses were restless in the late 1960's, and stripmined for that restlessness by the media, most of us were made acutely aware of a general countercultural phenomenon that often brought student interests and values into conflict with those of trustees, administrators and alumni. The conflict took many forms. One of the less dramatic but most persistent student complaints—dating even from the pre-Hip, pre-Beat, pre-Acid/Rock Pleistocene—was that educational institutions had become too large and depersonalized; lectures too crowded; administration too computerized; the campus, itself, stripped of those irregular influences that had always given colleges and universities a special identity, elan, and sense of community.

Students no longer recognized the college president at sight. To them he had become a distant figure, preoccupied with remote concerns, who addressed them en masse at convocations—much as the mechanical Lincoln android addresses the holiday throngs at Disneyland—except in a gargantuan and scaleless setting that reduced him, too often, to an optical zero.

Administrators and trustees felt these deprivations too, but under the pressure of surging enrollments and soaring costs, they saw their options narrowing. As campuses grew, buildings got larger and larger. At their worst, these new buildings were witless and savage. Mostly, though, they were just larger and more impersonal representations of what had been before. The net result was that in spite of mounting enrollments, many campuses overbuilt in the late '60s and in the process, found themselves at odds with large numbers of students who were unsympathetic to the new scale and refused to accept it as the only satisfactory response to new numbers. Thus, as trustees were authorizing expenditures for newer and larger dormitories, many students were declaring a preference for smaller living communes and housing co-ops. As administrators were talking about "multiversity"—and architects about "megaversity," students at several campuses were inventing fictitious fellow students, passing exams for them, earning them degrees.

Recently, some university planners and their architects, following the lead of California's higher educational system (which began to tackle the problem of scale and numbers early), have started to produce a generation of buildings that respond better to changing campus lifestyles, that offer students a wider range of options in living arrangements, patterns of encounter, and access to educational resources. These buildings are less the product of academic formulas, less shaped by campus prototypes. Typically, they are more concerned with experiment than expansibility. Most important, they struggle to retain a warmly human scale, a discernable character, a distinctive sense of place.

These are essential features of the buildings in this study.—Barclay F. Gordon





Julius Shulman

New Hampshire College by Huygens & Tappé

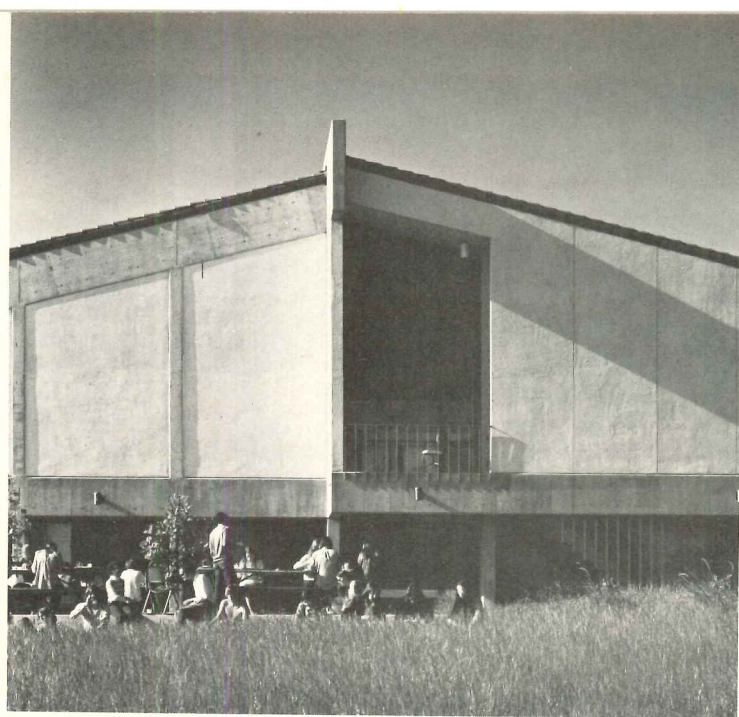

Morley Baer

Santa Cruz Campus No. 5 by Hugh Stubbins & Associates

At the Monterey Peninsula College in California (previous page and pages 158-160), architect Edward Larrabee Barnes designed two buildings, a student union and a theater that, together with an existing gymnasium, form an exciting focus for campus activity. Both buildings achieve individual design expression and architectural values were not suppressed in either for the sake of unity. Each building functions well. But by bringing the buildings together (they were master-planned for unrelated sites) and by designing the spaces between with special care and sympathy for the site's contours, Barnes has achieved a sum that seems larger than its parts.

Huygens & Tappé are architects and planners for New Hampshire College (pages 156-157 and front cover)—a campus of similar scale now rising on a wooded, 90-acre site in Manchester. Using the traditional New England town as both a physical and spiritual model, deriving from it a sense of scale, form and texture, the architects are developing a campus that is, in several ways, extraordinary. Built on the tightest of budgets, the buildings are conceived not so much as individual, special-use structures (although they are) but as parts of a townscape or as incidents along the town's main street. This design has not resulted in buildings that are anonymous or even characteristically understated. It has simply imbued the campus infrastructure—signpost graphics, street furniture, outdoor subspaces—with more than the ordinary design importance (color photo right). These decisions: the town form, the low-rise wood structures have combined to give the campus a very visible identity—an important commodity in attracting both students and faculty, and a commodity it did not previously have when the campus was located in rental space in downtown Manchester.

When the campus plan is starting from scratch, conflicting problems of program and scale are easier to reconcile. But when a new building must be muscled into an already crowded urban campus, vexing difficulties most often arise. At Radcliffe College, outside Boston, architects Ronald Gourley/Carleton Richmond, Jr. have designed a group of faculty houses (facing page and pages 154-155) that fit into a tight campus fabric and meet the problem of surrounding scale with

exceptional sensitivity. Gourley remarked, in an aside, "I'm pleased that these buildings are hard to photograph. That means that they are well knitted in. . . ."

Nearby, at Harvard University, Edward Larrabee Barnes has designed Rockefeller Hall (facing page and page 148) a dormitory for divinity students that fits snugly into a constricted site and responds to both social and visual cues surrounding sites. The architectural expression of humanistic impulses at Rockefeller Hall are unmistakable. For instance, brick walls on the east and west elevations rise sheer from grade to the fourth floor. They are essentially windowless. But by turning the windows on the other two elevations around the corners and thus letting them bite into the blind walls, Barnes has given these elevations a much livelier aspect. Otherwise they would have been brutal. And by selecting the brick already used in a nearby building designed by Ben Thompson, Barnes has begun to unify an area that was previously marked only by its physical dissimilarities. Readers will find examples of this kind of sympathetic design attention in all the buildings included in this study. The building also presents a built-in social order that is carefully conceived to give it a different kind of scale. Suites are gathered into four-room, single-sex clusters that share a single bath. Three such clusters (the size of a commune) share a kitchen and comprise a floor. The house consists of four such floors which produces a group the size of a fraternity. Individual students can therefore modulate their social interactions and encounters with somewhat more than the ordinary degree of control.

This kind of breakdown is present at a larger scale at Santa Cruz Campus No. 5 (above and pages 150-153). Here, at one of eight planned residential colleges on the site, students with a special interest in the performing arts share living spaces in what architects Hugh Stubbins and Associates have envisioned as a small-scale, special-purpose community. The individual structures and the spaces in between are carefully designed to heighten that sense of community.

The quest for humanistic campus environments is certainly not new and the architects whose work is shown here have long championed



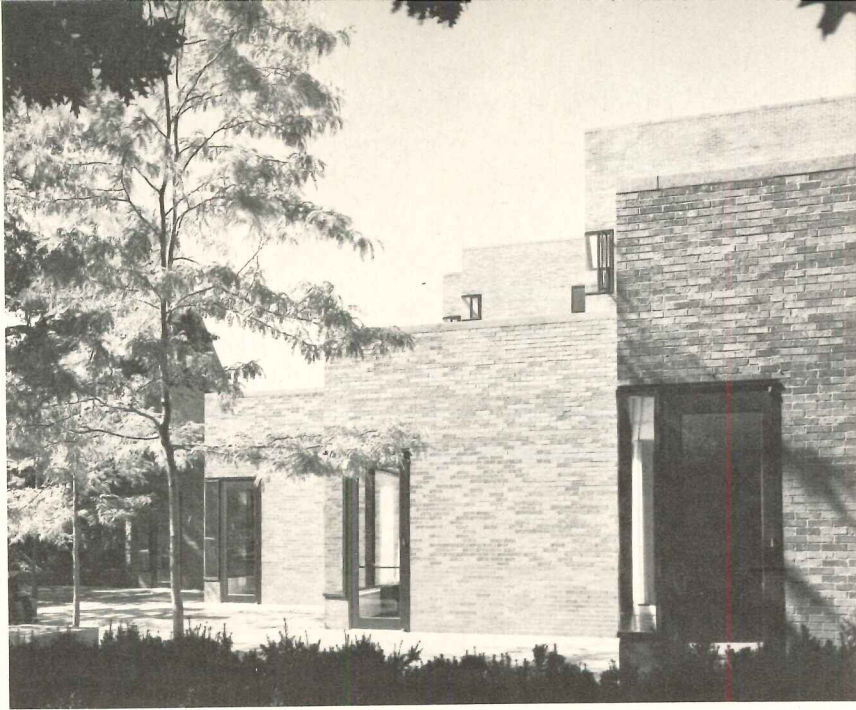
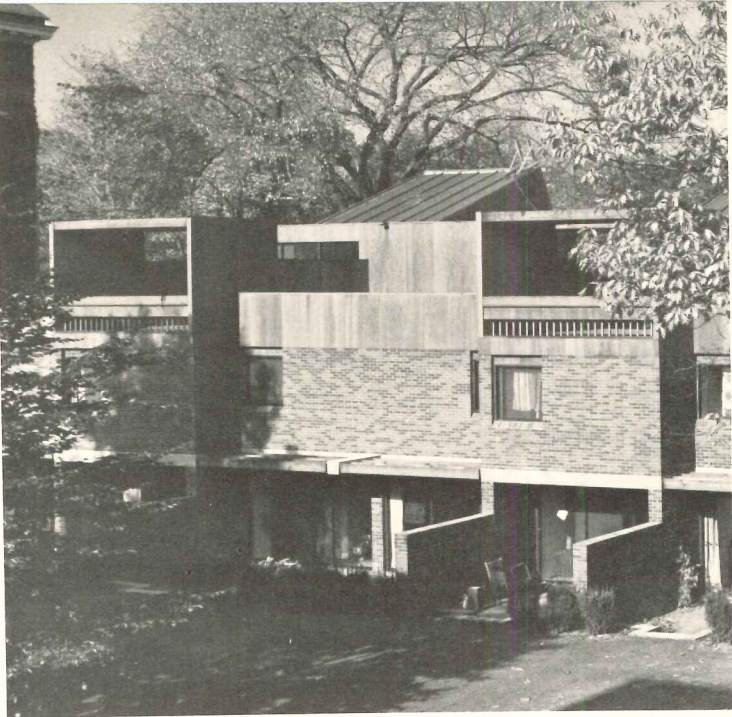

Faculty housing by Ronald Gourley/Carleton Richmond, Jr.

Rockefeller Hall by Edward Larrabee Barnes

these values. Nor can we be justified in claiming that largeness is synonymous with scalelessness—though too often the two seem to go hand in hand. What we can say, with some sense of certainty, is that the scale of yesterday's campuses is under increasing attack from a variety of forces ranged out in serried skirmish lines on every side. Of these, the economic pressures are the most insistent but they are also the most widely recognized and, perhaps, the best understood. Other forces acting to undermine the traditional campus community are less apparent but no less threatening. The shift of faculty emphasis from teaching to research and publication has sharpened a scholar's ties with professional colleagues on other campuses across the country. Usually this has come at the expense of traditional ties with his own campus community. The Federal government has been increasingly interested in drawing upon college and university resources and hitching them to national goals and policies. Finally, in the intensely restless climate of the late '60s, student populations themselves became more factionalized and discordant. All these pressures—and many others—tended to disturb the traditionally easy and inward-looking character of American college campuses.

These campuses are quieter now but it would be foolhardy to assert that the present retreat from the barricades signals a return to more traditional campus values. And it would be just as premature to hail a small group of more flexibly organized and more intimately scaled buildings as a triumph of humanism. If students and faculty like these buildings, and if their numbers multiply, then we may make more extravagant claims. For the present, these buildings can only be regarded as vectors, as countervailing forces, as conscious efforts by university planners, architects and others to check the drift toward a more impersonal and undifferentiated future. Colleges have always left an imprint on those who attended them. Sometimes the imprint was so clear that a student was marked with its style for life. What the imprint will be in the future is now unclear, but growing numbers of people seem determined that it will be something more substantial and more personal than the imprint left by a computer.

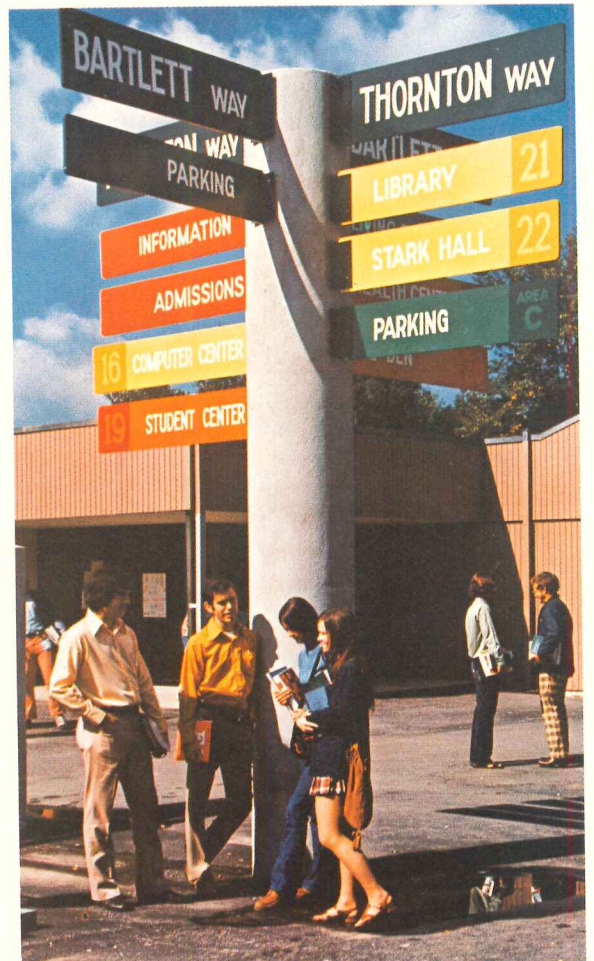

New Hampshire College by Huygens & Tappé



ROCKEFELLER HALL, HARVARD UNIVERSITY  
CAMBRIDGE, MASSACHUSETTS  
BY EDWARD LARRABEE BARNES

**"This is a little dormitory where the counterpoint of individual and group life styles has been carefully modulated. It is also a building that functions as an academic and community center as well as a residence for the inhabitants. Every effort has been made to keep the scale intimate." —Edward Larrabee Barnes**

Ezra Stoller © ESTO photos





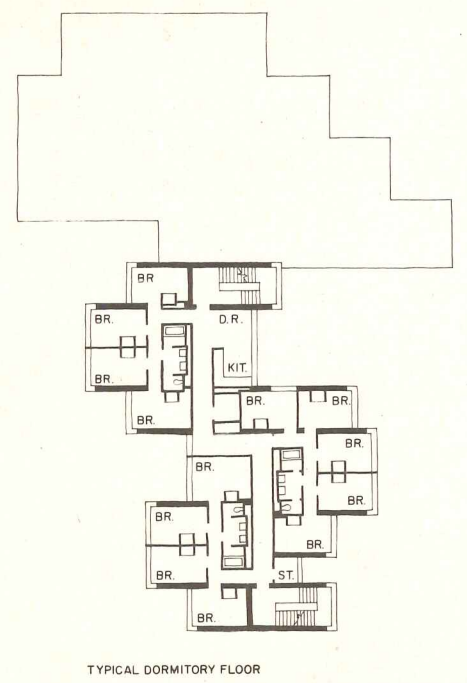
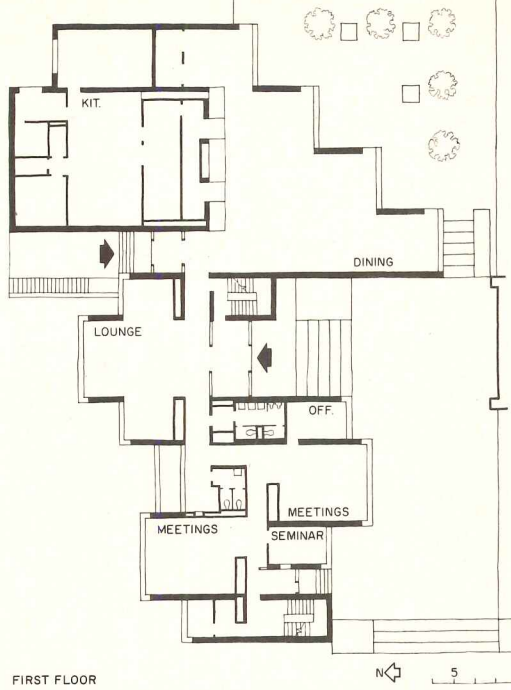
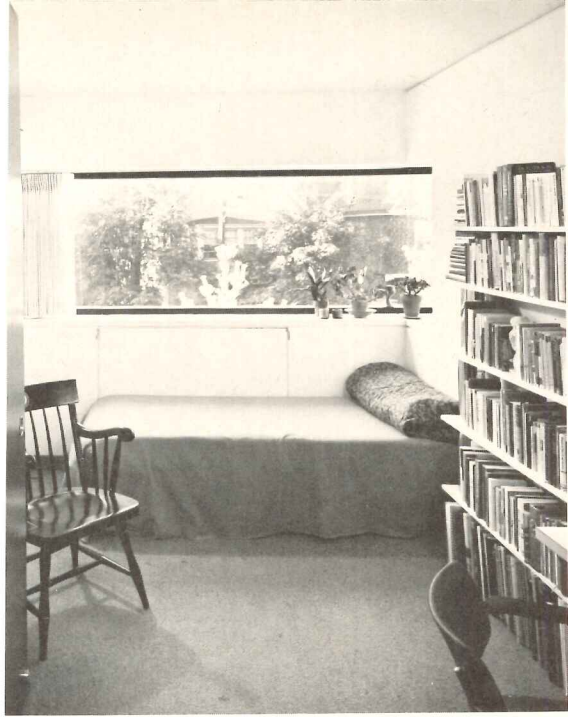

FIRST FLOOR

TYPICAL DORMITORY FLOOR

The site planning requirements for Rockefeller Hall, a residential structure for Harvard's divinity students, were unusually complex. The building occupies a site of irregular shape with a striking variety of boundary conditions. It had to relate to an adjacent Gothic classroom building used by the divinity students on a regular basis. It also had to maintain the scale of an established residential neighborhood to the east and southeast. To the west, the site faced a parking lot and a massive cyclotron structure. Barnes strove to respond to these neighboring conditions by carefully manipulating the building's mass between high- and low-rise, and by creating a grassy court to face the existing classroom building.

Rockefeller Hall functions round the clock as a dormitory on the upper floors and as teaching and community spaces below (photo right). A neighborhood day care center operates in the building's basement.

The search for scale extended into the building's program as well. The rooms are grouped four to a bath. Each floor includes a kitchen that serves the 13 students on the floor (the size of a commune). The four floors house a total of 39 students (the size of a fraternity). Students therefore have variously-scaled social frameworks, each gently structured, to which they can relate.

ROCKEFELLER HALL, Cambridge, Massachusetts. Architect: *Edward Larabee Barnes*—project architect: *Edward Z. Jacobson*. Structural engineers: *Le Messurier Associates* (structural); *Segner & Dalton* (mechanical). Landscape architect: *Peter G. Rolland*. Interior design: *Mary Barnes*. Contractor: *Porter Construction Company*.

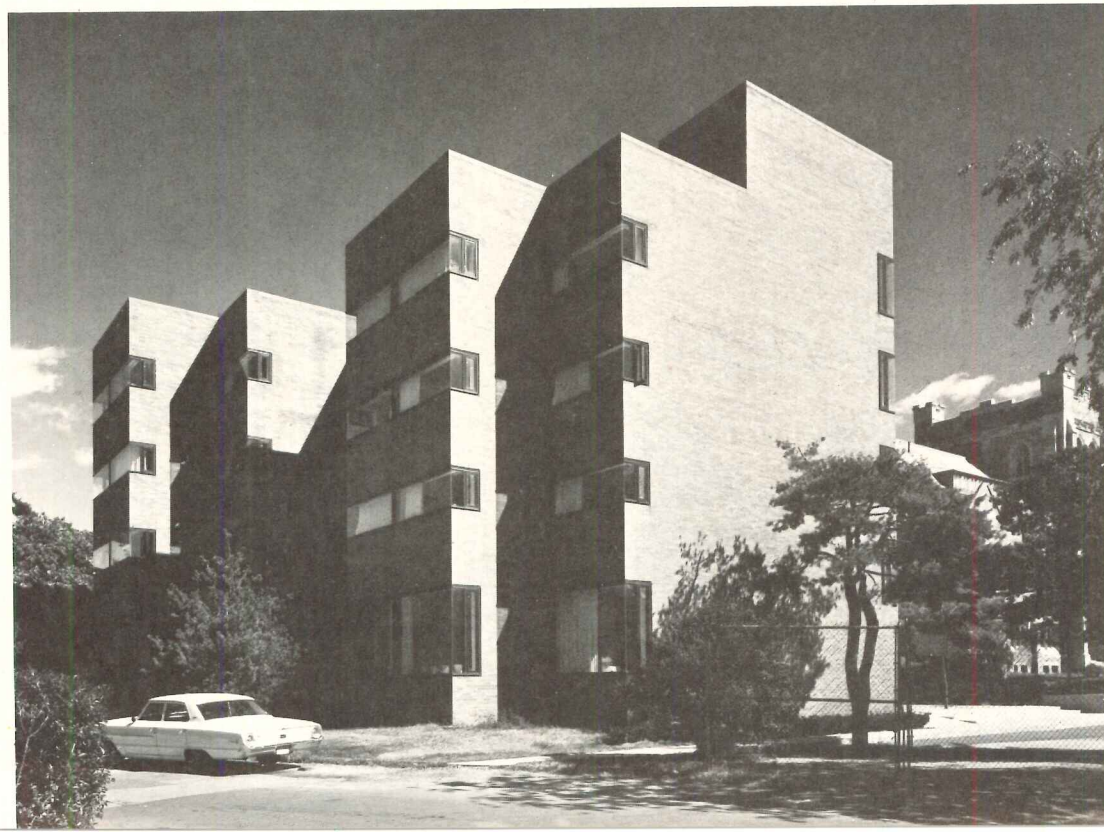



*SANTA CRUZ CAMPUS NO. 5, SANTA CRUZ, CALIFORNIA  
BY HUGH STUBBINS & ASSOCIATES*

*"The redwood forest, the deep draws, the pastoral slopes and the sea are inescapable parts of the inter-college scene. The student, as he goes from college to college, or from college to center, is constantly aware of this compelling landscape. A purposeful attempt is made in this college to give it a sense of identity—a sense of place—and to give a different and more cultivated 'environment' within the walls as compared to that on the outside."—Hugh Stubbins*

*Morley Baer photos*





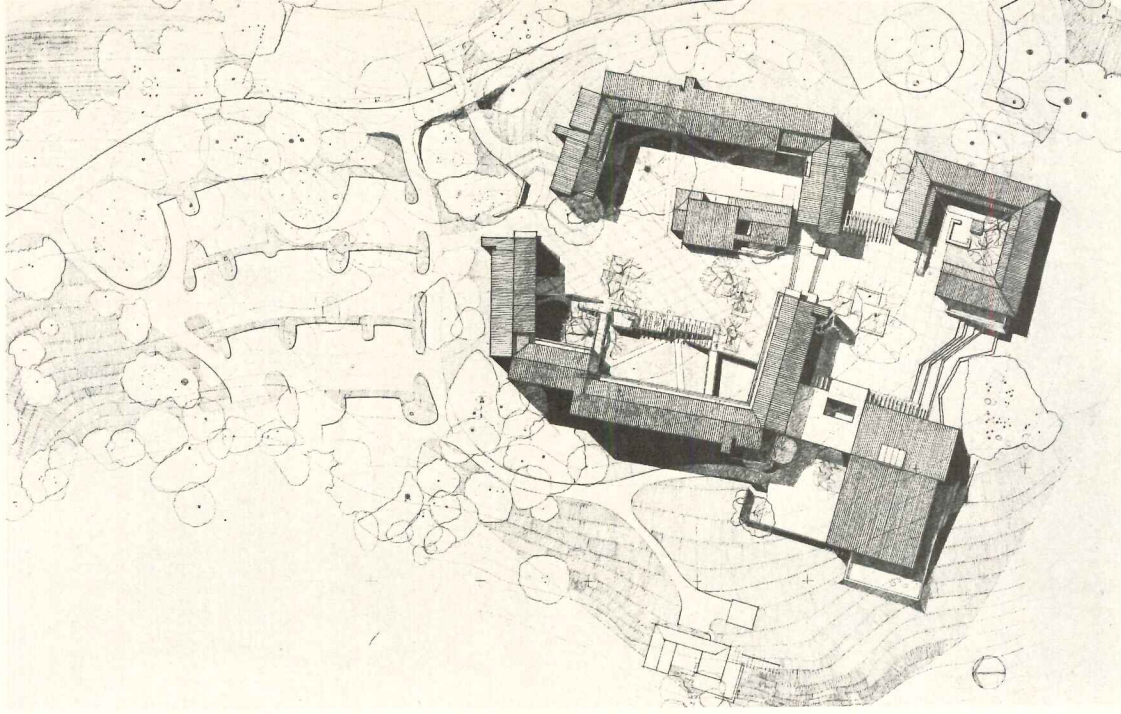
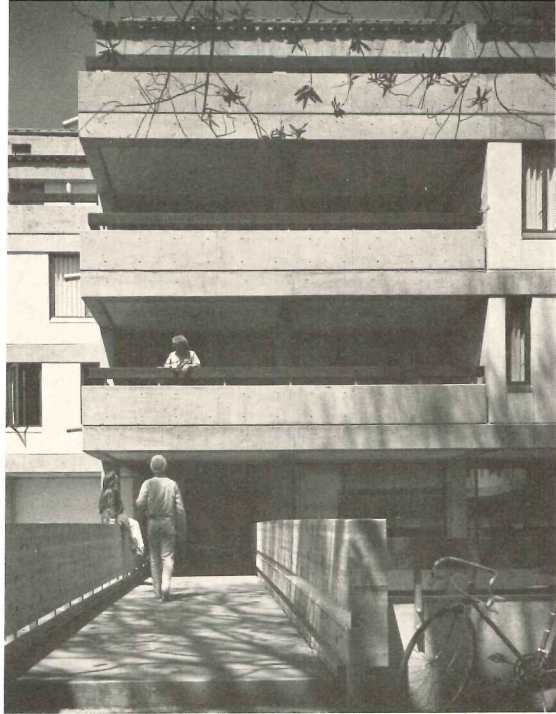

The campus shown here and on the following two pages is an 800 student increment of the University of California. Eight other residential colleges in the same system, each of roughly comparable size, share this 2000 acre site. Here the land swells in gentle undulations with contours and planting that the architects have been careful to preserve. Like a town, this campus has its place of work, its residences, its places of assembly and its seat of government. Housing is grouped around a large court and forms the walls that enclose the town square (photo left). While the court is large, it is broken down into sub-spaces and filled with scale-giving devices. Distances are never so great that students cannot recognize each other across its length. The main court gives way to secondary spaces, all sequenced to provide varying degrees of enclosure and carefully opened at intervals to long views of sea or hills. Most of the housing is four stories—one is five—and student residents have choices of living-study suites of various sizes. Faculty apartments are located near the major entrances.

Nowhere, inside or out, is there evidence that the need for economical structure or finishes is incompatible with human or cultural values.

SANTA CRUZ CAMPUS NO. 5, California. Architects: *Hugh Stubbins and Associates*; associate architect: *Corlett and Spackman*. Engineers: *Clarence Rinne* (structural), *Ralston and Dwyer* (mechanical). Landscape architect: *Thomas D. Church, Inc.* Food: *Harry John Dutton*. Contractor: *Carl N. Swenson Co.*





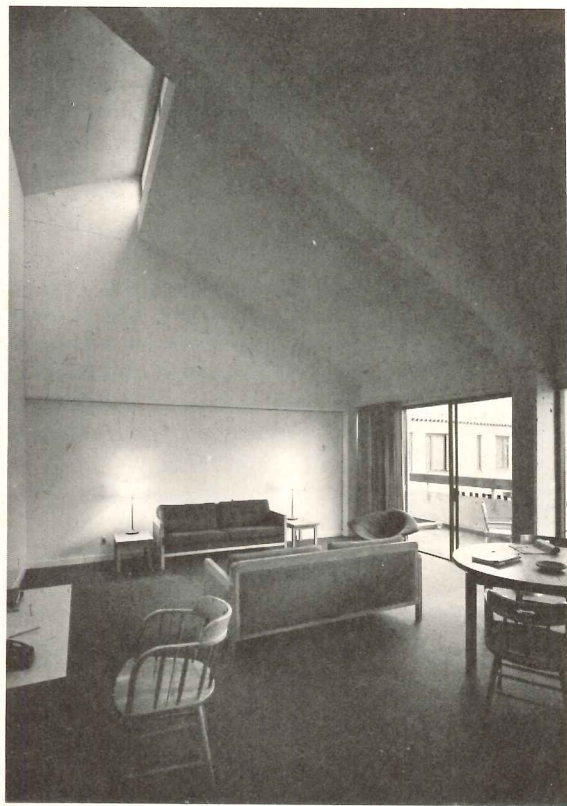
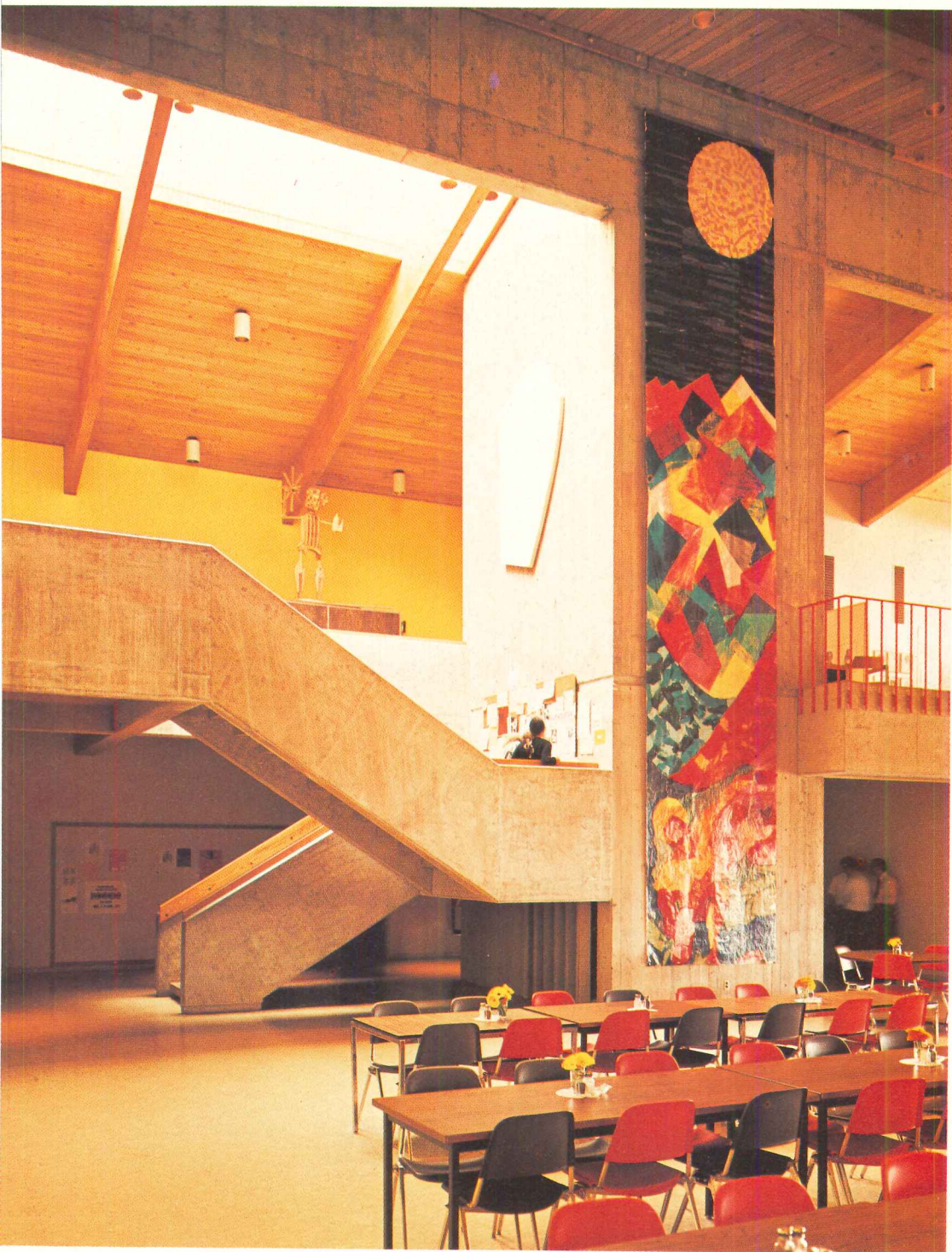
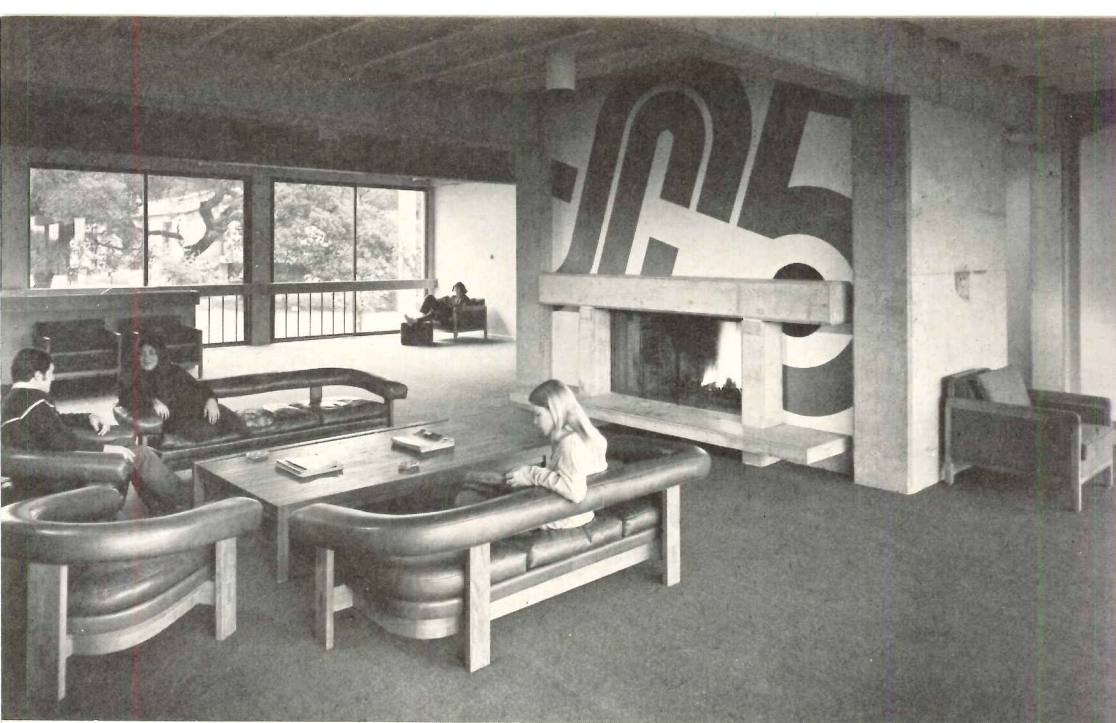

*The same unpretentious concerns are apparent in the design of the interiors at Santa Cruz Campus No. 5. The designers use humble materials in easy and natural ways. Color and light (sometimes from unexpected sources) as in the student dining hall give it a warm and cheerful character—a character that extends to the other interior spaces shown above. Detailing is kept extremely simple. Details only seem to occur where materials change, and even there the joints are not elaborated.*



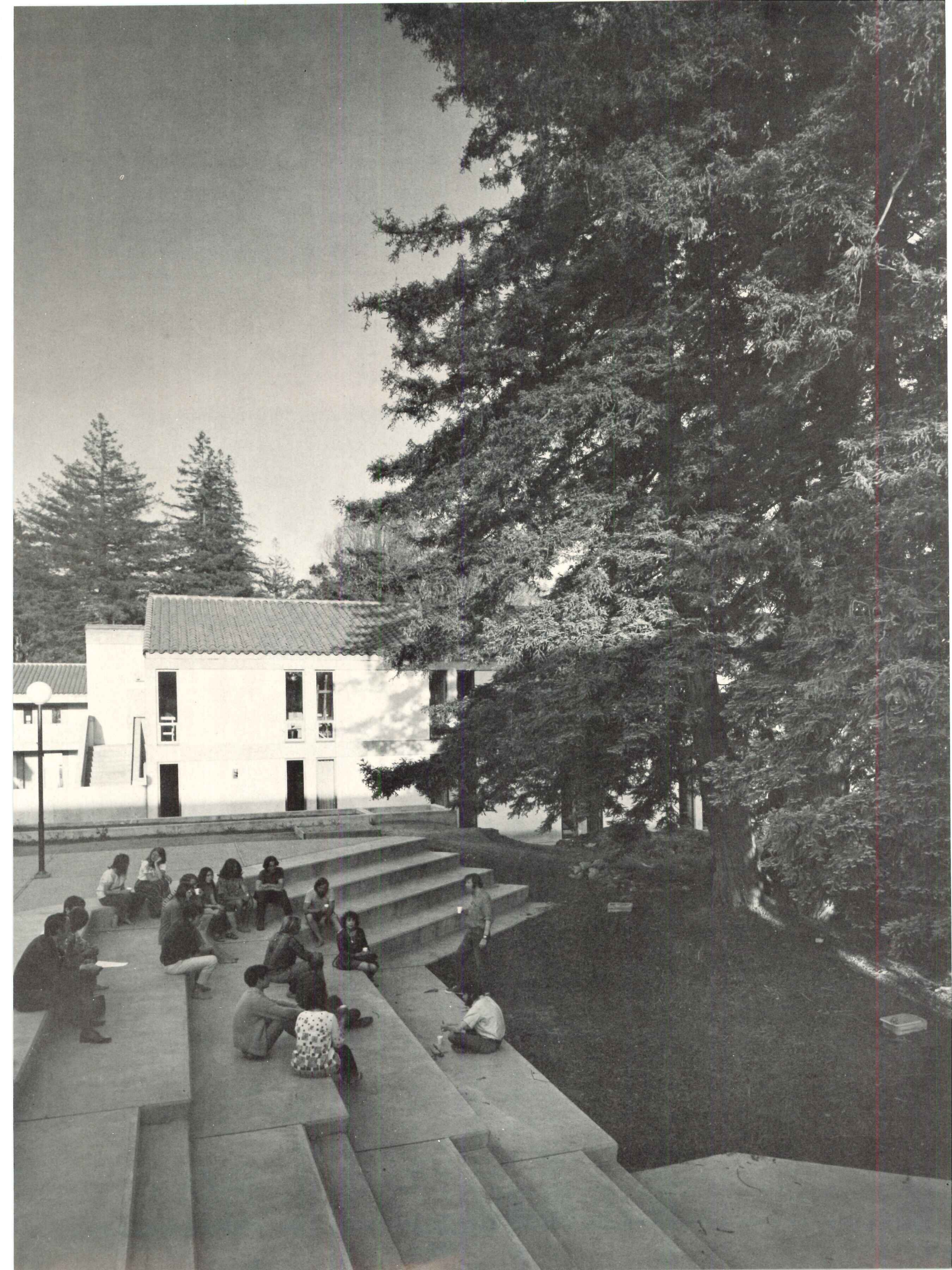



FACULTY HOUSING, RADCLIFFE COLLEGE  
CAMBRIDGE, MASSACHUSETTS  
BY RONALD GOURLEY/CARLETON RICHMOND, JR.

"... (I am) worried about the disappearance of genuine localness in buildings and places. It means to me that the general and the specific are out of order in the minds of the majority and they are working outside a rationally structured value system... Personally, I have elected to continue to search after a timeless architecture of belonging."—Ronald Gourley

Phokion Karas photos

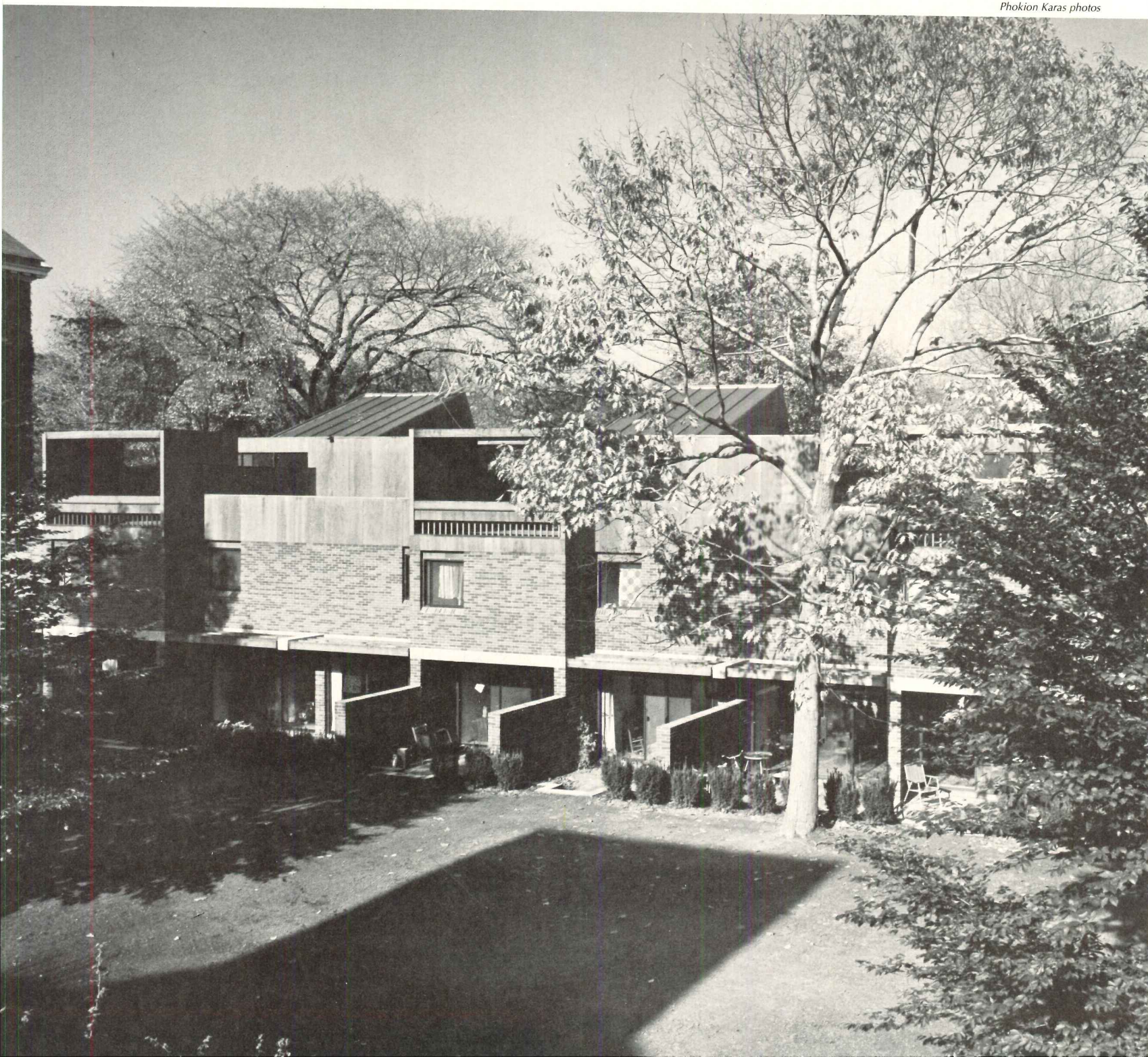



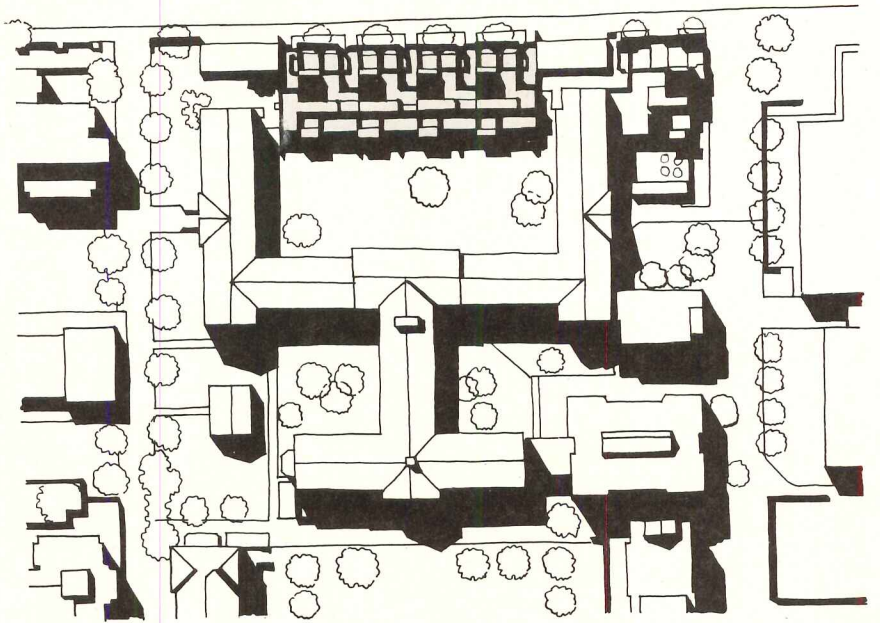
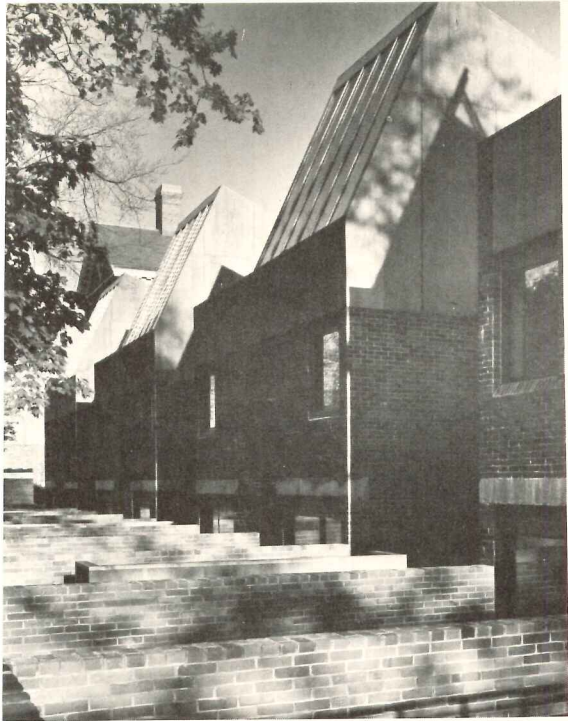

This group of faculty houses began the implementation of a general plan to expand and renew the Radcliffe College Residential Quadrangle. Placed at the north end of a large open lawn, the houses provide a firm edge to the quadrangle and strengthen the street form to the north. Carports and low walls tie the complex together and new planting helps to suppress the ends of existing dormitories which are much higher than other neighboring buildings.

The houses contain a mix of two-, three- and four-bedrooms and some have street floor studies to facilitate teacher-student conferences. By depressing the site slightly, Gourley achieved an important sense of separation from surrounding structures. But by careful ordering of the forms, by sensible fenestration and integral trellis work, the architect maintained a pleasing residential scale. These same devices bestowed on these houses a design personality quite their own, but not at the expense of the campus in general. A sense of place is very evident here, and the integration of building and site is handled with skill.

The structure and service cores of the apartments are repetitive, but each unit has a different combination of rooms and each has a private outdoor space at both ground and roof level. This faculty housing, among the best we have seen, was built at approximately \$25 psf inclusive.

FACULTY HOUSING, RADCLIFFE COLLEGE, Boston, Massachusetts. Architects: *Ronald Gourley/Carleton Richmond, Jr.* Engineers: *Souza & True* (structural); *Leo Brissette* (mechanical). Landscape architect: *Diane McGuire*. Furniture design consultant: *John Adden*. Contractor: *Boutin, Sandanato & Bogue*.

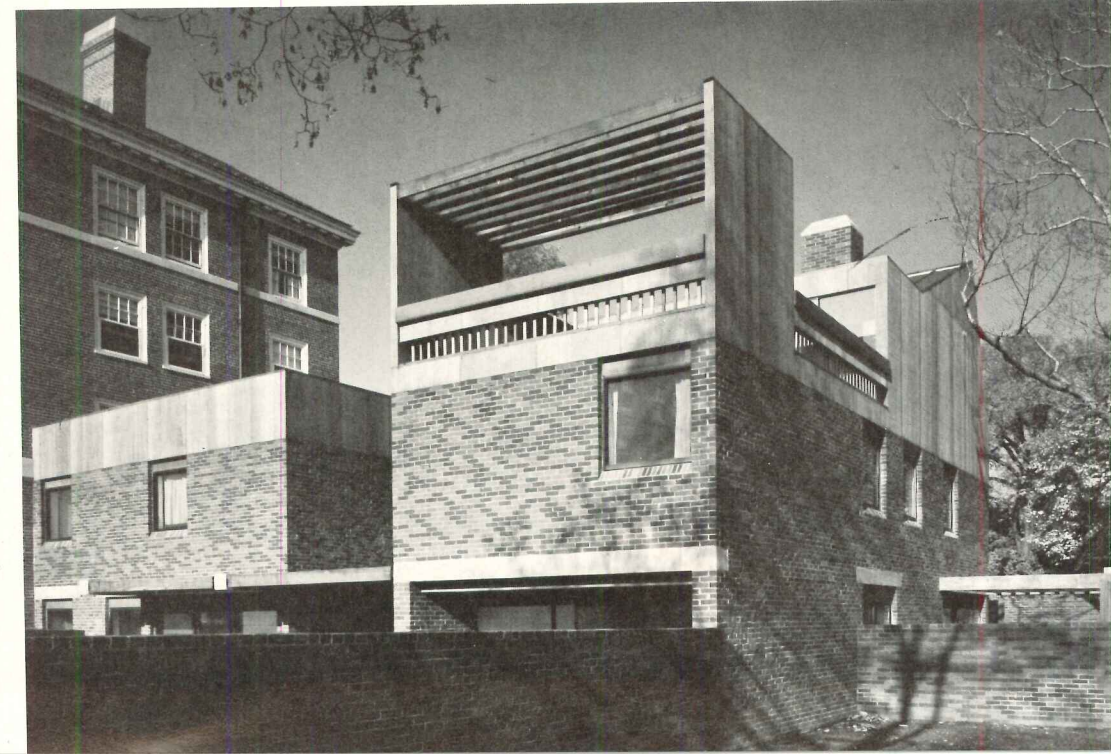



# NEW HAMPSHIRE COLLEGE, MANCHESTER BY HUYGENS AND TAPPÉ

"The buildings themselves are merely parts of the 'townscape'; street walls rather than independent forms. Their functions will be as those of a town: offices for town government (college administration), private business offices (classrooms), small professional offices (faculty), but also a restaurant and coffee shop, drug store, book store, and post office. . . . The community's social and recreational activities take place along or on the main street."—*Huygens and Tappé*

*Julius Shulman photos*

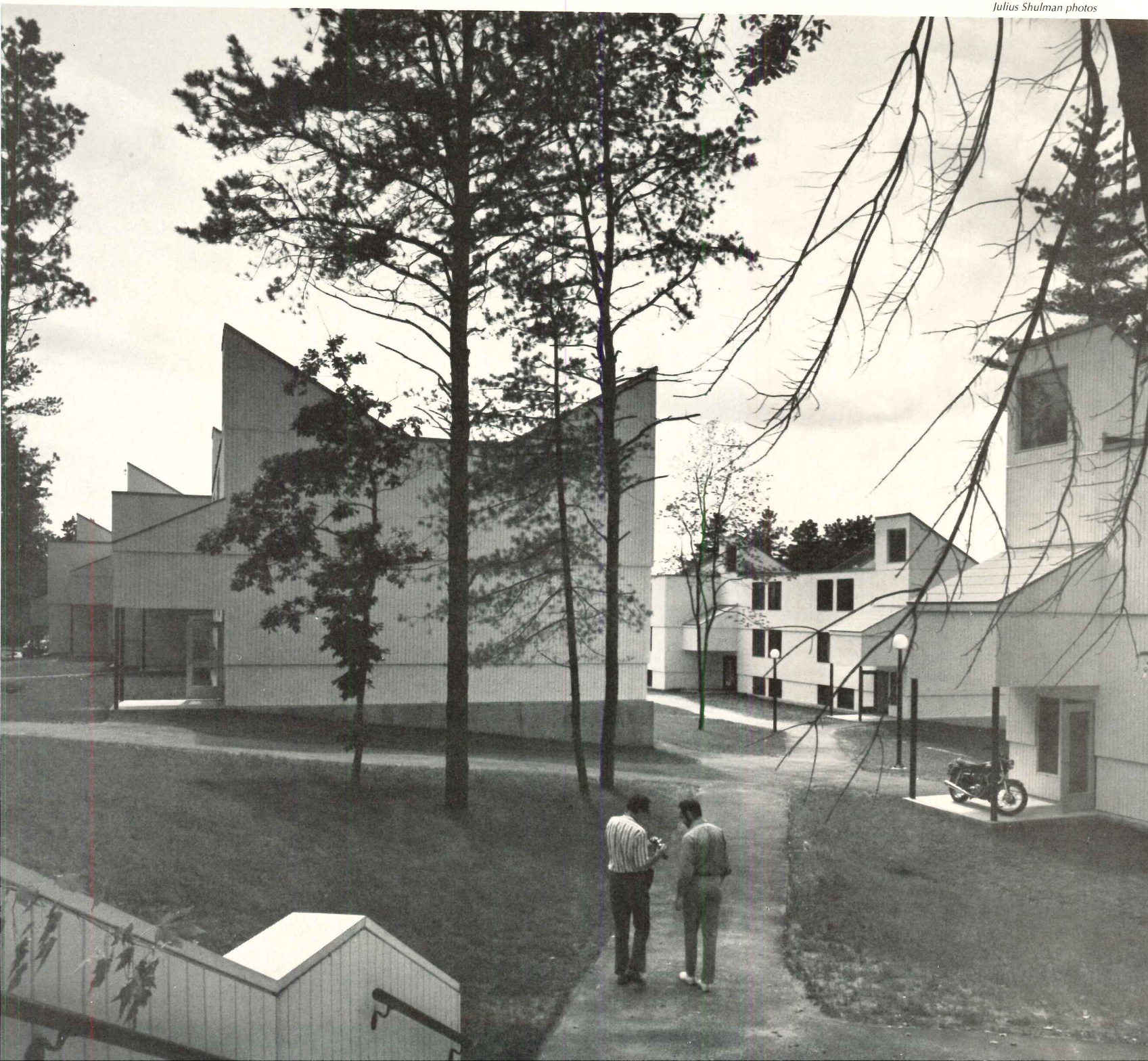



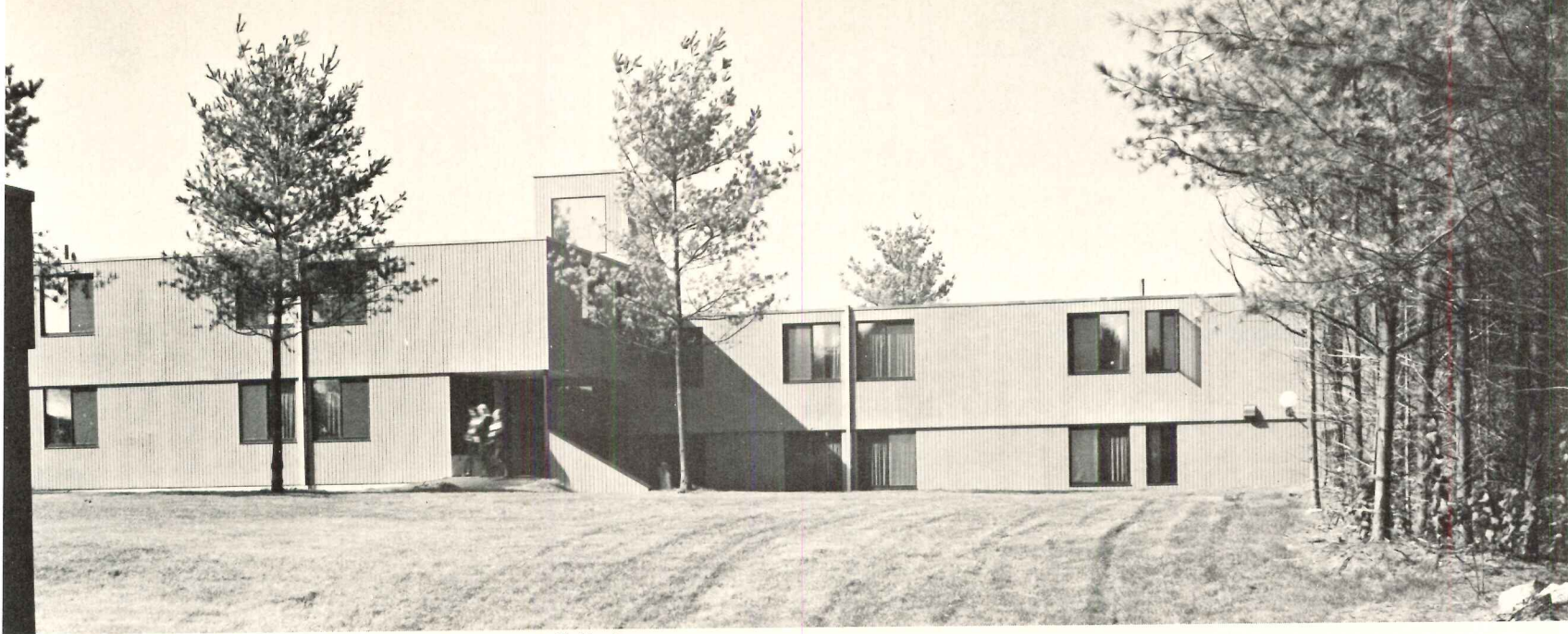

Phokion Karas

Before moving to its new campus, New Hampshire College was located in rented spaces scattered throughout downtown Manchester. The college suffered all the functional problems of dismemberment and had no visible identity. It was important, therefore, that the new campus (on a rural site 15 minutes from downtown) provide a forceful physical image. It was also important that the new buildings be very inexpensive and capable of quick erection. Huygens and Tappé filled these requirements and more. They developed a campus plan and building esthetic patterned appropriately on the traditional New England town. At the center of the "town" is a main street—a busy pedestrian way crossed by secondary circulation routes to the dormitories in one direction and to perimeter parking in the other (see site plan). The buildings, except for the gymnasium, are wood frame structures plywood clad.

The town character, evident in these photographs, extends to the treatment of street furniture and graphics (see page 156). These colorful elements are simply designed but woven with exceptional skill into the general fabric of the campus and they contribute to its obvious visual appeal.

NEW HAMPSHIRE COLLEGE, Manchester, N.H. Architects: *Huygens and Tappé*. Phase I: *Stuart Carter*, job captain. Engineers: *Linenthal, Eisenberg & Anderson, Inc.* (structural); *William R. Ginns* (mechanical); *Lottero-Mason, Associates, Inc.* (electrical). Program: *Dober, Paddock and Upton*. Contractor: *Blanchard Stebbins, Inc.* Phase II: *Archibald Currie III*, job captain. Engineers: *Steco Engineering* (structural); *Joseph Gildor* (electrical/mechanical); *Shurcliff, Merrill, Footit* (site). Contractor: *Northgate Construction Company*.

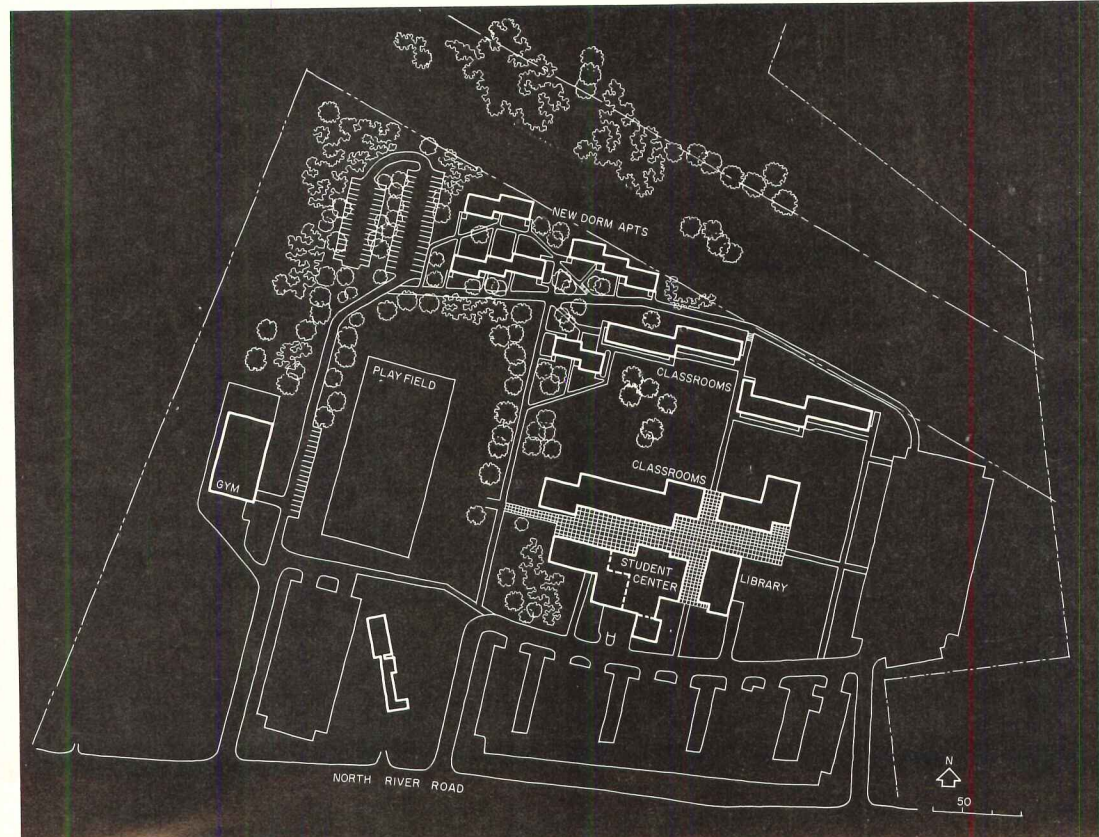
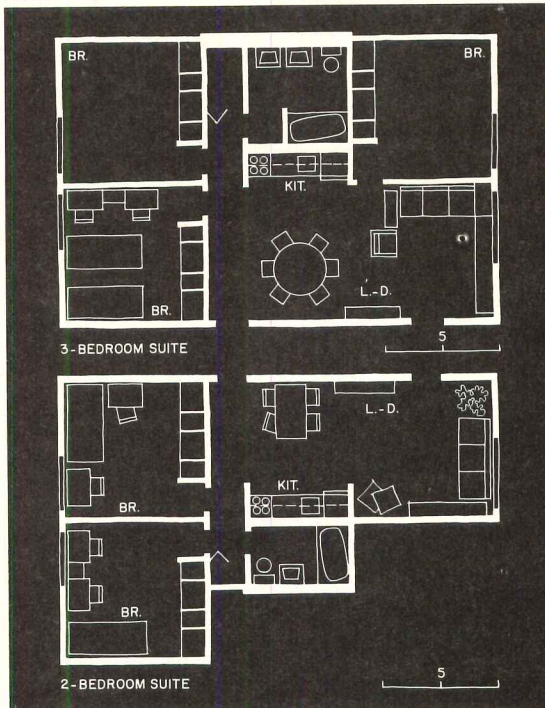



MONTEREY PENINSULA COLLEGE, CALIFORNIA  
BY EDWARD LARRABEE BARNES

"Our two buildings—the Student Center and Theater—are grouped at the head of a deep ravine that cuts the campus in half. The ravine now becomes an artery instead of a divider and the amphitheater between our buildings is the heart of the campus." —Edward Larrabee Barnes

Marshall Schultz photos





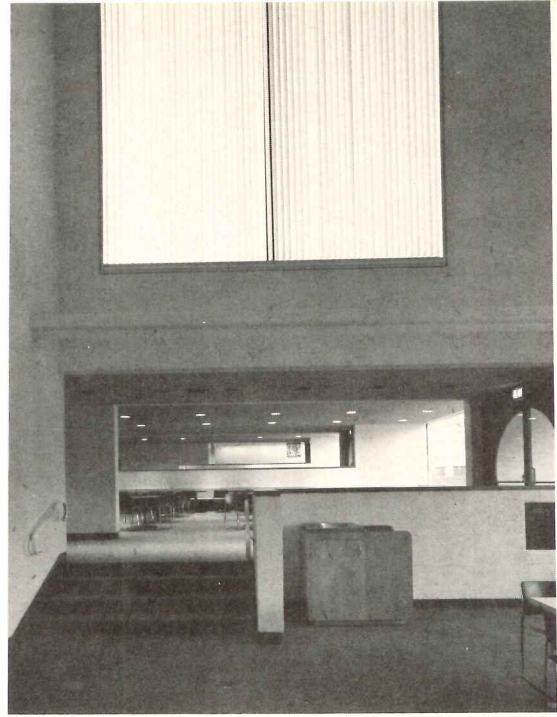

The campus of this California college is bisected by a deep cut—a ravine that stretches for more than a mile and terminates in front of an existing gymnasium. When Barnes was commissioned to design a Student Union and campus theater, he persuaded the university planners to let him build on two sites adjacent to the gymnasium but flanking the ravine left and right (see site plan). The sloping contours offered an opportunity to provide an outdoor amphitheater—a useful campus component and a particularly effective design device for terminating the ravine and easing the transition between the natural condition and the surrounding buildings.

The buildings themselves are fitted to their sites with care. The Student Union (photos left, above, and page 145) steps down in increments with its sloping site and brings daylight deep into its interiors by peaked clerestories. In the theater, (page 160) similar peaked forms mark the “green room” and the fly tower. Taken separately, each building is functional and appealing. Taken as a grouping, the three-building complex, with its amphitheater and beautifully designed connective tissue, offers a splendid setting for student interaction, both planned and impromptu. Because of the benign climate, the amphitheater gets year-round use.

MONTEREY PENINSULA COLLEGE, Monterey, California. Architects: Edward Larrabee Barnes; associate architects: Keeble and Rhoda, Architects, Douglas Barker, Architect. Structural engineers: Steven H. Sasson & Associates. Landscape architects: Eckbo, Dean, Austin and Williams. Interior design: Douglas Barker. Contractor: Geyer Construction Company.

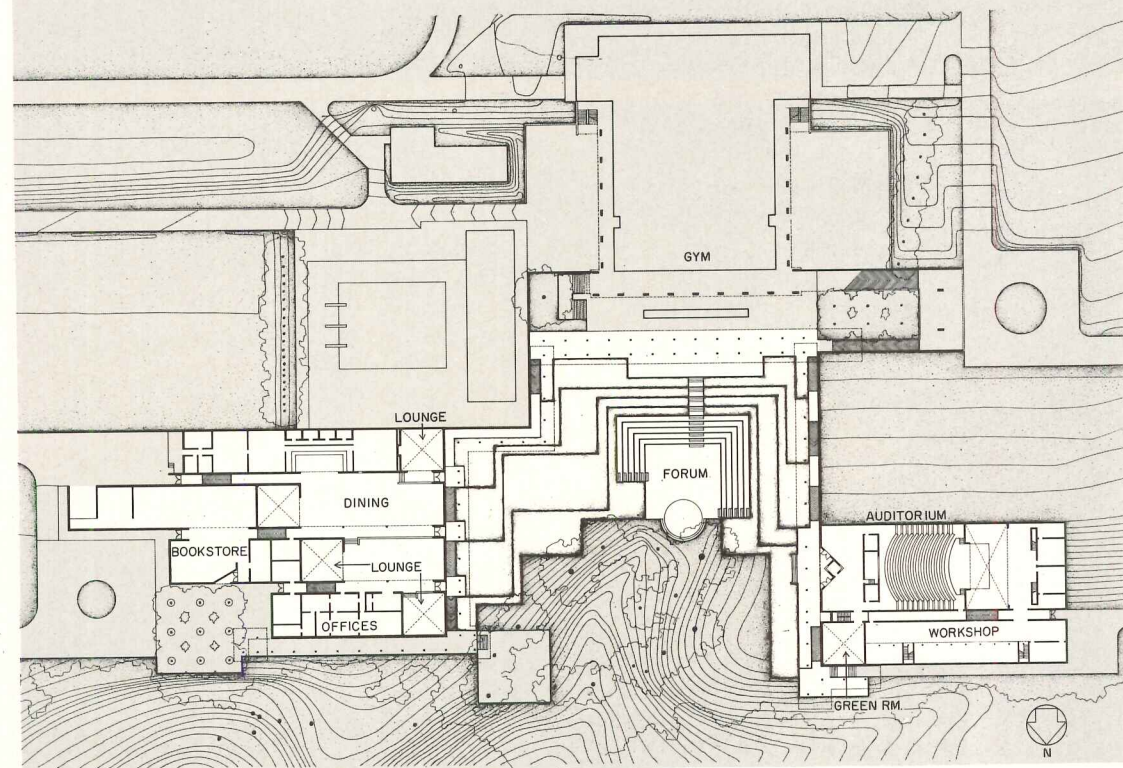
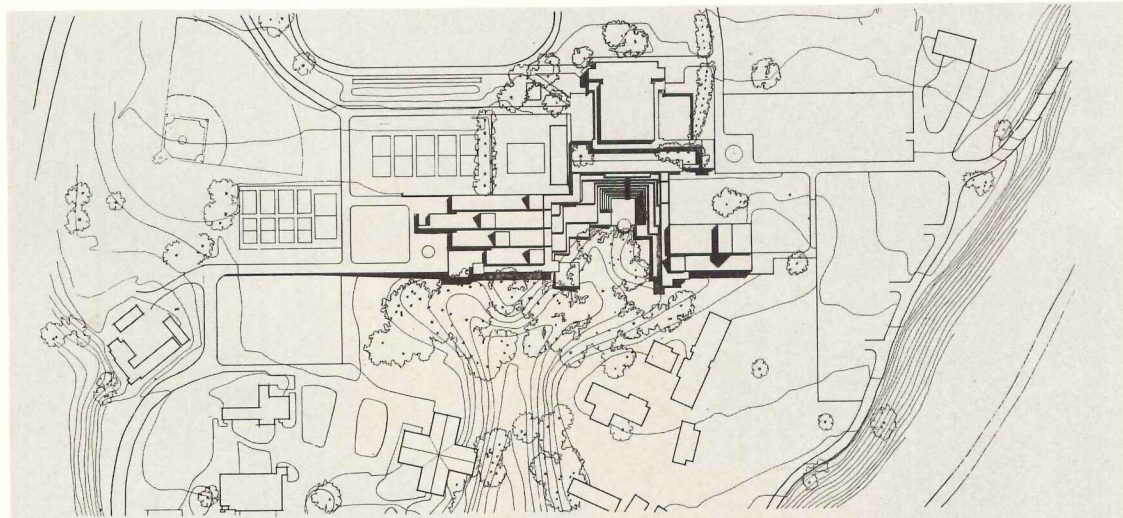



CAMPUS BUILDINGS

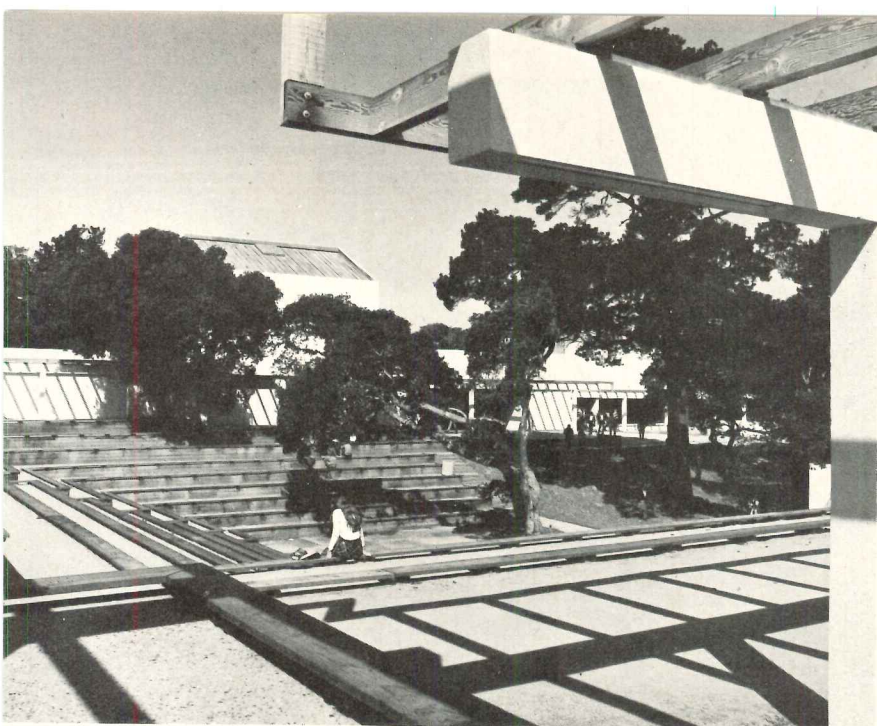

*The white masonry walls of the two buildings by Barnes catch and print shadows from surrounding trees and trellises in powerful abstracts. The specimen trees, protected during construction, enhance the natural character of the sites around both the theater and the Student Union building.*

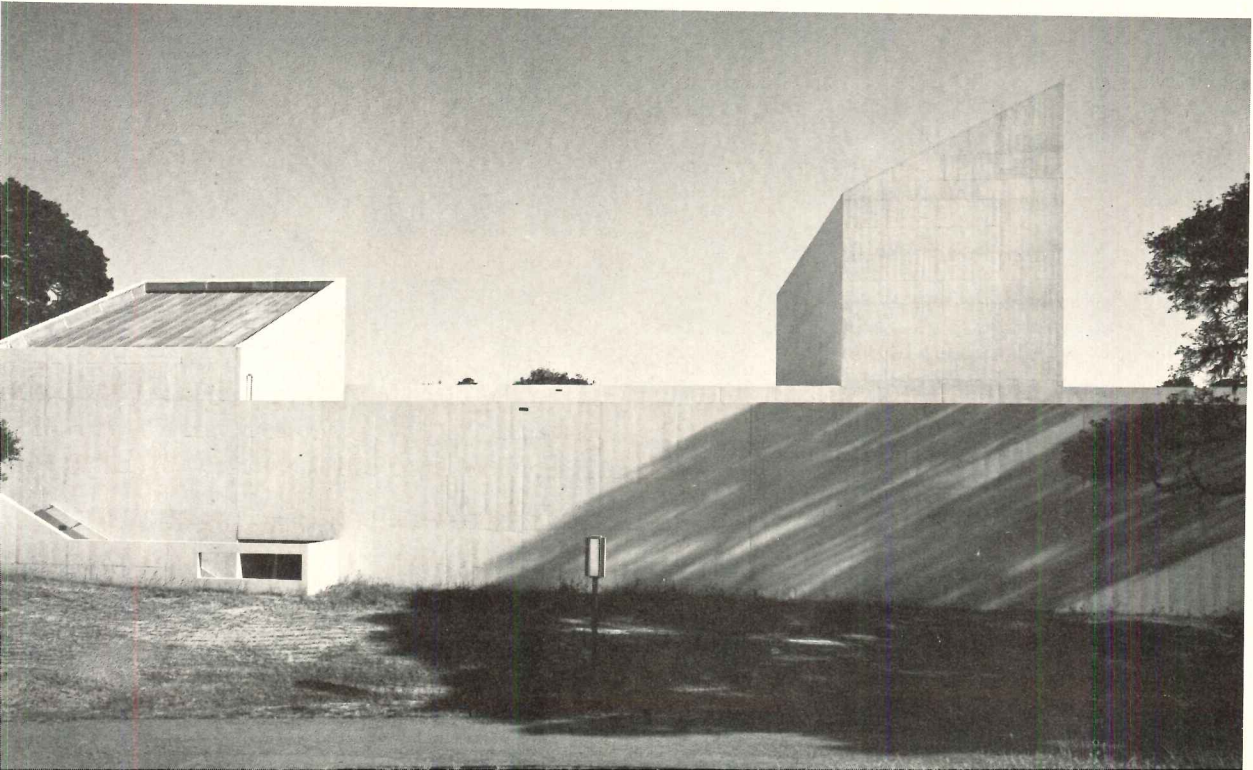
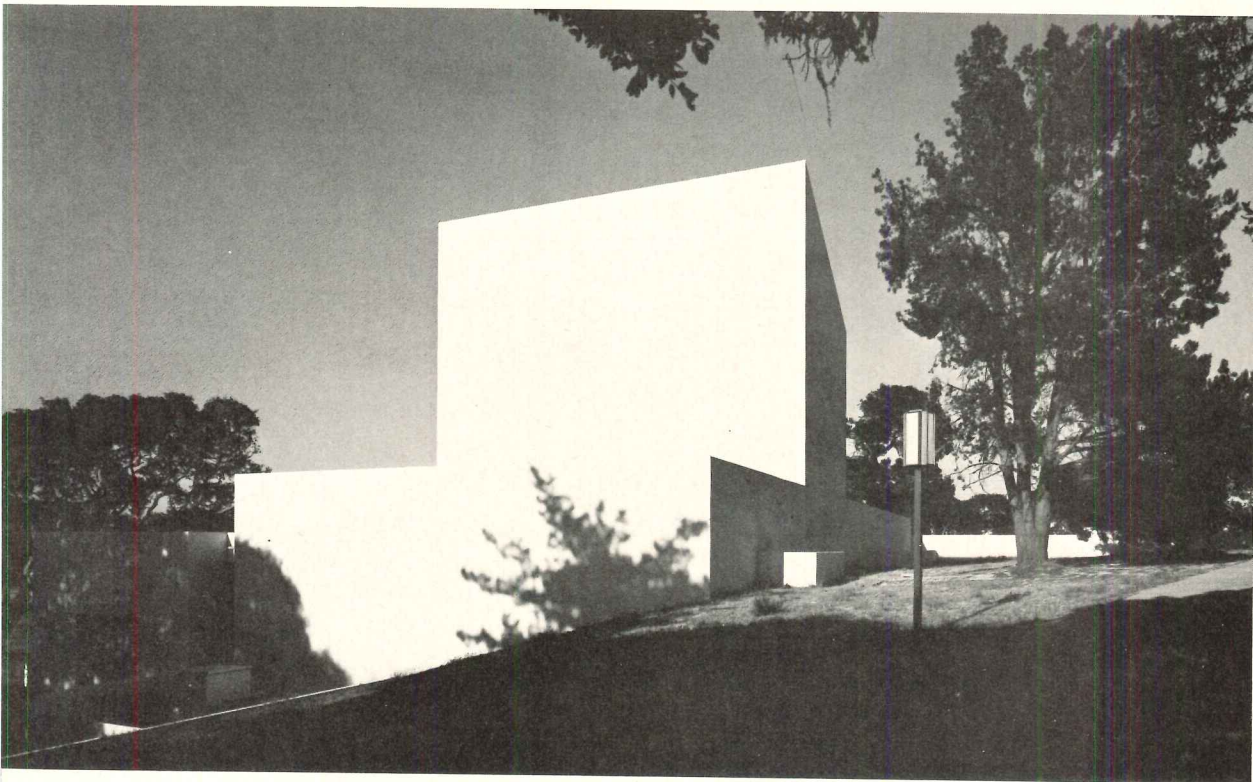



## Flying forms for concrete structures can save time and money, but just how much depends upon the architectural design

### Irregular tower facades and column spacings were a challenge for the technique, but it came out cheaper

Maximum economies in the application of flying forms to multistory concrete construction call for a building layout that allows large-size, consistently-shaped forms. But even with the irregularly-shaped facade and varied column spacing of the 21- and 9-story structures for New Hope Towers in Stamford, Connecticut, designed by architect Robert L. Wilson, the contractor reports significant savings with the method. Beyond the economies made possible by the flying forms, additional cost savings were achieved by precasting the wall panels at the site. To facilitate erection of the panels to the boxed-in recesses of the facade, a counter-balanced boom was used.

On New Hope Towers, the contractor, Frank Mercede and Sons, Incorporated used 14 table forms—ranging in width from 14 to 20 ft for the three different column spacings and in depth a maximum of 30 to 45 ft—to cast each floor. Rate of construction for the 6700-sq-ft floors was one floor every four or five days. The flying forms were supported and leveled by jacks attached to the sides of the columns. The forms, being set on the jacks, and having no cross-bracing, allowed freedom of movement for workers. The steel edges of the forms slide out of the building on wheels attached to the jacks. They were inserted and removed from all four sides of the building. Surface of the forms is a special plywood material imported from Finland. Infill panels the width of the columns finished the floor-form surface. Table forms and concrete were lifted by means of climbing cranes.

From a construction economics standpoint (related to crane capacity, labor capability, and form reuse), the floor areas, ideally would have been closer to 9000 sq ft, and both towers 21-stories high. As it was, the tall building had to carry the costs of the low building.

With conventional flat-plate construction, the engineer can locate the columns somewhat irregularly to suit the architectural layout, but in this case, the engineer Viggo Bonneson had to center column spacings so that the flying forms could be used. This discipline, in his opinion, can actually improve building layout rather than hinder it.

Steel-framed flying forms with different widths and depths are hoisted by climbing crane, inserted between columns, and set atop screw jacks attached to the columns. The forms slide on rollers that are part of the jack assemblies. Concrete panels for the modulated exteriors of the 9- and 21-story towers in Stamford, Connecticut were precast at the site.

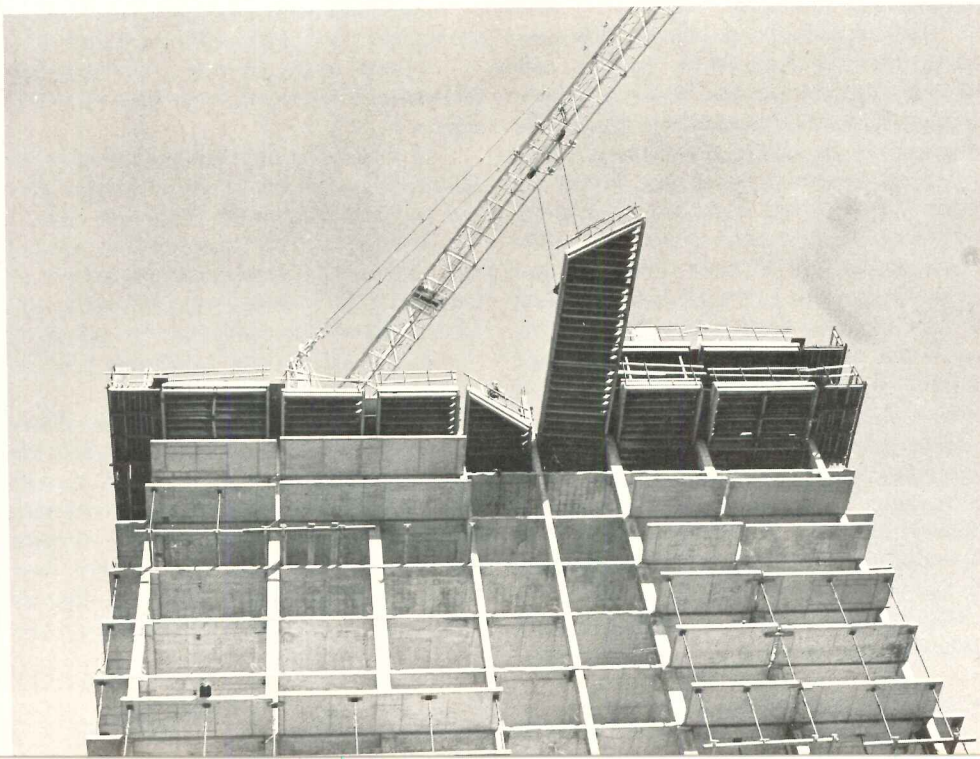
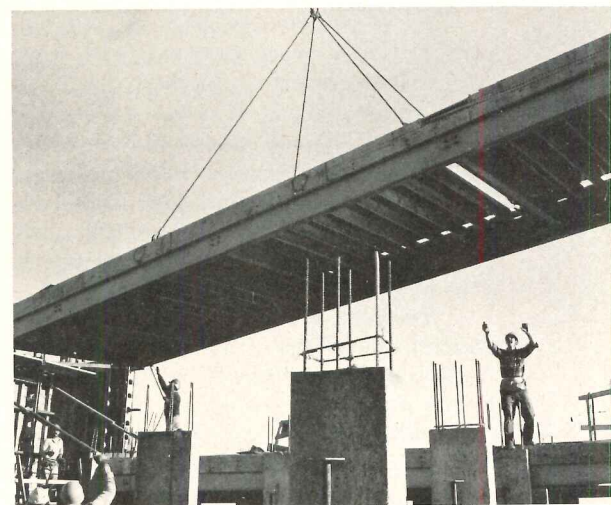
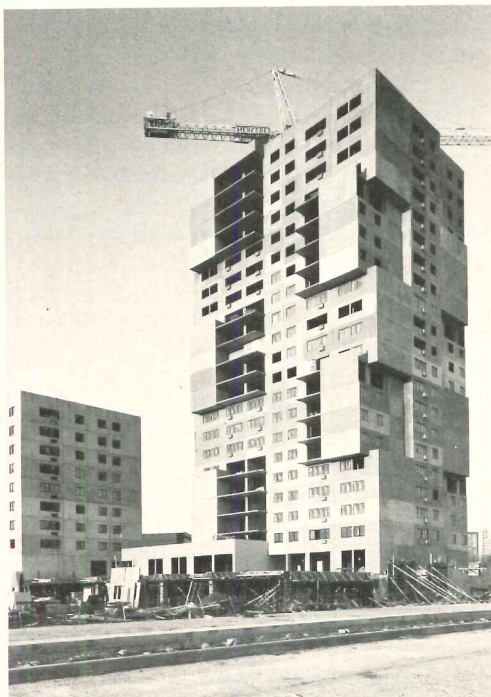



## The speed of cycling the forms is directly related to the repetition and typicality of the structural volumes

Economics of the flying-form technique are being put to a hard test in two housing projects of basically similar design in Yonkers, New York, and New York City's Roosevelt (formerly, Welfare) Island.

Because the objective of using flying forms is to speed on-site construction, builders are happiest with simple, box-like structures with double-loaded corridors, and the same floor plan repeated from base to top. But while this approach may keep costs down, it also may inhibit good architecture.

These projects—designed by architects Sert, Jackson & Associates for New York State's Urban Development Corporation—have low-rise wings stepping up to towers as high as 21 stories. Fire stairs and elevator shafts are external. Elevating is skip-stop, which means two different floor plans, with a single-loaded corridor provided every third floor. Depth of the buildings is 38 ft, except when bays increase it to 41 or 44 ft.

The speed of the flying-form construction process was limited by several factors which will be discussed later. Of course a builder wants construction operations to permit a smooth flow of construction cycles with as little lost time as possible between them. Also, he always looks for ways to cut construction time of the various steps within a cycle.

The Roosevelt Island project (1005 units) was at one time designed for flat-plate construction but the price from Building Systems Housing Corporation was attractive enough for UDC to have the architects and the structural engineers, Weidlinger Associates, change the design to a shear wall structure to accommodate the developer's system of wall forms. Riverview, Phase I, in Yonkers (454 units) was contracted for later, and was shear wall from the start. (Building Systems Housing Corporation is the development arm, and Concrete Building Systems, the construction arm, of Building Systems, Inc. of Cleveland.)

The system also called for the floor slabs to be post-tensioned. Span of the floor slabs is 22 ft, while the post-tensioning cables generally were 90-ft-long, though sometimes 180 ft. The builder anticipated that with post-tensioning there might be time-savings in laying the reinforcing steel, and that, hopefully, the lesser amount of steel theoretically possible would

save money, but, in the end, codes and other constraints made the costs about the same as for conventional steel reinforcement.

Five different types of forms were used: 1) table forms for the slabs; 2) self-braced steel forms, imported from the Netherlands, for interior walls; 3) custom steel forms for exposed concrete of the stair towers; 4) and 5), custom forms for exposed concrete of elevator towers and for end walls of buildings.

Construction cycling for the wall and floor slabs was the most efficient in the stretches of repeatable elements between stair towers, where construction could be done in a stepped, checkerboard fashion. But construction in the vicinity of the stair towers (called "knuckles" by the architect) was governed by how fast the towers could be erected. Reason is that these towers take the wind load in the longitudinal direction, and the horizontal framing of stair platforms had to be tied to the floor structure of the main building frame. This meant that the post-tensioning cables of the floor slabs had to be a part of the stair platforms. Alignment, fastening, and stripping of the tower forms for the exposed architectural concrete turned out to be time-consuming which, in turn, slowed down construction of the floors and walls.

The construction sequence is as follows, assuming a floor slab is ready for wall forms:

- 1) wall forms are set; reinforcing steel and conduit are placed; walls are poured (one day);

- 2) wall forms are stripped; table forms are pulled (rolling on dollies), from another location and reset on a finished floor (one day);

- 3) edge forms for table forms are set; bottom steel is laid; post-tensioning cables are laid; conduit is installed; top steel is laid; concrete is placed (one to two-and-one-half days);

- 4) three days later cables are post-tensioned (taking only 2 hours).

The builder would have to be characterized as adventurous to bring this system into the New York City market area where conventional flat plate and flat slab construction have such a foothold. Concrete Building Systems' forming method was not new to them, however, as they had used it previously for box-shaped housing in Cleveland and Boston, and also for a project in Brooklyn.

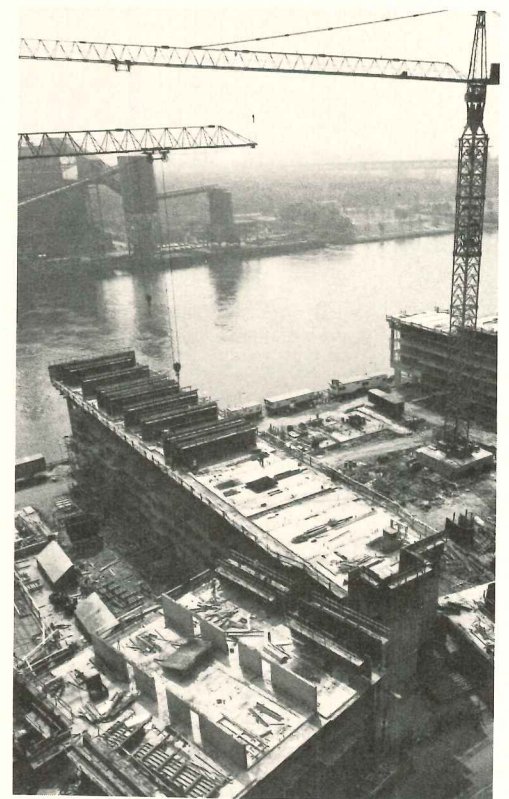



Bay-size table forms and steel wall forms were sequenced in checkerboard fashion to produce the wallbearing cellular structural frames for two New York State Urban Development Corporation housing projects in the Greater New York area. The designs consist of low-rise wings stepping up to towers. The end walls and the appended stair towers and elevator shafts were produced with custom forms on a floor-by-floor basis. Floor slabs were post-tensioned.

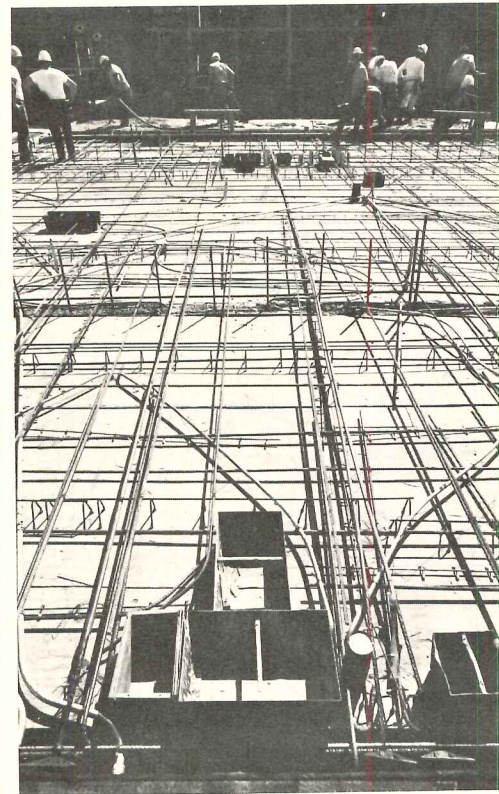
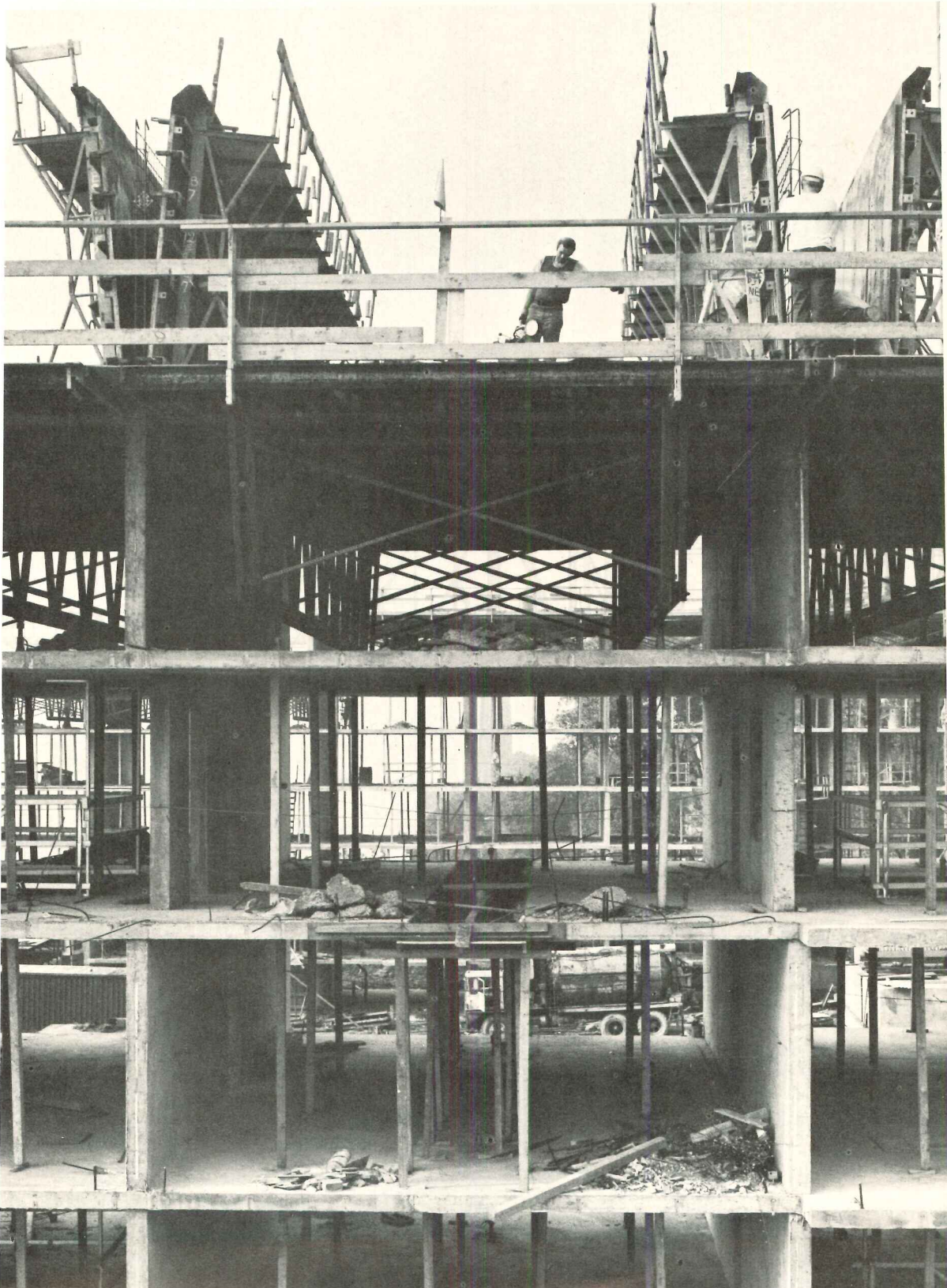
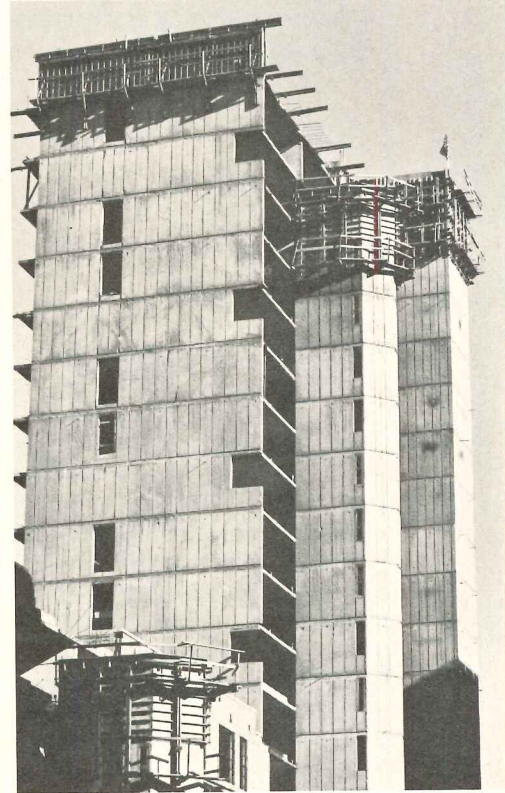

Robert E. Fischer photos



**A symmetrical free-form tower was a likely candidate for cycling one floor of forms at a time**

Use of flying forms for the 25-story Portland Plaza condominium (by Daniel, Mann, Johnson & Mendenhall, architects and engineers) reduced construction of the sculptured tower to a very simple process—allowing it to proceed at the rate of one 10,000-sq-ft floor a week. Because of the unusual shape of the building—which provides panoramic views of the mountains—pie-shaped forms were required for the circular nodes. The three shear walls with their contiguous columns were poured using a single 45-ft-long combination form. A split cylindrical form was used for the three remaining individual columns. The use of precast stairs eliminated forming within the building.

All the forms were “flown” every Saturday by a crew of nine men who completed stripping and resetting in a little over three hours. The forms were aligned by means of a laser level to give an accuracy of within  $\frac{1}{8}$  in.

On Monday and Tuesday the ironworkers installed the reinforcing steel. On Wednesday the concrete was placed for the 9-in. floor slab and on the remaining two days, concrete was placed for the walls and columns. All erection was handled by a climbing crane at the center.

Among the other advantages of the construction method are: 1) quality of concrete work is extremely high—paint finishes only; 2) accuracy of alignment is advantageous for erection of the stick-and-panel metal skin; 3) “unlimited” horizontal shapes with repetition of floors are possible; 4) the cycle is limited only by the setting of rebar and inslab services.

Architecturally, the floor plan is compact with minimal area for servicing and circulation functions. The open structural plan along the sides of the triangle allows conversion of two typical two-bedroom apartments to a combination of one three-bedroom and one single-bedroom apartment configuration.

Patrick E. Loukes, who was chief architect of DMJM-Northwest during design of the building, and is now a vice president with the builder, William Simpson Construction, emphasizes that for the potential of systems such as this one to be fully exploited, collaboration in the project programming is a must between the design disciplines and the builder. For example, it is much easier to make adaptations to the structure to facilitate the system before the design has proceeded too far.

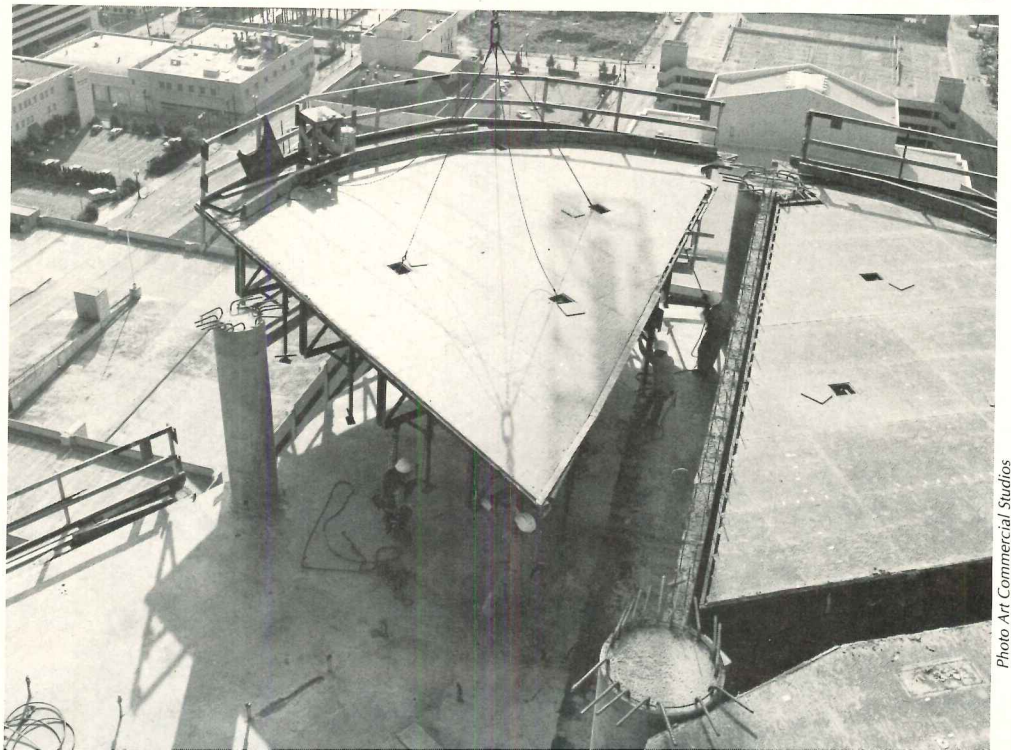
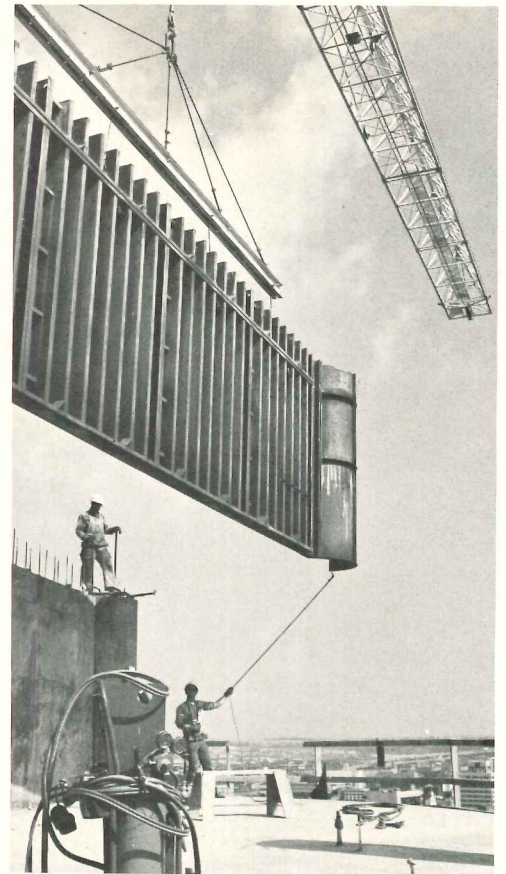
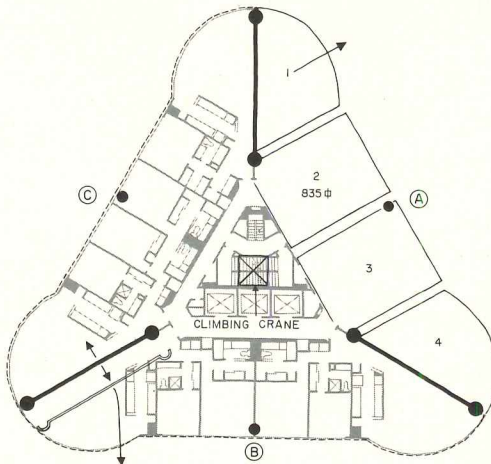

A forming system that included unusual pie-shaped table forms and combination wall-column steel forms was able to produce one floor a week for this 25-story condominium in Portland, Oregon. All of the forms for a floor were stripped, “flown,” and reset in just over three hours. Precast stairs were used to eliminate formwork within the building itself.

Photo Art Commercial Studios



# Lighting panelboards second to none.

NH1B panelboards with I-LINE® construction are your best bet for 277/480 volt lighting applications. The NH1B is perfect for 277 volt fluorescent lighting systems in office, industrial or institutional buildings. And in addition, power circuits can also be added so that air conditioning, office machines and lighting can all be controlled from the same panelboard. NH1B panelboards offer the exclusive I-LINE design that allows breaker additions or branch circuit rearrangement in an incredibly short time. Breakers just plug onto the bus stack.

Push-to-trip, an exclusive feature with Square D breakers, permits testing of the tripping mechanism at any time, without special test equipment and without removing the circuit breaker from the panelboard.

NH1B lighting panelboards from Square D have full Integrated Equipment Rating—branch breakers and panelboard are tested together as well as in component form—to assure you of reliable operation.

Easy to install Mono-Flat® fronts are standard on these panelboards. They are good looking, mount flush to

the wall and are people-proof to discourage tampering!

If you're putting in a high voltage lighting installation, make it easy on yourself and keep your customers satisfied with NH1B lighting panelboards from Square D. For specific engineering data, contact your nearby Square D Field Office. Or write Square D Company, Dept. SA, Lexington, Kentucky 40505.

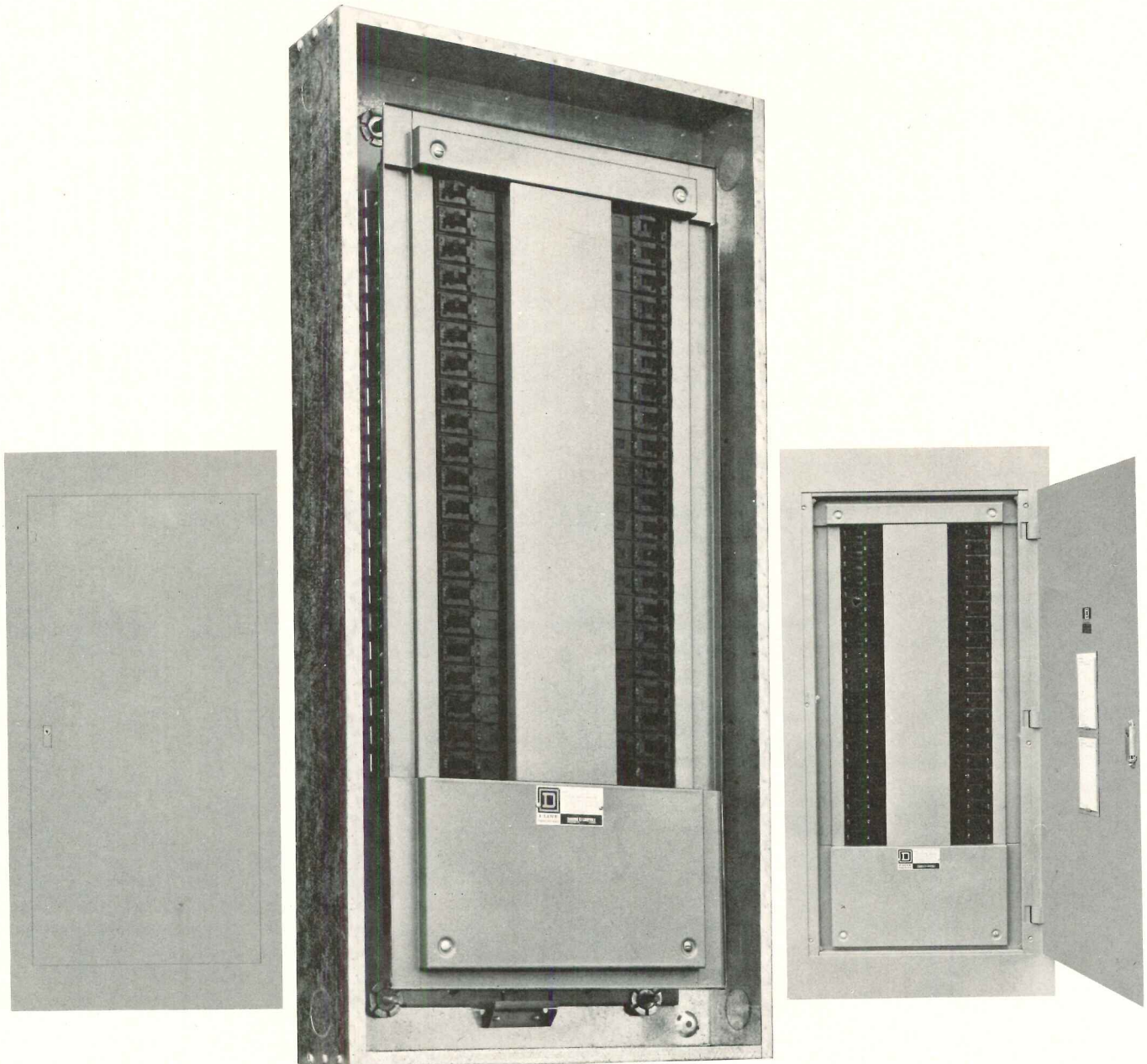

For more data, circle 76 on inquiry card



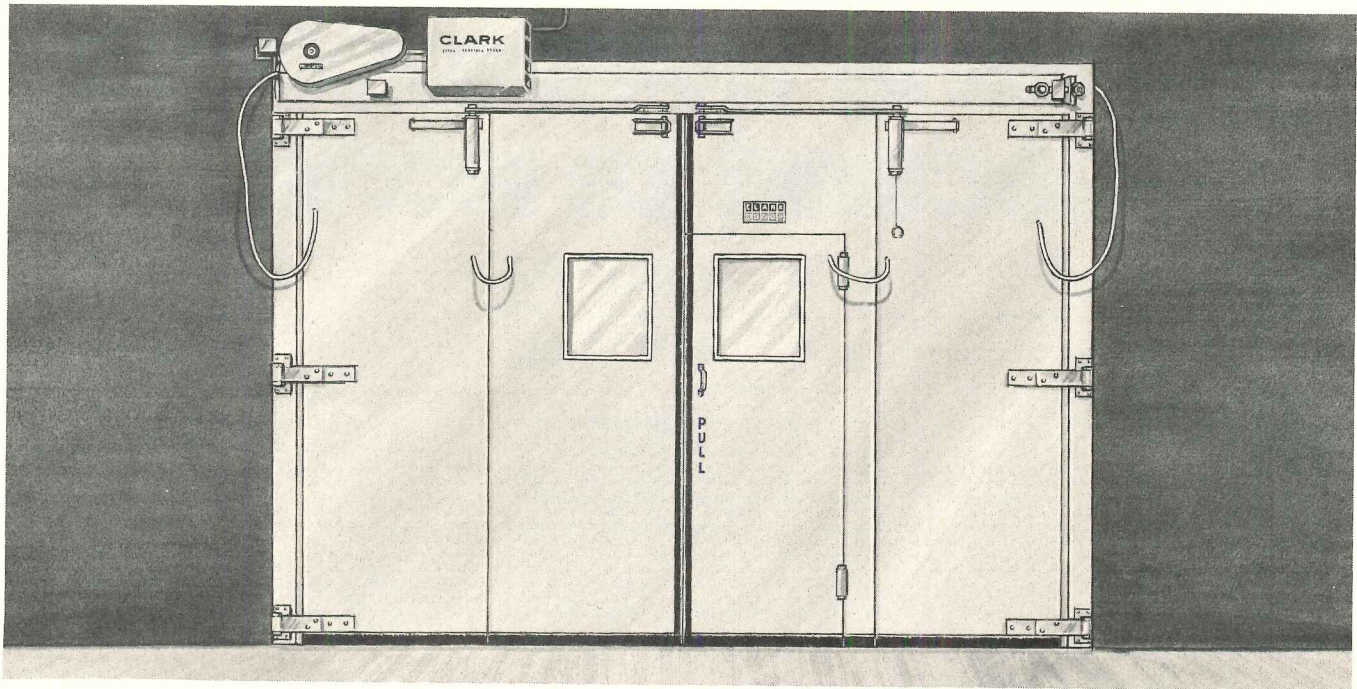

## In two seconds this 8' wide Clark Bifold will be completely open.

Clark bifold doors clear doorways at a rate of up to 4' per second; faster than any other type of industrial door. A door that operates this fast hustles out of the way before even the hottest fork truck driver can reach the doorway. And faster opening and closing means a shorter time for heated or refrigerated air to escape.

Clark bifold doors can be installed as close as 9½" from a sidewall or other obstruction.

That makes them ideal for vestibules, tunnels, narrow corridors, or between columns or equipment.

You can order Clark bifold doors in full bifold, half bifold or bifold-slide combinations. Like all Clark doors, bifolds are easy to install, easy to maintain and ruggedly constructed for many years of trouble-

free service.

Find out more. Call or write for free literature today . . .

**CLARK**  
**DOOR**

Doorway Specialists since 1878.

69 MYRTLE ST., CRANFORD, N.J. 07016 (201) 272-5100 TELEX 13-8268

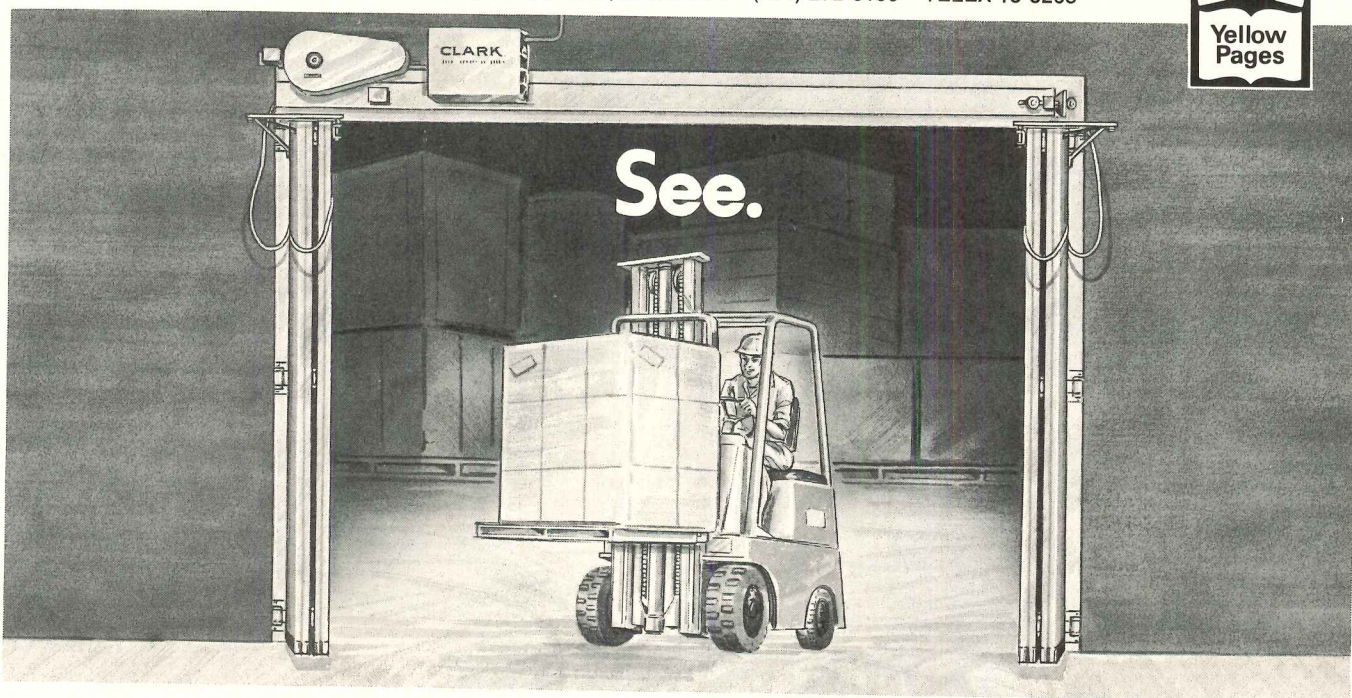

For more data, circle 77 on inquiry card



**Suburban Pittsburgh's  
Monroeville Mall serves 300,000  
shoppers a week with  
1.3 million sq. ft. of sales area**

Besides 126 specialty shops and four major stores, the complex features an Olympic size skating rink, community auditorium, church chapel and a branch of the Carnegie library.

A single duct variable volume system supplies cooled air with lighting and people functioning as a heat source. A warm-up override control supplies warm air when needed.

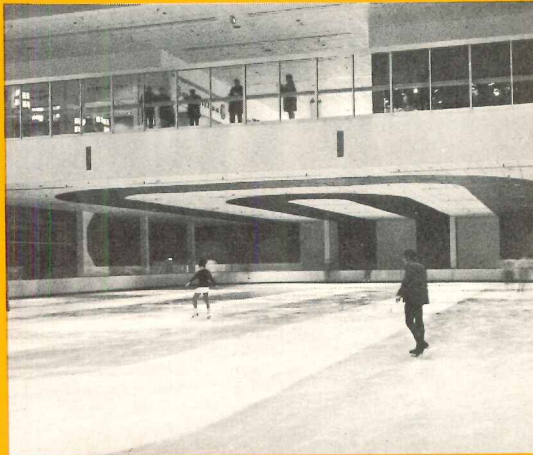

#### PROFESSIONALS AT WORK

★ *Mall Designer:* Dan Morganelli, Hewmann & Associates, Los Angeles • *Mall Architect:* Loeffler, Johnson and Associates, Pittsburgh • *Mall General Contractor:* Magnum Construction Corp., Pittsburgh • *Mall Mechanical Contractor:* Limbach Co., Pittsburgh • *Mall Developer:* Oxford Development Co., Pittsburgh  
★ *Gimbel's Store Architects & Engineers:* Abbot, Merkt & Company, New York • *Mechanical Contractor:* Sauer Inc., Pittsburgh • *Gimbel Corp. Director of Construction:* Tom DeAngelo  
★ *Joseph Horne Co.: Mechanical Contractor:* Sauer Inc., • *General Contractor:* Mellon Stewart Co., Pittsburgh

## Aerofin Coils contribute to the Custom Climate for one of the Top Ten Malls

Aerofin Heat Transfer Coils have been a part of many advanced technology heat recovery systems for shopping malls, publishing plants, high-rise office buildings. Depending on the system design, Aerofin "Deep" Coils produce a large temperature rise for cooling, and a corresponding drop for heating. That equates into smaller pipes, pumps, valves, less insulation — and significant savings. Ask for engineering help in Atlanta, Boston, Chicago, Cleveland, Dallas, Los Angeles, New York, Philadelphia, San Francisco, Toronto, Montreal.

108 Type C Cooling Coils  
used in enclosed Mall

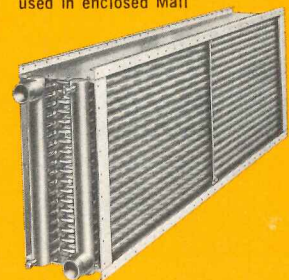

**AEROFIN CORPORATION**  
LYNCHBURG, VIRGINIA 24505

Aerofin is sold only by nationally advertised fan manufacturers. Ask for list.





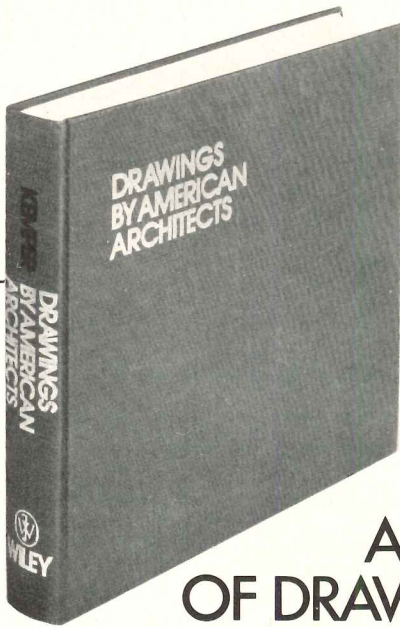

## A GALLERY OF DRAWINGS BY AMERICAN ARCHITECTS.

Enjoy in your own home or office over 500 original drawings from about 100 large and small architectural offices across the country.

You can study at your leisure all the latest presentation techniques and media and methods—space-time drawings, line drawings, washes, sprays and different solutions to problems like depicting glass and breaking down of scale.

You'll see drawings of urban renewal projects, new towns, high-rises, condominiums, cultural centers, private homes, civic centers, medical and government buildings.

The original drawings of Transpo '72, the Bahio Kino Development in Mexico, the World Trade Center, Los Angeles Rapid Transit Station, The Lower Manhattan Plan, Stowe in Vermont and the France Research Center done by IBM's Plotter Computer.

And the whole collection is easy to view. Each drawing is in black and white, printed in sepia tones, and appears on a full page with the name of the renderer, the project and the office. Some pages even show enlarged portions of a drawing to illustrate the techniques used.

The book's arranged in alphabetical order according to architectural offices and there's an index for offices and one for renderers.

*Drawings by American Architects*—On exhibit in one volume.

Send your coupon to Dept. 599 and receive your copy of—

### DRAWINGS BY AMERICAN ARCHITECTS

by Alfred M. Kemper, A. M. Kemper & Associates  
1973 613 pages \$30.00

### WILEY-INTERSCIENCE

a division of JOHN WILEY & SONS, Inc.  
605 Third Avenue, New York, N. Y. 10016

In Canada: 22 Worcester Road, Rexdale, Ontario



### WILEY-INTERSCIENCE • Dept. 637•

605 Third Avenue, New York, N. Y. 10016

Please send me Kemper's *Architects* • 0-471-46845-2 • \$30.00

My check (money order) for \$30.00 is enclosed.

Please bill me.\*

Name \_\_\_\_\_ Company \_\_\_\_\_

Address \_\_\_\_\_

City \_\_\_\_\_ State \_\_\_\_\_ Zip \_\_\_\_\_

price subject to change without notice

\*restricted to the continental United States

Please add state and local taxes where applicable.

093-A-4114-WI

For more data, circle 78 on inquiry card

New... the look of "Tomorrow"  
... from Artistic Brass.

Here is the ultimate in contemporary decorative bathroom fittings — so modern that it had to be called the "Tomorrow Line." See complete full color literature with specifying data in Section 15.16 ART, 1973 Sweet's Architectural File.

Write for full color brochures on all of our 90 lines of exquisitely designed lavatory, tub, and shower sets plus accessories. Dealer lists included.

ab artistic brass  
A Division of Norris Industries

3136-48 E. 11th ST., DEPT. AR, LOS ANGELES, CA 90023 • TEL.: (213) 268-3437

For more data, circle 79 on inquiry card

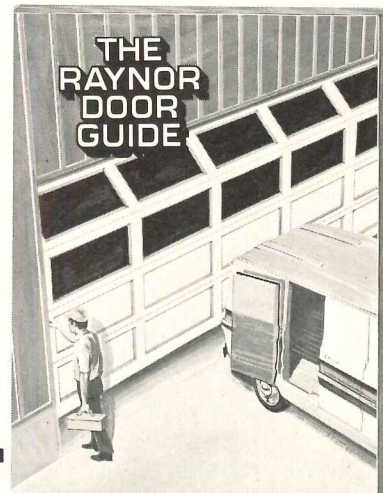

All the facts you should know about garage doors can be found in this complete Raynor reference guide. Garage door styles, materials, mountings, applications, specifications (including handy door and track selection guides),... **PLUS** information on Raynor's new deep-ribbed, good-looking 'Security Line' steel doors. See why Raynor builds better doors.

Just clip this coupon and mail to:  
**RAYNOR MANUFACTURING COMPANY**  
Dept. AR-10, DIXON, ILLINOIS 61021

Name \_\_\_\_\_

Firm \_\_\_\_\_

Address \_\_\_\_\_

City \_\_\_\_\_

State \_\_\_\_\_ Zip \_\_\_\_\_

For more data, circle 80 on inquiry card



For more information, circle item numbers on Readers Service Inquiry Card, pages 261-262

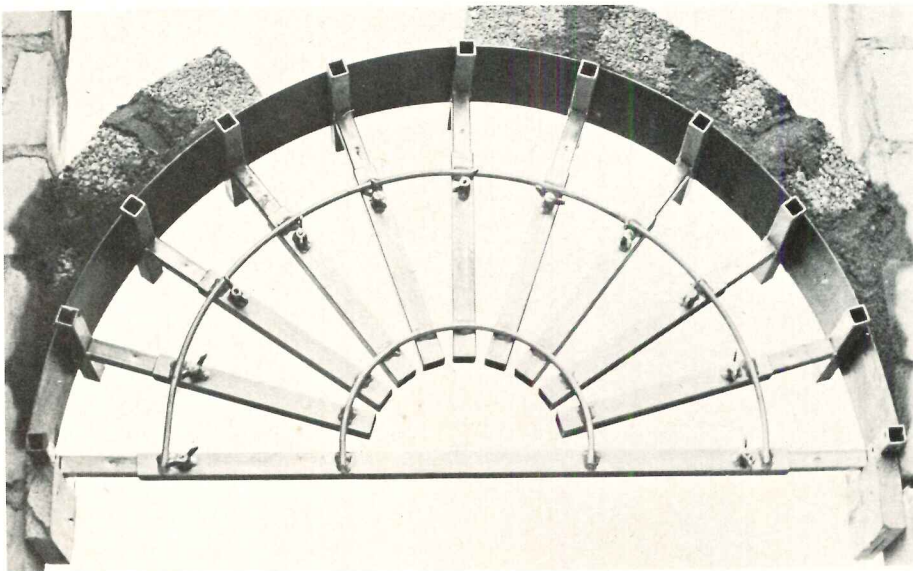

## Adjustable metal form speeds masonry or wood arch construction

This expandable metal form is said to provide support while building a wide variety of semi-circular and pointed arches. Unit will support itself and the arch in doorways and windows from 30 to 44 in. wide. The

company claims the choice of widths and arch styles should fit most residential and commercial applications. In masonry arch construction, the desired arch is drawn on paper. The Arch-maker arms are ex-

tended to match the shape. Wing-nuts are tightened, and the product placed in the door or window opening. ■ Western Reserve Arch Co., Asheville, N.C.

Circle 300 on inquiry card

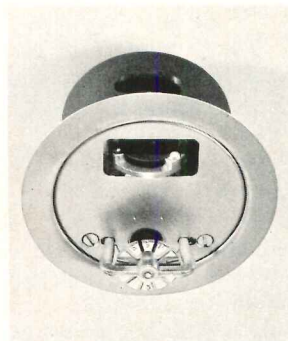

## Recessed sprinkler

This fully-automatic on-off unit features recessed design with chrome finishing. It is said to shut itself off after suppressing a fire and can be integrated with most existing systems or designed into new construction. ■ Grinnell Fire Protection Systems Co., Inc., Providence, R.I.

Circle 302 on inquiry card

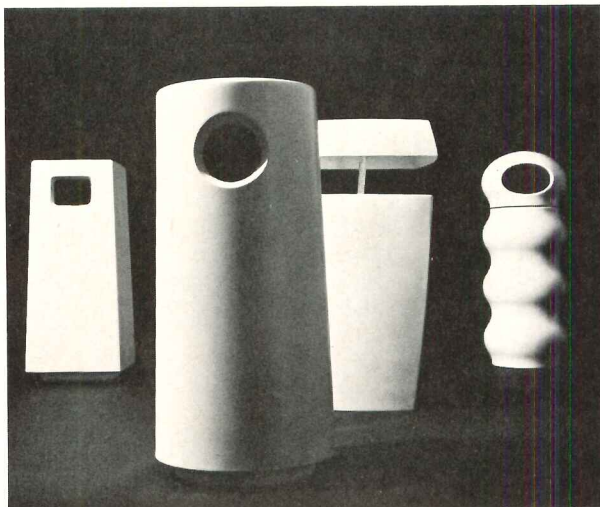

## Litter receptacles with side openings shield trash

With lift-off or swing-away covers, these fiberglass containers are recommended for public areas. Lightweight yet said to be strong, the bins are sculpted in both sleek and playful shapes, accommodating

poly bags that are neatly supported on an integral inner ring. The company states the receptacles are available in many colors. ■ Group Artec, Los Angeles, Cal.

Circle 301 on in inquiry card



## Incandescent lighting

The improvement to this luminous ceiling system is the addition of incandescent lighting to what was an all-fluorescent system. Two-lamp indirect fixtures are offered for mounting within standard modular coffers. ■ Integrated Ceilings Inc., Los Angeles, Cal.

Circle 303 on inquiry card



## A "free floating skin" for flat-roof construction

A roofing system developed in Germany and now available in the United States is said to be compatible with all forms of roofs and roof decks, but achieves the greatest advantage on a flat or slightly pitched roof. The chief component of the system is a rugged, flexible, stretchable heavy-gauge elastomeric plastic in sheet form, that

is welded, on-site or off, into a free-floating skin secured only at the roof edges and roof penetrations. Trocal roofing systems are said to offer savings on flat roofs because the fill normally required to create an incline can be eliminated. ■ Dynamit Nobel of America, Inc., Northvale, N.J.

Circle 304 on inquiry card



# Norton® Apollo Door Closer

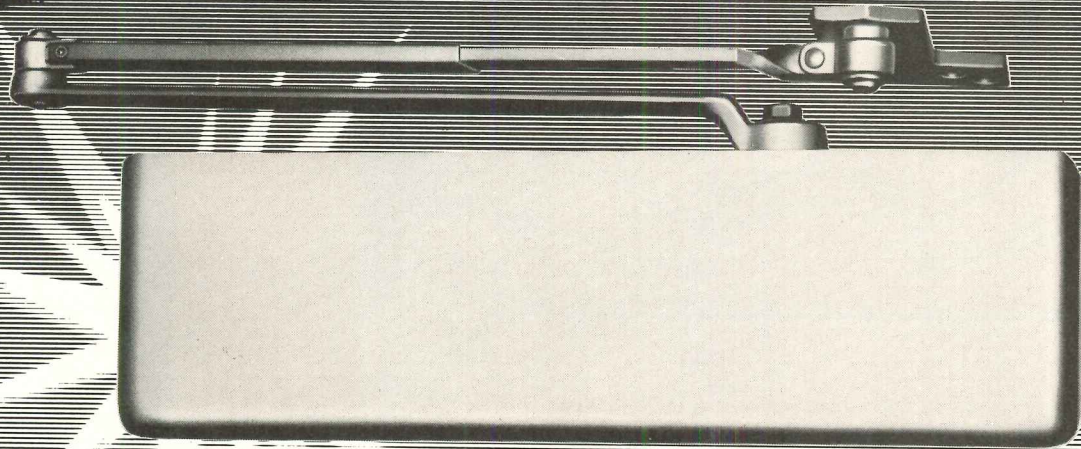

It's Always Been Versatile  
Now It's Proven  
Itself **Reliable**

Versatility is a dimension you can design and build into a door closer. Reliability is something else. The final judge of reliability is time. The Norton Apollo door closer has both: versatility and proven reliability.

Let's take versatility, first. We started with a spring power adjustment. Then we added an adjustable back-check and improved sweep and latch speed controls. Next, we made it available in either regular arm, parallel arm or top jamb. And we added a choice of covers in anodized brass, bronze or clear aluminum . . .

or 67 imported or native woods. That's versatility.

But when you have an 80-year reputation for quality, people expect your product to be reliable. *Especially* reliable. And we agree.

We tested the Norton Apollo closer. We put it through several lifetimes of wear. And there were no major problems.

But when you get right down to it, only time *really* proves reliability. The Norton Apollo door closer has been on the market for over three years, operating successfully

in prestige locations all over the country. Versatile? Sure. But reliable, too.

For more information on the Norton Apollo closer and its proven reliability, ask your Norton Representative. Or contact Eaton Corporation, Lock and Hardware Division, Norton Marketing Department, Box 25288, Charlotte, North Carolina 28212.

**Norton Door Closers . . .  
25 years of Aluminum Reliability**

**EATON** Security Products  
& Systems

1200

For more data, circle 81 on inquiry card



**KALWALL®**

Versatile Kalwall® sandwich panel with fiberglass reinforced face sheets permanently bonded to aluminum grid core is practically indestructible.

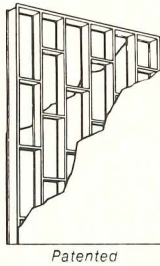

## THE MIRACLE SANDWICH

Kalwall Translucent Roof Systems enable you to work wonders with light. Their miracle, modular panels distribute natural daylight evenly. No more interior glare. No dark corners. Now you control light by specifying transmission from 60% to as little as 5%.

You can arrange Kalwall components in any combination. Vary the grid patterns. Add color panels and inserts for dramatic effect. As you design!

Precision-built Kalwall Roof Systems weigh little. Yet they are astonishingly strong and keep out heat and cold. (Optional insulation equals 40" of concrete!) They're maintenance-free, weatherproof, vandal-proof. And so easily handled, a few men with hand tools can enclose any size roof — quickly! No big cranes needed!

Kalwall Systems have cut costs for 40,000 plants, offices, shopping malls, motels, schools, residences. Write or phone for details.



2¾" translucent Kalwall Roof System at Summit School in South Dakota.

**KALWALL**

CORPORATION

88 Pine Street  
Manchester, N. H. 03103  
Tel: 603-627-3861

For more data, circle 82 on inquiry card

For more information, circle item numbers on Readers Service Inquiry Card, pages 267-268.

**ELECTRIC HEAT** / The 12-page brochure illustrated with line drawings and photographs, includes suggested architect-engineer specifications together with detailed specifications and capacity data for the 20 mix-and-match heating/cooling combinations available. Specific information is included for the various condensing units and cooling module units. Charts showing blower performance and temperature rise curves under various operating conditions are provided, along with electrical data on the furnaces and condensing units. ■ McGraw Edison Co., Albion, MI.

Circle 400 on inquiry card

**FIRE PROTECTION** / A newly revised 32-page booklet offers information on wood and plywood systems to meet code and insurance requirements. It is a guide to fire protection fundamentals and illustrates floor, roof and wall construction techniques. Case histories, sample specifications, and background information on building codes and insurance provisions are included. ■ American Plywood Assoc., Tacoma, WA.

Circle 401 on inquiry card

**PANELING** / All product literature on the company's 1973 line has been assembled in a keyed specification guide on panels and planks, graphics, doors, custom products, and partition systems. ■ Marlite Brand Paneling, Dover, OH.

Circle 402 on inquiry card

**THERMAL INSULATION** / A 16-page product catalog has been issued on industrial and commercial insulating materials and products manufactured of calcium silicate, mineral wool and glass fiber. The product catalog provides in pictures, technical charts and graphs, and descriptive words a guide to both block and pipe covering products of calcium silicate for applications up to 1200 degrees F and mineral wool in a variety of forms for use up to 1900 degrees F. ■ Keene Corp., Princeton, N.J.

Circle 403 on inquiry card

**COPPER METALS** / A newly updated 1973 edition of an application data sheet giving standard designations for copper and copper alloys now incorporates the new unified numbering system for commercial metals that currently is being developed by the American Society for Testing and Materials. ■ Copper Development Association Inc., New York, N.Y.

Circle 404 on inquiry card

**DOOR LOUVERS** / A four-page brochure describes extruded aluminum door louvers, available in numerous finishes, applicable to wood, hollow metal and plastic laminated doors. Along with the above explanation, are specifications, a stock selection chart and installation details. ■ Construction Specialties, Inc., Cranford, N.J.

Circle 405 on inquiry card

**CHALKBOARD COLORS** / A brochure contains a color chart of all the firm's standard chalkboard colors. The company's porcelain-on-steel chalkboards are guaranteed for 50 years or the life of the building in which they are installed. ■ AllianceWall Corp., Wyncotte, PA.

Circle 406 on inquiry card

**PLANT AIR** / A booklet pointing up the problems of fumes, smoke, dust and odors created by industrial manufacturing operations, presents solutions to these problems through the use of the company's replacement or make-up air heating equipment. ■ Weather-Rite, Inc., St. Paul, MN.

Circle 407 on inquiry card

**SOUND CONTROL CEILING** / A 1973 catalog of sound control ceiling products offers 47 pages describing a complete line of ceiling materials for industrial and commercial building applications. Full specifications are listed for over 25 different ceiling materials. ■ Hibbert Printing Co., Trenton, N.J.

Circle 408 on inquiry card

**ICE RINK HARDWARE** / A brochure describing the firm's line of heavy-duty door and gate hardware for ice rinks and skating arenas gives examples of applications for the various products on player and penalty box doors. ■ White Consolidated Industries, Aurora, IL.

Circle 409 on inquiry card

**JUTE CARPET BACKING** / A booklet detailing performance, "stretch" installation, direct glue-down and testing characteristics of jute primary and secondary backing plus other pertinent information helpful in specifying carpets is available free. ■ Jute Carpet Backing Council, New York, N.Y.

Circle 410 on inquiry card

**ROOFTOP HEATERS** / The company's brochure details the rooftop heating-cooling concept and shows how the units deliver the right combination of gas heating and electric cooling for any area in the nation. Charts and commercial application information are also included. ■ Tappan Air Conditioning, Elyria, OH.

Circle 411 on inquiry card

**VENTILATORS** / A catalog describing the company's line of draft regulators, power venters, domestic and industrial inducers, as well as a complete line of chimney caps is available along with a complete line of thermostats and accessories. ■ Walker-Carolina, Inc., Kinston, N.C.

Circle 412 on inquiry card

**PRECAST DECKS** / A 20-page booklet discusses a growing trend according to the company in medium rise apartment construction using precast concrete decks on bearing walls. ■ The Flexicore Co. Inc., Dayton, OH.

Circle 413 on inquiry card

**AUDIO-WALL** / This product features outer panels of roll-formed steel, hinged with steel connectors to create wall-to-wall metal. In addition to being constructed of all-incombustible materials, *Audio Wall 15M* provides sound privacy with a sound transmission class (STC) of 44 in independent laboratory tests. The steel outer panels have a vinyl surface in color permanently laminated to the face. Metal hardware and trim is satin black. *Audio-Wall 15M* is described in the color brochure. ■ Modernfold, New Castle, IN.

Circle 414 on inquiry card

**LABORATORY EQUIPMENT** / The illustrated 96-page catalog features the company's latest designs in laboratory fume handling equipment, fiberglass safety enclosures, laboratory carts, glassware washers, and a wide variety of products for the laboratory. ■ Labconco Corp., Kansas City, MO.

Circle 415 on inquiry card

**PRESS-DOWN LETTERS** / The company announces the release of their new catalog featuring a complete range of standard products and new innovations for the graphic designer. ■ Letraset USA, Inc., Bergenfield, N.J.

Circle 416 on inquiry card

More literature on page 185



# LOGAN ORIGINALITY HELPS YOU SELL PERSONALITY

Your prospects will recognize it: that "something different" that will set their home apart. Give it a distinctive personality that will express their individual taste. It's easy and inexpensive to add such powerful sales appeal. Simply install Colonel Logan Ornamental Iron. Inside and out. ■ You can be as creative as you like, with columns, railings, shutters, room dividers and accessories. Select from a wide variety of patterns in both cast and wrought iron. You can even establish your trademark; a special treatment that people can identify as yours.

■ Colonel Logan Standard sizes save as much as  $\frac{1}{3}$  the cost of custom ironwork, make installation quick and easy. Expensive handwork is practically eliminated. Many leading Builders and Architects have found a new source of inspiration in Colonel Logan Ornamental Iron.

You can too. Write today for full details, and a free copy of "Ideas in Iron" brochure. ■ LOGAN CO. Subsidiary ATO Inc., P.O. Box 6107, Louisville, Kentucky 40206. 2421-25 Hunter Street, Los Angeles, California 90021



## LOGAN CO.

SUBSIDIARY **ATO** INC.

## THE LOGAN DIFFERENCE IS PRIDE

*For more data, circle 83 on inquiry card*



**Planning a mailroom**

The day is past when "whatever space is left over" is relegated to a company's mailing operations. The mailroom, long a forgotten workhorse in many offices, is emerging in newer buildings as a communications center where both time and cost reductions (and increased profits) can be planned for and achieved.

According to Pitney Bowes, manufacturers of mailhandling systems, one of the "Big Three" automotive companies found that for every 58 cents it spends on postage, another 42 cents is spent in its mailroom processing the mail. Each of the 34 million pieces of mail handled costs an average of 2.5 cents for labor and overhead.

In smaller companies, Pitney Bowes reports, the figure is usually higher—an average of 16.8 cents a letter. However, mailroom planning can sharply reduce handling costs. For example, in its own new mailroom, a showcase for planners, the cost of handling 35 million pieces of mail (over 51 tons a year) is less than one-third of their total postage budget: 27 cents of each dollar, and the handling cost for each piece is one cent.

The secret to building discernible time- and cost-benefits into the mailroom can be the result of planning for both facilities and functions by an architect and his client.

Mailroom planning takes into account flow, volume, scheduling, staffing and available space. One New York State architect, David E. Chase, A.I.A. of Chase Architectural Associates, describes mailroom planning as a problem-solution process. "Mailing procedures are a fundamental process in an organization's daily activities. The means and the location of equipment are the result of analysis of that process with respect to the general processes of the business." Chase applies these decision-making steps:

1. Identify the mail handling process in the organization;
2. Identify the current equipment used;
3. Consult with client and mailhandling specialist to arrive at a total alternate method (if required) and an improved work pattern and upgraded equipment;
4. Work with specialists in document handling processes and systems for the most effective location of communications centers.

A new development in mailroom planning makes it easier to arrange operations centers. The growing use of modular furniture systems, with their mix-and-match elements, enables hand-tailoring a wide variety of systems to meet any requirements of space or tasks. Basic mailing consoles are available in a choice of sizes. Customizing accessories include shelves, drawers, cabinets, adjustable sorting racks, sliding doors and dividers, interchangeable in a wide variety of configurations.

After the size of the room and incoming and outgoing points for mailflow are established, it is usually separated into two areas, one is for equipment to handle outgoing mail;

*continued on page 179*

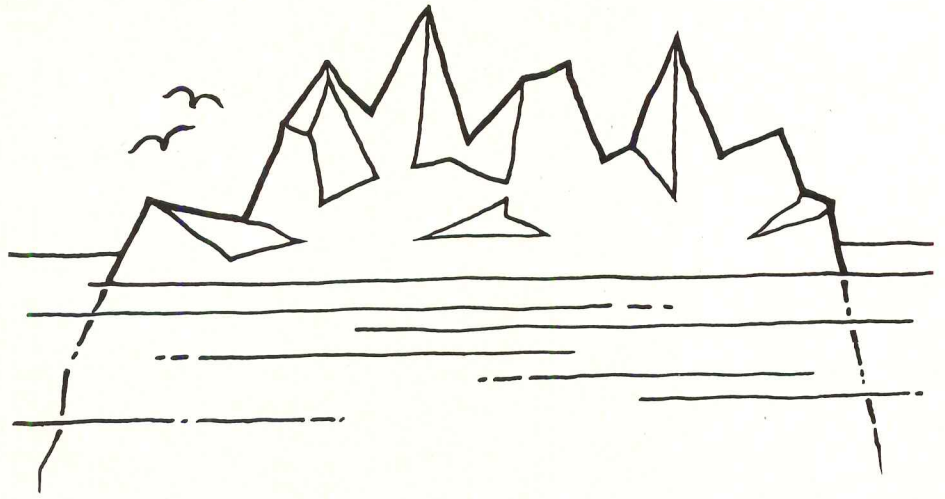

**Like an iceberg, there's more to an Oasis water cooler than meets the eye. For example, our warranty covers the cooler for a full five years. And, it covers more than just the compressor and a few other select items. It covers the entire cooler. To protect the owner. To protect you. Check our warranty in Sweet's. Or send for a copy. It takes about 60 seconds to read. But it's good for 60 months. Oasis. The warranty for water coolers.**

**OASIS<sup>®</sup>**  
The word for water coolers.



Ebco Manufacturing Co.  
Dept. AR-5  
265 N. Hamilton Rd.  
Columbus, Ohio 43213

I'll invest 60 seconds.  
Please send a copy of your five-year warranty.  
Plus your catalog.

NAME \_\_\_\_\_ TITLE \_\_\_\_\_

FIRM \_\_\_\_\_

ADDRESS \_\_\_\_\_

CITY \_\_\_\_\_ STATE \_\_\_\_\_ ZIP \_\_\_\_\_

For more data, circle 84 on inquiry card



**'Buffalo's' new**

# Model

**air handling systems...**

**The advantages of a built-up system with the economies of factory fabrication.**

If you are in the vanguard of Engineers and Contractors who are aware of the changes now taking place, and those to come in the construction industry, you realize a new approach to air handling system design and manufacture is needed to provide better control over system design costs and energy consumption. Model "J" is the practical answer for today's sophisticated air handling systems at a reasonable price. Model "J" was conceived with your requirement as guidelines. To find out the advantages of a built-up system with the economies of factory-fabrication please call your Buffalo Sales Engineering Representative. He's in the Yellow Pages of major business centers. Or, if you prefer, request Bulletin AC-100. Buffalo Forge Company, Buffalo, New York 14240.

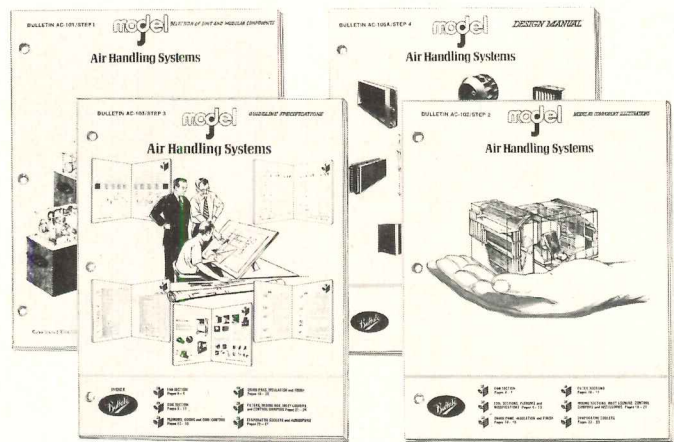
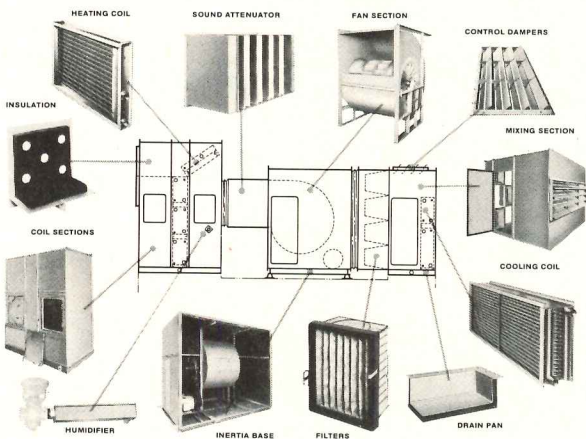

## The Hardware

Model "J" makes available the most complete selection of air handling system components ever offered in a factory fabricated unit. They are the same components you would specify for a quality built-up system. For example: the performance proven, AMCA rated, backward-curved, Buffalo BLD fan; variable inlet vanes for variable volume systems; Aero-fin coils; Thermal 90 insulation and adhesive to meet requirements of NFPA 90A. Model "J" also offers these exclusive design and construction features; internal isolation; built-in inertia base; double wall insulated construction; sound attenuators; split pillow block bearings; modern filters in factory assembled frames; access doors, service plenums and much more.

## The Software

Model "J" software is a whole new world of control over air handling system design, construction and installation. Every contingency is covered, including sound power data, fan heat of compression, sound and vibration isolation, comprehensive filter selection and more. Four interrelated cross-referenced manuals enable you to maximize your specifying effort. You proceed in a logical, step-by-step sequence through system design, unit selection, component selection, and specification writing. The systems you design will deliver the performance . . . conserve energy . . . be easy to install . . . and provide an extended low-maintenance service life . . . all at reasonable cost. The Buffalo Sales Engineer in your area has a set of Model "J" software for you. Ask him for it.



**Buffalo Forge Company**

*For more data, circle 85 on inquiry card*



**Some day  
you'll be asked  
to design a building  
with a  
heliport.**



**Get ready for it now  
by writing  
for  
Bell Helicopter's  
Heliport Guide.  
IT'S FREE**

TO: Bell Helicopter Company  
Fort Worth, Texas 76101

Please send me your  
Heliport Planning Guide.

NAME \_\_\_\_\_  
COMPANY \_\_\_\_\_  
ADDRESS \_\_\_\_\_  
CITY \_\_\_\_\_  
STATE \_\_\_\_\_ ZIP \_\_\_\_\_

the other for incoming mail.

Incoming functions include:

**Dumping:** Units for dumping incoming mail are equipped with back and side rims to prevent mail from falling onto the floor (or being lost between counters). A minimum of 45½ in. in length is usually preferred, with high legs for a stand up operation.

**Opening:** Working space from 45½ to 68 in. long is generally satisfactory with high or low legs for a stand-up or sit down operation. (A letter opener is usually situated on this working surface.)

**Reading:** Many companies receive mail which cannot be identified as to its destination (individual or department) until it is opened and scanned for content. A low working area is ideally suited to this function; sorting racks are required.

**Sorting:** For sorting incoming or outgoing mail, a 68 in. bridge arrangement with sort units is recommended. Through-sorting or two-way sorting can be accomplished by omitting backs on the sort modules.

Outgoing mailing procedures cover:

**Packing and wrapping:** Most mailers have a need for wrapping parcels. A table with a laminate top can be helpful, since it is suited to the wear and tear; the surface can be replaced as needed.

**Processing:** Involves sealing, and metering. A low 68 in. rear bridge console with an automatic mailing machine and scale placed on the rear bridge directly over the metering machine can allow the operator to quickly perform the weighing operations connected with the processing of outgoing mail.

Internal communications:

Internal mail functions involve the continuous delivery, sorting and distribution of communications originating within the facility or offices accommodating the mailroom. A separate area for handling this function may provide the most expedient means of maintaining the desired rate of mail flow.

Furniture and equipment for mailrooms is generally located so that the walking distance for personnel is minimized without restriction of movement. Other mail preparation functions such as bursting, reproducing, collating, folding, inserting and addressing are generally located convenient to the mailing area, but placed so as not to disrupt the flow of mail. Initial mailroom planning involves determining its location and size. Here are the types of questions that may prove pertinent.

Location:

- What is volume of mail flow between, to and from various parts of client's operations?
- Which departments have highest mail volume, and where are they to be situated in building?
- What is the most convenient access area for post office personnel and mail trucks? (Additional problems can be generated if client handles classified information)
- Is there a functional connection between EDP and mailroom operations (i.e., billing, computer-printed forms, etc.)?

*continued on page 181*

**Let us  
send you  
two free  
brochures  
that will  
show you  
how our  
central  
vacuum  
systems  
will keep  
your  
buildings  
as clean  
as your  
designs  
and save  
your clients  
money,  
too.**

**The Spencer Turbine Company**  
Hartford, Connecticut 06106

*For more data, circle 87 on inquiry card*

*For more data, circle 86 on inquiry card*



Architects for the new PNB Plaza (prime tenant, Philadelphia National Bank) know how to save money. They specified terra cotta-colored window frames and vertical trim that will stay like new without expensive maintenance.

That's because they are aluminum extrusions, factory-finished with DURANAR® from PPG. These fluoro-polymer coatings are noted for their

color integrity and durability. In fact, DURANAR coatings have a 20-years-and-longer rated service life.

They also have a high degree of resistance to dirt and mildew, plus excellent cleanability. Which means you're combining color, long life, and low maintenance when you write DURANAR color coatings into the specs.

It's a good investment in the future. For any building. For data on PPG color coatings, check Sweet's Architectural or Industrial Construction Files 9.10/PPG.

Or contact the Market Manager, Extrusion Coatings, PPG INDUSTRIES, Inc., Dept. 13S, One Gateway Center, Pittsburgh, Pa. 15222.

**PPG: a Concern for the Future**

*For more data, circle 88 on inquiry card*

## **EXTRUSION COATINGS FROM PPG. A SOLID INVESTMENT FOR THIS NEW BANK BUILDING.**



PNB PLAZA, Philadelphia, Pennsylvania Architect: Ewing Cole Erdman & Eubank Consulting Engineer: Synergo, Inc.  
Window fabricator: George Habgood & Company DURANAR coating applicator: Alcoa, Cressona, Pennsylvania

3A1

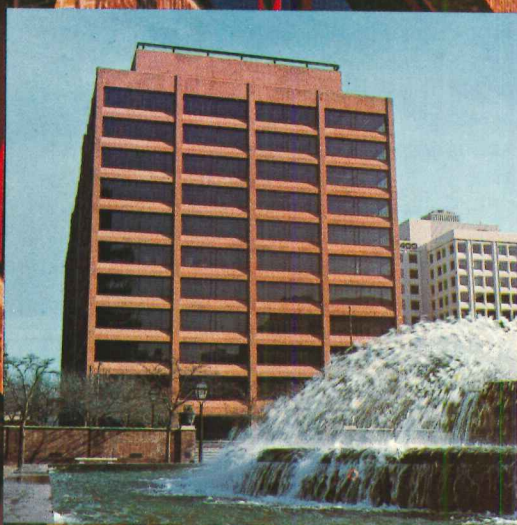



- If many packages are mailed, is there conveyor belt(s) leading from shipping or to loading dock? Is mailroom part of a warehouse delivery system, as in the case of mail order houses?
- Is noise from mailroom equipment likely to disturb nearby offices?
- Is there space to locate the mailroom in an attractive pleasant environment where windows can let sunlight in? (This would help eliminate the dark dingy aspect that plagues many mailrooms.)

Size:

- Volume of outgoing and incoming mail
- (First class letters, first class flats, rolled tubes, parcels)
- Degree of breakdown (necessitating sorting racks, etc.)?
- Need for a holding area for mail build-up?
- Number of mailroom employees? (work, traffic, and rest spaces.)
- Storage and movement of carts or other vehicles used for delivering mail internally or trays used in dumbwaiter delivery system?
- Volume and size of package regularly received?
- Type of postage metering equipment used?
- Functions performed other than mailing (e.g. bursting, addressing, folding-inserting etc.).
- Minimum psychological space required for good employee morale?
- Height of ceiling? Lighting?
- Space requirements for other adjacent departments? Messenger, Telex, copying, collating, etc.)

With this basic data in hand, layout is next. You may find it useful to discuss the requirements with a mailhandling specialist; such services are usually provided to a client and his architect without cost or obligation.

Shape:

- How and where are incoming (opening, sorting, routing) and outgoing (addressing, weighing, sealing, meter stamping) mail functions to be divided within mailroom?
- Where are mail deliveries and pick-ups, both external and internal, to be made? (bag and cart storage, holding area, traffic patterns)
- How can interruptions of mail flow because of jam-ups of people and materials be avoided?
- What kind of furniture (tables, sorting racks, cabinets, chairs, desks, bag racks, etc.) is being used or is under consideration?
- Is a visitor's area necessary (for mail security)?
- Is there a conference area for the manager; a rest area for employees?
- If modular, how can furniture be adapted to most convenient shape of mailroom?
- If not, how can mailroom shape be planned to accommodate the furniture?
- What size and shape would best suit the client's communication functions?

Mailroom furnishing and appointments:

- How can overhead lighting be used? Should it be recessed, or should frosted fixtures be used? How bright should a mailroom be? For

*continued on page 183*

# show 'em a better way: raywall duct heaters

Raywall duct heaters are custom designed for a better way to heat in all types of industrial, commercial and public buildings.

Ranging in size from 1/2 KW to 1,000 KW, and featuring zero clearance to combustible surfaces, Raywall duct heaters can solve a wide variety of space problems.

Ease of installation is also a Raywall feature. Blast coils fit spaces designed for other types of heating coils with no re-design or alteration of existing equipment.

Raywall duct heaters are engineered with safety in mind: each unit contains a grounding lug and is tested for 2,000 volts dielectric before shipping. Consider a better way for prime or auxiliary heating needs—Raywall duct heating.

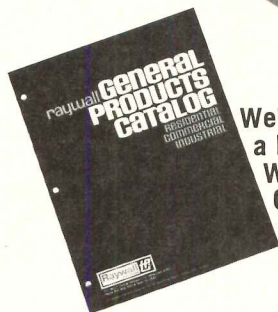
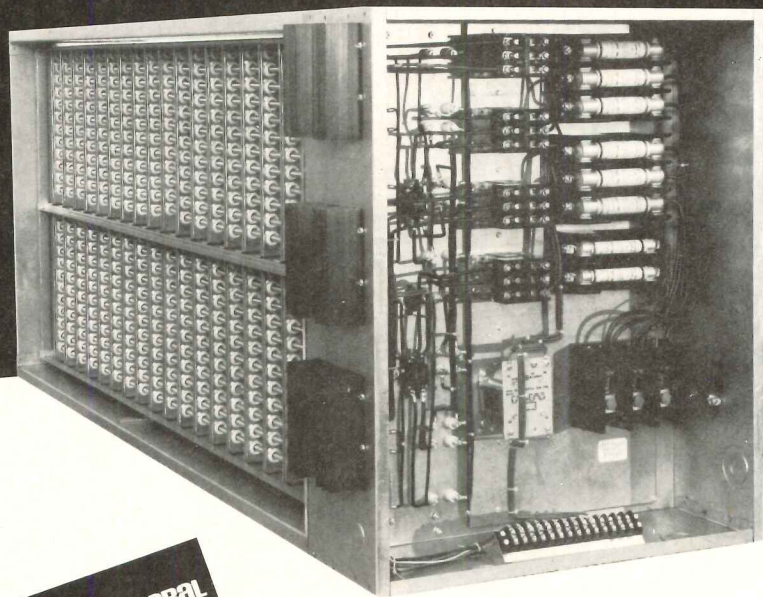

**We'll show you  
a better way.  
Write for our  
General Products  
Catalog.**

The Electricology Company



A TPI DIVISION

P.O. Box T, CRS Johnson City, Tennessee 37601 615/929-3151 Telex 55-3442

*For more data, circle 89 on inquiry card*



# GAFSTAT IS A BETTER WAY.

## GAF's GAFSTAT® is a totally new way to make anti-static carpet.

### Completely shockproof without wires.

Up to now you could only choose from two types of anti-static carpeting. Carpet made with a non-conductive coating. Or made with wire core fibers. A non-conductive coating is short lived. While wires affect carpet beauty and limit your choice of fibers and patterns. GAFSTAT® component from GAF eliminates these problems because the anti-static component is not a part of the carpet surface.

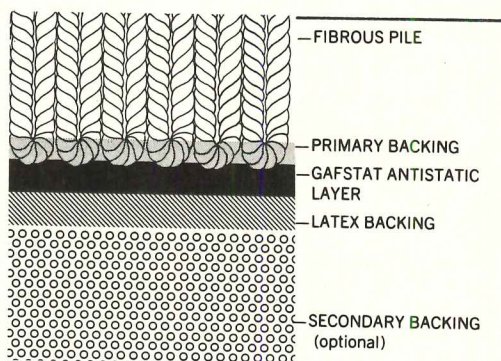
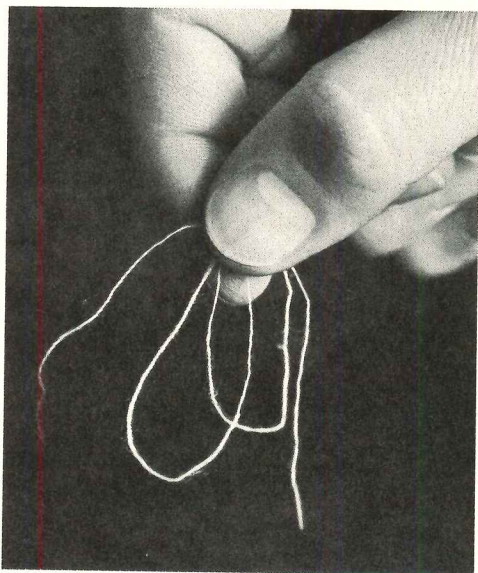

### Here's how we do it.

The conductive GAFSTAT component is sealed between the backing layers of the carpet. So it can't be washed out, cleaned out, or walked out. And because no wires are used the fibers are untouched. So you can specify the full range of patterns and colors. This flexibility of GAFSTAT makes possible the first shock-free carpet that's truly designed for residential use.

And GAFSTAT really does work. Its ability to disperse static-electricity below shock levels has been confirmed by independent laboratories using the American Association of Textile Chemists and Colorists static test methods. Even under extremely dry conditions.

### Why anti-static carpeting?

In addition to shock discomfort, there are other good reasons for specifying carpeting with GAFSTAT anti-static component. Static-electricity can cause malfunction of delicate electronic instruments. Imagine the dangers in a hospital. Or to computers. And a build-up of static-electricity can even cause fire or explosion. So when your clients ask for anti-static carpeting specify GAFSTAT. Because it is a better way.



**gaf** **GAFSTAT**  
A better way to  
end carpet static.

Anti-static carpet with GAFSTAT is available from

## Sikes Corporation

GA-025

For more data, circle 90 on inquiry card



reading and weighing areas? For bursting, folding and inserting areas.

- How many electrical outlets (110 and 220) will be needed for equipment, additional lighting, accessories, etc.?
- Should there be carpeting? If so, what kind? and where?
- Where should exits and entrances be located? What kinds of doors (swinging, sliding, automatic) would be most helpful to messengers and mail handlers?
- Should there be special storage closets where valuable parts and equipment be locked up after-hours?

By covering the points outlined above you can help your client to identify the present potential needs of his "communications center." The result can lead to an improved management of mail—at savings.

Several plans of varying sizes are shown here to aid in your planning.

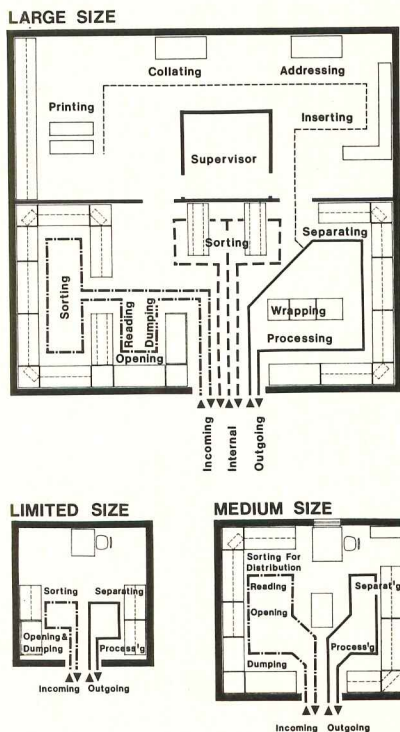

**Large mailroom:** Large mailers will appreciate the close proximity of all incoming functions with particular emphasis upon maximum sorting capabilities occupying a minimum amount of space. Placement of consoles in the outgoing area results in rapidly progressed mail that is bagged or trayed and ready for delivery to the Post Office. Mail preparation activities (reproducing, collating, addressing, folding, inserting) are shown in an area adjacent to the mailroom where they do not interfere with the continual processing of daily mail. From this area, documents can easily be incorporated into the mail flow for final processing.

**Limited size mailroom:** In a mailroom of limited size, the flow of incoming and outgoing mail can be separated to allow uninterrupted movement of mail and personnel. Combining convenient storage space for supplies beneath the work surface (of the consoles) provides efficient use of existing floor space.

**Medium size mailroom:** Delineation of incoming and outgoing mail patterns is the common denominator of mailroom layout. In the arrangement shown, processing of the outgoing mail is completed within close proximity to the exit door. Placement of consoles allows the incoming mail to be dumped immediately inside the entrance door.

## FOR FASCIA, STANDING, BATTEN SEAM AND MANSARD ROOFS, COPING, SOFFITS AND OTHER SHEET METAL FINISHING APPLICATIONS...

# Specify ColorKlad

"The metal with integrity"

## and give your clients some change!

COLORKLAD is the sensational new 24 ga. galvanized steel sheet that's practically armor plated in PPG's Duranar 200 with Kynar. COLORKLAD's integrity is warranted for 20 years for fade, chalk and color retention. We'll give you that warranty in writing.

COLORKLAD is available for immediate shipment in any amount... enough for a storefront or a supermarket—for a chapel or a church. It comes in six handsome architectural colors.

Yet, costwise, it's no more than the cost of shop or field painted galvanized (which usually requires maintenance in five years) and it's less than half the cost of copper!

And because it comes in 24 ga. sheets, it's extra strong, resists crinkling or buckling.



**Vincent**

BRASS & ALUMINUM CO.  
BUILDING PRODUCTS DIVISION  
724 - 24th Avenue S.E.  
Minneapolis, Minn. 55414  
A/C 612 378-1131



**20 Year Warranty on this roof!**

1 Mail coupon to: Vincent Brass & Aluminum Co.  
Building Products Division  
724-24th Ave. S.E., Minneapolis, Mn. 55414

**Please check:**

I am interested in receiving complete COLORKLAD information and specifications, plus a sample.

Have your local architectural representative contact me.

Name \_\_\_\_\_

Company \_\_\_\_\_

Address (Street) \_\_\_\_\_

City \_\_\_\_\_ State \_\_\_\_\_ Zip \_\_\_\_\_

For more data, circle 91 on inquiry card





# The road to the Magic Kingdom is paved with Earthstone.

Not far from the massive gates to Walt Disney World, travelers who arrive at a new Regency Red Carpet Inn are greeted in a spacious lobby that's paved with Florida Tile's Earthstone. This natural, hand-molded, half-inch thick tile has a rich look of quality, combined with a rustic, old-world warmth that offers a genuine "welcome" to tired travelers. Yet, it is durable enough to receive throngs of overnight visitors. And, Earthstone still needs no waxing, no buffing or stripping. Whether or not you have a mouse living down the road from you, Earthstone will enhance any interior floors you may be planning. There are six shapes and six colors immediately available.

*Regency Red Carpet Inn, Kissimmee, Florida*

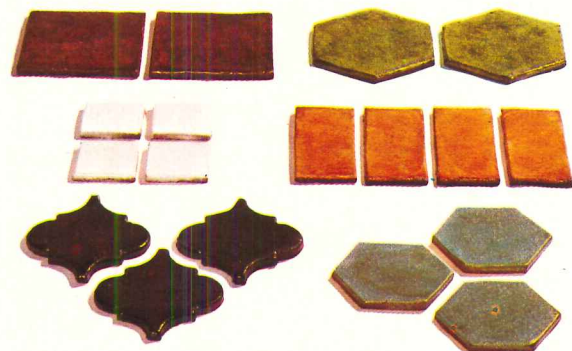

DIVISION OF SIKES CORPORATION  
FLORIDA TILE • P.O. BOX 447 • LAKELAND, FLORIDA 33802

*For more data, circle 92 on inquiry card*



**SAFETY RAILS** / Catalog shows recent additions to the company's line of structural pipe fittings. All comply with OSHA safety rail requirements. Simple, quick erection and architectural appearance at low cost are claimed. ■ The Hollaender Mfg. Co., Cincinnati, OH.

*Circle 417 on inquiry card*

**ILLUMINATION** / Emergency lighting systems and components are covered in a catalog illustrating a complete product line. Products include AC and DC power packs, remote emergency fluorescent power packs, emergency luminaires, emergency lighting consoles, and unit packs for retro-fitting existing fluorescent light fixtures. Complete specifications, dimensional data and drawings are included with product data. ■ Siltron Illumination, Gardena, CA.

*Circle 418 on inquiry card*

**BLOWERS** / The company has announced their 1100 Series line of direct drive blowers for heating-air conditioning applications that provide high performance in little space according to the company. Offered in two series the new units are available in 6- 7- 8- 9- and 10-in. models. Performance curves and dimensional information are available to engineers. ■ The Brundage Co., Kalamazoo, MI.

*Circle 419 on inquiry card*

**WASTE WATER TREATMENT** / Wastewater treatment systems have been designed to provide optimum treatment of small and large sewage flows. They comply with standards established by nearly all regulatory authorities and can be used in nearly any jurisdiction, for apartment buildings and mobile home parks of over forty units, according to the company. ■ Cromaglass Corp., Williamsport, PA.

*Circle 420 on inquiry card*

**ADJUSTABLE STEEL FRAMES** / A four-page brochure features a line of 1 3/8-in. and 1 3/4-in. steel adjustable frames for drywall openings and plastered openings, available in four profile sizes. Fabricated of 16- and 18-gauge steel, miters are precision-fit and reinforced. ■ Amweld Building Products, Niles, OH.

*Circle 421 on inquiry card*

**WATER CLOSET** / A bulletin describing a watersaving reverse trap water closet features installation information and order data. *Spacette* measures 17 1/2 by 25 1/2 in. overall, and the tank is equipped with an anti-siphon ballcock and trim. ■ Mansfield Sanitary, Inc., Perrysville, OH.

*Circle 422 on inquiry card*

**BUILDING COST** / An eight-page booklet describing the economic parameters for buildings designed to house automated storage systems relates building construction costs to costs of the automated storage system itself in order to establish "total cost" picture. ■ Clark Equipment Co., Battle Creek, MI.

*Circle 423 on inquiry card*

**FIRE/LIFE SAFETY** / The publication reviews the increasing demand for improved patient protection and new building code changes; details the application of contemporary early warning detection and smoke control technology in hospitals and nursing homes; and reports the findings of the recent "Project Corridor" fire tests by the California State Fire Marshal's Office. A special technical section presents guidelines for the specification of fire/life safety and door control equipment. ■ Rixson-Firemark, Inc., Franklin Park, IL.

*Circle 424 on inquiry card*

*More literature on page 187*

## Saving Money the no-red rust way. With Reynolds Aluminum ReynoRail.

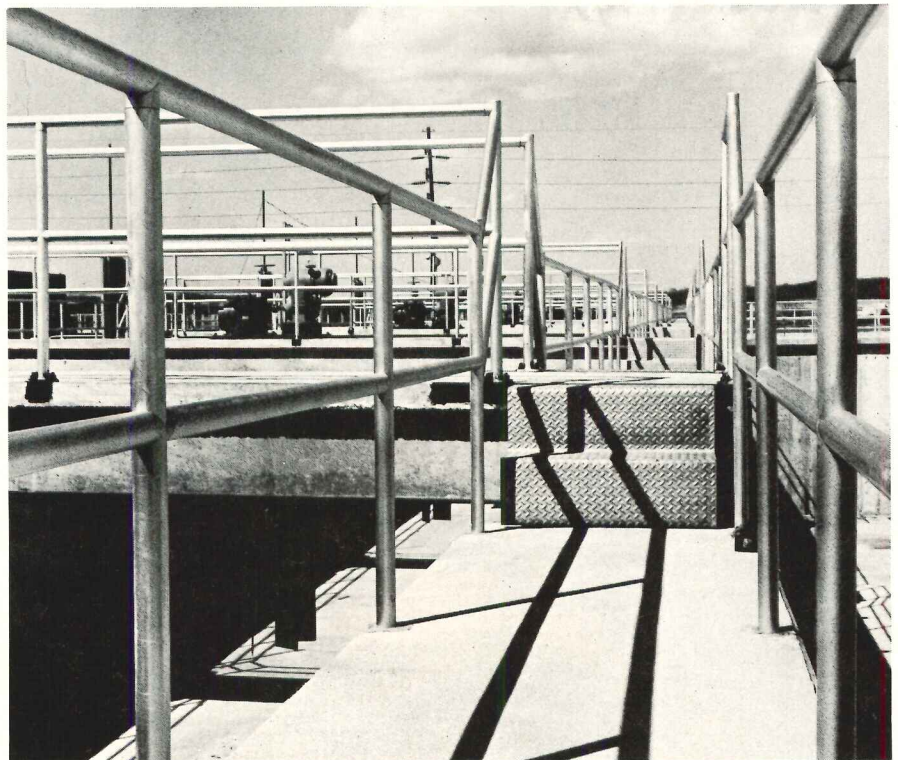

Corrosion-resistant railing at a competitive price? Most cities demand it for their sewage treatment plants. And that's exactly what light, strong Reynolds Aluminum ReynoRail provides. It's a new concept in railing that eliminates welds while using only a few standard parts. Installation is quick, simple—and economical. And so is maintenance. There is no red rust: the special anodizing coating will fight off corrosion for years.

Reynolds Aluminum is ready for the big jobs—whether it's rail systems for sewage treatment plants or siding for your next building or warehouse. Write or phone today for Reynolds "Products in Action" portfolio.

Reynolds Metals Company, Architectural and Building Products Division, 325 W. Touhy Avenue, Park Ridge, Illinois 60068 (312) 825-8811

Catalogs in Sweets 1973 Architectural, Industrial Construction and Plant Engineering Files.



**REYNOLDS**  
*for better building products in*  
**ALUMINUM**

*For more data, circle 93 on inquiry card*



**Introducing  
the ultimate sealant.**





**One part. Low modulus. Silicone. Dow Corning® 790 building sealant.**

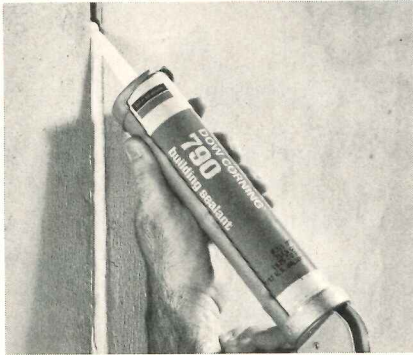

Now there's a building sealant with unprecedented advantages for both architect and contractor: Dow Corning 790 building sealant.

One part, so it's easy to apply, with no chance of mixing errors.

Low modulus, so there is little chance of joint failure because of sealant splitting or loss of adhesion.

Silicone, so it has superior resistance to aging and weathering. For 20 years or more.

Joints can expand or contract 50 percent again and again, and the sealant remains intact. And Dow Corning 790 building sealant will recover, at a controlled rate, from either type of stress.

Apply it in any temperature because this sealant has the same consistency from -20 F to +160 F. No primer is needed on concrete, brick, aluminum, ceramic, and marble; and you can use it as either a new or remedial sealant.

Whether you're designing the ultimate building or sealing the ultimate building, you can seal it and forget it with Dow Corning 790 building sealant. For complete technical data on the ultimate sealant, ask for Bulletin 61-207. Write Dow Corning Corp., Dept. A-3315, Midland, Michigan 48640. Or call 517 636-8000.

Construction sealants from

**DOW CORNING**

DOW CORNING

For more data, circle 94 on inquiry card

OFFICE LITERATURE *continued from page 185*

**WOOD USAGE** / The first edition of the Western Wood Use Book contains structural data and design tables for softwood lumber species. The format has been modified to reflect a more logical design process than formerly and a new chapter treats sound control. Of more than 300 pages, about half are devoted to text, illustrations examples and photographs all on timber design subjects. Copies are available at 10 dollars each. ■ Western Wood Products Association, Portland, OR.

Circle 425 on inquiry card

**MODULAR BUILDINGS** / Based on load bearing, insulated wall panels, the company states its patented system offers design flexibility, economy, and fast erection. It is particularly appropriate for manufacturing facilities, office buildings, warehouses and schools. A 12-page brochure includes advantages, photographs, a skeletal drawing, and specifications. ■ Epic Metals Corp., Rankin, PA.

Circle 426 on inquiry card

**COMMERCIAL LIGHTING** / The 32-page presentation lists over 600 fixtures with a wide variety of finishes and shade options. Four major design periods are represented: Contemporary, Early American, Old English and Mediterranean. ■ R. A. Manning Co., Inc., Sheboygan, WI.

Circle 427 on inquiry card

**AIR CONDITIONING** / The catalog is said to provide architects and engineers with the most complete data available today about the application and installation of the company's products for residential and commercial cooling, heating, and water heating systems. ■ Bryant Air Conditioning Co., Indianapolis, IN.

Circle 428 on inquiry card

**ROOF DECK** / A six-page brochure describes how the company's roof deck systems with gypsum concrete poured over glass-fiber formboard provide a low cost means to help meet OSHA standards for noise control in new plant construction. Brochure details how the suggested assemblies reduce reflected sound waves and retard sound-level build-up to improve industrial environment. ■ United States Gypsum Co., Chicago, IL.

Circle 429 on inquiry card

**WASHROOM ACCESSORIES** / A 36-page catalog covering over 300 soap dispensers and other washroom accessories, is illustrated and detailed concerning a wide range of individual wall-mounted, basin-type and recessed soap dispensers, as well as a line of multi-functional units serving a number of washroom needs. ■ American Dispenser Co., Inc., Carlstadt, N.J.

Circle 430 on inquiry card

**MASONRY COATING** / A 12-page brochure featuring modified epoxy coating for exterior masonry surfaces contains photographs and descriptions of applications on poured-in-place and pre-cast concrete masonry block, brick, and stucco. Surface preparation and application information, test data, and a color card featuring 20 special colors are included in the booklet. ■ Tnemec Company, Inc., N. Kansas City, MO.

Circle 431 on inquiry card

**PLASTIC FURNITURE** / At the back of this 20-page booklet, there is a specification sheet of all models plus a plastic color chart. This brochure is available to architects, designers, and office furniture dealers. ■ Stendig Inc., New York, N.Y.

Circle 432 on inquiry card  
More literature on page 193

For more data, circle 95 on inquiry card

# Our family comes with service.

Parker's Family of quality products is serviced by representatives in all 50 states. They're a part of the Parker Family too, and come to you with superior service as standard equipment when you specify from the broadest line of washroom and bathroom equipment in the industry ... Parker!

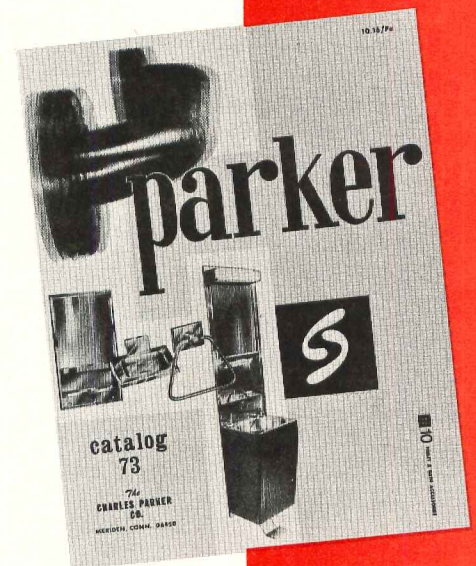

See our Parker family album in Sweet's Architectural File 10.16/Pa or write for your personal copy to ...

charles  
parker

290 PRATT STREET, MERIDEN, CONN.  
Tel. 203-235-6365 06450



# The subdued approach to Reflective Glass

With the increasing use of reflective glass for outstanding solar control and lower operating costs, more and more buildings are sticking out in harsh, metallic glare.

Now, Shatterproof Glass Corporation has developed a refined, subdued Reflective Glass that still offers the benefits of the harsh reflective glasses.

... Manufactured in three configurations—Insulating, Laminated and Monolithic—for complete versatility.

Depending on the type specified, it can also provide thermal control, sound control, security and safety benefits. Available in subdued tones of bronze, gold, gray and chrome ... in the largest quality sizes in the industry.

To learn more, write for our Reflective Brochure, Shatterproof Glass Corporation, Dept. 101A, 4815 Cabot Avenue, Detroit, Michigan 48210. Phone: 313/582-6200.

*For more data, circle 96 on inquiry card*

**Shatterproof**  
GLASS CORPORATION *Architectural Division*





# How to ship small packages in a big hurry.

## DELTA'S DASH

DELTA AIRLINES SPECIAL HANDLING

Delta guarantees delivery on the flight or routing you specify between most Delta cities.

Packages accepted up to 50 lbs. with length plus width plus height not to exceed 90" total, with only one dimension exceeding 30"

Delivery to Delta's passenger counter or air freight terminal at the airport at least 30 minutes prior to scheduled departure time.

Pick-up at DASH Claim Area next to airport baggage claim area 30 minutes after flight arrival at destination.

Charges for DASH shipments are nominal. Delta reservations will be pleased to quote actual charges between specific points.

Payments accepted in cash, by company check, most general-purpose credit cards, special credit arrangements or on government shipments by GBL. **DELTA**  
The airline run by professionals

**Rate examples (Tax included)**

Atlanta-Washington	\$21.00
Boston-Miami	\$26.25
Cincinnati-Louisville	\$21.00
Cleveland-Phoenix	\$26.25
Los Angeles-New Orleans	\$31.50
Dallas-Los Angeles	\$26.25
San Francisco-Atlanta	\$31.50
Philadelphia-Houston	\$26.25
New York-Tampa	\$26.25

For full details, call Delta reservations.



## Delta is ready when you are!

For more data, circle 98 on inquiry card

◀ For more data, circle 97 on inquiry card

OFFICE LITERATURE continued from page 187

**CANAL BULKHEADING** / An eight-page full color brochure describes a complete line of corrugated asbesto-cement canal bulkheading. Specifically designed to resist earth pressures and control erosion on waterfront properties. The brochure contains detailed information on the physical properties and characteristics. ■ GAF Corp., New York, N.Y.

Circle 433 on inquiry card

**ARCHITECT SUPPLIES** / The catalog illustrates a selection of supplies and special equipment requested by architects, engineers, draftsmen, graphic and industrial arts designers, etc. There is also a reference index which permits location of any item. A complete line of metric scales and slide rules is also featured. ■ Alvin & Co., Inc., Windsor, CT.

Circle 434 on inquiry card

**INDUSTRIAL SOUND CONTROL** / A brochure providing detailed product and application information for industrial sound control also includes a table of the maximum noise-level exposures established by the Occupational Safety and Health Act (OSHA). ■ Owens-Corning Fiberglas Corp., Toledo, OH.

Circle 435 on inquiry card

**CONCRETE HANDBOOK** / The first volume in a new series of educational publications of the American Concrete Institute is now available. Designed as a text book it combines sample problems, questions and discussion subjects. The reader is taken through a step-by-step procedure in dealing with the problems of quality control of concrete. This book is said to provide examples of applications to enable the practicing professional to understand and utilize these provisions of the code. ■ American Concrete Institute, Detroit, MI.

Circle 436 on inquiry card

**MATERIAL HANDLING** / A bulletin describes a complete line of overhead material handling equipment including hoists, cranes and monorails. The publication is said to illustrate common industrial, government utility and commercial applications and highlights the types of equipment best suited for solving a broad range of material handling problems. ■ Robbins & Myers, Springfield, OH.

Circle 437 on inquiry card

**WALL PLATES** / Wall plates in a range of styles, sizes, colors and configurations are described and illustrated in a 12-page catalog said to contain all pertinent data including the configuration for each group of plates, special design features, unit dimensions, and ordering information. ■ Leviton Mfg. Co. Inc., Brooklyn, N.Y.

Circle 438 on inquiry card

**CHAIR** / High-impact polypropylene chairs are described in five models: stack chair, stacking tablet arm chair, non-stacking tablet arm chair, sled base stack chair and stacking arm chair. Specifications, choice of colors, leg finishes, tablet arm surfaces and storage dollies plus add-on features such as bookracks and ganging mechanism are fully illustrated and described. ■ Krueger, Green Bay, WI.

Circle 439 on inquiry card

**CERAMIC TILE** / An eight-page color brochure showing crystalline ceramic tile in both residential and non-residential applications, introduces two shapes: 5 in. hexagon and 5<sup>7</sup>/<sub>16</sub>-in. valencia. ■ American Olean Tile Co., Lansdale, PA.

Circle 440 on inquiry card

More literature on page 195

**"ALL YOU NEED TO SPECIFY FOR 97% OF ALL MASONRY CLEANING"**

**➤SURE-KLEAN®**

**BIG 3**

**MASONRY CLEANERS**

**➤SURE-KLEAN®**

**600**

*For light colored brick, stone, structural tile and exposed aggregate.*

**➤SURE-KLEAN®**

**101**

*For easy cleaning of red brick and dark colored masonry.*

**➤SURE-KLEAN®**

**VANA-TROL**

*Cleans and treats new masonry subject to vanadium and manganese stains.*

Write for **FREE** information.

PSC

**Process Solvent Company**

Box 4437  
Kansas City, Kansas 66104  
913-621-0244

**Process Solvent Company**  
Box 4437, Kansas City, Kan. 66104

Tell me more about Sure-Klean products.

Name \_\_\_\_\_

Firm Name \_\_\_\_\_

Address \_\_\_\_\_

City \_\_\_\_\_

State \_\_\_\_\_ Zip \_\_\_\_\_

For more data, circle 99 on inquiry card



**The Pine Line.** A lounge group with nothing between you and the honesty of its natural wood. Elemental. Adaptable. And most comfortable. The random width pine planks enclose plump urethane cubes. Chair, two and three seaters in your choice of fabrics. Complementary tables also available. See it at the Thonet Center of Design. New York. Chicago. Los Angeles. Dallas. Or write Thonet Industries Inc., 491 East Princess Street, York, Pa. 17405. Telephone (717) 845-6666.





**GRAVEL STOPS** / Detailed illustrations and data to assist architects are included in a revised gravel stops and coping brochure that includes vertical sections, isometric and corner views and descriptions of the company's full range of gravel stops. ■ Aluminum Co. of America, Pittsburgh, PA.

*Circle 441 on inquiry card*

**LIGHTING FIXTURE WARNING** / A bulletin warning of overheating in some popular types of ceiling-mounted lighting fixtures has been issued by Underwriters' Laboratories, Inc. The warning applies to Type A ceiling pan fixtures having glass or metal coverings which enclose light bulbs and fit tightly against the ceiling. Tests showed that the majority of Type A fixtures installed on insulated ceilings will produce temperatures considerably above 90 degrees C (194 degrees F). ■ Underwriters' Laboratories, Inc., Westwood, N.J.

*Circle 442 on inquiry card*

**THERMOPLASTIC DUCT** / A four-page bulletin containing technical information on the application and installation of thermoplastic duct discusses typical industrial and institutional applications for thermoplastic fume exhaust systems, and illustrates standard corrosive fume handling equipment. ■ Harvel Plastics, Inc., Easton, PA.

*Circle 443 on inquiry card*

**RIGID VINYL** / Advantages of rigid vinyl as a low maintenance material for building products are discussed in a 16-page illustrated bulletin discussing performance characteristics and physical properties of rigid Geon vinyls. Building products made from Geon include solid vinyl siding, vinyl-clad windows and doors, storm windows and doors, shutters, window grilles, soffit systems, gutters and down-spouts, moldings and interior trim, baseboard raceway, PVC pipe and conduit and CPVC pipe. ■ B. F. Goodrich Chemical Co., Cleveland, OH.

*Circle 444 on inquiry card*

**ENERGY SAVINGS** / Some of the methods, systems and equipment that can contribute to efforts of shopping center and store designers and operators in behalf of resource conservation and cost savings are discussed in a booklet dealing with insulation, HVAC design and operating considerations, HVAC controls and lighting. The insulation section covers benefits to be realized from effective insulation; roof, ceiling, wall and perimeter insulation; glass area and multiple glazing. ■ Electric Energy Association, Inc., New York, N.Y.

*Circle 445 on inquiry card*

**FIRE RESISTANCE** / The 104-page book lists 240 fire-rated assemblies along with pertinent sound and structural data. Widely used, according to the company by building departments, architects, designers and contractors single copies are available free of charge. Gypsum Associates, Assoc., Chicago, IL.

*Circle 446 on inquiry card*

**INSTITUTIONAL CASEWORK** / An eight-page catalog illustrates a line of hospital and laboratory casework available in a wide choice of configurations and colors. Casework spotlighted in the catalog includes nurses' utility stations, general storage cabinets, clean and soiled utility room casework, reception area casework, etc. ■ American Sterilizer Co., Erie, PA.

*Circle 447 on inquiry card*

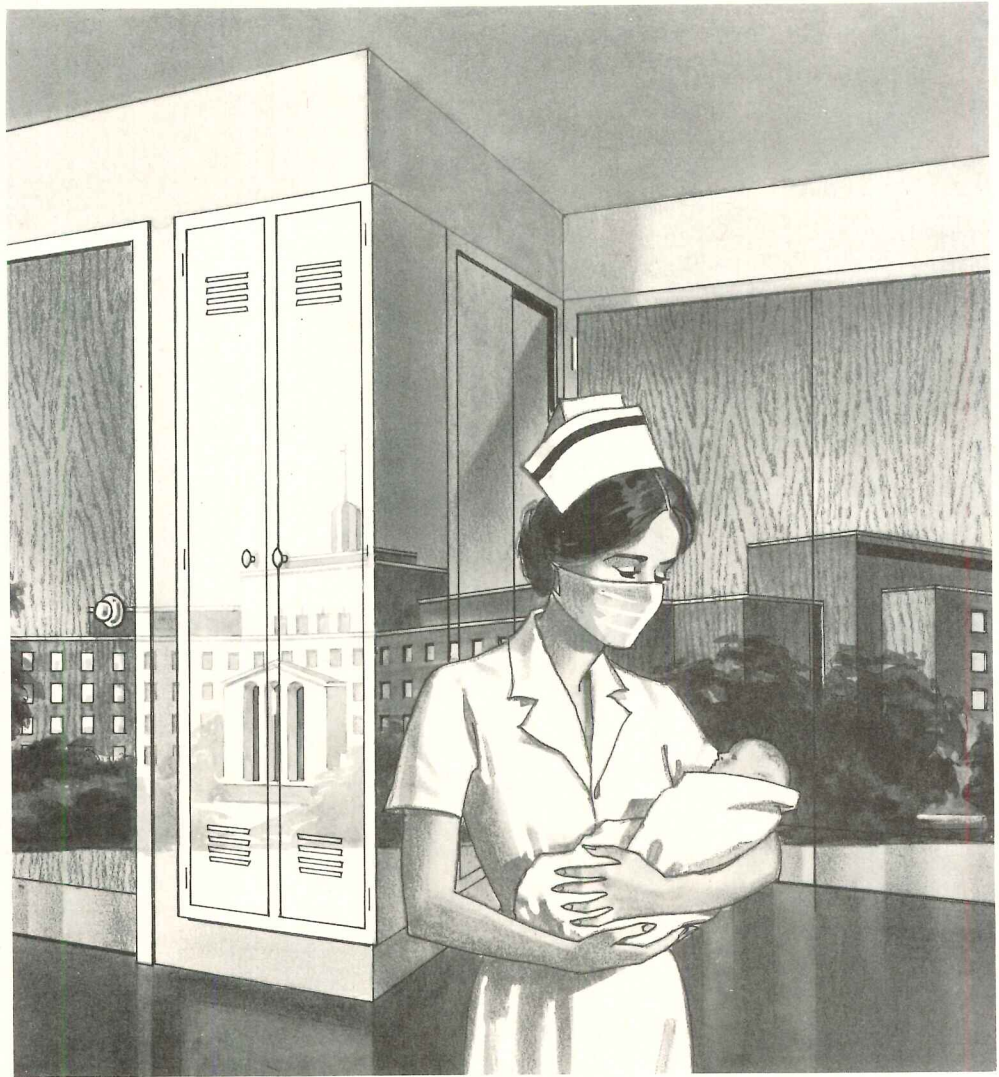

RESURRECTION HOSPITAL, CHICAGO, ILLINOIS

## THE ARCHITECT\* OF RESURRECTION HOSPITAL, MADE A DELIVERY

He delivered a plan for a hospital that would be as efficient on the inside as it was good looking on the outside. He specified cabinetry that would perform its vital tasks with time saving effectiveness for years to come. He specified Watson.

Hospitals cannot leave quality to chance. Not when time is of the essence . . . and lives depend on efficiency. Doors cannot stick. Drawers cannot jam. Medicines cannot be difficult to reach and dispense.

When you're called upon for hospital design, deliver the finest. Deliver Watson. Watson delivers.

HOSPITAL DIVISION  **WATSON**  
Manufacturing Company, Inc.  
Jamestown, New York 14701

\*SCHMIDT, GARDEN & ERIKSON, CHICAGO, ILLINOIS

*For more data, circle 101 on inquiry card*



## ULTIMATE PERFORMANCE IN AREA LIGHTING



# Landmark Ultra Flood

Sleek, contemporary, unobtrusive, the new NEMA heavy duty Landmark Ultra Flood is the perfect light for dramatic after-dark illumination of so many of today's finest design concepts—building facades, airports, marinas, industrial sites. Trim and compact, it is ruggedly constructed of cast aluminum alloy for light-weight ease of handling. The optical assembly utilizes a high percentage of the available light for maximum efficiency. Lamp socket has a simple 3-way adjustment capability for narrow, medium or wide beam selection.

Maintenance is easily accomplished. Loosening screw holding cover plate on top of unit allows plate to slide aside for access to lamp. Hinged upper housing opens for access to ballast and capacitor. Both lamp and reflector assembly and electrical component compartment are completely gasketed to seal out contaminants and moisture. Lens is heat and shock resistant tempered glass. Repositioning stop screw on calibrated steel yoke eliminates need for re-aiming unit after servicing. Landmark Ultra Flood comes factory pre-wired ready for mounting and is available in sizes to accommodate all standard ballast types and watt-ages. Optional features include NEMA twist-lock photo-electric control, polycarbonate lens shield, glare shield and lamp stabilizer.

For complete specifications, photometric data and prices, write ITT Landmark Lighting, a unit of International Telephone and Telegraph Corporation, Southaven, Miss. 38671.

LANDMARK LIGHTING **ITT**



*For more data, circle 102 on inquiry card*



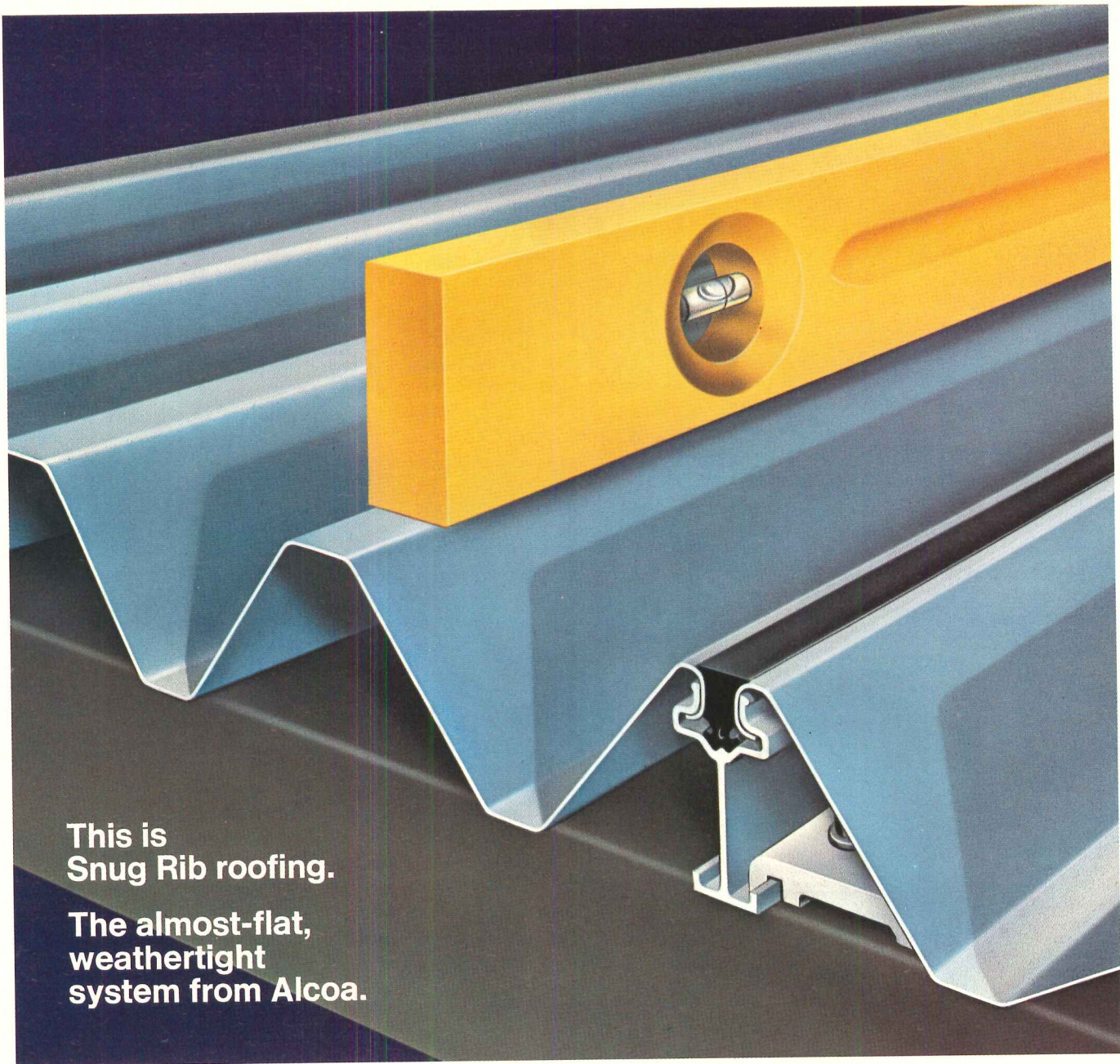

**This is  
Snug Rib roofing.  
The almost-flat,  
weathertight  
system from Alcoa.**

The Alcoa® Snug Rib roofing system gives you all the advantages of a low-pitch roof, plus excellent leak resistance, long-term maintenance savings and attractive appearance. Slopes as low as ¼ in. in 12 in. are possible, so there's less dead space to heat or air-condition. Snug Rib roofing is a floating, weathertight system. Because it floats, it is free to move under thermal cycling, so locked-up thermal stresses are eliminated. The patented Snug Seam®

joint holds panel edges securely in place to create a weathertight seal. No through-fasteners penetrate the weathering membrane. On most buildings, end laps can be eliminated because lengths are limited only by shipping conditions.

Snug Rib roofing saves you money several ways compared to conventional metal roofs. Less roofing material is required in relation to floor space. Steel trusses can be lighter. Fast erection cuts construction

costs and completion time. And long-term maintenance costs are reduced because aluminum takes care of itself. For manufacturing plants, port warehouses, airport facilities, recreational buildings, grandstands and sports complexes, Alcoa Snug Rib roofing is handsome, weathertight and economical. For more information, write Aluminum Company of America, 1130-A Alcoa Building, Pittsburgh, Pa. 15219.



**Change for the better with  
Alcoa Aluminum**

**ALCOA**

*For more data, circle 103 on inquiry card*



You  
can do  
more things  
with  
light

Whatever you want your glass to do, C-E Glass has the light, heat, glare, sound or safety control qualities, plus the colors and patterns to blend beauty with function and to open new horizons for structural design possibilities.

POLARPANE® insulating glass units with 20-year warranted moisture-free construction.

POLARPANE® reflective solar insulating units with pure gold or chrome mirror-like coating.

ARM-R-BRITE® insulated spandrel panels, fully tempered and tailored to your color specifications.

ARM-R-CLAD® tempered safety glass. Clear, tinted and textured. Standard thicknesses from 1/8".

SOUND CONTROL POLARPANE® hermetically sealed units for maximum sound transmission loss.

SUN CONTROL POLARPANE® hermetically sealed units with rotating venetian blind between glasses.

MISCO® wired glass listed fire retardant by Underwriters' Laboratories, Inc. Seven popular patterns.

MISSISSIPPI® PATTERNED GLASS in wide variety of general purpose and decorative patterns.

**CE GLASS**

**COMBUSTION ENGINEERING, INC.**  
*For more data, circle 104 on inquiry card*

See our catalog in Sweet's 8.26/Ce or contact your local C-E Glass office.  
C-E Glass, 825 Hylton Road, Pennsauken, New Jersey, 08110, (609) 662-0400.

Campbell Centre, Dallas  
Architects: Neuhaus + Taylor  
Polarpane Gold #2016

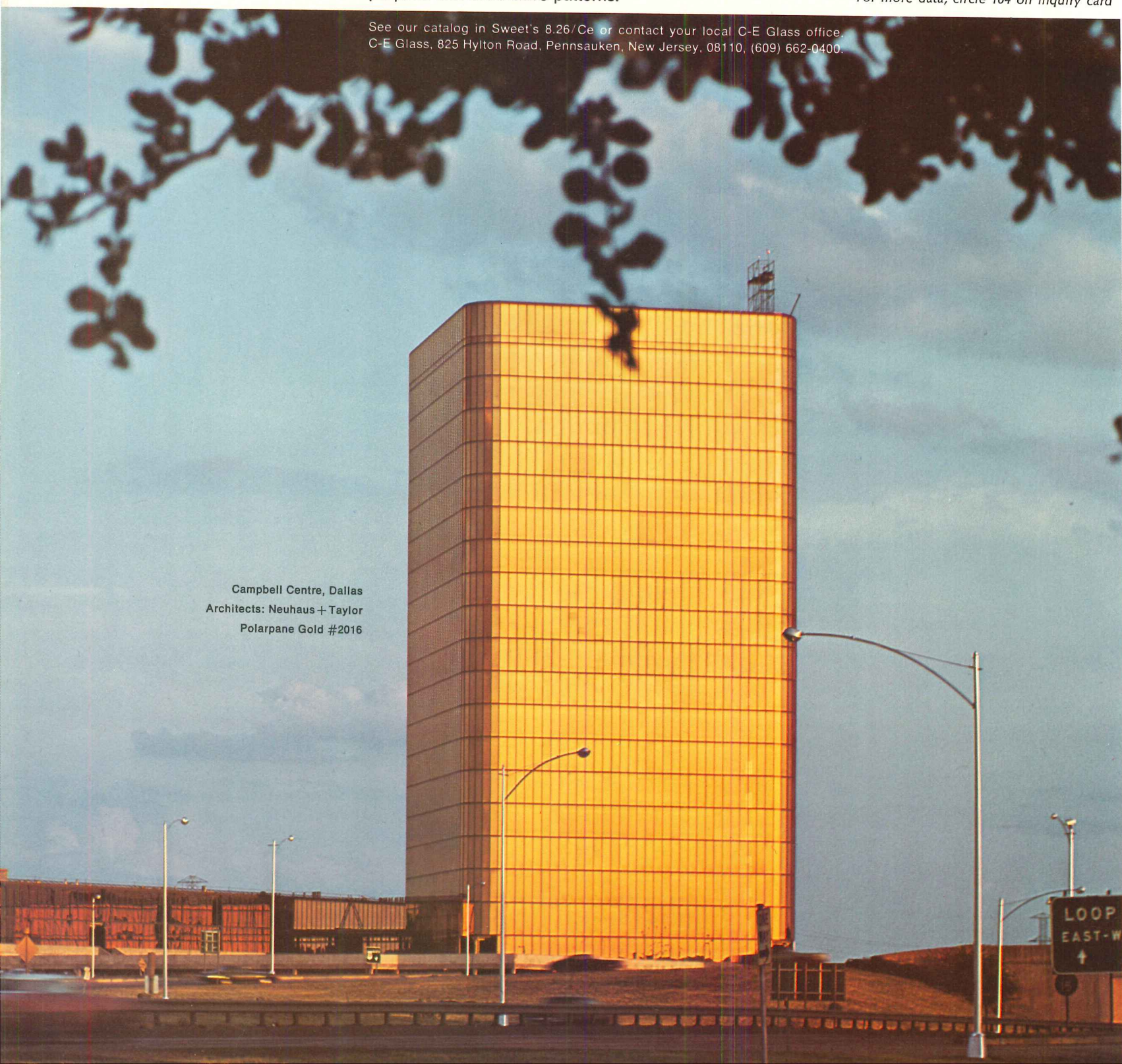



# ELECTRIC STRIKES

## STRONG RELIABLE VERSATILE

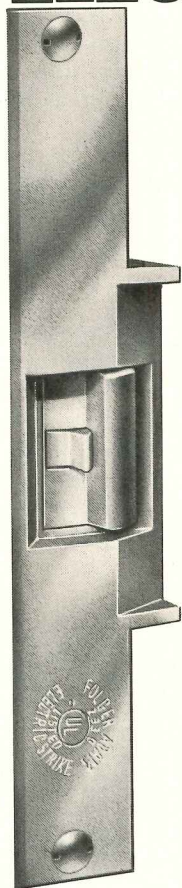

Folger Adam electric strikes are the ideal components for your door control systems. Strong—high quality, high strength materials throughout to prevent forcing. Reliable—precision workmanship and close tolerance mating of parts assure long service life and resistance to tampering. Versatile—Folger Adam electric strikes equipped with signalling switches, can be adapted to virtually any type of door control or surveillance system.

Write for literature on  
full line of security devices.



# FOLGER ADAM CO.

Architectural Security Division  
700 Railroad Street, Joliet, Ill. 60436  
815/723-3438

For more data, circle 106 on inquiry card

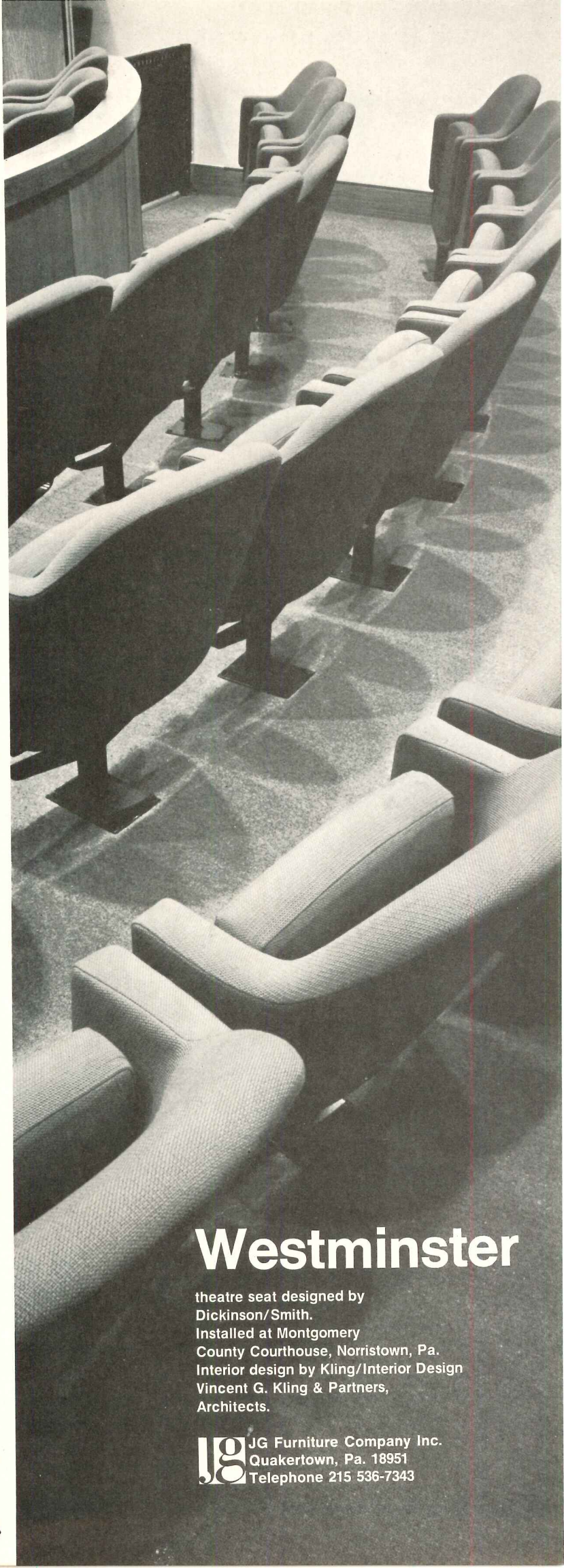

Over 102,500 engineers have bought and  
relied on this now classic working tool...

## FORMULAS for STRESS and STRAIN

By Raymond J. Roark

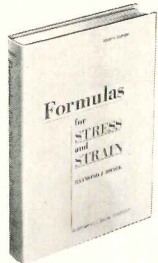

4th Ed.  
432 pp.  
6" x 9"  
Illus.  
\$13.50

Over 102,500 engineers have turned to *Formulas for Stress and Strain* because it's the **one book that puts at your fingertips 300 essential formulas on strength of materials.**

No need to waste time and energy looking here and there for all the facts, figures, formulas, and vital data you need to calculate stress, strain, and strength in structural members—they are all here, along with clearcut directions for applying them.

### Special Features of the 4th Ed.

*Expanded treatment of* — fatigue and brittle fracture — combined and simultaneous axial and transverse loading—stress concentration factors—*material on*—conical shells—the influence of localized loading on thin cylinders — mechanical vibrations and table of frequencies for simple structural elements—*new tables on*—allowable stresses and factors of safety—properties of materials.

**AVAILABLE from your BOOKSTORE  
or from McGraw-Hill Book Company**

1221 Ave. of the Americas, N.Y., N.Y. 10020

23-B414-4000-3

## Westminster

theatre seat designed by  
Dickinson/Smith.  
Installed at Montgomery  
County Courthouse, Norristown, Pa.  
Interior design by Kling/Interior Design  
Vincent G. Kling & Partners,  
Architects.



JG Furniture Company Inc.  
Quakertown, Pa. 18951  
Telephone 215 536-7343

For more data, circle 105 on inquiry card



# Today you can build a better condo or apartment after one phone call.

Call 412 255-3656 for the Westinghouse team. We make more products for construction than any other company, a few of which are shown here. One man will coordinate it all for you.

For high-rise or townhouse—air conditioners that heat as well as cool. Our quiet, through-wall RB units both cool and heat individual rooms. The complete line includes split systems, and central-station systems with the unique Westinghouse centrifugal chiller. All outstandingly simple, compact, and economical.

**Packaged subsystems you can install in 8 hours.** Westinghouse subsystems include kitchens, baths, laundries, heating/air conditioning, or modules that combine all of them. We work with your architect while you're clearing ground, then deliver units on your schedule.

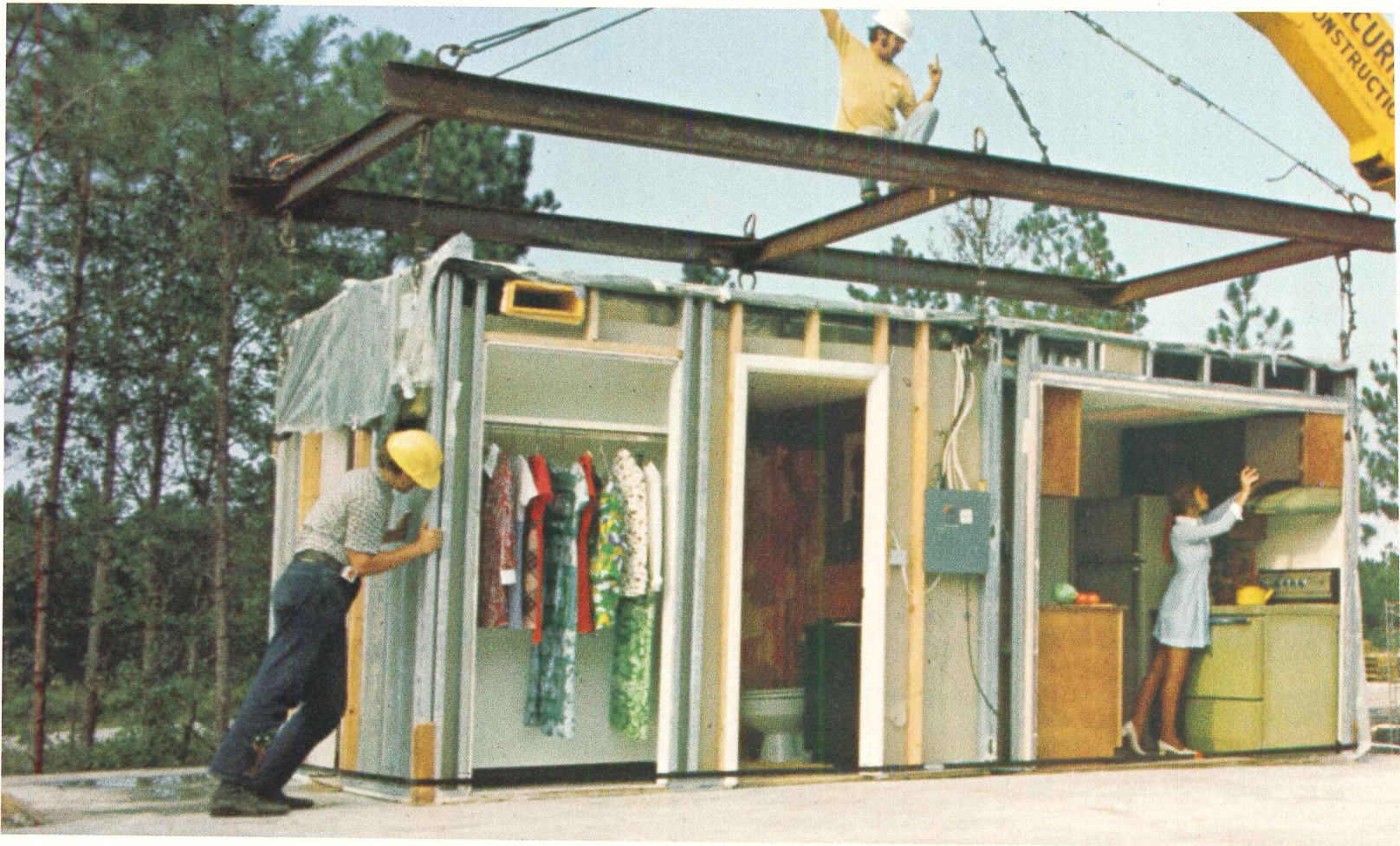

# Westinghouse



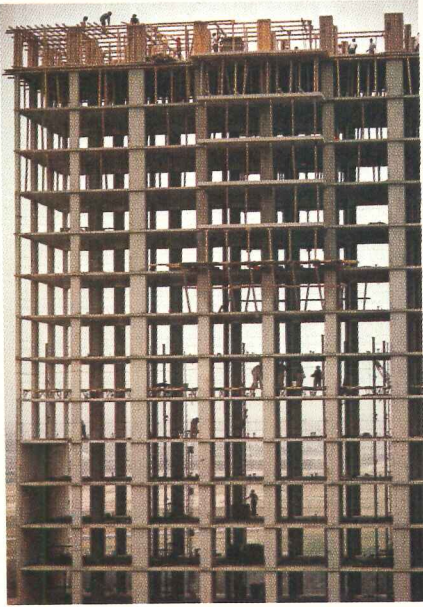

**Pre-engineered elevators.** Our geared traction elevators are pre-engineered for faster delivery of a wide choice of types, styles, and capacities. For higher capacities or speeds, we'll custom build to your needs.

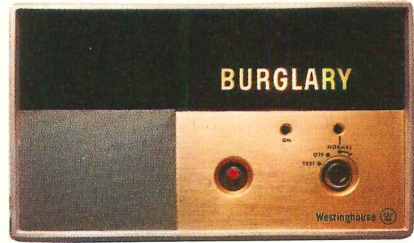

**Security systems you can promote.** They contact police or firemen through Westinghouse communications centers while sounding local alarm. For other emergencies, tenant can talk directly with the center or your on-premises guard.

Westinghouse Electric Corporation  
Pittsburgh, Pa. 15222



Wildwood Apartments, Jacksonville, Florida, Fletcher Properties, Inc.

# helps make it happen

For more data, circle 107 on inquiry card



# Our beautiful Designer Line™ works beautifully, too.

Our new Designer Line tub and integral wall surround has one thing no one else can duplicate... our name. And when Mr. & Mrs. Home Buyer meet fiberglass reinforced polyester for the first time, that's important!

Naturally they're attracted by the crisp modern styling and warm-to-the-touch properties of American-Standard FRP. (Just as you'll like its easy-to-handle, easy-to-install ways.)

And home buyers are happy to see there is no mildew and dirt-collecting grout. (As you'll be glad it's repairable in place and NAHB tested and certified.)

But just as important are the seat-wide front apron, shoulder-high accessory shelf and figure-fitting backrest — considerate features generations of homebuyers have come to expect from people who make solving bathroom problems their full time business.

For any further information, please write to American-Standard, Plumbing/Heating, P.O. Box 2003, New Brunswick, New Jersey 08903.

## We've been leading up to this for over 100 years.



Tub and Integral Wall Surround



Deluxe Recessed Shower

 **AMERICAN  
STANDARD**

For beautiful fixtures that work beautifully.

*For more data, circle 108 on inquiry card*



Copper was first choice for roofing community buildings at Eastman, a 3500-acre recreational home development rising in the hills of Grantham, New Hampshire.

Planner Emil Hanslin knew he wanted copper's warm, natural look right from the start. But he had some doubts about first cost.

New light gauge "Tough 12" high-strength copper sheet was the answer. The high yield strength of "Tough 12"

meant that copper weight per square foot could be cut 25% without affecting performance.

Copper's easy workability with hand tools helped keep on-site costs to a minimum. Bends, locks, and seams could be easily formed and there was no need to pre-punch holes for nails in cleats and edgings.

Durability and freedom from maintenance tipped the scales firmly in copper's favor. Once costs of repairing and

maintaining alternate materials were factored in, "Tough 12" copper sheet was clearly competitive.

Copper comes out on top in the long run. For Emil Hanslin. And for all the people who will work and play under the beautiful, practical standing-seam copper roofs of Eastman.

For an informative brochure on new "Tough 12" copper sheet, write

Copper Development Association Inc.  
405 Lexington Avenue, New York, N.Y. 10017

## Planner Emil Hanslin couldn't believe new "Tough 12" copper roofing was competitive. Now he's a believer.

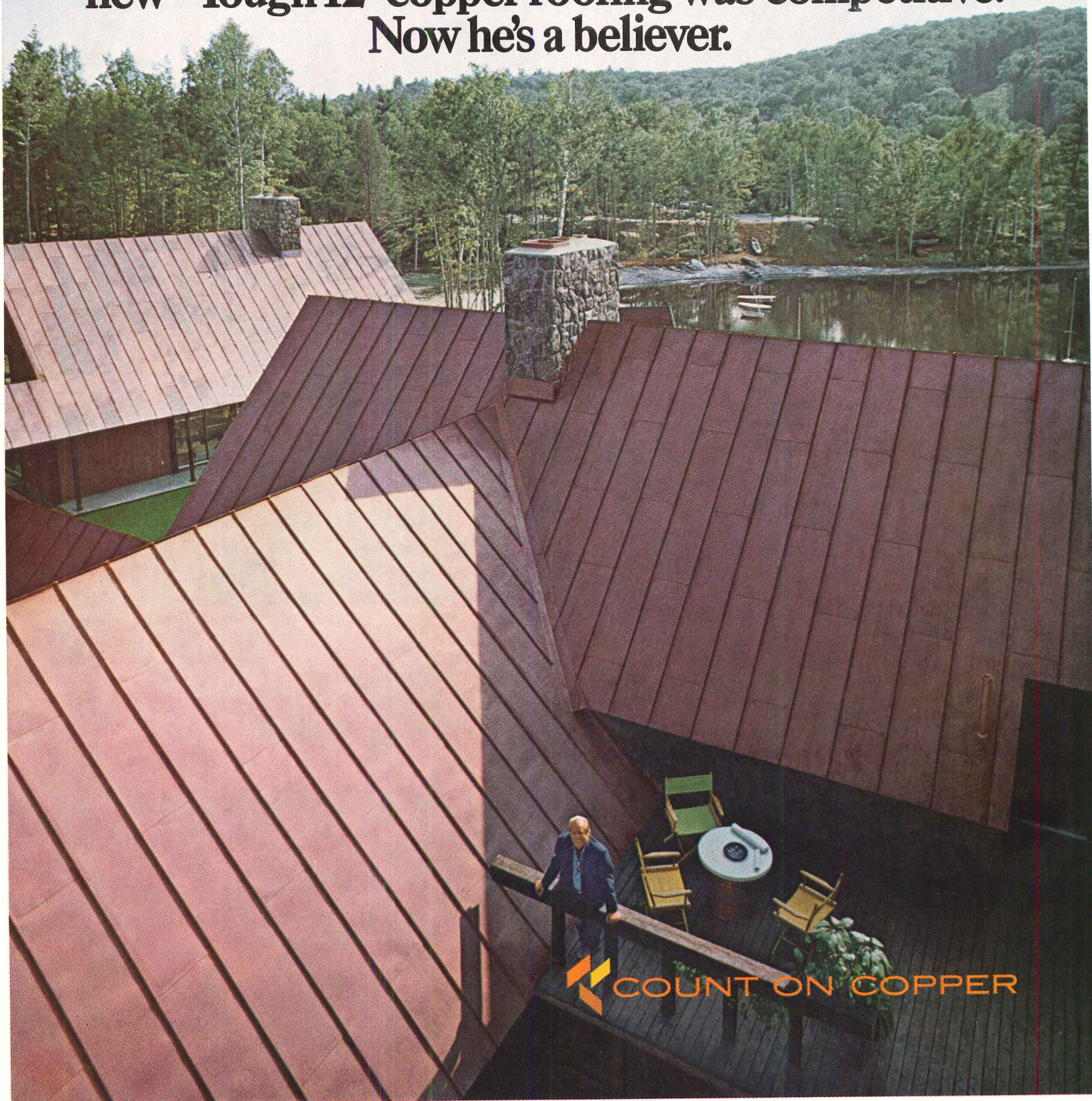

 **COUNT ON COPPER**



# Modine rooftop units can't be fooled by Mother Nature!

You can depend on our rooftop units for quiet, economical comfort . . . in all kinds of weather . . . in any climate. Our HVAC line is offered in both Multizone and Singlezone units . . . up to 60 tons. Want to know more about Modine rooftop units? Contact Modine, 1500 DeKoven Ave., Racine, Wis. 53401.

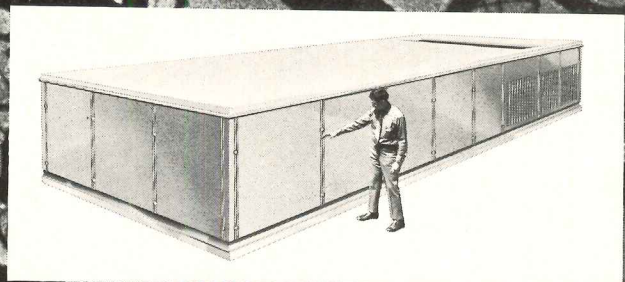

MODINE



# We "Wrote the Book" on Dock Design.



## Our 350 Dock Specialists put it into practice

Everything you move in or out of your plant, warehouse, or terminal moves across the loading dock. Today's competition, rising labor costs, and safety considerations place critical demands on your dock operation.

To help you achieve a safe, efficient dock, Kelley Company offers the services of one of 350 trained dock specialists. He will work with you, your personnel, architect and contractor. And he will assume complete responsibility for the dock layout, equipment recommendation, its installation and operation.

It's the kind of total responsibility you expect from the people who "wrote-the-book" on Dock Design, and who manufacture and install more permanent dockboards than anyone else in the world.

So if you're building, remodeling, or simply concerned about your present dock operation, ask for this free, no obligation consultation service. Just contact the "responsible" dockboard people.



Kelley Company, Inc.  
6768 North Teutonia Ave.  
Milwaukee, Wisconsin 53209  
Phone: (414) 352-1000 Telex: 26-661

For more data, circle 111 on inquiry card



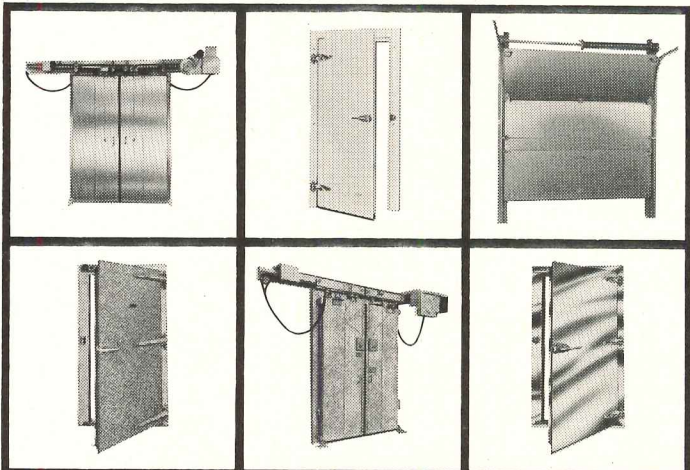

**YOU GET MORE FROM JAMISON**

(THE COLD STORAGE DOOR PEOPLE)

## More doors

designed and built  
by Jamison to meet  
your needs precisely!

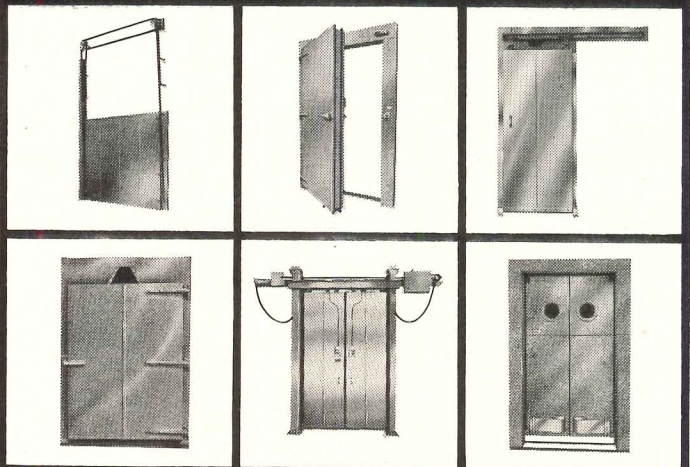

■ Our newly-expanded line now makes it possible for you to get traditional Jamison quality and service in **every** price range. Jamison completely controls design, materials, and manufacturing to assure maximum quality and performance. Also more technical assistance—from more door specialists—than you can get anywhere else. Write or call for full details on the complete Jamison line.

*The one to see in '73 . . .*

COLD STORAGE DOORS BY  
**JAMISON**

JAMISON DOOR CO • HAGERSTOWN, MD 21740

For more data, circle 112 on inquiry card



### Emergency lighting that works instantly. Every time.

BIG-EYE is a major improvement in emergency lighting. Its 2 sealed batteries are automatically kept charged at full rated capacity. They last about 8 years (up to 4 times life of wet cell batteries) without filling or maintenance. When power fails, the two 35W incandescent lamps highlight critical areas for 40 minutes (90 min. with single lamp model).

Only 5 1/8" x 6" x 27 3/8". Mounts horizontally, vertically or upside down on its own brackets. (Heads can mount remotely.) Theft and vandal-resistant. Gasketed model for wet areas and outdoors. Recessed model for

lay-in on T-bar ceilings.

It's another of our Holophane Emergency Lighting Products (H.E.L.P.™).

Call your local Holophane sales engineer for details on BIG-EYE or any of our indoor, outdoor and emergency lighting products. Or write Dept. AR-10 Holophane Co., Inc., Woodbro Div., 13500 Saticoy St., Van Nuys, Calif. 91402.

**Holophane®**  
A Johns-Manville Company

For more data, circle 113 on inquiry card

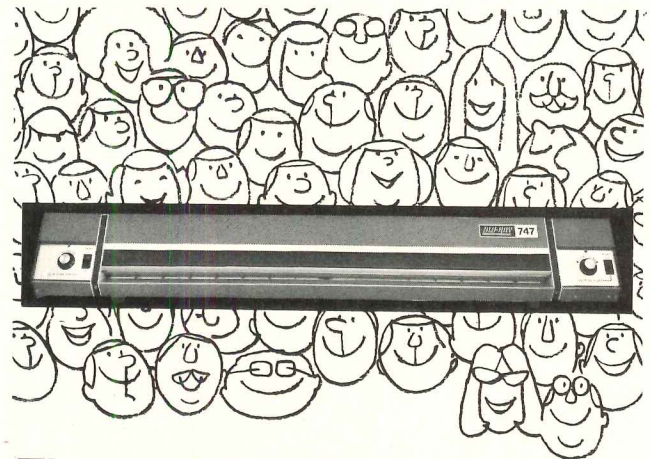

### Thousands of happy Blu-Ray owners must be right!

As the long time innovator in tabletop whiteprinters, we've made machines so good, so reliable, that thousands of people have invested in them.

They like the low cost of our whiteprinters, the ease in operation. They like the sharp copies, the speed and performance. They like having 3 models to choose from—to fit their need and budget. And do they like the *minimal* service required!

Our '73 models feature improvements. Join our happy club. Send for our brochure. Blu-Ray, Incorporated, 135 Westbrook Road, Essex, Connecticut 06426. Telephone (203) 767-0141.

**BLU-RAY**

For more data, circle 114 on inquiry card



This cost-cutting  
tool can save you  
20% on your  
next building's  
walls.

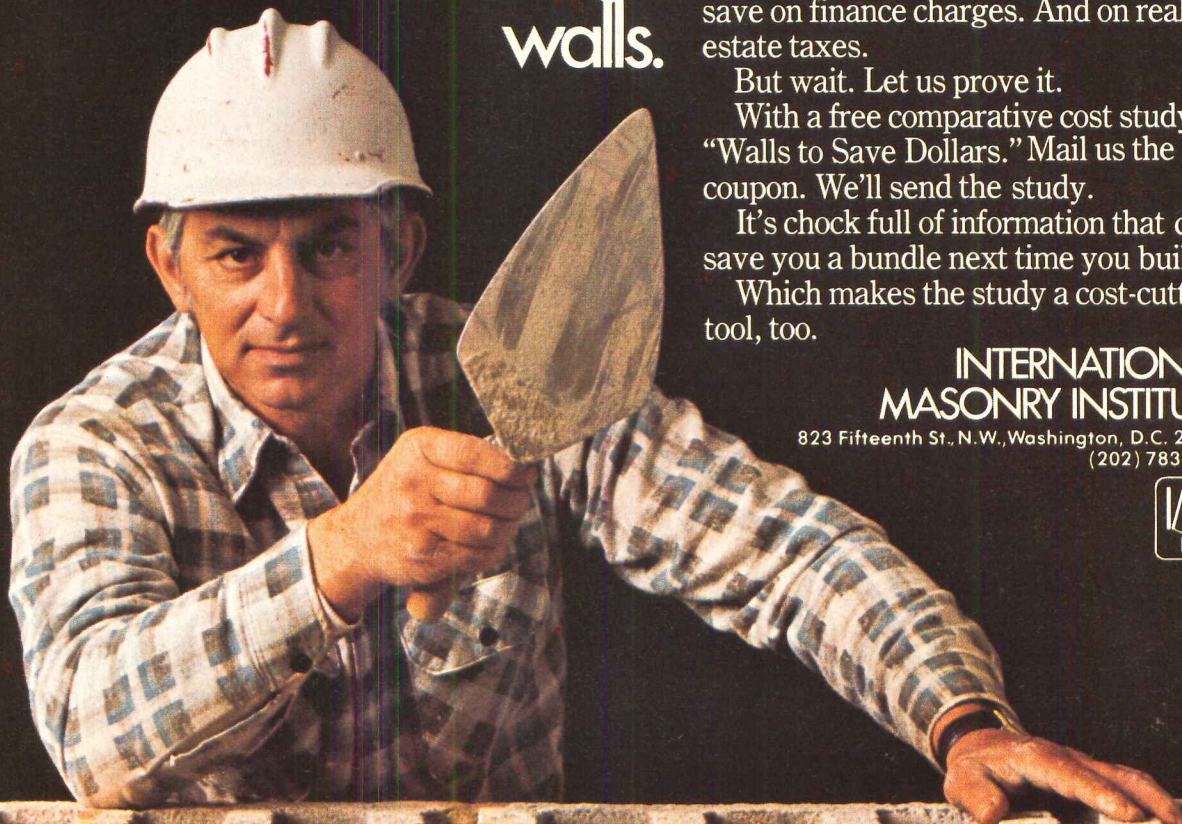

It's the mason's trowel.

And in the hand of a skilled craftsman, masonry can end up costing less than metal, glass or precast concrete.

Less initially. And less in the long run, too, since masonry needs less maintenance.

What's more, because masonry buildings aren't as expensive, you can save on finance charges. And on real estate taxes.

But wait. Let us prove it.

With a free comparative cost study, "Walls to Save Dollars." Mail us the coupon. We'll send the study.

It's chock full of information that can save you a bundle next time you build.

Which makes the study a cost-cutting tool, too.

### INTERNATIONAL MASONRY INSTITUTE

823 Fifteenth St., N.W., Washington, D.C. 20005  
(202) 783-3908



I want to cut costs. Send me the tool, "Walls to Save Dollars." Mail to International Masonry Institute, Suite 1001, 823 15th Street, N. W., Washington D. C. 20005

Name

Title

Company

Address

City  State  Zip

Nature of business  AR



## Weyerhaeuser® Panel 15 makes beautiful “afters” happen.



State Bank of Fall Creek, Wisconsin, **BEFORE** and **AFTER** Weyerhaeuser Prefinished Siding/Panel 15.  
Architect: Norman Sessing, A.I.A., of Neujahr, Drake and Sessing, St. Paul, Minnesota.



Section of downtown Atchison, Kansas, **BEFORE** and **AFTER** Weyerhaeuser Prefinished Siding/Panel 15.

## And exciting “originals.”



Drive-in restaurant concept, W. C. Murchow Associates, Denver, Colorado.



Swope Park Puppet Theater, Kansas City, Missouri, Morton Rolsky, Architect.



Whistle Stop Restaurant, Phoenix, Arizona, Clarke Modular, Inc., Glendale, Colorado.



LaRonde Apartments, Arthur M. Hemlock, Hemlock Associates, Cleveland, Ohio.

From re-creation of nostalgic significance to innovative design concepts, the uses for Weyerhaeuser Prefinished Siding/Panel 15 are virtually limitless.

The 10-mil, pebble-textured aluminum face of Panel 15 is available in 19 stock and special order colors, plus custom colors.

Durable acrylic finished aluminum bonded to rugged Structural I exterior-type Douglas fir plywood means exceptionally low maintenance plus structural strength permitting application to any conventional support system.

Regular panels finished one side for sidings and backed with reflective foil insulation. Double-faced panels for balconies or dividers where both faces are exposed.

All Weyerhaeuser Panel 15 guaranteed in writing not to need refinishing for fifteen years.

Approved by all building codes and FHA, qualifies for Class II Fire Hazard rating.

For more detailed information on Panel 15's unique qualities, uses and accessories write to Weyerhaeuser Company, Box B, Tacoma, Washington 98401.







## Republic lockers. Loud in one way, but not the other.

Bright. Bold. And, really, beautiful.

That's the way it is with Republic Steel lockers. Available in 19 decorator colors. No matter whether you want them in hallway style, gym style, in single, double, or multiple tier types.

But the great thing about these Republic steel lockers is that they are now much quieter.

The secret is in the new spring steel one-piece latching system we've developed that just doesn't "thump" when it's opened or "thump" as it's closed.

It's due to rubber silencers that just won't allow

metal-to-metal contact or let the doors go "bang." (As anybody knows, doors that don't slam take less maintenance and last years longer than doors that do.)

So, if you want lockers loud in one way (to please the eye), but not loud in the other (to please the ear), order from Republic.

Send for brochure L-102 that describes our whole locker line. Contact our nearby district sales office or write Republic Steel Corporation, Industrial Products Division, 1038 Belden Avenue NE, Canton OH 44705.

**Republicsteel**  
Industrial Products



For more data, circle 117 on inquiry card





... spray

... trowel and float

*Housing for the Elderly, Hawaii Housing Authority, Luke Miyamoto & Assoc., Inc.; Gen'l Cont., Reed & Martin, Inc.; Appl., R. D. Massengale*

## **Towering white High Rise against a blue Hawaiian sky**

***THORSEAL PLASTER MIX finishes and waterproofs quickly and economically at 1/2 the cost of rubbing.***

This contemporary building not only looks beautiful, but with the use of cement-base THORSEAL PLASTER MIX, the outstanding durability of this finished surface will stay as beautiful, as maintenance-free as the day it was applied. 800 bags of THORSEAL PLASTER MIX plus 400 gals. of super bonding ACRYL 60 were used to finish this Housing for the Elderly. The coating on the front of the building was applied by trowel and float, the remainder was sprayed on.

*For more data, circle 118 on inquiry card*



SDW 156

**S T A N D A R D   D R Y   W A L L   P R O D U C T S ,   I N C .**

DEPT. 73-AR-3   •   7800 N.W. 38th ST., MIAMI, FLA. 33166





ASG...  
The Glass Company

When it comes to flat glass, the only name you have to remember is ASG. Because from product to packaging to delivery, ASG does it all. It's your one-source glass company. And that includes everything from float glass to plate glass, tinted and clear, to patterned and insulating glass, lighting glass, reflective glass and safety glass. In short, any kind of flat glass you'll ever need.

And, ASG delivers the goods. Where you want it and when you

want it. In some of the most advanced package designs in the industry. Packaging systems that reduce handling to a bare minimum. And make breakage a rare occurrence, indeed.

So, when it comes to glass, to The Glass Company... ASG



**ASG Industries Inc.**

The Glass Company P.O. Box 929, Kingsport, Tennessee

For more data, circle 119 on inquiry card



# The Architect specified galvanized rebar to prevent "bleeding"

To protect the new \$40,000,000 Levi Strauss building in San Francisco against rust "bleeding" through to the surface, John Portman and Associates, architects, specified galvanized rebar.

The building is constructed with precast concrete panels which means that the reinforcing steel is relatively close to the surface. Experience has shown that subsurface rusting of ungalvanized reinforcement can "bleed" through and disfigure the facade with ugly stains. In extreme cases, rebar corrosion can also build up pressures which crack and even spall the concrete.

Galvanizing metallurgically bonds a tough zinc coat to the steel reinforcement, developing an impermeable, corrosion resistant coating. Even if this coat is gouged through during shipping, storage or installation, the zinc continues to prevent rust by its second line of defense, galvanic sacrificial action. This dual protection has been proven over the years in many buildings.

When you design for lasting beauty, specify galvanized rebar.

**ST. JOE**  
MINERALS CORPORATION  
250 Park Avenue  
New York, New York 10017

Over 1,800 tons of galvanized steel reinforce the precast concrete in the new \$40,000,000 Levi Strauss building in San Francisco.





# discover Cramer...

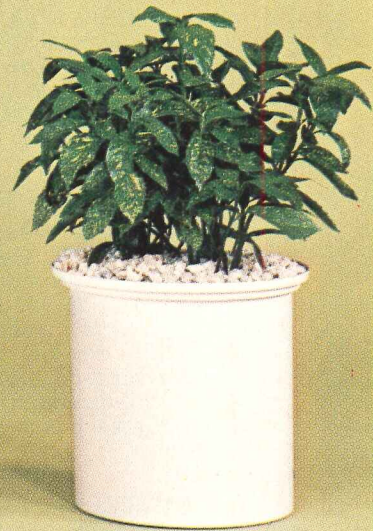
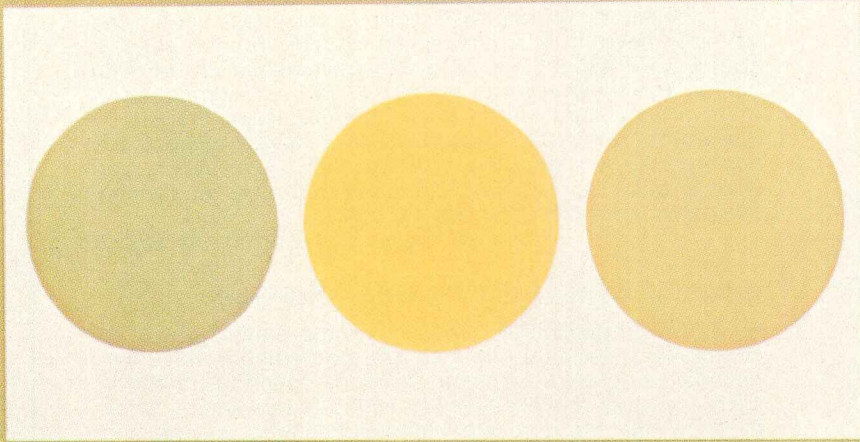

and you discover a choice

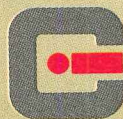

**CRAMER INDUSTRIES INC.**

625 Adams Street, Kansas City, Kansas 66105 Ph. (913) 621-6700

Showrooms in Chicago, Dallas, Kansas City, Los Angeles

Fiberglass Illustrated. Discover Cramer's full lines of wood, metal, fiberglass office furniture. Write for information.

For more data, circle 124 on inquiry card



# Books from McGraw-Hill on today's architecture

**SYMBOL SOURCEBOOK: An Authoritative Guide to International Graphic Symbols**

By **HENRY DREYFUSS**. This handbook, compiled by the world's foremost industrial designer, is the first single reference to graphic symbols used internationally in business, industry, the sciences, and in all walks of life. Valuable in symbol identification, design, and standardization, the book includes symbols used in Architecture, Business, Communications, Engineering, Handling of Goods, Manufacturing, Mathematics, Physics, Safety, Traffic, many other fields.

320 pages, illustrated, \$28.50

## MODEL BUILDING FOR ARCHITECTS AND ENGINEERS

By **JOHN TAYLOR, AIA**. This step-by-step working guide shows you how to build professional models of your architectural, engineering, and interior designs with *minimum effort and expense*. Photographs, drawings, diagrams, and plans demonstrate the steps to follow and the materials to use (including many new materials and synthetics.) It also shows how to represent a large number of traditional and contemporary building materials and effects.

160 pages, 185 illustrations, \$15.75

## MANUAL OF BUILT-UP ROOF SYSTEMS

By **C. W. GRIFFIN** for the American Institute of Architects. This volume discusses in detail each of the built-up roofing components: structural deck, vapor barrier, thermal insulation, membrane (including the new elastomeric membrane materials), and flashing. It reports the latest views on vapor barriers and examines new roofing specifications using coated base sheets. Focusing primarily on conventional built-up, multiply, felt-and-bituminous roofs, the book consolidates much vital information in convenient form.

256 pages, illustrated, \$15.50

## ARCHITECTURAL DELINEATION

A Photographic Approach to Presentation

By **ERNEST E. BURDEN**. This book shows you how to use photography—right at your drawing board, workbench, and in the field—to depict architectural projects in true perspective and to create an authentic relationship between proposed buildings and their surrounding environment. In easy-to-follow fashion, the author shows the actual workings of the photographic system and gives practical, proven solutions to every problem you might encounter.

288 pages, illustrated, \$18.50

## JOINT VENTURES FOR ARCHITECTS AND ENGINEERS

By **DAVID R. DIBNER**. Written primarily for architects, engineers, and contractors, this book discusses the *do's and don'ts* of temporary partnerships (generally called joint ventures) which are undertaken by several firms who are, individually, too small to take on a particular project by themselves. The book describes the relationships involved in this type of organization and discusses the advantages (and pitfalls) of joint ventures.

192 pages, \$16.50

## ENVIRONMENTAL ACOUSTICS

By **LESLIE L. DOELLE**. Created for professionals who are not experts in sound or noise control, this guide shows how everyday acoustic problems can be solved in practice. Keeping mathematics and physical details to a minimum, the book details simple, practical applications, with references to actual installations. The coverage ranges from basic principles and "how-to" information to follow-through procedures in actual construction.

288 pages, over 200 illustrations, \$18.50

## ANATOMY OF A PARK

By **ALBERT J. RUTLEDGE, ASLA**. This lively book presents a practical and analytical discussion of the essentials of good park design. It presents a system for evaluating the worth of a park design plan and a broad-scaled view of design criteria based upon behavioral science findings, relating to people's needs, both aesthetic and functional.

180 pages, 150 illustrations, \$15.95

## BETTER BUILDINGS FOR THE AGED

By **JOSEPH D. WEISS, AIA**. Here is the most timely and valuable book ever published on housing for the aged. It contains 77 successful, idea-packed designs for nursing homes and residences for the elderly by pace-setting architects in the United States, Canada, and Europe. Written by one of the nation's leading authorities on the subject, the book provides a practical guide on why, how, when, and what to build. A treasure-trove of photographs, renderings, site plans, and floor plans are included.

288 pages, 625 illustrations, \$22.50

## HOSPITAL MODERNIZATION AND EXPANSION

By **E. TODD WHEELER**. Written by the architect whose innovations in hospital planning and construction have won him international recognition, this book describes methods, both analytical and creative, by which the problems of expanding and modernizing hospital facilities can be successfully attacked. This master guide covers every step from the initial survey of needs to actual construction and equipment requirements.

288 pages, illustrated, \$22.50

**TOTAL DESIGN: Architecture of Welton Becket & Associates**

By **WILLIAM DUDLEY HUNT, JR., FAIA**. This book describes the philosophy and inner workings of a well-known architectural firm that, over the years, has developed a system of defining its client's needs and then imaginatively and creatively fulfilling those needs by following the "Total Design" concept. The author discusses and visually demonstrates how all aspects of architecture (i.e., programming, design, engineering, production, interior design, etc.) are effectively coordinated and handled.

244 pages, 546 illustrations (62 in color), \$22.50

## — 10 Days' Free Examination —

### Architectural Record

1221 Avenue of the Americas, New York, N.Y. 10020

Send me the following book(s) for 10 days' examination. I will either remit—plus local tax, postage, and handling costs—or return book(s) within 10 days. (Remit in full with coupon, plus local tax, and McGraw-Hill pays postage and handling costs.)

- 17837-2 — Symbol Sourcebook ..... \$28.50
- 62938-2 — Model Building for Architects and Engineers ..... 15.75
- 01489-2 — Manual of Built-Up Roof Systems ..... 15.50
- 08924-8 — Architectural Delineation ..... 18.50
- 16760-5 — Joint Ventures for Architects and Engineers ..... 16.50
- 17342-7 — Environmental Acoustics ..... 18.50
- 54347-X — Anatomy of a Park ..... 15.95
- 69071-5 — Better Buildings for the Aged ..... 22.50
- 69520-2 — Hospital Modernization and Expansion ..... 22.50
- 31298-2 — Total Design ..... 22.50

Name \_\_\_\_\_

Address \_\_\_\_\_

City \_\_\_\_\_

State \_\_\_\_\_ Zip \_\_\_\_\_

10-73 N

Order good only in the U.S. and subject to acceptance by McGraw-Hill.



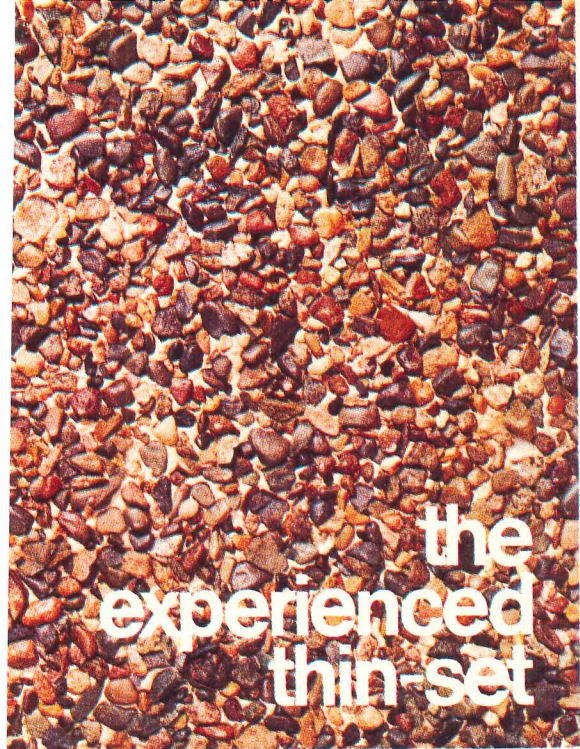

the  
experienced  
thin-set



Miami, Florida

**A textured environment with a sense for the future.**

Subtle texture or dramatic? Whichever you want in exposed aggregate walls, you can achieve it with H. B. Fuller Tuff-Lite® epoxy-based wall matrix. Proven by over a decade of use, it's as durable as it is beautiful for interior and exterior walls. It can be applied on-the-job or to panels off the job site.



Because it weighs far less than concrete, it's suitable for remodeling as well as new construction. Far more economical, too. It saves over stucco mastic systems, too, because it goes on directly over the substrate. There's no metal lath, scratch or brown

required. Tuff-Lite® is also weatherproof so it doesn't draw moisture and dirt through it.

H. B. Fuller also supplies light-weight, epoxy-based, seamless flooring systems suited to institutional and commercial as well as residential use. These thin-set floorings can be applied over most solid substrates.

For help with specifying, selection or application information call our toll free number — 800/323-7407.

**HB FULLER COMPANY**

Architectural Products Division  
315 S. Hicks Rd., Palatine, Ill. 60067, Dept. 513

For more data, circle 126 on inquiry card





# LEAD NEWSLETTER

FOR ARCHITECTS AND BUILDERS

Vol. 17, No. 5

## Data for your CSI-9 file

**Problem:**  
*How to locate a huge power generating plant in the midst of a "bedroom" community without generating noise problems as well.*

**Solution:**  
*Extensive use of lead sound barriers.*

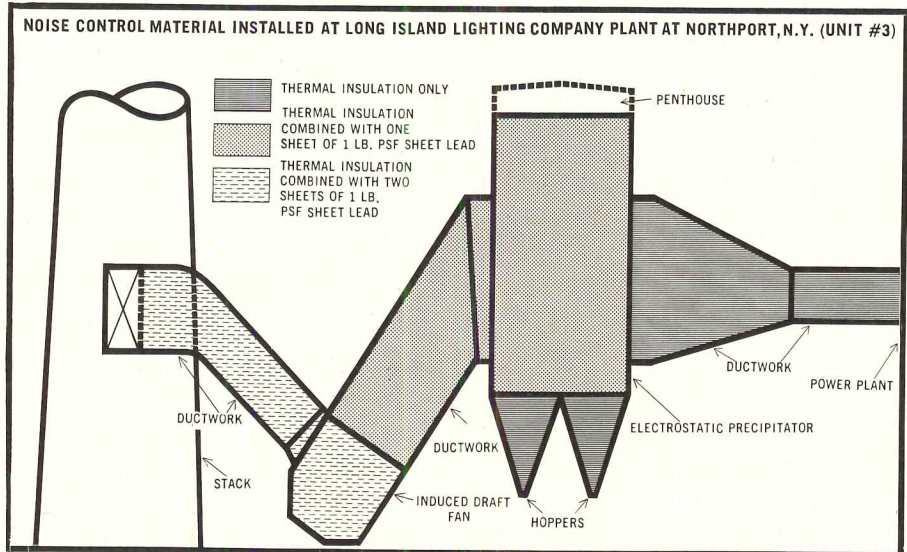

Induction draft fans used in utility air pollution control are powerful noise makers. But today's technology offers an answer in prefabricated, thermally insulated panels designed to provide noise reduction of up to 52 decibels. The panel is of layered construction. Five materials are used to produce the new thermal-acoustical panel: an exterior sheet of corrugated or box-rib galvanized steel or aluminum; a layer of mineral wool insulation; single or double layers of sheet lead sandwiched between one or more additional layers of mineral wool insulation; a layer of aluminum foil; and a wire mesh retainer on the sound-source side of the panel. The box-rib panels are commercially available in 40" widths; corrugated panels in 32" widths. There is a wide variety of lead sheet, lead vinyls and composites now at work helping industry comply with regulatory codes on noise.

Make sure your CSI file on sound insulation is complete. Write to Lead Industries Association, Inc., 292 Madison Avenue, New York, N.Y. 10017.

For more data, circle 125 on inquiry card



# Harbor...*the* system for both letter and legal filing in a single drawer.

We designed the Harbor Side File® with the idea that a business has more than one filing need.

The unique Side File drawer permits letter filing front to back or legal filing side to side.

Or filing in any combination of both... regular or hanging.

In addition, the Side File is available so many ways you'll be able to use it throughout the building.

Another unit, the unique Mobile Side File, allows you to move records and files quickly and easily to any locations in your facility.

A special data processing system neatly holds both large and small items from tab cards and microfilm to print-outs and disc packs.

And the Micro Center® is ideal for accepting combinations of microfiche, tab cards, signature cards, checks, as well as letter and legal size files.

Every Harbor Side File features our proven suspension design so the drawers open and close with a touch. And special safety interlock will not permit a second drawer to be opened when one drawer is already open.

The Harbor Side File comes in a complete range of sizes and file arrangements, including half-height drawers.

Together with File-Ons, sliding door cabinets, and recessed adjustable shelf files, they can be used to create a highly functional Office Landscape or working wall. They are all available in 25 mix or match color combinations, as well as in optional vinyl teak and walnut fronts and matching tops.

For more information on a filing system today that keeps pace with tomorrow's business, contact your local office furniture dealer. Or call or write Harbor Universal Inc., 1900 Marina Boulevard, San Leandro, California 94577, (415) 352-2100.

# Harbor

Solving tomorrow's office needs today

**Harbor Representatives:** Allentown — London Associates (301) 299-4941; Atlanta — Institutional Associates (404) 255-6460; Boston — Edward McKearney (617) 482-1862; Chicago — Donal Wolgemuth (312) 654-0545; Cleveland — Davis & Associates (216) 333-9665; Dallas — Glenn Hennings (214) 651-1556; Denver — Jack Nicoulin (303) 388-5272; Grand Rapids — George Reinhard (616) 459-2051; Kansas City — Lyons & Associates (913) 888-3504; Los Angeles — Harbor Universal (213) 724-3757; Milwaukee — Brian Wilburn (414) 284-2900; Nashville — Charles C. Whitehead (615) 832-3134; New York City — Heide-Lifton Associates (212) 689-1338; Washington, D.C. — London Associates (301) 299-4941.

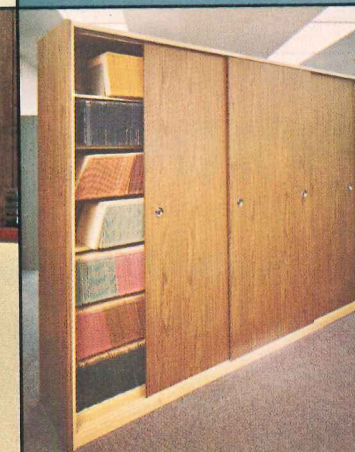
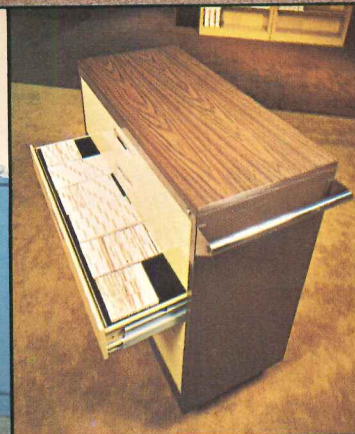



# Our photoelectric smoke detector story.

## You should read it.

Our story clears up a lot of misconceptions about what photoelectric smoke detectors do (reflected light type). And about what ionization smoke detectors do (or don't do). It points out that photoelectric detects the incipient fire and that ionization rarely does. That photoelectric requires *less* maintenance than ionization. That photoelectric is *more* reliable than ionization.

It points out that more and more key people in government agencies, testing organizations, insurance firms and OEM's are realizing these facts. And that many of these people are now going photoelectric.

Please. You've got big investments to protect. You should know the truth in this area. You should learn the facts. Just send this coupon to Pyrotec, 333 Lincoln Street, Hingham, Mass. 02043. Or call Joe Petkunas at (617) 749-3466 for some straight, hard facts.

And after you read our photoelectric story, we think you will specify our photoelectric smoke detectors.

Name \_\_\_\_\_

Company \_\_\_\_\_

Address \_\_\_\_\_

City \_\_\_\_\_ State \_\_\_\_\_ Zip \_\_\_\_\_

# PYROTECTOR

The photoelectric way.

For more data, circle 129 on inquiry card

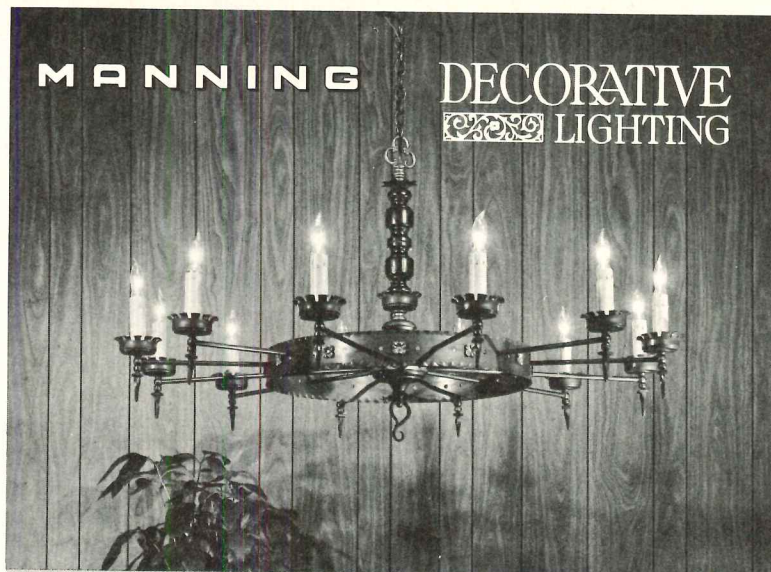

NEW

Complete line of decorative lighting equipment—specifically designed for commercial interiors.

REQUEST FULL COLOR CATALOG "M"

R. A. **MANNING** COMPANY INC.

P.O. BOX 643 SHEBOYGAN, WIS. 53081

For more data, circle 131 on inquiry card

Let an expert show you how to use office space for maximum efficiency . . .

## OFFICE PLANNING AND DESIGN

By MICHAEL SAPHIER

193 pages, 54 illustrations, \$15.00



If you are concerned in any way with office planning and design, this practical work—considered *the* standard since publication—offers thorough coverage of the subject for architects, designers, office managers, and business administrators. It presents space planning and the design effort in the logical sequence of an actual project, and shows you how to analyze a client's space requirements, how to obtain the space, how to set up a building program, how to prepare a space study, how to budget a project, and how to prepare drawings and photos that illustrate design solutions to functional problems. The book is supplemented with examples from the author's highly successful design firm.

### TWELVE INDISPENSABLE CHECKLISTS ARE AMONG THE BOOK'S MANY SPECIAL FEATURES

- |   |                        |
|---|------------------------|
| 1. Operational Requirements             | 7. Space Study         |
| 2. Departmental Questionnaire           | 8. Work Letter         |
| 3. Inventory                            | 9. Design Presentation |
| 4. Design And Construction Requirements | 10. Working Drawings   |
| 5. Tabulation Form                      | 11. The Move           |
| 6. Evaluation Report                    | 12. Project Procedures |

Available from your bookseller or from  
**McGRAW-HILL BOOK COMPANY**

Dept. 23-F597-4000-3  
1221 Avenue of the Americas, New York, N.Y. 10020





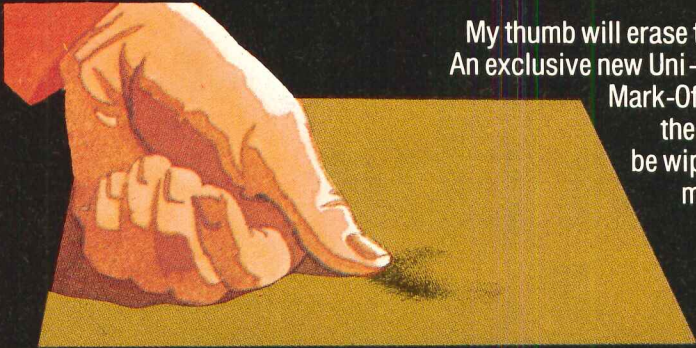

My thumb will erase this black heel mark. An exclusive new Uni-Turf® coating called Mark-Off keeps grime above the surface where it can be wiped away. That's low maintenance. It's part of every Uni-Turf installation. And only Uni-Turf.

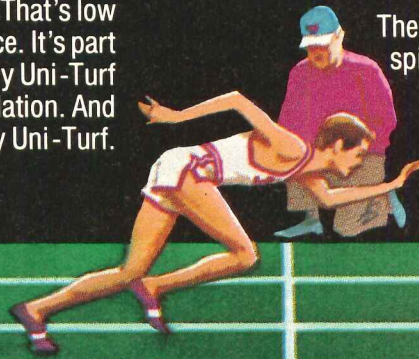

The track team is wearing spikes. It's okay though, because Uni-Turf is made of durable vinyl plastic to take that kind of punishment.

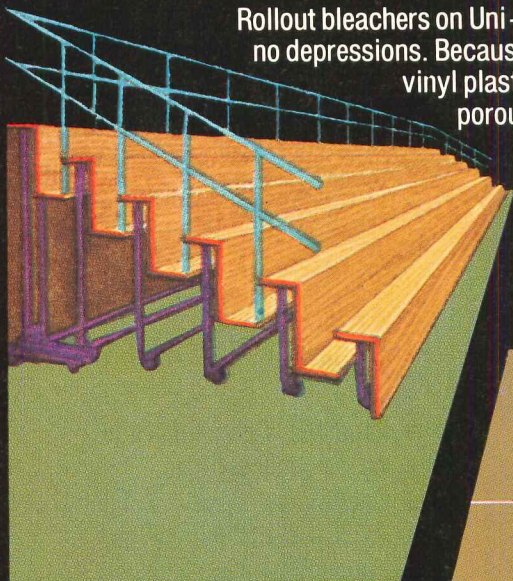

Rollout bleachers on Uni-Turf . . . no wheel marks, no depressions. Because it's an extremely dense vinyl plastic material. And it's non-porous . . . no stains, no warp.

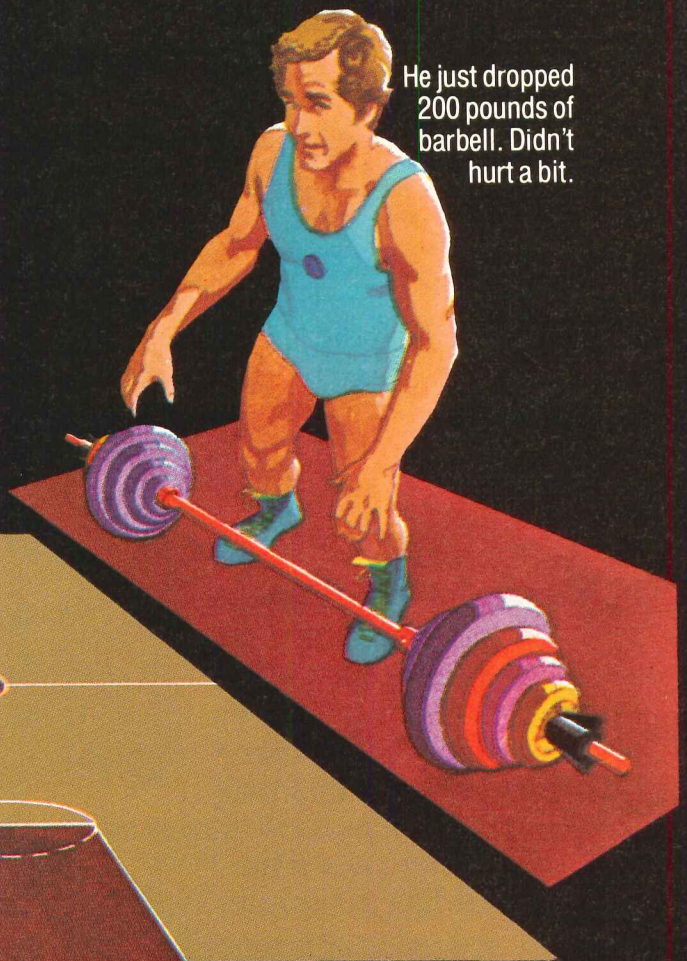

He just dropped 200 pounds of barbell. Didn't hurt a bit.

We make Uni-Turf in two different textures and five colors. So you can make the play any way you want . . . design-wise.

# Nobody leaves his mark on Uni-Turf®

Tell me about Uni-Turf for use in —

AR1073

- Field Houses     Tracks     Have representative call  
 Gyms     Tennis     Other \_\_\_\_\_

NAME \_\_\_\_\_ TITLE \_\_\_\_\_

COMPANY/INSTITUTION \_\_\_\_\_

ADDRESS \_\_\_\_\_

CITY \_\_\_\_\_ STATE \_\_\_\_\_ ZIP \_\_\_\_\_

**UNI-TURF®**  
 Sports Surfaces Department  
 American Biltrite Rubber Co., Inc.  
 P. O. Box 1071 Boston, Mass. 02103  
 For more data, circle 132 on inquiry card



# When we started to design the Mark II Blind we were just this far from a breakthrough.

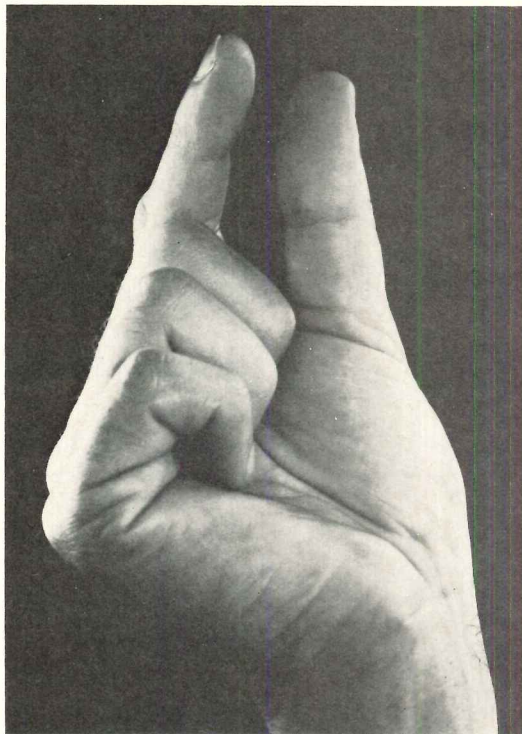

We set out to design the slimmest, smoothest working narrow-slat blind possible. And now we've done it. We attacked the cumbersome headrail

problem, and designed out  $\frac{3}{8}$ ", giving us a trim 1"x1". No other blind has a slimmer head than that!

Why go to all this trouble for a headrail?

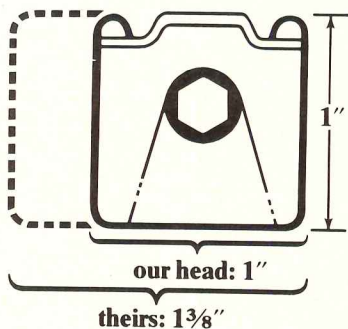

Because we know the architect or designer would like to see us disappear. So our 1" head and bottom rails aesthetically blend into the blind. Open or fully closed, the Mark II rails are virtually unseen. And a full range of decorator colors

provides total flexibility of design coordination. The reason you can't do without us is function, of course. The Mark II has been engineered for

maximum glare reduction and heat gain control. We made internal improvements too, like the crash-proof lock that snubs the cords without tearing them. And the smooth tilt-action that's responsive to the lightest touch. And the spring-tempered slats that won't bow or sag.

Now that we've completed the Mark II, we know we were right! We were on top of a breakthrough!

## Venette Mark II Blind

For complete details, specifications and color selection, write Alcan Building Products, 4519 Mahoning Avenue, N.W., Warren, Ohio 44483

**Alcan Aluminum Corporation**



For more data, circle 133 on inquiry card





# The Perfect Blend:

## American Concrete Light Poles...and the architecture, landscape, and luminaires of planned environments.

Whether for street or area lighting, there is an American Concrete Stress-Spun® pole in a design and color to blend with the motif of the environment.

Colors are not just skin deep; they go all the way through. The combination of the great density and strength of prestressed spun concrete resists the elements and minimizes vandalism to give Stress-Spun® concrete poles long-lasting, carefree beauty. Their polished, texturized surfaces consist of attractive hues that improve with age.

Select from popular mounting heights with interior wiring raceways, plus a choice of bases, including pre-cast foundations for fast, economical installations.

Consider the benefits of beauty, durability and economy when specifying light poles. Install Stress-Spun® concrete poles and receive the perfect blend — in more ways than one.

**Call or write: Union Metal Manufacturing Co.,  
P.O. Box 8530, Canton, OH 44711. Ph. (216) 454-6111.**

**We've got what it takes!**

**American Concrete**  
Division of **Union METAL**  
MANUFACTURING COMPANY





Marshall County Public Library  
 Benton, Kentucky  
 Architects: Lee Potter Smith Associates  
 Paducah, Kentucky  
 Project Architect: Gayle R. McGregor  
 Framing Contractor: Lassiter Plastering Company  
 Murray, Kentucky

## Four good reasons for considering Inryco™/Milcor® light gage steel framing when designing small buildings.

Design freedom, versatility, fast enclosure and economy . . . the benefits that make light gage steel framing so popular for the exterior walls of multi-story construction . . . can also be enjoyed on smaller buildings. Here are a few comments from project architect, Gayle McGregor, concerning the library pictured above:

"The variety of possible finishes available was an obvious advantage."

"Site conditions complicated the footings and foundation design. Light gage framing enabled us to cut down on bearing weight!"

"We were able to save about one

square foot of floor space for every two lineal feet of wall . . . a value of about five thousand dollars on this small project."

"Prefabricating framing assemblies in the shop saved on-site time and helped us meet a tough winter construction schedule."

"We have gone on to six other projects using the same systems, including an elementary school that ran \$15 per square foot compared to the \$22 per square foot statewide average for this type of facility."

There are further advantages we haven't covered here. See Sweet's, section 5.3/In; send for catalog 37-1;

or let a Milcor representative explain how they apply to one of your projects. Write to: Milcor Division, Inland-Ryerson Construction Products Co., Dept. F, 4033 W. Burnham St., Milwaukee, WI 53201.

**INLAND**   
**RYERSON**

General Offices: Melrose Park, Illinois

A member of the  steel family

For more data, circle 135 on inquiry card



# Soft Sell.

Ask your clients to step on the carpeting of their choice with and without padding. The difference in plushness will be obvious. The sale will be easy.



For more data, circle 137 on inquiry card

# WON'T BREAK DOWN

**TRANS-LOGIC™** pneumatic tube systems are super-reliable. Carriers can't open in transit. System 400's computer pinpoints trouble spots before trouble begins. All systems use solid state logic control to regulate carrier flow. No traffic jams. 4" and 6" dia. carriers.

Trans-Logic, the breakthrough system.



## POWERS

Powers Regulator Co. Transitube Division  
Skokie, Illinois 60076



For more data, circle 138 on inquiry card

## OVERHEAD ENCLOSURES

Structural Design Requirements for Dome Skylights.

An aid to designing and writing specifications for dome skylights of Plexiglas used individually, in rows, in grids and in dome enclosures. 20 pages.

## SOLAR CONTROL

Transparent Plexiglas Solar Control Series

This 20-page, four-color brochure describes a number of solutions for controlling solar heat and glare. Includes formulae for total heat transfer calculations.

## SUNSCREENS

Sunscreen Innovations With Plexiglas

Brochure contains information on sunscreen structural designs, methods of controlling light levels and the control of glare and solar heat gain with its energy conservation benefits. 24 pages.



# GET YOUR PLEXIGLAS® DAYLIGHT CONTROL LIBRARY!

Helpful literature for the architect on the use of Plexiglas acrylic sheet



PHILADELPHIA, PA. 19105

Plexiglas acrylic plastic is a combustible thermoplastic. Observe fire precautions appropriate for wood or paper products. For building uses, check code approvals. Impact resistance a factor of thickness. Avoid exposure to heat or aromatic solvents. Clean with soap and water. Avoid abrasives.

For more data, circle 139 on inquiry card



Britain's finest international architectural and design magazine

# The Architectural Review

The Architectural Review is read and enjoyed in major architectural and planning practices and by people with an interest in buildings and fine design in a hundred countries. It is one of the world's important publications. Each month The Architectural Review is studied, quoted and argued about for its views on topography and townscape and for its thorough and thoughtful criticism of new buildings and their interiors. Then it is kept for future reference.

It has a reputation for superb photo-journalism, for fine detailed drawings and for a positive and creative approach to criticism of significant buildings and the problems of the built environment. Sometimes most of a complete issue is devoted to an interesting complex of buildings or to a single subject. These special issues can become standard works of reference. Years afterwards architects and planners ask us for back numbers on specific subjects. Almost every

month interior design is featured and the current art scene is reviewed. The Review has a long history of encouragement to architectural and planning innovation and is continually searching for new talent. Awards are not usually given to publications in the UK but recently the Italian government's Gold Medal was awarded to The Architectural Review for outstanding international services to the better design of the human environment. The editorial

director in 1971 won the annual Royal Gold Medal of the RIBA (previous holders included Buckminster Fuller, Le Corbusier, Lewis Mumford, Mies van der Rohe, Walter Gropius) and the retiring editor recently won the Royal Society of Arts Bicentenary medal. Recent editorial excellence is, apparently, being maintained as current sales of the Review are higher than ever before in its 76-year history.

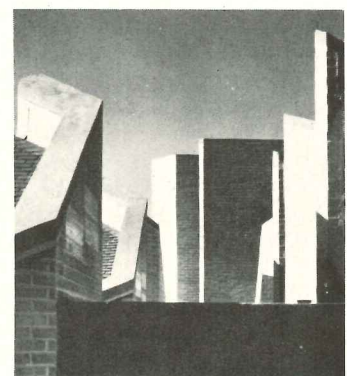
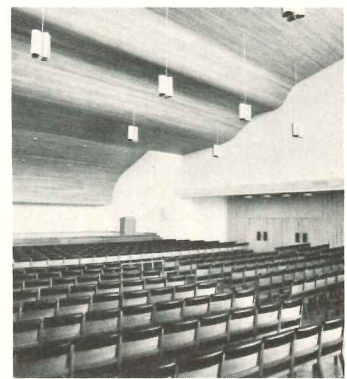
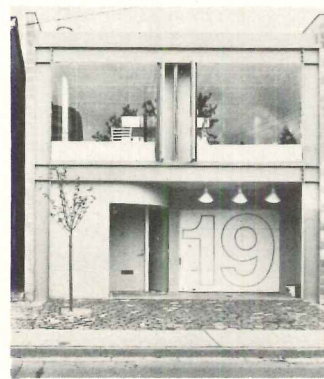
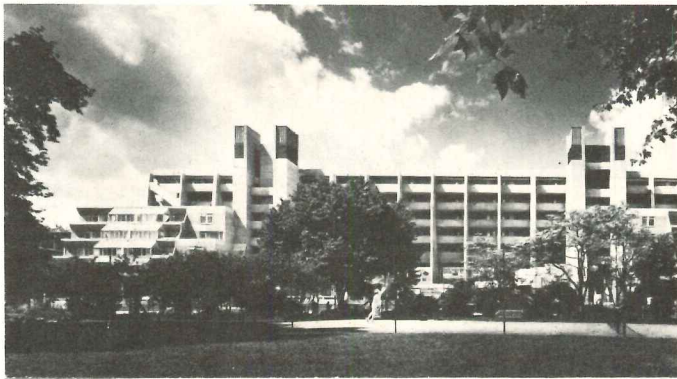

The Architectural Review is a valuable professional aid for busy practices. An annual subscription also makes a memorable all-the-year-round present for friends and colleagues. To see this provocative and professionally-stimulating publication regularly, please fill in and send off this coupon :

Please send me The Architectural Review monthly (12 copies) at the annual post-paid subscription rate of \$30.

MY NAME/POSITION \_\_\_\_\_

MAILING ADDRESS \_\_\_\_\_

Country \_\_\_\_\_

Type of Firm \_\_\_\_\_

I understand that the current issue will be despatched on your receipt of my cheque/int. money order/bankers draft.  
 Payment enclosed.

Signature \_\_\_\_\_

AR10-73

Indicate as appropriate.

- Architect
- Engineer
- Other

The Architectural Press Ltd,  
 Dept R, Registered Office  
 9 Queen Anne's Gate, Westminster,  
 London SW1H 9BY, England.

Registered England 75921



# The Big Sit-In



**astro/lounger**

Massey has the solution to your deep-seated problems — a big, luxurious oversized lounger featuring three-pillar back support, with full depth foam cushion and back. You can always rest assured that the Massey Astro-Lounger will answer your seating questions most comfortably. Also available as the Astro-Rocker.

You're always sitting pretty with

**Massey**  
seating co.  
NASHVILLE, TENNESSEE 37208

**S** FOR REFERENCE SEE SWEET'S ARCHITECTURAL CATALOG FILE 12.5 MA.

For more data, circle 140 on inquiry card

# GOOF PROOF



**TRANS-LOGIC™** pneumatic tube systems are people-proof. Carrier can't be dispatched until closed properly. Can't open in transit. Can't be inserted wrong. All terminals standard—anyone who can operate one—can operate them all. No mistakes possible in dispatching or receiving. 4" and 6" dia. carriers.

Trans-Logic,  
the breakthrough  
system.



**POWERS**

Powers Regulator Co. Transitube Division  
Skokie, Illinois 60076

For more data, circle 141 on inquiry card

## Stains, Waxes, Seals...in one operation

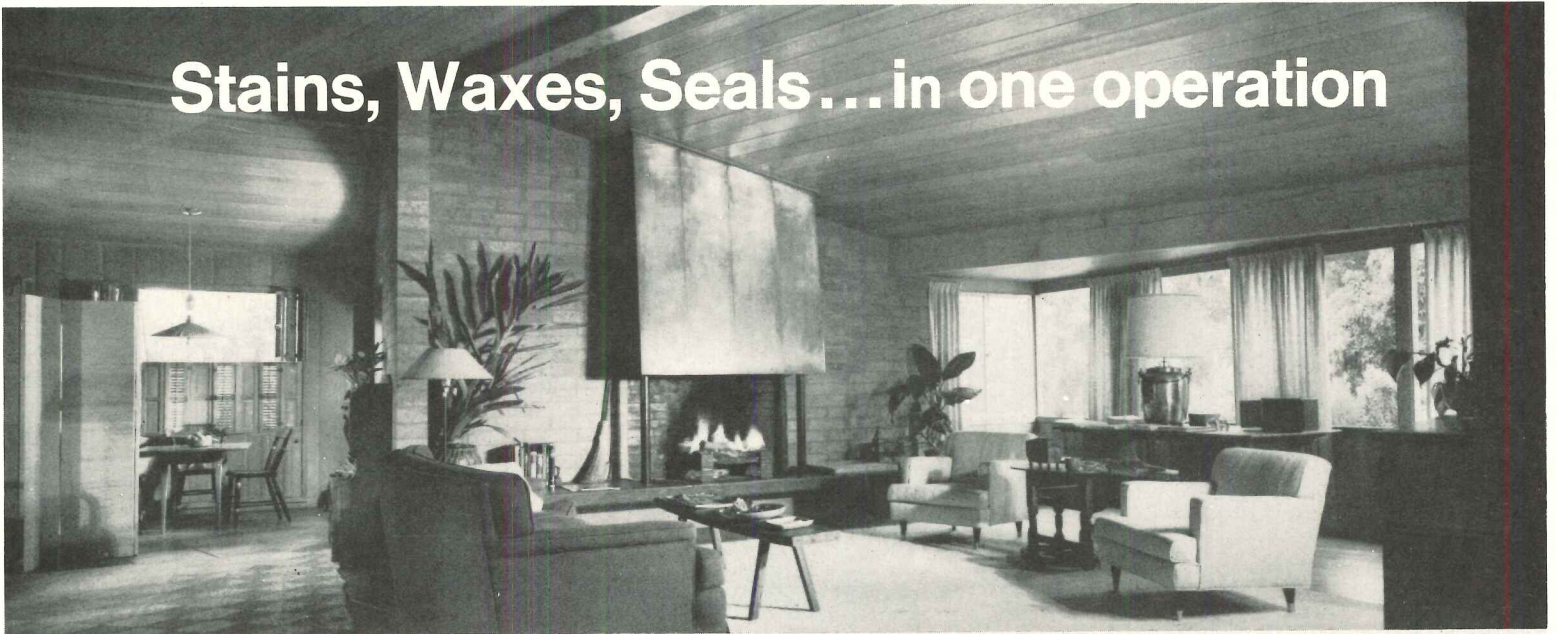

California home; Designer: Russell Forester, La Jolla, California; Cabot's Stain Wax on all interior woodwork

# Cabot's STAIN WAX



This unique "three-in-one" finish, suitable for all wood paneling, beams, and woodwork, brings out the best in wood, enhancing the grain and producing a soft, satin finish in a choice of thirteen colors plus ebony, white, and natural. When a flat finish is desired, specify Cabot's Interior Stains for all interior wood surfaces.

### Samuel Cabot Inc.

One Union Street, Dept. 1029, Boston, Mass. 02108

- Send color cards on Stain Wax and Interior Stains
- Please send Cabot's handbook on wood stains

---



---



---

For more data, circle 142 on inquiry card



**IF YOU JUST SPECIFIED I-BEAMS FOR  
A 10,000 SQUARE-FOOT ROOF,  
GO BACK TO THE DRAWING BOARD.**

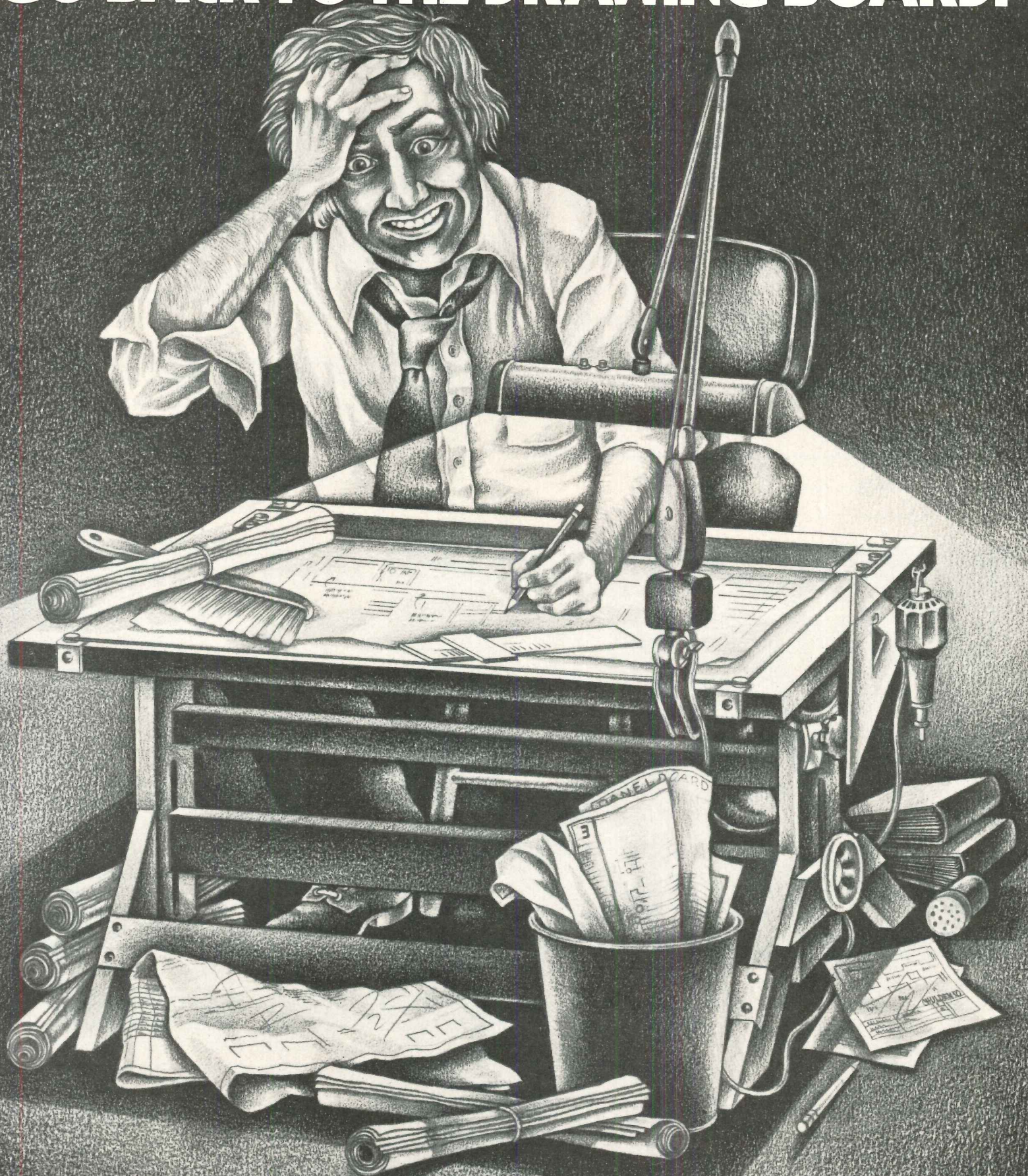



And specify something better. Joist girders. A more economical roof-framing system for anything over 10,000 square feet.

Now in volume production at all five Vulcraft plants.

Joist girders. Simple supported joists that carry concentrated loads such as bar joists at top chord panel points and that incorporate a modified Warren truss configuration using hot rolled double angle sections for top and bottom chords and single and double angle sections for web members.

Which is harder to explain than I-beams.

But easier to specify and erect.

For example, the simple span design of joist girders makes ponding calculations easy.

It speeds design time. It makes larger bay sizes possible. And it reduces the number of foundations and columns required. In a most spectacular way.

So when you go back to the drawing board, you won't end up with writer's cramp.

Then, after the drawing and shouting and groundbreaking are over—even greater economy begins to emerge.

Economy from the high strength-to-weight ratio of joist girders.

Economy from fast erection of the simple span sections.

Economy from faster bar joist erection. With top chord panel points indicating joist location and making any measurements unnecessary.

Then, to make the trades happy, there's the fact that you can run ducts, conduit and piping through joist girders. Which even Houdini couldn't do with I-beams.

This could go on forever.

But you have to get back to the drawing board. And before you do that, you'll need our Joist Girder Specification Guide.

So let us tell you how to get one:

Contact your nearest Vulcraft sales office. Or write P.O. Box 17656, Charlotte, N.C. 28211. Or call us at (704) 366-7000. Do that. And simplify your design task, your structures, and your life.

Vulcraft. Division of Nucor Corporation. Florence, S.C.: Fort Payne, Ala.: Grapeland, Tex.: Norfolk, Neb.: Saint Joe, Ind.

Members of the Steel Joist Institute. **VULCRAFT.**

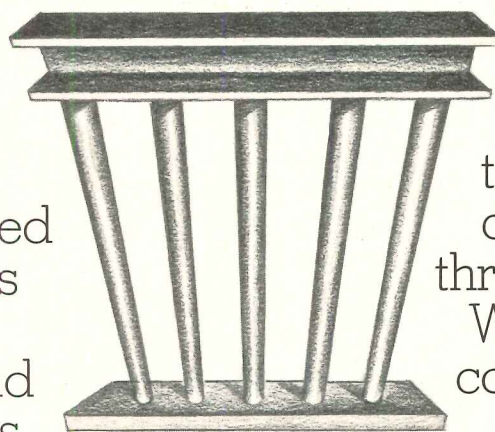

**I-BEAMS**

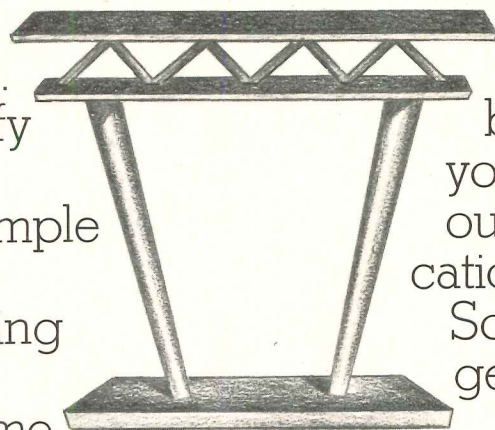

**SOMETHING BETTER**



# RECORD IMPRESSIONS

A convenient service offering reprints, reports and back issues

## RECENT LISTINGS

- ③⑧ THE YOUNG ARCHITECTS 56 pgs. 4-color 1.00 per copy
- ③⑨ RECORD HOUSES 1972 3.25 per copy
- ④⑩ RECORD INTERIORS of 1973 16 pgs. 4-color 1.00 per copy
- ④① ROLE OF THE ARCHITECT IN DEVELOPMENT HOUSING  
16 pgs. 2-color 1.00 per copy
- ④② PRODUCT REPORTS 1973 3.00 per copy
- ④③ MUSEUMS (JULY 1972) 16 pgs. 4-color 1.00 per copy
- ④④ CORPORATE OFFICES 16 pgs. 4-color 1.00 per copy
- ④⑤ STORES AND SHOPS 18 pgs. 4-color 1.00 per copy

## INTERIORS

- ③ RECORD INTERIORS of 1971 20 pgs. 4-color .50 per copy
- ②① SIX INTERIORS—AUGUST 1971 12 pgs. 4-color .50 per copy

## SPECIAL REPORTS

- ⑤ CREATING CONSOLIDATED CLINICAL TECHNIQUES SPACES FOR  
AN EXPANDING ROLE IN HEALTH CARE 8 pgs. 4-color .50 per copy
- ⑭ SEALING JOINTS: 1968 SPECIAL REPORT  
8 pgs. 2-color .50 per copy
- ⑰ PLANNING DISCIPLINES FOR AUDIO-VISUAL FACILITIES  
16 pgs. 4-color 1.00 per copy
- ⑲ ROUND TABLE ON ENERGY CONSERVATION THROUGH HIGHER QUALITY BUILDING  
8 pgs. B&W .50 per copy
- ⑳ NEW METHODS FOR EVALUATING  
LIGHTING SYSTEMS 6 pgs. 2-color .50 per copy
- ㉓ NEW LIFE FOR OLD BUILDINGS 58 pgs. 4-color 1.00 copy
- ㉔ SOLVING TODAY'S CURTAIN WALL PROBLEMS  
8 pgs. B&W .50 per copy

## PRACTICAL REFERENCE

- ⑨ AIR CONDITIONING: A NEW INTERPRETATION  
Updated reports from 1967, 1969, 1970  
64 pgs. 2-color softbound 4.95 per copy

## BACK ISSUES

- ⑩ RECORD HOUSES 1968—2.00 per copy
- ⑫ RECORD HOUSES 1970—2.00 per copy
- ⑬ RECORD HOUSES 1971—2.00 per copy

## BUILDING TYPE STUDIES

- ④ MUSEUMS (JUNE 1969) 16 pgs. 4-color .50 per copy
- ⑥ DESIGN FOR MERCHANDISING 16 pgs. 1.00 per copy
- ⑧ AIRPORTS 16 pgs. B&W 1.00 per copy
- ⑪ CORRECTIONAL ARCHITECTURE 16 pgs. 2-color .50 per copy
- ⑬ CAMPUS DESIGN FOR SUCF—AN ANALYSIS OF EXCELLENCE  
24 pgs. 2-color 1.00 per copy
- ⑮ BUILDING FOR A BROAD SPECTRUM OF HEALTH CARE  
16 pgs. B&W 1.00 per copy
- ⑰ URBAN HOUSING: 30 pgs. 2-color 1.00 per copy
- ⑲ LOW-INCOME HOUSING 16 pgs. 4-color 1.00 per copy
- ㉒ 5 CONTEMPORARY SCHOOLS 14 pgs. B&W .50 per copy
- ㉔ DESIGN FOR A VARIETY OF CAMPUS LIFESTYLES  
18 pgs. 4-color .50 per copy
- ㉖ SHOPPING MALLS IN SUBURBIA 16 pgs. 4-color 1.00 per copy
- ㉘ SUBURBAN OFFICE BUILDINGS 16 pgs. 4-color 1.00 per copy
- ㉚ INDUSTRIAL BUILDINGS 16 pgs. 4-color 1.00 per copy
- ㉜ HOSPITAL PLANNING RESEARCH 18 pgs. 4-color 1.00 per copy
- ㉞ HOUSING: ONE GOVERNMENT AGENCY REACHES FOR  
GOOD ARCHITECTURE 16 pgs. 4-color 1.00 per copy
- ㉟ RESORT HOTELS 16 pgs. 4-color 1.00 per copy

## PREPAID ORDERS ONLY

Record Impressions  
ARCHITECTURAL RECORD  
1221 Avenue of the Americas  
New York, New York 10020  
Att. Joseph R. Wunk

No. of copies

- |         |         |         |          |
|---------|---------|---------|----------|
| ③ _____ | ⑩ _____ | ⑲ _____ | ③③ _____ |
| ④ _____ | ⑪ _____ | ⑳ _____ | ③④ _____ |
| ⑤ _____ | ⑫ _____ | ㉑ _____ | ③⑤ _____ |
| ⑥ _____ | ⑬ _____ | ㉒ _____ | ③⑥ _____ |
| ⑧ _____ | ⑭ _____ | ㉓ _____ | ③⑦ _____ |
| ⑨ _____ | ⑮ _____ | ㉔ _____ | ③⑧ _____ |
|         |         | ㉕ _____ | ③⑨ _____ |
|         |         | ㉖ _____ | ④① _____ |
|         |         | ㉗ _____ | ④② _____ |
|         |         | ㉘ _____ | ④③ _____ |
|         |         | ㉙ _____ | ④④ _____ |
|         |         | ㉚ _____ | ④⑤ _____ |

Enclosed is my check  Money order  for \$ \_\_\_\_\_  
please include local sales tax

NAME \_\_\_\_\_

FIRM \_\_\_\_\_

ADDRESS \_\_\_\_\_

CITY/STATE \_\_\_\_\_ ZIP \_\_\_\_\_

valid through 12/31/73



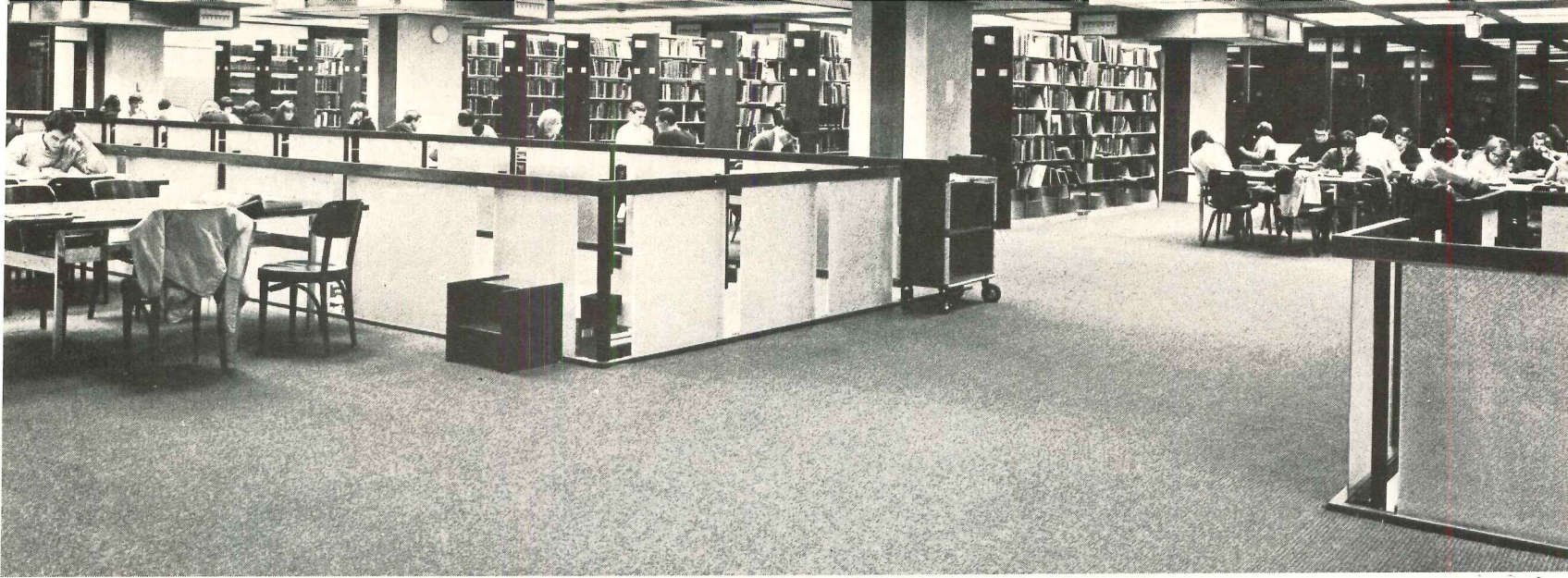

# School after school after school gives top grades to proven carpet by Bigelow.

If you're doing a school job, you can create your own specifications for the carpet you want. And we can make it for you.

However, Bigelow has another practical suggestion: specify carpeting that has already proven it can take the hard use (not to mention abuse) youngsters deal out. Carpet that has repeatedly demonstrated it can take a beating year after year after year.

Bigelow has that kind of proven in actual school use carpeting ready for you in a wide selection of carpet styles and patterns. Carpet that is the result of research and development combined with the realistic experience gained in hundreds of school installations.

And Bigelow will do more than just sell you proven carpet. We'll give you expert counselling in installation and through our Karpet Kare® Division, we'll give you the best advice available on maintenance. It's a total package designed to assure you that you can specify Bigelow with total confidence.

Bigelow-Sanford, Inc. Dept. A  
140 Madison Avenue, New York, N.Y. 10016

I'd like to hear the proof on Bigelow's proven carpets for schools.

NAME \_\_\_\_\_ Print Clearly

TITLE \_\_\_\_\_

ADDRESS \_\_\_\_\_

CITY \_\_\_\_\_

STATE \_\_\_\_\_ ZIP \_\_\_\_\_

**Bigelow**<sup>®</sup>  
RUGS & CARPETS SINCE 1825

AMERICA'S MOST EXPERIENCED CARPET MAKER

For more data, circle 145 on inquiry card







For every dollar invested  
**ZONOLITE Masonry Fill**  
 Insulation returns  
 up to 48% every year.

**ZONOLITE®** Masonry Fill Insulation, poured into cores or cavities of masonry walls, usually reduces heat loss by 50%—and more in some cases.

To the owner, this means his insulation cost is paid back to him in two or three years. Then savings continue year after year. A fact that should be of importance to every specifier or builder.

Heating and cooling savings are impressive in every area. Example:

	Chicago	Atlanta	Mpls.	Phila.	Denver
Combined Heating/Cooling Savings*	\$6400	\$3500	\$8150	\$6450	\$5400
Installed Cost of Insulation	1700	1700	1700	1700	1700
Average Annual Return on Insulation Investment	38%	21%	48%	38%	32%

\*10-year savings from insulating walls; 8" lightweight block; 2-story office building, net exterior wall area 10,000 sq. ft.

The new **FHA** standards for multi-family housing require masonry walls to have a heat loss factor ("U" value) no higher than .17. **ZONOLITE Masonry Fill** is the most economical way to bring block walls into conformance—as low as 17 cents per square foot installed, for 8" block.

In addition to cost savings, consider these important features:  
**Improves comfort**—Inside wall temperatures are increased up to 13°F. in winter. Body-to-wall radiant heat loss is reduced. Greater comfort results. Summer conditions are improved, too.

**Increases fire resistance**—Adding **ZONOLITE Masonry Fill** to a 2-hour fire-rated lightweight block gives more than four hours extra protection—earns 4-hour UL rating.

**Cuts sound transmission**—Users report that **Masonry Fill** in exterior or party walls improves the sound resistance.

For full information, contact your **ZONOLITE** sales office. Or send for booklet MF-164A, to Construction Products Division, W. R. Grace & Co., 62 Whittemore Avenue, Cambridge, Mass. 02140.



**CONSTRUCTION PRODUCTS**

For more data, circle 146 on inquiry card



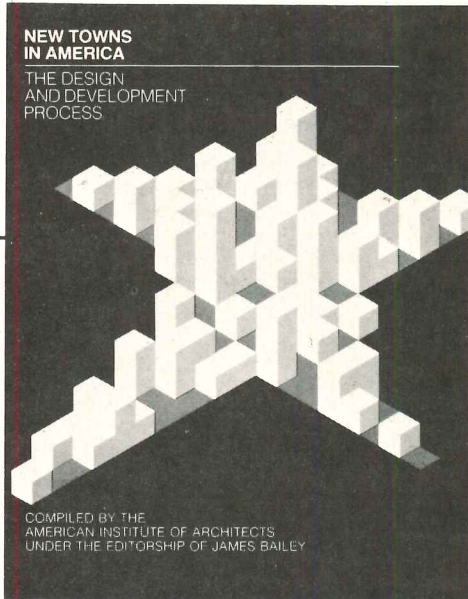

GET IT  
FROM  
THE  
HORSE'S  
MOUTH.

The AIA compiled 22 essays by new town experts so you can learn about the design and development of new towns from the people who've done it.

So you can, for instance, hear what Robert Tennenbaum, who's developed new community projects in many states, says about "Social Planning and Programming." How Alan M. Voorhees, a planner of many new towns including Reston, assesses "The Transportation System." And what Thomas Ludlow Ashley, a man who's helped pass landmark housing and development bills, thinks about "The Promise of Title VII."

There are 32 comparative new town plans so you can see first-hand how new towns evolved—plans of Philadelphia in 1865 and New Orleans in 1722 to Welfare Island and Soul City, North Carolina in 1972.

And the AIA included their National Policy Task Force Report so you can find out *verbatim* how lethal they feel America's architectural environment is, and what they propose to do about it.

In addition to the experts you'll learn from in the text, there's a bibliography of other books, magazine and news articles, reports and hearings you can go to.

*New Towns in America*. The people who wrote it know what they're talking about.

Send your coupon to Dept. 600 and receive your copy of—

**NEW TOWNS IN AMERICA:**

The Design and Development Process compiled by the American Institute of Architects under the Editorship of James Bailey, Consultant, Henry J. Kaufman & Associates, Washington, D.C. 1973 165 pages \$19.95

**WILEY-INTERSCIENCE**

a division of JOHN WILEY & SONS, Inc.  
605 Third Avenue, New York, N.Y. 10016  
In Canada: 22 Worcester Road, Rexdale, Ontario



WILEY-INTERSCIENCE • Dept. 638 •  
605 Third Avenue, New York, New York 10016

Please send me AIA's *New Towns* . . . 0-471-00975-X . . . \$19.95

- My check (money order) for \$19.95 is enclosed.
- Please bill me.\*

Name \_\_\_\_\_ Company \_\_\_\_\_

Address \_\_\_\_\_

City \_\_\_\_\_ State \_\_\_\_\_ Zip \_\_\_\_\_

Price subject to change without notice.

\*Restricted to the continental United States.

Please add state and local taxes where applicable.

093-A-4115-WI

For more data, circle 147 on inquiry card

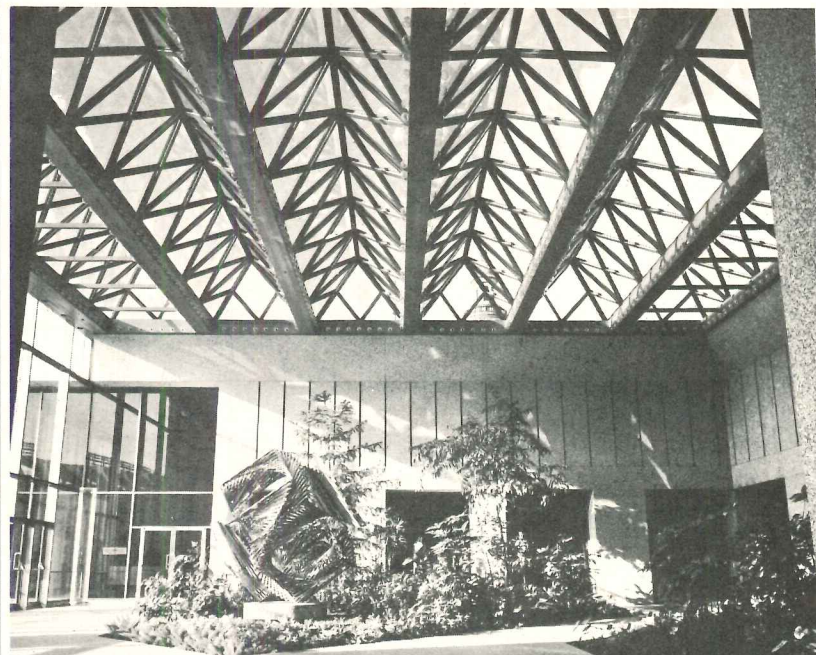

**IBG**

Natural Light  
Through Glazed Structures!

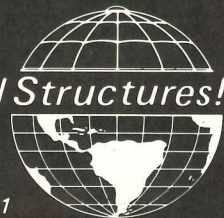

**ICKES-BRAUN GLASSHOUSES**

P.O. Box 147 Deerfield, Illinois 60015 312-634-3131  
Division of Roper Corporation

See us in Sweet's 13.1/1b-7.8/1b

For more data, circle 148 on inquiry card

# 1,344 STANDARD SIZE WALK-INS

When you need a walk-in cooler, we'll go to great lengths to meet your needs. Anything from 5 by 5 by 6½ ft. up to 20 by 18 by 10 ft., with 1,342 sizes in between. Nor-Lake walk-ins are fast to erect and enlarge. Simple to relocate. Underwriters' Laboratories approved.

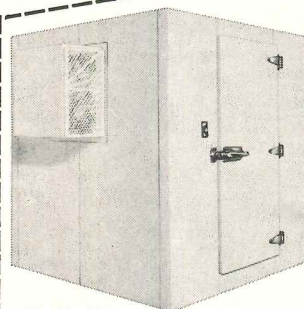

PLEASE SEND ME MORE  
INFORMATION ON NOR-LAKE  
WALK-IN COOLERS.

My temperature requirements  
are: \_\_\_\_\_

\_\_\_\_\_  
Name

\_\_\_\_\_  
Address

\_\_\_\_\_  
City

\_\_\_\_\_  
State ZIP

MAIL TO:



**NOR-LAKE INC.**

Second and Elm, Hudson, Wisconsin 54016 Dept. 3173

For more data, circle 149 on inquiry card



# The typing crisis in architecture.

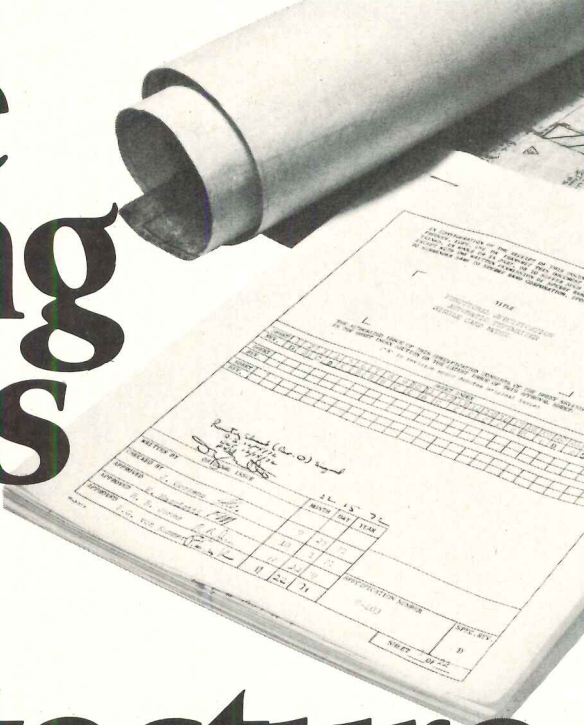

You're due to deliver 24 pages of neatly-typed recommendations for a preliminary bid on a major project, and you're nervously pacing the floor as your secretary frantically retypes the last page. For the third time.

Sound familiar? Then you know the typing crisis: the problem of keeping words flowing smoothly on paper under the pressures of time, work volume and mounting costs.

You can hire more typing help, but that's going to increase your costs. Costs are part of the crisis. A business letter already runs from \$3.00 to \$6.00. Next year you'll pay more.

#### What can you do about it?

Increase typing productivity. Do it with a word processor — an electric typewriter powered by a small computer.

Many architects are finding word processing saves so much typing time it can free secretaries for administrative duties, and boost office efficiency 50% or more.

Here's how the SPERRY REMINGTON™ word processor works for you. Your secretary types out original text, only once. At rough draft speed. Without worrying about errors. Everything is recorded as she types, either on magnetic tape or cards, both of which are reusable.

The word processor plays back the draft, with the typist

making your noted changes or revisions. Errors are corrected simply by typing back over them.

Because a whole page can be automatically duplicated in seconds, you can feel free to make as many changes as you want. Finished copy is played back as fast as 180 words a minute. Automatically and letter perfect. No need for re-proofing.

Save long hours in the typing of reports, specifications, presentations and documents using standard paragraphs. With our word processor up to 99 such paragraphs can be stored on one tape cassette and recalled automatically in any order. You can personalize standard letters, typing only the paragraph numbers to recall the copy.

The Sperry Remington word processor has more features that can best be appreciated by your secretary. Automatic underlining, electronic tab set and clear, and many others. All standard. Features we offer as standard are either costly options or nonexistent in other word processors. Maybe that's why so many users of word processing equipment are switching over to ours.

Let us put a Sperry Remington word processor in your office. We'll set it up without disturbing your scheme of things, and we can train your staff in your office, on your work.

Call your nearest branch office or use the coupon.

## We uncomplicate word processing.

SPERRY REMINGTON AR103  
Office Machines, P.O. Box 1000, Blue Bell, Pa. 19422

Show me how the Sperry Remington word processor ends the typing crisis in architecture.

Name \_\_\_\_\_ Title \_\_\_\_\_

Company \_\_\_\_\_

Address \_\_\_\_\_

City \_\_\_\_\_ State \_\_\_\_\_ Zip \_\_\_\_\_

SPERRY  REMINGTON  
OFFICE SYSTEMS AND MACHINES

SPERRY REMINGTON IS A DIVISION OF SPERRY RAND CORPORATION

For more data, circle 150 on inquiry card





**HEATILATOR FIREPLACE WARRANTY**

Your Heatilator Mark 123 Fireplace is guaranteed to provide smoke-free operation when installed as outlined in the installation directions accompanying the unit. The fireplace must also be equipped with a Heatilator grate or equivalent. Guarantee is effective on receipt of completed registration card (other half of this perforated card) within 90 days of fireplace installation.

During the first five year period the Company guarantees against defective material and workmanship. The Company will supply replacement parts at no charge and will pay for reasonable labor repair charges (such charges must be approved by a qualified Company representative, and must not exceed the retail price of the fireplace system).

During the second five year period the Company will supply replacement parts at no charge but will not assume responsibility for labor costs.

During the next ten year period the Company will supply replacement parts at minimum factory cost and will not assume responsibility for labor costs.

VEGA INDUSTRIES, INC. • MT. PLEASANT, IOWA 52641

# Heatilator Apartment Fireplacing... simple way to meet a tough competitive situation.

Heatilator fireplacing gives you a low cost way to add a highly competitive amenity to your apartments. Increases your earnings as well.

**Consider Earnings.** Renters are paying up to \$15 more per month for the charm of a fireplace—boosting rental profits, cash flow, loan and sales values, and keeping apartments filled.

**Consider Cost.** Heatilator factory-built fireplace systems are not only low priced, they are designed to reduce installation costs to a minimum. For example: Twist-Lock flue sections that quickly snap together; choice of roof terminations.

**Consider adaptability.** Place anywhere in any room—right on a wooden floor, against combustible wall materials—no masonry foundation required. Multi-level venting to meet every requirement.

**Consider Decorative Options.** Fireplace and surrounding area decorate to your plans—traditional, early American, modern—with paint, paper, paneling, brick, stone, tile, etc.

**Consider Reliability.** Mark 123 woodburning fireplaces feature a 20-year written warranty and smoke-free guarantee,

the best there is—U.L. listed! Gas models are A.G.A. design certified and tested.

Call collect (319) 385-3198 for fireplacing assistance from your Heatilator Man. He'll help you factor fireplacing simplified into your plans, and leave behind a useful Fireplace Planning Guide. Heatilator Fireplace, A Division of Vega Industries, Inc., 33103 W. Saunders Street, Mt. Pleasant, Iowa 52641. Also available in Canada.

See Catalog in Sweet's Architectural and Light Construction File.

**heatilator**<sup>®</sup>  
AMERICA'S LEADING FIREPLACE SYSTEMS



Want fireplacing help?  
The Heatilator man makes it  
easy to put fireplacing  
in your plans.



Built-in wood or gas fireplacing.



Wall-hung gas fireplacing.



Free-standing wood fireplacing.

For more data, circle 144 on inquiry card



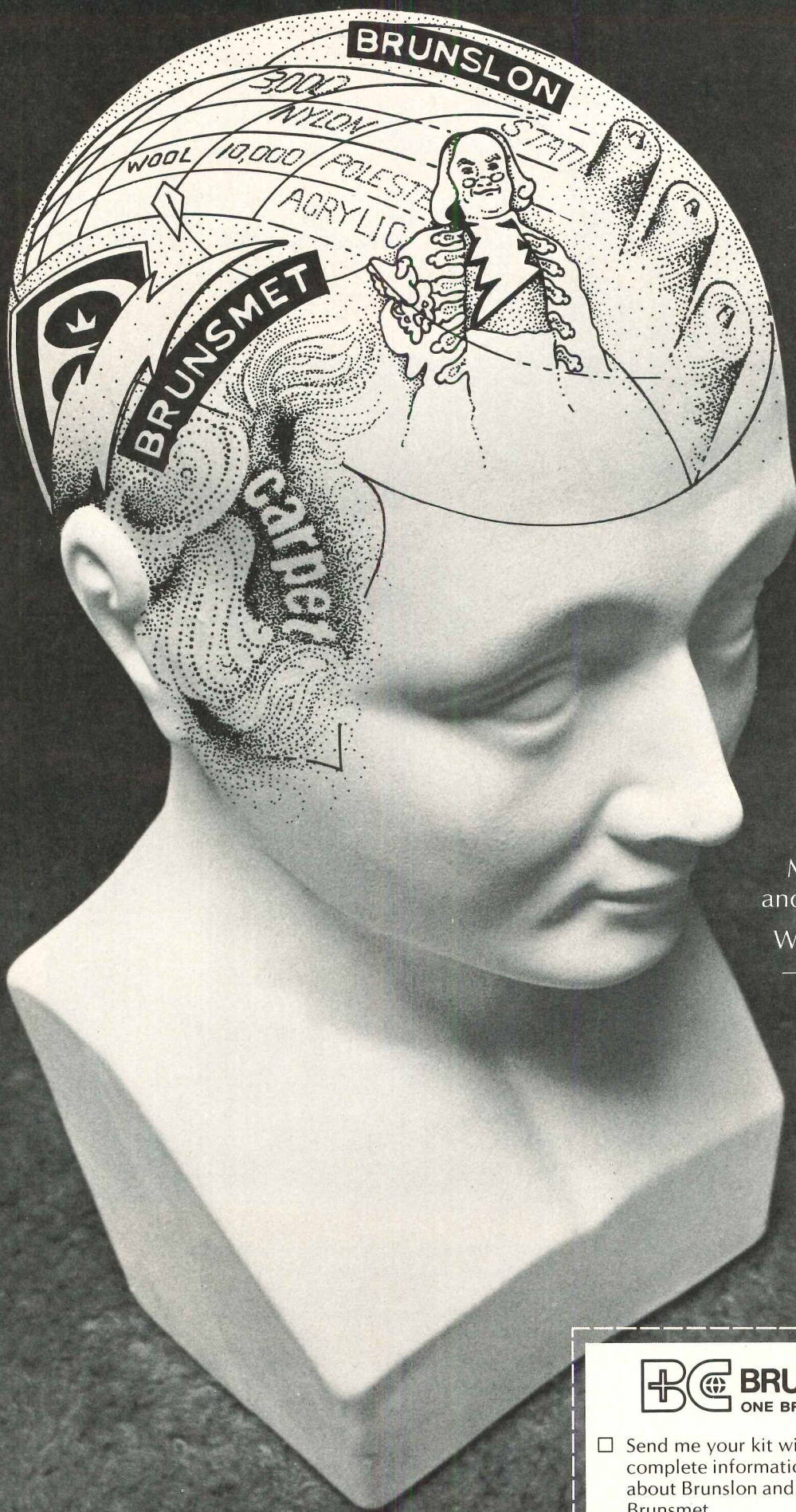

Say the word  
and we'll fill your head  
with important things  
about America's No. 1  
**STATIC-CONTROL  
SYSTEMS  
IN CARPETING**

To help you clarify your thinking about static-control in carpeting, we've got a kitful of information for you. Filled with solid, substantiated facts about static control: why it's needed, how it works, how to specify it, and why Brunslon® Static-Control Yarn and Brunsmet® Metal Fibers are the most widely used and most flexible systems on the market.

We'll put all the facts at your fingertips — including an up-to-the-minute list of manufacturers who offer Brunslon or Brunsmet in their carpet lines. Send for our kit. When all the facts are in, you'll know why Brunslon and Brunsmet are the best possible choices you can make for your clients.

And that's a useful piece of information to have inside your head.

**BC** TECHNICAL PRODUCTS DIVISION  
**BRUNSWICK CORPORATION**  
ONE BRUNSWICK PLAZA, SKOKIE, ILLINOIS 60076, U.S.A.

Send me your kit with complete information about Brunslon and Brunsmet.

I hear you have an Audio-Visual Presentation specially prepared for architects and specifiers. Arrange a showing for me. AR-10

Name \_\_\_\_\_ Title \_\_\_\_\_

Company \_\_\_\_\_

Address \_\_\_\_\_

City \_\_\_\_\_ State \_\_\_\_\_ Zip \_\_\_\_\_



# More and more builders are siding with prepainted galvanized steel.

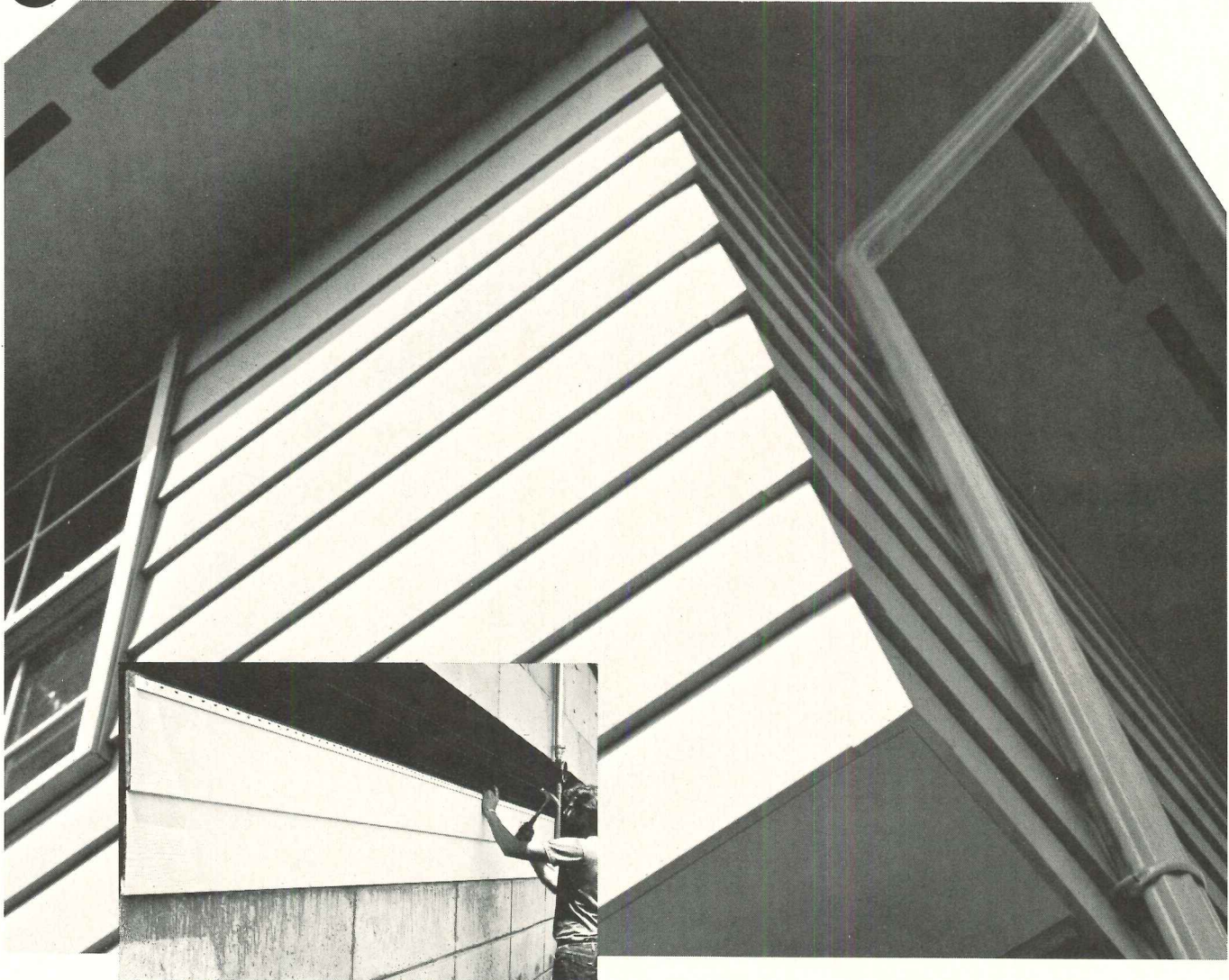

Whether you remodel or start from scratch, you want to be on the winning side. Today it's prepainted galvanized steel.

Zinc-coated steel survives a beating wood and other materials can't. It's immune to cracking from sun, storms, corrosion and the freeze and thaw cycle. It's twice as strong as other metal sidings, less subject to thermal expansion and denting. The paint is baked on for keeps, and washes clean like new.

To the home owner this brings pleasure without maintenance. To the builder it means a longer building season, and housing developments that look inviting even when they've been occupied for years.

Asarco, a major producer of galvanizing grade zinc, will be happy to send you a list of companies who make prepainted galvanized steel siding. Just drop us a line at 120 Broadway, New York, N.Y. 10005.

## **ASARCO**

AMERICAN SMELTING AND REFINING COMPANY

*For more data, circle 152 on inquiry card*



# 3 to 4 week delivery

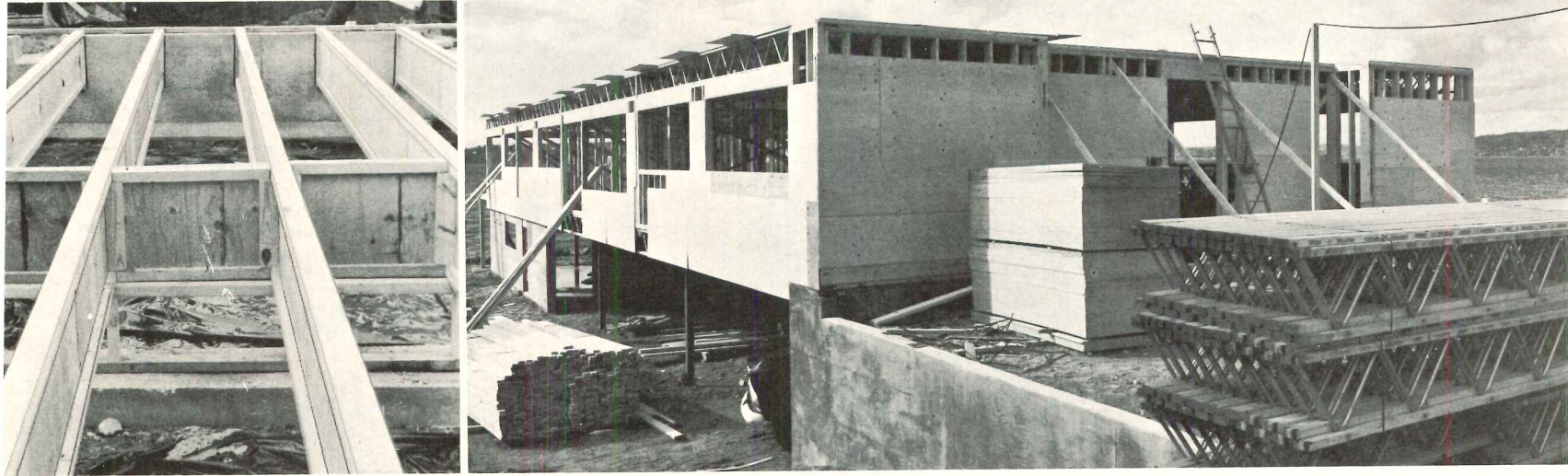

## on all TRUS JOIST Series

TRUS JOIST roof and floor structural components are on the job on time, four weeks at most on the I series floor joist which has become a runaway best seller for apartment, condominium or town house construction; three to four weeks after approval of shop drawings for the custom designed L, M or H Series open web roof and floor joists. Even though all twelve of our plants are jammed with orders we can keep up delivery schedules because we saw the crunch coming and prepared for it with new production facilities and added personnel.

You know the kind of top quality you get with TRUS JOIST, the wide nailable chords, long spans, light weight and fast erection that save you time and money. Couple that with on time delivery and personal service by highly qualified technical representatives and you'll understand why TRUS JOIST has become the leader in the light weight structural field.

Need more information, a complete design manual or a free and accurate cost estimate? Just drop us a card or call today and your TJ man will be on the way.

**trus joist**  *Corporation*

**Creative engineering in structural wood.**

*For more data, circle 153 on inquiry card*

9777 W. CHINDEN BLVD.  
BOISE, IDAHO 83702  
208/375-4450



by the editors of **Architectural Record**

The  
**ARCHITECTURAL RECORD**  
Book of

# VACATION HOUSES

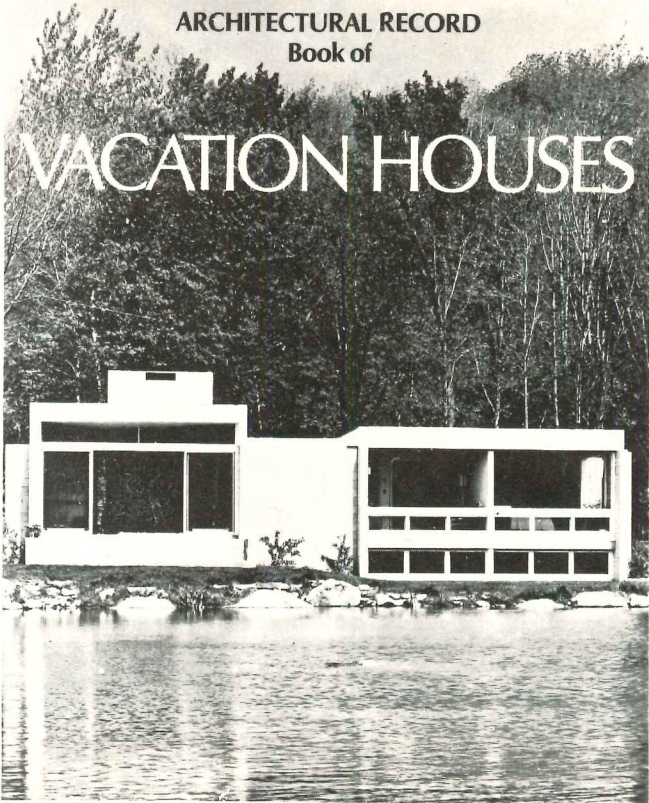

## Exciting ideas from 60 different dream hideaways

A sparkling collection of architect-designed vacation houses for all climates and terrains—from a mountain-top chalet in British Columbia to a beach house in Florida. Selected by Architectural Record editors, these houses range in price from less than \$5,000 for a very small two-room cottage to more than \$100,000 for large structures. Each house is fully described with floor plans, site plans, photographs and construction details.

For easy reference the book is divided into five sections: beach, mountain, lakeside, resort and country, weekend and summer homes.

256 pages 9 x 12 \$9.95

SEND FOR YOUR COPY TODAY

### ARCHITECTURAL RECORD

1221 Avenue of the Americas  
New York, New York 10020

Please send me \_\_\_\_\_ copies of Architectural Record Book of Vacation Houses @ \$9.95 each.

Name \_\_\_\_\_

Address \_\_\_\_\_

City \_\_\_\_\_

State \_\_\_\_\_ Zip \_\_\_\_\_

10-73

JUST PUBLISHED

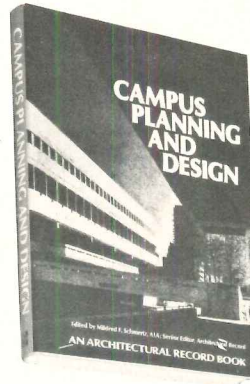

## CAMPUS PLANNING AND DESIGN

Edited by:  
Mildred Schmertz, AIA  
Senior Editor  
Architectural Record

## FOR ANYONE WITH A ROLE IN CAMPUS PLANNING AND DESIGN

This 266-page volume brings you practical data and creative ideas on handling such campus architecture problems as: designing well-scaled open space; dealing with existing architectural atmosphere; creating flexible prototypes for specialized buildings; planning expansible systems for an entire campus; organizing functional and aesthetic elements in relation to site and surroundings; integrating the building with interior space design, solving problems of architectural scale posed by the surrounding campus.

### SIX SECTIONS:

- Designing the Single Building
- Designing the Library for the Campus
- The Single Building or Complex Designed as Part of the Campus Master Plan
- Architecture Which Gives the Campus the Unity of a Single Building
- Campus Performing Arts Centers
- Designing Campus Interiors

Photographs, drawings, specifications and text illustrate some of the best campus architecture throughout the country—there isn't another single source that provides so much information and inspiration.

### ARCHITECTURAL RECORD BOOKS

1221 Avenue of the Americas, New York, N.Y. 10020

Please send me . . . . . copies of Campus Planning and Design @ \$22.50 each, plus postage and handling. (Include payment and we'll pay the postage and handling.)

Name \_\_\_\_\_

Street \_\_\_\_\_

City \_\_\_\_\_ State \_\_\_\_\_ Zip \_\_\_\_\_

10-73



# AIA Headquarters achieves energy conservation and thermal protection with All-weather Crete roof deck insulation.

The Architects Collaborative, realizing the importance of a properly functioning roof deck, wanted a system that would provide the ultimate in thermal protection as well as long, dependable resistance against the elements. One that would help make the AIA Headquarters an example of outstanding architecture. All-weather Crete insulation was selected.

The unique benefits of this material provide far more than complete thermal insulation. It offers a smooth, expansive surface without seams . . . one that "breathes" to allow vapor transmission. Most important, it is sloped to drains eliminating ponding that so rapidly causes membrane deterioration. Get the facts — see why most of this nation's outstanding architectural achievements utilize All-weather Crete for roof deck and plaza insulation. Contact Silbrico Corporation, 6300 River Road, Hodgkins, Illinois 60525, (312) 735-3322, or see Sweets for the address of your local applicator.

*For more data, circle 154 on inquiry card*



AIA National Headquarters, Washington, D. C. • The Architects Collaborative, Inc., Architects • Ezra Stoller, ESTO, Inc., Photographer





# CLASSIFIED SECTION

POSITIONS VACANT

## NEW YORK CITY HEALTH & HOSPITALS CORPORATION

Architectural, mechanical and electrical engineering firms interested in providing professional services to the Corporation are invited to complete an A/E Questionnaire which may be obtained from the Secretary. To be favorably considered consultants must demonstrate suitable experience in the design of health care facilities.

Richard F. Curran, R.A., Secretary

Architect—Engineer Selection Board

346 Broadway, Room 713, New York, New York 10013

### PROJECT ARCHITECT

Position available for registered architect with a rapidly expanding design oriented A-E firm. Applicant must have minimum of six years of experience and be capable of managing a variety of both large and small scale projects. Unlimited advancement opportunity and excellent personal benefits. Salary is dependent on background and experience. Please send detailed resume, including salary requirements to:

**HAYES, SEAY, MATTERN & MATTERN**  
Architects—Engineers—Planners  
P. O. Box 1490  
Roanoke, Virginia 24007  
Attention: Glynn D. Barranger

An Equal Opportunity Employer, M/F

### ARCHITECTS—PEACE CORPS/VISTA

**ACTION.** Volunteer overseas and U.S. . . . Low-income housing projects, design of schools, hospitals, community centers, etc. Most openings: singles, some couples. Information: Bruce Mazzie

#### ACTION

OCP Box 8, Washington, D.C. 20525.

### ARCHITECTURAL DRAFTSMAN

Senior Draftsman position leading to Project Architect for small multi-family housing division of a major corporation. Must be able to produce working drawings. Degree not mandatory. Live in family oriented mid-western city near university. Relocation, excellent salary, fringe benefits and growth potential. Send resume with salary history to: Ed Vance, Personnel Manager

#### GENERAL GROWTH COMPANIES

1055—6th Ave., Des Moines, Iowa 50306

Associate Space Analyst—Space planning and utilization specialist with wide latitude for independent action. Baccalaureate degree and a minimum of 3 years space planning experience required. \$17,100 to \$21,100. P-3683. Architectural Record.

### POSITION VACANT

**Design oriented graduates of strong program** interested in team approach to environmentally oriented projects. One with minimum of 3-5 years experience, preferably registered. One recent graduate. Outstanding opportunity for advancement and growth as key member of interdisciplinary design team for individuals with demonstrable leadership capability. Full benefit package. Outstanding community with University environment. Submit complete resume and brochure in confidence to Hansen Lind Meyer, 116 South Linn Street, Iowa City, Iowa 52240. An equal opportunity employer.

**Principal Space Analyst—Plan, coordinate, direct** and supervise space planning and allocation programs. Baccalaureate degree and a minimum of 5 years space planning experience with supervisory responsibility required. \$19,589 plus. P-3682. Architectural Record.

**Architects (R.A.) Architectural Lead Draftsmen.** If you have been involved in architectural planning of educational, institutional and industrial facilities for more than 5 years and feel that you have not received the recognition you deserve, then you will want to investigate this ad Today. Comprehensive hospitalization, life and disability insurance, vacation, sick leave and profit sharing plan all company paid. Credit Union privileges. Send resume or contact: Personnel Director, Buchart Associates, 611 West Market Street, York, Penna. 17405. Phone: 717-843-3854. "An Equal Opportunity Employer."

### POSITION WANTED

**Project Architect: 38, solvent, wife PhD.** Nine years comprehensive experience in all aspects of architectural practice. Now with leading architectural and planning firm. Design and administrative ability. Registered 2 states, N.C.A.—R.B. Oral Interview pending. Seeks negotiation of profit sharing and/or corporate practice agreement. Reply Box 13301, Kansas City, Mo. 64199.

### EMPLOYMENT SERVICE

**American Professionals: Our agency has a complete range of Architectural openings.** A "low key" approach is used with our client companies. Complete confidence is maintained at all times. All positions 100% Fee Paid. Send resume to 10730 Pacific St., Omaha, Nebraska 68114.

**Career Builders, Inc., Agency—Complete range of Architectural and Interior Design placement under the direction of Ruth Hirsch, Apprentices to Senior Designers and Project Architects, Professional screening and personalized service, References checked.** 501 Madison Av., New York, NY 10022; PL2-7640.

### BUSINESS OPPORTUNITIES

**456 Acres Interesting—Woodland less than one hour drive New York City.** Adjoins town school. Has pond, creek and views. Cluster housing allowed. Can be purchased with low cash and long terms at \$1900 per acre. Holding this land affords possibility of growth in value with tax advantages. Contact owner: James Greenberg, 257 Park Avenue South, New York City.

**Public Relations/Marketing—Public information and marketing programs. . . presentations . . . brochures. . . fresh ideas on communications and service. . . all matched sensitively to your own requirements and approach to the profession.** Twenty years of experience with architects, as well as developers, owners, corporations, boards of education and others. David S. Wachsman Associates, Inc., 51 East 42nd Street, New York, New York 10017, (212) -687-1196.

**Acquisitions Desired—Major architectural/engineering firm based in the East seeks similar firms interested in joining forces for common cause, expanded activity and increased challenges.** Preferences are for firms with revenues of \$500,000.00 and over. All replies confidential. BO-2271, Architectural Record.

## Job-seekers... be the first to know with McGraw-Hill's Advance Job Listings

By having our new weekly ADVANCE JOB LISTINGS sent First-Class (or by Air Mail, if you prefer) to your home every Monday you can be the first to know about nation-wide openings you qualify for both in and out of your field.

This preprint of scheduled employment ads will enable you to contact anxious domestic and overseas recruitment managers BEFORE their advertisements appear in upcoming issues of 21 McGraw-Hill publications.

To receive a free sample copy, plus information about our low subscription rates (from one month to 12), fill out and return the coupon below.

ADVANCE JOB LISTINGS / P.O. BOX 900 / NEW YORK NY 10020

PLEASE SEND A SAMPLE COPY  
OF ADVANCE JOB LISTINGS TO:



NAME \_\_\_\_\_ ADDRESS \_\_\_\_\_  
CITY \_\_\_\_\_ STATE \_\_\_\_\_ ZIP \_\_\_\_\_

AR 10/73



## NEW FIRMS, FIRM CHANGES

## BUSINESS OPPORTUNITY

NYC-55 Street, Duplex 20000 ft., 3 bedrooms, fireplaces, reasonable. Space Finders, 51 Clark St., Brooklyn, NY 11201. (212) 852-4800, 212-ox7-4887.

## SELLING OPPORTUNITY AVAILABLE

Manufacturers' Agents' Newsletter tells you which firms are looking for representatives, the firm's product line and territories available. For information write: Manufacturers' Agents' Newsletter, Dept. 163A, 23573 Prospect Ave., Farmington, Michigan 48024.

## NEWSLETTER

Creativity in Action—Unique monthly Newsletter, shows how to use techniques for getting more creative ideas and stimulating your imagination for effective and creative action. Sample issues only \$1.00. Satisfaction guaranteed to subscription service includes patented binder and bi-monthly mailings of valuable items to reinforce creative action. Box 272-c, Roslyn, N.Y. 11576.

## Classified Section Non-Display Order Form

To place a non-display advertisement, fill out this form, including your name, street address, city & state with ZIP code, attach it to a separate sheet containing your advertising copy, and mail it to:

ARCHITECTURAL RECORD/  
P.O. BOX 900  
NEW YORK, N.Y./10020

Rates: \$3.80 per line, minimum insertion ten lines, six words to a line, box number counts as one additional line. Display rates on request.

Payment Enclosed \$ . . . . .  Bill me  
 Use Name & Address  Use Box No.  
Advertisement to appear . . . . . time(s)  
.....  
Signature

**Crissman & Solomon** architects announced the relocation of their office to 272 Centre Street, Newton, Massachusetts.

**Jack Sevilla**, AIA, architect has opened his new office at 9885 Charleville Boulevard-Suite 2, Beverly Hills, California.

Myers and Bennett, a Minneapolis architectural firm, has merged with **Bather-Ringrose-Wolsfeld, Inc.**, a multi-disciplinary planning, engineering and transportation consulting firm. Offices are located at 2233 North Hamline Avenue, Roseville, Minnesota.

Frank B. Hunt, FAIA and Associates recently announced the continuation of the corporate practice of Kitchen and Hunt under the name of **Hunt and Company** with offices in San Francisco and Oakland, California.

George L. Dahl has merged his 40-year-old firm—George L. Dahl & Associates—with those of two other Dallas companies: Braden & Jones, Inc. and Max D. Chapman & Associates. The new firm, **Dahl, Braden, Jones & Chapman, Inc.** is located in Dallas, Texas.

The present partners of Raymond & Rado and Partners will continue their practice of architecture at 299 Park Avenue, New York City under the name of **Raymond, Rado, Caddy & Bonington**.

Formation of a new architectural and planning firm, **William C. Krommenhoek & Associates** has been announced. Located at 4305 Gesner Street, Suite 315, San Diego, California, the firm is involved in various commercial and residential projects.

**Peckham-Guyton Architects**, with offices in St. Louis, Kansas City and Los Angeles, has recently opened another new office at 6800 34th Street South, St. Petersburg, Florida.

**Peter A. Zorzi**, AIA, has announced the opening of new architectural offices at 1678 Ellington Road, South Windsor, Connecticut.

**Dalton•Dalton•Little•Newport** has moved to new offices at Plaza Executive Center, N.W. 167th Street, Miami, Florida.

Charles Bowman, Eugene Lew, Darryl Roberson, and Larry Wylie of **Environmental Planning & Research, Inc.**, have announced the relocation of their offices to 649 Front Street, San Francisco, California.

**Gaston J. Raetschelders**, AIA, ASCE, formerly with The Architects Collaborative, announced the opening of his office for the practice of architecture and engineering. The office is located at Gastelaenea, 64310 Saint-Pee-sur-Nivelle, France.

**Friedman and McKenna**, Architects have moved to new offices at 5440 Mariner Street, Suite 102, Tampa, Florida.

**Meyers, D'Aleo and Todd, Inc.** has opened its offices in One Plaza East, Salisbury, Maryland.

**Rolf Jensen & Associates, Inc.** have announced a new location at 100 Wilmont Road, Deerfield, Illinois.

Clarence M. Horton and Divyakant S. Parikh have been named associates in the consulting, engineering firm of **Pfisterer, Tor and Associates**, New Haven, Connecticut and New York City.

## Now Para-flyte deck equipment comes

# 4,608

## different ways to meet any (and we mean any) pool budget.



**Paragon's Exclusive New  
Interchangeable Option  
Plan of Materials, Lengths,  
Superstructure, Accessories, Etc.  
Permits Complete Design  
Freedom— Within Budget!**

Think of what this means for today's creative swimming pool Architect or Engineer. No more settling for "second best" because of budget limitations. Complete design flexibility. Beauty. Quality. And most important—proven performance.

For nearly two decades, Para-flyte equipment has been the choice of leading coaches and experienced competitors. Its rugged construction and functional design means added safety—an important reason why it is consistently specified when building a new or re-equipping an old school, club, municipal or residential pool.



SEE OUR CATALOG IN SWEET'S. OR WRITE

**KDI Paragon Inc. the architect's friend.**  
Mfrs. Of Quality Deck/Underwater Equipment  
12 Paulding St., Pleasantville, N.Y. 10570 • 914-769-6221

For more data, circle 155 on inquiry card



# ADVERTISING INDEX

Prefiled catalogs of the manufacturers listed below are available in the 1973 Sweet's Catalog File as follows.

- A Architectural File (green)
- I Industrial Construction File (blue)
- L Light Construction File (yellow)
- D Interior Design File (black)

<b>A</b>	
Aerofin Corp. ....	167
A-L Alcan Aluminum Corp. ....	232
A AllianceWall Corporation ....	224
A-D Allied Chemical Corp., Fibers Div. ....	89
A-I-L Aluminum Co. of America ....	197, 260A-260P
A-L American Bilrite Rubber— Uni-Turf ....	231
American Enka Corp. ....	59
American Louver Co. ....	17
American Smelting & Refining Co. ....	252
American Standard, Plumbing & Heating Div. ....	202
Applicon Inc. ....	47
Architect's Book Club ....	236-237
Architectural Review ....	240
A Armor Elevator Co., Inc. ....	63
A-I-L-D Armstrong Cork Co. ....	2-3
A-I-L-D Armstrong Cork Co. ...	2nd cover-1
A-L-D Artistic Brass Div.— Norris Industries ....	168
A-I-L ASG Industries Inc. ....	221
Atlantic Richfield Co. ....	217
A-L Azrock Floor Products ....	3rd cover
<b>B</b>	
A Bally Case & Cooler, Inc. ....	91
J. H. Baxter Co. ....	32-5 to 32-8
Bell Helicopter Co. ....	179
Bethlehem Steel Corp. ..	48-49, 80-81
A Bigelow-Sanford Inc. ....	245
Blu-Ray, Inc. ....	206
A-I Bradley Corporation ....	83
Bruning Division—Addressograph Multigraph Corporation ....	223
A-D Brunswick Corporation ....	251
I Buffalo Forge Co. ....	178
<b>C</b>	
A-L Cabot, Inc., Samuel Carpet Cushion Council ....	241 239
A-I Celotex Corp. ....	30
A-I Clark Door Co., Inc. ....	166
Collins & Aikman ....	66
A Cold Spring Granite Co. ....	86-87
A Combustion Engineering— C-E Glass Division ....	198
Commercial Carpet Corporation. ....	32
A Copper Development Association, Inc. ....	31, 203
Cramer Industries, Inc. ....	225
A Crouse-Hinds Company ....	78-79
<b>D</b>	
Delta Air Lines ....	193
Delta Faucet Company ....	95
A Dover Corp., Elevator Div. ....	38
Dow Corning Corp. ....	186
D DuPont Textile Fibers—Tygar ...	94
DuPont De Nemours & Co., Inc., E. I.—Pneumacel ....	104-105
<b>E</b>	
Eagle Electric Mfg. Co. Inc. ....	108
A Eastman Kodak Co. ....	82
A Eaton Corp., Lock & Hardware Div., Norton Door Closer Dept. ....	174
Eaton Corp. Security Products and Systems ....	109

A-I Ebco Mfg. Co. ....	177
A-I ECI Air Flyte Corp.—Sub. of Eastern Cyclone ....	62
Estey Corp. ....	43
<b>F</b>	
Featherock Inc. ....	259
A Florida Tile, Div. of Sikes Corp. ....	184
Folger Adam Co. ....	199
A Follansbee Steel Corp. ....	238
A-I H. B. Fuller Co. ....	227
<b>G</b>	
Gaco Western Inc. ....	32-2
A-I-L GAF Corp., Floor Products Division ....	182
A-I-L General Electric Co. ....	74-75
General Electric Co. Plastics Dept. ....	84-85
G F Business Equipment ....	97
A-I-L-D Georgia-Pacific Corporation ..	69, 260
A-L-D Goodrich General Products Co., B.F. ....	47
A Goodyear Tire & Rubber Co. ...	70
Graber Co., The ....	106
A-I-L Grace & Co., W. R., Construction Products ....	246-247
GTE—Sylvania, I/C Lighting ...	28-29
<b>H</b>	
Hager Hinge Company ....	16
Harbor Universal Inc. ....	229
A-L Heatilator Fireplace ....	250
A-L-D Hercules Incorporated ....	101
Holophane Co., Inc. ....	206
<b>I</b>	
A Ickes-Braun Glasshouses Inc. ...	248
A Inland-Ryerson Construction Products Co. ....	234
International Masonry Institute .	207
ITT Landmark Lighting ....	196
<b>J</b>	
A Jamison Door Co. ....	206
IG Furniture Company, Inc. ....	199
J & J Industries, Inc. ....	72
Jute Carpet Backing Council, Inc. ....	108
<b>K</b>	
A Kalwall Corp. ....	175
A Kawneer Co. ....	60-61
A KDI Paragon ....	257
A Keene Corp. ....	14-15
A-I Kelley Co., Inc. ....	205
Knoll International ....	6-7
<b>L</b>	
A LCN Closers, Inc. ....	44-45
Lead Industries Assn. Inc. ....	228
A-I-L Libbey-Owens-Ford Co. ....	20-21
Litecraft/Luminous Ceilings Company ....	54-55
Logan Co., The ....	176
A Lundia Myers Industries Inc. ....	99
Lyon Metal Products, Inc. ....	217
<b>M</b>	
Manning Co. Inc., R. A. ....	230
A Massey Seating Co. ....	241
McGraw-Hill Books ....	199, 226, 230
A McKee Door Co. ....	224
Modine Mfg. Co. ....	204
Moldcast Manufacturing Co. ..	36-37
I Monsanto Company, Textiles Div. ....	169 to 172
A Mosler/Airmatic Systems Division ....	26
<b>N</b>	
National Electrical Contractors Association ....	98
A-I-L-D National Gypsum Co. ....	50-51
A-D National Terrazzo ....	52-53
A-I-L Neenah Foundry Co. ....	224

A Nor-Lake, Inc. ....	248
Notifier Co. ....	8
Nucor Corp. Vulcraft Div. ...	242-243
<b>O</b>	
A Olin Corp. ....	64
A Overly Mfg. ....	90
<b>P</b>	
A Parker Co., Charles ....	187
A-L Pella Rolscreen Co. ....	209-210
Pennwalt Chemicals Corp. ....	92-93
Pfizer Inc.— Minerals, Pigments, Metals Div. ....	32-1
A-I Pittsburgh Corning Corp. ....	96
A-L-D Potlatch Corp. ....	27
Powers Regulator ....	239, 241
A-L PPG Industries, Inc., Commercial Glass ....	56-57
PPG Industries Inc. ....	180
Process Solvent Co. ....	193
Pyrotector Inc. ....	230
<b>R</b>	
Ralph Wilson Plastics ....	76-77
A-I Raynor Mfg. Co. ....	168
A-L Red Cedar Shingle & Handsplit Shake Bureau ..	11-13, 58
A-I Republic Steel Corp. ....	100, 219
Reynolds Metals Co. ....	185
A-L Rohm & Haas Company ....	239
<b>S</b>	
St. Joe Minerals Corporation ...	222
A Sargent & Company ....	24-25
A-I Shatterproof Glass Co. ....	188
A Silbrico Corp. ....	255
Simmons Company ....	18-19
Sloan Valve Company ....	4th cover
Southern California Gas Company ....	32-4
A Spencer Turbine Co. ....	179
A Sperry Remington, Office Machines Div. ....	249
Square D Company ....	165
A Standard Dry Wall Products, Inc. ....	220
Steelcase Inc. ....	112
Steel Joist Institute ....	107
Stem, Inc. Chester B. ....	108
<b>T</b>	
A-I Thiokol Chemical Corp. ....	88
Thonet American Chair Company ....	194
A TPI Corporation ....	181
Trus Joist Corp. ....	253
<b>U</b>	
Underwriters Laboratories ...	102-103
Union Metal Mfg. Co. ....	233
United Airlines, Ski the Rockies .	211
A-I-D United States Gypsum Co. ....	42
A-L-D U.S. Plywood Corp. ....	46
A-I United States Steel Corp. ....	22-23, 110-111
A-L Uvalde Rock Asphalt Co. ..	3rd cover
<b>V</b>	
Vincent Brass & Aluminum Co. .	183
<b>W</b>	
Watson Mfg. Co. ....	195
Westinghouse Electric— Corporate ....	200-201, 212-213
Westinghouse Electric Corp. Fluorescent & Vapor Lamp Div. ....	214-215
A-I-L Weyerhaeuser Company ....	208
Wiley & Sons, Inc., John ...	168, 248
A-D Wool Bureau Inc. ....	189 to 192
<b>X</b>	
Xerox Corporation, Telecopier ..	216



# Souther'Inn

Outside - Inside - Everywhere

it's featherrock®

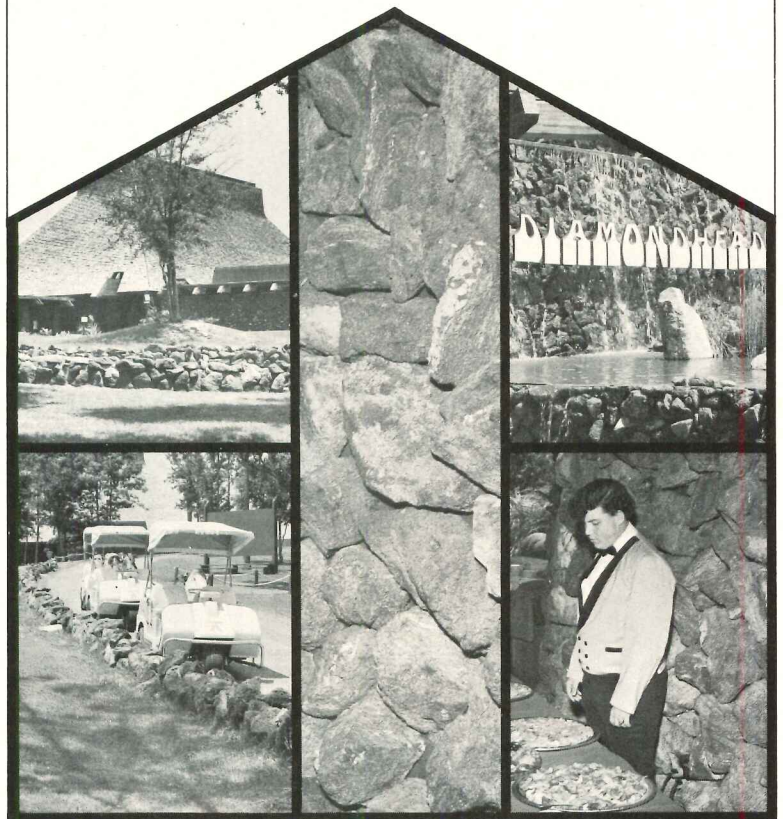

## ARCHITECTURAL RECORD

McGraw-Hill, Inc., 1221 Avenue of the Americas, New York  
New York 10020

Advertising Sales Mgr.: Louis F. Kutscher (212) 997-2838  
Eastern Sales Mgr.: Robert G. Kliesch (215) 568-6161  
Western Sales Mgr.: James A. Anderson (312) 751-3770  
Advertising Services Mgr.: Joseph R. Wunk (212) 997-2793  
Marketing Services Mgr.: Elizabeth Hayman (212) 997-2858  
Research Mgr.: Camille Padula (212) 997-2814  
Classified Advertising: (212) 997-2557

### District Offices:

#### Atlanta 30309

Edward G. Graves, 100 Colony Square, 1175 Peachtree St., N.E.  
(404) 892-2868

#### Boston 02116

Robert L. Tagen, 607 Boylston St., (617) 262-1160

#### Chicago 60611

James A. Anderson, Robert T. Franden, Edward R. Novak,  
645 N. Michigan Ave. (312) 751-3770

#### Cleveland 44113

Willis W. Ingersoll, 55 Public Square, (216) 781-7000

#### Denver 80202

Harry B. Doyle, 1700 Broadway, (303) 266-3863

#### Detroit 48202

Richard D. Thielmann, 1400 Fisher Bldg., (313) 873-7410

#### Los Angeles 90010

Richard R. Butera, 3200 Wilshire Blvd.-South Tower (213) 487-1160

#### New York 10020

Ted Rzempoluch, (212) 997-3584

#### Philadelphia 19102

Robert G. Kliesch, George T. Broskey, Three Parkway  
(215) 568-6161

#### Pittsburgh 15222

Edward C. Weil, III, 4 Gateway Center, (412) 391-1314

#### St. Louis 63011

Richard Grater, Manchester Rd., (314) 227-1600

#### San Francisco 94111

Richard R. Butera, 425 Battery Street (415) 362-4600

### Overseas Offices:

#### Brussels

Galerie Porte de Namur, 22-26, Chaussee de Wavre  
1050 Brussels, Belgium

#### Frankfurt/Main

Elsa-Brandstroen Str. 2, Frankfurt/Main, Germany

#### London

34 Dover Street, London W.1, England

#### Milan

Via Baracchini No. 1, Milan, Italy

#### Paris

17, rue Georges Bizet, 75 Paris 16°, France

#### Tokyo

2-5, 3-chome, Kasumigaseki, Chiyoda-ku, Tokyo, Japan

## A Total Concept in Architectural and Landscape Stone.

The very in place to be is Diamondhead, new avant-garde resort community on Bay St. Louis, Mississippi. Its beauty is real and so is the stone. Featherrock® decorative veneer facings and landscape stone are nature's design for today's economics and engineering. Unique, light weight with pre-sawed flat back. Featherrock facings work faster, easier. Ton-for-ton covers up to five times the surface area of granite. No footings, anchors or building ties are needed. Move giant boulders into position without heavy rigs. Featherrock's available most everywhere in colors and styles with cost savings all the way to Diamondhead. ICBO approved. Architects, interior designers: specify the one stone that does it all.

Consult your 1974-1975 Building Stone Institute Catalog.



Send me specifications \_\_\_\_\_ A.I.A. file \_\_\_\_\_ Dealer listings \_\_\_\_\_ for FEATHEROCK® NATURAL STONE VENEERS AND BOULDERS.

Name \_\_\_\_\_

Company \_\_\_\_\_

Address \_\_\_\_\_

City \_\_\_\_\_ State \_\_\_\_\_ Zip \_\_\_\_\_

featherrock® Inc., Dept. V2-103

2890 Empire Avenue, Burbank, California 91504

For more data, circle 156 on inquiry card



It's Georgia-Pacific's gypsum sound control system. It gives you a one-hour fire rating (Test UL No. U312). An STC of 45. It reduces wall thickness by 3/4". \*And it costs \$36 per thousand sq. ft. of wall area less than a 1/2" wood fiber sound control system.

Just apply 1/4" incombustible gypsum sound deadening board over a wood framing system (2" x 4" studs, 16" O.C.). Then apply 1/2" G-P Firestop® gypsumboard or Firestop® Eternawall™ vinyl surfaced gypsumboard to the sound deadening board. And that's it! Call your G-P representative today.

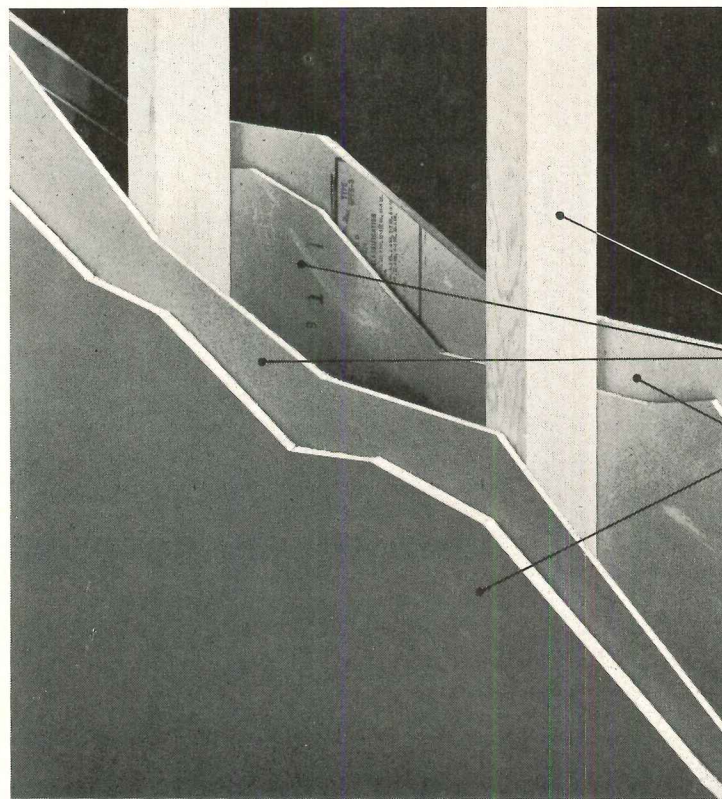

2" x 4" studs, 16" O.C.  
1/4" incombustible gypsum sound deadening board  
1/2" Firestop gypsumboard.

# This sound control system costs \$36 less\* than a wood fiber system.

**Georgia-Pacific**

The Growth Company

Gypsum Division, Portland, Oregon 97204



For more data, circle 157 on inquiry card





# Azrock—the best buy in flooring...



## for Office Buildings

Azrock vinyl asbestos tile is the best buy in flooring, because it serves more office building requirements better than any other type of flooring. Yet it costs less than half of what it did 20 years ago. Here's why you can specify Azrock with confidence:

- Styled to coordinate with contemporary interiors
- Long lasting durability
- Low-cost no-wax maintenance
- Low initial cost
- Permits maximum flexibility in office alterations
- Fire safe, will not support combustion
- Shock proof
- Resilient underfoot comfort
- Lowest motion resistance
- Non-allergenic, mildew proof, no odor retention
- Exceeds federal specifications

Vinyl asbestos tile is one of the most widely used floorings in office buildings today. Offer clients a colorful, high-style floor and cut maintenance and replacement problems with low-cost Azrock vinyl asbestos tile—the best buy in flooring.

*Floor shown: Pebbled-Onyx, one of over 150 colors and styles.*

the vinyl asbestos  
floor tile people





# The sure way to save water— without a brick

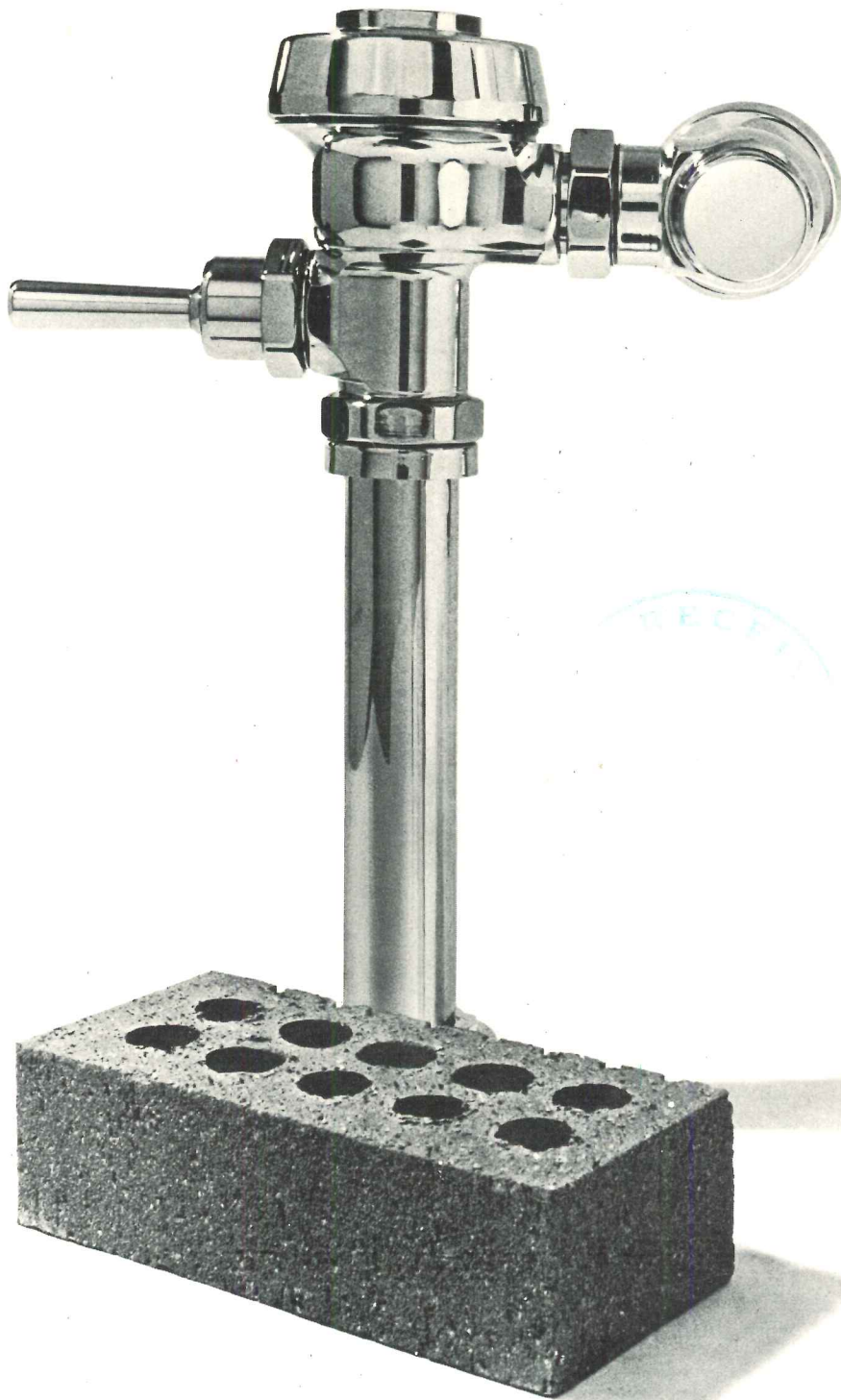

People have been putting bricks in toilet tanks for years.

It's an old trick that shuts the water off sooner than normal after operation and one which has received a lot of recent publicity.

You save one brick's worth of water — the brick's displacement volume. But you still may be losing many bricks of water due to leaks.

These days there's a better way for saving water and eliminating leaks,

The Sloan Flush Valve.

The Sloan Flush Valve positively prevents water waste.

It meters out water, automatically shutting off after delivering a sufficient amount to satisfy the requirements of the fixture.

You can't hold a Sloan Flush Valve open. It won't let you. Each flush uses the same minimal amount of water every time and does so for the life of the building.

So if you really want to save water, use flush valves — Sloan Flush Valves.

Sloan Flush Valves save water. Lots of it.

 **SLOAN VALVE COMPANY**  
10500 SEYMOUR • FRANKLIN PARK, ILL. 60131

For more data, circle 159 on inquiry card