

BAYSTATE WEST SHOPPING MALL BY EDUARDO CATALANO AND PIETRO BELLUSCHI

PARK CENTRAL: DISTINGUISHED BUSINESS CENTER FOR DENVER

ST. THOMAS CHURCH BY CRAM AND GOODHUE

BUILDING TYPES STUDY: DESIGNING THE NEW MARKETPLACE FOR DOWNTOWN AND SUBURB

FULL CONTENTS ON PAGES 10 AND 11

ARCHITECTURAL RECORD



J. PRZERADOWSKI

There's a lot more to Quiet Zone than meets the eye—or the ear. When you first see it, Armstrong Quiet Zone looks like a modern, attractive Armstrong Vinyl Corlon® floor. But when you walk on it, and feel its comfort, and listen to your footsteps, you might think it's carpet.

Because underneath, Quiet Zone is unlike any floor you've probably ever seen. A thick backing of Cushioncord® vinyl foam muffles footsteps and the clatter of dropped objects. It also cushions feet, for more walking and standing comfort.

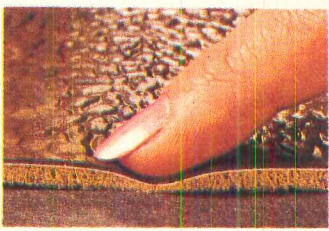

You know how important quietness and comfort are. You know how important good design is. And you know how important practicality is.

Quiet Zone is all of that. Its rugged, heavy-duty vinyl surface resists scuffs and stains. Maintenance is simple and economical. And Quiet Zone is available in two handsome patterns, which are richly textured to help disguise traffic marks and subfloor irregularities.

Install Quiet Zone. Listen to it work. More information? Please mail the coupon.

Shh. Quiet Zone™ at work. You know it's vinyl, but you might think it's carpet.

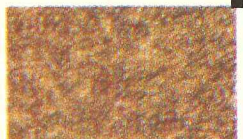

83020 Brown



83021 White



83022 Beige

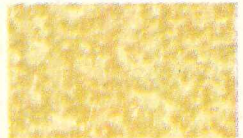

83023 Gold



83024 Green

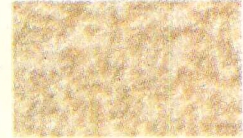

83025 Gray-Beige

The Quiet Zone pattern illustrated here is called Grand Central.

For more information, send this coupon to Armstrong, 304 Rock Street, Lancaster, Pa. 17604.

Name _____

Company _____

Address _____

City _____ State _____ Zip _____



Overly acoustical doors perform with distinction at Kennedy Center.



John F. Kennedy Center for the Performing Arts, Washington, D. C.
Architect: Edward Durrell Stone, New York, N. Y.
Acoustical consultant: Dr. Cyril M. Harris, New York, N. Y.
General contractor: John McShain, Inc., Arlington, Va.

Unique problems faced the architects who designed Kennedy Center for the Performing Arts. The hall combines a symphony hall, an opera

and a theatre, each with its own facilities and the capability to present simultaneous performances. The structure is on the approach to the Washington National Airport, so incoming aircraft could raise serious sound problems. Overly acoustical doors helped solve those problems.

Overly furnished and installed acoustical doors of various sizes, thickness and performance ratings throughout Kennedy Center. Some were in pairs, with transom panels with integral seals. Others had curved faces. All doors were prepared for various surface finishes. Performance ratings covered both 45 db and 50 db.

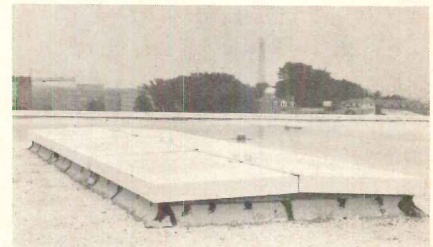
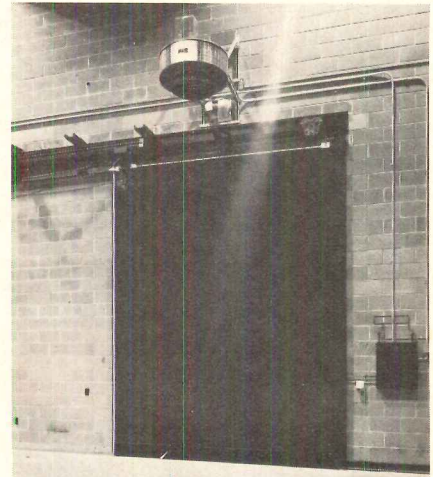
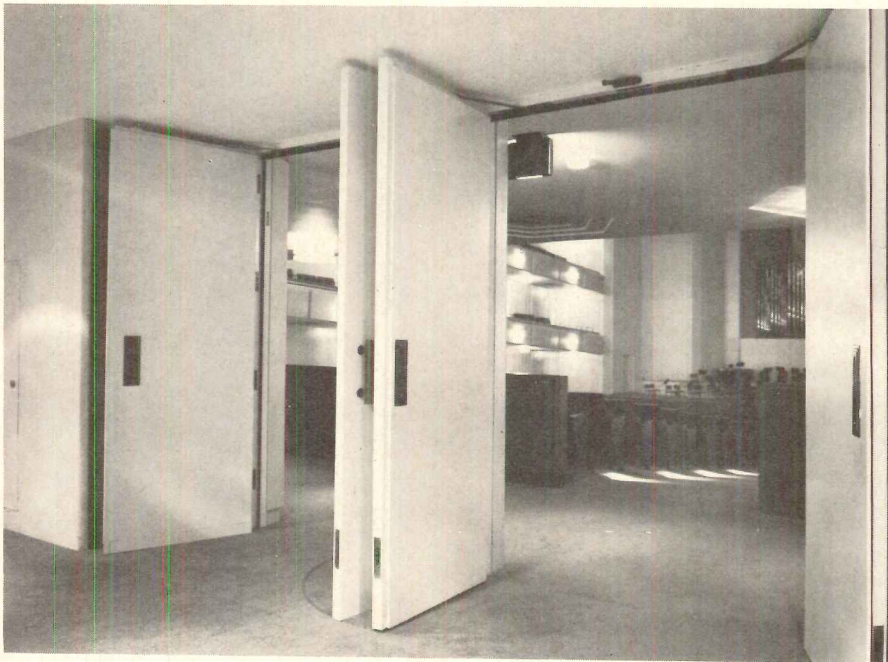

Overly also fabricated and installed smoke vents on the roof. Acoustical ratings were high, to suppress the outside noise. The vents were connected to a smoke detection system, and were designed to open automatically to release smoke in the event of a fire.

Aesthetically and acoustically, Overly doors are performing with distinction at Kennedy Center. We can show you how they can perform well for you. For more information, write Overly Manufacturing Co., Greensburg, Pa. 15601. Telephone (412) 834-7300.

overly
MANUFACTURING CO.

MAKES THE DOORS THAT OTHERS DON'T

For more data, circle 2 on inquiry card

Armstrong introduces the bold textured lay-in ceiling panel.

Boldface™



Easy-to-install, economical, and, above all, good-looking—those were the criteria that the Armstrong designers had to meet for our latest lay-in ceiling panel.

What they gave us was a panel with an exciting, bold, rough texture. We called it Boldface, and we think it's a beauty.

Its design is nondirectional with a white paint finish, making Boldface the ideal ceiling for any interior space.

Boldface is available in 24" x 24" or 24" x 48" lay-in panels and 24" x 48" Tegular lay-in panels which rest on a standard exposed-grid suspension system. Installation is simple and economical.

Its specifications rank Boldface well. It has an NRC of .60-.70; flame-spread rating of Class 25; good light reflectance—70-74%. And it has an average C factor of .52 at 3/4".

Boldface. It met all of our specifications and more. We're sure it will exceed yours, too.

For more information, write Armstrong, 4201-3 Rock Street, Lancaster, Pa. 17604.

FROM THE  INDOOR WORLD® OF

Armstrong

For more data, circle 3 on inquiry card

Letters to the editor

In this era of very mixed values, Bob Hastings was kind, helpful and ever ready to share his prodigious knowledge with all comers.

What is more, as your January news columns so well put it, "(he) set high standards, which he lived personally . . ."

A lot of us will miss him.

*Stephen A. Klimont, AIA
Architect, Editorial Consultant*

I read your editorial "Industrialization and Costs: Are we making the same mistakes again?" in the September 1973 Record, and I was delighted that you didn't pull any punches.

I am sick and tired, to coin a phrase, of listening to promoters pushing "systems" when in fact, these people have little or no knowledge of our business. Neither am I at all thrilled with the way a lot of big companies have been jumping into the construction business as if they were getting in the hula-hoop business or some other fad. I suggest that these conglomerates get into brain surgery instead, since everybody knows there is more money to be made there than in your office or my office.

Anyway, thanks again for writing what you did—I only hope that every architect reads it and benefits from it.

John M. Casey, P.E.

Commonwealth Engineering Co.

I would like to commend you and your staff for the outstanding December issue of the Architectural Record on planned communities. It is the finest publication dealing with this subject that I have ever seen anywhere. The thoroughness with which you analyzed the subject and your detailed presentation of major examples represents the highest level of architectural journalism. Jonathan Barnett's article and Felicia Clark's article with Todd Lee, both on how new communities are planned should elevate the understanding of this subject to a new high.

A hearty "well-done" from all of us in this office to the Record.

*Earl R. Flansburgh, FAIA
Earl R. Flansburgh and Associates, Inc.*

Congratulations on your high quality execution of a very ambitious project—the December number on New Towns. I know such a wrap-up is a difficult one, but your staff really excelled. However, I would like to make a few modifications—both major and minor—to the Flower Mound section.

Unfortunately, some old informa-

tion was apparently relied on instead of the most current which I forwarded to your publication. Our consultant Llewelyn-Davies Associates had nothing to do with direction of the plan. It was the firm of Marshall Kaplan, Gans and Kahn which was charged with that responsibility. Mr. Kaplan has since left his firm and is Project Manager of Flower Mound New Town. MKGK was not mentioned as the social services consultant to the project in the listing on page 129. The other major point is the fact that our current plans call for no neighborhoods or villages. Under an early plan by Richard Browne & Associates of Columbia, this was suggested but it is the feeling of our planners that the neighborhood that we have known is dead.

Only one other point and this is quite minor: no credit was given to Flower Mound New Town or the firm of Marshall Kaplan, Gans and Kahn for the diagram on pages 120-121.

Again, I congratulate you and your staff on the production of a very significant project. I am certain that our offices will be using it as reference time and time again.

*David Dunnigan
Director of communications
Flower Mound New Town, Ltd.*

Calendar

APRIL

17-18 Seminar on How to Market Professional Design Services, Boston. Sponsored by Architectural Record. Contact Building Industry Development Services, 1301 20th Street, N.W., Suite 104, Washington, D.C. 20036. Phone (202) 785-2133.

18-20 West Coast Women's Design Conference, University of Oregon, School of Architecture and Allied Arts, Eugene, Oregon 97403. Phone (503) 686-3631.

23-25 The National Interfaith Conference on Religion and Architecture, Stouffer Inn, Cincinnati, Ohio. Contact the Guild of Religious Architecture, 1777 Church Street, N.W., Washington, D.C. 20036.

23-25 Wisconsin Chapter, AIA convention, Playboy Club-Hotel, Lake Geneva, Wisconsin.

26-28 Preservation in New York State conference, sponsored by The National Trust for Historic Preservation and The Landmark Society of Western New York, Rochester, New York. Contact State Conference, 130 Spring Street, Rochester, New York 14608.

29-May 1 Apartment Builder/Developer Conference & Exposition, McCormick Place, Chicago. Contact

National Expositions Co., Inc., 14 West 40th Street, New York, New York 10018.

MAY

2-3 Seminar on How to Market Professional Design Services, Denver. Sponsored by Architectural Record. Contact Building Industry Development Services, Suite 104, 1301 20th Street, N.W., Washington, D.C. 20036. Phone (202) 785-2133.

2-3 First international conference on "The Professions and the Built Environment," Graduate School of Design, Harvard University, Cambridge, Massachusetts 02138.

3 Conference on building codes and OSHA, Washington University School of Architecture, St. Louis, Missouri.

7-8 Conference on plastics in construction, New York University, New York City. Contact Sandy Padrick, NYUSCE, Room 3700 S, 600 Third Avenue, New York, New York 10016.

9-10 Seminar on How the Architect and Engineer Can Profit as Builder-Developer, Atlanta. Sponsored by Architectural Record. Contact MCI, 505 Park Avenue, New York, New York 10022. Phone (212) 759-5830.

10-11 Seminar on documenting architectural and environmental heritage, Americana Hotel, Bal Harbour, Florida. Contact Architecture Department, University of Miami, Coral Gables, Fla. 33124.

13-14 Seminar on How the Architect and Engineer Can Profit as Builder-Developer, Los Angeles. Sponsored by Architectural Record. Contact MCI, 505 Park Avenue, New York, New York 10022. Phone (212) 759-5830.

19-23 AIA national convention, Sheraton Park Hotel, Washington, D.C. Contact The American Institute of Architects, 1735 New York Avenue, N.W., Washington, D.C. 20006.

26-June 1 FIP/PCI Congress, New York Hilton and Waldorf-Astoria, New York City. Contact the Prestressed Concrete Institute, 20 North Wacker Drive, Chicago, Illinois 60606.

JUNE

14-15 Seminar on How the Architect and Engineer Can Profit as Builder-Developer, Houston. Sponsored by Architectural Record. Contact MCI, 505 Park Avenue, New York, New York 10022. Phone (212) 759-5830.

27-29 International Bicycle/Pedestrian Planning and Design Seminar, Hotel Metropole, London, England. Contact MAUDEP, Box 722, Church Street Station, New York, New York 10008. Phone (212) 566-0396.

ARCHITECTURAL RECORD (Combined with AMERICAN ARCHITECT, ARCHITECTURE and WESTERN ARCHITECT AND ENGINEER)

April 1974, Vol. 155 No. 4, Title® reg. in U.S. Patent Office copyright® 1974 by McGraw-Hill, Inc. All rights reserved. Copyright not claimed on front cover and editorial four-color separations. Indexed in Reader's Guide to Periodical Literature, Art Index, Applied Science and Technology Index, Engineering Index, and The Architectural Index. Published monthly except May, August, and October when semi-monthly, by McGraw-Hill, Inc.

Quotations on reprints of articles available. Every possible effort will be made to return material submitted by possible publication (if accompanied by stamped, addressed envelope), but the editors and the corporation will not be responsible for loss or damage.

EXECUTIVE, EDITORIAL, CIRCULATION AND ADVERTISING OFFICES: 1221 Avenue of the Americas, New York, N.Y. 10020. Other Editorial Offices: 425 Battery Street, San Francisco, Cal. 94111; 1249 National Press Building, Washington, D.C. 20004.

PUBLICATION OFFICE: 1221 Avenue of the Americas, New York, New York 10020. Second class postage paid at New York, New York 10001 and at additional mailing offices.

OFFICERS OF MCGRAW-HILL PUBLICATIONS COMPANY: John R. Emery, president; J. Elton Tuohig, executive vice president-administration; David J. McGrath, group publisher-vice president; senior vice presidents: Ralph Blackburn, circulation; John B. Hoglund, controller; David G. Jensen, manufacturing; Gordon L. Jones, marketing; Jerome D. Luntz, planning & development; Walter A. Stanbury, editorial.

CORPORATION OFFICERS: Shelton Fisher, president; Wallace F. Traendly, group president—McGraw-Hill Publications Company and McGraw-Hill Information Systems Company; John J. Cooke, senior vice president and secretary; Ralph S. Webb, treasurer.

SUBSCRIPTIONS: Subscriptions solicited only from architects and engineers. Position, firm connection, and type of firm must be indicated on subscription orders; CHANGE OF ADDRESS or subscription service letters should be forwarded to Fulfillment Manager, ARCHITECTURAL RECORD, P.O. Box 430, Hightstown, N.J. 08520. Provide old and new addresses, zip code or postal zone number. If possible, attach issue address label. Annual subscription prices: U.S., U.S. possessions and Canada: \$10.00 for architects, engineers and other individuals in the fields served, all others \$22.00. Other countries: \$25.00 to architects, engineers; others \$35.00. Single copies \$3.00. GUARANTEE: Publisher agrees to refund that part of subscription price applying to unfilled part of subscription if service is unsatisfactory.

ASSOCIATED SERVICES / McGraw-Hill Information Systems Co.: Sweet's Catalog Files (Architectural, Light Construction, Interior Design, Industrial Construction, Plant Engineering, Canadian Construction), Dodge Building Cost Services, Dodge Reports and Bulletins, Dodge/SCAN Microfilm Systems, Dodge Management Control Service, Dodge Construction Statistics, Dodge regional construction newspapers (Chicago, Denver, Los Angeles, San Francisco).

THIS ISSUE is published in national and separate editions. Additional pages of separate edition numbered or allowed for as follows: Western Section 32-1 through 32-2. POSTMASTER: Please send form 3579 to Fulfillment Manager, ARCHITECTURAL RECORD, P.O. Box 430, Hightstown, N.J. 08520.



Armstrong introduces
a grand new look
in ceiling tiles.
Grandshire.

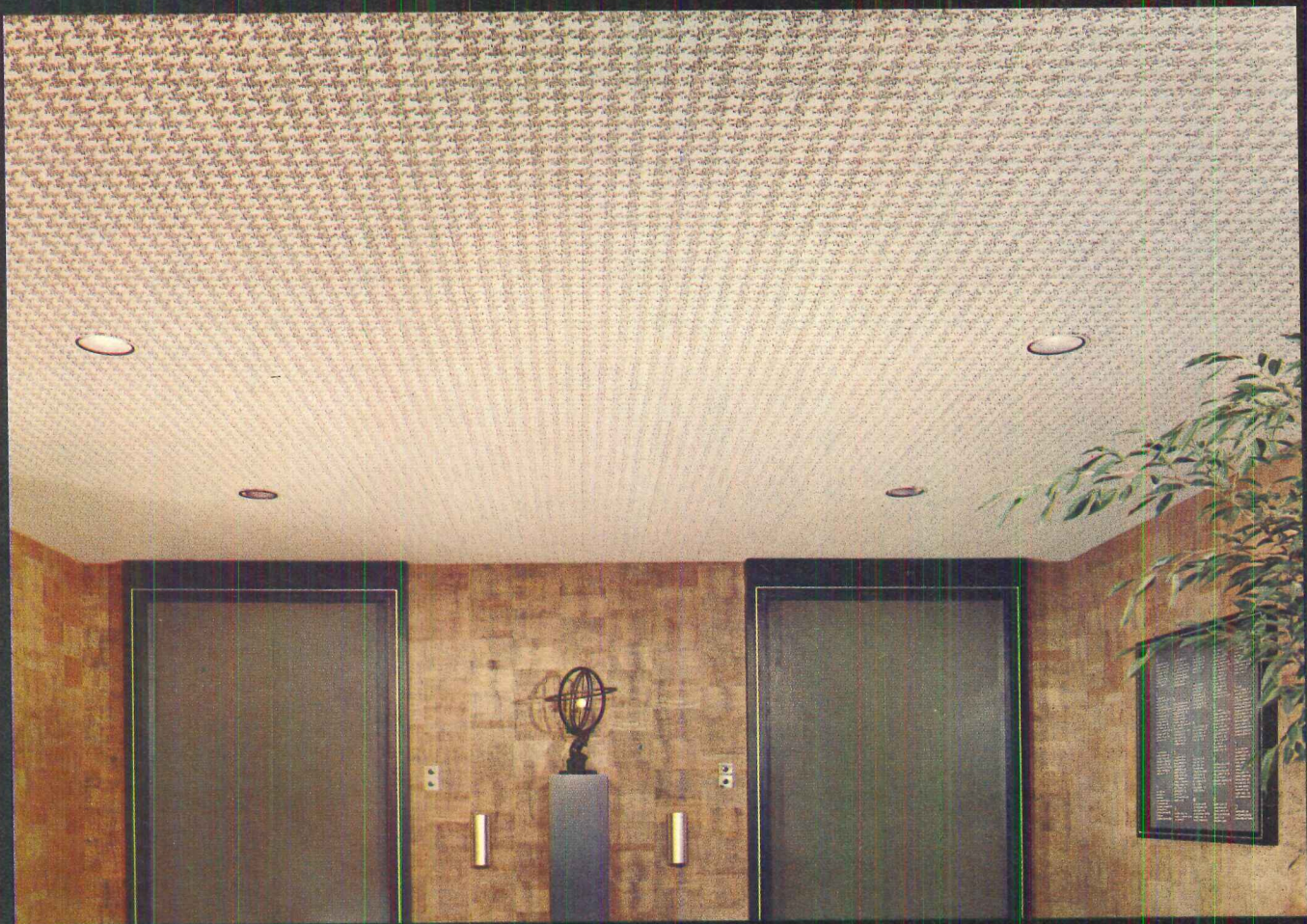
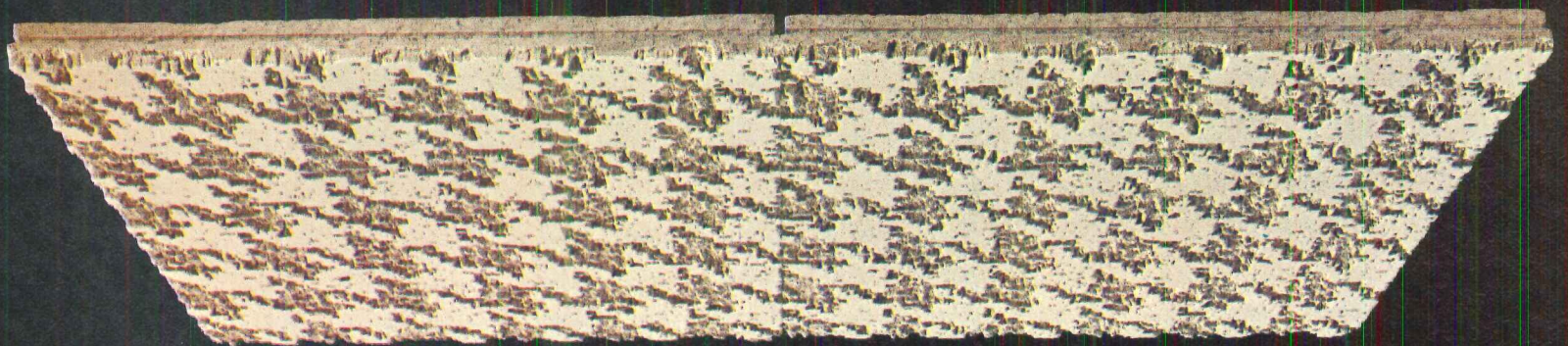

The look is houndstooth check, and its appearance is unbroken across an expanse of ceiling.

It's Grandshire, a 12" x 12" tile.

Grandshire is the newest addition to the Travertone™ ceiling line and offers a distinctively different monolithic look.

You can achieve this look two ways: by cementing the tiles directly to a sound, existing ceiling or by suspending the tiles from a concealed-grid system. Either way, it's an exciting seamless look.

Grandshire is an acoustically efficient, mineral fiber tile, with a Class 25 Flame Spread Index and an NRC of .60-.70.

For more information on Grandshire, write Armstrong, 4201-2 Rock Street, Lancaster, Pa. 17604.

You'll agree, it's a grand new look.

FROM THE  INDOOR WORLD® OF

Armstrong

For more data, circle 4 on inquiry card

The most beautiful roofing material you can use just happens to be the best insulation, too.

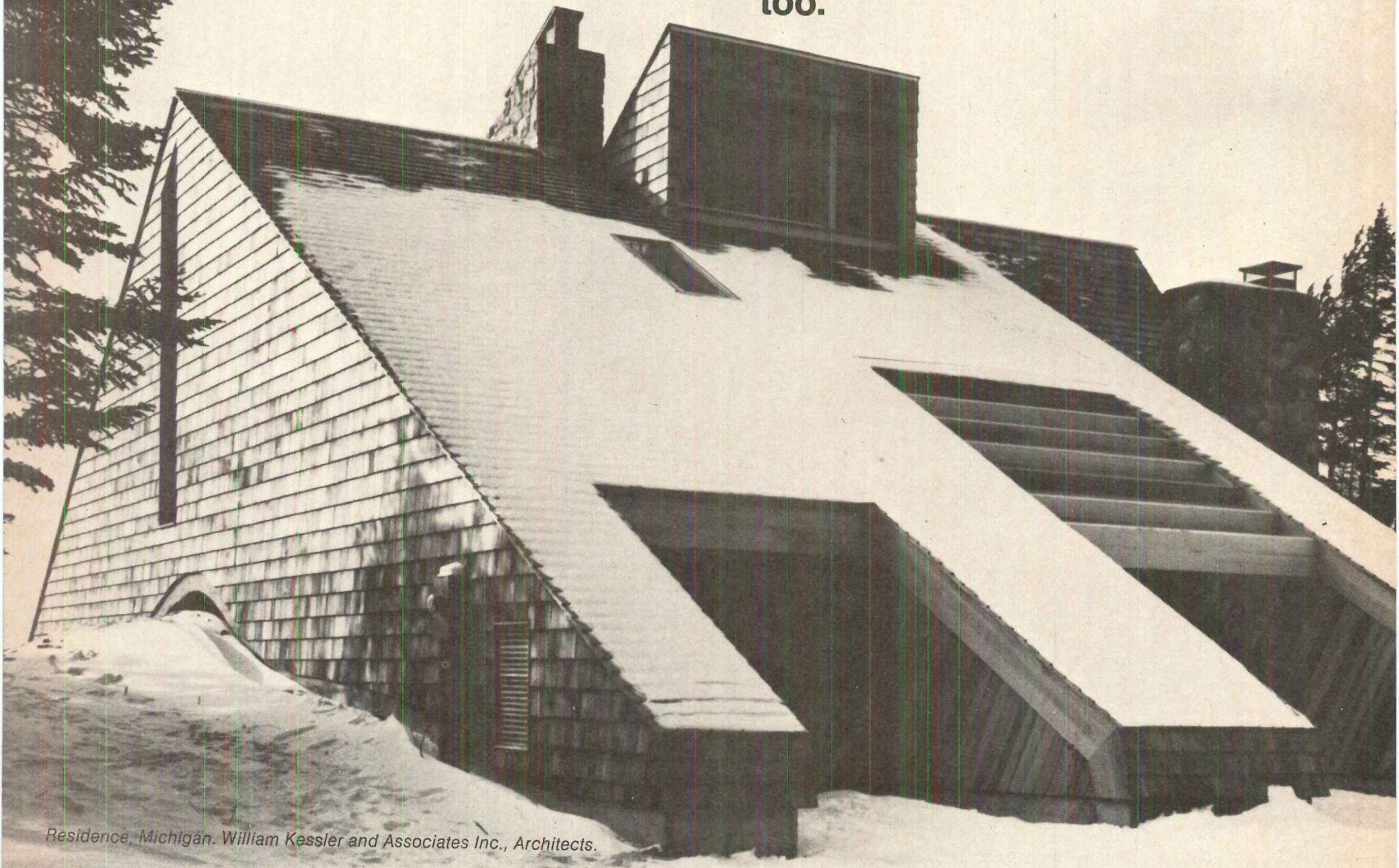

Residence, Michigan. William Kessler and Associates Inc., Architects.

Red Cedar shingles and handsplit shakes are twice as resistant to heat transfer as asphalt shingles. Three times more resistant than built-up roofing. In fact, red cedar out-insulates such roofing or siding materials as asbestos-cement shingles, slate, aluminum and architectural glass.*

Red cedar deserves close consideration for architects and builders concerned with the energy conservation of their structures. Its unique cellular structure makes it even more insulative than many other woods.

And the traditional overlapping application method effectively multiplies cedar's resistance to heat transfer.

Add to this the design flexibility and durability of red cedar on residences and commercial structures. It's no wonder the most beautiful roof and sidewall covering you can possibly use is also most efficient.

For more details, write Red Cedar Shingle & Handsplit Shake Bureau, 5510 White Bldg. Seattle, Washington 98101. (In Canada 1055 West Hastings St., Vancouver 1, B.C.)



These labels under the bandstick or on cartons of red cedar shingles, handsplit shakes and grooved shakes are your guarantee of Bureau-graded quality. Insist on them.

*ASHRAE Handbook of Fundamentals, 1972 ed., Chap. 20 "Design Heat Transfer Coefficients" Table 3A, pp. 362-63.

Red Cedar Shingle & Handsplit Shake Bureau

One of a series presented by members of the American Wood Council.

For more data, circle 5 on inquiry card

Armstrong introduces
a suspended ceiling panel
tough enough to take abuse.

Armatuff™*



You might look at this ceiling and think it's just another 2' x 4' lay-in. But its name gives away its distinguishing feature — toughness.

You can't see it, but Armstrong has coated these lay-in panels with a thick, tough mineral material that allows Armatuff to stand up to repeated abuse.

But, if these lay-in panels are subject to mistreatment, can't they be pushed into the plenum? If Armatuff

were an ordinary ceiling, the answer would be yes. But Armstrong has developed an impact clip that firmly anchors Armatuff to the suspended grid.

This combination makes Armatuff the ideal ceiling system for schools or anywhere else where a ceiling could possibly be damaged. And Armatuff can easily blend in with any decor, because its surface design is a nondirectional, rough natural texture, with a factory-applied white vinyl latex paint finish.

For more information, write to Armstrong, 4201-1 Rock Street, Lancaster, Pa. 17604.

You'll agree: Armatuff presents a good, tough case for itself.

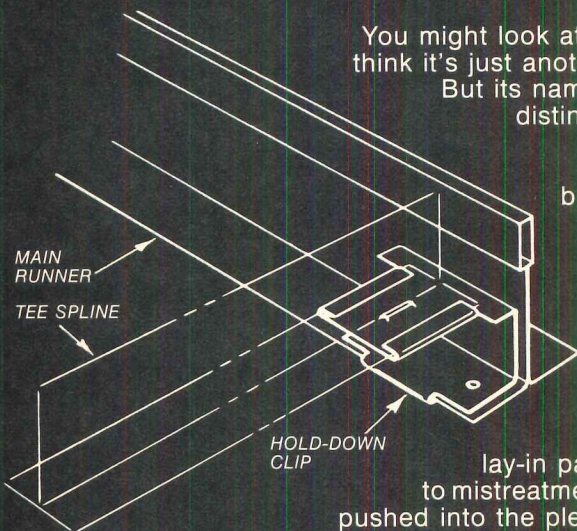

* Process patent pending

FROM THE  INDOOR WORLD® OF

Armstrong

For more data, circle 6 on inquiry card

If you find a cooler with 6 of these 12 features, consider it.

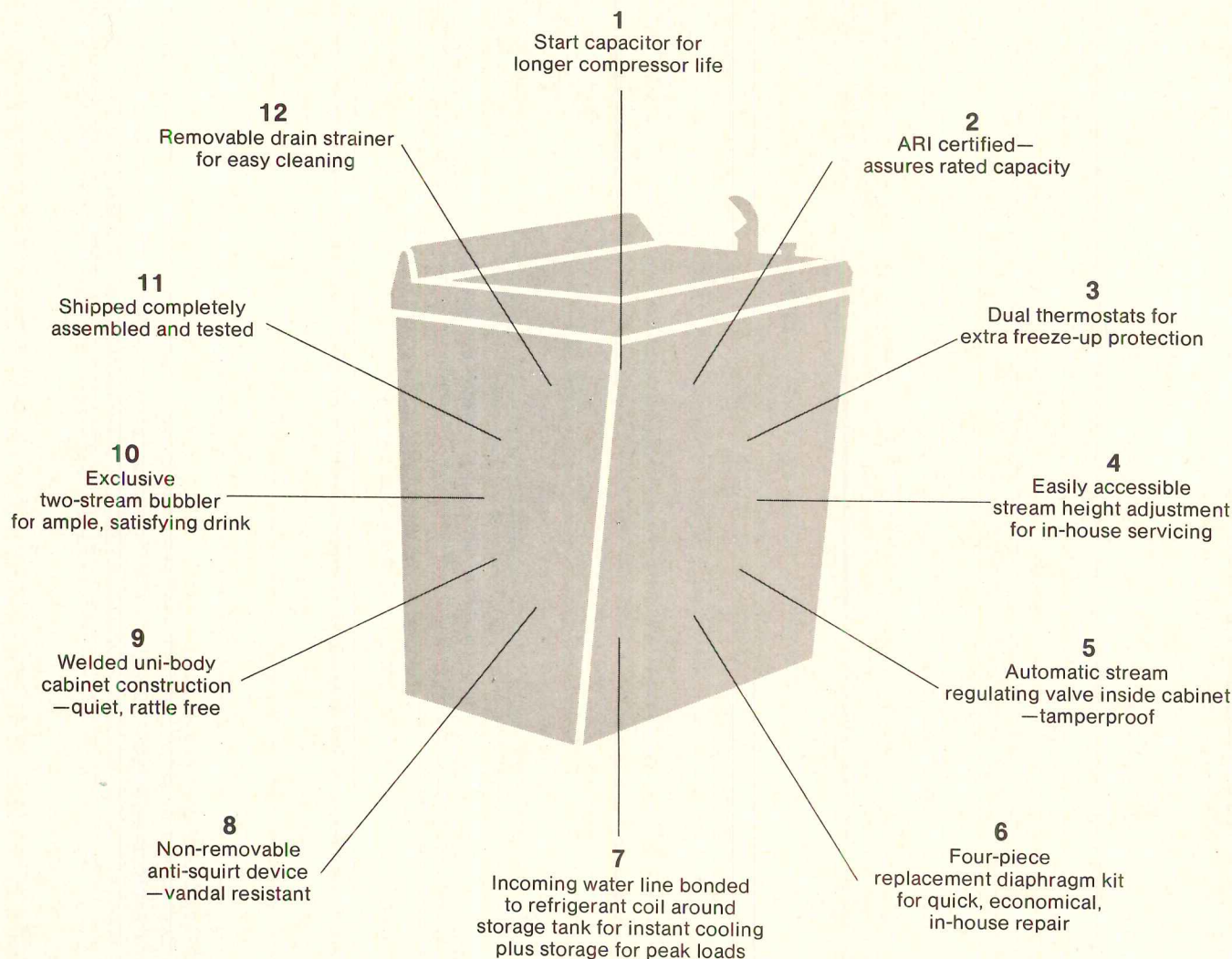

If it has all 12, buy it.

Okay, you're not fooled. You knew all the time that only Halsey Taylor offers all 12 of these features in its water coolers.

But there's more. We'll deliver our coolers in any of eight Polychrome colors. Or stainless steel. Or PATINA bronzetone stainless. Even vinyl-laminated steel in a choice of colors.

Now dwell a moment on point 11, above. It means that we test every Halsey Taylor

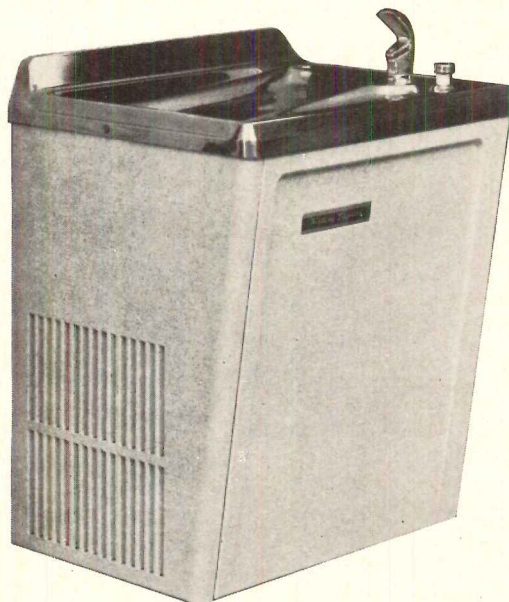

water cooler as it comes off the line. Thoroughly. Every cooler. No exceptions. And we completely assemble every cooler at the factory. It prevents installation booboos, makes the installer's job quick and simple.

If you can find a more dependable water cooler, buy it. If not, remember our name.

Halsey Taylor Division
1554 Thomas Road
Warren, Ohio 44481

Halsey Taylor[®]
KING-SEELEY **TS** THERMOS CO.

For more data, circle 7 on inquiry card

Take a second look.
Those ceiling tiles are really
lay-in panels.

Introducing the Second Look™ ceilings by Armstrong.

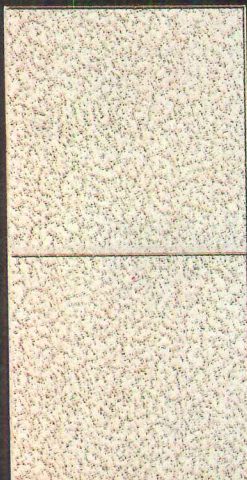
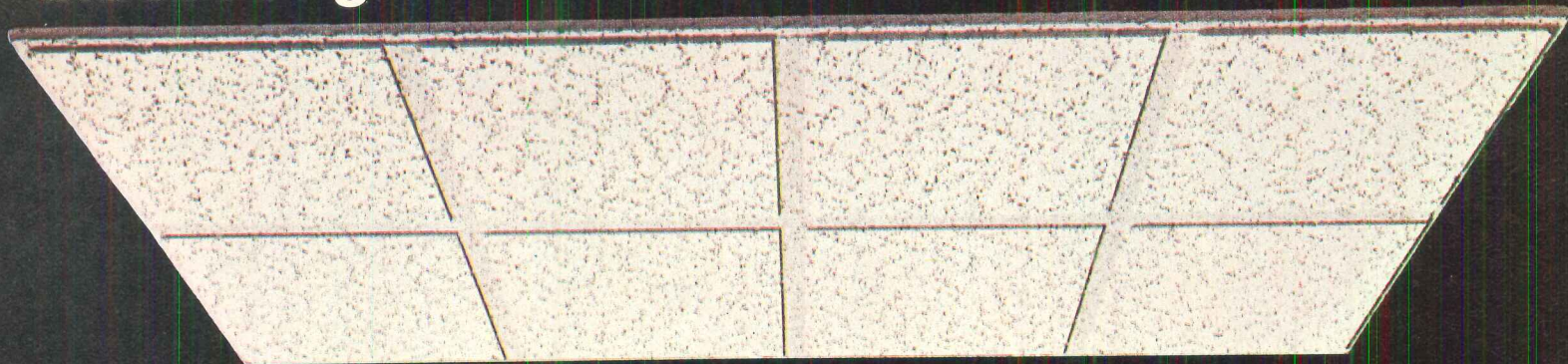

Second Look II ceiling panel

You really have to look twice. These are not 12" x 12" or 24" x 24" ceiling tiles, they are 2' x 4' lay-in panels.

That's why we call our new lay-in panels Second Look. They're designed to give ceilings the look of tile but with the economy of lay-in panels. What your client gets is a good-looking bargain. And the ceiling gets a lot of second looks.

We created this effect by scoring the panels to simulate 12" x 12" or 24" x 24" tiles—and we matched the exposed grid to the board finish in a speckled or low-gloss design.

Installation is the standard, economical suspended grid system. Just as soon as the panels are suspended, the total effect is achieved, because the grid and

the ceiling panels visually blend to give an overall appearance of more expensive tile.

Find out more about these unique Second Look lay-in ceiling panels. Write Armstrong, 4201-4 Rock Street, Lancaster, Pa. 17604.

Then you can take a good long second look at our Second Look.

*Second Look Ceiling Systems I and II patent pending

FROM THE



INDOOR WORLD® OF

Armstrong

For more data, circle 8 on inquiry card

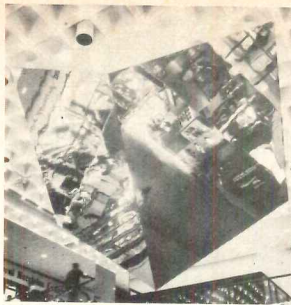

Cover: Interior court, Baystate West Shopping Mall
Springfield, Massachusetts
Architects: Eduardo Catalano and Pietro Belluschi
Photographer: Robert Bruce

EDITOR

WALTER F. WAGNER, JR., AIA

MANAGING EDITOR

HERBERT L. SMITH, JR., AIA

SENIOR EDITORS

ROBERT E. FISCHER
WILLIAM B. FOXHALL
MILDRED F. SCHMERTZ, AIA
ELISABETH KENDALL THOMPSON, FAIA

WASHINGTON EDITOR

ERNEST MICKEL, Hon. AIA

ASSOCIATE EDITORS

GERALD ALLEN
BARCLAY F. GORDON
CHARLES E. HAMLIN

ASSISTANT EDITORS

CHARLES K. HOYT, AIA
ANNETTE K. NETBURN

EDITORIAL ASSISTANT

JANET NAIRN

DESIGN

ALEX H. STILLANO, Director
ALBERTO BUCCHIANERI, Associate
ANNA-MARIA EGGER, Assistant
MURIEL CUTTRELL, Illustration
J. DYCK FLEDDERUS, Illustration
JAN WHITE, Consultant

EDITORIAL CONSULTANTS

EDWARD LARRABEE BARNES, FAIA
JONATHAN BARNETT, AIA, Urban design
GEORGE A. CHRISTIE, JR., Economics
PAUL RUDOLPH, FAIA
Foreign architecture:
L'Architecture d'Aujourd'hui, Paris

McGRAW-HILL WORLD NEWS

RALPH R. SCHULZ, Director
10 domestic and 8
international news bureaus:
Bonn, Brussels, Buenos Aires,
London, Milan, Moscow, Paris,
Tokyo.

SALES MANAGER

LOUIS F. KUTSCHER

CIRCULATION MANAGER

HUGH S. DONLAN

PUBLISHER

BLAKE HUGHES

THE RECORD REPORTS

13 Editorial

What can we do about housing
the world's poor?

14 Perspectives

12 Announcement of the formation of
The International Architectural
Foundation, Inc.

33 News in brief

Short items of major
national interest.

34 News reports

Solid-waste energy production
encouraged by EPA.
Building product manufacturers
plan capital spending increases.
GSA revises fire safety guidelines.
AIA will support a permanent
growth policy forum. Peoria, Illinois
reshapes its downtown. New movie
stars an "architect."

37 Buildings in the news

Boston's waterfront renewal.
Residence for USSR Mission to the
United Nations, Bronx, New York.
Dulin Gallery of Art, Knoxville,
Tennessee. Equibank Building,
Pittsburgh. Opera House competition,
Sofia, Bulgaria. Electric Energy
Conservation Station, Providence,
Rhode Island. San Francisco
International Office Center
(below), Burlingame, California.



Gerald Ratto

41 Human settlements: world news

43 Required reading

ARCHITECTURAL BUSINESS

**65 The guaranteed maximum price:
a sampling of views**

The myth of the GMP persists, so we
asked some knowledgeable thinkers
and doers in this vineyard for their
comment on professional and process
effects in today's practice:

1. John L. Tishman views GMP
in changing times
2. Bradford L. Perkins
states a clear case
3. George T. Heery says GMP
doesn't preclude CM
4. Charles B. Thomsen takes a
look at agency alternatives
5. Anthony J. Costanza makes a
contractor's plea for common sense
6. Randall N. Yearwood guarantees
only strict agency for clients.

77 Building costs

What's happening to prices
in the U.S.A. and Canada.

79 Building activity

George Christie takes a look at
the effects of energy, fuel and
other crises in this first update
of the outlook for 1974.



FEATURES

107 Park Central, Denver, Colorado

Dark, disciplined and distinguished Park Central is a remarkably handsome new business center in downtown Denver's Skyline renewal area. Its architectural elegance is especially significant in view of the fact that it was built as a speculative venture. Combined in the block-long building are rental offices, retail shops, an unusually spacious banking office, and a parking garage topped by a pedestrian plaza designed as part of a raised concourse through the area.

113 The fourth St. Thomas Church

RECORD reported in 1914 that the then new St. Thomas Church in New York, by Ralph Adams Cram and Bertram Grosvenor Goodhue, was "without doubt the most important and most successful parish church" in America. A second look 60 years later finds reasons, some of them unexpected, for vindicating this opinion.

119 Building renovation and the corporation image

Two projects—one urban and one rural—illustrate that occupying an older structure need not involve problems for the client desiring a progressive image. This concept is sure to grow in popularity, as the benefits of reduced costs are realized—and a surfeit of presently outmoded building stock continues to grow.

127 "The future of the office building," by Jonathan Barnett

A thoughtful analysis of how today's office buildings evolved into their world-wide stereotyped forms, and some portents for their future in the over-all urban complex.

131 Two houses at The Sea Ranch

The special character of The Sea Ranch—a second home development on the Sonoma County coast in northern California—requires a sensitive relationship between buildings and land. Simplicity is the essence of the two houses shown here: the Nimnicht house (page 131), Fred L. Osmon, architect; the Whiteside house (page 134), Donald Jacobs, architect.

BUILDING TYPES STUDY 459

137 Shopping centers

Will the typical regional center be replaced by the downtown mall within a hotel-office complex or "omnicenter"? What will the better suburban and exurban centers which do get built be like? What are the constraints which will be exacted by newer environmentally conscious zoning? No one knows for sure but architects who design merchandising facilities are giving these questions a lot of study.



Balthazar Korab

138 Broadway Plaza

Los Angeles, California
by Charles Luckman Associates

142 Baystate West Shopping Mall

Springfield, Massachusetts
by Eduardo Catalano and Pietro Belluschi

144 Crown Center retail complex

Kansas City, Missouri
by Edward Larrabee Barnes

146 Market Street East Transportation Mall Center

Philadelphia, Pennsylvania
by Bower and Fradley

150 Meadow Mall

Simsbury, Connecticut
by Gwathmey Siegel

ARCHITECTURAL ENGINEERING

151 Flexible electrical distribution for changing spaces

New wiring systems have been developed in response to owners' requirements for flexible and open spaces to get power and communications to convenient points of use. Even plug-in systems are available to allow lighting fixtures to be easily moved or changed. Examples are shown of the growing number of applications in office buildings, schools and stores.

161 Product Reports

163 Office Literature

193 A/E Update

198 Record Impressions

240 Classified Advertising

242 Advertising Index

245 Reader Service Inquiry Card

NEXT MONTH IN RECORD

Building Types Study

Alan Lapidus calls it an American hybrid in hotel design. William B. Tabler calls it a single-structure city. They are referring to the convention hotel, and with the help of these two noted hotel architects, the RECORD will examine the behind-the-scenes functional—and financial relationships that produce a successful convention hotel.

Four Houses

You don't have to be rich to have an architect-designed-to-order house in the Hamptons, if the architect—in this case Robert Loren Rotner—knows what good builder developers know about construction economies. Next month's RECORD will discuss four remarkably low-cost custom-built houses designed by Rotner and constructed in eastern Long Island.

*Architectural Record and L'Architecture d'Aujourd'hui announce
the formation of The International Architectural Foundation, Inc. for the purpose of conducting . . .*

An international design competition for the urban environment of developing countries

Desirous of helping the developing countries of the world to meet the challenges of unprecedented urban growth,

Inspired by the United Nations Resolution 3001 to hold a major United Nations Conference-Exposition on Human Settlements (Habitat '76) in Vancouver, Canada from May 31 to June 11, 1976, and wishing to contribute to its success,

The International Architectural Foundation, Inc. (IAF) has been formed for the purpose of organizing an International Design Competition open to the professions of architecture and planning throughout the world.

The IAF proposal has been described as "exciting and innovative" by Helena Z. Benitez, Coordinator, Preparatory Planning Group for Habitat '76. And Eric Carlson, its Deputy Director, has stated, "the IAF Competition has great potential for providing useful inputs to the important Vancouver meeting." In addition, prominent architects, planners and government officials around the world have expressed their enthusiasm and encouragement.

The Competition, scheduled to start in the late summer of 1974, when full details will be available to entrants, proposes to challenge the design professions to address themselves to a problem of grave and growing international concern: the human and environmental problem of *accelerating urbanization*. The challenge will be to design within a largely pre-existing urban-regional context a new and beneficent cell of urban growth—one that will foster human well being and development and one that will be fully considerate of environmental impacts. Thus, within a framework reflecting the universal problem of urbanization, three specific sites for a human settlement of moderate size will be selected to which designers can respond in the specific detail of both their physical characteristics and their social and economic factors. These sites will be located in three cities: one each in Central/South America, the Middle East/Africa, and

Asia/Oceania. Sponsoring local agencies will participate in the development of the Competition programs and agree to construct the winning designs and appoint their designers as project architects. In this unprecedented effort three design competitions, with three awards, to be built in three locations is projected; but the worldwide creative effort generated will yield the further benefit of many new ideas for urban community development which it is expected will be displayed at the Vancouver Conference-Exposition, featured in the world's leading architectural magazines, and published in book form.

The international consulting firm of Gutheim/Seeling/Erickson has been appointed by The IAF to organize and manage the Competition.

Funds needed to meet the Competition budget will be contributed by a small number of philanthropic sources in several countries and by interested business firms. The IAF is pleased to announce that the Graham Foundation has already endorsed its Competition and pledged its financial support.

If you would like to consider the possibility of joining a small group of financial sponsors, and being identified over a three-year period with a major effort to help developing countries find creative and practical solutions to some of their crucial problems of human settlements, write (in the U.S.) Blake Hughes, The International Architectural Foundation, Inc. (41), 1221 Avenue of the Americas, New York, N.Y. 10020, or (in France) Jean-Louis Servan-Schreiber, The International Architectural Foundation, Inc., 10 Rue Lyautey, Paris 16.



What can we do about housing the world's urban poor? We can try. And here's one way:

On the facing page, ARCHITECTURAL RECORD and L'ARCHITECTURE D'AUJOURD'HUI announce the formation of The International Architectural Foundation, Inc. for the purpose of organizing an "International Design Competition for the Urban Environment of Developing Countries."

That is a mouthful—and a *mindful!*

The Competition—as the announcement explains—is for the design of prototypical urban neighborhoods "within the existing urban context" of three cities—one in Central/South America, one in the Middle-East/Africa; and one in Asia/Oceania.

Full details are not yet available to entrants—since while The IAF is far along in developing commitments for program developments, commitments for building the premiated designs and commitments as to the three target cities, they are not yet locked in. But we expect these commitments soon (this has been an active project for just short of a year) and we expect the Competition to be formally underway this summer. For now, the most important questions to raise (and try to answer) are these:

Why such a competition now? How should one react to this idea? Can it really be done?

Fair questions. Only the last cannot be answered with certainty. We believe it can—and will—be done. We take pride in announcing and endorsing The IAF Competition, so enthusiastic are we about the project, so impressed by the reactions of eminent persons at home and abroad, and so deeply in agreement about the need.

The late Charles Abrams, who was perhaps the single most knowledgeable person on the housing problems of developing countries and who was long a consultant to the United Nations, wrote in 1964 in his splendid book, *Housing in the Modern World*, "The growing city, with all its faults, is the crucible in which man's destiny will be determined."

And, because it bears so much on the decision to sponsor an international design competition, we want to quote Abrams further on the urbanization of developing countries.

He said, "The solutions to the problems of urbanization may be the key to an international rapprochement—and even to a lasting peace." He added, without minimizing the problem of space shortages around urban cores or the increasing strain on food and material supplies, "The main obstacle is, of course, the dearth of talent and knowledge for

meeting the challenges of urbanization."

"The dearth of talent and knowledge." Certainly that is still the main obstacle—and it is to help remove that obstacle that the United Nations has scheduled one of the most important conventions in its history to be held in May 1976 in Vancouver, Canada: "The United Nations Conference-Exposition on Human Settlements [Habitat '76]."

Last year the Governing Council of the United Nations Environment Program (UNEP), seeking U.N. General Assembly endorsement for the Vancouver Conference-Exposition, defined its basic purpose as follows: "To stimulate innovation, serve as a means for the exchange of experience, and ensure the widest possible dissemination of new ideas and technologies in the field of human settlements."

The General Assembly responded in January by reaffirming its earlier decision to hold a Conference-Exposition and directed that the main purpose of Habitat '76 be "to serve as a practical means to exchange information about solutions to problems of human settlements against a broad background of environmental and other concerns. . . ."

We have applauded the objectives of Habitat '76 from the start, but at the same time we have asked whether it would be enough to assemble a couple of thousand official representatives and technical experts in Vancouver to confer on human settlements, exhibit solutions to the problems of urbanization, and disseminate large amounts of related literature around the world.

It seemed to us that something more was needed—something that would add to the effectiveness of Habitat '76 by engaging the attention of more people with something to contribute and eliciting new, creative and practical responses to problems of urbanization.

That is how the international design competition was conceived, and we are happy to say that The IAF has been greatly encouraged to pursue this difficult project by United Nations authorities responsible for planning Habitat '76. They feel, as we do, that the Competition can provide valuable inputs in two ways:

1) by focusing the attention of architects and planners (as well as students) around the world on the looming crisis of accelerating urbanization in developing countries;

2) by encouraging the submission of a substantial number of "designs for a small increment of urban growth within a larger urban planning context" for three widely separated cities—designs fully sensitive to local cultural,

The editorial page is the jealously guarded prerogative of the chief editor, and I've not given it up in the six years—and nearly 80 issues—that it has been my responsibility. But the responsibility-taker and team captain for the massive and important project described on these pages has been RECORD's publisher, Blake Hughes, and he deserves to be the one to tell you about it. —W. W.

economic and environmental factors; designs of architectural excellence; designs to be exhibited in Vancouver and communicated internationally in our magazines; and most important of all, *designs that will be built!*

We refer to a "looming crisis" in all earnestness—for we must do something

Much has been written about this crisis for a long time, but its full implications have not been well enough understood, nor have they penetrated deeply into the consciousness of people in general or even those equipped to do something constructive about easing it.

There is not room here to explore all aspects of the urbanization crisis, but it is, of course, terribly real. Consider this statement by the U.N. Expert Panel on the Vancouver Conference-Exhibition: "In the next 25 years the world's human settlements will confront pressures *unprecedented in human history.*"

Why? Well, for example. . .

- World population will nearly double,
- The majority of mankind will for the first time live in urban areas of more than 20,000 inhabitants,
- The buildings of all kinds required will exceed all the construction hitherto undertaken by all the world's people!

There is just no doubt that there are many new forces engendering perilous pressures in developing countries. As a high rate of technological and economic innovation brings changes around the world, the expectations of the poor are raised—but too often they do not share in the benefits of this innovation, and so it serves only to add bitterness to frustration. Winds of change drive millions of refugees from rural deprivation to the city—where all they find is a different kind of deprivation; perhaps worse because roots have been torn up, family and community patterns shattered, the opportunity for self-help reduced.

These are great winds—so far heedless and mindless and beyond control—yet, paradoxically, full of potential for a better life IF. . .

IF men of goodwill, vision and ability can be found and motivated to help turn this stormy flux to good account for the underprivileged of the world. There must be wider awareness, more understanding, more concern, more commitment—and above all, more of that which alone validates commitment: PARTICIPATION.

And that is what the Competition is all about: participation

We want to involve architects and planners around the world in the solution of real problems. And we hope that some architects and planners will be moved to continue to dedicate their skills long after to the task of creating better human settlements around the world.

We are not so naive as to believe that architecture is the solution to all the problems of the world; that good planning and design is a substitute for jobs that don't exist, or for food that doesn't exist or is too dear. But housing and a sense of community are basic human needs—and that is the part of the problem that we know most about and can best do something about. So let us try.

—Blake Hughes, publisher

Drawn for ARCHITECTURAL RECORD by Alan Dunn

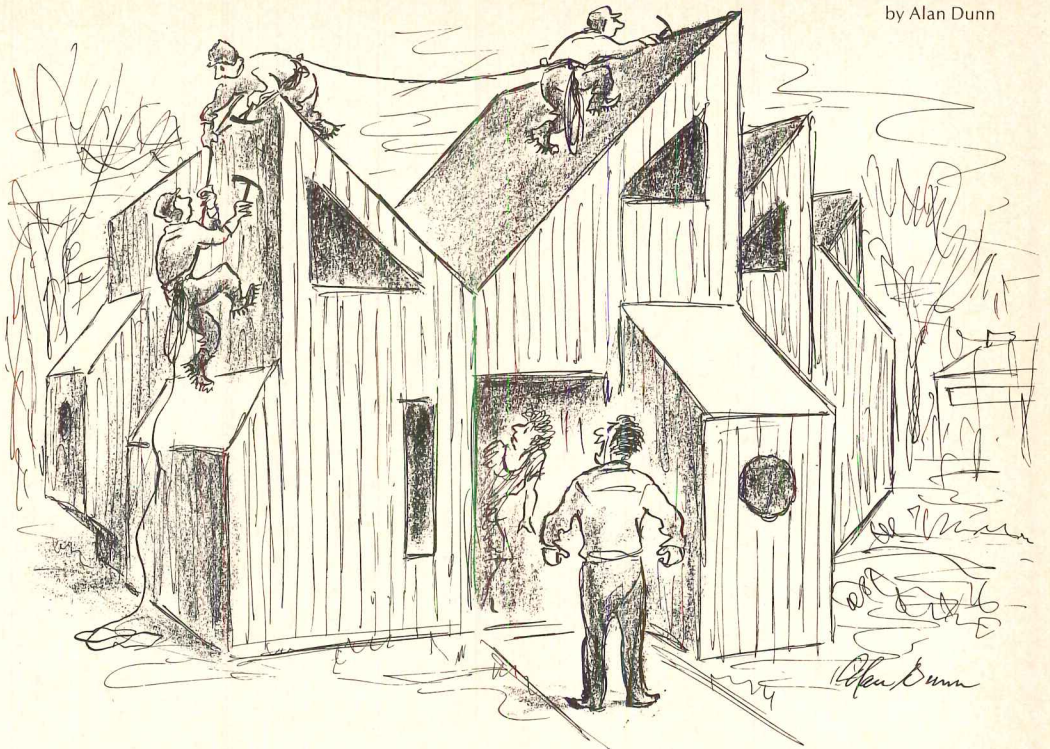

"Off the roof you guys, off the roof!"

Our seminar on selling professional services: a confident commercial

The first seminar on "Marketing professional services"—jointly sponsored by RECORD and Building Industry Development Services—took place last month in Washington—appropriately (for a seminar for architects and other professionals) in the chapel of Mt. Vernon College which won an AIA Honor Award for its architects, Hartman-Cox. Ray Gaio and Gerre Jones of B.I.D.S., who produced and directed and, as they say, played a leading role, did a very good job indeed—not just in my opinion, but in the opinion of the vast majority of the attendees. One architect-attendee, I'm sorry to say, left disappointed at the end of the first day (we're hoping he'll attend the second day of a later seminar) but the other 20 gave the seminar good marks, and most gave it excellent marks. A subjective but significant scorecard: All but three attendees attended the optional evening meeting on the first day, and all but three (who really did have to be home on time) stayed until 5 o'clock of the Friday session—and in my experience that's darn near unique. We made some mistakes in this first effort—the man who was supposed to show how to make most effective use audio-visual techniques delivered a dreadful commercial for his sponsor; and we scheduled more time for discussion of "political action"—a perfectly straightforward discussion of how and when to get help from your Congress-

man—than people either were interested in or wanted to hear about (these days).

Anyway, as editor of a magazine which is sponsoring these seminars (and which will get a fair profit from them if all goes well) I've been diffident about promoting them (unseemly commercialism in an Ivory-Tower type, and all that). But having attended and participated in the first one (and the second will have taken place, in Atlanta, by the time I have to put a final approval on this copy) I can say confidently that I think that the seminars are a good investment for architects and other professionals who are interested in developing within their firm a planned program for the development of the right kind of work.

The emphasis is on planning—on deciding how much of what kinds of work the firm can best handle, on assigning the responsibility to the right person, on figuring how much time and money needs to be spent, and on doing the job of "selling your services" in a steady, efficient, way that will meet your goals. The seminar is hard, concentrated work—and requires follow-through back at the office if any good is to come of the effort. Indeed, Gerre Jones and Ray Gaio intend to follow-up with each seminar attendee to see what action has been taken in their offices along the lines suggested and developed at the seminars.

You can get all the details on the seminar locations for the rest of the year—and a handy coupon for signing up—on page 186 of this issue. Or call me.—W.W.

The feature attractions: Gerre Jones



... and Ray Gaio

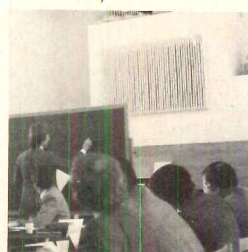

... and the group.



When it's 95° outside,
this brick cavity wall gains heat
at the rate of only .72 Btu/h
a square foot.



10" brick cavity wall. 4" brick units
with 2" polyurethane insulation.

A highly efficient glass
wall admits 60 times more heat;
a top-quality sandwich panel admits
nine times more; a concrete sandwich
panel admits three times more.

And, from a
design point-of-view, it's also a
more interesting square foot.

With a U value of only .06, brick
cavity walls provide the most efficient
barrier against solar heat gain in
buildings. A 10,000-square-foot brick
cavity wall gains only 7,200 Btu/h
under summer design conditions,
compared to 440,000 Btu/h for a
double-glazed reflective glass wall.

Brick solves energy conservation

problems inexpensively. In most areas,
a brick cavity wall can be installed
for \$4.50 to \$7.50 a square foot. Price
includes finished interior walls.

If the cavity wall doesn't meet
your design needs, other brick walls
will. All offer similar energy
conservation and none will shatter
your project's budget.

Brick Institute of America, 1750 Old Meadow Road, McLean, Virginia 22101

For informative booklet comparing energy conservation
characteristics of brick with competing systems, please
fill out and mail coupon to:

Brick Institute of America, Dept. EC AR
1750 Old Meadow Road, McLean, Virginia 22101

Name _____

Title _____

Firm Name _____

Street _____

City _____

State _____ Zip _____



For more data, circle 9 on inquiry card

Blowbacks. Another good reason for microfilm.

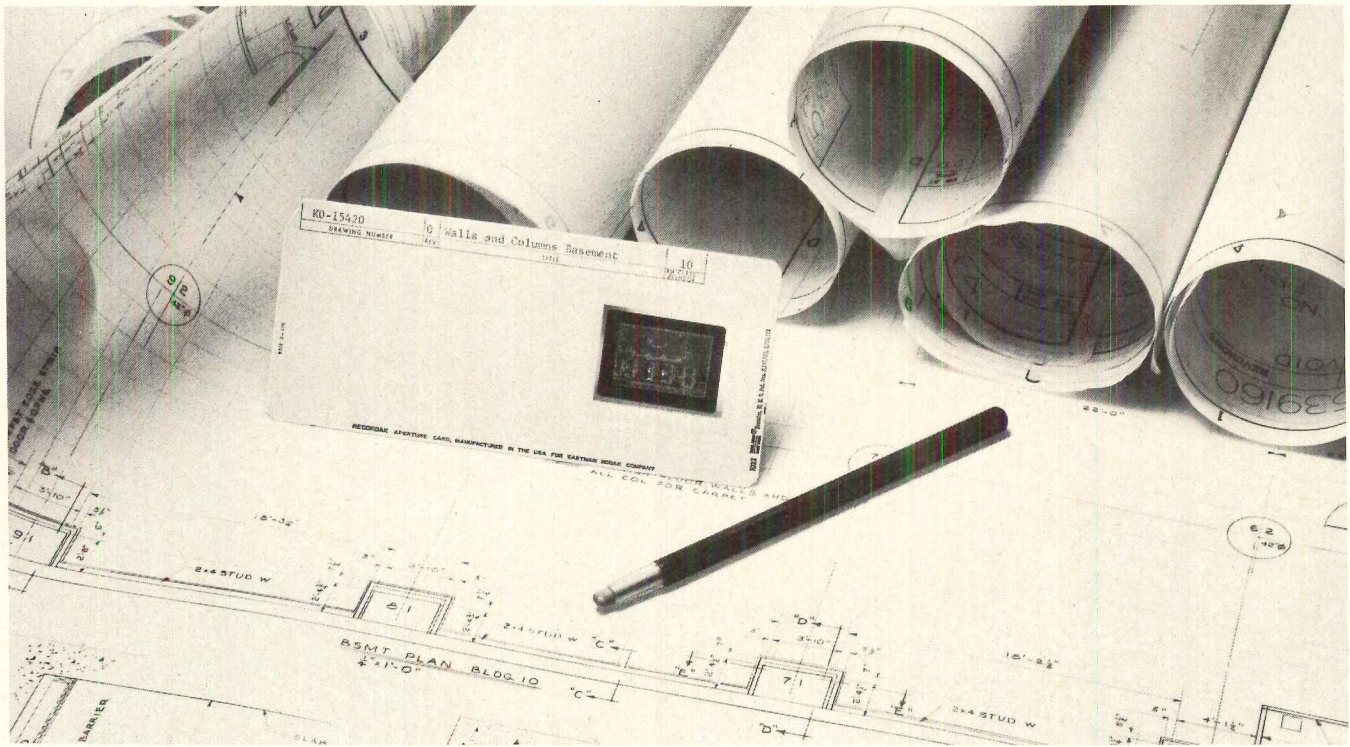

Put the flexibility of Kodak microfilm into your drawing operation.

There are many advantages to microfilming your drawings. It saves space, it provides security, and it's one of the most efficient methods of filing and retrieving engineering data. And now, you can make high-quality enlargements directly from the sharp, crisp microfilm images that Kodak products have produced.

Blowing back onto Kodagraph films or papers from microfilm is a fast, easy way to make second originals. And you not only eliminate the need to use original drawings; you also save material because you can

produce the exact size reproductions you require.

You'll find that you save in other ways, too! Whether the job is revising drawings or restoring them, or even making distribution prints, blowbacks from Kodak microfilm can save you time and money.

Get the details.

Find out how Kodak microfilm and drawing reproduction products can benefit your organization. Write for our booklet on Engineering Document Control or ask for a sales representative to call. Eastman Kodak Company, Business Systems Markets Division, Dept. DP752, Rochester, N.Y. 14650.

Kodak products for drawing reproduction.



For more data, circle 10 on inquiry card



**Bally Walk-Ins
belong where
food must
be right
and ready
for the daily
pupil parade**

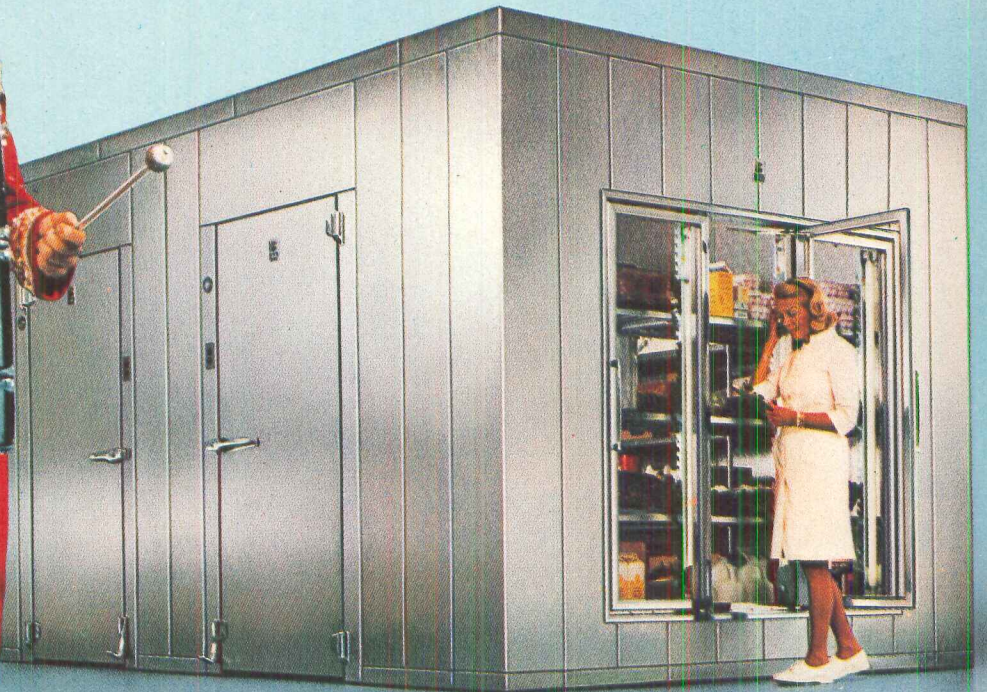

Bally Walk-In Coolers and Freezers belong everywhere mass feeding takes place. They can be assembled in any size for indoor or outdoor use from standard panels insulated with four inches of foamed-in-place urethane, UL 25 low flame spread rated and Factory Mutual research approved. Choice of stainless steel, aluminum or galvanized. Easy to enlarge . . . easy to relocate. Refrigeration systems from 35°F. cooling to minus

40°F. freezing. Subject to fast depreciation and investment tax credit. (Ask your accountant.) Write for 28-page book and urethane sample. **Bally Case & Cooler, Inc., Bally, Penna. 19503.**



© 1973. ALL RIGHTS RESERVED.

ADDRESS ALL CORRESPONDENCE TO DEPT. AR-4

For more data, circle 11 on inquiry card

This beach has the 3 essentials Owens-Corning has the system

1. Acoustically non-reflective "ceiling"



1. An acoustically non-reflective ceiling is a *must*—to keep sound from bouncing to other areas. An independent acoustical testing laboratory examined eight ceilings, including expensive coffered and baffled systems. Their verdict: Owens-Corning's Nubby II Fibreglas* Ceiling Board (left) in any standard exposed grid suspension system is *best* for achieving speech privacy at economical installed cost.

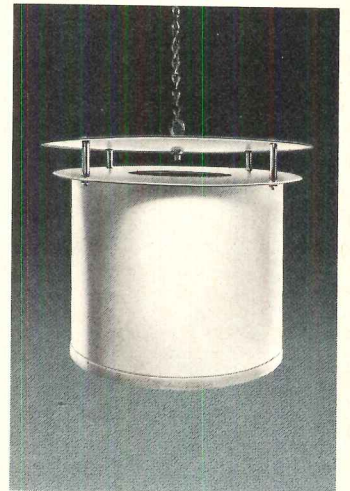

*Reg. T.M. O.-C.F.

for speech privacy in open offices. that puts it all indoors.

2. Masking sound

3. Sound barrier "screen"

2. An objectionable background sound helps mask distracting speech. Special electronic speakers, installed in the plenum, make it possible to hear normal conversation clearly within defined areas, without being overheard in other areas.



3. A barrier or the proper acoustical *screen* is necessary to keep unwanted speech from going *directly* between work areas.

All three essential elements should be "tuned" to work together with the help of an acoustical consultant.

For further information and our free 16-page guide, "Achieving Speech Privacy in the Open Office," write: N. K. Meeks, Architectural Products Division, Owens-Corning Fiberglas Corp., Fiberglas Tower, Toledo, Ohio 43659.

Owens-Corning is Fiberglas

OWENS/CORNING
FIBERGLAS
TRADEMARK ®

For more data, circle 12 on inquiry card

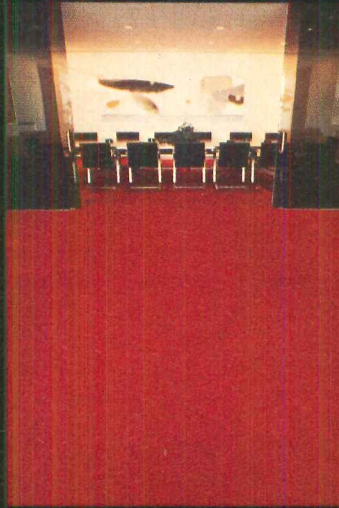

The reason our Acrilan® acrylic fiber is so versatile is that it's made in two distinctly different forms.

Carpets labeled **Acrilan Plus** offer a luxurious look and hand, and the styling versatility to set the tone for the Chairman's suite. In fact, custom designers, who have been traditionally committed to wool, are now using Acrilan® acrylic to make custom carpeting

**Q: THE LOBBY. THE
THE CAFETERIA. CAN
BE RIGHT FOR THEM**

that sells for as much as \$50 a yard.

Carpets labeled **Acrilan 2000+** contain the only solution-dyed acrylic fiber available. The color is not applied later, but is an integral part of the fiber, all the way through. Because of this, carpets of solution-dyed Acrilan® acrylic 2000+ are the most color-fast you can specify. In sunny locations with large

glass areas, like most lobbies these days, you can't beat this fiber. 2000+ is a Weatherometer rating, showing no visible fading after 2000 hours of burning noonday sun. (For comparison, the industry rating for normal carpets is 40 hours). And some of our colors actually rate up to 6000 hours!

Acrilan 2000+ carpets are also perfect for the

cafeteria. Or any location where food or chemical spills are a problem. We tested it with more than one hundred hospital stains, and with their solvents, which are even worse. It came through with glowing colors.

What's more, our licensing program is your guarantee of good quality. We insist that constructions meet specific weight/density

standards, because face weight minimums alone can't guarantee quality. We also require that pile density increase as pile height increases.

For all these reasons, consider Acrilan for your next contract installation. Meanwhile, for more information, write Monsanto Textiles Company, 1114 Avenue of the Americas, New York, N.Y. 10036.

CHAIRMAN'S SUITE. ANY CARPET FIBER ALL?

A: ACRILAN CAN.

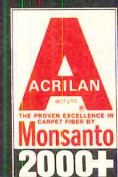

This is Triton I, *Rotolite's* new odor-free, non-ammonia whiteprinter. It gives you quick, clear, sharp prints or copies. At speeds up to 19 feet per minute. All for a \$50-per-month lease charge, a charge that includes everything. Which means you can use your Triton all you want. And never exceed your \$50 monthly lease charge.

Our non-ammonia machine vs their non-ammonia machine.

A price comparison.

There is only one other non-ammonia whiteprinter on the market. It costs \$25 per month to rent, plus \$5 per hour for every hour you use it (up to 18 hours a quarter). Even under moderate usage,

that adds up. In fact, even if you only use their machine two hours a week, it'll cost you more than ours. Not that we've sacrificed convenience for savings. Far from it. Our machine is easy to operate and clean (there's no daily clean-up) requires no warm-up, and installs easily atop any table or counter (it's only 60" long). All you do is plug it in.

Best of all, Triton I is made by *Rotolite*, the people who pioneered diazo printing equipment and have produced quality machines for over 20 years.

We think you'll like *Rotolite's* new Triton I whiteprinter. Why not write us for all the details? **Teledyne Rotolite, 328 Essex Street, Stirling, N.J. 07980.**

Now you're on the right scent.



**Why our
non-ammonia
whiteprinter
won't cause a
stink in the budget
department.**

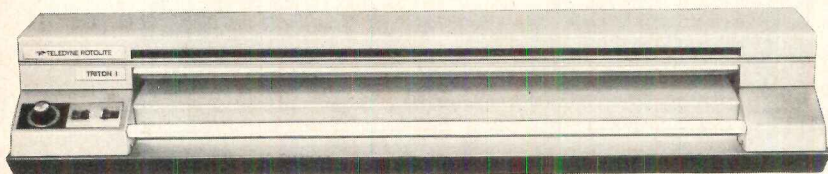

 **TELEDYNE ROTOLITE
TRITON I**

For more data, circle 14 on inquiry card

**Owens-Corning announces
its third annual
Energy Conservation Awards Program
for architects and engineers**

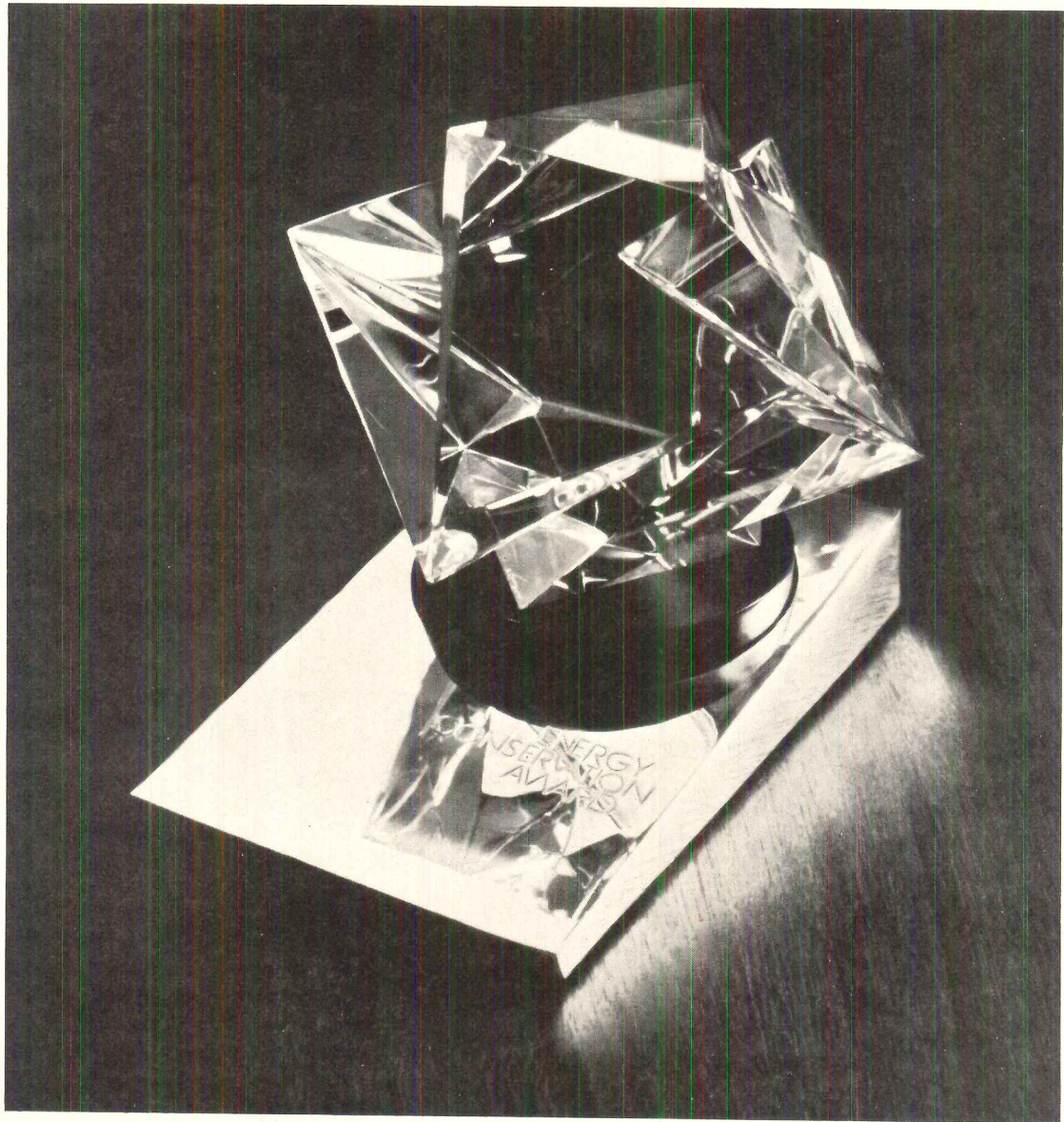

The Owens-Corning 1974 Energy Conservation Award.
"Triangles," a Steuben Crystal sculpture that captures and refracts light from multiple triangular planes.

This year, the whole world is watching.

Show our Awards Jury a building design that doesn't waste energy—and you could win one of the Energy Conservation Awards Owens-Corning will present for 1974.

The Awards Jury will be looking for three things: Creativity. Originality. And most important of all—designs that save energy.

Too many buildings waste fuel and contribute to environmental pollution.

By continuing the Energy Conservation Awards Program we initiated in 1972, Owens-Corning hopes to stimulate even more new ways to conserve energy. And it will let us honor the architects and engineers who do the best job of designing buildings and mechanical systems that conserve fuel.

Who can enter

Any registered architect or professional engineer practicing in the U.S. is eligible. As an individual. Or in a team. But to qualify, your entry must be a commissioned building project—in the design process, under construction, or a completed structure.

Although Fiberglas* products are an excellent way to conserve energy, their use is not a requirement.

Four entry categories

A winner will be selected in each of these categories:

Institutional—schools and hospitals, for example.

Commercial—office buildings, shopping centers, retail stores, and similar structures.

Industrial — including manufacturing plants, research centers, warehouses.

Governmental—post offices, administrative buildings, and military structures to name a few.

The Awards

Winning architects and/or engineers will receive the Steuben Crystal sculpture "Triangles." Owners or clients associated with winning entries will receive other Steuben Crystal awards.

The Awards Jury for 1974

Eight outstanding professionals in architecture and engineering will serve as the Awards Jury to select the winners.

H. Fred Campbell, H. F. Campbell Company, Detroit, Mich.; Walter H. Costa, Skidmore Owings & Merrill, San Francisco, Calif.; Sital Daryanani, Syska & Hennessy Inc., Engineers, N.Y., N.Y.; Dr. Donald P. Greenberg, Prof., Cornell Univ., Ithaca, N.Y.; George T. Heery, Heery & Heery, Atlanta, Ga.; Philip J. Meathe, Smith Hinchman & Grylls, Detroit, Mich.; Richard L. Mullin, Symes Maini & McKee, Cambridge, Mass.; Thomas A. Stokes, Cary B. Gamble & Associates, Inc., New Orleans, La.

Send for entry details now

Completed entries must be submitted by August 31, 1974. Winners will be selected and notified in early September.

For a brochure giving complete details, contact your local Owens-Corning representative. Or write N. E. Meeks, Owens-Corning Fiberglas Corporation, Architectural Products Division, Fiberglas Tower, Toledo, Ohio 43659.

*T.M. Reg. O.-C.F.

Owens-Corning is Fiberglas



For more data, circle 15 on inquiry card

Goodyear Speedramp.[®] Clearly the way to move people to move merchandise.



The new Speedramp[®] passenger conveyor system with glass balustrade (shown here in exact scale model) is a logical part of the new light, airy concept of interior design and merchandising.

The glass balustrade Speedramp is supported by an opaque enclosure less than 2 feet thick for a slim, attractive profile. Conventional escalator systems—even those using glass balustrade—require a heavier opaque enclosure, nearly 4 feet thick.

Speedramp offers passengers a clearer view of displays. And it offers you more opportunities to catch the shopper's gaze and turn it into sales.

Your customers also enjoy the convenience of cart shopping. A special Cart-Lock[®] feature allows the grooved cart

wheels to grip the belt and then release automatically at ramp end.

If you're planning to move lots of people—and lots of merchandise—you'd be wise to include a Speedramp system in your plans. For complete information, write to Goodyear, Transport Systems, Box 52, Akron, Ohio 44309.

The glass balustrade Speedramp.
A moving idea that's perfectly clear.

GOODYEAR
TRANSPORT SYSTEMS

For more data, circle 16 on inquiry card

OPEN OFFICES NEED CLOSED CONVERSATIONS

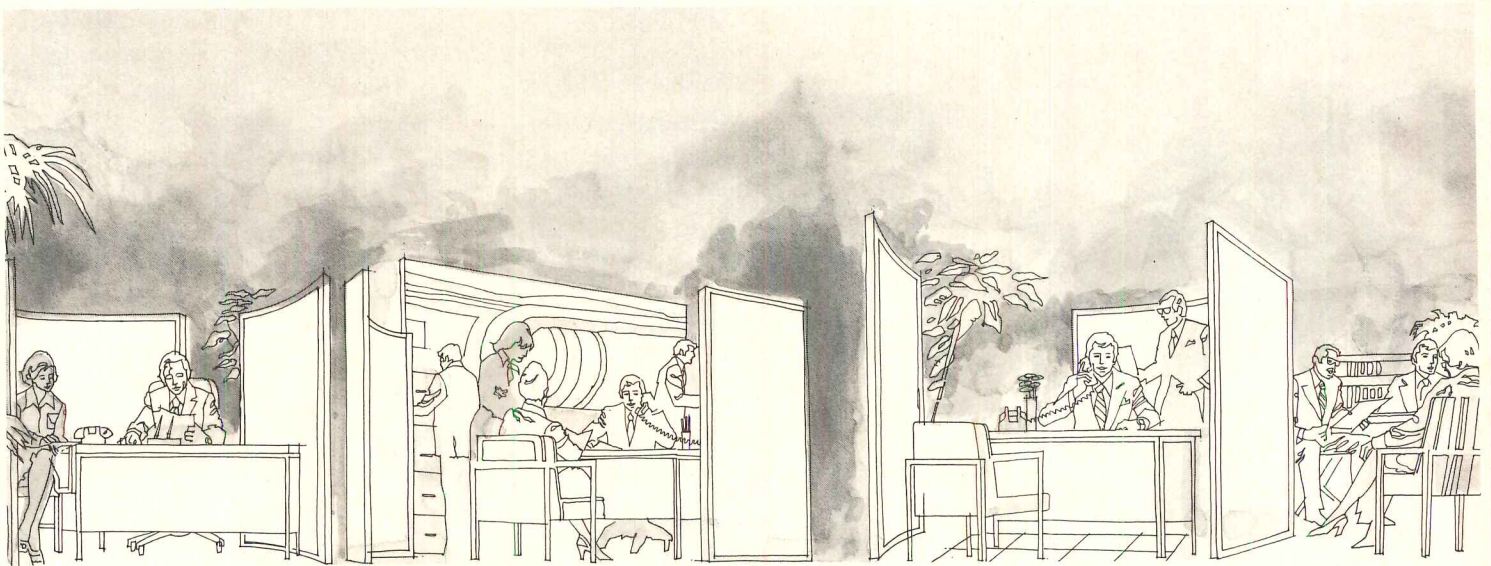

Some of your clients may be passing up the great economy and versatility of open plan office design. And only because they think they'll lose conversation privacy. Which is why we think you and your clients should know about the Executone electronic SoundScreen™ system.

By masking the specific "articulation" frequencies with a low-level background sound, the Executone system screens out unwanted conversations from adjoining office areas.

SoundScreen components include matched amplifiers, sound generators and heavy-duty ceiling speakers...all conservatively rated for continuous operation. They're tailored to your specifications and installed and serviced by Executone sound specialists. The same system can also be used for background music, paging and alarm signals.

Coordinated with proper acoustical materials,

SoundScreen makes closed conversations a reality in open offices.

For your copy of Executone's new sound masking brochure, just mail the coupon below.

Executone

Executone, Inc., Dept. U-5
29-10 Thomson Ave.
Long Island City, N.Y. 11101

Please send me literature on:

- Sound masking for open offices.
- Sound systems for schools, hospitals and other building types.

NAME _____

FIRM _____

ADDRESS _____

CITY _____ STATE _____ ZIP _____

In Canada: 331 Bartlett Ave., Toronto

For more data, circle 17 on inquiry card

Ideas that meet today's concerns.



Noise: panels that control it.

Inryco Acoustideck® and Acoustiwall™ reduce reverberation, a major contributor to uncontrolled noise levels which can be fatiguing, distracting...even physically damaging. In schools, factories, offices and other buildings, these panels absorb as much as 95% of sounds reaching them. Since they are integral with Inryco wall or ceiling systems, they permit noise control at minimum cost. Panels are 24" wide for fast installation, and are finished with a two-coat high-baked coating system.

For more data, circle 18 on inquiry card

Ideas from Inryco help you design

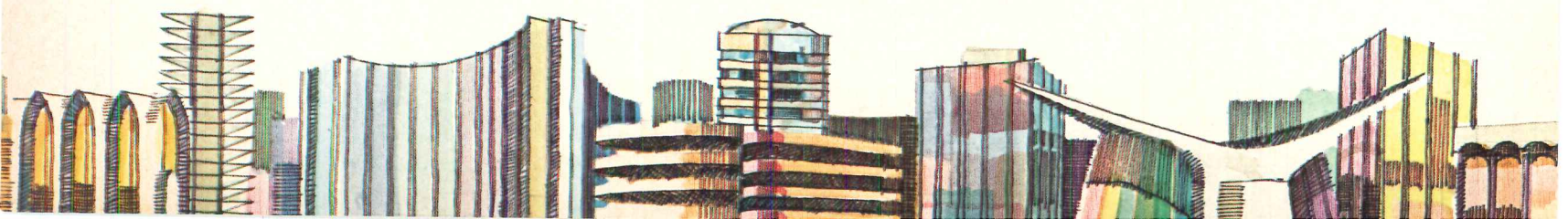

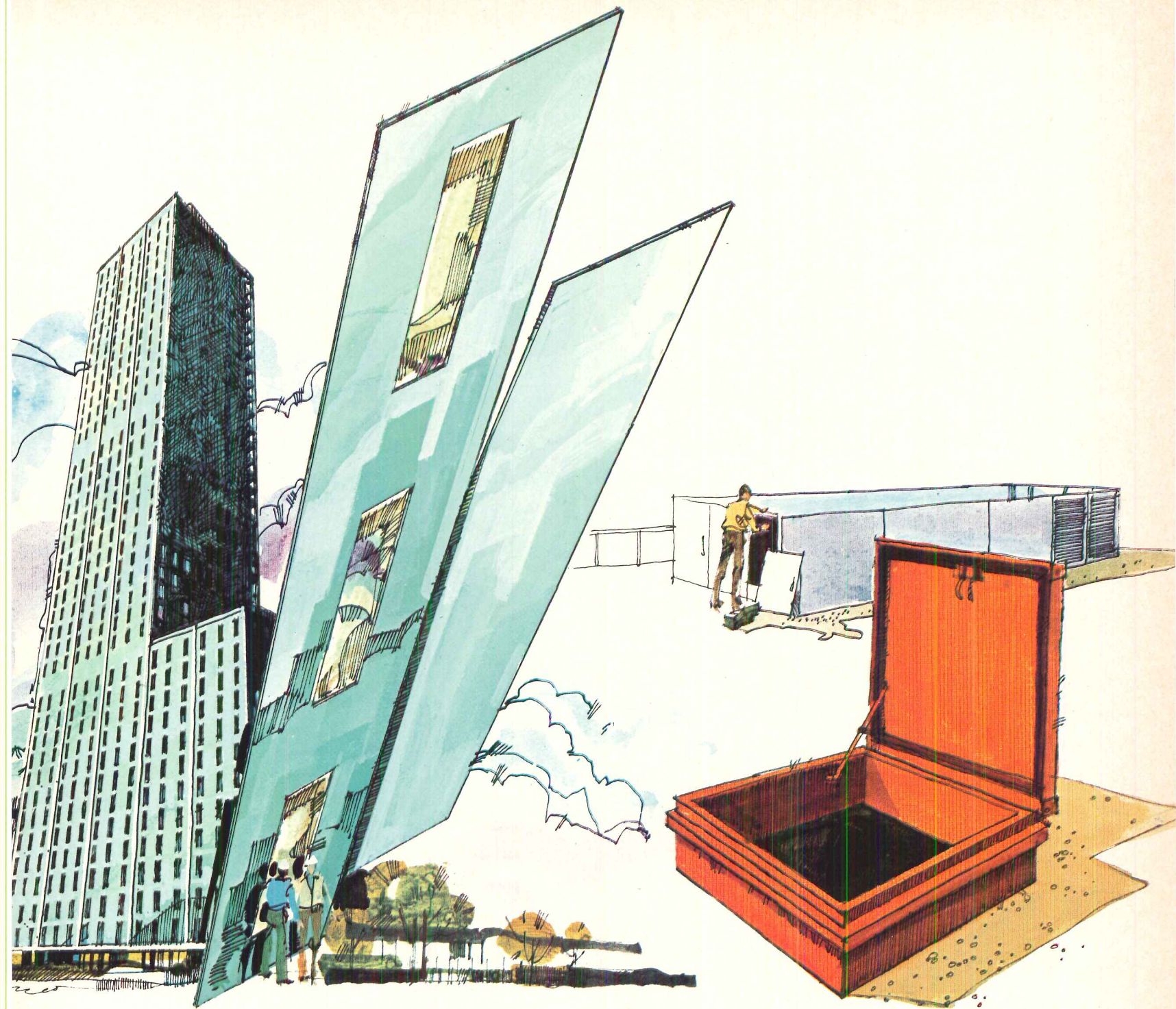

Energy: curtain walls that conserve it.

Inryco®/Fenmark® steel grid wall systems make possible flat surfaced walls with low U-factor ratings. Integrated glass areas of any size you choose, with or without ventilation. Or no glass at all. And you'll save more than energy. You get all the advantages of complete factory-fabricated grid construction—units up to 8' x 40' arrive ready to install. Metal exteriors are tough galvanized steel coated with any of a wide range of long-life oven-cured color finishes.

For more data, circle 19 on inquiry card

Cost: hatches that lower it.

Redesigned Inryco/Milcor® unobstructed roof hatch has low first cost. Light weight saves on shipping, installation and imposed roof loads. And improved U-factor—down from .26 to .17—reduces heat loss. Unique stressed skin cover is more rigid, increases load capacity to 70 psf. Torsion spring is in cover, leaving opening clear. Popular 3'0" x 2'6" size, steel or aluminum. Latter can have domed skylight cover. Full line of other styles and sizes, heat and smoke vents, floor and sidewalk doors.

For more data, circle 20 on inquiry card

better buildings

See our catalogs in Sweet's 

INLAND 
RYERSON

A member of the  steel family
Inland-Ryerson Construction Products Co.
Dept. D, 4033 West Burnham Street
Milwaukee, WI 53201

Send me more Inryco ideas, as checked:

On Inryco/Fenmark On Inryco On Inryco/Milcor
grid wall systems acoustical panels roof hatches

Name _____

Title _____

Company _____

Address _____

City _____ State _____ Zip _____

4-80-4



Why gamble
on unmatched
components?

We engineer,
test and ship
total standby
power systems.

Sure, you can pick up a generator here, an engine there, an automatic transfer switch somewhere else. If you're lucky, maybe they'll even work together as a system when the chips are down and the lights go out.

Maybe.

If "maybe" is good enough to stake your reputation on, fine. But please remember that we stake *our* reputation on a solid 5-year warranty that's nationally advertised.

We also take full responsibility for the whole system: engine, generator, automatic transfer switch. Every system is Performance Certified by an independent testing laboratory to deliver every watt of power you pay for.

So if anything goes wrong, you've got just one place to call.

That's a promise, not a bet.

Call your Onan Distributor now. Or write to: Onan Division, Onan Corporation, 1400 73rd Ave. N.E., Minneapolis, Minn. 55432.

For more data, circle 21 on inquiry card



Onan[®]

Power on demand
for the **Sure** things in life.

Vista/Sphere™
 Vista Prismsphere™
 Vista/III™

Luminaires that look as good as they light.

Graceful design plus superior lighting. The special combination that sets these fine Holophane luminaires apart.

For openers, there's a variety of shapes, textured with a delicate array of tiny light controlling prisms. There's even a unique prismatic sphere.

Other spheres are smooth, and surround intriguing geometric forms that are both appealing to the eye and functional in their control of light. The spheres can be clear. Or bronze. Or dusk. Or opal white.

It's a collection that's certain to challenge your imagination.

Mount them singly or in clusters. On wall brackets or on decorative wood or metal poles.

You'll like the way they look. And the way they light.

Your Holophane sales engineer will be glad to give you complete details on the entire collection. Or write to Department AR-4, Holophane, A Johns-Manville Division, Greenwood Plaza, Denver, Colorado 80217.

For more data, circle 22 on inquiry card

Holophane®
 A Johns-Manville Division

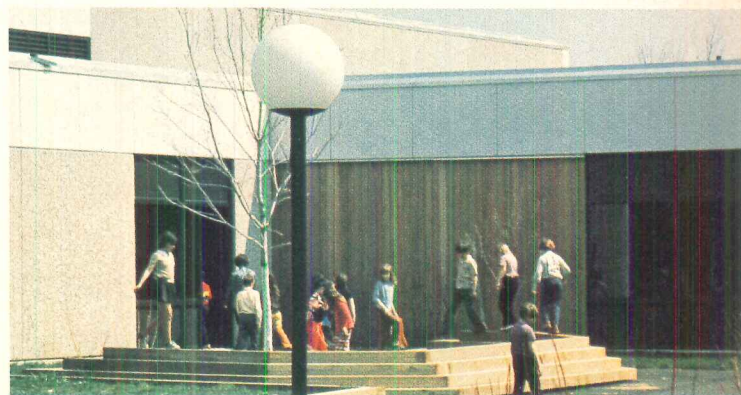
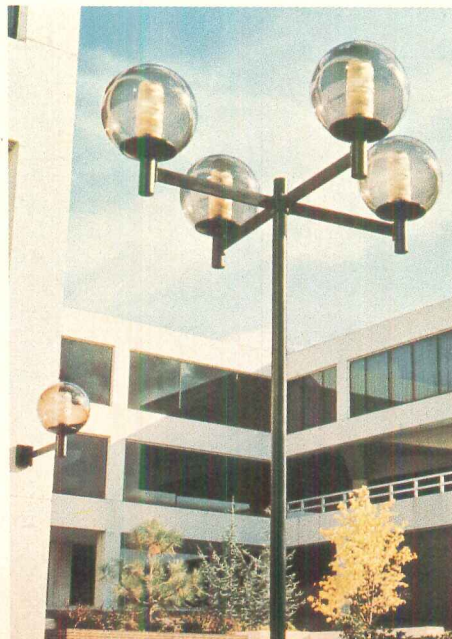



Three models of fully recessed water coolers in 8 to 12 gallon per hour capacities. In satin finish stainless steel or in bronze-tone finish. Model shown EFR-8A.

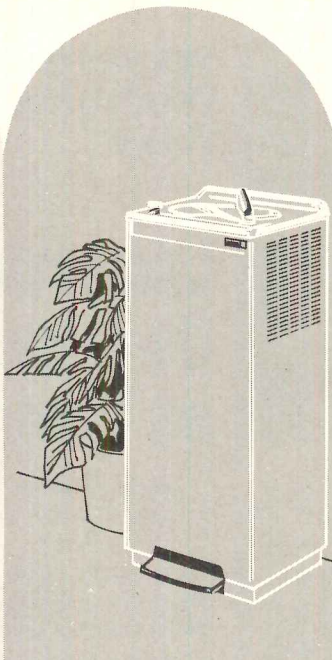

Self contained floor models in 4 to 20 gallon per hour capacities. Panels available in stainless steel, 9 vinyl decorator colors and two in baked enamel. Model shown EF-8.

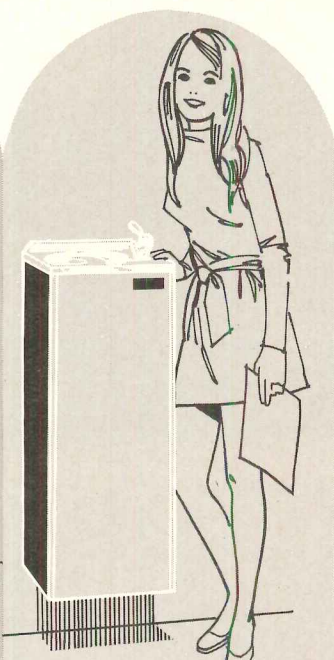

Space-ette series. The ideal water cooler where space is limited. Capacities are 3, 5 or 8 gallons per hour. Also in floor models. Model shown W-701-5.

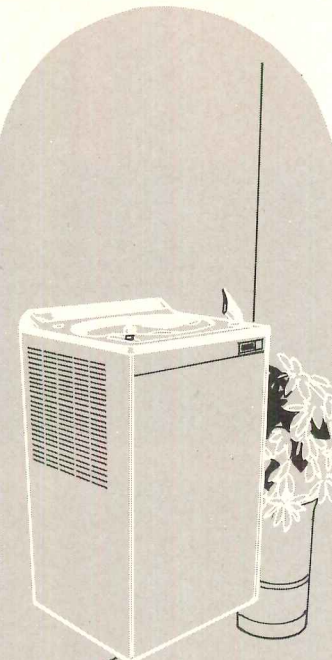

Wall mounted models in regular and compact sizes with Elkay's exclusive Cascade Basin. Full range of colored panels. Regular size 4 to 20 gallons. Compact in 4 to 14. Model shown EW-8.

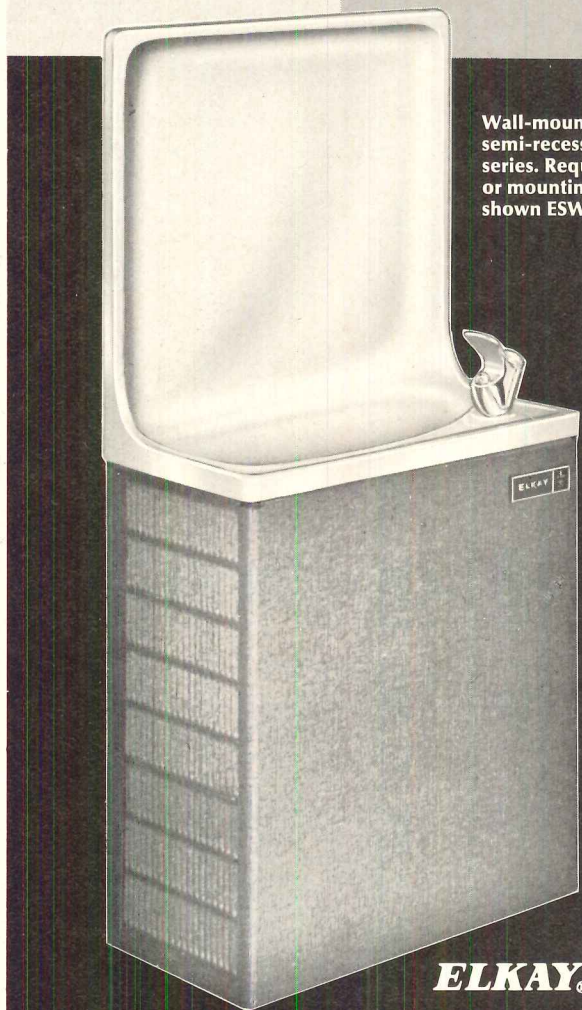

Wall-mounted, simulated semi-recessed coolers, ESW series. Require no wall cut-out or mounting box. Model shown ESW-13.

Elkay reinvented the water cooler and here's why

Water coolers needed to be redesigned to permit simple, fast and economic installation. Elkay did that with sectional construction to keep mechanical systems away from the plumbing connection area. Water coolers needed a basin that is vandal-proof, minimizes splashing, looks better. And Elkay has created water coolers to fit every need: corner models, free standing, multiple basin models, two-level models. All of them with contemporary styling and finishes and colors to complement any decor.

Write for Catalog DFC-4 for more information.

ELKAY® Manufacturing Company, 2700 S. 17th Avenue, Broadview, Illinois 60153

For more data, circle 23 on inquiry card

Louis I. Kahn, 73, died in New York on March 17. Cause of death was an apparent heart attack. He died in New York's Pennsylvania Station, on his way to Philadelphia after returning from India. Details on page 34.

The 1974 AIA Convention will be held May 19-23 at the Sheraton Park Hotel in Washington, D.C. For more information, contact AIA headquarters, 1735 New York Avenue, N.W., Washington, D.C. 20006.

A U.S. trade mission to the Middle East includes Clarence R. Jones, president of Jones & Fellers, Augusta, Georgia. Mr. Jones, a director of NSPE and chairman of the Architects and Engineers Liaison Committee, represents the construction-engineering-architectural community in talks aimed at developing work in that area for U.S. firms.

Congressional land-use advocates have opened a campaign in support of the sidetracked Federal land-use bill. The bill, delayed by the House Rules Committee, was opposed by President Nixon who earlier this year said it was top priority legislation. The President has instructed House Republican leaders to work out a compromise bill. Details on page 35.

The nation's supply of steel remains low and the forecast is gloomy. Exports are increasing, while imports are down, and coal strikes could slow production further, according to steel producers, who see no way to equal last year's 111 million tons of steel shipped. The most expected to be shipped this year is 105 million tons.

Federal assistance to city transit systems has been shunted aside in Congress, as the House Rules Committee refused to let the conference report on the bill come to the House floor for a vote. The reason: the Rules group will await the President's Unified Transportation Assistance Program before taking final action on the subsidy measure. The President's program, in another bill expected to come out of committee in several weeks, seeks to increase mass transit spending over the next three years from \$900 million to \$1.6 billion.

The proposed Housing and Community Development Act is ready to be taken up by the Senate. In the proposal is authority for HUD to undertake research of the social and environmental consequences of housing design. Also in the measure is authorization for \$2.5 million in the next fiscal year for demonstrations and research into the use of solar energy for heating and cooling residential space. Creation of a non-governmental entity, the National Institute of Building Sciences, is another aspect of this legislation, focusing on the need for a national unit to advise all sectors of the economy on building sciences and technology.

A United Nations-sponsored conference and exposition on human settlements will be held in Canada in 1976. The main purpose of the international gathering and display of environmental technology is to exchange information about solutions to the problems of human settlements. See Editorial (page 13) and "Human Settlements: World News" section, page 41.

Archibald C. Rogers, AIA president, will serve as jury chairman for the 1974 PCI Awards, to be given by the Prestressed Concrete Institute for excellence in designs using precast and/or prestressed concrete. Deadline for entries is July 19, 1974. Further information can be obtained from PCI, 20 North Wacker Drive, Chicago, Ill. 60606.

The Wainwright Building, St. Louis, is being considered as part of a state office complex competition. In an announcement made by Missouri's Office of Administration, it was confirmed that plans are under consideration for an AIA-supported design competition for a new state office building next to the Wainwright Building which the state plans to purchase. The competition would be open only to Missouri firms.

HUD has been advised not to apply Operation Breakthrough guide criteria beyond that program. A Building Research Advisory Board committee also recommended that HUD not incorporate guide criteria provisions that deviate from currently accepted practice into its own housing requirements. Details on page 35.

VISTA and the Peace Corps are looking for volunteer architects for 72 projects beginning this summer. VISTA volunteers work in 30 U.S. cities, while Peace Corps architect volunteers work in 42 countries, dealing with problems of rapid urban growth. Architects interested in either program are asked to contact John Albertella, ACTION, Box 810, Washington, D.C. 20525. Phone (800)425-8580.

Only one per cent of the revenue-sharing funds released to states has gone to housing or community development, according to a report from the Office of Revenue Sharing. Since the program began 16 months ago, 32,665 state and local governments have received \$6.6 billion, of which 42.5 per cent has been expended. Over half the funds spent went for public safety, education and public transportation. The report indicates that states chose to use 94 per cent of their funds for operation and maintenance, rather than for capital improvements.

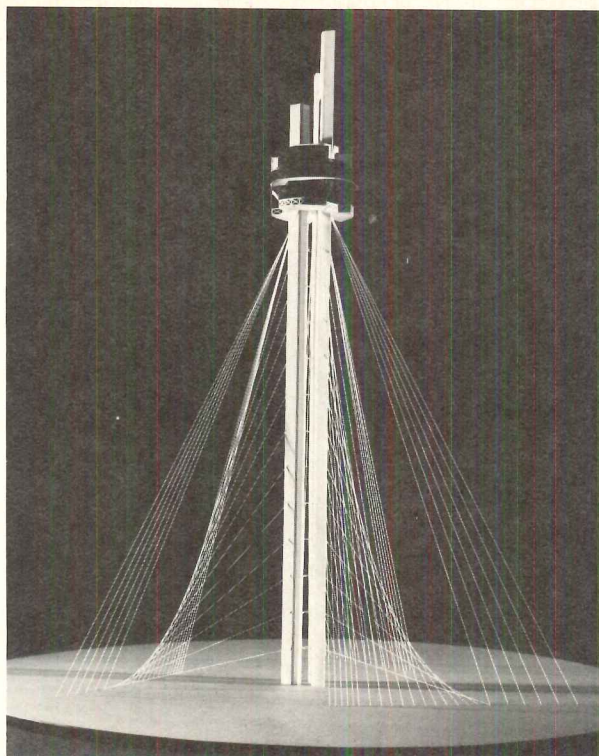

Environmental guides studied for Miami

To promote quality building and land development policy in South Florida, the local chapter of Associated General Contractors has commissioned the University of Miami to study environmental planning.

The UM's Center for Urban and Regional Studies is undertaking the AGC-funded project to produce an industry-wide document of building and land-use development guidelines and policies. The object: better methods for building in relation to the ecology, local building codes and land use regulations. Florida averages more than 6,000 new residents each week; 65 per cent move to south Florida.



Louis I. Kahn dead of heart attack at 73

Louis I. Kahn, one of the great architects and teachers of this century, died in New York's Pennsylvania Station, March 17 of an apparent heart attack. He was enroute to his home in Philadelphia, after a trip to India, where he was overseeing the partially-completed complex for the Institute of Management at Ahmedabad.

Recipient of the AIA Gold Medal in 1971, Mr. Kahn was a professor of architecture at the University of Pennsylvania and maintained an international private practice.

Fire fighters given data on volatile materials

From the good idea department, this item:

Under a HUD-sponsored program in Charlotte, N.C., a fire operations module has been developed there which provides fire fighters at the scene of an alarm with rapid access to stored computer data on the amount and location of volatile materials which can be critical to the fire fighting or rescue tactics. The information is available on any building on which a fire inspection has been conducted.

This project is part of HUD's Urban Information Systems Interagency Committee.

High, higher, highest: Toronto takes the lead with world's tallest structure

In the race for the world's tallest freestanding structure, the city of Toronto has shot ahead with the topping-out of the 1800-foot-high CN Tower (left).

Designed by John Andrews and Webb Zerafa Menkes Housden, the CN Tower—a \$125.5-million communica-

tions and observation tower—is being built primarily to meet the need for improved transmission facilities for Toronto television and radio stations. It is the first structure in Metro Centre, a 15-year redevelopment project embracing 190 acres of railway land between

the central business district and the waterfront. The project belongs to Metro Centre Limited, a partnership between Canadian National Railways and Canadian Pacific. Opening of the Tower will be in 1975.

In Miami, the Inter-American Center Authority has com-

missioned the 850-foot tower (at right) as the nucleus of a 1976 inter-American trade fair to coincide with American Bicentennial activities in Miami. The tower is for observation with a retail center at the base. It was designed by Ferendino, Grafton Spillis Candela.

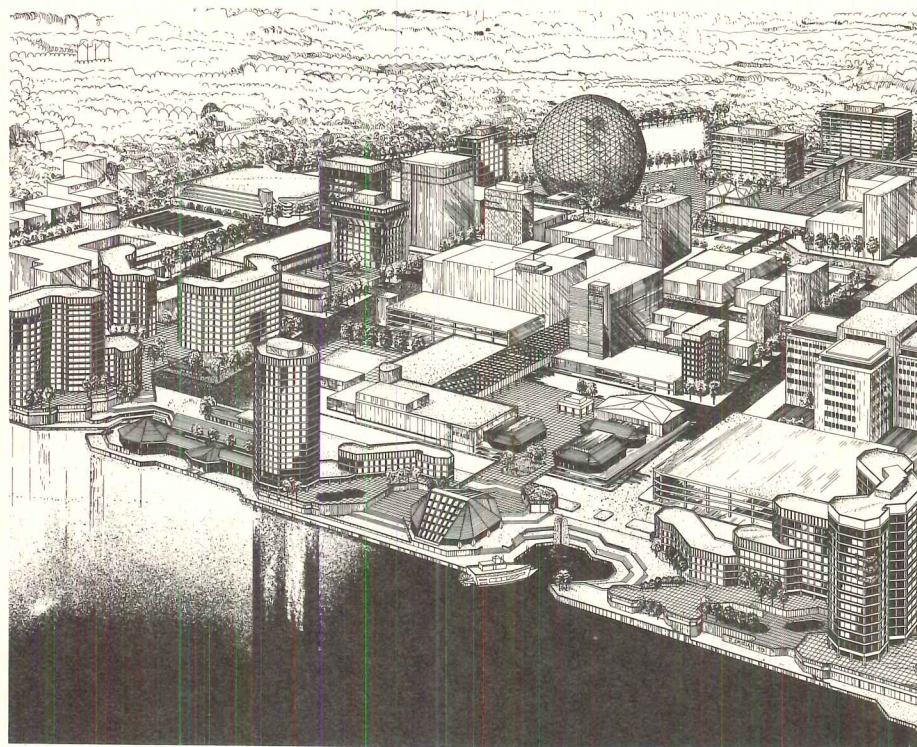

Peoria, Illinois downtown master plan will be developed by 1985

A current project in the office of urban designer Angelos C. Demetriou is the master plan shown for redeveloping downtown Peoria, Illinois. The concept, according to the firm, is to foster a series of 36 city, state and private projects including

government, sports, office, retail, residential and open spaces.

Critical to realizing the full impact of the plan are, according to the architect, a mini-mall and Civic Center. Eventual work will lead to construction of a

major residential enclave and civic auditorium along the waterfront.

The staging of the proposed projects is divided into two periods spanning from 1974 to 1985. The downtown plan comprises 200 acres.

Manufacturers plan expansion in 1974

Companies predominantly in building-materials manufacturing plan to increase their investment in plant and equipment sharply in 1974. The median increase in investment planned by these firms is 29 per cent, according to results of the 1974 Annual Survey of Corporate Profit Trends and a special recheck of capital spending plans conducted by the McGraw-Hill Department of Economics.

The biggest investment increases are planned by general companies (34 per cent).

National growth unit becomes permanent

AIA president Archibald C. Rogers has reported that a permanent "Forum for a National Growth Policy" is being formed by the interdisciplinary coalition of construction groups responsible for the recent report "Structure for a National Growth Policy."

The coalition consists of major professional and builder organizations who will continue the work begun by the AIA National Policy Task Force, now disbanded.

Land-use maps made for U.S. cities

The San Francisco Bay region became the first of eight selected metropolitan areas of the United States to be covered by an experimental series of maps showing various categories of land use and their changing patterns, the U.S. Geological Survey announced.

The USGS prepared a total of 44 maps covering 7000 square-miles of the nine San Francisco Bay counties. The maps document 14 major categories of land use from unimproved open space to multi-family residence.

Similar maps are being prepared for Boston; Cedar Rapids, Iowa; New Haven, Connecticut; Phoenix, Arizona; Pontiac, Michigan; Tucson, Arizona; and Washington, D.C.

Burning city waste: new energy source

The Environmental Protection Agency, in a new pitch for burning big city waste to augment other sources of electricity, said America's large cities generate about 90 million tons of residential and commercial solid waste each year.

It estimates that 70 to 80 per cent of this can be burned and if used as fuel would have an energy recovery of 800 trillion BTU's annually. That's equivalent to 150 million barrels of oil a year.

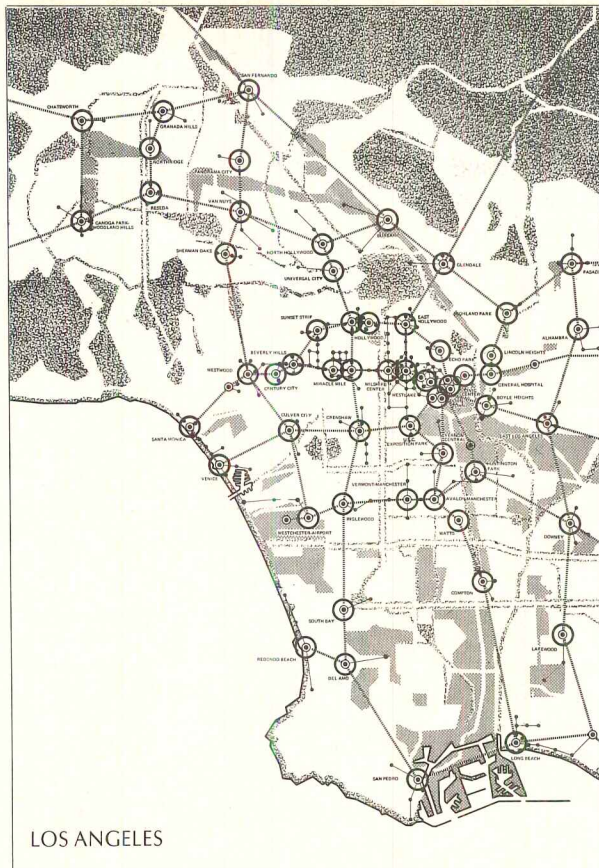

Los Angeles approves a new planning guide

After a decade of working on a master plan, Los Angeles has finally approved—although tentatively—its two key policy documents.

The detailed citywide plan is designed to be a blueprint for the next 20 years. "Concept Los Angeles" is a broad planning guideline for the next half cen-

tury. It will form a framework for a collection of 35 community plans that will make up the city's master plan.

Basically, the two documents preserve the city's single-family-dwelling way of life and direct new growth into 37 major high-density urban centers linked by mass rapid transit.

AIA claims solar role for architects

The architect is not about to be "left out" of the efforts to harness the sun to provide heating and cooling in buildings.

This much was clear in the testimony given recently before the Senate's Aeronautics and Space Science Committee by John P. Eberhard, AIA, president of the American Institute of Architects Research Foundation.

It was obvious that Eberhard was referring to the House-passed bill to finance a five-year study of solar energy when he indicated the architect would certainly expect to be a part—in cooperation with the scientists and engineers—of this work.

Eberhard explained that his organization resisted the notion of using design professionals simply to generate a series of stock plans for limited hardware application, and pictured the design issue as being far more basic and pervasive, in urging that the design professions be included in the conceptual and evaluation stages as well as in the applications.

HUD warned on use of unusual guidelines

The Building Research Advisory Board committee has recommended that the Department of Housing and Urban Development should not apply the present Operation Break-through guide criteria developed for it by the National Bureau of Standards beyond the OB program itself.

Nor should HUD incorporate guide criteria provisions that deviate from currently accepted practice into its own housing requirements unless or until it has established and documented their need to reduce certain risks.

Very significantly, the BRAB unit suggests that HUD work with and through the existing public and private building community organizations and processes to transfer the knowledge gained from use of the guides and all other experimental housing programs into the existing national regulatory system.

GSA revises rented space fire standards

GSA Administrator Arthur F. Sampson has announced that the agency no longer would recognize what is called the "grandfather clause" in fire safety regulations. This means that from now on, GSA will not approve space for Federal occupancy in a privately-owned building unless it meets current fire codes and standards. Heretofore tenants have been allowed in space governed by codes existing when it was built.

Land-use legislation backslides in House

Land-use legislation has suffered a severe setback on its tortuous route through Congress as the House Rules committee deferred indefinitely further consideration of the bill.

Advocates of the national legislation have maintained that local governments, delegated responsibilities over land-use planning, now need assistance and over-all guidance in their effort. Opponents of the legislation held that passage of the House version, and final enactment of its provisions, would result in the demise of private property rights due to the implicit sanctions of unconstitutional "taking" of land.

Most members of Congress appeared to agree that the Rules action firmly pigeon-holed the measure for the rest of this year in spite of many supporters.

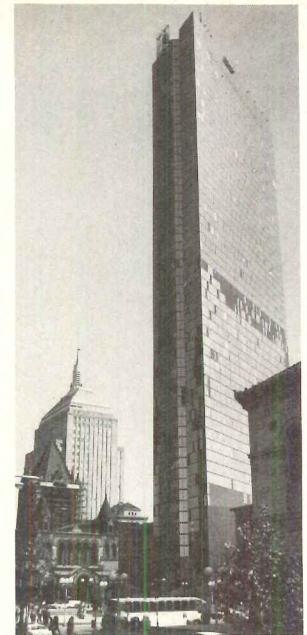

Hancock tower to be glazed

Each of the 10,348 window openings in the new John Hancock Tower in Boston will soon be covered with single sheets of tempered, reflective glass at an expected cost of about \$7 million, replacing double-pane windows that were breaking in high winds. Occupancy of the building is scheduled to begin in the fall.

A higher energy (heat) requirement is seen by architects with single rather than double glass. However, a member of the design firm of I.M. Pei & Partners believes the increased energy requirements will be relatively small because of reflective qualities of the single pane glass, which may lose more energy in winter but would tend to save some in summer.

Meantime, plans are underway to sell to the highest bidder the tons of plywood used to cover the broken windows. It is expected to bring more now in the market than it cost when bought by Hancock.

Used street lights for sale in New York

New York City will sell about 95,000 operational mercury-vapor street lights now being replaced during the city's "high intensity" street relighting program.

Municipal Service Administrator John T. Carroll said sealed bids will be opened May 1 by the Department of Purchase, Room 2217, Municipal Building, New York City.

The lights should be a bargain for communities seeking modern street lighting and for governmental agencies involved in lighting extensive areas. They can also be used for lighting parking lots.



Charles Bronson plays architect in new film

Architects are rarely portrayed on the silver screen, but one will be the central character of "Death Wish," a motion picture to be released by Paramount in July.

Filmed in the New York offices of McKee-Berger-Manueto, the movie stars Charles Bronson (center) as a liberal New York architect who turns to

vigilante justice and murder, imposed on the city's muggers, after his wife and daughter are attacked.

Certainly, an unorthodox—not to mention illegal—approach for an architect depicted as perceiving a connection between decaying urban environments and violence in the streets.

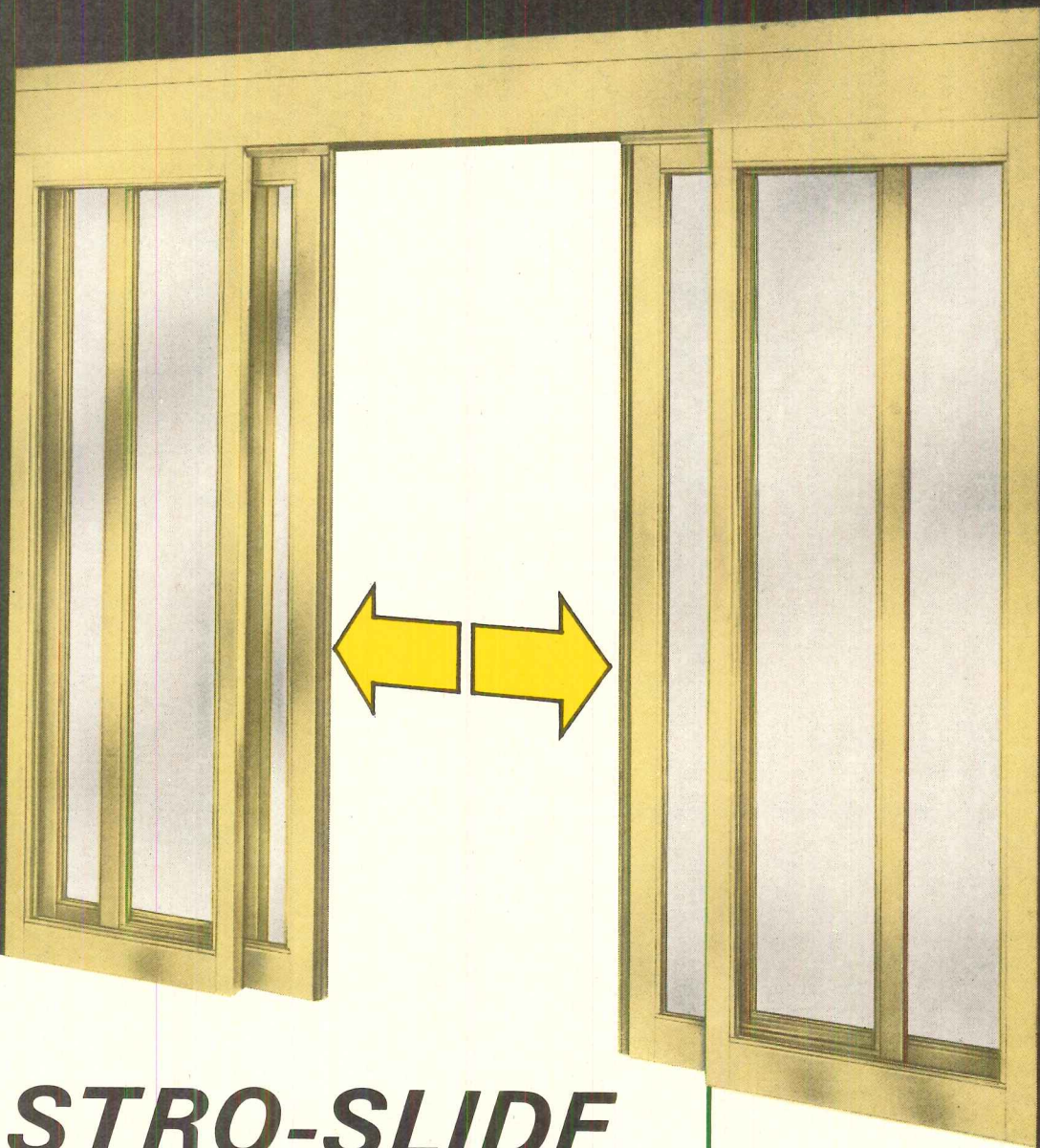

ASTRO-SLIDE

GLIDING BEAUTY...

SAFE BREAKAWAY!

Patented ASTRO-SLIDE Automatic Sliding Door Operators by DOR-O-MATIC convert constant r.p.m. drive shaft rotation into controlled linear motion—efficiently, economically. Instant-reversing (without reversing the motor); variable speed control (without varying motor speed). ASTRO-SLIDE provides smooth, coordinated opening, positive back-checking, and secure closing for single or biparting door openings to 8 feet without gears, clutches, pneumatic or hydraulic drive systems. Adaptable to tempered glass, aluminum, wood or hollow metal doors. Self-contained ASTRO-SLIDE is fully concealed overhead in a clear anodized aluminum header—also available in DOR-COTE* finish. Any DOR-O-MATIC actuating device, including our P.S. SENSOR, provides demand operation of the 115VAC-60Hz electro-mechanical system. Two-panel pocket installation on both sides of doors, as illustrated, is recommended. If power fails, doors and exterior panels breakaway for safe emergency exit. Breakaway from the ordinary!

Call your Dor-O-Matic distributor, or request Bulletin 8.31/Do.

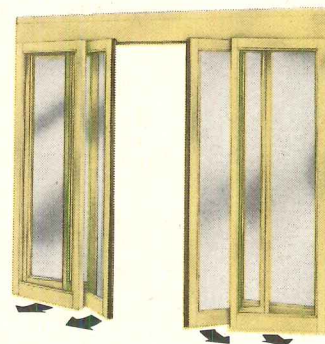

*DOR-COTE is Dor-O-Matic's integral color anodized hardcoat finish.

5805

BY

DOR-O-MATIC

Division of Republic Industries, Inc.

7350 West Wilson Avenue, Chicago, Illinois 60656 (312) 867-7400

For more data, circle 25 on inquiry card

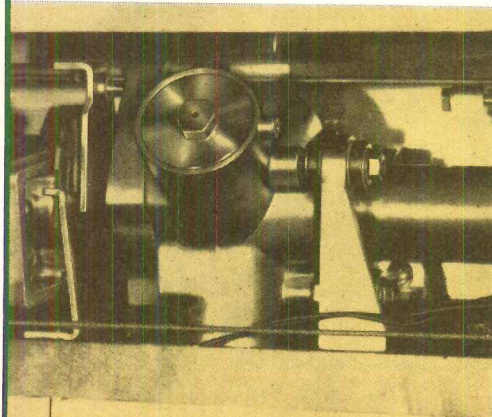

Sofia, Bulgaria opera house design selected

From 123 projects submitted by Bulgarian and foreign architects, the designs shown here were selected recently as first and second place entries in an international design competition for the new opera house in Sofia. The winning design (top) by Yugoslav architects Ivan Straus and Halid Muhasilovic consists of a large main hall and a smaller one linked by a pedestrian zone. The jury commended the design for its function-prescribed form. Second place was shared by a Soviet team (design lower left) headed by Alexander Velikanov, and a Bulgarian team (design lower right) including Boris Kamilarov, Mihail Sokolovski and Tsanco Hadjistoichev. Rules for the competition were set by the International Union of Architects. Designs for the opera house had to conform to the general plan of Sofia, taking into consideration a future subway station nearby. It was further determined that the auditorium should not be monumental, yet emphasize prestige.

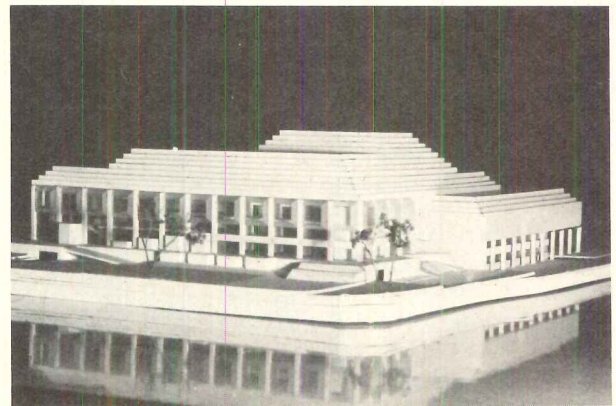
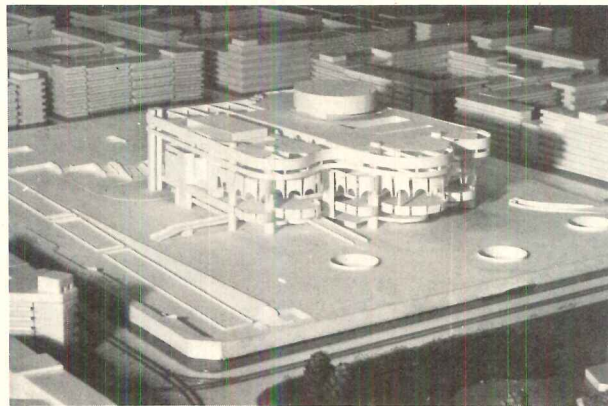
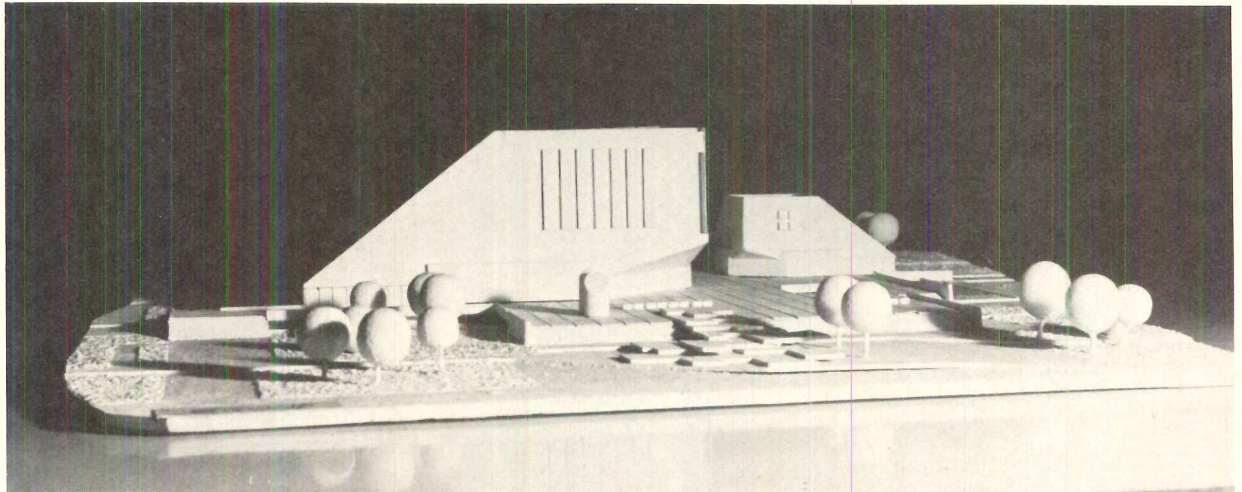

Office-commercial center to be built near San Francisco airport

Architects M. Arthur Gensler Jr. & Associates have recently completed this design for the San Francisco International Office Center in Burlingame, California. The 17-story structure fronting on San Francisco Bay will provide 288,000 sq ft of office space, ground-level commercial space, computer and conference facilities and parking for 800 cars in a separate five-story structure. Set in a one-acre plaza at 45 degrees to the street, the tower is planned to maximize views of the Bay, for both the building and surrounding residential areas. Completion of the \$10 million complex is planned for late this year.



Gerald Ratto

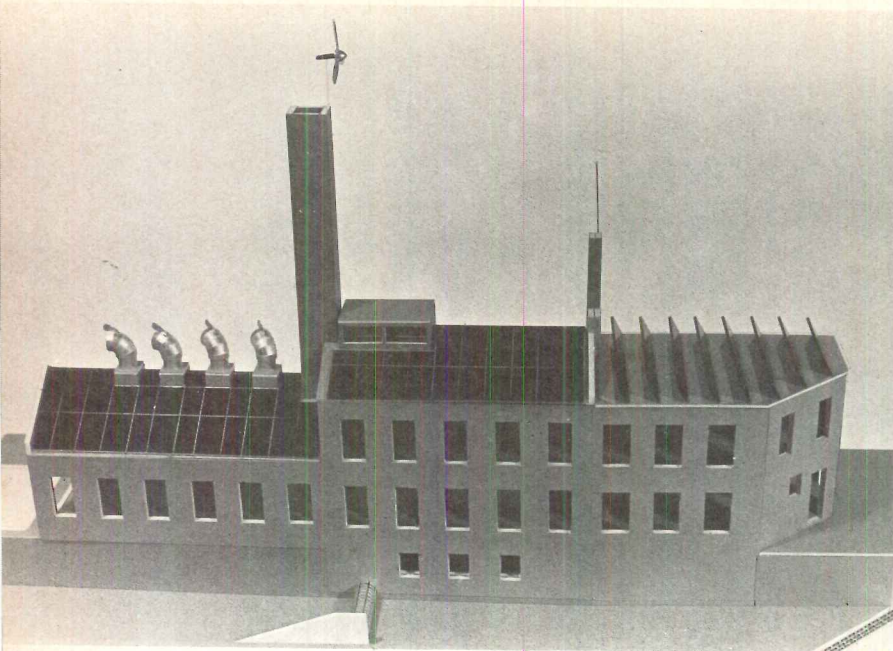

Energy research facility in a Rhode Island mill

A mid-19th century mill in Providence, Rhode Island is being "retro-fitted" with solar energy utilizing systems as part of a research program to demonstrate alternative sources of electrical power generation. The project is a cooperative effort of Brown University, Division of Engineering; the Research and Design Institute; and local industrial organizations. As a large-scale solar energy laboratory, the demonstration project is expected to show that existing buildings can be successfully equipped to be less of a burden in terms of energy consumption.

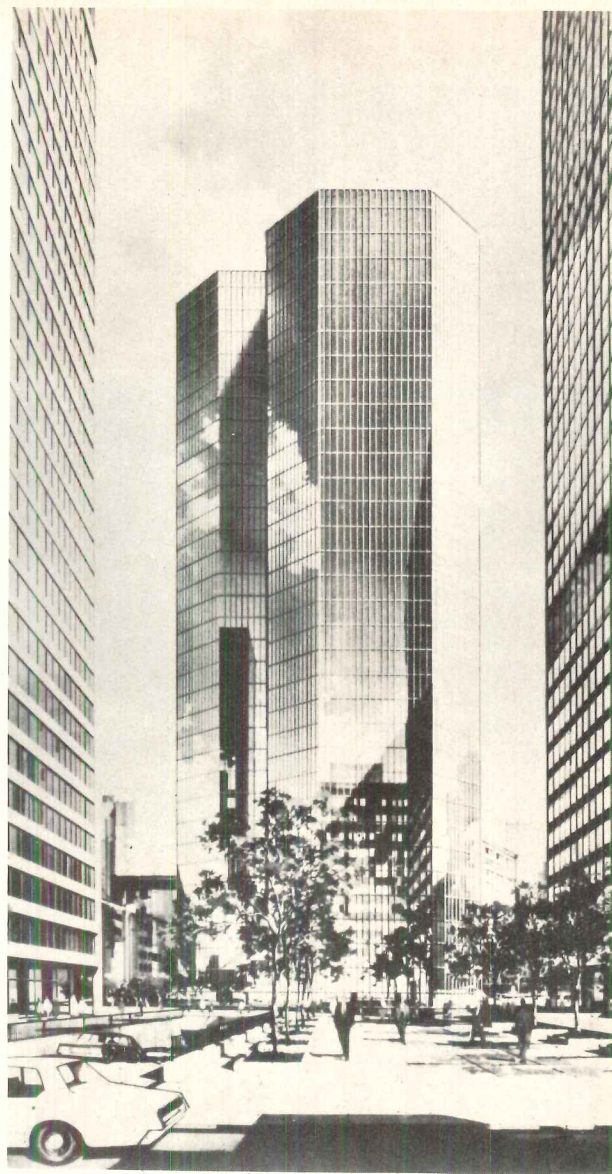
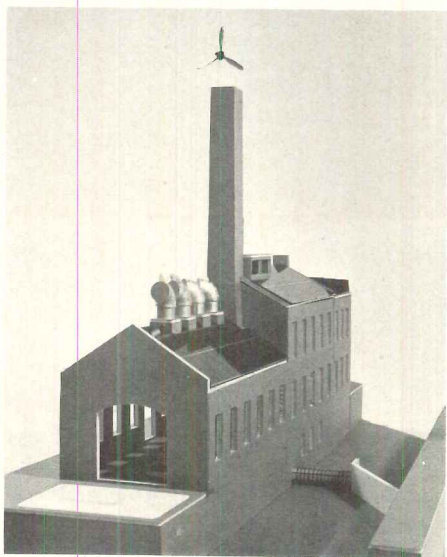

Pittsburgh bank by Skidmore, Owings & Merrill

This design by the Chicago office of SOM is being built in the geographic center of Pittsburgh's Golden Triangle, and is expected to be completed in the summer of 1975. The prime tenant will be Equibank, and Oliver Tyrone Corporation is the developer. The 34-story structure, sheathed in reflective glass, consists of two octagonal towers joined at one side. The unusual shape, use of reflective glass and interior systems of the building are said to represent an attempt to design space and en-

ergy conservation into a high-rise structure. A spokesman for the developer claims the Equibank building will use much less energy than any other office building of similar size in Pittsburgh. The shape of the building is said to be partially dictated by an unusual site, giving the architects a chance to design pleasant variety into the city's skyline. The building will contain 500,000 sq ft of space, and is the first major high-rise office building to be built in Pittsburgh in more than four years.

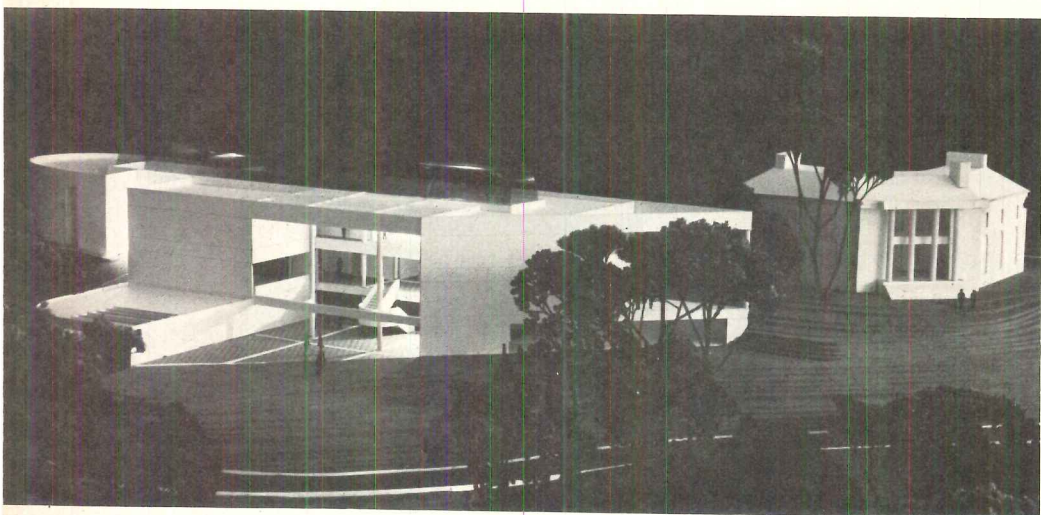

Knoxville art gallery addition timed for completion during Bicentennial

The proposed new museum facility for the Dulin Gallery of Art in Knoxville, Tennessee is sited to complement the existing historical Museum House on a wooded site overlooking the Tennessee River. Designed by McCarty Bullock Church Hol-

saple, the new building is scheduled to be under construction this year, with completion in July, 1976. Since the property is located on a bend in the river, the axis of the main concourse and three-story sculpture court allows views

down the river. Materials will include masonry walls with stucco to complement the existing house. Interior finishes will consist of brick and natural oak floors, with a suspended natural wood grid ceiling to integrate mechanical systems.

Community school for children, adults

Chloethiel Woodard Smith & Associated Architects have designed this 290,000-sq ft elementary and junior high school to serve the community's educational needs, except senior high school, from kindergarten to adult. All learning areas are based on the open plan concept. Presently under construction in Washington, D.C., the reinforced concrete structure utilizes exposed waffle slabs within a 30- by 30-ft column grid. A two-story skylighted commons is included.

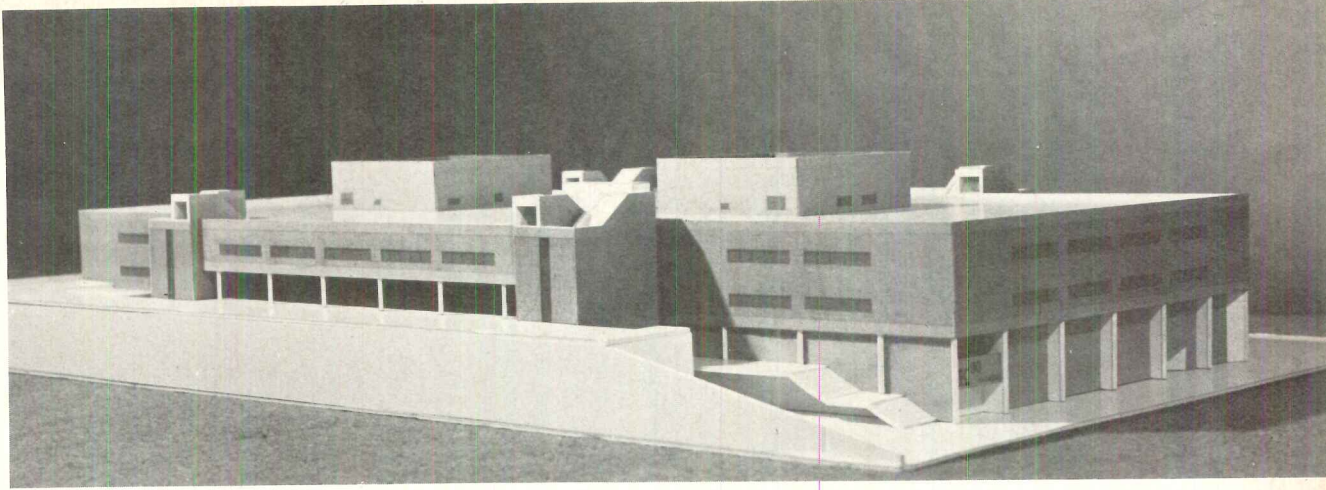

Soviet apartments in Bronx built from top down

A 19-story apartment house now under construction for the Soviet mission to the U.N. is being built largely from the top down using a patented system developed by International Environmental Dynamics, Incorporated. Pre-assembled floors, according to the concern, are hoisted to the top of twin sup-

port columns and secured, each floor installed from the top down. Skidmore, Owings & Merrill are the architects on the project which is expected to be completed at a cost saving of \$1 million because of the construction method. The towers contain elevators and mechanical equipment.

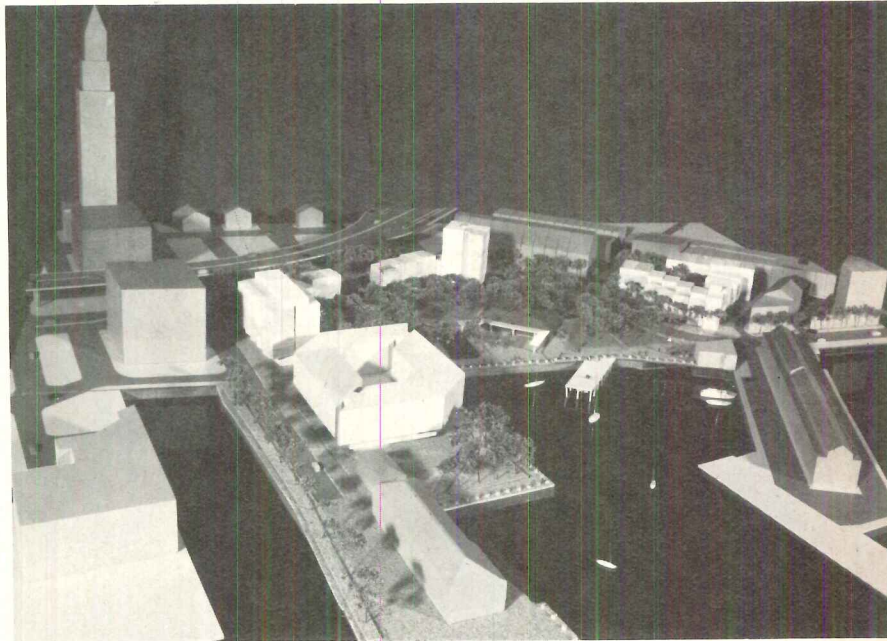

Boston's waterfront renewal plan modified

Recently announced by the Boston Redevelopment Authority are changes in the city's downtown-waterfront urban renewal plan. Two new features include realigning Atlantic Avenue (see plan) which would be built as a 44-ft-wide roadway

instead of the originally proposed 80-ft wide road. This will result in a larger waterfront park. Also changing the size and shape of the parcels would permit over 700 housing units to be built, half for elderly and low-income families.

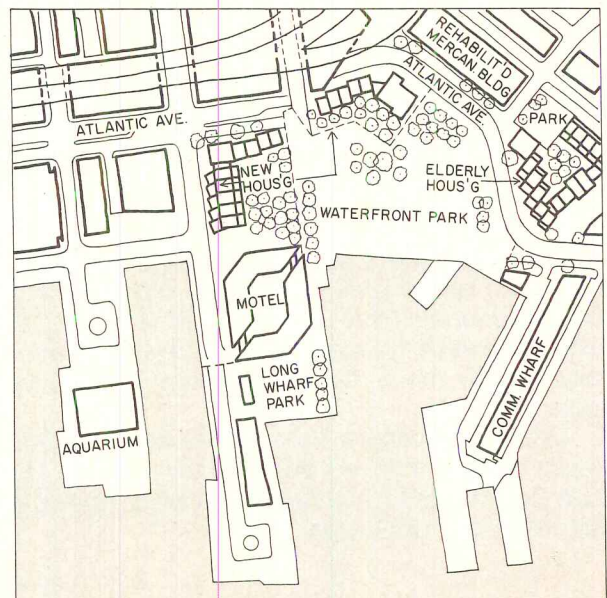

Dover® Stage Lifts. Rising star in the theater.

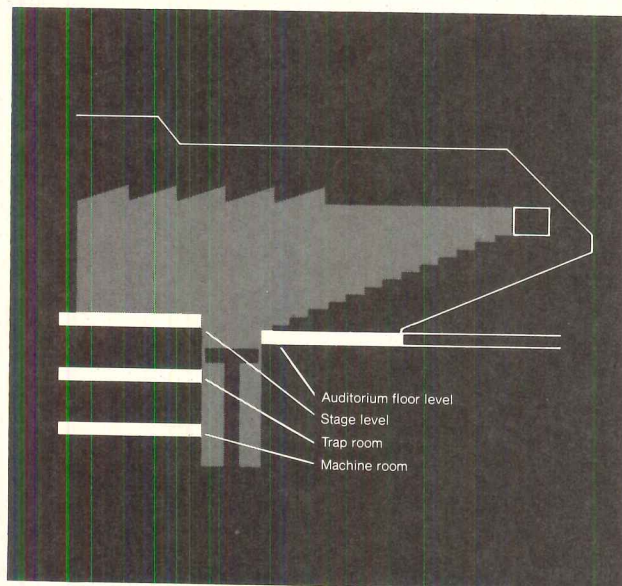
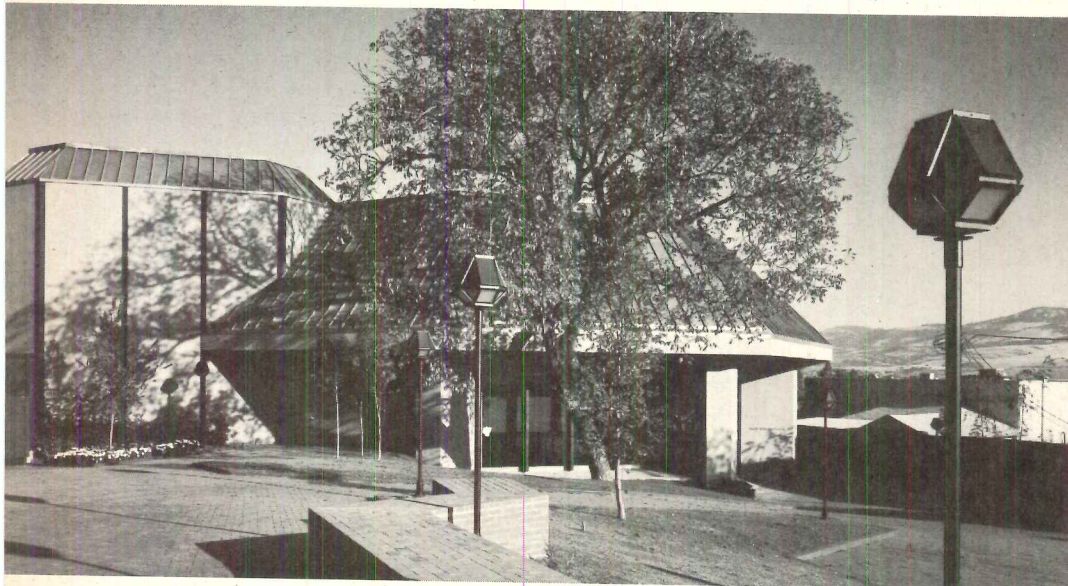
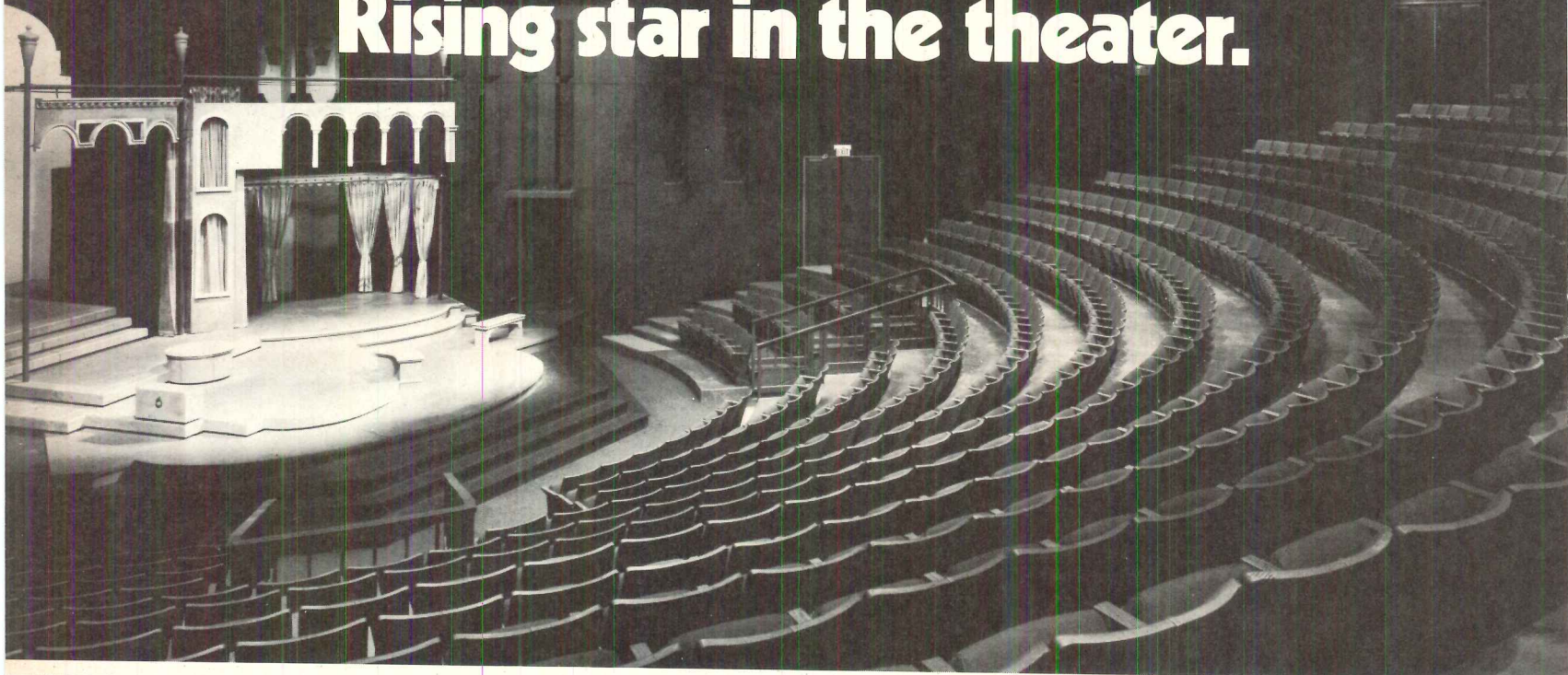

A good actor must adapt himself to a wide variety of roles and styles of interpretation. So must a good stage.

The designers of the Oregon Shakespearean Festival's Angus Bowmer Theater, Ashland, Oregon, recognized this and utilized a Dover Stage Lift as the heart of their new 600-seat playhouse.

This 28' x 8'6" lift is truly a versatile performer. It travels 21' and serves four levels: machine room, trap room, auditorium floor, and stage. In various positions it becomes part of the stage, part of the auditorium, and an easy way to move heavy, awkward scenery between floors.

Dover Lifts can be found in the Metropolitan Opera House and the Juilliard School, New York; in Harvard's Loeb Drama Center, the Santa Fe Opera House, and the Stardust Hotel, Las Vegas.

The same Dover skill that designed and built these lifts can be applied to your stage lift project, regardless of size or special requirements.

For more information, see our catalog in Sweet's Files, or write Dover Corporation, Elevator Division, Dept. AR-4, P. O. Box 2177, Memphis, Tenn. 38101. In Canada: Dover/Turnbull.

OREGON SHAKESPEAREAN FESTIVAL ASSOCIATION, Ashland, Ore.
Architects: Kirk, Wallace, McKinley, A.I.A. & Associates, Seattle, Wash.
Theater Consultants: Landry, Hunt & Bogan, Palo Alto, Calif.
General Contractor: Robert D. Morrow, Inc., Salem, Ore.
Stage Lift installed by Dover Elevator Co., Oakland, Calif.

DOVER
Stage Lifts

For more data, circle 26 on inquiry card

Settlements conference set for Vancouver

Habitat '76, a major United Nations conference and exposition on human settlements will be held in Vancouver, British Columbia from May 31 to June 11, 1976. The formal decision to convene and sponsor this meeting was taken at the 28th General Assembly of the United Nations on December 13, 1973.

Up to 2000 participants are expected, including official representatives and technical experts from member states of the United Nations. The exposition will consist of theme exhibits prepared by the U. N. explaining the global situation of human settlements, illustrating examples and demonstrating techniques and technologies for building better settlements.

Preliminary preparations for Habitat '76 are under the direction of the United Nations Environment Programme (UNEP) established by Maurice F. Strong, to prepare a budget and carry on planning through the 28th General Assembly.

Agenda topics

The conference will focus on: 1) the quality of life and human needs in these settlements 2) human settlements and national development policy 3) planning and managing of human settlements 4) international resources for human settlements 5) the global situation of human settlements and 6) community technology and eco-systems.

The main purpose of the conference-exposition is to provide solution-oriented, pragmatic dissemination of already-applied technologies that can improve the man-made environment in all human settlements, from megalopolis to rural village.

Exhibit plans

Chermayeff and Geismar Associates have been retained for a preliminary study of exposition design alternatives. The firm was jointly selected by representatives of the Canadian government and UNEP-PPG, the Preparatory Planning Group.

The exposition will focus on priority areas of human health, habitat, land, water, and

desertification. Similarly, all of the agenda themes are to be incorporated in the exposition, illustrating technical advances such as the application of low-cost housing. Member states attending the conference will be asked to prepare audiovisual presentations of their human settlements problems and solutions.

One such exhibit might pertain to the international design competition being developed by *Architectural Record* and *L'Architecture d'Aujourd'hui*, under the auspices of the International Architecture Foundation. (See Editorial, page 13, and advertisement on page 12). Preparations have begun.

Architects, engineers and planners will be asked to submit designs for an urban community that satisfies human needs without straining the environments of the three sites selected.

Proposals for exhibit projects will be received from governments on June 30, 1974 and selection and evaluation by an international panel will occur on September 30 of this year.

Projects from developed and developing nations, rural and urban areas, will be included, if they offer solutions rather than define problems; are capable of wider application to other countries; demonstrate imaginative use of local resources and skills; and use efficient and low-cost financial and administrative techniques.

For all countries, the cooperative sharing envisioned for the United Nations Conference on Human Settlements can facilitate and speed the goal of creating desirable, livable environments.

Oil wealth may prompt Arab growth

According to The Urban Strategy Center, at the Chamber of Commerce of the United States, the average revenue per barrel of oil producing nations has risen from \$1.60 in 1972 to \$8.50 in 1974, with the total revenues for 1974 estimated at \$95 billion. Arab nations will receive most of this money.

What will the Arab coun-

tries do with this abundance, which could be \$900 billion by 1980? Some Arab countries can and do use funds for development, and others, particularly Saudi Arabia will undoubtedly be seeking investment opportunities in the U.S., Japan, and Europe.

Trying to encourage some of the Arab currency to flow into U.S. architectural and engineering firms will be Clarence R. Jones, president of the Augusta, Georgia A/E firm of Jones & Fellers. He is part of a U.S. trade mission to the Middle East.

German Marshall Fund announces grants

Commitments totaling \$750,000 have been made by The German Marshall Fund of the United States for projects including the study of problems common to industrial societies.

The Fund, a memorial to the Marshall Plan, was formed in 1972 as a gift from the German people in gratitude for the American decision of 1947 which brought about the Marshall Plan.

The purpose of the Washington-based Fund is, like the Marshall Plan itself, to foster international cooperation in meeting the pressing needs of industrial societies—internally, and in their relationships with each other and with developing nations.

Among the projects to be initially funded is a 30-month, \$500,000 international comparative land use project (see RECORD, February 1974, News Briefs, page 35).

A grant of \$50,000 has been given to the National Center for Resource Recovery of Washington to aid in the transfer of its advanced organizational and technological capabilities in solid waste management and resource recovery to interested similar groups in other industrial nations.

The specific projects were announced by Benjamin H. Read, president of the Fund, which has American trustees and which administers its proceeds without any influence by German authorities.

U. N. focuses on technology applied to settlements

The United Nations Environment Programme recently held a series of meetings in New York to identify innovative solutions to the problems of human settlements, solutions that could be applied immediately and presented at Habitat '76 (see preceding item) in Vancouver.

The meetings, held in February and March featured speakers from 18 countries, discussing the technologies for food production, transportation, architectural design, energy and other problems relating to developing and industrial nations.

Dr. Othmar Ruthner, a manufacturer of tower greenhouses and one of the featured speakers, described his product which grows plants on a vertical conveyor under controlled conditions. Located in the heart of a

train; the first is now being built in the Canary Islands.

The train (see drawing) is an improvement over the monorail used in Japan and can also be used underground. The drawing shows the Japanese system compared with the Spanish train, which uses a narrow wagon in order to reduce excavation costs; the tunnel can be built economically, using screw-type machinery. According to the designer, the lightness of the fiberglass cars eliminates the need for heavy supporting structures, and the trains are suspended between the sides of the supporting track, riding on rubber wheels close to the cars' center of gravity. This gives a far greater degree of stability and safety, even at high speeds, than is possible in conventionally-designed trains.

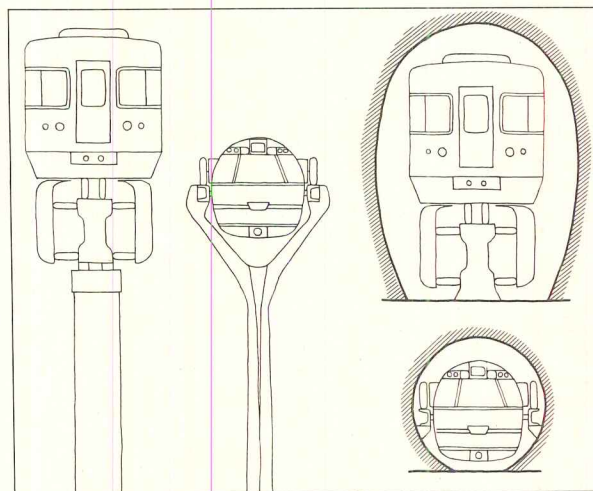

city, the greenhouse can supply fruit and vegetables regardless of weather conditions, delivered fresh to the consumer.

Speaking on climate control, R. Buckminster Fuller recommended his concept of roofing over entire communities with geodesic domes. On energy, Mr. C. A. Morrison, of the University of Florida, presented a number of simple methods for using solar energy for heating, cooling and water purification.

Under the topic of transportation, Mr. Alejandro Goicoechea Omar, an engineer from Madrid, described his invention, the elevated vertebrate

Frederick Gutheim, a consultant on urban affairs, concluded the discussion on long-range projects that might be initiated for Habitat '76 by suggesting the compilation of an urban atlas of city data in graphic form. All cities, according to Mr. Gutheim, could be mapped at the same scale, for comparability, with census and other social data superimposed in graphic form, using computer tapes now available in many countries. Washington University, in St. Louis, has already produced such an atlas for 20 U.S. cities, stated Mr. Gutheim, whose office is in Washington, D.C.



EXQUISITE®

(Pat. Pending)

Top Quality



Designed to please

Unsurpassed in quality of design and construction,
yet priced for your most conservative budget.

Precision cast, producing an even distribution
of light and **NO LIGHT LEAKS!**

AC Powered for today — adaptable for
emergency power in the future.

Meets requirements of OSHA - NFPA - Life Safety Code



DUAL-LITE COMPANY, NEWTOWN, CONN. 06470 A DIVISION OF THE SOUNDSCRIBER CORPORATION

IN CANADA: DUAL-LITE PRODUCTS LIMITED, MONTREAL, QUEBEC

For more data, circle 27 on inquiry card

Environment and Cognition

ENVIRONMENT AND COGNITION, edited by William Ittelson; Seminar Press, New York, 1973, 167 pages, illus., \$10.50.

In his most recent attempt to bridge the interdisciplinary gap between architecture and psychology, William Ittelson continues his leadership role by editing a respectable volume dealing with the complex interrelations between man and his environment. Gathered under the editor's umbrella is a group of contributors from the fields of architecture, planning, design, and geography as well as from the behavioral sciences.

Ittelson observes at the beginning that psychologists have largely neglected perceptual studies of the total environment. By paraphrasing Whitehead's famous comment, he explains this gap by saying "that it takes an uncommon mind to undertake the study of the obvious." There is nothing more obvious than the environment, and with few exceptions psychologists have not possessed minds uncommon enough to undertake its study."

At first glance the impression one gets is that \$10.50 is a lot of money for 167 pages. However, to us the content of these pages justifies the cost. The information contained in all six chapters is enlightening and provocative not only in content but also in the realization that other disciplines have been engaged for some time in environmental research, with man in mind.

A descriptive list of the contributors may be appropriate to display the breadth of the book. The five psychologists are all associated with the City University of New York. William Ittelson and Harold Proshansky are associated with the Environmental Psychology Program, coauthors of *Environmental Psychology* (1970), and both widely published in their own rights. Joel Kameron is associated with the School of Human Environment at Ramapo College of New Jersey as well as CUNY's Environmental Psychology Program. Gary Winkel is also with the Environmental Psychology Program at CUNY and editor of the journal on *Environment and Behavior*. Stanley Milgram is with the Department of Psychology at CUNY and is director of the Ph.D. Program of Social Psychology there.

Contributions from the field of architecture include Denise Scott-Brown, Steven Izenour and Robert Venturi; and Herman Field, who was formerly Planning Director of Tufts—New England Medical Center and presently with the Department of Political Science at Tufts University.

Geographers making their contribution in-

clude Reginald Golledge and Georgia Zannaras, both with the Department of Geography at Ohio State University and Thomas Saarinen with the Department of Geography and Area Development at the University of Arizona. The research reported in the book is as wide in scope as the disciplines themselves, even though methodologies are psychological in nature.

Ittelson's first chapter sets the stage for the book by acquainting the reader with "Environmental Perception and Contemporary Perceptual Theory." In explaining the elementary roots of perceptual theory, the professional terms are used with regularity and consistency, so that the reader who is not a psychologist is not confused by them. After satisfactory groundwork is laid to ensure that he is understood, Ittelson then describes the state of contemporary perceptual theory.

Proshansky provides an objective review in introducing the last nonpsychological contribution by Herman Field entitled "Environmental Design Implications of a Changing Health Care System." Field assumes the role of a sniper taking shots at the present day health care systems and their resistance to change. His thesis is that the hospital, the tool of the system, perpetuates obsolescence as a built-in handicap in its resistance to changing what has operated smoothly, regardless of its usefulness. As an alternative, Field proposes a decentralization of the facility out into the community. In his introduction to this research, Proshansky points out the realistic problems in Field's ideas.

In the last chapter, "Experimental Studies of Environmental Perception," Kameron gives a brief overview of some of the research on environmental perception to date. The focus of the research discussed falls into roughly four categories: architectural forms, perception of cities, perception of highways and streets, and perception of natural environments.

This book was not written as much for psychologists as for those currently in the planning and design fields. It provides a psychological focus to interrelate the many disciplines and to help bridge the gap between them. It does not serve as a panacea for research in environmental perception and cognition but rather as an eye-opener and knowledge-expander in understanding how man and his environment are related and how they interplay with each other.

—Calvin W. Taylor
and Wane D. Veneklasen

Mr. Taylor is Professor of Psychology at the University of Utah, and Mr. Veneklasen is a doctoral candidate at the same institution.

Women in architecture

FROM TIPI TO SKYSCRAPER: A history of women in architecture, by Doris Cole; i press incorporated, Boston, Mass., 1973, 136 pages, illus., \$8.95.

One of the more exasperating aspects of male chauvinism as practiced by this magazine staff is the custom of referring all editorial submissions relating, no matter how tenuously, to the themes of women's liberation, to one of the ranking females on the masthead. "This one's for you, Mildred—something about how women could be really terrific architects if us men would only let them, because they designed the first tipis back when they were squaws. We'll run a review," this is said magnanimously, "if you will review it." In other words, don't expect us men to read and respond to such a book as this, but go ahead and support your sex if you are so inclined.

Too bad, for *From Tipi to Skyscraper* is excellent social history with much to say to both men and women about the role of women in the practical arts, and the contributions of a few of them to the art of architecture. It covers architecture in the United States from pioneer days, emphasizing the humble buildings with which women had a lot to do since their concern for comfortable, convenient, artistic and healthful domestic arrangements was often greater than that of their husbands. The author traces women's participation in the social services and their concern for humanitarian design. The rise and fall of the Cambridge School, the first architectural school for women, and the rescue of its students by Harvard is very well documented.

Doris Cole is a young, registered architect with a Master of Architecture degree from the Harvard Graduate School of Design who practices in Boston and is married to architect Sergio Berizzi. She has not only thoroughly researched today's architectural scene from the standpoint of those who work in offices, but she is living in it and she is at her best in her last chapter on contemporary practice. Through her own experience, and doubtless through her husband's, she is completely without illusions as to what life is like for young architects, both male and female, working within the pyramidal structure of large architectural firms and she demonstrates convincingly how that pyramid actually works to the detriment of design. Armed with statistics proving the discrimination against women in these offices, she knows that the system can be tough on the men too. The message of her book is that women architects must join their male colleagues as equals to renew the practice of architecture. —Mildred F. Schmertz

METALASTIC[®]

IS UNLIKE ANY OTHER

EXPANSION JOINT COVER!

Metalastic is the only expansion joint cover that has a seamless extrusion. The perforated 2" wide tempered steel nailing strip within each flexible vinyl flange provides positive fastening and avoids concern of use over dissimilar metals. A 3/8" PVC closed cell foam insulates the bellows section. It is flexible at atmospheres down to -50°F and resistant to aging, cracking and atmospheric pollutants... will not work loose and shrink, rust or corrode.

Straight flange Metalastic is packed in 50' lengths to minimize joints. Curb shape and combination straight flange and curb shape come in 10' lengths. Factory-fabricated transitions and exclusive self-adhering splicing tabs assure permanent water-tight joints.

Get the facts. You'll specify Metalastic. It's available now.

Metalastic is for curb or cant installation and adapts to both conventional and irregularly shaped roofs.

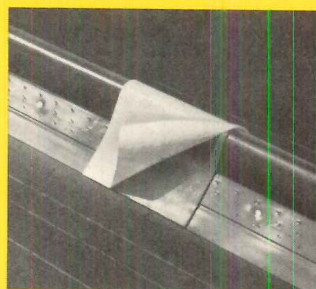

Reinforced, self-adhering splicing strips eliminate waste and error and provide permanent weather-resistant bonds. Splicing takes seconds regardless of temperature.



Ring shank Metalastic nails provide additional moisture protection. Vinyl flange self-seals around the nail shanks.

Metalastic[®]

Expansion Joint Cover

GREFCO, Inc. / Building Products Division
2111 Enco Drive
Oak Brook, Illinois 60521

 A subsidiary of General Refractories Co.

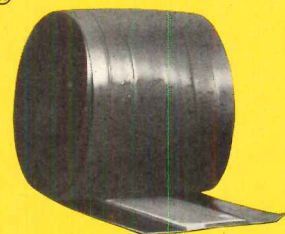

For more data, circle 28 on inquiry card

Continuous perforated strip of tempered steel within each vinyl flange assures positive fastening.

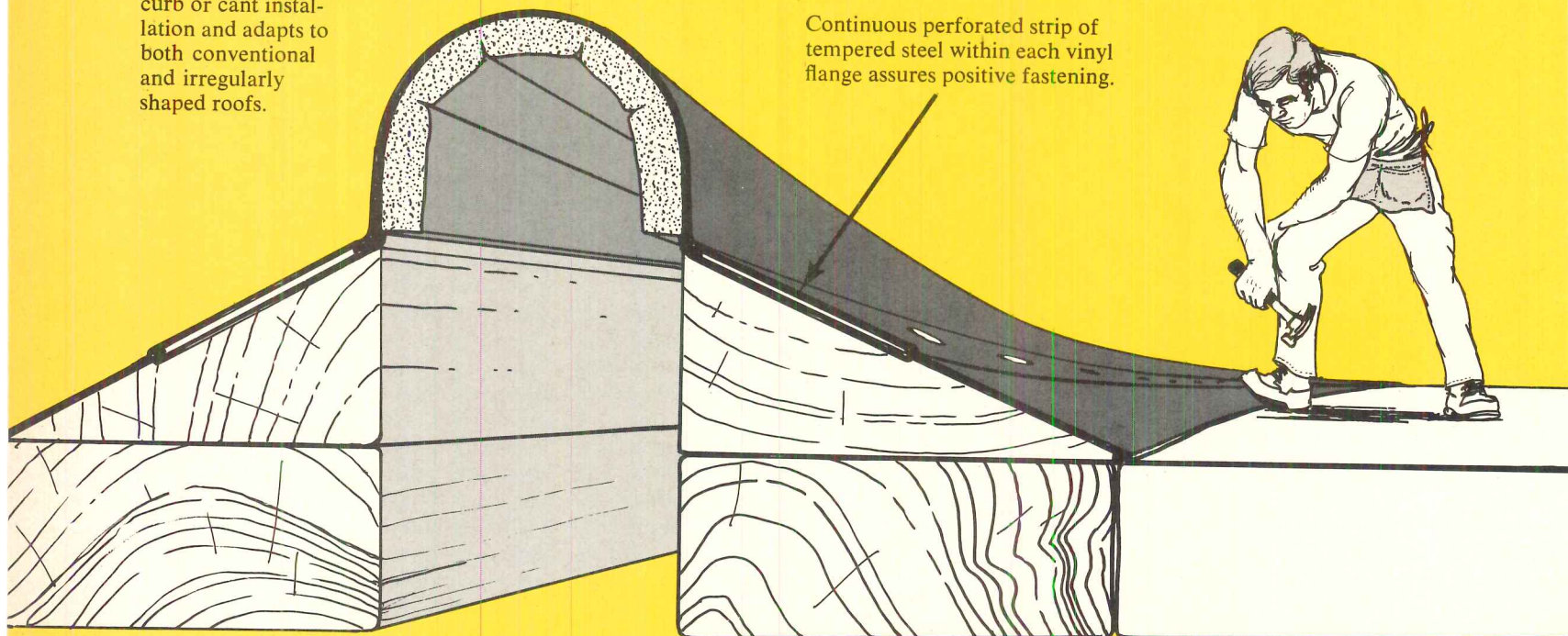

Want to save on electrical installations?



NECA study reveals opinions of design professionals.

The National Electrical Contractors Association (NECA) recently completed a study to find out how electrical contractors can help maintain high performance on projects requiring complex electrical system installations. On a question involving project planning, most participants agreed: the professional electrical contractor should have a role as a preconstruction consultant.

Reasons? The electrical contractor is an important member of the building team. And his specialized knowledge, applied early in the project, can be very valuable in assuring overall coordination of the electrical job. Skilled at project scheduling and expediting electrical work, his knowledge of product applications, code requirements, and his installation expertise can help

avoid costly potential problems and delays later in the project.

That's why many construction industry professionals involve electrical subcontractors in preconstruction planning: to make sure the job gets done—efficiently, economically, accurately, profitably. For more information on how you can benefit from the study, mail this coupon today.



National Electrical
Contractors Association, Inc.
Dept. R-04, 7315 Wisconsin Ave.
Washington, D.C. 20014

If electricity makes it possible, electrical contractors make it practical.

Please send a free copy of the NECA Preconstruction Conference Handbook, explaining how I can save time, headaches and money through preconstruction planning.

Name _____ Title _____

Firm _____

Address _____

City _____ State _____ Zip _____

Drawing on vellum?

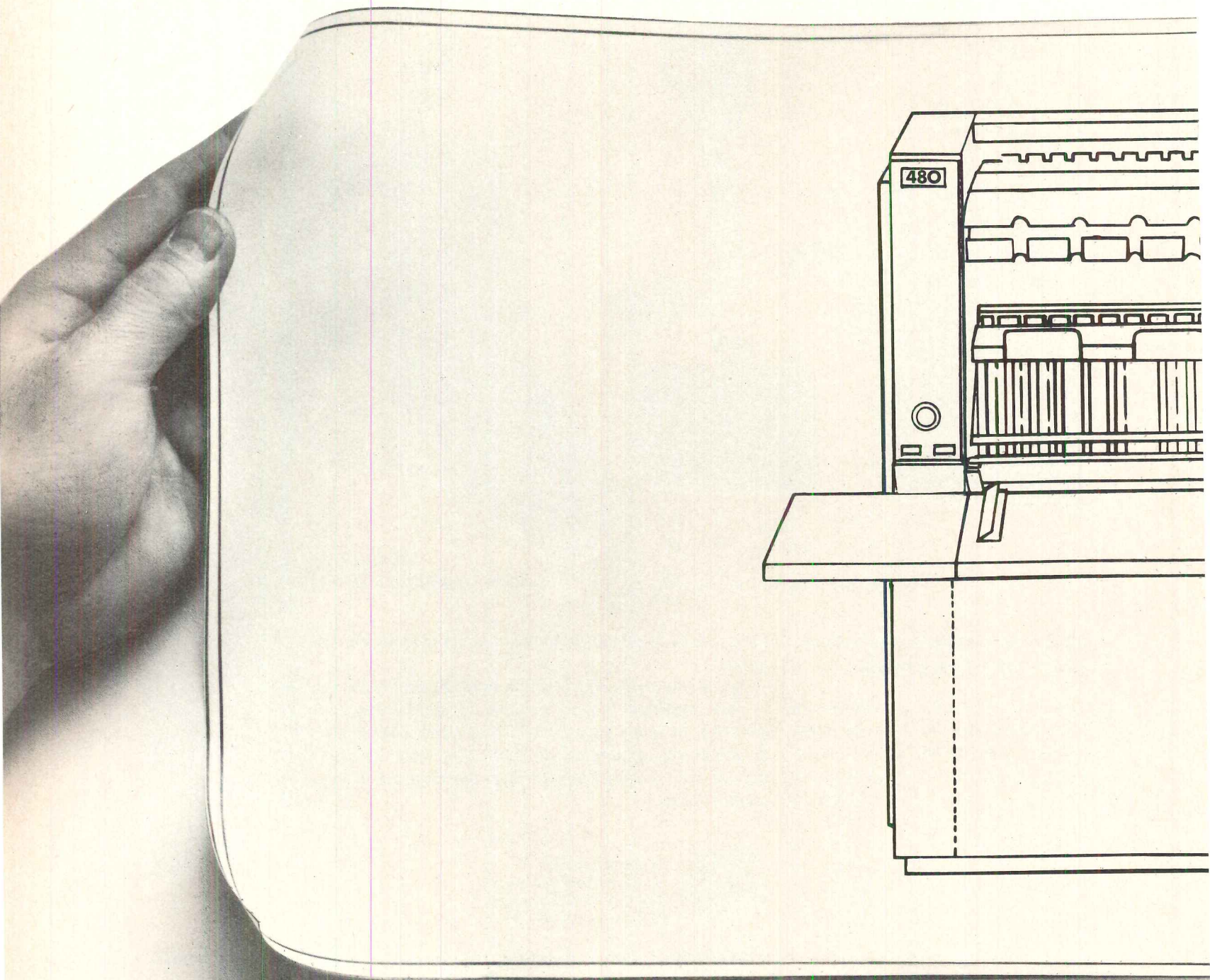

Draw on GAF!

Introducing GAF DRAFTRACE® and POLYTRACE®...drafting materials from America's oldest manufacturer of film, photographic papers and chemicals.

GAF DRAFTRACE-Papers—They're permanent so you eliminate re-dos of older drawings. They're non-yellowing which saves lots of drafting time (and money). High fracture resistance adds life to mis-handled drawings. DRAFTRACE accepts pen and pencil...so you use only one product. The special

Drawing on film?

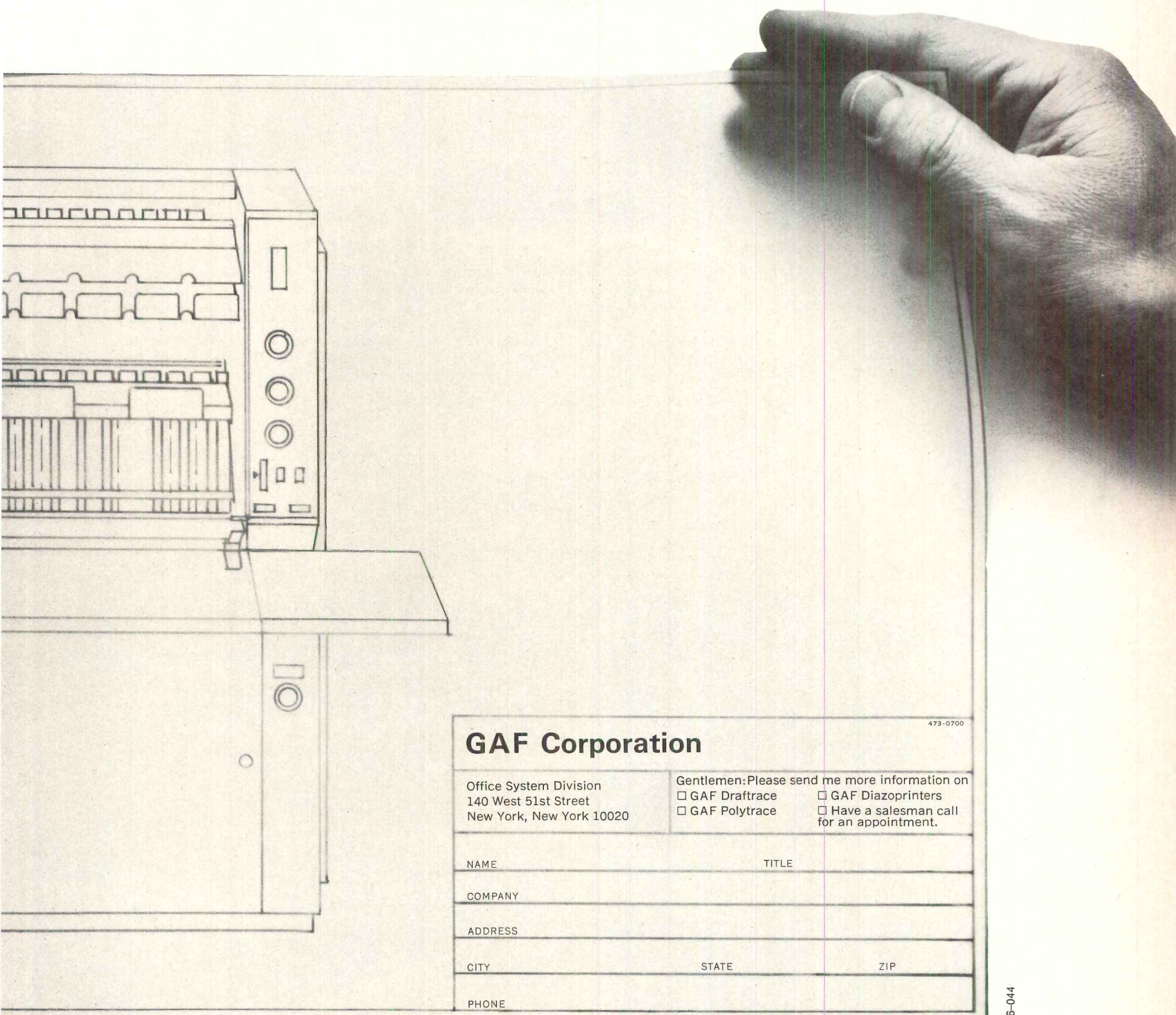

473-0700		
GAF Corporation		
Office System Division 140 West 51st Street New York, New York 10020	Gentlemen: Please send me more information on <input type="checkbox"/> GAF Drafrtrace <input type="checkbox"/> GAF Diazoprinters <input type="checkbox"/> GAF Polytrace <input type="checkbox"/> Have a salesman call for an appointment.	
NAME	TITLE	
COMPANY		
ADDRESS		
CITY	STATE	ZIP
PHONE		

Line drawing of the new GAF 480 Automatic Diazoprinter

666-044

optical brightness tint allows DRAFTRACE to deliver excellent contrast for high quality micro-filming. DRAFTRACE's erasability lets you pick up graphite particles, leaves no ghosts when reproduced.

GAF POLYTRACE-Films—Specially designed to take and hold pencil and ink. Erases easily without ghosting. High translucency assures excellent reprints at higher copying speeds. POLYTRACE is virtually impossible to tear, damage

or fracture. Delivers longer lasting drawings. Reduces re-dos of old ones. Its dimensionally stable base makes undimensioned drawings and templates a breeze. And its high whiteness assures quality reproduction on diazo and other systems.

Looking for materials that will help you deliver a quality end product? Get acquainted with GAF DRAFTRACE and GAF POLYTRACE. And don't forget our complete line of diazoprinters.



Rediscover
Diazo[®]
© COPYRIGHT GAF CORPORATION

For more data, circle 29 on inquiry card

NEW McCORMICK INN profits
from easy room division with



OPERABLE WALLS



R-W Operable Walls divide large room into 10 meeting/banquet rooms or combination of reception area plus rooms (shown in main photo).

Chicago's newest showcase hotel, McCormick Inn, can quickly divide four large rooms into as many as 20 separate rooms with "Quiet Quality" Richards-Wilcox Operable Walls.

According to James Freeman, Convention Services Manager of the spacious hotel located adjacent to McCormick Place convention center, R-W Operable Walls were selected for

three main reasons: **1.** Extremely high quality hardware which makes one-man operation of the walls fast and easy. **2.** Ability to enhance the rich decor of the Inn. The R-W Operable Walls are covered with bright vinyls as well as thick carpeting in a variety of hues. **3.** The expert engineering assistance provided by Richards-Wilcox to assure the optimum layout for maximum profitability.

Architect: A. Epstein & Sons, Inc.

Contractor: Brighton Construction Co.



FREE BROCHURE



Richards-Wilcox

MANUFACTURING COMPANY

116 Third Street, Aurora, Illinois 60507
Phone: (312) 897-6951

One of the White Consolidated Industries
WCI

For more data, circle 30 on inquiry card

interested
in
Energy Savings
through
efficient
architectural
lighting.
see page 97

For more data, circle 31 on inquiry card

Specify clean, pressure preserved
OSMOWOOD
for siding and decking



Long lasting protection
Needs no maintenance

Osmowood treated with OSMOSE K-33 has a pleasing green hue, which needs no painting or staining. Preservative treatment makes it impervious to decay and insect attack. Guaranteed for 25 years. Locally available. For specs, approvals and nearest treater, write:



980 ELLICOTT ST. BUFFALO, N.Y. 14209
Southern Office: 1016 Everee Inn Rd., Griffin, Ga. 30223

Greenfield Village, Dearborn, Michigan

For more data, circle 32 on inquiry card

The guaranteed maximum price: a sampling of views

The ringing sound of the words "guaranteed maximum price" applied to construction projects prior to bidding has a reassuring effect on certain owners and developers, while it incites many construction design and management professionals to a variety of highly argumentative response—pro and con. We have invited a number of professionals to express their views and the results reported here have excitement and cogent reasoning in them.

The reasons for the excitement are plain. Large amounts of money are involved, and the practitioner on the issuing end of the guarantee is accepting an element of risk for which there must be, in ordinary business prudence, a proportionate prospect of profit. Further, the role of the guarantee as an advantage to owners and as a constraint on professional service is a controversial issue. The views expressed here are those of the protagonist in each case. The effort has been to solicit views from a variety of sources without coloring the response by any survey-kind of averaging.

Some common elements emerge, but bear restating in each context to point up differences, procedural, philosophical and fundamental, that are important to the understanding and to the industry.

1

John L. Tishman views the GMP in changing times

First, a point of view expressed in an interview with John L. Tishman spoke not only to the definition and rationale of the guaranteed maximum price per se, but also to the basic client-design-construction universe that puts the GMP into its own perspective in these times.

Mr. Tishman is executive vice-president for construction, Tishman Realty and Construction Company. He pointed out that the classic pattern of design-bid-construct has not been working at all smoothly in recent years. He was calling upon the experience of the Tishman firm over some 75 years of activities in building development, ownership and construction. The pattern of activities in recent years has included increasing construction and consultation work for other owners and designers as well as for their own account as owners.

The Tishman firm has worked as both owner and co-consultant with hundreds of architects and other professional consultants. It is

zealous in protection of the quality of professional agency on behalf of owners. This quality guards against conflict of interest in the provision of any professional service: architectural, engineering, construction management, cost consultation or other.

Putting aside for the moment any debate as to which of these services may be usefully performed by architects (Mr. Tishman has understandable and strongly logical views in this area), the disarray in which the classic pattern has found itself in recent years is attributed to a clear set of the manifestations of our times that have made the single-bid, firm-price construction project difficult to assemble in the owner's best interest.

One of the manifestations has been that the scope of the average job has increased tremendously. At the same time, the normal time-span of the job has also increased. Many jobs, especially in the years following World War II, became so large that competition was limited by the available number of General Contractors large enough to bid them and obtain bonding for the required financial responsibility.

Citing the range of \$50 to \$100 million as common in jobs today, Mr. Tishman points out that, under the classic procedures, plans and specifications were completed and detailed before bidding took place. With the increase in cost and size, the drawings and specifications necessarily became even more detailed. These documents had to be understood and translated by contractors into their ultimate pricing detail. So, most General Contractors were forced to become the conduits through which plans and specifications packages were distributed to some 20 or 30 trades, and bids were then re-assembled as rapidly as possible for tendering by bid-opening day.

While he is assembling his bid, the GC adds up all the component sub-contracts, adds his own estimate for coping with general conditions on the site and further adds his own expectations of profit. If the General Contractors in a given area must assemble their bids from the same universe of sub-contractors, the only area in which there can be a difference is in the general site conditions and profit allocations (assuming that the sub-contractors submit the same price to each GC who requests it). On a \$50 million job, the difference in per cent from one GC to another is likely to be plus or minus two or three per cent—unless one or more of the GC's decides to forego any markup on bids and to make his profit on savings or purchased or change orders.

It turns out that where little of the actual work among the trades is performed by a GC with his own forces, the opportunities for cost-saving innovation in construction technique become more and more limited, especially where innovation might involve the interaction of various trades. Few GC's today employ their own forces in, for example, mechanical systems or steel framing systems. These systems comprise as much as half the cost of the work, so the opportunities for innovation are restricted on that much of the job to reside only in the separate ingenuity of the trades themselves.

Once the client accepts three or four bids on a single general contract, he must have overriding reasons for awarding the contract to other than the lowest bidder. Indeed, the Federal Government is constrained by law to make such an award. Once the job is awarded, the client has no problem and is assured of the final price of his building, provided the GC is assured of making his profit. If, on the other hand, conditions worsen or he finds he has made a mistake in the bidding, if inflation goes wild or one of his sub-contractors reneges on his part of the work, then the owner has a problem. Obviously, the GC, already facing a profit margin low enough to win the bid, is faced with a loss, which he can ill afford.

Where does the problem arise? In simple fact, it comes from the sub-contractor who has second thoughts or very real difficulties in getting his portion of the work put in place at the price he originally quoted. The reasons may have nothing to do with his competence in his trade. They may in fact derive solely from the lack of clarity in original specifications or in the inability of other trades to make schedules. In any case, the sub-contractor appeals to the GC with what may be a simple statement that he needs more money. The GC, then, who is accepting the over-all job at a low figure, is presented with a claim. Without pre-judgment of whether the claim is right or wrong, the GC sees his first duty as presentation of the claim to the owners. He marks the sub-contractor's claim as "received" and transfers it on to the owner.

The GC then waits for the owner to react to the sub-contractor's claim. An owner may refer the matter to the architect, and there may be a concurrence in the validity of the claim whereupon the sub-contractor's new price is written into the over-all cost of the project.

If, however, there is disagreement with the sub-contractor's claim, the owner then

Timely Turn

Courtesy Lock Museum of America, Inc.

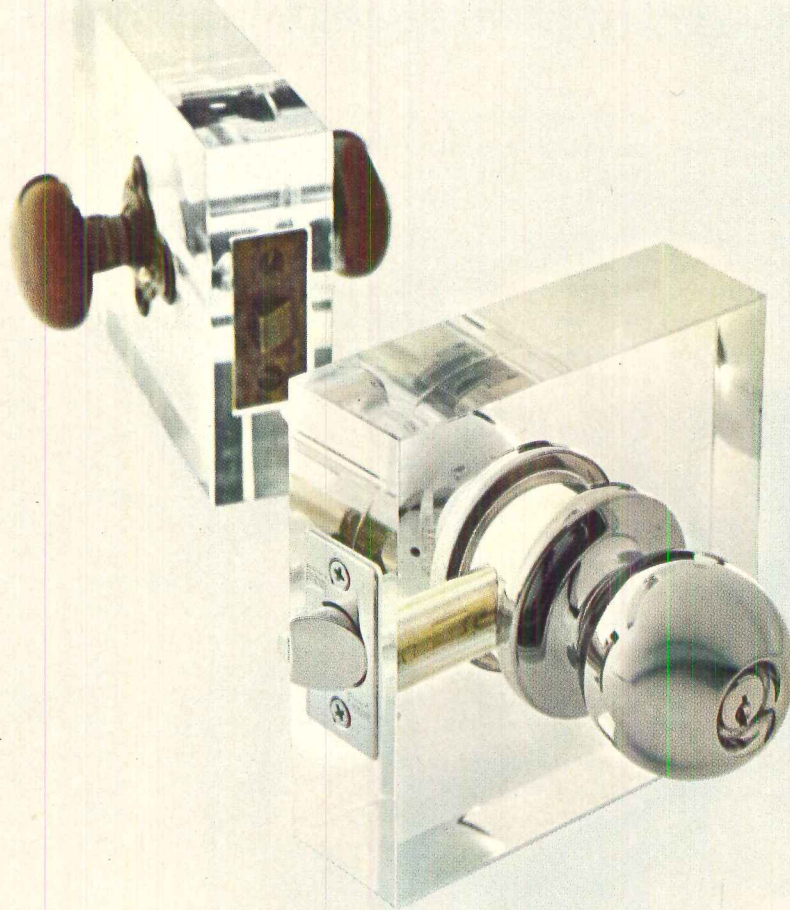

*Rondure design Ruswin Stilepacer™ lockset.
Refreshingly crisp and clean.*

*Whisper soft in its
velvet smooth response. A pace setter.
Progressive design in the Ruswin tradition.
Ruswin, Division of Emhart Corporation,
Berlin, Connecticut 06037.*

*In Canada — Ruswin, Division of
International Hardware.*



The Collector's Series by Ruswin

For more data, circle 41 on inquiry card

responds to the GC to that effect. The GC relays this information to the sub-contractor. The sub-contractor then decides to pursue the matter by way of the courts and bases his legal procedures on the fact that the general contractor has not taken a strong position between one or another.

A question of advocates and adversaries

This non-partisan attitude of the General Contractor is based on the balance of two sets of influences. On the one hand, he wishes to deliver the job to the owner within the price he has bid. On the other hand, had he taken a strong position as adversary to the sub-contractor and rejected the claim out of hand based on his own analysis, he would anticipate a confrontation on his own part as adversary to the sub-contractor. The outcome of any legal procedure then would apply only to his own position and responsibility relative to the claim. Win or lose, he would have spent his own profit on the case.

So the GC cannot afford to put himself in this position. That is, he cannot permit the owner to refer to his, the GC's, own correspondence relative to the invalidity of the sub-contractor's claim and simply state that he, the owner, has no position but agreement with this letter and it is up to the GC to deliver his promise. Nor can the General Contractor put himself in the position of being forced to pay additional amounts to the sub-contractor without being reimbursed by the owner.

The GC then is forced in the initial phases of the statement of claim to take the position of advocate of the sub-contractor in presenting the matter to the owner and/or architect.

In the days when the GC was performing a major portion of the work with his own forces, this issue of claim against the exigencies of the job did not arise. Now, however, the general contractor may indeed be an expert in buying and expediting construction services, but he is also the first adversary the owner confronts in a claim for an increase. The client has not only lost an advocate, he has gained an adversary in this situation.

The owner, then, is faced with the position of requiring either an in-house body of expertise to support his own advocacy, or he must rely on the professional consultation of the acknowledged expertise which will accept a professional role of advocacy on his behalf. Without such consultation or in-house support, the court can respond only to the General Contractor who stipulates, perhaps correctly, that he has nothing to gain by acknowledging the credibility of the sub-contractor's claim.

New interpretation of the bid process

Now, a reexamination of the bid process forces a new interpretation of what that process is capable of bringing about. The original intent was to fix the price of the project and permit the construction process to proceed in a climate where cost-saving ingenuity was a primary motive. Under the circumstances now

pertaining, the motivation for performance is still a strong one, but the power of the GC in his role of brokerage can seldom be directed toward inter-trade improvement of the process so much as it is toward protection of his profit.

The second loss to the process has developed along the lines described as the loss of the input of construction expertise at the planning stage of the project. Large clients, particularly government clients, have not had access to the expertise which may indeed still reside in the hands of General Contractors. This loss occurs because the contractors have little motivation to make the knowledge available without some assurance that the job will be theirs in the end. They may, of course, be consulted on a fee basis in planning stages. But without long-term commitment to success of the job, (in owner's terms), the discipline of such knowledge is likely to be less than stringent on the owner's behalf.

It has been the Tishman experience in coping with these problems from the point of view of both owner and builder that preservation of the essential role of advocacy or agency calls for an examination of where the reward of technical and economic sophistication may lie. If, for example, a true application of expertise and management discipline can make a saving of, say, 20 per cent on a job, it is a matter of history that at least half of this savings occurs in the disciplines applied in the planning stage—and the other half in buying the project. Once bidding has taken place, there is virtually no opportunity for further saving no matter what disciplines may be applied except in matters of schedule and management which are, in fact, only methods of avoiding disaster rather than ways to effect savings.

Thus, the essential role of construction management as a technique has been applied (with or without that label) over the years. Suppose, by application of the coordination of what might be called a professional team, a building is brought in at \$40 per square foot. Experience tells us that the same building without those disciplines would cost on the order of \$50 per square foot; and the real cost difference is not only in delivered price but also in the amount of the added time it takes to deliver a building for \$50 per square foot. There is a direct relationship between the cost and the time, even though the delivered product appears identical.

The owner who accepts the risk should share in the profit

Under the terms of construction management as it is now being defined, the owner begins to have more direct association and responsibility among the trades involved in his project. The Construction Manager, putting his expertise and advocacy virtually in-house to the owner, enables a process of pre-design communication to take place. The owner, through the CM, is able to talk to the trades and evaluate the options that arise in many basic alternates that are not available in a process that must arrive at construction documents before bidding in the open market place.

The whole building programming and design operation—and in fact proceeding back into elements of development and feasibility, and on through elements of ownership and operation—takes on a more uniform aspect. The owner does participate more directly with the project. This, of course, means that he accepts more risk, but at the same time, he is not required to pay the price of that risk to an entrepreneur whose profit is adversary to his own interests.

What, then, becomes of the owner's security-blanket residing in the guaranteed maximum price? If this price is important for reasons other than the quality of the job per dollar expended—that is, if the knowledge of a maximum is germane to the financing process or to the corporate responsibilities of the owner—a reasonable approach to the guaranteed maximum price can be made very early in the game under the multiple contract procedures of the usual construction management contract.

It is well known that the work of six or eight major sub-contractors represents 75 to 80 per cent of the cost of a typical job. If the systems represented by those major sub-contractors can be expedited and bid before the physical placement of the job begins, it is reasonable to assure the owner that this major portion has a fixed price and that the balance of the job is more than likely to come well within the projected figures.

The client then has the option to make his own decision about the risk of the ultimate bottom-line figure. He should understand that in accepting the risk without the guarantee on the part of the GC or the CM, he alone can benefit by savings. That is, the direct relationship between risk and profit pertains at this point. If the CM or GC is forced to take the risk of the guaranteed maximum price, he is not only entitled to, but in all prudence he *must* raise the level of the guaranteed price to cover contingencies and the certainty of his profit. This is seldom in the owner's best interest.

The point is frequently made that, if the CM is invited to participate in savings when the job comes in below the guaranteed max, there is an immediate dilution of the role of professional agency between the CM and the client. That is, the CM thereupon becomes involved in profit on the job and puts himself in the same position as any GC concerned with his own profit.

Mr. Tishman has a great deal to say about the role of the Construction Manager in handling the bidding process. He points out that at least half of the savings that can be expected as a result of the construction manager's professional services are made in the bidding phase as a result of the CM's fulfilling the role of GC in handling the bids of separate trades. The CM takes bids from the trades but he also is able to talk with them directly as the owner's agent, clarifying documents and scope so that each sub-contractor can submit his bid with confidence that the scope and detail are truly as stated in the documents. The construction manager is able to work in detail with each trade before the sealed bid is proffered. Fur-

PROGRAM WITH PLEXIGLAS®

...the problem solving plastic for glazing

You name the glazing need. Plexiglas brand acrylic plastic will provide the answer. Answers made possible through the unique combination of advantages that only the complete line of Plexiglas formulations offers.

Plexiglas offers properties like breakage resistance, weatherability, safety, optical clarity, light weight, formability.

Advantages that include availability in a wide assortment of sizes, colors and thicknesses . . . in clear form, in transparent tints and patterned sheets.

Right now Plexiglas is hard at work in a broad range of glazing areas—everything from hockey rinks to storm doors . . . from energy-conserving solar control windows to security partitions in banks and offices . . . from vandal-resistant school windows to a variety of beautiful architectural forms.

Look at the keys below for your specific glazing needs. Then write for literature and advice on how we can help you.

For more data, circle 42 on inquiry card

Plexiglas acrylic plastic is a combustible thermoplastic. Observe fire precautions appropriate for comparable forms of wood. For building uses, check code approvals. Impact resistance a factor of thickness. Avoid exposure to heat or aromatic solvents. Clean with soap and water. Avoid abrasives.



**ROHM
AND
HAAS**
PHILADELPHIA, PA. 19106

ther, he is able to relate the sequence of design completion to that of bidding so that the key trades are bid early enough in the process to arrive at a firm pre-construction commitment of the major elements of final price.

How to relate the process to government work

In order to open the process to the requirements of free bidding in government work, these conversations with the special trades begin very early in the planning process and are organized on a basis of open sessions of interested contractors in a given area. In private work, there are more opportunities to pre-qualify the audience of interested sub-contractors, but this is not critical to the communication process in this phase. The purpose of the exercise is merely to make sure that the trades understand the project in detail before the invitation for sealed bids is published. In private work, it is possible to negotiate after the opening of bids, but in public work the job is awarded to the low bidder. Even here, there is a possibility of feedback in that the detailing and bidding of, for example, the steel work may serve to initiate economies in documents pertaining to concrete or other trades. Control of the sequence of bidding holds open the options of alternates on subsequent trades while it still retains the requirement of accepting the low bid in each. The alternates in, for example, fireproofing in compliance with the codes may be affected by the options that have been exercised in steel or concrete trades prior to the need of a fireproofing specification.

It has been the Tishman experience that in handling a job properly on a trade by trade basis, the process takes several weeks. This is in contrast with the period measured in hours that is available to the GC between his assembly of all sub-contract bids and his submission of his own over-all job bid. The logic is that the GC is virtually forced to accept the sub-contract bids without much negotiation, almost certainly without technical review contributing to better quality of job; and his ability to participate in the balance and underlying quality of the project is thereby constrained.

Innovative buying is another area where the CM makes substantial contributions. It can be done at any level of participation. In private work, the opportunities for negotiation and pre-bid purchase of certain items or systems is one that calls upon the skills of the CM in the market place. In public work, some of this freedom to negotiate is limited by the stipulation of sealed bidding of each trade. Even in public work, however, the CM has opportunities for management of the interplay of trades.

Tishman Realty and Construction will guarantee a maximum price if the owner insists; but the fees for the work on such a project are higher than those in which the owner accepts the risk. Every CM can offer a guarantee with certain phases of the job, as previously described; but if he offers the guarantee too early, he either does so at his peril or sets the guarantee so high as to be inappropriate to his role of agency.—*John L. Tishman*

Bradford Perkins states a clear case for and against

When Bradford Perkins was an associate of construction management consultants, McKee-Berger-Mansueto (since the turn of the year he has been a partner of Llewelyn-Davies Associates, New York), he made many contributions to this department, among which was the following. This is the statement that started it all when Brad agreed to let it be shown among friends and not-so-friends to see what controversy might arise.

One of our (MBM's) consulting clients recently admitted "we finally are beginning to understand why you advised against the guaranteed maximum price (GMP) construction management contract!"

Even though they had signed such a contract with a highly ethical and capable firm, they were experiencing many problems stemming from weaknesses inherent in this approach. To a knowledgeable firm in the industry, the weaknesses should be clear as they are to many experienced owners. But the surface appeal of the GMP concept has made it a major issue in the development of construction management services and it will continue to be an issue until it is fully understood.

Six points in favor

Its attraction to the average owner is obvious. It provides an owner with an early answer to the question that scares him most: "What is the maximum cost I must be prepared to pay?" There are also some more tangible reasons for its use.

1. The major reason for its confusion with the construction management approach is the pseudo-CM contract recommended or required by a few major public agencies such as New York's hospital finance program, HEW's Hill-Burton program and others. Some of these are now moving away from their original requirement for a firm price as a pre-requisite for a commitment of their funds. In other cases, owners are building the first phases of a project with their own money and obtaining the commitment later when they can take bids on the remainder in the traditional fashion.
2. On public projects which permit CM only with a GMP, this at least allows the owner to select the contractor of his choice rather than the low bidder.
3. Some private as well as public financial institutions also require a fixed price before they will sell a project's bonds.
4. On some simple buildings, such as industrial facilities, it is possible to fix cost and quality relatively accurately early during design and the GMP provides the owner with some assurance.
5. There are firms which—in spite of the limited legal strength of the guarantee—treat it as a real guarantee. Thus, the two primary reasons that any GMP remains in effect are that

the GMP was either a "safe" number or a GMP given by a firm that equates it with a firm pledge of its word.

6. And occasionally, there are even some aspects of a guarantee which—if the contractor has not been careful—can be enforced.

Nine points against

1. The guarantee—if given before completion of design—is usually meaningless. The most important parts of the construction contract are the plans and specifications. Thus, any subsequent change in the documents—upon which the contractor had based his guarantee—is usually grounds for a change in this guaranteed price. The typical guarantee language contains *force majeure* and scope change escape clauses which are more than wide enough loopholes for any experienced contractor.
2. In many ways experience with guaranteed maximum contracts can be paralleled with the general experience of owners in enforcing liquidated damages or penalties for time delays. As most experienced firms will testify, it is rare for anyone to collect liquidated damages. If the liquidated damages are regarded as a significant possibility, the experienced contractor immediately begins issuing correspondence carefully structured to build a case for a time extension. The same is true of a GMP as the contractor immediately begins to label any development of the design as a basis for change in the GMP.
3. The analogy to the liquidated damages experience can be taken one step further. The quandary facing the writer of a liquidated damages specification is whether to call for large or small daily penalties. If the penalties are too large, all bidders build large contingencies into their bids; if they are too small, they are ignored. In the case of the GMP, if the contractor suspects that the GMP could be too low, he will immediately begin to build a change order justification as a cushion. If it is a safe number, the owner need not have the guarantee.
4. As a general rule, whenever an owner attempts to shift total liability or risk to another party, he ends up paying the price of this transfer. A major impetus for the rise of the project management and construction management approaches, is the realization that the owner is the real manager of any project, the chief beneficiary of its successful execution, and, thus, the proper risk taker. An owner cannot really ever successfully transfer his risk without incurring a cost, whether it is in increased project cost or reduced service.
5. The possibility of higher project cost can be traced in part to the normal bid impact of a no competition situation. The general contractor offering the GMP is typically a sole source and, thus, is under little compulsion to give his best price. Some agreements do not even require this sole-source bid to be given until the 90 percent point in the contract documents phase. This is a ridiculous compromise for at that point the owner might as well put the job out to bid. On the other hand, if the guarantee is required early any reasonable contractor will



PRICE PFISTER

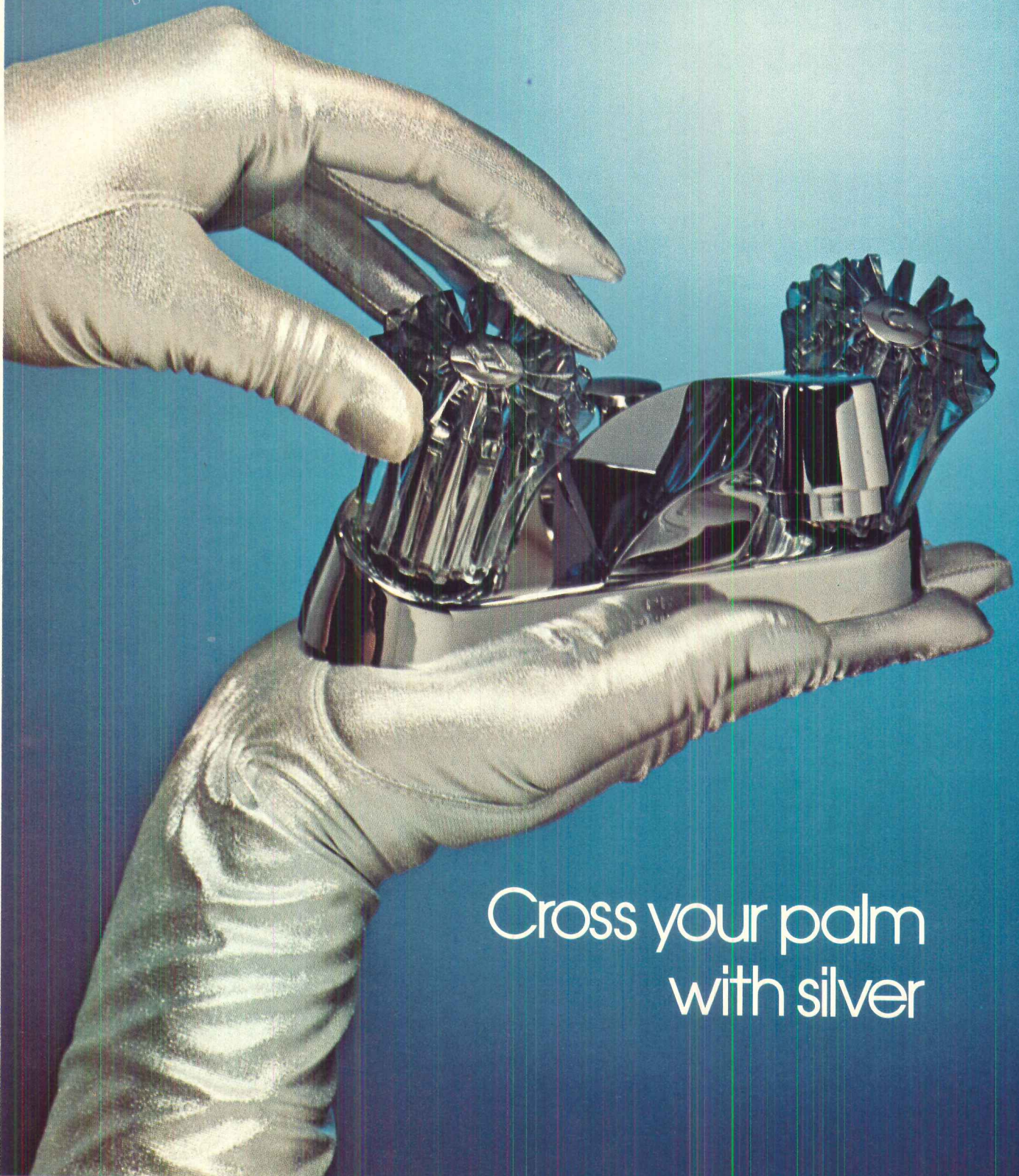

Cross your palm
with silver

PRICE PFISTER Manufacturers of Plumbing Brass • Pacolma, Calif. 91331 • Subsidiary of Norrils Industries

For more data, circle 43 on inquiry card

...ge contingency to protect himself. ...ntingency within a fixed budget ceiling means less building.

6. A far more serious deficit is the impact on services. "Construction management" with a GMP is not construction management. An essential element of construction management services is the CM's role as owner-agent. Once the GMP is given, the construction manager once again becomes an independent contractor. Thus, the owner faces the same adversary relationship, with all of its attendant problems, which have in large part led to the dissatisfaction with traditional contracting and, thus, to the popularity of construction management. Construction management is supposed to be a means of protecting the owner in a game where he typically does not know many of the rules, and to claim that a GMP rather than a bid makes a contractor a referee (owner-agent) rather than an adversary is a sham. Even Vincent Bush, former vice president of operations for Turner Construction supports this view in his recent book, *Construction Management*. Turner, one of the nation's best contractors and construction managers, will provide a GMP, but Mr. Bush notes: The CM-GC professional relationship "assures the owner that the builder will act in the best interest of the owner even more than the cost-plus-guaranteed-total approach. It is particularly valuable on large or complicated projects."

7. The architect/engineer should also beware, for to make a GMP at all effective as a guarantee leads to most of the weaknesses that the AIA, CEC and others have consistently pointed out in the design/build approach. Fixing the cost must be accompanied by a fix in the scope and quality of the project. Since design is a dynamic process, such a fix is a serious barrier to a meaningful design development effort.

8. Performance guarantees do not even work as a basis for the GMP. For example, some performance guarantees related to future tests must be based on a predetermined set of loadings, ambient conditions, and other performance parameters. Such criteria are not properly established until the project is well-defined.

9. Insurance carriers recognize the inherent conflict of interest facing "construction managers" offering GMP's as being similar to that of the design-construct contractor. Therefore, they will not write construction management professional liability insurance for such organizations.—Bradford L. Perkins

3

George T. Heery says the GMP doesn't preclude CM

George T. Heery, president of Heery & Heery, has been thinking and performing in the disciplines of architecture and construction management for many years, as RECORD has reported from time to time. Following is his direct response to Brad Perkins' statement.

First, let me summarize some of my views on

Mr. Perkins' article and the subject of the guaranteed maximum price (GMP), construction management and general construction contracts:

Generally, I agreed with Mr. Perkins in his various points, except for his liquidated damages analogy. (On this point we have used liquidated damages too long with many good successes, without added cost to the owner, and with collections, for me to agree on that.) But liquidated damages was not Perkins' main subject, and he is certainly right to point out that a GMP rarely even exists except in name, is not in an owner's best interest because it is misleading, and in most cases is but a subterfuge for a negotiated, cost plus construction contract.

Threaded through most discussions on construction management today is the narrow idea that an owner who must have or insists on a "maximum" or lump sum construction contract cannot really employ professional construction management. *This is not true*, and is very confusing when injected by statement or inference in such discussions. An owner who must have or wants a lump sum contract is simply precluded from non-cancellable early contracts, only one tool of the complete construction manager and not a necessary part of a specific project's plan of management. In fact, phasing is not *always* in a specific owner's best interests and *sometimes* does not contribute to early occupancy or cost control. That doesn't say, however, that every project and owner can't profit from professional construction management.

The pre-design GMP is meaningless. The owner has a price, but on what? Once the owner's requirements are fully defined, the GMP either evaporates or the owner's and the CM's interests divide (thereby doing away with professional CM), or both occur, this usually being the case.

I have never seen a GMP construction contract work as advertised unless the GMP was set too high in the first place. After 22 years' experience, I've learned that GMP is cocktail conversation and a glamorous sales pitch for a negotiated construction contract, nothing more.

Yet most owners *must* put a handle on cost before extensive design or other commitments are made, and there is a better way to accomplish this which may be carried out in either one of two modes, the key to both is a proper contractual obligation (and commensurate fee) in the AE agreement. The two modes are:

1. A combination design and construction management contract wherein the AECM accepts the obligation either pre-design or by the end of schematics.

2. The CM, separate from the AE (which arrangement has its pros and cons), in which the professional CM works out a compatible budget and program with his client and then puts the AE under contract for the owner with a pre-design obligation on the budget. (Any owner that uses a separate CM and doesn't follow this sequence and approach has missed

his biggest opportunity to make time *and* cost control effective.

Number 1 above is easier than 2 because one entity carries out design as well as CM services . . . a very efficient arrangement and frequently the best of the owner's options. Arguments that this represents a conflict of interests simply don't hold water. First, the design plus-construction-management contract must be fashioned to pair the professional's and his client's interests. This can be done through an objective approach to the agreement. In the case of pre-design setting of a maximum budget, the owner's requirements must be clearly stated, all latitudes that do not adversely affect the owner should be left to the designer, a schedule adopted, and an escalation index adopted and projected. There are, of course, many projects which are more complicated that do not lend themselves to a pre-design "lid" commitment by the AECM or anyone else. In these cases, though, the agreement is made in advance to set the maximum at the schematic phase. This may raise some eyebrows, but consider these points: The owner cannot force the AECM into an unreasonably low figure. The AECM cannot receive design approval and progress payment until he has justified his figure and obtained the owner's approval on budget as well as design. In both the pre-design and schematic design commitment cases, the owner is in the best shape he can be in for cost control in the construction industry if the AECM is of substance, the contract is clear, and the AECM's obligation is significant.

In 2 above, the finest single service the professional CM can perform for his client is to come as close as possible to the situation described above in putting the AE under contract. This points up the fact that when an owner subscribes to the theory of the separate and truly independent CM, and is actually serious about time and cost control, he must bring the CM on board before the AE is put under the main design contract, and make those negotiations part of the CM's services and responsibilities.—George T. Heery

4

Charles B. Thomsen takes a look at agency alternatives

President and founder of CM Associates, a CRS-linked firm for construction management, Charles B. Thomsen takes a fresh and independent view of GMP as an anachronism that can be lived with—but only if necessary.

There once was a clear understanding of who did what in the construction industry. When a client wanted a building, he hired an architect who designed it, drew plans, wrote specifications, and bid the project. The low bidder got the contract. Construction began. The design and construction phases were divorced entirely from one another. Essentially, the architect and client said, "We'll make all the de-



Executive Yen

Because an important contract is a measure of the man. In business, in carpet. And this carpet is an important contract.

Executive Yen is faced with 100% Vectra® olefin, tufted tight and businesslike into a fade resistant surface virtually static free. And with a No-Stain Guarantee. It's a combination of fiber and construction designed to

save face under the heavy traffic expected in an executive's office. Yet it has a unique high-low texture that creates subtle effects of light and shadow. Enhancing an expanse of floor and enriching linear decor.

Executive Yen is available in 11 tasteful colors. For the executive with a yen to make an impression without having to express it.

Executive Yen is one of five Capital Assets carpets. All rugged, but each styled differently for areas where appearances are important. These carpets complete the Wellco line of commercial carpets for every commercial installation, available in most commercial fibers, constructions and prices. Write or call for catalogs.



Because we're committed to commercial quality and nothing else.

wellco carpet corporation



WELLCO CARPET CORPORATION □ P. O. BOX 281 □ CALHOUN, GEORGIA 30701 □ TELEPHONE: 404/629-9276 □ A WHOLLY OWNED SUBSIDIARY OF MANNINGTON MILLS, INC. SALEM, N. J.

For more data, circle 44 on inquiry card

cisions, write a contract with every 't' crossed, bid it, and when we know exactly what the costs will be, we'll start construction."

There was logic in the process, the logic of one step at a time. But there also was waste, both in time and money. Independent activities that could have been accomplished concurrently were done sequentially, extending project schedules needlessly. The stodgy approach simply could not survive the inflationary market of the current economy.

Enter construction management. Its announced intentions were to make the process businesslike, predictable, and faster. And it has. But while construction management has solved some of the old problem, it has spun-off a new one: the spectre of client risk.

To gain speed in building, design and construction are usually phased. Construction management has abandoned the simplicity of the traditional process and with it the apparent security of the general contractor's lump sum price. The most frequent question asked the construction manager by clients is, "With construction underway before design is complete, how can I be sure of finishing my project within the budget?"

As a result, some clients are asking their construction manager to sign a Guaranteed Maximum Price contract. There is a significant difference between the two. In the GMP contract the construction manager becomes the vendor of the building. He says, in effect, "I agree to get you your building for X dollars and if I don't, I'll pay the difference." He is what lawyers would call a contractual adversary. He assumes the risk, so in order to protect himself, he may pad his estimate. *In the agency contract, instead of selling the building to the client for a maximum price, the construction manager represents the client in buying the building.* He says, "I'll get you your building for the best possible price, but you'll pay whatever it comes to." Since he has not assumed any risk, his advice need not be conditioned by the necessity to protect his own business.

And so the question has arisen: Which arrangement is best?

Perhaps because of their backgrounds, A/E derivative construction managers seem to have a predilection for the agency contract, while those deriving from general contracting firms lean to guaranteed maximum price agreements.

At CM Associates, we've used both. And while we can understand a client's interest in transferring risk to the construction manager, we believe the agency contract is usually the better way for the client, for, even with the GMP, a considerable amount of risk remains with the client. Under the agency contract the risk is clearly exposed so it can be dealt with directly.

In the final analysis, a project's success depends not on the contractual obligation but on the quality of people involved and the atmosphere in which they're placed. If they're skilled and conscientious and working towards a common goal and not against a threat, risk will be minimized.

The theory of guaranteed maximum price is that since the construction manager has guaranteed a price, an owner can begin construction before the plans and specs are complete with financial security assured. That's fine, but there's a basic, logical contradiction. With incomplete drawings and specs, it's hard to prove what it is the construction manager has guaranteed to do. In essence, the GMP requires a fixed price for an undefined product—and that's a less than rational proposition, no matter how you slice it. So the risk has apparently been assigned to the CM, but much still remains with the client.

There are numerous variations on the GMP contract, but in general they fall into three categories: scope drawing, phased purchasing, and client-architect-construction manager agreement.

Traditional GMP the scope drawings approach

GMP contracts usually are based on the scope drawings approach. The construction manager obtains a set of design development drawings and detailed outline specifications, then enters into a cost-plus contract with a guaranteed maximum price. The construction manager takes the design and specs to his major subcontractors and negotiates similar contracts with them. Everyone has a safety valve; a padded bid. If the project is built for less than the guarantee, the construction manager often gets a percentage of the savings—but the savings are probably nothing more than the pad.

In many instances, the construction manager knows what he's talking about and estimates costs correctly. The project is completed within the budget and everybody goes home happy. But in other instances, everybody goes home mad.

Guaranteed max contracts are not fool-proof. And with the wrong team, GMP will prove to be little more than a security blanket to the client who doesn't understand the facts of the matter—a blanket that has little warmth in it. When GMP goes wrong, it is usually for one or more of the following reasons:

1. When it's time for the CM to guarantee the project, he pads the price so much that it's out of the budget.
2. Someone underestimated and needs to cover anticipated losses after construction begins. He asks for substantial extras on items that are "out of scope."
3. A contractor gets into financial difficulty on another project and tries to make up losses out of the project with the "scope" contract.
4. There is a genuine misunderstanding by a contractor of the architects' and engineer's specifications.

When situations such as the above occur (and they're usual), the client and his architect are in for trouble. The construction manager and subs, realizing the varied interpretations that can be given to incomplete design documents, probably will push for all the extras they can. Some claims will get through; some won't.

It is certain that working relationships will

suffer, and with them performance, in the haggling that ensues. Instead of pulling together to straighten things out, everyone will be going his separate way to protect his own interest.

If the project winds up in the courts in pursuit of its guarantee, then everybody loses. Court cases take time. And time costs money in this business more than in any other. (Paradoxically, the same contractual confusions that makes a GMP questionable also can make it work. Everybody can build a case, and the other parties know it. Since court battles are unpredictable, time-consuming, and costly, the team will work together simply to avoid them. But what a way to do business!)

There are several variations on the GMP theme

There are variations of the GMP contract, almost any one of which is preferable to the scope drawings approach. One of these is phased purchasing.

Traditionally, all plans and specifications for all building systems (mechanical, structural, electrical and so on) are developed together and finished together. But good decision management (in some cases, the use of performance specifications and preengineered components) has allowed architects on construction managed projects to reschedule the drawings and specifications production so that complete contract packages for parts of the building become available sequentially instead of simultaneously. The project can be bid or negotiated as each pack becomes complete.

About 80 per cent of a project's cost may lie in only 40 per cent of its contracts. If work drawings and specs are completed on these contracts first, 80 per cent of the cost of the project may be under solid, fixed-cost contracts well before design is finished. A guarantee can then be signed for the remaining 20 per cent of the project, which substantially reduces the risk—especially if there is a contingency.

Another form of guarantee is an owner-architect-construction manager "cooperation" agreement. The architect/construction manager agrees to build a project of defined scope for a maximum price but retains the right to juggle quantity and/or quality. The construction manager simply guarantees that he'll continue to work to get the owner the best possible project for his money and the architect does, too. In other words, he guarantees the price but not the product. (There is a "fixed limit of construction cost" clause in the standard AIA owner/architect contract). This strikes us as excellent because the architect/construction manager have exactly the same contractual obligation and that increases the chance of their working together.

A clause can be written into this guarantee, if the client desires, which specifies that the final project will meet applicable codes and a general description of scopes required by the client (so many classrooms, so many hospital beds, so much administrative space, and so on.)

The danger with such an agreement lies in the participants' interpretations of "coopera-

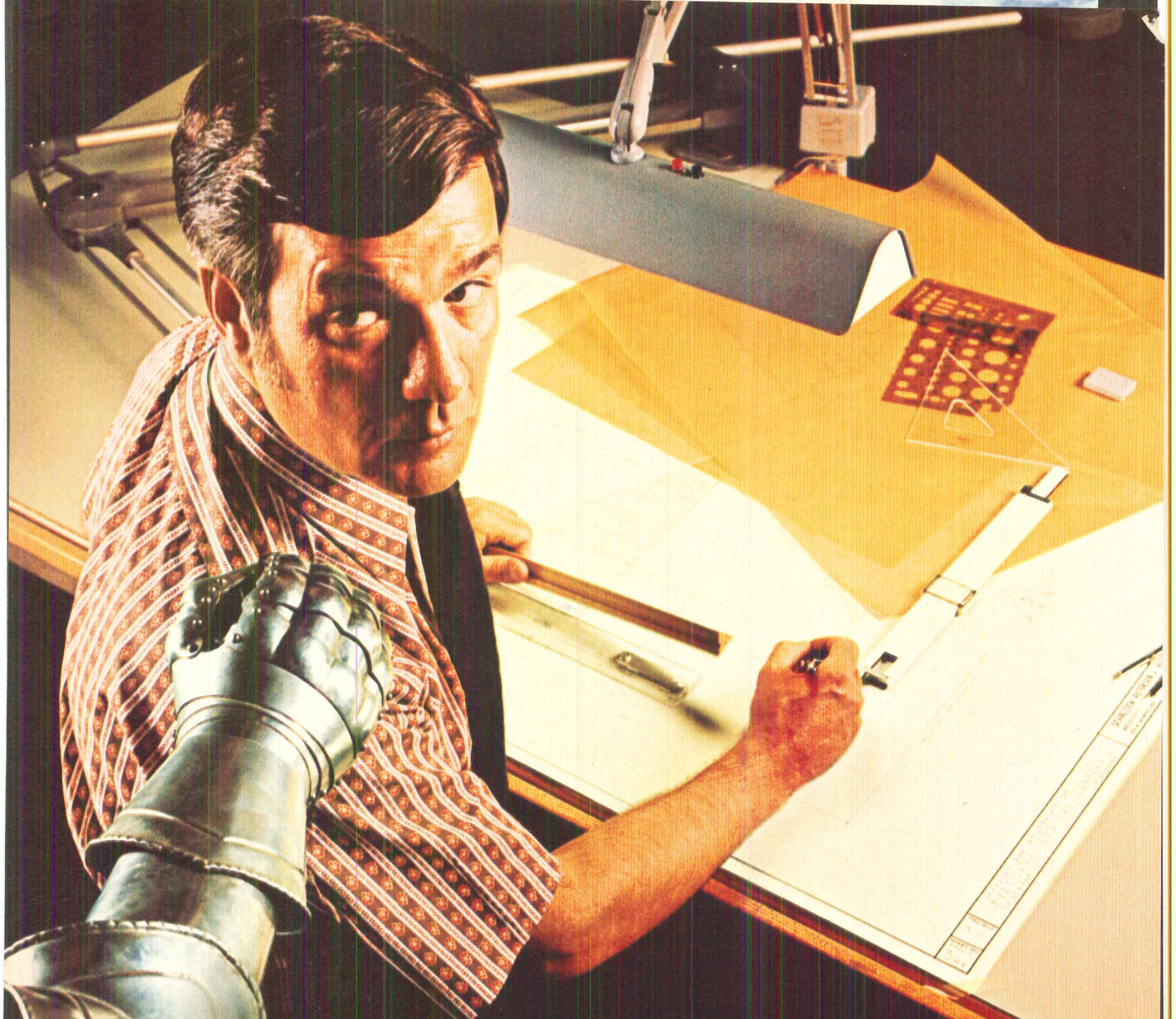

Thinking elevators? Escalators? Look around.

Don't stop at the first or second name you think of. Think of Armor.

We've been in vertical transportation more than 40 years. And right now we're growing faster than ever.

Especially in high-rise construction. With super-fast, super-smooth elevator systems. Sophisticated controls. Plus the sleekest new escalators around. And in low and medium rise buildings calling for tough, dependable geared or hydraulic elevators.

Armor covers them all. And delivers important bonuses too. Like eager, comprehensive design help from pit to penthouse. The finest engineering in the field. Contract maintenance programs tailored precisely to building needs. And more.

When you think of vertical transportation, think beyond the ordinary. Think Armor.

Armor Elevator Company, Inc., Louisville, Ky. 40214.
Armor Elevator Canada Limited, Pickering, Ontario.



A Subsidiary of **ASmith** Corporation

Fireplace planning...A to Z. Your Heatilator® fireplace man spells it all out.

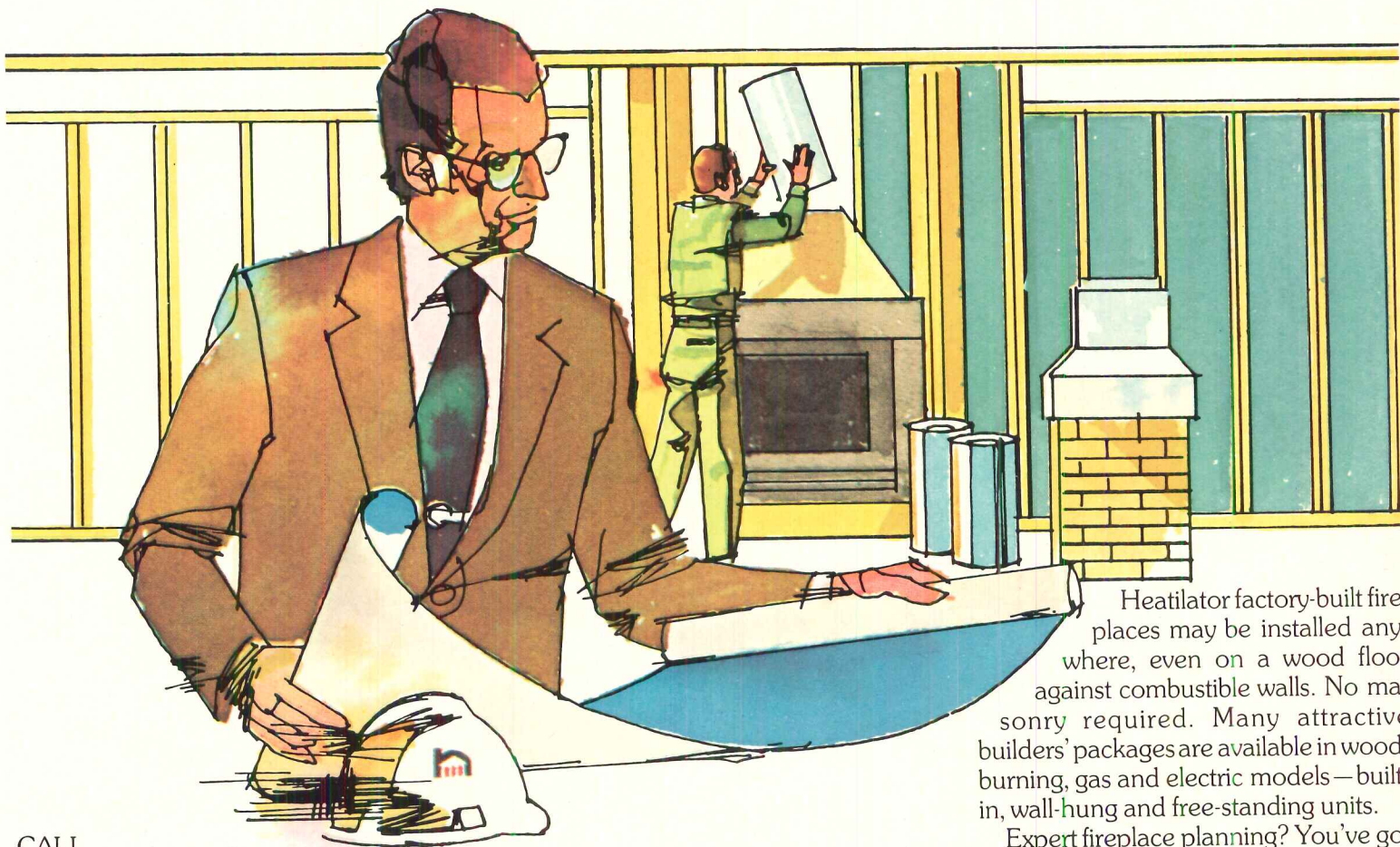

CALL
800-553-8905*
TOLL FREE. Do it

the next time you need help. Better yet, call your Heatilator fireplace man right now, and be ready. He's a fireplace expert—*your* expert. Trained to work fireplaces into your blueprints the easy way. Skilled in selecting the right fireplaces for your particular needs. And very savvy about cutting your installation costs to the bone.

Your Heatilator fireplace man has all the facts on fireplace economics. The increased sales and rentals from fireplaced homes and apartments. Cash flow information. Expected higher loan values. And dozens of other vital statistics you should have to stay competitive.

Right now, he is geared up to expedite deliveries. We've had shortages, of course. But if anyone can see that you get your fair share of fireplaces, your Heatilator fireplace man can.

Phone today, and you'll also receive a valuable Fireplace Planning Guide. It describes how



Heatilator factory-built fireplaces may be installed anywhere, even on a wood floor against combustible walls. No masonry required. Many attractive builders' packages are available in wood-burning, gas and electric models—built-in, wall-hung and free-standing units.

Expert fireplace planning? You've got it with your Heatilator fireplace man—the guy on your side. Heatilator Fireplace, A Division of Vega Industries, Inc. 3344 W. Saunders St., Mt. Pleasant, Iowa 52641. (Also available in Canada.)

See Catalog in Sweet's Architectural and Light Construction File



*Iowa residents call collect (319) 385-8880

heatilator®
AMERICA'S LEADING FIREPLACE SYSTEMS

For more data, circle 49 on inquiry card

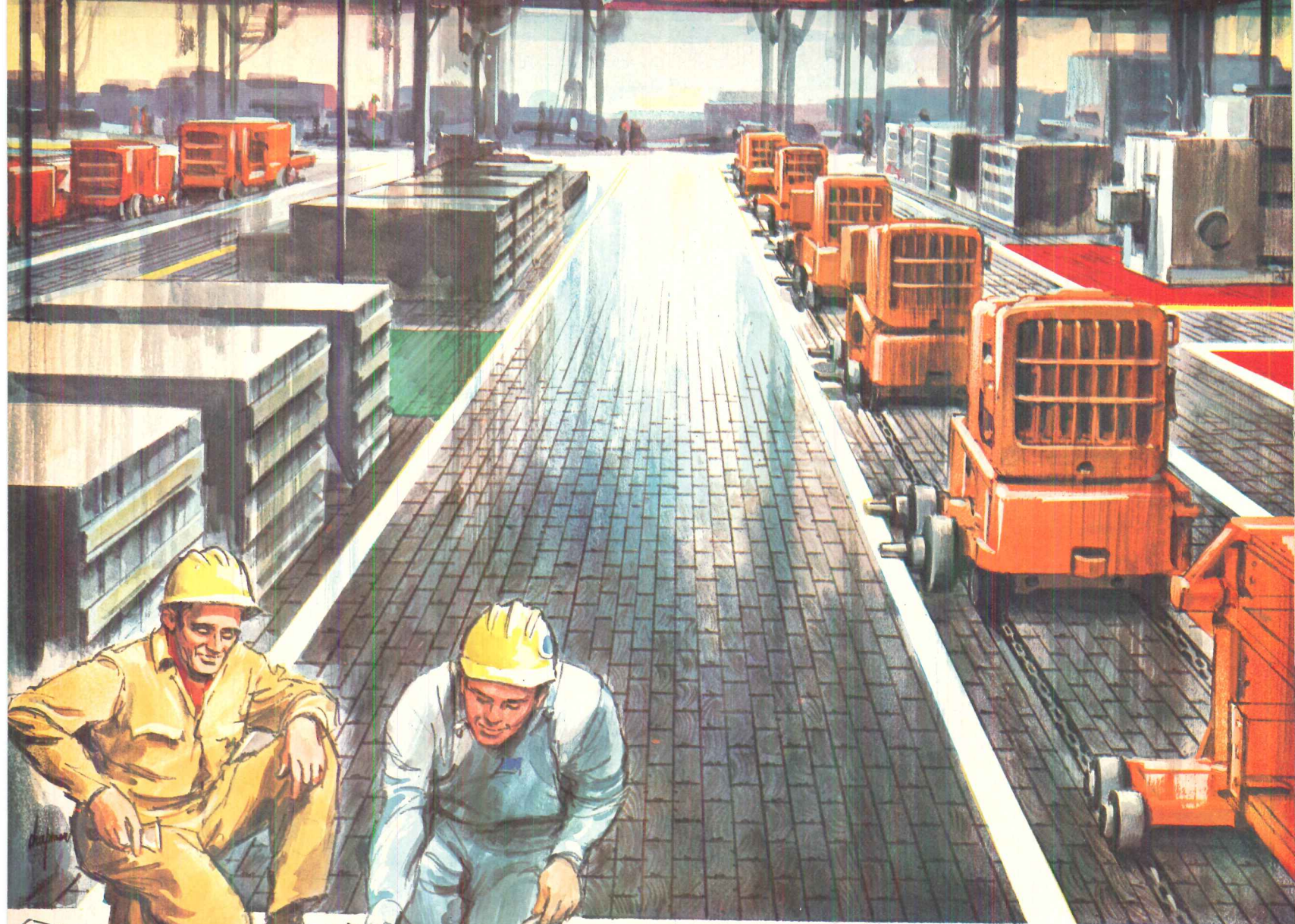

Customized

FACTORY FLOORS *by Jennison-Wright*

There's nothing ordinary about Kreolite® Wood Block factory floors! . . . In fact, they're very special and they deserve your special consideration. For instance: They have so many advantages over other types of floors (see panel at right), that we strongly recommend custom designing so that no feature will be overlooked. Therefore, when you choose Jennison-Wright End Grain Wood Block factory floors, be sure that they are given pre-installation planning so that they'll perform as they should. Our design engineers will expertly perform this service—at no charge, of course.

ADVANTAGES OF KREOLITE® FLOORS:

1. Easy relocation and concealment of service lines to machinery.
2. Speed and economy of replacement in aisles and other heavy wear areas.
3. Special finishes for absolutely dust-free surfaces.
- ✓ 4. Versatility in providing for in-floor conveyor systems, tow-lines, etc.
5. Measurable contributions to noise abatement.
6. Easy installation of oil dispersal and/or recovery systems.
7. Traditional properties of comfort through insulation.
8. Non-sparking surface in volatile areas.
9. Reduction of damage to dropped tools and products.
10. Priced for profitable production.



The Jennison-Wright Corp., P. O. Box 691, Toledo, Ohio 43694 . . . *you'll find us in Sweet's Catalog and in the Yellow Pages*

day or night
it works

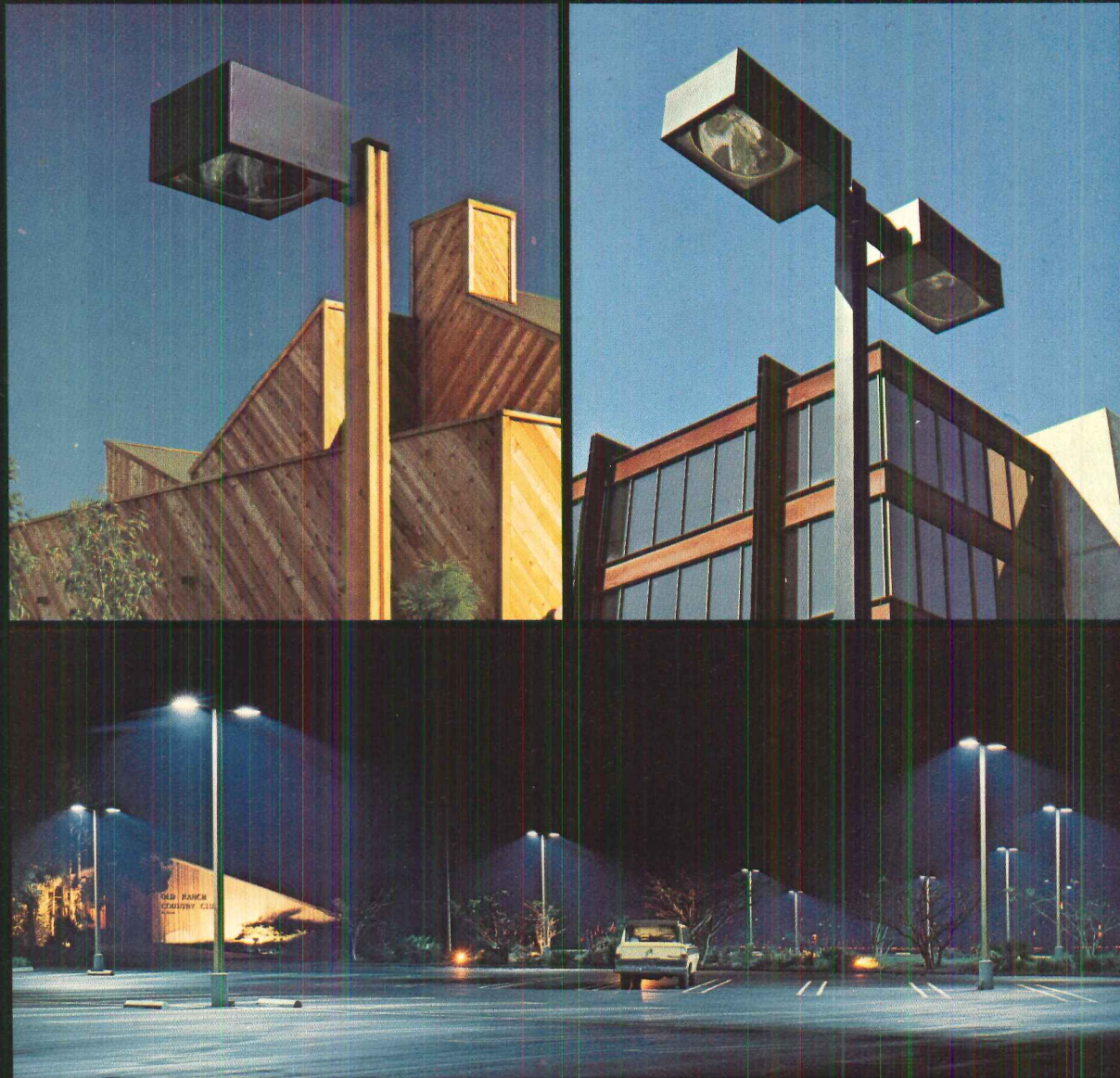

kim lighting, inc.

City of Industry, Calif. (213) 968-5666

Street and Area Lighting
Environmental Lighting
Landscape Lighting
Swimming Pool Lighting
Fountain Lighting
Custom Architectural Fountains
Pre Engineered Fountains
Fountain Components

SUBSIDIARY OF
LCA
CORPORATION

For nearly two decades we at Paragon have been designing, engineering and perfecting our Para-flye deck equipment which today is universally recognized as the industry standard, widely acclaimed by leading coaches, swimmers and divers everywhere.

With our exclusive ability to interchange materials, lengths, superstructure and accessories, specifications can be made to meet any and all individual requirements.

To you, the creative Architect or Engineer, this means custom fabrication and total design flexibility without compromise.

We at Paragon know the problems. We also know the answers.

Precision engineering; variable design capability; and proven service to your needs. That's why Paragon is consistently specified when building or re-equipping a school, club, municipal or residential pool.

See our catalog in Sweets File or write Paragon.



We build the best deck equipment so you can design a better pool.

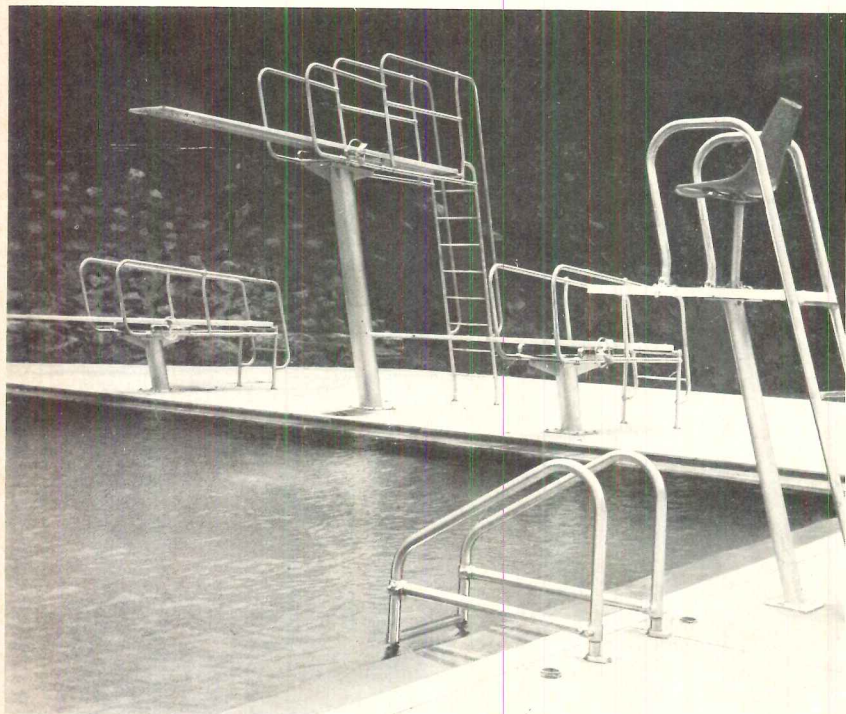

KDI Paragon Inc. The Architect's Friend.



Manufacturers of Quality
Deck/Underwater Equipment

12 Paulding Street
Pleasantville, N.Y. 10570
914-769-6221

For more data, circle 54 on inquiry card

As Charles Luce, Chairman of the Board, Consolidated Edison recently stated:

can help bring this about.

"Building Construction must be critically reviewed for long term energy efficiency—one of the most important places to start is with properly insulated walls and roofs."

Most major building projects



... and
we agree

ENERGY CONSERVATION in new buildings begins with a Smith Wall System

COMPARE ENERGY SAVINGS WITH SMITH WALLS
vs CONCRETE BLOCK CONSTRUCTION.....

How much energy and actual dollars can you save by using insulated metal panel walls instead of conventional concrete block? Naturally, it depends on many variables. However . . . to give you a valid comparison, we designed a typical building and had a professional heating consultant calculate the possible energy (and dollar) savings you could have. We found that over the life-span of the building . . . regardless of the type of heating energy used . . . savings would be considerable.

Energy must be conserved! So it makes sense to consider this particularly important factor early in the design stages of new building construction. The savings go on . . . and on . . . and on . . . during the life-cycle of the building. Write for further information and the report "THINK OF 'U' and \$."

Based on the design criteria, here is what we found:

12" CONCRETE BLOCK WALL VS SMITH VARISPAN PANEL SYSTEM WITH 3" GLASS FIBER INSULATION

49.8% LESS ENERGY AND DOLLARS
using VARISPAN*

*IMPORTANT: Even greater energy and dollar savings can be obtained by using SMITH FOAMWALL

COMPARE SMITH WALL-
U-FACTORS . . .



Varispans Panel System with 3" Glass Fiber Insulation. U-Value=0.111 btu



Standard Foamwall Panel System with 2" Urethane Insulation. U-Value=0.070 btu

DESIGN CRITERIA FOR THEORETICAL BUILDING ON WHICH COMPARISONS WERE BASED . . .

Size: 96' x 125' x 36' building.

Location: Pittsburgh, Pa.

Floor: Slab on Grade.

Glass: Single Pane.

Roof: Built-up on steel deck, 1" Insulation.

Walls: 12" Concrete Block vs. 3" SMITH VARISPAN INSULATED PANEL.

Results calculated by an Independent Consulting Mechanical Engineering Firm using recent ASHRAE procedures. Cost figures based on standard rates per KWH, per gal. of oil, or per cu. ft. of gas.

Write for a complete documented study report titled . . . "THINK OF 'U' AND \$."



ELWIN G. SMITH DIVISION

100 WALLS STREET, PITTSBURGH, PENNSYLVANIA 15202 | (412) 761-7474

EGS-113

For more data, circle 55 on inquiry card

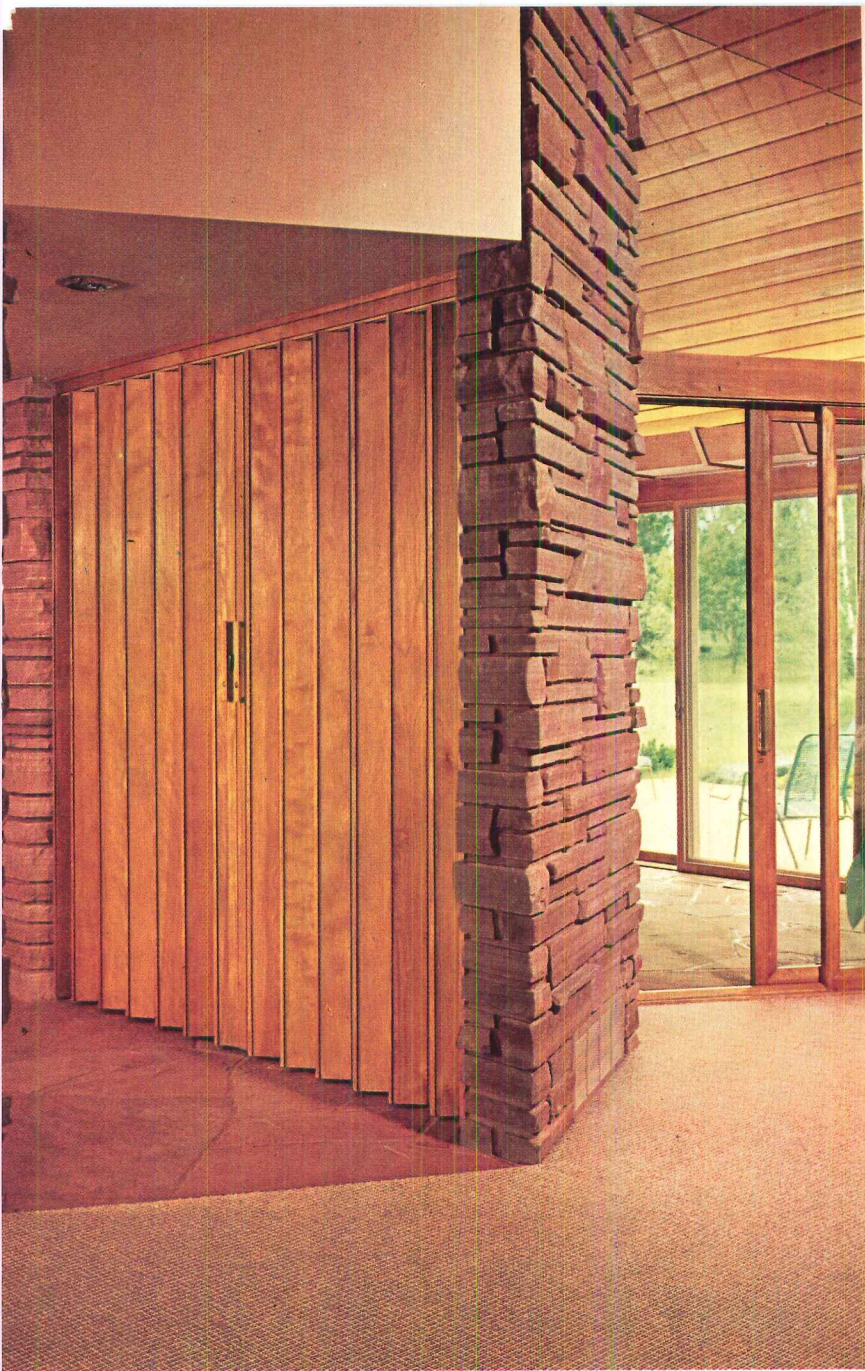

Pella wood folding doors move quietly, easily and with a certain natural beauty.

Genuine wood veneers or vinyl. Wood core panels. Hung on nylon rollers. Hinged by a patented system of steel alloy springs. Pella Wood Folding Doors are as practical as they are beautiful. The solid wood core construction minimizes possible surface damage. And it keeps the panels hanging straight and true, even in humid areas. The concealed steel spring hinging system creates equal tension on each of the panels, for smooth operating motion, uniformly positioned panels and flat, compact stacking. Pella Wood Folding Doors. Finished or ready-to-finish. In a wide variety of styles. Heights to 16'1". Unlimited widths.



For more detailed information, send for your free copies of our 8-page, full-color brochures on Pella Wood Folding Doors. See us in Sweet's Architectural File. Or look in the Yellow Pages, under "doors", for the phone number of your Pella Distributor.

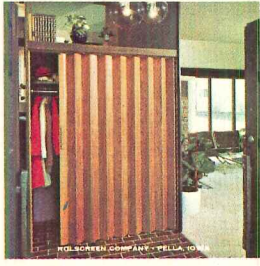

Please send me your 8-page brochures on Pella Wood Folding Doors. I would also like information on: Sliding Glass Doors, Casement Windows, Double-Hung Windows, Awning Windows.

Name _____
 Firm _____
 Address _____
 City _____ State _____ ZIP _____
 Telephone _____

Mail to: Pella Windows & Doors, 100 Main St., Pella, Iowa 50219 Dept. T31D
 Also Available Throughout Canada

For more data, circle 56 on inquiry card

Architectural Graphics Incorporated

Interior & Exterior Architectural Signage Systems

A "systems approach" to signing architectural structures will help rid our land of the urban plight created by the last quarter century of thoughtless signing.

An effective signage system must communicate to either pedestrian or vehicular movement, or both. The system must be carefully and creatively designed with equal care given to the selection of materials.

One of the more important facets of our business is the ever increasing need for new materials and processes. A great deal of effort is spent in product research and material analysis which is our insurance against inferior products. Materials are researched, tested, and evaluated thoroughly before acceptance and use, resulting in a broad spectrum of materials for consideration—fiberglass, acrylics, phenolics, wood, steel, aluminum, brass, bronze, etc.

The principals of AGI would enjoy meeting you at the AIA Marketplace of New Ideas in Washington at booth nos. 131—133 to further discuss how AGI can serve your firm in providing the finest signage for your many prestigious projects. Please request your personal copies of our Specifiers which cover our varied product lines.



For further information please contact:

Architectural Graphics Incorporated
Corporate Headquarters
Three Koger Executive Center
Norfolk, Virginia 23502

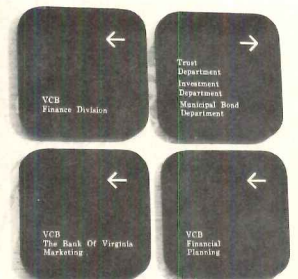
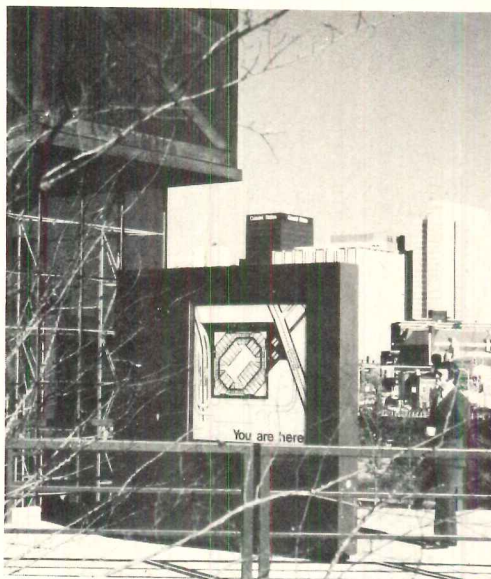
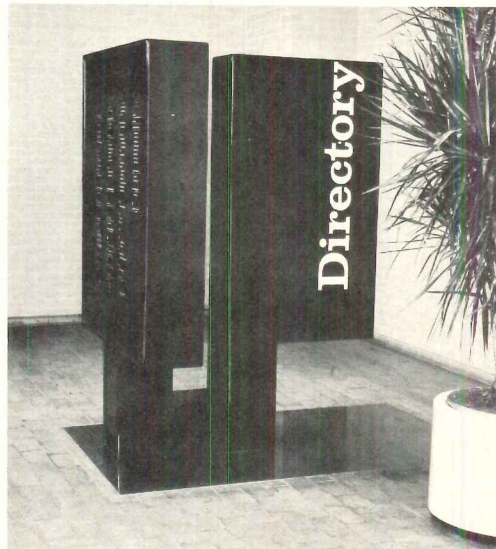

For more data, circle 57 on inquiry card

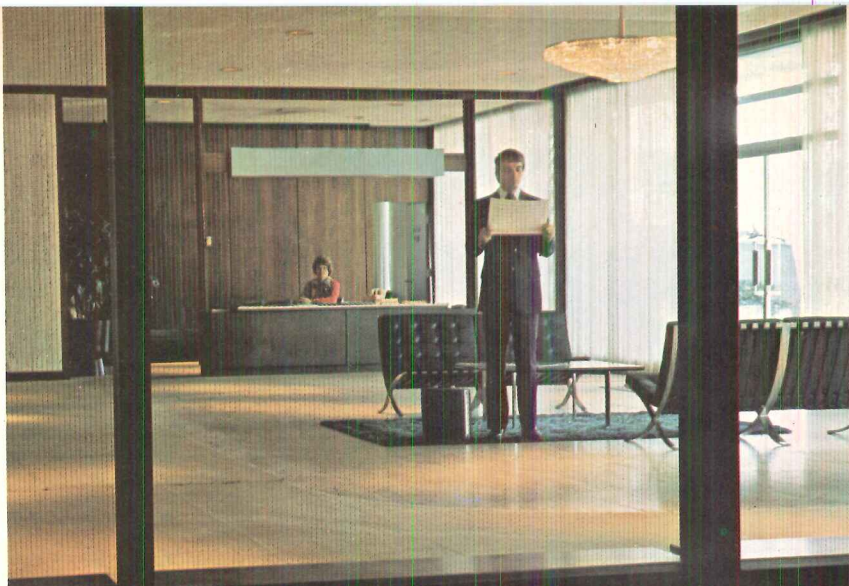

ASG SAFETY GLAZING

The Glass Company thinks safety should mean freedom of choice.

And we support that opinion with glasses like Pinstripe[®] wired glass, shown here. A unique combination of style and protection, manufactured and patented exclusively by ASG, and part of a complete line of safety glazing products in a variety of colors, patterns and finishes. Including Nuweld[®] wired glass, which qualifies as both safety and fire retardant glazing. Tru-Temp[®] tempered glass, produced with a special heat treatment

that makes it four to five times stronger than regular annealed glass. Supratest[®] laminated glass to reduce the potential hazards of flying glass in case of breakage. And, now, Polyflow[®] and Acryflow[®]—new plastic safety glazing materials that are amazingly strong, light in weight and transparent. All quality products from ASG, where safety glazing means the beginning of great things—not the end. Write us for complete information.

 **ASG Industries Inc.**

The Glass Company, P.O. BOX 929, KINGSPORT, TENN. 37662



“After 4 years of typical Holiday Inn traffic,
carpet would be threadbare.”



Tuff-Lite® epoxy terrazzo is doing beautifully
with a weekly wet mopping.”

Jay King, Chief Engineer, City Line Holiday Inn®-Philadelphia

Ease of maintenance and predictable cost of maintenance were important considerations when City Line Holiday Inn-Philadelphia was in the planning stage. They still are.

And its Tuff-Lite epoxy terrazzo flooring by the H. B. Fuller Company is living up to expectations.

Carpeting would have been spot cleaned many times, completely cleaned several times and possibly replaced. Other than mopping, Tuff-Lite requires just a programmed semi-annual seal treatment.

H. B. Fuller also supplies light-weight, epoxy-based wall matrix for beautifully textured interior and exterior walls.



For help with specifying, selection or application information call our toll free number — 800/323-7407.

 **H B FULLER COMPANY**

Architectural Products Division
315 S. Hicks Rd., Palatine, Ill. 60067, Dept. 526

For more data, circle 59 on inquiry card



The Mansards, Griffith, Indiana

“The whole idea of “The Mansards” is to provide gracious living accommodations in a natural setting of trees and water. The convenience of city living is combined with the graciousness of country living here. We have put top quality into “The Mansards” and that extends to our coin-operated laundry equipment. We chose Speed Queen for one simple over-riding reason—it’s the best we could get.”

Duane J. Hicks, Jr., General Manager

Lake Point Tower, Chicago, Illinois

“Lake Point Tower represents a new kind of urban life—a completely self-contained city at the edge of Lake Michigan. We appeal to individuals and families of middle and upper income. They expect and get the best at Lake Point Tower. That’s why we chose Speed Queen equipment for our laundry facility. Speed Queen represents quality which will be on the job—not out of order. And I understand the Stainless Steel feature is a real plus when laundering durable press fabrics.”

Robert E. DeCelles, Building Manager

“We chose Speed Queen laundry equipment for one simple reason—it’s the best we could get.”



Let SPEED QUEEN and your SPEED QUEEN COMMERCIAL ROUTE OPERATOR help you plan coin-operated laundry facilities



SPEED QUEEN®

Ripon, Wisconsin 54971



a McGraw-Edison Company Division

For more data, circle 60 on inquiry card

FORM NO. 5541C

AR-4

**Mr. E. W. Jess,
Manager, Commercial Department
Speed Queen, Ripon, Wisconsin 54971**

Gene, please forward your laundry room design brochure.

- Please send me name of the Speed Queen Route Operator nearest me.
- I would like a Speed Queen representative to call.

Name and title _____

Firm name _____

Address _____

City _____ State _____ Zip _____



Cool Slant

In Texas, the sun really unloads on this dramatic structure. Its sloping walls don't just live alongside the sun, they face up to it.

It takes a cool slant on the problem to solve it. And the spectacular Century Building in San Antonio has one: C-E Polarpane "20" Gold Reflective Insulating Units.

C-E Polarpane #2016 Gold was chosen for the entire building. Polarpane performance is the reason. These Gold Insulating Units face up to the sun beautifully, rejecting over 90% of infra-red solar energy. Total indoor heat gain is only 37 BTU/hr per square foot.

Polarpane Gold is easy on the eyes and restful inside thanks to its low 20% visible light transmission. Yet, this light level is sufficient to eliminate a requirement for excessive interior lighting and associated unnecessary interior heat gain.

When the heating season rolls around, Polarpane excels again . . . with a low .31 "U" value that means most room heat is retained by reflection back into the room.

Polarpane Silver works some wonders of its own with similar high performance characteristics.

There's no finer warranty than you get with C-E Polarpane "20" . . . a guarantee of 20 years of performance backed by Combustion Engineering, Inc., one of America's leading industrial firms.

Ask for your free copy of the Polarpane "20" catalog. Or, consult a C-E Glass specialist. C-E Glass, 825 Hylton Road, Pennsauken, N. J. 08110, (609) 662-0400.



Architect: Neuhaus + Taylor, San Antonio, Texas
Glazing Contractor: Samuels Glass Co., San Antonio, Texas

CE GLASS
COMBUSTION ENGINEERING, INC.

For more data, circle 62 on inquiry card

Cork parquet without the cost of cork parquet.

Introducing Gold Bond Mediterranean Parquet Durasan



New Gold Bond® Mediterranean Parquet® paneling offers the look of cork, the wearability of vinyl, and the price of Durasan.

If you like cork, but can't afford what cork does to your budget, here's a solution.

New Gold Bond Mediterranean Parquet Durasan® gypsum wall panels.

Like all Durasan panels, Mediterranean Parquet is available on standard 1/2-inch and 5/8-inch thick Gold Bond



regular, or Fire-Shield® gypsum wallboard. All panels are standard four-foot width. And your choice of lengths from six to 14 feet. Its variegated cork patterns are available in three distinctive colors: Spanish Cork in gold tones (see main illustration); Grecian Cork in shades of off-white and tan; or Moroccan Cork in varying densities of rich dark brown.

Mediterranean Parquet Cork . . . like all Durasan . . . saves money. Because the vinyl is factory-laminated, drywall mechanics can install these new Cork Parquet panels fast. Once they're up, they're finished. Costs less

than building a wall and job-applying most comparable grades of vinyl wall coverings.

So, for the look of cork, without the cost, why not look over Gold Bond Mediterranean Parquet Durasan?

For the look of wood, there are simulated grains . . . in Woodgrain Durasan.

Have elegant-looking Walnut, Teak or Pecan vinyl surfaced paneling anywhere you want it for less than the price of elegant real wood paneling.

With their tough vinyl surface, these panels resist dirt, dust or even scuffs. Wipe clean with just soap and water.

Woodgrain patterns, like most Durasan panels, are available in 8-foot, 9-foot and 10-foot lengths, ready for shipping.



All standard prefinished panels are 1/2-inch thick Gold Bond gypsum wallboard, in four-foot widths. Special orders include 3/8-inch or 5/8-inch Gold Bond gypsum wallboard or a Fire-Shield core in 1/2-inch or 5/8-inch thicknesses. Special order lengths run from six feet to 14 feet.

So for a wood panel look with the toughness of vinyl, look to Gold Bond Woodgrain Durasan.

Or, for the look of burlap, there's Burlap Durasan.

Odd, isn't it, how something as inexpensive as burlap can get very expensive when it takes special labor to put it up.

Gold Bond solved that with the texture of burlap embossed on high-quality vinyl film. Then factory laminated it to standard Gold Bond gypsum wallboard.

The result is a panel we can offer in 9 popular burlap colors, and one popular price.

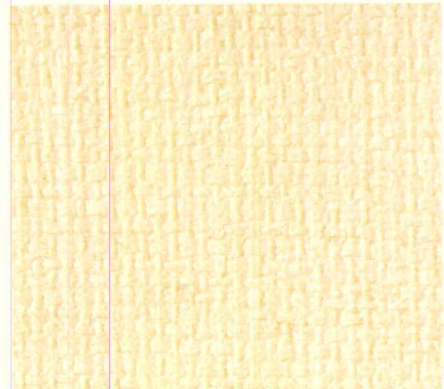

So from our standard Burlap Straw (shown) to any of 8 other decorator colors, Durasan can help you put up nearly any shade, for just a shade more than regular wallboard.

Mediterranean Cork Parquet, Woodgrain or Burlap Durasan is available through your local building materials dealer who handles Gold Bond Products.

For more details, write Gold Bond Building Products Division, Dept. AR-44G National Gypsum Company, 325 Delaware Avenue, Buffalo, N.Y. 14225

We're gypsum, and then some.

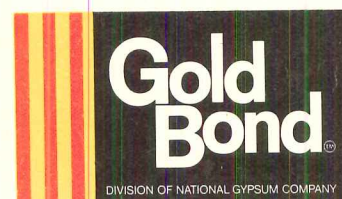

For more data, circle 63 on inquiry card

If granite is so hard to install, why didn't someone tell First Federal Savings and Loan, Detroit?

Sure. They'd heard the myth about granite posing costly installation problems. But they also knew you can't plan buildings on myths, so they went over the facts about Cold Spring granite with their architect. And they liked what they found: the natural beauty of Cold Spring's polished granite resists weather, stains and all types of traffic as no other building material can; it won't fade or deteriorate; it requires virtually no maintenance; it comes in a wide spectrum of colors; and . . . *it's economical to install, thanks to Cold Spring's development of new fabrication techniques that include improvements*

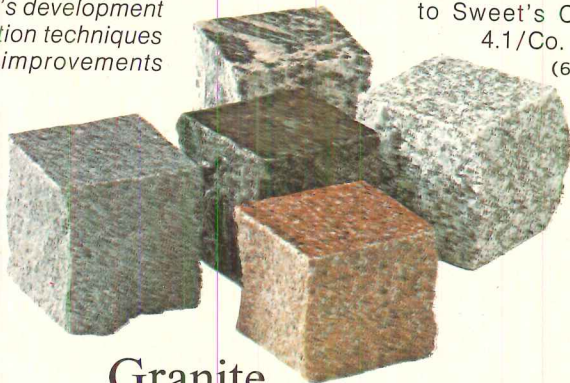

Granite
can color
your thinking.

subsidiaries:

*Lake Placid Granite Company
Jay, New York*

*Texas Granite Corporation
Marble Falls, Texas*

*Raymond Granite Company
Raymond, California*

*Cold Spring Granite (Canada) Ltd.
Lac Du Bonnet, Manitoba*

over 20 producing quarries

First Federal Savings & Loan,
Main Office, Detroit, Michigan

Architect:
Smith, Hinchman and Grylls

Contractor:
Fuller Construction Co.

Granite:
Dark Pearl

like steel-backed granite panels.

In fact, they liked the idea well enough to use granite inside as well. In heavy traffic, high wear areas like check writing tables, teller's counters, and the wall facing that encloses the elevators.

How expensive is granite? Talk to our Customer Service Department about that. Tell them what you want to do and they'll tell you how it can be done. Step by step. And likely as not you'll find that granite fits your plans well on a cost-in-place basis. Refer to Sweet's Catalog No. 4.1/Co. Or call us. (612) 685-3621.

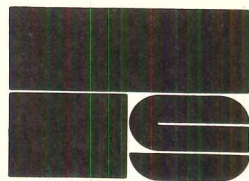
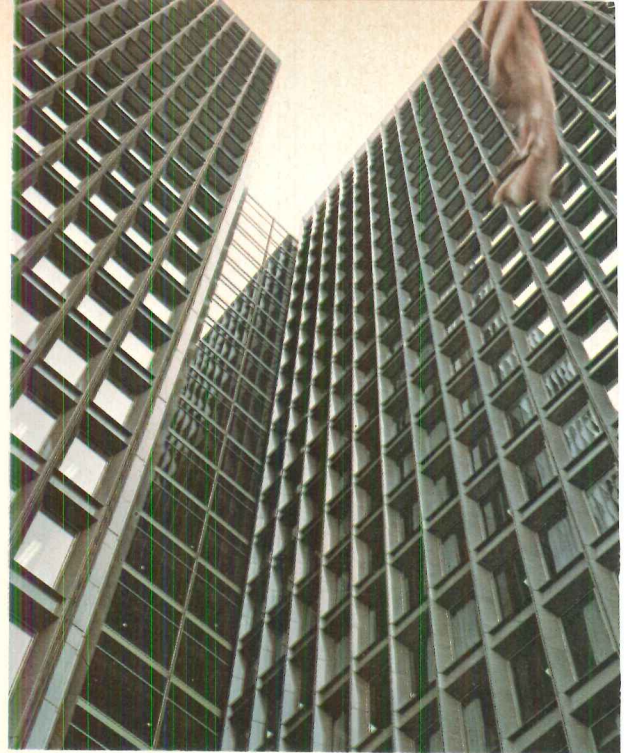

COLD SPRING GRANITE COMPANY / COLD SPRING, MINN.

For more data, circle 64 on inquiry card



Our Elongated Toilets Give You Something To Cheer About All Year Long!

The larger water area means better sanitation. Easier cleaning. The elongated shape — more comfort. All points that score with your customers. But you've got to tell 'em to sell 'em.

Re-modeling jobs? It's a natural. Roughing-in is the same as regular toilets.

Pocket the extra profit. All along the line. Cadet, Compact, Luxor, Glenwall, Carlyle and Yorkville toilets come with elongated bowls. There is even an elongated Water-Saver Cadet that uses 1/3 less water.

Talk it over with your American-Standard distributor. He's in the business of fielding winners.

The Original Super Bowl

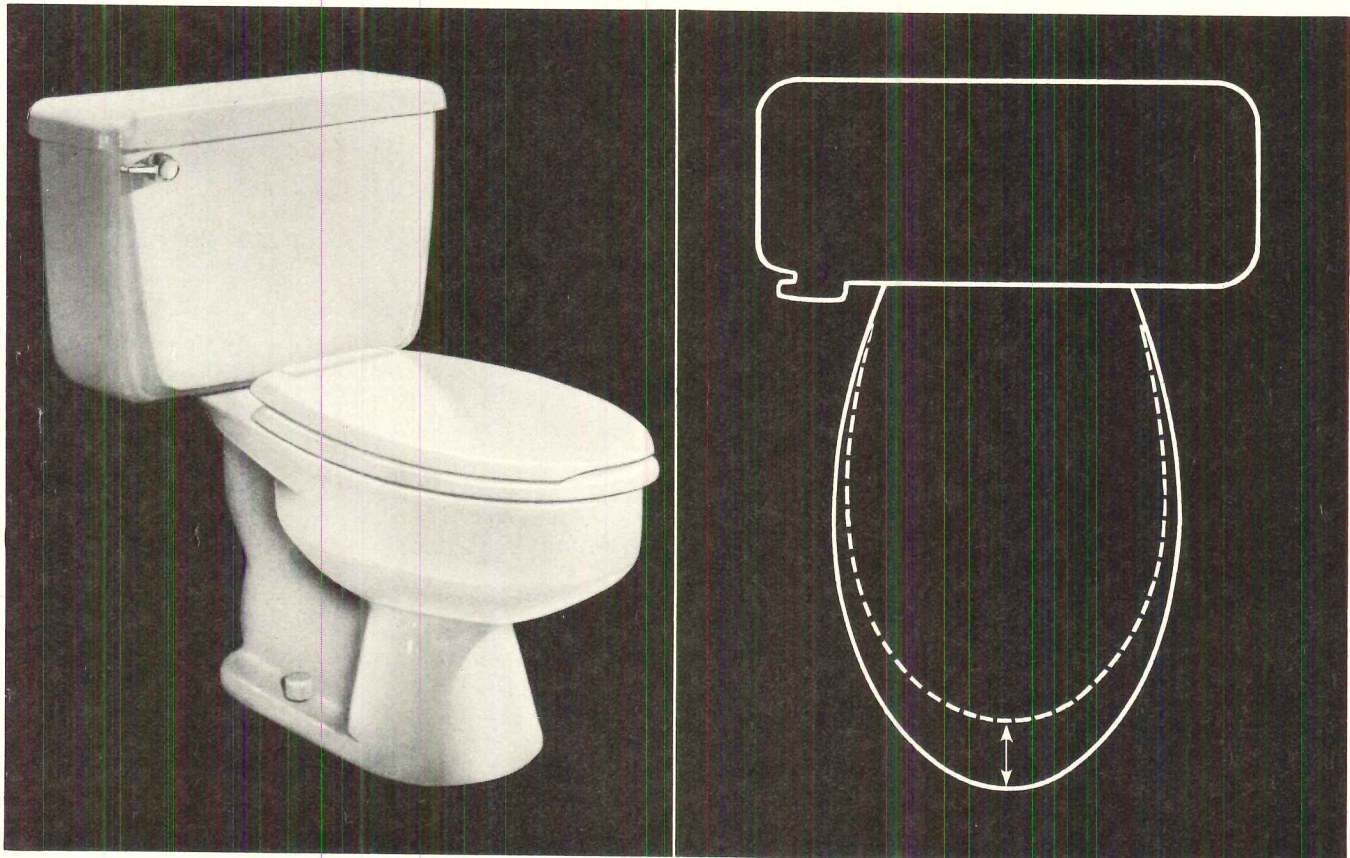

All product names mentioned are registered trademarks of American Standard, Inc.

**AMERICAN
STANDARD**
PLUMBING / HEATING

For more data, circle 65 on inquiry card

The new Weldwood Collection. Suddenly, anything else seems out of date.



Introducing The Weldwood Collection™ from U.S. Plywood. Quite simply, the finest group of prefinished panels available anywhere in the world.

The Weldwood Collection. A paneling created exclusively for those once-in-a-lifetime opportunities when nothing less than the finest in quality is acceptable. Where superb hardwoods are crafted into face veneers worthy of the term "heirloom".

The Weldwood Collection features veneers of hickory, teak and walnut. Just these are given a formal planked effect, with slender eighth-inch-wide grooves spaced two or four inches on center. Some are medium and dark shaded. Others light-toned for a contemporary feeling.

Three more fine woods — walnut, oak and cherry — are highlighted like fine furniture with normal random spacing and eighth-inch grooves. We also have retained the very best panels from our Charter® and Deluxe groups: Charter pecan and Gothic oak.

See this limited edition, now at your U.S. Plywood Branch Office.

U.S. Plywood

777 Third Avenue, New York, N.Y. 10017

For more data, circle 66 on inquiry card

 **U.S. Plywood** Division of Champion International

You could err. A year from now, you could be 10, 20 or 100 people stronger. Needing more space, more work stations. Don't worry, Steelcase Mobiles forgives. Mobiles is a system of Laterals, Desks and Movable Walls you can add to, subtract from and tailor to your individual needs.

Write Dept. G for literature and see your Steelcase dealer and showroom. They're in the Yellow Pages.

Steelcase Mobiles. Err, and it forgives.



Mobiles gets the job done.

Steelcase Inc., Grand Rapids, Mi. 49501; Tustin, Ca. 92680; Toronto, Ontario; Steelcase (Far East) Ltd., Tokyo.



Allendale Insurance, Johnston, R.I.

For more data, circle 67 on inquiry card

PARK CENTRAL

Dark, disciplined and distinguished, this new business center, built as a speculative venture in downtown Denver's renewal area, handsomely achieves the objectives of both developers and architects: an elegant building, designed and built within a tight budget, providing varied and stimulating spaces to excite both workers and visitors with a new definition of urban quality. Muchow Associates, with George Hoover as project architect, were the architects.

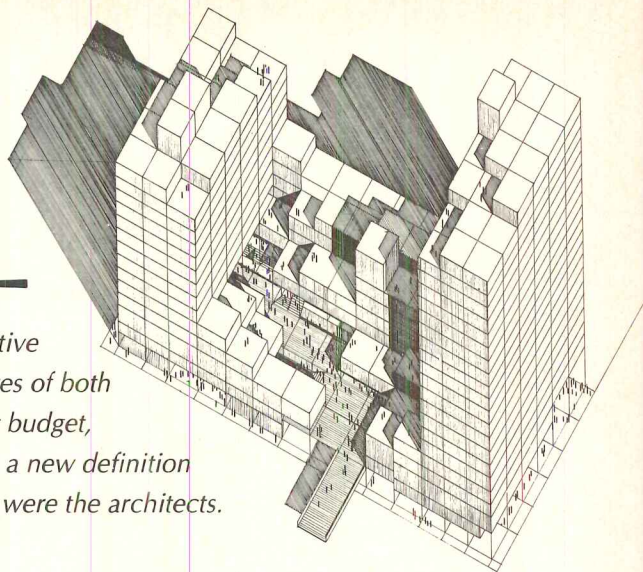

James Maxwell





Park Central's location in the Skyline renewal area of downtown Denver imposed certain constraints on its design—height limits, for instance, for each part of the site, and a raised pedestrian concourse—which influenced the final solution, but not so much, in fact, as the exigencies of the design process itself. The irregular form of the building is no mere design whimsy; it derives from the need for an overall concept which could, without loss of integrity, adjust to the frequent changes made by the developer-owners in the building program. Because of the lively building profile which evolved—three towers of varying height and mass rising from a raised plaza on top of a block-long structure—the curtain wall exterior of the building is dark in color—charcoal black anodized aluminum panels and bronze glass, set flush—in startling contrast to Denver's other tall buildings. To accomplish so elegant a building within a tight budget—total cost for the project was \$20.5 million, but the basic building cost came to 13 million dollars—was a notable achievement, obviously strongly affected by the early and close relationship among those most deeply involved: developer (who was also contractor and a part owner), curtain wall manufacturer, engineers and architects. The main entrance to the complex is by way of a unique and unusually lofty loggia leading from the street to the plaza level off which open the tower lobbies and shops and which will eventually connect by street overpass with other blocks.

PARK CENTRAL, Denver, Colorado. Architects: *Muchow Associates—George Hoover, project designer; Karl Berg and J. Michael Jacoby, project administration.* Engineers: *Ketchum, Konkell, Barrett, Nickel, Austin—Don Weber, project engineer (structural), Chen and Associates, Inc. (foundation), Hadji and Associates (mechanical/electrical).* Bank interiors: *Muchow Associates—Frank Zancanella in charge.* Consultants: *Alan M. Voorhees & Associates (parking), L. H. Antoine and Associates (curtain wall).* Landscape architect: *Chris Moritz.* General contractor: *C. H. Leavell & Company.*

The linear park along Park Central's front was not designed by the architects; although it guarantees a full view of the building, its fountain, unrelated in design to Park Central, is unfortunately and uncomfortably close to the building. The campanile, all that is left of the old D&F store, has been retained as an area landmark.

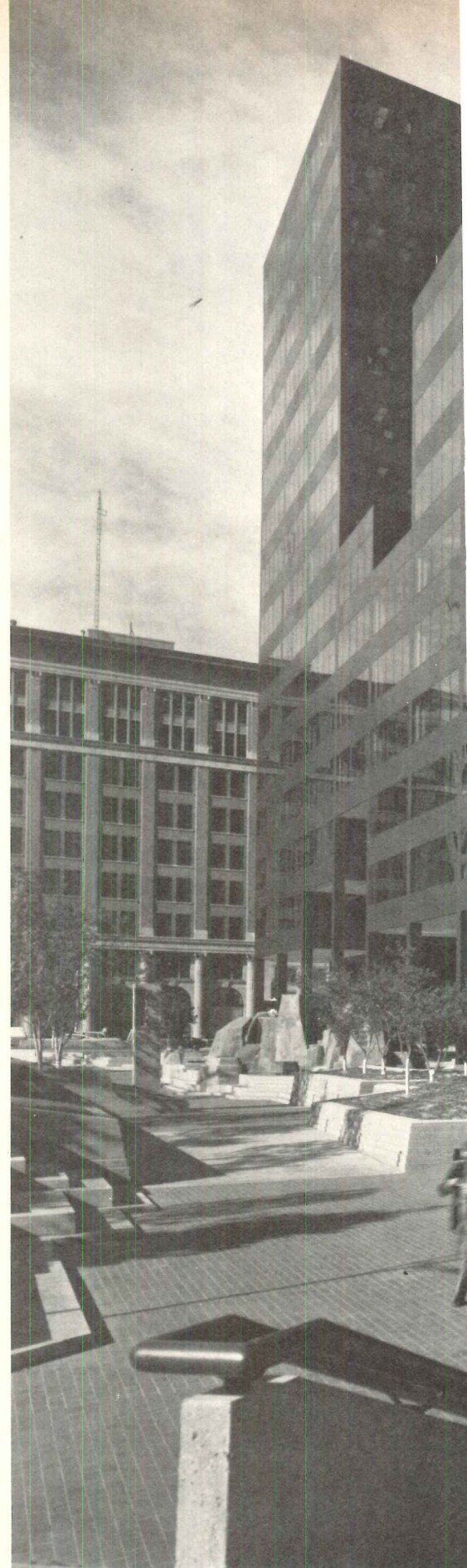
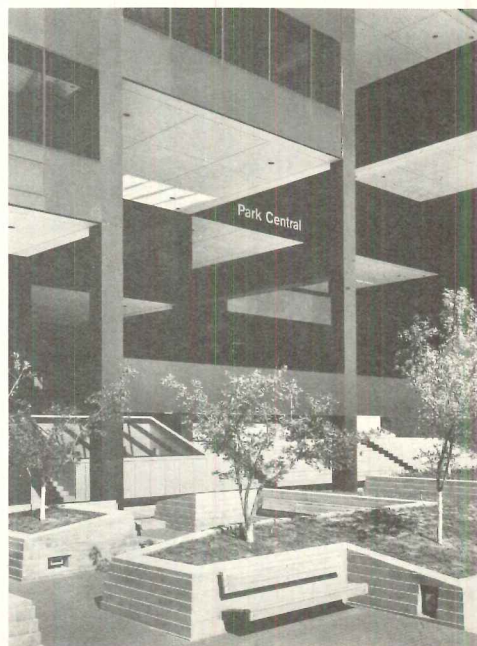
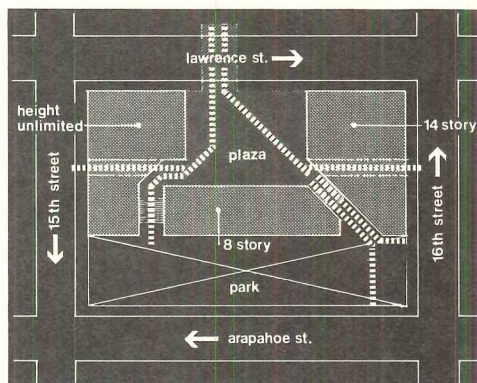

Ronald Wohlauer photos





Ronald Wohlawer photos

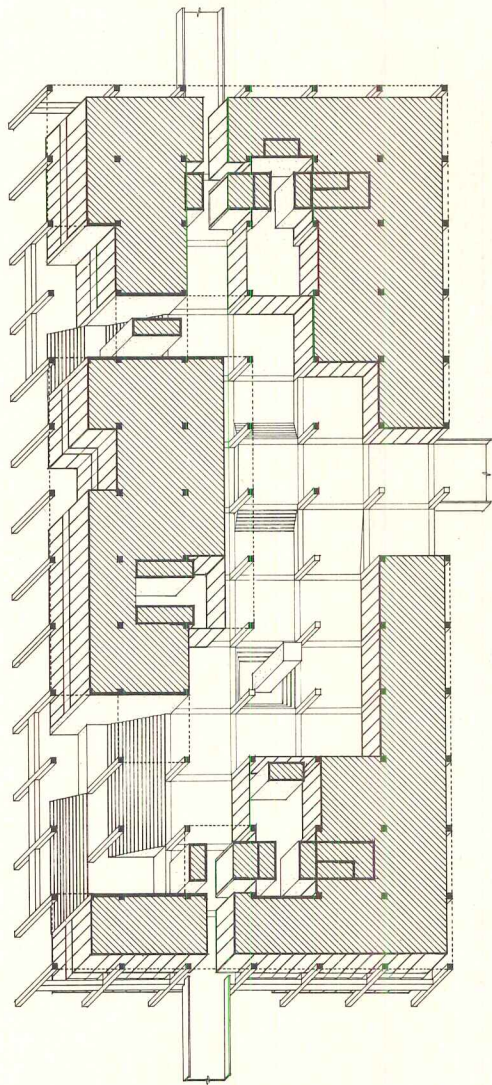
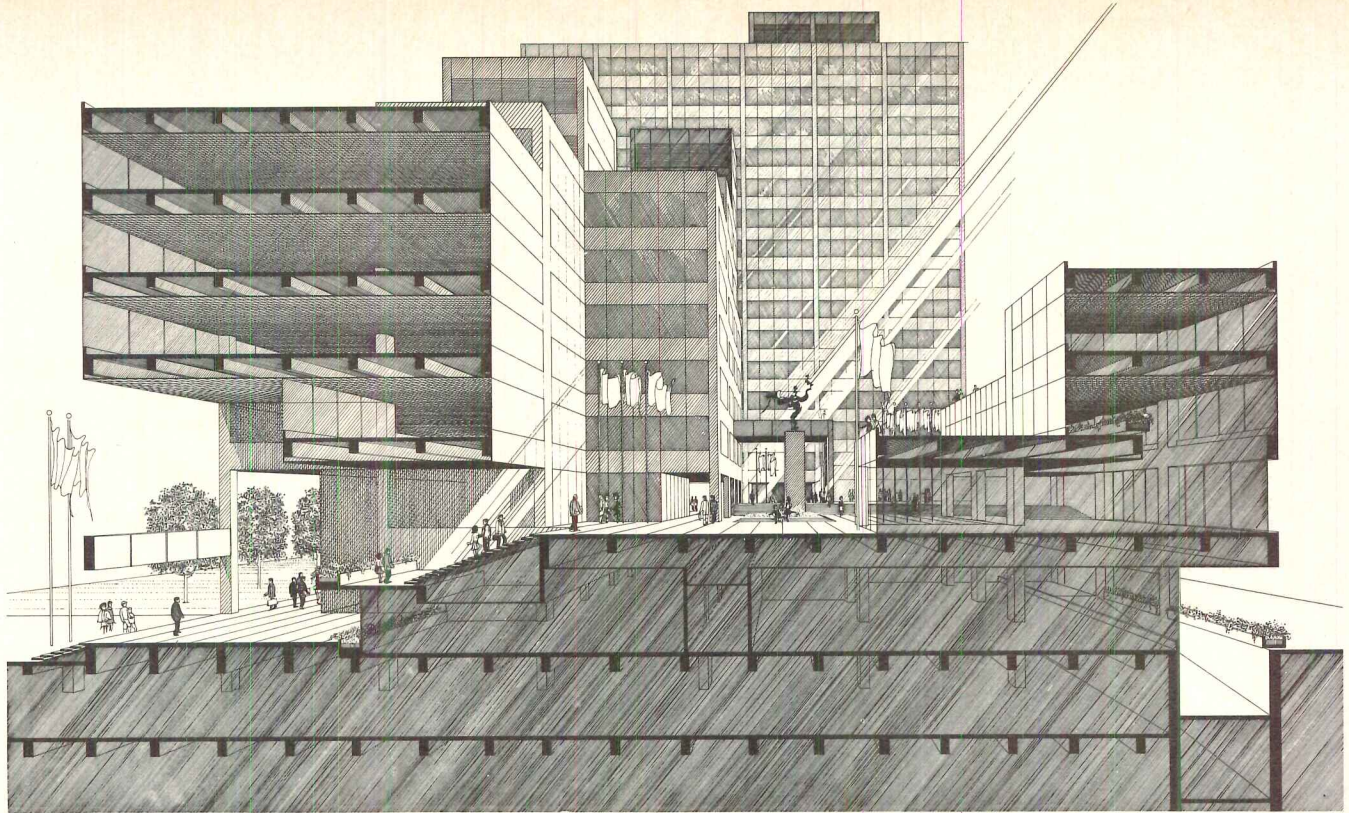

The pedestrian plaza tops a three-level, below-grade garage and is the base for Park Central's three office towers. It serves as both entrance to the tower lobbies and to the shops, and protected open space for pedestrians, intended eventually—if the master plan (by Marvin Hatami & Associates) is fully implemented, as it should be, in the adjacent blocks—to provide a raised concourse throughout the area. At plaza level, the precise detail and the terse design of each element is clear. The 30-by-30-foot structural grid which is the building's design discipline, applies both horizontally and vertically: where openness is needed, as for pedestrian access, it is "carved away"; where additional volume or space is required, it is added to. The result is the lively form and mass of the building.

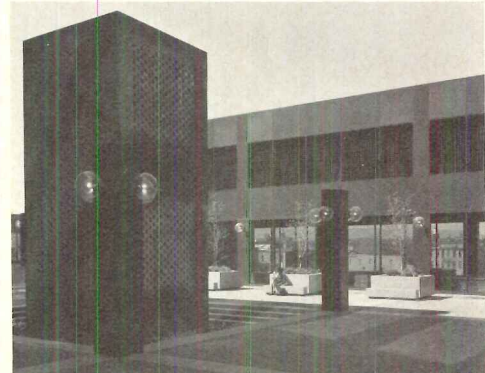
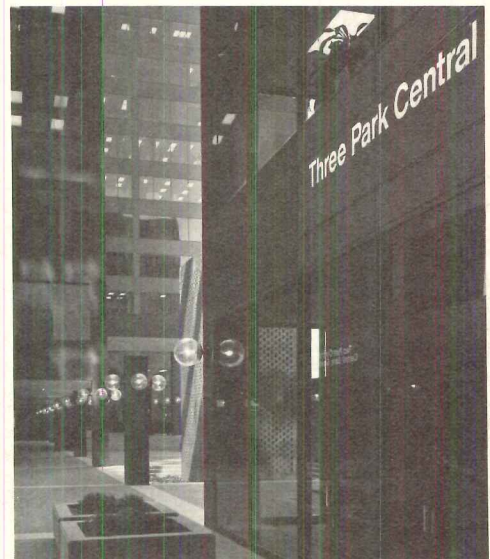

Ronald Wohlauer photos



Rush McCoy

The architects (Frank Zancanella in charge) were also designers of all interiors of the banking offices, and of the public spaces in the office towers. Bright colors are used for furniture upholstery; carpet, in a soft neutral color, is used on floors and on low space partitions. Alternating colors in elevator lobbies

effectively mask an uninteresting space. After steel had been ordered for the building, engineers redesigned the main bank space structure to obtain the unusually open space, but used only the steel already on order, despite the changed concept. The loggia steps afford a good view of the room.



THE FOURTH ST. THOMAS CHURCH

Some
practical lessons
for building
in today's cities
from Ralph Adams Cram
and
Bertram Grosvenor Goodhue

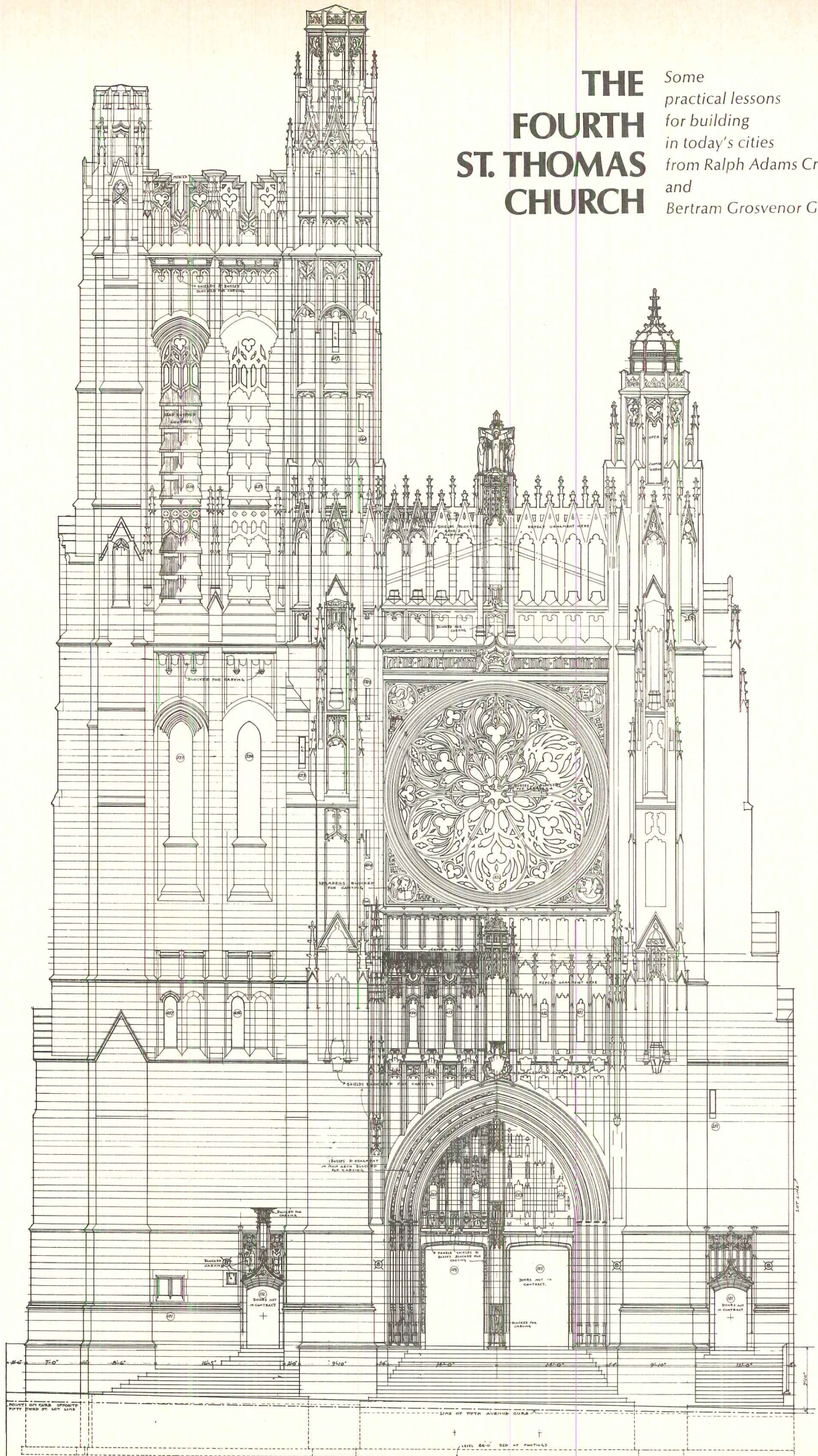

One of the oldest traditions in architecture is tradition itself—the use of understood and proven precedents which are partly repeated, partly modified to make a new building. No matter what they say, all architects rely on tradition. It may be an old one (“Georgian”) or it may be fairly new (“Modern”), and it may even be the latest fad brought hot from the drafting room of a fashionable architecture school. But tradition won’t be ignored, because a knowledge of what might be done under a particular set of circumstances—and how, in fact, it has been done—is too useful a tool of architectural practice, just as it is one of the cornerstones of architectural education. Such knowledge guides the architect through a bewildering variety of specific choices, emphasizing certain possibilities while giving others lower priority. Glass walls and exposed steel enclosing a rectilinear space, for instance, carry with them a host of suggestions for making the rest of the building, just as do walls of rough wood or shingles around a plan shot through with surprising diagonals. Traditions also conjure up images for both the inhabitant and the architect; they provide a set of alternatives for what a building might actually look like as well as how it can be formed. And a knowledge of what has been done in the past obviously avoids the useless reinvention of the wheel (happily leaving more time for those wheels that really do need reinventing).

Ralph Adams Cram and Bertram Goodhue, the designers of the 1911 St. Thomas Church in New York, paid notable attention to architectural tradition, and in fact they did so with so much erudition and scholarship that most of us now are likely to think of them as merely—to use that faintly derogatory word—“traditional” architects. St. Thomas Church certainly *looks* traditional, and people who remember it remember it most often for the abundance and elegance of its Gothic detail. Cram and Goodhue clearly understood the power that well-known architectural images have over the mind, and they knew just which set seemed appropriate in this case, and how to make them correctly. They also knew how traditional forms could be used to solve traditional problems like walling in an interior space and covering it over and lighting it.

It may therefore seem surprising that the building which resulted is in many ways boldly original, having finally about as much to do with real Gothic architecture as the town of Chartres with Manhattan. For Cram and Goodhue seem to have used Gothic precedent in a particularly creative way—not just to provide formal models for each of the parts and a controlling image for the whole, but as an indication of what was usual and what was unique about the design problem at hand. That is, if a tradition—any tradition—is taken as the framework for a particular design, then part of it will fit and part of it most probably will not, and will have to be modified. If, as in the case of St. Thomas Church, the chosen tradition has extensive associations, then the ways it fits and the ways it doesn’t each take on an unusual importance. A building like St. Thomas Church thus speaks as vividly of the particular (this church in a modern city) as of the general (the Church). It is this combination of general and particular, abstract and specific, traditional and original—and not some elegant mode of architectural historicism—that makes the building worth revisiting in the aggressively un-Gothic late 20th century.

Ralph Adams Cram and Bertram Goodhue were partners in the firm of Cram, Goodhue and Ferguson of New York and Boston, and together they designed a number of important buildings in the early 20th century—most of them in Gothic style and most of them religious



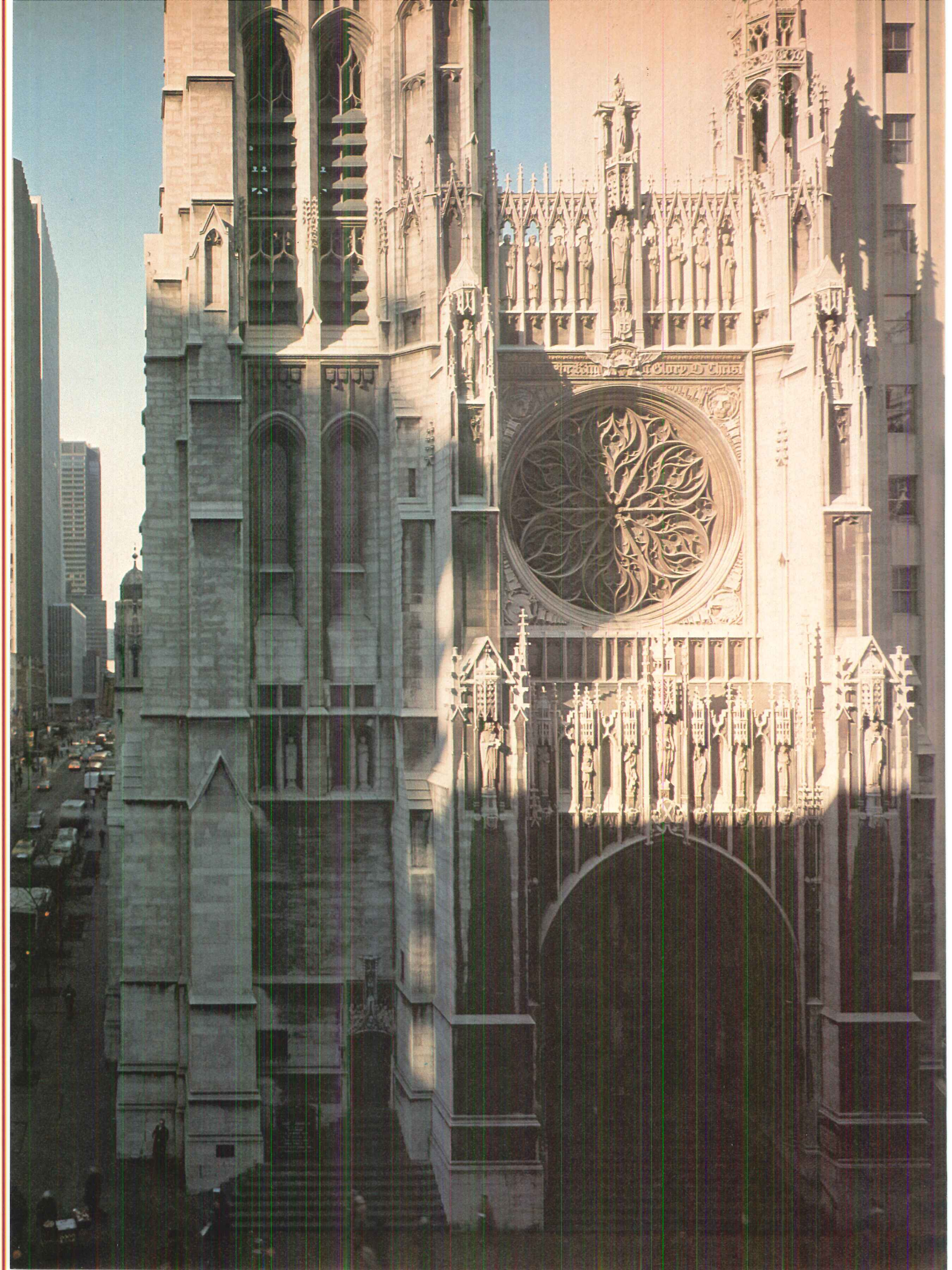

(including the chapel of the United States Military Academy at West Point). Cram, like many other Gothic Revivalists in England and America, was grandiosely spiritual in his allegiance to the style, attaching to it an almost moral significance. So great was his fervor that he insisted, for instance, on building St. Thomas Church, except for the roof truss, entirely out of masonry in the traditional manner, without the aid of structural steel—though, due to a miscalculation, steel had to be added later to keep the north wall from collapsing. Goodhue seems to have been a little more easygoing in his approach, regarding Gothic as one alternative among many, rather than the ultimate way. When the firm of Cram, Goodhue and Ferguson was dissolved in 1914, just as the major part of St. Thomas Church was being finished, he went on to design buildings in various other styles, including the exuberantly "Spanish" theme building for the Panama-Pacific Exposition in San Diego and the starkly pre-Modern Nebraska State Capitol in Lincoln. Because Goodhue became one of the most original of the established architects in the early 20th century, and because part of the originality of St. Thomas Church consists of the bold and chunky massing characteristic of Goodhue's work, it is hard to resist thinking that he had the upper hand in the building's design, even though custom says otherwise, possibly because at the time the building was built Cram was the more fashionable architect.

In any case, the design problem was this: how to provide seating for a large number of people (as well as space for offices and other parochial activities) on a relatively small urban site, and how to make a building that, from the outside, could remain a firm presence in the city even as its surroundings changed, as they inevitably must. The solution to the first part of the problem is straightforward if somewhat unorthodox; the main interior space of the building extends from virtually the front of the site to the very back, and it is shifted off center to the north, leaving just enough room for offices and a chapel with a gallery above on the south (53rd Street) side. The most memorable feature of the interior, which is otherwise dignified in a solid and rather plain way, is the enormous reredos above the altar at the (geographical) west end; it was designed by Goodhue and Lee Lawrie, a versatile artist who was also responsible for some of the best Art Deco sculpture in Rockefeller Center, and its ivory-colored stone contrasts with the warmer and darker sandstone of the rest of the interior. Though all of the figures conform to a carefully planned iconography, the reredos as a whole reads most strongly as a rich and delicate texture. In architectural terms the most instructive thing about it is that it is an object lesson in making virtue of necessity, for the sense of depth and lightness created by the multitude of niches and canopies in the reredos betrays the fact that, with the exception of three windows high above the floor, this end of the building is actually a blank wall that abuts the building next door, formerly a house and now the Museum of Modern Art. Similarly the north wall is blank, though that fact is obscured by the much more dominant clerestory windows set some ten feet back from the lot line, and identical to those on the south side of the nave. Thus there is a good deal of *seeming* here—architectural dishonesty, some would say—because what is in fact a symmetrical space set off center in an asymmetrical plan and walled in on two sides by adjacent buildings is made to feel central and unencumbered.

The asymmetrical plan which is a peculiar feature of the interior also plays an important part in solving the second part of the design problem—making a building that can

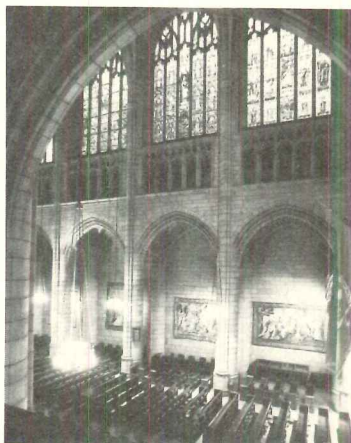
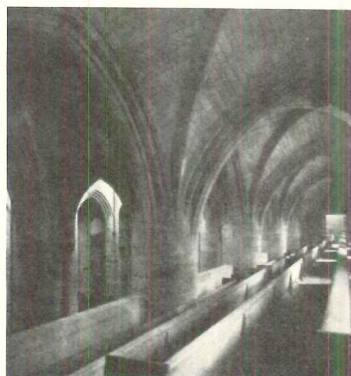
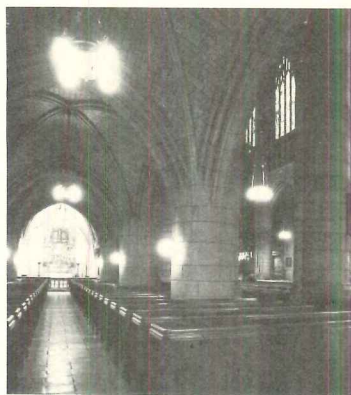
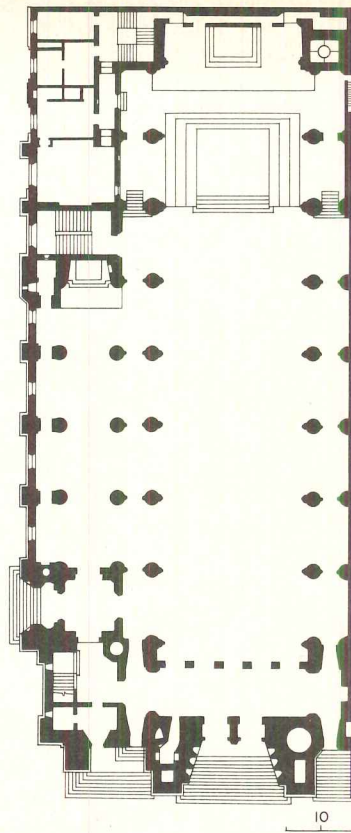

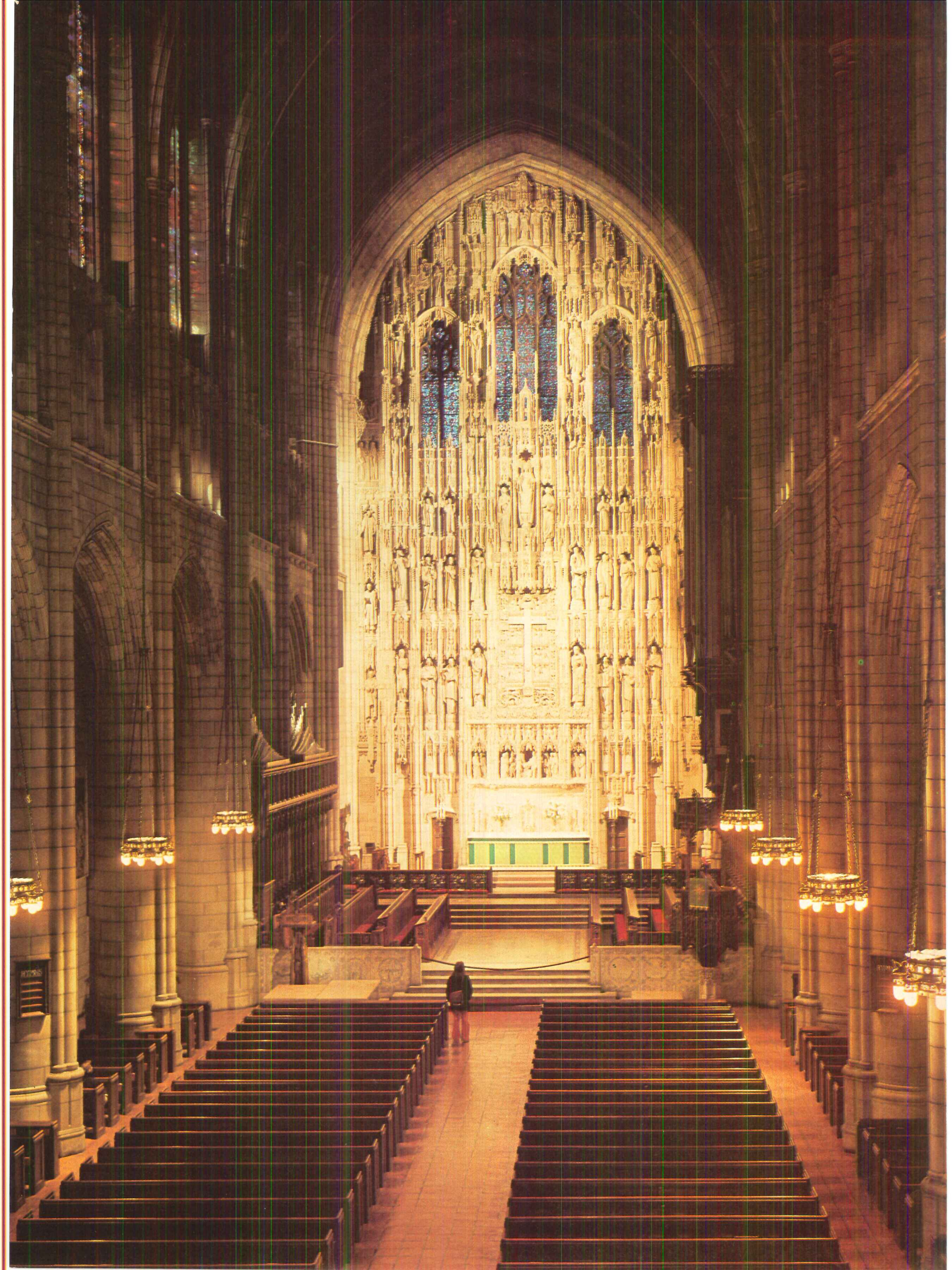

hold its own in the changing urban scene. When seen in elevation or as in the large photograph on page 115, the façade of St. Thomas Church seems truncated and almost bizarre—two-thirds of a Gothic façade, consisting of a massive and rather stubby tower and a more delicately ornamented “central” portal and rose window. The building, of course, has almost never been seen this way, except by an architectural draftsman, or by an adventurous architectural photographer, and the knowledge that it would not be must certainly have been one of the justifications for designing it this way. Normally, when the façade is seen straight on, the observer is at street level and fairly close by; from this vantage the projecting portal with its deep-set doors and wide stairs dominates, obscuring the eccentricity of the rest. When the building is seen from any distance at all, it must be from some point up or down the avenue, and from such an angle the tower—which is designed for solidity rather than for graceful height, in what would be futile competition with its neighbors—becomes by far the most dominant element.

Why, nevertheless, does it make any sense at all to organize a building in this way, except for the fact that such an organization reflects to some extent the arrangement of the spaces inside? The answer to this question, insofar as it suggests a general attitude, has important implications for urban design, because, unlike many buildings, St. Thomas Church is not composed around itself, nor indeed is it composed with any detailed regard for its immediate neighbors (all of which, incidentally, have changed since the building was built). Instead the exterior of the church allies itself with the most basic and almost certainly the most permanent feature of its surroundings—the city block and the city street. The outsize proportions of the square tower make it seem to the eye to mark the corner of Fifth Avenue and 53rd Street as surely as it marks the corner of the building, and the rest of the façade, not stopped by a second tower on the north, makes a gesture of continuity with its other neighbors on this side of the block.

It is interesting to note that in the late 1950s the architects and owners of Canada House (now called the Mutual Benefit Life Building) paid careful attention to St. Thomas Church when they designed and built their new building immediately to the north on Fifth Avenue by echoing the church's color and by silhouetting it against a plain and windowless south wall. Such urban courtesy is certainly not to be discounted, since it is rare, but one can't help wondering whether or not in this special case, where the older building is so strong, such courtesy was even required—and whether in fact it would not have been better simply to respect the format of street and sidewalk and façade (as the St. Thomas Church does) rather than to set the building back behind a small plaza (which is what happened with Canada House). Perhaps the architects mistook the older building for an elegant curiosity to be treated with delicate respect, rather than a fundamentally urban piece of architecture able to hold its own among its neighbors, as long as they respected the same rules. This is a mistake that is easy to make, but it is worth correcting, because St. Thomas Church in its close allegiance to the structure of the city and in its manifest concern for the way a building is perceived by people (rather than for some abstract formal clarity in the architect's mind) tells of a kind of architecture that is radically different from much that we have become accustomed to.—*Gerald Allen*

ST. THOMAS CHURCH, New York, New York. Architects: *Cram, Goodhue & Ferguson*.

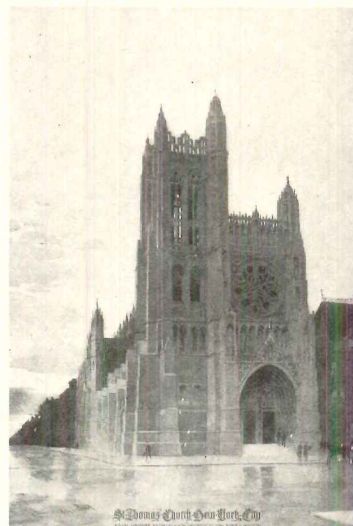

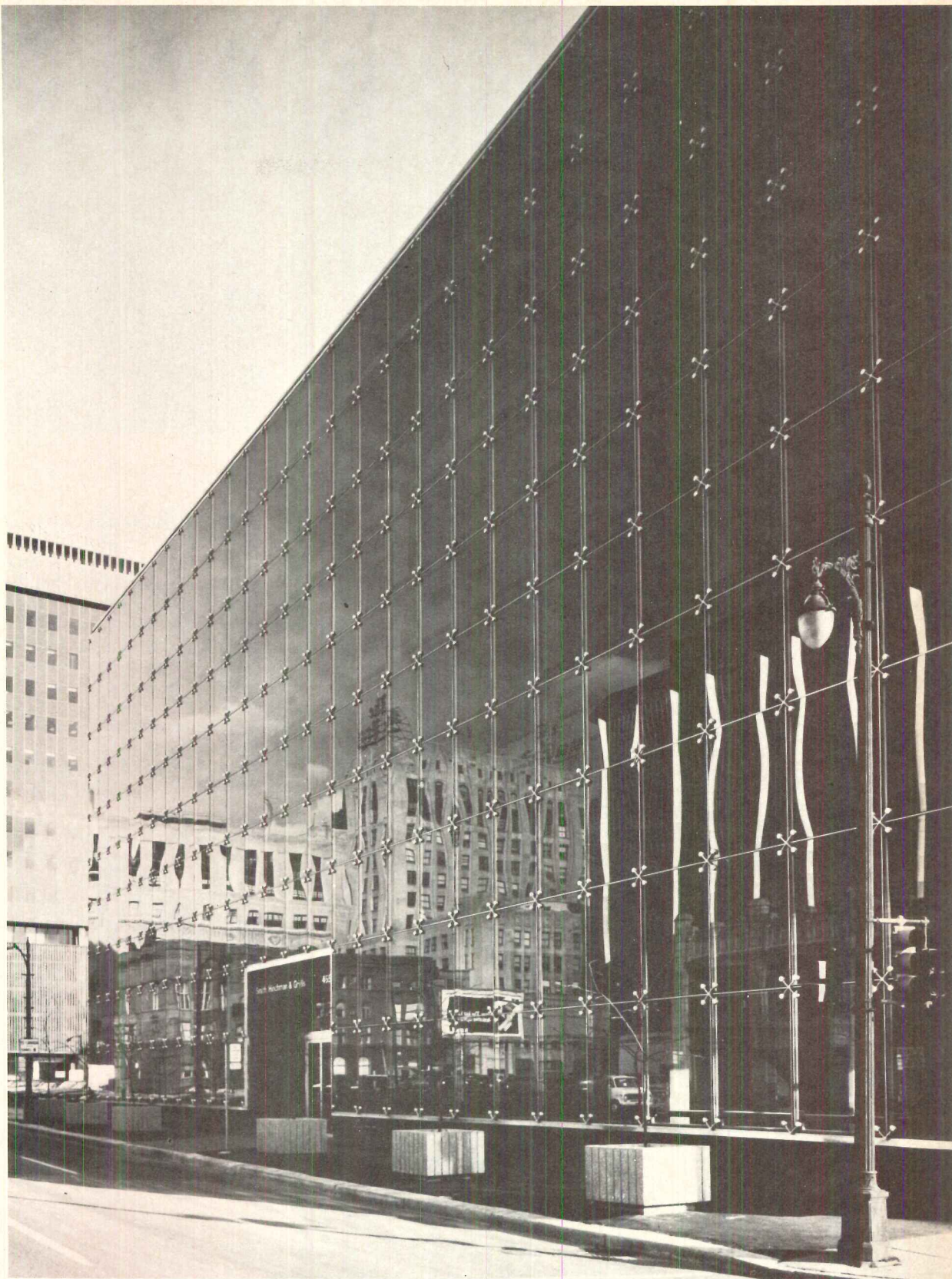

Smith, Hinchman & Grylls Headquarters

Building renovation and the corporation image

There is a lot of current discussion about recycling of the built environment, and there is also much said about improving the visual prestige of businesses. In tradition, the two concepts have seldom mixed—possibly due to the lack of image projected by “remodeling.” Two completed projects, on the next pages, illustrate that apparently diverse goals can be met simultaneously—and in both urban and rural locations.—Charles Hoyt

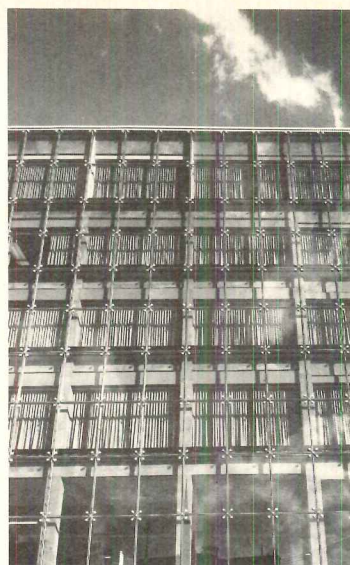
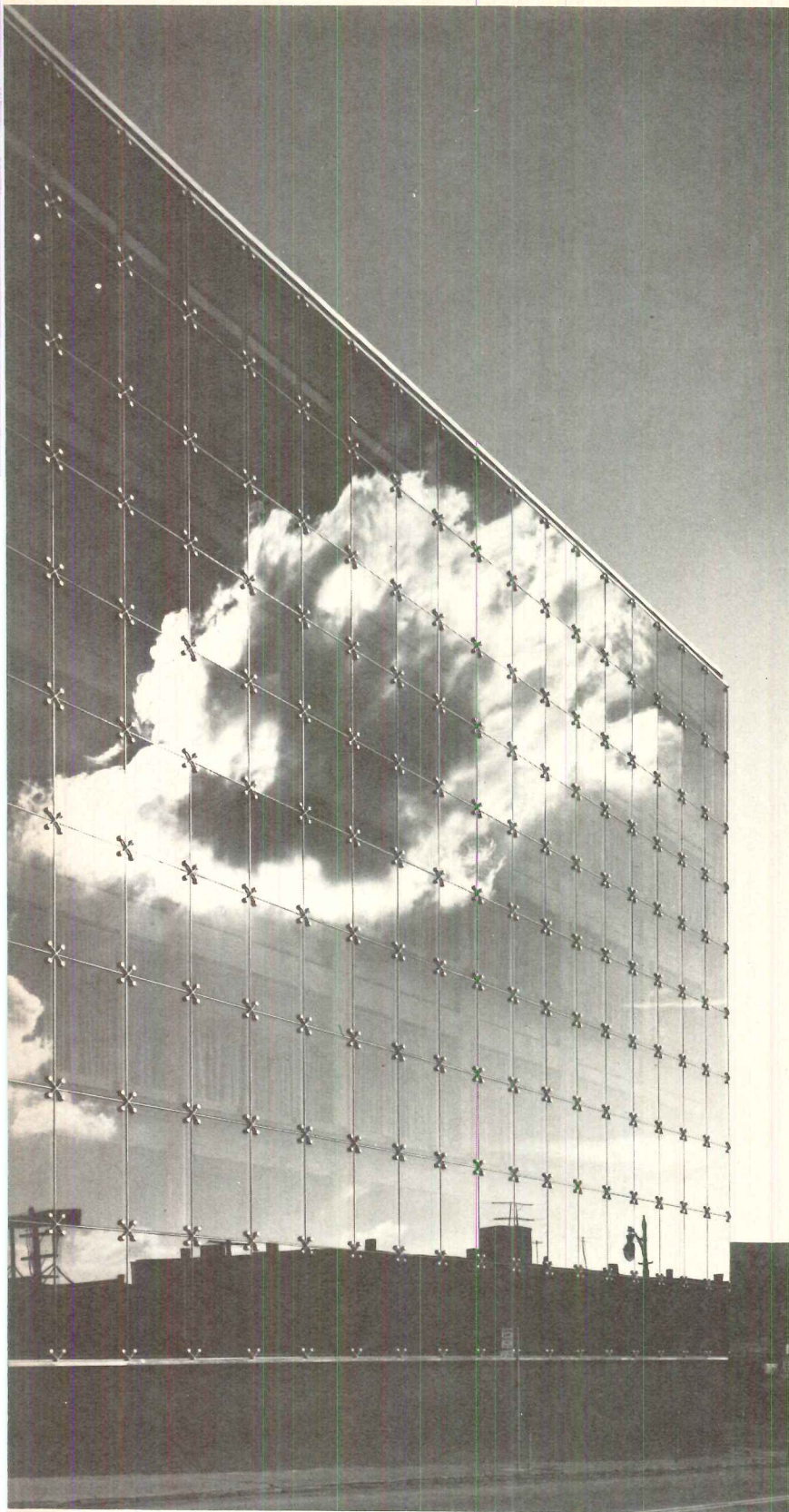

Balthazar Korab

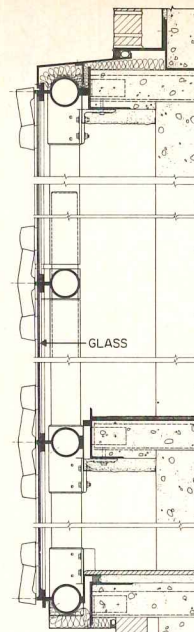

VERTICAL WALL SECTION

The original loft building (below) was stripped to its concrete frame and sheathed in an almost-all-glass curtain wall on the two street sides. The architects designed the innovative glazing support details (right). Once-scattered divisions are housed on intermediate floors (typical floor plan, right), executive offices are on the top (fifth) floor and services and potential rental are on the ground level. Interior spaces include executive reception (opposite page, top), typical drafting room with felt banner dividers, and a hallway.

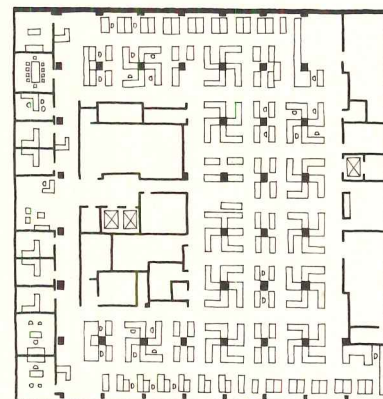

TYPICAL FLOOR



Hedrich-Blessing

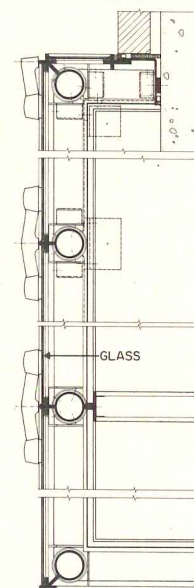

HORIZONTAL WALL SECTION

Smith, Hinchman & Grylls headquarters: staying downtown with style

Reuse of existing structures can fulfill a broad range of motives, and here is a case in point. The architect-client wanted to consolidate its scattered operations in a manner that would make the most economic sense and to still stay in central Detroit. SH&G's late chairman, Robert Hastings, was convinced that the resurgence of the city was just beginning, and that the firm's members should "be at the heart." They are, and they have a glistening reminder to the public of their presence.

SH&G began their new headquarters in 1971 by purchasing a 120,000-square-foot loft building the firm had designed in 1910, and which met their program requirements of location, sound structure and floor area (three floors can be added in the future). Purchase price plus extensive renovation costs were estimated to total considerably less than the

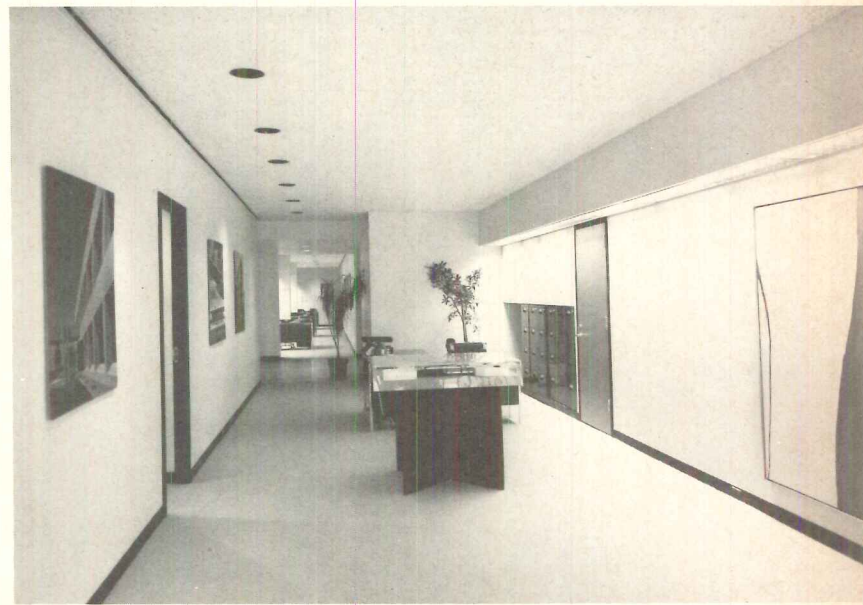

Bob Wallace photos

cost of a new building—final costs were \$31.66 per square foot. The first renovation procedure involved stripping the building to its concrete frame, retaining only stairwells and a freight elevator. The new plans were organized around the existing ability of respective floors to accommodate each of the firm's three working divisions. In a typical plan (opposite page) division executives are housed in offices on the north wall, and the large drafting rooms face the river views to the west. The columns—which were of various sizes and alignments—were furred out. Hung ceilings and carpeting were installed (the original wood floor could not be saved). An on-going art acquisition program has provided works of which the architects are duly proud. The artists include Moth-erwell, Frankenthaler and Lipshitz.

The most dramatic change is the essentially all-glass skin on the two street facades (a pre-energy crisis decision). The architects designed a tubular aluminum structural system to hold the glazing away from the exposed building frame. Five-foot by seven-foot sheets of bronze-tinted plate glass are held to polished aluminum supports, without stops, by silicone sealant. The x-shaped clamps held the glass while the sealant was curing, and provide extra support and a strong detail. Heating and cooling are provided by a variable volume system which utilizes light fixture heat in the winter, and the building's square shape coupled with two solid walls greatly reduce potential heat transfer.

SMITH, HINCHMAN & GRYLLS HEADQUARTERS, Detroit, Michigan. Owners, architects and engineers: *Smith, Hinchman & Grylls Inc.*

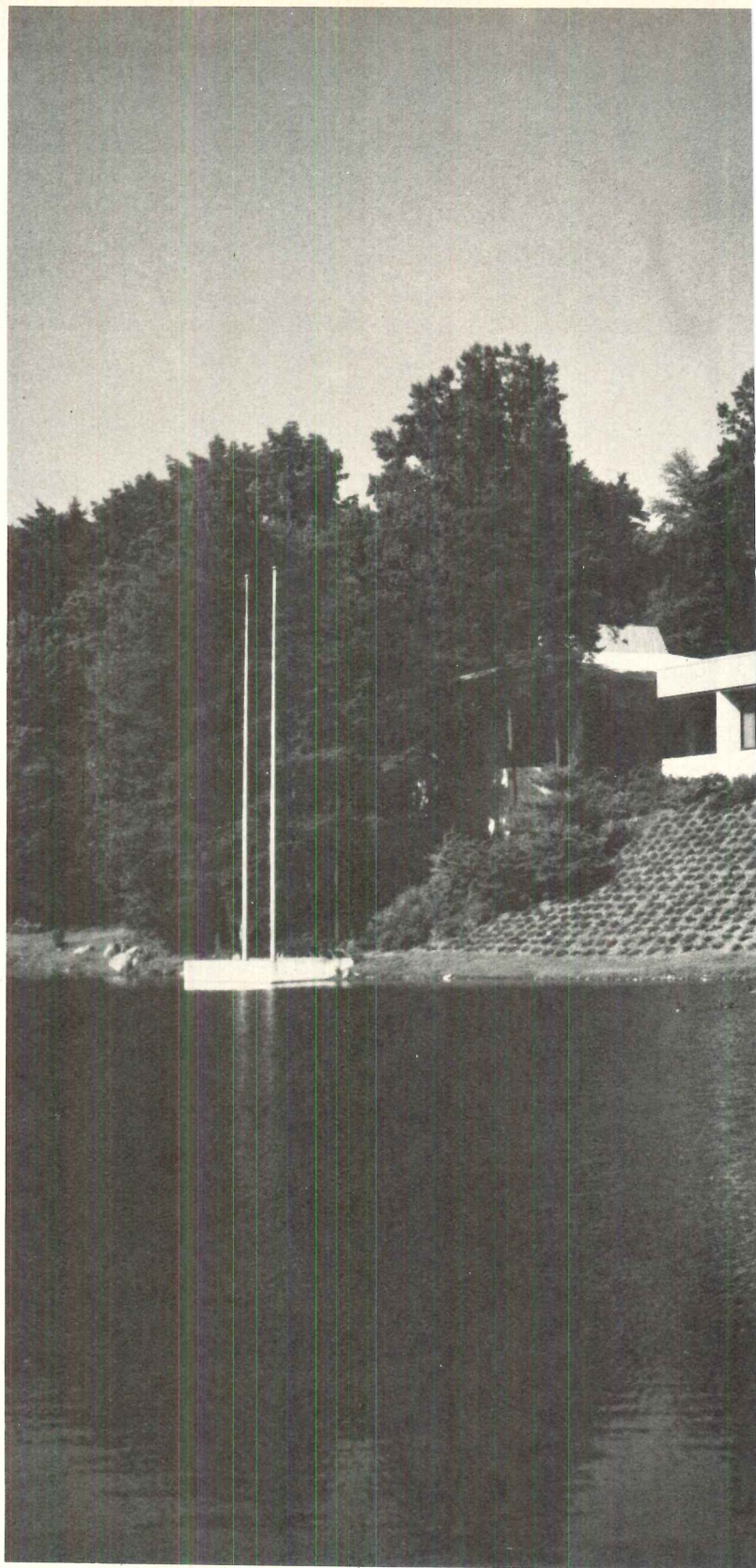
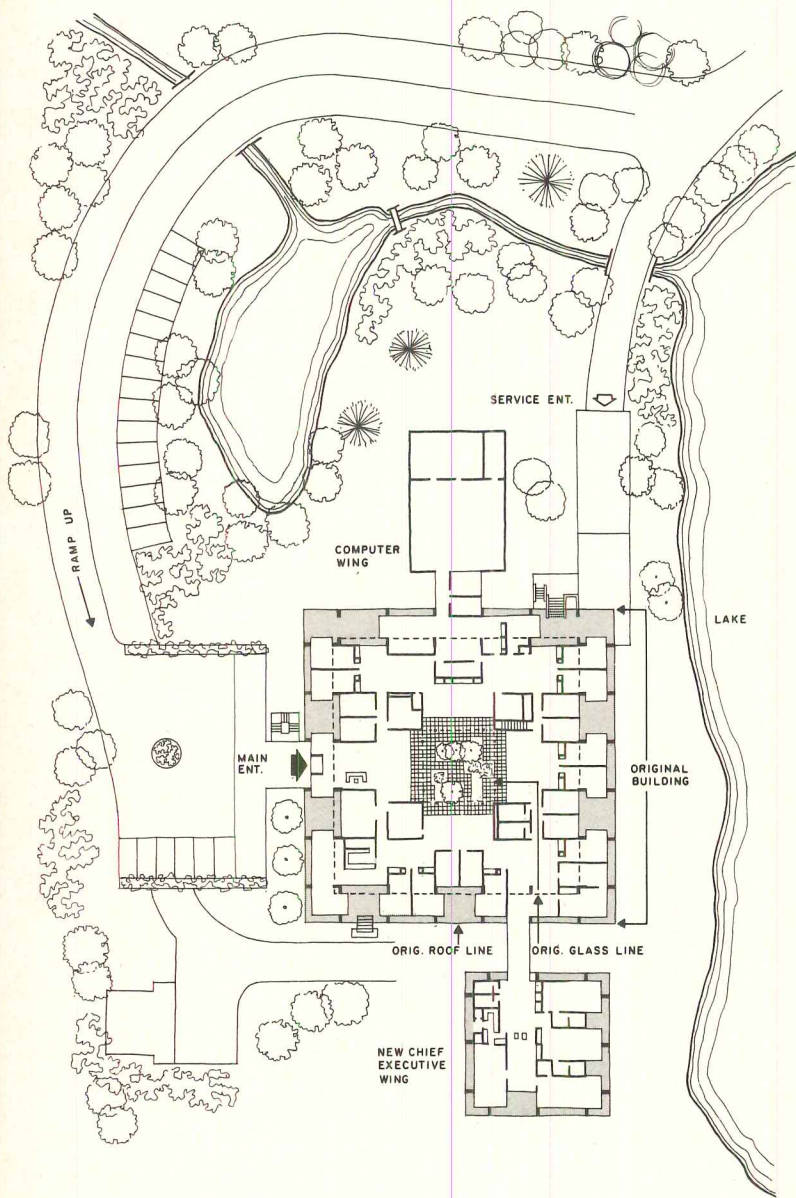

Harvey Hubbell headquarters: re-use on an idyllic site

The 30,000-square-foot building above is twice the size of the structural shell of the original building used as its core, and—because of the sensitive design work of architect Bruce Campbell Graham—this virtually new headquarters provides a fine corporate home in an invigorated relationship to the spectacular wooded site. The original structure (center of plan above) was well designed by architects Orr-deCossy-Winder Associates for a previous corporate client. It fitted the new owner's needs because it occupied an ideal position overlooking a man-made pond and was partially shielded from a major highway on the opposite shore. Both public visibility and internal tranquility were available at the same time. Many typically high expenses for suburban site work had already been made.



Am Gaydos

Despite the advantages, the original building lacked the floor area and operational arrangement that the new owner required. Expansion beyond the existing structure was complicated by the precipitous grade changes and a desire to maintain the site's natural beauty. Accordingly, an analysis of user needs dispersed the required new construction's bulk in multiple locations. Two new pavilions were built—for a computer center (top of plan) and for the chief executives (bottom). The original building had been placed at the crest of the spine of a hill parallel to the pond shore, and the new pavilions minimized visual impact and maintained original floor levels by following this crest. A new service room and entry (top of plan) was built at the basement level and this new construction extended the building's visual base (photo above).

Only the shell of the original building was maintained. Offices here were expanded by bringing the exterior solar glass walls out to within four feet of the roof edge (the original walls had been recessed 18 feet), and the new offices were widened beyond the 12-foot structural bays by overlapping the offices behind (see plan). This unique new plan configuration provided a high percentage of corner offices and there were numerous studies of the consequent effects of the sun and of privacy considerations before the solution was settled.

Landscaping was designed to bridge the transition between building and the natural surroundings. The clients were concerned with preservation of the local countryside character and appreciated landscape architect A. E. Bye's recommendations to restore the existing hemlock

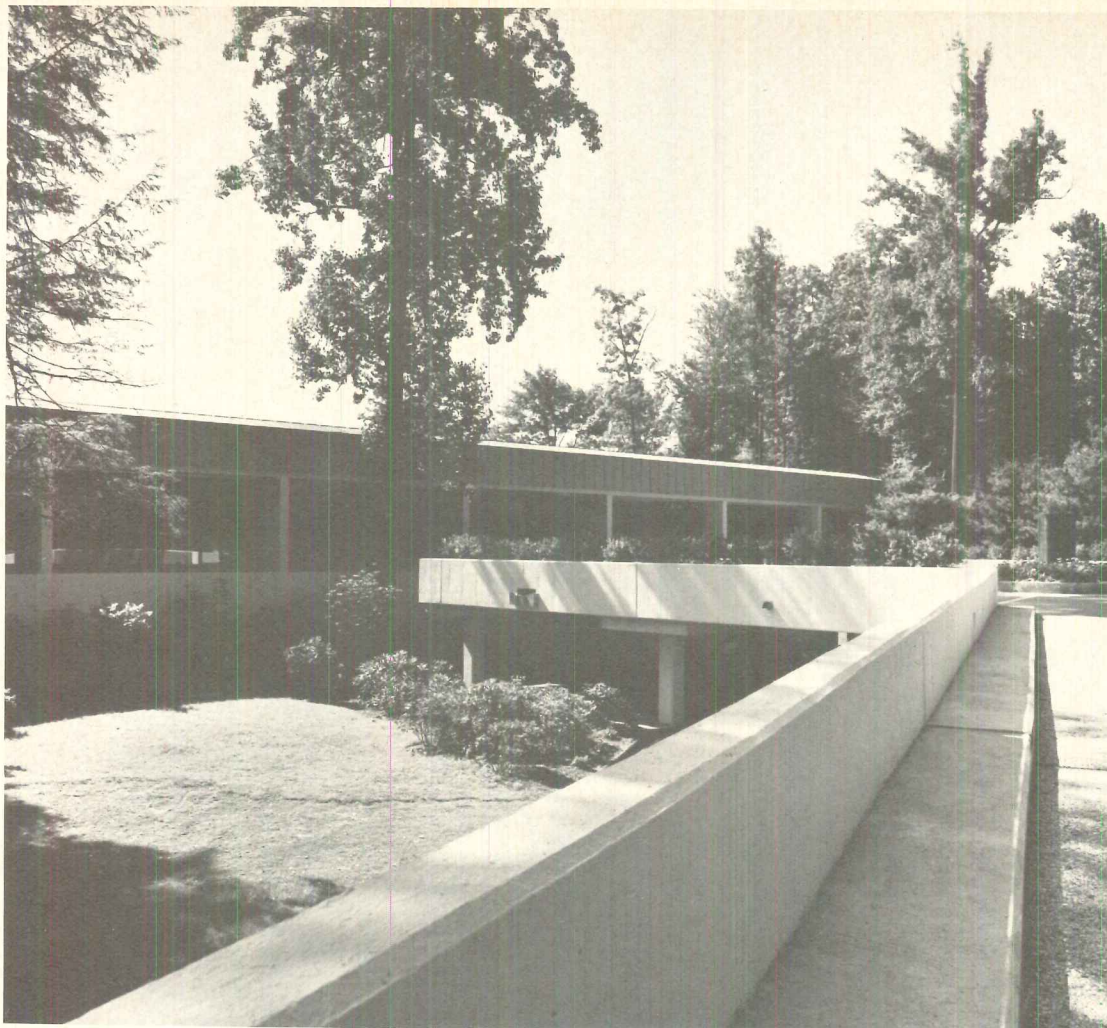

The original building (left, below) had open parking and a flight of stairs to the entrance. The new owner's requirement of covered parking produced the first seen of the changes (below and left): a raised approach road following an adjacent hill slope to a handsome entrance court both over the parking. Cars are now largely hidden, and the building entrance is much more formal—in keeping with the headquarters' expanded function. A unifying metal fascia has replaced the original detail between roof and exterior soffit. New sitework has included sub-grade power lines and revitalization of native planting which has been continued into the central court (opposite, above). Stairs from the parking level to the entrance level are seen at the right.

A.E. Bye photos

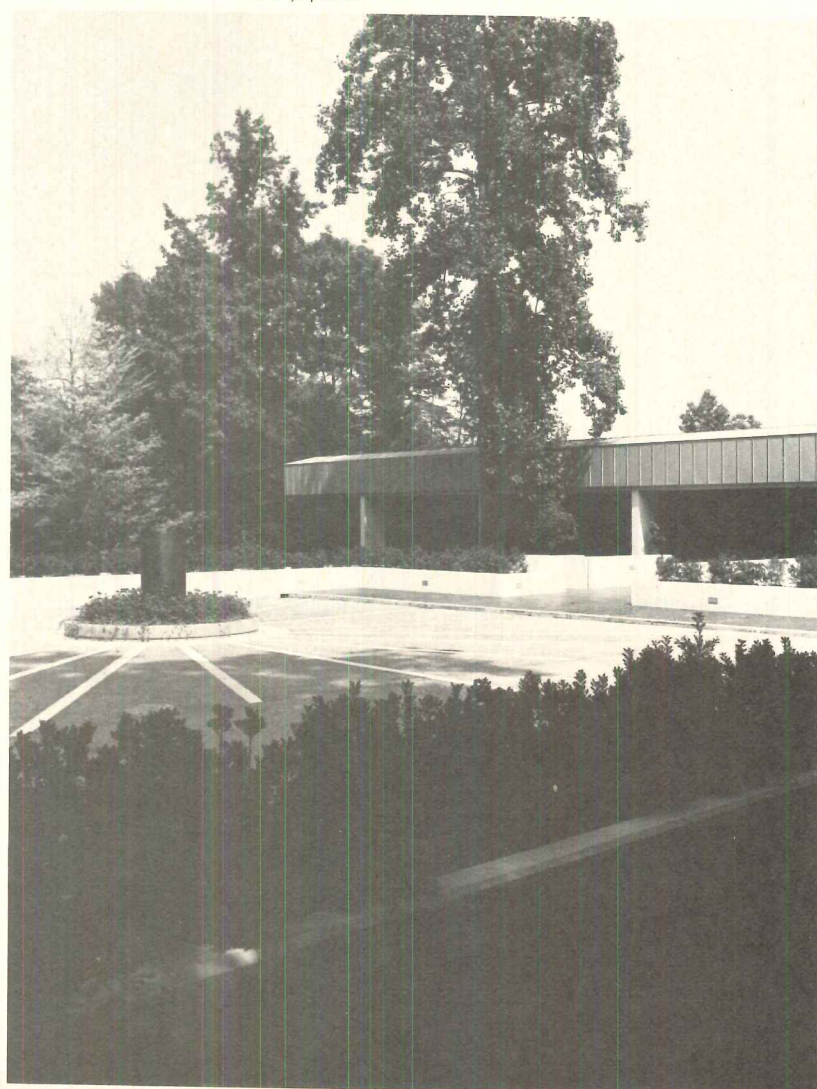
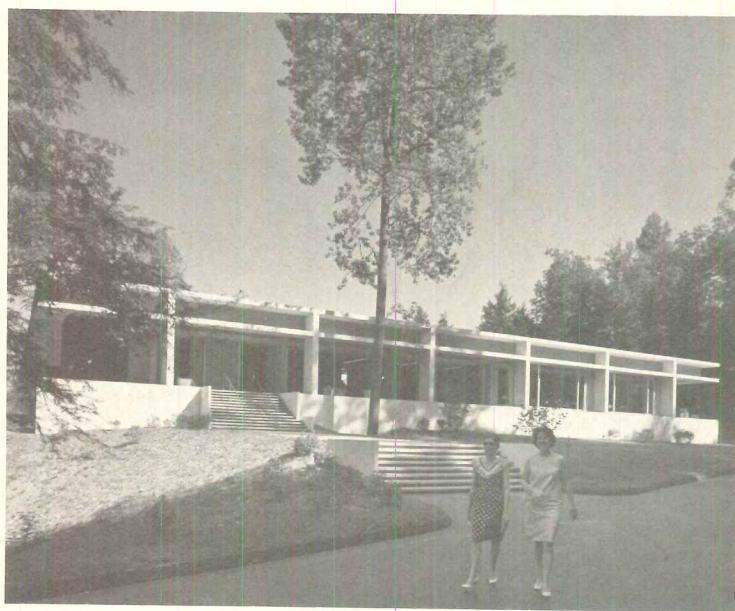

forest and provide new planting of native materials such as mountain laurel, rhododendron and partridge berry. Bye is an advocate of the natural approach, and he feels that client acceptance is no longer unusual. He stresses ease of maintenance as a practical factor, and indigenous plantings are brought to the building edge.

HARVEY HUBBELL CORPORATE HEADQUARTERS, Orange, Connecticut. Owner: *Harvey Hubbell, Incorporated*. Architects: *Bruce Campbell Graham—project architect; Boris Baranovich*. Engineers: *Joseph Layer (structural); Edward J. Zahorak Associates (mechanical/electrical)*. Interior design consultants: *Lubin Associates—designer; Richmond Bradford*. Landscape architects: *A. E. Bye Associates*. Cost consultants: *NASCO Associates*. General contractor: *Gellatly Construction Company*.

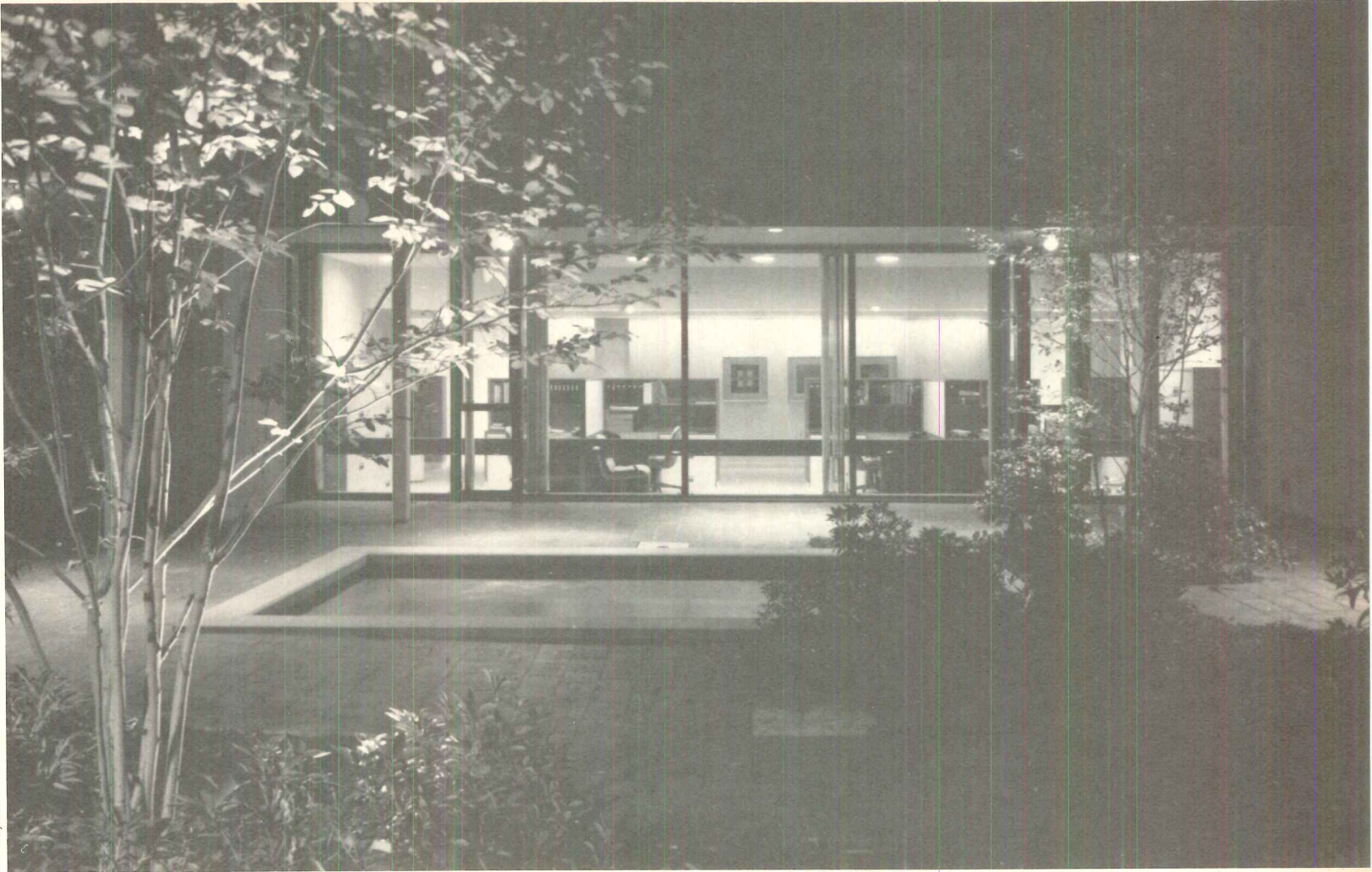

Am Caydos

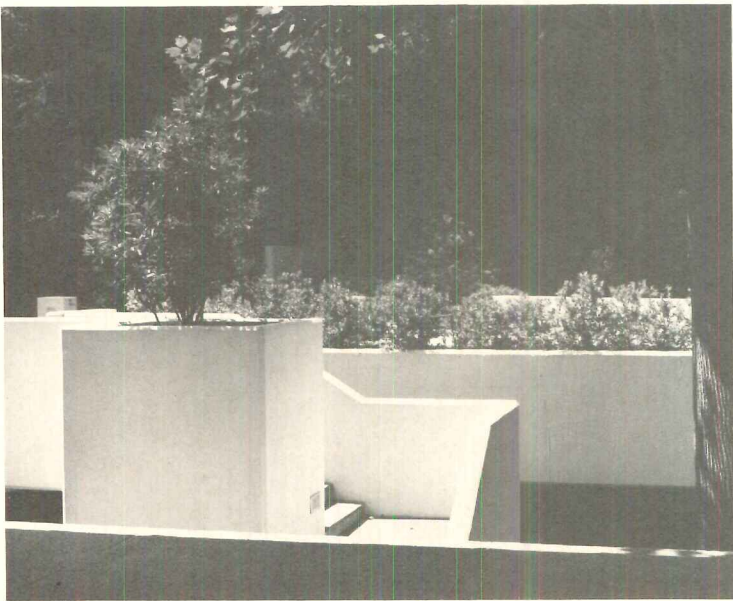

A. E. Bye photos

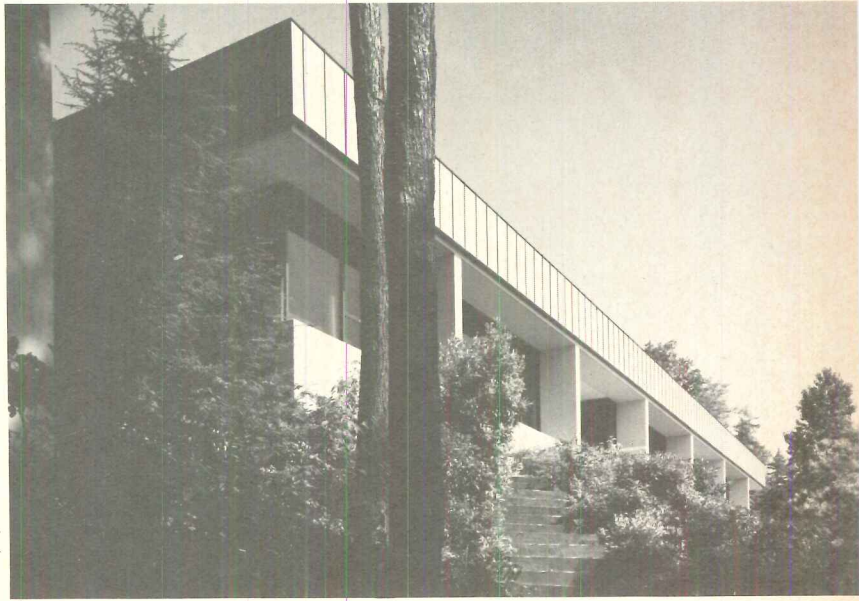

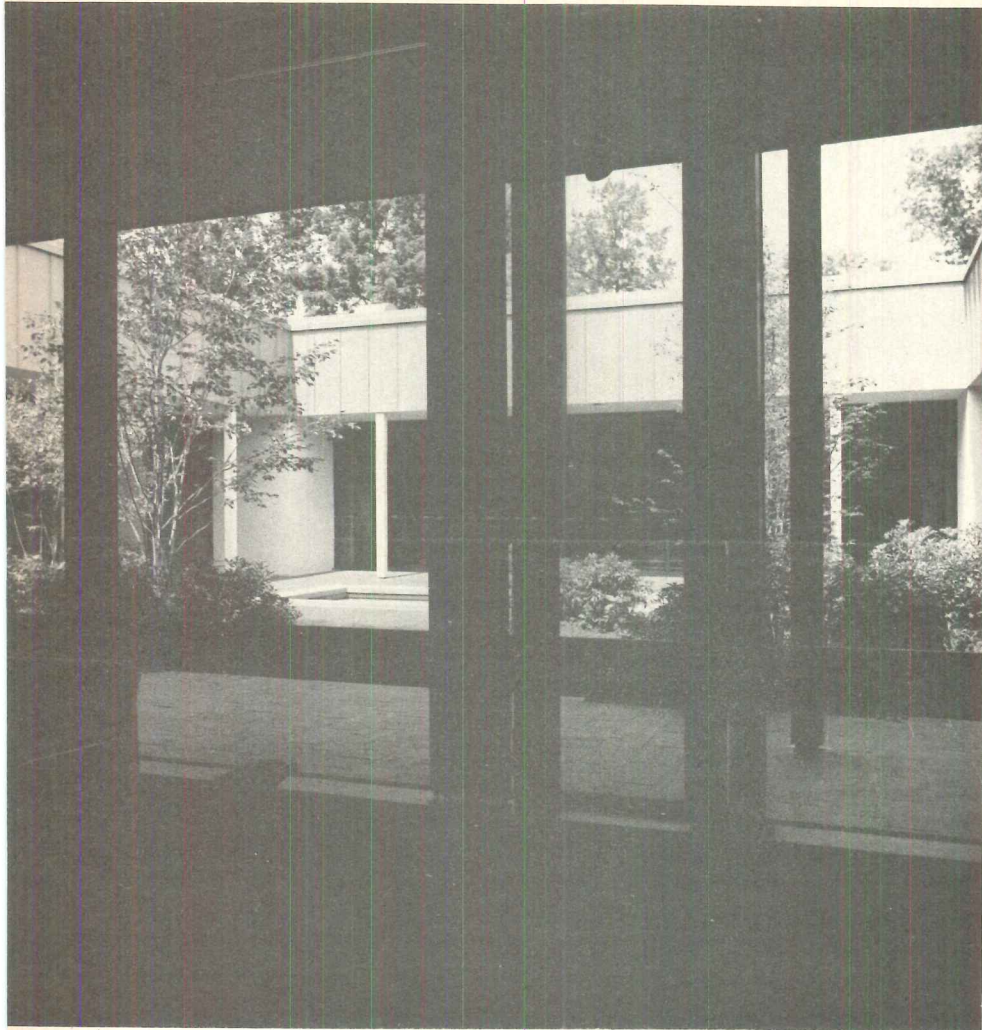

Am Gaydos

The central court (above) was enlarged by placing the surrounding glass walls in a position six feet in back of the original location at the edge of the roof. The result was a better proportioned exterior space and the ability to alternately widen and contract the surrounding corridor—providing separated secretarial positions and spatial variety (see plan, page 122). The court design included a new pool and indigenous planting growing from sod sections transferred from the nearby forest.

The future of the office building

by Jonathan Barnett, A. I. A.

Jonathan Barnett, a frequent contributor to *Architectural Record* is the author of the recent book: *Urban Design as Public Policy*.

It is not a bad rule of thumb, in a society that changes as quickly and drastically as ours does, to be a little suspicious of anything that seems definite, fixed and immutable. As soon as everyone has convinced himself that something is a certainty, it has a way of turning out not to be true any longer.

Keeping this rather cynical little axiom in mind, it is time architects took a good look at the way office buildings are designed. If ever there was a building type about which there seemed to be general agreement, the office building would be it. In London and Paris, New York and Tokyo, San Francisco and Sydney, the same building appears again and again, with variations only in the choice of materials and the proportions of the facade. Everyone has felt that such buildings are practically inevitable; and all over the world people shake their heads and mutter, in many different languages and accents, that, while they don't quarrel with the idea of progress, it is a shame what is happening to their cities.

Now the energy crisis is beginning to make people wonder about these buildings. Does it make sense to have so much glass, and to rely so completely on artificial climate? Whatever made architects design them that way in the first place?

When we stop to think where our ideas about the office building come from, it looks as

if Ludwig Mies van der Rohe had a lot to do with them. Starting in the early 1920's, Mies made drawings of office buildings that were considered revolutionary statements at the time, but which look reasonable, even common-place, today: simple industrial structures, both inside and out, whose regular bay system creates large, undifferentiated spaces that can be partitioned in a number of ways.

We still call such buildings "modern," although the first drawings were done a half century ago; we also call such buildings "Miesian" although many of the examples designed by other architects are not at all the sort of building that Mies really had in mind.

Mies was interested in the art of elimination: the quality of the single flower instead of the massed flower arrangement; but his art turned out to be very sympathetic to those who were more interested in a beautiful balance sheet than a beautiful building.

It is one thing to choose an ascetic life, it is another to inhabit a world where many interesting and attractive alternatives have been eliminated.

Mies' original, simplified vision of the office building, made more workable by improved artificial lighting and climate control, and more explicit as Mies had an opportunity to see some examples built, has ended by becoming a stereotype. It is even hard to imagine

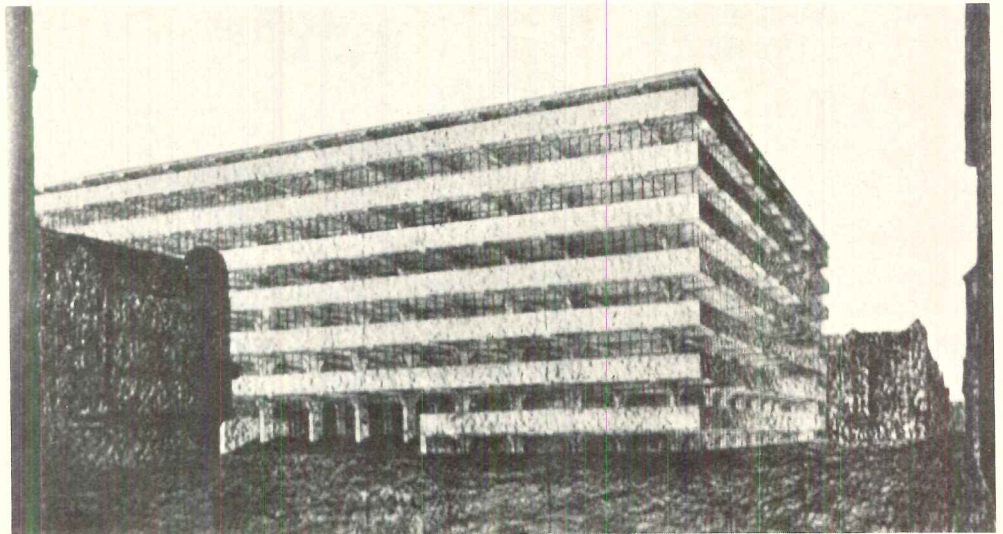
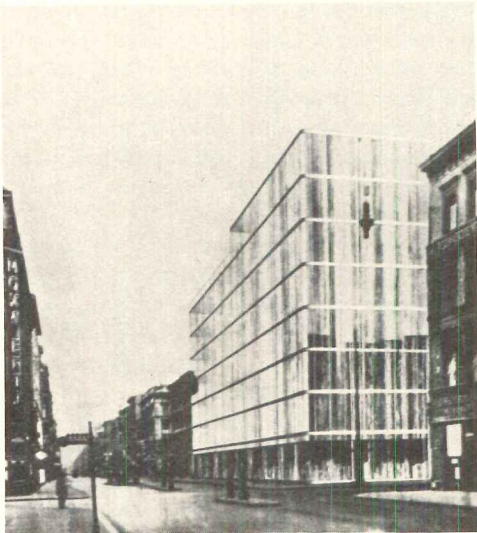

Illustrations from Philip Johnson's book on Ludwig Mies van der Rohe show where many of our ideas about the office building come from. These "modern" buildings were designed over 50 years ago.

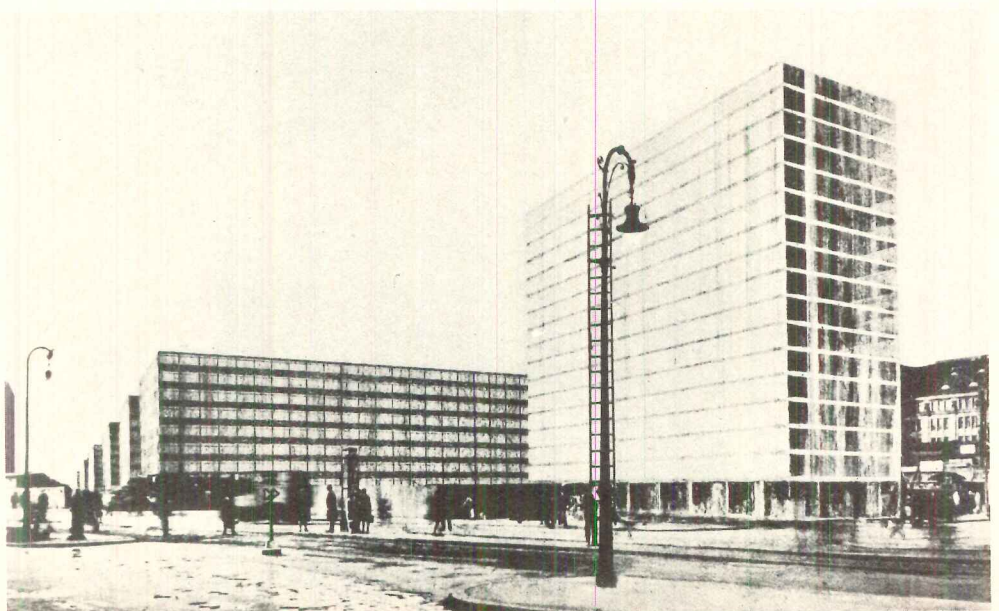

that there could be any other kind of office building. But the Miesian formulation, applied universally, is really a drastic oversimplification, both of the nature of office work, and of the relationship of such work to the rest of our society.

There are, of course, some well-known, non-Miesian ways to build office buildings but they have not caught on and swept the world as Mies' ideas have. Frank Lloyd Wright saw office work as a communal experience, which should be housed in a way that celebrated the spirit of group endeavor. The office buildings for the Larkin Soap Company, and the S. C. Johnson Wax Company, were done for firms that were able to accept, at least partially, Wright's ideas about society. Such buildings would appear, however, to be more closely related to large Japanese corporations, than to the much more impersonal, and interchangeable, corporate life in the United States which Mies' buildings represent so perfectly. Wright also designed buildings, like the Price Tower in Bartlesville, Oklahoma, which combined offices and apartments in a single structure. Except for the lower two floors, however, all the office space takes the form of individual, or executive offices, with no large "pool" areas devoted to clerical work.

Alvar Aalto designed a very successful office building for the Finnish equivalent of our

Social Security system, where the spaces are closely adapted to the many different types of work that go on there. But Aalto was dealing with an institution that did not expect to grow or change substantially.

The undifferentiated loft space of Mies' formulation seems to have considerable advantages of flexibility over the alternatives suggested by Wright or Aalto, which is why they have been so widely accepted.

Those who are worried about the boredom and lack of incentive felt by many workers today wonder if a new corporate structure, based on identifiable groups working towards a definable result, would not be more efficient—as well as more desirable—than training people to do isolated, repetitive tasks. The most obvious application of such thinking is to change the nature of the assembly line, as the Saab Company says it has done in Sweden; but there are many changes that could be made in office work that would have a similar effect.

It is a good question whether our places of work are impersonal and interchangeable because they express the institutional life of our society, or whether the nature of the office building has influenced the corporate structure. Are architects in a position to help change the nature of our institutions by suggesting new kinds of space for them to occupy?

It may be that the architect has no such power and that, in any case, undifferentiated loft space is an appropriate working environment; certainly many architects themselves prefer to live and work in lofts.

There are some indications, however, that other people are not as fond of lofts as architects are. Within loft buildings, experiments with "office landscape" indicate a dissatisfaction with the usual impersonal and hierarchical arrangement. Office landscape does present some real advantages to corporations with large clerical staffs that are subject to frequent changes in the size and organization of various departments; but the freedom created is superficial. The cards have been shuffled but they are still the same cards.

It is also rather strange, you must admit, that the executive floors of large loft buildings, those inhabited by people who have the authority to control their surroundings, so often drip with chandeliers suspended through hung ceilings, and are filled with classic columns, Georgian door surrounds, panelling and other accoutrements of a "high status" environment. Do these interiors represent incorrigible bad taste, or an unfulfilled hunger for something that the architect has not provided in the building itself?

Perhaps it will be the "energy crisis" rather than inchoate longings for different surroundings that will make a departure from the office building stereotype a necessity. We are all beginning to question the propriety of creating such totally artificial environments at a time of increasing demand on energy sources and increasing environmental pollution.

It seems likely that office buildings in the future will not look the same on all four sides, and that sun control will once again be an architectural determinant.

In the meantime, architects are already helping to change the relationship of the office building to the rest of the city, and, in the process, have begun to move away from the Miesian concept of the isolated, rational structure devoted solely to office work.

In the old commercial centers of cities, stores, offices, warehouses and factories, apartments and houses mingled together. The kind of office space in early office buildings was quite compatible with the size and shape of other uses. In Europe, in particular, it was not unusual for a single building to house office suites, hotel rooms and even apartments, as well as shops on the ground floor.

The loft office building with its ever larger floors was much less compatible with other uses, and the artificial lighting and climate required made the buildings too costly for most other occupants in any case. Only the highest paying tenants could afford the ground floor space, and no one thought of using the upper floors for hotels or apartments.

When big office buildings occurred at intervals among other commercial buildings, the situation described by Mies in his drawings, the office building functioned reasonably well as a unit of the city. As office buildings began to take over the downtowns of cities, however, their limitations became apparent.

Publicists for a new office building, after they finish explaining how all the components,

Frank Lloyd Wright's Larkin Building was an office structure where work was a communal experience, his Price Tower combined apartments and offices in the same building. Alvar Aalto's offices for the governmental pensions agency in Helsinki show another alternative for office space, but it is one in which growth and change are limited (below).

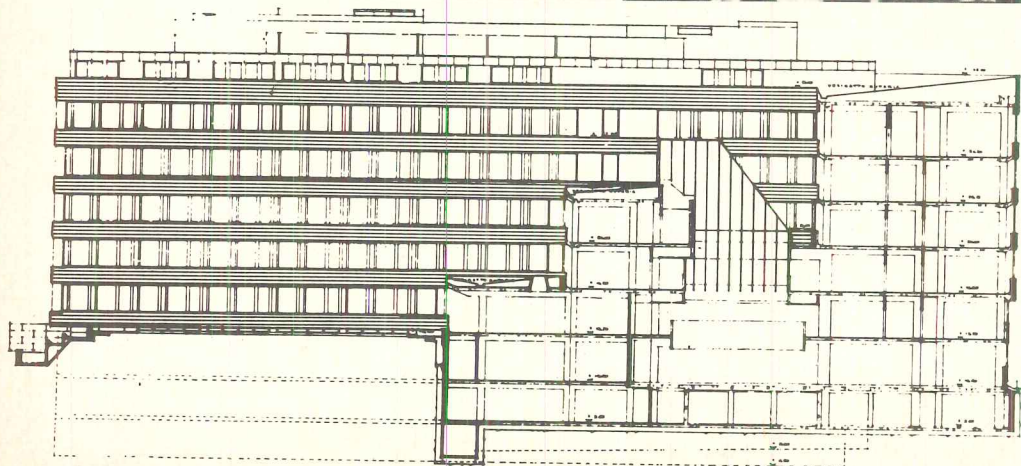
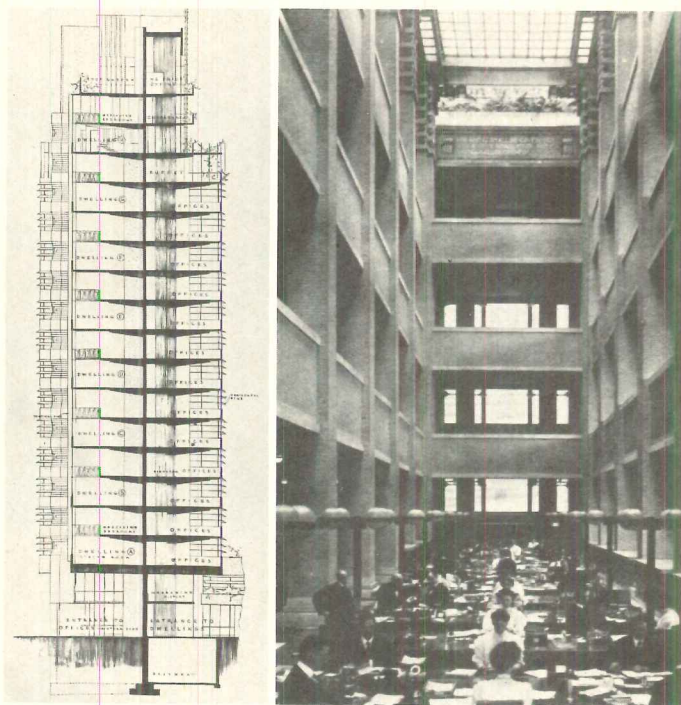

stretched out end to end would reach to South America or the Moon, are fond of describing office buildings as small cities in themselves. Many office buildings indeed house the equivalent of a small city's population, but they do not have the amenities and services that small cities need.

One or two big office buildings in a downtown or a suburb can be absorbed easily enough, but a suburb full of corporate headquarters, or a downtown with a dozen high intensity buildings, create all kinds of new demands. Traffic congestion increases, utilities must be improved, police and fire services must be strengthened. Where should employees eat lunch; where can they shop? In the suburbs, there may not be anywhere close by, and many corporate headquarters buildings have had to include shops and elaborate eating facilities. Downtown, the old locations for shops and restaurants may have been displaced by the new office buildings and the parking they require.

Large concentrations of office buildings do appear to make economic sense, as demonstrated by the enormous growth of downtown office activity in the last dozen years. Suburban office concentrations also make economic sense, but both are inefficient in comparison with a new kind of urban center that is in the process of being invented.

Urban designers and entrepreneurs are discovering that office space should be related to a matrix of shops, restaurants, entertainment, exhibition space, and hotel rooms, and that all of these elements, in turn, are more successful if there are residences nearby.

John Portman, the architect and real-estate developer, is one of those who has seen most clearly that downtown requires a variety of uses in order to keep its vitality. The Peachtree Center in Atlanta, which Portman designed, and which he has initiated and to a large extent financed himself, combines the country's second largest merchandise mart (after Chicago) with hotel rooms, office space, restaurants and shops. The principal architectural experiences are not the facades of the buildings, but the huge interior court of the hotel, the concourse system with its garden courtyard, and the roof-top restaurants.

Other urban renewal projects, whether private or government supported, have been planned to include a variety of uses and to introduce some of the amenities of a suburban shopping center into the downtown. Until recently, however, such developments have remained an amalgam of conventional building types. The Galleria complex in Houston, the Carlton Center in Johannesburg, the I. D. S. complex in Minneapolis, or Portman's Embarcadero Center in San Francisco and Renaissance Center in Detroit all represent steps in the evolution of a new concept of downtown, with the concourse system becoming the controlling element in the design and the office building a subsidiary part.

While developers have been discovering that this kind of integrated urban development made economic sense, cities have been trying to encourage it in order to preserve their competitive position against the newer suburban centers.

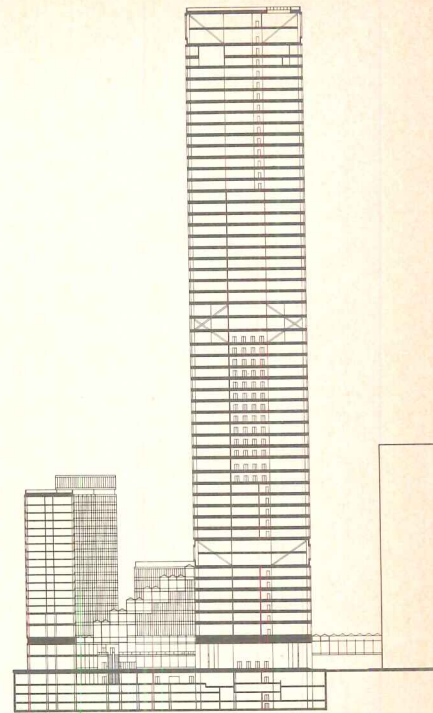
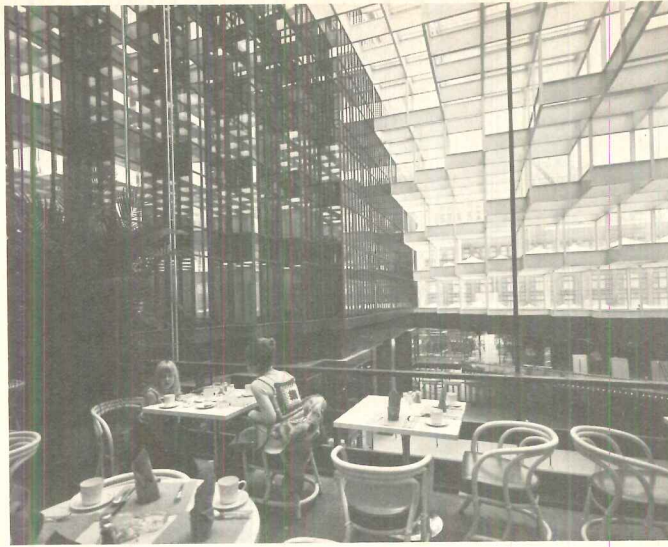

Three recent projects that combine office space with other downtown functions in new relationships (shown from top to bottom): the I. D. S. Center in Minneapolis by Philip Johnson and John Burgee, the Carlton Center in Johannesburg by Skidmore Owings and Merrill, and the Galleria center in Houston by Hellmuth, Obata and Kassabaum.

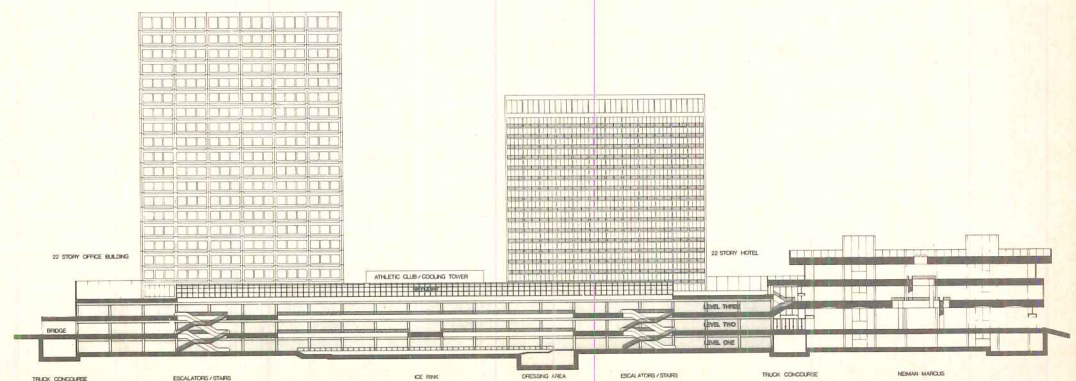
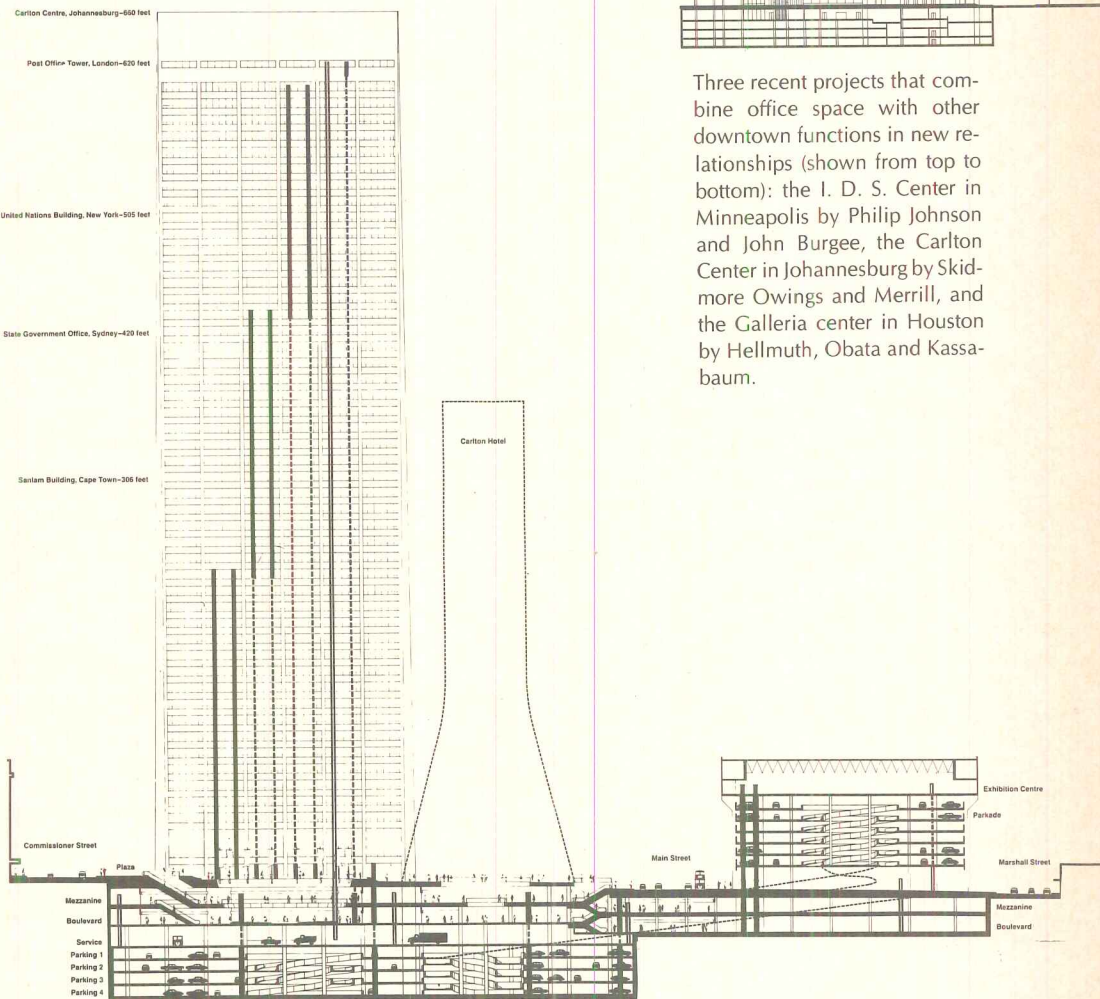

However, urban development of this nature is contrary to some of the conventional wisdom about the separation of land uses embodied in zoning controls. The special zoning districts created in New York City were needed to preserve a healthy variety of land uses in the congested central areas of midtown and lower Manhattan. Without special legislation, the legitimate theaters would have been obliterated by office buildings; without the Fifth Avenue Special Zoning District, office development might well have killed the effectiveness of Fifth Avenue as a shopping street. The Zoning District mandates or encourages greater complexity of uses: major retail shopping, large covered spaces, and apartments as well as office space.

The Fifth Avenue zoning district in effect requires architects to invent a new building type which combines apartments and offices in a single structure, and which gives over the lower floors to high-intensity retail uses. The John Hancock Tower in Chicago represented an important step towards this new kind of building, and was one reason why urban designers in New York City felt that it would be practical to specify combined residential and office uses in the Fifth Avenue Special District.

The architects of the John Hancock Building in Chicago were, by coincidence, the architects for Olympic Tower, the first building to be constructed in the Fifth Avenue special district, although it was the New York office of Skidmore Owings and Merrill that did the New York building, not the Chicago office.

The architects of Olympic Tower have elected to conceal the building's complexity behind a facade that is similar to a conventional office building, but the section shows the relationship between apartments, offices, shopping and a major Galleria space. No doubt, only a small number of people working in this building will actually live there as well, if only because the apartments will be very expensive. The principle is an interesting one, however: living over your place of work is a good way to cut down on commutation time.

Still another interesting example of the building that combines several different downtown uses in one structure is Water Tower Place in Chicago. It is located opposite the Hancock Building at the head of North Michigan Avenue, and was designed by Loeb Schlossman Bennett & Dart and C. F. Murphy Associates. There are only two floors of offices: the major ingredients are a multi-story shopping center, a hotel and apartments.

Another multi-story downtown shopping center will be located on the lower floors of the hotel that John Portman has designed and is developing on Times Square in New York.

The great spread of urbanization since the end of World War II has already destroyed the traditional difference between city and suburb. Many new relationships are possible, and many new types of buildings will be needed to house them. As the context for office space changes, we can expect to see major changes in the concept of the office building; and the design of the connections between office space and other activities, both inside and outside the building will become as significant as the design of the building itself.

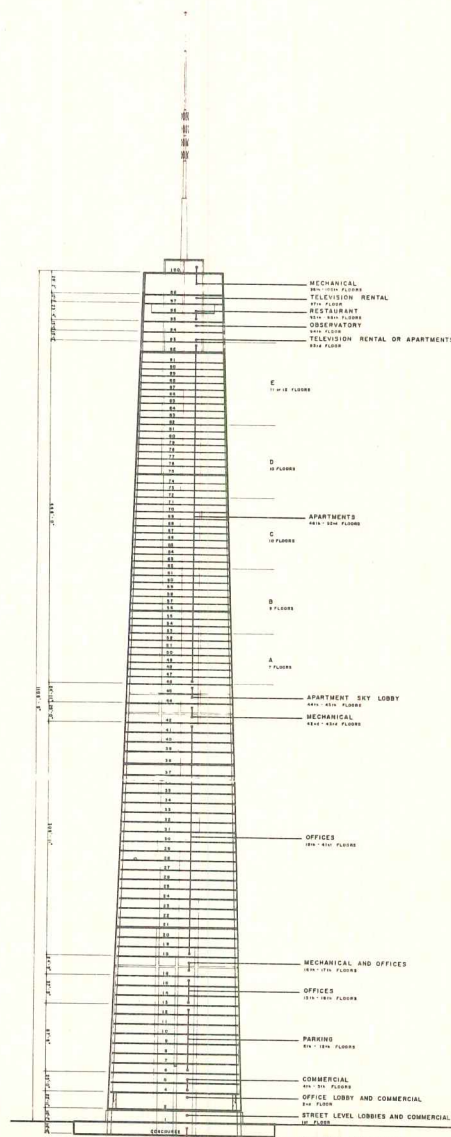
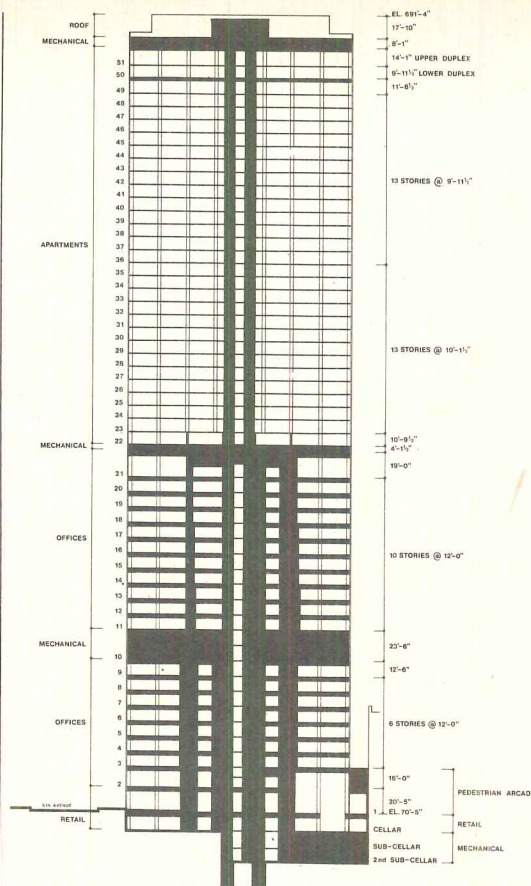

2 HOUSES AT SEA RANCH



The Sea Ranch is a second home development on a 10-mile section of the Northern California coast, spectacularly scenic and exceptionally masterplanned to retain as much of its original character as possible. The first buildings at the Sea Ranch—condominiums by Moore Lyndon Turnbull Whitaker, and hedgerow houses by Joseph Esherick and Associates—established distinctive criteria for design. In the years since, the criteria have some times been understood and used by other architects, but sometimes—at peril to the whole development when the resulting houses are on the open meadow—ignored. Simplicity and a strong relation with the site are the essence of these criteria, and they are expressed very differently for the different types of site: open meadow, exposed to view from the highway and from the hills; and forested hills. These two houses, on their very different sites and in their very individual ways, reflect these essentials and belong, as they should, to the land.—*Elisabeth K. Thompson*



1 ... a house on the meadow between the hedgerows

A house on the meadow at the Sea Ranch is a highly visible object, exposed to view from the hills and from the highway that separates meadow and hills. In such an open landscape, the size, form and color of a building are unusually important since they determine the degree of contrast between building and land.

The two buildings that make up this unpretentious weekend house are simple in form and color, and, in their straightforward use of rough-sawn stained wood, have the pleasant indigenous look of an old weathered barn. The smaller of the two buildings, now used as a studio-study and a garage, served as living quarters while the main building was under construction. The two principal requirements of the clients were simplicity and privacy for themselves and their three teenage children. Locating the bedrooms at either end of the big

room was a logical—though to the clients, unconventional—way of obtaining privacy, but the clients readily accepted it and found that it worked out well not only for the family but when the house is rented, as it often is, since two couples can occupy it and still have privacy. Guests are provided for in the main building; for an overflow number, window seats convert to bunks, and an aerie above one of the bedrooms can be used for sleeping. The big room, with a view to the ocean at one end and an open kitchen at the other, is the gathering place for everyone. With commendable understanding of the character of the place, the owners have allowed the indigenous wild grasses to grow up to the buildings.

RESIDENCE FOR GLEN NIMNICH, The Sea Ranch, California. Architect: *Fred L. Osmon*. Engineer: *Harold Davis* (structural). Contractor: *Rick Gladjo*.

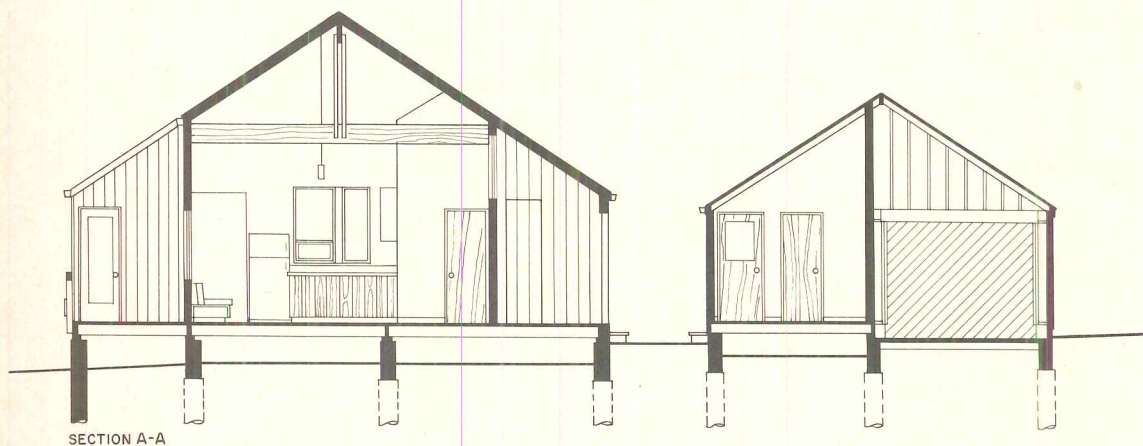
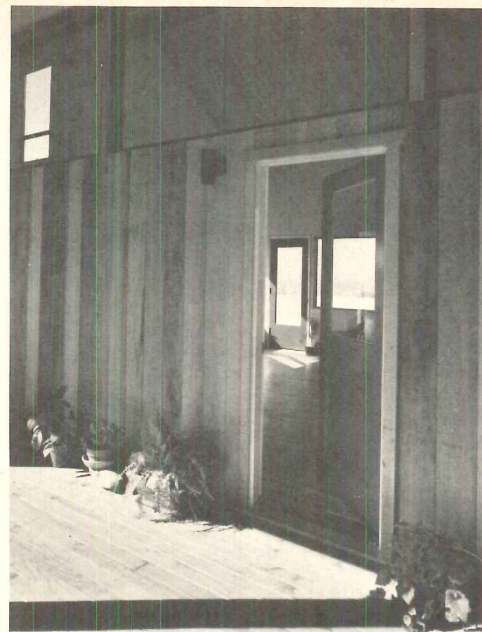

Merg Ross photos

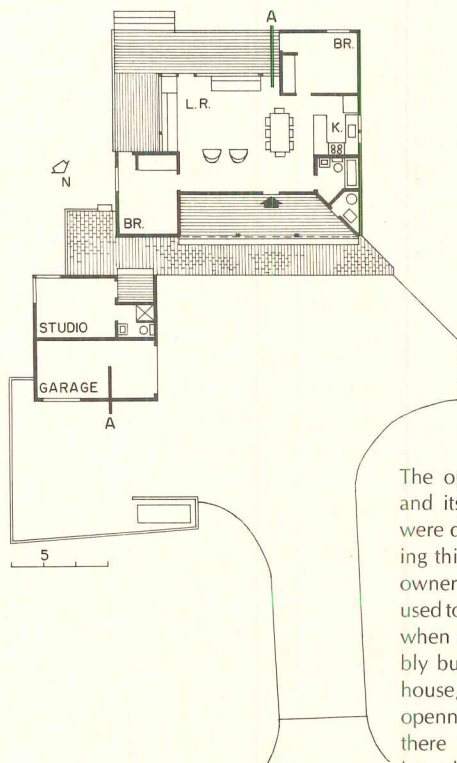

The openness of the meadow and its nearness to the ocean were deciding factors in selecting this site for the house. (The owner is from Wyoming, and used to great open spaces.) Even when other houses are inevitably built around and near this house, some of the feeling of openness will survive because there is no break—as would have happened with more formal landscaping—between house and land. The wide deck on two sides of the big room is directly accessible from both bedrooms as well as from the living room. The high ceiling over the big room is wood sheathed; dry wall is used for interior partitions.



2 . . . a house under the trees in the hillside forest

On the hills at Sea Ranch, most house sites are out of view among trees and bushes, although some—on the slope of the hill facing the ocean—are in plain view of the meadow. Up on the hill, however, sites tend to be shady, with sunlight filtered through the trees, so that daylight in the houses must be designed for. Since houses on the hill are so little exposed to general view—in contrast to those on the meadow—forms are often more complex. The overriding character is, nevertheless, simple. The owners of this house, a retired couple, had lived for several years at the Sea Ranch in one of the “Binker Barns” designed by William Turnbull and Charles Moore (RECORD HOUSES of 1973, pages 74-5), and had learned to know and appreciate the exceptional quality of the original Sea Ranch buildings and to want the same quality in their new

house. The house is simple and unpretentious, reminiscent of the Sea Ranch vernacular but individual in its handling of details and forms. The sloping site allowed for placement of garage, shop and storage under the main house with a minimum disturbance of grade. This gives living areas just enough elevation to afford some view of Black Point and the ocean and, through the trees, of a meadow on the south. Guest rooms are separate from the main house in a compact and appropriately simple unit on the same level as the house. The main living space is open and light, with large windows on two sides and additional light from a monitor window above. The main living space is open and light, with large windows on two sides and additional light from a monitor window above.

RESIDENCE FOR MR. AND MRS. HENRY O. WHITESIDE, The Sea Ranch, California. Architect: Donald Jacobs. Contractor: Custom Builders, Inc.

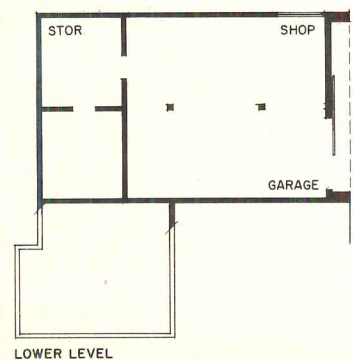
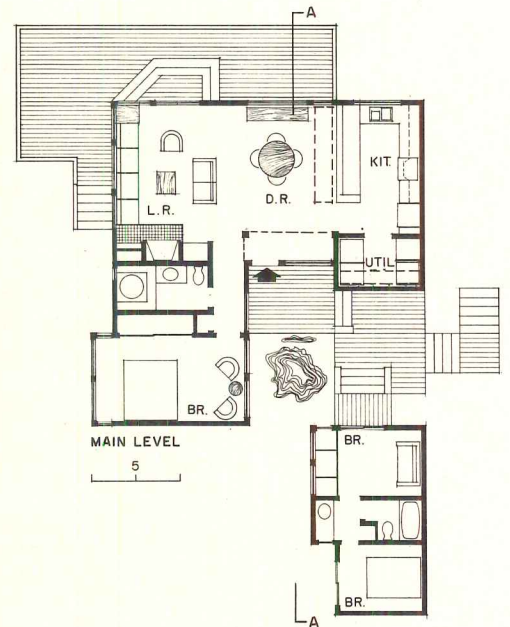
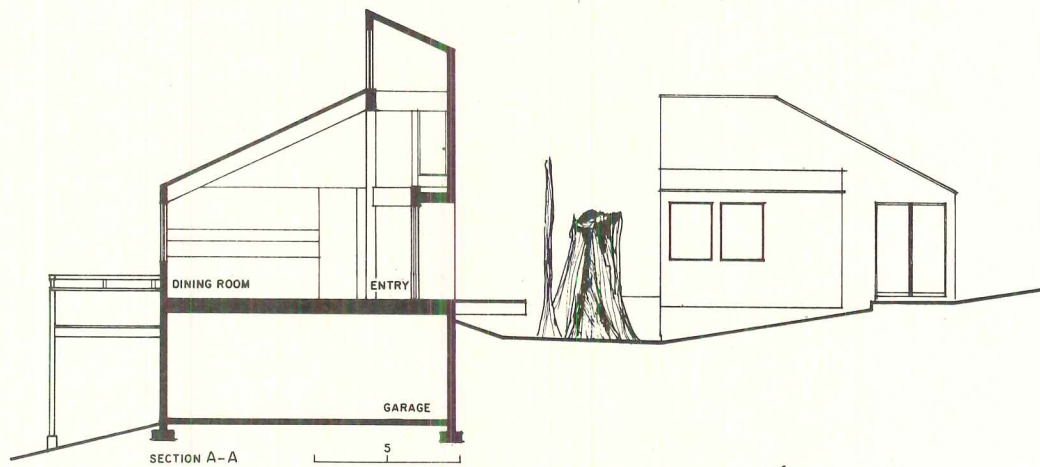
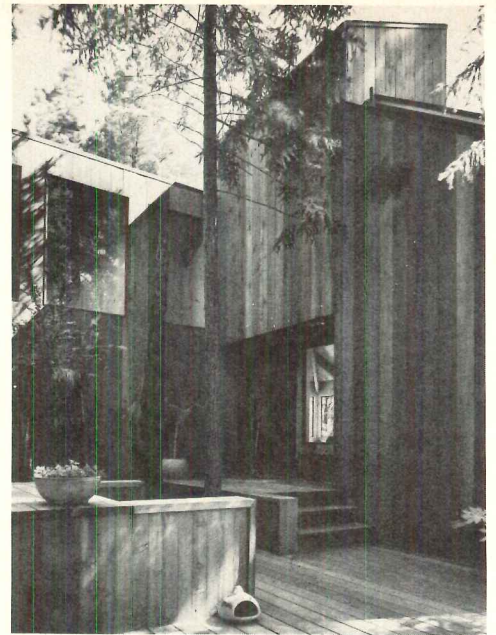

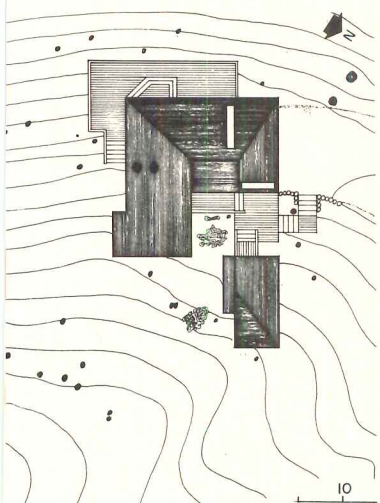

The sculptural forms of the charred remains of old tree stumps, retained and incorporated into the design, are a feature of the entrance to the house. Logs of various lengths, set vertically beside steps from driveway to entrance, further emphasize the woody character of the place. Very few living trees were removed to make way for the house, so during most of the day, sunlight reaches the house through the trees. To bring in as much daylight as possible to entry and dining area, a kind of "light tower" was placed over the entry (across page, top and bottom). Light from its high monitor window (see section) bounces against the opposite wall and ricochets across to dining area.

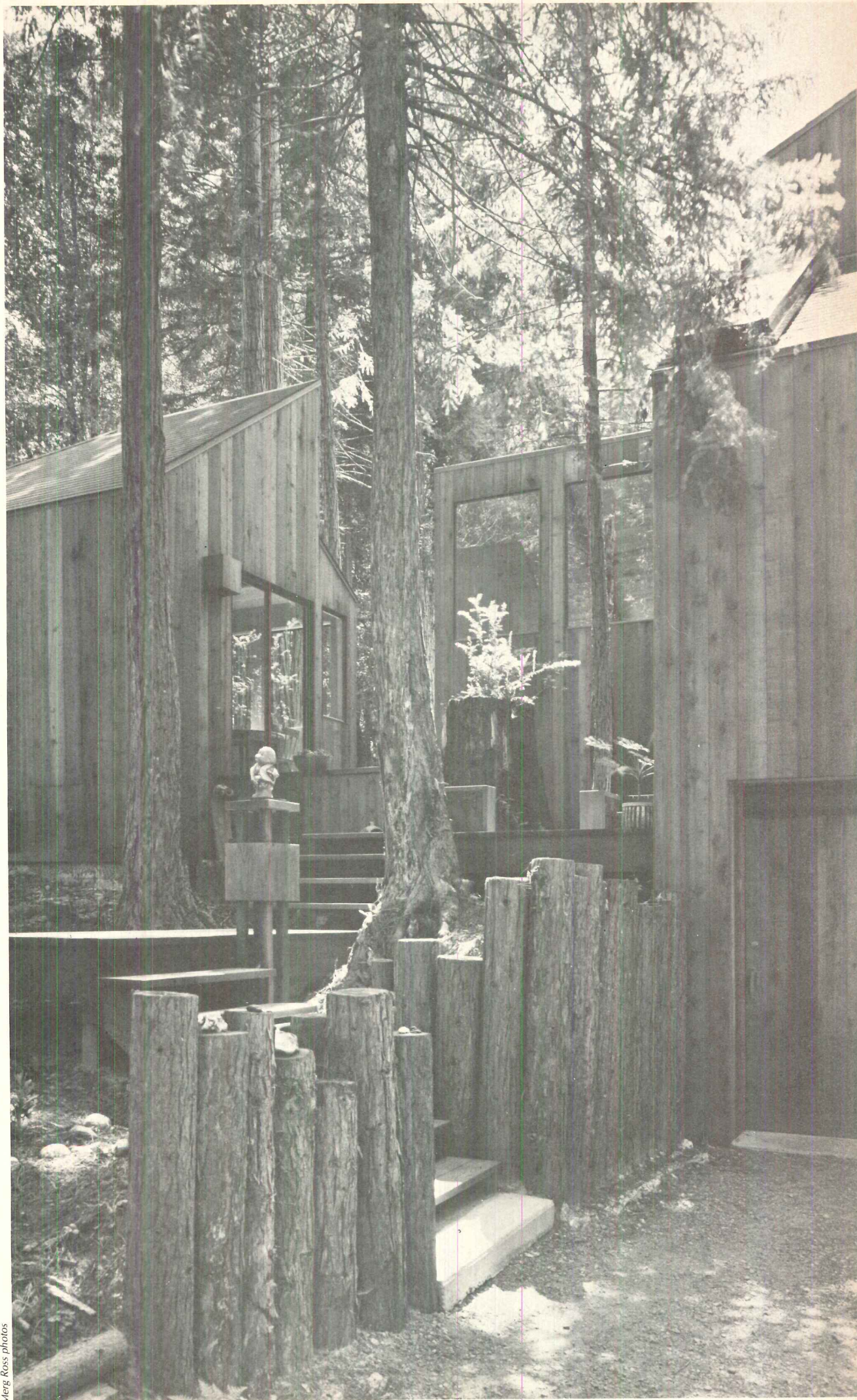

Merg Ross photos

According to Douglass, omniconers will be built in the suburbs as well as in the central business districts and will appear most frequently in cities with populations of 100 thousand to 1 million. He cites as the principal reasons for their emergence, the scarcity and high cost of suitable land, and the need for shopping centers to be more competitive in terms of the range of facilities and merchandise offered. The United States now has more than 14,000 shopping centers and the average consumer (back when he had gas and thanks to our well-developed highway system) had a choice of several which were convenient to his home. Now he must be more selective as the centers become more competitive. Douglass believes that only the small neighborhood centers (similar to Meadow Mall in Simsbury, Connecticut included in this study on pages 150-151) which are essentially supermarkets, will continue to survive.

He makes a strong economic and social case for the downtown omniconer. He points out that these centers, if successful, as he believes they will be, provide employment and increase the tax base. The suburban omniconer promises less obvious long-range benefits which are equally interesting. Because of stronger community resistance to shopping centers by citizens who now know what the word "ecology" means, and tougher Federal environmental regulations, the medium-sized center has become more and more difficult to build. The number of undertakings will diminish and land will be available for other uses. The suburban omniconer has the advantage of using valuable land intensively. Its concentration of activities should encourage the development of public transportation in suburban and regional areas.

Douglass' predictions of financial success for the downtown shopping mall within an omniconer are supported by current reports from Broadway Plaza designed by Charles Luckman Associates for the Ogden Development Corporation.

The omniconer can be a financial success right from the start

Except for the fact that architect Charles Luckman calls Broadway Plaza a megastructure rather than an omniconer, as a new building type it fits the general category defined by Lathrop Douglass. Its astonishing success should help bring about Douglass' long-range forecasts. According to Charles Luckman Associates, the original predictions for the volume of pedestrian traffic and retail sales made three years ago for Broadway Plaza have turned out to be a gross underestimation. In April 1971, Economic Research Associates estimated that an average of 18,000 persons would pour through Broadway Plaza daily. The actual average has been 40,000 persons, and this is with the office building less than one-third occupied.

Over 4,500 cars enter the Broadway Plaza

A department store and shopping center bring round-the-clock life to Broadway Plaza, in Los Angeles



Broadway Plaza in downtown Los Angeles is the nation's first urban center to integrate a hotel, office and retail concourse in one self-contained megastructure. The 4.5-acre, \$85 million project, planned and designed by Charles Luckman Associates, is a joint venture of Ogden Development Corporation, Broadway-Hale Stores, Inc. and Urban Center Associates. Already a commercial success, it helps point the way toward the revitalization of the nation's central cities.

Broadway Plaza, in addition to its 250,000-square-foot department store (the first major department store to be built in downtown Los Angeles in 50 years), and its skylighted two-level gallery lined with specialty shops and restaurants, includes the 23-story, 500-room Hyatt Regency (the first new luxury hotel to be built in downtown Los Angeles in 20 years); "700" Flower, a 32-story, 773,000-square-foot office building; and a 2,000-car parking facility with six levels above the Broadway department store and two levels beneath the entire complex.

Designed to be a dramatic invitation to the inhabitants of "sprawl city" to stop driving all over the place and return downtown to enjoy the best of urban life, Broadway Plaza is already experiencing unprecedented public response. There are high occupancy rates in the new hotel and the department store and shops are thriving.

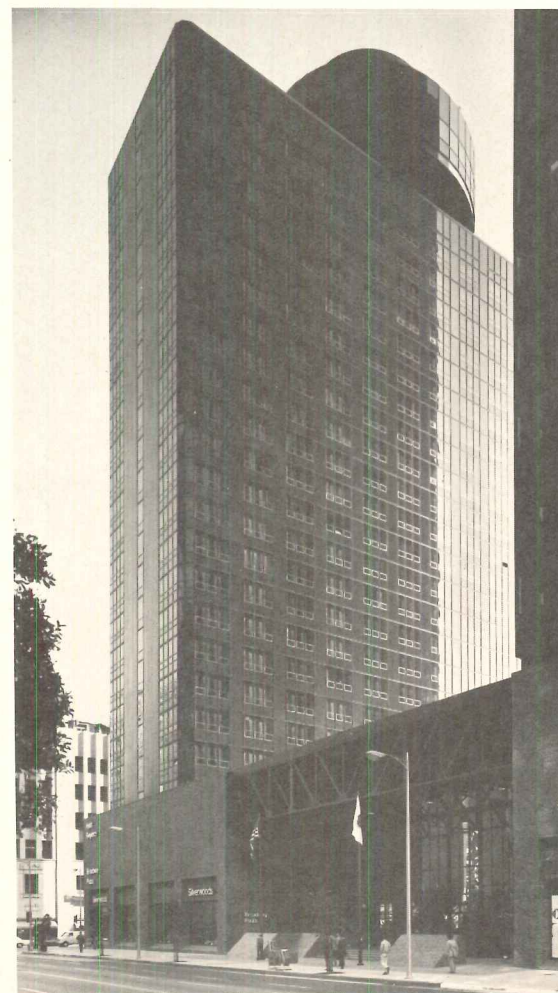

Halthazar Korab photos



As the site plan (left) indicates, the megastructure comprises an entire city block. Shown above is the principal entrance to the 50-foot-high two-level mall, which also appears in the photo of the hotel (opposite page bottom). The entire complex, including the office tower, can be seen in the bird's-eye photo (opposite page top). As the section (below) indicates the complex has four interconnected levels: "A" and "B"—the two lower levels—house the hotel meeting and banquet facilities, the employee facilities, subterranean parking, loading and storage areas and the central mechanical plant. The garden and plaza levels interconnect the mall, department store, office tower and hotel.

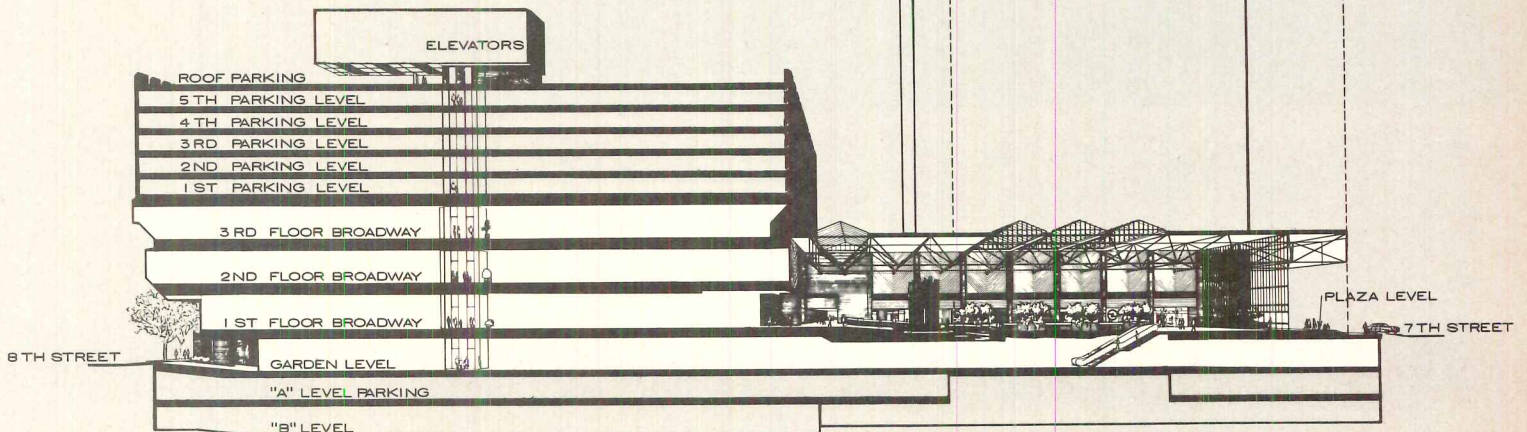
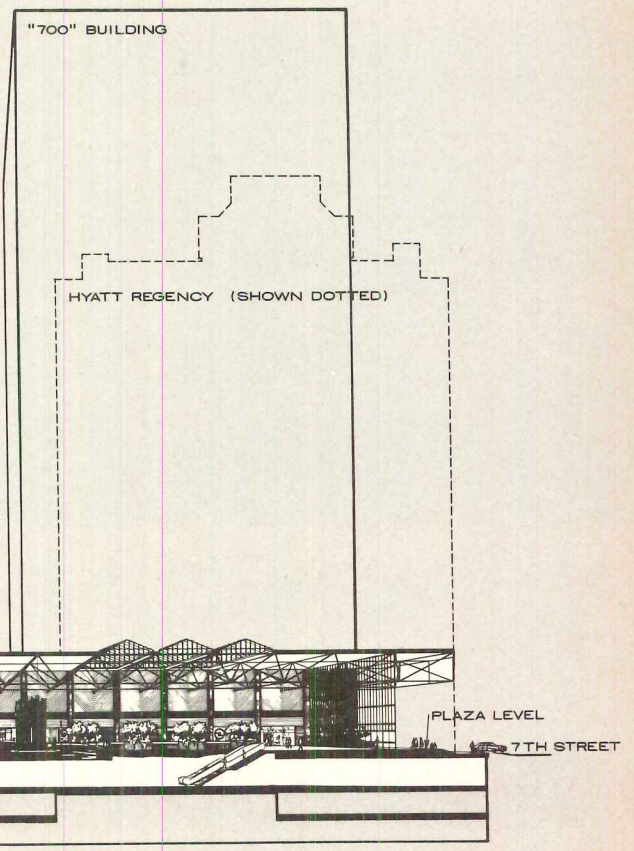
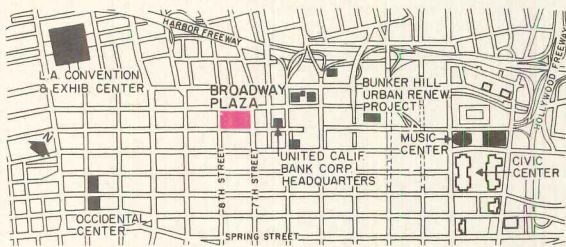



The skylight galleria roof is supported by visible trusses. Escalators and stairways lead from the plaza level of the galleria down to the garden level which opens onto the lobby of the Hyatt Regency (below left). According to architect Luckman: "Everything about the project was designed to provide an open, warm, inviting place for people. Extensive use of brick and wood throughout the two-level galleria, interior trees and flowering plants, benches, the fountain, the wide open store fronts, the flow of each element into the others—all were instigated by a desire to make this a hospitable place that says 'please come in and stay awhile.'" Daylight penetrates to the garden level and pool through the broad and spacious stairwell.

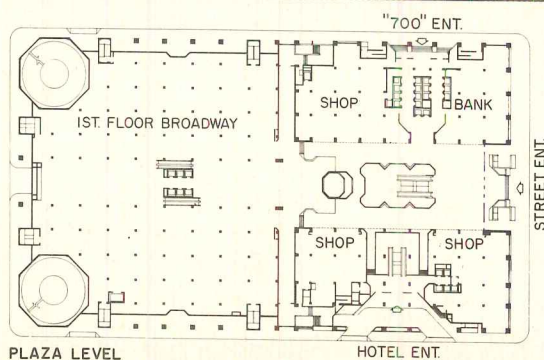
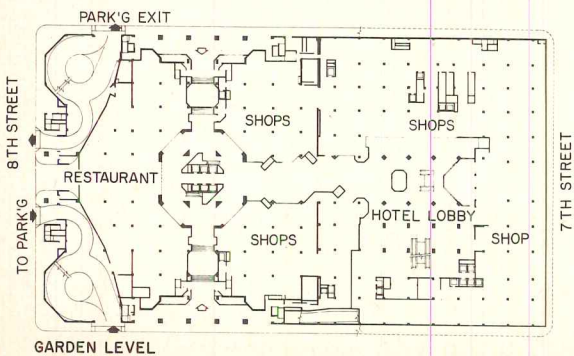
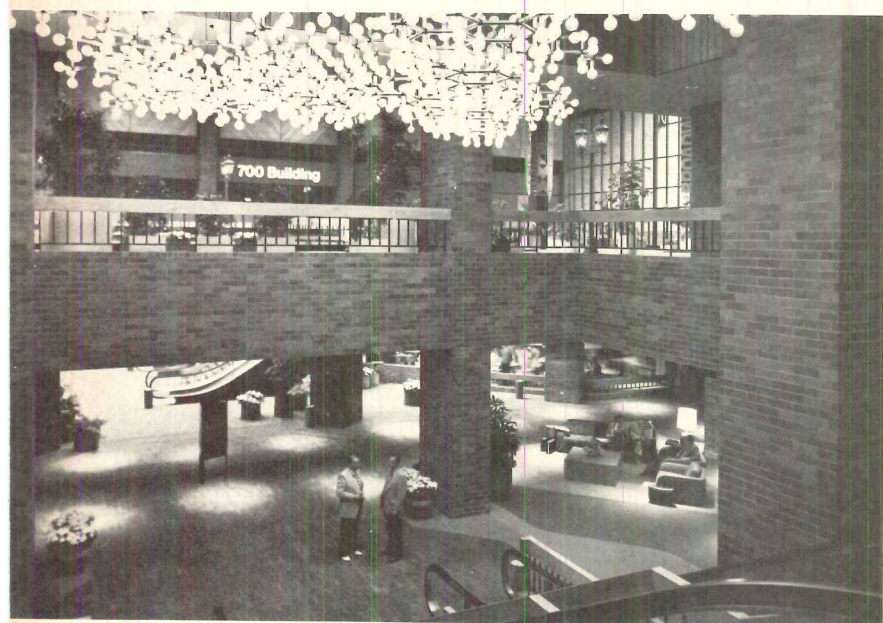



parking structure daily and more than 50 per cent of this traffic comes from outlying suburban communities, including San Gabriel Valley, San Fernando Valley, Palos Verdes and West Los Angeles. The department store's sales in December 1973 were 212 per cent over projections. Sunday traffic brings an average of 31,000 persons to Broadway Plaza and as a result the department store is open for business every Sunday as are most of the other shops in the retail concourse. The owners believe the gasoline shortage is boosting downtown trade, due to the availability of bus transportation to and within the central city. In addition, Broadway Plaza merchants are profiting from the new Sunday bus fares which permit passengers to go anywhere in Los Angeles for a single 10 cents fare. All of the retail tenants report business volumes far in excess of projections and complain that their most serious problem is keeping enough stock on their shelves.

Since opening, the Regency Hyatt Hotel has exceeded projections in all areas of operation—greater percentage of rooms occupied (56.9 per cent since opening last August with many days of more than 90 per cent), higher room rates (average rate of \$30.25), and food and beverage sales (total from August to November of nearly \$1 million). The total dollar volume for the hotel during the month of November was \$747,000, of which \$457,000 was derived from food and beverage sales. Previous projections did not anticipate achieving \$400,000 in food and beverage sales until the end of 1974.

Lunch business is booming. The lines are already too long from the customer's standpoint averaging 300 to 400 feet in length outside the more popular restaurants. Approximately 5,000 lunches are served on an average day throughout the complex.

Based upon its high volume of business, Hyatt has requested the owners to study and consider the addition of a third major restaurant and lounge area. The hotel banquet and catering services are also experiencing a far greater volume than had been anticipated. Preliminary "lost business" studies (banquet and meeting rooms all booked) indicate additional meeting and banquet space will be requested. Hyatt is projecting 80-85 per cent occupancy and has heavy convention bookings through June 1975.

The owners and their architects believe that Broadway Plaza's success already is having a dramatic effect on downtown Los Angeles and will probably influence the future of other downtowns as well. The Plaza is making it evident to retailers that there is a downtown market in Los Angeles larger than most believed until now. It has been forcefully demonstrated that the increased rents which must be paid in a downtown complex are offset by greater sales volumes. Broadway Plaza proves that if a developer spends the money to create a public space downtown where people want to be, and if the architects and planners make

the place attractive, people will come and spend their time and money.

Can a shopping center significantly improve the quality of urban life?

In the general spirit of euphoria which these centers arouse, there is a tendency to overstate their importance in revitalizing cities as places to be. Although their economic and social value is obvious, in physical terms they tend to be self-sufficient and self-serving enclaves. This is the fault of the urban context in which they are built rather than a failure on the part of their architects, or a lack of vision on the part of their developers. The downtown shopping center within a megastructure or omnicenter is potentially a strong shaping force and a major urban design element. Since none of the other downtown shopping malls shown in this study are located within an urban design framework comparable to Philadelphia's Market Street East (pages 146-149), the latter will be discussed separately. Broadway Plaza can be reached only by private motor car, taxi or bus. As its site plan (page 139) indicates, apart from sidewalks, there are no nearby pedestrian networks which link up with the shopping mall, nor does Broadway Plaza reinforce or extend an existing urban design structure of pedestrian ways and civic spaces. Few would seem to walk for the pleasure of it in downtown Los Angeles and Broadway Plaza, shaped by circumstance into a self-contained entity, doesn't improve the world of the pedestrian until he gets inside. It is essentially an island of inward turned amenities bearing no relationship except proximity by motor car to other developments in the area.

Like Broadway Plaza, Baystate West in Springfield, Massachusetts is also far less vital than it could be as a result of having been constructed without the benefits conferred by a well-conceived urban infrastructure imposed by the city to shape future development. Architects Catalano and Belluschi made the best of it, however, designing overhead bridges to connect the new mall with existing older department stores, and permitting the element containing the second level of shops to overhang the sidewalks, thus devising the semblance of a shaded pedestrian arcade. They created sunken gardens and other amenities, but the constraints were such that they could not bring daylight into the shopping mall. The latter consists entirely of artificially illuminated underground plazas and interconnecting shopping corridors.

The L-shaped shopping center at Crown Center (pages 144-145) serves as a multi-level pedestrian link, one leg of which spans a traffic artery to interconnect the office complex, the hotel and the Hallmark Card Inc. administration and production facility (RECORD, October 1973). Its architectural interest derives from the wit, style and playfulness with which such architects and designers as Francois Dallegret, Joseph Baker and Paul Laszlo have pro-

A shopping mall within an urban complex in Springfield, Massachusetts is the first step toward a two-level city

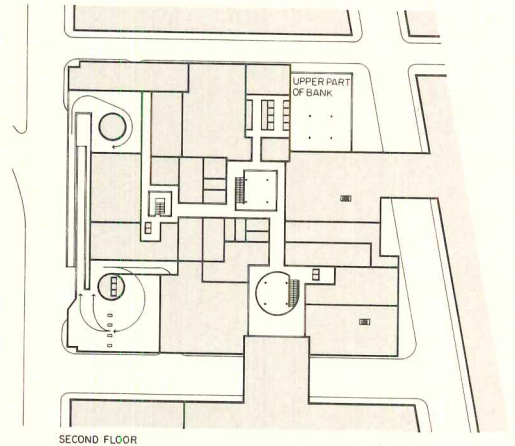
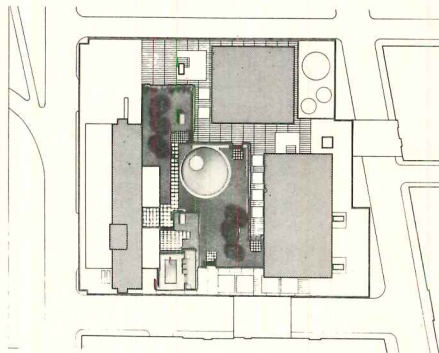

SECOND FLOOR

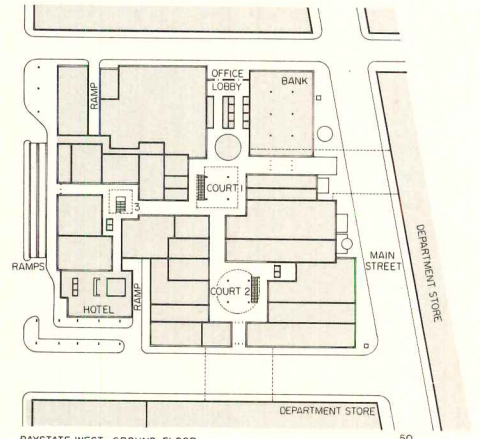

BAYSTATE WEST - GROUND FLOOR

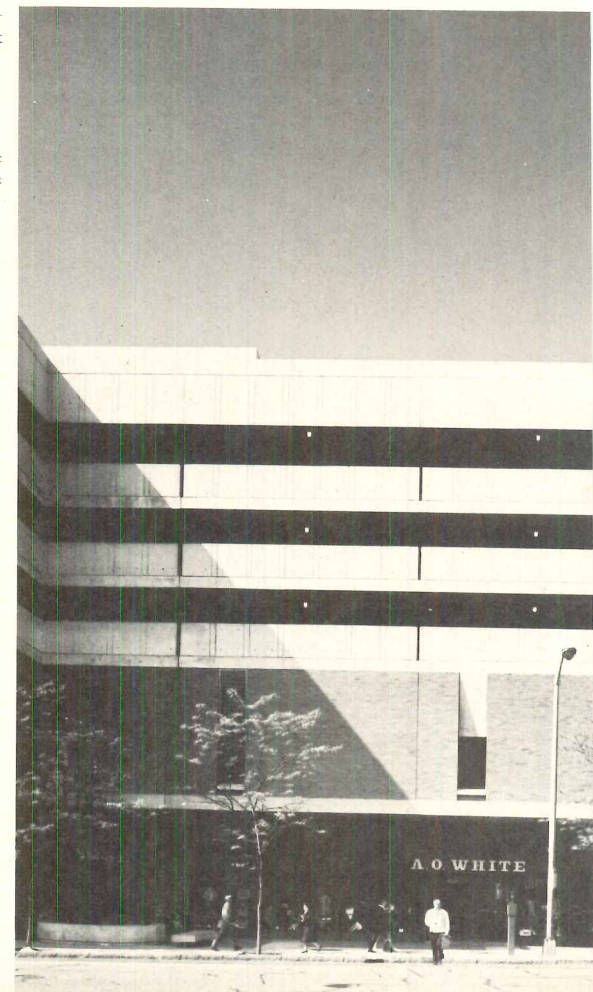



Baystate West was designed by Edward Catalano with Pietro Belluschi as consultant in association with Crawley Cooper, Paul Shimamoto, Fred Taylor and Peter Sugar. It includes a two-level shopping mall and parking for 1,200 cars within an urban complex which includes a 270-room hotel, a 30-story office building, sunken gardens, paved areas, a swimming pool, fountain and a private club pavilion. The complex is joined by two enclosed bridges to two older department stores.

The shopping mall itself is formed by three artificially lit interior courts interconnected by short and narrow streets. The two larger plazas contain escalators which join up with the bridges to the older stores. The interior court (above) is square and uses mirrors as reflective surfaces. The 10-foot-square cube, proposed and designed by architect William Wainwright who served as a consultant to Catalano and Belluschi, is made of reflective acrylic plastic. It slowly rotates reflecting the dynamics of the spaces which surround it (see cover).

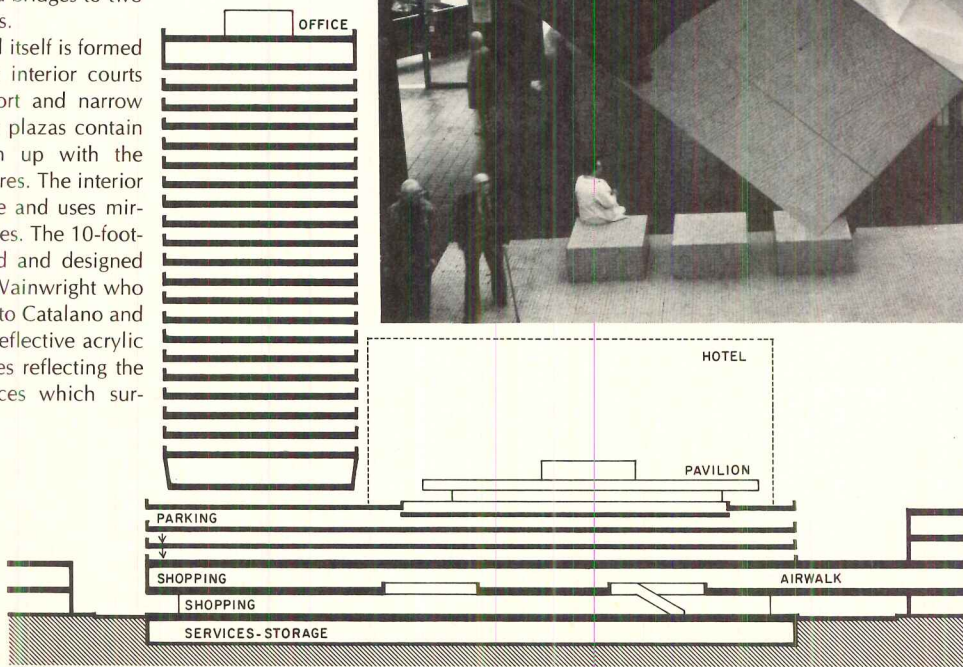
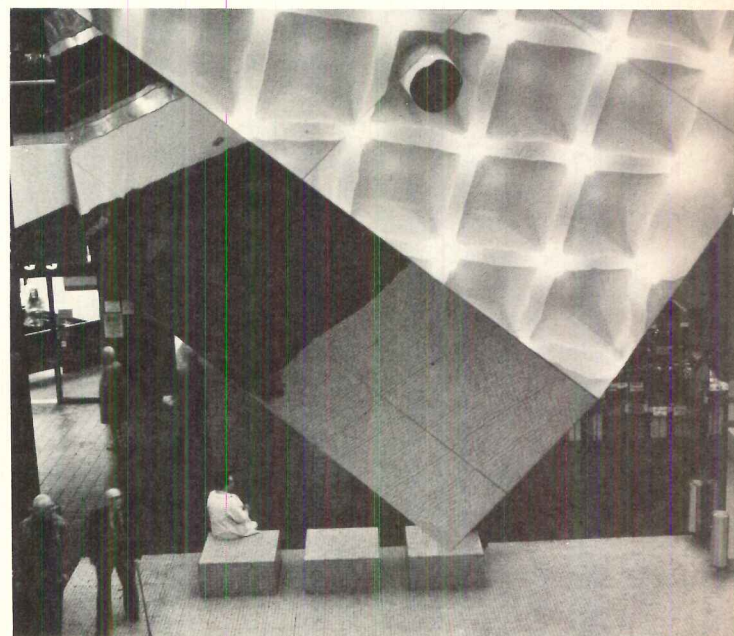

BAYSTATE WEST - SECTION

vided for the organization and display of a great variety of merchandise, and the freshness with which Harper & George have revived the idea of a farmers' market and designed a restaurant, rather than in the development of urban design concepts per se. Crown Center as a whole is a satellite rather than an integral part of downtown Kansas City and functions as a rival center in a Kansas City grey area rather than as a reinforcement of the downtown core. Its links with downtown are by automobile and bus only.

All three of the shopping malls just referred to and described in this study represent a high degree of commitment on the part of their developers to the idea that money can still be made in downtown retail. The spatial and functional complexity of all three required a high degree of programming and design skill on the part of their architects. No one of them, however, had the advantage of being designed within a long-range urban design framework of the kind which the Philadelphia Planning Commission has been developing since the end of World War II and of which Market Street East is a key element.

No one of them is part of a network of parks and squares linked by bicycle and pedestrian greenways to museums, landmarks and other places of historic interest. None is directly accessible by interurban train or subway. For these reasons, there are limits to the degree to which any one of them can truly revitalize the downtown areas of which they are a part. Shops, cinemas and restaurants opening off air-conditioned skylit malls which are linked up to parking garages fed by multi-lane expressways and crowned by towers a gleam in the sun do not a city make—public relations claims to the contrary. People need a broader choice of leisure time activities than these highly sophisticated omniconcenters offer. A person with a few hours off should be able to do more than shop and eat in a downtown mall. The shopping mall, although an essential element in a lively vibrant urban scene, must become part of a larger and more accommodating public environment. After 14 years of struggle by enlightened architects, planners and public officials, just such a mall is about to get underway—at Market Street East in the heart of Philadelphia.

The spine of Market Street East was established by William Penn

In 1683 when Penn laid out Philadelphia between the Delaware and the Schuylkill Rivers, he began with two intersecting axes—Broad Street running north and south and Market Street running east and west. At their intersection he placed a square, which was later to become the site for City Hall, and he placed four other squares in each of the quadrants formed by the intersecting axes.

This basic configuration, as Edmund N. Bacon, former executive director of the Philadelphia City Planning Commission, was one of

Crown Center adds the first retail component to serve its hotel-office-apartment complex in Kansas City

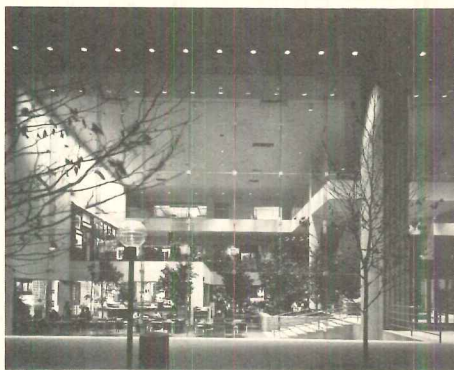

A large specialty store which does not departmentalize its merchandise but groups it by "mood or lifestyle" (opposite page, bottom left) a shopping village (right), a modern-day farmers' market (below) and a restaurant with seven cuisines (left) are the major elements in the new retail complex built by Hallmark Cards, Inc. for Crown Center.

The retail complex is an L-shaped, three-level structure with 400,000 square feet of space designed by Edward Larrabee Barnes who also serves as master planner of Crown Center. The interior of Halls, the large specialty store, was designed by Paul Laszlo Associates. The portion of the retail complex known as West Village (right) was designed by Francois Dalle-gret and Joseph Baker. It consists of cubical boutiques made of steel, plywood and glass arranged on two levels within a 32-foot high, two-story shell in which piping and ductwork is exposed. The farmers' market, called the "The Market Place," covers 18,000 square feet and includes, in addition to the market stalls, a variety of special stores. Harper & George designed the restaurant and the market.

The Crown Center retail complex also includes 44 independent retail outlets. Among these is a general store (opposite page, bottom right).



the first to point out, is the fundamental design idea which has influenced the subsequent growth of the city.

As far back as 1947 it was apparent to Bacon that a commercial link combining shops, office buildings and hotels, needed to be created between City Hall and a group of three department stores—Gimbel's, Lit's and Strawbridge & Clothiers—five blocks to the east between 7th and 9th Streets on Market Street. Between City Hall and the stores was a five-block strip of urban blight interrupted on the south side of Market Street by John Wanamaker's, the famous PSFS building and Snel-lenburg's and on the north by the Reading Railroad station.

By 1960, Penn Center, the linear multi-level development to the west of City Hall was virtually complete and it was time to think of the spine to the east. The first scheme was devised by Willo von Moltke who was then on the staff of the planning commission. He called for a linear three-story retail element. The lowest level was to be one story below the street and approximately one story above the platform level of the subway running under and in the same direction as Market Street and the commuter train tracks parallel to Market Street to the north. It was to serve as a commuter concourse for both the trains and subway. At various points along the spine this lower level would be open to the sky, at others it would be covered by medium-rise commercial buildings. The two upper levels were also to have shops and there were to be six levels of parking above that. Off-street truck loading was to come in at the second level and a bus station was planned for the third.

This scheme was soon abandoned when economic analysis established that the three levels of retail activity provided more linear feet of shop frontage than the area could support and the interweaving of the public infrastructure—pedestrian concourses and bus, truck, train and subway access—with retail and office space which would be paid for by the private sector made it too difficult to sort out the financing.

In 1963 Romaldo Giurgola was invited by the city to study the problem. He first proposed that a single, air-conditioned, glass-roofed, shop-lined pedestrian spine be constructed one level above the street, bridging the cross streets. This esplanade would interconnect by means of escalators the subway, bus station and parking. Access to the medium-rise structures was to have been at street level. This scheme failed because the department store executives accustomed to certain tried and true merchandising techniques, did not want their stores to be entered at the second story.

In 1964, Giurgola tried again. This time he put the mall level back to one story below the street. The north-south streets became bridges and a six-story air-conditioned mall was created, lit by a great diagonal skylight. Skidmore, Owings & Merrill were then engaged by the

Philadelphia's Market Street East Transportation Mall Center, conceived in the 1960's and long on the shelf, will soon commence construction, in block by block increments

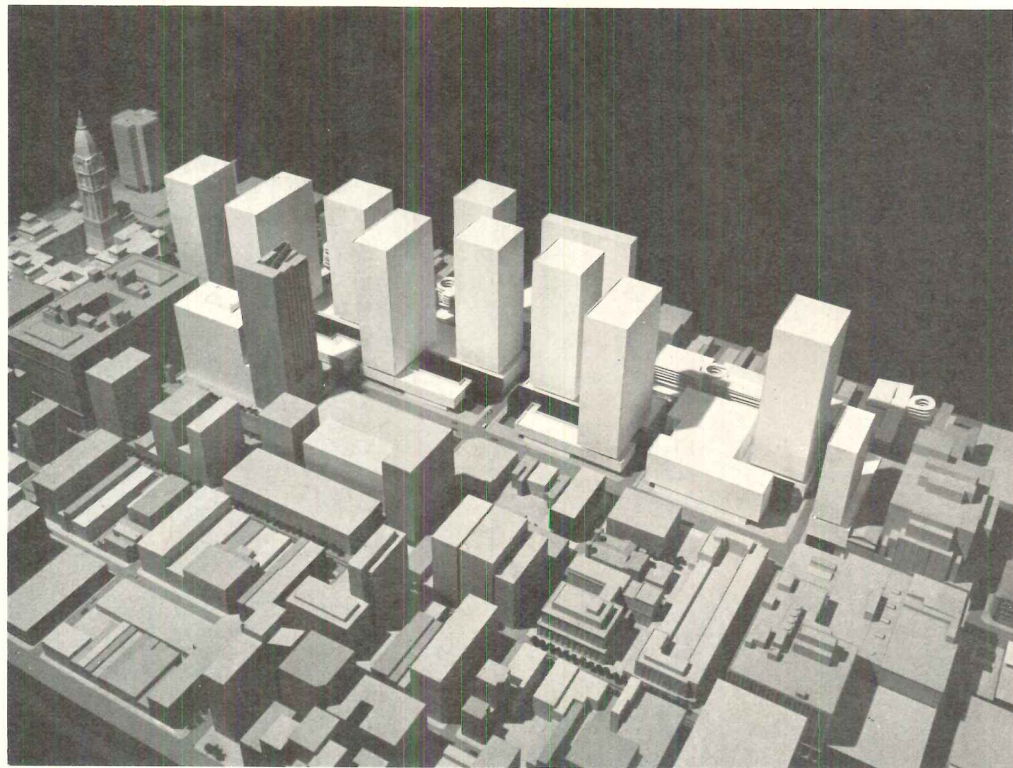

The development of Market Street East, covering a seven-block area extending from City Hall almost to Independence Mall, has been a long-range goal of the Philadelphia City Planning Commission and has been under study for many years. Its current form is the work of Bower and Fradley, building on concepts developed by Willo von Moltke, Romaldo Giurgola and Skidmore, Owings and Merrill successively. The shopping mall will be part of what Bower and Fradley describe as "a unique urban mini-city containing most of the major uses found in a city core. The goals of the project are to reverse the decline in downtown retail activities; to help the center city capture a major share of the anticipated office demand through 1983; to complete the interface of Philadelphia's potentially superb transit system; and to create a humane pedestrian environment for business, shopping, working and entertainment."

Market Street East is to be built on a transportation hub which includes commuter railroads, a high-speed inter-city rail line, subways, buses, streetcars and the automobile. This network will be tied together by a three-level pedestrian walkway system through an air-conditioned skylit shopping mall. The base formed by the mall and commercial space will be surmounted with a major air rights development of office and hotel space.



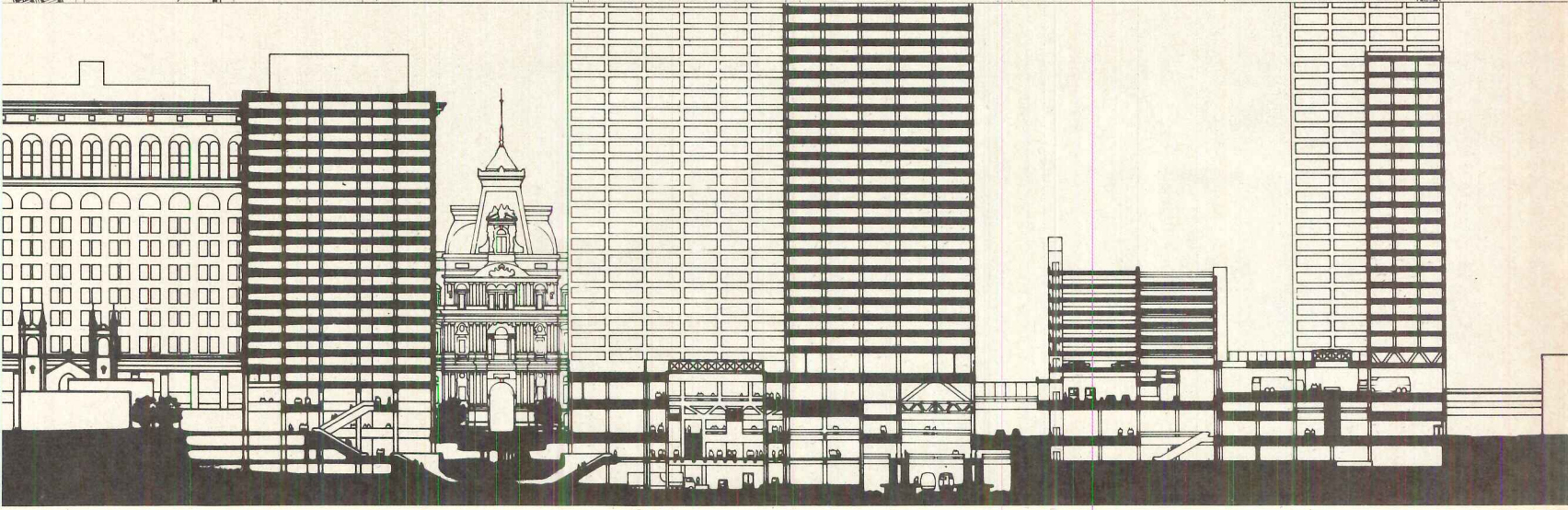
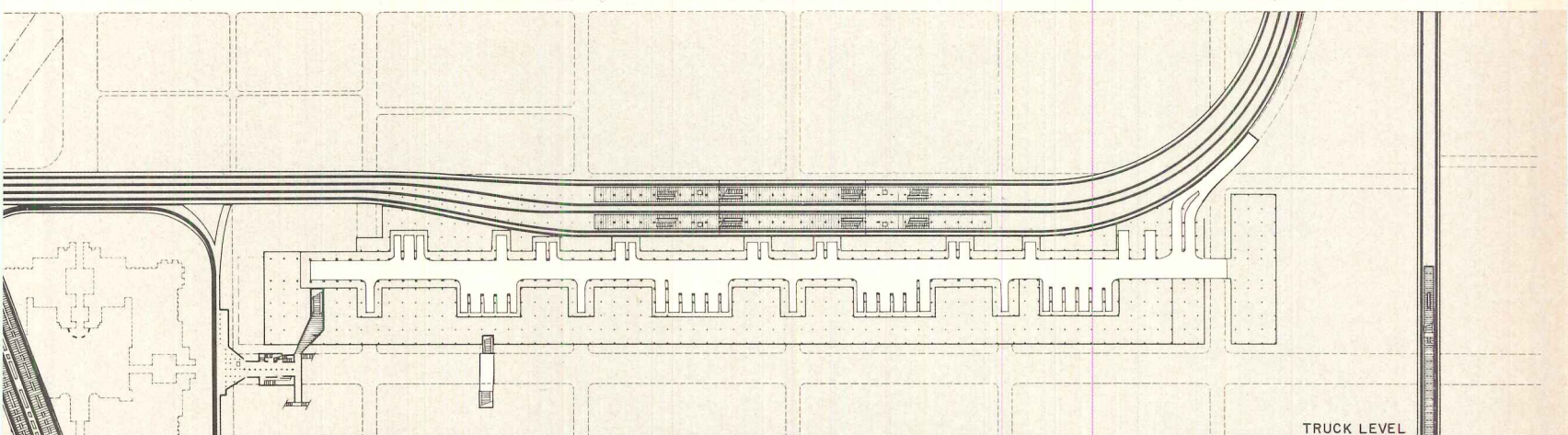
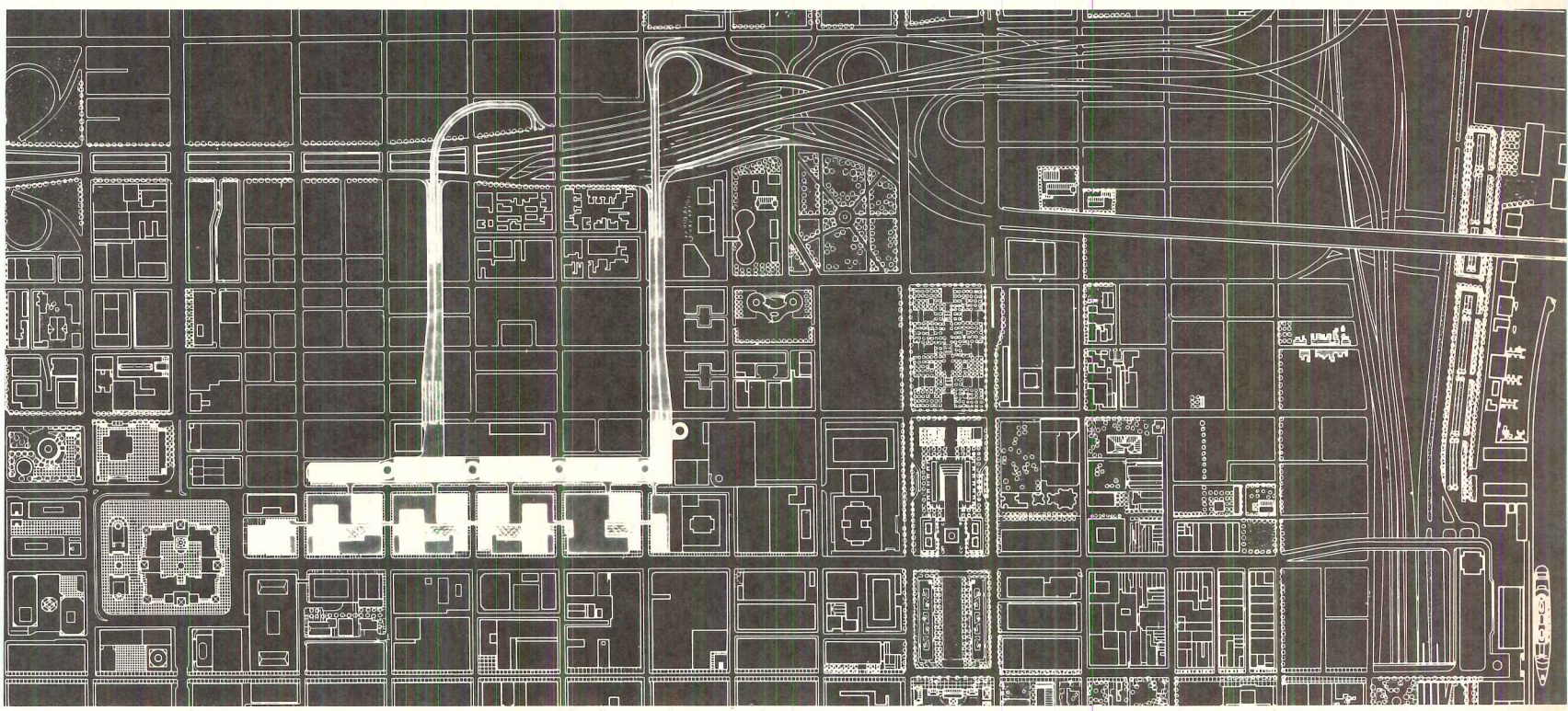
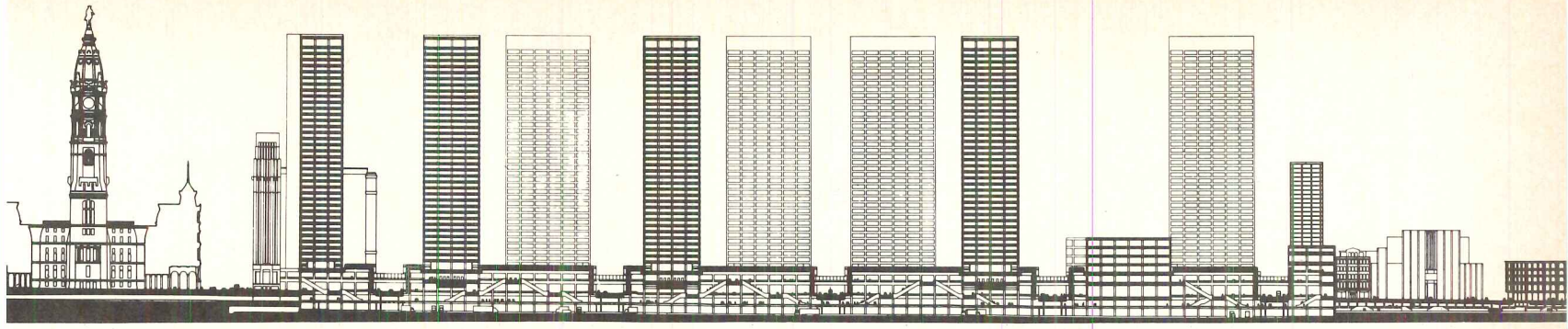



The mall level and the street level of the three-level pedestrian mall (both shown below) will be lined with shops. The office-level lobby (not shown) is not part of the shopping mall since the number of elevators it will require to serve the projected 10 million square feet of office spaces above will utilize all of the lobby areas not required for horizontal circulation. The mall, or "people street" as Edmund Bacon calls it, will be built independently of the shops which will align it and will be principally funded by HUD monies, with a commitment of funds by the city. The retail space as well as the offices and the two hotels above will be built incrementally by private developers. The work of Bower and Fradley, who have been appointed by the Redevelopment Authority as coordinating architects for Market Street East, has been limited to the design of the pedestrian mall.

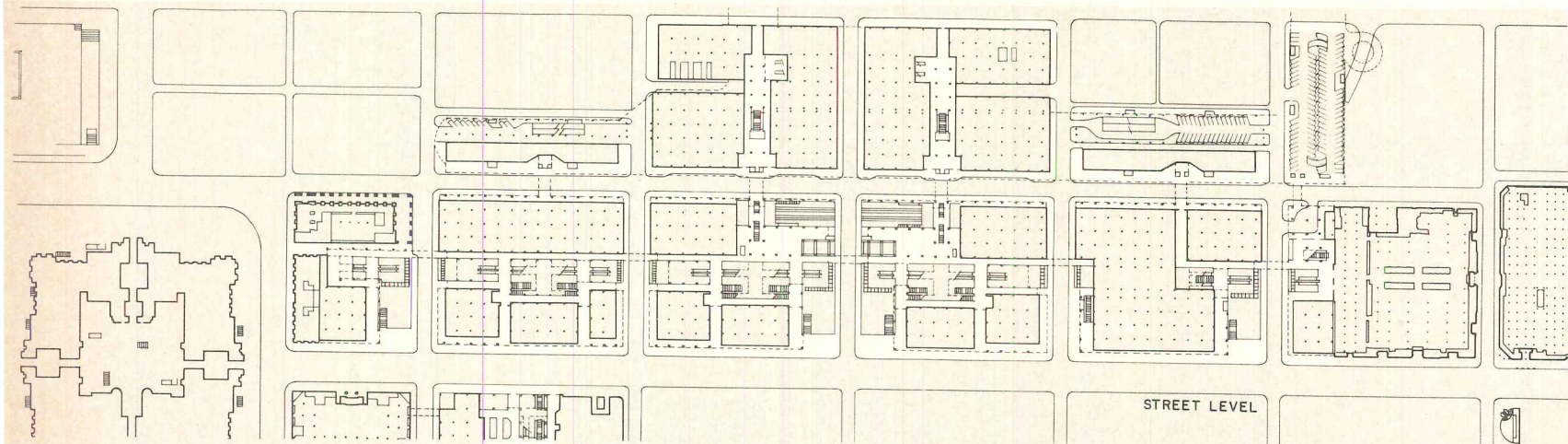
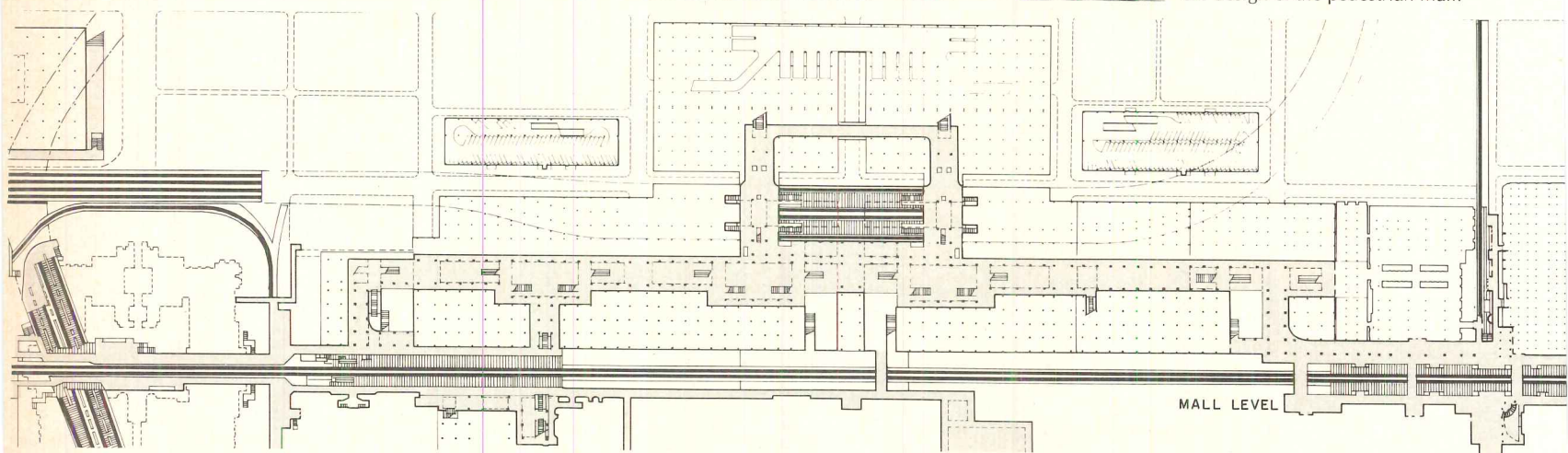

A catalyst for carrying the mall design to the completed working drawing stage for the first two blocks has been the construction of a new building—1234 Market Street, designed by Bower and Fradley—between the landmark PSFS building and the John Wanamaker Department Store, connecting them both below and above the street. Here the three-level concept of Market East was successfully carried through. The strongest impetus, however, has been the decision of Gimbels to build a new department store on an adjacent block within Market Street East. The first phase of construction will be for the two blocks between 8th and 10th Streets.

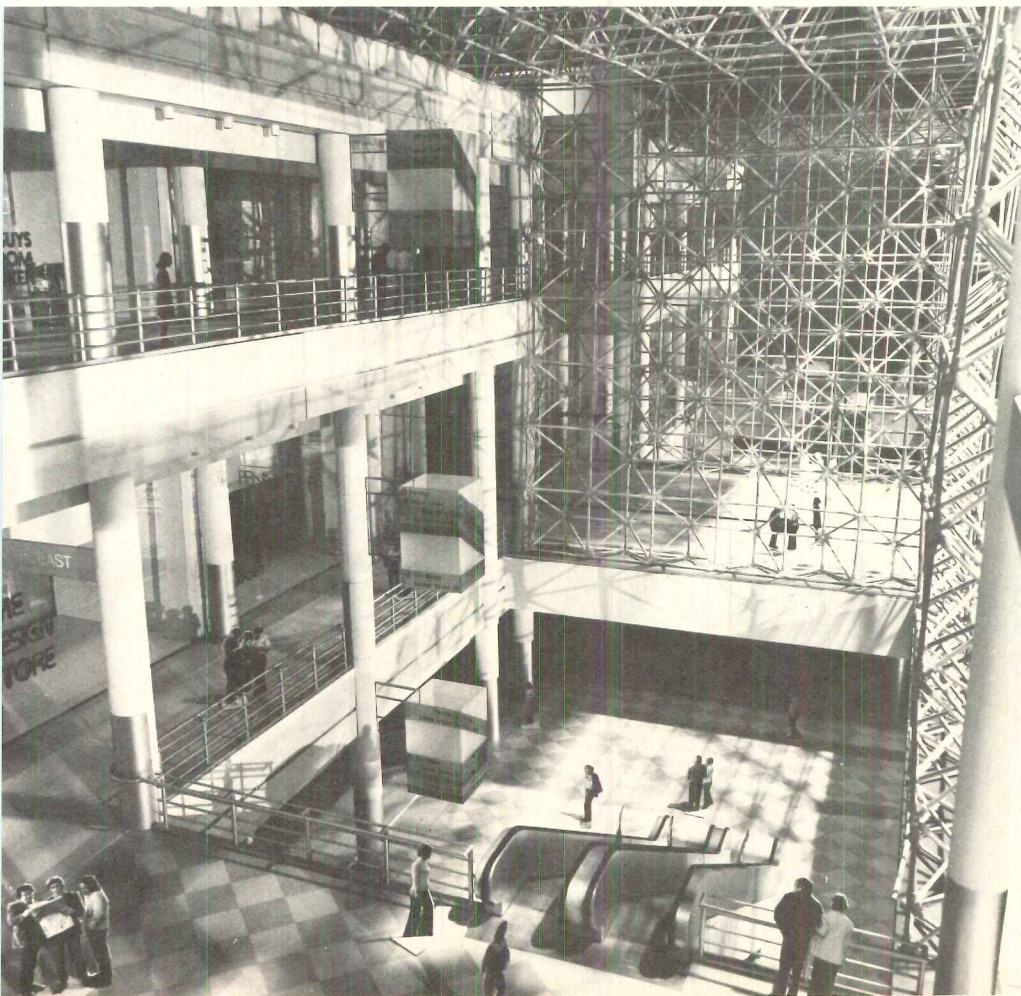

Philadelphia Redevelopment Authority to further clarify the idea.

Since government funds were unavailable to construct the public infrastructure, interest on the part of private developers lagged. Market Street East lay dormant until 1969 when a new structure to be called 1234 Market Street was designed to be constructed south of Market Street between John Wanamaker's and the PSFS building near City Hall. The work of Bower and Fradley and now nearing completion, it puts in place the first increment of the Market Street spine. Although it is not a part of the projected spine itself which will be to the north on the opposite side of Market Street, the new building establishes a three-story mall with a main level one story below the street. An underpass below the Market Street subway has been constructed to link the new building with Market Street East and a bridge spanning 13th Street links it with Wanamaker's. In the process of designing 1234 Market Street, Bower and Fradley strongly reinforced the Market Street East concept and literally brought it back to life. The Redevelopment Authority rewarded them by naming them coordinating architects to continue the work and bring the Market Street East design up-to-date.

Market Street East as now projected is bigger and more complex

Bower and Fradley began work on a project of much greater magnitude than originally conceived. In the years between 1960 and 1969, economic projections for Market Street East had pushed the square foot totals of required office space drastically upward from the 3 million proposed in the SOM studies to 10 million. Allowable office building heights went from under 30 to over 40 stories. The projected number of people expected to pass through the complex daily increased to 82,000 with 65,000 arriving during the rush hours. Fifteen per cent of these are expected to arrive by car, and the rest by some form of mass transit. The complex has been designed for 16 hours a day of commercial activity.

Market Street East is becoming a major transit arrival point comprising a fully automated high-speed line from New Jersey now in operation, a link-up between the Penn Central and Reading railroads, a high-speed line to the airport, improved subways and an upper level bus system connected by overhead ramps to the Vine Street expressway to the north.

It had become clear by this time to the Redevelopment Authority that the project had to be built in stages to meet changing market demands and that it had to be articulated into elements which could function separately before all the components were in place. The portions of Market Street East which were to be built by government funds (HUD and the city will pay for the pedestrian spine and it is hoped that the Department of Transportation will come up with in excess of \$100 million for a new commuter railroad station, a vital part of the proj-

ect) and those to be constructed by the private sector (retail areas, offices and hotels) had to be sorted out into self-contained systems. The shopping mall itself, for example, is really an air-conditioned, enclosed, multi-level, pedestrian-only public street for which the city is responsible up to the building line which corresponds to the building line of an ordinary street. As this public street is incrementally extended along the 5-block axis, retail and office building developers will become part of the network.

In the present scheme, the high-rise office building lobbies are much larger, requiring 20 or more elevators each, and will therefore be located at the third level and separated from the general retail circulation at that level. Although the model photograph (page 146) shows similarly shaped towers, the Market Street East zoning package is quite flexible and the office towers and hotels can take many configurations, offering the developer many options in terms of building design.

Bower and Fradley's work comprises the pedestrian mall, the truck tunnel, public courtyards and other public improvements and the development of the new train station. Truck, automobile and bus access as well as parking are still located to the north of the pedestrian spine but these are now separated horizontally, rather than vertically as before, and like the rest of the project have been designed so that they may be built and function in increments as they are completed.

Decisions are now being made on the basis of completed documents. At the present time Bower and Fradley have completed the working drawings for the segment of public infrastructure to be constructed between 8th and 10th Streets. Finished documents are expected to be biddable by summer. Gimbels is building a new department store between 9th and 10th Streets and this commitment by the private sector is expected to be a strong catalyst for further development. Another commercial developer who cannot be named at this time has agreed to construct the rest of the commercial space within these two blocks.

Of most importance is Market Street East's complimentary relationship to Philadelphia's great civic and historic spaces and to the existing street patterns of the city. Its circulation network reaches east toward Independence Mall, Society Hill and the waterfront, west toward City Hall and Penn Center and northwest to Fairmount Park. The citizen of Philadelphia lives in a city which preserves and strengthens the vital idea that a truly urban environment must be more than just an efficient and superficially attractive place to work, shop, congregate and eat.

Recreating "downtown" in Columbus, Indiana

The idea of expanding the functions of malls is beginning to take hold among the developers, architects and planners of shopping centers of

Now communities are resisting new shopping centers, zoning is stricter, and design has to be better

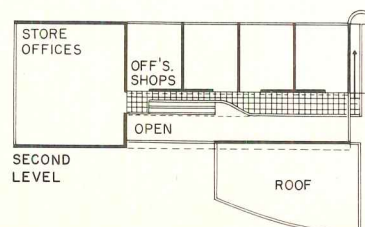
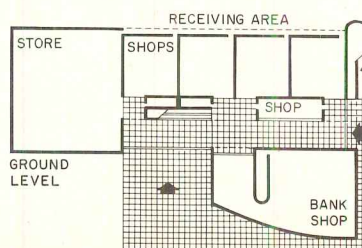
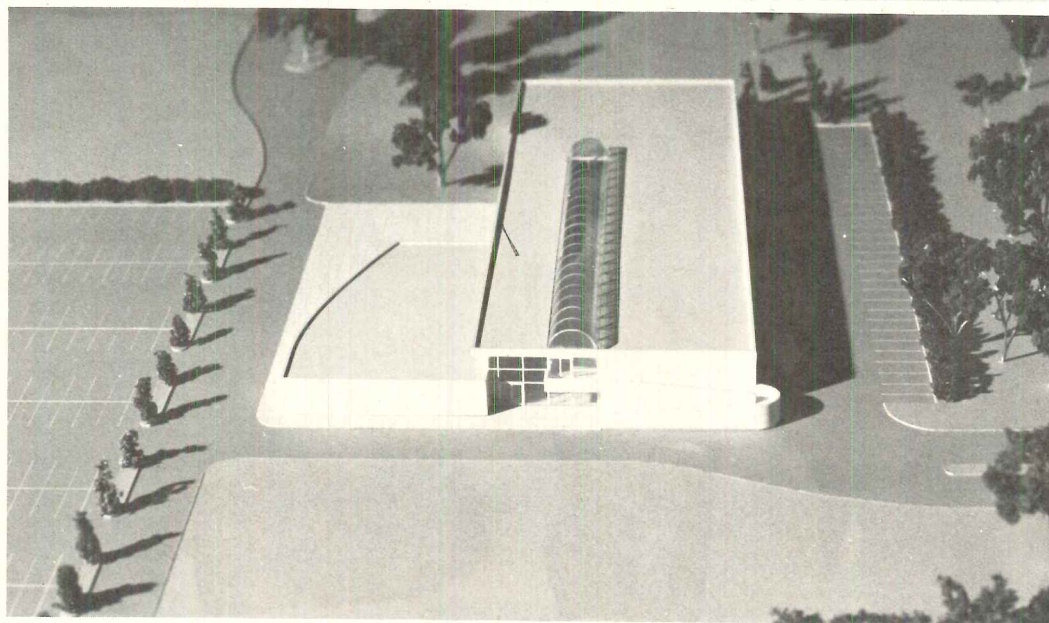
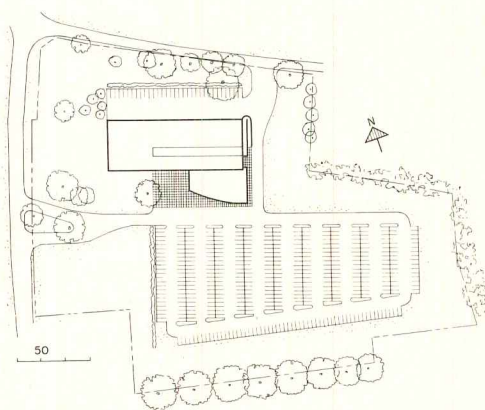

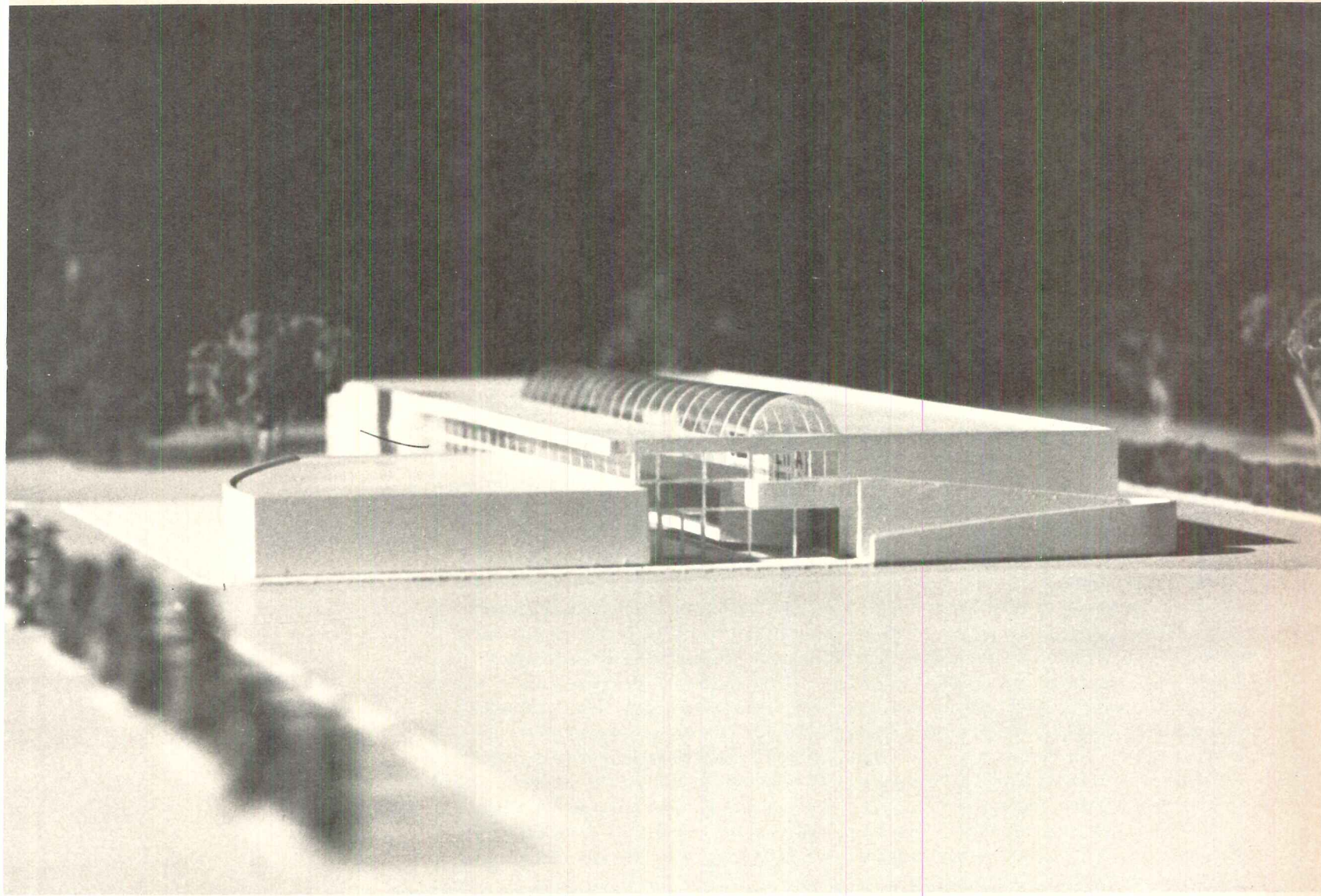

Although the high-rise "omnicenters" shown on the preceding pages appear to be the trend of the future, and the medium-sized regional shopping center may not survive as a type, small neighborhood centers such as Meadow Mall in Simsbury, Connecticut will continue to be built. In contrast to the omnicenters, these small shopping centers get little, if any, design attention. Meadow Mall is a distinguished exception. Designed by architects Gwathmey Siegel and about to go ahead, it is a handsome structure which will house a mixture of commercial and office spaces organized around a covered mall.

The solution meets strict design criteria imposed by the local zoning commission and planning commission, including considerations of traffic circulation within the site, location, amount and access to parking, traffic load or possible circulation problems on existing streets and the location and type of display signs and lighting, loading zones and landscape.

Parking for the facility is disposed to the rear of the site and is landscaped to minimize its view from neighboring sites. Site lighting is designed to eliminate the problems of glare and light spill off onto adjacent property. The lighting fixtures will be of the low bollard type. A low and discreet sign will be located at each entrance.

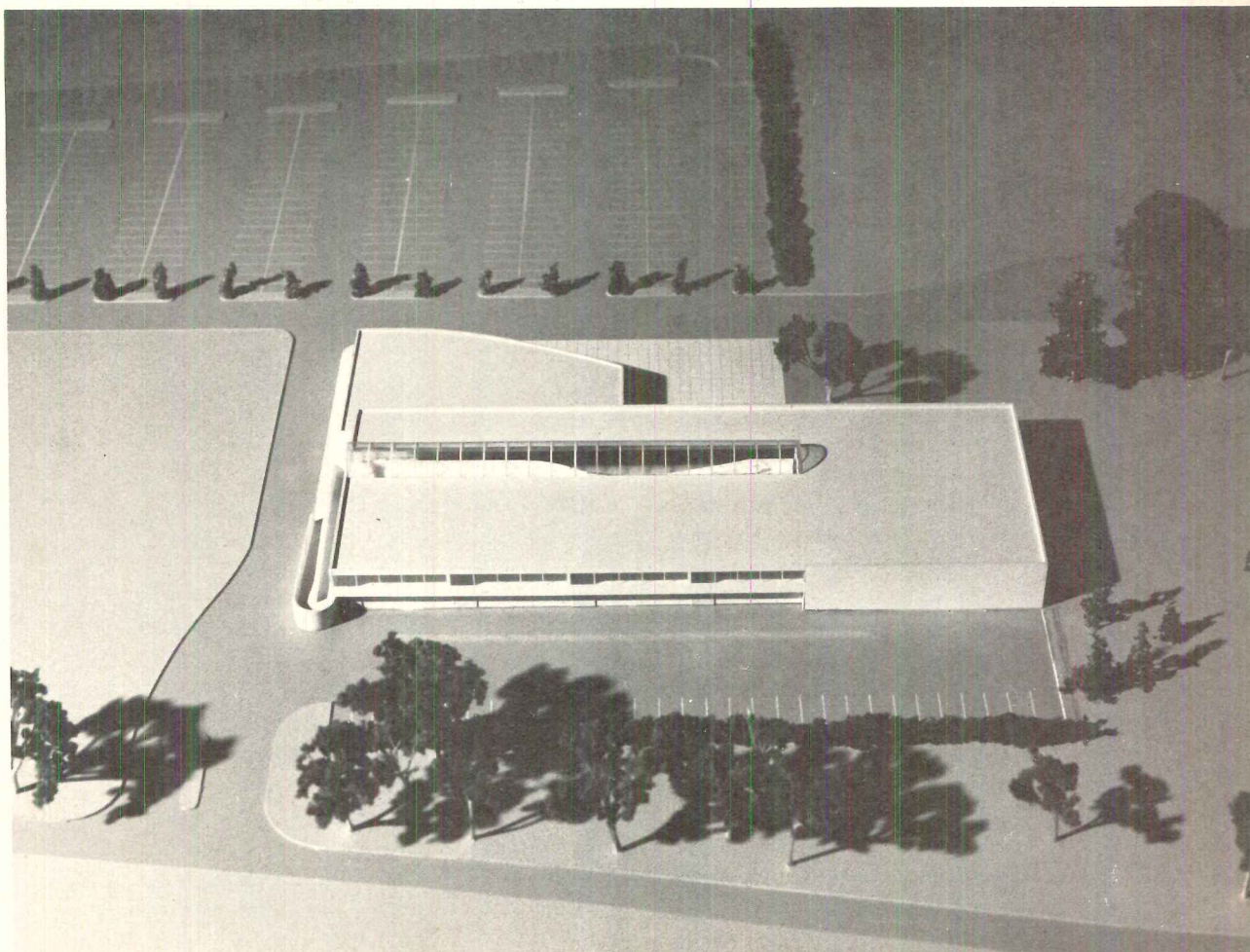

all sizes and types in every kind of location. Cesar Pelli, partner-in-charge for Gruen Associates, Inc. architects of Courthouse Center in Columbus, Indiana (RECORD March 1973) includes in this project a so-called "civic space," as well as a mall. Says he: "The usual modern shopping center is a completely introverted environment. It tries to connect in the most direct form possible the automobile to its air conditioned walkways. These ordinarily redirect the customer back to his own car, when he has completed his shopping. By placing such a center downtown, people are physically brought back to downtown, but in every other respect are isolated from it by the self-sufficient center. The problem of revitalizing all of downtown Columbus needed something more. . . . The civic space is conceived as a focal point for the entire community. It is a space designed to attract and be of use for many more occasions than shopping and at the same time is designed to draw people from the shopping center and bring them to the street itself. The civic space should become the place to which everybody in Columbus will gravitate. It should function as a modern American equivalent of the Italian piazza." Unlike most downtown shopping centers, Courthouse Center respects existing street patterns, and the scale of such nearby landmarks as the Bartholomew County Courthouse, a red brick and limestone structure built in the 1870's and one of the most beautiful buildings in Columbus. Courthouse Center also interconnects with and continues the pedestrian colonnade designed as part of the facade of the new post office by Kevin Roche and John Dinkeloo.

Within the civic space a number of community activities are taking place including dances and benefits, exhibits and concerts. It includes a stage for lectures, puppet shows and small plays. Exhibition spaces have been included for art, crafts, technology and science and flower shows. There are conference rooms for small banquets, gatherings and lectures. The civic space is not only used for special occasions, large and small, but is also an everyday part of the citizen's life. A large central clock serves as the focal point and meeting place. An information board contains directories, information about events in Columbus and surrounding areas, television screens for tapes, closed circuit TV for events of public importance, screens for slide and motion picture projection, and an illuminated news strip tied into an international news service. Architect Pelli believes that by concentrating so many community activities into one place, a magnet has been created which will bring people of every age and interest to downtown Columbus.

A shopping center brings unforeseen benefits to Monroeville

Even the best developers, architects, planners and programmers cannot foresee and plan for all the uses to which their projects will be put, but if they pay some attention to how people

actually do behave in their buildings, plazas and malls, they may become more aware of human needs which they have not considered, and apply this knowledge constructively in all their work.

The Monroeville Mall in suburban Pittsburgh, for example, has become a means of salvation for heart patients living nearby. Every morning more than a dozen of them drive to the shopping center and walk at least four or five miles in the mall. To circle back from Gimbel's at one end to Joseph Horne's at the other a mere fifteen times adds up to five health giving miles on a level surface. Within the mall the air is clean and at an even temperature and there is no wind, not even a breeze. At the end of their exertions the heart patients enjoy a cup of coffee together, bringing a little business to the mall's coffee shop, and some sense of community into their lives. And from time to time they make other purchases.

Whatever one may think of the fact that sidewalkless, parkless, sprawling suburbia offers people nowhere to walk or run, the fact remains that Monroeville Mall has by happenstance become a slow motion jogging track, serving an unexpected human requirement.

This five-year-old shopping center is one of the largest in the country. It has 1.25 million square feet of leasable space, three big stores and 120 shops of various sizes. Besides providing heart patients with a place to exercise, like many other malls it has a skating rink which is heavily used. Unlike most shopping centers whatever their size, however, Monroeville Mall has a full-time ministry. Since no one foresaw this, no interfaith chapel was included at the time the complex was built and spiritual counseling takes place in a so-called "talk shop" booth located in the mall, or if the problem seems to warrant, in the minister's office.

The ministry sets up dances for singles in the mall's community room, and formed an organization for old people known as the Vintage Club which also meets in the community room. According to James G. Driscoll, writing in the *National Observer*, the ministry at Monroeville Mall sponsors seminars and classes in transactional analysis, parent effectiveness, psychological stress in family life, and "Passover, Lord's Supper, Eucharist—What's the Difference?"

If the notion of a shopping mall as a place for ecumenical discussion is an astonishing one, it is because we are insufficiently aware of how poorly our newer suburbs are serving traditional, but nevertheless, essential human demands. It is clear that in Monroeville, if it weren't for the shopping center, it would be just that much tougher to walk, run, meet people and share important human concerns.

The optimistic can take hope in the realization that even though the athletic, community and spiritual happenings within a shopping mall may seem feeble indeed compared to what they can be and often are in real cities and towns, a start is being made.—M.F.S.

Flexible electrical distribution for changing spaces

The growing application of open planning and flexibility concepts in office buildings and schools has encouraged the development of a number of new systems using power/communication columns and/or ceiling raceways to: 1) provide convenient access to electrical and communication services; 2) allow rearrangement of furniture and partitions while still providing access to electrical services; and 3) make it possible to easily move lighting fixtures or to replace them with other types.

And now, the lighting flexibility capability of one new system has attracted the interest of chain-store planners because of the ease of changing lighting to match changes in merchandising.

In the school field, one of the outgrowths of Toronto's Study of Educational Facilities (SEF) school systems project (RECORD, October, 1970) was a technically-sophisticated electric-electronic subsystem. This above-ceiling plug-in system made possible easy relocation of service columns and lighting fixtures. A similar system (RECORD, August 1973) has been designed by a Boston consulting electrical engineer who was a consultant on the first schools in the city's BOSTCO project (Boston Standard Components System) which used SEF components.

Recent code changes made possible much more economical electrical flexibility

Since 1971, the National Electrical Code has permitted unsupported 6-ft lengths of flexible metal conduit, or prewired armored cable (BX) for taps from the outlet boxes to the lighting fixtures—allowing a degree of freedom for location of lighting fixtures in a suspended ceiling. Furthermore, the NE Code was changed in 1971 to allow the use of surface metal raceways (i.e., sheet-metal channels with covers) in nonair-handling plenums, and electrical taps and splices within the raceways. This meant that power/communication poles and columns could be installed in open-plan spaces on a modular basis corresponding to the layout of metal raceways above the ceiling. A proposed change for the 1974 NE Code allows "listed" over-ceiling metal raceways in air-handling plenums. This change would significantly enlarge the applicability of raceways above accessible suspended ceilings because the plenum space above these ceilings is often used by mechanical engineers for returning room air to air-handling units and to exhaust-air systems.

Speed of change is further enhanced by the use of plugs and quick disconnects

Electrical tap connections from power/communication poles and columns to raceways or junction boxes originally were—and still often are—made by hard wiring (i.e., wire-to-wire contact achieved by using wire connectors).

Toronto's SEF program introduced the use of plugs and receptacles for connecting service columns and lighting fixtures to electrical distribution boxes above hung ceilings. These plugs and receptacles had special configurations for the different voltages used for lighting, power, and low-voltage switching.

The following three pages show three different approaches that permit quick-change electrical connections for power poles and columns, and for lighting fixtures. These particular systems all provide access to power and communications wiring within the hung-ceiling space or at the ceiling surface.

One of these is a plug-in-type system that was developed in response to a chain-store company's need to have a quick, convenient way to change residential lighting fixtures in their ceiling display areas. The problem was solved by a manufacturer who had been supplying the store chain with its own building lighting fixtures. His answer was a plug-in-type raceway. As now marketed, the system is comprised of a prewired extruded aluminum raceway containing receptacles, and having an integral vertical fin to which is riveted a T-bar for supporting the ceiling tiles or panels of a suspended ceiling.

A different approach is used with another manufacturer's raceway in cases where there is no suspended ceiling. An exposed raceway is ceiling mounted at convenient spacings, and the prewired power columns are connected electrically by conventional plugs to raceway-mounted receptacles.

With the third system, the manufacturer relies on conventional branch-wiring methods—i.e., conduit and junction boxes—above the ceiling, but provides a twist-lock fitting for quick connect-disconnect. The rigid metal conduit and junction boxes are installed on a modular basis. Then, for each power pole, a length of flexible metal conduit is hard-wired to the junction box at one end; and, on the other end, it has a female quick disconnect that is joined to a male disconnect at the power columns. When only partial-height power columns are used, the flexible metal conduit is enclosed by a flexible tube connector.



**A quick-disconnect device,
used with conventional
wiring methods, makes it simple
to move power columns**

The power columns of this system can be easily relocated without expensive electrical changes because of the quick disconnect feature. Full-height power columns contain up to three power lines plus other low-voltage systems (telephone, clock signal, speakers, etc.). Screen-mounted power columns have one incoming power line plus additional low-voltage systems. Connect-disconnect fittings have different configurations for 120-volt, 15-amp power supply to duplex outlet service and for 120-volt, 15-amp switch leg.

For full-height power columns, the prewired flexible conduit length in the plenum gets fed to the columns via notched ceiling tile. For partial-height columns, the flexible conduit

hangs free in the space, covered by a flexible hose. The flexible hose can be expanded by twisting to fill the hole in the ceiling trim space (see detail drawing below).

The degree of modular flexibility is determined, in part, by the spacings of junction boxes in the ceiling plenum. Flexible conduit in the ceiling space can be as long as it needs to be, as long as it is supported every 4 ft (NE Code). Manufacturer's cost figures indicate little or no premium, under favorable circumstances, for typical office modularity.

The manufacturer chose the wiring method described because it believed this approach could achieve wide acceptance among code officials and electrical inspectors.

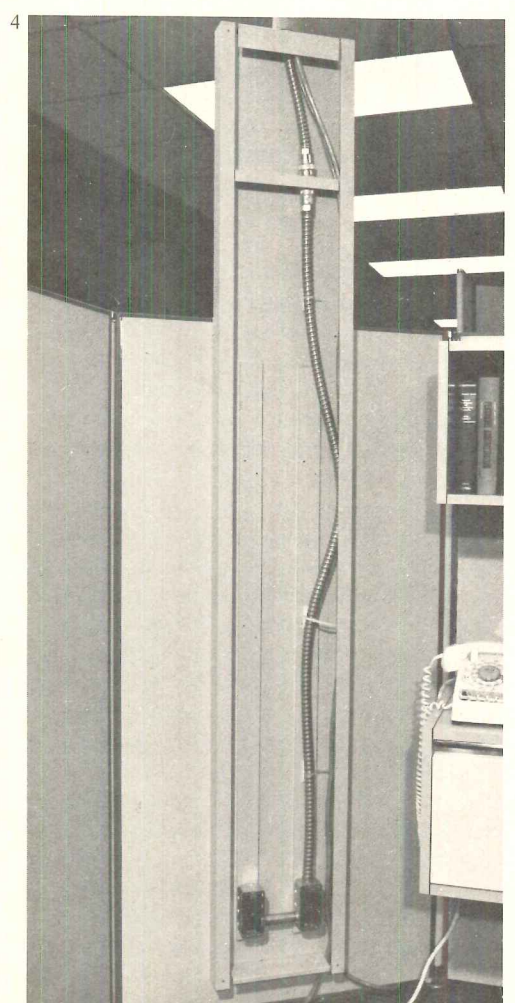
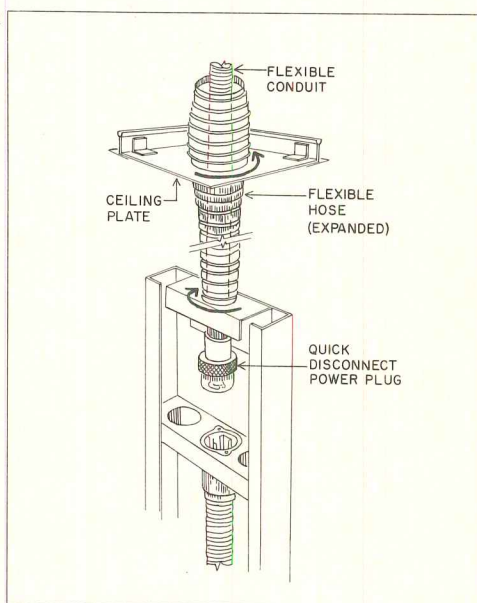
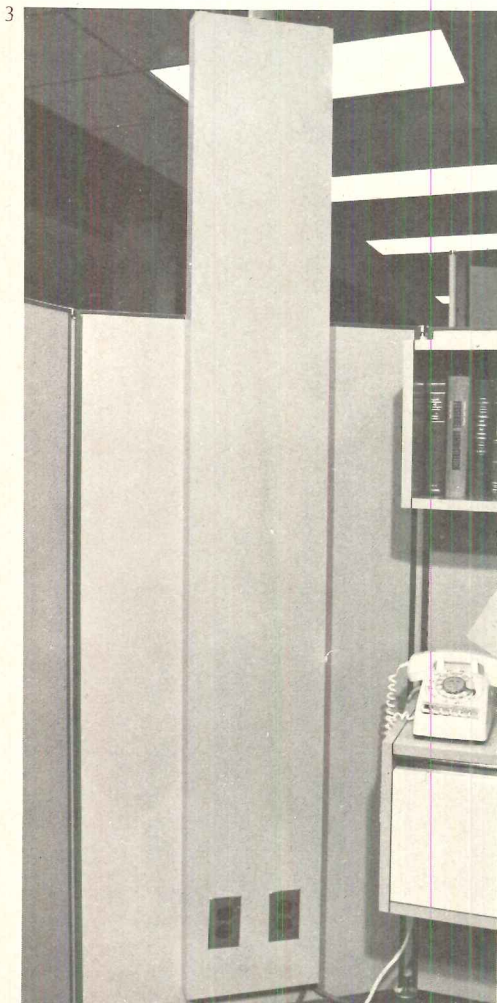
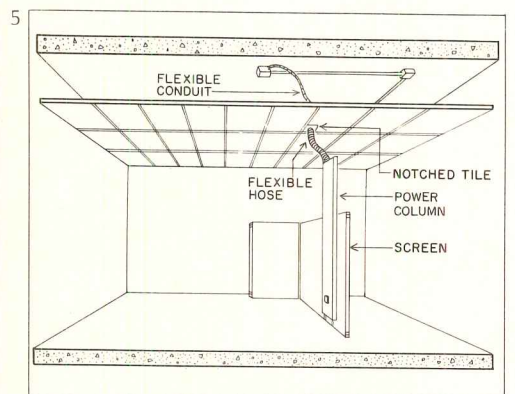
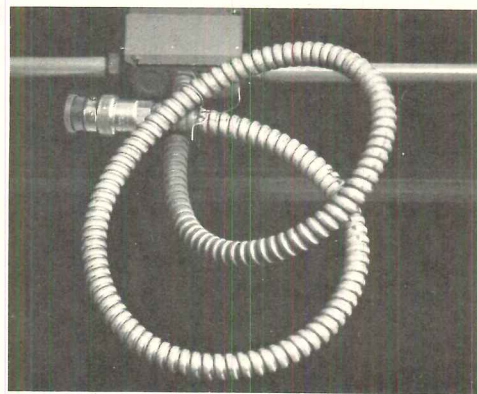

Flexible metal conduit (1) is connected electrically to a junction box in the ceiling, and has a female connector at the other end which joins a male connector on conduit within the power column (2). The screen-mounted power column (3) and (4) uses a flexible tube to enclose the flexible metal conduit which hangs in space and has access (5) to the plenum through notched tile.

Hauseman, Inc.

Dual-function raceway works as a ceiling T-bar and has plug-in receptacles for lights and power poles

Early application of this plug-in raceway system was in office buildings. Prewired lighting fixtures are quickly installed, as are power/communication poles. The prewired raceway (which comes in 12-ft lengths) combines the main T of a lay-in acoustical ceiling with branch-circuit wiring. The raceway has integral receptacles to receive the plug-in heads, and a splice box is provided to connect secondary feeders from panelboards to the raceways.

During construction the ceiling trades generally put in the wires that support the T-bar ceiling and the raceway. Electrical workers hang the raceway temporarily with the wires, and make the electrical connections.

Then the ceiling trades twist the support wires permanently.

The first application of this system in the store field was by Sears in its prototype-store program now underway. Under the direction of Sears corporate architect, Wesley King, the Chicago office of Skidmore, Owings & Merrill developed a modular approach consisting of a precast concrete shell enclosing 30- by 40-ft steel-framed bays, roof-mounted hvac system, prewired ceiling electrical distribution, and extensive use of HID downlighting. Two stores have opened: Cumberland Mall in Atlanta and Granite Run Mall in suburban Philadelphia.

The system also will be used in a J. C. Penney store in Harper Woods, Michigan.

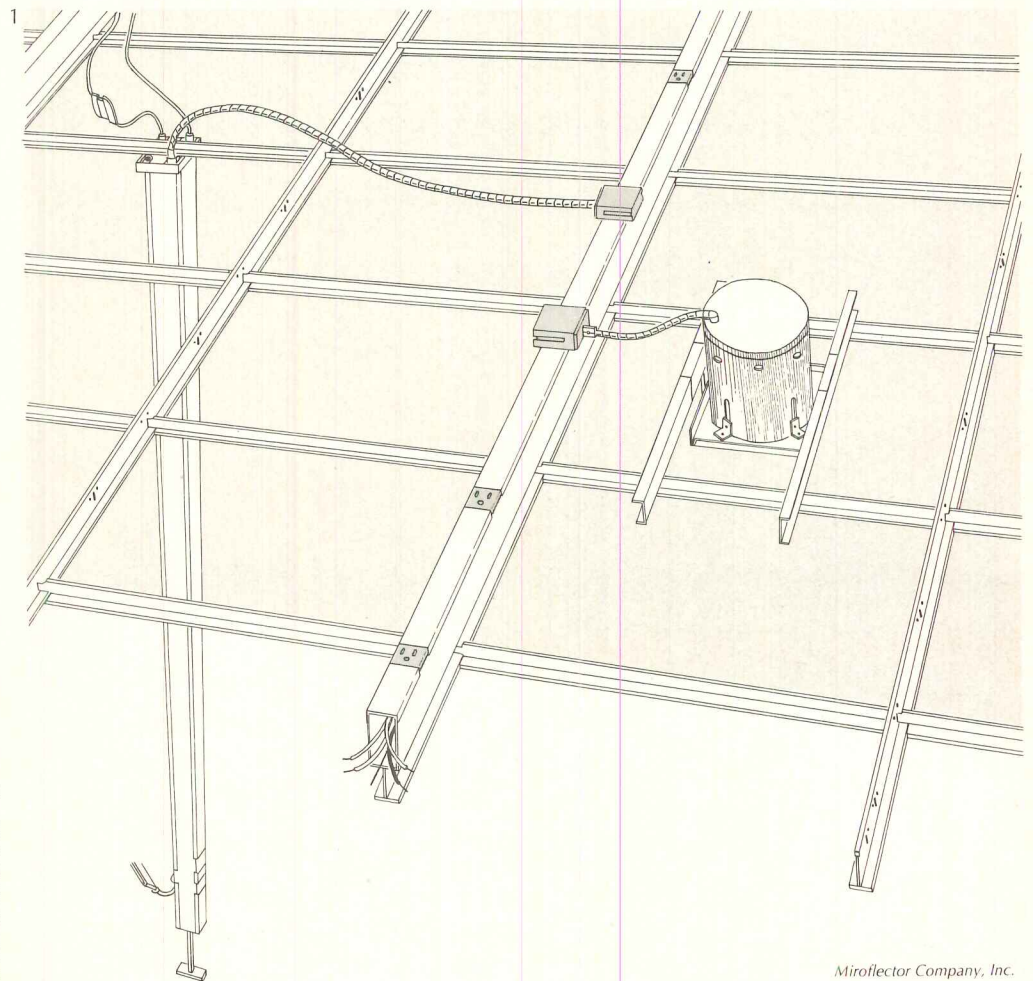

Miroflector Company, Inc.

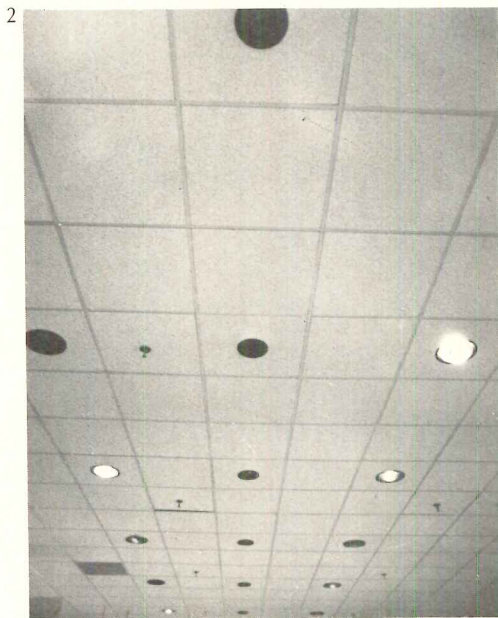

The raceway-T-bar system (1) uses plug-in power heads to connect lighting fixtures and power poles. Department store installations (2) and (3) are growing because of the ease of rearranging lighting fixtures or replacement with other types. Initial cost compares favorably with conventional wiring because electrical contractors can save on field labor installing the lighting.

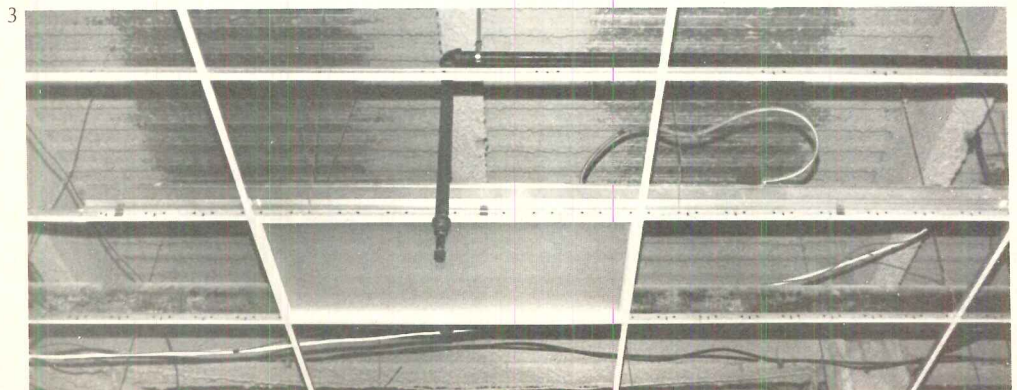

Power poles plug into an exposed overhead raceway for easy mobility in a variety of high school spaces

The architect for Severna Park School in Annapolis, Maryland, Arthur M. Love, used an exposed overhead raceway system for electrical flexibility because he eliminated a hung ceiling to keep costs down. The raceways, exposed ductwork and roof decking are all painted a dark blue-black so that all the elements blend together visually. Over 400 power poles have been installed for classrooms, library, home economics, and elsewhere. At the library, the poles supply power for cove lighting at study cubicles, as well as for audio-visual equipment.

The overhead raceway is the divided type that normally carries power wiring in one channel and communications in the other.

While communications wiring is not yet in use in this school, it can be installed at a later date—there is a hole in the device plate to bring communications wiring down into the pole.

A convenient method for anchoring the poles in place was devised: The overhead raceway has a built-in steel stud protruding downward. A metal sleeve built into the top of the pole slides over the stud (a tight fit); then, the pole is tightened in place via manipulation of the pole's adjustable stanchion which has a carpet gripper on the bottom.

The poles were prewired with TW insulated wire, and the plug-wired end merely comes out the top end of the poles.

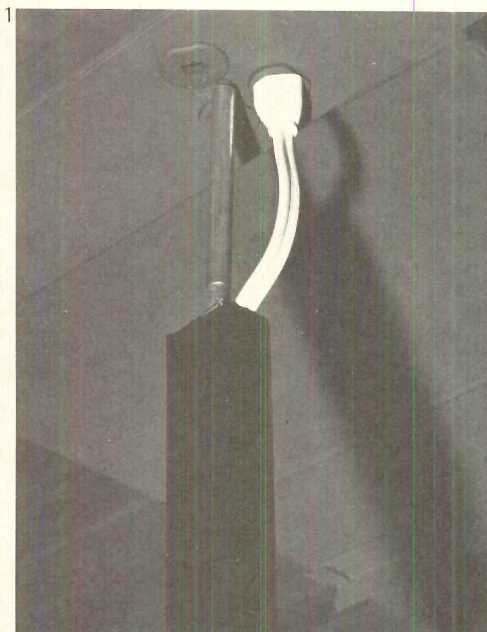

The Wiremold Company

Power poles plug into an overhead exposed raceway (1) in the Severna Park School. Ductwork also is exposed as is the underside of the roof deck—all painted dark. The power poles provide convenience outlets on a modular basis in classrooms (2) and in the library (3). In this space the power poles also are connected to the lighting fixtures of the carrels.

The Kenneth M. Brooks Studios, Inc.

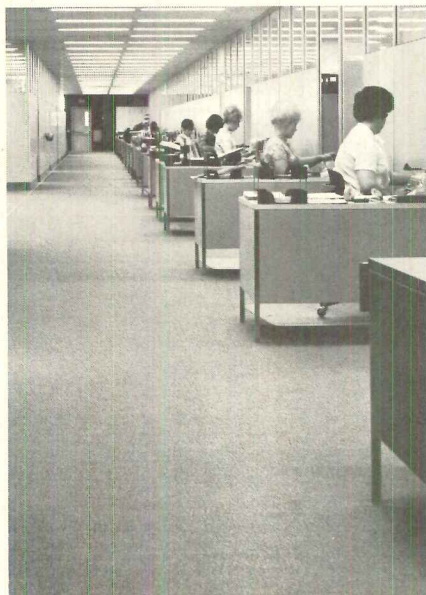
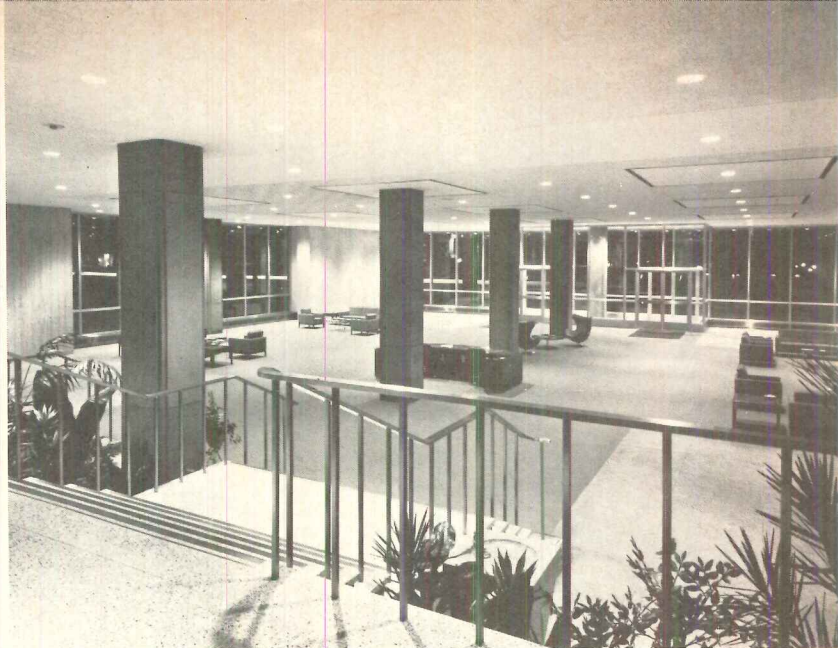

**Office
after office
after office
gives the business to
proven carpet
by Bigelow.**

If you're doing an office job, either new construction or remodeling, you can create your own specifications for the carpet you want. And we can make it for you.

However, Bigelow has another practical suggestion: specify carpeting that has already proven it can take the hard use (not to mention abuse) an office staff deals out. Carpet that has repeatedly demonstrated it can take a beating year after year after year.

Bigelow has that kind of proven in actual office use carpeting ready for you in a wide selection of carpet styles and patterns. Carpet that is the result of research and development combined with the realistic experience gained in hundreds of office installations.

And Bigelow will do more than just sell you proven carpet. We'll give you expert counselling in installation and through our Karpet Kare[®] Division, we'll give you the best advice available on maintenance. It's a total package designed to assure you that you can specify Bigelow with total confidence.

Bigelow-Sanford, Inc., Dept. A
140 Madison Avenue, New York, N.Y. 10016

I'd like to hear the proof on Bigelow's proven carpets for offices.

NAME _____ Print Clearly

TITLE _____

ADDRESS _____

CITY _____

STATE _____ ZIP _____

Bigelow[®]
RUGS & CARPETS SINCE 1825

AMERICA'S MOST EXPERIENCED CARPET MAKER

For more data, circle 68 on inquiry card



Part of The Celotex Team, geared to deliver. From top left clockwise: Brasher, Rissmiller, Waine, Hasselbách, Riley.

Celotex: We deliver long before your roofing specs have begun.

Because our deliveries begin with our service. Service in the form of an expert team of built-up roofing specialists.

Men who've made built-up roofing a major part of their daily lives. Men who want to share their knowledge with you.

Got a question?

Pick up your phone and contact your Celotex commercial roofing rep. He's handled a lot of roofing challenges and will probably have the answer. If he doesn't, he can quickly get in touch with the Celotex Team member who does.

Men like John Hasselbach, who guides the team in marketing and distribution; Ed Rissmiller of our R&D department; Arch Riley, 30 years in production and quality control; Bill Waine, sales manager with 20 years BUR experience; Sam Brasher, product manager... and many others including members of a fully-staffed architectural services group.

We call our roofing experts the Celotex Team. But, they're really your team.

To call on at any time.

We think good service is as important as good roofing products.

Celotex™

BUILDING PRODUCTS

The Celotex Corporation, Tampa, Florida 33622

a **Jim Walter** company

For more data, circle 69 on inquiry card

Specified for economy and beauty, built with strength. SUREWALL[®], the only white mortarless Surface Bonding Cement....

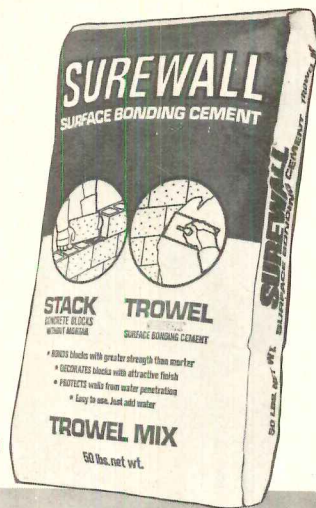

in Virginia.

ca Construction Associates of Tidewater, Ltd. (Newport News), general contractor, and McPhatter & Son, plastering contractor, chose SUREWALL as a water resistant stucco finish coat for the large Cordoba Apartment complex in Hampton.

Results: SUREWALL is superior to regular stucco in resistance to cracking. No further waterproofing agents required. Job time cut by elimination of usual brown coat on block areas. Cost factor, good! They'll use SUREWALL again. Soon.

You can specify SUREWALL with confidence because SUREWALL has major code approvals: Southern Building Code Congress, South Florida Building Code, North Carolina Building Code, BOCA 72-72.

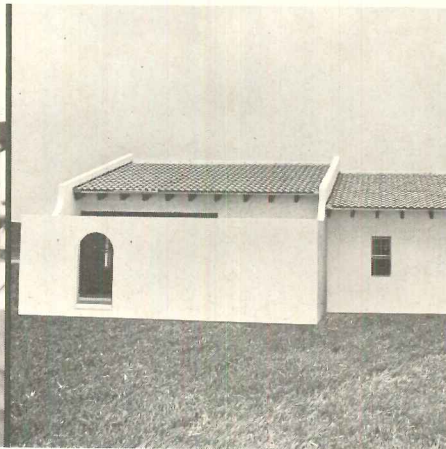

in Florida.

Despard Constructors (Winter Haven) approved SUREWALL's performance on other jobs. So they chose it for their own new office building — inside and out.

Dave Despard says: SUREWALL is even easier to work with than anticipated. What he likes most is that he has more control over the job. His own people do it all. He also appreciates the many different, attractive SUREWALL finishes. Despard Constructors continue to use SUREWALL. Now, on townhouses. SUREWALL is versatile. And, SUREWALL is pure white. Looks good. Even without paint. (For color, use one coat — not two — of regular masonry paint.)

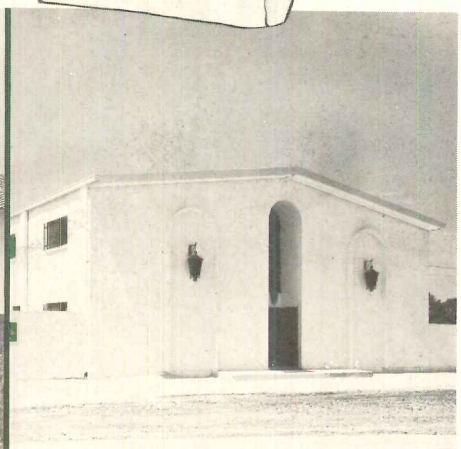

in Texas.

Mike Butler Construction Co. (San Antonio), plastering and masonry contractor, used SUREWALL for the Olmos Equipment Co. plant. Only 46 construction days to complete the 5,000 sq. ft. building — despite three ice and two snow storms. SUREWALL was used to bond the concrete blocks. And inside the office areas on dry wall. Butler, and Olmos, like SUREWALL's performance. Homes, apartments, offices, farm and industrial buildings, theatres, bank vaults, sea walls. All built with SUREWALL. Independent tests prove the superiority of SUREWALL concrete block bonding. Complete data is available.

SUREWALL[®] is a registered trademark of W. R. Bonsal Company, Lilesville, N. C. and Best Concrete Products Company, College Park, Georgia.

See SWEET'S 4.9/Bo

BONSAL COMPANY P.O. Box 38, Lilesville, N. C. 28091 Phone: 704/848-4141

Other plants: 483 Bonsal Rd., Conley, Ga. 30027, 404/361-0900 — 1775 N.E. 205th Terrace, Miami, Fl. 33126, 305/651-4500 — 5455 N. 59th St., Tampa, Fl. 33610, 813/621-2427. — Box 395, Flomaton, Al. 36441, 205/296-4252. SUREWALL[®] is also available from Barrett Industries, Inc., 6889 Evans Rd. East, San Antonio, Tx. 78218 and Post Distributing Company, Stanton & Empire Sts., Wilkes Barre, Pa. 18702.

For more data, circle 70 on inquiry card

For more information, circle item numbers on Readers Service Inquiry Card, pages 245-246.

Automatic transfer panel on standby unit

With the introduction in January of a complete line of automatic transfer panels, the company now offers matched component standby power systems comprised of generator set (such as the 7.5 kw unit shown), controller and automatic switch-gear. Circuit breaker transfer panels are rated from 30 to 2000 amperes and high inter-upt contactor panels are offered in models rated 30, 70 and 100 amperes. The panels automatically activate the generator set. The company's standby systems are available in numerous generating capacities and voltages, fuel choices, cooling options and accessories, with generator sets ranging up to 500 kw. ■ Kohler Co., Kohler, Wis.

Circle 300 on inquiry card

Emergency standby unit battery-operated

A complete, self-contained emergency standby power source for medium requirement service has been introduced for private homes, stores, offices, small plants, schools, etc. Unlike generator systems, the SPS system requires no engine installation, fuel or exhaust venting because it uses heavy-duty industrial grade lead-acid storage batteries. All elements are mounted in a storage rack measuring 3 by 3 by 5 ft. Models are available to provide 250-watt loads for 36 to 100 hours. Maximum load is 3000 watts. Additional batteries can be added to extend operating time. ■ Mule Battery Co., Providence, R.I.

Circle 301 on inquiry card

New generator added to standby system

A 25 KVA (25,000 watts at unity power factor) power plant for either standby or continuous duty has been recently developed by the company which draws attention to a newly designed generator in all standard one- or three-phase voltages up to 600 volts. Higher voltages are avail-

able to meet unique specifications. Voltage regulation is certified as two per cent standard and general regulation throughout the load range is said to be normally better than one per cent. The generator is powered by a four-cylinder, four-cycle air cooled V-465-D engine, and the machines are available with a variety of both engine and generator controls including manual transfer from commercial power to the generator or automatic transfer as illustrated. ■ Katolight Corp., Mankato, Minn.

Circle 302 on inquiry card

Diesel, dual fuel total energy engines

Shown is one of the company's diesel and dual fuel engines for standby and total energy uses. This company's engines are recommended as prime movers for large industrial and commercial total energy applications. The engines are designed, according to the company, for maximum mechanical energy from every Btu of fuel consumed, and lower weight per hp means less cubage where space is limited. The engine power generation equipment is available in ratings of 478 to 3125 kw. ■ Colt Industries, Beloit, Wis.

Circle 303 on inquiry card

Standby-continuous duty engine-generator

Designated the DES-550 and DES-500, two high-power engine-generator sets have been added to the company's line of diesel electric systems. Both units are recommended for standby, emergency and continuous-duty applications. The DES-550 model, with a standby rating of 550 kw and a continuous-duty rating 475 kw, has a 840 hp turbocharged/inter-cooled V-12 as a power source. The 750-hp turbocharged-only DES-500 unit delivers 500 kw in the standby mode and 425 kw in continuous-duty applications. Optional accessories permit parallel operation of two or more generating sets. ■ Allis-Chalmers Corp., Harvey, Ill.

Circle 304 on inquiry card



300

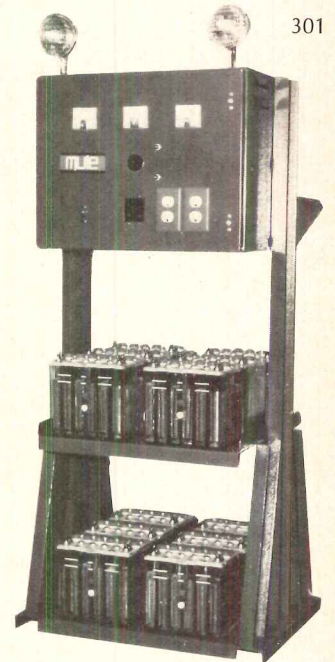

301

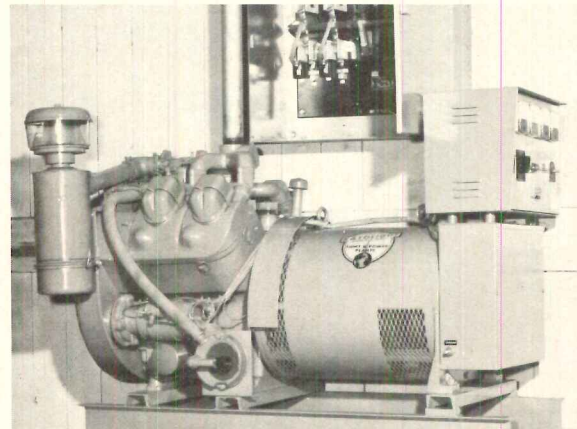

302

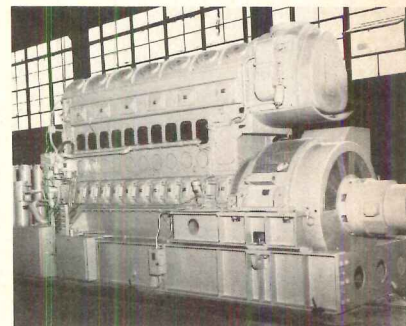

303

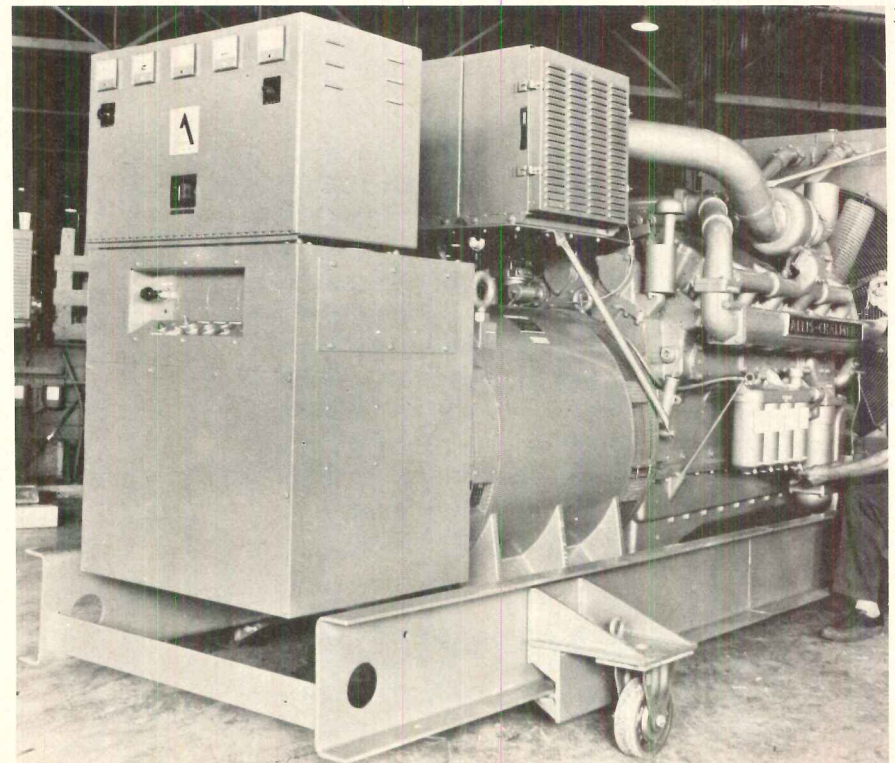

304

Now! Two great products bring you one great metal roof deck system.

- 2-hour fire rating
- Lowest U-value
- Slope to drains!

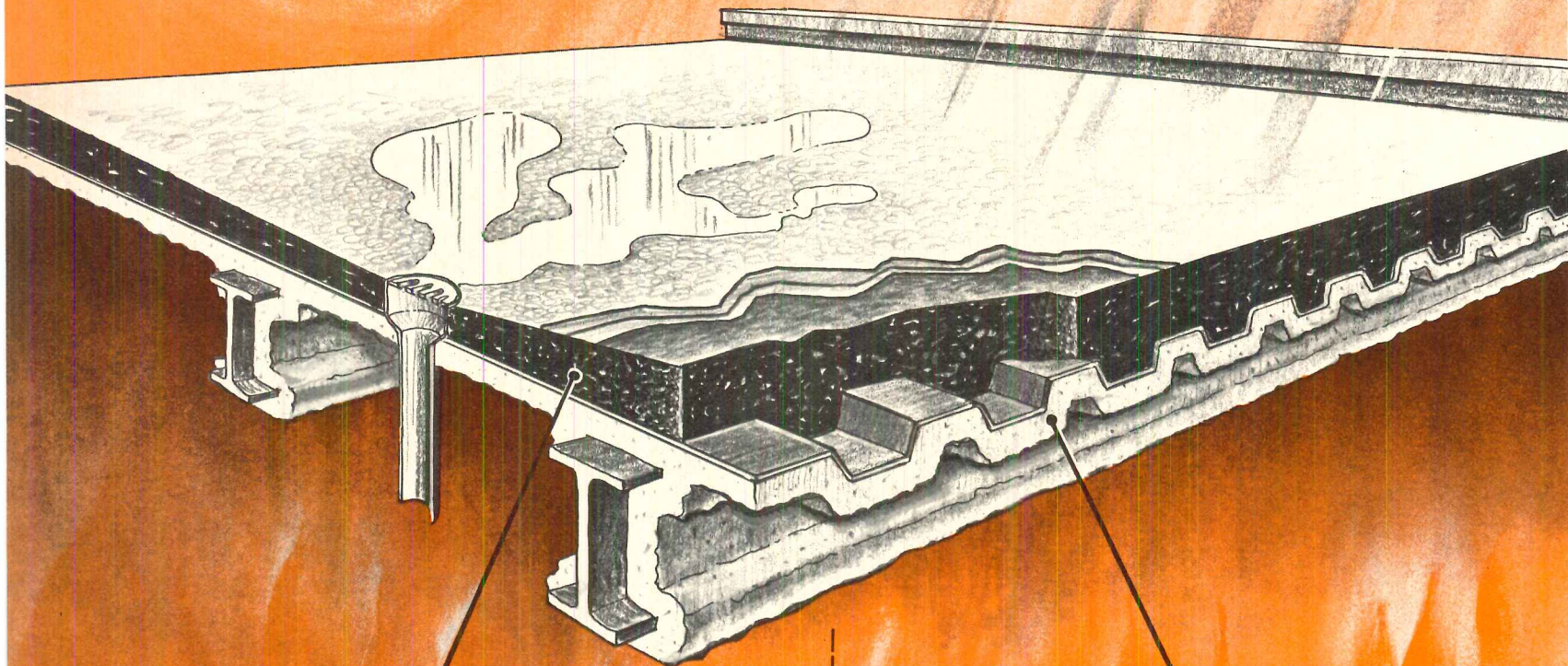

**All-weather Crete**[®]
ROOF DECK INSULATION

**DECK-SHIELD C/F**
CAFCOTE V
SPRAY FIRE PROOFING

ENERGY SAVER! The excellent insulating properties of All-weather Crete insulation provide this system with a completely dry, seamless installation having a better k factor than any other poured roof deck insulation (.40 k factor). It is applied hot to the metal deck, sloped to drains, and compacted to any desired thickness from 1½" to 5". Energy saving capabilities of this fine system offer life/cost economies that are unsurpassed by similar systems. Get the facts. For complete literature and specifications contact Silbrico Corporation, 6300 River Road, Hodgkins, Illinois 60525, (312) 735-3322.

FIRE PROTECTOR - Protecting and insulating the lower half of the system is CAFCO direct-to-steel spray fireproofing. CAFCO products are factory blends of non-crystalline refractory materials containing no asbestos. They have excellent fire resistive qualities, are usually applied in one coat, and harden quickly. CAFCO dependability has been proven in many of the world's finest buildings. Complete specifications for 1, 1½ and 2 hour systems can be found in the UL Fire Resistance Index (Design Nos. P-802, P-804, P-705 and P-706), or contact United States Mineral Products Company, Stanhope, New Jersey 07874, (201) 347-1200.

**SILBRICO**
CORPORATION

**UNITED STATES MINERAL**
USM
PRODUCTS COMPANY

For more data, circle 71 on inquiry card

Some day
you'll be asked
to design a building
with a
heliport.



Get ready for it now
by writing
for
Bell Helicopter's
Heliport Guide.
IT'S FREE

TO: Bell Helicopter Company
Fort Worth, Texas 76101

Please send me your
Heliport Planning Guide.

NAME _____

COMPANY _____

ADDRESS _____

CITY _____

STATE _____ ZIP _____

For more information, circle item numbers on
Readers Service Inquiry Card pages 245-246.

ELASTOMERIC ROOFING / The *Chem-Ply* roofing system is said to differ from a conventional four-ply, hot roof in that the *Chem-Ply* roofing sheet provides the waterproofing protection while in conventional roofs hot asphalt or pitch is the waterproofing agent. The *Chem-Ply* roofing is reinforced with a heavy glass fabric which remains dimensionally stable over a wide temperature range and eliminates stresses and strains normally developed in other roofing systems. A specification manual is available. ■ The Celotex Corp., Tampa, Fla.

Circle 400 on inquiry card

SOLID WASTE TRANSFER / The illustrated publication describes solid waste transfer systems in detail and provides approximate requirements and costs for transfer facilities of various capacities. In addition, a hypothetical case study is presented with the necessary data and calculations to assist the reader in comparing his present cost of operation to that of a solid waste transfer system. ■ The Heil Co., Milwaukee, Wis.

Circle 401 on inquiry card

FINNISH BIRCH PLYWOOD / The characteristics of Finnish birch plywood, Blockboards and Laminboard and the advantages of using them in such applications as concrete formwork, structural and high fashion interior panels, are described in two new booklets now available. One brochure illustrates the grades, thicknesses, finishes and other pertinent details of Finnish birch-faced products for walls and partitions, display stands, shelving, cabinetwork, doors and other interior and exterior applications. ■ Finnish Plywood Development Assn., Falls Church, Va.

Circle 402 on inquiry card

WHITEPRINTER/BLEUPRINTER / The literature gives complete operating instructions for a machine that features freedom from ammonia fumes found in conventional blueprinters. Features of the machine including variable speed control, minimum-maintenance design, and complete mechanical and electrical specifications are also described. ■ Teledyne Rotolite, Stirling, N.J.

Circle 403 on inquiry card

CEILING SYSTEMS / A guide to gypsumboard products to assist architects when specifying lightweight construction materials for use in residential, commercial and institutional wall and floor/ceiling systems features descriptions, specifications and application details for 19 gypsumboard products and 10 joint system materials. Technical data is also included for sound control and fire resistance properties. The catalog features *Shaft Liner*, a gypsum board partition for enclosing elevator shafts and other vertical openings, and *Eternawall*, a vinyl-surfaced gypsumboard in 30 colors, simulated wood-grains, patterns and textures. ■ Georgia-Pacific Corp., Portland, Ore.

Circle 404 on inquiry card

AUTOMATIC TRANSFER PANELS / A 12-page catalog describes the new line of automatic switchgear for standby power systems introduced in January. Designed for matched component reliability with standby generator sets, the transfer panels are offered in three contactor models rated 30, 70 and 100 amperes and 13 circuit breaker models rated 30 to 2000 amperes. Each model is UL-1008 listed and CSA approved and has a lockable NEMA I enclosure. ■ Kohler Co., Kohler, Wis.

Circle 405 on inquiry card

SPIKE GRID CONNECTORS / Available is a product design and specification sheet describing the firm's line of spike grid timber connectors and installation tools. Complete information on sizes manufactured and method of use is presented. Spike grid connectors are available in three different types for use in the construction of pole frame buildings, docks, wharves and railroad and highway trestles. The products also have wide application in transmission tower construction. ■ TECO, Washington, D.C.

Circle 406 on inquiry card

SHUTTERS, DAMPERS / A new, simplified 16-page bulletin shows a broad line of shutters, dampers and stationary louvers, featuring both steel and aluminum construction. ■ ELCO Shutters & Mfg. Co., Batavia, Ohio.

Circle 407 on inquiry card

FIRE RETARDANTS / The four-page folder shows how architects and builders, using *Pyresote* fire-retardant treated wood products, may now add one more story and 25 per cent more area under the existing building codes for certain types of commercial structures, according to the company. ■ J. H. Baxter & Co., San Mateo, Cal.

Circle 408 on inquiry card

ACCESS SYSTEM / A new specification data brochure for a card-controlled access system includes: applications, encoding, explanation of operation, interfacing with alarm system, exclusive features and functions, and detailed architectural and engineering specifications for standard and optional units. ■ Mosler Safe Co., Hamilton, Ohio.

Circle 409 on inquiry card

SIGN LIGHTING / A new 4-color brochure about sign lighting luminaires contains complete application data, comparative photographs, and technical information about the products. ■ J. H. Spaulding Co., Cincinnati, Ohio.

Circle 410 on inquiry card

CURTAIN WALLS / A new 24-page brochure includes 12 pages of details of basic design concepts for non-load bearing exterior walls. Among the new details in the brochure are those for a truss stud assembly for exterior masonry veneer with a concrete frame. Included in the five pages of tables are those detailing physical properties and limiting heights of studs. ■ United States Gypsum, Chicago, Ill.

Circle 411 on inquiry card

MUNICIPAL MAPPING / "Municipal Mapping—Color and Economy" is the title of this 16-page brochure. In reproductions of three actual city maps—one of the basic topographic type, one for district planning, and one for urban renewal—the brochure shows step by step how each was made from the original aerial photography to the final multi-color version. ■ Keuffel & Esser Co., Morristown, N.J.

Circle 412 on inquiry card

APPLIANCES / A new 40-page publication detailing appliances, room air conditioning and other electrical equipment provides product specifications and dimensional drawings of built-in dishwashers, food waste disposers, trash compactors, refrigerator-freezers, full size and compact washers and dryers, packaged terminals and built-in room air conditioners, and a complete line of freestanding and built-in ranges. ■ General Electric Co., Louisville, Ky.

Circle 413 on inquiry card

For more data, circle 78 on inquiry card

New Vandal/Impact Resistant Lighting From ITT Art Metal...

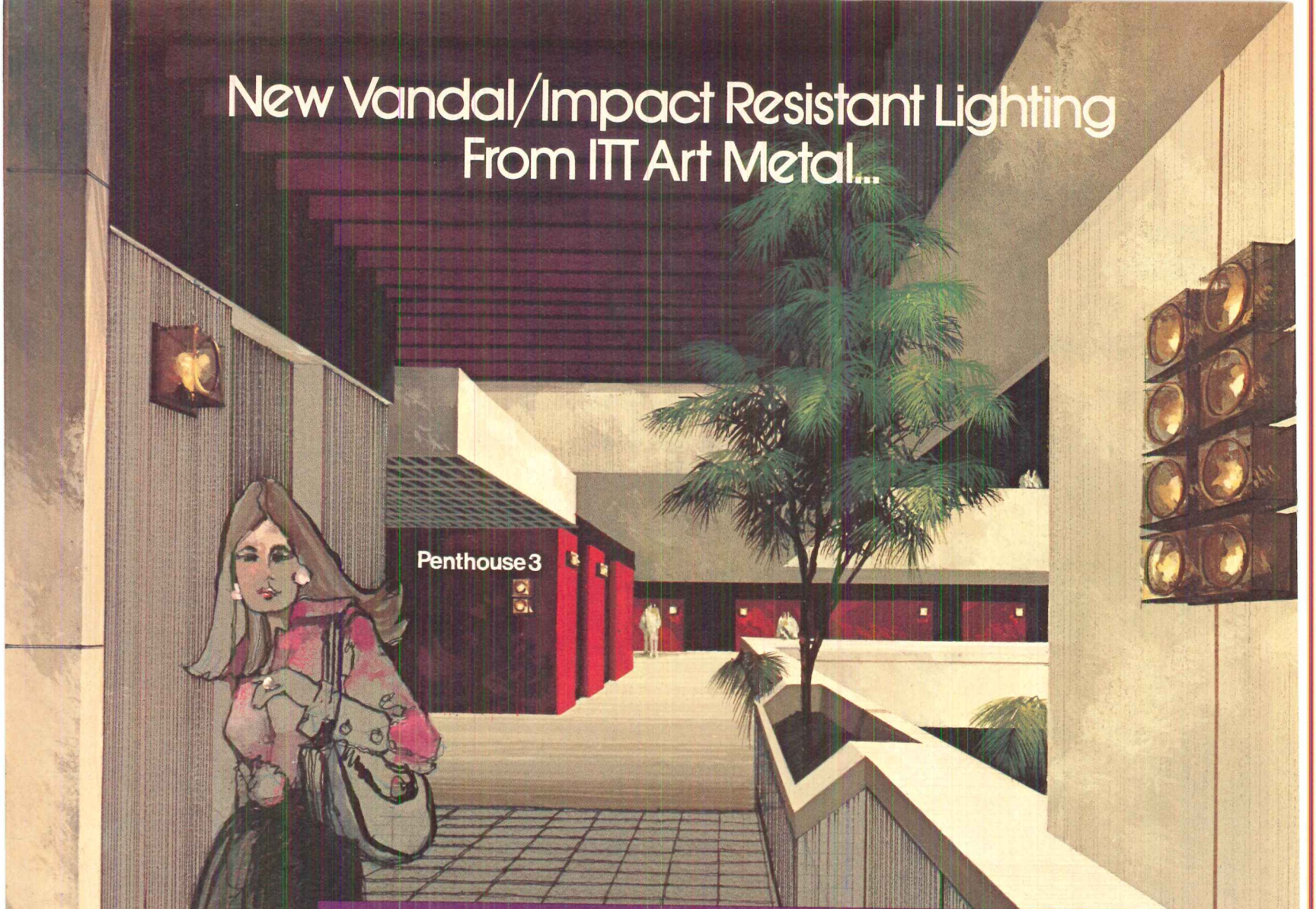

BRONZE



IRISMATIC



OPAL



An unbeatable combination of lighting elegance and durability.
Only part of a complete polycarbonate vandal resistant line.



**ART METAL LIGHTING
WAKEFIELD LIGHTING**
P.O. Box 195, Vermilion, Ohio 44089
In Canada: P.O. Box 3231, London, Ontario

ROOFTOP UNITS / A line of single package gas heating/electric cooling units for rooftop or slab mounted residential or light commercial application includes 2, 2½, 3½ nominal tons of electric cooling and 60,000 to 120,000 Btuh natural or propane gas. Power-vent forced draft combustion eliminates chimney vent stacks and hoods. Units can be used in multiples or singularly for year-round climate control. ■ Mueller Climatrol Corp., Piscataway, N.J.

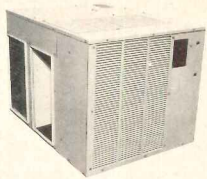

Circle 305 on inquiry card

PLASTIC DRAINS / Plastic commercial grade roof and floor drains are available in gray PVC with 2, 3 and 4 in. solvent weld hub outlets (roof) or in gray PVC or black ABS with 3 or 4 in. solvent weld hub outlets (floor). The new drains can be utilized with any type of floor or roof. ■ R & G Sloane Co., Woodland Hills, Cal.

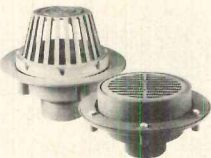

Circle 306 on inquiry card

HARDWOOD PLANTERS / The planters are of walnut veneer with a natural oiled finish, and can be supplied in squares or rectangles, with or without metal liners for use with artificial or live plants. ■ McDonald Products Corp., Buffalo, N.Y.

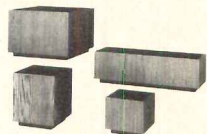

Circle 307 on inquiry card

SEATING SYSTEM / An English-designed institutional line of polypropylene seating in wide use throughout Europe is now being manufactured and marketed in the United States. *SIT 70+* is a comprehensive line of chair and tables for indoor and outdoor use. The basic chair shell from which the seating system is derived is a molded polypropylene. The chairs are fade-resistant because both color and an ultra-violet stabilizer are pre-blended in the polypropylene mix before the shells are formed. More than 18 variations of the chair are available, including stacking, ganging, tilt and swivel pedestal versions, bar stools, armchairs, tablet chairs, and concourse units. ■ Restall Design Group, Los Angeles.

Circle 308 on inquiry card

AUTOMATIC DRINKING VALVE / An automatic drinking valve system especially for dogs features a patented pivoting stem drinking valve. Surface tension allows a drop of water to remain at the edge of the valve, quickly teaching the animal where to find water. When the dog begins to drink the initial supply of water, the valve pumps more. The entire system meets the requirements of the ASTM standards and the portable water standards of the National Sanitation Foundation. ■ Long Environmental Systems, Gambrills, Md.

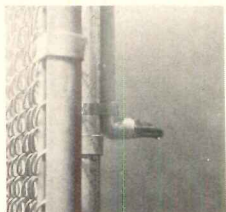

Circle 309 on inquiry card

more products on page 167

◆ For more data, circle 73 on inquiry card

For more data, circle 74 on inquiry card ◆

62-63

JG Furniture Company, Inc. 121 Park Avenue
Quakertown, Pa. 18951

Auditorium seat designed by Peter Dickinson
Installed at the Institute for Advanced Study, Princeton, N.J.
Architects: Geddes Brecher Qualls Cunningham, P.C.
Interior Consultants: Semanko-Bobrowicz



**5
YEAR
Guarantee**
RESISTS FADING,
WON'T CRACK,
PEEL OR BLISTER

Rez® Solid Color Latex Stain

On exterior or interior wood surfaces, REZ Latex Stain forms a tough, flexible film—so tough that we **guarantee*** that it won't crack, peel or blister for 5 years. And the color stays "like new."

There are other advantages, too—like easy application with less spattering, fast dry, and soap and water cleanup. Choose from 38 vogue solid or semi-transparent colors.

Detailed information on REZ Natural Wood Finishes can be found in Sweet's Catalog (9.9/Re). Or write to The REZ Company, One Gateway Center, Pittsburgh, PA 15222.



*** Guarantee**
REZ Latex Stain is guaranteed for 5 years to resist fading and not crack, peel or blister if applied according to the instructions on the label. If REZ Latex Stain fails to perform as stated in this guarantee, replacement stain will be furnished without cost or a refund will be made of the purchase price.

Rez® Natural Wood Finishes
by
PITTSBURGH® PAINTS

For more data, circle 84 on inquiry card

YOU NOTICE NEENAH CASTINGS AROUND THE WORLD



Architects, designers and planners know Neenah castings are found in Pakistan, Kuwait, Turkey, South Africa, Argentina, Bahamas . . . and from Paris to Pittsburgh.

They know Neenah makes the finest quality castings: from gray iron manhole covers . . . to ductile iron airport drainage grates . . . to decorative tree grates . . . and a complete line of building castings. But did you know Neenah has thousands of design variations to choose from? 60,000 castings on hand (over 10,000 tons)? Over 100 years of experience? Three modern plants?

Write or call for the most complete construction castings catalog, Neenah's Catalog "R", 6th edition.

NEENAH 
FOUNDRY COMPANY

NEENAH, WI 54956 Phone: 414-725-3041
Jobbers in most principal cities



At last — a fast acting double-slide industrial door that's also a UL-listed, Class A fire door.

Our new Fire Chief™ is the first double horizontal slide Class A, 3-hour endurance rated, UL and FM labeled door that's fast enough for the busiest doorway.

The Fire Chief's complete pre-assembled, pre-wired package installs easily and inexpensively. Provides equal or greater protection than much heavier conventional doors through years of dependable, maintenance-free service.

Before you invest in a fire door *and* an industrial door, see the one that does both jobs. Available in double or single slide. Write for free literature or find us in the Yellow Pages.

CLARK
DOOR

69 Myrtle Street, Cranford, N.J. 07016
(201) 272-5100 Telex 13-8268

For more data, circle 86 on inquiry card

◆ For more data, circle 85 on inquiry card

PAPER SHREDDER / The *Shredbasket* model is 20½ in. high, 13¼ in. wide and 11¾ in. deep with a throat opening of 8¾ in. The shredding unit of hardened steel cutting wheels accepts clips and staples with no harm to the unit and the shred width is 3/16 in. taking up to 7 sheets of 16 lb. bond paper at a time. The motor is a ¼ hp, 110 volts, 60 cycles, 1 phase, A.C. reversing type with built-in overload circuit breaker plus 3-wire ground cables for connection to electrical outlet. It comes with a removable waste-bin with disposable bags. ■ Electric Wastebasket Corp., New York City.

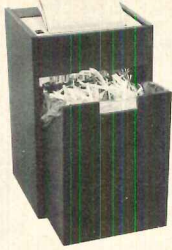

Circle 310 on inquiry card

CONFERENCE TABLE / Simple in design the table's uses vary from a coffee table to a large conference table. Standard sizes offered are 36, 54 and 72 in. diameters, the pedestal sized proportionately with the top. The table can be made in any of five standard lacquer colors or five woods, as well as in a tough new finish. Custom specifications in a broad range of colors, sizes, and wood finishes are available. ■ Intrex Incorporated, New York City.

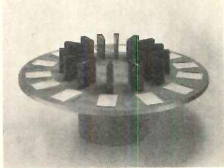

Circle 311 on inquiry card

BATHROOM FIXTURES / Shown is the "Continental Bath" featuring, from left to right: pedestal lavatory, toilet, and a 7-ft oval tub made of fiberglass-reinforced polyester. Fittings are furnished. ■ American-Standard, New Brunswick, N.J.



Circle 312 on inquiry card

CAST ALUMINUM LANTERNS / A new outdoor lighting system which incorporates octagonal shapes is available in clear, bronze, and white colors. The units are available in two different sizes in a complete line of post, wall bracket, and suspended lanterns. The top caps are removable for relamping and are equipped with safety chains. Side panels are translucent milk-white acrylic plastic. ■ Gardco Mfg. Co., San Leandro, Cal.

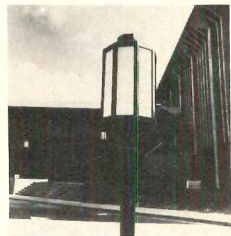

Circle 313 on inquiry card

CENTRIFUGAL WATER CHILLERS / Called the *Air Cooled CentraVac*, the new design is completely factory-assembled and ships as a single package for outdoor installation on the roof or at ground level. It is available in six sizes ranging from 130 to 320 nominal tons. A unique feature of the product is said to be its self-contained, heated and lighted equipment room. An electric space heater provides a tempered environment for maintenance personnel and helps protect the equipment. ■ The Trane Co., La Crosse, Wis.

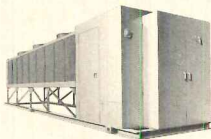

Circle 314 on inquiry card

more products on page 171

A necessary facility for every public building

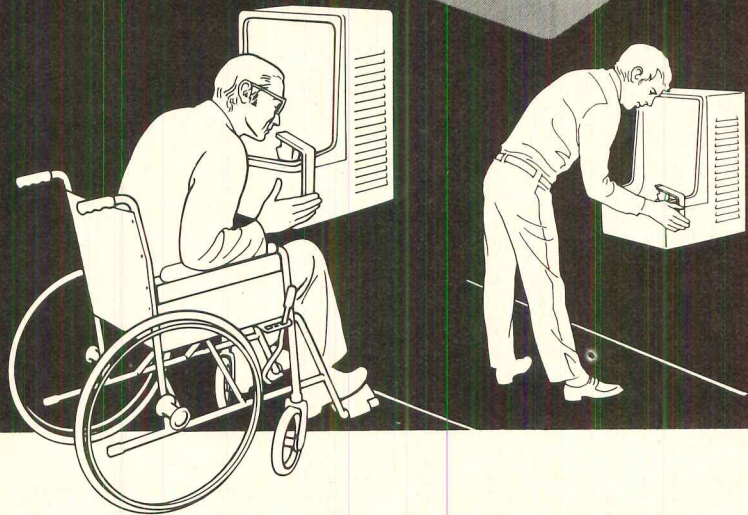
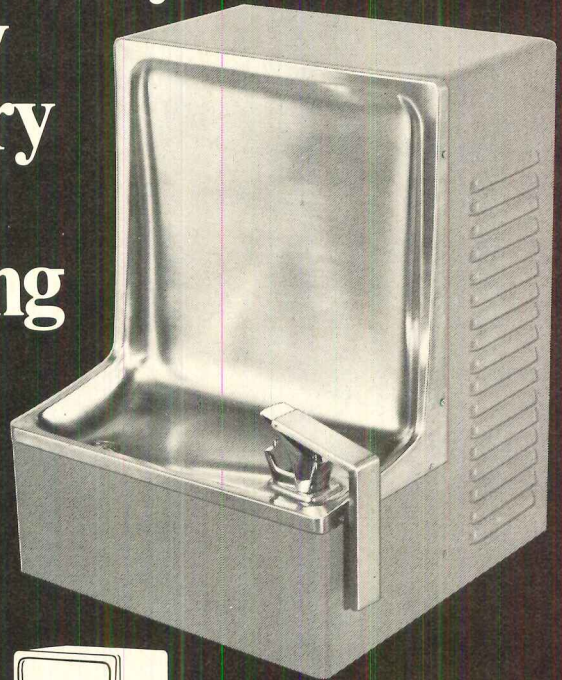

Haws Dual Use HWC-6 Water Cooler is designed particularly for persons in wheelchairs, yet it effectively provides service to foot traffic. It extends out from the wall and is mounted at a convenient height from the floor so that a person can easily wheel up to it. A compound-action bubbler valve actuates the cooler from a push on the side or top, making it easy to operate by handicapped persons.

Model HWC-6 helps you comply with public law 90-480 which states that buildings constructed, leased, or financed by the federal government must provide facilities suitable for use by the physically handicapped.

Available in stainless steel at extra cost. Write for detailed information.

Haws Drinking Faucet Co., 4th & Page Sts., Berkeley, Ca. 94710.



WATER COOLERS

For more data, circle 76 on inquiry card

A.

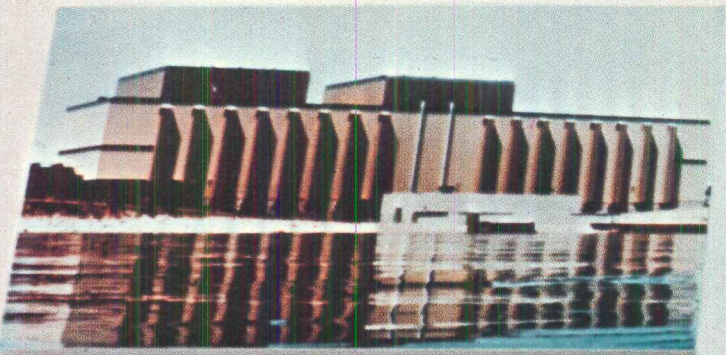

B.



E.



G.



D.



*Kynar is Pennwalt's registered trademark for its polyvinylidene fluoride resin.

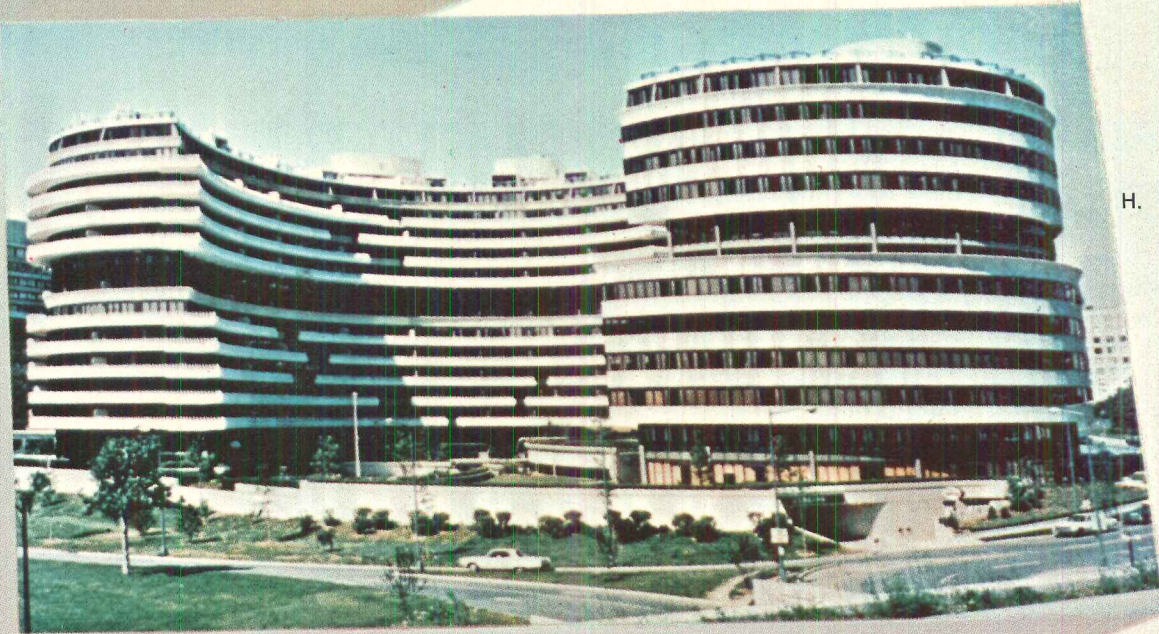
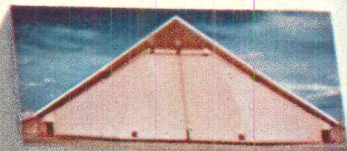

KYNAR[®] City... without limits.

KYNAR 500*-based finishes are at home in any city, in any country, in any kind of climate. From the seasonal extremes of Washington, D.C. to the baking, blistering heat in the heart of Texas, to the industrial environment of Los Angeles, finishes based on KYNAR 500 can take it all.

On metal curtain walls, louvers, window frames, trim and shingles, finishes based on KYNAR 500 resist chalking, chipping, cracking and fading long after other finishes have become eyesores.

For complete test data and technical details contact Page Murray, Plastics Dept., Pennwalt Corporation, Three Parkway, Philadelphia, Pa. 19102. (215) 587-7513

PENNWALT
ARCHITECTURAL COATINGS

For more data, circle 77 on inquiry card

- A. Point Beach Nuclear Plant
Two Creeks, Wisconsin
- B. Texas Stadium
Irving, Texas
- C. United Airlines Hangar
Minneapolis, Minnesota
- D. Zenith National
Insurance Building
Los Angeles, California
- E. VA Hospital
Gainesville, Florida
- F. Midland-Ross Warehouse
Maumee, Ohio
- G. Bailey Plaza Shopping Mall
Jackson, Mississippi
- H. The Watergate Development
Stage IV
Washington, D.C.

Pick the Brains of Our Refuse Experts

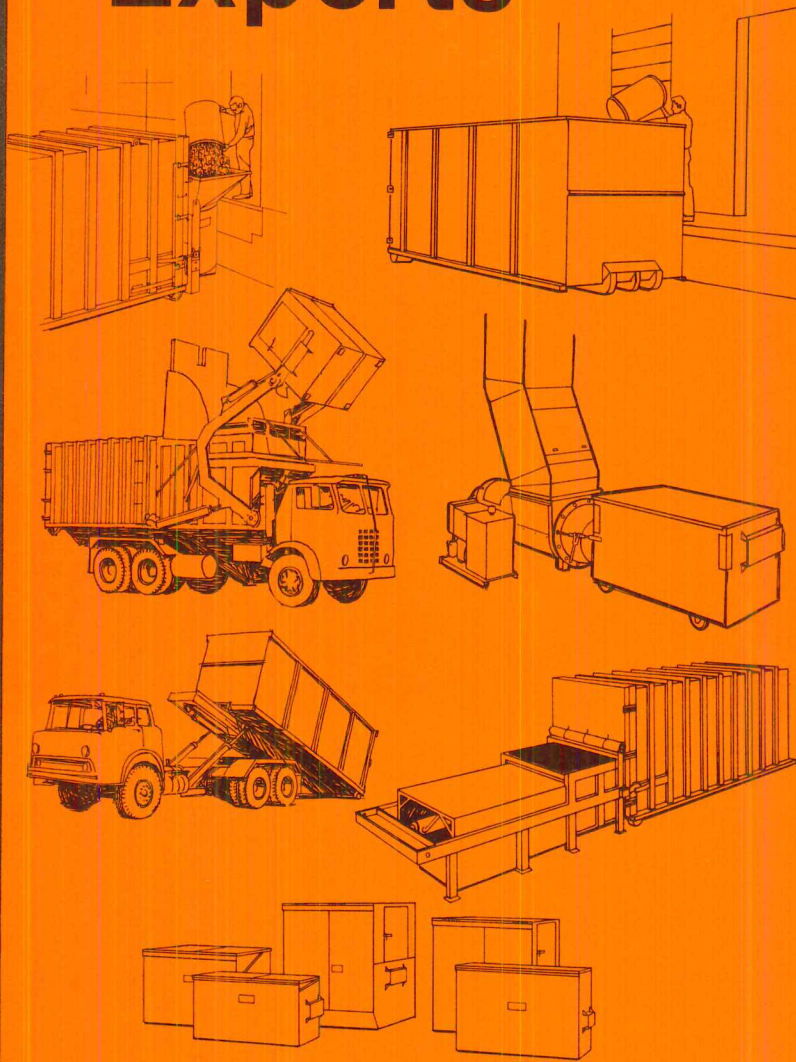

Dempster Consultants Provide Information and Planning Assistance Nationwide.

Dempster Consultants are walking, talking encyclopedias on the subject of waste and refuse handling. Their brain power and experience is mighty helpful when you need to know the latest word on local and national pollution laws, trends, refuse equipment, and practical techniques for handling and disposing of solid waste.

Your nearby Dempster Consultant has had years of experience in helping leading architects and designers plan disposal systems for hospitals . . . high rise office

buildings . . . apartments . . . shopping centers . . . cities . . . and many other commercial/industrial projects.

Give our expert a call. He has up to date information on pollution restrictions and how current and pending legislation (both local and national) will effect disposal now and years to come. Look for more information in Section 11.25 of Sweets Catalogue. Better yet, write today for the name of the Dempster Consultant nearest you and a free brochure.

Home Office: P.O. Box 3127, Knoxville, Tennessee 37917 / **Western Division:** P.O. Box 5703, Compton, California 90221

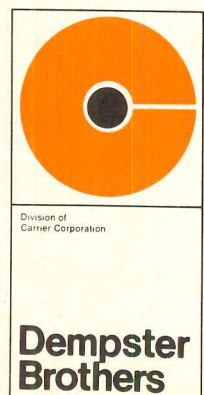

DAMAGE-RESISTANT CEILING / A rough surfaced,



damage-resistant acoustical lay-in panel called *Armatuff* has been developed for exposed-grid ceilings in schools and other buildings where damage might occur. The surface is said to be so tough that a force of 20 in. pounds dropped by an impact tester made only a slight dent that was virtually invisible. All that is required for installation is the company's impact clip and a standard 48 in. concealed tee spline. ■ Armstrong Cork Co., Lancaster, Pa.

Circle 315 on inquiry card

SNAP-ON BASE MOULDINGS / A plastic support is

nailed just above the base of the wall, using an enclosed "spacer" as a guide. Then the skirting is clipped on. No adhesives are necessary. The clip-on skirting is made of both hard and soft PVC plastic. The soft plastic on the bottom is meant to assure good contact with uneven floor surfaces. ■ Bendix Mouldings, Northvale, N.J.

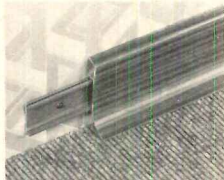

Circle 316 on inquiry card

WALL PARTITIONS / Since pressurization pushes



the panels against the floor, the weight is said to be completely removed from the support track which replaces the ceiling system T-bar and is suspended from the solid roof structure. The track has flanges to accommodate the ceiling tiles, giving the installation a finished appearance. ■ Richards-Wilcox Mfg., Co., Aurora, Ill.

Circle 317 on inquiry card

PLYWOOD DOORS / The precision-milled, eco-

nomically priced units are complete with matching jamb and trim. Said to be strong and durable, *Ready-Pak* is light in weight and comes in colors and textures designed to blend well with all architectural styles. Actual installation on the job site has been clocked at less than ten minutes, with no mortising or routing required under standard conditions. The doors have an expandable jamb design which allows them to adapt to varying wall thicknesses, are hinged to the jamb by a pair of brass mortise hinges, and are pre-bored to accept a cylinder lock. Units come in standard 1 3/8 in. thickness and 6 ft 8 in. height, with numerous widths. ■ U. S. Plywood, New York City.

Circle 318 on inquiry card



TENNIS STORAGE / An 18-compartment locker

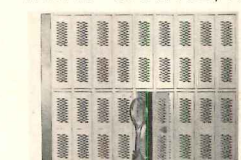

specifically designed for storage of tennis clothing and equipment is a completely assembled, all-welded unit requiring less than 7 sq ft of floor space.

Constructed of heavy-gauge steel, the lockers are fully ventilated to insure proper drying of contents. If desired, doors may be ordered with built-in, factory-installed key locks at additional cost. ■ De-Bourgh Mfg. Co., Minneapolis, Minn.

Circle 319 on inquiry card



SCOREBOARDS / No field wiring is required according to the company and smaller, less costly conduit can be used if it is needed. The 100 per cent solid state design is engineered for long life, reliability, and accuracy. The built-in circuitry allows for future scoreboard additions and the new operator's control panel can run one, two, four or more scoreboards fully synchronized at one time. The all-aluminum cabinet of basic model 2-2000 weighs 83 lbs. ■ Nevco Scoreboard Co., Greenville, Ill.

Circle 320 on inquiry card

REFRIGERATOR / The *Gastronorm* system provides

food service with its own tray size—a 20 by 24 in. module size. It economizes and speeds up food-service production because the same size tray is used from the refrigerator to oven to serving counter, permitting a smooth efficient flow pattern that eliminates food transfer from one size tray to another. The *Gastronorm* models feature urethane insulation, top-mount grilles removable without tools, and are available in stainless steel or aluminum. The cabinets are 30 in. deep with heights ranging from 84 to 88 in. (including 6 in. legs as standard). ■ Foster Refrigerator Corp., Hudson, N.Y.

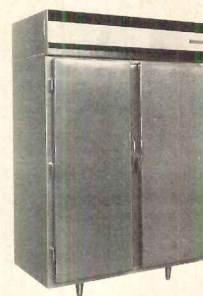

Circle 321 on inquiry card

more products on page 172

Write for Catalog:
VOGEL-PETERSON CO., ELMHURST, ILLINOIS 60126
 SHOWROOMS: MERCHANDISE MART, CHICAGO; NEW YORK.

High Rise/Life Safety Code Requirements

If you will be designing a multi-story building which must comply with the ICBO, BOCA or Southern Building Codes, Wasco Products can help you. Having worked very closely with the professionals in developing the smoke control provisions, Wasco is now able to provide the hardware that can meet them. For instance, we have completed or are now installing exterior wall smoke vents with remote release devices, similar to the drawing below, in eight multi-story buildings.

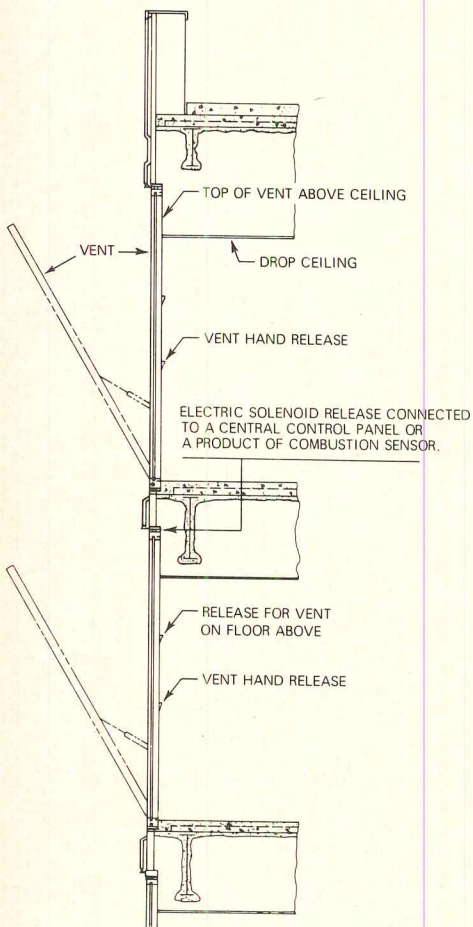

**WASCO EXTERIOR WALL
SMOKE CONTROL VENT**

These vents not only meet code requirements but allow the architect a wide range of choice of both exterior and interior panels or glazing.

Because Wasco has been so close to this life safety effort, we can also offer extensive design assistance.

For copies of the various code sections pertaining to life safety or for specific help on individual jobs, write Richard L. Swan, Wasco Products, Inc., Box 351, Sanford, Maine 04073, or call 207-324-8060.

For more data, circle 81 on inquiry card

PERSPECTIVE DRAWING / Operate the Perspec-T

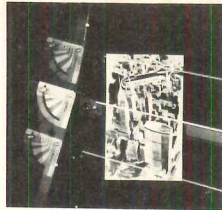

as a T-square. Lines drawn along its straightedge radiate from the intangible point selected to adapt reference sketches, photos, grids, etc. Perspec-T is an aid to the illustrator, architect and designer for: conceptual sketches, detailed renderings, photo reference analysis, computerized perspective embellishment, etc. No special drawing board or grids are required. ■ Perspec-T, Pompton Plains, N.J.

Circle 322 on inquiry card

UTILITY TURRET SYSTEM / A turret system designed

to consolidate all utilities such as a sink, water, gas and electricity into a compact area for school laboratory applications can accommodate one to 16 students. The turret pedestal is fabricated of 16 gauge stainless steel and the top of the pedestal is fitted with hot and cold water faucets, gas jets and electrical outlets. Sinks are available in various sizes including double bowls. ■ St. Charles Mfg. Co., St. Charles, Ill.

Circle 323 on inquiry card

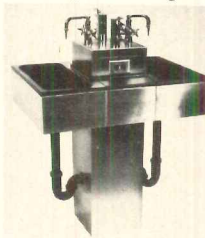

VINYL WALLCOVERING / A new line includes 164



vinyl wall fabrics, in 70 patterns in a variety of colorways. Many items in the collection offer coordinated cotton and upholstery grade fabrics. The collection also was styled for possible mix and match with current colors and patterns of the company's laminated plastic. ■ Formica Corp., Cincinnati, Ohio.

Circle 324 on inquiry card

THREE-DIMENSIONAL LAYOUT / The PlanPrint

system provides overlays and underlays to show overhead and underfloor installations relative to the floor plan. It is recommended for locating such services as: conveyors, compressed air, water, plumbing, lighting, electrical, machine foundation pads, and waste disposal. Adhesive-backed templates and strips represent the machinery, equipment, and services on the overlay, underlay, and floor level panels. ■ PlanPrint Co., Chalfont, Pa.

Circle 325 on inquiry card

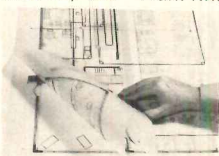

REEL RINSE HOSE / The unit is a lightweight, multi-

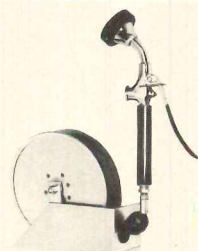

duty 8-in. metal reel, with 12 ft of 3/4 in. highpressure hose. The reel and base are finished with white metal plated, and may be mounted under the counter or on a wall. The vinyl covered squeeze lever permits easy, infinite adjustments in water control for various rinsing operations. The action is self-closing and designed for commercial use. ■ Fisher Mfg. Co., Los Angeles.

Circle 326 on inquiry card

Get the
tough protection
this little animal
can give you.

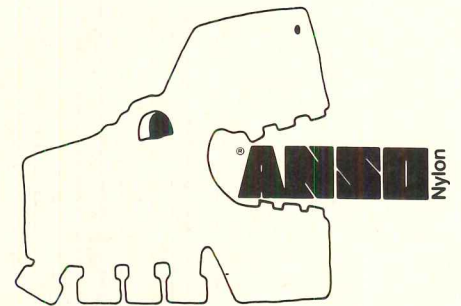

Get Guaranteeth.
The guarantee
with teeth.

It's yours when you specify
carpeting of ANSO nylon,
available from the following
contract furnishers.

Angelus Carpets
8380 Melrose Ave.
Los Angeles, Calif. 90069
Mr. Ken Snyder
Tel: (213) OL 1-2730

John Bloeser Carpet Co.
1325 Channing St.
Los Angeles, Calif. 90021
Mr. Terry Welch
Tel: (213) 627-4738

J.L. Hudson Co.
Contract Division—13th floor
1206 Woodward Ave.
Detroit, Mich. 48226
Mr. Harry Foster
Tel: (313) 223-1362, 1379

Kinney/Bernardi
4611 Malat St.
Oakland, Calif. 94601
Mr. William Kinney
Tel: (415) 261-3211

Orchard & Wilhelm
Commercial Interiors Inc.
8815 "F" St.
Omaha, Neb. 68127
Mr. John Randall
Tel: (402) 339-5000

The Slater Co.
300 W. Hubbard St.
Chicago, Ill. 60610
Mr. John Becker
Tel: (312) 467-7100

Thalhimer Industrial Sales Corp.
1925 Westmoreland Ave.
Richmond, Va. 23230
Mr. H.E. Glave
Tel: (804) MI 3-4211

All other areas call:
Allied Chemical Corporation
Home Furnishings Fibers
Advertising Manager
One Times Square
New York, New York 10036
Tel: 212-736-7000





In the carpet world, Anso[®] Nylon's five year guarantee is on top of the pile.

Two Shell Plaza is Houston's new pride.

So in the public areas and hallways, this building has "TXR-10" carpeting from Commercial Carpet Corporation.

It comes with Guarantesth—the guarantee with teeth. Allied Chemical's assurance that the carpet is guaranteed not to wear more than 10% in five years, or Allied Chemical will replace it, installation included. Promise.

Allied makes this promise because we make ANSO nylon—the second-generation soil-hiding

nylon. And, we test every carpet made of ANSO nylon 10 different ways to be sure it can take it.

So look for the label with the fierce little animal who symbolizes our Guarantesth. And get the carpet with the five year wear guarantee.

For your free copy of our Contract Carpet Manual, write to: Allied Chemical Corporation, Fibers Division, Contract Department AR, One Times Square, N.Y.®

N.Y. 10036. Phone: (212) 736-7000.



Guarantesth. The guarantee with teeth.

Two Shell Plaza, Houston, Texas/35,000 yds. "TXR-10"/Commercial Carpet Corp.



For more data, circle 82 on inquiry card

ARCHITECTURAL RECORD

A McGRAW-HILL PUBLICATION

ARCHITECTURAL
RECORD
REPEATS
ITS HIGHLY
SUCCESSFUL
CONFERENCE

PRESENTS

**... a special two-day
conference
examining the
exciting profit
opportunities
available in this
new vista**

How the Architect and Engineer can Profit as a Builder/Developer

All over the United States, pioneering architects and engineers are starting to capitalize on their expanding opportunities in development building. In doing so, they are entering new areas of profitability. These opportunities bring with them involvement in a whole range of problems with which the professional practitioner has had little or no previous experience. Now, for the first time, Architectural Record has developed a special conference designed to help cope with these problems and to take full advantage of emerging opportunities.

The faculty for these conferences includes not only successful architect/engineers-developers but attorneys, CPA's, mortgage bankers, contractors, marketing experts and brokers as well.

MAY 9-10 — ATLANTA / MAY 13-14 — LOS ANGELES / JUNE 14-15 — HOUSTON

Conference Highlights

- Feasibility Studies—how to determine the potential marketability and profitability of a project
 - Land acquisition—how to choose the right land—how to secure favorable zoning
 - Project financing—an evaluation of the alternative methods of real estate financing—how to find the money
 - Legal and ethical implications of the architects involvement in development building
 - Professional liability
 - How to organize for success and choose the kinds of partners you need
- Case studies in various building opportunities

MCi

Management Concepts International, Inc.

505 Park Avenue, New York, N. Y. 10022 • 212 759-5830

Please rush additional registration information on How the Architect and Engineer Can Profit as a Builder/Developer.

Name _____

Company _____

Address _____

City _____ State _____ Zip _____

Phone (A/C) _____ Number _____ Ext. _____

The background of the entire page is a photograph of a starry night sky. The stars are scattered across the frame, with some appearing as bright white dots and others as smaller, fainter points of light. The sky's color transitions from a deep, dark purple at the top to a vibrant, glowing red at the bottom, creating a dramatic, ethereal atmosphere. The overall effect is reminiscent of a nebula or a sunset over a vast, dark landscape.

**How do you light the
21st Century?**

Wide-Lite designs exterior lighting fixtures as new as tomorrow.

And calls them Elliptra.™

Contemporary architecture. It's lines. Angles. Shapes. Curves.

And it's tomorrow. Today.

So we wanted to introduce a family of fixtures that would go with the times. And complement the wide spectrum of "future" architecture.

The series had to be versatile enough to cover all facets of commercial and institutional exterior lighting. And, of course, it had to make use of efficient, energy-conserving HID lamps.

Well, our engineers and designers went right to work on the project. And came up with just what we wanted.

Elliptra.

Elliptra I. The area light.

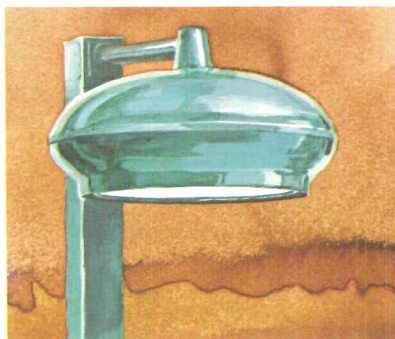

The first fixture in the series is Elliptra I. An area light whose unique housing is designed to contain four HID lamps. Each with an integral ballast, and a reflector that can be adjusted to let you aim patterns of light into divided malls, long narrow spaces, or areas of unusual shape.

Elliptra II. The post top luminaire.

Similar in appearance to Elliptra I, this fixture is available with an encapsulated integral ballast (housed in the stylish mounting arm) or in models designed for remote ballast operation.

Pole mounted, Elliptra II provides well defined symmetrical

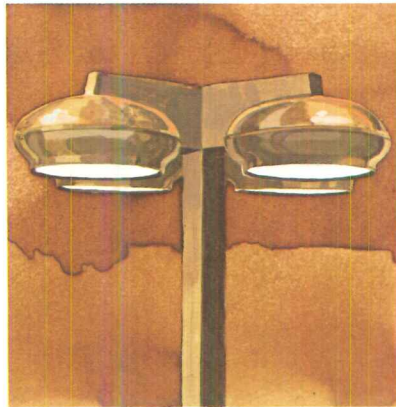

patterns of light for parking lots, walkways and drives, parks, and campuses. Wall mounted it can be effectively used along building fronts and over entryways.

Elliptra III. The floodlight.

Elliptra III's patented, segmented reflector makes it equal in efficiency to our famous "F" model; long the standard in superior floodlighting.

Pole or wall mounted, the fixture operates on a remote ballast. But Elliptra III can also be ground mounted on a specially designed conical shaped integral ballast housing.

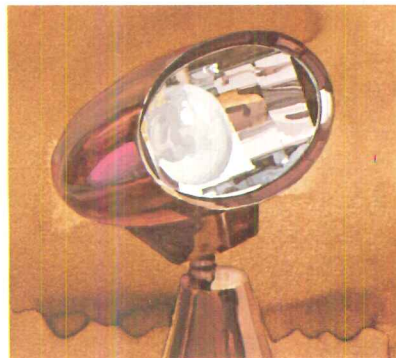

Add these mounting position possibilities to a swivel-arm mounting bracket that permits both vertical and horizontal aiming, and you can see why Elliptra III is perfect for any floodlighting situation where appearance and performance are both important.

Elliptra IV. The wall washer.

The fourth fixture in the Elliptra family mounts to flat surfaces. To create decorative accent lighting.



All Elliptra IV models have an integral ballast. And like all other Elliptra fixtures, the wall washer is finished in dark bronze baked enamel. With colors like terra cotta, slate blue, avocado, and golden bronze available by special order.

Some things never change.

There are a few things about the Elliptra series that aren't quite so new. At least not to Wide-Lite.

Like a dust tight, sealed optical assembly that keeps Luminaire Dirt Depreciation and maintenance low.

An encapsulated ballast that's rated for operation in ambient temperatures to 65°C.

And a three-year warranty on all ballasts and fixtures.

They've been standard on all our luminaires for some time now.

So if you're looking for a simple, graceful answer to an exterior lighting problem, talk to your Wide-Lite® representative about Elliptra. Together, you'll work out a solution that's right out of the next century.

WideLite®

P. O. Box 191, Dept. AR-1194-12/73
Houston, Texas 77001.

A Company of the  Esquire Lighting Group
Also manufactured in Australia, Belgium,
Canada, Mexico and Great Britain.

®Trademark of Wide-Lite Corporation
™Trademark Pending

The future of design lies right across the street.



An exclusive invitation to senior members of firms attending the 1974 AIA convention.

While you're in Washington, you'll be hearing a lot of talk about the future of design. We'd like to give you an opportunity to see it for yourself — right across the street from the convention.

At the Washington office of architects Perry, Dean and Stewart, they're using a computer-aided design system right now. And they'll be happy to let you see it in operation.

The system is Decision Graphic's ARK-2, based on Digital Equipment Corporation's popular PDP-15/Graphic 76 computer. What it does, very simply, is enable architects to

visualize, evaluate and restructure design solutions far more quickly, accurately — and profitably — than ever before. From project programming through design development and on through specifications, this comprehensive system complements and assists the architect in a natural and flexible way.

The ARK-2 system is not a pie-in-the-sky plaything. It is a working, profit-making system, proven over the years in a wide variety of architectural projects. Installations from Switzerland to Australia are proving this every day.

Take a look. Then judge for yourself.

To arrange for a visit, write

or call: Mr. John Nilsson, Decision Graphics, 905 Park Square Building, Boston, Massachusetts, (617) 482-6829, or

Mr. Richard Devlin, Digital Equipment Corporation, 146 Main Street, Maynard, Massachusetts, (617) 897-5111.

To be sure of a place, we suggest you reply early. If you can't visit us in Washington but would like more information, ask for it. We'll send it right away.

But while you're at the convention, try to pay us a visit. We think you owe it to yourself to see what a Graphic 76/ARK-2 system can do for your firm.

digital

DECISION © GRAPHICS

montgomery moves people throughout North America with over 3000 escalator installations

These thousands of escalator installations demonstrate Montgomery's Total Capability in design, manufacturing, installation and maintenance of Escalator, Power Walk and Power Ramp system throughout North America.

Total Capability means advanced design, complete product line and quality manufacturing...unique product features like level two-step entry and exit...the Crystal 2000 struc-

tural glass balustrade escalator that harmonizes with any decor...wide geographic scope of operations for efficient installation and maintenance service...vertical transportation planning assistance to help in the design of new construction or modernization projects.

Contact your nearest Montgomery office — we're not very far from anywhere in North America.

montgomery moves people



montgomery[®]

ELEVATORS/ESCALATORS/POWER WALKS & RAMPS

Montgomery Elevator Company, Moline, Illinois 61265 • Montgomery Elevator Co. Limited, Toronto, Ontario M9B3S5 • Offices in Principal Cities of North America

Scald-GuardTM keeps you and your customers from getting burned.

Most shower faucets require careful manipulation of the handles to get a comfortable blend of hot and cold water. Scald-Guard does not.

Most shower faucets have a quick handle turn into the critical hot water zone. Scald-Guard does not.

Most shower faucets require messy, expensive crosspiping and wrong-side, awkward maintenance. Scald-Guard does not.

Scald-Guard is simple to install and even simpler to operate.

It's safe. Constant. Reliable. With the optional pressure balance valve, dishwashers, flushed toilets and clotheswashers don't affect the shower water temperature.

And Scald-Guard rarely drips - because like all Delex faucets it has no washer to wear out.

Don't get burned. Don't let your customer get burned. Specify Scald-Guard.

*For illustrated literature, write
Delta Faucet Company,
A Division of Masco Corporation,
Greensburg, Indiana 47240,
and Rexdale, Ontario.*

Delta Faucets.
Washerless. To work as good
as they look.

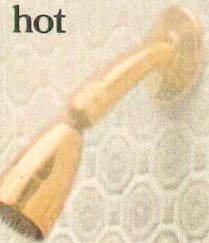

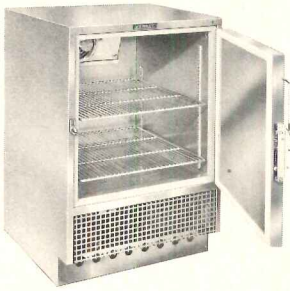

SPACE-SAVING REFRIGERATORS WITH MODULAR COMPATIBILITY, under-counter and eye-level models in a variety of standard dimensions that form an unbroken line of design. Polished stainless steel exterior (or your choice of finish) and interior. Designed for hospital labs, pharmacies or nurses' stations, explosion safe or total explosion proof construction optional.

Freezers with same dimensions available. Removable front grille facilitates easy servicing. Defrost systems, featuring condensate evaporator and accumulator, eliminate need for floor drain. Write: Jewett Refrigerator Co., Inc., 2 Letchworth St., Buffalo, N.Y. 14213.

For more data, circle 100 on inquiry card

Easy-Heat Series D Heating Mats melt snow and ice when installed in concrete. They are pre-wired at the factory ready for installation. Heats uniformly at the lowest material cost. Series D Heating Mats are applied quickly on the project site and are easy to work with when designing around special shapes. For more information, contact Easy-Heat, 555 North Michigan St., Lakeville, IN 46536. Ask for Bulletin #1-1079 Snow Melting and Floor Heating Systems.

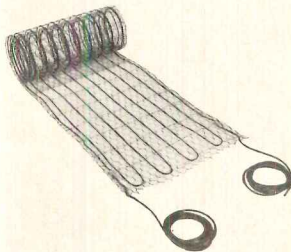

For more data, circle 102 on inquiry card

RECORD IMPRESSIONS CATALOG

SEND FOR A COMPLETE, DETAILED CATALOG of "Record Impressions." A convenient service offering reprints of Building Type Studies, Interiors and Special Reports. Offered are more than 30 items including back issues of Record Houses 1968 and 1970; Product Reports '73 and the practical reference guide, "Air Conditioning: A New Interpretation."

Address your request to: Record Impressions, Architectural Record, 1221 Avenue of the Americas, New York, New York 10020, Attn: Joseph R. Wunk

PREFABRICATED ANIMAL HOUSING is illustrated in the new 24-page catalog of Long Environmental Systems. Modular, chain-link panels allow construction of any number of indoor or outdoor kennels. No post holes required. Units disassemble for moving or storage. Accessories include slide-gate; new fiberglass resting bench; automatic watering system; automatic feeder; and automatic doors between indoor and outdoor kennels. Catalog, which provides construction drawings and specifications, appears in Sweets and is available from Long Environmental Systems, Box A, Gambrills, Md. 21054.

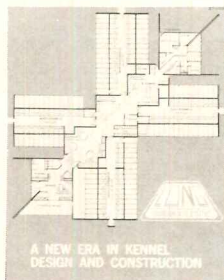

For more data, circle 105 on inquiry card



WIRING SYSTEMS FOR OPEN SPACE

How to choose a wiring system to bring electrical, communications, even electronic services to away-from-wall locations which will change on the average of twice a year? Tele-Power® systems distribute wiring above the suspended ceiling, then down to action centers via Tele-Power or Quick-E-Poles®. Movable poles

accommodate area rearrangement. Send for illustrated brochure featuring actual case histories. The Wiremold Company, West Hartford, Conn. 06110.

For more data, circle 101 on inquiry card

VPI VINYL-RAIL HANDRAIL COVERING

conforms smoothly to curves, spirals and angles to provide a colorful accent for all types of metal railings. It also offers a safe, firm grip that is pleasant to the touch. Seven colors are available in 12 profiles to fit flat rails and standard pipe. Easily installed in the shop or on the job. Color brochure available in Sweets Architectural File 5.11/Vi, or from Vinyl Plastics, Inc., Sheboygan, Wisconsin 53081.



For more data, circle 103 on inquiry card



NEW

Complete line of decorative lighting equipment—specifically designed for commercial interiors.

REQUEST FULL COLOR CATALOG "M"

R.A. MANNING COMPANY INC.
P.O. BOX 643 SHEBOYGAN, WIS. 53081

For more data, circle 106 on inquiry card

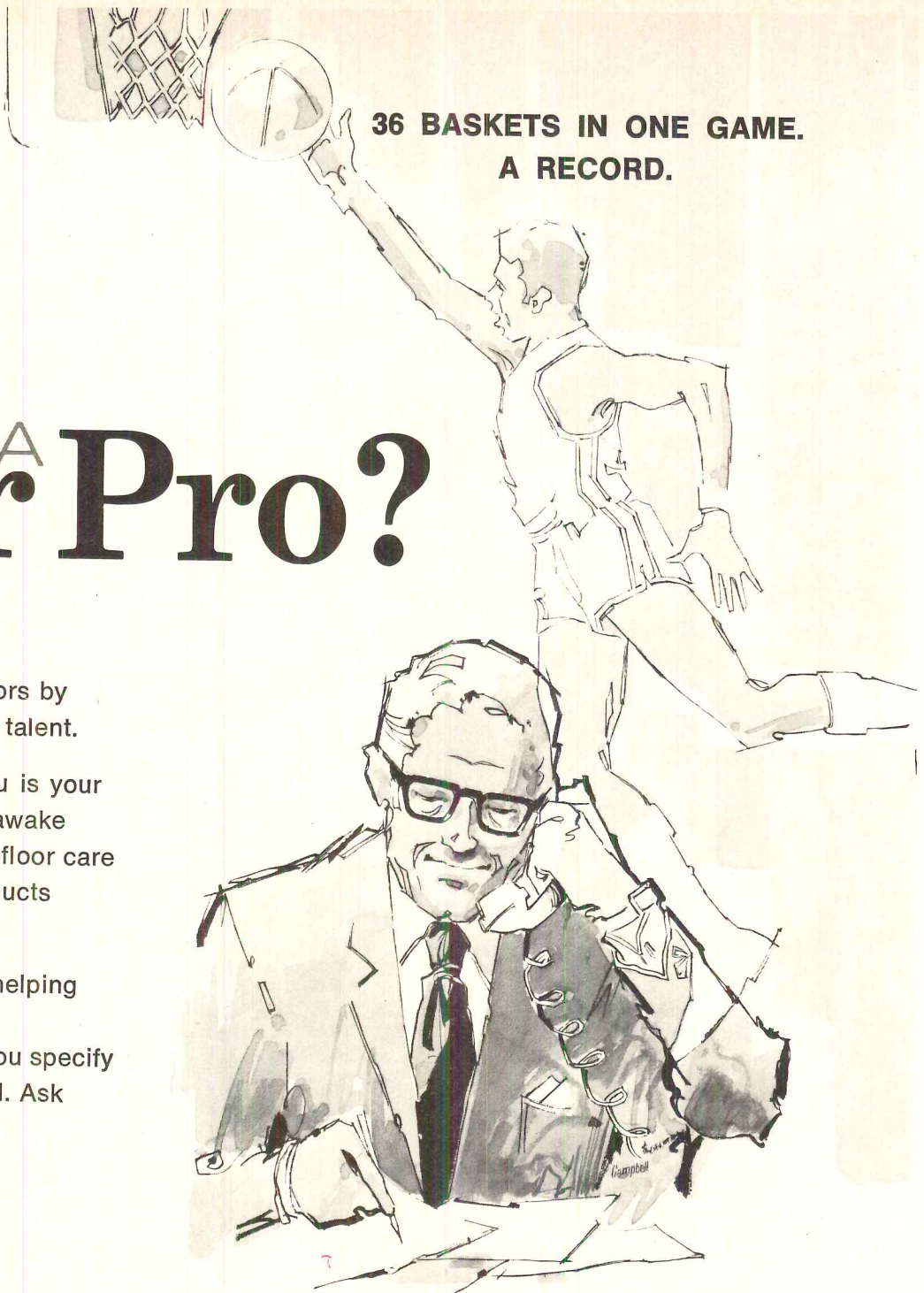

**36 BASKETS IN ONE GAME.
A RECORD.**

WHAT IS A **Super Pro?**

A man who outperforms all competitors by putting SUPER effort behind natural talent.

A Super Pro who is important to you is your Hillyard representative. He's a wide-awake professional who knows how to solve floor care problems with the use of quality products and his own super effort.

He is a Super Pro when it comes to helping recommend proper treatments and maintenance products so the floors you specify will live up to the standards expected. Ask us and we'll have him get in touch with you . . . *superfast*.



SUPER PRODUCTS FROM HILLYARD

TROPHY

Slip-resistant, glare-free, wood floor seal and finish.

CEM-SEAL II

Non-yellowing, single-coat; provides a quick seal and a slow cure for concrete floors.

ONEX-SEAL II

Penetrating finish and seal for terrazzo floors; prevents efflorescence and discoloring stains.



HILLYARD CHEMICAL COMPANY

302 North Fourth Street
St. Joseph, Missouri 64502
(816) 233-1321

Keeper of the floors world-wide

For more data, circle 107 on inquiry card

A Big Beautiful Swede... With A 50-Year Guarantee



This big well-built Swedish shopping center has its beauty protected by AllianceWall porcelain-on-steel panels which carry a 50-year guarantee. They are graffiti-proof, vandal-proof and fire resistant. And they never require painting or expensive maintenance. All of these are important considerations to the practical Swedes and to good businessmen all over the world. AllianceWall porcelain-on-steel panels are available in 112 standard colors in matte, semi-matte and glossy finishes.

Other AllianceWall Factories In:
Okmulgee, Okla.; Genk, Belgium and Odense, Denmark

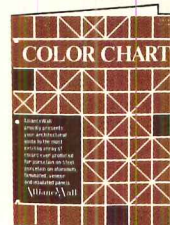

**FREE
COLOR
GUIDE**

Send for your
copy today

AllianceWall[®]

CORPORATION
Box 247
Alliance, Ohio 44601

For more data, circle 108 on inquiry card



Announcing Bruning Automated Diazo.

And the end of print department bottlenecks.

Bruning makes machines that make whiteprints. Convenience machines. High-volume production machines. In-between machines. It's no news that we're a leader in diazo.

So, here's the news: Bruning is now bringing automation to the whiteprint department. Automation that eliminates drudgery. Automation that eliminates human errors. Automation that boosts capacity, cuts time cycles, and cuts costs.

And eliminates print-room bottlenecks.

For automated print production, we offer two advanced-design machines:

- The new Bruning/Metem 625 is the ultimate high-volume, large-sheet whiteprinter—automatically handling originals up to 47" (120 cm) wide. Its magazine holds three large paper rolls of varying widths. From the instant an operator feeds in the original, operation is automatic. The 625 delivers dry, high-density prints cut exactly to the size of the originals. It is designed to operate reliably on a continuous basis, day after day.
- The Bruning 850 whiteprinter automatically produces prints from 8½" x 11" to 18" x 24" in the same automated manner. It's the ideal high-volume print-room companion to the new 625, or to any full-size whiteprinter, for processing your smaller originals.

For automated print processing, we now offer three Versafold models, one or all of which will greatly simplify your task of folding random-size engineering prints.

These unusually versatile units permit custom programming for special book-binding folds, flap folds, fan folds, and many others. Whichever folding machine you select, the big pay-off is in efficiency. Versafold folding is five to six times faster than tedious (and boring) manual folding. With substantially lower operating costs.

Truly, Bruning has advanced from a leader in diazo to a leader in automated diazo. Talk to your Bruning man soon about breaking the bottlenecks in your print room. Or write for descriptive color brochures to Bruning, 1834 Walden Office Square, Schaumburg, Ill. 60172.

**Your single best source
in engineering graphics.**

BRUNING

DIVISION OF
ADDRESSOGRAPH MULTIGRAPH
For more data, circle 109 on inquiry card

Specify Nord

Carved entry way doors.
Of select kiln-dried Douglas fir.
Richly carved. Finely detailed.

Choose from six lines and 35 designs. You'll find deep carvings, ornate grilles, solid raised panels, even amber glass inserts.

For full-color literature, write "doors" on your letterhead and mail it to E. A. Nord Company, Dept. AR, Everett, WA 98206.

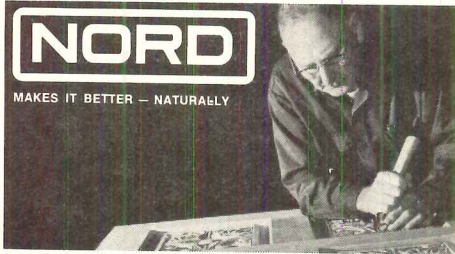

For more data, circle 110 on inquiry card

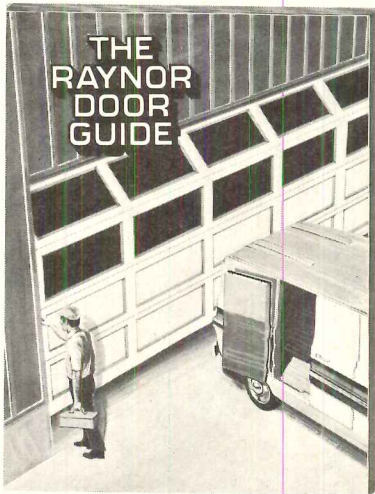

All the facts you should know about garage doors can be found in this complete Raynor reference guide. Garage door styles, materials, mountings, applications, specifications (including handy door and track selection guides),... **PLUS** information on Raynor's new deep-ribbed, good-looking 'Security Line' steel doors. See why Raynor builds better doors.

Just clip this coupon and mail to:
RAYNOR MANUFACTURING COMPANY
DEPT. AR-4 DIXON, ILLINOIS 61021

Name _____
Firm _____
Address _____
City _____
State _____ Zip _____

For more data, circle 111 on inquiry card

RECORD IMPRESSIONS

A new service offering reprints, reports and back issues.

RECENT LISTINGS

- ③⑧ THE YOUNG ARCHITECTS 56 pgs. 4-color 1.00 per copy
- ③⑨ RECORD HOUSES 1972 3.25 per copy
- ④⑩ RECORD INTERIORS of 1973 16 pgs. 4-color 1.00 per copy
- ④① ROLE OF THE ARCHITECT IN DEVELOPMENT HOUSING 16 pgs. 2-color 1.00 per copy
- ④② PRODUCT REPORTS 1973 3.00 per copy
- ④③ MUSEUMS (JULY 1972) 16 pgs. 4-color 1.00 per copy
- ④④ AIRPORTS 18 pgs. B&W 1.00 per copy
- ④⑤ RECORD INTERIORS OF 1974 16 pg. 4-color 1.00 per copy

INTERIORS

- ③ RECORD INTERIORS of 1971 20 pgs. 4-color .50 per copy
- ②① SIX INTERIORS—AUGUST 1971 12 pgs. 4-color .50 per copy

BUILDING TYPE STUDIES

- ④ MUSEUMS (JUNE 1969) 16 pgs. 4-color .50 per copy
- ⑥ DESIGN FOR MERCHANDISING 16 pgs. 1.00 per copy
- ⑧ AIRPORTS 16 pgs. B&W 1.00 per copy
- ①① CORRECTIONAL ARCHITECTURE 16 pgs. 2-color .50 per copy
- ①③ CAMPUS DESIGN FOR SUCF—AN ANALYSIS OF EXCELLENCE 24 pgs. 2-color 1.00 per copy
- ①⑤ BUILDING FOR A BROAD SPECTRUM OF HEALTH CARE 16 pgs. B&W 1.00 per copy
- ①⑥ URBAN HOUSING: 30 pgs. 2-color 1.00 per copy
- ②⑩ LOW-INCOME HOUSING 16 pgs. 4-color 1.00 per copy
- ②④ 5 CONTEMPORARY SCHOOLS 14 pgs. B&W .50 per copy
- ②⑥ DESIGN FOR A VARIETY OF CAMPUS LIFESTYLES 18 pgs. 4-color .50 per copy
- ②⑦ SHOPPING MALLS IN SUBURBIA 16 pgs. 4-color 1.00 per copy
- ②⑧ SUBURBAN OFFICE BUILDINGS 16 pgs. 4-color 1.00 per copy
- ③④ INDUSTRIAL BUILDINGS 16 pgs. 4-color 1.00 per copy
- ③⑤ HOSPITAL PLANNING RESEARCH 18 pgs. 4-color 1.00 per copy
- ③⑥ HOUSING: ONE GOVERNMENT AGENCY REACHES FOR GOOD ARCHITECTURE 16 pgs. 4-color 1.00 per copy
- ③⑦ RESORT HOTELS 16 pgs. 4-color 1.00 per copy

PREPAID ORDERS ONLY

Record Impressions

ARCHITECTURAL RECORD

1221 Avenue of the Americas

New York, New York 10020

Att. Joseph R. Wunk

No. of copies

- | | | | |
|---------|---------|---------|---------|
| ③ _____ | ⑧ _____ | ⑮ _____ | ⑳ _____ |
| ④ _____ | ⑪ _____ | ⑯ _____ | ㉑ _____ |
| ⑥ _____ | ⑬ _____ | ㉒ _____ | ㉓ _____ |
| | | ㉔ _____ | ㉕ _____ |
| | | ㉖ _____ | ㉗ _____ |
| | | ㉘ _____ | ㉙ _____ |
| | | ㉚ _____ | ㉛ _____ |
| | | ㉜ _____ | ㉝ _____ |
| | | ㉞ _____ | ㉟ _____ |
| | | ㊱ _____ | ㊲ _____ |
| | | ㊳ _____ | ㊴ _____ |
| | | ㊵ _____ | ㊶ _____ |

Enclosed is my check Money order for \$ _____
please include local sales tax

NAME _____

FIRM _____

ADDRESS _____

CITY/STATE _____ ZIP _____

valid through 6/30/74

Washfountains that wipe out vandalism while they clean up the kids.



Bradley's "School Board Special" Washfountain. Built right because we developed it to the specific needs of an actual school district. And built dependable because of Bradley's long experience in designing for school markets.

We work with school maintenance people to find features that will help solve their individual vandalism problem. And the result is Washfountains that require less

maintenance and are more vandal resistant. New ideas like the combination soap dispenser/restraining bracket that dispenses soap while anchoring the sprayhead support tube assembly. A pressurized system that dispenses soap with a minimum of effort. A foot controlled tape switch instead of a foot rail. And more.

You can even specify the material that best fits your needs. Stainless steel. Precast

terrazzo. Or new tough Bradglas®. Choose from a wide range of colors and options, too. For complete details, see your Bradley representative and write for latest literature, including a list of communities that have installed these special units. Or call (414) 251-6000. Bradley Corporation, 9109 Fountain Drive, Menomonee Falls, Wisconsin 53051.

Another bright idea from



Bradley

For more data, circle 112 on inquiry card

Some communication systems are a costly error.

The communications boom can drive you right up the walls. If you can't handle it, it's really going to cost you. Running wires around the bases. For more phones, more equipment. Taking chances on an

accident. So play it safe. Put a Walkerduct Underfloor System in your building specs. It will keep packing 'em in.

By running all the communication, power and signal requirements under the floor inside Walkerduct, you've got nothing to worry about. The building is safer, more efficient and able to handle any future needs quickly, easily and neatly. Without tearing up the floors. Without spending a small fortune.

Contact your nearby Walkerman for more information. Or write: Walkerduct, Parkersburg, West Virginia 26101. In Canada: Walkerduct of Canada.

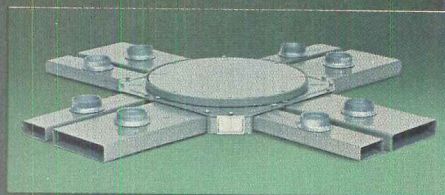

walkerduct[®]
WALKER / PARKERSBURG
A **textron** Company

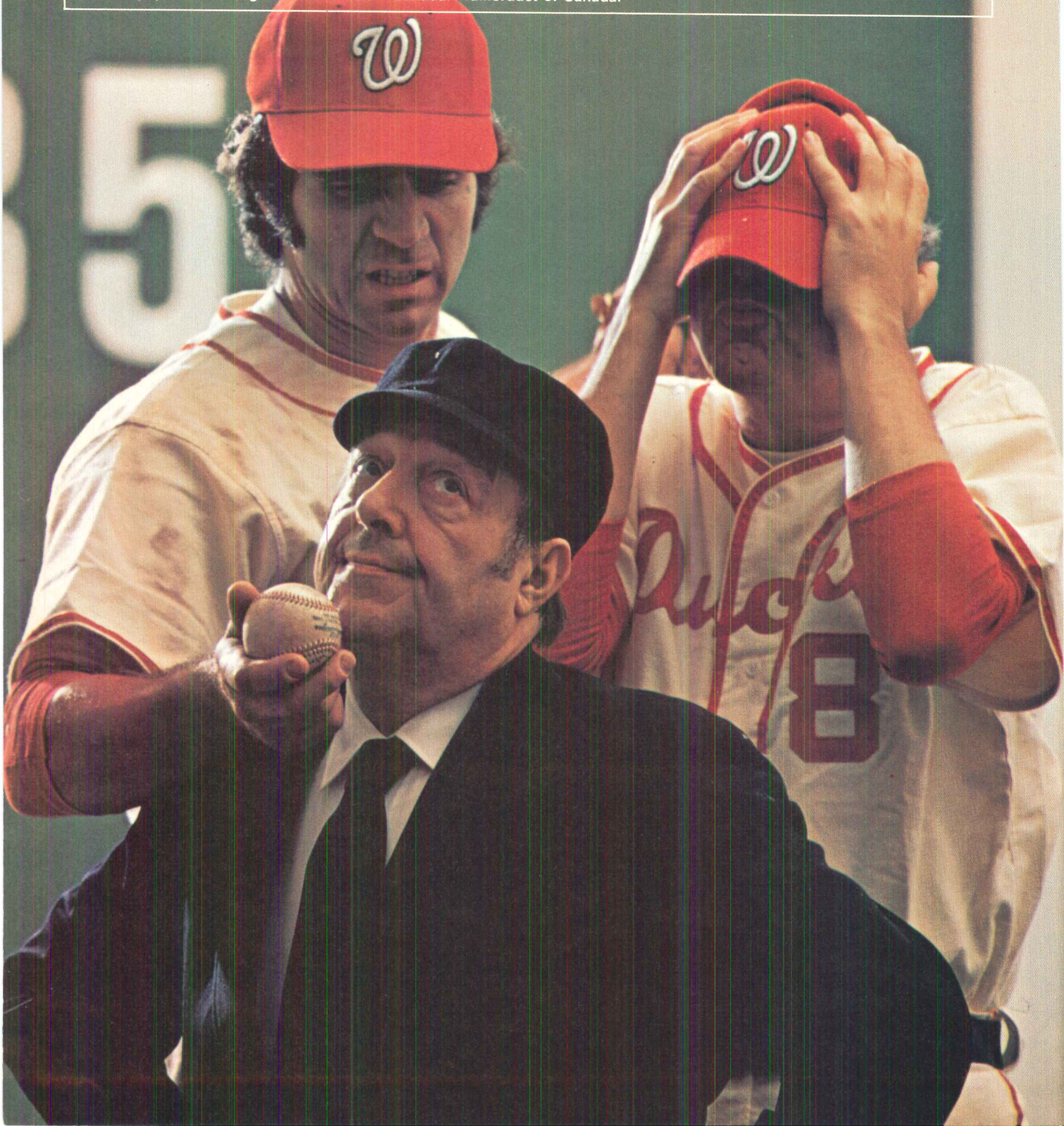

Seven reasons why your investments deserve Pyrotector photoelectric smoke detectors.

1. They provide earlier detection of incipient (smoldering) fire than ionization detectors. We'll prove this by demonstration.
2. They detect smoke of required density regardless of distance smoke particles have travelled.
3. They have none of the safety problems possible with radioactive devices.
4. They are not "threshold" alarm devices and thus have no threshold-related false alarm or desensitization problems.
5. They are nearly maintenance-free in normal environments.
6. They can be installed in or adjacent to air ducts or entries.
7. They carry all required listings and approvals.

Send the coupon to us at 333 Lincoln St., Hingham, Mass. 02043. We'll send you our brochure with even more reasons why you should protect your investments with Pyrotector photoelectric smoke detectors.

Name, Title _____

Firm _____

Address _____

City, State, Zip _____

PYROTECTOR

The photoelectric way.

For more data, circle 116 on inquiry card

◆ For more data, circle 113 on inquiry card

The guide spec that opened countless doors to carpet

Prepared by William E. Lunt, Jr., C. S. I.

Write, or use Reader Service card in back for your free copy, plus editorial reprint detailing this proven carpet installation system.

JUTE CARPET BACKING COUNCIL, INC.
30 ROCKEFELLER PLAZA • NEW YORK, N.Y. 10020

For more data, circle 114 on inquiry card

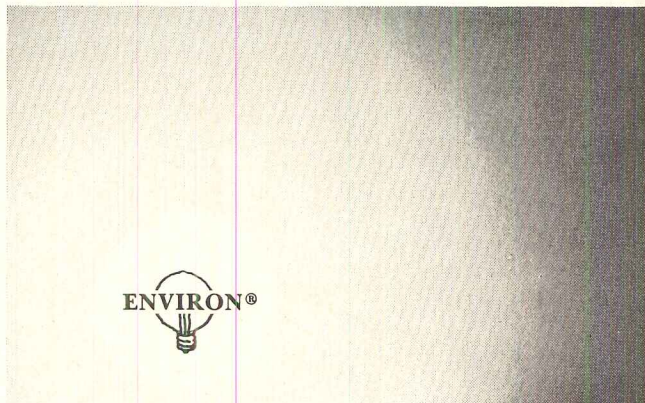

Strand Century lighting also conserves energy.

Has been for a long time.

Before energy conservation became a way of life, Strand Century was doing just that—for 40 years. Conserving energy while enhancing architectural lighting is a basic policy of the company that knows light.

Among our notable environmental systems are:

General Motors Building , New York	Bell Laboratories , New Jersey
Federal Reserve Bank , Minneapolis	Pepsico International , Purchase
Xerox Educational Center , Leesburg	Alcoa Building , Pittsburgh
Miami Beach Convention Center	Eastman Kodak Co. , Rochester

And now, Environ[®], the first modular, low-cost, all-electronic environmental lighting system. Ask us for further information.



STRAND CENTURY INC.

A COMPANY WITHIN THE BANK ORGANISATION
20 Bushes Lane, Elmwood Park, N.J. 07407 / (201) 791-7000

* Environ is a registered trade mark of Strand Century Inc.

For more data, circle 115 on inquiry card

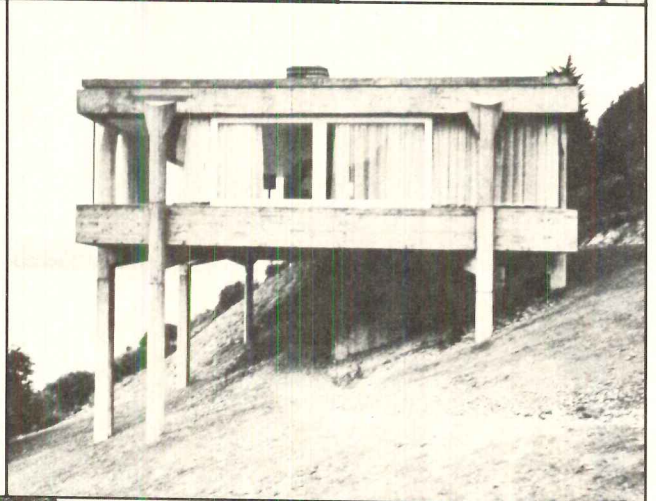
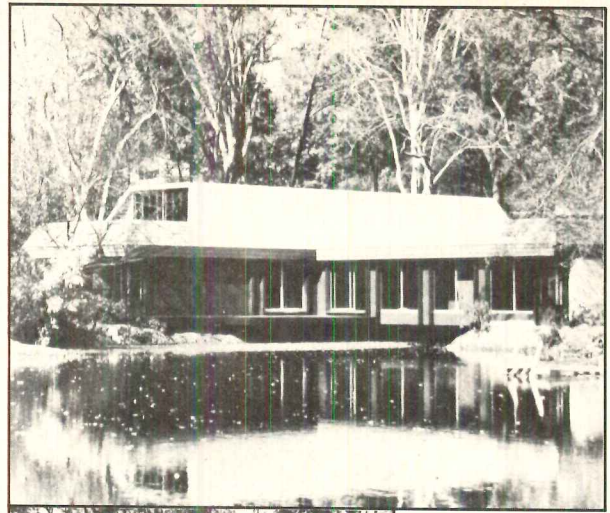
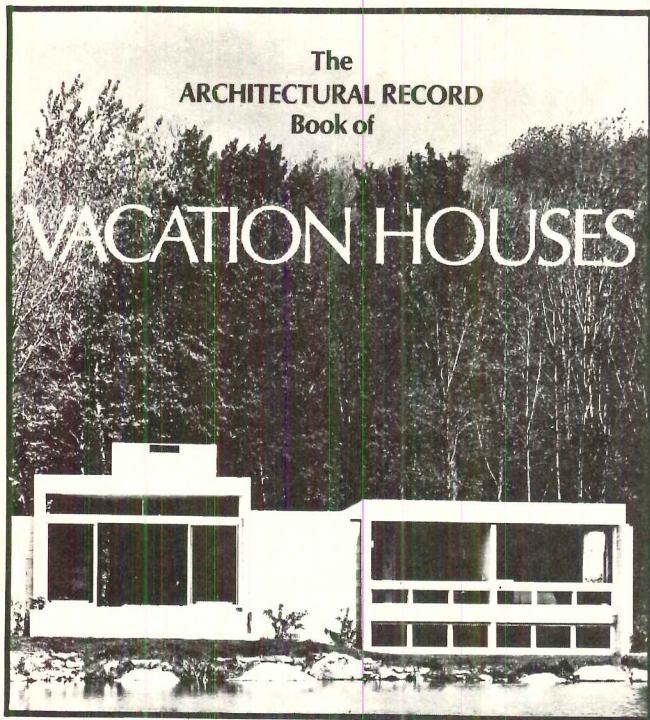

Exciting ideas from 60 different dream hideaways

A sparkling collection of architect-designed vacation houses for all climates and terrains—from a mountain-top chalet in British Columbia to a beach house in Florida. Selected by Architectural Record editors, these houses range in price from less than \$5,000 for a very small two-room cottage to more than \$100,000 for large structures. Each house is fully described with floor plans, site plans, photographs and construction details. For easy reference the book is divided into five sections: beach, mountain, lakeside, resort and country, weekend and summer homes.

256 pages 9 x 12 \$9.95

SEND FOR YOUR COPY TODAY

ARCHITECTURAL RECORD



Please send me _____ copies of Architectural Record Book of Vacation Houses @ \$9.95 each.

(Include payment and we'll pay postage.)

Name _____

Address _____

City _____

State _____ Zip _____

AR4-74

We "Wrote the Book" on Dock Design.

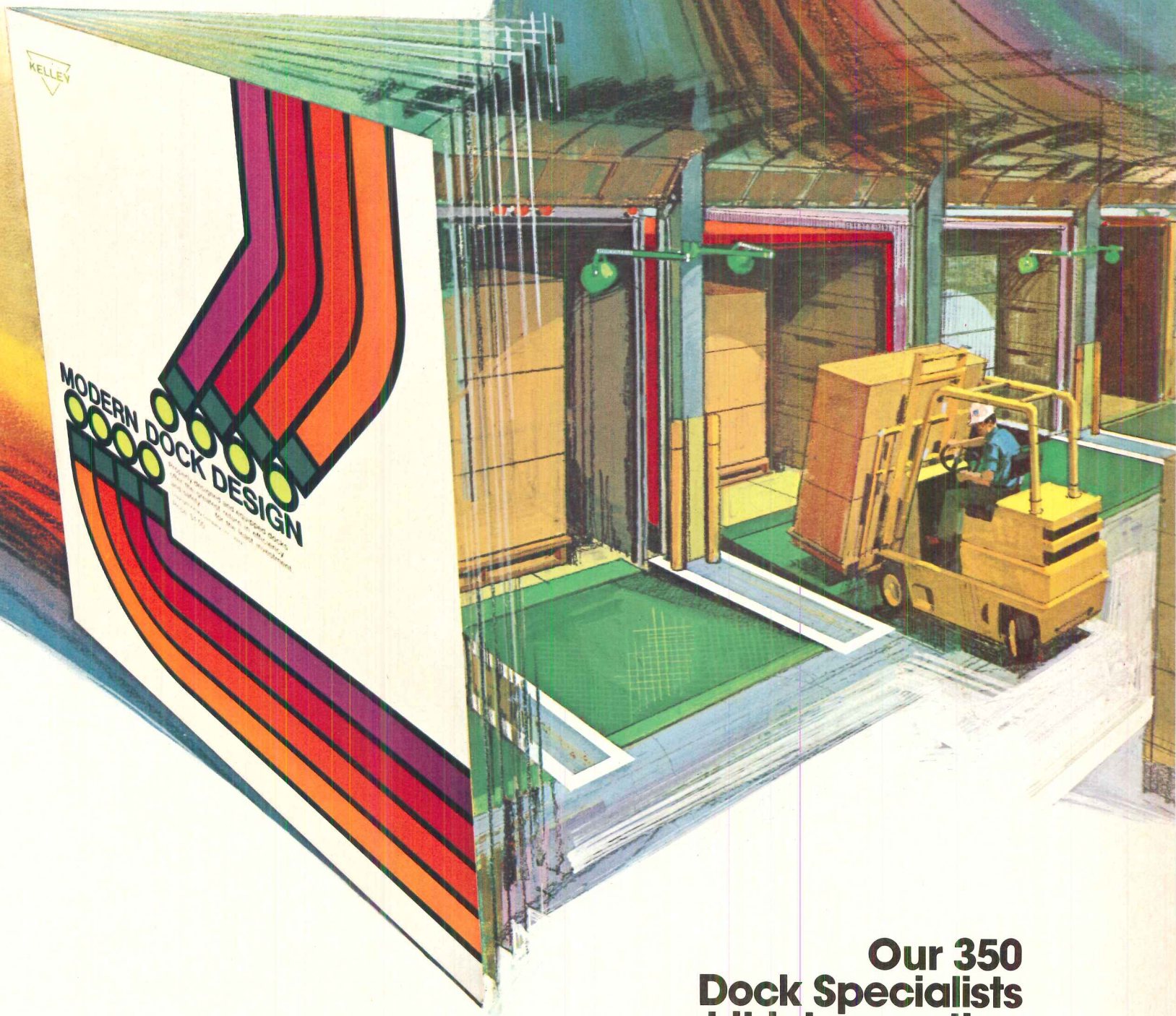

Our 350 Dock Specialists put it into practice

Everything you move in or out of your plant, warehouse, or terminal moves across the loading dock. Today's competition, rising labor costs, and safety considerations place critical demands on your dock operation.

To help you achieve a safe, efficient dock, Kelley Company offers the services of one of 350 trained dock specialists. He will work with you, your personnel, architect and contractor. And he will assume complete responsibility for the dock layout, equipment recommendation, its installation and operation.

It's the kind of total responsibility you expect from the people who "wrote-the-book" on Dock Design, and who manufacture and install more permanent dockboards than anyone else in the world.

So if you're building, remodeling, or simply concerned about your present dock operation, ask for this free, no obligation consultation service. Just contact the "responsible" dockboard people.



Kelley Company, Inc.
6768 North Teutonia Ave.
Milwaukee, Wisconsin 53209
Phone: (414) 352-1000 Telex: 26-661

For more data, circle 117 on inquiry card

This relatively simple but superbly designed bank is a striking example of the manner in which Terne roofing can become an integral part of a total architectural concept.

Aesthetics aside however, Terne also has certain outstanding functional characteristics. Among these are great tensile strength combined with light weight and a low coefficient of expansion; exceptional resistance to corrosive attack, and a durability measured in generations rather than years.

Terne roofs are also relatively inexpensive when judged by the standards of those to whom ultimate performance is no less significant than initial cost.

Citizens' Bank, N.A., Readington Township, New Jersey
Finne · Lyman · Finne · Reese,
Architects-Engineers, Elizabeth, New Jersey
Roofer: J. Strober and Sons, Ringoes, New Jersey
Photographs by Otto Baitz

FOLLANSBEE

FOLLANSBEE STEEL CORPORATION • FOLLANSBEE, WEST VIRGINIA

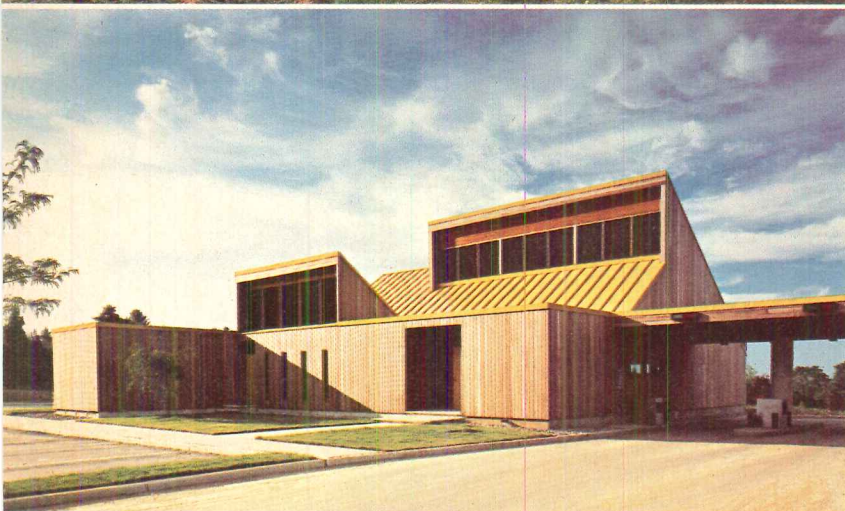

WHAT PRICE FORM, COLOR, FUNCTION?

Get the lead out.

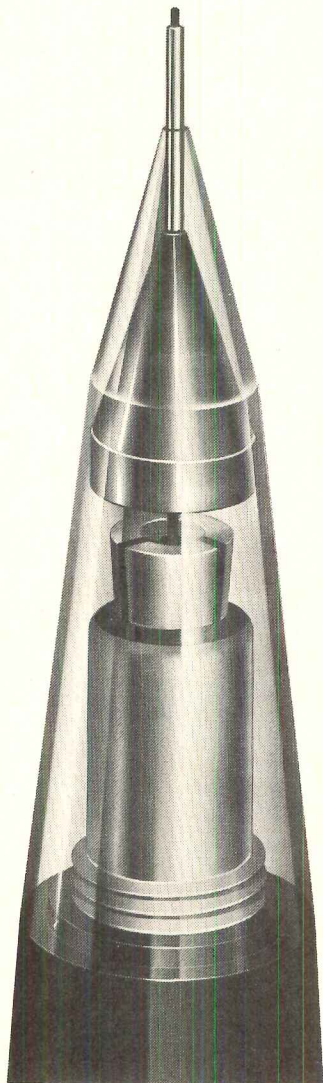

Sharp for Pros... The new sliding sleeve Ultra-Fine 0.5mm pencil. The Sharp for Pros is a professional's dream. It's perfect for draftsmen, engineers, and accountants. That's because broken leads become a thing of the past. As the lead wears down, the sliding sleeve retracts, protecting the lead as you continue to draw or write. So, even though the lead is concealed by the sleeve, the pencil continues to work. And heavy handed writers can enjoy Ultra-Fine lead without having it break. The 5mm long sleeve is especially convenient for accurate template work.

The Sharp for Pros is hand assembled with watch-makers' tools for precision accuracy. And it feeds itself automatically! Mechanical fingers advance the lead with a simple push of the Quick-Click top. You do not reload until a dozen leads are used.

The secret behind the precision of the Sharp for Pros is Pentel's exclusive Hi-Polymer 0.5mm Ultra-Fine lead. Made of a unique compound of synthetic resin, carbon, and graphite, the lead is much stronger than ordinary lead so it can be just half as thick.

The best thing about the Sharp for Pros 0.5mm sliding sleeve pencil is its price. Only \$3.50.

Pentel



Pentel of America, Ltd., 2715 Columbia St., Torrance, Ca 90503 • (213) 775-1256

For more data, circle 119 on inquiry card

SOUND IDEAS



Argos Sound Columns produce a layer of sound to the listener that solves acoustical problems faster, easier and at less cost without ugly horns and boxes.

FREE — Special Architects Data File — Full information on the largest selection of sound columns on the market. Send for yours today.



600 S. Sycamore St., Genoa, IL 60135

For more data, circle 120 on inquiry card



At last! A wall system that can match your imagination!

Solid hardwood prefinished wall planks

Random width, random length genuine solid hardwood wall planks, lovingly prefinished, in a choice of 13 woods with the full natural beauty and richness that no imitation can match. Send today for Designer's Sample Kit containing 13 full-size sample species, textures and finishes.

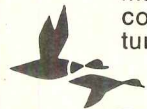

Townsend® Paneling

Potlatch Corporation
P.O. Box 916, Stuttgart, Arkansas 72160

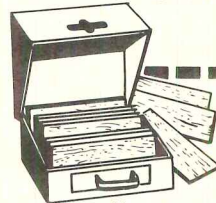

- Enclosed is my check for \$3 to cover cost of my sample kit.
 Please send additional literature.

Name _____ Phone _____
Firm _____
Title _____
Street No. _____
City _____ State _____ Zip _____

For more data, circle 121 on inquiry card



“General Electric HID lighting systems are easy to install, easy to maintain and there’s no ballast audibility problem.”

Richard R. Jencen — Richard R. Jencen Associates, architects and interior designers for the Marianne, Stuarts and Petrie chains

Architects, consultants, electrical contractors and building owners demand a lot of an indoor lighting system. And they’re finding that General Electric’s energy-efficient HID lighting systems meet their most exacting requirements.

Richard Jencen was concerned about ballast noise. He says, “We’ve encountered audibility problems with some HID systems, but the General Electric Panelglow® system solved all of our problems. It’s easy to install, easy to maintain and there’s no ballast audibility problem.”

If you’d like to know more about GE’s HID solutions for commercial lighting applications, contact your local GE representative or write:

GE Lighting Systems Business
Department, Section 460-99 A,
Hendersonville, N. C. 28739

**GE lighting
makes the
difference**



GENERAL  ELECTRIC

For more data, circle 122 on inquiry card

Another introductory offer to new members of the ARCHITECTS' BOOK CLUB

ANY ONE
of these great professional books
for only **\$1.00**

VALUES FROM \$7.50 to \$31.00

Special \$1.00 bonus book
comes to you with your
first club selection

	<p>463/45X STANDARD STRUCTURAL DETAILS FOR BUILDING CONSTRUCTION by M. Newman Pub. Price, \$17.70 Club Price, \$11.60</p>		<p>256/284 ARCHITECTURAL RENDERING, 2/e by A. O. Halse Pub. Price, \$21.50 Club Price, \$16.95</p>		
	<p>237/514 ARCHITECTURAL DRAWING AND PLANNING, 2/e by Goodban and Hayslett Pub. Price, \$9.50 Club Price, \$7.50</p>		<p>231/15X STRUCTURAL ENGINEERING HANDBOOK by Gaylord and Gaylord Pub. Price, \$31.00 Club Price, \$19.95</p>		
	<p>513/686 NEW DIMENSIONS IN SHOPPING CENTERS & STORES by L. G. Redstone Pub. Price, \$18.95 Club Price, \$13.95</p>		<p>678/502 LEGAL PITFALLS IN ARCHITECTURE, ENGINEERING AND BUILDING CONSTRUCTION by Walker, Walker & Rohdenburg Pub. Price, \$15.00 Club Price, \$10.65</p>		
	<p>173/427 ENVIRONMENTAL ACOUSTICS by L. L. Doelle Pub. Price, \$18.50 Club Price, \$12.50</p>		<p>773/742 CENTERS FOR THE URBAN ENVIRONMENT by V. Gruen Pub. Price, \$24.95 Club Price, \$17.95</p>		
	<p>256/187 THE USE OF COLOR IN INTERIORS by A. O. Halse Pub. Price, \$16.50 Club Price, \$13.95</p>		<p>415/064 BUILDING CONSTRUCTION HANDBOOK, 2/e by F. S. Merritt Pub. Price, \$26.50 Club Price, \$18.95</p>		<p>287/341 STANDARD HANDBOOK OF ENGINEERING CALCULATIONS by T. G. Hicks Pub. Price, \$19.50 Club Price, \$14.25</p>
					<p>162/182 TIME-SAVER STANDARDS FOR BUILDING TYPES by DeChiara and Callender Pub. Price, \$27.50 Club Price, \$19.50</p>
					<p>089/248 ARCHITECTURAL DELINEATION by E. E. Burden Pub. Price, \$18.50 Club Price, \$14.50</p>
					<p>543/47X ANATOMY OF A PARK by A. J. Rutledge Pub. Price, \$15.95 Club Price, \$10.95</p>

SAVE TIME AND MONEY BY JOINING McGRAW-HILL'S NEW ARCHITECTS' BOOK CLUB



MAIL ATTACHED POSTPAID CARD

(If card removed, send coupon below)

THIS new professional club is designed to meet your day-to-day needs by providing practical books in your field on a regular basis at *below publisher prices*. If you're missing out on important technical literature—if today's high cost of reading curbs the growth of your library—here's the solution to your problem.

The Architects' Book Club was organized for you, to provide an economical reading program that cannot fail to be of value. Administered by the McGraw-Hill Book Company, all books are chosen by qualified editors and consultants. Their understanding of the standards and values of the literature in your field guarantees the appropriateness of the selections.

How the Club operates: Every month you receive free of charge *The Architects' Book Club Bulletin*. This announces and describes the Club's featured book of the month as well as alternate selections available at special members' prices. If you want to examine the Club's feature of the month, you do nothing. If you prefer one of the alternate selections—or if you want no book at all—you notify the Club by returning the card enclosed with each *Bulletin*.

As a Club Member, you agree only to the purchase of four books (including your first selection) over a two-year period. Considering the many books published annually, there will surely be at least four you would want to own anyway. By joining the club, you save both money and the trouble of searching for the best books.

ARCHITECT'S BOOK CLUB

582 Princeton Road, Hightstown, New Jersey 08520

Please enroll me as a member of the Architects' Book Club and send me the two books indicated below. I am to receive the higher priced of the two for just \$1, and my first selection at the special Club price. A small charge for postage and handling will be included. These books are to be shipped on approval, and I may return them both without cost or further obligation. If I decide to keep the books, I agree to purchase as few as four additional books (including this first selection) during the next two years at special Club prices (guaranteed 15% discount, often more).

Write Code # of
higher priced
selection here

Write Code # of
lower priced
selection here

NAME _____

ADDRESS _____

CITY _____

STATE _____ ZIP _____

A36137

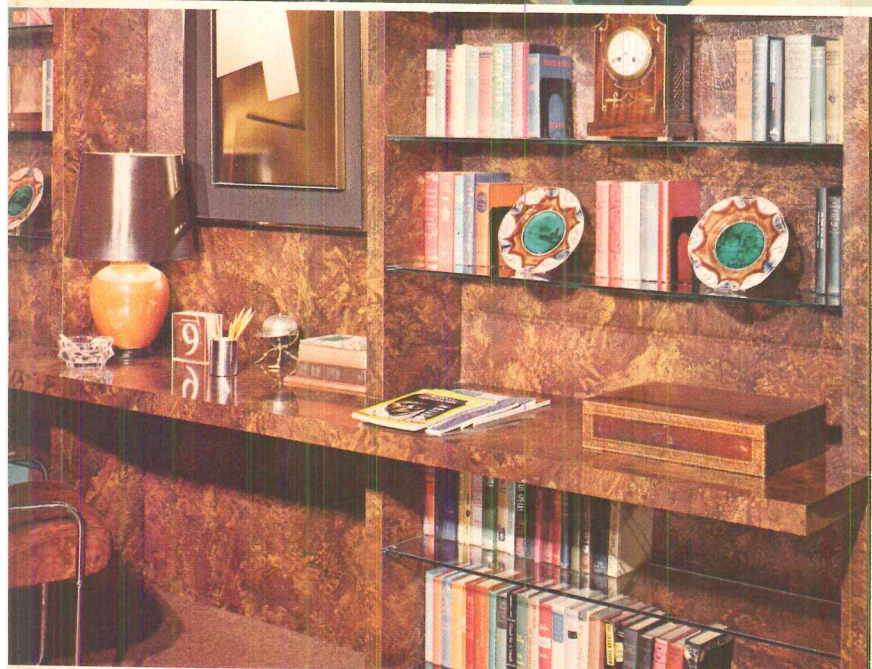

Upper left: Employee Cafeteria, Financial Institution, New York.
Lower left: Private Study, New York City Condominium, Louis Tregre, F.A.I.D., Architect.

Upper right: Reception Area, Seattle Chapter Office, A.I.A., Wendell H. Lovett, A.I.A., Architect.
Lower right: Patio Piano, Everett Piano Company.

Tell us the mood you want to create and we'll show you FORMICA®.

brand laminated plastic

Moods are made by the colors, patterns and textures you choose for your interiors. With FORMICA® brand laminated plastic, you have well over 100 choices to help you create the effect you desire. You also have a choice of materials for vertical and horizontal applications . . . even complete panel systems that retard flames as well as wall paneling that resists moisture.

And the mood you create won't wear off, fade, scratch, chip, or peel

away. FORMICA® brand laminated plastic resists all these things, keeps its new-looking beauty for years. Get more when you specify FORMICA® brand laminated plastic, give more when you install it. Your Formica man will be glad to help you create the mood you want. Contact him today. For complete product information, consult Sweet's Files 8.3/Fo, 9.12/Fo and 6.14/Fo, write Dept. AR-4, or call our toll-free Speciphone service—800-543-7155.



laminated plastic

© 1974, Formica Corporation, Cincinnati, Ohio 45202, subsidiary of
In Canada, Cyanamid of Canada Ltd., Montreal 101

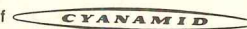



Carpetect

At Dow Badische we specially engineer our fibers and yarns for specific end-use carpet installations.

We believe that every installation job requires its own special kind of carpet. So Dow Badische "carpetects" specially engineer our fibers and yarns to provide the right carpet performance characteristics necessary to do the job.

Then we carry our engineering a step further—by providing mills with exact carpet specifications for style and construction. This ensures that the special features built into our products for specific end-uses result in a top-performing carpet. But just to make doubly sure, we put the finished carpet through a series of rugged torture tests. If it passes, it wins the right to carry our famed **Performance Certification** label.

Look for that label next time you specify contract carpet. It's not only dependable, it's specific.



Dow Badische Company
Williamsburg, Va. 23185
(804) 887-6573

for top
verifiable
building
market
coverage
there's

Architectural Record. Its architect and engineer paid subscribers are responsible for over 90 per cent of the total dollar volume of all architect-planned building, nonresidential and residential, large and small.

A fact documented by Dodge Reports.

With the aid of Dodge Reports, Architectural Record maintains an up-to-date file of the planning activity of the individual architectural offices throughout the U.S. by type of project and dollar volume. Continuing checks of the data against subscriber galleries provides the strongest assurance that your advertising is reaching the active factors in the marketplace.

Architectural Record's top market coverage stems from the unequaled quality and quantity of its editorial service to architects and engineers who have consistently voted it their preferred publication in 247 out of 266 studies sponsored by building product manufacturers and their agencies. Not surprisingly, far more architects and engineers in building subscribe to the Record than to any other architectural magazine . . . at the highest subscription price by far.

Advertisers are impressed. More building product advertisers place more advertising pages in Architectural Record than in any other magazine in the world!

ONE

When one magazine is strongly preferred by the readers you must reach and the companies you must compete with—shouldn't you do the best possible advertising job in THAT ONE?

architectural
magazine



when one advertising value leads to another...and another...and another...you've located the leader



The last word in environmental ceilings

Striking good looks, excellent performance, superb engineering, and quality craftsmanship are all brought together in the new "Project EC" environmental ceiling system — a simple, easily-installed four-component system that advances the concept to its ultimate refinement.

The 5-by-5 modules with perforated metal coffers are available with a wide range of options to allow unprecedented design flexibility.

The whole story is told in GUTH LIGHTING's "Project EC" Catalog. Write or call for a copy — it's good reading.

GUTH LIGHTING



P. O. BOX 7079 • ST. LOUIS, MO. 63177 • (314) 533-3200

SOLA BASIC DIVISIONS: ANCHOR ELECTRIC • BISHOP ELECTRIC • DIELECTRIC COMMUNICATIONS • DOWZER ELECTRIC • GUTH LIGHTING
HEVI-DUTY ELECTRIC • LINDBERG • NELSON ELECTRIC • SIERRA ELECTRIC • SOLA ELECTRIC • TEMPRESS • WARREN G-V COMMUNICATIONS

For more data, circle 130 on inquiry card

**LESS
POWER
TO THE
PEOPLE**

BUT MORE LIGHT.



The lamp you see here is a new 150-watt Unalux™ lamp we've developed for use in the streets.

It's the little brother of a 360-watt high pressure sodium lamp we developed for use on the highways.

Both are members of Sylvania's Unalux sodium lamp family, and both are terrific power savers. They consume less electricity than the mercury lamps they replace, and they put out a lot more light.

This 150-watt sodium lamp, for example, replaces 175-watt mercury street lamps. It uses 14% less power and gives off 50% more light.

What makes it a technical wonder is that in many street-lighting systems it will work in the same socket as the

mercury lamp it replaces.

Until the invention of Unalux lamps, sodium lamps weren't compatible with mercury systems. They needed different wiring, fixtures, ballasts and poles plus a lot of expensive labor for installation. Now it's just a matter of unscrewing the mercury lamp and screwing in the sodium lamp.

Unalux high pressure sodium lamps can brighten a whole street in minutes.

People see better.

And feel safer.

And—whether they know it or not—those lamps save energy they can use in their homes.

GTE SYLVANIA

For more data, circle 131 on inquiry card

IT FITS

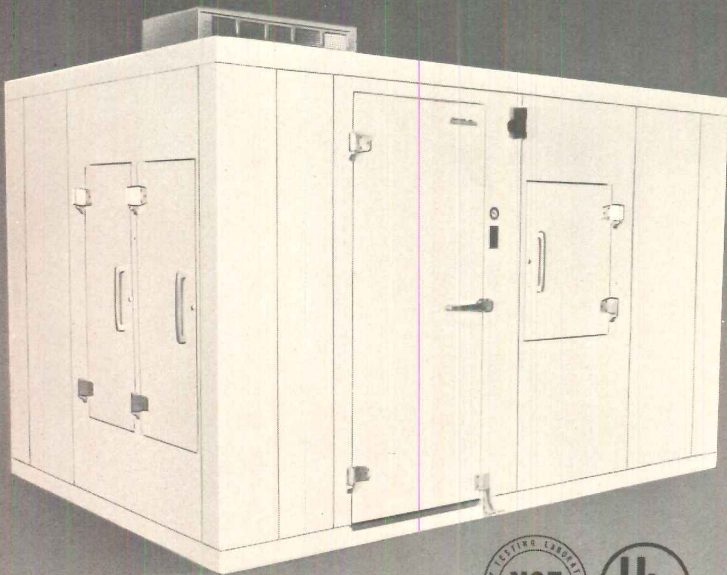

VOLLRATH WALK-IN COOLER/FREEZER

Name your dimensions and we'll provide a modular walk-in that fits . . . exactly. We use true, full-size dimensions, not nominals, making your specification work easier. Means more storage space, too. To insure a perfect fit, all components are factory tested. Vollrath walk-ins are fabricated in accordance with N.S.F. and U.L. standards, using the latest technology: foamed-in-place urethane insulation, posi-loc assembly, fully covered floors and ceilings, tight energy-saving joints and doors. Wide choice of options, finishes, self-contained or remote refrigeration systems to fit your needs and requirements.

Ask your Vollrath equipment specialist for details, or send for our comprehensive design/specification manual.

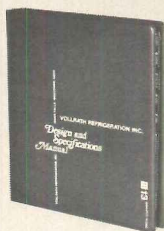

For more data, circle 132 on inquiry card

This John Chipman Bench was planted 500 years before Columbus sailed for America.

John Chipman works in Redwood. The Heartwood of the Redwood. Redwood over 1,000 years old. Tough. Resilient. Almost weatherproof.

Wood like this makes a bench that resists termites, warping, fire and decay, and looks good doing it...for generations.

But John Chipman and Landscape Forms not only offer you the beauty and durability of Redwood, their Woodforms Series turns this remarkable wood into fine mall and street furniture.

When you have a site furnishing job to do, think about Chipman in 1,000-year-old Redwood. Even if your benches only have to last another 100 years.

Landscape Forms, Inc.

Route #3, Kalamazoo, Michigan 49001
(616) 381-0396

See our complete listing in
Sweet's Architectural
File, 2.16/ La



For more data, circle 133 on inquiry card

REGULAR or SUPER ↓ GRAPHICS

The newest and most progressive structures aren't finished until the graphics are in place, and that's where we enter the picture. Our pressure-sensitive vinyl letters now enhance the Texas Heart Institute; the Bank of America, Calif.; Standard Oil Buildings, Chicago; Walla Walla Clinic, Washington; Holyoke Community College, Mass.; Valley National Bank Bldg., Arizona and numerous other structures.

We feel the graphics must complement the design and style of the architecture, so we prepare the graphics to your specifications. Why not consult with us the next time you require or desire pressure-sensitive graphics.

Black, White, Standard Colors or Color Matches 3/8" to 24", and larger if required. Call or write for samples.

Simple Space Rite® Lettering Systems, Inc.
3442 N. 29th Avenue/P.O. Box 11949
Phoenix, Arizona 85017
1-602-258-8353

For more data, circle 134 on inquiry card

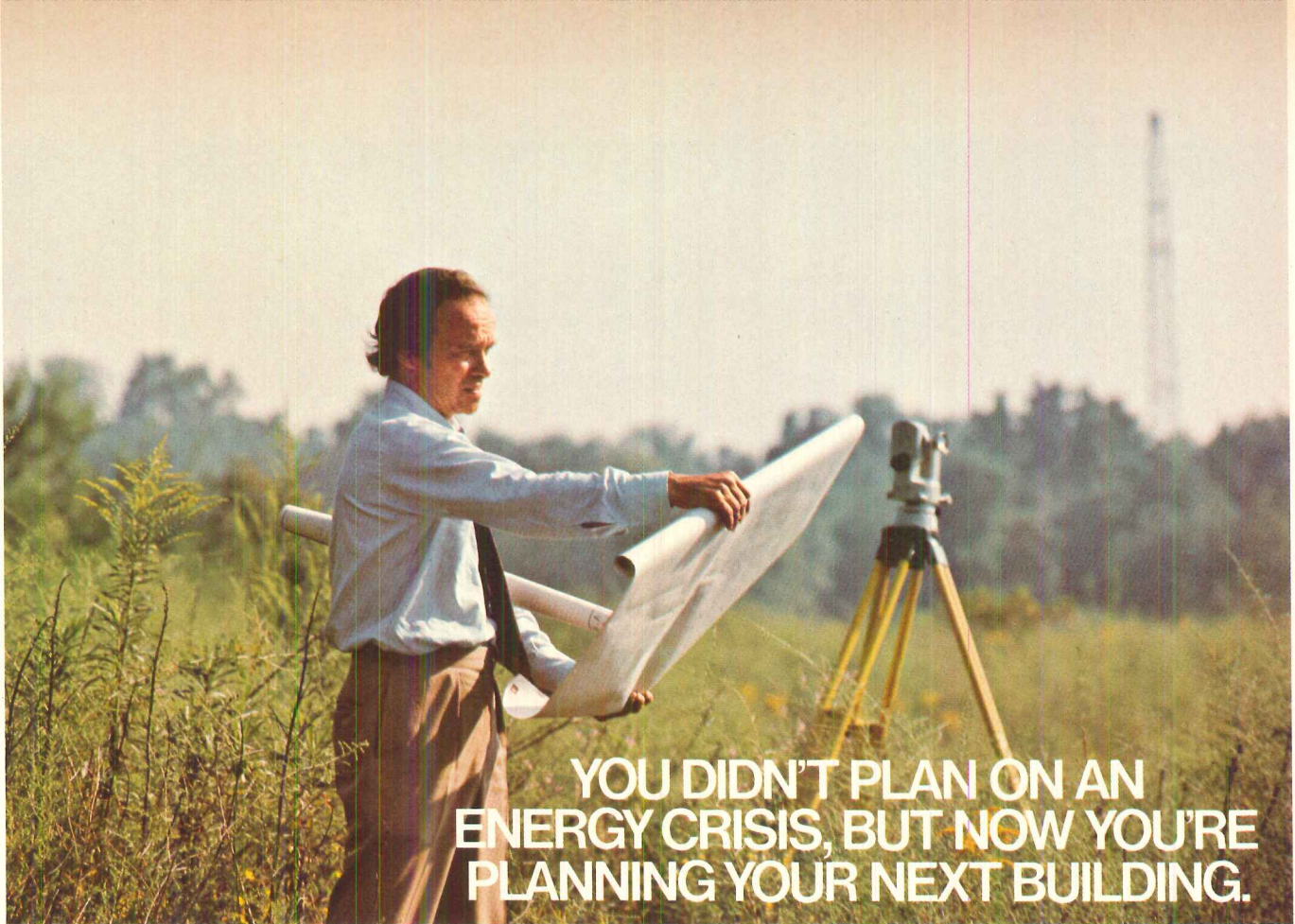

YOU DIDN'T PLAN ON AN ENERGY CRISIS, BUT NOW YOU'RE PLANNING YOUR NEXT BUILDING.

Which building material will you use?

You've got energy shortages to think about. Air-conditioning costs. Heat gain through the long, hot summers. Heat loss in the winter months. Heating equipment costs. The whole set of energy-use factors suddenly has become critically important. The building material you use affects all of them.

Compare the energy conserving capability of masonry, for instance, with double-plate glass walls.

At 4:00 P.M. on a hot August day in Washington, D.C., the heat gain through a square foot of west-facing insulated brick and concrete block wall will be 2.2 Btus an hour.

The heat gain through a double-plate glass wall in the same location will be 173 Btus a square foot in an hour. A big difference.

Project this differential over 10,000 square feet of wall. You come up with a heat gain through masonry of 22,000 Btuh, while the heat gain through double-plate glass is 1,730,000 Btuh.

In the case of the masonry wall, cooling equipment with a two-ton capacity can handle the heat gain. But with the double-plate glass wall, about 143 tons of cooling capacity will be needed.

An analysis of a typical 10-story building shows that over its useful life, the air-conditioning cost for a square foot of our masonry wall will be about 23 cents. For the double-plate glass wall, it will be \$7.60.

It takes a lot of money to buy, install and create space for all the extra air-conditioning equipment

required by the double-plate glass wall. A lot of money and a lot of energy to run that equipment.

Compare the heat loss in winter. It has a dramatic effect on energy consumption and building operation costs.

Our masonry wall, for example, has a "U-value" of .12. The double-plate glass wall has a "U-value" of .55. (U-values are used to determine heat loss through one square foot of wall area in Btuh per degree Fahrenheit differential across the wall.)

This means that the masonry wall is about 450% more efficient, on the average, than the glass wall in reducing heat loss.

Over the useful life of the building, the heating cost per square foot of wall area for masonry will be about 30 cents. For double-plate glass, about \$1.38.

In a time of one energy crisis after another, masonry makes eminently good sense as a good citizen.

The masonry industry believes that the thermal insulating qualities of masonry are an important economic consideration to building designers, owners and investors, and all citizens.

Masonry walls save on air-conditioning and heating costs. And just as important, they are less expensive to build. The masonry wall we've described would have a 38% lower initial cost than the double-plate glass wall.

If you'd like to find out more, write to us and we'll send you a booklet comparing the thermal

insulating qualities of masonry walls with double-plate glass walls, metal panel walls and pre-cast concrete walls.

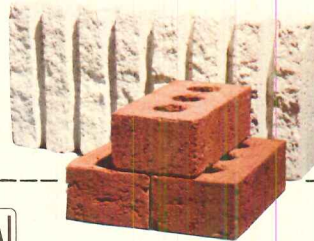

International Masonry Institute

823 15th Street, N.W., Washington, D.C. 20005 / (202) 783-3908

Please send the booklet comparing insulating qualities of masonry with other building materials.

Name _____

Title _____

Company _____

City _____ State _____ Zip _____

Nature of Business _____

For more data, circle 135 on inquiry card

Choosing Ra-matic thru-the-wall heating and air conditioning gives you many advantages over other types of heating and cooling units.

1. Ideal for year-round heating and air conditioning in hotels, motels, office building, schools, churches, hospitals, apartments, condominium and dormitories.
2. Easy access, color coded control center lets you select desired room climate at the touch of a finger.
3. Cooling, dehumidifying, heating, ventilating, air filtering and air circulation are the outstanding features of the Ra-matic unit.
4. Variable grilles adjust the air flow as desired.
5. AHAM certified accessibility, clean, easy maintenance and safe.
6. All heating and cooling components, fans and controls are mounted on one chassis and pre-wired ready for slip-in installation.
7. The cooling system consists of a hermetically

sealed compressor spring-mounted with vibration isolators.

8. The heating elements are low density totally enclosed sheathed type with thermal cut outs.

9. Built-in thermostat maintains room temperature to pre-selected level.

10. The wall sleeve is designed to fit standard and jumbo brick coursing, eliminating split brick.

11. The 18 gauge steel coated sleeve may be placed in the wall during construction and the grille and chassis installed from inside the building.

12. Quality, convenience and style make the Ra-matic thru-the-wall unit a better way for many applications.

13. Available in your choice of electric, hotwater or steam.



Ask your man
from Raywall.

or write for our Ra-matic Brochure.



A TPI DIVISION

P. O. Box T, CRS Johnson City, Tennessee 37601 615 / 929-3151 Telex 55-3442

For more data, circle 136 on inquiry card

Pick the hinge that hides

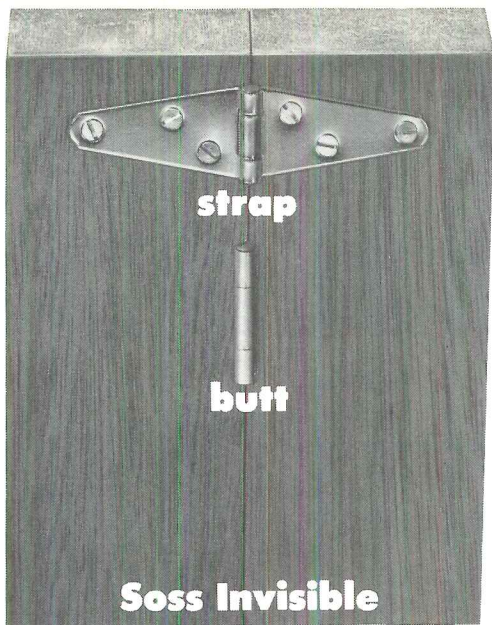

Compare the Soss look of invisibility with any strap or butt hinge and you'll choose The Soss Invisibles. These amazing hinges hide when closed to blend with any decor. With The Soss Invisibles you can create room, closet, or cabinet openings which are unbroken by hinges or gaps . . . the perfect look for doors, doorwalls, built-in bars, stereos, or T.V.'s. The Invisibles are extra strong, open a full 180 degrees, and are reversible for right or left hand openings. See listing in Sweet's or write for catalog: Soss Manufacturing Company, Division of SOS Consolidated, Inc., P.O. Box 8200, Detroit, Michigan 48213.

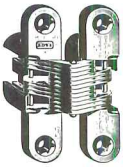

the SOSS
Invisibles

For more data, circle 137 on inquiry card

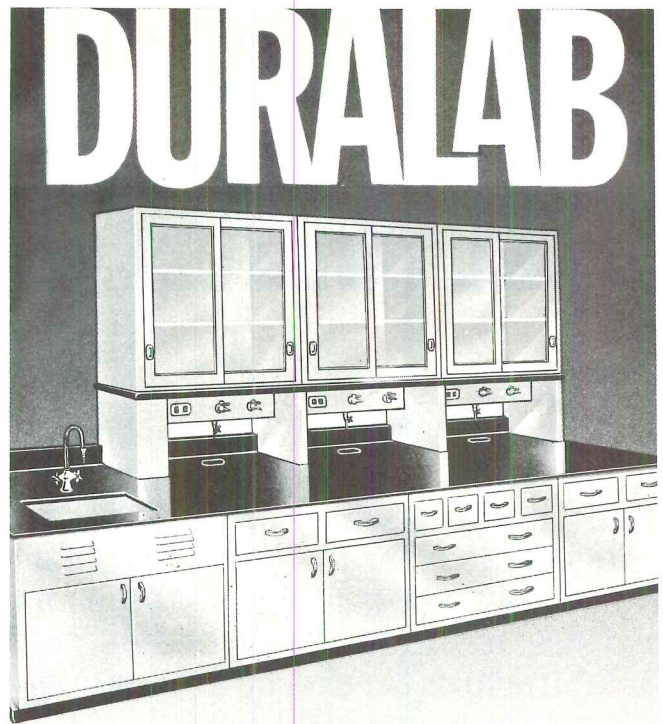

Plan for your Casework needs with Duralab.

Let our factory trained engineering team assist you without obligation.

Call or write the Planning Department now:

DURALAB EQUIPMENT CORP. 107-23 Farragut Rd., Brooklyn, N.Y. 11236
Phone: (212) 649-9600

For more data, circle 138 on inquiry card

Car Washing! The natural addition to any Shopping Center Development...

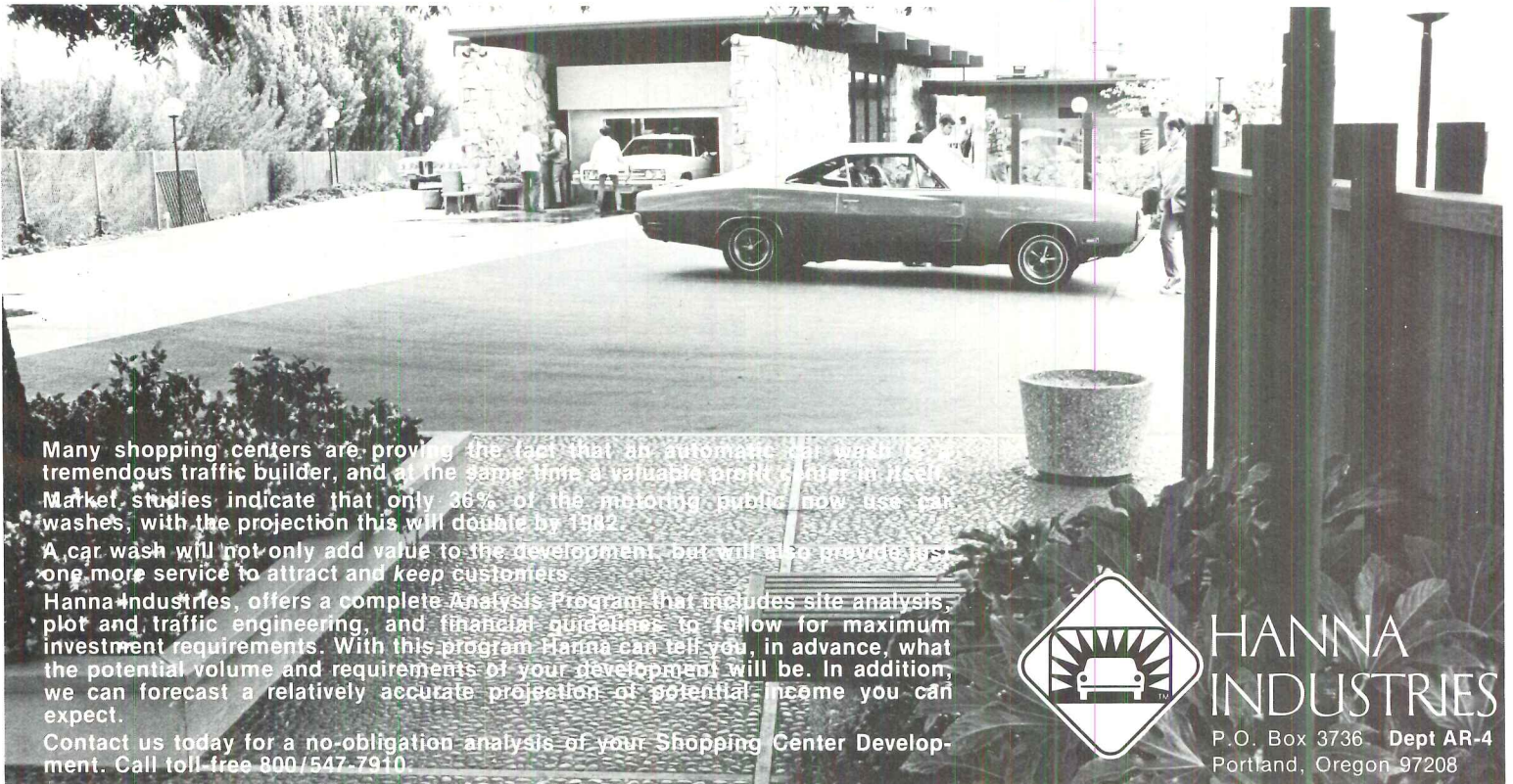

Many shopping centers are proving the fact that an automatic car wash is a tremendous traffic builder, and at the same time a valuable profit center in itself. Market studies indicate that only 36% of the motoring public now use car washes, with the projection this will double by 1982.

A car wash will not only add value to the development, but will also provide just one more service to attract and keep customers.

Hanna Industries, offers a complete Analysis Program that includes site analysis, plot and traffic engineering, and financial guidelines to follow for maximum investment requirements. With this program Hanna can tell you, in advance, what the potential volume and requirements of your development will be. In addition, we can forecast a relatively accurate projection of potential income you can expect.

Contact us today for a no-obligation analysis of your Shopping Center Development. Call toll-free 800/547-7910.



HANNA
INDUSTRIES
P.O. Box 3736 Dept AR-4
Portland, Oregon 97208

For more data, circle 139 on inquiry card

This steel-frame parking 7 months...at only \$5.97 a

The steel design for this self-park, open-deck garage in Greensburg, Pa., just had to be a contract winner. It had so much going for it: low construction cost, no fire protection required, optimum usable space and fast construction time — for a quick return on invested capital.

No wonder. The garage uses the increasingly popular exposed steel-frame, long-span design concept, with USS EX-TEN Structural Steel. The floors are steel reinforced concrete poured on metal decking.

Project budget was based on low “design/construct” bid. The winning design beat five others, including four pre-cast schemes. Actual cost: only \$5.97 a square foot!

The garage was a tremendous bargain. Parking ramps are 55 feet wide, so full-size cars can be parked at 60° angles. There’s a two-way access lane. Columns are few and far-between and there are *no* columns in the parking area! Gross area: 153,000 square feet, in five tiers. That adds up to space for 456 cars. And only 538 tons of structural steel (395 tons of high-strength, weight-saving USS EX-TEN 50 [ASTM A572-Grade 50] and 143 tons of ASTM A36).

Erection of structural steel took only 10 days! The garage was ready to make money just seven months from the time construction started. And that’s not the end of it. The garage has been designed to accommodate two more tiers at a later date.

If you’re planning or designing a parking garage, you should keep these points in mind: 1. The low fire risk of open-deck, steel-framed garages has been proved in actual tests. And insurance underwriters and code officials recognize this. 2. These structures are lighter, with more usable space, no interior columns, fewer footings. 3. They go up fast because of factors like shop fabrication, modular sub-assemblies and field bolting.

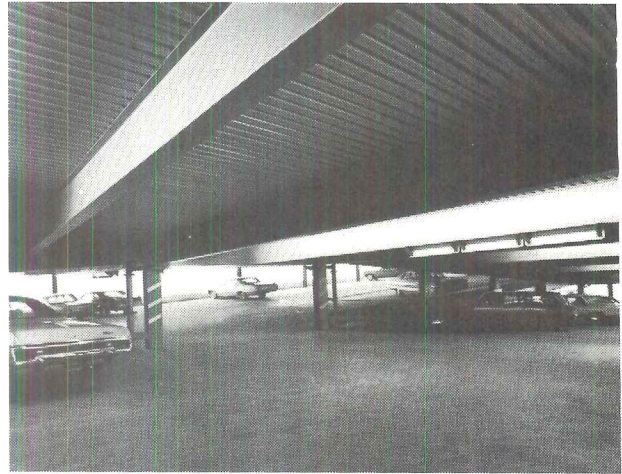

Owner: Greensburg Parking Authority, Greensburg, Pa. *Architect:* Thomas G. Donald, South Greensburg, Pa. *General Contractor:* L-D Building Company, Latrobe, Pa. *Fabricator:* Moore Metal Manufacturing Company, Greensburg, Pa. *Erector:* Penn Erection and Rigging Company, Turtle Creek, Pa.

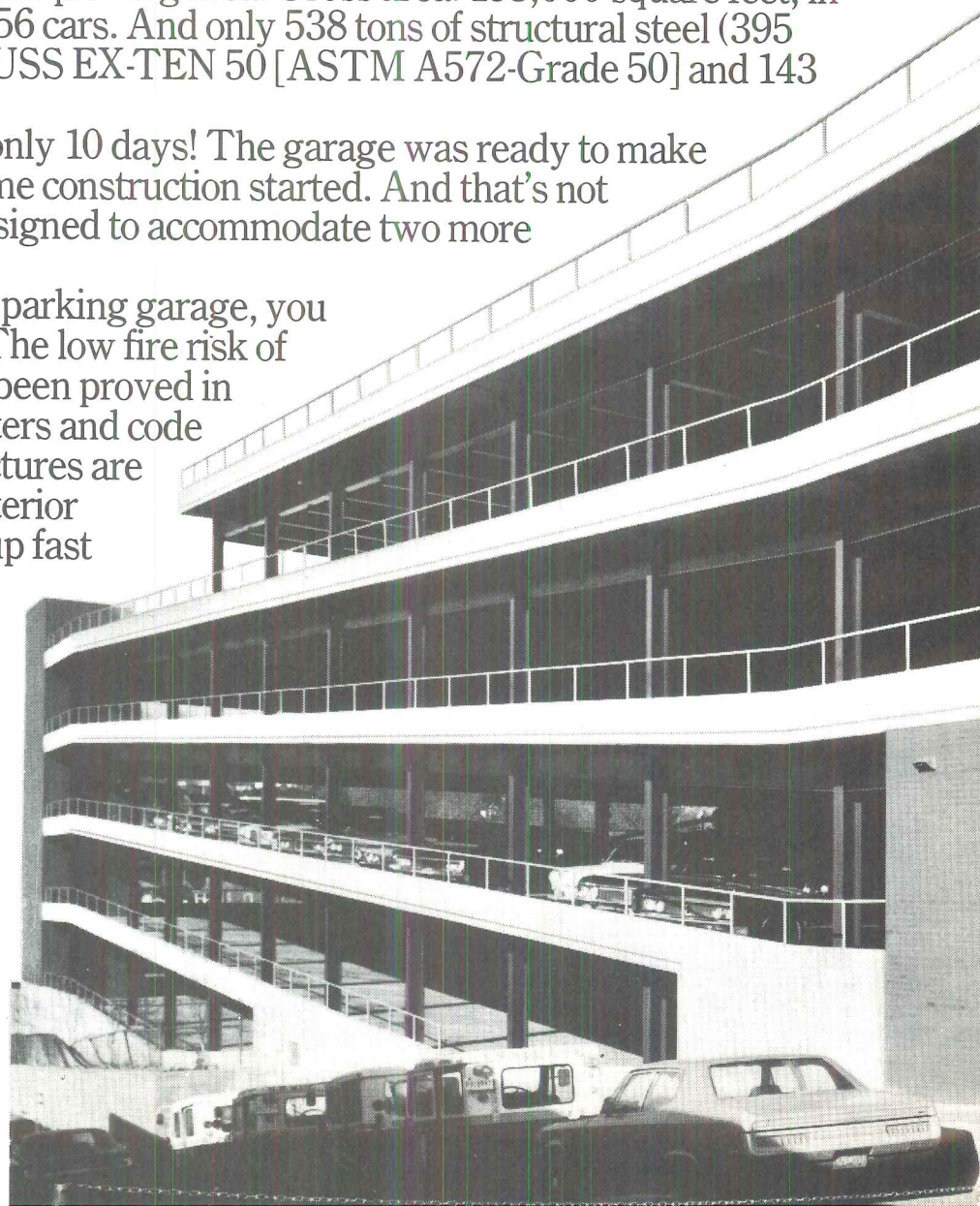

garage went up in just square foot!

When you're ready, United States Steel is ready—to help you design a long-span, open-deck garage. And to supply the steel.

For openers, we have two free brochures. The "USS Structural Report," which contains all the details of the Greensburg garage. And our 54-page "Technical Report on Steel-Framed Parking Structures" (shown at right).

To get them, contact a USS Construction Marketing Representative through your nearest USS Sales Office.

Or write U.S. Steel, Dept. C164,
Box 86, Pittsburgh, Pa. 15230.

USS and EX-TEN are registered trademarks.

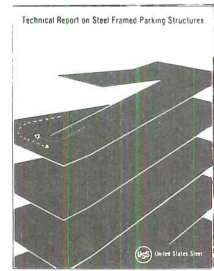

United States Steel



THAI-TEAKTM

Stands up under foot!



Elegant Thai-Teak prefinished or unfinished wood parquet floors are six times more wear resistant than oak and maple to stand up magnificently under the heaviest traffic. And Thai-Teak floors are priced no more than many custom vinyls, many other wood floors and many wall-to-wall carpetings. They also resist fire, termites, dry rot and decay to assure long life.

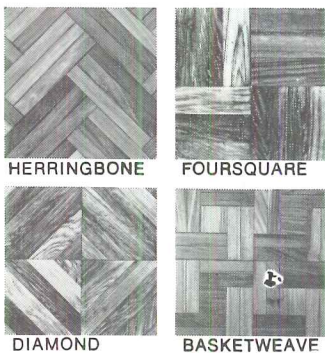

HERRINGBONE

FOURSQUARE

DIAMOND

BASKETWEAVE

(Illustrated)
Four of
150 available
patterns

Send today for **FREE** brochures on many new Thai-Teak patterns, technical data and prices.



GENUINE IMPORTED
THAI-TEAKTM
PARQUETRY FLORIDA

SEE OUR CATALOG IN SWEET'S 

Product of **BANGKOK INDUSTRIES, Inc.**
1900-10 S. 20th St., Phila., Pa. 19145 • (215) 334-1500

◆ For more data, circle 140 on inquiry card

ELECTRIC STRIKES

**STRONG
RELIABLE
VERSATILE**

Folger Adam electric strikes are the ideal components for your door control systems. Strong—high quality, high strength materials throughout to prevent forcing. Reliable—precision workmanship and close tolerance mating of parts assure long service life and resistance to tampering. Versatile—Folger Adam electric strikes equipped with signalling switches, can be adapted to virtually any type of door control or surveillance system.

Write for literature on
full line of security devices.



FOLGER ADAM CO.

Architectural Security Division
700 Railroad Street, Joliet, Ill. 60436
815/723-3438

For more data, circle 141 on inquiry card

Massey | backs you up.

All the way. Take the Polaris chair. It backs you up with a one-piece, moulded plastic back. Strong. Safe. And good looking. And it stays that way. For a long time. Massey backs you up with comfort. Two inches of foam with every back. And a thick foam cushion over the springs of the seat. Then they back you up with a nice little extra. Complete architectural, engineering and design assistance.



 FOR REFERENCE SEE SWEET'S
ARCHITECTURAL CATALOG FILE 12.5 MA.

You're always
Sitting Pretty with . . .
Massey
seating CO.
NASHVILLE, TENNESSEE 37208

For more data, circle 142 on inquiry card

Can you HEAT and COOL your place of business and still conserve energy and save money?

Lennox says, "Yes," and shows you how.

The new Lennox POWER SAVER II™ concept—when used with ZDB, constant volume air blenders—is a heat reclaim/heat reject system that uses every available Btu generated inside a building for heating...and rejects unneeded Btu's during cooling...to conserve energy and save money.

"Free" heat (throw-away heat from lighting) is reclaimed and distributed to zones calling for heat.

"Free" cooling comes from the ability to control and

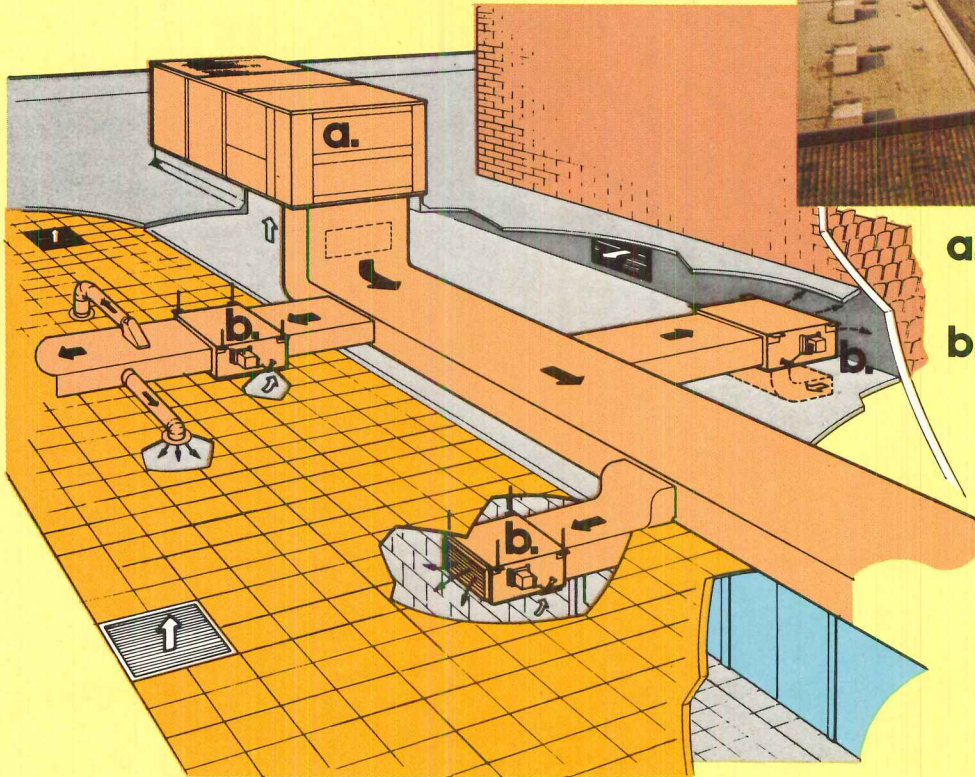

a. Central power supply.

b. Zone air blenders.

exhaust unwanted light fixture and ceiling plenum heat.

The efficiencies of POWER SAVER II will actually eliminate the need for owners to amortize any additional HVAC investment. The energy savings per square foot effectively offset the cost of added ducts, dampers, exhaust fans and ventilating light fixtures. Usually, original equipment size can be reduced enough to allow up to 7%* lower first cost...with no sacrifice in comfort!

Lennox blower-powered air blenders (ZDB) give you individ-

ual zone control from a central single zone unit... with constant air volume to the space. Use them as cooling/ventilating or combination heating/cooling units. The central unit supplies conditioned air to a central supply duct. A thermostatically controlled blower-powered air blender in each zone pulls air from the duct and discharges it into the control zone. It takes only the amount of cool air needed to satisfy cooling demands—the balance of the constant volume is recirculated air.

The POWER SAVER II application works well on all types of large stores, schools, restaurants and factories with ceiling plenums. Supermarkets can take additional advantage of the heat reclaim/heat reject capabilities by capturing the condenser heat from refrigerated fixtures.

Find out how this new energy conservation idea from Lennox can help you. Write Lennox Industries Inc., 470 S. 12th Ave., Marshalltown, Iowa 50158.

New Lennox POWER SAVER II™ concept saves you up to 35% energy consumption over conventional systems. (The concept has a Patent Pending status.)

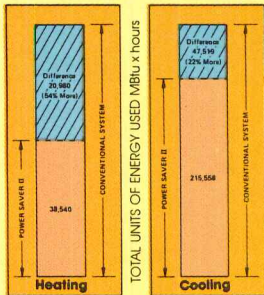

10,000 sq-ft. building with 3 zones. Mathematical model comparison of conventional economizer and POWER SAVER II. Kansas City, Missouri, climate. 9:00 a.m.—5:00 p.m. temperature occurrence frequency.

LENNOX®

AIR CONDITIONING • HEATING

*Savings established on mathematical model.

Nifty problem-solving ideas from Lennox.

For more data, circle 143 on inquiry card

More and more builders are siding with prepainted galvanized steel.



Whether you remodel or start from scratch, you want to be on the winning side. Today it's prepainted galvanized steel.

Zinc-coated steel survives a beating wood and other materials can't. It's immune to cracking from sun, storms, corrosion and the freeze and thaw cycle. It's twice as strong as other metal sidings, less subject to thermal expansion and denting. The paint is baked on for keeps, and washes clean like new.

To the home owner this brings pleasure without maintenance. To the builder it means a longer building season, and housing developments that look inviting even when they've been occupied for years.

Asarco, a major producer of galvanizing grade zinc, will be happy to send you a list of companies who make prepainted galvanized steel siding. Just drop us a line at 120 Broadway, New York, N.Y. 10005.

75 Years of Progress in Metals

ASARCO⁷⁵

American Smelting and Refining Company

For more data, circle 144 on inquiry card

A woman with blonde hair, wearing a long, sleeveless red dress, stands in a modern building lobby. She is positioned in the center-right of the frame, leaning slightly against a low, textured terrazzo wall. The lobby features a large, multi-level staircase with wooden treads and dark metal railings. In the background, there are large indoor plants, including a tall palm tree. The floor is made of light-colored terrazzo tiles. The word "just" is visible on a dark wall in the background. The overall atmosphere is bright and contemporary.

terr a z z o

***its only
limit is your
imagination.***

To meet today's modern design requirements, terrazzo contractors are installing this age-old material in a variety of ways. Poured in place to provide beautiful floors that last and last, and are easy on the maintenance budget. Textured surfaces for curbs, walls or outdoor paving that beautify walks, malls and plazas while adding an extra measure of safety under foot. Precast terrazzo for stairs, decorative accents, even flooring. Because terrazzo is a sensible solution to the rising costs of initial construction and building maintenance, what started as an ancient art is a thriving business today. Get all the facts from your terrazzo contractor or regional technical representative. Or write Terrazzo, 716 Church Street, Alexandria, VA 22314. Phone (703) 836-6765.

For more data, circle 145 on inquiry card

Type 38 injection molded Wraparounds are cleverly styled to present a pleasing geometric appearance that tends to break up monotonous flat ceilings. Their wafer-thin profile lends a "built-in" look to surface-mounted fluorescent fixtures.

With injection-molded, precisely formed prisms, glare is no problem. American Louver's Wraparounds provide even illumination of

surrounding ceiling areas, and well balanced concentration of light in working planes.

Special hinging feature makes servicing a snap. Available in two sizes: 11" wide for 2/40 watt, and 16" wide for 4/40 watt. Optional end caps: Crystal clear prismatic or handsome white opaque.

Send for Bulletin #202 and see what distinctive surface lighting can do for modern design.

**Don't
hide
the
light
source-**

feature it!



AMERICAN LOUVER COMPANY
7700 AUSTIN AVENUE • SKOKIE, ILLINOIS 60076 • (312) 966 0300

For more data, circle 146 on inquiry card

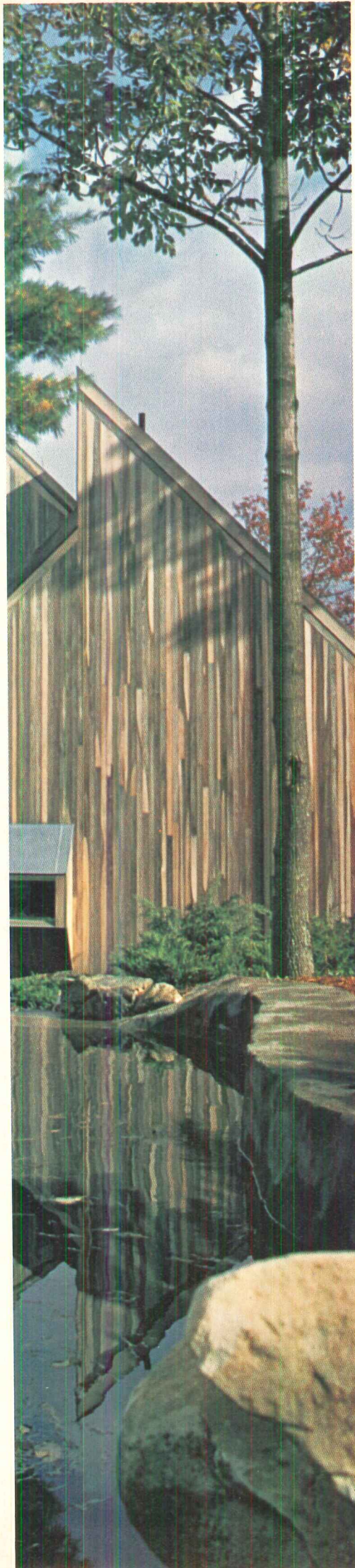
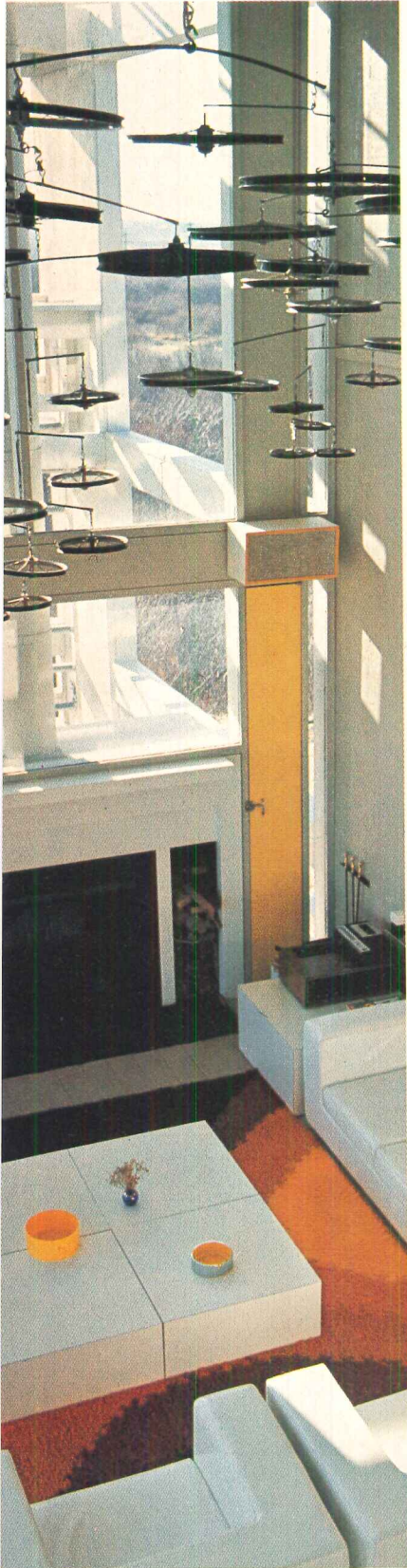

COMING IN MID-MAY. . .
 ARCHITECTURAL RECORD'S IDEA
 ANNUAL OF THE HOUSING FIELD

RECORD HOUSES AND APARTMENTS OF 1974

In mid-May Architectural Record's *Record Houses and Apartments of 1974* offers a timely opportunity for manufacturers of quality building products to exert year-in and year-out influence on those architects and builders who are at the forefront of the housing market. It will reach all major groups of specifiers and buyers in this market:

- over 43,000 architects and engineers who are verifiably responsible for 87 per cent of the dollar volume of all architect-planned residential building.
- 20,000 of the nation's foremost builders qualified by Sweet's on the basis of annual building activity to receive the Light Construction File.
- 4-5,000 leading interior design offices qualified by Sweet's to receive the Interior Design File.
- in addition, bonus bookstore distribution to an influential segment of the house building and buying public.

Record Houses and Apartments offers its advertisers a unique advantage:

The issue has the longest working life of any issue of any architectural magazine! Architects refer to it five, ten, even fifteen years after publication.

Don't miss it! Closing date: April 15.



**BERLIN STEEL
WAS IN BUSINESS
SEVENTY THREE
YEARS BEFORE
THEY SPECIFIED
JOIST GIRDERS
FOR THE FIRST
TIME. ELEVEN DAYS
LATER, THEY DID
IT AGAIN.**

Joist Girders. The advantages they had over I-beams were more than enough for Berlin Steel to specify them for the Sage-Allen Department Store they were building in West Hartford, Connecticut. So much



Joist girders have a simple span design. Which explains why ponding calculations are easier. And why design time is shortened.

more, that eleven days later they specified them again. Only this time for National Plastics and Plating Supply Co. in Plymouth, Connecticut.

Where did Berlin Steel learn about those advantages? From meeting with Vulcraft. The people who knew as



Joist girders need fewer foundations and columns. Which means less work for you and larger bay areas for your clients.

much about joist girders as Berlin did about steel fabricating.

And the first thing the Vulcraft engineers did was show Berlin Steel

why joist girders are easier to specify and erect. By explaining that the simple span design of joist girders make ponding calculations easy. And shorten design time.

By telling them about the larger bay areas possible with joist girders. And by talking about the fewer foundations and columns needed with joist girders than with I-beams.

Then came the subject of the advantages joist girders offer after they're erected.

And to explain that topic Vulcraft talked about the modified Warren truss configuration used in joist girders. And that it gave joist girders a high strength to weight ratio.



Joist girders have a modified Warren truss configuration using hot rolled double angle sections for top and bottom chords and single and double angle sections for web members. What that means is a high strength to weight ratio.

They mentioned further, that bar joist erection was faster. Because top chord panel points show joist location, eliminating a lot of measuring.

Finally, the matter of ducts, pipes and conduits came up. And Vulcraft explained how these things go right through a joist girder. Something no one can say about an I-beam.

What it all added up to for Berlin Steel was a change. A change from I-beams to another roof-framing system. A roof-framing system that was more economical and easier to erect



Joist girders have top chord panel points that show joist location. Which makes a lot of measuring unnecessary.

for anything over 10,000 square feet.

It wasn't surprising to Vulcraft, though. Because architects and engineers all over the country are discovering the advantages joist girders have over I-beams.

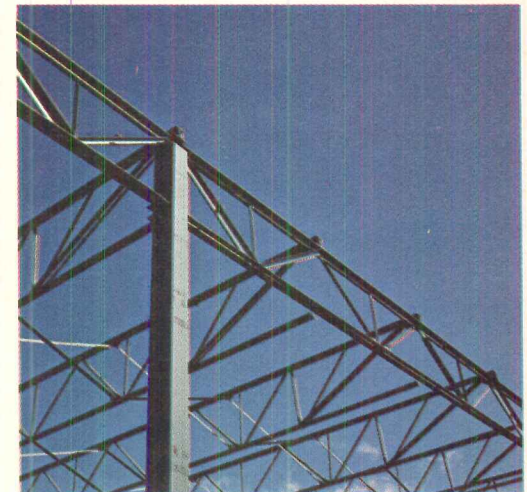

Joist girders already have spaces for pipes, conduits, and ducts to run through. So you don't have to cut them yourself.

If you'd like more information about how joist girders can work for you, send for Vulcraft's Joist Girder Specification Guide. Just contact your local Vulcraft sales office. Or write P.O. Box 17656, Charlotte, N.C. 28211. Or call (704) 366-7000. You'll find a few things even Berlin Steel didn't know. Until they asked.

VULCRAFT

Sage-Allen Department Store, West Hartford, Connecticut; Architect: Associated Architects, Farmington, Connecticut / General Contractor: Bartlett-Brainard & Eacott, Inc., Bloomfield, Connecticut / Consulting Engineer: Hallisey Engineering Associates, Inc., Hartford / Steel Fabricator: Berlin Steel Construction Company, Inc., Berlin, Connecticut. National Plastics and Plating Supply Co., Plymouth, Connecticut; Architect: Andrew C. Rossetti, Bristol, Connecticut / General Contractor: S. Carpenter Construction Co., Bristol / Consulting Engineer: Hallisey Engineering Associates, Inc. / Steel Fabricator: Berlin Steel Construction Co., Inc.

For more data, circle 147 on inquiry card

Last year we introduced new power and manually operated JAMIGLIDE™ COOLER DOORS to meet more specialized needs

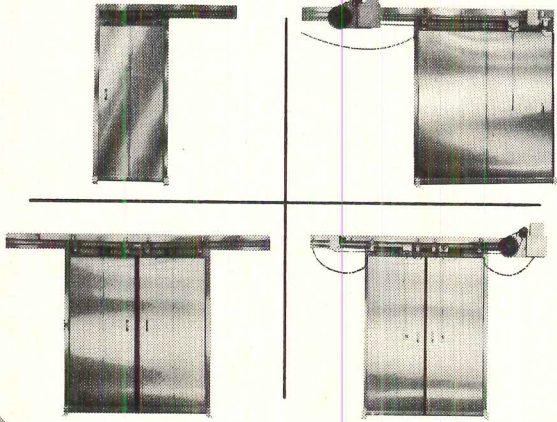

NOW

More from Jamison

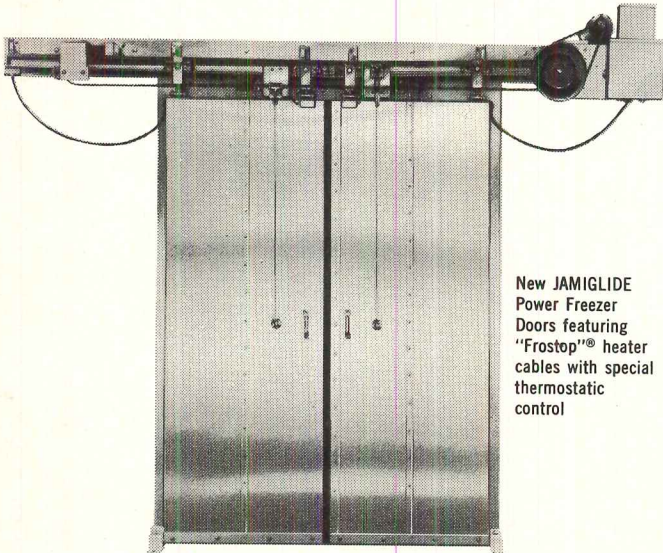

New JAMIGLIDE Power Freezer Doors featuring "Frostop"® heater cables with special thermostatic control

Announcing new JAMIGLIDE FREEZER DOORS

Single • Bi-Parting • Power and Manual

You keep getting more from Jamison in every price range! Now new Jamiglide freezer doors add to your selection. They add to your economy, too, because Jamison exercises complete control over design, materials and fabrication to assure traditional Jamison quality.

Write or call for information on new Jamiglide freezer doors . . . all Jamison designed and built for maximum performance.

COLD STORAGE DOORS BY
JAMISON
JAMISON DOOR CO • HAGERSTOWN, MD 21740

For more data, circle 154 on inquiry card

FOR ANYONE WITH A ROLE IN CAMPUS PLANNING AND DESIGN



CAMPUS PLANNING AND DESIGN

Edited by Mildred Schmertz, AIA
Senior Editor
Architectural Record

SIX SECTIONS:

- Designing the Single Building
- Designing the Library for the Campus
- The Single Building or Complex Designed as Part of the Campus Master Plan
- Architecture Which Gives the Campus the Unity of a Single Building
- Campus Performing Arts Centers
- Designing Campus Interiors

This 266-page volume brings you practical data and creative ideas on handling such campus architecture problems as: designing well-scaled open space; dealing with existing architectural atmosphere; creating flexible prototypes for specialized buildings; planning expansible systems for an entire campus; organizing functional and aesthetic elements in relation to site and surroundings; integrating the building with interior space design, solving problems of architectural scale posed by the surrounding campus.

ARCHITECTURAL RECORD
1221 Avenue of the Americas, New York, N.Y. 10020

AR-4-74

Please send me copies of Campus Planning and Design @ \$22.50 each, plus postage and handling. (Include payment and we'll pay the postage and handling.)

Name _____

Street _____

City _____ State _____ Zip _____

STAFF ARCHITECT

Abbott, a leading international pharmaceutical company, needs a top-notch experienced architect in a staff position to support an aggressive world-wide construction program. Requires 5-10 years experience in planning/programming for manufacturing facilities with emphasis on pharmaceutical facility needs. Salary will relate to experience. Outstanding fringe benefits package, including profit sharing. Send resume, including salary history, in confidence, to:

N. A. Tebo
Professional Employment

ABBOTT
NORTH CHICAGO, ILL. 60064

An Equal Opportunity Employer M/F



Warnel Metal panels offer an imaginative new vocabulary of building surfaces for exterior and interior applications. A wide range of sculptured textures and geometric patterns are embossed in the following metals: bronze, copper, stainless steel, weathering steel and aluminum, and in long-life color films permanently bonded to galvanized steel and aluminum. Lightweight panel systems engineered for speed and ease of erection offer savings over conventional construction. Forms & Surfaces Box 5215 Santa Barbara, Calif. 93108

Garden Grove Medical Center
Architects: Widom/Wein & Associates

COLLETTI SMITH



GAF PUT SOMETHING NEW INTO LIGHT COMMERCIAL TILE. FASHION.

Now there's a light commercial tile that's as fashionable as it is dependable. It's Fashioncraft™ Tile from GAF.

Fashioncraft is tough enough for either heavy residential or light commercial use. It has extra deep embossing for longer life.

But it looks beautiful, too! So you can put



it almost anywhere. In boutiques, bakeries, offices, or schools.

It doesn't just cover a surface, it decorates it. With a wide choice of exciting colors and high fashion patterns. Some tiles even feature the natural-like textures of slate and brick.



So next time you have to cover a light commercial area, remember where the fashion is. Fashioncraft Tile. You'll never settle for a dreary looking floor again.

For more information, call your GAF Flooring Distributor or write: GAF Floor Products Division, Dept. F44, Box 1121, Radio City Station, New York, New York 10019.

gaf Floor Tile

For more data, circle 152 on inquiry card

Now GE adds to & for performance approval...

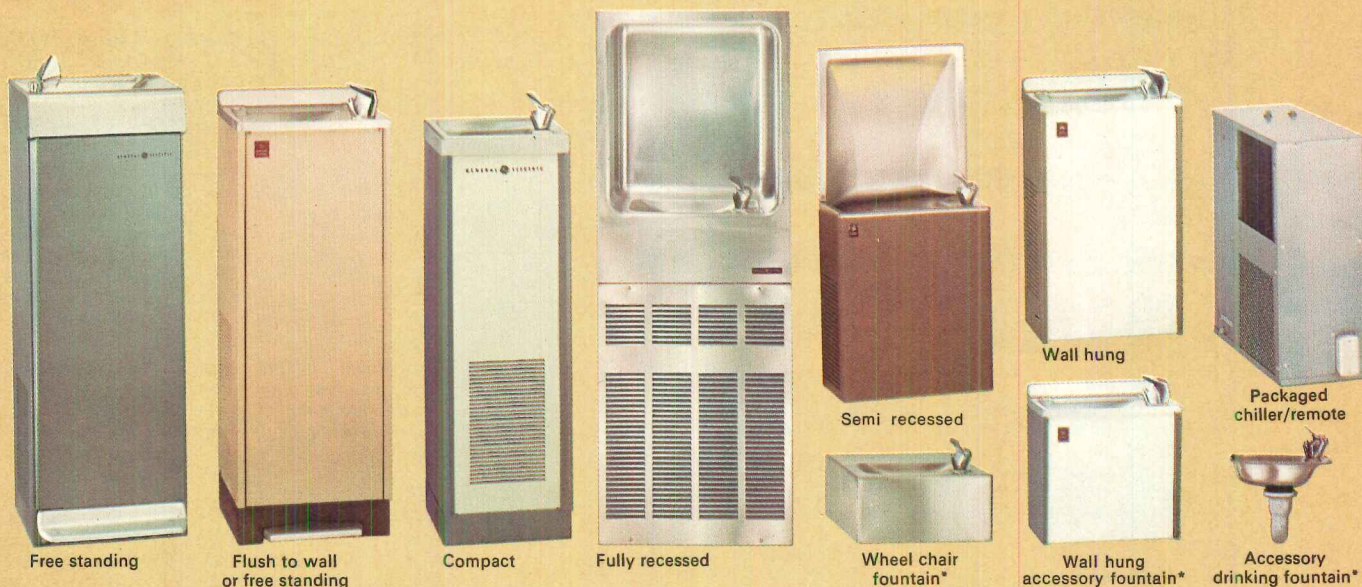

...& General Electric's pressure water cooler design and reliability testify for themselves

Assure performance in accordance with published capacity ratings with General Electric pressure water coolers, designed to meet Air Conditioning and Refrigeration Institute (ARI) Standard 1010-71. Listings by Underwriters' Laboratory and Canadian Standards Association add to GE quality and performance approval.

And, General Electric's design flexibility and reliability further satisfy your needs.

- Get modern design variations to utilize available space and enhance surroundings.
- Specially finished stainless steel tops reduce stains,

scratches and smudges

- Exclusive removable pre-cooler core permits cleaning without removing basin top, improves sanitation
- Hermetically sealed compressors feature permanent lubrication and overload protection

For all your water cooler needs, remember GE gives you excellent flexibility and reliability.

For a new four-color full-line brochure, write General Electric Company, 14th & Arnold Streets, Chicago Heights, Illinois 60411

761-53

*Non-refrigerated units to which the A.R.I. certification program does not apply.

GENERAL  ELECTRIC

For more data, circle 153 on inquiry card

CLASSIFIED SECTION

POSITIONS VACANT

CONSTRUCTION PROJECT MANAGEMENT

The JCPenney Company has excellent opportunities in its New York office and its regional offices for managers to be responsible for the supervision and coordination of field construction and installation of equipment in retail stores, warehouses, offices, and catalog operations. We have immediate need for:

- **DRAFTING SQUAD LEADERS**
Atlanta, New York, So. Calif., Chicago
- **PROJECT ARCHITECTS**
New York, Pittsburgh, Atlanta
- **STORE FIXTURE LAYOUT PLANNERS**
New York
- **FIELD CONSTRUCTION REPRESENTATIVES**
Pittsburgh, Atlanta, Dallas
- **ELECTRICAL SPECIALIST**
New York

Five to seven years experience in drafting, designing, and construction engineering preferred. Travel within a geographic region required. Excellent salaries commensurate with experience, outstanding promotion opportunities, numerous benefits. Send resume and salary history in confidence to:

JCPenney

JCPenney Company, Inc.
Executive Search Dept. CL
1301 Ave of the Americas
New York, N.Y. 10019
An Equal Opportunity Employer

University Facilities Planning Director—Five years experience of major administrative responsibility for overall coordination and development of facilities plans and construction, preferably in a university environment. Minimum education is undergraduate degree in Architecture, Civil, Mechanical or Industrial Engineering, Construction Management or related field. Masters degree preferred. Must be eligible for Florida registration within reasonable period. Salary from \$20,000. Send resume to G. E. Clayton, Administrative Planning Office, University of South Florida, Tampa, Florida 33620. An Affirmative Action Equal Opportunity Employer.

State Building Commissioner is sought by the R.I. State Building Codes Standards Committee to have the responsibility of enforcing the State Building Code, to serve as the Executive Secretary to the State Building Codes Standards Committee and Appeals Board. Minimum of ten years experience in building or building regulations, be an architect or professional engineer or a certified building official having at least ten years experience in the building construction or inspection field. Salary commensurate with experience. Send resume to: Frank Turano, Acting Secretary, 150 Washington Street, Prov., RI 02903. Application deadline: May 1, 1974.

Teaching Position—Architectural Engineer or Architect with some Civil Engineering background. Must have minimum of three years professional experience and some teaching experience desired. Registration not required, but desirable. Position open for full-time faculty in two-year community college in vicinity of Washington, D.C. starting August, 1974. Send resume to Prof. Cecil Van Allen, Chairman, Engineering and Engineering Technology Department, Montgomery College, Rockville, Maryland 20850.

Registered Architect: This could be an opportunity for a man with some experience and business acumen to become part of a medium size Massachusetts firm with an imposing background of municipal, state and federal projects. The owner plans gradual retirement. No investment required. Address Qualifications to: P-4639. Architectural Record.

Architects—We have many career openings for architects to serve as project architects for large designer-builder of medical and institutional facilities. Excellent companies. Good salary, bonus and car compensation packages. Send resume. Management Recruiters of Green Bay, 115 S. Jefferson St., Green Bay, Wis., 54301. Or direct dial 414/437-4353.

Specification Writer—Experienced specification writer capable of managing and implementing an architectural master specification program and related product information for diversified A-E firm. Working knowledge of the Uniform Construction Index, the 3-part section format and automation desired. Please contact Charles P. Murray, Vosbeck Vosbeck Kendrick Redinger, 720 N. St. Asaph Street, Alexandria, Virginia, (703) 549-5353, EOE.

Architects for expanding Midwest firm with national accounts. Design and produce drawings for projects throughout the midwest, New England, South, and Southwest. Registered architects preferred or persons with equivalent experience. Field representatives and construction contract managers also needed. Prefer persons with at least five years experience in supervision of commercial construction for architectural firm. Applicants must be ambitious with good references and willing to travel. Send resume to Richard Henry Eiselt, AIA, 398 S. Grandt, Columbus, Ohio 43215.

ARCHITECT Medical Projects

If you are a registered Architect and have at least 5 years of medical facilities design and planning experience, we have an excellent opportunity for you as a Project Architect. You would be responsible for the over-all direction and completion of a large variety of medical projects, and will work with a seasoned staff of professionals.

This position is a result of increased work load and offers exceptional opportunity for professional advancement.

Outstanding program of benefits includes profit sharing, bonus, regular salary reviews, health, life, disability and accident insurances.

If you have the medical experience and the desire to improve your position, please send a resumé in confidence to:

Cliff Schroeder

ELLERBE, INC.
Architects / Engineers / Planners

One Appletree Square
Minneapolis, Minn. 55420
Tel: (612) 853-2025

An Equal Opportunity Employer

ARCHITECTS—PEACE CORPS/VISTA

ACTION. Volunteer overseas and U.S.... Low-income housing projects, design of schools, hospitals, community centers, etc. Most openings: singles, some couples. Information: Bruce Mazzei

ACTION

OCP Box A-1, Washington, D.C. 20525.

Recent Graduates having first professional degrees in architecture, to join the architectural staff of Southwestern Bell in St. Louis. The position offers the opportunities of preparing working drawings under supervision of a registered architect (ultimate registration required) while learning business and evolving to a Project Architect handling all facets of construction. Reply to: Mr. L.L. Huges, General Architect, Southwestern Bell Telephone Company, 720 Olive Street, Room 2705, St. Louis, Missouri 63101.

Architect: Registered or eligible to register in New Mexico. Apply Mauck, Stastny & Rassam, P.A., 333 East Main Street, Farmington, New Mexico 87401.

Specification/Field Coordinator—Position available with a rapidly expanding design oriented firm. Applicant must have 5 years experience and capability to manage a variety of both large and small scale institutional projects through specification, bidding and construction. Please send detailed resume and salary requirements to: Hastings & Chivetta Architects & Planners, 7733 Forsyth, St. Louis, Missouri 63105.

University Executive—Campus Facilities—A major university in the Northeast invites nominations and applications for senior executive position responsible for planning, design, construction and operation of a highly sophisticated, multi-location campus with particular concern for comprehensive planning of the total physical environment. Position requires unique combination of architectural, engineering, and management skills and carries responsibility for oversight of approximately \$20 million annual capital and operating budget. At least ten years relevant experience required. Previous University experience and professional architectural or engineering license very helpful but not required. Compensation to be determined by qualifications. All correspondence will be held in strictest confidence. Applications must be received by April 15 and should be addressed to: P-4979, Architectural Record. An Equal Opportunity Employer.

Office Administrator—Established medium sized architectural firm which has received over 35 local, state and national design awards and maintains a growing and diversified practice in metropolitan Detroit, seeks an experienced registered architect as an associate level Office Administrator. Responsibilities include: Management of personnel, finance, facilities, contract negotiations, professional services, public relations and professional involvement. Send resume and references to: P.O. Box 8788, Detroit, Michigan, 48224. An Equal Opportunity Employer.

Director of Design—Minneapolis A-E firm of 75, with diverse, regional/national practice, seeks imaginative, aggressive architect for position of Director of Design. Must have degree, registration, and extensive experience as a senior architectural designer. Primary responsibility is for all visual design officewise. Director is design consultant for all projects, and chief critic and spokesman for architectural designers. Send confidential resume and salary history to William Scott, Setter, Leach & Lindstrom, Inc., 133 Foshay Tower, Minneapolis, Minnesota 55402.

PUZZLED?

Q. How do I reply to a box number ad?

A. Address an envelope with the box number indicated in the ad, c/o Architectural Record, Class. Adv. Dept., P.O. Box 900, NY, NY 10020.

Q. Who do I contact or call to renew my classified ad or make corrections?

A. Write Architectural Record, Class. Adv. Dept., P.O. Box 900, NY, NY 10020 or call: (212) 997-6585 or 6586. Give full company name, size of ad, & date or dates, it is scheduled to appear.

Landscape Architect—Expanding multi-disciplined A/E/P firm has opening for Landscape Architect. Registered or qualified to be registered in Ohio. Upon proven performance, position can lead to department head status. Send complete resume and technical references to: Samborn, Steketee, Otis and Evans, Inc., 600 LOF Building, Toledo, Ohio 43624 (419-248-6271). An Equal Opportunity M/F Employer.

SELLING OPPORTUNITIES AVAILABLE

Manufacturer's Reps or Agents in major U.S. cities. Engineering or tech. oriented reps with architect and building owner contact during planning stages of major hi-rise projects wanted by major mfr. of permanently installed exterior maintenance (window washing) scaffolding equipment. Reply with full particulars to: RW-4769, Architectural Record.

Manufacturer's Representative—Waterproofing and Construction Products—Well known specialty chemical and waterproofing products company seeks experienced rep with excellent local architectural and contractor contacts. Should have knowledge of waterproofing applications and compounds. RW-4729, Architectural Record.

EMPLOYMENT SERVICE

Edwards and Shepard Agency: An architectural and interior placement service for professionals seeking knowledge, guidance, confidentiality and informed representation. Bill Shepard, a Pratt graduate, offers effective results to: Architects, Planners, Production Specialists and Industrial Designers. Interviews by appointment—(212) 725-1280, 1170 Broadway, New York, N.Y. 10001.

Career Builders, Inc., Agency—Complete range of Architectural and Interior Design placement under the direction of Ruth Hirsch, Apprentices to Senior Designers and Project Architects, Professional screening and personalized service, References checked. 501 Madison Av., New York, NY 10022; PL2-7640.

CLOTHES CATALOG

Tall and Big Men: Write for Free 96 page, full color catalog of Guaranteed-To-Fit Apparel and Footwear. Dress and Sport Shirts with Sleeves to 38"; Double Knit Slacks and Jeans with Waists to 60"; Shoes and Boots to 16EEE. Satisfaction Guaranteed. Write Today: The King-Size Co., 2694 King-Size Bldg., Brockton, Mass. 02402.

POSITION WANTED

Architect, NCARB, with proven capabilities in design with award-winning firms plus related experience in project and office management. Programming, planning and design experience in educational, governmental, commercial, religious and multi-family housing projects. Recently sold my interest in Chicago based firm which I founded in 1969. 38 years old, single (again) and looking for a new challenge in any location. Reply PW-4749, Architectural Record.

Architect seeking new challenge as partner, associate, or top management. Would like to relocate warm climate. Strong background shopping centers, department stores, retail specialty stores. Currently architect management level. Licensed several States, NCARB certificate, AIA, ISP. Ready to meet rewarding Architectural endeavors requiring creative, administrative, management abilities. PW-4698. Architectural Record.

SPECIAL SERVICES

ARCHITECTURAL RENDERINGS

A complete source for the finest in architectural illustrations is described in a color brochure, available from Kinsey Architectural Arts.

Examples of full color and vignette style renderings graduated in cost are included. Additional services include building color selection and photo prints of renderings in a wide variety of sizes.

For a cost quotation forward floor plan, elevations and site plan. We will acknowledge by phone the same day received.

As a valuable addition to your office file write for your copy of our color brochure.

Kinsey Architectural Arts
2144 Alexis Dept. 5-A
Toledo, Ohio 43613
Phone: (419) 475-7011

Public Relations/Marketing—Public information and marketing programs . . . presentations . . . brochures . . . fresh ideas on communications and service . . . all matched sensitively to your own requirements and approach to the profession. Twenty years of experience with architects, as well as developers, owners, corporations, boards of education and others. David S. Wachsman Associates, Inc., 51 East 42nd Street, New York, 10017, (212) 687-1196.

Architectural—Structural Detailing Service available at Competitive rates on all building types, Schools, Hospitals, Hotels, Commercial and Industrial. Large Foreign competent architect engineering firm offers these services with possible U.S. based liaison for smooth co-ordination. Detailing will be carried out to the U.S. Standard by U.S. qualified architects & engineers. Apply with details of projects for charges to SS-4804, Architectural Record.

NEWSLETTER

Concrete Concepts: A bi-media Newsletter. An innovation in continuing education. Six issues per year on tape cassette along with booklet. Lively commentary and up-to-the minute course in concrete. Listen and learn while you drive to work or during your coffee break, etc. Information and ideas by experts help solve concrete problems: includes architectural, precast, prestressed, etc. A continuing examination of the best ideas in concrete technology and application know-how. Send \$15.00 for introductory sample cassette and text in handsome binder. Satisfaction guaranteed! Tectape, Box 848, Ithaca, New York 14850.

EQUIPMENT FOR SALE

MOVE UP ↑ A BETTER IDEA



MOORE
OVERHEAD CLOTHES
STORAGE SYSTEMS

Clothing stored overhead, where it should be. A complete standardized system—overhead grid supports, elevating Locker-baskets, bench units. Thrifty, attractive, sanitary.

Write for free catalogue.

THE MOORE COMPANY
1329 Quarrier St., Charleston, W. Va.
516 Fifth Ave., New York, N. Y.



ADVERTISING INDEX

Prefiled catalogs of the manufacturers listed below are available in the 1974 Sweet's Catalog File as follows.

- A Architectural File (green)
- I Industrial Construction File (blue)
- L Light Construction File (yellow)
- D Interior Design File (black)

A	
Abbott Laboratories	236
A-L Alcan Aluminum Corp.	74
A AllianceWall Corporation	195
D Allied Chemical Corp., Fibers Div.	172-173
American Louver Co.	232
A-L American Olean Tile Company	177
A-I American Smelting & Refining Co.	230
A-I American Standard, Plumbing & Heating Div.	104
A-L Andersen Corp.	56-57
Architect's Book Club	207 to 209
A Architectural Graphics Inc.	92
Architectural Record	218
Architectural Record Books	176, 202, 236
Argos Products Co.	205
A Armor Elevator Co. Inc.	80
A-I-L Armstrong Cork Co.	2nd cover-1, 3, 5, 7, 9
A-I-L ASG Industries Inc.	93
A-L Azrock Floor Products	3rd cover
B	
A Bally Case & Cooler, Inc.	17
A Bangkok Industries Inc.	228
Bell Helicopter Co.	163
Bethlehem Steel Corp.	54-55
A Bigelow-Sanford Inc.	157
A-I-L W.R. Bonsal Company	160
A-I Bradley Corporation	199
A-L Brick Institute of America Bruning Division-Addressograph Multigraph Corporation	15 196-197
C	
A-I Ceco Corp.	216
A-I Celotex Corp.	158-159
A-I Clark Door Co., Inc.	166
A Cold Spring Granite Co.	102-103
A Combustion Engineering—C-E Glass Division	98-99
D	
A-L Delta Faucet Company	192
A-I Dempster Brothers, Inc. Digital Equipment Corp.	170 180
A Dor-O-Matic Div. of Republic Industries Inc.	36
A Dover Corp., Elevator Div.	40
Dow Badische Co.	211
Dual-Lite Co.	42
Duralab Equipment Corp.	225
E	
Eastman Kodak Co.	16
Easy Heat-Wirekraft Div.—MSP Industries	193
A Eberhard Faber Inc.	184
A-I Elkay Mfg. Company	32
Executone, Inc.	27
F	
A Florida Tile, Div. of Sikes Corp.	244
Folger Adam Co.	228
A Follansbee Steel Corp.	204
A-L-D Formica Corp.	210
Forms & Surfaces	237
A-I H.B. Fuller Co.	94

G	
A-I Gaco Western Inc.	32-1
GAF Corp.—Diazo Equipment	46-47
A-I-L GAF Corp.—Floor Products Division	238
A-I-L General Electric Co.—Zoneline General Electric Co.—Lighting Systems Business Dept.	58-59 206
General Electric Co.—Water Coolers	239
A-I Georgia-Pacific Corporation	52-53
A Goodyear Tire & Rubber Co.	26
A-I Grefco Inc., Building Products Division	44
GTE—Sylvania, I/C Lighting	220-221
Guth Lighting—Div. Sola Basic Industries	219

H	
Hager Hinge Company	187
Hanna Industries	225
A Houghton Elevator Co.	62-63
A Haws Drinking Faucet Company	167
hc Products Co.	189-190
A-L Heatilator Fireplace	81
Herman Miller Inc.	60-61
A-I Hillyard Chemical Co.	194
A Holophane Co., Inc.	31

I	
Ideal Industries inc.	188
A-I Inland-Ryerson Construction Products Co.	28-29
International Masonry Institute	223
ITT—Lighting Fixture Div.	164

J	
A Jamison Door Co.	236
A-I Jennison-Wright Corp.	88
A Jewett Refrigeration Co., Inc.	193
J.G. Furniture Company, Inc.	165
Jute Carpet Backing Council, Inc.	201

K	
A KDI Paragon	90
A-I Kelley Co., Inc.	203
A Kim Lighting Inc.	89
A-D Kwik-Wall Company	213

L	
A Landscape Forms, Inc.	222
A-I-L Lennox Industries, Inc.	229
A-I-L Libbey-Owens-Ford Co.	182-183
A Long Environmental Systems	193

M	
Manning Co. Inc., R.A.	193
A Massey Seating Co.	228
McGraw-Hill Books	32-2
A-I McQuay Division McQuay—Perflex, Inc.	175
Moldcast Manufacturing Co.	48, 97
A Monsanto Company, Textiles Div.	20-21
A Montgomery Elevator Co.	191

N	
National Electrical Contractors Association	45
A-I-L-D National Gypsum Co.	100-101
A-D National Terrazzo	231
A-I-L Neenah Foundry Co.	166
A-L-D Nord Co., E.A.	198
A Nor-Lake, Inc.	188
Nucor Corp. Vulcraft Div.	234-235

O	
A-I Onan Division, Onan Corporation	30
A Osmose Wood Preserving Co.	48

A Overly Mfg.	2
A-I-L-D Owens-Corning Fiberglas Corp.	18-19, 24-25

P	
A-L Pella Rolscreen Co.	91
Pennwalt Chemicals Corp.	168-169
Pentel of America Ltd.	205
A-L Pomona Tile	177
A-L-D Potlatch Corp.	205
A-I PPG Industries Inc.—Coatings & Resins	96
A-L PPG Industries Inc., Rez.	166
Pre stressed Concrete Institute	82-83
Price Pfister Div.	70
Pyrotector Inc.	201

R	
A-I Raynor Mfg. Co.	198
Record Houses	233
A-L Red Cedar Shingle & Handsplit Shake Bureau	6
A-I Richards-Wilcox Mfg. Co.	48
A-L Rohm & Haas Company	68
A-D Roper Eastern Products Corp.	64
Russwin, Div. Emhart Corp.	66

S	
Sheaffer World-Wide	188
A-I Silbrico Corp.	162
Simple Space-Rite Lettering System	222
A-I Simpson Timber Co.	78
L Singer Co.—Climate Control Div.	76
Sloan Valve Company	4th cover
A Smith, Elwin G. Div. Cyclops Corp.	90
A Soss Mfg. Co.	225
A-L Speed Queen, Div. of McGraw- Edison Co.	95
Square D Company	181
A-I Standard Conveyor Co.	217
A-I Stanley Works, The	50-51
Steelcase Inc.	106
Strand Century Inc.	201
A Stratford Industries Inc., Subs. of Equipment Co. of America	243

T	
A-I Taylor Co., The Halsey W.	8
Teledyne Rotolite	22-23
A-I Thiokol Chemical Corp.	49
TPI Corporation	224
A-I Tremco Mfg. Co.	214-215
Trus Joist Corp.	243

U	
A-I United States Mineral Products Co.	162
A-I-L-D U.S. Plywood Corp.	105
A-I United States Steel Corp.	226-227
A-L Uvalde Rock Asphalt Co.	3rd cover

V	
A Vinyl Plastics, Inc.	193
A Vogel-Peterson Co.	171
A Vollrath Co.	222
A Von Duprin Inc.	212

W	
Walker/Parkersburg Div. of Textron Inc.	200
A Wasco Products, Inc.	172
Weil McLain Company, Inc.	48, 97
Wellco Carpet	72
Westinghouse Electric—Corporate	84-85
A-I-L Weyerhaeuser Company	185
Wide-Lite Corporation	178-179
Wilson Art	86-87
Wiremold Company	193

ARCHITECTURAL RECORD

McGraw-Hill, Inc., 1221 Avenue of the Americas, New York
New York 10020
Advertising Sales Mgr.: Louis F. Kutscher (212) 997-2838
Eastern Sales Mgr.: Robert G. Kliesch (215) 568-6161
Western Sales Mgr.: James A. Anderson (312) 751-3770
Advertising Services Mgr.: Joseph R. Wunk (212) 997-2793
Marketing Services Mgr.: Elizabeth Hayman (212) 997-2858
Research Mgr.: Camille Padula (212) 997-2814
Classified Advertising: (212) 997-2557

District Offices:

Atlanta 30309

Edward G. Graves, 100 Colony Square, 1175 Peachtree St., N.E.
(404) 892-2868

Boston 02116

Robert L. Tagen, 607 Boylston St., (617) 262-1160

Chicago 60611

James A. Anderson, Robert T. Franden, Edward R. Novak,
645 N. Michigan Ave. (312) 751-3770

Cleveland 44113

Willis W. Ingersoll, 55 Public Square, (216) 781-7000

Denver 80202

Harry B. Doyle, 1700 Broadway (303) 266-3863

Detroit 48202

Richard D. Thielmann, 1400 Fisher Bldg., (313) 873-7410

Los Angeles 90010

Richard R. Butera, 3200 Wilshire Blvd.-South Tower (213) 487-1160

New York 10020

Blair McClenachan (212) 997-3584

Philadelphia 19102

Robert G. Kliesch, George T. Broskey, Three Parkway
(215) 568-6161

Pittsburgh 15222

Edward C. Weil, III, 4 Gateway Center, (412) 391-1314

St. Louis 63011

Richard Grater, Manchester Rd., (314) 227-1600

San Francisco 94111

Richard R. Butera, 425 Battery Street (415) 362-4600

Overseas Offices:

Brussels

Galerie Porte de Namur, 22-26, Chaussée de Wavre
1050 Brussels, Belgium

Frankfurt/Main

Elsa-Brandstroen Str. 2, Frankfurt/Main, Germany

London

34 Dover Street, London W.1, England

Milan

Via Baracchini No. 1, Milan, Italy

Paris

17, rue Georges Bizet, 75 Paris 16e, France

Tokyo

2-5, 3-chome, Kasumigaseki, Chiyoda-ku, Tokyo, Japan

BEAUTIFUL DOORS INSTALLED IN FINISHED WALLS IN ONLY 20 MINUTES!

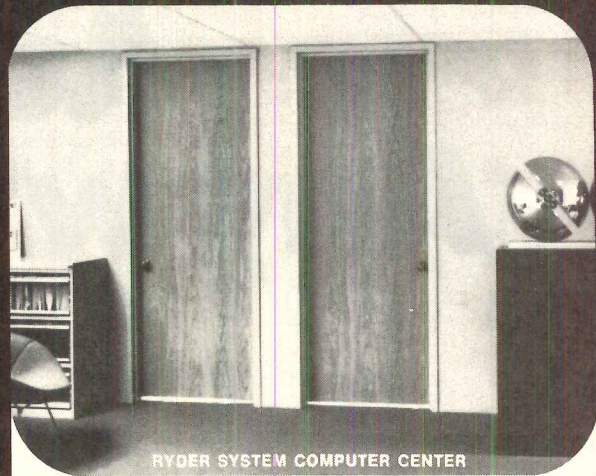

Doors laminated in wood-finish plastic
pre-hung in steel or aluminum adjustable
frames to meet your specifications. For
full information write or phone

STRATFORD INDUSTRIES, INC.

1000 Hialeah Drive, Hialeah, Florida 33010
Telephone: (305) 885-4512

See our brochure 8.3/Str in Sweet's.

For more data, circle 148 on inquiry card

A black and white photograph of a construction worker standing on a steel truss structure, likely part of a roof or ceiling. The worker is wearing a hard hat and safety gear. The structure consists of a complex network of steel beams and girders.

tj *trus joist*
ON THE JOB - ON TIME
EVERY TIME

For more data, circle 149 on inquiry card

Shape up. Across. Any which way.

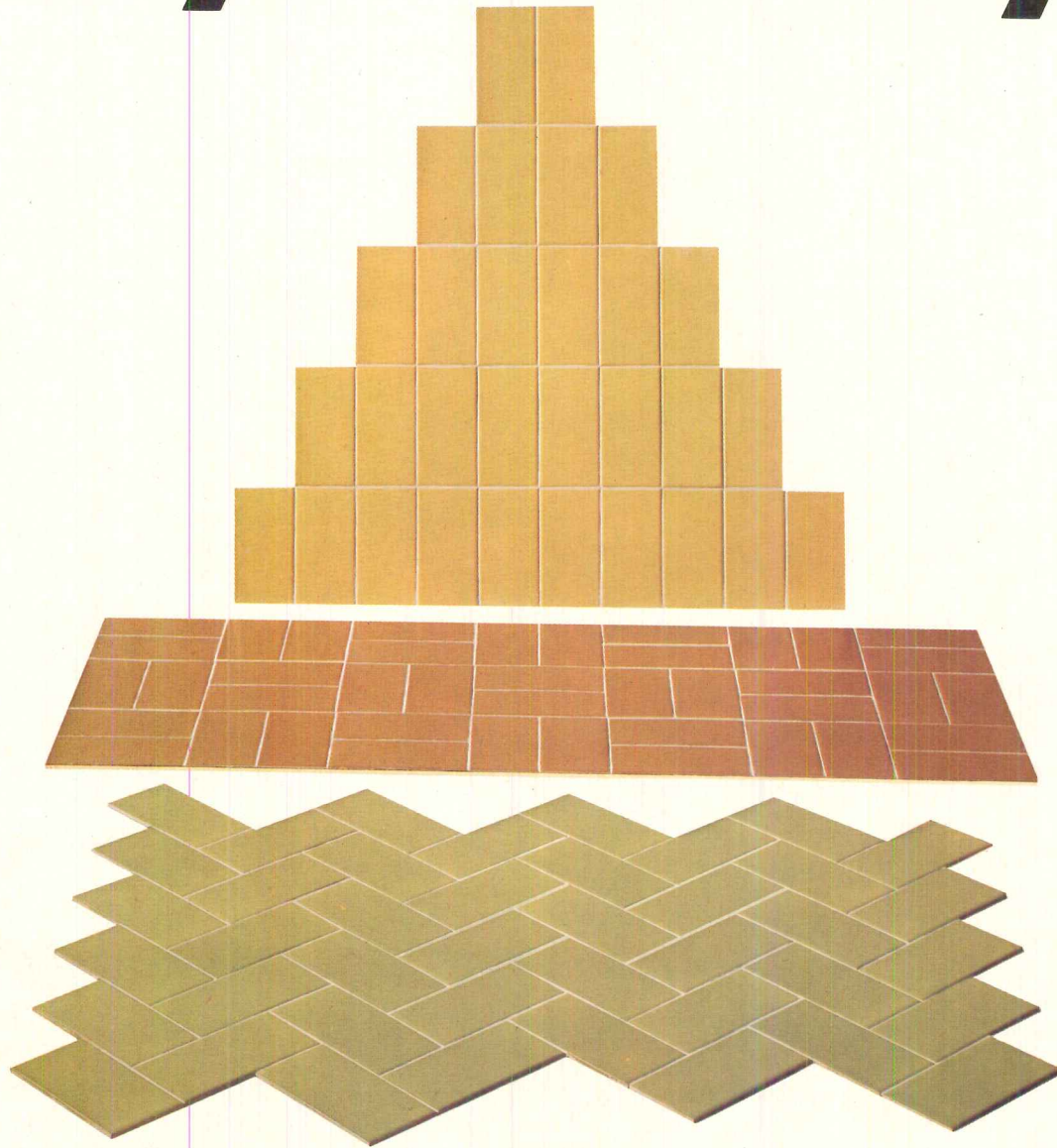

Come play with our new blocks and floor yourself with creativity.

New 3" x 6" modular shapes make it practical and easy to plan your wildest ideas. Bright crystal and Matte Glaze . . . a wide choice of colors (matching up with our Crystal Glaze and mosaic floors).

Count on Florida Tile's excellent distribution for immediate availability, too. Literature on our modular shapes and other Florida Tile products are yours for the asking. Ask.



Division of Sikes Corporation
Florida Tile, P. O. Box 447, Lakeland, Florida 33802

Product catalog in Sweets Architectural File.

For more data, circle 155 on inquiry card